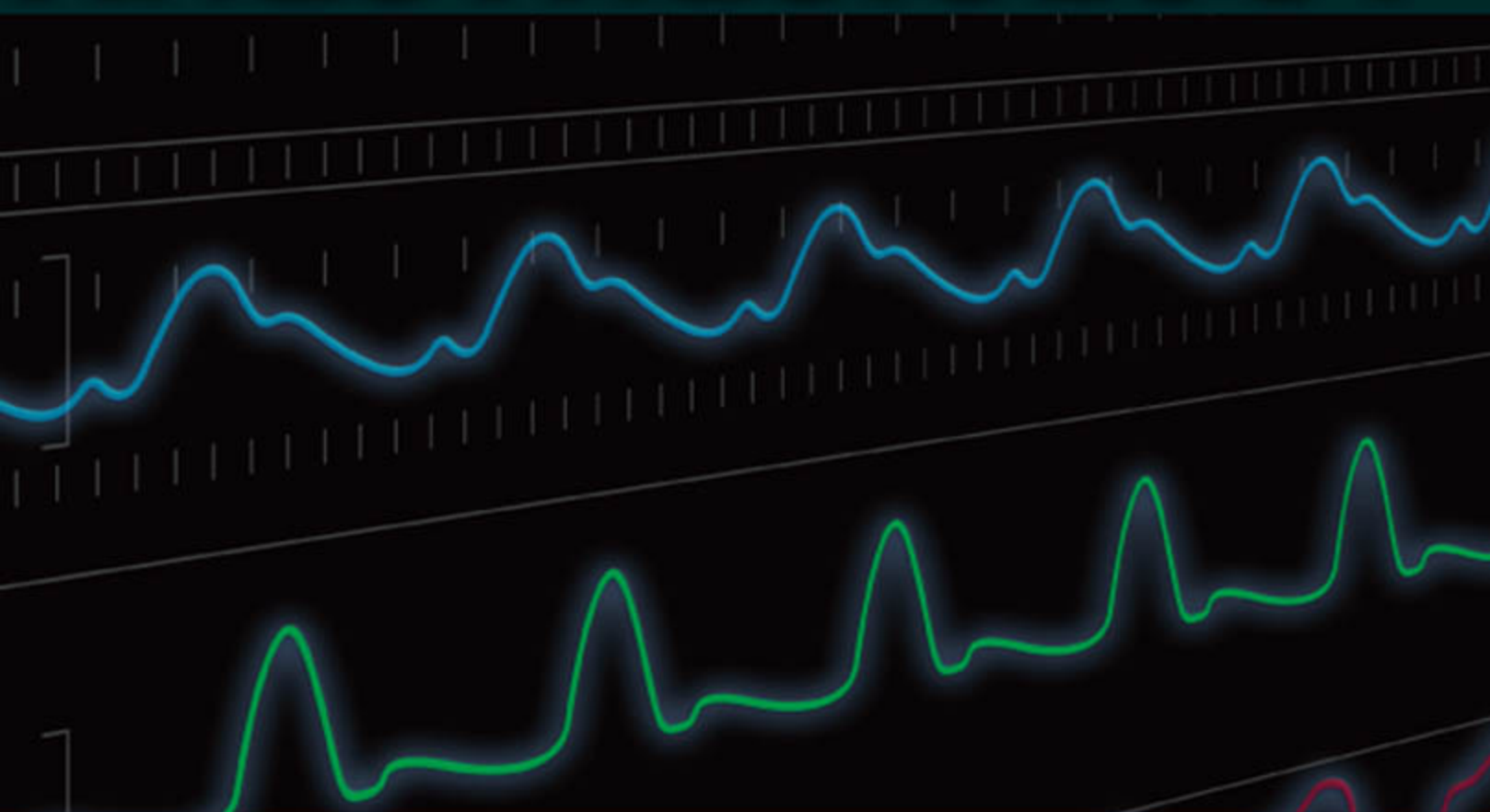


# ANESTHESIOLOGY



**DAVID E. LONGNECKER**

**DAVID L. BROWN ■ MARK F. NEWMAN ■ WARREN M. ZAPOL**



# **ANESTHESIOLOGY**



## **NOTICE**

Medicine is an ever-changing science. As new research and clinical experience broaden our knowledge, changes in treatment and drug therapy are required. The authors and the publisher of this work have checked with sources believed to be reliable in their efforts to provide information that is complete and generally in accord with the standards accepted at the time of publication. However, in view of the possibility of human error or changes in medical sciences, neither the authors nor the publisher nor any other party who has been involved in the preparation or publication of this work warrants that the information contained herein is in every respect accurate or complete, and they disclaim all responsibility for any errors or omissions or for the results obtained from use of the information contained in this work. Readers are encouraged to confirm the information contained herein with other sources. For example and in particular, readers are advised to check the product information sheet included in the package of each drug they plan to administer to be certain that the information contained in this work is accurate and that changes have not been made in the recommended dose or in the contraindications for administration. This recommendation is of particular importance in connection with new or infrequently used drugs.

# ANESTHESIOLOGY

## Edited By:

### **David E. Longnecker, MD, FRCA**

Robert D. Dripps Professor Emeritus  
Department of Anesthesiology and Critical Care  
University of Pennsylvania  
Philadelphia, Pennsylvania

### **David L. Brown, MD**

Edward Rotan Distinguished Professor and Chairman  
Department of Anesthesiology and Pain Medicine  
University of Texas, MD Anderson Cancer Center  
Houston, Texas

### **Mark F. Newman, MD**

Merel H. Harmel Professor and Chairman  
Department of Anesthesiology  
Duke University Medical Center  
Durham, North Carolina

### **Warren M. Zapol, MD**

Anesthetist-in-Chief  
Department of Anesthesia and Critical Care  
Massachusetts General Hospital  
Reginald Jenney Professor of Anaesthesia  
Harvard Medical School  
Boston, Massachusetts



**Medical**

New York Chicago San Francisco Lisbon London Madrid Mexico City  
New Delhi San Juan Seoul Singapore Sydney Toronto

Copyright © 2008 by The McGraw-Hill Companies, Inc. All rights reserved. Manufactured in the United States of America. Except as permitted under the United States Copyright Act of 1976, no part of this publication may be reproduced or distributed in any form or by any means, or stored in a database or retrieval system, without the prior written permission of the publisher.

0-07-159333-0

The material in this eBook also appears in the print version of this title: 0-07-145984-7.

All trademarks are trademarks of their respective owners. Rather than put a trademark symbol after every occurrence of a trademarked name, we use names in an editorial fashion only, and to the benefit of the trademark owner, with no intention of infringement of the trademark. Where such designations appear in this book, they have been printed with initial caps.

McGraw-Hill eBooks are available at special quantity discounts to use as premiums and sales promotions, or for use in corporate training programs. For more information, please contact George Hoare, Special Sales, at [george\\_hoare@mcgraw-hill.com](mailto:george_hoare@mcgraw-hill.com) or (212) 904-4069.

#### TERMS OF USE

This is a copyrighted work and The McGraw-Hill Companies, Inc. (“McGraw-Hill”) and its licensors reserve all rights in and to the work. Use of this work is subject to these terms. Except as permitted under the Copyright Act of 1976 and the right to store and retrieve one copy of the work, you may not decompile, disassemble, reverse engineer, reproduce, modify, create derivative works based upon, transmit, distribute, disseminate, sell, publish or sublicense the work or any part of it without McGraw-Hill’s prior consent. You may use the work for your own noncommercial and personal use; any other use of the work is strictly prohibited. Your right to use the work may be terminated if you fail to comply with these terms.

THE WORK IS PROVIDED “AS IS.” MCGRAW-HILL AND ITS LICENSORS MAKE NO GUARANTEES OR WARRANTIES AS TO THE ACCURACY, ADEQUACY OR COMPLETENESS OF OR RESULTS TO BE OBTAINED FROM USING THE WORK, INCLUDING ANY INFORMATION THAT CAN BE ACCESSED THROUGH THE WORK VIA HYPERLINK OR OTHERWISE, AND EXPRESSLY DISCLAIM ANY WARRANTY, EXPRESS OR IMPLIED, INCLUDING BUT NOT LIMITED TO IMPLIED WARRANTIES OF MERCHANTABILITY OR FITNESS FOR A PARTICULAR PURPOSE. McGraw-Hill and its licensors do not warrant or guarantee that the functions contained in the work will meet your requirements or that its operation will be uninterrupted or error free. Neither McGraw-Hill nor its licensors shall be liable to you or anyone else for any inaccuracy, error or omission, regardless of cause, in the work or for any damages resulting therefrom. McGraw-Hill has no responsibility for the content of any information accessed through the work. Under no circumstances shall McGraw-Hill and/or its licensors be liable for any indirect, incidental, special, punitive, consequential or similar damages that result from the use of or inability to use the work, even if any of them has been advised of the possibility of such damages. This limitation of liability shall apply to any claim or cause whatsoever whether such claim or cause arises in contract, tort or otherwise.

DOI: 10.1036/0071459847

# Dedication

“Life is no brief candle to me; it is a sort of splendid torch which I've got a hold of for the moment and I want to make it burn as brightly as possible before handing it on to future generations.”

**George Bernard Shaw**  
*Irish playwright (1856–1950)*

*The editors were fortunate indeed to have outstanding mentors who dedicated their professional lives to the development of our generation in the specialty. Through their guidance, wisdom and actions, they truly handed the torch to us. As their progeny, we are ever grateful for both their professional guidance and their personal friendship. In recognition of their influence on us individually, and the specialty overall, we dedicate this book to:*

Robert M. Epstein,  
Harold Carron Professor and Chair  
Emeritus of Anesthesiology,  
University of Virginia,  
on behalf of David E. Longnecker

Richard J. Kitz, Henry Isaiah Dorr Distinguished Professor  
of Research and Teaching in Anaesthetics and Anaesthesia,  
Harvard Medical School and Massachusetts General Hospital,  
on behalf of Warren M. Zapol

Edward Lowenstein, Henry Isaiah Dorr Professor of Research  
and Teaching in Anaesthetics and Anaesthesia,  
Harvard Medical School and Massachusetts General Hospital,  
on behalf of Warren M. Zapol

Daniel C. Moore, Chair Emeritus of Anesthesiology,  
Virginia Mason Medical Center, Seattle, Washington,  
on behalf of David L. Brown

Jerry Reves, Vice-President for Medical Affairs and Dean,  
College of Medicine, Medical University of South Carolina,  
Professor of Anesthesiology and Pharmacology  
(former Chair, Duke University Department of Anesthesiology),  
on behalf of Mark F. Newman

*This page intentionally left blank*



# Contents

CONTRIBUTORS	xiii		
FOREWORD	xxiii		
PREFACE	xxv		
<b>PART 1</b>			
<b>THE SPECIALTY OF ANESTHESIOLOGY</b>			
<b>CHAPTER 1</b>	<b>2</b>		
<b>The Evolution of Anesthesiology as a Clinical Discipline—A Lesson in Developing Professionalism</b>			
<i>Douglas R. Bacon, MD, MA</i>			
<b>CHAPTER 2</b>	<b>12</b>		
<b>The Scope and Future of Anesthesia Practice</b>			
<i>Michael S. Avidan, MBBCh, DA, FCA and Alex S. Evers, MD</i>			
<b>CHAPTER 3</b>	<b>20</b>		
<b>Safety and Quality: The Guiding Principles of Patient-Centered Care</b>			
<i>Jeffrey B. Cooper, PhD, and David E. Longnecker, MD, FRCA</i>			
<b>PART 2</b>			
<b>PREPARING FOR ANESTHESIA</b>			
<b>SECTION A: Approach to the Anesthesia Patient</b>			
<b>CHAPTER 4</b>	<b>40</b>		
<b>Overview of Preoperative Assessment and Management</b>			
<i>Bobbie Jean Sweitzer, MD</i>			
<b>CHAPTER 5</b>	<b>68</b>		
<b>The Anesthetic Plan for Healthy Patients</b>			
<i>Patrick E. Benedict, MD, and Kevin K. Tremper, PhD, MD</i>			
		<b>SECTION B: Preoperative Evaluation of the Anesthesia Patient</b>	
		<b>CHAPTER 6</b>	<b>89</b>
		<b>Appropriate and Effective Use of Consultants</b>	
		<i>Lee Goldman, MD, and Thomas H. Lee, MD</i>	
		<b>CHAPTER 7</b>	<b>95</b>
		<b>Evaluation of the Patient with Cardiovascular Disease</b>	
		<i>Ronald P. Olson, MD</i>	
		<b>CHAPTER 8</b>	<b>122</b>
		<b>Evaluation of the Patient with a Difficult Airway</b>	
		<i>James C. Phero, DMD, Andranik Ovassapian, MD, and William E. Hurford, MD</i>	
		<b>CHAPTER 9</b>	<b>134</b>
		<b>Evaluation of the Patient with Pulmonary Disease</b>	
		<i>Philip G. Boysen, MD, MBA</i>	
		<b>CHAPTER 10</b>	<b>145</b>
		<b>Evaluation of the Patient with Neuropsychiatric Disease</b>	
		<i>John Morris, MD, and Dell Burkey, MD</i>	
		<b>CHAPTER 11</b>	<b>156</b>
		<b>Evaluation of the Patient with Neuromuscular or Skeletal Disease</b>	
		<i>Philip D. Bailey, Jr., DO, and Joseph R. Tobin, MD</i>	
		<b>CHAPTER 12</b>	<b>173</b>
		<b>Evaluation of the Patient with Endocrine Disease or Diabetes Mellitus</b>	
		<i>A.D. John, MD, and F.E. Sieber, MD</i>	
		<b>CHAPTER 13</b>	<b>194</b>
		<b>Evaluation of the Patient with Renal Disease</b>	
		<i>Mark Stafford-Smith, MD, CM, FRCPC, George Lappas, MD, and Andrew D. Shaw, MB, BS, FRCA</i>	

<b>CHAPTER 14</b>	216	<b>PART 3</b>	
<b>Evaluation of Patients with Hepatic Disease</b>		<b>SAFETY AND RISK REDUCTION IN ANESTHESIA PRACTICE</b>	
<i>Richard A. Wiklund, MD</i>			
<b>CHAPTER 15</b>	239	<b>CHAPTER 24</b>	424
<b>Anesthetic Considerations for the Patient with Anemia or Coagulation Disorders</b>		<b>Anesthesia Risk</b>	
<i>Edwin G. Avery, IV, MD</i>		<i>Fredrick K. Orkin, MD, MBA, MSc, and David E. Longnecker, MD, FRCA</i>	
<b>CHAPTER 16</b>	267	<b>CHAPTER 25</b>	452
<b>Evaluation of the Patient with Perioperative Malnutrition</b>		<b>Approaches to Quality Improvement in Anesthesia Care</b>	
<i>Jacob T. Gutsche, MD, and Clifford S. Deutschman, MS, MD, FCCM</i>		<i>David S. Smith, MD, PhD, and Lee A. Fleisher, MD</i>	
<b>CHAPTER 17</b>	279	<b>CHAPTER 26</b>	465
<b>Principles of Antimicrobial Therapy</b>		<b>Positioning of Patients for Operation</b>	
<i>Richard Teplick, MD, and Robert H. Rubin, MD, FACP, FCCP</i>		<i>Vijaya Gottumukkala, MB, BS, MD (Anes), FRCA, DipABA</i>	
<b>CHAPTER 18</b>	300	<b>CHAPTER 27</b>	476
<b>Preoperative Assessment of the Newborn</b>		<b>Electricity, Electrical Safety, and Instrumentation in the Operating Room</b>	
<i>Myron Yaster, MD, and Richard A. Elliott, MD</i>		<i>Robert H. Stiefel, MS, CCE, and Julian M. Goldman, MD</i>	
<b>CHAPTER 19</b>	310		
<b>Evaluation of Children</b>		<b>PART 4</b>	
<i>Randall C. Wetzel, MBBS, MRCP, LRCS, MBA, FAAP, FCCM</i>		<b>MANAGING ANESTHESIA CARE</b>	
<b>CHAPTER 20</b>	341	<b>SECTION A: Monitoring the Anesthesia Patient</b>	
<b>Evaluation of the Geriatric Patient</b>		<b>CHAPTER 28</b>	498
<i>Stanley Muravchick, MD, PhD, and Katherine Grichnik, MD</i>		<b>Perioperative Information Management Systems</b>	
<b>CHAPTER 21</b>	358	<i>J.P. Abenstein, MSEE, MD</i>	
<b>Evaluation of the Pregnant Patient</b>		<b>CHAPTER 29</b>	519
<i>Robert Gaiser, MD</i>		<b>Hemodynamic Monitoring</b>	
<b>CHAPTER 22</b>	374	<i>Shahar Bar-Yosef, MD, Rebecca A. Schroeder, MD, and Jonathan B. Mark, MD</i>	
<b>Evaluation of the Obese Patient</b>		<b>CHAPTER 30</b>	552
<i>Babatunde O. Ogunnaike, MD, and Charles W. Whitten, MD</i>		<b>Intraoperative Transesophageal Echocardiography: A Systematic Approach</b>	
<b>CHAPTER 23</b>	396	<i>Larry Field, MD, George Lappas, MD, Angus Christie, MD, Andrew Green, MD, Steven Morozowich, MD, Tamas Szabo, MD, PhD, Qin Zhang, MD, Stephen Murphy, MD, Ravi Bissessar, MD, and Solomon Aronson, MD</i>	
<b>Evaluation of the Patient with Alcohol or Drug Addiction</b>		<b>CHAPTER 31</b>	579
<i>Paul S. Pagel, MD, PhD, Judith A. May, MD, and David C. Warltier, MD, PhD</i>		<b>Monitoring Respiratory Function</b>	
		<i>Dean R. Hess, PhD, RRT, and Robert M. Kacmarek, PhD, RRT</i>	

<b>CHAPTER 32</b>	<b>598</b>	<b>CHAPTER 42</b>	<b>897</b>
<b>Intraoperative Neurologic Monitoring</b>		<b>Total Intravenous Anesthesia</b>	
<i>John C. Keifer, MD, and Cecil O. Borel, MD</i>		<i>John Sear, MA, PhD, MBBS, FFARCS, FANZCA</i>	
<b>CHAPTER 33</b>	<b>619</b>	<b>CHAPTER 43</b>	<b>918</b>
<b>Monitoring and Managing Neuromuscular Blockade</b>		<b>Cardiovascular Drugs</b>	
<i>Richard M. Pino, MD, PhD, and Hassan H. Ali, MD</i>		<i>Alina Nicoara, MD, Mark Abel, MD, David Bronheim, MD, and Daniel Thys, MD</i>	
<b>CHAPTER 34</b>	<b>639</b>	<b>CHAPTER 44</b>	<b>954</b>
<b>Monitoring and Managing Perioperative Electrolyte Abnormalities, Acid-Base Disorders, and Fluid Replacement</b>		<b>Pharmacology of Local Anesthetics</b>	
<i>Patrick J. Neligan, MD, and Jiri Horak, MD</i>		<i>James E. Heavner, DVM, PhD</i>	
<b>SECTION B: Managing the Airway</b>		<b>SECTION D: Regional Anesthesia</b>	
<hr/>		<hr/>	
<b>CHAPTER 35</b>	<b>685</b>	<b>CHAPTER 45</b>	<b>974</b>
<b>Airway Management</b>		<b>Incorporating Regional Anesthesia into Anesthetic Practice</b>	
<i>P. Allan Klock Jr., MD, and Andranik Ovassapian, MD</i>		<i>Richard W. Rosenquist, MD, and David L. Brown, MD</i>	
<b>SECTION C: Anesthesia Drugs and Drug Delivery Systems</b>		<b>CHAPTER 46</b>	<b>978</b>
<hr/>		<b>Neuraxial Anesthesia</b>	
<b>CHAPTER 36</b>	<b>718</b>	<i>Daniel T. Warren, MD, and Spencer S. Liu, MD</i>	
<b>Mechanisms of General Anesthetic Action</b>		<b>CHAPTER 47</b>	<b>1009</b>
<i>Max B. Kelz, MD, PhD, Jay Yang, MD, PhD, and Roderic G. Eckenhoff, MD</i>		<b>Paravertebral Anesthesia</b>	
<b>CHAPTER 37</b>	<b>739</b>	<i>Holly Evans, MD, FRCPC, and Stephen M. Klein, MD</i>	
<b>Pharmacology of Inhalational Anesthetics</b>		<b>CHAPTER 48</b>	<b>1025</b>
<i>Stuart A. Forman, MD, PhD, and George A. Mashour, MD, PhD</i>		<b>Peripheral Nerve Blocks</b>	
<b>CHAPTER 38</b>	<b>767</b>	<i>Denise J. Wedel, MD, and Terese T. Horlocker, MD</i>	
<b>Anesthesia Delivery System</b>		<b>CHAPTER 49</b>	<b>1053</b>
<i>James B. Eisenkraft, MD</i>		<b>Managing Adverse Outcomes during Regional Anesthesia</b>	
<b>CHAPTER 39</b>	<b>821</b>	<i>Ban CH Tsui, MSc, MD, FRCPC, and Brendan T. Finucane, MBBCh, FRCPC</i>	
<b>Principles of Pharmacokinetics and Pharmacodynamics: Applied Clinical Pharmacology for the Practitioner</b>		<b>SECTION E: Specialty Areas of Anesthetic Practice</b>	
<i>Ken B. Johnson, MD, and Talmage D. Egan, MD</i>		<hr/>	
<b>CHAPTER 40</b>	<b>849</b>	<b>CHAPTER 50</b>	<b>1081</b>
<b>Pharmacology of Intravenous Anesthetics</b>		<b>Neuroanesthesia</b>	
<i>Mark Dershwitz, MD, PhD, and Carl E. Rosow, MD, PhD</i>		<i>Michael M. Todd, MD, David S. Warner, MD, PhD, Mazen A. Maktabi, MD, and Kamila Vagnerova, MD</i>	
<b>CHAPTER 41</b>	<b>869</b>	<b>CHAPTER 51</b>	<b>1140</b>
<b>Pharmacology of Opioid Analgesics</b>		<b>Cardiac Anesthesia</b>	
<i>Carl E. Rosow, MD, PhD, and Mark Dershwitz, MD, PhD</i>		<i>Mark A. Chaney, MD, Albert T. Cheung, MD, Christopher A. Troianos, MD, Jessica L. Willert, MD, David A. Zvara, MD, and Stanton K. Shernan, MD</i>	



<b>CHAPTER 73</b>	<b>1700</b>	<b>CHAPTER 83</b>	<b>1852</b>
<b>Postoperative Complications</b>		<b>Mechanical Ventilation for the Surgical Patient</b>	
<i>Edward A. Bittner, MD, PhD, Loreta Grecu, MD, and Edward George, MD, PhD</i>		<i>Robert M. Kacmarek, PhD, RRT, and Dean R. Hess, PhD, RRT</i>	
<b>CHAPTER 74</b>	<b>1716</b>	<b>CHAPTER 84</b>	<b>1873</b>
<b>Management of Acute Postoperative Pain</b>		<b>Cardiopulmonary Resuscitation</b>	
<i>Jane C. Ballantyne, MD, FRCA</i>		<i>Charles W. Otto, MD, FCCM</i>	
<b>PART 6</b>		<b>PART 7</b>	
<b>THE CRITICALLY ILL PATIENT</b>		<b>SPECIAL CONSIDERATIONS IN ANESTHESIA CARE</b>	
<b>CHAPTER 75</b>	<b>1738</b>	<b>CHAPTER 85</b>	<b>1892</b>
<b>The Pathophysiology of Critical Illness</b>		<b>Blood and Blood Component Therapy</b>	
<i>Luca M. Bigatello, MD, Judith Hellman, MD, David Liu, MD, PhD, and Warren M. Zapol, MD</i>		<i>Ian J. Welsby, BSc, MBBS, FRCA, and Steven J. Bredehoeft, MD</i>	
<b>CHAPTER 76</b>	<b>1754</b>	<b>CHAPTER 86</b>	<b>1912</b>
<b>Evaluation of the Patient with Multiple Organ Dysfunction Syndrome</b>		<b>Cognitive Dysfunction after Anesthesia and Surgery</b>	
<i>Jean Kwo, MD, and Judith Hellman, MD</i>		<i>Mark F. Newman, MD, and Joseph P. Matthews, MD</i>	
<b>CHAPTER 77</b>	<b>1772</b>	<b>CHAPTER 87</b>	<b>1925</b>
<b>Evaluation of the Burned Patient</b>		<b>Protection of the Central Nervous System in Surgical Patients</b>	
<i>Edward A. Bittner, MD, PhD, Loreta Grecu, MD, and J. A. Jeevendra Martyn, MD</i>		<i>W. Andrew Kofke, MD, MBA, FCCM</i>	
<b>CHAPTER 78</b>	<b>1784</b>	<b>CHAPTER 88</b>	<b>1947</b>
<b>Evaluation of the Trauma Patient</b>		<b>Anaphylactic Reactions and Anesthesia</b>	
<i>Edward George, MD, PhD</i>		<i>Robert S. Holzman, MD, FAAP</i>	
<b>CHAPTER 79</b>	<b>1797</b>	<b>CHAPTER 89</b>	<b>1964</b>
<b>Developing the Anesthetic Plan for the Critically Ill Patient</b>		<b>Malignant Hyperthermia, Thermoregulation, and Perioperative Hypothermia</b>	
<i>Jean Kwo, MD</i>		<i>Sheila Muldoon, MD, Nyamkhisig Sambuughin, PhD, Maria Voelkel, BA, Rolf Bunger, MD, PhD, Hilary P. Grocott, MD, FRCPC, and Christopher Sulzer, MD</i>	
<b>CHAPTER 80</b>	<b>1811</b>	<b>PART 8</b>	
<b>Monitoring and Transport of the Critically Ill Patient</b>		<b>CARE OF THE CHRONIC PAIN PATIENT</b>	
<i>Michael G. Fitzsimons, MD, FCCP, and Nathaniel Sims, MD</i>		<b>CHAPTER 90</b>	<b>2000</b>
<b>CHAPTER 81</b>	<b>1828</b>	<b>Mechanisms of Chronic Pain</b>	
<b>Postoperative Care of the Noncardiac Surgical ICU Patient</b>		<i>Gary J. Brenner, MD, PhD, and Clifford J. Woolf, MD, PhD</i>	
<i>Michael C. Banks, MD, and C. William Hanson, III, MD</i>		<b>CHAPTER 91</b>	<b>2020</b>
<b>CHAPTER 82</b>	<b>1841</b>	<b>Common Pain Syndromes</b>	
<b>Hemodynamic Support of the Critically Ill Patient</b>		<i>Basem Hamid, MD</i>	
<i>Jean-Louis Vincent MD, PhD</i>			



<b>CHAPTER 92</b>	<b>2042</b>	<b>CHAPTER 96</b>	<b>2135</b>
<b>Medical Management of Chronic Pain</b>		<b>Substance Dependence and Abuse in Anesthesia Care Providers</b>	
<i>Marc A. Huntoon, MD</i>		<i>Raymond C. Roy, PhD, MD</i>	
<b>CHAPTER 93</b>	<b>2072</b>	<b>CHAPTER 97</b>	<b>2155</b>
<b>Interventional Management of Chronic Pain</b>		<b>The Economics of Health Care and Anesthesia Practice</b>	
<i>Carlos A. Pino, MD, and James P. Rathmell, MD</i>		<i>Franklin Dexter, MD, PhD, and Amr E. Abouleish, MD, MBA</i>	
<b>CHAPTER 94</b>	<b>2106</b>	<b>CHAPTER 98</b>	<b>2172</b>
<b>Palliative and Cancer Pain Care</b>		<b>Practice Management</b>	
<i>Phillip C. Phan, MD, and Allen W. Burton, MD</i>		<i>Philip J. Mesisca, MBA, CMPE, and Susan Chapman Moss, MPH</i>	
<b>PART 9</b>		<b>APPENDIX A</b>	<b>2183</b>
<b>PRACTICE RELATED ISSUES</b>		<i>Mark Dershwitz, MD, PhD, and Carl E. Rosow, MD, PhD</i>	
<b>CHAPTER 95</b>	<b>2126</b>	<b>INDEX</b>	<b>2197</b>
<b>Legal Issues in Anesthesiology</b>			
<i>C. Lee Parmley, MD, JD</i>			

# Contributors

## **Mark Abel, MD**

Associate Professor of Clinical Anesthesiology  
Department of Anesthesiology  
Montefiore Medical Center  
Bronx  
New York

## **J. P. Abenstein, MSEE, MD**

Associate Professor of Anesthesiology  
Department of Anesthesiology  
Mayo Clinic College of Medicine  
Rochester  
Minnesota

## **Amr E. Abouleish, MD, MBA**

Professor of Department of Anesthesiology  
University of Texas Medical Branch  
Galveston  
Texas

## **Hassan H. Ali, MD**

Professor Emeritus  
Harvard Medical School  
Boston  
Massachusetts

## **Solomon Aronson, MD**

Professor of Anesthesiology  
Executive Vice Chairman  
Department of Anesthesiology  
Duke University Medical Center  
Durham  
North Carolina

## **Edwin G. Avery, IV, MD**

Chief  
Division of Cardiac Anesthesia  
Instructor of Anesthesia  
Department of Anesthesia and Critical Care  
Massachusetts General Hospital  
Harvard Medical School  
Boston  
Massachusetts

## **Michael S. Avidan, MBBCh., DA, FCA**

Associate Professor of Anesthesiology and Surgery  
Division Chief, CT Anesthesiology and CT Intensive Care  
Washington University School of Medicine  
St. Louis  
Missouri

## **Douglas R. Bacon, MD, MA**

Professor of Anesthesiology and History of Medicine  
Mayo Clinic College of Medicine  
Rochester  
Minnesota

## **Philip D. Bailey, Jr., DO**

Assistant Professor  
Department of Anesthesiology and Critical Care Medicine  
Uniformed Services University of the Health Sciences  
Bethesda  
Maryland

## **Jane C. Ballantyne, MD, FRCA**

Chief  
Division of Pain Medicine  
Massachusetts General Hospital  
Department of Anesthesia and Critical Care  
Associate Professor in Anesthesia  
Harvard Medical School  
Boston  
Massachusetts

## **Michael C. Banks, MD**

Assistant Professor of Clinical Anesthesiology and Critical Care  
Department of Anesthesiology and Critical Care  
University of Pennsylvania School of Medicine  
Philadelphia  
Pennsylvania

## **Shahar Bar-Yosef, MD**

Assistant Professor  
Department of Anesthesiology and Critical Care  
Duke University Medical Center  
Veterans Affairs Medical Center  
Durham  
North Carolina

## **Salvatore J. Basta, MD**

Chief  
Anesthesiology  
Massachusetts Eye and Ear Infirmary  
Assistant Professor  
Harvard Medical School  
Boston  
Massachusetts

## **David S. Beebe, MD**

Department of Anesthesiology  
University of Minnesota  
Minneapolis  
Minnesota

## **Kumar G. Belani, MBBS, MS**

Departments of Anesthesiology, Medicine, Pediatrics and Environmental Health  
University of Minnesota  
Minneapolis  
Minnesota

## **Patrick E. Benedict, MD**

Assistant Professor of Anesthesiology  
Director, Preoperative Assessment Clinic  
Department of Anesthesiology  
University of Michigan Health System  
Ann Arbor  
Michigan

## **Luca M. Bigatello, MD**

Associate Professor of Anesthesia  
Harvard Medical School  
Director, Critical Care Division  
Department of Anesthesia  
Massachusetts General Hospital  
Boston  
Massachusetts

## **Ravi Bissessar, MD**

University of North Carolina Hospital  
Chapel Hill  
North Carolina

## **Edward A. Bittner, MD, PhD**

Instructor of Anaesthesia  
Harvard Medical School  
Assistant in Anesthesia  
Massachusetts General Hospital  
Boston  
Massachusetts

## **Cecil O. Borel, MD**

Associate Professor of Anesthesiology and Surgery  
Duke University  
Division Chief  
Neuroanesthesia  
Duke University Medical Center  
Durham  
North Carolina

**Philip G. Boysen, MD, MBA**

Professor of Anesthesiology and  
Medicine  
Executive Associate Dean for Gradu-  
ate Medical Education  
University of North Carolina at Chapel  
Hill  
Chapel Hill  
North Carolina

**Steven J. Bredehoeft, MD**

Director  
Transfusion Services  
Duke University Medical Center  
Durham  
North Carolina

**Gary J. Brenner, MD, PhD**

Assistant Professor of Anesthesia  
Harvard Medical School  
Program Director  
Massachusetts General Hospital  
Pain Medicine Fellowship  
Boston  
Massachusetts

**Dara Breslin, MB**

Assistant Clinical Professor  
Duke University Medical Center  
Durham  
North Carolina

**David Bronheim, MD**

Associate Professor  
Department of Anesthesiology  
Mount Sinai School of Medicine  
New York  
New York

**David L. Brown, MD**

Edward Rotan Distinguished Professor  
and Chairman  
Department of Anesthesiology and  
Pain Medicine  
University of Texas, MD Anderson  
Cancer Center  
Houston, Texas

**Rolf Bunger, MD, PhD**

Professor  
Department of Anatomy, Physiology  
and Genetics  
Uniformed Services University of the  
Health Sciences  
Bethesda  
Maryland

**Dell Burkey, MD**

Clinical Associate Professor  
Anesthesiology and Pain Medicine  
Director of Acute Pain Service  
Hospital of the University of Pennsylvania  
Department of Anesthesiology and  
Critical Care  
Philadelphia  
Pennsylvania

**Allen W. Burton, MD**

Professor and Section Chief  
UT MD Anderson Cancer Center  
Section of Cancer Pain Management,  
Department of Anesthesiology and  
Pain Medicine  
Houston  
Texas

**Maurizio Cereda, MD**

Department of Anesthesiology and  
Critical Care  
University of Pennsylvania  
Philadelphia VA Medical Center  
Philadelphia  
Pennsylvania

**Mark A. Chaney, MD**

Associate Professor  
Director of Cardiac Anesthesia  
Department of Anesthesia and Critical  
Care  
University of Chicago  
Chicago  
Illinois

**Albert T. Cheung, MD**

Professor  
Department of Anesthesiology and  
Critical Care Medicine  
University of Pennsylvania  
Pennsylvania

**Angus Christie, MD**

University of North Carolina Hospital  
Chapel Hill  
North Carolina

**Jeffrey B. Cooper, PhD**

Director, Biomedical Engineering  
Partners HealthCare System, Inc.  
Associate Professor of Anesthesia  
Harvard Medical School  
Department of Anesthesia and Critical  
Care  
Massachusetts General Hospital  
Director, Center for Medical Simulation  
Boston  
Massachusetts

**Monica Davis, MD**

Assistant Professor  
Department of Anesthesiology  
MD Anderson Cancer Center  
Houston  
Texas

**Mark Dershwitz, MD, PhD**

Professor and Vice Chair of  
Anesthesiology  
Professor of Biochemistry and Molecu-  
lar Pharmacology  
University of Massachusetts  
Worcester  
Massachusetts

**Clifford S. Deutschman, MS, MD, FCCM**

Professor of Anesthesiology and  
Critical Care and Surgery  
University of Pennsylvania School of  
Medicine  
Philadelphia  
Pennsylvania

**Franklin Dexter, MD, PhD**

Director  
Division of Management Consulting  
Professor  
Departments of Anesthesia and Health  
Management and Policy  
University of Iowa  
Iowa City  
Iowa

**Roderic G. Eckenhoff, MD**

Austin Lamont Professor  
Department of Anesthesiology and  
Critical Care  
University of Pennsylvania  
Philadelphia  
Pennsylvania

**Talmage D. Egan, MD**

Professor of Anesthesiology  
KC Wong Presidential Chair  
University of Utah  
Department of Anesthesiology  
Salt Lake City  
Utah

**James B. Eisenkraft, MD**

Professor, Department of  
Anesthesiology  
Mount Sinai School of Medicine  
New York University  
Attending Anesthesiologist  
Mount Sinai Hospital  
New York  
New York

**Richard A. Elliott, MD**

Assistant Professor  
Department of Anesthesiology/Criti-  
cal Care Medicine  
The Johns Hopkins Medical  
Institutions  
Baltimore  
Maryland

**Holly Evans, MD, FRCPC**

Assistant Professor  
Department of Anesthesiology  
University of Ottawa  
Ontario  
Canada

**Lucinda L. Everett, MD**

Associate Professor of Anaesthesia  
Harvard Medical School  
Chief of Pediatric Anesthesiology  
Department of Anesthesia and Critical  
Care  
Massachusetts General Hospital  
Boston  
Massachusetts

**Alex S. Evers, MD**

Henry Mallinkrodt Professor and  
Chairman  
Department of Anesthesiology  
Professor of Internal Medicine and Mo-  
lecular Biology and Pharmacology  
Washington University School of  
Medicine  
Anesthesiologist-in-Chief  
Barnes-Jewish Hospital  
St. Louis  
Missouri

**Larry Field, MD**

Assistant Professor  
Departments of Anesthesia and Peri-  
operative Medicine  
Medical University of South Carolina  
Charleston  
South Carolina

**Brendan T. Finucane, MBBCh, FRCPC**

Professor  
Department of Anesthesiology and  
Pain Medicine  
University of Alberta  
Adult Anesthesiologist  
University of Alberta Hospital  
Edmonton  
Alberta  
Canada

**Michael G. Fitzsimons, MD, FCCP**

Instructor in Anesthesia  
Division of Cardiac Anesthesia  
Division of Critical Care  
Department of Anesthesia and Critical  
Care  
Massachusetts General Hospital  
Boston  
Massachusetts

**Lee A. Fleisher, MD**

Robert Dunning Dripps Professor and  
Chair  
Department of Anesthesiology and  
Critical Care  
University of Pennsylvania  
Philadelphia  
Pennsylvania

**Stuart A. Forman, MD, PhD**

Associate Professor of Anaesthesia  
Harvard Medical School  
Associate Anesthetist  
Department of Anesthesia and Critical  
Care  
Massachusetts General Hospital  
Boston  
Massachusetts

**Robert Gaiser, MD**

Associate Professor of Anesthesia,  
Pharmacology, Obstetrics and  
Gynecology  
Department of Anesthesiology and  
Critical Care  
University of Pennsylvania  
Philadelphia  
Pennsylvania

**Edward George, MD, PhD**

Instructor  
Harvard Medical School  
Assistant Anesthetist  
Department of Anesthesia and Critical  
Care  
Massachusetts General Hospital  
Boston  
Massachusetts

**Julian M. Goldman, MD**

Assistant in Anesthesia  
Massachusetts General Hospital  
Instructor  
Harvard Medical School  
Physician Advisor to Partners Health-  
Care Biomedical Engineering at  
Massachusetts General Hospital  
Boston  
Massachusetts

**Lee Goldman, MD**

Executive Vice President  
Health and Biomedical Sciences  
Columbia University  
Dean of the Faculties  
Health Sciences and Medicine  
Columbia's College of Physicians and  
Surgeons  
New York  
New York

**Vijaya Gottumukkala, MB, BS, MD  
(Anes), FRCA**

Associate Professor  
Clinical Director  
University of Texas MD Anderson  
Cancer Center  
Houston  
Texas

**Christopher M. Grande, MD, MPH**

Clinical Professor of Anesthesiology  
and CCM  
University of Pittsburgh School of  
Medicine  
Executive Director  
TraumaCare International (ITACCS)  
World Headquarters  
Baltimore  
Maryland

**Loreta Grecu, MD**

Instructor in Anesthesia  
Department of Anesthesia and Critical  
Care  
Harvard Medical School  
Department of Anesthesia and Critical  
Care  
Massachusetts General Hospital  
Boston  
Massachusetts

**Andrew Green, MD**

University of North Carolina  
Hospital  
Chapel Hill  
North Carolina

**Katherine Grichnik, MD**

Associate Professor  
Duke University  
Department of Anesthesia  
Duke University Medical Center  
Durham  
North Carolina

**Hilary P. Grocott, MD, FRCPC**

Professor  
Department of Anesthesiology  
Division of Cardiothoracic Anesthesi-  
ology and Critical Care Medicine  
Duke University Medical Center  
Durham  
North Carolina

**Jacob T. Gutsche, MD**

Instructor of Anesthesiology and Criti-  
cal Care  
University of Pennsylvania School of  
Medicine  
Philadelphia  
Pennsylvania

**Basem Hamid, MD**

Assistant professor  
Department of Anesthesiology and  
Pain Medicine  
University of Texas  
M.D. Anderson Cancer Center  
Houston  
Texas

**C. William Hanson, III, MD**

Professor of Anesthesiology and Critical Care,  
Surgery and Internal Medicine  
Department of Anesthesiology and Critical Care  
University of Pennsylvania School of Medicine  
Philadelphia  
Pennsylvania

**James S. Harrington, MD**

Instructor in Anesthesia  
Harvard Medical School  
Assistant in Cardiac Anesthesia  
Children's Hospital Boston  
Boston  
Massachusetts

**Robert S. Harris, MD**

Assistant Professor  
Department of Anesthesiology  
Emory University School of Medicine  
Atlanta  
Georgia

**James E. Heavner, DVM, PhD**

Professor  
Anesthesiology and Physiology  
Director of Research  
Department of Anesthesiology  
Tech University Health Sciences Center  
Lubbock  
Texas

**Judith Hellman, MD**

Department of Anesthesia and Critical Care  
Massachusetts General Hospital  
Harvard Medical School  
Boston  
Massachusetts

**Dean R. Hess, PhD, RRT**

Associate Professor of Anesthesiology  
Harvard Medical School  
Assistant Director  
Respiratory Care  
Massachusetts General Hospital  
Boston  
Massachusetts

**Paul R. Hickey, MD**

Professor of Anesthesia  
Harvard Medical School  
Anesthesiologist-in-Chief  
Children's Hospital Boston  
Boston  
Massachusetts

**Robert S. Holzman, MD, FAAP**

Department of Anesthesiology  
Perioperative and Pain Medicine  
Children's Hospital Boston  
Boston  
Massachusetts

**Jiri Horak, MD**

Assistant Professor  
Department of Anesthesiology and Critical Care  
Hospital of the University of Pennsylvania  
Philadelphia  
Pennsylvania

**Terese T. Horlocker, MD**

Department of Anesthesiology  
Mayo Clinic College of Medicine  
Rochester  
Minnesota

**Marc A. Huntoon, MD**

Chair  
Division of Pain Medicine  
Department of Anesthesiology  
Mayo Clinic  
Rochester  
Minnesota

**William E. Hurford, MD**

Professor and Chair  
Department of Anesthesiology  
University of Cincinnati College of Medicine  
Cincinnati  
Ohio

**A. D. John, MD**

Assistant Professor  
Department of Anesthesiology and Critical Care Medicine  
Johns Hopkins Bayview Medical Center  
Johns Hopkins Medical Institutions  
Baltimore  
Maryland

**Ken B. Johnson, MD**

Associate Professor of Anesthesiology  
Learned Family Associate Professorship  
University of Utah  
Department of Anesthesiology  
Salt Lake City  
Utah

**Robert M. Kacmarek, PhD, RRT**

Director, Respiratory Care  
Massachusetts General Hospital  
Professor of Anesthesiology  
Harvard Medical School  
Boston  
Massachusetts

**Suhas V. Kalghatgi, MBBS, MD, FFARCSI**

Anesthesiologist  
Trinity Medical Center  
Moline  
Illinois

**John C. Keifer, MD**

Associate Clinical Professor of Anesthesiology  
Duke University Medical Center  
Durham  
North Carolina

**Max B. Kelz, MD, PhD**

Assistant Professor  
Department of Anesthesiology and Critical Care  
University of Pennsylvania  
Philadelphia  
Pennsylvania

**Sean Kennedy, MD**

Associate Professor of Anesthesia  
Department of Anesthesiology and Critical Care  
University of Pennsylvania  
Chief of Anesthesia  
Philadelphia Veterans Affairs Medical Center  
Philadelphia  
Pennsylvania

**Stephen M. Klein, MD**

Assistant Professor  
Department of Anesthesiology  
Duke University Medical Center  
Durham  
North Carolina

**P. Allan Klock, Jr., MD**

Associate Professor  
Vice Chair for Clinical Affairs  
Department of Anesthesia and Critical Care  
University of Chicago  
Chicago  
Illinois

**W. Andrew Kofke, MD, MBA, FCCM**

Director of Neuroanesthesia  
Professor of Anesthesiology and Critical Care  
Department of Anesthesiology and Critical Care  
University of Pennsylvania  
Philadelphia  
Pennsylvania

**Benjamin A. Kohl, MD**

Assistant Professor  
Department of Anesthesiology and Critical Care  
Section of Cardiothoracic Anesthesia and Critical Care  
University of Pennsylvania School of Medicine  
Philadelphia  
Pennsylvania



**Jean Kwo, MD**

Instructor in Anaesthesia  
Harvard Medical School  
Assistant in Anesthesia  
Department of Anesthesia and Critical  
Care  
Massachusetts General Hospital  
Boston  
Massachusetts

**George Lappas, MD**

Fellow  
Cardiothoracic Anesthesia  
Department of Anesthesiology  
Duke University Medical Center  
Durham  
North Carolina

**Stephanie L. Lee, MD, PhD**

Associate Professor of Medicine  
Boston University School of  
Medicine  
Director of Endocrine Clinics  
Section of Endocrinology, Diabetes  
and Nutrition  
Department of Medicine  
Boston Medical Center  
Boston  
Massachusetts

**Thomas H. Lee, MD**

Professor of Medicine  
Harvard Medical School and the  
Harvard School of Public Health  
CEO of the Partners Community  
HealthCare, Inc  
Brigham and Women's Hospital  
Massachusetts General Hospital  
Boston  
Massachusetts

**J. Lance Lichtor, MD**

Professor  
Department of Anesthesia  
University of Iowa  
Iowa City  
Iowa

**David Liu, MD, PhD**

Instructor  
Department of Anesthesia and Critical  
Care  
Harvard University  
Clinical Instructor  
Staff Anesthesiologist  
Department of Anesthesia and Critical  
Care  
Massachusetts General Hospital  
Boston  
Massachusetts

**Spencer S. Liu, MD**

Staff Anesthesiologist  
Virginia Mason Medical Center  
Clinical Professor of Anesthesiology  
University of Washington School of  
Medicine  
Department of Anesthesiology  
Virginia Mason Medical Center  
Seattle  
Washington

**David E. Longnecker, MD, FRCA**

Robert D. Dripps Professor Emeritus  
Department of Anesthesiology and  
Critical Care  
University of Pennsylvania  
Philadelphia  
Pennsylvania

**Mazen A. Maktabi, MD**

Associate Professor  
University of Iowa  
Department of Anesthesia  
Iowa City  
Iowa

**Jonathan B. Mark, MD**

Department of Anesthesiology and  
Critical Care  
Duke University Medical Center  
Veterans Affairs Medical Center  
Durham  
North Carolina

**Gavin Martin, MB**

Associate Professor  
Duke University Medical Center  
Durham  
North Carolina

**J. A. Jeevendra Martyn, MD**

Professor  
Harvard Medical School  
Professor and Director  
Clinical and Biochemical Pharmacology  
Laboratory  
Massachusetts General Hospital  
Boston  
Massachusetts

**George A. Mashour, MD, PhD**

Instructor in Anaesthesia  
Harvard Medical School  
Department of Anesthesia and Critical  
Care  
Massachusetts General Hospital  
Boston  
Massachusetts

**Judith A. May, MD**

Assistant Professor  
Department of Anesthesiology  
Medical College of Wisconsin  
Milwaukee  
Wisconsin

**William T. Merritt, MD, MBA**

Department of Anesthesia and Critical  
Care Medicine  
Johns Hopkins University  
Baltimore  
Maryland

**Philip J. Mesisca, MBA, CMPE**

Chief Operating Officer  
Department of Anesthesiology and  
Critical Care  
Department of Otorhinolaryngology  
University of Pennsylvania Health  
System  
Philadelphia  
Pennsylvania

**Steven Morozowich, MD**

Clinical Associate  
Division of Cardiothoracic Anesthesia  
and Critical Care Medicine  
Department of Anesthesiology  
Duke University Medical Center  
Durham  
North Carolina

**John Morris, MD**

Department of Anesthesiology and  
Critical Care  
Hospital of the University of  
Pennsylvania  
Philadelphia  
Pennsylvania

**Susan Chapman Moss, MPH**

Senior Administrative Director  
Department of Anesthesia and Critical  
Care  
Massachusetts General Hospital  
Boston  
Massachusetts

**Sheila Muldoon, MD**

Professor  
Department of Anesthesiology  
Director of Malignant Hyperthermia  
Biopsy Center  
Uniformed Services University of the  
Health Sciences  
Bethesda  
Maryland

**Stanley Muravchick, MD, PhD**

Professor of Anesthesia  
University of Pennsylvania  
Department of Anesthesia  
Hospital of the University of  
Pennsylvania  
Philadelphia  
Pennsylvania

**Stephen Murphy, MD**

University of North Carolina Hospital  
Chapel Hill  
North Carolina

**Patrick J. Neligan, MD**

Assistant Professor  
Department of Anesthesiology and  
Critical Care  
Hospital of University of Pennsylvania  
Philadelphia  
Pennsylvania

**Mark F. Newman, MD**

Merel H. Harmel Professor and  
Chairman  
Department of Anesthesiology  
Duke University Medical Center  
Durham  
North Carolina

**Alina Nicoara, MD**

Assistant Professor  
Department of Anesthesiology  
Yale University School of Medicine  
Attending Anesthesiologist  
West Haven Veterans Affairs Medical  
Center  
West Haven  
Connecticut

**E. Andrew Ochroch, MD, MSCE**

Department of Anesthesiology and  
Critical Care  
University of Pennsylvania School of  
Medicine  
Philadelphia  
Pennsylvania

**Babatunde O. Ogunnaike, MD**

Associate Professor  
Director of Anesthesia  
Parkland Surgical Services  
Department of Anesthesiology and  
Pain Management  
University of Texas Southwestern  
Medical Center  
Dallas  
Texas

**Ronald P. Olson, MD**

Assistant Clinical Professor  
Department of Community and Family  
Medicine  
Department of Anesthesiology  
Duke University  
Director  
Preoperative Screening  
Duke University Health System  
Durham  
North Carolina

**Fredrick K. Orkin, MD, MBA, MSc**

Adjunct Professor of Anesthesiology  
Yale University School of Medicine  
New Haven  
Connecticut

**Charles W. Otto, MD, FCCM**

Professor of Anesthesiology  
Associate Professor of Medicine  
University of Arizona College of  
Medicine  
Director  
Critical Care Medicine  
University Medical Center  
Tucson  
Arizona

**Andranik Ovassapian, MD**

Professor of Clinical Anesthesia  
Department of Anesthesia and Critical  
Care  
University of Chicago  
Chicago  
Illinois

**Paul S. Pagel, MD, PhD**

Professor  
Department of Anesthesiology  
Medical College of Wisconsin  
Milwaukee  
Wisconsin

**C. Lee Parmley, MD, JD**

Professor of Anesthesiology  
Vanderbilt University Medical  
Center  
Department of Anesthesiology  
Division of Critical Care  
Nashville  
Tennessee

**Robert A. Peterfreund, MD, PhD**

Associate Professor of Anesthesia  
Harvard Medical School  
Anesthetist  
Department of Anesthesia and Critical  
Care  
Massachusetts General Hospital  
Boston  
Massachusetts

**Phillip C. Phan, MD**

Assistant Professor  
University of Texas MD Anderson  
Cancer Center  
Section of Cancer Pain Management,  
Department of Anesthesiology and  
Pain Medicine  
Houston  
Texas

**James C. Phero, DMD**

Professor of Clinical Anesthesia  
Clinical Surgery and Clinical Pediatrics  
Department of Anesthesiology  
University of Cincinnati College of  
Medicine  
Cincinnati  
Ohio

**Carlos A. Pino, MD**

Instructor  
Department of Anesthesiology  
University of Vermont College of  
Medicine  
Burlington  
Vermont

**Richard M. Pino, MD, PhD**

Associate Professor  
Harvard Medical School  
Associate Anesthetist  
Massachusetts General Hospital  
Boston  
Massachusetts

**Bil Ragan, MD**

Assistant Anesthesiologist  
Massachusetts Eye and Ear  
Infirmery  
Clinical Instructor of Anaesthesia  
Harvard Medical School  
Boston  
Massachusetts

**Douglas E. Raines, MD**

Associate Professor of Anesthesia  
Harvard Medical School  
Associate Anesthetist  
Department of Anesthesia and Critical  
Care  
Massachusetts General Hospital  
Boston  
Massachusetts

**James P. Rathmell, MD**

Professor of Anesthesiology,  
University of Vermont College of  
Medicine  
Burlington  
Vermont

**Richard W. Rosenquist, MD**

Professor of Anesthesia  
Director  
Pain Medicine Division  
University of Iowa  
University of Iowa Hospitals and  
Clinics  
Department of Anesthesia  
Iowa City  
Iowa

**Carl E. Rosow, MD, PhD**

Professor of Anaesthesia  
Harvard Medical School  
Anesthetist  
Department of Anesthesia and Critical  
Care  
Massachusetts General Hospital  
Boston  
Massachusetts

**Mark I. Rossberg, MD**

Assistant Professor,  
Department of Anesthesiology and  
Critical Care Medicine  
The Johns Hopkins Medical Institutions  
Baltimore  
Maryland

**Raymond C. Roy, PhD, MD**

Professor and Chair of Anesthesiology  
Wake Forest University School of  
Medicine  
Winston-Salem  
North Carolina

**Robert H. Rubin, MD, FACP, FCCP**

Gordan and Marjorie Osborne Professor  
of Health Sciences and Technology  
Professor of Medicine  
Harvard Medical School  
Co-director  
Division of Infectious Disease  
Brigham and Women's Hospital  
Boston  
Massachusetts

**Nyamkhishig Sambuughin, PhD**

Assistant Professor  
Department of Anesthesiology  
Uniformed Services University of the  
Health Sciences  
Bethesda  
Maryland

**Warren S. Sandberg, MD, PhD**

Assistant Professor of Anaesthesia  
Harvard Medical School  
Department of Anesthesia and Critical  
Care  
Massachusetts General Hospital  
Boston  
Massachusetts

**Joseph S. Savino, MD**

Associate Professor  
Vice Chairman, Strategic Planning and  
Clinical Operations  
Department of Anesthesiology and  
Critical Care  
Section of Cardiothoracic Anesthesia  
and Critical Care  
University of Pennsylvania School of  
Medicine  
Philadelphia  
Pennsylvania

**Rebecca A. Schroeder, MD**

Department of Anesthesiology and  
Critical Care  
Duke University Medical Center  
Veterans Affairs Medical Center  
Durham  
North Carolina

**John Sear, MA, PhD, MBBS, FFARCS, FANZCA**

Professor of Anaesthetics  
Hon. Consultant Anaesthetist  
Nuffield Department of Anaesthetics  
University of Oxford  
John Radcliffe Hospital  
Headington  
Oxford  
United Kingdom

**Peter S. Sebel, MB, BS, PhD, MBA**

Professor and Vice Chair  
Department of Anesthesiology  
Emory University School of Medicine  
Atlanta  
Georgia

**Andrew D. Shaw, MB, BS, FRCA**

Associate Professor of Anesthesiology  
Department of Anesthesiology  
Duke University Medical Center  
Durham  
North Carolina

**Stanton K. Shernan, MD**

Assistant Professor of Anesthesia  
Harvard Medical School  
Division Chief  
Cardiac Anesthesia  
Brigham and Women's Hospital  
Boston  
Massachusetts

**Avinash C. Shukla, MBBS**

Instructor in Anaesthesia  
Harvard Medical School  
Associate in Cardiac Anesthesia  
Children's Hospital Boston  
Boston  
Massachusetts

**F.E. Sieber, MD**

Associate Professor  
Department of Anesthesiology and  
Critical Care Medicine  
Johns Hopkins Bayview Medical Center  
Johns Hopkins Medical Institutions  
Baltimore  
Maryland

**Nathaniel Sims, MD**

Assistant Professor of Anesthesia  
Department of Anesthesia and Critical  
Care  
Massachusetts General Hospital  
Boston  
Massachusetts

**Martin Slodzinski, MD, PhD**

Department of Anesthesiology and  
Critical Care Medicine  
Johns Hopkins Bayview Medical  
Center  
Johns Hopkins Medical Institutions  
Baltimore  
Maryland

**David S. Smith, MD, PhD**

Associate Professor  
Department of Anesthesiology and  
Critical Care  
University of Pennsylvania  
Philadelphia  
Pennsylvania

**Mark Stafford-Smith, MD, CM, FRCPC**

Associate Professor of Anesthesiology  
Director  
Duke Cardiothoracic Anesthesia  
Fellowship  
Duke University Medical Center  
Durham  
North Carolina

**John K. Stene, MD, PhD**

Professor  
Department of Anesthesiology  
Penn State University  
College of Medicine  
Director  
Perioperative Anesthesia Trauma  
Services  
Penn State Milton S. Hershey Medical  
Center  
Hershey  
Pennsylvania

**Todd Stevens, MD**

Faculty Fellow  
Duke University Medical Center  
Durham  
North Carolina

**Robert H. Stiefel, MS, CCE**

Director  
Clinical Engineering Department  
University of Maryland Medical  
Center  
Baltimore  
Maryland

**Christopher Sulzer, MD**

Assistant Professor  
Department of Anesthesiology  
Division of Cardiothoracic Anesthesi-  
ology and Critical Care Medicine  
Duke University Medical Center  
Durham  
North Carolina

**Madhav Swaminathan, MD**

Associate Professor  
Division of Cardiothoracic Anesthesia  
Department of Anesthesiology  
Duke University Medical Center  
Durham  
North Carolina

**Bobbie Jean Sweitzer, MD**

Associate Professor  
Department of Anesthesia and Critical  
Care  
University of Chicago  
Director  
Anesthesia Perioperative Medicine  
Clinic  
Chicago  
Illinois

**Tamas Szabo, MD, PhD**

Department of Anesthesiology  
SUNY Upstate Medical University  
Syracuse  
New York

**Richard Teplick, MD**

Chief of Staff  
University of South Alabama Hospitals  
Associate Dean for Clinical Affairs  
University of South Alabama College  
of Medicine  
University of South Alabama  
Mobile  
Alabama

**Daniel Thys, MD**

Professor  
Department of Anesthesiology  
St. Luke's-Roosevelt Hospital Center  
College of Physicians and Surgeons  
Columbia University  
New York  
New York

**Joseph R. Tobin, MD**

Professor and Section Head  
Pediatric Anesthesiology and Pediatric  
Critical Care  
Wake Forest University School of  
Medicine  
Medical Center Boulevard  
Winston-Salem  
North Carolina

**Michael M. Todd, MD**

Professor and Chair  
University of Iowa  
Department of Anesthesia  
Iowa City  
Iowa

**Kevin K. Tremper, PhD, MD**

Robert B. Sweet Professor and Chairman  
Department of Anesthesiology  
University of Michigan Health System  
Ann Arbor  
Michigan

**Christopher A. Troianos, MD**

Chairman and Program Director  
Department of Anesthesiology  
Western Pennsylvania Hospital  
Pittsburgh  
Pennsylvania

**Lawrence C. Tsen, MD**

Associate Professor in Anaesthesia  
Harvard Medical School  
Brigham and Women's Hospital  
Boston  
Massachusetts

**Ban CH Tsui, MSc, MD, FRCPC**

Assistant Professor  
Director of Clinical Research  
Department of Anesthesiology and  
Pain Medicine  
University of Alberta  
Alberta  
Canada

**Kamila Vagnerova, MD**

Visiting Assistant Professor  
Oregon Health and Sciences University  
Department of Anesthesiology  
Portland  
Oregon

**Jean-Louis Vincent, MD, PhD**

Head  
Department of Intensive Care  
Erasmie Hospital  
Free University of Brussels  
Belgium

**Maria Voelkel, BA**

Research Assistant  
Department of Anesthesiology  
Uniformed Services University of the  
Health Sciences  
Bethesda  
Maryland

**David C. Wartier, MD, PhD**

Professor and Chairman  
Department of Anesthesiology  
Medical College of Wisconsin  
Milwaukee  
Wisconsin

**David S. Warner, MD, PhD**

Professor  
Duke University  
Department of Anesthesiology  
Medical Center  
Durham  
North Carolina

**Daniel T. Warren, MD**

Staff Anesthesiologist  
Virginia Mason Medical Center  
Department of Anesthesiology  
Virginia Mason Medical Center  
Seattle  
Washington

**Denise J. Wedel, MD**

Professor of Anesthesiology  
Department of Anesthesiology  
Mayo Clinic College of Medicine  
Rochester  
Minnesota

**Stuart J. Weiss, MD, PhD**

Associate Professor of Anesthesiology  
and Critical Care  
University of Pennsylvania  
Philadelphia  
Pennsylvania

**Ian J. Welsby, BSc, MBBS, FRCA**

Assistant Professor  
Department of Anesthesiology and  
Critical Care  
Duke University Medical Center  
Durham  
North Carolina

**Randall C. Wetzel, MBBS, MRCP, LRCS, MBA, FAAP, FCCM**

Chairman of Anesthesiology Critical  
Care Medicine  
The Anne O'M Wilson Professor of  
Critical Care Medicine  
Director of Critical Care Medicine  
Childrens Hospital Los Angeles  
Professor of Pediatrics and Anesthesiology  
USC Keck School of Medicine  
Director of the Laura P. and Leland K.  
Whittier Virtual PICU  
Los Angeles  
California

**Charles W. Whitten, MD**

Professor  
Vice Chairman for Resident Affairs  
M.T. "Pepper" Jenkins Professor in  
Anesthesiology  
Department of Anesthesiology and  
Pain Management  
University of Texas Southwestern  
Medical Center  
Dallas  
Texas

**Richard A. Wiklund, MD**

Associate Clinical Professor of Anesthesia  
Harvard Medical School  
Anesthetist  
Massachusetts General Hospital  
Boston  
Massachusetts

**Jessica L. Willert, MD**

Instructor  
Department of Anesthesiology  
Harvard Medical School  
Staff Cardiac Anesthesiologist  
Department of Anesthesiology  
Brigham & Women's Hospital  
Boston  
Massachusetts

**Clifford J. Woolf, MD, PhD**

Richard J. Kitz Professor of Anesthesia  
Research  
Harvard Medical School  
Director  
Neural Plasticity Research Group  
Boston  
Massachusetts

**Jay Yang, MD, PhD**

Professor  
Department of Anesthesiology  
Columbia University College of Physi-  
cians and Surgeons  
New York  
New York

**Myron Yaster, MD**

Richard J. Traystman Professor,  
Departments of Anesthesiology, Criti-  
cal Care Medicine and Pediatrics  
The Johns Hopkins Medical  
Institutions  
Baltimore  
Maryland

**Warren M. Zapol, MD**

Anesthetist-in-Chief  
Department of Anesthesia and Critical  
Care  
Massachusetts General Hospital  
Boston, Massachusetts  
Reginald Jenney Professor of  
Anaesthesia  
Harvard Medical School  
Boston  
Massachusetts

**Qin Zhang, MD**

Fellow  
Duke University  
Durham  
North Carolina

**David A. Zvara, MD**

Associate Professor  
Head, Section on Cardiothoracic Anes-  
thesiology and Perioperative Echo-  
cardiography  
Wake Forest University School of Med-  
icine  
Medical Center  
Winstom-Salem  
North Carolina



*This page intentionally left blank*

# Foreword

Fifteen years ago, Dr. Mark C. Rogers, then Chair of Anesthesiology at Johns Hopkins, “conned” the late Benjamin Covino, MD, then Chair at the Brigham and Women's Hospital and Professor at Harvard, and me, then Chair at Iowa, into joining him at a small hotel near Washington, D.C., where he spent the better part of a day “selling” us on his idea to create a more “user friendly” general text of anesthesiology. (The term “user friendly” was quite new and in vogue in those days.) His vision was to approach the subject in a way that would benefit the brand new trainee, while at the same time creating a definitive reference work for the “veteran” anesthesiologist. Up to then, major texts had started with dry history, then jumped into complex theories of anesthesia, then physiology and pharmacology. Rogers' idea was to start with the preoperative evaluation of the patient and delineate anesthesiology in the manner that trainees actually approach patients.

As Dr. Covino and I neared our saturation point with Rogers' “hard sell,” the two of us adjourned outside to talk it over. We agreed that Rogers had an exciting concept. That was never the issue. We simply wanted to try to figure out whether or not we had it in us to do that much work, at that stage in our careers! We decided to tackle the task.

Ben Covino's tragic death, before the first edition was completed, was devastating to us. Without the addition of David Longnecker, MD, Chair of Anesthesiology at the University of Pennsylvania, the submitted manuscripts would probably still be causing my office shelves to sag. Longnecker brought an organizational ability, and a “toughness” that spurred us on to finish the job.

A subsequent edition, which came out in 1998, was much improved; cleaner, leaner, and simply all-around better, but it followed the same philosophy. With that effort, I determined to “hang up my spikes” and not participate in another major editing effort, for the work is daunting.

Fortunately for the specialty of anesthesiology, Longnecker was persuaded by an outstanding medical publisher, McGraw-Hill, to carry this concept forward into an

entirely new work which you have here. This new text builds on the tradition of former efforts but is expanded considerably to include the increased breadth of the specialty in areas such as regional anesthesia, pain medicine and critical care medicine, yet all with the same philosophy of approaching the specialty as a medical discipline that encompasses the full range of patient care, not simply the technical aspects of anesthesia practice. With his legendary “arm twisting” ability, Longnecker even managed to persuade me to tackle writing a preface.

This is much more than a new cover on an old work. Dr. Longnecker and his colleagues have recognized that anesthesiology has moved dramatically forward. They have made a major effort to capture new concepts and have succeeded in encompassing the full spectrum of state-of-the-art anesthesiology. Section 1 sets the stage by discussing where we came from, where we are, and where we might go. The emphasis is on quality care and safety principles. Just as “user-friendly” was in vogue fifteen years ago, now a key principle is “evidence-based medicine.” The chapter authors and editors have worked diligently to apply this modern principle wherever possible throughout the work.

There is a new emphasis on the “operations” aspects of anesthesia care, which has been termed “OR management,” but which really emphasizes that we do need to learn how to run our OR suites more efficiently for the benefit of the patients and their surgeons. Notably, the emphasis on preoperative evaluation and preparation of the patient is extensive and rooted in the concept that anesthesiologists must think of themselves as perioperative physicians.

There has clearly been a resurgence of interest in and emphasis on regional anesthesia care, both intraoperatively and for postoperative pain management. Similarly, a separate and thorough section on chronic pain underscores the importance of this area in modern anesthetic practice.

Critical Care Medicine (CCM) has been an important part of anesthesiology training and practice for many years, but

recently emphasis on this aspect of our specialty has grown dramatically, and soon will result in a doubling of the required time in CCM in training programs. This new work has recognized this with an expanded ten chapter section dealing with the critically ill patient.

I would like to thank David Longnecker, MD, for several major contributions: first, for stepping in after Ben Covino's untimely death and helping us complete our prior book, next for spearheading a second edition of that work, and now for giving our specialty a wonderfully useful new general text.

From my early primitive attempts to blindly find the internal jugular vein so as to be able to pass a Swan Ganz catheter, to today's transesophageal echocardiography; from my primitive attempts to “find” a paresthesia to today's sophisticated nerve blocks using stimulators; from the monitors I began with in 1969, where the “bouncing ball” EKG signal disappeared, sometimes for minutes, whenever the surgeon fired the “spark gap Bovie;” from early volatile anesthetics which were associated with frightening hypotension and dysrhythmias, not to mention wakeups that had surgeons pacing and muttering, we have made strides in anesthesiology that are truly amazing. If anyone had told me in my training that patients would go home directly after a general or major regional anesthetic, I'd have told them...never mind what I'd have told them!

The famous Baltimore Oriole third baseman Cal Ripken, as he ended his career, said, “it's been a good run.” For me, that's just as true. It is just as exciting for me, nearing the end of my “good run,” to see the vitality, and feel the excitement, of my colleagues and trainees who are continuing to move forward with our wonderful specialty of anesthesiology. This new text and reference will make us proud.

With respect and admiration,

**John H. Tinker, MD**

Professor and Chair

Department of Anesthesiology

University of Nebraska Medical Center

Editor Emeritus, *Anesthesiology*

*This page intentionally left blank*

# Preface

The specialty of anesthesiology continues to evolve from an earlier era when it was often viewed as a technically oriented procedural discipline, to its present status as a medical discipline whose practitioners focus their expertise in the areas of perioperative and intraoperative care, critical care medicine and pain medicine. Anesthesiologists are now viewed as physicians who use combined medical and interventional approaches to achieve desired endpoints and enhanced outcomes across a broad spectrum of medical practice. Further, the specialty is recognized as the pioneering leader in the growing movement for patient safety. That movement is perhaps the most important new initiative to emerge in health care in the last century. The patient safety movement will likely be viewed in the future as akin to the “sea change” that Abraham Flexner pioneered in medical education some 100 years ago. We believe that positioning our specialty at the continued forefront of this movement is a key strategy for both the current and future success of anesthesiology and its practitioners.

In 2000, the Institute of Medicine published its landmark analysis of American health care, “To Err is Human,” a treatise that emphasized the fallibility of humans, even those with the greatest dedication to their profession and their patients, and emphasized that systems of safe care must be constructed to protect patients from potential harm. That report specifically cited anesthesiology as a leader in the patient safety movement and urged others to follow the lead of our discipline, which many throughout health care have done subsequently. A subsequent IOM publication, “Crossing the Quality Chasm; A New Health System for the 21st Century” (2001), went beyond patient safety alone; it described the attributes of a model health care system as one that is safe, timely, efficient, effective, patient centered and equitable to all. We agree with these principles and have worked diligently to adopt them in our own practic-

es and departments, for they are guideposts to the professional and ethical practice of medicine and anesthesiology. In particular, we have designed this text around the concepts of safe, effective and patient-centered care, and we urge others to approach their practice with the same enthusiasm that we share for these principles.

There are multiple sources of information about the clinical practice of anesthesiology, or about the research that forms the basis for that practice. Further, there are numerous subspecialty books that delve into the subdisciplines in great detail—often more detail than the advanced trainee or practitioner desires or needs. In this text, we have focused on what is truly important for the clinical practice of anesthesiology in all its dimensions, while being efficient in the presentation of this essential material. Throughout, we have asked “What is important?” “Why is it important?” “When should it be applied?” and “How should it be applied?” Our overarching goal was to write for the practitioner, not for the small cadre of physician scientists who may be exploring a narrow subdiscipline in great detail—such work is essential for the future scientific basis and direction of the specialty, but it often leads to extensive discussions of minutiae that distract rather than enlighten the clinical practitioner; it simply becomes too difficult to glean the key clinical principles from the blizzard of scientific detail. That said, this is not a user’s manual of anesthesia care, but rather a text that constantly builds on the concepts of safe, effective (i.e., evidence-based) and patient centered care, hopefully distilled in a manner that facilitates easy access to the key concepts that underpin the rationale for that practice.

We have taken a comprehensive approach to the full range of anesthesiology practice, and to the role of anesthesia care within the overall care process. Thus, we have emphasized the trends in

both the specialty and the health care system in general, to assure that the reader is not required to go elsewhere for additional information to support the mainstream of their practice. Those trends in the specialty include the expanded use of regional anesthesia, the remarkable explosion in pain medicine practice and the expanded need for the skills and experience that anesthesiologists bring to the practice of critical care medicine. No careful observer of the specialty could miss these trends, and no text could be considered “comprehensive” if it did not address each of them in a way that embraces them as full components of the modern practice of anesthesiology.

We view the key trends in health care overall as those involving patient safety, quality, patient centered care and a systems approach to care that encompasses the entire care process, rather than individual components that function independently. Here again, we have woven these concepts into the text by emphasizing that anesthesia care is a system of care within a larger system of care that focuses on overall patient outcomes, not isolated events by individual practitioners working in isolated clinical disciplines.

We have approached these and other key “drivers” of contemporary and future anesthesia practice with care, commitment and enthusiasm for the future of the specialty. We trust that you share this enthusiasm and hope our efforts will serve you well as you continue to translate your knowledge and skills into safe, effective, efficient and patient-centered care; our patients want nothing less and our surgical and medical colleagues are looking to anesthesiology to continue to set the example for implementation of these principles. We are honored to serve you through our efforts here.

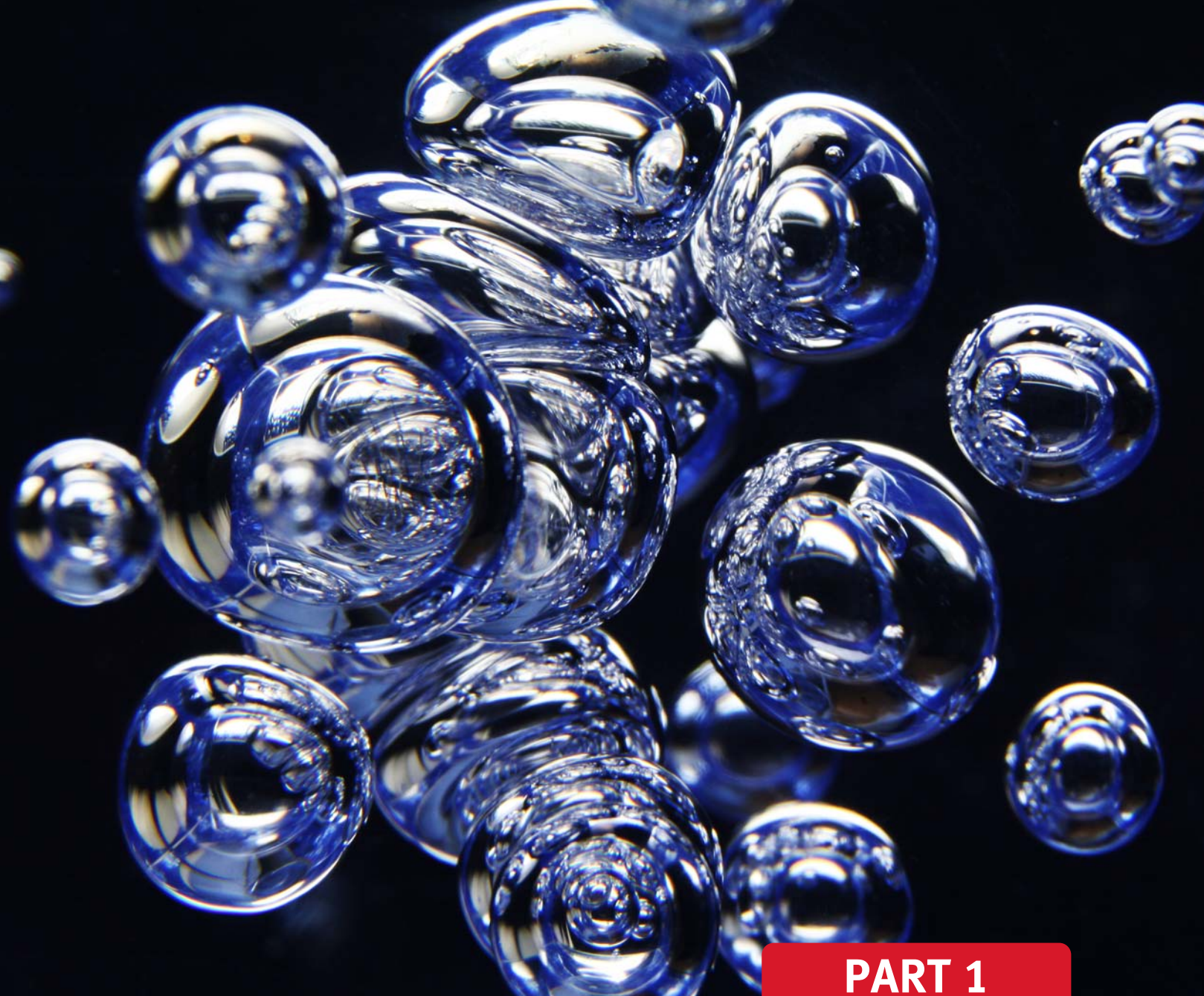
**David E. Longnecker, MD, FRCA**

**David L. Brown, MD**

**Mark F. Newman, MD**

**Warren M. Zapol, MD**

*This page intentionally left blank*



## **PART 1**

# THE SPECIALTY OF ANESTHESIOLOGY



# CHAPTER 1

## The Evolution of Anesthesiology as a Clinical Discipline: A Lesson in Developing Professionalism

Douglas R. Bacon, MD, MA

The quest for insensibility to the surgeon's knife is a primordial one. Stretching back to antiquity, physicians have sought ways to render a patient pain free while an operation was being performed. Many different regimens were tried, with varying success, until October 16, 1846, when surgical anesthesia was publicly demonstrated at the Massachusetts General Hospital by William Thomas Green Morton. Yet, there remained a long road from that fall day in Boston to the current operating room full of electronic machines whose sole purpose is to measure the anesthetic state, or physiologic parameters of the anesthetized patient. How did anesthesiology evolve from a simple glass globe inhaler to the vast array of machines that makes the modern operating room?

In many ways, the history of anesthesiology is the history of the men and women who have devoted their career to the administration of anesthetics. Without physicians interested in the anesthetic state and the ability to adapt to new conditions demanded of anesthesiologists by surgeons, there would be neither modern surgery nor the specialty of anesthesiology. Yet each individual was a real human, many displaying professionalism beyond what was required or expected; others seem reprehensible by "modern" standards. Although many of the individuals in this story would not consider themselves specialists in anesthesia, their contributions were critical in moving this area of the practice of medicine forward. The development of anesthesiology can be told as the history of involved physicians who

dedicated themselves to providing safer, focused care of the patient, first in the operating room, and later in the critical care unit and pain clinic. The story begins in ancient Egypt, and ends in the sterile environment of the modern operating room.

## PREHISTORY: THE QUEST FOR SURGICAL ANESTHESIA

Imagine, for a moment that there is no surgical anesthesia. The Edwin Smith Papyrus describes 48 surgical cases done between 3000 and 2500 B.C. Al-

### KEY POINTS

1. The history of anesthesiology is an interesting and complicated story of professionals seeking to understand the anesthetic state and to safely anesthetize patients.
2. Shortly after the first public demonstration of ether anesthesia on October 16, 1846, the news spread across the world. At first anesthetics were given based on written accounts, often in the lay press.
3. John Snow, a London physician, worked out the physics of vaporization of volatile agents using ether and chloroform and used this information to design vaporizers and anesthetic techniques that were safer for the patient.
4. The first professional organization devoted to anesthesia was the London Society of Anaesthetists founded on May 30, 1893. The first similar group in the United States was the Long Island Society organized by Adolph Frederick Erdmann in 1905. The Long Island Society eventually became the American Society of Anesthesiologists.
5. Francis Hoffer McMechan, crippled by rheumatoid arthritis and unable to work clinically after 1911, organized professional anesthesia. He helped create the first national organization, the Associated Anesthetists of America in 1912, and went on to found several national and international organizations, of which the International Anesthesia Research Society (IARS) remains active. He was the founding editor of the first journal in the world devoted to the specialty, *Current Researches in Anesthesia and Analgesia*, which is currently published as *Anesthesia and Analgesia*, giving the specialty a way to communicate the most recent advances in science, technique, and technology.
6. Ralph Water is credited with the first department of anesthesia within an academic setting at the University of Wisconsin in 1927. Much of the current residency structure comes from this seminal department. This helped establish the specialty on an equal footing with other medical specialties—and created a method to train physicians in the art and science of anesthesia.
7. John Lundy, working at the Mayo Clinic, organized the Anaesthetists Travel Club, whose members were the leading young anesthetists of the United States and Canada. These individuals helped create, by 1938, the American Board of Anesthesiology, which defined what it meant to be an anesthesiologist in the United States.
8. The need for physician specialists in World War II exposed a large number of young men to anesthesiology who would not have otherwise considered the specialty. After the hostilities ceased, these physicians returned and helped create the tremendous growth in the 1950s and 1960s that the specialty enjoyed.
9. In the mid-1950s, the World Federation of Societies of Anesthesiologists (WFSA) was formed. It was the culmination of a dream that dated to the late 1930s. The WFSA made it possible for nations with a long tradition of physician specialization in anesthesia to help train and create the specialty in countries that were either recovering from the effects of the war or were beginning their national infrastructure in healthcare.
10. In the 1980s, the Anesthesia Patient Safety Foundation (APSF) and the Foundation for Anesthesia Education and Research (FAER) were created. They are additional examples of the professionalism demonstrated throughout the history of anesthesiology. These two organizations work to create a safe anesthetic environment. In addition, they support educational and research efforts in the specialty.

though there is no specific mentioning of anesthesia, within the papyrus there is evidence of compression anesthesia. In one instance, a surgeon is compressing the antecubital fossa while operating on the hand; in another instance, the patient is compressing his brachial plexus while the surgeon operates on his palm.<sup>1</sup> The ancient Chinese reported the use of an anesthetic for surgery in the 2nd century B.C.<sup>2</sup> The use of hemp smoke as an anesthetic was noted in India<sup>3</sup> long before Western medicine developed crude forms of anesthesia.

During the Middle Ages and early Renaissance, a mixture of herbs purported to induce anesthesia was created. Boiled into a sponge, at the time of surgery the sponge was placed in water and the vapors inhaled. Although the vinca alkaloids were a major component of the drugs used in the *spongia somnifera*, the resultant anesthetic was less than satisfactory. Another Renaissance solution was the use of parallel lines of ice, with the incision placed between them. This was effective for simple operations, and found use in the Russo-Finnish War of 1939–1940. Compression anesthesia, whereby a large clamp-like device was used to put pressure on a nerve, succeeded in short, peripheral operations.<sup>4</sup> Yet, the nerve compression itself caused pain. Alcohol, when drunk in sufficient quantities, was noted to render individuals insensible. Thus, the age-old intoxicant was used as a standard against which all anesthetics could be measured.<sup>3</sup>

In the early 1840s, the effects of nitrous oxide and diethyl ether were well known. Humphry Davy had described the intoxicating effects well in his book, *Researches Chemical and Philosophical: Chiefly Concerning Nitrous Oxide*, published in 1800. Ether, which had been first synthesized in the 1500s, had been observed to lessen the “air hunger” of asthmatics.<sup>5</sup> Both drugs were well known to medical students as intoxicants. In January 1842, in Rochester, New York, a medical student, William E. Clark, anesthetized the sister of a classmate, for the extraction of a molar using ether. Instructed not to pursue this observation, as it most likely was a “hysterical reaction of women,” Clarke continued his training and became a respected Chicago, Illinois area physician.<sup>6</sup>

Two months later, in rural Georgia, a country doctor, Crawford Long, who

had hosted parties where ether was used as an intoxicant, used the drug to render James Venable insensitive for the removal of tumors from the back of his neck. He charged Venable \$2 for the anesthetic, thus delineating anesthesia as part of a professional service. Two years later, in 1844, Horace Wells, a Hartford Connecticut dentist, would gain the insight that, during a nitrous oxide (N<sub>2</sub>O) show, when an individual was intoxicated by N<sub>2</sub>O, pain was abolished. Wells then tried this idea on himself for the removal of one of his teeth by his partner, and was successful. Soon he was using “painless dentistry” as part of his professional advertisement. Wells even attempted to demonstrate a painless tooth extraction at the Massachusetts General Hospital in 1844, but the patient groaned, and the demonstration was considered a failure.<sup>7</sup>

Clearly, by the middle of the 19th century, there were sufficient observations about chemical agents that could potentially abolish the pain of surgery. On a limited scale in rural Jefferson, Georgia, surgery with ether anesthesia was happening. Yet, Long lacked sufficient cases to study the effects of this new agent because of the rural nature of his practice.<sup>8</sup> Wells' use of nitrous oxide was groundbreaking, yet he lacked the emotional stability to overcome his failed demonstration.<sup>9</sup> Thus, the stage was set for another dentist to demonstrate reproducible surgical anesthesia, and give birth to what would grow and develop into the specialty of anesthesiology.

## DISCOVERY

On October 16, 1846, William Thomas Green Morton, a dentist and medical student, provided surgical anesthesia for Gilbert Abbott for the removal of a tumor of the jaw at the Massachusetts General Hospital. The events of that day are well known.<sup>10</sup> Upon completing the operation, the surgeon, John Collins Warren, remarked, “Gentlemen, this is no humbug.” The miracle of pain-free surgery so impressed the Boston medical establishment that letters were sent to colleagues across the world. Considerable scholarship has been spent discerning when these letters arrived, and where they arrived, and who provided anesthesia first in the new location. For example, the

generally accepted view of the spread of anesthesia to the United Kingdom is a letter from Jacob Bigelow to Francis Boot. However, by careful study of the ships sailing between Boston and Liverpool, another letter, written almost 2 weeks before Bigelow's and only 12 days after the public demonstration of ether, arrived in England on November 1, 1846. Interestingly, this letter was to a patent attorney.<sup>11</sup>

Morton wanted to patent the process by which ether was administered, so writing to the foremost patent attorney in England to secure rights to the administration of ether in the United States and the United Kingdom,<sup>9</sup> and perhaps the world, is not surprising. He also tried to patent ether itself, calling his anesthetizing mixture “Letheon.” However, the distinctive odor of ether gave away the true nature of the concoction. The Boston medical establishment had convinced Morton to allow the Massachusetts General Hospital to use Letheon without charge. With ether a well-known and easy-to-synthesize compound, and its effects reproducible without the “Morton's Inhaler,” the patent was quickly broken. Morton would spend the rest of his life attempting to be compensated for patent infringement, fighting with the medical establishment and into the halls of Congress.<sup>8</sup> Morton clearly was not the embodiment of medical professionalism as we currently understand it.

Despite the patent, news of Morton's achievement did travel, and quickly, given the nature of communication in the 1840s. On December 16, 1846, the news, in the form of a letter, arrived in London. On December 19, the first ether anesthetic was given in the United Kingdom for the removal of a tooth. On December 21, Robert Liston, the famous surgeon, amputated the leg of a butler and uttered the famous words, “This Yankee dodge beats mesmerism hollow.” By early 1847, anesthetics were being given in Europe. By June of that year, the news had spread to Australia.<sup>12</sup> Peter Parker, minister and physician missionary in China, gave the first anesthetics there on October 4, 1847.<sup>13</sup>

How the news traveled, and when it arrived are matters of historical fact. Yet, for the profession of anesthesia, and the specialty of anesthesiology, what is almost more important is how willing physicians and dentists were to

use ether in this new way. Consider for a moment that outside of Boston, none of the recipients of the news that ether produced insensibility to the surgeon's knife had actually witnessed the event. Many accounts, especially those reaching South Africa and Australia, were newspaper articles or letters to the editor, often signed by a pseudonym. The hope that these medical professionals had, their desperation at their inability to alleviate pain, and their desire to help patients may well have motivated them to try this new technique. Yet, when viewed from the perspective of current early 21st century medical practice, this willingness to go on purely written accounts, often in the lay press, without the collaborating voices of the medical profession, seems to be dangerous, and without regard for the basic principle of medicine: first do no harm.

And what of the surgeons? Tolerance of the pain of surgery limited operations to those that could be performed quickly. Anesthesia obviated the need for speed, presenting the possibility of operating within the visceral cavities for hours rather than seconds. But as the physician responsible for the patient, long before the specialty of anesthesiology would be defined, why were these professionals willing to risk lives to find an anesthetic? What does this behavior say to the modern student of medical professionalism?

### JOHN SNOW, SPECIALIZATION, AND EARLY PROFESSIONALISM

As reprehensible as Morton's actions appear in patenting his "discovery," Morton was acting within the ethics of his time. The American Medical Association (AMA) was only just beginning to be formed. Meeting for the first time in May 1846, 5 months before the public demonstration, the National Medical Convention adopted a resolution to write a code of medical ethics. A year later, the code was adopted. Morton's actions were covered under section 4:

Equally derogatory to professional character is it, for a physician to hold a patent for any surgical instrument, or medicine, or to dispense a secret nostrum, whether it be the composition or exclusive property of himself or others. For, if such nostrum be of real efficacy, any concealment regarding it is inconsistent



**FIGURE 1-1.** John Snow. (Photograph courtesy of the Wood Library-Museum of Anesthesiology.)

with beneficence and professional liberality;...<sup>14</sup>

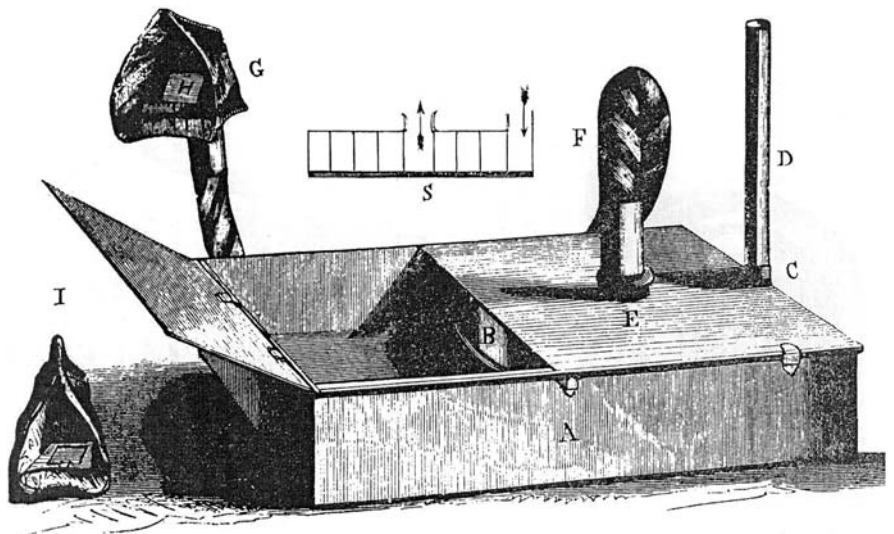
Thus, at the time when Morton was trying to patent ether or the apparatus for its vaporization, medicine was starting to organize and promulgate statements against such behavior.

In contrast, John Snow (Fig. 1-1), a London physician, became very interested in this new state of anesthesia. He began to study the chemical and physical properties of ether, and by 1847 had developed a vaporizer. "Snow never patented any apparatus he designed. On the contrary, he published clear descriptions, including engraved

figures, so that others could copy them if they chose."<sup>15</sup> Snow, by careful observation worked out the vaporization characteristics of ether. His vaporizer (Fig. 1-2) was temperature compensated, being made of coiled copper (Fig. 1-3), an excellent heat-conducting metal, housed in a water bath to ensure constant temperature of the ether. Thus, Snow was able to calculate the amount of ether a patient required for anesthesia within a decade of the discovery of anesthesia.<sup>13</sup>

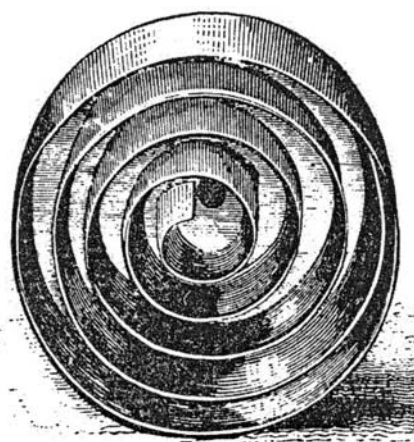
Following the introduction of chloroform as an anesthetic in 1847 by Edinburgh obstetrician James Young Simpson, Snow began to investigate this second anesthetic agent. Snow used his experience with ether as a guide for investigating the properties of chloroform. He concluded that it was far safer to give this new anesthetic in measured quantities through an inhaler. He did not favor the handkerchief method, whereby chloroform was applied to a cloth and held close to the nose and mouth, as being too difficult to adequately control the anesthetic depth of the patient. His deliberate nature and strong powers of observation allowed Snow to create a calibrated, temperature-compensated vaporizer for this agent as well.<sup>13</sup>

Snow is unique among his colleagues in the 1850s in London. A physician with many interests, it was the giving of anesthetics that accounted for the vast majority of Snow's clinical income throughout the decade. In a day when operations were still rarely performed, Snow specialized in anesthetics. In some ways, his expert knowledge al-



**FIGURE 1-2.** Snow's vaporizer. (Image courtesy of the Wood Library-Museum of Anesthesiology.)





**FIGURE 1-3.** Coil from Snow's vaporizer. (Image courtesy of the Wood Library-Museum of Anesthesiology.)

lowed him entrée into the upper echelons of both social and physician circles, a status he could not have obtained had he not limited his practice. Perhaps this is best illustrated by his attendance upon Queen Victoria for the birth of her last two children. While Snow did not use his inhaler, he also did not induce the full anesthetic state in the Queen. Rather, he strove for analgesia with chloroform, and in so doing, created a form of obstetrical analgesia, *chloroform a la reine*, which would persist in various forms over the next century.<sup>13</sup>

Aside from working out the physics of vaporization, Snow was intensely interested in outcome data. He studied every report concerning a death under anesthesia, and often times had data in advance of the published reports of death. He commented extensively on the death of Hannah Greener, thought to be the first death under anesthesia in the world.<sup>16</sup> In his posthumous book, *On Chloroform and other Anesthetics*,<sup>17</sup> published in 1858, Snow compiled the first 50 deaths under chloroform, with comments about the pathophysiology present. Snow's spirit of inquiry, which went from the bench top to the pathologic findings at death, helped him to understand the nature of the anesthetic process and the agents that produced insensibility. In following his inquiring mind, Snow created the scientific underpinnings for a specialty.<sup>18</sup>

## A PROFESSION EMERGES

After Snow's untimely death, anesthesia faded into the medical background again. In larger cities, there were those

who made a majority of their clinical income from providing anesthesia, yet it would not be until the advent of Listerism and the "taming" of infection that operations would become more frequent. As the number of operations increased, so did the need for anesthesia and, unfortunately, mortality became an issue. Chloroform was responsible for deaths that seemed unexplainable. Ether appeared to be safer, yet the side effects of nausea and vomiting, and the prolonged induction when compared to chloroform, made ether a less-than-ideal agent. Surgeons began to search for alternative methods for the administration of anesthetics.

In 1884, Carl Koller, a resident in ophthalmology in Vienna, was introduced by Sigmund Freud to a new crystalline substance called cocaine. Koller sought a local anesthetic to replace ether anesthesia for operations on the eye; because fine suture material to close the eye wound did not exist, any postoperative retching potentially could cause the loss of vision. Thus, when Koller's tongue became numb from droplets of a solution containing cocaine, he made the conceptual leap that this same solution could be applied to the cornea with similar anesthetic effects on the eye. Using the facilities of the laboratory in which he worked, Koller soon numbed the eyes of several animals, a fellow investigator, and himself. He took this new topical anesthetic to the clinic and used it with great success. On September 15, 1884, Koller had a paper on the subject on the program at the German Ophthalmological Society meeting in Heidelberg. Because Koller was too poor to travel, his colleague, Dr. Josef Brettauer presented the paper for him.<sup>19</sup>

While Koller continued his career in ophthalmology, eventually immigrating to the United States, other physicians modified this new form of anesthesia into an alternative to general narcosis. One of the early practitioners was William Halstead, future chair of surgery at Johns Hopkins University, who was in Vienna at the time of Koller's discovery. Using cocaine topically, Halstead eventually learned to dissect down to a nerve, and to anesthetize it directly. Much of the work he did on himself, becoming addicted to cocaine in the process.<sup>20</sup> Another of the pioneers of regional anesthesia was the German surgeon Carl Ludwig Schleich, who developed

the technique of infiltration anesthesia.<sup>21</sup> Combining infiltration techniques with the newly discovered lumbar puncture, August Bier, another academic German surgeon, initiated spinal anesthesia in the late 1890s. Working with his fellow August Hildebrandt, Bier successfully cannulated the subarachnoid space of Hildebrandt and produced a satisfactory anesthetic state. Hildebrandt was unsuccessful in cannulating Bier's subarachnoid space; however, both men suffered postdural-puncture headaches.<sup>22</sup> Ten years later, Bier described his intravenous regional anesthetic technique, which is still referred to as the Bier block.<sup>23</sup>

At the same time that regional anesthesia was being developed in Germany, concern over the safety of chloroform, especially when compared to ether, was developing. In India, then a colony of England, a Chloroform Commission was seated in Hyderabad to attempt to determine which anesthetic agent was safest. Funded by the Nizam of Hyderabad, the 1888 study of anesthetic agents was an effort to find out if there was an intrinsic mortality associated with chloroform. The findings were tainted by the British medical officer in charge, Dr. Edward Lawrie, who was a strong chloroform proponent, having trained in Edinburgh, chloroform's birthplace. The findings of the Hyderabad Chloroform Commission were not conclusive, and a second was ordered, which also was inconclusive. But what was important in these commissions, like the drive to discover regional anesthetic techniques, was that physicians were studying anesthesia and trying to increase patient safety. For many physicians, it was slowly becoming apparent that there was a need for a specialty practice of anesthesia.<sup>24</sup>

Early in the 20th century, the American Medical Association set up a commission to study anesthetics. A preliminary report was issued in 1908.<sup>25</sup> All forms of anesthesia were accounted for, including spinal anesthesia, and various combinations of inhalational agents. The conclusions of the report are interesting, for they foreshadow the development of a separate specialty:

...[A]ll the newer methods demand expertness, experience, and special apparatus. They appeal especially to the surgeons who are equipped with the paraphernalia of expensive and

highly specialized clinics. They are little suited to physicians in general practice. For the latter great class of practitioners, the old general anesthetics, chloroform and ether, will probably hold their own until increasing experience has enabled us to simplify and to make safe the newer and more novel methods.<sup>25</sup>

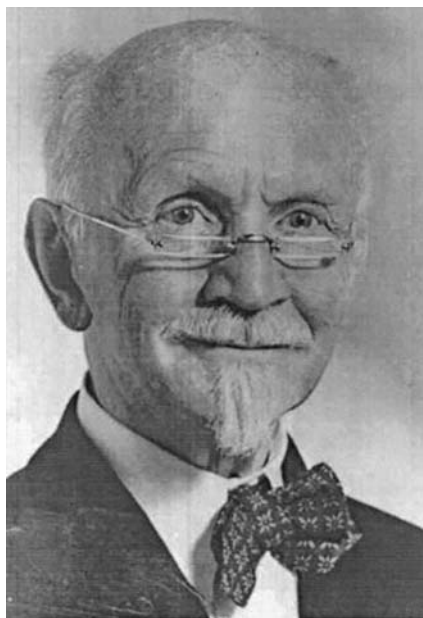
The commission had three very interesting recommendations:

1. That for the general practitioner, and for all anesthetists not specially skilled, ether must be the anesthetic of choice—ether administered by the open-drop method.
2. That the use of chloroform, particularly for the minor operations, be discouraged, unless it is given by an expert.
3. That the training of skilled anesthetists be encouraged and that undergraduate students be more generally instructed in the use of anesthetics.<sup>25</sup>

The third suggestion of the commission would take almost the entire 20th century to implement.

## THE RISE OF THE SPECIALIST

In 1905, in Brooklyn, New York, a group of 8 physicians and a medical student, led by Adolph Frederick Erdmann (Fig. 1-4), gathered to discuss



**FIGURE 1-4.** Adolph Frederick Erdmann. (Photograph courtesy of the Wood Library-Museum of Anesthesiology.)

the problem of anesthetics. These young physicians thought, like the AMA commission, that there was more to the giving of an anesthetic than simply dropping ether on a cloth held near the patient's face, and that there needed to be discussions and a free exchange of scientific and practical information about anesthesia.<sup>26</sup> This was the second specialty group in the world that was created, the first being the London Society of Anesthetists in 1893, and it would become the catalyst for the development and recognition of physicians who were specialists in anesthesia.<sup>27</sup> Thus, the Long Island Society of Anesthetists was born. The society met quarterly, in the evening, with a short business meeting followed by the presentation of 2 or 3 papers, or a couple of papers and a demonstration of a new anesthetic technique or apparatus. Science aside, the society provided a "support" group for those seeking to improve their anesthetic skills, and a forum at which to exchange ideas and deal with problems beyond the science of anesthesia.<sup>26</sup>

The group flourished and, in 1912, moved across the river to New York City, changed the organization's name, and became the New York Society of Anesthetists. Over the next 24 years, the society would grow, both in membership and in scope. Starting out as a New York City group, by the mid 1920s, the group encompassed all of the state. By 1936, it had become a national organization.<sup>28</sup> The transformation focused on the recognition of physicians who primarily anesthetized patients as specialists.

The first significant political move of the New York Society was a motion put before the House of Delegates of the American Medical Association asking for a Section on Anesthetics in 1912. The members of the society were concerned about nonphysicians giving anesthetics, and echoed some of the findings of the AMA's Commission on Anesthetics some 6 years earlier.<sup>28</sup> James Gwathmey (Fig. 1-5), the society's president, was developing a new method of anesthesia—rectal ether. Like chloroform, rectal ether could be unpredictable and needed to be administered by someone very familiar with its use and with the effects of anesthesia in general.<sup>29</sup> The quest for a section within the AMA was, in some ways, the beginning of a quest for patient safety in anesthesia, a



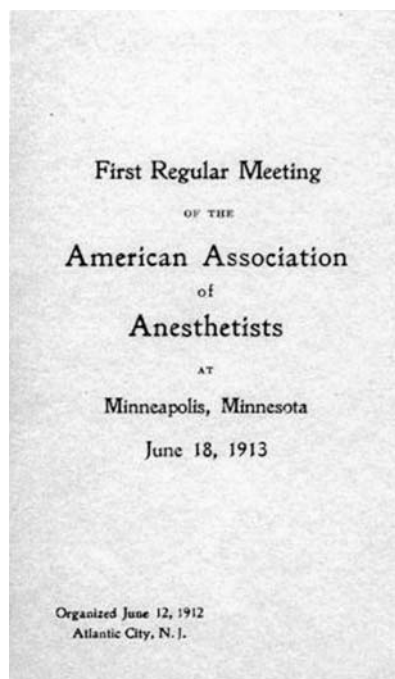
**FIGURE 1-5.** James Tayloe Gwathmey. (Photograph courtesy of the Wood Library-Museum of Anesthesiology.)

movement that would take the specialty by storm in the latter half of the 20th century.

The motion was denied by the AMA House of Delegates. However, Gwathmey and Francis Hoeffler McMechan (Fig. 1-6) gathered the defeated physician anesthetists and created the American Association of Anesthetists (AAA). This was the first national group of physician anesthetists in the United States. The following year, 1913, the group met for a day of papers, mostly clinical in origin, and a dinner, with spouses (Fig. 1-7). The



**FIGURE 1-6.** Francis Hoeffler McMechan. (Photograph courtesy of the Wood Library-Museum of Anesthesiology.)



**FIGURE 1-7.** Program of the first meeting of the American Association of Anesthetists, June 18, 1913, Minneapolis, Minnesota. (Image courtesy of the Wood Library-Museum of Anesthesiology.)

science presented at the meeting is memorable in that the day was devoted to anesthesia; the evening meal signified a group, however small, that was willing to be recognized as specialists in anesthetics and by uniting, to move the field forward.<sup>28</sup>

The AAA, and its successor, the Associated Anesthetists of the United States and Canada, were run by Francis Hoeffler McMechan. A third-generation physician who entered anesthesia against the advice of his father, McMechan had crippling rheumatoid arthritis, and was out of clinical practice by 1911. McMechan was a visionary who desired to see, on a worldwide scale, the elevation of anesthesia to “stand shoulder to shoulder” with surgery and internal medicine. He realized that without a place to publish papers on the specialty, and without a place to gather the news of the various societies and names of physicians practicing anesthesia, the specialty would be doomed. Convincing his friend Joseph McDonald, the editor of the *American Journal of Surgery* to publish a supplement on anesthesia gave the specialty its first U.S. quarterly. McMechan also edited the *Yearbook of Anesthesia* between 1914–1919, compiling all the papers published in the

specialty in the preceding year into a single volume.<sup>30</sup>

McMechan also understood that the specialty would never develop as a discipline within medicine without a strong scientific underpinning. To that end, first nationally, and internationally in the mid 1920s, McMechan organized a society devoted to research in anesthesia. The International Anesthesia Research Society brought together basic science researchers and the physicians most in need of their talents. Most importantly, the IARS sponsored the first journal in the world devoted to anesthesiology, *Current Researches in Anesthesia and Analgesia*.<sup>31</sup>

The education of physician specialists, especially in the postgraduate period, was another of McMechan's concerns. Partnering with Ralph Waters, an opportunity emerged at the University of Wisconsin in 1926, as the medical school transformed itself from a 2-year institution offering only basic science education into a 4-year curriculum with all the clinical sciences. One addition was a section on anesthesia, headed by Waters, in the department of surgery. Waters immediately began to teach anesthesia to medical students and interns. He collaborated with the basic science researchers, at first on problems of carbon dioxide absorbance, and later, through various members of his department, on all aspects of anesthesiology. Perhaps most importantly, Waters established the first residency training program in an academic center. The training was 3 years beyond the intern experience. Years 1 and 3 were clinical in nature, with year 2 devoted to laboratory research. Two weekly conferences were established, one discussing the week's cases in a format similar to current morbidity and mortality conferences, and another devoted to the current literature in anesthesia. By 1933, the teaching program was the envy of the world, and Waters understood that the final step had to be taken. He sent one of his faculty members, and an early graduate of the program, Emery Rovenstine, to Bellevue Hospital and New York University to try to replicate the University of Wisconsin department. Rovenstine was successful beyond any expectation and, in some ways, his graduates would eclipse the contributions of Waters' graduates in the development of academic anesthesiology across the country.<sup>32</sup>

In 1929, the year of the stock market crash and the beginnings of the Great Depression, another pivotal event occurred in anesthesiology. The Anaesthetists Travel Club was organized by John Lundy at the Mayo Clinic. The group was organized along the lines of the Society of Clinical Surgery, with members going to other members' institutions to see their anesthetic practice in action. It was a young man's group, with the oldest member being Lahey Clinic anesthesiologist Lincoln Sise at 55 years of age, and the youngest being Philadelphian and future first editor of *Anesthesiology* Henry Ruth at 30 years of age, and Mayo resident Ralph Tovell at 28 years of age. The average age was just 40 years. These young, influential anesthesiologists were those “standing in line” in the McMechan organization, or those who believed that McMechan's international vision of the specialty, while important, would not solve domestic issues. The Travel Club would come to dominate the New York Society, and become the nidus of leadership for the effort to create the American Board of Anesthesiology.<sup>33</sup>

## THE CREATION OF THE AMERICAN BOARD OF ANESTHESIOLOGY

Once there was an organization in place to address national issues, regular meetings of a society devoted to the specialty, a university presence, ongoing research into clinical problems, and a residency training program to continue to retain and transmit the knowledge already gained, some recognition of a physician practicing the specialty was important. The gains in clinical practice in the 1920s and 1930s are best summed up by Harold Griffith, a leading Canadian physician-anesthetist of the time when he wrote, in 1939, the following:

Seventeen years ago when I began to give anesthetics, the anesthesia equipment in the small hospital which has ever since been my hospital home, consisted of bottles of ether and chloroform and a few face masks. This was typical of the fairly well-equipped hospitals of that time. Today in that hospital there are eight gas machines of various models, suction equipment in every room, oxy-



gen- and helium-therapy equipment, at least fifteen different anesthetic agents, and much technical equipment for their administration. This transformation has been taking place everywhere in anesthesia.<sup>34</sup>

Economic reasons played a role in the need to define a specialist in anesthesia, for physician anesthetists were not well compensated and faced competition from a number of groups. Surgeons, for example, could hire a nurse to help in the office and give anesthetics. The surgeon could then charge each patient a fee for anesthesia in addition to the fee for surgery. The income generated from the anesthetic fee was in excess of what he paid the nurse, and thus profitable. Likewise, hospitals could hire nurses to give anesthetics, charge a fee that cumulatively was in excess of the salaries, and make a profit. Finally, general practitioners would refer cases to surgeons with the caveat that they could give the anesthetic and collect the anesthetic fee.<sup>35</sup>

McMechan proposed an International College of Anesthetists and certified the first fellows in 1935. There were two serious problems with his certification process. First, and foremost, the clinical criteria were weak. The applicant only had to document 10 anesthetic cases, with lessons learned, to be eligible. In one instance, an intern on the anesthesia service for 1 month wrote up the necessary cases and was certified. In another, a surgeon who occasionally gave an anesthetic, completed the necessary paperwork and was certified. With certificate in hand, he attempted to become the head of a hospital division of anesthesia. Second, the college had no standing with the AMA, and the certificate meant nothing "official" in the United States.<sup>36</sup>

Members of the Anaesthetists Travel Club, especially Paul Wood, John Lundy, and Ralph Waters, believed that certification was essential if anesthesia was going to be recognized as an equal with all other specialty practices. Using AMA criteria, which included documentation of either postgraduate training in the specialty, or 2500 cases where the applicant had administered the anesthetic, Wood and his colleagues at the New York Society created a special classification of members called "fellows." This new form of membership was extremely popular, and the membership of the New York Society skyrocketed. Now



**FIGURE 1-8.** Erwin Schmidt. (Photograph courtesy of the Wood Library-Museum of Anesthesiology.)

national in membership, the society changed its name to the American Society of Anesthetists in February of 1936.<sup>37</sup> In 1945, the American Society of Anesthetists became the American Society of Anesthesiologists.

The AMA took note largely through Lundy's efforts, and Waters, working closely with Erwin Schmidt (Fig. 1-8), the chair of surgery at the University of Wisconsin, was able to secure an agreement for the American Board of Anesthesiology (ABA) to be created as a subboard of the American Board of Surgery. Using AMA criteria, which included, in addition to the heavy clinical training, the stipulation that the physician had to be in full-time practice of the specialty the ABA was created in 1938. The first written examination of the ABA was held in March 1939. It was an essay format, with 5 subject subheadings: pharmacology, anatomy, physics and chemistry, pathology, and physiology. There was an oral examination and a practical one at the candidate's place of practice.<sup>38</sup> Thus, there was a heavy emphasis on the clinical practice of anesthesiology.

## WORLD WAR II AND BEYOND

The New York World's Fair opened on April 30, 1939, the eve of World War II. In the Hall of Man, an anesthesiology exhibit (Fig. 1-9) allowed the general public to learn more about the special-

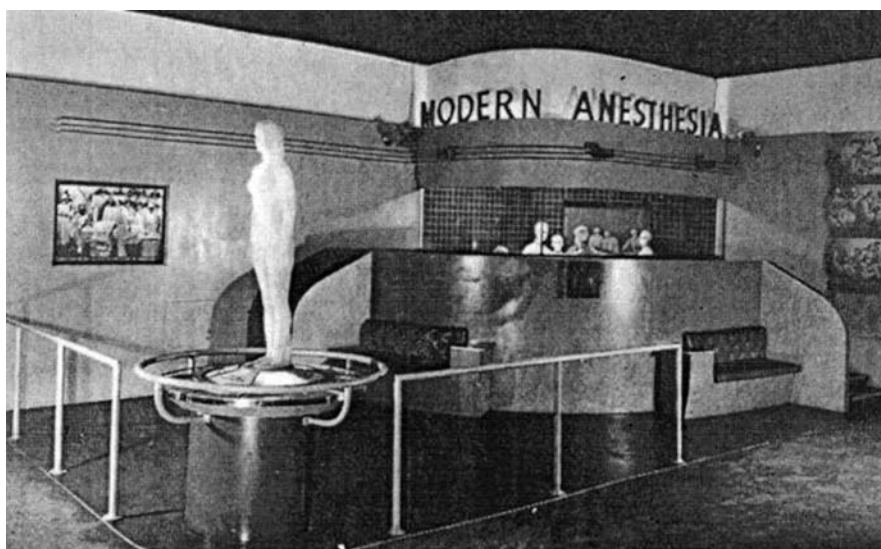
ty. The exhibit was paid for by the Winthrop Chemical Company at a cost equivalent to several million dollars today. This is important for two reasons; first, it demonstrated that anesthesia had enough of a market impact that industry was willing to spend lavishly to support such a display. Second, the clinical practice of anesthesiology had become both complex and commonplace enough that the lay public needed to learn about it.<sup>39</sup>

At the same time, Lewis Wright was hired by Squibb Pharmaceuticals to investigate new anesthesia drugs, among them, curare. Wright was a self-taught anesthesiologist who, in midcareer, took a leave of absence from his job at Squibb and did a residency with Emery Rovenstine at Bellevue Hospital.<sup>40</sup> It was to Rovenstine and Emmanuel Papper that he gave some of the first commercially prepared curare. Papper felt that the agent was a poor anesthetic, as all the test animals stopped breathing when it was administered to them.<sup>41</sup> It was Harold Griffith and Enid Johnson, of Montreal, who discovered the true value of curare in anesthesia.<sup>42</sup>

As the United States plunged into World War II, the anesthesia community was determined not to repeat the mistakes of World War I. Physician anesthetists had been in short supply and often ran from unit to unit training corpsmen in the administration of ether by open drop.<sup>43</sup> By the early 1940s, anesthesia had become too complex for this to be successful. The leaders of the American Society of Anesthetists worked with the advisors to the armed forces and developed short courses, 90 days in length, to train medical officers in the basics of anesthesia. These young physicians managed many horrific clinical situations and, applying what they learned, were able to decrease mortality.<sup>44</sup> The case of Samuel Lieberman, who won the Legion of Merit for his work in the South Pacific, is illustrative. By using continuous spinal anesthesia he decreased the mortality from abdominal wounds from 46–12.5%.<sup>45</sup>

Returning from the war, these physicians had tremendous clinical experience, especially with regional anesthesia. Nerve blocks were invaluable, because corpsmen could take vital signs and talk to the soldier while the operation was ongoing, freeing the anesthesiologist to treat others. Likewise, these military anesthesiologists had





**FIGURE 1-9.** Postcard image of the anesthesia exhibit at the 1939 World's Fair. (Image courtesy of the Wood Library-Museum of Anesthesiology.)

extensive experience with transfusion and fluid therapy. Returning to the United States, approximately 40% sought additional formal training as anesthesiologists. Thus, the specialty expanded tremendously after the end of the war, not only because of the returning physicians, but because surgeons exposed to the field work of the anesthesiologists demanded physician involvement in the anesthesia.<sup>44</sup>

## THE SECOND HALF OF THE 20TH CENTURY

McMechan's vision of an international community of anesthesiologists came to fruition in the 1950s. The first world meeting of anesthesiologists had been scheduled for Paris in the spring of 1940, but was canceled as the German army took the city. By the early 1950s, Europe was starting to recover from the effects of the war and the original French organizers were still interested in seeing the meeting become a reality. Working within the European community and Canada, and with help from the World Health Organization, preliminary meetings were organized and the structure of the WFSA was created. The first World Congress, held at The Hague in the Netherlands in 1955, was a success despite the absence of the Americans. The WFSA wanted to bring the best clinical practice of the specialty to the fore; the World Congress was a way to bring first-, second-, and third-world anes-

thesiologists together to discuss problems and to seek solutions. The WFSA set up programs to share information with those in need of it.<sup>46</sup>

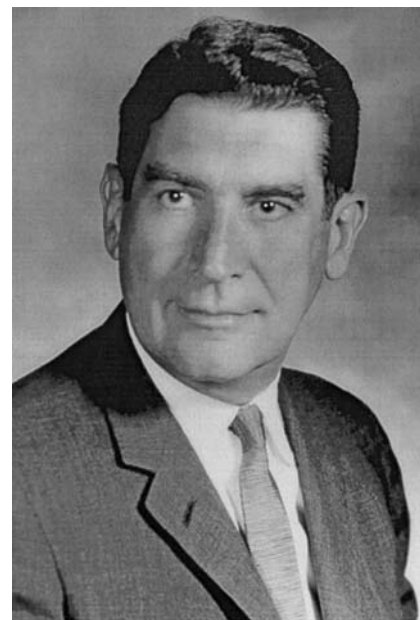
However, it would not be until the end of the decade of the 1950s that the American Society of Anesthesiologists would join the WFSA. The reluctance on the part of the Americans was multifactorial. First, because dues to the WFSA were on a per capita basis, the American Society of Anesthetists felt that they would be providing the majority of the finances of the organization without an equal voice in its government. There was also reluctance on the part of some American anesthesiologists to join an organization that contained communists. Time, dialogue, and the performance of the WFSA eliminated those fears.<sup>47</sup>

Along with the international concerns, the specialty faced a challenge in the United States as well. There was a significant part of the anesthesiology community that felt that no physicians should accept a contract for services and allow a third party, such as a hospital or other employer, to bill in the physician's name. Enforcement of this edict was done by the component societies of the American Society of Anesthetists. An anesthesiologist could not be a member of the American Society of Anesthetists if the anesthesiologist wasn't a component society member. If the anesthesiologist was not an American Society of Anesthetists member, the anesthesiologist was ineligible to take

the American Board of Anesthesiology examination.<sup>48</sup> In response to this, the Association of University Anesthesiologists (AUA) was formed. The majority of academic anesthesiologists were employed by the university for a salary, in violation of the American Society of Anesthetists rules. The establishment of the organization is important not only as a protest, but because it underscores how important academics had become to the fledgling field in the 30 years between the creation of the Waters department to the first AUA meeting.<sup>49</sup> It was a rapid expansion and one that continued to delineate the scientific underpinnings of the specialty.

In the 1960s, the U.S. federal government sought to support medical research and created the National Institutes of Health (NIH). Emmanuel Papper (Fig. 1-10) was invited to Washington, DC to help organize the new agency. Dr. Papper worked tirelessly to see that anesthesiologists were treated fairly by the NIH and were eligible for funding. However, he was unable to secure an independent study section for anesthesia, and the battle to obtain this for the specialty remains a leading agenda item for many.<sup>41</sup>

The 1970s were a decade of crisis for anesthesiology. To assure billing that was commensurate with services, the American Society of Anesthesiologists had endorsed a relative value guide that



**FIGURE 1-10.** Emmanuel Papper. (Photograph courtesy of the Wood Library-Museum of Anesthesiology.)

helped place a unit value on work done by the physician. Other specialties, including orthopedics and radiology, had adopted similar guides, but the Federal Trade Commission (FTC) thought this was a monopolistic practice. All of the specialties but anesthesiology agreed to cease and desist; the American Society of Anesthetists went to court. After a 2-week trial, the judge ruled that the relative value guide did not represent a monopolistic practice; rather, it was simply a tool that applied monetary value differently in different parts of the country. In one of history's little ironies, 30 years after the verdict, the federal government now states the relative value guides are the preferred billing methodology. The 1970s also saw another federal government suit against the American Society of Anesthetists for the fee-for-service rule. Here there was little chance of a successful suit, yet the federal government, cautious after its defeat, agreed to a cease-and-desist order.<sup>50</sup>

The 1980s, by contrast, witnessed the development of two organizations that have served anesthesiology well. The Foundation for Anesthesia Education and Research (FAER) is devoted to the promotion of research within the specialty. The group has a special interest in those just beginning their careers, and has supported a successful starter grant program. Indeed many of the leaders of academic anesthesiology in the early 21st century began their careers with a FAER grant. At the same time FAER was being established, the Anesthesia Patient Safety Foundation (APSF) was created. Its mission is simple: no patient should ever be harmed by an anesthetic. APSF has partnered the academic, private practice, and industrial communities to work toward decreasing anesthetic risk. The establishment of the Harvard standards of monitoring, at the beginning of the APSF, was an important step in this direction. APSF and its work is the model for the patient safety movement across the country, and is used by the AMA as a model for its patient safety foundation.<sup>51</sup>

## CONCLUSIONS

By comparison with most other medical specialties, the history of clinical anesthesia is short. Perhaps Francis

Hoeffler McMechan summed it best when he wrote, in 1935, the following:

Anesthesia was the gift of pioneer doctors and dentists to suffering humanity, and every significant advance in its science and practice has been contributed by doctors, dentists, and research workers of similar standing. In contrast, technicians have added nothing of any consequence. Anesthetics are among the most potent and dangerous drugs used in the practice of medicine; they penetrate to every cell and organ of the body and may cause almost instant or delayed death by their toxic effects. The dosage of general inhalation anesthetics cannot be prescribed in advance but must be determined from moment to moment during administration. The dosage of local and other anesthetics must be determined by the risk of the patient, the nature and duration of the operation to be done—certainly a challenge to the knowledge and experience of the keenest doctor. No patient should ever be given an anesthetic whose condition and risk has not been diagnosed in advance of the operation, so that every resource of medical science can be used to lessen the risk and make the recovery more assuring. Certainly in this preoperative evaluation and the selection of the safest anesthetic and best method of administration, the medical anesthetist is more in a position to act as a consultant than a technician....

The safety of the patient demands that the anesthetist be able to treat every complication that may arise from the anesthetic itself by the use of methods of treatment that may be indicated. The medical anesthetist can do this, the technician cannot. More recent developments have extended the field of medical anesthesia to include resuscitation, oxygen therapy, and therapeutic nerve block for intractable pain, and treatment of various conditions of disease, and the rehabilitation of the disabled—all fields of practice quite beyond the capacity of the technician.<sup>52</sup>

McMechan's vision of professionalism, and its 21st century equivalents, needs to continue to guide the specialty. The history of anesthesia is interesting, filled with fascinating events and people, and it is replete with the highest examples of professionalism.

## KEY REFERENCES

1. Smith HM, Bacon DR. The history of anesthesia. In: Barash P, Cullen B, Stoelting R, eds. *Clinical anesthesia*. 5th ed. Philadelphia: Lippincott Williams & Wilkins, 2005:3–26.
2. Fenster J. *Ether Day*. New York: HarperCollins, 2001.
3. Johansen PV, Paneth N, Rachman S, Rip M. *Cholera, Chloroform, and the Science of Medicine: A Life of John Snow*. New York: Oxford University Press, 2003.
4. Goerig M, Agarwal K, Schulte am Esch J. The versatile August Bier (1861–1949), father of spinal anesthesia. *J Clin Anesth* 2000;12:561–569.
5. Bacon DR, Lema MJ, McGoldrick KE, eds. *The American Society of Anesthesiologists: A Century of Challenges and Progress*. Park Ridge, IL: Wood Library-Museum of Anesthesiology Press, 2005.
6. Wells CJ. Francis Hoeffler McMechan. *Curr Res Anesth Analg* 1948;27:S.
7. Bacon DR, Lema MJ. To define a specialty: a brief history of the American Board of Anesthesiology's first written examination. *J Clin Anesth* 1992;4:489–497.
8. Waisel DB. The role of World War II and the European theater of operations in the development of anesthesiology as a physician specialty in the USA. *Anesthesiology* 2001; 94(5):907–14.
9. Bacon DR. The World Federation of Societies of Anesthesiologists (WFSA): McMechan's final legacy. *Anesth Analg* 1997;84:1130–1135.
10. Griffith HR, Johnson GE. The use of curare in general anesthesia. *Anesthesiology* 1942;3:418–420.

## REFERENCES

1. Smith HM, Bacon DR. The history of anesthesia. In: Barash P, Cullen B, Stoelting R, eds. *Clinical Anesthesia*. 5th ed. Philadelphia: Lippincott Williams & Wilkins, 2005:3–26.
2. Madigan SR, Raj PP. History and Current Status of Pain Management. In: Raj PP, ed.

- Practicle Management of Pain, 2<sup>nd</sup> ed. St. Louis, Mosby Yearbook, 1992:5.
3. Raper HR. *Man Against Pain*. New York: Prentice-Hall, 1945.
  4. Robinson V. *Victory Over Pain: A History of Anesthesia*. New York: Henry Schuman, 1945.
  5. Bergman NA. *The Genesis of Surgical Anesthesia*. Park Ridge, IL: Wood Library-Museum of Anesthesiology, 1998.
  6. Stetson JB. William E. Clark and His 1842 Use of Ether. In: Fink BR, Morris LE, Stephen CR, eds. *The History of Anesthesia: Third International Symposium Proceedings*. Park Ridge, IL: 1992:400–406.
  7. Lyman HM. *Artificial Anaesthesia and Anaesthetics*. New York: William Wood & Company, 1881.
  8. Long CW. An account of the first use of sulphuric ether by inhalation as an anaesthetic in surgical operations. *South Med Surg J* 1849;5:12.
  9. Wolfe RJ. "I sleep to awaken:" an appreciation of Elizabeth Wales Wells. In: Wolfe RJ, Menczer LF, eds. *I Awaken to Glory*. Boston: Boston Medical Library, 1994:229–231.
  10. Fenster J. *Ether Day*. New York: Harper-Collins, 2001.
  11. Ellis RH. Early ether anaesthesia: the news of anaesthesia spreads to the United Kingdom. In: Atkinson RS, Boulton TB, eds. *The History of Anaesthesia*. New York: Parthenon, 1989:69–76.
  12. Wilson G. *One Grand Chain*. Melbourne, Australia: The Australian and New Zealand College of Anaesthetists, 1995:41–43.
  13. Sim P, Du B, Bacon DR. Pioneer Chinese Anesthesiologists. *Anesthesiology* 2000;93:256–264.
  14. Anonymous. *Code of Medical Ethics of the American Medical Association*. Chicago, American Medical Association Press, 1847:98. Available at: <http://www.ama-assn.org/ama/pub/category/1930.html>. Last accessed November 16, 2005.
  15. Johansen PV, Paneth N, Rachman S, Rip M. *Cholera, Chloroform, and the Science of Medicine: A Life of John Snow*. New York: Oxford University Press, 2003:113.
  16. Knight PR, Bacon DR. An unexplained death: Hannah Greener and chloroform. *Anesthesiology* 2002;96(5):1250–1253.
  17. Snow J. *On Chloroform and Other Anesthetics*. London, John Churchill 1858, reprinted by The Wood Library-Museum of Anesthesiology, Park Ridge, Illinois.
  18. Shepard DAE. *John Snow*. Cornwall, PA: York Point Publishing, 1995.
  19. Koller C. Personal reminiscences of the first use of cocaine as a local anesthetic in eye surgery. *Curr Res Anesth Analg* 1928;7:9–11.
  20. Olch PD. William S. Halstead and local anesthesia: contributions and complications. *Anesthesiology* 1975;42:479–486.
  21. Goerig M. Carl Ludwig Schleich and the introduction of infiltration anesthesia into clinical practice. *Reg Anesth Pain Med* 1998;23(6):538–539.
  22. Bacon DR. Regional anesthesia and chronic pain therapy: a history. In: Brown DL, ed. *Regional Anesthesia and Analgesia*. Philadelphia: WB Saunders, 1996:10–22.
  23. Goerig M, Agarwal K, Schulte am Esch J. The versatile August Bier (1861–1949), father of spinal anesthesia. *J Clin Anesth* 2000;12:561–569.
  24. Ramachari A, Patwari A. Edward Lawrie and the Hyderabad Chloroform Commissions. In: Atkinson RS, Boulton TB, eds. *The History of Anaesthesia*. Park Ridge, NJ: Parthenon Publishing, 1989:236–242.
  25. Mumford JG, Binnie JF, Powers CA, Haggard WD, Rodman WL. Preliminary report of the anaesthesia commission of the American Medical Association. *JAMA* 1908;19:1572–1574.
  26. Erickson JC III. In the beginning: Adolph Frederick Erdmann and the Long Island Society of Anesthetists. In: Bacon DR, Lema MJ, McGoldrick KE, eds. *The American Society of Anesthesiologists: A Century of Challenges and Progress*. Park Ridge, IL: Wood Library-Museum of Anesthesiology Press, 2005:1–8.
  27. Young TM. A Short History of the Section on Anaesthetics of the Royal Society of Medicine and the Society of Anaesthetists. London: The Royal Society of Medicine, 1998.
  28. Bacon DR. The New York Society of Anesthetists: building the foundation. In: Bacon DR, Lema MJ, McGoldrick KE, eds. *The American Society of Anesthesiologists: A Century of Challenges and Progress*. Park Ridge, IL: Wood Library-Museum of Anesthesiology Press, 2005:9–18.
  29. Cope DK. James Tayloe Gwathmey: seeds of a developing specialty. *Anesth Analg* 1993;76:642–647.
  30. Wells CJ. Francis Hoeffler McMechan. *Curr Res Anesth Analg* 1948;27:S.
  31. Ranney O. Francis Hoeffler McMechan A.B., A.M., M.D., F.I.C.A. His life and work. *Curr Res Anesth Analg* 1939;18:(S).
  32. Bacon DR, Ament R. Ralph Waters and the beginnings of academic anesthesiology in the United States: The Wisconsin template. *J Clin Anesth* 1995;7:534–543.
  33. MacKenzie RA, Bacon DR, Martin DP. The Anaesthetists' Travel Club: A transformation of the Society of Clinical Surgery? *Bull Anesth Hist* 2004;22(3):7–10.
  34. Griffith HR. The recent revolution in anesthesia. *J Conn State Med Soc* 1939;1:509–514.
  35. Haines FE. Economic problems in anesthesia. *Curr Res Anesth Analg* 6:25–28 1927.
  36. Letter from Paul M. Wood, MD, to Wallace W. Dill, MD, May 27, 1937. *The Collected Papers of Paul M. Wood, MD*. Park Ridge, IL: Wood Library-Museum of Anesthesiology Collection.
  37. Bacon DR. The creation of the American Society of Anesthesiologists: an intriguing decade. In: Bacon DR, Lema MJ, McGoldrick KE, eds. *The American Society of Anesthesiologists: A Century of Challenges and Progress*. Park Ridge, IL: Wood Library-Museum of Anesthesiology Press, 2005:19–34.
  38. Bacon DR, Lema MJ. To define a specialty: a brief history of the American Board of Anesthesiology's first written examination. *J Clin Anesth* 1992;4:489–497.
  39. Bacon DR, Lema MJ, Yearley CK. For all the world to see: anesthesia at the 1939 New York World's Fair. *J Clin Anesth* 1993;5:252–258.
  40. Foldes FF. The impact of muscle relaxants on the development of anesthesia and surgery: the role of Lewis H. Wright. *Anesth Hist Assoc News* 1993;11(4):1, 4–6.
  41. Papper EM. The palate of my mind. In: Fink BR, ed. *Careers in Anesthesiology*. Vol I. Park Ridge, IL: The Wood Library-Museum of Anesthesiology, 1997:66–217.
  42. Griffith HR, Johnson GE. The use of curare in general anesthesia. *Anesthesiology* 1942;3:418–420.
  43. Courington FW, Calverley RK. Anesthesia on the western front: the Anglo-American experience of World War I. *Anesthesiology* 1986;65(6):642–653.
  44. Waisel DB. The role of World War II and the European theater of operations in the development of anesthesiology as a physician specialty in the USA. *Anesthesiology* 2001;94(5):907–914.
  45. Bacon DR, Lema MJ. Standing on the promises. *Sphere* 1989;42:20–24.
  46. Bacon DR. The World Federation of Societies of Anesthesiologists (WFSA): McMechan's final legacy. *Anesth Analg* 1997;84:1130–1135.
  47. Papper EM, Bacon DR. With great reluctance: the American perspective on joining the World Federation of Societies of Anesthesiologists 1935–1963. In: Rupprecht J, ed. *The History of the World Federation of Societies of Anesthesiologists*. Springer, Paris: 2004:35–54.
  48. Curry TB, Tandy CC. The 1950s: a decade of turmoil. In: Bacon DR, Lema MJ, McGoldrick KE, eds. *The American Society of Anesthesiologists: A Century of Challenges and Progress*. Park Ridge, IL: Wood Library-Museum of Anesthesiology, 2005:75–84.
  49. Papper EM. The origins of the Association of University Anesthesiologists. *Anesth Analg* 1992;74:436–53.
  50. Gotta AW. The 1970s: a decade of crisis. In: Bacon DR, Lema MJ, McGoldrick KE, eds. *The American Society of Anesthesiologists: A Century of Challenges and Progress*. Park Ridge, IL: Wood Library-Museum of Anesthesiology, 2005:147–157.
  51. Smith BE. The 1980s: a decade of change. In: Bacon DR, Lema MJ, McGoldrick KE, eds. *The American Society of Anesthesiologists: A Century of Challenges and Progress*. Park Ridge, IL: Wood Library-Museum of Anesthesiology, 2005:173–191.
  52. McMechan FH. Should the radiologist, pathologist and the anesthetist be licensed to practice medicine? Point of view of the anesthetist. *Proceedings of the Annual Congress on Medical Education, Medical Licensure and Hospitals*, 1935.



## CHAPTER 2

### The Scope and Future of Anesthesia Practice

Michael S. Avidan, MBBCh, DA, FCA, and Alex S. Evers, MD

Anesthesiology arose as a medical specialty because the dangers associated with anesthetic drugs and techniques demanded that they be administered by skilled and knowledgeable physicians. As safer drugs were developed and physiologic monitoring improved, the need for anesthesiologists was propelled by increasing surgical complexity and severity of patient illness, as well as by increasing expectations for patient safety. Whereas the original *raison d'être* for the specialty remains today, a variety of professional and economic factors have challenged anesthesiology and produced large “swings of fortune” during the past few decades.

During the 1970s and 1980s the emergence of critical care attracted many talented medical students to American anesthesiology training programs. However, these were halcyon days for anesthesiologists practicing in the operating room, where professional income was high, job opportunities were ample and increasing surgical complexity demanded an increasing level of medical knowledge and skills. Thus there was little incentive for anesthesiologists to expand their roles beyond the confines of the operating suites and most of the trainees who were initially attracted by critical care subsequently practiced operating room anesthesia only. In contrast, during this same period, anesthesiologists in Europe and Canada were consolidating their positions in the burgeoning subspecialties of pain, intensive care, and resuscitation.

In the mid 1990s, gloom beset anesthesiology in the United States as predictions, widely reported in lay press such as the *Wall Street Journal*, suggested that the need for anesthesiologists would decrease dramatically in an anticipated managed care environ-

ment. Medical graduates were discouraged from pursuing careers in anesthesiology, and residency programs contracted dramatically. Anesthesiologists in other parts of the world have also experienced fluctuating fortunes. Currently there is a shortage of doctors in general, and of anesthesiologists in particular, in many countries. The future of anesthesiology depends on several factors, including changes in surgery and interventional medical practice, technological advances in anesthesiology, the evolving scope of anesthesia practice, and the role of non-physicians (e.g., nurse anesthetists and anesthesia physician assistants) and physicians trained in other specialties in the provision of anesthesia care; healthcare financing will also influence trends in anesthesia practice. This chapter briefly reviews the current scope of anesthetic practice and offers some possible scenarios for future directions of the specialty.

#### OPERATING ROOM ANESTHESIA

The operating room remains the primary focus for the vast majority of anesthesiologists. The anesthesiologist's primary responsibility in this

arena is to ensure the patients' comfort and safety when they are exposed to the trespass of surgery; this includes protecting the patient from pain, undesired awareness and organ system injury, and fostering full recovery from the surgical and anesthetic interventions. Over the past decades it has become increasingly clear that the intraoperative conduct of anesthesia has a profound effect on patient safety and comfort in the postoperative period. For example, modest intraoperative hypothermia can either decrease the incidence of wound infection<sup>1</sup> or provide neuroprotection,<sup>2</sup> depending on the clinical situation. Anesthesiologists are increasingly sophisticated in their understanding of patient safety and they are focusing on such issues as appropriate perioperative medications, antibiotic prophylaxis and infection control, multimodal analgesia, maintenance of normothermia and normoglycemia, and appropriate fluid and electrolyte therapy. Recent findings raise the intriguing possibility that anesthetic management may contribute to postoperative cognitive decline and to long-term outcomes.<sup>3</sup> This growing responsibility for overall postoperative outcomes raises new expectations for knowledge and skills of the practicing anesthesiologist and challenges our

#### KEY POINTS

1. The operating room remains the primary focus for the vast majority of anesthesiologists.
2. The anesthesiologist's primary responsibility is to ensure patients' comfort and safety when they are exposed to the trespass of surgery.
3. The intraoperative conduct of anesthesia has effects on patient safety and comfort in the postoperative period.
4. The provision of safe anesthetic care across geographically dispersed sites and encompassing wide ranges of patient health, in an economically responsible manner, is a challenge that anesthesiologists need to address proactively.
5. It is arithmetically impossible to provide a fully trained anesthesiologist for every anesthetic procedure.
6. Meeting the manpower, safety, and cost demands of the future requires overcoming the political infighting between organized anesthesiology and nurse anesthesia.
7. It is important for the future of the specialty that anesthesiologists increase their commitment to critical care medicine.
8. Recent advances in knowledge and technology create an enormous opportunity for anesthesiologists to address the scientific questions at the core of the specialty as well as a variety of important clinical problems.
9. Apart from traditional areas of involvement, such as operating room anesthesia, critical care, pain medicine, teaching, research, and resuscitation, there will be future opportunities for anesthesiologists in pharmacogenomics, healthcare systems management and new technologies.

previously narrower definitions of anesthetic outcome.

Despite the demands imposed by increasing severity of illness in surgical patients, growing surgical complexity and more comprehensive postoperative considerations, anesthesiology is often viewed as a victim of its own perceived success. One widely cited study from the United Kingdom, the Confidential Enquiry into Perioperative Deaths (CEPOD) study, reports that patients undergoing general anesthesia have a 1 in 185,000 chance of dying as a consequence of anesthetic misadventure.<sup>4-6</sup> This finding was highlighted in the Institute of Medicine report on medical errors<sup>7</sup> and anesthesiology was cited as the specialty that had best addressed safety issues (see Chap. 3 for a more comprehensive review of quality and safety in anesthesia practice). Unfortunately, this widely publicized perception that anesthesia is “safe” has encouraged nonphysician anesthesia providers to advocate for independent practice and has suggested to insurers that anesthetic care by an anesthesiologist is needlessly expensive. However, studies from other countries have reported much higher rates of death attributable to anesthesia than those reported in the CEPOD study.<sup>8</sup> In a large French study, the perioperative mortality directly attributable to anesthesia was found to be 1 in 13,000.<sup>9</sup> In studies reported from Australia,<sup>10</sup> Denmark,<sup>11</sup> Finland,<sup>12</sup> and the Netherlands,<sup>13</sup> perioperative death attributable to anesthesia ranged from 1 in 2500<sup>11</sup> to 1 in 67,000.<sup>12</sup> The mortality attributable to anesthesia is probably much greater in developing countries. For example, a 1992 study from a Zimbabwean teaching hospital reported an alarming incidence of death or coma—1 in 388—attributable to anesthesia.<sup>14</sup> Whereas the bulk of evidence suggests that anesthesia is not nearly as safe as publicized,<sup>15</sup> it is undoubtedly true that advances in anesthetic practice in developed countries have rendered the care of healthy patients undergoing low- or intermediate-risk surgery much safer than in the past (see Chap. 24 for a more detailed review of anesthesia risk).

The challenges to anesthesiology are exacerbated by the massive expansion in demand for anesthesia services for a variety of nonoperative procedures, ranging from cerebral aneurysm coiling to general anesthesia for

screening colonoscopy, and by the introduction of freestanding ambulatory surgery centers and office-based surgical suites where anesthesia is administered. The demands for safe anesthesia care provided in numerous remote locations, present significant challenges to the workforce, and to the financing and practice of anesthesiology.

Current practice models vary widely both in the United States and worldwide. In the United States, some anesthesiologists (or practice groups) personally provide all anesthetic care regardless of complexity, an approach that is also common in the United Kingdom, Canada, and Australia. In other practices, anesthesiologists supervise ancillary providers (e.g., nurse anesthetists, residents, or anesthesia assistants) in more than one operating room; a practice model that is also common in the Netherlands. The provision of safe anesthetic care across geographically dispersed practice sites and encompassing wide ranges of severity of patient illness, in an economically responsible manner, is a major challenge that anesthesiologists need to address proactively.

The expectations for operating room anesthesia can be simply stated: we need to provide an ever-increasing quality of perioperative care for a lower cost. In turn, these expectations and predictions require that the anesthesiologist community consider who will, or should, provide each component of anesthesia care, what levels of knowledge and skill will be required of each provider, and how the responsibility for care will be organized, managed, and rewarded.

Currently, at least 50% of anesthesia care in the United States involves nurse anesthetists; in several states, physician supervision is not mandatory. Worldwide, anesthesia practice often includes some form of nonphysician provider, or a physician provider who is not a fully trained anesthesiologist. For example, staff-grade noncertified anesthetists provide a significant proportion of anesthesia care in the United Kingdom. One report asserts that nonanesthesiologists can safely provide anesthesia for selected procedures (e.g., colonoscopy) and patients.<sup>16</sup> It is also clear that patients with minimal physiologic reserve, those undergoing major interventions, and those with complex medical problems require the direct involvement of a skilled anesthesiologist

to enhance patient safety.<sup>17,18</sup> Unfortunately, practitioner skill and experience are often not matched to these factors, but determined by availability of providers, or a fixed model of care delivery, rather than one that is tailored to the specific clinical situation. This is a fruitful area for further work by anesthesiologists to assure proper matching of resources to the clinical needs.

It is arithmetically impossible to provide a fully trained anesthesiologist for every anesthetic procedure. Furthermore, the increasing demands for anesthesia services (aging population, proliferation of ambulatory surgery centers, escalating demand for nonsurgical anesthesia and sedation) will outstrip even the most aggressive output of anesthesiologists. Medical schools simply do not have the capacity to train sufficient numbers of doctors to feed exponentially increasing anesthesia programs. For reasons of both anesthesiologist availability and cost, it is apparent that the future of anesthesia practice will involve an increasing role for nonphysician providers.

How can this be made compatible with the demands for increasing safety and quality? By involving skilled anesthesiologists in the cognitive aspects of *every* anesthetic. This will require coordination and cooperation with nonphysician providers, allowing them to perform at the highest levels their training allows, while ensuring that a fully trained specialist is involved in planning and managing care for high-risk cases and is readily available for complex diagnostic and therapeutic decision making. Technologic developments in monitoring and information systems should facilitate these changes. The development of telemedicine could make this model of care feasible even in communities where an anesthesiologist is not physically present.<sup>19</sup> Meeting the manpower, safety and cost demands of the future will require that we overcome the political infighting between organized anesthesiology and nurse anesthesia. Furthermore, the training of anesthesiologists will increasingly need to encompass the development of skills in supervising other anesthesia providers. It is in the interests of public safety and healthcare delivery that unity be forged among anesthesia providers under the leadership of specialist anesthesiologists, whose medical training and education is required for

complex medical decision making, supplemented by the skills and abilities of nonphysician providers who enhance this team approach.

## OUTSIDE THE OPERATING ROOM

### Preoperative Care

Perioperative morbidity is frequently attributable to poor preoperative patient assessment and optimization. These roles have always been integral to the anesthesiologist's practice. However, as patients increasingly present to the hospital on the day of surgery, it has become necessary to ensure that patients are properly evaluated well before the immediate preoperative interval. Recognizing this need has led to burgeoning preoperative assessment clinics, where problems such as ischemic heart disease, pulmonary disease or sleep apnea may be evaluated and appropriate perioperative interventions may be planned. (See Chap. 4 for a more detailed discussion of the benefits and operation of preoperative clinics.) In some practice settings, preoperative assessment of complicated patients has been largely relegated to nonanesthesiology trained physicians or physician extenders. In other settings, the challenge of same-day surgery admission has left preoperative assessment as a day-of-surgery activity; neither of these approaches is optimal. From the standpoint of continuity of care and so that anesthesiologists can implement best practices that contribute to the continuum of care and long-term outcomes, it is essential that anesthesiologists continue to play an integral role in preoperative assessment clinics. This should also be a key component of anesthesia resident training programs, for it represents an important aspect of future anesthesia practice.

### Pain Medicine

Doctors cannot always cure disease but they should always try to alleviate suffering. Physical pain is among the most unpleasant of human experiences. Anesthesiologists are often involved in the management of severe pain associated with surgery and the perioperative use of analgesics constitutes an important component of anesthetic care. Anesthesiologists are more comfortable with opiate administration than many other

physicians, because of their knowledge of pharmacology (especially opioid pharmacology), as well as their skill and experience in managing side effects such as respiratory depression. Anesthesiologists pioneered regional anesthetic techniques, many of which are applicable to the treatment of chronic intractable pain. Increasing numbers of anesthesiologists are specializing in pain management and the effective relief of pain will remain an important component of the anesthesiologist's role even for those who do not subspecialize specifically in pain medicine.

### Critical Care Medicine

Anesthesiologists pioneered the development of critical care medicine.<sup>20</sup> In many countries, anesthesiologists constitute the bulk of the physician workforce in critical care. In most of Europe, full training in critical care is an integral component of an anesthesia residency and critical care anesthesiologists are responsible for organizing and staffing most hospital critical care units. In contrast, U.S. anesthesia residents receive only a few months of critical care training and anesthesiologists constitute a minority of the nation's critical care physicians. Many believe it is important for the future of the specialty that anesthesiologists increase their commitment to critical care medicine. Consistent with this view, there is impetus in the United States to increase the minimum duration of critical care training to 6 months during the anesthesia residency. The intent is to broaden the scope of expertise of anesthesiologists, thus partially addressing the marked shortage of critical care physicians in the United States.<sup>21</sup> Clearly, this would enhance the perception of anesthesiologists as broad-based physicians who can contribute additionally to the general healthcare needs of the United States, but the feasibility of this proposal requires both redesign of the residency programs (including either modifying the duration of the residency or altering the duration of specific rotations in the current residency continuum) and the commitment of future trainees to embrace the practice of critical care medicine.

### Clinical Services Administration

The operating suite is a complex environment that is inefficiently managed.

Anesthesiologists are an integral component of this important but unwieldy organization. The need for effective management and administration is being increasingly recognized and anesthesiologists are often sought for this management function. In many countries, including in Europe and North America, anesthesiologists are acquiring formal training in management and business administration. Today's doctors, even in academic institutions and national health services, cannot afford to isolate themselves from the realities of reimbursement, cost, efficiency, patient satisfaction, and overall system performance. There appears to be a bright future for physician leaders in healthcare organizations; anesthesiologists are, and will continue to be, an important part of this management evolution.

### Patient Safety

Anesthesiologists are at the forefront of pioneering patient safety. So dramatic have been the improvements implemented by anesthesiologists that liability insurance for anesthesia practice has decreased, while that for most other specialties has steadily increased (some dramatically). The Anesthesia Patient Safety Foundation (APSF) was founded in the United States in 1984 with the expressed purpose of assuring "that no patient shall be harmed by the effects of anesthesia." Since 1985, the American Society of Anesthesiologists' (ASA) Committee on Professional Liability has been studying records of closed malpractice claims files for anesthesia-related patient injuries.<sup>22</sup> More than 5000 claims have been studied. In 1987, the Australian Patient Safety Foundation was established and the Australian Incident Monitoring Study initiated.<sup>23</sup> More than 4000 critical incidents have been reported through 2000. Analysis of these incidents has reinforced the value of technological advances, such as capnography and oximetry, in improving patient safety. The results also confirm the value of structured algorithms in anesthesia care, by documenting favorable outcomes in a range of life-threatening crises during anesthesia. CEPD was started in the United Kingdom in 1989. Changes in consultant practice, an increase in the number of medical audits, improvements in physiologic monitoring, appropriate matching of specialist expe-

rience to patient's medical conditions, and increasing awareness of the need for critical care services are believed to have been influenced by this inquiry.<sup>24</sup> Critical events occur within the context of complex system failures, and anesthesiologists have been developing safeguards to decrease the likelihood that human error may result in patient harm. Examples include written "check lists," audible alarm settings, and automated anesthesia machine checks. This expertise in patient safety should be developed and translated into the broader medical context, including application in areas not historically viewed as the purview of anesthesia practice (such as diagnostic and treatment suites, obstetrical suites, intensive care units and intermediate care units).

## Research

Anesthesiology has a vibrant history of research and intellectual contributions to clinical medicine. Historically anesthesia research has focused on laboratory investigations in physiology and pharmacology and their application to patient care. These contributions have improved the safety of anesthesia and surgery, and constituted pioneering efforts in the initial application of scientific principles to individual patient care. Until recently many of the scientific questions at the core of anesthesiology have been relatively inaccessible to investigation; this stems from the absence of tools to study the mechanisms of the complex behaviors (e.g., consciousness, memory, pain) that anesthesiologists manipulate. Recent advances in cellular physiology (e.g., patch clamp recording), molecular biology, genetics, functional imaging, and behavioral sciences have enabled serious investigation of these complex behaviors. It is thus now possible that the fundamental mysteries of anesthesia (including the molecular mechanism of the hypnotic, amnestic, and analgesic effects of anesthetics agents) will be solved. These same new scientific tools also make it feasible to define the mechanisms of hyperalgesia and chronic pain and to design effective treatments. Finally, advances in the understanding and manipulation of inflammation and the immune response provide a new opportunity to delineate how organ system injury occurs in the perioperative period and to identify strategies for

protection of the brain, heart, kidneys and other organs. Collectively, recent advances in knowledge and technology create an enormous opportunity for anesthesiology to address the scientific questions at the core of the specialty, as well as a variety of important clinical problems.

The application of information technology and epidemiologic techniques (often referred to as outcomes research) to the perioperative period has also created new research opportunities for anesthesiology. These approaches quantify and describe perioperative morbidity and mortality, facilitating recognition of patterns and causes of adverse patient outcomes. Outcomes research has already identified a variety of problems with the process and substance of anesthetic care; it has also led to identification of previously unrecognized adverse patient outcomes (e.g. postoperative cognitive decline). The broad application of information technology coupled to epidemiologic analysis will provide the opportunity to define and monitor "best practices" and to systematically evaluate the efficacy of new technologies, techniques and approaches.

Academic anesthesia has been challenged in recent years, with decreased academic funding of some departments, a decreasing share of extramural grant funds,<sup>25</sup> and a contraction in the number of young anesthesiologists embarking on rigorous research training and careers. One reason put forward for reducing funding for anesthesia research is that the current safety of anesthesia implies that anesthesia research is not a pressing public health concern. As noted earlier, this may be a misconception; although intraoperative mortality is rare, postoperative mortality and major morbidity still occur commonly, and anesthesia care has been shown to contribute to this process, both positively and negatively. There is much room for improvement before any field can conclude that we have overcome the hurdles in surgical care that challenge the extremes of age, those with significant comorbidities or those undergoing extensive surgical procedures. Many of the advances in these areas will come from improved perioperative care, built on evidence-based techniques that are confirmed by careful clinical investigation and innovation. One of the priorities for research, as

identified by the National Institutes of Health, is for investigators to embark on more multidisciplinary and multicenter research initiatives. It is also crucial to foster translational research where advances in the basic sciences, including genetics, can lead to progress in the clinical arena. A strong commitment to research will be necessary to ensure the continued advance of the specialty, and to insure that anesthesiology remains a mainstream medical discipline that contributes to the overall good of society.

## EDUCATION AND TRAINING

Clearly, the future of the specialty requires a robust commitment to education and training at all levels, from undergraduate medical education through the most advanced subspecialty levels. Strong training programs depend on an excellent teaching faculty, ample and diverse clinical cases, a well-organized teaching program and an emphasis on the knowledge required for future as well as current practice. One challenge facing academic anesthesia in the United States is that reimbursement is halved when a resident provides anesthesia supervised by a teaching anesthesiologist. This reduces the funds available to the academic department for support of nonclinical teaching time, educational resources such as simulators, libraries, or administrative support staff, and compensation for the teaching faculty. The American Society of Anesthesiologists has engaged in a major legislative effort to remedy this funding problem, but resolution of this issue is far from assured because of overall funding limitations and political maneuvering among medical and surgical specialties. Adequate funding for anesthesiology education by the federal government, by teaching hospitals and by our specialty societies is an imperative if the specialty is to flourish in future decades. The current shortfall in anesthesiologists (particularly in teaching hospitals) creates a temptation to increase training numbers and churn out many more anesthesiologists; this may be particularly true in training programs that need to use residents primarily as work force. The danger is that this approach will decrease the selectivity of training programs and downgrade the quality of anesthesiology.



gists. Training must be broadened as well; if the next generation of anesthesiologists is to be prepared for the future, anesthesiology training programs must emphasize preoperative assessment, critical care, pain management, supervision of nonphysician providers and operating room administration, among others. Also important will be an increased emphasis on fellowship programs, with formal recognition of fellowships in areas such as regional anesthesia, transplant anesthesia, and obstetric anesthesia.

To attract high-caliber applicants to anesthesiology, it is important that medical students continue to receive adequate exposure to the specialty. In addition to perioperative medicine and pain medicine, anesthesiologists are well placed to teach medical students applied respiratory and cardiovascular physiology, several aspects of neuroscience and numerous aspects of pharmacology, in addition to their more traditional educational roles in resuscitation and emergency airway management. The model of academic anesthesia care facilitates excellent learning, with medical students able to spend high quality one-on-one time with experienced anesthesiologists.

## SIMULATION

The aerospace industry has long appreciated the value of simulation in increasing safety and decreasing errors. Within the medical profession, anesthesiologists were among the first to recognize the potential role of simulation in improving both education and patient safety. Anesthesiologists established simulation facilities to train anesthesiologists in the management of infrequent but life-threatening problems that arise in the operating room. It rapidly became apparent that simulation might be useful for teaching other topics that are not unique to anesthesia practice (e.g., diagnosis and management of pneumothorax, hemorrhagic shock, myocardial infarction, insertion of central vascular catheters). Computer modeling also can be employed in research. Speculation is rife about a role for simulation in credentialing and recredentialing in various medical specialties. Increasingly, physician and nursing professionals, including those in critical care and emergency medicine,

are seeking time in simulation facilities for purposes of training and honing their skills in crisis management. Simulation centers are mushrooming internationally and are also being embraced by medical schools. Anesthesiologists have led this initiative, and it is important that we continue to lead innovation in this field of evolving technology.

## Public Perception of Anesthesiologists

Anesthesiology is one of the largest physician based specialties, but few mainstream medical specialties are as poorly understood by members of the public and by other health professionals.<sup>26</sup> Many patients do not realize that anesthesiologists are doctors or that they have responsibilities outside the operating room.<sup>26</sup> In Swiss and Austrian studies 93–99% of patients knew that anesthesiologists are qualified physicians. In addition, many of the patients were aware that the anesthesiologists are engaged in activities outside the operating room. However, many patients also thought that the anesthesiologists played a subservient role to the surgical team.<sup>27,28</sup> In studies from Singapore, Pakistan, and the West Indies, only 56–66% of patients were aware that anesthesiologists are physicians, and most patients had a limited knowledge of the anesthesiologists' roles.<sup>29–31</sup> In contrast to these findings, a Finnish study reported that anesthesiologists were generally recognized as specialist physicians and were held in high esteem.<sup>32</sup> In the United Kingdom, the bodies representing anesthesiologists initiated National Anaesthesia Day in an attempt to increase the profile of anesthesiologists. Clearly, there is variation among countries in the way anesthesiologists are perceived. Heightening public awareness and improving public perception about anesthesiologists and their many essential functions may be important to the future of the specialty in several respects, including allocation of research funding, quality of applicants to residencies and the future role of anesthesiologists within healthcare in general.

A recent Scandinavian study explored perceptions of the anesthesiologist's role. The study was titled: "Professional artist, good Samaritan, servant and co-coordinator: four ways of understanding the anesthetist's

work."<sup>33</sup> According to these authors, the current scope of anesthesia practice encompasses:

1. The provision of safe anesthesia while controlling patients' vital functions.
2. Helping patients including the alleviation of pain and anxiety.
3. Providing service to the whole hospital, including support to other doctors and nurses who are caring for severely ill patients.
4. Participation in the organization and direction of the operating suites to ensure that lists run smoothly.

Whereas these are essential and important components of the specialty, even collectively they do not encompass the spectrum of anesthesiology as we view it currently, or as we look to the future, which seems particularly attractive if we maintain a comprehensive view of the opportunities for our discipline.

## THE FUTURE OF ANESTHESIA PRACTICE

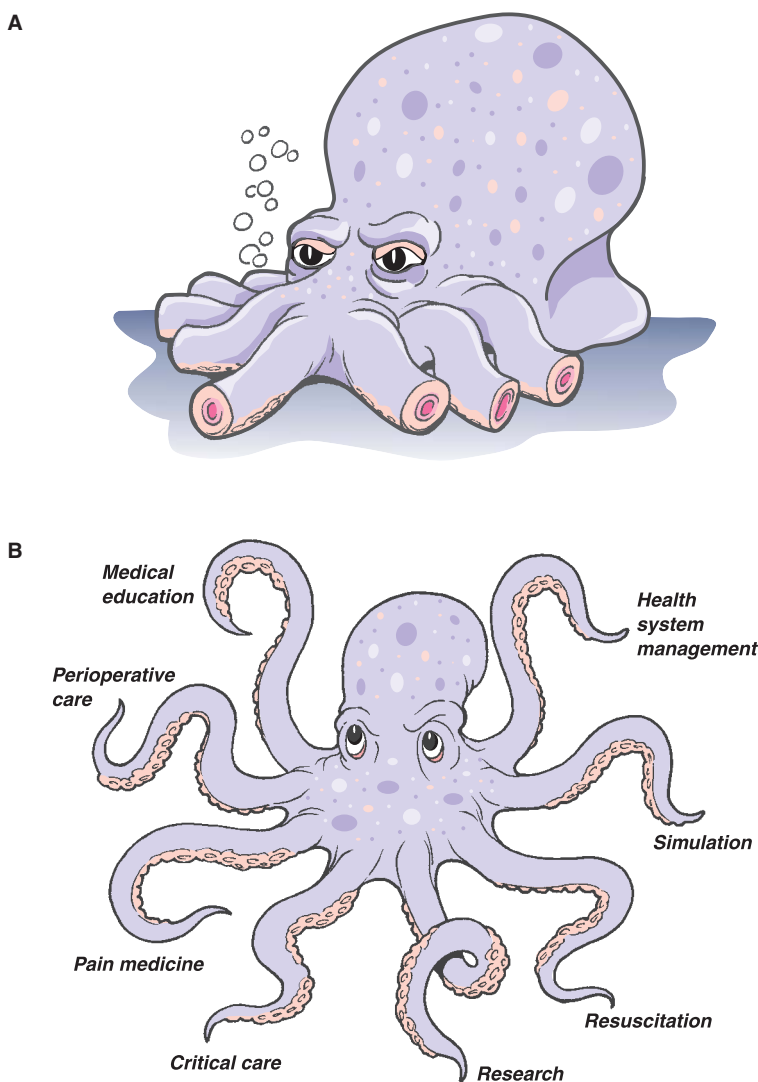
The future of the specialty depends on several key drivers: (a) the vision and actions of organized anesthesiology; (b) technological changes in surgery and anesthesiology and; (c) the directions chosen by academic institutions, the trainers of future practitioners. These drivers will influence the attractiveness of anesthesiology as a specialty choice for medical students, the career paths of young anesthesiologists, and the scope and organization of anesthetic practice.

There will be tough choices faced by future anesthesiologists. New drugs and increasingly sophisticated monitoring will facilitate safer anesthesia. Such technological advances will allow more effective remote supervision of anesthesia providers. There is likely to be a steady growth in the demand for anesthesia. Anesthesiologists will have to decide whether to try to expand their ranks at all costs and to defend their turf, or refine their training according to future conditions. It is highly unlikely that anesthesiologists alone will be able to meet all the demands for anesthesia.

Anesthesiology faces many challenges in the years ahead. To meet these challenges, perioperative medi-

cine, which includes the spectrum of care from preoperative assessment to postoperative care, may offer the best chance for the specialty to survive and prosper.<sup>34</sup> While there is a vision that future anesthesiologists will practice as much outside as inside operating rooms,<sup>35</sup> the expansion of anesthesiologists' activities could lead to dilution of the specialty's identity, endangering the vitality of anesthesiology in an era of sweeping changes in healthcare-delivery systems.<sup>36</sup> An expansion of anesthesiology practice into nonoperative domains of perioperative medicine may also be challenged by other specialties. The role of perioperative physician may fall to hospitalists, the role of critical care physicians to intensivists and the role of pain management to pain specialists. Anesthesia may grow and acquire new tentacles or it may have its subspecialties amputated, leaving it as a restricted operating room bound specialty (Fig. 2-1). In the United Kingdom, there was a recent struggle in which the Royal College of Anaesthetists opposed efforts to establish a fully autonomous College of Intensive Care Medicine; it is likely that this will be revisited in the United Kingdom and other countries in future.

As an academic specialty, anesthesiology evolved out of fundamental contributions to healthcare, including the prevention of pain from surgery and the development of critical care medicine, cardiopulmonary resuscitation, and pain medicine.<sup>37</sup> In recent years, many advances have occurred in the basic science of anesthesiology, including mechanisms of pain, receptor physiology, modes of action of anesthetic agents, and cellular responses to sepsis. If anesthesiology is to flourish as an academic specialty, it is crucial that research is pursued and encouraged. Without intellectual advances, anesthesiology is in danger of becoming a sterile technical discipline.<sup>37</sup> University departments of anesthesiology are increasingly experiencing pressure to emphasize clinical delivery at the expense of academic pursuits. Succumbing to these pressures will threaten undergraduate perioperative medicine teaching, development of critical appraisal skills among anesthesiologists, and the future of research programs.<sup>38</sup> The irony would be that by immersing themselves entirely in the clinical arena, anesthesiologists would neglect the



**FIGURE 2-1.** The future of anesthesiology—two possible outcomes. **A.** The specialty may come to resemble a bloated octopus, based only in the operating room with all its tentacles amputated. **B.** Anesthesiology may retain its integral role in the operating room (lean body), but expand its tentacles in other areas, such as critical care, pain medicine, medical education, health system management, simulation, resuscitation, and research.

education of medical students and trainees, thus jeopardizing the future of clinical anesthesiology practice.

Although it is easy to teach others as we were taught, or as we practice today, focus on the future is an essential element of education. Long-term success for the specialty will depend on our efforts in undergraduate and graduate medical education, whereas short-term success will depend on our efforts in the continuing medical education of current practitioners.<sup>39</sup> A different approach may be required to redefine the scope of the practice with broadened training to provide increased expertise in the evolving medical marketplace. This approach could include solid training in business, informatics, data man-

agement, and critical thinking on outcomes. This paradigm shift may be challenging, and requires redirection, reallocation of assets, reeducation, and a new mindset. If successfully applied, however, it presents a means to strengthen the respected position of the specialty and to promote the medical care and practice of perioperative specialists in the rapidly changing landscape of modern medicine.<sup>40</sup>

## VISIONS OF THE FUTURE

### Scenario 1: To Each Patient a Dedicated Anesthesiologist

This is the current model of anesthesia care in much of the developed world

and many in the United States are adherents of this model. Most American residency programs are structured to train anesthesiologists to practice in this model. As discussed earlier, it is unlikely that this model of anesthesia care will be sustainable given the mismatch between surgical demand and anesthesiology manpower and the inevitable pressure to reduce the cost of anesthesia.

### Scenario 2: Physicians for the Perioperative Period

Many advocate that anesthesiologists should play a greater role in perioperative care. This is an appealing option, but is fraught with difficulties. An expansion of anesthesiologists' roles will mean that even more anesthesiologists must be trained. There is simply a limited capacity to achieve this. It also is not clear whether anesthesiologists are prepared to financially compete in many perioperative roles. Anesthesiologists are accustomed to high remuneration for their procedure-driven roles, whereas hospitalists are willing to accept lower compensation. Thus far anesthesiologists have not shown enthusiasm in adopting the mantle of perioperative physicians. Tremendous inertia will have to be overcome for this to become a possibility.

### Scenario 3: Process Managers and Perioperative Care Directors

To achieve this, anesthesiologists will require formal training in business, management and finance. They will also need to broaden their medical knowledge and experience. Perhaps, most importantly, anesthesiologists would have to be trained to supervise others effectively and to utilize physician extenders throughout the perioperative period. Certified registered nurse anesthetists (CRNAs) are also expensive, and other physician extender roles should be explored. This model runs counter to the current training process. There are anesthesia programs that are offering novel fellowships, such as operating room management. The philosophy behind this model is that anesthesiologists would receive broader training, where operating room anesthesia would be only a component. Fellowships and academic tracks would also increase. If this model is to succeed, residencies will have to undergo major paradigm shifts.

### Meeting the Challenge of Change

At the ASA's 2005 Rovenstein Lecture, Mark Warner opined that as long as anesthesiologists remain steadfast in their commitment to the specialty's core values, the specialty would continue to develop as a vibrant academic medical specialty.<sup>41</sup> Dr Warner identified two quintessential values of anesthesiology<sup>41</sup>:

1. Commitment to the care of critically ill patients as well as those experiencing acute and chronic pain.
2. Promoting and improving patient safety in the operating room and in the perioperative period.

Change will be driven by several imperatives, including shifting demographics, technological advances, patterns of surgery, and economic realities. There will be an increasing number of elderly people, high-risk obstetric patients, and children with complex medical problems requiring surgery. It is important to further increase the safety of surgical, anesthetic, and perioperative care to minimize both short-term morbidity and long-term deterioration when vulnerable patients undergo surgery and anesthesia.

Improved monitoring, safer drugs, less-invasive surgery, and sophisticated communication networks may allow anesthesiologists and other anesthesia providers to extend their roles without compromising patient safety. Intensive care units may serve as a useful model. Typically, one nurse attends to 1 or 2 critically ill patients. Usually a small number of physicians, with 1 experienced intensivist, regularly assess all the patients and modify treatment plans over the course of the day. A derivative of this model could be conceptualized for future operating room anesthesia care. As individual patients present with their genetic profiles, it may become possible to tailor anesthetic and analgesic therapy with increased efficacy and decreased side effects. This pharmacogenomic model would represent a major advance in patient safety.

### CONCLUSION

Healthcare systems are evolving at a rapid rate. Anesthesiology as a specialty must adapt to the changes so that anesthesiologists remain invaluable

and irreplaceable members of the healthcare team. Anesthesiologists must extend their physician skills and increasingly pursue subspecialty fellowships. Anesthesiologists should have a meaningful presence in all areas of medicine. Apart from traditional areas of involvement, such as operating room anesthesia, critical care, pain medicine, teaching, research and resuscitation, there will be future opportunities for anesthesiologists in pharmacogenomics, healthcare systems management, and new technologies.

### KEY REFERENCES

1. Lagasse RS. Anesthesia safety: model or myth? A review of the published literature and analysis of current original data. *Anesthesiology* 2002;97:1609–1617.
2. Ewart GW, Marcus L, Gaba MM, Bradner RH, Medina JL, Chandler EB. The critical care medicine crisis: a call for federal action. A white paper from the critical care professional societies. *Chest* 2004;125:1518–1521.
3. Schwinn DA, Balser JR. Anesthesiology physician scientists in academic medicine: a wake-up call. *Anesthesiology* 2006;104:170–178.
4. Larsson J, Holmstrom I, Rosenqvist U. Professional artist, good samaritan, servant and co-ordinator: four ways of understanding the anaesthetist's work. *Acta Anaesthesiol Scand* 2003;47:787–793.
5. Warner MA. Who better than anesthesiologists? The 44th Rovenstein lecture. *Anesthesiology* 2006;104:1094–1101.

### REFERENCES

1. Kurz A, Sessler DI, Lenhardt R. Perioperative normothermia to reduce the incidence of surgical-wound infection and shorten hospitalization. Study of Wound Infection and Temperature Group. *N Engl J Med* 1996;334(19):1209–1215.
2. Mild therapeutic hypothermia to improve the neurologic outcome after cardiac arrest. *N Engl J Med* 2002;346(8):549–556.
3. Monk TG, Saini V, Weldon BC, Sigl JC. Anesthetic management and one-year mortality after noncardiac surgery. *Anesth Analg* 2005;100(1):4–10.

4. Buck N DH, Lunn JN. Report on the Confidential Enquiry into Perioperative Deaths. London: Nuffield Provincial Hospitals Trust, The Kings Fund Publishing House; 1987.
5. Devlin HB, Lunn JN. Confidential inquiry into perioperative deaths. *Br Med J* 1986; 292(6536):1622–1623.
6. Lunn JN, Devlin HB. Lessons from the confidential enquiry into perioperative deaths in three NHS regions. *Lancet* 1987; 2(8572):1384–1386.
7. Kohn LT CJ, Donaldson MS, eds. *To Err Is Human: Building a Safer Health System*. Washington, DC: National Academy Press, 2000.
8. Aitkenhead AR. Injuries associated with anaesthesia. A global perspective. *Br J Anaesth* 2005;95:95–109.
9. Tiret L, Desmouts JM, Hatton F, Vourc'h G. Complications associated with anaesthesia—a prospective survey in France. *Can Anaesth Soc J* 1986;33:336–344.
10. Holland R. Anaesthetic mortality in New South Wales. *Br J Anaesth* 1987;59:834–841.
11. Pedersen T. Complications and death following anaesthesia. A prospective study with special reference to the influence of patient-, anaesthesia-, and surgery-related risk factors. *Dan Med Bull* 1994;41:319–331.
12. Tikkanen J, Hovi-Viander M. Death associated with anaesthesia and surgery in Finland in 1986 compared to 1975. *Acta Anaesthesiol Scand* 1995;39:262–267.
13. Chopra V, Bovill JG, Spierdijk J. Accidents, near accidents and complications during anaesthesia. A retrospective analysis of a 10-year period in a teaching hospital. *Anaesthesia* 1990;45:3–6.
14. McKenzie AG. Mortality associated with anaesthesia at Zimbabwean teaching hospitals. *S Afr Med J* 1996;86:338–342.
15. Lagasse RS. Anaesthesia safety: model or myth? A review of the published literature and analysis of current original data. *Anesthesiology* 2002;97:1609–1617.
16. Kulling D, Rothenbuhler R, Inauen W. Safety of nonanesthetist sedation with propofol for outpatient colonoscopy and esophagogastroduodenoscopy. *Endoscopy* 2003;35:679–682.
17. Silber JH, Kennedy SK, Even-Shoshan O, et al. Anesthesiologist direction and patient outcomes. *Anesthesiology* 2000;93:152–163.
18. Silber JH, Kennedy SK, Even-Shoshan O, et al. Anesthesiologist board certification and patient outcomes. *Anesthesiology* 2002;96:1044–1052.
19. Breslow MJ, Rosenfeld BA, Doerfler M, et al. Effect of a multiple-site intensive care unit telemedicine program on clinical and economic outcomes: an alternative paradigm for intensivist staffing. *Crit Care Med* 2004;32:31–38.
20. Ibsen B. The anaesthetist's viewpoint on the treatment of respiratory complications in poliomyelitis during the epidemic in Copenhagen, 1952. *Proc R Soc Med* 1954; 47:72–74.
21. Ewart GW, Marcus L, Gaba MM, Bradner RH, Medina JL, Chandler EB. The critical care medicine crisis: a call for federal action. A white paper from the critical care professional societies. *Chest* 2004;125:1518–1521.
22. Cheney FW, Posner K, Caplan RA, Ward RJ. Standard of care and anesthesia liability. *JAMA* 1989;261:1599–1603.
23. Webb RK, Currie M, Morgan CA, et al. The Australian Incident Monitoring Study: an analysis of 2000 incident reports. *Anaesth Intensive Care* 1993;21:520–528.
24. Lunn JN. The history and achievements of the National Confidential Enquiry into Perioperative Deaths. *J Qual Clin Pract* 1998;18:29–35.
25. Schwinn DA, Balsler JR. Anesthesiology physician scientists in academic medicine: a wake-up call. *Anesthesiology* 2006;104: 170–178.
26. Smith A. Audit commission tackles anaesthetic services. *BMJ* 1998;316:3–4.
27. Deusch E, Weber T, Libal G, Christian L, Ofner C. Patient knowledge concerning anaesthesia general practice and the responsibilities of the anesthetist. *Anesthesiol Intensivmed Notfallmed Schmerzther* 1996; 31:409–413.
28. Kindler CH, Harms C, Alber C. The patients' perception of the anaesthetist in a Swiss university hospital. *Anaesthesist* 2002;51:890–896.
29. Chew ST, Tan T, Tan SS, Ip-Yam PC. A survey of patients' knowledge of anaesthesia and perioperative care. *Singapore Med J* 1998;39:399–402.
30. Khan FA, Hassan S, Zaidi A. Patients view of the anaesthetist in a developing country. *J Pak Med Assoc* 1999;49:4–7.
31. McGaw CD, Hanna WJ. Knowledge and fears of anaesthesia and surgery. The Jamaican perspective. *West Indian Med J* 1998;47:64–67.
32. Tohmo H, Palve H, Illman H. The work, duties and prestige of Finnish anesthesiologists: patients' view. *Acta Anaesthesiol Scand* 2003;47:664–666.
33. Larsson J, Holmstrom I, Rosenqvist U. Professional artist, good Samaritan, servant and co-ordinator: four ways of understanding the anaesthetist's work. *Acta Anaesthesiol Scand* 2003;47:787–793.
34. Rock P. The future of anesthesiology is perioperative medicine. *Anesthesiol Clin North America* 2000;18:495–513.
35. Lindahl SG. Future anesthesiologists will be as much outside as inside operating theaters. *Acta Anaesthesiol Scand* 2000;44: 906–909.
36. Greene NM. The 31st Rovenstine Lecture. The changing horizons in anesthesiology. *Anesthesiology* 1993;79:164–170.
37. Miller RD. The place of research and the role of academic anaesthetists in anaesthetic departments. *Best Pract Res Clin Anaesthesiol* 2002;16:353–370.
38. Menon DK, Wheeler DW, Wilkins IA, et al. Integrated approaches to academic anaesthesia—the Cambridge experience. *Anaesthesia* 2004;59:785–792.
39. Longnecker DE. Education in anesthesiology for the twenty-first century. *J Anesth* 2002;16:65–69.
40. Coursin DB, Maccioli GA, Murray MJ. Critical care and perioperative medicine. How goes the flow? *Anesthesiol Clin North America* 2000;18:527–538.
41. Warner MA. Who better than anesthesiologists? The 44th Rovenstine lecture. *Anesthesiology* 2006;104:1094–1101.



## CHAPTER 3

## Safety and Quality: The Guiding Principles of Patient-Centered Care

Jeffrey B. Cooper, PhD, and  
David Longnecker, MD, FRCA

Anesthesia providers develop a comfort with their craft, despite its inherent dangers. Over time, the administration of potentially lethal drugs, the management of apnea, and the control of altered physiologic systems become almost routine. As experience grows, they may even take for granted the inherently hazardous art and science of rendering patients insensible to pain, unconscious, and paralyzed. Yet, patients do not take anesthesia for granted. To the contrary, many fear it. They fear the possibility of experiencing pain or awareness, as well as the potential for death or other serious complications.<sup>1,2</sup> They also fear what professionals might consider “minor complications.” Anesthesia providers may view postoperative nausea and vomiting as minor side effects that pale when compared with the potential life-threatening complications that can occur during complex surgical and medical procedures, but patients often view postoperative nausea and vomiting as dreaded and prominent complications associated with the procedure.

Although this chapter focuses on patient safety and quality, it is firmly based on the concept that the patient is the center of care. The person or team performing the procedure has requirements that must be accommodated in the anesthetic plan. But the patient's concerns, fears, values, and expectations also must be addressed. Although that may seem obvious, historically, the design of healthcare systems, including anesthesia care, has been centered on the needs and convenience of the providers and the facility. The underlying concept was that quality of care alone was enough,

whereas quality of service (i.e., “patient centeredness”) was relatively insignificant in the process. That concept is changing, but it is not yet fully addressed in many approaches to teaching, education, and practice in anesthesia. Thus, to establish the foundation for talking about patient safety and quality, this chapter begins by emphasizing that patient perceptions must be considered in the design of a safe, high-quality anesthetic experience.

The patient's most fundamental needs are for high quality and complete safety. Meeting these expectations demands knowledge, skills, and continuous vigilance. Equally important is a system that ensures safe practitioners; provides the appropriate drugs, technologies, policies, and procedures to foster safe practice; monitors performance of the entire process (including both outcomes and patient satisfaction); identifies safety and quality problems; and implements corrections. All of these demand a culture of safety and quality at all levels of the system, a culture that supports these needs not just in word, but in deeds and actions.

In 2001, an Institute of Medicine (IOM) committee identified patient safety, quality of care, and patient-centered care (i.e., individualized care) as progressively increasing levels of excellence in the overall healthcare process.<sup>3</sup> This view is consistent with the tenants of other organizations that serve the public while dealing with potentially lethal outcomes (e.g., the commercial aviation industry). In

short, safety is the foundation upon which quality (e.g., the application of evidence-based approaches) and then patient-centeredness are built, but all are required to meet the goal of highest-quality care.

The demands for quality and safety start with the patient's needs guided by the needs of the physicians performing the procedure (medical, surgical, or diagnostic) that requires anesthesia care. Quality and safety goals must be met before, during, and after application of the anesthetic, including the various transport processes. Within this framework, constraints are introduced by the needs of all parties in the care process, including the expectations of other clinicians (e.g., surgeon or other operator, medical consultants), facilities (e.g., hospital or ambulatory care site), and the patient (or family or guardian, for example). Sometimes these are competing expectations, requiring thoughtful tradeoffs based on essential priorities. When balancing these tradeoffs, involvement of the patient is a key to positive patient satisfaction with the overall process.

Every subsequent chapter in this text has the delivery of safe and high-quality care as its primary objectives. This chapter defines a strategy and generic principles for achieving these objectives, centering on the patient while also meeting the other demands of modern perioperative care. Subsequent sections in this book provide specific elements of evidence-based anesthesia care that are required to meet these strategic objectives.

### KEY POINTS

1. The patient should be the center focus of anesthesia care.
2. The goal of anesthesia care must be to ensure that *no* patient is harmed.
3. Preventing harm is challenging because care is complex, serious adverse events are relatively rare and almost always the result of many causes rather than a single one.
4. Serious adverse events are usually the result of weaknesses in the “system” of anesthesia care, not the fault of incompetent clinicians.
5. To prevent adverse events, a strategy is needed, not simply vigilance.
6. Organizations, departments, and groups must employ a top-down approach and a commitment to creating a safe environment and system for safety.
7. Safety must be the number 1 organizational priority to create an organization that operates at the highest level of reliability.
8. Anesthesia professionals must employ a broad array of safety tactics.
9. Teamwork and communication among the perioperative caregivers are critical components of patient safety.

## DEFINING QUALITY AND SAFETY

The key terms commonly used to discuss quality and patient safety are as follows:

- *Patient-centered care* encompasses the qualities of compassion, empathy, open and complete communication, and responsiveness to the needs and preferences of each patient.<sup>3</sup>
- *Quality of care* is the extent to which health services for individuals and populations increase the likelihood of desired health outcomes and are consistent with current professional knowledge.<sup>4</sup>
- *Patient safety* is the avoidance, prevention, and amelioration of adverse outcomes or injuries stemming from the processes of healthcare. These events include “errors,” “deviations,” and “accidents.” Safety emerges from the interactions among the components of the system; it does not reside in a single person, device, or department. Improving safety depends on learning how safety emerges from the interactions of the components through analysis of “near misses” and adverse outcomes or injuries. Patient safety is a subset of healthcare quality.<sup>5</sup>
- *Quality assurance* is the formal and systematic monitoring and reviewing of medical care delivery and outcome; designing activities to improve healthcare and to overcome identified deficiencies in providers, facilities, or support systems; and the carrying out of followup steps or procedures to ensure that actions have been effective and no new problems have been introduced.<sup>6</sup>
- *Adverse event* is an injury that was caused by medical management that results in measurable disability.<sup>7</sup>
- *Accident* is an unplanned, unexpected, and undesired event, usually with an adverse consequence.<sup>8</sup>
- *Error* is when a planned sequence of mental or physical activities fails to achieve its intended outcome and these failures cannot be attributed to the intervention of some chance agency.<sup>9</sup>
- *Human factors* refers to the scientific discipline concerned with understanding interactions among humans and other elements of a sys-

tem, and to the profession that applies theory, principles, data, and methods to design so as to optimize human well-being and overall system performance.<sup>10</sup>

- *Risk management* is the clinical and administrative activities undertaken to identify, evaluate, and reduce the risk of injury to patients, staff, and visitors, and to identify, evaluate, and reduce the risk of loss to the organization itself.<sup>11</sup>

The concepts of quality and safety are a continuum. There is no uniform agreement on their differences in the larger healthcare community. Some view safety as a subset of quality; most agree that quality care must be founded on safe care. There is perhaps more of an argument for that in the larger world of healthcare and less in anesthesia. One important difference is that quality is generally measured in terms of success in achieving desired outcomes, whereas safety is measured in failures, particularly catastrophic failures. Success in achieving the desired outcomes includes not only a safe experience, but also one that incorporates the elements of evidence-based medicine, especially because personal provider experience is almost never adequate to evaluate either the overall positive or negative consequences of a specific drug, technique, or procedure. Because anesthesia is generally not therapeutic, complete safety must be the most important goal of every anesthetic. Simply stated, this means a goal that *no patient is caused any injury or complication from the effects of the overall anesthesia encounter*. This may seem unattainable. But, as described below, adopting such lofty goals and committing to achieve them leads to greater safety and better care. The concept of healthcare quality has broader implications than safety alone. In the context of anesthesia, quality can be thought of as a balance between providing the patient a healing experience with the least possible pain and discomfort, optimal conditions for surgery, smooth flow of patient care for the organization, and absolutely no injury or unwanted complication caused by the anesthetic.

Because safety focuses on preventing rare events, it is much harder to develop an evidence base for actions that create safety. Randomized con-

trolled trials, while possible for testing many types of quality improvement measures, are almost unheard of for trials of safety measures. Many safety measures arise from investigation of serious adverse events. More intuitive arguments and judgments guide the implementation of safety principles.

To the benefit of all, quality and safety have attained increasing importance in modern healthcare. There is a rich history of attention to quality assurance; that is, attention to the processes of improving care. Those activities can be traced to the work of Donebadian, who developed principles by which quality can be measured and improved for healthcare in general, but with specific applications to hospital care.<sup>12</sup> It was only in the late 1990s that the concept of patient safety was raised to prominence in the broad healthcare environment, a result of a landmark study of medical error.<sup>13</sup> Yet, in anesthesia, patient safety has a much richer history. Indeed, the specialty of anesthesiology is often identified as the earliest adopter of patient safety principles, and lauded for achieving dramatic improvements in outcomes (see Anesthesia Risk and Accidents below for the history of patient safety in anesthesia).

The concepts of patient safety, quality assurance, and risk management are related but have important distinctions. Patient safety is focused on prevention of injury. Quality assurance generally deals with the broader spectrum of quality, including the success of treatments. Risk management historically was directed at managing the aftermath of adverse outcomes, especially to manage legal issues, malpractice, and avoidance of financial loss for insurers. But modern risk management is focused on proactive patient safety, based on the principle that prevention of injuries via error reduction and system improvements reduces the adverse events from which malpractice awards arise.

## ANESTHESIA RISK AND ACCIDENTS

The roots of safety run deep in anesthesiology. Dating to the first survey of anesthetic deaths,<sup>14,15</sup> there has been a regular and continuous self-examination within the anesthesia profession

to understand the causes of harm and how to prevent them. In the modern era of healthcare, anesthesia was the specialty that coined the term “patient safety,” which is now in the lexicon of healthcare and broadly applied to all medical disciplines.

### History of Patient Safety in Anesthesia

The history of safety in anesthesiology may have begun with the first description of an anesthetic death—that of Hannah Greener, who died during administration of chloroform for amputation of her large toe in 1848.<sup>16</sup> This examination of cause illustrates the early focus of anesthesia providers on understanding mechanisms of adverse outcomes and their prevention. Although outcome studies were reported over the years, it was not until the landmark study of Beecher and Todd that a large population was sampled and specific causality suggested.<sup>17</sup> Although that study drew the wrong conclusion from the data, ascribing inherent toxicity to curare, the stage was strongly set to document and enhance the safety of anesthesia care through frequent reviews of outcome and revisions in practice based on these reviews. Other studies followed during the 1950s and 1960s, with a focus generally on the morbidity and mortality associated with general or regional anesthesia, and the cause of death or serious injury in surgical patients.<sup>18,19</sup>

One of the earliest safety interventions of relatively modern times was the development of safety features of anesthesia equipment. Safety features incorporated into anesthesia machines in the 1950s and 1960s are still in use today, including the fail-safe system for protecting against loss of oxygen supply pressure and pin-indexing of gas cylinders to prevent their being interchanged.

The concept of “patient” safety arose in the early 1980s, in response to several factors. The first study of the contribution of human error in anesthesia was reported in 1978, and was followed by later studies of a larger cohort and specific issues of how errors occur and strategies for their prevention.<sup>20,21</sup> In these studies, Cooper et al. studied “critical incidents” gathered in interviews with anesthesiologists, residents and nurse anesthetists from four hospitals. The

findings elucidated the mechanisms of what were then called anesthesia “mishaps” as being multidimensional in that a number of errors and other factors contributed to each event. Other reports described attributes of a specific event, disconnection in the breathing circuit, and a generic contributor to critical events, the relief of one anesthesia provider by another. Several studies replicated the methods and general findings in other settings and countries.<sup>22,23</sup>

A “crisis” of increasing costs for malpractice insurance for many medical specialists, especially anesthesiologists, prompted intense interest in reducing settlements for claims through tort reform. More importantly, leadership among the anesthesia community took a then unique approach of concentrated efforts to reduce the number of adverse events that led to claims. The American Society of Anesthesiologists (ASA), under its then president, Ellison C. Pierce, Jr., MD, created a committee on Patient Safety and Risk Management, which likely was the first use of the term “patient safety.”<sup>24</sup> In 1984, an International Symposium on Preventable Anesthesia Mortality and Morbidity was held in Boston, and the concept of a directed effort toward anesthesia patient safety was conceived. The Anesthesia Patient Safety Foundation (APSF) was formed in 1985. Its newsletter, research program, and other activities represented the first organized efforts in healthcare to address patient safety as a single topic. The ASA later sponsored studies of closed malpractice claims, which led to numerous reports about causes of the most severe adverse events and their trends.<sup>25</sup>

Many efforts contributed to what appears to be a substantial reduction in catastrophic adverse anesthesia outcomes among relatively healthy patients.<sup>26</sup> Among these were improvements in educational programs, safer drugs and equipment, more intense patient monitoring (especially oxygen analyzers, pulse oximetry, and capnography), and new technologies for managing difficult airways (a specific contributor to numerous severe adverse outcomes). Standards and guidelines for anesthesia care also played a role in reducing adverse events. The Harvard Medical School Department of Anaesthesia promulgated the first standards for care in 1986;<sup>27</sup> these were later adopted by the ASA as national stan-

#### BOX 3-1.

##### Key Influences Leading to Increasing Patient Safety in Anesthesia

- Research in human error, human factors, and closed claims.
- Development and routine use of pulse oximetry.
- Development and routine use of capnometry.
- Enhanced alarms and safety features in anesthesia machines/workstations.
- Development of safer anesthetic drugs.
- Anesthesia Patient Safety Foundation focus on patient safety.
- ASA adoption of standards and guidelines for safe practice.
- Development of new airway-management tools such as fiberoptic bronchoscopy.

Data from American Society of Anesthesiologists: Standards, Guidelines and Procedures. <http://www.asahq.org/publications/AndServices/sgstoc.htm>. Accessed May 23, 2006.

dards. It is claimed that these standards are associated with a reduction in serious outcomes among ASA physical status (ASA-PS) 1 and 2 patients in the ensuing years.<sup>30</sup> Many other standards and guidelines followed. Box 3-1 summarizes key milestones in the path to safer anesthesia care.

A national movement in patient safety was catalyzed by the 1999 publication of the IOM report *To Err is Human: Building a Safer Healthcare System*.<sup>13</sup> This landmark study identified failures in the healthcare system to be an important public health issue and the eighth leading cause of death in the United States. It and subsequent reports recommended fundamental changes in the healthcare system to combat a problem with deep roots in the way patient care is organized (or disorganized), particularly the culture of healthcare that did not place a high priority on the overall safety of patients relative to the delivery of specific services. A federal agency was later assigned to direct U.S. government initiatives to improve safety. Patient safety became a higher priority in the mission of numerous health-related organizations, and the sole mission of others. Anesthesiology was singled out in the IOM's report, and in other writings, as the one specialty that addressed patient safety early and with positive results.



## Current State of Knowledge of Anesthesia Risk and Relationship to Error

There is a general belief that the risk of preventable death or injury from anesthesia is relatively low compared to many other medical and nonmedical risks. Yet, there are no accurate estimates of the rate of adverse outcomes in general or for an individual patient presenting with specific risk factors. One reason is that there are no standard methods for assigning causality appropriately among numerous factors that include anesthesia, surgery, the facility (and its systems), and the patient's disease. Particularly in the United States, the fear of malpractice claims hinders reporting and open, candid discussion of errors. Federal legislation, similar to that enacted in Australia in the late 1980s, now protects voluntary reporting, although the process for doing that has not been implemented as of this writing.<sup>28</sup> Despite the absence of strong evidence, estimates of the risk of untoward outcome to a relatively healthy patient are believed to be on the order of 1:100,000 patients.<sup>29,30</sup> However, for patients presenting at greater risk, the risk may be on the order of 1:10,000, which is not different from early estimates for all patients.<sup>29,31</sup> Thus, there remains substantial room for improvement in overall safety of anesthesia. Chapter 24 has a comprehensive discussion of risk, mortality, and morbidity.

## ACCIDENT MODELS

Most people, both in and out of healthcare, seek to assign blame to specific individuals for specific lapses in performance associated with an adverse event. Yet, the evidence demonstrates that most injurious accidents are typically complex events for which there is no single cause.<sup>32-34</sup> Although it would be possible to envision a scenario wherein a specific act by one individual led to an accident, assigning such pinpoint causality is not a useful approach to accident prevention. Substantial research is targeted at learning how accidents occur and how humans are involved in that process. The science emerging from that research supports the concept that there are few simple solutions for

prevention of accidents. However, it offers possible strategies and tactics for lowering the potential for accidents, by preventing human error and its precursors (i.e., the factors that promote and propagate errors), and by creating resilience in systems to respond to those errors that will inevitably occur despite the best of intentions and preventive actions.

When moving toward a goal of zero failures in patient care, we must consider models for both organizational and individual failure. The goal of adverse event-free anesthesia care can be achieved only by applying a broad spectrum of prevention strategies and building resilience throughout the entire system of anesthesia care, for the overall system is no stronger than its weakest links. This section examines several models and issues at the organizational and human levels to inform our thinking about designing for failure.

## The “System” of Anesthesia Care

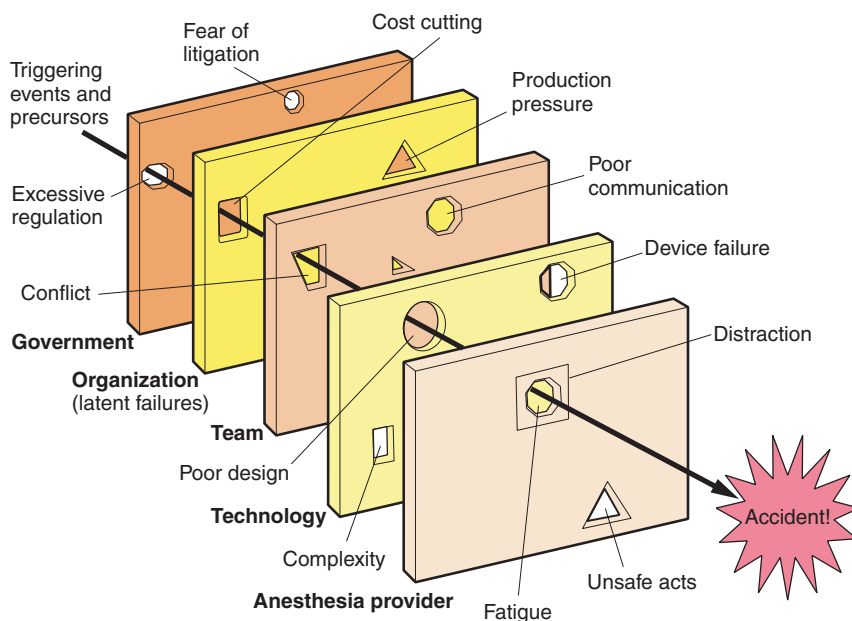
Before examining models for failure, we need a model for anesthesia practice. Whereas anesthesia could be viewed simply as a single provider administering drugs to a single patient, that narrow perspective does not represent the much more intricate and multidimensional processes that characterize care delivery. Rather, the anesthesia encounter consists of several components that comprise the “system of anesthesia care.” The anesthesia processes can be thought of broadly in three phases: preanesthetic planning and preparation, provision of anesthesia for the procedure, and postanesthesia care. Within each of these phases, the anesthesia provider (or providers) performs a set of tasks that are intended to provide quality care for the patient, surgeon, or other operator, and the healthcare organization. Achieving patient care quality and safety requires that these anesthesia activities not be independent from the needs of other providers, allied health professionals, technical staff, support staff, hospital or organization programs, and, especially, not independent of the patient's needs and expectations. The interactions between all of these components comprise a “system” of care that has yet to be fully modeled for the perioperative experience. Furthermore, this “anes-

thesia system” takes place within a system of systems that comprise the overall course of care, and numerous elements of this larger system may interact with anesthesia care at multiple points in the delivery process; such interactions often contribute to a less-than-optimal experience for the patient.

The Accreditation Council for Graduate Medical Education (ACGME) has established a set of 8 competencies that must be met for all medical trainees.<sup>35</sup> One competency is to understand and know how to practice within a system of healthcare. That requirement arose in recognition of the interdependencies among all the members of the care team and the larger system in which they all operate. In the case of anesthesia, that implies having an understanding of the requirements and needs of all other participants in the perioperative system and implementing an anesthesia plan that appropriately meets these various needs, rather than acting individually in an introverted fashion.

## Models of Organizational Failure

Several models offer generic explanations of how accidents occur. James T. Reason is perhaps the most widely cited author for overall conceptual thinking about the mechanisms of human error and system failures, although his work is founded on the basic work of Rasmussen. Their thinking derives from research in high-hazard industries, such as nuclear power, aviation, and chemical manufacture. Gaba has offered insightful interpretations of this work and other research as it applies specifically to anesthesia practice.<sup>34</sup> The basic concepts are relatively simple: Accidents are not one-dimensional; rather, they are the result of the interaction of several elements. There are generic, individual elements that influence the evolution of accidents, but each accident is somewhat unique in the way that elements combine to result in injury. (Note that in the context of “safety,” we are addressing only those adverse outcomes that could be prevented given the application of current knowledge; death or injury that appears to be caused primarily by the patient's disease process or the unpredictable influences of drugs or operation, likely cannot be altered by safety



**FIGURE 3-1.** “Swiss cheese” model of accidents in anesthesia. Reason J. *Managing the Risk of Organizational Accidents*. Aldershot, Hants, UK: Ashgate Publishing; 1997.

interventions.) Reason depicted the process of accident evolution in what is widely referred to as the “Swiss cheese” model (Fig. 3-1).<sup>9</sup>

The “Swiss cheese” model illustrates that accidents are typically the result of a series of events that include precursors, which trigger or allow the chain of events that result in the final (active) adverse event. Reason termed these precursors *latent errors*. This concept is now widely accepted in understanding healthcare system failures. Latent factors are situations that exist on a regular basis within any work environment. They have the potential for influencing the initiation or propagation of an evolving accident. Examples are failure to maintain equipment or replace obsolete equipment; selection of low-quality supply items; poor scheduling practices that promote haste or fatigue; and case scheduling and staffing models that allow assignment of relatively inexperienced clinicians to unfamiliar cases or high-risk patients. Cultural influences are an important source of latent failures. Examples include the pressure to proceed with cases in remote locations where the resources are insufficient to meet minimal anesthesia safety requirements; pressures to move rapidly to avoid “turnover delays;” pressures to assign an experienced provider to a case in order to “keep the schedule moving;” a hostile

atmosphere within an operating room that limits preemptive communication of care concerns; and failure to heed a patient’s warnings or concerns. Latent errors rarely lead to an immediate accident. Rather, they can be seen as a lurking enemy, or, as Reason called them, “resident pathogens,” awaiting the circumstances that will combine to produce a catastrophic outcome, often in ways that are unusual and what may be called “unpredictable.” Avoiding the consequences of latent errors requires a broad set of defenses and resilience throughout the system, to mitigate evolving failure that results from alignment of the “holes in the cheese.”

Reason’s model highlights the need for broad and varying mechanisms to trap errors and failures during the patient’s healthcare encounter and thus mitigate or prevent the full cascade from unfolding. His work on managing risk begins at the organizational level and offers a spectrum of strategies and tactics for accident prevention. Both the attitude and actions of the organization and each individual in the chain of care can either bolster or undermine those defense mechanisms.

There is a competing theory that postulates that prevention is not always possible or even probable. The normal accident theory (NAT), as described by Perrow,<sup>32</sup> characterizes

some industrial systems as being particularly resistant to strategies for prevention of catastrophic accidents if the systems are both complex and “tightly coupled”; that is, the connections between processes are such that one quickly affects the other in ways that can evolve into an accident that is not predictable by deterministic analysis. NAT does not offer much hope for prevention of accidents in many high-risk industries. Fortunately, although human physiology and all of the processes involved in anesthesia administration may together create a “complex” system, there is not usually the extent of “tight coupling” that is necessary in Perrow’s model, although it may occur in certain high-risk patients whose disease processes present a less-stable condition. Still, the NAT view of accidents and how they evolve provides many lessons for anesthesia practice, and for constructing resilient systems to minimize the potential for accidents. Of special concern is that some protections and safety features can actually make systems more complex, mask impending problems, and impart a false sense of security. This concept is an example of how certain prevention or mitigation strategies may affect other parts of the system in unanticipated ways and thus lead to new, unexpected risks. Anesthesia has many examples: Pulse oximetry can lead to practicing closer to the edge of acceptable levels of oxygenation or inappropriate assumptions that a functioning pulse oximeter implies adequate blood flow as well; automated noninvasive blood pressure monitors can fail to cycle and thus continue to present falsely high readings even in the presence of blood loss; or alarms on anesthesia monitors may be turned off to avoid “distraction” during the procedure. Moreover, the relative safety of anesthesia itself has been called an “insidious hazard,” for some become complacent about anesthesia care and vigilance and assume that nothing will go wrong, based on prior experience.<sup>21</sup> The development of complacency about safety, based on prior experiences, has led to major disasters in a variety of organizations; a prime example is the loss of the orbiter (“shuttle”) *Columbia* on February 1, 2003. The Columbia Accident Investigation Board identified a number of contributing latent factors that resulted in complacency within the

National Aeronautics and Space Administration (NASA), including the acceptance of “normal deviation” and the loss of checks and balances that should have guided NASA safety efforts; many of these latent factors resulted from the lack of serious events in the years immediately preceding the loss of *Columbia*.<sup>36</sup>

Reason’s commentary about creating effective defenses against accidents fits well for anesthesia:

If eternal vigilance is the price of liberty, then chronic unease is the price of safety. Studies of high-reliability organizations—systems that have fewer than their share of accidents—indicate that the people who operate and manage them tend to assume that each day will be a bad day and act accordingly. But this is not an easy state to sustain, particularly when the thing about which one is uneasy has either not happened or has happened a long time ago, and perhaps in another organization. Nor is this Cassandra-like attitude likely to be well received within certain organizational cultures....<sup>33</sup>

### Models of Human Error/Failure

The modern theory of accident causality and safety views the human as a component of a system. Most experts now tend to play down the operator’s responsibility for accidents, perhaps because so often the attention and blame has been so heavily directed at those who are at what Woods and Cook term the “sharp end” of the pyramid of accident control.<sup>37</sup> In fact, there is substantial evidence about human error and how humans interact with systems in diverse ways to either help or hinder the accident process. This is a topic of serious study that applies to all of society, and numerous textbooks of general and specific areas are available.<sup>9,38</sup> Whereas the vast majority of research has been in industry, most notably aviation and nuclear power applications, there has been substantial study in anesthesia specifically, where the earliest studies and discussions of human error and human factors in healthcare are found.

The studies of critical incidents mentioned earlier identified the basic issue of human error as a component of what were termed “mishaps.” Factors associated with mishaps, what would now be called latent factors, were identified,

such as lapses in training, equipment design weaknesses, and the contribution of fatigue. In these and other areas, the science of human performance and human factors has revealed much more about the weaknesses of humans and the many ways in which we can fail, including how system design and other factors can influence our performance and conspire to weaken even the most expert clinician.

There has been a strong reliance on “vigilance” during anesthesia as the primary approach to error prevention, so much that the word is the motto of the ASA. Vigilance means sustaining attention.<sup>39</sup> It has been defined as having 3 components: alertness, selection of information, and conscious effort. It is a much more complex process than is immediately apparent, and vigilance is the subject of much investigation in many fields that require sustained attention to assure safety and performance. The observant practitioner is aware of some of the many ways that vigilance can be thwarted and performance degraded. Furthermore, vigilance is only one task of a complex set of tasks that compromise safe anesthesia practice.

Human error in general is the subject of intense investigation in the fields of human factors, ergonomics, and industrial psychology. Again, we look to James Reason for an overview of the subject.<sup>9</sup> Reason built on the work of Rasmussen in defining and characterizing human performance and error. Performance is defined in 3 levels: skill based, rule based, and knowledge based. Error is defined as the failure of planned actions to achieve their desired ends without the intervention of some unforeseeable event. Errors are divided into 2 main types: slips and mistakes (Box 3–2).

These definitions do not of themselves help prevent errors, but the thoughtful practitioner will consider that his or her slips and mistakes vary in type and cause, most of all recognizing that all forms of error require efforts toward prevention and mitigation of the consequences of those errors that occur despite the best of efforts.

Many factors influence vigilance and performance (performance-shaping factors), including fatigue and sleep deprivation, environmental influences, production pressures, human-interface design, and teamwork. Other factors associated with adverse events in

#### BOX 3–2.

##### Slips and Mistakes

**Slip:** The plan is adequate but the actions fail to go as planned. These are unintended failures of execution, also referred to as lapses, trips, or fumbles. They are further divided into attentional slips of action and lapses of memory.

**Mistake:** The actions conform to plan but the plan is inadequate to achieve its intended outcome. Mistakes are divided into rule based (e.g., misapplication of normally good rules but not correct for this situation) and knowledge based (e.g., incorrectly thinking out a solution for which there is not a pre-packaged solution).

anesthesia that either may promote errors or foster their propagation have been identified.<sup>20,21</sup> We consider some as examples of the kinds of issues that anesthesia providers must address to maintain accident-free performance throughout a professional career. Measures to prevent performance decrement or to help maintain optimal performance are described in Creating Safety at the Organizational and Department Level below.

### Fatigue and Sleep Deprivation

There is recent evidence (in trainees) that shows a clear association between sleep deprivation and human errors, including lack of attention to task, serious auto accidents, and medical errors involving both diagnosis and treatment.<sup>40–42</sup> There are many examples of large-scale industrial accidents where sleep deprivation or fatigue was identified as a major contributing factor.

Howard et al. reviewed the literature on sleep and fatigue with particular reference to anesthesia.<sup>43</sup> Among the key findings were the following: (a) Inadequate sleep degrades performance; (b) Individuals require different amounts of sleep to feel awake and alert; (c) The failure to obtain adequate sleep results in a sleep “debt” that is cumulative and can only be diminished by sleep to pay back the debt; (d) Circadian rhythms have an important influence both on the tendency to sleep and the ability to sleep. The circadian lull associated with degraded performance is between 2 and 6 A.M. and 2 and 6 P.M.; and (e) Stimu-

lants such as caffeine can aid in maintaining alertness and wakefulness, but side effects must be understood in order to use these effectively.<sup>44</sup>

### **Transitions Among Care Providers (“Handoffs”)**

There are conflicting findings about the impact of handoffs among anesthesia providers to mitigate the effects of fatigue, boredom, hunger, and so forth. Cooper et al. examined critical incidents associated with relief of one anesthesia provider by another.<sup>45</sup> They concluded that, overall, relief provided more benefit from detecting undiscovered problems than harm from transferring responsibility to a provider with less serial knowledge of the specific patient and procedure. These conclusions were verified by interpretation of data from a similar study by Short et al.<sup>46</sup> More recently, Arbous et al. found that a change of anesthesiologists was associated with a greater incidence of severe morbidity and mortality.<sup>47</sup> Yet, routine breaks are generally found to be useful and necessary in anesthesia and in high-hazard industries. Provisions for adequate transfer of critical information and situational awareness are required. Cooper suggested a specific set of guidelines for conduct of handoffs, which was recently updated.<sup>48,49</sup> The hazards of transitions in care are now more widely recognized in healthcare and receiving increasing attention for remediation. More handoffs now occur among trainees as a result of the recent ACGME work-limitation requirements that are intended to mitigate the consequences of sleep deprivation and fatigue.

### **Environmental Factors**

Many environmental factors can affect the performance of the anesthesia provider. Among these are noise, extremes of temperature and humidity, lighting, and toxic vapors.<sup>39</sup> Listening to music or reading during anesthesia administration are controversial issues with conflicting tradeoffs.<sup>50,51</sup> There are no robust studies in healthcare, nor simple extrapolations from studies in other fields, to guide the development of evidence-based standards. Rather, good judgment appears to be the best guideline. Background music can alleviate stress and boredom, but different musical tastes may lead to different effects among all on the operating team. Loud music or other noises can obscure verbal communications

and be especially disruptive during periods of high workload or management of critical events. Similarly, reading in the operating room could alleviate boredom during uneventful intervals, but it could also foster a lack of vigilance and alertness. Reading appears especially problematic intuitively, and would be difficult to justify during an accident investigation involving pilots, air traffic controllers, or anesthesia providers, among others.

### **Human Factors and Human Interface Design**

Human factors engineering (HFE) is a broad topic that encompasses all of the different aspects of the ways in which humans interact with systems.<sup>38</sup> The importance of human factors, especially the design of the human-machine interface, is well known in other fields, but greatly underappreciated in healthcare.<sup>10</sup> Human error can be either encouraged or discouraged, depending on the attention given to understanding human limitations and the ways in which humans interact with the machines and technologies. The goal of HFE is to “design tools, machines, and systems that take into account human capabilities, limitations, and characteristics.”<sup>52</sup> Given that anesthesia is very technology-intensive, human factors issues play an important role in prevention of errors and adverse outcomes.

Several studies have examined the anesthesia work environment, the tasks of anesthesia providers, and how the design of displays and alarms impact on ease of use and errors.<sup>39,53,54</sup> The results indicate that technology is not generally well designed to accommodate the ways people use it. There are numerous examples of how the design of a device interface can be especially dangerous.<sup>55–57</sup> The design of anesthesia monitors is particularly problematic, especially when the anesthesia provider works in facilities that have various models or different suppliers of devices. Software complexity, for example, the depth of menus, excessive flexibility in options for alarms, and displays, can cause confusion and distract the provider from other important tasks that should be higher priority.

### **Production Pressure**

Production pressure refers to “overt or covert pressures and incentives on personnel to place production, not safety, as their primary priority.”<sup>58</sup>

Based on a survey of anesthesiologists in California, Gaba et al. reported that nearly half of the respondents had witnessed instances of what they believed to be unsafe actions by an anesthesiologist because of production pressure.<sup>58</sup> These included internal pressures (e.g., to foster good relations with a surgeon, accrue personal income) and external pressures (e.g., proceed rather than cancel a case to appease patient or family, accept an unfamiliar patient or procedure to foster facility throughput).

### **Teamwork**

The importance of good teamwork and communication is now more widely recognized in healthcare, especially for surgical teams. A substantial body of literature from high-hazard domains, especially aviation, and in healthcare, demonstrates the value of teamwork for successfully preventing and managing critical situations.<sup>59–61</sup> Gaba et al. were the first to develop teamwork and crisis management training techniques for healthcare, adapting crew resource management (CRM) techniques from aviation for applications in anesthesia.<sup>62</sup> These approaches have since been extended to nearly all healthcare settings but are particularly applicable to those where rapid action is required to successfully treat acute complex events, such as dire surgical emergencies.<sup>63</sup>

A team can be defined as “two or more individuals who have specific roles, perform interdependent tasks, are adaptable, and share a common goal.”<sup>59</sup> Box 3–3 lists some characteristics of effective teams.<sup>59,64,65</sup> These definitions and characteristics, derived from other industries, generally apply to healthcare and to anesthesia practice. Anesthesia providers have a varying dependency on others, depending on the setting and circumstances. Good teamwork can prevent errors or prevent them from propagating. Teamwork is vital to the successful management of critical events. The team within which anesthesia providers work varies depending on the setting, but it typically has a surgeon, a circulating nurse, a surgical technician, and other support personnel, including environmental workers, technicians (e.g., blood bank, laboratory, or radiology), and clerical personnel. Within the broad system of care, the team can include those who provide care pre- and postoperatively and specialists,



**BOX 3-3.****Some Effective Practices of High-Performance Teams**

Introduce all members of the team to each other at the start of each procedure.

Regularly conduct *preoperative briefings* with the entire operative team, which can be done via a specific checklist as described by Lingard.<sup>64</sup>

Use specific *communication protocols* within the team (SBAR is gaining increasing acceptance. It calls for a specific sequence for describing the patient's status: describe the Situation, the Background, Assessment, and Recommendations [SBAR]).<sup>65</sup>

Establish communication standards such as "read-back" of all verbal orders, e.g., medications.

Conduct *debriefings* with the team following unusual occurrences, near misses, or critical events.

Establish an environment that encourages cross-monitoring and backup behaviors across the entire team.

Create a language that signifies recognition of potential hazards.

Practice for emergency situations (Box 3-4).

such as radiologists, pathologists, and intensivists. The immediate operative team has been given the most attention for training and research.

Surgical teams have several distinguishing features that create obstacles to effective performance. The hierarchy in surgical care places physicians above other workers. It is common for surgeons to be accorded higher status and to assume a self-designated role of "captain of the ship." Whereas leadership is a key feature for team success, the person in that role should vary depending on the situation. Similarly, anesthesia providers may treat other team members as subordinates rather than colleagues. High-reliability organization (HRO; see The Elements of Safe, High-Quality Anesthesia Care/The High-Reliability Organization Model) theory, which is based on characteristics of organizations that function at high levels of safety, calls for a nonhierarchical culture in which the leader is the one with the most expertise, not the

highest status. Conflict among these roles can be problematic in management of acute operative events, especially when the care team does not work together regularly (e.g., during nights and weekends when the care team consists of "night call" personnel from various work rosters).

CRM techniques have been applied for training teamwork skills and performance. There are now many different approaches to such training but the principles are generally the same. Teamwork needs should be assessed for the specific environment; all team members must be motivated and engaged in accepting the need for teamwork and agree about skills and behaviors they will adopt; those behaviors must be taught and practiced via drills; and the behaviors assessed and periodically reinforced via more drills and didactic sessions.<sup>59</sup>

In anesthesia, simulation of the patient and environment in which anesthesia is administered has been employed, both for motivation and for training of technical and nontechnical teamwork skills.<sup>66,67</sup> The level of realism (fidelity) employed varies depending on the training objectives and philosophy.<sup>68</sup> One of several models of computer-controlled mannequin is used to simulate the patient, whose physiology, anatomy and life signs can be varied to simulate normal or abnormal situations.<sup>66,69</sup> In high-fidelity simulation, props and actors are employed to create realism, which is believed to strengthen the engagement of the learners. The early applications were for the anesthesia "crew" of the larger surgical team. More recently, simulations have involved training for entire operative teams. CRM concepts are the basis for training in behavioral skills. Prominent among these is the concept that all team members are expected to communicate openly, ranging from confirming a directive (e.g., "heparin, xx units, has been administered," "I'm confirming that these are Mrs. Jones' radiographs"), to speaking out when a concern for safety exists (e.g., "Are you sure you should be prepping the right hand? The consent says left." or "Have you noticed that this patient's blood pressure has been falling over the past several minutes?"). Training sessions use patient-care scenarios to elicit treatment responses from the individuals or teams being trained. Debriefing using videotapes of the session are

conducted to review actions. There is some evidence that such sessions can effectively instill good team behaviors.<sup>70</sup> Team training without simulation also is effective, as is the combination of both approaches.<sup>61,71</sup>

### SOME SPECIFIC HAZARDS ASSOCIATED WITH ANESTHESIA

There are a seemingly infinite number of case reports of specific hazards and complications of anesthesia that were largely preventable, although a litany of isolated cases is perhaps less helpful than a series of organized observations. Studies of closed malpractice claims, funded by the ASA, have examined many of these events in a more systematic manner, one that assists in developing action plans for reducing risks. These closed claims studies have explored several categories of adverse outcomes, the most notable addressing errors related to airway management, monitoring, sudden cardiac arrest during spinal anesthesia, equipment failures, or nerve injuries.<sup>25,72,73</sup>

The Australian Incident Monitoring project analyzed 4000 critical events and developed an algorithm (COVER ABCD: A Swift Check) that accounts for the majority of common anesthetic emergencies (Box 3-4)<sup>74</sup>. Use of the mnemonic will prevent injury in the majority of cases if specific practices are followed. A detailed review of even a substantial subset of these concepts is beyond the scope of this chapter. Rather, we present here examples of the types of failures that establish an argument for having organized principles for general prevention of errors. Analysis of these types of events also suggests tactics that could reduce the likelihood that these would become a trigger or propagator of an accident chain.

### Adverse Respiratory Events

Events associated with management of respiration are the most serious remaining hazards in anesthesia, as evidenced by data from the ASA closed claims analyses.<sup>73</sup> The three most common causes of death and brain damage are inadequate ventilation, esophageal intubation, and difficult tracheal intubation. The large majority of cases in the first 2 causes were judged to have been preventable

## BOX 3-4.

Crisis Management Algorithm—Memorize and Practice: An Explanation of Each Cue in the Mnemonic COVER ABCD<sup>74</sup>

C1	Circulation	Establish adequacy of peripheral circulation (rate, rhythm, and character of pulse). If pulseless, institute cardiopulmonary resuscitation (CPR). The core algorithm must still be completed as soon as possible.
C2	Color	Note saturation. Examine for evidence of central cyanosis. Pulse oximetry is superior to clinical detection and is recommended. Test probe on own finger, if necessary, while proceeding with O <sub>1</sub> and O <sub>2</sub> .
O1	Oxygen	Check rotameter settings, ensure inspired mixture is not hypoxic.
O2	Oxygen analyzer	Adjust inspired oxygen concentration to 100% and note that only the oxygen flowmeter is operating. Check that the oxygen analyzer shows a rising oxygen concentration distal to the common gas outlet.
V1	Ventilation	Ventilate the lungs by hand to assess breathing circuit integrity, airway patency, chest compliance, and air entry by “feel,” careful observation, and auscultation. Also inspect capnography trace.
V2	Vaporizer	Note settings and levels of agents. Check all vaporizer filler ports, seatings, and connections for liquid or gas leaks during pressurization of the system. Consider the possibility of the wrong agent being in the vaporizer.
E1	Endotracheal tube	Systematically check the endotracheal tube (if in use). Ensure that it is patent with no leaks or kinks or obstructions (see suggested protocol in <i>Anaesth Intensive Care</i> 1993;21:615). Check capnograph for tracheal placement and oximeter for possible endobronchial position. If necessary, adjust, deflate cuff, pass a catheter, or remove and replace.
E2	Elimination	Eliminate the anesthetic machine and ventilate with self-inflating (e.g., Ambu®) bag with 100% oxygen (from alternative source if necessary). Retain gas monitor sampling port, but be aware of possible problems.
R1	Review monitors	Review all monitors in use (preferably oxygen analyzer, capnograph, oximeter, blood pressure, electrocardiograph, temperature and neuromuscular junction monitor). For proper use, the algorithm requires all monitors to have been correctly sited, checked, and calibrated.
R2	Review equipment	Review all other equipment in contact with or relevant to the patient (e.g., diathermy, humidifiers, heating blankets, endoscopes, probes, prostheses, retractors, and other appliances).
A	Airway	Check patency of the nonintubated airway. Consider laryngospasm or presence of foreign body, blood, gastric contents, or nasopharyngeal or bronchial secretions.
B	Breathing	Assess pattern, adequacy, and distribution of ventilation. Consider, examine, and auscultate for bronchospasm, pulmonary edema, lobar collapse, and pneumo- or hemothorax.
C	Circulation	Repeat evaluation of peripheral perfusion, pulse, blood pressure, electrocardiograph, and filling pressures (where possible) and any possible obstruction to venous return, raised intrathoracic pressure (e.g., inadvertent peak end-expiratory pressure) or direct interference to (e.g., stimulation by central line) or tamponade of the heart. Note any trends on records.
D	Drugs	Review intended (and consider possible unintended) drug or substance administration. Consider whether the problem may be a consequence of an unexpected effect, a failure of administration, or wrong dose, route, or manner of administration of an intended or “wrong drug.” Review all possible routes of drug administration.

Runciman WB, Kluger MT, Morris RW, et al. Crisis management during anaesthesia: the development of an anaesthetic crisis management manual. *Qual Saf Health Care* 2005;14(3):e1. With permission from the BMI Publishing Group.

if “better monitoring” had been employed. For management of the difficult airway, prevention is more challenging. Peterson et al. reported that “Persistent failed attempts at intubation were associated with an outcome of death or brain damage in claims in which a ‘cannot ventilate and cannot intubate’ emergency situation developed prior to surgical incision.”<sup>75</sup> They concluded that this was confirming evidence for limiting conventional ventilation efforts to 3 attempts before using other strategies. Despite substantial advances in technologies that aid endotracheal intubation and some

helpful, although far from foolproof, methods of airway assessment, there remain many opportunities for unanticipated difficulties with airway management, tracheal intubation, and effective ventilation (see Chaps. 12 and 35). Each is an opportunity for a serious adverse outcome. Although airway management skills are greatly emphasized during training, there is great variance in experience and abilities among anesthesia providers, as are the opportunities to practice emergency skills. Thus, periodic retraining and practice in the application of difficult airway management protocols is pru-

dent. (This is an example of the value of simulation as a tool for learning and maintaining skills that may be needed infrequently, but which are essential for patient safety.)

### Monitoring and Alarms

Failure to monitor the patient adequately is an important contributor to anesthesia adverse events, both in critical incident studies and in the closed claims studies. Aside from failures of vigilance, which are often related to performance-shaping factors, monitoring technology design and lack of experience with technology can contribute

to adverse outcomes. There are numerous ways in which pulse oximetry, capnometry, and automated noninvasive blood pressure monitors can give false information, leading to missed or incorrect diagnoses. The failure to use alarms has led to a requirement in the relevant standard that when a pulse oximeter is used, the variable pulse pitch tone and low-threshold alarm of the oximeter must always be audible.<sup>76</sup> Similarly, when capnography or capnometry is used, the end-tidal CO<sub>2</sub> alarm must be audible.

### Medication Errors

Medication errors are among the most frequent errors in anesthesia, and in healthcare practice in general.<sup>21</sup> Similarity of drug names, containers, and label colors contribute to the ease by which such errors can be made, especially during periods of high stress. Dosing errors are also common and related to the frequent need for individual numerical calculations when drawing and mixing drugs for bolus administration or intravenous infusion. Choosing the wrong form of drug (e.g., among various insulin formulations), flushing a catheter with a solution containing another potent drug, and confusion in the programming of infusion pumps are other examples of ways in which patients can be injured.

An obvious recommendation for prevention of some medication errors is to admonish the provider to read the label carefully.<sup>77</sup> Another tactic is to read each label 3 times. Yet, human factors issues are widely recognized as contributing greatly to medication errors, especially because of similarity of drug names, the small or obscure print on vials or ampules, and the failure to organize medication carts optimally to avoid errors. Distractions and production pressure also are likely contributors to medication errors. No universal remedy for prevention has been identified. There is a standard for label colors and grouping by drug type, but some argue that it is unlikely to be effective and, if anything, all drug labels should be in black and white to force careful reading of the drug identity and concentration.<sup>78</sup>

### Errors in Diagnosis

Diagnostic errors are likely underreported because of the difficulty in their identification. Yet it is likely that diagnostic errors occur, especially dur-

ing the management of critical events. Gaba has described 3 forms of fixation errors, including “this and only this” (fixating on a single diagnostic possibility to the exclusion of others, a form of “tunnel vision”), “everything but this” (searching among many possibilities but not including the real explanation) and “everything’s OK” (persistent belief that there is no problem in spite of substantive signs that there is a problem).<sup>62</sup>

### Equipment Errors and Failures

Current anesthesia machines and associated technology incorporate substantial safety features (see Chap. 38), which have been developed over decades in response to specific series of patient injuries associated with failure or misuse of equipment. Equipment failure is frequent and can occur in many ways, but rarely causes injury directly.<sup>21,79,80</sup> When there is an equipment-associated injury, it is more likely to be from misuse than from overt failure of a device. Whereas the end user may be at fault, human factors research dictates that causes related to the design of technology and the lack of training and practice are equally, if not more, responsible. Among the legendary failures associated with poor human factors are the failure to turn on a ventilator that was briefly suspended during measurement of cardiac output or performance of radiologic studies, or the accidental, unnoticed disconnection of an intravenous or arterial pressure cannula leading to blood loss or failure of fluid or drug administration. Users can reduce hazards by ensuring they obtain adequate training before using a new device, conducting a systematic preuse inspection of devices, and using backup monitoring devices as aids to vigilance. Never turning off an alarm is an essential precept to safe care.

### Errors Associated with a Lack of Standard Practice and Unusual Situations

The complexities of anesthesia create many opportunities for preventable adverse events caused by unusual circumstances or pitfalls. Goldhaber-Feibert and Cooper, taking from a convenient sample of clinician experiences, offers numerous examples<sup>49</sup>:

- A Passy-Muir valve (PMV), a form of “talking” tracheotomy tube, left on a tracheostomy when inflating the

cuff to deliver positive-pressure ventilation causes repeated inflation of the patient’s lungs with no mechanism for exhalation.

- An emergency can arise during transport of the intubated patient if the tracheal tube is accidentally dislodged.
- Administration of undiluted phenytoin (Dilantin) by rapid intravenous infusion can cause refractory hypotension, arrhythmias, and death.
- Administration of undiluted potassium by rapid intravenous infusion can cause ventricular fibrillation and cardiac arrest.
- Neostigmine given without an antimuscarinic drug (e.g., glycopyrrolate) can cause asystole/severe bradycardia and atrioventricular (AV) block, and can be fatal.
- Inadvertent intravascular injection of local anesthetics during a nerve block can cause neurologic and cardiac toxicity, which can be fatal (especially with bupivacaine).
- Air embolism can occur during the placement or removal of central venous catheters.
- Limb necrosis can develop if the tourniquet used for intravenous placement or blood draw is left on the anesthetized patient for a prolonged period.
- Intracranial pressure (ICP) may be increased if a ventriculostomy drain is connected to a pressurized bag of heparinized saline (in a patient who likely already has a high ICP).

Even though these situations are likely obvious to experienced clinicians, they might occur under periods of stress and might not be obvious to the uninformed neophyte. Learning may arise haphazardly in the absence of a systematic approach to training.

## THE DIMENSIONS OF QUALITY

Despite the widespread use of the term by both the public and the professions, *quality* in healthcare continues to have multiple meanings, depending especially on the views of the beholder. However, few would deny that the concept of quality care has gained increasing importance over the past 2 decades, as both health professionals and the public have focused greater



attention on this aspect of healthcare delivery. A discussion of all aspects of quality goes beyond the bounds of this chapter, but focus on some of the key concepts is appropriate if anesthesia providers are to become full participants in the quality movement, a prominent force in the early 21st century. Our comments are limited to some of the essential features of quality and its application to anesthesia practice.

What is quality as applied to healthcare? “Quality” is an abstract concept, with little intrinsic meaning. Rather, it represents the extent to which the expectations of healthcare consumers are met by healthcare providers, whether that consumer is the patient, a professional colleague, the payer, or the facility that provides resources for the care delivery. In this context, the “consumer” of anesthesia services includes not only the patient, but the surgeon or other operator who requires anesthesia services to perform a diagnostic or therapeutic procedure.

Numerous definitions of quality exist, but perhaps the most widely accepted definition is that of the IOM, which we noted earlier: Quality is the “extent to which health services for individuals and populations increase the likelihood of desired health outcomes and are consistent with current professional knowledge.”<sup>4</sup> Thus quality represents not a distinct entity or end point, but a continuum in the

process of meeting the rational expectations of others who interact with the providers of healthcare services. Two major concepts are inherent in the IOM definition of quality: measurement (i.e., “outcomes”) and evidence-based care (i.e., “current professional knowledge”). Inherent in the definition of quality is the view that safety is the essential foundation for quality, and that high quality practice cannot be achieved in the absence of safe practice. Figure 3–2 illustrates these concepts.

Donabedian, a leader in the genesis of the quality movement, proposed that quality could be evaluated by examining its major components: structure, process, and outcomes.<sup>12</sup> Structure involves the facilities and environment in which care is delivered (e.g., governance, policies and procedures, and specific details, such as cleanliness, attractiveness, ease of access, noise levels, privacy); process involves how care is actually delivered, including the interactions between clinicians and patients (e.g., the elements of communication including listening, sensitivity, compassion, the development of trust); outcomes involves measures of results of the care provided (e.g., mortality, morbidity, speed of recovery). Inherent in these evaluations of quality are the patients’ perspectives on each of these areas, whereas historically, both clinicians and facilities focused primarily on the

technical aspects of care delivery. Thus the role of the consumer (especially the patient) in the evaluation of healthcare quality has increased considerably in recent years.

Building on these concepts, the IOM has gone further in defining quality, by identifying 6 desired characteristics of healthcare. Thus high-quality care should be safe, timely, effective, efficient, equitable, and patient-centered (often abbreviated as STEEEP, for ease of recall). Here, also, the concepts of measurement and current knowledge are apparent throughout.

Although recent quality initiatives have focused on the patient–provider relationship, there are other dimensions of healthcare delivery that require attention for both safe and high quality practice. The relationships among providers are key elements in the care process, especially in an era when complex care management is provided by specialists and subspecialists who focus on specific aspects of care. That complexity often leads to communication lapses and fragmentation without subsequent integration into a coordinated system of care that focuses on the patient’s needs for understanding, planning, and decision making. Thus patients often rate communication as one of the most important components in the evaluation of quality healthcare, whereas physicians often rate technical abilities as considerably more important than communication.<sup>81</sup>

Eliminating these lapses in communication is essential for both patient compliance and patient satisfaction; eliminating the lapses benefits both process and outcome in the delivery of care. Furthermore, it minimizes the frustrations that patients and families experience as a result of conflicting or inadequate communications among professionals, leading to mistrust of the provider by the consumer. Finally, the development of relationship-centered care teams, wherein all parties have developed a pattern of open communication and mutual respect and trust, increase both safety and quality in multiple industries, including healthcare.<sup>82</sup>

These concepts apply as much to the discipline of anesthesiology as to other disciplines in the healthcare delivery process. Anesthesia providers, as individuals and departments, must institute these principles, including practical measurement of outcomes

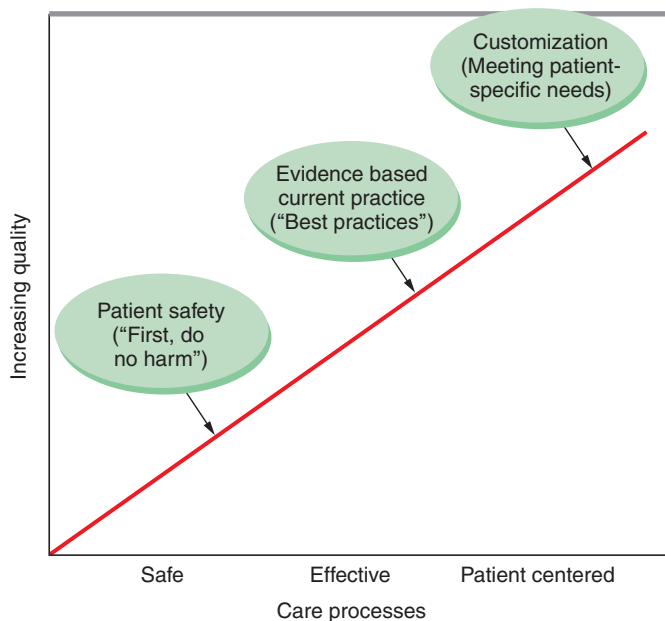


FIGURE 3–2. The relationship between safety and quality and the process of care.

and the development of relationship-centered clinical teams, if they expect to practice at the higher levels of the quality spectrum (i.e., beyond the fundamental level of safe practice).

## THE ELEMENTS OF SAFE, HIGH-QUALITY ANESTHESIA CARE

Creating a safe, high-quality practice of anesthesia depends on a combination of broad strategies and effective tactics for day-to-day work. Many models for establishing safe environments and practices and for ensuring quality have been described, but there is no empirical evidence from controlled studies to demonstrate that a specific model is superior to other models. Still, there is face validity from qualitative studies in specific industries and organizations to suggest that having an overall systematic approach leads to both safer and higher quality care. Indeed, a recent combined report from the National Academy of Engineering and the IOM emphasized that systems approaches to healthcare delivery were most likely to transform healthcare to deliver the goals of safe, timely, effective, efficient, patient-centered care in the future.<sup>83</sup>

### The High-Reliability Organization Model

Although several models have been promulgated for managing quality (see Chap. 25), there are fewer directed primarily at safety. For the latter, the concept of the HRO was formulated from observations in highly hazardous industries that, despite operating under conditions of high risk, have many fewer serious accidents than expected.<sup>84,85</sup> Such industries included naval aviation, nuclear power, and offshore oil platforms. Weick and Sutcliffe further describe how organizations can be successful if they appropriately “manage uncertainty.”<sup>86</sup> Gaba applied these concepts to healthcare.<sup>34</sup> Although there is no single, accepted model of an HRO, Weick lists the following elements that characterize a typical highly reliable organization:

- *Preoccupation with failure*—Despite its good safety records, an HRO will constantly be on the lookout for any signs of weak systems or impending failure. An HRO assumes that failure is imminent and plans for the worst. In anesthesia, this extends to organizational and individual plan-

ning for potential failures or problems in every procedure.

- *Reluctance to simplify interpretations*—Managers often look for simple answers to problems. In an HRO, interpretations are more nuanced and skepticism about apparent explanations is encouraged. Rather than simply blaming the people who are the proximal agents in a causal chain of events, an HRO seeks to understand the latent failures that led to an individual’s failure to perform flawlessly.
- *Sensitivity to operations*—An HRO pays close attention to how work actually gets done on the frontline rather than merely proposing solutions that appear reasonable from a distance. Cook wrote about the danger of ignoring the ways in which workers must act to do their jobs, often needing to circumvent rules made by managers or regulators who do not understand the complexity and challenges in healthcare systems.<sup>37</sup>
- *Commitment to resilience*—The HRO understands that regardless of its best efforts, things do go wrong and people do make mistakes. An HRO “develop[s] capabilities to detect, contain, and bounce back from those inevitable errors that are part of an indeterminate world.” In the operating room, this translates to ensuring adequate backup of personnel, supplies, and equipment.
- *Deference to expertise*—During a crisis in an HRO, decision making falls to the person most experienced in dealing with that kind of problem, not to the most senior person. A good leader seeks out that expertise rather than squelching disagreement or demanding loyalty.

Another critical feature of an HRO is that safety is the highest priority over all other concerns. That is, the interests of production and speed are not allowed to supersede the need to ensure safety.<sup>34</sup> Another element of HROs, one that has direct implications for anesthesia practice, is the need for intensive and regular training, especially with simulation.<sup>87</sup> For high-hazard industries that face rare events requiring expertise to avoid an adverse outcome, frequent training and practice are essential; all of these conditions are met in the practice of anesthesiology.

HROs are also noted for organizational learning, especially from accidents and near misses. Healthcare recently embraced the process of root cause analysis (RCA).<sup>11</sup> An RCA is applied to unusual, potentially harmful events in an effort to understand the many elements that contribute to an event and use the findings to design and implement corrective interventions (see Chap. 25 for more detail on RCA). Failure mode and effect analysis (FMEA) is one of several industry techniques to study new processes proactively, before an adverse event occurs.<sup>88</sup> The FMEA is used to identify potential failure modes and key points where barriers are needed to minimize the potential for failure (see Chap. 25 for a more detailed discussion of RCA and FMEA as risk-reduction strategies).

Vaughan described the concept of “normalization of deviance” that arises when an otherwise safe organization drifts into unsafe conditions.<sup>89</sup> In analyzing the sociologic features of the disintegration of the *Challenger* orbiter (“shuttle”) in 1988, Vaughan identified how NASA, under intense financial and political pressures, evolved from an organization that had once highly valued safety to one that gave production a higher priority. This led to what she called a “normalization of deviance” in the way engineers made decisions about safety issues. Rather than demanding that assurance of safety was the highest priority at each step, the “burden of proof” had shifted—to cancel or delay a launch, engineers were asked to prove that conditions were unsafe, where previously, to allow a launch, they were required to prove that each item was safe. This critical shift in emphasis has direct applications to anesthesia and surgery.

To ensure safety, strategies and tactics must be implemented at all levels throughout an organization, from senior management to bedside provider. That process has 2 major elements of responsibility: the organization and the individual.

### Creating Safety at the Organizational and Department Level

The organization is responsible for creating a safe culture throughout its various levels.

Culture is the “shared values and beliefs that interact with an organiza-

tion's structures and control systems to produce behavioral norms."<sup>33</sup> More simply stated, it is "the way we do things around here." Cultural characteristics are usually deeply ingrained, not immediately visible, and often difficult to modify. Yet, it is the culture that defines the overall commitment to safety of an organization. Although highest reliability can likely only be achieved within a consistent culture of safety across an organization, the perioperative subcultures and anesthesia practices and departments can establish strong safety cultures within their sphere of influence. Batalden refers to these smaller elements as "microsystem environments," and emphasizes that safety and quality must be applied at these levels, as well as in the more global "macrosystems environments" (i.e., it must be brought from the corporate or departmental office to the bedside to be effective).<sup>90</sup> In contrast, the individual practitioner working in various environments (e.g., *locum tenens* practice), will find it difficult to achieve an overall high-quality, safe practice in an organization that gives only lip service to safety.

There is a growing literature about safety culture (also referred to as "climate"; the terms are similar but not synonymous) in healthcare.<sup>91,92</sup> One means to assess the organizational culture is to conduct periodic surveys. Little is written about the perioperative or anesthesia department patient safety culture or what should be its defining characteristics. Helmreich reported on use of one survey instrument, the Operating Room Management Questionnaire, and compared attitudes of surgeons to pilots, whose safety culture is generally believed to be superior to that found in many industries as a result of long-standing attention to safety training and interventions.<sup>93</sup> (Others, less reverently, attribute the safety focus of pilots to the observation that they are usually first on the scene of aviation accidents!). Although there are many similarities with pilots, surgeons appear to have attitudes that are not aligned with safety science, such as a perception that their performance is not affected by fatigue. Flin reported on results of a survey from anesthesia departments in the United Kingdom with a similar finding about the effects of stress and fatigue.<sup>94</sup> Also, for example, although perceptions of teamwork were generally positive, only 65% of

respondents perceived that operating room personnel worked well together as a team. Respondents also reported variable compliance with procedures and policies.

The Joint Commission on Accreditation of Healthcare Organizations (JCAHO) presumes to assess the organizational and department level of safety through its process of accreditation, which lists many requirements for anesthesia services. Included among those are processes to credential individual practitioners, processes for evaluating unusual clinical events (quality assurance or quality improvement), policies and procedures for common procedures, and a program for ensuring that individuals are trained on the technologies they use.<sup>95</sup> Periodic inspections are used to assess the compliance with the JCAHO requirements, but these requirements are generally viewed by practitioners as bureaucratic and of limited value in ensuring that safety is deeply ingrained in ongoing practices.

Extrapolating from the earlier descriptors of an HRO, we can imagine that a safe perioperative culture demonstrably places safety as its priority with regular meetings of the group and teams; organizational learning via reporting systems that are open, fair, and nonpunitive; a formal and active quality improvement process; by implementing corrective actions on learning of unsafe practices; having policies and procedures defining standard operations; have regular training for common emergencies; being nonhierarchical during emergencies; rewarding those who raise safety concerns and have open discussions about those concerns; having processes for briefing and debriefing about near misses and adverse events; having standard processes for communication among providers especially for transitions in care; and use other similar processes and attributes. Amazingly, few organizations have these attributes, especially those related to multispecialty analyses of the causes of errors and adverse events; too often these analyses take place in parallel processes that result in the allocation of blame rather than resolution of the root causes that are embedded in the larger system, or the interfaces between services or providers.

The safe organization ensures that its workers practice safety and provides the support and resources to

enable them to do so. It is then the responsibility of the individual to develop and maintain a continuous personal commitment to safety by adopting a spectrum of safe practices as outlined in the next section.

## **Practical Elements for the Practitioner for Producing Safe, High-Quality Patient Care**

### ***Importance of Instilling Values of Patient Safety, Quality and Patient Centeredness***

Safety demands that each individual, as well as the organization, make preventing any injury or harm to the patient the highest priority. For the individual clinician, a continual commitment to safe practice includes avoidance of unnecessary risk taking and avoidance of corner cutting, an almost unending anticipation of what might go wrong, projection of actions in anticipation of failure and, above all, mindfulness. Weick describes mindfulness for HROs as organizing in such a way as to "better notice the unexpected in the making and halt its development."<sup>86</sup> The concept applies equally well to the individual practitioner or member of the perioperative care team. Weick goes on to say that "[m]indfulness preserves the capability to see the significant meaning of weak signals and to give strong responses to (them). This counterintuitive act holds the meaning to managing the unexpected." Being patient-centered includes placing the patient's needs above all others, especially protecting the patient from harm. Thus, patient safety and patient centeredness are intimately connected and the hallmarks of high-quality practice.

### ***Maintaining Vigilance and Mitigating Performance Decrement***

Although vigilance cannot be relied on solely to protect the patient from harm, it remains the strongest underpinning of safety in anesthesia. This means that the anesthesia provider must maintain alertness and be aware of, compensate for, and counteract the forces working against vigilance. This, too, requires mindfulness about the state of one's own vigilance.

Fatigue and sleep deprivation are probably the most common causes of lapses in vigilance. Howard et al. have recommended several "fatigue



countermeasures.<sup>43</sup> Among these are education about the effects of fatigue on vigilance, employing good sleep hygiene (regular bedtime and wake-up time; restricting alcohol, caffeine, and nicotine use; creating good conditions for sleep), rest breaks, strategic napping, and selected medications, if necessary.

There is no evidence to support any specified time between breaks, but awareness of a fatigued state can suggest when a break is needed. Naps are often inconsistent with daily clinical routines, but may be appropriate when routines are disrupted or during “on call” intervals. Optimal nap times are on the order of 45–60 minutes to improve alertness while minimizing sleep inertia on awakening. Napping is best done when circadian rhythms are enabling sleep (between 2:00 and 6:00 P.M. and 2:00 and 6:00 A.M.), and is more difficult to do when circadian rhythms are encouraging wakefulness. The evidence that napping improves performance of flight crews is strong enough that appropriate napping is recommended during long duration flights.<sup>96</sup> Caffeine can be used judiciously to compensate for fatigue.<sup>43</sup> Excessive use or inappropriate timing of caffeine use can have the negative consequence of preventing subsequent sleep.

Relief breaks, either during a procedure or at a change of shift, are a double-edged sword, providing an opportunity to identify an undiscovered problem or to create a new problem because of lesser situational awareness by the relieving provider.<sup>45,46</sup> A preplanned protocol should be followed to optimize information transfer during the handoff.<sup>48,49</sup>

### **Practice in a System of Care**

Anesthesiologists must identify and integrate into the larger system of care in which they operate. Safe care depends on the effective work of many others working as a team, and understanding their constraints and processes can go far toward creating an environment of safety. This includes learning how to operate within a team rather than primarily as an individual. If the anesthesiologist can determine how the surgeon, consultant physicians, nurses, allied health professionals, and laboratory support personnel and systems function, and where “glitches” may develop in these systems, then the anesthesiologist can

be prepared to mitigate or interrupt cascades that lead to adverse events. For example, understanding how and under what conditions delays in delivery of laboratory information might occur, knowing when nursing turn-overs occur, and understanding what factors affect surgical judgment can alert the anesthesia practitioner to strategies that might reduce errors. An example is failure to transfuse when blood loss is excessive (e.g., a system of events where estimation of blood loss by the nurses is interrupted by change of shift, laboratory reports are delayed due to time pressures in the laboratory and the surgeon “hopes” that the bleeding is controlled; this sequence is a classic example of the “holes in the Swiss cheese” aligning in a way that fosters medical error). Integrating anesthesia practices into the overall system, rather than acting in isolation, is more likely to result in safe and efficient processes for the entire patient-care experience.

### **Teamwork**

Although teamwork can be seen as a subset of working within a system of care, it also includes specific practices for optimizing safety. Box 3–3 lists some of the recommended practices of high-performance teams in nonhealth-care domains.

### **Preparation**

The failure to adequately prepare for anesthesia administration often contributes to anesthesia critical incidents.<sup>20,21,97</sup> Preparation encompasses a large set of issues, including complete preoperative assessment (see Preoperative Assessment and Planning below); ensuring availability of emergency drugs, equipment, and supplies; checking out the function of equipment (especially using the FDA recommended procedure for ensuring functionality of the anesthesia machine<sup>98</sup>); and ensuring communication pathways in the event of an emergency.

### **Preoperative Assessment and Planning**

Preoperative assessment and planning involves evaluation of the patient and development of the anesthesia plan that includes the anesthetic technique, the requirements for monitoring, and the plans for postoperative care, all of which must be consistent with the wishes of the patient and the needs of the surgeon or other operator (e.g.,

radiologist, cardiologist), and the resources of the facility.

The evaluation must be thorough and appropriate for the procedure and the patient; most especially, it must include a systematic evaluation of comorbidities or other factors that might lead to adverse outcomes. Even in healthy patients, there may be conditions that can lead to adverse events, such as difficult airway access, family history of relevant disease, or the recent use of nonprescription or illicit drugs. (Preoperative evaluation is considered in Chap. 4, and for specific conditions in Chaps. 6–23.) Similarly, an anesthetic plan must be developed that is consistent with both patient wishes and operator requirements, and with the plans for postoperative care. The anesthetic plan should never be based on a rote formula that depends on the procedure only; it should be tailored to the needs of patient, operator, and facility, including the environment and plans for postoperative care. Chapter 5 addresses the development of the anesthetic plan in detail.

### **Monitoring**

Because failure to monitor is so often associated with adverse outcomes, this issue deserves special attention. The safe practitioner follows the standards promulgated by the ASA except in truly extraordinary situations, and should those occur, documents the reason for noncompliance. Critical alarms should never be disabled.

### **Control for Human Factors**

Although the individual anesthesia provider has little control over the design of equipment and local systems, he or she does have substantial control over many of the human factors features that are part of the environment. Attention to the organized arrangement of supplies and drugs, especially adherence to consistent labeling of drugs, and establishing and adhering to local standards are examples. Care to keep arterial and intravenous cannulae and monitoring cables orderly, ensuring reasonable lighting, and reducing clutter, noise, and distractions are general, sound, safety practices. Control of noise levels and background music can be contentious issues among staff, surgeons, and anesthesia providers, who sometimes are urged to compromise the principle that patient safety takes preeminence.

Reasonable efforts should be made to reach compromise and music should be discontinued during management of critical events.

### **Applying Systematic Crisis Management Techniques**

Anesthesia crisis resource management (ACRM) is an organized set of principles for managing crisis situations in anesthesia. Adapted by Gaba et al. from CRM in aviation, it consists of several founding principles for effective management of acute events.<sup>62,70,99,100</sup> Although there is no single adopted standard, the following principles are generally applicable:

- Seek assistance early and quickly—inform others on the surgical team and call for extra assistance as soon as unusual circumstances are recognized.
- Establish clarity of roles for each person involved in management of the event; especially identify who will manage the event (event manager).
- Use effective communication processes, including reading back of instructions, being clear to whom directions are being given.
- Use resources effectively and identify what additional resources (people, supplies, equipment, transportation, etc.) are available to manage the situation.
- Maintain situational awareness and avoid fixations, which is perhaps the most challenging task as situational awareness is difficult to retrieve once it is lost. Having one person act as event manager, observing the big picture rather than becoming immersed in the details, is thought to be effective.

The algorithm of ABCD COVER swift check discussed earlier (Box 3-4) should be available for reference.

### **Infection Control**

Care in the safe use and sterility of all anesthesia systems is essential, especially in the modern hospital environment where hospital-acquired infections with resistant organisms (e.g., methicillin- or vancomycin-resistant *Staphylococcus aureus* organisms) are increasingly common. Adherence to carefully timed protocols for antibiotic administration in the perioperative interval reduces postoperative wound infection.<sup>101</sup> Surgical wound infection rates are increased 3-fold by hypother-

mia and reduced by increased perioperative oxygen administration.<sup>102,103</sup>

### **Following Standards and Practice Guidelines**

The ASA has established a large set of practice standards and guidelines.<sup>104</sup> Standardizing practices across providers is widely accepted as a critical component for safety and reliability. Box 3-5 lists common practice standards. Each practitioner is obligated to be familiar with such guidelines and apply them appropriately in his or her practice. Similarly, healthcare facilities are required to establish local policies and procedures to ensure standardization of basic practices. These, too, must be known and followed.

### **Periodic Training**

Because critical events are relatively rare and demand expert and effective treatment, it is important to practice skills periodically. Schwid demonstrated that advanced cardiac life support (ACLS) skills are generally maintained for only approximately 6 months.<sup>105</sup> Periodic training includes practice in management of the unanticipated difficult airway, generic skills in ACRM, and drills for operating room fires and other specific anesthetic emergencies, such as malignant hyperthermia. Simulation is increasingly used for such training. Some practice can be achieved via computer-based simulators and trainers, which are effective for obtaining knowledge in management of acute events.<sup>106</sup> Simulation using various forms of simulators, from basic to the most realistic environment, is effective for imparting generic, nontechnical (behavioral) skills in managing critical events.<sup>66</sup> Resources for obtaining such training are expanding and the ASA is encouraging its members to maintain their skills in this way. In the future, simulation may become part of evaluation processes of accrediting agencies.

## **INVOLVING THE PATIENT IN SAFETY AND QUALITY**

Patients increasingly are being urged to take a role in ensuring the safety of their own care, as well as being involved in patient safety by their healthcare providers.<sup>107</sup> Anesthesia professionals should encourage and assist in this because it benefits everyone. Providers should also be concerned with

### **BOX 3-5.**

#### **Key Standards of Care of the American Society of Anesthesiologists**

- Ambulatory Anesthesia and Surgery, Guidelines for—2003
- Basic Anesthetic Monitoring, Standards for—2004
- Clinical Privileges in Anesthesiology, Guidelines for Delineation of—2003
- Critical Care by Anesthesiologists, Guidelines for the Practice of—2004
- Documentation of Anesthesia Care—2003
- Ethical Guidelines for the Anesthesia Care of Patients with Do-Not-Resuscitate Orders or Other Directives That Limit Treatment—2001
- Ethical Practice of Anesthesiology, Guidelines for the—2003
- Labeling Pharmaceuticals for Use in Anesthesiology, Statement on—2004
- Nonoperating Room Anesthetizing Locations, Guidelines for—2003
- Obstetrics, Guidelines for Regional Anesthesia Care in—2000
- Obstetrics, Optimal Goals for Anesthesia Care in—2000
- Office-Based Anesthesia, Guidelines for—2004
- Patient Care in Anesthesiology, Guidelines for—2001
- Postanesthesia Care, Standards for—2004
- Preanesthesia Care, Basic Standards for—2005

Data from American Society of Anesthesiologists.<sup>104</sup>

the patient's perceptions of the quality of care and consider more than just the needs of the direct surgical process. There are several ways in which these goals can be achieved.

To encourage patient involvement, actions can be taken to foster "patient-centered communication," which has been defined as including the following:<sup>108</sup>

- Eliciting and understanding the patient's perspectives—concerns, ideas, expectations, needs, feelings, and functioning.
- Understanding the patient within his or her unique psychosocial context.
- Reaching a shared understanding of the problem and its treatment with the patient that is concordant with the patient's values.



- Helping patients share power and responsibility by involving them in choices to the degree that they wish to be involved.

What specific things can anesthesia providers do to involve patients in their own care that will not just improve satisfaction but also safety? Consider the following:

- Tell the patient as much as practical (assessing how much the patient can handle knowing) about the process of anesthesia care the patient will experience.
- Provide information preoperatively about the process of anesthesia care and expectations; several references are available on the Internet in addition to books and pamphlets.
- Encourage the patient to speak up if the patient doesn't understand something or believes something is inappropriate, such as drugs being given, absence of handwashing or glove wearing.
- Involve the patient's family members in care whenever practical.
- Advise the patient to contact you if there are any concerns or possible side effects after the anesthetic.
- In concert with other providers, disclose errors and adverse events (a strategy that enhances trust and decreases skepticism in concerned patients).
- Involve patients on committees that involve the design of anesthetizing locations, and in the process of patient flow and family communication in such facilities.

## SUMMARY AND CONCLUSIONS

The concepts of quality, safety, and patient centeredness are prominent themes throughout American health care, and they have been embraced by patients and affirmed by third-party payers, specialty societies, and health care organizations, both governmental and private. Despite the increased focus on these factors, the goals have yet to be met, especially because most initiatives have focused on individual practitioners or within specific disciplines. To achieve the full goals of quality and safety, the processes must include systematic approaches that cross the boundaries of specialties,

clinical services, and facilities. In short, the delivery of care must be recognized as a complex matrix of interactions among multiple providers, including both clinicians and facilities, all interacting with one another in a system of systems. The specialty of anesthesiology is a leader in the development of patient safety approaches within its discipline; the next steps involve building safety and quality into this larger system of care. Anesthesia providers can contribute significantly to achieving these goals by participating fully in the system-of-systems approach, as well as by building highly reliable microsystems within their department or group. These approaches are best understood by adopting a patient-centered approach, whereby all providers interpret the integrated care process from the patient's viewpoint, and include that viewpoint in the design and delivery of care.

## KEY REFERENCES

1. Baker DP, Salas E, King H, et al. The role of teamwork in the professional education of physicians: current status and assessment recommendations. *Jt Comm J Qual Patient Saf* 2005;31(4):185–202.
2. Cooper JB, Newbower RS, Kitz RJ. An analysis of major errors and equipment failures in anesthesia management: considerations for prevention and detection. *Anesthesiology* 1984;60(1):34–42.
3. Gaba D, Fish K, Howard S. *Crisis Management in Anesthesiology*. Philadelphia: Churchill Livingstone; 1994.
4. Gaba DM, Howard SK, Fish K, et al. Simulation-based training in anesthesia crisis resource management (ACRM): a decade of experience. *Simul Gaming* 2001;32(2):175–193.
5. Kohn LT, Corrigan JM, Donaldson MSE. *To Err is Human: Building a Safer Healthcare System*. Washington, DC: National Academy Press, 1999.
6. Reason J. *Managing the Risk of Organizational Accidents*. Aldershot, Hants, UK: Ashgate Publishing, 1997.

## REFERENCES

1. Shafer A, Fish MP, Gregg KM, et al. Preoperative anxiety and fear: a comparison of assessments by patients and anesthesia and surgery residents. *Anesth Analg* 1996;83(6):1285–1289.
2. Klafta JM, Roizen MF. Current understanding of patients' attitudes toward and preparation for anesthesia: a review. *Anesth Analg* 1996;83(6):1314–1312.
3. Committee on Quality of Health Care in America. *Crossing the Quality Chasm: A New Health System for the 21st Century*. Washington, DC: National Academy Press, 2001.
4. Lohr KNE. *Medicare: A Strategy for Quality Assurance*. Washington, DC: National Academy Press, 1990.
5. Cooper JB, Gaba DM, Liang B, et al. Agenda for research and development in patient safety of the National Patient Safety Foundation. *MedGenMed* 2000. Available at <http://www.medscape.com/viewarticle/408064>. Last accessed January 27, 2007.
6. Tricare Management Activity. MHS Optimization and Population Health Support Center: Glossary of Terms. Military Health System, 2001. Available at: [http://www.tricare.osd.mil/mhsophsc/mhs\\_supportcenter/Glossary/Qg.htm](http://www.tricare.osd.mil/mhsophsc/mhs_supportcenter/Glossary/Qg.htm). Last accessed May 30, 2006.
7. Quality Interagency Coordination Task Force. *Doing what counts for patient safety: Federal actions to reduce medical errors and their impact*. Washington, DC: Quality Interagency Coordination Task Force, 2000. Report No.: # 1–58763–000–1.
8. Senders JW. Medical devices, medical errors, and medical accidents. In: Bogner MS, ed. *Human Error in Medicine*. Hillsdale, NJ: Lawrence Erlbaum Associates, 1994:166.
9. Reason J. *Human Error*. Cambridge, UK: Cambridge University Press, 1990.
10. Gosbee J, Gosbee L. *Using Human Factors Engineering to Improve Patient Safety*. Oakbrook Terrace, IL: Joint Commission on Accreditation of Healthcare Organizations, 2005.
11. Joint Commission Resources. *Root Cause Analysis in Healthcare*. Chicago: Joint Commission on Accreditation of Healthcare Organizations, 2003.
12. Donabedian A. *Explorations in Quality Assessment and Monitoring, Volume 1: The Definition of Quality and Approaches to Its Assessment*. Ann Arbor, MI: Health Administration Press, 1980.
13. Kohn LT, Corrigan JM, Donaldson MSE. *To Err is Human: Building a Safer Healthcare System*. Washington, DC: National Academy Press, 1999.
14. Snow J. *On Chloroform and Other Anesthetics*. London: John Churchill, 1858.
15. Vandam L. The approach to safety in anesthesia: an historical perspective. In: Eichhorn JH, ed. *Patient Safety in Anesthetic Practice*. New York: Churchill Livingstone, 1997:1–21.
16. Anonymous. Fatal application of chloroform. *London Medical Gazette* 1848;Sect. 253.

17. Beecher HK, Todd DP. A study of the deaths associated with anesthesia and surgery: based on a study of 599,548 anesthetics in ten institutions 1948–1952, inclusive. *Ann Surg* 1954;140(1):2–3.
18. Dripps RD, Lamont A, Eckenhoff JE. The role of anesthesia in surgical mortality. *JAMA* 1961;178:261–266.
19. Dripps RD, Vandam LD. Long-term follow-up of patients who received 10,098 spinal anesthetics: failure to discover major neurological sequelae. *JAMA* 1954;156(16):1486–1489.
20. Cooper JB, Newbower RS, Long CD, et al. Preventable anesthesia mishaps: a study of human factors. *Anesthesiology* 1978;49(6):399–404.
21. Cooper JB, Newbower RS, Kitz RJ. An analysis of major errors and equipment failures in anesthesia management: considerations for prevention and detection. *Anesthesiology* 1984;60(1):34–34.
22. Craig J, Wilson ME. A survey of anaesthetic misadventures. *Anaesthesia* 1981;36(10):933–936.
23. Kumar V, Barcellos WA, Mehta MP, et al. An analysis of critical incidents in a teaching department for quality assurance. A survey of mishaps during anaesthesia. *Anaesthesia* 1988;43(10):879–878.
24. Pierce EC Jr. The 34th Rovenstine Lecture. 40 years behind the mask: safety revisited. *Anesthesiology* 1996;84(4):965–967.
25. Cheney FW. The American Society of Anesthesiologists closed claims project: what have we learned, how has it affected practice, and how will it affect practice in the future? *Anesthesiology* 1999;91(2):552–556.
26. Gaba DM. Anaesthesiology as a model for patient safety in health care. *BMJ* 2000;320(7237):785–788.
27. Eichhorn JH, Cooper JB, Cullen DJ, et al. Standards for patient monitoring during anesthesia at Harvard Medical School. *JAMA* 1986;256(8):1017–1012.
28. US Congress. Patient Safety and Quality Improvement Act of 2005. Public Law #109-41. Available at [www.ahrq.gov/qual/psqact.htm](http://www.ahrq.gov/qual/psqact.htm). Last accessed January 27, 2007.
29. Cooper JB, Gaba D. No myth: anesthesia is a model for addressing patient safety. *Anesthesiology* 2002;97(6):1335–1337.
30. Eichhorn JH. Prevention of intraoperative anesthesia accidents and related severe injury through safety monitoring. *Anesthesiology* 1989;70(4):572–577.
31. Lagasse RS. Anesthesia safety: model or myth? A review of the published literature and analysis of current original data. *Anesthesiology* 2002;97(6):1609–1617.
32. Perrow C. *Normal Accidents—Living with High-Risk Technologies*. New York: Basic Books, 1984.
33. Reason J. *Managing the Risk of Organizational Accidents*. Aldershot, Hants, UK: Ashgate Publishing, 1997.
34. Gaba D. Structural and organizational issues in patient safety: a comparison of health care to other high-hazard industries. *Calif Manage Rev* 2000;43:83–102.
35. American College of Graduate Medical Education. General competencies, 1999. Available at: [www.acgme.org/outcome/comp/compFull.asp](http://www.acgme.org/outcome/comp/compFull.asp). Last accessed May 23, 2006.
36. Columbia Accident Investigation Board. Columbia Accident Investigation Board Report. Washington, DC: Government Printing Office, 2003.
37. Cook RI, Woods DD. Operating at the sharp end: the complexity of human error. In: Bogner MS, ed. *Human Error in Medicine*. Hillsdale, NJ: Lawrence Erlbaum Associates, 1994:255–310.
38. Vicente K. *The Human Factor*. New York: Routledge, 2004.
39. Weinger MB, Englund CE. Ergonomic and human factors affecting anesthetic vigilance and monitoring performance in the operating room environment. *Anesthesiology* 1990;73(5):995–1001.
40. Barger LK, Cade BE, Ayas NT, et al. Extended work shifts and the risk of motor vehicle crashes among interns. *N Engl J Med* 2005;352(2):125–123.
41. Landrigan CP, Rothschild JM, Cronin JW, et al. Effect of reducing interns' work hours on serious medical errors in intensive care units. *N Engl J Med* 2004;351(18):1838–1834.
42. Lockley SW, Cronin JW, Evans EE, et al. Effect of reducing interns' weekly work hours on sleep and attentional failures. *N Engl J Med* 2004;351(18):1829–1833.
43. Howard SK, Rosekind MR, Katz JD, et al. Fatigue in anesthesia: implications and strategies for patient and provider safety. *Anesthesiology* 2002;97(5):1281–1289.
44. Van Dongen HP, Price NJ, Mullington JM, et al. Caffeine eliminates psychomotor vigilance deficits from sleep inertia. *Sleep* 2001;24(7):813–819.
45. Cooper JB, Long CD, Newbower RS, et al. Critical incidents associated with intraoperative exchanges of anesthesia personnel. *Anesthesiology* 1982;56(6):456–461.
46. Short TG, O'Regan A, Jayasuriya JP, et al. Improvements in anaesthetic care resulting from a critical incident reporting programme. *Anaesthesia* 1996;51(7):615–621.
47. Arbous MS, Meursing AE, van Kleef JW, et al. Impact of anesthesia management characteristics on severe morbidity and mortality. *Anesthesiology* 2005;102(2):251–252.
48. Cooper J. Do short breaks increase or decrease anesthetic risk? *J Clin Anesth* 1989;1:228–231.
49. Goldhaber-Feibert SN, Cooper JB. Safety in anesthesia. In: Dunn P, ed. *Clinical Anesthesia Procedures of the Massachusetts General Hospital* 7th ed. Philadelphia: Lippincott Williams & Wilkins, 2007:127–134.
50. Hawksworth C, Asbury AJ, Millar K. Music in theatre: not so harmonious. A survey of attitudes to music played in the operating theatre. *Anaesthesia* 1997;52(1):79–83.
51. Monk TG, Giesecke AH. Reading in the operating room: is it acceptable just because we can? *Anesthesia Patient Safety Foundation Newsletter* 2004;19(3):33.
52. Gosbee J. Human factors engineering and patient safety. *Qual Saf Health Care* 2002;11(4):352–354.
53. Weinger MB, Herndon OW, Gaba DM. The effect of electronic record keeping and transesophageal echocardiography on task distribution, workload, and vigilance during cardiac anesthesia. *Anesthesiology* 1997;87(1):144–145.
54. Williams S, Beatty PC. Measuring the performance of audible alarms for anaesthesia. *Physiol Meas* 2005;26(4):571–578.
55. Gosbee JW. Conclusion: you need human factors engineering expertise to see design hazards that are hiding in "plain sight!" *Jt Comm J Qual Saf* 2004;30(12):696–697.
56. Fraind DB, Slagle JM, Tubbesing VA, et al. Reengineering intravenous drug and fluid administration processes in the operating room: step one: task analysis of existing processes. *Anesthesiology* 2002;97(1):139–134.
57. Vicente KJ, Kada-Bekhaled K, Hillel G, et al. Programming errors contribute to death from patient-controlled analgesia: case report and estimate of probability. *Can J Anaesth* 2003;50(4):328–332.
58. Gaba DM, Howard SK, Jump B. Production pressure in the work environment. California anesthesiologists' attitudes and experiences. *Anesthesiology* 1994;81(2):488–500.
59. Baker DP, Salas E, King H, et al. The role of teamwork in the professional education of physicians: current status and assessment recommendations. *Jt Comm J Qual Patient Saf* 2005;31(4):185–202.
60. Simon R, Salisbury M, Wagner G. MedTeams: teamwork advances emergency department effectiveness and reduces medical errors. *Ambul Outreach Spring* 2000;21–24.
61. Morey JC, Simon R, Jay GD, et al. Error reduction and performance improvement in the emergency department through formal teamwork training: evaluation results of the MedTeams project. *Health Serv Res* 2002;37(6):1553–1558.
62. Gaba D, Fish K, Howard S. *Crisis Management in Anesthesiology*. Philadelphia: Churchill Livingstone, 1994.
63. Grogan EL, Stiles RA, France DJ, et al. The impact of aviation-based teamwork training on the attitudes of health-care professionals. *J Am Coll Surg* 2004;199(6):843–848.
64. Lingard L, Espin S, Rubin B, et al. Getting teams to talk: development and pilot implementation of a checklist to promote interprofessional communication in the OR. *Qual Saf Health Care* 2005;14(5):340–346.

65. Leonard M, Graham S, Bonacum D. The human factor: the critical importance of effective teamwork and communication in providing safe care. *Qual Saf Health Care* 2004;13(Suppl 1):i85–i90.
66. Gaba DM, Howard SK, Fish K, et al. Simulation-based training in anesthesia crisis resource management (ACRM): a decade of experience. *Simul Gaming* 2001; 32(2):175–193.
67. Gaba D. Simulators in anesthesiology. *Adv Anesth* 1997;14:55–92.
68. Beaubien JM, Baker DP. The use of simulation for training teamwork skills in health care: how low can you go? *Qual Saf Health Care* 2004;13(Suppl 1):i51–i56.
69. Gaba D. Anesthesia simulations in an actual operating room environment. *Anesthesiology* 1987;67(3A):A467.
70. Blum R, Cooper JB, Feinstein D, et al. Sustaining development of crisis resource management training for academic faculty: a new approach to continuing education. *Anesth Analg* 2003;97(S2):S10.
71. Small SD, Wuerz RC, Simon R, et al. Demonstration of high-fidelity simulation team training for emergency medicine. *Acad Emerg Med* 1999;6(4):312–323.
72. Caplan RA, Ward RJ, Posner K, et al. Unexpected cardiac arrest during spinal anesthesia: a closed claims analysis of predisposing factors. *Anesthesiology* 1988;68(1):5–11.
73. Caplan RA, Posner KL, Ward RJ, et al. Adverse respiratory events in anesthesia: a closed claims analysis. *Anesthesiology* 1990;72(5):828–833.
74. Runciman WB, Kluger MT, Morris RW, et al. Crisis management during anaesthesia: the development of an anaesthetic crisis management manual. *Qual Saf Health Care* 2005;14(3):e1.
75. Peterson GN, Domino KB, Caplan RA, et al. Management of the difficult airway: a closed claims analysis. *Anesthesiology* 2005;103(1):33–39.
76. American Society of Anesthesiologists. Standards for basic anesthetic monitoring, 2005. Available at: <http://www.asahq.org/publicationsAndServices/standards/02.pdf>. Last accessed May 30, 2006.
77. Orser BA, Byrck R. Anesthesia-related medication error: time to take action. *Can J Anaesth* 2004;51(8):756–760.
78. ASTM International. ASTM D4774–1997;94(2000) standard specification for user applied drug labels in anesthesiology, 2000. Available at <http://webstore.ansi.org/ansidocstore/default.asp>. Last accessed January 31, 2007.
79. Caplan RA, Vistica MF, Posner KL, et al. Adverse anesthetic outcomes arising from gas delivery equipment: a closed claims analysis. *Anesthesiology* 1997;87(4):741–748.
80. Weinger MB. Anesthesia equipment and human error. *J Clin Monit Comput* 1999;15(5):319–323.
81. Sofaer S, Firminger K. Patient perceptions of the quality of health services. *Annu Rev Public Health* 2005;26:513–559.
82. Safran DG, Miller W, Beckman H. Organizational dimensions of relationship-centered care. Theory, evidence, and practice. *J Gen Intern Med* 2006;21(Suppl 1):S9–S15.
83. Reid P, Compton WD, Grossman JH, et al. Building a Better Delivery System: A New Engineering/Health Care Partnership. Washington, DC: National Academies Press, 2005.
84. Rochlin GI, La Porte TR, Roberts KH. The self-designing high-reliability organization: aircraft carrier flight operations at sea. *Naval War Coll Rev* 1987;40(4):76–79.
85. Roberts KH, Rousseau DM, La Porte TR. The culture of high reliability: quantitative and qualitative assessment aboard nuclear powered aircraft carriers. *J High Tech Mgmt Res* 1994;5:141–161.
86. Weick K, Sutcliffe KM. *Managing the Unexpected*. San Francisco: Jossey-Bass, 2001.
87. Gaba DM. Safety first: ensuring quality care in the intensely productive environment—the HRO model. *Anesthesia Patient Safety Foundation Newsletter* 2002;18:1–4.
88. DeRosier J, Stalhandske E, Bagian JP, et al. Using health care failure mode and effect analysis: the VA National Center for Patient Safety's prospective risk analysis system. *Jt Comm J Qual Improv* 2002; 28(5):248–246.
89. Vaughn D. *The Challenger Launch Decision: Risky Technology, Culture And Deviance at NASA*. Chicago: University of Chicago Press, 1996.
90. Mohr J, Batalden P, Barach P. Integrating patient safety into the clinical microsystem. *Qual Saf Health Care* 2004;13(Suppl 2):ii34–ii38.
91. Gaba DM, Singer SJ, Sinaiko AD, et al. Differences in safety climate between hospital personnel and naval aviators. *Hum Factors* 2003;45(2):173–178.
92. Colla JB, Bracken AC, Kinney LM, et al. Measuring patient safety climate: a review of surveys. *Qual Saf Health Care* 2005; 14(5):364–366.
93. Helmreich RL, Merritt AC. *Culture at Work in Aviation And Medicine*. Aldershot, UK: Ashgate, 1998.
94. Flin R, Fletcher G, McGeorge P, et al. Anaesthetists' attitudes to teamwork and safety. *Anaesthesia* 2003;58(3):233–242.
95. Joint Commission for Accreditation of Healthcare Organizations: 2004, 2005, and 2006 Comprehensive Accreditation Manual for Hospital: The Official Handbook (CAMH). Oakbrook Terrace, IL: Joint Commission Resources, 2006.
96. Rosekind MR, Gander PH, Connell LJ, et al. Crew factors in flight operations X. Alertness management in flight operations. NASA Technical Memorandum #208780. NASA Ames Research Center, 1999.
97. Short TG, O'Regan A, Lew J, et al. Critical incident reporting in an anaesthetic department quality assurance programme. *Anaesthesia* 1993;48(1):3–7.
98. U.S. Food and Drug Administration. Anesthesia apparatus checkout recommendations. Available at: <http://www.fda.gov/cdrh/humfac/aneskot.pdf>. Last accessed May 23, 2006.
99. Howard SK, Gaba DM, Fish KJ, et al. Anesthesia crisis resource management training: teaching anesthesiologists to handle critical incidents. *Aviat Space Environ Med* 1992;63(9):763–767.
100. Holzman RS, Cooper JB, Gaba DM, et al. Anesthesia crisis resource management: real-life simulation training in operating room crises. *J Clin Anesth* 1995;7(8):675–678.
101. Classen DC, Evans RS, Pestotnik SL, et al. The timing of prophylactic administration of antibiotics and the risk of surgical-wound infection. *N Engl J Med* 1992;326(5): 281–286.
102. Kurz A, Sessler DI, Lenhardt R. Perioperative normothermia to reduce the incidence of surgical-wound infection and shorten hospitalization. Study of Wound Infection and Temperature Group. *N Engl J Med* 1996;334(19):1209–1215.
103. Greif R, Akca O, Horn EP, et al. Supplemental perioperative oxygen to reduce the incidence of surgical-wound infection. Outcomes Research Group. *N Engl J Med* 2000;342(3):161–167.
104. American Society of Anesthesiologists. Standards, guidelines and procedures. Available at: <http://www.asahq.org/publicationsAndServices/sgstoc.htm>. Last accessed May 23, 2006.
105. Schwid HA, O'Donnell D. Anesthesiologists' management of simulated critical incidents. *Anesthesiology* 1992;76(4):495–495.
106. Schwid HA, Rooke GA, Michalowski P, et al. Screen-based anesthesia simulation with debriefing improves performance in a mannequin-based anesthesia simulator. *Teach Learn Med* 2001;13(2):92–96.
107. Edgman-Levitan S. Involving the patient in safety efforts. In: Leonard M, Frankel A, Simmonds T, eds. *Achieving Safe and Reliable Healthcare*. Chicago: Health Administration Press, 2004:81–92.
108. Epstein RM, Franks P, Fiscella K, et al. Measuring patient-centered communication in patient-physician consultations: theoretical and practical issues. *Soc Sci Med* 2005;61(7):1516–1528.

*This page intentionally left blank*





## PART 2

### PREPARING FOR ANESTHESIA



## SECTION A

## APPROACH TO THE ANESTHESIA PATIENT

40

## CHAPTER 4

## Overview of Preoperative Assessment and Management

Bobbie Jean Sweitzer, MD

### GOALS AND BENEFITS

As the practice of medicine becomes increasingly outcomes-driven and cost-conscious, clinicians need to reevaluate and streamline methods of patient care. Preoperative assessment and management have evolved as the role of the anesthesiologist has expanded outside of the operating theater and as an increasing number of procedures are performed on patients who are not hospitalized the night before. Reasons for preoperative assessment may entail some or all of the following:

1. To screen for and properly manage comorbid conditions.
2. To assess the risk of anesthesia and surgery and lower it.
3. To identify patients who may require special anesthetic techniques or postoperative care.
4. To establish baseline results for perioperative decisions.
5. To educate patients and families about anesthesia and the anesthesiologist's role.
6. To obtain informed consent.
7. To facilitate timely care and avoid cancellations on the day of operation.

### KEY POINTS

1. Comprehensive preoperative evaluation and management improves patient satisfaction, outcomes, and safety.
2. Inadequate preoperative evaluation and management increase perioperative adverse events.
3. At a minimum, the preanesthesia visit should include an interview with the patient to review the medical history (including medications, allergies, comorbid conditions, and previous operations), an appropriate physical examination, review of diagnostic data, assignment of an American Society of Anesthesiologists physical status score, and a formulation and discussion of the planned anesthetic with the patient.
4. The medical history is the most important component of preoperative assessment.
5. Findings from the history and physical examination determine the need for further diagnostic testing.
6. Diagnostic tests should only be ordered if the results will alter the planned anesthetic or procedure or establish an already suspected diagnosis. "Screening" tests are never appropriate.
7. A determination of functional capacity or the patient's cardiorespiratory fitness can guide further testing and predict a wide range of complications and outcome.
8. Cardiovascular morbidity and mortality are the leading cause of significant perioperative adverse events.
9. Identification and optimization of cardiovascular disease is an important goal of preoperative evaluation.
10. Knowledge of risk factors for cardiovascular disease and familiarity with the American College of Cardiology–American Heart Association guidelines for cardiovascular evaluation for noncardiac surgery is essential.
11. Other "high-risk" patients include those with the following conditions:
  - a. Congestive heart failure
  - b. Murmurs
  - c. Pacemakers and implantable cardioverter-defibrillators (ICDs)
  - d. Pulmonary disease
  - e. Obstructive sleep apnea
  - f. Obesity
  - g. Diabetes mellitus
  - h. Poorly controlled hypertension
    - i. Renal disease
    - j. Hepatic disease
    - k. Substance abuse
    - l. Geriatric patient
    - m. Difficult airway
12. Poor communication is a common source of medical errors and patient dissatisfaction.
13. Practice guidelines can standardize care, decrease delays, and improve outcomes.
14. Anesthesia-directed preoperative evaluation centers can be cost-effective, improve care and patient safety, and offer services beyond history acquisition, physical examinations, and diagnostic testing.

8. To motivate patients to stop smoking, lose weight, or commit to other preventive care.
9. To train personnel in the art and science of preoperative assessment and optimization of a patient's condition.

The Australian Incident Monitoring Study (AIMS) found that 3.1% (197 of the first 6271 reports) of adverse events were unequivocally related to insufficient, and 11% to inadequate, preoperative assessment.<sup>1</sup> More than half of incidents were considered preventable. An analysis of the first 2000 reports to AIMS found a 6-fold increase in mortality in patients who were inadequately assessed preoperatively.<sup>2</sup> Davis concluded that 53 (39%) of 135 deaths attributed to anesthesia involved inadequate preoperative assessment and management.<sup>3</sup> Delays, complications, and unanticipated postoperative admissions are significantly reduced by preoperative screening and patient contact. Others have shown that preoperative health status can predict both operative clinical outcomes and resource use. Preoperative preparation and education can facilitate recovery and reduce the incidence of postoperative morbidity. Anxiety, postoperative pain, and length of stay have been positively affected by comprehensive preoperative care. From the patient's perspective, an opportunity to meet an anesthesiologist (preferably the one providing anesthesia on the day of surgery) is very important. In a study conducted in Canada and Scotland, patients rated meeting the anesthesiologist as the highest priority—above that of information on pain relief, alternative methods of anesthesia, and complications.<sup>4</sup>

Preoperative evaluation must be efficient for both patient and hospital personnel. It can be cost-effective and can reduce turnover times, cancellations, length of hospital stays, and postoperative complications. Preoperative visits should be comprehensive, including plans for postdischarge patient care. As the numbers of patients undergoing surgery on an outpatient basis or presenting to the hospital on the day of operation increases, anesthesiologists have to adapt to provide patients with the best preoperative services. Many anesthesiologists perform preoperative evaluations, review diagnostic studies (chosen and or-

dered by someone else), discuss anesthetic risks, and obtain informed consent moments before a patient undergoes a major, potentially life-threatening or disfiguring procedure. This choice offers little opportunity to manage comorbid conditions or alter risk. Legally, morally, and psychologically anesthesiologists and patients are in awkward, and often unpleasant, situations. The effects of extensive disclosure are stressful for patients and families at a time when they may be ill-prepared to consider the implications rationally. An increase in preoperative anxiety may adversely affect postoperative outcomes because increased anxiety correlates with increased postoperative analgesic requirements and prolonged recovery and hospital stay. Anxiety impairs retention of information, which could result in legal action because of inadequate communication or discussion of the risks of anesthesia.

At a minimum, the guidelines of the American Society of Anesthesiologists (ASA) indicate that a preanesthesia visit should include the following<sup>5</sup>:

1. Interview with the patient to review medical, anesthesia, and medication history
2. Appropriate physical examination
3. Review of diagnostic data (laboratory, electrocardiograms, radiographs)
4. Assignment of ASA physical status score
5. Formulation and discussion of an anesthesia plan with patient or responsible adult

Table 4-1 outlines the criteria and medical conditions of patients likely to benefit from evaluation in a preanesthetic clinic before the day of surgery.

## RISK ASSESSMENT AND REDUCTION

The current ASA risk classification system was developed in 1941 by Meyer Saklad at the request of the ASA (Table 4-2). This classification was the first attempt to quantify risk associated with anesthesia and surgery. The type of anesthesia and the operation were not even considered in this classification system. Moreover, this system attempted to estimate the mortality rate based only on the patient's preoperative medical condition. Since

then other studies have corroborated an association of mortality and morbidity with ASA physical status (ASA PS) scores. Studies also have shown a correlation between ASA PS and unanticipated intensive care unit admissions, longer hospital stays for some procedures, and adverse cardiopulmonary outcomes. No correlation was shown between ASA PS class and cancellations, unplanned admissions, and other perioperative complications and cost.<sup>6</sup> Fewer studies have evaluated the effect of combining the risk of the surgical procedure and the ASA PS score. Among the first was the Johns Hopkins Risk Classification System.<sup>7</sup> Many institutions use a more simplified version of high, intermediate, and low risk.<sup>8</sup> Table 4-3 offers one definition of these risk stratifications.

Goldman et al. further advanced risk assessment by identifying risk factors and cardiac complications in noncardiac surgery. Several studies followed, culminating in the joint guideline publication by the American College of Cardiology and the American Heart Association (ACC/AHA) in 1996, which was updated in 2002.<sup>8</sup> (See Heart Disease below and Chap. 7 for more detailed discussions of the ACC/AHA guidelines.)

Some assessment of risk is important to prepare for the anesthetic and surgical procedure. The need for invasive monitoring, blood salvage and hypothermic techniques, postoperative care in the intensive care unit, and special monitoring must be considered. Patients must be informed during the consent process. Risk assessment is useful to compare outcomes, control costs, allocate compensation, and assist in the difficult decision of canceling or recommending a procedure not be done when the risks are too high. Yet risk assessment, at its best, is hampered by individual patient variability.

## TIMING OF ASSESSMENT

The Practice Advisory for Preanesthesia Evaluation commissioned by the ASA determined that the time of the preanesthesia assessment depends on the patient's condition, the type of procedure, the health care system, and the patient's access to care providers.<sup>5</sup> The recommendations, which were based on the opinions of experts and random-

TABLE 4-1.

## General Criteria and Medical Conditions for Which Preoperative Evaluation is Recommended Before the Date of Surgery

Medical Condition	Criteria
<b>General</b>	<b>Age</b>
Normal activity inhibited	>75 years, unless surgery is minor (e.g. cataract) and under monitored anesthesia care
Monitoring or medical assistance at home within 6 months	
Hospital admission within 2 months	<b>Language</b>
Obesity >140% ideal body weight	Patient or parent/guardian cannot hear, speak, or understand English
<b>Cardiovascular</b>	<b>Anesthesia Effects</b>
Angina	Patient or family has had previous difficult intubation, elevated temperature during anesthesia, is allergic to succinylcholine, has malignant hyperthermia or pseudocholinesterase deficiency or paralysis or nerve damage during surgery
Coronary artery disease	
History of myocardial infarction	<b>Procedure related</b>
Symptomatic arrhythmias	Intraoperative blood transfusion likely
Poorly controlled hypertension	ICU admission likely
Systolic blood pressure >180 mm Hg or diastolic blood pressure >110 mm Hg	High risk surgery
Congestive heart failure	<b>Pregnancy</b>
<b>Respiratory</b>	Patient is pregnant (unless the procedure is dilation and evacuation or dilation and curettage)
Asthma	
Chronic obstructive pulmonary disease (COPD) requiring medication	
Exacerbation or progression of COPD within 6 months	
Previous airway surgery	
Unusual airway anatomy	
Airway tumor or obstruction	
Home ventilatory assistance or monitoring	
<b>Endocrine</b>	
Diabetes	
Adrenal disorders	
Active thyroid disease	
<b>Neuromuscular</b>	
Seizure disorder	
CNS disease (e.g., multiple sclerosis)	
Myopathy or other muscle disorders	
<b>Hepatic</b>	
Active hepatobiliary disease or compromise	
<b>Renal</b>	
Renal insufficiency or failure	
<b>Musculoskeletal</b>	
Kyphosis or scoliosis compromising function	
Temporomandibular joint disorder	
Cervical or thoracic spine injury/disease	
<b>Oncology</b>	
Chemotherapy	
Significant physiologic compromise	

The medical condition portion of this table has been adapted with permission from Pasternak LR. Preoperative evaluation of the ambulatory surgery patient. *Ambulatory Surgery*. *Anesthesiol Rep* 1990;3(1):8.

ly selected ASA members, favor assessments on or before the day of surgery for low to medium invasive procedures and before the day of operation for highly invasive procedures. The consensus is for assessments before the day of surgery for patients with less-severe disease if they are scheduled for highly invasive procedures and for less-invasive procedures in patients with severe disease. For selected patients, evaluations on the day of surgery can be safe and effective.

*The importance of a visit to the preoperative clinic before a surgical procedure cannot be overstated.*<sup>9</sup> A Canadian survey found that more than 60% of patients thought it was important to see an anesthesiologist preoperatively, more than 30% thought it was ex-

TABLE 4-2.

## American Society of Anesthesiologists Physical Status Classification

P1	Healthy patient without organic, biochemical, or psychiatric disease.
P2	A patient with mild systemic disease, e.g. mild asthma or well-controlled hypertension. No significant impact on daily activity. Unlikely impact on anesthesia and surgery
P3	Significant or severe systemic disease that limits normal activity, e.g. renal failure or dialysis or class 2 congestive heart failure. Significant impact on daily activity. Likely impact on anesthesia and surgery.
P4	Severe disease that is constant threat to life or requires intensive therapy, e.g. acute myocardial infarction, respiratory failure requiring mechanical ventilation. Serious limitation of daily activity. Major impact on anesthesia and surgery.
P5	Moribund patient who is equally likely to die in the next 24 hours with or without surgery.
P6	Brain-dead organ donor.

“E” added to the above (P1–P5) indicates emergency surgery. Adapted from American Society of Anesthesiologists. ASA physical status classification system. Available at: [www.asahq.org](http://www.asahq.org).

TABLE 4-3.

## Preoperative Testing Guidelines for Healthy Patients, American Society of Anesthesiologists Physical Status 1

Procedure Type	Invasive Status	Tests <sup>a,b,c</sup>
Low risk, e.g., breast biopsy, knee arthroscopy, cataracts	Minimal	Baseline creatinine if procedure involves injection of contrast dye
Intermediate risk, e.g., inguinal hernia or lumbar laminectomy	Moderate	Baseline creatinine if procedure involves injection of contrast dye
High risk, e.g., thoracotomy, colectomy, or other procedures with expected fluid shifts or significant blood loss	High	Complete blood count with platelets, electrolytes, blood urea nitrogen, and creatinine

<sup>a</sup>Results from laboratory tests within 6 months of surgery are acceptable unless major abnormalities are present or patient's condition has changed.

<sup>b</sup>Routine pregnancy test before surgery is not recommended before the day of surgery. A careful history and local practice determine whether a pregnancy test is indicated.

<sup>c</sup>Age alone is not an indication for an electrocardiogram (ECG). Reimbursement for an ECG depends on indication (pallor, dizziness, hypertension) or a diagnosis documented by history or physical examination. No new ECG is needed if results from an ECG within 6 months of surgery are normal and the patient's condition has not changed.

tremely important, and more than half indicated that the visit should be before the day of operation.<sup>10</sup> Anesthesiologists at Massachusetts General Hospital demonstrated that a preoperative visit before the day of surgery was as good as or better than medication in reducing preoperative anxiety and postoperative pain.

## DETECTING DISEASE

It has been written that the history and physical examination, often referred to as the *clinical examination*, frequently are all that are required for a diagnosis or elimination of alternative hypotheses.

Several studies have proved the usefulness of the history and physical examination in deciding a diagnosis. A study of patients in a general medical clinic found that 56% of correct diagnoses were made with the history alone and rose to 73% with the physical examination. In patients with cardiovascular disease, the history established the diagnosis 66% of the time, and the physical examination contributed to 25% of diagnoses. Moreover, routine investigations, mainly chest radiography and electrocardiography (ECG), helped with only 3% of diagnoses, and special tests, mainly exercise ECG, assisted with 6%.<sup>11</sup> History is also the most important diagnostic

method in respiratory, urinary, and neurologic conditions. The skill of performing a clinical examination derives from pattern recognition learned by seeing patients and listening to the stories of their illnesses. The diagnostic acumen of the physician is a result of the ability to assimilate and develop an overall impression, rather than just reviewing a compilation of facts.

## Medical History

One common problem is the variability of the medical history. Asking and recording symptoms in ordinary words leads to greater interobserver agreement between practitioners. History taking is not simply asking the questions; history taking includes interpreting and carefully recording the answers. Complete and thorough histories not only assist in planning appropriate and safe anesthesia care, but also are more accurate and cost-effective in establishing diagnoses than are screening laboratory tests.

The patient's medical problems, past operations, previous anesthesia-related complications, allergies, and use of tobacco, alcohol, or illicit drugs should be documented. Equally important to identifying the presence of a disease is establishing the severity, the stability, and prior treatment of the condition. A screening review of systems needs special emphasis on airway abnormalities, personal or family history of adverse

events related to anesthesia, and cardiovascular, pulmonary, endocrine, or neurologic symptoms.

The patient's medical problems, previous operations, and responses to questions should elicit further questions to establish the severity of disease, its stability, current or recent exacerbations, and recent or planned interventions. Rarely is a simple notation of diseases or symptoms such as hypertension (HTN), diabetes mellitus (DM), coronary artery disease (CAD), shortness of breath (SOB) or chest pain sufficient. The severity, extent, degree of control, and the activity-limiting nature of the problems are equally important.

A determination of the patient's cardiorespiratory fitness or functional capacity is useful in guiding additional preanesthetic evaluation and predicting outcome and perioperative complications.<sup>8,12</sup> Exercise or work activity can be quantified in metabolic equivalents (METs), which refer to the volume of oxygen consumed during an activity. One's ability to exercise is two-pronged in that better fitness decreases mortality through improved lipid and glucose profiles and reductions in blood pressure and obesity. An inability to exercise may be a *result* of cardiopulmonary disease. Several studies show that inability to perform average levels of exercise (4–5 METs) identifies patients at risk of perioperative complications.

Table 4-4 shows the important components of an anesthesia history. The form can be completed by the patient in person (paper or electronic version), via Internet-based programs, via a telephone interview, or by anesthesia staff. A more detailed discussion of important components of the history for specific medical conditions is presented below (see Medication Instructions).

## Physical Examination

At a minimum, the preanesthetic examination should include the airway, a heart and lung examination, vital signs, including oxygen saturation, and height and weight. Body mass index (BMI) is one of many factors associated with development of chronic diseases such as heart disease, cancer, and diabetes, and can be calculated from an individual's height and weight. The two formulas for calculating the BMI are the English and the metric.



TABLE 4-4.

Sample Patient Preoperative History

Patient's Name \_\_\_\_\_ Age \_\_\_\_\_ Sex \_\_\_\_\_  
 Planned Operation \_\_\_\_\_ Date of Surgery \_\_\_\_\_  
 Surgeon \_\_\_\_\_ Primary Doctor \_\_\_\_\_  
 Cardiologist? \_\_\_\_\_

1. Please list **all operations** (and approximate dates)

a. _____	d. _____
b. _____	e. _____
c. _____	f. _____

2. Please list any **allergies** to medicines, latex, or other (and your reactions to them)

a. _____	c. _____
b. _____	d. _____

3. Please list **all medications** you have taken in the last month (include over-the-counter drugs, inhalers, herbals, dietary supplements, and aspirin)

Name of Drug	Dose and how often	Name of Drug	Dose and how often
a. _____	_____	f. _____	_____
b. _____	_____	g. _____	_____
c. _____	_____	h. _____	_____
d. _____	_____	i. _____	_____
e. _____	_____	j. _____	_____

(Please check YES or NO and circle specific problems)

- |  | YES                      | NO                       |
|--|--------------------------|--------------------------|
| 4. Have you taken steroids (prednisone or cortisone) in the last year?   | <input type="checkbox"/> | <input type="checkbox"/> |
| 5. Have you <i>ever</i> smoked? (Quantify in ___ packs/day for ___ years)  | <input type="checkbox"/> | <input type="checkbox"/> |
| Do you still smoke?  | <input type="checkbox"/> | <input type="checkbox"/> |
| Do you drink alcohol? (If so, how much?) _____   | <input type="checkbox"/> | <input type="checkbox"/> |
| Do you use or have you ever used any illegal drugs? (We need to know for your safety.)   | <input type="checkbox"/> | <input type="checkbox"/> |
| 6. Can you walk up one flight of stairs without stopping?  | <input type="checkbox"/> | <input type="checkbox"/> |
| 7. Have you ever had any problems with your heart? ( <b>circle</b> ) (chest pain or pressure, heart attack, abnormal ECG, skipped beats, heart murmur, palpitation, heart failure [fluid in the lungs], require antibiotics before routine dental care)                | <input type="checkbox"/> | <input type="checkbox"/> |
| 8. Do you have high blood pressure?  | <input type="checkbox"/> | <input type="checkbox"/> |
| 9. Have you had any problems with your lungs or your chest? ( <b>circle</b> ) (shortness of breath, emphysema, bronchitis, asthma, tuberculosis [TB], abnormal chest x-ray)  | <input type="checkbox"/> | <input type="checkbox"/> |
| 10. Are you ill now or were you recently ill with a cold, fever, chills, flu, or productive cough?   | <input type="checkbox"/> | <input type="checkbox"/> |
| Describe recent changes _____  |                          |                          |
| 11. Have you or anyone in your family had serious bleeding problems? ( <b>circle</b> ) (prolonged bleeding from nosebleed, gums, tooth extractions, or surgery)  | <input type="checkbox"/> | <input type="checkbox"/> |
| 12. Have you had any problems with your blood (anemia, leukemia, sickle cell disease, blood clots, transfusions)?  | <input type="checkbox"/> | <input type="checkbox"/> |
| 13. Have you ever had problems with your: ( <b>circle</b> )  |                          |                          |
| Liver (cirrhosis, hepatitis, jaundice)?  | <input type="checkbox"/> | <input type="checkbox"/> |
| Kidney (stones, failure, dialysis)?  | <input type="checkbox"/> | <input type="checkbox"/> |
| Digestive system (frequent heartburn, hiatus hernia, stomach ulcer)?   | <input type="checkbox"/> | <input type="checkbox"/> |
| Back, neck, or jaws (temporomandibular joint, rheumatoid arthritis)?   | <input type="checkbox"/> | <input type="checkbox"/> |
| Thyroid gland (underactive or overactive)?   | <input type="checkbox"/> | <input type="checkbox"/> |
| 14. Have you ever had: ( <b>circle</b> )   |                          |                          |
| Seizures, epilepsy, or fits?   | <input type="checkbox"/> | <input type="checkbox"/> |
| Stroke, facial, leg or arm weakness, difficulty speaking?  | <input type="checkbox"/> | <input type="checkbox"/> |
| Cramping pain in your legs with walking?   | <input type="checkbox"/> | <input type="checkbox"/> |
| Problems with hearing, vision, or memory?  | <input type="checkbox"/> | <input type="checkbox"/> |
| 15. Have you ever been treated for cancer with chemotherapy or radiation therapy? ( <b>circle</b> )  | <input type="checkbox"/> | <input type="checkbox"/> |
| 16. Women: Could you be pregnant?  | <input type="checkbox"/> | <input type="checkbox"/> |
| Last menstrual period began: _____   |                          |                          |
| 17. Have you ever had problems with anesthesia or surgery? ( <b>circle</b> ) (severe nausea or vomiting, malignant hyperthermia [in blood relatives or self], prolonged drowsiness, anxiety, breathing difficulties, or problems during placement of a breathing tube) | <input type="checkbox"/> | <input type="checkbox"/> |
| 18. Do you have any chipped or loose teeth, dentures, caps, bridgework, braces, or problems opening your mouth, swallowing, or choking ( <b>circle</b> )?  | <input type="checkbox"/> | <input type="checkbox"/> |
| 19. Do your physical abilities limit your daily activities?  | <input type="checkbox"/> | <input type="checkbox"/> |
| 20. Do you snore?  | <input type="checkbox"/> | <input type="checkbox"/> |
| 21. Please list any medical illnesses not noted above:   |                          |                          |
| _____  |                          |                          |
| _____  |                          |                          |
| _____  |                          |                          |
| 22. Additional comments or questions for nurse or anesthesiologist?  |                          |                          |
| _____  |                          |                          |
| _____  |                          |                          |
| _____  |                          |                          |

English formula:

$$\text{BMI} = \left( \frac{\text{Weight in pounds}}{\left( \frac{\text{Height}}{\text{in inches}} \right) \times \left( \frac{\text{Height}}{\text{in inches}} \right)} \right) \times 703$$

Metric formula:

$$\text{BMI} = \left( \frac{\text{Weight in kilograms}}{\left( \frac{\text{Height}}{\text{in meters}} \right) \times \left( \frac{\text{Height}}{\text{in meters}} \right)} \right)$$

or

$$\text{BMI} = \left( \frac{\text{Weight in kilograms}}{\left( \frac{\text{Height in}}{\text{centimeters}} \right) \times \left( \frac{\text{Height in}}{\text{centimeters}} \right)} \right) \times 10,000$$

See Obesity below for further discussion and for definitions of BMI for adults.

Components of the airway examination should include the following<sup>13</sup>:

- Length of upper incisors
- Condition of the teeth
- Relationship of upper (maxillary) incisors to lower (mandibular) incisors
- Ability to protrude or advance lower (mandibular) incisors in front of upper (maxillary) incisors
- Interincisor or intergum (if edentulous) distance
- Visibility of uvula
- Presence of heavy facial hair
- Compliance of mandibular space
- Thyromental distance
- Length of neck
- Thickness of neck
- Range of motion of head and neck

Because of the relatively frequent incidence of dental injuries during anesthesia, a thorough documentation of preexisting tooth abnormalities is useful. Either a tooth chart (Fig. 4-1) or standard nomenclature (e.g., right upper central incisor, left lower lateral incisor, or right lower bicuspid) can be helpful.

A good time to discuss with patients variant options of airway management or techniques other than general anesthesia when applicable, and to prepare patients for possible awake fiberoptic intubation, is after examination of the airway. When challenging airways are identified, advance planning ensures that necessary equipment and skilled personnel are available.

The physical examination contributes 25% of diagnoses in patients with cardiovascular disease. Auscultation of the heart and inspection of the pulses, peripheral veins, and extremities for the presence of edema are important diagnostically and for risk assessment in development of care plans. One should auscultate for murmurs, rhythm disturbances, and signs of volume overload. Murmurs, without a clear etiology (anemia, hyperthyroidism, or pregnancy, with confirmation that the murmur was not present prior to these conditions), warrant further evaluation (see Heart Disease below).

The pulmonary examination should include auscultation for wheezing, decreased or abnormal breath sounds, notation of cyanosis or clubbing, and effort of breathing.

Observing whether the patient can walk up 1–2 flights of stairs can predict a variety of postoperative complications, including pulmonary and cardiac events and mortality, and aid in decisions regarding the need for further specialized testing such as pulmonary function tests (PFTs) or noninvasive cardiac stress testing.<sup>14</sup>

For selective patients (e.g., those with deficits or disease who are undergoing neurologic surgery or regional anesthesia) a neurologic examination is necessary to document preexisting abnormalities that may aid in diagnosis or that can interfere with positioning, and to establish a baseline in

defense of potential malpractice claims of adverse events.

Obesity, HTN, and large neck circumference predict an increased incidence of obstructive sleep apnea (OSA). See Obstructive Sleep Apnea below.

## PREOPERATIVE TESTING

Preoperative testing is performed to evaluate existing medical conditions and to diagnose asymptomatic conditions based on known risk factors for particular diseases. Diagnostic tests can aid in the assessment of the risk of anesthesia and operation, guide medical intervention to lower this risk, and provide baseline results to direct intra- and postoperative decisions. The choices of laboratory tests should depend on the probable impact of the test results on the differential diagnosis and on patient management. A test should be ordered only if the results will impact the decision to proceed with the planned procedure or alter the care plans. The history and physical examination should be used to direct test ordering. Tables 4-3 and 4-5 contain recommendations for testing based on specific medical conditions.

Preoperative tests without specific indications lack clinical usefulness and may actually lead to patient injury because of unnecessary interventions, delay of surgery, anxiety, and even inappropriate therapies. The history is

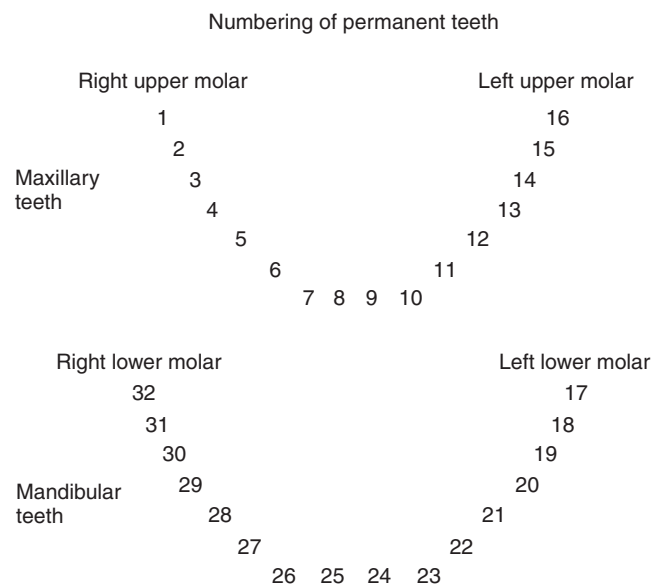


FIGURE 4-1. Dental chart.

TABLE 4-5.

## Preoperative Diagnostic Testing Order Form

Healthy patient	
<input type="checkbox"/>	Standard Order CBC w/plt; BUN/Creat; glucose
<b>Disease/therapy/procedure-based indications</b>	
<input type="checkbox"/>	AST/AlkP Alcohol abuse; exposure to hepatitis; hepatic disease; personal or family history of bleeding
<input type="checkbox"/>	$\beta$ -hCG Possible pregnancy
<input type="checkbox"/>	BUN/Creat Cardiovascular, hepatic, intracranial, peripheral vascular, or renal disease; diabetes; morbid obesity; poor exercise tolerance; systemic lupus; use of digoxin, diuretics, steroids; procedures with significant blood loss, with radiographic dye, or in a high-risk category
<input type="checkbox"/>	CBC w/plt Alcohol abuse, anemia; cardiovascular, intracranial, pulmo- nary, or renal disease; malignancy; malnutrition; person- al or family history of bleeding; poor exercise tolerance; radiation therapy; rheumatoid arthritis; sleep apnea; smoking >40 pack-years; anticoagulant use; procedures with significant blood loss or in a high-risk category
<input type="checkbox"/>	CXR Only for active, acute symptoms especially with cardiovas- cular or pulmonary disease; rheumatoid arthritis; smok- ing >40 pack-years; systemic lupus; radiation therapy
<input type="checkbox"/>	ECG Alcohol abuse; cardiovascular, cerebrovascular, intracra- nial, peripheral vascular, pulmonary, or renal disease; diabetes; morbid obesity; poor exercise tolerance; rheu- matoid arthritis; sleep apnea; smoking >40 pack-years; systemic lupus; radiation therapy to chest or breasts; use of digoxin
<input type="checkbox"/>	Electrolytes Cerebrovascular, intracranial, or renal disease; diabetes; malnutrition; use of digoxin, diuretics, or steroids; high- risk procedure
<input type="checkbox"/>	Glucose Cerebrovascular or intracranial disease; diabetes; morbid obesity; poor exercise tolerance; steroid use
<input type="checkbox"/>	PT/PTT Alcohol abuse; hepatic disease; malnutrition; personal or family history of bleeding; use of anticoagulants
<input type="checkbox"/>	Thyroid tests Thyroid disease; use of thyroid medications
<input type="checkbox"/>	T&S Procedure with significant blood loss or high-risk category
<input type="checkbox"/>	Urinalysis Suspected urinary tract infection

Abbreviations: AST/AlkP = aspartate transaminase/alkaline phosphatase;  $\beta$ -hCG =  $\beta$ -human chorionic gonadotropin; BUN/Creat = blood urea nitrogen/creatinine; CBC w/plt = complete blood count with platelets; CXR = chest radiograph; ECG = electrocardiogram; PT/PTT = prothrombin time/partial thromboplastin time; T&S = type and screen.

With the exception of  $\beta$ -hCG for pregnancy, all tests are valid for 6 months before surgery unless abnormal or patient's condition has changed. Guidelines may not apply for low-risk procedures where testing is only indicated if the medical condition is newly diagnosed or unstable.

responsible for the diagnosis 75% of the time and is more important than the physical examination and laboratory investigations combined. In addition, the evaluation of abnormal results is costly. Many studies have evaluated the benefits of disease/condition-indicated testing versus screen-

ing batteries of tests. Few abnormalities detected by nonspecific testing resulted in changes in management, and rarely have such changes had a beneficial patient effect.<sup>15</sup> At most 1 in 1000 patients has benefited from findings derived from nonindicated testing.<sup>16</sup> Blery et al. found that 0.4% of

tests without specific indications provided useful clinical information.<sup>15</sup> However, 1 in 2000 preoperative tests resulted in patient harm from pursuit of abnormalities detected by those tests; only 1 in 10,000 was of benefit to the patient.<sup>6</sup> It has been suggested that not following up on an abnormal result is a greater medicolegal risk than not identifying the abnormality to begin with.

Preoperative ECGs are one of the most frequently ordered and costly noninvasive tests. Preoperative ECGs are ordered because occult heart disease is common in the middle-age population and increases with advancing age; preexisting heart disease increases perioperative risk; and establishing a baseline value is desirable.

However, a *resting* ECG is not a reliable screen for CAD and is a poor predictor of heart disease (without a supporting history) in nonsurgical patients. It appears that only some ECG abnormalities are important in the perioperative period (e.g., new Q waves and arrhythmias). One study found only 2% of patients had one or both of these abnormalities.<sup>17</sup> It has been estimated that the frequency of silent Q-wave infarctions found *only* by ECG in men age 75 years or older (the highest risk group) is 0.5%. Gold et al. found that in ambulatory surgical patients, the incidence of abnormal ECGs was 43%. Only 1.6% (12/751) of patients had an adverse perioperative cardiac event and in only half (6/751) of these was the preoperative ECG of potential value.<sup>18</sup>

Many abnormalities may have implications for anesthesia care beyond the detection of CAD. Arrhythmias, such as atrial fibrillation, which should be detected on physical examination and confirmed by ECG, conduction abnormalities, and left ventricular hypertrophy, may alter anesthesia plans. Adjustments may be necessary to avoid hemodynamic instability, ischemia, or pulmonary edema because of drug interactions or the stress of surgery combined with previous, but not necessarily clinically significant, disease. Plans can be made on the day of operation when monitors are placed in the preoperative area or the operating room rather than incurring the expense of a 12-lead ECG beforehand.

Unfortunately, the specificity of an ECG abnormality for predicting postoperative cardiac complications is

only 26%; consequently, a normal ECG does not exclude cardiac disease.<sup>19</sup> The ACC/AHA *Guidelines for Perioperative Cardiovascular Evaluation for Noncardiac Surgery* consider ECG abnormalities (other than Q waves) as a minor predictor of complications.<sup>8</sup> History is far more important. An abnormal ECG will be found in 62% of patients with known cardiac disease, in 44% of patients with strong risk factors for ischemic heart disease, and in only 7% of patients older than 50 years with no risk factors. Even more significant is that results are abnormal in only 3% of patients between ages 50 and 70 years without risk factors for heart disease.<sup>20</sup> Tait et al. suggested that routine preoperative ECG testing is not indicated in patients without a history of cardiovascular disease and no significant risk factors.<sup>21</sup> In summary, the prevalence of abnormalities on ECG may incur costly evaluation, delaying necessary surgery, and the yield of these workups is quite low. Tables 4–3 and 4–5 list the indications for ECG testing.

Coagulation studies (platelet count, prothrombin, or activated partial thromboplastin time) are not recommended unless the patient history suggests a coagulation disorder or the procedure is high risk. Given a patient's negative history for a bleeding disorder, the cost of screening coagulation tests before minor surgery outweighs the benefit. Many practitioners mistakenly believe that a *screening* prothrombin time (PT) is more likely to be abnormal because of the numbers of patients with liver disease, malnutrition or warfarin use, conditions that should be readily identified by history. If "screening" tests (not based on history) are ordered, a platelet count and activated partial thromboplastin time (aPTT) are indicated to detect the uncommon patient with thrombocytopenia, an acquired anticoagulant (e.g., lupus anticoagulant) or a reduced level of a contact activation factor (e.g., von Willebrand disease or factor VIII, IX, XI, or XII deficiencies). Additionally, a *short* aPTT may be equally as important as a prolonged aPTT. A short aPTT increases the risk of postoperative thromboembolism. The Centers for Medicare and Medicaid Services (CMS) does not reimburse for "routine" or "preoperative" PT/partial thromboplastin time (PTT) without an appropriate International Classification of Diseases (ICD-9) code.<sup>22</sup>

There are few data to recommend age-based testing. No correlation has been established, independent of coexisting disease, a positive history, or findings on physical examination, between age and abnormalities in hemoglobin (Hgb), serum chemistries, radiographs, or PFTs.<sup>16,23,24</sup> Chest radiographs are indicated only in patients with pulmonary signs or symptoms of undetermined cause or severity. Hgb and hematocrit (Hct) levels are frequently abnormal in otherwise healthy patients, but rarely impact anesthetic care or management unless the planned procedure involves the potential for significant bleeding.

Even though ECG abnormalities are more common with advanced age, abnormalities alone do not predict postoperative cardiac complications in the elderly.<sup>18,19</sup> Significant abnormalities that impact care are rare in the absence of a history or symptoms of cardiac disease.<sup>18</sup> Even the ASA Practice Advisory for Preanesthesia Evaluation states, "The Task Force recognizes that age alone may not be an indication for an electrocardiogram."<sup>5</sup> CMS will not provide coverage for age-based ECGs or simply as a "preoperative" test; one must provide a supporting diagnosis with an acceptable ICD-9 code.<sup>22</sup>

There is much controversy about and no consensus regarding routine pregnancy testing, especially in adolescents. Surveys show that 30–50% of practitioners mandate testing in females of childbearing age, primarily because of the unreliability of the history, especially from minors, and the concern over the potential harm to the pregnancy or fetus with anesthesia and surgery, with the attendant medicolegal implications.<sup>25</sup> Opponents of mandatory testing cite the false-positive rate, cost, the belief that history is reliable if taken in privacy, and the paucity of data establishing risks of anesthesia in early pregnancy. When minors are pregnant, their privacy is governed by state laws. One must be familiar with local statutes and how unexpected positive pregnancy results will be handled. With the high reliability of urine testing, it is best to delay testing until the day of operation instead of testing in the preoperative clinic, unless the patient suspects pregnancy or the menstrual period is delayed. This delay in testing will obviate a negative test days before surgery that

may be positive on the day of surgery. The ASA Preoperative Evaluation Practice Advisory "[r]ecognizes the literature is insufficient to inform patients or physicians on whether anesthesia causes harmful effects on early pregnancy. Pregnancy testing may be offered to female patients of childbearing age and for whom the result would alter the patient's management."<sup>5</sup>

*Healthy* patients of any age undergoing low- or intermediate-risk procedures without expected significant blood loss are unlikely to benefit from any tests (Table 4–3). Exceptions are a procedure with the injection of contrast (screening blood urea nitrogen [BUN] and creatinine levels are indicated), or the possibility of pregnancy (a pregnancy test should be done). Table 4–5 contains the recommendations for diagnostic tests for patients with coexisting diseases, and taking certain medications, or who are scheduled for a high-risk operation or one in which there is anticipated blood loss. In general, tests are recommended only if their results may

- Change, cancel, or postpone the surgical procedure.
- Change anesthesia and medical management.
- Change monitoring or intra- or postoperative care.
- Confirm an abnormality suspected from the history or physical examination.

The ASA Task Force states that test results are valid and acceptable for up to 6 months prior to the operation if the medical history has not changed substantially.<sup>5</sup>

Many facilities have developed diagnostic testing guidelines to improve patient care, standardize clinical practice, improve efficiency, and reduce costs. With implementation of guidelines, one facility reduced the tests ordered by 60%, improved testing by 81%, and saved almost \$80,000 per year. The Mayo Clinic reduced preoperative testing and its costs without a change in outcomes. A cost-to-benefit analysis found that routine urinalysis for all knee replacement surgery in the United States would cost \$1.5 million to prevent 1 wound infection.<sup>26</sup> Interestingly, one study found 50% more routine ECGs and 40% more chest radiographs were done in a fee-for-service versus a prepaid practice.<sup>27</sup>



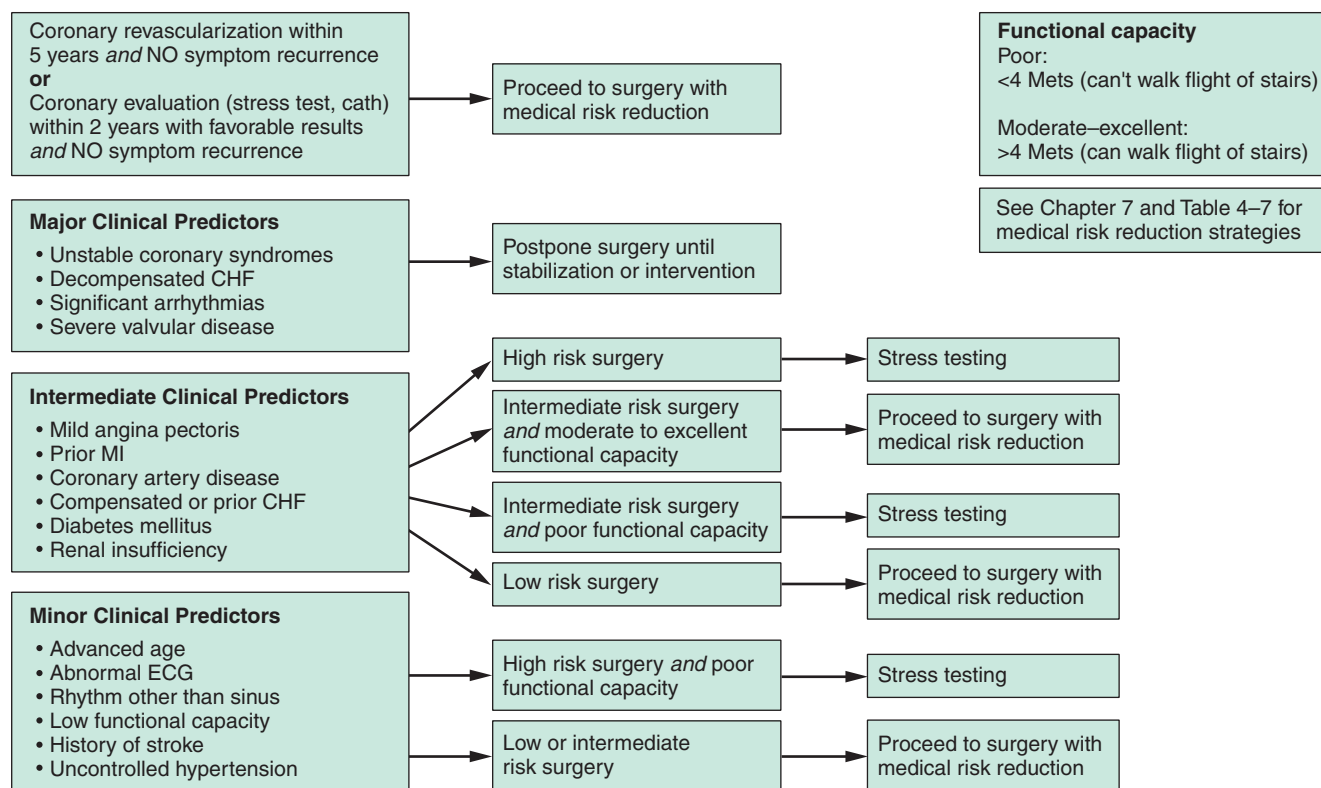


FIGURE 4-2. Simplified cardiac evaluation for noncardiac surgery.

## HIGH-RISK PATIENTS

Although many of these conditions are discussed in greater detail in other chapters of this text, here is a brief review of some conditions commonly seen in the preanesthetic assessment clinic and for which preoperative intervention is important. Identification of patients with these comorbid conditions often presents an opportunity for the anesthesiologist to intervene to lower risk. The following conditions are best managed before the day of surgery, which allows ample time for thoughtful evaluation, consultation, and planning.

### Heart Disease

Cardiovascular complications are the most common serious adverse event perioperatively. It is estimated that 1–5% of unselected noncardiac surgical patients will suffer a cardiac morbidity. Below is a brief discussion of a few high-risk issues that are likely to be encountered in the preoperative clinic. The patient with ischemic heart disease, heart failure, a rhythm disturbance, an abnormal ECG, an undiagnosed murmur, or a cardiac rhythm management device is discussed. Chapter 7 provides a comprehensive review of cardiovascular disease.

### Ischemic Heart Disease

The goals in the preanesthetic encounter are to

- Identify the risk of heart disease based on comorbid diseases (Fig. 4-2);
- Identify the presence and severity of heart disease from symptoms, physical findings, or diagnostic tests;
- Determine the need for preoperative interventions; and
- Modify the risk of perioperative adverse events.

The basis of cardiac assessment is the history, the physical examination, and the ECG. The guidelines for cardiac evaluation before noncardiac surgery published by the ACC/AHA are the national standard of care.<sup>8</sup> Figure 4-2 presents a simplified approach to the evaluation of patients with a history of heart disease before noncardiac surgery. The complete ACC/AHA algorithm is found in Chapter 7. The goal is to identify patients with heart disease who have a significantly high risk of cardiac morbidity and mortality perioperatively. Clinical predictors, functional or exercise capacity, and level of surgical risk guide further diagnostic and therapeutic interventions. Not in-

cluded in the ACC/AHA guidelines are conditions such as chronic inflammatory diseases (e.g., rheumatoid arthritis, systemic lupus erythematosus), chronic steroid use, and chest irradiation, either alone or associated with more traditional risk factors, identifies patients at risk for CAD and cardiac complications.<sup>28-30</sup>

Anesthesiologists in preanesthetic clinics who apply the ACC/AHA recommendations and develop practice guidelines (Fig. 4-2) are well positioned to initiate evaluation with stress tests. Results may obviate the need for a cardiac consultation or be available at the time of consultation. Exercise treadmill testing is indicated for patients with normal ECGs who can exercise. Pharmacologic tests, such as dobutamine echocardiography or nuclear perfusion imaging, are necessary for those unable to exercise or who have significant ECG abnormalities that may interfere with the interpretation of ischemia via ECG.

Currently, the benefits versus risk reduction of coronary revascularization before noncardiac surgery are controversial.<sup>31</sup> Factors to consider are the urgency of the noncardiac surgery (e.g., in cancer cases) and the potential long-term benefits of revascular-

ization. Noncardiac surgery soon after revascularization (bypass grafting and percutaneous coronary intervention with or without stents) is associated with high rates of perioperative cardiac morbidity and mortality.<sup>32</sup>

Patients who have had a percutaneous coronary intervention, especially with newer, drug-eluting stents, require several weeks, if not months, of antiplatelet therapy to avoid restenosis or acute thromboses. These patients must be identified in the preanesthetic clinic and managed in collaboration with a cardiologist. Given that up to half of all perioperative myocardial infarctions and cardiac deaths can be attributed to plaque rupture in noncritical coronary stenoses, intensive medical management in revascularized patients is likely to be helpful and may account for the lack of benefits of revascularization.<sup>31,33</sup>

Decisions to revascularize patients before noncardiac surgery should be made only after evaluating the risk of perioperative cardiac adverse events, the risks and benefits of the various methods of risk reduction, the benefits of the noncardiac surgery, and the patient's preferences. A face-to-face dialogue with all involved parties, similar to "tumor-board" discussions, may assist decision making. Because cardiac complications are the leading cause of perioperative morbidity and mortality, anesthesiologists must be current on the latest evidence-based recommendations and be active in decision making and in the management of patients at risk.

## Heart Failure

Heart failure affects 4–5 million people in the United States and is a significant risk factor for postoperative adverse events. The goal in the preoperative clinic is to identify and minimize the effects of heart failure. Recent weight gain, complaints of shortness of breath, fatigue, orthopnea, paroxysmal nocturnal dyspnea, and edema, recent hospitalizations, and recent changes in management are all significant. Physical findings should focus on examination for third or fourth heart sounds, rales, jugular venous distension, ascites, hepatomegaly, and edema. Classifying the patient's medical status according to the New York Heart Association's (NYHA) categories is useful.<sup>34</sup>

- Class I—no limitation of physical activity; ordinary activity does not cause fatigue, palpitations, or syncope

- Class II—slight limitation of physical activity; ordinary activity results in fatigue, palpitations, or syncope
- Class III—marked limitation of physical activity; less than ordinary activity results in fatigue, palpitations, or syncope; comfortable at rest
- Class IV— inability to do any physical activity without discomfort; symptoms at rest

Diastolic dysfunction may be as common as systolic dysfunction and predicts a poor prognosis outside the perioperative period. The significance of diastolic dysfunction for anesthesia and surgery is less-well defined.

Preoperative ECG, electrolytes, BUN, and creatinine tests are indicated (Table 4–5). An objective measure of left ventricular ejection fraction (LVEF) and ventricular performance is helpful, especially in patients with NYHA class III or IV heart failure. Normal LVEF is >50%; mildly diminished, 41–49%; moderately diminished, 26–40%; and severely diminished, <25%. Patients with class III or IV heart failure should be evaluated by a cardiologist before undergoing general anesthesia or any intermediate- or high-risk procedure. Very minor procedures under monitored anesthesia care (MAC) can proceed as long as the patient's condition is stable.

## Rhythm Disturbances and ECG Abnormalities

Arrhythmias and conduction disturbances are common in the perioperative period. Supraventricular and ventricular arrhythmias are associated with a greater risk of perioperative adverse events because of the arrhythmia itself and because they are markers for cardiopulmonary disease. Because uncontrolled atrial fibrillation and ventricular tachycardia are high-risk clinical markers, elective surgery should be postponed until evaluation and stabilization are complete.<sup>8</sup> Rhythms other than sinus are minor clinical predictors (Fig. 4–2).

New-onset atrial fibrillation, symptomatic bradycardia, or high-grade heart block (second or third degree) identified in the preoperative clinic warrant postponement of elective procedures and referral to cardiology for further evaluation. Left bundle-branch block (LBBB) is highly associated with CAD and a recent onset or no previous evaluation of LBBB requires stress testing or cardiology consultation. Right bun-

dle-branch block (RBBB) is likely to be congenital, either a result of calcification and degeneration of the conduction system or secondary to pulmonary disease. Brugada syndrome is a congenital disease characterized by RBBB with ST-segment elevation in the right precordial leads and is associated with a risk of sudden death and lethal arrhythmias. If the history and physical do not suggest significant pulmonary or congenital heart disease, no further evaluation is warranted because of an isolated RBBB. However, RBBB in a patient with pulmonary symptoms is suggestive of severe respiratory compromise that warrants a pulmonary evaluation and echocardiography if an intermediate- or high-risk operation is planned. If congenital heart disease or Brugada syndrome is suspected, a cardiology consultation is indicated.

Left ventricular hypertrophy (LVH) and ST-segment depression on preoperative ECG are associated with a greater risk of myocardial infarction and cardiac death perioperatively.<sup>35</sup> LVH may be associated with diastolic dysfunction and poorly controlled hypertension. Prolonged QT intervals should prompt an evaluation of electrolytes, magnesium, and calcium and a cardiology referral.

## Murmurs

The quandary in the preoperative clinic is to determine the cause of cardiac murmurs and to distinguish between significant murmurs and clinically unimportant ones. Diastolic murmurs are always pathologic and require further evaluation. Regurgitant disease is tolerated perioperatively much better than stenotic disease.

Aortic stenosis is the most common valvular lesion in the United States, affecting 2–4% of adults older than 65 years of age; severe stenosis is associated with a high risk of perioperative complications.<sup>8</sup> Once considered a degenerative lesion increasing with age or a congenital bicuspid valve, aortic stenosis is now thought to have much in common with CAD and is an independent marker of CAD.<sup>36</sup>

Aortic sclerosis, which also causes a systolic ejection murmur similar to that of aortic stenosis, is present in 25% of adults 65–74 years of age and almost half of those older than 84 years of age.<sup>36</sup> Aortic sclerosis is associated with a 40% increase in the risk of myocardial infarction (MI) and a

50% increase in the risk of cardiovascular death in patients without a history of CAD.<sup>37</sup> There is no hemodynamic compromise with aortic sclerosis.

The cardinal symptoms of severe aortic stenosis are angina, heart failure, and syncope, although patients are much more likely to complain of a decrease in exercise tolerance and exertional dyspnea. Aortic stenosis causes a systolic ejection murmur that is best heard in the right upper sternal border, which often radiates to the neck. Any patient with a previously undiagnosed murmur needs an ECG, and any ECG abnormality warrants an echocardiogram. Because of the difficulties noncardiologists have in distinguishing murmurs of aortic stenosis from those of aortic sclerosis, an echocardiogram should be ordered even without ECG abnormalities, especially if general anesthesia or an intermediate- or high-risk procedure is planned. Current guidelines recommend echocardiography annually for patients with severe aortic stenosis, every 2 years for moderate stenosis, and every 5 years for mild stenosis.<sup>38</sup>

Mitral stenosis is much less common than aortic stenosis and is usually associated with a history of rheumatic heart disease. Mitral stenosis causes a diastolic murmur and should always be further evaluated with ECG and echocardiography. Patients with hypertrophic obstructive cardiomyopathy are often young and male, and may be asymptomatic and without murmurs. An ECG and echocardiogram should be done if there is a personal or family history of syncope with exertion or sudden death, or if a murmur is detected. LVH and ST-segment and T-wave abnormalities on an ECG in an otherwise healthy nonhypertensive patient need to be further evaluated with echocardiography.

Patients at risk for bacterial endocarditis (e.g., those with valvular abnormalities, valve replacements, or complex congenital heart disease but not coronary revascularization) who are scheduled for procedures with the potential for transient bacteremia should be identified preoperatively to plan for treatment.<sup>39</sup>

### Cardiac Rhythm Management Devices: Pacemakers and Implantable Cardioverter-Defibrillators

It is estimated that more than 100,000 new cardiac rhythm-management devices (CRMDs) are implanted yearly in

the United States. Electromagnetic interference is likely to occur with electrocautery, radiofrequency ablation, magnetic resonance imaging (MRI), and radiation therapy, and can result in malfunction or adverse events.<sup>40</sup> Some patient monitors and ventilators may cause electromagnetic interference in patients with CRMDs with rate-adaptive mechanisms. The preoperative evaluation should determine the type of device and the features (e.g., rate-adaptive mechanisms) likely to malfunction if electromagnetic interference should occur perioperatively. Consultation with the device manufacturer, cardiologist, or the electrophysiology or CRMD service may be needed. Ideally, patients with CRMDs should have these devices interrogated preoperatively. Special features, such as rate adaptive mechanisms and antitachyarrhythmia functions, need to be disabled or the device reprogrammed to an asynchronous pacing mode before surgical procedures and anesthesia where electromagnetic interference is anticipated.<sup>40</sup> Newer-generation devices are more complex and reliance on a magnet, except in emergency situations, is not recommended. Planning ahead is important.

### Pulmonary Disease or Patients with Risk Factors for Postoperative Pulmonary Complications

Postoperative pulmonary complications develop in 5% of patients undergoing nonthoracic surgery and as many as 1 in 4 deaths occurring within a week of operation are pulmonary related, making it the second most common serious morbidity after cardiovascular adverse events.<sup>41</sup> Established risk factors for an increased risk of pulmonary complications include the following:<sup>42</sup>

- History of cigarette use (current or >40 pack-years)
- ASA PS scores >2
- Age older than 70 years
- Chronic obstructive pulmonary disease
- Neck, thoracic, upper abdominal, aortic, or neurologic surgery
- Anticipated prolonged procedures (>2 hours)
- Planned general anesthesia (especially with endotracheal intubation)
- Albumin less than 3 g/dL

- Exercise capacity of less than 2 blocks or 1 flight of stairs
- BMI >30 kg/m<sup>2</sup>

Surprisingly absent predictors in the above list are asthma or results from arterial blood gas (ABG) analysis or PFTs. Risk of complications is surprisingly low in well-controlled asthma and in patients treated preoperatively with corticosteroids.<sup>43</sup> Risk is greater in asthmatics with recent exacerbations, a history of postoperative pulmonary complications, recent hospitalizations, or recent intubations for asthma. ABGs are useful in predicting pulmonary function after lung resection surgery but do not predict risk for complications. The degree of airway obstruction, measured by the forced expiratory volume in 1 second (FEV<sub>1</sub>) is not predictive of pulmonary complications.<sup>44</sup>

The focus in the preoperative clinic should be on identifying patients at risk for postoperative pulmonary complications and on optimizing those patients with preexisting pulmonary disease (Table 4–5). PFTs may be indicated to diagnose disease (dyspnea caused by lung disease or heart failure?) or assess management (can dyspnea or wheezing be improved further?), but *not* as a risk assessment tool or to deny a beneficial procedure.<sup>44</sup>

The pulmonary status of patients with recent exacerbations or infections should be improved whenever possible. Prescriptions for antibiotics, bronchodilators, and steroids, referral to pulmonologists or internists, or delay of surgery might be necessary. Training patients preoperatively in lung expansion maneuvers, such as deep-breathing exercises and incentive spirometry, reduces pulmonary complications more than giving the training postoperatively.<sup>45</sup> Additionally, a change in perioperative management, including altering the planned surgical procedure if possible, discussing alternatives to general anesthesia, and educating the patient about the benefits of epidural pain management, may provide effective measures to decrease pulmonary complications.<sup>46</sup>

Patients with pulmonary arterial hypertension have a high rate of perioperative morbidity and mortality. The patient's care should be coordinated with a pulmonologist. An ECG and echocardiogram are useful in patients with more than mild disease. Signs and symptoms of disease severity include the following<sup>47</sup>:



- Dyspnea at rest
- Metabolic acidosis
- Hypoxemia
- Right heart failure (peripheral edema, hepatomegaly, jugular venous distension)
- History of syncope

Traditionally, especially with children, cases scheduled for elective procedures were cancelled for patients with current or recent upper respiratory tract infections. With modern anesthetic practices, cancellation is not routine. In patients with severe symptoms, especially those with underlying conditions that may further compromise a safe anesthetic, elective surgery should be postponed for at least 4 weeks.<sup>48</sup> When infection is mild or uncomplicated in healthy patients, there is little risk in proceeding with a procedure to avoid the inconvenience of a cancellation. The dilemma lies with the patients between these extremes. Decisions regarding suitability to proceed should be made on an individual basis. Chapter 19 discusses the pediatric patient with an upper respiratory tract infection in greater detail. Chapter 9 discusses the patient with pulmonary disease in detail.

### Obstructive Sleep Apnea

Sleep-disordered breathing affects up to 9% of middle-age women and 24% of middle-age men; less than 15% of these cases have been diagnosed. OSA, the most common serious manifestation of sleep-disordered breathing, is caused by intermittent airway obstruction. OSA is characterized by total collapse of the airway with complete obstruction for more than 10 seconds. Obstructive hypopnea is partial collapse (30–99%) associated with at least a 4% arterial oxygen desaturation. OSA severity is measured on the apnea-hypoxia index (AHI), the number of apneic and hypopneic episodes per hour of sleep. Patients with severe OSA have >30 episodes per hour.

Cardiovascular disease is common in patients with OSA. These patients have an increased incidence of hypertension, atrial fibrillation, bradyarrhythmias, ventricular ectopy, endothelial damage, stroke, heart failure, dilated cardiomyopathy, and atherosclerotic CAD.<sup>49</sup> Mask ventilation, direct laryngoscopy, endotracheal intubation, and even fiberoptic visualization of the airway are more difficult in

patients with OSA than in healthy patients.

The Berlin Questionnaire is useful to identify patients with undiagnosed OSA.<sup>50</sup> The presence of any two of the following is considered a high risk for sleep apnea:

- Snoring
- Daytime sleepiness
- Hypertension
- Obesity

Preoperative evaluation should focus on identification of patients at risk for OSA and improving associated comorbid conditions. Table 4–5 identifies the testing guidelines. Echocardiography may be indicated if heart failure or pulmonary hypertension is suspected. Patients should be instructed to bring their continuous positive airway pressure (CPAP) devices to the hospital on the day of operation. Chapter 9 discusses OSA in detail.

### Obesity

A BMI of  $\geq 40$  kg/m<sup>2</sup> defines extreme obesity; obesity is defined as a BMI of 30–39.9 kg/m<sup>2</sup>. An overweight person has a BMI of 25–29.9 kg/m<sup>2</sup> (see Physical Examination above for BMI calculation formulas). It is estimated that 64% of adults in the United States are overweight or obese and that 4.7% are extremely obese. Annually 300,000 U.S. adults die of obesity-related issues, and almost 10% of healthcare expenditures in the United States are associated with obesity and inactivity. Obesity is an independent risk factor for heart disease. Hypertension, stroke, hyperlipidemia, osteoarthritis, diabetes mellitus, cancer, and OSA are more common in obese people.

Extremely obese patients may have challenging airways that require specialized equipment, techniques and personnel. They may need prophylaxis for deep venous thrombosis (DVT) with advanced techniques such as inferior vena cava filter placements. They require special operating room tables and gurneys to support excessive weight. Venous access and invasive and noninvasive monitoring can be difficult. Preoperative identification and planning for these contingencies will avoid delays on the day of the operation. Preoperative evaluation should be directed toward coexisting diseases (Table 4–5). Chapter 22 discusses this in greater detail.

### Diabetes

An estimated 18 million U.S. adults have diabetes mellitus, which increases the risk of CAD, is considered a CAD equivalent, and is an intermediate-risk factor for perioperative cardiac complications on a par with angina or a previous myocardial infarction.<sup>8,51</sup> Figure 4–2 and Chapter 7 address cardiac evaluation for noncardiac surgery.

Heart failure is twice as common in males and 5 times as common in females with diabetes as in those without diabetes. Poor glycemic control is associated with an increased risk for heart failure and both systolic and diastolic dysfunction may be present. Diabetics are also at increased risk for renal failure perioperatively (see Chap. 13 and Renal Disease below), and for postoperative infections. Recent studies suggest that tighter perioperative control may be warranted. Patients with poor preoperative management of glucose are likely to be more out of control intra- and postoperatively.<sup>52</sup> Obtaining a glycosylated hemoglobin (HgbA<sub>1c</sub>) concentration preoperatively can guide glucose management with intensification of therapy before the procedure. Aggressive management of hyperglycemia decreases postoperative complications. The American College of Endocrinologists position statement recommends a target fasting glucose of <110 mg/dL in noncritically ill patients.<sup>53</sup>

In the preoperative clinic, the focus should be on assessing organ damage and the control of blood sugar. Cardiovascular, renal, and neurologic systems should be evaluated. Ischemic heart disease is often asymptomatic in the diabetic. Table 4–5 has testing suggestions. The goals of perioperative diabetic management include avoidance of hypoglycemia and marked hyperglycemia. Table 4–6 has suggestions for hypoglycemic medication management on the day of the operation.

### Hypertension

HTN, defined by 2 or more measurements of blood pressure greater than 140/90, affects 1 billion individuals worldwide. The incidence of HTN increases with age. In the United States, 25% of adults and 70% of patients older than age 70 years have HTN and fewer than 30% are adequately treated. The degree of end-organ damage and morbidity and mortality correlate with the duration and severity of HTN.



TABLE 4-6.

## Preoperative Medication Guidelines

Continue on the day of the operation<sup>a</sup>

- Antidepressant, antianxiety, and psychiatric medications
  - Antihypertensive medications, except angiotensin-converting enzyme inhibitors or angiotensin receptor blocking agents, which may be selectively discontinued on the day of the operation
  - Antiseizure medications
  - Asthma medications
  - Birth control pills
  - Cardiac medications (e.g. digoxin)
  - Diuretics, such as triamterene or hydrochlorothiazide, for hypertension
  - Heartburn or reflux medications
  - Insulin—all intermediate, combination, and long-acting insulins
    - Type 1 diabetics should take a small amount (usually one-third) of their usual morning long-acting insulin (e.g., lente or NPH) on the day of the operation
    - Type 2 diabetics should take none or up to one-half of long-acting or combination (70/30 preparations) insulins on the day of the operation
    - Patients with an insulin pump should continue only their basal rate on the day of the operation
  - Narcotic pain medications
  - Ophthalmic drops
  - Statins
  - Steroids, oral or inhaled
  - Thyroid medications
  - Cyclooxygenase-2 inhibitors, unless surgeon is concerned about bone healing
- Discontinue 7 days before the operation
- Aspirin, except for vascular patients and patients having cataract surgery
  - Clopidogrel (Plavix), except for vascular patients and patients having cataract surgery
  - Herbals and nonvitamin supplements
  - Hormone replacement therapy
- Discontinue 4 days before the operation
- Warfarin (Coumadin), except for patients having cataract surgery without a bulbar block
- Discontinue 48 hours before the operation
- Nonsteroidal antiinflammatory drugs
- Discontinue 24 hours before the operation
- Erectile dysfunction medications
- Discontinue on the day of the operation
- Diuretics, except triamterene or hydrochlorothiazide for hypertension, which should be continued
  - Insulin—all regular insulins
    - Type 1 diabetics should take a small amount (usually one-third) of their usual morning long-acting insulin (e.g., lente or NPH) on the day of the operation
    - Type 2 diabetics should take none or up to one-half of long-acting or combination (70/30 preparations) insulins on the day of the operation
    - Patients with an insulin pump should continue only their basal rate on the day of the operation
  - Iron
  - Oral hypoglycemic agents
  - Topical medications (e.g., creams or ointments)
  - Vitamins
- Special considerations before the operation
- Monoamine oxidase inhibitors—patients taking these antidepressant medications need an anesthesia consultation before the operation (preferably 3 weeks before)

<sup>a</sup>Patients should take medications with a small sip of water even if otherwise nothing by mouth (NPO).

Ischemic heart disease is the most common form of organ damage associated with HTN. *Uncontrolled* HTN is an ACC/AHA *minor* cardiac risk factor and the odds ratio for an association between HTN and perioperative cardiac risk is 1.31.<sup>8,54</sup> There is little evidence of an association between preoperative blood pressures <180/110 mm Hg and perioperative cardiac risk. Heart failure, renal insufficiency, and cerebrovascular disease are more common in hypertensive patients.

It is generally recommended that elective surgery be delayed for severe HTN (diastolic blood pressure >115 mm Hg; systolic blood pressure >200 mm Hg) until the blood pressure is <180/110 mm Hg. If severe end-organ damage is present, the goal should be to normalize blood pressure *as much as possible* before the operation.<sup>54</sup> There is no evidence to justify cancellation of an operation when blood pressure is <180/110 mm Hg, although interventions preoperatively are appropriate. Severely elevated blood pressure should be lowered over several weeks.

Testing should be determined by the history and physical examination (Table 4-5). Guidelines suggest that cardioselective  $\beta$ -blocker therapy is the best treatment preoperatively because of a favorable profile in lowering cardiovascular risk (Table 4-7).<sup>8</sup> Effective lowering of risk may require 6–8 weeks of therapy to allow regression of vascular changes and too rapid or extreme lowering of blood pressure may increase cerebral and coronary ischemia. The Antihypertensive and Lipid-Lowering Treatment to Prevent Heart Attack (ALLHAT) trial showed that effective treatment of HTN is not simply a matter of lowering blood pressure.<sup>55</sup> Continuation of antihypertensive treatment preoperatively is critical (Table 4-6). Chapter 7 has more information on the hypertensive patient.

## Renal Disease

A normal creatinine level is often not an accurate indicator of renal function. A doubling of serum creatinine from 0.8 to 1.6 mg/dL represents a halving of glomerular filtration rate (GFR). Creatinine does not exceed the normal limits until GFR has fallen below 50 mL/min. GFR decreases with age and the renal reserve of a healthy 80-year-old is less than half that of a

TABLE 4-7.

**β-Blockers: Preoperative Instructions**

**Rationale.** The pre- and postoperative administration of β-blockers reduces morbidity and mortality in patients at risk for cardiac complications after surgery of intermediate or high risk. The purpose of this protocol is to identify at-risk patients for prophylactic treatment with β-blockers preoperatively.

**Inclusion criteria**

1. Patients scheduled for surgical procedures of moderate to high risk such as
  - All vascular surgical procedures: aortic, peripheral, carotid
  - Major orthopedic, total joints, open back
  - Open abdominal or pelvic, GI, urologic, gynecologic
  - Open thoracic or procedures requiring one-lung ventilation
  - Major neurosurgical such as craniotomy, spinal
  - Major head and neck

and

2. Known coronary artery disease

or

3. At least 2 of the following risk factors for coronary artery disease
  - Age >70 years
  - Diabetes mellitus
  - Poorly controlled hypertension (systolic >160 mm Hg; diastolic >100 mm Hg)
  - Peripheral vascular or carotid arteriosclerosis
  - Renal insufficiency (creatinine  $\geq$  2.0)
  - Cerebrovascular disease (stroke, transient ischemic attack)
  - Poor functional status (fewer than 5 METS; i.e., unable to walk up a flight of stairs or walk 2 blocks without stopping) (Table 4-4)

**Exclusion Criteria**

1. Pulmonary disease with significant reactive component, taking β-agonists daily or oral steroids, unless already taking a β-blocker
2. Acute congestive heart failure or severe left ventricular dysfunction (ejection fraction <0.30) or recent (<1 month) hospitalization for congestive heart failure unless already taking a β-blocker
3. Second- or third-degree heart block
4. β-Blocker allergy
5. Systolic blood pressure <90 mm Hg or heart rate <50 beats/min

**Preoperative Instructions**

1. Start atenolol or metoprolol 25–50 mg/d titrating heart rate to <65 beats/min
2. Patients already taking a β-blocker should continue until the day of the operation; titrate to target heart rate of 65–80 beats/min

healthy 40-year-old. The focus of the preoperative evaluation of patients with renal insufficiency or failure should be on the cardiovascular and cerebrovascular systems, fluid volume, and electrolyte status. Chronic metabolic acidosis is common but usually mild and compensated for by chronic hyperventilation. Table 4-5 has testing recommendations.

Chronic renal disease is a significant risk factor for cardiovascular morbidity and mortality and is an ACC/AHA intermediate cardiac risk factor equal to a history of known CAD. The annual incidence of death from CAD in patients with both diabetes and end-stage

renal disease who are on hemodialysis is 8.2%. A creatinine  $\geq$  2.0 mg/dL should trigger an assessment of cardiac risk using the ACC/AHA guidelines (Fig. 4-2).<sup>8</sup> Chapter 7 provides a more detailed discussion of these guidelines.

In elective cases, hemodialysis should be performed within 24 hours of the operation, but not immediately before. Hemodialysis is associated with fluid and electrolyte (sodium, potassium, magnesium, phosphate) imbalance and shifting of electrolytes between intra- and extracellular compartments. Hemodialysis should be performed to correct volume overload, hyperkalemia, and acidosis.

Patients at risk for perioperative renal failure include those with preexisting renal insufficiency and diabetes, especially in combination, and those undergoing procedures with the administration of contrast medium. If all 3 conditions are present, the risk of renal failure may be as high as 50%. Preoperative identification of at-risk patients may change management, such as administration of sodium bicarbonate, a change in type of contrast medium, and avoidance of hypovolemia or even vigorous hydration. Chapter 13 has a complete discussion of the patient with renal disease.

**Hepatic Disease**

Predictors of poor perioperative outcome in patients with liver disease include the following<sup>56</sup>:

- Acute hepatitis (viral or alcoholic)
- Chronic active hepatitis with jaundice, encephalopathy, coagulopathy, or elevated liver enzymes
- Child's C cirrhosis (bilirubin >3 mg/dL, albumin <3 g/dL, PT >6 seconds more than control, poor nutritional status, large amount of ascites, and moderate encephalopathy)
- Abdominal surgery
- PT >3 seconds prolongation refractive to vitamin K therapy

Salt and water restriction, diuretic therapy (spironolactone is preferred), enteral nutritional supplements, and oral vitamin K (1–5 mg daily for 3–5 days) are indicated preoperatively to correct deficiencies. Delaying elective surgery until after an acute episode of hepatitis or an exacerbation of chronic disease has resolved is appropriate. Table 4-5 suggests the appropriate tests; Chapter 14 discusses the patient with liver disease in detail.

**Anemia**

Consequences from moderate levels of anemia and Hgb levels  $\geq$  6.0 g/dL in patients without CAD are minimal. The ASA Task Force on Blood Component Therapy concluded that red blood cells should not be transfused solely because of a Hgb level but rather because of risk for complications from inadequate oxygenation.<sup>57</sup> Transfusion is rarely indicated when the Hgb is >10 mg/dL, and almost always needed when the Hgb is <6 mg/dL. The goal in the preoperative clinic is to determine the etiology, duration, and stabil-

ity of the anemia, and to consider the extent and type of surgery, the anticipated blood loss, and the patient's comorbid conditions that may impact oxygenation, such as pulmonary, cerebrovascular, or cardiovascular disease. Type and screen testing before the day of operation and planning for the availability of blood will avoid delay of the procedure. This can ease the burden on the blood bank personnel for same-day admission or outpatient surgery. A protocol can be instituted with the department of surgery and the blood bank. In special circumstances, such as a patient's refusal of perioperative blood transfusions or for elective procedures with expected significant blood loss in anemic patients, postponement of surgery to treat with recombinant human erythropoietin and iron may be warranted.

Sickle cell disease is a hereditary hemoglobinopathy and vasoocclusion is responsible for most of the associated complications. Preoperative assessment should focus on identification of organ dysfunction and acute exacerbations.<sup>58</sup> Frequent hospitalizations or a recent increase in hospitalizations, increasing age, preexisting infections, and pulmonary disease predict perioperative vasoocclusive complications.<sup>58</sup> The preoperative history and physical examination should focus on the frequency, severity, and pattern of vasoocclusive crises and the degree of pulmonary, cardiac, renal, and central nervous system damage. Measurement of pulse oximetry, Hct, BUN, and creatinine, ECG, and a chest radiograph are indicated. Additional testing (e.g., echocardiogram, arterial blood gases) may be needed. Prophylactic transfusion may be beneficial, especially before intermediate- to high-risk operations. Preoperative prophylactic transfusion is controversial and the decision to transfuse should be made in concert with a hematologist familiar with the disease. Chapter 15 discusses in detail the patient with anemia.

### Neurologic Disease

For a patient with neurologic disease (e.g., stroke, seizure disorder, multiple sclerosis), a detailed history is required with focus on recent events, exacerbations, or evidence for poor control of the medical condition. A basic neurologic examination documenting deficits in mental status,

speech, cranial nerves, gait, and motor and sensory function is important. This baseline enables postoperative comparison and evaluation of new deficits. If a stroke or transient neurologic deficit is not fully evaluated or occurs within 1 month before the operation, elective surgery should be delayed pending complete evaluation. A newly discovered carotid bruit requires a careful history of related symptoms and carotid Doppler studies, especially if the procedure is likely to involve manipulation of the neck or if the patient has a potentially difficult airway. Significant abnormalities on Doppler studies should prompt a referral to a vascular surgeon or neurologist.

Routinely ordering tests for serum drug levels of antiseizure medications is not indicated unless toxicity is a concern or the patient is having breakthrough seizures. Patients with good control of seizures may have levels outside the therapeutic range and results may be confounded if the timing of the administration of the drugs in relation to when the test is drawn is not considered. Table 4–5 has testing suggestions and Chaps. 10 and 11 discuss neurologic diseases in detail.

### Cancer Patients

Patients with a history of cancer may have complications related to the disease or the treatment. Preoperative evaluation should focus on evaluation of the heart, lungs, and neurologic and hematologic systems. Previous head and neck irradiation may cause carotid artery disease, hypothyroidism, or difficulty with airway management.<sup>59</sup> Auscultation for bruits, thyroid function tests (thyroid-stimulating hormone levels), and carotid Doppler studies are recommended.

Mediastinal, chest wall, and left breast irradiation can cause conduction abnormalities, cardiomyopathy, valvular abnormalities, and premature CAD even without traditional risk factors.<sup>60</sup> Cardiovascular disease is the second most common cause of mortality in survivors of Hodgkins disease. One study found that 88% of patients had echocardiographic abnormalities 5–20 years after treatment, most of them asymptomatic. Treatment at a younger age increases risk. These risk factors were not considered in the ACC/AHA *Guidelines for Cardiac Evaluation for Noncardiac Surgery* but they

may be important predictors of CAD.<sup>60</sup> ECG, echocardiography, and stress testing may be indicated. Table 4–5 lists suggested diagnostic testing.

### Substance Abuse

Patients who use alcohol to excess or illicit drugs may not give a reliable history. Addicts may be at risk for a myriad of perioperative complications, including withdrawal, acute intoxication, an altered tolerance to anesthetic and opioid medications, infections, and end-organ damage. Preferably, patients with drug or alcohol dependence should be drug-free well before an elective operation. Acute preoperative abstinence in alcoholics, however, is associated with a poorer outcome postoperatively than if drinking is continued.<sup>61</sup>

Preanesthesia clinic staff should be prepared to refer patients to addiction specialists or programs or prescribe medications to prevent withdrawal in the preoperative period if patients agree to abstinence. Intravenous drug use should prompt an evaluation for cardiovascular, pulmonary, neurologic and infectious complications. Because intravenous access is often limited in users, interventional radiology may be needed to help with line placement. Alcoholics need assessment of cardiovascular, hepatic, and neurologic alterations. Testing depends on symptoms and findings from the history and physical. ECG, echocardiography, chest radiography, and chemistry and hepatic panels may be needed. Table 4–5 and Chap. 23 provide additional information.

### Patients with or at Risk of Thromboembolism and/or Pulmonary Emboli

Recent arterial or deep venous thromboembolism requires postponement of non-life-saving procedures. Without anticoagulation, the risk of recurrent DVT within 3 months of a proximal deep venous thromboembolism is approximately 50%. A month of warfarin treatment reduces the risk to 10%; and 3 months of warfarin treatment reduces the risk to 5%. Patients with a hereditary hypercoagulable state, cancer, or multiple episodes of DVT are at higher risk indefinitely. Patients with nonvalvular atrial fibrillation who have had a previous cerebral embolism also are at high risk. Patients with mechanical heart valves, especially

multiple valves, are at risk for embolism. Risk is greater with mitral than with aortic valves. Surgery increases the risk of deep venous thromboembolism, but there is no evidence that surgery increases the risk of arterial embolism in patients with atrial fibrillation or mechanical valves.<sup>62</sup>

An elective operation scheduled for the first month after an episode of venous or arterial thromboembolism should be postponed. If postponement is not possible, then the patient should receive preoperative heparin while the international normalized ratio (INR) is below 2.0.<sup>62</sup> Ideally, 3 months of anticoagulation is recommended before an elective operation. See the section on Medication Instructions and Table 4-6 for further discussion of warfarin management preoperatively. Chapter 15 discusses patients with coagulation disorders.

### Smokers and Those Exposed to Secondhand Smoke

Exposure to tobacco, directly or through “secondhand” smoke, increases the risk of many perioperative complications. Smokers are more likely to experience wound infections, respiratory or airway complications (including oxygen desaturation), and severe coughing.<sup>63</sup> Smoking decreases macrophage function, negatively impacts coronary flow reserve, and causes vascular endothelial dysfunction, hypertension, and ischemia. Smokers require longer hospital stays and more often need postoperative intensive care than do nonsmokers.

The greatest benefit of smoking abstinence is probably only realized after several months of cessation. In studies reporting a greater perioperative risk in recent quitters than in smokers, selection bias may have contributed to the results. The patients who were motivated to stop or advised to quit smoking may have been at greater risk because of health status. Soon after a patient quits smoking carbon monoxide levels decrease, which improves oxygen delivery and use. Cyanide levels decrease, which benefits mitochondrial oxidative metabolism. Lower nicotine levels improve vasodilatation and many toxic substances that impair wound healing decrease. Patients without a history of ischemic heart disease who smoked shortly before operation had significantly more episodes of rate-pressure

product-related ST-segment depression than did nonsmokers, former smokers, or chronic smokers who did not smoke in the immediate preoperative period.<sup>64</sup>

A preoperative smoking cessation intervention in patients who underwent knee and hip replacements decreased rates of surgical-site infections from 23% in the conventional group to 4% in those who stopped smoking. The U.S. Public Health Service recommends that “*all* physicians should strongly advise every patient who smokes to quit because evidence shows that physician advice to quit smoking increases abstinence rates.”<sup>65</sup> Nearly 70% of smokers want to quit.

Effective interventions include medical advice and pharmacotherapy, such as nicotine-replacement therapy, which is safe in the perioperative period. Nicotine patches, gum, and lozenges are available without a prescription; nasal spray and bupropion (Wellbutrin) require prescriptions. Clonidine is also effective. Bupropion or clonidine should be started 1–2 weeks before a quit attempt; nicotine replacement therapy is effective immediately.<sup>66</sup> Individual and group counseling may increase rates of long-term abstinence. Many hospitals, insurance companies, and communities offer smoking cessation programs. Excellent resources are available on the Internet and from the U.S. government. Advice and guidelines are available at <http://www.surgeongeneral.gov/tobacco/default.htm>. Tobacco-intervention training during medical school and residency can significantly improve the quality of physician counseling and rates of abstinence.

### The Elderly

By the year 2030 almost 70 million persons older than 65 years of age will be alive in the United States and a significant portion of these will be 85 years of age or older. The number of patients older than 65 years of age who will undergo noncardiac surgery will increase from 7 to 14 million by 2025. Chronological age, however, is a less important determinant of operative outcome than are comorbid conditions and physiologic age. Age >70 years is an independent predictor of postoperative mortality, cognitive dysfunction, major perioperative complications, and longer hospital stays.<sup>67</sup> Organ function declines in the elderly, who respond differently to medications and have a greater number of

comorbid conditions. Among the conditions are arthritis, hypertension, heart disease, and diabetes. One study found coexisting disease in 95% of geriatric patients scheduled for surgery. Postoperatively 35% of patients had cardiac or pulmonary complications that were associated with comorbid conditions, and many could have been predicted preoperatively.<sup>68</sup> Other studies have found that the rate of perioperative complications among the very elderly (>85 years of age) is not prohibitive.<sup>67</sup>

Elderly individuals often do not return home immediately after an operation for various reasons. They need rehabilitation, their recovery takes longer, they have a high incidence of postoperative delirium (26% prevalence at 1 week, 10% at 3 months), or support services are lacking. Discharge planning in advance may lessen the costs of perioperative elder care. Preoperative clinics can be designed to offer multidisciplinary care and after-discharge planning that coordinates with surgical, nursing, and social service departments.<sup>69</sup>

Testing in the elderly patient should be based on disease indications rather than age alone (see Tables 4-3 and 4-5 and the section in this chapter on age-based testing under Preoperative Testing). Chapter 20 presents an expanded discussion of the evaluation of the geriatric patient.

### Cataract Patients

Patients undergoing cataract surgery are often elderly with extensive comorbid disease. The procedure is minor, however, without expected systemic physiologic disturbances or significant postoperative pain. Topical anesthesia is commonly used and because general anesthesia is rarely required, the risk is lessened. Elective cataract surgery has the enormous benefits of allowing individuals to drive, read, avoid isolation, watch television, and decrease the incidence of falls. The cost of routine medical testing before cataract surgery is estimated at \$150 million annually. In a study of more than 18,000 patients randomly allocated to no *routine* testing before cataract surgery or to a battery of tests, including ECG, complete blood count (CBC), and electrolytes, BUN, creatinine, and glucose levels, no differences in postoperative adverse events were found between the two groups.<sup>70</sup>



The results of this study do not suggest that patients undergoing cataract surgery require no laboratory testing.<sup>70</sup> The study of cataract patients eliminated routine tests, not tests indicated for a new or worsening medical problem. The group that crossed over from no testing to some testing had significantly more coexisting illness and poor self-reported health status. This finding suggests that the preoperative care provider screen patients to order tests for those who require them. In the study described, exclusion criteria were general anesthesia or a myocardial infarction within 3 months. All patients underwent a *preoperative medical assessment*. More than 85% of enrollees reported good to excellent health status, almost 25% reported no coexisting illnesses (including hypertension, anemia, diabetes, and heart or lung disease), almost 30% were <70 years old, and 65% were ASA PS 1 or 2 status, suggesting a fairly healthy group.<sup>70</sup> If patients are comparable to those in the study, are routinely evaluated by primary care physicians, have stable mild disease, and will undergo cataract operation under topical or bulbar block, then no special testing is required because of cataract surgery. Serious, poorly controlled conditions must be normalized before surgery, and selective testing suggested by history and physical examination may be necessary. Although testing is rarely necessary because of cataract surgery, patients with limited access to healthcare services may benefit from medical evaluation. The ACC/AHA *Guidelines for Cardiac Evaluation for Noncardiac Surgery* consider cataract surgery to be low risk.<sup>8</sup> Tables 4–3 and 4–5 list testing indications for particular diseases.

### The Difficult Airway

An important part of preoperative evaluation is assessment of the airway. If a patient with a difficult airway can be identified before the day of operation, special equipment or personnel with advanced training and skills in airway management can be available without delaying or postponing procedures or compromising patient safety.<sup>1</sup> Patients with the following characteristics may have a challenging airway:

- Obstructive sleep apnea
- Snoring
- Obesity

- Facial and neck deformities from previous operation
- Head and neck radiation
- Head and neck trauma
- Congenital abnormalities
- Rheumatoid arthritis
- Down syndrome
- Scleroderma
- Cervical spine disease or previous operation

The ease or difficulty of laryngoscopy and intubation are discussed extensively in the literature. However, equally, if not more, important is the ability to predict difficulty with mask ventilation.<sup>71</sup> The following patient characteristics independently suggest difficulty with mask ventilation:

- Age >55 years
- BMI >26 kg/m<sup>2</sup>
- Lack of teeth
- A beard
- Snoring history

Patients with Down syndrome or rheumatoid arthritis may have asymptomatic atlantoaxial subluxation and cervical spine instability. A careful history may elicit neurologic deficits or neck and shoulder pain. Patients with neurologic deficits or symptoms, and rheumatoid arthritis patients with long-standing, severely deforming disease need cervical spine radiographs with special flexion, extension, and open-mouth odontoid views.

Chapter 8 discusses the evaluation of the patient with a difficult airway. The goals in the preoperative clinic should be documentation of an airway examination, including Mallampati score, status of teeth (Fig. 4–1), range of motion of the neck, thyromental distance, body habitus, and pertinent deformities. Previous anesthetic records should be obtained and a discussion of awake fiberoptic intubation with the patient may be appropriate. See Physical Examination above for components of the airway examination.

### Anesthesia-Specific Concerns

A personal or family history of pseudocholinesterase deficiency should be identified preoperatively. Records from previous anesthetics may clarify an uncertain history. If time allows, a dibucaine number and pseudocho-

linesterase, chloride, and fluoride levels should be obtained. A history of malignant hyperthermia (MH) or a suggestion of it (hyperthermia or rigidity during anesthesia) either in a patient or family member should be clearly documented and arrangements made before the day of operation.

### Ambulatory Surgery

Approximately 60–70% of surgical procedures are performed on an outpatient basis, and of these, 5–8% are performed in an office setting. A study of ambulatory surgery in Medicare beneficiaries older than 65 years of age found no deaths on the day of operation when the procedure was performed in a physician's office; 2.3 deaths per 100,000 procedures when performed in a freestanding ambulatory surgical center; and 2.5 deaths per 100,000 when performed at an outpatient hospital. The 7-day mortality was 35 per 100,000, 25 per 100,000, and 50 per 100,000 respectively. Age >85 years, significant comorbidity, and type of procedure predicted adverse events.<sup>72</sup>

Almost half of ambulatory surgical procedures are performed in patients age 65 years and older. Elderly patients may bring specific problems to the ambulatory setting as they often have multiple chronic conditions and poor eyesight, and may be unable to perform activities of daily living such as feeding themselves or driving. Some patients have limited support during the stress of recovery from anesthesia and surgery.<sup>69</sup> Chapter 20 and The Elderly above discuss preoperative evaluation of this population in greater detail.

Patients with OSA may require skilled and specialized airway management. They are typically sensitive to anesthetic agents (less airway muscle tone than normal, which leads to airway collapse) and narcotics (greater than average respiratory depression). They may require longer postoperative monitoring and the American Sleep Apnea Association suggests that some patients with sleep apnea might not be candidates for ambulatory surgery.

Obese patients may require specialized equipment to accommodate their weight, which might not be readily available in ambulatory facilities. Patients with a history or family history of MH may require prolonged observa-

tion in the recovery period, so planning is important. Whether a patient susceptible to MH is a candidate for ambulatory surgery should be decided well before the day of operation. Patients with a history or who are at risk of a difficult airway may need specialized equipment and personnel that might not be available. Individuals with pacemakers and ICDs may not be candidates for freestanding ambulatory facilities if electromagnetic interference is likely.

## PATIENT MANAGEMENT

Management of comorbid conditions and interventions to reduce risk are as important as identification and diagnosis of medical disease. If anesthesiologists are not going to intervene to improve new or chronic disease states, then close collaboration with primary care physicians, specialists, and surgeons are essential. Far too many anesthesia practices collect information without having processes in place to follow through to manage patients and risk so as to improve outcomes and reduce adverse events.

### Consultations

Collaborative care of patients is often necessary and beneficial. Consultation initiated by the preoperative physician should seek specific advice regarding diagnosis and status of the patient's condition(s). Asking specific questions such as "Does this patient have CAD?" or "Is this patient in the best medical condition for planned thoracotomy with lung resection under general anesthesia?" is the first step. Letters or notes stating "cleared for surgery" are rarely sufficient to design a safe anesthetic. A letter summarizing the patient's medical problems and condition, along with the results of diagnostic tests, are necessary.

Close coordination and good communication among the preoperative anesthesiologist, surgeon, and consultant is vitally important. Miscommunication among care providers was central to most reported incidents in the Australian Incident Monitoring Study (AIMS) whenever preoperative assessment was implicated.<sup>1</sup>

In many practices the cardiology service is most frequently consulted preoperatively. In one survey, however, the usefulness of such consultations was questioned by anesthesiolo-

gists. Unfortunately, only 17% of anesthesiologists felt obligated to follow the consulting cardiologist's recommendations. Forty percent of the consultations contained only the recommendation to "proceed with the case," "cleared for surgery," or "continue with current medications." Recommendations regarding intraoperative monitoring or cardiac medications were largely ignored. Part of this responsibility lies with the consulting physicians (be that surgeons or anesthesiologists) and the long-standing practice of asking for or receiving cardiac "clearance." This is a vague request and a response (often scribbled on a prescription pad) simply stating "low risk" or "cleared for surgery" is meaningless and unhelpful. In general, preoperative consultations should be sought for diagnosis, evaluation, and improvement of a new or poorly controlled condition, and for creation of a clinical risk profile that the patient, anesthesiologist, and surgeon use to make management decisions.

Detailed discussions and communication, preferably oral, are essential for the best management of complicated patients. Copies of diagnostic studies that accompany the consultation letter help the anesthesiologist to make an independent decision about patient risk and to plan anesthetic care. Chapter 6 has a detailed discussion of consultations.

### Practice Guidelines

An important element for a successful preoperative evaluation system is a uniform, consistent method for assessment and management. Even though individual judgment is necessary, guidelines and policies for the group should be developed. Cancellations, delays, or demands for additional diagnostic testing on the day of operation after a patient has been evaluated and deemed acceptable for anesthesia by the preoperative clinic is detrimental to the success of a preoperative assessment program.

Practice guidelines improve the process of preoperative evaluation and management and affect surgical outcomes. Guidelines minimize variation in clinical practice and make good use of resources. They may help to avoid cancellations or delays on the day of operation when the anesthesiologist in the preanesthetic clinic and the one performing the anesthesia have differ-

ences in opinion about the patient's fitness for operation. This will prevent patient inconvenience and disappointment and surgeon dissatisfaction. Guidelines synthesized from the best, most current sources help practitioners stay up-to-date with recommendations and the literature by assimilating treatments and diagnostics into their practices. Guidelines can be as simple as an organization of the type and timing of care delivered to typical, uncomplicated patients, or as complex as instructions for dealing with a specific issue expressed by decision trees in branching logic format.<sup>73</sup> Acceptance is more likely when disease-specific algorithms are developed and agreed to by all stakeholders. The intent is not to design inflexible standards, but to provide a consistent, straightforward method to evaluate a particular disease such as hypertension or CAD; a finding such as a murmur; or a symptom such as chest pain. Practice guidelines recommend care based on scientific evidence and broad consensus, but leave room for justifiable variations in practice.

Practice guidelines typically rely on evidence-based medicine that examines the data from clinical research. Intuition, personal clinical experience, and pathophysiologic rationale are less important. The practice and teaching of evidence-based medicine requires skills that are not part of traditional medical training. Precisely defining a problem and the information required to resolve the problem are important first steps. The pertinent studies from a well-conducted literature search are selected and applied to the treatment of medical conditions found in patients.

Algorithms such as in Figure 4-2, and guidelines such as those in Tables 4-3, 4-5, and 4-7, are examples.

### Nothing by Mouth Guidelines

Historically, patients have been told to abstain from oral intake (nothing by mouth [NPO]) after midnight regardless of the time of their procedure to reduce the risk of aspiration. Twenty years ago Miller found that a light breakfast (of tea and toast) 2-4 hours before an operation did not negatively impact gastric pH or volume. In many European countries today, patients are allowed to eat a "light breakfast" if an operation is scheduled for noon or after. However, this practice has not received widespread adoption in the

United States. Because oral fluids have short gastric transit times many, if not most, departments of anesthesia modified the “nothing after midnight” approach. The ASA recommends that healthy patients who will undergo elective procedures be allowed to drink clear liquids (e.g., water, juice without pulp, coffee or tea without cream or milk) until 2 hours before anesthesia; breast milk until 4 hours before anesthesia; and nonhuman milk, infant formula, or a light breakfast until 6 hours before procedures requiring anesthesia (Table 4–8).<sup>74</sup>

### Medication Instructions

Some medications should be continued on the day of operation because of their beneficial effects; others may be harmful or contraindicated.<sup>75</sup> Medications associated with withdrawal effects (e.g.,  $\beta$ -blockers, centrally acting sympatholytics, benzodiazepines, and opioid analgesics) should be continued through the preoperative period. Table 4–6 describes in detail drugs to be continued or discontinued before an operation.

Most antihypertensive medications, with the possible exception of angiotensin-converting enzyme inhibitors (ACEIs) and angiotensin receptor-blocking agents (ARBs) should be taken before operation.<sup>76</sup> ACEIs and ARBs may be associated with greater risk for hypotension upon induction of general anesthesia. For significant procedures with planned neuraxial blockade or general anesthesia in well-controlled hypertensive patients, it may be beneficial to hold these drugs on the day of operation. In our preoperative clinic patients who will undergo minor procedures with monitored anesthesia care, and those with poorly controlled hypertension are advised to continue these drugs on the day of operation to reduce the risk of significantly elevated blood pressure in the pre- and postoperative periods.  $\beta$ -Blockers and centrally acting sympatholytics (e.g., clonidine) can be associated with rebound hypertension when withdrawn.

Consensus is lacking on the recommendations to discontinue diuretics preoperatively. Diuretics (e.g., hydrochlorothiazide) to treat HTN may help to control blood pressure when continued on the day of operation. Withholding potent loop diuretics (e.g., furosemide) on the day of operation may

TABLE 4–8.

### Guidelines for Food and Fluids Before Elective Surgery

Time Before Surgery	Food or Fluid Intake
Up to 8 hours	Food and fluids as desired
Up to 6 hours <sup>a</sup>	Light meal (e.g., toast and clear liquids <sup>b</sup> ), infant formula, nonhuman milk
Up to 4 hours <sup>a</sup>	Breast milk
Up to 2 hours <sup>a</sup>	Clear liquids <sup>b</sup> only; no solids or foods containing fat in any form
During the 2 hours	No solids, no liquids

<sup>a</sup>This guideline applies only to patients who are not at risk for delayed gastric emptying. Patients with the following conditions are at risk for delayed gastric emptying: morbid obesity; diabetes mellitus; pregnancy; a history of gastroesophageal reflux; a surgery limiting stomach capacity; a potential difficult airway; opiate analgesic therapy.

<sup>b</sup>Clear liquids are water, carbonated beverages, sports drinks, and coffee or tea (without milk). The following are not clear liquids: juice with pulp, milk, coffee or tea with milk, infant formula, and any beverage with alcohol.

decrease the risk of hypokalemia, volume depletion, and renal insufficiency. Intravenous admission by the anesthesiologists on the day of operation is an option.

Medications used by patients with a history of or who are at risk for heart disease, such as  $\beta$ -blockers, digoxin, antiarrhythmics, and statins, should not be withdrawn before operation. Not only are they beneficial, but risk may be increased when they are not taken.<sup>8</sup>

Pulmonary medications, such as theophylline, inhaled  $\beta$ -agonists, inhaled anticholinergics, and inhaled or oral steroids, should be continued preoperatively.

Oral hypoglycemic agents should be held the day of operation to avoid hypoglycemia. Taking small amounts of long-acting insulin on the day of operation presents little risk of hypoglycemia, but results in improved perioperative control. Patients with types 1 and 2 diabetes should discon-

tinue all short-acting insulins on the day of operation. Type 2 diabetics should take none or up to one-half dose of long-acting (e.g., lente or neutral protamine Hagedorn [NPH]) or combination (70/30 preparations) insulins on the day of operation. Type 1 diabetics should take a small amount (usually one-third to one-half) of their usual morning long-acting insulin (e.g., lente or NPH) on the day of operation to avoid diabetic ketoacidosis. Patients with an insulin pump should continue their basal rate only.

Warfarin may be associated with increased bleeding except for minor procedures such as cataract surgery without bulbar blocks. There is no consensus on the optimal perioperative management of patients on warfarin. The usual recommendation is to withhold 4 doses of warfarin before operation (if the INR is 2.0–3.0) to allow the INR to decrease to <1.5, a level considered safe for surgical procedures and neuraxial blockade.<sup>6,77</sup> If the INR is >3.0, it is necessary to withhold warfarin longer than 4 doses. If the INR is measured the day before the operation and remains >1.8, a small dose of vitamin K (1.0–5.0 mg orally or subcutaneously) can reverse anticoagulation.<sup>63</sup>

Substitution with shorter acting anticoagulants such as unfractionated or low-molecular-weight heparin, referred to as bridging, is controversial and should be individualized.<sup>62</sup> Kearon recommends preoperative bridging with intravenous heparin only for patients who have had an acute arterial or venous thromboembolism within 1 month before operation if the procedure cannot be postponed.<sup>62</sup>

Most medications for neurologic and psychological problems should be continued on schedule in the preoperative period. Antiepileptics, antiparkinson medications, antidepressants, including monoamine oxidase inhibitors (MAOIs), antipsychotics, benzodiazepines, and drugs to treat myasthenia gravis are best maintained to avoid exacerbations of symptoms. Antianxiety and psychiatric medications should be continued up until the time of the procedure. Communication is crucial to alert the day of operation caregivers because alterations in anesthesia may be necessary when caring for patients on these medications, especially for patients taking MAOIs.

Highly active antiretroviral regimens to treat human immunodeficien-

cy virus require regular dosing to prevent drug resistance. It is important to maintain these as scheduled. Antibiotics should be taken to complete a prescribed course of therapy.

Patients taking narcotic pain medications should be told to continue these medications as needed, including on the day of operation. Missed doses may result in withdrawal symptoms and significant pain with the associated stress response and hemodynamic perturbations.

Aspirin and other nonsteroidal anti-inflammatory drugs (NSAIDs) are generally discontinued before the day of operation. Circumstances may dictate otherwise to prevent myocardial infarction or stroke, to improve patency of vascular grafts, and to achieve better pain control. There is a lack of consensus about discontinuing these medications. Stopping aspirin and NSAIDs may be more important for intracranial, spinal, and some ophthalmologic (other than cataract) procedures. Aspirin may be continued for patients at high risk for cardiovascular and cerebrovascular complications and for those scheduled for vascular reconstruction. Discontinuation of nonaspirin NSAIDs may benefit patients at risk for renal insufficiency and continuation may be preferred to improve pain management. Aspirin and other NSAIDs do not need to be discontinued for planned neuraxial or regional anesthesia techniques. If the decision to discontinue these agents is made, aspirin should be stopped 5–7 days before the operation and other NSAIDs 24–48 hours before the operation.<sup>78</sup> Many cold preparations and over-the-counter drugs (e.g., Alka-Seltzer and Pepto-Bismol) may contain aspirin.

More potent antiplatelet agents, such as clopidogrel (Plavix) may be associated with a substantial risk of perioperative bleeding. These drugs should be discontinued 7 days before the operation.

Thyroid replacement drugs and antithyroid medications should continue on schedule.<sup>75</sup> Patients taking steroids regularly should take their usual dose on the day of operation.<sup>79</sup> Patients who have taken more than the equivalent of 7.5 mg of prednisone a day for at least 2 weeks within the previous year may be at risk for stress-associated adrenal insufficiency.

Postmenopausal hormone replacement therapies containing estrogen increase the risk of perioperative throm-

boembolic complications and should be discontinued before operation.<sup>80</sup> Estrogens must be stopped approximately 1 month before the operation to return coagulation to baseline. Most modern oral contraceptives have low doses of estrogen that increase thromboembolic risk minimally. The risk of unanticipated pregnancy may outweigh the benefits of discontinuing oral contraceptives.

Herbals and supplements may interact with anesthetic agents, alter the effects of prescription medications, and increase bleeding. Many patients do not consider supplements to be medications and will not report them in a list of their medications unless asked. Ginkgo biloba, echinacea, garlic, ginseng, kava, St. John's wort, and valerian may be associated with increased bleeding, or a resistance or increased sensitivity to anesthetic and sedative agents.<sup>81</sup> Herbals and supplements should be discontinued 7–14 days before the operation. The exception is valerian, a central nervous system depressant that may cause a benzodiazepine-like withdrawal when discontinued. If time permits, valerian should be tapered before a planned anesthetic.

Patients who are particularly anxious should be offered a prescription for a short course of benzodiazepines, such as lorazepam, to be taken in the days preceding the operation, as well as on the day of operation.

### Therapies to Modify Cardiac Risk

Perioperative  $\beta$ -blockers may reduce adverse cardiac events in patients who will undergo intermediate- to high-risk operation, if significant clinical predictors are present.<sup>82,83</sup> One survey found that almost 60% of surgeons and 50% of cardiologists thought that the best place to institute or coordinate a  $\beta$ -blocker protocol is in a preoperative anesthesiology clinic.<sup>84</sup> Anesthesiologists, especially those working in preoperative clinics, need to participate in this effort to identify at-risk patients and prescribe these drugs. Although these drugs can be given in the immediate preoperative period on the day of operation, patients may derive added benefit from starting these drugs sooner. Starting  $\beta$ -blockers preoperatively allows more time to titrate to effect and provides an opportunity to identify intolerance. Table 4–7 lists  $\beta$ -blocker prescribing guidelines.

A combination of  $\beta$ -blockers and statins reduced cardiovascular complications and mortality in vascular surgery patients, and statins alone were beneficial in patients who had other high-risk procedures.<sup>85</sup> Elective operations should be postponed for at-risk patients scheduled to undergo vascular or other high-risk procedures to implement statin therapy (see Chap. 7 and Heart Disease above).

$\beta$ -Blockers should not be started in patients with an acute or recent (within 1 month) exacerbation of heart failure (although they are beneficial for patients with chronic heart failure), in patients with high-degree heart block or significant bradycardia, or in patients with reactive airways disease who are dependent on daily  $\beta$ -agonists or who have an acute exacerbation of bronchospasm.  $\beta$ -Blockers are *not* contraindicated in patients with stable, mild to moderate chronic obstructive lung disease or asthma.<sup>86</sup> Table 4–7 lists exclusion criteria.

Chapter 7 discusses this topic in greater detail.

## CLINICAL MODELS AND MANAGEMENT

As the practice of surgery has moved into the outpatient arena with the majority of patients presenting to the hospital within minutes to hours of undergoing complex procedures anesthesiologists have struggled with how best to accomplish their evaluations. Various models exist. Lee originally proposed an anesthesia-based outpatient clinic in 1949. Some clinics do no more than document information provided by the patient, the medical record, or others who have seen the patient. Some anesthesiologists rely on other physicians operating independently to prepare patients for operation, either based on anesthesia-derived guidelines or not. This allows for review of information but little direct oversight of the process. Practices that do not have preanesthesia clinics need to develop guidelines to direct testing and to prepare patients for anesthesia (Tables 4–3, 4–5, 4–6, 4–8, and 4–9).

Many surgeons and anesthesiologists rely on prior screening of patients or referrals to primary care physicians, internists, or specialists to “clear” patients or to manage comorbid conditions. Although this reliance



TABLE 4-9.

## Surgeon's Checklist

If the patient has not had an anesthesia consultation before the day of surgery, please adhere to the following guidelines:

- 1. Surgical history and results of physical examination are available on the day of the operation.
- 2. Preoperative Questionnaire (Table 4-4) is given to the patient with instructions to fill it out and bring it on the day of surgery or fax it before hand to \_\_\_\_\_
- 3. Appropriate diagnostic tests are completed and are available. You are responsible for followup on any tests that you order (Tables 4-3 and 4-5 and Fig. 4-2).
- 4. Medical information from outside our healthcare system (diagnostic tests, blood work, cardiac stress tests, echocardiograms, catheterizations, pulmonary function tests, consultations) is available on the day of the operation.
- 5. Patient has been given preoperative medication instructions (Table 4-6).
- 6. Patient has been given NPO guidelines (Table 4-8).
- 7. "Clearance" letters or notes are rarely sufficient to design a safe anesthetic. A letter summarizing the patient's medical problems and condition and verifying that the patient's medical status is optimized is necessary. Surgery may be delayed or postponed for patients with chronic medical conditions if they have not been evaluated in the Anesthesia Preoperative Medicine Clinic (APMC) and necessary information is not available preoperatively, or their medical status is not optimized. The staff of APMC encourage you to use the clinic for complex patients or those undergoing major operations (Tables 4-1 and 4-3).

may be appropriate for a few, very select diseases and patients, the management of conditions for everyday life and for reducing long-term complications is very different from the stresses of a surgical procedure and anesthesia. Proficiency in preoperative care is a prerequisite for board certification in anesthesia; internists who are not specifically trained in preoperative care may "feel insecure when called on to evaluate the preoperative patient because this important aspect of medicine is not formally taught in many training programs."<sup>87</sup> Anesthesiologists are best suited to do preoperative assessments because of our comprehensive understanding of surgical procedures, anesthetic techniques, and the pharmacologic and physiologic responses of patients during procedures.

Anesthesiologist-staffed preoperative clinics improve the satisfaction of patients and physicians, reduce operating room cancellations and delays, and decrease unnecessary testing and costs.<sup>88</sup> To expand the anesthesiologist's responsibilities beyond the operating room, an educational system must be developed to train anesthesiologists in preoperative care. Concern has been expressed that current anesthesiology training programs are inadequately preparing practitioners to evaluate and manage patients with complicated medical conditions prior to anesthesia and operation.<sup>89</sup> During residency training, honing the cognitive aptitude for preoperative medicine is not emphasized because of the inordinate amount of time anesthesiologists spend in the operating room learning technical and procedural skills. One study found that fewer than half of residency programs have a formal preoperative management curriculum.<sup>89</sup> Anesthesiology often attracts physicians who either do not want to work in clinic settings, or do not want to develop proficiency in preoperative medicine, communication, and multidisciplinary management of care. Kluger, from the AIMS study, stated: "Anaesthetists must recognize they are responsible for the overall clinical management of the patient rather than simply providing a technical service."<sup>1</sup>

As anesthesiologists assume a greater out-of-operating room presence and take on the tasks of evaluating and managing patients before operation

and anesthesia, expert practices using cost-efficient management, outcomes measures, and practice guidelines must be developed. Diagnostic expertise and clinical decision making should be emphasized. It would be unrealistic to expect anesthesiologists to manage the administrative and clinical roles of perioperative medicine without training in these skills during residency.<sup>89</sup> Greater involvement of anesthesiologists in preoperative medicine has potential benefits to patients, institutions, the healthcare system, and the specialty. Preoperative clinics enable anesthesiologists to be responsible for perioperative care resources, to attract a diverse population of healthcare providers to the specialty, and to establish an expertise beyond the operating suite.

Preanesthesia clinics vary widely in services offered and the personnel involved in preoperative evaluation. They are staffed by anesthesiologists, internists, or physician extenders, such as nurse practitioners, physician assistants, registered nurses, or some combination (M. Higgins, personal communication, Vanderbilt University December 2005).<sup>73</sup> Little difference has been shown in patient outcomes when those cared for by physicians and other health practitioners were compared. Little data from preanesthetic clinics exist to guide staffing. When outcomes were compared between patients cared for by nurse practitioners versus primary care physicians, no difference in health status of patients or quality of care was found. In one study, a physician's diagnostic accuracy was improved 20-30% after a physician's assistant took a detailed history.<sup>90</sup>

Anesthesiologists are highly qualified to perform preoperative assessment and management because of their intimate knowledge of anesthesia, the planned surgical procedures, and the associated physiologic perturbations. For the sake of cost-efficiency, physician extenders, such as registered nurses, physician assistants, advanced nurse practitioners, and medical assistants, can contribute to evaluation under the direction of the anesthesia department. Depending on services that are offered, additional staff might include clerks, phlebotomists, ECG technicians, administrators, social workers, case managers, and physical therapists.

## Scheduling

Scheduling should be based on the anticipated requirements of the preoperative visit, such as the numbers and types of practitioners (e.g., nurses, physicians, physical therapists, phlebotomists) who will be seeing the patient, required diagnostic studies, and the general health of the patient. The general health of the patient is estimated by the ASA PS or a screening mechanism offered by various Internet-based tools, a previsit telephone call, or a patient-completed information form sent from the surgeon's office (Table 4-4). Standardized appointment times for all patients inherently result in delays and long waits. Facilities should consider open-access scheduling that accommodates walk-ins for those patients traveling long distances or who have physical disabilities or unexpected scheduling of operation to prevent inconveniencing them with a return appointment. Reserving a block of time to coordinate appointments with high-volume office visits to surgeons might be useful. Scheduling patients far enough in advance allows time for ordering tests, improving the patient's medical condition, and recruiting social services. Evening and weekend hours afford patients the least disruption from work or family responsibilities.

Because long wait times contribute to patient dissatisfaction, strategies should lessen wait times to improve satisfaction. If patients arrive early or late for an appointment, if practitioners take longer than an appointment time, or if patients without appointments delay the evaluation of other patients, wait times will increase. Scheduling appointments that reflect time needed, using longer appointment intervals, providing necessary clinical information, using a computerized anesthesia record, accepting provider idle time, scheduling breaks, and deliberately expecting many "no-show" patients might decrease wait time.

## Improving Patient Experience with Preoperative Evaluation

Patients who are scheduled for operation want information, want to have their concerns addressed, and want their questions answered.<sup>91</sup> Patient anxiety is reduced when a patient's coping style is not threatened. Too much information, especially detailed information

about the dangers of anesthesia and operation, creates anxiety in patients who prefer to cope by avoidance. Patients without prior anesthetic exposure desire more information than patients who have had previous anesthetics. Patients desire information in layperson language. Respecting a patient's feelings, explaining complex issues in a simple manner, and learning effective communication skills can improve patient satisfaction.<sup>92</sup> Nonverbal communication, dress, and avoidance of jargon are important. Videos about anesthesia can be time-efficient and well received. Written instructions, especially regarding NPO guidelines, medications, and when and where to go on the day of operation, are essential.

Patient satisfaction questionnaires should be designed and used to improve the processes.<sup>93</sup> Some questions that might be asked in such a survey are as follows:

- Did the anesthesiologist explain the planned anesthetic in terms you understood?
- How well did the anesthesiologist answer your questions and address your concerns?
- How well did the anesthesiologist explain what you could expect after your anesthesia?
- Did you have to wait long?
- Was the staff courteous and respectful to you?
- Overall, how satisfied were you with your preanesthetic visit?
- How might we improve our services?

## Informatics

Modern, up-to-date information systems streamline acquisition, storage, and transfer of data about patients among primary care providers, the laboratory, consultants, surgeons, and operating room and clinic personnel. Many institutions have developed their own computer-based programs (Figs. 4-3, 4-4, and 4-5) and a variety of commercial products are available. These can be as simple as a questionnaire (Table 4-4) or as advanced as complex systems that include decision support tools for diagnostic testing, suggestions for consultations, physician computer order entry, direct links to laboratory databases, and the capability of printing patient preoperative instructions, as well as a summary of the evaluation.

Computerized order-entry, prescription generation, and management programs can improve patient care and reduce costs. Patients can transfer information via e-mail, facsimile machines, and interactive telephone systems. Simple telephone reminders improve appointment keeping, patient satisfaction, patient compliance, use of services, and medication compliance, and decrease use of alcohol and tobacco (prevention programs).

Computer-program patient interviews save valuable physician time and may be convenient for the patient. Computer programs that gather information directly from patients allow planning for needed services in advance, and can provide patient education and instruction. Internet-based sites such as [www.onemedicalpassport.com](http://www.onemedicalpassport.com) and tools such as HealthQuest and telemedicine have been used for preoperative evaluation.<sup>73</sup> Airway evaluation is particularly enhanced with telemedicine.

Electronic technology has enhanced the ease and efficiency of data acquisition and this data can be accessed for patient care simultaneously by multiple providers in diverse locations. Technology can improve management of clinical studies, be used for cost analysis, and used for staffing, resource allocation, and managed care or capitated contract negotiations.

A computerized preanesthetic evaluation system can improve hospital (not just preoperative clinic) reimbursement by improved documentation of diagnosis-related group (DRG) codes when ICD-9 codes are changed.<sup>94</sup>

## Medicolegal Culpability

As anesthesiologists broaden their scope of practice and responsibilities, concerns over medical liability arise. Professional negligence, or malpractice, is generally characterized as a failure on the part of the physician to possess or exercise reasonable skill or diligence in the diagnosis or treatment of a patient. The essential elements of a medical malpractice claim include a duty toward the patient, a breach of that duty, and an injury to the patient because of the breach of duty. A physician's responsibility is to act in accordance with *national* standards of care established by the profession, which are defined in terms of care delivered by an average practitioner, not the *best* practitioner.

The Department of Anesthesia & Critical Care  
Anesthesia Perioperative Medicine ClinicMHID: .4145253  
PTID: .888523504

Approval Required?:

Class:

**BOGUS, BOGUS**

PreOp Date: 8/18/05    Req. Anesth Type: Choice    Surgery Facility: GOR-UCH    Patient Phones: 773-773-7373    773-773-3737    DOB: 2/20/1958    Age: 47    Gender:  M  F

Dx: Breast Mass 611.72    Side: Left    Surgeon: Bogus Bogus, Jr    Scheduled Surg Date: 9/21/2005

Procedure: mastectomy

**History****• MEDICATIONS**

● Lexi-Com

	Dose	Freq
<input checked="" type="checkbox"/> albuterol (Ventolin®)		PRN
<input checked="" type="checkbox"/> Atenolol	50 mg	BID
<input checked="" type="checkbox"/> HCTZ (Dyazide; Hydrochlorothiazide)	25 mg	QAM
<input checked="" type="checkbox"/> acetaminophen (Tylenol®)		PRN
<input checked="" type="checkbox"/> Insulin 70/30	20 u	BID
<input checked="" type="checkbox"/> Lipitor	1 tab	QHS
<input checked="" type="checkbox"/> Delete		

Medication Notes

**• ALLERGIES**

	Reaction
<input checked="" type="checkbox"/> PCN	hives
<input checked="" type="checkbox"/>	

**• SOCIAL HABITS**

Tobacco: >20 pk-yrs; Quit >6 mo  
 Alcohol: Occasional  
 Drugs: - None -  
 Habit comment:

**• PROBLEMS**

	Date Onset
<input checked="" type="checkbox"/> Type 2 Diabetes	1999
<input checked="" type="checkbox"/> Hypercholesterolemia	1997
<input checked="" type="checkbox"/> Hypertension	1997
<input checked="" type="checkbox"/>	

Problems Comments

**• SURGERIES**

	Date	Anesth?	Probs?
<input checked="" type="checkbox"/> C-section	1992	Epid	No
<input checked="" type="checkbox"/> Cholecystectomy	1994	GA	Yes
<input checked="" type="checkbox"/>			

Surgeries Comments

PONV

**• ROS**

● Enter Normal

CV(-); Resp(-); Hep(-); GI(-); Renal(-); Heme(-); CNS(-); Endo(-); Pregnant?(LNMP 8/1/06; denies pregnancy); FH Anesth Probs(-); CP(-); SOB(occ when walking stairs); Heartburn(+); Snores(+); Cardiology?(-); Stress Test?(-)

Select Best Exercise Level: Walking on a flat surface for one or two blocks

METs Est: 3

**• OTHER MDs**

● Has Patient ever seen a Cardiologist?

Last Name	First Name	Phone	Date	Note

**EXIT****SUSPEND**

Reception

**In** 15:46

Case Manager

**Fremarek**

Vitals

**Start** 15:46**Done** 15:46

Room

5 6 7 8

9 10 11 12

Top

History

Physical Exam

Labs

Patient Instructions

Plan

Billing

Print

**EXIT**

Interview

**Start** 15:46**Done** 15:46

⚡ Elapsed: 1:16

Clinic Status:  
ExamDone

Exam Room:

FIGURE 4-3. Computerized patient history.

Duties of the preoperative physician include examination of the patient and referral to a specialist if necessary. Part of the examination requires the use of diagnostic information or techniques that an average, reasonable practitioner would use in similar circumstances.

Often physicians are concerned about failure to diagnose a condition by failing to order a diagnostic screening test. The traditional system of ordering preoperative tests routinely evolved from the mistaken belief that more information, no matter how irrelevant or expensive, will improve care, enhance safety, and decrease liability. In reality, nonselective screening may increase legal culpability. Unanticipated abnormalities on laboratory test results

are uncommon. The relationship between these abnormalities and surgical and anesthetic morbidity is weak at best. More than half of all abnormal test results obtained in routine preoperative screening are ignored or not noted in the medical record, which is the document of interest to the courts. Failure to followup an abnormal result is, from a legal point of view, probably riskier than failure to order the test in the first place.

Physicians without malpractice claims are more likely than physicians with malpractice claims to encourage patients to talk and give their opinions. The physicians clarify what has been discussed, and keep patients informed about what to expect during a visit. One

study found that communication problems were predominant in most of the reported incidents involving a failure of preoperative preparation.<sup>1</sup> Chapter 95 discusses legal issues in anesthesiology in greater detail.

**Economics**

It has been said that anesthesiologists do not get paid to do preoperative evaluations. In reality, the fee for preoperative assessment is part of the total operating room payment, and preoperative assessment by an anesthesiologist is required by both regulatory bodies and CMS.<sup>24</sup> One study showed that preanesthetic care can reduce delays and cancellations on the day of operation.<sup>88</sup> This can improve revenues by



Physical Exam

**VITAL SIGNS** SBP:  DBP:  HR:  SpO2:  HT:   in  cm WT:   kg  lb

**GENERAL** ● Enter Normal Exam

Appearance:   
 Affect:   
 Mental Status:   
 Comment:

Skin:   
 Digits:   
 BMI:   
 NOTE: Do not exceed space provided for Comments ^

**AIRWAY**

Mallampati:   
 Oral Aperture:   
 Teeth:   
 TM Dist:   
 Comment:

Neck:   
 Neck ROM:   
 Thyroid:   
 Impression:

**CV**

Exam:   
 Pulses:   
 Comment:

CV Peripheral Exam:

**RESPIRATORY**

Exam:   
 Comment:

Respiratory Effort:

**OTHER EXAM**

Labs

● Enter T&S and Instructions ● PDR.net

Select a Lab:	Select an Indication:	ICD9:	Req?	Date:	Status:	Results / Interpretation (NOTE: <u>Do not</u> exceed space provided):
<input checked="" type="checkbox"/> KPNL	<input type="text"/>	<input type="text"/>	<input type="text"/>	8/11/05	Pend	<input type="text"/>
<input checked="" type="checkbox"/> Hgb1AC	DM, Type 2	250.00	Anes	8/11/05	Pend	<input type="text"/>
<input checked="" type="checkbox"/> ECG	DM, type 2	250.00	<input type="text"/>	8/9/05	Pend	<input type="text"/>
<input checked="" type="checkbox"/> CBC w/Pit	Presurgical Testing Visit	V72.84	<input type="text"/>	8/9/05	Pend	<input type="text"/>
<input checked="" type="checkbox"/>	<input type="text"/>	<input type="text"/>	<input type="text"/>	<input type="text"/>	<input type="text"/>	<input type="text"/>

x Delete ● Diagnosis Entry Required

**CONSULTS**

Date:	Status:	Results (NOTE: <u>Do not</u> exceed space provided):
<input checked="" type="checkbox"/> Stress Thallium	8/12/05	Scheduled
<input checked="" type="checkbox"/>	<input type="text"/>	<input type="text"/>

x Delete

Examination

**Start** 15:46

**DM2 Enroll**

✦ Elapsed: 1:16  
 Clinic Status: ExamDone  
 Exam Room:

Examination

**Start** 15:46

**DM2 Enroll**

✦ Elapsed: 1:16  
 Clinic Status: ExamDone  
 Exam Room:

FIGURE 4-4. Computerized patient physical examination and diagnostic test ordering.

increasing time spent on billable cases rather than incurring personnel costs with an empty operating room. Avoiding delays and cancellations on the day of operation eliminates waste associated with unnecessary setups with disposal products. Preoperative assessment clinics also reduce costs by decreasing unnecessary testing and identifying patients with special needs on the day of operation.

According to CMS, preoperative assessments by anesthesiologists can be billed separately as visits or consultations “if medically necessary” and “beyond a routine preanesthetic assessment.”<sup>24</sup> When anesthesiologists

perform at the level of a perioperative physician by ordering diagnostic studies such as echocardiograms or stress tests; by identifying problems and requesting consultations with specialists; by prescribing therapies such as  $\beta$ -blockers or bronchodilators; and by coordinating care beyond a simple anesthetic plan, they are offering care “beyond a routine preanesthetic assessment” and should bill for consultative services. Chapter 97 describes the criteria required to bill for preoperative consultations.

Physicians working in or administering preanesthetic clinics must become familiar with the CMS Advance Beneficiary Notice (ABN) billing rules. These

rules govern whether physicians and other Medicare Part B providers can bill beneficiaries directly if Medicare does not cover services because of a lack of medical necessity. In the past, under Medicare, liability for uncovered services was the responsibility of the beneficiary. Recent changes to the rules relieve beneficiaries from financial liability if the provider did not disclose that the service was not reimbursed by CMS. Unless the physician or facility has followed the ABN rules, payment may not be sought from the patient. ABN rules apply only to outpatient services. Additional information can be obtained from <http://www.cms.hhs.gov>.



**Patient Instructions**

**BOGUS, BOGUS**  
 Surgery Date: 9/21/2005  
 Case Manager: Fremarek

Planned Procedure:  
 mastectomy

Medications	Freq	Select Instructions
albuterol (Ventolin®)	PRN	Take morning of surgery
Atenolol	BID	Take morning of surgery
HCTZ (Dyazide,Hydrodiuril®)	QAM	Take morning of surgery
acetaminophen (Tyleno®)	PRN	May take if needed on day of surgery
Insulin 70/30	BID	Take 1/2 usual dose morning of surgery

Clinic Status: ExamDone  
 Exam Room:

Special Instructions to Patient (NOTE: Do not exceed space provided):

---

**Plan**

GA  
  GA/Epid  
  Spinal/Epid  
  Regional  
  Reg/Spinal  
  MAC
 

Select ASA PS:  1  2  3  4

Dx: Breast Mass 611.72  
 Surgery type: mastectomy  
 Surgeon: Bogus Bogus, Jr  
 Requested anes type: Choice  
 Surgery Date: 9/21/2005  
 UCH Primary Care MD:  
 Requesting MD:  
 Contact:

Anesthesia:

NPO:

Medication:

Monitoring:

Analgesia:

PostOp:

Preop Anesthesiologist:

Resident:

---

**OVERVIEW**

● **Auto Enter**    Current Character count = 761. Maximum 1100 characters allowed. [CLICK HERE](#) to update count.

47 yo F for mastectomy on 10/20/2006 with Dr. Bogus. GA Discussed. Type 2 DM, not well controlled per patient (BS 16-200), HTN, usually well controlled but didn't take meds this AM & high in clinic. Has ACC/AHA intermediate risk factor of DM and ?? minor risk factor of poorly controlled HTN but and poor functional capacity undergoing intermediate risk procedure so will order stress test. Patient unable to exercise due to her "bad knee". Unless stress indicates significant burden of ischemic heart disease given her history of cancer and her use of betablocker with excellent blood pressure control recommend proceeding to surgery without coronary intervention. Excellent pain mgmt and hemodynamic control throughout perioperative period are important

**URGENT**    Enter Special Anesthesia Concerns to be highlighted    (NOTE: Do not exceed space provided)

This is not a real patient.

**CONSENT**    ● **Alternate Consent Statements**

I have discussed the risks and benefits of the planned anesthetic and its options with the patient who appears to understand and accept.

**Billing**

**NECESSITY**

Preop1  cardiac risk assessment

Preop2

1  2 Type 2 Diabetes

1  2 Hypercholesterolemia

(Problems)

1  2 Hypertension

1  2

NONE -NOT BILLABLE  
 99241 -PROB FOCUSED  
 99242 -EXTENDED PROB  
 99243 -DETAILED  
 99244 -COMPREHENSIVE MOD  
 99245 -COMPREHENSIVE HIGH

Exam  Pre-operative cardiovascular examination

Elapsed: 1:17  
 Exam Done: 0:00  
 Clinic Status: ExamDone

**Out**

EXIT

Print

Billing

Plan

Patient Instructions

Labs

Physical Exam

History

Top

FIGURE 4–5. Computerized patient assessment and plan, patient medication instructions, and billing documentation.

## THE FUTURE OF PREOPERATIVE CLINICS

Preoperative clinics are ideal settings for offering comprehensive care beyond anesthesia evaluation. Advanced care and postdischarge planning, respiratory therapy training, counseling about smoking and substance abuse, vaccinations, and end-of-life care discussions have been effectively implemented in preanesthesia clinics.<sup>67,95</sup> When a patient is scheduled for operation, the patient may be more focused on health issues and improvement in-

terventions may be particularly successful. These times have been called “teachable moments.”<sup>95</sup>

Warner has rightfully challenged the anesthesia community to do its part in reducing the substantial burden of tobacco abuse.<sup>67</sup> Physical therapists can offer crutch training, social workers can begin postdischarge planning, especially for patients requiring rehabilitation services, and case managers can coordinate care across many disciplines. A 5-minute intervention in a preoperative clinic significantly increased and improved discussions of

advance care planning and increased completion of a durable power of attorney to 25%, compared to 10% by controls.<sup>96</sup>

Some day it may be possible to identify patients with genetic polymorphisms linked to adverse outcomes during the preoperative assessments. Then pharmacologic interventions and management can directly alter morbidity and mortality.<sup>97</sup> Molecular biology is rapidly changing our ability to identify genetic variability and its effects on diseases and responses to therapies. This new approach could dramatically alter the way

we perform risk assessment and how we design management plans. It would allow us to move away from expectations of results based on population studies to treatments based on individual patient characteristics. Pharmacogenetics may eventually lead to genetic screening tests to identify patients who are at risk for adverse perioperative outcomes, such as patients with pseudocholinesterase deficiency, halothane hepatitis, and susceptibility to malignant hyperthermia, as well as less familiar traits associated with the duration and response to drugs such as benzodiazepines, opioids, anesthetics, and NSAIDs, and pain tolerance.<sup>97</sup>

## CONCLUSION

The prevention of complications during and after procedures requiring anesthesia is the most important task for preoperative anesthesiologists. Identification of risk requires fundamentally good medicine, systems of care, clinical and laboratory assessment, and experienced, knowledgeable, and dedicated healthcare providers. Risk reduction and outcome improvement are the ultimate goals of preoperative assessment and management.

## KEY REFERENCES

1. American Society of Anesthesiologists Task Force on Preanesthesia Evaluation. Practice advisory for preanesthesia evaluation: a report by the American Society of Anesthesiologists Task Force on Preanesthesia Evaluation. *Anesthesiology* 2002;96:485–496. Available at: <http://www.asahq.org>. Last accessed October 11, 2005.
2. Eagle K, Berger P, Calkins H, et al. ACC/AHA guideline update for perioperative cardiovascular evaluation for noncardiac surgery—executive summary. A report of the American College of Cardiology/American Heart Association Task Force on Practice Guidelines (Committee to update the 1996 Guidelines on Perioperative Cardiovascular Evaluation for Noncardiac Surgery). *J Am Coll Cardiol* 2002;39:542–553. Available at: <http://www.acc.org>. Last accessed October 11, 2005.

3. McFalls EO, Ward HB, Mortiz TE, et al. Coronary artery revascularization before elective major vascular surgery. *N Engl J Med* 2004;351:2795–2804.

4. American Society of Anesthesiologists Task Force on Perioperative Management of Patients with Cardiac Rhythm Management Devices. Practice advisory for the perioperative management of patients with cardiac rhythm management devices: pacemakers and implantable cardioverter-defibrillators. *American Society of Anesthesiologists. Anesthesiology* 2005;103:186–198. Available at: <http://www.asahq.org>. Last accessed October 11, 2005.

5. McAlister FA, Khan NA, Straus SE, et al. Accuracy of the preoperative assessment in predicting pulmonary risk after nonthoracic surgery. *Am J Respir Crit Care Med* 2003;167:741–744.

6. De Nino LA, Lawrence VA, Averyt EC, et al. Preoperative spirometry and laparotomy: blowing away dollars. *Chest* 1997;111:1536–1541.

7. Tait AR, Malviya S. Anesthesia for the child with an upper respiratory tract infection: still a dilemma? *Anesth Analg* 2005;100:59–65.

8. Netzer NC, Stoohs RA, Netzer CM, et al. Using the Berlin Questionnaire to identify patients at risk for the sleep apnea syndrome. *Ann Intern Med* 1999;3:485–491.

9. Haffner SM, Lehto S, Ronnema T, et al. Mortality from coronary heart disease in subjects with type 2 diabetes and in nondiabetic subjects with and without prior myocardial infarction. *N Engl J Med* 1998;339:229–234.

10. Howell SJ, Sear JW, Foex P. Hypertension, hypertensive heart disease and perioperative cardiac risk. *Br J Anaesth* 2004;92:570–583.

11. Kearon C, Hirsh J. Management of anticoagulation before and after elective surgery. *N Engl J Med* 1997;336:1506–1511.

12. Warner DO. Helping surgical patients quit smoking: why, when and how? *Anesth Analg* 2005;101:481–487.

13. Schein OD, Katz J, Bass EB, et al. The value of routine preoperative medical testing before cataract surgery. *N Engl J Med* 2000;342:168–175.

14. Practice guidelines for preoperative fasting and the use of pharmacologic agents to reduce the risk of pulmonary aspiration: application to healthy patients undergoing elective procedures. A report by the American Society of Anesthesiologists Task Force on Preoperative Fasting. *Anesthesiology* 1999;90:896–905. Available at: <http://www.asahq.org>. Last accessed October 11, 2005.

15. Auerbach AD, Goldman L.  $\beta$ -Blockers and reduction of cardiac events in noncardiac surgery. *JAMA* 2002;287:1435–1444.

16. Ferschl MB, Tung A, Sweitzer BJ, Glick DB. Preoperative clinic visits reduce operating room cancellations and delays. *Anesthesiology* 2005;103:855–859.

## REFERENCES

1. Kluger MT, Tham EJ, Coleman NA, et al. Inadequate pre-operative evaluation and preparation: a review of 197 reports from the Australian incident monitoring study. *Anaesthesia* 2000;55:1173–1178.
2. Runciman WB, Webb RK. *Aust Soc Anaesth Newslett* 1994;94:15–17.
3. Davis NJ, ed. *Anaesthesia-Related Mortality in Australia 1994–1996*. Melbourne: Capital Press, 1999.
4. Lonsdale M, Hutchison GL. Patients' desire for information about anaesthesia: Scottish and Canadian attitudes. *Anaesthesia* 1991;46:410–412.
5. American Society of Anesthesiologists Task Force on Preanesthesia Evaluation. Practice advisory for preanesthesia evaluation: a report by the American Society of Anesthesiologists Task Force on Preanesthesia Evaluation. *Anesthesiology* 2002;96:485–496. Available at: <http://www.asahq.org>. Last accessed October 11, 2005.
6. Apfelbaum JL. Preoperative evaluation, laboratory screening, and selection of adult surgical outpatients in the 1990s. *Anesth Rev* 1990;17(Suppl 2):4–1.
7. Pasternak LR. Screening patients: strategies and studies. In: McGoldrick K, ed. *Ambulatory Anesthesiology: A Problem-Oriented Approach*. Baltimore: Williams and Wilkins, 1995:1–19.
8. Eagle K, Berger P, Calkins H, et al. ACC/AHA guideline update for perioperative cardiovascular evaluation for noncardiac

- surgery—executive summary. A report of the American College of Cardiology/American Heart Association Task Force on Practice Guidelines (Committee to Update the 1996 Guidelines on Perioperative Cardiovascular Evaluation for Noncardiac Surgery). *J Am Coll Cardiol* 2002;39:542–553. Available at: <http://www.acc.org>. Last accessed October 11, 2005.
9. Roizen MF, Klock PA, Klafta J. How much do they really want to know? Preoperative patient interviews and the anesthesiologist. *Anesth Analg* 1996;82:443–444.
10. Matthey P, Finucane BT, Finegan BA. The attitude of the general public towards preoperative assessment and risks associated with general anesthesia. *Can J Anaesth* 2001;48:333–339.
11. Sandler G. The importance of the history in the medical clinic and the cost of unnecessary tests. *Am Heart J* 1980;100:928–931.
12. Hlatky MA, Boineau RE, Higginbotham MB, et al. A brief self-administered questionnaire to determine functional capacity (The Duke Activity Status Index). *Am J Cardiol* 1989;64:651–654.
13. American Society of Anesthesiologists Task Force on Management of the Difficult Airway. Practice guidelines for management of the difficult airway. An updated report by the American Society of Anesthesiologists Task Force on Management of the Difficult Airway. *Anesthesiology* 2003;98:1269–1277. Available at: <http://www.asahq.org>. Last accessed October 11, 2005.
14. Girish M, Trayner E, Dammann O, et al. Symptom-limited stair climbing as a predictor of postoperative complications after high-risk surgery. *Chest* 2001;120:1147–1151.
15. Blery C, Szatan M, Fourgeaux B, et al. Evaluation of a protocol for selective ordering of preoperative tests. *Lancet* 1986;18:139–141.
16. O'Connor ME, Drasner K. Preoperative laboratory testing of children undergoing elective surgery. *Anesth Analg* 1990;70:176–180.
17. Rabkin SW, Horne JM. Preoperative electrocardiography: its cost-effectiveness in detecting abnormalities when a previous tracing exist. *Can Med Assoc J* 1979;121:301–306.
18. Gold BS, Young ML, Kinman JL, et al. The utility of preoperative electrocardiograms in the ambulatory surgical patient. *Arch Intern Med* 1992;152:301–305.
19. Liu LL, Dzankic S, Leung JM. Preoperative electrocardiogram abnormalities do not predict postoperative cardiac complications in geriatric surgical patients. *J Am Geriatr Soc* 2002;50:1186–1191.
20. Callaghan LC, Edwards ND, Reilly CS. Utilization of the pre-operative ECG. *Anesthesia* 1995;50:488–490.
21. Tait AR, Parr HG, Tremper KK. Evaluation of the efficacy of routine preoperative electrocardiograms. *J Cardiothorac Vasc Anesth* 1997;11:752–755.
22. Centers for Medicare and Medicaid Services. ICD-9 codes. Available at <http://www.cms.hhs.gov>. Last accessed October 11, 2005.
23. Charpak Y, Blery C, Chastang C, et al. Prospective assessment of a protocol for selective ordering of preoperative chest x-rays. *Can J Anaesth* 1988;35:259–264.
24. Zibrak JD, O'Donnell CR, Marton K. Indications for pulmonary function testing. *Ann Intern Med* 1990;112:763–771.
25. Hennrickus WL, Shaw BA, Gerardi JA. Prevalence of positive preoperative pregnancy testing in teenagers scheduled for orthopedic surgery. *J Pediatr Orthop* 2001;21:677–679.
26. Lawrence VA, Gafni A, Gross M. The unproven utility of the preoperative urinalysis: Economic evaluation. *J Clin Epidemiol* 1989;42:1185–1192.
27. Epstein AM, Begg CB, McNeil BJ. The use of ambulatory testing in prepaid and fee-for service group practices. *N Engl J Med* 1986;314:1089–1094.
28. Wei L, MacDonald TM, Walker BR. Taking glucocorticoids by prescription is associated with subsequent cardiovascular disease. *Ann Intern Med* 2004;141:764–770.
29. Coskun S, Ozoran K, Mermerci B, et al. Cardiac involvement in patients with rheumatoid arthritis. *APLAR J Rheumatol* 2005;8:23–31.
30. Asanuma Y, Oeser A, Shintani AK, et al. Premature coronary artery atherosclerosis in systemic lupus erythematosus. *N Engl J Med* 2003;349:2407–2415.
31. McFalls EO, Ward HB, Mortiz TE, et al. Coronary artery revascularization before elective major vascular surgery. *N Engl J Med* 2004;351:2795–2804.
32. Breen P, Wee JW, Pomposelli F, Park KW. Timing of high-risk vascular surgery following coronary artery bypass surgery: a 10-year experience from an academic medical centre. *Anaesthesia* 2004;59:422–427.
33. Dawood MM, Gutpa DK, Southern J, et al. Pathology of fatal perioperative myocardial infarction: implications regarding pathophysiology and prevention. *Int J Cardiol* 1996;57:37–44.
34. The Criteria Committee of the New York Heart Association. Nomenclature and Criteria for Diagnosis of Disease of the Heart and Great Vessels. 9th ed. Boston: Little, Brown, 1994.
35. Landesberg G, Einav S, Christopherson R, et al. Perioperative ischemia and cardiac complications in major vascular surgery: importance of the preoperative twelve-lead electrocardiogram. *J Vasc Surg* 1997;26:570–578.
36. Otto CM, Lind BK, Kitzman DW, et al. Association of aortic-valve sclerosis with cardiovascular mortality and morbidity in the elderly. *N Engl J Med* 1999;341:142–147.
37. Aronow WS, Ahn C, Shirani J, Kronzon I. Comparison of frequency of new coronary events in older subjects with and without valvular aortic sclerosis. *Am J Cardiol* 1999;83:599–600.
38. Bonow RO, Carabello B, de Leon AC Jr, et al. ACC/AHA guidelines for the management of patients with valvular heart disease: a report of the American College of Cardiology/American Heart Association Task Force on Practice Guidelines (Committee on Management of Patients With Valvular Heart Disease) *J Am Coll Cardiol* 1998;32:1486–1588. Available at: <http://www.acc.org>. Last accessed October 11, 2005.
39. Dajani A, Taubert K, Wilson W, et al. Prevention of bacterial endocarditis: recommendations by the American Heart Association. *JAMA* 1997;96:358–366.
40. American Society of Anesthesiologists Task Force on Perioperative Management of Patients with Cardiac Rhythm Management Devices. Practice advisory for the perioperative management of patients with cardiac rhythm management devices: Pacing and implantable cardioverter-defibrillators. *American Society of Anesthesiologists. Anesthesiology* 2005;103:186–198. Available at: <http://www.asahq.org>. Last accessed October 11, 2005.
41. McAlister FA, Khan NA, Straus SE, et al. Accuracy of the preoperative assessment in predicting pulmonary risk after nonthoracic surgery. *Am J Respir Crit Care Med* 2003;167:741–744.
42. Arozullah AM, Daley J, Henderson WG, Khuri SF. Multifactorial risk index for predicting postoperative respiratory failure in men after major noncardiac surgery. The National Veterans Administration Surgical Quality Improvement Program. *Ann Surg* 2000;232:242–253.
43. Warner DO, Warner MA, Barnes RD, et al. Perioperative respiratory complications in patients with asthma. *Anesthesiology* 1996;85:460–467.
44. De Nino LA, Lawrence VA, Avery EC, et al. Preoperative spirometry and laparotomy: blowing away dollars. *Chest* 1997;111:1536–1541.
45. Castillo R, Haas A. Chest physical therapy: comparative efficacy of preoperative and postoperative in the elderly. *Arch Phys Med Rehabil* 1985;66:376–379.
46. Ballantyne JC, Carr DB, deFerranti S, et al. The comparative effects of postoperative analgesic therapies on pulmonary outcome: cumulative meta-analyses of randomized, controlled trials. *Anesth Analg* 1998;86:598–612.
47. Blaise G, Langleben D, Hurbert B. Pulmonary arterial hypertension: pathophysiology and anesthetic approach. *Anesthesiology* 2003;99:1415–1432.
48. Tait AR, Malviya S. Anesthesia for the child with an upper respiratory tract infection: still a dilemma? *Anesth Analg* 2005;100:59–65.
49. Bradley TD, Floras JS. Sleep apnea and heart failure: part I. Obstructive sleep apnea. *Circulation* 2003;107:1671–1678.



50. Netzer NC, Stoohs RA, Netzer CM, et al. Using the Berlin Questionnaire to identify patients at risk for the sleep apnea syndrome. *Ann Intern Med* 1999;3:485-491.
51. Haffner SM, Lehto S, Ronnemaa T, et al. Mortality from coronary heart disease in subjects with type 2 diabetes and in nondiabetic subjects with and without prior myocardial infarction. *N Engl J Med* 1998;339:229-234.
52. Moitra V, Greenberg J, Sweitzer BJ, Drum M. Long-term glucose control as measured by hemoglobin A<sub>1c</sub> predicts preoperative fasting blood glucose. *Anesthesiology* 2005;103:A448.
53. Garber AJ, Moghissi ES, Bransome ED Jr, et al. American College of Endocrinology position statement on inpatient diabetes and metabolic control. *Endocr Pract* 2004;10:77-82.
54. Howell SJ, Sear JW, Foex P. Hypertension, hypertensive heart disease and perioperative cardiac risk. *Br J Anaesth* 2004;92:570-583.
55. Furberg CD, Psaty BM, Pahor M, Alderman MH. Clinical implications of recent findings from the Antihypertensive and Lipid-Lowering Treatment To Prevent Heart Attack Trial (ALLHAT) and other studies of hypertension. *Ann Intern Med* 2001;135:1074-1078.
56. Friedman LS. The risk of surgery in patients with liver disease. *Hepatology* 1999;29:1617-1623.
57. Practice guidelines for blood component therapy: a report by the American Society of Anesthesiologists Task Force on Blood Component Therapy. *Anesthesiology* 1996;84:732-747. Available at: <http://www.asahq.org>. Last accessed October 11, 2005.
58. Firth PG, Head CA. Sick cell disease and anesthesia. *Anesthesiology* 2004;101:766-785.
59. Cameron EH, Lipshultz SE, Tarbell NJ, Mauch P. Cardiovascular disease in long-term survivors of pediatric Hodgkin's disease. *Circulation* 1998;8:139-144.
60. Adams MJ, Hardenbergh PH, Constine LS, Lipshultz SE. Radiation-associated cardiovascular disease. *Crit Rev Oncol Hematol* 2003;45:55-75.
61. Kennedy JM, van Rij AM, Spears GF, et al. Polypharmacy in a general surgical unit and consequences of drug withdrawal. *Br J Clin Pharmacol* 2000;49:353-362.
62. Kearon C, Hirsh J. Management of anticoagulation before and after elective surgery. *N Engl J Med* 1997;336:1506-1511.
63. Myles PS, Iacono GA, Hunt JO, et al. Risk of respiratory complications and wound infection in patients undergoing ambulatory surgery: smokers versus non-smokers. *Anesthesiology* 2002;97:842-847.
64. Woehlick HJ, Connolly LA, Cinquegrani MP, et al. Acute smoking increases ST depression in humans during general anesthesia. *Anesth Analg* 1999;89:856-860.
65. A clinical practice guideline for treating tobacco use and dependence. A U.S. Public Health Service report. The Tobacco Use and Dependence Clinical Practice Guideline Panel, Staff, and Consortium Representatives. *JAMA* 2000;283:3244-3254.
66. Warner DO. Helping surgical patients quit smoking: why, when and how? *Anesth Analg* 2005;101:481-487.
67. Polanczyk CA, Marcantonio E, Goldman L, et al. Impact of age on perioperative complications and length of stay in patients undergoing noncardiac surgery. *Ann Intern Med* 2001;134:637-643.
68. National Confidential Enquiry into Patient Outcome and Death (NCEPOD). Extremes of age. Available at: <http://www.ncepod.org.uk>. Last accessed October 11, 2005.
69. Tappen RM, Muzic J, Kennedy P. Preoperative assessment and discharge planning for older adults undergoing ambulatory surgery. *AORN J* 2001;73:464-470.
70. Schein OD, Katz J, Bass EB, et al. The value of routine preoperative medical testing before cataract surgery. *N Engl J Med* 2000;342:168-175.
71. Langeron O, Masso E, Huraux C, et al. Prediction of difficult mask ventilation. *Anesthesiology* 2000;92:1229-1236.
72. Fleisher LA, Pasternak LR, Herbert R, Anderson GF. Inpatient hospital admission and death after outpatient surgery in elderly patients. *Arch Surg* 2004;139:67-72.
73. Maurer WG, Borkowski RG, Parker BM. Quality and resource utilization in managing preoperative evaluation. *Anesthesiol Clin North America* 2004;22:155-175.
74. Practice guidelines for preoperative fasting and the use of pharmacologic agents to reduce the risk of pulmonary aspiration: application to healthy patients undergoing elective procedures. A report by the American Society of Anesthesiologists Task Force on Preoperative Fasting. *Anesthesiology* 1999;90:896-905. Available at: <http://www.asahq.org>. Last accessed October 11, 2005.
75. Spell NO III. Stopping and restarting medications in the perioperative period. *Med Clin North Am* 2001;85:1117-1128.
76. Comfere T, Sprung J, Kumar MM, et al. Angiotensin system inhibitors in a general surgical population. *Anesth Analg* 2005;100:636-644.
77. Horlocker TT, Wedel DJ, Benzon H, et al. Regional anesthesia in the anticoagulated patient: defining the risks (the Second ASRA Consensus Conference on Neuraxial Anesthesia and Anticoagulation). *Reg Anesth Pain Med* 2003;28:172-197.
78. Goldenberg NA, Jacobson MT, Manco-Johnson MJ. Brief communication: duration of platelet dysfunction after a 7-day course of ibuprofen. *Ann Intern Med* 2005;142:506-509.
79. Salem M, Tainsh RE, Bromberg J, et al. Perioperative glucocorticoid coverage: a re-assessment 42 years after emergence of a problem. *Ann Surg* 1994;219:416-425.
80. Grady D, Wenger NK, Herrington D, et al. Postmenopausal hormone therapy increases risk for venous thromboembolic disease. The heart and estrogen/progestin replacement study. *Ann Intern Med* 2000;132:689-696.
81. Ang-Lee MK, Moss J, Yuan CS. Herbal medicines and perioperative care. *JAMA* 2001;286:208-216.
82. Auerbach AD, Goldman L.  $\beta$ -blockers and reduction of cardiac events in noncardiac surgery. *JAMA* 2002;287:1435-1444.
83. Poldermans D, Boersma E, Bax JJ, et al. The effect of bisoprolol on perioperative mortality and myocardial infarction in high-risk patients undergoing vascular surgery. *N Engl J Med* 1999;341:1789-1794.
84. London MJ, Itani KMF, Perrino AC, et al. Perioperative beta-blockade: a survey of physician attitudes in the Department of Veteran Affairs. *J Cardiothorac Vasc Anesth* 2004;18:14-24.
85. Poldermans D, Bax JJ, Kertai MD, et al. Statins are associated with a reduced incidence of perioperative mortality in patients undergoing major noncardiac vascular surgery. *Circulation* 2003;107:1848-185.
86. Salpeter SS, Ormiston TM, Salpeter EE. Cardioselective  $\beta$ -blockers in patients with reactive airway disease: a meta-analysis. *Ann Intern Med* 2002;137:715-725.
87. Adler AG. *Medical Evaluation of the Surgical Patient*. Philadelphia: WB Saunders, 1985.
88. Ferschl MB, Tung A, Sweitzer BJ, Glick DB. Preoperative clinic visits reduce operating room cancellations and delays. *Anesthesiology* 2005;103:855-859.
89. Tsen LC, Segal S, Pothier M, Bader AM. Survey of residency training in preoperative evaluation. *Anesthesiology* 2000;93:1134-1137.
90. Horrocks JC, DeDombal FT. Diagnosis of dyspepsia from data collected by a physician's assistant. *Br Med J* 1975;16:421-423.
91. Fung D, Cohen M. What do outpatients value most in their anesthesia care? *Can J Anaesth* 2001;48:12-19.
92. Smith AF, Shelly MP. Communication skills for anesthesiologists. *Can J Anaesth* 1999;46:1082-1088.
93. Auquier P, Pernoud N, Bruder N, et al. Development and validation of a perioperative satisfaction questionnaire. *Anesthesiology* 2005;102:116-1123.
94. Gibby GL, Paulus DA, Sirota DJ. Computerized pre-anesthetic evaluation results in additional abstracted comorbidity diagnoses. *J Clin Monit* 1997;13:35-41.
95. McBride CM, Emmons KM, Lipkus IM. Understanding the potential of teachable moments: the case of smoking cessation. *Health Educ Res* 2003;18:156-170.
96. Grimaldo DA, Wiener-Kronish JP, Jurson T, et al. A randomized, controlled trial of advanced care planning discussions during preoperative evaluations. *Anesthesiology* 2001;95:43-50.
97. Palmer SN, Giesecke NM, Body SC, et al. Pharmacogenetics of anesthetic and analgesic agents. *Anesthesiology* 2005;102:663-671.



## CHAPTER 5

## The Anesthetic Plan for Healthy Patients

Patrick E. Benedict, MD, and  
Kevin K. Tremper, PhD, MD

68

This chapter focuses on the development of an anesthetic plan for healthy adults undergoing elective surgery. Like their medically ill counterparts, healthy patients undergo a variety of surgical procedures. By virtue of their favorable physical status, however, healthy patients generally undergo shorter and simpler operations. This is fortunate as the complexity of surgical procedures is one determinant of overall perioperative risk.<sup>1</sup> Additionally, healthy patients, by definition, are free of major medical comorbidity, a major contributor to perioperative risk.<sup>2</sup> For purposes of this chapter, “healthy” patients are defined as American Society of Anesthesiologists<sup>3</sup> (ASA) physical status (PS) 1 or 2. Despite the fact that perioperative risk is low in healthy patients, development of an anesthetic plan is, in many respects, the same as that for patients with serious comorbidities. Development of a successful anesthetic plan in any patient consists of several important steps. The first is a thorough evaluation of the patient via history and physical examination. In healthy patients, a key component of this evaluation is the history of perioperative, and specifically anesthetic, problems and complications. Any successful plan must also take into account the exact nature of the proposed surgical procedure. Finally, expectations and needs of both the patient and the surgeon must be taken into consideration. Of these expectations, safety and efficacy are of utmost importance. This chapter reviews the evaluative phase of the anesthetic plan, with a special focus on recognition and avoidance of complications that can occur in healthy patients. This is followed by a review of the implementation phase, with specific emphasis on meeting the needs of both the patient and the surgeon, within the bounds of safety and efficacy. Finally, we review the use of routine and specialized monitors in healthy patients undergoing elective operations.

## EVALUATION OF THE HEALTHY PATIENT

## History

Formulating an anesthetic plan begins with a thorough evaluation of the patient. The starting point for this evaluation is the complete history and physical examination. In October 2001, the ASA published a Practice Advisory for Preanesthesia Evaluation.<sup>4</sup> This practice advisory provides guidelines regarding the minimum requirements with respect to the history, physical examination, testing, and timing of the preoperative assessment. Throughout this chapter, the principles of this advisory are invoked when specific issues relate to the healthy patient, whether they are undergoing simple or complex surgical procedures.

In the context of the healthy patient, the purpose of the history and physical examination is fourfold:

- To fully elucidate the nature of the proposed operation and the problem for which the operation is being performed.
- To investigate for the presence or absence of comorbidities or conditions that can heighten perioperative risk (to verify that the patient is, in fact, healthy).
- To ascertain whether the patient has a history of perioperative complications.

- To educate the patient and determine the patient's preferences.

The preoperative history and physical examination are typically a joint effort between the surgeon and the anesthesiologist. The following sections are specific goals and methods for the conduct of such a preoperative history and physical examination, which are also well summarized in the American Society of Anesthesiologists Practice Advisory for Preoperative Evaluation.<sup>4</sup>

**Nature of the Surgical Disease and the Planned Surgical Procedure**

In planning a successful anesthetic, the primary goals of the anesthesiologist are patient safety, patient satisfaction, and the provision of ideal operating conditions. The starting point for the development of this plan is a thorough understanding of the surgical problem. In many cases, the physical problem that necessitates an operation can have a significant impact upon the provision of safe anesthesia. For example, patients presenting for surgical correction of temporomandibular joint disease may have significant issues with airway management. In addition, operations that achieve the same end point are often performed using differing approaches and techniques. For example, otherwise healthy men may undergo prostatectomy using either a laparoscopic or an open approach. Surgical

## KEY POINTS

1. The main objectives in anesthetizing healthy patients are safety and efficacy.
2. The purpose of the anesthetic history and physical examination in healthy patients is fourfold:
  - To fully elucidate the nature of the surgical problem and the specific requirements of the operation being performed.
  - To ensure that the patient is, in fact, healthy.
  - To identify patient features that could potentially complicate the anesthetic.
  - To interview the patient and determine the patient's preferences.
3. A successful anesthetic plan must take into account the needs of the patient, the surgeon, and the anesthesiologist.
4. Healthy patients can undergo most of their preoperative evaluation and preparation immediately prior to surgery.
5. Extensive evaluation and testing are rarely necessary in healthy patients undergoing uncomplicated surgical procedures.
6. Anesthetic monitoring has evolved greatly and is believed to prevent complications and improve outcomes.
7. Healthy patients rarely require more than basic, noninvasive intraoperative monitoring.
8. Healthy patients occasionally undergo complicated surgical procedures that require additional and more invasive monitoring.

technique alone can have a profound impact upon the choice of anesthesia.

Much information regarding the surgical condition and planned procedure is obtained from the surgical history and physical, which is performed by the surgeon or an agent of the surgeon (physician assistant, resident, nurse practitioner). It is critical that effective communication be established and maintained between members of the surgical and anesthesia teams at all times. Computerized medical records aid greatly in achieving this goal. Most healthy patients do not require a visit with an anesthesiologist prior to their operation date. It is important, however, that the surgical team recognize when an advance visit with an anesthesiologist is appropriate, and that the opportunity for the visit be made available. To this end, preoperative anesthesia assessment clinics have evolved, along with screening criteria<sup>5</sup> to aid surgical teams in deciding who needs this consultation. Preoperation clinics are discussed in subsequent sections.

### Defining “Healthy”

For purposes of this chapter, “healthy” patients are considered to be ASA physical status (PS) classifications 1 and 2.<sup>6</sup> Hence, by definition, these patients either have no disease, or minor disease processes that are well controlled and cause no physical limitation. In 1993, Menke et al. demonstrated that ASA classification independently predicted overall perioperative risk, and that this risk was low in ASA PS 1 and 2 patients.<sup>7</sup> Similar findings have been verified by other authors, and the classification is still in common use (Table 5–1), demonstrating low perioperative risk in healthy patients.<sup>8</sup>

Once the surgical condition and the specifics of the operation are clarified, the next goal of the anesthesiologist is verification that the patient is, in fact, free of disease. This constitutes the bulk of the preoperative history and physical in healthy patients, and again, should be a joint venture between surgical and anesthesia teams. A comprehensive review of systems is the tool of choice for this purpose, and this is generally obtained by a member of the surgical team. It is good practice for anesthesiologists to verify and further explore these findings, especially when they are pertinent for provision of safe anesthesia. The use of assessment tools or guidelines is helpful for this purpose. The American College of Cardiology/

TABLE 5–1.

American Society of Anesthesiologists Physical Status Classification

Class	Description	Examples
P1	No organic, physiologic, biochemical, or psychiatric disturbances	Otherwise healthy patient
P2	Mild to moderate systemic disturbance(s)	Hypertension; well-controlled diabetes; mild obesity; age <1 or >70 years; malignancy without evidence of significant spread or physiologic disturbance
P3	Severe systemic disturbance that may or may not be related to the reason for surgery	Angina; poorly controlled diabetes; massive obesity; uncontrolled thyroid dysfunction
P4	Severe systemic disturbance that is life-threatening	“Unstable” angina; congestive heart failure; debilitating respiratory disease; hepatorenal failure
P5	Moribund patient who has little chance of survival	Septic patient with multiorgan failure; patient in cardiac arrest with major trauma
P6	Brain-dead patient for organ harvesting	
E	Any patient in whom an emergency operation is required	

Data from American Society of Anesthesiologists Physical Status Classification.<sup>6</sup>

American Heart Association guidelines are extremely useful for evaluating patients with suspected cardiovascular disease.<sup>9</sup> Similar guidelines exist for evaluation of the respiratory system.<sup>10</sup> The review of systems is also a valuable tool for careful screening of hepatic and gastrointestinal, neurologic, musculoskeletal, endocrine, genitourinary, and blood coagulation systems.

Occasionally, findings from the review of systems (e.g., history of gastroesophageal reflux disease, neuropsychiatric disorders, clotting abnormalities), can alter the anesthetic plan in otherwise “healthy” patients. In addition, medical disease (e.g., hypertension, diabetes, coronary artery disease, asthma, obstructive pulmonary disease) will occasionally be diagnosed in surgical patients previously assumed to be “healthy.” It is critical that these patients be referred for definitive evaluation and potential optimizing therapy. Communication with the referring surgeon is important, as this evaluation and treatment can delay the planned procedure. A full discussion of the impact of comorbidity on perioperative risk is beyond the scope of this chapter.

### Identification of Potential Anesthetic Complications

Even patients who are free of comorbidity are susceptible to a range of anesthetic complications (Table 5–2).

In healthy patients, a primary determinant of the success of an anesthetic is avoidance of these complications. Hence a major focus of the anesthesiologist's portion of the medical history in healthy patients is identification of potential complications. Patients may have a personal or a family history of such complications. When a history of complications is suspected, the patient should always be asked to provide a thorough account of the events and their consequences. It also is important to obtain medical records if possible. This is usually a simple process, but consent is required. Once the com-

TABLE 5–2.

Potential Anesthetic Complications in Healthy Patients

Complication	Frequency (Reference)
Postoperative nausea and vomiting	1:3 <sup>11</sup>
Ocular injury	1:600–1:1600 <sup>103,104</sup>
Unanticipated difficult airway	1:8–1:1000 <sup>45</sup>
Intraoperative awareness	1:100–1:500 <sup>25,105</sup>
Malignant hyperthermia	1:30,000 <sup>16,106</sup>

TABLE 5-3.

## Risk Factors for Postoperative Nausea and Vomiting

Patient	Surgical	Anesthetic	Postoperative
Female gender	Longer duration	Nitrous oxide use	Pain
History of PONV or motion sickness	Gynecologic operation	Gastric distension	Dizziness
High preoperative anxiety level	Laparoscopic operation	Reversal of neuromuscular blockade	Early oral intake
Obesity	Middle ear operation	Opioid use	Opioid use
Delayed gastric emptying			
Nonsmoking patient			
Younger age			

PONV, postoperative nausea and vomiting.  
Reprinted and adapted from Golembiewski JA, O'Brien D. A systematic approach to the management of postoperative nausea and vomiting. *J PeriAnesth Nurs* 2002;17:363-376, with permission from The American Society of PeriAnesthesia Nurses.<sup>107</sup>

plication is identified and fully elucidated, the anesthetic plan should be altered so as to minimize the risk of the particular complication. This plan should be clearly documented, and the patient informed that steps have been taken for prevention of the complication. Below is a discussion of common anesthetic complications and steps that can be taken to minimize or eliminate them.

**Postoperative Nausea and Vomiting** The most common complication that patients experience in relation to anesthesia is postoperative nausea and vomiting (PONV). This complication is highly distressing, yet relatively amenable to prevention.<sup>11</sup> Recognition of this problem, followed by alterations in the anesthetic plan has resulted in marked improvements in patient outcome and satisfaction.<sup>12</sup> Untreated, nausea occurs in as many as 40% of patients undergoing general anesthesia.<sup>13</sup> Golembiewski's excellent review of this subject outlines patient characteristics that have been shown to heighten risk (Table 5-3).

When these characteristics, or a strong history of PONV are encountered, the anesthetic plan should include use of anesthetic agents with less likelihood of causing the disorder (e.g., consideration of total intravenous anesthesia [TIVA] with propofol).<sup>12</sup> In addition, strong consideration should be given to use of prophylactic preventative agents, which are highly effective.<sup>12</sup> Figure 5-1 illustrates the PONV algorithm used at the University of Michigan.

Note that postinduction droperidol (0.625 mg IV) is included as a primary prophylactic agent in high-risk pa-

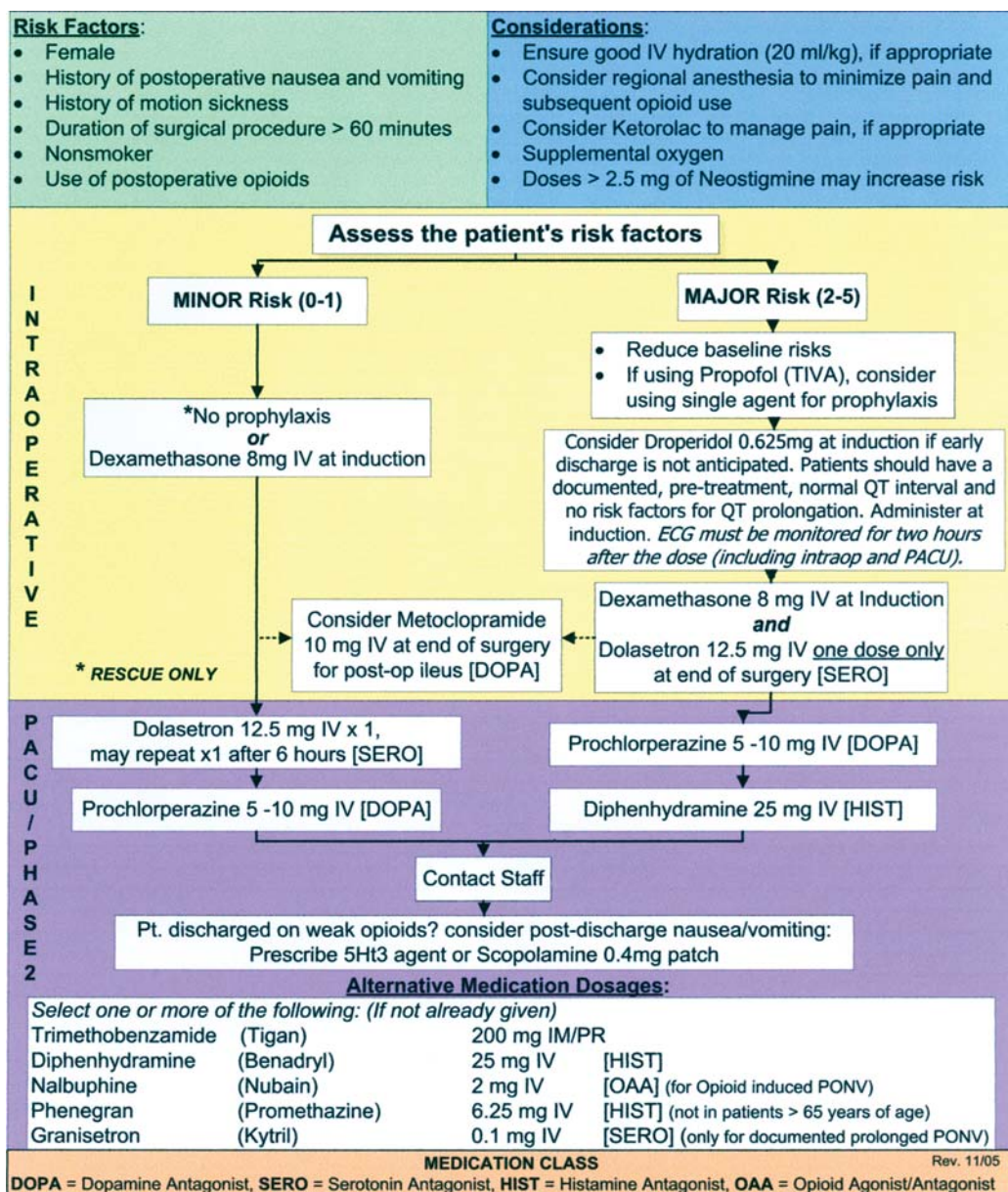
tients. The U.S. Food and Drug Administration (FDA) recently placed a "black box" warning on droperidol, noting its propensity to prolong the QT interval, which may be associated with serious cardiac rhythm disturbances.<sup>14</sup> Subsequent investigations have challenged this measure by the FDA, citing remarkable safety at the typical dosages used in modern anesthetic practice.<sup>15</sup> It is therefore controversial whether there should be any limit on the use of droperidol, given its long track record of safety and efficacy in anesthetic use. Finally, anxiety, as a possible causative factor, can be effectively addressed by a frank acknowledgment to the patient that the problem has been recognized and that steps are in place for prevention.

**History of Difficult Airway** An important potential complication that must be recognized prior to elective surgery is a history of difficult airway management. When this problem is known or suspected, a thorough account of the findings and management must be sought from both the patient and old medical records. In this regard, a thorough, legible account of the intraoperative events is critical for subsequent management. "Difficult airway" usually means that airway anatomy was such that standard laryngoscopy was either difficult or impossible. When this is identified in the preoperative history, subsequent management via an awake technique must be considered. Patients with difficult airways, temporomandibular joint disorders, congenital airway disorders, etc are often otherwise healthy. The prospect of awake

airway management can be anxiety provoking, and it is best that this possibility be communicated well in advance of the operative date. Explaining this plan in a slow, reassuring fashion serves to inform and prepare the patient so that the patient can present on the day of the operation with minimal anxiety. A brief review of airway assessment is found in Physical Examination below; airway evaluation and assessment are considered in greater detail in Chap. 35.

**Malignant Hyperthermia** A rare anesthetic complication that must be recognized and planned for is malignant hyperthermia (MH). Estimates of the incidence of this complication range from 1:20,000 to 1:70,000.<sup>16</sup> Recognition, prevention, and treatment of MH are a major success story in anesthesia. What used to be a nearly uniformly fatal disorder now has a mortality rate of less than 10%.<sup>17</sup> When patients present with either a personal or family history of the disorder, the evaluating anesthesiologist is confronted with decisions regarding testing and perioperative management. Muscle biopsy testing for the disorder is available at a diminishing number of centers and is costly, time-consuming, and not completely reliable.<sup>18</sup> This test is characterized by excellent sensitivity, but marginal specificity.<sup>19</sup> Although genetic testing appears promising, it is currently not widely available. Consequently, many anesthesiologists proceed on the assumption that the patient is at risk and provide a nontriggering anesthetic. In certain cases, regional anesthesia, or even conscious sedation, may be appropriate. In cases where this is inappropriate.





**FIGURE 5-1.** Guidelines for the prevention of postoperative nausea/vomiting in the adult patient.

ate, however, a nontriggering general anesthetic is provided. Bryson et al. demonstrated recently that general anesthesia could be safely provided to MH-susceptible outpatients as long as triggers were avoided.<sup>20</sup> "Nontriggering" in this sense means avoidance of the only two reliable MH triggers: succinylcholine and the potent inhaled anesthetics. This is typically accomplished with TIVA, which includes propofol, nondepolarizing neuromuscular blocking agents, and opiates. A minimum of 4 hours of observation are recommended following an uneventful anesthetic.<sup>21</sup> It is appropriate that patients with potential MH risk be seen well in advance of surgery so that

an accurate clinical history can be obtained and a plan can be devised and communicated to the patient.

### Pseudocholinesterase Deficiency

Pseudocholinesterase (butyrylcholinesterase) is a plasma enzyme that has no known physiologic function. Most cases of deficiency of this enzyme are attributable to alterations in the gene that codes for it. In 2003, Yen et al. estimated the incidence of homozygous (affected) individuals to be approximately 1:1800.<sup>22</sup> Deficiency is usually identified when an anesthetized patient has prolonged recovery from the depolarizing neuromuscular blocking agent succinylcholine. Suspi-

cion of this deficiency first arose in 1953, when Nilsson gave succinylcholine to a patient who then failed to resume spontaneous ventilation after completion of a short operation.<sup>23</sup> Hence the colloquial name "suxamethonium apnea." Mivacurium, a short-acting, nondepolarizing, neuromuscular blocking agent, also depends on this enzyme for elimination.<sup>24</sup> Despite being far more common than its inherited counterpart MH, pseudocholinesterase deficiency should pose far less danger to patients. In addition, testing for the disorder is far simpler and more widely available than that for MH. Once identified, safe management simply entails ventilatory sup-



port, combined with sedation until the drug is eliminated via the kidney (after several hours in homozygous recessive patients). Identification of this condition in advance allows for alteration of the anesthetic plan so that use of these drugs can be avoided.

**Awareness** A great deal of public concern has been expressed about intraoperative awareness. Recently, Matthey identified the concept of “awake paralysis,” the subject of much recent media attention, to be a top concern in patients undergoing general anesthesia. Unfortunately, the true incidence of intraoperative awareness under general anesthesia, reported to range from 0.2–1.0%, is probably underestimated.<sup>25</sup> Not all patients who are aware in the operating room remember the fact afterward. This can be a particularly bothersome experience for many patients and lasting adverse sequelae are common.<sup>26</sup> Domino et al., using an analysis of litigation records, identified awareness as a common root cause for legal action against anesthesiologists.<sup>27</sup>

As with other complications, a thorough account of the events from both the patient and the patient's records should be sought. Occasionally, a patient misinterprets the goals of conscious sedation and labels this as intraoperative awareness. It is important to clarify this distinction to patients, so that expectations are realistic. In light of the recent focus that intraoperative awareness has received, a new monitor, the bispectral index (BIS) has evolved.<sup>28</sup> Although use of BIS monitoring may reduce the incidence of awareness, recent reports by Mychaskiw and Rampersad cast doubt on this technology. Both demonstrated awareness, despite BIS values being maintained in the low (anesthetized) range.<sup>29,30</sup> Use of this device is more thoroughly reviewed in Monitoring in Healthy Patients below. Whenever strong suspicion of awareness under general anesthesia exists, plans must be made to alter the anesthetic to prevent its recurrence. Kazanjian provides an excellent list of methods (Table 5–4) to reduce the incidence of awareness, and of steps to take in response to this complication.<sup>31</sup>

Recent ASA guidelines on intraoperative awareness and brain-function monitoring also provide practitioners with useful information for evaluation and treatment plans to prevent this

TABLE 5–4.

## Intraoperative Awareness

Prevention	Followup
Consider amnestic premedication (midazolam, scopolamine)	Punctual postoperative checks with inquiries about awareness
Routine equipment checks: e.g., correct placement of vaporizer	Precise documentation of suspected events, as reported by patient
End-tidal monitoring of volatile anesthetics with low-concentration alarm	Attempt to corroborate patient's account with actual events
Adequate dosing of induction agents	Do not trivialize or deny patient's assertion
Use of appropriate volatile anesthetic concentration or propofol dose for maintenance	Provide a full explanation of events to patient
Realize potential for awareness with hypotension/hypovolemia	Offer patient appropriate followup, e.g., psychological support, if desired
Judicious use of neuromuscular blocking agents combined with careful monitoring	Try to determine a cause
Frequent checks of intravenous lines and pumps when using total intravenous anesthesia	Assure patient that risk of awareness is still low with subsequent anesthetics
Clear labeling of all syringes	Notify hospital risk management
Quiet, professional operating room atmosphere: minimize auditory input	Notify surgeon and primary care physician
Consider use of anesthetic depth monitor (Bispectral Index)	
Calm reassurance when strong possibility of awareness suspected	

Data from Kazanjian P.<sup>31</sup>

worrisome complication.<sup>32</sup> These include careful preoperative evaluation, as certain patient features, such as drug resistance, may be predictive.<sup>27</sup> In addition, various types of surgery (cardiac, obstetric, trauma), as well as anesthetic techniques, may place patients at particular risk.<sup>33</sup> The ASA recognizes that processed electroencephalogram (EEG) devices, which assign a numeric value to a patient's level of sedation, are marketed to help minimize the risk of intraoperative awareness, and the ASA states “we are interested in following their continued evolution and in conducting further research in this area.” Hence, the ASA concludes, “[b]rain function monitors are an *option* to be used when the anesthesiologist deems it appropriate, just as he or she makes choices about specific drugs, dosages, warming devices, and other types of monitors depending on the individual patient.”

**Additional Complications** A variety of additional perioperative complications exist and early recognition of these complications is critical in preventing their reoccurrence. In a recent review, Mertes et al. found that seri-

ous drug reactions are surprisingly common in anesthetic practice,<sup>34</sup> and that in many cases, alternative drugs could have been selected (antibiotics, local anesthetics, opiates, others) or avoided altogether (succinylcholine in the case of pseudocholinesterase deficiency). Pulmonary aspiration of acidic gastric contents has the potential to complicate any anesthetic, even in otherwise healthy patients. Gastroesophageal reflux disease (GERD) and a full stomach are potential risk factors in healthy patients. If general anesthesia is being contemplated when aspiration risk exists, the anesthetic plan is altered in two ways:

1. Prophylactic anti-aspiration measures should be taken (gastric motility drugs, pharmacologic stomach acid reduction, and rapid sequence induction), and
2. Laryngeal mask airway should not be used.

Finally, even in the absence of anticipated risks or complications, many patients simply have high-anxiety levels. It is appropriate for these patients to visit with an anesthesiologist,

TABLE 5-5.

## Pharmacologic Effects and Potential Perioperative Complications of 8 Commonly Used Herbal Remedies

Name of Herb	Common Uses	Pharmacologic Effects	Potential Perioperative Complications
Echinacea, purple coneflower, root	Treatment of viral infections	Immune system stimulation	Reduced effectiveness of immunosuppressants; infection with long-term use; potential hepatotoxicity
Ephedra, ma huang	Weight loss, athletic performance	Indirect- and direct-acting sympathomimetic	Dose-dependent increase in heart rate and blood pressure with potential for perioperative myocardial infarction and stroke; arrhythmias with halothane; tachyphylaxis with intraoperative ephedrine
Garlic, ajo	Antihypertensive, anti-thrombus-forming	Inhibits platelet aggregation	Concerns for perioperative bleeding
Ginkgo, maidenhair, fossil tree	Circulatory stimulant	Inhibits platelets	Concerns for perioperative bleeding; may potentiate platelet inhibitors
Ginseng, ajo	General well-being	Poorly understood	Concerns for perioperative bleeding
Kava-kava	Anxiolytic, sedative	Anxiolytic, sedative	Potentiates sedative effects of anesthetic agents
St. John's wort	Depression, anxiety	Inhibition of serotonin, noradrenaline and dopamine; cytochrome P450 enzyme induction	Decreased effectiveness of multiple medications
Valerian, vandal root, all heal	Anxiolytic and sleep aid	Sedation	Potentiates anesthetic agents

Data from Skinner, CM and Rangasami J.<sup>108</sup>

in advance of their operation date, to address and ameliorate this anxiety. There is even evidence to suggest that nonpharmacologic strategies may play a significant role in treating both pain and anxiety.<sup>35</sup>

### Medication Review

A thorough and meticulous drug history must be obtained from all patients undergoing elective surgery. Even healthy patients may take a variety of prescription and nonprescription medications. All medications must be recorded, and the reasons for their use must be assessed. Patients must also be questioned carefully about drug allergies and drug intolerances, and a clear distinction between the two must be documented in the medical record. When obtaining a drug history, it is important to ask that *all* regularly ingested exogenous compounds, including over-the-counter medications, herbal preparations and vitamin supplements be reported. Several of these compounds have been associated with serious perioperative complications and drug-drug interactions.<sup>36</sup> The ASA recommends avoidance of these preparations (generally for a period of 2 weeks) prior to administration of an anesthetic.<sup>37</sup> Table 5-5 lists common

herbal preparations and adverse interactions that are associated with them.

Finally, it is important to determine whether the patient is using any illicit drugs, as many of these drugs are also associated with anesthetic complications.<sup>38</sup> Patients must be advised to abstain from all forms of illicit drugs as soon as possible prior to an elective operation.

### Physical Examination

The purpose of the physical examination in healthy surgical patients is to corroborate and augment findings from the medical history. Thus the first goal of the physical examination is to rule out disease. The second goal is to identify physical features that may make provision of anesthesia difficult, or potentially lead to complications. In actuality, the physical examination begins while the history is being obtained. This direct interaction is a good time to observe the gross physical appearance and mental status of the patient. It is also a good time to look for any obvious skin (jaundice, cyanosis, signs of dehydration, rashes) or musculoskeletal abnormalities (especially spine deformities) that may be clues to underlying pathologic conditions. This examination begins with a set of vital signs,

including room air oxygen saturation. Even if previously documented from the surgical history and physical examination, it is important for anesthesiologists to perform baseline examinations of both the cardiovascular and respiratory systems prior to an elective operation. Finally, a meticulous examination of the airway must be performed to assess for features that predict difficult airway management if the need for general anesthesia should arise.

### Vital Signs

Even in the presence of a negative medical history, abnormal vital signs can be an important first clue to the presence of underlying disease. In fact, potential medical risks, such as hypertension and thyroid disease, are occasionally diagnosed during the preoperative history and physical examination. The "white coat" phenomenon is responsible for hypertension in many preoperative patients.<sup>39</sup> Significant elevations in blood pressure or heart rate, however, especially on repeated measures, warrant further investigation and possible therapy. Rather than simply asking, height and weight should be accurately measured. Arterial blood pressure should be determined either via sphygmoma-

nometry or oscillometry, using an appropriate-size cuff. It is desirable to obtain blood pressure in both arms. We feel strongly that baseline room air oxygen saturation should be measured via pulse oximetry on every patient.

### Cardiorespiratory Examination

Examination of cardiovascular and respiratory systems also begins with observation of the patient, which is conveniently accomplished while obtaining the history. Findings such as labored breathing, wheezing, coughing, clubbing of the nails, jugular venous distension, and cyanosis are typically identified while simply conversing with a patient. Obviously, these are signs of potentially serious pathologic conditions, and should be investigated further by more in-depth examination. Physical examination of the cardiovascular system should aid in ruling out hypertension, valvular heart disease, and heart failure. Palpation and auscultation of the heart should be performed to identify heaves, rubs, extra heart sounds, and murmurs. Peripheral pulses should be assessed for both quality and magnitude. The chest should be examined for wheezes, rales, and rhonchi.

### Airway Evaluation

Regardless of the anesthetic that is ultimately chosen for a particular operation, it is important that a careful examination of the airway be performed in every patient. While much of the remainder of the physical examination represents a combined or even redundant effort between anesthesiologists, surgeons, and internists, a complete airway examination is generally not the purview of other medical specialists. The anesthesiologist is solely responsible for securing the airway and establishing ventilation. Difficulty with these processes may place the patient in great peril. This is borne out by the fact that airway management problems account for a relatively large proportion of anesthesia-related morbidity and mortality. In ASA closed claims analyses, both Caplan and Domino demonstrated that loss of the airway is a frequent cause of litigation associated with severe injury or death.<sup>40,41</sup> If a patient is known to have a difficult airway, alternative management plans are available (e.g., awake fiberoptic intubation) to the anesthesiologist. Identifying patients with difficult airways, followed by these alter-

TABLE 5–6.

Features Associated with Difficult Laryngoscopy

Feature	Likelihood Ratio (LR) That Laryngoscopy Will Be Difficult
Difficult mask ventilation	>2 Factors, LR = 2.5 <sup>46</sup>
Body mass index >26	
Edentulous	
Age >55 years	
History of snoring	
Facial hair	Limited jaw protrusion (Mallampati Class III), LR = 6.5 <sup>44</sup>
Mouth opening/jaw protrusion	
Mallampati classification	Mallampati Class III, IV, LR = 1.5–6.0 <sup>109,110</sup>
Mandibular space	Thyromental distance <6 cm, LR = 2 <sup>111</sup>
Obesity	Body mass index >35, LR = 2 <sup>112</sup>

Data from Pearce A.<sup>43</sup>

native induction techniques, should eliminate the “unconscious patient, can’t intubate, can’t ventilate” scenario. Consequently, it is a major goal of anesthesiologists to predict the potentially difficult airway in advance of anesthetic induction.

**Tests to Predict Difficult Laryngoscopy** Preoperative airway assessment, with the aim of detecting the anticipated difficult airway, has evolved over the years. Currently, a number of strategies exist for systematic evaluation of the airway and various guidelines endorse the use of such strategies.<sup>42</sup> Key elements of the airway examination include neck anatomy, neck flexion and extension, thyromental distance, mouth opening, Mallampati score, and, more recently, jaw protrusion and the presence of a beard. Excellent reviews are available of various tests and strategies commonly used by anesthesiologists to assess physical and symptomatic features that may predict difficult laryngoscopy (Table 5–6).<sup>43</sup>

Mandibular displacement (upper lip bite test) recently was correlated with difficulty of laryngoscopy and may have clinical usefulness.<sup>44</sup> Although these various tests and maneuvers are typically simple to perform, they usually have poor sensitivity and specificity, and hence unreliable predictive value.<sup>45</sup> This explains the occasional finding of the “unanticipated difficult airway” after seemingly reliable testing preoperatively predicted otherwise.<sup>45</sup> Typically, these tests have attempted to correlate symptomatic (e.g. sleep ap-

nea) and anatomic patient features with difficulty of laryngoscopy.<sup>43</sup>

### Difficult Mask Ventilation

Although successful laryngoscopy followed by endotracheal intubation constitutes definitive management for an unconscious and apneic patient, ventilation by mask can be a lifesaving maneuver. Despite this fact, the historical precedent for investigators with an interest in predicting the difficult airway has been to focus on laryngoscopy alone. With the potentially lifesaving importance of mask ventilation in mind, however, investigators are beginning to stress both laryngoscopy and mask ventilation in their predictive strategies. In 2000, Langeron et al. estimated the incidence of difficult mask ventilation and identified several predictive physical features: history of snoring, body mass index (BMI) >26, lack of teeth, age >55 years, and beard.<sup>46</sup> In 2004, Han et al. devised a scale for categorizing difficulty of mask ventilation. This 4-point scale elaborates on Langeron’s work, which only noted difficult and impossible ventilation, whereas Han’s scale describes four degrees of assessment of ventilation, similar to scales used for laryngoscopy (Table 5–7).

Han et al. noted an incidence of difficult mask ventilation of approximately 1.5% in the 3000 patients studied.<sup>47</sup> More recently, a study of more than 41,000 patients confirmed the incidence of difficult ventilation to be approximately 1.5% and that the incidence of impossible ventilation was 0.5%.<sup>48</sup> This large study by Kheterpal

TABLE 5-7.

## Mask Ventilation Scale

0	Not attempted
1	Easy mask ventilation (with and without neuromuscular block)
2	Ventilated by mask with oral airway or other adjuvant (with or without neuromuscular block)
3	Difficult mask ventilation—inadequate, unstable, or required two practitioners
4	Unable to ventilate

Data from Han R, Tremper KK, Kheterpal S, and O'Reilly M.<sup>47</sup>

et al. noted 6 preoperative independent predictors (four of Langeron's) of difficult mask ventilation: history of snoring, age >58 years, BMI >30, Mallampati class III or IV, limited jaw protrusion, and the presence of a beard (Table 5-8).

It should be noted that the only modifiable risk factor is the presence of a beard. These results suggest that the anesthesiologist might consider recommending that the patient shave

TABLE 5-8.

## Independent Predictors of Difficult Ventilation and Intubation

Difficult Mask Ventilation	P-Value
Beard	0.0001
History of snoring	0.001
BMI >30	0.0001
Mallampati III or IV	0.001
Age >50 years	0.01
Severely limited jaw protrusion	0.03
<b>Difficult Mask Ventilation<sup>a</sup> and Difficult Intubation<sup>b</sup></b>	
Severely limited jaw protrusion	0.0001
Thick neck/mass	0.02
History of sleep apnea	0.04
BMI >30	0.05
History of snoring	0.05

Data from Kheterpal S HR, Shanks A, O'Reilly M, and Tremper KK.<sup>48</sup>

<sup>a</sup>Difficult mask is a grade III or IV mask (see Table 5-7).

<sup>b</sup>Difficult intubation is a Mallampati grade III or IV laryngoscopic view.

prior to an elective procedure, especially if the patient has several other risk factors for difficult mask ventilation. Table 5-9 illustrates the standard preoperative airway features that we assess and record via electronic data entry at the University of Michigan.

**Anticipated Difficult Airway Strategy**

When a potential difficult airway is identified, it is the anesthesiologist's responsibility to develop a strategy to manage the airway in the event that general anesthesia becomes necessary. When a truly difficult airway is known or strongly suspected, and general anesthesia is necessary, the usual management plan entails placement of an oral or nasal endotracheal tube while the patient is awake and spontaneously breathing. Several important steps in planning and patient preparation for this process are worth mentioning.

The very thought of a potential airway problem can be anxiety provoking. Often, the source of this anxiety stems from the patient's perception that theirs is a rare problem that places them in grave danger. To allay much of this anxiety, it is helpful to have a frank discussion with the patient and fully inform the patient about the nature of the problem, and the rationale and plan for safely dealing with it. Patients are reassured knowing that the difficult airway is relatively common and that appropriate management poses no untoward danger. Careful anxiolytic sedation is appropriate preoperatively, to the extent that airway compromise is avoided. Antisialagogue premedication (typically glycopyrrolate 0.4–0.6 mg IV) aids greatly in the ability to anesthetize airway mucosa (typically with 2–4% lidocaine). Profound topical anesthesia of upper airway mucosa, combined with judicious sedation, are the key elements in conducting a safe, effective, and comfortable awake intubation.

**Special Preoperative Considerations**

**Preoperative Anesthesia Assessment Clinics** Currently, the vast majority of patients who present for elective operations are admitted to the hospital on the day of their procedure. Fortunately, most healthy patients can be seen and assessed by the anesthesia team immediately prior to their opera-

TABLE 5-9.

## Airway Physical Exam Elements

Test	Findings
Dentition	Normal Dentures Edentulous Poor dentition
Beard	Yes/no
Mouth opening	≥3 cm <3 cm Unable to assess
Mallampati class	Class I, II, III, IV, Unable to assess
Hyoid to mentum	≥6 cm <6 cm
Cervical spine	Normal Limited flexion Limited extension Limited flexion and extension Known unstable Possible unstable Unable to assess
Existing airway	None Tracheostomy Endotracheal tube Unable to assess
Neck anatomy	Normal Laryngeal mobility limited status Postradiation therapy Mass Previous tracheostomy scar Radiation changes Thick, obese Thyroid cartilage not visible Tracheal deviation Unable to assess
Jaw protrusion	A: Normal, lower incisors can protrude past upper B: Limited, lower incisors can only be advanced to meet upper C: Severely limited, lower incisors cannot protrude to meet upper

tion. The ASA Practice Advisory on Preanesthesia Evaluation recommends the timing of the preoperative evaluation based on not only the health of the patient, but the invasiveness of the surgical procedure.<sup>49</sup> The ASA recom-



TABLE 5–10.

## Patient Information Report: Sample Questions

Question	Criteria	Answer	Action
Do you have or have you had any of the following heart-related conditions?	Heart disease	Yes or No	If yes, send patient for ECG and preoperative anesthesia visit
	Heart attack within the last 6 months	Yes or No	If yes, send patient for ECG and preoperative anesthesia visit
	Angina (chest pain)	Yes or No	If yes, send patient for ECG and preoperative anesthesia visit
	Irregular heartbeat	Yes or No	If yes, send patient for ECG and preoperative anesthesia visit
	Heart failure	Yes or No	If yes, send patient for ECG and preoperative anesthesia visit
Do you have or have you ever had any of the following?	Rheumatoid arthritis	Yes or No	If yes, send patient for preoperative anesthesia visit
	Kidney disease	Yes or No	If yes, send patient for electrolytes, creatinine, BUN, CBC, and preoperative anesthesia visit
	Liver disease	Yes or No	If yes, send patient for SGOT/ALT, PT/PTT, and preoperative anesthesia visit
	Diabetes	Yes or No	If yes, send patient for ECG and preoperative anesthesia visit

BUN, blood urea nitrogen; CBC, complete blood count; PT, prothrombin time; PTT, partial thromboplastin time; SGOT (ALT), serum glutamic oxaloacetic transaminase.  
Data from Tremper KK, and Benedict P.<sup>5</sup>

mends that all patients undergoing highly invasive surgical procedures be seen prior to the day of surgery. These patients require evaluation, counseling, or therapy in advance of their surgical date. An appropriate and convenient place to coordinate this work-up is the preoperative anesthesia assessment clinic (PAC). To derive the most benefit from PACs, surgeons need to use them discriminately. We find it helpful to provide screening criteria to our surgeons in the form of a patient self-assessment sheet.<sup>5</sup> This screening questionnaire (Table 5–10) is filled out by the patient using a series of check boxes. The boxes are aligned to a back page such that positive answers will check (via carbon copy) the recommended preoperative laboratories and whether a PAC consultation is suggested. For example if an affirmative answer is recorded for the question “Do you have heart disease?”, an electrocardiogram is ordered (if not recently done) and the patient is referred. Chapter 4 provides a detailed account of the role, functioning, and benefits of PACs.

**Obesity and Obstructive Sleep Apnea** Obesity is a well-established public health problem in developed countries. More specifically, obesity presents a major problem for all practitioners who care for patients in the perioperative period. Obese patients not only have alterations in physiology at baseline that result in major lifestyle limitations, they also have a well-documented elevation in periop-

erative risk.<sup>50</sup> This would seem to justify (by convention) ASA classification of at least PS 2, and perhaps PS 3. Multiple physiologic comorbidities tend to exist in obese patients (diabetes mellitus, obstructive sleep apnea, cardiovascular disease, osteoarthritis, others).<sup>51</sup> In addition, anatomical alterations of the airway also place these patients at increased risk for difficult mask ventilation and laryngoscopy.<sup>48</sup> Intravenous access can be extremely difficult in obese patients and in some cases central access must be considered. Many consider obesity to be a risk factor for gastric aspiration and preventative measures should be considered. Obesity clearly heightens risk for adverse perioperative respiratory outcomes.<sup>52</sup> Blum et al. reviewed the quality assurance events recorded from 25,767 anesthetics. They found a statistically significant increase in failed intubation, reintubation, dental injury, and airway obstruction associated with increasing body mass index.<sup>50</sup>

Short of substantial weight loss prior to elective surgery (with a poor success rate, as shown recently by Coe et al.),<sup>53</sup> however, the aforementioned perioperative risks are generally not modifiable. Hence, a key element for practitioners to consider in preparation for an elective operation in obese patients is counseling, specifically with regard to weight loss (if time permits) and full disclosure of significantly heightened perioperative risks.<sup>53</sup>

It might also be beneficial to prepare obese patients for practical issues such as difficult IV access and the possible

need for awake intubation and extubation. Obstructive sleep apnea (OSA) is a syndrome that is commonly associated with obesity and is characterized by periodic, partial, or complete airway obstruction during sleep. It is estimated that approximately 9% of women and 24% of men have some degree of OSA, while the severe, symptomatic disease is present in approximately 2% of women and 4% of men.<sup>54</sup> In October 2005, the ASA published a practice guideline on the *Perioperative Management of Patients with Obstructive Sleep Apnea (OSA)*. This practice guideline comprehensively reviews the preoperative and postoperative management of patients with this disorder.<sup>55</sup> On occasion, patients who are considered to be healthy may have undiagnosed OSA; thus it is important to get a complete history, specifically as it relates to snoring and daytime somnolence. If the patient is, indeed, suspected of having the syndrome, then the patient should be worked up prior to an elective procedure as recommended by the practice guideline.

**Old Age** Another well-established public health concern that has specific perioperative implications is aging. This is critical for anesthesiologists because of the rapid aging of the population, combined with the fact that an increasing proportion of surgical procedures are performed in the elderly. In 1986, Tiret et al. provided evidence that the elderly have higher perioperative complication rates and higher risk than their younger counterparts, even in the

absence of comorbidities.<sup>56</sup> The issue of perioperative risk, as it relates solely to advancing age, however, is far from settled.<sup>57</sup> Some would therefore assert that anesthetizing “healthy” elderly patients poses no significant elevation in perioperative risk. It must be remembered, however, that even “healthy” elderly patients have marked diminution in the function of all major organ systems.<sup>58</sup> This would cause some to assign the ASA classification of PS 2 or even PS 3 to all such patients. Aside from the universal physiologic changes seen in all elderly patients (“aging”), elderly patients definitely tend to accumulate coexisting disease, which Kim et al. clearly demonstrated to be a strong predictor of complications.<sup>59</sup>

Elderly patients often have additional and unique perioperative challenges. Many have poor hearing and eyesight, and some suffer from cognitive impairment. This can make communication difficult. Simple issues like transportation home after conscious sedation can become logistical problems in the elderly. An important result of the aforementioned physiologic changes is markedly altered drug disposition in the elderly. Elderly patients have diminished volumes of distribution, decreased clearance, and heightened sensitivity to nearly all medications.<sup>58</sup> This explains why elderly patients are more sensitive to the therapeutic actions of most drugs, and markedly more susceptible to side effects. In summary, despite changes attributable to normal aging, there is no strong association between age itself and perioperative risk. Thus, chronologic age should not be a contraindication to surgery. The elderly tend to accumulate coexisting disease, however, so anesthesiologists should be especially vigilant in the detection of such disease. Finally, to avoid complications and dissatisfaction in the elderly, anesthesia providers need to understand the altered pharmacology, physiology, and special needs that accompany the normal aging process.

**Smoking** Approximately 1 in 5 adult Americans currently smoke and millions of elective surgical procedures are performed each year on these individuals.<sup>60</sup> This is unfortunate, as cigarette smoking is independently responsible for an alarming elevation in the rate of serious perioperative pulmonary complications.<sup>61</sup> Cigarette smoking is definitely an addictive disease that adverse-

ly alters the lifestyle of those affected. This fact, coupled with the well-known perioperative risks that smoking confers,<sup>62</sup> should result (again, by convention) in otherwise healthy smokers being classified as at least ASA PS 2, and in many cases, ASA PS 3. A recent United States Public Health Service guideline has advised *all* physicians to “strongly advise every patient who smokes to quit because evidence shows that physician advice to quit smoking increases abstinence rates.”<sup>63</sup> Furthermore, anesthesiologists are uniquely positioned to give such advice. The preoperative interaction has been described by Warner as a “teachable moment” that not only lowers their immediate perioperative risk, but also is of great benefit to their long-term health.<sup>60</sup> Quitting smoking immediately prior to surgery does not heighten risk, produce untoward anxiety, or consistently precipitate nicotine withdrawal.<sup>64</sup> Hence, patients who smoke should not be considered “healthy.” These patients should be advised of the elevation in perioperative risk that is attributable to their habit, and be encouraged to quit as soon as possible prior to their elective surgical procedure.

### **Preoperative Testing in Healthy Patients**

Billions of dollars are wasted in the United States each year on unnecessary preoperative testing.<sup>65</sup> In the case of healthy patients, this testing is almost always unnecessary.<sup>66</sup> It is generally accepted that healthy patients undergoing low-risk surgical procedures require no specific laboratory testing unless clinically indicated.<sup>67</sup> Little evidence exists regarding the propriety of such routine testing in healthy patients undergoing more complicated procedures with the potential for major blood loss (e.g., major corrective orthopedic procedures, brain aneurysm clipping). Many recommend obtaining a preoperative hematocrit level in menstruating women, but there are little data to support this.<sup>67</sup> Women of childbearing age should be given pregnancy tests if it cannot be ascertained for certain whether or not they are pregnant. It is our institutional policy that women 18 years of age and older be asked, “Is it possible that you could be pregnant?” If they answer “no,” they are not tested. This is in general agreement with the ASA stance on this issue: “The task force believes that the literature is inadequate to inform patients or

physicians on whether anesthesia causes harmful effects on early pregnancy. Pregnancy testing may be offered to female patients of childbearing age and for whom the result would alter the patient’s management.”<sup>49</sup>

The indiscriminate ordering of batteries of routine tests, even in patients with serious comorbidities, has been the subject of intense review, and has been found to be excessively expensive and ineffective.<sup>36</sup> In fact, batteries of routine tests and their subsequent interpretations were found to predict morbidity more poorly than the simple use of either the ASA physical status classification, or the ACC/AHA<sup>9</sup> guidelines. What is recommended by the ASA Practice Advisory is that “specific tests and their timing should be individualized and based upon information obtained from sources such as the patient’s medical record, interview, physical examination, and the types and invasiveness of the planned procedure.”<sup>49</sup> Halaszynski et al. well-summarized these concepts in their recent article addressing this issue (Table 5–11).<sup>36</sup>

They suggest that age be used as a basic indication for testing, with the additional components of surgical complexity and medical illness allowing for layers of flexibility. According to this paradigm, healthy patients < 45 years of age, having uncomplicated operations require no testing. As patients deviate from this healthy/uncomplicated baseline, testing may be indicated, but in a directed and temporally related fashion (if a test was recently done, it does not generally need to be repeated). Thus, if it can be ascertained from the preoperative history and physical examination that a patient is healthy, “routine” testing is rarely indicated in patients having uncomplicated surgical procedures. At the University of Michigan, the only “screening” test that we routinely order preoperatively is an electrocardiogram (ECG) in asymptomatic men older than 45 years of age and in women older than 55 years of age if they have any cardiovascular risk factors.<sup>1,68</sup>

## **IMPLEMENTATION OF THE PLAN**

### **Type of Anesthesia: General, Regional, Monitored Anesthesia Care**

Once the goal of preoperative evaluation has been achieved, the anesthesi-

TABLE 5-11.

## Preoperative Testing in Healthy Patients

Test	Low-Risk Operation				High-Risk Operation					
	<45	Age (years)			Cardiac/ Thoracic	Vascular	Major Abdominal	Major Blood Loss Possible	Intracranial	Major Orthopedic
Electrocardiogram	M	Y	Y	Y	Y	S	S	S	S	
Complete blood count		Y	Y	Y	Y	Y	Y	Y	Y	
Electrolytes			Y	Y	Y	Y	Y	Y	Y	
Glucose			Y	Y	Y	Y	Y	Y	Y	
Liver function tests						S				
Coagulation studies				Y	Y	S				
Urinalysis										
Pregnancy	S			S	S	S	S	S	S	
Chest radiograph				Y		S	S		S	
BUN/Cr				Y	Y	Y	Y	Y	Y	

M = male; Y = usually indicated; S = sometimes indicated, may be requested by surgeon.  
Data from Tremper KK, Benedict P. Paper "preoperative computer". *Anesthesiology* 2000;92:1212-1213.

ologist and patient must devise an anesthetic plan. This is where surgeon requirements and patient preference directly interface. Surgeon requirements vary widely, but most patients simply want their surgical experience to be safe and comfortable. Surgeons want the best conditions possible to perform their operations and it is advisable that surgeons and anesthesiologists communicate in advance of the operation to express their requirements and limitations. Anesthesiologists have direct control over many variables that surgeons require to carry out their operations safely and swiftly, including degree of consciousness, blood pressure control, ventilatory control, and level of consciousness at the conclusion of surgery. If other factors are equal (patient has no particular preference, perceived safety is equal), surgeon preference must be taken into consideration. Patient safety, however, is always of paramount importance and at times may outweigh surgeon preference (e.g., performing a regional anesthetic for a lower-extremity procedure in a patient with severe pulmonary disease).

Keeping safety in mind, the anesthetic choice is often influenced by two key patient features: coexisting disease and aging. A completely acceptable technique for a particular op-

eration (e.g., a subarachnoid block for a total-knee arthroplasty) may be contraindicated in patients presenting with certain disease states (e.g., aortic stenosis). Whereas general anesthesia is performed rather indiscriminately in young, healthy patients, regional, or even local anesthesia with sedation might be the safest option in patients with severe respiratory disease. The same holds true for the elderly patient. Even "healthy" elderly patients have well-documented diminutions in the function of renal, hepatic, cardiorespiratory, and drug-metabolizing systems<sup>58</sup> that are progressive. Drugs and doses that are innocuous in young, healthy patients can have long-lasting, debilitating effects in the elderly. Consequently, it may be desirable, whenever possible, to consider regional, or even local anesthesia with minimal sedation in the elderly.

Type and location of surgery play an important role in planning for anesthesia, but patient preference and the destination of the patient in the postoperative phase also must be considered. Newer, more rapidly eliminated anesthetics have made postoperative destination less of an issue than in times past, but one that still must be considered. For example, long-lasting regional blocks and long-acting intravenous medications may be inappro-

priate for patients scheduled on an outpatient basis. Following is an overview of common surgical operations and factors that influence the anesthetic plan.

### Type of Procedure

#### Head and Neck Procedures

Head and neck procedures range from minor, superficial operations to complex resections and reconstructions involving nerve monitoring, large fluid shifts, and blood loss. Many simple, superficial operations are performed for skin cancer excision, followed by closure of the defect. Unless these lesions are deep or large, the cases can usually be safely and comfortably managed with conscious sedation combined with local anesthetic applied by the surgeon. Unless brief and superficial, ear surgery usually necessitates general anesthesia to achieve suitable patient comfort. It is common for these procedures to be performed on an outpatient basis. Cosmetic facial surgery is often performed with conscious sedation combined with local anesthesia to preserve awake muscle tone. Complex head and neck operations are often performed for invasive (mouth, throat, neck) cancers. These operations can be very complex and involve much fluid shifting and blood loss. In addition, these lesions can compromise the airway, necessitating non-

standard (awake) airway management techniques. Presence of a tracheostomy is relatively common at completion of these operations. Because of the length and complexity of these procedures, invasive monitoring (arterial lines) is common. Communication with the patient and family is important in achieving realistic expectations.

On occasion, intracranial neurosurgery is performed in the awake patient, but the majority of these operations are performed under general endotracheal anesthesia. Anesthesia for awake craniotomy is beyond the scope of this chapter. Success in these cases depends on an intimate surgeon-patient-anesthesiologist interaction with much preoperative communication. Because operating conditions for intracranial operations depend on and, conversely, can impact on vasomotor control, invasive (particularly arterial) monitoring is common. Neurologic function (somatosensory evoked potentials) monitoring is common and the anesthesiologist must be knowledgeable in the interactions of anesthetic agents and these monitors. Additionally, neurosurgeons will often request (if feasible) that a rapid wake-up be accomplished at the conclusion of surgery so that early assessment of neurologic function can be carried out.

**Thoracic Procedures** Thoracic surgical procedures range from outpatient thoracoscopic procedures (minor pulmonary resections and biopsies, sympathectomy) to major pulmonary and upper gastrointestinal tract procedures involving major body cavity and cardiovascular trespass, blood loss, and fluid shifting. The majority of these procedures require single-lung ventilation, and this must be planned for. Open thoracic procedures are typically associated with a high degree of postoperative pain, which is best controlled with postoperative epidural analgesia. Because of their proximity to major vascular structures and potential for adverse ventilatory interactions these procedures often necessitate invasive intravascular lines and monitors, which must be discussed with the patient as part of the preoperative plan.

**Abdominal Procedures** Increasingly, abdominal procedures are being performed laparoscopically. General anesthesia with endotracheal intubation must be employed for patients to

safely and comfortably tolerate this technique. Regional techniques can be used successfully for open intraabdominal procedures, but these operations are frequently long and complex, so general anesthesia is often favored. When general anesthesia is employed, endotracheal intubation is indicated to provide abdominal muscle relaxation and to protect against gastric aspiration. Epidural is an excellent option for postoperative analgesia in open abdominal operations, but is usually not necessary when procedures are performed laparoscopically. Because of the potential for vascular involvement, major blood loss, and fluid shifting, invasive monitors are sometimes indicated, even in otherwise healthy patients.

**Urologic Procedures** Many urologic procedures are performed through a cystoscope and are of relatively short duration. In these cases, short-acting regional and general anesthetics are equally safe and effective options. Patient preference can play a major role in devising a plan for these cases. Both nephrectomy and prostatectomy typically have been performed via large, open approaches, but are increasingly being performed laparoscopically. Open prostatectomy has been performed successfully under both general and regional anesthesia, but the laparoscopic approaches for these procedures necessitate general anesthesia with endotracheal intubation.

**Gynecologic Procedures** As with abdominal and urologic procedures, gynecologic procedures are being performed increasingly via the laparoscopic approach. The same principles as for abdominal and urologic procedures apply. When performed via an open abdominal approach, gynecologic procedures generally require general anesthesia with endotracheal intubation to allow profound muscle relaxation. Vaginal, cervical, and hysteroscopic procedures can be completed safely and comfortably using either general or regional anesthesia. Thus patient preference combined with anesthesiologist experience must be taken into account when planning for these cases.

**Orthopedic Procedures** At one extreme, orthopedic operations can be brief and minor peripheral extremity procedures amenable to either region-

al or local anesthesia with sedation. At the other end of the spectrum are long, complicated procedures that involve large blood losses, fluid shifting, and intraoperative nerve monitoring. Total knee and hip joint replacement operations are very common and can be carried out with either general or regional anesthesia. Epidural anesthesia is an effective choice and can be continued into the postoperative period to provide excellent analgesia. Some patients are extremely anxious about the prospect of being awake during orthopedic procedures. Serious consideration must be given to general anesthesia in these patients. Major spine surgery, operations for major orthopedic malignancies and revision hip operations can be long and complex, so general anesthesia with endotracheal intubation and invasive monitoring should be considered. Upper-extremity nerve blocks are increasingly common for procedures on the shoulder and arm. Interscalene blocks and catheters are useful for shoulder surgery. Infraclavicular blocks and/or catheters are useful for procedures on the forearm and hand. Chapter 74 discusses the use of these techniques more fully. Because of the significant pain associated with shoulder reconstructive surgery and the need for postoperative manipulation as part of the rehabilitation, interscalene catheters are very popular. They can be used as the sole anesthetic, or in combination with general anesthesia. These blocks have proven efficacy in the successful treatment of immediate postoperative pain.<sup>69</sup>

**Ocular Procedures** Many surgical procedures on the eye can be carried out safely and comfortably using local anesthesia. When formulating the anesthetic plan preoperatively with the patient, this technique must be fully explained so that the patient has realistic expectations. Some ocular procedures can be very long, necessitating use of general anesthesia to provide optimal operating conditions. In these cases, plans may need to be devised for "deep" extubation to avoid coughing and elevation of intraocular pressure on emergence from anesthesia.

### **Regional Anesthesia versus General Anesthesia**

Whether general anesthesia or regional anesthesia should be used for major surgical operations is controversial.



TABLE 5–12.

## Perceived Advantages of Regional Anesthesia

Regional anesthesia
Very targeted site of drug action
Necessitates far less intravenous sedations and analgesia (especially important in elderly patients)
Profound analgesia and relaxation
No need for airway management or mechanical ventilation
Possible decreased blood loss, decreased risk of thromboembolism <sup>70</sup>
General anesthesia
Indiscriminate drug administration to entire body
Far greater requirement for intravenous and potentially long-acting medications
Intravenous drugs with potential side effects required to achieve same effect
Airway management is always necessary and mechanical ventilation is often necessary
Patients at risk for hemorrhage, venous thromboembolism

Both techniques have advocates and detractors from both a safety and efficacy standpoint. Table 5–12 identifies the advantages commonly cited for general and regional anesthetic techniques.

Although there is no convincing evidence that morbidity and mortality are decreased with either technique, there is a suggestion of improvement in specific outcomes with use of regional anesthesia.<sup>70</sup> Despite the common perception that regional anesthesia is generally “safer” than general anesthesia, its principal advantage is in providing analgesia postoperatively. For certain operations, regional anesthesia offers distinct advantages compared to general anesthesia,<sup>71</sup> but some of the perceived benefits of regional anesthesia recently have been questioned.<sup>72</sup> For regional techniques to be successful, the patient must be accepting of the technique, a skilled clinician must be available to perform it, and the block must be effective. If long-lasting blocks or indwelling catheters are to be used, educational efforts must be made regarding the special care that these techniques necessitate. Lastly, patients must be informed of the potential complications that can result from the use of regional anes-

thesia. Chapters 45–49 provide a more in-depth analysis of this controversial subject.

### Monitored Anesthesia Care: Potential Pitfalls

Superficial operations are commonly performed in healthy patients using the monitored anesthesia care (MAC) technique. This entails use of anxiolytic, sedating, and analgesic medications administered by anesthesia personnel, combined with local anesthesia administered by the surgeon. In a recent editorial, Hug describes the attitude of anesthesia providers regarding such cases as “routine, simple, and low-risk.”<sup>73,74</sup> In addition, these operations are often performed hastily, in remote locations, and involve positioning that provides anesthetists poor access to the airway. This can result in a situation where “diligence is less by both the anesthetist and the surgeon.”<sup>73</sup> Combined with liberal use of sedating respiratory-depressant medications, MAC has the potential to result in life-threatening anesthetic-related complications.

Complications attributable to MAC anesthesia have been reported in the literature, and a recent closed claims analysis by Bhanaker et al. sheds new light on this devastating, yet uncommon problem. In this study, MAC anesthesia represented a “liability profile similar to claims associated with general anesthesia.” This led the authors to conclude that “oversedation leading to respiratory depression was an important mechanism of patient injury during MAC. Appropriate use of monitoring, vigilance, and early resuscitation could have prevented many of these injuries.”<sup>74</sup> Hence, anesthesia providers need to be cognizant of the potential for serious complications associated with MAC anesthesia and avoid the pitfall of trivializing this technique to the extent of compromised vigilance and potential serious complications.

### Preoperative Instructions

A clear, concise set of preoperative instructions can contribute greatly to patient safety and operating room efficiency. Provision of these instructions can be carried out in a variety of ways, but we feel that a combination of both verbal and written communication is most likely to achieve the desired result. At our institution the verbal communication is carried out in either the preoperative clinic, or via a combina-

tion of surgical and nursing preoperative “teaching.” Our written preoperative instructions are in the form of a folder, or “packet,” that is periodically reviewed by perioperative surgical, anesthesia, and nursing teams. The most important elements of preoperative instruction that relate to the provision of safe anesthesia are dietary (nothing by mouth [NPO]) and medication instructions. Even when general anesthesia is not the primary anesthetic plan, it is an eventual possibility in many cases. Consequently, it is important that patients fast appropriately so that the risk of aspiration is minimized. Fasting guidelines for elective surgery are clearly delineated by the ASA,<sup>75</sup> and we tend to instruct patients conservatively (e.g., interpreting “clear liquids” to mean “water”).

ASA PS 1 and PS 2 patients may be taking a variety of prescription and non-prescription medications. To avoid potential complications, clear instructions must be given regarding continuation and avoidance of various medications prior to elective surgery. Medications that are typically continued include antireflux, cardiovascular, and antihypertensive (with the possible exception of angiotensin-converting enzyme inhibitors and angiotensin receptor blockers),<sup>76</sup> pain (with the possible exception of aspirin and nonsteroidal anti-inflammatory medications), psychotropic (with the exception of monoamine oxidase inhibitors), asthma, and antiseizure medications. Medications taken on the day of surgery should be consumed with as little water as possible. Alternative medications and herbal preparations deserve special consideration. Many patients do not consider these to be medications and hence must be specifically asked about their use. These products are poorly regulated and often contain unknown quantities of substances that can lead to serious perioperative drug interactions and complications.<sup>77</sup> Because of the lack of data on many of these preparations, the ASA recommends that practitioners continually familiarize themselves with alternative medications and advise the discontinuation of all such products for at least 2 weeks prior to elective surgery.<sup>78</sup>

### Premedication

It is difficult to find consensus on what constitutes the best plan for pharmacologic premedication prior to anesthesia. What is important is that each agent be

administered only if there is a clear and specific indication for its use. The most common indications for preoperative administration of medications are anxiolysis, analgesia, and gastric aspiration, surgical wound infection, and thromboembolic prophylaxis. None of these classes of medications should be administered on a purely “routine” basis. Each of these medications has a unique set of potentially dangerous side effects, including allergic reactions, drug–drug interactions, prolonged effects, and added cost. Hence, in the absence of clear indications, healthy patients undergoing elective operations should receive little or no pharmacologic premedication.

Anxiety is common in patients undergoing even minor surgery, and it tends to heighten as the surgical event approaches. It is difficult to discern which patients will be anxious prior to surgery by any other means but a direct interview. Treating preoperative anxiety not only improves patient satisfaction,<sup>79</sup> but may have more far-reaching effects, such as reduction of surgical stress response and lowering the incidence of PONV.<sup>80</sup> Although, the most commonly used agents used for this purpose are benzodiazepines, particularly midazolam, other agents, such as melatonin, are safe and efficacious.<sup>81</sup>

Preoperative analgesia may be considered when painful conditions, such as orthopedic fractures, are present. If opiates are chosen for this purpose, patients must be monitored for sedative and respiratory depressant side effects. Some studies even support the use of “preemptive analgesia” with agents such as ketorolac as a means to lower anesthetic requirements and their attendant side effects. Evaluation for the risk of nausea and vomiting was discussed above (see Postoperative Nausea and Vomiting). When this risk is identified, consideration should be given to single, or in select cases, multimodal, therapy to prevent this complication. Healthy patients occasionally will require thromboembolism prophylaxis in the perioperative period. This is most commonly accomplished with either low-dose or low-molecular-weight heparin preparations.

### Postoperative Destination

The anesthetic plan must take into account the postoperative destination of the patient. Pre- and intraoperative planning must be flexible, so that safe

and appropriate medical care is available if the ongoing needs of the patient change. For example, many airway procedures can be accomplished on an outpatient basis. However, there is a relatively high risk with this type of surgery that complications could require admission to, or even mechanical ventilation in, an intensive care unit. This sort of eventuality must be taken into account for two reasons. First, operations with a relatively high likelihood of admission or intensive care unit management (even in otherwise healthy patients) should not be scheduled in facilities that lack the means to provide this care. Second, patients and their families must be advised beforehand of this possibility. Patients and family members must be aware that intraoperative events can change the postoperative destination of the patient, even if the initial plan was for same-day discharge.

Patients have three ultimate postoperative destinations: home, a hospital “floor” or “ward” bed, or the intensive care unit. A stay in the postanesthesia care unit (PACU, or “recovery room”) may precede any of these final destinations. Planning for the eventuality of any of these destinations must occur in both the pre- and intraoperative phases of an anesthetic. In the case of both the PACU and the intensive care unit, advance planning must be carried out so that a bed is available and the unit is appropriately staffed. Both patients and family members need to be made aware of the destination that was initially planned, and of any changes that may have been made based on intraoperative (or PACU events). Fortunately, many procedures that are planned on an outpatient basis and are free of complications entail very short PACU stays, or (as is increasingly common) bypass a recovery room altogether. This is generally safe, cost-effective, and well-received by patients, but necessitates simple, but crucial, advance planning. For example, it is mandatory that patients who have received sedating medications have safe transportation home, usually in the person of a caregiver who can also assist with medication, surgical dressing issues, and other forms of assistance.

### Postoperative Pain

Postoperative pain resulting from surgical procedures performed in healthy

patients ranges from none to severe and relatively long-lasting. As such, treatment of postoperative pain ranges from no treatment at one extreme (noninvasive endoscopic procedures) to invasive techniques, including epidural analgesia and indwelling nerve plexus catheters. This section provides a simple overview of available pain-control options in healthy patients, and readers are referred to Chap. 74 for a more in-depth review of this subject. It is the anesthesiologist's responsibility to couple analgesia with hypnosis in the intraoperative phase, and then continue some form of analgesia postoperatively, while minimizing additional drug effects such as sedation and respiratory depression. A key feature in the success of this plan is education, and physician–caregiver rapport in the preoperative phase. Although it is important for patients to wake up as pain free as possible, it is also critical that they be informed that they will likely experience some degree of postoperative pain. Realistic expectations regarding postoperative pain, as discussed further in Chap. 74, are a vital component in patient satisfaction and avoidance of complications related to pharmacologic control of pain.

As stated previously, healthy patients generally undergo short, simple surgical procedures. Occasionally, however, complicated operations are performed that result in severe postoperative pain. Thus, the entire array of pain-control modalities at the anesthesiologist's disposal must be available in this population. Despite controversy over its efficacy,<sup>82</sup> preemptive analgesia with agents such as acetaminophen and nonsteroidal antiinflammatory drugs (NSAIDs) must be considered. Use of these compounds is also typically the first line of therapy in patients having minor operations, such as carpal tunnel repair or vasectomy. These compounds are generally devoid of side effects, but patients must be cautioned regarding overdose with resultant damage to the liver and kidneys.

Opiates are indicated for moderate to severe pain, via either oral or intravenous routes of administration. Patient-controlled analgesia (PCA) represents a major advance in the use of opiates for postoperative analgesia, but success with the technique is dependent on proper planning and patient instruction. Grass published an excellent and

thorough review of this subject, covering its history, safety, efficacy, and current practice guidelines.<sup>83</sup> Major nerve conduction blockade (nerve blocks, plexus blocks) and epidural analgesia are occasionally necessary in healthy patients undergoing surgical procedures that will result in severe pain (e.g., orthopedic, intraabdominal, and pelvic procedures). Liu published an excellent practical review of indwelling catheters for postoperative pain relief.<sup>84</sup> Although highly successful, both techniques are associated with potentially serious complications and proper planning and consent entails disclosure of both aspects of these techniques. Finally, the issues of aging, opiate dependence, and abuse all have important implications for the successful planning and management of postoperative pain; Chap. 74 discusses these issues in detail.

## MONITORING IN HEALTHY PATIENTS

The medical community, the anesthesia community, and to some extent patients assume that monitoring during anesthesia and surgery results in fewer preventable mishaps and improved outcomes. Fortunately, since its introduction into modern medicine, anesthesia is an increasingly safe proposition.<sup>85</sup> As Domino and others continue to point out, however, rare anesthesia mishaps continue to have catastrophic outcomes (death, major morbidity) that are very costly to society.<sup>41</sup> Every year, thousands of cases of death and serious morbidity are attributed solely to the provision of anesthesia.<sup>86</sup> In a large proportion of these cases, the cause of the morbidity or mortality is believed to be preventable.<sup>87</sup> Failure to prevent anesthetic catastrophes usually results from lapses in vigilance or simple human error. Anesthetic monitors are intended to aid in the maintenance of vigilance and to alert providers to the possibility of human error. Following is an overview of monitors commonly used in healthy patients and the rationale for their use in various clinical scenarios. For a more in-depth review of monitoring devices and their clinical applications and limitations, the reader is referred to Chaps. 29–34.

Despite the assumption that there is a correlation between monitoring and outcome, there is little in the way of scientific validation to support this as-

**TABLE 5–13.**

### American Society of Anesthesiologists Standards for Basic Intraoperative Monitoring<sup>a</sup>

#### Standards

**Standard 1: Qualified anesthesia personnel shall be present in the room throughout the conduct of all general and regional anesthetics, and monitored anesthesia care**

**Standard 2: Oxygenation, ventilation, circulation, and temperature shall be continually evaluated**

#### Oxygenation

Oxygen concentration of inspired gas

Observation for the patient

Pulse oximetry

#### Ventilation

Auscultation

Observation of the patient

Observation of reservoir bag

End-tidal carbon dioxide analysis

#### Circulation

Continuous ECG display

Heart rate and blood pressure recorded every 5 min

Evaluation of circulation: auscultation of heart sounds, palpation of pulse, pulse plethysmography, pulse oximetry, intraarterial pressure tracing

#### Temperature

Core temperature and/or skin temperature

<sup>a</sup>The term *continuously* means prolonged without interruption, whereas *continually* means repeated regularly and frequently.<sup>89</sup>

sumption. In 1986, Eichhorn et al. suggested that intraoperative monitors may reduce adverse events and therefore improve outcomes.<sup>88</sup> From this body of work arose the ASA guidelines for intraoperative monitoring,<sup>89</sup> which have been amended (Table 5–13).

The assumption that monitoring improves outcome, coupled with the zeal of anesthesia providers to gather information, can lead to practitioners erring on the side of more, rather than fewer, monitoring devices. This would be ideal if monitors were cheap, completely accurate, and completely safe. Most modern monitoring devices, however, are expensive and not always accurate. Some forms of monitoring have the potential to mislead anesthesia providers, while others are even capable of

causing serious physical harm.<sup>90,91</sup> Therefore, in planning for an anesthetic, anesthesiologists must weigh the perceived advantages with the known potential for complications when choosing a monitoring strategy (Table 5–14).

Healthy patients having uncomplicated surgical procedures rarely need more than the ASA basic intraoperative monitors. Before considering machines that monitor the human body however, it is vital that anesthesiologists maintain basic physical examination skills. These skills can give vital information about patients quickly and reliably. For example, failure of the chest to rise combined with a bubbling sound emanating from the patient's throat, may indicate cuff failure or improper placement of an endotracheal tube. Tactile sensation of a bounding pulse in the presence of a low machine reading, may indicate a problem with mechanical blood pressure measurement. Discoloration of a patient's skin combined with a feeling of warmth could be an early indicator of malignant hyperthermia. Smelling a potent anesthetic vapor could be a sign of an airway leak or disconnect. Although it would be crude and unwise to rely solely on sense perception to assess patients, clinicians must maintain vital physical examination skills in addition to their knowledge and skills in use of mechanical monitoring devices. Analyses of anesthetic mishaps leading to serious morbidity and mortality<sup>41</sup> consistently reveal one common mechanism as a root cause for catastrophe: failure to deliver oxygen to vital organs. The most common cause of critical end-organ hypoxia is failure to ventilate the lungs, hence the ASA recommendation for continuous evaluation of oxygenation and ventilation, even in healthy patients. The goal of this monitoring is early recognition of ventilatory inadequacy, which can be rectified before end-organ damage ensues. Observation is still a vital skill in assessing tissue oxygenation, especially in the case of the awake patient. Signs of hypoxemia in an awake patient include decreased level of consciousness, loss of judgment, and disorientation, but these signs are not specific and occur in many other conditions. Cyanosis might be an indicator of hypoxemia, but it is late occurring and generally unreliable. Given the devastating consequences of arterial hypoxemia, however, this cause must be at the top of any differ-

TABLE 5–14.

## Types of Anesthesia Monitors and Their Properties

Type of Monitor	What Is Measured	Invasiveness	Potential for Complications
Physical examination	Heart tones, breath sounds, pulse, color, etc.	Noninvasive	–
Pulse oximetry	Arterial oxygen saturation	Noninvasive	–
Arterial blood gas analysis	Ventilatory and acid–base status	Invasive	++
Sphygmomanometry, oscillometry	Blood pressure	Noninvasive	+
Arterial catheterization	Blood pressure	Invasive	++
Electrocardiography	Cardiac rhythm, integrity	Noninvasive	–
Capnography	Ventilatory, circulatory status	Non- to semi-invasive	–
EEG, bispectral index, entropy, others	Brain function, depth of anesthesia	Noninvasive	±
Temperature probes	Body temperature	Non- to semi-invasive	±
Central venous cannulation, pulmonary artery catheter	Volume status, cardiac function	Invasive	+++

ential diagnosis when these physical signs are encountered.

### Measurement of Oxygenation

Three methods of assessing oxygen delivery are widely available: arterial blood gas analysis, pulse oximetry, and measurement of inspired oxygen concentration. The need for blood gas analysis in healthy surgical patients is relatively rare. This test is invasive (and therefore has potential complications), relatively expensive, and can only be performed intermittently. Its use in healthy patients should be considered when complex surgical procedures are being performed or when perioperative complications necessitate in-depth analysis of ventilation and acid–base status. Pulse oximetry is completely noninvasive, well accepted (despite being a continuous monitor), and is relatively inexpensive. Extensive reviews of the development, theory, and applications of pulse oximetry are available. Pulse oximetry and inspired oxygen analysis should be used in every patient undergoing general anesthesia. Pulse oximetry should be used in all patients anesthetized with sedating intravenous medications. What follows is a summary of pulse oximetry's technical aspects, perioperative uses, and limitations.

Pulse oximetry relies on two principles to continuously measure the degree of arterial blood oxygenation: differential light absorption of oxy- and deoxyhemoglobin, and pulsation of arterial blood. The pulse oximeter displays a number that corresponds to the arterial saturation obtained from an in vivo cooximeter. Also displayed on

most units is a plethysmograph, or pulse waveform. Some advantages of pulse oximetry can also be viewed as limitations. First, the pulse oximeter is quite accurate when compared to in vivo oximetry, but only under ideal conditions and within a fixed range of arterial saturation. Artifacts that create less-than-ideal conditions include shivering, cold extremity, intravascular dyes, venous congestion, and electrocautery. In addition, the processor algorithms built into the device are unable to give meaningful output for oxygen saturations below 70%. Second, users must be familiar with limitations of the plethysmograph feature. It should not be assumed that the plethysmograph accurately reflects the magnitude of the arterial pulsation, and hence the adequacy of perfusion. This signal is variably (and sometimes highly) amplified to aid in the measurement of oxygen saturation.<sup>92</sup> Hence the plethysmograph magnitude should not be used to infer information about the adequacy of blood perfusion.

### Hemodynamic Monitors

Hemodynamic monitors are those intended to assess the adequacy of circulatory function. All anesthetized patients must have at least intermittent blood pressure monitoring. For healthy patients having uncomplicated surgical procedures, intermittent cuff measurement is usually sufficient. Cuff measurement of blood pressure can be achieved via either sphygmomanometry or oscillometry. Both methods are accurate, noninvasive, and well tolerated. Clinicians using either of these methods must

understand a few guidelines to insure accurate measurement. First, cuff size must be appropriate for the patient. Too large or too small a cuff size can under- or overestimate blood pressure, respectively. This is most common in obese patients, where cuff size is too small. Second, this method of blood pressure measurement is subject to motion artifact.

Direct intraarterial blood pressure monitoring involves insertion of a catheter into an artery followed by its connection to a pressure transduction system. Arterial lines are occasionally necessary in healthy patients because of procedural length or complexity. This technique is invasive and serious complications can result from its use. When correctly performed, this method provides continuous measurement of blood pressure that is very accurate. The data obtained from this measurement technique can even be used as an accurate measure of intravascular volume status.<sup>93</sup>

In patients who are intubated and mechanically ventilated, variation in the peak systolic pressure with ventilation has been used as a method to determine intravascular volume status.<sup>94</sup> This measurement, known as systolic pressure variation (SPV), has been compared to central venous pressure measurements, pulmonary artery occlusion pressure measurements, and transesophageal echo measurement of left ventricular volume, and found to be more accurate than other pressure measurements for determining adequacy of volume resuscitation.<sup>94</sup> Normal values of SPV are between 5 and 10 mm Hg, with high



values representing possible underresuscitation (hypovolemia) and low values meaning the patient may be overresuscitated.<sup>94</sup> This SPV has been described as a “dynamic variable of volume responsiveness.”<sup>94,95</sup>

Clinicians must not forget basic physical examination skills that can be valuable when specifically assessing circulatory status. Palpation and auscultation are the two most useful of these skills. These tests can be immediately performed and require no mechanical devices. These methods are not sufficient to completely monitor the circulatory status in healthy patients. Regular use of these techniques, however, especially when baseline assessments were performed for comparison, can give anesthesia providers accurate and early information that can guide therapy or aid in selection of more complex assessment techniques. Palpation of a peripheral pulse can give valuable information about the circulatory status of the patient. Two properties of the pulse must be ascertained: magnitude and character. The pulse of a healthy patient at baseline should be strong and regular. Performing a baseline examination is mandatory so that later comparison can be made.

Auscultation is another physical examination skill with usefulness in the modern operating room. Auscultation is simple to perform, even on a continuous basis, and is an excellent qualitative measure of ventilation. Auscultation is most valuable to the clinician when a baseline examination is performed and used for later comparison. Baseline auscultation of heart and lungs should be performed in every anesthetized patient. As with palpation, both the quality and the magnitude of the sounds must be ascertained. Auscultation is never sufficient on its own to make definitive diagnoses or to guide therapy, but it can be performed easily, immediately, and without harm, and may guide the clinician in planning additional diagnostic steps. An example is development of a third heart sound combined with new pulmonary rales, raising suspicion of fluid overload and pulmonary edema.

The heart is not only a pump, but a vital end-organ that is susceptible to hypoxic insult. In addition, even healthy, anesthetized patients are susceptible to cardiac rhythm abnormali-

ties that can compromise circulatory adequacy. Consequently, it is routine for anesthesiologists to monitor the integrity of the heart muscle and heart rhythm during anesthesia. This is accomplished mainly via the electrocardiogram (ECG) and, when possible, feedback from an awake patient (angina or anginal equivalent). ECG monitoring is considered a standard of care in modern anesthesia. ECG monitoring is completely noninvasive, relatively inexpensive, and can be assessed continuously. ECG data are crude representations of the heart's electrical activity, but critical information can be inferred from the trace regarding the integrity of the myocardium. Specific patterns of abnormality on ECG tracings can represent cardiac dysrhythmias, cardiac ischemia, and electrolyte imbalances that can compromise the integrity of the heart muscle and its function as a pump.

The most common ECG abnormality found in healthy anesthetized patients is dysrhythmias. Thus when using an ECG to monitor healthy patients, it is wise to monitor leads that are best suited for rhythm identification, such as lead II or V<sub>1</sub>. Common causes of perioperative dysrhythmias are autonomic nervous system overactivity, ventilatory abnormalities such as hypoxemia and hypercarbia, and cardiac effects of anesthetic medications and adjuvants. Perioperative dysrhythmias in otherwise healthy patients are often well tolerated and self-limited. Some, such as severe bradycardia and junctional rhythms, can compromise circulatory status and require intervention. On occasion, the perioperative ECG will identify myocardial ischemia in patients who were previously thought to be healthy.

By definition, healthy patients are free of coronary artery disease. Use of perioperative ECG monitoring, however, will identify possible coronary ischemia in patients who were previously thought to be free of ischemic heart disease. The relationship between perioperative ECG evidence of coronary ischemia and the diagnosis of ischemic heart disease remains unclear. For ECG to function well as a monitor for myocardial ischemia, correct combinations of leads must be used. Highest sensitivity can be achieved when these combinations include lead V<sub>5</sub>. Changes in ST segments and in T-wave configurations are the most uni-

versally accepted ECG findings representative of coronary ischemia, but the specificity of these findings is far from perfect.<sup>96</sup> Newer monitors use computer-assisted ST-segment analysis to assist in early detection of coronary ischemia. Most monitors allow printing or “freezing” of a short ECG trace to compare with later findings. When these are not performed, clinicians should closely observe a preinduction ECG tracing so that comparisons can be made later, if necessary.

## Capnography

Measurement of respiratory carbon dioxide is useful and strongly encouraged in all anesthetized patients. The methodology most commonly used is end-tidal carbon dioxide measurement, or capnography, to measure the carbon dioxide concentration in respiratory gas. Portable colorimetric devices are also available for use at the bedside and in the emergency room, and are used to confirm proper placement of an endotracheal tube. Capnographic samples can be obtained from closed or open (e.g., near the nose of a patient who is spontaneously breathing room air) breathing circuits. Capnography gives clinicians vital information regarding the pattern and the magnitude of ventilation. Capnography gives useful information regarding cardiopulmonary function. To produce a normal capnogram, the patient must be producing CO<sub>2</sub> at the normal rate, blood must be returning it to the pulmonary circulation, and the lungs must be ventilated. Therefore, a continuous capnogram insures, on a breath-to-breath basis, that all of the following are functioning normally: metabolism, blood flow, and ventilation.

A sudden drop in end-tidal carbon dioxide might indicate pulmonary embolism.<sup>97</sup> Capnography is useful in confirming proper placement of endotracheal tubes, but it is not useful in ruling out endobronchial intubation. End-tidal carbon dioxide concentration can be monitored continuously, the machinery is relatively inexpensive and the technique noninvasive.

## Mental Status and Depth of Anesthesia

The best monitor of cerebral function in a healthy patient who requires anesthesia is interaction with a conscious patient. This is the rationale for using

awake anesthetic techniques in certain settings where feedback regarding brain integrity is critical (carotid endarterectomy, prostatectomy with use of nonionic irrigants). In many surgical settings, however, awake anesthetic techniques are unsuitable. A concept that is intimately related to perioperative cerebral function is the ability of anesthesia providers to accurately assess the efficacy, or “depth,” of anesthesia in unconscious patients. The ideal general anesthetic renders a patient unconscious and pain free, facilitates ideal surgical working conditions, is rapidly reversible at the conclusion of surgery, and has no lasting side effects. During anesthesia-induced unconsciousness, however, there is no completely reliable method of assessing whether a patient is aware and possibly perceiving intraoperative events. Anesthesia providers undergo rigorous training in pharmacology and physiology to correctly dose medications and interpret physiologic data so that they can provide assurance *on these grounds* that patients are adequately anesthetized. Unfortunately, correct drug dosing and “normal” physiologic values do not insure that all patients are unconscious and free from pain.

One method of monitoring brain function (and, presumably, consciousness) that has seen occasional intraoperative use is the EEG. This monitoring technique is cumbersome, expensive, and requires highly trained personnel to interpret the highly complex data generated. Currently, an unprocessed EEG is rare in intraoperative settings. A variation of the EEG that has gained much notoriety in both the medical community and with the lay media is bispectral index (BIS), or “entropy” monitoring. These devices use only select EEG leads and then filter and transform the signals into a single digitized value.<sup>98</sup> BIS or entropy values correlate inversely with depth of anesthesia.<sup>98</sup> Use of the device has been advocated for two reasons: its use reduces both the incidence of intraoperative awareness during general anesthesia and anesthetic drug costs.<sup>99</sup> Although intraoperative awareness is a real problem, the issue has been somewhat sensationalized by the public media, which has led to much public interest in BIS. The ability of BIS to eliminate awareness, however, remains controversial,<sup>100</sup> and some

even argue that BIS could actually cause anesthesiologists to underdose their medications, leading to a higher incidence of awareness.<sup>101</sup> This issue remains unsettled and requires further investigation.

### Temperature Monitoring

It is vital that temperature be monitored in some way in all anesthetized patients, especially when general anesthesia is chosen or when MH triggering agents are used. Multiple investigators have shown improved outcome with maintenance of normothermia during major operations.<sup>102</sup> Hypothermia slows metabolism, inhibits coagulation, can cause cardiovascular lability, and is very uncomfortable in awake patients. Hypothermia is easily and commonly achieved in the operating room, but the best treatment strategy is prevention. Several methods of temperature monitoring are available to anesthesia providers. The simplest and least-invasive method is use of a skin temperature probe. These probes are somewhat accurate but it must be kept in mind that skin temperature is not truly representative of core, or internal, temperature. In addition, skin probes are easily rendered inaccurate by ambient conditions, such as warming and cooling mattresses and forced air blowers. Several semi-invasive methods of temperature monitoring are available, including tympanic, nasopharyngeal, esophageal, and rectal. Although these methods are quite safe, accurate, and more reflective of core temperature, complications are possible (ruptured tympanic membrane, nosebleed, irretrievable probe wires). The most accurate monitors of core body temperature are also the most invasive. Temperature probes are present on the tips of pulmonary artery and urinary catheters, but these are generally reserved for major operations in medically ill patients.

### CONCLUSION

Safety and efficacy are the primary determinants of a successful anesthetic. Safety in anesthesia is mainly achieved through the avoidance of complications. A main source of complications is patient comorbidity. Healthy patients, by definition, lack comorbidity, but may still experience anesthetic complications. The main

goals of the anesthetic plan in healthy patients are insuring the absence of comorbidity and the identification of potential complicating factors. The primary method of accomplishing these goals is the careful performance of a preoperative history and physical examination, which is typically a joint effort between the surgeon and anesthesiologist. In most cases, the anesthetic portion of this evaluation can be performed on the same day as surgery. Once the evaluation of the healthy surgical patient is complete, the plan is formulated, taking into account the needs of both the patient and the surgeon. The patient must be fully informed of the nature of the operation and the type of anesthesia involved. Patient instructions and use of premedications are important steps that lead to safe and successful anesthesia. Finally, monitoring devices are believed to be a major contributor to avoidance of complications and overall patient safety. Generally, healthy patients only need basic ASA intraoperative monitoring, but on occasion, the extent of surgery may dictate a more invasive monitoring scheme.

### KEY REFERENCES

1. Bryson GL, Chung F, Cox RG, et al. Patient selection in ambulatory anesthesia—an evidence-based review: part II. *Can J Anaesth* 2004; 51(8):782–794.
2. Choban PS, Flancbaum L. The impact of obesity on surgical outcomes: a review. *J Am Coll Surg* 1997;185(6):593–603.
3. Domino KB, Posner KL, Caplan RA, Cheney FW. Awareness during anesthesia: a closed claims analysis. *Anesthesiology* 1999;90(4): 1053–1061.
4. Eagle KA, Berger PB, Calkins H, et al. ACC/AHA guideline update for perioperative cardiovascular evaluation for noncardiac surgery—executive summary. A report of the American College of Cardiology/American Heart Association Task Force on Practice Guidelines (Committee to Update the 1996 Guidelines on Perioperative Cardiovascular Evaluation for Noncardiac Surgery). *Anesth Analg* 2002;94(5): 1052–1064.

5. Halaszynski TM, Juda R, Silverman DG. Optimizing postoperative outcomes with efficient preoperative assessment and management. *Crit Care Med* 2004;32(4 Suppl):S76–S86.

6. Inouye SK, Peduzzi PN, Robison JT, Hughes JS, Horwitz RI, Concato J. Importance of functional measures in predicting mortality among older hospitalized patients. *JAMA* 1998;279(15):1187–1193.

7. Lagasse RS. Anesthesia safety: model or myth? A review of the published literature and analysis of current original data. *Anesthesiology* 2002;97(6):1609–1617.

8. Pearce A. Evaluation of the airway and preparation for difficulty. *Best Pract Res Clin Anaesthesiol* 2005;19(4):559–579.

9. Smetana GW. Preoperative pulmonary evaluation. *N Engl J Med* 1999;340(12):937–944.

10. Warner DO. Helping surgical patients quit smoking: why, when, and how. *Anesth Analg* 2005;101(2):481–487.

## REFERENCES

- Eagle KA, Rihal CS, Mickel MC, Holmes DR, Foster ED, Gersh BJ. Cardiac risk of noncardiac surgery: influence of coronary disease and type of surgery in 3,368 operations. CASS Investigators and University of Michigan Heart Care Program. *Coronary Artery Surgery Study*. *Circulation* 1997;96(6):1882–1887.
- Alves A, Panis Y, Mathieu P, Mantion G, Kwiatkowski F, Slim K. Postoperative mortality and morbidity in French patients undergoing colorectal surgery: results of a prospective multicenter study. *Arch Surg* 2005;140(3):278–283, discussion 284.
- Lagasse RS. Anesthesia safety: model or myth? A review of the published literature and analysis of current original data. *Anesthesiology* 2002;97(6):1609–1617.
- American Society of Anesthesiologists. Practice advisory for preoperative evaluation 2003. Available at: <http://www.asahq.org/publicationsAndServices/preeval.pdf>. Last accessed 03/2006.
- Tremper KK, Benedict P. Paper “preoperative computer.” *Anesthesiology* 2000;92(4):1212–1213.
- American Society of Anesthesiologists. New classification of physical status. *Anesthesiology* 1963;24:111.
- Menke H, Klein A, John KD, Junginger T. Predictive value of ASA classification for the assessment of the perioperative risk. *Int Surg* 1993;78(3):266–270.
- Gilbert K, Larocque BJ, Patrick LT. Prospective evaluation of cardiac risk indices for patients undergoing noncardiac surgery. *Ann Intern Med* 2000;133(5):356–359.
- Eagle KA, Berger PB, Calkins H, et al. ACC/AHA guideline update for perioperative cardiovascular evaluation for noncardiac surgery—executive summary. A report of the American College of Cardiology/American Heart Association Task Force on Practice Guidelines (Committee to Update the 1996, Guidelines on Perioperative Cardiovascular Evaluation for Noncardiac Surgery). *Anesth Analg* 2002;94(5):1052–1064.
- Smetana GW. Preoperative pulmonary evaluation. *N Engl J Med* 1999;340(12):937–944.
- Apfel CC, Korttila K, Abdalla M, et al. A factorial trial of six interventions for the prevention of postoperative nausea and vomiting. *N Engl J Med* 2004;350(24):2441–2451.
- Golembiewski J, Chernin E, Chopra T. Prevention and treatment of postoperative nausea and vomiting. *Am J Health Syst Pharm* 2005;62(12):1247–1260; quiz 1261–1242.
- Apfel CC, Stoocklein K, Lipfert P. PONV: a problem of inhalational anaesthesia? *Best Pract Res Clin Anaesthesiol* 2005;19(3):485–500.
- Gan TJ. “Black box” warning on droperidol: report of the FDA convened expert panel. *Anesth Analg* 2004;98(6):1809.
- Dershwitz M. Droperidol: should the black box be light gray? *J Clin Anesth* 2002;14(8):598–603.
- Ording H. Incidence of malignant hyperthermia in Denmark. *Anesth Analg* 1985;64(7):700–704.
- Ali SZ, Taguchi A, Rosenberg H. Malignant hyperthermia. *Best Pract Res Clin Anaesthesiol* 2003;17(4):519–533.
- Brandom BW, Muldoon SM. The practicality and need for genetic testing for malignant hyperthermia. *Anesthesiology* 2005;103(5):1100.
- Rosenberg H, Antognini JF, Muldoon S. Testing for malignant hyperthermia. *Anesthesiology* 2002;96(1):232–237.
- Bryson GL, Chung F, Cox RG, et al. Patient selection in ambulatory anesthesia—an evidence-based review: part II. *Can J Anaesth* 2004;51(8):782–794.
- Malignant Hyperthermia Association of the United States. Medical FAQs. Available at: <http://www.mhaus.org/index.cfm/fuseaction/Content.Display/PagePK/MedicalFAQs.cfm>. Last accessed 03/2006.
- Yen T, Nightingale BN, Burns JC, Sullivan DR, Stewart PM. Butyrylcholinesterase (BCHE) genotyping for post-succinylcholine apnea in an Australian population. *Clin Chem* 2003;49(8):1297–1308.
- Nilsson E. [Case of prolonged apnea after succinylcholine administration.] *Sven Lakartidn* 1953;50(42):2167–2170.
- Cerf C, Mesguish M, Gabriel I, Amselem S, Duvaldestin P. Screening patients with prolonged neuromuscular blockade after succinylcholine and mivacurium. *Anesth Analg* 2002;94(2):461–466.
- Kerssens C, Klein J, Bonke B. Awareness: monitoring versus remembering what happened. *Anesthesiology* 2003;99(3):570–575.
- Osterman JE, Hopper J, Heran WJ, Keane TM, van der Kolk BA. Awareness under anesthesia and the development of posttraumatic stress disorder. *Gen Hosp Psychiatry* 2001;23(4):198–204.
- Domino KB, Posner KL, Caplan RA, Cheney FW. Awareness during anesthesia: a closed claims analysis. *Anesthesiology* 1999;90(4):1053–1061.
- Leslie K, Myles PS, Forbes A, Chan MT, Short TG, Swallow SK. Recovery from bispectral index-guided anaesthesia in a large randomized controlled trial of patients at high risk of awareness. *Anaesth Intensive Care* 2005;33(4):443–451.
- Mychaskiw G 2nd, Horowitz M, Sachdev V, Heath BJ. Explicit intraoperative recall at a bispectral index of 47. *Anesth Analg* 2001;92(4):808–809.
- Rampersad SE, Mulroy MF. A case of awareness despite an “adequate depth of anesthesia” as indicated by a bispectral index monitor. *Anesth Analg* 2005;100(5):1363–1364.
- Kazanjian P. Complications in surgery: anesthesia complications. In: Mulholland W, Doherty G, eds. *Anesthesia Complications*. Philadelphia: Lippincott Williams & Wilkins, 2006:69–101.
- American Society of Anesthesiologists practice advisory for intraoperative awareness and brain function monitoring: A report by the American Society of Anesthesiologists task force on intraoperative awareness. *Anesthesiology* 2006;104:847–864.
- Sebel PS, Bowdle TA, Ghoneim MM, et al. The incidence of awareness during anesthesia: a multicenter United States study. *Anesth Analg* 2004;99(3):833–839.
- Mertes PM, Laxenaire MC. Allergy and anaphylaxis in anaesthesia. *Minerva Anesthesiol* 2004;70(5):285–291.
- Yilmaz E, Ozcan S, Basar M, Basar H, Batislam E, Ferhat M. Music decreases anxiety and provides sedation in extracorporeal shock wave lithotripsy. *Urology* 2003;61(2):282–286.
- Halaszynski TM, Juda R, Silverman DG. Optimizing postoperative outcomes with efficient preoperative assessment and management. *Crit Care Med* 2004;32(4 Suppl):S76–S86.
- American Society of Anesthesiologists. What you should know about your patients’ use of herbal medicines and other dietary supplements. 2003. Available at: <http://www.asahq.org/patientEducation/herbPhysician.pdf>. Last accessed 06/2006.



38. Hyatt B, Bensky KP. Illicit drugs and anesthesia. *CRNA* 1999;10(1):15–23.
39. Angeli F, Verdecchia P, Gattobigio R, Sardone M, Reboldi G. White-coat hypertension in adults. *Blood Press Monit* 2005;10(6):301–305.
40. Caplan RA, Posner KL, Ward RJ, Cheney FW. Adverse respiratory events in anesthesia: a closed claims analysis. *Anesthesiology* 1990;72(5):828–833.
41. Domino KB, Posner KL, Caplan RA, Cheney FW. Airway injury during anesthesia: a closed claims analysis. *Anesthesiology* 1999;91(6):1703–1711.
42. Arne J, Descoins P, Fusciardi J, et al. Preoperative assessment for difficult intubation in general and ENT surgery: predictive value of a clinical multivariate risk index. *Br J Anaesth* 1998;80(2):140–146.
43. Pearce A. Evaluation of the airway and preparation for difficulty. *Best Pract Res Clin Anaesthesiol* 2005;19(4):559–579.
44. Khan ZH, Kashfi A, Ebrahimkhani E. A comparison of the upper lip bite test (a simple new technique) with modified Mallampati classification in predicting difficulty in endotracheal intubation: a prospective blinded study. *Anesth Analg* 2003;96(2):595–599.
45. Rosenstock C, Gillesberg I, Gatke MR, Levin D, Kristensen MS, Rasmussen LS. Inter-observer agreement of tests used for prediction of difficult laryngoscopy/tracheal intubation. *Acta Anaesthesiol Scand* 2005;49(8):1057–1062.
46. Langeron O, Masso E, Huraux C, et al. Prediction of difficult mask ventilation. *Anesthesiology* 2000;92(5):1229–1236.
47. Han R, Tremper KK, Khetarpal S, O'Reilly M. Grading scale for mask ventilation. *Anesthesiology* 2004;101(1):267.
48. Khetarpal S HR, Shanks A, O'Reilly M, Tremper KK. Incidence and predictors of difficult and impossible mask ventilation. *Anesthesiology* 2005;103:A1415.
49. American Society of Anesthesiologists. Practice advisory for preoperative evaluation, 2003. Available at: <http://www.asahq.org/publicationsAndServices/preeval.pdf>. Last accessed 05/2006.
50. Blum JM PJ, Rosenberg A, Turner C, Tremper KK. Risk of quality assurance events in obese patients. *Anesthesiology* 2005;103:A1173.
51. Bray GA. Risks of obesity. *Endocrinol Metab Clin North Am* 2003;32(4):787–804, viii.
52. Adams JP, Murphy PG. Obesity in anesthesia and intensive care. *Br J Anaesth* 2000;85(1):91–108.
53. Coe AJ, Saleh T, Samuel T, Edwards R. The management of patients with morbid obesity in the anaesthetic assessment clinic. *Anaesthesia* 2004;59(6):570–573.
54. Alchanatis M, Tourkohoriti G, Kakouros S, Kosmas E, Podaras S, Jordanoglou JB. Daytime pulmonary hypertension in patients with obstructive sleep apnea: the effect of continuous positive airway pressure on pulmonary hemodynamics. *Respiration* 2001;68(6):566–572.
55. American Society of Anesthesiologists. Practice guidelines for the perioperative management of patients with sleep apnea 2005. Available at: <http://www.asahq.org/publicationsandservices/sleepapnea103105.pdf>. Last accessed 06/2006.
56. Tiret L, Desmots JM, Hatton F, Vourc'h G. Complications associated with anaesthesia—a prospective survey in France. *Can Anaesth Soc J* 1986;33(3 Pt 1):336–344.
57. Warner MA, Saletel RA, Schroeder DR, Warner DO, Offord KP, Gray DT. Outcomes of anesthesia and surgery in people 100 years of age and older. *J Am Geriatr Soc* 1998;46(8):988–993.
58. McLean AJ, Le Couteur DG. Aging biology and geriatric clinical pharmacology. *Pharmacol Rev* 2004;56(2):163–184.
59. Kim JP, Kim SJ, Lee JH, Kim SW, Choi MG, Yu HJ. Surgery in the aged in Korea. *Arch Surg* 1998;133(1):18–23.
60. Warner DO. Helping surgical patients quit smoking: why, when, and how. *Anesth Analg* 2005;101(2):481–487.
61. Brooks-Brunn JA. Predictors of postoperative pulmonary complications following abdominal surgery. *Chest* 1997;111(3):564–571.
62. Myles PS, Iacono GA, Hunt JO, et al. Risk of respiratory complications and wound infection in patients undergoing ambulatory surgery: smokers versus nonsmokers. *Anesthesiology* 2002;97(4):842–847.
63. A clinical practice guideline for treating tobacco use and dependence: A US Public Health Service Report. *JAMA* 2000;283(24):3244–3254.
64. Warner DO, Patten CA, Ames SC, Offord K, Schroeder D. Smoking behavior and perceived stress in cigarette smokers undergoing elective surgery. *Anesthesiology* 2004;100(5):1125–1137.
65. Schein OD, Katz J, Bass EB, et al. The value of routine preoperative medical testing before cataract surgery. Study of Medical Testing for Cataract Surgery. *N Engl J Med* 2000;342(3):168–175.
66. Turnbull JM, Buck C. The value of preoperative screening investigations in otherwise healthy individuals. *Arch Intern Med* 1987;147(6):1101–1105.
67. Olson RP, Stone A, Lubarsky D. The prevalence and significance of low preoperative hemoglobin in ASA 1 or 2 outpatient surgery candidates. *Anesth Analg* 2005;101(5):1337–1340.
68. Tait AR, Parr HG, Tremper KK. Evaluation of the efficacy of routine preoperative electrocardiograms. *J Cardiothorac Vasc Anesth* 1997;11(6):752–755.
69. Candido KD, Sukhani R, Doty R Jr, et al. Neurologic sequelae after interscalene brachial plexus block for shoulder/upper arm surgery: the association of patient, anesthetic, and surgical factors to the incidence and clinical course. *Anesth Analg* 2005;100(5):1489–1495.
70. Rodgers A, Walker N, Schug S, et al. Reduction of postoperative mortality and morbidity with epidural or spinal anaesthesia: results from overview of randomised trials. *BMJ* 2000;321(7275):1493.
71. Farag E, Dilger J, Brooks P, Tetzlaff JE. Epidural analgesia improves early rehabilitation after total knee replacement. *J Clin Anesth* 2005;17(4):281–285.
72. Liu SS, Strödtbeck WM, Richman JM, Wu CL. A comparison of regional versus general anesthesia for ambulatory anesthesia: a meta-analysis of randomized controlled trials. *Anesth Analg* 2005;101(6):1634–1642.
73. Hug CC Jr. MAC should stand for maximum anesthesia caution, not minimal anesthesiology care. *Anesthesiology* 2006;104(2):221–223.
74. Bhananker SM, Posner KL, Cheney FW, Caplan RA, Lee LA, Domino KB. Injury and liability associated with monitored anesthesia care: a closed claims analysis. *Anesthesiology* 2006;104(2):228–234.
75. American Society of Anesthesiologists. Practice guidelines for preoperative fasting and the use of pharmacologic agents to reduce the risk of pulmonary aspiration: application to healthy patients undergoing elective procedures: a report by the American Society of Anesthesiologist Task Force on Preoperative Fasting. *Anesthesiology* 1999;90(3):896–905.
76. Comfere T, Sprung J, Kumar MM, et al. Angiotensin system inhibitors in a general surgical population. *Anesth Analg* 2005;100(3):636–644.
77. Ang-Lee MK, Moss J, Yuan CS. Herbal medicines and perioperative care. *JAMA* 2001;286(2):208–216.
78. Leak J. Herbal Medicines: What do we need to know? *ASA News* 2000;64:3–5.
79. Jenkins K, Grady D, Wong J, Correa R, Armanious S, Chung F. Post-operative recovery: day surgery patients' preferences. *Br J Anaesth* 2001;86(2):272–274.
80. Bauer KP, Dom PM, Ramirez AM, O'Flaherty JE. Preoperative intravenous midazolam: benefits beyond anxiolysis. *J Clin Anesth* 2004;16(3):177–183.
81. Acil M, Basgul E, Celiker V, Karagoz AH, Demir B, Aypar U. Perioperative effects of melatonin and midazolam premedication on sedation, orientation, anxiety scores and psychomotor performance. *Eur J Anaesthesiol* 2004;21(7):553–557.
82. Ong CK, Lirk P, Seymour RA, Jenkins BJ. The efficacy of preemptive analgesia for acute postoperative pain management: a meta-analysis. *Anesth Analg* 2005;100(3):757–773.
83. Grass JA. Patient-controlled analgesia. *Anesth Analg* 2005;101(5 Suppl):S44–S61.
84. Liu S. Update in use of continuous periurinal catheters for postoperative analgesia. *Anesth Analg*; supplement from 2006 IARS review course lectures. Presented March 24–28, 2006; San Francisco, CA.
85. Arbous MS, Meursing AE, van Kleef JW, et al. Impact of anesthesia management characteristics on severe morbidity and



- mortality. *Anesthesiology* 2005;102(2):257-268; quiz 491-252.
86. Lienhart A, Auroy Y, Pequignot F, et al. [Preliminary results from the SFAR-INSERM inquiry on anaesthesia-related deaths in France: mortality rates have fallen ten-fold over the past two decades.] *Bull Acad Natl Med* 2004;188(8):1429-1437; discussion 1437-1441.
87. Pedersen T. Complications and death following anaesthesia. A prospective study with special reference to the influence of patient, anaesthesia-, and surgery-related risk factors. *Dan Med Bull* 1994;41(3):319-331.
88. Eichhorn JH, Cooper JB, Cullen DJ, Maier WR, Philip JH, Seeman RG. Standards for patient monitoring during anesthesia at Harvard Medical School. *JAMA* 1986;256(8):1017-1020.
89. American Society of Anesthesiologists. Standards for basic intraoperative monitoring. <http://www.asahq.org/publicationsandservices/standards/02.pdf>. Last accessed 12/2006.
90. O'Toole JD, Wurtzbacher JJ, Wearner NE, Jain AC. Pulmonary-valve injury and insufficiency during pulmonary-artery catheterization. *N Engl J Med* 1979;301(21):1167-1168.
91. Yamada M, Tsuda K, Nagai S, Tadokoro M, Ishibe Y. [A case of crush syndrome resulting from continuous compression of the upper arm by automatically cycled blood pressure cuff.] *Masui* 1997;46(1):119-123.
92. Swedlow DB IS. Monitoring and patient safety. In: Blitt CD, ed. *Monitoring in Anesthesia and Critical Care Medicine*. New York: Churchill Livingstone, Inc. 1985.
93. Dorje P, Tremper K. Systolic pressure variation: a dynamic measure of the adequacy of intravascular volume. *Semin Anesth* 2005;24(3):147-153.
94. Perel A, Pizov R, Cotev S. Systolic blood pressure variation is a sensitive indicator of hypovolemia in ventilated dogs subjected to graded hemorrhage. *Anesthesiology* 1987;67(4):498-502.
95. Frederic M. Changes in arterial pressure during mechanical ventilation. *Anesthesiology* 2005;103(2):419-428.
96. Mahenthiran J, Bangalore S, Yao SS, Chaudhry FA. Comparison of prognostic value of stress echocardiography versus stress electrocardiography in patients with suspected coronary artery disease. *Am J Cardiol* 2005;96(5):628-634.
97. Kline JA, Kubin AK, Patel MM, Easton EJ, Seupal RA. Alveolar dead space as a predictor of severity of pulmonary embolism. *Acad Emerg Med* 2000;7(6):611-617.
98. March PA, Muir WW. Bispectral analysis of the electroencephalogram: a review of its development and use in anesthesia. *Vet Anaesth Analg* 2005;32(5):241-255.
99. Penuelas-Acuna J, Oriol-Lopez SA, Castelazo-Arredondo JA, Hernandez-Bernal CE. [Usefulness of bispectral index in pharmaceutical cost reduction for anesthesia.] *Cir Cir* 2003;71(4):300-303.
100. Messner M, Beese U, Romstock J, Dinkel M, Tschaikowsky K. The bispectral index declines during neuromuscular block in fully awake persons. *Anesth Analg* 2003;97(2):488-491.
101. Dahaba AA. Different conditions that could result in the bispectral index indicating an incorrect hypnotic state. *Anesth Analg* 2005;101(3):765-773.
102. Fiedler MA. Maintaining intraoperative normothermia: meta-analysis of outcomes with costs. *AANA J* 1999;67(4):307-308.
103. Roth S, Thisted RA, Erickson JP, Black S, Schreider BD. Eye injuries after nonocular surgery. A study of 60,965, anesthetics from 1988 to 1992. *Anesthesiology* 1996;85(5):1020-1027.
104. Roth S, Gillesberg I. *Injuries to the Visual System and Other Sense Organs*. St. Louis, MO: Mosby, 1999.
105. Sandin RH, Enlund G, Samuelsson P, Lennmarken C. Awareness during anaesthesia: a prospective case study. *Lancet* 2000;355(9205):707-711.
106. Bachand M, Vachon N, Boisvert M, Mayer FM, Chartrand D. Clinical reassessment of malignant hyperthermia in Abitibi-Temiscamingue. *Can J Anaesth* 1997;44(7):696-701.
107. Golembiewski JA, O'Brien D. A systematic approach to the management of postoperative nausea and vomiting. *J Peri-anesth Nurs* 2002;17(6):364-376.
108. Skinner CM, Rangasami J. Preoperative use of herbal medicines: a patient survey. *Br J Anaesth* 2002;89(5):792-795.
109. Samsom GL, Young JR. Difficult tracheal intubation: a retrospective study. *Anaesthesia* 1987;42(5):487-490.
110. Cattano D, Panicucci E, Paolicchi A, Forfori F, Giunta F, Hagberg C. Risk factors assessment of the difficult airway: an Italian survey of 1956 patients. *Anesth Analg* 2004;99(6):1774-1779.
111. Farmery AD. Sternomental distance as predictor of difficult laryngoscopy. *Br J Anaesth* 1997;78(5):626-627.
112. Juvin P, Lavaut E, Dupont H, et al. Difficult tracheal intubation is more common in obese than in lean patients. *Anesth Analg* 2003;97(2):595-600.

## SECTION B

## PREOPERATIVE EVALUATION OF THE ANESTHESIA PATIENT

## CHAPTER 6

## Appropriate and Effective Use of Consultants

Lee Goldman, MD, and  
Thomas H. Lee, MD

As pressures to improve the quality, safety, and efficiency of healthcare intensify, perioperative consultation has evolved into an increasingly well-defined area of medicine, and hospital staffs are giving more thought on when and how to use them. Like most medical interventions, perioperative consultations are susceptible to the three basic types of medical errors:

1. Overuse—requesting consultations on patients who are unlikely to benefit from them leads to delays and needless expense.
2. Underuse—failing to request a consultation on a patient who might benefit from such an evaluation; this failure can contribute to the occurrence of preventable complications.
3. Misuse—unnecessarily endangering patients as a result of poor communication or advice.

Although the risk of such errors has always been present, the need to reduce their frequency has grown as a consequence of several trends. First, the proportion of patients who might benefit from consultations has grown as a result of the aging of the population and the rise in the prevalence of comorbid illnesses in patients who undergo or are considered for procedures.

This trend toward increased risk in the patient population has been accompanied by surgical and anesthetic advances that encourage the performance of ambitious procedures in increasingly aged patients. Progress in the fields of anesthesiology and medicine has made these disciplines so sophisticated that the interfaces between them require special skills. Multiple specialists must often be involved if these complex patients are to receive optimal care.

Additional pressure for efficiency and coordination comes from the healthcare marketplace. Rising insurance premiums are causing employers and other healthcare purchasers to use every possible tactic to reward efficiency (and to punish inefficiency) among hospitals and physicians. One of these tactics is publication on the Internet and elsewhere of data on quality of care, including mortality and complication rates for surgical procedures, so that patients who are bearing an increasing portion of their costs can decide where they might get the highest quality care.

In response, hospitals have developed preadmission evaluation centers where patients can be seen and examined by anesthesiologists and consultants before admission for same-day procedures. The informal scramble to obtain immediate preoperative consultation for a patient with an unexpected problem is being replaced by the development of coordinated team care, with consultants who have a special interest in perioperative medicine and a commitment to provide on-demand consultations at these centers.<sup>1-3</sup> Several investigations have shown that such consultations can lead to the detection of important new diagnoses that may warrant preoperative interventions<sup>2-5</sup> or help in arranging followup care.<sup>4</sup>

However, the effectiveness of consultations provided by such services or by individual physicians is highly variable and is influenced by communication among the surgeon, anesthesiologist, and medical consultant.<sup>6-11</sup> In one study of 156 cases at a teaching hospital, consultants and the physi-

## KEY POINTS

1. The increasing prevalence of high-risk patients undergoing complex surgical procedures and the increasing pressures for improved efficiency and quality have created an increased need for effective and timely perioperative medical consultation.
2. Anesthesiologists and surgeons have a duty to recognize when consultations are needed, to notify the patient of the planned consultation, and to inform the patient of important consultation findings.
3. The questions to be answered by the consultant should be stated clearly.
4. The consultant should limit initial recommendations to those of high priority in the perioperative period.
5. Direct communication between the primary physician and the consultant can help to avoid misunderstandings and to clarify management goals.
6. In addition to estimating perioperative risk and developing appropriate initial management strategies, the consultant should follow the patient through the postoperative period.
7. The consultant should respect the primary physician's relationship with the patient.

cians who requested the consultation disagreed on the reason for the consultation and the principal clinical issue in 14% of cases.<sup>10</sup> When communication among physicians is so tenuous, it is not surprising that rates of compliance with the recommendations of consultants are only 54–77%.<sup>12–14</sup>

In summary, the potential contribution by consultants has never been greater, but there are many opportunities for the perioperative consultation process to go awry. This chapter describes ways in which consultations may be used and misused by describing their role, performance, medicolegal issues, and factors associated with effectiveness.

## ROLE OF THE CONSULTANT

One of the most common reasons for perioperative consultation is a request for “clearance” for surgery.<sup>4</sup> For medicolegal and clinical reasons, requesting physicians and the consultants should narrow the purpose of the consultation in such cases. “Clearance” implies a guarantee of a good outcome, which is impossible to provide. The provision of such a guarantee is considered ill-advised from a medicolegal perspective; in addition, the impact of consultations aimed at “clearing” patients usually is limited.<sup>15</sup>

Instead of providing “clearance,” the consultant should provide an estimate of the risk of cardiac and noncardiac complications associated with the planned procedure for the patient (Table 6–1). For higher-risk patients, the consultant should identify strategies

that might mitigate those risks and can help compare the risks associated with surgical versus medical therapy. Finally, the consultant can anticipate potential intra- and postoperative problems, and follow the patient postoperatively to help prevent, detect, and manage such complications.

In the management of acute or chronic medical conditions that often complicate perioperative care, consultants can play a role analogous to that of a primary care internist. Input from an internist may be required when the patient has an unstable medical problem (e.g., acute ischemic heart disease), an uncertain medical status (e.g., dyspnea of unknown cause), multiple chronic diseases (e.g., diabetes, hypertension, or alcohol abuse), or psychological distress. When the internist has been the primary care physician for that patient, familiarity with the past history and the baseline condition can enhance management of clinical and social issues.

Although the perioperative consultation process virtually always goes smoothly, the potential complexity of the consultant’s role and relationship to the patient and the other physicians involved in the patient’s care become painfully apparent. The consultant is a physician directly involved in the patient’s care, and thus should perform thorough evaluations and gather primary data through a history and examination (as opposed to a review of the medical record). However, the primary physicians are the surgeon and the anesthesiologist. Thus, consultants should not be delegated responsibility for performing the definitive preoperative evaluation—and the primary physicians bear ultimate responsibility for the overall care.

On the other hand, the consultant should respect the relationships among the patient, surgeon, and anesthesiologist, and be appropriately circumspect in conversations with the patient. For example, a consultant might answer a patient’s questions about diabetes mellitus but should not generally engage in lengthy discussions concerning whether the surgery should be performed or is likely to succeed. The consultant’s obligations to the patient can almost always be met through the consultant’s primary relationship with the other physicians.

Occasionally, however, these obligations come into conflict. A trilateral deliberative model has been proposed to describe the ethical duties of the

primary physician and the consultant.<sup>7</sup> This model cautions that both the consultant and the primary physician should avoid seeking to “dominate” each other and should minimize expression to the patient of insignificant differences of judgment between them. Both consultants and primary physicians have an obligation to the patient to keep information confidential from each other if the patient so desires, as long as the information is not relevant to immediate healthcare concerns.

According to this model, consultants can have a direct discussion with the patient over a difference of opinion with the primary physician (e.g., regarding the issue of whether surgery be performed) to avoid serious harm to the patient or in the case of malpractice by the primary physician. Implicit in this model is the assumption that the consultant and the primary physician have attempted to resolve differences of opinion before either alarms the patient through such discussions.

Although consultants may be expert in their own specialties, they should recognize issues on which their expertise is less than that of the anesthesiologist or surgeon. For example, an internist’s recommendations on the choice and route of anesthesia are not authoritative and may generate animosity within the healthcare team. Similarly, trivial recommendations (e.g., “avoid hypotension”) are unlikely to improve care but remain distressingly common. In a series of medical consultations to surgeons at one teaching hospital, 122 (12%) of 1016 recommendations were judged to be “insulting.”<sup>12</sup>

Just as consultants can learn from colleagues in anesthesia and surgery, they can play important roles as teachers. This educational role requires tact and sensitivity. Opinions should be expressed concisely and without condescension; references should be provided selectively. The description of a differential diagnosis may be helpful, but a long, intellectual discussion in the medical record is unlikely to be read.

## LOGISTIC ISSUES IN THE PERFORMANCE OF A CONSULTATION

### Timing of the Preoperative Evaluation

The increase in ambulatory and “same-day” inpatient surgery has been ac-

TABLE 6–1.

#### Key Functions of the Consultant

- Estimation of cardiac and noncardiac risk of surgery
- Identification of management strategies that minimize risks
- Anticipation of complications that may occur during the perioperative period
- Postoperative followup to help prevent, detect, and manage complications
- Perioperative management of acute and chronic medical conditions
- Education—teaching and learning

accompanied by the development at several institutions of “preadmitting test centers,” where large numbers of patients undergo preoperative laboratory work and evaluations by anesthesiologists and other personnel. As the volume at such centers increases, the historical practice of searching for consultants as the need arises becomes untenable. Consequently, many hospitals have identified consultants who are onsite or nearby, available to perform general medical, cardiology, and other types of preoperative consultations on short notice. The availability of such consultations minimizes costly disruptions to the operating room schedule.

In the ideal situation, the surgeon who plans elective surgery for a patient should perform an evaluation that is sufficiently thorough to determine whether a consultation will be needed. If so, an elective outpatient consultation should be arranged well in advance of the surgical date, allowing the consultant time to obtain previous medical records, electrocardiograms (ECGs), and radiographs; perform additional tests (e.g., an exercise tolerance test); and make adjustments in the patient's medical regimens, such as the initiation of therapy for hypertension. Unfortunately, the need for such information or intervention often is detected during the surgeon's or anesthesiologist's evaluation only a few days or hours before an operation. For this reason, institutions with high surgical volumes need to develop mechanisms for providing consultations with an internist or cardiologist on a “walk-in” basis.

One approach that some organizations have used to identify patients who need consultation more reliably and in a more timely manner is to have the surgeon or anesthesiologist use a risk index to stratify patients according to their likelihood of major cardiac complications.<sup>16</sup> In this approach, higher risk patients (e.g., class III or IV according to the Revised Cardiac Risk Index) are automatically referred for cardiology or other consultation. Such standardized approaches to use of perioperative consultations are consistent with a substantial emerging literature supporting the use of clinical guidelines or critical pathways for a variety of medical and surgical conditions.

Technologic advances both increase the need for these consultations and

make evaluations of patients easier. Computerized ECG machines provide preliminary interpretations of the tracing, but the interpretative software generally is written to have a high sensitivity for detecting abnormalities. An unofficial reading of “poor R-wave progression; cannot exclude anterior myocardial infarction” often will force the evaluating anesthesiologist to request a cardiology consultation. However, electronic medical records often make old tracings and other data readily available, so that new findings can be readily differentiated from old abnormalities.

Even with the most effective systems for detecting patients who might benefit from preoperative consultations, the need for consultation may be recognized the evening before, or even the morning of, a scheduled procedure. Last-minute preoperative cardiology consultations are most commonly precipitated by a history of cardiovascular disease that might not have been fully evaluated previously or by an abnormality on the preoperative ECG. In one study of 166 last-minute consultations,<sup>2</sup> the cardiology consultant recommended an exercise test or echocardiogram in 21% of patients, sometimes leading to a delay in surgery. In 13% of patients, the cardiology consultants suggested an adjustment or change in medications. In 5 patients (3%), the consultant specifically suggested that surgery be delayed or cancelled because of the ECG finding of an unexpected previous myocardial infarction of uncertain age, marked ischemia, or advanced conduction system disease.

When consultations are requested at the last minute before surgery, consultants should resist the temptation to “punish” other physicians (and the patient) by forcing a postponement of the procedure. Because operating room time is among the most costly of hospital resources, the consultant should make every effort to see the patient before the scheduled procedure time. Afterward, the various members of the healthcare team should attempt to identify strategies for a more orderly consultative process.

When performed in a timely and effective manner, perioperative consultations can improve the efficiency of care. For example, in one study, the addition of an internist to a cardiothoracic surgery service at a tertiary care

teaching center was associated with major reductions in postoperative lengths of stay and in the number of radiologic procedures and laboratory tests that were ordered.<sup>17</sup> Involvement of a diabetes consultation team reduces the length of stay for patients with diabetes.<sup>18</sup> In a randomized trial at a Veterans Affairs hospital, outpatient preoperative evaluation by an internist significantly reduced hospital length of stay.<sup>19</sup>

Unfortunately, consultants also have the ability to worsen efficiency. When consultants suggest additional tests, hospital length of stay may be prolonged.<sup>20</sup> Consequently, consultants should exercise restraint in suggesting additional tests and limit recommendations to those that are absolutely necessary during hospitalization. Elective tests may be postponed until after the patient has been discharged.

### Postoperative Care

A rule used by many experienced consultants is “never go home before the patient is out of the operating room.” Patients are often unstable in the immediate postoperative period, so consultants should be prepared to reevaluate patients shortly after their admission to the recovery room. For example, postoperative hypertension often occurs 30–60 minutes after the end of anesthesia, and ischemia on an initial ECG in the recovery room is a powerful predictor of major postoperative cardiac complications.<sup>21</sup> Thus, consultants and primary physicians should evaluate the patient's volume status and fluid orders so as to avoid marked hemodynamic changes, and should consider early performance of an ECG to detect asymptomatic ischemia.

The period of risk does not end with the immediate perioperative period. Mobilization of extravascular fluid, high sympathetic tone associated with pain, and hypercoagulable states may contribute to cardiovascular complications, such as acute myocardial infarction, 24–48 hours or more after surgery.<sup>22</sup> Other medical conditions also may worsen later in the hospitalization; for example, mild renal failure may be unmasked by perioperative fluid volume shifts. Thus, consultants should follow patients for at least 3–5 days after surgery, or until discharge, if the patient leaves sooner.

Formal medical comanagement incorporates the medical physician into



postoperative care as a codecision maker rather than as a consultant. This model can reduce the percentage of patients who have postoperative problems, while simultaneously being preferred over standard care by both nurses and surgeons.<sup>23</sup>

Some hospitals have instituted rapid-response teams to aid in the postoperative care of patients whose impending complications might otherwise not be addressed as promptly, completely, and expertly as desired. Data are inconclusive on the benefits of this model—one study showed striking benefits after this type of service was instituted compared with before,<sup>24</sup> whereas a randomized trial showed equal improvement in both the control and intervention groups compared with the historical, preintervention period.<sup>25</sup>

## MEDICOLEGAL ISSUES

Consultations are often ordered mainly for “defensive medicine” purposes, but such consultations can lead to delays and increased resource use.<sup>10</sup> Several legal decisions have made clear that primary physicians have a duty to request consultations when clinical problems lie outside their expertise,<sup>26</sup> but there is no such duty to consult when the anesthesiologist or surgeon does not recognize any special problems. Nevertheless, judgments have been made against physicians when the patient’s recovery does not progress and no consultation was sought, or when a physician undertook a procedure beyond his or her training when specialists were available. Furthermore, the primary physician has an obligation to inform the consultant of any subsequent developments that may be relevant to the consultant’s expertise.<sup>26,27</sup>

The implication of these principles is that anesthesiologists and surgeons should have a low threshold for requesting consultation from internal medicine and subspecialty colleagues when patient outcomes are potentially influenced by acute or chronic medical conditions. Although anesthesiologists may be comfortable managing common problems such as hypertension or diabetes, cardiology consultations are appropriate for reviewing equivocal ECGs or evaluating a chest pain syndrome. Informal or “hallway” consultations, in which the internist or

subspecialist does not examine the patient but may write a note, are inadequate.<sup>28,29</sup> These informal consultations sometimes can suffice if the question is brief and simple, but, especially in the era of managed care, physicians should resist the financial temptation to avoid formal consultation on difficult or complex cases.<sup>30</sup>

The consultant bears an important legal, ethical, and financial responsibility for formalizing and documenting the relationship with both the primary physician and the patient. Even though the request for a consultation is made by the anesthesiologist or surgeon, the primary physician should inform the patient and obtain the patient’s consent because of legal and ethical considerations.<sup>27</sup> Legal decisions indicate that the patient may not be liable for the consultant’s fees if the patient does not give such consent.<sup>26,27</sup> The request for a consultation and patient consent should be documented in writing;<sup>28</sup> under many payment systems, the consultant’s fee may be denied if the request for consultation is not evident in the medical notes.

Despite the consultant’s direct duties to the patient, the primary physician remains the individual who is responsible for all decisions regarding the patient’s treatment. The consultant should write a full report to the primary physician because oral recommendations may not be recognized in any legal proceedings. In general, the consultants should not discuss findings directly with the patient unless the primary physician has given permission, particularly if the clinical decisions that flow from those findings have not been discussed yet. The primary physician is the individual with the duty to convey important information to the patient.<sup>28</sup>

## FACTORS ASSOCIATED WITH THE EFFECTIVENESS OF CONSULTATIONS

Consultations often lead to new diagnoses and management decisions, including changes in medical therapy, triage to a new service, and delay or cancellations of surgery.<sup>1-4</sup> Nevertheless, in the perioperative setting, about half of consultants’ recommendations are ignored.<sup>14</sup> Consultants sometimes make unimportant or ill-advised recommendations, do not convey the rec-

ommendations appropriately to the primary physicians, or have appropriate recommendations ignored by primary physicians.

Effective communication between the consultant and the primary physician who requests a consultation is gaining increasing attention as the pace of modern healthcare accelerates, and face-to-face contact among colleagues becomes less predictable. In one study, disagreement existed between the consultant and the primary physician on the issues of a consultation in 14% of internal medicine consultations at a teaching hospital.<sup>10</sup> At another teaching hospital, no specific question was asked in 24% of preoperative diabetes consultations, and consultants ignored the stated question in another 12%.<sup>31</sup> Primary physicians report that the impact of the consultation is diminished when breakdowns in communication occur.<sup>10</sup>

The best way to prevent such misunderstanding, of course, is direct oral communication between the consultant and primary physicians<sup>32</sup> (Table 6-2), both just after the initial consultation and in the days afterward. Nonetheless, face-to-face or telephone conversations between busy colleagues are often difficult to arrange, so written notes in the medical record are critical to communication—and for documentation. E-mail or faxed communications may be useful for coordination of care, but should not be relied upon for transmittal of critical or confidential information.

The consultant should continue to be involved in the patient’s case after surgery when such involvement is appropriate. Several investigations have found that recommendations are more likely to be followed if consultants write periodic followup notes, repeat-

TABLE 6-2.

### Factors Associated with Compliance with Consultant’s Recommendations

- Direct contact between consultant and primary physician<sup>32</sup>
- Continued followup of patients<sup>14,31,34</sup>
- Limited number of recommendations<sup>13,34</sup>
- Identification of high-priority recommendations<sup>13</sup>
- Specification of drug dosage, route, and duration<sup>33</sup>

ing essential recommendations.<sup>31,33,34</sup> In one study, consultations that included more than one followup note had an effect on diagnosis in 92% of patients and an effect on treatment in 84% of patients.<sup>33</sup> When one or no followup note was written, effects on diagnosis were detected in just 74% of patients ( $p < 0.001$ ), and effects on treatment were found in only 56% of patients ( $p < 0.001$ ).

When consultants make a higher number of recommendations, compliance decreases<sup>13,34</sup> with any recommendation. In one series of 202 consultations, compliance was highest when 5 or fewer recommendations were made, regardless of the severity of the patient's illness.

The number of recommendations can usually be reduced by thoughtful prioritization and elimination of trivial suggestions. One study<sup>12</sup> found that 12% of recommendations made by a general medical consultation team were judged to be "insulting" by the reviewer, a surgical chief resident, and an additional 6% were considered nonessential. After the consultants at this teaching hospital were encouraged to use moderation in making recommendations, the mean number of recommendations per consultation decreased from 6.2 per patient to 3.8.

Clear identification of important recommendations in the written record leads to a greater rate of compliance. One study<sup>32</sup> found that labeling recommendations as "crucial" resulted in more than 90% compliance, even if they were part of a long list of suggestions. Clarifying the priority of recommendations is best accomplished by direct oral communication. Communication of urgent recommendations should not rely on written communication alone.

Another tactic for the consultant seeking to reduce the number of recommendations in the initial consultation note is to determine which issues can be deferred until after surgery. If the consultant continues to be engaged in the patient's care, evaluations and management of some issues can be conducted later without disrupting the surgical schedule. For example, because postponing surgery to improve control of hypertension in patients with a moderately increased diastolic blood pressure does not affect cardiac risk,<sup>22</sup> the consultant need not emphasize potential recommendations, such as screening for renovascular hy-

perension or pheochromocytoma, for moderate hypertension that is newly discovered before surgery.

The effectiveness of the consultation is likely to increase if the consultant makes important recommendations as specific and complete as possible. When suggesting a drug, the dose and duration should be provided so that a surgeon or anesthesiologist who may not be familiar with a drug can copy the recommendations directly into the order book. In one study,<sup>33</sup> for example, compliance decreased to 85% when only one was specified and to 64% when neither was listed ( $p < 0.001$ ).

## SUMMARY

The importance of the role of the consultant has increased because of increasing clinical risk among the patient population undergoing procedures, logistic changes that have accompanied the trend toward outpatient and same-day surgery, and intensifying pressures for efficiency and improvement in quality. Advances in anesthesia and internal medicine have helped create a special area of medicine for the consultants who function at their interface.

Primary physicians (surgeons and anesthesiologists) and consultants should be aware of the medicolegal issues in the consultative process and the impact of communication breakdowns on patient care. Primary physicians should recognize when consultations are needed, inform patients that a consultation will be requested, make the request in writing, and identify the specific issue to be addressed (Table 6-3).

The consultant has a duty to respond to the consultation request in a

TABLE 6-3.

### Responsibilities of the Primary Physician

- Care of the patient
- Identification of problems beyond his or her expertise
- Obtaining the patient's consent to call a consultation
- Making the request for the consultation in writing
- Clearly identifying the issues for the consultant to address
- Conveying the results of the evaluation to the patient

TABLE 6-4.

### Ten Commandments for Effective Consultations

1. Determine the question
2. Establish urgency
3. Look for yourself
4. Be as brief as appropriate
5. Be specific
6. Provide contingency plans
7. Honor thy turf
8. Teach...with tact
9. Talk is cheap...and effective
10. Follow up

Goldman L, Lee T, Rudd P. Ten commandments for effective consultations. *Arch Intern Med* 1983;143:1753. Copyright 1983, American Medical Association. All rights reserved.

timely manner, to provide a written note detailing the evaluation, to respect the primary physician's relationship with the patient, and to transmit recommendations to the physician as clearly as possible.

With these considerations in mind, a list of "Ten Commandments for Effective Consultation"<sup>35</sup> can be directed at medical physicians who perform consultations (Table 6-4). These "commandments" recommend that consultants clarify the issue of the consultation, establish priorities, gather primary data via a history and physical examination (as opposed to just a review of the chart), and make concise, yet detailed, recommendations. Consultants should provide contingency plans so that their notes may provide guidance regardless of how a case develops, respect the primary physicians and their relationships with the patient, and directly communicate with the primary physicians. Finally, the consultants are urged to follow the patient for at least several days postoperatively.

## KEY REFERENCES

1. Emanuel LL, Richter J. The consultant and the patient-physician relationship: a trilateral deliberative model. *Arch Intern Med* 1994; 154:1785.
2. Goldman L, Lee T, Rudd P. Ten commandments for effective consultations. *Arch Intern Med* 1983; 143:1753.

3. Kleinman B, Czinn E, Shah K, et al. The value to the anesthesia-surgical care team of the preoperative cardiac consultation. *J Cardiothorac Anesth* 1989;3:682.

4. Macpherson DS, Lofgren RP. Outpatient internal medicine preoperative evaluation: a randomized clinical trial. *Med Care* 1994;32:498.

5. Varon AJ, Hudson-Civetta JA, Civetta JM, Yu M. Preoperative intensive care unit consultation: accurate and effective. *Crit Care Med* 1993;21:234-239.

## REFERENCES

- Charlson ME, Cohen RP, Sears CL. General medicine consultation: lessons from a clinical service. *Am J Med* 1983;75:121.
- Dudley JC, Brandenburg JA, Hartley LH, et al. Last-minute preoperative cardiology consultations: epidemiology and impact. *Am Heart J* 1996;131:245.
- Robie PW. The service and educational contributions of a general medicine consultation service. *J Gen Intern Med* 1986;1:225.
- Kleinman B, Czinn E, Shah K, et al. The value to the anesthesia-surgical care team of the preoperative cardiac consultation. *J Cardiothorac Anesth* 1989;3:682.
- Mollema R, Berger P, Girbes ARJ. The value of peri-operative consultation on a general surgical ward by the internist. *Neth J Med* 2000;56:7-11.
- Park K. Preoperative cardiology consultation. *Anesthesiology* 2003;98:754-762.
- Emanuel LL, Richter J. The consultant and the patient-physician relationship: a trilateral deliberative model. *Arch Intern Med* 1994;154:1785.
- Lee TH, Goldman L. Principles of effective communication in consultative medicine. In: Bolt RJ, ed. *Medical evaluation of the surgical patient*. Mount Kisco, NY: Futura Publishing, 1987.
- Lee TH, Goldman L. Perioperative consultation: the science and the art. *J Cardiothorac Anesth* 1989;3:679.
- Lee TH, Pappius EM, Goldman L. Impact of inter-physician communication on the effectiveness of medical consultations. *Am J Med* 1983;74:106.
- Rudd P. Contrasts in academic consultations. *Ann Intern Med* 1981;94:537.
- Ballard WP, Gold JP, Charlson ME. Compliance with the recommendations of medical consultants. *J Gen Intern Med* 1986;1:220.
- Sears CL, Charlson ME. The effectiveness of a consultation: compliance with initial recommendations. *Am J Med* 1983;74:870.
- Klein LE, Levine DM, Moore RD, et al. The preoperative consultation: response to internists' recommendations. *Arch Intern Med* 1983;143:743.
- Choi JJ. An anesthesiologist's philosophy on "medical clearance" for surgical patients. *Arch Intern Med* 1987;147:2090.
- Lee TH, Marcantonio ER, Mangione CM, et al. Derivation and prospective validation of a simple index for prediction of cardiac risk of major noncardiac surgery. *Circulation* 1999;100:1043.
- Macpherson DS, Parenti C, Nee J, et al. An internist joins the surgery service: does comanagement make a difference? *J Gen Intern Med* 1994;9:440.
- Levetan CS, Salas JR, Wilets IF, Zumoff B. Impact of endocrine and diabetes team consultant on hospital length of stay for patients with diabetes. *Am J Med* 1995;99:22.
- Macpherson DS, Lofgren RP. Outpatient internal medicine preoperative evaluation: a randomized clinical trial. *Med Care* 1994;32:498.
- Braham RL, Aran R, Ruchlin HS, et al. Diagnostic test restraint and the specialty consultation. *J Gen Intern Med* 1990;5:95.
- Rinfret S, Goldman L, Polanczyk CA, Cooke EF, Lee TH. Value of immediate postoperative electrocardiogram to update risk stratification after major non-cardiac surgery. *Am J Cardiol* 2004;94:1017-1022.
- Auerbach A, Goldman L. Assessing and reducing the cardiac risk of non-cardiac surgery. *Circulation* 2006;113:1361.
- Huddleston JM, Long KH, Naessens JM, et al. Medical and surgical comanagement after elective hip and knee arthroplasty: a randomized, controlled trial. *Ann Intern Med* 2004;141;28-38.
- Bellomo R, Goldsmith D, Uchino S, et al. Prospective controlled trial of effect of medical emergency team on postoperative morbidity and mortality rates. *Crit Care Med* 2004;32:916-921.
- Hillman K, Chen J, Cretikos M, et al. Introduction of the medical emergency team (MET) system: a cluster-randomised controlled trial. *Lancet* 2005;365:2091-2097.
- Holder AR. Duty to consult. *JAMA* 1973;226:111.
- Holder AR. Consultants and implied contracts. *JAMA* 1973;226:1497.
- Cetrulo CL, Cetrulo LG. The legal liability of the medical consultant in pregnancy. *Med Clin North Am* 1989;73:557.
- Keating NL, Zaslavsky AM, Ayanian JZ. Physician experiences and beliefs regarding informal consultation. *JAMA* 1998;280:900-904.
- Manian FA, Janssen DA. Curbside consultants: a closer look at a common practice. *JAMA* 1996;275:145.
- Rudd P, Siegler M, Byyny RL. Preoperative diabetic consultation: a plea for improved training. *J Med Educ* 1978;53:590.
- Pupa LE, Coventry JA, Hanley JF, et al. Factors affecting compliance for general medicine consultations to non-internists. *Am J Med* 1986;81:508.
- Horwitz RI, Henes CG, Horwitz SM. Developing strategies for improving the diagnostic and management efficacy of medical consultations. *J Chronic Dis* 1983;36:213.
- MacKenzie TB, Popkin MK, Callies AL, et al. The effectiveness of cardiology consultations: concordance with diagnostic and drug recommendations. *Chest* 1981;79:16.
- Goldman L, Lee T, Rudd P. Ten commandments for effective consultations. *Arch Intern Med* 1983;143:1753.

# CHAPTER 7

## Evaluation of the Patient with Cardiovascular Disease

Ronald P. Olson, MD

### PREOPERATIVE ASSESSMENT

Preoperative evaluation has changed over the last few years. In an increasingly distant past, the attending anesthesiologist would interview the hospitalized patient and family a day or two before surgery. All resources of the medical systems were mobilized to ensure that all aspects of the patient's health were assessed and treated. Surgery was delayed until any cardiac condition was fully addressed. Now patients usually arrive on the morning of surgery, and anesthesia is administered by a practitioner who has not previously met the patient. Cardiac conditions may (or may not) have been stabilized by other physicians. Some surgical procedures are unlikely to cause any more stress than activities of daily living; other procedures are high risk, but the risk of postponing surgery to allow the anesthesiologist to interview the patient is higher. In essence, the paradigm of preoperative assessment is shifting from predicting risk to actively managing risk.<sup>1</sup> The issue is less whether to cancel surgery, and more whether indicated cardiac tests and management need to be done preoperatively under the supervision of the perioperative physician or postoperatively in a more elective fashion by primary care clinicians. Consequently, there is a need for a reassessment of what preoperative investigations and treatments are indicated preoperatively.<sup>2</sup> This chapter focuses on the patient presenting for noncardiac surgery. Many of the studies in this area have been done on patients having vascular or cardiac surgery, but as much as possible, evidence on other surgical populations is presented.

Evaluation of a patient's cardiac status is based first and foremost on a clinical examination. The general level

of risk can usually be determined with questions, hands, and a stethoscope. Although detailed quantification of that risk may require investigations, it is important to remember that the history and physical examination may provide all the information needed for a given anesthesia plan. If further testing will not result in interventions or change the anesthesia plan, there is no need to require such testing preoperatively.

### Benefits of Preoperative Assessment

Because of a sometimes fragmented healthcare system, the preoperative encounter may be one of the few times a careful assessment of a patient's cardiac status will occur. Conditions such as hypertension, chronic obstructive pulmonary disease (COPD), asthma, and diabetes may be identified and treated so that the patient's health will be im-

proved for years to come. Some medications, such as antihypertensives,  $\beta$ -blockers, statins, and hypoglycemics, can be easily initiated with instructions for followup with primary care. To miss these opportunities to improve the patient's health is reprehensible.

### Dangers of Testing in Low-Risk Populations

On the other hand, investigations and interventions should not be started by clinicians who cannot ensure followup, as doing so entails some risk. If enough tests are done, especially in a low-prevalence population, there inevitably are mild abnormalities. These are likely to be either false positives or to be true positives that have little bearing on the perioperative period. If surgery is delayed to follow up even just the true positives, the inconvenience and risks of delayed surgery

### KEY POINTS

1. Although imbalance of oxygen supply and demand of the myocardium during perioperative stress continues to be a common mechanism of perioperative morbidity and mortality, an equally important cause is the rupture of a vulnerable plaque with subsequent thrombosis of a coronary artery. Maintenance of healthy endothelial function is vital to prevent this.
2. Perioperative risk assessment requires consideration of the functional status of the patient and the risk inherent in the surgical procedure, as well as the diseases of the patient and how optimal is the disease management.
3. The history and physical examination, along with limited indicated tests, are often adequate to determine the perioperative risk of a patient. Preoperative cardiac testing is generally not needed unless a patient has at least two of the following: chronic disease, need for high risk surgery, poor exercise tolerance. Perhaps surprisingly, preoperative cardiac testing is sometimes not needed in patients who have two or three of these conditions, but who have detailed documentation of optimal management. Further testing is unlikely to change management and these patients may proceed directly to surgery.
4. Preoperative cardiac testing is most useful in those patients who do not clearly fit into the low-risk or the fully optimized category. In these patients, further testing is usually needed to formulate an anesthesia plan.
5. In some of these intermediate-risk patients, risk can be managed by relatively simple interventions by the anesthesiologist. If these patients can be so optimized, testing may not be necessary.
6. A few small studies have shown that perioperative  $\beta$ -blockade has a dramatic reduction in long-term morbidity and mortality after surgery. Like any medication, however, there are some risks and it needs to be used selectively.
7. There are many interventions, such as control of diabetes, hypertension, and endothelial function, that can be well within the scope of an anesthesiologist's skill set. If anesthesiologists wish to consider themselves perioperative clinicians, they must be active in these well-established aspects of medicine.



might outweigh the minimal benefits of followup. Also, perioperative clinicians are unlikely to follow up on these abnormalities,<sup>3</sup> and thus to expose the patient to possible false reassurance and delayed diagnosis. The clinician may be left vulnerable to litigation if there is any remotely related adverse event. The perioperative period is too short and isolated for disease screening. Screening is better done by primary care, where follow up is done over time in the context of overall health, and the few true positives will be sifted out from the many false positives.

Each institution must balance how much intervention can be done without exposing the patient and institution to the dangers of inadequate followup. Generally, what can be done easily and safely should be done; other investigations or interventions that do not directly impact on the perioperative period should be deferred to primary care. The perioperative team and the primary care practitioners ideally should share information and resources.

### Who Should Do the Preoperative Assessment?

One method of preoperative assessment is to refer any patient with potential cardiac risk to the cardiology service, and await “clearance” for surgery by that specialist. Unfortunately, cardiologists are not generally in the best position to balance the risk of surgery, risk of not proceeding with surgery, risks of various anesthesia techniques, and skills of a specific anesthesiologist. Thus it is inappropriate for a cardiologist, or any other clinician, to “clear” the patient for surgery. The decision whether it is appropriate for a specific patient to undergo a specific procedure with the given resources can only be done by the anesthesiologist responsible for that patient on the day of surgery. This chapter clarifies what information the anesthesiologist needs to make that final decision and to formulate the anesthesia plan.

Someone must first determine if the patient is at increased risk. If risk is low, surgery can proceed. On the other hand, if the risk is high, it will be necessary to ensure that everything has been done to reduce or manage that risk. If so, no further investigation is needed. It is the intermediate- or indeterminate-risk patients who require the most careful assessment to

determine whether extra intervention is required. These assessments of increased risk may require consultation with cardiologists, but increasingly can be done by the anesthesia team, especially if the patient has had previous cardiac care.

## PHYSIOLOGY OF PERIOPERATIVE CARDIAC MORBIDITY

Patients with cardiac disease are at increased risk for perioperative morbidity and mortality. The overall rate of perioperative myocardial infarction (MI) in these patients is approximately 5%.<sup>4,5</sup> Approximately 50% of patients with cardiac disease develop other complications perioperatively.<sup>6</sup> Vascular surgery patients are in a yet higher risk category by virtue of the disease which brings them to surgery. Even vascular patients with no risk factors for coronary artery disease (CAD) have a 5% incidence of perioperative cardiac complications (PCCs).<sup>7</sup> This chapter focuses primarily on the cardiac complications, but it is important to remember that these changes are also occurring elsewhere in organs such as the brain, kidneys, and lungs.

Several cardiac complications can occur perioperatively (Table 7-1). As most of these are either the cause or the result of ischemia,<sup>8</sup> all of which may ultimately lead to infarction,<sup>9</sup> the emphasis is on the causes of ischemia.

The traditional view of PCCs is one of a mismatch between oxygen supply and demand. Recently there is more appreciation of the mechanism of endothelial dysfunction, leading to rupture of a vulnerable plaque, followed by thrombosis. This chapter describes the physiology of perioperative morbidity as a result of myocardial ischemia resulting from these two mechanisms. The etiology is clearly multifactorial and defies simple classification, but this approach assists in developing different strategies needed to prevent and treat the different etiologies.<sup>10</sup>

### Supply–Demand Mismatch

Some infarctions occur at a site of relatively high-grade stenosis that has formed gradually and with the development of collaterals. These tend to present with ST elevation and result in non-Q-wave infarctions. These are the sites where a supply–demand mis-

TABLE 7-1.

#### Perioperative Cardiac Complications

Sudden death  
Myocardial infarction  
Myocardial ischemia  
Systolic heart failure  
Diastolic heart failure  
Arrhythmias

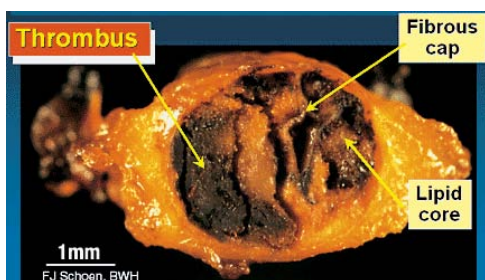
match results in ischemia. Infarction probably occurs only after several hours of ischemia.<sup>10</sup> Reduction of the mismatch by reducing heart rate and increasing oxygen supply may relieve the ischemia. These sites are often amenable to coronary artery bypass grafting or percutaneous transluminal coronary angioplasty (PTCA) with stenting.

Angiography may not be the gold standard for detecting sites of critical stenosis. Angiography compares the lumen of a segment of artery with the lumen before and after that segment. But atherosclerosis is a systemic disease in which all of the arteries are affected to some degree; thus angiography cannot compare diseased with healthy segments, but compares severely diseased with mildly or moderately diseased. A severe stenosis in the middle of moderate stenosis will not show up as a critical lesion (Fig. 7-1). There is also evidence of a “Glagov” phenomenon of vascular remodeling where the plaque may increase in size, yet the lumen remains unchanged or even enlarges slightly.<sup>11,12</sup> Repeated small leaks from plaque fissures may cause the growth of plaques until they become unstable. Angiography is unlikely to measure these changes. Instead, intravascular ultrasound or cardiac MRI is needed.

### Thrombosis from Endothelial Dysfunction

Other infarcts start with an abrupt occlusion of an often insignificant coronary stenosis because of plaque rupture at that site (Fig. 7-2). The sudden blockage of these less-critical stenoses may be more lethal because it is more difficult to reverse the pathology and there are no collateral arteries. These episodes result in ST depression on an electrocardiogram (ECG).

Ellis et al. assessed the preoperative angiograms of vascular patients experiencing a postoperative MI and com-



**FIGURE 7-1.** Plaque rupture with thrombosis. Available at: <http://images.medscape.com/pi/editorial/cmecircle/2004/3598/images/libby/slide005.gif>. Last accessed July 5, 2007. Illustration courtesy of Frederick J. Schoen, MD, PhD.

pared them with the findings in a matched group of nonoperative MIs; they did not find a high-grade stenosis (>70%) in any of the patients who had a PCC.<sup>13</sup> Cohen studied the coronary artery autopsies of 26 cases of fatal postoperative MIs. Plaque rupture was present in 12 cases and intracoronary thrombus was present in 9 cases. A thrombus occurred on a stenosis of >50% in only 31% of cases.<sup>14</sup> This is consistent with Dawood's earlier study of coronary artery autopsies, which showed evidence of plaque disruption in 55% of fatal perioperative MIs and in 40% of nonoperative MIs.<sup>15</sup> As described in Figure 7-2, part of the reason for occlusion occurring at so many noncritical lesions may be that the angiogram cannot detect that

some of these are actually high-grade stenoses.

Endothelial dysfunction is a result of three broad groups of cardiovascular etiologies: hypercoagulability, inflammation, and sympathomimetic overdrive. These detrimental forces are controlled to some extent by endothelial protective factors (Fig. 7-3).

### Hypercoagulability

Surgery induces a prothrombotic state that may be variable and measurable.<sup>16</sup> If this could be measured, it would be valuable to selectively treat high-risk patients with anticoagulants. Some patients are probably predisposed to hypercoagulability. Factor V Leiden is an example of this which has not turned out to be very significant perioperatively.<sup>17</sup>

### Inflammation

Surgery initiates an inflammatory response, and current research on the utility of markers such as C-reactive protein (CRP) in prediction of myocardial infarction<sup>18</sup> are yet to be extended to the perioperative period. This topic is discussed further in sections below.

### Sympathetic Stimulation

The obvious sympathetic response to the stress of surgery may be attenuated by neuraxial anesthesia<sup>19</sup> or  $\beta$ -blockers.<sup>20</sup> Reduction of anxiety is important to reduce all the above factors.

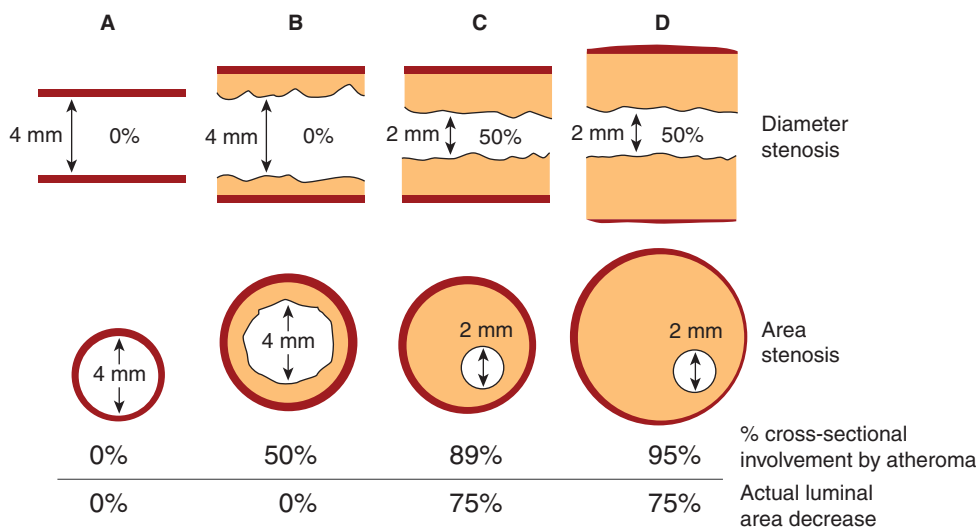
### Protective Factors

A few short episodes of ischemia may induce preconditioning that results in less damage if later ischemia occurs. Zaugg et al. summarized these concepts.<sup>21</sup>

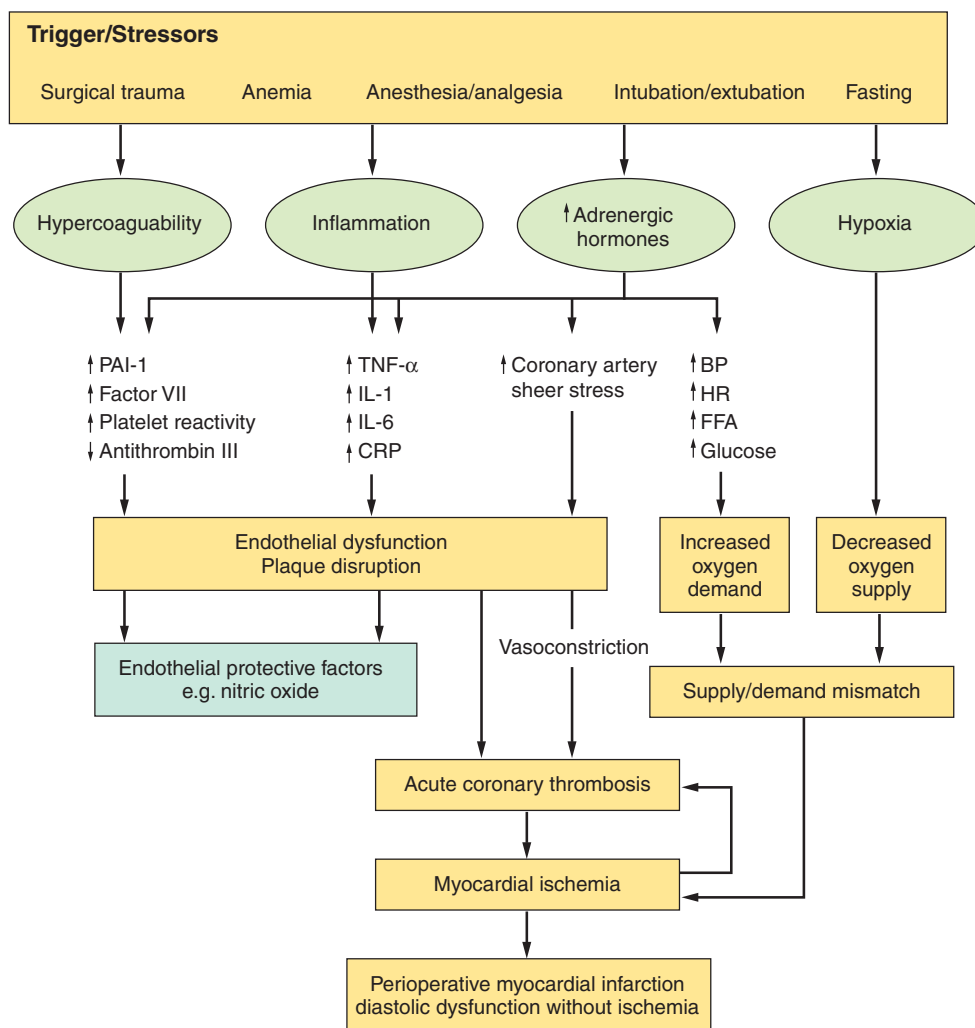
Nitric oxide induces endothelial stability. The anesthetic nitrous oxide does the opposite.

### Postoperative Ischemia

Advances in anesthesia have resulted in the intraoperative period being a controlled and safe period. Most ischemia occurs in the immediate postoperative period during emergence from anesthesia, when catecholamines are surging,<sup>22</sup> rather than during anesthesia. Landesberg showed



**FIGURE 7-2.** Angiographic versus pathologic views of stenosis. **Top row:** angiographic views; **bottom row:** pathologic views. **Column A:** normal artery; **column B:** artery with "moderate" atherosclerosis. Because of remodeling, angiography shows a normal lumen with enlargement of the vessel. A pathologic view of the same artery would see the same lumen, but 50% of the cross-sectional area would be occupied by plaque. **Column C:** more involved artery. Angiography shows that the lumen is 50% less in diameter than the adjacent "normal" (B) segment. Pathology shows the 2-mm lumen but a larger plaque and measures the stenosis as an 89% narrowing. **Column D:** same situation but with even more remodeling present. Angiography shows a 50% diameter narrowing even though the plaque is much larger than in column C, and still concludes that this is not severe disease. Because of the greater enlargement of the artery, the pathology now shows the stenosis as a 95% cross-sectional narrowing, even though the lumen size is actually the same as in column C. Reproduced with permission from Fishbein MC and Siegel RJ.<sup>12</sup>



**FIGURE 7-3.** Etiology of perioperative myocardial infarction. BP, blood pressure; CRP, C-reactive protein; FFA, free fatty acids; HR, heart rate; IL, interleukin; PAI-1, plasma activator inhibitor-1; TNF- $\alpha$ , tumor necrosis factor. Adapted from Devereaux PJ, Goldman L, Cook D, et al. Perioperative cardiac events in patients undergoing noncardiac surgery: a review of the magnitude of the problem, the pathophysiology of the events and methods to estimate and communicate risk *CMAJ* 2005;173:627–634. Reprinted with permission of the publisher. Copyright 2000, CMA Media Inc.<sup>182</sup>

that most ischemic events, and most ischemic events that result in infarction, occur immediately postoperatively (Fig. 7-4).<sup>23</sup> Badner, among others, has shown that postoperative MIs occur mostly in the first few days after an operation (Fig. 7-5), and are often asymptomatic.<sup>5,22,24</sup> Prolonged ischemia is more likely to result in infarct than is a shorter duration of ischemia. When the endothelium is damaged, acetylcholine causes muscarinic receptor-mediated vasoconstriction instead of endothelium-dependent vasodilatation.<sup>21</sup> Thus, prolonged ischemia may be the cause, as well as the result, of vasoconstriction and subsequent thrombus formation.<sup>23</sup>

Although much emphasis is placed on ischemia, postoperative stress may result in the anaerobic threshold of a patient being reached, leading to diastolic dysfunction, which may cause

later morbidity even if no ischemia occurs.<sup>25</sup> Cardiac damage is a continuum, not a dichotomy of infarction or no infarction.<sup>26</sup> Even asymptomatic ischemia may predict long-term complications.<sup>8</sup> Asymptomatic plaque rupture may heal but leave the plaque more vulnerable to subsequent rupture.<sup>27,28</sup>

With these mechanisms in mind, we proceed to an analysis of risk for these events.

## IDENTIFYING PERIOPERATIVE RISK

This section reviews the overall incidence of PCC in the set of patients with cardiovascular disease, as well as why it is important to identify higher-risk patients. After comparing the common risk indices that are used for identifying these patients,

individual risk factors are discussed in greater detail. Finally, an updated scheme for determining which patients need further preoperative cardiac assessment is presented. The selection of preoperative tests is the topic of the last section.

## Overall Perioperative Risk in Patients with Cardiovascular Disease

Cardiovascular complications may be the most common of all perioperative complications,<sup>4</sup> although one recent study found that gastrointestinal, pulmonary, renal, infectious, wound, and pain control complications were all more common in hospitalized patients.<sup>29</sup>

Risk of perioperative complications is very low (<1%) in patients with no evidence of cardiac disease.<sup>30</sup> A recent analysis of the 6 studies assessing the

incidence of major cardiac complications in patients at risk showed an overall rate of 3.9%.<sup>182</sup> Patients with peripheral vascular disease are a well-studied group because they are easily identifiable and have a high complication rate. Polderman's  $\beta$ -blocker study of a selected group of vascular patients with stress echocardiography wall motion abnormalities showed a 34% cardiac complication rate.<sup>31</sup> The Coronary Artery Surgery Study (CASS) showed an 8.5% complication rate in vascular surgery patients with medically managed coronary artery disease.<sup>32</sup>

An observational study of 67,548 patients undergoing total hip arthroplasty between 1987 and 2000 gives a more contemporary comparison of the difference between patients with and without vascular disease<sup>33</sup> (Fig. 7-6). This study shows that in both groups, the majority of complications occur during the first 20 postoperative days.

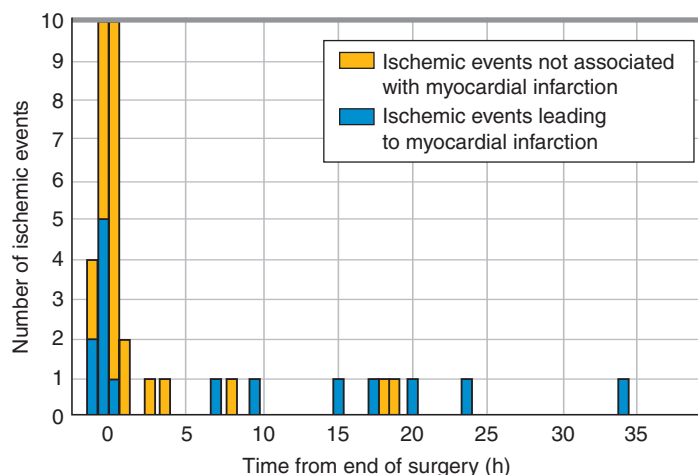
Mangano's  $\beta$ -blocker study showed how the risk from surgery may extend up to 2 years beyond the immediate perioperative period. This is likely because even asymptomatic infarct or ischemia may have long-term detrimental effects.<sup>34</sup>

### Purpose of Identifying and Quantifying Risk in Individuals

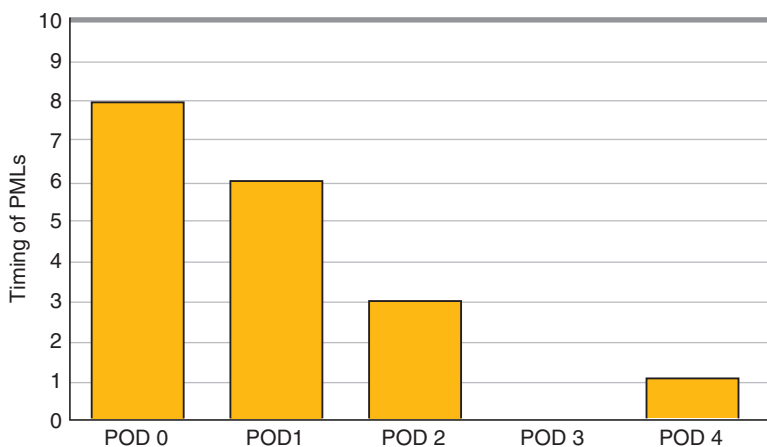
It is somewhat useful to know what the overall risk of adverse events is for a given group of patients, but it is more critical to identify individual patients who are at risk and in whom optimization is possible.

Initial assessment places the patient into a low-risk, high-risk, or intermediate/indeterminate-risk category. The threshold for testing has traditionally been set somewhere in the intermediate- or indeterminate-risk category. However, this concept of a threshold for testing in the middle of a graduated risk scale is not always helpful. Certainly patients at low risk for PCC do not require special testing; but neither do high-risk patients who have documented optimization. In both these cases, surgery can usually proceed with no further investigation. It is important to use previous records and common sense to avoid tests that only duplicate previous investigations.

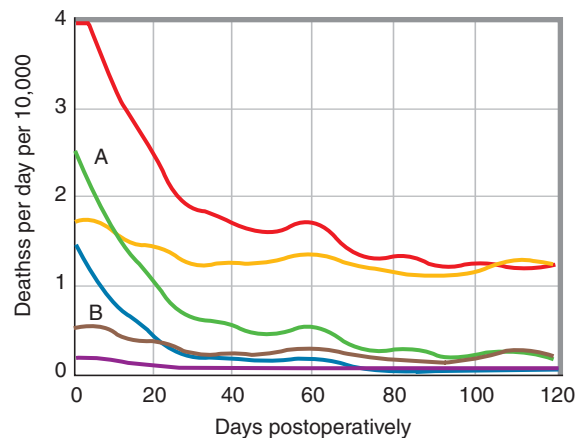
It is also clear that testing should be done if the individual is at high risk and not optimized. In this case, how-



**FIGURE 7-4.** Timing of postoperative ischemia. The time of onset of longest ischemia relative to the end of surgery ( $T = 0$ ). *Orange bars* represent the onset time of longest ischemic events of all patients who had ischemia but no myocardial infarction; *blue bars* represent the onset time of longest ischemic events that culminated in myocardial infarction. Reprinted from Landesberg G, Mosseri M, Zahger D, et al. Myocardial infarction after vascular surgery: the role of prolonged stress-induced, ST depression-type ischemia. *J Am Coll Cardiol* 2001;37(7):1839-1845, with permission from American College of Cardiology Foundation.<sup>23</sup>



**FIGURE 7-5.** Timing of postoperative myocardial infarctions. Reproduced with permission from Badner NH, Knill RL, Brown JE, Novick TV, and Gelb AW.<sup>5</sup>



**FIGURE 7-6.** Postoperative mortality after hip surgery. Smoothed total early postoperative daily mortality (hazard) for vascular diseases (A) and nonvascular diseases (B) with 95% confidence limits. Reproduced with permission from Lie SA, Engesaeter LB, Havelin LI, Furnes O, and Vollset SE.<sup>33</sup>



ever, the patient should be sent to the consultant, who can choose the tests.

It is the intermediate- or indeterminate-risk patient who most needs further preoperative testing to quantify risk and guide optimization choices. The tests are needed not because the patient falls above a threshold for testing, but because the patient's place on the risk continuum and adequacy of optimization are unknown. This testing can often be done by the anesthesia team without cardiac consultation. The main questions to be answered are these: "Can the patient be made better?" and "Can the risk of PCC be reduced?" The main goal of preoperative assessment, then, is not just to identify perioperative risk, but to identify those patients who may benefit from some change in perioperative management. Table 7-2 lists the reasons for doing preoperative risk assessment.

### Comparison of Risk Indices

Starting with Lee Goldman in 1977, a number of collections of risk factors have been proposed to determine which patients are high risk and require detailed cardiac investigations. The most commonly used index is the one set out by the American Heart Association and American College of Cardiology. The Revised Cardiac Index proposed and validated by Lee is probably the best studied.<sup>35</sup> Risk indices are cost-effective in vascular surgery.<sup>36,37</sup> They are derived from, and most appropriately applied to, populations.<sup>26</sup> Although they do not perform well in defining exact risks in individuals, they can place a patient in a general risk category.<sup>38</sup> Most divide patients into one of three risk groups: high, moderate, or low.

### High Risk for PCC

This is a group of patients who have a greater than 5% risk of PCC. These patients warrant full precautions, such as postponement of surgery to allow optimization or special perioperative measures to control risk as well as careful assessment and acceptance of the risk-to-benefit ratio of proceeding to surgery. In the past, these patients were believed to require an automatic referral to cardiology. However, as described above, if the patient is already known to be optimized, further investigation is unnecessary.

### Moderate or Indeterminate Risk for PCC

This group of patients are not clearly either high risk or low risk, and are the

patients who often warrant further risk analysis. Increasingly, however, if these patients are stable, they may proceed to surgery with relatively simple risk reduction interventions such as the initiation of  $\beta$ -blockers.

### Low Risk for PCC

These patients rarely require preoperative testing.<sup>39</sup> Tests that might be indicated in routine primary care should not be ordered unless full followup of results can be guaranteed.

Paul's study of 4 risk factors (history of diabetes, prior angina, previous myocardial infarction, and history of congestive heart failure) in 878 vascular surgery patients showed good correlation with coronary angiography<sup>40</sup> (Fig. 7-7).

Table 7-3 compares the contents of the most common risk indices. The next section discusses the specific risk factors that have been proposed for these and other assessments of perioperative risk.

### Specific Risk Factors

The clinical history will uncover risk factors for PCCs. These risk factors are usually the same as the risk factors for cardiovascular disease in general.<sup>41</sup> Because they are part of the disease etiology, changing the risk factor (if possible) might reduce the perioperative risk. Thus identification of these factors provides initial guidance on perioperative optimization options. If these risk factors have already been minimized as much as possible, or if the perioperative assessment clinician

TABLE 7-2.

#### Reasons for Risk Assessment

- Determine if the risk of proceeding to surgery is acceptable
- Assist anesthesiologist in reducing and balancing risks
- Assist surgeon in choosing procedure with best risk-to-benefit balance
- Identify those cases that are inappropriate for ambulatory surgical sites
- Identify conditions that may be improved
- Identify needs for postoperative management (monitoring, admission, ICU)
- Enable informed consent by the patient

can easily arrange for optimization, there may be no need to investigate further.

This section discusses the putative risk factors individually.

### Known Coronary Artery Disease

Before discussing the various risk factors for CAD, it is important to review how patients with known CAD should be evaluated. As recommended by American College of Cardiologists/American Heart Association (ACC/AHA) guidelines, any unstable CAD (major clinical predictor) needs to be addressed before surgery.<sup>42</sup> It has sometimes been assumed that the presence of known CAD automatically required a detailed cardiology consultation to "clear" the patients. But

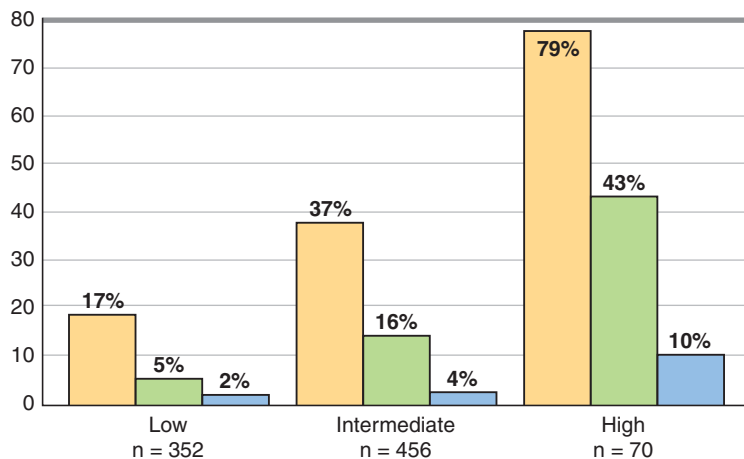


FIGURE 7-7. Concordance of clinical risk score and severity of coronary angiography. Bars represent proportions of patients with severe multivessel disease (orange), critical three-vessel and/or left main disease (green), and left main stenosis  $\geq 70\%$  (blue) within each clinical risk group. Reproduced with permission from Paul SD, Eagle KA, Kuntz KM, Young JR, and Hertzner NR.<sup>40</sup>

**TABLE 7-3.**

**Comparison of Risk Indices**

Risk Factor	Cardiac Risk Index Goldman 1977 <sup>68</sup>	Points	Modified Cardiac Risk Index Detsky 1986 <sup>184</sup>	Points	Revised Cardiac Risk Index Lee 1999 <sup>56</sup>	Boersma 2001 <sup>64</sup>	ACC/AHA 2002 <sup>42</sup>	Chassot 2002 <sup>45</sup>	Kertai 2005 <sup>a 65</sup>	Points
Ischemic heart disease	MI <6 mo ago	10	MI <6 mo	10	History of MI, or Q waves	Current or prior angina, prior MI	Previous MI by history or Q waves on ECG	Prior MI >6 wk and <3 mo	Prior MI, prior or current angina	13
			MI >6 mo	5	History of + treadmill test		Angina CCS I or II			
			CCS angina class III; CCS angina class IV	10 20	Use of NTG, current angina		Post CABG/PTCA >6 wk & <3 mo, or >6 y			
			Unstable angina <6 mo	10						
CHF		11	Pulmonary edema <1 wk	10	CHF or History of	History of CHF	Compensated or prior HF	Compensated or prior, EF <0.35	CHF	14
			Pulmonary edema ever	5						
CVD					History of TIA or stroke	History of CVA			History of CVA	10
Arrhythmias	Other than sinus or premature atrial contractions on last preoperative ECG, >5 premature ventricular contractions/min	7	Other than sinus or premature atrial contractions on last preoperative ECG, >5 premature ventricular contractions/min	5				Ventricular	CHF	
High-risk surgery	Intraperitoneal, Intrathoracic, aortic	3			Vascular, thoracic, abdominal, orthopedic				AAA rupture	43
							Thoracoabdominal	26		
								Abdominal aortic	26	
	Emergency	4	Emergency	10				Infrainguinal	15	

*(continued)*

TABLE 7-3.

Comparison of Risk Indices (Continued)

Risk Factor	Cardiac Risk Index Goldman 1977 <sup>68</sup>	Points	Modified Cardiac Risk Index Detsky 1986 <sup>184</sup>	Points	Revised Cardiac Risk Index Lee 1999 <sup>56</sup>	Boersma 2001 <sup>64</sup>	ACC/AHA 2002 <sup>42</sup>	Chassot 2002 <sup>45</sup>	Kertai 2005 <sup>a 65</sup>	Points
Diabetes					Requiring insulin <sup>b</sup>		Diabetes mellitus	Diabetes mellitus		
Renal insufficiency					Creatinine >2 mg/dL <sup>b</sup>		Renal insufficiency		Renal dysfunction	16
Age	>70 y	5	>70 y	5		>70 y		Physiologic >70 y		
Valvular disease	Aortic stenosis	3	Aortic stenosis	20						
Medical status	PO <sub>2</sub> <60 mm Hg; PCO <sub>2</sub> >50 mm Hg; K <3.0 mmol/L; HCO <sub>3</sub> <20 mmol/L; BUN >50 mg/dL (18 mmol/L); creatinine >3.0 mg/dL (260 μmol/L); abnormal AST; chronic liver disease; bedridden	3	PO <sub>2</sub> <60 mm Hg; PCO <sub>2</sub> >50 mm Hg; K <3.0 mmol/L; HCO <sub>3</sub> <20 mmol/L; BUN >50 mg/dL (18 mmol/L); creatinine >3.0 mg/dL (260 μmol/L); abnormal AST; chronic liver disease; bedridden	5						
Other									Hypertension	7
									COPD	7
									β-blocker use	-15
									Statin use	-10

AAA, abdominal aortic aneurysm; ACC/AHA, American College of Cardiologists/American Heart Association; AST, aspartate aminotransferase; BUN, blood ureanitrogen; CABG, coronary artery bypass grafting; CCS, Canadian Cardiovascular Society; CHF, congestive heart failure; COPD, chronic obstructive pulmonary disease; CVA, cardiovascular accident; CVD, cardiovascular disease; ECG, electrocardiogram; EF, ejection fraction; HCO<sub>3</sub>, bicarbonate; HF, heart failure; MI, myocardial infarction; NTG, nitroglycerin; PCO<sub>2</sub>, partial pressure of carbon dioxide; PO<sub>2</sub>, partial pressure of oxygen; PTCA, percutaneous transluminal coronary angioplasty; TIA, transient ischemic attack.

<sup>a</sup>Vascular surgery, predictors of all-cause mortality.

<sup>b</sup>Although trending to association, was not a statistically significant independent predictor.

“clearing” a patient for surgery is a nebulous concept, implying some impossible guarantee against bad outcome. What is really needed is someone to judge whether the patient is optimized and to clarify the risks involved. Ideally, one would also have the assurance that the patient is stable. When is CAD considered stable? Certainly either lack of symptoms or optimization and stabilization of symptoms is an important part of this assessment. Left main vessel disease or three-vessel disease should be carefully assessed even if asymptomatic.

The time period of increased risk after infarction or invasive intervention has changed, and is discussed next.

**Previous Myocardial Infarction** A couple decades ago, a patient was considered at high risk for PCC for 6 months after an MI, and at some increased risk forever. Today, advances in treatment of acute coronary syndrome have improved the prognosis after MI. However, as shown by Van Belle’s angiography study of 56 post-MI patients, plaques remain unstable and vulnerable to reocclusion for at least 4 weeks, even after thrombolysis.<sup>43</sup> Now the high-risk period is 6 weeks, with a period of relative risk from 6–12 weeks. In this relative-risk period, cardiac function is more important than time.

**Recent Coronary Artery Bypass** In 1997, the Coronary Artery Surgery Study showed that high-risk patients undergoing a variety of noncardiac operations fared better if they had coronary artery bypass (CABG) surgery than if they had not. Clinically stable patients who had undergone CABG within the last 5 or 6 years were relatively “protected” from myocardial infarction complicating noncardiac surgery and thus probably did not warrant routine preoperative stress testing.<sup>32</sup> McFalls’ study in vascular patients suggests revascularization may not be necessary preoperatively.<sup>44</sup> Revascularization should be done if it would have been indicated irrespective of the planned surgery. Which procedure should be done first requires a case-by-case analysis. This topic and the McFalls’ study are discussed in more detail in the section, Managing Risk: What Interventions?

**Recent Percutaneous Transluminal Coronary Angioplasty** Recommendations for surgery after PTCA

have changed dramatically. In the 1990s, it appeared that PTCA performed a couple of weeks before an operation resulted in halving the rate of PCC.<sup>45</sup> However, with the advent of stenting during PTCA, things changed. In 2002, Kaluza studied 40 patients who underwent noncardiac surgery less than 6 weeks after PTCA with stents. Ticlopidine and aspirin were continued postoperatively. There were 8 deaths, all in patients who had operations less than 2 weeks after PTCA. Six deaths were from MI; 2 were from bleeding complications.<sup>46</sup>

Wilson retrospectively studied 207 patients who had undergone PTCA with stent placement followed by noncardiac operations in the following 2 months. Eight (3.9%) had PCC; 6 (3%) died. All 8 complications occurred in patients who had had an operation less than 6 weeks after PTCA. There were no PCC in patients who were operated on 7–9 weeks after PTCA. Patients had received ticlopidine or clopidogrel for 2–4 weeks after stent placement. No major clinical adverse outcomes were attributed to excessive bleeding.

Posner retrospectively studied 686 matched pairs of patients with CAD undergoing noncardiac operations—one set having undergone PTCA preoperatively, and one set who did not get revascularization of their CAD. These groups were compared with 2155 normal controls; 142 patients had had PTCA less than 90 days before surgery. There was no difference in PCC between these patients and matched patients with CAD who were not revascularized. Patients who had PTCA more than 90 days before the operation had a lower risk of PCC than did CAD patients who were not revascularized, although not as low as normal controls.<sup>47</sup>

On this basis, it is recommended that surgery be delayed until at least 6 weeks after PTCA, and preferably for 12 months after PTCA and stenting with a drug-eluting stent.<sup>47a</sup>

### Hypertension

Hypertension is the leading cause of cardiac morbidity and strokes.<sup>48</sup> Even white-coat hypertension is associated with endothelial dysfunction<sup>49</sup> and increased risk of cardiac events.<sup>50</sup>

Evidence that hypertension actually results in increased perioperative morbidity is limited. A meta-analysis of 30 observational studies demonstrated an odds ratio of the association between

hypertension and PCC of 1.35 (range: 1.17–1.56).<sup>51</sup> This difference is not clinically significant in the short-term. However, even if hypertension in and of itself is not a significant perioperative risk factor, the cardiac conditions which often accompany hypertension are. These include left ventricular hypertrophy (LVH),<sup>52,53</sup> renal failure, and stroke. Uncontrolled hypertension becomes an unoptimized risk factor that should be addressed preoperatively. Management of preoperative high blood pressure is discussed in the section Management of Hypertension.

### Diabetes

Asymptomatic type 2 diabetics have the same risk of MI as do patients with previous MI.<sup>54</sup> Diabetes is considered a risk factor for perioperative cardiac complications by most sources,<sup>42,45,55</sup> although some studies have not shown it to be so.<sup>56–59</sup> Whether strict control of diabetes reduces risk is discussed in the section Medications: What to Start and What to Stop.

### Smoking

Smoking is a clear risk factor for cardiac disease and poor wound healing. Smoking cessation is one of the most effective ways to reduce cardiovascular risk. The unsolved question is how long before surgery is cessation necessary in order for there to be some benefit. There is concern that the stress of withdrawal may add to perioperative catecholamine surge. The issue of preoperative cessation is discussed in Smoking Cessation below.

### Hyperlipidemia

Hyperlipidemia is a major risk factor for CAD, and improving the lipid profile leads to a reduction in risk. It was initially assumed that because lipid profiles change so slowly, management of lipids was not a practical perioperative issue. However, treatment with statins is proving to have some fairly rapid benefits, although there is no study specifically in the perioperative setting. The benefit of statins is more than just improvement of hyperlipidemia. The perioperative benefits of statins are discussed in Medications: What to Start and What to Stop below.

### Peripheral Vascular Disease

Of patients with peripheral vascular disease (PVD), 30% have CAD. The fact that many of these patients are unable to exercise puts them at in-



creased risk and also makes quantification of cardiac status difficult. This is a very significant, but unfortunately a minimally modifiable, risk factor.

### **Congestive Heart Failure/Cardiomegaly**

Congestive heart failure is both a cause and a result of ischemia. Cardiomegaly is a risk factor for PCC.<sup>52</sup>

### **Renal Insufficiency**

This was added to the list of intermediate clinical predictors of PCC by the last update of the ACC/AHA guidelines.<sup>42</sup> Lee's analysis showed increased risk with creatinine > 2 mg/dL in the derivation cohort but not the validation cohort.<sup>56</sup>

### **Arrhythmias**

Arrhythmias are a cause and an effect of ischemia. Generally arrhythmias in and of themselves will not precipitate problems unless the heart is already compromised. Therefore, they are of more concern if there is other evidence of cardiac disease.

Conditions that may occur in otherwise healthy persons which are of perioperative concern are Wolff-Parkinson-White (WPW) disease and prolonged QT syndrome. These conditions have a bearing on which drugs are selected to treat arrhythmias that might occur.

### **Valvular Lesions**

An increase in the sensitivity of echocardiography a couple of decades ago resulted in a plethora of diagnoses of trivial regurgitation. Trivial regurgitation is just that; it is virtually never of consequence perioperatively, even for consideration of endocarditis prophylaxis. Mitral valve prolapse is also quite common. If asymptomatic, it is generally of no concern perioperatively, except in men older than 40 years of age, who will require prophylaxis against endocarditis.<sup>60</sup> Detection of any diastolic murmur requires further investigation.

Aortic stenosis is of very grave concern to the anesthesiologist, and the discovery of this condition is a primary objective of preoperative assessment. The history may give evidence of some recent change in exercise capacity if this lesion is becoming significant. However, where aortic stenosis is a possibility, the threshold for investigation of a heart murmur

should be very low, as the rate of PCC can be very high.<sup>61,62</sup> With advance planning and careful technique this risk can be minimized.<sup>63</sup>

### **History of Cardiovascular Accident**

History of stroke or transient ischemic attack was an independent correlate of PCC in both the derivation and the validation cohort of the Revised Cardiac Risk Index,<sup>56</sup> as well as in Boersma and Kertai's studies.<sup>64,65</sup>

### **Anemia**

The general trend is toward greater tolerance of perioperative anemia. However, patients with CAD are an exception to this.<sup>66</sup> If this condition is identified far enough in advance of the operation, arrangements can be made for preoperative erythropoietin and iron, intraoperative isovolemic hemodilution, and special ICU maneuvers.<sup>67</sup> With advance preparations, transfusion can be avoided in many situations. In addition to disrupting the supply-demand balance, anemia is a marker for other comorbidities.

### **Age**

Age greater than 70 years was an independent risk factor in some multivariate analyses,<sup>64,68</sup> but not in others.<sup>56,65,69</sup> Age in and of itself is probably not a significant risk factor if it is carefully separated from the associated comorbidities. If an MI does occur, however, mortality is higher.<sup>68,70</sup>

### **Markers of Inflammation**

A recent analysis of more than 14,000 women in the Women's Health Initiative shows that increased CRP is predictive of adverse cardiovascular events.<sup>71</sup> Other studies also show it to be an independent risk factor, and a recent workshop by the Centers for Disease Control and Prevention and the American Heart Association concluded that the high sensitivity test for CRP is the recommended marker of inflammation in atherosclerotic disease.<sup>72</sup> Whether it can be used to guide perioperative management is yet to be determined.<sup>18</sup>

B-type natriuretic peptide is a marker of inflammation that is abnormal in advanced heart failure.<sup>73</sup> It has a high negative predictive value and might be useful to select out some high-risk patients who do not need echocardiograms to rule out ventricular dysfunction.<sup>74</sup>

### **Albumin**

Low albumin is a marker of overall debilitation and acute-phase reactants, and thus serves as a very good prognostic test for PCC. Unfortunately, this test result does not offer much guidance in perioperative management, aside from possibly a long delay in surgery to allow improved nutrition.

### **Depression**

A recent quantitative review suggests that depressive symptoms contribute a significant independent risk for the onset of coronary disease, a risk (odds ratio [OR] = 1.64) that is greater than the risk conferred by passive smoking (OR = 1.25) but less than the risk conferred by active smoking (OR = 2.5).<sup>75</sup> Patients with coronary heart disease who also display depressive symptoms have an increased risk of mortality.<sup>76</sup>

The Neurological Outcome Research Group conducted a prospective study of 555 CABG patients for 6 months and showed that, after adjustment for other risk factors, depression was associated with a 2- to 3-fold increase in risk of death. Patients who were depressed at the time of surgery, but not depressed at 6 months, did not have the same increased death rate.<sup>77</sup> This reminds us of the importance of treating depression discovered preoperatively. Again, cooperation with primary care or consultant specialists is critical.

### **Genetic Polymorphisms**

Genetic testing is increasingly commonplace, and there is increasing interest in how this might be applied to perioperative risk stratification. Factor V Leiden is a good example of a common genetic polymorphism. However, with the possible exception of cardiac surgery, routine antithrombotic measures are sufficient to counteract the effects of this condition and routine preoperative testing for this is not recommended.<sup>17</sup>

Some studies show an association of specific genetic polymorphisms with atherosclerotic complications after CABG,<sup>78-80</sup> whereas others have not shown strong associations.<sup>81</sup> The Multicenter Study of Perioperative Ischemia Research Group showed that certain polymorphisms for platelet glycoprotein IIIa and the degree of platelet activation are related to levels of troponin after CABG, suggesting

that this platelet polymorphism contributes to perioperative myocardial injury.<sup>82</sup> Inflammatory response is also altered by genetic variability of key inflammatory genes.<sup>83–86</sup> Genetic variability in  $\beta$ -adrenergic responses may assist in determining who should receive perioperative  $\beta$ -blockers and who should not.<sup>87–89</sup>

Although not routinely indicated at this time, genetic testing is a significant frontier in perioperative medicine.

### Carotid Stenosis

In addition to being a marker for cardiovascular disease, carotid stenosis may predispose a patient to perioperative stroke. A common dilemma is whether or not carotid surgery should precede other operations. The risk of serious stroke in patients undergoing a nonvascular operation is less than 1%. It is no higher in patients with bruits than in those without bruits.<sup>90</sup> The benefits of carotid surgery in patients with asymptomatic stenosis is small, and likely achievable only in certain centers.<sup>91</sup> In the case of coronary artery surgery, selective duplex ultrasound screening for carotid stenosis does have benefits,<sup>92</sup> but there is no evidence to support prophylactic carotid endarterectomy before general surgery.<sup>93</sup> Even in cardiac surgery patients, most strokes occur in patients without carotid stenosis.<sup>92,94</sup> The exception may be high risk patients—those with stenosis >90% and either a history of transient ischemic attacks (TIAs) or elevated creatinine. These patients warrant carotid surgery whether or not they are scheduled for other surgery.<sup>95</sup>

### Surgical Procedure Risk

The planned surgical procedure defines the overall requirements for preoperative assessment. High-risk operations, such as an abdominal vascular operation, is almost guaranteed to include significant stress from events such as cross-clamping of the aorta. By definition, a vascular operation occurs in a patient with cardiovascular disease. At this level of surgical risk, it is imperative to know that cardiac function has been optimized.

At the other end of the spectrum, low-risk operations, such as cataract removal, entails risks not much different from activities of daily living. If the patient can walk to the surgical suite, the patient has probably demonstrated

the cardiac capacity necessary to endure the stress of surgery. Schein's large study of 18,189 cataract surgery patients showed that foregoing preoperative testing did not result in any change in outcome. The critical element of this study, which is sometimes missed, is that all of these patients were assessed by their primary care practitioners, and any tests required for general health maintenance were done. This study supports the concept that a clinical examination is the irreplaceable foundation of preoperative assessment, and tests are secondary.

The ACC/AHA guidelines categorize surgical risk (Table 7–4). Kumar's study verifies the profound influence of the type of surgical procedure on perioperative risk.<sup>69</sup>

### Functional Status

The remarkably simple tool of asking about the functional status of the patient provides good prediction of risk for PCC. It is a descriptor of how much the risk factors impact the patient, and is most useful as a screening tool to select out patients who are very unlikely to have PCCs. Reilly showed that patients who reported they could not climb 2 flights of stairs or walk 4 blocks had twice as many PCCs as those who reported they could.<sup>96</sup> Although patient self-description of exercise capacity correlates well with actu-

al functional capacity,<sup>97</sup> the accuracy of this test can be improved by actually observing the stair climbing. Girish observed maximum stair climbing in 83 operation candidates. The overall rate of postoperative complications, including cardiac events, arrhythmias, reintubation, atelectasis, and pneumonia, was 25%. The rate in those who could not complete 1 flight of stairs was 89%. No patient able to climb 7 flights of stairs had a complication.<sup>98</sup> It is important that the patient be able to climb 2 flights of stairs without developing dyspnea, chest pain, or leg pain. This helps ensure that a poor anaerobic capacity does not coexist with a good aerobic capacity.<sup>99</sup> Biccard recently described this and other limitations of a stair-climbing test.<sup>100</sup>

### Clinical Determination of Need for Specific Preoperative Cardiac Investigations

Increasingly, the options for testing have outstripped the resources for testing; as a result, it is important to be selective. Testing where it is not needed depletes resources needed elsewhere, and may delay surgery needlessly. Selective testing is cost-effective and safe.<sup>36</sup> Similar to other aspects of medicine, preoperative assessment of cardiac status should occur in two stages: through a clinical history that defines general risk, then through se-

TABLE 7–4.

Cardiac Risk<sup>a</sup> Stratification for Noncardiac Surgical Procedures

High	(Reported cardiac risk often greater than 5%) <ul style="list-style-type: none"> <li>• Emergent major operations, particularly in the elderly</li> <li>• Aortic and other major vascular surgery</li> <li>• Peripheral vascular surgery</li> <li>• Anticipated prolonged surgical procedures associated with large fluid shifts and/or blood loss</li> </ul>
Intermediate	(Reported cardiac risk generally less than 5%) <ul style="list-style-type: none"> <li>• Carotid endarterectomy</li> <li>• Head and neck surgery</li> <li>• Intraoperative and intrathoracic surgery</li> <li>• Orthopedic surgery</li> <li>• Prostate surgery</li> </ul>
Low <sup>b</sup>	(Reported cardiac risk generally less than 1%) <ul style="list-style-type: none"> <li>• Endoscopic procedures</li> <li>• Superficial procedure</li> <li>• Cataract surgery</li> <li>• Breast surgery</li> </ul>

<sup>a</sup>Combined incidence of cardiac death and nonfatal myocardial infarction.  
<sup>b</sup>Do not generally require further preoperative cardiac testing.  
Reproduced with permission from Eagle KA, Berger PB, Calkins H, et al.<sup>42</sup>

lective tests that further define that risk.

The Bayesian theorem states that testing a group with a low prevalence of a given condition results in too many false positives for the information to be useful. The purpose of the clinical assessment is to select patients who have a roughly 5% or greater likelihood of PCCs,<sup>101</sup> and in whom further testing will yield a useful change of pretest to posttest probabilities. Applying tests to a lower prevalence (unselected) group is ineffective.

A rapid initial assessment of risk can be done by assessing three areas: (a) the number of clinical risk factors present; (b) the type of operation planned; and (c) the functional status of the patient.<sup>45</sup> This format is the foundation of the ACC/AHA guidelines, specifically the shortcut to determination of need for cardiac investigation.<sup>42</sup>

The ACC/AHA guidelines will soon be updated to reflect the increasingly common situation where management of risk does not necessarily need to be preceded by extensive investigation. A modified scheme foreshadowing this is presented below. This is not meant to be yet another competing scheme, but a simplification and refinement of existing schemes.

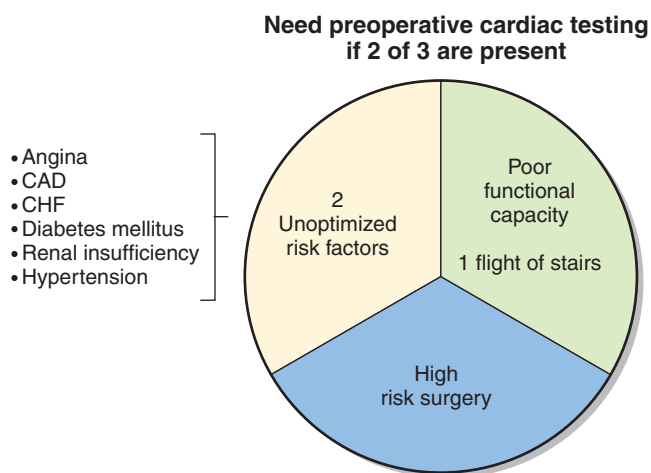
If the patient is not in an emergency situation or experiencing serious cardiac conditions such as unstable coronary syndromes, decompensated congestive heart failure (CHF), significant arrhythmias, and severe valvular disease (all major clinical predictors in the ACC/AHA guideline), then 3 factors will determine the need for preoperative cardiac investigations. Presence of 2 of these 3 factors generally warrants further cardiac investigations (Fig. 7–8).

### Functional Status

As described above, inability to do 1 flight of stairs is a predictor of increased perioperative risk.<sup>96,98</sup> Climbing 1 flight of stairs is equivalent to an aerobic capacity of 4 metabolic equivalents (METs) (Duke Activity Status Assessment)<sup>97</sup> and probably represents a capacity to endure postoperative stresses without ischemia.

### Presence of Unoptimized Risk Factors

Unoptimized risk factors include the conditions categorized as intermediate clinical predictors in the ACC/



**FIGURE 7–8.** Clinical determination of need for preoperative cardiac investigation.

AHA guidelines (angina pectoris, prior MI, CHF, diabetes, and renal insufficiency) that have not been assessed, managed, and deemed to be under optimal control by a qualified physician. This physician may be the primary care physician, a consultant, or the anesthesiologist. Also considered are other conditions, such as hypertensive urgencies and dyspnea.

Often one risk factor that is stable but not fully optimized (e.g., hyperlipidemia, hypertension, smoking) does not warrant further preoperative investigation. Two or more unoptimized risk factors do warrant the change of perioperative management.<sup>65,102,103</sup> This is consistent with Lee's algorithm and the American College of Physicians guidelines where the use of a scoring system results in no further testing unless more than 1 risk factor is present.<sup>56,104</sup>

### Surgical Procedure

A planned operation in the high-risk category (Table 7–4) requires consideration of further quantification of risk if there is also poor functional status or presence of 2 unoptimized risk factors.

Moderate-risk procedures entail a less than 1% risk of PCC, even in patients with known cardiac disease.<sup>32</sup> Very-low-risk procedures such as cataract surgery and diagnostic arthroscopy entail no more risk than activities of daily living; they could be done even with disease that is not fully optimized. Disease management may be required, but could occur postoperatively.

It is important to remember that the patient is an active partner in the risk analysis. If a patient refuses invasive cardiac intervention, then medical optimization is likely all that will be done, regardless of what tests are considered.

### PREOPERATIVE CARDIAC TESTS TO FURTHER QUANTIFY RISK

If the initial clinical assessment of risk factors shows that further quantification of risk will be useful, it is appropriate to proceed to other tests. These tests are usually good prognostic indicators of outcome, but are not parameters that directly cause risk. The information provided by these second-level tests may not lead to quick, direct modification of risk, as is the case for risk factors. These tests provide prognostic information, and are useful if the information will change the risk above or below some management threshold—for example if the patient is on the threshold for having the operation done at an ambulatory center, or it is not clear whether angina is stable or not. If the patient is already clearly on one side or the other of the threshold, there is no need to apply prognostic indicators. This is another application of the principle that tests are not useful if the pretest probability is very low because the number of false positives (with needless delay of surgery) will be high. Even angiography is imprecise in a low-risk population.<sup>40</sup>

Not all testing is useful. A common case example is a patient with known stable cardiac disease for whom it would be “nice” to have more information. A stress echocardiogram is arranged, and the result is indeterminate. The cardiologist, when faced with the possibility of serious cardiac disease, wants to be sure nothing is missed. This motivation may stem as much from the concern for litigation as from indications for good medical practice. Thus an angiogram is scheduled, and it shows a stenosis amenable to stenting. A stent is placed and clopidogrel started, which means that surgery should be delayed for up to 12 months.<sup>47a</sup> All this is done for cardiac disease that may have been less hazardous than the indication for operation. Delay of operation is inconvenient at least, probably unnecessary, and possibly dangerous. McFalls showed that there is no benefit in preoperative versus postoperative cardiac intervention in vascular surgery. If this is true for vascular surgery, it is likely even more true for lower-risk operations and lower-risk patients<sup>44</sup> (the shortcomings of this study are addressed in Preoperative Invasive Interventions: When Should CABG or PTCA Be Done Preoperatively? below).

It is sometimes best to keep a patient off the “cardiac train” of stress test, angiogram, angioplasty, and antiplatelet agent, because once a patient is onboard, the patient is unavailable for elective surgery until the end of the journey. Before purchasing the “ticket” of a stress test, the clinician and patient must be willing to go the full journey. The Dutch Echocardiographic Cardiac Risk Evaluation Applying Stress Echocardiography Group analyzed<sup>45</sup> patients with PCCs. They suggest that in intermediate-risk patients, the addition of perioperative  $\beta$ -blockers reduces the risk of PCCs to a level where dobutamine stress echocardiography would not change management.<sup>64</sup>

Invasive tests, such as angiography, or alternatives, such as intravascular ultrasonography, coronary artery calcium by electron-beam tomography,<sup>105,106</sup> cardiac CT,<sup>107</sup> or cardiac MRI<sup>106</sup> are not discussed. These specialized tests are not generally ordered or interpreted without a cardiology consultation.

Second-level tests, for purposes of discussion, are divided into resting cardiac tests, cardiac stress tests, and postoperative tests.

## Resting Cardiac Tests

### Electrocardiogram

An ECG is often done routinely. This test may be useful as a baseline in case of subsequent PCCs, but it is not useful for screening or for diagnostic purposes except in high-risk patients. This is because the specificity of abnormalities is too low. An ECG should not usually be done preoperatively in low-risk operations, unless it would have been done outside of the perioperative period. Having said that, either the presence of 2 risk factors for CAD or diabetes alone warrants having a baseline ECG even in low-risk operations. For baseline purposes, an ECG less than 6 months old is adequate if there have been no clinical changes.

If there is a change on the ECG, what does it mean perioperatively? Most studies show that preoperative ST-T-wave changes (ST segment elevation or depression or T-wave inversion) are not associated with worse outcomes.<sup>56,108</sup> However, this generalization does not apply to high-risk patients. In a study of exclusively vascular surgery patients, Landesberg showed that ECG changes of LVH and ST depression were predictive of PCCs.<sup>52</sup>

What about Q waves? Again, if the Q waves would have raised concerns outside of the operation, they should also be investigated before the operation. Liu's study of surgical patients age 70 years and older suggests ECG changes are not predictive of PCCs. But this study of 386 patients with abnormal ECGs, only 104 (27%) of whom had major Q waves, did not have an adequate sample size to draw firm conclusions.<sup>108</sup>

### Ejection Fraction

Transthoracic (2D) echocardiography or radionuclide ventriculography are used to measure ejection fraction.

Left ventricular dysfunction is a predictor of future cardiovascular events and increased overall mortality.<sup>109</sup> Although helpful in monitoring heart failure and valvular disease, if there is concern about ischemia, it is preferable to select other tests.

### Measurement of Heart-Rate Variability

A decrease in heart-rate variability predicts adverse cardiac outcomes.<sup>110</sup> A recent study of high-risk patients showed that a decreased low-frequency-to-high-frequency power ratio before induction of anesthesia predicted adverse cardiac events up to 2 years after the operation.<sup>103</sup> A small study by Laitio showed that fractal analysis of certain preoperative heart-variability parameters may be predictive of prolonged postoperative myocardial ischemia in emergency hip operation patients.<sup>111</sup>

With current analysis methods, the resting cardiac tests give supportive data only. Stress tests are usually needed to define risk or optimization.

## Cardiac Stress Tests

Cardiac stress tests involve 2 components: a stressor and a test. These can be mixed in any way, but the most common combinations are treadmill ECG, dobutamine echocardiography, and adenosine radionuclide (Table 7-5).

### Treadmill Exercise Testing

This is the simplest of the stress tests. Treadmill ECG testing is a good first-line test in those patients able to do the exercise.<sup>45,112</sup> It is not useful in patients unable to exercise, with ECG changes (left bundle-branch block, pacemaker, WPW, ST elevation at rest), or with a history of revascularization. It produces 30% false positives in women. In practice, if a patient is able to do treadmill

TABLE 7-5.

Matching of Stressor and Test in Cardiac Stress Test

Stressor	Test		
	ECG	Echocardiogram	Myocardial Perfusion
Exercise treadmill	Common	Sometimes	
Pharmaceutical stimulation (e.g., dobutamine)		Common	
Vasodilation (e.g., dipyridamole)		Sometimes	Common



testing, the patient probably does not need further preoperative testing. If further testing is needed, a more accurate test, such as stress echocardiography, is generally preferred.

Older has shown that cardiorespiratory exercise testing for anaerobic threshold is useful for identifying high-risk patients who are unlikely to develop diastolic heart failure postoperatively, and therefore are unlikely to need postoperative ICU admissions.<sup>25</sup> Unfortunately, few institutions can logistically arrange these tests preoperatively.

### **Dobutamine Stress Echocardiography**

This test has the advantage of requiring relatively little time to complete. It is a functional test in that it shows how cardiac function is affected by underlying pathology. Image quality is limited in obesity. Both Kertai's and Beattie's meta-analyses show that the receiver operating curve of dobutamine stress echocardiography is better than other tests.<sup>113</sup> Table 7-6 summarizes the other characteristics in Kertai's study.<sup>114</sup> Beattie's analysis, which included 68 studies of 10,049 patients, judged that stress echocardiography was superior to thallium imaging because the negative predictive value of stress echocardiography was superior. Because accuracy and availability vary between locations, each institution may have a different preferred test.<sup>45</sup>

A common dilemma is whether a dobutamine stress echocardiogram should be postponed in the case of a patient taking  $\beta$ -blockers. Weissman's study in dogs showed that dobutamine was less able to reproduce ischemia if esmolol was administered.<sup>115</sup> If the test is being done to assess whether  $\beta$ -blockade will reduce ischemia, then  $\beta$ -blockers should be stopped before the test. If, on the other hand, the purpose is to see if the  $\beta$ -blockade is providing protection from ischemia, the test should be done with  $\beta$ -blockers on board. If we are trying to minimize preoperative stress, stopping  $\beta$ -blockers may be counterproductive, even if it is informative.

### **Radionuclide Imaging**

This test may be more sensitive than others in this category as it will detect flow anomalies that do not yet cause wall-motion abnormalities; however, it is also less specific. Compared with echocardiography, its accuracy is less affected by obesity, but is altered by large breasts.

### **Cardiac MRI**

This is a new test that can combine flow studies with wall-motion studies in remarkable resolution. It is useful for complex high-risk cases, but does not yet have a clear role in preoperative screening. Fuster and Kim published a recent review of this technology.<sup>116</sup>

### **Tests of Endothelial Dysfunction**

As described above, endothelial dysfunction is one of the unifying mecha-

nisms of PCCs. Several new tests for this are showing prognostic value for cardiovascular disease in general, and may prove to be useful in the perioperative period. One of these is brachial artery flow-mediated dilation. In this "stress test" of the vasculature, nitroglycerin dilation is the "stressor" and ultrasonic observation of the brachial artery is the test.<sup>117</sup>

### **Postoperative Tests**

As most ischemia occurs postoperatively and is silent, it makes sense to monitor for it. Postoperative ECG changes suggesting ischemia may be predictive of postoperative morbidity and mortality even in low-risk patients.<sup>118,119</sup>

Postoperative troponin elevation indicates increased risk of cardiac events.<sup>8,120</sup> It is more sensitive than ECGs<sup>5</sup> or creatine kinase myocardial band (CK-MB),<sup>119</sup> and has become the gold standard for identifying postoperative ischemia. Le Manache studied the postoperative troponin levels of 1136 abdominal aortic aneurysm surgical patients, and found that a slightly elevated level was associated with delayed postoperative myocardial infarction. Discovery of elevated postoperative troponin may represent an opportunity to reduce asymptomatic ischemia.<sup>10</sup> Landesberg's study of major vascular surgery showed a similar correlation of troponin and CK-MB and overall mortality.<sup>121</sup>

**TABLE 7-6.**

**Summary of Clinical Characteristics of Cardiac Tests**

Type of Test	No. of Studies	No. of Patients	Mean Age (years)	Proportion of Men (%)	History of CAD (%)	Proportion of DM (%)	Sensitivity (%; 95% CI)	Specificity (%; 95% CI)
Radionuclide ventriculography	8	532	67.0	83	45	25	50 (32-69)	91 (87-96)
Ambulatory electrocardiography	8	893	68.0	72	55	32	52 (21-84)	70 (57-83)
Exercise electrocardiography	7	685	64.5	72	36	28	74 (60-88)	69 (60-78)
Dipyridamole stress echocardiography	4	850	66.8	78	28	33	74 (53-94)	86 (80-93)
Myocardial perfusion scintigraphy	23	3119	65.5	78	40	30	83 (77-89)	49 (41-57)
Dobutamine stress echocardiography	8	1877	67.3	76	37	16	85 (74-97)	70 (62-79)

CAD, coronary artery disease; CI, confidence interval; DM, diabetes mellitus.

Tests are sorted according to ascending sensitivities.

Kertai MD, Boersma E, Bax JJ, et al. A meta-analysis comparing the prognostic accuracy of six diagnostic tests for predicting perioperative cardiac risk in patients undergoing major vascular surgery. *Heart* 2003;89(11):1327-1334. Reproduced with permission from the BMJ Publishing Group.<sup>113</sup>

## MANAGING RISK: WHAT INTERVENTIONS?

Anesthesiologists are well situated to practice perioperative medicine. Increasingly, this includes perioperative optimization of cardiac conditions. Although consultation and cooperation with cardiology specialists are needed for many aspects of this optimization, some interventions are well within the anesthesiologist's range of skills. This is because it is the anesthesiologist assigned to a case who best knows what information is needed or not needed in order to balance risks, obtain informed consent, and form an anesthesia plan. The anesthesiologist is in the best position to know when detailed investigations would not change any of these decisions, and thus would entail needless delay, expense, and risk.

This section focuses on preoperative and postoperative interventions. Intraoperative management is addressed in other chapters.

Many of the medical interventions for reducing perioperative risk are part of the secondary prevention of cardiac disease. While the perioperative team must limit itself largely to the management required in the perioperative period, this is an ideal time to institute or reinforce long-term cardiac care, especially the simple, proven interventions, such as control of hypertension and diabetes, along with the use of  $\beta$ -blockers and statins.

### Preoperative Invasive Interventions: When Should CABG or PTCA Be Done Preoperatively?

Because of the known increase in PCCs in patients with cardiac disease, and because initial studies showed increased PCCs after MI, it has been deemed logical to postpone elective operations until the cardiac status is optimized.<sup>122</sup> This optimization has generally been either an operation or intensive medical management.

Glance, in a decision-tree model, found that proceeding directly to vascular surgery resulted in the poorest 5-year survival (77.4%) compared with 3 screening strategies: (a) screening all patients with a dipyridamole-thallium test (86.1% 5-year survival); (b) screening all patients with coronary angiography (87.9% 5-year survival); and (c) selective screening where high-risk patients underwent

preoperative angiography, intermediate-risk patients were screened noninvasively, and low-risk patients proceeded directly to surgery without further testing (86.0% 5-year survival). While the 5-year survival rate was similar in all screening strategies, the cost (\$/year of life saved) of selective screening was half that of either nonselective strategy. There was no difference in 30-day outcome between any of the 4 strategies.<sup>36</sup>

The Asymptomatic Cardiac Ischemia Pilot study randomized 558 patients who had coronary anatomy suitable for revascularization to 3 treatment strategies: (a) angina-guided drug therapy (n = 183); (b) angina plus ischemia-guided drug therapy (n = 183); and (c) revascularization by angioplasty or bypass surgery (n = 192). Two years after randomization, the total mortality was 6.6% in the angina-guided strategy, 4.4% in the ischemia-guided strategy, and 1.1% in the revascularization strategy.<sup>123</sup>

On the other hand, the following studies raise doubts about the need to revascularize before surgery in reasonably stable cardiac patients.

Mason did a decision analysis modeling comparing 3 perioperative strategies for vascular surgery in high-risk patients: (a) proceed directly to vascular surgery with close monitoring of cardiac status and aggressive treatment of myocardial ischemia; (b) perform coronary angiography followed by selective coronary revascularization, then proceed to vascular surgery except in patients with severe, inoperable CAD; and (c) perform coronary angiography followed by selective coronary revascularization, then proceed to vascular surgery in all patients, including those with inoperable CAD. In the best-case analysis of the 4 end points of nonfatal myocardial infarction, stroke, cost, and a successful vascular procedure, the first strategy of proceeding directly to vascular surgery with close monitoring of cardiac status led to better outcomes than either of the coronary angiography strategies.<sup>124</sup>

McFalls randomized 510 Veterans Administration patients undergoing abdominal aortic aneurysm repair to either coronary artery revascularization before surgery or no revascularization before surgery. Percutaneous coronary intervention was performed in 59%, and bypass surgery in 41%. There was no difference in MI in the first 30 days after surgery or in mortal-

ity at 2.7 years.<sup>44</sup> This study excluded patients with more than 50% stenosis of the left main coronary artery from randomization. Drug-eluting stents were not used. This widely quoted study needs to be repeated with these shortcomings addressed.

Godet's group analyzed a cohort of 1152 patients after abdominal aortic surgery in which 78 patients underwent percutaneous coronary intervention. A propensity score analysis was performed. The observed percentages of patients in the percutaneous coronary intervention group with severe postoperative coronary events (9.0% [95% confidence interval (CI), 4.4–17.4]) or death (5.1% [95% CI, 2.0–12.5]) were not significantly different than the expected percentages (8.2% and 6.9%, respectively).<sup>125</sup>

Coronary interventions should be performed as indicated by guidelines used in nonsurgical settings. Whether or not an operation should be delayed depends more on the urgency of the surgery than on the presence of CAD.

### Management of Hypertension

In 1988, Stone et al. described the effect of a single preoperative dose of  $\beta$ -blocker on mild hypertensives.<sup>126</sup> The dramatic reduction in postoperative ischemia made it appear that treatment of hypertension was very important. Subsequent studies suggest the important aspect of this study was not the mild hypertension, but the  $\beta$ -blockers.

Hypertension as a risk factor for cardiovascular disease was discussed previously in Specific Risk Factors: Hypertension above. Management is usually elective, and an operation does not need to be delayed unless blood pressure is quite high. There are no evidence-based guidelines on the threshold of hypertension that warrant delay of surgery. The oft-quoted threshold for postponing surgery of 180/110 mm Hg is the result of a recommendation by Goldman and Caldera in their 1979 study which included 5 such patients, none of whom had any complications.<sup>68</sup> Rohgi did show an increased risk of cardiac complications in vascular surgery patients whose diastolic blood pressure was >110 despite taking 2 or more antihypertensive medications.<sup>37</sup>

The important aspect of management of severe hypertension (>180/110 mm Hg) is the search for end-

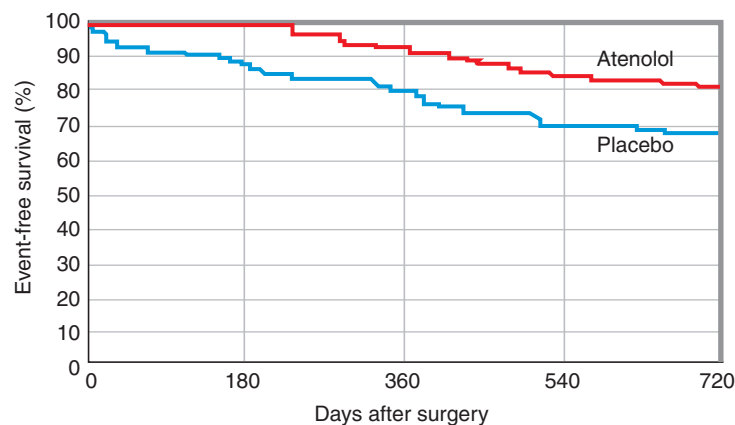
organ damage (cardiac ischemia, renal dysfunction, cerebral impairment). If there is any evidence of end-organ damage, the patient needs emergency care. In the absence of these, the condition is termed a hypertensive urgency, and the treatment goal is to gradually improve blood pressure control. Indeed, rapid reduction of blood pressure has added risks. If these patients are sent to the emergency department, they will be assessed with a clinical examination, ECG, and simple blood tests to rule out end-organ damage. If there is no such damage, they will be started on an oral antihypertensive and sent home. The anesthesiologist can often do this as well as the emergency department. There is probably no need to delay an operation if there is no end-organ damage and improvement in long-term management is underway.<sup>51</sup>

Blood pressure control must be continued through and beyond the perioperative period.<sup>127</sup> Hypertension is the classic condition that may present preoperatively and whose treatment will result in long-term health benefits. Modena has shown that treatment of hypertension results in improvement in endothelial function and reduction in cardiovascular events in 6 months.<sup>128</sup> The reasons for treating hypertension may not stem so much from perioperative benefits as from the clear lifelong benefits. Patient compliance is often suboptimal and perioperative attention to this condition by the anesthesiologist will assist greatly in long-term management. Compared to the potent drugs used daily for anesthesia, antihypertensives have great margins of safety. Anesthesiologists need to learn to write prescriptions for long-term hypertension management where needed. Primary care physicians can assume responsibility for titration of medication prescribed perioperatively.

## Medications: What to Start and What to Stop

### $\beta$ -Blockers

Large studies have demonstrated the benefit of  $\beta$ -blockers after MIs and in heart failure.<sup>129,130</sup> There are small studies showing marked benefit from perioperative use. Mangano's prospective study of 1 week of perioperative  $\beta$ -blocker use showed dramatic results in morbidity and mortality extending to 2 years<sup>131</sup> (Fig. 7-9).



**FIGURE 7-9.** Event-free survival after surgery: atenolol versus placebo. Event-free survival in the 2 years after noncardiac surgery among 192 patients in the atenolol and placebo groups who survived to hospital discharge. The outcome measure combined the following events: myocardial infarction, unstable angina, the need for coronary artery bypass surgery, and congestive heart failure. The rate of event-free survival at 6 months (180 days) was 100% in the atenolol group and 88% in the placebo group ( $P < 0.0001$ ); at 1 year (360 days), the rates were 92% and 78%, respectively ( $P = 0.003$ ); and at 2 years (720 days), 83% and 68% ( $P = 0.008$ ). Mangano DT, Layug EL, Wallace A, Tateo I, The Multicenter Study of Perioperative Ischemia Research Group. Effect of atenolol on mortality and cardiovascular morbidity after noncardiac surgery. *N Engl J Med* 1996; 335(23):1713–1721. Copyright 1996, Massachusetts Medical Society. All rights reserved.<sup>131</sup>

Stevens estimates the number needed to treat (NNT) for prevention of 1 episode of intraoperative or postoperative ischemia with  $\beta$ -blockers to be 8.<sup>132</sup> The benefits of perioperative use are based on only 5 studies.<sup>133,134</sup> (Table 7-7). There were only 83 serious adverse events in all the studies.<sup>132,135</sup>

Polderman's study of high risk patients randomized 59 of them to an average of 30 days of preoperative bisoprolol, and 53 of them to standard care. In the first 30 postoperative days, there were 18 (34%) PCCs in the standard care group and 2 (3.4%) in the bisoprolol group. This very dramatic result was recently questioned.<sup>135</sup>

Although the mechanism of  $\beta$ -blockers is likely multifactorial, a probable major effect is reduction of postoperative asymptomatic ischemia and resultant long-term morbidity. Although this may not affect immediate PCC,<sup>131,136</sup> it reduces long-term PCC for up to 2 years<sup>9</sup> (see Physiology of Perioperative Cardiac Morbidity above).  $\beta$ -Blockers also reduce the likelihood of fibrillation with ischemia. Esmolol reduces anesthetic requirements.<sup>137,138</sup>

Who should get perioperative  $\beta$ -blockers is not well defined. There is recent evidence that low-risk patients do not benefit.<sup>133</sup> The Dutch Echocardiographic Cardiac Risk Evaluation Applying Stress Echocardiography Group's analysis of 45 patients with PCCs suggests that only patients with at least 1 risk

factor benefit from addition of  $\beta$ -blockers. As all of the patients in this study were vascular patients, this equates to a threshold for treatment of 2 risk factors. Because there are side effects that might not be fully monitored after discharge,  $\beta$ -blockers should be reserved for cases when 2 of the risk factors are present and there are no contraindications.<sup>139</sup> An exception would be uncontrolled hypertension, which in and of itself may warrant initiation of  $\beta$ -blockers.

Asthma and COPD are not contraindications to initiation of cardioselective  $\beta$ -blockade unless the patient is having an acute attack.<sup>140,141</sup> Diabetics benefit from  $\beta$ -blockers,<sup>142</sup> although other cardiac medications may be preferable.<sup>48,143</sup>

Bradycardia is a relative contraindication. The ACC/AHA guidelines actually recommend titration of  $\beta$ -blockers to achieve a heart rate of 50–60 beats per minute.<sup>42</sup>

The  $\beta$ -blocker should not be one with intrinsic sympathomimetic activity. Atenolol,<sup>131</sup> bisoprolol,<sup>31</sup> and metoprolol<sup>144</sup> have proven beneficial in studies. Preliminary animal studies show that metoprolol does not interfere with preconditioning<sup>145</sup> but that atenolol and propranolol do.<sup>146</sup> Lanfear's study of the benefit of  $\beta$ -blockers after acute coronary syndromes shows that not all genotypes respond equally well.<sup>89</sup>

TABLE 7-7.

Summary of Perioperative  $\beta$ -Blocker Studies

Source, y	Study Population and Eligibility	$\beta$ -Blocker Regimen	Target Heart Rate	Findings (Postoperative Ischemia/Other)	Number Needed to Treat	Adverse Events <sup>†</sup>	Comments
Mangano et al, 1996; Wallace et al, 1998	200 patients undergoing elective noncardiac surgery according to several clinical criteria (see Box 1)	Atenolol, 5–10 mg intravenously 30 min before and after surgery and 50–100 mg/d by mouth throughout the hospital stay (up to 7 days)	55–65/min (doses held if rate <55/min or systolic blood pressure <100 mm HG or if there was a defined adverse event)	No difference in in-hospital cardiac or mortality outcomes. All-cause mortality at 2 years: 9% vs 21% ( $P = .02$ ); cardiac death at 2 years: 4% vs 12% ( $P = .03$ ); postoperative ischemia: 24% vs 39% ( $P = .03$ )	All-cause mortality at 2 years, 8.3; ischemia, 6.7	Intraoperative bradycardia more common with atenolol (38% vs 15%; $P < .001$ ) but no difference in need for treatment. No increase in third-degree heart block, hypotension, bronchospasm, or congestive heart failure	Included patients taking $\beta$ -blockers long-term, most of whom (19% vs 8%) were in the $\beta$ -blocker group
Poldermans et al, 1999	112 patients with positive test results on dobutamine echocardiography and undergoing elective abdominal aortic or infringuinal arterial reconstruction	Bisoprolol, 5–10 mg/d by mouth begun an average of 37 days preoperatively and continued for 30 days postoperatively	Intravenous metoprolol to target heart rate if patient not taking by mouth perioperatively; doses held if heart rate <50/min or systolic blood pressure <100 mmHg	Reduced incidence of perioperative cardiac death and nonfatal MI. Cardiac death: 3.4% vs 17% ( $P = .02$ ); nonfatal MI: 0% vs 17% ( $P < .001$ )	Cardiac death or nonfatal MI, 3.2	No exacerbation of peripheral vascular disease	Excluded patients taking $\beta$ -blockers long-term
Raby et al, 1999	26 patients with preoperative ischemia by Holter monitor and undergoing aortic aneurysm repair, infringuinal endarterectomy	Esmolol, intravenous for 48 hours postoperatively	Titrate to heart rate 20% below ischemic threshold but no less than 60/min	Postoperative myocardial ischemia: 33% vs 73% ( $P < .05$ )	2.5	No patient had $\beta$ -blocker therapy suspended because of unacceptable adverse events	Physicians prescribe postoperative $\beta$ -blockers more often in control groups (82% vs 13%; $P < .05$ ) (continued)



TABLE 7-7.

Summary of Perioperative  $\beta$ -Blocker Studies (continued)

Source, y	Study Population and Eligibility	$\beta$ -Blocker Regimen	Target Heart Rate	Findings (Postoperative Ischemia/Other)	Number Needed to Treat	Adverse Events <sup>†</sup>	Comments
Stone et al, 1988	128 untreated hypertensive (systolic blood pressure, 160–200 mm Hg; diastolic, 90–100 mm Hg) patients undergoing elective surgery	Labetalol, atenolol, oxprenolol; patients randomized to control, labetalol (100 mg by mouth), atenolol (50 mg by mouth), or oxprenolol (20 mg by mouth) given before induction of anesthesia	None described	Postoperative MI: 2/89 (2%) vs 11/39 (28%) untreated ( $P < .001$ )	3.8	21 patients taking $\beta$ -blockers had bradycardia and half required atropine; no bradycardia in control patients	Patients had similar baseline characteristics, but these were not statistically compared. No description of surgeries performed
Urban et al, 2000	120 patients undergoing elective knee arthroplasty according to the criteria of Mangano et al	Esmolol intravenously within 1 hour after surgery; change to metoprolol the morning of the first postoperative day	<80/min (esmolol); <80/min for 48 hours postoperatively and then continue dose until discharge (metoprolol)	Postoperative ischemia: 6% vs 15% (NS); postoperative MI: 2% vs 6% (NS)	Not calculated	None noted	Included patients with long-term $\beta$ -blocker use (30% in each treatment arm)

MI indicated myocardial infarction; NS, not significant.  
<sup>†</sup>All comparisons are presented as  $\beta$ -blocker vs control.  
 Auerbach AD, Goldman L. Beta-blockers and reduction of cardiac events in noncardiac surgery: scientific review. JAMA 2002;287(11):1435–1444. Copyright 2002, American Medical Association. All rights reserved.<sup>133</sup>

There are no studies comparing the different timing of perioperative  $\beta$ -blocker usage. Generally, the rule of thumb is the sooner the better, so as to allow titration to maximum effect without side effects. It is very important that  $\beta$ -blockers not be discontinued postoperatively.<sup>147,148</sup> Chronic  $\beta$ -blocker use does not seem to provide the same benefit as acute perioperative use.<sup>148</sup>

Perioperative  $\beta$ -blockers have perhaps not turned out to be quite as wonderful as initially believed, but are clearly beneficial. Like all medications, there is a risk-to-benefit ratio that requires some selectivity.

### Statins

Inhibitors of the 3-hydroxy-3-methylglutaryl coenzyme A (statins) may reduce perioperative mortality partly through the improvement of lipid profile, but also through the stabilization of coronary plaques, improvement in endothelial function, and anti-inflammatory effects (pleomorphic effects). The Heart Protection Study has shown that even at-risk patients with normal low-density lipoprotein (LDL) benefit from simvastatin.<sup>149</sup> Poldermans' group did a case analysis of 160 vascular surgery patients who died in hospital postoperatively. They were each matched to 2 controls who had similar surgery in the same time period. Statin therapy was significantly less common in cases than in controls (8% vs. 25%;  $P = 0.001$ ).<sup>150</sup>

Pan undertook a study of 1663 patients undergoing primary CABG surgery with cardiopulmonary bypass. Patients were classified into a group receiving statin therapy at the time of operation ( $n = 943$ ) and a group who were not receiving statin therapy ( $n = 720$ ). Multivariate logistic regression analysis demonstrated that preoperative statin therapy was independently associated with a reduction in all-cause mortality. There was, however, no reduced risk of postoperative MI, cardiac arrhythmias, stroke, or renal dysfunction. An independently associated reduction in the composite end point of 30-day all-cause mortality and stroke (7.1% vs. 4.6%;  $P = 0.05$ ) was found only when the cohort was matched for propensity (presence of CAD or risk factors for CAD).

Lindenhauer retrospectively studied 780,591 patients who underwent a variety of noncardiac surgical proce-

dures, of which fewer than 10% were vascular cases. Of the studied patients, 77,082 received lipid-lowering agents, which included statins in 70,145 (91%) of these patients. Using propensity-matched groups and conditional logistic regression, they showed that treated patients had a risk of mortality with an adjusted odds ratio of 0.62 (95% CI, 0.58–0.67). The lowest quintile of risk did not benefit from lipid-lowering therapy.<sup>151</sup>

Durazzo randomized 100 patients to receive either 20 mg atorvastatin or placebo at least 2 weeks before vascular surgery, and continuing for 45 days. The occurrence of a 6-month composite of PCCs was analyzed in a double-blind fashion. During the 6-month followup, primary end points occurred in 17 patients—4 in the atorvastatin group and 13 in the placebo group. The Kaplan-Meier graph shown in Figure 7–10 displays event-free survival after vascular surgery.

The Anglo-Scandinavian Cardiac Outcomes Trial–Lipid-Lowering Arm (ASCOT-LLA)<sup>152</sup> showed significant reduction in adverse cardiac end points at the first analysis 1 month after randomization. Statins may improve endothelial function in as little as 3 days.<sup>153</sup> Given the proven risk reduction even in asymptomatic nonsurgical patients,<sup>149</sup> there is enthusiasm that statins will prove equal to  $\beta$ -blockers as a simple, safe, and effective intervention to reduce PCCs. The ben-

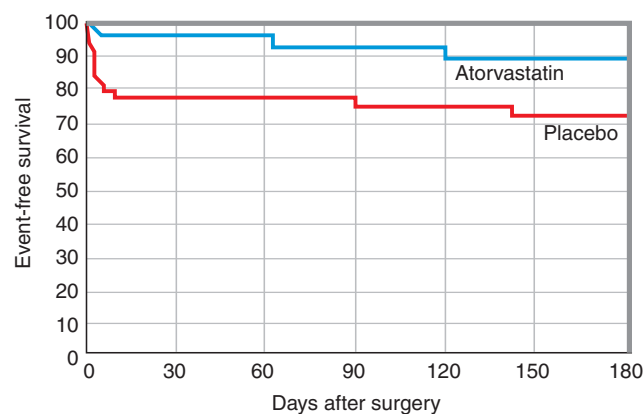
efits of statins and  $\beta$ -blockers are probably additive in high-risk patients.<sup>154</sup>

### Angiotensin-Converting Enzyme Inhibitors/Angiotensin Receptor Blockers

$\beta$ -Blockers and diuretics have been recommended as first-line treatment for hypertension, but evidence is building that other classes of medication are at least as efficacious. The Anglo-Scandinavian Cardiac Outcomes Trial–Blood Pressure Lowering Arm (ASCOT-BPLA) showed that an antihypertensive regimen based on a calcium channel blocker (CCB) and an angiotensin-converting enzyme inhibitor (ACEI) results in less adverse cardiovascular end points than a regimen based on atenolol and a diuretic.<sup>143,155</sup> The effects cannot all be attributed to blood pressure reduction alone.<sup>143</sup>

A angiotensin receptor blockers (ARBs) decrease cardiac end points in patents with normal cholesterol by 35% in 3 years.<sup>156</sup> Losartan was shown to produce superior reduction in adverse cardiac end points when compared to atenolol, even though blood pressure reduction was similar.<sup>155</sup>

Whether or not ACEIs or ARBs should be discontinued preoperatively is unclear. A recent retrospective study of 267 hypertensives by Comfere supports the clinical suspicion that moderate hypotension during anesthesia is more common if ACEIs and ARBs are not stopped, but that it is usually easily



**FIGURE 7–10.** Event-free survival after vascular surgery—with and without statin. Event-free survival in the 6 months after vascular surgery, according to study group. Outcome measures included death from cardiac causes, nonfatal acute myocardial infarction, ischemic stroke, and unstable angina. Rate of event-free survival at 6 months (180 days) was 91.4% in the atorvastatin group and 73.5% in the placebo group ( $P = .018$ ). Reprinted from Durazzo A, Machado F, Ikeoka D, Caramelli B. Reduction in cardiovascular events after vascular surgery with atorvastatin: a randomized trial. *J Vasc Surg* 2004;39:967–976, with permission from Society for Vascular Surgery.<sup>183</sup>

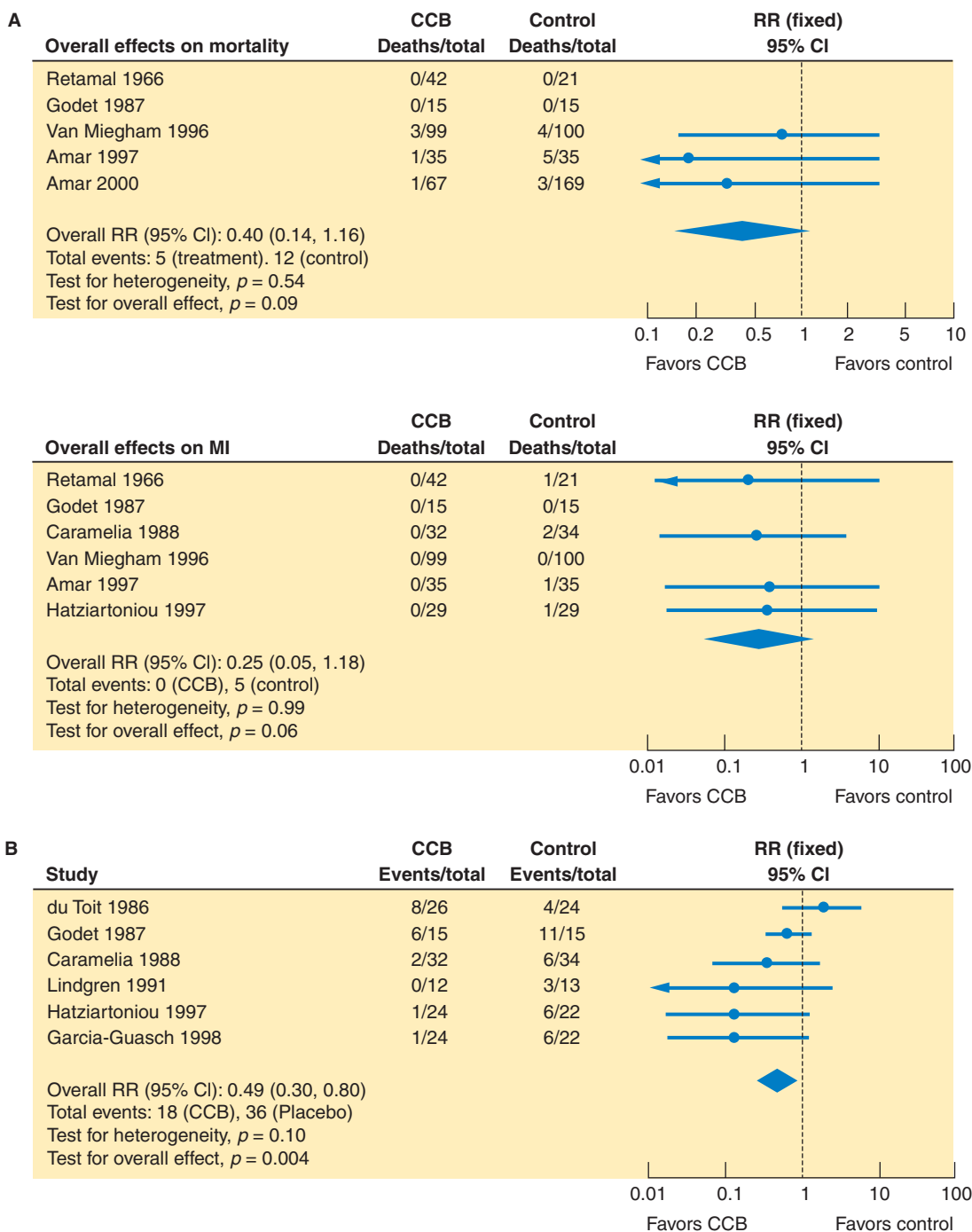
managed.<sup>157</sup> That study did not show an increase in the incidence of severe hypotension, although other studies have.<sup>158,159</sup> Angiotensin is important for reversal of hypotension in volume-depleted states, especially during general or epidural anesthesia.<sup>160</sup> It may

be advisable to stop ACEIs and ARBs the night before an operation where the risk of volume depletion is high.<sup>158</sup>

### Calcium Channel Blockers

Even normotensive patients with CAD benefit from calcium channel

blockers.<sup>161</sup> This reduction was similar to enalapril, but was not compared to  $\beta$ -blockers. A meta-analysis by Wijeyesundera and Beattie showed that calcium channel blockers, mostly diltiazem, significantly reduced PCCs<sup>162</sup> (Fig. 7-11).



**FIGURE 7-11.** Effect of calcium channel blockers on mortality and myocardial infarction. **A:** Effect of calcium channel blockers (CCBs) on mortality (above) and myocardial infarction (MI) (below), with a combined analysis of these results. Circles represent point estimates. The area of a circle correlates with its contribution towards the weighted summary estimate. Horizontal lines denote 95% confidence intervals (CI), some of which extend beyond the limits of the scale. The diamonds represent overall summary estimates. **B:** Effect of CCBs on myocardial ischemia, with a combined analysis of these results. Circles represent point estimates. The area of a circle correlates with its contribution towards the weighted summary estimate. Horizontal lines denote 95% confidence intervals, some of which extend beyond the limits of the scale. The diamonds represent overall summary estimate. RR, relative risk. Reproduced with permission from Wijeyesundera D, and Beattie S.<sup>162</sup>

### Diuretics

Whether or not to discontinue diuretics should be determined on a case-by-case basis. The benefit of holding them is a reduction in the dehydration induced by preoperative fluid restrictions. Sometimes intravenous access is made more difficult with diuresis. The danger of holding diuretics is the potential loss of control in patients with heart failure or hypertension.

### Clonidine

Clonidine is an old drug with several beneficial perioperative effects. A recent meta-analysis by Nishina showed reduction of preoperative ischemia with the use of clonidine without an increase in bradycardia<sup>163</sup> (Fig. 7-12). Most of these studies are of CABG patients. Wijeyesundera's meta-analysis of various types of surgery showed benefit in cardiac and vascular surgery, but not in nonvascular surgery.<sup>164</sup> A recent prospective trial by Wallace that included nonvascular surgery did show positive benefits<sup>165</sup> (Fig. 7-13).

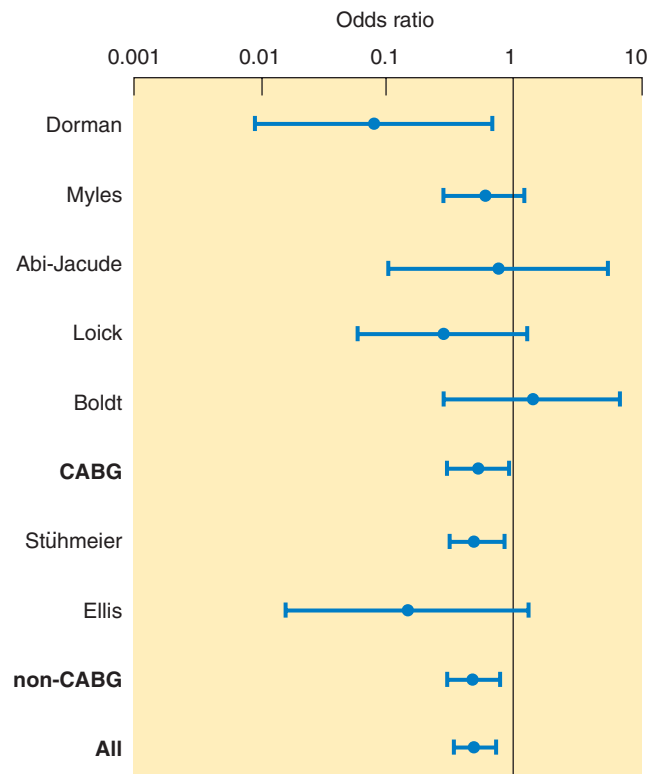
Oliver showed that the absolute risk of cardiac death among vascular surgery patients randomized to placebo was 4%, and mivazerol reduced this to 1.3%, an absolute risk reduction of 2.7%. However, the number needed to treat is 37. Mivazerol is not currently available in the United States. Clonidine may be a good alternative for those patients for whom  $\beta$ -blockers are not indicated.<sup>132</sup>

### Nitroglycerin

Dodd's small prospective study did not show any benefit to preoperative nitroglycerin.<sup>166</sup> Sear's small case control study suggested slightly increased risk.<sup>136</sup> There are no randomized studies of postoperative benefit of preoperative nitroglycerin.

### Antiplatelet and Anticoagulant Agents

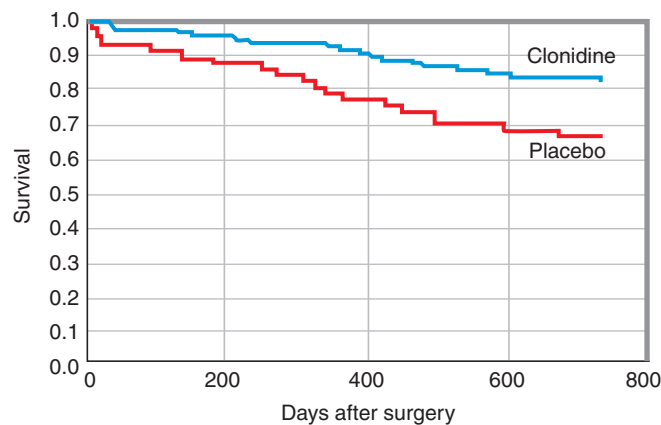
Balancing aspirin's cardioprotective effects in the procoagulant milieu of perioperative stress, against the increased risk of surgical bleeding must be done on a case-by-case basis. Generally, aspirin should be stopped 5 days before an operation and clopidogrel should be stopped 7 days before an operation. In vascular surgery cases, aspirin is generally continued throughout the perioperative period. In some cases, continuation of both aspirin and clopidogrel may be the



**FIGURE 7-12.** Pooled odds of myocardial ischemia in patients receiving perioperative clonidine. The subgroup analysis is based on surgery. The odds ratios are plotted on the X-axis on a logarithmic scale. *Solid circles* indicate the odds ratio of each study and *horizontal lines* show the 95% confidence interval of each study. CABG, coronary artery bypass grafting. Reproduced with permission from Nishina K, Mikawa K, Uesugi T, et al.<sup>163</sup>

best balance of risks. Tuman showed that aspirin use did not increase the need for transfusion in redo CABG,<sup>167</sup> and Anekstein showed that femur fracture repair on patients taking aspirin resulted in the transfusion of an average of 0.5 more units of blood.<sup>168</sup> This is a small increase in risk compared to the benefit.

Patients on anticoagulants because of valvular heart disease and prosthetic valves likewise require a balancing of the risk of bleeding from continued anticoagulation versus the increased risk of thromboembolism resulting from a cessation of therapy. For patients with a bileaflet mechanical valve and no other risk factors, war-



**FIGURE 7-13.** Postoperative survival—clonidine versus placebo. Survival for clonidine-treated versus placebo-treated patients. Survival curves for 2 years after surgery for patients treated with clonidine ( $n = 125$ ) and placebo ( $n = 65$ ). Clonidine reduced the incidence of death ( $P = 0.01$  by long-rank test and  $P = 0.01$  by Wilcoxon test). Reproduced with permission from Wallace AW, Galindez D, Salahieh A, et al.<sup>165</sup>



farin should be discontinued 2–3 days before the procedure so that the international normalized ratio (INR) is less than 1.5 at the time of operation, and restarted within 24 hours of the procedure.<sup>169,170</sup> Because the evidence defining the perioperative management of anticoagulation in this patient population is so sparse, the specifics of cessation or bridging with heparin of a patient with any of the risk factors in Table 7–8 must be individualized.<sup>171</sup> A rough guideline is that a patient with 2 risk factors should have therapeutic doses of intravenous heparin started when the INR has been allowed to fall below 2.0 (typically 48 hours before surgery). Heparin should be adjusted to maintain the activated partial thromboplastin time at 55–70 seconds, stopped 4–6 hours before the procedure, restarted as early after the operation as possible, and continued until the INR is therapeutic on warfarin.<sup>170</sup> Although there are some concerns over the use of low-molecular-weight heparin for bridging,<sup>172</sup> especially in patients with mechanical valves,<sup>173</sup> this is an attractive option.

### Glucose Control/Insulin

Metformin has traditionally been stopped up to 1 week preoperatively because of fear of metabolic acidosis and renal insult. A recent Cochrane analysis revealed no cases of fatal or nonfatal lactic acidosis in 35,619 patient-years of metformin use.<sup>174</sup> Metformin is proving to be valuable in improving endothelial function.<sup>175</sup> Stopping it preoperatively may turn out to be a counterproductive measure.

Ideally, no patient should proceed to an elective operation without stable glucose control. Although there is strong evidence that perioperative hyperglycemia increases risk of surgical wound infections in cardiac surgery, and fairly good evidence that hyperglycemia increases overall risk of CAD,<sup>176</sup> evidence that tight perioperative glucose control changes perioperative outcome is elusive.<sup>177</sup>

Van den Berghe's study on intensive insulin therapy in the intensive care unit showed that a history of diabetes or hyperglycemia at the time of admission did not affect measures of morbidity.<sup>178</sup>

### Antibiotics

Clinicians should refer to established guidelines for the use of preoperative antibiotics to prevent surgical infections<sup>179</sup> and to prevent endocar-

TABLE 7–8.

### Risk Factors for Thrombotic Complications

Atrial fibrillation  
 Previous thromboembolism  
 Hypercoagulable state  
 Older-generation mechanical valves (e.g., Bjork-Shiley)  
 Left ventricular ejection fraction <30%  
 More than 1 mechanical valve  
 Any mitral valve replacement

ditis.<sup>180</sup> Effective prophylaxis against surgical infections requires that the antibiotic be administered within the hour before incision. Antibiotics for endocarditis prophylaxis are often overused, and should be given only when indicated.

### Smoking Cessation

Smoking is one of the strongest modifiable risk factors for cardiovascular disease. Whether the stress of smoking cessation outweighs the short-term benefits of preoperative cessation is unclear. Warner showed that it took more than 6 months to see a benefit from preoperative smoking cessation. There was actually an increase in pulmonary complications during the first 2 months.<sup>181</sup> Moller studied 120 joint replacement patients who were randomized to either a 6-week preoperative smoking cessation program that included weekly meetings and free nicotine replacement medication or to standard care. The overall complication rate was 18% in the smoking intervention group and 52% in controls ( $P = 0.0003$ ). Wound-related complication rate was 5% in the intervention group and 31% in the controls ( $P = 0.001$ ). There were no cardiovascular complications in the intervention group and 10% in the controls ( $P = 0.08$ ).

It is likely that smoking cessation programs would pay for themselves in the savings from reduced postoperative complications, to say nothing of the long-term benefits of smoking cessation.

There are a number of risk-reducing interventions that can be implemented preoperatively in a relatively easy fashion. If anesthesiologists are serious about being perioperative physicians, participation in these well-established practices of medicine will be important.

## CONCLUSION

The perioperative plan can often be made on the basis of good interviewing and examination skills. Specialized tests should only be applied as needed to refine management decisions. Perioperative management now entails more than just identifying high-risk patients and referring them back to other specialists. It is possible for the anesthesiologist to actually reduce perioperative risk through relatively simple medical interventions. The extent and timing of interventions can be tailored to each patient according to specific perioperative risks. Anesthesiologists are well positioned to efficiently reduce perioperative risk and institute simple forms of secondary disease management.

## KEY REFERENCES

1. Auerbach AD, Goldman L. Beta-blockers and reduction of cardiac events in noncardiac surgery: scientific review. *JAMA* 2002;287(11):1435–1444.
2. Boersma E, Poldermans D, Bax JJ, et al. Predictors of cardiac events after major vascular surgery: role of clinical characteristics, dobutamine echocardiography, and beta-blocker therapy. *JAMA* 2001;285(14):1865–1873.
3. Chassot P, Delabays A, Spahn D. Preoperative evaluation of patients with or at risk of coronary artery disease undergoing non-cardiac surgery. *Br J Anaesth* 2002;89:747–759.
4. Devereaux PJ, Beattie WS, Choi PT-L, et al. How strong is the evidence for the use of perioperative beta blockers in non-cardiac surgery? Systematic review and meta-analysis of randomised controlled trials. *BMJ* 2005;1–9.
5. Devereaux PJ, Goldman L, Cook D, Gilbert K, Leslie K, Guyatt G. Perioperative cardiac events in patients undergoing noncardiac surgery: a review of the magnitude of the problem, the pathophysiology of the events and methods to estimate and communicate risk. *CMAJ* 2005;173:627–634.

6. Eagle KA, Berger PB, Calkins H, et al. ACC/AHA guideline update for perioperative cardiovascular evaluation for noncardiac surgery—executive summary. A report of the American College of Cardiology/American Heart Association Task Force on Practice Guidelines (Committee to Update the 1996 Guidelines on Perioperative Cardiovascular Evaluation for Noncardiac Surgery). *Anesth Analg* 2002;94(5):1052–1064.

7. Grines CL, Bonow RO, Casey DE, et al. Prevention of premature discontinuation of dual antiplatelet therapy in patients with coronary artery stents. *Circulation* 2007;115:813–818.

8. Howell SJ, Sear JW, Foex P. Hypertension, hypertensive heart disease and perioperative cardiac risk. *Br J Anaesth* 2004;92(4):570–583.

9. Landesberg G. The pathophysiology of perioperative myocardial infarction: facts and perspectives. *J Cardiothorac Vasc Anesth* 2003;17(1):90–100.

10. Lindenauer PK, Pekow P, Wang K, Gutierrez B, Benjamin EM. Lipid-lowering therapy and in-hospital mortality following major noncardiac surgery. *JAMA* 2004;291(17):2092–2099.

11. Wallace AW, Galindez D, Salahieh A, et al. Effect of clonidine on cardiovascular morbidity and mortality after noncardiac surgery. *Anesthesiology* 2004;101(2):284–293.

ity in men undergoing noncardiac surgery. The Study of Perioperative Ischemia Research Group. *N Engl J Med* 1990;323(26):1781–1788.

5. Badner NH, Knill RL, Brown JE, Novick TV, Gelb AW. Myocardial infarction after noncardiac surgery. *Anesthesiology* 1998;88(3):572–578.

6. Fleischmann KE, Goldman L, Young B, Lee TH. Association between cardiac and noncardiac complications in patients undergoing noncardiac surgery: outcomes and effects on length of stay. *Am J Med* 2003;115(7):515–520.

7. Bartels C, Bechtel JFM, Hossmann V, Horsch S. Cardiac risk stratification for high-risk vascular surgery. *Circulation* 1997;95(11):2473–2475.

8. Lopez-Jimenez F, Goldman L, Sacks DB, et al. Prognostic value of cardiac troponin T after noncardiac surgery: 6-month follow-up data. *J Am Coll Cardiol* 1997;29(6):1241–1245.

9. Wallace A, Layug B, Tateo I, et al. Prophylactic atenolol reduces postoperative myocardial ischemia. *Anesthesiology* 1998;88:7–17.

10. Le Manach Y, Perel A, Coriat P, Godet G, Bertrand M, Riou B. Early and delayed myocardial infarction after abdominal aortic surgery. *Anesthesiology* 2005;102(5):885–891.

11. Glagov S, Weisenberg E, Zarins CK, Stankunavicius R, Kolettis GJ. Compensatory enlargement of human atherosclerotic coronary arteries. *N Engl J Med* 1987;316(22):1371–1375.

12. Fishbein MC, Siegel RJ. How big are coronary atherosclerotic plaques that rupture? *Circulation* 1996;94(10):2662–2666.

13. Ellis SG, Hertzner NR, Young JR, Brener S. Angiographic correlates of cardiac death and myocardial infarction complicating major nonthoracic vascular surgery. *Am J Cardiol* 1996;77(12):1126.

14. Cohen M, Aretz T. Histological analysis of coronary artery lesions in fatal postoperative myocardial infarction. *Cardiovasc Pathol* 1999;8:133–139.

15. Dawood M, Gutpa D, Southern J, Walia A, Atkinson J, Eagle K. Pathology of fatal perioperative myocardial infarction: implications regarding pathophysiology and prevention. *Int J Cardiol* 1996;57:37–44.

16. McCrath DJ, Cerboni E, Frumento RJ, Hirsh AL, Bennett-Guerrero E. Thromboelastography maximum amplitude predicts postoperative thrombotic complications including myocardial infarction. *Anesth Analg* 2005;100(6):1576–1583.

17. Donahue BS. The response to activated protein C after cardiopulmonary bypass: impact of factor V Leiden. *Anesth Analg* 2004;99(6):1598–1603.

18. Biasucci LM. CDC/AHA workshop on markers of inflammation and cardiovascular disease: application to clinical and public health practice: clinical use of inflammatory markers in patients with

cardiovascular diseases: a background paper. *Circulation* 2004;110(25):e560–e567.

19. Breslow MJ, Jordan DA, Christopherson R, et al. Epidural morphine decreases postoperative hypertension by attenuating sympathetic nervous system hyperactivity. *JAMA* 1989;261(24):3577–3581.

20. Raby KE, Brull SJ, Timimi F, et al. The effect of heart rate control on myocardial ischemia among high-risk patients after vascular surgery. *Anesth Analg* 1999;88(3):477–482.

21. Zaugg M, Schaub M. Myocardial injury and its prevention in the perioperative setting. *Br J Anaesth* 2004;93:21–33.

22. McCann RL, Clements FM. Silent myocardial ischemia in patients undergoing peripheral vascular surgery: incidence and association with perioperative cardiac morbidity and mortality. *J Vasc Surg* 1989;9(4):583–587.

23. Landesberg G, Mosseri M, Zahger D, et al. Myocardial infarction after vascular surgery: the role of prolonged stress-induced, ST depression-type ischemia. *J Am Coll Cardiol* 2001;37(7):1839–1845.

24. Landesberg G. The pathophysiology of perioperative myocardial infarction: facts and perspectives. *J Cardiothorac Vasc Anesth* 2003;17(1):90–100.

25. Older P, Hall A, Hader R. Cardiopulmonary exercise testing as a screening test for perioperative management of major surgery in the elderly. *Chest* 1999;116(2):355–362.

26. Howell SJ, Sear JW. Perioperative myocardial injury: individual and population implications. *Br J Anaesth* 2004;93(1):3–8.

27. Burke AP, Kolodgie FD, Farb A, et al. Healed plaque ruptures and sudden coronary death: evidence that subclinical rupture has a role in plaque progression. *Circulation* 2001;103(7):934–940.

28. Fujii K, Kobayashi Y, Mintz G, Takebayashi H, Dangas G, Moussa I. Intravascular ultrasound assessment of ulcerated ruptured plaques: a comparison of culprit and nonculprit lesions of patients with acute coronary syndromes and lesions in patients without acute coronary syndromes. *Circulation* 2003;103:2473–2478.

29. Bennett-Guerrero E, Welsby I, Dunn TJ, et al. The use of a postoperative morbidity survey to evaluate patients with prolonged hospitalization after routine, moderate-risk, elective surgery. *Anesth Analg* 1999;89(2):514–519.

30. Ashton CM, Petersen NJ, Wray NP, et al. The incidence of perioperative myocardial infarction in men undergoing noncardiac surgery. *Ann Intern Med* 1993;118(7):504–510.

31. Poldermans D, Boersma E, Bax JJ, et al. The effect of bisoprolol on perioperative mortality and myocardial infarction in high-risk patients undergoing vascular surgery. *N Engl J Med* 1999;341(24):1789–1794.

32. Eagle KA, Rihal CS, Mickel MC, et al. Cardiac risk of noncardiac surgery. Influ-

## REFERENCES

1. Grayburn PA, Hillis LD. Cardiac events in patients undergoing noncardiac surgery: shifting the paradigm from noninvasive risk stratification to therapy. *Ann Intern Med* 2003;138(6):506–511.

2. Mangano DT. Perioperative medicine: NHLBI working group deliberations and recommendations. *J Cardiothorac Vasc Anesth* 2004;18(1):1.

3. Kaplan E, Sheiner L, Boeckmann A, et al. The usefulness of preoperative laboratory screening. *JAMA* 1985;253:3576–3581.

4. Mangano DT, Browner WS, Hollenberg M, London MJ, Tubau JF, Tateo IM. Association of perioperative myocardial ischemia with cardiac morbidity and mortal-

- ence of coronary disease and type of surgery in 3368 operations. *Circulation* 1997;96(6):1882-1887.
33. Lie SA, Engesaeter LB, Havelin LI, Furnes O, Vollset SE. Early postoperative mortality after 67,548, total hip replacements: causes of death and thromboprophylaxis in 68 hospitals in Norway from 1987 to 1999. *Acta Orthop Scand* 2002;73(4):392-399.
  34. Myocardial infarction redefined—a consensus document of The Joint European Society of Cardiology/American College of Cardiology Committee for the Redefinition of Myocardial Infarction. *J Am Coll Cardiol* 2000;36(3):959-969.
  35. Beattie WS. Evidence-based perioperative risk reduction. *Can J Anaesth* 2005;52(Suppl 1):R5.
  36. Gance LG. Selective preoperative cardiac screening improves five-year survival in patients undergoing major vascular surgery: a cost-effectiveness analysis. *J Cardiothorac Vasc Anesth* 1999;13(3):265-271.
  37. Roghi A, Palmieri B, Crivellaro W, Sara R, Puttini M, Faletta F. Preoperative assessment of cardiac risk in noncardiac major vascular surgery. *Am J Cardiol* 1999;83(2):169.
  38. Gilbert K, Larocque BJ, Patrick LT. Prospective evaluation of cardiac risk indices for patients undergoing noncardiac surgery. *Ann Intern Med* 2000;133(5):356-359.
  39. L'Italien GJ, Paul SD, Hendel RC, et al. Development and validation of a Bayesian model for perioperative cardiac risk assessment in a cohort of 1,081 vascular surgical candidates. *J Am Coll Cardiol* 1996;27(4):779.
  40. Paul SD, Eagle KA, Kuntz KM, Young JR, Hertzner NR. Concordance of preoperative clinical risk with angiographic severity of coronary artery disease in patients undergoing vascular surgery. *Circulation* 1996;94(7):1561-1566.
  41. D'Agostino RB Sr, Grundy S, Sullivan LM, Wilson P, Group CHDRP. Validation of the Framingham coronary heart disease prediction scores: results of a multiple ethnic groups investigation [see comment]. *JAMA* 2001;286(2):180-187.
  42. Eagle KA, Berger PB, Calkins H, et al. ACC/AHA guideline update for perioperative cardiovascular evaluation for noncardiac surgery—executive summary. A report of the American College of Cardiology/American Heart Association Task Force on Practice Guidelines (Committee to Update the 1996, Guidelines on Perioperative Cardiovascular Evaluation for Noncardiac Surgery). *Anesth Analg* 2002;94(5):1052-1064.
  43. Van Belle E, Lablanche J-M, Bauters C, Renaud N, McFadden EP, Bertrand ME. Coronary angiographic findings in the infarct-related vessel within 1 month of acute myocardial infarction: natural history and the effect of thrombolysis. *Circulation* 1998;97(1):26-33.
  44. McFalls EO, Ward HB, Moritz TE, et al. Coronary-artery revascularization before elective major vascular surgery. *N Engl J Med* 2004;351(27):2795-2804.
  45. Chassot P, Delabays A, Spahn D. Preoperative evaluation of patients with or at risk of coronary artery disease undergoing non-cardiac surgery. *Br J Anaesth* 2002;89:747-759.
  46. Kaluza GL, Joseph J, Lee JR, Raizner ME, Raizner AE. Catastrophic outcomes of noncardiac surgery soon after coronary stenting [see comment]. *J Am Coll Cardiol* 2000;35(5):1288-1294.
  47. Posner KL, Van Norman GA, Chan V. Adverse cardiac outcomes after noncardiac surgery in patients with prior percutaneous transluminal coronary angioplasty. *Anesth Analg* 1999;89(3):553.
  - 47a. Grines CL, Bonow RO, Casey DE, et al. Prevention of premature discontinuation of dual antiplatelet therapy in patients with coronary artery stents. *Circulation* 2007;115:813-818
  48. Chobanian AV, Bakris GL, Black HR, et al. Seventh report of the Joint National Committee on Prevention, Detection, Evaluation, and Treatment of High Blood Pressure. *Hypertension* 2003;42(6):1206-1252.
  49. Gomez-Cerezo J, Rios Blanco JJ, Suarez Garcia I, et al. Noninvasive study of endothelial function in white coat hypertension. *Hypertension* 2002;40(3):304-309.
  50. Gustavsen PH, Hoegholm A, Bang LE, Kristensen KS. White-coat hypertension is a cardiovascular risk factor: a 10-year follow-up study. *J Hum Hypertens* 2003;17(12):811-817.
  51. Howell SJ, Sear JW, Foex P. Hypertension, hypertensive heart disease and perioperative cardiac risk. *Br J Anaesth* 2004;92(4):570-583.
  52. Landesberg G, Einav S, Christopherson R, et al. Perioperative ischemia and cardiac complications in major vascular surgery: importance of the preoperative twelve-lead electrocardiogram. *J Vasc Surg* 1997;26(4):570-578.
  53. Hollenberg M, Mangano DT, Browner WS, London MJ, Tubau JF, Tateo IM. Predictors of postoperative myocardial ischemia in patients undergoing noncardiac surgery. The Study of Perioperative Ischemia Research Group. *JAMA* 1992;268(2):205-209.
  54. Haffner SM, Lehto S, Ronnema T, Pyorala K, Laakso M. Mortality from coronary heart disease in subjects with type 2, diabetes and in nondiabetic subjects with and without prior myocardial infarction. *N Engl J Med* 1998;339(4):229-234.
  55. Roghi A, Palmieri B, Crivellaro W, Faletta F, Puttini M. Relationship of unrecognized myocardial infarction, diabetes mellitus and type of surgery to postoperative cardiac outcomes in vascular surgery. *Eur J Vasc Endovasc Surg* 2001;21(1):9-16.
  56. Lee TH, Marcantonio ER, Mangione CM, et al. Derivation and prospective validation of a simple index for prediction of cardiac risk of major noncardiac surgery. *Circulation* 1999;100(10):1043-1049.
  57. Subramaniam B, Pomposelli F, Talmor D, Park K. Perioperative and long-term morbidity and mortality after above-knee and below-knee amputations in diabetics and nondiabetics. *Anesth Analg* 2005;100:1241-1247.
  58. Hamdan AD, Saltzberg SS, Sheahan M, et al. Lack of association of diabetes with increased postoperative mortality and cardiac morbidity: results of 6565 major vascular operations. *Arch Surg* 2002;137(4):417-421.
  59. Axelrod D, Upchurch G, DeMonner S, Stanley JC, Khuri S, Hayward R. Perioperative cardiovascular risk stratification of patients with diabetes who undergo elective major vascular surgery. *J Vasc Surg* 2002;35:894-901.
  60. Dajani AS, Taubert KA, Wilson W, et al. Prevention of bacterial endocarditis. Recommendations by the American Heart Association [see comment]. *JAMA* 1997;277(22):1794-1801.
  61. Kertai MD, Bountioukos M, Boersma E, et al. Aortic stenosis: an underestimated risk factor for perioperative complications in patients undergoing noncardiac surgery. *Am J Med* 2004;116(1):8.
  62. Christ M, Sharkova Y, Geldner G, Maisch B. Preoperative and perioperative care for patients with suspected or established aortic stenosis facing noncardiac surgery. *Chest* 2005;128(4):2944-2953.
  63. Raymer K, Yang H. Patients with aortic stenosis: cardiac complications in non-cardiac surgery. *Can J Anaesth* 1998;45(9):855-859.
  64. Boersma E, Poldermans D, Bax JJ, et al. Predictors of cardiac events after major vascular surgery: role of clinical characteristics, dobutamine echocardiography, and beta-blocker therapy. *JAMA* 2001;285(14):1865-1873.
  65. Kertai MD, Boersma EP, Klein JM, van Urk HM, Poldermans DM. Optimizing the prediction of perioperative mortality in vascular surgery by using a customized probability model. *Arch Intern Med* 2005;165:898-904.
  66. Carson J, Duff A, Berlin J. Effect of anaemia and cardiovascular disease on surgical mortality and morbidity. *Lancet* 1996;348:1055-1060.
  67. Goodnough L, Shander A. Transfusion medicine: looking to the future. *Lancet* 2003;361:161-169.
  68. Goldman L, Caldera DL, Nussbaum SR, et al. Multifactorial index of cardiac risk in noncardiac surgical procedures. *N Engl J Med* 1977;297(16):845-850.
  69. Kumar R, McKinney WP, Raj G, et al. Adverse cardiac events after surgery: assessing risk in a veteran population. *J Gen Intern Med* 2001;16(8):507-518.
  70. Palda VA, Detsky AS. Perioperative assessment and management of risk from coronary artery disease. *Ann Intern Med* 1997;127(4):313-328.
  71. Ridker PM, Rifai N, Cook NR, Bradwin G, Buring JE. Non-HDL cholesterol, apolipoproteins A-I and B100, standard lipid measures, lipid ratios, and CRP as risk



- factors for cardiovascular disease in women. *JAMA* 2005;294(3):326–333.
72. Roberts W. CDC/AHA workshop on markers of inflammation and cardiovascular disease: application to clinical and public health practice: laboratory tests available to assess inflammation—performance and standardization: a background paper. *Circulation* 2004;110(25):e572–e576.
73. Cohn JN, Quyyumi AA, Hollenberg NK, Jamerson KA. Surrogate markers for cardiovascular disease functional markers. *Circulation* 2004;109(Suppl IV):IV-31–IV-46.
74. Nielsen OW, McDonagh TA, Robb SD, Dargie HJ. Retrospective analysis of the cost-effectiveness of using plasma brain natriuretic peptide in screening for left ventricular systolic dysfunction in the general population. *J Am Coll Cardiol* 2003;41(1):113–120.
75. Wulsin LR, Singal BM. Do depressive symptoms increase the risk for the onset of coronary disease? A systematic quantitative review. *Psychosom Med* 2003;65(2):201–210.
76. Barth J, Schumacher M, Herrmann-Lingen C. Depression as a risk factor for mortality in patients with coronary heart disease: a meta-analysis. *Psychosom Med* 2004;66(6):802–813.
77. Blumenthal JA, Lett HS, Babyak MA, et al. Depression as a risk factor for mortality after coronary artery bypass surgery. *Lancet* 2003;362(9384):604–609.
78. Iacoviello L, Burzotta F, Di Castelnuovo A, Zito F, Marchioli R, Donati MB. The 4G/5G polymorphism of PAI-1, promoter gene and the risk of myocardial infarction: a meta-analysis. *Thromb Haemost* 1998;80(6):1029–1030.
79. Kastrati A, Schomig A, Seyfarth M, et al. PLA polymorphism of platelet glycoprotein IIIa and risk of restenosis after coronary stent placement. *Circulation* 1999;99(8):1005.
80. Koch W, Bottiger C, Mehilli J, et al. Association of a CD18, gene polymorphism with a reduced risk of restenosis after coronary stenting. *Am J Cardiol* 2001;88(10):1120.
81. Bottiger C, Koch W, Lahn C, et al. 4G/5G polymorphism of the plasminogen activator inhibitor-1, gene and risk of restenosis after coronary artery stenting. *Am Heart J* 2003;146(5):855–861.
82. Rinder CS, Mathew JP, Rinder HM, et al. Platelet PLA2, polymorphism and platelet activation are associated with increased troponin I release after cardiopulmonary bypass [see comment]. *Anesthesiology* 2002;97(5):1118–1122.
83. Burzotta F, Iacoviello L, Di Castelnuovo A, et al. Relation of the -174, G/C polymorphism of interleukin-6, to interleukin-6, plasma levels and to length of hospitalization after surgical coronary revascularization. *Am J Cardiol* 2001;88(10):1125–1128.
84. Grocott HP, Newman MF, El-Moalem H, Bainbridge D, Butler A, Laskowitz DT. Apolipoprotein E genotype differentially influences the proinflammatory and anti-inflammatory response to cardiopulmonary bypass. *J Thorac Cardiovasc Surg* 2001;122(3):622–623.
85. Galley HF, Lowe PR, Carmichael RL, Webster NR. Genotype and interleukin-10, responses after cardiopulmonary bypass. *Br J Anaesth* 2003;91(3):424–426.
86. Tomasdottir H, Hjartarson H, Ricksten A, Wasslavik C, Bengtsson A, Ricksten S-E. Tumor necrosis factor gene polymorphism is associated with enhanced systemic inflammatory response and increased cardiopulmonary morbidity after cardiac surgery. *Anesth Analg* 2003;97(4):944–949.
87. Kim NS, Lee IO, Lee MK, Lim SH, Choi YS, Kong MH. The effects of beta2 adrenoceptor gene polymorphisms on pressor response during laryngoscopy and tracheal intubation. *Anaesthesia* 2002;57(3):227–232.
88. Johnson JA, Terra SG. Beta-adrenergic receptor polymorphisms: cardiovascular disease associations and pharmacogenetics. *Pharm Res* 2002;19(12):1779–1787.
89. Lanfear DE, Jones PG, Marsh S, Cresci S, McLeod HL, Spertus JA. Beta2-adrenergic receptor genotype and survival among patients receiving beta-blocker therapy after an acute coronary syndrome. *JAMA* 2005;294(12):1526–1533.
90. Ropper AH, Wechsler LR, Wilson LS. Carotid bruit and the risk of stroke in elective surgery. *N Engl J Med* 1982;307(22):1388–1390.
91. Rothwell PM, Goldstein LB. Carotid endarterectomy for asymptomatic carotid stenosis: asymptomatic carotid surgery trial. *Stroke* 2004;35(10):2425–2427.
92. Durand DJ, Perler BA, Roseborough GS, et al. Mandatory versus selective preoperative carotid screening: a retrospective analysis. *Ann Thorac Surg* 2004;78(1):159–166.
93. Paciaroni M, Caso V, Acciarresi M, Baumgartner RW, Agnelli G. Management of asymptomatic carotid stenosis in patients undergoing general and vascular surgical procedures. *J Neurol Neurosurg Psychiatry* 2005;76(10):1332–1336.
94. Naylor AR, Mehta Z, Rothwell PM, Bell PR. Carotid artery disease and stroke during coronary artery bypass: a critical review of the literature. *Eur J Vasc Endovasc Surg* 2002;23(4):283–294.
95. Nicolaidis AN, Kakkos SK, Griffin M, et al. Severity of asymptomatic carotid stenosis and risk of ipsilateral hemispheric ischaemic events: results from the ACSRS study. *European J Vasc Endovasc Surg* 2005;30(3):275.
96. Reilly DF, McNeely MJ, Doerner D, et al. Self-reported exercise tolerance and the risk of serious perioperative complications. *Arch Intern Med* 1999;159(18):2185–2192.
97. Hlatky M, Boineau R, Higginbotham M, et al. A brief self-administered questionnaire to determine functional capacity (The Duke Activity Status Index). *Am J Cardiol* 1989;64:651–654.
98. Girish M, Trayner E Jr, Dammann O, Pinto-Plata V, Celli B. Symptom-limited stair climbing as a predictor of postoperative cardiopulmonary complications after high-risk surgery. *Chest* 2001;120(4):1147–1151.
99. Chayet M, Pines A, Fisman EZ, Levo Y, Drory Y. Onset of intolerance symptoms during exercise testing is a reproducible threshold for evaluation of cardiac function. *Cardiology* 1993;83(3):183–189.
100. Biccard BM. Relationship between the inability to climb two flights of stairs and outcome after major non-cardiac surgery: implications for the pre-operative assessment of functional capacity. *Anaesthesia* 2005;60(6):588–593.
101. Olson RP, Stone A, Lubarsky D. The prevalence and significance of low preoperative hemoglobin in ASA 1, or 2, outpatient surgery candidates. *Anesth Analg* 2005;101(5):1337–1340.
102. Lindenaier P, Pekow P, Wang K, Marnidi D, Gutierrez B, Benjamin E. Perioperative beta-blocker therapy and mortality after major noncardiac surgery. *N Engl J Med* 2005;353:349–361.
103. Filipovic M, Jeger RV, Girard T, et al. Predictors of long-term mortality and cardiac events in patients with known or suspected coronary artery disease who survive major non-cardiac surgery. *Anaesthesia* 2005;60(1):5–11.
104. Anonymous. Guidelines for assessing and managing the perioperative risk from coronary artery disease associated with major noncardiac surgery. American College of Physicians. *Ann Intern Med* 1997;127(4):309–312.
105. Hecht H. Atherosclerotic risk factors revisited. *Am J Cardiol* 2004;93:73–75.
106. Kondos GT, Hoff JA, Sevrukov A, et al. Electron-beam tomography coronary artery calcium and cardiac events: a 37-month follow-up of 5635, initially asymptomatic low- to intermediate-risk adults. *Circulation* 2003;107(20):2571–2576.
107. Hoffmann MH, Shi H, Schmitz BL, et al. Noninvasive coronary angiography with multislice computed tomography. *JAMA* 2005;293(20):2471–2478.
108. Liu LL, Dzankic S, Leung JM. Preoperative electrocardiogram abnormalities do not predict postoperative cardiac complications in geriatric surgical patients. *J Am Geriatr Soc* 2002;50(7):1186–1191.
109. Quinones M, Greenberg B, Kopelen H, et al. Echocardiographic predictors of clinical outcome in patients with left ventricular dysfunction enrolled in the SOLVD registry and trials: significance of left ventricular hypertrophy. *J Am Coll Cardiol* 2000;35:1237–1244.
110. Tsuji H, Larson MG, Venditti FJ Jr, et al. Impact of reduced heart rate variability on risk for cardiac events. The Framingham Heart Study. *Circulation* 1996;94(11):2850–2855.
111. Laitio TT, Huikuri HV, Makikallio TH, et al. The breakdown of fractal heart rate



- dynamics predicts prolonged postoperative myocardial ischemia. *Anesth Analg* 2004; 98(5):1239–1244.
112. Gauss A, Rohm HJ, Schaufelen A, et al. Electrocardiographic exercise stress testing for cardiac risk assessment in patients undergoing noncardiac surgery. *Anesthesiology* 2001;94(1):38–46.
113. Kertai MD, Boersma E, Bax JJ, et al. A meta-analysis comparing the prognostic accuracy of six diagnostic tests for predicting perioperative cardiac risk in patients undergoing major vascular surgery. *Heart* 2003;89(11):1327–1334.
114. Beattie W, Abdelnaem E, Wijeyesundera D, Buckley D. A meta-analytic comparison of preoperative stress echocardiography and nuclear scintigraphy imaging. *Anesth Analg* 2006;102:8–16.
115. Weissman N, Levangie M, Guerrero J, Weyman A, Picard M. Effect of beta-blockade on dobutamine stress echocardiography. *Am Heart J* 1996;131:698–703.
116. Fuster V, Kim RJ. Frontiers in cardiovascular magnetic resonance. *Circulation* 2005;112(1):135–144.
117. Chan S, Mancini G, LKuramoto, Schulzer M, Frohlich J, Ignaszewski A. The prognostic importance of endothelial dysfunction and carotid atheroma burden in patients with coronary artery disease. *J Am Coll Cardiol* 2003;42:1037–1043.
118. Rinfred S, Goldman L, Polanczyk C, Cook E, Lee T. Value of immediate postoperative electrocardiogram to update risk stratification after major noncardiac surgery. *Am J Cardiol* 2004;94:1017–1022.
119. Bottiger BW, Motsch J, Teschendorf P, et al. Postoperative 12-lead ECG predicts peri-operative myocardial ischaemia associated with myocardial cell damage. *Anaesthesia* 2004;59(11):1083–1090.
120. Kim LJ, Martinez EA, Faraday N, et al. Cardiac troponin I predicts short-term mortality in vascular surgery patients [see comment]. *Circulation* 2002;106(18):2366–2371.
121. Landesberg G, Shatz V, Akopnik I, et al. Association of cardiac troponin, CK-MB, and postoperative myocardial ischemia with long-term survival after major vascular surgery. *J Am Coll Cardiol* 2003;42:1547–1554.
122. Foster ED, Davis KB, Carpenter JA, Abele S, Fray D. Risk of noncardiac operation in patients with defined coronary disease: the Coronary Artery Surgery Study (CASS) registry experience. *Ann Thorac Surg* 1986;41(1):42–50.
123. Davies RF, Goldberg AD, Forman S, et al. Asymptomatic Cardiac Ischemia Pilot (ACIP) study two-year follow-up: outcomes of patients randomized to initial strategies of medical therapy versus revascularization. *Circulation* 1997;95(8):2037–2043.
124. Mason JJ, Owens DK, Harris RA, Cooke JP, Hlatky MA. The role of coronary angiography and coronary revascularization before noncardiac vascular surgery. *JAMA* 1995;273(24):1919–1925.
125. Godet G, Arhangelschi I. Cardiac troponin I predicts short-term mortality in vascular surgery patients. *Circulation* 2003; 107(18):e125.
126. Stone JG, Foex P, Sear JW, Johnson LL, Khambatta HJ, Triner L. Myocardial ischemia in untreated hypertensive patients: effect of a single small oral dose of a beta-adrenergic blocking agent. *Anesthesiology* 1988;68(4):495–500.
127. Fleisher LA. Preoperative evaluation of the patient with hypertension. *JAMA* 2002;287(16):2043–2046.
128. Modena M, Bonetti L, Coppi F, Bursi F, Rossi R. Prognostic role of reversible endothelial dysfunction in hypertensive postmenopausal women. *J Am Coll Cardiol* 2002;40:505–510.
129. Gottlieb SS, McCarter RJ, Vogel RA. Effect of beta-blockade on mortality among high-risk and low-risk patients after myocardial infarction. *N Engl J Med* 1998; 339(8):489–497.
130. Heidenreich PA, Lee TT, Massie BM. Effect of beta-blockade on mortality in patients with heart failure: a meta-analysis of randomized clinical trials. *J Am Coll Cardiol* 1997;30(1):27–34.
131. Mangano DT, Layug EL, Wallace A, Tateo I, The Multicenter Study of Perioperative Ischemia Research Group. Effect of atenolol on mortality and cardiovascular morbidity after noncardiac surgery. *N Engl J Med* 1996;335(23):1713–1721.
132. Stevens R, Burri H, Trame M. Pharmacologic myocardial protection in patients undergoing noncardiac surgery: a quantitative systematic review. *Anesth Analg* 2003; 97:623–633.
133. Auerbach AD, Goldman L. Beta-blockers and reduction of cardiac events in noncardiac surgery: scientific review. *JAMA* 2002;287(11):1435–1444.
134. Fleisher LA. Con: beta-blockers should not be used in all patients undergoing vascular surgery. *J Cardiothorac Vasc Anesth* 1999;13(4):496.
135. Devereaux PJ, Beattie WS, Choi PT-L, et al. How strong is the evidence for the use of perioperative beta blockers in non-cardiac surgery? Systematic review and meta-analysis of randomised controlled trials. *BMJ* 2005;331(7512):313–321.
136. Sear JW, Howell SJ, Sear YM, Yeates D, Goldacre M, Foex P. Intercurrent drug therapy and perioperative cardiovascular mortality in elective and urgent/emergency surgical patients. *Br J Anaesth* 2001; 86(4):506–512.
137. Johansen JW, Schneider G, Windsor AM, Sebel PS. Esmolol potentiates reduction of minimum alveolar isoflurane concentration by alfentanil. *Anesth Analg* 1998;87(3):671–676.
138. Johansen JW, Flaishon R, Sebel PS. Esmolol reduces anesthetic requirement for skin incision during propofol/nitrous oxide/morphine anesthesia. *Anesthesiology* 1997;86(2):364–371.
139. Smetana GW, Cohn SL, Lawrence VA. Update in perioperative medicine. *Ann Intern Med* 2004;140(6):452–461.
140. Salpeter SR, Ormiston TM, Salpeter EE, Poole PJ, Cates CJ. Cardioselective beta-blockers for chronic obstructive pulmonary disease: a meta-analysis. *Respir Med* 2003;97(10):1094–1101.
141. Salpeter SR, Ormiston TM, Salpeter EE. Cardioselective beta-blockers in patients with reactive airway disease: a meta-analysis. *Ann Intern Med* 2002;137(9):715–725.
142. Deedwania PC, Giles TD, Klibaner M, et al. Efficacy, safety and tolerability of metoprolol CR/XL in patients with diabetes and chronic heart failure: experiences from MERIT-HF. *Am Heart J* 2005;149(1):159–167.
143. Poulter NR, Wedel H, Dahlof B, et al. Role of blood pressure and other variables in the differential cardiovascular event rates noted in the Anglo-Scandinavian Cardiac Outcomes Trial-Blood Pressure Lowering Arm (ASCOT-BPLA). *Lancet* 2005; 366(9489):907–913.
144. Juul AB, Wetterslev J, Kofoed-Enevoldsen A, et al. The Diabetic Postoperative Mortality and Morbidity (DIPOM) trial: rationale and design of a multicenter, randomized, placebo-controlled, clinical trial of metoprolol for patients with diabetes mellitus who are undergoing major noncardiac surgery. *Am Heart J* 2004; 147(4):677–683.
145. Wikstrom BG, Ronquist G, Waldenstrom A. No further improvement of ischaemic myocardial metabolism by combining preconditioning with beta-blockade: an in vivo experimental study in the pig heart using a microdialysis technique. *Acta Physiol Scand* 1997;159(1):23–32.
146. Frances C, Nazeyrollas P, Prevost A, et al. Role of beta 1- and beta 2-adrenoceptor subtypes in preconditioning against myocardial dysfunction after ischemia and reperfusion. *J Cardiovasc Pharmacol* 2003; 41(3):396–405.
147. Shammash JB, Trost JC, Gold JM, Berlin JA, Golden MA, Kimmel SE. Perioperative beta-blocker withdrawal and mortality in vascular surgical patients. *Am Heart J* 2001;141(1):148–153.
148. Giles JW, Sear JW, Foex P. Effect of chronic beta-blockade on peri-operative outcome in patients undergoing non-cardiac surgery: an analysis of observational and case control studies [see comment]. *Anaesthesia* 2004;59(6):574–583.
149. Group HPSC. MRC/BHF Heart Protection Study of cholesterol lowering with simvastatin in 20,536 high-risk individuals: a randomised placebo-controlled trial. *Lancet* 2002;360(9326):7–22.
150. Poldermans D, Bax JJ, Kertai MD, et al. Statins are associated with a reduced incidence of perioperative mortality in patients undergoing major noncardiac vascular surgery. *Circulation* 2003;107(14):1848–1851.

151. Lindenauer PK, Pekow P, Wang K, Gutierrez B, Benjamin EM. Lipid-lowering therapy and in-hospital mortality following major noncardiac surgery. *JAMA* 2004; 291(17):2092–2099.
152. Sever PS, Dahlof B, Poulter NR, et al. Prevention of coronary and stroke events with atorvastatin in hypertensive patients who have average or lower-than-average cholesterol concentrations, in the Anglo-Scandinavian Cardiac Outcomes Trial–Lipid Lowering Arm (ASCOT-LLA): a multicentre randomised controlled trial. *Lancet* 2003;361:1149.
153. Tsunekawa T, Hayashi T, Kano H, et al. Cerivastatin, a hydroxymethylglutaryl coenzyme A reductase inhibitor, improves endothelial function in elderly diabetic patients within 3 days. *Circulation* 2001; 104(4):376–379.
154. Kertai MD, Boersma E, Westerhout CM, et al. A combination of statins and beta-blockers is independently associated with a reduction in the incidence of perioperative mortality and nonfatal myocardial infarction in patients undergoing abdominal aortic aneurysm surgery. *European J Vasc Endovasc Surg* 2004;28(4):343.
155. Dahlöf B, Sever PS, Poulter NR, et al. Prevention of cardiovascular events with an antihypertensive regimen of amlodipine adding perindopril as required versus atenolol adding bendroflumethiazide as required, in the Anglo-Scandinavian Cardiac Outcomes Trial–Blood Pressure Lowering Arm (ASCOT-BPLA): a multicentre randomised controlled trial. *Lancet* 2005;366:895–906.
156. Sever PS, Poulter NR, Dahlof B, Wedel H. Different time course for prevention of coronary and stroke events by atorvastatin in the Anglo-Scandinavian Cardiac Outcomes Trial–Lipid-Lowering Arm (ASCOT-LLA). *Am J Cardiol* 2005;96(5 Suppl 1):39.
157. Comfere T, Sprung J, Kumar MM, et al. Angiotensin system inhibitors in a general surgical population. *Anesth Analg* 2005;100(3):636–644.
158. Bertrand M, Godet G, Meersschaert K, Brun L, Salcedo E, Coriat P. Should the angiotensin II antagonists be discontinued before surgery? *Anesth Analg* 2001;92(1):26–30.
159. Colson P, Saussine M, Seguin JR, Cuchet D, Chaptal PA, Roquefeuil B. Hemodynamic effects of anesthesia in patients chronically treated with angiotensin-converting enzyme inhibitors. *Anesth Analg* 1992;74(6):805–808.
160. Colson P, Ryckwaert F, Coriat P. Renin angiotensin system antagonists and anesthesia. *Anesth Analg* 1999;89(5):1143–1155.
161. Nissen SE, Tuzcu EM, Libby P, et al. Effect of antihypertensive agents on cardiovascular events in patients with coronary disease and normal blood pressure: the CAMELOT study: a randomized controlled trial. *JAMA* 2004;292(18):2217–2225.
162. Wijeyesundera D, Beattie S. Calcium channel blockers for reducing cardiac morbidity after noncardiac surgery: a meta-analysis. *Anesth Analg* 2003;97:634–641.
163. Nishina K, Mikawa K, Uesugi T, et al. Efficacy of clonidine for prevention of perioperative myocardial ischemia: a critical appraisal and meta-analysis of the literature. *Anesthesiology* 2002;96(2):323–329.
164. Wijeyesundera DN, Naik JS, Beattie WS. Alpha-2 adrenergic agonists to prevent perioperative cardiovascular complications: a meta-analysis. *Am J Med* 2003;114(9):742–752.
165. Wallace AW, Galindez D, Salahieh A, et al. Effect of clonidine on cardiovascular morbidity and mortality after noncardiac surgery. *Anesthesiology* 2004;101(2):284–293.
166. Dodds TM, Stone JG, Coromilas J, Weinberger M, Levy DG. Prophylactic nitroglycerin infusion during noncardiac surgery does not reduce perioperative ischemia. *Anesth Analg* 1993;76(4):705–713.
167. Tuman KJ, McCarthy RJ, O'Connor CJ, McCarthy WE, Ivankovich AD. Aspirin does not increase allogeneic blood transfusion in reoperative coronary artery surgery. *Anesth Analg* 1996;83(6):1178–1184.
168. Anekstein Y, Tamir E, Halperin N, Mirovsky Y. Aspirin therapy and bleeding during proximal femoral fracture surgery. *Clin Orthop Relat Res* 2004;418:205–208.
169. Bonow RO, Carabello B, de Leon AC Jr, et al. Guidelines for the management of patients with valvular heart disease: executive summary: a report of the American College of Cardiology/American Heart Association Task Force on Practice Guidelines (Committee on Management of Patients With Valvular Heart Disease). *Circulation* 1998;98(18):1949–1984.
170. Kearon C, Hirsh J. Management of anticoagulation before and after elective surgery. *N Engl J Med* 1997;336(21):1506–1511.
171. Salem DN, Stein PD, Al-Ahmad A, et al. Antithrombotic therapy in valvular heart disease—native and prosthetic: the seventh ACCP conference on antithrombotic and thrombolytic therapy. *Chest* 2004; 126(3 Suppl):457S–482S.
172. Kovacs MJ, Kearon C, Rodger M, et al. Single-arm study of bridging therapy with low-molecular-weight heparin for patients at risk of arterial embolism who require temporary interruption of warfarin. *Circulation* 2004;110(12):1658–1663.
173. Hirsh J, Fuster V, Ansell J, Halperin JL, American Heart Association, American College of Cardiology Foundation. American Heart Association/American College of Cardiology Foundation guide to warfarin therapy. *Circulation* 2003;107(12):1692–1711.
174. Salpeter S, Greyber E, Pasternak G, Salpeter E. Risk of fatal and nonfatal lactic acidosis with metformin use in type 2, diabetes mellitus [update of Cochrane Database Syst Rev]. *Cochrane Database Syst Rev* 2003(2);CD002967.
175. Vitale C, Mercurio G, Cornoldi A, Fini M, Volterrani M, Rosano GMC. Metformin improves endothelial function in patients with metabolic syndrome. *J Intern Med* 2005;258(3):250–256.
176. Moss SE, Klein R, Klein BE, Meuer SM. The association of glycemia and cause-specific mortality in a diabetic population. *Arch Intern Med* 1994;154(21):2473–2479.
177. Talbot TR. Diabetes mellitus and cardiothoracic surgical site infections. *Am J Infect Control* 2005;33(6):353.
178. Van den Berghe G, Wouters P, Weekers F, et al. Intensive insulin therapy in critically ill patients. *N Engl J Med* 2001; 345(19):1359–1367.
179. Bratzler DW, Houck PM. Antimicrobial prophylaxis for surgery: an advisory statement from the National Surgical Infection Prevention Project. *Am J Surg* 2005;189(4): 395.
180. Wilson W, Taubert KA, Gewitz M, et al. Prevention of infective endocarditis. Guidelines from the American Heart Association. *Circulation* 2007;doi:10.1161. Available online at <http://circ.ahajournals.org/cgi/content/abstract/CIRCULATIONAHA.106.183095>. Last accessed July 5, 2007.
181. Warner MA, Offord KP, Warner ME, Lennon RL, Conover MA, Jansson-Schumacher U. Role of preoperative cessation of smoking and other factors in postoperative pulmonary complications: a blinded prospective study of coronary artery bypass patients. *Mayo Clin Proc* 1989;64(6):609–616.
182. Devereaux PJ, Goldman L, Cook D, Gilbert K, Leslie K, Guyatt G. Perioperative cardiac events in patients undergoing noncardiac surgery: a review of the magnitude of the problem, the pathophysiology of the events and methods to estimate and communicate risk. *CMAJ* 2005;173(6): 627–634.
183. Durazzo A, Machado F, Ikeoka D, Caramelli B. Reduction in cardiovascular events after vascular surgery with atorvastatin: a randomized trial. *J Vasc Surg* 2004; 39:967–976.
184. Detsky AS, Abrams HB, McLaughlin JR, et al. Predicting cardiac complications in patients undergoing non-cardiac surgery. *J Gen Med*. 1986;1:211–219.

## CHAPTER 8

## Evaluation of the Patient with a Difficult Airway

James C. Phero, DMD,  
Andranik Ovassapian, MD,  
and William E. Hurford, MD

## SCOPE OF THE PROBLEM AND INCIDENCE

A difficult airway may present as difficulty with ventilation, difficulty with rigid laryngoscopic tracheal intubation, or both. The American Society of Anesthesiologists' (ASA) *Practice Guidelines for Management of the Difficult Airway* has defined difficult ventilation as a circumstance where "it is not possible for the unassisted anesthesiologist to prevent or reverse signs of inadequate ventilation during positive pressure ventilation."<sup>1</sup>

Difficult rigid laryngoscopy is defined as a situation in which "it is not possible to visualize any portion of the vocal cords with conventional laryngoscopy." A difficult intubation is defined as a circumstance in which "the proper insertion of an endotracheal tube using conventional laryngoscopy requires more than three attempts, or greater than 10 minutes."<sup>1</sup>

The incidence of difficult intubation by rigid laryngoscopy varies from 0.5–13.6% in published studies.<sup>2–3</sup> Discrepancies in the reported incidence of difficult intubation are to be expected. Most reports are retrospective studies and apply different definitions of what constitutes a difficult intubation. The incidence of failed intubation in the general surgical population has been reported as one in every 2230 patients.<sup>4</sup> The incidence of failed intubation in the parturient population has been reported as 1 in 283–750 patients.<sup>4,8</sup> This represents a 3- to 10-fold increase compared with the incidence in nonparturient patients. The precise frequency of difficult mask ventilation is unknown, but an Australian study indicated that 15% of difficult intubations were also associated with difficult mask ventilation.<sup>9</sup>

Thirty to 40% of all anesthetic deaths have been attributed to inability to manage a difficult airway.<sup>10</sup> The ability to predict with precision difficulty with ventilation and intubation would help minimize disasters related to airway management. Unfortunately, the positive identification of all difficult airways is not possible at present. The coexistence of difficult ventilation is even more difficult to predict accurately.

Difficult airway management results from anatomic extremes or diseases affecting the airway. These factors may prevent a good mask fit or adequate positioning of a laryngeal mask airway (LMA), interfere with positioning of the head and neck, limit the opening of the mouth, and narrow or distort the airway. Inability to ventilate the lungs or intubate the trachea may of course also result from poor technique and/or lack of technical skills.

## GRADING THE DIFFICULTY OF TRACHEAL INTUBATION

Cormack and Lehane developed a classification for the view obtained at laryn-

gосcopy.<sup>11</sup> This classification uses four grades as follows: grade I—a full view of glottis; grade II—only the posterior commissure is visible; grade III—only the tip of the epiglottis is visible; grade IV—no glottic structures are visible (Fig. 8-1). Use of the original Cormack and Lehane scoring system led Yentis and Lee to develop a modified Cormack and Lehane scoring system in which grade II (only part of the glottis visible) was divided into IIa (part of the cords are visible) and IIb (only the arytenoids or the very posterior origin of the cords are visible) (Fig. 8-2).<sup>12</sup> In this system, grade IIb denotes a laryngoscopic view that is relatively common and often associated with difficulty passing a tracheal tube. This system is now frequently used for recording the ease or difficulty in laryngoscopic view in the anesthetic record and in studies of tracheal intubation.

The Intubation Difficulty Scale (IDS) is another tool used in airway research that can be a useful indicator of total intubation difficulty in a prior intubation.<sup>13,14</sup> The IDS is a quantitative measure of the total intubation difficulty encountered during a chosen

## KEY POINTS

1. A patient with a history of difficult intubation should be treated as having a difficult airway, even though physical appearance and physical examination may be unremarkable.
2. A patient with anatomic variations indicative of possible difficult intubation should receive a careful history and physical examination to define the scope of the potential airway problem.
3. Possible or potentially difficult intubation may be predicted by the Mallampati test, evidence of receding mandible, limited mouth opening as a result of tissue or TMJ restriction, enlarged teeth, high arched palate, narrow small mouth, or restricted cervical spine movement.
4. All tests to predict difficulty with airway management are associated with a high incidence of false-positive and false-negative results and have low predictive value. To minimize airway-related complications, it may be necessary to accept a high incidence of false-positive predictions by the various tests and treat any patient identified as having a possible difficult intubation accordingly.
5. Unexpected failed ventilation and intubation may result from a supraglottic mass or lingual tonsillar hyperplasia that may not be identified by external examination.
6. In pediatrics, infection-related airway compromise and congenital airway malformations are the major airway management problems.
7. In adults, stridor at rest indicates a serious degree of obstruction with a cross-sectional opening less than 4 mm.
8. Upper airway endoscopy with a rigid laryngoscope or fiberoptic bronchoscope is useful in defining anatomic challenges in patients with upper airway pathology before induction of general anesthesia.
9. If in doubt about the ability to ventilate or intubate, the airway is best secured while the patient is awake and breathing spontaneously.





FIGURE 8-1. Laryngoscopic views obtained per Cormack and Lehane.

procedure or sequence of procedures and is calculated after the fact. The score is based on 7 parameters known to be associated with difficult intubation. The 7 parameters are number of supplementary attempts, number of supplementary operators, number and type of alternative techniques used, laryngoscopic grade, subjective lifting force, the use of external laryngeal manipulation, and mobility or position of the vocal cords. The scoring of each individual parameter represents a divergence from ideal, and the total score represents the sum divergence from a zero difficulty, ideal intubation.

Patients with difficult tracheal intubation can be categorized into 3 groups (Box 8-1). The first group consists of patients in whom tracheal intubation is known or expected to be difficult. The second group includes patients with external anatomic features indicative of probable airway difficulties. The third group includes patients who present no external anatomic evidence or history of a difficult airway, but nonetheless prove to be difficult.

## EVALUATION OF THE POTENTIALLY DIFFICULT AIRWAY

These patients have anatomic variations that may interfere with rigid laryngoscopy and tracheal intubation.

The failure to identify these patients correctly may lead to an improper anesthetic induction plan and an unexpected failed intubation. If ventilation proves impossible, a life-threatening emergency situation is created.

To identify patients with potentially difficult to manage airways, a careful history regarding patient breathing, sleep position, and voice quality is taken. During physical examination, the patient should be viewed from a frontal and profile view to assess mandibular size. Thyromental distance is measured, and neck rotation, flexion, and extension mobility are evaluated and graded. The neck is palpated for identification of the cricothyroid membrane. Additionally, one should check for temporomandibular joint (TMJ) problems, mouth opening, loose or protruding teeth, degree of overbite, size of the tongue, visibility of faucial structures, and patency of the nares.

A number of predictive tests have been described that detect potentially difficult intubation (Box 8-2). These clinical examinations are straightforward and can be done at the bedside. Although useful in airway evaluation, all these tests are associated with relatively high rates of false-positive and false-negative predictions (Box 8-3).

## Anatomic Considerations

In the early development of rigid laryngoscopy, certain anatomic features

were recognized as contributing to the difficulty of intubation.<sup>15</sup> These features included a recessed mandible, limited extension of the head and neck, limited mouth opening, and mandibular depth.

Five physical features were evaluated prospectively by Wilson et al. in an attempt to identify potentially difficult intubations (Table 8-1).<sup>6</sup> Each risk factor was given three possible scores (0, 1, or 2). A total score of greater than 2 predicted a 75% chance of difficult intubation, but with a significant incidence of false-positive results. Changing the prediction criteria to a score of greater than 4 reduced the number of false-positive results, but also increased the incidence of false-negative predictions. In this study of 778 patients, 1.5% of rigid laryngoscopies were found to be difficult.

## Atlantooccipital Mobility

Adequate cervical mobility and mouth opening are essential for alignment of the oral, pharyngeal, and laryngeal axes required for visualization of the glottis during rigid laryngoscopy.<sup>15,16</sup> Decreased neck mobility also limits maneuvers that can be used to keep the airway open, thereby predisposing to difficult mask ventilation.

Bedside evaluation of atlantooccipital extension is performed by having the patient sit straight and extending the head while maintaining the cervical spine in a neutral position.<sup>16</sup> The greater the atlantooccipital distance in the neutral position, the greater the possible degree of head extension. A reduction of atlantooccipital extension by one-third or more will contribute to the difficulty of intubation.<sup>16</sup> If the posterior tubercle of the atlas is in

Original Cormack and Lehane system	1	2		3	4
	Full view of the glottis	Partial view of the glottis or arytenoids		Only epiglottis visible	Neither glottis nor epiglottis visible
View at laryngoscopy					
Modified system	1 As for original Cormack and Lehane above	2a Partial view of the glottis	2b Arytenoids or posterior part of the vocal cords only just visible	3 As for original Cormack and Lehane above	4 As for original Cormack and Lehane above

FIGURE 8-2. Original versus modified Cormack and Lehane scoring system: Description of the two scoring systems used for recording laryngoscopy view. E, epiglottis; Li, laryngeal outlet.



## BOX 8-1.

## Categories of Difficult Airway

Known or expected difficult airway  
 History of difficult or failed intubation  
 History of difficult or failed mask ventilation  
 Conditions associated with difficult airway  
 Acquired  
 Congenital  
 Potentially difficult airway  
 Limited neck extension  
 Limited mouth opening  
 Receding mandible  
 Mallampati class 3  
 Short thyromental distance  
 Unexpected difficult airway  
 Unknown supraepiglottic mass  
 Hyperplasia of lingual tonsils  
 Supraepiglottic cyst or tumor  
 Missed evidence of difficult airway  
 Poor preoperative evaluation  
 Ignoring presence of evidence

contact with the occiput in the neutral position, attempts to extend the head result in anterior bowing of the cervical spine and forward displacement of the larynx.<sup>17</sup> Limitations in head extension may occur secondary to anatomic variations of the atlantooccipital gap in otherwise healthy people or secondary to pathologic conditions such as rheumatoid arthritis.

**Mouth Opening**

In addition to head and neck extension, other anatomic factors may inter-

## BOX 8-2.

## Tests Applied to Predict Difficult Intubation

External anatomic features  
 Head and neck movement (atlantooccipital joint)  
 Jaw movement (temporomandibular joint)  
 Mouth opening  
 Subluxation of mandible  
 Receding mandible  
 Protruding maxillary incisors  
 Obesity  
 Thyromental distance  
 Sternomental distance  
 Visualization of the oropharyngeal structures  
 Anterior tilt of larynx  
 Radiographic assessment

## BOX 8-3.

## Shortcomings of Tests Predicting Difficult Intubation

High incidence of false-positive results  
 High incidence of false-negative results  
 Do not address lower airway problems  
 Do not address mask ventilation difficulties  
 Miss lingual tonsil as cause of failed intubation

ferre with the line of vision from mouth opening to vocal cords and exposure of the glottic opening. The hinge movement of the mandible controls mouth opening. A horizontal gliding movement allows for subluxation of the mandible, which allows additional anterior displacement of the tongue during rigid laryngoscopy. A mouth opening (distance between mandibular and maxillary central incisors) limited to 3.5 cm or less tends to make intubation more difficult. Temporomandibular joint dysfunction, congenital fusion of the joints, trauma, tissue contracture around the mouth, and trismus may limit mouth opening. Trismus secondary to pain associated with infection usually relaxes under general anesthesia, but this cannot be assured if the infection has been long-standing or involves the pterygoid space.

Protruding maxillary anterior teeth may interfere with laryngoscope placement and passage of the endotracheal tube during intubation. During rigid laryngoscopy, the tongue is displaced into the mandibular space, opening the line of vision from mouth to the larynx. A small mandibular space may fail to adequately accommodate tongue displacement, thus interfering with visualization of the larynx.

**Thyromental Distance**

Patil et al. reported that rigid laryngoscopy may be impossible in adults if the thyromental distance is less than 6.0 cm (3 finger breadths).<sup>18</sup> Alignment is more difficult in the patient with a receding mandible where the thyromental distance is short, as the laryngeal axis must form a more acute angle with the pharyngeal axis. The thyromental distance is measured between the bony point of the mentum of the mandible and the thyroid notch with the head fully extended. Maxi-

## TABLE 8-1.

## Five Risk Factors of Difficult Intubation

Risk factor	Level of Risk
Weight	
<90 kg	0
90–110 kg	1
>110 kg	2
Head and neck movement	
>90°	0
~90°	1
<90°	2
Jaw movement	
Interincisor gap (IG) measured with mouth fully open	
Subluxation (SLux) (maximal forward protrusion of the lower incisors beyond the upper incisors)	
IG >5 cm or SLux >0	0
IG <5 cm or SLux =0	1
IG <5 cm or SLux <0	2
Receding mandible	
Normal	0
Moderate	1
Severe	2
Protruding maxillary anterior teeth	
Normal	0
Moderate	1
Severe	2

From Wilson ME, Spiegelhalter D, Robertson JA, et al. Predicting difficult intubation. *Br J Anaesth* 1988;61:211. The Board of Management and Trustees of the British Journal of Anesthesia. Reproduced by permission of Oxford University Press/British Journal of Anesthesia.

imum extension of the head ensures reproducibility of measurements.

**Sternomental Distance**

The sternomental distance is measured with the head fully extended and the mouth closed. This measurement is reported to be more sensitive and specific in predicting difficult rigid laryngoscopy than the Mallampati test, thyromental distance, mouth opening, and mandibular subluxation measurements.<sup>5</sup> The predictive value of sternomental distance regarding difficult intubation has not been studied by other investigators.

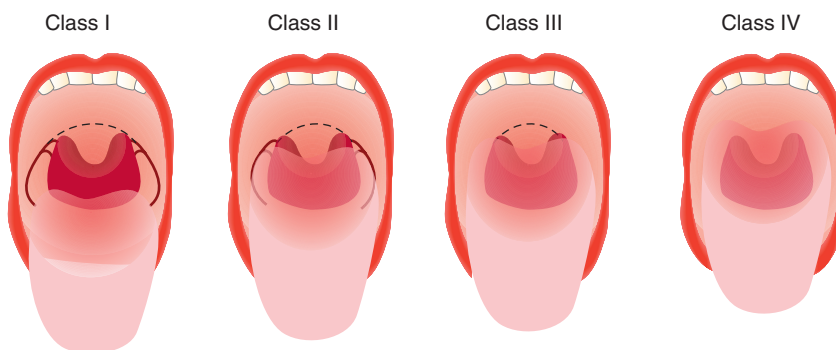
**Visibility of Oropharyngeal Structures**

Predicting probability of laryngoscopy difficulty by physical evaluation was reported by Skolimowski et al. in 1975, when describing a micrognathic patient who could not be intubated: "The an-

teroposterior dimension of the pharynx was markedly reduced by a large tongue reaching far posteriorly. It was not possible to examine the lower pharynx by means of a laryngoscope mirror because the tongue was situated too far posteriorly to be pulled forward.<sup>19</sup>

Mallampati described the examination signs and related them to intubation difficulty. He correlated the degree of visibility of the oropharyngeal structures with the difficulty of rigid laryngoscopy.<sup>20</sup> In this study, a sitting patient was asked to open his or her mouth as wide as possible and maximally protrude the tongue. The visibility of the faucial pillars, soft palate, and uvula was noted. The airway was classified into three categories: class I—soft palate, fauces, uvula, and pillars are visualized; class II—soft palate, fauces, and pillars are visualized, but the uvula is masked by the base of the tongue; and class III—only the soft palate can be visualized. In class III, visualization of the glottis with rigid laryngoscopy is expected to be difficult.<sup>20</sup> Samssoon and Young extended the oropharyngeal exposures to include a fourth class.<sup>4</sup> This four-category system is in common use and classified as follows: class I—soft palate, fauces, uvula, and pillars are visualized; class II—soft palate, fauces, uvula are seen; class III—only the soft palate and base of the uvula are observed; class IV—the soft palate is not visible (Fig. 8-3). A further modification of the Mallampati visualization scoring included a class zero view.<sup>21,22</sup> Class zero is defined as the ability to see any part of the epiglottis upon mouth opening and tongue protrusion. Ezri et al. evaluated 764 patients and reported that 1.18% of patients had a class zero airway.<sup>23</sup> A class zero airway was noted to be an excellent predictor of uncomplicated laryngoscopy.

In a retrospective study of 13 patients with failed intubations, Samssoon and Young found that in 12 of the patients there was a good correlation between the degree of difficulty of tracheal intubation and the visibility of the oropharyngeal structures.<sup>4</sup> Rocke et al. reported the association between Mallampati class and difficulty of intubation to be significant ( $p < 0.001$ ), but only 6.6% of class IV airway cases were associated with difficult tracheal intubation, and all could be intubated.<sup>8</sup> Using the concept of relative risk they calculated the probability of difficult intubation. The presence of class III



**FIGURE 8-3.** Classification of pharyngeal structures as proposed by Mallampati and Samssoon. Note: class III—soft palate visible; class IV—soft palate not visible.

airway was associated with a relative risk of 7.58 times greater than class I, and airway class IV had a relative risk of 11.2 times greater than class I. Oates et al. compared Mallampati's classification with that of Wilson's 5 risk factors.<sup>24</sup> The predictive value of both tests was found to be similar, but both tests had a high incidence of false-positive and false-negative predictors. Interobserver variability was less with Wilson's scoring system. Other investigators have found Mallampati's classification too subjective and the class III classification not useful as a predictor of difficult intubation when used alone.<sup>25-27</sup>

Phonation during tongue protrusion increases the specificity of the Mallampati test, thus improving its correlation with difficult intubation, but also increases the number of false-negative results.<sup>26</sup> Tham reported that phonation created a marked improvement in view.<sup>28</sup> Evaluation of the airway in the supine position produced a small but nonsignificant worsening of the view. Lewis et al. recommended that the visibility of oropharyngeal tissues be conducted with the patient in the sitting position, with the head in full extension, the tongue out, and during phonation.<sup>29</sup>

In a retrospective review of failed intubations by Samssoon and Young, 7 of 1980 obstetric patients could not be intubated (incidence of 1:280) and 6 of 13,380 surgical patients could not be intubated (incidence of 1:2230).<sup>4</sup> All patients had a class IV airway except one class II patient who had tracheal stenosis. These authors felt that pre-anesthetic assessment using the Mallampati classification had merit. Lee et al. used the Cormack and Lehane grading system in their systematic meta-analysis review of the accuracy of Mal-

lampati tests to predict the difficult airway.<sup>30</sup> In their review of 42 studies involving 34,513 patients, they found that both versions of the Mallampati test had good accuracy for predicting difficult laryngoscopy. The modified Mallampati score had good accuracy, but the original Mallampati had poor accuracy in predicting difficult tracheal intubation. Both versions of Mallampati score were poor at identifying difficult mask ventilation. The authors concluded that to be useful the Mallampati test must be part of a comprehensive evaluation that also includes assessment of dentition, thyromental distance, and neck extension, as recommended by the American Society of Anesthesiologists Task Force on the management of the difficult airway.<sup>1</sup>

In summary, the Mallampati test has been broadly applied, even though its predictive value for difficult intubation is low. As a result, some essential factors, such as suppleness and mobility of the neck or dentition status, may be minimized. No test is perfect, but this should not discourage practitioners from seeking a more reliable test or combination of tests.<sup>31</sup>

### Anteriorly Tilted Larynx

Roberts et al. measured the degree of anterior tilt of the thyroid cartilage relative to the horizontal and demonstrated a relationship between degree of the thyroid cartilage tilt and the difficulty of laryngeal exposure using a Macintosh laryngoscope.<sup>32</sup> Laryngeal tilt can be directly measured using a bubble inclinometer. When the tilt of the anterior surface of the thyroid cartilage is greater than 40°, rigid laryngoscopy was predicted to be difficult. The sensitivity of this test was reported to be 70%, with a specificity of 95% and a positive predictive value of 80%.

Anterior laryngeal tilt is reduced by depression of the thyroid cartilage but is increased by cricoid pressure.

### Radiographic Assessment

Lateral radiographs of the head and neck and the measurement of distances between bony landmarks have been used to identify predictive factors for difficult rigid laryngoscopy.<sup>33</sup> Reduction in the distance between the occiput and the spinous process of C1 (atlantooccipital distance), and to the C1-C2 interspinous gap, has been correlated with the degree of difficulty in intubation. Reduction of the atlantooccipital gap may be found in some otherwise normal cases. Any limitation of cervical extension may interfere with rigid laryngoscopy and glottic exposure. Radiographic assessment is not considered cost effective for routine airway evaluation.

### Multiple Factors

Combining several tests for the prediction of difficult laryngoscopy and tracheal intubation improves the accuracy of the assessment. The simplified airway risk index (SARI) was developed to preoperatively evaluate airway status using multiple factors: mouth opening measurement, thyromental distance, ability to protrude the mandible, Mallampati class, head mobility, and body weight.<sup>34</sup> Calculation of the SARI in 136 patients revealed good interobserver agreement in assessing the Mallampati classification, mouth opening, and mandible protrusion, whereas measurement of thyromental distance and neck mobility did not have good interobserver agreement.<sup>35</sup>

Multiple factors often play roles in both difficulty with intubation and difficulty with mask ventilation. In a prospective study of 1502 patients, difficult mask ventilation was reported in 5%, with one occurrence of impossible ventilation.<sup>36</sup> Difficulty with mask ventilation was anticipated by the anesthesiologist in only 17% of the cases in which difficulty occurred. Using multivariate analysis, 5 criteria were recognized as independent factors for difficult mask ventilation: age older than 55 years, body mass index (BMI) >26 kg/m<sup>2</sup>, presence of a beard, lack of teeth, and a history of snoring. The presence of two factors suggested a high likelihood of difficult mask ventilation.

Bellhouse and Dore reported that combining factors (e.g., limited atlan-

tooccipital extension, chin protrusion, and tongue size) increases the sensitivity of predicting a difficult intubation.<sup>16</sup> Frerk reported that combining two tests, Mallampati and thyromental distance, improved the specificity of the prediction to 97.8% but did not improve sensitivity, which remained at 81.2%.<sup>37</sup> A meta-analysis performed by Shiga et al. of preanesthetic airway evaluation test performance on 50,760 patients in 35 studies demonstrated a 5.8% overall incidence of difficult intubation.<sup>38</sup> Each test in their analysis, including the Mallampati classification, thyromental distance, sternomental distance, mouth opening, and the Wilson risk score,<sup>39</sup> possessed only poor to moderate sensitivity and moderate to fair specificity. The most useful evaluations were found to be combinations of the Mallampati classification and thyromental distance. These authors concluded that the clinical value of airway evaluation tests for predicting difficult intubation remains limited.

A stepwise approach to decision making in the evaluation of the airway is the airway approach algorithm.<sup>40</sup> This algorithm is based on 5 clinical questions: Is airway control necessary? Is there potential for difficult laryngoscopy? Can supralaryngeal ventilation be used? Is there an aspiration risk? Will the patient tolerate an apneic period? Answers to these basic questions can help guide the practitioner in potential use of the ASA difficult airway algorithm.

### EVALUATION OF THE COMPLEX AIRWAY

Patients with a history of difficult ventilation or intubation and patients with

anatomic or abnormal conditions associated with a complex airway fall into the category of known difficult airway.<sup>41</sup> The causes of the expected difficult airway may be grouped into congenital or acquired conditions, and be further classified on the basis of the location of involvement or disease.

Increased frequency of ventilation, chest retractions, increased use of accessory muscles, stridor, voice weakness, or hoarseness, alone or in combination, may indicate a potential airway problem (Table 8–2). Stridor is a particularly important sign, and may provide evidence of the site and severity of airway obstruction related to severe glossopharyngeal, glottic, and/or upper tracheal occlusion. Stridor during inspiration generally indicates obstruction at or above the larynx. Expiratory stridor is most often associated with intrathoracic or subglottic obstructions. Obstruction associated with the larynx or glottic region may produce biphasic stridor, although either inspiratory or expiratory sounds may predominate. In the adult, stridor at rest indicates a serious degree of obstruction with a cross-sectional airway opening of less than 4 mm or an irregularly narrowed airway several centimeters in length.

### Obesity

Airway assessment of the obese patient should be performed with the patient in both the sitting and supine positions. Respiratory function and airway patency can be significantly altered by this change in position.<sup>42</sup> A large neck circumference is associated with obstructive sleep apnea (OSA) in obese patients. In evaluating 123 patients with thick necks for OSA, Katz et

TABLE 8–2.

#### History Findings That Suggest Difficult Airway Management

Finding	Implication
Dry cough	Possible tracheobronchial compression
Easy bleeding	Epistaxis risk
Gastroesophageal reflux	Aspiration risk
Long-standing diabetes mellitus	Limited cervical mobility
Loud snoring	Prone to soft-tissue obstruction
Major trauma	Unstable neck, limiting safe mobility
Radiation to neck	Fibrosis, immobility
Recent temporal craniotomy	Limited mandibular motility
Smoking	Salivation, cough, laryngospasm
Undigested food returning to mouth	Aspiration risk from pharyngeal pouch

al. found that the sleep apnea-hypopnea index (AHI) correlated with external neck circumference, BMI, and the internal circumference of the distal pharynx.<sup>43</sup> Men more commonly have sleep-disordered breathing than women and the sleep-disordered breathing tends to be more severe.<sup>44</sup> In an evaluation of 3942 OSA patients, the frequency and severity of OSA in the sleep clinic population was found to be greater in men than women, with unknown factors other than neck circumference, age, and BMI contributing to the gender differences.<sup>45</sup> In a prospective study of 100 morbidly obese patients (BMI >40 kg/m<sup>2</sup>), preoperative measurements of height, weight, neck circumference, width of mouth opening, sternomental distance, thyromental distance, and Mallampati score were recorded.<sup>46</sup> The view during direct laryngoscopy was graded, and the number of attempts at tracheal intubation was recorded. Neither absolute obesity nor BMI was associated with intubation difficulties. Large neck circumference and high Mallampati score were the only predictors of potential intubation problems.

In the supine position, changes in chest compliance and vital capacity may interfere with adequate spontaneous ventilation. The incidence of hiatal hernia, gastric pH of 2.5 or lower, and reduced functional residual capacity found in obese patients places these patients at increased risk for the consequences of aspiration of gastric contents.<sup>47,48</sup> To minimize the risk of aspiration, a rapid sequence induction is commonly performed in obese patients.

There is consensus that airway management is more difficult in the morbidly obese patients. Opinions differ, however, on the difficulty of endotracheal intubation. Wilson and coworkers regarded obesity as a weak predictor of difficult intubation.<sup>6</sup> Buckley et al. reported a 13% rate of difficult intubation using a rapid sequence technique in the obese patient.<sup>48</sup> Rocke et al. excluded obesity as a risk factor in intubation.<sup>8</sup> Bond et al. found no correlation between BMI and difficulty of laryngoscopy.<sup>47</sup> Juvin et al. compared difficulty in tracheal intubation in obese to lean patients using the IDS and patient vital signs. A Mallampati score of III to IV was the only independent risk factor for difficult intubation in obese patients. Difficult

tracheal intubation was more frequent in obese (15.5%) than lean (2.2%) patients. The use of the IDS score demonstrated that tracheal intubation, not laryngoscopy, was more difficult in obese than lean patients.

Body weight may not be as critical as the location of excess weight. Massive weight in the lower abdomen and hip area may be less important than when the weight is in the upper body area. A short, thick, immobile neck caused by cervical spine fat pads will interfere with rigid laryngoscopy. Furthermore, the redundancy of soft-tissue structures inside the oropharyngeal and supralaryngeal area may also make visualization of the laryngeal structures difficult.

Mask ventilation may prove difficult in the obese patient. When high positive pressure is required to ventilate the patient, the chance of inflating the stomach is increased. Rapid oxygen desaturation during apnea, secondary to reduced functional residual capacity, limits available intubation time. In the case of a cannot intubate-cannot ventilate situation, access to the neck for transtracheal jet ventilation or establishing a surgical airway (e.g., emergency tracheostomy or cricothyroidotomy) will also be more complex.

### Pregnancy

The incidence of failed intubation is predicted as 1 in 300 patients undergoing cesarean section.<sup>4</sup> Airway-related problems account for one-third of all anesthetic related maternal mortality.<sup>49</sup> During pregnancy, mucosal vascular engorgement, laryngeal edema, immobility of the floor of the mouth related to tongue engorgement, enlarged breasts, and general weight gain contribute to difficult intubation.<sup>49-51</sup>

Airway anatomy may become distorted during prolonged labor or toxemia, leading to edematous soft-tissue encroachment of the upper airway.<sup>50,51</sup> Nasal intubation in these patients should be avoided, as the mucous membranes become increasingly engorged and friable during late pregnancy. Similar to the obese patient, the obstetric patient should be considered to have a full stomach and at increased risk for gastric aspiration.

The physical changes created by pregnancy may lead to marked alteration in cardiovascular and respiratory function when the patient changes from a sitting to a supine position.

Furthermore, in cases of fetal distress or maternal hemorrhage, the emergency nature of the circumstances compounds airway management problems.

### Rheumatoid Arthritis

The airway management of these patients should be based on an understanding of the pathologic changes affecting the airway. In patients with advanced rheumatoid arthritis and spondylosis, airway management may be extremely difficult. Rheumatoid arthritis may involve any joint of the body, including the cervical spine, temporomandibular joint, and cricoarytenoid joint. A change in voice, the presence of dysphagia, dysarthria, stridor, or a sense of fullness in the oropharynx may indicate laryngeal involvement. A careful fiberoptic examination of the larynx and glottic structures may be informative when such signs and symptoms are present. An edematous larynx with hyperemic arytenoids and/or mucosa with swollen aryepiglottic folds and false cords may be observed. Changes in phonation may be associated with decreased mobility of the vocal cords. In the case of a narrowed glottic opening, endotracheal intubation frequently requires a smaller sized endotracheal tube. Temporomandibular joint ankylosis may prevent orotracheal intubation because of limited mouth opening.

Physical examination of the patient with rheumatoid arthritis should include flexion, extension, and rotation of the head with palpation of the larynx and trachea for evidence of deviation and/or limitation. A history of neck pain radiating to the occiput may be associated with decreased neck mobility. Upper-extremity radiculopathy suggests cervical spine arthritis. Progressive cervical spondylosis associated with rheumatoid arthritis leads to severe flexion deformity of the cervical spine, which complicates airway management.<sup>52</sup> Synovial destruction and vertebral erosion, along with ligamentous changes, lead to instability of the cervical spine.<sup>53</sup> Instability of the atlas and odontoid or of subaxial vertebral alignments may lead to subluxation of the cervical spine and cord compression. Cervical spine flexion and extension radiographs may be required for evaluation of instability and potential spinal cord compression. While chin lift and jaw thrust are commonly used to improve mask ven-



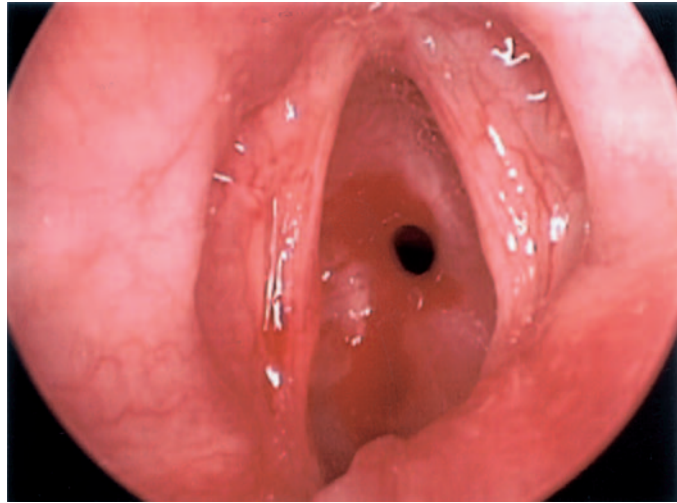
tilation and oxygenation, these maneuvers may increase the possibility of spinal cord compression and damage.<sup>54</sup> If a head and neck stabilizing device is used by the patient, it generally should be left in place to prevent unintended movement of the cervical spine.<sup>55</sup> Chest wall distortion in patients with rheumatoid arthritis may produce a major decrease in total lung volume and vital capacity. Pulmonary function tests may be helpful in determining a patient's ventilatory status in some cases.

### Congenital Disease

Anomalies of the cardiovascular, nervous, musculoskeletal, or excretory systems may produce abnormalities of the head, neck, or upper airway. Rosenberg and Rosenberg have tabulated the syndromes most often accompanied by aberrations of the upper airway.<sup>41</sup> These include Crouzon, Goldenhar, Pierre Robin, and Treacher Collins syndromes, which are known for their grossly abnormal head and neck anatomy. Patients with congenital malformations associated with micrognathia, retrognathia, and macroglossia have a smaller oropharyngeal cross section and are prone to soft-tissue upper-airway obstruction.<sup>56,57</sup> Children with craniocarpotarsal dysplasia have severe microstomia that becomes more inadequate as they grow older and develop teeth. These children often require repeated anesthetics for correction of their musculoskeletal and soft-tissue deformities and can pose a significant problem for the anesthesiologist.

The most significant vascular malformations related to airway compromise are vascular rings, usually of aortic arch origin, encircling the trachea. Tracheomalacia, congenital tracheal stenosis, shortened trachea, and bronchogenic cysts can contribute to difficult airway management (Fig. 8-4).<sup>58</sup> Wells et al. reported that a significant percentage of infants with congenital malformation syndromes associated with cardiovascular anomalies and skeletal dysplasia have a shortened trachea.<sup>59</sup> These infants may benefit from fiberoptic evaluation of endotracheal tube position to avoid unrecognized bronchial intubation.

Congenital malformation syndromes also may be associated with varying degrees of acute, progressive, or chronic airway obstruction. Congenital tumors or cysts may invade or obstruct



**FIGURE 8-4.** Tracheal stenosis. (Photo courtesy of Dr. Dana M. Thompson, Department of Otolaryngology, UC College of Medicine, Cincinnati, Ohio.)

the airway. Preoperative assessment should include determination of the site of the tumor and the extent of obstruction or distortion of the airway.

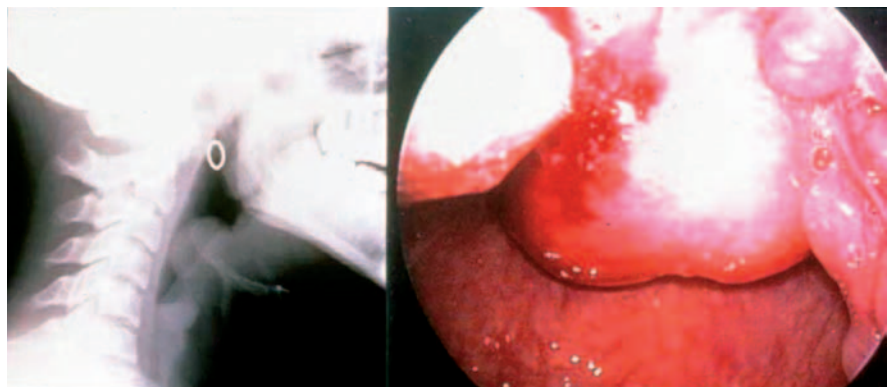
### Airway Infection

Inflammation and edema can distort the anatomy, fix the tissues, and compress the airway, interfering with ventilation and intubation.<sup>60,61</sup> Airway compromise by infection poses a major airway management problem in patients younger than 10 years old. Of 90 deaths resulting from upper airway obstruction in children, 36 were related to airway infections.<sup>62</sup> Advanced or fulminant peritonsillar or retropharyngeal abscesses and acute epiglottitis can produce rapid deterioration of the airway in young children. Evaluation of lateral neck radiographs to determine the extent of the prevertebral involvement and narrowing of the oropharynx may be beneficial in the pre-

anesthetic examination of the patient with peritonsillar infection. Fungal epiglottitis can initially be difficult to diagnosis because of no spike in the patient's temperature (Fig. 8-5). In older children and adults, retropharyngeal or intraoral abscesses and Ludwig angina are more common.<sup>63</sup> Patients with advanced Ludwig angina have a greatly decreased oropharyngeal space because of edema in the floor of the mouth and tongue. They breathe with their mouths open, tongues protruded, and lean forward in a sitting position. Inflammation of the pharyngeal soft tissue may severely reduce oropharyngeal patency and interfere with rigid laryngoscopy.

### Trauma

Trauma to the head and neck may produce major acute or chronic anatomic changes. These changes may affect airway accessibility, making



**FIGURE 8-5.** Left: Epiglottis lateral radiograph. Right: Afebrile fungal epiglottitis. (Photo courtesy of Dr. Dana M. Thompson, Department of Otolaryngology, UC College of Medicine, Cincinnati, Ohio.)

tracheal intubation or mask ventilation difficult. Blunt or penetrating trauma to the larynx, trachea, hyoid structure, and facial bones can result in a complex, difficult-to-manage airway.<sup>64,65</sup> Subcutaneous emphysema, hoarseness, stridor, and tracheal deviation are warning signs of airway injury. Such patients should be observed closely as progression of the condition may lead to airway obstruction. With direct trauma, the larynx may be crushed, the cricoid or other tracheal cartilages may be fractured, and the larynx or trachea may be severed. Tracheostomy below the injury site often is required.

The trauma patient should be examined for cervical spine injuries, because movement of the neck during intubation may lead to irreversible paralysis. Maintaining cervical collar placement or applying axial traction may minimize spinal cord injury during intubation.<sup>66</sup> Mouth opening may be limited in the patient with facial trauma. Improvement in the ability to open the patient's mouth after induction of anesthesia and paralysis cannot be guaranteed.

Blunt cervical trauma or internal jugular vein cannulation resulting in a retropharyngeal hematoma may produce tracheal compression and airway obstruction. Symptoms include neck pain, dysphagia, dyspnea, and hoarseness. Clinical signs include superior mediastinal obstruction and bruising on the neck appearing within 48 hours and spreading to the chest wall. Diagnosis is aided by a lateral radiograph of the neck to determine if there is a widening of the prevertebral space.<sup>67</sup> Although most retropharyngeal hematomas occur within hours of the precipitating incident, airway obstruction has been reported 2–5 days from onset of initial symptoms.<sup>68</sup>

Tissue destruction and scarring caused by surgery, chemotherapy, or radiotherapy may result in severe limitation of neck mobility and mouth opening, which limits direct rigid laryngoscopy. Airway management may be seriously impaired by tracheal scarring, webs, or granulomas related to previous intubation, tracheostomy, or airway surgery.

## Tumors

Mouth opening and proper positioning of the head and neck for rigid laryngoscopy can be limited by tumors,

surgical scars, or radiation fibrosis of head and neck tissues (Table 8–3).<sup>2,53</sup> Supraepiglottic masses may severely limit mobility of the epiglottis and cause complete airway obstruction after induction of anesthesia. Routine maneuvers, such as jaw thrust and head positioning, may not resolve the situation, because the supraglottic mass can prevent displacement of the epiglottis away from the posterior pharyngeal wall.<sup>69,70</sup>

The presence of cancerous goiters is also a concern. Difficult tracheal intu-

bation was reported in 17 (5.3%) of 320 patients undergoing thyroidectomy.<sup>71</sup> Multivariate analysis suggested that the presence of a cancerous goiter and Cormack and Lehane grade III or IV laryngoscopic view were independently associated with difficult intubation. Large goiters were not specifically associated with increased difficulty with intubation.

Radiologic studies are indicated in the presence of trauma or tumors in or near the airway.<sup>72</sup> Lateral cervical spine films, computed tomography

**TABLE 8–3.**

**Physical Findings That Suggest Difficult Airway Management**

Finding	Implication
Obesity	Easily obstructed airway, aspiration risk, diminished chest wall compliance, difficult laryngoscopy because of macroglossia and immobile head
Pregnancy	All the problems associated with obesity, especially aspiration risk; large breasts impair laryngoscope insertion; swollen mucosa bleed easily
Ascites	Aspiration risk, diminished chest wall compliance
Whiskers, flat nasal bridge, large face	Difficult mask seal
Mouth opens less than 40 mm	Glottic exposure blocked by maxillary teeth
Cervicooccipital extension limited to an angle at the hyoid less than 160°	Difficult to align mouth and pharynx for glottic exposure
Short, thick, muscular neck	Prone to soft tissue obstruction, difficult to extend neck for intubation or mask ventilation
Thyromental distance less than 60 mm, receding chin	Difficult to mobilize tongue for glottic exposure, glottis too anterior to visualize
Maxillary gap from missing incisors with other teeth present to the right	Laryngoscope fits into gap while adjacent teeth, lip, or gums block view of glottis and passage of tracheal tube
Edentulous with atrophic mandible	Small face and furrowed cheeks impair mask fit, tongue and soft palate block exhalation
Prominent or protruding maxillary incisors	Teeth block view of glottis
Advanced caries, loose teeth, caps, bridges	Dentition can be damaged or aspirated, rough edges can tear tube cuff
Stridor, retractions	Risk or insurmountable airway obstruction
Hoarseness	Chance of vocal cord dysfunction or airway masses
“Underwater” voice	Vallecular or epiglottic cysts
Nasogastric tube in situ	Difficult to seal mask
Poorly visualized soft palate and fauces in upright patient with mouth fully open (Mallampati sign)	Difficult to expose glottis with rigid laryngoscopy
Large goiter or immobile tumor displacing trachea	Difficult to expose glottis, airway obstruction, or tracheal collapse
Tracheostomy scar	Possible tracheal stenosis

(CT), or magnetic resonance imaging (MRI) may be used to assess the degree of airway compression and the involvement of associated structures. Topical anesthesia, sedation, and fiberoptic laryngoscopy may prove beneficial in airway inspection.<sup>55</sup>

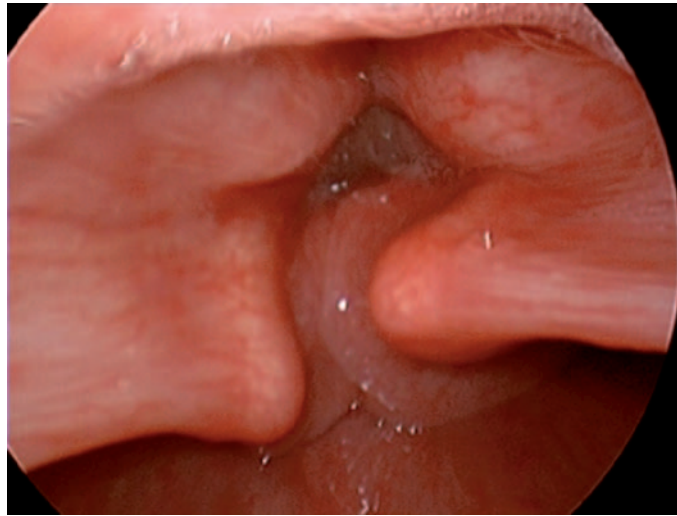
### Airway Stents

Patients with malignant and benign tracheal and endobronchial disorders such as Wegner disease and relapsing polychondritis may receive rigid Teflon or silastic airway stents to treat airway malacia and stenosis (Figs. 8-6 and 8-7).<sup>73,74</sup> Conditions treated by stent placement include tracheomalacia, posttracheostomy stricture/rupture, postpneumectomy bronchopleural fistula, stricture related to lobectomy, tuberculosis, traumatic injury, or compression secondary to achalasia, multinodular goiter, aortic aneurysm, and brachiocephalic artery aneurysm. Preoperative evaluation requires communication with the otolaryngologist to verify the underlying diagnosis, position of the stent, and the best method of airway management. Presence of a stent may complicate or prevent traditional endotracheal intubation. Laryngeal mask airways, however, can often be used to manage the airways of such patients.

### Intrathoracic Lesions

Intrathoracic lesions can compromise airway integrity through compression of the tracheobronchial tree or by invasion of the trachea or bronchi. Mediastinal lesions leading to life-threatening airway obstructions may be found in neonates, infants, children, or adults.<sup>61,75-78</sup> Congenital tumors or tumors arising in early infancy include hemangiomas, lymphangiomas, cystic hygromas, teratomas, dermoids, rhabdomyosarcomas, neurofibromas, neuromas, and thymic hyperplasia. Adults with mediastinal masses, commonly lymphomas and thymic tumors, appear to be less at risk for perioperative complications than are children.<sup>79,80</sup>

By nature of their anatomical location, these lesions may produce compression of the heart, compression of the large vessels, primarily the vena cava, and compression of the trachea and main bronchi. Anterior mediastinal tumors that are undiagnosed or underestimated as to degree of airway obstruction may completely block the airway on induction of anesthesia and

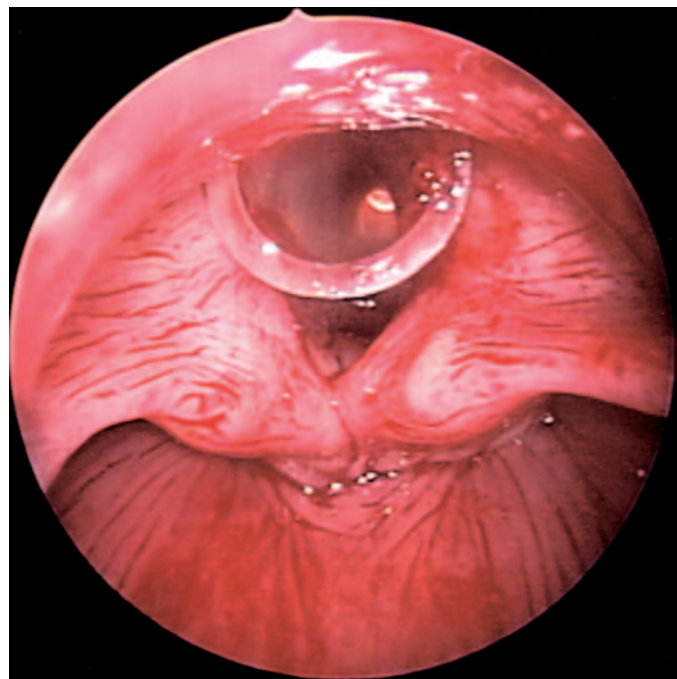


**FIGURE 8-6.** Relapsing polychondritis. (Photo courtesy of Dr. Dana M. Thompson, Department of Otolaryngology, UC College of Medicine, Cincinnati, Ohio.)

induced muscle relaxation.<sup>76,81</sup> Evaluation focuses on an estimate of the presence and degree of obstruction of the tracheobronchial tree and the possibility of avoiding general anesthesia if possible.

Evaluation to assess the patency of the airway at the tracheal and the bronchial level is necessary to formulate an anesthetic plan. By history, symptoms of airway obstruction including dyspnea at rest, on exertion,

and in different positions require additional workup. The presence of stridor, wheezing, rhonchi, and diminished breath sounds should be reviewed with the patient in different positions. Careful analysis of chest radiographs, CT, and MRI studies may prove essential for planning airway control in the patient with a mediastinal mass. Chest radiographs in the posteroanterior position allow measurement of the tracheal diameter at the level of the clav-



**FIGURE 8-7.** Suprastomal stent for management of tracheal compromise caused by subglottic and glottic stenosis. (Photo courtesy of Dr. Dana M. Thompson, Department of Otolaryngology, UC College of Medicine, Cincinnati, Ohio.)



icles.<sup>82</sup> A lateral chest view shows the degree of compression of the trachea in an anteroposterior position. A CT scan of the chest permits accurate measurements of airway diameters and indicates the exact level and extent of compression of the tracheo-bronchial tree.

Pericardial effusion on preoperative CT scan was the only variable associated with intraoperative complications in a review of 98 patients with mediastinal mass.<sup>79</sup> In this population, postoperative respiratory complications were related to tracheal compression of greater than 50% on a preoperative CT scan and a finding of mixed restrictive and obstruction disease on pulmonary function testing. A review of 29 pediatric patients with mediastinal masses who were undergoing general anesthesia concluded that CT evidence of superior vena compression along with symptoms and signs of superior vena cava syndrome (SVCS) were associated with potential development of life-threatening situations.<sup>80</sup> In this review, SVCS was the only nonrespiratory sign or symptom that was associated with increased anesthetic risk. All 4 children with SVCS developed acute airway compromise with general anesthesia.

Pulmonary flow volume loop studies performed in the upright and supine positions may sometimes assist in defining the severity of position-related airway compromise. Maximal inspiratory and expiratory flow volume curves may help to quantify the degree of impairment and differentiate extrathoracic from intrathoracic obstruction.<sup>61,76</sup> In an evaluation of 37 patients with anterior mediastinal masses by Hnatiuk et al., however, the incidence of perioperative surgical complications was found to be low. The results of upright and supine spirometry did not always alter the anesthetic technique and normal spirometry results did not exclude the occurrence perioperative complications.<sup>83</sup> In a review of 77 mediastinal mass patients who underwent pulmonary function tests prior to general anesthesia, airway collapse did not occur in any patient.<sup>79</sup> This patient population included 10 cases with a peak expiratory flow rate (PEFR) that was less than 50% of the predicted rate and 6 cases with a PEFR that was 40% or less of the predicted rate. A PEFR of 40% or less of predicted, however, was

associated with a more than 10-fold increase in the risk of postoperative respiratory complications.

In general, patients with mediastinal masses are considered at high risk for perioperative complications if they have cardiorespiratory signs and symptoms, tracheal compression >50%, pericardial effusion on CT scan, or combined obstructive and restrictive patterns on pulmonary function testing.<sup>79</sup> General anesthesia and the use of neuromuscular blocking agents may reduce lung volume, relax bronchial smooth muscle leading to greater compressibility of the airway from the overlying mass, and reduce the transmural pressure gradient across the airway that helps maintain airway diameter.<sup>76</sup> A conservative management strategy may be necessary in such patients as mask ventilation may not be possible. Tracheostomy may not relieve airway obstruction, because the obstruction may occur at or below the level of the carina. Some clinicians have advocated femoral vessel cannulation in high-risk patients so that cardiopulmonary bypass can immediately be initiated in a crisis.<sup>81</sup>

### UNEXPECTED DIFFICULT AIRWAY

Both the ASA difficult airway algorithm<sup>1</sup> and the British Difficult Airway Society *Guidelines for Management of the Unanticipated Difficult Intubation*<sup>84</sup> conclude that even the experienced anesthesiologist's airway evaluation will not predict the difficult airway. In evaluation of 24 cases of unanticipated difficult airway, both personnel and system failures were noted that could have been reduced by combining several preanesthesia airway evaluation checks.<sup>85</sup>

In several reported cases, a supraepiglottic mass contributed to an unexpected failed intubation.<sup>69,70</sup> Difficult mask and LMA ventilation, combined with an inability to intubate, is common in these patients and can result in anesthetic morbidity and mortality.<sup>69</sup> Hyperplasia of the lingual tonsils, a lingual thyroid, and epiglottic cysts are commonly missed conditions that can contribute to failure to ventilate and/or intubate, because patients with these finding often have no obvious physical findings indicative of a problem. In clinical studies of the difficult airway, lack of information regarding the epi-

glottis or lingual tonsils complicates interpretation of tests used to predict the probability of difficult intubation.

### RECOMMENDATIONS

A patient with a history of difficult intubation or with conditions associated with difficult airway management should be approached with organized primary and secondary plans for airway management. Often awake intubation, especially if a history of difficult mask intubation is present, is the optimal approach. Patients with physical findings suggestive of a high possibility of difficult intubation may benefit from an awake intubation or the maintenance of spontaneous ventilation during induction of anesthesia. The patient who unexpectedly presents with a difficult or failed intubation history is at most risk because the anesthesiologist may not be prepared.

The hidden cause of a difficult airway (e.g., an asymptomatic supraepiglottic cyst) may not be detectable without direct or indirect laryngoscopy. Physicians involved with airway management should be aware of the weaknesses of various tests used to predict difficult airway management and must be prepared to manage an unexpected difficult airway. The American Society of Anesthesiologists' difficult airway algorithm suggests limiting attempts at intubation to avoid trauma. It encourages changing to other techniques to establish ventilation and oxygenation. In a prospective study of 11,257 intubations, this predefined algorithm was effective in solving most problems.<sup>86</sup> Impossible ventilation never occurred during the 18-month study; 100 cases (0.9%) of unexpected difficult intubation were recorded. A preanesthetic diagnosis of difficult intubation remains a task of recognizing subtle signs, with a tendency for the experienced practitioner to err on the side of a conservative diagnosis because of the difficulty associated with managing an unexpected airway problem.

### KEY REFERENCES

1. Practice guidelines for management of the difficult airway: an updated report by the American Society of Anesthesiologists task



force on management of the difficult airway. *Anesthesiology* 2003;98:1269–1277.

2. Lee A, Fan LT, Gin T, Karmakar MK, Ngan Kee WD. A systematic review (meta-analysis) of the accuracy of the Mallampati tests to predict the difficult airway. *Anesth Analg* 2006;102:1867–1878.

3. Rosenstock C, Gillesberg I, Gatke MR, Levin D, Kristensen MS, Rasmussen LS. Inter-observer agreement of tests used for prediction of difficult laryngoscopy/tracheal intubation. *Acta Anaesthesiol Scand* 2005;49:1057–1062.

4. Shiga T, Wajima Z, Inoue T, Sakamoto A. Predicting difficult intubation in apparently normal patients: a meta-analysis of bedside screening test performance. *Anesthesiology* 2005;103:429–437.

5. Rosenblatt WH. The airway approach algorithm: a decision tree for organizing preoperative airway information. *J Clin Anesth* 2004;16:312–316.

6. Hastings RH, Marks JD. Airway management for trauma patients with potential cervical spine injuries. *Anesth Analg* 1991;73:471–482.

7. Goh MH, Liu XY, Goh YS. Anterior mediastinal masses: an anaesthetic challenge. *Anaesthesia* 1999;54:670–674.

8. Henderson JJ, Papat MT, Latto IP, Pearce AC. Difficult Airway Society guidelines for management of the unanticipated difficult intubation. *Anaesthesia* 2004;59:675–694.

9. Rosenstock C, Hansen EG, Kristensen MS, Rasmussen LS, Skak C, Ostergaard D. Qualitative analysis of unanticipated difficult airway management. *Acta Anaesthesiol Scand* 2006;50:290–297.

10. Combes X, Le Roux B, Suen P, et al. Unanticipated difficult airway in anesthetized patients: prospective validation of a management algorithm. *Anesthesiology* 2004;100:1146–1150.

the American Society of Anesthesiologists task force on management of the difficult airway. *Anesthesiology* 2003;98:1269–1277.

2. Latto IP. Management of difficult intubation. In: Latto IP, Rosen M, eds. *Difficulties in Tracheal Intubation*. London: Balliere Tindall, 1985:141.

3. Lyons G. Failed intubation. Six years' experience in a teaching maternity unit. *Anaesthesia* 1985;40:759–762.

4. Samsoun GL, Young JR. Difficult tracheal intubation: a retrospective study. *Anaesthesia* 1987;42:487–490.

5. Savva D. Prediction of difficult tracheal intubation. *Br J Anaesth* 1994;73:149–153.

6. Wilson ME, Spiegelhalter D, Robertson JA, Lesser P. Predicting difficult intubation. *Br J Anaesth* 1988;61:211–216.

7. Crosby ET, Elliott RD. Anaesthesia for caesarean section in a parturient with quintuplet gestation, pulmonary oedema and thrombocytopenia. *Can J Anaesth* 1988;35:417–421.

8. Rocke DA, Murray WB, Rout CC, Gouws E. Relative risk analysis of factors associated with difficult intubation in obstetric anaesthesia. *Anesthesiology* 1992;77:67–73.

9. Williamson JA, Webb RK, Szekely S, Gillies ER, Dreosti AV. The Australian incident monitoring study. Difficult intubation: an analysis of 2000 incident reports. *Anaesth Intensive Care* 1993;21:602–607.

10. Caplan RA, Posner KL, Ward RJ, Cheney FW. Adverse respiratory events in anaesthesia: a closed claims analysis. *Anesthesiology* 1990;72:828–833.

11. Cormack RS, Lehane J. Difficult tracheal intubation in obstetrics. *Anaesthesia* 1984;39:1105–1111.

12. Yentis SM, Lee DJ. Evaluation of an improved scoring system for the grading of direct laryngoscopy. *Anaesthesia* 1998;53:1041–1044.

13. Adnet F, Borron SW, Racine SX, et al. The intubation difficulty scale (IDS): proposal and evaluation of a new score characterizing the complexity of endotracheal intubation. *Anesthesiology* 1997;87:1290–1297.

14. Benumof JL. Intubation difficulty scale: anticipated best use. *Anesthesiology* 1997;87:1273–1274.

15. Bannister FB, Macbeth RG. Direct laryngoscopy and tracheal intubation. *Lancet* 1944;651–654.

16. Bellhouse CP, Dore C. Criteria for estimating likelihood of difficulty of endotracheal intubation with the macintosh laryngoscope. *Anaesth Intensive Care* 1988;16:329–337.

17. Nichol HC, Zuck D. Difficult laryngoscopy—the “anterior” larynx and the atlanto-occipital gap. *Br J Anaesth* 1983;55:141–144.

18. Patil VU, Stehling LC, Zauder HL. Predicting the difficulty of intubation utilizing an intubation gauge. *Anesthesiol Rev* 1983;X:32–33.

19. Skolimowski J, Urbanski M, Stopa J, Naroznik K. Microgenia as a factor making

endotracheal intubation impossible. *Anaesth Resusc Intensive Ther* 1975;3:273–276.

20. Mallampati SR, Gatt SP, Gugino LD, et al. A clinical sign to predict difficult tracheal intubation: a prospective study. *Can Anaesth Soc J* 1985;32:429–434.

21. Ezri T, Cohen I, Geva D, Szmuk P. Pharyngoscopic views. *Anesth Analg* 1998;87:748.

22. Maleck WH, Koetter KK, Less SD. Pharyngoscopic views. *Anesth Analg* 1999;89:256–257.

23. Ezri T, Warters RD, Szmuk P, et al. The incidence of class “zero” airway and the impact of Mallampati score, age, sex, and body mass index on prediction of laryngoscopy grade. *Anesth Analg* 2001;93:1073–1075, table of contents.

24. Oates JD, Macleod AD, Oates PD, Pearsall FJ, Howie JC, Murray GD. Comparison of two methods for predicting difficult intubation. *Br J Anaesth* 1991;66:305–309.

25. Charters P, Perera S, Horton WA. Visibility of pharyngeal structures as a predictor of difficult intubation. *Anaesthesia* 1987;42:1115.

26. Oates JD, Oates PD, Pearsall FJ, Macleod AD, Howie JC. Phonation affects Mallampati class. *Anaesthesia* 1990;45:984.

27. Cattano D, Panicucci E, Paolicchi A, Forfori F, Giunta F, Hagberg C. Risk factors assessment of the difficult airway: an Italian survey of 1956, patients. *Anesth Analg* 2004;99:1774–1779.

28. Tham EJ, Gildersleve CD, Sanders LD, Mapleson WW, Vaughan RS. Effects of posture, phonation and observer on Mallampati classification. *Br J Anaesth* 1992;68:32–38.

29. Lewis M, Keramati S, Benumof JL, Berry CC. What is the best way to determine oropharyngeal classification and mandibular space length to predict difficult laryngoscopy? *Anesthesiology* 1994;81:69–75.

30. Lee A, Fan LT, Gin T, Karmakar MK, Ngan Kee WD. A systematic review (meta-analysis) of the accuracy of the Mallampati tests to predict the difficult airway. *Anesth Analg* 2006;102:1867–1878.

31. Wilson ME. Predicting difficult intubation. *Br J Anaesth* 1993;71:333–334.

32. Roberts JT, Ali HH, Shorten GD. Using the bubble inclinometer to measure laryngeal tilt and predict difficulty of laryngoscopy. *J Clin Anesth* 1993;5:306–309.

33. White A, Kander PL. Anatomical factors in difficult direct laryngoscopy. *Br J Anaesth* 1975;47:468–474.

34. el-Ganzouri AR, McCarthy RJ, Tuman KJ, Tanck EN, Ivankovich AD. Preoperative airway assessment: predictive value of a multivariate risk index. *Anesth Analg* 1996;82:1197–1204.

35. Rosenstock C, Gillesberg I, Gatke MR, Levin D, Kristensen MS, Rasmussen LS. Inter-observer agreement of tests used for prediction of difficult laryngoscopy/tracheal intubation. *Acta Anaesthesiol Scand* 2005;49:1057–1062.

## REFERENCES

1. Practice guidelines for management of the difficult airway: an updated report by

36. Langeron O, Masso E, Huraux C, et al. Prediction of difficult mask ventilation. *Anesthesiology* 2000;92:1229–1236.
37. Frerk CM. Predicting difficult intubation. *Anaesthesia* 1991;46:1005–1008.
38. Shiga T, Wajima Z, Inoue T, Sakamoto A. Predicting difficult intubation in apparently normal patients: a meta-analysis of bedside screening test performance. *Anesthesiology* 2005;103:429–437.
39. Wilson ME, Spiegelhalter D, Robertson JA, Lesser P. Predicting difficult intubation. *Br J Anaesth* 1988;61:211–216.
40. Rosenblatt WH. The airway approach algorithm: a decision tree for organizing preoperative airway information. *J Clin Anesth* 2004;16:312–316.
41. Rosenberg H, Rosenberg H. Syndromes associated with upper airway abnormalities. In: Orkin FK, Cooperman LH, eds. *Complications in Anesthesiology*. Philadelphia: JB Lippincott, 1983:137.
42. Paul DR, Hoyt JL, Boutros AR. Cardiovascular and respiratory changes in response to change of posture in the very obese. *Anesthesiology* 1976;45:73–78.
43. Katz I, Stradling J, Slutsky AS, Zamel N, Hoffstein V. Do patients with obstructive sleep apnea have thick necks? *Am Rev Respir Dis* 1990;141:1228–1231.
44. Bixler EO, Vgontzas AN, Lin HM, et al. Prevalence of sleep-disordered breathing in women: effects of gender. *Am J Respir Crit Care Med* 2001;163:608–613.
45. Dancy DR, Hanly PJ, Soong C, Lee B, Shepard J Jr, Hoffstein V. Gender differences in sleep apnea: the role of neck circumference. *Chest* 2003;123:1544–1550.
46. Brodsky JB, Lemmens HJ, Brock-Utne JG, Vierra M, Saidman LJ. Morbid obesity and tracheal intubation. *Anesth Analg* 2002;94:732–736; table of contents.
47. Bond A. Obesity and difficult intubation. *Anaesth Intensive Care* 1993;21:828–830.
48. Buckley FP, Robinson NB, Simonowitz DA, Dellinger EP. Anaesthesia in the morbidly obese. A comparison of anaesthetic and analgesic regimens for upper abdominal surgery. *Anaesthesia* 1983;38:840–851.
49. Hood DD, Dewan DM. Anesthetic and obstetric outcome in morbidly obese parturients. *Anesthesiology* 1993;79:1210–1218.
50. Brock-Utne JG, Downing JW, Seedat F. Laryngeal oedema associated with pre-eclamptic toxemia. *Anaesthesia* 1977;32:556–558.
51. Jouppila R, Jouppila P, Hollmen A. Laryngeal oedema as an obstetric anaesthesia complication: case reports. *Acta Anaesthesiol Scand* 1980;24:97–98.
52. Ovassapian A, Land P, Schafer MF, Cerullo L, Zalkind MS. Anesthetic management for surgical corrections of severe flexion deformity of the cervical spine. *Anesthesiology* 1983;58:370–372.
53. Keenan MA, Stiles CM, Kaufman RL. Acquired laryngeal deviation associated with cervical spine disease in erosive polyarticular arthritis. Use of the fiberoptic bronchoscope in rheumatoid disease. *Anesthesiology* 1983;58:441–449.
54. Hastings RH, Kelley SD. Neurologic deterioration associated with airway management in a cervical spine-injured patient. *Anesthesiology* 1993;78:580–583.
55. Ovassapian A, Ovassapian A. *Fiberoptic Endoscopy and the Difficult Airway*. 2nd ed. Philadelphia: Lippincott-Raven, 1996.
56. Audenaert SM, Montgomery CL, Stone B, Akins RE, Lock RL. Retrograde-assisted fiberoptic tracheal intubation in children with difficult airways. *Anesth Analg* 1991;73:660–664.
57. Finer NN, Muzyka D. Flexible endoscopic intubation of the neonate. *Pediatr Pulmonol* 1992;12:48–51.
58. Reah G, Entress A. Prolonged tracheal intubation in an infant with tracheomalacia secondary to a vascular ring. A useful adjunct to treatment? *Anaesthesia* 1995;50:341–342.
59. Wells AL, Wells TR, Landing BH, Cruz B, Galvis DA. Short trachea, a hazard in tracheal intubation of neonates and infants: syndromal associations. *Anesthesiology* 1989;71:367–373.
60. Heindel DJ. Deep neck abscesses in adults: management of a difficult airway. *Anesth Analg* 1987;66:774–776.
61. Prakash UB, Abel MD, Hubmayr RD. Mediastinal mass and tracheal obstruction during general anesthesia. *Mayo Clin Proc* 1988;63:1004–1011.
62. Baxter FJ, Dunn GL. Acute epiglottitis in adults. *Can J Anaesth* 1988;35:428–435.
63. Schwartz HC, Bauer RA, Davis NJ, Guralnick WC. Ludwig's angina: use of fiberoptic laryngoscopy to avoid tracheostomy. *J Oral Surg* 1974;32:608–611.
64. Flood LM, Astley B. Anaesthetic management of acute laryngeal trauma. *Br J Anaesth* 1982;54:1339–1343.
65. Seed RF. Traumatic injury to the larynx and trachea. *Anaesthesia* 1971;26:55–65.
66. Hastings RH, Marks JD. Airway management for trauma patients with potential cervical spine injuries. *Anesth Analg* 1991;73:471–482.
67. Senthuran S, Lim S, Gunning KE. Life-threatening airway obstruction caused by a retropharyngeal haematoma. *Anaesthesia* 1999;54:674–678.
68. al-Fallouji HK, Snow DG, Kuo MJ, Johnson PJ. Spontaneous retropharyngeal haematoma: two cases and a review of the literature. *J Laryngol Otol* 1993;107:649–650.
69. Jones DH, Cohle SD. Unanticipated difficult airway secondary to lingual tonsillar hyperplasia. *Anesth Analg* 1993;77:1285–1288.
70. Mason DG, Wark KJ. Unexpected difficult intubation. asymptomatic epiglottic cysts as a cause of upper airway obstruction during anaesthesia. *Anaesthesia* 1987;42:407–410.
71. Bouaggad A, Nejmi SE, Bouderkha MA, Abbassi O. Prediction of difficult tracheal intubation in thyroid surgery. *Anesth Analg* 2004;99:603–606, table of contents.
72. Groves J, Edwards N, Hood G. Difficult intubation following thoracic trauma. *Anaesthesia* 1994;49:698–699.
73. Madden BP, Loke TK, Sheth AC. Do expandable metallic airway stents have a role in the management of patients with benign tracheobronchial disease? *Ann Thorac Surg* 2006;82:274–278.
74. Faul JL, Kee ST, Rizk NW. Endobronchial stenting for severe airway obstruction in relapsing polychondritis. *Chest* 1999;116:825–827.
75. Filston HC, Ferguson TB, Jr, Oldham HN. Airway obstruction by vascular anomalies. importance of telescopic bronchoscopy. *Ann Surg* 1987;205:541–549.
76. Neuman GG, Weingarten AE, Abramowitz RM, Kushins LG, Abramson AL, Ladner W. The anesthetic management of the patient with an anterior mediastinal mass. *Anesthesiology* 1984;60:144–147.
77. Levin H, Bursztein S, Heifetz M. Cardiac arrest in a child with an anterior mediastinal mass. *Anesth Analg* 1985;64:1129–1130.
78. Hammer GB. Anaesthetic management for the child with a mediastinal mass. *Pediatr Anaesth* 2004;14:95–97.
79. Bechard P, Letourneau L, Lacasse Y, Cote D, Bussieres JS. Perioperative cardiorespiratory complications in adults with mediastinal mass: incidence and risk factors. *Anesthesiology* 2004;100:826–834; discussion 5A.
80. Lam JC, Chui CH, Jacobsen AS, Tan AM, Joseph VT. When is a mediastinal mass critical in a child? An analysis of 29 patients. *Pediatr Surg Int* 2004;20:180–184.
81. Goh MH, Liu XY, Goh YS. Anterior mediastinal masses: an anaesthetic challenge. *Anaesthesia* 1999;54:670–674.
82. Brodsky JB, Macario A, Mark JB. Tracheal diameter predicts double-lumen tube size: a method for selecting left double-lumen tubes. *Anesth Analg* 1996;82:861–864.
83. Hnatiuk OW, Corcoran PC, Sierra A. Spirometry in surgery for anterior mediastinal masses. *Chest* 2001;120:1152–1156.
84. Henderson JJ, Popat MT, Latto IP, Pearce AC, Difficult Airway Society. Difficult Airway Society guidelines for management of the unanticipated difficult intubation. *Anaesthesia* 2004;59:675–694.
85. Rosenstock C, Hansen EG, Kristensen MS, Rasmussen LS, Skak C, Ostergaard D. Qualitative analysis of unanticipated difficult airway management. *Acta Anaesthesiol Scand* 2006;50:290–297.
86. Combes X, Le Roux B, Suen P, et al. Unanticipated difficult airway in anesthetized patients: prospective validation of a management algorithm. *Anesthesiology* 2004;100:1146–1150.

## CHAPTER 9

## Evaluation of the Patient with Pulmonary Disease

Philip G. Boysen, MD, MBA

134

Pulmonary disease results in ventilatory defects that can be characterized as either restrictive or obstructive in nature.<sup>1</sup> Restrictive ventilatory defects (RVDs), although less common and less amenable to reversal, often coexist with and complicate obstructive ventilatory defects (OVDs). Typified by chronic obstructive pulmonary disease (COPD), OVDs are a major source of morbidity and mortality.<sup>2</sup> Irrespective of the type of ventilatory defect, the surgical patient with preexisting pulmonary disease experiences additional risk of postoperative respiratory complications in the immediate postoperative period. Thus, preanesthetic identification and treatment of reversible ventilatory defects, most often those associated with COPD, are essential to improving outcome.<sup>3,4</sup> Knowledge of the typical clinical presentations of the various types of ventilatory defects allows rational development of preoperative, intraoperative, and postoperative management techniques to improve physiologic function. Familiarity with the objective tests used to define limitations of pulmonary function is essential to rational management of the surgical patient with pulmonary disease. Advances in monitoring have made possible continued sophisticated evaluation of lung function intraoperatively.<sup>5</sup>

## PULMONARY FUNCTION TESTS

The decision regarding the need for pulmonary function tests is based on the history and physical examination of the patient with pulmonary defects. Spirometric tests are the most used and useful pulmonary function tests.<sup>6</sup> Spirometry helps distinguish RVDs from OVDs, and irreversible from reversible disease processes.

Simple in concept, spirometry often is difficult for the patient with chronic pulmonary disease to perform.<sup>7</sup> Much effort is required to meet testing standards and achieve quality results. Forced exhalation of lung gas from total lung capacity (TLC) to residual volume (RV) is measured as a function of time.<sup>8</sup> Graphic depiction of this maneuver reveals several measurable and derivable parameters (Fig. 9-1). They include, but are not limited to, forced vital capacity (FVC), forced expiratory volume at 1 second ( $FEV_1$ ),  $FEV_1$ /FVC ratio, and midflow rate (i.e., forced expiratory flow from 25% to 75% of vital capacity [ $FEF_{25-75\%}$ ]) and

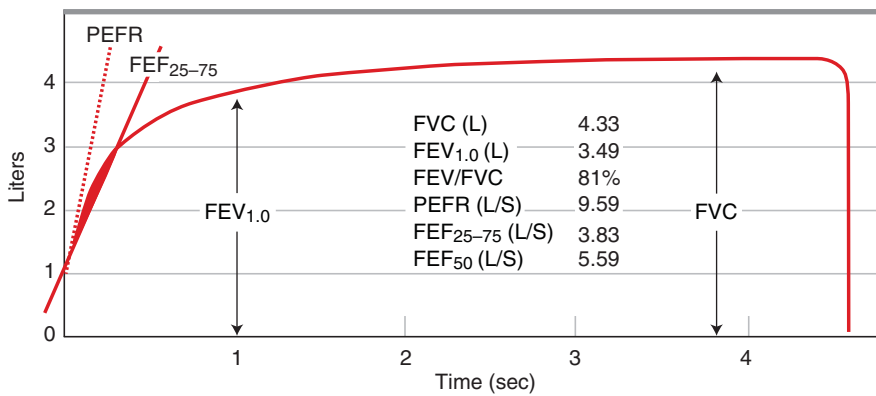
forced expiratory flow at 50% of vital capacity [ $FEF_{50\%}$ ]).<sup>9</sup>

An alternative way of representing the FVC maneuver is to plot the change in exhaled and inhaled gas flow in relation to attainable lung volumes.<sup>10</sup> By coupling an inspiratory maneuver from RV back to TLC following forced exhalation beginning at TLC to RV, a *flow-volume loop* is derived. Data similar to those obtained from spirometry are measured using flow-volume loops. They include FVC,  $FEV_1$ , peak expiratory flow rate (PEFR),  $FEF_{25-75\%}$ , and  $FEF_{50\%}$  (Fig. 9-2). This technique is a sensitive means of detecting early chronic obstructive lung disease be-

## KEY POINTS

- Ventilatory defects can be restrictive or obstructive in nature, with mixed defects often making diagnosis problematic.
- Patients with chronic obstructive pulmonary disease usually do not show reduction in forced vital capacity (FVC) until late in the course of the disease.
- The hallmark of chronic airflow obstruction is a decreased ratio of forced expiratory volume in 1 second ( $FEV_1$ ) to FVC.
- Flow-volume loops can differentiate among extrathoracic, intrathoracic, and fixed obstructions.
- Asthma and chronic bronchitis lead to changes in the bronchial lumen wall such as hypertrophy and bronchospasm.
- Emphysema is characterized by destruction of lung parenchyma and loss of surface area for gas transfer.
- Chronic bronchitis is characterized by proliferative hypertrophy of bronchial glands and smooth muscle.
- In asthma, the balance between (1) cyclic adenosine monophosphate-mediated bronchial relaxation and cyclic guanosine monophosphate-mediated bronchoconstriction and (2) sympathetic nervous system-mediated bronchial relaxation and parasympathetic nervous system bronchoconstriction is affected by antigens/IgE and mediators from mast cell contents (e.g., slow-releasing substance of anaphylaxis, eosinophilic chemotactic factor-A, bradykinin, and histamine).
- Lung volume in chronic bronchitis is near normal, except during acute exacerbation. In emphysema, usually total lung capacity is increased, with increased functional residual capacity and increased residual volume.
- Bronchodilator therapy may improve airflow obstruction and gas exchange (e.g.,  $\beta$ -agonists, methylxanthines, ipratropium bromide, corticosteroids, and, for patients in remission, cromolyn sodium).
- The carbon dioxide dissociation curve is linear and the gas is readily diffusible; hence, the ability to eliminate carbon dioxide is well preserved until ventilation-perfusion abnormalities and bronchospasm are severe.
- Physiologic changes in pulmonary function, seen particularly during abdominal and thoracic surgery, include (1) diaphragmatic dysfunction, (2) decreased forced residual capacity, (3) decreased total lung capacity, (4) decreased tidal volume, (5) increased respiratory rate, and (6) increased alveolar-to-arterial oxygen tension gradient.
- For the patient about to undergo thoracotomy and lung resection, analysis of the total contribution of each lung to overall function or split lung function studies is necessary (e.g., ventilation-perfusion lung scanning). Predicted postoperative  $FEV_1$  must exceed 800 mL for the patient to survive pneumonectomy.



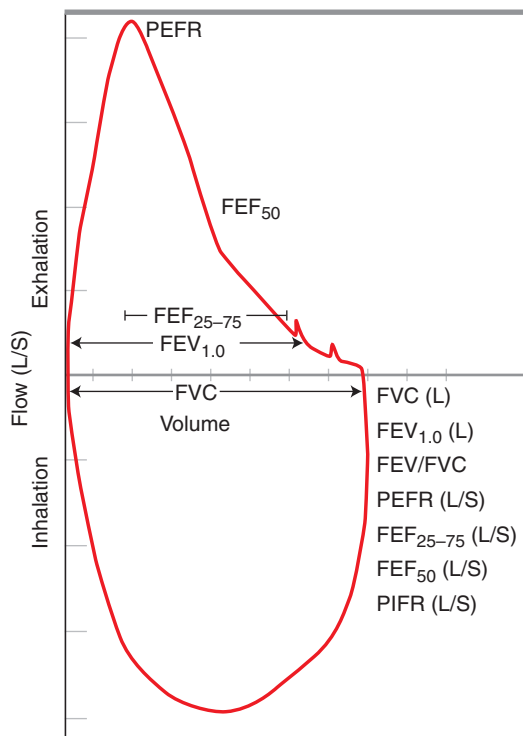


**FIGURE 9-1.** Spirogram plots volume versus time during a forced exhalation. Several attempts are made to achieve the best effort. The forced vital capacity (FVC), forced expiratory volume at 1 second (FEV<sub>1</sub>), FEV/FVC ratio, peak expiratory flow rate (PEFR), forced expiratory flow between 25% and 75% of vital capacity (FEV<sub>25-75%</sub>), and forced expiratory flow at 50% of vital capacity (FEV<sub>50%</sub>) then are calculated. Spirometry is repeated after bronchodilator therapy.

cause the final decrement in flow (i.e., at low lung volume) is independent of effort, and decreased flows are evident before changes in FEV<sub>1</sub> or FEV<sub>1</sub>/FVC are obvious.

An advantage of flow-volume loops over standard spirometry is their ability to differentiate the anatomic location of flow obstructions. Because both exhalation and inhalation are depicted

by flow-volume loops, intrathoracic distal airway obstruction can be differentiated from extrathoracic upper airway obstruction by analyzing flow-volume loops.<sup>11</sup> Extrathoracic obstruction at the level of the upper airway, larynx, or trachea is of particular interest to the anesthesiologist. Abnormalities of anatomy in these regions often result in fixed but limited airflow



**FIGURE 9-2.** Same forced exhalation as shown in Fig. 9-1 represented on a flow versus volume graph. A deep inspiration closes the loop. Forced expiratory volume at 1 second (FEV<sub>1</sub>), forced vital capacity (FVC), peak expiratory flow rate (PEFR), forced expiratory flow between 25% and 75% of vital capacity (FEV<sub>25-75%</sub>), and forced expiratory flow at 50% of vital capacity (FEV<sub>50%</sub>) also can be obtained. Note the concave shape of the last half of the exhalation curve, suggesting early airflow obstruction in small airways despite apparently normal FEV<sub>1</sub> and FVC.

through an obstructing lesion (Fig. 9-3). When the obstruction is extrathoracic, changes on the flow-volume loop are most obvious during inhalation. The clinical correlate is inspiratory stridor. Conversely, when the lesion is intrathoracic, exhalation is affected and the clinical correlate is wheezing. Fixed obstruction in the upper airway affects the entire loop.

Coupled with history and physical examination, data from spirometry and flow-volume loops form the basis of clinical judgments. Specific test result patterns characterize and differentiate OVDs and RVDs. Reduction of FVC with preservation of FEV<sub>1</sub> and FEV<sub>1</sub>/FVC is characteristic of either extrinsic (e.g., paralyzed diaphragm, obesity, kyphoscoliosis) or intrinsic (e.g., interstitial fibrosis) RVDs. In contrast, patients with OVDs usually do not show a reduction in FVC until late in the natural history of the disease, long after reductions of FEV<sub>1</sub> and FEV<sub>1</sub>/FVC ratio are present.

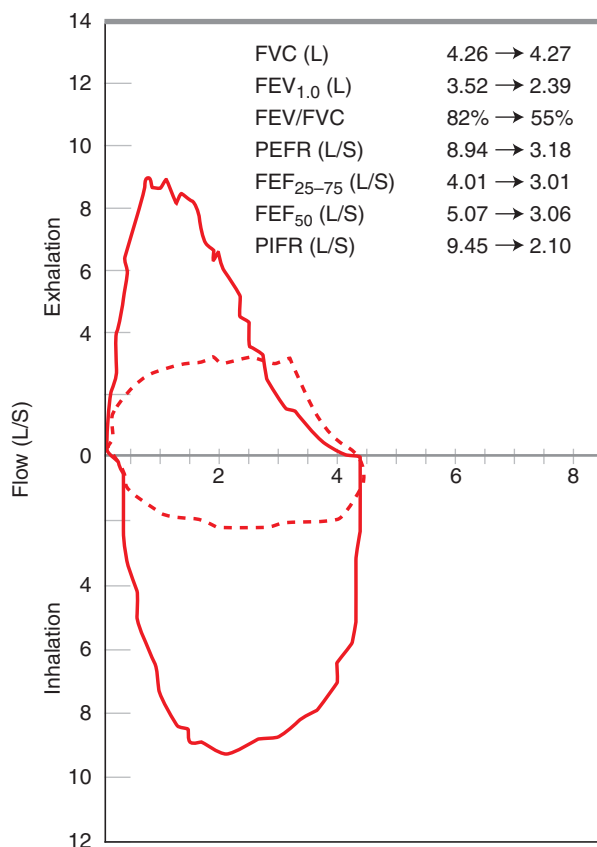
Evidence of reversibility is always sought with spirometric and flow-volume loop test results. Patients with surgically correctable extrathoracic or intrathoracic airway obstructions can be appropriately managed based on knowledge of flow-volume loops. Because patients with asthma and chronic bronchitis will show immediate improvement in test results after bronchodilator therapy,<sup>12,13</sup> documented improvement in exhaled midflow rates (FEV<sub>25-75%</sub> and FEV<sub>50%</sub>) is valuable preanesthetic information in patients with OVDs. Thus, preanesthetic attention should be focused on patients with reversible pathology because of the benefit they derive from preoperative therapy to maximize pulmonary function.

## RESTRICTIVE VENTILATORY DEFECTS

RVDs exist when ventilation is impaired by mechanical forces that restrict alveolar ventilation (Fig. 9-4). Inspiratory and expiratory resistive forces are increased. RVDs are either intrinsic or extrinsic in nature. Primary disease of alveoli and supporting tissues, constrictive diseases of the pleura and chest wall, and neural disorders that alter ventilatory mechanics constitute the spectrum of RVDs.

Patients with RVDs present with tachypnea and dyspnea, features also





**FIGURE 9-3.** Normal flow–volume loop (solid line) superimposed on a box-shaped loop (dashed line) characteristic of fixed upper airway obstruction. Major limitations in peak flow and midflow are recorded.

commonly present in postoperative patients experiencing pain. The chest radiograph reveals interstitial patterns and concentric decreases in lung volumes. Arterial hypoxemia may be present at rest in severe cases and may be exacerbated by exercise. Chronic hypoxemia can result in altered pulmonary arterial pressures superimposed on any preexisting vascular involvement, placing these individuals at high risk for right heart failure over time.

Pulmonary function tests reveal parallel and proportional decreases in FVC and FEV<sub>1</sub> that result in near-normal or greater than normal values for FEV<sub>1</sub>/FVC. This is in contradistinction to OVDs, in which factors that obstruct alveolar gas flow exist even when ventilatory mechanics are normal and pulmonary function tests reveal decreases in FEV<sub>1</sub> out of proportion to decreases in FVC. When RVDs and OVDs coexist, mixed ventilatory defects are present. These may have spirometric patterns that combine features of both types of ventilatory defects. Although isolated RVDs usually

are progressive and irreversible, palliative measures (e.g., antibiotics or bronchodilator or steroid therapies) are directed at the reversible components of mixed conditions.

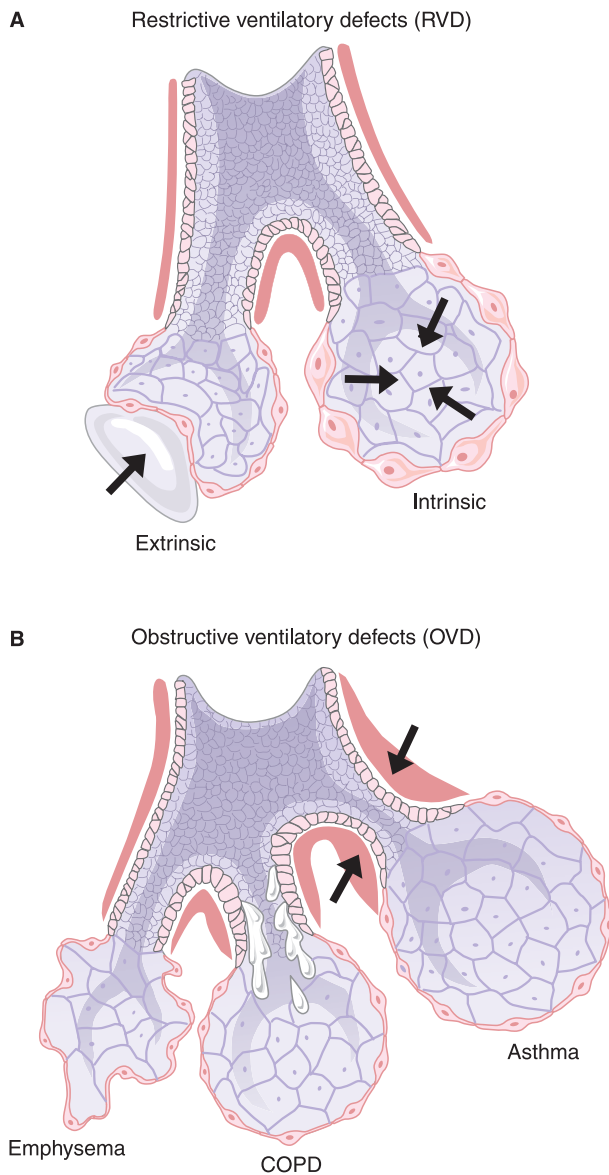
Intrinsic RVDs exist when alveolar membranes are thickened and present a barrier to gas diffusion (e.g., in patients with pneumonia, bronchiolitis obliterans, pulmonary alveolar proteinosis, or pulmonary fibrosis). Extrinsic RVDs exist when alveolar volume is reduced because of either specific mass compression of alveoli (e.g., blood, effusion, tumor) or generalized reduction of thoracic compliance with secondary diminution of ventilated alveoli (e.g., scoliosis, muscular dystrophy, neuromuscular diseases, obesity). Sarcoidosis initially is restrictive in nature but can develop obstructive characteristics. Adult respiratory distress syndrome is an example of a potentially reversible RVD that has a 50% mortality rate. It often presents in the perioperative period in patients with a history of severe trauma, sepsis, pancreatitis, or failure of multiple organ systems.<sup>14</sup>

RVDs are important for two reasons. First, they present a diagnostic and management challenge, especially with coexisting OVDs. Second, they serve as a model for the reversible restrictive changes that follow anesthesia and surgery, especially intrathoracic and upper abdominal surgery. Pain, residual neuromuscular blockade, thoracic or abdominal wound dressings, and neuromuscular dysfunction of the diaphragm and chest wall can result in RVDs that are a source of significant postoperative respiratory complications if not adequately treated but are reversible if adequately and systematically treated. It is this second point that must be emphasized with respect to either RVDs or OVDs: anesthesia and surgery superimpose mechanical restrictions upon preexisting ventilatory defects that are largely restrictive in nature. Acute restrictive ventilatory physiology is observed during laparoscopic procedures with gas insufflation of the abdomen.

## OBSTRUCTIVE VENTILATORY DEFECTS

OVDs are pathologic conditions in which increased airflow resistance results from airflow obstruction during the respiratory cycle. OVDs are either acute or chronic. Whether acute or chronic, airflow obstruction is intraluminal, extraluminal, or mixed. Because OVDs are more common than RVDs and are more amenable to reversal than are RVDs, a more detailed discussion of their pathology is warranted.

OVDs include obstructing airway tumors, foreign bodies, anatomic problems such as vocal cord paralysis or tracheobronchomalacia, and the COPDs of emphysema, chronic bronchitis, and asthma. Among OVDs, entities included under the rubric of COPD are the most common. Although distinct patterns exist, acute and chronic OVDs all are characterized by airflow resistance during exhalation caused by decreased airway diameters. These may be caused by glottic or subglottic obstructing airway masses, accumulation of inadequately cleared mucus secretions, local inflammation, smooth muscle hypertrophy, and bronchiolar and alveolar structural weaknesses. The patient with COPD, unlike the patient with upper airway or pharyngeal level obstruction, usually has no problem



**FIGURE 9-4.** A. Restrictive ventilatory defects (RVD). B. Obstructive ventilatory defects (OVD).

during inspiration. Inspiratory resistive forces do not contribute to additional respiratory work during ventilation. Expiratory resistive forces, however, are significant because of air trapping behind obstructed small airways. Pulmonary function test results for COPD are discussed in Pulmonary Function and Chronic Obstructive Pulmonary Disease below.

## CHRONIC OBSTRUCTIVE PULMONARY DISEASES

As a category of OVD, COPD includes emphysema, chronic bronchitis, and chronic asthma.<sup>15</sup> Each of these pathophysiologic states is accompanied by typical clinical presentation, history,

physical examination, and changes in pulmonary function test results. Although asthma is characterized by episodic alteration of bronchial smooth muscle tone with normal pulmonary function and a complete absence of symptoms during remission, it is best considered a chronic disorder. Asthma patients usually function in a compromised state because of increased smooth muscle tone and experience symptomatic exacerbations that cause acute worsening of their pulmonary function test results. Because these patients are at increased risk when anesthetized for surgical procedures, they are included under the classification of COPD.

COPD is marked by intraluminal and extraluminal airflow obstruction result-

ing in air trapping. Intraluminal small airway changes may be caused by altered ciliary function, increased mucus production by goblet cells, and ineffective clearance of secretions from the airway. Aspiration of liquid contents from the pharynx or stomach and chronic inflammatory conditions also may increase airway secretions. Specific airway wall changes include hypertrophy and hyperreactivity of bronchial smooth muscle, conditions especially evident in patients with asthma and chronic bronchitis. Also, edema and inflammation of the airway walls decrease lumen diameters and cause airflow obstruction during exhalation.

Extraluminal airway changes associated with airflow obstruction include loss of lung parenchyma and concomitant structural support, external compression of the airway by lymph nodes or tumors, and peribronchial and perivascular edema impinging on the airway wall. Any of these changes, alone or in combination, may be present in patients with COPD.

Specific examples of COPD include emphysema, chronic bronchitis and asthma.

### Emphysema

Emphysema often is referred to as type A COPD.<sup>16</sup> Although many patients present with symptoms that indicate a diagnosis of pure emphysema, some show a clinical and physiologic picture consistent with chronic bronchitis, and some show a mixed clinical picture.

Emphysema is characterized by destruction of lung parenchyma and loss of effective surface area for gas exchange caused by loss of radial traction within the thin, filamentous alveoli where gas exchange occurs. Descriptively referred to as *pink puffers* because of their acyanotic appearance and tendency to exhale through pursed lips to provide end-expiratory pressure, patients with emphysema can have relatively advanced disease with preservation of arterial oxygen tension. In addition, they usually do not retain carbon dioxide, so increases in alveolar and arterial carbon dioxide tensions usually are not evident in blood gas analyses until very late in the disease course.

Spirometry in emphysematous patients is characterized by a decrease in  $FEV_1/FVC$ , the hallmark of chronic airflow obstruction, and diminished air-

flow at all lung volumes.<sup>16</sup> Because of the tendency toward hyperinflation and gas trapping, an increase in the ratio of RV to TLC may be evident and reflected in specific changes in the chest radiograph.<sup>17</sup> These changes include low, flat diaphragms and extremely hyperlucent lung fields, consistent with both gas trapping and the loss of lung parenchyma. Because of these changes, the heart usually appears small on the chest radiograph, and evidence of decreased pulmonary vasculature with destruction of alveolar septae is seen.

Most patients with emphysema do not suffer repeated episodes of respiratory failure, have scant or insignificant sputum production, and tend not to manifest signs of right heart failure and cor pulmonale.

### Chronic Bronchitis

Chronic bronchitis sometimes is referred to as type B COPD. It is characterized by anatomic changes that include proliferation and hypertrophy of the bronchial goblet cells and hyperreactivity of the bronchial smooth musculature. Because of changes in goblet cell structure and function, mucus secretion is increased. Copious secretions tend to inspissate and occlude the airways. A chronic, usually productive, cough is characteristic. Secretions often are purulent because of gram-positive and gram-negative bacteria colonization.

Unlike emphysematous patients, patients with chronic bronchitis have marked tendency toward decreased arterial oxygen tension and desaturation early in their disease course. In addition, alveolar and arterial carbon dioxide tensions tend to be increased, so hypoxia and hypercapnia are characteristic of chronic bronchitis. Because of arterial oxygen desaturation and cardiopulmonary dysfunction, patients may appear cyanotic, plethoric, and bloated, giving rise to the descriptive term *blue bloaters*, in contradistinction to the emphysematous *pink puffers*.

As in emphysema, resting pulmonary function is characterized by a decrease in FEV<sub>1</sub>/FVC. Nonetheless, lung volumes usually are near-normal unless there is an exacerbation of infection and bronchospasm, in which case there is a tendency toward hyperinflation and gas trapping.<sup>16</sup> Both of these changes are observable on the chest radiograph and with measurement of lung volumes. Successful treatment of

acute episodes usually results in return to baseline lung volumes.

The course of chronic bronchitis is characterized by multiple episodes of respiratory compromise or overt failure. Acute and episodic bronchospasm, increased mucus secretions, and a purulent productive cough accompanied by fever herald an exacerbation of disease.<sup>18</sup> During these episodes, hypoxia and hypercapnia may worsen. Acutely ill patients usually do not do well if tracheal intubation and mechanical ventilation are necessary. For this reason, therapy concentrates on pharmacologic management and low-flow oxygen therapy to preserve oxygen delivery during an acute episode.

These patients often have increased pulmonary vascular resistance, most likely caused by the changes in arterial oxygen saturation. As the disease progresses, right-sided work of the heart increases, predisposing patients to right-heart failure and cor pulmonale. This is manifested by increased hepatjugular reflux and peripheral edema.

### Asthma

Asthma, which is common in young patients, is characterized by long periods of remission punctuated by exacerbations.<sup>19</sup> During remission, the patient usually is asymptomatic with measured pulmonary function data that are normal or near normal. During exacerbations, when airflow obstruction and bronchial smooth muscle constriction occur, changes in FEV<sub>1</sub>/FVC are noted. Secretions may increase and occlude the airway, further compromising exhaled gas flow.<sup>20</sup> These secretions often are thick and tenacious, but sterile. When they occlude the airway the secretions are referred to as *Curschmann spirals*. Examination of these secretions may reveal hypereosinophilia, a finding consistent with the observation that an allergic process can either initiate or complicate episodes of asthmatic airflow obstruction.

The mechanisms for changes in the airway and in bronchial smooth muscle function are not fully elucidated. A series of intracellular events modulate smooth muscle function through the production of cyclic adenosine monophosphate (cAMP) or cyclic guanosine monophosphate (cGMP). These two compounds have opposite effects, such that an increase in cAMP results in

relaxation of bronchial smooth muscle, whereas an increase in cGMP results in constriction of bronchial smooth muscle. This balance is further modulated by reaction to specific antigens, which is initiated when immunoglobulin E (IgE) is released in the presence of antigenemia and fixes itself to plasma cells in the bronchial smooth muscle in the wall of the airway. Once this occurs, mediators are released from granules in the mast cell. Some of these mediators include histamine, slow-releasing substance of anaphylaxis (SRSA), eosinophilic chemotactic factor-A (ECF-A), and bradykinins. All of these compounds increase the tone of bronchial smooth muscle and cause local edema, thereby causing airway obstruction and bronchospasm.

The autonomic nervous system also plays a role in control of bronchial smooth muscle tone. A balance between the sympathetic and parasympathetic nervous systems results in differential alteration of the caliber of the airways: stimulation of the sympathetic nervous system causes bronchial relaxation or bronchodilation, whereas parasympathetic stimulation causes bronchoconstriction or increased bronchomotor tone. The latter mechanism is particularly instrumental in patients who tend to have bronchospasm triggered by emotional stress, nonallergic irritants, inhalation of cold air, or exercise. For this reason, a therapeutic approach has been advised that includes stimulation of the sympathetic nervous system using sympathomimetic agents and/or blockade of the parasympathetic nervous system using parasympatholytic drugs.

Because activation of the parasympathetic system tends to be vagally mediated, parasympatholysis should be used in the patient about to undergo general anesthesia with an endotracheal tube because manipulation and intubation of the upper airway may cause bronchospasm. In addition to bronchodilation therapy, administration of systemic corticosteroids often is indicated. Use of corticosteroid therapy has been shown not to interfere with wound healing or to increase the incidence of postoperative infections.<sup>21</sup>

## PULMONARY FUNCTION AND COPD

Early in the course of emphysema or chronic bronchitis, FVC usually is nor-

mal. Nonetheless, both conditions are diagnosed by history, physical examination, and a measurable decrease in  $FEV_1/FVC$ , as noted previously. Because of airflow obstruction, the maximal voluntary ventilation also decreases.

Lung volume measurements are near normal in the patient with chronic bronchitis unless measurements are taken during an acute exacerbation of the disease.<sup>22</sup> In the emphysematous patient, TLC usually is increased, but functional residual capacity (FRC) and RV are markedly increased. Thus,  $RV/TLC$  or  $FRC/TLC$ , which are evidence of hyperinflation and increased gas trapping, are useful measures of disease status in emphysema.

The diffusing capacity for carbon monoxide usually is normal or near normal for the patient with chronic bronchitis<sup>18,23</sup> because the anatomic changes occur in bronchial smooth muscle and not in lung parenchyma.<sup>4</sup> Nevertheless, because the emphysematous patient has loss of effective surface area for gas exchange, a decrease in diffusing capacity for carbon monoxide is present.

When either disease is progressive, additional changes may mimic the other condition. For example, the patient with chronic bronchitis may manifest changes in lung volumes and diffusing capacity similar to those in the patient with emphysema. Conversely, the severely affected emphysematous patient may become so compromised and hyperinflated that his or her vital capacity is restricted because of lung volume changes. When this occurs, marked prolongation of  $FEV_1$  and a decrease in FVC are consistent with the severe hyperinflation associated with marked COPD.

The patient with asthma also tends to have specific pulmonary function abnormalities, especially during exacerbations. In addition to the decrease in  $FEV_1/FVC$ , airflow decreases throughout the range of vital capacity. Tests used to describe these changes include the maximal midexpiratory flow rate (MMEFR), maximal midflow rate (MMFR), and  $FEF_{50\%}$ . In addition, during acute attacks of bronchospasm,  $RV/TLC$  and  $FRC/TLC$  may increase.<sup>24</sup>

The diffusing capacity of lung for carbon monoxide (DLCO) may be abnormal and varies depending on how it is measured. Many investigators have suggested correcting the DLCO for the lung for the inhaled gas volume

when the single-breath measurement technique is used.<sup>25</sup> This measurement, the ratio of diffusing capacity for the lung (DL), divided by the alveolar gas volume (VA) is designated as the  $DL/VA$ .<sup>26</sup> This measurement usually is normal, especially during disease remission.

The patient with asthma may have a significant response to bronchodilators when spirometry is repeated. In the untreated asthmatic patient, administration of a nebulized bronchodilator (e.g., isoproterenol or other  $\beta$ -agonist) has been suggested to result in an improvement in airflow and, if the obstruction relieved is severe enough, an increase in the vital capacity. The degree of improvement in airflow is debatable, but in general a 20–25% increase in either  $FEV_1$  or FVC is considered a significant response to the bronchodilator, consistent with a diagnosis of asthma.

Like the patient with asthma, the patient with chronic bronchitis tends to respond immediately to a nebulized bronchodilator. In this case, anatomic changes in the airway but also some degree of bronchospasm may occur. However, rarely does the patient with chronic bronchitis manifest a 25% improvement in spirometric function. A change in the range from 5–10% is consistent with the clinical diagnosis of chronic bronchitis.<sup>12</sup>

It should be reemphasized that spirometric testing is useful only in demonstrating physiologic abnormalities or the degree of impairment. As an example, a patient with chronic bronchitis is diagnosed by history and physical examination. If this patient produces sputum 2 months out of the year for 2 years in a row and has the stigmata and history of wheezing, cyanosis, and so on, the diagnosis is confirmed.<sup>16</sup>

The patient's response to bronchodilators has been used as a technique to determine who may benefit from a preoperative regimen of bronchopulmonary toilet that usually includes bronchodilators. This response, when seen in a patient with a consistent history and physical examination, indicates the need for preoperative therapy. Both the intraoperative and postoperative courses improve with pharmacologically sustained improvement in airflows. It is becoming more apparent that such treatment not only can decrease morbidity but also mortality, particularly after upper abdominal surgery.

## GAS EXCHANGE ABNORMALITIES

Gas exchange abnormalities occur whenever pulmonary mechanics change. Bronchospasm, in particular, affects pulmonary mechanics, with dramatic effects on gas flow and blood distribution. The end result of bronchospasm is mismatching of ventilation and perfusion. During bronchospasm, blood flow patterns change to maintain matching between regions of ventilation and perfusion. Although compensatory to some degree, the resulting low ventilation-perfusion ( $\dot{V}/\dot{Q}$ ) state characteristic of chronic bronchitis and acute asthma results in arterial oxygen desaturation and hypoxemia.

These abnormalities have been elegantly demonstrated in studies using six gas techniques to demonstrate regions of low  $\dot{V}/\dot{Q}$  and their improvement following administration of bronchodilators. Bronchodilator therapy not only improves airflow obstruction and lung mechanics but also gas exchange and related perfusion abnormalities. Indeed, a transient decrease in arterial oxygen saturation is sometimes noted after administration of a bronchodilator. This presumably is caused by an effect on vascular smooth muscle that is more immediate than the subsequent effect on bronchial smooth muscle that results in airway dilation and improved gas exchange. The fall in the arterial oxygen tension usually is transient, not clinically significant, and followed by an immediate rise as bronchial smooth muscle tone decreases. Bronchial provocation tests also have been used to demonstrate the dynamic nature of  $\dot{V}/\dot{Q}$  matching.<sup>27,28</sup>

In most patients with acute bronchospasm, carbon dioxide elimination is normal, but hypoxemia may be severe. Unlike the oxyhemoglobin dissociation curve, the carbon dioxide dissociation curve is linear, a reflection of carbon dioxide's higher diffusibility compared with oxygen. As a result, carbon dioxide elimination is relatively well preserved until  $\dot{V}/\dot{Q}$  abnormalities and bronchospasm are severe. When arterial carbon dioxide tension begins to rise, however, the acutely ill asthmatic patient has reached the point of impending respiratory failure.

Chronic carbon dioxide retention, as seen in the patient with chronic bronchitis, usually is observed as the dis-



ease progresses and occurs so slowly that a compensated respiratory acidosis is noted on arterial blood gas analysis. The reason for this rise in carbon dioxide tension is not well defined but probably is caused by the increased work of breathing that occurs late in the course of the disease.<sup>29</sup> At some point, the ability to maintain normal carbon dioxide tension apparently is overwhelmed by a significant increase in respiratory muscle work such that a new baseline must be established, and a new steady state then evolves.

## BRONCHODILATOR THERAPY

Bronchodilator therapy is efficacious in patients with bronchospasm and increased intraluminal secretions. The sympathetic and parasympathetic nervous systems regulate bronchomotor tone, and humoral factors and inflammation play a role in airway obstruction. Thus, therapeutic approaches using sympathomimetic and parasympatholytic agents continue to evolve alongside approaches that prevent mediator release or decrease inflammation. Combined therapy with drugs that influence each component also can help achieve the desired therapeutic results.

The primary sympathomimetic therapeutic strategy is to stimulate intracellular cAMP production. Therapy usually starts with an inhaled  $\beta_2$ -agonist bronchodilator. These sympathomimetic agents are designed to act at  $\beta_2$ -receptor sites that modulate changes in smooth muscle tone. Drugs that are relatively free of  $\alpha_1$  and  $\beta_1$  side effects, such as tachycardia and increased blood pressure, are particularly useful. Albuterol, metaproterenol, and orciprenaline are the sympathomimetic agents of choice.

The second sympathomimetic approach is to increase availability of cAMP by administration of methylxanthines. This therapeutic effect is mediated by inhibition of the phosphodiesterase enzyme that breaks down cAMP. Whereas other sympathomimetics are delivered by a metered-dose aerosol inhaler, methylxanthines are given either intravenously or orally. Aminophylline (85% theophylline) is the agent of choice.

Together or alone,  $\beta$ -agonists (by stimulating cAMP production) and methylxanthines (by inhibiting cAMP breakdown) achieve the same effect.

Parasympatholytic drugs, such as atropine and its analogues, help alleviate bronchospasm by blocking the effects of acetylcholine on bronchial smooth muscles. In an attempt to avoid atropine's often troublesome side effects, the atropine analogue ipratropium bromide has been introduced as an adjunct to bronchodilator therapy. Like  $\beta$ -agonists, it is given by metered-dose inhaler. To date it appears remarkably free of adverse side effects. Once adequate sympathomimetic and parasympatholytic therapy is achieved, cardioselective  $\beta$ -blocker therapy can be administered safely if indicated.<sup>30</sup>

Cromolyn sodium and corticosteroids are useful in preventing bronchospasm in the asthmatic patient in remission, but they are of limited use during acute episodes. Cromolyn sodium stabilizes mast cell granules and prevents release of mediators, but it has no role in treatment of acute bronchospasm. Inhaled corticosteroids are relatively nonabsorbable, whereas oral and parenteral steroids have a wide variety of effects, including suppression of inflammation. These drugs can be used during the consolidation therapy phase of acute asthma and for long-term therapy for severe COPD. Beclomethasone dipropionate and triamcinolone acetonide are examples of these drugs.

When devising an anesthetic plan for the patient with asthma or chronic bronchitis, it is important to consider that although volatile anesthetics alter upper airway function and reflexes to varying degrees,<sup>31</sup> all volatile agents are bronchodilators.<sup>32</sup>

## PREOPERATIVE EVALUATION

A thorough history and physical examination, including assessment of functional capability at rest and with activity, serve as the basis for obtaining further diagnostic tests as part of the preoperative evaluation.<sup>33</sup> The type of surgical procedure the patient is to undergo also is considered before preoperative tests are ordered.

If a patient is suspected of having compromised pulmonary function, it is reasonable and cost effective to measure baseline spirometry—both before and after administration of a nebulized bronchodilator—and maximal voluntary ventilation. Arterial blood gas analysis provides a baseline

assessment of gas exchange and identifies the patient who is chronically hypoxemic or hypercapnic.

Additional studies, such as measurement of lung volumes and diffusing capacity, further define abnormal physiology and are helpful for the patient being assessed for thoracotomy.<sup>34,35</sup>

For the patient about to undergo an abdominal surgical procedure, no evidence indicates that additional testing is helpful. Also controversial is whether to extend testing to patients who are elderly or obese or who smoke. Tisi<sup>36</sup> recommends an approach to preoperative pulmonary function testing (Box 9-1). The predictive value of various pulmonary function tests was extensively reviewed by Zibrak et al.<sup>37</sup>

It is important to recognize the physiologic abnormalities that are superimposed on baseline pulmonary function in the immediate postoperative period, particularly after abdominal or thoracic surgery.<sup>38</sup> Because of a combination of factors, including pain-related splinting and non-pain-related abnormal diaphragmatic function,<sup>39,40</sup> there is a loss of lung volume (FRC and TLC), an increase in respiratory rate, a decrease in tidal volume, and a widening of the alveolar-to-arterial oxygen tension gradient in the postsurgical patient. The latter change is caused by the fall in lung volume (often referred to as *microatelectasis*) and manifests as right-to-left shunting in the lung.

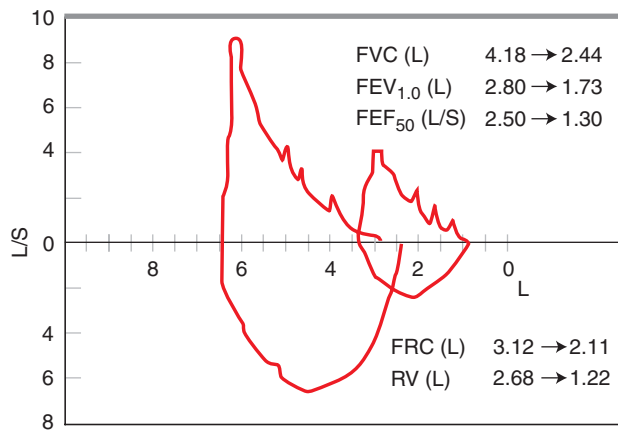
In essence, the abnormalities in pulmonary function are characteristic of a transient, superimposed, restrictive physiologic process that is most evident on the first postoperative day (Fig. 9-5). Recovery of 80% of preoperative function usually is evident by the third

### BOX 9-1.

#### Candidates for Preoperative Evaluation of Pulmonary Function

- Patients having thoracic surgery
- Patients having upper abdominal surgery
- Patients with history of heavy smoking and cough
- Obese patients
- Elderly patients (age >70 years)
- Patients with documented pulmonary disease

Data from Tisi GN. Pulmonary physiology in clinical medicine. Baltimore: Williams & Wilkins, 1980.



**FIGURE 9-5.** Flow-volume loops measured before cholecystectomy (*left*) and on the first postoperative day after coaching and pain medication (*right*). The shift to the right indicates a fall in lung volumes. The smaller, but similarly shaped, loop indicates a restrictive process.

day after surgery. An underlying chronic change in physiology—either restriction or airway obstruction—may combine with acute changes, resulting in the patient's inability to sustain spontaneous ventilation. Intraoperative and postoperative monitoring, combined with preoperative assessment, are essential to assist recovery during this crucial time.

Unfortunately, no pulmonary function test specifically relates to postoperative outcome or the occurrence of postoperative pulmonary complications. In addition, assigning a specific value for each test or reduction in function that defines risk is difficult; however, some guidelines are useful (Box 9-2).

If a patient fails to meet any of these parameters, the risk of postoperative pulmonary complications is increased. How to respond to these abnormalities depends on the type of surgery being

considered. For the patient about to undergo an abdominal procedure, adequate attention should be focused on a regimen of preoperative therapy. This regimen should include administration of a nebulized  $\beta_2$ -agonist for bronchodilation, an oral theophylline preparation, and antibiotic therapy if the patient has a productive cough and purulent sputum. Consideration should be given to the addition of nebulized atropine or an atropine analogue to achieve parasympatholysis and thus facilitate anesthetic induction, especially if there is clinical evidence of reactive bronchospasm.<sup>41</sup>

The patient about to undergo thoracotomy and lung resection who fails to meet these criteria is at considerable risk.<sup>42-45</sup> If a pneumonectomy is required, the remaining lung tissue may be inadequate to sustain life. Severe hypoxemia and cor pulmonale leading to imminent death may result.<sup>46</sup> An analysis of the total contribution of each lung to overall function, or *split-lung function studies*, is necessary. This has been accomplished by bronchospirometry,<sup>47</sup> the lateral position test,<sup>48-51</sup> balloon occlusion studies,<sup>52-54</sup>  $\dot{V}/\dot{Q}$  lung scanning,<sup>55-58</sup> and photon emissive tomography.<sup>59</sup>

Bronchospirometry, an early method of measuring split-lung function, is the most direct technique.<sup>47</sup> An awake patient is prepared with topical anesthetics, and then a double-lumen tube is passed into the patient's airway. Because the distal portion of the tube allows endobronchial intubation, inflation of appropriately positioned cuffs allows collection of exhaled gas from each lung. Flow resistance through these orifices is markedly increased, but

exhaled volume can be measured and the total FVC appropriately partitioned into right versus left components.

The hemodynamic correlate of the ventilatory measurement achieved by bronchospirometry is temporary unilateral balloon occlusion of the pulmonary artery of the lung about to be resected. Interruption of flow to that lung causes a temporary pneumonectomy, with subsequent shift of ventilation away from the occluded lung. A rise in the proximal pulmonary arterial pressure or a decrease in oxygen tension or saturation indicates a lessened likelihood of survival with one lung remaining. If the arterial oxygen tension falls < 45 mm Hg during occlusion or mean pulmonary artery pressure rises > 30 mm Hg, the occurrence of cor pulmonale after pneumonectomy is likely.<sup>54</sup>

The results of these studies are combined with those found during low levels of exercise. For general exercise tolerance studies, the usefulness of various protocols has yielded conflicting results.<sup>17,60-66</sup> If low levels of exercise cause arterial oxygen saturation to fall > 2% from resting baseline, the prognosis is serious.<sup>67</sup> Exercise testing is increasingly available,<sup>65</sup> and postoperative testing is consistent with routine pulmonary function testing combined with split function testing.<sup>68</sup>

Less invasive methods of achieving similar information are available, including the lateral position test and  $\dot{V}/\dot{Q}$  lung scanning. The latter test is widely available. Lung scanning data can be combined with preoperative pulmonary function data to predict postoperative level of function. The less expensive perfusion scan can be used alone with technetium or iodine isotopes,<sup>69</sup> but radioactive xenon provides information for both ventilation and perfusion with one study.<sup>56</sup> The total number of counts over both lungs is obtained, and each lung is scanned separately through a split function crystal and collimator.

Ventilation and perfusion are reported as the percent of overall function in each lung relative to the total number of radioactive counts taken over a specified period. Predictive formulas usually involve FEV<sub>1</sub> as follows:<sup>58</sup>

$$\text{Predicted postoperative FEV}_1 = \text{preoperative FEV}_1 \times \% \text{ perfusion nonoperative lung.}$$

#### BOX 9-2.

##### Pulmonary Function Criteria Indicating Increased Risk of Postoperative Complications from Respiratory Failure:

Forced vital capacity (FVC) < 50% of predicted

Forced expiratory volume at 1 second (FEV<sub>1</sub>) < 50% of predicted or < 2.0 L

Maximal voluntary ventilation (MVV) < 50% of predicted or < 50 L/min

Diffusing capacity of lung for carbon monoxide (DLCO) < 50% of predicted

Residual volume/total lung capacity (RV/TLC) > 50%

Data from Tisi GN. Pulmonary physiology in clinical medicine. Baltimore: Williams & Wilkins, 1980.

The predicted postoperative FEV<sub>1</sub> must be >800 mL for the patient to survive pneumonectomy after curative surgical resection. Calculations are made for pneumonectomy in all patients because removal of the entire lung may be necessary once the opened chest is examined during surgery. In the event that less resection is adequate, postoperative function also can be predicted using anatomic information. For example, right upper lobectomy involves removal of three of the 10 bronchopulmonary segments on the right side. Therefore:

$$\text{Predicted postoperative FEV}_1 = \text{preoperative FEV}_1 \times \% \text{ perfusion nonoperative lung} + 0.7 \times \% \text{ perfusion operative lung.}$$

Using this approach to physiologic assessment to predict postoperative pulmonary function in combination with use of newer anesthetic agents and improved monitoring, lung resection surgery can be offered to older and more compromised patients.<sup>70,71</sup>

## POSTOPERATIVE MANAGEMENT

As with cardiac morbidity and mortality, pulmonary morbidity and mortality may be more influenced by postoperative management than intraoperative management.

Recovery of lung volume and thus lung function is the goal of postoperative therapy. Inspiratory maneuvers designed to increase FRC include active regimens, such as incentive spirometry, deep-breathing exercises, or passive lung inflation by intermittent positive-pressure breathing. If FRC increases as a result of these measures, lung mechanics and gas exchange are improved. This improvement is manifested as increased tidal ventilation, decreased respiratory rate, and improved arterial oxygen saturation and oxygen tension. The ability to cough adequately and to clear accumulated secretions further decreases the risk of developing postoperative pulmonary complications.

Although adequate management of postoperative pain is an integral part of postoperative therapy, it will not totally reverse the abnormalities induced by surgery. Furthermore, narcotic therapy—intravenous or other-

wise—may unmask a tendency to retain carbon dioxide in patients with COPD. Especially after thoracotomy, pain relief, postoperative breathing maneuvers, and inhalational therapy can be important to recovery of function. Following lobectomy, the remaining 70% or so of lung tissue on the operative side may be edematous as a result of manipulation. Maneuvers that help reexpand the lung are important to normal gas exchange. They may be more readily accomplished in the presence of adequate pain control, such as local anesthetic administration via a thoracic-level epidural catheter. Evidence indicates that this same technique can improve diaphragmatic function, independent of pain control, in a manner not achieved when narcotics are administered instead of local anesthetics.<sup>72</sup>

## CONCLUSION

Preoperative assessment of the patient with pulmonary compromise is based on sound physiologic principles. Knowledge of chronic pulmonary disease and pathophysiologic alterations in pulmonary function is integral to preanesthetic evaluation. Changes in function intraoperatively and postoperatively depend on the site of surgical incision, duration of operation, and underlying pulmonary function. An adequately designed regimen for anesthetic management is used to maximize pulmonary function during the preoperative, intraoperative, and postoperative periods. Judicious use of epidural analgesia postoperatively can have a salutary effect on recovery of pulmonary function.

## KEY REFERENCES

1. Beckles MA, Spiro SG, Colice GI, et al. The physiologic evaluation of patient with lung cancer being considered for resectional surgery. *Chest* 2-3;123:105S-114S.
2. Evans SE, Scanlon PD. Current practice in pulmonary function testing. *Mayo Clin Proc* 2003;78:758-763.
3. Sundman E, Witt H, Sandin R, et al. Pharyngeal function and airway protection during subhypnotic concentrations of propofol, isoflurane,

and sevoflurane: volunteers examined by pharyngeal videography and simultaneous manometry. *Anesthesiology* 2001;95:1125-1132.

4. Tirumalasetty J, Grammer LC. Asthma, surgery, and general anesthesia: a review. *J Asthma* 2005;4:251-254.
5. Volta CA, Alvisi V, Petrini S, et al. The effect of volatile anesthetics on respiratory system resistance in patients with chronic obstructive pulmonary disease. *Anesth Analg* 2005;100:348-353.

## REFERENCES

1. Evans SE, Scanlon PD. Current practice in pulmonary function testing. *Mayo Clin Proc* 2003;78:758-763.
2. Anthonisen NR, Wright FC, Hodgkin JE. Prognosis in chronic obstructive pulmonary disease. *Am Rev Respir Dis* 1986;133:14.
3. Ginsberg RJ, Hill LD, Eagan RT, et al. Modern 30-day operative mortality for surgical resections in lung cancer. *J Thorac Cardiovasc Surg* 1983;86:654.
4. Knudson RJ, Kalterborn WT, Knudson DE, et al. The single breath carbon monoxide diffusing capacity: reference equations derived from a healthy non-smoking population and the effects of hematocrit. *Am Rev Respir Dis* 1987;135:805.
5. Berger MM, Gust R. Perioperative evaluation of lung function. *Der Anaesthetist* 2005;3:273-287.
6. Crapo RO. Pulmonary function testing. *N Engl J Med* 1994;331:25.
7. Hankinson JL, Gardner RM. Standard waveforms for spirometric testing. *Am Rev Respir Dis* 1982;126:362.
8. Gardner RM. ATS statement: snowbird workshop on standardization of spirometry. *Am Rev Respir Dis* 1979;119:831.
9. Crapo RO, Morris AH, Gardner RM. Reference spirometric values using techniques and equipment that meet ATS recommendations. *Am Rev Respir Dis* 1981;123:659.
10. Knudson RJ, Lebowitz MD, Hobberg CJ, et al. Changes in the normal maximal expiratory flow-volume curve with growth and aging. *Am Rev Respir Dis* 1983;127:725.
11. Miller RD, Hyatt RE. Evaluation of obstructing lesions of the trachea and larynx by flow-volume loops. *Am Rev Respir Dis* 1973;108:475.
12. Berger R, Smith D. Acute postbronchodilator changes in pulmonary function parameters in patients with chronic airway obstruction. *Chest* 1988;93:541.
13. Light RW, Conrad SA, George RB. The one best test for evaluating effects of bronchodilator therapy. *Chest* 1977;72:512.



14. Weinberger SE. Recent advances in pulmonary medicine (part two). *N Engl J Med* 1993;328:1462.
15. Becklake MR. Concepts of normality applied to the measurement of lung function. *Am J Med* 1986;80:1158.
16. Cherniack RM, Cherniack L, Naimark A. *Respiration in Health and Disease*. 2nd ed. Philadelphia: WB Saunders, 1972.
17. Coleman NC, Schraufnagel DE, Rivington RN, et al. Exercise testing in evaluation of patients for lung resection. *Am Rev Respir Dis* 1982;125:604.
18. Cotes JE. *Lung Function: Assessment and Application in Medicine*. 4th ed. Oxford: Blackwell Scientific Publications, 1979.
19. *Lung Disease Data, 1995*. New York: American Lung Association, 1995.
20. McKenzie DK, Gandevia SC. Strength and endurance of inspiratory, expiratory and limb muscles in asthma. *Am Rev Respir Dis* 1986;134:999.
21. Tirumalasetty J, Grammer LC. Asthma, surgery, and general anesthesia: a review. *J Asthma* 2005;4:251–254.
22. Brugman TM, Morris JF, Temple WP. Comparison of lung volume measurements by single breath helium and multiple breath nitrogen equilibration methods in normal subjects and COPD patients. *Respiration* 1986;49:52.
23. Burrows B, Kasik JE, Niden AN, et al. Clinical usefulness of the single breath diffusing capacity test. *Am Rev Respir Dis* 1961;84:789.
24. Short S, Metic-Emili J, Martin JG. Reassessment of body plethysmographic techniques for measurement of thoracic gas volumes in asthmatics. *Am Rev Respir Dis* 1982;126:515.
25. Ayers LN, Ginsberg MC, Fein J, et al. Diffusing capacity, specific diffusing capacity and interpretation of diffusion defects. *West J Med* 1975;123:255.
26. Rosenberg E, Ernso P, Leech, J, et al. Specific diffusing capacity (DL/VA) as a measure of the lung diffusing characteristics: predictor formulas for young adults. *Lung* 1986;164:207.
27. Alberts WM, Goldman AC. Clinical use of methacholine bronchial challenge testing. *South Med J* 1987;80:827.
28. Myers JR, Carrow WM, Braman SS. Clinical applications of methacholine inhalational challenge. *JAMA* 1981;246:225.
29. Roussos C. Function and fatigue of respiratory muscles. *Chest* 1985;88:124.
30. Salpeter S, Ormiston T, Salpeter E. Cardioselective beta-blockers for chronic obstructive pulmonary disease. *Cochrane Database Syst Rev* 2005;(4):CD003566.
31. Sundman E, Witt H, Sandin R, et al. Pharyngeal function and airway protection during subhypnotic concentrations of propofol, isoflurane, and sevoflurane: volunteers examined by pharyngeal videography and simultaneous manometry. *Anesthesiology* 2001;95:1125–1132.
32. Volta CA, Alvisi V, Petrini S, et al. The effect of volatile anesthetics on respiratory system resistance in patients with chronic obstructive pulmonary disease. *Anesth Analg* 2005;100:348–353.
33. Celli BR. What is the value of preoperative pulmonary function testing? *Med Clin North Am* 1993;77:309.
34. Beckles MA, Spiro SG, Colice GI, et al. The physiologic evaluation of patient with lung cancer being considered for resectional surgery. *Chest* 2003;123:105S–114S.
35. Mazzone PJ, Arroliga ACL. Lung cancer: preoperative pulmonary evaluation of the lung resection candidate. *Am J Med* 2005;118:578–583.
36. Tisi GN. *Pulmonary Physiology in Clinical Medicine*. Baltimore: Williams & Wilkins, 1980.
37. Zibrak JD, O'Donnell CR, Marton K. Indications for pulmonary function testing. *Ann Intern Med* 1990;112:763–771.
38. Latimer RG, Dickman M, Day WC, et al. Ventilatory patterns and pulmonary complications after upper abdominal surgery determined by preoperative and postoperative computerized spirometry and blood gas analysis. *Am J Surg* 1971;122:622.
39. Ford GT, Whitelaw WA, Rosenthal TW, et al. Diaphragm function after upper abdominal surgery in humans. *Am Rev Respir Dis* 1983;127:431.
40. Tahir AH, George RB, Weill H, et al. Effects of abdominal surgery upon diaphragmatic function and regional ventilation. *Int Surg* 1973;58:337.
41. Gracey DR, Divertie MB, Didier EP. Preoperative pulmonary preparation of patients with chronic obstructive pulmonary disease. *Chest* 1979;76:123.
42. Boushy SF, Billig DM, North LB, et al. Clinical course related to preoperative and postoperative pulmonary function in patients with bronchogenic carcinoma. *Chest* 1971;59:383.
43. Gaensler EA, Cusell DW, Lindgren I, et al. The role of pulmonary insufficiency in mortality and invalidism following surgery for pulmonary tuberculosis. *J Thorac Cardiovasc Surg* 1955;29:163.
44. Lockwood P. Lung function test results and the risk of postthoracotomy complications. *Respiration* 1973;30:529.
45. Mittman C. Assessment of operative risk in thoracic surgery. *Am Rev Respir Dis* 1961;84:197.
46. Harrison RW, Adams WE, Long ET, et al. The clinical significance of cor pulmonale in the prediction of cardiopulmonary reserve following extensive pulmonary resection. *J Thorac Surg* 1958;36:352.
47. Neuhaus H, Cherniak NS. A bronchspirometric method of estimating the effect of pneumonectomy on the maximum breathing capacity. *J Thorac Cardiovasc Surg* 1968;55:144.
48. Jay SJ, Stonehill RB, Kiblan SO, et al. Variability of the lateral position test in normal subjects. *Am Rev Respir Dis* 1980;121:165.
49. Marion JM, Alderson PO, Lefrak SS, et al. Unilateral lung function: comparison of the lateral position test with radionuclide ventilation-perfusion studies. *Chest* 1976;69:5.
50. Schoonover GA, Olsen GN, Habibian MR, et al. Lateral position test and quantitative lung scan in the preoperative evaluation for lung resection. *Chest* 1984;86:854.
51. Walkup RH, Vossell LF, Griffin JP, et al. Prediction of postoperative pulmonary function with the lateral position test: a prospective study. *Chest* 1960;77:24.
52. Carlens E, Hanson HE, Nordenstrom B. Temporary unilateral occlusion of the pulmonary artery. *J Thorac Surg* 1951;22:527.
53. Laros CD, Swierenga J. Temporary unilateral pulmonary artery occlusion in the preoperative evaluation of patients with bronchial carcinoma. *Med Thorac* 1967;24:269.
54. Uggla LG. Indication for and results of thoracic surgery with regard to respiratory and circulatory function tests. *Acta Chir Scand* 1956;111:197.
55. Boysen PG, Block AJ, Olsen GN, et al. Prospective evaluation for pneumonectomy using the 99m technetium quantitative perfusion lung scan. *Chest* 1977;72:422.
56. Kristerson S, Lindell S, Stranberg L. Prediction of pulmonary function loss due to pneumonectomy using <sup>133</sup>Xe radiosprometry. *Chest* 1972;62:694.
57. Olsen GN, Block AJ, Swenson EW, et al. Pulmonary function evaluation of the lung resection candidate: a prospective study. *Am Rev Respir Dis* 1975;111:379.
58. Olsen GN, Block AJ, Tobias JA. Prediction of postpneumonectomy pulmonary function using quantitative macroaggregate lung scanning. *Chest* 1974;66:13.
59. Sudoh M, Uueda K, Kaneda Y, et al. Breath-hold single-photon emission tomography and computed tomography for predicting residual pulmonary function in patients with lung cancer. *J Thorac Cardiovasc Surg* 2006;131:994–1001.
60. Bagg LR. The 12-minute walking distance: its use in the preoperative assessment of patients with bronchial carcinoma before lung resection. *Respiration* 1984;46:342.
61. Berggren H, Ekroth R, Malmberg R, et al. Hospital mortality and long-term survival in relation to preoperative function in elderly patients with bronchogenic carcinoma. *Ann Thorac Surg* 1984;38:633.
62. Boysen PG, Clark CA, Block AJ. Graded exercise testing and postthoracotomy complications. *J Cardiovasc Anesth* 1980;4:68.
63. Eugene J, Brown SE, Light RW, et al. Maximum oxygen consumption: a physiologic guide to pulmonary resection. *Surg Forum* 1982;33:260.



64. Fee JH, Holmes EC, Gerwitz HS, et al. Role of pulmonary resistance measurement in preoperative evaluation of candidates for lung resection. *J Thorac Cardiovasc Surg* 1975;75:519.
65. Smith TP, Kinasewitz GT, Tucker WY, et al. Exercise capacity as a predictor of post-thoracotomy morbidity. *Am Rev Respir Dis* 1984;129:730.
66. Soderholm B. The hemodynamics of the lesser circulation in pulmonary tuberculosis: the effect of exercise, temporary unilateral pulmonary artery occlusion, and operation. *Scand J Clin Lab Invest* 1957;26:1.
67. Markos J, Mullin BP, Hillman DR, et al. Preoperative assessment as a predictor of mortality and morbidity after lung resection. *Am Rev Respir Dis* 1989;139:902.
68. Wang JS, Abboud RT, Wang LM. Effect of lung resection on exercise capacity and on carbon monoxide diffusing capacity during exercise. *Chest* 2006;129:863-872.
69. Reichel J. Assessment of operative risk of pneumonectomy. *Chest* 1972;62:570.
70. Linden PA, Bueno B, Colson YL, et al. Lung resection in patients with a preoperative FEV1 < 35% predicted. *Chest* 2005;127:1984-1990.
71. Sullivan V, Tran T, Holmstrom A, et al. Advanced age does not exclude lobectomy for non-small cell lung carcinoma. *Chest* 2005;128:2761-2766.
72. Simonneau G, Viven A, Sartene R, et al. Diaphragm dysfunction induced by upper abdominal surgery: role of postoperative pain. *Am Rev Respir Dis* 1983;128:899.

# CHAPTER 10

## Evaluation of the Patient with Neuropsychiatric Disease

John Morris, MD, and  
Dell Burkey, MD

### PREEXISTING NEUROLOGIC DISEASE

Patients with preexisting neurologic disease present challenges for the anesthesiologist, both as a consequence of their pathology and as a result of concurrent management of their neurologic disease. Anesthesiologists can expect to have more frequent encounters with these patients as the general population ages.<sup>1</sup> Although longevity is not a neurologic disease, the incidence of most common neurologic diseases increases markedly with age. The “cognitive reserve,” a qualitative measure of the brain’s ability to restore normal cognitive function after anesthesia, may also be reduced in the aged, independent of a formally diagnosed disease process.<sup>2</sup> Happily, the management of patients with neurologic diseases is well reviewed.<sup>3,4</sup>

### Multiple Sclerosis

Multiple sclerosis (MS) consists of a constellation of symptoms caused by demyelination of the white matter of the central nervous system. These symptoms exacerbate and remit, are generally focal, and progress over time. MS affects women twice as frequently as men, and patients are generally young to middle age and more often white. Although smoking is a risk factor, the cause of MS is unknown. A body of evidence supports the theory that MS is an autoimmune disease triggered by environmental exposures in genetically susceptible individuals. Because the symptoms of MS can affect nearly every organ system, the anesthetic management of such patients depends far more on their individual condition than on the diagnosis of MS.<sup>5,6</sup>

MS patients are often particularly anxious that the perioperative period will lead to an exacerbation of their condition. Although there is anecdotal evidence that stress and surgery increase MS symptoms, there is no research evidence that general anesthesia leads to a relapse.<sup>7</sup> However, postoperative infection with associated fever might.<sup>8</sup>

The situation regarding regional or local anesthesia is less clear. Local anesthetics, whether given intravenously, locally, or neuraxially, may transiently worsen or unmask previously undiagnosed MS symptoms.<sup>9</sup> Although epidural anesthesia and analgesia have been used safely in obstetric patients with MS, there are case reports of the worsening of symptoms.<sup>10–15</sup> As such, although not specifically contraindicated, neuraxial anesthesia using local anesthetics should be used with caution in these patients.

Preoperative evaluation of the MS patient must include a history of steroid intake to screen for adrenal suppression and as an index of disease severity. Patients may also have a restrictive lung disease secondary to muscular impairment. Patients taking baclofen at home may suffer from withdrawal perioperatively, which can cause seizures and hallucinations.

There are a number of other perioperative issues that are particularly im-

portant to the MS patient. Hyperthermia must be scrupulously avoided in these patients, as increased temperature has been shown to worsen MS symptoms;<sup>16</sup> in fact, in the late 19th century, hot baths were used as a diagnostic test for multiple sclerosis. Platelet aggregation is increased in patients with MS for unknown reasons. Finally, patients with MS are at increased risk for postoperative urinary retention.<sup>17</sup>

### Myasthenia Gravis

Myasthenia gravis is an autoimmune disease in which antibodies attack the postsynaptic acetylcholine receptors at the neuromuscular junction, causing varying degrees of weakness and fatigability. Symptoms usually begin with the ocular muscles, progressing to other bulbar muscles, and then the proximal skeletal muscles. Muscle function is worse at the end of the day or after exertion. Epidemiologically, the disease is bimodal, relatively more common in women younger than 30 years of age and men older than 50 years of age.<sup>18</sup> Patients may present for thymectomy outside of these age distributions, however.

Patients with myasthenia gravis represent a significant challenge to the anesthesiologist. Both their disease process and the medications used to treat it cause difficulties in anesthetic

### KEY POINTS

1. As the population ages, surgical patients with neuropsychiatric diseases will become more common. Older patients, even in the absence of diagnosed disease, may have a reduced “cognitive reserve.”
2. Multiple sclerosis patients can safely undergo both general and conduction anesthesia. However, anesthesiologists should scrupulously avoid hyperthermia and prevent postoperative pain.
3. Patients with myasthenia gravis may benefit from an anesthetic technique that does not use muscle relaxants or volatile agents, such as a propofol-remifentanyl total intravenous anesthetic.
4. Although it has traditionally been held that perioperative neuropathies resulted from preventable failures of patient positioning, particularly in courts of law, more recent data indicate that these injuries are multifactorial and not necessarily preventable.
5. The risk of autonomic hyperreflexia in chronic spinal cord injury patients mandates adequate anesthesia even for procedures below the level of injury.
6. Although there is concern that general anesthesia represents a risk factor for the development of Alzheimer’s disease or a worsening of its symptoms, research is inconclusive. Furthermore, no conclusive advantage of regional over general anesthesia has been demonstrated.
7. Depression is a significant risk factor for postoperative complications, and therefore its presence should be screened for in any preoperative evaluation.

management. Classically, these patients are inordinately weak after anesthesia, are resistant to succinylcholine, and are sensitive to the nondepolarizing muscle relaxants.<sup>19–22</sup> As a result, despite the availability of practice recommendations for these patients, their perioperative management may require the consultation of a neurologist.<sup>23</sup> A neurology consultation may provide a quantitative assessment of the patient's baseline impairment, as well as a strategy for maintaining their home medication regimen through the perioperative period, during which the patient may be unable to take oral medications.

Because patients with myasthenia gravis are at heightened risk for perioperative respiratory difficulties, the preoperative assessment should focus on identifying factors that contribute to postoperative respiratory compromise. Although pulmonary function tests may provide quantitative assessment of ventilatory mechanics, a history of bulbar symptoms may be more informative. Patients with difficult swallowing or speaking, weakness in flexion of the neck or movement of the face are at particularly high risk for postoperative respiratory compromise. The presence of steroids in the patient's medication regimen indicates higher-risk patients, and elective operations should be postponed if possible in patients requiring steroids. Intravenous immunoglobulin (IVIg) or plasma exchange may be used in emergent cases. If pyridostigmine is needed, the IV dose is  $1/30$  the oral dose. Patients should take their usual dose on the morning of surgery, but this practice may result in prolongation of the action of mivacurium or succinylcholine.<sup>3</sup> Preoperatively patients should be evaluated for coexisting diseases. Diseases associated with myasthenia gravis include diabetes, thyroid disorders, systemic lupus erythematosus (SLE), and rheumatoid arthritis.

Choice of anesthetic may have a dramatic effect on the patient's postoperative course. All volatile anesthetics negatively impact neuromuscular function, as do nondepolarizing muscle relaxants. Although both have been used safely in these patients, it seems wiser to avoid these agents when possible.<sup>19,20</sup> Case reports have suggested various combinations of total intravenous anesthesia (TIVA), including remifentanyl and propofol, in these patients.<sup>23–25</sup> In the authors' experience, intravenous anesthesia without the use

of muscle relaxants results in superior wakefulness and a lack of postoperative respiratory compromise in patients undergoing thymectomy. If nondepolarizing agents must be used,  $1/5$  of the usual dosage is recommended, with avoidance of long-acting agents. Reversal with an anticholinesterase postoperatively may trigger a cholinergic crisis. Similarly, ester local anesthetics should be avoided, and amides, at lower doses, used instead for regional anesthesia. Other agents that can result in weakness in myasthenics include  $\beta$ -blockers, aminoglycosides, and procainamide. In cases of inadequate reversal of neuromuscular blockade, 3,4-diaminopyridine may be effective.<sup>26</sup>

In summary, it may be safest to avoid muscle relaxants whenever possible in these patients. The need for postoperative ventilation in these patients may be predicted by an increased length of disease, preoperative respiratory symptoms, pyridostigmine dosage greater than 750 mg/d, and vital capacity  $< 40$  mL/kg.<sup>27</sup> In obstetric practice, myasthenic mothers have not been shown to have a higher incidence of cesarean section or other complications than normal mothers. The acetylcholine receptor antibodies do cross the placenta, however, and neonatal weakness is possible.<sup>28</sup>

### Neuropathy

Perioperative nerve injuries account for one-third of all anesthesia malpractice claims in the United States, with a third of these nerve injuries involving the ulnar nerve.<sup>29–31</sup> Patients presenting for an operation from the ICU are at increased risk of weakness and neuropathy, particularly patients with sepsis or multiorgan dysfunction syndrome.<sup>32</sup>

Peripheral nerve injuries may occur as a result of myriad mechanisms; however, the most common etiologies are likely prolonged compression, stretch, trauma, and ischemia. There are a number of comorbidities and medications that predispose to nerve injury (Tables 10–1 and 10–2).<sup>33</sup> These injuries are rare in children, three times more common in males, and more common in cardiac surgery. The incidence of ulnar neuropathy has ranged from a high of 1.5–24% of patients undergoing cardiac surgery to 0.040.5% in noncardiac surgery.<sup>34–38</sup> Risk factors for ulnar nerve injuries include male gender, prolonged hospitalization, and extremes of body habitus.<sup>33,39</sup> Patients often do not report

TABLE 10–1.

### Diseases and Conditions That May Predispose Patients to Neuropathies

Acromegaly  
Amyloidosis  
Carcinoma  
Cryoglobulinemia  
Chronic obstructive lung disease  
Diabetes mellitus  
Hereditary predisposition to pressure palsy  
Hypoglycemia  
Hypothyroidism  
Liver disease  
Lymphoma  
Macroglobulinemia  
Malabsorption syndromes and vitamin deficiencies  
Monoclonal gammopathy  
Multiple myeloma  
Polycythemia vera  
Porphyrias  
Uremia

Reprinted from Prielipp RC, Morell RC, Butterworth J. Ulnar nerve injury and perioperative arm positioning. *Anesthesiol Clin North America* 2002;20:589–603, with permission from Elsevier.

neuropathy until more than 48 hours after surgery, leading to the hypothesis that prolonged supine position combined with preexisting defects may be the deciding factor in neuropathy.<sup>33</sup> Although it has traditionally been held that perioperative neuropathies result from preventable failures of patient positioning, particularly in courts of law, more recent data indicate that these injuries are multifactorial and not necessarily preventable.<sup>31,40</sup>

The American Society of Anesthesiologists (ASA) has published recommendations for the reduction in risk of perioperative neuropathies (Table 10–3).<sup>41</sup> These recommendations include arm abduction less than or equal to 90°, avoidance of pressure on the ulnar groove, use of padded arm boards, and elbow padding that *might* reduce the risk.

### Parkinson Disease

Parkinson disease is the second most common neurodegenerative disease, affecting more than 3% of persons older than the age of 65 years.<sup>42,43</sup> If one includes parkinsonism, the constellation of extrapyramidal symptoms of which one cause is Parkinson dis-

TABLE 10-2.

## Drugs and Chemicals That May Predispose Patients to Neuropathies

Acrylamide  
 Amiodarone  
 Arsenic  
 Aurothioglucose  
 Buckthorn (toxic berry)  
 Carbon disulfide  
*cis*-Platinum  
 Dapsone  
 Diketone hexacarbons  
 Dimethylamino propionitrile  
 Diphtheria  
 Disulfiram  
 Hydralazine  
 Isoniazid  
 Lead  
 Metronidazole  
 Misonidazole  
 Organophosphates  
 Perhexiline  
 Phenytoin  
 Pyridoxin  
 Thalidomide  
 Thallium  
 Vincristine

Reprinted from Prielipp RC, Morell RC, Butterworth J. Ulnar nerve injury and perioperative arm positioning. *Anesthesiol Clin North America* 2002;20:589–603, with permission from Elsevier.

ease, the incidence is even higher. More than half of persons aged 85 years or older have parkinsonian symptoms.<sup>44</sup> The cause of Parkinson disease is unknown, but it involves neuronal destruction in the substantia nigra, locus ceruleus, and other brain centers. Parkinson disease is a disorder of the extrapyramidal system caused by an imbalance between the inhibitory actions of dopamine and the excitatory actions of acetylcholine. The characteristic signs of Parkinson disease are bradykinesia, festinating gait, tremor, rigidity, and postural instability. The coexistence of dementia with Parkinson disease doubles the mortality rate.<sup>45</sup> Smoking is protective for Parkinson disease.<sup>46</sup> One of the more severe causes of parkinsonism, multisystem atrophy (of which Shy-Drager syndrome is a variant), consists of a progressive neurologic disease characterized by parkinsonism, autonomic dysfunction, impaired cerebellar function, and mild cognitive impairment.<sup>42</sup> The autonomic dysfunction in these

TABLE 10-3.

## American Society of Anesthesiologists Consensus Practice Advisory for Preventing Perioperative Peripheral Neuropathies

## Preoperative assessment

- When judged appropriate, it is helpful to ascertain that patients can comfortably tolerate the anticipated operative position.

## Upper-extremity positioning

- Arm abduction should be limited to 90° in supine patients; patients who are positioned prone may comfortably tolerate arm abduction greater than 90°.
- Arms should be positioned to decrease pressure on the postcondylar groove of the humerus (ulnar groove). When arms are tucked at the side, a neutral forearm position is recommended. When arms are abducted on armboards, either supination or a neutral forearm position is acceptable.
- Prolonged pressure on the radial nerve in the spiral groove of the humerus should be avoided.
- Extension of the elbow beyond a comfortable range may stretch the median nerve.

## Lower-extremity positioning

- Lithotomy positions that stretch the hamstring muscle group beyond a comfortable range may stretch the sciatic nerve.
- Prolonged pressure on the peroneal nerve at the fibular head should be avoided.
- Neither extension nor flexion of the hip increases the risk of femoral neuropathy.

## Protective padding

- Padded armboards may decrease the risk of upper-extremity neuropathy.
- The use of chest rolls in laterally positioned patients may decrease the risk of upper-extremity neuropathies.
- Padding at the elbow and at the fibular head may decrease the risk of upper- and lower-extremity neuropathies, respectively.

## Equipment

- Properly functioning automated blood pressure cuffs on the upper arms do not affect the risk of upper-extremity neuropathies.
- Shoulder braces in steep head-down positions may increase the risk of brachial plexus neuropathies.

## Postoperative assessment

- A simple postoperative assessment of extremity nerve function may lead to early recognition of peripheral neuropathies.

## Documentation

- Charting specific positioning actions during the care of patients may result in improvements of care by (a) helping practitioners focus attention on relevant aspects of patient positioning; and (b) providing information that continuous improvement processes can lead to refinements in patient care.

Modified with permission from ASA Task Force.<sup>41</sup>

patients results in difficult-to-treat orthostatic hypotension. The mainstay of treatment for Parkinson disease is levodopa, a prodrug converted to dopamine in the brain. Dopamine agonists or type B monoamine oxidase inhibitors (MAOIs) may also be used.

General anesthesia represents an added degree of risk in Parkinson disease patients.<sup>47</sup> Parkinson disease patients have a baseline degree of respiratory impairment caused by dysfunctional control of the airway and ventilatory muscles, resulting in an obstructive pattern.<sup>48–50</sup> In fact, respiratory complications (i.e., aspiration) represent the most common cause of death in

these patients.<sup>51</sup> Parkinson disease patients may also be at increased risk of laryngospasm secondary to this upper airway dysfunction.<sup>52</sup> Withdrawal of Parkinson disease medications in the perioperative period can cause a clinically significant worsening of the respiratory symptoms.<sup>53</sup> The short half-life of levodopa (1–3 hours) and its lack of parenteral formulation create a risk of symptom exacerbation during long procedures. Its administration intraoperatively by nasogastric tube might be a solution.<sup>54</sup>

Regional anesthesia may offer significant advantages in patients with Parkinson disease by allowing an earlier return to PO intake, eliminating the



use of neuromuscular blocking drugs and the risks of general anesthesia.<sup>47,55</sup> The addition of systemic opiates for postoperative analgesia to patients who are already on a number of sedating medications may make management difficult. This may contribute to the fact that Parkinson disease patients have an 8-fold increase in the risk of postoperative delirium.<sup>56</sup>

Polypharmacy in Parkinson disease patients may also contribute to their higher incidence of orthostatic hypotension.<sup>57</sup> This hypotension is exacerbated by the direct vasodilatory effects of dopamine agonists or tricyclic antidepressants, agents often used in this population.

There are reported problems with the use of most anesthetic agents and medications in Parkinson disease patients. Parkinson symptoms were triggered in a patient by general anesthesia who went on to develop the disease.<sup>58</sup> Propofol has triggered dyskinesic movements in these patients.<sup>59</sup> Levodopa should be avoided with halothane because of the theoretical risk created by halothane's action of sensitizing the heart to catecholamines. Succinylcholine has been used safely in Parkinson disease patients.<sup>60</sup> There are no reports, yet, of nondepolarizing muscle relaxants worsening Parkinson disease symptoms. Alfentanil has been linked to an acute dystonic reaction in a Parkinson disease patient.<sup>61</sup> Morphine has been reported to reduce dyskinesia at low doses and to induce akinesia at higher doses.<sup>62</sup> The concomitant use of meperidine and selegiline, a selective monoamine oxidase (MAO) type B inhibitor, has resulted in agitation, muscle rigidity, sweating, and hyperpyrexia, and its use is not recommended with these agents.<sup>63</sup> Ketorolac has been used safely in patients taking MAOIs.<sup>64</sup> Phenothiazines, butyrophenones, and metoclopramide should be used with caution, if at all, in the management of Parkinson patients secondary to their antidopaminergic effects.

In summary, the patient's home regimen should be administered immediately preoperatively and resumed as soon as possible postoperatively. The anesthesiologist must be aware of potential interactions with anesthetic agents. Patients should be carefully screened for comorbidities, including dysautonomia, respiratory, and cardiovascular problems. Baseline cognition should be established prior to surgery.

## Seizure Disorder

Patients presenting for surgery with a history of seizure may be categorized as having either chronic seizures with a known diagnosis or a new-onset seizure. Patients with new seizures require evaluation to determine the cause of the seizure, preferably prior to the induction of anesthesia. Apart from epilepsy, seizures may be caused by fever, trauma, medication ingestion or withdrawal, toxins, metabolic derangements, and neurologic and infectious disorders, among other things. Anesthetic management is influenced more by the cause of the seizure than the presence of the seizure itself.

Seizure disorders are relatively common, with a prevalence in the general population estimated as high as 1%.<sup>4</sup> Two million Americans have epilepsy, and it has a bimodal distribution with increased incidence below the age of 15 and above the age of 65.<sup>65</sup> Seizures may be partial, affecting only part of the brain, or generalized, spreading from a foci to cover the entire brain. Complex seizures involve a change in consciousness; simple seizures do not. Absence seizures are similar to complex seizures in that they involve a change in consciousness but are more often of short duration, have different electroencephalogram (EEG) findings, have a rapid onset and recovery, and may be initiated by hyperventilation.<sup>65</sup>

Different agents are used to treat the different types of seizures, and each agent has unique concerns in the perioperative period. In general, most anticonvulsants induce the P450 enzyme system and cause resistance to neuromuscular blockers. This resistance is extended to agents, such as cisatracurium, that do not rely on the liver for metabolism. Valproic acid may interfere with hemostasis by reducing fibrinogen, von Willebrand factor, as well as platelet count and function. Preoperative coagulation profiles should be obtained from patients taking this medication.<sup>66</sup>

Anesthetic agents have both pro- and anticonvulsant properties. Propofol, thiopental, benzodiazepines, and potent agents (with the exception of enflurane) all increase the seizure threshold, whereas methohexital, alfentanil, and remifentanil all reduce it. In refractory cases of status epilepticus anesthesia may be induced, preferably without the use of muscle relaxants.<sup>67</sup>

Perioperative plans for patients with seizures must include maintenance of the patient's home anticonvulsant therapy. This will often require conversion to intravenous agents, such as phenobarbital and phenytoin.

## Spinal Cord Disorder

Surgery on the spinal column is most commonly performed on the cervical and lumbar regions. These operations are generally for pain and carry a mortality rate of less than 1%.<sup>68-70</sup> The chance of postoperative nerve injury ranges from 0.2-0.6%.<sup>69</sup> The risks of these operations are dependent largely on the patient's comorbidities, the duration of the surgery, and the surgical complexity. The syndrome of inappropriate antidiuretic hormone secretion may develop in up to 5% of spinal surgery patients, more commonly in patients with large blood loss and undergoing spinal fusion.<sup>71</sup>

Patients with spinal injury or who are undergoing a spinal operation that results in immobility have a 42% incidence of deep venous thrombosis (DVT), an incidence similar to that of stroke patients.<sup>72</sup> Low-dose unfractionated subcutaneous heparin is only slightly more effective (70% risk reduction) than elastic stockings (60%) or intermittent pneumatic compression devices (66%) in preventing DVT in neurosurgical patients.<sup>73</sup> These mechanical agents are not recommended as sole prophylaxis in acute stroke or spinal injury patients, however. Acute stroke or spinal injury patients should receive low-molecular-weight heparin prophylaxis despite the possibility of increased CNS bleeding.<sup>73,74</sup>

Patients with prior spinal injuries presenting for surgery may have altered physiologic responses to anesthesia and surgical stimuli. The sympathetic response to intubation is blunted in acute and chronic quadriplegics but not in paraplegics.<sup>75</sup> The risk of autonomic hyperreflexia mandates adequate anesthesia even for procedures below the level of injury.

## CARDIOVASCULAR DISEASE

### Dementia

Dementia of the Alzheimer type affects approximately 4 million Americans, making it the most common cause of dementia, with that number expected to triple by 2050.<sup>76-78</sup> The incidence

increases markedly with age, with half of those older than age 85 years affected and 1 in 10 of those older than age 65 years. Life expectancy after a new diagnosis is 8 years.<sup>76</sup> Risk factors for Alzheimer disease include family history, age greater than 65 years, female gender, poor education, and a history of seizures, head injury, myocardial infarction, or hypothyroidism.<sup>77</sup> Furthermore, the presence of the allele apolipoprotein E 4 on chromosome 19 has been definitively associated with Alzheimer disease.<sup>78</sup> The pathologic changes in Alzheimer disease focus on the cortex and limbic system.<sup>79</sup> Although concern has been raised that general anesthesia represents a risk factor for the development of Alzheimer disease or a worsening of its symptoms, research is inconclusive,<sup>80–83</sup> and no conclusive advantage of regional over general anesthesia has been demonstrated.<sup>84–87</sup>

The onset of Alzheimer disease is insidious, and the patient may be misdiagnosed as depressed. Defects in recent memory are the first sign of the disease, and executive functions and planning are lost early.<sup>88</sup> The differential diagnosis for Alzheimer disease is myriad, but Alzheimer disease and multiinfarct (vascular) dementia account for the vast majority of cases seen in clinical practice.

Treatment of Alzheimer disease is aimed at improving the quality of life. Acetylcholinesterase inhibitors such as rivastigmine, donepezil, and galantamine, are the mainstays of treatment.

Alzheimer disease patients are at increased risk during anesthesia and surgery. Although a recent review reported that “no specific complications have been reported of anesthesia for patients with Alzheimer disease,” patients with preoperative cognitive impairments have a higher overall mortality rate than those who do not have such impairments on a general surgical service.<sup>88,89</sup> Alzheimer disease patients receiving antipsychotics are at increased risk for aspiration, whereas those taking only benzodiazepines are not.<sup>90</sup> In patients with advanced Alzheimer disease, the swallowing reflex is impaired secondary to dysfunction of the basal ganglia.<sup>91</sup>

Postoperative delirium may be either hypo- or hyperactive.<sup>92</sup> Preoperative cognitive defects, depression, longer operative time, and impaired vision suggest risk factors for postop-

erative confusion.<sup>93</sup> Demonstrated risk factors for postoperative delirium include prior delirium, age greater than 70 years, preexisting cognitive impairment, substance abuse, and abnormal laboratories.<sup>4,94,95</sup> Increased postoperative pain correlates with postoperative confusion, and the addition of analgesics to the anesthetic reduces the incidence of confusion.<sup>96,97</sup> Elderly patients with postoperative confusion have increased levels of cortisol and interleukin (IL)-6.<sup>98</sup> A proportion of postoperative confusion in the elderly may simply be unmasked dementia.<sup>99</sup>

### Stroke and Transient Ischemic Attack

Surgery and anesthesia represent a period of increased risk for stroke.<sup>100–101</sup> The perioperative period often is the setting of abrupt changes in blood pressure, cardiac output, coagulability, and oxygen delivery. The risk of perioperative stroke in a general surgical population is reported to be between 0.02% and 0.7%.<sup>100,102–105</sup> Most of these strokes occur postoperatively, on average 7 days after the surgery.<sup>103</sup> It is rare for a stroke to occur intraoperatively, but this risk increases dramatically in vascular surgery (0.8–3.0%), head and neck surgery (4.8%), and cardiac surgery (3–5%).<sup>104,106,107</sup> Previous stroke doubles the risk of perioperative stroke.<sup>104,108</sup> The largest study available (173 patients) reported an even higher rate of recurrent stroke perioperatively of 2.9%.<sup>109</sup> The incidence of vertebrobasilar stroke may be as high as 6.0% in high-risk patients.<sup>110</sup> In patients with a history of symptomatic vertebrobasilar stenosis or occlusion, confirmed by vascular imaging, who underwent surgical procedures with general anesthesia, 3 of 50 operations resulted in stroke. Each of the patients with a postoperative stroke had an episode of hypotension (systolic blood pressure <100 torr) for longer than 10 minutes during the surgery. Transient neurologic symptoms (transient ischemic attacks) may also increase the risk of perioperative stroke, but neither asymptomatic carotid stenosis nor asymptomatic bruits increase risk.<sup>111–114</sup> Other risks for cerebrovascular events include increasing age, atrial fibrillation, recent myocardial infarction, hypotension, dehydration, and emergency surgery.<sup>104,115–117</sup> The highest risk operations are cardiac, carotid, and

aortoiliac.<sup>103,117</sup> The hypercoagulable state occurring after surgery may be the most important factor in these primarily thrombotic events.

There is no clinical evidence available for deciding how long to delay surgery after a stroke. Recommendations have ranged from 3 weeks to 2 years. Current recommendations are 2–3 weeks' delay after acute stroke for general surgery and 2–3 months' for elective cases.<sup>4</sup>

Anesthetic choice may effect the risk of stroke by effecting coagulability; however, no anesthetic type has been shown to be superior for the prevention of stroke. Propofol and epidural anesthesia may reduce the hypercoagulable state,<sup>118,119</sup> but these results are far from conclusive.<sup>120</sup> In general, clinical management should seek to maintain or increase oxygen delivery to at-risk tissue, reduce the oxygen demands of at-risk tissue, or interrupt the apoptotic signaling cascade. It has been conclusively demonstrated that hypotension results in a decrease in cerebral blood flow in hypertensive patients with acute ischemic stroke, and further treatment of postoperative hypertension may worsen outcome.<sup>121,122</sup> This must be balanced against a possible worsening of brain edema and increased risk for hemorrhage. The management of intracerebral hemorrhage and intracranial hypertension is beyond the scope of this chapter but has been well-reviewed elsewhere.<sup>100,123</sup> Even mild hyperthermia is associated with worsened outcome. On the other hand, mild hypothermia may be beneficial.<sup>124</sup> Models of global ischemia have demonstrated worse outcomes with hyperglycemia, and treatment of hyperglycemia is currently recommended. Propofol, as compared to a volatile technique, may limit infarct size.<sup>125</sup> Methods that have been studied but not found to be of benefit include hemodilution to a hematocrit of 30%, deep hypothermia, hyperoxia, and hyperventilation.<sup>126</sup> Techniques for which there no conclusive benefit has been demonstrated but that might be of use include barbiturate therapy, isoflurane (as compared to other volatile anesthetics), ketamine, etomidate, nimodipine, and magnesium.<sup>125</sup> Possible future agents include nonsteroidal antiinflammatory drugs (NSAIDs), chelation agents, antibodies to the *N*-methyl-D-aspartate (NMDA) receptor, and lazaroids.<sup>127–130</sup> Lidocaine infusions show

promise in cardiac surgical patients, through a postulated interruption of the ischemic cascade, in reducing postoperative cognitive defects.<sup>131,132</sup> It is likely that all general anesthetics except nitrous oxide (which increases cerebral metabolism) reduce infarct size as compared to being awake.<sup>133,134</sup>

Stroke patients should be carefully evaluated to determine functional status, particularly in terms of their ability to ambulate and communicate. Strokes that result in a degree of immobility increase the patient's risk for DVT, with reported incidence as high as 42%.<sup>72</sup> Dysfunction of the bulbar muscles may increase aspiration risk after extubation. While the evidence of this is inconclusive, it seems prudent to manage all patients at risk for cerebral ischemia in a manner that minimizes cerebral oxygen demand and maximizes delivery.

## PSYCHIATRIC DISORDERS

A perhaps surprisingly high percentage of patients presenting for surgery are taking psychotropic medications or carry a psychiatric diagnosis.<sup>135</sup> Of patients presenting for elective surgery, 35% report the current use of antidepressants and 34% report the use of benzodiazepines.<sup>136</sup> Benzodiazepines are the most frequently prescribed psychotropic drugs in the elderly, a population particularly susceptible to their effects.<sup>137</sup>

### Schizophrenia

The perioperative management of patients with schizophrenia is challenging not only because of the disease process and the medications used to treat it, but because these patients often also have undiagnosed or undertreated comorbidities.<sup>138</sup> Patients with schizophrenia are at increased risk for diabetes and cardiopulmonary diseases, and should be screened for both.<sup>139,140</sup> This increased rate of comorbidities is likely secondary to the disease itself, side effects of chronic antipsychotic treatment and the relatively higher incidence of obesity and smoking among schizophrenics.<sup>141-143</sup> These comorbidities, in turn, may explain the higher postoperative mortality rates observed in schizophrenics.<sup>144</sup>

Patients taking antipsychotic drugs are at increased risk from sudden death as a result of torsade de

pointes and have a markedly higher rate of postural hypotension and tachycardia.<sup>145</sup> A relative insensitivity to pain has been reported in schizophrenics, which may lead to a delay in diagnosis of postoperative complications.<sup>146</sup> Discontinuing home antipsychotic medications prior to surgery is not recommended, as patients whose medications were withheld for 72 hours preoperatively had a markedly higher incidence of confusion but no differences in incidence of hypotension.<sup>147</sup> An additional risk of antipsychotic medications is an increased incidence of intraoperative hypothermia, without an increased incidence of postoperative shivering.<sup>148</sup>

Anesthetic choice may impact postoperative confusion in patients suffering from psychosis, neurosis, or anxiety disorders. Ketamine is safe for use in these patients, with no increased risk of postoperative hallucinations.<sup>149,150</sup> In fact, total intravenous anesthetic techniques that include ketamine may decrease the incidence of postoperative confusion.

While antipsychotic agents may cause neuroleptic malignant syndrome, which is clinically similar to malignant hyperthermia, there is no evidence that patients with this side effect to antipsychotics should receive nontriggering anesthetics. Patients taking long-term antipsychotics have an increased incidence of postoperative ileus, and epidurals are effective at reducing the rate of postoperative ileus in these patients.<sup>151</sup>

### Depression

Depression is a significant risk factor for postoperative complications, and therefore its presence should be screened for in any preoperative evaluation. In a prospective cohort of 648 Veterans Administration patients presenting for cardiac valve surgery, an incidence of preoperative depression was found to be 29.2%. Their 6-month mortality was nearly twice that of nondepressed patients. Depressed patients were more likely to be younger, have worse heart function, and present emergently for surgery. And in multivariate analysis, depression remained a significant predictor of death.<sup>152</sup>

Antidepressants should be continued perioperatively, as withholding antidepressants for 72 hours prior to surgery results in a higher incidence of postoperative confusion and depression.<sup>153</sup> Depressed patients who abuse

alcohol have a 33% higher incidence of confusion postoperatively than depressed patients who do not.<sup>154</sup> Postoperative confusion in this group was coincident with increased plasma levels of cortisol.

Anesthetic choice has not been shown to impact outcome for depressed patients significantly. Low-dose ketamine is a safe, and possibly beneficial, addition to anesthetic regimens for depressed patients.<sup>155</sup>

Management of postoperative pain may be more challenging in depressed patients. These patients report higher postoperative pain scores but, paradoxically, do not differ from controls in response to a standardized stimulus.<sup>156</sup>

## Electroconvulsive Therapy

The perioperative management of patients for electroconvulsive therapy (ECT) must encompass the physiologic effects of ECT, the interaction of the anesthetic agents with the duration and intensity of the seizure, and the patient's comorbidities and concomitant psychotropic medications. Ideally, the anesthetic should be of short duration to match the procedure duration; be free of the need for intense postprocedure monitoring; and if not increase seizure duration or intensity, then at least not decrease it.

Anesthesia for ECT is one of the most common anesthetic procedures performed in the United States each year.<sup>157</sup> Indications for ECT are wide ranging and include severe major depression, schizophrenia, anorexia, and catatonia. Patients presenting for ECT may not be active participants in their healthcare and may also be taking potent antipsychotic drugs that may impact their anesthetic management.

The application of electrical current to the brain results in both a generalized motor seizure and a significant autonomic discharge. A brief initial parasympathetic discharge resulting in bradycardia is generally followed by a vigorous sympathetic outflow with increased heart rate and blood pressure.<sup>158,159</sup> The increases in cardiac output and myocardial oxygen consumption may be significant. Adverse events associated with ECT have included myocardial infarction, stroke, and blindness.<sup>160-162</sup> Additionally, the convulsions induced by ECT have resulted in fractures and dislocations in inadequately anesthetized subjects.<sup>163,164</sup>

TABLE 10-4.

**Anesthetic and Cardiovascular Drugs and Their Effects on the Duration of ECT-Induced Seizure Activity (Relative to Methohexital or Saline)**

Drug	Increased	No Change	Decreased
Anesthetic drugs	Etomidate, alfentanil, remifentanil	Methohexital	Thiopental, thiamylal, lorazepam, ketamine, fentanyl, propofol, midazolam
Cardiovascular drugs	Aminophylline, caffeine	Clonidine, esmolol, labetalol, nifedipine, dexmedetomidine, nicardipine, nitroglycerin, trimethaphan, nitroprusside	Diltiazem, lidocaine, labetalol, esmolol

Reproduced with permission from Ding Z, and White PF.<sup>166</sup>

As patients experiencing seizure duration of less than 15 seconds or greater than 120 seconds have suboptimal responses to ECT, and because many common anesthetics increase the seizure threshold, much debate has centered around the choice of anesthetic agent and dose.<sup>165</sup> Because methohexital (0.5–1.0 mg/kg) has a limited effect on duration of seizure duration, is short acting, and is relatively free of postprocedure side effects, its use is touted as the “gold standard” (Table 10-4).<sup>166</sup> Etomidate is useful in patients with brief seizure durations despite maximal electrical stimulus, as it may increase seizure duration. This, however, comes at the price of increased post-ECT confusion, emesis, and an increased autonomic response.<sup>83,167,168</sup>

Seizure activity may also be impacted by ventilatory management.<sup>177</sup> As elevated CO<sub>2</sub> increases the seizure threshold, more effective ventilation during ECT, as may be achieved by a laryngeal mask airway, improves seizure duration.<sup>169</sup>

## SUMMARY

Patients who present for surgery with neuropsychiatric diseases represent a host of challenges for the consultant anesthesiologist. Careful assessment of baseline function, screening for comorbidities, and a catalogue of the patient's current home medications are prerequisites for successful anesthetic management. In general, changes to the patient's home regimens should be minimized so as to make the perioperative period as much of a “nonevent” as possible. Newer, shorter-acting anesthetic agents allow safer, more patient-centered management regimens.

## KEY REFERENCES

- Loran DB, Hyde BR, Zwischenberger JB. Perioperative management of special populations: the geriatric patient. *Surg Clin North Am* 2005;85:1259–1266.
- Rubino FA. Perioperative management of patients with neurologic disease. *Neurol Clin* 2004;22:261–276.
- Dillon FX. Anesthesia issues in the perioperative management of myasthenia gravis. *Semin Neurol* 2004;24(1):83–94.
- Practice advisory for the prevention of perioperative peripheral neuropathies. A report by the ASA Task Force on Prevention of Perioperative Peripheral Neuropathies. *Anesthesiology* 2000;92:1168–1182.
- Nicholson G, Pereira AC, Hall GM. Parkinson's disease and anaesthesia. *Br J Anaesth* 2002;89:904–916.
- Kudoh A. Perioperative management for chronic schizophrenic patients. *Anesth Analg* 2005;101(6):1867–1871.
- Ding Z, White PF. Anesthesia for electroconvulsive therapy. *Anesth Analg* 2002;94:1351–1364.

## REFERENCES

- US Department of the Census. 65 + in the United States. Washington, DC: Bureau of the Census, 1996.
- Loran DB, Hyde BR, Zwischenberger JB. Perioperative management of special populations: the geriatric patient. *Surg Clin North Am* 2005;85:1259–1266.

- Rubino FA. Perioperative management of patients with neurologic disease. *Neurol Clin* 2004;22:261–276.
- Lefevre F, Woolger JM. Surgery in the patient with neurologic disease. *Med Clin North Am* 2003;87:257–271.
- Jones RM, Healy TE. Anaesthesia and demyelinating disease. *Anaesthesia* 1980;35(9):879–884.
- Schneider KM. An overview of multiple sclerosis and implications for anesthesia. *AANA J* 2005;73(3):217–224.
- Bamford C, Sibley W, Laguna J. Anesthesia in multiple sclerosis. *Can J Neurol Sci* 1978;5(1):41–44.
- National Multiple Sclerosis Society. Library and literature: Anesthesia, 2006. Available at: <http://www.nationalmssociety.org/Sourcebook-anesthesia.asp>. Last accessed February 7, 2006.
- Perlas A, Chan VWS. Neuraxial anesthesia and multiple sclerosis. *Can J Anaesth* 2005;52(5):454–458.
- Sakurai M, Mannen T, Kanazawa I, Tanabo H. Lidocaine unmasks silent demyelinating lesions in multiple sclerosis. *Neurology* 1992;42:2088–2093.
- Levesque P, Marsepoil T, Venutolo PH, Lesouef JM. Multiple sclerosis revealed by spinal anesthesia. *Ann Fr Anesth Reanim* 1988;7:68–70.
- Bader AM, Hunt CO, Datta S, Naulty S, Ostheimer GW. Anesthesia for the obstetric patient with multiple sclerosis. *J Clin Anesth* 1988;1:21–24.
- Dalmas AF, Texier C, Ducloy-Bouthors AS, Krivosic-Horber R. Obstetrical analgesia and anaesthesia in multiple sclerosis. *Ann Fr Anesth Reanim* 2003;22:861–864.
- Crawford JS, James FM III, Nolte H, et al. Regional analgesia for patients with chronic neurologic disease and similar conditions. *Anaesthesia* 1981;36:821.
- Bouchard P, Caillet JB, Monnet F, Bainsillon V. Spinal anaesthesia and multiple sclerosis. *Ann Fr Anesth Reanim* 1984;3:194–198.
- Guthrie TC, Nelson DA. Influence of temperature changes on multiple sclerosis: critical review of mechanisms and re-



- search potential. *J Neurol Sci* 1995;129(1):1–8.
17. Rudick RA, Cohen JA, Weinstock-Guttman B, et al. Management of multiple sclerosis. *N Engl J Med* 1997;337:1604–1611.
18. Saperstein DS, Barohn RJ. Management of myasthenia gravis. *Semin Neurol* 2004;24(1):41–48.
19. Eisenkraft JB, Book WJ, Mann SM, et al. Resistance to succinylcholine in myasthenia gravis: a dose–response study. *Anesthesiology* 1988;69:760–763.
20. Mann R, Blobner M, Jelen-Esselborn S, et al. Preanesthetic train of four fade predicts the atracurium requirement of myasthenia gravis patients. *Anesthesiology* 2000;93:346–350.
21. Dillon FX. Anesthesia issues in the perioperative management of myasthenia gravis. *Semin Neurol* 2004;24(1):83–94.
22. Book WJ, Abel M, Eisenkraft JB. Anesthesia and neuromuscular disease. *Anesthesiol Clin North America* 1996;14:515–542.
23. Lorimer M, Hall R. Remifentanyl and propofol total intravenous anaesthesia for thymectomy in myasthenia gravis. *Anaesth Intensive Care* 2003;26(2):210–212.
24. Fodale V, Pratico C, Piana F, et al. Propofol and remifentanyl without muscle relaxants in a patient with myasthenia gravis for emergency surgery. *Can J Anaesth* 1998;50(10):1083–1084.
25. Mekis D, Kamenik M. Remifentanyl and high thoracic epidural anaesthesia: a successful combination for patients with myasthenia gravis undergoing transsternal thymectomy. *Eur J Anaesth* 2005;22(5):397–399.
26. Telford RJ, Hollway TE. The myasthenic syndrome: anaesthesia in a patient treated with 3,4 diaminopyridine. *Br J Anaesth* 1990;64:363–366.
27. Leventhal SR, Orkin FK, Hirsh RA. Prediction of the need for postoperative mechanical ventilation in myasthenia gravis. *Anesthesiology* 1980;53(1):26–30.
28. Podciechowski L, Brocka-Nitecka U, Dabrowska K, et al. Pregnancy complicated by myasthenia gravis—twelve years experience. *Neurol Endocrinol Lett* 2005;26(5):603–608.
29. Kroll DA, Caplan RA, Posner K, et al. Nerve injury associated with anesthesia. *Anesthesiology* 1990;73:202–207.
30. Cheney FW, Domino KB, Caplan RA, et al. Nerve injury associated with anesthesia: a closed claims analysis. *Anesthesiology* 1999;90:1062–1069.
31. Warner MA. Perioperative neuropathies. *Mayo Clin Proc* 1998;73:567–574.
32. De Jonghe B, Sharshar T, Lefaucheur JP, et al. Paresis acquired in the intensive care unit: a prospective multicenter study. *JAMA* 2002;288:2859–2867.
33. Prielipp RC, Morell RC, Butterworth J. Ulnar nerve injury and perioperative arm positioning. *Anesthesiol Clin North America* 2002;20:589–603.
34. Warner MA, Warner ME, Martin JT. Ulnar neuropathy: incidence, outcome, and risk factors in sedated or anesthetized patients. *Anesthesiology* 1994;81:1332–1340.
35. Roy RC, Stafford MA, Charlton JE. Nerve injury and musculoskeletal complaints after cardiac surgery. *Anesth Analg* 1988;67:277–279.
36. Seyfer AE, Grammar NY, Bogumill GP, et al. Upper extremity neuropathies after cardiac surgery. *J Hand Surg* 1985;10:16–19.
37. Sharma AD, Parmley CL, Sreeram G, et al. Peripheral nerve injuries during cardiac surgery: risk factors, diagnosis, prognosis, and prevention. *Anesth Analg* 2000;91:1358–1369.
38. Warner MA, Warner DO, Matsumoto YJ, et al. Ulnar neuropathy in surgical patients. *Anesthesiology* 1999;90:54–59.
39. Warner MA, Warner DO, Harper CM, et al. Ulnar neuropathy in medical patients. *Anesthesiology* 2000;92:613–615.
40. Coppieters MW, Van de Velde M, Stappaerts KH. Positioning in anesthesiology: toward a better understanding of stretch induced perioperative neuropathies. *Anesthesiology* 2002;97(1):75–81.
41. Practice advisory for the prevention of perioperative peripheral neuropathies. A report by the ASA Task Force on Prevention of Perioperative Peripheral Neuropathies. *Anesthesiology* 2000;92:1168–1182.
42. Burton DA, Nicholson G, Hall GM. Anaesthesia in elderly patients with neurodegenerative disorders. *Drugs Aging* 2004;21(4):229–242.
43. Moghal S, Rajput AH, D'Arcy C, et al. Prevalence of movement disorders in elderly community residents. *Neuroepidemiology* 1994;13:175–178.
44. Bennett DA, Beckett LA, Murray AM, et al. Prevalence of parkinsonian signs and associated mortality in a community population of older people. *N Engl J Med* 1996;334:71–76.
45. Levy G, Tang M-X, Louis ED, et al. The association of incident dementia with mortality in Parkinson's disease. *Neurology* 2002;59:1708–1713.
46. Fratiglioni L, Wang H-X. Smoking and Parkinson's and Alzheimer's disease: review of the epidemiological studies. *Behav Brain Res* 2000;113:117–120.
47. Nicholson G, Pereira AC, Hall GM. Parkinson's disease and anaesthesia. *Br J Anaesth* 2002;89:904–916.
48. Vincken WG, Gauthier SG, Dollfuss RE, et al. Involvement of upper airway muscles in extrapyramidal disorders: a cause of airflow limitation. *N Engl J Med* 1984;311:438–442.
49. Neu HC, Connolly JJ, Schwertley FW, et al. Obstructive respiratory dysfunction in parkinsonian patients. *Am Rev Respir Dis* 1967;95:33–47.
50. Obenour WH, Stevens PM, Cohen AA, et al. The causes of abnormal pulmonary function in Parkinson's disease. *Am Rev Respir Dis* 1972;105:382–387.
51. Hoehn MM, Yahr MD. Parkinsonism: onset, progression and mortality. *Neurology* 1967;17:427–442.
52. Backus WW, Ward RR, Vitkun SA, et al. Postextubation laryngospasm in an anesthetized patient with Parkinson's disease. *J Clin Anesth* 1991;3:314–316.
53. Easdown LJ, Tessler MJ, Minuk J. Upper airway involvement in Parkinson's disease resulting in postoperative respiratory failure. *Can J Anaesth* 1995;42:344–347.
54. Furuya R, Hirai A, Andoh T, et al. Successful perioperative management of a patient with Parkinson's disease by enteral levodopa administration under propofol anesthesia. *Anesthesiology* 1998;89:261–263.
55. Reed AP, Han DG. Intraoperative exacerbation of Parkinson's disease. *Anesth Analg* 1992;75:850–853.
56. Golden WE, Lavender RC, Metzger WS. Acute postoperative confusion and hallucinations in Parkinson disease. *Ann Intern Med* 1989;111:218–222.
57. Gross M, Bannister R, Godwin-Austin R. Orthostatic hypotension in Parkinson's disease. *Lancet* 1972;1:174–176.
58. Muravchick S, Smith DS. Parkinsonian symptoms during emergence from general anesthesia. *Anesthesiology* 1995;82:305–307.
59. Krauss JK, Akeyson EW, Giam P, et al. Propofol-induced dyskinesias in Parkinson's disease. *Anesth Analg* 1996;83:420–422.
60. Muzzi DA, Black S, Cucchiara RF. The lack of effect of succinylcholine on serum potassium in patients with Parkinson's disease [letter]. *Anesthesiology* 1989;71:322.
61. Mets B. Acute dystonia after alfentanil in untreated Parkinson's disease. *Anesth Analg* 1991;72:557–558.
62. Berg D, Becker G, Reiners K. Reduction of dyskinesia and induction of akinesia induced by morphine in two Parkinsonian patients with severe sciatica. *J Neural Transm* 1999;106:725–728.
63. Zornberg GL, Bodkin JA, Cohen BM. Severe adverse interaction between pethidine and selegiline [letter]. *Lancet* 1991;337:246.
64. Fischer SP, Mantin R, Brock-Ultné JG. Ketorolac and propofol anesthesia in a patient taking chronic monamine oxidase inhibitors. *J Clin Anesth* 1996;8:245–247.
65. Hauser WA, Annegers JF, Anderson VE. Epidemiology and the genetics of epilepsy. In: Ward AA et al., eds. *Epilepsy*. New York: Raven Press, 1983:274.

66. Chambers HG, Weinstein CH, Mubarak SJ, et al. The effect of valproic acid on blood loss in patients with cerebral palsy. *J Pediatr Orthop* 1999;19(6):792-795.
67. Kofke WA, Tempelhoff R, Dasheiff RM. Anesthetic implications of epilepsy, status epilepticus, and epilepsy surgery. *J Neurosurg Anesthesiol* 1997;9(4):349-372.
68. Zeidman SM, Ducker TB, Raycroft J. Trends and complications in cervical spine surgery: 1989-1993. *J Spinal Disord* 1997;10:523-526.
69. Romano PS, Campa DR, Rainwater JA. Elective cervical discectomy in California: postoperative in hospital complications and their risk factors. *Spine* 1997;22:2677-2692.
70. Young HF. Complications of spinal surgery and trauma. In: Greenfield LJ, ed. *Complications in Surgery and Trauma*. 2nd ed. Philadelphia: JB Lippincott, 1990:713-722.
71. Brown CA, Eismont FR. Complications in spinal fusion. *Orthop Clin North Am* 1998;29:679-699.
72. Hamilton MG, Hull RD, Pineo GF. Venous thromboembolism in neurosurgery and neurology: a review. *Neurosurgery* 1994;34:280-296.
73. Geerts WH, Heit JA, Clagett CP, et al. Prevention of venous thromboembolism. *Chest* 2001;119(Suppl):1325-1755.
74. Clagett GP, Anderson FA, Geerts W, et al. Prevention of venous thromboembolism. *Chest* 1998;114:531S-60S.
75. Yoo KY, Jeong SW, Kim SJ, et al. Cardiovascular responses to endotracheal intubation in patients with acute and chronic spinal cord injuries. *Anesth Analg* 2003;97:1162-1167.
76. Sloane PD, Zimmerman S, Suchindran C, et al. The public health impact of Alzheimer's disease, 2000-2050. Potential implication of treatment advances. *Annu Rev Public Health* 2002;23:213-231.
77. Hebert LE, Scherr PA, Beckett LA, et al. Age-specific incidence of Alzheimer's disease in a community population. *JAMA* 1995;273:1354-1359.
78. Ott A, Breteler MMB, van Harskamp F, et al. Prevalence of Alzheimer's disease and vascular dementia: association with education: the Rotterdam Study. *BMJ* 1995;310:970-973.
79. Tsuchiya K, Ikeda K, Niizato K, et al. Parkinson's disease mimicking senile dementia of the Alzheimer type: a clinicopathological study of four autopsy cases. *Neuropathology* 2002;22:77-84.
80. Bohnen N, Warner MA, Kokmen E, et al. Early and midlife exposure to anesthesia and age of onset of Alzheimer's disease. *Int J Neurosci* 1994;77:181-185.
81. Bone I, Rosen M. Alzheimer's disease and anaesthesia. *Anaesthesia* 2000;55:592-593.
82. Bohnen NI, Warner MA, Kokmen E, et al. Alzheimer's disease and cumulative exposure to anesthesia: a case control study. *J Am Geriatr Soc* 1994;42:198-201.
83. Gasparini M, Vanacore N, Schiaffini C, et al. A case control study on Alzheimer's disease and exposure to anesthesia. *Neurol Sci* 2002;23:11-14.
84. Chung FF, Chung A, Meier RH, et al. Comparison of perioperative mental function after general anaesthesia and spinal anaesthesia with intravenous sedation. *Can J Anaesth* 1989;36:382-387.
85. Crul BJP, Hulstijn W, Burger IC. Influence of the type of anaesthesia on postoperative subjective physical well being and mental function in elderly patients. *Acta Anaesthesiol Scand* 1992;36:615-620.
86. Neilson WR, Gelb AW, Casey JE, et al. Long-term cognitive and social sequelae of general versus regional anaesthesia during arthroplasty in the elderly. *Anesthesiology* 1990;73:1103-1109.
87. Williams-Russo P, Sharrock NE, Mattis S, et al. Cognitive effects after epidural vs general anesthesia in older adults: a randomized trial. *JAMA* 1995;274:44-50.
88. Fernandez CR, Fields A, Richards T, et al. Anesthetic considerations in patients with Alzheimer's disease. *J Clin Anesth* 2003;15:52-58.
89. Bernstein GM, Offenbartl SK. Adverse surgical outcomes among patients with cognitive impairments. *Am Surg* 1991;57(11):682-690.
90. Wada H, Nakajoh K, Satoh-Nakagawa T, et al. Risk factors of aspiration pneumonia in Alzheimer's disease patients. *Gerontology* 2001;47:271-276.
91. Kobayashi H, Nakagawa T, Sekizawa K, et al. Levodopa ad swallowing reflex. *Lancet* 1996;348:1320-1321.
92. Gustafson Y. Postoperative delirium—a challenge for the orthopedic team. *Acta Orthop Scand* 2004;75(4):375-377.
93. Hamann J, Bickel H, Schwaibold H, et al. Postoperative acute confusional state in typical urologic population: incidence, risk factors, and strategies for prevention. *Urology* 2005;65(3):449-453.
94. Litaker D, Locala J, Franco K, et al. Preoperative risk factors for postoperative delirium. *Gen Hosp Psychiatry* 2001;23:84-89.
95. Marcantonio ER, Goldman L, Mangione CM, et al. A clinical prediction rule for delirium after elective noncardiac surgery. *JAMA* 1994;271:134-139.
96. Lynch EP, Lazor MA, Gellis JE, et al. The impact of postoperative pain on the development of postoperative delirium. *Anesth Analg* 1998;86:781-785.
97. Kudoh A, Takahira Y, Katagai H, et al. Cortisol response to surgery and postoperative confusion in depressed patients under general anesthesia with fentanyl. *Neuropsychobiology* 2002;46:22-26.
98. Kudoh A, Takase H, Katagai H, et al. Postoperative interleukin-6 and cortisol concentrations in elderly patients with postoperative confusion. *Neuroimmunomodulation* 2005;12(1):60-66.
99. Pfitzenmeyer P, Musat A, Lenfant L, et al. Postoperative cognitive disorders in the elderly. *Presse Med* 2001;30(13):648-652.
100. Wong GY, Warner DO, Schroeder DR, et al. Risk of surgery and anesthesia for ischemic stroke. *Anesthesiology* 2000;92:425-432.
101. Gelb AW, Cowie DA. Perioperative stroke prevention. *IARS Rev Course Lect* 2001:46-53.
102. Hindman BJ. Perioperative stroke: the noncardiac surgery patient. *Int Anesthesiol Clin* 1986;24:101-134.
103. Kam PC, Calcroft RM. Perioperative stroke in general surgical patients. *Anaesthesia* 1997;52:879-883.
104. Kim J, Gelb AW. Predicting perioperative stroke. *J Neurosurg Anesthesiol* 1995;7:211-215.
105. Warner MA, Shields SE, Chute CG. Major morbidity and mortality within 1 month of ambulatory surgery and anesthesia. *JAMA* 1993;270:1437-1441.
106. Nosan DK, Gomez CR, Maves MD. Perioperative stroke in patients undergoing head and neck surgery. *Ann Otol Rhinol Laryngol* 1993;102:717-723.
107. Arrowsmith JE, Grocott HP, Reves JG, et al. Central nervous system complications of cardiac surgery. *Br J Anaesth* 2000;84:378-393.
108. Knapp FM, Topkins MJ, Artusio JF. The cerebrovascular accident and coronary occlusion in anesthesia. *JAMA* 1962;182:332-334.
109. Landercasper J, Merz BJ, Cogbill TH, et al. Perioperative stroke risk in 173 consecutive patients with a past history of stroke. *Arch Surg* 1990;125:986-989.
110. Blacker DJ, Flemming KD, Wijdicks EFM. Risk of ischemic stroke in patients with symptomatic vertebralbasilar stenosis undergoing surgical procedures. *Stroke* 2003;34:2659-2663.
111. Ropper AH, Wechsler LR, Wilson LS. Carotid bruit and the risk of stroke in elective surgery. *N Engl J Med* 1982;307:1388-1390.
112. Carney WI Jr, Stewart WB, DePinto DJ, et al. Carotid bruit as a risk factor in aortoiliac reconstruction. *Surgery* 1977;81:567-570.
113. Treiman RL, Foran RF, Cohen JL, et al. Carotid bruit: a follow-up report on its significance in patients undergoing an abdominal aortic operation. *Arch Surg* 1979;114:1138-1140.
114. Sauve JS, Laupacis A, Ostbye T, et al. Does this patient have a clinically important carotid bruit? *JAMA* 1993;270:2843-2845.
115. Larsen SF, Zaric D, Boysen G. Postoperative cerebrovascular accidents in gener-

- al surgery. *Acta Anaesthesiol Scand* 1988;32:698-701.
116. Hart R, Hindman B. Mechanisms of perioperative cerebral infarction. *Stroke* 1982;13:766-773.
117. Chung F, Mezei G. Adverse outcomes in ambulatory anesthesia. *Can J Anaesth* 1999;46:R18-R34.
118. Kohro S, Yamakage M, Omote T, et al. In vitro effects of propofol on blood coagulability and fibrinolysis by the use of thromboelastograph technique. *Acta Anaesthesiol Scand* 1999;43:217-219.
119. Kohro S, Yamakage M, Arakawa J, et al. Surgical/tourniquet pain accelerates blood coagulability but not fibrinolysis. *Br J Anaesth* 1998;80:460-463.
120. Gibbs NM, Crawford GP, Michalopoulos N. The effect of epidural blockade on postoperative hypercoagulability following abdominal aortic bypass surgery. *Anaesth Intensive Care* 1992;20:487-490.
121. Lisk DR, Grotta JC, Lamki LM, et al. Should hypertension be treated after acute stroke? A randomized trial using single photon emission computed tomography. *Arch Neurol* 1993;50:855-862.
122. Brott T, Lu M, Kothari R, et al. Hypertension and its treatment in the NINDS rt-PA Stroke Trial. *Stroke* 1998;29:1504-1509.
123. Fewel ME, Thompson GT, Hoff JT. Spontaneous intracerebral hemorrhage: a review. *Neurosurg Focus* 2000;15(4):E1.
124. Hindman BJ, Todd MM, Gelb AW, et al. Mild hypothermia as a protective therapy during intracranial aneurysm surgery: a randomized prospective pilot trial. *Neurosurgery* 1999;44:23-32.
125. Todd MM, Warner DS. A comfortable hypothermia reevaluated: cerebral metabolic depression and brain protection during ischemia. *Anesthesiology* 1992;76:161-164.
126. Schell RM, Cole DJ. Cerebral protection and neuroanesthesia. *Anesthesiol Clin North America* 1992;10:453-69.
127. Gelb AW, Cowie DA. Perioperative stroke prevention. *IARS 2001 Review Course Lectures*: 46-53
128. Schell RM, Cole DJ. Cerebral protection and neuroanesthesia. *Anesthesiol Clin North America* 1992;10:453-469.
129. Gelmers HJ, Gorter K, de Weerd CJ, et al. A controlled trial of nimodipine in acute ischemic stroke. *N Engl J Med* 1988;318:203-207.
130. The American Nimodipine Report Group. Clinical trial of nimodipine in acute stroke. *Stroke* 1992;23:3-8.
131. Mitchell SJ, Pellett O, Gorman DF. Cerebral protection by lidocaine during cardiac operations. *Ann Thorac Surg* 1999;67:1117-1124.
132. Gelb AW. Local anesthetics in cerebral ischemia. *J Neurosurg Anesth* 1989;1:383-386.
133. Cechetto DF, Gelb AW. Propofol sedation compared to awake reduces infarct size in rats. *Anesth Analg* 1999;88:S236.
134. Warner DS, McFarlane C, Todd MM, et al. Sevoflurane and halothane reduce focal ischemia brain damage in the rat: possible influence on thermoregulation. *Anesthesiology* 1993;79:985-992.
135. Desan PH, Powsner S. Assessment and management of patients with psychiatric disorders. *Crit Care Med* 2005;32(4):S166-S73.
136. Scher CS, Anwar M. The self-reporting of psychiatric medications in patients scheduled for elective surgery. *J Clin Anesth* 1999;11:619-621.
137. Kirby M, Denihan A, Bruce I, et al. Benzodiazepine use among the elderly in the community. *Int J Geriatr Psychiatry* 1999;14:280-284.
138. Kudoh A. Perioperative management for chronic schizophrenic patients. *Anesth Analg* 2005;101(6):1867-1871.
139. Goldman LS. Medical illness in patients with schizophrenia. *J Clin Psychiatry* 1999;60(Suppl 21):10-15.
140. Baxter DN. The mortality experience of individuals on the Salford Psychiatric Case Register: I. All-case mortality. *Br J Psychiatry* 1996;168:772-779.
141. Davidson M. Risk of cardiovascular disease and sudden death in schizophrenia. *J Clin Psychiatry* 2002;63(Suppl 9):5-11.
142. Baptista T. Body weight gain induced by antipsychotic drugs: mechanisms and management. *Acta Psychiatr Scand* 1999;100:3-16.
143. de Leon J, Diaz FJ, Rogers T, et al. Initiation of daily smoking and nicotine dependence in schizophrenia and mood disorders. *Schizophr Res* 2002;56:47-54.
144. Matsuki A, Oyama T, Izai S, et al. Excessive mortality in schizophrenic patients on chronic phenothiazine treatment. *Aggressologie* 1972;13:407-418.
145. Buckley NA, Sanders P. Cardiovascular adverse effects of antipsychotic drugs. *Drug Saf* 2000;23:215-228.
146. Katz E, Kluger Y, Ravinovic R, et al. Acute surgical abdominal disease in chronic schizophrenic patients: a unique clinical problem. *Isr J Med Sci* 1990;26:275-277.
147. Kudoh A, Katagai H, Takazawa T. Effect of preoperative discontinuation of antipsychotics in schizophrenic patients on outcome during and after anesthesia. *Eur J Anaesth* 2004;21:414-416.
148. Kudoh A, Takase H, Takazawa T. Chronic treatment with antipsychotics enhances intraoperative core hypothermia. *Anesth Analg* 2004;98:111-115.
149. Ishihara H, Kudoh H, Murakawa T, et al. Uneventful total intravenous anaesthesia with ketamine for schizophrenic surgical patients. *Eur J Anaesthesiol* 1997;14:47-51.
150. Kudoh A, Katagai H, Takazawa T. Total intravenous anaesthesia with ketamine decreases incidence of postoperative psychosis emergence in schizophrenic patients. *J Clin Anesth* 2002;14:107-110.
151. Kudoh A, Katagai H, Takazawa T. Effect of epidural analgesia on postoperative paralytic ileus in chronic schizophrenia. *Reg Anesth Pain Med* 2001;26(5):456-460.
152. Ho PM, Masoudi FA, Spertus JA, et al. Depression predicts mortality following cardiac valve surgery. *Ann Thorac Surg* 2005;79(4):1255-1259.
153. Kudoh A, Katagai H, Takazawa T. Antidepressant treatment for chronic depressed patients should not be discontinued prior to anesthesia. *Can J Anaesth* 2002;49(2):132-136.
154. Kudoh A, Katagai H, Takase H, et al. Endocrine response to surgical stress and postoperative confusion in depressed patients with alcohol abuse. *Neuropsychobiology* 2004;50:195-199.
155. Kudoh A, Takahira Y, Katagai H, et al. Small dose ketamine improves the postoperative state of depressed patients. *Anesth Analg* 2002;95(1):114-119.
156. Kudoh A, Katagai H, Takazawa T. Increased postoperative pain scores in chronic depressed patients who take antidepressants. *J Clin Anesth* 2002;14:421-425.
157. Thompson JW, Weiner RD, Myers CP. Use of ECT in the United States in 1975, 1980, and 1986. *Am J Psychiatry* 1994;151:1657-1661.
158. Weinger MB, Partridge BL, Hauger R, et al. Prevention of the cardiovascular and neuroendocrine response to electroconvulsive therapy. II. Effects of pretreatment regimens on catecholamines, ACTH, vasopressin, and cortisol. *Anesth Analg* 1991;80:563-569.
159. Castelli I, Steiner LA, Kaufmann MA, et al. Comparative effects of esmolol and labetalol to attenuate hyperdynamic states after electroconvulsive therapy. *Anesth Analg* 1995;80:557-561.
160. Lopez-Gomez D, Sanchez-Corral MA, Cobo JV, et al. Myocardial infarction alter electroconvulsive therapy. *Rev Esp Cardiol* 1999;52:536.
161. Weisberg LA, Elliott D, Mielke D. Intracerebral hemorrhage following electroconvulsive therapy. *Neurology* 1991;41:1849.
162. Rikher KV, Johnson R, Kamal M. Cortical blindness after electroconvulsive therapy. *J Am Board Fam Pract* 1997;10:141-143.
163. Sarpel Y, Togrul E, Herdem M, et al. Central acetabular fracture-dislocation following electroconvulsive therapy: report of two similar cases. *J Trauma* 1996;41:342-344.

164. Nott MR, Watts JS. A fractured hip during electroconvulsive therapy. *Eur J Anaesthesiol* 1999;16:265–267.
165. Sackeim HA, Devanand DP, Prudic J. Stimulus intensity, seizure threshold, and seizure duration: impact on the efficacy and safety of electroconvulsive therapy. *Psychiatr Clin North Am* 1991;14:803–843.
166. Ding Z, White PF. Anesthesia for electroconvulsive therapy. *Anesth Analg* 2002;94:1351–1364.
167. Avramov MN, Husain MM, White PF. The comparative effects of methohexital, propofol, and etomidate for electroconvulsive therapy. *Anesth Analg* 1995;81:596–602.
168. Saffer S, Berk M. Anesthetic induction for ECT with etomidate is associated with longer seizure duration than thiopentone. *J ECT* 1998;14:89–93.
169. Nishihara F, Ohkawa M, Hiraoka H, et al. Benefits of the laryngeal mask for airway management during electroconvulsive therapy. *J ECT* 2003;19(4):211–216.



# CHAPTER 11

## Evaluation of the Patient with Neuromuscular or Skeletal Disease

Philip D. Bailey, Jr., DO,  
and Joseph R. Tobin, MD

156

Perioperative management of patients with neuromuscular disorders is challenging because of the low incidence, diverse etiology, coexisting diseases, and variable responses to anesthetics that often are present. Paramount to developing a safe anesthetic plan is the ability of the anesthesia provider to assess the extent and rate of the disease's progression. Despite distinct etiologies, all neuromuscular disorders may adversely affect the respiratory and cardiovascular systems. Unfortunately, the extent of peripheral muscle involvement does not always correlate with the extent of cardiovascular and respiratory system involvement. Indeed, during an acute illness, anesthesia, or surgery, the patient with a neuromuscular disorder may have his or her reserve easily overwhelmed, resulting in unanticipated complications, especially when the extent of the underlying neuromuscular disorder is underestimated.

This chapter focuses on the perioperative evaluation of patients with neuromuscular and skeletal diseases, emphasizing the respiratory and cardiovascular systems while highlighting important anesthetic issues. Individual neuromuscular disorders are grouped anatomically in an attempt to delineate specific anesthetic issues and to help predict possible anesthetic complications.

### PREOPERATIVE ASSESSMENT

#### Respiratory System

The major cause of death in patients with neuromuscular disorders is respiratory insufficiency.<sup>1</sup> Respiratory involvement often varies considerably among various neuromuscular disorders, and the extent of general muscle

weakness does not necessarily correlate with the severity of respiratory muscle involvement.<sup>2</sup> In fact, patients with peripheral neuropathy tend to experience less frequent and less severe respiratory involvement compared to individuals with myopathy, myelopathy, and neuromuscular junction disease.<sup>3</sup> Significant respiratory muscle involvement may occur early

(e.g., Guillain-Barré syndrome) in the course of the disease or late (e.g., myasthenia gravis), and it may be progressive, reversible, or intermittent. Impaired upper airway function and cranial nerve involvement often result in airflow obstruction and recurrent aspiration. Symptoms of airway involvement may be present preoperatively, following administration of se-

### KEY POINTS

1. The major cause of death in patients with neuromuscular disorders is respiratory insufficiency. Respiratory involvement often varies considerably among the various neuromuscular disorders, and the extent of general muscle weakness does not necessarily correlate with the severity of respiratory muscle involvement.
2. Cardiovascular involvement in patients with neuromuscular disorders may manifest as myocardial failure in patients with myopathic disorders and as autonomic dysfunction in patients with neuropathic disorders. Clinical signs of autonomic dysfunction include orthostatic hypotension, resting tachycardia, paralytic ileus, anhidrosis, and constricted pupils. The presence of these clinical signs may indicate profound hemodynamic instability that may manifest during the perioperative period, requiring invasive monitoring to manage the patient's volume status and ventricular contractility.
3. In patients with neuromuscular disorders, the severity of skeletal muscle involvement does not necessarily correlate with the severity of cardiac involvement.
4. Children with asymptomatic, undiagnosed muscular dystrophy are at significant risk for serious, life-threatening anesthetic complications. Specifically, these patients may develop intractable hyperkalemic cardiac arrest after receiving succinylcholine intravenously.
5. Spinal anesthesia has been associated with exacerbation of multiple sclerosis, although the mechanism is unclear. Speculation is that demyelinated areas of the spinal cord are more sensitive to the effects of the local anesthetic, causing a relative neurotoxicity.
6. Numerous anesthetics have been implicated in exacerbating an acute attack of porphyria and should be avoided. Propofol, ketamine, local anesthetics, muscle relaxants, nitrous oxide, isoflurane, and opioids are considered safe.
7. Myasthenic crisis is a rapid deterioration of neuromuscular and respiratory function that may occur at any time perioperatively as a result of infection, stress, or an overdose with anticholinesterase drugs (cholinergic crisis).
8. Patients with myasthenia gravis and myasthenic syndrome are exquisitely sensitive to the effects of nondepolarizing muscle relaxants.
9. Succinylcholine should be avoided in patients with muscular dystrophies. In light of the abnormal muscle membrane, succinylcholine administration may further damage the muscle membrane and cause the release of intracellular contents.
10. Succinylcholine produces an exaggerated contracture, and its use should be avoided in patients with myotonias. The myotonic response produced by succinylcholine may be so severe that ventilation and tracheal intubation are difficult and may be impossible.
11. Rheumatoid arthritis, osteoarthritis, and ankylosing spondylitis all share possible cervical spine disease and may make airway management difficult.
12. Some musculoskeletal disorders are associated with an abnormal heat dissipation mechanism such that central temperature monitoring is important.
13. Many etiologies of high creatine kinase concentrations or rhabdomyolysis may be associated with malignant hyperthermia susceptibility.

dation or induction agents, or develop early after anesthetic administration, requiring persistent airway control.

Inspiratory muscle disease is frequently observed as a change in respiratory pattern, alternating work between fatiguing muscles and accessory muscles and increasing the respiratory rate to allow more efficient use of weakened muscles early in the course of the disease.<sup>4</sup> In addition, inspiratory time and the ratio of dead space to tidal volume are increased, resulting in decreased ventilatory efficiency, increasing the risk of respiratory embarrassment. More advanced inspiratory muscle disease is characterized by hypoventilation, atelectasis, and hypoxemia. When muscle strength is <30% of normal, hypercapnia develops.<sup>5</sup> Ventilatory responses to hypercapnia and hypoxia usually are impaired, especially in the presence of motor neuron and demyelinating disorders.<sup>6</sup> Although central ventilatory drive usually remains intact, it may be diminished in some patients with certain neuromuscular disorders (e.g., myotonic dystrophy). Indeed, respiratory drive may reflexively diminish in order to protect against respiratory muscle fatigue, injury, and failure. Chronic hypoventilation or hypoxemia may result in pulmonary hypertension, further complicating cardiopulmonary function.

The ability to cough and clear secretions is impaired in patients who have expiratory muscle dysfunction, and reductions in forced expiratory capacity after abdominal and thoracic procedures may be exacerbated. When cough is impaired, atelectasis may develop and secretions are retained, predisposing patients to bacterial contamination and pneumonia.

Preoperative evaluation should focus on history, physical examination, and diagnostic studies. Breathlessness on exertion is common; however, many patients who have advanced disease cannot generate sufficient exertion to offer this complaint. Orthopnea is a prominent symptom of diaphragmatic weakness because the abdominal contents limit diaphragmatic movement when a patient is in the supine position. Snoring, morning headaches, and daytime somnolence are indicative of sleep-related breathing disorders that are commonly present in patients with neuromuscular disease. In addition, liquids tend to be harder to swallow than solids in patients who have pharyngeal

muscle weakness, and patients often report a perioperative history of aspiration or chest infection after procedures. A history of use of nocturnal respiratory assist devices (continuous positive airway pressure or bilevel positive airway pressure) predicts an increased propensity to postanesthesia airway or respiratory problems and may require advanced monitoring (ICU or similar site) for postoperative respiratory/airway complications.

Important findings indicative of ventilatory muscle weakness, such as frequent changes in respiratory pattern, tachypnea, use of accessory muscles, and ventilatory muscle incoordination, may be observed during relaxed breathing and auscultation.<sup>7</sup> In addition, paradoxical motion of the abdomen during inspiratory efforts suggests profound weakness of the diaphragm; this is best observed when a patient is supine.

Preoperative laboratory evaluation should focus on the patient's oxygenation and ventilation. Radiographic examination of the chest is useful to exclude pulmonary abnormalities but is not very helpful for diagnosing muscle weakness. Arterial blood gas analysis helps identify patients with hypercapnia and hypoxia. Restrictive patterns typically are demonstrated by classic pulmonary function testing. However, vital capacity is not significantly affected until respiratory muscle strength is 50% below normal. Diaphragmatic weakness is suggested when a >25% decrease in vital capacity is observed between upright and supine positions.<sup>8</sup> Total lung capacity decreases in patients with inspiratory muscle weakness whereas residual volume increases. Flow-volume loop studies commonly reveal truncation of peak inspiratory and expiratory flow rates, a delay reaching peak expiratory flow rate, and an abrupt decrease in end-expiratory flow rate. Upper airway muscle weakness results in oscillations of forced inspiratory or expiratory flow as well as plateauing of the inspiratory flow curve.<sup>9</sup> Inspiratory pressure generated by maximal effort against a closed airway can be used to measure the strength of respiratory muscles. Clinically significant ventilatory failure becomes more likely when maximum inspiratory pressure generated is <30 cm H<sub>2</sub>O.<sup>10</sup>

### Cardiovascular System

Cardiovascular involvement in patients with neuromuscular disorders may

manifest as myocardial failure in patients with myopathies or as autonomic dysfunction in patients with neuropathic disorders. Patients are at risk for left ventricular thrombi, systemic emboli, pulmonary hypertension, and right ventricular failure. Also, because most patients with neuromuscular disorders are relatively immobile, deep venous thromboses and pulmonary emboli are a concern.

Paradoxically, cardiomyopathy can range from subclinical in individuals with advanced neuromuscular disease to severe in patients with mild neuromuscular disorders, such as mildly affected female carriers of Duchenne muscular dystrophy<sup>11</sup> or patients with Friedreich ataxia. Factors influencing the severity of Duchenne muscular dystrophy cardiomyopathy are multifactorial and may not be predicted by the extent of Xp21 (dystrophin) gene deletion.<sup>12</sup>

Heart rate, inotropic state, venous tone, and systemic vascular resistance are regulated by the autonomic nervous system. The most sensitive indicator of autonomic cardiac involvement is loss of beat-to-beat variability.<sup>13</sup> Resting tachycardia and postural hypotension often are observed when autonomic dysfunction is present and has been associated with intraoperative hemodynamic instability. Clinical signs of autonomic dysfunction include orthostatic hypotension, resting tachycardia, paralytic ileus, anhidrosis, and constricted pupils.

The presence of these clinical signs suggests profound hemodynamic instability that may manifest in the perioperative period and require invasive monitoring to manage volume status. Recently transesophageal echocardiography has been used more commonly to monitor cardiovascular performance and diastolic ventricular volume.

Cardiomyopathy typically is difficult to assess by auscultation in the early stages. Persistent tachycardia usually is the earliest manifestation of cardiomyopathy. Although determination of creatine phosphokinase level is used to detect active systemic myopathy, it may not detect myocardial dystrophy. Both atrial natriuretic peptide and norepinephrine concentrations are useful for detecting and monitoring heart failure. Atrial natriuretic peptide concentrations typically increase in patients with muscular dystrophy once left ventricular ejection fraction is <25%.<sup>14</sup>

The electrocardiogram (ECG) is a very reliable test for evaluating suspected cardiac involvement in patients with neuromuscular disorders. Characteristics include tall right precordial R and Q waves in leads I, aVL, V<sub>5</sub>, and V<sub>6</sub>.<sup>15</sup> Fibrous replacement of the myocardium is thought to be responsible for the Q wave often observed on the ECG. Unfortunately, the prognostic value of the ECG is not very good because of very little correlation among the clinical course, ECG alterations, and the level of cardiac enzymes.<sup>16</sup> Chest radiograph may be helpful to determine heart size; however, echocardiography is preferred to determine the size of the cardiac chambers, valvular involvement, and regional wall-motion abnormalities. In addition, serial measurements of fractional shortening and left ventricular ejection fraction are useful to monitor progression of cardiomyopathy and response to therapy.<sup>17</sup>

### Anesthetic Considerations

In patients with neuromuscular disorders, the severity of disease tends to correlate well with the incidence of perioperative complications. Postoperative respiratory failure can occur, especially in patients with severe restrictive lung disease. The presence of cardiomyopathy can lead to arrhythmias, blood pressure lability, and increased sensitivity to the depressant effects of anesthetics. The risk of aspiration is increased in patients who have a diminished, or absent, gag reflex. Positioning injuries may occur as a result of contractures, skeletal deformity, and lack of subcutaneous adipose tissue. Also, adverse reactions with anesthetics, particularly succinylcholine-induced hyperkalemia, are well documented in patients with neuromuscular disorders.<sup>18–20</sup> The anesthetic concerns for patients with neuromuscular disease are summarized in Table 11–1.

Of concern are reports of children with asymptomatic, undiagnosed muscular dystrophy who are at significant risk for serious, life-threatening, anesthetic complications. Specifically, these patients may develop intractable cardiac arrest after receiving succinylcholine intravenously (IV) or after intramuscular injection, with or without the use of halogenated agents.<sup>21,22</sup> In this situation, hyperkalemia, acidosis, and myoglobinuria are common clinical

findings. A number of these patients have been found to have abnormal or absent dystrophin, usually indicating myopathy, more specifically Duchenne muscular dystrophy. As a result, the United States Food and Drug Administration has determined that succinylcholine should be used in children and adolescent patients only for emergency tracheal intubation or in cases where immediate securing of the airway is necessary.

## PERIOPERATIVE ASSESSMENT OF SPECIFIC NEUROMUSCULAR DISEASES

### Myelopathy

#### ***Amyotrophic Lateral Sclerosis***

Amyotrophic lateral sclerosis (ALS) is a degenerative disease involving the corticospinal tract and anterior horn cells. Loss of motor function is progressive, with development of asymmetric weakness of the limbs (lower motor neurons are affected first), spasticity, and muscle atrophy. Death usually occurs within 3–5 years of diagnosis, although approximately 10% of patients may live more than 10 years.<sup>23</sup> The etiology of ALS is unknown, but possible causes include viral or prion infection, glutamate excitotoxicity, free radical stress, autoimmune response, and heavy metal exposures.<sup>24</sup>

Involvement of the bulbar region typically manifests as respiratory and pharyngeal muscular insufficiency. Pulmonary function tests reveal a decrease in vital capacity, maximal voluntary ventilation, and diminished expiratory muscle function.<sup>25</sup> Ventilatory support will be necessary as the disease progresses because respiratory failure eventually develops in all patients. Indeed, the cause of death in most patients with ALS, as is in most patients with neuromuscular disorders, is respiratory failure. Autonomic dysfunction may be present in patients with ALS, as evidenced by resting tachycardia, orthostatic hypotension, and increased concentrations of catecholamines.

The antiglutamate drug riluzole is the only drug approved specifically for treatment of ALS. Riluzole has been demonstrated to prolong survival and delay the need for tracheostomy.<sup>26</sup> Anticholinergic agents usually are administered to decrease secretions and facilitate swallowing, where-

as dantrolene sodium and benzodiazepines are commonly administered to relieve muscle cramps and spasticity. However, these agents may exacerbate respiratory and skeletal muscle weakness. Anticholinesterase therapy may transiently improve muscle function and therefore is sometimes administered to these patients.

Ventilatory and upper airway muscle impairment significantly affects anesthetic management. Aspiration is an ongoing risk, and the need for postoperative ventilatory support is high because the already decreased respiratory reserve is reduced even further postoperatively. In ALS patients, the response to muscle relaxants, either depolarizing or nondepolarizing, is altered and may be compounded by perioperative administration of anticholinesterase medication. As with other patients with muscle denervation and muscle wasting, ALS patients are susceptible to succinylcholine-induced hyperkalemia and cardiovascular arrest.<sup>27</sup> Therefore, whenever possible, depolarizing and long-acting nondepolarizing muscle relaxants should be avoided. Autonomic dysfunction may produce exaggerated decreases in cardiovascular function in response to anesthesia. No evidence indicates that any one specific anesthetic drug or anesthetic technique is best for patients with ALS. Neuraxial anesthesia has been safely used in patients and can be considered.<sup>28,29</sup> Concern has been raised regarding neuraxial anesthesia and acute or subacute worsening of symptoms postoperatively, but no scientific evidence has been forthcoming.

### ***Multiple Sclerosis***

Multiple sclerosis is a chronic disease of the central nervous system (CNS) that is characterized by a demyelinating process of the brain and spinal cord with unpredictable intervals of exacerbations and remissions. The cause of the disease is multifactorial, involving immunologic-mediated events occurring in susceptible individuals. Initially, a virus or other agent triggers an inflammatory response that initiates an autoimmune response to myelin. Plaques in the white matter of the CNS are the fundamental lesions. The ability of the CNS to repair itself during the early phases of the disease accounts for the relapsing nature of the disease. Unfortunately, there is no curative treatment.

TABLE 11-1.

## Anesthetic Considerations in Patients with Neuromuscular Disorders

Disease	Response to Succinylcholine	Response to Nondepolarizing Muscle Relaxants	Other Anesthetic Considerations
Myelopathy Amyotrophic lateral sclerosis (ALS)	Hyperkalemia, contracture	Increased sensitivity	Impaired ventilation Aspiration risk Epidural anesthetics have been used successfully
Multiple sclerosis	Hyperkalemia in severe disease	Decreased sensitivity	Avoid stress and hyperthermia Spinal anesthesia may exacerbate disease and cause neurotoxicity Epidural anesthetics have been used successfully
Peripheral Neuropathy Guillain-Barré syndrome	Hyperkalemia	Increased/decreased sensitivity depending on phase of disease	Autonomic instability Aspiration risk Postoperative respiratory failure
Porphyrias	Normal response	Normal response	Avoid barbiturates, etomidate Propofol, ketamine, local anesthetics, opioids, nitrous oxide, isoflurane considered safe
Neuromuscular Junction Disease Myasthenia gravis	Decreased sensitivity	Increased sensitivity	Avoid muscle relaxants Postoperative respiratory failure
Myasthenic syndrome	Increased sensitivity	Increased sensitivity	Avoid muscle relaxants
Myopathy Dystrophinopathies	Increased sensitivity, hyperkalemic response	Increased sensitivity	Succinylcholine contraindicated Regional anesthesia safe Avoid inhalational agents if possible Postoperative respiratory failure Delayed recovery of muscle strength
Myotonias	Induced myotonia	Increased sensitivity if major muscle wasting is present	Avoid factors known to induce perioperative myotonia (cold, succinylcholine, hypothermia, anticholinesterase drugs) Monitor for cardiac dysrhythmias
Periodic Paralysis Hyperkalemic	Hyperkalemic response	Increased sensitivity	Avoid factors known to induce myotonia Avoid potassium supplementation Avoid carbohydrate depletion Monitor for dysrhythmias Monitor serum potassium levels Regional anesthetics best avoided
Hypokalemic	Alters serum potassium level	Increased sensitivity	Avoid hypothermia Avoid carbohydrate loading Monitor serum potassium levels Monitor for dysrhythmias Regional anesthetics best avoided

Published in and adapted from Longnecker DE, Tinker JH, Morgan GE, eds. Principles and Practice of Anesthesiology. 2nd ed. St. Louis, Mosby, 1998. Copyright Elsevier.

The symptoms of multiple sclerosis depend on the site(s) of demyelination. The most common presenting symptoms are sensory losses and ocular disturbances. Limb weakness and paresthesias may occur as a result of demyelination of motor neurons and

sensory pathways. The lower extremities are affected more than the upper extremities. Brainstem involvement may produce cranial nerve deficits and abnormal ventilatory drive. Hypotension may reflect the presence of autonomic nervous system involvement.

Bowel and bladder irregularities are frequent complaints. The course of multiple sclerosis is characterized by exacerbation of symptoms at unpredictable intervals over a prolonged period. Eventually, residual symptoms persist and lead to progressive disability. However,



10–20% of patients have a relatively benign course and trivial disability.<sup>30</sup> Interestingly, pregnancy is associated with an improvement in symptoms, but relapse occurs postpartum.<sup>31</sup>

The diagnosis is based primarily on clinical signs and symptoms. Laboratory confirmation of the diagnosis may be made by analysis of the cerebrospinal fluid (CSF) and magnetic resonance imaging (MRI). The CSF typically reveals increased concentrations of albumin and IgG. MRI can detect CNS and spinal cord involvement and can be used as a measure to determine the effectiveness of various treatment modalities.<sup>32,33</sup>

Therapeutic modalities are directed at modulating the immunologic and inflammatory responses that damage myelin. Corticosteroids and interferon are used most commonly. Glatiramer is a polypeptide mixture that mimics the structure of myelin and serves as a distraction for autoantibodies. Mitoxantrone can be used to treat aggressive disease; however, it is cardiotoxic. Dantrolene, baclofen, and benzodiazepines can be used to treat spasticity. Carbamazepine can be used to treat painful dysesthesias, seizures, and paroxysmal symptoms. Antidepressants and anticholinergic drugs can be given for depression and urinary incontinence, respectively. Avoidance of emotional stress, fatigue, and hyperthermia is essential. Indeed, a 0.5°C increase in temperature can block impulse conduction in demyelinated fibers, resulting in an exacerbation or relapse.<sup>34</sup>

Surgery may be required more frequently in patients with multiple sclerosis because of orthopedic, urologic, and neurologic issues. Unfortunately, the effects of surgery and anesthesia on the course of this disease are controversial. Both regional and general anesthesia have been reported to exacerbate multiple sclerosis. However, factors other than anesthesia, such as emotional stress and hyperpyrexia, may increase the risk of an exacerbation as well.<sup>35,36</sup> The patient should be adequately informed that, despite a well-managed anesthetic, a relapse might occur perioperatively. Patients with multiple sclerosis should undergo a comprehensive, well-documented neurologic examination aimed at identifying any existing deficits. After surgery, the neurologic examination should be repeated in order to correlate preoperative and postoperative findings.

Spinal anesthesia has been associated with exacerbation of multiple sclerosis, although the mechanism is unclear.<sup>35</sup> Speculation is that lesions may cause the breakdown of the blood-brain barrier, and, in demyelinated areas of the spinal cord, the CNS is more sensitive to the effects of the local anesthetic, causing a relative neurotoxicity. Indeed, higher concentrations of local anesthetics are more likely to cause a relapse than are lower concentrations of local anesthetics. Interestingly, epidural analgesia has been used safely and does not appear to increase the incidence of disease relapse.<sup>31,36</sup> General anesthetics do not appear to have any significant intrinsic adverse effect.

Consideration must be given to the potential interactions of anesthetics with medications patients may be taking for their disease. Patients receiving corticosteroids may require stress doses in the perioperative period. Immunosuppressants may produce subclinical cardiac dysfunction. Anticonvulsants produce resistance to nondepolarizing muscle relaxants,<sup>37–39</sup> whereas baclofen may increase the sensitivity to nondepolarizing agents. Patients with significant muscle atrophy theoretically have an increased risk of a hyperkalemic response to succinylcholine, so its use should be avoided. The hypotensive effects of volatile anesthetics may be exaggerated by autonomic dysfunction, so patients with severe disease may require invasive monitoring. Respiratory dysfunction, when present, increases the likelihood of the need for postoperative mechanical ventilation.

### Peripheral Neuropathy Guillain-Barré Syndrome

Guillain-Barré syndrome, the most common cause of acute flaccid paralysis, is an autoimmune inflammatory polyneuropathy of motor, sensory, autonomic, and cranial nerves. The syndrome is triggered by an immune response to either a viral or bacterial infection that produces antibodies to an antigen of the infectious agent. The antigen mimics an epitope of the Schwann cell, and affected axons undergo lymphocytic infiltration and demyelination. A respiratory or gastrointestinal infection 3–4 weeks earlier usually precedes the onset of this disorder. Usually, the disease evolves over the course of 3–4 weeks, with complete

recovery eventually occurring in >80% of patients. Unfortunately, 3% of patients will experience a relapse, and 5% are permanently disabled.<sup>40</sup>

The clinical course is characterized by an ascending, symmetric muscle weakness of the lower extremities that develops over several days, followed by gradual recovery. Paresthesias often precede weakness and paralysis. Difficulty swallowing and impaired ventilation may occur if bulbar and respiratory muscles are involved. Respiratory insufficiency often is characterized by decreased forced exhalation and impaired cough.<sup>41</sup> Rapid shallow breathing indicates inspiratory muscle weakness and usually develops later in the disease. Vital capacity should be measured frequently. When vital capacity is <15–20 mL/kg, mechanical ventilation often is required.<sup>42</sup> In addition, tracheostomy may be required for management of ventilatory failure and for bulbar muscle weakness even after ventilatory function returns to normal. Autonomic dysfunction may be severe, especially in patients experiencing respiratory failure and quadriparesis. Blood pressure lability, tachycardia, and cardiac conduction abnormalities may be present. Physical stimulation may precipitate hypertension, tachycardia, and cardiac dysrhythmias.<sup>43</sup>

Management is primarily supportive and directed at intensive respiratory care and treatment of autonomic dysfunction. Plasmapheresis and IV immunoglobulin may hasten recovery and may alleviate the harmful effects of the immune response. Corticosteroids and immunosuppressive therapy have not been demonstrated to be effective.<sup>19</sup>

Anesthetic management of the patient with Guillain-Barré syndrome often is dictated by the severity of respiratory and autonomic nervous system dysfunction. Compensatory cardiovascular responses may be absent. Hypotension secondary to hypovolemia, positional changes, and positive-pressure ventilation is possible. Severe autonomic dysfunction may produce exaggerated responses in heart rate and blood pressure; thus, invasive monitors may be necessary and direct acting vasopressors and antihypertensives must be readily available.

Succinylcholine should be avoided because it can precipitate hyperkalemic arrest.<sup>44</sup> Interestingly, this risk may persist for some time after recovery from the disease. Depending on the phase of

the disease, the sensitivity of patients to nondepolarizing muscle relaxants may vary from extreme sensitivity to resistance.<sup>45</sup> Mechanical ventilation should be anticipated postoperatively. Profound sensory disturbance may be present, and patients will need adequate pain control. Although the use of regional anesthesia is limited, the use of epidural opioids has been reported and appears beneficial to patients experiencing intense sensory disturbance.<sup>46</sup> Systemic opioid use must be judicious and closely monitored because these patients may be more sensitive to respiratory weakness or depression secondary to their underlying disease.

### **Familial Dysautonomia (Riley-Day Syndrome)**

Familial dysautonomia is an inherited disease thought to be caused by a deficiency of dopamine-hydroxylase with a subsequent decrease in the level of norepinephrine. Patients with this disorder exhibit impaired temperature regulation, denervation supersensitivity, insensitivity to pain, vasomotor instability, and copious pulmonary secretions.

Riley-Day syndrome has numerous anesthetic implications, including excess secretions, pneumonia, decreased responsiveness to hypoxia and hypercarbia, labile blood pressure, intravascular volume depletion, postural hypotension, decreased gag reflex, corneal abrasions, and emetic crisis. Preparation of the patient for surgery includes achieving adequate pulmonary function and correcting fluid and electrolyte imbalance. Opioids should be used sparingly because pain, hypercapnic, and hypoxic responses are blunted. Because of a risk for aspiration, a nonparticulate antacid can be given. Invasive monitoring may be necessary, and vasopressors should be titrated carefully using direct acting agents as needed.<sup>47</sup> Profound bradycardia and hemodynamic collapse may occur, and the anesthesiologist should be prepared for hemodynamic support and resuscitation.

### **Porphyrias**

Porphyrias are a group of inherited disorders of heme synthesis that result in overproduction and accumulation of porphyrin compounds because of a specific enzyme deficiency in the production of heme. Porphyrias are classified as acute (inducible) or nonacute (noninducible) based on clinical presentation.

Several reviews contain more detailed discussions of porphyrias.<sup>48,49</sup>

Acute porphyria may affect the CNS and peripheral nervous system via direct neuronal damage, axonal degeneration, and demyelination. Generally, clinical manifestations of acute attacks occur after puberty. Severe abdominal pain, nausea and vomiting, autonomic dysfunction, mental status changes, electrolyte abnormalities, and peripheral neuropathy ranging from paresis to flaccid quadriplegia characterize acute attacks. Death may occur from respiratory muscle paralysis. The cause of neurologic involvement is unknown but may be related to metabolites of heme intermediates or result from deficiency of the heme pigment in the nerve cell. Factors known to precipitate acute porphyric crisis include fasting, dehydration, infection, emotional stress, excessive ethanol intake, and administration of certain drugs.<sup>50</sup> Nonacute porphyrias are not associated with neurologic disorders or acute crisis.

Because the porphyrias are rare disorders, experience with the clinical use of many drugs, particularly anesthetics, is limited. Pharmacologic therapy of acute attacks is aimed at decreasing the activity of aminolevulinic acid synthetase, the rate-limiting step in heme production. Hematin and heme arginate are potent suppressors of aminolevulinic acid synthetase and markedly decrease the pain associated with acute crisis within 48 hours.<sup>51,52</sup> Hydration and correction of electrolyte imbalance, glucose infusion to prevent starvation, and propranolol to control autonomic dysfunction and aminolevulinic acid suppression are several mainstays of treatment. Avoidance of precipitating factors is the foundation of therapy in the latent period.

Commonly used anesthetics rarely precipitate an acute attack during latent porphyria.<sup>53</sup> Numerous anesthetics have been implicated to exacerbate an acute attack of porphyria and should be avoided. Propofol, ketamine, local anesthetics, muscle relaxants, nitrous oxide, isoflurane, and opioids are considered safe (Table 11–2). Drugs that induce cytochrome enzyme production may trigger a crisis and should be avoided (e.g., barbiturates, ethyl alcohol, etomidate, nonbarbiturate sedatives, hydantoin anticonvulsants, hydralazine and glucocorticoids).<sup>50</sup> Although re-

**TABLE 11–2.**

### **Safe Anesthetic Drugs in the Presence of Acute Porphyria**

<b>Inhaled Anesthetics</b>
Nitrous oxide: safe
Isoflurane: probably safe
Desflurane: probably safe
Sevoflurane: probably safe
<b>Intravenous Anesthetics</b>
Propofol: safe
Ketamine: probably safe
<b>Analgesics</b>
Morphine: safe
Fentanyl: safe
Sufentanil: safe
Acetaminophen: safe
<b>Neuromuscular Blocking Agents</b>
Succinylcholine: safe
Pancuronium: safe
Cisatracurium: probably safe
Vecuronium: probably safe
Rocuronium: probably safe
Mivacurium: probably safe
<b>Anticholinesterases and Anticholinergics</b>
Neostigmine: safe
Atropine: safe
Glycopyrrolate: safe
<b>Local Anesthetics</b>
Lidocaine: safe
Bupivacaine: safe
Tetracaine: safe
Mepivacaine: safe
Ropivacaine: probably safe
<b>Anxiolytics</b>
Midazolam: probably safe
<b>Antiemetics</b>
Droperidol: safe
Metoclopramide: probably safe
Ondansetron: probably safe

gional anesthetic techniques have been described in porphyria, most experts advise against them because of a risk for exacerbating preexisting neuropathy, which could create confusion if neurologic signs develop postoperatively.<sup>54</sup> Perioperative glucose infusion should be administered. Careful positioning is necessary to protect fragile blisters and skin during surgery.

### **Charcot-Marie-Tooth Disease**

Charcot-Marie-Tooth disease is the most frequent inherited peripheral neuropathy. Typically, the defect is restricted to the lower third of the legs, causing foot deformities and peroneal muscle atrophy; however, the disease

may slowly progress and affect other areas. Patients typically have stocking-glove sensory loss. Sensory deficits usually are milder than are the motor disturbances.<sup>55</sup> Pregnancy has been associated with exacerbations.<sup>56</sup> Despite long-term disability, life expectancy is not decreased, and treatment usually is supportive.

The effects of nondepolarizing neuromuscular blocking agents appear to be predictable. Although succinylcholine has been used without untoward consequences, it seems prudent to avoid using this neuromuscular blocker based on theoretical concerns about hyperkalemia and cardiac arrest.<sup>57</sup> Respiratory insufficiency, vocal cord paresis, and cardiac conduction disturbances have been described.<sup>58-60</sup>

### Neuromuscular Junction *Myasthenia Gravis*

Myasthenia gravis is an autoimmune disorder involving the neuromuscular junction. Antibodies develop and are directed against postsynaptic acetylcholine receptors and other muscle membrane proteins.<sup>61,62</sup> The thymus is abnormal in 90% of patients with this disorder (i.e., thymic hyperplasia, thymoma, or thymic atrophy).<sup>63,64</sup> Autoimmune disorders such as thyroiditis and systemic lupus erythematosus are common in patients with myasthenia gravis.

The hallmark of this disorder is skeletal muscle weakness that is aggravated by exercise and improves with rest. Exacerbations and remissions are common. Any skeletal muscle may be affected, but the most common clinical presentation is ocular muscle weakness. Bulbar involvement may cause difficulty swallowing and respiratory insufficiency. When peripheral muscle groups are involved, ambulation may be difficult. Interestingly, the first manifestation of myasthenia gravis may occur when a patient is administered drugs that stabilize the muscle membrane, such as magnesium sulfate or local anesthetics. Myasthenic crisis occurs in approximately 20% of patients during the course of the disease and usually is precipitated by pulmonary infections.<sup>64</sup>

The diagnosis of myasthenia gravis is suggested by complaints of muscle weakness, particularly ocular and bulbar muscles. In addition to clinical history, the edrophonium tests (or challenge), electromyography, and de-

tection of circulating antiacetylcholine receptor antibodies may confirm the diagnosis. Surprisingly, the extent of the disease is not proportional to the receptor antibody titer.

Treatment aims to improve function by increasing the amount of acetylcholine available at the neuromuscular junction. Cholinesterase inhibitors effectively increase the concentration of acetylcholine available at the neuromuscular junction. Because of its long duration of action, pyridostigmine is the drug of choice. Consistent control of myasthenia gravis with cholinesterase inhibitors may be a challenge. Underdosing results in worsening of the disease, and overdosing may cause cholinergic crisis. Circulating acetylcholine receptor antibodies are reduced by plasmapheresis, immunosuppressants, and corticosteroids. Thymectomy is controversial, but improvement occurs in the majority of patients with myasthenia gravis, especially if performed early in the course of the disease.<sup>65</sup>

Myasthenic crisis is a rapid deterioration of neuromuscular and respiratory function that may occur at any time perioperatively as a result of infection, stress, or an overdose with anticholinesterase drugs (cholinergic crisis). Cholinergic crisis typically presents with respiratory and bulbar muscle weakness, excessive salivation, miosis, bradycardia, and abdominal cramps. The diagnosis usually is made after a small dose of edrophonium is administered and worsening of these symptoms is observed. Control of a cholinergic crisis is achieved with supportive measures and administration of atropine or glycopyrrolate.

Preoperative preparation includes assessment of pulmonary function and optimization of medical therapy. Preoperative plasmapheresis has been shown to decrease ICU stay and the need for mechanical ventilation after thymectomy.<sup>66</sup> Risk factors that have been identified to predict postoperative respiratory failure after transsternal thymectomy are disease duration >6 years, history of chronic respiratory disease, pyridostigmine dose >750 mg/d, and preoperative vital capacity <2.9 L.<sup>66</sup> Transcervical thymectomy carries a lower incidence of prolonged postoperative mechanical ventilation than does transsternal thymectomy.<sup>67</sup> Whether anticholinesterase medication should be continued up to and including the day of surgery is controversial.<sup>68</sup>

Volatile anesthetics can be used as the sole anesthetic to provide analgesia, amnesia, and muscle relaxation.<sup>69</sup> Muscle relaxants should generally be avoided in most patients with myasthenia gravis. Anticholinesterase therapy should antagonize nondepolarizing muscle relaxants in theory, but in practice patients with myasthenia gravis may be up to 100 times more sensitive to nondepolarizing relaxants than are normal patients.<sup>70</sup> Increased sensitivity remains in patients who are asymptomatic. The need for careful titration of nondepolarizing neuromuscular blockers via monitoring with a peripheral nerve stimulator in all patients with a history of myasthenia gravis is confirmed by these findings. Also, anticholinesterase therapy prolongs the response to succinylcholine by impairing plasma cholinesterase activity. Phase II block may be seen after administration of low doses of succinylcholine.<sup>71</sup> The decrease in the number of acetylcholine receptors also resists the action of succinylcholine.

Adjuvant drugs such as aminoglycoside antibiotics, magnesium, corticosteroids, loop diuretics, lithium salts, quinidine, and procainamide may exacerbate muscle weakness in myasthenic patients. Central respiratory depression is common in myasthenic patients, and the respiratory depressant effects of opioids and benzodiazepines may be enhanced.<sup>72</sup>

Epidural analgesia and anesthesia has been described in myasthenic patients.<sup>73,74</sup> However, caution is necessary because the muscle relaxation induced by regional anesthesia may accentuate the weakness of myasthenia. Amide local anesthetics are theoretically a better choice than are the ester local anesthetics because cholinesterase activity does not affect amide anesthetic metabolism (see Chapter 44 for a discussion of the local anesthetic structures). Pregnancy has an unpredictable affect on myasthenia, and exacerbations should be anticipated.

### **Myasthenic Syndrome (Eaton-Lambert Syndrome)**

Myasthenic syndrome (Eaton-Lambert syndrome) is an acquired autoimmune disorder of the neuromuscular junction, often associated with carcinomas, in which release of acetylcholine from the nerve terminal is impaired despite normal production and processing of acetylcholine by the nerve cell. Onset of this disorder, when present, often

precedes discovery of the malignancy by several years. Antibodies are produced against calcium channels, specific to tumor cells, but unfortunately cross-reactivity with calcium channels at the neuromuscular junction results in a decreased release of acetylcholine. Proximal extremity weakness is common, with the bulbar musculature less likely to be involved. In contrast to myasthenia gravis, muscle weakness is not consistently reversed by anticholinesterase administration, and exercise tends to improve muscle function (Table 11-3). Diagnosis may be made with electromyography or antibody assay. 3-4-Diaminopyridine is commonly administered and increases the presynaptic release of acetylcholine. Treatment of an underlying neoplasm, if present, usually improves symptoms. Immunosuppression, plasmapheresis, and immunoglobulin may be effective.<sup>75</sup>

Anesthetic management should focus on interactions with muscle relaxants. Patients with myasthenic syndrome are hypersensitive to the effect of depolarizing and nondepolarizing muscle relaxants. Doses should be reduced and titrated to effect with a peripheral nerve stimulator. Administration of 3-4-diaminopyridine should be continued perioperatively.<sup>76</sup>

## Myopathies and Channelopathies

### Muscular Dystrophies

Muscular dystrophies are disorders associated with abnormalities of the muscle membrane, resulting in variable, and progressive, loss of skeletal muscle function (Table 11-4). Dystrophin is a major component of the muscle cell cytoskeleton, which provides structural support to the muscle membrane in normal muscle. Lack of dystrophin results in membrane instability and permeability, eventually leading to intracellular calcium accumulation, cell necrosis, and replacement of degenerated muscle by fibrous and adipose tissue.<sup>77</sup> In addition to skeletal muscle dysfunction, cardiac and smooth muscle are affected. Indeed, in many types of muscular dystrophy, cardiac muscle involvement may be more significant than skeletal muscle involvement.

Duchenne muscular dystrophy is the most common muscular dystrophy (1:3,500 male births) and has the most severe clinical course.<sup>78</sup> This disorder

TABLE 11-3.

### Myasthenia Gravis and Myasthenic Syndrome

Myasthenia Gravis	Myasthenic Syndrome
Extraocular, bulbar, facial muscle weakness	Proximal limb (arms > legs) weakness
Fatigue with exercise	Improved strength with exercise
Female > male	Male > female
Thymoma	Carcinoma (small cell of the lung)
Resistant to succinylcholine	Sensitive to succinylcholine
Sensitive to nondepolarizing muscle relaxants	Sensitive to nondepolarizing muscle relaxants
Good response to anticholinesterases	Poor response to anticholinesterases
Published in and adapted from Stoelting RK, Dierdorf SF, eds. <i>Anesthesia and Co-existing Disease</i> . 4th ed. New York: Churchill Livingstone, 2002. Copyright Elsevier.	

is a recessive, sex-linked genetic abnormality that is clinically evident in males, although female carriers may manifest subclinical abnormalities. Duchenne muscular dystrophy is characterized by painless skeletal muscle degeneration and atrophy. Muscle degeneration and weakness usually manifest in early childhood (age 2-5 years). Severe limitation in movement with development of contractures and kyphoscoliosis confine the child to a wheelchair by early adolescence. Marked increases of serum creatine kinase levels are present. Death commonly results from congestive heart failure or pneumonia. Although aggressive therapy for cardiopulmonary dysfunction has improved survival, afflicted individuals rarely survive beyond the third decade of life.<sup>79,80</sup>

As the patient ages and the disease progresses, cardiac muscle involvement typically is reflected by a progressive loss of R-wave amplitude in the lateral precordial leads of the ECG. Cardiomyopathy, ventricular dysrhythmias, and mitral regurgitation may develop as cardiac muscle is progressively lost and fibrous tissue replaces myocardial and conducting tissue. Treatment options include administration of angiotensin-converting enzyme inhibitors and  $\beta$ -adrenergic blockers to slow the deterioration of cardiac function.<sup>80</sup> Pulmonary function testing reveals a restrictive pulmonary disease pattern. Ineffective cough, resulting from diminished respiratory muscle strength, causes retention of secretions, pneumonia, and oftentimes death.<sup>81</sup> Many patients and families choose a tracheostomy and assisted ventilation, which may add years of life, but repetitive pulmonary infection

contributes to a shortened life span.<sup>82</sup> Intestinal tract hypomotility develops as a result of smooth muscle involvement. Supplemental feedings may slow the process of cachexia, but the disease continues.

Although the cause of Duchenne muscular dystrophy is known, specific genetic therapy is elusive. Therapy is supportive and focuses on improving cardiopulmonary function and better nutrition.

Becker muscular dystrophy is similar to Duchenne muscular dystrophy; however, it has a later onset in life and slower clinical progression. Typically, patients remain ambulatory past the age of 16 years, and cardiac failure caused by occult cardiomyopathy may be the presenting symptom.<sup>83</sup> Any male with a persistent elevation in serum creatine kinase concentration

TABLE 11-4.

### Types of Muscular Dystrophies and Myotonias

<b>Muscular Dystrophies</b>
Becker
Congenital
Duchenne
Emery-Dreifuss
Fascioscapulohumeral
Limb-girdle
Oculopharyngeal
<b>Myotonias</b>
Hyperkalemic periodic paralysis
Hypokalemic periodic paralysis
Myotonia congenita
Myotonic dystrophy
Paramyotonia congenita
Proximal myotonic dystrophy
Recessive myotonia



should be evaluated for Becker muscular dystrophy.

Emery-Dreifuss X-linked muscular dystrophy is characterized by humerpectoral muscle weakness and contractures of the spine, elbows, and ankles. The autosomal dominant type of this disorder is caused by a defect in the protein lamin, whereas the recessive form is caused by a defect in the protein emerin. Clinical manifestations of skeletal muscle weakness usually are mild, but cardiac conduction defects may manifest as sudden death. Patients with this disorder are candidates for implantable defibrillating pacemakers.<sup>84</sup>

Limb-girdle muscular dystrophy patients have weakness of the muscles of the shoulder and pelvic girdles. Most forms of this disorder are inherited in an autosomal recessive fashion, although autosomal dominant defects have been discovered. A defect in the sarcoglycan protein is the usual etiology of this abnormality.<sup>85</sup> Cardiomyopathy and cardiac conduction defects may occur.

Fascioscapulohumeral muscular dystrophy is a disease with diverse clinical manifestations that is inherited in an autosomal dominant fashion. Facial, scapulohumeral, anterior tibial, and pelvic-girdle muscle weakness are common. Cardiac conduction defects as well as deafness and retinal vascular disease may occur.

Oculopharyngeal muscular dystrophy primarily manifests with ptosis and dysphagia late in adulthood. Commonly, weakness of the head and neck develop in addition to dysphagia that is present from pharyngeal muscle weakness and esophageal dysmotility.

Merosin-deficient muscular dystrophy, Fukuyama muscular dystrophy, Walker-Warburg syndrome, Ulrich disease, muscle-eye-brain disease, nemaline myopathy, myotubular myopathy, and rigid spine muscular dystrophy are a group of muscular dystrophies that comprise congenital muscular dystrophy.<sup>85,86</sup> Congenital muscular dystrophies are characterized by early onset of muscle weakness, feeding difficulties, respiratory dysfunction, and mental retardation.

Perioperative complications from anesthesia in patients with muscular dystrophies usually result from the effects of anesthetic drugs on myocardial and skeletal muscle. Preexisting myocardial dysfunction makes the pa-

tient with muscular dystrophy susceptible to the myocardial depressant effects of anesthetics. The abnormal muscle cell membrane predisposes patients with muscular dystrophy to hyperkalemia and rhabdomyolysis when subjected to volatile anesthetics alone or in combination with succinylcholine, as numerous case reports support. In light of the abnormal muscle membrane, succinylcholine administration may further damage the muscle membrane and cause the release of intracellular contents. Therefore, succinylcholine should be avoided in patients with muscular dystrophies. It has been speculated that volatile anesthetics cause the release of calcium from the sarcoplasmic reticulum and may elicit damage to the muscle cell membrane and cause rhabdomyolysis. Interestingly, sevoflurane appears to be a less potent stimulus for release of calcium from the sarcoplasmic reticulum than are other volatile agents.<sup>87</sup>

Nondepolarizing muscle relaxants may have a prolonged duration of action in patients with muscular dystrophy, although the response to mivacurium appears to be normal.<sup>88</sup> Therefore, close monitoring of neuromuscular function is indicated. Although unpredictable, some patients with muscular dystrophies may be susceptible to developing malignant hyperthermia (MH). Without regard to specific etiology, patients who have chronically increased creatine phosphokinase levels may have a 40–45% risk of being MH susceptible.<sup>89</sup> Therefore, careful consideration of anesthetic plan may be to avoid all MH-triggering agents until a patient has been evaluated by the caffeine-halothane contracture test on a muscle biopsy specimen.

Delayed gastric emptying and impaired swallowing increases the risk of perioperative aspiration. Postoperatively, patients with muscular dystrophies must be closely monitored for evidence of pulmonary dysfunction and retained secretions. Vigorous pulmonary toilet and mechanical ventilation are frequently required. Regardless of the need for postoperative mechanical ventilation, these patients should be placed in an advanced monitoring unit (ICU) for appropriate analgesic therapy and respiratory monitoring.

### **Myotonias**

The myotonias are a diverse group of hereditary skeletal muscle disorders

with a common clinical sign: myotonia (Table 11-1). Myotonia is the persistent contracture and delayed relaxation of skeletal muscle after cessation of voluntary contraction or stimulation of the muscle. One of the typical signs of myotonic dystrophy is the inability to relax the handgrip. Progressive muscle wasting, ptosis, and facial muscle weakness also are common in patients with myotonic dystrophy. Interestingly, in other myotonic syndromes, the most common finding is stiffness that improves with exercise. However, paramyotonia (cold-induced myotonia) is an exception, wherein exercise exacerbates symptoms. Recently, genetic defects in sodium, chloride, and calcium ion channels in the muscle membrane have been identified as the abnormalities responsible for myotonia. Therefore, drugs such as mexiletine, procainamide, tocainide, and quinine may relax myotonic contractures by altering ion channel activity and skeletal muscle membrane excitability.

The most common of the myotonic disorders is myotonic dystrophy (Steinert disease), although proximal myotonic myopathy, myotonic dystrophy type II, and proximal myotonic dystrophy are other myotonic diseases. Myotonic dystrophy is inherited in an autosomal dominant pattern, and symptoms typically appear in the second or third decade of life. A defect on chromosome 19 produces a decrease in protein kinase that causes degeneration of the sarcoplasmic reticulum.<sup>90</sup> This myotonic dystrophy is the only myotonic disorder to exhibit extramuscular manifestations. Cataracts, premature balding, diabetes mellitus, thyroid dysfunction, adrenal insufficiency, gonadal dysfunction, and cardiac conduction defects are common. Cardiac involvement does not correlate with the severity of skeletal muscle involvement.<sup>91</sup> There is a progressive deterioration of the conduction system resulting in atrioventricular conduction delay. First-degree atrioventricular block, bundle branch block, and widening of the QRS complex are common. Cardiomyopathy, cardiac failure, and sudden death may occur, and the incidences of septal defects, mitral valve prolapse, and valvular disease are increased.

Recurrent pulmonary infections and aspiration may result when bulbar musculature is affected. Pulmonary

function testing demonstrates a restrictive lung disease pattern, mild arterial hypoxemia, and diminished ventilatory responses to hypercapnia and hypoxia. Gastric atony may develop as a result of alterations in smooth muscle function. Exacerbations of myotonic dystrophy often occur during pregnancy as a result of increased concentrations of progesterone. Congestive heart failure is common during pregnancy, and cesarean delivery is indicated because of uterine smooth muscle involvement. Labor typically is prolonged, and the incidence of postpartum hemorrhage is increased. Infants may have congenital myotonic dystrophy, which typically is characterized by hypotonia, respiratory insufficiency, and feeding difficulties.

Therapy for myotonic dystrophy is focused on treating coexisting diseases and cardiac dysrhythmias. Drugs that alter sodium channel function have been the most effective for managing myotonia (e.g., mexiletine). Avoiding factors known to precipitate myotonia is important.

Anesthetic considerations for patients with myotonic dystrophy include the presence of coexisting diseases, abnormal responses to drugs, and avoiding factors that are associated with the development of perioperative myotonia. Perioperative myotonia has been precipitated by drugs (propofol and succinylcholine), physical factors (hypothermia), electrocautery, and surgical manipulation. Potassium administration will worsen clinical myotonia. Succinylcholine produces an exaggerated contracture, and its use should be avoided. The myotonic response produced by succinylcholine may be so severe that ventilation and tracheal intubation are difficult and may be impossible. The typical presentation of succinylcholine-induced myotonic contracture includes jaw, abdominal, and chest rigidity. Perioperative myotonia may be difficult to differentiate from MH. Recent evidence does not support an association between myotonic dystrophy and MH.<sup>92</sup> Nondepolarizing muscle relaxants and peripheral nerve blocks do not abolish myotonic contractures. Induction agents, volatile anesthetics, opioids (systemic and neuraxial), and sedatives may cause profound respiratory depression. Increased sensitivity to nondepolarizing muscle relaxants may occur, especially when there is muscle wasting. Prudence dic-

tates the use of short-acting muscle relaxants when necessary, with careful monitoring of the response. Peripheral nerve stimulation may cause myotonia or be misinterpreted as sustained tetanus even though significant neuromuscular blockade exists. Reversal of neuromuscular blockade may induce myotonia.

Although no specific anesthetic technique has been determined to be superior for patients with myotonic dystrophy, close monitoring of cardiac and pulmonary function is critical to ensure an optimal perioperative outcome. Mechanical ventilation should be used until muscle strength and function return to baseline.<sup>93</sup> Regional anesthesia has been successfully performed in patients with myotonic dystrophy.<sup>94</sup>

### **Familial Periodic Paralysis**

Periodic paralyses are skeletal muscle channelopathies, which include hyperkalemic and hypokalemic periodic paralysis, paramyotonia congenita, and potassium aggravated myotonia.<sup>95–97</sup> Periodic paralyses are characterized by acute reversible episodes of muscle weakness or paralysis of the extremities with sparing of the respiratory muscles. Although these disorders are classified by changes in serum potassium concentrations during an acute episode, these changes are relative to the baseline potassium concentration and are not always abnormally increased or decreased (Table 11–5).

Hyperkalemic periodic paralysis is inherited in an autosomal dominant fashion. The dominant trait has been discovered as a mutation in the sodium ion channel on chromosome 17.<sup>90</sup> As a consequence of this dysfunction, when the resting membrane potential becomes slightly more positive, the myofiber can more easily reach threshold and the muscle becomes hyperexcitable, which clinically manifests as myotonia.<sup>98</sup> When the membrane potential becomes even more positive, the myofiber cannot fire an action potential because of the loss of a sufficient membrane potential, and the result is paralysis.<sup>98</sup> Normokalemic periodic paralysis is rare and most likely is a variant of hyperkalemic paralysis in which the potassium concentration does not change during attacks.<sup>99</sup>

Attacks usually begin during childhood and vary in frequency from several times per week to once in a lifetime. These episodes of myotonia and paraly-

**TABLE 11–5.**

### **Clinical Features of Hypokalemic and Hyperkalemic Familial Periodic Paralysis**

<b>Hyperkalemic</b>
Potassium concentration >5.5 mEq/L (or normal) during crisis
<b>Precipitating events</b>
Potassium infusion
Hypothermia
Rest after strenuous exercise
Metabolic acidosis
<b>Duration of paralysis</b>
Minutes to hours
<b>Hypokalemic</b>
Potassium concentration <3 mEq/L during crisis
<b>Precipitating events</b>
High glucose intake
Strenuous exercise
Stress
Hypothermia
Glucose-insulin infusion
Pregnancy
<b>Duration of paralysis</b>
Hours to days

sis may last several hours after exposure to a trigger. Triggering events include eating potassium-rich foods, IV infusion of potassium, fasting, cold exposure, and rest after strenuous exercise. Thiazide diuretics and a low-potassium diet are the mainstays of preventive treatment. Glucose and insulin infusion and IV calcium administration can be used to manage acute attacks.

Hypokalemic periodic paralysis is inherited in an autosomal dominant pattern. The dominant trait produces a defect in the calcium ion channel on chromosome 1.<sup>100</sup> The dihydropyridine receptor is a voltage-gated ion channel that is responsible for attacks, but the mechanism by which this defect results in attacks of paralysis is under investigation.

Attacks usually begin during childhood and vary in frequency. In contrast to the hyperkalemic form, attacks last longer—from hours to days. Also, cardiac arrhythmias are more common, myotonia is absent, and permanent muscle weakness eventually develops by the fifth decade of life. Paralysis is commonly triggered by ingestion of carbohydrates, strenuous exercise, glucose and insulin infusion, IV calcium, and exposure to cold. Paralysis often is incomplete, affecting

the limbs and trunk but sparing the diaphragm. Treatment involves the administration of potassium, acetazolamide, and dichlorphenamide.

Maintenance of normal potassium concentrations and avoidance of events that precipitate weakness are the primary goals of the perioperative management of patients with hyperkalemic and hypokalemic periodic paralysis. Electrolyte abnormalities should be addressed and corrected as best as possible prior to surgery. Patients may be sensitive to nondepolarizing muscle relaxants; therefore, short-acting relaxants should be administered when necessary. The response should be monitored with a peripheral nerve stimulator. Reversal should be avoided because of concern that reversal agents may precipitate myotonia. However, adequate muscle strength must be assured prior to extubation.<sup>101</sup> Succinylcholine should be avoided because it alters serum potassium concentrations and therefore may precipitate an attack. Reductions in serum potassium from metabolic changes or medications should be avoided because this situation may initiate an episode of paralysis. Perioperative potassium values should be monitored serially. The ECG should be continuously monitored for evidence of arrhythmia, and normothermia and normocapnia should be maintained. Volatile anesthetics have been administered without complication. Regional anesthesia has been used successfully, although there is concern that regional techniques can create confusion if neurologic signs develop postoperatively.<sup>102</sup> MH has been associated with periodic paralysis.<sup>103</sup>

## Skeletal Muscle Diseases

### Central Core Disease

Central core disease is a hereditary, nonprogressive congenital myopathy that typically is characterized by lower extremity muscle weakness. Increased lumbar lordosis, kyphoscoliosis, and hip dislocations may occur. Histologically, type I muscle fibers display amorphous central areas (cores). The underlying defect is thought to be associated with the ryanodine receptor gene, similar to MH.<sup>104</sup> Of great concern when anesthetizing patients with central core disease is MH susceptibility.<sup>105,106</sup> MH precautions should be taken and nontriggering anesthetics used when anesthetizing patients with central core disease (see Chapter 89

for a thorough discussion of malignant hyperthermia).

### Glycogen Storage Diseases

Glycogen storage diseases are inherited disorders characterized by a deficiency of enzymes involved in glucose metabolism. An enzyme deficiency results in a lack or excess of precursors and end-products of glycogen formation and breakdown. Type II (Pompe disease) glycogen storage disease is notable for the buildup of glycogen in smooth, skeletal, and cardiac muscle. Cardiac involvement typically leads to congestive heart failure. Anesthetic experience is limited.<sup>107,108</sup> Skeletal muscle involvement predisposes patients to upper airway obstruction secondary to glycogen infiltration of the tongue. Aspiration is common secondary to neurologic involvement and subsequent impairment of cough, gag, and swallowing mechanisms. Volatile anesthetics may precipitate cardiovascular embarrassment. Administration of succinylcholine to these patients may not be prudent because theoretically it could result in myoglobinuria and perhaps hyperkalemia with subsequent cardiac arrest. Hypoglycemia and acidosis may develop perioperatively, and patients should be hydrated and receive exogenous glucose. Hepatic dysfunction usually is present, so judicious administration of drugs hepatically metabolized should be taken into consideration. Regional anesthesia has been performed in patients with glycogen storage disorders.<sup>109</sup> Patients with type V (McArdle disease) glycogen storage disease are prone to developing myoglobinuria and rhabdomyolysis. Automated blood pressure readings should be performed cautiously, and tourniquets should be avoided to prevent muscle damage.<sup>110</sup>

### Mitochondrial Myopathies

Mitochondrial myopathies are a group of disorders that affect oxidative phosphorylation, resulting in impaired adenosine triphosphate production. These disorders have many manifestations, including CNS and muscle pathology. Exercise intolerance, fatigue, muscle pain, progressive weakness, and cardiomyopathy may be present. Respiratory depression is common after administration of general anesthesia. There does not appear to be an association with MH with most mitochondrial disorders.<sup>111-114</sup> However, avoidance of succinylcholine

seems prudent because of the potential for hyperkalemia.

Kearns-Sayre syndrome and mitochondrial myopathy, encephalopathy, lactic acidosis, and stroke-like episodes (MELAS) syndrome are distinct mitochondrial disorders. The anesthetic concerns are similar to the general concerns previously stated, with the following additional concerns. Kearns-Sayre syndrome is associated with heart block due to involvement of the cardiac conduction system. General anesthesia should be used with caution because it may increase the risk of myocardial depression and cardiac conduction defects.<sup>115</sup> MELAS syndrome is characterized by stroke-like episodes, seizures, dementia, recurrent headaches, vomiting, and lactic acidosis. There is suspicion that MH susceptibility may be increased.<sup>116</sup> Myocardial depression may occur with administration of volatile anesthetics, so they therefore should be used with caution.

## PERIOPERATIVE ASSESSMENT OF MUSCULOSKELETAL CONDITIONS

Patients with musculoskeletal disease may present varied challenges to the anesthesiologist. A number of more common musculoskeletal conditions are included here for consideration in the evaluation of a patient for anesthesia.

### Osteoarthritis

Osteoarthritis (OA) is a prevalent condition with advancing age.<sup>117</sup> Multiple joints are affected, most commonly weight-bearing joints. Patients with OA may require joint replacement surgery or other intricate orthopedic procedures. In patients with OA, the cervical spine may have a reduced range of motion, and the lumbar spine may be affected with osteal growths such that performing regional anesthesia may be difficult. Determination of what the surgical approach required for patient positioning is important. Whether regional anesthesia will be used intraoperatively or only for postoperative analgesia must be considered. How soon the patient is expected to become ambulatory and require full sensation and motor capabilities may dictate whether long-acting regional anesthetics or techniques can be used.

A careful list of recent nonsteroidal antiinflammatory drug (NSAID) use should be obtained. With many of the newer, more powerful, and long-lasting NSAIDs, there is concern for possible hematoma formation following regional or neuraxial anesthesia. Most practitioners are willing to perform peripheral blocks in patients who are receiving moderate doses of NSAIDs, provided there is no history of excessive bleeding; however, high-dose NSAID use or a history of bleeding should trigger a note of caution.

OA results in moderate to severe disability that may be relieved by surgical approaches. Of significant concern to the anesthesiologist is cervical spine disease with reduced range of motion and implications of difficulty in visualizing or securing the airway. Neurologic manifestations may occur from development of spinal stenosis at any spinal level. Chronic, subacute, and acute symptoms may be present, and acute neurologic symptoms may require emergency operation. This may require rapid sequence intubation, which may become complicated if the airway is not easily visualized.

Treatment of OA includes salicylates, NSAIDs, local heat, and surgical procedures to ameliorate painful symptoms. There is no effective therapy for slowing the pathogenesis of the disease. Selective cyclooxygenase-2 inhibitors were found to be effective in patients with OA, and their side effect profile initially was thought to be advantageous compared with other nonselective NSAIDs. However, some of these drugs were withdrawn from the market when cardiovascular events associated with use of cyclooxygenase-2 agents were discovered. A careful history of medication use is necessary before considering neuraxial blockade.

### Rheumatoid Arthritis

Rheumatoid arthritis (RA) is an autoimmune disease that attacks numerous joints throughout the body and has some special considerations for the anesthesiologist. Patients with RA may have complications primarily from their disease or secondarily from treatment of the disease, including use of glucocorticoids, NSAIDs, as well as immunosuppressive drugs.

Patients with advanced stages of RA may have temporomandibular ankylosis that makes direct laryngoscopy for endotracheal intubation very challeng-

ing, if not impossible. Fiberoptic intubation may be required, or tracheostomy may be necessary. The cervical spine may be involved, including laxity of the C1–2 ligament causing instability of the cervical spine. Subluxation of the atlantoaxial joint and instability can progress to spinal cord compression. Long tract signs, including bowel and bladder dysfunction, may occur, and sudden death has occurred from spinal cord laceration by the odontoid process. Recognizing early signs of serious cervical spine instability is critical in planning the approach to the airway. Awake or fiberoptic intubation may be necessary to permit neurologic examination immediately following placement of an endotracheal tube (see Chapters 8 and 35 regarding airway evaluation and management). Patients with RA often have involvement of multiple digits and may suffer from compression fractures of the vertebral bodies secondary to glucocorticoid use. These presentations in this illness may make anesthesia particularly challenging.

RA afflicts peripheral joints, most often symmetrically. As the disease advances, patients may have severe limitations in movement because of inflammatory contractions, pain with motion, or bone joint fusions due to long-standing inflammation. These patients may present for multiarticular surgical procedures or other surgical procedures secondary to complications of RA.

Cricoarytenoid joint involvement may occur in RA. This condition may make the glottis more rigid and require insertion of a smaller-diameter endotracheal tube. Joints that are fixed in adduction may be life-threatening and require tracheostomy in order to establish a stable airway.

RA is a systemic disease with pulmonary and cardiac manifestations. Restrictive lung disease occurs from multiple complications. Pulmonary interstitial fibrosis, pulmonary effusions, and parenchymal rheumatoid nodules may lead to crepitations. With advanced disease, ventilation and oxygenation may require attention to small-volume, positive-pressure ventilation during surgery and supplemental oxygen use preoperatively and postoperatively. Consideration for assisted ventilation postoperatively should be discussed with the patient.

RA can be associated with pericardial effusion and pericarditis. Tamponade

is rare but well described. Conduction disturbances and valvular dysfunction occurs in advanced stages of RA. Preoperative echocardiographic evaluation and a 12-lead ECG are indicated based upon symptomatology or length of duration of the disease.

Treatment of RA includes use of NSAIDs, glucocorticoids, gold salts, penicillin, and immunosuppressive (cytotoxic) drugs.<sup>118,119</sup> These drugs have multiple serious side effects. Glucocorticoids cause hypertension, cataracts, skin and muscle atrophy, and osteopenia, which may result in vertebral compression fractures. Immunosuppressive therapy may predispose to infections and can be cardiotoxic. NSAIDs and aspirin will result in thrombosthenia or other coagulation disorders, which must be considered prior to performance of regional neuraxial blockade. Peripheral neural blockade may have less risk of hemorrhagic complications, but the rare complications do not deter some anesthesiologists from careful use of peripheral neural blockade after thorough preoperative assessment of alternatives.

### Ankylosing Spondylitis

Ankylosing spondylitis is an inflammatory disease of the spine and paraspinal tissue.<sup>120</sup> Ankylosing spondylitis typically affects young men and may become disabling due to chronic pain in less than a decade. Back pain with or without peripheral arthritis occurs. Ankylosis of the hip and sacroiliac joints may occur, and the cervical spine may also be involved. Cauda equina syndrome may occur with devastating consequences.

Anesthetic considerations are similar to those for patients with RA. Cervical fusion (ankylosis) or atlantoaxial subluxation may occur. Cardiopulmonary complications include restrictive pulmonary fibrosis, and possibly cardiac conduction abnormalities and aortic insufficiency.

Pharmacologic therapy includes NSAIDs and glucocorticoids. Side effect profiles of each of these classes are as discussed previously. Neuroaxial blockade may be contraindicated based upon coagulation status and recent use of NSAIDs.

### Cerebral Palsy

Cerebral palsy (CP) is considered a static encephalopathy. It is included in the discussion of musculoskeletal diseases



because of the number of symptoms secondary to loss of upper motor neuron control. Patients have imbalances of flexor/extensor muscle activity resulting in significant contractures. These conditions may make the patient's airway difficult to approach, and the neck may have a reduced range of motion or fixed abnormal position. The usual extremity positions may not be obtainable because of contractures, and IV access may be difficult. Because patients with CP live into adulthood, the anesthesiologist must be aware that multiple procedures for CP are meant to reduce the patient's burden of care by allowing him or her to obtain a more neutral or balanced position. Procedures including osteotomies, botulinum toxin and phenol injections, and other major procedures often are necessary. Patients with CP are one of a group of patients presenting for neuromuscular scoliosis repair. Kyphoscoliosis can be a particularly challenging orthopedic problem requiring extensive instrumentation of the spine posteriorly and sometimes release of multiple ligaments anteriorly. The two-phased approach may be performed in one procedure or may be separated by a number of days or weeks (see Chapter 64 for a discussion of spinal surgery).

Anesthesia considerations include providing a stable airway, appropriate invasive monitoring for anticipated major blood loss, IV access for resuscitative fluid administration, and possible postoperative assisted ventilation. Patients may be limited to nonverbal communication skills, thereby making pain management challenging. Patients with CP may have a seizure disorder from brain injury at birth or traumatic or anoxic brain injury later in life. Anesthesia clinicians should be familiar with the many antiepileptic drugs currently prescribed. If therapeutic monitoring methods are available, optimal serum concentrations should be achieved preoperatively.

### Osteoporosis

Osteoporosis is a generic diagnostic term describing loss of bone mass from one of several disease states. Osteoporosis occurs with advancing age and affects women more frequently than men. Decreased bone density may result in pathologic fractures and kyphosis. Although a systemic disorder, axial spine involvement usually is responsible for acute manifestations,

and this is the problem that often presents the most difficulty for the anesthesia practitioner.

Osteoporotic fractures and kyphosis may significantly complicate regional anesthetic neuroaxial procedures. Acute fractures may be severely painful and, in rare circumstances, may result in neurologic compromise necessitating urgent operation. Patients may be unable to assume a sitting or supine position comfortably. With increasing kyphosis, a restrictive lung disease pattern appears. Airway management should include plans to ameliorate the patient's pain, use thorough preoxygenation, and institute assisted ventilation for neurodecompressive procedures with prone position. Postoperative respiratory insufficiency should be monitored secondary to underlying respiratory concerns and the moderate-to-heavy opioid requirement for postoperative analgesia.

Most patients with osteoporosis may have an idiopathic etiology. These patients have normal laboratory values for calcium, phosphorus, and alkaline phosphatase. Patients with abnormal laboratory values should be evaluated for coexisting diseases such as hyperparathyroidism or malignancy (hypercalcemia). Paget disease usually is accompanied by a high alkaline phosphatase.

### Osteogenesis Imperfecta

Osteogenesis imperfecta (OI) is an inherited disorder of connective tissue that usually manifests in one of two presentations: osteogenesis imperfecta congenita or osteogenesis imperfecta tarda.<sup>121</sup> Newborns and children suffer multiple fractures in the congenital form, whereas the onset of fractures occurs in later childhood, adolescence and adulthood in the tarda form. In addition to musculoskeletal presentations, these patients may suffer otosclerosis and progressive hearing loss, dental hypoplasia, ligamentous laxity, cardiac valvular insufficiency, and easy bruisability.

Evaluation of a patient with OI includes attention to dental deformities preexisting at the time of anesthesia and echocardiographic evaluation if a murmur is present. Airway management usually is not complicated; however, patient positioning for comfort may be challenging. Regional anesthesia is a reasonable option as in healthy patients, but tourniquet use should be avoided to reduce risk of fracture.

When surgeons may not have the benefit of tourniquet use for a specific procedure, greater than expected blood loss should be anticipated. Although bleeding tendency in patients with OI has been described, this finding does not absolutely contraindicate regional anesthesia.

Patients with OI and many patients with musculoskeletal dysplasias tend to become febrile in the operating room. Ectodermal dysplasia or lack of vasorelaxation may prevent mechanisms of heat loss usually encountered in the operating room or during anesthesia. Special attention should be directed to temperature monitoring and control, even for short procedures. With recent attention to prevention of heat loss during anesthesia, patients often are protected from hypothermia. However, in patients with OI, moderate-to-severe generalized hyperthermia may occur, and this may be confused with MH. Patients with OI do not have an increased susceptibility for MH.

### Scleroderma

Scleroderma (progressive systemic sclerosis [PSS]) is a disorder of connective tissue with destruction of small arterioles, leading to fibrosis of the skin and internal organs. It is not specifically a musculoskeletal disease. PSS causes swollen and stiff fingers and Raynaud phenomenon. Pain of the digits and knee joints is common, and a polyarthritides resembling RA may occur. Limited mobility secondary to diffuse fibrosis (scleroderma) becomes a feature that may make patient positioning for surgery difficult.

Visceral involvement in scleroderma includes esophageal (dysphagia and gastroesophageal reflux), gastric atony and dilation, intestinal (abdominal pain), pulmonary fibrosis, and cardiac involvement, including varying degrees of heart block, cardiomyopathy, and pericarditis, which may result in tamponade.<sup>122</sup>

Preoperative evaluation includes a comprehensive history of symptoms related to the airway, pulmonary, and cardiac systems. Airway management may require a rapid sequence or an awake technique. Cardiopulmonary evaluation depends on duration of the disease and symptoms of disability or signs on physical examination. Cardiac rhythm and performance should be thoroughly evaluated prior to elective anesthesia and operation.

When a patient with PSS presents for emergent surgery, a 12-lead ECG, and possibly echocardiography, should be considered. Electrolytes should be measured. Causes of death in PSS include cardiovascular etiologies and renal failure. Subclinical renal failure (increased blood urea nitrogen and creatinine, hyperkalemia, and hyperphosphatemia) is a relative contraindication to succinylcholine use. Patients may experience amnesia from lack of absorption of nutrients, and microangiopathic hemolytic anemia.

Postoperative care should include cardiovascular monitoring, serial electrolytes evaluation, and supplemental oxygen to address the combined effects of pulmonary involvement and opioid use for postoperative analgesia.

### Carpel Tunnel Syndrome

Carpal tunnel syndrome is an entrapment neuropathy that may be idiopathic or secondary to a number of illnesses, including RA, tenosynovitis, and amyloidoses, and may occur secondary to edema during pregnancy. The surgical approach to entrapment is decompression by release of the transverse ligaments or removal of a space-occupying lesion compressing the nerve.

The anesthetic approach may include general anesthesia, upper extremity regional blockade, or local IV anesthesia (Bier block). These procedures usually are performed in an ambulatory surgical suite, and the anesthesia plan should anticipate the need for rapid recovery. Some surgeons will want to perform a sensorimotor examination immediately postoperatively to establish that no surgical complication occurred, but most are comfortable with regional anesthetic techniques for this procedure.

### Achondroplasia

Achondroplasia is one etiology of dwarfism. A defect in endochondral ossification appears to lead to short tubular bones. Children often are identified at birth by their phenotypic presentation. Relative macrocephaly and hypoplastic midfacial features are common.

The two most concerning issues with achondroplasia are a relative stenotic foramen magnum, which may result in obstructive hydrocephalus, and atlantoaxial instability. These problems may cause acute neurologic presentation of

increased intracranial pressure or spinal cord compression, respectively. These problems may present early in infancy and require emergent decompression.

As these children grow, they develop increasing lordosis and require spinal fixation/stabilization.<sup>123</sup> Multiple procedures may be necessary.

Anesthetic implications in patients with achondroplasia include anticipating a difficult seal of a face mask because of midfacial hypoplasia. Tracheal intubation is generally not difficult; however, care should be taken not to hyperextend the neck for visualization of the vocal cords so as to avoid cervical spinal cord injury. No additional side effects are associated with use of succinylcholine, and there is no association of achondroplasia with susceptibility to MH.

Patients with achondroplasia may have an inability to disseminate heat effectively. Special attention to central temperature monitoring and management should be anticipated. These patients may have an excessive thermal response to anticholinergic agents.

### Polymyositis/ Dermatomyositis

Polymyositis and dermatomyositis are diseases that involve skeletal muscle, connective tissue, and the skin.<sup>124</sup> The etiology is unknown, but autoimmune phenomena are suspected. Usually slow progressive weakness occurring over months to years affects proximal extremity muscle groups, followed by neck involvement. Pharyngeal and laryngeal muscles also may be involved.

Cardiac involvement may include rhythm disturbances, myocardial necrosis, or inflammation. Pulmonary fibrosis or interstitial pneumonitis may be seen. Treatment of the illness consists of corticosteroids and immunosuppressive drugs. The consequences of these treatments should be considered in the preoperative evaluation (e.g., stress doses of corticosteroids may be indicated for major invasive procedures, and meticulous attention to sterile technique is required to prevent risk of infection following vascular access, etc.).

Anesthetic implications of these diseases are primarily of pharyngeal muscle activity and the risk for aspiration. No known anesthetic-associated exacerbation of cardiac involvement has been reported. Patients do not routinely experience respiratory weakness fol-

lowing anesthesia or use of neuromuscular blocking agents.

### RHABDOMYOLYSIS

Rhabdomyolysis is a condition associated with many inherited disorders,<sup>125</sup> toxin and drug exposure,<sup>126,127</sup> ischemia, crushing, and burn injury.<sup>128</sup> Exercise-induced rhabdomyolysis can occur secondary to inborn errors or secondary to exercise-induced bioenergetic failure at the cellular level. Perioperative rhabdomyolysis has been associated with positioning, cardiopulmonary bypass, an excessive response to succinylcholine, and as a prominent symptom of MH syndrome<sup>129</sup> (see Chapter 89 for details regarding malignant hyperthermia).

A preoperative history of rhabdomyolysis should alert the anesthesiologist to the possibility of inborn genetic errors (carnitine palmitoyltransferase deficiency [not related to MH]) and susceptibility to MH. Exercise-induced rhabdomyolysis patients and patients with chronic hypercreatinemia (hyperCKemia) are considered subgroups at high risk for MH susceptibility.<sup>89,130,131</sup> When in doubt regarding the possibility of susceptibility to MH, the MH hotline consultants are available 24 hours per day (1-800-MH-HYPER) in the United States and Canada (see Chapter 89).

### Malignant Hyperthermia

MH is related to very specific muscle disorders as referred (hyperCKemia and exercise-induced rhabdomyolysis). MH is covered extensively in Chapter 89.

### SUMMARY

Patients with neuromuscular or skeletal disease present special problems for anesthetic care. Issues range from physical problems such as airway access or patient positioning to biochemical problems such as abnormal thermal regulation. Cardiovascular or respiratory abnormalities accompany several of these diseases and further complicate perioperative anesthetic care. Susceptibility to serious anesthetic-related complications, such as rhabdomyolysis or MH, may occur in some patients. Thorough preoperative evaluation, knowledge of the underlying disease, and careful anesthetic plan-

ning and management are required to achieve the goals of safe and uneventful anesthetic care.

## KEY REFERENCES

1. Rowland LP, Shneider NA. Amyotrophic lateral sclerosis. *N Engl J Med* 2001;344:1688–700.
2. Dorotta IR, Schubert A. Multiple sclerosis and anesthetic implications. *Curr Opin Anaesthesiol* 2002;15:365–370.
3. Briggs ED, Kirsch JR. Anesthetic implications of neuromuscular disease. *J Anesth* 2003;17:177–185.
4. Davies NP, Hanna MG. The skeletal muscle channelopathies: distinct entities and overlapping syndromes. *Curr Opin Neurol* 2003;16:559–568.
5. Abel M, Eisenkraft JB. Anesthetic implications of myasthenia gravis. *Mt Sinai J Med* 2002;69:31–37.
6. Klingler W, Lehmann-Horn F, Jurkat-Rott K. Complications of anaesthesia in neuromuscular disorders. *Neuromuscul Disord* 2005;15:195–206.

## REFERENCES

1. Ferguson IT, Murphy RP, Lascelles RG. Ventilatory failure in myasthenia gravis. *J Neurol Neurosurg Psychiatry* 1982;45:217–222.
2. Vincken W, Elleker MG, Cosio MG. Determinants of respiratory muscle weakness in stable chronic neuromuscular disorders. *Am J Med* 1987;82:53–58.
3. Aboussouan LS. Respiratory disorders in neurologic diseases. *Cleve Clin J Med* 2005;72:511–520.
4. Grinman S, Whitelaw WA. Pattern of breathing in a case of generalized respiratory muscle weakness. *Chest* 1983;84:770–772.
5. Schmidt-Nowara WW, Altman AR. Atelectasis and neuromuscular respiratory failure. *Chest* 1984;85:792–795.
6. Johnson DC, Kazemi H. Central control of ventilation in neuromuscular disease. *Clin Chest Med* 1994;15:607–617.
7. Gibson GJ, Pride NB, Davis JN, et al. Pulmonary mechanics in patients with respiratory muscle weakness. *Am Rev Respir Dis* 1977;115:389–395.
8. DePalo VA, McCool FD. Respiratory muscle evaluation of the patient with neuromuscular disease. *Semin Respir Crit Care Med* 2002;23:201–209.

9. Vincken W, Elleker G, Cosio MG. Detection of upper airway muscle involvement in neuromuscular disorders using the flow-volume loop. *Chest* 1986;90:52–57.
10. Rochester DF, Esau SA. Assessment of ventilatory function in patients with neuromuscular disease. *Clin Chest Med* 1994;15:751–763.
11. Mirabella M, Servidei S, Manfredi G, et al. Cardiomyopathy may be the only clinical manifestation in female carriers of Duchenne muscular dystrophy. *Neurology* 1993;43:2342–345.
12. Ishikawa Y, Bach JR, Sarma RJ, et al. Cardiovascular considerations in the management of neuromuscular disease. *Semin Neurol* 1995;15:93–108.
13. Persson A, Solders G. R-R variations in Guillain-Barre syndrome: a test of autonomic dysfunction. *Acta Neurol Scand* 1983;67:294–300.
14. Kameda K. Clinical significance of the relationship between cardiac insufficiency and atrial natriuretic polypeptide and dystrophin in patients with Duchenne muscular dystrophy. *Sapporo Med J* 1991;60:535.
15. Perloff JK. The heart in neuromuscular disease. *Curr Probl Cardiol* 1986;11:512–557.
16. Lane RJ, Gardner-Medwin D, Roses AD. Electrocardiographic abnormalities in carriers of Duchenne muscular dystrophy. *Neurology* 1980;30:497–501.
17. Goldberg SJ, Stern LZ, Feldman L, et al. Serial left ventricular wall measurements in Duchenne's muscular dystrophy. *J Am Coll Cardiol* 1983;2:136–142.
18. Cooperman LH. Succinylcholine-induced hyperkalemia in neuromuscular disease. *JAMA* 1970;213:1867–1871.
19. Briggs ED, Kirsch JR. Anesthetic implications of neuromuscular disease. *J Anesth* 2003;17:177–185.
20. Klingler W, Lehmann-Horn F, Jurkat-Rott K. Complications of anaesthesia in neuromuscular disorders. *Neuromuscul Disord* 2005;15:195–206.
21. Rosenberg H, Gronert GA. Intractable cardiac arrest in children given succinylcholine. *Anesthesiology* 1992;77:1054.
22. Henderson WA. Succinylcholine-induced cardiac arrest in unsuspected Duchenne muscular dystrophy. *Can Anaesth Soc J* 1984;31:444–446.
23. Borasio GD, Miller RG. Clinical characteristics and management of ALS. *Semin Neurol* 2001;21:155–166.
24. Rowland LP, Shneider NA. Amyotrophic lateral sclerosis. *N Engl J Med* 2001;344:1688–1700.
25. Schiffman PL, Belsh JM. Pulmonary function at diagnosis of amyotrophic lateral sclerosis. Rate of deterioration. *Chest* 1993;103:508–513.
26. Dib M. Amyotrophic lateral sclerosis: progress and prospects for treatment. *Drugs* 2003;63:289–310.
27. Beach TP, Stone WA, Hamelberg W. Circulatory collapse following succinylcho-

- line: report of a patient with diffuse lower motor neuron disease. *Anesth Analg* 1971;50:431–437.
28. Hara K, Sakura S, Saito Y, et al. Epidural anesthesia and pulmonary function in a patient with amyotrophic lateral sclerosis. *Anesth Analg* 1996;83:878–879.
29. Kochi T, Oka T, Mizuguchi T. Epidural anesthesia for patients with amyotrophic lateral sclerosis. *Anesth Analg* 1989;68:410–412.
30. Dorotta IR, Schubert A. Multiple sclerosis and anesthetic implications. *Curr Opin Anaesthesiol* 2002;15:365–370.
31. Bader AM, Hunt CO, Datta S, et al. Anesthesia for the obstetric patient with multiple sclerosis. *J Clin Anesth* 1988;1:21–24.
32. Baum K, Nehrig C, Girke W, et al. Multiple sclerosis: relations between MRI and CT findings, cerebrospinal fluid parameters and clinical features. *Clin Neurol Neurosurg* 1990;92:49–56.
33. Bruck W, Stadelmann C. The spectrum of multiple sclerosis: new lessons from pathology. *Curr Opin Neurol* 2005;18:221–224.
34. Kieseier BC, Hemmer B, Hartung HP. Multiple sclerosis—novel insights and new therapeutic strategies. *Curr Opin Neurol* 2005;18:211–220.
35. Perlas A, Chan VW. Neuraxial anesthesia and multiple sclerosis. *Can J Anaesth* 2005;52:454–458.
36. Warren TM, Datta S, Ostheimer GW. Lumbar epidural anesthesia in a patient with multiple sclerosis. *Anesth Analg* 1982;61:1022–1023.
37. Spacek A, Neiger FX, Krenn CG, et al. Rocuronium-induced neuromuscular block is affected by chronic carbamazepine therapy. *Anesthesiology* 1999;90:109–112.
38. Whalley DG, Ebrahim Z. Influence of carbamazepine on the dose-response relationship of vecuronium. *Br J Anaesth* 1994;72:125–126.
39. Kim CS, Arnold FJ, Itani MS, et al. Decreased sensitivity to metocurine during long-term phenytoin therapy may be attributable to protein binding and acetylcholine receptor changes. *Anesthesiology* 1992;77:500–506.
40. Hahn AF. Guillain-Barre syndrome. *Lancet* 1998;352:635–641.
41. Sunderrajan EV, Davenport J. The Guillain-Barre syndrome: pulmonary-neurologic correlations. *Medicine (Baltimore)* 1985;64:333–341.
42. Hadden RD, Hughes RA. Guillain-Barre syndrome: recent advances. *Hosp Med* 1998;59:55–60.
43. Truax BT. Autonomic disturbances in Guillain-Barré syndrome. *Semin Neurol* 1984;4:462.
44. Feldman JM. Cardiac arrest after succinylcholine administration in a pregnant patient recovered from Guillain-Barre syndrome. *Anesthesiology* 1990;72:942–944.



45. Fiacchino F, Gemma M, Bricchi M, et al. Hypo- and hypersensitivity to vecuronium in a patient with Guillain-Barre syndrome. *Anesth Analg* 1994;78:187-189.
46. Kieseier BC, Hartung HP. Therapeutic strategies in the Guillain-Barre syndrome. *Semin Neurol* 2003;23:159-168.
47. Axelrod FB, Donenfeld RF, Danziger F, et al. Anesthesia in familial dysautonomia. *Anesthesiology* 1988;68:631-635.
48. James MF, Hift RJ. Porphyrias. *Br J Anaesth* 2000;85:143-153.
49. Jensen NF, Fiddler DS, Striepe V. Anesthetic considerations in porphyrias. *Anesth Analg* 1995;80:591-599.
50. Harrison GG, Meissner PN, Hift RJ. Anaesthesia for the porphyric patient. *Anaesthesia* 1993;48:417-421.
51. Bissell DM. Treatment of acute hepatic porphyria with hematin. *J Hepatol* 1988;6:1-7.
52. Mustajoki P, Nordmann Y. Early administration of heme arginate for acute porphyric attacks. *Arch Intern Med* 1993;153:2004-2008.
53. Mustajoki P, Heinonen J. General anesthesia in "inducible" porphyrias. *Anesthesiology* 1980;53:15-20.
54. McNeill MJ, Bennet A. Use of regional anaesthesia in a patient with acute porphyria. *Br J Anaesth* 1990;64:371-373.
55. Greenberg RS, Parker SD. Anesthetic management for the child with Charcot-Marie-Tooth disease. *Anesth Analg* 1992;74:305-307.
56. Scull T, Weeks S. Epidural analgesia for labour in a patient with Charcot-Marie-Tooth disease. *Can J Anaesth* 1996;43:1150-1152.
57. Antognini JF. Anaesthesia for Charcot-Marie-Tooth disease: a review of 86 cases. *Can J Anaesth* 1992;39:398-400.
58. Chan CK, Mohsenin V, Loke J, et al. Diaphragmatic dysfunction in siblings with hereditary motor and sensory neuropathy (Charcot-Marie-Tooth disease). *Chest* 1987;91:567-570.
59. Tetzlaff JE, Schwendt I. Arrhythmia and Charcot-Marie-Tooth disease during anesthesia. *Can J Anaesth* 2000;47:829.
60. Sulica L, Blitzer A, Lovelace RE, et al. Vocal fold paresis of Charcot-Marie-Tooth disease. *Ann Otol Rhinol Laryngol* 2001;110:1072-106.
61. Martyn JA, White DA, Gronert GA, et al. Up-and-down regulation of skeletal muscle acetylcholine receptors. Effects on neuromuscular blockers. *Anesthesiology* 1992;76:822-843.
62. Lindstrom JM. Acetylcholine receptors and myasthenia. *Muscle Nerve* 2000;23:453-477.
63. Palace J, Vincent A, Beeson D. Myasthenia gravis: diagnostic and management dilemmas. *Curr Opin Neurol* 2001;14:583-589.
64. Vincent A, Palace J, Hilton-Jones D. Myasthenia gravis. *Lancet* 2001;357:2122-2128.
65. Saperstein DS, Barohn RJ. Management of myasthenia gravis. *Semin Neurol* 2004;24:41-48.
66. Leventhal SR, Orkin FK, Hirsh RA. Prediction of the need for postoperative mechanical ventilation in myasthenia gravis. *Anesthesiology* 1980;53:26-30.
67. Eisenkraft JB, Papatostas AE, Kahn CH, et al. Predicting the need for postoperative mechanical ventilation in myasthenia gravis. *Anesthesiology* 1986;65:79-82.
68. Abel M, Eisenkraft JB. Anesthetic implications of myasthenia gravis. *Mt Sinai J Med* 2002;69:31-37.
69. Ruiz-Neto PP, Halpern H, Cremonesi E. Rapid inhalation induction with halothane-nitrous oxide for myasthenic patients. *Can J Anaesth* 1994;41:102-106.
70. Drachman DB. Present and future treatment of myasthenia gravis. *N Engl J Med* 1987;316:743-745.
71. Baraka A, Baroody M, Yazbeck V. Repeated doses of suxamethonium in the myasthenic patient. *Anaesthesia* 1993;48:782-784.
72. Dillon FX. Anesthesia issues in the perioperative management of myasthenia gravis. *Semin Neurol* 2004;24:83-94.
73. Hubler M, Litz RJ, Albrecht DM. Combination of balanced and regional anaesthesia for minimally invasive surgery in a patient with myasthenia gravis. *Eur J Anaesthesiol* 2000;17:325-328.
74. Kirsch JR, Diringer MN, Borel CO, et al. Preoperative lumbar epidural morphine improves postoperative analgesia and ventilatory function after transsternal thymectomy in patients with myasthenia gravis. *Crit Care Med* 1991;19:1474-1479.
75. Sanders DB. The Lambert-Eaton myasthenic syndrome. *Adv Neurol* 2002;88:189-201.
76. Newsom-Davis J. Therapy in myasthenia gravis and Lambert-Eaton myasthenic syndrome. *Semin Neurol* 2003;23:191-198.
77. Emery AE. The muscular dystrophies. *Lancet* 2002;359:687-695.
78. Roland EH. Muscular dystrophy. *Pediatr Rev* 2000;21:233-237.
79. Muntoni F. Cardiomyopathy in muscular dystrophies. *Curr Opin Neurol* 2003;16:577-583.
80. Townsend D, Yasuda S, Metzger J. Cardiomyopathy of Duchenne muscular dystrophy: pathogenesis and prospect of membrane sealants as a new therapeutic approach. *Expert Rev Cardiovasc Ther* 2007;5:99-109.
81. Gozal D. Pulmonary manifestations of neuromuscular disease with special reference to Duchenne muscular dystrophy and spinal muscular atrophy. *Pediatr Pulmonol* 2000;29:141-150.
82. Toussaint M, Steens M, Soudon P. Lung function accurately predicts hypercapnia in patients with Duchenne muscular dystrophy. *Chest* 2007;131:368-375.
83. Nigro V, Politano L, Nigro G, et al. Detection of a nonsense mutation in the dystrophin gene by multiple SSCP. *Hum Mol Genet* 1992;1:517-520.
84. Boriani G, Gallina M, Merlini L, et al. Clinical relevance of atrial fibrillation/flutter, stroke, pacemaker implant, and heart failure in Emery-Dreifuss muscular dystrophy: a long-term longitudinal study. *Stroke* 2003;34:901-908.
85. Wagner KR. Genetic diseases of muscle. *Neurol Clin* 2002;20:645-678.
86. Lisi MT, Cohn RD. Congenital muscular dystrophies: new aspects of an expanding group of disorders. *Biochim Biophys Acta* 2007;1772:159-172.
87. Kunst G, Graf BM, Schreiner R, et al. Differential effects of sevoflurane, isoflurane, and halothane on Ca<sup>2+</sup> release from the sarcoplasmic reticulum of skeletal muscle. *Anesthesiology* 1999;91:179-186.
88. Uslu M, Mellinshoff H, Diefenbach C. Mivacurium for muscle relaxation in a child with Duchenne's muscular dystrophy. *Anesth Analg* 1999;89:340-341.
89. Weglinski MR, Wedel DJ, Engel AG. Malignant hyperthermia testing in patients with persistently increased serum creatine kinase levels. *Anesth Analg* 1997;84:1038-1041.
90. Hudson AJ, Ebers GC, Bulman DE. The skeletal muscle sodium and chloride channel diseases. *Brain* 1995;118:547-563.
91. Bhakta D, Lowe MR, Groh WJ. Prevalence of structural cardiac abnormalities in patients with myotonic dystrophy type I. *Am Heart J* 2004;147:224-227.
92. Rosenbaum HK, Miller JD. Malignant hyperthermia and myotonic disorders. *Anesthesiol Clin North America* 2002;20:623-664.
93. Mathieu J, Allard P, Gobeil G, et al. Anesthetic and surgical complications in 219 cases of myotonic dystrophy. *Neurology* 1997;49:1646-1650.
94. Aquilina A, Groves J. A combined technique utilising regional anaesthesia and target-controlled sedation in a patient with myotonic dystrophy. *Anaesthesia* 2002;57:385-386.
95. Davies NP, Hanna MG. The skeletal muscle channelopathies: distinct entities and overlapping syndromes. *Curr Opin Neurol* 2003;16:559-568.
96. Hanna MG. Genetic neurological channelopathies. *Nat Clin Pract Neurol* 2006;2:252-263.
97. Jurkat-Rott K, Lehmann-Horn F. Paroxysmal muscle weakness—the familial periodic paralyses. *J Neurol* 2006;253:1391-1398.
98. Hoffman EP. Voltage-gated ion channelopathies: inherited disorders caused by abnormal sodium, chloride, and calcium regulation in skeletal muscle. *Annu Rev Med* 1995;46:431-441.
99. Walsh F, Kelly D. Anaesthetic management of a patient with familial normokalaemic periodic paralysis. *Can J Anaesth* 1996;43:684-686.



100. Elbaz A, Vale-Santos J, Jurkat-Rott K, et al. Hypokalemic periodic paralysis and the dihydropyridine receptor (CACNL1A3): genotype/phenotype correlations for two predominant mutations and evidence for the absence of a founder effect in 16 Caucasian families. *Am J Hum Genet* 1995;56:374–380.
101. Ashwood EM, Russell WJ, Burrow DD. Hyperkalaemic periodic paralysis and anaesthesia. *Anaesthesia* 1992;47:579–584.
102. Weller JF, Elliott RA, Pronovost PJ. Spinal anesthesia for a patient with familial hyperkalemic periodic paralysis. *Anesthesiology* 2002;97:259–260.
103. Lehmann-Horn F, Iaizzo PA. Are myotonias and periodic paralyses associated with susceptibility to malignant hyperthermia? *Br J Anaesth* 1990;65:692–697.
104. McCarthy TV, Quane KA, Lynch PJ. Ryanodine receptor mutations in malignant hyperthermia and central core disease. *Hum Mutat* 2000;15:410–417.
105. Shuaib A, Paasuke RT, Brownell KW. Central core disease. Clinical features in 13 patients. *Medicine (Baltimore)* 1987;66:389–396.
106. Frank JP, Harati Y, Butler IJ, et al. Central core disease and malignant hyperthermia syndrome. *Ann Neurol* 1980;7:11–17.
107. Cox JM. Anesthesia and glycogen-storage disease. *Anesthesiology* 1968;29:1221–1225.
108. McFarlane HJ, Soni N. Pompe's disease and anaesthesia. *Anaesthesia* 1986;41:1219–1224.
109. Rosen KR, Broadman LM. Anaesthesia for diagnostic muscle biopsy in an infant with Pompe's disease. *Can Anaesth Soc J* 1986;33:790–704.
110. Lobato EB, Janelle GM, Urdaneta F, et al. Noncardiogenic pulmonary edema and rhabdomyolysis after protamine administration in a patient with unrecognized McArdle's disease. *Anesthesiology* 1999;91:303–305.
111. Rosaeg OP, Morrison S, MacLeod JP. Anaesthetic management of labour and delivery in the parturient with mitochondrial myopathy. *Can J Anaesth* 1996;43:403–407.
112. Driessen J, Willems S, Dercksen S, et al. Anesthesia-related morbidity and mortality after surgery for muscle biopsy in children with mitochondrial defects. *Paediatr Anaesth* 2007;17:16–21.
113. Flick RP, Gleich SJ, Herr MM, et al. The risk of malignant hyperthermia in children undergoing muscle biopsy for suspected neuromuscular disorder. *Paediatr Anaesth* 2007;17:22–27.
114. Ross AK. Muscular dystrophy versus mitochondrial myopathy: the dilemma of the undiagnosed hypotonic child. *Paediatr Anaesth* 2007;17:1–6.
115. Kitoh T, Mizuno K, Otagiri T, et al. Anesthetic management for a patient with Kearns-Sayre syndrome. *Anesth Analg* 1995;80:1240–1242.
116. Thompson VA, Wahr JA. Anesthetic considerations in patients presenting with mitochondrial myopathy, encephalopathy, lactic acidosis, and stroke-like episodes (MELAS) syndrome. *Anesth Analg* 1997;85:1404–1406.
117. Goldring SR, Goldring MB. Clinical aspects, pathology and pathophysiology of osteoarthritis. *Musculoskelet Neuronal Interact* 2006;6:376–378.
118. Howe CR, Gardner GC, Kadel NJ. Perioperative medication management for the patient with rheumatoid arthritis. *J Am Acad Orthop Surg* 2006;14:544–551.
119. Ouarzane M, Zouali M. Novel opportunities for therapeutic targeting in systemic autoimmune diseases. *Methods Mol Biol* 2007;361:285–297.
120. Clegg DO. Treatment of ankylosing spondylitis. *J Rheumatol Suppl* 2006;78:24–31.
121. Rauch F, Glorieux FH. Osteogenesis imperfecta. *Lancet* 2004;363:1377–1385.
122. Sakkas LI, Chikanza IC, Platsoucas CD. Mechanisms of disease: the role of immune cells in the pathogenesis of systemic sclerosis. *Nat Clin Pract Rheumatol* 2006;2:679–685.
123. Ain MC, Browne JA. Spinal arthrodesis with instrumentation for thoracolumbar kyphosis in pediatric achondroplasia. *Spine* 2004;29:2075–2080.
124. Briani C, Doria A, Sarzi-Puttini P, et al. Update on idiopathic inflammatory myopathies. *Autoimmunity* 2006;39:161–170.
125. Lofberg M, Jankala H, Paetau A, et al. Metabolic causes of recurrent rhabdomyolysis. *Acta Neurol Scand* 1998;98:268–275.
126. Sieb JP, Gillessen T. Iatrogenic and toxic myopathies. *Muscle Nerve* 2003;27:142–156.
127. Graham DJ, Staffa JA, Shatin D, et al. Incidence of hospitalized rhabdomyolysis in patients treated with lipid-lowering drugs. *JAMA* 2004;292:2585–2590.
128. Warren JD, Blumbergs PC, Thompson PD. Rhabdomyolysis: a review. *Muscle Nerve* 2002;25:332–347.
129. Jurkat-Rott K, McCarthy T, Lehmann-Horn F. Genetics and pathogenesis of malignant hyperthermia. *Muscle Nerve* 2000;23:4–17.
130. Ali SZ, Taguchi A, Rosenberg H. Malignant hyperthermia. *Best Pract Res Clin Anesthesiol* 2003;17:519–533.
131. Davis M, Brown R, Dickson A, et al. Malignant hyperthermia associated with exercise-induced rhabdomyolysis or congenital abnormalities and a novel RYR1 mutation in New Zealand and Australian pedigrees. *Br J Anaesth* 2002;88:508–515.

# CHAPTER 12

## Evaluation of the Patient with Endocrine Disease or Diabetes Mellitus

A.D. John, MD and  
F.E. Sieber, MD

Although often not obvious as a physical deformity, a disturbance in endocrine function may increase the complexity of anesthesia care and the risks to the patient. The anesthesiologist must be attuned to the issues of endocrine abnormalities to ensure that the patient is treated preoperatively. This chapter focuses on the proper preoperative treatment of patients with specific endocrine abnormalities, with an emphasis on decreasing anesthetic-related complications.

### THYROID

#### Physiology

The synthesis and release of thyroid hormones occurs as a result of the complex interaction between the hypothalamic–pituitary axis, the thyroid gland, and the thyroid hormones. The hypothalamus controls the release of thyrotropin-releasing hormone (TRH), which is secreted by the hypothalamic neurons and delivered to adenohypophysis via the hypophyseal portal system. Within the pituitary gland, TRH may stimulate the secretion of thyroid-stimulating hormone (TSH), which acts at the thyroid gland. A negative feedback loop is present between the pituitary and the thyroid gland, in which increased levels of thyroid hormone inhibit the secretion of TSH from the pituitary gland. Thyroid hormone levels are the primary determinants of TSH secretion, and increased thyroid hormone levels can override TRH-mediated hypothalamic influences.<sup>1,2</sup>

Thyroid hormones play several important roles—they function as important regulators of metabolism and development, and have effects on many different organs. Thyroid hormones stimulate calorogenesis and metabo-

lism by increasing metabolic rate and oxygen consumption. In addition to regulating cellular respiration these hormones cause an increase in body protein turnover and adipocyte lipolysis. Thyroid hormones are necessary for skeletal maturation in the fetus, and for brain development during infancy, as demonstrated by the effects of thyroid hormone depletion in cretinism. Thus thyroid hormones affect multiple processes, including cellular metabolism; the cardiovascular system; bone formation and development with implications related to osteoporosis; and the neuronal system with regards to development, maturation, and maintenance, with implications of neuropsychiatry and dementia in adults. Thyroid hormones exert their effects by binding to nuclear receptors within cells, thereby affecting the synthesis and release of proteins

and messengers regulating intracellular processes.<sup>3,4</sup>

The thyroid gland, using a sodium iodide symporter, takes absorbed iodide into the gland and sequentially synthesizes the thyroid hormones triiodothyronine ( $T_3$ ) and thyroxine ( $T_4$ ). Selenocysteine deiodinases found in tissues such as the liver, kidney, thyroid, pituitary, CNS, cardiac and skeletal muscle, placenta, as well as the skin, act on thyroxine to convert it to triiodothyronine, reverse  $T_3$  ( $rT_3$ ) with almost no physiologic activity, and also to inactive  $T_3$  and  $T_4$ .<sup>1–3</sup> The thyroid gland secretes approximately 80–100  $\mu\text{g}/\text{d}$  of  $T_4$  with a serum half-life of 6–7 days. Approximately 20% of  $T_3$  is also synthesized and released by the thyroid gland. The remaining  $T_3$  is formed mostly in the liver and kidney by peripheral conversion of  $T_4$  by selenodeiodinases. Once released into the bloodstream  $T_4$  and  $T_3$

### KEY POINTS

1. Thyroid disorders are the second most common endocrine disease after diabetes. The range of presentation is vast, ranging from subclinical hyperthyroidism to life-threatening thyroid storm, and from subclinical hypothyroidism to myxedema coma with high mortality if not appropriately treated.
2. The current thyroid-stimulating hormone (TSH) assays, along with the free thyroxine ( $FT_4$ ) level, will often lead to the correct diagnosis of the thyroid disorder. Although the signs and symptoms of hypo- and hyperthyroidism are quite distinct, with aging, the clinical picture may not be quite as clear. A high level of suspicion, the appropriate use of tests, and clarity in appropriately differentiating coexisting conditions will lead to increased patient safety.
3. Patients with mild hypo- and hyperthyroidism may safely undergo elective surgery if proper care is exercised; but, patients with thyroid storm or myxedema coma may have significant morbidity with elective surgery.
4. Hypercalcemia places a patient at increased risk for hypovolemia and cardiac dysrhythmias. Hypocalcemia may present with decreased myocardial contractility, tetany, cardiac dysrhythmias, and altered response to muscle relaxants leading to increased perioperative patient risk. Prompt recognition and successful treatment can be lifesaving.
5. The complex interplay between the thyroid, adrenal, and pituitary glands must be considered in anesthetizing patients for surgery. Appropriate corticosteroid replacement will often result in a smooth and stable perioperative course.
6. The major goal in preoperative preparation of the patient with pheochromocytoma is to decrease cardiovascular morbidity and mortality resulting from excess catecholamine secretion. However, the optimal drug for preoperative preparation of the patient with pheochromocytoma is controversial.
7. Cranial diabetes insipidus (decreased vasopressin secretion) may have effects on both intravascular volume and electrolytes. Patients with acromegaly have a higher incidence of airway difficulty, as well as diabetes, hypertension, and cardiomegaly.
8. Diabetes has been strictly defined by the American Diabetes Association. Multiple studies demonstrate the beneficial effects of tight glucose control and consensus conferences have defined in-hospital goals, but where intraoperative glucose levels should be remains to be determined.

are tightly protein bound, with  $T_3$  and  $T_4$  being primarily bound to thyroid-binding globulin. Other binding proteins include albumin, which binds more than transthyretin, with only a very small amount being bound to lipoproteins.  $T_4$  is more tightly bound than  $T_3$ , which accounts for the longer half-life of  $T_4$ —1 week—when compared to the less-than-1-day half-life of  $T_3$ . A larger amount of  $T_3$  (0.4%) in comparison with  $T_4$  (0.04%), circulates in the free form. It is the free form that is active and drives the patient's metabolic state. With stress, the levels of  $T_3$  increase. Once carrier proteins transport  $T_4$  and  $T_3$  into the cell, cellular nuclear receptors have a much greater affinity for  $T_3$  than  $T_4$ , leading to increased protein synthesis and cellular metabolic activity.<sup>3,4</sup> This makes  $T_3$  much more potent than  $T_4$ .

### Thyroid-Function Tests

To assess thyroid disease, it is important to combine the clinical picture with the laboratory tests of thyroid function. The principal tests currently used include TSH, serum  $T_4$ , serum  $T_3$ , resin triiodothyronine uptake ( $RT_3U$ ), free thyroxine index ( $FT_4I$ ), serum thyroglobulin,  $rT_3$ , and radioactive iodine uptake (RAIU). Currently, the third-generation TSH measurements with a functional sensitivity of 0.02  $\mu\text{U}/\text{mL}$  or less are all that are required to assess primary thyroid disease, covering the range from overt hypothyroidism to overt hyperthyroidism, with sufficient specificity and sensitivity. Table 12-1 gives the reference ranges for normal values. Even though free thyroxine ( $FT_4$ ) and free triiodothyronine ( $FT_3$ ) assays tend to avoid the variation caused by thyroid-binding globulin fluctuations as seen with hormones, estrogens, and pregnancy,

TABLE 12-1.

Reference Values for Thyroid Function Tests at Johns Hopkins Medical Institutions

Thyroid Function Test	Reference Range
Thyroid-stimulating hormone	0.5–4.5 m U/L
Thyroxine unbound ( $FT_4$ )	0.7–1.6 ng/dL
Triiodothyronine unbound ( $FT_3$ )	230–420 pg/dL

they may still be affected by artifact and coexisting conditions, such as severe illness, heparin therapy, medications, and severe disturbances in binding proteins.<sup>5-7</sup> These circumstances are more likely to occur with an ill hospitalized population requiring surgery than with an outpatient ambulatory clinic. The TSH and free  $T_4$  can be used to assess for common conditions (Table 12-2).

With aging, there is an increase in baseline TSH normal values. For those younger than 50 years of age, the median TSH value is 1.49  $\mu\text{U}/\text{mL}$ . After 50 years of age, it increases to 1.60  $\mu\text{U}/\text{mL}$ . After 70 years of age, it increases to 1.98  $\mu\text{U}/\text{mL}$ , and after 80 years of age it is 2.08  $\mu\text{U}/\text{mL}$  in a population without thyroid disease.<sup>5,8</sup> Whether it is necessary to adjust the current reference range with respect to age is being debated.<sup>9,10</sup>

### Other Tests to Assess Thyroid Function

$RT_3U$  does not measure  $T_3$ ; rather, it is a measure of the thyroid-hormone-binding-to-plasma-protein ratio. It actually measures the percentage of  $FT_4$  not bound to protein. The  $FT_4I$  corrects  $T_4$  for abnormalities caused by protein binding and is calculated by multiplying the  $T_4$  by the  $RT_3U$  and dividing the result by 100.  $rT_3$  measures the inactive metabolite of  $T_4$  and may be useful in states of nonthyroidal illness. Serum thyroglobulin may be elevated in thyroid cancer and may be useful in differentiating thyrotoxicosis secondary to exogenous administration from thyroid gland dysfunction. RAIU measures thyroid uptake of iodine. This test is helpful in differentiating various entities: iodine deficiency and Graves disease have uni-

form increased uptake, whereas a single focus indicates a hyperfunctioning nodule, and multiple foci indicate multiple nodules.

### Hyperthyroidism

Hyperthyroidism has a wide clinical spectrum that ranges from subclinical hyperthyroidism to mild hyperthyroidism to fulminant life-threatening crisis with thyroid storm. Laboratory values consistent with hyperthyroidism are a low TSH ( $<0.05 \mu\text{U}/\text{mL}$ ) and a high  $FT_4$  ( $>1.8 \text{ ng}/\text{dL}$ ). Occasionally the  $FT_4$  may be in the normal range, but the  $FT_3$  may be elevated ( $>596 \text{ pg}/\text{dL}$ ).<sup>5</sup> In subclinical hyperthyroidism the TSH is low but both  $FT_4$  and  $FT_3$  are within the normal range. An elevated TSH with an elevated  $FT_4$  may be suggestive of a TSH-secreting pituitary tumor.<sup>5,6</sup>

Table 12-3 lists the signs and symptoms of hyperthyroidism. Heat intolerance and weight loss despite increased food intake are 2 symptoms closely associated with hyperthyroidism.<sup>10</sup> Common causes of hyperthyroidism include Graves disease, toxic multinodular goiter, autonomously functioning thyroid nodule, thyroiditis (subacute, lymphocytic, or postpartum), exogenous thyroid hormone ingestion, and iodine induced.<sup>6</sup> Less common causes include follicular carcinoma of the thyroid, TSH-secreting pituitary tumor, human chorionic gonadotropin (hCG)-mediated trophoblastic disease, and struma ovarii.<sup>6</sup> Goiter is present in Graves disease and thyrotoxicosis, but may or may not be present in a patient with hyperthyroidism. If a patient has exophthalmos, care must be exercised in protecting the eyes during anesthesia

TABLE 12-2.

Assessment of Thyroid Function with TSH and  $FT_4$

Condition	TSH	Free $T_4$
Hyperthyroidism	Decreased	Increased
Primary hyperthyroidism	Increased	Decreased
Secondary hypothyroidism	Decreased or normal	Decreased
Sick euthyroid		
Mild	Normal to low	Normal
Severe	Decreased	Normal to low
Pregnancy	Normal (may be low in 1st trimester)	Normal; Increased total $T_4$ ; Increased $T_3$

Adapted with permission from Bigatello LM, ed. MCH Handbook of Critical Care, 4th ed. Philadelphia: Lippincott Williams and Wilkins, 2006:496, Table 27-6.

TABLE 12-3.

## Symptoms and Signs of Hyperthyroidism

Symptoms	Signs
Nervousness	Thyroid enlargement
Increased sweating	Tachycardia
Heat intolerance	Atrial fibrillation
Palpitations	Hyperkinesia
Dyspnea	Eye signs
Fatigue and weakness	
Weight loss or gain	
Increased appetite	
Hyperdefecation	

with ointment (lubrication) and protective goggles. In the elderly (older than age 70 years), hyperthyroidism may be difficult to recognize because the hyperkinetic picture is often absent.<sup>12</sup> Also in the elderly, apathy, tachycardia, weight loss, anorexia, and atrial fibrillation are more frequent, whereas in patients younger than age 50 years, heat intolerance, increased appetite, sweating, tremor, hyperreflexia, goiter, and polydipsia are more prevalent.<sup>13,14</sup>

Hyperthyroidism affects many systems, including the cardiovascular, respiratory, and neuromuscular systems. McDevitt et al.<sup>15</sup> demonstrated the role of the thyroid gland in regulating the resting heart rate. Hyperthyroidism caused an increased heart rate when compared with healthy individuals. Hyperthyroidism is associated with an increase in heart rate, stroke volume, cardiac output, pulse pressure, and ectopy, including premature ventricular contractions and atrial fibrillation. Forfar et al.<sup>16</sup> showed a relationship between lone atrial fibrillation in the elderly and hyperthyroidism. In the elderly hyperthyroid patient, there is also an increase in the incidence of congestive heart failure. With increased chronotropy and decreased lusitropy, a third heart sound may be present. Both increased jugular venous pressure and peripheral edema may occur, even in the absence of heart failure. In hyperthyroidism, cardiovascular events as a result of embolic phenomena or myocardial disease may result in death.<sup>4,17,18</sup> The hypermetabolism caused by hyperthyroidism re-

sults in increased CO<sub>2</sub> production and, as a consequence, an increase in minute ventilation. Unfortunately, weakness of the respiratory muscles can occur, resulting in reductions in vital capacity and compliance and, ultimately, respiratory collapse. Myopathy is present in more than 50% of patients with hyperthyroidism with electromyograph (EMG) abnormalities present in more than 90% of hyperthyroid patients.<sup>19</sup> Graves disease may be associated with myasthenia gravis, and an association between hyperthyroidism and familial hypocalcemia periodic paralysis has been noted in Asian men.

Treatment of hyperthyroidism<sup>6,18,20</sup> usually consists of antithyroid medications, chiefly the thionamides (propylthiouracil or methimazole). Propylthiouracil is given at a dose of 75–100 mg 3 times a day and methimazole is given at a dose of 10–20 mg once a day. These medications are given for weeks to months and then thyroid function tests are used to ensure that a euthyroid state is being achieved. Radioactive iodine may be used for recurrent hyperthyroidism or persistent hyperthyroidism. Surgical treatment with thyroidectomy should be done only after a euthyroid state has been achieved with medication.

### Subclinical Hyperthyroidism

Subclinical hyperthyroidism is characterized by a low TSH and normal FT<sub>4</sub> and FT<sub>3</sub>. The prevalence of subclinical hyperthyroidism is approximately 2% and it is more common in the elderly, women, and African Americans.<sup>21</sup> Subclinical hyperthyroidism commonly occurs with multinodular goiter, hyperfunctioning solitary thyroid nodule, and thyroxine overreplacement. It is also associated with an increased risk of atrial arrhythmias in patients older than age 60 years, decreased bone mineral density in postmenopausal women,<sup>6</sup> and an increased risk of mood and affective disorders. There is possibly an increased risk of dementia in patients with antithyroid peroxidase antibodies.<sup>22</sup> The consensus panel's recommendation is to observe and monitor patients with partial suppression of TSH but to treat patients who have complete suppression of TSH (<0.1 mU/L).<sup>21</sup>

### Thyroid Storm

At the other end of the spectrum from subclinical hyperthyroidism is thyroid

storm. Thyroid storm is an acute life-threatening form of hyperthyroidism with a significant mortality rate of >20%.<sup>23,24</sup> The diagnosis of thyroid storm is a clinical one, because serum levels of thyroid hormones are about the same as encountered in hyperthyroidism. Four clinical features are required for the diagnosis of thyroid storm:<sup>23,24</sup> (a) Temperature elevation with diaphoresis. Temperatures above 106°F have been reported. (b) A marked tachycardia that is disproportionate to the temperature elevation. This may manifest as sinus tachycardia, atrial fibrillation, or other supraventricular or ventricular tachycardia. (c) Cerebral dysfunction, which may range from agitation, restlessness, and emotional lability to confusion, psychosis, seizures, and coma. (d) Gastrointestinal disturbance ranging from nausea, vomiting, and diarrhea to intestinal obstruction or acute abdomen. The presence of jaundice is a poor prognostic sign.<sup>23,24</sup> The precipitating event varies and may include (most commonly) infection; surgery; treatment with radioactive iodine, or the administration of iodinated contrast dyes; cessation of antithyroid medication; amiodarone; exogenous administration of thyroid hormone; diabetic ketoacidosis; hypoglycemia; congestive heart failure; pulmonary embolism, cerebrovascular accident (CVA); bowel infarction; any acute trauma; toxemia of pregnancy, parturition, and the postpartum state; dental extraction; and even vigorous palpation of the thyroid.<sup>23,24</sup>

### Treatment

The approach to treatment of thyroid storm is 4-fold<sup>20,23–25</sup>:

1. Decrease production and secretion of thyroid hormone.
2. Block the peripheral effects of thyroid hormones.
3. Maintain supportive care. Aggressive treatment of fever, temperature elevation, acid-base abnormalities, along with respiratory and cardiovascular support.
4. Determine the underlying cause.

Chapter 69 provides a more detailed discussion.

### Preoperative

Ideally, the patient is euthyroid prior to any surgical procedure, because of the high risk of precipitating a cata-



strophic thyroid storm. Airway compromise by goiters may be present with laryngeal nerve compression, tracheal deviation or displacement, or even erosion of tracheal cartilage by large goiters. A CT scan or MRI of the neck may provide useful information. Because the use of thyroid medications and the testing takes a period of weeks to months, 1–2 months of treatment with antithyroid medication and a recent TSH and FT<sub>4</sub> may be optimal to indicate levels of effectiveness of treatment prior to an elective operation. In patients requiring emergency surgery, a combination of antithyroid medication, propranolol, and sodium iodide might be effective. The regimen includes propylthiouracil at a dose of 600–1000 mg orally in conjunction with intravenous propranolol to control heart rate; followed in 2–3 hours by an iodine solution to prevent the release of thyroid hormone.<sup>24</sup> Corticosteroids should also be administered, both to prevent the release and conversion of thyroid hormones and to avoid the possibility of coexisting adrenal suppression.<sup>25,26</sup> Heightened awareness must be maintained to quickly detect the manifestations of thyroid storm in patients who are thus prepared for emergency surgery.

### Hypothyroidism

Hypothyroidism<sup>5,6</sup> is characterized by a hypometabolic state with generalized slowing of physical processes with fatigue, lethargy, diminished reflexes and slowing of intellectual processes. Hypothyroidism encompasses a vast clinical spectrum, ranging from subclinical hypothyroidism to classical hypothyroidism to fulminant life-threatening myxedema coma. Table 12–4 lists the signs and symptoms of hypothyroidism. Laboratory values characteristic of hypothyroidism are a high TSH (>10 mU/L) and a low FT<sub>4</sub> (<5 pmol/L). Secondary hypothyroidism characterized by both a low TSH (<0.4 mU/L) and a low FT<sub>4</sub> (<9 pmol/L) is a result of pituitary or hypothalamic dysfunction and is quite rare. The primary causes of hypothyroidism are autoimmune lymphocytic thyroiditis which may be either atrophic or of the Hashimoto's variety. This is diagnosed with a positive thyroid peroxidase antibody level. Hypothyroidism may occur after thyroidectomy or after radioactive iodine therapy. In many parts of the world, iodine deficiency is

TABLE 12–4.

#### Symptoms and Signs of Hypothyroidism

Symptoms	Signs
Cold intolerance	Weight gain (or loss)
Dyspnea	Bradycardia
Anorexia	Diastolic hypertension
Constipation	Cardiac rub or soft heart tones caused by pericardial effusion
Decreased libido	Ileus
Menorrhagia, amenorrhea	Galactorrhea
Oliguria	Urinary retention
Arthralgias	Loss of brow and scalp hair
Myalgia, muscle stiffness and cramps	Yellow (carotinemic) skin
Dryness	Psychosis
Fatigue	Coma
Depression	Carpal tunnel syndrome
Irritability	
Impaired concentration and memory	
Paresthesia	
Pallor	

a major cause of hypothyroidism. Hypothyroidism is inducible by a variety of drugs including iodine, thionamides, lithium, amiodarone, interferon, iron, cholestyramine, and Carafate. Infiltrative diseases, such as sarcoid, amyloid, and hemochromatosis, may be associated with hypothyroidism. A transient hypothyroidism or sick euthyroid state may be seen in the postpartum period or after trauma, burns, and infections.<sup>5,6</sup>

Hypothyroid patients<sup>3,4</sup> show decreased heart rates, sinus bradycardia, atrioventricular blocks, and QT prolongation. Pathologically, there is myofibril swelling, loss of striation, and lipid accumulation in the heart. A widened heart shadow is often caused by pericardial effusion. There is a decrease in myocardial contractility, with a prolongation of diastolic relaxation<sup>27</sup> resulting in decreased myocardial work efficiency.<sup>28</sup> Patients with hypothyroidism and heart failure often have underlying cardiac disease.<sup>4</sup> Hyperlipidemia, diastolic hypertension, and increased cardiac risk factors are offset by the decreased metabolic demand and the negative inotropic and chronotropic state of hypothyroidism. The rapid correction of hypothyroidism may precipitate myocardial ischemia.<sup>4</sup>

The pulmonary system may be affected by myxedematous infiltration of the respiratory muscles, and depression of the respiratory responses to hypoxia and CO<sub>2</sub> may occur.<sup>29</sup> Wilson and

Bedell<sup>30</sup> showed that myxedema decreases maximal breathing capacity and lung diffusion capacity. Enlargement of the tongue and changes in the voice may occur with severe hypothyroid myopathy. Even in the absence of muscle symptoms, serum creatine phosphokinase (CPK) may be elevated.<sup>31</sup> Other abnormalities noted with hypothyroidism include increased bleeding, hyponatremia, hypoglycemia, and hypothermia from a decreased basal metabolic rate.

#### Subclinical Hypothyroidism

Subclinical hypothyroidism in women older than 50 years of age has a prevalence of almost 20%, whereas the overall prevalence in the population is between 4% and 10%.<sup>21</sup> Subclinical hypothyroidism is defined by an elevated TSH (>4.5 mU/L) and normal FT<sub>4</sub> and FT<sub>3</sub>. The consensus panel recommends that the level of thyroid peroxidase antibody also be measured. If it is positive, the risk per year of progressing to overt hypothyroidism is almost doubled. There is also an increased risk for other autoimmune diseases such as type 1 diabetes mellitus and adrenal insufficiency. For TSH >10 mU/L, the consensus panel recommends treatment to decrease the TSH in patients with subclinical hypothyroidism.

#### Treatment

In treating hypothyroidism, thyroxine is the preferred agent.<sup>31</sup> Because of its

long half-life (approximately 1 week), once-daily dosing is all that is required. Replacement dosing should begin gradually with a starting dose of 12.5–25 µg/d with the possibility that a small dose of 50 µg/d may be all that is necessary for replacement.<sup>6</sup>

### Myxedema Coma

Myxedema coma<sup>23,33</sup> represents an extreme form of hypothyroidism often in elderly female patients with known hypothyroidism and carries with it a significant mortality rate of >20%. The three essential components to establish a diagnosis are<sup>1</sup> (a) altered mental status, which may range from disorientation, lethargy, and confusion to frank coma;<sup>2</sup> (b) abnormal thermoregulation with temperatures lower than 95°F as a result of impaired hypothalamic temperature regulation (note that pseudo normalization caused by infection may mask the low temperatures);<sup>3</sup> and (c) a precipitating illness or event such as a pulmonary or urinary tract infection. Other causes include cold exposure, stroke, trauma, congestive heart failure (CHF), GI bleeding, and medications such as amiodarone, anesthetics, and narcotics. Laboratory examination may reveal markedly elevated TSH with low FT<sub>4</sub> and FT<sub>3</sub>, but with concomitant severe illness, glucocorticoid therapy, and pressors, such as dopamine, this clinical scenario may not be observed.<sup>23,33</sup>

Treatment of myxedema coma is based on thyroid hormone replacement and supportive care. The optimal method to replace thyroid hormones in myxedema coma is the subject of controversy and debate.<sup>23,33</sup> A common approach is to administer 300–500 µg of T<sub>4</sub> as an IV bolus and continue with 50–100 µg of IV T<sub>4</sub> until the patient is able to take oral medications. Supportive care is necessary to address the issues of hypoventilation, hypothermia, hyponatremia, hypoglycemia, hypotension, and sepsis. Hypoventilation may result from CO<sub>2</sub> narcosis or coma, and may be exacerbated by myopathy and an underlining pulmonary process. This may require mechanical ventilation and correction of arterial blood gas abnormalities. Hypothermia will correct with thyroid replacement, but is best initially treated by warming the room and using regular blankets. Warming blankets and aggressive correction may lead to vasodilatation and subsequent cardiovas-

cular collapse. Hyponatremia if below 120 mg/dL may need correction with saline solutions, but this must be done gradually so as to avoid central pontine myelinolysis. Correct half the deficit over 24 hours and then reassess. Hypoglycemia may indicate adrenal suppression and should be treated with stress-dose steroids. Hypotension should be carefully addressed because of depressed myocardial contractility and the potential for cardiovascular dysfunction from aggressive resuscitation.<sup>23,33</sup>

### Preoperative

An euthyroid state is desirable prior to elective surgery. For emergent surgery, the possibility of precipitating myxedema coma must be borne in mind, as well as the possibility of precipitating myocardial ischemia with overly aggressive thyroid replacement of a hypothyroid patient.<sup>3,23,24</sup>

## CALCIUM DISORDERS ASSOCIATED WITH PARATHYROID DISEASE

### Physiology

Within the circulation, calcium is distributed among a protein-bound, complex, and a free or ionized states.<sup>1,2,34</sup> The physiologically most important component is ionized calcium. Ideally, it is the direct measurement of ionized calcium that should be obtained in circumstances wherein measurement of serum calcium is clinically relevant. Alterations in serum proteins will affect the proportion of bound calcium. Thus, when interpreting total serum calcium levels, a convenient guide is to adjust the serum total calcium level by 0.8 mg/dL for each 1 g by which the serum albumin level is above or below 4.0 g/dL. If the serum albumin concentration is increased, the serum total calcium concentration should be adjusted downward, and vice versa if albumin concentration is decreased. In addition, acidosis may provoke hypercalcemia by decreasing calcium binding.

Total serum calcium levels are regulated within a range of 9–10.5 mg/dL. Three hormones interact to provide calcium homeostasis: parathyroid hormone, calcitonin, and vitamin D. Parathyroid hormone is secreted from the parathyroid gland and raises serum calcium levels while promoting bone resorption. In the kidney, parathyroid

hormone increases the renal absorption of calcium, while increasing the excretion of phosphate, bicarbonate, potassium, sodium, and some amino acids. Vitamin D and its active metabolites, 25-hydroxycholecalciferol and 1,25-dihydroxycholecalciferol, increase intestinal Ca<sup>2+</sup> absorption. Calcitonin is secreted by the thyroid gland in response to hypercalcemia. Calcitonin inhibits bone resorption and promotes renal excretion of phosphate, sodium, and potassium. In humans, calcitonin is of little physiologic importance. Several feedback mechanisms serve to regulate the levels of these hormones. Of importance, parathyroid hormone release is increased by hypocalcemia, whereas vitamin D inhibits parathyroid hormone secretion by increasing serum calcium. Hypermagnesemia may inhibit parathyroid hormone release, although severe hypomagnesemia causes paradoxical hypocalcemia resulting from inhibition of parathyroid hormone secretion and end-organ response.<sup>1,2,34</sup>

### Hypercalcemia

Table 12–5 lists the clinical manifestations of hypercalcemia.<sup>34–36</sup> Patients usually are asymptomatic with calcium levels up to 12 mg/dL. At levels between 12 and 14 mg/dL, symptoms may vary. In this latter circumstance, the clinical manifestations of hypercalcemia should serve as a guide for the need and speed of treatment. Severe hypercalcemia (serum calcium level >14 mg/dL) may be life-threatening and requires immediate treatment, regardless of symptomatology. The majority of patients presenting with severe hypercalcemia develop this as a complication of malignancy.

Hypercalcemia secondary to parathyroid disease is a common condition. With the advent of routine chemical screening, there has been a marked increase in the incidence of diagnosed hyperparathyroidism, with approximately 50,000 new cases of primary hyperparathyroidism each year in the United States. Of these patients, 25–50% are asymptomatic with calcium levels less than 11 mg/dL. The disease primarily affects elderly women. The most common cause of primary hyperparathyroidism is a parathyroid adenoma (80–90%), followed by parathyroid hyperplasia (15%). Parathyroid carcinoma is uncommon. Secondary hyperparathyroidism usu-

TABLE 12-5.

## Symptoms and Signs of Hypercalcemia

Symptoms	Signs
Hypertension	Constipation
Dysrhythmias	Anorexia
Digitalis sensitivity	Nausea, vomiting
Catecholamine resistance	Weakness, atrophy
QT shortening	Depression
Nephrocalcinosis	Personality change
Nephrolithiasis	Psychomotor retardation
Tubular dysfunction	Memory impairment
Renal tubular acidosis	Psychosis
Impaired Na reabsorption	Disorientation
Free water loss	Obtundation
Glomerular disorders	Coma
Interstitial nephritis	Pruritus
Peptic ulcers	
Pancreatitis	
Hyporeflexia	
Seizures	
EEG abnormalities	
Osteopenia	
Osteitis fibrosa cystica	
Skin necrosis	
Corneal calcification	
Conjunctivitis	
Decreased bronchial clearance of secretions	
Hypomagnesemia	

ally is not associated with hypercalcemia. In patients with renal failure with secondary hyperparathyroidism, however, hypercalcemia may occur after correction of the renal failure (tertiary hyperparathyroidism). Hyperparathyroidism also may occur as a manifestation of multiple endocrine neoplasia type II (MEN II), which includes pheochromocytoma, hyperparathyroidism, and medullary thyroid carcinoma.

Hyperparathyroidism in pregnant women deserves special mention. Maternal hypercalcemia may have profound effects on the fetus and newborn, leading to neonatal hypocalcemia or tetany. The literature suggests that maternal hyperparathyroidism is associated with increased fetal morbidity and mortality rates. Because the primary treatment for symptomatic hyperparathyroidism is surgery, it is not unusual for the anesthesiologist to care for a pregnant woman undergoing parathyroidectomy.

Hypercalcemia has profound effects on cardiac function, with diverse clinical manifestations. The primary risk in anesthetizing patients with hypercalce-

mia is cardiac dysrhythmias. Hypercalcemia decreases the refractory period and increases ventricular excitability. These effects may depend on  $Ca^{2+}$  level. In addition, QT interval changes are an unreliable indicator of hypercalcemia. Bradyarrhythmias, bundle-branch blocks, and complete heart block are well-documented complications of acute hypercalcemia. Digitalis should be administered with caution because these patients may show increased sensitivity to the drug. Hypercalcemia also increases vascular tone, so the blood pressure often gives an inaccurate assessment of the severity of dehydration and volume contraction that is present.

### Treatment

When confronted with an elevated calcium value the first test to order is a repeat calcium.<sup>37-39</sup> Laboratory abnormalities in a patient with hyperparathyroidism usually include hypercalcemia, hypophosphatemia, hypercalciuria, elevations of serum uric acid, and chloride with a decreased serum bicarbonate. The diagnosis of hyperparathyroidism

is best supported by an increased parathyroid hormone level associated with hypercalcemia.

The basic goals of therapy for hypercalcemia include correction of dehydration, enhancing renal calcium excretion, inhibiting bone resorption, and managing the underlying disorder. Saline hydration and furosemide rapidly decrease the serum calcium level by 2-3 mg/dL by correcting the underlying fluid deficit and increasing renal calcium clearance. A commonly used regimen is to administer 3-4 L of isotonic saline daily along with a diuretic if signs of fluid overload become apparent. The diuretic agents of choice are the loop diuretics because they inhibit calcium reabsorption in the ascending loop of Henle. Complications of this therapy include hypokalemia, hypomagnesemia, and congestive heart failure.

General measures such as the use of hydration and diuretics do not affect the excessive mobilization of calcium from bone. In patients with an initial serum calcium concentration >15 mg/dL, and in patients with serum calcium concentrations >12 mg/dL after aggressive hydration measures, specific therapy to inhibit osteoclast-mediated bone resorption should be instituted. Several agents are useful in this regard, including bisphosphonates, plicamycin, calcitonin, gallium nitrate, phosphate, and glucocorticoids.<sup>39,40</sup> Bisphosphonates bind to hydroxyapatite in bone and inhibit the dissolution of crystals. Etidronate and pamidronate are the bisphosphonates available in the United States. These agents are given as slow IV infusions with decreases in serum calcium concentrations occurring within 2 days of the initial dose. Plicamycin, which acts directly on bone to block calcium resorption, has a faster onset of action. Its effects occur in 6-12 hours, and the dosage is 25 µg/kg administered intravenously over 4-6 hours. Use of plicamycin is effective for all types of hypercalcemia associated with increased bone resorption. Contraindications to the use of plicamycin include thrombocytopenia, coagulopathy, and overt renal or hepatic dysfunction. Among the drugs used in managing hypercalcemia, calcitonin has the most rapid onset of action. The dosage of synthetic salmon calcitonin is 4 IU/kg every 12 hours, subcutaneously. Calcitonin lasts 6-12 hours, with onset of action

in 1–2 hours. Calcitonin is a relatively weak agent, and it is unlikely that the serum calcium level will normalize with the use of calcitonin alone. To enhance its effectiveness, a combination of calcitonin and steroids have been administered, although whether glucocorticoids enhance the action of calcitonin is controversial.<sup>34</sup> Gallium nitrate is administered as a continuous infusion for 5 days. Its effects are slow, taking approximately 5 days for the normalization of serum calcium. In addition, nephrotoxicity is a major side effect of this drug. Although in certain circumstances glucocorticoids can be effective calcium-lowering agents, patients with primary hyperparathyroidism do not respond to this treatment. Intravenous phosphates have a rapid onset of action in managing hypercalcemia, although they are associated with risks of hypotension, pulmonary edema, hypocalcemia, and metastatic calcification and are contraindicated in renal failure. Intravenous phosphate is given in a dose of 1500 mg phosphorus over 6–8 hours. Indomethacin, which is used for prostaglandin-associated hypercalcemia, also has a slow onset of action.

### Preoperative

When managing hypercalcemia preoperatively, reversible complications, such as dehydration, mental obtundation, and electrolyte disorders, should be corrected. Patients with calcium levels less than or equal to 12 mg/dL require no intervention (except possibly preoperative hydration), although the cause of the hypercalcemia should be sought. Management of more severe hypercalcemia may include pharmacologic intervention or hydration with diuresis.

### Hypocalcemia

Hypocalcemia<sup>37–39</sup> associated with parathyroid hormone resistance is most commonly caused by hypomagnesemia, whereas decreases in parathyroid hormone are most commonly caused by surgical ablation. There are several other causes of decreased parathyroid hormone levels, such as DiGeorge syndrome in children, but these are far less common.

Table 12-6 lists the signs and symptoms of hypocalcemia. The cardinal sign of hypocalcemia is tetany. On laboratory examination, the electrocardiograph may exhibit a prolonged QT interval,

TABLE 12-6.

#### Symptoms and Signs of Hypocalcemia

Symptoms	Signs
Hypotension	Paresthesias
Cardiac insufficiency	Weakness
Bradycardia	Anxiety
Dysrhythmias	Dementia
Insensitivity to catecholamines and digitalis	Depression
QT- and ST-interval prolongation	Irritability
T-wave inversion	Psychosis
Laryngeal spasm	Confusion
Apnea	
Bronchospasm	
Tetany	
Chvostek and Trousseau signs	
Muscle spasm	
Seizures	
Extrapyramidal manifestations	
Coarse, dry, scaly skin	
Brittle nails	
Thin, brittle hair	
Cataracts	

which indicates a predisposition to ventricular dysrhythmias. Primary hypoparathyroidism often is associated with hypocalcemia, hyperphosphatemia, and depressed levels of parathyroid hormone. In assessing the severity of hypocalcemia, decreased serum albumin levels might not be associated with symptoms if the ionized  $\text{Ca}^{2+}$  level is normal. Alkalosis also may predispose patients to hypocalcemia. Magnesium level should be determined for all patients with hypocalcemia, especially in cases of alcohol abuse, malabsorption, or poor nutrition. Hypomagnesemia induces hypocalcemia by one of several mechanisms, including a reduction of parathyroid hormone secretion, a resistance to the humeral actions of parathyroid hormone, and a direct parathyroid hormone-independent hypocalcemic effect.<sup>35</sup>

### Preoperative

Clinical signs of hypocalcemia should be controlled before surgical procedures are performed. Hypocalcemia is managed chronically with dietary calcium and vitamin D supplementation. For emergency management of hypo-

calcemia, 10–20 mL of IV 10% calcium gluconate or calcium chloride is given over 10 minutes followed by infusion of 0.5–2 mg  $\text{Ca}^{2+}$ /kg/h with monitoring of  $\text{Ca}^{2+}$  levels. Magnesium levels can be restored acutely by administering 1–2 g of 10% magnesium solution IV.

The major anesthetic risks of hypocalcemia are cardiac dysrhythmias, decreased contractility, development of tetany (especially with hyperventilation), and altered response to muscle relaxants. Such patients may be resistant to digitalis.<sup>36</sup>

## ADRENAL DISORDERS

### Physiology

Adrenal corticosteroid secretion is controlled via a negative feedback loop with the hypothalamic-pituitary axis.<sup>2,41</sup> Corticotropin-releasing factor from the hypothalamus stimulates the release of corticotropin from the pituitary gland, which, in turn, stimulates the release of adrenal corticosteroids. Within the negative feedback loop, elevated corticosteroid levels depress the corticotropin secretion. In addition to the influences of corticosteroids and corticotropin-releasing factor, corticotropin release is modulated by stress and diurnal variation. Peak secretion occurs in the morning, with an evening nadir. Random plasma cortisol levels are of marginal benefit in diagnosing the integrity of the adrenal-pituitary axis, and various stimulation and suppression tests are used. In particular, assessment of adrenal-cortical reserve often is done with the corticotropin-stimulation test.

Glucocorticoids have several functions. Steroids increase hepatic gluconeogenesis and decrease fatty acid, nucleic acid, and protein synthesis. They also suppress the inflammatory reaction and inhibit vitamin D by reducing calcium absorption from the gut. Steroids antagonize the effects of antidiuretic hormone (ADH) and enhance catecholamine vasoconstriction. High doses of glucocorticoids can exhibit a mineralocorticoid effect, causing sodium and water retention with potassium loss.

Aldosterone is secreted by the adrenal cortex in response to hyperkalemia and is inhibited by increases in plasma volume. Aldosterone secretion is controlled by the renin-angiotensin system and circulating levels of corti-



TABLE 12-7.

## Symptoms and Signs of Cushing Syndrome

Symptoms	Signs
Weakness/proximal myopathy	Centripetal obesity
Psychiatric changes	Hypertension
Impotence	Skin changes
Backache	Thin skin/bruising
Thirst/polyuria	Acne, greasy skin
Headache	Hirsutism
Abdominal pain	Plethora
	Abdominal striae
	Infection (e.g., tinea versicolor)
	Pigmentation
	Oligomenorrhea/amenorrhea
	Osteoporosis
	Vertebral collapse
	Pathologic fracture
	Glucose intolerance
	Ankle edema
	Renal calculi
	Exophthalmos

cortropin. Aldosterone works in the distal convoluted tubules of the kidney to promote sodium retention and potassium excretion. It is the major regulator of extracellular fluid volume and potassium balance.

After surgery, plasma cortisol increases 5–10 times by 6 hours postoperatively, with peak levels decreasing by 24 hours postoperatively, unless the stress continues. Epidural anesthesia delays the cortisol stress response, although it does not prevent it.<sup>42</sup>

Disorders of the adrenal gland present clinically as 1 of 3 problems: Cushing syndrome (excess secretion of corticosteroids), Conn syndrome (excess secretion of aldosterone), or Addison disease (corticosteroid insufficiency).

### Cushing Syndrome

Prolonged exposure to excess glucocorticoids-cortisol results in the manifestation of Cushing syndrome (Table 12-7). Although the classic features of Cushing syndrome—round or “moon” facies, supraclavicular fat pad or “buffalo hump,” purple striae, and proximal muscle weakness—may often be seen in a minority of patients, nonspecific features—such as obesity, hypertension, glucose intolerance, osteoporosis, osteopenia/fractures, emotional lability, depression, anxiety, easy bruisability, and thick skin—may be attributable to other causes or diseases.<sup>43,44</sup>

The most common cause of Cushing syndrome tends to be exposure to exogenous glucocorticoids such as topical or inhaled corticosteroids.<sup>44</sup> The most common endogenous cause of Cushing syndrome (≈70%) is Cushing disease—the secretion by pituitary tumors of corticotropin (adrenocorticotrophic hormone [ACTH]); approximately 15% is caused by ACTH-independent cortisol secretion by adrenal tumors and 15% is caused by ACTH-producing tumors elsewhere.<sup>43</sup> A high level of suspicion should be maintained, especially in patients who are atypical or difficult to control, as many diseases may have similar symptoms.

If there is clinical suspicion that a patient is at risk for Cushing syndrome, then any 1 of 4 tests may be employed to diagnose Cushing syndrome and if nonconfirmatory, more than 1 test may be used. These tests include<sup>1</sup> an elevated urinary free cortisol level on three 24-hour urine samples;<sup>2</sup> a serum cortisol >50 nmol/L on dexamethasone suppression testing;<sup>3</sup> an examination of midnight plasma cortisol—if awake, >207 nmol/L, and if asleep, >50 nmol/L;<sup>4</sup> and an elevated late-night salivary cortisol. If one of these tests is positive, then the diagnosis of Cushing syndrome can be made.<sup>44</sup> Once the diagnosis is made, the next step is to localize the cause. The first step is to measure plasma corticotropin. If the

level of plasma corticotropin is <1.1 pmol/L on 2 or more occasions, this is corticotropin-independent Cushing syndrome, which should be followed up with CT imaging of the adrenal glands. The presence of an adrenal lesion may indicate adenoma, carcinoma, or corticotropin-independent macronodular hyperplasia. The absence of a lesion in the adrenals tends to favor exogenous glucocorticoids. If the plasma corticotropin level is >3.3 pmol/L, this is corticotropin-dependent Cushing syndrome, which should be followed up with a pituitary MRI along with a positive response to corticotropin-releasing hormone and suppression with high-dose dexamethasone, after which the diagnosis of Cushing disease can be made. If the MRI is negative, this should be followed up by bilateral inferior petrosal sinus sampling. A positive corticotropin gradient indicates Cushing disease. The absence of a corticotropin gradient should be followed up with CT and MRI of the thorax and abdomen, along with somatostatin scintigraphy to localize the ectopic source of corticotropin.<sup>44</sup>

Therapy for Cushing syndrome consists of removal of the source of glucocorticoid, usually surgically. Ketoconazole and metapyrone are enzyme inhibitors of cortisol synthesis. Mitotane is an adrenolytic that can be used to lower cortisol.<sup>44</sup> Pituitary radiotherapy may also be used. Patients who undergo adrenal-sparing surgery require replacement with hydrocortisone until the hypothalamic-pituitary-adrenal axis recovers, and those who undergo bilateral adrenalectomy require both glucocorticoid and mineralocorticoid replacement.<sup>43</sup> Temporary adrenal supplementation considers the type of surgical or medical stress. For instance, minor procedures, such as herniorrhaphy or colonoscopy, would be supplemented with 25 mg of hydrocortisone or 5 mg of methylprednisolone IV for the procedure only, whereas a moderate procedure, such as open cholecystectomy or hemicolectomy, would be supplemented with 50–75 mg of hydrocortisone or 10–15 mg of methylprednisolone IV on the day of the procedure, followed by a 1–2-day taper to the usual dose. Severe stress or procedure, such as cardiac surgery, liver resection, and Whipple surgery, would be supplemented with hydrocortisone 100–150 mg or methylprednisolone 25–30 mg

TABLE 12–8.

## Symptoms, Signs, and Laboratory Abnormalities in Addison Disease

Symptoms	Signs	Laboratory Abnormalities
Weakness, tiredness, fatigue	Skin hyperpigmentation	Hyponatremia
Weight loss	Hypotension	Hyperkalemia
Anorexia	Buccal or tongue pigmentation	Azotemia
Nausea, vomiting	Calcification of the pinnae	Fasting or reactive hypoglycemia (infrequent in adults)
Unspecified gastrointestinal complaints	Vitiligo	Hypercalcemia
Abdominal pain	Hyperthermia or hypothermia	
Diarrhea	Loss of axillary hair in women	
Muscle pain		
Salt craving		
Orthostatic hypotension, dizziness, or syncope		
Lethargy, disorientation		

IV followed by a rapid taper to the usual dose over 1–2 days.<sup>45</sup>

### Conn Syndrome

Primary hyperaldosteronism (Conn syndrome)<sup>46–48</sup> is characterized by diastolic hypertension, hypokalemic alkalosis, inability to concentrate urine, and skeletal muscle weakness. A normal serum K<sup>+</sup> level in a hypertensive patient will rule out this syndrome unless the patient is on a sodium-restricted diet or taking spironolactone. The preoperative preparation is aimed at improving fluid and electrolyte balance. Spironolactone is given in a dosage of 25–100 mg every 8 hours for at least 1 week preoperatively with concurrent potassium replacement.<sup>39</sup>

### Adrenal Insufficiency

Adrenocortical insufficiency<sup>49</sup> can be classified as primary (adrenal gland destruction) or secondary (hypothalamic–pituitary axis dysfunction). Primary adrenal insufficiency usually is iatrogenic, resulting from bilateral adrenalectomy, inadequate steroid administration, or unilateral adrenalectomy for a hyperfunctioning adrenal tumor. A patient with primary adrenal insufficiency presenting as Addison disease usually exhibits hypoaldosteronism. Table 12–8 lists the signs and symptoms of Addison disease. In patients with secondary adrenal insufficiency related to suppressed hypothalamic–pituitary axis, aldosterone secretion remains intact, and hyperkalemia does not occur. An additional syndrome of isolated hypoaldosteronism occurs as a result of renin deficiency in patients with normal cortisol secretion but

unexplained hyperkalemia. Patients with suspected adrenal insufficiency should undergo systemic examination to assess function before surgery. Associated laboratory findings include decreased plasma cortisol levels and impaired corticotropin stimulation. Additional provocation testing of the pituitary–adrenal axis might include using metyrapone stimulation or insulin-induced hypoglycemia. In addition to adequate steroid coverage, volume status replacement, electrolyte management, and correction of hypotension should occur preoperatively.

When adrenal insufficiency develops acutely, the symptoms can be severe and dramatic (Table 12–9). This may occur in a trauma or intensive care setting in patients with previously unsuspected inadequate adrenal reserve.<sup>45</sup> The dosage of glucocorticoids given depends on the urgency and severity of the clinical situation. Mineralocorticoid properties must be provided if primary adrenal insufficiency exists. Fluid support with 5% dextrose

and normal saline should be instituted immediately to replace volume deficits and provide glucose.

### PHEOCHROMOCYTOMA

Pheochromocytomas are chromaffin cell tumors and are members of the family of amino precursor uptake and decarboxylation (APUD) tumors. Massive amounts of catecholamines are released by these tumors, causing their characteristic signs and symptoms. They are rare, occurring in 0.5% of all hypertensive patients.<sup>50</sup> Although usually located unilaterally near the adrenal gland, pheochromocytomas may be found in various locations, including urinary bladder and bilaterally in the chest and abdomen. The extraadrenal pheochromocytomas are called paragangliomas. From 2–3% of these growths constitute neck or thoracic masses. Most tumors occur in adults. Children with pheochromocytomas have fewer malignant tumors but tend to have a greater incidence of bilaterality, extraadrenal location, and associated multiple endocrine neoplasias.

### Diagnosis

Pheochromocytomas may be either sporadic or hereditary. Most tumors are sporadic and classic teaching has been that 10% of all tumors are hereditary. Pheochromocytoma can be a manifestation of the hereditary disorders of MEN IIA, IIB, neurofibromatosis (NF) type 1, familial paraganglioma syndrome, and von Hippel-Lindau (vHL) disease. A group of susceptibility genes

TABLE 12–9.

## Symptoms and Signs of Acute Adrenal Insufficiency

Symptoms	Signs
Severe clinical deterioration	Fever
Nausea, vomiting	Hypotension
Abdominal or flank pain	Abdominal distension
Lethargy, obtundation	Hyponatremia
	Hyperkalemia

TABLE 12–10.

## Major Genetic Syndromes Associated with Pheochromocytoma

Syndrome	Clinical Features	Gene
MEN IIA	Medullary thyroid carcinoma Parathyroid hyperplasia Pheochromocytoma	RET
MEN IIB	Medullary thyroid carcinoma Pheochromocytoma Ganglioneuromas Marfanoid habitus	
NF1	Neurofibromas Café-au-lait spots Lisch nodules Plexiform neurofibromas Sphenoid dysplasia Optic gliomas Axillary and inguinal freckling	NF1
vHL	Hemangioblastomas (brain, spine, retina) Clear-cell renal cell cancer Pheochromocytoma	vHL

MEN, multiple endocrine neoplasia; NF, neurofibromatosis; vHL, von Hippel-Lindau.  
Reprinted and modified with permission from Nieman LK and Ilias I. Evaluation and treatment of Cushing's syndrome. *Am J Med* 2005;118:1340–1346, with permission from Elsevier.

has been identified including protooncogene RET (associated with MEN type II), the tumor-suppressor gene VHL (associated with von Hippel-Lindau disease), and succinate dehydrogenase subunits D and B (which predispose carriers to pheochromocytomas and glomus tumors) (Table 12–10). Identification of mutations in these susceptibility genes has been found in 24% of suspected sporadic tumors, suggesting that heredity syndromes may play a greater role in pheochromocytoma occurrence than previously appreciated.<sup>51</sup> Current recommendations suggest that genetic testing should be considered in patients initially presenting with pheochromocytoma prior to age 50 years.<sup>52</sup> Genetic testing has demonstrated that pheochromocytomas presenting after age 50 years are almost always sporadic.<sup>52</sup>

Diagnosis depends on a high index of suspicion and observing for clinical signs and symptoms of this tumor. Signs and symptoms of pheochromocytoma should be sought in hypertensive individuals, and workup performed in those patients displaying characteristic signs and symptoms (Table 12–11). The diagnostic algorithm includes<sup>1,2</sup> documentation of increased catecholamine breakdown products in plasma, and tumor localization by appropriate imaging techniques, including

CT, magnetic resonance imaging (MRI), I-metaiodobenzylguanidine scintigraphy, or positron emission tomography (PET) scanning. The first step in diagnosis is biochemical verification of

the presence of pheochromocytoma. A multicenter cohort study of 858 patients with suspected pheochromocytoma compared the diagnostic ability of plasma free metanephrines, plasma catecholamines, urinary catecholamines, urinary total and fractionated metanephrines, and urinary vanillyl-mandelic acid.<sup>53</sup> Plasma free metanephrines were the best test to confirm or exclude the tumor. The sensitivity of plasma free metanephrines was 97% and 99% in hereditary and sporadic pheochromocytomas, respectively. The specificity was 96% and 82% in hereditary and sporadic pheochromocytomas, respectively.<sup>54</sup> A normal plasma metanephrine level excludes the tumor, and a large elevation confirms its presence. However, the problem comes with marginally elevated values, as there may be at least a 15% false-positive rate. Marginally elevated plasma metanephrine values should undergo further evaluation via additional biochemical testing (repeat plasma metanephrines or urinary total metanephrine and catecholamines)<sup>54</sup> or pharmacologic testing (e.g., clonidine suppression or glucagon stimulation).<sup>51</sup> When interpreting metanephrine and catecholamine levels, physicians should be aware of medical conditions and

TABLE 12–11.

## Symptoms and Signs of Pheochromocytoma

Symptoms	Signs
Headache (severe)	Blood pressure changes
Excessive sweating (generalized)	Hypertension with wide fluctuations
Palpitations with or without tachycardia	Hypertension induced by physical maneuver such as exercise, postural change, or palpation and massage
Anxiety or nervousness	Orthostatic hypertension
Pain in chest, abdomen, lumbar regions, lower abdomen, groin	Paradoxical blood pressure response to some anti-hypertensive drugs and marked pressor response with induction of anesthesia
Nausea and vomiting	Hyperhidrosis
Weakness, fatigue, prostration	Tachycardia or reflex bradycardia; very forceful heartbeat, dysrhythmia
Weight loss (severe)	Pallor of face and upper part of body
Dyspnea	Anxious, frightened, troubled appearance
Warmth with or without heat intolerance	Hypertensive retinopathy
Visual disturbances	Leanness or underweight
Dizziness or faintness	Tremor
Constipation	Raynaud phenomenon
Paresthesia or pain in arms	Fever
Bradycardia (noted by patient)	Dilated pupils

TABLE 12-12.

**Medications That Can Cause False-Positive Results for Catecholamines and Metanephrines**

Tricyclic antidepressants and antipsychotics  
 Levodopa  
 Drugs containing catecholamines  
 Ethanol  
 Withdrawal from clonidine and other drugs  
 Acetaminophen and phenoxybenzamine (plasma metanephrines)  
 Major physical stress (i.e., surgery, stroke, obstructive sleep apnea)

drugs, which can influence the results (Table 12-12). Care must be taken to eliminate these confounding factors.<sup>54</sup> Following biochemical confirmation, the next step is tumor localization with adrenal CT and MRI having comparable sensitivity and specificity (Fig. 12-1). As depicted in Figure 12-1, adrenal CT and MRI have comparable sensitivity and specificity. Metaiodobenzylguanidine (MIBG) scanning offers superior specificity to MRI and CT, and is particularly helpful in localizing extraadrenal masses. However, MIBG is not sensitive enough to exclude pheochromocytoma, as there is a false-negative rate of 13–25%.<sup>50</sup> Use of MIBG scanning in sporadic unilateral adrenal tumors has been questioned because in this clinical circumstance, the test rarely contributes additional information.<sup>55</sup> In patients with biochemical evidence of pheochromocytoma, but in whom the presence of the tumor cannot be excluded by CT, MRI, or MIBG, PET scanning may be performed for tumor localization.<sup>50</sup>

**Preoperative Preparation**

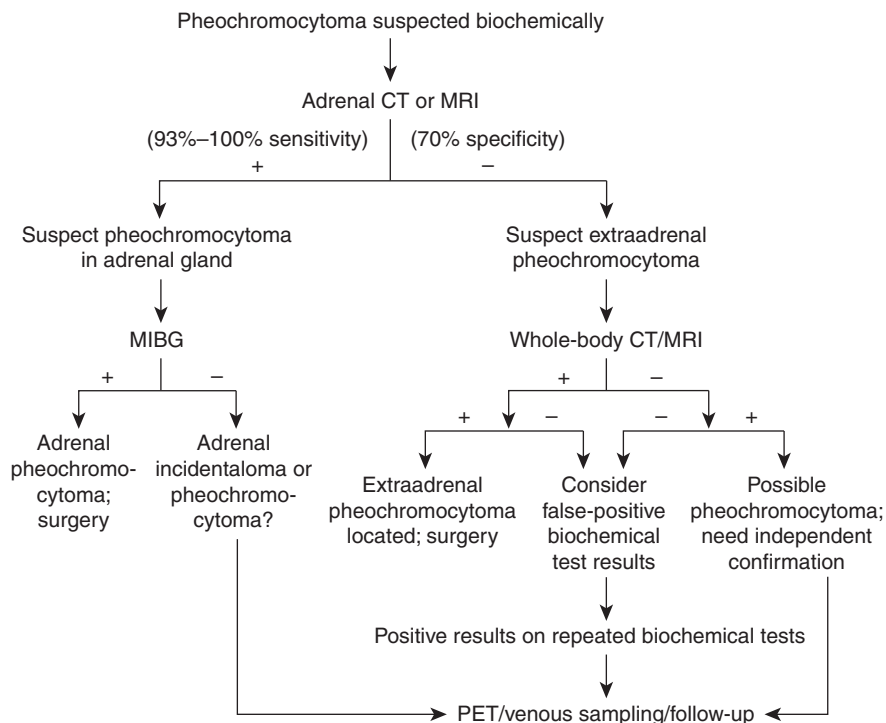
Preoperative preparation should be a joint venture involving the surgeon, the internist or endocrinologist, and the anesthesiologist. The major goal of preoperative preparation is to decrease cardiovascular morbidity and mortality resulting from excess catecholamine secretion. Pheochromocytomas may secrete norepinephrine, epinephrine, or dopamine.<sup>56</sup> The acute effects of catecholamine bursts and their chronic end-organ sequelae may influence postoperative outcome. A review of cardiovascular changes associated

with pheochromocytoma reported that 6 of 25 patients initially presented with ischemic changes on electrocardiogram.<sup>57</sup> Chronically elevated catecholamine levels with pheochromocytomas were associated with a 38% incidence (24 of 63 patients) of preoperative transthoracic echocardiographic abnormalities.<sup>58</sup> Left ventricular hypertrophy was the most common abnormality (14 of 63 patients), followed by dilated cardiomyopathy (4 of 63 patients), valvular abnormalities (3 of 63 patients), and segmental wall motion abnormalities (2 of 63 patients).<sup>58</sup>

The optimal drug for preoperative preparation of the patient with pheochromocytoma is controversial. A common initial approach has been to use phenoxybenzamine for long-term  $\alpha$ -blockade.<sup>59</sup> Preoperative treatment with phenoxybenzamine results in a significantly smoother course than in untreated patients. This drug has a long half-life (approximately 12 hours) and is highly lipid soluble. However, it has unpredictable absorption through the gut. Its primary side effect is orthostatic hypotension. The starting dosage is 10–20 mg daily in 2 doses. Every 3–4 days the dose is increased until either no marked symptoms of catecholamine excess are evident or the patient com-

plains of side effects from postural hypotension and/or a stuffy nose, with a final dosage range of 40–100 mg/d. The adequacy of  $\beta$ -blockade may be assessed by determining if ongoing symptoms of catecholamine excess are occurring. Signs and symptoms of pheochromocytoma should be specifically sought (see Table 12-11). The preoperative cardiovascular evaluation should seek signs of orthostasis, evidence of heart failure or cardiomyopathy, and determine volume status. Preoperative preparation should include 1–2 weeks of  $\alpha$ -adrenergic-blocker therapy. Volume replacement is important when starting  $\alpha$ -blocker therapy, and patients often have a decreased hematocrit after beginning therapy.

There are several disadvantages to the use of phenoxybenzamine.<sup>59</sup> Adequate volume expansion after institution of the drug may take as long as 2–3 weeks. Thus, patients presenting for surgery who have been on phenoxybenzamine for a shorter time period should have their hypovolemia corrected preoperatively. Total elimination of cardiovascular changes is seldom achieved despite reaching therapeutic end points with phenoxybenzamine.  $\alpha$ -Blockade with phenoxybenzamine is irreversible and depends



**FIGURE 12-1.** CT, computed tomography; MIBG metaiodobenzylguanidine; MRI, magnetic resonance imaging; PET, positron emission tomography. Imaging algorithm for patients whose results on biochemical tests are consistent with pheochromocytoma.



on synthesis of  $\alpha$ -adrenergic receptors. Thus, there may be continued  $\alpha$ -blockade following tumor removal, which can contribute to postoperative hypotension. Phenoxybenzamine causes significant orthostatic hypotension and reflex tachycardia.

Selective  $\alpha_1$ -blockers, such as prazosin and doxazosin,<sup>60</sup> have been used with success for preoperative preparation. The rationale behind their selection is a shorter duration of action providing easier dose adjustment and potentially decreasing the postoperative hypotension period. Reflex tachycardia is decreased because the presynaptic  $\alpha$ -receptors are not blocked.<sup>52</sup>

$\beta$ -Blockers are administered for persistent tachycardia and for control of other peripheral  $\beta$ -adrenergic effects of catecholamine excess. These drugs should never be given before  $\alpha$ -blockade because serious hypertensive sequelae may result. Both labetalol and atenolol have been suggested as appropriate drug choices.<sup>61</sup>

The drug  $\alpha$ -methyltyrosine inhibits the synthesis of norepinephrine. The drug does not produce hypotension and preserves the tissue responsiveness to adrenergic agents when the dosage of 500–2000 mg 4 times daily is given. Adequate blockade is achieved in 1 or 2 weeks.  $\alpha$ -Methyltyrosine without concurrent  $\alpha$ -adrenergic-blocking agents does not prevent hypertensive crisis.  $\alpha$ -Methyltyrosine has fallen out of favor, possibly because there is a high incidence of side effects with including somnolence, anxiety, agitated depression, and tremor.<sup>62</sup>

Calcium channel blockers also have been advocated for preoperative and intraoperative blood pressure control in patients with pheochromocytomas. In comparison to the  $\alpha$ -adrenergic blockers, calcium channel blockers do not produce orthostatic or overshoot hypotension. In addition, therapy may be started as late as 24 hours prior to surgery and optimal cardiovascular effects are still obtained.<sup>63</sup> Several reports suggest that calcium channel blockers may be the drug of choice for antihypertensive therapy during preoperative preparation of the pheochromocytoma patient.<sup>64</sup>

## PITUITARY DISORDERS

The pituitary diseases that are of special concern for the anesthesiologist

include those associated with secondary metabolic alterations or diabetes insipidus.

### Hypopituitarism

The pituitary gland is composed of the anterior portion (adenohypophysis) and the posterior portion (neurohypophysis). The adenohypophysis responds to hypothalamic release factors by secreting corticotropin, TSH, growth hormone, and gonadotropins. The neurohypophysis secretes vasopressin (ADH) and oxytocin. Hormone deficiencies leading to hypopituitarism may be caused by lesions in the brain, pituitary adenoma (especially macro adenoma), trauma, irradiation, or granulomatous disease. Gonadotropin deficiency is not of major significance to anesthetic management. Patients with hypopituitary disorders may present with hypothyroidism and inadequate corticotropin secretion. Steroid coverage or thyroid replacement may be required, although mineralocorticoid therapy usually is not necessary in these patients. Cranial diabetes insipidus (decreased vasopressin secretion) requires special consideration because volume status and electrolytes may be affected. Diabetes insipidus is one of several medical conditions characterized by polyuria and may be nephrogenic or cranial in origin. Cranial diabetes insipidus is an uncommon disease and usually is a result of hypothalamic tumors, infiltrative processes, cerebral aneurysm, ischemia, head trauma, or pituitary surgery.

The first step in diagnosis of diabetes insipidus is to determine that the patient indeed has polyuria. A 24-hour urine volume of more than 2.5 L characterizes polyuria of diabetes insipidus.<sup>65</sup> Once polyuria has been confirmed then routine blood tests can eliminate alternative diagnoses such as diabetes mellitus, chronic renal failure, hypercalcemia, or hypokalemia. The water deprivation test is the preferred diagnostic maneuver for diabetes insipidus. The water deprivation test involves two steps: fluid restriction and desmopressin administration. In normal individuals, water deprivation for approximately 8 hours produces a rise in plasma osmolality, stimulating a release of vasopressin, with a subsequent decrease in urine output and increase in urine concentration. Healthy persons will increase urine

osmolality to greater than 700 mOsm/kg following water deprivation,<sup>65</sup> whereas patients with diabetes insipidus are unable to concentrate their urine. Following water deprivation, in patients with suspected diabetes insipidus, exogenous ADH (desmopressin) is administered either subcutaneously or intramuscularly. The desmopressin step distinguishes between cranial and nephrogenic diabetes insipidus. Patients with nephrogenic diabetes insipidus remain unable to concentrate their urine, whereas persons with cranial diabetes insipidus will respond to desmopressin by increasing their urine osmolality. In patients with diabetes insipidus, careful preoperative assessment of volume status, renal function, electrolytes, and plasma osmolality is important. Management of diabetes insipidus is dependent on whether it is vasopressin responsive (cranial diabetes insipidus) or is not vasopressin responsive (nephrogenic diabetes insipidus). In both forms, however, an intact thirst mechanism helps to ensure adequate hydration. Cranial diabetes is managed with adequate hydration and oral desmopressin 0.05–8 mg once or more daily.<sup>66</sup> Nasal and intramuscular are alternate routes of administration. The management of nephrogenic diabetes insipidus is often more difficult and includes hydration, decreased sodium intake, thiazide diuretics, amiloride, and prostaglandin inhibitors such as indomethacin.

### Hyperpituitarism

Hypersecretion by the pituitary gland presents specific problems for the anesthesiologist. Disease states related to excess secretion of thyroid-stimulating hormone or corticotropin are discussed above. Excess secretion of growth hormone is associated with acromegaly. Macroglossia and prognathism in this condition may be associated with airway management problems and difficulty with intubation. In a retrospective case series of 28 patients, acromegalic patients were more likely to be a difficult intubation, have enlarged tongue, and present with airway difficulty.<sup>67</sup> In addition, patients with acromegaly had a higher incidence of preoperative hypertension, diabetes, and cardiomegaly.<sup>67</sup> With this in mind, the anesthetic preevaluation should focus on both the airway and cardiovascular system.

TABLE 12-13.

## Diseases Associated with the Syndrome of Inappropriate Secretion of Antidiuretic Hormone

Tumors	Bronchogenic cancer Mesothelioma Ureteric cancer Pancreatic cancer Duodenal cancer Lymphoma Endometrial cancer Leukemia
Pulmonary disease	Lung abscess Empyema Pneumonia Tuberculosis Aspergillosis HIV infections Positive-pressure ventilation
Central nervous system disorders	Cerebral tumors Cerebral abscess Hydrocephalus Subdural hematoma Subarachnoid hemorrhage Meningitis Encephalitis
Drugs	Phenothiazines Tricyclic antidepressants Chlorpropamide Ecstasy Carbamazepine Cyclophosphamide Selective serotonin reuptake inhibitors

The syndrome of inappropriate antidiuretic hormone secretion (SIADH) results from abnormal production or sustained release of ADH. SIADH is associated with normovolemic hyponatremia and has numerous causes (Table 12-13). Of note, SIADH is most often not the result of an intrinsic pituitary disorder.<sup>68</sup> The criteria for SIADH have been well described in the past (Table 12-14). The severity of signs and symptoms associated with SIADH are dependent on the degree of hyponatremia and how rapidly the drop in sodium occurs. The faster the rate of fall of serum sodium and the lower the concentration, the more severe the symptoms. The symptoms and signs are primarily neurologic (Table 12-15). The first step in treatment is to eliminate the underlying cause. Fluid restriction is the next step in correction of chronic hyponatremia. For patients with severe neurologic symptoms or hyponatremia, administration of hypertonic saline with

or without furosemide may be required. In patients unable to tolerate fluid restriction, demeclocycline, a tetracycline that causes nephrogenic diabetes insipidus, has been used as adjunct therapy. Correction of serum sodium should be done gradually because of the possibility of neurologic complications. The rate of increase should not exceed 0.5 mmol/L/h.<sup>69</sup>

## DIABETES

### Definition and Classification

The American Diabetes Association<sup>70</sup> defines diabetes with reference to abnormal glucose tests, which have been confirmed with repeat testing on a different day. The 3 principal criteria used to define diabetes are (a) a fasting blood glucose concentration >126 mg/dL or (b) a nonfasting blood glucose concentration >200 mg/dL or (c) a blood glucose concentration >200 mg/

TABLE 12-14.

## Criteria of Syndrome of Inappropriate Secretion of Antidiuretic Hormone

- Hyponatremia with hypotonicity of plasma
- Urine osmolality in excess of plasma osmolality
- Increased renal sodium excretion
- Absence of edema or volume depletion
- Normal renal and adrenal function

TABLE 12-15.

## Symptoms and Signs of Hyponatremia

Serum Sodium <sup>a</sup>	
<120 mmol/L	<110 mmol/L
Lethargy	Drowsiness
Anorexia	Confusion
Nausea, vomiting	Depressed reflexes
Irritability	Extensor plantar responses
Headache	Seizures
Muscle weakness	Coma
Cramps	Death

<sup>a</sup>The severity of the clinical features are determined by the absolute concentration in which serum sodium falls and its rate of fall.

dL in the 2-hour sample after an oral glucose tolerance test. Impaired glucose tolerance is a fasting blood glucose >110 mg/dL but <126 mg/dL, or a 2-hour postprandial glucose concentration >140 mg/dL but <200 mg/dL. Risk factors for diabetes include age older than 45 years; obesity (body mass index >27); high-risk ethnic group (Native American, African American, Hispanic, and Asian); gestational diabetes or delivery of a large infant over 9 lbs; impaired glucose tolerance; hypertension; and a low high-density lipoprotein (HDL) (<35 mg/dL) or elevated triglycerides (>250 mg/dL).<sup>70</sup>

Diabetes mellitus<sup>71</sup> is in essence a disease that is characterized by hyperglycemia. A variety of pathogenic mechanisms including defects in insulin secretion, insulin action, or both may be involved.<sup>71</sup> The American Diabetes Association has currently classified diabetes mellitus into 4 specific categories: (a) *type 1 diabetes*, which is caused by  $\beta$ -cell destruction and usually results in

insulin deficiency; (b) *type 2 diabetes*, which encompasses a range from insulin resistance with relative insulin deficiency to insulin secretory defects with insulin resistance; (c) *specific types* of diabetes such as genetic defects of  $\beta$ -cell function, genetic defects in insulin action, diseases of the exocrine pancreas, endocrinopathies, drug or chemical induced, infections, and genetic syndromes associated with diabetes; and (d) *gestational diabetes mellitus*.<sup>71</sup>

Type I diabetes results from  $\beta$ -cell destruction that leads to insulin deficiency accounts for approximately 5–10% of patients with diabetes mellitus.<sup>71</sup> Type I diabetes is further classified as immune mediated or idiopathic. Immune mediated is characterized by cell-mediated autoimmune destruction of pancreatic  $\beta$  cells with a subsequent decrease in insulin secretion and the risk for ketoacidosis. Ketoacidosis and hyperglycemia are often the initial presentation in conjunction with infection or stress. The rate of destruction of  $\beta$  cells may vary. Often this is manifested in childhood or adolescence, but may also present at any age even in elderly patients, including those in their 80s. Markers of autoimmune destruction such as autoantibodies to islet cells, insulin, glutamic acid decarboxylase (GAD65), and tyrosine phosphatases IA-2 and IA-2B are found in approximately 90% of these patients.<sup>72</sup> There is a strong human leukocyte antigen (HLA) association with the HLA-DR/DQ alleles. Some patients who present with autoimmune destruction of the  $\beta$  cells may be obese, but most tend to be thin. Patients with immune-mediated type I diabetes are prone to other autoimmune disease such as Graves disease, Hashimoto thyroiditis, Addison disease, autoimmune hepatitis, myasthenia gravis, and pernicious anemia.<sup>71</sup> In contrast, idiopathic diabetes mellitus comprises only a minority of type I diabetes usually in patients of African or Asian descent. Although this form is strongly inherited, there is no HLA association or indication of  $\beta$  cell autoimmunity and the requirement for insulin may come and go in affected patients.<sup>71</sup>

Type 2 diabetes<sup>71</sup> is the principal form of diabetes and approximately 90–95% of patients have this form of diabetes. Although the cause or causes of this form of diabetes may be varied, by definition as determined by the American Diabetes Association, pa-

tients who have type I diabetes, gestational diabetes, or specific type diabetes cannot be classified as type 2 diabetics. Type 2 diabetics are characterized by a range and progression of insulin resistance and relative insulin deficiency. Type 2 diabetes has a stronger genetic predisposition than type 1, but the genetic relationships are complex and ill defined. There is a greater risk of developing type 2 diabetes with increasing age, obesity, lack of exercise, hypertension, dyslipidemia, and gestational diabetes. Ketoacidosis is more characteristic of type 1 diabetes, but it can occur with type 2 diabetes in association with the stress of another illness or infection. Type 2 diabetes tends to go undetected for years with the result of developing microvascular complications.<sup>71</sup> It is for this reason that the American Diabetes Association advocates the adoption of the strict criteria discussed above for the definition of diabetes.

Blood glucose levels in the diabetic parturient are important in determining neonatal outcome during labor and delivery. The incidence of neonatal hypoglycemia—defined as a blood glucose concentration of  $>40$  mg/dL in the first 12 hours of life—is influenced by maternal glucose control during labor and delivery. Maternal glucose concentrations  $>90$  mg/dL during delivery significantly increase the frequency of neonatal hypoglycemia.<sup>73,74</sup> Consequently, glucose boluses should be avoided in the peripartum period and strict glucose control should be initiated. The results of multiple studies, including Diabetes Control and Complications Trial (DCCT), United Kingdom Prospective Diabetes Study (UKPDS), van den Berghe et al.,<sup>75</sup> and Umpierrez et al.<sup>76</sup> have led both the American College of Endocrinology and the American Diabetes Association to advocate tight control of in-hospital glucose use. The target level of fasting blood sugars is 110 mg/dL with a maximal level of 180 mg/dL.<sup>77,78</sup> Ideally, an aim of achieving a glycosylated hemoglobin ( $HgbA_{1c}$ ) of less than 7 might be beneficial.

## Medications

Five classes of oral glucose-lowering agents<sup>78–81</sup> with a variety of formulations are currently available.<sup>82–85</sup> The first class is the *sulfonylureas*, which act on the pancreas to increase insulin secretion from the  $\beta$  cells, reduce

serum glucagon, and increase insulin binding to the insulin receptors on target tissues. They are protein bound, metabolized by the liver, and excreted by the liver and kidney. The currently used sulfonylureas are second-generation sulfonylureas, with peak action between 1 and 6 hours and half-lives varying between 4 and 10 hours, depending on the formulation, and include glyburide, glipizide, and glimepiride. These effects are more pronounced in the elderly because of reduced metabolism and elimination, putting them at greater risk of hypoglycemia. The second class is the *biguanides*, which decrease hepatic glucose production, reduce low-density lipoprotein (LDL) and very-low-density lipoprotein (VLDL) concentrations, and inhibit intestinal glucose absorption. They have a half-life of more than 12 hours, are not metabolized, and are excreted in the urine. Metformin is the currently used biguanide and it may decrease vitamin B<sub>12</sub> absorption and occasionally cause diarrhea. Metformin may, on rare occasions, be associated with lactic acidosis, and should not be given to patients with renal failure, cardiac failure or infarction, hepatic disease, or hypoxic lung disease, and should be discontinued prior to surgery.<sup>79</sup> The third class, is the  *$\alpha$ -glucosidase inhibitors*. Acarbose and miglitol are agents of this class and act by inhibiting  $\alpha$ -glucosidase in the brush borders of the small intestine, decreasing the breakdown of oligosaccharides and disaccharides to glucose, thereby decreasing the amount of postprandial glucose. These drugs are metabolized within the gastrointestinal tract, have a half-life of 2 hours, and are excreted in the urine. These agents cause abdominal discomfort, flatulence, and diarrhea as the main side effects, rather than hypoglycemia. The fourth class, is the *thiazolidinediones*, of which troglitazone, rosiglitazone, and pioglitazone are currently used. These agents decrease hepatic glucose production, enhance insulin's action in the liver and skeletal muscle, and decrease insulin resistance by binding to nuclear receptors and subsequently activating or suppressing genes. These agents are metabolized in the liver and excreted by the kidney. Although liver function needs to be closely followed, the dosages are not affected by aging. The fifth class is the *meglitinides*, of which repaglinide and nateglinide are examples.

These agents are rapid acting with short half-lives and work by slowing adenosine triphosphate (ATP)-dependent potassium channels leading to an increase in insulin secretion. These agents are highly protein bound to albumin and are metabolized in the liver by cytochrome P450 (CYP) 3A4. The meglitinides are insulin secretagogues and as such are associated with hypoglycemia.

Insulin preparations are classified by their speed of action, with the principal categories being rapid acting, short acting, intermediate acting, mixed short and intermediate acting, and long acting. Lispro and Aspart are rapid-acting insulins whose onset is within minutes and peak effect is within an hour. Regular insulin is short acting. The onset is within an hour with peak effect in about 2 hours and a duration of about 4 hours. Neutral protamine Hagedorn (NPH) and Lente are intermediate-acting insulins with onset of action in about 3–4 hours, peak occurring in 8–10 hours, and duration of action lasting 12–14 hours. Glargine and ultralente are long-acting insulin's that have delayed onset, with duration of action lasting more than 24 hours. Linkeschova et al.<sup>84</sup> advocate the use of continuous insulin infusion to achieve better glycemic and metabolic control.

Not only are there multiple combinations of insulin now available, but newer delivery methods of insulin, such as inhaled insulin,<sup>85</sup> are approved for use in type 2 diabetics. Exenatide<sup>85</sup> is a synthetic exendin-4. This binds to the glucagon-like peptide-1 (GLP-1) receptor on pancreatic cells and increases insulin secretion. Exenatide belongs to the GLP-1 agonist class and is administered subcutaneously twice a day. It suppresses glucagon secretion, slows gastric motility, and may be associated with nausea, vomiting, diarrhea, and weight loss. Pramlintide<sup>85</sup> represents an amylin agonist. It is a synthetic analog of amylin, a  $\beta$ -cell hormone. It is administered subcutaneously before meals and slows gastric emptying, inhibits glucagon production, and decreases postprandial glucose elevations. It is also associated with nausea, GI side effects, and weight loss.

### Perioperative Changes in Glucose Metabolism

The surgical stress response is characterized by increases in sympathetic

tone, glucagon levels, pituitary hormone levels (notably corticotropin and growth hormone), and interleukin-1. During the perioperative period, increases in plasma norepinephrine and epinephrine also occur. Epinephrine and norepinephrine stimulate liver glycogenolysis and gluconeogenesis<sup>86</sup> and inhibit glucose uptake by insulin-dependent tissues. The  $\alpha$  and  $\beta$  effects of the catecholamines may influence glucose metabolism. For instance, epinephrine increases metabolic rate through its  $\beta$  effects.<sup>87</sup> The  $\alpha$  and  $\beta$  effects also have profound influences on pancreatic function.  $\beta$ -Receptor stimulation enhances insulin and glucagon release, whereas  $\alpha$ -receptor stimulation inhibits the release of insulin. During the intraoperative and immediate postoperative course,  $\alpha$  effects predominate, causing suppression of insulin secretion. Decreased insulin levels coupled with increased gluconeogenesis and insulin resistance cause hyperglycemia and glucose intolerance, prompting the term “diabetes of injury.”

During the subsequent convalescent stage, there is increased gluconeogenesis, and glucose uptake by the peripheral tissues is normal and insulin secretion is increased. The pancreas is able to respond normally to the increased glucose loads. A contributing factor to this change in glucose kinetics is the hormonal shift from  $\alpha$ - to  $\beta$ -adrenergic catecholamine effects.<sup>88</sup> Plasma glucagon levels increase after surgery and promote hepatic amino acid uptake, gluconeogenesis, and glycogenolysis.<sup>89</sup> Nonetheless, the increase in splanchnic glucose production with glucagon is a transient phenomenon, and it is only with the combined effects of all the stress hormones that hepatic gluconeogenesis is maintained.<sup>90</sup> Increased pituitary release of corticotropin leads to increased glucocorticoid levels, which can produce a moderate glycemic response.<sup>91</sup> Postoperative increases in growth hormone have an anabolic effect, causing nitrogen retention, protein synthesis, lipolysis, and decreased peripheral glucose uptake.<sup>92</sup> The net effects of the neuroendocrine response on metabolism during the convalescent stage after tissue injury include increased blood glucose, stimulation of lipolysis, and increased rate of gluconeogenesis.

During surgery, blood glucose concentrations in nondiabetic patients

may increase to as much as 60 mg/d above preoperative levels.<sup>93</sup> The extent of operation stress is the primary determinant of the absolute increase in glucose values. Inadequate insulin secretion, coupled to the stress hormone milieu and the preoperative fasting state, makes the diabetic patient more susceptible to hyperglycemia, hypovolemia, osmotic diuresis, ketosis, and possible changes in acid-base balance. Hyperglycemia may have detrimental effects if it is unmanaged. Osmotic diuresis resulting from the osmotic activity of glucose occurs when the patient's blood glucose level exceeds the renal glucose threshold (approximately 180–250 mg/dL). This osmotic diuresis can result in dehydration, acidosis, and electrolyte abnormalities. Although hyperglycemia per se does not have direct effects on the patient's acid-base status, the ketone bodies that result from inadequate insulin therapy can elicit such effects. Acetoacetic acid and  $\beta$ -hydroxybutyric acid may alter pH status by the accumulated dissociation of hydrogen ions.

### Diabetic Complications

Not only are there many causes of diabetes, but the complications that arise from diabetes are enormous because of the multiplicity of systems affected by the disease.<sup>70,77–79,94</sup> The cardiovascular complications of diabetes include coronary heart disease, congestive heart failure, diabetic cardiomyopathy, peripheral vascular disease, hyperlipidemia, and autonomic dysfunction. Renal complications include hypertension, microalbuminuria, proteinuria, type IV renal tubular acidosis, and, ultimately, end-stage renal disease. The gastrointestinal system is affected by gastroparesis and changes in motility that can result in diarrhea, constipation, and gastroesophageal reflux disease. The neurologic complications include peripheral neuropathy, radiculopathy, neurogenic bladder, erectile dysfunction, autonomic dysfunction, and orthostatic hypotension. Diabetics are at risk for ophthalmologic changes, including diabetic retinopathy. Infections are much more prevalent especially with organisms such as *Candida*, *Staphylococcus*, *Pseudomonas*, and fungi, as well as increased incidence of urinary tract infections and foot ulcers.



### Cardiovascular Disease and Diabetes

The relationship between diabetes and cardiovascular disease is complex. Not only is cardiovascular disease a major complication of diabetes, but diabetes is one of the major risk factors for cardiovascular disease. Diabetes reduces overall life span.<sup>95</sup> Diabetics have a higher incidence of cardiovascular disease.<sup>96–98</sup> Diabetics are at increased risk of myocardial infarction with a greater risk of death from a myocardial infarction both prior to reaching the hospital and, also, once in the hospital.<sup>99</sup> The National Cholesterol Education Program has defined diabetes as a coronary risk equivalent and a higher mortality is associated with diabetes and coronary artery disease.<sup>100</sup> With intensive focus, the risk as a consequence of cardiovascular disease has decreased, but there has not been a decrease in patients with diabetes.<sup>101</sup> Thus risk factor modification assumes greater significance in diabetics.

Similarly, the relationship between diabetes and hypertension is complex and interrelated. Not only should diabetes be aggressively treated, but hypertension should also be aggressively addressed as revealed in two key studies—the UKPDS and the Hypertension Optimal Treatment (HOT) trial.<sup>102–104</sup> The UKPDS study found that although intensive glucose therapy was beneficial in reducing cardiovascular risk, there was an even more significant effect with reducing blood pressure, not only for cardiovascular events, but also cerebrovascular events. The HOT study demonstrated that aggressive diastolic blood pressure reduction reduced cardiovascular mortality. These findings have been incorporated into the Joint National Committee on Prevention, Detection, Evaluation, Treatment of High Blood Pressure 7th Report (JNC-7) guidelines.<sup>105</sup> In high-risk cardiovascular patients angiotensin-converting enzyme (ACE) inhibitors improve cardiovascular morbidity and mortality.<sup>106,107</sup> Despite all the recommendations and the higher prevalence of hypertension among diabetics, hypertension remains, for the large part, uncontrolled.<sup>108</sup>

Dyslipidemias are widely prevalent among diabetics and are part of the complex relationship between diabetes, and associated cardiovascular and cerebrovascular events leading to increased morbidity and mortality. Mul-

tiples studies—the Heart Protection Study,<sup>96</sup> the Scandinavian Simvastatin Survival Study,<sup>110</sup> the Veterans Affairs High-Density Lipoprotein Cholesterol Intervention Trial Study Group,<sup>111</sup> and the MRC/BHF Heart Protection Study<sup>112</sup>—show the clear benefit of aggressive lipid management. The American Diabetes Association used this information to help set its lipid goal recommendations:<sup>78</sup> LDL cholesterol in diabetics <100 mg/dL. The National Cholesterol Education Program (NCEP)<sup>100</sup> has set a more aggressive goal in high-risk patients: LDL <70 mg/dL, triglycerides <150 mg/dL, and HDL >40 mg/dL.<sup>100</sup> The Lescol Intervention Prevention Study found a marked reduction of more than 50% in major adverse cardiac events such as death or nonfatal myocardial infarction (MI) with the use of a statin.<sup>114</sup>

Diabetes is associated with a prothrombotic state that contributes to the increased risk of higher mortality from cardiovascular disease.<sup>115,116</sup> One of the early studies to show the benefits of aspirin was the Physicians Health Study,<sup>117</sup> which noted a marked reduction in myocardial infarctions among diabetic physicians on aspirin. Subsequent work, such as the HOT trial, continued to show a significant reduction in cardiovascular events, as well as myocardial infarction for patients on aspirin. The benefits of aspirin plus clopidogrel, as well as aspirin plus glycoprotein 2b/3a inhibitors, has been noted,<sup>115</sup> although the risk of bleeding is increased with these combinations versus aspirin alone.

Although recent studies<sup>118</sup> indicate that current assessment guidelines may miss a number of patients with silent ischemia, there is still no well-established data in asymptomatic patients that advanced testing with nuclear stress tests or stress echocardiography leads to better outcomes. The emphasis should rather be on risk reduction and adopting proven beneficial therapies—lipid reduction, blood pressure control, smoking cessation, weight reduction, increasing physical activity, and aspirin therapy. A detailed history and physical examination including laboratory and electrocardiogram (ECG) analysis should be done. Exercise capacity should be determined in accordance with the American College of Cardiologists/American Heart Association preoperative assessment guidelines.

### Diabetic Neuropathy

Diabetic neuropathy is common, varied, and affects between 75% and 90% of all diabetics, with the elderly having more pronounced effects. There exists a multiplicity of classification systems for diabetic neuropathy.<sup>119–121</sup> The American Diabetes Association<sup>122</sup> uses a classification of neuropathies as (a) sensory neuropathies—acute sensory neuropathy and chronic distal symmetric polyneuropathy; (b) focal and multifocal neuropathies; and (c) autonomic neuropathy. The classification system used by Vinik and Mehrabyan<sup>123</sup>—small-fiber neuropathies, large-fiber neuropathies, and autonomic neuropathy—is somewhat more intuitive. A key point emphasized by the American Diabetes Association<sup>122</sup> is that early recognition and treatment of neuropathy is important, and that it is as equally important to determine which neuropathies are not attributable to diabetes and to correctly diagnose and exclude them.

The small-fiber neuropathies<sup>123</sup> are characterized by being electrophysiologically silent with preservation of reflexes and motor strength, but with loss of cutaneous nerve fibers on tissue staining. Allodynia with burning superficial pain of the c-fiber type is a characteristic; but later there is hypoalgesia. There is a decreased thermal sensation with impaired vasomotor and blood flow and decreased autonomic function, leading to decreased sweating, dry skin, and increased risk for foot ulceration and gangrene.

The large-fiber neuropathies encompass both sensory and motor nerves and are more amenable to diagnosis with electromyography, nerve conduction velocity studies and quantitative sensory tests.<sup>119,121,123</sup> Clinical manifestations include changes in perception presenting with impaired vibratory perception and position sense. There is depression of the deep tendon reflexes, sensory ataxia, and a deep-seated, dull, aching pain in the feet, and initially there is a feeling of warming in the feet because of increased blood flow. There is a shortening of the Achilles tendon and wasting of the small muscles of the feet with hammertoes, and subsequent weakening of the hands and feet. Distal muscle weakness can be seen as an inability to stand on the heels or toes. Distal symmetric neuropathy, diffuse motor neuropathy, and distal motor neuropathy,

thy are part of the large-fiber neuropathy syndrome. It is important to exclude other causes of these types of neuropathies such as familial, B<sub>12</sub> deficiency, folate deficiency, Lyme disease, heavy-metal poisoning, reaction to cytotoxins, immunologically mediated and those neuropathies caused by malignancy. In the elderly, there is an increase in proximal muscle neuropathy. These can present as pain in the buttocks, thighs, and hips that can have a variable initiation that is either abrupt or gradual onset. Symptoms can progress to weakness with inability to get up from a sitting position and can coexist with distal symmetric polyneuropathy. Fasciculations may be provoked by percussion or may occur spontaneously with electrophysiologic studies indicating a lumbosacral plexopathy. The elderly are also at greater risk for mononeuropathies. These tend to occur spontaneously, acutely, and with pain. They tend to effect the ulnar, median, peroneal nerves, and cranial nerves III, VI, and VII, and are characterized by a spontaneous remission and lack progression. These mononeuropathies must be distinguished from the nerve-entrapment syndromes such as carpal tunnel, which are more frequent in diabetics, but which tend to be gradual in onset, and progressive in nature.<sup>119-123</sup>

Autonomic neuropathy<sup>119-123</sup> has many clinical manifestations and involves multiple physiologic systems. Cardiovascular manifestations include resting tachycardia, exercise intolerance, orthostatic hypotension, cardiac degeneration and silent myocardial infarction, alterations in blood flow to skin and extremities, and temperature intolerance. The gastrointestinal system is affected with a variety of changes, including esophageal dysmotility, diarrhea, constipation, incontinence, and diabetic gastroparesis. Genitourinary syndromes include cystopathy, neurogenic bladder, and sexual dysfunction in women, and erectile dysfunction in men. Besides temperature intolerance, there are abnormalities of sweating. These include increased upper-body sweating, and increased gustatory sweating in response to certain foods such as cheeses and spicy foods. There is decreased lower-body sweating, with resulting skin dryness and cracking contributing to increased infections and ulcerations of the diabetic foot. Autonomic neuropathy affects

metabolic response to glucose regulation with both a decreased ability to detect and respond to hypoglycemia. Ocular manifestations of autonomic neuropathy include Argyll-Robertson-like pupil and a decreased diameter of a dark-adapted pupil.<sup>119-123</sup>

As pointed out by Luukinen and Airaksinen,<sup>124</sup> orthostatic hypotension for older diabetics is predictive of a higher risk of vascular death. This increase in morbidity and mortality associated with autonomic neuropathy is one of the reasons the American Diabetes Association<sup>122</sup> advocates the performance of standard examinations for the diagnosis of autonomic neuropathy. Examination of the resting heart rate is key, because a resting heart rate >100 beats per minute is abnormal. Next an examination of fasting, non-hypoglycemic heart rate with an examination for heart rate variability is done with a patient monitored by ECG breathing 6 breaths per minute; the difference in heart rate between resting and supine should be greater than 15 beats per minute and if the heart rate variability is less than 10 beats per minute and the R-R interval ratio is not greater 1.17, then the heart rate variability is abnormal.

As noted by Cox et al.,<sup>125</sup> hyperglycemia impairs cognitive performance in diabetics. Arvanitakis et al.<sup>114</sup> note that diabetes, in addition to aging, contributes to the progression and worsening of rigidity and gait disturbance in the elderly. The DCCT trial<sup>127,128</sup> demonstrated the beneficial effect of tight glucose control on limiting the microvascular complications of diabetes; the goal advocated is an HgbA<sub>1c</sub> less than 7. In addressing the pain and discomfort associated with diabetic neuropathy, the American Diabetes Association<sup>122</sup> recommends a stepwise approach starting with an exclusion of nondiabetic causes, stabilizing the blood sugar, and then attempting to achieve a HgbA<sub>1c</sub> of less than 7. Tricyclics are the first-line drugs for pain control, then anticonvulsants, and finally opiates. However, Gilron et al.<sup>129</sup> recently demonstrated that the lower-dose combination of opiates and anticonvulsants achieves better analgesia than higher doses of either drug alone. The EURODIAB Study Group,<sup>130</sup> in addition to the findings of the UKPDS, emphasize the importance of addressing all modifiable risk factors so as to minimize diabetic neuropathy.

## **Nephropathy and Urologic Complications**

Diabetic effects on the urologic system encompasses diabetic nephropathy, urologic cystopathy, erectile dysfunction, and infection. Diabetic nephropathy affects more than 40% of type 1 diabetics and more than 20% of type 2 diabetics.<sup>77,131</sup> The National Kidney Foundation<sup>132</sup> defines diabetes as a risk factor for chronic kidney disease and recommends screening and risk factor reduction. The effects of diabetes in leading to end-stage renal disease are worse for certain ethnic groups, namely Native Americans, Hispanics, and African Americans.<sup>77</sup> It appears that aggressive risk-factor reduction and tight blood pressure and glucose control<sup>133</sup> can decrease both the rate of progression to end-stage kidney disease and the renal complications of diabetes. The American Diabetes Association recommends the early diagnosis and treatment of microalbuminuria along with aggressive risk-factor reduction with blood glucose control so as to prevent the albuminuria, blood pressure elevation, and persistent decline in glomerular filtration rate (GFR) that is characteristic of diabetic nephropathy and which ultimately contributes to increased mortality and morbidity.

Diabetic cystopathy affects almost 50% of diabetics and increases with age.<sup>122</sup> In diabetic cystopathy there is impaired sensation of bladder fullness, an increase in bladder capacity, a reduction in bladder contractility, and an increase in residual urine. This residual urine increases the risk for urinary tract infections, urethral reflux, hydro-nephrosis, pyelonephritis, and urosepsis. A urologic evaluation for cystopathy may include cystometry, sphincter electromyography, uroflowmetry, and urethral pressure profile. Both cystopathy and erectile dysfunction result from microvascular changes of diabetes and the polyneuropathy associated with diabetes.<sup>134</sup>

## **Diabetic Ketoacidosis**

Poorly controlled diabetes may cause severe metabolic abnormalities, including diabetic ketoacidosis or hyperglycemic hyperosmolar nonketotic state. The hyperosmolar nonketotic state is characterized by marked hyperglycemia, dehydration, and hyperosmolality, but severe ketosis is absent. Patients unable to compensate

for hyperglycemia and dehydration are often elderly type 2 diabetics. The presence of diabetic ketoacidosis is suggested strongly by history and physical examination, along with a high blood sugar level and positive urine ketones, although the definitive diagnosis of diabetic ketoacidosis must be verified with arterial blood gases and consists of (a) hyperglycemia ( $>250$  mg/dL), (b) decreased bicarbonate ( $<15$  mEq/L), and (c) decreased arterial pH ( $<7.3$ ) with ketonemia (positive at 1:2 dilution) and moderate ketonuria. The principal therapy includes hydration, IV insulin, potassium, phosphate, and bicarbonate therapy, and frequent monitoring of electrolytes, glucose, and acid–base status. The details of therapy have been summarized elsewhere.<sup>135,136</sup>

### Diabetes Preoperative Evaluation

Diabetes is a disease with enormous physiologic impact, and the preoperative evaluation should be done in accordance with current American College of Cardiologists/American Heart Association guidelines. The preoperative evaluation should include assessment of the systemic manifestations noted above. The electrocardiogram should be analyzed. The rate, rhythm, presence of left and/or right atrial hypertrophy, ventricular enlargement, and ectopy, and signs of prior myocardial infarction should be noted. Any interval change since the prior electrocardiogram is important, bearing in mind the higher incidence of silent myocardial infarctions among diabetics. In examining the chest films, the lung characteristics, the size and position of the heart and great vessels, the degree of calcification of the bony structures and vertebrae, the presence or absence of fluid collections, and the characteristics of the diaphragm should be noted.

Because diabetic patients tend to be on multiple medications, obtaining a metabolic profile may be worthwhile. The levels of key electrolytes, sodium, and potassium should be determined. Current glucose levels both in reference to a patient's baseline, and also, as a baseline for subsequent comparisons is useful. A hemoglobin A<sub>1c</sub> is useful to indicate overall glycemic control with current American Diabetes Association recommendation being below 7 and values above 10 corre-

sponding to plasma blood glucose in the 300 mg/dL range and poor control.<sup>77</sup> A fasting lipid profile provides information as concomitant cardiovascular risk rather than acute glycemic issues. The serum creatinine along with blood urea nitrogen (BUN) helps to provide information on volume status, and renal function. It must be borne in mind that as patients age, their muscle mass diminishes, as does the creatinine that one measures. A blood count provides information on the patient's hemoglobin, platelets, and the presence or absence of anemia, with blood cell indices providing even more detailed information as to the marrow's ability to produce the various cell lines. Because urinary tract infections tend to be common among diabetics, a urinalysis can provide insight as to the presence of infection, ketones, protein, and sediment.

### Laryngoscopy and Intubation

Diabetes may be associated with a greater incidence of difficult laryngoscopy and intubation. In patients with diabetes, stiff joint syndrome can occur, affecting all joints, including those of the cervical and thoracic spine. The incidence of difficult laryngoscopy in long-term type 1 diabetic patients is reported to be 30–40%.<sup>137–139</sup> The diagnosis of stiff-joint syndrome is relatively easy. Besides evaluation of spine mobility, the wrists and elbows should be observed for incomplete extension and flexion. The hands should be assessed for thick, waxy skin and an inability to oppose the interphalangeal joints of the fingers assessed in the “prayer” position.<sup>139</sup>

### Metabolic Syndrome

A variety of terms have been used to describe the clustering of metabolically related cardiovascular risk factors. Commonly used names to denote this relationship include “syndrome X,” insulin resistance syndrome, and now metabolic syndrome. Recently, the International Diabetes Foundation defined the metabolic syndrome as (a) central obesity—ethnically specific increased waist circumference; *plus* any two of the additional findings of (b) increased triglycerides ( $>150$  mg/dL); (c) reduced HDL cholesterol ( $<40$  mg/dL in men and  $<50$  mg/dL in women) or undergoing the treatment for lipid disorders; (d) elevated blood pressure (systolic  $\geq 130$ , diastolic  $\geq 85$ )

or undergoing treatment for hypertension; and (e) elevated fasting plasma glucose ( $\geq 100$  mg/dL) or undergoing treatment for diabetes.<sup>140</sup> This definition is fairly similar to that of NCEP Adult Treatment Panel III.<sup>100</sup> Even after adjusting for traditional risk factors, patients with metabolic syndrome are at increased risk for cardiovascular and cerebrovascular disease, as well as diabetes.<sup>141–143</sup> Whether this is a result of dyslipidemia, insulin resistance, vascular dysregulation, a proinflammatory state, a prothrombotic state, hormonal factors, or some other mechanism remains to be determined.

### KEY REFERENCES

1. American Diabetes Association. Diagnosis and classification of diabetes mellitus. *Diabetes Care* 2005; 28(Suppl):S37–S42.
2. Jacobs TP, Bilezikian JP. Clinical review: rare causes of hypercalcemia. *J Clin Endocrinol Metab* 2005; 90:6316–6322.
3. Boelaert K, Franklyn JA. Thyroid hormone in health and disease. *J Endocrinol* 2005;187:1–15.
4. Clemens A, Siegel E, Gallwitz B. Global risk management in Type 2, diabetes: blood glucose, blood pressure, and lipids—update on the background of the current guidelines. *Exp Clin Endocrinol Diabetes* 2004;112:493–503.
5. Coursin DB, Connery LE, Ketzler JT. Perioperative diabetic and hyperglycemic management issues. *Crit Care Med* 2004;32(Suppl):S116–S125.
6. Demers LM. Thyroid disease: pathophysiology and diagnosis. *Clin Lab Med* 2004;24:19–28.
7. Gharib H, Tuttle RM, Baskin HJ, et al. Subclinical thyroid dysfunction: a joint statement on management from the American Association of Clinical Endocrinologist, the American Thyroid Association and the Endocrine Society. *Thyroid* 2005;15:24–28.
8. Moore K, Thompson C, Trainer P. Disorders of water balance. *Clin Med* 2003;3:28–33.
9. Prys-Roberts C. Pheochromocytoma—recent progress in its man-



agement. *Br Anaesth J* 2000;85:44–57.

10. Seidman PA, Kofke WA, Policare R, Young M. Anaesthetic complications of acromegaly. *Br Anaesth J* 2000;84:179–182.

11. Van Den Berghe G, Wouters P, Weekers F, et al. Intensive insulin therapy in critically ill patients. *N Engl J Med* 2001;345:1359–1367.

## REFERENCES

1. Jameson JL. Principles of endocrinology. In: Kasper DL, Braunwald E, Fauci AS, eds. *Harrison's Principles of Internal Medicine*. 16th ed. New York: McGraw-Hill, 2005: 2067–2075.

2. Boron WF, Boulpaep EL. *Medical Physiology*, Updated Edition. Philadelphia: Elsevier Saunders, 2005.

3. Boelaert K, Franklyn JA. Thyroid hormone in health and disease. *J Endocrinol* 2005;187:1–15.

4. Kahaly GJ, Dillmann WH. Thyroid hormone action in the heart. *Endocr Rev* 2005; 26:704–728.

5. Demers LM. Thyroid disease: pathophysiology and diagnosis. *Clin Lab Med* 2004;24: 19–28.

6. Topliss DJ, Eastman CJ. Diagnosis and management of hyperthyroidism and hypothyroidism. *Med J Aust* 2004;180:186–193.

7. Stockigt JR. Free-thyroid hormone measurement. A critical appraisal. *Endocrinol Metab Clin North Am* 2001;30:265–289.

8. Hollowell JG, Staehling NW, Flanders WD, et al. Serum TSH, T<sub>4</sub>, and thyroid antibodies in the United States population (1988 to 1994): National Health and Nutrition Examination Survey (NHANES III). *J Clin Endocrinol Metab* 2002;87:489–499.

9. Wartofsky L, Dickey RA. The Evidence for a narrower thyrotropin reference range is compelling. *J Clin Endocrinol Metab* 2005;90:5483–5488.

10. Surks MI, Goswami G, Daniels GH. The thyrotropin reference should remain unchanged. *J Clin Endocrinol Metab* 2005; 90:5489–5496.

11. Ginsberg J. Diagnosis and management of Grave's disease. *CMAJ* 2003;168:575–585.

12. Reid JR, Wheeler SF. Hyperthyroidism: diagnosis and treatment. *Am Fam Physician* 2005;72:623–630.

13. Rehman SU, Cope DW, Senseney AD, et al. Thyroid disorders in elderly patients. *South Med J* 2005;98:543–549.

14. Habra M, Sarlis NJ. Thyroid and aging. *Rev Endocrinol Metab Disord* 2005;6:145–154.

15. McDevitt DG, Shanks RC, Iiadden DR, et al. The role of the thyroid in the control of heart rate. *Lancet* 1968;1:998.

16. Forfar JC, Miller HC, Toft AD, et al. Occult thyrotoxicosis: a correctable cause of "idiopathic" atrial fibrillation. *Am J Cardiol* 1979;44:9.

17. Squizzato A, Gerdes VEA, Brandes DPM, et al. Thyroid diseases and cerebrovascular disease. *Stroke* 2005;36:2302–2310.

18. Papi G, Pearce EN, Brauerman LE, et al. A clinical and therapeutic approach to thyrotoxicosis is with thyroid-stimulating hormone suppression only. *Am J Med* 2005;118:349–361.

19. Ramsay EI. Muscle dysfunction in hyperthyroidism. *Lancet* 1966;2:931.

20. Cooper DS. Antithyroid Drugs. *N Engl J Med* 2005;352:905–917.

21. Gharib H, Tuttle RM, Baskin HJ, et al. Subclinical thyroid dysfunction: A joint statement on management from the American Association of Clinical Endocrinologist, the American Thyroid Association and the Endocrine Society. *Thyroid* 2005;15:24–28.

22. Hoogendoorn EH, den Heijer M, van Dink APJ, et al. Subclinical hyperthyroidism: to treat or not to treat? *Postgrad Med J* 2004;80:394–398.

23. Sarlis NJ, Gourgiotis L. Thyroid emergencies. *Rev Endocrinol Metab Disord* 2003;4:129–136.

24. Ringel MD. Endocrine and metabolic dysfunction syndromes in the critically ill: management of hypothyroidism and hyperthyroidism in the intensive care unit. *Crit Care Clin* 2001;17.

25. Farwell AP, Brauerman LE. Thyroid and antithyroid drug. Brunton LL, Lazo JS, Parker KL, eds. *Goodman and Gilman's The Pharmacological Basis of Therapeutics*. 11th ed. New York: McGraw-Hill, 2006:1530.

26. Davies TF, Larsen PR. Thyrotoxicosis. In Larsen PR, Kronenberg HM, Melmed S, eds. *Williams Textbook of Endocrinology*. 10th ed. Philadelphia: Saunders, 2003:374–421.

27. Kahaly G, Mohr-Kahaly S, Beyer J, et al. Left ventricular function analyzed by Doppler and echocardiography methods in short-term hypothyroidism. *Am J Cardiol* 1995;75:645–648.

28. Bengel FM, Nekolla SG, Ibrahim T, et al. Effect of thyroid hormones on cardiac function, geometry, and oxidative metabolism assessed noninvasively by position emission tomography and magnetic resonance imaging. *J Clin Endocrinol Metab* 2000; 85:1822–1827.

29. Zwillich CW, Pierson DJ, Hofeldt FD, et al. Ventilator control in myxedema and hypothyroidism. *N Engl J Med* 1975;292:6.

30. Wilson WR, Bedell GN. The pulmonary abnormalities in myxedema. *J Clin Invest* 1960;39:42.

31. Nevins MA, Saran M, Bright M, et al. Pitfalls in interpreting serum creatine phosphokinase activity. *JAMA* 1973;224:1382.

32. Escobar-Morreale HF, Botella-Carretero JI, Escobar Del Rey F, et al. Review: treatment of hypothyroidism with combinations of levothyroxine plus liothyronine. *J Clin Endocrinol Metab* 2005;90:4946–4954.

33. Fliers E, Wiersinga WM. Myxedema coma. *Rev Endocrinol Metab Disord* 2003;4: 137–141.

34. Potts JT. Diseases of the parathyroid gland and other hyper- and hypocalcemic disorders. In: Kasper DL, Braunwald E, Fauci AS, eds. *Harrison's Principles of Internal Medicine*. 16th ed. New York: McGraw-Hill, 2005:2249–2268.

35. Jacobs TP, Bilezikian JP. Clinical review: rare causes of hypercalcemia. *J Clin Endocrinol Metab* 2005;90:6316–6322.

36. Ralston SH, Coleman R, Fraser WD, et al. Management of hypercalcemia. *Calcif Tissue Int* 2004;74:1–11.

37. Taniegra E. Hyperparathyroidism. *Am Fam Physician* 2004;69:333–340.

38. Spinazz ES, Schrijvers D. Metabolic emergencies. *Crit Rev Oncol Hematol* 2006;58:78–89.

39. Kraft MD, Btaiche IF, Sack GS, et al. Treatment of electrolyte disorders in adult patients in the intensive care unit. *Am J Health Syst Pharm* 2005;62:333–340.

40. Cuitkovic F, Armand JP, Tubiana-Hulin M, et al. Randomized, double blind, phase II treat of gallium nitrate compared with pamidronate for acute control of cancer related hypercalcemia. *Cancer J* 2006;12:47–53.

41. Williams GH, Dluhy RG. Disorders of the adrenal cortex. In: Kasper DL, Braunwald E, Fauci AS, eds. *Harrison's Principles of Internal Medicine*. 16th ed. New York: McGraw-Hill, 2005:2127–2148.

42. Bromage PR, Shibuta HR, Willoughby HW, et al. Influence of prolonged epidural blockage on blood sugar and cortisol responses to operations upon the upper part of the abdomen and thorax. *Surg Gynecol Obstet* 1971;132:1051.

43. Nieman LK, Ilias I. Evaluation and treatment of Cushing's syndrome. *Am J Med* 2005;118:1340–1346.

44. Newill-Price J, Bertogna X, Grossman AB, et al. Cushing's syndrome. *Lancet* 2006; 367:1605–1617.

45. Connery LE, Coursin DB. Assessment and therapy of selected disorders. *Anesthesiol Clin North Am* 2004;22:92–123.

46. Wheeler MH, Harris DA. Diagnosis and management of primary aldosteronism. *World J Surg* 2003;27:627–631.

47. Stowasser M, Gordon RD. Primary aldosteronism. *Best Pract Res Clin Endocrinol Metab* 2003;17:591–605.

48. Young WF. Mini review: primary aldosteronism—changing concepts in diagnosis and treatment. *Endocrinology* 2003;144: 2208–2213.

49. Marzotti S, Falorni A. Addison's disease. *Autoimmunity* 2004;37:333–336.

50. Pacak K, Linehan WM, Eisenhofer G, Walther MM, Goldstein DS. Recent advances in genetics, diagnosis, localization, and treatment of pheochromocytoma. *Ann Intern Med* 2001;134:315–329.

51. Neumann HP, Bausch B, McWhinney SR, et al. Germ-line mutations in nonsyn-



- dromic pheochromocytoma. *N Engl J Med* 2002;346:1459–1466.
52. Bryant J, Farmer J, Kessler LJ, Townsend RR, Nathanson KL. Pheochromocytoma: the expanding genetic differential diagnosis. *J Natl Cancer Inst* 2003;95:1196–1204.
  53. Lenders JW, Pacak K, Walther MM, et al. Biochemical diagnosis of pheochromocytoma: Which test is best? *JAMA* 2002;287:1427–1434.
  54. Kudva YC, Sawka AM, Young WF, Jr. Clinical review 164: the laboratory diagnosis of adrenal pheochromocytoma: The Mayo Clinic experience. *J Clin Endocrinol Metab* 2003;88:4533–4539.
  55. Miskulin J, Shulkin BL, Doherty GM, Sisson JC, Burney RE, Gauger PG. Is preoperative iodine 123 meta-iodobenzylguanidine scintigraphy routinely necessary before initial adrenalectomy for pheochromocytoma? *Surgery* 2003;134:918–922; discussion 922–923.
  56. Van der Harst E, de Herder WW, de Krijger RR, et al. The value of plasma markers for the clinical behaviour of pheochromocytomas. *Eur Endocrinol J* 2002;147:85–94.
  57. Liao WB, Liu CF, Chiang CW, Kung CT, Lee CW. Cardiovascular manifestations of pheochromocytoma. *Am J Emerg Med* 2000;18:622–625.
  58. Devaux B, Lentschener C, Jude N, et al. Predictive value of preoperative transthoracic echocardiography in patients undergoing adrenalectomy for pheochromocytoma. *Acta Anaesthesiol Scand* 2004;48:711–715.
  59. Bravo EL. Pheochromocytoma: an approach to antihypertensive management. *Ann NY Acad Sci* 2002;970:1–10.
  60. Sparks WJ, Seefelder C, Shamberger R, et al. The perioperative management of a patient with complex single ventricle physiology and pheochromocytoma. *Anesth Analg* 2005;100:972–975.
  61. Prys-Roberts C. Pheochromocytoma—recent progress in its management. *Br Anaesth J* 2000;85:44–57.
  62. Booij L, Van der Does A, Riedel W. Monoamine depletion in psychiatric and healthy populations: review. *Mol Psych* 2003;8:951–973.
  63. Janetschek G, Neumann HP. Laparoscopic surgery for pheochromocytoma. *Urol Clin North Am* 2001;28:97–105.
  64. Ulchaker JC, Goldfarb DA, Bravo EL, Novick AC. Successful outcomes in pheochromocytoma surgery in the modern era. *Urol J* 1999;161:764–767.
  65. Moore K, Thompson C, Trainer P. Disorders of water balance. *Clin Med* 2003;3:28–33.
  66. Fukuda I, Hizuka N, Takano K. Oral DDAVP is a good alternative therapy for patients with central diabetes insipidus: experience of five-year treatment. *Endocr J* 2003;50:437–443.
  67. Seidman PA, Kofke WA, Policare R, Young M. Anaesthetic complications of acromegaly. *Br Anaesth J* 2000;84:179–182.
  68. Verbalis JG. Management of disorders of water metabolism in patients with pituitary tumors. *Pituitary* 2002;5:119–132.
  69. Baylis PH. The syndrome of inappropriate antidiuretic hormone secretion. *Int J Biochem Cell Biol* 2003;35:1495–1499.
  70. American Diabetes Association. Diagnosis and classification of diabetes mellitus. *Diabetes Care* 2005;28(Suppl):S37–S42.
  71. American Diabetes Association. Diagnosis and classification of diabetes mellitus. *Diabetes Care* 2006;29:543–548.
  72. Falorni A, Brozzetti A. Diabetes-related antibodies in adult diabetic patients. *Best Pract Res Clin Endocrinol Metab* 2005;19:119–133.
  73. Soler NG, Soler SM, Malins JM. Neonatal morbidity among infants of diabetic mothers. *Diabetes Care* 1978;1:340.
  74. Van Den Berghe G, Wouters P, Weekers F, et al. Intensive insulin therapy in critically ill patients. *N Engl J Med* 2001;345:1359–1367.
  75. Umpierrez GE, Isaacs SD, Bazargan H, et al. Hyperglycemia: an independent marker of in hospital mortality in patients with undiagnosed diabetes. *J Clin Endocrinol Metab* 2002;87:978–982.
  76. Clemens A, Siegel E, Gallwitz B. Global risk management in type 2 diabetes: blood glucose, blood pressure, and lipids—update on the background of the current guidelines. *Exp Clin Endocrinol Diabetes* 2004;112:493–503.
  77. American Diabetes Association. Standards of medical care in diabetes. *Diabetes Care* 2005;28(Suppl):S42–S36.
  78. American Diabetes Association. Standards of medical care in diabetes. *Diabetes Care* 2006;29:S42–S42.
  79. Krentz AJ, Bailey CS. Oral antidiabetic agents: current role in type 2 diabetes mellitus. *Drugs* 2005;65:385–411.
  80. Willett LL, Albright ES. Achieving glycemic control in type 2 diabetes: a practical guide for clinicians on oral hypoglycemics. *South Med J* 2004;97:1088–1092.
  81. Vivian EM, Olarte SV, Gutierrez AM. Insulin strategies for type 2 diabetes mellitus. *Ann Pharmacother* 2004;38:1916–1923.
  82. Edelman SV, Morello CM. Strategies for insulin therapy in type 2 diabetes. *South Med J* 2005;98:363–371.
  83. Linkeschova R, Raoul M, Bott U, et al. Less severe hypoglycemia, better metabolic control, and improved quality of life in type 1 diabetes mellitus with continuous subcutaneous insulin infusion (CSII) therapy; an observational study of 100 consecutive patients followed for a mean of 2 years. *Diabetes Med* 2002;19:746–751.
  84. Davis SN. Insulin, oral hypoglycemic agents, and the pharmacology of the endocrine pancreas. Brunton LL, Lazo JS, Parker KL, eds. Goodman and Gilman's *The Pharmacological Basis of Therapeutics*. 11th ed. New York: McGraw-Hill, 2006;1613–1645.
  85. Nathan DM, Buse JB, Davidson MB, et al. Management of hyperglycemia in type 2 diabetics: a consensus statement from the American Diabetes Association and the European Association for the Study of Diabetes. *Diabetologia* 2006;49:1711–1721.
  86. Sherwin RS, Sacca L. Effect of epinephrine on glucose metabolism in humans' contribution of the liver. *Am J Physiol* 1984;247:E157.
  87. Wilmore DW. Hormonal responses and their effect on metabolism. *Surg Clin North Am* 1976;56:999.
  88. Wilmore DW. Carbohydrate metabolism in trauma. *Clin Endocrinol Metab* 1976;5:731.
  89. Russell RCG, Walker CJ, Bloom SR, et al. Hyperglucagonemia in the surgical patient. *BMJ* 1975;1:10.
  90. Sherwin R, Wahren J, Felig P, et al. Evanescent effect of hypo- and hyperglucagonemia on blood glucose homeostasis. *Metabolism* 1976;25:1381.
  91. Gelfand RA, Matthews DE, Bier DM, et al. Role of counterregulatory hormones in the catabolic response to stress. *J Clin Invest* 1984;74:2238.
  92. Wright PD, Johnston IDA. The effect of surgical operation on growth hormone levels in plasma. *Surgery* 1975;77:479.
  93. Clarke RSJ. The hyperglycemic response to different types of surgery and anesthesia. *Br J Anaesth* 1970;42:45.
  94. Stratton IM, Adler AI, Neil HA, et al. Association of glycemia with macrovascular and microvascular complications of type 2 diabetes (UKPDS 35): prospective observational study. *BMJ* 2000;321:405–412.
  95. Morgan CL, Currie CJ, Peters JR. Relationship between diabetes and mortality: a population study using record linkage. *Diabetes Care* 2000;23:211.
  96. Nesto RW. Correlation between cardiovascular disease and diabetes mellitus current concepts. *Am Med J* 2004;116:11S–22S.
  97. Hu FB, Stampfer MJ, Haffner SM, et al. Elevated risk of cardiovascular disease prior to clinical diagnosis of type 2 diabetes. *Diabetes Care* 2002;25:1129–1134.
  98. Norhammer A, Tenerey A, Nilsson G, et al. Glucose metabolism in patients with acute myocardial infarction and no previous diagnosis of diabetes mellitus: a prospective study. *Lancet* 2002;359:2140–2144.
  99. Miettinen H, Lehto S, Salomaa V, et al. Impact of diabetes on mortality after the first myocardial infarction. The FINMONICA Myocardial Infarction Register Study Group. *Diabetes Care* 1998;21:69–75.
  100. Executive summary of the third report of the National Cholesterol Education Program (NCEP) Expert Panel on Detection, Evaluation and Treatment of High Blood Cholesterol in Adults (Adult Treatment Panel III). *JAMA* 2001;285:2486–2497.
  101. Gu K, Cowie CC, Harris MI. Diabetes and decline in heart disease mortality in adults US. *JAMA* 1999;281:1291–1297.
  102. UK Prospective Diabetes Study Group. Tight blood pressure control and risk of

- macrovascular and microvascular complications in type 2 diabetes (UKPDS 38). *BMJ* 1998;317:703–713.
103. UK Prospective Diabetes Study Group. Efficacy of atenolol and captopril in reducing the risk of macrovascular complications in type 2 diabetes (UKPDS 39). *BMJ* 1998;317:713–720.
104. Hansson L, Zanchette A, Carruthers SG, et al. Effects of intensive blood pressure lowering and low dose aspirin in patients with hypertension; principal results of the hypertension optimal treatment (HOT) randomized trial. HOT study group. *Lancet* 1998;351:1755–1762.
105. The seventh report of the Joint National Committee on Prevention, Detection, Evaluation, Treatment of High Blood Pressure. The JNC 7 Report. *JAMA* 2003;289:2560–2572.
106. Heart Outcomes Prevention Evaluation Study Investigators. Effects of ramipril on cardiovascular and microvascular outcomes in people with diabetes mellitus: results of the HOPE study and MICRO-HOPE substudy. *Lancet* 2000;355:253–259.
107. Progress Group. Randomized trial of a perindopril-based blood pressure lowering regimen among 6,105 individuals with previous stroke or transient ischemic attack. *Lancet* 2001;358:1033–1041.
108. Maahs DM, Kinney GL, Wadwa P, et al. Hypertension prevalence, awareness, treatment and control in an adult type 1 diabetic population and a comparable general population. *Diabetes Care* 2005;28:301–306.
109. Heart Protection Study Collaborative Group. MRC/BHF Heart Protection Study of cholesterol lowering with simvastatin in 20,536 high risk individuals: a randomized placebo controlled trial. *Lancet* 2002;360:7–22.
110. Haffner SM, Alexander CM, Cook TJ, et al. Reduced coronary events in simvastatin-treated patients with coronary heart disease and diabetes or impaired fasting glucose levels: subgroup analysis in the Scandinavian Simvastatin Survival Study. *Arch Intern Med* 1999;159:2661–2667.
111. Rubins HB, Robbins SJ, Collins D, et al. Gemfibrozil for the secondary prevention of coronary heart disease in men with low levels of high density lipoprotein cholesterol. Veterans Affairs High-Density Lipoprotein Cholesterol Intervention Trial Study Group. *N Engl J Med* 1999;341:410–418.
112. Collins R, Armitage J, Parish S, et al. MRC/BHF Heart Protection Study of cholesterol-lowering with simvastatin in 5,963 people with diabetes: a randomized placebo controlled trial. *Lancet* 2003;361:2005–2016.
113. Grundy SM, Clemon JI, Merz CN, et al. Implications of recent clinical trials for the National Cholesterol Education Program Adult Treatment Panel Guidelines III. *J Am Coll Cardiol* 2004;44:720–732.
114. Arampatzis, CA, Goodhart D, Serruys PW, et al. Fluvastatin reduces the impact of diabetes on long term outcome after coronary intervention—a Lescol Intervention Prevention Study (LIPS) sub-study. *Am Heart J* 2005;149:329–335.
115. Colwell JA. Antiplatelet agents for the prevention of cardiovascular disease in diabetes mellitus. *Am J Cardiovasc Drugs* 2004;4:87–106.
116. American Diabetes Association. Aspirin therapy in diabetes. *Diabetes Care* 2004;27:S72–S73.
117. Final report on the aspirin component of the ongoing Physicians Health Study Research Group. *N Engl J Med* 1989;321:129–135.
118. Wackers FJ, Young LH, Inzucchi SE, et al. Detection of silent myocardial ischemia in asymptomatic diabetic subjects: the DIAD study. *Diabetes Care* 2004;27:1954–1961.
119. Sinnreich M, Taylor BU, Dyck PJ. Diabetic neuropathies. Classification, clinical features, and pathophysiological basis. *Neurologist* 2005;11:63–79.
120. Freeman R. Autonomic peripheral neuropathy. *Lancet* 2005;365:1259–1270.
121. Kelkar P. Diabetic neuropathy. *Semin Neurol* 2005;25:168–173.
122. Boulton AJM, Vinik AI, Arezzo JC. Diabetic neuropathies. A statement by the American Diabetes Association. *Diabetes Care* 2005;28:956–962.
123. Vinik AI, Mehrabyan A. Diabetic neuropathies. *Med Clin North Am* 2004;88:947–999.
124. Luukinen H, Airaksinen KE. Orthostatic hypotension predicts vascular death in older diabetic patients. *Diabetes Res Clin Pract* 2005;67:163–166.
125. Cox, DJ, Kovatchev BP, Gonder-Fredrick LA, et al. Relationships between hyperglycemia and cognitive performance among adults with type 1 and type 2 diabetes. *Diabetes Care* 2005;28:71–77.
126. Avanitakis R, Wilson RS, Schneider JA, et al. Diabetes mellitus and the progression of rigidity and gait disturbance in older persons. *Neurology* 2004;63:966–1001.
127. The DCCT Research Group. The effect of intensive treatment of diabetes on the development and progression of long-term complications in insulin dependent diabetes mellitus. *N Engl J Med* 1993;329:977–986.
128. DCCT/EDIC Writing Group. Effect of intensive therapy on the microvascular complications of type 1 diabetes mellitus. *JAMA* 2002;287:2563–2569.
129. Gilron I, Bailey JM, Tu D, et al. Morphine, gabapentin, or their combination for neuropathy pain. *N Engl J Med* 2005;352:1324–1334.
130. Tesfaye S, Chaturvedi N, Eaton SEM, et al. Vascular risk factors and diabetic neuropathy. *N Engl J Med* 2005;352:341–350.
131. American Diabetes Association. Nephropathy in diabetes. *Diabetes Care* 2004;27(Suppl):79S–83S.
132. National Kidney Foundation. Clinical practice guidelines for chronic kidney disease: evaluation, classification, and stratification. *Am J Kidney Dis* 2002;2(Suppl):S46–S75.
133. Writing Team for DCCT/EDIC Research Group. Sustained effect of intensive treatment of type 1 diabetes mellitus on development and progression of diabetic nephropathy. *JAMA* 2003;290:2159–2167.
134. Sasaki K, Yoshimura N, Chancellor MB. Implication of diabetes mellitus in urology. *Urol Clin North Am* 2003;30:1–12.
135. Kitabchi AE, Wall BM. Diabetic ketoacidosis. *Med Clin North Am* 1995;79:9–37.
136. Coursin DB, Connery LE, Ketzler JT. Perioperative diabetic and hyperglycemic management issues. *Crit Care Med* 2004;32(Suppl):S116–S125.
137. Warner ME, Contreras MG, Warner MA, et al. Diabetes mellitus and difficult laryngoscopy on renal and pancreatic transplant patients. *Anesth Analg* 1998;86:516–519.
138. Hogan K, Rusy D, Springman SR, et al. Difficult laryngoscopy and diabetes mellitus. *Anesth Analg* 1988;67:1162.
139. Reissell E, Orko R, Manunuksela E-L, et al. Predictability of difficult laryngoscopy in patients with long-term diabetes mellitus. *Anaesthesia* 1990;45:1024.
140. Alberti KGMM, Zimmet P, Shaw J. Metabolic syndrome—a new worldwide definition. A consensus statement from the International Diabetes Federation. *Diabetes Med* 2006;23:469–480.
141. Alexander CM, Landsman PB, Teutsch SM, et al. NCEP—defined metabolic syndrome, diabetes, prevalence of coronary heart disease among NHANES III participants age 50 years and older. *Diabetes* 2003;52:1210–1214.
142. Seuteri A, Najjar S, Morrell CH, et al. The metabolic syndrome in older individuals: prevalence and prediction of cardiovascular events. *Diabetes Care* 2005;28:882–887.
143. Skilton MR, Moulin P, Serusclat A, et al. A comparison of NCEP-ATP III, IDF and AHA/NHLBI metabolic syndrome definitions with relation to early carotid atherosclerosis in subjects with hypercholesterolemia or at risk for CVD. Evidence for sex specific differences. *Atherosclerosis* 2006 (In press)

# CHAPTER 13

## Evaluation of the Patient with Renal Disease

Mark Stafford-Smith, MD, CM, FRCPC, George Lappas, MD, and Andrew D Shaw, MB, BS, FRCA

“The composition of the blood is determined not by what the mouth ingests but by what the kidneys keep....”<sup>1</sup> This is the well-known quote of the renal physiologist Dr. Homer Smith that highlights not only the kidneys’ domain of influence, but why even minor renal perturbations can have widespread effects. Because the kidneys play a key role in whole-body homeostasis, review of kidney function is an essential part of even the most abbreviated perioperative assessment. Although the kidneys’ actions are generally described in terms of filtration and clearance, these tasks comprise only a part of their involvement in maintaining homeostasis. Normal renal physiology and the consequences of impairment are reviewed below in the context of their implications for the perioperative physician.

### THE NORMAL KIDNEY: CORRELATES OF STRUCTURE AND FUNCTION

The kidneys are paired mesoderm-derived retroperitoneal organs that weigh approximately 150 g each. Notably, renal tissue makes up only 0.4% of body weight but receives 25% of cardiac output; in comparison, this exceeds blood flow to muscle during heavy exercise by 8-fold and makes the kidney the most highly perfused major organ in the body. Unlike many tissues, metabolic demand is not the main determinant of blood flow to the kidney, and this “luxury perfusion” facilitates plasma filtration at rates as high as 125–140 mL per minute in adults. It is simplistic, however, to

think that the kidneys receive excess nutrients and oxygen, as this ignores marked differences in blood flow that, paradoxically, make some kidney regions (i.e., the medulla) highly vulnerable to ischemic injury.

The functions of the kidney are numerous. The normal “resting” kidney is continuously processing filtered plasma to regulate composition, including feedback mechanisms that maintain body-fluid volume, osmolality, electrolyte content and concentration, and acidity within narrow limits. Every 3 minutes an amount of water equivalent to a 12-oz soft drink is filtered, and all but 1%, or 4 mL, is returned to the circulation—the remnant is urine. Extracellular solutes are tightly regulated, including sodium, potassium, hydrogen ion, bicarbonate, and glucose. The kidney also generates ammonia and glucose, and eliminates nitrogenous and other metabolic waste, including urea, creatinine, and

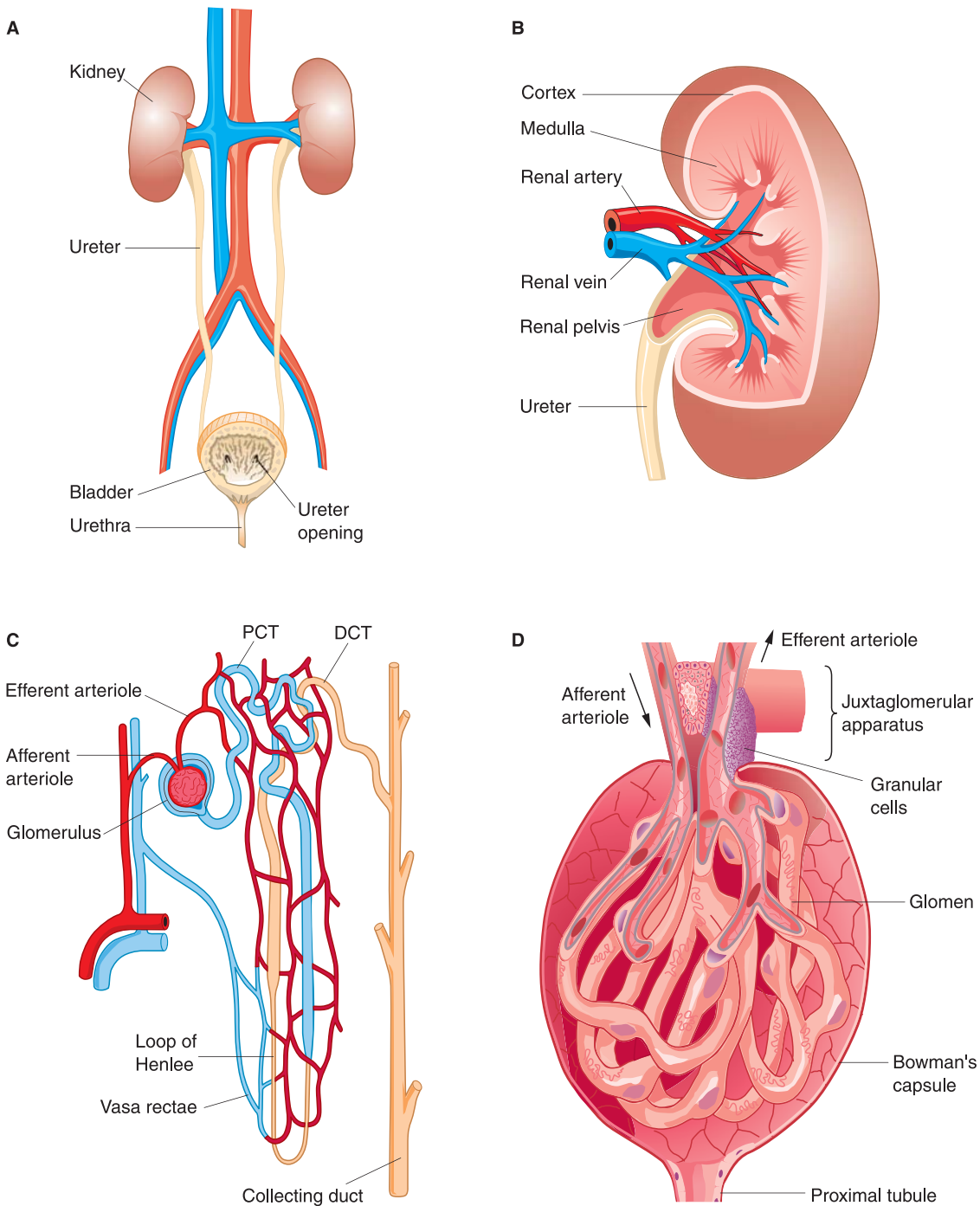
bilirubin, as well as toxins and many classes of drugs. Finally, circulating hormones secreted by the kidney influence red blood cell generation, calcium homeostasis, and systemic blood pressure.

The anatomy of the kidney has been extensively studied and is described in detail elsewhere.<sup>2</sup> In summary, each bean-shaped kidney is highly internally organized, including a superficial cortical layer, deeper medullary regions, and a network of ducts that feeds urine to the renal pelvis and onward to the ureter and bladder (Fig. 13–1). The parenchyma of each kidney contains approximately  $1 \times 10^6$  tightly packed nephrons, the functional units of the kidney. The nephron is a tubular structure that is segmented into specialized parts, including the glomerulus, proximal convoluted tubule, loop of Henle, distal convoluted tubule, and collecting duct (Fig. 13–1). The cortex, or superficial outer por-

### KEY POINTS

1. Kidney functions are centrally involved in whole-body homeostasis and normally keep body fluid volume, osmolality, electrolyte content and concentration, and acidity within narrow limits.
  2. Knowledge of normal kidney function is particularly important to interpret the physiology of the neonate, the parturient, and the elderly patient, where differentiating normal from abnormal may be challenging and even counterintuitive.
  3. While the search for a substance with “ideal” properties (i.e., steady production, complete filtration, no secretion or absorption, convenient inexpensive measurement) to assess glomerular filtration rate through its clearance from the circulation continues, serum creatinine and creatinine clearance are the current clinical standards.
  4. Kidney-mediated acid–base, electrolyte, and/or fluid disorders are common preoperatively and may be sufficiently important to require correction before surgery can proceed.
  5. Familiarity with the spectrum of acute and chronic renal disorders that may be encountered in the perioperative patient is essential to log-
- ically anticipate perioperative problems and design rational therapeutic strategies.
6. Prevention is the most important tool in the approach to perioperative acute renal injury; this requires knowledge of potential insults, including the renoprotective value of meticulous attention to maintaining normoglycemia and minimizing hemodilution and transfusion.
  7. Major renal injuries significantly impair the kidneys’ ability to maintain the internal environment; in these situations, adherence to guidelines aimed at preserving volume, electrolyte, acid–base, and nutrition balance within the limits of the remaining renal homeostatic reserve may be sufficiently effective that dialysis can be avoided.
  8. Patients with renal impairment have altered responses to normal medication dosing; a simple prescribing approach for water-soluble agents involves a calculated percentage reduction in drug dosage to match the reduction in glomerular filtration; however, drug-level measurement or algorithms for a specific drug dosing may be recommended.





**FIGURE 13–1.** **A.** The kidney is part of the genitourinary system. Reproduced with permission from <http://www.yourdictionary.com/images/ahd/jpg/A4urinar.jpg>. Last accessed April 10, 2006. **B.** The internal structure of the kidney includes the vasculature, cortex, and medulla regions, and urinary tract structures. Reproduced with permission from <http://www.nida.nih.gov/consequences/kidney/>. Last accessed April 10, 2006. **C.** The functional unit of the kidney is the nephron. From <http://www.pathology.vcu.edu/education/PathLab/pages/renalpath/rpsrhme.htm> (from Lecture 1). Last accessed April 10, 2006. Reprinted with permission of the Department of Pathology, Virginia Commonwealth University and the VCU Health System. The glomerulus is the site where plasma filtration occurs; approximately 20% of plasma entering the glomerulus (**D**) will pass through the specialized capillary wall into the Bowman capsule and enter the tubule to be processed and generate urine. DCT, distal convoluted tubule; PCT proximal convoluted tubule. From InterActive Physiology CD (ADAM) Urinary Physiology, Benjamin Cummings Publishing.

tion of the kidney, is made up primarily of glomeruli and proximal and distal convoluted tubules. The medulla is subdivided into an inner and outer (more superficial) layer and includes the loops of Henle and collecting

ducts. Nephrons are grouped by location of their glomeruli into cortical and juxtamedullary types; the latter have loops of Henle that course deep into the medulla and participate in *countercurrent exchange*, a mechanism

that makes possible the formation of highly concentrated urine (Fig. 13–2).

Like the tubules, the vasculature of the kidney is highly organized. The *renal artery* enters the kidney at the hilum, and then divides many times



Low medullary blood flow

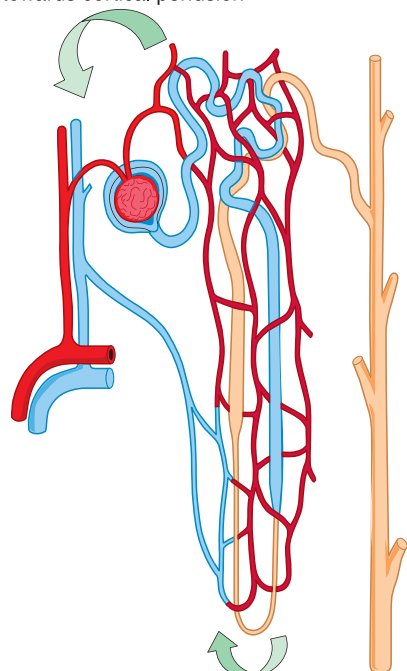
+

Countercurrent exchange

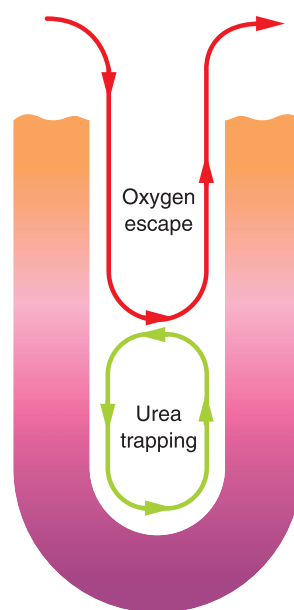
=

Medullary hypoxia

90-95% renal artery blood flow directed towards cortical perfusion



5-10% renal artery blood flow directed towards medullary perfusion



Oxygen tension (mm Hg)

Cortex

70  
50

Outer medulla

30  
20

Inner medulla

10  
7

**FIGURE 13-2.** Medullary hypoxia refers to the physiologically very low  $PO_2$  values (e.g., 10–20 mm Hg) in the renal medulla that are present even under normal conditions. Factors contributing to this state include a high rate of oxygen consumption, relatively poor blood supply, and inefficient oxygen delivery related to countercurrent  $O_2$  “escape” as a result of the parallel arrangement of entering and exiting capillaries. Ironically, this same sluggish perfusion is also essential to create and maintain the urea gradient required to concentrate urine. Reprinted from Grocott HP, Stafford-Smith M. Organ protection during cardiopulmonary bypass. In: Kaplan JA, Reich DL, Lake CL, Konstadt SN, eds. *Cardiac Anesthesia*. 5th ed. Philadelphia: Elsevier, 2006:985–1022, with permission from Elsevier.

before producing the *arcuate arteries* that run along the boundary between cortex and outer medulla. *Interlobular arteries* branch from arcuate arteries toward the outer kidney surface, giving rise as they pass through the cortex to numerous *afferent arterioles* that each lead to a single *glomerular capillary tuft*. The barrier where filtration from the vascular to tubular space within the glomerulus occurs is highly specialized and includes fenestrated, negatively charged, capillary endothelial cells and tubular epithelial cells (podocytes) separated by a basement membrane. Normally, selective permeability permits approximately 25% of the plasma elements to pass into the Bowman capsule; only cells and proteins larger than 60–70 kDa cannot cross. However, abnormalities of this barrier can occur with disease that may permit filtration of much larger proteins and even red blood cells; these changes manifest as nephrotic syndrome (proteinuria >3.5 g/24 h) or glomerulonephritis (hematuria and proteinuria).

The glomerular capillaries exit the Bowman capsule and merge to form the *efferent arteriole* and *peritubular capillaries* that nourish the tubules. The renal vasculature is unusual in having this arrangement of two capillary beds joined in series by arterioles. Two major types of nephrons exist: the majority (85%) have glomeruli closer to the outer surface of the kidney, and tubular structures that remain predominantly in the cortex and are termed *cortical nephrons*, whereas nephrons with glomeruli located in the deep portion of the cortex (the *juxtamedullary glomeruli*) have associated loops of Henle, which form hairpin loops that pass deep into the medulla. The peritubular capillaries that accompany the medullary loops of Henle are known as *vasa rectae*. Collectively, the peritubular capillaries perfuse tubular cells and receive reabsorbed fluids before rejoining to form *venules*. Throughout the kidney, the venous system runs in parallel and close to the arterial vasculature, ultimately returning blood to

the circulation through the *renal vein*. The vasculature of the kidney is strictly segmental, hence embolic obstruction of an arteriole will cause infarction of a “pizza wedge” of parenchyma encompassing the involved glomeruli and all cortical and medullary tubular elements of the affected nephrons.

In summary, the plasma fraction that has been filtered through the glomerular capillary membrane ( $\sim 120$  mL/min) enters the Bowman capsule and passes into the proximal convoluted tubule where active transport processes facilitate absorption of up to two-thirds of the water and electrolytes. The remaining tubular fluid then enters the loop of Henle and distal convoluted tubule where two-thirds of what remains is reabsorbed and further processing occurs. Finally, the effluent (5–10 mL/h) passes from the collecting duct, where more water is reabsorbed, into urine-collecting structures (1–2 mL/min).

To facilitate the specialized goals of the kidney, an important physiologic

TABLE 13-1.

## Clinical Correlates of Glomerular Filtration Rate Values

GFR Value	Serum Creatinine (mg/dL)	Implication
120 mL/min	1.0	Normal (healthy, 20-year-old)
80 mL/min	1.2	Normal (healthy, 65-year-old)
60 mL/min	1.1	Normal (healthy, 85-year-old)
30–60 mL/min	1.3–2.5	Moderate renal dysfunction; dosage adjustments may be needed
15–29 mL/min	1.7–3.5	Severe decrease in GFR may reflect chronic disease, prerenal failure, or acute tubular necrosis
<15 mL/min	2.0–18.0	Renal failure (acute or chronic) requiring dialysis

Normal kidney filtration keeps serum creatinine levels stable with increasing age as a result of the roughly matched age-related decline in GFR (creatinine clearance) and the reduction in creatinine generation by muscle. In the elderly, moderate to severe degrees of renal impairment can be associated with only modest rises in serum creatinine.

compromise has evolved in the renal medulla that permits the formation of highly concentrated urine at the expense of diminished oxygen reserve; it is this precarious arrangement that underlies the extreme vulnerability of the renal medulla to ischemic injury (see Postoperative Renal Disorders below).<sup>3</sup> *Medullary hypoxia* is a key concept that refers to the fine balance between oxygen supply and demand that exists in the medulla, even during normal resting conditions. Factors necessary to create a urea gradient and allow countercurrent exchange conspire to make normal PO<sub>2</sub> values in the medulla very low (e.g., 10–20 mm Hg); these include sluggish blood supply (5–10% of renal blood flow) and high oxygen demand from active solute transport. Finally, medullary O<sub>2</sub> delivery is inefficient because of the unique hairpin loop anatomy of the vasa rectae that allows “O<sub>2</sub> escape” from entering or exiting capillaries (Fig. 13-2).<sup>4,5</sup>

## CLINICAL ASSESSMENT OF THE KIDNEY

There is general agreement that measures such as urine output correlate extremely poorly with the rate of renal filtration;<sup>6</sup> however, much information about the state of the kidneys can be gained by evaluating how effectively they clear circulating substances. Urinalysis can also be informative.

## Renal Function Tests

Filtration is the most clinically assessed renal function. As a key indicator of perioperative renal disease, knowledge of limited filtration capacity is important in preoperative risk stratification and guides drug management for agents cleared by the kidneys. In addition, acute declines in filtration capacity indicate renal injury and consistently predict a more complicated clinical course.<sup>7</sup> *Glomerular filtration rate* (GFR) refers to the plasma volume filtered by the kidneys per unit time, and normal values range from 90–137 mL/min. Normal glomerular filtration rates are proportionate to patient size and body surface area, and decline approximately 10% per decade after age 30 years (Table 13-1).<sup>8</sup> Generally men have GFR values approximately 10 mL/min higher than women. GFR values below 60 mL/min are considered moderately impaired, and individuals with GFRs below 15 mL/min often have uremic symptoms and may require dialysis.

Any substance used to assess GFR through its clearance from the circulation must have certain “ideal” properties, which include a steady supply to the circulation, free filtration by glomeruli, no reabsorption or excretion by the tubules, and, preferably, easily measured in blood and urine. Unfortunately, such an ideal substance has yet to be identified. The most precise and accurate GFR determination tools involve cumbersome “gold-standard” method-

ologies (e.g., inulin, chromium-51-labeled ethylenediaminetetraacetate [<sup>51</sup>Cr-EDTA] or technetium-99-labeled diethylenetriamine pentaacetic acid [<sup>99</sup>Tc-DTPA] clearance), while the most practical and inexpensive tests involve imperfect “ideal” substances (e.g., creatinine). Overall, despite creatinine’s limitations as a marker, its relatively steady supply from muscle breakdown and modest tubular secretion make it the most clinically useful renal filtration marker currently available. Although more “ideal” substances are being sought as practical clinical tools, candidates currently under evaluation (e.g., cystatin C<sup>9,10</sup>) have yet to be generally accepted as superior to creatinine.

Estimates of GFR (eGFR) can be made by determining *creatinine clearance* (CrCl) from blood and urine creatinine tests. In stable, critically ill patients, 2-hour urine collections are sufficient to determine CrCl,<sup>11</sup> calculated using the following formula:

$$\text{CrCl (mL/min)} = \frac{U_{\text{Cr}} \text{ (mg/dL)} \times V \text{ (mL)}}{P_{\text{Cr}} \text{ (mg/dL)} \times \text{time (min)}}$$

where U<sub>Cr</sub> = urine creatinine; V = total volume of urine collected; P<sub>Cr</sub> = plasma creatinine; and time = collection time.

However, GFR can also be predicted using a single steady-state serum creatinine value if patient characteristics are known. Importantly, predictive formulas are developed in stable nonoperative populations, and perioperative fluid shifts may introduce an “unsteadiness” to the operative patient that makes serum creatinine less useful to predict GFR. Nonetheless, serum creatinine remains a useful, inexpensive, and, so far, unsurpassed clinical tool, particularly for reflecting *trends* of change in renal filtration function and predicting outcome, even during the perioperative period.<sup>12–14</sup> Of the many predictive formulas that exist, the Cockcroft-Gault equation has been the most validated and durable.<sup>15</sup> The Cockcroft-Gault equation estimates GFR based on patient gender, age (years), weight (kg), and serum creatinine (mg/dL):

$$\text{Males: Cockcroft-Gault eGFR (mL/min)} = \frac{(140 \times \text{age}) \times \text{weight (kg)}}{(\text{Cr [mg/dL]} \times 72)}$$

$$\text{Females: Cockcroft-Gault eGFR (mL/min)} = \frac{(140 \times \text{age}) \times \text{weight (kg)}}{(\text{Cr [mg/dL]} \times 0.85)}$$

An estimating method from the Modification of Diet in Renal Disease (MDRD) study that adds knowledge of ethnicity (black versus nonblack) to standard components of the Cockcroft-Gault equation may improve accuracy.<sup>16</sup> An abbreviated MDRD Formula is available that can estimate GFR measured in mL/min/1.73 m<sup>2</sup>:

Nonblack males:  $eGFR = 186 \times (\text{serum creatinine mg/dL})^{1.154} \times (\text{age})^{0.203}$

Nonblack females:  $eGFR = 186 \times (\text{serum creatinine mg/dL})^{1.154} \times (\text{age})^{0.203} \times 0.742$

All blacks:  $eGFR = 186 \times (\text{serum creatinine mg/dL})^{1.154} \times (\text{age})^{0.203} \times 1.210$

However, even the most detailed MDRD eGFR equation under ideal conditions correlates poorly with GFR determined using “gold-standard” tools, with more than a 30% error in 10% of patients and 2% of results deviating more than 50%.<sup>16</sup>

Some consensus definitions for significant perioperative renal dysfunction have been published. For example, the Society of Thoracic Surgeons definition of postoperative renal failure includes either a new requirement for dialysis, a rise in serum creatinine to greater than 2.0 mg/dL, or at least a 50% increase in serum creatinine over baseline values.<sup>17</sup> Another definition requires serum creatinine to rise more than 25% or 0.5 mg/dL (44 μmol/L) within 48 hours.<sup>18</sup> The Acute Dialysis Quality Initiative Group definition for critically ill patients grades acute renal failure by an acute creatinine rise as follows: a rise of 50% = Risk; of 100% = Injury; of 200% = Failure (the RIFLE criteria).<sup>19</sup> Notably, serum creatinine does not usually rise significantly until GFR rates fall below 50 mL/min, so preoperative serum creatinine may be normal in patients even with some degree of renal dysfunction.

Blood urea nitrogen (BUN) remains widely used to assess renal function but possesses few of the characteristics of an “ideal” substance. Tubular transport of urea changes with some conditions (e.g., dehydration), and urea generation can also be highly variable, particularly in the postoperative period (e.g., catabolic state). In addition, perioperative hemodilution (e.g., cardiopulmonary bypass) may affect circulating BUN levels.

## Urinalysis and Urine Characteristics

The examination of urine can reveal much information. Standard aspects of urinalysis include gross appearance, specific gravity, chemical tests for abnormal substances, and microscopic examination for cells and formed elements.

Urine inspection can reveal abnormal color, cloudiness, and unexpected odors. Because there are many available detailed descriptions of examination of the urine,<sup>20</sup> we provide only a summary here. Color changes reflect increased amounts of dissolved substances; this occurs most commonly with dehydration, but other causes include food colorings, drugs, and liver disease (e.g., bilirubin). In contrast, cloudy urine is caused by suspended elements such as crystals and/or white or red blood cells. Lightly centrifuged urine sediment will normally reveal up to 2 red blood cells per high-power field (400×). In addition, normal urine will contain up to 80 ± 20 mg protein per day. As noted above, high levels of red blood cells or protein reflect abnormal kidney function. Urine protein electrophoresis can trace proteinuria to a glomerular (filtering), tubular (reuptake), overflow (supply that saturates the reuptake system), or tissue (e.g., kidney inflammation) abnormality.<sup>21</sup> Unusual odors are less common but can also be diagnostic (e.g., maple syrup urine disease). Chromogenic “dipstick” chemical tests can determine urine pH and provide a semi-quantitative analysis of protein, glucose, ketones, blood, urobilinogen, bilirubin, nitrites, and leukocyte esterase. In addition, urine microscopy can identify bacteria, crystals, cells, and casts from renal tubules.

Urine specific gravity refers to the weight of urine relative to distilled water; normal values range between 1.001 and 1.035. Specific gravity is often used as a surrogate for osmolality (normal range 50–1000 mOsm/kg), with 1.010 reflecting a urine specific gravity the same as plasma osmolality. High specific gravity (>1.018) implies a preserved concentrating ability of the kidney, unless substances that raise specific gravity without significantly changing osmolality are present in large amounts (e.g., glucose, protein, contrast dye).

Although poor urine output (e.g., <400 mL urine/24 h) may reflect hypovolemia or impending *prerenal*

failure, the majority of renal failure episodes develop in the presence of normal urine output.<sup>6</sup> The kidney's typical response to hypovolemia is to retain solute; this produces concentrated urine with a low sodium content (<20 mEq/L) through fluid and electrolyte retention. In contrast, if renal injury has impaired concentrating ability, urine will approach plasma osmolality (isosthenuria) and have a higher sodium content (>40 mEq/L). Calculation of *fractional excretion of sodium* ( $FE_{Na}$ ) evaluates the kidneys' ability to retain electrolytes by comparing sodium and creatinine excretion from a spot sample of urine and blood; this test can be useful to distinguish hypovolemia and renal injury:

$$FE_{Na} = U_{Na}/P_{Na} \times P_{Cr}/U_{Cr} \times 100$$

where  $U_{Na}$  = urine sodium;  $P_{Na}$  = plasma sodium;  $U_{Cr}$  = urine creatinine; and  $P_{Cr}$  = plasma creatinine.

$FE_{Na}$  values less than 1% imply that sodium is being normally conserved by the tubules, whereas values greater than 1% are consistent with acute tubular necrosis.

## THE NORMAL KIDNEY IN SPECIAL CIRCUMSTANCES: MATURATION, AGING, AND PREGNANCY

For additional discussion see Chaps. 19–22.

### The Immature Kidney

Amniotic fluid (fetal urine) through the third trimester amounts to about a cup every hour. At birth, much of the anatomic development of the kidney has occurred, including growth of approximately 1 million nephrons per kidney. However, nephrons continue to increase in size and steadily gain function with some kidney activities reaching adult levels as early as a few weeks after birth (e.g., urine acidification), whereas other measures of renal function only attain adult levels by 1–3 years of age (e.g., renal blood flow, GFR, urea clearance, tubular excretion and concentrating capacity).<sup>22</sup> Renal development in preterm infants is correlated with conceptual age, and normal kidney function will be achieved in these children, but may be delayed. Children undergoing heart surgery are vulnerable to postoperative renal dys-

function relative to adults, and renal failure following surgery that requires dialysis carries a particularly grave prognosis.<sup>23</sup>

### The Kidney during Pregnancy

Progesterone and relaxin, hormones secreted by the corpus luteum, are believed to mediate most of the renal effects of pregnancy. Renal blood flow, GFR, and clearance of nitrogenous waste rise early in pregnancy and are 50–60% increased at term, making typical serum creatinine and urea values 40% lower (and levels that are usually considered normal concerning high) for pregnant patients. In addition, saturation of tubular uptake mechanisms may contribute to the aminoaciduria, proteinuria, and glycosuria that are common. Other renally mediated alterations include mild hyponatremia and mild alkalemia with bicarbonate and carbon dioxide tension (PCO<sub>2</sub>) values 4 mEq/L and 10 mm Hg below normal, respectively. Maternal blood volume is doubled by 7 months, and at term the pregnant mother is 7.5 L of water and 900 mmol of sodium net-positive. Preterm labor can be precipitated by dehydration and sometimes halted by rehydration. Hormonal and obstructive factors (i.e., compression of the ureter between the pelvic rim and gravid uterus) cause dilation of all the urine-collecting structures from the first trimester to 3–4 months after delivery. The major practical concern from the resulting stasis is increased risk for urinary tract infection.

### The Aging Kidney

An approximately parallel progressive decline of all renal functions with age starts around 30–40 years of age, including renal blood flow, GFR, tubular active transport, urine concentration, dilution, and acidification.<sup>24</sup> In addition, decreased thirst and impaired hormonal functioning of the renin-angiotensin system, vitamin D metabolism, and antidiuretic hormone response are also associated with aging. Because creatinine clearance and production of creatinine from muscle decrease at approximately the same rate (1% per year), it would be expected that serum creatinine values would also change; curiously, the values typically do not change with age (Table 13-1).<sup>25,26</sup> However, by the eighth decade, GFR is reduced by 33–50%.<sup>27</sup> The

practical consequences of these changes include reduced renal reserve to deal with extreme challenges of any kind to the internal environment and changes in the pharmacokinetics of drugs that are cleared by the kidneys. Drug toxicity is a common problem in the elderly, and drug dosage decisions should be based on knowledge of kidney function. In addition, the aging kidney is more likely to be subjected to potentially harmful processes including chronic illness (e.g., hypertension, diabetes, atherosclerosis) and toxic drugs (e.g., nonsteroidal antiinflammatory drugs, antibiotics, and diuretics).<sup>28</sup>

## ACID-BASE, FLUID, AND ELECTROLYTE DISORDERS

For additional discussion see Chap. 42.

Awareness of kidney-mediated acid-base, electrolyte and/or fluid disorders prior to a procedure may significantly reduce perioperative risk by influencing selection of intravenous fluids and choice of anesthetic agents, and, occasionally, by requiring that an operation be delayed to correct abnormalities; consequently, these conditions are reviewed below.

### Sodium Disorders

Sodium is the principal electrolyte of the extracellular environment and derangements of this cation primarily affect normal functioning of excitable cells, including nerve and muscle tissue. Normal serum values are regulated by the kidney to between 135 and 145 mmol/L but may be falsely lowered as a consequence of hyperglycemia, hyperproteinemia, or hyperlipidemia; low serum osmolality differentiates true hyponatremia from pseudohyponatremia.

### Hyponatremia

Hyponatremia is the most common electrolyte disorder.<sup>29,30</sup> Symptoms rarely occur unless sodium values are less than 125 mmol/L, and these include a spectrum ranging from anorexia, nausea, and lethargy to convulsions, arrhythmias, coma, and even death as a consequence of osmotic brain swelling.<sup>31–33</sup> These symptoms resemble those from local anesthetic toxicity, presumably because of the local anesthetic-related sodium channel blockade. Notably, excessively rapid correction of chronic hyponatremia can also produce severe neurologic

TABLE 13-2.

### Causes of Hyponatremia

Volume Status	
Hypovolemic	Edema as a consequence of burns Sweating Hemorrhage Peritonitis Diuretics GI loss Vomiting Diarrhea Pancreatitis
Euvolemic	SIADH Pseudohyponatremia Hyperglycemia Hyperlipidemia Hyperproteinemia
Hypervolemic	Cirrhosis TURP syndrome CHF Nephrotic syndrome Primary polydipsia Dilute infant formula Hyperthyroidism Glucocorticoid deficiency

CHF, congestive heart failure; GI, gastrointestinal; SIADH, syndrome of inappropriate antidiuretic hormone; TURP, transurethral resection of the prostate.

deficit (central pontine myelinolysis) and death.<sup>34</sup> Hyponatremia may occur in the setting of an expanded, normal, or contracted extracellular fluid volume (Table 13-2). Volume status and urine sodium concentration are key markers in differentiating the large number of potential causes of hyponatremia. If water excess is a reason for hyponatremia, dilute urine (sodium >20 mmol/L) is expected, whereas avid sodium conservation (urine sodium <20 mmol/L) suggests sodium loss as a cause.

If hyponatremia is acute, the risk of neurologic complications is higher, and cautious treatment may be indicated to prevent cerebral edema and seizures. This should be accomplished with intravenous hypertonic saline and furosemide to enhance water excretion and prevent sodium overload. More conservative management, such as water restriction, is the usual treatment for chronic hyponatremia, which



should only be treated aggressively if symptomatic.

### Hyponatremia

Hyponatremia (serum sodium  $>145$  mmol/L) is generally the result of sodium gain or water loss, most commonly caused by a negative water balance as with respiratory losses, sweating, and urinary losses without replacement. Febrile infants have immature kidneys and a greater surface area per unit of body mass; as a result, febrile infants are particularly at risk for water losses. Dehydration of brain cells leads to symptoms ranging from confusion to convulsions and coma.

In evaluating the hyponatremic patient, laboratory studies often show evidence of hemoconcentration (increased hematocrit and serum protein concentrations). In addition, urine output is usually low ( $<500$  mL/d) and hyperosmolar ( $>1000$  mOsm), with very low urine sodium concentration and evidence of prerenal failure (elevations of BUN and serum creatinine). Occasionally the urine is not maximally concentrated, suggesting an osmotic diuresis or an intrinsic renal disorder such as diabetes insipidus. The primary goal of treatment is restoration of serum tonicity that can be achieved with isotonic or hypotonic parenteral fluids and/or diuretics unless irreversible renal injury is present where dialysis may be necessary.

### Metabolic Acid–Base Disorders

The balance between plasma bicarbonate ( $\text{HCO}_3^-$ ) concentration and  $\text{PCO}_2$  in the extracellular space is the primary factor that predicts serum pH. Acid–base homeostasis involves the tight regulation of  $\text{HCO}_3^-$  and  $\text{PCO}_2$ . Primary extracellular pH derangements caused by abnormal bicarbonate reabsorption and proton ( $\text{H}^+$ ) elimination by the kidney cause metabolic acidosis or alkalosis, whereas factors that abnormally affect respiratory drive influence  $\text{PCO}_2$  tension, leading to respiratory acidosis or alkalosis (Fig. 13–3). Because combined problems are often seen in perioperative critically ill patients, an approach to both “pure” and “mixed” acid–base disorders is presented below.

#### Metabolic Acidosis

Accumulation of nonvolatile acid can result from numerous causes and is the basis for metabolic acidosis. The “anion gap” represents the concentration of all unmeasured anions and can be calculated

from serum electrolyte values (anion gap =  $[\text{Na}^+] - ([\text{HCO}_3^-] + [\text{Cl}^-])$ ) to differentiate metabolic acidosis into normal anion gap ( $8 \pm 4$ ) and increased anion gap ( $>16$  mmol/L) types. Only conditions that cause an increase in negatively charged ions other than bicarbonate and chloride (e.g., lactate, salicylate) will increase the anion gap. In contrast, typically nonanion gap metabolic acidosis results from renal or gastrointestinal bicarbonate loss and is associated with high chloride levels (*hyperchloremic metabolic acidosis*). A usual compensatory response to all types of metabolic acidosis is hyperventilation leading to a partial pH correction towards normal. *Winter's formula* predicts expected  $\text{PCO}_2$  for a metabolic acidosis as follows:

$$\text{PCO}_2 = (1.5 \times [\text{HCO}_3^-]) + 8 \pm 2$$

#### Metabolic Alkalosis

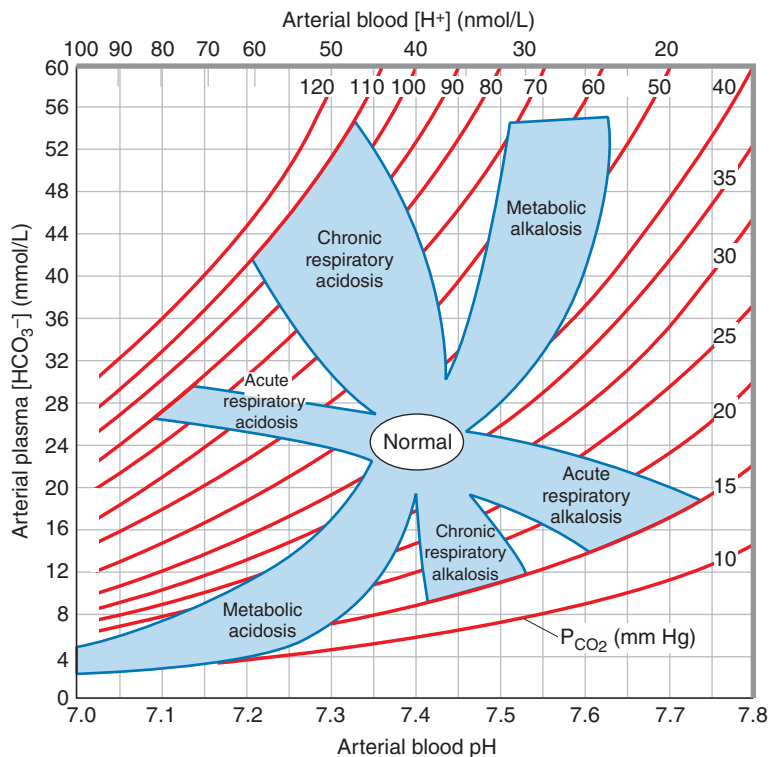
Metabolic alkalosis is a very common primary acid–base disturbance associated with increased plasma  $\text{HCO}_3^-$ ; an analysis of more than 13,000 arterial blood gas samples found metabolic alkalosis in 51% of those with an acid–

base abnormality.<sup>35</sup> Increased extracellular  $\text{HCO}_3^-$  is due to net loss of  $\text{H}^+$  and/or addition of  $\text{HCO}_3^-$ . The most common cause of metabolic alkalosis is gastrointestinal acid loss because of vomiting or nasogastric suctioning; the resulting hypovolemia leads to secretion of renin and aldosterone and enhanced absorption of  $\text{HCO}_3^-$ . Diuretics are another common cause of metabolic alkalosis. Thiazides (e.g., hydrochlorothiazide) and loop diuretics (e.g., furosemide) induce a net loss of chloride and free water, without altering bicarbonate excretion, and can cause a volume “contraction” alkalosis. When metabolic alkalosis is persistent, it usually reflects an inability of the kidney to excrete  $\text{HCO}_3^-$ . Rare inherited renal causes of metabolic alkalosis exist (e.g., Bartter syndrome). A typical respiratory response to all types of metabolic alkalosis is hypoventilation leading to a pH correction towards normal.

### Respiratory Acid–Base Disorders

#### Respiratory Acidosis

If the lungs fail to eliminate  $\text{CO}_2$ , hypercapnia and respiratory acidosis re-



**FIGURE 13–3.** Acid–base map. Plotting plasma  $\text{HCO}_3^-$  (from the serum chemistry panel) against the  $\text{PCO}_2$  and  $\text{H}^+$  (from the arterial blood gas) will fall in the shaded areas in a simple acid–base disorder. Should a mixed disorder exist, the values may fall in the nonshaded areas. Reprinted from DuBose TD Jr. Acid–base disorders. In: Brenner BM, ed. Brenner & Rector’s The Kidney. 7th ed. Philadelphia: WB Saunders, 2004:938, with permission from Elsevier.

sult, characterized by increased  $\text{PCO}_2$  and decreased blood pH. Acute and chronic etiologies can be differentiated by examining arterial pH,  $\text{PCO}_2$ , and  $\text{HCO}_3^-$  values. In the early phase of respiratory acidosis, increased  $\text{PCO}_2$  stimulates renal generation and secretion of  $\text{H}^+$ . The kidneys continue to adapt to the increased pH through greater titratable acid excretion (e.g., ammonium) and  $\text{HCO}_3^-$  generation. Therefore, acute respiratory acidosis is characterized by an elevated  $\text{PCO}_2$ , acidemia, and a relatively normal  $\text{HCO}_3^-$ . In contrast, chronic respiratory acidosis is associated with an elevated  $\text{HCO}_3^-$  caused by renal compensation. Important information about the cause of primary respiratory acidosis is usually available from the history and physical examination. In the acute postoperative period, respiratory effort may be labored (e.g., bronchospasm, pulmonary edema) or depressed because of medications such as opioids, sedatives, or residual volatile anesthetic agents. In contrast, obesity, restrictive and obstructive lung diseases, and neuromuscular diseases (e.g., myasthenia gravis, Guillain-Barré syndrome) are all potential causes of chronic hypoventilation and respiratory acidosis.

### Respiratory Alkalosis

Increased minute ventilation is the primary cause of respiratory alkalosis, characterized by decreased  $\text{PCO}_2$  and increased pH. Patients with acute, uncompensated respiratory alkalosis have normal plasma  $\text{HCO}_3^-$ . In chronic respiratory alkalosis, renal compensation will lead to decreased plasma  $\text{HCO}_3^-$ . The causes of respiratory alkalosis relate to abnormal respiratory drive because of stimulants or toxins (e.g., salicylate, caffeine, nicotine, progesterone), central nervous system abnormalities (e.g., anxiety, stroke, increased intracranial pressure), pulmonary abnormalities (e.g., pulmonary embolus, pneumonia), mechanical hyperventilation, or systemic conditions, such as liver failure and sepsis.

### Mixed Acid–Base Disorders

It is common for a metabolic derangement to coexist with a respiratory derangement, particularly in the intensive care unit setting. For example, a patient subjected to an aggressive diuresis who is also overly sedated may have a “normal” blood pH in the presence of coexisting respiratory acidosis

and metabolic (contraction) alkalosis. Although the patient's acid–base status is far from normal, the Henderson-Hasselbalch equation ( $\text{pH} = \text{pK} + \log \left( \frac{[\text{HCO}_3^-]}{0.03 \times \text{PCO}_2} \right)$ ) predicts that as long as a normal ratio exists between  $\text{HCO}_3^-$  and  $\text{Paco}_2$ , blood pH will be normal. Conversely, a normal concentration of  $\text{HCO}_3^-$  only predicts a normal pH if the  $\text{Paco}_2$  is also normal.

A general approach to the diagnosis of mixed acid–base disorder requires a stepwise logical approach that begins with a focused history and physical examination. An arterial blood gas (ABG) and a simultaneously obtained “chemistry panel” that includes  $\text{Na}^+$ ,  $\text{K}^+$ ,  $\text{Cl}^-$ , and total  $\text{CO}_2$  concentrations, should also be obtained, and use of an acid–base map will differentiate simple from mixed disorders (Fig. 13–3).

### Potassium Disorders

It is critical that there be minimal fluctuation in extracellular potassium levels as even minor variations can lead to skeletal muscle weakness, gastrointestinal ileus, rhabdomyolysis, myocardial depression, malignant ventricular arrhythmias, and sudden death. Nearly 98% of total-body potassium (50 mEq/kg) is intracellular. Circulating potassium levels are tightly controlled chronically through renal and gastrointestinal excretion–reabsorption, as well as by short-term exchanges between the intra- and extracellular compartment under the influence of mediators such as insulin and  $\beta_2$ -adrenergic receptors. Dietary potassium ingested approximates 100 mEq per day and is normally balanced by the same amount of excretion by the kidneys (90–95%) and gut (5–10%) to regulate and maintain the extracellular potassium level between 3.5 and 4.4 mEq/L. In the kidney, 70% of potassium reabsorption occurs in the proximal tubule and another 15–20% in the loop of Henle. The collecting duct is responsible for potassium excretion under the influence of aldosterone. Renal potassium secretion is also influenced by the rate of distal tubule fluid flow and acid–base balance. Increased distal tubule flow increases, whereas metabolic acidosis (and to a lesser extent respiratory acidosis) suppresses, potassium secretion. Metabolic alkalosis has the opposite effect.

### Hypokalemia

Low serum potassium may be a result of net potassium deficiency or of

transfer of extracellular potassium to the intracellular space. Notably, total-body depletion may exist even with normal extracellular potassium levels (e.g., diabetic ketoacidosis). Causes of hypokalemia can be grouped into extrarenal loss (e.g., vomiting, diarrhea), renal loss (impaired processing caused by drugs, hormones, or inherited renal abnormalities), potassium shifts between the extra- and intracellular spaces (e.g., insulin therapy), and, rarely, inadequate intake. Clinical manifestations of hypokalemia include electrocardiogram (ECG) changes (flattened T waves, U waves, proarrhythmic state) and skeletal muscle weakness, and because hypokalemia interferes with the concentrating ability of the kidney, nephrogenic diabetes insipidus can also result. Hypokalemia treatment involves supplementation with intravenous or oral potassium; however, overly rapid potassium intravenous administration should be avoided as it can cause hyperkalemic cardiac arrest.

### Hyperkalemia

If a patient has elevated serum potassium levels ( $>4.4$  mEq/L), it is important to discover the duration of the condition as chronic hyperkalemia is better tolerated than acute rises. Beyond laboratory artifact (e.g., hemolyzed sample), causes of hyperkalemia can result from abnormal kidney excretion, abnormal potassium release from cells, or abnormal potassium distribution between the intra- and extracellular spaces. Table 13–3 lists some commonly encountered causes of hyperkalemia. The ECG is a useful test to evaluate the significance of hyperkalemia to a patient's cardiac conduction system, as a good example of the spectrum of acute hyperkalemic ECG occurs during cardiac surgery when high-potassium cardioplegia is administered. Changes include peaked T waves, shortened QT interval, and ST-segment depression with mild potassium elevations, widened QRS complex, increased PR interval, and decreased P-wave amplitude with moderate elevation, and absent P waves, sine wave QRS, ventricular fibrillation, and asystole when hyperkalemia is severe. The anesthesiologist must be aware of drugs that can acutely raise potassium levels (e.g., succinylcholine,  $\beta$ -blockers, certain antibiotics). Fortunately, several therapies can shift potassium

into the intracellular space to treat acute hyperkalemia (Fig. 13-4).

### Calcium, Magnesium, and Phosphorus Disorders

Adults contain 1–2 kg of calcium. Most calcium is in bone (98%); the remaining 2% exists in 1 of 3 forms: ionized, chelated, or protein bound. Normal serum calcium values range between 8.5 and 10.2 mg/dL, but only the ionized fraction (50%) is biologically active and precisely regulated. Ionized extracellular calcium concentration ( $iCa^{2+}$ ) is controlled by the combined actions of parathyroid hormone (PTH), calcitonin, and vitamin D, and further modulated by dietary and environmental factors. Hypocalcemia caused by reduced serum protein levels (e.g., hypoalbuminemia) is physiologically unimportant. Extracellular magnesium represents only 0.3% of total (mainly intracellular) stores, making normal serum levels (1.6–2.2 mg/dL) a poor reflection of total-body magnesium. Magnesium is an essential cofactor in adenosine triphosphate (ATP) reactions, DNA replication and transcription, and translation of messenger ribonucleic acid (mRNA), and deficits may have deleterious effects on energy production and protein metabolism. Phosphorus is a major intracellular anion that plays a role in regulation of glycolysis, ammoniagenesis, and calcium homeostasis, and is an essential component of ATP and red blood cell 2,3-diphosphoglyceric acid synthesis.

#### Hypocalcemia

Clinical manifestations of hypocalcemia are mainly neurologic and muscular, including cramping, numbness in the digits, laryngeal spasm, carpopedal spasm, bronchospasm, seizures, and even respiratory arrest. A positive *Chvostek sign* (facial muscle twitching in response to tapping the facial nerve) or *Trousseau sign* (carpal spasm induced by brachial artery occlusion) is classic for hypocalcemia but often absent. Mental status changes, including irritability, depression, and impaired cognition may also occur. Cardiac manifestations include QT interval shortening and arrhythmias. Dry skin, coarse hair, alopecia, brittle nails, and evidence of basal ganglia and cerebral cortex calcifications may develop with long-standing hypocalcemia.

Hypocalcemia may be caused by several mechanisms (Table 13-4), in-

TABLE 13-3.

#### Causes of Hyperkalemia

Pseudohyperkalemia	Hemolysis Leukocytosis Thrombocytopenia
Decreased renal potassium excretion	Acute or chronic kidney failure Aldosterone deficiency Diabetic nephropathy Adrenal insufficiency Drugs (e.g., potassium-sparing diuretics, some antibiotics, spironolactone, $\beta$ -blockers)
Abnormal potassium distribution	Intrinsic kidney disease Insulin deficiency Metabolic or respiratory acidosis
Abnormal potassium release from cells	Rhabdomyolysis Tumor lysis syndrome

Reprinted and adapted from Greenberg A. Primer on Kidney Diseases. 4th ed. Philadelphia: WB Saunders, 2005:116, with permission from Elsevier.

cluding a decrease in PTH secretion or action, a reduction in vitamin D synthesis or action, resistance of bone to PTH or vitamin D effects, or calcium sequestration. Administration of large amounts of citrate-containing blood may precipitate hypotension, particularly when given rapidly, and is the most common perioperative

cause of symptomatic hypocalcemia.<sup>36</sup> Citrate used for regional anticoagulation with dialysis can also cause hypocalcemia and may also lead to hypomagnesemia from decreased PTH secretion. Deliberate or inadvertent parathyroidectomy during neck surgery will reduce PTH levels and is the most common cause of acquired

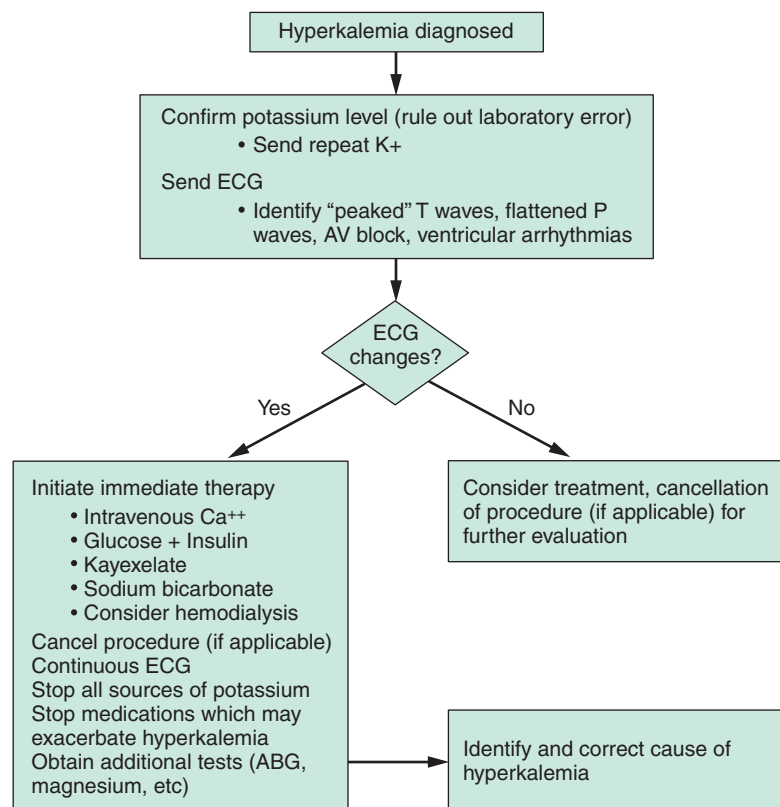


FIGURE 13-4. Treatment algorithm of hyperkalemia. AV, atrioventricular.

TABLE 13-4.

## Common Causes of Hypocalcemia

Hypoparathyroidism	Altered Ca <sup>2+</sup> /parathyroid hormone set point (calcium receptor mutations) Parathyroid hormone gene defects Post parathyroidectomy Neck irradiation Infiltrative disease Hypomagnesemia/hypomagnesemia Autoimmune disease
Parathyroid hormone resistance	Hypomagnesemia Pseudohypoparathyroidism Pseudo-pseudohypoparathyroidism
Other	Vitamin D deficiency Altered vitamin D metabolism Drug induced Acute citrate toxicity

hypoparathyroidism.<sup>37</sup> Hypocalcemia in the nonacute setting can result from hypoparathyroidism, hypomagnesemia, renal failure, and vitamin D deficiencies. Medications that are used to treat hypercalcemia (e.g., bisphosphonates, mithramycin, and calcitonin) may also cause hypocalcemia. Other drugs associated with hypocalcemia include pentamidine, ketoconazole, asparaginase, cisplatin, and doxorubicin. Severe hypocalcemia from acute citrate toxicity responds to 1–3 g of calcium gluconate or calcium chloride given intravenously, whereas oral calcium supplementation may be sufficient for more chronic conditions. Because peripheral infiltration of an intravenous fluid containing calcium can cause tissue necrosis, whenever possible this electrolyte should be infused through a central line.

### Hypercalcemia

Hypercalcemia occurs with elevation of the ionized fraction of total serum calcium. Clinical symptoms correlate with the acuity of hypercalcemia and include constipation, nausea and vomiting, drowsiness, lethargy, weakness, stupor, and coma. Cardiovascular manifestations include hypertension, shortened QT interval, heart block, and other arrhythmias. Hypercalcemia can also cause polyuria and polydipsia because of its effect on vasopressin-mediated water reabsorption; kidney stones are common. The most frequent causes of hypercalcemia are primary hyperparathyroidism and malignancy. Other causes include thiazide (an increase in renal calcium

reabsorption) or lithium (inhibition of PTH release) drug usage and rarer medical conditions, including granulomatous disease, thyrotoxicosis, and multiple endocrine neoplasia types I and II.

Although hypercalcemia is usually chronic and treatment involves addressing the underlying cause, occasionally acute severe hypercalcemia (or acute worsening of chronic hypercalcemia) may require prompt intervention. Because hypercalcemic patients are often volume depleted, intravenous saline can both rehydrate and induce calcium diuresis.<sup>38</sup> Loop diuretics (e.g., furosemide) inhibit renal calcium reabsorption and can expedite treatment. In addition, drugs such as bisphosphonates (etidronate pamidronate, clodronate), gallium, and plicamycin (mithramycin) can lower serum calcium concentrations by impairing or inhibiting osteoclast function. In severely hypercalcemic patients, dialysis may be required.

### Hypermagnesemia

Clinical manifestations of hypermagnesemia (>4–6 mg/dL) are serious and potentially fatal. Minor symptoms include hypotension, nausea, vomiting, facial flushing, urinary retention, and ileus. In more extreme cases, flaccid skeletal muscular paralysis, hyporeflexia, bradycardia and bradyarrhythmias, respiratory depression, coma, and cardiac arrest can occur. Hypermagnesemia generally occurs in two clinical settings: compromised renal function (GFR <20 mL/min)

and excessive magnesium intake (e.g., excessive intravenous therapy in preeclamptic patients or oral magnesium-containing antacids and cathartics). An abnormally low (or even negative) serum anion gap may be a clue to hypermagnesemia.<sup>39</sup> Although mild hypermagnesemia in the setting of normal renal function can be treated with supportive care and withdrawal of the cause, in some cases dialysis is necessary.

### Hypomagnesemia

Although low serum magnesium levels (<1.6 mg/dL) may be asymptomatic, clinically important problems may manifest, including neuromuscular (muscles cramps and weakness, positive Chvostek and Trousseau signs), cardiac (torsade de pointes and other arrhythmias), neurologic (apathy, seizures), and related electrolyte (hypokalemia and hypocalcemia) abnormalities. Causes of hypomagnesemia can be divided into four broad categories: decreased intake, gastrointestinal loss, renal loss, and redistribution. Many drugs (e.g., loop and thiazide diuretics, cisplatin, aminoglycosides, amphotericin, cyclosporine) induce renal magnesium wasting (24-hour urine magnesium excretion greater than 24 mg in the face of hypomagnesemia).<sup>40</sup> Nutritional deficiency can result from malabsorption syndromes, from patients receiving parenteral nutrition, and is present in 25% of alcoholics.<sup>41–43</sup> Redistribution occurs with acute pancreatitis, administration of catecholamines, and “hungry bone syndrome” after parathyroidectomy.<sup>44</sup> Magnesium can be supplemented orally or via the parenteral route. Over half of hypomagnesemic patients are also hypokalemic, and potassium deficits are usually refractory to repletion, unless magnesium also is supplemented.

### Hypophosphatemia

Hypophosphatemia is more clinically relevant than hyperphosphatemia to the perioperative physician and can result in symptoms including muscle weakness, respiratory failure, and difficulty in weaning critically ill patients from mechanical ventilation when serum levels are less than 0.32 mmol/L. In addition, low phosphate levels may diminish oxygen delivery to tissues and rarely cause hemolysis. Hypophosphatemia can result from intracellular redistribution caused by



catecholamines, or an anabolic state, inadequate intake or absorption secondary to alcoholism or malnutrition, or increased renal or gastrointestinal losses.<sup>45</sup> Hypophosphatemia is common in alcoholic and poorly controlled diabetic patients, where increased urine phosphate excretion can occur. Intravenous and oral supplementation can be used to treat hypophosphatemia.

### Hyperphosphatemia

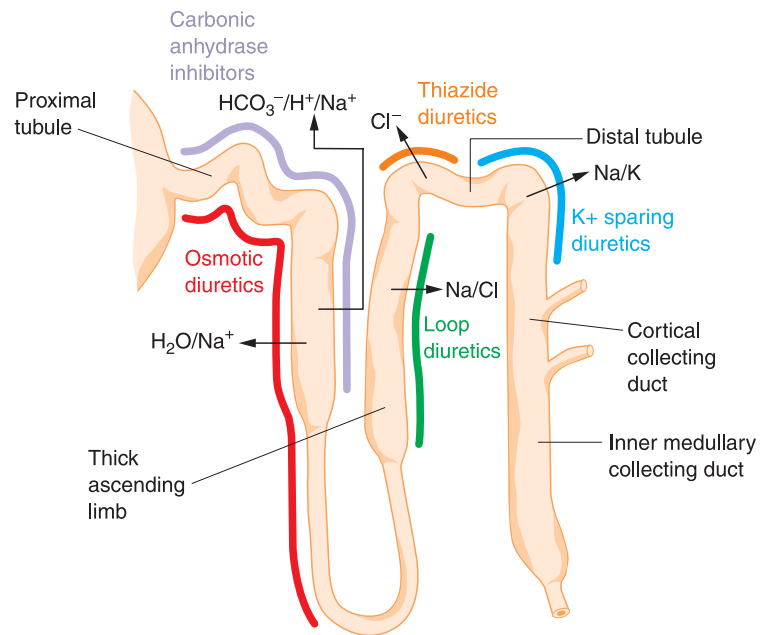
Clinical manifestation of hyperphosphatemia (>5 mg/dL) is generally related to the hypocalcemia that often accompanies this disorder, although increased phosphorus levels may also lead to calcium precipitation and decreased intestinal calcium absorption.<sup>46,47</sup> Significantly elevated serum phosphate levels are most commonly a result of reduced excretion from renal insufficiency (GFR <25 mL/min), but can also result from excess intake or redistribution of intracellular phosphorus. Treatment of chronic hyperphosphatemia includes dietary phosphate restriction and oral phosphate binders.

### Diuretics and Edema

Fluid overload occurs when salt or water intake exceeds renal plus extrarenal losses and is characterized by increased total body water and usually sodium. Fluid overload may be evenly distributed among the body compartments (e.g., congestive heart failure) or the interstitial space may be increased while the circulating blood volume may be normal or even decreased (e.g., posttraumatic or postoperative third-space fluid shifts). Pulmonary edema is a life-threatening complication of fluid overload. Edema results when Starling forces, which regulate fluid transfer between capillaries and interstitium, favor passage of fluid into the interstitial space. A variety of chronic medical conditions (congestive heart failure, renal failure, and hepatic cirrhosis) can lead to fluid overload and edema that might even require a procedure be delayed for treatment to reduce operative risk. The first line of therapy for fluid overload that includes all body compartments involves restriction of salt and water ingestion; however, diuretic therapy is often indicated.

### Physiologic Basis of Diuretic Action

The different classes of diuretic agents have numerous effects that are impor-



**FIGURE 13-5.** Site of action of commonly available diuretics. Available at: <http://sprojects.mmi.mcgill.ca/nephrology/presentation/presentation3.htm>. Last accessed August 10, 2006.

tant for the perioperative physician to consider and which extend beyond the common capability of these drugs to increase urine flow. Diuretics are grouped according to their site and mechanism of action (Fig. 13-5). Under normal conditions, kidney function assures that less than 1% of filtered  $\text{Na}^+$  load enters the urine (i.e.,  $\text{FE}_{\text{Na}}$  is <1%). The  $\text{Na}^+$ - $\text{K}^+$  adenosine triphosphatase (ATPase) pump on the basolateral surface (blood side) of renal tubular cells is primarily responsible for active pumping of  $\text{Na}^+$  out of cells into blood in exchange for  $\text{K}^+$ . This pump causes net movement of positive charges out of the cell (2  $\text{K}^+$  in for every 3  $\text{Na}^+$  out) creating an electrochemical gradient that also causes  $\text{Na}^+$  to enter the luminal (urine) side of the cell. Renal tubular cells in different portions of the nephron have different luminal “systems” to allow this  $\text{Na}^+$  influx. These systems are the sites of action where the different diuretics work.

### Proximal Tubule Diuretics

In the proximal tubule, a specialized luminal transporter exchanges protons ( $\text{H}^+$ ) for sodium ions; the result is sodium reabsorption and acidification of the urine. The excreted  $\text{H}^+$  combines with bicarbonate  $\text{HCO}_3^-$  in the tubule to form carbonic acid:



Carbonic acid converts to water ( $\text{H}_2\text{O}$ ) and carbon dioxide ( $\text{CO}_2$ ) in a reaction catalyzed by *carbonic anhydrase*:



The same enzyme, carbonic anhydrase, allows this reaction to occur in reverse within tubular cells, converting  $\text{H}_2\text{CO}_3$  to  $\text{HCO}_3^-$  and  $\text{H}^+$ , generating more  $\text{H}^+$  for countertransport with  $\text{Na}^+$ , and releasing bicarbonate that passes into the circulation.

Carbonic anhydrase inhibitors are drugs that inhibit this enzyme; the net effect of these agents is that sodium and bicarbonate that would otherwise have been reabsorbed remain in the urine, resulting in an alkaline diuresis.

Although patients may develop metabolic acidosis when taking these agents, interestingly, compensatory processes in the tubule accommodate to the effects of carbonic anhydrase inhibitors so that their long-term use rarely causes this problem. However, these agents can be useful, for example, with contraction alkalosis from aggressive diuresis with loop diuretics (see Loop Diuretics below); administration of these agents can reduce  $\text{Paco}_2$  and improve  $\text{Pao}_2$  for these patients with little change in blood pH. Specific use for carbonic anhydrase inhibitors include the treatment of mountain sickness and open-angle glaucoma, and to increase respiratory

drive in patients with central sleep apnea.<sup>48,49</sup>

### Osmotic Diuretics

Substances that are freely filtered at the glomerulus but poorly reabsorbed by the renal tubule, such as mannitol, will cause an osmotic diuresis. In the water-permeable segments of the proximal tubule and loop of Henle, fluid reabsorption occurs and filtered mannitol is concentrated. Eventually osmotic pressure in the tubular fluid resists further fluid reabsorption. Mannitol also draws water from cells into the plasma and effectively increases renal blood flow (RBF).

Mannitol has been widely used, especially for the prophylaxis of acute renal failure. In select patient populations, such as cadaveric kidney transplantation recipients, it is effective.<sup>50</sup> However, in a controlled trial of mannitol prophylaxis in patients with mild chronic renal failure, it was less effective than hydration alone in preventing contrast-associated nephropathy.<sup>51</sup> This trial has reduced enthusiasm for the prophylactic use of mannitol. Although animal studies showed initial promise, apart from acute renal failure (ARF) prophylaxis in kidney transplantation, there is no clear evidence that mannitol is effective in prevention or treatment of ARF.<sup>52</sup> However, as a therapy for cerebral edema, mannitol therapy is more effective than loop diuretics or hypertonic saline in reducing brain water content.<sup>53</sup>

As mannitol shifts water between fluid compartments, there can be effects on plasma and intracellular electrolyte concentrations, including hyponatremia and hypochloremia and intracellular increases in  $K^+$  and  $H^+$ . Patients with normal renal function quickly correct these changes, but patients with renal impairment may develop significant circulatory overload with hemodilution and pulmonary edema, hyperkalemic metabolic acidosis, central nervous system depression, and even severe hyponatremia requiring urgent hemodialysis.<sup>54</sup>

### Loop Diuretics

The electrochemical gradient established by the  $Na^+K^+$  ATPase in the loop of Henle drives the electroneutral transport of 1  $Na^+$ , 1  $K^+$  and 2  $Cl$  ions into the tubule cells from the tubular fluid. Because the thick ascending limb segment of the loop of Henle is water-impermeable, reabsorption of solute concentrates the interstitium

and dilutes the tubule fluid. Loop diuretics, such as furosemide, bumetanide, and torsemide, directly inhibit the electroneutral transporter, preventing salt reabsorption from occurring. Because 25% of filtered  $NaCl$  is normally reabsorbed in the loop of Henle, loop diuretics cause a large salt load to pass to the distal convoluted tubule that is beyond the extra reserve of this tubular segment to reabsorb; consequently, large volumes of dilute urine ensue. Other effects of loop diuretics include a weak inhibition of carbonic anhydrase (see Proximal Tubule Diuretics) and an increase in the fractional excretion of  $Ca^{2+}$ .

Interestingly, hormones that stimulate cyclic adenosine monophosphate (cAMP), such as arginine vasopressin, enhance salt reabsorption by the thick ascending limb of the loop of Henle, making the effect of loop diuretics all the more impressive. Conversely, substances that stimulate cyclic guanosine monophosphate (cGMP), such as nitric oxide and atrial natriuretic peptide, inhibit thick, ascending-limb reabsorption and attenuate the loop diuretic response.<sup>55,56</sup>

Loop diuretics are a first-line therapeutic modality for acute treatment of congestive heart failure (CHF). Although diuretics have no proven mortality benefit, they reduce left ventricular filling pressures and effectively relieve symptoms of congestion, pulmonary edema, extremity swelling, and hepatic congestion.

Adverse loop diuretic effects include hypokalemia, hyponatremia, and acute renal dysfunction. Heart failure patients with atrial fibrillation may also be prescribed digitalis, which, in combination with furosemide, can lead to hypokalemia-induced arrhythmias. Loop diuretics, especially furosemide, may cause ototoxicity particularly in patients with renal insufficiency.<sup>57</sup>

### Distal Convoluted Tubule Diuretics

Distal convoluted tubule diuretics, such as thiazides (e.g., hydrochlorothiazide) and metolazone, act in the earliest part of this segment to block the  $NaCl$  cotransport mechanism across apical plasma membranes. Because the distal tubule is relatively water impermeable,  $NaCl$  absorption causes urinary dilution. Distal tubule diuretics also increase magnesium excretion, but, unlike loop diuretics, they inhibit calcium excretion.

Clinically, distal convoluted tubule diuretics are used for the treatment of hypertension (often as sole therapy), volume overload disorders, and to relieve the symptoms of edema in pregnancy.

Adverse reactions associated with distal tubule diuretics include electrolyte disturbances and volume depletion. Hydrochlorothiazide specifically is associated with a number of other side effects, including pancreatitis, jaundice, diarrhea, aplastic anemia, and anaphylaxis.

### Distal (Collecting Duct)-Acting Diuretics

Unlike in more proximal nephron segments,  $NaCl$  absorption in the collecting duct cells (also called principal cells) is electrogenic; that is, a net electrical gradient is maintained both by the  $Na^+K^+$  ATPase  $Na^+$  ion channels and in the luminal membranes. As a result, the tubule lumen is negatively charged with respect to the blood. This normally causes  $K^+$  secretion into the tubular lumen through  $K^+$ -specific ion channels. Distal  $K^+$ -sparing diuretics (e.g., amiloride and triamterene) directly inhibit luminal  $Na^+$  entry, blocking this mechanism, and resulting in a  $K^+$ -“sparing” effect. In addition,  $H^+$  secretion is inhibited.

A second class of distal-acting potassium-sparing diuretics includes the competitive aldosterone antagonists (e.g., spironolactone and eplerenone). Ordinarily, the mineralocorticoid hormone aldosterone is released by the body in response to angiotensin II or hyperkalemia. Aldosterone normally stimulates  $Na^+$  reabsorption and  $K^+$  excretion by the collecting duct. Inhibition of the aldosterone effect by these drugs causes a mild natriuresis and  $K^+$  retention. Distal  $K^+$ -sparing agents are used primarily for  $K^+$ -sparing diuresis (e.g., in patients with volume overload receiving digitalis or with hypokalemic alkalosis). In addition, these drugs are especially useful in treating disorders involving secondary hyperaldosteronism, such as cirrhosis with ascites. Spironolactone treatment improves survival with volume overload and left ventricular dysfunction or heart failure.<sup>58</sup>

Hyperkalemia and hyperkalemic-hyperchloremic metabolic acidosis are significant complications of the injudicious use of spironolactone, triamterene, or amiloride. Metabolic acidosis itself can further contribute to

hyperkalemia. These effects are dose dependent, and the risk of their occurrence increases considerably with renal failure or therapy with  $K^+$  supplements, angiotensin-converting enzyme inhibitors, angiotensin receptor blockers,  $\beta$ -blockers, heparin, or ketoconazole.<sup>59</sup> In addition, amiloride and triamterene accumulate with renal failure, and triamterene also accumulates with liver impairment.<sup>60,61</sup> Spironolactone can cause gastrointestinal distress and antiandrogenic effects (e.g., impotence, loss of libido, gynecomastia). Gynecomastia is a dose-related complication.<sup>62</sup>

### Other Diuretics

**Dopaminergic Agonists** Intravenous low-dose infusion of dopamine (1–3  $\mu\text{g}/\text{kg}/\text{min}$ ) is natriuretic, owing primarily to a modest increase in the GFR and a reduction in proximal  $\text{Na}^+$  reabsorption mediated by dopamine type 1 (DA1) receptors.<sup>63</sup> Fenoldopam is a selective DA1 receptor agonist with little cardiac stimulation. At higher doses, the pressor response to dopamine is beneficial in patients with hypotension, but it has little or no renal effect in critically ill or septic patients.<sup>63,64</sup> So-called renal-dose dopamine for the treatment of ARF, although advocated, has not been demonstrated to have significant renoprotective properties in numerous studies<sup>65–67</sup> and can cause worsened splanchnic oxygenation, impaired gastrointestinal function, impaired endocrine and immunologic system function, blunting of ventilatory drive, and increased risk of postcardiac operation atrial fibrillation.<sup>68–70</sup>

## RENAL DISORDERS ENCOUNTERED IN THE PERIOPERATIVE PATIENT

Disorders of the kidney can selectively involve the glomerulus and/or tubule and reflect localized or systemic disease. Other considerations include a variety of inherited conditions and the transplanted kidney. These topics are extensively reviewed elsewhere,<sup>20</sup> but an abbreviated summary with focus on features important to the perioperative physician are discussed below.

### Prerenal Azotemia

Prerenal azotemia accounts for approximately 70% of hospital-acquired acute renal failure.<sup>71,72</sup> Prerenal azotemia

is a normal physiologic response to decreased renal perfusion pressure resulting in a hemodynamically mediated reduction in the GFR. No immediate injury occurs to the renal parenchyma, and the GFR rapidly returns to normal with reversal of the hemodynamic insult. Overt pathologic changes can occur if the renal hypoperfusion is sustained. The decrease in glomerular ultrafiltration pressure can be secondary to a true decrease in blood volume (e.g., hemorrhage, dehydration) or a decrease in the effective arterial blood volume (e.g., congestive heart failure, cirrhosis, capillary leak syndromes, sepsis). When mean arterial pressure falls below 80–90 mm Hg, there is a reduction in renal blood flow. Progression of the prerenal state can lead to acute tubular necrosis (ATN). Prerenal azotemia and ischemic ATN are manifestations of renal hypoperfusion. The severity and duration of the insult will dictate the likelihood of progression from prerenal azotemia to ischemic tubular damage.

In renal hypoperfusion states, GFR is maintained by the interplay of several neurohumoral systems. The renin-angiotensin axis increases the vasomotor tone of the efferent arteriole, whereas afferent arteriolar vasomotor tone decreases under the influence of nitric oxide, vasodilatory prostaglandins, and the kallikrein-kinin system. The sympathetic nervous system reacts to hypoperfusion with release of norepinephrine and antidiuretic hormone (ADH). With sustained reductions in renal blood flow, the ability of the kidney to maintain glomerular perfusion pressure is overwhelmed, and the GFR declines, resulting in azotemia and cellular hypoxia with ischemic tubular damage.

Nonsteroidal antiinflammatory drugs (NSAIDs) can influence renal perfusion. These drugs can be divided into nonselective inhibitors of both cyclooxygenase-1 (COX-1) and cyclooxygenase-2 (COX-2), or selective inhibitors of COX-2. Both classes of drugs cause inhibition of various prostaglandins and other substances, including some that are involved in the paracrine regulation of renal perfusion. Patients at greatest risk for NSAID-induced acute renal failure include the elderly and those with congestive heart failure, advanced liver disease, atherosclerotic vascular disease, or chronic kidney dis-

ease.<sup>73,74</sup> Special attention should be given to elderly patients treated with NSAIDs of any type. In a population-based study, the risk of acute renal failure in the elderly increased by 58% with prescription NSAID use.<sup>75</sup> The nonselective NSAIDs are inhibitors of the prostaglandins responsible for vasodilatation in the kidney and can promote prerenal azotemia in susceptible patients. The selective COX-2 inhibitors also cause a similar renal vasoconstriction. The renal safety profile of celecoxib (COX-2) is similar to ibuprofen. One selective COX-2 inhibitor, rofecoxib, was found to have a higher incidence of renal toxicity than the nonselective inhibitors or celecoxib.<sup>76</sup> The renal toxicity of NSAIDs is increased when they are used in combination with other medications with the potential to alter the kidneys' ability to autoregulate glomerular filtration pressure such as angiotensin-converting enzyme inhibitors (ACEIs) and angiotensin receptor blockers (ARBs). The renal vascular changes associated with NSAID use are typically reversible, although prolonged use can lead to permanent renal injury. NSAIDs are also known to cause acute tubulointerstitial nephropathy (see Tubulointerstitial Nephropathies and Disorders of the Urinary Tract below), in which case there is often a sudden change in GFR that may persist for days to weeks.

ACEIs reduce blood pressure by inhibiting the proteolytic cleavage of angiotensin I to angiotensin II. ARBs occupy the angiotensin receptor. The renin-angiotensin system contributes to the autoregulation of glomerular perfusion pressure, and inhibition of this system has the potential to induce prerenal azotemia. Much like the prostaglandin inhibitors, ACEIs and ARBs increase the risk of ARF in patients on diuretic therapy who have volume depletion, congestive heart failure, or diabetes, and in the elderly.<sup>77,78</sup> Their use in conjunction with NSAIDs, cyclosporine, tacrolimus, and aprotinin put patients at an even greater risk for ARF.<sup>77,79,80</sup> The incidence of ARF is also higher in patients with chronic kidney disease of any etiology. Patients with chronic kidney disease usually depend on local angiotensin II production to maintain GFR in the face of decreased functional renal mass. Consequently, a decline in GFR when these patients receive ACEIs is not unexpected. The rise in serum



creatinine is typically less than 30% and does not constitute renal failure. More dramatic increases in serum creatinine suggest the presence of underlying renal vascular disease.

## Glomerular Diseases

Glomerular disorders declare in numerous ways (Table 13-5), but the commonest presentations are either as a nephritic or nephrotic syndrome. Nephritic syndrome involves a collection of renal signs and symptoms that predominantly reflect inadequate and/or ineffective glomerular filtration, including accumulation of nitrogenous waste products (azotemia), fluid retention, edema, hypertension, oliguria/anuria, proteinuria, and hematuria. In contrast, nephrotic syndrome involves signs and symptoms that predominantly reflect excessively porous filtration and “escape” of substances into the urine that are normally retained in the circulation, including significant proteinuria ( $>3$  g/d/1.73 m<sup>2</sup>), hypoproteinemia, edema, lipiduria, and hyperlipidemia. With nephrotic syndrome, characteristic oval fat bodies appear in the urine, and these may help guide diagnosis. The nature and severity of the presentation is determined by the underlying glomerular insult; a definitive diagnosis almost always requires a renal biopsy. The two commonest primary diseases causing nephrotic syndrome are minimal change glomerulopathy and membranous glomerulopathy, but more commonly nephrotic syndrome arises in adults as a manifestation of diabetic glomerulosclerosis or systemic amyloidosis.

## Tubulointerstitial Nephropathies and Disorders of the Urinary Tract

Tubulointerstitial nephritis (TIN) primarily involves the renal tubule and is a common problem, accounting for 10% of acute renal dysfunction in hospitalized cases.<sup>81</sup> The hallmark of TIN is an interstitial mononuclear cell infiltrate on renal biopsy including T- and B-lymphocytes, macrophages, and natural killer cells.<sup>82</sup>

Most TIN involves cell-mediated immune responses, although some cases are the direct consequence of infection.<sup>83-87</sup> The clinical features of TIN are variable and depend partly on the initiating process.<sup>88</sup> Disruption of the normal tubulointerstitial compartment is associated with a urinary concentrating defect, hyperchloremic

**TABLE 13-5.**

### The Spectrum of Clinical Disorders Involving Glomerular Disease

Asymptomatic proteinuria  
Nephrotic syndrome  
Asymptomatic microscopic hematuria  
Recurrent gross hematuria  
Acute nephritis  
Focal or diffuse proliferative glomerulonephritis  
Type I and type II membranoproliferative glomerulonephritis  
Fibrillary glomerulonephritis  
Rapidly progressive nephritis  
Pulmonary–renal vasculitic syndrome  
Antineutrophilic cytoplasmic antibodies vasculitis  
Chronic kidney disease

metabolic acidosis, hypo- or hyperkalemia, hypomagnesemia, and, typically, modest proteinuria. A few triggering medications, such as NSAIDs, interferon- $\alpha$ , and methicillin, are sometimes associated with nephrotic range proteinuria. TIN can progress to acute renal failure requiring dialysis. Notably, TIN triggered by NSAIDs is much more common in women than men, and the onset may be weeks to months after the start of the offending agent. Although recovery usually occurs within days to weeks of drug cessation, up to 20% progress to chronic renal failure.

### Drug-Induced Tubulointerstitial Nephritis

Drug reactions are a major cause of TIN in hospitalized patients; the most common agents are penicillins,<sup>89</sup> cephalosporins,<sup>88,89</sup> and NSAIDs.<sup>90,91</sup> Other offending agents include fluoroquinolones,<sup>89,92</sup> sulfonamides,<sup>93</sup> interleukin-2, and interferon- $\alpha$ .<sup>94,95</sup> Because of the variety of potentially nephrotoxic medications that many patients are exposed to, it is often difficult to establish a single responsible agent with certainty. Additionally, comorbid conditions capable of causing renal dysfunction may be present and, as renal biopsy is not routine, the diagnosis of TIN is often presumptive. TIN typically occurs within days to a few weeks of drug exposure and is unrelated to cumulative dose. The most common presentation is with symptoms of edema, hypertension, diminished urine output, and renal failure. Occasionally,

flank pain is a prominent symptom. Classical allergic manifestations, such as skin rash, arthralgias, fever, eosinophilia, and eosinophiluria, are rarely present; eosinophiluria has only a 40% positive predictive value and a 70% negative predictive value.<sup>89,96,97</sup> The diagnosis of TIN requires a high index of suspicion and knowledge of the potential causes.

Primary treatment of drug-induced TIN is cessation of the causative agent. Although some reports indicate clinical response to corticosteroid administration,<sup>88,98,99</sup> there are no large, randomized, placebo-controlled trials to guide treatment, and steroids are generally restricted to patients with progressive renal failure despite stopping the offending drug. Renal biopsy is often performed in these cases to confirm the diagnosis of TIN.

### Infection-Induced Tubulointerstitial Disease

Renal biopsy findings of TIN from infection usually have acute interstitial inflammatory cells and microabscesses. There are many causes, including bacterial,<sup>100</sup> fungal (candidiasis, histoplasmosis), and viral (adenovirus, polyomavirus, Epstein-Barr virus) sources.

Bacterial cases usually present with a history of ascending urinary tract infection superimposed on obstructive nephropathy. Pyelonephritis may cause renal failure as a result of direct bacterial effects (TIN) or of ATN from septic shock. The prognosis in acute bacterial TIN is significantly worse than for ATN. Whereas patients with ATN are expected to make full recovery, bacterial TIN often progresses to severe interstitial scarring and progressive chronic renal failure. Patients require prolonged antibiotic treatment to eradicate the infection and close monitoring to minimize chronic progressive renal damage.

Renal candidiasis is common in patients with a history of prolonged hospitalization, prior exposure to antimicrobial agents, corticosteroid therapy, the postoperative state, surgical wounds, chronic indwelling urinary catheters, and/or underlying malignancy. Renal candidiasis should be considered in vulnerable patients whenever unexplained progressive renal failure occurs, particularly if it is accompanied by flank pain, fever, candiduria, and microscopic hematuria.<sup>101,102</sup> A useful diagnostic test in the catheterized patient with candiduria involves bladder



washings with amphotericin B; this will clear the urine of colonization but not renal candidosis.<sup>103</sup> In septic patients, a positive urine culture for candida is considered proof of renal candidiasis.<sup>104</sup>

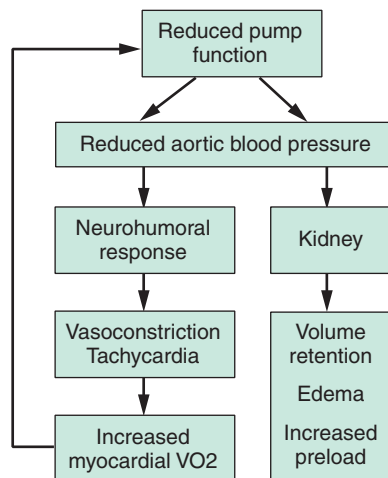
Most other viral and fungal causes are seen only in immunocompromised patients.<sup>105–110</sup> However, Epstein-Barr virus is associated with TIN and renal failure in both immunocompetent and immunocompromised patients.<sup>111</sup> Other renal lesions associated with Epstein-Barr virus and infectious mononucleosis include acute glomerulonephritis, hemolytic uremic syndrome, and rhabdomyolysis-induced ARF.<sup>112</sup>

### The Kidney in Systemic Disease

The kidney may manifest abnormal function and disease as a consequence of the systemic effects of other disorders. Some of the more common conditions that are pertinent to the perioperative period are reviewed below.

#### Congestive Heart Failure

CHF is the one cardiovascular disease whose incidence and prevalence is still increasing in the Western world. In fact, the long-term prognosis for CHF is now worse than for many common cancers. Uniquely, the kidneys both suffer from and contribute to the pathophysiology of CHF; Figure 13–6 summarizes this. The underlying hormonal state with CHF is the normal response to hypovolemia (e.g., hemorrhage) and preserves circulating volume. Although the humoral response is very



**FIGURE 13–6.** The pathophysiology of fluid retention that contributes to congestive heart failure.

effective in retaining fluid, the primary cause of a reduced perfusion in the setting of CHF—pump failure—does not respond as hypovolemia, and the vicious cycle of more volume retention, edema, vasoconstriction, and increased myocardial oxygen consumption occurs, leading to further reductions in pump function. When congestive heart failure and pulmonary edema are diagnosed preoperatively, it is imperative that aggressive treatment occur prior to surgery as this condition, untreated, is highly predictive of early postoperative mortality.

#### Diabetes

Diabetes is the most common cause of kidney failure in the United States and accounts for more than 40% of all end-stage renal disease, of which more than 80% is caused by type II diabetes. Overwhelmingly, the most important feature in the management of diabetic kidney disease is blood pressure control. Together with good chronic glyce-mic control, this can postpone (but not prevent) the onset of end-stage renal disease.

Diabetic nephropathy develops because of exposure to chronically elevated levels of blood glucose. Glycemic control is the cornerstone of diabetes management in general, and this is also the case in the prevention of diabetic nephropathy. Although improved glycemic control reduces risk, there does appear to be a large genetic element also. Management of diabetic nephropathy also consists of aggressive blood pressure control, aiming for a level of 125/75 mm Hg, and often more than one drug is required. Antihypertensive drugs that inhibit the renin-angiotensin-aldosterone axis (such as ACEIs and ARBs) are effective for this purpose. Metformin is relatively contraindicated once renal disease develops because of the risk of significant lactic acidosis, and it may also be necessary to reduce the dose of other hypoglycemic drugs—including insulin—so as to avoid deleterious hypoglycemic episodes.

#### Liver Failure

Hepatorenal syndrome (HRS) involves the combination of renal vasoconstriction, declining GFR, and normal renal histology that occurs in the setting of liver failure. Without confounding renal injuries, renal failure from HRS will resolve with liver transplantation. The clinical picture associated with

HRS is that of a prerenal azotemia, and the pathogenesis is not completely understood. Systemic and splanchnic vascular resistance is decreased leading to reduced effective arterial volume and renal hypoperfusion. Compensatory increases in mediators of renal vasoconstriction occur, including increased renin-angiotensin-aldosterone activity, ADH levels, sympathetic tone, and endothelin levels. The kidney responds by increasing salt and water retention, leading to worsening ascites and edema.<sup>113,114</sup> The diagnosis of HRS is a diagnosis of exclusion, characterized by liver failure and unexplained oliguric ARF with very low urine sodium and bland urine sediment. Other causes for the ARF should be ruled out, including causes of prerenal azotemia, intrinsic renal disease, and obstructive nephropathy. Major and minor criteria have been established for the diagnosis of HRS (Table 13–6). Liver transplant is the definitive therapy for HRS. However, patients who develop HRS prior to

**TABLE 13–6.**

#### Diagnostic Criteria for Hepatorenal Syndrome

##### Major Criteria

- Acute or chronic liver disease with advanced hepatic failure and portal hypertension
- Depressed GFR with a serum creatinine  $>1.5$  mg/dL or a creatinine clearance  $<40$  mL/min
- Absence of shock, ongoing bacterial infection, fluid loss, and treatment with nephrotoxic medications
- No sustained improvement in renal function after withdrawal of diuretics and fluid resuscitation with 1.5 L of isotonic saline
- Proteinuria  $<500$  mg/d and no evidence of obstructive nephropathy on ultrasonogram

##### Minor criteria

- Oliguria
- Urine sodium  $<10$  mEq/L
- Urine osmolality  $>$  plasma osmolality
- Urine red blood cells  $<50$  per high-power field
- Serum sodium concentration  $<130$  mEq/L

Reproduced with permission from Arroyo V, Gines P, Gerbes AL, et al.<sup>122</sup>

transplant have worse graft and patient survival.<sup>115</sup> Newer pharmacologic therapy with vasopressin analogues (e.g., ornipressin and terlipressin), which are splanchnic vasoconstrictors, has shown some benefit. However, the major complication associated with these medications is mesenteric ischemia.<sup>116–118</sup> Other potential therapies include oral midodrine (a selective  $\alpha_1$ -adrenergic agonist) in combination with octreotide,<sup>119</sup> N-acetylcysteine,<sup>120</sup> and transjugular intrahepatic portosystemic shunting (TIPS).<sup>116,121</sup> Given the poor prognosis of HRS, patients with rapid onset of renal failure are rarely offered dialysis unless they are candidates for liver transplant or have a chance of hepatic recovery.<sup>113,114,122</sup>

### Hereditary Renal Disorders

Autosomal dominant polycystic kidney disease affects between 1 in 400 and 1 in 1000 live births in the United States. It accounts for 5% of all end-stage renal disease in the United States and Europe. The genetic defect occurs in the polycystin gene on chromosome 16p13.3 (type 1) and on chromosome 4q21.2 (type 2). The clinical hallmark is massive cystic enlargement of the kidneys, and the diagnosis is made in at-risk individuals by renal ultrasonography scan. Typically, the kidney volume must increase to greater than 1000 mL (normal: 150 mL) before there is an appreciable reduction in GFR. Reduced GFR occurs from stretching and narrowing of intrarenal blood vessels leading to ischemia. There is also interstitial fibrosis and cytokine release leading to inflammatory cell infiltration.

Autosomal dominant polycystic kidney disease presents clinically with flank and back pain (which may be acute if cyst hemorrhage occurs), and hematuria may also develop. Hypertension occurs early and commonly. The treatment of choice is transplantation, and autosomal dominant polycystic kidney disease patients in general respond well to this treatment, typically outliving their noncystic transplant peers. Of particular interest to anesthesiologists are the associated features of intracranial aneurysm formation, hepatic cyst formation, and secondary hypertension.

### Contrast Nephropathy

Contrast-associated nephropathy occurs in 2–7% of patients and consti-

tutes 10% of all in-hospital acute renal injury. The diagnosis is made when a significant rise in serum creatinine occurs within 5 days following intravascular contrast injection.<sup>123,124</sup> Typically, it is those with preprocedure renal impairment who are at greatest risk;<sup>125</sup> additionally, the pathophysiology is related to direct renal tubular cell injury and vasoconstriction. Notably in some patients, atheroembolism, caused by catheter manipulation and dislodgment of plaque within the aorta, may be misdiagnosed as contrast nephropathy. Prehydration and sodium bicarbonate (154 mEq/L, 3 mL/kg bolus 1 hour prior to the procedure, then 1 mL/kg infusion  $\times$  6 hours) are useful as prophylaxis for contrast-induced nephropathy.<sup>126</sup> Because some studies indicate that preoperative (<48 h) contrast administration is predictive of postoperative renal complications,<sup>127</sup> avoiding an elective procedure immediately after contrast administration and permitting recovery of contrast-associated nephropathy before an operation seems prudent.

### The Renal Transplant Patient

After corneal transplantation, kidney transplantation is the most common transplantation operation performed with more than 9000 procedures performed annually in the United States. Patients presenting for an operation with a transplanted kidney have filtration function ranging from normal to severely impaired and are typically receiving immunosuppressant medications with specific acute and chronic nephrotoxic effects. However, also pertinent to the perioperative physician is the concern of allograft rejection. The hallmark of allograft rejection is an unexplained rise in serum creatinine. Recognition of rejection and referral for effective treatment (i.e., increased immunosuppression) is a key aspect of the preoperative assessment of a patient with a renal allograft, because if it is missed, the patient may lose the graft and be obliged to return to chronic dialysis. The preoperative visit may be the time that an undesirable accumulation of nitrogenous waste is first discovered, particularly if the patient has been otherwise well.

Three types of allograft rejection are recognized: hyperacute, accelerated acute, and acute. Hyperacute rejection occurs within minutes to hours of transplant reperfusion and is a conse-

quence of the effect of preexisting human leukocyte antigens (HLAs) and/or ABO blood-type antibodies. Antibodies bind to graft endothelium and to activate complement, inflammatory, and coagulation pathways, causing widespread thrombosis and subsequent loss of graft function. Hyperacute rejection is now rare as a consequence of improved matching of donors and recipients. In contrast, accelerated acute rejection occurs in the first 5 days following transplant reperfusion and is caused by activation of recipient T and B “memory” lymphocytes. The diagnosis is confirmed by graft biopsy, which demonstrates cells staining positively for C4d. Finally, acute rejection occurs between 5 days and 3 months after reperfusion. It is a cell-mediated process that classically presents as fever, chills, arthralgia, myalgia, and pain over the graft site. Modern immunosuppressive therapy with calcineurin inhibitors (e.g., cyclosporine, tacrolimus) has significantly reduced this clinical presentation, and diagnosis is usually made following renal biopsy prompted by a subacute rise in serum creatinine noted on routine testing.

In addition to procedure-related infectious risk, renal transplantation recipients are vulnerable to specific infections, including *Pneumocystis carinii* pneumonia, urinary tract infections, and sinusitis, and are prescribed trimethoprim-sulfamethoxazole therapy for a period after transplantation to protect against them. It is important that these antibiotics be continued through any subsequent (and unrelated) perioperative period.

The calcineurin-inhibitors cyclosporine and tacrolimus are widely used as immunosuppressants in solid organ and bone marrow transplantation. Cyclosporine and tacrolimus can cause both ARF and chronic renal failure. The vascular changes with cyclosporine and tacrolimus in the critically ill patient include a direct afferent arteriolar vasoconstriction that is reversible with discontinuation of the drug. Dose reduction is sometimes sufficient to reverse the decrease in glomerular filtration pressure and GFR. Chronic nephrotoxicity is a ubiquitous complication of prolonged use of the calcineurin-inhibitors that presents with proteinuria, tubular dysfunction, arterial hypertension, and rising serum creatinine values. Chronic changes may occur as soon as 6 months after

therapy is started, and includes arteriolar damage, interstitial fibrosis, tubular atrophy, and glomerulosclerosis. The pathologic changes of the chronic nephrotoxicity are irreversible.<sup>128–130</sup> A less common complication of cyclosporine and tacrolimus therapy is hemolytic uremic syndrome; patients may have partial recovery with drug discontinuation.<sup>131–133</sup> Calcineurin-inhibitors are also associated with hyperkalemia, although thought to be secondary to tubular resistance to aldosterone.<sup>134</sup>

## POSTOPERATIVE RENAL DISORDERS

A recent study reported acute deterioration of renal function in 5% of all hospital patients and in 30% of those admitted to intensive care units.<sup>71</sup> Many of these patients sustain their acute renal impairment as a consequence of surgery or its complications. Some surgical procedures are highly associated with postoperative renal dysfunction. Significant renal injury complicates up to 30% of trauma, cardiac, vascular, and hepatobiliary procedures.<sup>135</sup> The importance of acute renal injury after an operation lies not only in the resulting physiologic derangements, but also in the strong predictive relationship of this condition with in-hospital mortality, even after adjustment for other contributing factors.<sup>7,136,137</sup> Not all surgical procedures are vulnerable to postoperative acute renal injury. Notably, some highly invasive procedures (e.g., thoracotomy)<sup>138</sup> are relatively rarely complicated by acute renal failure requiring dialysis. Even small perioperative declines in renal function are associated with increased risk of major complications and mortality, possibly as a result of, at least in part, the effects of acute renal injury on the normal functioning of many other organ systems.<sup>139–141</sup> Preoperative predictive factors include African American race,<sup>142</sup> advanced age,<sup>7,143–147</sup> obesity,<sup>7</sup> hypertension,<sup>148,149</sup> peripheral or carotid atherosclerotic vascular disease,<sup>7,148</sup> elevated preoperative serum glucose and diabetes,<sup>7,146,149,150</sup> obstructive pulmonary disease, and reduced left ventricular function.<sup>7,143,148,151,152</sup> Although preoperative genetic testing may be useful in the future,<sup>153,154</sup> there are no tests currently available as predictive tools.

The role of preexisting renal disease as an acute renal injury risk factor is complicated. It is undeniable that patients with severe baseline renal disease need only have a small additional renal insult to lose sufficient renal function to require dialysis, thus having acute renal failure. Postoperative patients requiring new dialysis are more likely to have preexisting renal dysfunction.<sup>7,144,146–148</sup> Interesting, however, is that patients with preexisting renal dysfunction are not more likely to sustain renal injury, described as a relative change in renal function perioperatively (e.g., 50% rise in serum creatinine).<sup>145,155,156</sup> This is often misunderstood as patients with high baseline serum creatinine values will have higher postoperative rises in serum creatinine, simply because of the non-linear relationship between changes in renal filtration and serum creatinine rise. Patients with preexisting renal disease as a group have more associated comorbidities, and these individuals also have a higher risk for other major postoperative complications.<sup>157–159</sup>

The high metabolic demands and poor oxygen delivery to tubule cells in the outer medulla make this the most vulnerable region of the kidney.<sup>5</sup> As outlined in *The Normal Kidney: Correlates of Structure and Function* earlier, the medulla plays an important role in water and solute reabsorption but receives limited perfusion (5–10% renal blood flow). Normal oxygen extraction in the outer medulla is the highest in the body (79%), exceeding even that of the heart (65%). In the face of hypoperfusion (e.g., salt and volume depletion, dehydration), three components of renal homeostasis preserve body composition at the expense of further stress on the medulla. First, avid reabsorption of electrolytes by tubular cells increases metabolic requirements. Second, autoregulation preserves glomerular filtration at the “cost” of efferent arteriolar constriction, further reducing medullary perfusion. Finally, the vasa rectae hairpin loops within the medulla allow oxygen to “escape” from vessels entering to those leaving the medulla. As medullary perfusion drops, this so-called countercurrent exchange of oxygen increases such that medullary PO<sub>2</sub> may be as low as 10–20 mm Hg (Fig. 13–2).<sup>4,5</sup> Outer medullary oxygen supply-demand inequalities are believed to be

an important substrate for onset of “acute renal failure” syndrome.<sup>3</sup> The outer medulla is also vulnerable as the site of concentration for many nephrotoxins. Unfortunately, although “renal angina” is an appealing concept, renal ischemia is a painless and, to date, a state that cannot be monitored.

## RENAL FAILURE AND ITS THERAPY

Loss of adequate renal function may have occurred long before surgery and may be irreversible or acute, in which case renal recovery usually takes days or weeks; in both cases, the goal is to support the patient through this period.

Patients with serious renal impairment have limitations in their ability to regulate electrolyte, acid–base, and volume homeostasis. Approaches that avoid the complications of exceeding the renal homeostatic reserve with renal failure are outlined below. The most severe cases of renal impairment require rigorous adherence to guidelines aimed at limiting complications. When guidelines are inadequate, generally dialysis is required.

### Volume Homeostasis

Free water deficit or excess is normally adjusted for by renal elimination of less or more dilute urine, respectively. When kidneys fail, they usually lose their ability to respond to these challenges and commonly produce a fixed amount of isosmotic urine. If this occurs, the clinician must maintain euvolemia without help from the kidneys through fluid management. To achieve this, meticulous attention must be paid to accurate assessment of volume status and review of fluid status (*ins vs. outs*). A fluids prescription should then be formulated. If the patient is euvolemic, then the volume of fluid should match the urine output plus an additional 500 mL/d for insensible losses. Fluid restriction or supplementation can occur if hyper- or hypovolemia are present.

### Electrolyte Homeostasis

Because a major problem with renal failure is clearance of accumulated substances, fluid should contain supplemental electrolytes (e.g., potassium, magnesium, phosphorus) if deficits are identified. Sodium intake should be 2 g or less per day. Excess

potassium can be avoided by a restrictive diet and identifying other sources (e.g., fluids, parenteral nutrition, potassium penicillin). Hyperkalemia that causes cardiac dysrhythmias should be treated emergently (e.g., intravenous calcium chloride or calcium gluconate). Inhaled  $\beta$ -agonists and an infusion of sodium bicarbonate or insulin and glucose can also be used to shift potassium intracellularly. Although these approaches antagonize the cardiac effects of hyperkalemia, they do not reduce total body potassium. Elimination of excess body potassium in patients with ARF can only be accomplished with resins or dialysis. Potassium removal with peritoneal dialysis approaches 10–15 mEq/h compared with 50 mEq/h for hemodialysis.

Low calcium levels are common with ARF but rarely symptomatic. Hypocalcemia in these settings is often accompanied by hypomagnesemia. Because this inhibits parathyroid hormone release, calcium and magnesium should be supplemented when this is found. Functional hypoparathyroidism, together with the decreased vitamin D synthesis by the failing kidney, contribute to the hypocalcemia. Hyperphosphatemia is also common and requires phosphorus restriction and/or administration of calcium salts or aluminum hydroxide gels.

### Acid–Base Homeostasis

When the inability of failing kidneys to reclaim filtered bicarbonate removes the ability to eliminate all the acid produced by protein breakdown, the result is an anion gap metabolic acidosis. Sometimes restricting protein intake to 0.6–0.8 g/kg of body weight is sufficient to treat this problem, but this might not be ideal in the healing phase for postoperative patients. Lactic- or ketoacidosis should always be considered as alternate causes of metabolic acidosis in the critically ill patients.

### Uremia

Uremia results from the accumulation of nitrogenous waste products and is a syndrome characterized by lethargy, fatigue, nausea, anorexia, and hiccups. Blood urea nitrogen measurement can be used as a marker; values less than 70 mg/dL are rarely symptomatic, whereas values greater than 100 mg/dL are almost always associated with symptoms. When uremic symptoms develop, dialysis is usually required.

### Nutrition

Adequate nutrition is essential to successful postoperative recovery, and any benefits of avoiding short-term dialysis by protein restriction should be weighed against this. Parenteral or enteral nutrition should provide a daily minimum of 30–35 kcal/kg and 1.0–1.2 g/kg of protein. Sodium bicarbonate or acetate should be added to buffer the acid generated by protein breakdown (60–80 mEq/d).

### DRUG PRESCRIBING IN PATIENTS WITH RENAL IMPAIRMENT

For additional discussion see Chap. 47.

Patients with renal impairment have altered responses to normal dosing of medication. Although, particularly in the case of water-soluble agents, this is often a result of changes in rates of drug clearance from the circulation, other factors, such as effects on absorption, distribution, and metabolism, related to renal dysfunction may also be important.

If an agent relies solely on the kidney for clearance, then a simple prescribing approach involves a calculated percentage reduction in drug dosage that matches the reduction in GFR. Although GFR can be accurately measured, an estimated clearance derived from serum creatinine is usually adequate for these purposes. Unfortunately, clearance of most medications involves a more complex combination of both hepatic and renal function, and drug level measurement or algorithms for a specific drug dosing may be recommended.

Acute renal failure may affect drug absorption. For example, a reduced first-pass effect through the gastrointestinal tract and liver is attributed with the increased serum levels of oral  $\beta$ -blockers and opioids in patients with acute renal failure. Also, an increase in volume of distribution is seen in most patients with chronic renal failure caused by increased plasma volume and decreased plasma protein binding. However, plasma protein binding is highly variable, with acidic drugs (e.g., warfarin, phenytoin) reducing binding and basic agents (e.g., amide local anesthetics) increasing binding. Importantly, for drugs with less binding, “normal” drug levels may reflect dangerously high active (un-

bound) drug levels. For example, therapeutic phenytoin levels are 10–20  $\mu\text{g}/\text{mL}$  normally, but 4–10  $\mu\text{g}/\text{mL}$  with renal failure. Finally, liver metabolism of drugs is difficult to predict in the setting of renal failure; some hepatic enzymes are inhibited, whereas others are induced, and accompanying liver disorders may alter the relationship of drug clearance with GFR.

### SUMMARY

Review of kidney function is an essential component of even the most hurried preoperative assessment for surgical candidates. To best manage patients, clinicians must be familiar with the kidney responses to hemodynamic stress and other homeostatic disturbances, and with normal states that influence kidney function, such as pregnancy, maturation, and aging. Special considerations are required in caring for surgical patients with kidney disease, and the consequences of kidney injury and postoperative renal dysfunction play importantly into the care of the critically ill patient. The well-being of the kidney throughout the perioperative period is highly associated with good outcome, and renal insult and injury are predictive of other complications. Thus, in the absence of effective interventions to treat acute renal injury, and with limited point-of-care tools to monitor renal stress, perioperative clinicians must act as ambassadors to protect the kidney throughout the perioperative period.

### KEY REFERENCES

1. Preuss HG. Basics of renal anatomy and physiology. *Clin Lab Med* 1993;13:1–11.
2. Brezis M, Rosen S. Hypoxia of the renal medulla—its implications for disease. *N Engl J Med* 1995;332:647–655.
3. Cockcroft DW, Gault MH. Prediction of creatinine clearance from serum creatinine. *Nephron* 1976;16:31–41.
4. Levey AS, Bosch JP, Lewis JB, et al. A more accurate method to estimate glomerular filtration rate from serum creatinine: a new pre-



diction equation. Modification of Diet in Renal Disease Study Group. *Ann Intern Med* 1999;130:461–470.

5. Bellomo R, Ronco C, Kellum JA, et al. Acute renal failure—definition, outcome measures, animal models, fluid therapy and information technology needs: the Second International Consensus Conference of the Acute Dialysis Quality Initiative (ADQI) Group. *Crit Care* 2004;8:R204–R212.

6. Greenberg A, ed. *Primer on Kidney Diseases*. 4th ed. Philadelphia: Elsevier Saunders, 2005.

7. Stafford-Smith M. Perioperative renal dysfunction: Implications and strategies for protection. In: Newman MF, ed. *Perioperative Organ Protection*. Baltimore: Lippincott Williams & Wilkins, 2003:89–124.

8. Chertow GM, Lazarus JM, Christiansen CL, et al. Preoperative renal risk stratification. *Circulation*. 1997;95:878–884.

## REFERENCES

- Smith HW. *Lectures on the Kidney*. Lawrence. University Extension Division, University of Kansas, 1943.
- Preuss HG. Basics of renal anatomy and physiology. *Clin Lab Med* 1993;13:1–11.
- Brezis M, Epstein FH. Cellular mechanisms of acute ischemic injury in the kidney. *Annu Rev Med* 1993;44:27–37.
- Leonhardt K, Landes R, McCauley R. Anatomy and physiology of intrarenal oxygen tension: Preliminary study of the effect of anesthetics. *Anesthesiology* 1965;26:648–658.
- Brezis M, Rosen S. Hypoxia of the renal medulla—its implications for disease. *N Engl J Med* 1995;332:647–655.
- Alpert RA, Roizen MF, Hamilton WK, et al. Intraoperative urinary output does not predict postoperative renal function in patients undergoing abdominal aortic revascularization. *Surgery* 1984;95:707–711.
- Conlon PJ, Stafford-Smith M, White WD, et al. Acute renal failure following cardiac surgery. *Nephrol Dial Transplant* 1999;14:1158–1162.
- Coresh J, Astor BC, Greene T, et al. Prevalence of chronic kidney disease and decreased kidney function in the adult US population: Third National Health and Nutrition Examination Survey. *Am J Kidney Dis* 2003;41:1–12.
- Levin A. Cystatin C, serum creatinine, and estimates of kidney function: searching for better measures of kidney function and cardiovascular risk. *Ann Intern Med* 2005;142:586–588.
- Grubb A, Bjork J, Lindstrom V, et al. A cystatin C-based formula without anthropometric variables estimates glomerular filtration rate better than creatinine clearance using the Cockcroft-Gault formula. *Scand J Clin Lab Invest* 2005;65:153–162.
- Sladen RN, Endo E, Harrison T. Two-hour versus 22-hour creatinine clearance in critically ill patients. *Anesthesiology* 1987;67:1013–1016.
- Bloor GK, Welsh KR, Goodall S, et al. Comparison of predicted with measured creatinine clearance in cardiac surgical patients. *J Cardiothorac Vasc Anesth* 1996;10:899–902.
- Gowans EM, Fraser CG. Biological variation of serum and urine creatinine and creatinine clearance: ramifications for interpretation of results and patient care. *Ann Clin Biochem* 1988;25:259–263.
- Morgan DB, Dillon S, Payne RB. The assessment of glomerular function: creatinine clearance or plasma creatinine? *Postgrad Med J* 1978;54:302–310.
- Cockcroft DW, Gault MH. Prediction of creatinine clearance from serum creatinine. *Nephron* 1976;16:31–41.
- Levey AS, Bosch JP, Lewis JB, et al. A more accurate method to estimate glomerular filtration rate from serum creatinine: a new prediction equation. Modification of Diet in Renal Disease Study Group. *Ann Intern Med* 1999;130:461–470.
- Ferguson TB Jr, Dziuban SW Jr, Edwards FH, et al. The STS National Database: current changes and challenges for the new millennium. Committee to Establish a National Database in Cardiothoracic Surgery, The Society of Thoracic Surgeons. *Ann Thorac Surg* 2000;69:680–691.
- Barrett BJ, Parfrey PS. Prevention of nephrotoxicity induced by radiocontrast agents. *N Engl J Med* 1994;331:1449–1450.
- Bellomo R, Ronco C, Kellum JA, et al. Acute renal failure—definition, outcome measures, animal models, fluid therapy and information technology needs: the Second International Consensus Conference of the Acute Dialysis Quality Initiative (ADQI) Group. *Crit Care* 2004;8:R204–R212.
- Greenberg A, ed. *Primer on Kidney Diseases*. 4th ed. Philadelphia: Elsevier Saunders, 2005.
- Stafford-Smith M. Antifibrinolytic agents make alpha<sub>1</sub>- and beta<sub>2</sub>-microglobulinuria poor markers of postcardiac surgery renal dysfunction. *Anesthesiology* 1999;90:928–929.
- Solhaug MJ, Bolger PM, Jose PA. The developing kidney and environmental toxins. *Pediatrics* 2004;113:1084–1091.
- Fernandez F, de Miguel MD, Barrio V, et al. Beta-2-microglobulin as an index of renal function after cardiopulmonary bypass surgery in children. *Child Nephrol Urol* 1988;9:326–330.
- Lindeman RD. Overview: renal physiology and pathophysiology of aging. *Am J Kidney Dis* 1990;16:275–282.
- Lindeman RD. Assessment of renal function in the old. Special considerations. *Clin Lab Med* 1993;13:269–277.
- Fliser D, Franek E, Joest M, et al. Renal function in the elderly: impact of hypertension and cardiac function. *Kidney Int* 1997;51:1196–1204.
- Anderson S, Brenner BM. Effects of aging on the renal glomerulus. *Am J Med* 1986;80:435–442.
- Muhlberg W, Platt D. Age-dependent changes of the kidneys: pharmacological implications. *Gerontology* 1999;45:243–253.
- Anderson RJ, Chung HM, Kluge R, et al. Hyponatremia: a prospective analysis of its epidemiology and the pathogenetic role of vasopressin. *Ann Intern Med* 1985;102:164–168.
- Verbalis JG. Hyponatremia: epidemiology, pathophysiology, and therapy. *Curr Opin Nephrol Hypertens* 1993;2:636–652.
- Arieff AI. Hyponatremia, convulsions, respiratory arrest, and permanent brain damage after elective surgery in healthy women. *N Engl J Med* 1986;314:1529–1535.
- Arieff AI, Ayus JC, Fraser CL. Hyponatremia and death or permanent brain damage in healthy children. *BMJ* 1992;304:1218–1222.
- Ayus JC, Wheeler JM, Arieff AI. Postoperative hyponatremic encephalopathy in menstruant women. *Ann Intern Med* 1992;117:891–897.
- Sterns RH, Cappuccio JD, Silver SM, et al. Neurologic sequelae after treatment of severe hyponatremia: a multicenter perspective. *J Am Soc Nephrol* 1994;4:1522–1530.
- Hodgkin JE, Soeprono FF, Chan DM. Incidence of metabolic alkalemia in hospitalized patients. *Crit Care Med* 1980;8:725–728.
- Rudolph R, Boyd CR. Massive transfusion: complications and their management. *South Med J* 1990;83:1065–1070.
- Isaacson SR. Hypocalcemia in surgery for carcinoma of the pharynx and larynx. *Otolaryngol Clin North Am* 1980;13:181–191.
- Suki WN, Yium JJ, Von Minden M, et al. Acute treatment of hypercalcemia with furosemide. *N Engl J Med* 1970;283:836–840.
- Mordes JP, Wacker WE. Excess magnesium. *Pharmacol Rev* 1977;29:273–300.
- Sutton RA, Domrongkitchai S. Abnormal renal magnesium handling. *Miner Electrolyte Metab* 1993;19:232–240.
- Jones JE, Shane SR, Jacobs WH, et al. Magnesium balance studies in chronic alcoholism. *Ann N Y Acad Sci* 1969;162:934–946.
- Dickerson RN, Brown RO. Hypomagnesemia in hospitalized patients receiving nutritional support. *Heart Lung* 1985;14:561–569.

43. Booth CC, Babouris N, Hanna S, et al. Incidence of hypomagnesaemia in intestinal malabsorption. *Br Med J* 1963;3:530:141-144.
44. Schuck P, Gammelin G, Resch KL. Magnesium and phosphorus. *Lancet* 1998;352:1474-1475; author reply 1475-1476.
45. Weisinger JR, Bellorin-Font E. Magnesium and phosphorus. *Lancet* 1998;352:391-396.
46. Gray RW, Wilz DR, Caldas AE, et al. The importance of phosphate in regulating plasma 1,25-(OH)<sub>2</sub>-vitamin D levels in humans: studies in healthy subjects in calcium-stone formers and in patients with primary hyperparathyroidism. *J Clin Endocrinol Metab* 1977;45:299-306.
47. Knochel JP. The pathophysiology and clinical characteristics of severe hypophosphatemia. *Arch Intern Med* 1977;137:203-220.
48. Larson EB, Roach RC, Schoene RB, et al. Acute mountain sickness and acetazolamide. Clinical efficacy and effect on ventilation. *JAMA* 1982;248:328-332.
49. White DP, Zwillich CW, Pickett CK, et al. Central sleep apnea. Improvement with acetazolamide therapy. *Arch Intern Med* 1982;142:1816-1819.
50. Better OS, Rubinstein I, Winaver JM, et al. Mannitol therapy revisited (1940-1997). *Kidney Int* 1997;52:886-894.
51. Solomon R, Werner C, Mann D, et al. Effects of saline, mannitol, and furosemide to prevent acute decreases in renal function induced by radiocontrast agents. *N Engl J Med* 1994;331:1416-1420.
52. Conger JD. Interventions in clinical acute renal failure: what are the data? *Am J Kidney Dis* 1995;26:565-576.
53. Toung TJ, Hurn PD, Traystman RJ, et al. Global brain water increases after experimental focal cerebral ischemia: effect of hypertonic saline. *Crit Care Med* 2002;30:644-649.
54. Borges HF, Hocks J, Kjellstrand CM. Mannitol intoxication in patients with renal failure. *Arch Intern Med* 1982;142:63-66.
55. Bailly C. Transducing pathways involved in the control of NaCl reabsorption in the thick ascending limb of Henle's loop. *Kidney Int Suppl* 1998;65:S29-S35.
56. Isenring P, Forbush B. Ion transport and ligand binding by the Na-K-Cl cotransporter, structure-function studies. *Comp Biochem Physiol A Mol Integr Physiol* 2001;130:487-497.
57. Gallagher KL, Jones JK. Furosemide-induced ototoxicity. *Ann Intern Med* 1979;91:744-745.
58. Pitt B, Zannad F, Remme WJ, et al. The effect of spironolactone on morbidity and mortality in patients with severe heart failure. Randomized Aldactone Evaluation Study Investigators. *N Engl J Med* 1999;341:709-717.
59. Brater DC. Diuretic therapy. *N Engl J Med* 1998;339:387-395.
60. Knauf H, Mohrke W, Mutschler E. Delayed elimination of triamterene and its active metabolite in chronic renal failure. *Eur J Clin Pharmacol* 1983;24:453-456.
61. Mutschler E, Gilfrich HJ, Knauf H, et al. Pharmacokinetics of triamterene. *Clin Exp Hypertens A* 1983;5:249-269.
62. de Gasparo M, Whitebread SE, Preiswerk G, et al. Antialdosterones: incidence and prevention of sexual side effects. *J Steroid Biochem* 1989;32:223-227.
63. Jose PA, Felder RA. What we can learn from the selective manipulation of dopaminergic receptors about the pathogenesis and treatment of hypertension? *Curr Opin Nephrol Hypertens* 1996;5:447-451.
64. Bellomo R, Cole L, Ronco C. Hemodynamic support and the role of dopamine. *Kidney Int Suppl* 1998;66:S71-S74.
65. Marik PE. Low-dose dopamine: a systematic review. *Intensive Care Med* 2002;28:877-883.
66. Kellum JA, J MD. Use of dopamine in acute renal failure: a meta-analysis. *Crit Care Med* 2001;29:1526-1531.
67. Prins I, Plotz FB, Uiterwaal CS, et al. Low-dose dopamine in neonatal and pediatric intensive care: a systematic review. *Intensive Care Med* 2001;27:206-210.
68. Holmes CL, Walley KR. Bad medicine: low-dose dopamine in the ICU. *Chest* 2003;123:1266-1275.
69. Argalious M, Motta P, Khandwala F, et al. "Renal dose" dopamine is associated with the risk of new-onset atrial fibrillation after cardiac surgery. *Crit Care Med* 2005;33:1327-1332.
70. Denton MD, Chertow GM, Brady HR. "Renal-dose" dopamine for the treatment of acute renal failure: scientific rationale, experimental studies and clinical trials. *Kidney Int* 1996;50:4-14.
71. Hou SH, Bushinsky DA, Wish JB, et al. Hospital-acquired renal insufficiency: a prospective study. *Am J Med* 1983;74:243-248.
72. Anderson JD, Smith RB. Renal failure associated with vesicoureteral reflux. *Urology* 1977;10:539-543.
73. Whelton A. Nephrotoxicity of nonsteroidal anti-inflammatory drugs: physiologic foundations and clinical implications. *Am J Med* 1999;106:13S-24S.
74. Bennett WM, Henrich WL, Stoff JS. The renal effects of nonsteroidal anti-inflammatory drugs: summary and recommendations. *Am J Kidney Dis* 1996;28:S56-S62.
75. Griffin MR, Yared A, Ray WA. Nonsteroidal antiinflammatory drugs and acute renal failure in elderly persons. *Am J Epidemiol* 2000;151:488-496.
76. Zhao SZ, Reynolds MW, Lejkowith J, et al. A comparison of renal-related adverse drug reactions between rofecoxib and celecoxib, based on the World Health Organization/Uppsala Monitoring Centre safety database. *Clin Ther* 2001;23:1478-1491.
77. Knight EL, Glynn RJ, McIntyre KM, et al. Predictors of decreased renal function in patients with heart failure during angiotensin-converting enzyme inhibitor therapy: results from the studies of left ventricular dysfunction (SOLVD). *Am Heart J* 1999;138:849-855.
78. Schoolwerth AC, Sica DA, Ballermann BJ, et al. Renal considerations in angiotensin converting enzyme inhibitor therapy: a statement for healthcare professionals from the Council on the Kidney in Cardiovascular Disease and the Council for High Blood Pressure Research of the American Heart Association. *Circulation* 2001;104:1985-1991.
79. Adhiyaman V, Asghar M, Oke A, et al. Nephrotoxicity in the elderly due to co-prescription of angiotensin converting enzyme inhibitors and nonsteroidal anti-inflammatory drugs. *J R Soc Med* 2001;94:512-514.
80. Kincaid EH, Ashburn DA, Hoyle JR, et al. Does the combination of aprotinin and angiotensin-converting enzyme inhibitor cause renal failure after cardiac surgery? *Ann Thorac Surg* 2005;80:1388-1393.
81. Michel DM, Kelly CJ. Acute interstitial nephritis. *J Am Soc Nephrol* 1998;9:506-515.
82. Rastegar A, Kashgarian M. The clinical spectrum of tubulointerstitial nephritis. *Kidney Int* 1998;54:313-327.
83. Kelly CJ. T cell regulation of autoimmune interstitial nephritis. *J Am Soc Nephrol* 1990;1:140-149.
84. Eddy AA, McCulloch L, Liu E, et al. A relationship between proteinuria and acute tubulointerstitial disease in rats with experimental nephrotic syndrome. *Am J Pathol* 1991;138:1111-1123.
85. Neilson EG. Pathogenesis and therapy of interstitial nephritis. *Kidney Int* 1989;35:1257-1270.
86. Neilson EG, Sun MJ, Kelly CJ, et al. Molecular characterization of a major nephritogenic domain in the autoantigen of anti-tubular basement membrane disease. *Proc Natl Acad Sci U S A* 1991;88:2006-2010.
87. Wilson CB. Nephritogenic tubulointerstitial antigens. *Kidney Int* 1991;39:501-517.
88. Linton AL, Clark WF, Driedger AA, et al. Acute interstitial nephritis due to drugs: Review of the literature with a report of nine cases. *Ann Intern Med* 1980;93:735-741.
89. Rossert J. Drug-induced acute interstitial nephritis. *Kidney Int* 2001;60:804-817.
90. Clive DM, Stoff JS. Renal syndromes associated with nonsteroidal antiinflammatory drugs. *N Engl J Med* 1984;310:563-572.
91. Kleinknecht D. Interstitial nephritis, the nephrotic syndrome, and chronic renal failure secondary to nonsteroidal anti-inflammatory drugs. *Semin Nephrol* 1995;15:228-235.
92. Lien YH, Hansen R, Kern WF, et al. Ciprofloxacin-induced granulomatous interstitial nephritis and localized elastolysis. *Am J Kidney Dis* 1993;22:598-602.
93. Cryst C, Hammar SP. Acute granulomatous interstitial nephritis due to co-trimoxazole. *Am J Nephrol* 1988;8:483-488.

94. Webb DE, Austin HA 3rd, Beldegrun A, et al. Metabolic and renal effects of interleukin-2, immunotherapy for metastatic cancer. *Clin Nephrol* 1988;30:141-145.
95. Ault BH, Stapleton FB, Gaber L, et al. Acute renal failure during therapy with recombinant human gamma interferon. *N Engl J Med* 1988;319:1397-1400.
96. Ruffing KA, Hoppes P, Blend D, et al. Eosinophils in urine revisited. *Clin Nephrol* 1994;41:163-166.
97. Nolan CR 3rd, Anger MS, Kelleher SP. Eosinophiluria—a new method of detection and definition of the clinical spectrum. *N Engl J Med* 1986;315:1516-1519.
98. Galpin JE, Shinaberger JH, Stanley TM, et al. Acute interstitial nephritis due to methicillin. *Am J Med* 1978;65:756-765.
99. Pusey CD, Saltissi D, Bloodworth L, et al. Drug associated acute interstitial nephritis: clinical and pathological features and the response to high dose steroid therapy. *Q J Med* 1983;52:194-211.
100. Huang JJ, Sung JM, Chen KW, et al. Acute bacterial nephritis: a clinicoradiologic correlation based on computed tomography. *Am J Med* 1992;93:289-298.
101. Wise GJ, Silver DA. Fungal infections of the genitourinary system. *J Urol* 1993;149:1377-1388.
102. Bhattacharya S, Bryk D, Wise GJ. Clinicopathological conference: renal pelvic filling defect in a diabetic woman. *J Urol* 1982;127:751-753.
103. Wise GJ, Kozinn PJ, Goldberg P. Amphotericin B as a urologic irrigant in the management of noninvasive candiduria. *J Urol* 1982;128:82-84.
104. Ramsay AG, Olesnick L, Pirani CL. Acute tubulo-interstitial nephritis from candida albicans with oliguric renal failure. *Clin Nephrol* 1985;24:310-314.
105. Levy E, Bia MJ. Isolated renal mucormycosis: case report and review. *J Am Soc Nephrol* 1995;5:2014-2019.
106. Myerowitz RL, Stalder H, Oxman MN, et al. Fatal disseminated adenovirus infection in a renal transplant recipient. *Am J Med* 1975;59:591-598.
107. Erdogan O, Bulbul M, Demircin G, et al. Acute necrotizing tubulointerstitial nephritis due to systemic adenoviral infection. *Pediatr Nephrol* 2001;16:265-268.
108. Rosen S, Harmon W, Krensky AM, et al. Tubulo-interstitial nephritis associated with polyomavirus (BK type) infection. *N Engl J Med* 1983;308:1192-1196.
109. Nasr SH, Koscica J, Markowitz GS, et al. Granulomatous interstitial nephritis. *Am J Kidney Dis* 2003;41:714-719.
110. Walker JV, Baran D, Yakub N, et al. Histoplasmosis with hypercalcemia, renal failure, and papillary necrosis. Confusion with sarcoidosis. *JAMA* 1977;237:1350-1352.
111. Frazao JM, Elangovan L, Felsenfeld AJ, et al. Epstein-Barr virus-induced interstitial nephritis in an HIV-positive patient with progressive renal failure. *Nephrol Dial Transplant* 1998;13:1849-1852.
112. Mayer HB, Wanke CA, Williams M, et al. Epstein-Barr virus-induced infectious mononucleosis complicated by acute renal failure: case report and review. *Clin Infect Dis* 1996;22:1009-1018.
113. Kramer L, Horl WH. Hepatorenal syndrome. *Semin Nephrol* 2002;22:290-301.
114. Gines P, Arroyo V. Hepatorenal syndrome. *J Am Soc Nephrol* 1999;10:1833-1839.
115. Gonwa TA, Klintmalm GB, Levy M, et al. Impact of pretransplant renal function on survival after liver transplantation. *Transplantation* 1995;59:361-365.
116. Guevara M, Gines P, Bandi JC, et al. Transjugular intrahepatic portosystemic shunt in hepatorenal syndrome: effects on renal function and vasoactive systems. *Hepatology* 1998;28:416-422.
117. Uriz J, Gines P, Cardenas A, et al. Terlipressin plus albumin infusion: an effective and safe therapy of hepatorenal syndrome. *J Hepatol* 2000;33:43-48.
118. Mulkay JP, Louis H, Donckier V, et al. Long-term terlipressin administration improves renal function in cirrhotic patients with type 1, hepatorenal syndrome: a pilot study. *Acta Gastroenterol Belg* 2001;64:15-19.
119. Angeli P, Volpin R, Gerunda G, et al. Reversal of type 1, hepatorenal syndrome with the administration of midodrine and octreotide. *Hepatology* 1999;29:1690-1697.
120. Holt S, Goodier D, Marley R, et al. Improvement in renal function in hepatorenal syndrome with N-acetylcysteine. *Lancet* 1999;353:294-295.
121. Brensing KA, Textor J, Perz J, et al. Long term outcome after transjugular intrahepatic portosystemic stent-shunt in non-transplant cirrhotics with hepatorenal syndrome: a phase II study. *Gut* 2000;47:288-295.
122. Arroyo V, Gines P, Gerbes AL, et al. Definition and diagnostic criteria of refractory ascites and hepatorenal syndrome in cirrhosis. *International Ascites Club. Hepatology* 1996;23:164-176.
123. Porter GA. Contrast-associated nephropathy: presentation, pathophysiology and management. *Miner Electrolyte Metab* 1994;20:232-243.
124. Kahn JK, Rutherford BD, McConahay DR, et al. High-dose contrast agent administration during complex coronary angioplasty. *Am Heart J* 1990;120:533-536.
125. Gussenhoven MJ, Ravensbergen J, van Bockel JH, et al. Renal dysfunction after angiography; a risk factor analysis in patients with peripheral vascular disease. *J Cardiovasc Surg (Torino)* 1991;32:81-86.
126. Merten GJ, Burgess WP, Gray LV, et al. Prevention of contrast-induced nephropathy with sodium bicarbonate: a randomized controlled trial. *JAMA* 2004;291:2328-2334.
127. Provenchere S, Plantefeve G, Hufnagel G, et al. Renal dysfunction after cardiac surgery with normothermic cardiopulmonary bypass: incidence, risk factors, and effect on clinical outcome. *Anesth Analg* 2003;96:1258-1264.
128. Myers BD, Newton L. Cyclosporine-induced chronic nephropathy: an obliterative microvascular renal injury. *J Am Soc Nephrol* 1991;2:S45-52.
129. Myers BD, Sibley R, Newton L, et al. The long-term course of cyclosporine-associated chronic nephropathy. *Kidney Int* 1988;33:590-600.
130. Lopau K, Kleinert D, Erler J, et al. Tacrolimus in acute renal failure: does L-arginine-infusion prevent changes in renal hemodynamics? *Transpl Int* 2000;13:436-442.
131. Medina PJ, Sipols JM, George JN. Drug-associated thrombotic thrombocytopenic purpura-hemolytic uremic syndrome. *Curr Opin Hematol* 2001;8:286-293.
132. Busca A, Uderzo C. BMT: bone marrow transplant-associated thrombotic microangiopathy. *Hematology* 2000;5:53-67.
133. Gharpure VS, Devine SM, Holland HK, et al. Thrombotic thrombocytopenic purpura associated with FK506, following bone marrow transplantation. *Bone Marrow Transplant* 1995;16:715-716.
134. Kamel KS, Ethier JH, Quaggin S, et al. Studies to determine the basis for hyperkalemia in recipients of a renal transplant who are treated with cyclosporine. *J Am Soc Nephrol* 1992;2:1279-1284.
135. Novis BK, Roizen MF, Aronson S, et al. Association of preoperative risk factors with postoperative acute renal failure. *Anesth Analg* 1994;78:143-149.
136. Levy EM, Viscoli CM, Horwitz RI. The effect of acute renal failure on mortality. A cohort analysis. *JAMA* 1996;275:1489-1494.
137. Chertow GM, Levy EM, Hammermeister KE, et al. Independent association between acute renal failure and mortality following cardiac surgery. *Am J Med* 1998;104:343-348.
138. Urschel JD, Antkowiak JG, Takita H. Acute renal failure following pulmonary surgery. *J Cardiovasc Surg (Torino)* 1994;35:215-218.
139. Stafford-Smith M. Perioperative renal dysfunction: Implications and strategies for protection. In: Newman MF, ed. *Perioperative Organ Protection*. Baltimore: Lippincott Williams & Wilkins, 2003:89-124.
140. Rabb H, Wang Z, Nemoto T, et al. Acute renal failure leads to dysregulation of lung salt and water channels. *Kidney Int* 2003;63:600-606.
141. Kelly KJ. Distant effects of experimental renal ischemia/reperfusion injury. *J Am Soc Nephrol* 2003;14:1549-1558.
142. Conlon PJ, Lynn K, Winn MP, et al. Spectrum of disease in familial focal and segmental glomerulosclerosis. *Kidney Int* 1999;56:1863-1871.
143. Zanardo G, Michielon P, Paccagnella A, et al. Acute renal failure in the patient

- undergoing cardiac operation. Prevalence, mortality rate, and main risk factors. *J Thorac Cardiovasc Surg* 1994;107:1489–1495.
144. Abel RM, Buckley MJ, Austen WG, et al. Etiology, incidence, and prognosis of renal failure following cardiac operations. Results of a prospective analysis of 500 consecutive patients. *J Thorac Cardiovasc Surg* 1976;71:323–333.
145. Andersson LG, Ekroth R, Bratteby LE, et al. Acute renal failure after coronary surgery—a study of incidence and risk factors in 2009, consecutive patients. *Thorac Cardiovasc Surg* 1993;41:237–241.
146. Mora-Mangano C, Diamondstone LS, Ramsay JG, et al. Renal dysfunction after myocardial revascularization: risk factors, adverse outcomes, and hospital resource utilization. The Multicenter Study of Perioperative Ischemia Research Group. *Ann Intern Med* 1998;128:194–203.
147. Corwin HL, Sprague SM, DeLaria GA, et al. Acute renal failure associated with cardiac operations. A case-control study. *J Thorac Cardiovasc Surg* 1989;98:1107–1112.
148. Chertow GM, Lazarus JM, Christiansen CL, et al. Preoperative renal risk stratification. *Circulation* 1997;95:878–884.
149. Ostermann ME, Taube D, Morgan CJ, et al. Acute renal failure following cardiopulmonary bypass: a changing picture. *Intensive Care Med* 2000;26:565–571.
150. Swaminathan M, Phillips-Bute BG, Conlon PJ, et al. The association of lowest hematocrit during cardiopulmonary bypass with acute renal injury after coronary bypass surgery. *Ann Thorac Surg* 2003;76:784–791.
151. Hilberman M, Myers BD, Carrie BJ, et al. Acute renal failure following cardiac surgery. *J Thorac Cardiovasc Surg* 1979;77:880–888.
152. Llopart T, Lombardi R, Forselledo M, et al. Acute renal failure in open heart surgery. *Ren Fail* 1997;19:319–323.
153. Chew ST, Newman MF, White WD, et al. Preliminary report on the association of apolipoprotein E polymorphisms, with postoperative peak serum creatinine concentrations in cardiac surgical patients. *Anesthesiology* 2000;93:325–331.
154. Gaudino M, Di Castelnuovo A, Zamparelli R, et al. Genetic control of postoperative systemic inflammatory reaction and pulmonary and renal complications after coronary artery surgery. *J Thorac Cardiovasc Surg* 2003;126:1107–1112.
155. Mangos GJ, Brown MA, Chan WY, et al. Acute renal failure following cardiac surgery: incidence, outcomes and risk factors. *Aust N Z J Med* 1995;25:284–289.
156. Stafford-Smith M, Phillips-Bute B, Reddan DN, et al. The association of postoperative peak and fractional change in serum creatinine with mortality after coronary bypass surgery. *Anesthesiology* 2000;93:A240.
157. Rao V, Weisel RD, Buth KJ, et al. Coronary artery bypass grafting in patients with non-dialysis-dependent renal insufficiency. *Circulation* 1997;96:II-38–II-43.
158. Anderson RJ, O'Brien M, MaWhinney S, et al. Mild renal failure is associated with adverse outcome after cardiac valve surgery. *Am J Kidney Dis* 2000;35:1127–1134.
159. Anderson RJ, O'Brien M, MaWhinney S, et al. Renal failure predisposes patients to adverse outcome after coronary artery bypass surgery. VA Cooperative Study #5. *Kidney Int* 1999;55:1057–1062.



## CHAPTER 14

## Evaluation of Patients with Hepatic Disease

Richard A. Wiklund, MD

216

The liver is a unique vital organ because it serves multiple, independent functions each of which is necessary for sustaining life. These functions include synthesis of proteins required for coagulation (fibrinogen, prothrombin, factor VII) and fluid volume homeostasis (albumin), conjugation and excretion of metabolic products (bilirubin and ammonia), carbohydrate metabolism (glycogen storage and glucose release), drug metabolism (muscle relaxants, local anesthetics, narcotics, many others), and defense from pathogens (reticuloendothelial cells). When the liver fails, these functions are compromised and cause a cascade of effects that result in multiorgan failure. Patients with liver failure develop abnormal neurologic function (encephalopathy), altered cardiovascular performance and hemodynamics, altered metabolism with accumulation of waste products (jaundice), abnormal accumulation of extracellular fluid volume (ascites), and compromised immune and endocrine function. Some patients are at risk for acute renal failure (hepatorenal syndrome) and altered pulmonary physiology (hepatopulmonary syndrome or portopulmonary hypertension).

Despite advances in the perioperative care of high-risk surgical patients, patients with acute or chronic liver failure continue to experience an increased incidence of postoperative complications and excess mortality.<sup>1</sup> Identifying and addressing risk factors preoperatively may prevent postoperative morbidity and reduce mortality. This chapter reviews the fundamentals of hepatic anatomy, physiology, and biochemistry, and presents an overview of many and diverse liver diseases to provide a foundation to identify risk factors and improve preoperative conditions for anesthesia and surgery. A case scenario, a request for consultation, is included to emphasize the im-

portance of the chapter content for a consulting anesthesiologist.

Anesthesia consultation requested for a patient with cirrhosis: An ortho-

pedic surgeon has asked you to evaluate the risk of surgery for his patient and to make recommendations for preoperative optimization of the patient's

## KEY POINTS

1. The Child-Pugh scoring system accurately assesses the high risk of surgery for patients with liver disease. This system requires knowledge of the patient's nutrition, control of ascites, history of encephalopathy, international normalized ratio (INR), plasma bilirubin level, and plasma albumin level.
2. The leading causes of perioperative death or complications for patients with advanced liver disease include hemorrhage secondary to coagulopathy, elevated intracranial pressure secondary to encephalopathy, sepsis secondary to peritonitis or pneumonitis, an ascites fluid leak at the site of surgical incision, and acute renal failure secondary to hemodynamic instability or hepatorenal syndrome.
3. Serious but rare complications of chronic liver disease include the hepatorenal syndrome, the hepatopulmonary syndrome, and portopulmonary hypertension. These may resolve following liver transplantation.
4. Most forms of chronic liver disease lead to cirrhosis, a histologic diagnosis that is characterized by fibronodular hyperplasia leading to compression and obstruction of sinusoidal capillaries and bile canaliculi. These histologic findings account for the development of portal hypertension that is manifested by ascites, esophageal varices, and hypersplenism. In a few patients, portal hypertension also leads to the development of the hepatopulmonary syndrome and/or the hepatorenal syndrome.
5. Autoimmune and uncontrolled inflammatory cellular mechanisms are key concepts for understanding the etiology of most forms of liver disease. Inflammatory mechanisms initiate hepatocellular dysfunction, hepatocyte necrosis, and portal fibrosis.
6. Laboratory testing for the evaluation of liver disease includes tests of plasma levels of synthetic proteins (INR, serum albumin, and other serum proteins), excretory function (plasma bilirubin levels), metabolic function (blood glucose, cholesterol, lipoprotein levels), evidence of bile duct obstruction (plasma alkaline phosphatase), and hepatocellular injury (plasma aspartate aminotransferase and alanine aminotransferase levels). Ultrasonography, computed tomography, and magnetic resonance imaging contribute to the ability to establish an anatomic cause of liver dysfunction.
7. The risk of transmission of viral infection by means of blood product administration has become extremely small as a result of the advances in routine immunologic and molecular screening of donors for various infectious diseases. Transmission to healthcare workers continues to be a hazard because of the lack of immunization against hepatitis C. Healthcare workers who are carriers of hepatitis B or C should limit the risk of transmitting their disease to their patients.
8. Nonalcoholic fatty liver disease is emerging as a leading cause of liver disease in the United States. Its prevalence is tied to the frequency of type 2 diabetes and the increasing problem of morbid obesity.
9. Liver transplantation offers improved chances of survival to patients following many forms of severe liver disease. Unfortunately, many patients with advanced liver disease die while waiting for suitable liver donors. Expanded criteria for suitable organ donation, organ donation immediately after cardiac death, and living-related liver segment donation have improved access to liver transplantation for patients with advanced or inherited liver disease.
10. Preoperative attention to the control of ascites, correction of coagulopathy, control of encephalopathy, improved nutrition, optimization of renal and pulmonary function, and reducing the risk of sepsis will reduce the risk of postoperative complications and improve survival rates following surgery in patients with liver disease.

medical problems. The patient is a 66-year-old male with an infected hip prosthesis that is eroding through the pelvis and impinging on the iliac vessels. The surgical procedure will be removal of prosthesis and possible reconstruction of the pelvic vessels. The patient has had autoimmune hepatitis since age 45 years. Aseptic necrosis secondary to steroid therapy led to hip arthroplasty 10 years ago. Currently, he is confined to a wheelchair and is severely depressed because of his limited activities of daily living. Medications include prednisone, azathioprine, propranolol, Prilosec, spiro lactone, furosemide, and lactulose.

He has no known allergies. He has never smoked cigarettes, is abstinent from alcohol, and maintains a low-protein diet. He is a retired former chief financial officer for a large corporation.

## OVERVIEW OF THE LIVER

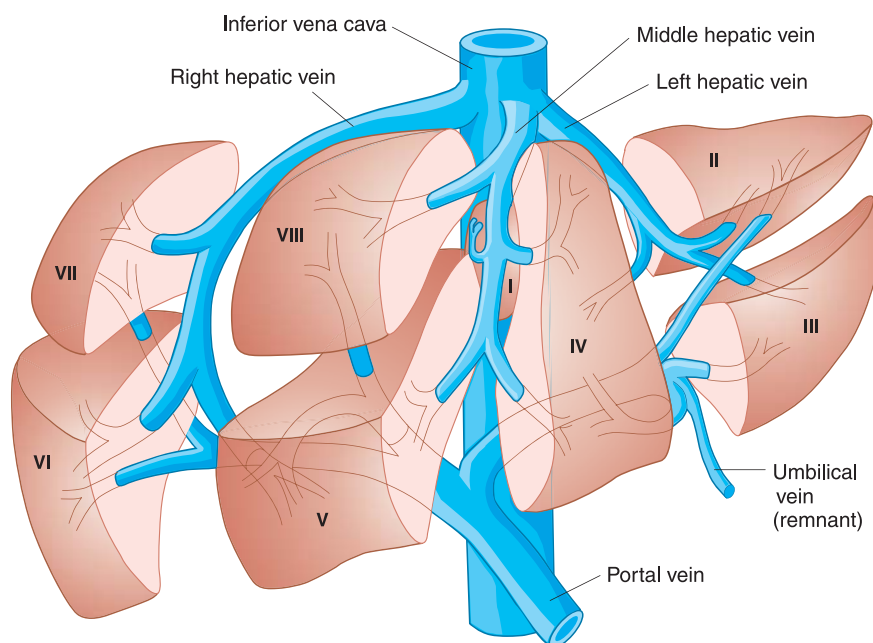
The liver is the largest solid organ in the body, normally weighing between 1200 and 1500 g. Unlike most organs, the liver is able to regenerate itself following injury. With repeated injury, however, regeneration is limited by surrounding fibrous scar tissue (cirrhosis). Early in the course of many hepatic diseases the liver becomes enlarged as a consequence of fatty infiltration, cellular infiltration, and fibronodular regeneration. With continued injury, however, it decreases in size as bridging fibrosis leads to cirrhosis.

### Functional Anatomy of the Liver

The functional anatomy follows the vascular supply and biliary drainage.

#### Strategy for the Preoperative Assessment of a Patient with Advanced Liver Disease

- How severely impaired is the patient's hepatocellular function?
- Has the patient had any complications related to his liver disease?
- What is the objective evidence for stratification of his liver disease?
- What laboratory data do you need to stratify the risk of surgery?
- Should the patient develop acute liver failure postoperatively, is he a candidate for urgent liver transplantation?



**FIGURE 14-1.** Segmental anatomy of the liver. The liver is divided into 8 segments based on the branches of the portal and hepatic veins. The left, middle, and right hepatic veins functionally divide the liver into 4 sectors, and these are further subdivided based on the portal inflow into a total of 8 segments. (Adapted with permission from Tanabe KK, Blaszkowsky LS, Chung R T, et al. Case 23–2005: A 57-year-old man with a mass in the liver. *N Engl J Med* 2005;353:401. Copyright 2005, Massachusetts Medical Society. All Rights Reserved.)

It is important because the anatomy forms the boundaries for hepatic resection of tumors and segmentectomy for living-related liver donation (Fig. 14-1). The branches of the vasculature and bile ducts describe the boundaries of the 8 liver segments. The hepatic acinus is the microscopic unit of the liver. The hepatic acinus is hexagonal in shape with the hepatic venule and bile canaliculus at the center and the hepatic arterioles and venules at the corners (Fig. 14-2).<sup>2</sup> Fibrosis leads to portal hypertension from compression of these blood vessels. Hepatocytes are described as being in zone 1, 2, or 3 based on their distance from blood flow with oxygen supply and available nutrients. Those in zone 3 are at greatest risk of ischemic, viral, and toxic injury as they are more remote from their source of oxygen and nutrients.<sup>3</sup> Zone 3 is the area of the hepatic acinus where bridging fibrosis first occurs following ischemic or metabolic injury.

### Functions of the Liver

Hepatocellular function includes synthesis of proteins, production of bile, clearance of drugs and metabolites, glycogenesis and glycogenolysis, cholesterol and fatty acid metabolism (Table 14-1). Reticuloendothelial function includes phagocytosis (Kupffer cells),

hematopoiesis (stem cells for both red and white blood cells), production of immunoglobulins (lymphoid tissue), and lipid metabolism (lipocytes). All of these functions can be impaired with liver disease.

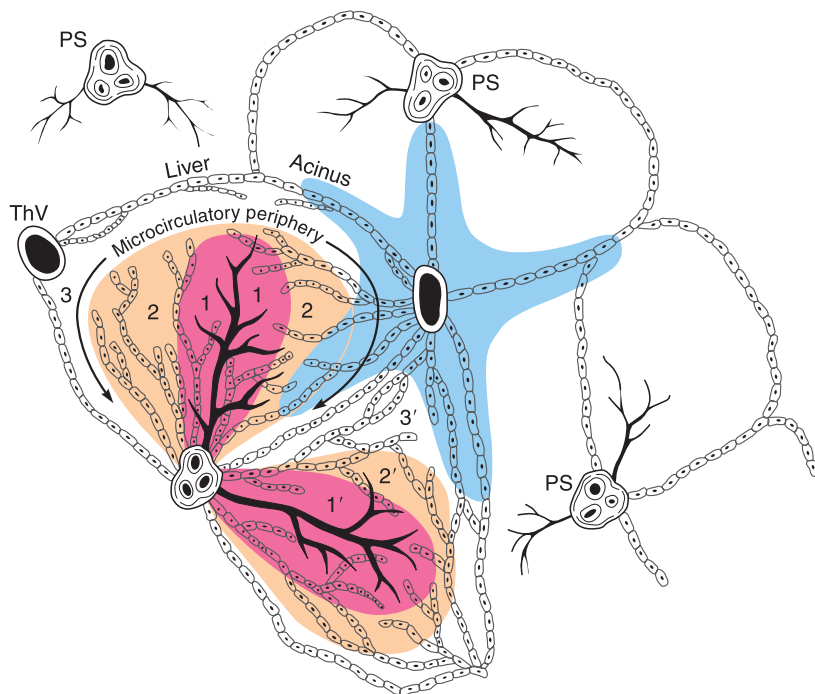
#### Synthetic Function

Albumin, fibrinogen, prothrombin, other coagulation factors, glycoproteins, transferrin, pseudocholinesterase, and  $\alpha$ -globulins (such as ceruloplasmin) are the major proteins synthesized in the liver. The liver also synthesizes cholesterol and glycogen.

#### Excretory Function

Bile excretion is the final pathway for the hepatic elimination of heme, cholesterol, and drug metabolites cleared from plasma. The principal mechanism of hepatic excretion is the conversion of nonpolar, lipid-soluble compounds to polar, water-soluble compounds by means of conjugation with glucuronic acid.

Heme molecules are oxidized and eventually conjugated to form bilirubin. Approximately 80% of bilirubin is derived from hemoglobin. The remainder comes from other heme molecules, such as those contained by myoglobin and cytochromes. Unconjugated bilirubin is tightly bound to albumin until it reaches the plasma membrane of hepa-



**FIGURE 14–2.** Anatomy of the hepatic sinusoids. The sinusoids are a collection of hepatocytes in a hexagonal arrangement with the final branches of the bile duct, hepatic artery, and portal vein in the center, and the hepatic venules at the periphery. The hepatocytes are divided into zones 1, 2, and 3, based on their proximity to the availability of oxygen supply. Those in zone 3 are most vulnerable to ischemic injury and this is the area where fibrosis first begins. Kupffer cells and lymphatics are located in the periphery. (Adapted with permission from Sherlock S, Dooley J. Anatomy and function. In: *Diseases of the Liver and Biliary System*. Sherlock S, Dooley J, eds. 9th ed. London: Blackwell Scientific, 1993:9.)

**TABLE 14–1.**

**Physiologic and Biochemical Functions of the Liver**

Liver Function	Examples
Protein synthesis	Albumin, fibrinogen, $\gamma$ -globulin, ceruloplasmin, $\alpha_1$ -antitrypsin, $\alpha_1$ -fetoprotein, others
Bilirubin excretion	Active transport and conjugation with glucuronic acid
Coagulation	Factors II, V, VII, IX, X
Drug elimination	Phase I metabolism (oxidation, hydroxylation, dealkylation, demethylation, deamination, desulfuration, sulfoxide formation, dehydrogenation) involving microsomal P450 enzymes Phase II metabolism (glucuronidation, sulfonation, acylation, methylation) Highly extracted drugs, poorly extracted drugs, enterohepatic circulation, enzyme induction
Waste-product elimination	Ammonia conversion to urea, amino acid elimination, hemoglobin, myoglobin, others
Energy metabolism	Glycogen synthesis, glucose production, cholesterol formation, fatty acid metabolism
Hormone metabolism	Estrogens, androgens, thyroxine, TSH, ACTH, catecholamines
Immune response	Kupffer cell phagocytosis, $\gamma$ -globulins, complement, protein C and S

ACTH, adrenocorticotropic hormone; TSH, thyroid-stimulating hormone.

toocytes, which may contain specific albumin receptors that enable transfer of bilirubin across the cell membrane.<sup>4</sup> Unconjugated bilirubin, a nonpolar, lipid-soluble compound, is released into the endoplasmic reticulum where it is conjugated by bilirubin uridine diphosphate (UDP) glucuronyl transferase to form conjugated bilirubin monoglucuronide. The same enzyme further conjugates bilirubin to conjugated bilirubin diglucuronide, the principal form of bilirubin found in bile following normal metabolism. Plasma levels of unconjugated bilirubin and conjugated bilirubin monoglucuronide are increased when high levels of free hemoglobin overwhelm conjugation or when there are reduced levels of bilirubin UDP glucuronyl transferase.

Excretion of conjugated bilirubin at the canaliculi requires energy and is a rate-limited process that occurs against a concentration gradient. Transport failure leads to direct hyperbilirubinemia. Bacteria in the colon convert conjugated bilirubin to urobilinogen, which can be reabsorbed by the ileum but not the colon. The liver normally metabolizes the small amount of urobilinogen reabsorbed in the small bowel (enterohepatic circulation).

Jaundice is more apparent with conjugated hyperbilirubinemia because it is water soluble and is able to diffuse easily through tissues. Rapidly appearing and severe jaundice causes pruritus but the symptoms can be relieved with cholestyramine, ursodeoxycholic acid, or rifampin. On the other hand, rifampin may cause drug-induced liver dysfunction and worsen the hepatic disease being treated.<sup>5</sup>

Jaundice can be prehepatic (a result of hemolysis), hepatocellular (metabolic, toxic, viral, alcoholic, cirrhotic), or cholestatic (sex hormones, hepatobiliary-pancreatic malignancies, gallstones). Unconjugated bilirubin is the primary component of hyperbilirubinemia with prehepatic disease, whereas conjugated hyperbilirubinemia is present with cholestatic disease. Both may be elevated with hepatic disease. History, physical findings, clinical course (encephalopathy, ascites, steatorrhea, etc.), and laboratory testing (plasma albumin and hepatic enzymes) can determine the cause of hyperbilirubinemia.

**Metabolic Function**

The liver, as a target for insulin, plays an important role in glucose metabo-

TABLE 14-2.

## Key Biochemical Markers in Hepatic Systems and Function

System or Function	Marker	Site or Significance	Function
Hepatocyte integrity	AST	Liver, heart, skeletal muscle, kidney, brain, red blood cell	
	ALT	Liver	Aminotransferases catabolize amino acids for entry into the citric acid cycle
Cholestasis	Alkaline phosphatase	Bone, intestine, liver, placenta	Canalicular enzyme that plays a role in bile production
	$\gamma$ -GT	Correlated levels with alkaline phosphatase indicate hepatobiliary origin	Catalyzes transfer of $\gamma$ -glutamyl group from peptides to other amino acids
	Bilirubin	Elevations may indicate hepatic or extrahepatic disorder	Breakdown product of hemolysis taken up by liver cells and conjugated to water soluble product excreted in bile
Liver function mass	Serum albumin	Diet or liver	Liver synthesizes albumin
	Prothrombin time	Liver synthesizes vitamin K-dependent clotting factors	Bile salts are necessary for normal vitamin K absorption

ALT, alanine aminotransferase; AST, aspartate aminotransferase;  $\gamma$ -GT, gamma-glucuronyl transpeptidase.

Reprinted and adapted from Giannini EG, Testa R, Savarino V. Liver enzyme alteration: a guide for clinicians. *CMAJ* 2005;172:367–379, by permission of the publisher. ©2005 CMA Media Inc.

lism and energy production. Insulin is also a hepatotropic growth factor contributing to hepatocyte regeneration following injury.<sup>6</sup>

Glucagon and  $\beta$ -adrenergic agonists are second-messenger hormones that stimulate production of cyclic adenosine monophosphate (cAMP) and release of glucose from hepatocytes. Both glucagon and insulin are secreted into the portal venous blood flowing into the liver. Drainage into the portal venous system is critical for the binding of insulin and glucagon and the release of glucose. Insulin and glucagon are much less effective in releasing glucose when pancreatic venous blood flow is extraportal (e.g. pancreatic transplantation) or when they are administered intravenously.

Insulin is not cleared effectively in cirrhosis.<sup>7</sup> Patients with diabetes and cirrhosis manifest hyperinsulinemia and continue to secrete glucose from the liver even in the face of severe hyperglycemia.<sup>8</sup> Hypoglycemia can occur in late acute liver failure but is rare in chronic liver failure

### Assessment of Liver Function

The results of liver function tests should provide information about hepatocyte integrity, cholestasis, and liver function (Table 14-2). Other tests are valuable in establishing the extent

of hepatocellular injury, as well as morphologic and histologic effects of disease.

Hepatic synthetic function is easily assessed by measurement of plasma albumin, fibrinogen and determination of the prothrombin time or the international normalized ratio.\* Assay of plasma cholinesterase activity can be used to measure synthetic function but this test should not be confused with the determination of the dibucaine number.<sup>9</sup> The dibucaine number can remain normal in patients with decreased levels of the normal isoform of pseudocholinesterase.

In acute liver failure, plasma proteins decrease late in the time course of the disease because of a long half-life (albumin = 22 days). Factor VII, however, has a short half-life (approximately 4–6 hours)<sup>10</sup> and is a better index of hepatocellular synthetic function in the face of acute hepatocellular injury or graft function following transplantation. Serum albumin and the prothrombin time are the standard tests of synthetic function and are used in the algorithm establishing the Child-Pugh score (see below).<sup>11</sup>

The best laboratory tests of hepatic excretion are serum levels of indirect and direct bilirubin (Table 14-3), another laboratory test used to compute the Child-Pugh score. Although most forms

of liver disease will eventually produce an elevation of bilirubin, it is most common with biliary obstruction or secondary autoimmune biliary disease.

Cellular enzymes are used to diagnose hepatocellular injury and bile duct obstruction (Table 14-4). The pattern of enzyme elevation helps distinguish between hepatocellular injury (ischemic, toxic, inflammatory), biliary obstruction, and alcohol abuse. Beyond that, they are relatively nonspecific and do not provide sufficient information to discriminate amongst the different liver diseases.<sup>12</sup>

With any form of bile duct obstruction, alkaline phosphatase, which is normally excreted in bile, leaks into the systemic circulation. Patients with bile duct obstruction will develop elevated plasma levels of alkaline phosphatase before hyperbilirubinemia. Bile duct obstruction at the level of the canaliculi can occur with granulomatous disease, amyloidosis, and infections, as well as with infiltrative disease such as leukemia and metastatic malignancies. Cholelithiasis is the most common cause of extrahepatic bile duct obstruction but other causes include tumors, strictures, infection, inflammation, or extrinsic compression.

Serum aspartate aminotransferase (AST) and alanine aminotransferase (ALT) are hepatic mitochondrial en-

\* (INR:  $INR = [PT_{patient}/PT_{midrange\ control}]ISI$  where ISI is the international standardization index and PT is prothrombin time. The ISI shows the relative activity of the reagents used to generate prothrombin. The ISI correction allows the comparison of the INR from one laboratory with that of another laboratory. Most clinical laboratories use reagents with an equal to 1.)



TABLE 14-3.

## Causes, Clinical Features and Biochemical Abnormalities of Hyperbilirubinemia

Type	Cause	Clinical Features and Biochemical Abnormalities
Unconjugated hyperbilirubinemia	Hemolysis	Decreased hemoglobin and haptoglobin levels
	Gilbert syndrome	None
	Hematoma absorption	Increased CK and LDH levels
Conjugated hyperbilirubinemia	Ineffective erythropoiesis	Bone marrow abnormalities
	Bile duct obstruction	Preceded by marked increase in AST/ALT levels Presence of abdominal pain
	Hepatitis	Increase in AST/ALT levels
	Cirrhosis	AST/ALT normal or slightly elevated Presence of physical findings of chronic liver disease
	Autoimmune cholestasis	Marked elevation of ALP with normal AST/ALT levels
	Parenteral nutrition	Increased ALP and $\gamma$ -GT
Toxic hepatitis	Concomitant increase in ALP levels	
	Vanishing bile duct syndrome	Associated with drug reactions or liver transplantation

ALP, alkaline phosphatase; ALT, alanine aminotransferase; AST, aspartate aminotransferase; CK, creatine phosphatase;  $\gamma$ -GT, gamma-glucuronyl transpeptidase; LDH, lactate dehydrogenase. Reprinted and adapted from Giannini EG, Testa R, Savarino V. Liver enzyme alteration: a guide for clinicians. *CMAJ* 2005;172:367–379, by permission of the publisher. ©2005 CMA Media Inc.

TABLE 14-4.

## Biochemical Features of Common Causes of Moderate to Marked Increase in Aminotransferase Levels

Cause	AST/ALT Level Increase (value $\times$ reference limit)	Bilirubin Level Increase (value $\times$ reference limit)	Comments
Ischemic injury	$>10$ to $>50$	$<5$	AST $>$ ALT; rapid decrease of both after initial peak; ALT: LDH $<1$ ; presence of comorbid conditions
Toxic injury	$>10$	$<5$	Pattern of enzyme alteration similar to that of ischemic hepatitis History suggestive of toxic injury
Acute viral hepatitis	5–10 to $>10$	5–10	Slow decrease of AST/ALT levels
Acute biliary obstruction	5–10	5–10 to $>10$	Presence of risk factors AST/ALT increase precedes cholestasis Presence of typical symptoms
Alcoholic hepatitis	5–10	5–10 to $>10$	AST:ALT $>2$ May occur as both acute and acute-on-chronic injury

ALT, alanine aminotransferase; AST, aspartate aminotransferase; LDH, lactate dehydrogenase. Reprinted and adapted from Giannini EG, Testa R, Savarino V. Liver enzyme alteration: a guide for clinicians. *CMAJ* 2005;172:367–379, by permission of the publisher. ©2005 CMA Media Inc.

zymes. Elevated levels indicate hepatocellular injury from a variety of causes, including viral infection, alcohol abuse, and obesity (Fig. 14-3). The highest elevations of the transaminases occur with ischemic or toxic liver injury and acute viral hepatitis. Gamma-glutamyl transpeptidase ( $\gamma$ -GT) and lactate dehydrogenase are enzymes that can be elevated in both hepatocellular injury and bile duct obstruction.

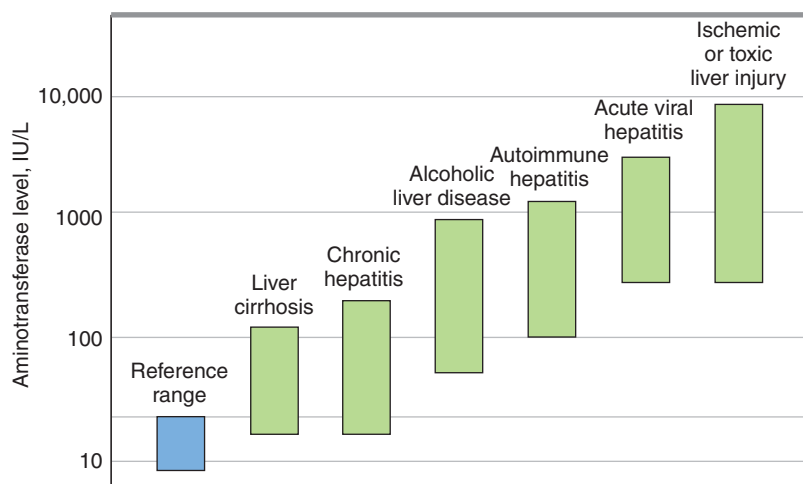
The serum liver enzyme response to hepatocellular injury can be confusing because elevations occur in the early phase of injury. Decreasing enzyme levels may indicate either recovery or worsening to severe, irretrievable injury. A good example is the fulminant hepatic failure seen with acetaminophen overdose. Falling enzyme levels can lead to a false sense of security and lower the sense of urgency for liver transplantation. In this situation, factor VII levels can be helpful.

Closed liver biopsy, guided by imaging, can be performed percutaneously or transvenously. Percutaneous liver biopsy is simple and safe as long as established guidelines are followed.<sup>13</sup> It is usually contraindicated in patients with a coagulopathy, thrombocytopenia, encephalopathy and tense ascites. The risks include hemorrhage from penetration of a major intrahepatic vessel, bile leak with peritonitis, pneumothorax, and hemothorax. Hemobilia may follow transfixion of adjacent hepatic arteries and bile ducts and may require embolization for control of bleeding.

Transvenous liver biopsy via a catheter passed from the internal jugular vein and wedged into a branch of the hepatic vein allows measurement of the intrahepatic capillary wedge pressure, a surrogate for portal venous pressure, as well as the opportunity to obtain a transcatheter needle biopsy of liver parenchyma. Transjugular biopsy may be indicated in patients with very small livers, patients with coagulopathy, or patients who are uncooperative.<sup>14</sup>

Chronic hepatitis is the most common indication for liver biopsy. Serial liver biopsies are helpful in following the progression or resolution of disease, as well as gauging the effects of treatment. Percutaneous imaging and a guided biopsy can establish the diagnosis of hepatocellular carcinoma, metastatic malignancy, or other invasive diseases of the liver.

Needle biopsy helps establish the severity of cirrhosis of the liver by



**FIGURE 14-3.** Serum aminotransferase levels in various liver diseases. The early elevation of the level of aminotransferase corresponds to the extent of inflammatory response in the hepatic sinusoids. (Reprinted and adapted from Giannini EG, Testa R, Savarino V. Liver enzyme alteration: a guide for clinicians. *CMAJ* 2005;172:367-379, by permission of the publisher. ©2005 CMA Media Inc.)

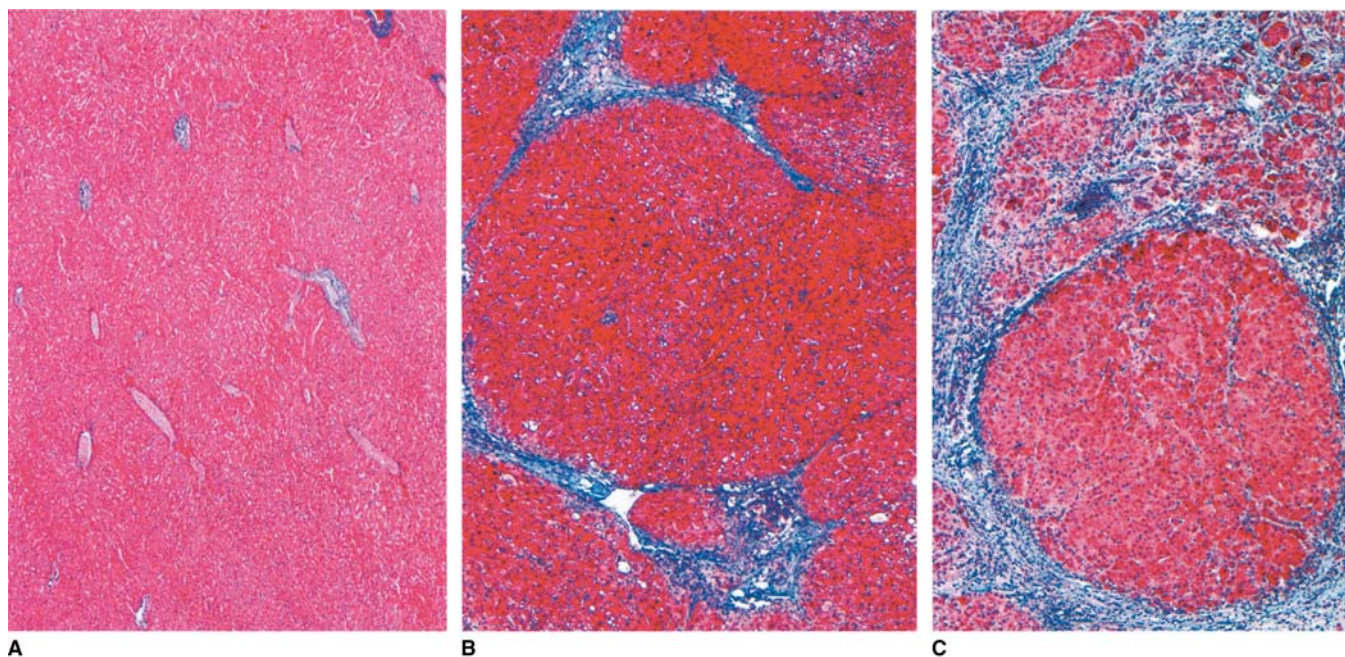
grading the extent of fibrosis in areas of fibronodular hyperplasia.<sup>3</sup> Ishak grade 0-2 reflects no or minimal fibrosis; Ishak grade 3-4 reflects incomplete bridging fibrosis; and Ishak grade 5-6 reflects precomplete and complete cirrhosis (Fig. 14-4).

High-resolution ultrasonography and Doppler ultrasonography examinations of the liver are noninvasive, uncompli-

cated, and simple to perform.<sup>15</sup> They give detailed information about the liver parenchyma, liver blood vessels, and lesions of the liver. Doppler examination can demonstrate the patency or occlusion of the hepatic artery, portal vein, hepatic veins, and inferior vena cava. Lesions as small as 1 cm can be identified with high-resolution ultrasonography and ultrasonographic imag-

ing can guide needle biopsy with good accuracy. Intraoperatively, ultrasonography guidance can be used to guide hepatic segmentectomy. Ultrasonography is most helpful in determining the cause of cholestatic jaundice and in locating gallstones.<sup>16</sup> It is less helpful in obese patients and in patients with gaseous distension of the stomach or intestines.

Computed tomography (CT) and magnetic resonance imaging (MRI)<sup>15</sup> have advantages over ultrasonography. Hard copy images are produced and can be readily interpreted. The spiral CT has greatly improved liver imaging because a complete scan with high resolution can be obtained during voluntary breath holding, thus eliminating motion artifacts.<sup>17</sup> Blood vessel anatomy is enhanced with oral or intravenous contrast material and CT scanning.<sup>18</sup> CT and MRI studies also provide additional information about surrounding structures, such as the spleen, kidney, collateral circulation, and shunts. CT with blood vessel enhancement provides better definition of liver segments for future resection. High-resolution ultrasonography and serum  $\alpha$ -fetoprotein are the most sensitive and specific means of surveillance for patients at risk for hepatocellular carcinoma.<sup>19</sup>



**FIGURE 14-4.** Ishak classification of cirrhosis. **Panel A:** There is minimal fibrosis and no bridging between areas of fibrosis. Synthetic and excretory functions are maintained. These findings do not cause significant portal hypertension and they are compatible with Child-Pugh class A. **Panel B:** There is moderate fibrosis with incomplete bridging between segments. Synthetic function is diminished and hyperbilirubinemia may be present. These findings are compatible with Child-Pugh class B and there may be mild portal hypertension. **Panel C:** There is complete bridging fibrosis and nodular hyperplasia. Patients will have portal hypertension with ascites, varices, and encephalopathy. They meet the criteria for Child-Pugh class C. (Used with the permission of the Department of Pathology, Massachusetts General Hospital, Boston, Massachusetts.)

MRI is highly specific and sensitive for iron overload in hemochromatosis and can be used to gauge the effectiveness of iron depletion therapy.<sup>20</sup>

## HEPATIC DRUG METABOLISM

### Hepatic Metabolism of Highly Extracted Drugs

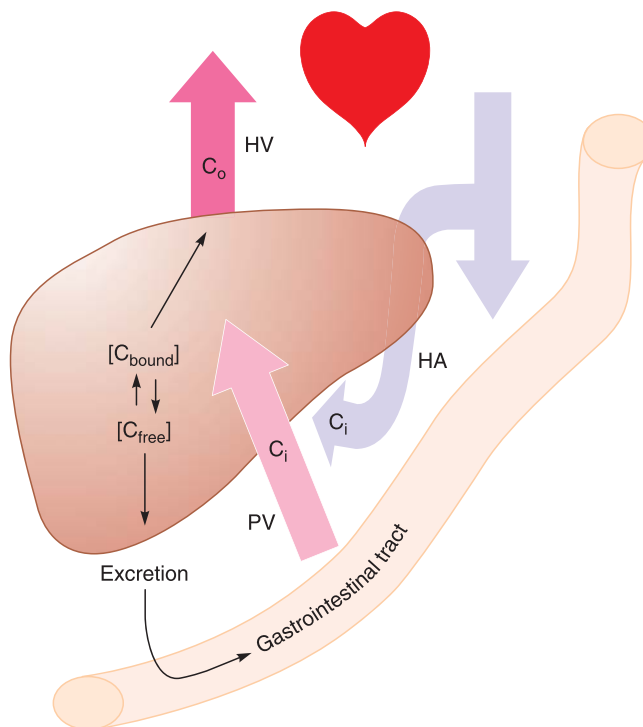
Hepatic drug extraction occurs at the level of the hepatocyte with its dual, afferent blood flow. Systemically administered drugs arrive at the hepatic sinusoid via the hepatic artery, whereas most orally administered drugs are absorbed in the small intestine and arrive at the liver via the portal vein (Fig. 14-5). When a drug is absorbed in the small intestine, the liver has the opportunity to remove it from the bloodstream before the drug can exert systemic effects. Drugs can be divided into two groups based on the ability of the liver to remove them from the circulation: highly extracted, lipid-soluble (nonpolar) compounds and poorly extracted, water-soluble (polar) compounds. In reality, the distinction between these two groups is imperfect, but it serves to help us understand hepatic drug clearance.

Hepatic clearance is expressed as

$$CL_H = Q_{\text{TTHBF}} [(C_{\text{TTHBF}} - C_{\text{HV}})/C_{\text{TTHBF}}]$$

where  $Q_{\text{TTHBF}}$  is total hepatic blood flow,  $C_{\text{TTHBF}}$  is the drug concentration in the mixed portal venous blood and hepatic arterial blood, and  $C_{\text{HV}}$  is the concentration in hepatic vein blood.

If a drug is completely extracted from either, or both, the hepatic artery or portal venous blood, the concentration in the hepatic vein is zero and the value of  $[(C_{\text{TTHBF}} - C_{\text{HV}})/C_{\text{TTHBF}}]$  is 1. Then  $CL_H$  is proportional to  $Q_{\text{TTHBF}}$ . Thus, clearance of highly extracted drugs is proportional to total liver blood flow. Liver disease, abnormal hemodynamics and drugs can decrease both hepatic artery and portal vein blood flow and will exaggerate the systemic effects of a drug that is normally highly cleared by the liver. Also, intraabdominal surgery and inhalational anesthetics can reduce liver blood flow by more than 80%.<sup>21</sup> Because cirrhosis of the liver markedly decreases total hepatic blood flow as a result of fibrosis at the portal triad, patients with cirrhosis can be expected to have increased sensitivity to highly extracted drugs.



**FIGURE 14-5.** Hepatic drug metabolism. Drugs are cleared by the liver from blood flow via the hepatic artery (HA) and the portal vein (PV). Drug concentration ( $C_o$ ) in the hepatic vein (HV) of highly extracted drugs approaches zero. Thus clearance is dependent on the concentration of drug ( $C_i$ ) in blood from the total hepatic blood flow (HA + PV). Total hepatic blood flow is proportional to cardiac output. Poorly extracted drug blood concentration is dependent on the extraction ratio ( $C_o/C_i$ ). The extraction ratio is decreased with diminished hepatocellular microsomal function. (Courtesy of Richard A. Wiklund, MD.)

For example, propranolol, which decreases total hepatic blood flow and is commonly prescribed for esophageal varices, will increase the sensitivity of patients to highly extracted drugs.

Nitroglycerine is also highly extracted. It undergoes first-pass hepatic clearance when it is administered orally. Consequently, it is most effective when given sublingually or intravenously. Examples of other highly extracted drugs include labetalol, metoprolol, morphine, verapamil, and acetaminophen.

### Protein Binding of Drugs Metabolized by the Liver

In practice, the clearance of highly extracted drugs, such as lidocaine, is more complex because of the role of protein binding. Protein binding limits the availability of lidocaine for hepatic extraction. Despite this, lidocaine is highly extracted. In fact, very little lidocaine reaches the systemic circulation when it is administered orally. Lidocaine is rapidly absorbed in the small bowel and is delivered to the liver via the portal veins. The near complete extraction of lidocaine is called "first-pass clearance," a phenomenon common to orally ad-

ministered highly extracted drugs. Similarly, systemically administered drugs that are highly extracted are rapidly cleared from blood because the total hepatic blood flow is equivalent to 30% of the cardiac output.

### Hepatic Metabolism of Poorly Extracted Drugs

The same clearance expression can be used to understand the role of the liver in the metabolism of poorly extracted drugs:

$$CL_H = Q_{\text{TTHBF}} [(C_{\text{TTHBF}} - C_{\text{HV}})/C_{\text{TTHBF}}]$$

where  $Q_{\text{TTHBF}}$  is total hepatic blood flow,  $C_{\text{TTHBF}}$  is the drug concentration in the mixed portal venous and hepatic arterial blood, and  $C_{\text{HV}}$  is the concentration in the hepatic vein blood. In this case, however,  $C_{\text{HV}}$  is not zero and  $Q_{\text{TTHBF}}$  is not as important as the ability of the liver to extract drugs:

$$C_{\text{HV}} = C_{\text{TTHBF}} * ER \sim C_f * C_b$$

where ER is the extraction ratio,  $C_f$  is the concentration of free drug (unbound), and  $C_b$  is the protein bound



concentration of the drug. The ER is a hepatocellular microsomal function.

Hepatic microsomal enzymes are responsible for the metabolism of many of the drugs cleared by the liver. Because the activity of microsomal enzymes is dependent on normal hepatocellular function, hepatic metabolism is decreased after hepatocellular injury and in cirrhosis of the liver. The principal hepatic microsomal enzymes include the monooxygenases, cytochrome c reductase, and cytochrome P450. Oxidation and hydroxylation by these enzymes convert drugs into polar, water-soluble compounds. Alternatively, alcohols can be converted to acetaldehydes by alcohol dehydrogenase. Once these reactions have occurred, the drugs' metabolites are conjugated with glucuronic acid and undergo active excretion (energy requiring) into the bile. Patients with cirrhosis are more sensitive to these drugs as the process can be saturated because of compromised hepatocellular function. Some examples of drugs that are poorly extracted and are enzyme dependent for their metabolism include certain barbiturates, benzodiazepines, nonsteroidal antiinflammatory drugs (NSAIDs), diphenylhydantoin, caffeine, theophylline, and warfarin.

The cytochrome P450 system is a complex collection of endoplasmic heme proteins capable of producing toxic drug metabolites. Many of the P450 enzymes are inducible by drugs (ethanol, phenobarbital, omeprazole, isoniazid) and enzyme induction leads to abnormal responses to drugs that undergo hepatic metabolism (acetaminophen,  $\beta$ -blockers, neuroleptics, benzodiazepines). This is important for causing increased sensitivity to acetaminophen-induced acute liver failure and is brought on by chronic alcohol abuse (see Acetaminophen Toxicity) or isoniazid therapy.

### Other Pharmacokinetic Abnormalities in Liver Disease

Liver disease leads to other intrinsic and extrinsic effects that alter the plasma half-life or pharmacokinetic profile of drugs. First, hypoalbuminemia is a characteristic finding in advanced liver disease. The normal liver is capable of producing 10 g of albumin per day, and this may be limited to less than 4 g per day in advanced cirrhosis. Albumin is the principal plasma protein capable of drug binding. Severe hypoalbuminemia

will increase the unbound concentration of any polar drug.

Hypoalbuminemia and portal hypertension lead to an accumulation of extracellular fluid in the form of peripheral edema, abdominal ascites, and pleural effusion. The apparent volume of drug distribution is greatly increased in the patient with a large volume of ascites.

Cirrhosis secondary to chronic alcohol abuse will lead to increased effect of drugs that affect the central nervous system, especially the benzodiazepines.<sup>22</sup> This is caused not only by generalized cerebral cortical atrophy but also by the accumulation of benzodiazepine-like substances and ammonia in the central nervous system, leading to hepatic encephalopathy. Benzodiazepine antagonists improve mental function in advanced encephalopathy.<sup>23</sup> Benzodiazepine therapy for agitation should be used with caution in patients with any evidence of hepatic encephalopathy.

The kidney shares the load of drug excretion with the liver, especially of lower-molecular-weight conjugated compounds. Renal blood flow is diminished in advanced liver disease by virtue of the increased abdominal pressure seen with uncontrolled ascites. Acute renal failure (hepatorenal syndrome, see Chronic Liver Failure) can be a complication of severe, usually acute, liver failure.

### Muscle Relaxants

The metabolism of muscle relaxants deserves special attention. Succinylcholine is metabolized by plasma pseudocholinesterase. Patients with advanced liver disease may have decreased plasma levels of pseudocholinesterase leading to a prolonged duration of neuromuscular blockade following succinylcholine administration. Pseudocholinesterase has a high affinity (low  $K_m$  [Michaelis constant]) for its substrate (succinylcholine) and metabolizes it rapidly (high  $V_{max}$  [maximal velocity]). Even very low concentrations of plasma pseudocholinesterase will result in only moderately prolonged paralysis. This is an unlikely cause of clinical problems. Purified pseudocholinesterase has been administered to homozygotes for atypical pseudocholinesterase that have received ester muscle relaxants.<sup>24</sup> This resulted in significant acceleration of recovery from neuromuscular blockade.

Most of the nondepolarizing muscle relaxants are metabolized in the liver and metabolites are excreted either in bile or urine or both. Active metabolites of vecuronium accumulate in the plasma of patients with advanced liver disease. Although there are theoretical advantages of using steroidal muscle relaxants such as atracurium in patients with cirrhosis, the prolonged paralytic effects of repeated doses of vecuronium is not an important clinical problem.

## HISTORY OF SURGICAL RISK

### Child-Pugh Stratification of Liver Disease

In 1964, Child and Turcotte<sup>25</sup> described the features of advanced liver disease leading to a high mortality rate in a group of 128 patients undergoing a portocaval shunt. Mortality was increased in patients with jaundice, malnutrition, encephalopathy, elevated serum bilirubin levels, or decreased serum albumin levels. Mortality was proportional to the extent of these abnormalities. All patients had variceal bleeding and had failed conservative treatment. The mortality rate for patients with advanced cirrhosis was 53%; it was only 4.3% for patients with earlier stages of cirrhosis.

Pugh and Murray-Lyon modified Child's classification 10 years later.<sup>11</sup> Because their 38 patients with variceal bleeding were considered to be at too high a risk to safely undergo portal decompression, transthoracic ligation was performed for variceal bleeding as a bridge to portocaval shunting. Of the 38 patients, 21 died from either continuing hemorrhage or acute liver failure. Pugh then added the prolonged prothrombin time as an additional laboratory measurement that was predictive of a poor outcome. Estimation of the severity of encephalopathy, malnutrition, ascites, hyperbilirubinemia, hypoalbuminemia, and prolongation of the prothrombin time became the basis for the Child-Pugh score. Each abnormality was graded as minimal (score = 1), moderate (score = 2), or severe (score = 3). Child-Pugh class A patients had an aggregate score of 5–6; class B patients, 7–9; and class C patients = 10–15 (Table 14–5). The operative mortality was 77% for patients in class C, 38% in class B, and 29% in



TABLE 14-5.

## Child-Pugh Scoring System for Staging the Severity of Liver Disease

Child-Pugh Class	A	B	C
Ascites	None evident (1 point)	Adequate control (2 points)	Poorly controlled (3 points)
Nutrition	Well nourished (1 point)	Poorly nourished (2 points)	Malnourished (3 points)
Encephalopathy	None evident (1 point)	Grade 1–2 (2 points)	Grade 3–4 (3 points)
Albumin	>3.5 g/dL (1 point)	3.0–3.5 g/dL (2 points)	<3.0 g/dL (3 points)
Bilirubin	<2.0 mg/dL (1 point)	2–3 mg/dL (2 points)	>3.0 mg/dL (3 points)
Prothrombin time (INR)	<4 sec > control (INR <1.7) (1 point)	4–6 sec > control (INR = 1.7–2.2) (2 points)	>6 sec > control (INR >2.2) (3 points)
<b>Total score</b>	<b>6 points</b>	<b>7–12 points</b>	<b>13–18 points</b>

Adapted from Pugh RN, Murray-Lyon IM, Dawson JL et al. Transection of the oesophagus for bleeding oesophageal varices. *Br J Surg* 1973;60:646. Copyright British Journal of Surgery Society Ltd. Reproduced with permission. Permission is granted by John Wiley & Sons Ltd on behalf of the BJSS Lt.

class A. None of the patients in class C survived for more than 1 year, and the overall mortality was 68% at 6 months.

Garrison et al.<sup>26</sup> reviewed 100 consecutive patients with cirrhosis undergoing intraabdominal surgery (Table 14–6). No patient had variceal hemorrhage. The authors correlated preoperative, intraoperative, and postoperative variables with survival without complications, survival with complications, and in-hospital death. Surgery included open cholecystectomy, common duct exploration, gastrectomy, intestinal resection, liver biopsy, splenectomy, pancreatectomy, vascular surgery, and exploratory laparotomy. Multivariate analysis showed that the features that correlated well with intraoperative and postoperative complications and death were similar to those factors in the Child-Pugh classification. Poor outcome was associated with malnutrition, uncontrolled ascites, late stages of encephalopathy, perioperative sepsis, coagulopathy, and abnormal liver function tests. The average Child-Pugh class (not score) was 2.4 (equivalent to Child-Pugh class C) in nonsurvivors, 1.6 (equivalent to Child-Pugh class B) in survivors with complications, and 1.25 (equivalent to Child-Pugh class A) in survivors without complications. Garrison's study added two new parameters to those of Child and Pugh that need consideration in evaluating the risk of surgery for patients with chronic liver disease. Sepsis, as evidenced by elevated circulating

white blood cell (WBC) counts and reoperative surgery were highly predictive of complications and death. Their data suggest that patients with chronic liver disease are at high risk for sepsis syndrome whenever they develop respiratory, urinary, or intraabdominal infections in the perioperative period. The mortality rate was 100% for exploratory laparotomy, most likely because these patients had developed spontaneous bacterial peritonitis. Reoperative surgery, for the most part, was performed to control ascites leaking out via the surgical wound, providing another portal of entry for infection.

In 1997, Mansour et al. reported results of 92 patients who were undergoing elective and emergency surgery.<sup>27</sup> The mortality rate for Child-Pugh class A was 10%; Child-Pugh class B, 30%; and Child-Pugh class C, 82%. For all three groups, mortality rose significantly following emergency surgery (26% overall for elective cases; 50% after emergency surgery). Furthermore, Aranha et al. reported an 83% mortality rate associated with cholecystectomy and common duct exploration for patients with liver disease and a prothrombin time more than 2.5 seconds greater than the control.<sup>28</sup> Cholecystostomy and retrograde cholangiography were recommended as options with a much lower mortality (14%).<sup>29</sup>

There are reports of improved outcome following laparoscopic cholecystectomy in patients with cirrhosis.

Fernandes et al. compared liver disease patients with matched controls.<sup>30</sup> The patients with cirrhosis had greater length of stay, longer duration of surgery, greater need for transfusion, more frequent complications, and a higher rate of conversion of open cholecystectomy. Mortality, however, was not significantly greater. There were no Child-Pugh class C patients in this series. In fact, 80% were Child-Pugh class A.

Shaw reviewed the role for portosystemic shunting and showed a low mortality rate (5–7%) for selected candidates, and for those with early cirrhosis or uncontrolled alcoholism or advanced age precluding transplantation.<sup>31</sup>

### Model of End-Stage Liver Disease

The Model for End-Stage Liver Disease (MELD)<sup>32,33</sup> has been recommended as a better predictor of outcomes for patients with liver disease than the Child-Pugh strategy for risk assessment. It is widely used for evaluation of the suitability for hepatic transplantation and it is discussed in detail in Chap. 56.

The risk of complications and death following major surgery for patients with cirrhosis is high (Table 14–7) and there has been little reduction in these risks despite the advances in surgery, anesthesia, intensive care, and blood component therapy that have evolved over the past 4 decades. Intraabdominal surgery is associated with a high-risk of complications and death in patients with early, moderate, and advanced liver disease. The increased risk is proportional to the extent of liver disease, which is readily estimated by simple clinical and laboratory data. The traditional risk factors of encephalopathy, uncontrolled ascites, malnutrition, abnormal serum albumin and bilirubin, and prolonged prothrombin time should be expanded to include the presence of sepsis and emergency surgery.

### BRIEF OVERVIEW OF LIVER DISEASES

#### Congenital and Infantile Liver Disease

##### *Biliary Atresia*

Biliary atresia results from destruction of bile ducts in utero. Infants do not survive childhood with complete atresia. Surgical correction of a distinct

TABLE 14-6.

Variables Associated with Morbidity and Mortality following Intraabdominal Surgery

<b>Preoperative</b>			
<b>Preoperative Variable</b>	<b>Survivors without Complications</b>	<b>Survivors with Complications</b>	<b>Nonsurvivors</b>
Ascites	12.5%	33%	70%
Malnutrition	7.5%	16.7%	43%
Emergency surgery	15%	40%	80%
Infection	7.5%	16.7%	47%
Elevated bilirubin	1.2 mg/dL	2.0 mg/dL	4.1 mg/dL
Decreased albumin	3.7 g/dL	3.3 g/dL	2.5 g/dL
Prolonged PT (> control)	0.3 sec	1.5 sec	4.5 sec
Prolonged PTT (> control)	3.0 sec	0.8 sec	7.9 sec
Child-Pugh class <sup>a</sup>	1.25	1.6	2.4
<b>Operative</b>			
<b>Operative Variable</b>	<b>Mortality if Present (%)</b>	<b>Mortality if Absent (%)</b>	
Ascites	58	11	
Malnutrition	62	22	
Emergency surgery	57	10	
Infection	64	21	
Elevated bilirubin	62	17	
Decreased albumin	58	12	
Prolonged PT	47	7	
Prolonged PTT	54	18	
Child-Pugh class A	10	50	
Child-Pugh class B	31	30	
Child-Pugh class C	76	18	
<b>Postoperative</b>			
<b>Postoperative Variable</b>	<b>Mortality if Present (%)</b>	<b>Mortality if Absent (%)</b>	
Lung failure	100	0	
Heart failure	92	8	
Renal failure	73	9	
Liver failure	66	8	
Infected ascites	85	16	
Ascitic leak	82	18	
Second operation	81	20	
Blood >2 units	69	22	
FFP	61	19	

<sup>a</sup>Average Child-Pugh class calculated assigning a numerical value of 1 for class A, 2 for class B, and 3 for class C.  
FFP, fresh frozen plasma; PT, prothrombin time; PTT, partial thromboplastin time.  
Adapted with permission from Garrison RN, Cryer HM, Howard DA, and Polk HC Jr.<sup>26</sup>

segment of biliary atresia with a choledochojejunostomy or Kasai procedure (hepatic portoenterostomy) may provide relief from severe jaundice and liver failure until liver transplantation can be performed.

### **Reye Syndrome**

Reye syndrome is an acute encephalopathy precipitated by aspirin therapy for children with acute viral infection. In the United States, the incidence of

Reye syndrome has been tied to salicylate ingestion and the incidence has fallen as acetaminophen is substituted for salicylates in children with viral illness.

### **Wilson Disease**

Wilson disease consists of progressive lenticular degeneration associated with cirrhosis of the liver. It is an autosomal recessive abnormality of copper metabolism and results in characteristic, greenish Kayser-Fleischer rings in the

TABLE 14-7.

Estimated Risk of Major Intraabdominal Surgery<sup>a</sup> for Patients with Cirrhosis

<b>Child-Pugh Classification</b>	<b>Mortality</b>
A	10%
B	30%
C	80%

<sup>a</sup>Does not include orthotopic liver transplantation.  
Data derived from Child CG and Turcott JG;<sup>25</sup> Pugh RN, Murray-Lyon IM, Dawson JL, et al;<sup>11</sup> Garrison RN, Cryer HM, Howard DA, and Polk HC Jr;<sup>26</sup> and Mansour A, Watson W, Shayani V, and Pickleman J.<sup>27</sup>

cornea. The plasma ceruloplasmin level is decreased. However, Wilson disease is not a failure to produce ceruloplasmin; it is a failure of copper transport followed by coupling to ceruloplasmin. Penicillamine therapy chelates copper, leading to improvement of the neurologic symptoms and prevention of cirrhosis. Fulminant hepatic necrosis can occur in 25% of cases, and requires urgent liver transplantation. Patients with Wilson disease require uninterrupted penicillamine therapy in the perioperative period.

### **Hemochromatosis**

Chronic excessive iron exposure causes hepatic fibrosis (hemochromatosis) irrespective of whether the accumulation is the result of multiple transfusions or abnormal absorption and accumulation of dietary iron. Hemochromatosis leads to cirrhosis and hepatocellular carcinoma.

Hereditary hemochromatosis results in macronodular cirrhosis, diabetes from pancreatic fibrosis, and cardiac iron deposition, often with heart failure, conduction abnormalities, and coronary atherosclerosis. This disease is an autosomal recessive metabolic disorder. Although present from birth, tissue injury does not begin until age 30 to 40 years. Iron toxicity is controlled by aggressive removal of blood. Multiple organ (heart, liver, pancreas) transplantation may be required.

### **$\alpha_1$ -Antitrypsin Deficiency**

$\alpha_1$ -Antitrypsin is an enzyme inhibitor produced in the liver that inhibits key proteases (such as trypsin) and neutrophil elastase. Two genes (Pi or protease inhibitor gene), one received from each parent, control the produc-

### Potential Complications of Advanced Liver Disease That Should Be Explored during the Consultation with the Patient

- **Ascites:** The patient's diuretic therapy would suggest that the patient has long-standing ascites with poor control.
- **Variceal Hemorrhage:** The patient has a history of one episode of variceal hemorrhage. This is suggested by the patient's therapy with propranolol.
- **Jaundice:** The patient has not been jaundiced but jaundice is unusual in patients with autoimmune hepatitis.
- **Malnutrition:** The patient weighs 220 lb and is 74" tall. Some of the patient's weight is attributable to the patient's ascites. On examination the patient shows some evidence of muscular wasting.
- **Encephalopathy:** The patient was hospitalized once for grade II hepatic encephalopathy (see Table 14–9). The patient is on a low-protein diet and is being treated with lactulose, both of which suggest that the patient is at risk of developing encephalopathy.
- **Hepatorenal Syndrome:** The patient has no history of renal dysfunction.
- **Hepatopulmonary Syndromes:** The patient has no evidence of hepatopulmonary hypertension or hepatopulmonary syndrome.
- **Spontaneous Bacterial Peritonitis:** The patient has no history of hospitalization for peritonitis or unexplained abdominal pain.
- **Sepsis:** The patient has an infected hip prosthesis.
- **Hyperdynamic Circulation:** The patient's blood pressure is 105/75 mm Hg, and the patient's pulse is 85 beats/min. These are consistent with hyperdynamic circulation but confirmation will be obtained at the time of pulmonary artery catheterization.

tion of  $\alpha_1$ -antitrypsin. There are many alleles but only two are associated with disease. M is the normal allele; S and Z are the two alleles that are clinically significant. Silent genes result in complete lack of  $\alpha_1$ -antitrypsin production. The normal genotype is PiMM. The abnormal genotype, PiZZ, causes emphysema and, in approximately 20% of patients, cirrhosis. The PiSS and PiMZ do not cause lung disease. The PiSZ genotype presents some increased risk of lung disease.

Liver disease can be associated with the PiMZ and PiZZ genotypes.

### Other Inherited Liver Diseases

Hereditary tyrosinemia is an autosomal recessive inborn error of metabolism that results in progressive liver disease and possible acute liver failure early in life.

There are at least 10 defects in glycogen synthesis or storage that affect the liver, skeletal muscle, and red and white blood cells.<sup>34</sup> For the most part

all result in excessive amounts of glycogen stored in these tissues.

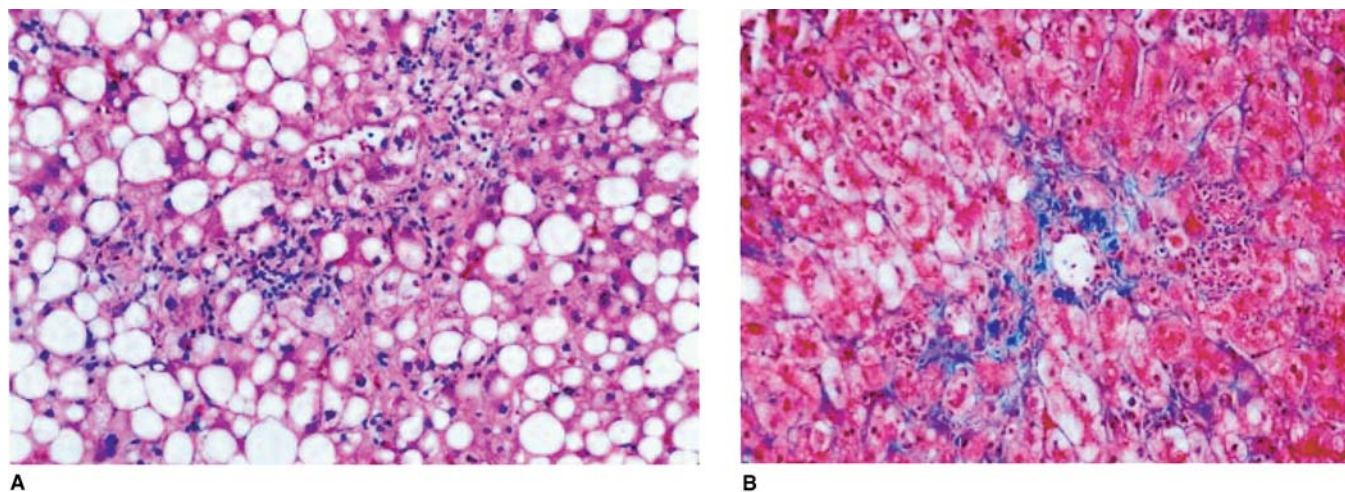
The mucopolysaccharide storage disorders are a group of lysosomal storage disorders associated with deficiencies of the lysosomal enzymes required for normal sequential degradation of glycosaminoglycans. Abnormal lysosomal enzymes lead to lysosomal storage diseases such as Hurler syndrome, another autosomal recessive abnormality.

## Nutritional Liver Disease

### Nonalcoholic Fatty Liver Disease

Nonalcoholic fatty liver disease (NAFLD) is prevalent in the obese population.<sup>35</sup> In a prospective study of 1124 asymptomatic patients referred for evaluation of abnormal liver function tests, 73 of 81 patients without markers for liver disease (infection, metabolic, autoimmune, hereditary, alcoholic, toxic) were found to have some degree of steatosis on liver biopsy.<sup>36</sup> NAFLD is believed to be the most common cause of abnormal liver function tests in the United States.<sup>37</sup> It is most prevalent in morbidly obese patients with type 2 diabetes mellitus.<sup>38</sup> Paradoxically, it occurs frequently following bariatric surgery.<sup>39</sup>

In its earliest stage, NAFLD is manifested by macrovesicular fatty infiltration of less than one-third of hepatocytes (grade 1), mostly in zone 3, with minimal inflammation (Fig. 14–6). Serum transaminases are elevated and ultrasonography demonstrates a diffuse increase of echogenicity. Zone 3



**FIGURE 14–6.** Histologic findings with nonalcoholic fatty liver disease. **A.** Photomicrograph shows macrovesicular fatty infiltration, an inflammatory infiltrate, Mallory hyaline deposits, and hepatocyte ballooning. **B.** This panel shows zone 3 fibrosis in a pattern typical of nonalcoholic liver disease as opposed to that seen in alcoholic liver disease. (Adapted with permission from Angulo P. Nonalcoholic fatty liver disease. *N Engl J Med* 2002;346:1221. Copyright 2002, Massachusetts Medical Society. All rights reserved.)



TABLE 14–8.

## Clinical and Chemical Characteristics of Viral Hepatitis

Disease	Viral Particle	Transmission	Testing	Course	Immunization and Treatment
Hepatitis A	RNA	Fecal–oral contamination of food or water	HVA-AB	Self-limited icteric disease FHF rare	Vaccine HIG
Hepatitis B	DNA	Sexual and familial contact Blood products Intravenous drug abuse Healthcare workplace exposure Immunocompromised patients	HVBsAg HVBeAg HVB-AB HVB-AB HBV DNA	Subclinical anicteric illness, or full recovery in 4–6 months, or chronic active hepatitis High incidence of FHF	Vaccine HIG Corticosteroids Interferon Antiviral therapy
Hepatitis D	Defective RNA	Intravenous drug abuse Blood products Immunocompromised patients	HVD-AB HVD RNA	Coinfection with hepatitis B Chronic active hepatitis	Protection with hepatitis B vaccination
Hepatitis C	RNA	Blood products Intravenous drug abuse Sexual contact Healthcare workplace exposure	HVC RNA	Subclinical hepatitis Chronic active hepatitis common FHF rare Cirrhosis and hepatocellular carcinoma	HIG and antiviral therapy (exposure) Interferon No vaccine
Hepatitis E	RNA	Fecal–oral contamination of water in tropical climates	HVE-Ag HVE-AB	Self-limited FHF a risk during pregnancy	Vaccine pending
Hepatitis G	RNA	Possibly blood products Unknown		Uncertain May coexist with hepatitis C	None

FHF, fulminant hepatic failure; HIG, human immunoglobulin; HVA, homovanillic acid; HVB, hepatitis B; HVC, hepatitis C virus; HVD, hantavirus disease; HVE, hepatitis E.

Data from Hoofnagle JH, di Bisceglie AM. The treatment of chronic viral hepatitis. *N Engl J Med* 1997;336:347.

fibrosis may be focal or extensive (stage 1 fibrosis). Grade 2 steatosis is a more advanced form of NAFLD, involving up to two-thirds of the hepatocytes with extensive fibrosis in the periportal areas. Grade 3 (more than two-thirds of hepatocytes), stages 3 and 4 (bridging fibrosis and cirrhosis), is an advanced form of the disease.<sup>40</sup> In this respect, NAFLD is difficult to distinguish from alcoholic liver disease. It is hypothesized that NAFLD is an abnormality of lipid uptake, synthesis, degradation, or secretion resulting from insulin resistance.<sup>35</sup> Although NAFLD is an infrequent indication for liver transplantation,<sup>41</sup> it has the potential to be a precipitating cause of postoperative liver dysfunction.

## Acquired Liver Disease

### Viral Hepatitis

Viral hepatitis is a broad collection of illnesses that have hepatic dysfunction as the only common thread. The etiology, modes of transmission, clinical course, and late complications are different (Table 14–8).<sup>42</sup>

All forms of viral hepatitis show diffuse acute inflammation with leukocyte and histiocyte infiltration followed by hepatic necrosis and regeneration with recovery. Zone 3 hepatocytes suffer the greatest injury. Inflammation may be limited to zone 3 in mild forms of viral hepatitis, or it may extend to the entire acinus in fulminant hepatic necrosis. When the entire acinus is involved the patients will eventually develop postnecrotic scarring with fibrosis (bridging fibrosis).

Hepatitis A is the least severe of the known forms of viral hepatitis. The fecal–oral route as a contaminant of drinking water or food, especially uncooked shellfish, causes hepatitis A. The incubation period for the disease is approximately equal to or greater than 15 days and plasma transaminases and bilirubin levels may not rise until several weeks into the course of disease.

Although recovery may take several weeks to months, most patients with hepatitis A have an unpleasant course but uncomplicated recovery. Fulmi-

nant hepatic necrosis with liver failure requiring transplantation is extremely rare with hepatitis A infection.

Hepatitis E is a form of viral hepatitis that is very similar to hepatitis A. It occurs in developing countries where there is fecal contamination of the drinking water. Fulminant hepatic failure following hepatitis E infection can be a serious complication of the third trimester of pregnancy.<sup>43</sup>

Hepatitis B is often an anicteric illness; however, hepatitis B can lead to either fulminant hepatic necrosis and liver failure or chronic hepatitis. Hepatitis B is a viral infection of the liver caused by a complex virion that contains double-stranded DNA, DNA polymerase, a surface antigen (HBsAg), a core antigen, and the e antigen. HBsAg was first identified in two patients who had received multiple transfusions for hemophilia when their serum, which had antibodies to HBsAg, was tested in a panel that contained an antigen from an Australian aborigine. The antigen was called the “Australian Antigen” and was sub-



sequent identified as the antigen of viral hepatitis B.

The antigens and antibodies found in patients with hepatitis B form the basis for both diagnosis and prognosis. HBsAg is present in the bloodstream during the acute phase of the disease and persists for more than 6 months if the patient becomes a carrier of hepatitis B. HBsAg disappears with recovery and is replaced with the antibody (anti-HB) to HBsAg. Antihepatitis antibodies (anti-HBs) persist and are evidence of prior hepatitis B infection or exposure. Serum IgM antibodies to the core antigen (HBcAb) rise during the acute phase of infection and then disappear. Hepatitis B is spread by sexual contact or exposure to blood products. Evidence of exposure to blood products by positive anti-HBs has been a common finding in surgeons and anesthesiologists who have been in practice for years prior to the availability of hepatitis B immunization and the adoption of universal precautions. Today, hepatitis B vaccination of healthcare workers is mandated by institutional regulation. Body fluids, including blood, urine, saliva, and semen, have been shown to carry hepatitis B virus (HBV) DNA in samples obtained from HBsAg-positive patients. HBsAg is found in approximately 0.1% of potential first-time blood donors. In other areas of the world, especially Africa and Asia, the incidence is higher. HBsAg is routinely tested for by radioimmunoassay in all donors in the United States and Europe. High-risk populations are identified by predonation questionnaires. Testing has contributed significantly to the reduction in the risk of viral hepatitis from the transfusion of blood or blood products.

There are reports of healthcare workers who become carriers for hepatitis B and have transmitted the disease to patients,<sup>44</sup> and of a cardiac surgeon who transmitted hepatitis C virus.<sup>45</sup>

Hepatitis D is a severe viral infection of the liver that occurs as a coinfection of a patient with acute hepatitis B or as a superinfection in a patient with chronic hepatitis B, but hepatitis D does not cause hepatitis independently. In western cultures, it occurs most often in patients with a history of intravenous drug abuse, but healthcare workers and transfusion recipients are also at risk, as are other

patients who have acquired acute or chronic active hepatitis B.

The virus of hepatitis C is an enveloped single-stranded RNA virus. Immunologic identification of infection with the hepatitis C virus (HCV) can be difficult. Antibodies against hepatitis C may not be present for long periods following initial infection. This has important public health implications because of the prevalence of asymptomatic carriers, approximately 0.5–1.0% of blood donors in the United States. Routine testing of donated blood for HCV and HIV by polymerase chain reaction (PCR) has reduced the incidence of transmission of hepatitis C and HIV to approximately 1:2,000,000 transfusions. PCR testing is not available for HBV, thus the incidence is much higher at 1:75,000. Testing for HBV does include HBsAg and HBcAb. Additional blood testing to meet current FDA and American Association of Blood Banks standards includes screening for syphilis, human T-cell leukemia, anti-HB<sub>core</sub>, and HIV-Ab (human immunodeficiency virus antibody).

Much like hepatitis B, those patients at increased risk of hepatitis C include recipients of blood products, intravenous drug abusers, hemophiliacs, and healthcare workers following hollow needle sticks. Sexual transmission of hepatitis C may be possible.

Hepatitis C rarely causes fulminant hepatic failure; in fact subclinical, chronic, nonicteric infection is fairly common. Unfortunately, about half of the patients with acute hepatitis C infection will have evidence of ongoing hepatitis after 1 year. At least 20% of these patients will eventually develop cirrhosis. These patients are also at high-risk of developing hepatocellular cancer through several possible immunologic and genetic events.<sup>46</sup> There is no vaccine yet to prevent hepatitis C infection.

An RNA virus has been identified in the serum of blood donors and blood recipients that may be responsible for the remaining portion of cases of transfusion hepatitis. This virus has been classified as non-A, non-B, and non-C.<sup>47</sup> However, many of the patients who have received blood products containing this RNA virus did not develop clinical or laboratory signs of hepatocellular injury. In the few cases that have been followed for months to a few years, hepatitis G virus RNA has

been present in the serum of some patients, suggesting the possibility of a persistent viral infection, but the target organ may not be the liver.<sup>48</sup> To add to the confusion on this issue, the so-called hepatitis G virus may be an agent that coexists with the hepatitis C virus.

Hepatitis can occur from systemic infections caused by other viruses such as the Epstein-Barr virus (infectious mononucleosis) and cytomegalovirus. These are important infections of immunocompromised patients.

### Chronic Hepatitis

The histologic findings on needle biopsy of the liver will define several types of chronic hepatitis including, in order of severity, chronic persistent, chronic lobular, mild chronic active, and severe chronic active hepatitis. The extent of portal hepatitis, the degree of necrosis, and the presence of fibrosis all indicate increasing severity. Viral hepatitis, autoimmune hepatitis, and drug-induced hepatitis are the most common causes of chronic hepatitis. Of the viral diseases, hepatitis B and hepatitis C are the most important.

When all other causes of hepatitis have been eliminated, there remains a group of patients with cirrhosis with no identifiable etiology. These patients are given the diagnosis of cryptogenic cirrhosis, a diagnosis of exclusion, but one with the features of advanced cirrhosis.

The role of liver transplantation for the treatment of chronic hepatitis is discussed in Chap. 56.

### Toxic Liver Disease

#### Alcoholic Liver Disease

The excessive daily consumption of alcohol can lead to alcoholic hepatitis, especially in individuals with a low-calorie and low-protein diet. Ingestion of 80 g of alcohol a day places the individual at risk for alcoholic hepatitis, a precirrhotic lesion. Chronic consumption of lower doses of alcohol may lead to fatty infiltration of the liver and, eventually, to cirrhosis of the liver.

Alcohol is metabolized by alcohol dehydrogenase to acetaldehyde. Acetaldehyde dehydrogenase is the rate-limiting step in eliminating acetaldehyde, but it can be overwhelmed when large amounts of alcohol are ingested. Acetaldehyde, when it cannot be rapidly eliminated, is toxic to a number of

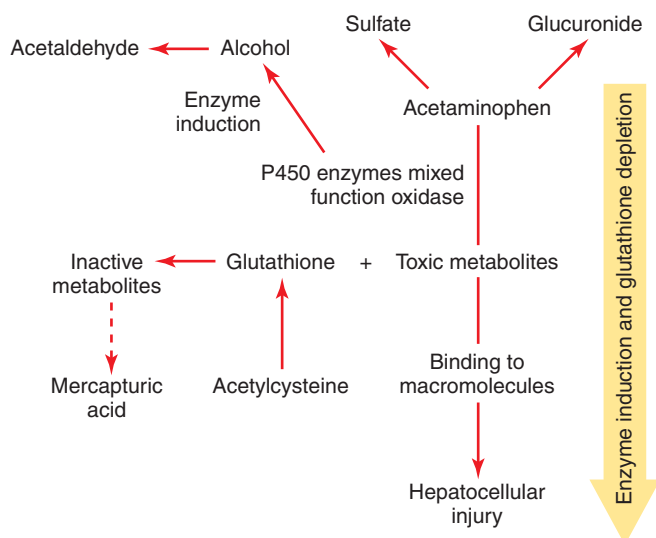
cellular components and can lead to zone 3 hepatic necrosis. Alcohol can also be metabolized by the microsomal ethanol-oxidizing system, an alcohol-inducible P450 enzyme that also metabolizes acetaminophen.

The metabolism of acetaldehyde alters the reduced form of nicotinamide adenine dinucleotide (NADH):nicotinamide adenine dinucleotide (NAD) ratio in the cytoplasm of hepatocytes. This change in energy metabolism leads to fatty acid accumulation in zones 2 and 3 cells, an early feature of alcoholic hepatitis. Severe hepatitis secondary to alcohol ingestion alone is rare; however, a fatty liver and chronic alcoholic hepatitis will lead to cirrhosis. Advanced cirrhosis secondary to long-term alcohol abuse is irreversible and patients will demonstrate the cardinal features of portal hypertension secondary to obliteration of portal venules. In early stages, patients with alcoholic cirrhosis do well, as compared to other causes of cirrhosis, if they can abstain from alcohol and correct their nutritional deficiencies (primarily vitamins and protein) that are associated with alcohol abuse. However, the 5-year survival rate in patients with ascites, jaundice, and variceal bleeding and who are from higher socioeconomic backgrounds, is 50% overall, 40% with continued alcohol abuse, and 60% with abstinence. With patients in lower socioeconomic groups the chance of survival is lower, as low as 50% at 33 months. Chronic alcohol abuse of greater than 90 g per day for more than 5 years can lead to alcoholic cardiomyopathy in addition to cirrhosis of the liver. Alcohol abuse is the leading cause of nonischemic cardiomyopathy in the United States.<sup>49</sup> Cardiac performance may improve with abstinence from alcohol.

Many patients with alcoholic cirrhosis often have concomitant risk factors for coronary atherosclerosis, others may have cardiac valvular abnormalities requiring valve replacement. Cardiac surgery performed using cardiopulmonary bypass has a high mortality rate, especially in Child-Pugh class B and class C patients.<sup>50</sup>

### Acetaminophen Toxicity

Suicide attempts are the most common cause of acetaminophen-induced hepatic necrosis and subsequent fulminant hepatic failure. The lethal adult dose of acetaminophen is ap-



**FIGURE 14-7.** Mechanism of acetaminophen hepatotoxicity. Acetaminophen can be conjugated to a sulfate or a glucuronide prior to excretion. Alternatively, it can be oxidized to highly reactive compounds by P450 mixed function oxidases. Binding to glutathione inactivates these toxic compounds. When glutathione is depleted, the reactive metabolites bind to hepatocellular macromolecules and cause cell necrosis. P450 enzyme activity is induced by chronic alcohol ingestion. Increased P450 enzyme activity can deplete glutathione and enhance the toxic binding to macromolecules. Acetylcysteine can augment glutathione and prevent hepatic necrosis if given early after the ingestion of a lethal dose of acetaminophen. (Courtesy of Richard A. Wiklund, MD.)

proximately 10 g but this can be greatly reduced in patients with concomitant alcohol abuse or preexisting liver disease. Acetaminophen is metabolized by the P450 system in the microsomes of hepatocytes to metabolites (*N*-acetyl-*p*-benzoquinone) binding to cellular macromolecules (Fig. 14-7). Glutathione normally binds to and clears the metabolites of acetaminophen and its depletion may lead to accumulation of toxic acetaminophen metabolites. Acetylcysteine can increase the production of glutathione and may prevent hepatic necrosis if given within the first few hours after acetaminophen ingestion.<sup>51</sup>

Fulminant hepatic necrosis and acute liver failure can occur 2-3 days following an acetaminophen overdose. Plasma transaminases are markedly elevated during the first few days after ingestion. Coagulopathy can become severe when the international normalized ratio (INR) increases. Severe coagulopathy and encephalopathy are signs of a poor prognosis. The outcome of acetaminophen-induced hepatic necrosis can be predicted by measuring the plasma level of acetaminophen 4 hours after ingestion. Blood levels greater than 300 µg/mL predict that hepatic necrosis will occur. Blood levels less than 120 µg/mL

usually do not result in hepatic necrosis. Acetylcysteine is most effective when given intravenously or orally within 24 hours after the ingestion of acetaminophen, but it may be effective even if given up to 72 hours after ingestion.

### Halothane and Other Halogenated Anesthetics

Halothane was the first of the modern generation of nonflammable halogenated anesthetic agents that changed the practice of anesthesiology. Halothane, a halogenated alkane, was introduced in the late 1950s. It was followed by methoxyflurane, the first of the halogenated methyl-ethyl ethers, which now include enflurane, isoflurane, desflurane, and sevoflurane. A series of case reports describing fulminant hepatic necrosis following surgery led to a review of 850,000 halothane anesthetics and the famous report of the National Halothane Study.<sup>52,53</sup> After other causes of severe acute liver failure were ruled out, 7 cases were identified wherein exposure to halothane was the probable cause. The controversy about the continued use of halogenated anesthetics gradually faded with the subsequent introduction of isoflurane and the replacement of halothane. As much as

17–20% of an administered dose of halothane undergoes oxidative and reductive metabolism, mostly in the liver. Reactive metabolites bind to hepatocellular proteins as haptens to produce antigens that can rarely provoke an immune response evidenced by the appearance of immunoglobulins, an inflammatory response in the liver, eosinophilia and hepatic necrosis. The immunologic basis of halothane hepatitis has been challenged by other theories suggesting hepatic oxygen deprivation (decreased supply and increased demand) or direct toxicity of metabolites may be responsible. Massive hepatic necrosis was seen more often in patients with prior or frequent exposures to halothane. Few patients survived massive hepatic necrosis believed to be caused by halothane, which usually occurred before the era of liver transplantation.

### Drug-Induced Liver Disease

Many other drugs are hepatotoxic; their toxicity mimics other liver diseases. Carbon tetrachloride, for one, causes zone 3 hepatocyte necrosis. Valproic acid causes fatty infiltration of the liver. Drugs such as NSAIDs, methyldopa, amiodarone, nifedipine, and isoniazid may mimic acute viral hepatitis and chronic active hepatitis. Methotrexate may cause hepatic fibrosis and portal hypertension. Antibiotics, tranquilizers, and sex hormones may cause cholestasis. Sex hormone therapy may also cause thrombosis of portal and hepatic veins. In most cases of drug-induced hepatic dysfunction, recovery occurs following withdrawal of the drug. Recovery may be prolonged with a drug like amiodarone because of its long half-life and the extremely long time required to eliminate metabolites. Furthermore, some drugs can become “locked” in the enterohepatic circulation by the intestinal reabsorption of their toxic metabolites.

### Autoimmune and Inflammatory Liver Disease

Autoimmune hepatitis, primary biliary cirrhosis, and primary sclerosing cholangitis appear to result from autoimmune mechanisms.<sup>54</sup> At times they are difficult to distinguish from each other or from other inflammatory disease such as viral hepatitis. Patients with these autoimmune diseases often do well following liver transplantation.

### Autoimmune Hepatitis

Autoimmune hepatitis is a disease characterized by autoantibodies against a variety of liver antigens, including mitochondrial and nuclear antigens. It is most common in young women.<sup>55</sup> Blood testing shows elevated  $\gamma$ -globulins and positive antinuclear antibodies. Early treatment with corticosteroids and antiinflammatory drugs can slow the progression of this disease and delay or prevent the need for liver transplantation.<sup>56</sup> Consequently, it is important to distinguish autoimmune hepatitis from other forms of hepatitis with similar histology on liver biopsy.

Patients with autoimmune hepatitis may develop cirrhosis and hepatocellular carcinoma if the autoimmune process is not controlled. Jaundice is not common in autoimmune hepatitis and patients often remain well nourished, making them good candidates for liver transplantation. Corticosteroids may produce a remission in the disease and often reduce plasma bilirubin, transaminases, and  $\gamma$ -globulin levels. Azathioprine therapy can be used to decrease the dose and side effects of corticosteroid therapy and may eliminate the need for corticosteroids once remission is achieved.<sup>57</sup>

Primary biliary cirrhosis (PBC) is an inflammatory disease of the intrahepatic bile ducts.<sup>58</sup> Ninety percent of patients are women, with onset occurring between the ages of 30 and 70 years. PBC is characterized by severe jaundice, disproportionate to the other features of liver disease and, thus, higher bilirubin levels are used for the Child-Pugh stratification. Human leukocyte antigens (HLAs) expressed in bile ducts appear to be a target for the lymphocytes. Other ductal glands (lacrimal glands, pancreas) are also targets in this disease. Patients with PBC have high serum cholesterol levels. They develop disabling cutaneous xanthomas of their hands and feet and severe pruritus. They may have other autoimmune diseases, such as rheumatoid arthritis, systemic lupus erythematosus, scleroderma (CREST [calcinosis cutis, Raynaud phenomenon, esophageal motility disorder, sclerodactyly, and telangiectasia] syndrome) and Sjögren syndrome. PBC can also cause interstitial lung disease with giant cell granulomas.

Serum bilirubin levels rise dramatically as the disease progresses and are

predictive of the length of survival. Once serum bilirubin levels exceed 6 mg/dL, expected survival is less than 2 years.<sup>59</sup> However, these patients appear clinically healthier than patients with similar levels of jaundice secondary to alcoholic cirrhosis. PBC patients can do well after transplantation. It is unclear whether they are at risk of developing recurrent PBC in the transplanted liver.

Primary sclerosing cholangitis (PSC) is another inflammatory disease of the intra- and extrahepatic bile ducts of undetermined etiology affecting more men than women.<sup>60</sup> It may be difficult to distinguish in the early phases from primary biliary cirrhosis. Serum anti-mitochondrial antibodies are positive in primary biliary cirrhosis and negative in primary sclerosing cholangitis. This inflammatory disease will eventually obliterate the bile ducts and cause jaundice and eventually liver failure. Cholangiography reveals a characteristic beading and stenosis of the common bile duct. Ulcerative colitis is diagnosed in as many as 70% of patients with primary sclerosing cholangitis.<sup>61</sup> In addition, PSC patients are at increased risk of developing cholangiocarcinoma. The only successful treatment of primary sclerosing cholangitis is liver transplantation.

### Infiltrative Liver Disease

Amyloidosis is often not a single-organ disease and its variants can involve single or multiple organs.<sup>62</sup> Each variant involves infiltration of a fibrillar, insoluble protein with a unique pleated structure.<sup>63</sup> The liver is involved in most forms of amyloidosis, but infiltration of the kidneys or heart may produce for most of the clinical symptoms. Treatment includes chemotherapy for primary amyloidosis and treatment of the underlying disease in secondary amyloidosis. The causes of death from the amyloidoses include sepsis from the underlying disease, renal failure, or cardiac failure, but not usually liver failure. In rare cases of slowly progressive primary amyloidosis (multiple myeloma), liver transplantation may be recommended for liver dysfunction.<sup>64</sup>

### Malignant Liver Disease

Hepatocellular carcinoma (HCC) is rare in Western countries, but common in Asian and African countries. It can present as a discrete encapsulated

mass (most common in Asian countries), as an infiltrative disease, or as a multicentric disease (most common in the United States). Predisposing factors for HCC include chronic active viral hepatitis and hemochromatosis, although it may also be associated with other forms of cirrhosis. Hepatitis C is the leading risk factor for HCC in the Western world whereas hepatitis B is the leading risk factor in Asian and African patients. Other risk factors for HCC include long-standing heavy alcohol abuse, cigarette smoking, diabetes, and fatty liver.<sup>65</sup> The incidence of HCC in Asian and African countries correlates closely with dietary exposure to aflatoxin, a carcinogen produced by *Aspergillus flavus*, a mold that contaminates food in these continents.<sup>66</sup>

$\alpha$ -Fetoprotein is a biochemical marker for HCC. Serial plasma levels correlate with the growth of HCC, as well as with improvement following tumor mass resection. Ultrasonography, CT scanning, and MRI are helpful in diagnosing and localizing HCC tumors for diagnosis and biopsy, but their value is decreased in patients with cirrhosis characterized by large areas of fibro-nodular regeneration.

Hepatic resection for HCC in patients with intact synthetic liver function offers a 26% 5-year survival rate. Predictors of survival include excellent preoperative hepatocellular function, the presence or absence of multiple tumors, resection margins free of tumor, and the need for blood transfusion during surgery.<sup>67</sup> Liver transplantation as a therapy for limited HCC is now an established therapy (see Chap. 58).

Cholangiocarcinoma is a highly malignant disease that is rare in the Western world, but endemic in Asia and those regions where patients are at risk for parasitic infection with the liver fluke (*Clonorchis sinensis*).<sup>68</sup> It is also associated with primary sclerosing cholangitis (see Autoimmune and Inflammatory Liver Disease) and ulcerative colitis. Liver transplantation is contraindicated for patients with cholangiocarcinoma. Patients are often jaundiced and without other signs of liver failure. Diagnosis is established by ultrasonography and CT imaging, and by endoscopic retrograde cholangiopancreatography and biopsy. When the tumor involves the secondary branches of the left and right hepatic ducts it is not resectable, but palliation

can be achieved with stenting of the bile ducts by an endoprosthesis.<sup>69</sup>

## Vascular Diseases of the Liver

Hepatic vein thrombosis (Budd-Chiari syndrome) is usually secondary to another systemic disease, often a myeloproliferative disorder.<sup>70</sup> This syndrome can be acute or chronic and can be asymptomatic or lead to chronic liver failure. MRI or ultrasonography diagnoses thrombosis of the hepatic vein. Treatment options include anticoagulation in the absence of a coagulopathy, thrombectomy, thrombolysis, transjugular intrahepatic portosystemic shunting (TIPS), or liver transplantation.<sup>71,72</sup>

Portal vein thrombosis is most often a complication of orthotopic liver transplantation.

## LIVER FAILURE

### Acute Liver Failure

Acute liver failure or fulminant hepatic failure (FHF) is a catastrophic illness resulting from many of the liver diseases described in this chapter; it develops within 2 weeks of the onset of disease and carries a poor prognosis without transplantation. It occurs so rapidly that patients may not have developed jaundice. Subfulminant hepatic failure, with onset occurring up to 8 weeks after the onset of jaundice, has a better prognosis with some chance of complete recovery. Transaminase levels rise rapidly with FHF but they may fall to normal levels after massive necrosis occurs. Coagulopathy can become progressively more severe.

The common features of fulminant hepatic failure include a severe coagulopathy, metabolic acidosis, hypoglycemia, rapidly progressive encephalopathy, and acute renal failure.<sup>73</sup> Encephalopathy with severe cerebral edema is the usual cause of death, which may occur while the patient awaits a donor liver (Table 14-9).

The most common cause of FHF is acute viral hepatitis (A, B, others). FHF in patients with hepatitis B can be precipitated by superinfection with hepatitis D. Immunocompromised patients are at high-risk for FHF with acute viral hepatitis, including hepatitis A, B, herpes simplex, Cytomegalovirus, Epstein-Barr, and varicella.<sup>74</sup>

There is another cause of FHF that needs to be considered in surgical

### Physical Findings Suggestive of Advanced Cirrhosis

- Scleral icterus: mild scleral icterus is seen.
- Fetor hepaticus: none appreciable
- Asterixis: not evident on testing
- Neck vein distension: not appreciable
- Spider angiomas: angiomas seen on the extremities, thoracic and abdominal walls
- Caput medusa: some increased venous distension on the abdominal wall
- Abdominal distension with demonstrable fluid wave: present
- Palpable liver with appreciable nodular hyperplasia: not appreciated
- Splenomegaly: moderate splenomegaly

patients. Alterations of total hepatic blood flow during anesthesia and surgery may precipitate FHF in patients with stable, underlying chronic liver disease. In these patients, acute liver failure is usually noticed on the second or third postoperative day and can be manifested by an unexplained encephalopathy. These patients have adequate hepatocellular function preoperatively but with very little reserve to combat acute stress associated with anesthesia and surgery. Small decreases in hepatic oxygen supply associated with decreased total hepatic blood flow during surgery cause acute hepatocellular ischemic injury and failure.

The encephalopathy of FHF is different than that noted with chronic liver failure and the blood ammonia levels are much higher. In addition, amino acids, which can contribute to the encephalopathy, accumulate in the central nervous system and are excreted in the urine as tyrosine and leucine crystals, FHF with grade 3 or worse encephalopathy is associated with an 80% mortality rate. In contrast, two thirds of patients survive if encephalopathy does not proceed beyond grade 2.<sup>75</sup> The principal causes of death are cerebral edema, hemorrhage secondary to a severe coagulopathy, and sepsis syndrome secondary to pneumonia.

Metabolic derangements seen in FHF may include severe hypoglycemia, hyperinsulinemia, hyponatremia,



TABLE 14–9.

## Grading of Hepatic Encephalopathy

Grade	Consciousness	Cognition	Signs	Electroencephalogram (EEG)
0	Normal	Normal	None	Normal
Subclinical	Normal	Normal	Abnormal on psychometric testing	Normal
1	Restless; abnormal sleep pattern	Forgetful, confused, agitated	Tremor, ataxia, uncoordinated, impaired handwriting	Abnormal
2	Lethargic	Disoriented at times; uninhibited, inappropriate behavior	Asterixis, dysarthria, ataxia, hyporeflexia	Abnormal
3	Somnolent but rousable, confused	Disoriented, aggressive	Asterixis, hyperreflexia, Babinski sign, muscle rigidity	Abnormal
4	Coma	None	Decerebration	Abnormal

Modified with permission from Riordan SM, Williams R. Treatment of hepatic encephalopathy. *N Engl J Med* 1997;337:473. Copyright 1997, Massachusetts Medical Society. All rights reserved.

hypokalemia, and lactic acidosis. Respiratory alkalosis may be caused by hyperventilation. Acute renal failure (hepatorenal syndrome) is seen in as many as 55% of patients with FHF. Acute respiratory failure may be caused by aspiration pneumonitis or form part of the multi-organ failure associated with sepsis.

Survival is frequent with transplantation but many patients die while awaiting the availability of a donor organ.

### Chronic Liver Failure

Chronic liver failure eventually can impair most of the organ systems in the body. Many of the manifestations are caused by the hepatic fibrosis that follows hepatocellular injury. Portal fibrosis produces compression of the portal venules, capillaries, biliary canaliculi and obliteration of hepatocytes. The result is portal hypertension, obstructive jaundice, coagulopathy, encephalopathy and metabolic abnormalities. If the underlying cause of fibrosis is treated effectively, fibrosis of the liver may be reversible.<sup>76</sup> In the early stages of chronic liver failure (Child-Pugh class A), ascites is controlled with diuretic therapy. In later stages, ascites is uncontrolled and patients develop the protuberant abdomen with a fluid wave on physical examination that is typical of advanced cirrhosis. Portal hypertension leads to abnormal renal function with marked sodium reabsorption in response to a decreased effective circulating plasma volume. Volume receptor stimulation increases renin secretion and

aldosterone production. Urinary excretion of sodium is limited and total body sodium is greatly increased, yet the patients show mild hyponatremia. This forms the basis for therapy with loop diuretics, such as furosemide, and aldosterone antagonists, such as spironolactone. Renal blood flow and glomerular filtration rate can be decreased in chronic liver failure because of the increased intraabdominal pressure caused by ascites, diuretic therapy, and other hemodynamic abnormalities.

Ascites is associated with spontaneous bacterial peritonitis (SBP), another life-threatening complication of chronic liver failure. An aerobic gram-negative organism is the usual cause of the peritonitis. It may be truly spontaneous and caused by incidental bacteremia but often follows paracentesis to reduce the volume of ascites. The 30-day mortality rate for SBP is approximately 32%; 1-year mortality 78%.<sup>77</sup> Survivors are at high risk of recurrence.

Portal hypertension can lead to the development of collateral circulation with large veins in the abdominal and chest walls, the mediastinum, stomach, and esophagus. In extreme cases these venous collaterals can anastomose with pulmonary vessels, leading to portopulmonary shunting. This can produce a high-blood volume, high-blood flow state with intrapulmonary shunts, the so-called hepatopulmonary syndrome (HPS). The collateral circulation that occurs with portal hypertension can produce esophageal,

gastric, and intestinal varices that are prone to rupture and bleeding.

Obstructive jaundice is a late finding in most forms of cirrhosis and indicates a poor prognosis. Severe jaundice predicts death within a few years. Severe jaundice is usually accompanied by poor synthetic function with coagulopathy, progressive encephalopathy, and severe malnutrition.

There are two causes of the coagulopathy associated with chronic liver disease. The first is decreased production of coagulation factors produced in the liver (all except factor VIII); the second

#### Laboratory Testing Used to Stratify Hepatocellular Function

- Emphasized findings are elements of the Child-Pugh classification of liver disease (Table 14–5).
- CBC: hemoglobin = 10.2g/dL ; hematocrit = 32%; white blood count = 9500 cells/mm<sup>3</sup>
- Blood urea nitrogen = 22 mg/dL; serum creatinine = 1.5 mg/dL
- Serum sodium = 132 mEq/dL; chloride = 90 mEq/dL; bicarbonate = 28 mEq/dL; potassium = 3.1 mEq/dL  
INR = 1.4; partial thromboplastin time = 28 seconds
- Serum bilirubin = 4.0 mg/dL; albumin = 3.0 g/dL (consider measuring fibrinogen level and factor VII activity)
- Aminotransferases: AST = 200 IU/L; ALT = 300IU/L (aminotransferases are nonspecific; see Fig. 14–3)

is the hypersplenism resulting from portal hypertension. Measuring the INR, plasma fibrinogen level, or direct measurement of coagulation factor activity readily assesses coagulopathy secondary to impaired synthetic function. Hypersplenism with sequestration of platelets is common in advanced liver disease, and results in platelet concentration equal to or less than 70,000/mm<sup>3</sup>. Bleeding from thrombocytopenia is uncommon unless it is complicated by other causes of thrombocytopenia, such as active bleeding with either a consumption coagulopathy or a dilutional coagulopathy.

Metabolic abnormalities include hypoglycemia, hyperinsulinemia, aminoacidemia and aminoaciduria, respiratory alkalosis, lactic acidosis, hyponatremia, and hypokalemia. If patients require rapid multiple transfusions, hypocalcemia secondary to citrate toxicity may become a problem.

Encephalopathy in chronic liver failure is associated with elevation of the plasma ammonia level. However, encephalopathy and neurological manifestations of chronic liver disease are much more complex than simple ammonia intoxication. Ammonia is only one of the many potentially neurotoxic compounds that are produced in the intestines and reach the brain by virtue of the collateral porto-systemic shunting of chronic liver disease. Other compounds that contribute to encephalopathy include octopamine and the aromatic amino acids, tyrosine, phenylalanine, and tryptophan. Normally, the liver extracts all of these compounds from portal vein blood. Central nervous system  $\gamma$ -aminobutyric acid (GABA), an inhibitory neurotransmitter, is also increased in chronic liver disease, as are GABA and benzodiazepine receptors in the brain.<sup>78</sup>

There are other causes of abnormal neurologic findings in chronic liver disease. There can be generalized cortical atrophy and the increased presence of astrocytes often associated with Alzheimer disease. The electroencephalogram (EEG) shows generalized slowing. Vitamin deficiencies can lead to Wernicke encephalopathy (inadequate thiamine and B<sub>1</sub>), which also contributes to the neurologic findings of chronic liver disease. Portal-systemic encephalopathy is characterized by depressed consciousness, personality changes, slurred speech, apraxia, and a flapping tremor. Severity is graded

from minimal confusion through coma (Table 14–9).<sup>79</sup> Grade 4 coma is usually a terminal event.

The circulation in chronic liver disease is hyperdynamic and characterized by a markedly increased cardiac index, a low systemic vascular resistance, mild tachycardia, a normal to increased stroke volume, a high mixed venous oxygen saturation, and a poor oxygen extraction ratio. Patients with a normal cardiac index at cardiac catheterization should be considered to have a cardiomyopathy and the differential diagnosis should include ischemic cardiomyopathy, alcoholic cardiomyopathy, and cardiomyopathy secondary to hemochromatosis. Systemic precapillary arteriovenous shunting can cause the hemodynamic changes seen in chronic liver disease. Circulating blood volume is reduced and extracellular fluid volume is often markedly increased.

Coronary artery disease in patients with advanced liver disease may require coronary revascularization. Patients who are Child-Pugh class A may tolerate coronary artery bypass grafting (CABG) with cardiopulmonary bypass without an increased mortality, but patients who are class B or C have an elevated risk of death.<sup>80</sup> Combined CABG and orthotopic liver transplantation has been performed, but there are insufficient data to support this as a standard approach.<sup>81</sup>

Two pulmonary syndromes are noted in patients with advanced liver disease. The first is the HPS; the second is portopulmonary hypertension (PPH).<sup>82</sup> HPS, as described above, is characterized by pulmonary precapillary and capillary vasodilatation and direct pulmonary arteriovenous communications. This syndrome is associated with 3-fold elevation of exhaled nitric oxide as compared to control subjects.<sup>83</sup> The patients are short of breath, cyanotic, and display systemic arterial hypoxemia. Dyspnea with tachypnea and oxygen desaturation is worsened in the upright position, a syndrome described as platypnea and orthodeoxia.<sup>84</sup> This is a high-volume/low-pressure pulmonary blood state with normal right ventricular function and a low pulmonary vascular resistance.<sup>85</sup> PPH, on the other hand, is a high-pressure state similar to primary pulmonary hypertension. The right ventricle is often dilated, cyanosis is absent, right ventricular ejection fraction is low, and systemic hypoxia is

rare. These patients may acutely respond to inhaled nitric oxide. Patients with HPS fare better after liver transplantation than do those with PPH.<sup>86</sup>

Hepatorenal syndrome is a form of renal failure associated with liver disease. It is more common in acute liver failure but also occurs in patients with chronic liver failure. Hepatorenal syndrome is the result of intense renal arteriolar vasoconstriction in response to the functional hypovolemia caused by splanchnic vasodilatation and other physical changes of liver failure.<sup>87</sup> Type 1 hepatorenal syndrome typically evolves over less than 1 week and is an indication for urgent liver transplantation.<sup>87</sup> Type 2 hepatorenal syndrome develops over a period of months and is less of an emergency. Standard treatment of hepatorenal syndrome includes intravascular volume expansion with administration of albumin, and the reduction of intraabdominal pressure by relieving tense ascites. The prognosis of the hepatorenal syndrome is poor. The administration of a vasopressin analogue, terlipressin, may improve renal function by its action as a splanchnic vasoconstrictor.<sup>88</sup> Portal venous pressure reduction by TIPS has been used for hepatorenal syndrome but it is not recommended on the basis of controlled clinical trials.<sup>89</sup>

## APPROACH TO MANAGEMENT

### Correction of Coagulopathy

Fresh-frozen plasma infusion and/or cryoprecipitate administration greatly improve the coagulopathy of either acute or chronic liver failure.<sup>90</sup> Recombinant factor VII may also improve the coagulopathy.<sup>91,92</sup> Therapy should be guided by measurement of the INR, plasma fibrinogen levels, and specific coagulation factor analysis when available. Patients may require infusion of large volumes of fresh-frozen plasma, which can itself contribute to circulatory overload. If there is evidence of a consumption coagulopathy, aprotinin or  $\epsilon$ -aminocaproic acid can be administered. It is important to avoid the inadvertent administration of small doses of heparin via monitoring lines to patients with a coagulopathy secondary to liver disease. Platelet transfusion is not indicated unless the platelet count is less than 70,000/mm<sup>3</sup>. Plate-

### Stratification of the Patient's Liver Disease Using the Child-Pugh Criteria (Table 14-5)

- Ascites: poorly controlled on diuretics = 3 points
- Nutrition: mild malnutrition = 2 points
- Encephalopathy: well controlled on diet and lactulose = 1 point
- INR; moderately prolonged = 2 points
- Albumin: hypoalbuminemic = 2 points
- Bilirubin: moderately elevated = 2 points
- Total = 12 points, Child-Pugh class C, high risk for surgery especially in view of patient's sepsis

lets can be sequestered in the spleen when the patient has hypersplenism.

The coagulopathy can be monitored by the use of the thrombelastogram (TEG).<sup>93,94</sup> Coagulopathy (Fig. 14-8) is manifested on the TEG by a delayed onset of coagulation (prolonged R time), decreased or flattened slope (A), and a decreased maximum amplitude (MA). A useful technique to rule out inadvertent heparin administration is to perform a dual assay using heparinase in 1 cuvette of the TEG assay. A normal tracing in the presence of heparinase and an abnormal tracing without suggests a significant heparin anticoagulant effect.

### Varices and Variceal Hemorrhage

Endoscopic band ligation therapy is the mainstay of treatment to reduce esophageal varices and prevent variceal hemorrhage.<sup>95</sup> Treatment with nonspecific  $\beta$ -adrenergic blockers, particularly propranolol and nadolol,<sup>96,97</sup> may decrease the size of esophageal varices. However, these agents do not reduce the portal hypertension, which caused the development of the varices.

Portal decompression can be accomplished surgically (portocaval shunt, mesocaval shunt, splenorenal shunt) or by means of a transjugular intrahepatic portal vein-to-hepatic vein shunt.<sup>98</sup> TIPS has a high complication rate and a mortality rate that is similar to that reported by centers with extensive experience in surgical shunting.<sup>99</sup> Preexisting encephalopathy may preclude any form of portal shunting because of the decrease in

ammonia extraction that follows the decrease in portal vein blood flow to the liver.<sup>100</sup>

Octreotide is a somatostatin analogue<sup>101</sup> that has been used for control of nonvariceal upper and lower gastrointestinal bleeding secondary to portal hypertension.<sup>102</sup> It is administered as a continuous infusion and produces vasoconstriction of the portal circulation vessels.

### Ascites

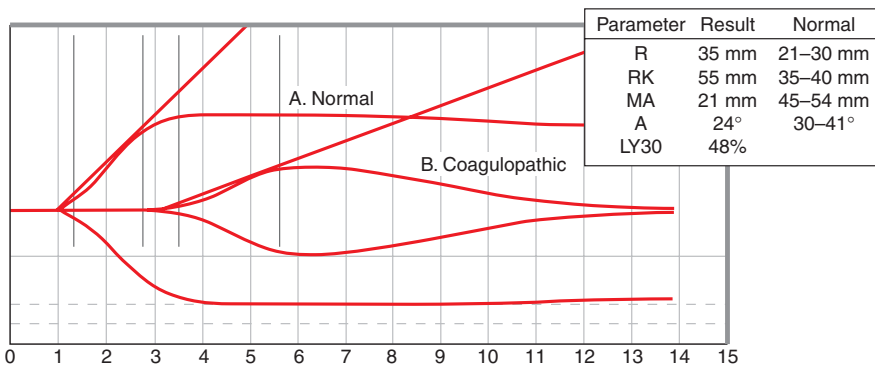
Ascites is the accumulation of an extracellular colloidal fluid in the abdominal cavity as a result of longstanding portal hypertension. It is a consistent finding in patients with cirrhosis, and it is a poor prognostic finding as only 50% of patients with ascites will survive for 2 years.<sup>103</sup> The diagnosis of ascites can be made by ultrasonography when it is not apparent on physical examination. Ascites can be controlled by restriction of sodium intake in the diet, by the administration of diuretics, or by abdominal paracentesis. Dietary sodium restriction is often difficult to maintain because of noncompliance. Diuretic therapy includes the use of furosemide and spironolactone or amiloride. Optimal diuretic therapy requires several weeks during which time the balance of sodium intake versus renal excretion of sodium is monitored. Potassium balance is achieved with the use of potassium-wasting diuretics (furosemide) and potassium-sparing diuretics (spironolactone or amiloride). If diuretic therapy is ineffective, invasive procedures may be necessary to relieve tense

abdominal swelling. These procedures include large volumes of fluid removal by paracentesis, peritoneovenous shunting (LeVeen shunt), or TIPS. Large-volume paracentesis leads to progressive wasting of protein but not usually to hemodynamic instability. Slow removal of ascites by paracentesis can relieve the symptoms of massive ascites and improve quality of life for these patients.<sup>103</sup>

Currently, peritoneovenous shunting is performed infrequently because of the risks associated with the procedure and the lack of advantages over paracentesis and TIPS.<sup>104</sup> The risks include hepatic failure secondary to a major surgical procedure in patients with marginal hepatocellular function, the risk of bacterial contamination with subsequent peritonitis, and the risk of a postoperative ascites leak. The procedure can be complicated by thrombosis followed by nonfunction of the shunt. Fluid overload is another consideration in patients who may have a concomitant cardiomyopathy.

### Control of Encephalopathy

Encephalopathy is present in the majority of patients with cirrhosis, although at times it may only be demonstrated by psychometric testing.<sup>105</sup> Because encephalopathy can progress rapidly from subclinical findings to overt coma, it should be anticipated in any patient with cirrhosis undergoing surgery. Encephalopathy is graded according to the level of consciousness, personality and intellectual features, neurologic signs, and electroencephalographic findings (Table 14-6 "Preop-



**FIGURE 14-8.** Thrombelastogram. **A:** Normal onset of coagulation, normal platelet function, no significant fibrinolysis. **B:** Delayed onset of coagulation (prolonged R value and diminished angle A), evidence of decreased platelet function (diminished maximum amplitude or MA), and early onset of marked fibrinolysis (decreased amplitude at 30 minutes [LY30]). (Courtesy of Richard A. Wiklund, MD.)

erative Values").<sup>79</sup> Standard therapy for the cerebral edema contributing to grade 3 and grade 4 encephalopathy includes endotracheal intubation, moderate hyperventilation, and monitoring and control of intracranial pressure (ICP). ICP monitoring involves substantial risk of intracranial hemorrhage in coagulopathic patients. Control of ICP may prevent seizures, which lead to elevated ICP.

Encephalopathy can be improved in the short-term by limiting protein in the diet. Obviously this counters the objective of improving protein nutrition in chronic liver disease, but limitation of protein in the diet will decrease the amount of nitrogenous waste and ammonia produced in the bowel. Ammonia is an uncharged molecule that readily passes into the blood from the gut. It can be converted to ammonium ion in the presence of excess hydrogen ions; ammonium ion does not cross the gut mucosa. Conversion of ammonia to ammonium ion can be achieved by the oral administration of lactulose, an enzyme that increases the acid content of the colon.<sup>106</sup> Acidification of the stool traps ammonia as ammonium ion in the gut contents. Neomycin can reduce the number of bacteria producing ammonia from protein.

If encephalopathy is life-threatening, charcoal hemoperfusion can be used to eliminate the responsible metabolites from the blood. So can exchange transfusion and extracorporeal organ perfusion.<sup>107,108</sup> However, these are experimental therapies used as a strategy that may worsen the coagulopathy and are only a bridge to transplantation.

## SUMMARY

The liver is a complex organ that serves multiple functions, including protein synthesis, carbohydrate and lipid metabolism, excretion of waste products, drug metabolism, and phagocytosis. Recognizing that each of these vital functions can be impaired with liver disease leads to an understanding of the primary features of liver failure, namely ascites, jaundice, coagulopathy, encephalopathy, altered metabolism, and abnormal fluid balance. Cirrhosis is the final common histologic manifestation of most forms of liver disease.

In the preadmission anesthesia assessment clinic, the severity of liver disease and the risk of surgery can be estimated using the Child-Pugh scoring system, substituting the INR for the prothrombin time. It includes three clinical and three laboratory assessments. The clinical features are the degree of malnutrition, the control of ascites, and the history of encephalopathy; laboratory assessments are determination of the INR, and plasma albumin and bilirubin levels. Each of these 6 parameters can be assessed as normal or near normal (class A), moderately abnormal or fairly well controlled (class B), and markedly abnormal or poorly controlled (class C). The surgical mortality rate, particularly for intraabdominal and other major surgery, is near 10% for patients assessed to be class A, up to 30% for class B, and up to 70% for class C.

Preoperative preparation includes correction of coagulopathy by the administration of fresh-frozen plasma or cryoprecipitate, control of ascites with diuretic therapy or paracentesis, and correction of encephalopathy by limiting protein intake and the administration of lactulose. Transfusion of packed red blood cells may be necessary to correct blood loss from bleeding esophageal varices. Preoperative platelet transfusion is usually unnecessary unless the platelet count is less than 70,000/mm<sup>3</sup>. Prevention of sepsis by minimizing invasive procedures and use of strict sterile technique for the insertion of lines and surgery is extremely important. These steps may reduce the risk of complications or death for surgical patients with acute or chronic liver disease.

Acute liver failure should be anticipated in the postoperative period in patients presenting with marginal liver function, especially following intraabdominal procedures, because of the effects of surgery and anesthesia to decrease total hepatic blood flow.

Hepatitis B and C viruses are highly infective following exposure. Immunization against hepatitis B virus is critically important for all healthcare workers, especially anesthesiologists and certified registered nurse anesthetists, because it is effective and safe. Hepatitis B can be a fulminant illness with high mortality. Immunization against hepatitis C virus is not available. Exposure caused by accidental hollow-needle sticks can cause acute

hepatitis C infection, which has a high risk of evolving into chronic active hepatitis, cirrhosis, and hepatocellular carcinoma. Most hospitals offer the options for prophylaxis against viral infection following inadvertent needle stick. These include the administration of hyperimmune  $\gamma$ -globulin for prophylaxis against transmission of hepatitis C. Universal precautions are effective in controlling the risk of transmission of hepatitis B and C.

With current testing standards in the United States, viral infection following the administration of blood products is rare, approximately 1:75,000 to 1:2,000,000 transfusions.

## KEY REFERENCES

1. Wiklund RA. Preoperative preparation of patients with advanced liver disease. *Crit Care Med* 2004; 32(4 Suppl):S106.
2. Pugh RN, Murray-Lyon IM, Dawson JL, et al. Transection of the oesophagus for bleeding oesophageal varices. *Br J Surg* 1973;60:646.
3. Giannini EG, Testa R, Savarino V. Liver enzyme alteration: a guide for clinicians. *CMAJ* 2005;172:367.
4. Gelman SI. Disturbances in hepatic blood flow during anesthesia and surgery. *Arch Surg* 1976;111:881.
5. Garrison RN, Cryer HM, Howard DA, et al. Clarification of risk factors for abdominal operations in patients with hepatic cirrhosis. *Ann Surg* 1984;199:648.
6. Piano MR. Alcoholic cardiomyopathy: incidence, clinical characteristics, and pathophysiology. *Chest* 2002;121:1638.
7. Bunker JP. Final report of the national halothane study. *Anesthesiology* 1968;29:231.
8. O'Grady JG. Acute liver failure. *Postgrad Med J* 2005;81:148.
9. Riordan SM, Williams R. Treatment of hepatic encephalopathy. *N Engl J Med* 1997;337:473.
10. Lyew MA, Isaacson IJ. Template for rapid analysis of the thrombelastogram. *Anesth Analg* 1992;74:782.



11. Shiffman ML, Jeffers L, Hoofnagle JH, et al. The role of transjugular intrahepatic portosystemic shunt for treatment of portal hypertension and its complications: a conference sponsored by the national digestive diseases advisory board. *Hepatology* 1995;22:1591.

## REFERENCES

- Wiklund RA. Preoperative preparation of patients with advanced liver disease. *Crit Care Med* 2004;32:S106.
- Rappaport AM. The microcirculatory acinar concept of normal and pathological hepatic structure. *Beitr Pathol* 1976;157:215.
- Ishak KG, Zimmerman HJ, Ray MB. Alcoholic liver disease: pathologic, pathogenetic and clinical aspects. *Alcohol Clin Exp Res* 1991;15:45.
- Stremmel W. What's new in the hepatocellular uptake mechanism of bilirubin and fatty acids [review]? *Pathol Res Pract* 1988;183:524.
- Balsells F, Wyllie R, Steffen R, Kay M. Benign recurrent intrahepatic cholestasis: improvement of pruritus and shortening of the symptomatic phase with rifampin therapy: a case report. *Clin Pediatr (Phila)* 1997;36:483.
- Baker AL. Hepatotrophic factors: basic concepts and clinical implications. *Acta Med Scand Suppl* 1985;703:201.
- Yoshida T, Ninomiya K, Matsumoto T, Baatar D, Bandoh T, Kitano S. Glucagon and insulin metabolism in cirrhotic patients. *Hepatogastroenterology* 1998;45:468.
- Nolte W, Hartmann H, Ramadori G. Glucose metabolism and liver cirrhosis. *Exp Clin Endocrinol Diabetes* 1995;103:63.
- Pantuck EJ. Plasma cholinesterase: gene and variations. *Anesth Analg* 1993;77(2):380.
- Rivard GE, Kovac I, Kunschak M, Thone P. Clinical study of recovery and half-life of vapor-heated factor VII concentrate. *Transfusion* 1994;34:975.
- Pugh RN, Murray-Lyon IM, Dawson JL, Pietroni MC, Williams R. Transection of the oesophagus for bleeding oesophageal varices. *Br J Surg* 1973;60:646.
- Giannini EG, Testa R, Savarino V. Liver enzyme alteration: a guide for clinicians. *CMAJ* 2005;172:367.
- Jacobs WH, Goldberg SB. Statement on outpatient percutaneous liver biopsy. *Dig Dis Sci* 1989;34:322.
- Lebrec D, Goldfarb G, Degott C, Rueff B, Benhamou JP. Transvenous liver biopsy: an experience based on 1000 hepatic tissue samplings with this procedure. *Gastroenterology* 1982;83:338.
- Whalen E. Liver imaging—current trends in MRI, CT, and US. *International symposium and course*, June 1990. *AJR Am J Roentgenol* 1990;155:1125.
- Tandon BN, Rana S, Acharya SK. Bedside ultrasonography. A low-cost definitive diagnostic procedure in obstructive jaundice. *J Clin Gastroenterol* 1987;9:353.
- Zeman RK, Fox SH, Silverman PM, et al. Helical (spiral) CT of the abdomen. *AJR Am J Roentgenol* 1993;160:719.
- Silverman PM, Roberts S, Tefft MC, et al. Helical CT of the liver: clinical application of an automated computer technique, SmartPrep, for obtaining images with optimal contrast enhancement. *AJR Am J Roentgenol* 1995;165:73.
- Regan LS. Screening for hepatocellular carcinoma in high-risk individuals. A clinical review. *Arch Intern Med* 1989;149:1741.
- Gomori JM, Horev G, Tamary H, et al. Hepatic iron overload: quantitative MR imaging. *Radiology* 1991;179:367.
- Gelman SI. Disturbances in hepatic blood flow during anesthesia and surgery. *Arch Surg* 1976;111:881.
- Branch RA. Is there increased cerebral sensitivity to benzodiazepines in chronic liver disease? *Hepatology* 1987;7:773.
- Ferenci P, Grimm G, Meryn S, Gangl A. Successful long-term treatment of portal-systemic encephalopathy by the benzodiazepine antagonist flumazenil. *Gastroenterology* 1989;96:240.
- Ostergaard D, Viby-Mogensen J, Rasmussen SN, Gatke MR, Varin F. Pharmacokinetics and pharmacodynamics of mivacurium in patients phenotypically homozygous for the atypical plasma cholinesterase variant: effect of injection of human cholinesterase. *Anesthesiology* 2005;102:1124.
- Child CG, Turcotte JG. Surgery and Portal Hypertension. In: Child CG, eds. *The Liver and Portal Hypertension*. 1st ed. Philadelphia: WB Saunders, 1964:1.
- Garrison RN, Cryer HM, Howard DA, Polk HC Jr. Clarification of risk factors for abdominal operations in patients with hepatic cirrhosis. *Ann Surg* 1984;199:648.
- Mansour A, Watson W, Shayani V, Pickleman J. Abdominal operations in patients with cirrhosis: still a major surgical challenge. *Surgery* 1997;122:730.
- Aranha GV, Sontag SJ, Greenlee HB. Cholecystectomy in cirrhotic patients: a formidable operation. *Am J Surg* 1982;143:55.
- Aranha GV, Kruss D, Greenlee HB. Therapeutic options for biliary tract disease in advanced cirrhosis. *Am J Surg* 1988;155:374.
- Fernandes NF, Schwesinger WH, Hilsenbeck SG, et al. Laparoscopic cholecystectomy and cirrhosis: a case-control study of outcomes. *Liver Transpl* 2000;6:340.
- Rikkers LF, Jin G, Langnas AN, Shaw BW Jr. Shunt surgery during the era of liver transplantation. *Ann Surg* 1997;226:51.
- Yu AS, Ahmed A, Keeffe EB. Liver transplantation: evolving patient selection criteria. *Can J Gastroenterol* 2001;15:729.
- Brown RS Jr, Kumar KS, Russo MW, et al. Model for end-stage liver disease and Child-Turcotte-Pugh score as predictors of pretransplantation disease severity, post-transplantation outcome, and resource utilization in United Network for Organ Sharing status 2A patients. *Liver Transpl* 2002;8:278.
- Wolfsdorf JI, Weinstein DA. Glycogen storage diseases. *Rev Endocr Metab Disord* 2003;4:95.
- Angulo P. Nonalcoholic fatty liver disease. *N Engl J Med* 2002;346:1221.
- Daniel S, Ben-Menachem T, Vasudevan G, Ma CK, Blumenkehl M. Prospective evaluation of unexplained chronic liver transaminase abnormalities in asymptomatic and symptomatic patients. *Am J Gastroenterol* 1999;94:3010.
- Clark JM, Brancati FL, Diehl AM. The prevalence and etiology of elevated aminotransferase levels in the United States. *Am J Gastroenterol* 2003;98:960.
- Clain DJ, Lefkowitz JH. Fatty liver disease in morbid obesity. *Gastroenterol Clin North Am* 1987;16:239.
- Chitturi S, Farrell GC. Etiopathogenesis of nonalcoholic steatohepatitis. *Semin Liver Dis* 2001;21:27.
- Brunt EM, Janney CG, Di Bisceglie AM, Neuschwander-Tetri BA, Bacon BR. Nonalcoholic steatohepatitis: a proposal for grading and staging the histological lesions. *Am J Gastroenterol* 1999;94:2467.
- Charlton M, Kasparova P, Weston S, et al. Frequency of nonalcoholic steatohepatitis as a cause of advanced liver disease. *Liver Transpl* 2001;7:608.
- Hoofnagle JH, Di Bisceglie AM. The treatment of chronic viral hepatitis. *N Engl J Med* 1997;336:347.
- Kumar A, Beniwal M, Kar P, Sharma JB, Murthy NS. Hepatitis E in pregnancy. *Int J Gynaecol Obstet* 2004;85:240.
- Transmission of hepatitis B to patients from four infected surgeons without hepatitis B e antigen. The Incident Investigation Teams and others. *N Engl J Med* 1997;336:178.
- Esteban JI, Gomez J, Martell M, et al. Transmission of hepatitis C virus by a cardiac surgeon. *N Engl J Med* 1996;334:555.
- Chisari FV. Rous-Whipple Award Lecture. Viruses, immunity, and cancer: lessons from hepatitis B. *Am J Pathol* 2000;156:1117.
- Kleinman S. Hepatitis G virus biology, epidemiology, and clinical manifestations: Implications for blood safety. *Transfus Med Rev* 2001;15:201.
- Alter MJ, Gallagher M, Morris TT, et al. Acute non-A-E hepatitis in the United States and the role of hepatitis G virus

- infection. Sentinel Counties Viral Hepatitis Study Team. *N Engl J Med* 1997;336:741.
49. Piano MR. Alcoholic cardiomyopathy: incidence, clinical characteristics, and pathophysiology. *Chest* 2002;121:1638.
50. Kaplan M, Cimen S, Kut MS, Demirtas MM. Cardiac operations for patients with chronic liver disease. *Heart Surg Forum* 2002;5:60.
51. Harrison PM, Wendon JA, Gimson AE, Alexander GJ, Williams R. Improvement by ace tylcysteine of hemodynamics and oxygen transport in fulminant hepatic failure. *N Engl J Med* 1991;324:1852.
52. Summary of the national Halothane Study. Possible association between halothane anesthesia and postoperative hepatic necrosis. *JAMA* 1966;197:775.
53. Bunker JP. Final report of the National Halothane Study. *Anesthesiology* 1968;29:231.
54. Krawitt EL. Autoimmune hepatitis. *N Engl J Med* 1996;334:897.
55. Johnson PJ, McFarlane IG. Meeting report: International Autoimmune Hepatitis Group. *Hepatology* 1993;18:998.
56. Sanchez-Urdazpal L, Czaja AJ, van Hoek B, Krom RA, Wiesner RH. Prognostic features and role of liver transplantation in severe corticosteroid-treated autoimmune chronic active hepatitis. *Hepatology* 1992;15:215.
57. Stellon AJ, Keating JJ, Johnson PJ, McFarlane IG, Williams R. Maintenance of remission in autoimmune chronic active hepatitis with azathioprine after corticosteroid withdrawal. *Hepatology* 1988;8:781.
58. Kaplan MM, Gershwin ME. Primary biliary cirrhosis. *N Engl J Med* 2005;353:1261.
59. Dickson ER, Grambsch PM, Fleming TR, Fisher LD, Langworthy A. Prognosis in primary biliary cirrhosis: model for decision making. *Hepatology* 1989;10:1.
60. Wiesner RH, Grambsch PM, Dickson ER, et al. Primary sclerosing cholangitis: natural history, prognostic factors and survival analysis. *Hepatology* 1989;10:430.
61. Fausa O, Schruppf E, Elgjo K. Relationship of inflammatory bowel disease and primary sclerosing cholangitis. *Semin Liver Dis* 1991;11:31.
62. Falk RH, Comenzo RL, Skinner M. The systemic amyloidoses. *N Engl J Med* 1997;337:898.
63. Merlini G, Bellotti V. Molecular mechanisms of amyloidosis. *N Engl J Med* 2003;349:583.
64. Kumar KS, Lefkowitz J, Russo MW, et al. Successful sequential liver and stem cell transplantation for hepatic failure due to primary AL amyloidosis. *Gastroenterology* 2002;122:2026.
65. Yu MC, Yuan JM. Environmental factors and risk for hepatocellular carcinoma. *Gastroenterology* 2004;127:S72.
66. McGlynn KA, London WT. Epidemiology and natural history of hepatocellular carcinoma. *Baillieres Best Pract Res Clin Gastroenterol* 2005;19:3.
67. Chen MF, Tsai HP, Jeng LB, et al. Prognostic factors after resection for hepatocellular carcinoma in noncirrhotic livers: univariate and multivariate analysis. *World J Surg* 2003;27:443.
68. Choi D, Lim JH, Hong ST. Relation of cholangiocarcinomas to clonorchiasis and bile duct stones. *Abdom Imaging* 2004;29:590.
69. Dooley JS, Dick R, George P, Kirk RM, Hobbs KE, Sherlock S. Percutaneous transhepatic endoprosthesis for bile duct obstruction. Complications and results. *Gastroenterology* 1984;86:905.
70. Bogin V, Marcos A, Shaw-Stiffel T. Budd-Chiari syndrome: in evolution. *Eur J Gastroenterol Hepatol* 2005;17:33.
71. Sharma S, Texeira A, Texeira P, Elias E, Wilde J, Olliff SP. Pharmacological thrombolysis in Budd-Chiari syndrome: a single centre experience and review of the literature. *J Hepatol* 2004;40:172.
72. Klein AS, Molmenti EP. Surgical treatment of Budd-Chiari syndrome. *Liver Transpl* 2003;9(9):891.
73. Palmes D, Skawran S, Spiegel HU. Acute liver failure: from bench to bedside. *Transplant Proc* 2005;37:1628.
74. O'Grady JG. Acute liver failure. *Postgrad Med J* 2005;81:148.
75. Sherlock S, Dooley J. Fulminant hepatic failure. In: *Diseases of the Liver and Biliary System*. Sherlock S, Dooley J (eds.). 9th ed. London: Blackwell Scientific, 1993:102.
76. Bonis PA, Friedman SL, Kaplan MM. Is liver fibrosis reversible? *N Engl J Med* 2001;344:452.
77. Bac DJ. Spontaneous bacterial peritonitis: an indication for liver transplantation? *Scand J Gastroenterol Suppl* 1996;218:38.
78. Venturini I, Corsi L, Avallone R, et al. Ammonia and endogenous benzodiazepine-like compounds in the pathogenesis of hepatic encephalopathy. *Scand J Gastroenterol* 2001;36:423.
79. Riordan SM, Williams R. Treatment of hepatic encephalopathy. *N Engl J Med* 1997;337:473.
80. Hayashida N, Shoujima T, Teshima H, et al. Clinical outcome after cardiac operations in patients with cirrhosis. *Ann Thorac Surg* 2004;77:500.
81. Kniepeiss D, Iberer F, Grasser B, Schaffellner S, Tscheliessnigg KH. Combined coronary artery bypass grafting and orthotopic liver transplantation: a case report. *Transplant Proc* 2003;35:817.
82. Krowka MJ. Hepatopulmonary syndrome versus portopulmonary hypertension: distinctions and dilemmas. *Hepatology* 1997;25:1282.
83. Cremona G, Higenbottam TW, Mayoral V, et al. Elevated exhaled nitric oxide in patients with hepatopulmonary syndrome. *Eur Respir J* 1995;8:1883.
84. Krowka MJ, Cortese DA. Hepatopulmonary syndrome. Current concepts in diagnostic and therapeutic considerations. *Chest* 1994;105:1528.
85. Castro M, Krowka MJ, Schroeder DR, et al. Frequency and clinical implications of increased pulmonary artery pressures in liver transplant patients. *Mayo Clin Proc* 1996;71:543.
86. Collisson EA, Nourmand H, Fraiman MH, et al. Retrospective analysis of the results of liver transplantation for adults with severe hepatopulmonary syndrome. *Liver Transpl* 2002;8:925.
87. Guevara M, Gines P. Hepatorenal syndrome. *Dig Dis* 2005;23(1):47-55.
88. Moreau R. Hepatorenal syndrome in patients with cirrhosis. *J Gastroenterol Hepatol* 2002;17:739.
89. Boyer TD. Transjugular intrahepatic portosystemic shunt: current status. *Gastroenterology* 2003;124(6):1700.
90. Kujovich JL. Hemostatic defects in end-stage liver disease. *Crit Care Clin* 2005;21:563.
91. Franchini M, Zaffanello M, Veneri D. Recombinant factor VIIa. An update on its clinical use. *Thromb Haemost* 2005;93:1027.
92. Levi M, Peters M, Buller HR. Efficacy and safety of recombinant factor VIIa for treatment of severe bleeding: a systematic review. *Crit Care Med* 2005;33:883.
93. Lyew MA, Isaacson IJ. Template for rapid analysis of the thrombelastogram. *Anesth Analg* 1992;74:782.
94. Clayton DG, Miro AM, Kramer DJ, Rodman N, Wearden S. Quantification of thrombelastographic changes after blood component transfusion in patients with liver disease in the intensive care unit. *Anesth Analg* 1995;81:272.
95. Lata J, Hulek P, Vanasek T. Management of acute variceal bleeding. *Dig Dis* 2003;21:6.
96. Brown MW. Gastroesophageal varices. Management of hemorrhage in the cirrhotic patient. *Prim Care* 1988;15:175.
97. Grace ND. A hepatologist's view of variceal bleeding. *Am J Surg* 1990;160:26.
98. Gordon JD, Colapinto RF, Abecassis M, et al. Transjugular intrahepatic portosystemic shunt: a nonoperative approach to life-threatening variceal bleeding. *Can J Surg* 1987;30:45.
99. Shiffman ML, Jeffers L, Hoofnagle JH, Tralka TS. The role of transjugular intrahepatic portosystemic shunt for treatment of portal hypertension and its complications: a conference sponsored by the National Digestive Diseases Advisory Board. *Hepatology* 1995;22:1591.

100. Sanyal AJ, Freedman AM, Shiffman ML, Purdum PP 3rd, Luketic VA, Cheatham AK. Portosystemic encephalopathy after transjugular intrahepatic portosystemic shunt: results of a prospective controlled study. *Hepatology* 1994;20:46.

101. Lamberts SW, van der Lely AJ, de Herder WW, Hofland LJ. Octreotide. *N Engl J Med* 1996;334:246.

102. Valenzuela JE, Schubert T, Fogel MR, et al. A multicenter, randomized, double-blind trial of somatostatin in the manage-

ment of acute hemorrhage from esophageal varices. *Hepatology* 1989;10:958.

103. Inturri P, Graziotto A, Rossaro L. Treatment of ascites: old and new remedies. *Dig Dis* 1996;14:145.

104. Rosemurgy AS, Zervos EE, Clark WC, et al. TIPS versus peritoneovenous shunt in the treatment of medically intractable ascites: a prospective randomized trial. *Ann Surg* 2004;239:883.

105. Gitlin N, Lewis DC, Hinkley L. The diagnosis and prevalence of subclinical hepatic encephalopathy in apparently

healthy, ambulant, non-shunted patients with cirrhosis. *J Hepatol* 1986;3:75.

106. Morgan MY. The treatment of chronic hepatic encephalopathy. *Hepatogastroenterology* 1991;38:377.

107. Horslen SP, Hammel JM, Fristoe LW, et al. Extracorporeal liver perfusion using human and pig livers for acute liver failure. *Transplantation* 2000;70:1472.

108. Sechser A, Osorio J, Freise C, Osorio RW. Artificial liver support devices for fulminant liver failure. *Clin Liver Dis* 2001;5:415.

# CHAPTER 15

## Anesthetic Considerations for the Patient with Anemia or Coagulation Disorders

Edwin G. Avery, IV, MD

### ANEMIA

Anemia is a common blood disorder of perioperative patients.<sup>1,2</sup> The physiologic consequence of severe anemia to the surgical patient is inadequate delivery of oxygen that may lead to tissue hypoxia, biochemical imbalance, organ dysfunction and ultimately organ damage.<sup>3,4</sup> Mismanagement of the anemic surgical patient can adversely affect perioperative morbidity and mortality.<sup>5-7</sup> To provide optimal care for anemic surgical patients, the anesthesiologist should understand the laboratory techniques used to assess anemia, as well as the various etiologies and classifications of anemia.

### Anemia Defined and Measured

Anemia is defined as a reduction of the body's total red cell mass (RCM). Both hematocrit (Hct) level and hemoglobin (Hgb) concentration measurements reflect the RCM present in the body but do not define it. The Hct level, defined as the fractional volume of sampled blood that erythrocytes occupy, is an indirect measurement of the body's RCM. The Hct is a simple, inexpensive, commonly used test to indirectly assess the severity of anemia as well as whole-blood viscosity, oxygen-carrying capacity, and RCM.<sup>8</sup> Hgb, the predominant component of a red blood cell, serves as the major carrier to transport oxygen within the blood.<sup>9</sup> Hgb concentration is a directly measured value that is also used to indirectly assess RCM.<sup>10</sup>

RCM is most accurately measured using isotopic dilution assays of erythrocytes and albumin that take into account the total volume of red cells and plasma present in any patient. In

everyday clinical practice, Hct level and Hgb concentration are simple assays that are used to estimate RCM because of the impractical nature of using the more costly and complex isotope labeled assays.<sup>9,11</sup>

Although measurement of Hgb and Hct values generally provide reliable estimates of a patient's RCM, they inaccurately reflect the total circulating erythrocyte mass under certain conditions.<sup>12,13</sup> The importance of considering the measured Hct and Hgb values in the context of overall plasma volume cannot be over emphasized. Hgb and Hct values are influenced by dynamic changes of the plasma volume and thus are subject to error under certain physiologic conditions. Examples of the Hgb or Hct value misrepresenting the RCM are clinical scenarios involving major, acute blood loss. In this situation, the concurrently obtained circulating Hgb and Hct values will overestimate the RCM because the body has not had sufficient time to redistribute fluid from the interstitial space into the intravascular compart-

ment. The Hct and Hgb values will spuriously indicate an increased RCM. A second example of a failure of the Hct and Hgb values to adequately reflect RCM occurs in the physiologic anemia of pregnancy. During normal pregnancy, both the RCM and the plasma volume expand. The plasma volume increases more rapidly and to a greater extent than the RCM and creates an apparent anemia termed the physiologic anemia of pregnancy.<sup>13</sup> Beginning in the first trimester of pregnancy, the reduced Hct value does not represent a decrease in RCM. A third pertinent example of Hct and Hgb values misrepresenting the RCM is in the clinical setting of dehydration. In the dehydrated patient an apparently normal or elevated Hct or Hgb value leads the clinician to overestimate the patient's RCM.<sup>8,9</sup>

Thus, there are two necessary considerations when attempting to correctly identify anemia in an individual patient. First, the laboratory values of Hgb, Hct and/or Hct must be compared to a standard set of age- and sex-

### KEY POINTS

1. Anemia is common in surgical patients.
2. Hemoglobin (Hgb) concentration and hematocrit (Hct) level are appropriate tests to rapidly assess the severity of anemia.
3. Treatment of anemia should be based on the physiology and etiology of anemia. Maintenance and restoration of normovolemia and cardiac output are necessary but insufficient aims in treating anemia.
4. Tachycardia and hypotension are important clinical signs of hypovolemia and anemia, but compensatory increases in heart rate and cardiac output may be impeded by insufficient cardiac reserve or anesthetic-induced sympathectomy.
5. Consideration of the physiologic signs and laboratory evidence of inadequate tissue oxygen delivery is mandatory before making a decision to transfuse red blood cells (RBCs).
6. Because evidence-based outcomes supporting a specific transfusion trigger level of Hgb or Hct are lacking for perioperative patients, further clinical investigation is needed.
7. Alternatives to transfusion of allogeneic RBCs are available and are appropriate to integrate into a blood-conservation strategy in selected surgical patients.
8. Given the broad range of congenital and acquired disease states as well as the multiple pharmacotherapies that can result in a hypocoagulable state, serious attention to these pathologies are needed by anesthesiologists in order to avoid the adverse effects of transfusions, excessive perioperative bleeding and the depletion of community blood bank resources.
9. The perioperative management of hypercoagulable disorders is also a responsibility of the anesthesiologist in that many of these patients require perioperative management of their anticoagulant regimens.
10. Hematology consultation is indicated for the perioperative management of many of the hypocoagulable and hypercoagulable disorders so as to avoid exposing the patient to unnecessary perioperative morbidity and mortality.



TABLE 15-1.

## Normal Red Blood Cell Values

Age	Hemoglobin (g/dL)		Hematocrit (%)		Red Cell Count ( $10^{12}/L$ )		MCV (fL)		MCH (pg)		MCHC (g/dL)	
	Mean	-2 SD	Mean	-2 SD	Mean	-2 SD	Mean	-2 SD	Mean	-2 SD	Mean	-2 SD
Birth (cord blood)	16.5	13.5	51	42	4.7	3.9	108	98	34	31	33	30
1-3 days (capillary)	18.5	14.5	56	45	5.2	4.0	108	95	34	31	33	29
1 week	17.5	13.5	54	42	3.1	3.9	107	88	34	28	33	28
2 weeks	16.5	12.5	51	39	4.9	3.6	105	86	34	28	33	28
1 month	14.0	10.0	43	31	4.2	3.0	104	85	34	28	33	29
2 months	11.5	9.0	35	28	3.8	2.7	96	77	30	26	33	29
3-6 months	11.5	9.5	35	29	3.8	3.1	91	74	30	25	33	30
0.5-2 years	12.0	11.0	36	33	4.5	3.7	78	70	27	23	33	30
2-6 years	12.5	11.5	37	34	4.6	3.9	81	75	27	24	34	31
6-12 years	13.5	11.5	40	35	4.6	4.0	86	77	29	25	34	31
12-18 years												
Female	14.0	12.0	41	36	4.6	4.1	90	78	30	25	34	31
Male	14.5	13.0	43	37	4.8	4.5	88	78	30	25	34	31
18-49 years												
Female	14.0	12.0	41	36	4.6	4.0	90	80	30	26	34	31
Male	15.5	13.5	47	41	5.2	4.5	90	80	30	26	34	31

MCH, mean cell hemoglobin; MCHC, mean cell hemoglobin concentration; MCV, mean cell volume; SD, standard deviations. Reproduced with permission from Felgar RE and Ryan DH.<sup>10</sup>

normalized reference values (Table 15-1).<sup>10,14</sup> Second, the patient's overall plasma volume status must be assessed to determine if the patient is significantly plasma volume contracted or expanded.

### Prevalence of Anemia in Surgical Patients

The prevalence of anemia in various surgical populations has been reported to range from 5-75%, depending on both the underlying clinical status and the severity of disease.<sup>1,2</sup> As one might expect, the prevalence of anemia decreases with more stringent criteria. Anemia may be produced or exacerbated by the surgical procedure and postoperative care.<sup>15-17</sup>

### Red Blood Cell Maturation

Normal red blood cells (RBCs) mature by proliferation and differentiation of precursor stem cells in the bone marrow in a process termed *erythropoiesis*.<sup>18</sup> A mature RBC will circulate for a period of approximately 100-120 days, after which time it will be removed from the circulation by the body's reticuloendothelial system. The body replenishes the total RCM with the

goal of achieving a constant steady state, depending on the rate at which RBCs are being produced and removed or lost. The kidney plays a vital role in this process by producing the hormone erythropoietin. This process is upregulated when the kidney senses a

decrease in receipt of oxygen because of a contracted RCM (Fig. 15-1). Optimal erythropoiesis can only occur when the body possesses sufficient substrate (e.g., folate, iron, vitamin B<sub>12</sub> and other nutrients) to produce new erythrocytes.<sup>10</sup>

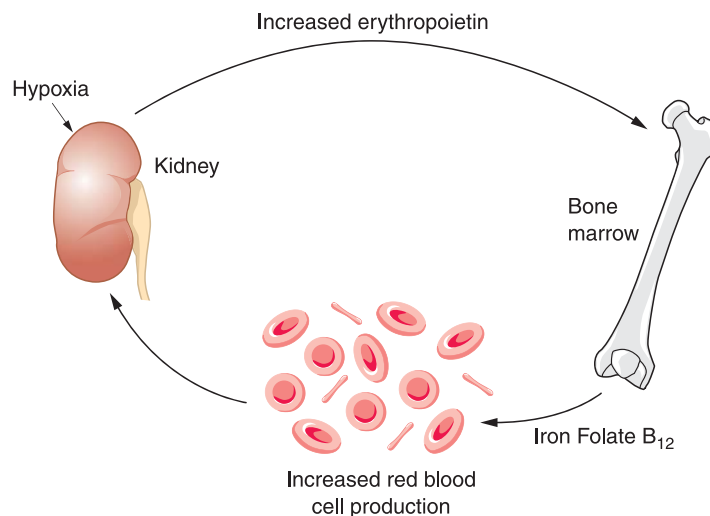


FIGURE 15-1. Regulation of erythropoiesis. Reproduced with permission from Felgar RE and Ryan DH.<sup>10</sup>

TABLE 15-2.

## Usefulness of the Reticulocyte Count in the Diagnosis of Anemia

Diagnosis	Value
<i>Hypoproliferative anemias</i>	Corrected reticulocyte $<2\%$ or absolute reticulocyte count $<100,000 \mu\text{L}$
Anemia of chronic disease	
Anemia of renal disease	
Congenital dyserythropoietic anemias	
Effects of drugs or toxins	
Endocrine anemias	
Iron deficiency	
Marrow replacement	
<i>Maturation abnormalities</i>	
Vitamin B <sub>12</sub> deficiency	
Folate deficiency	
Sideroblastic anemia	
Appropriate response to blood loss or nutritional supplementation	
<i>Hemolytic anemias</i>	
Hemoglobinopathies	
Immune hemolytic anemias	
Infectious causes of hemolysis	
Membrane abnormalities	
Metabolic abnormalities	
Mechanical hemolysis	

Reproduced with permission from Felgar RE and Ryan DH.<sup>10</sup>

## Classifications of Anemia

Anemias can be divided into 3 classes: hemorrhage-related, hypoproliferative, and hyperproliferative anemias. Anemias are either primary or secondary. Secondary anemias result from a separate disease process that precipitates the decreased RCM. Many RBC-related laboratory parameters may help determine the etiology of an anemia, including the reticulocyte count,

mean corpuscular volume, and RBC distribution width. Examination of the peripheral smear using light microscopy can also aid in determining etiology. This section provides an introduction to various RBC parameters enabling classification of anemia, not a comprehensive review of all of the known anemia diagnoses and their associated RBC parameter findings. The association of these parameters

with the various classes of anemia is summarized in tabular form (Tables 15-2, 15-3, and 15-4).<sup>10</sup>

**Hemorrhage-Related Anemia**

Anemias related to acute or chronic loss of RCM are frequently encountered by the anesthesiologist.<sup>2</sup> The anesthetic implications for the various classes of anemias are discussed in The Decision to Transfuse Red Blood Cells below.

**Hypoproliferative Anemia**

Hypoproliferative anemias are common in surgical patients and are attributed to impaired RBC production. These anemias result from the body's inability to synthesize an adequate number of erythrocytes in response to a physiologic stimulus (e.g., increased plasma erythropoietin levels). Hypoproliferative anemias are commonly caused by acquired nutritional deficiencies (e.g., iron-deficiency anemia) and/or systemic disease (e.g., anemia of chronic disease). A corrected reticulocyte count of less than 2% (or an absolute reticulocyte count of less than 100,000/ $\mu\text{L}$ ) is frequently found in patients with hypoproliferative anemias (Table 15-2).<sup>10</sup>

**Hyperproliferative Anemia**

Hyperproliferative anemias are commonly termed *hemolytic anemias*. These anemias occur as a consequence of the premature destruction of RBCs and may be attributable to a host of disorders, either congenital or acquired, such as sickle cell anemia,  $\beta$ -thalassemia major, glucose-6-phosphate dehydrogenase deficiency, autoimmune hemolytic anemia, and microangiopathic hemolytic anemia. Sickle cell anemia is an exam-

TABLE 15-3.

## Usefulness of the Mean Corpuscular Value (MCV) and Red Blood Cell Distribution Width (RDW) in the Diagnosis of Anemia

	Low MCV ( $<80 \text{ fL}$ )	Normal MCV ( $80\text{--}99 \text{ fL}$ )	High MCV ( $>100 \text{ fL}$ )
<b>Normal RDW</b>	Anemia of chronic disease $\alpha$ - or $\beta$ -Thalassemia trait Hemoglobin E trait	Acute blood loss Anemia of chronic disease Anemia of renal disease	Aplastic anemia Chronic liver disease Chemotherapy/antivirals/alcohol
<b>Elevated RDW</b>	Iron deficiency  Sickle cell, $\beta$ -thalassemia	Early iron, folate or vitamin B <sub>12</sub> deficiency Dimorphic anemia (e.g., iron + folate deficiency) Sickle cell anemia Sickle cell disease Chronic liver disease Myelodysplasia	Folate or vitamin B <sub>12</sub> deficiency  Immune hemolytic anemia  Cytotoxic chemotherapy Chronic liver disease Myelodysplasia

Reproduced with permission from Felgar RE and Ryan DH.<sup>10</sup>

TABLE 15-4.

## Combining the Reticulocyte Count and Red Blood Cell Parameters for Diagnosis

	Corrected Reticulocyte Count <2%	Corrected Reticulocyte Count ≥2%
Low MCV, normal RDW	Anemia of chronic disease	
Normal MCV, normal RDW	Anemia of chronic disease	
High MCV, normal RDW	Chemotherapy/antivirals/alcohol Aplastic anemia	Chronic liver disease
Low MCV, high RDW	Iron-deficiency anemia	Sickle-cell, β-thalassemia
Normal MCV, high RDW	Early iron, folate, vitamin B <sub>12</sub> deficiency Myelodysplasia	Sickle cell anemia, sickle cell disease
High MCV, high RDW	Folate or vitamin B <sub>12</sub> deficiency Myelodysplasia	Immune hemolytic anemia Chronic liver disease

MCV, mean corpuscular volume; RDW, red blood cell distribution width.  
Reproduced with permission from Felgar RE and Ryan DH.<sup>10</sup>

ple of a hemoglobinopathy that has important implications for anesthetic management and is discussed in detail in Special Anesthetic Considerations in Patients with Sickle Cell Anemia. In contrast to hypoproliferative anemias, the corrected reticulocyte count in patients with hyperproliferative anemias is usually greater than or equal to 2% (or an absolute reticulocyte count of greater than 100,000/ $\mu$ L) (Table 15-2).<sup>10</sup>

### Anesthesia and Anemia

The perioperative management of the anemic patient frequently requires a decision of whether to transfuse RBCs or to consider alternatives to transfusion (e.g., employ RBC salvage techniques). Making the correct transfusion decision involves considering the balance of the risks and merits of transfusing allogeneic and/or autologous RBCs. A consensus conference of the National Institutes of Health (NIH) and the Food and Drug Administration (FDA) was convened in June 1988 to determine the appropriate Hgb concentration or Hct level to trigger the administration of a perioperative RBC transfusion to a surgical patient.<sup>19</sup> The conference concluded that insufficient data existed to suggest a single transfusion trigger and there was a lack of data demonstrating that mild-to-moderate reductions in RCM contribute to perioperative morbidity. Furthermore, because perioperative transfusion of allogeneic erythrocytes is associated with a risk of immunologic changes and infections, alternatives to RBC transfusion may reduce the need for this therapy in the future.

Hgb concentration and Hct level are important predictors of the risk for transfusion; consequently, it is prudent

to continue to use these tests in concert with wise clinical judgment to make a transfusion decision for an individual patient.<sup>20-22</sup> The conclusions of the NIH-FDA consensus conference reinforce the importance of understanding the physiology of anemia so as to make an informed decision regarding erythrocyte transfusion. The subsequent sections of this chapter on anemia review the physiology of anemia, present an approach to determining an individual patient's transfusion threshold that is supported by the limited current body of literature, discuss alternatives to RBC transfusion, discuss risks of RBC transfusion, and describe special anesthetic considerations for patients with sickle cell disease.

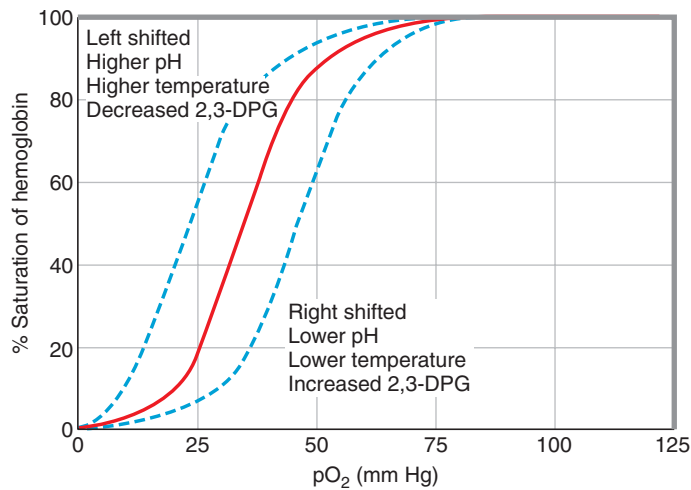
### Physiology of Anemia

The physiologic response to anemia should be considered from at least 2 vantage points: acute anemia and chronic anemia. The physiologic response to acute anemia, most often a result of hemorrhage, will depend on the extent and rate of acute blood loss. Baroreceptor reflexes mediate the initial response to acute blood loss; chemoreceptors do not play a significant role.<sup>23</sup> Heart rate and minute ventilation initially increase after hemorrhage in the absence of volume replacement. Hyperventilation and tachycardia serve to increase cardiac output, which, in turn, increases blood flow to tissues. The increased heart rate augments cardiac output more directly than hyperventilation, which increases cardiac output by increasing right-heart filling.<sup>24</sup> Acute hyperventilation reduces  $P_{aCO_2}$ , increasing arterial pH (pHa) and both of these changes increase the oxygen saturation of arte-

rial Hgb via the Bohr effect; these changes favor a higher affinity of oxygen for the Hgb molecule and decrease oxygen unloading to the tissues.<sup>23,25</sup> The reduced  $P_{aCO_2}$  causes a left shift in the oxyhemoglobin dissociation curve, which speeds the uptake of oxygen in the pulmonary capillaries, but ultimately decreases the amount of oxygen that can be unloaded at any partial pressure of oxygen (Fig. 15-2). The increased cardiac output that accompanies this left shift of the oxyhemoglobin dissociation curve can compensate for the higher affinity of oxygen for the Hgb molecule. If insufficient cardiac reserve exists to increase cardiac output under these conditions, tissue hypoxia can worsen.

Concurrent with the baroreceptor-mediated response to acute blood loss is the near-immediate release of catecholamines, angiotensin II, and vasoactive hormones.<sup>23</sup> These biochemical mediators increase systemic vascular resistance and thereby increase systemic blood pressure. The increase in systemic vascular resistance is selective in that blood flow is increased to a lesser extent to gut, skin, muscle and renal tissue than to the heart and brain, so these organs receive preferential blood flow.<sup>26</sup> The increase in catecholamines will also confer a positive inotropic and chronotropic effect on the heart that will further augment cardiac output.

Decreased intravascular volume stimulates the renin-angiotensin-aldosterone axis, which contributes to increasing cardiac output and improving tissue oxygen delivery by water retention. Water retention augments cardiac preload.<sup>26</sup> Acute hemorrhage is associated with redistribution of



**FIGURE 15-2.** Oxyhemoglobin dissociation curve.  $O_2$  consumption to  $O_2$  delivery relationship. The solid line demonstrates the biphasic relationship between  $O_2$  consumption and  $O_2$  delivery. The dashed line illustrates the postulated changes in the relationship with diseases such as sepsis and acute respiratory distress syndrome (ARDS). The anaerobic threshold is shifted to the right, suggesting that patients require increased levels of  $O_2$  delivery to avoid ongoing ischemic damage to vital organs. Reprinted from Hébert PC, Van der Linden P, Biro G, Hu LQ. Physiologic aspects of anemia. *Crit Care Clin* 2004;20:187, with permission from Elsevier.

water from the extravascular space into the intravascular space, accompanied by decreased Hgb concentration. As intravascular volume is replenished, Hgb concentration and Hct level decline, producing decreased blood viscosity. Redistribution of water occurs rapidly with severe hemorrhage; a significantly lower Hgb concentration is measurable within 2 minutes with an acute loss of 40% of the circulating blood volume. Complete fluid redistribution, however, takes hours. The rapid redistribution of water is attributable to the decreased hydrostatic pressure of the intravascular compartment and increased plasma oncotic pressure due to acute mobilization of albumin from the interstitial matrix as well as increased hepatic production of glucose and amino acids.<sup>27,28</sup> The resulting lower blood viscosity serves to reduce resistance to blood flow and increase venous return to the right heart; these changes help maintain or increase cardiac output. Reduced resistance to blood flow reduces myocardial work and oxygen consumption despite the overall increase in cardiac output.<sup>29</sup>

If the rate of blood loss is too severe for these compensatory changes to be effective in restoring blood flow to tissues, or if cardiac performance cannot be increased secondary to preexisting cardiac pathology (e.g., cardiomyopathy), then unmet tissue oxygen

needs can result in lactic acid production and decreased pHa. Under these conditions acidosis results in a decreased Hgb-oxygen affinity that augments the delivery of oxygen to hypoxic tissues (i.e., there is a right shift of the oxyhemoglobin dissociation curve) (Fig. 15-2).<sup>30-32</sup>

Another compensatory mechanism for acute anemia occurs within the erythrocyte; RBCs can increase their intracellular concentration of 2,3-DPG (diphosphoglycerate), a product of anaerobic metabolism within RBCs. Increased levels of 2,3-DPG reduce the affinity of Hgb for oxygen, thereby favoring decreased oxygen uptake in the pulmonary capillaries but resulting in increased tissue oxygen delivery (Fig. 15-2).<sup>25,26,33</sup> Stored allogeneic RBCs have lower 2,3-DPG levels immediately following transfusion (i.e., there is a left shift of the oxyhemoglobin curve) and therefore do not readily unload oxygen to tissues.

Subsequent to these physiologic compensations (e.g., hyperventilation, decreased  $Paco_2$ , increased 2,3-DPG levels, and, ultimately, an increased cardiac output) there is an increase in erythropoiesis that appears to be linked to the renal sensitivity to oxygen flux (Fig. 15-1). Increased erythropoietin concentration and an increase in the circulating reticulocyte count can be detected in as little as 2 days after a hemorrhagic event. The Hgb

concentration will start to increase within 7 days after a major hemorrhage. This continuum of physiologic responses occurs in the healthy surgical patient. An individual patient's ability to mount these physiologic responses largely depends on the patient's ability to increase cardiac output and augment tissue oxygen delivery.<sup>31</sup> The compensatory physiologic response to acute, unreplaced volume loss is reduced under general anesthesia, emphasizing the importance of maintaining intravascular volume.<sup>34</sup> The extent of the sympathetic stimulatory response to acute anemia is impaired during general anesthesia in that the heart rate does not increase to the same degree as in unanesthetized patients and the systemic vascular resistance is lower.<sup>35,36</sup> The inability to appropriately increase heart rate and augment cardiac output during general anesthesia, or because of medications (e.g.,  $\beta$ -blockers), must also be considered when determining an individual patient's transfusion threshold. Anesthetized patients with marked impairment of their compensatory responses to anemia should be treated with a more liberal transfusion threshold despite limited data supporting this approach.

Chronic anemia is associated with expansion of plasma volume, hyperventilation, and an increased cardiac output.<sup>31,37</sup> In determining whether to transfuse a chronically anemic patient the clinician should inquire about signs and symptoms of anemia (e.g., fatigue, decreased exercise capacity, and increased frequency of angina in patients with ischemic cardiac disease). For anesthetized patients who are chronically anemic but who have had partial volume repletion, electrocardiographic evidence of myocardial ischemia or systemic acidosis should prompt the clinician to transfuse erythrocytes. However, rapid transfusion of physiologically compensated chronically anemic patients can precipitate congestive heart failure because of intravascular volume overload even in patients with normal myocardial function.

To understand the physiology of anemia, one must consider oxygen delivery ( $\dot{D}O_2$ ), volume of oxygen consumption ( $\dot{V}O_2$ ) and the relationship between them ( $\dot{V}O_2:\dot{D}O_2$ ) or the oxygen extraction ratio).  $\dot{D}O_2$  is calculated by the formula:



$$\dot{V}O_2 = \text{cardiac output} \times (\{SaO_2 \times k1 \times [Hgb]\} + \{k2 \times PaO_2\})$$

where  $SaO_2$  is arterial oxygen saturation (%);  $k1$  is the oxygen-carrying capacity of Hgb and equals  $1.34 \text{ mL} \cdot \text{g}^{-1}$ ;  $[Hgb]$  is the hemoglobin concentration;  $k2$  is the plasma oxygen dissolution coefficient at body temperature and equals  $0.23 \text{ mL} \cdot \text{L}^{-1} \cdot \text{kPa}^{-1}$ ; and  $PaO_2$  is the partial pressure of oxygen in arterial blood.<sup>22</sup>  $\dot{V}O_2$  is determined by multiplying the oxygen content difference between the arterial and venous blood by cardiac output. Unfortunately all the data required for these calculations are not routinely available. When these data are available, they can aid in determining the transfusion trigger. Additional information on physiologic transfusion triggers is provided in The Decision to Transfuse Red Blood Cells below.

### Anemia and Intravascular Volume

Simultaneously restoring normovolemia and maintaining oxygen delivery are principal goals of treating surgical blood loss. A patient's requirement for RBC transfusion should only be considered after intravascular volume status has been restored to normal. The ability to tolerate a lower Hgb concentration in the perioperative period is integrally dependent on an adequate intravascular volume.<sup>26,29,35</sup>

### Crystalloid versus Colloid for Nonerythrocyte Fluid Replacement

Crystalloidal solutions (e.g., normal saline, lactated Ringer, hypertonic saline) possess a lower viscosity compared with the more viscous colloidal solutions (e.g., 5% albumin, hetastarch) and although the crystalloidal solutions can theoretically be delivered more rapidly, contemporary rapid infusion devices help to make this difference in viscosity clinically negligible. Normalizing blood volume with crystalloid solutions requires a ratio of approximately 3 mL of crystalloid per 1 mL of whole blood as most goes quickly to the extravascular space. Crystalloids avoid the risk of infectious disease such as hepatitis and AIDS, and are far less expensive than colloid-based solutions. Synthetic starch-based solutions (e.g., hydroxyethyl starch [HES] or Hespan) are the least-expensive colloids (Table 15-5). Although administration of large

TABLE 15-5.

#### Hospital Acquisition Costs for Intravenous Volume Replacement Solutions

Fluid	Volume (mL)	Cost <sup>a</sup> (U.S. Dollars)
0.9% Sodium chloride	1000	\$3.50
Lactated Ringer	1000	\$3.50
Hespan	500	\$16.25
5% Albumin	250	\$20.00

<sup>a</sup>Fluid costs reflect high volume purchasing through the Partners Healthcare System, Inc. in January 2006.

volumes of crystalloid can produce a dilutional coagulopathy, HES colloidal solutions carry a greater risk of producing a coagulopathy and other unwanted side effects (e.g., pruritus) as described later in Drug-Induced Hypocoagulable States below.<sup>38,39</sup>

### The Decision to Transfuse Red Blood Cells

After establishing normovolemia the anesthesiologist should incorporate physiologic data from the patient as well as assess the patient's ability to compensate for a given degree of anemia (loss of RCM) when weighing the risks (e.g., immunosuppression, infection, and mistransfusion) and benefits (e.g., relieving organ ischemia) of administering a RBC transfusion.<sup>40-43</sup> Strong consideration should be given to the patient's ability to increase the cardiac output, given the important role that augmented systemic oxygen delivery plays in compensating for anemia. Physiologic indications of inadequate tissue oxygenation include electrocardiographic or echocardiographic evidence of myocardial ischemia (e.g., new ST-segment elevation/depression, new regional wall motion abnormalities, or new spectral Doppler evidence of significant diastolic dysfunction), systemic acidosis related to tissue lactic acid production, an increase in the calculated oxygen extraction ratio,  $\dot{V}O_2:\dot{D}O_2$  (i.e., normal  $\dot{V}O_2:\dot{D}O_2$  is 20-30%; a  $\dot{V}O_2:\dot{D}O_2 > 50\%$  may indicate global inadequate tissue oxygenation), a mixed venous oxygen saturation ( $SvO_2$ )  $< 50\%$ , a low mixed venous partial pressure ( $PvO_2$ )  $< 32 \text{ mm}$

Hg or tachycardia unrelated to hypovolemia and/or inadequate anesthesia (Table 15-6).<sup>22</sup> Often these more specific indicators of tissue hypoxia are not available. Consequently, clinicians consider systemic acidemia in the setting of tachycardia and hypotension to indicate a requirement for augmenting a patient's RCM.

Since 1988 only a single multicenter, prospective, randomized, controlled trial has been conducted to assess the effect of RBC transfusion on morbidity and mortality. This study, the Transfusion Requirements in Critical Care (TRICC) trial,<sup>36</sup> enrolled 838 intensive care unit (ICU) patients that were randomized to either a restrictive (i.e.,  $[Hgb]$  7.0-9.0 g/dL) or liberal (i.e.,  $[Hgb]$  10.0-12.0 g/dL) transfusion strategy. The overall 30-day mortality was lower in the restrictive transfusion strategy group (18.7% vs. 23.3%), but this difference was not statistically significant ( $P = 0.11$ ). A priori subgroup analysis of subjects who were less acutely ill and ages older than 55 years demonstrated a significantly lower mortality in the restrictive group. Although the TRICC trial is the largest study of its kind, it was stopped prematurely by its executive committee because of less than 20% of projected enrollment, consequently falling far short of its anticipated potential to examine the question of an appropriate transfusion strategy in critically ill patients. The authors concluded that a restrictive approach to RBC transfusion is as effective and potentially superior to a liberal transfusion strategy for ICU patients, with the possible exception of patients with unstable angina and acute myocardial infarction.<sup>36</sup> Unfortunately, the TRICC trial was conducted at a time when leukoreduction of transfused blood was not a common practice. A review of the importance of this practice suggests that it may improve the clinical outcomes of transfused patients.<sup>44</sup>

Three large observational studies in varied patient populations have been completed since the NIH-FDA consensus conference.<sup>45-47</sup> In one study, the number of transfused RBC units was found to be an independent risk factor for hospital length of stay, mortality, and number of complications.<sup>45</sup> In another large study, mortality was significantly higher in patients with similar levels of organ dysfunction in whom RBCs were transfused.<sup>46</sup> A large ( $n =$

TABLE 15-6.

Physiologic Transfusion Trigger Parameters

Hgb-based and physiologic transfusion triggers as a function of patient-related and logistical factors (modified according to Marcucci et al.<sup>49</sup>). RBC transfusion is indicated if one of the criteria given in the table is reached: Hgb threshold, circulation criterion, myocardial ischemia, or one of the oxygenation variables (PvO<sub>2</sub>, O<sub>2</sub>ER, SvO<sub>2</sub>, or  $\dot{V}O_2$ ). For all physiologic transfusion triggers, normovolemia, optimization of the anesthesia and the correction of tachycardia (if present) is assumed and anemia should be the only probable cause. Includes all patients except the subcategories patients age >80 y, patients with CAD, patients with CVD, and patients with fever/hypermetabolism. One may choose not to transfuse the individual patient without any physiologic transfusion triggers.

Situation	Patients	Hgb (g/dL)	Circulation	Myocardial Ischemia	PvO <sub>2</sub> <32 mm Hg, O <sub>2</sub> ER >50%, SvO <sub>2</sub> <50%, decrease in $\dot{V}O_2$ >10%
Intraoperative, ICU	All patients	6	Rel. inc. HR/dec. BP	ST-segment changes	Yes
	>80 y	7	Rel. inc. HR/dec. BP	ST-segment changes	Yes
	CAD	8	Rel. inc. HR/dec. BP	ST-segment changes	Yes
	CVD	7	Rel. inc. HR/dec. BP	ST-segment changes	Yes
	Fever/hypertension	7	Rel. inc. HR/dec. BP	ST-segment changes	Yes
Ward	All patients	6	Rel. inc. HR/dec. BP	Clinical signs	NA
	>80 y	8	Rel. inc. HR/dec. BP	Clinical signs	NA
	CAD	9	Rel. inc. HR/dec. BP	Clinical signs	NA
	CVD	8	Rel. inc. HR/dec. BP	Clinical signs	NA
	Fever/hypertension	8	Rel. inc. HR/dec. BP	Clinical signs	NA

CAD, coronary artery disease; CVD, cardiovascular disease; O<sub>2</sub>ER, oxygen extraction ratio (%); PvO<sub>2</sub>, partial venous pressure of oxygen (mm Hg); Rel. inc. HR, relative increase in heart rate defined as heart rate >120–130% of baseline or >110–130 beats/min; Rel. dec., relative decrease in systemic blood pressure defined as a mean arterial pressure <70–80% of baseline or <60 mm HG (<55 mm Hg in young healthy patients, <70–80 mm Hg in patients with CAD or CVD and in hypertensive patients, and even higher in severely hypertensive patients); SvO<sub>2</sub>, venous oxygen saturation (%);  $\dot{V}O_2$ , oxygen consumption; ST-segment changes, new ST-segment depression >0.1 mV or ST-segment elevation >0.2 mV that is to be confirmed with ECG and/or troponin measurement if possible in a timely fashion; NA, not applicable.

Madjdpour C, Spahn DR. Allogeneic red blood cell transfusions: efficacy, risks, alternatives and indications. Br J Anaesth 2005;95:33. © The Board of Management and Trustees of the British Journal of Anaesthesia. Reproduced by permission of Oxford University Press/British Journal of Anaesthesia.

8787) observational study of elderly, orthopedic surgical patients found that postoperative transfusion did not influence 30- or 90-day mortality after adjusting for the transfusion strategy (i.e., transfusion trigger between 8 and 10 g·dL<sup>-1</sup> or <8 g·dL<sup>-1</sup>), cardiovascular disease, and other risk factors.<sup>47</sup> These large observational studies suggest a clear relationship between RBC transfusions and worse outcome. However, it remains unclear whether patients who received transfusions were more ill.

**Undesirable Effects of Red Blood Cell Transfusion**

Presently, human error, or mistransfusion, accounts for the greatest incidence of adverse transfusion effects (Fig. 15-3).<sup>43</sup> RBC transfusion can produce other undesirable clinical effects including immunodepression and infection in surgical patients.<sup>41-43,48,49</sup> Prion-associated transfusion infection (e.g., variant Creutzfeldt-Jakob disease) and transfusion-related acute lung injury (TRALI) are additional clinical problems that may result from RBC transfusion.<sup>50-53</sup>

**Alternatives to Transfusion**

**Acute Normovolemic Hemodilution**

Acute normovolemic hemodilution (ANH) involves prehemorrhage, intra-

operative removal of a specified quantity of an individual patient's blood (i.e., up to 50% of select patients' total circulating RCM can be safely removed) while intravascular volume is concurrently replaced.<sup>35</sup> Because the RCM is

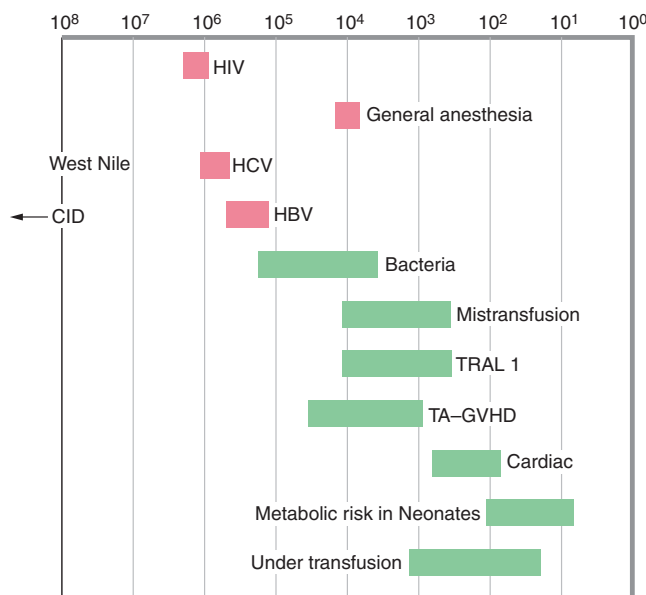


FIGURE 15-3. Estimates of the current risk per unit of blood transfusion. The vertical bars represent log risk estimates (1–10, 1–100, etc.). Reproduced with permission from Gafou A, Georgopoulos G, Bellia M, et al.<sup>43</sup>

decreased before intraoperative bleeding begins, there is a smaller net loss of RCM per unit blood loss during hemorrhage. Additionally, the benefit of transfusing the shed autologous whole blood, including functional platelets and coagulation proteins, exists for the patient at any point during or after the operative procedure.<sup>54</sup> Individuals with religion-based aversion to RBC transfusion (e.g., Jehovah's Witness) are a population of patients that can benefit from ANH if the shed blood is kept in a parallel circuit connected to the patient.

### Red Blood Cell Substitutes

Further development of RBC transfusion alternatives is needed before they can be considered as a viable alternative to erythrocyte transfusion. Extensive laboratory and clinical research has been done with Hgb-based oxygen-carrying solutions.<sup>55–57</sup> Despite many years of concentrated research efforts with Hgb-based oxygen-carrying solutions, there is no FDA-approved product for any human clinical indication. Currently at least 2 general types of Hgb-based oxygen-carrying solutions are under investigation. One is derived from bovine Hgb and presents the advantage of being available in an abundant supply, while another is manufactured from outdated banked human blood.<sup>55</sup> Problems that have impeded the development of Hgb-based oxygen-carrying solutions include renal toxicity, gastrointestinal symptoms, systemic hypertension, coronary vasoconstriction, pulmonary hypertension, short half-life of the transfused molecules, methemoglobin production and fear of infection (e.g., prions and bovine spongiform encephalitis) from bovine-derived Hgb. The vasoconstrictor effects of these molecules appear to be related to their small size, tendency to migrate into the interstitium, and ability to scavenge nitric oxide from the vascular endothelium.<sup>55</sup> The small size of some Hgb molecules results in their being filtered out through the glomerulus. Modifications of the Hgb molecule, including polymerization into a larger molecule and liposome encapsulation, appear to have resulted in some success in solving these problems. However, there is limited evidence that they are equivalent to banked RBCs.<sup>56–59</sup> Perfluorocarbons are a non-Hgb-based RBC substitute; these synthetic solutions are not available for clinical use.<sup>55,60</sup>

### Red Blood Cell Salvage

Red cell salvage techniques are associated with a significant reduction in allogeneic transfusion requirements and a cost benefit in some patients.<sup>61–63</sup> Autologous RBC salvage involves the collection of blood from a wound site, processing (e.g., centrifugal washing and/or filtering through a 20- $\mu$ m filter) of scavenged blood, and reinfusion into the same patient.<sup>64</sup> Centrifugal washing concentrates the salvaged blood to allow the infusion of an autologous product with a high Hct level (e.g., 45–65%) and removes undesirable components of shed blood (e.g., free Hgb, tissue debris, and fibrin split products).<sup>65</sup> Cell salvage requires specialized equipment and device-specific disposable units (Fig. 15–4). The processed blood primarily contains morphologically normal erythrocytes suspended in normal saline. Centrifugal washing removes coagulation proteins, although some leukocytes and a small number of platelets are retransfused.

Alternatively, the collected shed autologous blood is passed through a filter with 20- $\mu$ m-sized pores and retransfused without centrifugal washing.<sup>66,67</sup> Red cell salvage with centrifugal washing within certain guidelines has been studied and found to be generally safe.<sup>64,66–70</sup> Malignancy, infection at the operative site, or the use of microfibrillar collagen materials are presently considered contraindications to the use of RBC salvage techniques.<sup>71–73</sup>

### Antifibrinolytic Therapy

Antifibrinolytic therapy (e.g., aprotinin,  $\epsilon$ -aminocaproic acid, and tranexamic acid) can reduce blood loss in certain patients at risk for major hemorrhage (e.g., cardiac surgical patients, orthotopic liver transplantation patients, and selected orthopedic surgery patients).<sup>74–76</sup> The results of several prospective, randomized, controlled trials indicate aprotinin therapy can reduce transfusion requirements. Tranexamic acid and  $\epsilon$ -aminocaproic acid are also effective in blood conservation for selected patient populations, although there is less supportive data for their efficacy in reducing RBC transfusion requirements.<sup>77</sup> Aprotinin was recently associated with an increased mortality rate, myocardial infarction, decreased coronary graft patency, and renal failure.<sup>78–80</sup> One of the largest observational studies of aprotinin demonstrated significant associations of



FIGURE 15–4. Haemonetics Cell Saver device.

aprotinin administration with increased risk of renal failure, myocardial infarction or heart failure, and stroke or encephalopathy. However, the same study did not raise safety concerns about tranexamic acid or  $\epsilon$ -aminocaproic acid.<sup>78</sup> The results of this study resulted in an FDA practice alert surrounding the use of aprotinin and the validity of the data is under investigation.<sup>81</sup> Some evidence suggests that aprotinin treatment may produce a reduced risk of stroke and plans are currently underway to study this.<sup>76</sup>

### Special Anesthetic Considerations in Patients with Sickle Cell Anemia

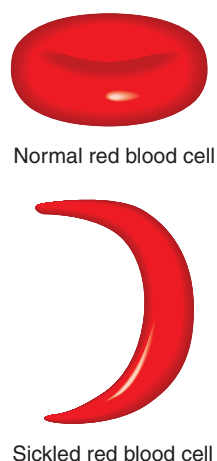
Sickle cell disease (SCD) is prevalent among the African American population. Patients with this hemoglobinopathy can exhibit both anemia and a functional defect of their circulating Hgb. Hgb is composed of globin chains combined with a heme molecule. Four distinct types of globin chains are normally produced in the human body including alpha ( $\alpha$ ), beta ( $\beta$ ), gamma ( $\gamma$ ), and sigma ( $\sigma$ ) globin chains. Normally the body will produce three types of Hgb using different combinations of these four distinct globin chains including HgbA ( $\alpha_2\beta_2$ ), HgbF ( $\alpha_2\gamma_2$ ), and HgbA<sub>2</sub> ( $\alpha_2\sigma_2$ ). In early infancy, 97% of the circulating Hgb exists as HgbA. Hemoglobinopathies result from the decreased synthesis of normal globin chains (e.g., thalas-



semia syndromes), or in the case of SCD, the functional defect of the Hgb complex involves a qualitative defect in globin synthesis.<sup>82</sup>

The pathophysiology of SCD and sickle cell trait (SCT) is caused by an alteration in the synthesis of  $\beta$ -globin chains by a substitution of the amino acid valine for glutamine at the sixth amino acid location, resulting in the production of HgbS when these  $\beta$ -globin chains are combined with the  $\alpha$ -globin chains. In individuals with both chromosomes directing HgbS synthesis (homozygous SS disease), the normal HgbA is substituted by HgbS. Increased production of HgbA<sub>2</sub> and HgbF are minimally effective in alleviating the pathophysiologic changes associated with SCD. A major percentage (80–95%) of the synthesized Hgb is in the HgbS form for patients afflicted with homozygous SS disease.<sup>82,83</sup> SCT represents the heterozygous state and is produced by 1 sickle cell gene locus and 1 normal gene locus. SCT results in few clinical problems despite the HgbS level rising to nearly 40% of circulating Hgb.<sup>82</sup> Among African Americans in the United States, 0.4% possess the homozygous state of SCD, while a prevalence of 6–8% of heterozygotes is reported.<sup>84–86</sup>

There is a spectrum of tissue oxygen-delivery-related sequelae that result from the pathophysiologic mechanisms of SCD. Patients with SCD exhibit an abnormal change in the conformation of the deoxygenated HgbS molecule that reduces the solubility of the molecule and results in intraerythrocyte precipitation of HgbS.<sup>87</sup> The precipitated intraerythrocyte deoxyhemoglobin S alters red cell function, resulting in damage to the intracellular contents and to the cell membrane. These cellular changes result in reduced capillary blood flow and early cell destruction.<sup>83,87</sup> Specifically, the normally pliable, biconcave-shaped erythrocyte is transformed into a smaller, less compliant, characteristically shaped, sickled erythrocyte that is pathognomonic of this disease (Fig. 15–5).<sup>83,87,88</sup> Erythrocytes in patients with SCD have a reduced circulating life span of approximately 10–20 days, which contributes to the patient's anemia.<sup>89</sup> Sickled erythrocytes increase the viscosity of blood and along with thrombus formation in the blood vessels can create a vasoocclusive crisis.<sup>90,91</sup> The goal of SCD treatment is to prevent initiation of the sickling process as this process is irreversible once intracellular HgbS has precipitated.<sup>86</sup>



**FIGURE 15–5.** Diagram art of a normal RBC and a sickled RBC. Reproduced with permission from Lewin J. Electron Microscopy Unit, Royal Free Hospital School of Medicine, London, UK. Available at: <http://healthgate.partners.org/browsing/LearningCenter.asp?fileName=11561.xml&title=Sickle%20Cell%20Anemia>. (Google Images). Last accessed 1/04/2007.

Vasoocclusive crisis can result in damage to multiple organs (e.g., renal papillary necrosis, renal medullary infarction, retinal or vitreous hemorrhage, aseptic necrosis of the femoral head, and splenic infarction).<sup>92–94</sup> Central nervous system and pulmonary infarctions are also common and are most likely related to emboli of sickled cells and platelet aggregates that form in distant tissue beds.

Patients with SCD should be treated to prevent perioperative hypoxia, dehydration, and hypothermia, which can result in a vasoocclusive crisis. Preventative measures are the mainstay of treatment for individuals with this disorder.<sup>88</sup> General anesthesia per se does not overtly increase the risk of the precipitation of sickled erythrocytes.<sup>86</sup>

One approach used to avoid a perioperative vasoocclusive crisis is to reduce the percentage of HgbS to less than 30–40% before surgery by exchange and standard transfusions.<sup>86</sup> As with other chronic anemic states, there is physiologic compensation that results in an increased intravascular volume and augmented cardiac output. The increase in intravascular volume places the anemic SCD patient at risk for volume overload if they are rapidly transfused with allogeneic blood; consequently, a cautious approach to transfusion is mandated. The benefit of transfusion has been demonstrated to persist for weeks into the postoperative period as evidenced by a reduced incidence of sickling episodes.<sup>95,96</sup>

Perioperative mortality in SCD patients is most commonly caused by fulminant infection related to immunosuppression associated with prior splenic infarction.

## COAGULATION DISORDERS

The coagulation system of the human body maintains a delicate balance between hemostasis and the distribution of fluid blood to the tissues. Pathologic changes within the coagulation system may result in either a hypocoagulable state (i.e., a tendency to hemorrhage inappropriately) or a hypercoagulable state (i.e., a tendency to inappropriately form thrombus). The coagulation system relies on the appropriate level and function of several blood components to allow normal clotting. The process of blood coagulation relies on the interaction of platelets, vascular endothelium, vascular smooth muscle, soluble coagulation proteins, and various local and systemic biochemical mediators to produce a hemostatic clot.<sup>97</sup>

### Hypocoagulable States

It is crucial to recognize and treat a preexisting hypocoagulable state to avoid massive hemorrhage and potentially unnecessary blood product transfusion. Optimal treatment of a hypocoagulable disorder is best accomplished by selectively transfusing the blood component(s) that is/are deficient (e.g., transfuse factor VIII concentrate into a hemophiliac requiring surgery rather than fresh-frozen plasma). Hypocoagulable states are usually either congenital or acquired; both can occur simultaneously in the same patient. Knowledge of both the coagulation cascade and the biologic half-life of a particular coagulation element are needed to effectively treat many hypocoagulable disorders (Fig. 15–6, Table 15–7). It is of paramount importance to combine a history and physical examination with appropriate laboratory testing to discover congenital and/or acquired hypo-/hypercoagulable disorders in surgical patients. After direct questioning of whether a patient has a known coagulation disorder, one must ask specific questions to elicit the presence or absence of these disorders (Table 15–8). If a patient answers “yes” to any of these questions, inquire as to the details and frequency of the problem. Depending on the complexity of the presenting hypo- or hy-



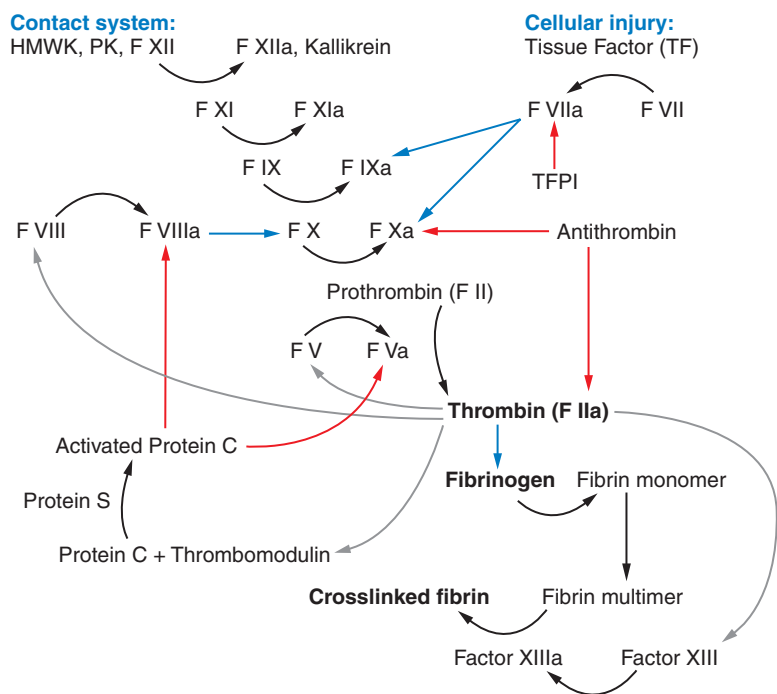


FIGURE 15-6. The coagulation cascade.

percoagulable state, a hematology consultation might be indicated.<sup>98</sup>

### Factor VIII Deficiency (Hemophilia A)

Patients with factor VIII deficiency, or hemophilia A, can require urgent surgical intervention for bleeding episodes (e.g., craniotomy to decompress an intracranial hemorrhage or fasciotomy to

relieve a compartment syndrome). Hemophilia A is an X-linked recessive trait that occurs with a frequency of 1 in 5000 live male births.<sup>99,100</sup>

Individuals with hemophilia A manifest a range of bleeding symptoms and symptom severity inversely correlates with their plasma activity level of factor VIII. Normally, factor VIII activity ranges from 50–150% (or 0.5–1.5

U/mL). Mild hemophilia is present in patients with factor VIII activity levels greater than 5%. Moderate hemophilia is present in patients with factor VIII activity levels from 1–5%, and severe hemophilia symptoms manifest with levels less than 1% (or 0.01 U/mL).

Spontaneous hemarthroses are the hallmark of severe hemophilia; they do not generally occur until the child walks. Recurrent joint hemorrhage produces a painful degeneration of the cartilage (hemophilic arthropathy) that eventually destroys the joint.<sup>101</sup> Hemophiliacs with 1–5% factor VIII activity do not generally have spontaneous bleeding events, but trauma and surgery can precipitate a hemorrhagic episode.

Intracranial and intracerebral bleeding are the most common causes of death in hemophiliacs. Approximately half of intracranial hemorrhages in hemophiliacs occur spontaneously.<sup>102</sup> Gastrointestinal and oropharyngeal bleeding may also occur. Oropharyngeal bleeding is of great importance because this can lead to airway compromise.<sup>103</sup> Finally, in severe hemophilia, recurrent hemorrhagic episodes may produce an enlarged pseudotumor that might invade local soft tissue and bone. Operative removal of pseudotumors is associated with a high mortality despite provision of recommended perioperative therapies.<sup>103,104</sup>

TABLE 15-7.

Summary of Clotting Factor Deficiencies

Factor Deficiency	Prevalence and Biologic Half-Lives			Screening Abnormalities	
	Biologic Half-Life	Estimated Incidence	Type of Bleeding	Abnormal	Normal
I	2–4 days	1:1 million	None to severe	PT, PTT, TCT, BT	None
II	3 days	Very rare	Mild-moderate	PT, PTT	TCT, BT
V	36 hours	1:1 million	Moderate	PT, PTT, BT	TCT
VII	3–6 hours	1:500,000	Mild-severe	PT	PTT, TCT, BT
X	40 hours	1:500,000	Mild-severe	PT, PTT	TCT, BT
XI	80 hours	Rare	Mild-moderate	PTT	PT, TCT, BT
XII	50–70 hours	Unknown	No bleeding	PTT	PT, TCT, BT
XIII	9 days	1:5 million	Moderate-severe	None	PT, PTT, TCT, BT
PK	35 hours	Unknown	None	PTT	PT, TCT, BT
HK	150 hours	Very rare	None	PTT	PT, TCT, BT
$\alpha_2$ -Pi	3 days	Unknown	Mild-moderate	None	PT, PTT, TCT, BT
$\alpha_1$ -ATP	—	Very rare	Variable-severe	PT, PTT, TCT, BT	None
Protein Z	2–3 days	Unknown	None	None	PT, PTT, TCT, BT
ZPI	Unknown	Unknown	None	None	PT, PTT, TCT, BT

$\alpha_1$ -ATP, alpha<sub>1</sub>-antitrypsin Pittsburgh;  $\alpha_2$ -Pi, alpha<sub>2</sub>-plasmin inhibitor; BT, bleeding time; HK, high-molecular-weight kininogen; PK, prekallikrein; PT, prothrombin time; PTT, partial thromboplastin time; TCT, thrombin clotting time; ZPI, protein Z-dependent protease inhibitor.

TABLE 15–8.

**Preanesthetic Assessment Coagulation Disorder Queries**

- Is there a family history of making blood clots inappropriately or of excessive bleeding after dental or surgical procedures?
- Do you bleed excessively after having a blood sample drawn?
- Have you ever required a transfusion for any reason? If yes, why was the transfusion administered?
- Do you have problems with bleeding gums when you brush your teeth?
- Do you bruise easily?
- Do you have a history of nosebleeds, blood/red-tinged urine, or tarry, black stools?
- Do you experience heavy bleeding with menstruation?
- Are you taking any medications or herbal supplements? If yes, which ones?

Reprinted and modified from Kitchens CS. The consultative process. In: Kitchens CS, Alving BM, Kessler CM, eds. *Consultative Hemostasis and Thrombosis*. Philadelphia: WB Saunders, 2002:3, with permission from Elsevier.

In the United States, the diagnosis and management of hemophilia A is achieved with an activated partial thromboplastin time (aPTT)-based one-stage assay. The aPTT is abnormally prolonged in all hemophiliacs. The prothrombin time (PT), thrombin time (TT), bleeding time, platelet count, and platelet function are all usually normal in hemophiliacs.<sup>102</sup>

Hemophilia A is treated by administration of factor VIII concentrate. The goal of chronic therapy is to maintain the trough factor VIII activity at a level (approximately 3%) that reduces the incidence of spontaneous intracranial hemorrhage and minimizes spontaneous intraarticular hemorrhage.<sup>102</sup> Plasma-derived and recombinant factor VIII concentrates are available, and both substances provide equally effective treatment (Table 15–9). The treatment goal for acute, life-threatening, bleeding episodes (e.g., intracranial hemorrhage or limb-threatening hemorrhage) is to attain a factor VIII activity of 50–100% of normal, as estimated by the aPTT-based one-stage assay.

One anesthetic consideration for patients with hemophilia A involves in-

creasing preoperative factor VIII activity levels to approximately 100% of normal. Additionally, it seems sensible to avoid using nonsteroidal antiinflammatory drugs (e.g., Toradol) as these drugs have precipitated spontaneous gross hematuria in hemophiliacs.<sup>102</sup> Patients requiring a lumbar puncture should first be restored to approximately 100% of normal factor VIII activity levels; specific data regarding spinal anesthesia are not available but a similar therapeutic goal seems warranted if the benefits of spinal anesthesia outweigh the risks to a patient.<sup>102</sup> Administration of factor VIII concentrates to hemophiliacs with an active pharyngeal hemorrhage may not provide acute airway protection and elective intubation may be indicated to protect against life-threatening airway obstruction.<sup>103</sup> Additionally, a complete history and physical examination will reveal whether the hemophiliac patient has developed narcotic tolerance associated with the prior treatment of painful complications related to their disease (e.g., hemophilic arthropathy or ureteral blood clots).

**Factor IX Deficiency (Hemophilia B)**

Factor IX deficiency, also termed hemophilia B or Christmas disease, results in a similar clinical syndrome to hemophilia A. Hemophilia B is transmitted as an X-linked recessive trait

and occurs in 1 of 30,000 live male births. The clinical manifestations of hemophilia B are similar to those described for hemophilia A. Mild, moderate, and severe forms of hemophilia B are defined by the same criteria used for hemophilia A (i.e., severe hemophilia B is defined by a factor IX activity level of less than 1% or 0.01 U/mL). Severity will correlate with the factor IX plasma activity; patients with less than 1% activity will exhibit spontaneous hemarthroses, intramuscular hemorrhages, and gross hematuria among their symptoms. The diagnosis of hemophilia B is also made with an aPTT-based one-stage assay. The aPTT will be prolonged in patients with hemophilia B, but will correct when the patient's plasma is mixed in equal parts with plasma from a normal individual.<sup>102</sup>

Hemophilia B is treated by administration of concentrated factor IX. Factor IX concentrates are available as either recombinant or plasma-derived preparations. The plasma half-life of transfused or endogenous factor IX is approximately 18 hours. The same levels of factor activity replacement are targeted as described in the preceding section on hemophilia A. Development of inhibitory antibodies can complicate treatment of both factor VIII and IX deficiency. They arise more commonly in patients treated with ultrahigh-purity factor concentrates (i.e.,

TABLE 15–9.

**Factor VIII Concentrates Licensed in the United States**

Type/Product Name	Manufacturer	Specific Activity (IU/mg Protein, Discounting Albumin)
<i>Ultrapure Recombinant</i>		
Recombinate	Baxter Hyland	>3000
Kogenate FS	Bayer	>3000 (albumin-free formulations)
Helixate FS	Aventis-Behring	>3000
Re Facto	Genetics Institute (American Home Products)	11,200–15,500 (albumin-free formulations)
<i>Ultrapure Plasma Derived</i>		
Monoclate P	Aventis-Behring	>3000
Hemofil M	Baxter Hyland	>3000
Monarc M	Immuno Baxter (using volunteer donor plasma collected by American Red Cross)	>3000
<i>Intermediate-Purity and High-Purity Plasma Derived</i>		
Alphanate SD	Alpha Therapeutics	8–30
Humate P	Aventis-Behring	1–2
Koate DVI	Bayer	9–22

Reproduced with permission from Cohen AJ and Kessler CM.<sup>102</sup>

the incidence is approximately 1–4% in patients with severe factor IX deficiency).<sup>105</sup> Recombinant activated factor VII (rVIIa) is FDA approved for the treatment of both hemophilia A and hemophilia B in patients with inhibitors to factors VIII and IX, respectively.<sup>106</sup> The anesthetic implications for factor IX deficiency are analogous to those of hemophilia A.

### von Willebrand Disease

von Willebrand disease (vWD) is a platelet function disorder caused by a deficiency of normally functioning von Willebrand factor (vWF).<sup>107</sup> vWD can result in a hypocoagulable state that manifests as bleeding episodes.<sup>108</sup> vWD is a congenital disorder with an equal male-to-female distribution ratio that is inherited by an autosomal dominant pattern and occurs with an incidence of approximately 1%.

vWF plays two major roles in the hemostatic process. First, vWF acts as a bridge between platelet receptors and exposed collagen in disrupted endothelium. Platelet binding to exposed collagen in disrupted endothelium initially occurs via a glycoprotein Ib–vWF and collagen interaction, and soon thereafter by firmer adhesion of the platelet to the collagen molecule via the glycoprotein IIb/IIIa–vWF and collagen interaction. vWF enables platelets to create a primary plug in the disrupted endothelium and start the hemostatic process at the site of vessel injury. vWF also acts as a bridge between platelet receptors,

specifically between glycoprotein IIb/IIIa receptors, for the purpose of platelet aggregation.<sup>109</sup> Second, vWF circulates in the plasma to create a complex bound to factor VIII and provides protection to factor VIII against proteolytic cleavage.<sup>110</sup>

There is a broad range of severity in bleeding associated with vWD. Individuals with moderate or severe vWD tend to bleed abnormally in childhood or young adulthood. The majority of affected individuals have only mild or moderate disease. Symptoms of vWD include easy bruising, epistaxis, and bleeding of mucous membranes. Gastrointestinal bleeding and menorrhagia occur in vWD. Severe gastrointestinal bleeding can be life-threatening in vWD.<sup>111</sup> Surgical procedures can also be associated with excessive bleeding in patients with vWD.<sup>108</sup>

The diagnosis of vWD is complex and is made with a battery of tests that includes vWF antigen (accomplished with the enzyme-linked immunosorbent assay), vWF activity (commonly measured as ristocetin cofactor), factor VIII activity (accomplished with a modified aPTT assay), and the bleeding time. These tests are followed by a second series of assays to determine the classification of vWD and include a ristocetin-induced platelet aggregation assay, as well as vWF multimer studies.<sup>108,112,113</sup>

The treatment of vWD depends on the type of vWD that is diagnosed (Tables 15–10 and Table 15–11). Use of

nonsteroidal antiinflammatory drugs can further impair an already compromised level of platelet function and are contraindicated in vWD. Because the correlation of the degree of diagnostic laboratory test abnormalities in vWD with the severity of bleeding is poor, an empirical goal of treatment is pursued. The treatment goal for the perioperative period should be to increase the activity of vWF and factor VIII to 50–100% of normal, an analogous goal to the treatment of bleeding episodes in vWD.<sup>108</sup>

vWF and factor VIII activity levels are increased in patients with vWD through the intravenous administration of DDAVP (1-deamino-8-D-arginine-vasopressin or desmopressin) and the administration of vWF-rich plasma-derived blood products. The use of topical hemostatic agents (e.g., fibrin glue, Gelfoam or Surgicel soaked in thrombin) will also promote hemostasis in these patients.<sup>108</sup> Alternatively, vWF concentrates (e.g., Humate-P, a heat-treated, highly purified vWF concentrate) can be administered intravenously for patients who do not respond positively to DDAVP therapy.

Pregnant patients with vWD merit special consideration. Although evidence-based recommendations for central neuraxial blockade do not exist, consideration must be given to the fact that spinal or epidural hematoma related to instrumentation can be permanently debilitating. vWF levels increase 2–3 times above the baseline

TABLE 15–10.

#### Classification of von Willebrand Disease

Type	Inheritance	Frequency of vWD Type	vWF Activity	RIPA	Multimer Pattern
Type 1 (classic)	Autosomal dominant	70–75%	↓	↓	Uniform ↓ All multimers present
Type 2 (variant)					
2A	Autosomal dominant (and recessive)	10–15%	↓	↓	↓ Large and intermediate multimers
2B	Autosomal dominant	5%	↓	↑	↓ Large multimers
2M	Autosomal dominant (and recessive)	Infrequent	↓	↓	Normal multimers
2N	Autosomal recessive	Infrequent	Normal	Normal	Normal multimers
Type 3 (severe)	Autosomal recessive	Rare	↓↓	↓↓	Undetectable (usually cannot visualize)

vWD, von Willebrand disease; vWF, von Willebrand factor; RIPA, ristocetin-induced platelet aggregation; ↓, decrease; ↑, increase; ↓↓, marked decrease.  
Reproduced with permission from Rick ME.<sup>108</sup>

TABLE 15–11.

## von Willebrand Disease Treatment Approaches

Medication	Dose	Comments
DDAVP (desmopressin)	IV: 0.3 µg/kg in 50 mL saline over 20 min (maximum 20 µg)	Useful in most patients with type 1; variable in type 2; not useful in type 3; patient should have therapeutic trial before invasive procedure; may repeat dose after 12 hours and q24h; tachyphylaxis and hyponatremia may occur—need to monitor patient
	Nasal spray: Weight >50 kg = 300 µg (1 spray each nostril) Weight <50 kg =150 µg (1 spray in only 1 nostril)	
vWF concentrates containing all vWF multimers	20–30 IU/kg q12h to keep vWF levels 50–100% or to control clinical bleeding; levels should be maintained 3–10 days for major surgery	Dose and duration based on clinical experience
Antifibrinolytic agents:		Use alone or in conjunction with other therapy
ε-aminocaproic acid	50 mg/kg (maximum 5 g/dose) QID	Especially useful for mucosal bleeding (often for dental procedures)
Tranexamic acid	25 mg/kg TID	
IVIg (for use in immune-acquired inhibitors of vWF)	1 g/kg daily for 2 days; infusion over 8–12 hours	Use after trial of DDAVP or other measures in patients with acquired vWD, particularly when associated with autoimmune diseases
DDAVP, 1-desamine-8-D-arginine vasopressin; Type 2, thrombocytopenia may worsen in some type 2B patients; vWF, von Willebrand factor. Reproduced with permission from Rick ME. <sup>108</sup>		

during the second and third trimesters of a pregnancy and may provide some protection from bleeding complications. The increased levels should be verified with the assays previously described because the increase in vWF is not universal and some patients with qualitative vWF defects will not correct their vWF activity during pregnancy.<sup>113</sup> DDAVP can be administered to laboring vWD patients who are known to have a positive response to this therapy. vWF replacement therapy can be employed for individuals who are still bleeding following DDAVP administration. Individuals who are known nonresponders to DDAVP should be treated with vWF concentrates.<sup>108</sup>

### Factor V Deficiency

Congenital deficiency of factor V is rare; the estimated incidence is 1 in 1 million live births. It is inherited as an autosomal recessive trait that is characterized by an absent or decreased level of factor V activity. Factor V is synthesized by the liver and circulates in plasma. Factor V deficiency can range from mild to severe.

Severely affected individuals have less than 1% of factor V activity and may present in infancy with umbilical stump hemorrhage or later with epistaxis, easy bruising, trauma-related hemarthroses, menorrhagia, and obstetrical-related hemorrhage.<sup>114</sup> Thrombotic complications have also been reported in patients with congenital factor V deficiency.<sup>115</sup>

Congenital factor V deficiency is diagnosed definitively with a specific factor V assay. Additionally, the PT, aPTT, and bleeding time are prolonged in this disorder; the TT is normal.<sup>114</sup> Factor V deficiency can occur in an acquired form (e.g., as a result of hepatic synthetic dysfunction) or can present concurrently with other congenital coagulation factor deficiencies (e.g., a combination syndrome exists of factor V and VIII deficiencies). An acquired form of factor V deficiency can also occur as a result of the formation of antibodies to factor V.<sup>116</sup>

The treatment of surgical patients with factor V deficiency will depend on the magnitude of the reduction in functional factor V activity. There are no commercially available factor V

concentrates, so treatment is by administration of fresh-frozen plasma at a loading dose of 15–20 mL/kg followed by 3–6 mL/kg every 24 hours for patients who exhibit either mild or moderate hemorrhagic events. Factor V has a half-life of approximately 36 hours. In the preoperative preparation of a patient with a severely reduced level of factor V activity, plasma exchange transfusion may be needed to avoid fluid overload.<sup>117</sup> Mild bleeding episodes have been treated with local measures and antifibrinolytic therapy (e.g., tranexamic acid or ε-aminocaproic acid).<sup>114</sup>

### Factor VII Deficiency

Factor VII deficiency has an estimated incidence of 1 in 500,000 live births without an apparent sex or racial predilection; inheritance occurs as an autosomal recessive trait. Factor VII and tissue factor complex are needed for the initiation of coagulation *in vivo* (Fig. 15–6); significant deficiencies of this protein can result in severe hemorrhage.<sup>118</sup> Factor VII deficiency can present with a low antigen level and low functional activity of factor VII



(accounting for more than half of patients) or low functional activity in the setting of measured normal antigen levels of factor VII.

Factor VII deficiency presents with a range of clinical manifestations that do not necessarily correlate with the measured plasma level of factor VII.<sup>119</sup> Patients that demonstrate a measured factor VII activity of less than 10% have a higher tendency to exhibit bleeding episodes (e.g., soft-tissue hemorrhage, epistaxis, easy bruising, menorrhagia, menometrorrhagia, and postpartum hemorrhage). Postoperative bleeding is of particular concern in patients with severely reduced factor VII activity. Individuals with less than 1% of normal factor VII activity are most likely to exhibit hemarthroses, muscle hematomas, retroperitoneal hemorrhage, and mortal intracranial bleeds.<sup>118,120</sup> Thrombotic events have been described in patients with factor VII deficiency.<sup>121</sup>

The definitive diagnosis of factor VII deficiency is made with a specific factor VII assay. Affected individuals will also have a prolonged PT along with a normal aPTT, TT, and bleeding time.<sup>114</sup> Congenital factor VII deficiency should be differentiated from the acquired forms of factor VII deficiency that most commonly arise from hepatic dysfunction, coumarin therapy, vitamin K deficiency, and acquired factor VII inhibitors such as antibodies directed specifically toward factor VII.<sup>122</sup>

Individuals with factor VII activity levels less than 25% of normal require preoperative treatment to avoid perioperative life-threatening hemorrhage. The treatment of choice for these patients is the administration of rVIIa (NovoSeven) in an initial dose of 20–30 µg/kg with supplementary doses if bleeding persists. NovoSeven is not FDA approved for treatment of factor VII deficiency because of insufficient safety data.<sup>123–125</sup> Fresh-frozen plasma treatment of factor VII deficiency can be effective but has the disadvantage of requiring the administration of large volumes of plasma as the half-life of factor VII is 3–4 hours.<sup>126</sup>

### Factor X Deficiency

Factor X deficiency is an inherited autosomal coagulation disorder with an estimated incidence of 1 in 500,000 live births. Patients with factor X deficiency produce abnormal factor X in

either normal or reduced amounts. The clinical bleeding manifestations of factor X deficiency vary and correlate with the measured level of factor X activity. Individuals with less than 1% of measurable factor X activity will exhibit hemorrhagic episodes similar to those seen in hemophilia A.<sup>114,127</sup> Individuals with factor X activity that is 15% or higher exhibit fewer bleeding episodes but may exhibit perioperative hemorrhage.<sup>114</sup>

Factor X deficiency is diagnosed by a specific factor X assay. Affected individuals demonstrate a prolongation of the PT and aPTT, and may describe a lifelong history of bleeding problems. Acquired factor X deficiency is most commonly seen in patients with hepatic pathology, vitamin K deficiency, and, rarely, in patients with amyloidosis.<sup>128</sup>

Perioperative factor X activity levels should be maintained at approximately 50% of normal; higher levels may precipitate a thrombotic complication.<sup>114</sup> Factor X may be administered through the transfusion of fresh-frozen plasma (an appropriate loading dose is 15–20 mL/kg followed by 3–5 mL/kg every 24 hours) or prothrombin complex concentrates (an appropriate loading dose is 20–30 U/kg every 24 hours). It is crucial to define the chosen biologic's precise concentration of factor X to avoid overtreatment of the deficiency and the risk of thromboembolic events. Individuals who require chronic supplementation of their factor X levels may develop antibodies to factor X that will limit the effectiveness of exogenous sources of factor X. In such cases, the use of prothrombin complex concentrates may be more effective than fresh-frozen plasma. Amyloidosis may impede the effectiveness of exogenously administered factor X because of the absorption of factor X to the amyloid fibrils. Plasma exchange, chemotherapy, and splenectomy have all been attempted in the treatment of amyloidosis.<sup>128–131</sup>

### Factor XI Deficiency

Congenital factor XI deficiency is a rare, autosomal recessive disorder that occurs without a sex predilection, most commonly among Ashkenazi Jews. Individuals with factor XI deficiency may not exhibit a bleeding tendency in the surgical setting, although patients with less than 20% of factor XI activity can exhibit excessive bleeding but will not manifest episodes of

spontaneous hemorrhage or hemarthroses.<sup>114</sup> A mild bleeding tendency (e.g., hematuria, epistaxis, hematomas, postpartum hemorrhage, menorrhagia, increased bleeding after aspirin administration and following dental or prostate surgery) is seen in some individuals with this disease.<sup>114,132,133</sup>

Definitive diagnosis is made with a specific factor XI assay. Individuals with factor XI deficiency have a prolonged aPTT; the PT and TT are normal. Factor XI deficiency has been observed in association with Noonan syndrome, hemophilia A, factor IX deficiency, vWD and other platelet disorders.<sup>114</sup>

A preoperative factor XI level of 45% is recommended for major surgical procedures and a 30% level is recommended for minor surgery. Individuals with a diagnosis of factor XI deficiency and no history of bleeding problems following trauma or surgery may not require any replacement therapy perioperatively.<sup>114,134,135</sup> Factor XI's half-life is approximately 50 ± 22 hours. Consequently, treatment is accomplished by a loading dose of 15–20 mL/kg of fresh-frozen plasma followed by 3–6 mL/kg every 12 hours. Plasma exchange has been used in individuals with uncontrolled bleeding.<sup>114</sup> Antifibrinolytic agents (e.g., ε-aminocaproic acid and tranexamic acid) have been recommended alone or in conjunction with fresh-frozen plasma administration to control bleeding in factor XI-deficient patients.<sup>114</sup> Tranexamic acid is effective in patients undergoing dental procedures.<sup>136</sup> Finally, perioperative treatment of factor XI deficiency can be complicated by the presence of inhibitors, specifically alloantibodies, which can prolong bleeding episodes.<sup>137,138</sup> NovoSeven, or rVIIa, treatment has been recommended for individuals with inhibitors at a dose of 100–120 µg/kg every 2–4 hours until the bleeding stops, although rVIIa is not FDA approved for this indication.<sup>139</sup> Immunosuppressants (e.g., prednisone) and chemotherapeutics (e.g., cyclophosphamide) have also been tried as therapies for patients with inhibitors to factor XI.<sup>114</sup>

### Contact Factor Deficiency

Factor XII, high-molecular-weight kininogen, and prekallikrein constitute the contact factors of the coagulation cascade (Fig. 15–6); definitive diagnosis is made with a specific assay for the

deficient contact factor.<sup>114</sup> Contact factor deficiencies are not associated with bleeding, although these individuals demonstrate a prolonged aPTT. No specific perioperative treatment is required for these disorders.

### Factor XIII Deficiency

Factor XIII is important for the structural stabilization of a fibrin clot; it creates cross-linking peptide bonds between the fibrin strands within a blood clot (Fig. 15–6). Blood clots that lack these cross-linked peptide bonds are unstable, permeable to blood, susceptible to fibrinolysis, and provide a poor framework for wound healing.<sup>114</sup> Although three different forms of congenital factor XIII deficiency have been described, they are all rare (estimated incidence of 1 in 5 million live births). All share the tendency for excessive perioperative bleeding, as well as a lifelong history of bleeding problems when factor XIII activity is less than 1%.<sup>140</sup> Hemorrhage may be seen from birth and throughout life. Although most bleeding episodes are triggered by trauma in these patients, spontaneous intracranial bleeding can occur.<sup>141</sup>

Definitive diagnosis of factor XIII deficiency is made with a specific clot solubility assay and an assay to quantify the level of factor XIII deficiency.<sup>142</sup> An acquired version of factor XIII deficiency exists that involves the generation of a factor XIII autoantibody in affected individuals.<sup>114</sup>

The treatment of factor XIII deficiency is accomplished by the administration of fresh-frozen plasma or cryoprecipitate. In Europe, factor XIII concentrate (Fibrogammin-P, Aventis-Behring) is available for the treatment of this disorder. Normal hemostasis occurs with factor XIII levels of approximately 5%. Preoperative preparation of individuals with factor XIII activity levels of less than 5% are treated with 2–3 mL/kg of fresh-frozen plasma or with 1 bag of cryoprecipitate per 10–20 kg of body weight. The long half-life of factor XIII (9–10 days) obviates the need to redose frequently. Lifelong supplementation of factor XIII is indicated in individuals with very low levels to prevent intracranial hemorrhage even if an operation is not planned.<sup>143</sup> The treatment of individuals who have developed inhibitory antibodies to factor XIII is more complex and may involve exchange transfusion,

administration of platelets (platelets are known to contain factor XIII), or administration of immunosuppressants (e.g., intravenous  $\gamma$ -globulin, steroids, and cyclophosphamide).<sup>114,144</sup>

### Afibrinogenemia

Fibrinogen serves as the precursor molecule for the proteinaceous fibrin scaffolding of a blood clot. Congenital or acquired deficiency of fibrinogen can result in clinically important bleeding disorders, especially in the surgical patient. Congenital homozygous afibrinogenemia is a rare (estimated incidence of 1–2 in 1 million live births), autosomal recessive disorder without a sex or race predilection that is associated with a varying severity of bleeding problems (e.g., easy bruising, mucosal hemorrhage, hematuria, hemarthroses, hemopericardium, hemoperitoneum, menometrorrhagia, obstetrical complications, intracerebral hemorrhage, and spontaneous splenic rupture) in afflicted patients.<sup>145</sup> Afflicted individuals have no detectable serum fibrinogen as manifest by an infinitely prolonged PT, aPTT, TT, occasional thrombocytopenia, and a fibrinogen assay that reveals no detectable fibrinogen.<sup>146,147</sup>

Fibrinogen levels must be restored to between 50 and 100 mg/dL preoperatively through the use of cryoprecipitate. To bring fibrinogen levels into the therapeutic range of 50–100 mg/dL, 5–10 bags of cryoprecipitate are needed. A single bag of cryoprecipitate contains approximately 250–300 mg of fibrinogen. Fibrinogen levels will persist for 2–4 days following infusion. Operations associated with postoperative hemorrhage result in decreased levels so they should be monitored perioperatively on a daily basis. Thrombosis has been reported in patients who have had their fibrinogen levels normalized via cryoprecipitate infusion.<sup>148–150</sup>

### Dysfibrinogenemia

Many variants of congenital dysfibrinogenemia exist. They share the common feature of abnormal conversion of fibrinogen to fibrin. The polymerization defects that account for the most common dysfibrinogenemias are usually inherited in an autosomal dominant pattern with high penetrance.<sup>151</sup> Most individuals with dysfibrinogenemias are heterozygous and usually produce nearly 50% of the

normal fibrinogen level, enabling effective hemostasis. Some dysfibrinogenemia variants result in fibrinogen levels that are well-below normal or, despite near-normal levels of fibrinogen, that are associated with bleeding problems if the abnormal variant affects the function of the structurally normal fibrinogen.

Clinical manifestations of dysfibrinogenemia include the following: thromboses (17%), mild bleeding after trauma (20%), both thrombotic and hemorrhagic manifestations (20%), no hemorrhagic phenomenon, or asymptomatic (43%). Affected individuals that demonstrate bleeding problems usually manifest them as soft-tissue bleeding, easy bruising, menorrhagia, and, most commonly, perioperative bleeding.<sup>114</sup> Individuals that manifest thromboses can experience either venous (e.g., deep venous thrombosis, pulmonary embolism) or arterial involvement (e.g., thrombosis of the aorta and carotid arteries).<sup>151</sup> Individuals with thrombotic manifestations can possess concurrent disorders within other portions of the coagulation axis (e.g., factor V Leiden mutation, protein S deficiency, other thrombophilias) that contribute to their propensity to inappropriately clot. Poor surgical wound healing can be associated with dysfibrinogenemia.<sup>152</sup>

Standard laboratory tests of the coagulation system (e.g., PT, aPTT, and TT) are usually prolonged despite normal levels of fibrinogen because of a functional defect in the circulating fibrinogen. Reptilase time is often prolonged and fibrinogen immunoelectrophoresis using agarose gels can reveal an abnormal pattern of protein migration. Acquired dysfibrinogenemia associated with hepatic disease can be differentiated from congenital dysfibrinogenemia because it demonstrates decreased levels of other clotting factors that are synthesized by the liver.

Symptomatic dysfibrinogenemia is treated by administering cryoprecipitate in a manner similar to that described in Afibrinogenemia above (i.e., the goal is to restore functional fibrinogen levels to 50–100 mg/dL). Fresh-frozen plasma or fibrinogen concentrates (not available in the United States) can also be administered to restore functional levels of fibrinogen to normal. The thrombotic variants of dysfibrinogenemia require treatment by intravenous anticoagulation with

unfractionated heparin and conversion to oral anticoagulants.<sup>114</sup>

### Prothrombin (Factor II) Deficiency

Prothrombin deficiency consists of either a quantitative (hypoprothrombinemia) or qualitative (dysprothrombinemia) defect. Prothrombin (factor II) is normally converted to thrombin (factor IIa) (Fig. 15–6). Thrombin is needed for the conversion of fibrinogen to fibrin, which serves as the proteinaceous scaffolding of a blood clot. Dysprothrombinemia is an extremely rare, autosomal recessive disorder that can be either homozygous, heterozygous, or compound heterozygous.<sup>153</sup>

Heterozygous individuals generally have prothrombin activity levels of 50%, normal quantitative levels of prothrombin, and are asymptomatic or have only minor bleeding symptoms (e.g., may develop bleeding only after surgical procedures). Homozygous or compound heterozygous individuals demonstrate a lifelong history of bleeding.<sup>154,155</sup>

Dysprothrombinemia is definitively diagnosed using an assay of functional prothrombin activity. PT and aPTT are prolonged; both will correct when mixed 1:1 with normal plasma. Disordered hepatic function may cause acquired dysprothrombinemia. Acquired dysprothrombinemia is distinct in that multiple hepatic synthetic defects are present in the absence of a lifelong history of bleeding problems.<sup>114</sup>

Symptomatic dysprothrombinemia may be treated by administration of fresh-frozen plasma at a loading dose of 15–20 mL/kg followed by 3 mL/kg every 12–24 hours (an appropriate regimen for individuals with severe bleeding), administration of prothrombin complex concentrates with a loading dose of 20 U/kg prothrombin followed by 5 U/kg every 24 hours, or plasma exchange transfusion to restore near-normal levels of prothrombin.<sup>156,157</sup> Knowledge of the precise quantity of prothrombin in each individual prothrombin concentrate product is necessary to avoid the risk of precipitating thromboembolism from oversupplementation.<sup>156</sup>

### Drug-Induced Hypocoagulable States

Thrombotic complications associated with surgery and percutaneous coronary interventions have stimulated de-

velopment of intravenous, subcutaneous, and oral anticoagulant drugs over the past decade. There are two general classes of anticoagulant drugs: the antiplatelet agents and the antithrombotic agents.<sup>158,159</sup>

Knowing the pharmacodynamic and pharmacokinetic profiles of drugs that affect the coagulation system is necessary to make safe decisions regarding the timing of surgical procedures. Safe conduct of regional anesthesia mandates knowledge of how these drugs affect coagulation. An anticoagulant's half-life may not predict the duration of its effects on the coagulation axis if it irreversibly inhibits one or more aspects of the coagulation system. For example, aspirin has an elimination half-life of 15–20 minutes but irreversibly inhibits platelet activation through a select pathway.<sup>160</sup> Consideration of the route of elimination and the individual patient's level of organ function is necessary to predict a drug's effect. For instance, compromised renal function will prolong the elimination half-life of a drug that relies on the kidney to clear its active form. In some instances suppression or supplementation of select components of the coagulation system will be necessary to allow the safe conduct of an invasive procedure (i.e., patients that are systemically anticoagulated with unfractionated heparin may require the administration of protamine to neutralize the effects of the heparin–antithrombin complex on factor II and activated factor X).

### The Antithrombotic Agents

The antithrombotic agents include 5 subcategories of drugs: unfractionated heparin (UFH), low-molecular-weight heparin (LMWH), activated factor X inhibitor, direct thrombin inhibitors, and coumarins. Antithrombotic agents are used both to treat thrombotic events and to prevent them.<sup>158</sup>

UFH, a large molecule that is extracted either from porcine intestine or bovine lung, exerts its antithrombotic effect primarily through its interaction with antithrombin. The heparin–antithrombin complex permits an approximately 1000-fold increase in the ability of heparin to inhibit factor II (prothrombin) activity and activated factor X activity.<sup>161</sup> The result of UFH's action is suppression of the coagulation cascade as reflected in a dose-dependent prolongation of the

aPTT and the activated clotting time (ACT). The half-life of the anticoagulation effect of UFH as estimated by the aPTT is approximately 1.5 hours, irrespective of the heparin dose. In contrast, the functional half-life varies with the magnitude of the administered dose from approximately 40–150 minutes, with larger doses yielding a longer duration. UFH's elimination half-life is not affected by renal dysfunction as the drug is cleared from the plasma by transfer to the extravascular space, most likely to the reticuloendothelial system.<sup>162</sup> UFH dosage is calculated according to actual body weight; depending on the anticoagulation goal, different dosing schemes are used (e.g., initiation of cardiopulmonary bypass requires a bolus of approximately 300 U/kg, whereas treatment of a venous thrombosis requires a bolus of approximately 5000 U plus an infusion).<sup>161</sup> Laboratory monitoring is required (e.g., the aPTT, ACT or anti-factor Xa activity) because some individuals exhibit insensitivity to heparin.<sup>163</sup> An elapsed time of 4 hours following intravenous heparin therapy cessation may be required to achieve an aPTT of less than 35 seconds, indicating abatement of UFH's anticoagulant effects, before safely initiating an elective surgical procedure or attempting central neuraxial blockade. Alternatively, protamine sulfate can be administered to rapidly neutralize UFH's anticoagulant effect.

LMWH was developed to create an antithrombotic agent that does not require anticoagulant monitoring in the absence of renal insufficiency. LMWH is produced from UFH by a process that decreases the size of the polysaccharide chains on the heparin molecule, resulting in a smaller molecule with potent antiactivated factor X activity. Both UFH and LMWH require antithrombin to exert their effect on activated factor X.<sup>161,166</sup> A number of LMWH preparations are available for clinical use: enoxaparin (Lovenox), dalteparin (Fragmin), ardeparin (Normiflo), and tinzaparin (Innohep). Patients with renal insufficiency receiving LMWH require dose adjustment and plasma monitoring of antiactivated factor X activity.<sup>164</sup> Because the elimination half-lives of the various preparations of LMWH vary from 3–5 hours, waiting 24 hours after administration is recommended following higher doses (i.e., any dose of enox-

aparin >1 mg/kg or dalteparin >120 U/kg) of LMWH before initiating an elective surgical procedure or attempting central neuraxial blockade.<sup>165</sup> Although the anticoagulant effect of LMWH can be partially reversed by protamine sulfate,<sup>166</sup> one retrospective study of enoxaparin in cardiac surgical patients found that preoperative use was associated with increased red cell and platelet use, early reoperation for bleeding, and higher chest tube output in the first 24 hours postoperatively despite protamine reversal.<sup>167</sup>

The activated factor X inhibitor fondaparinux (Arixtra) requires interaction with antithrombin to exert its anticoagulant effect. Once bonded with antithrombin the fondaparinux-antithrombin complex selectively increases antithrombin's ability to inhibit activated factor X by approximately 300-fold. The molecule is smaller than that of LMWH and does not elicit formation of or react with the platelet factor 4 (PF4) antibody associated with heparin-induced thrombocytopenia type II. The elimination half-life is 17–21 hours. No definite recommendations exist for management of this drug before attempting neuraxial blockade, although it is recommended to use a single-needle atraumatic placement technique and avoid an indwelling catheter if a neuraxial procedure is mandated. Although no evidence-based recommendations exist, delaying an elective operation for approximately 5 half-lives, or 4 days, is a conservative management strategy for patients treated with this drug. Because there is minimal metabolic breakdown and the primary route of elimination is renal, dose adjustment is required in patients with renal insufficiency. Anti-activated plasma factor X levels are not required in the absence of renal insufficiency.<sup>168</sup>

Direct thrombin inhibitors include lepirudin (Refludan), argatroban, and bivalirudin (Angiomax). They exert their effect by interacting with free or clot-bound thrombin to inhibit conversion by thrombin of fibrinogen to fibrin. Direct thrombin inhibitors do not rely on the presence of antithrombin to exert their effects. They are used for treatment and prevention of thrombotic events, including treatment of patients undergoing percutaneous coronary interventions (PCIs) with, or who are at risk for, heparin-induced thrombocytopenia (argatroban), or for PCI

(bivalirudin).<sup>158</sup> The half-lives of these drugs vary (Table 15–12). Bivalirudin was recently demonstrated to be a safe and effective option for anticoagulation of cardiac surgical patients requiring cardiopulmonary bypass.<sup>169,170</sup> Although no evidence-based recommendations exist, conservative management suggests that patients on continuous intravenous infusions of direct thrombin inhibitors should have the drug discontinued 5 elimination half-lives before an operation or neuraxial blockade. Direct thrombin inhibitors do not elicit formation of, or cross-react with, the PF4 antibody associated with heparin-induced thrombocytopenia type II and are therefore useful to prevent and treat thrombotic events in patients afflicted with this syndrome. Clinical effects of direct thrombin inhibitors are commonly followed with the aPTT or the ACT.

Coumarins, a subclass of antithrombotics that are orally administered, exert their anticoagulant effect by inhibiting the hepatic synthesis of vitamin K-dependent coagulation factors. Specifically, coumarins inhibit the synthesis of factors II, VII, IX, and X, as well as proteins C and S. Assessment of the PT or international normalized ratio (INR) can quantify low levels of these specific coagulation proteins. Because these vitamin K-dependent factors participate in the extrinsic and common coagulation pathways (Fig. 15–6), the PT is the best test to assess coumarin effects. PT is reported as an INR to avoid interlaboratory variation in absolute PT results.<sup>159</sup> Coumadin is the only coumarin approved by the FDA. It is metabolized by the liver and possesses an elimination half-life of 20–60 hours. Anticoagulant effects of Coumadin take several days to abate, depending on the level of Coumadin effect at discontinuation. Administration of vitamin K decreases the time for the effects of Coumadin to abate, but may make it difficult to reinstitute a therapeutic Coumadin effect, complicating perioperative anticoagulation therapy. Alternatively, administration of fresh-frozen plasma acutely reverses the anticoagulant effects of Coumadin. However, anticoagulation may recur several hours later because of the longer half-life of Coumadin than of the coagulation factor levels that it affects (e.g., the half-life of Coumadin is 20–60 hours whereas the half-life of factor VII is approxi-

TABLE 15–12.

## Direct Thrombin Inhibitor Elimination Half-Lives

Drug	Half-Life (Minutes)
Argatroban <sup>a</sup>	30–51
Bivalirudin (Angiomax) <sup>b</sup>	25
Lepirudin (Refludan) <sup>c</sup>	48–120

Data from <sup>a</sup> Casserly IP, Kereiakes DJ, Gray WA, et al;<sup>220</sup> <sup>b</sup> Thomson MICROMEDEX;<sup>222</sup> and <sup>c</sup> Francis CW and Berkowitz SD.<sup>158</sup>

mately 6 hours). Excessive operative hemorrhage and neuraxial anesthesia associated with spinal or epidural hematoma may occur if Coumadin is not neutralized. Individuals at increased risk for a serious thrombotic event should be anticoagulated with a second intravenous or subcutaneous antithrombotic agent (e.g., UFH, LMWH or a short-acting direct thrombin inhibitor) before Coumadin is discontinued or neutralized. Titration of antithrombotic therapy is complex in the presence of more than one antithrombotic agent or when a preexisting factor deficiency is present. A hematology consultation should be considered for these patients.

## Antiplatelet Agents

The 5 subcategories of antiplatelet agents are nonsteroidal antiinflammatory drugs; glycoprotein IIb/IIIa receptor inhibitors; platelet adhesion inhibitors; platelet adenosine diphosphate (ADP)-receptor antagonists and platelet-production-limiting agents. Because platelets can be activated by more than one stimulus, not all antiplatelet agents clearly place surgical patients at increased risk for bleeding. Indeed antiplatelet drugs are beneficial to patients with cardiovascular disease.<sup>171,172</sup> The increasing use of herbal medications in the United States has drawn attention to the anticoagulant effects of garlic, ginkgo, ginseng, ginger, dong quai, feverfew, and fish oil; limited evidence-based data exists describing interactions of herbal medications with other medications and their effect on the clinical course of surgical patients.<sup>173,174</sup>

## Nonsteroidal Antiinflammatory Drugs

Aspirin exerts its antiplatelet effects by creating irreversible inhibition of platelet cyclooxygenase. This prevents the



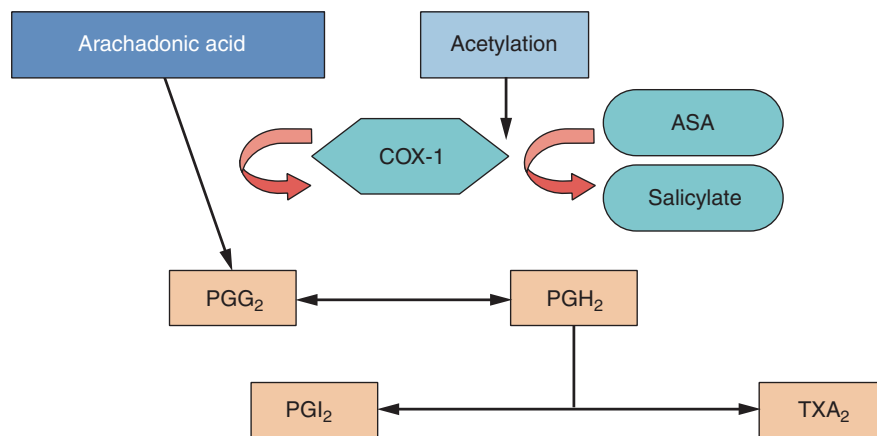


FIGURE 15-7. Pharmacodynamics of aspirin.

formation of thromboxane A<sub>2</sub> from arachidonic acid for the life of the platelet, which, in turn, blocks the platelet activation, aggregation, and internal mediator release that would propagate further platelet activation (Fig. 15-7). Because normal platelets have an average circulating life span of approximately 10 days, it may take up to 5 days for half of the normal platelet function to return after treatment with aspirin, despite measurement of a normal platelet count. Aspirin's half-life is 15–20 minutes in the plasma and it undergoes primarily hepatic metabolism, although it also undergoes plasma esterase metabolism. Other nonsteroidal antiinflammatory drugs (NSAIDs), such as ibuprofen and naproxen, produce reversible platelet cyclooxygenase inhibition. Thus the return of platelet function correlates with the drug's half-life and perioperative management of these antiplatelet agents is easily accomplished when one considers that permitting 5 half-lives to elapse following the last dose will eliminate the effects of these particular NSAIDs. For aspirin a separate perioperative treatment strategy is needed. Provided that aspirin blood levels do not exist, antiplatelet effects of aspirin can be overcome by platelet transfusion.<sup>160</sup> Doubt exists whether NSAIDs result in significant surgical hemorrhage. If an NSAID is the only inhibitory influence on the coagulation cascade central neuraxial blockade can be safely undertaken.<sup>165,175</sup> In selected patients with severe peripheral arterial vascular disease, it is advisable to continue perioperative aspirin.<sup>176</sup>

### Glycoprotein IIb/IIIa Receptor Inhibitors

The glycoprotein IIb/IIIa (GP IIb/IIIa) receptor inhibitors are available only in intravenous preparations and are among the most potent inhibitors of platelet function. Currently, the following GP IIb/IIIa receptor inhibitors are approved for clinical use in the United States: abciximab (ReoPro), eptifibatid (Integrilin), and tirofiban (Aggrastat). Platelets are activated by several different stimuli, including thromboxane, ADP, epinephrine, serotonin, and mechanical shear stress. The final common pathway of platelet activation involves platelet aggregation via interaction of GP IIb/IIIa receptors and either fibrinogen or vWF as an intermediate molecule. Complete inhibition of this final step of platelet aggregation could render a patient completely thrombasthenic.

Abciximab (ReoPro) is the Fab portion of the chimeric human–murine monoclonal antibody 7E3 that is directed against the platelet GP IIb/IIIa receptor. In therapeutic doses, it creates a marked decrease in the ability of platelets to aggregate. In approximately 1–2% of patients, it produces significant thrombocytopenia.<sup>177</sup> Abciximab also inhibits thrombus formation by suppressing tissue factor-induced thrombin generation. It is FDA approved for use as an adjunct in PCI and as an adjunct in the treatment of refractory angina. Abciximab has a 30-minute plasma half-life. However, once bound to the platelet GP IIb/IIIa receptor, it remains in the circulation for up to 15 days. The putative mechanism for this is migration from platelet

to platelet. The antiaggregation effect lasts for 12–48 hours. Platelet transfusion may partially restore platelet function if significant bleeding occurs 12–48 hours after infusion.<sup>177</sup> Central neuraxial blockade is contraindicated within 24–48 hours of abciximab administration. Delaying a cardiac operation in the stable patient treated with abciximab for 12–24 hours allows the return of platelet function.<sup>165</sup>

Tirofiban (Aggrastat), a nonpeptide chemical antagonist of the platelet GP IIb/IIIa receptor, produces a greater than 90% reduction in platelet aggregation that is reversible. Tirofiban is FDA approved for the treatment of acute coronary syndrome (ACS) in patients undergoing angioplasty or being medically managed.<sup>178</sup> The half-life is reported as 90–180 minutes; it undergoes renal excretion largely as unchanged drug. Central neuraxial blockade should be delayed for 8 hours in patients who are receiving tirofiban.<sup>165</sup> It does not appear to confer an increased risk of hemorrhage following emergent or urgent coronary surgery.<sup>178</sup> No specific recommendations are available for general surgical patients at this time.

Eptifibatid (Integrilin), a heptapeptide molecule that inhibits the platelet GP IIb/IIIa receptor, is a potent inhibitor of platelet aggregation with FDA approval for use in PCI and for the treatment of ACS. The drug is cleared from the circulation by the kidneys with a half-life of 2.5 hours. Approximately 71% of the drug is eliminated unmetabolized.<sup>179</sup> A delay of 4–8 hours is recommended after discontinuation of this drug before attempting central neuraxial blockade.<sup>165</sup> One large trial suggested that it was safe to perform a coronary operation within 2 hours of the discontinuation of eptifibatid; the drug was also associated with a platelet-sparing effect in these patients.<sup>180</sup> No evidence-based recommendations are available for general surgical patients at this time.

### ADP Antagonists

Clopidogrel (Plavix) and ticlopidine (Ticlid), the only two FDA-approved ADP-receptor antagonists, selectively and irreversibly inhibit ADP-induced platelet aggregation by blocking the P2Y<sub>12</sub> ADP receptor on the platelet surface. These oral agents do not affect prostacyclin and thromboxane synthesis and work by preventing the ADP

platelet P2Y<sub>12</sub> receptor from transmitting a signal to the platelet to activate its GP IIb/IIIa receptor complexes.

Clopidogrel is FDA approved for the reduction of thrombotic events related to recent myocardial infarction, stroke and established peripheral arterial disease. Additionally, clopidogrel is approved for both the medical management and PCI performed for the treatment of ACS. Clopidogrel and ticlopidine both undergo extensive hepatic metabolism. Clopidogrel is excreted in both the urine and feces in a balanced fashion. The half-life of clopidogrel is reported to be 8 hours.<sup>181,182</sup> The irreversible nature of clopidogrel's effect on platelets requires a full 5–7 days to elapse following drug cessation before a population of functional platelets are available to participate in the coagulation process. A delay of 7 full days is recommended following treatment with this drug before attempting central neuraxial blockade.<sup>165</sup> Clopidogrel-treated patients bleed more and require significantly higher rates of blood product transfusion following cardiac surgery.<sup>182</sup> Evidence-based recommendations do not exist for general surgery patients at this time.

Ticlopidine is FDA approved for the placement of coronary stents in conjunction with aspirin therapy. Ticlopidine is also FDA approved for the prophylaxis of thromboembolic stroke. At least 1 metabolite of ticlopidine is a potent inhibitor of ADP-induced platelet aggregation. This metabolite is excreted primarily in the urine. Ticlopidine has a reported half-life of 12.6 hours, which increases dramatically to 5 days with repeated dosing. Ticlopidine is used less frequently than clopidogrel because of hematologic toxicity (e.g., neutropenia, agranulocytosis, and thrombotic thrombocytopenic purpura). A delay of 14 days is recommended following discontinuation of this drug before attempting central neuraxial blockade.<sup>165</sup> Evidence-based recommendations do not exist for general surgery patients at this time.

### Platelet-Adhesion Inhibitors

Dipyridamole (Persantine), Aggrenox, and cilostazol (Pletal) are the three available drugs classified as platelet-adhesion inhibitors. Their mechanisms of action differ from those previously described. Dipyridamole, available in oral and intravenous prep-

arations, suppresses platelet aggregation by inhibiting the ability of the platelet to take up adenosine. The increased concentration of adenosine local to the platelet stimulates the platelet A<sub>2</sub>-receptor which potentiates the platelet's production of cyclic-3',5'-adenosine monophosphate (cAMP). Additionally, dipyridamole has been found to inhibit cellular phosphodiesterase activity which is also speculated to increase intraplatelet cAMP levels. The increased intraplatelet levels of cAMP act to inhibit platelet aggregation by blocking the activation of platelets by 3 different stimuli—ADP, platelet-activating factor, and collagen. Dipyridamole also inhibits phosphodiesterase in other tissues and results in vasodilatation as a result of its effects on vascular endothelium.<sup>183</sup> It is FDA approved to be used as an adjunct with Coumadin for the prophylaxis of thromboembolic complications associated with cardiac valve replacement and for use with thallium in myocardial imaging studies. It is also employed to prevent thromboembolic events associated with coronary surgery. Dipyridamole primarily undergoes hepatic metabolism and has a reported half-life of approximately 9–13 hours.

Dipyridamole administration is associated with bleeding. The risk is greater when dipyridamole is combined with aspirin therapy.<sup>183,184</sup> A combination of dipyridamole and aspirin, Aggrenox, is commercially available. Aggrenox is FDA approved for the prophylaxis of cerebrovascular accidents in patients with a previous history of stroke or transient ischemic attacks. It may be prudent to delay central neuraxial anesthesia for 7 days following Aggrenox therapy to allow for approximately 50% of normal platelet function to return. Published literature does not present the use of dipyridamole alone to be a direct contraindication to proceeding with elective surgery or neuraxial blockade; however, given that dipyridamole works by suppressing the platelet's ability to be activated by ADP, collagen and platelet-activating factor it may be prudent to avoid elective surgery and neuraxial blockade for 4 days. A meta-analysis concluded that among antiplatelet drugs dipyridamole was associated with the lowest incidence of bleeding complications.<sup>185</sup> In one large trial of antiplatelet drugs

used for the prevention of stroke in medical patients, dipyridamole was indistinguishable from placebo in terms of bleeding complications.<sup>186</sup>

Cilostazol (Pletal) increases intracellular cAMP by inhibiting the enzyme phosphodiesterase III. An increase in levels of cAMP results in the reversible inhibition of platelet aggregation that is normally stimulated by thrombin, ADP, collagen, epinephrine, arachidonic acid, and shear stress. Cilostazol's phosphodiesterase inhibition also causes systemic vasodilatation. It is FDA approved for the reduction of symptoms of intermittent claudication. It is extensively metabolized by the liver into active metabolites that are primarily cleared by the kidneys and has a reported elimination half-life of 11–13 hours. Because no evidence-based recommendations exist, a conservative management approach may be to delay elective surgery or central neuraxial blockade for 48 hours following administration.<sup>187</sup>

### Herbal Therapies

Self-medication with herbal therapies has been increasing in the United States for the past several years.<sup>173</sup> Specific herbal therapies are now recognized as having deleterious effects on elements of the coagulation cascade, although there is a paucity of sound research.<sup>174</sup> Garlic, ginkgo, ginseng, ginger, feverfew, fish oil, and dong quai have all been implicated in inhibiting normal hemostasis; several of these biologics have been proven to interfere with platelet aggregation.<sup>165,174</sup> Anesthesiologists should routinely inquire during the preoperative evaluation whether patients are taking any herbal supplements. Patients taking these supplements should be advised to discontinue their use perioperatively. The current lack of literature makes it difficult to impossible to recommend delaying elective surgical procedures or neuraxial blockade in patients using these supplements.

### Hypocoagulable Effects of the Synthetic Colloid Infusions

HES, a synthetic colloid solution derived from amylopectin, is a useful volume expander that has a well-recognized profile of anticoagulant effects.<sup>38</sup> Hespan, a commercially available HES solution, is FDA approved for use in leukopheresis and as volume expander in hypovolemic adults and children

undergoing surgery or in patients in shock secondary to hemorrhage or sepsis. The reported half-life is between 67 hours and 17 days, depending on the size of the molecule. As an alternative to banked blood products, it avoids infection, immunosuppression, and transfusion reactions. Patients prone to develop procedure-associated coagulopathy (e.g., cardiac surgery patients undergoing cardiopulmonary bypass or hepatic transplant patients) may be poor candidates for HES. A meta-analysis comparing HES to albumin in patients undergoing cardiopulmonary bypass concluded that HES was associated with greater postoperative blood loss.<sup>188</sup> One literature review demonstrated that adhering to the recommended HES dose of 20 mL/kg was still associated with adverse effects, particularly in intensive care and cardiac surgical patients. This review confirmed that bleeding is associated with the administration of artificial colloids and that protracted pruritus is a commonly reported troublesome reaction. Non-life-threatening anaphylactoid reactions are more likely with HES than with albumin. Additionally, the authors concluded that albumin appears to be the safest option among albumin, dextran, HES, and gelatin (unavailable in the United States) for colloid-based plasma volume expanders.<sup>189</sup>

### Hypercoagulable States

Thrombophilias, or hypercoagulable states, put surgical patients at increased risk for experiencing a postoperative thrombotic event. Many of these hypercoagulable states are managed with either temporary or lifelong systemic anticoagulation therapy. Environmental influences (e.g., trauma, surgery, infection, or administration of a drug) will increase the likelihood of a patient with either a congenital or acquired hypercoagulable disorder to develop a thromboembolic event and thus will affect the perioperative management of these patients.<sup>190,191</sup> Several thrombophilias are currently recognized and anesthesiologists should be familiar with them to aid in the provision of optimal perioperative care. Discontinuation and reinitiation of systemic anticoagulation in the perioperative period is most safely managed in concert with a hematologist.

### Antithrombin Deficiency

Antithrombin (also termed antithrombin III) is a plasma protein made by the

liver that prevents hypercoagulability by binding to and neutralizing thrombin (factor IIa) and to factors IXa, Xa, XIa, and XIIa (Fig. 15-6).<sup>192</sup> Antithrombin (AT) deficiency is associated with a predilection for thrombosis. AT deficiency is a congenital disorder inherited as an autosomal dominant trait that is estimated to occur in the general population with a prevalence of between 1 in 250–500 people.<sup>192,193</sup> Individuals with a history of an unexplained thrombotic event should be evaluated to rule out this disorder.

AT deficiency may be a result of a decreased synthesis (type I) of the protein or a decreased activity of the protein in the presence of normal levels (type II).<sup>194</sup> AT levels are reported to be between 75% and 120% in normal individuals.<sup>195</sup> AT levels are measured by a specific assay. Disease states associated with a reduction in AT activity include sepsis, disseminated intravascular coagulation, burns, acute thrombosis, hepatic disease, severe trauma, and nephritis.<sup>192</sup>

Patients with an AT deficiency have a predisposition to develop deep vein thromboses and therefore are often maintained on Coumadin. Perioperative management of anticoagulation should be tailored to the invasiveness of the planned intervention or surgical procedure. Surgery induces a prothrombotic state and increases the risk of perioperative thrombosis.<sup>196</sup> Preoperative discontinuation and postoperative reinstitution of systemic anticoagulation therapy in these patients should be done in conjunction with a hematologist.

Anticoagulation with UFH is frequently required for cardiac, endovascular and open vascular surgical procedures. Importantly, many AT-deficient patients exhibit a relative resistance to UFH as UFH anticoagulation requires coupling with AT to induce a several-fold increase in AT's neutralizing effect on the procoagulant factors IIa, IXa, Xa, XIa, and XIa.<sup>197</sup> ACT or aPTT assays will reveal heparin resistance in patients with an AT deficiency. Heparin resistance in this context is defined as a failure of UFH to produce the expected degree of ACT or aPTT prolongation. Heparin resistance caused by AT deficiency is most efficiently treated with plasma-derived, purified AT III concentrate (Thrombate III). Bolus Thrombate III administration of 50 IU/kg has been

recommended. In practice, 1–2 vials of purified AT concentrate are often administered and the biologic's effect is ascertained by performing the ACT assay. If Thrombate III is not available (or not desired), heparin resistance can be treated with 2–4 units of fresh-frozen plasma; the effect of this therapy can be verified with the ACT assay.<sup>198</sup>

### Protein C Deficiency

Protein C is a hepatically synthesized vitamin K-dependent protein that, when converted to its active form (activated protein C), exerts an anticoagulant effect through interaction with factors Va and VIIIa. Protein C deficiency may be caused by a quantitative or qualitative defect. It is estimated to occur in the general population with a prevalence of between 1 in 200–500.<sup>199</sup>

Many individuals with protein C deficiency will exhibit a prothrombotic tendency and hence require systemic anticoagulation. Protein C deficiency is diagnosed by an aPTT-based clotting assay.<sup>192</sup> The diagnosis of protein C deficiency in patients who were recently treated with Coumadin is complex.<sup>200</sup> Individuals with protein C deficiency presenting for surgical intervention require perioperative modification of their anticoagulation therapy, which is best accomplished in consultation with a hematologist.

### Protein S Deficiency

Protein S is synthesized primarily in the liver, and functions as a cofactor for activated protein C.<sup>201</sup> Quantitative and qualitative congenital protein S deficiencies have been described.<sup>202</sup> Individuals with protein S deficiency can exhibit a prothrombotic tendency and may be maintained on systemic oral anticoagulation as outpatients. Perioperative management should be accomplished in conjunction with a hematologist.

### Factor V Leiden (Activated Protein C Resistance)

Factor V Leiden, also termed activated protein C resistance, is associated with recurrent venous thromboembolic events.<sup>203</sup> It is caused by a single point mutation in the gene that encodes for factor V.<sup>204</sup> This mutation is common among patients who experience thrombotic events; Griffin et al. found that 50% of patients with unexplained

thrombotic events demonstrated activated protein C resistance.<sup>205</sup> It is commonly diagnosed by an aPTT-based assay. Because individuals with the factor V Leiden mutation may be on either temporary or lifetime systemic oral anticoagulation,<sup>206</sup> perioperative management should be determined in consultation with a hematologist.

### Prothrombin G20210 Mutation

Prothrombin, or factor II, is an essential element of the coagulation cascade. A single base pair substitution mutation results in affected individuals expressing higher plasma prothrombin activity, which is associated with the occurrence of thromboembolic disease in these patients.<sup>192,207,208</sup> This disorder is the second most common thrombophilia, with a prevalence of 2% in whites, with considerable geographic variation.<sup>209</sup> It is commonly diagnosed using a polymerase chain reaction-based test.<sup>192</sup> Hematologic consultation is advisable in the perioperative period.

### Heparin-Induced Thrombocytopenia

Heparin-induced thrombocytopenia (HIT) involves an immune-mediated response to either LMWH or UFH administration that results in pathologic platelet activation causing arterial and/or venous thrombosis with or without associated tissue ischemia and infarction. There are two types of HIT. Type I is a non-immune-mediated activation of platelets in heparin-treated patients causing a mild reduction in circulating platelets.<sup>210</sup>

HIT type II, or heparin-induced thrombosis-thrombocytopenia syndrome (HITTS), is immune mediated. It is caused by the interaction of a heparin-dependent IgG antibody with the molecular complex of PF4 and heparin. The heparin-PF4-bound IgG antibody stimulates platelet activation via the platelet FcγIIa receptor.<sup>211</sup> Once platelets are activated, they release internal biochemical mediators that induce platelet aggregation and stimulate other platelets to become activated. The same biochemical mediators that are released from the activated platelets also stimulate thrombin generation.<sup>212</sup> The heparin-PF4 IgG antibody-induced platelet aggregation, along with the thrombin that is generated, contributes to the formation of thrombus. Although venous thrombosis oc-

curs most commonly in HIT type II, arterial thrombosis is also observed. Thrombi can cause organ ischemia and/or infarction. Thrombotic emboli may damage organs distant to the site of thrombus formation. Loss of limbs and damage to vital organs, such as renal failure or strokes, are recognized complications of this disorder.<sup>213</sup>

Numerous features of HIT type II are not well understood. Only a portion of the patients who are exposed to heparin develop the IgG antibody directed against heparin and PF4 (commonly termed the PF4 antibody). Only a small percentage of the patients who develop the PF4 antibody develop thrombocytopenia and a recognized thrombotic event.<sup>214</sup> At least a 50% decrease of platelet count from the preheparin administration baseline is required to establish the diagnosis of HIT type II.<sup>213</sup> Using the absolute laboratory criterion of less than 150,000 platelets/mm<sup>3</sup> is not completely appropriate to diagnose HIT type II. Patients who are generating the PF4 antibody upon initial exposure to heparin characteristically take at least 5 days to develop PF4 antibody sufficient to cause thrombocytopenia. Patients previously exposed to heparin who have generated PF4 antibody in the past 100 days may develop thrombocytopenia more rapidly.<sup>215</sup> In contrast, the thrombocytopenic response and thrombotic event can occur several days to weeks following the discontinuation of heparin therapy.<sup>216</sup>

HIT type II may be diagnosed using either an antigen assay or a platelet activation assay; these tests are indicated in patients with a history of thrombocytopenia temporally related to heparin administration or in patients receiving heparin with previously documented HIT type II. The antigen type assays use the enzyme-linked immunosorbent assay to detect the presence of the PF4 antibody, which has proven to be highly sensitive for PF4 antibody detection.<sup>211,217,218</sup> The activation assays detect the PF4 antibodies by detecting their ability to activate platelets in the presence of heparin.<sup>211</sup> The platelet serotonin release assay is an example of an activation assay that detects HIT type II by quantifying the release of <sup>14</sup>C-labeled serotonin from platelets activated by heparin in the presence of the PF4 antibody.<sup>219</sup>

Treatment of HIT type II consists of immediate and complete discontinua-

tion of heparin by any routes. Additionally, immediate systemic anticoagulation is indicated in the setting of thrombosis; the current agents of choice are the direct thrombin inhibitors (e.g., argatroban, bivalirudin, or lepirudin). After systemic levels of a direct thrombin inhibitor are achieved, oral anticoagulation with a coumarin may be established and the direct thrombin inhibitor discontinued. Oral coumarin therapy must not be established until effective thrombin suppression has been achieved to avoid precipitating warfarin-induced skin necrosis.<sup>210,215</sup>

Given the widespread use of heparin, HIT type II is an important consideration for anesthesiologists. Cardiac and vascular anesthesiologists as well as intensivists will be challenged by this clinical disorder on a regular basis.<sup>218</sup> Heparin should be scrupulously avoided in patients with HIT type II and an elevated PF4 antibody titer in order to avoid precipitation of a thrombotic event. Patients with a distant history of an elevated PF4 antibody titer should not be treated with heparin unless the clinical situation mandates systemic anticoagulation (e.g., acute need for cardiac surgery requiring cardiopulmonary bypass [CPB] at an institution that is not experienced with using a direct thrombin inhibitor in the same clinical setting). Alternatives for vascular and other noncardiac surgical procedures that require systemic anticoagulation include argatroban and bivalirudin. Argatroban, a univalent direct thrombin inhibitor, is approved by the FDA for systemic anticoagulation in patients diagnosed with HIT type II.<sup>220</sup> Bivalirudin (Angiomax), a bivalent direct thrombin inhibitor, is also an option despite lack of FDA approval. Bivalirudin is the first safe and effective alternative to heparin in cardiac surgical patients with HIT type II.<sup>169,170,221</sup> No reversal agents are available for either argatroban or bivalirudin; their suppression of activated factor II abates only after the drug has cleared from the circulation. Argatroban is primarily cleared by hepatic metabolism, whereas bivalirudin is partially metabolized by plasma enzymes and then cleared by renal metabolism.<sup>222</sup> The use of bivalirudin in CPB surgical procedures is complex and requires both an in-depth understanding of the drug and training for the entire cardiac sur-



gical team (e.g., cardiac anesthesia, surgery, nursing, and perfusion) in order to be used safely. The use of bivalirudin in patients on CPB mandates that blood continuously flow in all native and extracorporeal circulations to avoid thrombus formation in areas of blood stagnation because the drug is metabolized by thrombin itself. Both argatroban and bivalirudin can be titrated with the aPTT if the desired level of systemic anticoagulation is between 1.5 and 3 times the baseline aPTT.<sup>220,222</sup> If higher levels of systemic anticoagulation are desired, then the ACT is currently the preferred method to titrate the effect of these drugs.<sup>223</sup>

### Disseminated Intravascular Coagulation

Disseminated intravascular coagulation (DIC) is presently recognized as a deviation from the normal physiologic balance between the processes of thrombus formation and fibrinolysis. Pathologic hemorrhage, pathologic thrombosis, or both may occur in DIC. Numerous disease processes have been identified as being associated with DIC (Table 15–13).<sup>224</sup> All of these disease states have in common the production of intense, sustained stimulation of the coagulation axis, achieved by inflam-

matory mediators resulting in dysregulation of coagulation and/or fibrinolysis.<sup>225,226</sup> The association of DIC with inflammation helps to explain why this condition can be associated with multi-organ dysfunction syndrome (MODS) and adult respiratory distress syndrome, two disorders that also involve inappropriate regulation of the inflammatory response. The pathophysiologic mechanism of DIC is incompletely understood. Pathologic thrombosis at the microcirculatory level results in organ malperfusion, ischemia, infarction, and dysfunction, as well as pathologic consumption of essential coagulation elements (e.g., platelets, fibrinogen, and soluble coagulation proteins). Dysregulation of fibrinolysis can contribute to DIC-associated thrombosis (i.e., there is oversuppression of fibrinolysis from excessive plasminogen activator inhibitor type 1) or to DIC-associated hemorrhage (i.e., there is overstimulation of fibrinolysis from high levels of inflammatory mediators, including interleukin-1, interleukin-6, interleukin-10, and tissue necrosis factor).<sup>227,228</sup>

The diagnosis of DIC is approached from two vantage points. First, because DIC is the manifestation of a primary disease process, one must investigate potential clinical causes that may give

rise to DIC (Table 15–13). Second, although DIC is often initially suspected as a clinical diagnosis, central laboratory values may help to establish the diagnosis. Some authorities advocate for the more readily available central laboratory tests including the aPTT, PT, TT, fibrin degradation products (FDPs) level, D-dimer level and complete blood count. Although measured elevation in FDPs, elevation in D-dimers, prolonged aPTT, PT, and TT, and decreased platelet counts are not universally seen in DIC, they can be very helpful in making the diagnosis if a high level of clinical suspicion exists.<sup>224,229</sup>

The treatment of DIC is most appropriately directed at the underlying cause of the disorder. For example, DIC in a septic patient with an intraabdominal abscess is most effectively treated by abscess drainage. An obstetrical patient who develops DIC in association with abruptio placentae is best treated with uterine evacuation. Exhaustive efforts to correct laboratory abnormalities may not be needed in all cases of DIC, especially those in which patients require surgical treatment.

Perioperative goals include maintaining the platelet count in the range of 25,000–50,000/ $\mu$ L and the fibrinogen level greater than 50 mg/dL. However, few data exist on the effective management of the patient with DIC.<sup>224</sup> Presently, with the exception of Trousseau syndrome (occurrence of thrombophlebitis migrans with visceral cancer), anticoagulation is not recommended as a treatment for DIC. Intravenous administration of antithrombin concentrate, although advocated by some, is presently not recommended.<sup>230–232</sup> Hemorrhaging DIC patients should be volume resuscitated as appropriate to restore intravascular volume to a level consistent with organ perfusion. As previously stated, coagulopathy is not expected to fully correct until the underlying cause of DIC is appropriately addressed.

### Hyperhomocysteinemia

Hyperhomocysteinemia is an independent risk factor for stroke, myocardial infarction, carotid artery disease, and venous thrombosis.<sup>233–236</sup> Plasma homocysteine levels are partially genetically determined, but are also influenced by environmental factors, specifically by dietary intake of folic acid, vitamin B<sub>12</sub>, and vitamin B<sub>6</sub>. Hyperhomocysteinemia is present in 10–20% of patients who develop venous thrombosis. Hyperho-

TABLE 15–13.

#### Processes That Can Induce Disseminated Intravascular Coagulation

Tissue Damage	Obstetric Conditions
Trauma	Abruptio placentae
Crush injuries	Placenta previa
CNS injuries	Uterine atony
Heat stroke	Therapeutic abortion
Burns	Toxemia of pregnancy
Hemolytic transfusion reaction	Retained dead fetus syndrome
Acute transplant rejection	Amniotic fluid embolism
Neoplasia	Miscellaneous
Cancers	Shock
Leukemias	Cardiac arrest
Cancer chemotherapy	Near drowning
Tumor lysis syndrome	Fat embolism
Infections	Aortic aneurysm
Gram-positive bacteria	Giant hemangiomas
Gram-negative bacteria	Snake bites
Spirochetes	
Rickettsia	
Protozoa	
Fungi	
Viruses	

Reprinted from Kitchens CS. Disseminated intravascular coagulation. In: Kitchens CS, Alving BM, Kessler CM, eds. Consultative Hemostasis and Thrombosis. Philadelphia: WB Saunders, 2002:165, with permission from Elsevier.

homocysteinemia is diagnosed by measuring plasma levels of homocysteine.<sup>196</sup> No specific recommendations exist for the perioperative management of patients with hyperhomocysteinemia, although vitamin supplementation does reduce plasma homocysteine levels in the elderly population.<sup>237</sup> However, reduction of homocysteine levels by vitamins does not decrease the risk of vascular disease. It might be prudent to employ postoperative venous thrombotic prophylaxis, especially in patient populations considered at risk for the development of a postoperative thrombosis (e.g., orthopedic surgical patients). However, no specific recommendations as to a particular antithrombotic or antiplatelet treatment regimen currently exist.

### KEY REFERENCES

- Hébert PC, Van der Linden P, Biro G, Hu LQ. Physiologic aspects of anemia. *Crit Care Clin* 2004;20:187.
- Hébert PC, Wells G, Blajchman MA, et al. A multicenter, randomized, controlled clinical trial of transfusion requirements in critical care. *N Engl J Med* 1999;340:409.
- Madjdpour C, Spahn DR. Allogeneic red blood cell transfusions: efficacy, risks, alternatives and indications. *Br J Anaesth* 2005;95:33.
- Spieß BD, Counts RB, Gould SA. *Perioperative Transfusion Medicine*. Baltimore: Williams & Wilkins, 1998.
- Levy JH. Hemostatic agents. *Transfusion* 2004;44:58S.
- Esseltine DW, Baxter M, Bevan JL. Sickle cell states and the anaesthetist. *Can J Anaesth* 1988;35:385.
- Kitchens CS, Alving BM, Kessler CM. *Consultative Hemostasis and Thrombosis*. Philadelphia: WB Saunders, 2002.
- Horlocker TT, Wedel DJ, Benzon HT. Regional anesthesia in the anticoagulated patient: defining the risks (the second ASRA consensus conference on neuraxial anesthesia and anticoagulation). *Reg Anesth Pain Med* 2003;28:171.
- Warkentin TE, Greinacher A. Heparin-Induced Thrombocytopenia.

3d ed. New York: Marcel Dekker, 2004.

- Levi M, ten Cate H. Disseminated intravascular coagulation. *N Engl J Med* 1999;341:586.

### REFERENCES

- Cappell MS, Goldberg ES. The relationship between the clinical presentation and spread of colon cancer in 315 consecutive patients: a significant trend of earlier cancer detection from 1982 through 1988 at a university hospital. *J Clin Gastroenterol* 1992;14:227.
- Shander A, Knight K, Thurer R, et al. Prevalence and outcomes of anemia in surgery: a systematic review of the literature. *Am J Med* 116:58S, 2004.
- Practice guidelines for blood component therapy: a report by the American Society of Anesthesiologists Task Force on blood component therapy. *Anesthesiology* 1996;84:732.
- Greenburg AG. Pathophysiology of anemia. *Am J Med* 1996;101(Suppl 2A):7S.
- Hogue CW Jr, Goodnough LT, Monk TG. Perioperative myocardial ischemic episodes are related to hematocrit level in patients undergoing radical prostatectomy. *Transfusion* 1998;38:924.
- Nelson AH, Fleisher LA, Rosenbaum SH. Relationship between postoperative anemia and cardiac morbidity in high-risk vascular patients in the intensive care unit. *Crit Care Med* 1993;21:860.
- Carson JL, Noveck H, Berlin JA, et al. Mortality and morbidity in patients with very low postoperative Hb levels who decline blood transfusion. *Transfusion* 2002;42:812.
- Beutler E. Production and destruction of erythrocytes. In: Beutler E, Coller BS, Lichtman MA, et al., eds. *William's Hematology*. 6th ed. New York: McGraw-Hill, 2001:355.
- Fischbach FT. Blood studies: hematology and coagulation. In: Fischbach FT, Dunning MB, eds. *Manual of Laboratory and Diagnostic Tests*. 7th ed. Philadelphia: Lippincott Williams & Wilkins, 2004:39.
- Felgar RE, Ryan DH. Automated analysis of blood cells. In: Hoffman R, Benz EJ, Shattil SJ, et al., eds. *Hematology: Basic Principles and Practice*. 4th ed. Philadelphia: Elsevier Churchill Livingstone, 2005:2673.
- Fairbanks VF, Klee GG, Wiseman GA, et al. Measurement of blood volume and red cell mass: re-examination of <sup>51</sup>Cr and <sup>125</sup>I methods. *Blood Cells Mol Dis* 1996;22:169.
- Spahn DR, Smith LR, Veronee CD, et al. Acute isovolemic hemodilution and blood transfusion. Effects on regional function and metabolism in myocardium with compromised coronary blood flow. *J Thorac Cardiovasc Surg* 1993;105:694.
- Lund CJ, Donovan JC. Blood volume during pregnancy. *Am J Obstet Gynecol* 1967;98:393.
- Tsang CW, Lazarus R, Smith W, et al. Hematological indices in an older population sample: derivation of healthy reference values. *Clin Chem* 1998;44:96.
- Goodnough LT, Vizmeg K, Marcus RE. Blood lost and transfused in patients undergoing elective orthopedic operation. *Surg Gynec Obstet* 1993;176:235.
- Despotis GJ, Skubas NJ, Goodnough LT. Optimal management of bleeding and transfusion in patients undergoing cardiac surgery. *Semin Thorac Cardiovasc Surg* 1999;11:84.
- Vincent JL, Baron JF, Reinhart K, et al. for the ABC (Anemia and Blood Transfusion in Critical Care) Investigators. Anemia and blood transfusion in critically ill patients. *JAMA* 2002;288:1499.
- Perry C, Soreq H. Transcriptional regulation of erythropoiesis: fine tuning of multi-domain elements. *Eur J Biochem* 2002;269:3607.
- Consensus Conference. Perioperative erythrocyte transfusion. *JAMA* 1998;260:2700.
- Keating EM, Meding JB, Faris PM, et al. Predictors of transfusion risk in elective knee surgery. *Clin Orthop* 1998;357:50.
- Benoist S, Panis Y, Pannegon V, et al. Predictive factors for perioperative blood transfusions in rectal resection for cancer: a multivariate analysis of a group of 212 patients. *Surgery* 2001;129:433.
- Madjdpour C, Spahn DR. Allogeneic red blood cell transfusions: efficacy, risks, alternatives and indications. *Br J Anaesth* 2005;95:33.
- Meyers RL, Paulick RP, Rudolph CD, et al. Cardiovascular responses to acute, severe haemorrhage in fetal sheep. *J Dev Physiol* 1991;15:189.
- Guyton AC, Richardson TQ. Effect of hematocrit on venous return. *Circ* 1961;9:157.
- Torrance J, Jacobs P, Restrepo A. Intraerythrocytic adaptation to anemia. *N Engl J Med* 1970;283:165.
- Hébert PC, Van der Linden P, Biro G, Hu LQ. Physiologic aspects of anemia. *Crit Care Clin* 2004;20:187.
- Ping Wang ZF, Ba M-CL, Ayala A, et al. Measurement of circulating blood volume in vivo after trauma—hemorrhage and hemodilution. *Am J Physiol* 1994;266:R368.
- Ebert RV, Stead EA, Gibson JG II. Response of normal subjects to acute blood loss. *Arch Intern Med* 1941;68:578.
- Jan K-M, Chien S. Effect of hematocrit variations on coronary hemodynamics and oxygen utilization. *Am J Physiol* 1977;233:H106.
- Wasserman K, Hansen JE, Sue DY. Facilitation of oxygen consumption by lactic acidosis during exercise. *News Physiol Sci* 1991;6:29.

31. Winslow RM. A physiologic basis for the transfusion trigger. In: Spiess BD, Counts RB, Gould SA, eds. *Perioperative Transfusion Medicine*. Baltimore: Williams & Wilkins, 1998:27.
32. Torres Filho IP, Spiess BD, Pittman RN, et al. Experimental analysis of critical oxygen delivery. *Am J Physiol* 2004;288:H1071.
33. Hillman RS. Anemia in the postoperative period. In: Spiess BD, Counts RB, Gould SA, eds. *Perioperative Transfusion Medicine*. Baltimore: Williams & Wilkins, 1998:571.
34. Theyl RA, Tuohy GF. Hemodynamics and blood volume during operation with ether anesthesia and unreplaced blood loss. *Anesthesiology* 1964;25:6.
35. Jamnicki M, Kocian R, Van der Linden P, et al. Acute normovolemic hemodilution: physiology, limitations, and clinical use. *J Cardiothorac Vasc Anesth* 2003;17:747.
36. Hébert PC, Wells G, Blajchman MA, et al. A Multicenter, randomized, controlled clinical trial of transfusion requirements in critical care. *N Engl J Med* 1999;340:409.
37. Saxena S, Rabinowitz AP, Johnson C, et al. Iron-deficiency anemia: a medically treatable chronic anemia as a model for transfusion overuse. *Am J Med* 1993;94:120.
38. Barron M, Wilkes M, Navickis R. A systematic review of the comparative safety of colloids. *Arch Surg* 2004;139:552.
39. Thomson MICROMEDEX. Hydroxyethyl starch. MICROMEDEX Healthcare Series. Greenwood, CO: Thomson Healthcare, 2006.
40. Sreeram GM, Welsby IJ, Sharma AD, et al. Infectious complications after cardiac surgery: lack of association with fresh-frozen plasma or platelet transfusions. *J Cardiothorac Vasc Anesth* 2005;19:430.
41. Shander A. Emerging risks and outcomes of blood transfusion in surgery. *Semin Hematol* 2004;41(1 Suppl 1):17.
42. Wagner SJ. Transfusion-transmitted bacterial infection: risks, sources and interventions. *Vox Sang* 2004;86:157.
43. Gafou A, Georgeopoulos G, Bellia M, et al. Review in the literature of the new solutions to an old problem: human error in transfusion practice. *HAEMA* 2005;8:598.
44. Shapiro MJ. To filter blood or universal leukoreduction: what is the answer? *Crit Care* 2004;8(Suppl 2):S27.
45. Corwin HL, Gettinger A, Pearl RG, et al. The CRIT study: anemia and blood transfusion in the critically ill-current clinical practice in the United States. *Crit Care Med* 2004;32:39.
46. Vincent JL, Baron JF, Reinhart K, et al. Anemia and blood transfusion in critically ill patients. *JAMA* 2002;288:1499.
47. Carson JL, Duff A, Berlin JA, et al. Perioperative blood transfusion and postoperative mortality. *JAMA* 1998;279:199.
48. Blumberg N, Triulzi DJ, Heal JM. Transfusion-induced immunomodulation and its clinical consequences. *Transfus Med Rev* 1990;4:24.
49. Spiess BD. Risks of transfusion: outcome focus. *Transfusion* 44:4S, 2004.
50. Llewelyn CA, Hewitt PE, Knight RS, et al. Possible transmission of variant Creutzfeldt-Jakob disease by blood transfusion. *Lancet* 2004;363:417.
51. Peden AH, Head MW, Ritchie DL, et al. Preclinical vCJD after blood transfusion in a PRNP codon 129 heterozygous patient. *Lancet* 2004;364:527.
52. Goodnough LT, Brecher ME, Kanter MH, Aubuchon JP. *Transfusion medicine: blood transfusion*. *N Eng J Med* 1999;340:438.
53. Lecamwasam HS, Katz D, Vlahakes GJ, et al. Cardiopulmonary bypass following severe transfusion-related acute lung injury. *Anesthesiology* 2002;97:1311.
54. Ereth MH, Oliver WC Jr, Santrach PJ. Intraoperative techniques to conserve autologous blood: red-cell salvage, platelet-rich plasma, and acute normovolemic hemodilution. In: Spiess BD, Counts RB, Gould SA, eds. *Perioperative Transfusion Medicine*. Baltimore: Williams & Wilkins, 1998:325.
55. Gould SA, Sehgal LR, Sehgal LA, et al. Red cell substitutes. In: Spiess BD, Counts RB, Gould SA, eds. *Perioperative Transfusion Medicine*. Baltimore: Williams & Wilkins, 1998:147.
56. Creteur J, Vincent JL. Hemoglobin solutions. *Crit Care Med* 2003;31:5698.
57. Kim HW and Greenburg AG. Artificial oxygen carriers as red blood cell substitutes: a selected review and current status. *Artif Organs* 2004;28:813.
58. Torres-Filho IP, Spiess BD, Barbee RW, et al. Systemic responses to hemodilution after transfusion with stored blood and a hemoglobin-based oxygen carrier. *Anesth Analg* 2005;100:912.
59. Tremper KK. Hemoglobin-based oxygen carrying solutions: will they replace red blood cells? *Anesth Analg* 2005;100:910.
60. Habler O, Kleen M, Messmer K. Clinical potential of intravenously administered perfluorocarbons. *Acta Anesthesiol Scand Suppl* 1997;111:256.
61. Desmond M, Gillon J, Thomas MJG. Perioperative red cell salvage: a case for implementing the 1995 consensus statement. *Transfusion Med* 1999;9:265.
62. Hall RI, Schweiger IM, Finlayson DC. The benefit of the Haemonetics Cell Saver apparatus during cardiac surgery. *Can J Anaesth* 1990;37:618.
63. McCarthy PM, Popovsky MA, Schaff HV, et al. Effect of blood conservation efforts in cardiac operations at the Mayo Clinic. *Mayo Clin Proc* 1988;63:225.
64. Hemstad J. Blood conservation techniques in anesthesia. In: Spiess BD, Counts RB, Gould SA, eds. *Perioperative Transfusion Medicine*. Baltimore: Williams & Wilkins, 1998:309.
65. Fuller JA, Buxton BF, Picken J, et al. Haematological effects of reinfused mediastinal blood after cardiac surgery. *Med J Aust* 1991;154:737.
66. de Haan J, Schonberger J, Haan J, et al. Tissue-type plasminogen activator and fibrin monomers synergistically cause platelet dysfunction during retransfusion of shed blood after cardiopulmonary bypass. *J Thorac Cardiovasc Surg* 1993;106:1017.
67. Bull BS, Bull MH. The salvaged blood syndrome: a sequel to mechanicochemical activation of platelets and leukocytes? *Blood Cells* 1990;16:215.
68. Giordano GF, Giordano DM, Wallace BA, et al. An analysis of 9918 consecutive patients perioperative autotransfusions. *Surg Gynecol Obstet* 1993;176:103.
69. Tawes RL, Duvall TB. Is the "salvaged-cell syndrome" myth or reality? *Am J Surg* 1996;172:172.
70. Stump DA. Embolic factors associated with cardiac surgery. *Semin Cardiothorac Vasc Anesth* 2005;9:151.
71. Robicsek F. Microfibrillar collagen hemostat in cardiac surgery. *J Thorac Cardiovasc Surg* 2004;127:1228.
72. Karczewski DM, Lema MJ, Glaves D. The efficacy of an autotransfusion system for tumor cell removal from blood salvaged during cancer surgery. *Anesth Analg* 1994;78:1131.
73. Zulim RA, Rocco M, Goodnight JE Jr, et al. Intraoperative autotransfusion in hepatic resection for malignancy. Is it safe? *Arch Surg* 1993;128:206.
74. Kokoszka A, Kuflik P, Bitan F, et al. Evidence-based review of the role of aprotinin in blood conservation during orthopedic surgery. *J Bone Joint Surg* 2005;87A:1129.
75. Lentschener C, Roche K, Ozier Y. A review of aprotinin in orthotopic liver transplantation: can its harmful effects offset its beneficial effects? *Anesth Analg* 2005;100:1248.
76. Sedrakyan A, Treasure T, Elefteriades JA. Effect of aprotinin on clinical outcomes in coronary artery bypass graft surgery: a systematic review and meta-analysis of randomized clinical trials. *J Thorac Cardiovasc Surg* 2004;128:442.
77. Levy JH. Hemostatic agents. *Transfusion* 2004;44:58S.
78. Mangano DT, Tudor LC, Dietzel C. The risk associated with aprotinin in cardiac surgery. *N Engl J Med* 2006;354:353.
79. Karkouti K, Beattie WS, Dattilo K, et al. A propensity score case-controlled comparison of aprotinin and tranexamic acid in high-transfusion-risk cardiac surgery. *Transfusion* 2006;46:327.
80. Alderman EL, Levy JH, Rich JB, et al. Analyses of coronary graft patency after aprotinin use: results from the International Multicenter Aprotinin Graft Patency Ex-



- perience (IMAGE) trial. *J Thorac and Cardiovasc Surg* 1998;116:716.
81. United States Food and Drug Administration Center for Drug Evaluation and Research. Aprotinin Alert. February 2006. Available at: <http://www.fda.gov/cder/drug/InfoSheets/HCP/aprotininHCP.htm>. Last accessed 1/15/2007.
  82. Eaton WA, Hofrichter J. Hemoglobin S gelation and sickle cell disease. *Blood* 1987;70:1245.
  83. Brittenham GM, Schechter AN, Noguchi CT. Hemoglobin S polymerization: primary determinant of the hemolytic and clinical severity of the sickling syndromes. *Blood* 1985;65:183.
  84. Charache S. The treatment of sickle cell anemia. *Arch Intern Med* 1974;133:698.
  85. Powars D, Overturf GD, Wilkins J. Commentary: infections in sickle cell and SC disease. *J Pediatrics* 1983;103:242.
  86. Esseltine DW, Baxter M, Bevan JL. Sickle cell states and the anaesthetist. *Can J Anaesth* 1988;35:385.
  87. Noguchi CT, Schechter AN. The intracellular polymerization of sickle hemoglobin and its relevance to sickle cell disease. *Blood* 1981;58:1057.
  88. Nash GB, Johnson CS, Meiselman HJ. Mechanical properties of oxygenated red blood cells in sickle cell (HbSS) disease. *Blood* 1984;64:73.
  89. Murray DJ. Evaluation of the patient with anemia and coagulation disorders. In: Longnecker DE, Tinker JH, Morgan GE, eds. *Principles and Practice of Anesthesiology*. 2nd ed. Philadelphia: Mosby, 1998:360.
  90. Baumgartner HR. The role of blood flow in platelet adhesion, fibrin deposition, and formation of mural thrombi. *Microvasc Res* 1973;5:167.
  91. Heibel RP, Boogaerts MA, Eaton JW, et al. Erythrocyte adherence to endothelium in sickle-cell anemia: a possible determinant of disease severity. *N Engl J Med* 1980;302:992.
  92. Keeley KK, Buchanan GR. Acute infarction of long bones in children with sickle cell anemia. *J Pediatrics* 1982;101:170.
  93. Minkin SK, Oh KS, Sanders RC, Siegelman SS. Urologic manifestations of sickle hemoglobinopathies. *South Med J* 1979;72:23.
  94. Rao S, Gooden S. Splenic sequestration in sickle cell disease and role of transfusion therapy. *Am J Pediatr Hematol Oncol* 1985;7:298.
  95. Honig GR. Sickle cell syndromes. *J Pediatrics* 1978;92:556.
  96. Foster H. Transfusion therapy in pregnant patients with sickle cell disease: a National Institute of Health consensus development conference. *Ann Intern Med* 1979;91:122.
  97. Horne MK. Hemostatic testing and laboratory interpretation. In: Kitchens CS, Alving BM, Kessler CM, eds. *Consultative Hemostasis and Thrombosis*. Philadelphia: WB Saunders, 2002:15.
  98. Kitchens CS. The consultative process. In: Kitchens CS, Alving BM, Kessler CM, eds. *Consultative Hemostasis and Thrombosis*. Philadelphia: WB Saunders, 2002:3.
  99. Andes WA, Wulff K, Smith WB. Head trauma in hemophilia: a prospective study. *Arch Intern Med* 1984;144:1981.
  100. Lusher JM, Blatt PM, Penner JA, et al. Autoplex versus Proplex: a controlled, double-blind study of effectiveness in acute hemarthroses in hemophiliacs with inhibitors to factor VIII. *Blood* 1983;62:1135.
  101. Arnold WD, Hilgartner MW. Hemophilic arthropathy: Current concepts of pathogenesis and management. *J Bone Joint Surg Am* 1977;59:287.
  102. Cohen AJ, Kessler CM. Hemophilia A and B. In: Kitchens CS, Alving BM, Kessler CM, eds. *Consultative Hemostasis and Thrombosis*. Philadelphia: WB Saunders, 2002:43.
  103. Kitchens CS. Retropharyngeal hematomas in a hemophilic. *South Med J* 1977;70:1421.
  104. Rodriguez Merchan EC. The hemophilic pseudotumors. *Int Orthop* 1995;19:255.
  105. Ljung RC. Gene mutations and inhibitor formation in patients with hemophilia B. *Acta Haematol* 1995;94(Suppl 1):49.
  106. Thomson MICROMEDEX. *Coagulation Factor VIIA. MICROMEDEX Healthcare Series*. Greenwood, CO: Thomson Healthcare, 2006.
  107. Nichols WC, Ginsburg D. Reviews in molecular medicine: von Willebrand disease. *Medicine* 1997;76:1.
  108. Rick ME. von Willebrand disease. In: Kitchens CS, Alving BM, Kessler CM, eds. *Consultative Hemostasis and Thrombosis*. Philadelphia: WB Saunders, 2002:91.
  109. Ruggeri ZM, Ware J. von Willebrand factor. *FASEB J* 1993;7:308.
  110. Koedem JA, Meijers JC, Sixma JJ, et al. Inactivation of human factor VIII by activated protein C. Cofactor activity of factor S and protective effect of von Willebrand factor. *J Clin Invest* 1988;82:1236.
  111. Ahr DJ, Rickles FR, Hoyer LW, et al. von Willebrand's disease and hemorrhagic telangiectasia: association of two complex disorders of hemostasis resulting in life-threatening hemorrhage. *Am J Med* 1977;62:452.
  112. Favaloro EJ, Smith J, Petinos P, et al. Laboratory testing for von Willebrand's disease: an assessment of current diagnostic practice and efficacy by means of a multi-laboratory survey. RCPA Quality Assurance Program (QAP) in Haematology. *Haemostasis Scientific Advisory Panel. Thromb Haemost* 1999;82:1276.
  113. Krizek DM, Rick ME. A rapid method to visualize von Willebrand factor multimers using agarose gel electrophoresis, immunolocalization and laminographic detection. *Thromb Res* 2000;97:457.
  114. Roberts HR, Escobar MA. Less common congenital disorders of hemostasis. In: Kitchens CS, Alving BM, Kessler CM, eds. *Consultative Hemostasis and Thrombosis*. Philadelphia: WB Saunders, 2002:57.
  115. Manotti C, Quintavalla R, Pini M, et al. Thromboembolic manifestations and congenital factor V deficiency: a family study. *Haemostasis* 1989;19:331.
  116. Zehnder JL, Leung LL. Development of antibodies to thrombin and factor V with recurrent bleeding in a patient exposed to topical bovine thrombin. *Blood* 1990;76:2011.
  117. Sallah AS, Angchaisuksiri P, Roberts HR. Use of plasma exchange in hereditary deficiency of factor V and factor VIII. *Am J Hematol* 1996;52:229.
  118. Cooper DN, Millar DS, Wacey A, et al. Inherited factor VII deficiency: molecular genetics and pathophysiology. *Thromb Haemost* 1997;78:151.
  119. Mariani G, Mazzucconi MG. Factor VII congenital deficiency. Clinical picture and classification of the variants. *Haemostasis* 1983;13:169.
  120. Ragni MV, Lewis JH, Spero JA, et al. Factor VII deficiency. *Am J Hematol* 1981;10:79.
  121. Gershwin ME, Gude JK. Deep vein thrombosis and pulmonary embolism in congenital factor VII deficiency. *N Engl J Med* 1973;288:141.
  122. Delmer A, Horellou MH, Andreu G, et al. Life-threatening intracranial bleeding associated with the presence of an antifactor VII antibody. *Blood* 1989;74:229.
  123. Mayer SA, Brun MC, Begtrup K, et al. Recombinant activated factor VII for acute intracerebral hemorrhage. *N Engl J Med* 2005;352:777.
  124. MacLaren R, Weber LA, Brake H, et al. A multicenter assessment of recombinant factor VIIa off-label usage: clinical experiences and associated outcomes. *Transfusion* 2005;45:1434.
  125. Velik-Salchner C, Sergi C, Fries D, et al. Use of recombinant factor VIIa (NovoSeven) in combination with other coagulation products led to a thrombotic occlusion of the truncus brachiocephalicus in a neonate supported by extracorporeal membrane oxygenation. *Anesth Analg* 2005;101:924.
  126. Lusher J, Ingerslev J, Roberts H, et al. Clinical experience with recombinant factor VIIa. *Blood Coagul Fibrinolysis* 1998;9:119.
  127. Peyvandi F, Mannucci PM, Lak M, et al. Congenital factor X deficiency: spectrum of bleeding symptoms in 32 Iranian patients. *Br J Haematol* 1998;102:626.
  128. Furie B, Greene E, Furie BC. Syndrome of acquired factor X deficiency and systemic amyloidosis in vivo studies of the metabolic fate of factor X. *N Engl J Med* 1977;297:81.
  129. Greep PR, Kyle RA, Bowie EJ. Factor X deficiency in primary amyloidosis: resolution after splenectomy. *N Engl J Med* 1979;301:1050.
  130. Camoriano JK, Greipp PR, Bayer GK, et al. Resolution of acquired factor X defi-



- ciency and amyloidosis with melphalan and prednisone therapy. *N Engl J Med* 1987;316:1133.
131. Breadell FV, Varma M, Martinez J. Normalization of plasma factor X levels in amyloidosis after plasma exchange. *Am J Hematol* 1997;54:68.
132. Kitchens CS. Factor XI. A review of its biochemistry and deficiency. *Semin Thromb Hemost* 1991;17:55.
133. Sidi A, Seligsohn U, Jonas P, et al. Factor XI deficiency: detection and management during urological surgery. *J Urol* 1978;119:528.
134. Vander Woude JC, Milam JD, Walker WE, et al. Cardiovascular surgery in patients with congenital plasma coagulopathies. *Ann Thorac Surg* 1988;46:283.
135. Blatt PM, McFarland DH, Eifrig DE. Ophthalmic surgery and plasma prothrombin antecedent (factor XI) deficiency. *Arch Ophthalmol* 1980;98:863.
136. Berliner S, Horowitz I, Martinowitz U, et al. Dental surgery in patients with severe factor XI deficiency without plasma replacement. *Blood Coagul Fibrinolysis* 1992;3:465.
137. Stern DM, Nossel HL, Owen J. Acquired antibody to factor XI in a patient with congenital factor XI deficiency. *J Clin Invest* 1982;69:1270.
138. Ginsberg SS, Clyne LP, McPhedran P, et al. Successful childbirth by a patient with congenital factor XI deficiency and an acquired inhibitor. *Br J Haematol* 1993;84:172.
139. Hedner U. NovoSeven as a universal hemostatic agent. *Blood Coagul Fibrinolysis* 2000;11(Suppl 1):S107.
140. Lai T, Greenberg CS. Factor XIII. In: High KA, Roberts HR, eds. *Molecular Basis of Thrombosis and Hemostasis*. New York: Marcel Dekker, 1995:287.
141. Duckert F. Documentation of the plasma factor XIII deficiency in man. *Ann N Y Acad Sci* 1972;202:190.
142. Anwar R, Miloszewski KJ. Factor XIII deficiency. *Br J Haematol* 1999;107:468.
143. Fear JD, Miloszewski KJ, Lowsowsky MS. The half-life of factor XIII in the management of inherited deficiency. *Thromb Haemost* 1983;49:102.
144. Tosetto A, Rodehiero F, Gatto E, et al. Autoimmune antibody (IgG Kansas) against the fibrin stabilizing factor (factor XIII) system. *Proc Natl Acad Sci U S A* 1988;85:232.
145. Al-Mondhuiry H, Ehmann WC. Congenital afibrinogenemia. *Am J Hematol* 1994;46:343.
146. Weiss HJ, Rodgers J. Fibrinogen and platelets in the primary arrest of bleeding. Studies in two patients with congenital afibrinogenemia. *N Engl J Med* 1971;285:369.
147. Soria J, Soria C, Borg JY, et al. Platelet aggregation occurs in congenital afibrinogenemia despite the absence of fibrinogen or its fragments in plasma and platelets, as demonstrated by immunoenzymology. *Br J Haematol* 1985;60:503.
148. Ingram GI, McBrien DJ, Spencer H. Fatal pulmonary embolus in congenital fibrinopenia. Report of two cases. *Acta Haematol* 1966;35:56.
149. Cronin C, Fitzpatrick D, Temperley I. Multiple pulmonary emboli in a patient with afibrinogenemia. *Acta Haematol* 1988;79:53.
150. Calenda E, Bor JY, Peillon C, et al. Perioperative management of a patient with afibrinogenemia [letter]. *Anesthesiology* 1989;71:622.
151. Lord ST. Fibrinogen. In: High KA, Roberts HR, eds. *Molecular Basis of Thrombosis and Hemostasis*. New York: Marcel Dekker, 1995:51.
152. Forman WB, Ratnoff OD, Boyer MH. An inherited qualitative abnormality in plasma fibrinogen: fibrinogen Cleveland. *J Lab Clin Med* 1978;72:455.
153. Degen SJF. Prothrombin. In: High KA, Roberts HR, eds. *Molecular Basis of Thrombosis and Hemostasis*. New York: Marcel Dekker, 1995:75.
154. Catanzarite VA, Novotny WF, Cousins LM, et al. Pregnancies in a patient with congenital absence of prothrombin activity: case report. *Am J Perinatol* 1997;14:135.
155. Pool JG, Desai R, Kropatkin M. Severe congenital hypoprothrombinemia in a Negro boy. *Thromb Diath Haemorrh* 1962;8:235.
156. Philippou H, Adami A, Lane DA, et al. High purity factor IX and prothrombin complex concentrate (PCC): pharmacokinetics and evidence that factor IXa is the thrombogenic trigger in PCC. *Thromb Haemost* 1996;76:23.
157. Roberts HR, Hoffman M. Other clotting factor deficiencies. In: Hoffman R, Benz EJ, Shattil SJ, et al. eds. *Hematology: Basic Principles and Practice*. 3rd ed. New York: Churchill Livingstone, 2000:1912.
158. Francis CW, Berkowitz SD. Antithrombotic and thrombolytic agents. In: Kitchens CS, Alving BM, Kessler CM, eds. *Consultative Hemostasis and Thrombosis*. Philadelphia: WB Saunders, 2002:375.
159. Comp P. Implications of anticoagulant therapy in anesthesia and surgery. In: Spiess BD, Counts RB, Gould SA, eds. *Perioperative Transfusion Medicine*. Baltimore: Williams & Wilkins, 1998:259.
160. Thomson MICROMEDEX. Aspirin. MICROMEDEX Healthcare Series. Greenwood, CO: Thomson Healthcare, 2006.
161. Thomson MICROMEDEX. Heparin. MICROMEDEX Healthcare Series. Greenwood, CO: Thomson Healthcare, 2006.
162. Estes JW, Poulin PF. Pharmacokinetics of heparin: distribution and elimination. *Thromb Diath Haemorrh* 1975;33:26.
163. Bharadwaj J, Jayaramna C, Shrivastava R. Heparin resistance. *Lab Hematol* 2003;9:125.
164. The Columbus Investigators. Low-molecular weight heparins. *N Engl J Med* 1997;337:688.
165. Horlocker TT, Wedel DJ, Benzon HT. Regional anesthesia in the anticoagulated patient: defining the risks (the second ASRA consensus conference on neuraxial anesthesia and anticoagulation). *Reg Anesth Pain Med* 2003;28:171.
166. Thomson MICROMEDEX. Low molecular weight heparins. MICROMEDEX Healthcare Series. Greenwood, CO: Thomson Healthcare, 2006.
167. McDonald SB, Renna M, Spitznagel EL, et al. Preoperative use of enoxaparin increases the risk of postoperative bleeding and re-exploration in cardiac surgery patients. *J Cardiothorac Vasc Anesth* 2005;19:4.
168. Thomson MICROMEDEX. Fondaparinux. MICROMEDEX Healthcare Series. Greenwood, CO: Thomson Healthcare, 2006.
169. Koster A, Spiess B, Chew DP, et al. Effectiveness of bivalirudin as a replacement for heparin during cardiopulmonary bypass in patients undergoing coronary artery bypass grafting. *Am J Cardiol* 2004;93:356.
170. Dyke CM, Smedira NG, Koster A, et al. A comparison of bivalirudin to heparin with protamine reversal in patients undergoing cardiac surgery with cardiopulmonary bypass: the EVOLUTION-ON study. *J Thorac Cardiovasc Surg* 2006;131:533.
171. Antithrombotic Trialists' Collaboration. Collaborative meta-analysis of randomized trials of antiplatelet therapy for prevention of death, myocardial infarction, and stroke in high risk patients. *BMJ* 2002;324:71.
172. Moussa I, Oetgen M, Roubin G, et al. Effectiveness of clopidogrel and aspirin versus ticlopidine and aspirin in preventing stent thrombosis after coronary stent implantation. *Circulation* 1999;99:2364.
173. Bauer BA. Herbal therapy: what a clinical needs to know to counsel patients effectively. *Mayo Clin Proc* 2000;75:835.
174. Magee KA. Herbal therapy: a review of potential health risks and medicinal interactions. *Orthod Craniofac Res* 2005;8:60.
175. Horlocker TT, Wedel DJ, Schroeder DR, et al. Preoperative antiplatelet therapy does not increase the risk of spinal hematoma associated with regional anesthesia. *Anesth Analg* 1995;80:303.
176. Neilipovitz DT, Bryson GL, Nichol G. The effect of perioperative aspirin therapy in peripheral vascular surgery: a decision analysis. *Anesth Analg* 2001;93:573.
177. Thomson MICROMEDEX. Abciximab. MICROMEDEX Healthcare Series. Greenwood, CO: Thomson Healthcare, 2006.
178. Thomson MICROMEDEX. Aggrastat. MICROMEDEX Healthcare Series. Greenwood, CO: Thomson Healthcare, 2006.
179. Thomson MICROMEDEX. Eptifibatid. MICROMEDEX Healthcare Series. Greenwood, CO: Thomson Healthcare, 2006.
180. Dyke CM, Bhatia D, Lorenz TJ, et al. Immediate coronary artery bypass surgery

- after platelet inhibition with eptifibatide: results from PURSUIT. *Ann Thorac Surg* 2000;70:866.
181. Thomson MICROMEDEX. Clopidogrel. MICROMEDEX Healthcare Series. Greenwood, CO: Thomson Healthcare, 2006.
182. Hongo RH, Ley J, Dick SE, Yee RR. The effect of clopidogrel in combination with aspirin when given before coronary artery bypass grafting. *J Am Coll Cardiol* 2002;40:231.
183. Thomson MICROMEDEX. Dipyridamole. MICROMEDEX Healthcare Series. Greenwood, CO: Thomson Healthcare, 2006.
184. Cremer KF, Pieper JA, Joyal M, et al. Effects of diltiazem, dipyridamole, and their combination on hemostasis. *Clin Pharmacol Ther* 1984;36:641.
185. Serebruany VL, Malinin AI, Eisert RM, Sane DC. Risk of bleeding complications with antiplatelet agents: meta-analysis of 338,191 patients enrolled in 50 randomized controlled trials. *Am J Hematol* 2004;75:40.
186. Diener HC, Cunha L, Forbes C, et al. European Stroke Prevention Study: II. dipyridamole and acetylsalicylic acid in the secondary prevention of stroke. *J Neurol Sci* 1996;143:1.
187. Thomson MICROMEDEX. Cilostazol. MICROMEDEX Healthcare Series. Greenwood, CO: Thomson Healthcare, 2006.
188. Wilkes M, Navickis R, Sibbald W. Albumin versus hydroxyethyl starch in cardiopulmonary bypass surgery: a meta-analysis of postoperative bleeding. *Ann Thorac Surg* 2001;72:527.
189. Barron M, Wilkes M, Nivickis R. A systematic review of the comparative safety of colloids. *Arch Surg* 2004;139:552.
190. Vandenbroucke JP, Rosing J, Bloemenkamp K, et al. Oral contraceptives and the risk of venous thrombosis. *N Engl J Med* 2001;344:1527.
191. Gerhardt A, Scharf RE, Beckmann MW, et al. Prothrombin and factor V mutations in women with a history of thrombosis during pregnancy and the puerperium. *N Engl J Med* 2000;342:374.
192. Zwicker J, Bauer KA. Thrombophilia. In: Kitchens CS, Alving BM, Kessler CM, eds. *Consultative Hemostasis and Thrombosis*. Philadelphia: WB Saunders, 2002:181.
193. Meade TW, Dyer S, Howarth DJ, et al. Antithrombin III and procoagulant activity: sex differences and effects of the menopause. *Br J Haematol* 1990;84:77.
194. Lane DA, Bayston T, Olds RJ, et al. Antithrombin mutation database: 2nd (1997) update. *Thromb Haemost* 1997;77:197.
195. Odegard OR, Lie M, Abildgaard U. Heparin cofactor activity measured with an amidolytic method. *Thromb Res* 1975;6:287.
196. Bauer K. Inherited and acquired hypercoagulable states. In: Loscalzo J, Schafer AI, eds. *Thrombosis and Hemorrhage*. 3rd ed. Philadelphia: Lippincott Williams & Wilkins, 2002:648.
197. Bharadwaj J, Jayaraman C, Shrivastava R. Heparin resistance. *Lab Hematol* 2003;9:125.
198. Koster A, Fischer T, Gruendel M, et al. Management of heparin resistance during cardiopulmonary bypass: the effect of five different anticoagulation strategies on hemostatic activation. *J Cardiothorac Vasc Anesth* 2003;17:171.
199. Tait RC, Walker ID, Reitsma PH, et al. Prevalence of protein C deficiency in the healthy population. *Thromb Haemost* 1995;73:87.
200. D'Angelo SV, Comp PC, Esmon CT, et al. Relationships between protein C antigen and anticoagulant activity during oral anticoagulation and in selected disease states. *J Clin Invest* 1986;77:416.
201. Lane DA, Mannucci PM, Bauer KA, et al. Inherited thrombophilia: part 2. *Thromb Haemost* 1996;76:824.
202. Borgel D, Gandrille S, Aiach M. Protein S deficiency. *Thromb Haemost* 1997;78:351.
203. Kalafatis M, Bertina RM, Rand MD, et al. Characterization of the molecular defect in factor V R506Q. *J Biol Chem* 1995;270:4053.
204. Comp PC, Esmon CT. Recurrent venous thromboembolism in patients with a partial deficiency of protein S. *N Engl J Med* 1984;311:1525.
205. Griffin JH, Evatt B, Wideman C, et al. Anticoagulant protein C pathway defective in majority of thrombophilic patients. *Blood* 1993;82:1989.
206. Bauer KA. Approach to thrombosis. In: Loscalzo J, Schafer AI, eds. *Thrombosis and Hemorrhage*. 3d ed. Philadelphia: Lippincott Williams & Wilkins, 2002:330.
207. Soria J, Almasy L, Souto J, et al. Linkage analysis demonstrates that the prothrombin G20210 mutation jointly influences plasma prothrombin levels and risk of thrombosis. *Blood* 2000;95:2780.
208. Poort SR, Rosendaal FR, Reitsma PH, et al. A common genetic variation in the 3'-untranslated region of the prothrombin gene is associated with elevated prothrombin levels and an increase in venous thrombosis. *Blood* 1996;88:3698.
209. Rosendaal FR, Doggen CJM, Zvelin A, et al. Geographic distribution of the 20210 G to A prothrombin variant. *Thromb Haemost* 1998;79:706.
210. Warkentin TE. Heparin-induced thrombocytopenia. In: Kitchens CS, Alving BM, Kessler CM, eds. *Consultative Hemostasis and Thrombosis*. Philadelphia: WB Saunders, 2002:355.
211. Kelton JG, Sheridan D, Santos A, et al. Heparin-induced thrombocytopenia: laboratory studies. *Blood* 1988;72:925.
212. Warkentin TE, Chong BH, Greinacher A. Heparin-induced thrombocytopenia: toward consensus. *Thromb Haemost* 1998;79:1.
213. Warkentin TE. Clinical picture of heparin-induced thrombocytopenia. In: Warkentin TE, Greinacher A, eds. *Heparin-Induced Thrombocytopenia*. 3d ed. New York: Marcel Dekker, 2004:53.
214. Lee DH, Warkentin TE. Frequency of heparin-induced thrombocytopenia. In: Warkentin TE, Greinacher A, eds. *Heparin-Induced Thrombocytopenia*. 3d ed. New York: Marcel Dekker, 2004:107.
215. Warkentin TE, Kelton JG. Temporal aspects of heparin-induced thrombocytopenia. *N Engl J Med* 2001;344:1286.
216. Warkentin TE, Kelton JG. Delayed-onset heparin-induced thrombocytopenia and thrombosis. *Ann Intern Med* 2001;135:502.
217. Juhl D, Eichler P, Lubenow N, et al. Incidence and clinical significance of anti-PF4/heparin antibodies of the IgG, IgM, and IgA class in 755 consecutive patient samples referred for diagnostic testing for heparin-induced thrombocytopenia. *Eur J Haematol* 2006;76:420.
218. Warkentin TE, Sheppard JI, Horsewood P, et al. Impact of the patient population on the risk for heparin-induced thrombocytopenia. *Blood* 2000;96:1703.
219. Sheridan D, Carter C, Kelton JG. A diagnostic test for heparin-induced thrombocytopenia. *Blood* 1986;67:27.
220. Thomson MICROMEDEX. Argatroban. MICROMEDEX Healthcare Series. Greenwood, CO: Thomson Healthcare, 2006.
221. Merry AF, Raudkivi PJ, Middleton NG, et al. Bivalirudin versus heparin and protamine in off-pump coronary artery bypass surgery. *Ann Thorac Surg* 2004;77:925.
222. Thomson MICROMEDEX. Bivalirudin. MICROMEDEX Healthcare Series. Greenwood, CO: Thomson Healthcare, 2006.
223. Casserly IP, Kereiakes DJ, Gray WA, et al. Point-of-care ecarin clotting time versus activated clotting time in correlation with bivalirudin concentration. *Thromb Res* 2004;113:115.
224. Kitchens CS. Disseminated intravascular coagulation. In: Kitchens CS, Alving BM, Kessler CM, eds. *Consultative Hemostasis and Thrombosis*. Philadelphia: WB Saunders, 2002:165.
225. Gando S, Kameve T, Nanzaki S, et al. Disseminated intravascular coagulation is a frequent complication of systemic inflammatory response syndrome. *Thromb Haemost* 1996;75:220.
226. Levi M, ten Cate H. Disseminated intravascular coagulation. *N Engl J Med* 1999;341:586.
227. Levi M, van der Poll T, ten Cate H, et al. The cytokine-mediated imbalance between coagulant and anticoagulant mechanisms in sepsis and endotoxaemia. *Eur J Clin Invest* 1997;27:3.
228. ten Cate JW, van der Poll T, Levi M, et al. Cytokines: triggers of clinical thrombotic disease. *Thromb Haemost* 1997;78:415.
229. Carr JM, McKinney M, McDonagh J. Diagnosis of disseminated intravascular coagulation. Role of D-dimer. *Am J Clin Pathol* 1989;91:280.

230. Minnema MC, Chang CK, Jansen PM, et al. Recombinant human antithrombin III improves survival and attenuates inflammatory responses in baboons lethally challenged with *Escherichia coli*. *Blood* 2000;95:1111.

231. Baudo F, Caimi TK, deCataldo F, et al. Antithrombin III replacement therapy in patients with sepsis and/or postsurgical complications: a controlled, double-blind, randomized, multicenter study. *Intensive Care Med* 1998;24:336.

232. Wheeler AP, Bernard GR. Treating patients with severe sepsis. *N Engl J Med* 1999;340:207.

233. Stampfer MJ, Malinow MR, Willett WC, et al. A prospective study of plasma homocyst(e)ine and risk of myocardial infarction in US physicians. *JAMA* 1992;268:877.

234. Perry IJ, Refsum H, Morris RW, et al. Prospective study of serum total homocysteine concentration and risk of stroke in middle-aged British men. *Lancet* 1995;346:1395.

235. Selhub J, Jacques PF, Bostom AG, et al. Association between plasma homocysteine concentrations and extracranial carotid artery stenosis. *N Engl J Med* 1995;332:286.

236. D'Angelo A, Selhub J. Homocysteine and thrombotic disease. *Blood* 1997;90:1.

237. Selhub J, Jacques PF, Wilson PWF, et al. Vitamin status and intake as primary determinants of homocysteinemia in an elderly population. *JAMA* 1993;270:2693.

# CHAPTER 16

## Evaluation of the Patient with Perioperative Malnutrition

Jacob T. Gutsche, MD, and  
Clifford S. Deutschman,  
MS, MD, FCCM

As a result of advances in medical and surgical care, operative intervention is now provided for older and sicker patients. These individuals frequently suffer the consequences of disease-induced altered metabolism and nutritional depletion. Consequently, today's anesthesiologist requires a solid working knowledge of perioperative metabolic abnormalities and their effects on organ function, drug metabolism, and patient outcome. This chapter addresses (a) definitions of malnutrition, (b) assessment of malnutrition, (c) the incidence of malnutrition in surgical patients, (d) the effects on organ system function, (e) the consequences of attempted reversal on organ system function, and (f) the association of reversal with improved outcome.

### DEFINITION AND SCOPE OF PROTEIN-ENERGY MALNUTRITION

Inadequate intake of macronutrients (carbohydrate, protein, fat) is referred to as protein-energy malnutrition (PEM). The hallmark of this process is a reduction in lean body cell mass. Original work on PEM centered on children in underdeveloped nations and in adults receiving experimental diets designed to mimic famine or "life-raft" conditions. A brief review of these two different conditions is important because the clinical presentation of the two conditions is different, and because nutritional management principles derived for use in starvation are ineffective (and can lead to complications) in the presence of stress. However, what is most often seen in surgical patients

reflects the interplay of metabolic changes resulting from starvation with those occurring as a result of "stress" (inflammation, infection, surgery, trauma, and neoplasia). In fact, as detailed by Bistrian<sup>1</sup> and Bistrian et al.,<sup>2</sup> PEM in sick adults represents a broad spectrum of abnormalities.

### Starvation

In the initial period of fasting, metabolic rate decreases to conserve endogenous substrate, especially nitrogen. Glucose is the predominant fuel of early starvation and continues to be made available to those tissues that require it (brain, fibroblasts, erythrocytes, leukocytes, renal medullary tissue). Other tissues quickly alter metabolism to adapt to alternative substrate. Glucose is derived initially from glycogen stores (about 24 hours of fasting) hepatic and renal gluconeogenesis from amino acids supplied by muscle catabolism predominate.<sup>3</sup> Insulin secretion decreases because gluconeogenesis is unable to maintain blood glucose concentration at prestarvation values.<sup>3</sup> Decreased insulin promotes lipolysis (by activation of a hormone-sensitive lipase) and ketonemia. Ketones inhibit pyruvate dehydrogenase and prevent the conversion of pyruvate to acetyl coenzyme A (CoA), thereby blocking use of the end products of glycolysis in the tricarboxylic acid cycle. As a consequence, the primary fuel for most tissues switches to acetyl CoA derived from fat or ketones. This change is reflected in a decrease in the respiratory quotient (carbon dioxide production/oxygen consumption).<sup>3</sup> In addition, the decrease in glucose is associated with secretion of epinephrine, cortisol, and glucagon. The effect of these three "counterregulatory" hormones is stimulation of proteolysis, lipolysis, and gluconeogenesis.<sup>3</sup> Muscle-derived gluconeogenesis provides fuel for tissues

usually detoxified may lead to pathologic responses that require dosage alteration.

### KEY POINTS

1. Although the incidence of malnutrition is unclear, the problem in patients presenting for surgery may be widespread. In addition, a large number of patients acquire protein-energy malnutrition (PEM) during hospitalization, which can alter the response to anesthetics.
2. In contrast to starvation, acute stress metabolism involves extensive neurohumoral modulation. Inflammation, surgery, trauma, or infection activates monokines, lymphokines, prostanooids, hormones, neural pathways, complement, and other endogenous mediators that "drive" metabolism and increase energy expenditure.
3. PEM is a metabolic disorder that affects virtually every organ system.
4. Decreased total circulating albumin has wide implications for drug administration and volume of distribution.
5. As a result of decreased microsomal enzyme activity and altered cytochrome P<sub>450</sub>/nicotinamide adenine dinucleotide phosphate (NADPH)-dependent transport mechanisms protein deficiency may reduce drug metabolism. Decreased transformation of compounds that are hepatically detoxified may lead to pathologic responses that require dosage alteration.
6. A number of studies confirm that decreased serum transport protein levels, anergy, and weight loss are associated with poor postoperative outcomes.
7. Accurate estimation of the presence and severity of PEM remains problematic for the anesthesiologist whose evaluation of the patient is often brief. The most useful tool for assessing a patient's nutritional status is a well-performed history and physical examination.
8. Abnormalities of plasma proteins are associated with an increased incidence of bowel anastomotic dehiscence.
9. The anesthesiologist should ensure that the patient presenting for elective surgery is in the best possible condition to tolerate the operation and postoperative course. The relatively poor outcome associated with malnutrition, coupled with the apparent benefits of repletion in the severely depleted individual, constitutes one more problem that must be addressed to improve overall patient outcome.



that are obligate glucose users. If allowed to continue unchecked, such a process would culminate in rapid depletion of endogenous protein, primarily because of the demands of neural tissue. To counter this effect, brain tissue adapts to the use of ketones, permitting a further decrease in glucose demand and some sparing of lean body mass.<sup>4</sup>

In starvation, adaptation to exogenous substrate is effective; when given glucose, a starved individual responds to the increase in serum glucose by increasing insulin secretion and decreasing levels of counterregulatory hormones. This decreases levels of proteolysis, lipolysis, and gluconeogenesis. The resulting reliance on the externally supplied glucose spares endogenous tissues and decreases ketosis (blocked by insulin).<sup>3</sup> Similar patterns are observed when exogenous fuel is supplied as fat or protein. When demand for energy increases, as in exercise, anaerobic metabolism of glucose also increases.

Primary use of branched-chain amino acids by muscle may help meet the new demand.<sup>3</sup> Lactate from anaerobiosis and amino acids derived from proteolysis (which result, in part, from increased catecholamines) are released by exercising muscle and are recycled by the liver via the gluconeogenic pathway. The newly synthesized glucose can return to skeletal muscle and again be metabolized to lactate. These processes make metabolic rate responsive to tissue demand and exogenous substrate availability with only modest neuroendocrine modulation.<sup>5</sup> Prolonged fasting metabolism eventually results in a clinical picture similar to the form of PEM described in children as marasmus. This is characterized by uniform loss of fat and muscle mass in all tissues and a concomitant loss of water in proportion to nonaqueous mass.

### Stress Hypermetabolism

In contrast to starvation, acute stress metabolism involves extensive neurohumoral modulation.<sup>6</sup> Inflammation, operation, trauma, or infection activates monokines, lymphokines, prostanoids, hormones, neural pathways, complement, and other endogenous mediators that “drive” metabolism and increase energy expenditure. Part of the source for this alteration appears to be derived directly from the energy and substrate

demands of hepatic macrophages and the leukocyte infiltrate in wound tissue.<sup>7</sup> After a specific injury, this response follows a regulated time course, with a peak in metabolic rate about 2–3 days after the insult and a gradual decline to baseline by postinjury day 7.<sup>6,8</sup> The response will persist if a new activating event occurs or if the source of the initial event (e.g., an undrained abscess) is not removed.<sup>6,8</sup> The magnitude of the response is proportional to the magnitude of the injury.<sup>6,8</sup>

The liver responds to neurohumoral stimulation by generating substrate for the increased metabolism. Amino acids from proteolysis, lactate from devascularized tissues and glycerol from lipolysis are directed into gluconeogenic pathways.<sup>8</sup> Amino acids are also used to synthesize enzymes and structural proteins, while free fatty acids provide an alternate energy source. Endogenous mediators, stimulated in part by devascularized wound tissue, mediate this process. Because the response is initiated and driven by this internal source, it remains relatively unresponsive to exogenous substrate.<sup>9</sup> The hormonal pattern is characterized by increased glucagon, cortisol, and epinephrine that appear to be driven by demands from damaged tissue and infiltrating leukocytes. As blood glucose levels increase, insulin secretion is stimulated. This pattern of metabolism leads to depletion of visceral protein (in excess of muscle mass) and fat and is associated with an expansion of the extracellular fluid compartment.<sup>10</sup> Physical findings (edema, hypoalbuminemia, fatty liver) are similar to those noted in childhood kwashiorkor.<sup>1</sup>

### Assessment of Protein-Energy Malnutrition

Protein-energy malnutrition can significantly alter perioperative physiology. Therefore, it is important to identify the presence of PEM and quantify its severity. This is best accomplished by direct measurement of body cell mass, which, unfortunately, requires the use of multiple isotopic techniques and is not realistic clinically.<sup>11</sup> Less-precise estimates involve the use of indirect parameters that are believed to correlate with body cell mass. Anthropometrics, biochemical markers (most often circulating hepatic-derived proteins), and test of immunologic function all have been used. Un-

fortunately, each is associated with serious limitations that make their validity in the perioperative period questionable. We review each of these methods briefly and recommend how they might be used in clinical perioperative practice.

Most anthropometric measures were developed for the assessment of malnutrition in childhood starvation.<sup>12</sup> Consequently, parameters that are of key importance in adults but are negligible in children (frame size, build, fat patterning) are neglected and 95% confidence intervals have not been determined.<sup>1,12</sup> Furthermore, because edema is a prominent characteristic in stress-induced PEM, the interpretation of anthropometric measurements becomes difficult. Changes in specific hepatic-derived transport proteins (albumin, transferrin, prealbumin, retinal-binding protein), also often used to detect PEM, are common in any stress state and reflect the interplay of decreased synthesis, tissue extravasation and extracellular fluid expansion, both from endogenous and exogenous sources.<sup>13</sup> The relationship between actual depletion of body cell mass and these biochemical markers is unclear. In stress states, serum proteins will decrease irrespective of the extent of loss of body cell mass.<sup>13</sup> Serum protein concentrations are often only mildly decreased in pure starvation PEM despite significant loss in body cell mass because the loss of mass and water is proportional.<sup>14</sup> Despite this, serum proteins are frequently used in the metabolic assessment of the chronically malnourished patient. Low serum albumin may be associated with increased mortality in surgical and chronically ill patients.<sup>15</sup> Serum albumin has a half-life of 14–20 days making it insensitive to acute changes in nutritional status. It is also affected by albumin transfusion, dehydration, inflammation, and liver disease. Serum albumin less than 3.5 g/dL is suggestive of malnutrition, and less than 2.5 g/dL of severe malnutrition. Serum transferrin is also somewhat useful for evaluating malnutrition. It has a half-life of about 9 days, which is midway between albumin and prealbumin. Unfortunately, unlike albumin and prealbumin, transferrin increases whenever there is bleeding. This decreases its reliability in the perioperative state. Serum prealbumin is the most reliable of the hepatic-derived transport pro-

teins to signal acute malnutrition. It has a half-life of 24–48 hours. Prealbumin is a negative acute phase reactant and in the postoperation setting, prealbumin levels decline. Abnormalities of cell-mediated immunity and absolute lymphopenia have also been touted as indices of PEM. The presence of these abnormalities in such diverse disease states as cancer, collagen-vascular disease, sepsis, uremia, and cirrhosis, as well as the alterations produced by drug administration, make them particularly nonspecific. Finally, all three of these commonly used measures lack specificity and are derived from population studies that may have little bearing on individual patients.<sup>12</sup>

Alternative approaches have been advocated to overcome the deficiencies inherent in the standard assessment of malnutrition. Forse and Shizgal<sup>16</sup> used isotopic techniques to measure the ratio of exchangeable potassium to exchangeable sodium, which should estimate the ratio of extracellular to intracellular mass and thus estimate lean body mass. The problem with this approach is that there may be variability in potassium from tissue to tissue. Studies to determine normal exchangeable potassium values have never been performed. Other individuals have recommended following multiple parameters over time.<sup>6</sup> Composite prognostic indices calculated from a series of unrelated variables have been formulated to classify and stratify the extent of PEM.<sup>17</sup> Nonetheless, these indices lack specificity. Prognostic indices are capable of identifying patients at risk for complications, but it is not clear that these complications are related to PEM. Several clinicians have proposed that a thorough history and physical examination, coupled with evidence of weight loss or the presence of known “catabolic” disease, is as valid as any sophisticated test or technique.<sup>18</sup> New studies are directed at assessing PEM using indirect calorimetry. This technique directly measures oxygen consumption and carbon dioxide production and uses these values to calculate resting energy expenditure. In one small trial, use of indirect calorimetry improved nitrogen balance and outcome.<sup>19</sup> Further testing is required to fully assess the usefulness of this modality.

Accurate estimation of the presence and severity of PEM clearly remains problematic, especially for the anesthesiologist whose evaluation of the pa-

tient is often brief. The presence of a severe disease producing rapid depletion of body cell mass (e.g., aggressive malignancy) or a prolonged disease that limits intake or absorption (vomiting, diarrhea, upper gastrointestinal obstruction) makes PEM likely. New developments offer promise. Functional testing of recovery time from isolated twitch in somatic muscle, direct measurement of extracellular compartment size, and quantification of T-cell subpopulations, particularly killer cells, are promising techniques and may soon be routinely available.

Malnutrition, as detailed in the following sections, is often present in patients presenting for surgery and has profound effects on organ function and physiology. Consequently, the anesthesiologist should suspect the presence of PEM and recognize its potential for precipitating difficulties in perioperative management.

### Incidence of Malnutrition in Hospitalized Surgical Patients

Malnutrition in the hospitalized patient does not represent a new concern; true recognition of the presence of a serious nutritional problem can be traced to the work of Bistrian et al.<sup>2</sup> These researchers identified abnormalities of anthropometrics or biochemical markers consistent with malnutrition in 50% of general surgical patients<sup>2</sup> and 44% of general medical patients<sup>20</sup> in a large urban hospital. Numerous other investigations confirm these findings in various hospital settings and patient populations. Nonetheless, the use of anthropometrics, biochemical markers and demonstration of altered delayed hypersensitivity as diagnostic criteria for malnutrition is of uncertain specificity and value and may overestimate the extent of the problem. In a study conducted at a Veterans Administration hospital, an abnormality of one or more of these variables was present in 97% of patients.<sup>21</sup> Such an estimate seems unreasonable. Symreng et al.<sup>22</sup> found that 28% of surgical patients had, on admission to the hospital, three or more abnormalities consistent with depleted body cell mass. This would appear to be a more valid estimate and is consistent with data reported elsewhere. Another study validates this data, noting that 38% of surgical patients admitted for treatment of benign abdominal processes

had biochemical or anthropomorphic evidence of PEM.<sup>23</sup> Perhaps of even greater significance is a study noting that 75% of patients admitted to the hospital without PEM developed abnormalities consistent with PEM during hospitalization.<sup>24</sup> Together these findings suggest that, although the actual incidence of malnutrition is unclear, the problem exists on a relatively wide scale in hospitalized patients and may develop or worsen over the course of hospitalization. For the anesthesiologist, there are two key points. First, PEM represents a real and not uncommon problem that alters normal physiology. Second, PEM acquired over the course of hospitalization may alter a patient's response from one anesthetic episode to the next.

### Effects of Protein-Energy Malnutrition and Nutritional Repletion on Individual Organ System Function

The effects of protein-energy malnutrition and its correction on individual organ systems are reviewed in this section. When possible, human data is cited; otherwise, appropriate animal studies are presented. An attempt has been made to separate the effects of starvation from stress, but the former is disproportionately represented.

#### Cardiovascular Changes

Starvation PEM is associated with morphologic, functional, and electrical abnormalities of the cardiovascular system. Heart size decreases in proportion to loss of body mass<sup>25</sup> and the left ventricular free wall is thinned.<sup>26</sup> Histologic examination reveals myocardial atrophy and interstitial edema.<sup>27</sup> Left atrial, aortic root, and left ventricular end-systolic and end-diastolic dimensions are decreased relative to normal controls valves,<sup>28</sup> and left ventricular compliance is reduced.<sup>26</sup>

Functionally, resting heart rate, blood pressure and pulse pressure are reported to decrease in PEM<sup>29</sup> and a subnormal response is noted in each of these parameters during exercise testing.<sup>28</sup> Cardiac index and ejection fraction remain at prestarvation levels<sup>26,28</sup> and appear to increase appropriately with exercise<sup>28</sup> or  $\beta$ -adrenergic stimulation.<sup>26</sup>

On electrocardiography (ECG), amplitude is diminished, axis shows a rightward deviation, PR and QT intervals are prolonged, T waves are inverted to flat-

tened, ST-T segments are depressed, and nodal escape beats and ventricular tachycardia have been reported.<sup>28</sup>

Echocardiographic studies done in anorexic patients reveal decreased ventricular mass with associated ventricular dysfunction.<sup>30</sup> Also common in the anorexic population is the finding of prolonged QT and QTc with ventricular arrhythmias.<sup>31</sup> In one study, treatment and weight recovery resulted in normalization of ventricular mass and improvement in ventricular function in adolescents with anorexia.<sup>31</sup>

Stress metabolism in cachectic humans is associated with a somewhat different picture than noted in isolated starvation. Heart rate and indexed ventricular mass (per kilogram of body weight) are increased.<sup>32</sup> This suggests that stressed myocardium is spared from some of the protein-depleting aspects of PEM. It is logical to assume that the heart in stress can respond normally to increased demand for work even when other tissues are being wasted. This may result, in part, because the heart can use virtually any fuel (glucose, fat ketones, lactate) to support energy requirements.

Protein and calorie repletion in previously healthy adults subjected to semistarvation results in a rapid increase in heart size.<sup>28</sup> With refeeding, heart rate, blood pressure, and pulse pressures initially increase to above prestarvation levels and gradually return to baseline. Ejection fraction and cardiac output and index may decrease and congestive failure has been reported. The cause of these abnormalities is unknown but may reflect mobilization of interstitial fluid coupled with the inability of depleted cardiac muscle to handle the fluid load. ECG amplitude and QT interval abnormalities persist for variable periods despite repletion.<sup>28</sup>

To date, only one study has focused on the effects of correction of stress-induced PEM on cardiac function.<sup>32</sup> Ventricular mass, heart rate, end-diastolic volume, cardiac output, and ejection fraction all increased, but congestive heart failure developed in 3 of 5 patients and pericardial effusion developed in a fourth patient.

### **Pulmonary Changes**

Relative cell mass (lung weight/body weight) appears to increase in cases of PEM, but overall wet and dry lung weights decrease with depletion.<sup>33</sup>

Morphologic changes similar to those observed in emphysema are characteristic; distances between alveolar walls are increased, the surface area for gas exchange is decreased and air space is grossly enlarged as a result of disruption of alveolar septae.<sup>34</sup> Peripheral lung tissue is more affected than central mass and a significant loss of collagen and elastin is noted.<sup>34</sup> The phospholipoprotein content of surfactant is grossly depleted.<sup>35</sup> In the early stages of depletion, pressure-volume relationships are normal,<sup>35</sup> but after prolonged starvation surfactant concentrations decrease, active surface forces increase, and exposure of alveolar surfaces leads to an altered functional residual capacity.<sup>36</sup>

Diaphragmatic muscle mass decreases in direct proportion to the loss of body weight.<sup>37</sup> As a result, the tension developed in isolated diaphragmatic muscle strips is reduced. Mechanical efficiency appears to be unchanged.<sup>38</sup> Observed changes in the time to achieve 50% tension reduction following 20- or 100-Hz tetanus indicate that diaphragmatic fatigability is reduced.<sup>37</sup> Animal studies indicate a selective depletion of fast (glycolytic) fibers with sparing of the slow oxidative fibers, a finding that supports the notion of decreased fatigability.<sup>37</sup>

After an acute period of mild starvation in otherwise healthy adult women, forced vital capacity, forced expiratory volume, inspiratory pressure, and maximal voluntary ventilation were normal.<sup>39</sup> A prolonged course of severe depletion in both human and animal subjects results in decreases in all lung volumes, maximal pressure generation and maximal ventilatory effort.<sup>40</sup> Respiratory rate is decreased, perhaps reflecting altered carbon dioxide production; the ventilatory response to carbon dioxide is preserved but hypoxic ventilatory drive is markedly attenuated.<sup>41</sup> The number of alveolar macrophages and their ability to clear aerosolized *Staphylococcus aureus* is decreased.<sup>42</sup> Refeeding in rats leads to a return to normal lung weight and normal levels of lung hydroxyproline, elastin, and surfactant contents.<sup>33</sup> Parenchymal emphysematous changes are incompletely reversed.<sup>33</sup> Diaphragmatic contractile force is regained as body weight is regained.<sup>40</sup> Respiratory muscle function, maximal inspiratory pressure, and phagocytic capacity improve also, but abnormalities of hypoxic ven-

tilatory drive are not prevented despite the provision of amino acid formulas sufficient to prevent negative nitrogen balance.<sup>43</sup> The effects of repletion on lung volumes and hypoxic ventilatory drive are unknown.

### **Renal Changes**

During starvation, renal mass is lost in proportion to body mass and renal protein content is reduced. Clearance of creatinine and free water are decreased and effective renal plasma flow, glomerular filtration rate, and filtration fraction decrease dramatically, although total renal blood flow is not reduced. The ability to concentrate the urine in response to water restriction is impaired.

Total body water is decreased by starvation PEM but exchangeable sodium remains normal, implying that cellular mass and exchangeable potassium are decreased.<sup>44</sup> Free water clearance and sodium excretion are increased early in the course of starvation but decline after several days. Renin and aldosterone are increased in this early natriuretic period. Their role in sodium homeostasis during PEM is uncertain. Titratable acid excretion is decreased whereas serum bicarbonate and urinary ammonia concentrations increase. Refeeding following starvation PEM improves glomerular filtration rate, filtration fraction, concentrating ability, and free water clearance.<sup>45</sup> Sodium and acid excretion increase, as do plasma and extracellular volume. After a period of refeeding, accompanied by increasing plasma osmolality, interstitial water moves into the intravascular compartment. This is associated with a diuretic phase.

Surgical or traumatic stress activates renal mechanisms to conserve salt and water,<sup>6,11</sup> and thus expand the vasculature to improve substrate delivery. Both antidiuretic hormone and aldosterone are involved in this response, and plasma volume contraction in this setting can produce a metabolic alkalosis. The effects of prolonged stress are unknown and no data exist regarding repletion.

### **Gastrointestinal Changes**

Intestinal mass, a rapid turnover tissue, is lost at a proportionately greater rate than body weight in starved rats.<sup>46</sup> Small intestine as a whole, and mucosal cells in particular, have de-

creased contents of DNA, RNA, and nitrogen. Epithelial cell renewal and migration are reduced and villus size and crypt cell number, size, and mitotic rate are decreased. Gastric ulceration, gastric and intestinal atrophy, and mucosal hemorrhage are all present to a great extent, perhaps reflecting mucosal breakdown either as a result of increased lysosomal acid hydrolase<sup>47</sup> or failure to synthesize mucosal glycoproteins. Gastrin concentrations decrease. Long-term fasting appears to be required for mucosal changes to occur; Knudsen et al.<sup>48</sup> found normal histologic conditions following a 7-day fast in obese individuals.

Mucosal transport, reflected in decreased uptake of oral mannitol, may be impaired. Sucrase and maltase (but not lactase) activities are decreased, with these changes most prominent in the proximal gastrointestinal tract. Glucose transfer across the mucosa decreases but mucosal-to-serosal transport of both glucose and histidine increase. Loss of brush border enzymes impairs absorption and promotes bacterial overgrowth.

Healing of mucosal ulcerations has been reported in depleted patients with Crohn disease who receive parenteral nutrition. Increased nitrogen retention and improved gastric motility in starved individuals has been noted.<sup>49</sup> Cell populations and absorptive capacity improve, activity of brush border enzymes is restored,<sup>47</sup> and lysosomal enzyme activities decrease to normal.

Enteral feeding seems to be more effective than parenteral nutrition in restoring gastrointestinal function postoperatively.<sup>50</sup> Mucosal integrity, brush border enzyme levels, and absorptive capacity all improve rapidly in depleted animal that are refed orally.<sup>51</sup> Use of glutamine is implicated in this improvement; it appears that even parenterally administered glutamine (which is not present in most total parenteral nutrition formulas) is of benefit.<sup>52</sup>

In critically ill patients there is a concern that bacteria may overgrow and translocate from the intestinal lumen to the systemic circulation leading to infection. In theory, part of the benefit of early enteral nutrition in the critically ill is to prevent this overgrowth. While multiple animal studies support this theory, a study by Moore et al. failed to find bacteria or endotox-

in in the blood from the portal vein in severely injured trauma patients.<sup>53</sup> Indeed, careful examination of most of the work on translocation in animals demonstrates (a) at least two insults (overgrowth of a single bacterial species and some form of injury) are required for translocation and (b) bacteria translocate to the intestinal lymph nodes and occasionally, the liver but rarely beyond.<sup>54</sup> Thus, the clinical importance of translocation is unlikely to be great.

### **Pancreatic Changes**

Pancreatic mass decreases in direct proportion to body mass and acinar atrophy, loss of architecture, fibrosis, and exocrine duct dilation are all noted in response to starvation PEM.<sup>3</sup> Rough endoplasmic reticulum and mitochondria are decreased. Amylase and trypsinogen content in the pancreas falls and lipase is increased.<sup>3</sup> Duodenal aspirates show a sequential decrease in level of lipase, trypsin and amylase as PEM progresses. Bicarbonate secretion also decreases in adults. Loss of structural integrity is reflected in increased serum amylase levels and indices of amylase production in patients with anorexia nervosa.<sup>55</sup> Following PEM in rats, the exocrine pancreas shows decreased responsiveness to carbachol stimulation and insulin responsiveness to glucose stimulation is attenuated.<sup>56,57</sup> Insulin secretion, exocrine responses to carbachol, and serum amylase and lipase values return to normal after refeeding.<sup>57</sup>

### **Hepatic Changes**

In humans, starvation results in a rapid loss of liver glycogen. Because of defective triglyceride excretion and carnitine-limited uptake, reesterification of free fatty acids in the periportal region occurs.<sup>3</sup> Prolonged PEM will eventually deplete even the periportal fat deposits. In chronic protein deficiency in rats, liver mass and rough endoplasmic reticulum are lost.<sup>46</sup> Loss of RNA, water, fat, and protein, as well as cellular atrophy, have been reported, but it appears that hepatocytes are remarkably resistant to loss of structure or number.<sup>3</sup> Patients with weight loss as great as 55 kg have had histologically normal liver biopsies, although the presence of pigment deposits, fibrosis, and fatty infiltration has also been reported.<sup>3</sup> In pure starvation, hepatic enzymes and bilirubin

may be normal or increased,<sup>58</sup> albumin synthesis and total albumin content decrease, but concentrations may be normal. Urinary nitrogen loss decreases, reflecting activation of amino acid-conserving enzymes and decreased urea cycle activity.<sup>59</sup>

Protein deficiency often reduces drug metabolism, reflecting decreased microsomal enzyme activity and altered cytochrome P450/nicotinamide adenine dinucleotide phosphate (NADPH)-dependent transport mechanisms.<sup>20</sup> Thus, decreased transformation of compounds that are hepatically detoxified may lead to pathologic responses that require dosage alteration. Conversely, compounds that are biotransformed into toxic metabolites are better tolerated.<sup>60</sup>

Many products of hepatic protein synthesis are altered during stress. Messenger ribonucleic acid (mRNA) is increased for acute-phase products, such as fibrinogen, or  $\alpha_1$ -antitrypsins, whereas synthesis of transport proteins such as albumin is decreased.

Liver size and function return to normal with refeeding; gross and ultrastructural morphology are restored after several weeks of repletion. Serum hepatocellular enzymes increase initially with refeeding but then return to normal.<sup>61</sup> Effects of repletion on drug metabolism are unknown.

### **Immunologic Changes**

Protein-energy malnutrition is associated with a reduction in the mass of lymphoid tissue in excess of loss of body mass. Both small lymphocytes and germinal centers are affected. Total circulating polymorphonuclear (PMN) cell counts are reduced but the fraction of total erythrocytes that are PMNs is increased. Macrophage and PMN chemotaxis, bacterial engulfment, and intracellular killing are impaired. Serum levels and activity of complement components C3 and C5 are normal in stress, but all other components of both the direct and indirect pathways are reduced in stress and all components are reduced in starvation.<sup>62</sup>

Circulating B-cell numbers are reduced but account for an increased percentage of the total lymphocyte count. Serum immunoglobulin may be low, normal, or high. Impairments of antibody binding and antigen specificity have been reported.<sup>63</sup> Impaired cell-mediated immunity is one charac-



teristic of the malnourished state.<sup>63</sup> Absolute numbers of T cells and the ratio of T cells to total leukocytes is reduced.<sup>63</sup> The proportion of T-helper and T-suppressor cells is normal in starvation but reduced in stress; T-killer cells are reduced in both states.<sup>64</sup>

Lymphoid tissue mass, cell populations, and germinal center populations respond well to nutritional repletion. Phagocytosis and chemotaxis improve, but the effects of refeeding on engulfment and intracellular killing are unknown.<sup>63</sup> Delayed hypersensitivity to skin testing,<sup>65</sup> antibody levels (circulating or fixed),<sup>65,66</sup> and complement levels return to normal with nutritional therapy.<sup>66</sup> Short-term repletion has no effect on T-cell subpopulations in stress or starvation.<sup>64</sup> The effects of longer treatment are unknown.

### **Nervous System Changes**

Peripheral nerve conduction velocity is decreased and associated sensory abnormalities have been reported in PEM.<sup>67</sup> In moderate PEM, nerve biopsies are normal but severe depletion is associated with segmental demyelination.<sup>67</sup> Chronic malnutrition may lead to lethargy, confusion, and impaired initiative.<sup>68</sup> Cerebral atrophy, ventricular dilatation and diffuse electroencephalographic slowing have been noted.<sup>3</sup> In adult rats deprived of protein, the phosphatidylglycerol and sphingophospholipid fraction are decreased but other myelin components are present in normal quantities.<sup>69</sup> Refeeding appears to restore nerve conduction and structure<sup>70</sup> and to improve mental status.<sup>68</sup>

### **Anesthetic Implications of Organ System Dysfunction**

The dysfunctions caused by PEM have important perioperative implications. Cardiac reserve may be compromised, as evidenced by subnormal blood pressure and heart rate responses to stress testing, but appropriate increases in cardiac output in response to exercise or  $\beta$ -adrenergic stimulation argue against this. The potential for myocardial depression caused by volatile anesthetics should be considered in patients with PEM. In addition, the partially repleted patient may be at risk for pulmonary edema when mobilization of fluid occurs because the cardiac response to fluid challenges may be inadequate. Cardiac dysfunction and renal abnormalities make it

important to watch fluid balance. Assisting postoperative diuresis may be necessary.

Pulmonary disease resembling emphysema may impair gas exchange, whereas respiratory muscle failure may preclude early extubation, especially with residual paralysis. The selective depletion of fast muscle fibers may alter the ability to respond to acute increases in carbon dioxide. It may be prudent to mechanically ventilate the severely depleted patient for some time postoperatively. In the healthy individual, resistance to pulmonary infection is maintained by bacterial clearance (ciliary action and coughing) and macrophage function. Both are impaired in PEM and further decreased by general anesthesia.

Renal abnormalities may reduce the clearance of both solute and solvent, resulting in retention of water as well as toxic byproducts. Thus fluid loads may be poorly tolerated and clearance of drugs and cellular debris impaired. Altered gastric motility increases the risk of aspiration. In addition, because of the loss of brush border enzymes and depletion of gastrointestinal mucosa, oral absorption of drugs may be altered.

Blood sugar values should be monitored perioperatively because of the relatively impaired insulin response to hyperglycemia.

Hepatic drug metabolism may also be altered but this is unpredictable. Clearance of some drugs (e.g., vecuronium) may be impaired, but tolerance for others with toxic metabolites (e.g., nitroprusside) might be noted. Metabolism of inhalational anesthetics may be decreased. Perhaps most important, decreased total circulating albumin has wide implications for drug administration and volume of distribution. Table 16-1 is a partial list of commonly used drugs that might be affected by decreased total circulating albumin.

Other effects occur as well. For example, the increased risk of infection mandates the use of careful sterile technique for even routine vascular access. Use of inhalational anesthetics may further depress leukocyte function. Finally, the associated peripheral neuropathy may alter the effects of conduction anesthesia, and mental status changes associated with PEM may impair rapid recovery from general anesthesia.

**TABLE 16-1.**

**Commonly Used Drugs That are Plasma-Protein Bound**

Drug	Protein Bound (%)
<b>Narcotics</b>	
Morphine	30
Meperidine	60
Fentanyl	84
Sufentanil	92
Alfentanil	92
<b>Barbiturates</b>	
Thiopental	72-86
Phenobarbital	40-60
<b>Benzodiazepines</b>	
Diazepam	96-98
Midazolam	96-98
Lorazepam	96-98
<b>Nonbarbiturate Induction Agents</b>	
Etomidate	76
Propofol	98
<b>Local Anesthetics</b>	
Tetracaine	80
Lidocaine	70
Mepivacaine	77
Bupivacaine	95
Etidocaine	95
Prilocaine	55
<b>Cardioactive Drugs</b>	
Digitalis	25
Labetalol	50
Propranolol	90-95
Nadolol	40-60
Pindolol	50
Captopril	25-30
<b>Others</b>	
Phenytoin	90

### **Effects of Perioperative Protein-Energy Malnutrition on Outcome in Surgical Patients**

#### **Effects of Malnutrition on Mortality**

In 1936, Studley<sup>71</sup> reported that when preoperative weight loss exceeded 20% of pre-morbid weight, the mortality after operation for peptic ulcer disease was 33%. This early and unsophisticated study first underscored the influence of nutritional status on surgical outcome. More recent studies, which focused on alterations in anthropomet-

rics, transport proteins, and leukocyte parameters, confirmed these data. Reinhardt et al.<sup>72</sup> found that serum albumin values less than 3.0 mg/dL were associated with a 30-day mortality of 24% and that levels below 2.0 mg/dL were associated with a mortality of 62% in patients undergoing intraabdominal surgery. In a study on similar patients, Seltzer et al.<sup>73</sup> noted that albumin values less than 3.5 mg/dL were associated with 4-fold increases in mortality and morbidity, whereas lymphocyte counts of less than 1500/mm<sup>3</sup> were associated with a 4-fold increase in mortality alone. Concurrent abnormalities of both albumin and lymphocyte counts were associated with an 18-fold increase in mortality relative to patients with normal indices.

Impaired cell-mediated immunity also appears to be an important marker for increased mortality. Meakins et al.<sup>74</sup> noted a perioperative death rate of 3.1% in general surgical patients with normal delayed hypersensitivity (assessed by intradermal injection of a battery of antigens), whereas anergy was associated with a mortality of 35%. The development of anergy following normal initial testing was invariably fatal. A number of studies have confirmed the association of anergy and poor postoperative outcome. Anergy is associated with numerous other factors, however, all of which may increase perioperative risk independent of malnutrition.

In an attempt to improve specificity, Harvey et al.<sup>75</sup> developed a discriminate function that was used to predict the development of sepsis and surgical mortality. This function was based primarily on delayed hypersensitivity testing, transferring, albumin, and total lymphocyte counts. Prospective evaluation of the index has not been reported. Mullen et al.<sup>21</sup> developed a “prognostic nutritional index” (PNI) based on a number of nutritionally relevant variables. Patients identified by this index as high risk had a mortality of nearly 60%; those categorized as low risk had mortalities of only 3%. Prospective evaluation of this index has confirmed its usefulness for identifying high-risk patients, but the true relationship between the variables studied and malnutrition is unclear.

### **Effects of Malnutrition on Complications**

Surgical complications occur more frequently in patients with markers for

PEM. Patients with preoperative anergy and patients in whom anergy developed postoperatively have greatly increased rates of postoperative sepsis.<sup>74</sup> Preoperative anergy is further associated with a doubling of nonseptic postoperative complications,<sup>74</sup> and anergy is a predictor of prolonged hospitalization. Rhoads and Alexander<sup>76</sup> associated hypoproteinemia in surgical patients with twice the rate of wound infections and an increased incidence of other infectious complications. In both patients and experimental animals, punch biopsies of wound tissue in starvation showed evidence of impaired collagen synthesis<sup>77</sup>; Cruse and Foord<sup>78</sup> concluded that malnutrition increased the incidence of clean wound infections from 1.8% to 16.6%.

Abnormalities of plasma proteins and albumin are associated with an increased incidence of bowel anastomosis dehiscence. Starved rats with low serum proteins and albumin were reported to have decreased colonic collagen content and decreased colonic wall-bursting tension, as well as loss of tensile anastomotic strength and collagen content.<sup>79</sup> These final findings could not be confirmed by a second group of investigators.<sup>80</sup> The use of nutritional indices in predicting complications requires further testing.

The uniform association of abnormalities of weight loss, serum proteins, and leukocyte function with mortality and morbidity in the perioperative period is impressive. Animal studies of PEM demonstrate similar results. Nonetheless, human studies have used nonspecific markers that may correlate with not only PEM, but also with other risk factors not tested for independence. Thus, the true impact of PEM as an independent risk factor for surgical outcome is unknown.

### **Effect of Nutritional Repletion on Outcome**

Although nutritional repletion may reverse many of the abnormalities that develop in individual organ systems as a result of malnutrition the overall effect of perioperative alimentation on outcome is unclear. Most studies that address the issue were poorly designed—patients were not randomized, investigators were not blinded, and patient populations lacked uniformity. Most studies compared different alimentation regimens without an untreated control group. Finally, the end

points are not objective measures of outcome. Despite these limitations, some conclusions can be drawn.

Patients with mild to moderate preoperative depletion do not appear to benefit from combined preoperative and postoperative alimentation as compared to postoperative support alone. In comparing nonrandomized, mildly depleted patients with gastrointestinal malignancies to undepleted control patients, Thompson et al.<sup>81</sup> were unable to demonstrate that combined preoperative and postoperative repletion altered mortality or morbidity.

Outcome appears to be improved when significant malnutrition is corrected prior to surgery. When comparing combined preoperative and postoperative intravenous alimentation to postoperative support alone, both Mullen et al.<sup>21</sup> and Smale et al.<sup>82</sup> reported reductions in mortality (9% vs. 47%) and morbidity (23% vs. 56%). Muller et al.<sup>83</sup> confirmed these findings in a randomized study of patients with cancer. Outcome is significantly affected by the duration and efficacy of therapy. Thus, Rombeau et al.<sup>84</sup> retrospectively studied patients undergoing surgery for inflammatory bowel disease and noted that only 5% of patients who had received hyperalimentation for 5 or more days had postoperative complications, whereas 46% of those receiving less than 5 days of therapy had complications.<sup>84</sup> Grimes et al.<sup>85</sup> noted similar findings in general surgical patients who were severely depleted. In another study, only 4% of patients who responded to 1 week of repletion had a perioperative complication, whereas 9 (45%) of 20 who did not respond had perioperative morbidity.<sup>86</sup> When therapy in nonresponders was continued for an additional 4–6 weeks, until a response consistent with improved nutritional status was noted, the complication rate was 13%. Thus it appears that preoperative repletion of appropriate duration to improve nutritional status also improves perioperative outcome. Questions of methodology in all the studies cited mandate that conclusions be drawn cautiously.

The blueprint for a well-designed, randomized, prospective trial unfortunately led to results that are difficult to interpret.<sup>87</sup> Only 395 patients were studied; this fell short of the original projection. Patients were randomized to receive either 7–15 days of preoperative total parenteral nutrition (TPN)

followed by 3 days of postoperative TPN or no TPN until the third postoperative day. No differences in major complications or mortality were noted. However, when patients were stratified by the extent of preexisting malnutrition (based on the PNI), severely malnourished patients receiving TPN had fewer complications. Unfortunately, there was no assessment of the efficacy of nutritional support to demonstrate improved nutritional status before surgery as a result of TPN. Thus the conclusions are difficult to interpret and the role of TPN remains to be fully elucidated.

Finally, there remains the patient with normal preoperative nutritional status about to undergo an extremely stressful procedure or who will be unable to eat for a prolonged period after surgery. Despite the myriad studies addressing nutritional support, there exists no reasonably designed, well-performed study that deals with such patients relative to a meaningful control group. Thus, although it seems self-evident that appropriate support of the catabolic patient should improve outcome, no data exist to support this hypothesis.

### **Implications of Altered Outcome for the Anesthesiologist**

The anesthesiologist should ensure that the patient presenting for elective operation is in the best possible condition to tolerate the operation and postoperative course. The relatively poor outcome associated with malnutrition, coupled with the apparent benefits of repletion in the severely depleted individual, constitutes one more problem that can be addressed to improve overall patient outcome. An appropriate course of repletion in a highly malnourished individual may well be necessary, and calling attention to this potential problem and its remedy is part of a comprehensive anesthesia evaluation and plan.

### **Immunonutrition**

Recent advances in nutritional support include the addition of “pharmakonutrients” or “immunonutrients” to standard nutritional formulas. These additives improve outcome in animal models and in several human studies. There are several commercially available formulas that include a combination of arginine, glutamine, omega-3 fatty acids, and RNA nucleotides. We

first introduce the evidence supporting each individual pharmacnutrient and then provide the evidence for use in individual surgical groups.

### **Arginine**

Arginine is a conditionally essential amino acid. It is an intermediate of the urea cycle and is the precursor for creatine, a substrate for energy metabolism in muscle. Of critical importance, the guanidino nitrogen atom of L-arginine provides the nitrogen used to synthesize nitric oxide (NO). Because NO modulates cytokine production and other aspects of white cell function and, as a free radical, can kill pathogenic bacteria, it has been proposed that arginine is essential for host defense. In addition, it is an essential element of the system that regulates vascular tone. A relative arginine deficiency state is theoretically produced where induced nitric oxide synthase activity increases; it has been shown that septic patients with low systemic arginine levels have a greater mortality rate.<sup>88</sup> In addition, arginine may have beneficial effects on wound healing. This has led to the inclusion of arginine in the immunonutrition formulas.

### **Omega-3 Fatty Acids**

Lipids are included in most nutritional formulas to provide calories and to avoid essential fatty acid deficiency. The human body is able to manufacture all of the lipids necessary for existence with the exception of the long-chain fatty acids (LCFAs) in the omega-3 and omega-6 family. Omega-6 fatty acids have immune-stimulating effects whereas omega-3 fatty acids have immune-suppressive effects. This has led to investigations examining the ratio of omega-3 to omega-6 fatty acids in critically ill surgical patients. In septic rats, substitution of omega-3 fatty acid for omega-6 fatty acid lowered prostaglandin E<sub>2</sub> production in Kupffer cells and decreased mortality.<sup>89</sup> It is possible to modulate the human immune response in a similar manner. However, outcome data are lacking.

### **Glutamine**

Glutamine is a nonessential amino acid that is synthesized from glutamate and glutamic acid in large quantities. It is used as a fuel source in rapid turnover cells and is the preferred fuel source in the rat gastrointestinal tract. Glutamine

is also a precursor to the antioxidant glutathione. Glutamine is now included in immunonutrition supplements to prevent gut mucosal atrophy and perhaps prevent immune dysfunction. In septic rats, glutamine-enriched parenteral nutrition decreases mortality<sup>90</sup> and increases jejunal villus height. Glutamine may also decrease bacterial translocation,<sup>91</sup> but other studies show no effect.<sup>92</sup> Critically ill humans fed with glutamine supplemented parenteral feeds have greater intestinal absorptive capacity compared with patients receiving a conventional solution.<sup>93</sup> In a meta-analysis of randomized clinical trials on surgical and critically ill patients, glutamine was shown to be beneficial.<sup>94</sup> In surgical patients glutamine supplementation reduced infectious complications and hospital length of stay. However, no treatment effect was seen with enteral glutamine with respect to reduction in mortality or length of stay.

### **Nucleotides**

RNA nucleotides include the purines adenine and guanine and the pyrimidines cytosine and uracil. They are not considered essential nutrients because they are synthesized endogenously. Their inclusion in immunonutrition formulas is based on evidence from animal studies. In the murine model injected with *Candida albicans*, mice supplemented with RNA nucleotides had an increased survival time.<sup>95</sup> Other studies demonstrate an increased type 1 response to antigen,<sup>96</sup> and a decreased intestinal mucosa atrophy.<sup>97</sup> To date, no studies have been published looking at nucleotide supplementation alone in any human patient population.

### **Immunonutrition Studies**

Immunonutrition consists of formulations of the pharmacnutrients arginine, glutamine, omega-3 fatty acids, and nucleotides in a solution of protein and carbohydrates. Data from multiple studies randomizing patients to immune-enhanced early enteral nutrition (IEEN) versus standard enteral nutrition have been analyzed in multiple patient groups (Table 16-2). In some, such as elective gastrointestinal surgery patients, clear benefit has been shown. However, no benefit has been demonstrated in heterogeneous populations of critically ill patients. Combining studies using meta-analysis also failed to reveal a benefit.

TABLE 16-2.

## Recommendations on Immune Enhanced Diets (Combinations of Arginine, Glutamine, Omega-3 Fatty Acids, and Nucleotides)

Surgery	Patient Group	Recommendation
Elective GI surgery	Esophageal, gastric, pancreatic, hepatobiliary	Patients with moderate to severe malnutrition (Albumin <3.5 g/dL) benefit from preop immunonutrition for 5–7 days <sup>98</sup>
	Colonic and rectal surgery	Patients with severe malnutrition (Albumin <2.8) benefit from periop immunonutrition
Trauma patients	Blunt and penetrating	ISS >20 or ATI >25 benefit of reduced length of stay and septic morbidity <sup>99</sup>
Burn patients	Blunt and penetrating	Theoretically beneficial, lack of sufficient number of studies
Coronary artery	Elderly patients	Small study shows benefit of reduced infection <sup>100</sup>
Critically ill patients	Heterogeneous group	No benefit <sup>101</sup>
Severe sepsis		May harm patient <sup>102</sup>

**Intraoperative Management of the Patient Receiving Nutritional Support**

Box 16-1 summarizes the principles that guide intraoperative nutritional support. Total parenteral nutrition should be continued throughout surgery. Most formulas have some form of carbohydrate, putting the patient at risk for hyperglycemia. Careful evaluation of blood glucose should be continued throughout the perioperative period.

Critically ill patients frequently have trouble reaching the goal level of nourishment. Often the cause is discontinuing the enteral nutrition in anticipation of procedures to reduce the risk of aspiration. This can be a serious problem in the patient undergoing multiple procedures, such as in the burn and multiple-trauma population. Moncure et al. prospectively evaluated patients

undergoing nonabdominal procedures with jejunal tube nourishment.<sup>103</sup> There were no cases of aspiration. Jenkins et al. studied 40 duodenally fed patients undergoing a total of 161 surgical procedures in whom the duodenal nourishment was continued.<sup>104</sup> Again, no aspiration was documented. Consequently, postpyloric enteral nutrition should be continued in critically ill patients brought to the operating room. Gastric nourishment should be withheld starting 6–8 hours before any procedure requiring anesthesia. Patients requiring anesthetic for procedures are usually in a supine position without elevation of the head of bed increasing the risk of aspiration.<sup>105</sup>

**SUMMARY**

As the field of anesthesiology grows in scope and practice, the extent of knowledge of the anesthesiologist also must expand. Malnutrition constitutes another area in which patient disease might alter function under anesthesia and outcome after operation. Knowledge of these effects and their reversal by repletion therapy is useful and potentially lifesaving.

**KEY REFERENCES**

- Mullen JL, Buzby GP, Matthews DC, Smale BF, Rosato EF. Reduc-

tion of operative morbidity and mortality by combined preoperative and postoperative nutritional support. *Ann Surg* 1980;192:604–613.

- Khuri SF, Daley J, Henderson W, et al. Risk adjustment of the postoperative mortality rate for the comparative assessment of the quality of surgical care: results of the National Veterans Affairs Surgical Risk Study. *J Am Coll Surg* 1997; 185:315–327.

- Weinsier RL, Hunker EM, Krumdieck CL, Butterworth CE Jr. Hospital malnutrition. A prospective evaluation of general medical patients during the course of hospitalization. *Am J Clin Nutr* 1979;32: 418–426.

- The Veterans Affairs Total Parenteral Nutrition Cooperative Study Group. Perioperative total parenteral nutrition in surgical patients. *N Engl J Med* 1991;325:525–32.

- Heyland DK, MacDonald S, Keefe L, Drover JW. Total parenteral nutrition in the critically ill patient: a meta-analysis. *JAMA* 1998; 280:2013–2019.

- Bertolini G, Iapichino G, Radrizani D, et al. Early enteral immunonutrition in patients with severe sepsis: results of an interim analysis of a randomized multicentre clinical trial. *Intensive Care Med* 2003;29:834–840.

- Cerra FB. Hypermetabolism, organ failure, and metabolic support. *Surgery* 1987;101:1–14.

**REFERENCES**

- Bistrian BR. Interaction of nutrition and infection in the hospital setting. *Am J Clin Nutr* 1977;30:1228–1235.
- Bistrian BR, Blackburn GL, Hallowell E, Heddle R. Protein status of general surgical patients. *JAMA* 1974;230:858–860.
- Levenson SM, Seifter E. Starvation; metabolic and physiologic responses. In: Fischer JE, ed. *Surgical Nutrition*. Boston: Little Brown, 1983;430–2.
- Gjedde A, Crone C. Induction processes in blood-brain transfer of ketone bodies during starvation. *Am J Physiol* 1975;229: 1165–1169.

**BOX 16-1.****Intraoperative nutritional support**

- Parenteral nutrition should be continued whenever possible.
- Postpyloric enteral nutrition should be continued with the possible exception of intraabdominal procedures.
- Gastric enteral nutrition should be discontinued 6–8 hours before procedures requiring general anesthesia and endotracheal intubation



5. Elia M, Lammert O, Zed C, Neale G. Energy metabolism during exercise in normal subjects undergoing total starvation. *Hum Nutr Clin Nutr* 1984;38:355-362.
6. Cerra FB. Hypermetabolism, organ failure, and metabolic support. *Surgery* 1987;101:1-14.
7. Caldwell MD. Importance of cellular metabolism in the inflammatory response to tissue injury. In: Bihari DH, Cerra FB, ed. *Multiple Organ Failure*. Fullerton, CA: Society of Critical Care Medicine, 1989:37-60.
8. Cuthbertson D, Tilstone W. Metabolism during the post-injury period. *Adv Clin Chem* 1977;12:1.
9. Clowes GH Jr, Heideman M, Lindberg B, et al. Effects of parenteral alimentation on amino acid metabolism in septic patients. *Surgery* 1980;88:531-543.
10. Kinney JM, Weissman C. Forms of malnutrition in stressed and unstressed patients. *Clin Chest Med* 1986;7:19-28.
11. Moore FD, Oleson KH, McMurray JD, et al. *The Body Cell Mass and Its Supporting Environment*. Philadelphia: WB Saunders, 1978.
12. McLaren DS. A fresh look at protein-energy malnutrition. *Lancet* 1966;2(7461):485-8.
13. Fleck A. The acute phase response: implications for nutrition and recovery. *Nutrition* 1988;4:109-117.
14. James WP, Hay AM. Albumin metabolism: effect of the nutritional state and the dietary protein intake. *J Clin Invest* 1968;47:1958-1972.
15. Sullivan DH, Roberson PK, Bopp MM. Hypoalbuminemia 3 months after hospital discharge: significance for long-term survival. *J Am Geriatr Soc* 2005;53:1222-1226.
16. Forse RA, Shizgal HM. The assessment of malnutrition. *Surgery* 1980;88:17-24.
17. Buzby GP, Mullen JL, Matthews DC, Hobbs CL, Rosato EF. Prognostic nutritional index in gastrointestinal surgery. *Am J Surg* 1980;139:160-167.
18. Detsky AS, Baker JP, Mendelson RA, Wolman SL, Wesson DE, Jeejeebhoy KN. Evaluating the accuracy of nutritional assessment techniques applied to hospitalized patients: methodology and comparisons. *JPEN J Parenter Enteral Nutr* 1984;8:153-159.
19. Scheinkestel CD, Kar L, Marshall K, et al. Prospective randomized trial to assess caloric and protein needs of critically ill, anuric, ventilated patients requiring continuous renal replacement therapy. *Nutrition* 2003;19:909-916.
20. Bistran BR, Blackburn GL, Vitale J, Cochran D, Naylor J. Prevalence of malnutrition in general medical patients. *JAMA* 1976;235:1567-1570.
21. Mullen JL, Buzby GP, Matthews DC, Smale BF, Rosato EF. Reduction of operative morbidity and mortality by combined preoperative and postoperative nutritional support. *Ann Surg* 1980;192:604-613.
22. Symreng T, Anderberg B, Kagedal B, Norr A, Schildt B, Sjudahl R. Nutritional assessment and clinical course in 112 elective surgical patients. *Acta Chir Scand* 1983;149:657-662.
23. Dannhauser A, Van Zyl JM, Nel CJ. Preoperative nutritional status and prognostic nutritional index in patients with benign disease undergoing abdominal operations—part I. *J Am Coll Nutr* 1995;14:80-90.
24. Weinsier RL, Hunker EM, Krumdieck CL, Butterworth CE Jr. Hospital malnutrition. A prospective evaluation of general medical patients during the course of hospitalization. *Am J Clin Nutr* 1979;32:418-426.
25. Alexander JK, Peterson KL. Cardiovascular effects of weight reduction. *Circulation* 1972;45:310-318.
26. Alden PB, Madoff RD, Stahl TJ, Lakatua DJ, Ring WS, Cerra FB. Left ventricular function in malnutrition. *Am J Physiol* 1987;253:H380-H387.
27. Chauhan S, Nayak NC, Ramalingaswami V. The heart and skeletal muscle in experimental protein malnutrition in rhesus monkeys. *J Pathol Bacteriol* 1965;90:301-309.
28. Gottdiener JS, Gross HA, Henry WL, Borer JS, Ebert MH. Effects of self-induced starvation on cardiac size and function in anorexia nervosa. *Circulation* 1978;58:425-433.
29. Bloom WL, Azar G, Smith EG Jr. Changes in heart size and plasma volume during fasting. *Metabolism* 1966;15:409-413.
30. Franzoni F, Galetta F, Cupisti A, Rolla M, Santoro G, Pentimone F. Ultrasonic tissue characterization of the myocardium in anorexia nervosa. *Acta Paediatr* 2003;92:297-300.
31. Olivares JL, Vazquez M, Fleita J, Moreno LA, Perez-Gonzalez JM, Bueno M. Cardiac findings in adolescents with anorexia nervosa at diagnosis and after weight restoration. *Eur J Pediatr* 2005;164:383-386.
32. Heymsfield SB, Bethel RA, Ansley JD, Gibbs DM, Felner JM, Nutter DO. Cardiac abnormalities in cachectic patients before and during nutritional repletion. *Am Heart J* 1978;95:584-594.
33. Sahebajani H. Nutrition and the pulmonary parenchyma. *Clin Chest Med* 1986;7:111-126.
34. Kerr JS, Riley DJ, Lanza-Jacoby S, et al. Nutritional emphysema in the rat. Influence of protein depletion and impaired lung growth. *Am Rev Respir Dis* 1985;131:644-650.
35. Brown LA, Bliss AS, Longmore WJ. Effect of nutritional status on the lung surfactant system: food deprivation and caloric restriction. *Exp Lung Res* 1984;6:133-147.
36. Myers BA, Dubick MA, Gerreits J, et al. Protein deficiency: effects on lung mechanics and the accumulation of collagen and elastin in rat lung. *J Nutr* 1983;113:2308-2315.
37. Kelsen SG, Ference M, Kapoor S. Effects of prolonged undernutrition on structure and function of the diaphragm. *J Appl Physiol* 1985;58:1354-1359.
38. Lewis M, Sieck G, Fournier M, et al. Effect of nutritional deprivation on diaphragm contractility and muscle fiber size. *J Appl Physiol* 1986;60(2):596-603.
39. Bender PR, Martin BJ. Ventilatory and treadmill endurance during acute semistarvation. *J Appl Physiol* 1986;60:1823-1827.
40. Rochester DF. Malnutrition and the respiratory muscles. *Clin Chest Med* 1986;7:91-99.
41. Baier H, Somani P. Ventilatory drive in normal man during semistarvation. *Chest* 1984;85:222-225.
42. Green GM, Kass EH. Factors influencing the clearance of bacteria by the lung. *J Clin Invest* 1964;43:769-776.
43. Askanazi J, Rosenbaum SH, Hyman AI, et al. Effects of parenteral nutrition of ventilatory drive. *Anesthesiology* 1980;53:S185.
44. Smith R, Drenick EJ. Changes in body water and sodium during prolonged starvation for extreme obesity. *Clin Sci* 1966;31:437-447.
45. Thompson CS, Mikhailidis DP, Jeremy JY, Bell JL, Dandona P. Effect of starvation on biochemical indices of renal function in the rat. *Br J Exp Pathol* 1987;68:767-775.
46. Steiner M, Bourges HR, Freedman LS, Gray SJ. Effect of starvation on the tissue composition of the small intestine in the rat. *Am J Physiol* 1968;215:75-77.
47. Desai ID. Regulation of lysosomal enzymes. II. Reversible adaptation of intestinal acid hydrolases during starvation and realimentation. *Can J Biochem* 1971;49:170-176.
48. Knudsen KB, Bradley EM, Lecocq FR, Bellamy HM, Welsh JD. Effect of fasting and refeeding on the histology and disaccharidase activity of the human intestine. *Gastroenterology* 1968;55:46-51.
49. Ju JS, Nasset ES. Changes in total nitrogen content of some abdominal viscera in fasting and realimentation. *J Nutr* 1959;68:633-645.
50. Schlichtig RAS. *Nutritional Support of the Critically Ill*. Chicago: Year Book Medical, 1988.
51. Thompson JS, Vaughan WP, Forst CF, Jacobs DL, Weekly JS, Rikkers LF. The effect of the route of nutrient delivery on gut structure and diamine oxidase levels. *JPEN J Parenter Enteral Nutr* 1987;11:28-32.
52. O'Dwyer ST, Smith RJ, Hwang TL, Wilmore DW. Maintenance of small bowel mucosa with glutamine-enriched parenter-

- al nutrition. *JPEN J Parenter Enteral Nutr* 1989;13:579-585.
53. Moore FA, Moore EE, Poggetti R, et al. Gut bacterial translocation via the portal vein: a clinical perspective with major torso trauma. *J Trauma* 1991;31:629-636.
54. Deitch EA. Bacterial translocation or lymphatic drainage of toxic products from the gut: what is important in human beings? *Surgery* 2002;131:241-244.
55. Nordgren L, von Scheele C. Hepatic and pancreatic dysfunction in anorexia nervosa: a report of two cases. *Biol Psychiatry* 1977;12:681-686.
56. Dixit PK, Kaung HL. Rat pancreatic beta-cells in protein deficiency: a study involving morphometric analysis and alloxan effect. *J Nutr* 1985;115:375-381.
57. Lee PC, Brooks S, Lebenthal E. Effect of fasting and refeeding on pancreatic enzymes and secretagogue responsiveness in rats. *Am J Physiol* 1982;242:G215-G221.
58. Barrett PV. Hyperbilirubinemia of fasting. *JAMA* 1971;217:1349-1353.
59. McLaren DS, Bitar JG, Nassar VH. Protein-calorie malnutrition and the liver. *Prog Liver Dis* 1972;4:527-536.
60. McLean AE, Verschuuren HG. Effects of diet and microsomal enzyme induction on the toxicity of dimethyl nitrosamine. *Br J Exp Pathol* 1969;50:22-25.
61. Deutschman CS, Raups P, Peterson M, et al. Transient elevation of hepatic enzymes following resumption of gut feedings in ICU patients. *Nutr Int* 1987;3:42.
62. Popp MB, Brennan MF. Metabolic response to trauma and infection. In: Fischer JE, ed. *Surgical Nutrition*. Boston: Little Brown, 1983:479-513.
63. Gross RL, Newberne PM. Role of nutrition in immunologic function. *Physiol Rev* 1980;60:188-302.
64. Abbott WC, Tayek JA, Bistrian BR, et al. The effect of nutritional support on T-lymphocyte subpopulations in protein-calorie malnutrition. *J Am Coll Nutr* 1986;5:577-584.
65. Law DK, Dudrick SJ, Abdou NI. Immunocompetence of patients with protein-calorie malnutrition. The effects of nutritional repletion. *Ann Intern Med* 1973;79:545-550.
66. Law DK, Dudrick SJ, Abdou NI. The effect of dietary protein depletion on immunocompetence: the importance of nutritional repletion prior to immunologic induction. *Ann Surg* 1974;179:168-173.
67. Chopra JS, Dhand UK, Mehta S, Bakshi V, Rana S, Mehta J. Effect of protein-calorie malnutrition on peripheral nerves. A clinical, electrophysiological and histopathological study. *Brain* 1986;109(Pt 2):307-323.
68. Keys A, Brozek J, Henschel A, et al. *The biology of human starvation*. Minneapolis: University of Minnesota Press, 1950.
69. Vrbaski SR. The effect of long-term low protein intake on lipids of rat brain during adulthood. *J Nutr* 1983;113:899-904.
70. Sima A. Studies on fibre size in developing sciatic nerve and spinal roots in normal, undernourished, and rehabilitated rats. *Acta Physiol Scand Suppl* 1974;406:1-55.
71. Studley HO. Percentage of weight loss: a basic indicator of surgical risk in patients with chronic peptic ulcer. *JAMA* 1936;106(6):458-460.
72. Reinhardt GF, Myscofski JW, Wilkens DB, Dobrin PB, Mangan JE Jr, Stannard RT. Incidence and mortality of hypoalbuminemic patients in hospitalized veterans. *JPEN J Parenter Enteral Nutr* 1980;4:357-359.
73. Seltzer MH, Bastidas JA, Cooper DM, Engler P, Slocum B, Fletcher HS. Instant nutritional assessment. *JPEN J Parenter Enteral Nutr* 1979;3:157-159.
74. Meakins JL, Pietsch JB, Bubenick O, et al. Delayed hypersensitivity: indicator of acquired failure of host defenses in sepsis and trauma. *Ann Surg* 1977;186:241-250.
75. Harvey KB, Moldawer LL, Bistrian BR, Blackburn GL. Biological measures for the formulation of a hospital prognostic index. *Am J Clin Nutr* 1981;34:2013-2022.
76. Rhoads JE, Alexander CE. Nutritional problems of surgical patients. *Ann N Y Acad Sci* 1955;63:268-275.
77. Stein HD, Keiser HR. Collagen metabolism in granulating wounds. *J Surg Res* 1971;11:277-283.
78. Cruse PJ, Foord R. A five-year prospective study of 23,649 surgical wounds. *Arch Surg* 1973;107:206-210.
79. Irvin TT, Hunt TK. Effect of malnutrition on colonic healing. *Ann Surg* 1974;180:765-772.
80. Temple WJ, Voitk AJ, Snelling CF, Crispin JS. Effect of nutrition, diet and suture material on long term wound healing. *Ann Surg* 1975;182:93-97.
81. Thompson BR, Julian TB, Stremple JF. Perioperative total parenteral nutrition in patients with gastrointestinal cancer. *J Surg Res* 1981;30:497-500.
82. Smale BF, Mullen JL, Buzby GP, Rosato EF. The efficacy of nutritional assessment and support in cancer surgery. *Cancer* 1981;47:2375-2381.
83. Muller JM, Brenner U, Dienst C, Pichlmaier H. Preoperative parenteral feeding in patients with gastrointestinal carcinoma. *Lancet* 1982;1:68-71.
84. Rombeau JL, Barot LR, Williamson CE, Mullen JL. Preoperative total parenteral nutrition and surgical outcome in patients with inflammatory bowel disease. *Am J Surg* 1982;143:139-143.
85. Grimes CJ, Younathan MT, Lee WC. The effect of preoperative total parenteral nutrition on surgery outcomes. *J Am Diet Assoc* 1987;87:1202-1206.
86. Starker PM, LaSala PA, Askanazi J, Todd G, Hensle TW, Kinney JM. The influence of preoperative total parenteral nutrition upon morbidity and mortality. *Surg Gynecol Obstet* 1986;162:569-574.
87. Perioperative total parenteral nutrition in surgical patients. The Veterans Affairs Total Parenteral Nutrition Cooperative Study Group. *N Engl J Med* 1991;325:525-532.
88. Freund H, Atamian S, Holroyde J, Fischer JE. Plasma amino acids as predictors of the severity and outcome of sepsis. *Ann Surg* 1979;190:571-576.
89. Barton RG, Wells CL, Carlson A, Singh R, Sullivan JJ, Cerra FB. Dietary omega-3, fatty acids decrease mortality and Kupffer cell prostaglandin E<sub>2</sub> production in a rat model of chronic sepsis. *J Trauma* 1991;31:768-773.
90. Inoue Y, Grant JP, Snyder PJ. Effect of glutamine-supplemented intravenous nutrition on survival after *Escherichia coli*-induced peritonitis. *JPEN J Parenter Enteral Nutr* 1993;17:41-46.
91. Gianotti L, Alexander JW, Gennari R, Pyles T, Babcock GF. Oral glutamine decreases bacterial translocation and improves survival in experimental gut-origin sepsis. *JPEN J Parenter Enteral Nutr* 1995;19:69-74.
92. Barber AE, Jones WG, Minei JP, et al. Harry M. Vars award. Glutamine or fiber supplementation of a defined formula diet: impact on bacterial translocation, tissue composition, and response to endotoxin. *JPEN J Parenter Enteral Nutr* 1990;14:335-343.
93. Tremel H, Kienle B, Weilemann LS, Stehle P, Furst P. Glutamine dipeptide-supplemented parenteral nutrition maintains intestinal function in the critically ill. *Gastroenterology* 1994;107:1595-1601.
94. Novak F, Heyland DK, Avenell A, Drovner JW, Su X. Glutamine supplementation in serious illness: a systematic review of the evidence. *Crit Care Med* 2002;30:2022-2029.
95. WC Fanslow, Kulkarni AD, Van Buren CT, Rudolph FB. Effect of nucleotide restriction and supplementation on resistance to experimental murine candidiasis. *JPEN J Parenter Enteral Nutr* 1988;12(1):49-52.
96. Jyonouchi H, Sun S, Abiru T, Winship T, Kuchan MJ. Dietary nucleotides modulate antigen-specific type 1 and type 2 T-cell responses in young c57bl/6 mice. *Nutrition* 2000;16:442-446.
97. Tsujinaka T, Kishibuchi M, Iijima S, Yano M, Monden M. Role of supplementation of a nucleic acid solution on the intestinal mucosa under total parenteral nutrition. *Nutrition* 1997;13:369-371.
98. Sax HC. Effect of immune-enhancing formulas (IEF) in general surgery patients.

JPEN J Parenter Enteral Nutr 2001;25:S19-S22.

99. Jacobs DG, Jacobs DO, Kudsk KA, et al. Practice management guidelines for nutritional support of the trauma patient. *J Trauma* 2004;57:660-678.

100. Tepaske R, Velthuis H, Oudemans-van Straaten HM, et al. Effect of preoperative oral immune-enhancing nutritional supplement on patients at high risk of infection after cardiac surgery: a randomised placebo-controlled trial. *Lancet* 2001;358:696-701.

101. Heyland D, Dhaliwal R. Immunonutrition in the critically ill: from old approaches to new paradigms. *Intensive Care Med* 2005;31:501-503.

102. Bertolini G, Iapichino G, Radrizzani D, et al. Early enteral immunonutrition in patients with severe sepsis: results of an interim analysis of a randomized multicentre clinical trial. *Intensive Care Med* 2003;29:834-840.

103. Moncure M, Samaha E, Moncure K, et al. Jejunostomy tube feedings should not be

stopped in the perioperative patient. *JPEN J Parenter Enteral Nutr* 1999;23:356-359.

104. Jenkins ME, Gottschlich MM, Warden GD. Enteral feeding during operative procedures in thermal injuries. *J Burn Care Rehabil* 1994;15:199-205.

105. Drakulovic MB, Torres A, Bauer TT, Nicolas JM, Nogue S, Ferrer M. Supine body position as a risk factor for nosocomial pneumonia in mechanically ventilated patients: a randomised trial. *Lancet* 1999;354:1851-1858.

# CHAPTER 17

## Principles of Antimicrobial Therapy

Richard Teplick, MD, and  
Robert H. Rubin, MD,  
FACP, FCCP

In general, antimicrobials may be used in three different modes: therapeutic, prophylactic, and preemptive. In the therapeutic mode, they are prescribed to treat established clinical infection. The appropriate therapeutic use of antimicrobial drugs requires the prompt diagnosis of clinical infection and a clear understanding of the pharmacologic principles governing treatment of such infections. In the prophylactic mode, antimicrobials are prescribed to all members of a given population prior to an event, for example, an operation, to prevent infection. Successful prophylactic programs require that the antimicrobial therapy be sufficiently nontoxic, inexpensive, and efficacious to justify the intervention. Finally, in the preemptive mode, antimicrobial therapy is administered to the subgroup of individuals based on either laboratory markers or clinical epidemiologic characteristics that place them at significant risk of a serious clinical infection. Effective preemptive therapy requires the careful delineation of the factors that justify antimicrobial intervention at a point when clinical disease is not yet manifest.<sup>1,2</sup> This chapter presents the pharmacologic and clinical principles that underlie all three forms of antimicrobial use, distinguishing between that which is known and that which needs further study. Reviews of specific antibiotics can be found in a series published in the *Mayo Clinics Proceedings*.<sup>3-12</sup> Information on newer antibiotics, such as cyclic lipopeptides, glycylcyclines, ketolides, oxazolidinones, streptogramins, and newer fluoroquinolones can be found in specific review articles and newer textbooks such as Mandell.<sup>13</sup> However, there are important differences among classes of anti-

biotics, which are discussed below. First, some antibiotics are bacteriostatic, for example, tetracyclines. That is, they prevent bacteria from growing but generally require leukocytes to kill them. Another important distinction is their mechanisms of action, especially the distinction between antimicrobials that directly affect cell-wall synthesis and those that affect protein or nucleic acid synthesis.  $\beta$ -Lactams and vancomycin are examples of the former whereas aminoglycosides and fluoroquinolones are examples of the latter. There are other important distinctions, such as the rate of development of resistance, presence of postantibiotic effect, and pharmacokinetics and pharmacodynamics.

When antimicrobials are used prophylactically in surgical patients, initial therapy is often empirical, directed against the most likely organisms and their antimicrobial resistance patterns in a particular hospital or area within the hospital, such as an intensive care unit. Most commonly, surgical antimicrobial prophylaxis is directed against the organisms most likely associated with a particular type of surgery. Other important considerations in selecting a prophylactic antimicrobial agent are its toxicity, its spectrum, its antimicrobial properties (i.e., bacteriostatic or bacteriocidal), postantibiotic effect, the likely source of bacteria (e.g., colon, skin, biliary tract), and the drugs' pharmacokinetics and pharmacodynamics.

It is of great concern that a significant proportion of antimicrobial use, particularly broad-spectrum agents, both in the inpatient and outpatient setting, are often inappropriate.<sup>14,15</sup> Antibiotic use is clearly associated with the emergence and dissemination of antibiotic-resistant organisms, with this occurring far more commonly in ICUs than in non-ICU inpatient areas, and more commonly in inpatient than outpatient settings.

### GENERAL PRINCIPLES OF ANTIMICROBIAL THERAPY

#### Minimal Inhibitory Concentration and Minimal Bactericidal Concentration

Antimicrobial therapy designed to treat active infection is predicated on the reliable *delivery* of the drug to the site of infection at the *concentration* required

to contain the infection for the *time* required to produce this effect. Antimicrobials may exert a *bactericidal* (killing) effect on the targeted organisms or a *bacteriostatic* (inhibition of growth) one. Although it seems likely that bactericidal therapy is inherently superior to bacteriostatic therapy, in most instances of clinical infection either form of therapy is effective. There are, however, a few instances in which there is an absolute requirement for a bactericidal regimen:

- Systemic infection in a severely neutropenic patient.
- Staphylococcal and, presumably, other forms of osteomyelitis.
- Cardiovascular infection (e.g., endocarditis).
- Central nervous system (CNS) infection, both meningitis and cerebritis/abscess (in which a trough level of bactericidal effect >1:8 is achieved).
- Infection in the face of a foreign body that remains in place.

The most effective therapy for tuberculosis deploys three bactericidal drugs; isoniazid, rifampin, and pyrazinamide. Such a regimen permits shortening of the duration of therapy, and its use is associated with greater efficacy.

If there are no bactericidal regimens that can be formulated for these conditions because of the nature of the invading organism, then high-dose and prolonged bacteriostatic therapy in association with aggressive surgery becomes the alternative management strategy.

Modern microbiologic techniques permit not only the isolation and identification of the infecting microbe, but also can determine the susceptibility to different antibiotics, thus guiding the choice of antibiotics for a particular patient. When exposed *in vitro* to possible therapies, bacteria may be killed or their growth may be inhibited without being killed. The lowest concentration required to prevent growth is termed the *minimal inhibitory concentration* (MIC) (a variant of which is the MIC<sub>90</sub>, which is the concentration of drug required to inhibit 90% of strains of the same species); similarly, the *minimal bactericidal concentration* (MBC), presents the lowest concentration required to kill the bacterial isolate (with the MBC<sub>90</sub> defining the lowest concentration of drug needed to kill 90% of isolates of the same spe-



cies). The MBC is technically much more difficult and time-consuming to determine than the MIC; it is subject to multiple potential errors and is not needed for routine clinical care.<sup>16</sup>

These *in vitro* results are then interpreted in terms of blood levels that are attainable when appropriate doses of the antimicrobial agent in question are administered. One of three results is registered: *susceptible*, *resistant*, or *intermediate*. *Susceptibility* suggests that blood levels attainable with the therapeutic doses of an antibiotic should be effective in the management of infection caused by this organism. Whether such efficacy is obtained depends on other factors, particularly the site of infection; for example, blood levels may not provide adequate concentrations at sites such as the eye, the brain, or the prostate gland. Thus, *in vitro* susceptibility is only the first step in choosing the appropriate antimicrobial.

In contrast to the sometimes complex assessments that are required after a drug is shown to be effective *in vitro*, *resistance* is more easily interpreted. The organism in question is not inhibited by usually achievable systemic concentrations of the agent with normal dose schedules and/or fall in the range where specific microbial resistance mechanisms are likely and when clinical efficacy has not been reliable in treatment studies. In other words, prescribing a drug to which resistance has been demonstrated *in vitro* is strongly associated with therapeutic failure.

*Intermediate* sensitivity means that MICs of the organism(s) in question are higher than blood and tissue levels that are achievable without potential toxicity. For the most part, the use of antimicrobial agents to which the bacterial isolate only exhibits intermediate susceptibility should be avoided. However, particularly when dealing with a broadly resistant infection in the urinary tract, the issue is not attainable blood levels, but rather the relationship between the isolate's MIC and the attainable urine concentration. For example, *Pseudomonas aeruginosa* strains isolated from the urine that are "resistant" to routine therapy can often be effectively treated by tetracycline. The reason for this phenomenon is the dissociation between blood and urine levels of tetracycline that can be expected in the blood (<5 µg/mL) and in the urine (≤500 µg/mL).

## Pharmacologic Principles in the Successful Use of Antimicrobia

The application of certain pharmacologic principles is important in optimizing the effectiveness of antimicrobial therapy.

### Pharmacokinetics and Pharmacodynamics

The terms *pharmacokinetics* (PK) and *pharmacodynamics* (PD)<sup>17</sup> are used to describe the interaction of the drug administered with the individual receiving the therapy. PK describes the effects of the individual's bodily functions on the drug, specifically absorption, distribution, metabolism, and excretion. PD summarizes the effects of the drug, both toxic and beneficial, on the individual.<sup>18,19</sup> Perhaps the most useful measure of change in drug levels over time is to determine the area under the curve (AUC) and divide it by the dosing interval. This permits the determination of drug concentration at a particular site over the dosing interval. Determining the PK-PD relationship is the foundation of efforts to define the appropriate dose in the context of human therapeutics.

The *volume of distribution* is the ratio of the drug concentration in blood or plasma that is assumed to be in equilibrium with all spaces where it distributes to the amount of drug administered. Theoretically, the volume of distribution cannot exceed total body water but the calculated values may be far greater than total body water. This *apparent volume of distribution* may exceed the true volume of distribution because of tissue binding or protein binding if only free drug is measured. This value is also altered by lipid solubility, the drug's blood-tissue partition coefficient, perfusion, volume status, and pH.

High serum protein binding of a drug can alter the PK behavior of the molecule without significant effects on the PD profile. Because unbound drug is the only form of the drug that is able to manifest antimicrobial activity, the protein "buffers" uptake from plasma so that there is little change in the concentration of free drug. Because albumin is the major binding protein, the greatest amount of binding usually occurs in the plasma. In addition, at sites of active inflammation, there can be leakage of serum proteins, account-

ing for higher concentrations of drug at these sites.

The nature of the capillary bed at a particular site is an important factor in the distribution of drugs. At most sites the capillary bed has small pores (fenestrations) that allow for the unencumbered movement of substances with molecular weights of <1000 daltons (the great majority of antibiotics are of that size—so-called small molecules). There are, in addition, specialized sites, such as the retina, the brain, and the prostate gland, where the capillaries are unfenestrated. Because the antimicrobial molecules must pass through these capillaries, the lipid solubility of the molecules (as well as their size) becomes the major determinant of tissue diffusion. A final mechanism contributing to the distribution of antimicrobial molecules is active transport pumps. These pumps act on organic anions and are present in the choroid plexus, the retina, the proximal tubules of the kidney, and the biliary ducts. β-Lactam drugs are pumped out by these active transport pumps, with probenecid competitively inhibiting this mechanism.

### Pharmacokinetics and the Choice of Antimicrobial Therapy

Three pharmacokinetic issues should be considered in the choice of antimicrobial therapy: the ability of the drug to penetrate to the site of presumed infection, the presence of local factors at the site of infection that might modify the efficacy of particular antimicrobial agents, and the route of delivery that should be employed. Thus if infection of the CNS is suspected, drugs that reach effective concentrations within the CNS should be employed in doses adequate to achieve this objective (Table 17-1). However, there are exceptions. For example, although not recommended, meningitis caused by high-level penicillin-resistant *Streptococcus pneumoniae* has been successfully treated with antibiotics that typically do not penetrate the CNS well. This may be a result of increased penetration resulting from inflammation.

Local factors that modify the effectiveness of particular antimicrobial agents include the following: (a) Inadequately drained infections limit the effectiveness of aminoglycoside therapy even if the organisms present are sensitive *in vitro* because these drugs are far less effective in the presence of

TABLE 17-1.

**Penetration of the Cerebrospinal Fluid by Different Antimicrobial Agents**

**Penetrate noninflamed meninges:** chloramphenicol, trimethoprim-sulfamethoxazole, isoniazid, rifampin, pyrazinamide, flucytosine, fluconazole

**Penetrate to therapeutic levels in the presence of inflammation:** penicillin, ampicillin, oxacillin, nafcillin, ticarcillin, azlocillin, mezlocillin, piperacillin, cefuroxime, ceftriaxone, ceftizoxime, ceftazidime

**Penetrate poorly or unreliably even in the presence of inflammation:** cephalothin, cefazolin, cephapirin, cefoxitin, cefotetan, all aminoglycosides, vancomycin, fluoroquinolones, ketoconazole, itraconazole, amphotericin B

pus (both aminoglycosides and vancomycin are bound by pus, limiting their antimicrobial activity) and in conditions of low pH and low oxygen tensions.<sup>20</sup> (b) The requirement for oxygen-dependent transport for aminoglycosides to penetrate the outer membranes of susceptible bacteria explains the latter point and why they are generally ineffective against anaerobic bacteria.<sup>21</sup> (c) In the presence of mixed infections,  $\beta$ -lactamases produced by such organisms as *Bacteroides fragilis* can cause local inactivation of  $\beta$ -lactam antibiotics and failure to clear organisms from the site that are sensitive in vitro to the  $\beta$ -lactam drug.<sup>20</sup> (d) Penicillins and tetracyclines bind to hemoglobin, thus rendering therapy with these drugs less effective with infected hematomas.<sup>22</sup> (e) In most instances, the continuing presence of a foreign body at the site of infection will prevent the elimination of the microbial invaders even with the best antimicrobial regimen available.<sup>23</sup> Finally, antimicrobials such as trimethoprim-sulfamethoxazole, fluoroquinolones, and fluconazole can be administered orally and still achieve blood levels that are comparable to those obtained with parenteral therapy, provided gastrointestinal function is adequate and, at least in the case of levofloxacin, food or substances containing divalent metal ions are not given at the same time. In addition, even if therapy is initiated intravenously, completion of a course of treat-

ment can be accomplished with a more cost-effective oral regimen once the patient stabilizes.

**Absorption**

The amount of drug that reaches the systemic circulation from the gastrointestinal tract after oral administration is expressed as a percentage of the total amount administered via this route. Although such measurements can be carried out from any site of administration, the term *bioavailability* is usually reserved for the evaluation of the degree and reliability of oral administration. A number of factors which, if present, can have an effect on bioavailability must be kept in mind: the *first-pass effect* in which drugs that are absorbed in the small intestine are metabolized in the liver; *metabolism* by drug-metabolizing enzymes in the gut; and the *presence of diseases* such as inflammatory bowel disease, parasitic infestation, and diarrhea of any etiology.

**Postantibiotic Effect**

Some antibiotics continue to suppress the growth of certain bacteria after the antibiotic is no longer detectable in the media; a phenomenon termed the *postantibiotic effect* (PAE). For example, following a 2-hour exposure of susceptible staphylococcal cultures to penicillin, growth is still inhibited for 1.4–1.6 hours after multiple washings removed the penicillin.<sup>24</sup> Although PAE can be demonstrated for virtually all antimicrobials, the bacteria affected and the duration of the effect are highly variable.  $\beta$ -Lactam antibiotics, with the exception of carbapenems such as imipenem, have significant PAEs only for some gram-positive bacteria. In contrast, most antimicrobials that inhibit protein or nucleic acid synthesis in gram-negative bacteria generally exhibit a PAE for these organisms. For example, for gram-negative bacteria, aminoglycosides and fluoroquinolones produce PAEs of 1–4 hours in duration, whereas  $\beta$ -lactams have essentially no PAEs. Importantly, the PAE duration tends to be reduced for aminoglycosides and fluoroquinolones in acidic media as might be encountered in necrotic tissue. A related but poorly understood phenomenon is that during the PAE phase, bacteria are more susceptible to killing by leukocytes, an effect termed *postantibiotic leukocyte enhancement* (PALE).<sup>25,26</sup> In addition,

the PAE itself may be prolonged by leukocytes.

**Concentration-Dependent and Time-Dependent Killing Agents**

The distinction between time-dependent and concentration-dependent killing coupled with the presence or absence of a PAE has important clinical ramifications, particularly with respect to dosing intervals. For antimicrobial–bacteria combinations that exhibit time-dependent killing, especially when there is no PAE, the duration that the antimicrobial level is above the lethal range should be important. There is general agreement that for  $\beta$ -lactams to be effective, their concentration must be well above the MIC for most of the dosing interval. This is especially true for gram-negative bacteria, which usually do not exhibit PAE for  $\beta$ -lactams. However, there are very few human studies with continuous infusions and it is puzzling that continuous infusions of  $\beta$ -lactams have not uniformly proven superior to more conventional dosing schedules in animal models of infection.<sup>27</sup>

In contrast, for antibiotic–bacteria combinations that do exhibit concentration-dependent killing and significant PAEs, it may be more important to achieve very high peak levels and allow the trough to decrease below the MIC because efficacy will still be maintained by the PAE while toxicity might be minimized. This is the theoretical basis for the success of once-daily dosing of aminoglycosides. For combinations of antibiotics, the situation is more complicated. The PAEs for gram-positive bacteria are increased either additively or synergistically when aminoglycosides are added to cell-wall active antibiotics. However, this does not occur with gram-negative bacteria except when imipenem was used with an aminoglycoside.<sup>28</sup>

These considerations led to the concept that administering aminoglycosides in large doses once daily would prove more beneficial and less toxic than the usual standard of three times daily.<sup>29</sup> In particular, because aminoglycosides exhibit concentration-dependent killing, concentrations that reach a level 8–10 times the MIC will rapidly kill all susceptible bacteria and suppress the survival of higher MIC mutants. Because of the PAE, suppression can be sustained during the period that the concentration drops below

the MIC. The maintenance of drug-free intervals for a period before the next dose may also help prevent adaptive resistance, which may occur from decreased aminoglycoside uptake by bacteria exposed to lower levels of the drug. Finally, because renal uptake is saturable, the very high initial levels are not accompanied by proportionally increased renal uptake. Consequently, renal toxicity should not increase. Numerous studies show that in most patients, and even in febrile neutropenic patients, these tenets seem to hold: efficacy is at least equal to multiple daily dosing and renal toxicity is not increased.<sup>30,31</sup>

## Resistance

### General Concepts

Bacteria may be intrinsically resistant to antimicrobials or they may acquire resistance. *Intrinsic resistance* reflects a natural resistance to an antimicrobial, and is demonstrated when bacteria encounter an antimicrobial that has no effect on the organisms, even though no new genetic information has been acquired. For example, vancomycin is ineffective against gram-negative bacteria because it cannot penetrate their outer membrane. *Acquired resistance* reflects a genetic alteration in the bacteria that renders a once effective antimicrobial ineffective. The general mechanisms for bacterial resistance to antimicrobials are (a) decreased permeability to the antimicrobial, thus preventing its entry; (b) increased efflux pumps that keep the antimicrobial concentrations in the space between the inner and outer membranes of gram-negative bacteria and/or the cytoplasm low; (c) antimicrobial inactivation; (d) modification of the antimicrobial target; and (e) development of pathways that bypass the target. The genes encoding these phenotypes may be chromosomal or plasmid/transposon in origin, inducible or constitutive. Methicillin-resistant *Staphylococcus*, vancomycin-resistance in *Enterococcus*, and broad-spectrum  $\beta$ -lactam resistance in gram-negative organisms have important diagnostic and therapeutic implications, particularly in the hospital setting.<sup>32–36</sup>

In gram-negative bacteria, antimicrobials usually must penetrate the outer membrane via specialized channels termed porins. Alterations in the permeability of porins to specific antimicrobials can either prevent sufficient

quantities from entering the bacteria or limit the rate of entry to the extent that even a relatively low inactivation rate is sufficient to render them ineffective. The former is a frequent cause of *P. aeruginosa* resistance to aminoglycosides and carbapenems, and the latter allows many gram-negative bacteria to inactivate  $\beta$ -lactams via  $\beta$ -lactamases. Increased active efflux of antimicrobials is a less common mechanism of resistance but can be important for macrolides, fluoroquinolones, some  $\beta$ -lactams, and, possibly, meropenem.

Inactivation is the predominant mechanism of resistance for several classes of antimicrobials. Aminoglycosides can be inactivated by both gram-positive and gram-negative bacteria, usually by plasmid-mediated enzymes. These enzymes modify specific sites on the aminoglycoside molecule, such that acetylation, adenylation, or phosphorylation takes place. These modified aminoglycoside molecules bind poorly to the ribosome target, rendering them inactive in their interaction with normally susceptible bacteria.

Perhaps the most comprehensively studied and categorized inactivating enzymes are the  $\beta$ -lactamases. There are an enormous number of these enzymes. They are often characterized by their genomic sequence and the  $\beta$ -lactams they can hydrolyze. Virtually every  $\beta$ -lactam, monobactam, or carbapenem can be inactivated by one or more of these enzymes. Target modifications in penicillin-binding proteins account for methicillin resistance in staphylococci and penicillin resistance in pneumococci and enterococci. Finally, bypass pathways account for vancomycin resistance in *Enterococcus faecium* and resistance of many bacteria to folate antagonists such as trimethoprim-sulfamethoxazole.

### Specific Mechanisms

Perhaps the best-studied and most problematic mechanism of antimicrobial resistance is the  $\beta$ -lactamases. There are at least 340 different  $\beta$ -lactamases, one or more of which can inactivate virtually any  $\beta$ -lactam-based antimicrobial. The classification of  $\beta$ -lactamases is constantly evolving and is based both on phenotype and genotype. The class A  $\beta$ -lactamases comprise the largest group and include the extended-spectrum  $\beta$ -lactamases that can inactivate third-generation cephalosporins and aztreonam.

Fortunately, most of these enzymes can be inhibited by  $\beta$ -lactamase inhibitors that may be used in conjunction with selected  $\beta$ -lactams.

Class C  $\beta$ -lactamases can inactivate virtually all classes of  $\beta$ -lactams except the carbapenems and are not inhibited by  $\beta$ -lactamase inhibitors. These enzymes are largely derived from the chromosomal *Escherichia coli* ampC gene but they may also be plasmid borne. They tend to be produced by *Enterobacter*, *Citrobacter*, *Serratia*, *Pseudomonas*, and some species of *Proteus*. Certain  $\beta$ -lactam antibiotics induce this enzyme. Clinical failure associated with the emergence of resistance often occurs when serious *Enterobacter* infection is treated with a cephalosporin despite initial cephalosporin susceptibility.<sup>37</sup> Thus, cephalosporins should be used carefully in the setting of infection with the above-mentioned gram-negative pathogens.<sup>32</sup>

Although  $\beta$ -lactamases are produced by some gram-positive bacteria, notably staphylococci (but not streptococci) and many anaerobes, the efficacy of these  $\beta$ -lactamases is limited because they are diluted by the extracellular space as opposed to being confined in the periplasmic space in gram-negative bacteria.<sup>38</sup> Although plasmid encoded  $\beta$ -lactamases cause staphylococcal resistance to many penicillins, resistance of some staphylococci and other gram-positive bacteria can also occur by completely different mechanisms. For example, methicillin-resistance in *Staphylococcus aureus* (MRSA) is a result of the chromosomal presence of the *mecA* gene, which decreases the binding affinity of methicillin to penicillin binding proteins. Similarly, ampicillin-resistant *E. faecium* has an altered penicillin-binding protein that has a greatly reduced affinity for these antibiotics and most  $\beta$ -lactams. In contrast, vancomycin resistance in enterococci is related, in the majority of cases, to a multigene plasmid, which is easily spread among enterococci. This plasmid alters a terminal amino acid group in one of the cross-linking amino acids that prevents vancomycin from binding to the growing cell membrane.<sup>39,40</sup>

It is astonishing that the first time vancomycin-resistant enterococci (VRE) were observed was in 1986,<sup>41</sup> and within 15 years it represented more than 24% of U.S. ICU enterococcal isolates. Unfortunately, there are limited options for the treatment of severe infections relat-



ed to VRE, which are typically also resistant to ampicillin and aminoglycosides. Several new agents that have efficacy against VRE and other resistant gram-positive bacteria have been approved by the FDA: quinupristin-dalfopristin, a combination of streptogramins; linezolid, an oxazolidinone; and tigecycline, a glycylcycline.<sup>42,43</sup> The optimal treatment programs using these drugs, however, remain to be defined.

There is great concern that *S. aureus* will acquire the vancomycin-resistance determinant from enterococci. This was first shown to be possible in the laboratory,<sup>44</sup> and scattered clinical cases have now been reported of MRSA strains with both decreased vancomycin susceptibility known as vancomycin-intermediate *S. aureus* (VISA), and vancomycin-resistant *S. aureus* (VRSA).<sup>45</sup> The mechanism for this diminished susceptibility appears to be a consequence of a thickening of the cell wall leading to decreased antibiotic penetration and sequestration of vancomycin, rather than the transfer of vancomycin-resistance genes from enterococcus leading to an altered vancomycin-binding target.<sup>46–48</sup>

### Emerging Bacterial Resistance

In the last decade, there has been a dramatic increase in the development and dissemination of antibiotic-resistant organisms. Many factors have contributed to the marked increase in resistance; however, indiscriminate broad-spectrum antibiotic use is an important factor.<sup>49</sup> Other factors that will select for resistance include the use of too low a dose for too short a period of time. Thus, it is critically important to use antimicrobials judiciously, as overuse will facilitate the propagation of pathogens that are difficult or impossible to treat. One example of antimicrobial misuse is in farming, where the widespread deployment of antimicrobials to animals has not only resulted in resistant flora on the farms, but also with the spread of such resistant organisms to humans.

### Combination Antimicrobial Therapy

A common practice, in the hospital use of antimicrobial agents, is “double coverage” in an effort to improve efficacy and “prevent resistance from developing.” Indeed, *in vitro* studies often suggest benefits from such an approach, with at least the following five reasons justify-

ing the combination therapy proposed: (a) prevention of the development of antimicrobial resistance; (b) known or suspected polymicrobial infection; (c) initial therapy; (d) decreased toxicity; and (e) synergistic therapy.

### Prevention of the Development of Antimicrobial Resistance

Combination therapy to prevent development of resistance is most effective when the mechanism for resistance involves chromosomal mutations, with the merits of combination therapy being most easily seen with tuberculosis. The microbial burden in a particular patient and the known rate of mutational resistance to each of the antituberculous drugs are the major determinants of the most effective regimen for a particular patient. Thus, in a nonimmunosuppressed host, primary tuberculosis is associated with a microbial burden of  $\sim 10^4$  organisms; noncavitary, reactivation disease of the lungs, a microbial burden of  $10^{6-8}$ ; cavitary disease, a microbial burden of  $10^{8-10}$ , and so forth. The rate of mutation to resistance for the drugs is as follows: 1 in  $10^6$  for isoniazid and ethambutol; 1 in  $10^8$  for rifampin; and 1 in  $10^5$  for streptomycin. Consequently, the treatment for primary tuberculosis typically requires a single drug (usually isoniazid), noncavitary reactivation disease requires two drugs, and so forth. Although other factors enter into the design of the therapeutic program, the approach outlined fits with the efforts to avoid resistance. However, chromosomal mutation is an uncommon mechanism of resistance (the great majority of bacterial resistance is a result of the acquisition of a plasmid or transposon that mediates resistance). Thus, the prevention of development of resistance is not an adequate reason for combination therapy of pyogenic infection.

### Known or Suspected Polymicrobial Infection

This is a legitimate reason for deploying multiple drugs. For example, a perforation of the distal colon will result in the release of anaerobes (particularly *B. fragilis*), gram-negative bacilli, and bowel streptococci (including enterococci) into the peritoneal cavity. This event has traditionally required a 2- or 3-drug regimen (e.g., ampicillin, metronidazole, and gentamicin) to deal with the range of organisms. The

only difference today is the availability of single agents with a spectrum of activity that will accomplish the same task. Such single agents as carbapenems,  $\beta$ -lactam- $\beta$ -lactamase combinations, and newer fluoroquinolones can provide the same coverage as the older multidrug regimens.

### Initial Therapy

When the initial assessment of a patient suggests the possible presence of a therapeutic emergency, then broad-spectrum therapy is obligatory, at least until the results of cultures are available. The issue that remains controversial is whether this is best accomplished with a single drug or multiple drugs. There is incomplete evidence that the combination of a  $\beta$ -lactam with an aminoglycoside provides a higher probability of success than a single drug, particularly if *P. aeruginosa* is thought to be involved. Our approach is to initiate therapy with an antipseudomonal  $\beta$ -lactam and an appropriate aminoglycoside, and then discontinue the aminoglycoside once the patient has “come under control.”

### Decreased Toxicity

A principle of cancer chemotherapy is that the toxicity of such therapy can be decreased by using multiple drugs with different mechanisms of action and toxicities at lower doses. Unfortunately, the efficacy of this approach in the treatment of significant infection remains to be demonstrated.

### Synergistic Therapy

*In vitro* synergistic killing of both gram-positive and gram-negative bacteria has been demonstrated. The greatest evidence for this is when appropriate  $\beta$ -lactams are combined with aminoglycosides. Whether this can be demonstrated in clinical situations is unknown. The best evidence of the usefulness of synergistic therapy comes from the study of patients with endocarditis. Treatment of enterococcal endocarditis with penicillin (or ampicillin) alone results in a bacteriostatic regimen, and a distinctly inferior clinical outcome compared with that achieved with the addition of streptomycin or gentamicin to the penicillin. Enterococcal strains with high levels of aminoglycoside resistance (MIC >2000  $\mu\text{g/mL}$ ) do not have the potential for bactericidal therapy, and have a distinctly poorer outcome. Nonenterococ-



cal streptococci also can be shown to benefit from combination therapy requiring shorter courses of therapy if a penicillin is combined with gentamicin.

Part of the problem with existing studies is the lack of stratification of patients into “therapeutic emergency” versus “a need for parenteral therapy” versus “outpatient management.” As a result, even with the lack of definitive evidence, our approach to staphylococcal endocarditis is as follows: stable patients will get single-drug therapy with nafcillin; those who are more ill (e.g., hemodynamically unstable, evidence of emboli) receive potentially synergistic therapy with a minimum of two drugs. A similar approach is taken with infection caused by *P. aeruginosa*. Many experienced clinicians employ potentially synergistic therapy of this type for other serious gram-negative infections, particularly those occurring in compromised hosts, despite a lack of compelling evidence.

### CLINICAL PHARMACOLOGY: GENERAL PRINCIPLES OF THERAPEUTIC ANTIMICROBIAL USE

Effective antimicrobial therapy requires the integration of a sizable body of information regarding the patient, the invading microbe(s), and the antimicrobial agents themselves into an effective antimicrobial prescription. Several factors must be considered in creating such a prescription, including those discussed below.

#### Identity of the Organism

The identity of the infecting organism(s) must be known, or at the very least, it must be possible to make a high probability assessment of the most likely culprit(s). The initial choice of antimicrobial agents is usually based on probability assessments of the most likely pathogen(s) causing a particular clinical syndrome, with subsequent adjustment of the regimen once specific microbiologic information becomes available. Important factors to be weighed in determining the likely infecting organism include the probable source (e.g., vascular access device, lung, or urinary tract) and whether the infection is likely to be community-acquired or nosocomial. Other issues of importance include recent antibiotic use, the presence of

such growth factors as iron and elevated blood sugar, and the presence of devitalized tissue.

#### Urgency of Treatment

The key question is whether one is dealing with a therapeutic emergency or a diagnostic dilemma. In the former case the broadest possible regimen should be used initially with later modifications based on precise microbiologic information. This is often termed “front loading” of the antimicrobial regimen. In the latter case, narrower spectrum initial therapy is possible, with fine-tuning of the regimen once specific information is available.

#### Epidemiology

Epidemiologic considerations must also be factored into antimicrobial decision making. When dealing with primary illnesses acquired in the community, the nature and timing of possible exposures must be considered. Important exposures include the geographically restricted systemic mycoses (*Blastomyces dermatitidis*, *Coccidioides immitis*, and *Histoplasma capsulatum*), *Mycobacterium tuberculosis*, influenza, group A streptococci, *Legionella*, and meningococcus. Even more important is the special epidemiology of the nosocomial environment, be it a nursing home, a hospital, or a specialized area of the hospital such as an ICU. Specifically, the microbiologic flora within a hospital, of even a particular ICU within the hospital, and their respective resistance patterns are essential information. The rising incidence of infection with diffi-

cult to treat organisms such as methicillin-resistant *S. aureus*, vancomycin-resistant enterococci, and multiresistant gram-negative bacilli is having a profound influence on the initial choice of antibiotics. For example, vancomycin is usually preferred over nafcillin as initial therapy for suspected staphylococcal infection, and advanced-spectrum  $\beta$ -lactam agents such as imipenem rather than cefazolin or gentamicin for gram-negative infection that could be caused by highly resistant *Klebsiella* species.<sup>50,51</sup> It is likely that these problems with antibiotic resistance will increase, not just in terms of these organisms but also with rising incidences of infections with penicillin-resistant pneumococci<sup>52,53</sup> and ampicillin-, vancomycin-, and gentamicin-resistant enterococcal (Table 17-2).<sup>53</sup> These considerations highlight the importance of the reservoir of a given organism and the selective pressure that reservoir is under, for example, *Salmonella* and *Campylobacter* in domestic animals versus *S. pneumoniae* in the community at large versus resistant gram-negative rods in the nosocomial environment.<sup>54,55</sup> By understanding the reservoir, the prevalence of antimicrobial resistance in the reservoir, and the risk of exposure of a patient to a given organism, one can determine appropriate initial antimicrobial therapy. The implication of these principles is 2-fold. First, every hospital and patient area within the hospital must engage in ongoing surveillance of the most common organisms and antimicrobial susceptibility patterns causing nosocomial in-

TABLE 17-2.

Emergence of Antibiotic Resistance

Resistant to	Bacteria	% Resistance by Year		
		1998	1998–2002 <sup>a</sup>	2003
Vancomycin	Enterococci	23.9	25.4	28.5
Methicillin	<i>Staphylococcus aureus</i>	46.7	53.6	59.5
Third-generation cephalosporin	<i>Klebsiella pneumoniae</i>	10.7	14.0	20.6
Third-generation cephalosporin	<i>Enterobacter</i> spp.	34.0	33.1	31.1
Imipenem	<i>Pseudomonas aeruginosa</i>	17.1	18.3	21.1
Quinolones	<i>Pseudomonas aeruginosa</i>	23.3	27.1	29.5

<sup>a</sup>Average percent resistant from 1998 to 2002.  
Data from National Nosocomial Infections Surveillance (NNIS).<sup>62,131</sup>

fection in their particular units. Second, decisions about antimicrobial use should take into consideration such information, particularly in patients who have been subjected to the selection pressures of previous courses of antibiotics that will have rendered them more vulnerable to colonization and/or invasion with resistant flora.

### Host Factors

A number of host factors must be considered in formulating an antimicrobial regimen. These can be divided into three groups: those that increase a patient's risk for a specific type of infection; those that increase a patient's risk of complications from an infection such as the presence of prostheses such as artificial joints, synthetic vascular grafts, or cardiac valves, and those that increase the risks of treating an infection with specific drugs.

### Specific Drug Risks

Perhaps the most important consideration is the history of previous adverse reactions to the drugs in question. Great precision is needed in defining the nature of the adverse reaction. For example, nausea, vomiting, and diarrhea, particularly after oral administration, do not preclude the use of an antimicrobial agent, especially intravenously. In contrast, a history of anaphylaxis, Stevens-Johnson syndrome, toxic epidermal necrolysis, or allergic interstitial nephritis does preclude further use of an antimicrobial agent. Commonly, the exact nature of the allergy is unclear. In this circumstance, either the class of drug implicated should be avoided or else skin testing with a subsequent desensitization regimen should be performed.

The presence of renal dysfunction in the patient being treated can also have a profound effect on antimicrobial therapy (Table 17-3). Antimicrobials cleared by the kidney require an alteration in the dosage regimen with renal impairment. Unless such adjustments are made, toxic side effects may occur, such as injury to the eighth cranial nerve or renal injury with aminoglycosides,<sup>56</sup> seizures with penicillin and imipenem,<sup>57</sup> and bleeding caused by platelet dysfunction (added to that already caused by the uremic state) induced by ticarcillin, mezlocillin, and piperacillin.<sup>58</sup> Although many drugs are cleared or metabolized by the liver, hepatic dysfunction usually

requires less adjustment of antimicrobial therapy than does renal dysfunction. In general, little dosage adjustment is required until the bilirubin exceeds 5 mg/dL. With hepatic dysfunction chloramphenicol, clindamycin, the tetracyclines, and the antituberculous drugs isoniazid and rifampin should be avoided, if possible.<sup>59</sup> (In the case of the antituberculous drugs, if they are required for emergency therapy, then special effort should be made to monitor blood levels in the face of serious hepatic dysfunction.) When both renal and hepatic dysfunction are present, then therapy with essentially all  $\beta$ -lactam antimicrobial agents should be carried out with great care.<sup>60</sup>

### Impaired Host Defenses

Special considerations need to be extended to those patients who have specific impairments in host defenses. Impairment may be anatomical such as cutaneous ulcerations or mucosal abnormalities, or it may be secondary to functional host defense defects such as neutropenia, asplenia, malignancy, immunosuppressive therapy, and HIV infection. Patients with prosthetic heart valves, prosthetic joints, vascular grafts or other prostheses, can suffer dire consequences from metastatic spread of infection if initial therapy is inadequate. Therefore, such patients should be considered for front-loading of the regimen, ideally with a bactericidal drug, even if their initial clinical state would not normally require it.

### Pregnancy

A critically ill patient who is pregnant, and for whom termination of the pregnancy is not an option, represents a particular challenge. First, the pharmacokinetics of many antibiotics are altered in pregnancy because of a larger volume of distribution and increased glomerular filtration rate. Second, the database on the safety of different antibiotics during pregnancy is woefully incomplete. However, the following appear reasonable at the present time. Penicillins (except ticarcillin, which is teratogenic in rodents), cephalosporins, and macrolides appear to be relatively safe. Aminoglycosides and isoniazid should only be prescribed if absolutely necessary because the former may be associated with eighth cranial nerve dysfunction

TABLE 17-3.

### Use of Antimicrobial Agents in the Presence of Renal or Hepatic Dysfunction

*Contraindicated in the presence of renal failure:* tetracyclines (except doxycycline), nitrofurantoin, ceph-aloridine, long-acting sulfon-amides, methenamine, paraami-nosalicylic acid

*Require no dosage change in the presence of renal failure:* erythro-mycin, azithromycin, clarithromy-cin, clindamycin, chloramphenicol, doxycycline, cefoperazone, nafcillin, oxacillin, rifampin, amphotericin B, ceftriaxone, metronidazole, grepafloxacin, minocycline, linezo-lid, quinupristin/dalfopristin

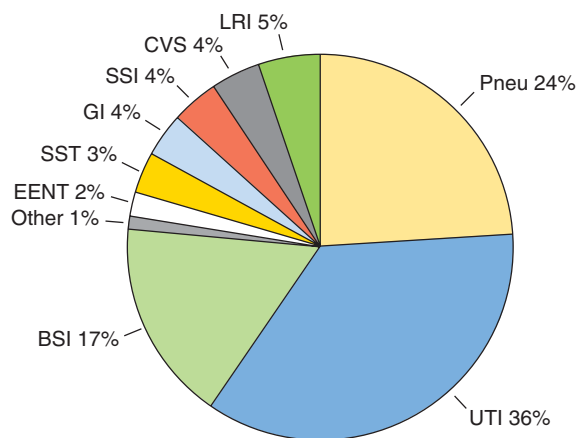
*Require dosage adjustment with mod-erate renal failure:* carbenicillin, ti-carcillin, cefazolin, all aminoglyco-sides, vancomycin, imipenem, flucytosine, penicillin G, 5-fluorocy-tosine, fluconazole

*Require dosage adjustment only with severe renal failure:* ampicillin, ce-foxitin, cefotaxime, ceftizoxime, piperacillin, isoniazid, ethambutol, trimethoprim-sulfamethoxazole, cefotetan, ceftazidime, cefuroxime, mezlocillin, meropenem, nalidixic acid, ciprofloxacin, ofloxacin, levo-floxacin, norfloxacin, itraconazole

*Avoid or dose adjust in the setting of significant hepatic dysfunction (e.g., bilirubin >5 mg/dL):* quinu-pristin/dalfopristin, chlorampheni-col, clindamycin, lincomycin, all the tetracyclines, cefoperazone, ceftri-axone, metronidazole, nafcillin, ni-trofurantoin, fusidic acid, isoniazi-id, rifampin, rifabutin, pyrazinamide, rimantadine, keto-conazole, fluconazole, itraconazole

Modified with permission from Amsden GW.<sup>132</sup>

in the infant and the latter with an increased incidence of psychomotor retardation, myoclonus, and seizures. Metronidazole, ticarcillin, rifampin, trimethoprim, the fluoroquinolones, and the tetracyclines should be avoided completely because of the potential for injuring the developing fetus. In addition, tetracycline use in the pregnant woman is associated with acute fatty necrosis of the liver, pancreatitis, and possibly renal injury.<sup>61</sup>



**FIGURE 17-1.** Site distribution of 2321 nosocomial infections in coronary care units, NNIS System, 1992–1997. BSI, primary bloodstream infection; CVS, cardiovascular system infection; EENT, eye, ear, nose throat infection; GI, gastrointestinal infection; LRI, lower respiratory tract infection other than pneumonia; PNEU, pneumonia; SSI, surgical site infection; SST, skin and soft-tissue infection; UTI, urinary tract infection. (Reproduced with permission from reference NNIS.<sup>131</sup>)

### PRACTICAL ASPECTS OF DRUG ADMINISTRATION: ANTIMICROBIAL THERAPY OF PARTICULAR CLINICAL SITUATIONS

When choosing the appropriate antibiotic therapy it is critical to decide if the infectious process is nosocomially acquired or present at admission, that is,

community acquired. Of the nosocomially acquired infections, the National Nosocomial Infections Surveillance (NNIS) system has demonstrated that almost 80% occur in three sites: 24% in the respiratory system, 17% in the bloodstream, and 36% in the urinary tract. The majority of the remaining 19% of nosocomial acquired infections are associated with the gastrointestinal

tract, cardiovascular system, skin and soft tissue, surgical site, or ear, eye, nose, and throat, as shown in Fig. 17-1. Table 17-4 lists the primary pathogens associated with these various sites. It is important to recognize that gram-positive pathogens, particularly *Staphylococcus epidermidis*, *S. aureus*, and enterococci are the leading bloodstream pathogens, whereas *S. aureus* and gram-negatives, particularly *P. aeruginosa*, are the predominant pathogens associated with nosocomial pneumonia. In addition to *S. aureus* and *P. aeruginosa*, *E. coli* and *Candida albicans* are the primary pathogens found in urinary tract infections, with the great majority of these being associated with urinary tract instrumentation.<sup>62-68</sup> These data are consistent across continents.<sup>68</sup>

It is of interest that *Candida* species now account for the fourth most common cause of nosocomial bloodstream infection. Ten years ago it was 24<sup>th</sup>, a testimonial to the increasing importance of this organism, particularly in ICU patients.

The incidence of nosocomial infections is highly associated with the use of devices such as ventilators, vascular access catheters, and urinary cath-

**TABLE 17-4.**

**Primary Pathogens in Nosocomially Acquired Infections**

Pathogen	Blood Stream Infection		Pneumonia		Urinary Tract Infection	
	CCU (n = 1159)	ICU (n = 2971)	CCU (n = 1635)	ICU (n = 4389)	CCU (n = 2321)	ICU (n = 4956)
SCN	37	36	2	1	3	2
SA	24	13	21	20	3	2
<i>Enterococcus</i>	10	16	2	2	14	14
<i>Escherichia coli</i>	3	3	4	4	28	14
<i>Enterobacter</i>	3	3	9	9	4	5
<i>Candida albicans</i>	2	6	6	5	10	21
<i>Klebsiella pneumoniae</i>	2	4	8	8	6	6
<i>Serratia marcescens</i>	2	1	4	4	1	0.7
<i>Pseudomonas aeruginosa</i>	2	3	14	21	7	10
Other <i>Candida</i>	2	3	0.2	1	4	5
<i>C. glabrata</i>	2	2	3	0.2	3	5
<i>Acinetobacter</i>	1	2	3	6	0.2	1
Other fungi	1	0.8	2	1	5	8
<i>Proteus mirabilis</i>	0.6	0.5	2	2	4	2
<i>Citrobacter</i>		0.58		2		1
<i>Streptococcus pneumoniae</i>	0.4		2		0	
<i>Haemophilus influenzae</i>	0.1		3		0	
Other	7	6	16	14	8	3

CCU, critical care unit; MICU, medical intensive care unit; SA, *Staphylococcus aureus*; SNC, coagulase-negative *Staphylococcus*.

Data derived from the National Nosocomial Infections Surveillance (NNIS) database elucidating the relative frequency of various pathogens by site of infection and by type of ICU (MICU vs. CCU). Data were obtained from 1992 to 1997.

Adapted from Richards MJ, Edwards JR, Culver DH, et al;<sup>65,66</sup> National Nosocomial Infections Surveillance;<sup>131</sup> el-Ebiary M, Tomes A, Fabregas N, et al;<sup>133</sup> and Kauffman CA, Vazquez JA, Sobel JD, et al.<sup>134</sup>

ters. This is likely a result of the breakdown of normal host defenses and clearance mechanisms. In addition, the various devices may support various microorganisms differently. For example, the development of biofilms on urinary and central venous catheters enhances the adherence of certain microorganisms such as *E. coli* and impairs the penetration of antimicrobials, whereas the condensation of water in ventilator circuits is a conducive environment for *Pseudomonas* and *Acinetobacter*.<sup>66</sup> The rate of device-related infections per 1000 device days also varies by type of ICU from 3.0 (cardiothoracic) to 6.7 (burn) for urinary catheter-associated urinary tract infections; from 2.7 (cardiothoracic) to 7.0 (burn) for central line-associated bloodstream infections; and from 4.9 (medical) to 12.0 (burn) for ventilator-associated pneumonia.<sup>62</sup>

### Catheter-Related Infections

Intravascular access devices are common causes of bacteremia and fungemia. A catheter-related infection is defined as a bacteremia or fungemia in a patient with a central venous catheter who has at least one positive blood culture drawn at a peripheral site, clinical manifestations of an infection and no apparent source for the infection except the catheter. A positive semi-quantitative (>15 colony-forming units [CFU]/catheter segment) or quantitative (>1000 CFU/catheter segment) culture of the same organism from a catheter segment (usually the tip) should also be present.<sup>69,70</sup> The most widely used diagnostic technique to assay for catheter infection is a semi-quantitative method, which involves rolling the catheter tip across an agar plate and then counting the number of CFU after overnight incubation. A positive culture drawn through a catheter is relatively nonspecific but a negative culture generally rules out a catheter-related infection because of the low false-negative rate. It is difficult to find current data on the risk of bacteremia associated with various vascular devices, probably because of the large variation in type of catheter (antibiotic coated or not), techniques (skin preparation), care of the site, and barrier precautions between regions of the country and hospitals within a region.

To put this risk in perspective, it is worth noting that 50,000–100,000 patients in U.S. hospitals develop nosoco-

mial bloodstream infections (BSIs) each year, with 70–90% of these infections being related to central venous catheters of various types.<sup>62,71</sup> Such infections are associated with a mortality of 25–35% and a 2- to 3-fold increase in attributable mortality. The Infectious Diseases Society of America has published guidelines for the management of intravascular catheter-related infections, as has the Centers for Disease Control and Prevention (CDC).<sup>69,70</sup> Although the guidelines state that “there is a notable absence of compelling clinical data to make firm recommendations for an individual patient,” understanding the pathogenesis and virulence of the typical organisms involved still permits this problem to be approached rationally.

For nontunneled central catheters, the organism usually comes from a colonized catheter, often the hub or lumen. These organisms usually reflect the flora of the skin. *S. epidermidis*, *S. aureus*, *Enterococcus* species, and *Candida* species are the prime culprits, but gram-negative bacilli also cause infection. The latter is particularly true when there is gram-negative infection of the respiratory tract or surgical wounds and drains as they increase the incidence of gram-negative skin colonization and hence the reservoir of organisms from which infection is derived. This pathogenic mechanism explains the increasing infection rate associated with central line position (femoral > internal jugular > subclavian). Presumably, internal jugular catheter infection is more likely than subclavian catheter infection because the former is more likely to be exposed to orotracheal secretions. One solution has been to use antibiotic-impregnated catheters, which have been shown to prevent microbial contamination of the catheter and subsequent bacteremia in some, but not all studies. In one study, catheter-associated bacteremia decreased from 3.4% to 0.3% with the use of a minocycline- and rifampin-impregnated catheter.<sup>72</sup> However, these results should be interpreted cautiously because these coatings may lead to false-negative culture results.

Initial therapy of suspected intravascular catheter infection usually includes vancomycin because of the high prevalence, in the nosocomial environment, of methicillin-resistant *S. aureus* and *S. epidermidis*. Additional coverage directed at gram-negative organisms

should be considered if gram-negative infection is present at other bodily sites or if the patient manifests cardiovascular instability that is thought to be a result of infection. Empiric therapy directed at vancomycin-resistant enterococci is rarely indicated, as this organism is an unusual cause of acute hemodynamic instability. Antifungal therapy is also not initiated unless there is microbiologic evidence of fungal infection. Once the offending bloodstream pathogen is identified and its resistance profile known, focused antimicrobial therapy should be used.

There are several important issues to consider in the treatment of the common BSI pathogens. *S. epidermidis* is often a contaminant. However, when it does cause a BSI, it typically behaves as a relatively avirulent pathogen. Consequently, it usually can be treated with removal of the catheter and a short course of antibiotics. Nonetheless, this organism has a propensity to adhere to prosthetic devices such as cardiac valves and artificial joints. Therefore, when *S. epidermidis* bacteremia occurs in such a patient, one must carefully evaluate the prosthetic device for evidence of secondary infection. In light of these considerations, patients with indwelling prostheses should be considered at higher risk for consequences of central catheter placement, and they should be discontinued at the earliest opportunity.

*S. aureus*, on the other hand, is an extremely virulent organism, which in the setting of bacteremia, often disseminates and causes osteomyelitis, endocarditis, and other severe, destructive infections. Thus when a bacteremia with this organism is confirmed a careful evaluation for metastatic infection should occur and prolonged therapy (2–4 weeks) is often recommended. Enterococcal BSI behaves in a similar manner as *S. epidermidis* and typically responds to removal of the catheter. However, endocarditis may occur, particularly in the setting of prolonged bacteremia. The optimal therapy for this organism is ampicillin plus an aminoglycoside although some of the newer antibiotics show therapeutic promise. When *C. albicans* is cultured from the blood, the patient should be evaluated for metastatic infectious foci (e.g., hepatic, ocular, and skin), the catheter should be removed, and antifungal therapy initiated, typically with



fluconazole.<sup>73</sup> If metastatic foci of candidal infection are found, the optimal management of these complications will determine the duration of therapy.

## Prophylaxis

### Surgical

**Need for Prophylaxis** The need for antibiotic prophylaxis for surgery depends on the risk of *surgical site infection* (SSI), generally defined as purulence within the wound. SSIs are related to the wound classification, patient-related factors such as immunocompetence, the bacterial milieu and hospital infection rate for various procedures, and factors relating to the wound itself. Wounds are usually classified as clean (class I), clean-contaminated (class II), contaminated (class III) and dirty-infected (class IV).<sup>74</sup> A clean wound is atraumatic in which there has been no break in sterile technique and the respiratory, alimentary, or genitourinary tracts have not been entered. Clean-contaminated wounds result from surgery in areas known to harbor bacteria, such as the biliary, respiratory, alimentary, and genitourinary tracts, when there is no spillage of contents. Contaminated wounds occur with a major break in sterile technique, or with surgery on a traumatic wound, or gross gastrointestinal spillage, or entrance into an infected biliary or genitourinary tract. Dirty-infected wounds are those for which infection existed before the surgery, such as old wounds with devitalized tissue or surgery for patients with perforated viscera. This classification scheme indicates the risk of postoperative infection and is thought to be related to the bacterial burden except for dirty-infected wounds, which are, by definition, already infected. However, careful microscopic examination shows that even clean wounds are contaminated with skin flora.<sup>75</sup>

*Staphylococcus* species are the most common wound pathogens for most SSIs. Prophylaxis is debatable for some clean procedures such as an inguinal hernia repair or mastectomy. However, for other clean procedures, especially for cardiothoracic and vascular surgery, hip or knee arthroplasty, and any procedure when bone is excised or a prosthesis is inserted, gram-positive coverage, usually with cefazolin, is recommended. However because of the increasing incidence of methicil-

lin-resistant *Staphylococcus* not only in hospitals but also in the community, the trend seems to be shifting back toward vancomycin. Prophylactic antibiotics should be administered for all clean-contaminated and contaminated wounds, as well as for hysterectomies and most urologic procedures. Sterilization of the urinary tract is recommended before any urologic procedure if possible. Even with successful treatment of urinary tract infection (UTI), deep-seated infection of the prostate gland can be reactivated by manipulation and/or surgery of the prostate gland. Prophylaxis is advised for high- and moderate-risk patients undergoing procedures involving infected tissues and should include anti-staphylococcal antibiotics for cellulitis and osteomyelitis. Similar coverage is advised for patients receiving prosthetic cardiac valves. Patients with urinary tract infections should receive antibiotics active against gram-negative bacilli such as fluoroquinolones, third-generation cephalosporins, or an aminoglycoside. Convincing evidence of prophylactic antimicrobial benefit is also found in patients undergoing endoscopic manipulation of the biliary tree or in patients undergoing manipulation of an infected urinary tract. For these conditions antibiotics such as ampicillin-sulbactam and piperacillin-tazobactam are reasonable choices.

**Timing of Prophylaxis** It is generally believed intravenous administration of prophylactic antibiotics should be initiated no more than 1 hour before incision. The major impetus for this practice comes from Classen's study that looked retrospectively at the timing of prophylactic antibiotic administration in patients in whom a wound infection was reported.<sup>76</sup> The investigators found that patients who developed wound infections were more likely to have received prophylaxis between 24 and 2 hours prior to surgery or postoperatively. Often missed in this study was that the incidence of wound infection was statistically no different if the antibiotics were initiated within the first 4 hours following incision or in the 2 hours before incision. When the data were subjected to a multiple logistic regression, the only variables related to wound infection were underlying disease, nursing service, type of surgery, duration of surgery and time after the start of surgery

for the first dose of prophylactic antibiotics. Notably, of the 41 wound infections, 58% were resistant to the antimicrobial drug used.

Thus, although this study is widely quoted as showing that prophylaxis must be given within 1 hour of the incision, these data does not support this conclusion. Moreover, this study does not address when the antibiotic infusions were completed and a prospective study validating these retrospective findings has never been published. Finally, an animal study widely cited as documenting the need to have the antimicrobial given before the incision lacks statistical testing, uses very high inocula and varying doses of antimicrobials.<sup>77</sup> Interestingly, a recent study of vancomycin prophylaxis in 2048 cardiac surgical patients indicated that vancomycin initiated from 16 to 60 minutes before incision and administered over 1 hour was associated with the lowest rate of surgical site infections.<sup>78</sup>

Although it seems logical to have adequate tissue levels of prophylactic antimicrobials before skin incision, supporting data are only inferential and it is likely that the importance depends upon the size of the inoculum. Nonetheless, Classen's study<sup>76</sup> apparently led the Center for Medicare and Medicaid Services to set a standard that all preoperative antibiotics should be administered within 1 hour of skin incision except for vancomycin which can be administered 2 hours prior to skin incision, presumably because it is often infused over 1 hour. These recommendations also specify that therapy should be stopped within 24 hours except in special circumstances, notably cardiothoracic surgery for which it may be extended to 48 hours. The latter exception occurred because of a document drafted by the Society of Thoracic Surgeons that made the following points: (a) although prolonged use of antibiotics can lead to the emergence of resistant infections, there are no data that this can occur with administration for under 48 hours; (b) antibiotic prophylaxis for 48 hours is "clinically effective in minimizing infectious complications in cardiac surgery" and is as effective as prophylaxis administered for more than 48 hours; and (c) antibiotic prophylaxis should not be used for indwelling catheters of any type or chest tubes.<sup>79</sup> There is general agreement on this last point for all types of

surgery with the possible exception of transplantation.

### ICU

Comparable successes with prophylactic antimicrobial regimens in ICU patients have been more difficult to prove as have attempts to prevent infection with selective gut decontamination regimens. The latter involves using either nonabsorbable antimicrobial agents or fluoroquinolones to eliminate the aerobic gram-negative flora while leaving the anaerobic flora intact, which provides some protection against colonization with a variety of potential pathogens, so-called colonization resistance. Similarly, aerosolized antibiotics, particularly polymyxin or aminoglycosides, do not prevent pneumonia. Topical antibiotic ointments do not decrease the incidence of intravenous access related bloodstream infection.

### Preemptive Therapy

Recently the concept of preemptive therapy has come to the fore. Preemptive therapy was initially defined in transplant patients, where the initiation of ganciclovir therapy in bone marrow transplant patients with evidence of cytomegalovirus (CMV) replication either in the blood or in the respiratory secretions, at a time when they were asymptomatic, prevented the development of otherwise life-threatening CMV pneumonia. In organ transplant patients, the initiation of preemptive ganciclovir during intensive antirejection therapy markedly decreases the incidence of systemic CMV infection normally associated with such therapy.<sup>1,2</sup>

The efficacy of prophylaxis for fungal infection has not been well established. Data for fungal prophylaxis suggests that fluconazole may be effective prophylaxis for certain high-risk patients such as bone marrow transplant recipients and patients undergoing reoperation for gastric or upper small bowel perforations that are the anatomic sites where large numbers of *Candida* species are normally found. However, there is no evidence that this reduces mortality.<sup>80,81</sup> Such studies are difficult to interpret, however, because the diagnosis of invasive fungal infection is often difficult and the ability of the clinician to distinguish between candidal colonization and invasion is not very great. Several studies show

that when a patient is colonized at three or more sites, there is a 30–60% incidence of invasive disease, with a high associated mortality. There is some agreement that preemptive therapy should be initiated only following recent abdominal surgery with recurrent gastrointestinal perforations or anastomotic leaks and is not necessary for the initial surgery even if there is soilage, so long as it has not been present for a relatively long period.<sup>82</sup> However, this issue is further complicated by the emergence of fluconazole-resistant *C. albicans* and the change in common fungal species to more resistant yeast such as *Candida krusei* and *Candida glabrata* which are sensitive to newer antifungal drugs.

### Bacterial Endocarditis

Although there are generally agreed upon guidelines for surgical prophylaxis for bacterial endocarditis there are no studies that definitively show that antibiotic prophylaxis prevents bacterial endocarditis during procedures that can produce a bacteremia. Nonetheless, given the consequences of endocarditis and the minimal risk associated with prophylaxis, the use of antibiotics to prevent cardiac infection is sensible in high-risk procedures. A summary of the most recent recommendations is available from the American Heart Association.<sup>83</sup> These recommendations are based on the risk of a procedure producing a significant bacteremia with an organism likely to produce endocarditis and the risk of a patient developing bacterial endocarditis with such a bacteremia. They are also predicated on cardiac conditions that are associated with an increased risk of endocarditis even without surgery. Patients considered to be at highest risk of endocarditis are those with prosthetic heart valves, a previous history of endocarditis, complex cyanotic heart disease and those with surgical systemic-pulmonary shunts or conduits. Moderate risk patients include those with uncorrected ventricular septal defects, primum atrial septal defects, patient ductus arteriosus, aortic coarctation, bicuspid aortic valves, acquired valvular dysfunction and hypertrophic cardiomyopathy. Prophylaxis for mitral valve prolapse is an enlightening controversy for several reasons. First, prolapse can occur in normal mitral valves under conditions that reduce the end-

diastolic volume of the left ventricle such as hypovolemia or enhanced contractility, especially in young adults. Second, prolapse without regurgitation is not thought to increase the risk of bacterial endocarditis because the regurgitant jet seems to produce the valvular abnormalities that make bacteria more likely to adhere to the valve. Thus, it is thought that only patients with mitral valve prolapse who also have mitral regurgitation should receive antibiotic prophylaxis. However, this is further complicated by the observation that regurgitation may occur only with exercise. Consequently, it might be missed on routine examination. In addition, men older than age 45 years with mitral valve prolapse are at higher risk for developing bacterial endocarditis.

Procedures such as central catheter placement through skin that is otherwise normal and has been cleansed with povidone-iodine or chlorhexidine are not associated with significant bacteremias and therefore do not warrant prophylaxis. In contrast, patients undergoing dental procedures associated with bleeding or patients with poor dental hygiene should receive prophylaxis. Viridans streptococci ( $\alpha$ -hemolytic streptococci) are the most common cause of endocarditis in association with dental or oral surgical procedures. A single oral dose of 2 g of amoxicillin given 1 hour prior to the procedure is the recommended prophylaxis. If oral medications cannot be used, intravenous ampicillin or penicillin is recommended. Clindamycin or azithromycin are alternatives for penicillin allergic patients. Other procedures for which similar prophylaxis is recommended include rigid (but not flexible) bronchoscopy, esophageal stricture dilation, and sclerotherapy (but not banding). Surgery that involves the biliary tree or intestinal mucosa or endoscopic procedures of the pancreatic or biliary tree is also associated with bacteremia with organisms that cause endocarditis, especially *Enterococcus faecalis*. The recommended prophylaxis for high-risk patients undergoing such procedures is ampicillin and gentamicin. Vancomycin may be substituted for ampicillin in penicillin-allergic patients. Gentamicin may be omitted in medium-risk patients.

Endocarditis prophylaxis is recommended for some clean procedures such as abdominal and lower-extrem-

ity vascular procedures, craniotomies, orthopedic procedures with hardware insertion and any procedure that includes implantation of permanent prosthetic material. In contrast, the need for prophylactic antibiotics for orthopedic procedures such as laminectomies and spinal fusions is controversial.

The rate of endocarditis-causing bacteremia with genitourinary tract surgery or instrumentation is high in patients with urinary tract infections, prostatitis, and prostatic surgery. *E. faecalis* is the most common bacterial species, but *Klebsiella* species are also common. Prophylaxis recommendations are the same as for intestinal or biliary tract surgery but attempted sterilization of the urinary tract before any procedure is also thought to be beneficial. Prophylaxis is not recommended for uncomplicated vaginal delivery, cervical biopsy, or manipulation of an intrauterine device in the absence of infection. However, because bacteremia following removal of an intrauterine device is thought to be relatively common, prophylaxis similar to that used for other genitourinary procedures is recommended.

## Pneumonia

Patients with pneumonia can be divided into two general categories: those with community-acquired and those with nosocomial pneumonia (particularly ICU-acquired).

### Community-Acquired Pneumonia

It is useful to consider community-acquired pneumonias (CAP), in three different categories. First are the typical pneumonias of conventional bacterial origin, which are characterized by the abrupt onset (within less than 24 hours) of fever, chills, systemic toxicity, cough, purulent sputum production, and dyspnea, often after a preceding viral illness. Second are the atypical pneumonias, characterized by a subacute onset of fever, nonproductive cough, and malaise, with a gradual progression over a several days. Legionnaires disease, which combines features of both, has an abrupt onset of fever, rigors, nonproductive cough, systemic toxicity, and increasing dyspnea, often after a several-day prodrome of gastrointestinal upset, headache, malaise, and encephalopathy. Although there is considerable overlap among these presentations, initial therapy can

TABLE 17-5.

### Etiology of Community-Acquired Pneumonia

Etiology	Incidence (%)
Typical (acute onset or abrupt deterioration after viral prodrome, with productive cough, systemic toxicity, and a lobar infiltrate)	
<i>Streptococcus pneumoniae</i>	20–60
<i>Haemophilus influenzae</i>	5–20
<i>Staphylococcus aureus</i>	2–10
<i>Enterobacteriaceae</i>	4–8
Others ( <i>Branhamella catarrhalis</i> , anaerobes, <i>Pseudomonas aeruginosa</i> )	5–10
Atypical (subacute onset, nonproductive cough, interstitial infiltrate)	
Viral (influenza, RSV, parainfluenza, adenovirus)	30–60
<i>Mycoplasma pneumoniae</i>	20–40
<i>Chlamydia pneumoniae</i>	4–15
Legionella	1–15
Others (PCP, Q fever, psittacosis RSV, PCP, <i>Pneumocystis jirovecii</i> )	1–2

PCP, *Pneumocystis carinii* pneumonia; RSV, respiratory syncytial virus.

be guided by such categorization and by considering the different etiologies within each category (Table 17-5).

The bacterial species or virus causing CAP is never identified in approximately 40–60% of patients. However, *S. pneumoniae* is the most common cause, accounting for approximately two-thirds of bacteremic pneumonias. Other relatively common typical bacteria are *Haemophilus influenzae*, *S. aureus* with an increasing frequency of methicillin resistant strains, *Neisseria meningitidis*, and *Moraxella catarrhalis*. The atypical bacteria are *Chlamydia pneumoniae*, *Mycoplasma pneumoniae*, and *Legionella* species. The most common viruses are influenza A and B, depending on the season, respiratory syncytial virus, and adenovirus.<sup>84,85</sup> The choice of appropriate antimicrobial therapy is helped by Gram stain of sputum; urinary *Legionella* antigen assays that detect more than 80% of cases of pneumonia caused by *Legionella pneumophila* type I but not other *Legionella* species or types; polymerase chain reaction (PCR) test for mycoplasma and/or IgM titers for chlamydia; detection of the appropriate antigen for respiratory viruses; and special studies for other pathogens. In most patients, however, antimicrobial therapy needs to be initiated in the absence of clear-cut microbiologic information. Patients without a predisposing host defense defect or history of a gross aspirational episode, in whom a typical pneumonia

is suspected as a cause of respiratory failure, should have initial therapy especially directed against *S. pneumoniae*, *H. influenzae*, and possibly *S. aureus*. Recommended empirical therapy for such inpatients is either a  $\beta$ -lactam plus a macrolide, usually azithromycin, or a fluoroquinolone, such as levofloxacin, alone. For ICU patients, the recommended therapy is either a  $\beta$ -lactam plus a fluoroquinolone or a  $\beta$ -lactam plus a macrolide, although the supporting data are very limited. If *S. aureus* is suspected and the incidence of MRSA in the community is high, adding vancomycin may be appropriate until the organism and its sensitivities are confirmed. If atypical pneumonia is suspected, then a fluoroquinolone such as levofloxacin, or erythromycin, or one of the newer macrolides (azithromycin or clarithromycin), with or without trimethoprim-sulfamethoxazole, would constitute reasonable initial therapy. For patients with a *Legionella*-like presentation, high-dose erythromycin is the traditional therapy of choice; however, azithromycin or levofloxacin combined with one of the regimens used for the treatment of typical bacterial pneumonia such as ampicillin-sulbactam or ceftriaxone might be preferable if resistant pathogens are a concern. It is also important to consider viral pathogens because they are a common cause of community-acquired pneumonia; rapid diagnostic tests are available, and the possibility of anti-

ral therapy exists. Although the initiation of empiric therapy is often obligatory, invasive diagnostic techniques, such as bronchoalveolar lavage or lung biopsy, should be considered for any patient with respiratory failure in whom the etiologic diagnosis is not quickly apparent or in whom there is a failure to respond to therapy. This is especially important for individuals with underlying conditions that predispose them to a broader range of pathogens such as alcoholics and the immunocompromised.

### Nosocomial Pneumonia

Nosocomial pneumonia can be divided into three groups: hospital-acquired pneumonia (HAP), which occurs at least 48 hours after admission; ventilator-associated pneumonia (VAP), which occurs at least 48 hours after endotracheal intubation and healthcare-associated pneumonia (HCAP), which occurs at least 48 hours after admission of patients who had a previous infection within 90 days or resided in a nursing home or long-term care facility or received intravenous antibiotics or wound care within the last 30 days.<sup>86</sup> These infections can be divided further into early onset, within the first 2–4 days of hospitalization, and late onset, 5 or more days after hospitalization. Early onset nosocomial pneumonia is less likely to result from multidrug resistant (MDR) organisms and has a better prognosis than late-onset pneumonia. Infections in HCAP patients usually are similar to those in late onset HAP or VAP.

The etiology of nosocomial pneumonia, especially when acquired within the ICU, is vastly different from the etiology of community-acquired infection. The pathogenesis is typically an extension of a tracheobronchitis into a bronchopneumonia. In the hospital setting, relatively antibiotic-resistant, aerobic, gram-negative bacilli had been the most frequent invading pathogens but this has been surpassed by gram-positive bacteria. This is thought to be a result of the increased rate of oropharyngeal and gastric colonization with these organisms, with such colonization serving as a reservoir for the introduction of this flora into the lower respiratory tract, usually as a result of aspiration, and the impaired ability to clear these organisms. This is especially true among intubated patients, those with previous lung injury, significant atelectasis, and immunocompromised patients.

Although Tables 17–4 and 17–5 list the etiologies of nosocomial pneumonias caused by different bacteria nationally, it should be emphasized that the etiology of nosocomial pneumonia in each individual hospital may be very different from the national average. Although, gram-negative bacillary pneumonia had been the major problem, gram-positive bacteria, especially MRSA, are rapidly overtaking gram-negative bacteria. Regardless, the type of the bacteria causing infection and their antibiotic sensitivity patterns will vary widely in different hospitals and even in different areas within a hospital. Thus, precise antibiotic recommendations for initiating therapy must be based on ongoing surveillance of the resident bacterial flora and antibiotic sensitivities in the particular hospital area.

Initial therapy should reflect the ongoing surveillance information and be modified on the basis of sputum examinations including Gram stains that provide important information about the relative importance of a particular organism found on culture. Initial therapy is usually accomplished with a single, advanced-spectrum, anti-gram-negative drug such as ceftazidime, piperacillin-tazobactam, imipenem, ciprofloxacin, or levofloxacin for less-severe disease, and perhaps one of these drugs with an aminoglycoside for patients with more-severe illness.<sup>87</sup> Because of the increasing prevalence of MRSA, vancomycin is often appropriate pending more definitive bacterial

identification. As noted previously, clear-cut evidence in humans that two-drug, potentially synergistic therapy is more effective than a single drug is controversial, but such therapy is used by many clinicians in the face of rapidly progressive *Pseudomonas* or *Klebsiella* infection.<sup>88</sup> Because some species of *Klebsiella* are sensitive to cefazolin, it can be substituted for the more expensive advanced-spectrum drugs once the sensitivity is confirmed.

In immunocompromised patients, pulmonary infection is the most common form of life-threatening infection. Although a detailed discussion of the approach to pulmonary infection in these patients is beyond the scope of this chapter, certain principles are worth noting here in terms of antimicrobial strategies. As outlined in Table 17–6, particular host defense defects are associated with particular infections, and initial therapy should reflect these associations. Even more than other ICU patients, these immunocompromised individuals are especially susceptible to nosocomial infection, both with the resident gram-negative flora and with *Aspergillus* species. Because of the importance of such infections in these patients, precise diagnosis is essential, using invasive techniques if necessary.

### Bacteremia

Bacteremias occurring in hospitalized patients can be considered as arising from two separate pathogenic routes. One route is a consequence of definable tissue infection at an anatomic

TABLE 17–6.

Frequent Causes of Pneumonia in Patients with Various Defects in Host Defenses and Initial Antimicrobial Therapy

Host Defense Defect	Pulmonary Infection	Initial Therapy
Impaired antibody formation or splenectomized	<i>Streptococcus pneumoniae</i> ; <i>Haemophilus influenzae</i> type B	Levofloxacin, azithromycin or ampicillin + $\beta$ -lactamase inhibitor
Depressed cell-mediated immunity	<i>Pneumocystis jiroveci</i> ; <i>Mycobacteria</i> species; fungi; <i>Nocardia</i> ; <i>Legionella</i> ; herpes group viruses; <i>Strongyloides stercoralis</i>	Trimethoprim-sulfamethoxazole
Decrease in the number and/or function of granulocytes	Oral bacterial flora; <i>Enterobacteriaceae</i> ; <i>Pseudomonas aeruginosa</i> ; <i>Aspergillus</i>	Ceftazidime, carbapenem, $\pm$ an aminoglycoside
Oral and tracheobronchial ulcerations	Oral bacterial flora; <i>Enterobacteriaceae</i>	Ceftazidime, carbapenem



site. Common causes of bacteremia of this type are biliary and urinary tract sepsis, usually caused by gram-negative bacilli and/or enterococci; peritonitis caused by a disruption of bowel integrity (mixed infection caused by such anaerobic organisms as *B. fragilis*, the Enterobacteriaceae, especially *E. coli*, and bowel streptococci, especially enterococci); and pneumonia. The incidence of bacteremia with pneumonia varies according to which organism is causing the infection. For example, 30–50% of patients with pneumococcal infection will have demonstrable bacteremia compared to less than 10% with gram-negative or aspiration pneumonia. In pneumococcal infection, the bacteremia is typically a result of hematogenous seeding from the pulmonary infection, whereas in gram-negative VAP, the bacteremia is likely related to heavy oropharyngeal colonization leading to skin contamination with consequent seeding of a central venous catheter. Thus, in the setting of VAP, all vascular access devices should be carefully evaluated, especially for duration of implantation, exit-site erythema, and drainage, and by blood cultures. The initial antimicrobial therapy of bacteremia secondary to invasive tissue infection is identical to that which would be prescribed in the absence of bacteremia.

### Urinary Tract Infection

Urosepsis is relatively uncommon unless complicating factors such as obstruction to urine flow, diabetes, advanced age, spinal cord injury or bladder catheterization are present. The likely bacteria are also different than in uncomplicated urinary tract infections, UTI, or asymptomatic UTIs. In these two instances likely organisms are *E. coli* or other Enterobacteriaceae, and *Pseudomonas* can be treated with a fluoroquinolone or trimethoprim-sulfamethoxazole. In patients with complicating factors, gram-positive and antibiotic-resistant gram-negative bacteria, including *P. aeruginosa*, are more common.<sup>89</sup> Consequently, therapy should be initiated with broader-spectrum antibiotics, usually fluoroquinolones or advanced spectrum  $\beta$ -lactam agents such as ceftazidime, ampicillin-sulbactam, ticarcillin-clavulanate, aztreonam, and imipenem. As with all infections, antimicrobial therapy should be adjusted so that the spectrum is as narrow as possible.

A more common problem in hospitalized patients, especially those with urinary catheters, is nosocomial bacteriuria. The etiology of such infections is far different from that observed in community-acquired infections. Whereas *E. coli* account for more than 85% of community-acquired urinary tract infections, it is responsible for only one-third of nosocomial infections. Enterococci, *P. aeruginosa*, relatively antibiotic-resistant Enterobacteriaceae such as *Klebsiella*, *Proteus*, *Enterobacter*, and *Serratia* species, as well as *Candida* species, now account for the majority of these infections.<sup>90</sup> Antibiotic therapy can delay the appearance of bacteriuria for a while, but the price to be paid if catheterization is maintained is that when infection does occur, it will be relatively resistant. Treatment of asymptomatic positive cultures when the catheter is still present is generally not indicated because this represents colonization rather than invasive infection and long-term benefits of such therapy are unlikely. However, when to treat critically ill patients may be problematic because they may not be able to relate symptoms. Usually a quantitative colony count of  $>10^5$  CFU is used as a criterion for treatment with the choice of antibiotic guided by the culture. Treatment if symptoms develop and/or instrumentation of the urinary tract is to be carried out is clearly indicated.

### Other Syndromes *Clostridium difficile*

*Clostridium difficile* is the leading cause of gastrointestinal infection in the nosocomial environment. This pathogen is an important cause of fever and leukocytosis, which may precede the diarrheal phase. The pathogenesis of this disease is typically mediated by enterotoxin A or cytotoxin B and bacteremia is extremely rare. The diagnosis is confirmed with the detection of either of the aforementioned toxins. The spores from *C. difficile* are extremely hearty and impervious to antimicrobial therapy, which explains the 10% relapse rate in successfully treated patients. Metronidazole is the therapy of choice even in relapsing cases; however, in recalcitrant cases where there is no response to metronidazole therapy, oral vancomycin can be considered. In patients being treated with other antibiotics for an ongoing pyogenic process, the treatment of *C. diffi-*

*cile* is particularly vexing. In this setting, where continued broad-spectrum antibiotic use is required, we recommend continuing the *C. difficile* therapy in parallel with the other antimicrobial agents and extend the course of therapy for *C. difficile* for several days after completion of the other antibiotics, typically 5–10 days. The extended *C. difficile* course of therapy is required because of the role of antibiotic therapy in provoking *C. difficile* disease by altering the normal bowel flora. Future antibiotic therapy needs to be considered with great care in a previously infected patient as *C. difficile* can be provoked with subsequent antibiotic courses, in part due to the latent spores. In patients who are severely ill from *C. difficile* several adjuvant approaches should be considered including minimization of other antimicrobial therapy, toxin binding resins such as cholestyramine, fecal enemas, and in severe cases surgical resection of the colon, for example, in the setting of toxic megacolon. In a patient who undergoes a colectomy for *C. difficile* toxic megacolon, the rectal stump, if one is left behind, may be a source of residual disease. Patients receiving immunosuppressive therapy appear to be at particularly high risk for severe *C. difficile* disease.

### Acute Pancreatitis

Antibiotic management in acute pancreatitis is challenging because the severity of illness often indicates a therapeutic emergency so that the traditional markers of infection may not be present and there may be limited supporting clinical data. Depending on the degree of pancreatic injury, these patients may present with septic physiology, including hypotension, tachycardia, hypoxemia, tachypnea, metabolic acidosis, leukocytosis with a left shift, thrombocytopenia, and coagulopathy. These findings are all consistent with the pathogenesis of this disease where an inciting event such as alcohol, gallstones, or trauma leads to pancreatic injury and inflammation which, in turn, leads to autodigestion, liquefaction and, necrosis. This tissue necrosis results in a cytokine release, which can mimic all aspects of septic physiology. If the necrotic pancreatic tissue becomes infected, by biliary reflux, which is often polymicrobial, colonic bacterial translocation or hematogenous seeding, there is an associated increased morbidity

and mortality.<sup>91</sup> It is important to note that infection is rarely the inciting event but rather a consequence of pancreatitis and often occurs weeks into the hospital course. Abdominal imaging, with a contrast CT scan, has enabled stratification of those patients at risk for developing superimposed infection with increasing degree of pancreatic necrosis. Infection of the pancreatic bed is extremely rare in the absence of necrosis.<sup>91</sup> Unfortunately imaging, like the physical examination and laboratory evaluation, cannot reliably distinguish an infectious from sterile inflammation. The most reliable means of making this determination is through a Gram stain and culture of the peripancreatic fluid. As an infected necrotic pancreas requires surgical debridement in addition to antibiotic therapy and supportive care, a diagnostic procedure, such as an ultrasound-guided fine-needle aspirate is extremely helpful prior to initiating antimicrobial therapy.<sup>92</sup> Once cultures have been obtained, the microbiologic results should guide antibiotic therapy, given the high sensitivity of the Gram stain from the pancreatic aspirate (>90% in one study).<sup>93</sup>

In the critically ill patient in whom it is too risky to delay antimicrobial therapy, targeting the typical infecting organisms, which includes aerobic enteric gram-negative rods and gram-positive cocci, is appropriate. A variety of antibiotics have been shown to achieve pancreatic levels above the MIC for the commonly encountered bacteria—fluoroquinolones, imipenem, ceftazidime, cefepime, metronidazole, clindamycin, chloramphenicol, doxycycline, and fluconazole. Two reasonable combinations are (a) ceftazidime, a fluoroquinolone, or piperacillin plus metronidazole or (b) imipenem or a carbapenem.<sup>94</sup> Imipenem-cilastatin 500 mg three times a day for 2 weeks is frequently used preemptively in patients with documented pancreatic necrosis because it has been shown to decrease the need for surgical intervention. However, *S. aureus* species, which are not sensitive to carbapenems, and *Candida* species, including *C. glabrata*, which is generally not susceptible to fluconazole, are emerging as significant pathogens in severe acute pancreatitis. If empiric antibiotics were initiated and Gram stain is negative and the microbiologic cultures are sterile, typically at 48–72 hours, then antimicrobial therapy should

be discontinued. Otherwise therapy should be directed at the pathogens identified. Surgical debridement is considered an essential element in documented pancreatic necrosis with infection.

### Antiretroviral Therapy in the Patient with HIV Infection and AIDS

A remarkable body of information regarding the treatment of HIV infection has emerged since 1981, when AIDS was first recognized. The occurrence of oral thrush, *Pneumocystis jirovecii* pneumonia, *Toxoplasma* encephalitis, and other opportunistic infections in apparently healthy gay males was quickly recognized as something unusual; that is, the net state of immunosuppression should not have been great enough to allow such infections to occur. Very quickly the characteristics of this epidemic emerged: profound and progressive immune compromise; efficient transmission from infected individuals by intimate contact, blood transfusion, organ transplantation, intravenous drug abuse, and perinatal transmission. In 1984, the identification of the cause of these events, infection with a unique retrovirus now known as the human immunodeficiency virus (HIV) was reported. HIV is now recognized as the cause of a worldwide pandemic of infection (particularly those caused by opportunistic organisms), Kaposi sarcoma, and other malignancies. More than 30 million individuals are believed to have been infected by HIV since 1981, with devastating consequences.<sup>95–97</sup>

Three different phases of disease have been recognized once HIV has been acquired<sup>98,99</sup>:

1. **Primary HIV Infection:** A mononucleosis-like illness is observed in ~50% of individuals 2–6 weeks after infection. Primary infection is associated with a marked increase in plasma viremia (this can exceed 1,000,000 copies per mL); a significant decrease in the CD4 T-lymphocyte count; and a large increase in the blood CD8 T-lymphocyte count.
2. **Chronic Asymptomatic Stage:** An extended phase of clinical latency occurs, persisting for 10–12 years in the majority of individuals. An estimated 20% of individuals (“rapid progressors”) have an accelerated course, having full-blown AIDS in

less than 5 years; conversely, ~10% (“slow progressors”) remain free of AIDS for 15 or more years. At the end of this period the level of viremia rises rapidly and there is a significant fall in the CD4 T-lymphocyte count. AIDS-defining opportunistic infections begin to appear.

3. **Overt AIDS:** In the absence of effective therapy, there is a progressive decrease in CD4-positive lymphocytes and an increase in viral load. These events are correlated with recurrent opportunistic infection, the occurrence of certain malignancies, and death in 2–3 years.

The specifics of anti-HIV therapy are still evolving, although certain principles remain constant: HIV replication remains at a very high level throughout the stages of illness. This high rate of replication is coupled with a remarkable amount of errors in the function of the reverse transcriptase (the daily production of  $\sim 10^8$ – $10^{10}$  virions and a mutation rate of  $3 \times 10^3$ ). The frequency of these events virtually guarantees the presence and the rapid development of mutants that are responsible for drug resistance. Resistant clones of HIV may be present even before the initiation of any therapy. Such findings mandate that multiple drugs will be needed to effectively treat this infection.

The general principle that applies to HIV therapy is “hit early and hit hard,” with multiple drugs being started simultaneously.<sup>99–101</sup>

Although the precise point when therapy should be instituted is still being studied, at present it is recommended that highly active antiretroviral therapy (HAART), which consists of multidrug regimens, be initiated in asymptomatic patients who have circulating CD4 T-lymphocyte counts < 500 cells/mL and/or an HIV RNA load of 5000–10,000 copies/mL. Table 17-7 lists the drugs currently available. Commonly used combinations include two nucleoside reverse transcriptase inhibitors plus one protease inhibitor and two viral protease inhibitors plus a nucleoside inhibitor or a nonnucleoside inhibitor. The goal of HAART therapy is to lower the HIV burden to undetectable and to maintain it at that level. Such an approach has been quite effective, but there are several issues that must be kept in mind. There are at least two mechanisms that are opera-

TABLE 17-7.

## Antiretroviral Drugs Available for Highly Active Antiretroviral Therapy (HAART) Combination Regimens

Nucleoside Reverse Transcriptase Inhibitors (NRTI)	Nonnucleoside Reverse Transcriptase Inhibitors	Protease Inhibitors
Zidovudine	Delavirdine	Saquinavir
Didanosine	Nevirapine	Ritonavir
Zalcitabine	Efavirenz	Indinavir
Lamivudine		Nelfinavir
Stavudine		
Abacavir		

Modified with permission from Vella S and Florida M,<sup>101</sup> and Carpenter CCCJ, Fischl MA, Hammer SM, et al.<sup>104</sup>

tive in the antiviral effects of these drugs: they act as “chain terminators,” and they competitively bind to reverse transcriptase at key sites of the virus. Protease inhibitors bind to the catalytic site of the HIV aspartic protease to produce their effect. We appear to be in a new era for the treatment of HIV. There are now a large number of drugs that are available for HAART regimens. Two key issues must be kept in mind: side effects (e.g., pancreatitis, hepatotoxicity, and a lipodystrophy syndrome), drug–drug interactions, including changes in drug metabolism by the hepatic cytochrome P450 enzymes, and the development of drug resistance. Of these, drug resistance is the most important, with the occurrence of clinically important resistance being particularly likely when the level of mutants is particularly high, the ability of the mutant strain to replicate is relatively high, and the presence of quasispecies suggests persistence of a given mutation.<sup>101–104</sup>

### Antifungal Therapy for the Treatment of Invasive Fungal Infection

The incidence of invasive fungal infection in recent years has increased greatly, as a result of the marked increase in immunocompromised patients, for example, AIDS patients, transplantation and cancer patients, and patients with autoimmune disease, surviving as the therapy for their primary conditions has improved. The most common cause of invasive fungal infection has long been *Candida* species, and this is still true, but there has been an increase in the range of fungal species causing serious infection, as well as an increase in antimicrobial

resistance. In addition, new sites of infection are being seen. For example, in the intensive care unit the use of invasive vascular access devices is becoming an important source for candidemia. Whereas in the past nosocomial bloodstream infection was uncommonly caused by *Candida* species (more than 20 other microbial species, particularly gram-negative and staphylococcal infection, were far more common), today *Candida* are the sixth most common nosocomial isolate, and fourth most common cause of nosocomial bloodstream infections. As this has occurred, the range of candidal species has changed from azole-susceptible *C. albicans* to more resistant non-*albicans* infection.<sup>105–107</sup>

The risk of invasive fungal infection is largely determined by the interaction of four factors.<sup>105</sup> The *environmental exposures* to which a patient is subjected is an important factor in the occurrence of many fungal infections, with the density of organisms that are aerosolized and then inhaled, the critical first step in the initiation of many infections. These exposures can occur in the community or within the hospital. In the hospital, the patient is vulnerable to organisms that are aerosolized and inhaled on the ward where the patient resides (*domiciliary exposure*) or to exposure to aerosols while traveling through the hospital for an essential procedure (*nondomiciliary exposure*). In both instances, construction activities are the most common activity resulting in aerosolization of infectious organisms, particularly *Aspergillus* species. In addition, person-to-person spread on the hands of medical personnel is a not uncommon event, with the spread of antimicrobi-

al-resistant *Candida* species being a particular problem.<sup>105–109</sup>

The patient's *net state of immunosuppression* is a complex function determined by host defense deficits from the underlying disease and its therapy, infection with immunomodulating viruses (including HIV, cytomegalovirus, and the hepatitis viruses), and the presence of protein-calorie malnutrition.<sup>105</sup>

The presence of foreign bodies, such as orthopedic prostheses, devitalized tissues, undrained fluid collections, and invasive vascular catheters, contributes significantly to the pathogenesis of invasive *Candida* infection. These *technical/anatomic* problems are commonly the substrate for developing opportunistic yeast infection. Whether one is dealing with candidemia associated with vascular access catheters, peritonitis in association with peritoneal dialysis catheters or orthopedic prosthesis infection, the chances of successful therapy are greatly enhanced by the removal of the foreign body in association with effective antifungal therapy.<sup>105,110,111</sup>

*Darwinian* factors can play an important role as well. Thus, prolonged therapy with broad-spectrum antibacterial drugs will create an ecologic niche easily occupied by *Candida* species. The presence of excess growth factors such as glucose and iron can have a significant effect on the occurrence of mucocutaneous candidiasis, invasive mucormycosis and other types of invasive infection. Unless the ecologic niche is eliminated, recurrent fungal infection may occur. For example, therapy with the newer azoles can be associated with the development of mucormycosis.<sup>105,107,109,110</sup>

The fungal species capable of causing invasive infection can be divided into three general categories. The *geographically restricted systemic mycoses*, blastomycosis, coccidioidomycosis, and histoplasmosis, are important in North America. In addition, paracoccidioidomycosis in Latin America and penicilliosis in southeast Asia exhibit similar clinical and epidemiologic patterns. These are *dimorphic fungi* that grow in the soil as molds and yeast-like forms in tissue. Invasive infection with one of these is greatly amplified by the presence of immunocompromise. Treatment of these infections at present has two parts: induction therapy with amphotericin to gain control of the disease, and then prolonged oral



therapy with an azole to consolidate the antifungal effects. At present, itraconazole is the therapy of choice for this purpose, with the exception of prescribing fluconazole in the treatment of coccidioidomycosis.<sup>105,110,111</sup>

The *opportunistic fungi* are ubiquitous in the environment where they are nonpathogenic, particularly for normal hosts, but can cause invasive infection when the inhaled inoculum harbors a high microbial burden and when the host is immunocompromised. These organisms include *Aspergillus* species, *Cryptococcus neoformans*, and *Sporothrix schenckii*. Voriconazole is currently the treatment of choice for *Aspergillus* infection, fluconazole for cryptococcal infection (often following induction therapy with amphotericin plus flucytosine); sporotrichosis can be treated with saturated potassium iodide or itraconazole.<sup>105,110,111</sup>

The *newly emerging fungi* now account for approximately 10% of invasive fungal infections, with the major species involved including the following: Mucorales, *Fusarium*, and *Trichosporon*. These species tend to be more resistant to fluconazole, echinocandins, and even amphotericin. Drugs such as voriconazole and the newly licensed posaconazole (the first really effective agent for mucormycosis, particularly when combined with surgery) should be considered as the first choice for therapy.<sup>105,110,111</sup>

There are two types of exposure that are important in the development of invasive fungal infections, the effects of both being amplified if immunocompromise is present. Infection with *Candida* as a consequence of contaminated vascular access devices is common, particularly in the intensive care unit. A less common variant on this theme is when the mucocutaneous surfaces are compromised, not only is candidal infection a concern, but invasion by *Aspergillus*, the Mucorales, and other fungal species can occur.<sup>106,107,111,112</sup>

The other portal of entry is the respiratory tract. Inhalation of the organisms can result in invasive fungal infection of the nasal sinuses and the lungs, with *Aspergillus* species being the most common invader recognized. The first host response to these organisms is the migration of polymorphonuclear leukocytes, dedicated phagocytic cells, which can kill the inhaled inoculum. If the inhaled organisms escape this first defense, then a number of events oc-

cur: bloodstream invasion with the potential for metastatic spread; tissue invasion both at the primary site of infection and metastatic sites that mobilizes the major host defense—cell-mediated immunity, which includes alveolar macrophages. In the particular case of histoplasmosis, persistent infection of macrophages is established, making lipid-associated amphotericin B particularly effective by targeting the macrophages with the lipid moiety. Thus, an increased risk of invasive aspergillosis and other such infections, for example, fusariosis, is to be expected in patients with either or both neutropenia and impaired cell mediated immunity.<sup>108,109,111–114</sup>

Drugs that are available for the treatment of invasive fungal infection can be listed as follows:

- *Amphotericin B and the lipid-associated amphotericin products*: Amphotericin B is a broad-spectrum polyene that acts by binding to fungal cell membranes, specifically ergosterol (for which it has a >500-fold increase in affinity when compared to binding to cholesterol in mammalian cell membranes). Binding to ergosterol results in increased membrane permeability and cytolysis, the probable mechanism of fungal injury and death. Amphotericin B remains the broadest spectrum antifungal known, producing fungicidal effects against the majority of pathologic fungi, including those that are resistant to other antifungal compounds. The dose-limiting toxicity is to the kidneys, which is particularly important when such nephrotoxic drugs such as gentamicin or cyclosporine are administered to a patient receiving amphotericin. In addition, the administration of amphotericin B usually produces a “cytokine storm” which can include not only fever and chills but also hypotension. These “storms” are usually not a problem after the first several days of therapy. Lipid-associated amphotericin appears to decrease but not eliminate both the febrile reactions and the renal toxicity. However, as with all the amphotericin products the optimal dose (3–5 mg/kg/d for a lipid-associated drug and 0.1–1.5 mg/kg/d for the standard amphotericin molecules) is not known, and the optimal duration of therapy is unclear. Our practice is to

treat until all overt disease is gone and then add a buffer for safety. The duration of this buffer is a clinical decision usually determined by the nature of the original infection and the speed with which the patient responded.

- Flucytosine is mentioned in this context because its optimal use is in patients with cryptococcosis in conjunction with amphotericin. This synergistic regimen protects against a single-step mutation to flucytosine resistance. Dose-related hepatic and/or bone marrow toxicity can occur with the use of flucytosine. A common approach is to administer amphotericin and flucytosine for 7–10 days to gain control of the process, and then complete the course of therapy with oral fluconazole.<sup>115,116</sup>

*Azoles* act by blocking the enzyme lanosterol synthetase, a cytochrome P450-associated enzyme. This results in an inhibition of ergosterol synthesis. The effect is fungistatic. There are five azoles that have been approved for the treatment of systemic fungal invasion.

- *Ketoconazole and miconazole* are essentially of historical interest only and are rarely prescribed today.
- *Fluconazole*, in contrast, was a major event, with the only weakness of the drug being a rather narrow spectrum of activity, limited mostly to *Candida* species and *C. neoformans*. Pharmacokinetically, the drug is well behaved, able to penetrate the urinary tract, the eye, and the brain, as well as the spleen, liver, and other sites. The bioavailability when given by mouth is complete, and thus the dose given by mouth is the same as the parenteral dose. Side effects are seen, but are relatively uncommon or minor: a measles-like rash, hepatocellular dysfunction, and minimal GI complaints. Fluconazole does interact with cytochrome P450 enzymes, as do all the azoles, and thus can increase the blood levels of such important therapies as cyclosporine and tacrolimus.<sup>116</sup>
- *Itraconazole* has an appealing spectrum of activity, including *Aspergillus* species and other fungal species. The problem has been poor and unreliable drug delivery. With substitution of an oral suspension, more reliable bioavailability has been



achieved, and the usefulness of the drug should be reassessed. Up to now, the major use of this drug has been in oral “wrap up” therapy after amphotericin had gained control of the infection.<sup>116</sup>

- *Voriconazole* is the newest of the azoles. It can be administered either orally or parenterally. It appears that voriconazole is the most effective of the current anti-*Aspergillus* drugs, as well as has efficacy for other resistant molds. Side effects are similar to other azoles (e.g., rash, hepatocellular dysfunction, nausea). Voriconazole does have a unique side effect, the occurrence of visual effects including bright colors and lights, akin to that seen with digitalis toxicity. Such symptoms appear to be most common with high doses, and appear to be caused by retinal dysfunction. All such symptoms disappear when the drug is stopped, and extensive study has failed to reveal any persistent visual or structural consequences. Voriconazole appears to be the drug of choice for invasive aspergillosis. Treatment with voriconazole, however, carries a small risk of selecting for Mucorales infection (mucormycosis).<sup>116,117</sup>

The echinocandins are large lipopeptide molecules that damage fungal cell walls by inhibiting B-(1,3)-glucan synthase. In vitro these compounds are fungicidal for *Candida* and fungistatic for *Aspergillus* species. These molecules appear to have activity against candidal strains that are amphotericin, fluconazole, and itraconazole resistant. On the other hand, species such as *C. neoformans* and the Mucorales are inherently resistant to echinocandin therapy, presumably because they do not possess significant amounts of B-glucan in their cell walls.<sup>118</sup>

- Three echinocandins, caspofungin, micafungin, and anidulafungin are approved by the Food and Drug Administration. The echinocandins, with the limited evaluation in the clinical arena that has occurred thus far, appear to be useful in the treatment of both drug-resistant candidiasis and invasive aspergillosis. The results thus far suggest comparable efficacy to that achieved with amphotericin and the licensed azoles. The possibility of achieving better results with combination therapy that includes an echinocandin is

particularly intriguing. The cell wall damage that is caused by echinocandins is reminiscent of synergistic therapy of enterococcal infection with ampicillin and gentamicin with the echinocandin playing the role of a cell wall active agent that potentiates the penetration of additional drugs. Indeed, the echinocandins have been called “the antifungal penicillins.”<sup>118-120</sup>

### The Future of Antifungal Therapy

Since the advent of new drugs for the treatment of fungal disease great progress has been made in terms of efficacy and adverse events. What we need now is a new generation of diagnostic tests that will inform us on the appropriate drugs to use, how long to treat, whether multiple drugs should be deployed, and a determination to define microbial load objectively that will allow us to treat preemptively rather than empirically. The present data on the use of (1-3)-B-D-glucan testing in defining the presence or absence of invasive fungal infection suggests that we are getting closer to that possibility.

### NEW DIAGNOSTICS

One of the greatest frustrations when caring for a potentially septic patient is having to wait 1–2 days for culture results to find out if the patient is infected, and then to wait another 1–2 days to discover the identity and later the susceptibility profile of the infecting organism. With the molecular biologic revolution, new tests have emerged, typically PCR-based technology, enabling the rapid identification of specific pathogens directly from the infected body site. Nonetheless, this technology is prone to interpretation challenges. For example, does a positive result represent colonization or disease? To help both diagnostically and prognostically, the development of new assays are focusing on the levels (or presence) of mediators in the inflammatory cascade or on circulating bacterial moieties, such as endotoxin or nuclear factor- $\kappa$ B, to improve our ability to risk stratify patients or determine the infecting pathogen.<sup>121-124</sup>

A broad array of pathogens can now be identified by molecular techniques, including viruses (HIV, CMV), fungi (*Candida*, *Aspergillus*), and bacteria

(VRE, *E. coli*, *M. tuberculosis*, *Bacteroides*).<sup>125-130</sup> As learned for HIV-positive patients, monitoring the HIV viral load has become an important parameter in gauging the success of therapy. The development of technology may allow us to provide pathogen-directed therapy earlier in a patient's illness enabling more focused narrow spectrum antimicrobial use. This would diminish the selective pressure, which leads to the emergence and dissemination of resistance as well as yielding novel markers to gauge the duration and intensity of therapy.

### SUMMARY

Antimicrobial therapy is complicated by the increasing incidence of microbial resistance. As a result, a broader range of antimicrobial agents has come into use, with the basic approach to antimicrobial therapy in these patients being front loading broad-spectrum antimicrobials. This therapy is then modified to relatively narrow spectrum specific therapy. The regimens chosen and the doses prescribed are based on the principle that effective therapy is dependent on the delivery of a level of antimicrobial agent to the site of infection that significantly exceeds the MIC of the invading organism. Bactericidal therapy is essential when dealing with cardiovascular infection, CNS infection, prosthesis associated infection, osteomyelitis, and infection in the neutropenic patient. Synergistic therapy may be important when dealing with life-threatening enterococcal, *P. aeruginosa*, and perhaps other gram-negative infections, but the definition of synergy varies and the clinical efficacy is not firmly established. Finally, it is hoped that a better definition of high-risk patients will permit the more effective use of preemptive antimicrobial regimens. It is clear that many questions remain unanswered and that many therapeutic decisions must be based on a thorough understanding of the properties of antimicrobials and the pathogenesis of infections rather than efficacy demonstrated in clinical studies.

### REFERENCES

1. Rubin RH, Tolkoff-Rubin NE. Antimicrobial strategies in the care of organ trans-

- plant recipients. *Antimicrob Agents Chemother* 1993;37:619–624.
2. Rubin RH. Preemptive therapy in immunocompromised hosts [editorial; comment]. *N Engl J Med* 1991;324:1057–1059.
  3. Estes L. Review of pharmacokinetics and pharmacodynamics of antimicrobial agents. *Mayo Clin Proc* 1998;73:1114–1122.
  4. Thompson RL, Wright AJ. General principles of antimicrobial therapy. *Mayo Clin Proc* 1998;73:995–1006.
  5. Alvarez-Elcoro S, Enzler MJ. The macrolides: erythromycin, clarithromycin, and azithromycin. *Mayo Clin Proc* 1999;74:613–634.
  6. Edson RS, Terrell CL. The aminoglycosides. *Mayo Clin Proc* 1999;74:519–528.
  7. Kasten MJ. Clindamycin, metronidazole, and chloramphenicol. *Mayo Clin Proc* 1999;74:825–833.
  8. Marshall WF, Blair JE. The cephalosporins. *Mayo Clin Proc* 1999;74:187–195.
  9. Smilack JD. Trimethoprim-sulfamethoxazole. *Mayo Clin Proc* 1999;74:730–734.
  10. Smilack JD. The tetracyclines. *Mayo Clin Proc* 1999;74:727–729.
  11. Wilhelm MP, Estes L. Symposium on antimicrobial agents—part XII. Vancomycin. *Mayo Clin Proc* 1999;74:928–935.
  12. Wright AJ. The penicillins. *Mayo Clin Proc* 1999;74:290–307.
  13. Mandell GL, Bennett JE, Dolin R. Principles and Practice of Infectious Diseases. 6th ed. Philadelphia: Elsevier, 2005.
  14. Gonzales R, Steiner JF, Sande MA. Antibiotic prescribing for adults with colds, upper respiratory tract infections, and bronchitis by ambulatory care physicians [see comments]. *JAMA* 1997;278:901–904.
  15. McCaig LF, Hughes JM. Trends in antimicrobial drug prescribing among office-based physicians in the United States [see comments] [published erratum appears in *JAMA* 1998;279(6):434]. *JAMA* 1995;273:214–219.
  16. Lorian V. Antibiotics in Laboratory Medicine. Baltimore: Williams & Wilkins, 1996.
  17. Gibaldi M, Perrier D. Pharmacokinetics. 2nd ed. New York: Marcel Dekker, 1982.
  18. Van Bambeke F, Barcia-Macay M, Lemaire S, et al. Cellular pharmacodynamics and pharmacokinetics of antibiotics: current views and perspectives. *Curr Opin Drug Discov Devel* 2006;9:218–230.
  19. Craig WA. Pharmacokinetic/pharmacodynamic parameters: rationale for antibacterial dosing of mice and men. *Clin Infect Dis* 1998;26:1–12.
  20. Verklín RM Jr, Mandell GL. Alteration of effectiveness of antibiotics by anaerobiosis. *J Lab Clin Med* 1977;89:65–71.
  21. Edson RS, Terrell CL. The aminoglycosides. *Mayo Clin Proc* 1999;74:519–528.
  22. Craig WA, Kunin CM. Significance of serum protein and tissue binding of antimicrobial agents. *Annu Rev Med* 1976;27:287–300.
  23. Dickinson GM, Bisno AL. Infections associated with indwelling devices: concepts of pathogenesis; infections associated with intravascular devices [see comments]. *Antimicrob Agents Chemother* 1989;33:597–601.
  24. Wilson DA, Rolinson GN. The recovery period following exposure of bacteria to penicillins. *Chemotherapy* 1979;25:14–22.
  25. Novelli A, Fallani S, Cassetta MI, et al. Postantibiotic leukocyte enhancement of meropenem against gram-positive and gram-negative strains. *Antimicrob Agents Chemother* 2000;44:3174–3176.
  26. McDonald PJ, Pruell WB. Postantibiotic leukocyte enhancement: increased susceptibility of bacteria pretreated with antibiotics to activity of leukocytes. *Rev Infect Dis* 1981;3:38–44.
  27. MacGowan AP, Bowker KE. Continuous infusion of  $\beta$ -lactam antibiotics. *Clin Pharmacokinet* 1998;35:391–402.
  28. Fuursted K. Comparative killing activity and postantibiotic effect of streptomycin combined with ampicillin, ciprofloxacin, imipenem, piperacillin or vancomycin against strains of *Streptococcus faecalis* and *Streptococcus faecium*. *Chemotherapy* 1988;24:229–234.
  29. Lacy MK, Nicolav DP, Nightingale CH, et al. The pharmacodynamics of aminoglycosides. *Clin Infect Dis* 1998;27:23–27.
  30. Turnidge J. Pharmacodynamics and dosing of aminoglycosides. *Infect Dis Clin North Am* 2003;17:503–528.
  31. Freeman CD, Nicolav DP, Belliveau PP, et al. Once-daily dosing of aminoglycosides: review and recommendations for clinical practice. *J Antimicrob Chemother* 1997;39:677–686.
  32. Pfaller MA, Jones RN, Marshall SA, et al. Inducible amp C beta-lactamase producing gram-negative bacilli from bloodstream infections: frequency, antimicrobial susceptibility, and molecular epidemiology in a national surveillance program (SCOPE). *Diagn Microbiol Infect Dis* 1997;28:211–219.
  33. Jacoby GA, Munzo-Price LS. The new beta-lactamases. *N Engl J Med* 2005;352:380–391.
  34. Pitout JD, Sanders CC, Sanders WE Jr. Antimicrobial resistance with focus on beta-lactam resistance in gram-negative bacilli. *Am J Med* 1997;103:51–59.
  35. Gold HS, Moellering RC Jr. Antimicrobial-drug resistance. *N Engl J Med* 1996;335:1445–1453.
  36. Bush K. New  $\beta$ -lactamases in gram-negative bacteria: diversity and impact on the selection of antimicrobial therapy. *Clin Infect Dis* 2001;32:1085–1089.
  37. Chow JW, Fine MJ, Shlaes DM, et al. Enterobacter bacteremia: clinical features and emergence of antibiotic resistance during therapy. *Ann Intern Med* 1991;115:585–590.
  38. Lee NLS, Yuen KY, Kumana CR. Beta-lactam antibiotic and beta-lactamase inhibitor combinations. *JAMA* 2001;285:386–388.
  39. Kaye KS, Engemann JJ, Fraimow HS. Pathogens resistant to antimicrobial agents. Epidemiology, molecular mechanisms and clinical management. *Infect Dis Clin North Am* 2000;14.
  40. Cunha BA. Antibiotic resistance. *Med Clin North Am* 2000;84:1407–1429.
  41. Leclercq R, Derlot E, Duval J, et al. Plasmid-mediated resistance to vancomycin and teicoplanin in *Enterococcus faecium*. *N Engl J Med* 1988;319:157–161.
  42. Murray BE. Vancomycin-resistant enterococcal infections. *N Engl J Med* 2000;342:710–721.
  43. Stein GE, Craig WA. Tigecycline, a critical analysis. *Clin Infect Dis* 2006;43:518–524.
  44. Noble W, Virani Z, Cree RG. Co-transfer of vancomycin and other resistance genes from *Enterococcus faecalis* NCTC 12201, to *Staphylococcus aureus*. *FEMS Microbiol Lett* 1992;72:195–198.
  45. Appelbaum PC. The emergence of vancomycin-intermediate and vancomycin-resistant *Staphylococcus aureus*. *Clin Microbiol Infect* 2006;12:16–23.
  46. Smith TL, Pearson ML, Wilcox KR, et al. Emergence of vancomycin resistance in *Staphylococcus aureus*. Glycopeptide-Intermediate *Staphylococcus aureus* Working Group. *N Engl J Med* 1999;340:493–501.
  47. Wong SS, Ho PL, Woo PC, et al. Bacteremia caused by staphylococci with inducible vancomycin heteroresistance. *Clin Infect Dis* 1999;29:760–767.
  48. Moellering RC Jr. Editorial response: Staphylococci vs. glycopeptides—how much are the battle lines changing? *Clin Infect Dis* 1999;29:768–770.
  49. Fridkin SK, Steward CD, Edwards JR, et al. Surveillance of antimicrobial use and antimicrobial resistance in United States hospitals: project ICARE phase 2. Project Intensive Care Antimicrobial Resistance Epidemiology (ICARE) hospitals. *Clin Infect Dis* 1999;29:245–252.
  50. Meyer KS, Urban C, Eagan JA, et al. Nosocomial outbreak of *Klebsiella* infection resistant to late-generation cephalosporins [see comments]. *Ann Intern Med* 1993;119:353–358.
  51. Brun-Buisson C, Legrand P, Philippon A, et al. Transferable enzymatic resistance to third-generation cephalosporins during nosocomial outbreak of multiresistant *Klebsiella pneumoniae*. *Lancet* 1987;8554:302–306.
  52. Lynch JP, Zhanel GG. Escalation of antimicrobial resistance among streptococcus pneumoniae: implications for therapy. *Semin Resp Crit Care Med* 2005;26:575–616.
  53. Zirakzadeh A, Patel R. Vancomycin-resistant enterococci: colonization, infection, detection, and treatment. *Mayo Clin Proc* 2006;81:529–536.

54. Fey PD, Safranek TJ, Rupp ME, et al. Ceftriaxone-resistant *Salmonella* infection acquired by a child from cattle. *N Engl J Med* 2000;342:1242-1249.
55. Molbak K, Baggesen DL, Aarestrup FM, et al. An outbreak of multidrug-resistant, quinolone-resistant *Salmonella enterica* serotype typhimurium DT104. *N Engl J Med* 1999;341:1420-1425.
56. Lacy MK, Nicolau DP, Nightingale CH, et al. The pharmacodynamics of aminoglycosides. *Clin Infect Dis* 1998;27:23-27.
57. Rodloff AC, Goldstein EJC, Torres A. Two decades of imipenem therapy. *J Antimicrob Chemother* 2006;58:916-929.
58. Burroughs SF, Johnson GJ. Beta-lactam antibiotic-induced platelet dysfunction: evidence for irreversible inhibition of platelet activation in vitro and in vivo after prolonged exposure to penicillin. *Blood* 1990;75:1473-1480.
59. Davey PG. Pharmacokinetics in liver disease. *J Antimicrob Chemother* 1988;21:1-5.
60. Singh N, Yu VL, Miele LA, et al. Beta-lactam antibiotic-induced leukopenia in severe hepatic dysfunction: risk factors and implications for dosing in patients with liver disease [see comments]. *Am J Med* 1993;94:251-256.
61. Chow AW, Jewesson PJ. Pharmacokinetics and safety of antimicrobial agents during pregnancy. *Rev Infect Dis* 1985;7:287-313.
62. NNIS System of the Centers for Disease Control and Infection. National Nosocomial Infections Surveillance (NNIS) System Report, data summary from January 1992, through June 2004, issued October 2004. *Am J Infect Control* 2004;32:470-485.
63. Fridkin SK, Gaynes RP. Antimicrobial resistance in intensive care units. *Clin Chest Med* 1999;20:303-316.
64. Pittet D, Wenzel RP. Nosocomial bloodstream infections. Secular trends in rates, mortality, and contribution to total hospital deaths. *Arch Intern Med* 1995;155:1177-1184.
65. Richards MJ, Edwards JR, Culver DH, et al. Nosocomial infections in coronary care units in the United States. National Nosocomial Infections Surveillance System. *Am J Cardiol* 1998;82:789-793.
66. Richards MJ, Edwards JR, Culver DH, et al. Nosocomial infections in medical intensive care units in the United States. National Nosocomial Infections Surveillance System [see comments]. *Crit Care Med* 1999;27:887-892.
67. Richards MJ, Edwards JR, Culver DH, et al. Nosocomial infections in pediatric intensive care units in the United States. National Nosocomial Infections Surveillance System. *Pediatrics*. Available at: <http://www.pediatrics.org/cgi/content/full/103/4/e39> 1999;103:1-7. Last accessed August 30, 2007.
68. Spencer RC. Predominant pathogens found in the European Prevalence of Infection in Intensive Care Study. *Eur J Clin Microbiol Infect Dis* 1996;15:281-285.
69. O'Grady NP, Alexander M, Dellinger EP, et al. Guidelines for the prevention of intravascular catheter-related infections. *MMWR Recommendations and Reports* 2002;51(RR 10):1-29.
70. Mermel LA, Farr BM, Sheretz RJ, et al. Guidelines for the management of intravascular catheter-related infections. *Clin Infect Dis* 2001;32:1249-1268.
71. Wenzel RP, Edmond MB. The evolving technology of venous access. *N Engl J Med* 1999;340:48-50.
72. Darouiche RO, Raad II, Heard SO, et al. A comparison of two antimicrobial-impregnated central venous catheters. *Catheter Study Group*. *N Engl J Med* 1999;340:1-8.
73. Pappas PG, Rex JH, Sobel JD, et al. Guidelines for the treatment of candidiasis. *Clin Infect Dis* 2004;38:161-189.
74. Cardo DM, Falk PS, Mayhall CG. Validation of surgical wound classification in the operating room. *Infect Control Hosp Epidemiol* 1993;14:255-259.
75. Howe CW. Bacterial flora of clean wounds and its relation to subsequent sepsis. *Am J Surg* 1964;107:696-700.
76. Classen DC, Evans RS, Pestotnik SL, et al. The timing of prophylactic administration of antibiotics and the risk of surgical-wound infection. *N Engl J Med* 1992;326:281-286.
77. Burke JF. The effective period of preventive antibiotic action in experimental incisions and dermal lesions. *Surgery* 1961;50:161-168.
78. Garey KW, Dao T, Chen H, et al. Timing of vancomycin prophylaxis for cardiac surgery patients and the risk of surgical infection. *J Antimicrob Chemother* 2006;58:645-650.
79. Edwards FH, Engelman RM, Houck P, et al. The Society of Thoracic Surgeons Practice Guideline Series: antibiotic prophylaxis in cardiac surgery, part I. duration. *Ann Thorac Surg* 2006;81.
80. Lipsett PA. Surgical critical care: fungal infections in surgical patients. *Crit Care Med* 2006;34(Suppl):S215-S224.
81. Vardakas KZ, Samonis G, Michalopoulos A, et al. Antifungal prophylaxis with azoles in high-risk, surgical intensive care unit patients: a meta-analysis of randomized, placebo-controlled trials. *Crit Care Med* 2006;34:1216-1224.
82. Eggimann P, Francioli P, Bille J, et al. Fluconazole prophylaxis prevents intra-abdominal candidiasis in high-risk surgical patients. *Crit Care Med* 1999;27:1066-1072.
83. Dajani AS, Taubert KA, Wilson W, et al. Prevention of bacterial endocarditis. Recommendations by the American Heart Association. *JAMA* 1997;277:1794-1801.
84. Mandell LA, Bartlett JG, Dowell SF, et al. Update of practice guidelines for the management of community-acquired pneumonia in immunocompetent adults. *Clin Infect Dis* 2003;37:1405-1433.
85. Bartlett JG, Dowell SF, Mandell LA, et al. Practice guidelines for the management of community-acquired pneumonia in adults. *Clin Infect Dis* 2000;31:347-382.
86. Niederman MS, Bonten MJ, Craig WA, et al. Guidelines for the management of adults with hospital-acquired, ventilator-associated, and healthcare-associated pneumonia. *Am J Respir Crit Care Med* 2004;171:388-416.
87. Bonten MJ, Chastre J, Craig WA, et al. Guidelines for the management of adults with hospital-acquired, ventilator-associated, and healthcare-associated pneumonia. *Am J Respir Crit Care Med* 2005;171:388-416.
88. Korvick JA, Bryan CS, Farber B, et al. Prospective observational study of *Klebsiella* bacteremia in 230 patients: outcome for antibiotic combinations versus monotherapy. *Antimicrob Agents Chemother* 1992;36:2639-2644.
89. Ronald A. The etiology of urinary tract infection: traditional and emerging pathogens. *Am J Med* 2002;113(Suppl 1A):14S-19S.
90. Kumon H, Hashimoto H, Nishimura M, et al. Catheter-associated urinary tract infections: impact of catheter materials on their management. *Int J Antimicrob Agents* 2001;17:311-316.
91. Isenmann R, Rau B, Beger HG. Bacterial infection and extent of necrosis are determinants of organ failure in patients with acute necrotizing pancreatitis [see comments]. *Br J Surg* 1999;86:1020-1024.
92. Rau B, Pralle U, Mayer JM, et al. Role of ultrasonographically guided fine-needle aspiration cytology in the diagnosis of infected pancreatic necrosis. *Br J Surg* 1998;85:179-184.
93. Banks PA, Gerzof SG, Langevin RE, et al. CT-guided aspiration of suspected pancreatic infection: bacteriology and clinical outcome. *Int J Pancreatol* 1995;18:265-270.
94. Kramer KM, Levy H. Prophylactic antibiotics for severe acute pancreatitis: the beginning of an era. *Pharmacotherapy* 1999;19:592-602.
95. Carael M, Schwartlander B, Piot P. HIV and AIDS. In: Clumeck N, Powderly WG, eds. *Infectious Diseases*. Philadelphia: Mosby-Year Book, 2004:1297.
96. Gottlieb MS, Schroff R, Schanker HM, et al. *Pneumocystis carinii* pneumonia and mucosal candidiasis in previously healthy homosexual men: evidence of a new acquired cellular immunodeficiency. *N Engl J Med* 1981;305:1425-1431.
97. Masur H, Michelis MA, Greene JB, et al. An outbreak of community-acquired *Pneumocystis carinii* pneumonia: initial manifestation of cellular immune dysfunction. *N Engl J Med* 1981;305:1431-1438.
98. Kahn JO, Walker BD. Acute human immunodeficiency virus type 1 infection. *N Engl J Med* 1998;339:33-39.
99. Bart PA, Pantaleo G. The immunopathogenesis of HIV-1 infection. In: Clumeck N, Powderly WG, eds. *Infectious Diseases*. Philadelphia: Mosby-Year Book, 2004:1234-1249.
100. Richman DD. Resistance of clinical isolates of human immunodeficiency virus



- to antiretroviral agents. *J Clin Microbiol* 1993;31:2557–2564.
101. Hanna GJ, Hirsch MS. Antiretroviral therapy for human immunodeficiency virus infection. In: Mandell GL, Bennett JE, Dolin R, eds. *Principles and Practice of Infectious Diseases*. 6th ed. New York: Elsevier, Churchill, Livingstone, 2005:1655–1675.
102. Mellors JW, Rinaldo CR Jr, Gupta P, et al. Prognosis in HIV-1 infection predicted by the quantity of virus in plasma. *Science* 1996;272:1167–1170.
103. O'Brien WA, Hartigan PM, Martin D, et al. Changes in plasma HIV-1, RNA and CD4+ lymphocyte counts and the risk of progression to AIDS. *N Engl J Med* 334:426–431.
104. Carpenter CCJ, Fischl MA, Hammer SM, et al. Antiretroviral therapy for HIV infection in 1998: updated recommendations of the International AIDS Society–USA Panel. *JAMA* 1998;280:78–86.
105. Rubin RH. *Clinical Approach to Infection in the Compromised Host*. 4th ed. New York: Kluwer/Academic Press, 2003.
106. Jarvis WR. Epidemiology of nosocomial fungal infection with emphasis on *Candida* species. *Clin Infect Dis* 1995;20:1526–1530.
107. Pfaller MA. Epidemiology of candidiasis. *J Hosp Infect* 1995;20(Suppl):329–338.
108. Hopkins CC, Weber DH, Rubin RH. Invasive *Aspergillus* infection: possible nonward common source within the hospital environment. *J Hosp Infect* 1989;13:19–35.
109. Paya CV. Fungal infections in solid organ transplantation. *Clin Infect Dis* 1993;16:677–688.
110. Rubin RH, Ikonent GJ, Morris R. The therapeutic prescription for the organ transplant recipient: the linkage of immunosuppression and antimicrobial strategies. *Transplant Infect Dis* 1999;1:29–39.
111. Edwards JE Jr, Bodey GP, Bowden RA, et al. International Conference for the Development of a Consensus on the Management and Prevention of Severe Candidal Infections. *Clin Infect Dis* 1997;25:43–59.
112. Fraser VJ, Jones M, Dunkel J, et al. Candidemia in a tertiary care hospital: epidemiology, risk factors, and predictors of mortality [see comments]. *Clin Infect Dis* 1992;15:414–421.
113. Denning DW. Invasive aspergillosis. *Clin Infect Dis* 1998;26:781–805.
114. Boutati EI, Anaissie EJ. *Fusarium*, a significant emerging pathogen in patients with hematologic malignancy: ten years' experience at a cancer center at a cancer center and implications for management. *Blood* 1997;90:999–1008.
115. Stamm AM, Diasio RB, Dismukes WE, et al. Toxicity of amphotericin B plus flucytosine in 194 patients with cryptococcal meningitis. *Am J Med* 1987;83:236–242.
116. Rex JH, Stevens DA. Systemic antifungal agents. In: Mandell GL, Bennett JE, Dolin R, eds. *Principles and Practice of Infectious Diseases*. 6th ed. New York: Elsevier, Churchill, Livingstone, 2005:502–514.
117. Herbrecht R, Denning DW, Patterson TF, et al. Voriconazole versus amphotericin for primary therapy of invasive aspergillosis. *N Engl J Med* 2002;347:408–415.
118. Deresinski SC, Dam S. Caspofungin. *Clin Infect Dis* 2003;36:1445–1457.
119. Marr KA, Boeckh M, Carter RA, et al. Combination antifungal therapy for invasive aspergillosis. *Clin Infect Dis* 2004;39:797–802.
120. Torres HA, Hachem RY, Chemaly RF, et al. Posaconazole: a broad-spectrum triazole antifungal. *Lancet Infect Dis* 2005;5:775–785.
121. Romaschin AD, Harris DM, Ribeiro MB, et al. A rapid assay of endotoxin in whole blood using autologous neutrophil dependent chemiluminescence. *J Immunol Methods* 1998;212:169–185.
122. Carlet J. Rapid diagnostic methods in the detection of sepsis. *Infect Dis Clin North Am* 1999;13:483–494.
123. Arnalich F, Garcia-Palomero E, Lopez J, et al. Predictive value of nuclear factor kappaB activity and plasma cytokine levels in patients with sepsis. *Infect Immun* 2000;68:1942–1945.
124. Bohrer H, Qiu F, Zimmermann T, et al. Role of NFkappaB in the mortality of sepsis. *J Clin Invest* 1997;100:972–985.
125. Pfeiffer CD, Fine JP, Safdar N. Diagnosis of invasive aspergillosis using a galactomannan assay: a meta-analysis. *Clin Infect Dis* 2006;42:1417–1427.
126. Dutka-Malen S, Evers S, Courvalin P. Detection of glycopeptide resistance genotypes and identification to the species level of clinically relevant enterococci by PCR. *J Clin Microbiol* 1995;33:24–27.
127. Einsele H, Hebart H, Roller G, et al. Detection and identification of fungal pathogens in blood by using molecular probes. *J Clin Microbiol* 1997;35:1353–1360.
128. Flahaut M, Sanglard D, Monod M, et al. Rapid detection of *Candida albicans* in clinical samples by DNA amplification of common regions from *C. albicans*-secreted aspartic proteinase genes. *J Clin Microbiol* 1998;36:395–401.
129. Kane TD, Alexander JW, Johannigman JA. The detection of microbial DNA in the blood: a sensitive method for diagnosing bacteremia and/or bacterial translocation in surgical patients. *Ann Surg* 1998;227:1–9.
130. Warwick S, Wilks M, Hennessy E, et al. Use of quantitative 16S ribosomal DNA detection for diagnosis of central vascular catheter-associated bacterial infection. *J Clin Microbiol* 2004;42:1402–1408.
131. NNIS Hospital Infections Program, National Center for Infectious Diseases, Centers for Disease Control and Prevention. National Nosocomial Infections Surveillance (NNIS) system report, data, summary from October 1986–April 1998. Issued June 1998. National Center for Infectious Disease 1998:1–25.
132. Amsden GW. Tables of antimicrobial agent pharmacology. In: Mandell GL, Bennett JE, Dolin R, eds. *Principles and Practice of Infectious Diseases*. 6th ed. Philadelphia: Elsevier Churchill Livingstone, 2005:634–700.
133. el-Ebiary M, Torres A, Fabregas N, et al. Significance of the isolation of *Candida* species from respiratory samples in critically ill, non-neutropenic patients. An immediate postmortem histologic study. *Am J Respir Crit Care Med* 1997;156:583–590.
134. Kauffman CA, Vazquez JA, Sobel JD, et al. Prospective multicenter surveillance study of funguria in hospitalized patients. The National Institute for Allergy and Infectious Diseases (NIAID) Mycoses Study Group. *Clin Infect Dis* 2000;30:14–18.



# CHAPTER 18

## Preoperative Assessment of the Newborn

Myron Yaster, MD, and  
Richard A. Elliott, MD

300

The newborn presenting for surgery is among the most daunting and challenging patients facing the anesthesiologist. Critically ill and hemodynamically unstable, these tiny and fragile patients demand a level of specialized knowledge, skill, and attention to detail that is inversely proportional to their size and gestational age. Providing safe anesthesia is only possible when the specialized equipment and techniques necessary to conduct an anesthetic are in the hands of individuals who understand the anatomic, physiologic, and pathologic differences that characterize these patients during their transition from intra- to extrauterine life.

The types of surgical procedures in the newborn span a wide variety of life-threatening congenital anomalies, each with its own set of unique management strategies. Nevertheless, there are many aspects of preoperative and intraoperative anesthetic management common to all neonates. This chapter focuses on neonatal physiology and its impact on anesthetic and surgical techniques. Emphasis is placed on those aspects of preoperative assessment, monitoring, and supportive care that are pertinent to newborn patients in general, with special attention to disease states, anesthetic agents, and surgical interventions that can influence the infant's transition from fetal to newborn existence.

Historically, the newborn has been undertreated for pain and for painful experiences, including surgery. For example, in 2006, healthy newborn males are routinely circumcised without analgesia or anesthesia.<sup>1</sup> It is our belief that, except for extraordinary circumstances, all newborns require anesthesia for surgery.<sup>2-4</sup> Why this even remains an issue of debate in the 21st century is discussed in detail in Chap. 62.

## FAMILY INTERACTIONS AND PREPARATION

The parents of critically ill children require substantial support and reassurance that their newborn child will perceive no pain during a procedure and will be as safe as possible. Parents experience an acute emotional crisis when their newborns face surgery. Aside from the deprivation of contact with their child, parents experience anticipatory grief and a profound sense of failure.<sup>5,6</sup> When confronted with surgery and anesthesia, many parents undergo a period of mourning for the loss of the perfect infant or anticipate their infant's death or mutilation. The overwhelming nature of the situation may deafen parents to explanations during the preoperative interview and repetition may be necessary. The child's parents should be counseled that the overwhelming majority of children not only survive their surgery but grow up to live healthy and productive lives. Without

being inappropriately optimistic or avoiding the issues of informed consent, it is important to emphasize the normal, healthy aspects of the baby and give positive affirmation regarding the correction that will be achieved by surgery. Failure at this may significantly impact the parents future interactions and bonding to their child.

The newborn undergoing surgery must be optimally prepared within the constraints of performing an emergent procedure. Essential to this process is a thorough history and physical examination. This evaluation must focus on maternal and peripartum history, neonatal physiology and its relation to anesthesia, as well as the presence of coexisting anomalies in the child.

## Maternal and Peripartum History

A thorough review of maternal past medical history and prenatal assessments is essential for the preoperative evaluation of the neonate. Maternal

### KEY POINTS

1. Except for extraordinary circumstances, all newborns require anesthesia for surgery.
2. Maternal factors associated with increased perinatal risk include hypertension, diabetes, prolonged rupture of membranes, drug abuse (tobacco, alcohol, opioids, amphetamines) and use (antipsychotics, antidepressants, anticonvulsants), collagen vascular disease, and maternal infection (prolonged rupture of membranes) or inflammation.
3. The younger the infant, the more fragile the neurologic, pulmonary, and gastrointestinal systems, and the more likely the severity of complications.
4. The presence of a congenital anomaly should always alert the anesthesiologist to the potential for others.
5. The presence of any midline defect is almost always associated with another defect.
6. The newborn is an obligate nose breather.
7. The narrowest part of the infant's airway is at the level of the cricoid ring and not the vocal cords.
8. Premature infants are at risk of developing postanesthesia apnea for weeks after birth (48–60 weeks postconception age) whenever a potent vapor or ketamine is used.
9. Arterial hypoxemia, hypercarbia, acidosis, hypothermia, or pain may reverse this transitional circulation and restore the fetal circulatory pattern; it is referred to as either *persistent fetal circulation* or *persistent pulmonary hypertension of the newborn*.
10. The newborn's myocardium is less compliant than that of the adult or older child and cardiac output is primarily heart-rate dependent.
11. The most common cause of bradycardia in the newborn is hypoxia. Unexplained bradycardia in the operating room should always be considered caused by hypoxia until proven otherwise.
12. Hypoglycemia is common in infants born to diabetic mothers and in infants who require resuscitation, are premature, or who are small for gestational age.

TABLE 18-1.

## Maternal History

## Pregnancy

## Polyhydramnios

High intestinal obstruction, e.g., duodenal atresia, congenital diaphragmatic hernia, omphalocele

Central nervous anomalies, e.g., hydrocephalus, spina bifida

Respiratory abnormalities, e.g., pulmonary hypoplasia, pleural effusions

Genitourinary tract abnormalities, e.g., posterior urethral valves, urethral structure

Maternal diabetes

Rh-immunization

Multiple pregnancy

## Oligohydramnios

Renal failure

Hypoplastic lungs

Marked crowding of fetal limbs causing multiple skeletal contractures

Neonatal infection (chorioamnionitis)

## Toxemia of pregnancy

Frequency associated with decreased placental perfusion and premature separation of the placenta; associated problems include small for gestational age infants, hypoglycemia, and anemia; magnesium used in blood pressure control produces neonatal hypotonia and apnea

Diabetes: large for gestational age infants; hypoglycemia despite enormous glucose loading, prematurity (yet > 2,500 gram birth weight); congenital heart disease; anencephaly; sacral agenesis

Maternal seizures 2–3 × greater incidence of congenital malformations

Intra-uterine infection: prematurity; fetal infection; particularly pneumonia; persistent fetal circulation; heart defects (rubella)

Medication: teratogens, e.g., anticonvulsants, warfarin, anti-metabolites; hypoglycemia, floppy infant

## Drug abuse

Fetal alcohol syndrome: growth retardation, mental deficiency, heart defects, flexion contractures

Opioid withdrawal: seizures; jittery, irritable infants; hypoglycemia; diarrhea

Amphetamines: congenital heart disease

Maternal age: trisomy 13, 18, 21

Single umbilical artery: renal malformations

medical history and pathology may indicate the likelihood of an anomaly or be its possible cause (Table 18-1). Maternal factors associated with increased perinatal risk include hypertension; diabetes, prolonged rupture of membranes; drug abuse (tobacco, alcohol, opioids, amphetamines) and use (antipsychotics, antidepressants, anti-convulsants); collagen vascular disease; and maternal infection (prolonged rupture of membranes) or inflammation. Maternal exposures to teratogens such as thalidomide, phenytoin, or ethanol are well described and are associated with specific anomalies. Less dramatic are the effects of tobacco and opioids, which can affect brain development or somatic size. Additionally, maternal intravenous drug addiction, particularly to opioids, can result in acute with-

drawal and seizures or in HIV virus infection in the neonate. Finally, some perinatal conditions provide insight into potential future problems. For example, polyhydramnios is associated with high intestinal obstruction and oligohydramnios is associated with renal and lung hypoplasia (Tables 18-1 and 18-2).

The peripartum history is of equal importance for the evaluation of the neonate (Table 18-2). Prolonged labor and premature rupture of membranes are indicators of potential infectious complications in the neonate. Moreover, a traumatic delivery or abnormal fetal presentation can imply fractures or nerve injury. Other factors that can imply co-existing disorders are an abnormal umbilical cord or placenta, and the child's age, birth weight, and Apgar scores.

TABLE 18-2.

## Peripartum History

## Prolonged labor

Abnormal fetus, e.g., hydrocephalus, abdominal wall defect, breech presentation

## Premature rupture of membranes

Prematurity

Infection, pneumonia

Oligo- or polyhydramnios

## Traumatic delivery

Intracranial hemorrhage, skull fracture, vocal cord paralysis, brachial plexus injury

## General anesthesia

Hypotonia, respiratory distress

Prematurity (< 37 weeks post-conceptual age or birth weight < 2,500 grams)

Hyaline lung disease

Hypocalcemia, hypoglycemia, hypomagnesemia

Infection

Necrotizing enterocolitis

Patent ductus arteriosus

Hyperbilirubinemia

Increased risk of oxygen toxicity to the eyes (retinopathy of prematurity or “retrolental fibroplasia”)

Postmaturity (> 42 weeks post-conceptual age)

Infants who are asphyxiated at birth must be identified prior to surgery. These newborns have depressed myocardial function and decreased perfusion to the brain and gastrointestinal system. Additionally, a variety of metabolic derangements, such as hypoglycemia, hypocalcemia, and hyperkalemia, occur in asphyxiated newborns. Other problems seen in these infants are clotting abnormalities, meconium aspiration, and intracranial hemorrhage. The latter is particularly devastating and may be a result of impaired autoregulation of the cerebral circulation and/or large swings in blood pressure, cardiac output, and arterial blood gasses.

## Gestational Age

Babies born at term, 37–42 weeks post-conception age, can either be normal in size, small (< 10th percentile) for gestational age (SGA) or large (> 90th percentile) for gestational age (LGA). SGA and LGA babies often have glucose homeostatic instability and require 10% glucose infusions to maintain normoglycemia (60–100 mg/dL). Additionally, calcium homeostasis may be ab-

normal in these infants. The well-accepted definition of prematurity is an infant born at <37 weeks of gestation. Like the full-term infant, premature infants can be SGA or LGA. The physiologic variability between 24 and 36 weeks of gestation is enormous and it is probably best to subdivide this group into infants on the edge of survivability (<26 weeks of gestation), fragile infants (between 27 and 30 weeks of gestation), and more robust infants (between 31 and 35 weeks of gestation). The younger the infant, the more fragile the neurologic, pulmonary, and gastrointestinal systems, and the more likely the severity of complications.

### Patient History—Congenital Anomalies

The presence of a congenital anomaly should always alert the anesthesiologist to the potential for other anomalies. Currently, approximately 2% of liveborn infants have a congenital anomaly recognized at birth.<sup>7</sup> Congenital anomalies fall into 4 broad categories. The first is known as a *congenital malformation*. This is a primary structural defect that results from a localized error of morphogenesis, such as a cleft lip or a ventricular septal defect. The second category is a *malformation syndrome*. This is a recognized pattern of malformations believed to have the same etiology, but which are not the result of a single error of morphogenesis, such as trisomy 21. The third category is known as an *anomalad*. It is described as a single localized error of morphogenesis, as in Pierre Robin syndrome. Finally, patterns of recognized malformations that occur in a nonrandomized fashion and are called an *association*. The VATER (vertebral defects, imperforate anus, tracheoesophageal fistula, and renal defects) association, which is currently also known as the VACTERL (vertebral defects, imperforate anus, congenital heart disease, tracheoesophageal fistula, renal and limb defects) association, is a classic example.

Table 18-3 is a concise list of the more common congenital anomalies, syndromes, and associations. Table 18-4 provides a more detailed account of the anesthetic implications of some of the more common syndromes and malformations. A wonderful Internet resource can be found at the website of the National Center for Biotechnology Information's (NCBI) Online Mendelian

Inheritance in Man (OMIM) (<http://www.ncbi.nlm.nih.gov/omim>). The presence of an anomaly or an associated defect can often be inferred from a detailed history and physical examination of the patient, as well as from the child's parents and referring physician. Finally, a good rule of thumb to remember is that the presence of any midline defect is almost always associated with another defect.

## REVIEW OF SYSTEMS AND DEVELOPMENTAL PHYSIOLOGY

### Head and Neck

The newborn is an obligate nose breather. If both nostrils are obstructed, respiratory distress occurs. Choanal atresia, an anomaly in which there is absence or complete obstruction of the nasopharynx bilaterally, is diagnosed by respiratory distress in the delivery room that is easily treated by oral intubation and by an inability to pass a catheter through the nostrils. A subset of patients with choanal atresia have the CHARGE syndrome: colobomas of the eye, congenital heart disease, atresia choanae, retardation, genital hypoplasia, and ear abnormalities. Occasionally, respiratory distress is caused by obstruction of the nasopharynx by a nasogastric tube and overzealous taping that occludes the opposite nostril. The airway must be evaluated for any abnormality that may result in a difficult intubation, such as a small or receding jaw (micrognathia: Pierre Robin syndrome, Treacher Collins syndrome), or a large tongue (Beckwith syndrome, glycogen storage diseases, hypothyroidism, Down syndrome). In many of these patients, intubation with conventional laryngoscopy is extremely difficult, if not impossible, and alternative methods (e.g., laryngeal mask airways, lightwands, and fiberoptic bronchoscopy) and surgical backup should always be available. Additional lesions that make intubation difficult or impossible are airway hemangiomas, lymphangiomas, cystic hygromas, and laryngeal webs and cysts. The presence of a hemangioma should always raise a "red flag"; some of these lesions trap and consume platelets and may produce a bleeding diathesis. When an impossible airway situation arises and the patient's condition is known in utero, the EXIT (ex

TABLE 18-3.

### Commonly Encountered Lesions in the Neonate

<b>Airway lesions</b>
Choanal atresia
Pierre Robin syndrome
Upper airway obstruction
Cystic hygroma
Cleft lip and/or palate
Upper airway cysts and webs
<b>Thoracic lesions</b>
Tracheoesophageal fistula (TEF) or atresia
Congenital diaphragmatic hernia
Congenital heart disease
Pneumothorax, pneumomediastinum, pneumopericardium
Lobar emphysema, cystic adenomatoid malformation
Mediastinal masses
<b>Abdominal lesions</b>
Omphalocele
Gastroschisis
Intestinal obstruction
Malrotation and volvulus
Imperforate anus
Exstrophy of bladder or cloaca
Hirschsprung's disease
Biliary atresia
Incarcerated hernia
Necrotizing enterocolitis (NEC)
<b>Neurosurgical lesions</b>
Myelomeningocele
Cephalocele
Craniosynostosis
Intracranial masses
Arteriovenous malformations (vein of Galen)
Skull fractures
Hydrocephalus
Subdural hemorrhage
Spinal tumors

utero intrapartum treatment) procedure may be lifesaving.<sup>8,9</sup> In the EXIT procedure, which was originally designed for fetal surgery, the infant is partially delivered via a cesarean section and intubated in a controlled manner, prior to delivery of the placenta. The placenta acts as a "heart-lung machine" and the procedure avoids a "crash" intubation or tracheostomy at birth in the delivery room. At the other end of the spectrum, cleft lips and palates do not usually present intubation problems. Indeed, the cleft may provide more room for the laryngoscope blade and facilitate endotracheal intubation.

TABLE 18-4.

## Anesthetic Implications of Syndromes and Unusual Disorders

Name	Description	Anesthetic Implications
Arthrogryposis multiplex	Multiple congenital contractures; congenital heart disease	Possible airway problems due to limitations of mandibular movement
Asplenia syndrome	Absent spleen; complex congenital heart disease; malrotation of abdominal organs	Cyanotic heart disease very common; echocardiography essential preoperatively
Beckwith's syndrome	Birth weight > 4000 gms; macroglossia, visceromegaly	Airway problems due to large tongue; hypoglycemia common
Cherubism	Fibrous dysplasia of the mandible and maxilla	Intubation may be extremely difficult; tracheostomy may be the only way to secure the airway
Congenital hypothyroidism	Goiter; large tongue; respiratory depression; hypoglycemia; hypotension	Airway obstruction secondary to large tongue, particularly in supine position; slow to awaken at the completion of surgery
Crouzon's disease	Craniosynostosis, hypertelorism, hypoplastic mandible	Intubation may be difficult
Dandy-Walker syndrome	Hydrocephalus	Increased intracranial pressure rare in newborn period; head may be enormously enlarged
DiGeorge's syndrome	Thymus and parathyroids absent; hypocalcemia, immune deficiency; aortic arch abnormalities	Irradiate all blood products to prevent graft vs. host disease; stridor may be due to hypocalcemia
Down's syndrome (trisomy 21)	Large tongue, unstable cervical spine, small mouth; high incidence of congenital heart disease, particularly AV canal; intestinal obstruction	Intubation may be difficult; ? in line traction during intubation, ? cervical spine films prior to intubation in older children; echocardiography required prior surgery in the newborn
Ehlers-Danlos syndrome	Collagen abnormality-hyperelasticity and fragile tissue; dissection aneurysm of aorta; bleeding diathesis; heart, lung, GI problems	Poor tissue and clotting defects may lead to hemorrhage; spontaneous pneumothorax
Ellis-van Creveld syndrome	Ectodermal and skeletal defects; congenital heart disease; cleft lip and palate, mandibular hypoplasia; hepatosplenomegaly	Airway problems, intubation may be difficult; chest wall anomalies cause poor lung function
Epidermolysis bullosa	Skin cleavage at dermal-epidermal junction, minor trauma denudes skin	Do not use adhesive tape of any sort; avoid instrumentation of the airway if possible; use a well padded mask or apply ointment to rim; secure IV, monitoring devices with Kerlex; sterile technique
Familial dysautonomia (Riley Day syndrome)	Poor suck and swallow; hyper- and hypotension; insensitivity to pain; absent sweating and lacrimation	Recurrent aspiration and pneumonia; respiratory center insensitive to CO <sub>2</sub> ; labile intraoperative blood pressure
Fetal alcohol syndrome	Growth retardation; microcephaly, craniofacial abnormalities; congenital heart disease; renal abnormalities	Intubation is usually not difficult; ventricular septal defects are common and require SBE prophylaxis
Glucose-6-phosphate deficiency	Hemolytic anemia caused by drugs and infection	Aspirin, sulfa, methylene blue cause anemia
Goldenhar's syndrome	Hemifacial microsomia, congenital heart disease	Very difficult intubation; vertebral instability
Hemangioma with thrombocytopenia	May involve the airway; bleeding, anemia	Airway involvement may require radiation therapy; transfuse components as necessary
Jeune's syndrome (asphyxiating thoracic dystrophy)	Severe thoracic malformations, renal failure	Respiratory failure prolonged mechanical ventilation; care with drugs excreted by kidneys
Klippel-Feil syndrome	Hemi- or fused vertebra	Intubation may be difficult
Maple syrup urine disease	Inability to metabolize leucine, isoleucine, and valine	Acid base imbalance; avoid preoperative fasting, start glucose early and check frequently
Mucopolysaccharidoses (Hurler's, Hunter's, Morquio's syndrome)	Bony abnormalities, dwarfism, kyphoscoliosis, abnormal facies, congenital heart disease	Very difficult intubations, unstable necks, respiratory failure perioperatively
Myasthenia congenita	Similar to adult form	Avoid muscle relaxants and narcotics

(continued)



TABLE 18-4.

## Anesthetic Implications of Syndromes and Unusual Disorders (Continued)

Name	Description	Anesthetic Implications
Osteogenesis imperfecta	Pathologic fractures; abnormal platelets, vascular fragility	Extreme caution when positioning and during intubation; blood pressure cuff may cause fractures
Pierre-Robin syndrome	Cleft palate, micrognathia, glossoptosis, congenital heart disease	Very difficult intubation, may require tongue suture or awake tracheostomy; best nursed in prone position
Prader-Willi syndrome	Hypotonia, obesity	Hypoglycemia common; assisted ventilation may be required postop
Prune-belly syndrome	Agenesis of the abdominal musculature, renal failure	Respiratory failure common, postoperative ventilation, avoid drugs excreted by the kidneys
Treacher Collins syndrome	Micrognathia, mid-face hypoplasia, congenital heart disease	Very difficult intubation, may require tongue suture or awake tracheostomy; best nursed in prone position
Thrombocytopenia with absent radius syndrome	Episodic thrombocytopenia precipitated by stress, infections, surgery; congenital heart disease	Platelet transfusions prior to surgery; SBE prophylaxis
Trisomy 18	Congenital heart disease; micrognathia; renal malformations; most die in infancy	Ethical considerations concerning surgery in a patient with a fatal anomaly; assess cardiac status carefully
Trisomy 21 (see Down's syndrome)		
VATER syndrome	Vertebral, Anal, Tracheal, Esophageal fistula, Renal; cardiac	Examine carefully for associated anomalies

Reprinted and modified from Amsden GW. Tables of Antimicrobial Agent Pharmacology. In: Mandell GL, Bennett JE, and Dolin R, eds. Principles and Practice of Infectious Diseases. 6th ed. Elsevier Churchill Livingstone, 2005.  
For more information, see [www.ncbi.nlm.nih.gov/omim](http://www.ncbi.nlm.nih.gov/omim).

Infants with a history of endotracheal intubation who are stridulous or who have a weak cry may have developed subglottic stenosis or subglottic granulomas. Unlike in an adult, the narrowest part of the infant's airway is at the level of the cricoid ring and not the vocal cords.<sup>10</sup> Furthermore, the infant's trachea may be only 4–5 cm in total length, making endobronchial intubation extremely easy to accomplish even by very experienced practitioners. To minimize this risk, we use the "1-2-3...7-8-9" rule to assist in correct endotracheal tube positioning. The "1-2-3" refers to the patient's weight in kilograms and the "7-8-9" refers to the position of the endotracheal in centimeters at the patient's lip. Thus, a 1-kg infant would have the tip of his endotracheal tube taped at the 7-cm mark at the lip. The trachea is very easily injured and explains in part the use of noncuffed endotracheal tubes in this age group.<sup>11</sup> Typically the trachea of most infants can be intubated with a 3.0-mm endotracheal tube. Premature infants occasionally require smaller, 2.5-mm tubes. In infants in whom subglottic narrowing is anticipated or who require intubation with tubes smaller than 2.5 mm,

tracheostomy and/or bronchoscopy should be considered and discussed with the parents prior to surgery.

### Gas Exchange and Oxygen Consumption

During fetal life, respiratory gas exchange occurs at the placenta. The first breath after birth generates a negative intrapleural pressure of 80 cm H<sub>2</sub>O, expands the lungs, establishes the residual volume and the functional residual capacity, increases alveolar oxygen content, and causes pulmonary arterial vasodilatation.<sup>12</sup> Gas exchange in the lungs is maintained with successful removal of the lung fluid from the airways and alveoli. This is achieved by drainage and increased pulmonary lymphatic flow for several hours after birth and by the presence of surface active phospholipids (surfactant).<sup>13–15</sup> The increase in arterial oxygen content that occurs with the successful transition to extrauterine life decreases pulmonary vascular resistance and leads to the functional closure of the ductus arteriosus and atrial septum.<sup>12,16–18</sup>

Oxygen consumption in the newborn is 2–3 times that of older children and adults. Unfortunately, the

newborn responds to hypercarbia and hypoxia paradoxically when compared to the adult or older child.<sup>19–25</sup> Unlike the adult, the newborn's response to hypoxia during the first 3 weeks of life is biphasic and paradoxical; that is, rather than maintaining an increased minute ventilation they rapidly develop apnea.<sup>19,20,26,27</sup> Furthermore, hypoxia that normally increases the respiratory response to hypercapnia, paradoxically depresses the newborn's ventilatory response to carbon dioxide. Indeed, apnea may also occur in response to hypothermia or when energy reserves are limited (e.g., in the premature infant).<sup>28</sup> Thus, a devastating cascade of events may be set in motion. Increased oxygen consumption, depressed respiratory function, and limited reserves lead to hypoxemia. Hypoxemia results in apnea and cardiovascular collapse. Other disadvantages of the newborn include a very compliant rib cage, which tends to collapse the chest wall, inefficient diaphragmatic contraction, and a low percentage of fatigue resistant type I muscle fibers in the diaphragm.<sup>29,30</sup> The combination of high work of breathing, increased oxygen consumption, and less resistance to

muscle fatigue can produce abnormal breathing patterns, such as periodic breathing and apneic episodes, and respiratory failure.

The respiratory depressant effects of opioids and inhalational agents are also profound and long-lasting. Morphine penetrates the newborn's brain more easily than the adult and achieves levels that are 2–4 times higher.<sup>31,32</sup> Furthermore, the  $\mu$  opioid receptor is exquisitely sensitive to respiratory depression in the newborn when compared to the adult.<sup>33,34</sup> Thus, a history of prematurity and or apnea must alert the anesthesiologist to possible respiratory compromise in the postoperative period, particularly if a narcotic based anesthetic is used. Indeed, premature infants are at risk of developing post anesthetic apnea for weeks after birth (48–60 weeks post-conception age) whenever a potent vapor or ketamine is used.<sup>35–38</sup>

Neonates suffering from respiratory distress syndrome (hyaline membrane disease) have low lung compliance, a diminished functional residual capacity, and diffuse microatelectasis. These infants are often hypoxemic and hypercarbic and exhibit tachypnea, expiratory grunting, and inspiratory retractions. They are often intubated and either positively pressure ventilated or spontaneously ventilating on continuous positive airway pressure (CPAP). Maintaining normal gas exchange in these infants requires careful monitoring and respiratory support. Increased peak inspiratory pressures and positive end-expired pressures may be needed to maintain adequate oxygenation. Unfortunately, this may lead to pneumothorax, pneumomediastinum and interstitial emphysema. Indeed, the perioperative development of pulmonary barotrauma should alert the anesthesiologist to the possibility of intraoperative pneumothorax, which will manifest itself by catastrophic and sudden cardiovascular collapse.

### Cardiac Physiology

The fetal circulation is characterized by the preferential shunting of “arterialized” placental (“right-sided”) blood across the foramen ovale and ductus arteriosus into the systemic (“left-sided”) circulation.<sup>39,40</sup> This right-to-left shunting of blood is caused by the increased pulmonary vascular resistance and decreased systemic vascular resistance that characterizes the fetal circulation. The combination of breathing room air

and clamping the umbilical cord reverses these resistances and results in the functional closure of the foramen ovale and the ductus arteriosus. Bidirectional shunting through the ductus arteriosus or an incompletely closed foramen ovale may normally persist for 24–72 hours and underscores the need to meticulously debubble all IV tubing. Unfortunately, arterial hypoxemia, hypercarbia, or acidosis will reverse this transitional circulation and restore the fetal circulatory pattern, and is referred to as *persistent fetal circulation* or *persistent pulmonary hypertension of the newborn*.<sup>41–43</sup> It has catastrophic consequences. The increased pulmonary artery hypertension caused by arterial hypoxemia reduces pulmonary blood flow and reopens the foramen ovale and ductus arteriosus. This further exacerbates the hypoxemia and acidosis. It can occur with sepsis, hypotension, meconium aspiration, diaphragmatic hernia, and inefficient ventilation. Treatment with some combination of inhaled nitric oxide, oscillatory ventilation, and/or extracorporeal membrane oxygenation (ECMO) is increasingly successful.<sup>42,44</sup>

On the other hand, closure of the foramen ovale and ductus arteriosus may be detrimental in patients with certain types of congenital heart disease. Patients with transposition of the great vessels, complete or partial tricuspid, or pulmonary valvular obstruction or atresia, and hypoplastic left-heart syndrome are critically dependent for their very survival on continued flow across these shunts. Indeed, intravenous infusion of prostaglandin E<sub>1</sub>, to maintain the patency of the ductus arteriosus, may be life-sustaining in these patients.

The newborn's myocardium is less compliant than that of the adult or older child and cardiac output is primarily heart-rate dependent.<sup>45–47</sup> The heart has incomplete or decreased sympathetic innervation, with reduced catecholamine stores.<sup>48</sup> Studies performed in newborns during exchange transfusions have revealed that the newborn has reduced capacity for peripheral vasoconstriction during hypovolemia.

Several powerful reflexes control the cardiovascular system of the neonate. The arterial baroreceptor is the most powerful of these and consists of the carotid sinus and aortic arch baroreceptors. These receptors are stretch receptors stimulated by pressure deformation of the vessel wall tissue in which they reside. An increase in transmural pres-

sure stretches these receptors and increases the rate of baroreceptor firing. Afferent nerves carry these signals to the vasomotor centers of the medulla and parasympathetic and sympathetic efferent fibers slow the heart rate, strengthen contraction, and reduce venous and arterial resistance. A reduction in arterial blood pressure has the opposite effect causing a central afferent sympathoadrenal discharge which increases systolic and diastolic blood pressure. The arterial baroreceptor reflex is intact in healthy full-term newborns, but may be significantly depressed in stressed or premature infants. Anesthetics, particularly halothane, may also significantly depress this response.<sup>49,50</sup>

The arterial chemoreceptors form a second powerful cardiovascular reflex arc. The carotid and aortic chemoreceptor bodies are responsible for the cardiovascular response to acute hypoxia. The primary central response to hypoxia is bradycardia. The peripheral chemoreceptors once stimulated cause tachypnea and increased sympathetic discharge to the heart and peripheral tissues. These receptors are stimulated by hypoxic hypoxia (low Pao<sub>2</sub>) and decreased cardiac output, but not by reduced oxygen content as a result of anemia. Once again, the stressed or premature infant, or the full-term infant anesthetized with halothane may have a blunted or absent sympathetically mediated response to hypoxia. Indeed, the most common cause of bradycardia in the newborn is hypoxia, and in the operating room, unexplained bradycardia should always be considered due to hypoxia until proven otherwise.

Consequently, it may be dangerous to anesthetize a stressed neonate who is either hypovolemic or dehydrated, particularly with the potent inhalational anesthetic vapors. Hypovolemia or dehydration should be assumed in septic patients (necrotizing enterocolitis), ventilated patients who are being treated with diuretics and fluid restriction (hyaline membrane disease, patent ductus arteriosus), and when hemorrhage occurs in the operating room.

### Central Nervous System

The central nervous system is the least-mature major organ system at birth. This structural immaturity predisposes the newborn to certain risks, including intraventricular hemorrhages, seizures, respiratory depression, and retinopathy

of the premature.<sup>51–53</sup> Hypoxia, hypercarbia, hypotension, acidosis, and pain may produce any or all of these complications. The stressed premature infant is particularly at risk. Indeed, intraventricular hemorrhage, in which subependymal hemorrhage occurs, is now the leading cause of death and morbidity in these infants, particularly in the premature infant born at less than 28 weeks of gestation, and has an incidence as high as 50%.<sup>51,52,54,55</sup>

Hydrocephalus also occurs frequently either as noncommunicating hydrocephalus, in which the flow of cerebral spinal fluid is obstructed (aqueductal stenosis, spina bifida) or as communicating hydrocephalus, in which the flow of cerebral spinal fluid is unimpeded but resorption is affected (intraventricular hemorrhage). Increased intracranial pressure secondary to hydrocephalus may or may not be present because the newborn's cranial sutures are open at birth and allow for intracranial decompression. On the other hand, the resulting large head may present very difficult airway management problems. Furthermore, the stretching of cranial nerves that may occur with hydrocephalus or with other intracranial pathology such as the Arnold-Chiari malformation, may cause vocal cord paralysis and/or stridor.<sup>56</sup> Finally, autoregulation may be disrupted during hypoxia, acidosis, seizures, or in the presence of a patent ductus arteriosus. Thus, rapid increases in blood pressure may produce intracerebral bleeding and rapid decreases may produce ischemia.<sup>57–60</sup>

### Thermoregulation

The newborn infant, even the premature infant, is quite capable of maintaining a stable core temperature in the face of modestly changing ambient temperatures. This is accomplished by balancing heat production with skin blood flow, sweat production, and changing minute ventilation. However, when exposed to cold, neonatal compensatory mechanisms operate only within a narrow temperature range. For adults, the lower range of thermoregulation is 32° F (0° C), whereas for full-term newborns it is 71.6° F (22° C). Premature infants require even higher ambient temperature to ensure thermal homeostasis. Indeed, at ambient temperatures of less than 89.6–93.2° F (32–34° C), the premature infant must significantly increase its oxygen

consumption in order to stay warm. The ambient temperature at which a state of thermal equilibrium exists, that is in which heat loss and heat production are equal and occur without an increase in oxygen consumption, is called the neutral thermic state.<sup>61,62</sup>

Following delivery, the newborn infant rapidly loses heat because of its large surface area relative to its body mass and because of its lack of heat insulating subcutaneous tissue (fat). The infant loses heat by evaporation, convection, conduction, and radiation. Evaporative heat loss is the major source of heat loss in the perioperative period.<sup>63,64</sup> Physical factors that govern evaporative losses include relative humidity, velocity of air flow, and minute ventilation. The driving force for evaporative heat loss is the difference between vapor pressure on the surface of the skin and vapor pressure in the environment. Physiologic factors that affect evaporative loss relate to the infant's ability to sweat and to increase minute ventilation. Premature infants less than 30 postconception weeks of age have underdeveloped sweat glands and do not perspire. Preventing or minimizing evaporative heat loss is the primary means of heat control in the perioperative period. Wrapping newborns inside plastic bags is one of the easiest ways of minimizing evaporative heat losses and should be used not only in the operating room during a procedure, but also in transport.<sup>65,66</sup>

Heat production is achieved by voluntary muscle activity, shivering, and nonshivering thermogenesis. Shivering is rarely observed in the newborn and with the small muscle mass present, is not very effective. Nonshivering thermogenesis is a heat-producing and oxygen-consuming mechanism stimulated by cold, in which there is a generalized increase in metabolism and a marked increase in the metabolic activity in certain specialized tissues, most notably in the brown adipose tissue ("fat").<sup>67</sup> This tissue, is principally located in the interscapular region, mediastinum, and the tissues surrounding the kidneys and adrenal glands. Unlike white fat, it has a rich blood supply and very high oxygen consumption when metabolically active. Morphologically, brown fat contains multiloculated cells with numerous mitochondria. The mitochondria appear densely packed with cristae and have increased respiratory

chain components. It is also abundantly enervated by the sympathetic nervous system. In fact, the metabolism of brown fat is stimulated by the local release of catecholamines, particularly norepinephrine.<sup>67</sup>

Thus, the control of heat-producing mechanisms depends on skin (not central) thermoreceptors. When skin temperature decreases, central control mechanisms trigger increased metabolic activity in brown adipose tissue. This is mediated by the sympathetic nervous system. Unfortunately, vapor anesthetics can paralyze these systems and convert the infant into a poikilotherm. Alternatively, hypoxia may interfere with thermoregulation. Hypoxia impairs heat production and impairs heat conservation by producing peripheral vasodilatation.

The infant can be protected from unnecessary heat loss quite easily. Aside from wrapping the infant in plastic bags and humidifying the anesthetic vapors, heat can be conserved by warming the operating room to 85° F (25° C), using a forced air heating blanket, warming intravenous fluids, blood, and irrigation solutions, and using a radiant heater with a servocontrol mechanism.<sup>68</sup>

### Renal Physiology and Metabolism

The glomerular filtration rate in a newborn is less than a quarter of an adult's. Furthermore, the newborn's ability to concentrate urine is significantly reduced. In fact, the maximum concentrating ability of the newborn's kidney does not exceed 700 mOsm/kg compared to 1400 in the older child.<sup>69</sup> Thus, the newborn requires sodium-containing fluids intraoperatively.<sup>70</sup> Not only will these infants lose salt intraoperatively through the third space and hemorrhaging, but they continue to lose sodium through obligate urinary losses because of tubular inability to increase sodium reabsorption.

### Glucose Metabolism

Another physiologic transition that must occur at birth involves glucose and energy homeostasis. Prior to birth, all of the newborn's nutritional needs are continuously provided by the maternal circulation. Following birth, major physiologic and metabolic changes are required to adjust to intermittent enteral feeding. Glucose is the substrate used for the energy production necessary for

maintenance of body temperature, respiration, and muscular activity.<sup>71–73</sup> Blood glucose concentration is normally maintained at a relatively constant level by a fine balance between hepatic glucose output and peripheral glucose uptake. Hepatic glucose output depends on adequate glycogen stores, sufficient supplies of endogenous gluconeogenic substrate, a normally functioning gluconeogenic and glycogenolytic system, and a normal endocrine system for modulating these processes. The newborn has limited glycogen stores, which may be rapidly depleted. However, endogenous gluconeogenic substrate availability is not a limiting factor nor is the liver's gluconeogenic and glycogenolytic systems.

Hypoglycemia is common in infants born to diabetic mothers and in infants who require resuscitation, are premature, or who are small for gestational age.<sup>72–74</sup> By definition, hypoglycemia is a blood glucose level less than 45 mg/dL in the infant during the first 3 days of life.<sup>72–74</sup> After 3 days of age glucose values should be greater than 75–90 mg/dL. The clinical manifestations of hypoglycemia include tremors or jitteriness, apnea, cyanotic spells, convulsions, limpness or lethargy, hypothermia, sweating, refusal to feed, and cardiac failure or arrest. These are nonspecific signs and symptoms and must be differentiated from birth asphyxia, central nervous system abnormalities, such as hemorrhage or cerebral edema, congenital heart disease, sepsis, drug withdrawal, apnea, and other metabolic abnormalities such as hypocalcemia, hypomagnesemia, and hyponatremia.

Symptomatic babies must be treated rapidly to prevent neurologic damage. Treatment should be started with a 250–500 mg/kg bolus of glucose (25% dextrose [D<sub>25</sub>]-containing solution), followed by an infusion of 4–6 mg/kg/min (65–100 mL/kg/h) of a 10% dextrose (D<sub>10</sub>)-containing solution. Failure of this regimen to produce blood glucose concentration of 80–120 mg/dL should alert the physician to the possibility of hyperinsulinism. Hyperinsulinism and hypoglycemia occurs in maternal diabetes, erythroblastosis, Beckwith-Wiedemann syndrome, SGA and LGA infants, polycythemia, and in insulin-secreting tumors (nesidioblastosis).

## Calcium

Calcium in the blood circulates as 3 fractions—protein bound, complexed,

and ionized—and is tightly regulated by the intricate interplay of parathyroid, renal, and skeletal factors.<sup>75,76</sup> Ionized calcium is the only physiologically active fraction, whereas the protein-bound calcium provides a reserve of available calcium should a need for increased ionized calcium arise acutely.<sup>75,76</sup> In fact, if total calcium levels in the blood are reduced as a result of low plasma protein, and if the ionized fraction remains normal, there may be no physiologic changes. Conversely, if total calcium levels are normal, but the ionized levels are low, as might occur when chelating agents are used (e.g., as with citrated blood products), significant physiologic effects occur.

During pregnancy, there is rapid transfer of calcium from mother to fetus, via an active placenta pump.<sup>77</sup> At birth there is an abrupt termination of maternal-to-fetal calcium supply. Furthermore, dietary calcium in the first few days of life is significantly less than the amount normally received from the mother. A decrease in serum calcium is expected. In the sick newborn, even greater deprivation of calcium is common because of the conventional withholding of milk feeding and the substitution of calcium-free intravenous feeding.

Consequently, neonatal hypocalcemia is common in the first few days of life. Definitions vary as to the level of serum calcium required for the diagnosis, but most agree that in infants up to 3 months of age, hypocalcemia is defined as a serum total calcium level of less than 8.8 mg/dL or ionized calcium less than 4.9 mg/dL (1.22–1.4 mmol/L).<sup>76</sup> Infants at particular risk are those born prematurely or to diabetic mothers, or who are small for gestational age, or who have received large volumes of citrated blood products or sodium bicarbonate. Additionally, infants who are alkalotic secondary to hyperventilation, or who experienced birth asphyxia, or who are hypoparathyroid or born with the DiGeorge syndrome also present with hypocalcemia.

The classic clinical signs and symptoms of hypocalcemia, namely the Chvostek sign (facial muscle twitching when stimulated) and the Trousseau sign (carpal spasm after constriction of the upper arm), are of little value in the newborn. Rather, nonspecific symptoms occur; namely, jitteriness, twitching, convulsions, and, occasionally, hypotension. An electrocardio-

gram will reveal prolonged QT intervals. The treatment of symptomatic hypocalcemia is the administration of calcium salts. Acute intravenous administration of 1–2 mL/kg of either 10% calcium gluconate or chloride should be administered and the heart rate monitored continuously. In the newborn, the acute administration of calcium can produce significant bradycardia. The other important complication of this therapy relates to extravasation of calcium into the soft tissues when a peripheral intravenous catheter is used. This can cause skin sloughing and necrosis.

## SUMMARY

Except for extraordinary circumstances, all newborns require anesthesia and analgesia for surgery. During the first month of life, the newborn must function independently and adapt to extrauterine life. This involves anatomic, physiologic, and pharmacologic changes to maintain homeostasis and to insure the infant's survival. Disease, congenital anomalies, surgery, and anesthesia may interfere with these adaptations and threaten survival. This chapter has provided an in-depth review of developmental physiology and pathophysiology that is essential in the provision of safe anesthesia to the newborn.

## KEY REFERENCES

1. Berde CB, Jaksic T, Lynn AM, Maxwell LG, Soriano SG, Tibboel D. Anesthesia and analgesia during and after surgery in neonates. *Clin Ther* 2005;27:900–921.
2. Anand KJ, Hickey PR. Pain and its effects in the human neonate and fetus. *N Engl J Med* 1987;317:1321–1329.
3. Maze A, Bloch E. Stridor in pediatric patients. *Anesthesiology* 1979;50:132–145.
4. Pasternak GW, Zhang A, Tecott L. Developmental differences between high and low affinity opiate binding sites: their relationship to analgesia and respiratory depression. *Life Sci* 1980;27:1185–1190.
5. Cote CJ, Zaslavsky A, Downes JJ, et al. Postoperative apnea in former



preterm infants after inguinal herniorrhaphy. A combined analysis. *Anesthesiology* 1995;82:809–822.

6. Welborn LG, Rice LJ, Hannallah RS, Broadman LM, Ruttimann UE, Fink R. Postoperative apnea in former preterm infants: prospective comparison of spinal and general anesthesia. *Anesthesiology* 1990;72:838–842.

7. Volpe JJ. Brain injury in the premature infant: overview of clinical aspects, neuropathology, and pathogenesis. *Semin Pediatr Neurol* 1998;5:135–151.

8. du Plessis AJ, Volpe JJ. Perinatal brain injury in the preterm and term newborn. *Curr Opin Neurol* 2002;15:151–157.

9. Menon RK, Sperling MA. Carbohydrate metabolism. *Semin Perinatol* 1988;12:157–162.

10. Kalhan S, Peter-Wohl S. Hypoglycemia: what is it for the neonate? *Am J Perinatol* 2000;17:11–18

11. Hsu SC, Levine MA. Perinatal calcium metabolism: physiology and pathophysiology. *Semin Neonatol* 2004;9:23–36.

## REFERENCES

1. Maxwell LG, Yaster M. Analgesia for neonatal circumcision: no more studies, just do it. *Arch Pediatr Adolesc Med* 1999;153:444–445.
2. Yaster M. Analgesia and anesthesia in neonates. *J Pediatr* 1987;111:394–396.
3. Berde CB, Jaksic T, Lynn AM, Maxwell LG, Soriano SG, Tibboel D. Anesthesia and analgesia during and after surgery in neonates. *Clin Ther* 2005;27:900–921.
4. Anand KJ, Hickey PR. Pain and its effects in the human neonate and fetus. *N Engl J Med* 1987;317:1321–1329.
5. Kennell JH, Slyter H, Klaus MH. The mourning response of parents to the death of a newborn infant. *N Engl J Med* 1970;283:344–349.
6. Dyer KA. Identifying, understanding, and working with grieving parents in the NICU, Part I. Identifying and understanding loss and the grief response. *Neonatal Netw* 2005;24:35–46.
7. Smith DW. *Recognizable Patterns of Human Malformation*. Philadelphia: WB Saunders, 1982.
8. Hirose S, Farmer DL, Lee H, Nobuhara KK, Harrison MR. The ex utero intrapartum treatment procedure: Looking back at the EXIT. *J Pediatr Surg* 2004;39:375–380.

9. Liechty KW, Crombleholme TM, Flake AW, et al. Intrapartum airway management for giant fetal neck masses: the EXIT (ex utero intrapartum treatment) procedure. *Am J Obstet Gynecol* 1997;177:870–874.

10. Maze A, Bloch E. Stridor in pediatric patients. *Anesthesiology* 1979;50:132–145.

11. Holzki J, Laschat M, Stratmann C. Stridor in the neonate and infant. Implications for the paediatric anaesthetist. Prospective description of 155 patients with congenital and acquired stridor in early infancy. *Paediatr Anaesth* 1998;8:221–227.

12. Pang LM, Mellins RB. Neonatal cardiorespiratory physiology. *Anesthesiology* 1975;43:171–196.

13. King RJ. Pulmonary surfactant. *J Appl Physiol* 1982;53:1–8.

14. Jobe A. The role of surfactant in neonatal adaptation. *Semin Perinatol* 1988;12:113–123.

15. Chernick V. The first expiration: role of pulmonary surfactant. *Semin Perinatol* 1977;1:351–355.

16. Avery ME. The J. Burns Amberson Lecture—in pursuit of understanding the first breath. *Am Rev Respir Dis* 1969;100:295–304.

17. Szwast A, Rychik J. Current concepts in fetal cardiovascular disease. *Clin Perinatol* 2005;32:857–875, viii.

18. Kiserud T. Physiology of the fetal circulation. *Semin Fetal Neonatal Med* 2005;10:493–503.

19. Rigatto H, Brady JP. Periodic breathing and apnea in preterm infants. II. Hypoxia as a primary event. *Pediatrics* 1972;50:219–228.

20. Rigatto H, Brady JP, de la Torre Verdusco R. Chemoreceptor reflexes in preterm infants: I. The effect of gestational and postnatal age on the ventilatory response to inhalation of 100% and 15% oxygen. *Pediatrics* 1975;55:604–613.

21. Rigatto H, de la Torre Verdusco R, Gates DB. Effects of O<sub>2</sub> on the ventilatory response to CO<sub>2</sub> in preterm infants. *J Appl Physiol* 1975;39:896–899.

22. Albersheim S, Boychuk R, Seshia MM, Cates D, Rigatto H. Effects of CO<sub>2</sub> on immediate ventilatory response to O<sub>2</sub> in preterm infants. *J Appl Physiol* 1976;41:609–611.

23. Rigatto H, Kwiatkowski KA, Hasan SU, Cates DB. The ventilatory response to endogenous CO<sub>2</sub> in preterm infants. *Am Rev Respir Dis* 1991;143:101–104.

24. Moriette G, Van Reempts P, Moore M, Cates D, Rigatto H. The effect of rebreathing CO<sub>2</sub> on ventilation and diaphragmatic electromyography in newborn infants. *Respir Physiol* 1985;62:387–397.

25. Rigatto H, Brady JP, de la Torre Verdusco R. Chemoreceptor reflexes in preterm infants: II. The effect of gestational and postnatal age on the ventilatory response to inhaled carbon dioxide. *Pediatrics* 1975;55:614–620.

26. Alvaro R, Alvarez J, Kwiatkowski K, Cates D, Rigatto H. Small preterm infants

(less than or equal to 1500 g) have only a sustained decrease in ventilation in response to hypoxia. *Pediatr Res* 1992;32:403–406.

27. Rigatto H. Ventilatory response to hypoxia. *Semin Perinatol* 1977;1:357–362.

28. Sidi D, Kuipers JR, Heymann MA, Rudolph AM. Effects of ambient temperature on oxygen consumption and the circulation in newborn lambs at rest and during hypoxemia. *Pediatr Res* 1983;17:254–258.

29. Keens TG, Ianuzzo CD. Development of fatigue-resistant muscle fibers in human ventilatory muscles. *Am Rev Respir Dis* 1979;119:139–41.

30. Keens TG, Bryan AC, Levison H, Ianuzzo CD. Developmental pattern of muscle fiber types in human ventilatory muscles. *J Appl Physiol* 1978;44:909–913.

31. Kupferberg HJ, Way EL. Pharmacologic basis for the increased sensitivity of the newborn rat to morphine. *J Pharmacol Exp Ther* 1963;141:105–109.

32. Way WL, Costley EC, Way EL. Respiratory sensitivity of the newborn infant to meperidine and morphine. *Clin Pharmacol Ther* 1965;6:454–461.

33. Pasternak GW, Zhang A, Tecott L. Developmental differences between high and low affinity opiate binding sites: their relationship to analgesia and respiratory depression. *Life Sci* 1980;27:1185–1190.

34. Zhang AZ, Pasternak GW. Ontogeny of opioid pharmacology and receptors: high and low affinity site differences. *Eur J Pharmacol* 1981;73:29–40.

35. Cote CJ, Zaslavsky A, Downes JJ, et al. Postoperative apnea in former preterm infants after inguinal herniorrhaphy. A combined analysis. *Anesthesiology* 1995;82:809–822.

36. Kurth CD, Spitzer AR, Broennle AM, Downes JJ. Postoperative apnea in preterm infants. *Anesthesiology* 1987;66:483–488.

37. Kurth CD, LeBard SE. Association of postoperative apnea, airway obstruction, and hypoxemia in former premature infants. *Anesthesiology* 1991;75:22–26.

38. Welborn LG, Rice LJ, Hannallah RS, Broadman LM, Ruttimann UE, Fink R. Postoperative apnea in former preterm infants: prospective comparison of spinal and general anesthesia. *Anesthesiology* 1990;72:838–842.

39. Rudolph AM, Heymann MA. Circulatory changes during growth in the fetal lamb. *Circ Res* 1970;26:289–299.

40. Clyman RI, Mauray F, Wong L, Heymann MA, Rudolph AM. The developmental response of the ductus arteriosus to oxygen. *Biol Neonate* 1978;34:177–181.

41. Rudolph AM, Itskovitz J, Iwamoto H, Reuss ML, Heymann MA. Fetal cardiovascular responses to stress. *Semin Perinatol* 1981;5:109–121.

42. Konduri GG. New approaches for persistent pulmonary hypertension of newborn. *Clin Perinatol* 2004;31:591–611.

43. Kinsella JP, Abman SH. Recent developments in the pathophysiology and treatment of persistent pulmonary hypertension of the newborn. *J Pediatr* 1995;126:853-864.
44. Kinsella JP, Abman SH. Recent developments in inhaled nitric oxide therapy of the newborn. *Curr Opin Pediatr* 1999;11:121-125.
45. Anderson PA, Glick KL, Killam AP, Mainwaring RD. The effect of heart rate on in utero left ventricular output in the fetal sheep. *J Physiol* 1986;372:557-573.
46. Anderson PA, Manring A, Glick KL, Crenshaw CC Jr. Biophysics of the developing heart. III. A comparison of the left ventricular dynamics of the fetal and neonatal lamb heart. *Am J Obstet Gynecol* 1982;143:195-203.
47. Anderson PA, Manring A, Crenshaw C Jr. Biophysics of the developing heart. II. The interaction of the force-interval relationship with inotropic state and muscle length (preload). *Am J Obstet Gynecol* 1980;138:44-54.
48. Friedman WF. The intrinsic physiologic properties of the developing heart. *Prog Cardiovasc Dis* 1972;15:87-111.
49. Gregory GA. The baroresponses of preterm infants during halothane anaesthesia. *Can Anaesth Soc J* 1982;29:105-107.
50. Wear R, Robinson S, Gregory GA. The effect of halothane on the baroresponse of adult and baby rabbits. *Anesthesiology* 1982;56:188-191.
51. Volpe JJ. Brain injury in the premature infant: overview of clinical aspects, neuropathology, and pathogenesis. *Semin Pediatr Neurol* 1998;5:135-151.
52. Volpe JJ. Brain development—normal and abnormal. *J Perinat Med* 1991;19(Suppl 1):29-34.
53. du Plessis AJ, Volpe JJ. Perinatal brain injury in the preterm and term newborn. *Curr Opin Neurol* 2002;15:151-157.
54. Volpe JJ. Brain injury in the premature infant. *Neuropathology, clinical aspects, pathogenesis, and prevention. Clin Perinatol* 1997;24:567-587.
55. Haynes RL, Baud O, Li J, Kinney HC, Volpe JJ, Folkerth DR. Oxidative and nitrate injury in periventricular leukomalacia: a review. *Brain Pathol* 2005;15:225-233.
56. Ross DA, Ward PH. Central vocal cord paralysis and paresis presenting as laryngeal stridor in children. *Laryngoscope* 1990;100:10-13.
57. Lou HC. Perinatal hypoxic-ischaemic brain damage and intraventricular haemorrhage. *Baillieres Clin Obstet Gynaecol* 1988;2:213-220.
58. Lou HC. Perinatal hypoxic-ischemic brain damage and intraventricular hemorrhage. A pathogenetic model. *Arch Neurol* 1980;37:585-587.
59. Lou HC, Skov H, Pedersen H. Low cerebral blood flow: a risk factor in the neonate. *J Pediatr* 1979;95:606-609.
60. Lou HC, Lassen NA, Friis-Hansen B. Impaired autoregulation of cerebral blood flow in the distressed newborn infant. *J Pediatr* 1979;94:118-121.
61. Du JN, Oliver TK Jr. The baby in the delivery room. A suitable microenvironment. *JAMA* 1969;207:1502-1504.
62. Miller DL, Oliver TK Jr. Body temperature in the immediate neonatal period: the effect of reducing thermal losses. *Am J Obstet Gynecol* 1966;94:964-969.
63. Rowe MI, Taylor M. Transepidermal water loss in the infant surgical patient. *J Pediatr Surg* 1981;16:878-881.
64. Rowe MI, Weinberg G, Andrews W. Reduction of neonatal heat loss by an insulated head cover. *J Pediatr Surg* 1983;18:909-913.
65. Cramer K, Wiebe N, Hartling L, Crumley E, Vohra S. Heat loss prevention: a systematic review of occlusive skin wrap for premature neonates. *J Perinatol* 2005;25:763-769.
66. Vohra S, Roberts RS, Zhang B, Janes M, Schmidt B. Heat loss prevention (HeLP) in the delivery room: a randomized controlled trial of polyethylene occlusive skin wrapping in very preterm infants. *J Pediatr* 2004;145:750-753.
67. Cannon B, Nedergaard J. Brown adipose tissue: function and physiological significance. *Physiol Rev* 2004;84:277-359.
68. Buisson P, Bach V, Elabbassi EB, et al. Assessment of the efficiency of warming devices during neonatal surgery. *Eur J Appl Physiol* 2004;92:694-697.
69. Aronson AS, Svenningsen NW. DDAVP test for estimation of renal concentrating capacity in infants and children. *Arch Dis Child* 1974;49:654-659.
70. Bonilla-Felix M. Development of water transport in the collecting duct. *Am J Physiol Renal Physiol* 2004;287:F1093-F1101.
71. Menon RK, Sperling MA. Carbohydrate metabolism. *Semin Perinatol* 1988;12:157-162.
72. Hume R, Burchell A, Williams FL, Koh DK. Glucose homeostasis in the newborn. *Early Hum Dev* 2005;81:95-101.
73. Pierro A. Metabolism and nutritional support in the surgical neonate. *J Pediatr Surg* 2002;37:811-822.
74. Kalhan S, Peter-Wohl S. Hypoglycemia: what is it for the neonate? *Am J Perinatol* 2000;17:11-18.
75. Wandrup J. Critical analytical and clinical aspects of ionized calcium in neonates. *Clin Chem* 1989;35:2027-2033.
76. Hsu SC, Levine MA. Perinatal calcium metabolism: physiology and pathophysiology. *Semin Neonatol* 2004;9:23-36.
77. Kovacs CS, Kronenberg HM. Maternal-fetal calcium and bone metabolism during pregnancy, puerperium, and lactation. *Endocr Rev* 1997;18:832-872.

# CHAPTER 19

## Evaluation of Children

Randall C. Wetzel, MBBS,  
MRCP, LRCS, MBA, FAAP, FCCM

310

The preanesthetic evaluation of the child requires not only an understanding of the different surgical procedures children undergo, but also an understanding of the unique psychology, development, and physiology of children. There are many obvious differences between adults and children that affect anesthetic management. Apart from the differences of size, communication skills, and issues involving parents, there also are multiple, less obvious differences in the physiology, psychol-

ogy, anatomy, and pharmacology of children. The most characteristic and important feature of childhood is development. Not only does children's responsiveness to other people follow recognized patterns of psychological development that require appropriate responses from the anesthesiologist, but virtually every organ system undergoes distinct, well-described development that is relevant to the anesthetic management of children. The key to understanding pediatric anesthesiology

### KEY POINTS

- The percentage of total body composition that is water decreases with age; intracellular fluid increases, whereas extracellular fluid decreases.
- Fat and muscle mass increase from 13 to 22% and 20 to 50%, respectively, with age.
- The distribution of blood flow varies, with a decreased percentage of flow going to the vessel-rich groups with increased age.
- Infants have a large tongue and relatively small jaw. Infants usually are described as having an anterior and cephalad displacement of the airway with the narrowest segment at the level of the cricoid. The epiglottis generally is large and floppy compared with that of adults.
- Younger children tend to experience airway closure and alveolar collapse with atelectasis because the end-expiratory lung volume from which tidal breathing occurs is close to closing capacity.
- Although the functional residual capacity in mL/kg is smaller in infants compared with adults (30 vs. 34), increased oxygen consumption is the major factor in the rapid desaturation of infants.
- The perioperative risk of reversion to a transitional circulation is related to pulmonary hypertension triggered by hypoxemia, hypercarbia, hypothermia, acidosis, and increased catecholamines.
- Cardiac output depends on heart rate in infants and young children. Infants have parasympathetic hyper-tonia, decreased sympathetic innervation, and a ventricle with less muscle and more noncontractile mass per unit volume. These all lead to a myocardium that is less able to generate adequate force than in adults.
- A hematocrit nadir of approximately 35 at about age 3 months is the so-called physiologic anemia of infancy.
- The glomerular filtration rate/1.73 m<sup>2</sup> increases from 40–130 mL/min with age. Ability to concentrate urine is limited, and maximal osmolarity may be only 700 mOsm.
- Slack lower esophageal sphincter tone with reflux is common in infants aged less than 6 months, but the maintenance of low gastric volumes by nothing-by-mouth (NPO) regulations should be balanced by awareness of the risk of hypoglycemia.
- The liver is functionally immature in children, affecting synthetic and metabolic function.
- Defending the thermoneutrality of infants is a cornerstone of pediatric anesthesia.
- Cold stress in neonates can increase oxygen consumption and decrease oxygen delivery, leading to increased hydrogen ion concentration and decreased glycogen and glucose. This may result in respiratory distress, disseminated intravascular coagulation, shock, and persistent fetal circulation.
- The large surface-area-to-mass ratio in children and decreased subcutaneous tissue mass lead to increased heat loss via conduction, convection, radiation, and evaporation.
- The large volume of distribution noted in neonates is related to decreased protein binding and a greater proportion of extracellular water.
- In preoperative evaluation, the anesthesiologist should prepare himself or herself, the family, and the child for the procedure. The primary objective is to ensure that the child is in optimal condition. Developmental milestones and growth charts should be reviewed to assist in the general assessment of well-being. Optimal drug levels (e.g., anticonvulsants and theophylline) should be ensured.
- Many congenital anomalies are associated with airway and cardiac abnormalities.
- In children with known cardiopulmonary disease, it is imperative that the anesthesiologist be completely familiar with the child's current status and be assured that therapy has been optimized preoperatively.
- In infants, feeding is the major exercise, and failure to thrive may indicate compromised cardiovascular function.
- The "runny nose" remains a controversial area, but whenever possible, surgery and anesthesia should be delayed at least 2 weeks when the child has a runny nose associated with lower respiratory or systemic symptoms.
- Routine laboratory testing for healthy children remains controversial and should be dictated by clinical situation.
- The trend of NPO status is toward a more liberal NPO restriction for clear liquids.
- Rigorous, compulsive, and systematic evaluation of critically ill children is essential.

is to recognize the dynamic processes that occur at the various developmental stages of childhood. The mindset required is not that of understanding anesthesia that is appropriate for adult physiology and adapting this approach to children, but rather to flexibly approach the child as the child grows from fetus to adult. A specific anesthetic plan appropriate to developmental stages should be designed for each child. Because the developmental characteristics of children determine anesthetic management, this chapter focuses on those changes that occur after the neonatal period. Chapter 18 discusses neonatal physiology. This chapter familiarizes the anesthesiologist with the anesthetic implications of development from neonates to adults.

## DEVELOPMENTAL IMPLICATIONS

Growth is not solely a process of proportional enlargement. Total body composition, including proportional fluid content, the relationship of head-to-body size, and cardiorespiratory function, all change disproportionately during development. For example, the head becomes proportionately smaller with relatively little change in the size of the cranial vault after 2 years of age. At the same time, major changes in facial configuration occur. Most striking is the development of the mandible, which develops from being small and obliquely set to the skull of infants to becoming proportionately larger, less obliquely set, and more mobile in adults.

The development of body composition is important because it is an essential determinant of developmental pharmacology. In the fetus, 90% of total body composition is water; at full term, 75% of total body composition is water, but by age 1 year, 60% of total body content is water.<sup>33</sup> Adult water composition is attained by age 1 year. There is also a change in the relative proportion of extracellular water over the first years of life. Extracellular water volume demonstrates a greater decrease than intracellular volume, which undergoes a complementary increase. Intracellular fluid increases from approximately 20% in premature infants to 30% in term infants and to 40% in adults, whereas extracellular fluid falls from 60% in premature in-

**TABLE 19-1.**

**Tissue Type Volume As Percent of Body Volume**

Age	Vessel-Rich Group	Muscle Group	Vessel-Poor Group
Neonate	22	39	13
1 year	17	39	25
4 years	17	41	23
8 years	13	45	21
Adult	10	50	22

Modified from Gregory G. Pharmacology. In: Gregory G ed. Pediatric Anesthesia. New York: Churchill Livingstone, 1989;396.

fants to 45% in term infants and 20% in adults.<sup>104</sup> The percentage of body composition that is muscle in premature infants is less than 20% and increases to more than 20% at term, and attains 50% in adults.<sup>33</sup> Fat likewise increases with age, from 13% in term infants to 22% of total body weight in adults.<sup>33</sup> There also is an age-dependent change in the relative proportion of blood flow to the various organs. Distribution of blood flow to various organ groups defined by their vascularity (vessel-rich group [VRG], muscle group [MG], and vessel-poor group [VPG]) also demonstrates major developmental change (Table 19-1).<sup>27</sup> For example, there is a decreased percentage of flow going to VRGs with increasing age. The VRG in neonates accounts for 22% of total body volume, whereas in adults, it only accounts for 10%. Thus, an anesthetic caregiver would expect a smaller portion of blood flow to VPGs in infants and a more rapid attainment of the plateau phase of the alveolar end-tidal concentration (FA)-to-inspired concentration (FI) ratio with use of inhalational anesthetics. This has clear implications for the induction of inhalational anesthesia in children, and, not surprisingly, the uptake and distribution of inhalational anesthetics in children.<sup>27</sup>

## Respiratory System

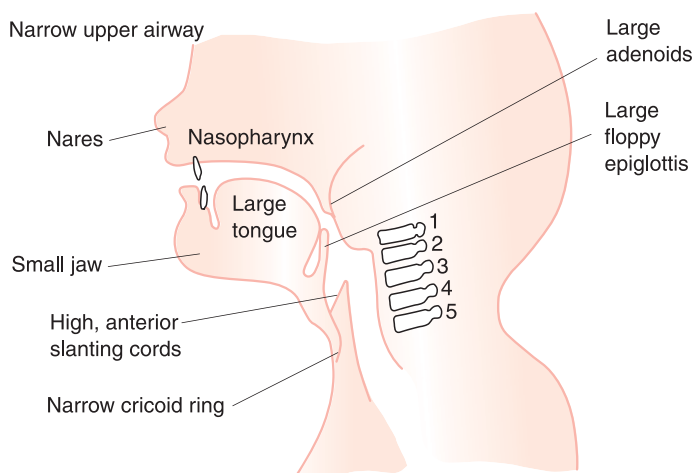
The major features of the respiratory system that undergo important developmental changes are (a) the upper airway, (b) airway caliber, (c) respiratory system (chest wall and lung) mechanics, (d) central control of breathing, and (e) respiratory muscle characteristics. Each is described in the following material.<sup>22</sup>

The upper airway undergoes major development (Fig. 19-1). The first developmental difference is that an in-

fant's tongue is relatively large compared with the rest of the airway. Intubation may be hampered by the overlarge tongue situated in the relatively small jaw. Infants usually are described as having an anterior, cephalad-displaced glottis, with the airway forming an inverse cone (Fig. 19-2). The narrowest segment of the airway is at the cricoid cartilage and remains so until puberty. These factors are important for intubation. An endotracheal tube that will be admitted to the glottis may be too tight for the subglottic area. The presence of an air leak below 30 cm H<sub>2</sub>O airway pressure always should be assured for routine anesthesia.

In infants, the glottis is located at C2, 2-3 vertebral bodies higher than in adults, in whom the glottis is located at C4-C5. The cricoid cartilage is found at C4 in children and at C6-C7 in adults. The obliquity of the vocal cords also changes with age. In infants, these are slanted down and anteriorly compared with adults. This makes the angle for intubation more acute and more difficult in children, and makes blind nasal intubation difficult. Another difference in the child's airway is the nature of the epiglottis. The epiglottis in small children is relatively larger, longer, more curved (omega [Ω] shaped), and floppy compared with that in adults. Maturation begins to occur at age 2 years, and the adult configuration is achieved sometime near puberty, when the epiglottis is shorter, smaller, blunter, and less curved rather than Ω shaped. These anatomic differences in the airway have a major effect on which intubation techniques will be useful in children. For example, a straight laryngoscope blade (e.g., Miller blades) that can lift directly the epiglottis out of the larynx during glottic visualization is useful in children.





**FIGURE 19–1.** Diagram of a coronal section through the airway of an infant. Areas where there are important differences from adults are highlighted. (Reproduced with permission from Wetzel RC.<sup>107</sup>)

Airway caliber undergoes continuous developmental change from the nares to the small airways. Although airway branching has been completed by birth, the caliber of the airways continues to increase. Airway resistance is inversely proportional to the fourth power of the radius, as seen in the Poiseuille equation:

$$\text{Resistance} = 8Ln/r^4$$

where  $L$  is the airway length,  $n$  is the viscosity of the fluid, and  $r$  is the radius of the airway. It should be noted that total airway resistance is affected by consideration of caliber from the nares to the alveoli. Small airways have high resistance. The consideration of size also makes the seriousness of airway edema greater in

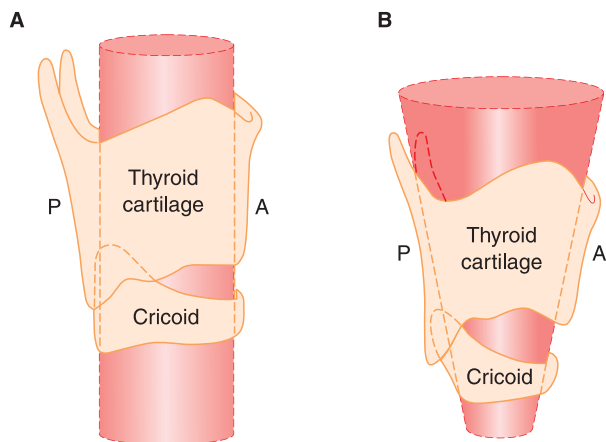
younger children. A proportional increase in mucosal thickness in children increases resistance to a greater extent than it does in adults because equal mucosal thickening proportionately decreases caliber more in children. Airway resistance decreases approximately 15 times from infancy to adulthood, with a dramatic change occurring near age 8 years.<sup>41</sup> This decrease in resistance with increasing age largely results from an increase in diameter of the small airways.<sup>111</sup> Infants are obligate nose breathers, and nasal obstruction can cause severe respiratory embarrassment, which is more severe in premature infants.<sup>66</sup>

Respiratory mechanics change dramatically from birth to adulthood. These changes result from increased alveolarization, increased airway size,

and changes in the chest wall. Only as the rib cage ossifies does its configuration change and become more rigid. In infants, the chest wall is soft and pliable because of its largely cartilaginous structure, which makes the chest wall highly compliant. This compliance promotes chest wall collapse when increased work of breathing requires more negative intrathoracic pressure. The clinical consequences associated with these chest wall factors are seen in infants with respiratory distress as marked sternal and subcostal retractions. In infants, the chest wall is at a mechanical disadvantage during breathing because greater pressure is required per unit of tidal volume moved. In addition to the compliance of the chest wall, there is also a decrease in elastic recoil of the total respiratory system and chest wall. This low elastic recoil tends to alter the relationship between closing volume, functional residual capacity (FRC), and residual volume.

The respiratory system undergoes major neuromuscular development. Central respiratory control, muscle fiber makeup (type I vs. type II), and neural innervation of the chest wall show distinct developmental changes in infants and small children.<sup>49</sup> The central respiratory control undergoes dramatic developmental changes. For example, full and preterm neonates demonstrate depression of the  $\text{CO}_2$  response curve and secondary apnea with hypoxia.<sup>81,82</sup> This contrasts with the characteristic adult response, which is increased  $\text{CO}_2$  responsiveness in the presence of hypoxia, resulting in tachypnea. The impact of hypoxia in the presence of this paradoxical, immature response can be catastrophic in neonates.<sup>81</sup> This infantile pattern of respiratory control is related to the risk of postanesthetic apnea in neonates.<sup>57</sup> Anesthetic effects on the  $\text{CO}_2$  response curve are similar in infants and adults. The  $\text{CO}_2$  response curve undergoes depression by potent inhalational anesthetic agents and narcotics in children as it does in adults.<sup>51</sup>

Respiratory muscle type does not reach the adult pattern of distribution until approximately age 2 years. This predisposes the infant to fatigue. Type II muscle fibers predominate and do not have the ability to perform repeated exercise against increased workloads as do type I fibers.<sup>49</sup> Type I fibers become predominant around age 2

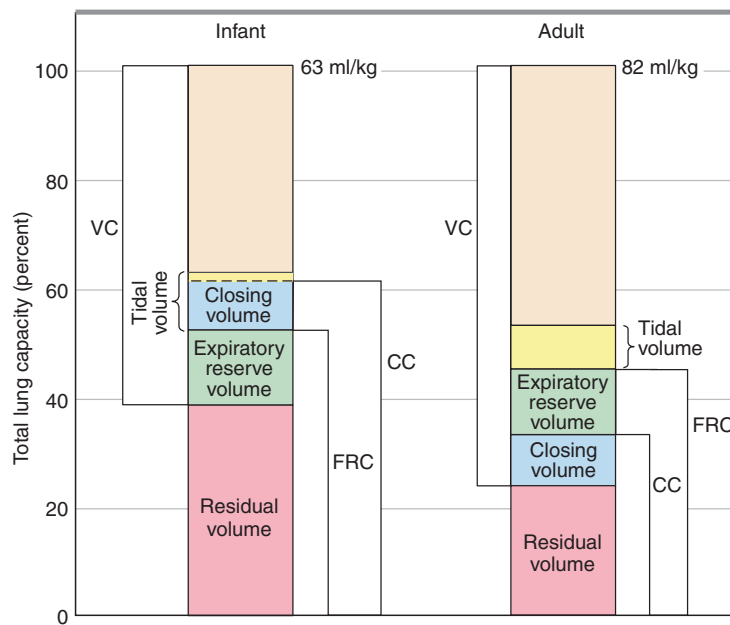


**FIGURE 19–2.** Schematic of an adult (A) and infant (B) airway. Note the comparison between the cylindrically shaped airway with uniform diameters in the adult and the conically shaped airway of the child with the narrowest region at the cricoid. A, anterior; P, posterior. Reprinted from Cote CJ, Todres ID. The pediatric airway. In: Ryan JF, Todres ID, Cote CJ, et al., eds. A practice of anesthesia for infants and children. Philadelphia: WB Saunders, 1986;35–58, with permission from Elsevier.

years. Regarding neural innervation, reflex responses and spindle innervation of the thoracic cage also undergo developmental changes. For example, the Hering-Breuer response is accentuated in preterm infants compared to full-term infants, and leads to apnea with lung inflation in preterm infants.<sup>76</sup> These characteristics have a major impact on cyclic respiration as can be seen from the immature respiratory pattern of periodic breathing. In addition, sleep-state-dependent respiratory patterns show distinct developmental differences.<sup>44</sup>

These changes in chest wall recoil, elasticity, compliance, and neural control have a major effect on lung volumes (Fig. 19-3). One of the most important factors is the tendency in younger children for airway closure and alveolar collapse with atelectasis to occur. Children breathe from an end-expiratory lung volume (EELV) close to closing capacity (CC). Their FRC is actually below CC in premature infants and term neonates, increasing with age. Airway closure may occur even during normal tidal respiration in small infants.<sup>88</sup> Induction of anesthesia is associated with decreased elastic recoil and airway tone and decreased respiratory muscle tone. Thus, an expected lung volume decrease occurs with tidal respiration falling below closing volumes. These factors and those responsible for the decrease in EELV to less than FRC on induction of anesthesia, in part account for the rapid occurrence of hypoxemia in apneic infants during induction of anesthesia. The other major factor related to the rapid occurrence of hypoxemia in apneic infants is their relatively increased oxygen consumption. In neonates, oxygen consumption is approximately 7 mL/kg/min.<sup>40</sup> On a consumption-to-weight basis, this is approximately double that seen in adults, in whom oxygen consumption undergoes a gradual decrease with age. Although FRC/kg is less (30 mL vs. 34 mL) in infants than adults, increased oxygen consumption is the major cause of the rapidity of desaturation in infants and small children who are apneic. Table 19-2 summarizes the developmental differences in respiratory physiology between infants and adults.

In addition to oxygenation issues, development of the respiratory system also affects ventilation. For example,  $V_{DS}/V_T$ , the ratio of dead space gas



**FIGURE 19-3.** Bar graphs representing proportional lung volumes in infants and adults. Note the relationship of functional residual capacity (FRC) to closing volume and how this changes with age. CC, closing capacity; VC, vital capacity. (Smith CA, Nelson NM. *The Physiology of the Newborn Infant*. Springfield, IL: Charles C Thomas, 1976. Courtesy of Charles C Thomas Publisher, Ltd., Springfield.)

**TABLE 19-2.**

### Respiratory Mechanics

	Infant	Adult
Respiratory frequency (breaths/min)	30–40	12–16
Inspiratory time (sec)	0.4–0.5	1.2–1.4
I:E ratio	1:1.5–1:2	1:2–1:3
Inspiratory flow (L/min)	2–3	24
Tidal volume		
mL	18–24	500
mL/kg	6–8	6–8
Functional respiratory capacity (FRC)		
mL	100	2200
mL/kg	30	34
Vital capacity		
mL	120	3500
mL/kg	33–40	52
Total lung capacity		
mL	200	6000
mL/kg	63	86
Total respiratory compliance		
mL/cm H <sub>2</sub> O	2.6–4.9	100
mL/cm H <sub>2</sub> O/mL FRC	0.004–0.06	0.04–0.07
Lung compliance		
mL/cm H <sub>2</sub> O	4.8–6.2	170–200
mL/cm H <sub>2</sub> O/mL FRC	0.04–0.07	0.04–0.07
Specific airway conductance		
mL/sec/cm H <sub>2</sub> O/mL FRC	0.24	0.28
Respiratory insensible water loss		
mL/24 hr	45–55	300

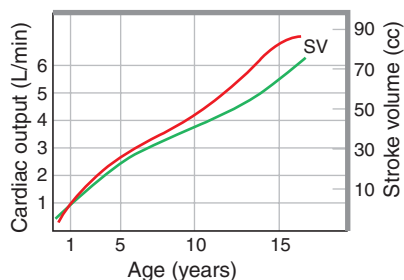
Data from Gioia FR, Stephenson RL, Alterwitz SA. Principles of respiratory support and mechanical ventilation. In: Rogers MC, ed. *Textbook of pediatric intensive care*. Baltimore: Williams & Wilkins, 1987.<sup>35</sup>

volume to tidal gas volume ventilation, is approximately 33% in neonates and adults.<sup>110</sup> Thus, an infant would be expected to have a 7-mL dead space gas volume with a 20-mL tidal gas volume. The addition of a few milliliters of dead space gas volume by the superimposition of anesthetic equipment may increase dead space gas volume from 7–12 mL and have a serious effect on  $V_{DS}/V_T$  and  $CO_2$  clearance in neonates. The dead space gas volume of all ventilatory equipment, endotracheal tubes, and especially face masks and anesthesia circuitry should be minimized.

### Cardiovascular System

The cardiovascular system also undergoes dramatic developmental changes.<sup>32,68</sup> The most obvious and dramatic changes occur perinatally, and these are detailed in the section on perinatal physiology. Even in full-term infants, there is a perioperative risk of complications related to the transitional circulation. Any factor that contributes to pulmonary hypertension (e.g., infection, acidosis, hypoxia, hypercarbia, hypothermia, and aspiration) may lead to a serious decrease in cardiac output, hypoxemia, and hypotension. These factors should be avoided in the anesthetic plan for infants.

Multiple developmental changes occur in myocardial function. Changes in the proportion of muscle to connective tissue with development lead to an alteration in myocardial compliance.<sup>32</sup> Developing left ventricular dominance also alters ventricular characteristics. Nearly every determinant of cardiac output (heart rate,<sup>68</sup> contractility,<sup>79</sup> afterload,<sup>98</sup> and preload relationships<sup>50</sup>) undergoes distinct developmental changes (Fig. 19–4).<sup>107</sup> Although myocardial ischemia only rarely plays a role in the anesthetic management of children,

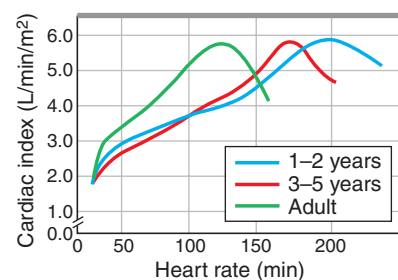


**FIGURE 19–4.** Stroke volume and cardiac output increase with age. Data from Wetzel RC, Rogers MC. Pediatric hemodynamic monitoring. In: Shoemaker WC, Thompson WL, eds. Critical Care-State of the Art. Fullerton, CA: The Society of Critical Care Medicine, 1983.

these factors and the varying responses to pharmacologic agents can lead to rapid, and occasionally catastrophic, hemodynamic decompensation in children undergoing anesthesia.<sup>109</sup>

In neonates and infants, heart rate is the predominant determinant of cardiac output.<sup>86</sup> The infant's heart is able to sustain greater rates than that of the adult while maintaining preload, contractility, and myocardial oxygenation before there is a decrease in cardiac output (Fig. 19–5). Figure 19–6 shows the normal heart rates for infants and children. Bradycardia can drastically and seriously decrease the cardiac output in infants and children. Increasing cardiac output by increasing heart rate should be considered early in responding to intraoperative decreases in cardiac output as represented by hypotension. Bradycardia results from a predisposition to parasympathetic hypertension, which is common in young children and can be induced by painful stimuli or hypoxia. Laryngoscopy, intubation, eye surgery, airway surgery, abdominal traction, and herniorrhaphy frequently are associated with marked increases in vagal tone and profound bradycardia. Under these circumstances, the cardiac output of the heart rate-dependent infant heart can decrease dramatically. That children adapt to changes in cardiac output by changes in heart rate accounts for the wide ranges in heart rate seen in healthy children. Anesthetic suppression of atrial conduction and loss of P waves on the electrocardiograph with nodal escape rhythms are seen in children during anesthesia, and the resultant bradycardia can be dramatic. Heart-rate depression during anesthesia is readily treated with atropine and is the reason many anesthesiologists make atropine part of any inhalational anesthetic plan in infants and small children. Sinus dysrhythmia, a variation in the heart rate with respirations, is so common in children that it is considered normal, although it can be confused with extra systoles or sinus arrest during anesthesia.

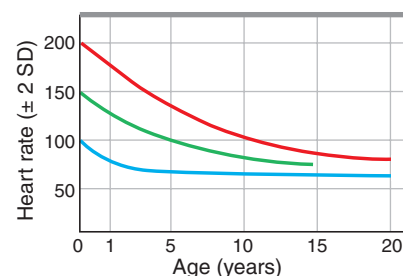
As Friedman originally reported in 1973, the myocardial length–tension relationships vary between the hearts of children and adults, and developmental differences in contractility are clearly seen.<sup>32</sup> These differences are explained by changes in muscle mechanics, innervation, myocardial blood flow, and histologic structure, all of which have been implicated in children's relative inability



**FIGURE 19–5.** Cardiac output is shown as it relates to heart rate in healthy children and adults. Data from Wetzel RC, Rogers MC. Pediatric hemodynamic monitoring. In: Shoemaker WC, Thompson WL, eds. Critical Care-State of the Art. Fullerton, CA: The Society of Critical Care Medicine, 1983.

to increase contractility. Fetal myocardial muscle sarcomeres are active and have about the same contractile power as the adult sarcomere.<sup>32</sup> The fact that neonatal ventricular tissue contains less muscle mass and more noncontractile mass per unit volume than adult tissue accounts for the fact that the neonatal myocardium is less able than the adult myocardium to generate adequate force.<sup>97</sup> The neonatal heart is only innervated partially by the autonomic nervous system (this innervation increases until mid childhood). Therefore, not only is the myocardium less able to develop inotropic force, but sympathetic innervation also is decreased. The Frank-Starling preload relationship also appears to be altered by differences in the fiber makeup of the infant myocardium and by the relationship of the right and left ventricles.<sup>32</sup> These changes in compliance characteristics frequently make the infant heart preload insensitive. Volume load may generate higher filling pressures over a narrower proportional range in infants and small children than in adults.<sup>85</sup> Normal adult contractility and compliance is reached between 1 and 2 years of age.

The final determinant of cardiac output—afterload—also changes with age. At birth, systemic resistance greatly



**FIGURE 19–6.** Normal heart rates  $\pm 2$  standard deviations shown in relation to age.

TABLE 19-3.

## Normal Range of Blood Pressures

Age	Mean Systolic/ Diastolic
Premature neonates	Systolic 40–60
Full-term neonates	75/50
1–6 months	80/50
6–12 months	90/65
12–24 months	95/65
2–6 years	100/60
6–12 years	110/60
12–16 years	110/65
16–18 years	120/65
Adult	125/75

Approximate ranges: pressure  $\pm 20\%$  = 95% confidence limits. Females are approximately 5% lower than these levels. Data from Lowry GA: *Growth and development of children*, ed 6, Chicago, 1975, Year Book Medical Publishers; and Report of the Task Force on Blood Pressure Control in Children, National Heart, Lung, and Blood Institute, *Pediatrics* 59(suppl):803, 1977.

increases with removal of the placenta, whereas afterload in the pulmonary circuit decreases dramatically.<sup>85,97</sup> Adjustment to this massively increased afterload in the systemic circulation occurs rapidly, but further increases in afterload may be poorly tolerated in the first year of life. Right and left ventricular mass and wall thickness are relatively equal in neonates. During the next year or so of life, the left ventricle becomes markedly dominant. As a result of the factors mentioned previously, optimal cardiac output occurs at lower filling pressures in neonates compared with adults.<sup>85</sup>

All of these factors lead to optimal cardiovascular function at higher heart rates and lower blood pressures in infants than in adults (Fig. 19-5). Familiarity with the normal range of blood pressures (Table 19-3) is essential to guide appropriate intraoperative management.

Congenital heart defects can affect the determinants of cardiac output: heart rate, contractility, preload, afterload, and oxygenation. Left-to-right intracardiac shunting alters preload, potentially alters contractility, and even alters right ventricular afterload as pulmonary vascular resistance increases. Right-to-left shunting affects systemic

oxygenation. Valvular disease can increase preload (regurgitant lesions), decrease preload (mitral and tricuspid stenosis), or increase afterload (aortic and pulmonic stenosis). Congenital and surgically acquired lesions can alter conduction and give rise to cardiac dysrhythmias. Thus, careful evaluation of all aspects of cardiac function is necessary in assessing children with congenital heart disease. The specific anatomic diagnosis, the presence of intracardiac shunts, and myocardial function all have a bearing on the conduct of the anesthetic in children.

Hemoglobin content and oxygen affinity also vary with age.<sup>13</sup> In the infant born at term, the normal hemoglobin concentration falls dramatically during the first year of life, reaching a nadir around age 2–3 months, the so-called physiologic anemia of infancy.<sup>13</sup> Although a physiologic hematocrit at this age could dip below 29%, a hemoglobin of  $< 10$  g/dL is rare. In the preterm infant, the hemoglobin concentration may fall to between 6 and 8 g/dL within the first 6–8 weeks of life.<sup>92</sup> Although not unusual, this should not be considered “physiologic,” and the same concern regarding a hematocrit of  $< 25\%$  in older children is appropriate. The hematocrit slowly increases to adult levels after puberty. Knowledge of these normal levels is necessary to guide blood transfusion and the timing of elective surgery that may be associated with significant blood loss.

Circulating blood volume is greater in neonates than in adults on the basis of body weight. Intravascular volume for neonates generally is 80 to 90 mL/kg (Table 19-4). Understanding this relative change in total estimated blood volume (EBV) (body weight  $\times$  estimated blood volume/kg) is necessary when determining allowable blood loss (ABL) in children. The following formula is useful for estimating how much blood children can lose before the hematocrit is unacceptably low (ABL):

$$ABL = EBV \times \frac{Hct_1 - Hct_2}{\text{Mean Hct}}$$

$Hct_1$  is the starting hematocrit;  $Hct_2$  is the minimum desired or allowable hematocrit; and the Mean Hematocrit is the simple arithmetic mean of  $Hct_1 - Hct_2$ . Thus, in a 12-kg, 1-year-old child with an initial hematocrit of 37% in whom a final hematocrit of 25% is acceptable, the ABL is:

TABLE 19-4.

## Intravascular Blood Volume

Age	Blood Volume/ Kilogram Body Weight (mL/kg)
Infants	
Premature	90–100
Full-term	80–90
Less than 1 year	75–80
1–6 years	70–75
>6 years and adult	65–70

From Wetzel RC: *Evaluation of Children*. In Longnecker DE, Tinker JH, and Morgan GE, et al, eds., *Principles and Practice of Anesthesiology*, Vol 1, 2 ed, Mosby, Inc., 1998.

$$\begin{aligned} ABL &= \\ 12 \text{ kg} \times \frac{75 \text{ mL}}{\text{kg}} \times \frac{0.37 - 0.25}{0.5(0.25 + 0.37)} \\ &= 348 \text{ mL} \end{aligned}$$

A comparison of the estimate of expected intraoperative loss with the estimate of allowable loss should be made before surgery. If possible, preoperative therapy should be designed to decrease the need for blood transfusion. Iron and nutritional supplements may be beneficial. Erythropoietin should be considered in some children to increase the preoperative hemoglobin concentration when the child is chronically anemic, where there are religious reasons to refuse transfusion, or if the child is erythropoietin deficient, e.g., renal disease. Preoperative treatment with erythropoietin has been advocated to increase the hematocrit in children to facilitate autotransfusion, either in directed autotransfusion with preoperative blood collection, or to facilitate intraoperative autotransfusion.<sup>34</sup>

## Renal Function

Renal function changes dramatically with age.<sup>17</sup> For example, glomerular filtration rate (GFR)/1.73 m<sup>2</sup> changes from less than 40 mL/min at birth to 100 mL/min in the first year of life, which compares with 130 mL/min in adults (Table 19-5). These changes in renal function and GFR are accompanied by changes in the ability to regulate salt and water metabolism and by responses to changes in antidiuretic hormone (ADH) that occur during anesthesia.<sup>8</sup> Although the factors regulating neonatal kidney function are com-



TABLE 19-5.

## Development of Renal Function

Age	Kidney Weight (g)	GFR/1.73 m <sup>2</sup> mean $\pm$ SD mL/min
Infants		
Term	27	20 $\pm$ 4
6 mo	32	77 $\pm$ 18
1 yr	71	115 $\pm$ 25
Children		
2 yr	93	127 $\pm$ 19
8 yr	149	127 $\pm$ 19
12 yr	191	127 $\pm$ 19
Adults	290	131 $\pm$ 21

Modified from Chantler C: The kidney. In Godfrey S, Baum JD, editors: *Clinical paediatric physiology*, Oxford, 1979, Blackwell Scientific Publication.<sup>47</sup>

plex in the transitional phase, the net result is that water is excreted in excess of sodium. The neonatal kidney wastes sodium, and there is a tendency toward hyponatremia in the premature and full-term neonate. The kidney of the full-term infant is able to conserve sodium.<sup>91</sup> The ability of the kidney to concentrate urine is limited, and maximal osmolarity may be only 700 mOsm/L in infants.<sup>8,17</sup> Thus, infants are less able to defend intravascular volume against water deprivation.

Complete maturation of renal function usually occurs by about age 2 years. These developmental aspects of renal function have an effect on pharmacology. The effects of these changes are most prominent in the first few months of life and require careful fluid management in neonates and attention to sodium and potassium balance.<sup>6</sup> Blood pressure regulation and the characteristics of hypertensive renal disease also show distinct differences in children.<sup>38</sup> In children with renal disease, hypertension should be looked for because intraoperative blood pressure regulation may be difficult.

### Dentition

Although teeth occasionally are present at birth, they may not erupt until nearly 1 year of age. The mean age for the development of the first tooth, usually a lower incisor, is around 6 months. By 1 year, children usually have upper and lower teeth present. By age 6 years, permanent teeth begin to appear, and the average 6-year-old has an intubation

gap between the front incisors. The importance of deciduous teeth is that they fall out, and they should not fall out during anesthesia. Children younger than 12 years of age, especially those with loose incisors at around age 6 years, should be questioned and examined for the presence of loose teeth. Loose and carious teeth are at increased risk for dislodgment by the placement of oral airways, laryngoscope blades, and endotracheal tubes. A history of endotracheal intubation in the neonatal period is associated with subsequent development of abnormal dentition in neonates.<sup>70</sup> Whether this is a result of direct trauma from the laryngoscope or from long-term placement of an endotracheal tube is not clear.<sup>106</sup> Attention to children's oropharynx and condition of dentition is an essential part of the anesthetic evaluation.

### Gastrointestinal System

Developmental changes in the gastrointestinal (GI) tract also have important anesthetic implications. At birth, gastric pH is alkalotic; however, by the second day of life, the normal physiologic range of gastric pH is achieved. The secretion and amount of gastric contents in full-term infants is similar to adults. Although fasting gastric contents and pH in children are similar to those in adults, the reflex coordination of swallowing and lower esophageal sphincter (LES) function is not fully mature until age 6 months.<sup>10,11,108</sup> Slack LES tone with reflux is common in this age group. This is relevant to the question of preoperative fasting. The maintenance of low residual gastric volumes by nothing-by-mouth (NPO) regulations (a questionable assumption) should be balanced against the propensity of fasting children to develop hypoglycemia.<sup>10,11</sup> This especially is true if the infants or children are born prematurely, small for gestational age (SGA), nutritionally deprived, or with increased metabolic needs because of conditions such as fever, sepsis, increased respiratory effort, or the condition that requires surgery. To assure a suitable period of fasting, especially in small, ill children, preoperative intravenous (IV) supplementation with dextrose-containing solutions is indicated.

Development of the GI tract generally is complete at birth. Problems caused by congenital malformations or developmental anomalies generally

are obvious within the first few days after birth.<sup>10</sup> Upper GI obstruction (e.g., duodenal atresia, malrotation) is indicated by bilious vomiting and regurgitation within the first few days of life. Lower intestinal anomalies (e.g., volvulus or atresia of the small or large bowel) are manifested by failure to pass stools and by abdominal distension. Pyloric stenosis, another major cause of GI dysfunction in the first year of life, usually presents between ages 3 and 6 weeks. Its major symptoms are failure to gain weight and projectile vomiting.

The liver in neonates and young infants is functionally immature. This functional immaturity generally is a result of two main causes: (a) the development and growth of enzyme systems that, although present at birth, are not fully induced, and (b) relatively decreased hepatic blood flow.<sup>103</sup> The ability of the liver to conjugate and catabolize circulating substrate and pharmacologic substances is diminished at birth. For this reason, drugs tend to have longer half-lives in neonates compared with older children. This functional immaturity of the liver is reflected by decreased concentrations of products of hepatic synthesis, such as albumin, in neonates.<sup>42</sup> These decreased concentrations lead to decreased protein binding of many pharmacologic agents, which alters pharmacokinetics and pharmacodynamics.<sup>5,46</sup> Hepatic function usually reaches adult levels within the first few months of life.

### Thermoregulation

Perhaps no area is of greater concern to the pediatric anesthesiologist than the need to maintain normal body temperature perioperatively. The need for thermoregulatory control is underemphasized in adults but is critical in the treatment of children. Defending the thermoneutrality of infants has been a cornerstone of pediatrics since the 19th century. In 1900, Pierre-Constant Boudin demonstrated that there were striking differences in the survival of infants weighing less than 2000 g that depended solely on their rectal temperatures.<sup>12</sup> The mortality rate for infants with core temperatures less than 95° F (35° C) was greater than 90% and for those with temperatures greater than 95° F (35° C) was only 23%. Boudin designed an incubator that provided heated air and humidity and then

conclusively demonstrated that its use could dramatically improve the survival of neonates.<sup>12</sup> This observation found its way to Julius Hays Hess, who is considered the founder of premature care in North America.<sup>95</sup> He recognized the importance of these observations, and in 1922, opened the first premature infant center at the Michael Reese Hospital in Chicago.

Thermoregulation is a complex process involving peripheral and central thermoreceptors, the central nervous system (CNS), and hypothalamic integration with central thermoreceptors.<sup>37</sup> A complex integration of responses leads to alterations in cutaneous blood flow and thermogenesis from shivering and nonshivering sources.<sup>16</sup> This complex system is necessary to maintain mammalian core temperature within a normal range. Sources of heat production include basal metabolism, movement, shivering thermogenesis, and nonshivering thermogenesis. Basal metabolism is responsible for the greatest amount of baseline heat production. Shivering thermogenesis is the uncontrolled, rapid contraction of skeletal muscles, and is common on emergence from anesthesia in older patients. Nonshivering thermogenesis is under direct control of the autonomic nervous system and produces heat by mobilizing fat from muscles, liver, and brain.<sup>14</sup> Although neonates metabolize both white and brown fat, brown fat is used by neonates to a greater extent than by adults. This is important because neonates cannot respond to cold stress with shivering thermogenesis until age 6 months to 1 year. Brown fat is distributed around the back of the neck, mediastinum, and interscapular regions, and around the kidneys and adrenals. Brown fat owes its color to a high content of mitochondria and rich blood supply, which mirror its metabolic capability. Brown fat metabolism increases heat production when stimulated by autonomic catecholamine release.<sup>14</sup> Cold stress also leads to norepinephrine secretion, which causes adipocytes to release glycerol and fatty acids from brown fat depots. Brown fat metabolism provides the only possibility of increasing body temperature in the immobile, anesthetized infant with decreased metabolic rate. Cardiac output is diverted from other organs to brown fat depots. Vasoconstriction of the systemic and pulmonary circulations occurs as a result of norepinephrine re-

lease. Consequently, cold stress can lead to peripheral vasoconstriction, pulmonary vasoconstriction, decreased cardiac output, and shunting of cardiac output away from other organ systems to brown fat depots, all of which may pose a serious threat to neonates. Importantly, inhalational anesthetics inhibit brown fat-dependent thermogenesis, which explains the propensity of neonates to become hypothermic during inhalational anesthesia.<sup>75</sup> This complex system can compensate for heat loss, but at a high cost. Avoiding cold stress is preferred.

During anesthesia, environmental challenges to thermal integrity should be minimized, especially as inhalational anesthetics inhibit brown fat thermogenesis.<sup>75</sup> Hypothermia increases cardiorespiratory demand because of increased oxygen demand and the need for thermogenesis, and alters every basic enzyme system. Environmental cold stress in neonates leads to increased oxygen consumption, hypoxia, acidosis, respiratory distress, depletion of glycogen stores, hypoglycemia, pulmonary vasoconstriction, pulmonary hypertension with persistence of the fetal circulation, shock, and even disseminated intravascular coagulation. Altered drug metabolism, delayed emergence, prolongation of the effects of neuromuscular blocking agents, and other pharmacologic effects accent the need for intraoperative thermoregulatory control in children.<sup>95</sup>

Heat loss occurs through four basic mechanisms: conduction, convection, radiation, and evaporation. Each of these, under certain circumstances, can be the major cause of heat loss. Conductive heat losses can be eliminated by minimizing the direct contact of children with surfaces colder than themselves. The use of a warming pad or heating blanket in the operating room can eliminate heat loss to the cold operating room table. Warming of the operating room greatly reduces conductive heat loss. Convective heat losses can be further limited by the use of an incubator, by surgical drapes and warm blankets for the child. Radiant heat losses also should be minimized. Heat is radiated to objects of lower temperature. Warming objects in the patient's environment will lead to decreased radiant losses. This is the principle that underlies "radiant" neonatal warmers.<sup>24</sup> The use of double-walled incubators decreases radiant

losses. Transportation of neonates to the operating room in double-walled isolettes probably is optimal, but the use of radiant warmers that minimize convective loss also is acceptable. Finally, evaporative losses intraoperatively should be curtailed to minimize heat loss.

The use of warmed solutions for skin preparation and irrigation is important. The use of heated humidified air for ventilation also contributes to the thermoregulatory control of children. It is the Children's Hospital of Los Angeles' routine practice to use humidifiers in all pediatric circuits, maintain warm operating rooms with a high humidity, and use heating pads for all children who are anesthetized. For newborns and small neonates, the operating room should be maintained at 80°F (26.7°C), for infants ages 0–6 months at 78°F (25.6°C), and for children age 6 months to 2 years at 76°F (24.4°C), always maintaining a minimum of 80% humidity. Warming of intravascular fluids and rapidly transfused blood also is necessary. Factors that contribute to infants becoming cold are basically related to their large surface-area-to-mass ratio. In addition, areas richly supplied with blood, such as the head and cranial vault, are proportionally larger in infants, giving rise to heat loss. In premature neonates, this situation is aggravated by their decreased subcutaneous tissue. Some method should be used to eliminate heat loss from the skin surface, especially the head, such as the use of plastic wraps and blankets. Convective warming with forced warm air devices is probably more effective than conductive (heat pad) warming and appears to decrease postoperative thermal stress when used in the recovery area.<sup>2,15</sup>

## GENERAL PRINCIPLES OF PEDIATRIC PHARMACOLOGY

The developmental differences among neonates, infants, and adults impact pediatric pharmacology. Until recently, our understanding of pediatric pharmacology was at best, sketchy, and at worst, incorrect. Pharmacokinetic principles that govern the distribution and metabolism of anesthetic agents in adults are not directly applicable to children. Pediatric drug dosages initially were determined by calculating the proportionate amount of an adult dose

on a weight basis. Some assumptions about converting adult dosages to children's dosages on a per kilogram, surface area, or age basis have been proven incorrect.<sup>5</sup> Perhaps no other area demonstrates more clearly that children are not small adults. There are many reasons why merely scaling down dosages on a per-kilogram basis does not yield equivalent drug concentrations or pharmacologic effects. During the development from fetus to adult, factors that affect drug uptake, distribution, metabolism, and sensitivity to drugs change. Volume of distribution, elimination half-lives, drug sensitivity, side effects, organ function, protein binding, and clearance undergo major changes with age.

Complex issues of clinical investigation contribute to the poor knowledge of pharmacokinetics in children. Medical and ethical issues affect the ability to obtain data directly applicable to children. These factors have resulted in a largely empiric approach to pediatric anesthesia. This empiricism is yielding to better-designed, better-informed studies in small children, aided by the advent of microassay techniques that require smaller volumes of blood sampling. There are now several excellent studies of the pharmacokinetics of many agents, including local anesthetics, narcotics, and sedatives, and of the uptake and distribution of inhalational agents in children.

### Drug Administration

Anesthetic agents may be delivered orally, rectally, transnasally, percutaneously, conjunctivally, intramuscularly, intravenously, or by inhalation. Administration of drugs across mucous membranes requires passive diffusion, which depends on the concentration and the chemical properties of the agents used and on the amount of surface area exposed. The fact that agents are absorbed across the mucous membrane in the rectum has made this route of administration popular for numerous sedatives and induction agents, such as methohexital, midazolam, thiopental, and ketamine.<sup>62</sup> Because the degree of ionization generally depends on pH and surface area, formulation is particularly important. Rectal absorption is generally slow and uneven, but can be enhanced by large volumes of dilute solutions, which come in contact with a greater surface area.<sup>30</sup> Analgesic agents also can be

administered by this route, allowing mild analgesia without the need for oral administration perioperatively. This route is acceptable for most children younger than 5 years old.

Intranasal and transconjunctival administration of benzodiazepines, ketamine, and narcotics has been reported.<sup>1,39,102</sup> Formulation, solubility characteristics, desired end points, and concentration affect the rapidity, duration, and depth of sedation and define an agent's suitability to induce anesthesia. Novel formulations, such as oral transmucosal fentanyl citrate, have yet to find a place in routine clinical practice.<sup>9,62</sup>

Intramuscular administration is not recommended in children because of pain on injection and pain after injection, which may last for several days.<sup>72</sup> Induction, neuromuscular blocking, and analgesic agents may be administered intramuscularly. When no other route of administration of an induction agent is possible, intramuscular ketamine (5–10 mg/kg) might achieve anesthetic induction in agitated, uncooperative children within 5–7 minutes. Although intramuscular administration of narcotics is time-honored, it is generally avoided. Administration of diazepam is associated with burning and muscle pain; however, water-soluble midazolam appears to be less irritating. Pain on injection and its variable duration make intramuscular administration rarely used in children.<sup>72</sup>

The distribution of drugs administered intravenously depends on many factors, most of which are affected by developmental changes. Degree of binding to circulating blood elements, such as proteins and erythrocytes, blood-tissue partition coefficients, distribution of blood flow to various tissue beds, and changes in tissue volumes, affect the distribution of intravenously administered agents.

### Drug Distribution

The existence of the free, nonbound, water-soluble moiety in the circulation is required for a drug to cross the endothelium and other cell membranes (where its effect is achieved) and for plasma clearance. The bulk of protein binding is by albumin, however,  $\alpha_1$ -acid glycoprotein also is a significant circulating protein to which drugs bind. The concentration of the latter and its contribution to protein binding appear to be greater in older children than in adults. In contrast,

infants have low concentrations of  $\alpha_1$ -acid glycoprotein, therefore, they may have a larger, unbound, circulating concentration of certain drugs.<sup>112</sup> Curare, metocurine, propranolol, lidocaine, bupivacaine, digoxin, barbiturates, and narcotics demonstrate protein binding. Their protein affinities have a major effect on the pharmacokinetics of drugs in infants and children. Because the protein-bound fraction acts as a reservoir for the drug to maintain tissue and plasma concentrations, concomitant presence of substances that displace drugs from binding sites, such as bilirubin in the neonate, will alter the pharmacology of highly protein-bound agents. Substances that reduce protein binding include free fatty acids, maternal steroids, and sulfonamides. Protein binding affects a drug's volume of distribution. Agents that are poorly protein bound have a larger apparent volume of distribution because the free drug penetrates tissues more easily. Thus a reduction in plasma protein binding causes an increase in the apparent volume of distribution, which partially explains the large volume of distribution frequently found in neonates. Nearly twice as much barbiturate and morphine is bound in the neonatal CNS as compared to what is bound in adults and older children, at least partly as a result of reduced plasma protein binding in neonates.<sup>36</sup> Plasma protein binding also may have a major effect on determination of blood-gas and blood-tissue partition coefficients and leads to developmental differences in uptake and distribution of anesthetics.<sup>20</sup>

The developmental changes of blood flow to various tissue compartments and body fluid composition cause differences in drug distribution with increasing age.<sup>5</sup> Distribution is altered by the relatively small muscle mass and fat stores in neonates, which results in greater flow to the central organs, such as the liver, brain, blood, heart, and kidneys. A water-soluble drug may require a larger initial dosage to achieve a desired blood level. This is relevant for most antibiotics and, most notably, for succinylcholine. The increased volume of distribution also has an effect on clearance, causing delayed excretion and metabolism and prolonged half-lives. A further effect of change in body composition is seen with fat-soluble drugs. Drugs that rely on redistribution

into fat for the termination of their therapeutic effects, such as thiopental, may have a more prolonged clinical effect in younger children. Those that redistribute into muscle, such as narcotics, also have a prolonged effect.<sup>52</sup>

Other factors may alter the uptake and distribution of anesthetic agents. First is the change in the blood-brain barrier that occurs perinatally.<sup>5,88</sup> The integrity of the blood-brain barrier is immature at birth. Because many anesthetic drugs are lipid soluble, this leads to a more rapid uptake of anesthetic agents by the neonatal CNS than occurs in adults. The proportion of blood flow to the brain is higher in neonates than in adults, and for highly lipid-soluble drugs, diffusion across the blood-brain barrier leads to higher brain concentrations and a larger apparent volume of distribution in neonates compared with adults. A second factor that may affect uptake of anesthetic agents arises from differences in dose-response relationships, which may result from receptor affinities, changes in receptor density, or sensitivity with age. With uptake and distribution considered, the minimum alveolar concentration (MAC) of inhalational anesthetics, the hypnotic dose of thiopental, and the sensitivity to succinylcholine have age-related differences that can be explained by potential differences in receptor sensitivity to these agents.

The termination of a drug's effect depends on distribution, metabolism, and excretion. Distribution, as shown previously, varies dramatically with age. Drug metabolism and the enzyme systems responsible, especially cytochrome P450 and hepatic conjugation, also undergo distinct developmental changes.<sup>36,88</sup> Finally, the developmental differences in renal function also have an effect on the clearance and termination of drug effects.

Myriad developmental differences and multiple factors varying dramatically with age determine the uptake, distribution, metabolism, and excretion of anesthetic agents. Thus it is not surprising that there is no simple relationship between age and a dosage calculated on a mg/kg basis.

## PREOPERATIVE EVALUATION AND PREPARATION

Examining and preparing children for anesthesia and surgery require a spe-

cialized approach because of the unique physiologic and psychological needs of children and their families. The same basic goals of preoperative examination that should be achieved in adults also are applicable to children, but in addition, the emotional and psychological needs of not only the child but the child's family should be addressed. Familiarity with the specific perioperative needs of children and their families is necessary for the anesthesiologist to obtain an appropriate history, physical examination, and thorough preoperative evaluation from a wailing infant, a hyperactive child, or a shy, frightened 5-year-old, without undue trauma for all concerned. In these situations, although it may be difficult, it is necessary to thoroughly examine children. Understanding the physiology and psychology of children is necessary.<sup>47,61</sup>

### Purpose

The two goals of preoperative evaluation are (a) for the anesthesiologist to obtain, through interview history and physical examination of the patient, information pertinent to the child's physiologic and emotional preparedness for surgery, and (b) for the patient, to allay the anxieties of the child and parent and prepare them for surgery. Both of these goals are important and should be viewed as necessarily compatible in the anesthetic treatment of children. From the outset, both goals should be constantly kept in mind (Box 19-1).

The anesthesiologist's first contact with the child and family necessarily sets the stage for the remainder of the anesthesia management. The information obtained and the interactions that occur during the preoperative evaluation will determine the quality of the intraoperative management and the postoperative recovery. Although this is obvious when examining the physiologic status of the child, which is used to guide the choice of preoperative medication, induction agent, and anesthetic maintenance, as well as the postoperative requirements, it likewise is true for addressing the emotional and psychological needs of the child and family. Not only should the preoperative evaluation familiarize the anesthesiologist with the child and the parents, it also should provide an excellent and critical opportunity for the child and family to become comfortable with the

### BOX 19-1.

#### Purposes of Preoperative Evaluation

Prepare the anesthesiologist  
Prepare the child and family

anesthesiologist and to understand the anesthesiologist's responsibilities. The preconceived notions of children and their families about the events that will occur in the perioperative period and the personnel with whom they will interact form the background for the preoperative interview. The skilled and experienced anesthesiologist is aware of these preconceptions and addresses them whether or not they are mentioned by the child or the family. This anticipatory approach to the child's needs frequently smoothes the path for induction and emergence from anesthesia for the child, the family, and, not unimportantly, the anesthesiologist.

The key to smooth anesthetic management is not only the complete familiarity of the anesthesiologist with the child's medical and psychoemotional background but also of the child's and family's understanding of the procedures associated with anesthesia and surgery. A comfortable and competent anesthesiologist, familiar with all aspects of the perioperative course of surgery in children, is able to optimize this experience for all concerned. This approach applies to infants or older children, as well as to inpatients and outpatients. The exact setting and the child's unique characteristics determine the specific technique for dealing with each circumstance. Whereas it may be necessary in one case to separate the child from the family early and use preoperative sedation, in another case, parental presence during induction and emergence may be the optimal approach. The knowledge and experience of the anesthesiologist are important in determining which approach is best for which child.

The first objective of preoperative examination and preparation is to assure that the child is in his or her optimal status for the procedure planned. The question of whether or not the child can tolerate the anesthetic and surgery is less relevant than in the past. Pediatric anesthesiologists are capable of providing the most advanced physiologic support for children who require complex surgery. It almost al-



ways is possible to provide monitored critical care and analgesia for any surgical procedure. What does vary from patient to patient is not the ability of the anesthesiologist to deliver anesthesia care and assure survival, but the risk to the child for each set of circumstances. The all-important question of whether the anesthetic and surgical risk to the child is greater than the benefits of the procedure should be addressed. Concerns of survival largely are replaced by a precise, accurate, and clear evaluation of the risks of anesthesia for each child, which then can be realistically compared with the child's surgical needs. The underlying goal is that for each child, given the circumstances, the best possible preoperative status will be attained for the procedure. This varies tremendously if the child is undergoing decompression of an epidural hematoma after a traffic accident in which the child has sustained bilateral femoral fractures, a ruptured spleen, pulmonary contusion, and intracranial injury with little time for preoperative assessment compared with myringotomy in a child with Down syndrome and a recently diagnosed atrioventricular canal defect who also happens to be wheezing. Both of these children can be anesthetized and are likely to survive the anesthetic; however, the wisdom of immediately proceeding varies considerably based on the results of an analysis of the specific risk-to-benefit relationship.

It is the anesthesiologist's responsibility to ensure that an accurate assessment of the risks and benefits of the anesthetic is as clear as possible to the child, the parents, the surgeon, and the pediatrician. Careful attention to these details is essential in evaluating and preparing children for anesthesia. Questions of preoperative preparation, timing of surgery, specific surgical procedure, and anesthetic plan are within the anesthesiologist's purview. These should be addressed by the anesthesiologist in the preoperative evaluation. A thorough and adequate examination of the child is essential for identifying and predicting physiologic as well as psychological and emotional problems that the child might encounter intraoperatively and postoperatively.<sup>18,47</sup> The anesthesiologist, armed with this extensive background information, can provide the best intraoperative care and advise on postoperative treatment (Box 19-2).

**BOX 19-2.****Preparation for Surgery****Goal**

Optimal physical and mental status for surgery

**Contingencies**

Medical judgment

Optimization of medical therapy

Timing

Psychoprophylaxis of child and family

**General Approach****Preconceptions**

It is essential to understand some of the preconceived notions that the child and family may have acquired from society and the surgeon. Most parents think that anesthesia is a source of some risk to their child; the spectrum may vary from fear of postoperative nausea, vomiting, headaches, and behavioral disturbances, to fear of a serious threat to the child's life. It is important to recognize, inquire about, and address these issues because these preconceptions frequently differ from the anesthesiologist's view.

Whereas the anesthesiologist may view a child whose American Society of Anesthesiologists physical status (ASA PS) score is P1 for a unilateral myringotomy as being at extremely low risk and very low on the anxiety scale, parents do not necessarily always appreciate this (Box 19-3). They frequently may demonstrate a parental "Moro response" to any perceived threat to their child, no matter how trivial the threat. Any threat to their child naturally may trigger defensive and protective responses, as well as high levels of anxiety in families. The underlying concerns and anxieties experienced by parents of children undergoing what to anesthesia caregivers may be a routine procedure frequently do not qualitatively differ from those of parents whose children have been admitted to the pediatric intensive care unit. For parents of former premature infants and critically ill children, the perception of vulnerability, not surprisingly, heightens anxiety.<sup>3</sup> Although anesthesia caregivers may consider this parental response inappropriate, it is important to recognize that the parents of a child undergoing a routine procedure may be terribly concerned for their child's well-being. A sympathetic and

**BOX 19-3.****Sources of Parental Anxiety****Anesthesia complications**

Brain damage

Death

**Results of surgery**

Disfigurement

Dismemberment

Death

**Separation, loss of control****Hostility generated by**

Poor information and communication

Apparent lack of due concern by

caregivers and physicians

understanding approach to this parental response is a crucial ingredient of expert management. Insuring calm, informed, confident parents is frequently the most essential aspect of insuring calm, cooperative children. Terrified, nervous, defensive, angry, ill-informed parents are incapable of allaying their child's anxieties for the upcoming procedure.<sup>101</sup> Time taken to explain, answer questions, anticipate and allay anxieties, and demonstrate care and concern for the child is time well spent.

**Areas of Childhood Anxiety**

Childhood anxieties in the perioperative period center on 5 areas (Box 19-4).<sup>18</sup> The first, fear of injury, is universal; fear of death (even for minor procedures) often is present. Fear of pain and the potential for resulting body disfigurement is common. Second, fear of parental separation (separation anxiety) is common in children age 6 months or older and can be a concern in adolescents. Common sense dictates that the less time the conscious child is separated from the parents the better for all concerned. Apart from obvious humanitarian concerns, a calm, comfortable, nonscreaming child is more aesthetically physiologically and is better able to tolerate anesthesia and surgery than a distraught child.<sup>101</sup> The third

**BOX 19-4.****Sources of Childhood Anxiety**

Fear of pain, injury, and death

Fear of parental separation

Fear of loss of autonomy

Fear of the unknown

Fear of punishment

area of anxiety that correlates with the developmental stage of separation—individuation—concerns fears centered on the loss of individuality and autonomy, which may be a source of considerable stress in children. Taking a child who has spent several years learning to walk, who is comfortable away from his or her parents only for short times, and who has independent control of major functions, and suddenly reducing the child to lying on his or her back, surrounded by what appear to be giants, with no control of the situation, certainly provokes anxiety. Along with the loss of autonomy is the threatened loss of function and loss of control that were won so recently. Anything that can be done to encourage and enhance the child's autonomy and control of the situation, such as allowing choices (e.g., position [sitting, lying, standing], method of induction, which stuffed animal to bring to the operating room, or color of gown) can help calm the child's fears.

The fourth issue is fear of the unknown. Children often are intimidated by the new. Most children will not have undergone either anesthesia or surgery in the past, and this generates anxiety. Recognition of this issue, followed by frank, honest, and as complete a disclosure as possible of the procedures and occurrences that the child will experience is necessary. The child's knowledge reduces the dark, mysterious areas of ignorance and uncertainty. The phrases "it won't hurt" or "you have nothing to worry about" can be some of the most anxiety-provoking words an anesthesiologist can utter. The child knows it is not true and suspects a coverup.

The fifth area, and perhaps the least obvious, is the child's fear of breaching behavioral standards and eliciting from authority figures, including parents, a reprimand. The fear of transgression and punishment is a characteristic underlying anxiety of childhood (and frequently extends into adulthood) and may be a major source of concern to the child. Explaining the permissibility of crying appropriately, of expressing anxiety and fear about the procedure, and of having a negative attitude toward the procedure, thus validating the child's emotions, decreases the anxiety associated with this childhood concern.

These areas should be always remembered and addressed consciously by the anesthesiologist in his or her

TABLE 19-6.

## Developmental Behavior

Age	Stage	Characteristics
0–6 months	Infantile	No expression Passivity Dependence
9 months–5 yrs		Separation–individuation Communicative Separation anxiety Poor reality perception Developing independence
5 yrs–adolescent	Childhood	Imaginative rationale Self-focused Fearful Limited expressiveness

From Wetzel RC: Evaluation of Children. In Longnecker DE, Tinker JH, and Morgan GE, et al, eds., *Principles and Practice of Anesthesiology*, Vol 1, 2 ed, Mosby, Inc., 1998.

approach to the child.<sup>47,61</sup> Openness, honesty, and cheerful confidence are the main tools for allaying child and family anxieties and in producing a setting that is most conducive to obtaining information by history and by physical examination. Children are capable of seeing through fraud and spotting lack of confidence. Once their trust is lost, the ability to provide them with the best anesthesia care also is lost. Honestly telling a child that an IV start might be unsuccessful and will be painful is preferable to saying "it won't hurt" and then repeating this painful procedure unsuccessfully several times. Spending the extra time to gently talk a child through a mask inhalational induction frequently may be more rewarding (although more time-consuming) for the child, the parent, and the anesthesiologist, than walking into the room, and with little preparation, jabbing a needle in the child's thigh. Developing the skills necessary to approach children and their families increases the facility with which the anesthesiologist provides the best anesthesia care and increases the rewards of anesthesia practice.<sup>83,115</sup>

**Developmental Stage**

Just as an adult approach is inappropriate for the child, so is an approach that does not consider the developmental stage of the child. The anesthesiologist's approach to a 6-month-old infant is different from the approach taken with a 14-year-old pubertal adolescent. Developmental stage determines approach (Table 19-6).

**Neonates and Infants Younger Than 6 Months**

Probably because infants and neonates are unable to express themselves, it is assumed that the psychological ramifications of separation and surgery are minimal. This assumption may be as erroneous as the assumption by earlier medical practitioners that infants were unable to feel pain. Although infants do not have the apparent adverse responses to strangers that are seen in older children (older than 6 months of age) and can be comforted by a nurse or physician, they unquestionably recognize their mother and are comforted by her presence.<sup>53</sup> Consequently, it is judicious to minimize the time children are separated from their parents. For this age group, although direct psychological preparation of children is not possible, parental preparation can form the basis of the approach to neonates and young infants. Experience indicates that fretful, anxious, uptight parents frequently convey this attitude to their young infants. Psychological preparation should be directed toward the child's family. Parents know that anesthesia and surgery present a threat to adults and reason that this threat is much greater for frail infants. Specifically addressing this frequent, although false, assumption, and pointing out that a robust infant undergoing routine surgery is more likely to recover rapidly from the stress of surgery and anesthesia than a grandparent or a parent, is important. Such information can alleviate anxiety and remarkably calm the parents, who, in turn, calm the infant.

**Nine months to 5 years** Older infants and preschool children ages approximately 9 months to 5 years are in a difficult stage. They are aware of their environment and surroundings, are able to perceive a threat, and can remember painful experiences. Unfortunately, this is combined with an inability to reason and a poor perception of reality. Although these children are able to recognize stressful situations, they are unable to express their fears by modes of communication other than crying, regressive behaviors, sullen withdrawal, or other nonspecific responses to stressful situations.<sup>26</sup> Even though it may not be possible to determine exactly what is most disturbing to a child, attention to the areas mentioned previously and a specific explanation can alleviate their concerns. There is value in explaining what is going to happen and in familiarizing the child with the procedure, even though the child might not appear to be receptive. If this has no benefit other than to demonstrate the anesthesiologist's concern for the child's well-being to the parents, it is worthwhile.

**Five Years to Adolescence** This developmental stage of childhood is characterized by an increasing capability of expression and reasoning. Gaining control over behavioral and emotional responses is one of the major tasks of this period. The ability to understand and trust adults, even strangers, generally develops during this time. Disclosure of anesthetic procedures and careful, honest, and compassionate explanation of the events that surround surgery generally is rewarded in this age group. Explaining to the child and parents the anesthesiologist's role and what happens during the perioperative period decreases anxiety. In this age group, and throughout adolescence, children's imaginations are well developed. Frequently, this imagination, aided and abetted by exposure to the hyperkinetic modern media (e.g., television), can lead to vivid and distorted anticipation of what actually goes on inside an operating room. As much realistic exposure to personnel, equipment, and methods of dress as possible before the procedure may drive some of these vivid, preconceived, and frequently terrifying notions from the child's (and parents') mind.<sup>61,83</sup> It often is informative to ask the child what he or she anticipates, and, if one is fortunate to

have a communicative child, this can be worthwhile.

In older children and adolescents, an underlying fear is that of death. This fear may be reinforced by well-meaning parents, friends, and adults, as well as by medical personnel. Saying that the child "will be put to sleep" or the anesthesiologist's reference to "getting him down" may be counterproductive. Unfortunately, these statements may remind a child of what happened to a pet. In adolescents, the fear of death can be strong, and this, coupled with the loss of control and autonomy that accompanies anesthesia, frequently worries children and teenagers. Talking expectantly and openly about the postoperative period is worthwhile. Discussing how the child will feel and what steps will be taken to awaken him or her and to relieve pain will confidently lead the child away from any notion that he or she will not awaken after surgery.

A "macho" attitude in teenagers may lead them to be trapped in silence with their fears. In dealing with adolescents, it is worthwhile to specifically ask if they have any fears and specifically ask if there is concern about pain and dying. The frequency with which these questions are answered affirmatively is revealing. Understanding these underlying anxieties and specifically, honestly, and openly addressing them is valuable and certainly rewards the time required to do it. This is true even if the adolescent bravely denies such fears.

### Preoperative Psychologic Preparation

Psychologic preoperative preparation begins for children before coming to the hospital. Informing the parents that they should explain openly and honestly to the child what is about to occur can begin the child's psychological preparation at home.<sup>114</sup> Honesty and an open demeanor cannot be overemphasized as the cornerstones of this reassurance.<sup>47,83,101</sup> Many hospitals have programs for inpatients and outpatients designed to introduce children and their families to the hospital and operative setting in an enjoyable manner. There are many alternatives for accomplishing these goals, including a preoperative film, a puppet show, a coloring book, a tour of the hospital, and a friendly meeting with doctors and nurses.<sup>47,53</sup> Selecting from these options is not as important as imple-

menting a program to ensure that the child's association with the hospital or surgical center begins on a positive note. This provides a major contribution to the preoperative preparation of children. Younger children, and occasionally older children, should be encouraged to bring familiar things to the hospital. They should bring their stuffed animals and their own pajamas, arrive in their own clothes, and be allowed to retain them as long as possible. Comforting, familiar books and toys certainly should be encouraged. Parents should be reminded of the importance of this. Encouraging older children to be involved in the planning of the surgery also can be beneficial. Allowing them to select the time of surgery and participate in the planning process can raise the young adult's spirits and reassure the child.

During the preoperative evaluation, it should be remembered that the evaluation is a two-way process. Not only does the medical establishment (whether it is a nurse, nurse practitioner, or anesthesiologist) gain information pertinent to the anesthetic management of the child, but the child and family gain information that is useful for building confidence and anxiolysis about the anesthesiologist and hospital setting. It is useful to remember that throughout the interview with the family, the child is the center of attention.<sup>115</sup> The battle may be lost with the parent and child if the anesthesiologist interacts only with the parent to obtain information about the child, tells the parent the procedure, and leaves the room. The initial contact should be made with the child with a cheerful greeting and an attempt made to win the child's confidence before beginning the medical interview. Assuring the child that the main intent is not to inflict injury but to get to know him or her is crucial. No one will appreciate this more than the parents. Making it clear to the child and family that the anesthesiologist takes the child's procedure as seriously as the child does and is there to help, not only during the painful times but also during the anxiety-provoking times, is beneficial. Explanations of how the child will awaken and what will be done to manage pain are worthwhile.

Many parents will expect to be with their child during the induction of anesthesia. This may frequently be a pleasant experience for the child, parent and

practitioner. The benefit for the child has been greatly debated recently.<sup>47</sup> Parents seem to prefer to be present, whereas practitioners prefer they are not. The focus should be on the child and, after much study, parental presence does not appear to provide a significant benefit over preoperative medication. Clearly, tearing a terrified child away from the comforting arms of a parent is difficult for the child, the parent, and the caregivers. If this parental separation cannot be achieved comfortably with preoperative psychoprophylaxis and behavioral modification as described above, or with pharmacologic means, such as preoperative medications including benzodiazepine and barbiturates, then there may be a need to defer parent-child separation until general anesthesia has been induced. Medicating the child preoperatively with an oral benzodiazepine more frequently provides smooth, calm conditions for induction than does parental presence without medication.<sup>47</sup> A confident, competent anesthesia practitioner may be able to reduce the need for preoperative medication. Parental presence appears neither to decrease emergence phenomena nor the incidence of postoperative behavioral changes and does not add an advantage over that provided by preoperative sedative medication, such as oral midazolam.

## PREOPERATIVE EVALUATION

Just as psychoemotional preoperative preparation of the child should begin before the anesthesiologist meets the child, the anesthesiologist also should have prepared before the meeting. The anesthesiologist should be familiar with the surgery that the child requires, the surgeon's needs, and the anesthetic implications of the surgical procedure. The anesthesiologist should be as familiar as possible with the child's medical background as documented in the medical records. Communication with the pediatrician and surgeon before meeting the child and family will reveal areas of particular interest to the anesthesiologist before the interview.<sup>115</sup> An anesthesiologist who is aware of the child's name, age, general background, medical problems, and surgical procedure, and who has communicated with the child's pediatrician and surgeon is in a strong position to win the confidence of the child and family. When a

child has an extensive previous medical history, it is worthwhile reviewing old records. Specific attention should be directed to the presence of congenital anomalies and pediatric syndromes that may be associated with anomalies that are unrelated to the surgery but that could complicate the anesthetic management. A review of the drug and allergy history may provide information critically important to the anesthetic management.

Finally, if there were any previous anesthetic procedures, careful review of these records may provide an opportunity to improve anesthetic management. Specifically noting whether premedication was necessary, its effect when given, the response to various anesthetic agents, airway management, and emergence particularly may be useful. There may be information in this record that the anesthesiologist wishes to have before speaking to the parents. If the child, after what appeared to be a minor procedure, was intubated and ventilated in the intensive care unit for 3 days, the parents would be, not surprisingly, somewhat skeptical should the anesthesiologist be unaware of this occurrence. In children who have had several operations consideration of latex allergy is important. A review of the previous anesthetic records for unexplained hypotension or wheezing should raise the consideration of latex allergy and the need for latex precautions.<sup>78</sup>

It may be worthwhile to discuss areas of concern with the surgeon and the child's physicians before meeting the family so the family can have the most complete information possible at the preoperative assessment. When meeting with the family, the anesthesiologist can determine the child's general health, level of activity, interests, favorite toys, background, and mental and medical condition. Knowledge of the parents' nickname for the child might be useful during emergence. Finding out which fingers or thumb the child sucks as a guide to IV placement may make the difference between a calm patient and an inconsolable patient postoperatively.

A systems review of appropriate depth always is indicated. A history of current and recent drugs and a history of allergies should be completed in all patients. Specific questioning about previous anesthetics and any history of siblings or family members who have

had prolonged awakening, cancelled surgery while in the operating room, intraoperative cardiorespiratory catastrophes, or unexplained fevers specifically should be sought in each case. Frequently, no one else will have asked questions concerning potential drug allergies, malignant hyperthermia, or adverse anesthetic reactions.

## Physical Examination

The examination of the child should begin as soon as the physician enters the room. During the time spent obtaining the history from the parents and, when appropriate, from the child, important observations can be made. This period is invaluable for establishing rapport with the child and family. Constant efforts to gain the child's confidence (e.g., by getting down to the child's level [sitting down is necessary], offering a toy, or interacting with the child), are of tremendous help. While discussing the child with the family, attempting to interact with the child and desensitizing the child to the close presence of the anesthesiologist is critical. Briskly walking into the room, interrogating the mother or father, and turning to the child will not yield optimal information from the physical examination. Interacting with, humoring, reassuring, and playing with the child during the interview not only calms the child, but can also provide valuable information regarding the child's general health status, developmental status,<sup>31</sup> respiratory condition, level of activity, state of hydration and perfusion, and level of anxiety concerning hospitalization.

The examination of the child falls into 3 areas: (a) general health and systems examination, (b) areas specifically related to the provision of anesthesia, and (c) areas related to surgery. The physical examination is guided by the findings in the history and interview and the needs of the surgical procedure. As mentioned above, the examination begins when the anesthesiologist first meets the child. A great deal can be learned about the patient's perfusion, hemodynamic status, and respiratory status by general observation. Determining the child's growth and weight (e.g., short stature, failure to thrive) are essential because they guide anesthetic management and may indicate the necessity for closer evaluation (Figs. 19-7 to 19-10).<sup>26,53</sup>

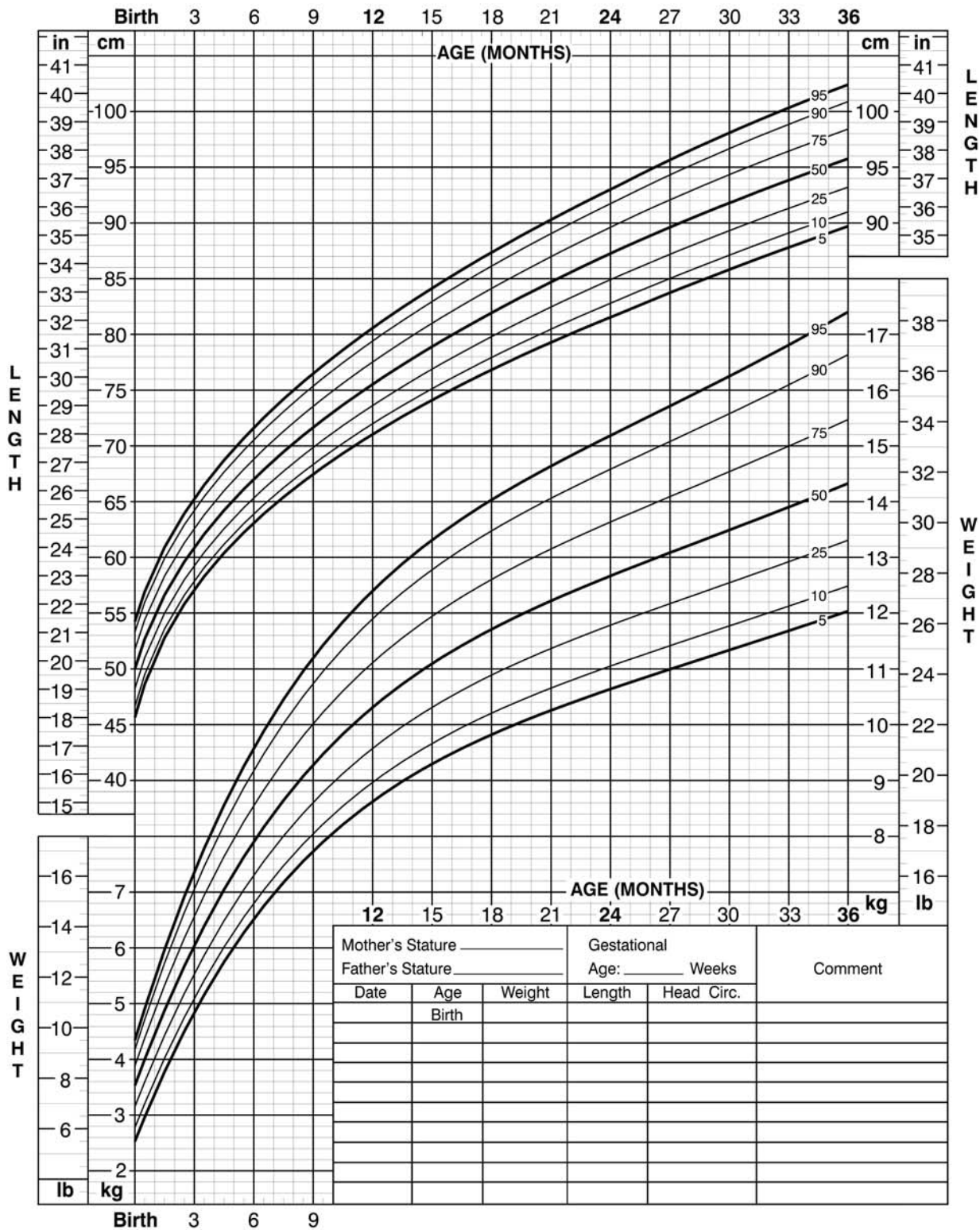
The airway can be assessed by observing phonation, inspiratory sounds, and



### Birth to 36 months: Boys Length-for-age and Weight-for-age percentiles

NAME \_\_\_\_\_

RECORD # \_\_\_\_\_



Published May 30, 2000 (modified 4/20/01).  
 SOURCE: Developed by the National Center for Health Statistics in collaboration with the National Center for Chronic Disease Prevention and Health Promotion (2000).  
<http://www.cdc.gov/growthcharts>

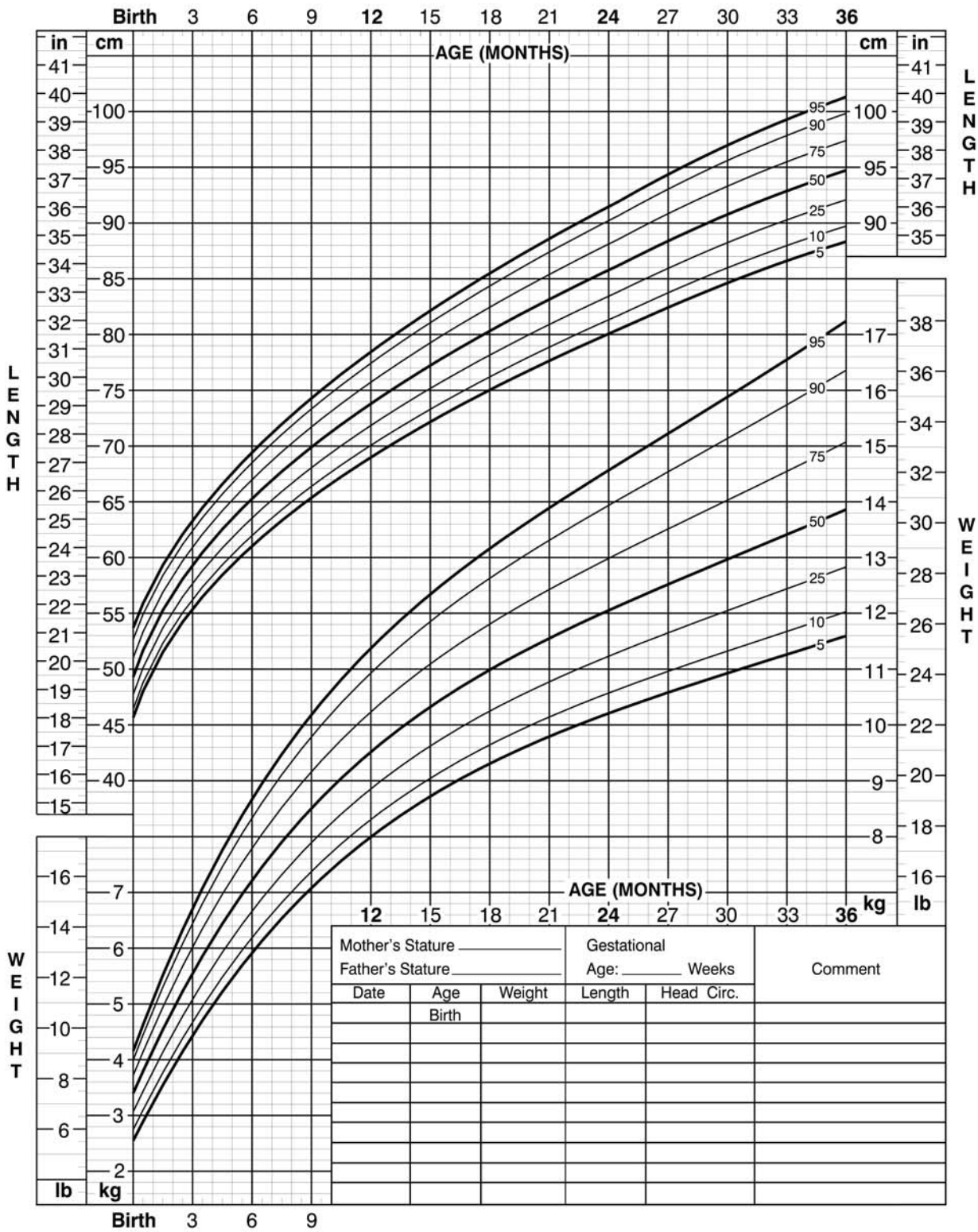


**FIGURE 19-7.** Standard growth curves for length and weight for newborn to 36-month-old boys. Published May 30, 2000 (modified 4/20/01). Developed by the National Center for Health Statistics in collaboration with the National Center for Chronic Disease Prevention and Health Promotion (2000). Available at: <http://www.cdc.gov/growthcharts>. Last accessed March 2007.

**Birth to 36 months: Girls**  
**Length-for-age and Weight-for-age percentiles**

NAME \_\_\_\_\_

RECORD # \_\_\_\_\_



Published May 30, 2000 (modified 4/20/01).  
 SOURCE: Developed by the National Center for Health Statistics in collaboration with the National Center for Chronic Disease Prevention and Health Promotion (2000).  
<http://www.cdc.gov/growthcharts>



SAFER • HEALTHIER • PEOPLE™

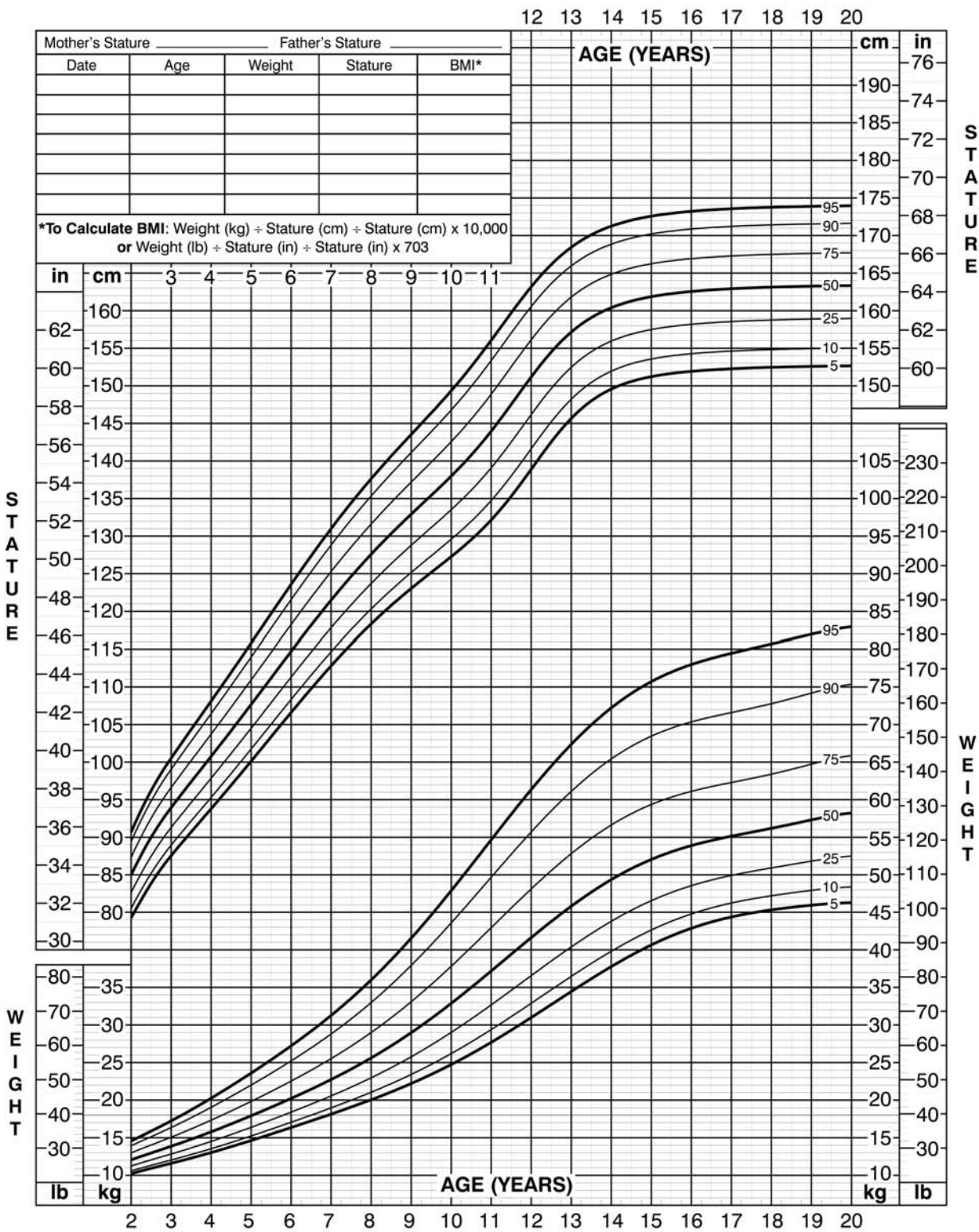
**FIGURE 19-8.** Standard growth curves for length and weight for newborn to 36-month-old girls. Published May 30, 2000 (modified 4/20/01). Developed by the National Center for Health Statistics in collaboration with the National Center for Chronic Disease Prevention and Health Promotion (2000). Available at: <http://www.cdc.gov/growthcharts>. Last accessed March 2007.



## 2 to 20 years: Girls Stature-for-age and Weight-for-age percentiles

NAME \_\_\_\_\_

RECORD # \_\_\_\_\_



Published May 30, 2000 (modified 11/21/00).  
SOURCE: Developed by the National Center for Health Statistics in collaboration with the National Center for Chronic Disease Prevention and Health Promotion (2000).  
<http://www.cdc.gov/growthcharts>



**FIGURE 19-9.** Standard growth curves for height and weight for girls aged 2–20 years. Published May 30, 2000 (modified 11/21/00). Developed by the National Center for Health Statistics in collaboration with the National Center for Chronic Disease Prevention and Health Promotion (2000). Available at: <http://www.cdc.gov/growthcharts>. Last accessed March 2007.





respiratory rate; evidence of respiratory distress, such as retractions or tachypnea, are readily noted without interfering with the child. Coughs, runny noses, and upper respiratory tract infections can be detected without hands-on examination of the child. With specific regard to airway evaluation, determining the presence of airway anomalies, such as cleft lip or palate, large tonsils, the state of the child's dentition, loose teeth, or absent teeth is essential. A small jaw or a skeletal anomaly that may indicate a difficult intubation should be noted. It is possible to obtain a fairly comprehensive impression of the child's overall status without actually having to physically examine the child.

Familiarity with the surgical procedure also is necessary. The anesthesiologist should have a fair idea of how extensive the surgery is, whether it will affect airway management, what sort of blood loss to expect, and if there are any particular factors complicating anesthesia management. Concerns about positioning and duration of surgery should be addressed. The presence of a cystic hygroma, for example, should dictate meticulous examination of the airway, auscultation for upper airway sounds, and determination if any airway involvement may have occurred. Discovery of capillary hemangiomas also may indicate the need to rule out airway involvement.

## Systems Review

### Neuromuscular System

Much will be apparent about the developmental stage of the child's CNS during the initial contact. Conversely, assessment of anesthesiologically relevant neurologic conditions will depend on the child's age and developmental status. Familiarity with the development of children gives the anesthesiologist a background by which to assess the child (Fig. 19-11). A wide spectrum of neuromuscular disorders that are important to the anesthesiologist accompanies various childhood conditions. In all children, information concerning mental and developmental stage, gestational age, gross motor function, presence of a seizure disorder, and any preexisting neurologic sensory deficits should be sought.

**Cerebral Palsy and Mental Retardation** A common problem in children who present for surgery for ei-

ther multiple congenital anomalies or complications after prematurity is mental retardation or cerebral palsy. It should be stressed that not all children with cerebral palsy, even those with severe neuromuscular involvement, are mentally retarded. Incapacitating hypertonicity and spasticity, which may render a child unable to readily express himself or herself, do not necessarily interfere with the ability of the child to understand or the anesthesiologist's responsibility to inform the child about the course of the perioperative period. The anesthetic implications of mental retardation and cerebral palsy are legion. The response to a host of anesthetic drugs, including muscle relaxants, sedatives, analgesics, and hypnotics, varies and is less predictable in these children compared with healthy children. Older children with mental retardation and cerebral palsy also may have significant pulmonary complications that arise from musculoskeletal anomalies caused by imbalance of muscle groups, resulting in scoliosis and kyphosis and leading to restrictive lung pathology. Pharyngeal discoordination, difficulty with handling secretions, and the not infrequent association of gastroesophageal reflux in children with mental retardation and cerebral palsy can lead to recurrent, chronic, pulmonary parenchymal injury, which may complicate the anesthetic management. The presence of gastroesophageal reflux should be sought because it is frequent in this patient population. This may have particular relevance to NPO precautions and may indicate the need for histamine receptor ( $H_2$ ) antagonism, antacids, agents that hasten gastric emptying, and rapid sequence intubation. Specific questioning about gastroesophageal reflux, recurrent aspiration, recurrent pneumonias, and wheezing should be directed toward the parents, and the anesthetic should be altered accordingly.<sup>108</sup>

**Seizure Disorders** Children with a history of epilepsy or seizure disorders also are of concern perioperatively. In the past, problems have resulted from a failure to maintain adequate anticonvulsant levels perioperatively. Most oral anticonvulsants can be given on the morning of surgery and have a sufficiently long half-life to assure adequate levels intraoperatively. Sodium valpro-

ate and carbamazepine may be exceptions. The anesthesiologist should ensure that the optimal serum levels of anticonvulsants are achieved preoperatively and that these are maintained perioperatively. If a prolonged NPO status postoperatively is anticipated, alteration of anticonvulsant therapy preoperatively may be indicated to include agents that can be given parenterally. A consultation with the child's pediatrician or pediatric neurologist may be required. Preoperative awareness of the child's epilepsy should lead to avoiding epileptogenic anesthetic agents, such as methohexital and possibly etomidate.

**Intracranial Hypertension** The management of anesthesia for children with intracranial hypertension requires special care. Recognition of the classic triad of hypertension, bradycardia, and apnea in children who may require neurosurgical procedures, or ventricular peritoneal shunts, or who have suffered acute head injury is crucial in determining the anesthetic management of these children. In younger children with chronically elevated intracranial hypertension, the need for perioperative management of intracranial pressure is indicated by complaints of nausea, vomiting, headache, irritability, lethargy, and finding on physical examination of the sunsetting sign. Careful questioning for an acute change in the child's status may indicate the need preoperatively for measures directed at decreasing intracranial pressure, such as diuresis and osmolar therapy. Intraoperative provision of deep anesthesia and controlled ventilation to maintain normocapnia would be wise.

If the child has an existing decompressive shunt, the anesthesiologist should be aware of it. If it contains a valve and pump mechanism, its function should be evaluated. Perioperative fluid shifts may alter cerebrospinal fluid (CSF) function and upset the balance of CSF production and drainage, leading to elevated intracranial pressure and perioperative catastrophe, especially in the anesthetized child. Assurance of shunt patency and functional history is necessary.

**Muscular Dystrophy** Congenital neuromuscular disease, such as muscular dystrophy, myotonic dystrophy, and acquired diseases, such as myositis, dermatomyositis, and collagen vascular



**FIGURE 19–11.** Denver Developmental Screening Test serves as a guide to the development of language, motor, and social skills of children aged from 1 month to 6 years. (Reproduced with permission from Frankenberg WK and Dodds JB.<sup>31</sup>)

diseases, raise questions concerning the use of muscle relaxants. In patients with myotonic dystrophy, the use of succinylcholine should be avoided.<sup>67</sup>

Although this is less clear in patients with some of the muscular dystrophies, the occurrence of rhabdomyolysis and the suspicion of an increased incidence

of malignant hyperthermia in patients with Duchenne muscular dystrophy suggests caution in the use of depolarizing muscle relaxants and inhalational

## BOX 19-5.

**Neuromuscular Diseases in Which Neuromuscular Agents Should Be Used with Caution**

Muscular dystrophy  
 Facioscapulohumeral  
 Duchenne  
 Myasthenia gravis  
 Eaton-Lambert (very rare)  
 Cerebral palsy  
 Myotonias  
 Myotonia congenita  
 Spinal muscle atrophy  
 Spina bifida (thoracic level)

anesthetics.<sup>65</sup> The use of nondepolarizing muscle relaxants in children who have muscle weakness and neuromuscular impairment should be guided by meticulous perioperative monitoring and perhaps are best avoided when possible (Box 19-5).

The majority of neurologic deficits and impairments will be obvious from a review of the patient's records, the parents' interview, and observation of the child. If detailed neurologic examination and documentation are required, or if the presence of serious CNS disease is suspected, a pediatric neurologist should be consulted. With the increasing use of regional anesthesia, it is wise for the anesthesiologist to search for and document existing neurologic deficits before performing nerve blocks.

**Respiratory System**

A host of illnesses and congenital abnormalities affect respiratory function in children. Many congenital anomalies are associated with small, difficult-to-visualize airways, upper airway obstruction, and difficult intubation. All of these conditions should specifically be sought and investigated whenever the suspicion arises (Table 19-7). The relatively small diameter of a child's airway, a child's different anatomic makeup, and high oxygen consumption relative to FRC put children at increased risk for developing hypoxia, decreasing the margin for error.

Specific questioning about airway obstruction (e.g., snoring), recurring episodes of croup, tonsil or adenoid hypertrophy, and any history of apnea, is part of routine history taking in pediatric anesthesia. Noticing characteristic facies, such as those associated with Treacher Collins syndrome, Pierre

Robin syndrome, or Hunter and Hurler mucopolysaccharidosis, is an essential skill of the pediatric anesthesiologist in detecting the potential for difficulty with intubation and upper airway obstruction perioperatively. Careful examination of the nares, of the oropharynx for loose teeth, and for the presence of respiratory distress indicating airway obstruction should be part of every examination. Routine attention to these airway issues may prevent potentially lethal complications in the operating room.

Assessment of children with chronic respiratory disease also is necessary. The high frequency of chronic lung disease (bronchopulmonary dysplasia [BPD]) in former premature infants who required ventilatory support in the neonatal period should be remembered.<sup>93</sup> Evidence should be sought for this in the patient's record and by questioning the parents. BPD may range from mild recurrent wheezing to a chronic oxygen requirement—even mechanical ventilation at home. In children with BPD and asthma, the anesthesiologist should be completely familiar with the child's respiratory status and ensure that therapy has been optimized preoperatively. The child's exact therapy should be ascertained, and when possible, an effort should be made to ensure that an appropriate dose of bronchodilator therapy have been achieved. A history of recent steroid use should be sought, and consideration should be given to initiating steroid therapy preoperatively.

Particular attention should be directed to the history of exercise tolerance in children with or suspected of having chronic lung disease. In patients with musculoskeletal disease, especially kyphosis or scoliosis, one should seek evidence of restrictive lung abnormalities. Preoperative investigations in children with chronic lung disease may include determination of blood gases and pulmonary function tests. A cardiac examination with electrocardiography and possibly echocardiography may be necessary to discover and define the severity of pulmonary hypertension and cor pulmonale.

Acute lung disease is an indication for canceling elective surgery. Pneumonia, croup, and acute asthma pose serious perioperative threats, both acutely as well as after apparent resolution. Airway reactivity is increased for several weeks after an acute asth-

matic attack.<sup>7,94</sup> Deteriorating pulmonary status caused by viral or bacterial infection, superimposed on BPD, cystic fibrosis, or asthma may cause serious intraoperative hypoxia, increased secretions with the risk of endotracheal tube obstruction, and difficulty in maintaining airway patency. Postoperative atelectasis and pneumonia can be serious complications after surgery. Specific questioning about episodes of apnea should be included because these may be associated with fatal postoperative respiratory difficulties.<sup>54</sup>

**Runny Nose Problem** Frequently, the problem of the child with a runny nose arises. Rhinorrhea can be caused by an acute viral or bacterial upper respiratory tract infection (URI), allergic rhinitis, or foreign object. There is evidence that recent URIs increase airway hyperreactivity for 6–8 weeks after infection.<sup>7</sup> Anecdotally, most anesthesiologists believe that URIs are associated with increased secretions, incidence of laryngospasm and bronchospasm, endotracheal tube obstruction, and intraoperative respiratory difficulties.<sup>63</sup> An increased incidence of postintubation stridor and other postoperative respiratory complications also has been reported.<sup>19</sup> Experience in recent years has failed to substantiate an increased risk of complications in patients with simple URIs.

When is it appropriate to cancel elective surgery on the basis of rhinorrhea? The patient should be in optimal condition before induction of anesthesia. The recent onset of mucopurulent rhinorrhea, especially if accompanied by pharyngitis and fever, is an indication for cancellation of elective surgery. The child who always has clear rhinorrhea on the basis of allergic rhinitis probably is at no increased anesthetic risk. Multiple considerations, such as the inconvenience to the family because of long travel or arranged time off work, the potential of complications from delaying surgery, and the risks of proceeding, need to be weighed when deciding whether to proceed. With healthy children who are afebrile and have clear rhinorrhea, we proceed with elective surgery. Anesthesia caregivers are more cautious with other respiratory diseases, especially asthma and BPD.<sup>7,94</sup> Although this topic remains controversial, whenever possible, surgery and anesthesia should be delayed for at least 2 weeks.<sup>43</sup>

TABLE 19-7.

## Common Syndromes Associated with Difficult Intubation

Syndrome	Airway	Associated Anomalies
Achondroplasia	Small nares and mouth Midface hypoplasia Megacephaly	Hydrocephalus Atlantoaxial instability Atropine sensitivity
Apert	Narrow, occasionally cleft palate Small maxilla Craniosynostosis Flat facies	Mental retardation Cardiac anomalies Renal abnormalities Syndactyly, often severe
Arthrogryposis, congenital	Small mandible Cleft palate Torticollis, contracture Klippel-Feil syndrome	Scoliosis Ventricular septal defect
Beckwith-Wiedemann	Large tongue Prognathism	Retardation Hypoglycemia Exomphalos Gigantism
Cornelia de Lange	Micrognathia Short neck Cleft palate Mandibular spurs	Cardiac abnormalities Retardation
Crouzon	Small maxilla Large tongue Craniosynostosis	Proptosis
Down	Large tongue Small mouth Small mandible	Cardiac abnormalities Atlantoaxial instability Hypotonia
Goldenhar	Small mandible and zygoma Cleft palate Macrostomia	Cervical spine defects
Congenital hypothyroidism	Large tongue	Hypothermia Retardation, if untreated Umbilical hernia
Freeman-Sheldon (whistling face)	Very small mouth High palate	Scoliosis
Klippel-Feil	Short neck, limited extension	Deafness Ventricular septal defect
Marfan	Narrow face Narrow palate	Cardiac anomalies Scoliosis Restrictive lung disease
Möbius	Small mandible Small mouth Aspiration	Talipes equinovarus Ptosis Cranial nerve palsies
Mucopolysaccharidosis	Large tongue Narrow airway Limited opening	Cardiac abnormalities
Pierre-Robin Robinow	Micrognathia Small mouth Micrognathia Crowded teeth Large tongue	Hemivertebra Hypertelorism Atrial septal defect
Rubinstein-Taybi	Small maxilla Narrow palate	Retardation Cardiac anomalies Cervical instability
Russel-Silver	Small stature Small mandible	Hypoglycemia

(continued)



TABLE 19-7.

## Common Syndromes Associated with Difficult Intubation (Continued)

Syndrome	Airway	Associated Anomalies
Treacher-Collins	Facial hypoplasia Mandible, maxilla Cleft palate Choanal atresia	Cardiac disease Cervical vertebral anomalies
Turner	Small narrow maxilla, mandible Short neck	Coarctation Hypertension
Zellweger	Small mandible Short neck	Cardiac anomalies Contractures

Data from Smith DW: *Recognizable patterns of human malformation: genetic, embryologic and clinical aspects*, ed 5, Philadelphia, 1997, WB Saunders.<sup>90</sup>

**Cardiovascular System**

Because of the multiple cardiovascular effects of anesthetics in children and the frequency with which cardiac anomalies accompany other congenital malformations, particular attention to the cardiovascular system is necessary (Table 19-8). Recognition of the setting in which congenital heart disease may occur, coupled with careful attention to the previous history and questioning of the family, help define the type and severity of the defect. Examination of the child may lead to discovery of hitherto undiagnosed cardiac defects or to the presence of a cardiac murmur and demonstrate the need to alter the anesthetic plan and perhaps to seek further pediatric cardiology consultation. The cardiovascular system undergoes significant developmental changes, and reference to normal age-related values is essential in assessing children (see Figs. 19-4, 19-5, and 19-6).<sup>84,80</sup>

Poor exercise tolerance, as in adults, is a hallmark of inadequate cardiovascular function. Children who tire easily, become tachypneic, have dyspnea on exertion, or have orthopnea must be evaluated carefully. In infants, the major exercise is feeding. An irritable child with a history of poor feeding accompanied by diaphoresis and tachypnea may have borderline cardiac function. Failure to thrive may indicate compromised cardiac function. In younger infants, clubbing is never present, and cyanosis may be difficult to detect. Palpation and auscultation remain the cornerstones of the cardiology examination. Particular attention should be paid to the presence of a brachial-femoral delay, indicating coarctation, and for left and right ven-

tricular heaves. Detection of a new murmur frequently raises the question of whether it is benign or significant. Differentiating between a venous hum or ventricular outflow murmur and more serious murmurs requires specific examination (Table 19-9). When in doubt, consultation with a pediatric cardiologist is indicated. The child with a murmur who is asymptomatic, acyanotic, healthy, and gaining weight along appropriate percentiles and who has a normal  $S_1$  and  $S_2$ , almost certainly will tolerate routine anesthesia without serious complications. Questions arise regarding the need for further cardiology followup, evaluation and subacute bacterial en-

docarditis (SBE) prophylaxis (Table 19-10 and Box 19-6). When the history and physical examination indicate possible serious cardiac disease, a hematocrit, electrocardiogram (ECG), chest radiograph, and oxygen saturation (pulse oximetry) form the basis of the laboratory workup. In patients with known serious heart disease, the anesthesiologist should understand the anatomy and physiology of the defect. A hemodynamically inconsequential atrial septal defect, ventricular septal defect, mitral valve prolapse, or the presence of a bicuspid aortic valve may predispose the child to an untoward intraoperative event, and consultation with a pediatric cardiol-

TABLE 19-8.

## Syndromes Associated with Congenital Heart Disease

Syndrome	Associated Disease
Apert	Pulmonic stenosis, VSD
Asplenia or polysplenia	ASD, VSD
Cornelia de Lange	VSD
DiGeorge	Aortic arch, truncus, VSD, PDA, tetralogy
Down	AV canal, ASD, VSD
Ellis-van Creveld	ASD
Fetal alcohol	VSD, cardiomyopathy
Holt-Oram	ASD, VSD
Kartagener's	ASD, VSD
Marfan	Aortic and mitral valve diseases, dilated aortic root
Noonan	Pulmonic stenosis, ASD
Opitz	ASD
Robinow	ASD
VATER	VSD
Williams	Pulmonic stenosis

VSD, ventricular septal defect; ASD, atrial septal defect; PDA, patent ductus arteriosus; AV, atrioventricular.

Data from Smith DW: *Recognizable patterns of human malformation—genetic embryologic, and clinical aspects*, ed 5, Philadelphia, 1997, WB Saunders.<sup>90</sup>

TABLE 19–9.

## Innocent Asymptomatic Murmurs

	Venous Hum	Vibratory Murmur
Area	Aortic area into neck Pulmonary	Apex to sternum Basal (occasionally mitral) Not transmitted to axilla
Timing	Continuous (ductus murmur)	Systolic Diastolic accentuation
Character	Increased with inspiration  Loudest in sitting position Jugular pressure diminishes intensity S <sub>1</sub> and S <sub>2</sub> normal	Coarse, low-pitched, scratchy, twang  Short, limited area Decreased with inspiration  S <sub>1</sub> may be softened; S <sub>2</sub> normal Very common

From Wetzel RC: Evaluation of Children. In Longnecker DE, Tinker JH, and Morgan GE, et al, eds., *Principles and Practice of Anesthesiology, Vol 1, 2 ed*, Mosby, Inc., 1998.

TABLE 19–10.

## Subacute Bacterial Endocarditis Prophylaxis Regimens

	Time	Dosage
Dental and respiratory Routine		
Amoxicillin PO Or Ampicillin IV	1 hour before procedure Within 30 minutes of procedure	50 mg/kg (max 3 g) 50 mg/kg
For maximal protection		
Ampicillin IV	Within 30 minutes of start of procedure	50 mg/kg
And		
Gentamicin IV	Within 30 minutes of start	1.5 mg/kg
Followed by:		
Ampicillin IV Or Amoxicillin PO		25 mg/kg 50 mg/kg
PCN-allergic patients		
Vancomycin IV	Within 30 minutes of start (administer slowly)	20 mg/kg (max 1 g)
Or		
Clindamycin PO Or Cefazolin IV	1 hour before start Within 30 minutes of start	20 mg/kg 25 mg/kg
Gastrointestinal or genitourinary procedure Routine		
As for maximal protection above		
Minor or repetitive in low-risk children		
Amoxicillin PO	1 hour before	50 mg/kg (max 3 g)
PCN-allergic patients		
Vancomycin IV	Complete within 30 minutes of start of procedure, infuse over 1–2 hours	20 mg/kg (max 1 g)

From Wetzel RC: Evaluation of Children. In Longnecker DE, Tinker JH, and Morgan GE, et al, eds., *Principles and Practice of Anesthesiology, Vol 1, 2 ed*, Mosby, Inc., 1998.

BOX 19–6.

## Subacute Bacterial Endocarditis Prophylaxis

## Indications

## Moderate risk (routine)

- Congenital or acquired valvular heart disease (rheumatic heart disease)
- Hypertrophic cardiomyopathy
- Mitral valve prolapse with regurgitation
- Subaortic stenosis

## High risk (maximal)

- Surgically constructed shunts (Waterston, Blalock-Taussig, Potts, etc.)
- Complex cyanotic heart disease (single ventricle, transposition of the great arteries, tetralogy)
- Prosthetic valve
- Previous bacterial endocarditis

## Procedures

- All genitourinary or gastrointestinal operations
  - Tonsillectomy/adenoidectomy
  - Endoscopic retrograde cholangiopancreatography, stricture dilation, biliary tract surgery
  - Dental extractions, implants, where gingival bleeding is anticipated, endodontics, periodontal surgery, initial placement of orthodontic bands
  - Incision and drainage procedures
  - Airway surgery or rigid bronchoscopy
- Prophylaxis not necessary for secundum atrial septal defect or patent ductus arteriosus repaired >6 months ago, endotracheal intubation, tympanostomies

gist may be indicated. For most children with heart disease, it is prudent to obtain a recent consultation with the child's pediatric cardiologist.

**Renal System**

Asymptomatic renal disease, apart from bacteriuria, is rare in children. The likelihood of discovering a new renal lesion during routine physical examination done for the preanesthetic evaluation is almost nonexistent. The presence of hypertension (see Table 19–3) should indicate the need for urinalysis and electrolyte analysis.<sup>38</sup> The unexpected presence of anemia also may indicate chronic renal disease. The anesthetic implications of renal disease in the presence of normal electrolytes, normal

growth and development, and normotension, are minimal. In infants, there may be the inability to concentrate urine or to handle a large fluid load, both of which dictate cautious fluid management perioperatively.

In the presence of serious preexisting renal disease, careful attention should be paid to the child's preoperative preparation. If the child requires dialysis (peritoneal dialysis or hemodialysis) to maintain optimal electrolyte levels and growth, consideration of dialysis on the day before surgery is indicated. Antihypertensive therapy, if required, should be optimized. Electrolytes should be monitored carefully. Particular attention is necessary concerning the serum potassium concentration. Serum potassium greater than 5.5 mEq/L is worrisome in children with renal disease. The propensity of succinylcholine to induce hyperkalemia in patients who may have a concurrent metabolic acidosis puts these patients at particular risk. Elective surgery should be cancelled in the presence of a potassium level higher than the acceptable upper level of normal for the individual hospital's laboratory (5.5 mEq/L, generally). Regarding hematocrit in patients with chronic renal failure, there is some controversy. It is usual practice to accept a lower hematocrit (20%) in these children than would be normally tolerated. This is based on the assumption of chronic adaptation, which includes increased blood volume and increased cardiac output. These may be compromised during anesthesia. Although the child may be chronically adapted, it should be remembered that the reserve necessary to tolerate the stresses that may accompany anesthesia and surgery is markedly decreased. Preoperative erythropoietin therapy and transfusion before surgery may be administered if time allows.

### **Gastrointestinal System**

The major anesthetic issues concerning the GI system center on a predisposition to aspiration pneumonitis. Children with increased gastric residual volumes and gastroesophageal reflux should be identified preoperatively. Those children who have a history of tracheoesophageal fistula, mental retardation, cerebral palsy, apnea, and recurrent aspiration pneumonia always should be suspected of having gastroesophageal reflux (Box 19-7).<sup>77,108</sup> Careful scrutiny of medical records and

#### **BOX 19-7.**

##### **Conditions Associated with Gastroesophageal Reflux**

- Apnea
- Prematurity
- Recurrent pneumonia syndromes
- Cerebral palsy or mental retardation
- Gross obesity
- Tracheoesophageal fistula
- Bronchopulmonary dysplasia
- Pregnancy
- Recurrent, persistent vomiting

questioning of the parents may indicate that gastroesophageal reflux has been evaluated in the past. If not, consultation with pediatricians might prove worthwhile. The history of recurrent aspiration pneumonia in a child with a predisposing condition raises the likelihood of aspiration during anesthesia, and a rapid sequence induction is indicated. The treatment of children with gastroesophageal reflux includes administration of antacids, histamine (H<sub>2</sub>) receptor antagonists, agents that encourage gastric emptying (metoclopramide), and the Sellick maneuver during induction and intubation.<sup>58</sup> Consider awake intubation in young infants.

Halothane hepatitis developing de novo in children appears to be exceedingly rare, occurring in perhaps less than 1 in 50,000–250,000 anesthetic inductions.<sup>56</sup> The relationship between the occurrence of halothane toxicity in patients with previous liver damage and resulting hepatitis is unclear. Many premature infants have abnormal liver function tests and elevated bilirubins. Some children also may have hyperbilirubinemia and elevated transaminases. Although the advisability of using halothane under these circumstances is not clear, it probably is best avoided because suitable alternatives are available. Currently, sevoflurane has almost entirely replaced halothane in practice, and reports of hepatitis following sevoflurane are extremely rare.

### **Laboratory Investigations**

It may seem surprising that the American Society of Anesthesiologists, the American College of Surgeons, and the American Academy of Pediatrics do not make any specific recommendations for preoperative testing in children.<sup>4</sup> Specific laboratory testing that is indicated by information obtained

from the chart review, history, and examination of the child is straightforward. Routine testing for healthy children remains controversial. In the past, guidelines that had been developed for adults were applied to children. These tests included a complete blood count, urinalysis, and chest radiograph. With the streamlining influence prevalent in healthcare systems today, critical appraisal of the need for these examinations has been undertaken. All aspects of the preoperative laboratory investigation have been questioned. The standard that required a routine chest radiograph in healthy children without symptoms or signs was abandoned.<sup>113</sup> Recent experience with large numbers of outpatient anesthetics has raised serious questions about the need for routine performance of other laboratory tests. In general, preoperative laboratory testing should be dictated by the child's condition and status, rather than merely by the need for an anesthetic.<sup>61</sup>

### **Hematology**

It generally is accepted that a preoperative hematocrit is unnecessary in most healthy children for operations in which significant blood loss is not expected. The value of a complete blood count and whether there is a role for determination of platelets and coagulation studies are also unclear. These decisions should be guided by patient considerations. There are developmental differences in the standard level of hematocrit (Table 19-11).<sup>71</sup> For years, "normal" hematocrits were required for elective surgery. Later, the lower limit of normal (i.e., hematocrit of 30% or a hemoglobin of >10 g/dL) became the requirement. Elective surgery probably should await attaining this level, short of transfusion. Iron and nutritional support are indicated. In the emergent situation, transfusion therapy may be indicated as directed by patient need, such as anticipated blood loss and cardiorespiratory status. Transfusion should not rely on arbitrary and unsupported boundary of "normal" hemoglobin.<sup>73</sup>

What are the essential considerations? In a healthy child with normal cardiorespiratory function, a fully saturated hemoglobin of 10 g/dL would require a cardiac index of 3.4 L/min/m<sup>2</sup> to provide an oxygen delivery 3 times the average oxygen consumption. If the child's hemoglobin were 7 g/dL (hematocrit approximately 20%), a cardiac

TABLE 19–11.

## Mean Hematocrit and Hemoglobin versus Age

Age	Hct (SD) %	Hgb (SD) g/dL
1–3 days	56 ± 5	18.5 ± 2.0
2 weeks	53 ± 4	16.6 ± 1.6
1 month	44 ± 5	13.9 ± 1.6
2 months	35 ± 4	11.2 ± 0.9
6 months	36 ± 3	12.6 ± 0.7
6–24 months	36 ± 2	12.0 ± 0.8
2–6 years	37 ± 2	12.5 ± 0.5
6–12 years	40 ± 3	13.5 ± 1.0
12–18 years	43 ± 4	14.5 ± 0.7
Adult	41 ± 2	14.0 ± 1.0

From Rowe PC. Laboratory values. In Oski FA, De Angelis CD, Feigin RD, et al, editors: *Principles and practice of pediatrics*, Philadelphia, 1990, JB Lippincott.

index of 4.8 L/min/m<sup>2</sup> is required to maintain the same level of oxygen delivery. This is well within a healthy child's cardiac reserve and should represent no major difficulty. The assumptions underlying this are that the child remains 100% saturated, receives no cardiac-depressant drugs, and loses little blood. These circumstances frequently cannot be guaranteed during surgery and anesthesia, and this lack of guarantee is the key issue. The major concern is not for healthy children having minor surgery, but when surgery will result in blood loss and lower this margin of reserve further. A child whose hemoglobin drops to 5 g/dL from 10 g/dL should double cardiac output to around 6.6 L/min/m<sup>2</sup> to maintain oxygen delivery. This remains well within the average child's cardiac reserve. If a child's hemoglobin drops to 2 g/dL from 7 g/dL intraoperatively, the child requires a cardiac index of nearly 17 L/min/m<sup>2</sup> to maintain a marginal oxygen delivery, which is beyond the ability of even the healthy child's cardiovascular system to compensate for, especially when anesthetized.

A third issue that frequently is raised is adaptation. The classic teaching is that children with renal disease tolerate lower hematocrits because they have had time to adapt. There is little evidence to demonstrate this is so; 2,3-diphosphoglyceric acid may not be increased in children with renal disease, and there is no reason to suggest that

they have a shift in the oxyhemoglobin dissociation curve. The concept that they can adapt to lower levels of oxygen delivery or consumption is unsupported. If serious blood loss is expected perioperatively, the margin of safety is considerably less in patients who begin with low hematocrit.

As mentioned above, there are no absolute guidelines for preoperative hematocrit, and at present, each anesthesiologist should decide on a standard for each child. Motoyama and Glasner<sup>69</sup> found that a hemoglobin of 7.5–8.5 g/dL will deliver oxygen to the tissues of children equivalent to what a hemoglobin of 10 g/dL will in adults. In neonates, 12–13 g/dL is necessary. This is largely related to shifts in the P50 (partial pressure of oxygen at which hemoglobin is 50% saturated).<sup>69</sup> It seems reasonable that a hemoglobin of 8 g/dL in an ASA PS P1 child may be acceptable if no major perioperative blood loss is expected. A child who has chronic restrictive lung disease and is about to undergo scoliosis repair probably should have a hemoglobin higher than 10 g/dL (at least initially).

Many abnormalities can be discovered during preoperative laboratory screening.<sup>48</sup> These abnormalities fall into two categories: those that are relevant to the anesthetic management of the child and those that are relevant to the child's general health. The degree to which a preanesthesia screening clinic wishes to be responsible for the general healthcare of children needs to be determined by each facility. There is a responsibility to ensure followup evaluation for abnormal laboratory tests that may be discovered coincidentally with preoperative assessment. O'Connor and Drasner<sup>74</sup> reported that 17% of children who had a complete blood count (CBC) were anemic or had a microcytosis. Only 2 of these children had surgery cancelled because of anemia (hemoglobins <10 g/dL).<sup>74</sup> A mechanism to arrange followup evaluation with the pediatric clinic should be available, and communication should be assured.

**Sickle Cell Disease** The American Academy of Pediatrics recommends that a sickle preparation or other screening test be performed in all children of African descent.<sup>99</sup> Is it reasonable for the anesthesiologist to insist on receiving the results of a sickle cell preparation in all children of African descent requiring anesthesia and sur-

gery?<sup>28</sup> Is anesthetic management different for those who have sickle trait than for those who do not? Is it necessary to have a sickle cell preparation in nonanemic at-risk children? Anesthetizing a child with sickle cell disease who is anemic and with 95% sickle hemoglobin poses a major threat to that child and should never be undertaken without good reason. The likelihood of a child older than age 2 years with a normal hemoglobin having sickle cell disease is extremely low. If all children with hemoglobins less than 10 g/dL require further investigation, among the factors to be investigated, in addition to iron deficiency, is sickle hemoglobin status in at-risk children. This might not apply to neonates or infants who may have hemoglobin concentration greater than 10 g/dL and have sickle cell disease and high levels of sickle hemoglobin. Unless a sickle hemoglobin preparation is performed, cases might be missed in this population which is at risk for hypoxia and low cardiac output during anesthesia. Common practice is to perform a sickle cell preparation on all children of African descent unless their status is known and to screen for anemia in all other children. In those with positive sickle screen, hemoglobin electrophoresis is required.<sup>23,60</sup> It should be noted that infants younger than age 4 months have maternal antibodies that interfere with performing a quick sickle index preparation. These children require hemoglobin electrophoresis to determine their sickle cell disease status.

Does sickle trait pose a threat to older children who may not be anemic but who have some amount of sickle hemoglobin? Although there are some anecdotal stories of sickling and rare vasoocclusive phenomena in children with sickle cell trait during anesthesia with resulting hypothermia, ischemia, and hypoxia, sickle cell trait generally is associated with less than 40% of hemoglobin S in the circulating blood.<sup>60</sup> This is the target level that is obtained with transfusion protocols for sickle cell disease. Prudent avoidance of tourniquets that cause blood stasis and hypoxia in the affected limb probably is wise in patients with sickle cell trait. Anesthetic management will not vary because the routine goals of anesthesia (avoidance of hypoxia, hypothermia, hypovolemia, and hypotension) are as important in routine anesthetic management as they are for patients with sickle cell trait.<sup>29,60</sup>



In patients with sickle cell disease, preoperative treatment is directed at reducing sickle hemoglobin to less than 40%. Chronic transfusion, exchange transfusion, and acute blood transfusion are reported to be useful in achieving this goal.<sup>99,100</sup>

**Leukocyte Counts** In one study, leukocyte counts were abnormal only in patients who were ill or otherwise suspected of having an infection.<sup>61,71</sup> No occult leukocytosis was discovered in 463 preoperative screening evaluations.<sup>74</sup> When indicated by suspicion of sepsis, infection, fever, or respiratory tract infection, a CBC might be useful in arriving at the diagnosis; however, routine leukocyte determination does not appear to be warranted.

### Urinalysis

Routine urinalysis is part of preoperative recommendations in children. Apart from providing a possible contribution to routine health screening, the relevance to anesthetic management is unclear.<sup>55,61</sup> In children who are febrile, have congenital anomalies of the urinary tract, or have suspected renal function anomalies, urinalysis might be beneficial. In otherwise healthy children in whom urinalysis can be difficult to obtain and unreliable, abnormal results appear to occur in 15% of children and usually are asymptomatic bacteriuria.<sup>74</sup> The majority of these are either false-positive results, clinically insignificant, or previously known. In only 2 of 453 cases was surgery cancelled, and both of these were cancelled because of suspected colonization or asymptomatic bacteriuria, which was of no anesthetic relevance. In afebrile, ASA PS P1 children with no history of renal disease, most centers have abandoned routine urinalysis.

Screening for pregnancy varies widely from center to center. The evidence that anesthesia, per se, is deleterious to the continued pregnancy or the fetus is extremely sparse. On the other hand, the logistic, behavioral, privacy, and social implications of testing all female children of child-bearing age for pregnancy, with or without consent, are quite complex. Each institution must resolve these issues for itself.

### Drug Levels

In children who are receiving therapeutic drugs, it frequently is worthwhile to know whether the therapeutic level has been achieved. The two major

areas in which this is of concern are in children with epilepsy and asthma. Obtaining routine blood levels of theophylline (although now only rarely used) and anticonvulsants to ensure compliance with therapy and adequate levels for the perioperative management appears to be a wise precaution. It is not so clear what should be done when an abnormal result is found. Does an asymptomatic healthy child with a nontherapeutic drug level require therapy? Should therapeutic levels of indicated drugs be achieved before elective surgery? These decisions may require input from the child's primary care physician and perhaps a pediatric neurologist in children with epilepsy. Frequently, it is worthwhile to inform the primary caretaker that the level is subtherapeutic, so that the drug can be discontinued before surgery. There is a caveat. Discontinuing anticonvulsants may lead to withdrawal seizures, which is not a pleasant prospect perioperatively. Asymptomatic children with low theophylline levels may not be wheezing on the day of examination but may develop wheezing on the day of surgery and may have serious underlying bronchial hyperreactivity, which may pose difficulties intraoperatively. Our current practice is if a child requires theophylline to suppress wheezing episodes, the child requires therapeutic theophylline levels perioperatively. If this is not possible, knowing the level will allow the anesthesiologist to specifically direct therapy intraoperatively if required. Further testing is guided by the patient's underlying medical condition.

Preoperative assessment for elective surgery should be done early enough to allow all special investigations to be performed before surgery. Consultation with other services and the performance of other investigative procedures, such as computed tomography (CT) scans, ECGs, and echocardiograms, should be timed so that the results will be available to the anesthesiologist before induction of anesthesia. Deciding that such information is important preoperatively but acting before it is obtained or reported sets the stage for medical or legal misadventures.

### NPO Status and Preoperative Fasting

Of all the shibboleths of pediatric anesthesia, perhaps the one most time honored and most frequently under

attack is the duration of preoperative fasting. The days of NPO after midnight for all children who require surgery is over. For years, we have realized that small infants, with their unique glucose and fluid requirements, do not benefit by being NPO for 12 hours before surgery. Serious hypovolemia with intraoperative hypotension and hypoglycemia is the result.<sup>61,105</sup> Concerns have been raised about hypoglycemia occurring in older children after a prolonged fast.<sup>45,96,105</sup> There also are concerns about comfort and the need for the imposition of starvation on children preoperatively. The goal is to reduce gastric volume and minimize the risk of aspiration pneumonia perioperatively. There are many studies looking at factors predisposing to gastric acid aspiration and lung injury and their relationship to gastric residual volumes. The fact remains that perioperative aspiration pneumonia is remarkably rare (a fact that may attest to the success of severe NPO restrictions).

There is little evidence that in a healthy child prolonged fasts are required to ensure minimal gastric volumes. NPO for solid foods and large meals for 8 hours before surgery should be maintained because gastric volumes may be increased for up to 6 hours. The question becomes less clear with fluids. Several studies demonstrate that ad lib clear liquids up until 2 hours before surgery are associated with lower gastric volumes and higher pHs than those found in fasting patients.<sup>59,87</sup> If this is the case, the recommendation ought to be to encourage oral clear fluids preoperatively rather than to limit them. Studies demonstrate that not only is there no major burden of hypoglycemia placed on the healthy child by fasting, but that feeding the child clear liquids is not associated with increased gastric volumes.<sup>64</sup>

The final factor that needs to be considered is whether one should change an age-old guideline for a more liberal approach that may be confusing and lead to unintended changes in other requirements. The guideline of NPO after midnight perhaps is draconian, but it is clear to all concerned. No solids after midnight and clear liquids up to 1 hour before surgery ad lib, if the patient is healthy, without gastroesophageal reflux, or other significant GI disease, certainly is less

clear. These liberal rules are bound to be applied in inappropriate situations, potentially leading to catastrophe. Some major institutions allow clear liquids until 1–2 hours before surgery in their outpatients, and a large series reported from the Children's Hospital of Philadelphia reports no incidence of gastric aspiration after years of this approach.<sup>87</sup> ASA guidelines indicate fasting for clear liquids from 2 hours preinduction. Communication, education, monitoring current protocols, and flexibility in approach, based on known facts, should form the guidelines for anesthesia practice. This is no less true regarding preoperative fasting rules. The trend is toward more liberal fasting requirements for clear liquids (Table 19–12).<sup>21,25</sup>

One final question: What are clear liquids? Water, glucose water, and commercially available pediatric electrolyte solutions are clear. Some institutions consider breast milk a clear liquid and cow's milk a solid food. Breast milk is not emptied as rapidly as clear liquids from the stomach and the ASA guidelines state breast milk should not be given within 4 hours of induction. Some institutions encourage gelatin (no additives) and fruit juices, including pulp-free orange juice, as perfectly allowable. It is unlikely that there will be hard scientific data to aid the anesthesiologist in these decisions. The application of common sense and the provision of clear instructions for families are essential. Simplicity is best. Adhering to local protocols is important to avoid confusion and ignoring stated regulations is detrimental to the organized anesthetic care of children.

## EVALUATION OF THE CRITICALLY ILL CHILD

Intraoperative treatment of critically ill children can present the anesthesiologist with great challenges. The use of cardiovascularly active anesthetic agents in critically ill children can demand the most meticulous anesthesia care. Thorough preoperative evaluation and preparation is essential to assure optimal intraoperative management. A rigorous, compulsive systematic evaluation of critically ill children is essential, and although it follows the basic outline of systems review, the underlying assumption is that the se-

**TABLE 19–12.**

**Fasting Guidelines Childrens Hospital Los Angeles: The 2-4-6-8 Rule**

Time Prior to Anesthetic	All Age Groups	Example
Up to 8 hours	Full diet	
Up to 6 hours	Liquid diet, infant formula, milk	Formula, jello
Up to 4 hours	Breast milk, clear liquids	
Up to 2 hours	Clear liquids only	Electrolyte, glucose, water solutions, apple juice
From 2 hours before	NPO	

verity of illness in each system is much worse than in the patient for elective surgery.

Establishing rapport with a child in an intensive care unit can range from difficult to impossible. An unconscious, heavily sedated, paralyzed child requiring mechanical ventilation and neuroresuscitation will not be communicative. Discussing the anesthesia care with the child's family often may be awkward because survival is the parents' primary concern. Before contacting the family, it is essential that the anesthesiologist be completely familiar with the child's problems so that the parents can be confident that all physicians who are caring for their child are knowledgeable and concerned. Many parents have bonded with the intensive care unit staff, and transferring their child's care to other physicians can provoke anxiety. The anesthesiologist needs to demonstrate concern and state that the intraoperative care and management will be as meticulous as that provided for the child in the intensive care unit. Although it is natural to focus entirely on the child's immediate surgical needs or indication for admission to the intensive care unit, other problems that may have anesthetic importance should be sought as they would be in a routine evaluation. A systems review, previous drug and allergy history, and family history should not be neglected.

### Neurologic Status

The level of consciousness, presence of CNS injury, intracranial pressure, and neurologic deficits specifically should be determined. Psychotropic drugs, sedatives, and other obtunding agents that may supplement, augment, or interact with anesthetic agents should be

identified. Some children in the intensive care unit will be essentially anesthetized at transfer to the operating room, whereas others may have received little medication. Complete review of current neurologic status and psychotropic drugs is mandatory.

### Respiratory Status

Respiratory evaluation should be meticulous. The level of oxygen required, respiratory rate, ventilatory rate, tidal volume, airway pressures, and arterial blood gases form the basis of this information. If the child requires a ventilator, it is necessary to be familiar with the degree of ventilatory support the child requires, including the fraction of inspired oxygen ( $F_iO_2$ ), mean airway pressure, peak end-expiratory pressure, and respiratory rate. A blood gas just before transfer to the operating room may provide critical information. Anesthesia machine ventilators, although more than adequate for patients with normal pulmonary function, may be inadequate in those with advanced stages of lung disease. The anesthesiologist should be able to organize sophisticated ventilatory support in the operating room when indicated. This should be done before transfer of the child to the operating room in conjunction with respiratory therapy.

### Cardiovascular System

Complete familiarity with the child's hemodynamic function is essential. All patients in the critical care unit should be suspected of having compromised cardiovascular function and borderline oxygen delivery. Complete evaluation of perfusion status, temperature, and hemodynamic information as obtained from invasive monitor catheterization should be reviewed

and optimized. Optimization of intravascular volume and the hematocrit and availability of blood products should be ensured. Finally, a review and optimization of cardiovascular drugs the child is receiving should be undertaken. It is necessary to ensure that constant, uninterrupted delivery of cardiovascular drugs and infusions be continued during transportation. Finally, an ECG and review of the child's rhythm history for the presence of cardiac dysrhythmias should be conducted.

### Renal Status

Recent urine output, fluid requirements, creatinine, and blood urea nitrogen (BUN) should be reviewed. Renal function should be assessed and may have an important bearing on the use of neuromuscular relaxants, intraoperative fluid requirements, and electrolyte status. Electrolyte abnormalities are common in those with critical illness and may lead to cardiorespiratory failure and cardiac dysrhythmias intraoperatively. These, in general, should be corrected preoperatively.

### Gastroenterology

All patients who are ill enough to require admission to an intensive care unit should be suspected of having full stomachs. Acute, critical, and chronic illnesses delay gastric emptying. Even though the child may have been NPO for a prolonged period, hypersecretion and high gastric acid content may predispose the child to aspiration on induction. Patients who have suffered trauma and for whom no NPO history is available should, as a precaution, be treated as having full stomachs.

### Laboratory Tests

Laboratory investigation should be reviewed thoroughly. At a minimum, baseline CBCs, electrolyte profiles, calcium, and blood gases are essential. Therapeutic levels of drugs, such as theophylline and anticonvulsants, are indicated, if the child is receiving them. A final check to ensure cross-matched blood is available, when indicated, is prudent.

### KEY REFERENCES

1. Allen EC, Manuel JC, Legault C, et al. Perception of child vulnerability among mothers of for pre-

ture infants. *Pediatrics* 2004;113:267–273.

2. American Academy of Pediatrics, Section on Anesthesiology. Evaluation and preparation of pediatric patients undergoing anesthesia. *Pediatrics* 1996;98:502–508.

3. Anderson BJ, McKee AD, Holford NH. Size, myths and the clinical pharmacokinetics of analgesia in paediatric patients. *Clin Pharmacokinet* 1997;33:313–327.

4. Buisson P, Bach V, Elabbassi EB, et al. Assessment of the efficiency of warming devices during neonatal surgery. *Eur J Appl Physiol* 2004;92:694–697.

5. Jacoby DB, Hirshman CA. General anesthesia in patients with viral respiratory infections—an unsound sleep? *Anesthesiology* 1991;74:969.

6. Kain ZN, Caldwell-Andrews AA. Preoperative psychological preparation of the child for surgery: an update. *Anesthesiol Clin North America* 2005;23:597–614.

7. Lehrman J. Inhalational anaesthetics. *Paediatr Anaesth* 2004;14:380–383.

8. Marchant WA, Walker I. Anaesthetic management of the child with sickle cell disease. *Paediatr Anaesth* 2003;13:473–489.

9. Maxwell LG, Deshpande JK, Wetzel RC. Preoperative evaluation of children. *Pediatr Clin North Am* 1994;41:93–110.

10. Maxwell LG, Wetzel RC. Induction techniques in pediatric anesthesia. *Anesth Rep* 1988;1:110.

11. O'Connor ME, Drasner K. Preoperative laboratory testing of children undergoing elective surgery. *Anesth Analg* 1990;70:176.

12. Porri F, Pradal M, Lemiere C, et al. Association between latex sensitization and repeated latex exposure in children. *Anesthesiology* 1997;86:599–602.

13. Wetzel, RC. Gastro-oesophageal reflux: theory over experience. *Paediatr Anaesth* 1998;8:101–104.

14. Zuckerberg AL. Perioperative approach to children. *Pediatr Clin North Am* 1994;41(1):15–29.

### REFERENCES

1. Aldrete JA, Roman-de Jesus JC, Russell LJ, et al. Intranasal ketamine as induction adjunct in children: preliminary report. *Anesthesiology* 1987;67:A514.
2. Alfonsi P, Nourredine KE, Adam F, et al. Effect of postoperative skin-surface warming on oxygen consumption and the shivering threshold. *Anaesthesia* 2003;58:1228–1234.
3. Allen EC, Manuel JC, Legault C, et al. Perception of child vulnerability among mothers of for premature infants. *Pediatrics* 2004;113:267–273.
4. American Academy of Pediatrics, Section on Anesthesiology. Evaluation and preparation of pediatric patients undergoing anesthesia. *Pediatrics* 1996;98:502–508.
5. Anderson BJ, McKee AD, Holford NH. Size, myths and the clinical pharmacokinetics of analgesia in paediatric patients. *Clin Pharmacokinet* 1997;33:313–327.
6. Aperia A, Zellerstrom R. Renal control of fluid homeostasis in the newborn infant. *Clin Perinatol* 1982;9:523.
7. Aquilina AT, Hill WJ, Douglas RG, et al. Airway reactivity in subjects with viral upper respiratory tract infections. *Am Rev Respir Dis* 1980;122:3.
8. Arant Jr BS. Renal and genitourinary disease. In: Oski FA, DeAngelis CD, Feigin RD, et al., eds. *Principles and Practice of Pediatrics*. Philadelphia: JB Lippincott, 1990;1614–1615.
9. Ashburn MA, Streisand JB, Tarver SD, et al. Oral transmucosal fentanyl citrate in paediatric outpatients. *Can J Anaesth* 1990;37:857.
10. Belknap WM. Developmental disorders of gastrointestinal function. In: Oski FA, DeAngelis CD, Feigin RD, et al., eds. *Principles and Practice of Pediatrics*. Philadelphia: JB Lippincott, 1990;369–378.
11. Belknap WM. Sucking and swallowing disorders and gastroesophageal reflux. In: Oski FA, DeAngelis CD, Feigin RD, et al., eds. *Principles and Practice of Pediatrics*. Philadelphia: JB Lippincott, 1990;382–384.
12. Boudin P. LeNourisson, alementation et hygiene des enfants debeles-enfant nes a Terme. Paris: Dion, 1900.
13. Buchanan GR. Hematopoietic diseases. In: Oski FA, DeAngelis CD, Feigin RD, et al., eds. *Principles and Practice of Pediatrics*. Philadelphia: JB Lippincott, 1990;431–441.
14. Britt BA. Temperature regulation. In: Gregory GA, ed. *Pediatric Anesthesia*. 2nd ed. New York: Churchill-Livingstone, 1989;287–357.
15. Buisson P, Bach V, Elabbassi EB, et al. Assessment of the efficiency of warming devices during neonatal surgery. *Eur J Appl Physiol* 2004;92:694–697.
16. Cabanac M. Temperature regulation. *Ann Rev Physiol* 1975;37:415.
17. Chantler C. The kidney. In: Godfrey S, Baum JD, eds. *Clinical Paediatric Physiology*. Oxford: Blackwell Scientific, 1979;356–398.



18. Chapman AH, Loeb DG, Gibbons MJ. Psychiatric aspects of hospitalizing children. *Arch Paediatr* 1956;73:77.
19. Cohen MM, Cameron CB. Should you cancel the operation when a child has an upper respiratory tract infection? *Anesth Analg* 1991;72:282.
20. Cook DR, Davis PJ. Pharmacology of pediatric anesthesia. In: Motoyama EK, Davis PJ, eds. *Smith's Anesthesia for Infants and Children*. 5th ed. St. Louis: Mosby-Year Book, 1990;157–197.
21. Cote CJ. NPO after midnight for children—a reappraisal. *Anesthesiology* 1990;72:589.
22. Cote CJ, Todres ID. The pediatric airway. In: Ryan JF, Todres ID, Cote CJ, et al., eds. *A practice of anesthesia for infants and children*. Philadelphia: WB Saunders, 1986;35–58.
23. Crawford MW, Galton S, Abdelhaleem M. Preoperative screening for sickle cell disease in children: clinical implications. *Can J Anaesth* 2005;52:1058–1063.
24. Darnall RA Jr, Ariagno RL. Minimal oxygen consumption in infants cared for under overhead radiant warmers compared with conventional incubators. *J Pediatr* 1978;93:283.
25. Davies JM, Davison JS, Nimmo WS, et al. The stomach: factors of importance to the anaesthetist. *Can J Anaesth* 1990;37:896.
26. Eckenhoff JE. Relationship of anesthesia to postoperative personality changes in children. *Am J Dis Child* 1953;86:587.
27. Eger EI II. *Anesthetic Uptake and Action*. Baltimore: Williams & Wilkins, 1974.
28. Firth PG. Anaesthesia for peculiar cells—a century of sickle cell disease. *Br J Anaesth* 2005;95:287–299.
29. Firth PG, Head CA. Sickle cell disease and anesthesia. *Anesthesiology* 2004;101:766–785.
30. Forbes RB, Vandewalker GE. Comparison of two and ten per cent rectal methohexitone for induction of anaesthesia in children. *Can J Anaesth* 1988;35:345.
31. Frankenberg WK, Dodds JB. *Denver Developmental Screen Test*. Denver, CO: University of Colorado Medical Center, 1969.
32. Friedman WF. The intrinsic physiologic properties of the developing heart. In: Friedman WF, Lesch M, Sonnenblick EH, eds. *Neonatal Heart Disease*. New York: Grune and Stratton, 1973;1–47.
33. Fries-Hansen B. Body composition during growth. In vivo measurements and biochemical data correlated to differential anatomical growth. *Pediatrics* 1971;47:264.
34. Garcia-Erce JA, Solano VM, Saez M, Muoz M. Recombinant human erythropoietin facilitates autologous blood donation in children undergoing corrective spinal surgery. *Transfusion* 2005;45:820–821.
35. Gioia FR, Stephenson RL, Alterwitz SA. Principals of respiratory support and mechanical ventilation. In: Rogers MC, ed. *Textbook of Pediatric Intensive Care*. Baltimore: Williams & Wilkins, 1987;134–200.
36. Gregory G. Pharmacology. In: Gregory GA, ed. *Pediatric Anesthesia*. 2nd ed. New York: Churchill-Livingstone, 1989;385–430.
37. Hansel H. Thermoreceptors. *Am Rev Physiol* 1974;36:233.
38. Hanna JD, Chan JCM, Gill JR Jr. Hypertension and the kidney. *J Pediatr* 1991;118:327–340.
39. Helmers JH, Noorduyn H, VanPeer A, et al. Comparison of intravenous and intranasal sufentanil absorption and sedation. *Can J Anaesth* 1989;36:494.
40. Hill J, Rahintull KA. Heat balance and the metabolic rate of newborn babies in relation to environmental temperature and the effect of age and weight on basal metabolic rate. *J Physiol* 1965;180:239.
41. Hogg JC, Williams J, Richardson B, et al. Age as a factor in the distribution of lower airway conductance and in the pathologic anatomy of obstructive lung disease. *N Engl J Med* 1970;282:1283.
42. Hyvarinen M, Zelter P, Oh W, et al. Influences of gestational age on serum levels of  $\alpha_2$  fetoprotein, IgG globulin and albumin in newborn infants. *J Pediatr* 1973;82:430.
43. Jacoby DB, Hirshman CA. General anesthesia in patients with viral respiratory infections—an unsound sleep? *Anesthesiology* 1991;74:969.
44. Jansen AH, Chernick V. Development of respiratory control. *Physiol Rev* 1983;63:437.
45. Jensen BH, Werberg M, Adersen M. Preoperative starvation and blood glucose concentration in children undergoing inpatient and outpatient anesthesia. *Br J Anaesth* 1982;54:1071.
46. Johnson TN. The development of drug metabolising enzymes and their influence on the susceptibility to adverse drug reactions in children. *Toxicology* 2003;192:37–48.
47. Kain ZN, Caldwell-Andrews AA. Preoperative psychological preparation of the child for surgery: an update. *Anesthesiol Clin North America* 2005;23:597–614.
48. Kaplan EB, Sheiner LB, Boeckmann AJ, et al. The usefulness of preoperative laboratory screening. *JAMA* 1985;253:3576.
49. Keens TG, Bryan AC, Levinson H, et al. Developmental pattern of muscle fiber types in human ventilatory muscles. *J Appl Physiol* 1978;44:909.
50. Kirkpatrick SE, Pitlick PT, Naliboff J, et al. Frank-Starling relationship as an important determinant of fetal cardiac output. *Am J Physiol* 1976;231:495.
51. Knill RL, Gelb KW. Ventilatory responses to hypoxia and hypercapnia during halothane sedation and anesthesia in man. *Anesthesiology* 1978;49:244.
52. Koehntop DE, Rodman JH, Brundage DM, et al. Pharmacokinetics of fentanyl in neonates. *Anesth Analg* 1986;65:227.
53. Korsch BM. The child and the operating room. *Anesthesiology* 1975;43:251.
54. Kurth CD, Spitzer AR, Broennille AM, et al. Postoperative apnea in preterm infants. *Anesthesiology* 1987;66:483.
55. Lawrence VA, Gafni A, Gross M. The unproven utility of the preoperative urinalysis: economic evaluation. *J Clin Epidemiol* 1989;42:1185.
56. Lehrman J. Inhalational anaesthetics. *Paediatr Anaesthesiol* 2004;14:380–383.
57. Liu LMP, Cote CS, Goudsouzian NG, et al. Life-threatening apnea in infants recovering from anesthesia. *Anesthesiology* 1983;59:506.
58. Machida HM, Forbes DA, Gall DG, et al. Metoclopramide in gastroesophageal reflux of infancy. *J Pediatr* 1988;112:483.
59. Maltby JR, Sutherland AD, Sale JP, et al. Preoperative oral fluids: is a five-hour fast justified prior to elective surgery? *Anesth Analg* 1986;65:1112.
60. Marchant WA, Walker I. Anaesthetic management of the child with sickle cell disease. *Paediatr Anaesth* 2003;13:473–489.
61. Maxwell LG, Deshpande JK, Wetzel RC. Preoperative evaluation of children. *Pediatr Clin North Am* 1994;41:93–110.
62. Maxwell LG, Wetzel RC. Induction techniques in pediatric anesthesia. *Anesth Rep* 1988;1:110.
63. McGill WA, Coveler LA, Epstein BS. Subacute upper respiratory infection in small children. *Anesth Analg* 1979;58:331.
64. Meakin G, Dingwall AE, Addison GM. Effects of fasting and oral premedication on the pH and volume of gastric aspirate in children. *Br J Anaesth* 1987;59:678.
65. Miller ED, Sanders DB, Rowlingson JC, et al. Anesthesia-induced rhabdomyolysis in a patient with Duchenne's muscular dystrophy. *Anesthesiology* 1978;48:146.
66. Miller MJ, Carlo WA, Strohl KP, et al. Effect of maturation on oral breathing in sleeping premature infants. *J Pediatr* 1986;109:515.
67. Mitchell MM, Ali MM, Savarese JJ. Myotonia and neuromuscular blocking agents. *Anesthesiology* 1976;49:216.
68. Montague TJ, Taylor PG, Stockton R, et al. The spectrum of cardiac rate and rhythm in normal newborns. *Pediatr Cardiol* 1982;2:33.
69. Motoyama EK. Respiratory physiology in infants and children. In: Motoyama EK, Davis PJ, eds. *Smith's Anesthesia for Infants and Children*. 5th ed. St. Louis: Mosby-Year Book, 1990;11–76.
70. Moylan FMB, Selden EB, Shannon DC, et al. Defective primary dentition in survivors of neonatal mechanical ventilation. *J Pediatr* 1980;96:106.
71. Nicholson JF, Pesce MA. Reference ranges for laboratory tests and procedures. In: Behrman RE, Kliegman RM, Jensen HB, eds. *Nelson's Textbook of Pediatrics*. Philadelphia: WB Saunders, 2004;2398–2426.



72. Nicolson SC, Betts EK, Jobes DR, et al. Comparison of oral and intramuscular pre-anesthetic medication for pediatric inpatient surgery. *Anesthesiology* 1989;71:8.
73. NIH and FDA Perioperative Red Blood Cell Transfusion Consensus Conference. Bethesda, MD, April, 1988.
74. O'Connor ME, Drasner K. Preoperative laboratory testing of children undergoing elective surgery. *Anesth Analg* 1990;70:176.
75. Ohlson KB, Mohell N, Cannon B, et al. Thermogenesis in brown adipocytes is inhibited by volatile anesthetic agents. A factor contributing to hypothermia in infants? *Anesthesiology* 1994;81:176-183.
76. Olinsky A, Bryan MH, Bryan AC. Influence of lung inflation on respiratory control in neonates. *J Appl Physiol* 1974;36:426.
77. Orenstein SR, Orenstein DM. Gastroesophageal reflux and respiratory disease in children. *J Pediatr* 1988;112:847.
78. Porri F, Pradal M, Lemiere C, et al. Association between latex sensitization and repeated latex exposure in children. *Anesthesiology* 1997;86:599-602.
79. Reiminschnieder TA, Breener RA, Mason DT. Maturational changes in myocardial contractile state of newborn lambs. *Pediatr Res* 1981;15:349.
80. Report of the Task Force on Blood Pressure Control in Children: National Heart, Lung, and Blood Institute. *Pediatrics* 1977;59(Suppl):803.
81. Rigatto H, Brady JP. Periodic breathing and apnea in the preterm infant. I. Evidence for hypoventilation possibly due to central depression. *Pediatrics* 1972;50:202.
82. Rigatto H, de la Torre Verduzco R, Cates DB. Effects of O<sub>2</sub> on the ventilatory response to CO<sub>2</sub> in preterm infants. *J Appl Physiol* 1975;39:896.
83. Roberts MC, Wurtele SK, Boone RR, et al. Reduction of medical fears by use of modelling. *J Pediatr Psych* 1981;6:293.
84. Robertson J, Shilkofski N, eds. *Harriet Lane Handbook*. 17th ed. Mosby Elsevier, 2005.
85. Romero TE, Friedman WF. Limited left ventricular response to volume overload in the neonatal period: a comparative study with the adult animal. *Pediatr Res* 1979;13:910.
86. Rudolph AM, Heyman MA. Cardiac output in the fetal lamb: the effects of spontaneous and induced changes of heart rate on right and left ventricular output. *Am J Obstet Gynecol* 1976;124:183.
87. Schreiner MS, Triebwasser A, Keon TP. Ingestion of liquids compared with preoperative fasting in pediatric outpatients. *Anesthesiology* 1990;72:593.
88. Sereni F. Principals of developmental pharmacology. *Am Rev Pharmacol* 1968;8:453.
89. Smith CA, Nelson NB. *The Physiology of the Newborn Infant*. 4th ed. Springfield, IL: Charles C Thomas, 1976.
90. Smith DW. Recognizable Patterns of Human Malformation: Genetic, Embryologic and Clinical Aspects. 5th ed. Philadelphia: WB Saunders, 1997.
91. Spitzer A. The role of the kidney in sodium homeostasis during maturation. *Kidney Int* 1982;21:539.
92. Stockman JA III. Anemia of prematurity: current concepts in the issue of when to transfuse. *Pediatr Clin North Am* 1986;33:111.
93. Stoll B, Kliegman RM. The fetus. In: Behrman RE, Kliegman RM, Jensen HB, eds. *Nelson's Textbook of Pediatrics*. 17th ed. Philadelphia: WB Saunders, 2004;536-546.
94. Tait AR, Knight PR. Intraoperative respiratory complications in patients with upper respiratory tract infections. *Can J Anaesth* 1987;34:300.
95. Tander B, Baris S, Karakaya D, et al. Risk factors influencing inadvertent hypothermia in infants and neonates during anesthesia. *Paediatr Anaesth* 2005;15:574-579.
96. Thomas DKM. Hypoglycaemia in children before operation. *Br J Anaesth* 1974;51:161.
97. Tietel DF, Side D, Chen T, et al. Developmental changes in myocardial contractile reserve in the lamb. *Pediatr Res* 1985;19:948.
98. Tobin JR, Wetzel R. Cardiovascular physiology and shock. In: Nichols DG, Greeley WJ, Wetzel RC, eds. *Critical Heart Disease in Infants and Children*. St. Louis: Mosby, 2005;17-70.
99. Vichinsky EP. Current issues with blood transfusions in sickle cell disease. *Semin Hematol* 2001;38:14-22.
100. Vichinsky EP, Haberkern CM, Neumayr L, et al. A comparison of conservative and aggressive transfusion regimens in the perioperative management of sickle cell disease. *N Engl J Med* 1995;333:206.
101. Visintainer MA, Wolfer JA. Psychological preparation for surgical pediatric patients. The effect of children's and parents' stress responses and adjustment. *Pediatrics* 1975;56:87.
102. Walbergh EJ, Willis RJ, Eckhart J. Plasma concentrations of midazolam in children following intranasal administration. *Anesthesiology* 1991;74:233.
103. Walker-Smith JA. Gut and digestion. In: Godfrey S, Baum JD, eds. *Clinical Paediatric Physiology*. Oxford: Blackwell Scientific, 1979;321-355.
104. Weil WB Jr, Bailie MD. Fluid and Electrolyte Metabolism in Infants and Children: a Unified Approach. New York: Grune and Stratton, 1977.
105. Wellborn LG, McGill WA, Hannallah RS, et al. Perioperative blood glucose concentrations in pediatric outpatients. *Anesthesiology* 1986;65:543.
106. Wetzel RC. Defective dentition following mechanical ventilation. *J Pediatr* 1980;97:334.
107. Wetzel RC. Anesthesia for pediatric trauma. In: Stene JK, ed. *Pediatric Trauma*. Baltimore: Williams & Wilkins, 1989;312-329.
108. Wetzel, RC. Gastro-oesophageal reflux: theory over experience: *Paediatr Anaesth* 1998;8:101-104.
109. Wetzel, RC, Desphande JK, Rogers MC. Unusual causes of myocardial ischemia pulmonary edema and cyanosis. In: Rogers MC, ed. *Textbook of Pediatric Intensive Care*. Vol 1. Baltimore: Williams & Wilkins, 1996;423-466.
110. Wetzel RC, Rogers MC. Pediatric hemodynamic monitoring. In: Shoemaker WC, Thompson WL, eds. *Critical Care—State of the Art*. Fullerton, CA: The Society of Critical Care Medicine, 1983.
111. Wood L, Prichard S, Weng T, et al. Relationship between anatomic dead space and body size in health, asthma, and cystic fibrosis. *Am Rev Respir Dis* 1971;104:215.
112. Wood M, Wood AJJ. Changes in plasma drug binding and  $\alpha$ -1-glycoprotein in mother and newborn infant. *Clin Pharmacol Ther* 1981;29:522.
113. Wood RA, Hoekelman RA. Value of the chest x-ray as a screening test for elective surgery in children. *Pediatrics* 1981;67:447.
114. Yuan N, Skaggs DL, Dorey F, et al. Preoperative predictors of prolonged postoperative mechanical ventilation in children following scoliosis repair. *Pediatr Pulmonol* 2005;40:414-419.
115. Zuckerberg AL. Perioperative approach to children. *Pediatr Clin North Am* 1994;41(1):15-29.

# CHAPTER 20

## Evaluation of the Geriatric Patient

Stanley Muravchick, MD, PhD,  
and Katherine Grichnik, MD

The term *geriatrics*, created early in the 20th century, describes the clinical subspecialty area of medicine that focuses on care of the elderly patient.<sup>1</sup> Since then, advances in medical science and healthcare have continued to increase the relative “agedness” of industrialized societies to the point that the economics of healthcare for the elderly have, for the first time, assumed roles of major social and political importance. Elderly patients now account for more than one-half of all hospital care days in the United States. In addition, almost one-third of all surgical patients are 65 years of age or older, with an even larger fraction anticipated in the next 2 decades. Virtually every nonpediatric hospital provides a wide range of surgical services for elderly adults; consequently, almost every anesthesiologist in contemporary practice is expected to have expertise in geriatric medicine as it relates to anesthetic practice.<sup>2</sup>

As they age, adults exhibit an increasingly varied array of physical responses to lifelong exposure to environmental and socioeconomic conditions and to the accumulated stigmata of prior traumatic injuries and medical therapies. Prolonged longevity also reveals all intrinsic physiologic strengths and weaknesses and full expression of genetic differences that might not be fully apparent over shorter life-span intervals. The terms *elderly* and *geriatric* are used synonymously in this chapter to describe patients who are 65 years of age or older. The term *aged* is used to describe individuals older than 80 years of age.

As you shall see, neither elderly nor aged surgical patients require a “special” anesthetic. Rather, as advocated prophetically more than a half century ago,<sup>3</sup> a well-conducted anesthetic of any type can be both safe and appropriate for an elderly patient if the

anesthesiologist (a) adheres to high standards of preoperative assessment, (b) closely controls and monitors pre-existing disease, and (c) pays meticulous attention to drug dosage and to the details of pain management and postoperative care.<sup>4</sup> The sections that follow describe some of the current concepts of human aging that are relevant to contemporary anesthetic practice, examine common disease states, and review common surgical procedures in the elderly.

### CONCEPTS AND THEORIES OF AGING

The exact mechanisms that control the aging process remain unknown. However, it is very clear that aging is not simply the result of accumulated disease. Aging is a physiologic phenomenon that manifests itself in mammalian species as universal and progressive degenerative changes in both the structure and the functional capacity of organs and tissues. The implied consequence of aging in all species is an increasing probability of death as a function of time. Currently, there is no consensus as to when the geriatric era begins in human subjects or whether any single physiologic marker can identify an elderly or an aged patient.

Throughout adulthood, increasing levels of oxygen-derived free radicals, or reactive oxygen species (ROS), create oxidative stress within the mitochondria and disrupt the structural and enzymatic machinery of oxidative phosphorylation.<sup>5</sup> Investigations of oxidative phosphorylation in aging mitochondria suggest that aging is associated with progressive impairment of bioenergetic efficiency and increases in the incidence of defects

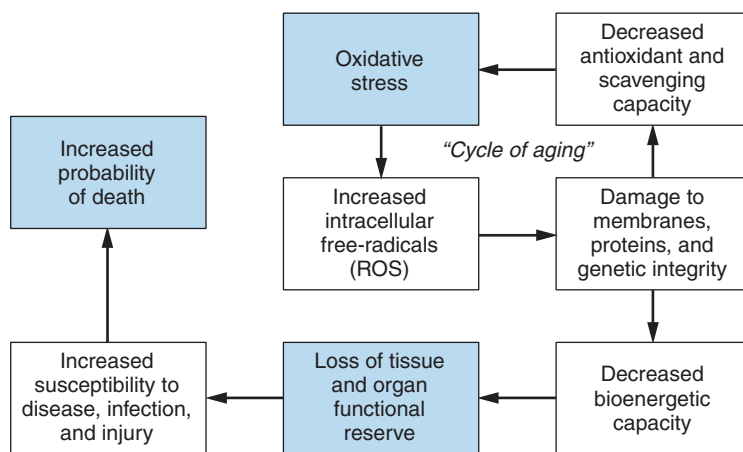
in DNA, primarily mitochondrial DNA (mtDNA), presumably because of increasing levels of ROS.<sup>6</sup> As the ability of the cell to scavenge these byproducts of aerobic metabolism declines, ROS may create a self-perpetuating “cycle of aging” within the mitochondria (Fig. 20–1).<sup>7</sup> Many gerontologists have concluded that changes in mitochondrial bioenergetics largely explain much of normal human aging and that these appear to play a central role in the diffuse deterioration of cellular and organ function that characterizes human senescence.<sup>8</sup>

The mitochondria, by modulating both bioenergetics and programmed cell death, or apoptosis, may serve as “biosensors” for oxidative stress as well as the final mediators of both declining energy production and termination of cell function.<sup>9</sup> Viewed from this perspective, the unique life span demonstrated by each species probably reflects the net result of interaction between the genetically determined bioenergetic attributes of each species and the randomly destructive environmental factors that produce disorder in biologic systems.

Two recent observations support this concept. Cellular resistance to oxidative stress has been shown to be intrinsically involved in both aging and longevity,<sup>10</sup> and an experimental mtDNA mutation has produced what appears to be premature aging in laboratory animals.<sup>11</sup> There is also a general correlation between species longevity and the capacity to repair damaged DNA but still no solid evidence that the ability to recover from random oxidative DNA damage is progressively or universally compromised in older human subjects.<sup>12</sup> In addition, although it has been shown that there is more defective mtDNA in the cells of older subjects,<sup>13</sup> it is not certain that

### KEY POINTS

1. The elderly are the fastest-growing segment of the population.
2. A healthy elderly patient may have normal organ function but less reserve.
3. There are normal organ and overall functional changes of aging that do not imply disease but must be considered when planning an anesthetic.
4. Elderly patients have a high incidence of chronic disease states.
5. Elderly patients do not require a “special” anesthetic, but rather require strict attention to meticulous preoperative assessment, detailed management of intraoperative variables and concurrent disease states, and cautious titration of drug administration and dosages.



**FIGURE 20-1.** There may be a self-sustaining “cycle of aging” in which accumulated oxidative stress as a result of aerobic metabolism eventually damages the metabolic machinery and the genetic integrity of mitochondria.

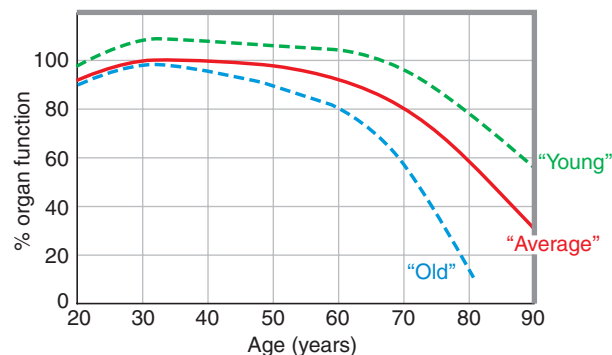
this actually produces a critical reduction of the macromolecules needed for normal bioenergetics.<sup>14</sup>

### Organ System Senescence

Classically, age-related physiologic change was represented as a linear decline of maximal organ system function. The physiologic decline was believed to begin early in young adulthood and continue inexorably downward thereafter. However, contemporary analysis suggests that there is a more complex relationship, with relatively minor decrements in maximal organ function first becoming apparent just after peak of somatic maturation, in the fourth decade of human

life. Additional decrements of average maximal function or functional capacity during the middle adult years also appear to be relatively subtle but subsequently become more obvious during the seventh decade of life and beyond (Fig. 20-2).

Nevertheless, although some decline of maximal function is inevitable, the competence of integrated organ system function varies greatly from one elderly patient to the next, even in the absence of disease. Functional capacity is significantly altered by differences in physical and mental activity level, comorbidities, social habits, diet, and genetic background. Those elderly patients who maintain

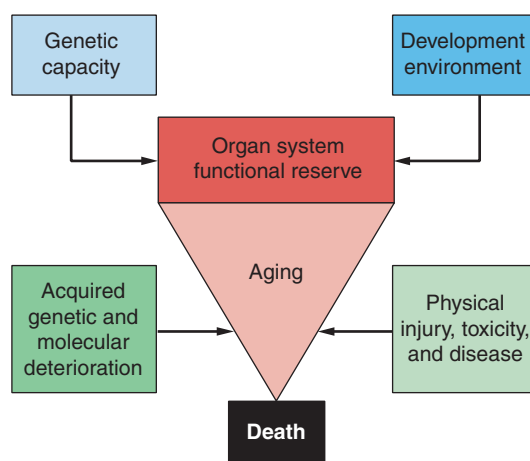


**FIGURE 20-2.** Differences in the rate at which maximal organ system functions decline with increasing age and differences in initial functional levels explain the inevitable variability seen in geriatric patients, clinically recognized as physiologically “younger” or “older” than average.

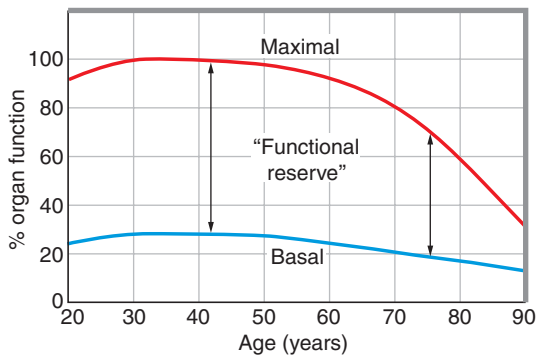
greater than average functional capacities are considered “physiologically young.” However, when organ function declines at an earlier age than usual, or at a more rapid rate, elderly patients are often described as “physiologically old.”

In fact, the extreme variability of signs, symptoms, and physical presentation common among older patients is an essential characteristic of geriatric medicine.<sup>15</sup> This is not surprising, given that human aging represents the interaction of many factors, some universal and some idiosyncratic (Fig. 20-3). In all healthy geriatric patients, however, maximal organ system function remains greater than basal demand at all ages. The difference between maximal organ system capacity and basal function defines organ system “functional reserve.” Aging is also inevitably associated with a decrease in functional reserve, which also is considered a defining physiologic characteristic of human aging (Fig. 20-4).

Clinically, decreased functional reserve implies a universal and predictable increase in the susceptibility of elderly patients to stress- and disease-induced organ system dysfunction. Organ system functional reserve is the “safety margin” that is available to meet, for example, the additional demands for cardiac output, carbon dioxide excretion, or protein synthesis imposed on the patient by trauma or disease or by surgery, healing, and con-



**FIGURE 20-3.** One concept of organ system functional reserve describes a “wedge” that is broadest at birth but then declines progressively after maturity (Reprinted with permission from Jazwinski SM. Longevity, genes, and aging. *Science* 1996;273:54–59<sup>197</sup> Copyright, 1996 AAAS). Genetically determined organ system functional reserve may determine life span, but life expectancy reflects “real-world” estimates of human longevity given extrinsic environmental factors. Actual observed life expectancy for a population of individuals is a measure of typical or average longevity and includes those with a “poor” genetic profile as well as those individuals who die of external, nongenetic causes.



**FIGURE 20-4.** For any organ system, “functional reserve” represents the difference between basal (minimal) and maximal organ system function. The age-related decline in functional reserve may not be clinically apparent until demands made on the organ system are increased by stress, disease, polypharmacy, or surgical intervention.

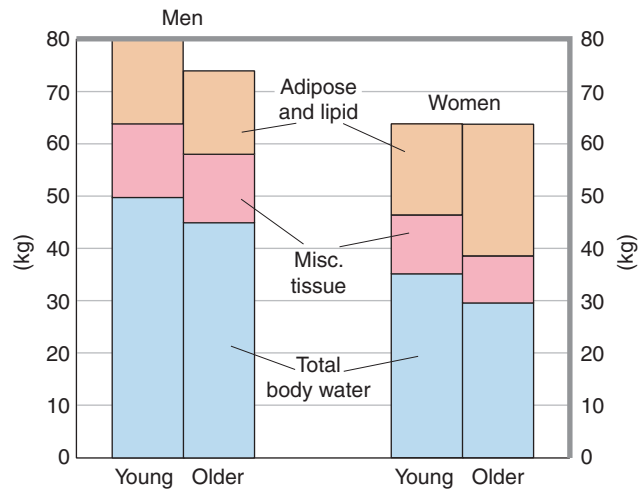
valescence. It is therefore of great importance to the anesthesiologist, and preoperative testing in the elderly patient is most effective when it provides the anesthesiologist with a quantifiable assessment of functional reserve. Testing should be clinically directed according to symptoms and complaints referable to age-related disease or to functional decline suggesting erosion of physiologic homeostasis.<sup>16</sup> However, although cardiopulmonary functional reserve can be assessed clinically using various exercise or aerobic stress tests, there are no comparable techniques for assessment of hepatic, immune, or nervous system functional reserve, at least at the present time. These require subjective clinical assessment and detailed clinical history and physical examination, with particular focus on activity levels and the ability to participate fully in the normal activities of daily life.

### **Aging, Metabolism, and Body Composition**

Despite the assumptions of many physicians that elderly patients are often malnourished, surveys do not suggest that the elderly and aged commonly live in a state of poor nutrition. Dietary inadequacy, if anything, is related to income, not to age, and probably affects less than 10% of the elderly population.<sup>17</sup> The well-nourished normal elderly also do not appear to have altered requirements for vitamins or dietary supplements. Nevertheless, older adults of both sexes undergo signifi-

cant atrophy of most metabolically active tissues, especially brain, liver, and kidney. In addition, normal aging, particularly in men, is associated with a progressive loss of skeletal muscle mass. In aged men, continuing loss of muscle and central organ atrophy eventually produces a significant decline in total body weight, often to levels less than those of young adulthood. In women, however, muscle and bone loss due to osteoporosis are largely offset by increasing body fat, and therefore total body weight usually returns toward, but rarely falls below, young adult values (Fig. 20-5).

Skeletal muscle and large, well-perfused organs comprise the lean tissue mass (LTM) component of total body weight. Age-related loss of LTM plays a powerful role in altering perioperative metabolism, cardiopulmonary function, and the pharmacokinetics of anesthetic agents. The linear correlation between basal metabolic rate (BMR) and creatinine excretion suggests that decreased muscle mass is largely responsible for the age-related decline in BMR,<sup>18</sup> although middle-aged subjects have a slightly lower BMR than younger subjects even when they are comparable in body size, body composition, or activity.<sup>19</sup> BMR decreases in parallel with the contraction of total body water (TBW) throughout most of adulthood, but a more accelerated decline in energy expenditure at rest occurs later in senescence, with kcal/d in the tenth



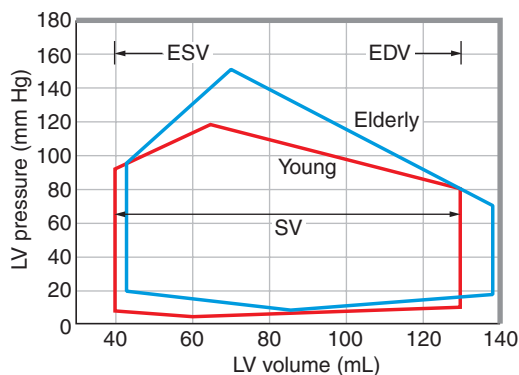
**FIGURE 20-5.** Age-related changes in body composition are gender specific. In women, total body mass remains constant because increases in body fat (*upper shaded segment*) offset bone loss (*middle segment*) and intracellular dehydration (*lower shaded segment*). In men, body mass decreases despite maintenance of body lipid and skeletal tissue elements because accelerating loss of skeletal muscle and other components of lean tissue mass produces marked contraction of intracellular water (*lower shaded segment*).

decade only one-half that of young adults. There do not appear to be any gender-specific differences in the effects of age on BMR that are not related to body composition or activity. Nevertheless, because BMR for both men and women eventually decreases somewhat faster than can be explained from the decrease in LTM, lessened thyroid hormone activity may eventually limit the level of metabolic activity, as well as the mass, of lean tissue components.<sup>20</sup>

After the young adult years, TBW falls 10–20%. Virtually all of the age-related changes in body water content are limited to the intracellular compartments. Decreases in circulating blood volume, once believed to be inevitable, actually reflect deconditioning and dehydration and are typical only in bedridden elderly or those with essential hypertension.<sup>21</sup> Plasma volume, red cell mass, and extracellular fluid volumes are well maintained in nonhypertensive elderly individuals who maintain reasonable levels of daily physical activity.

Decreasing LTM reduces the capacity for body heat production, and impairment of thermoregulatory vasoconstriction places elderly surgical patients at increased risk for inadvertent intraoperative hypothermia.<sup>22</sup> In fact, intraoperative core temperature decreases at a rate twice as great as that observed in young adults under comparable conditions, and the time needed for spontaneous postoperative





**FIGURE 20-6.** Left ventricular (LV) cardiac pressure-volume loops for fit young (solid line) and elderly (broken line) subjects. Older subjects have a slightly higher end-diastolic ventricular volume (EDV) and larger stroke volume (SV), as well as elevated pressures throughout the cardiac cycle, because of increased myocardial stiffness and delayed active relaxation during diastole, delaying the passive phase of ventricular filling. Consequently, aging alters ventricular hemodynamics by increasing dependence on atrial contraction for the maintenance of normal stroke volume.

rewarming increases in direct proportion to patient age.<sup>23,24</sup> Because muscle, liver, and other components of LTM provide storage for carbohydrates, aging limits the ability to handle a glucose challenge even though the timing and the magnitude of insulin release is normal in the elderly. Consequently, aging may be associated with a loss of pancreatic islet cell sensitivity to hyperglycemia, the so-called glucoreceptor defect.<sup>25</sup> Alternatively, age-related glucose intolerance may reflect antagonism of insulin's effect on target tissues.<sup>26</sup> Thus fluid replacement with glucose-containing solutions should be limited to environments that permit frequent measurement of blood sugar levels in elderly patients.

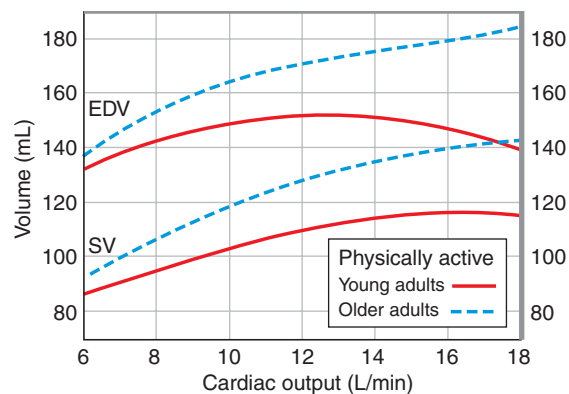
### Cardiovascular Function

The heart, unlike other major organs, does not atrophy with age. The aging left ventricle is actually thicker and less elastic than its younger counterpart, exhibiting the physical characteristics of *presbycardia*.<sup>27</sup> This is caused by, at least in part, an increase in collagen cross-linking in the myocardial cytoskeleton to which the myocytes are attached.<sup>28</sup> Cross-linking may reflect the buildup of advanced glycation end products produced by the chemical transformation of sugar moieties normally found in tissues.<sup>29</sup> Mitochondrial dysfunction has also been invoked as an explanation for the age-related changes in ventricular dynamics.<sup>30</sup>

Whatever the precise mechanism, the stiffer ventricle and atrium do not

permit complete chamber relaxation until relatively late in diastole. Consequently, passive ventricular filling, which occurs during the early phase of diastole, is significantly reduced in older adults, producing a form of diastolic dysfunction (Fig. 20-6). As a result, the elderly are particularly dependent on the synchronous atrial contraction of sinus rhythm for complete ventricular filling and may experience significant increases in pulmonary blood volume during exercise.<sup>31,32</sup> Small decreases in venous return, such as those produced by positive pressure ventilation, surgical hemorrhage, or venodilator drugs, can significantly compromise stroke volume if even minor cardiac dysrhythmias are present.

Resting cardiac index in healthy elderly subjects decreases slightly throughout adulthood and into senescence, but this is not evidence of degenerative cardiovascular change.<sup>33,34</sup> To the contrary, reduced cardiac output at rest is an appropriate integrated cardiovascular response to the reduced metabolic activity that occurs because of age-related loss of LTM. Normal aging simply produces a smaller “aerobic machine” with reduced perfusion requirements. Under conditions of submaximal demand, myocardial contractility is well maintained, at least until the eighth decade of life.<sup>35</sup> Short-term demands for increased cardiac output are first met by moderate increases in heart rate and then by increasing left ventricular end-diastolic volumes and pressures.



**FIGURE 20-7.** In healthy older adults (broken lines), maximal heart rate is less than can be achieved by young adults (solid lines). Consequently, increases in cardiac output during aerobic metabolic stress are achieved by augmentation of stroke volume (SV) caused by generalized ventricular dilation and increased end-diastolic volume (EDV), with ejection fraction maintained at constant levels.

During vigorous aerobic exercise, the aging but well-conditioned heart can increase cardiac output to levels near those of younger adults by generating progressively larger stroke volumes through the Starling mechanism, a nonpathologic adaptation unique to older adults (Fig. 20-7).<sup>36</sup> Nevertheless, although many aged individuals compete successfully in a variety of strenuous athletic events, aging does ultimately impose significant limitations of maximal aerobic power generation (maximal oxygen consumption:  $\text{VO}_2\text{max}$ ) by reducing both the inotropic and chronotropic responses to  $\beta$ -agonists and to autonomic reflex pathways.<sup>37,38</sup> In general, however, peripheral factors, such as lactate production and musculoskeletal stiffness, and not cardiac reserve actually limit  $\text{VO}_2\text{max}$  during strenuous physical exercise in older adults.<sup>33</sup>

Systolic hypertension with widening of arterial pulse pressure is a major cardiovascular risk factor.<sup>39</sup> It is common in the geriatric population and reflects a gradual increase in large artery stiffness caused by fibrotic replacement of elastic tissues during the adult years.<sup>40</sup> This reduces the ability of the aorta and large arteries to store hydraulic energy and increases vascular impedance to ejection of stroke volume. The end result of these changes is a progressive and sustained increase in left ventricular wall tension and myocardial workload that produces symmetrical ventricular hypertrophy and increased ventricular mass. Impedance to the ejection of stroke volume in-

creases in older adults, even when systemic vascular resistance (SVR) is unchanged.<sup>41</sup> Increased vascular stiffness and loss of arterial cross-sectional area also increase the reflection of arterial pressure waves that produces the familiar “ringing” characteristics of radial artery waveform tracings in geriatric patients.

### Pulmonary Function

Loss of tissue elasticity occurs in the lungs as well as in the cardiovascular system, and all elderly individuals eventually demonstrate some degree of emphysema-like increases in lung compliance. However, calcification and stiffening of the costochondral joints of the thorax reduce chest wall compliance, so net pulmonary compliance does not increase but is usually unchanged.<sup>42</sup> Within the lung parenchyma, fibrous connective tissue proliferates and there is degeneration and cross-linking of lung elastin.<sup>43</sup> Breakdown of alveolar septae also reduces total alveolar surface area, increasing both anatomic and alveolar dead space.

Loss of lung elastic recoil is the primary anatomic mechanism by which aging degrades the efficiency of pulmonary gas exchange.<sup>44</sup> Small airway patency, normally maintained by elastic recoil, is compromised, and closing capacity increases to the point at which it becomes greater than the volume of the lung at rest.<sup>45</sup> The elderly individual probably experiences closure of some small airways even before the end of exhalation, and chronic airway obstruction is increasingly common but

often undiagnosed in senescence.<sup>46</sup> Vital capacity is significantly and progressively compromised because residual lung volume increases at the expense of inspiratory and expiratory reserve volumes (Fig. 20–8).<sup>47</sup> Because the changes in elasticity are nonuniform, they severely disrupt the normal matching of ventilation and perfusion within the lungs, increasing both shunting and physiologic dead space.

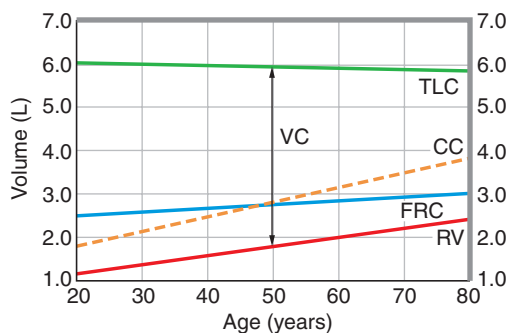
Overall, pulmonary function in older adults during general anesthesia is best characterized as decreased efficiency of gas exchange as a consequence of significant ventilation-perfusion mismatch, primarily because of the deterioration of intrinsic recoil, disruption of alveolar architecture, and increased sensitivity to anesthetic-induced depression of active hypoxic pulmonary vasoconstriction.<sup>48</sup> As a result, total venous admixture during anesthesia increases steadily with advancing age (Fig. 20–9).<sup>49</sup> Although the strength and endurance of the ventilatory apparatus remain adequate to meet moderate demands, skeletal calcification and rising airway resistance increase the work of breathing in elderly subjects, predisposing them to acute postoperative ventilatory failure.<sup>50,51</sup>

The cardiovascular and ventilatory responses to imposed hypoxia or hypercarbia are also delayed in onset and are of smaller magnitude in geriatric patients.<sup>52</sup> However, the moment-to-moment neural control of ventilation and the responses to changes in pH and respiratory gases appear to be essentially unchanged. Informal but

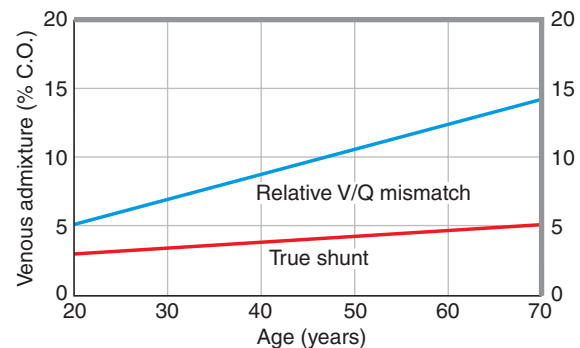
clinically valuable assessment of pulmonary function may be possible by questioning the elderly with regard to ability to climb stairs, provided that other causes for stopping, such as claudication, can be excluded. Inability to climb 2 flights of stairs correlates with a forced expiratory volume (FEV) that is less than 70% of predicted value, and failure to achieve 3 flights of stairs may predict severe pulmonary complications after thoracic surgery.<sup>53,54</sup>

### Hepatic, Endocrine, and Immune Systems

The age-related changes in hepatosplanchnic function are predominantly quantitative rather than qualitative.<sup>55</sup> Liver tissue mass decreases approximately 40% by age 80 years, and hepatic blood flow is proportionally reduced, primarily because of decreasing portal perfusion.<sup>56</sup> Hepatic enzyme activities are comparable to those of young adults, but there is great variability of metabolic function that may reflect loss of hepatocyte density.<sup>57</sup> Plasma concentrations of transaminase and other hepatocyte-derived enzymes are similar to those of young adults, but the bromsulphophthalein (BSP) retention test is prolonged with increasing age, approaching the upper limit of normal in the seventh decade of life.<sup>58</sup> Functional capacity for nitrogen clearance is also progressively reduced in aging adults, as is galactose elimination—both to an extent somewhat greater than can be accounted for based on changes in liver blood flow alone.<sup>59,60</sup> As a result, hepatic biotransformation and protein synthesis, although adequate to



**FIGURE 20–8.** Total lung capacity (TLC)—the sum of vital capacity (VC) and residual volume (RV)—decreases slowly in older adults of either gender. However, VC, which represents exchangeable intrathoracic gas volume, is markedly compromised by increases in thoracic rigidity and loss of ventilatory muscle power. RV increases because intrinsic lung elastic recoil is progressively reduced. Closing capacity (CC, dotted line) increases to a value greater than that of functional residual capacity (FRC). CC greater than FRC implies that there is persistent closure of small airways when the lung is at rest in the neutral state.



**FIGURE 20–9.** During anesthesia, total venous admixture (expressed as percentage of cardiac output [CO]) increases with increasing age largely because of a progressively greater amount of diffuse ventilation-perfusion (V/Q) mismatching, with only minimal increases in true intrapulmonary shunting.

meet modest increases in metabolic demand, may easily be overwhelmed by the metabolic demands of trauma, disease, or surgical intervention, especially if associated with arterial hypotension, low cardiac output, hypothermia, or direct hepatic injury.<sup>61</sup> Loss of hepatic functional reserve also explains the reduced rates of plasma clearance and prolonged clinical effects of narcotics and many other xenobiotics in geriatric subjects.<sup>62</sup> Overt hepatic dysfunction and failure appear in approximately 4% of elderly surgical patients, but more subtle degrees of hepatic compromise and limited hepatic functional reserve produce many postoperative complications and may require supportive therapy and intensive care.<sup>63</sup>

Aging appears to have little effect on macrophage and other aspects of phagocytic activity, but even fit elderly subjects exhibit subtle evidence of decreased immune responsiveness and specificity. As people age, the ability of the immune system to distinguish “self” from “nonself” antigens is reduced, increasing the prevalence of autoimmune phenomena and decreasing resistance to infection.<sup>64,65</sup> The effects of aging on mitochondrial function and control of apoptosis may play an important role in this process.<sup>66</sup> Thymic involution at sexual maturity is associated with marked changes in lymphocytic balance that progresses through senescence. Older adults have decreased B- and T-cell lymphocyte activity and depressed serum titers of immunoglobulin E, depressed skin response to exogenous allergens, and impaired delayed hypersensitivity.<sup>67</sup> Older adults are particularly predisposed to streptococcal pneumonia, meningitis, and septicemia. Sepsis is second only to respiratory failure as a cause of morbidity and mortality in elderly trauma patients.<sup>68</sup>

Adrenal tissues also show evidence of age-related atrophy, and cortisol secretion declines at least 15% by 80 years of age, although plasma levels of cortisol remain similar to those of younger adults because of reduced rates of degradation. Similarly, in the pituitary–thyroid axis, thyroxine levels are relatively unchanged, but there is a damped pituitary response to thyrotropin-releasing factor (TRF) and decline of thyroid-stimulating hormone (TSH) levels, although the end-organ cellular response to TSH is not affected by age.<sup>25,69</sup> However, plasma concentrations of norepinephrine are 2–4-

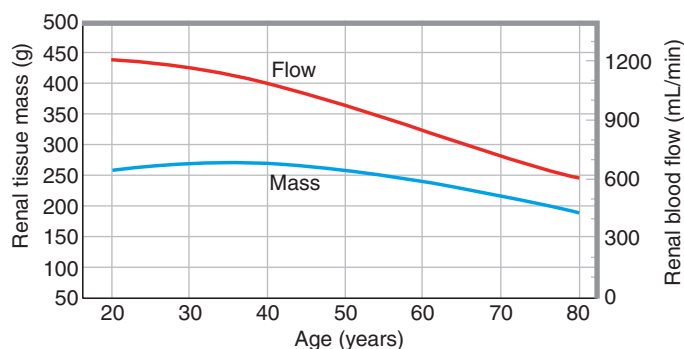
fold higher in elderly subjects than in younger adults during sleep, at rest, and even in response to exercise-induced physical stress.<sup>70</sup> These are rarely apparent clinically in elderly patients because aging markedly and progressively depresses  $\beta$ -adrenergic end-organ responsiveness, producing, in effect, endogenous  $\beta$ -blockade.<sup>71</sup> In contrast, there appears to be little change in  $\alpha$ -adrenoceptor or cholinergic activity.<sup>72</sup>

### Renal System

As people age, there is a progressive reduction in renal tissue mass and renal blood flow (Fig. 20–10). Renal plasma flow, glomerular filtration rate, and, most important, creatinine clearance decline significantly.<sup>73</sup> These deficits are further exacerbated by decreased perfusion caused by cardiovascular system aging and superimposed disease.<sup>74</sup> One must be wary of perioperative fluid balance, potential electrolyte imbalance, and the potential for impaired renal metabolism of perioperatively administered medications. Of note, a “normal” plasma creatinine concentration may not indicate normal renal functional reserve in the elderly patient because creatinine load is greatly reduced by atrophy of skeletal muscle mass. Calculated creatinine clearance remains the most sensitive marker of renal function in the elderly.<sup>73</sup>

### Pharmacology of Aging

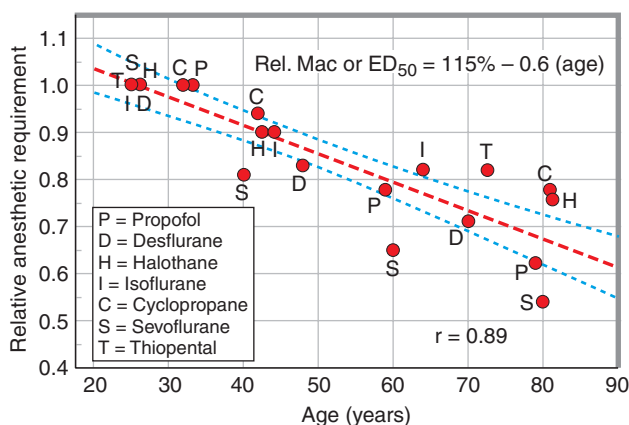
The high prevalence of disease in an elderly surgical patient population exposes them not only to the stigmata of the disorders themselves, but also to the risks of polypharmacy from the drugs used for medical therapy.<sup>75</sup> One-half of all adults age 75 years or older take at least 2 different types of medi-



**FIGURE 20–10.** Renal blood flow decreases more rapidly than does renal tissue mass with increasing age. Glomerular filtration rate (not shown) decreases somewhat more slowly than plasma flow because filtration fraction actually increases in some elderly individuals.

cation for the purpose of treating an age-related disease. Elderly patients account for 30% of all drug prescriptions, approximately twice the rate expected from their representation in the general population, and they consume 40% of all over-the-counter medications.<sup>76</sup> Adverse drug interactions occur more often in older than in younger patients because polypharmacy is more common in older adults and the reduced hepatic and renal functional reserve of the elderly patient prolongs both the desired and the unwanted effects of their medications. Although it is appropriate to maintain elderly patients perioperatively on all medications needed to effectively control the symptoms of their disorders, especially cardiovascular, neurologic, and metabolic disease, some drug interactions may complicate perioperative management or make the pharmacokinetics of drugs used perioperatively less predictable.<sup>77</sup>

The effect of nervous system aging on requirements for general anesthesia is well established.<sup>78</sup> Between young adulthood and the geriatric era, relative minimum alveolar concentration (MAC) values for the newer inhalational agents decline by approximately 30%, the same decrement seen with older anesthetics such as cyclopropane (Fig. 20–11).<sup>79,80</sup> However, the mechanisms producing this age-related increase in pharmacodynamic sensitivity to anesthetic agents remain unknown. Declining neuronal bioenergetics as a consequence of mitochondrial genetic mutation or because of age-related oxidative stress reduce anesthetic requirement, but it is not yet established that this, in fact, explains the reduced anesthetic requirement in the elderly.<sup>81,82</sup> Given this empirical



**FIGURE 20-11.** The age-related decline in relative anesthetic requirement (MAC or median effective dose [ $ED_{50}$ ]) in unsedated human subjects is a consistent characteristic reported for a wide variety of inhaled and injected anesthetic agents.

phenomenon, however, agedness itself may be an indication for additional monitoring of anesthetic depth using a processed electroencephalogram (EEG) or similar device.<sup>83</sup>

Clinical experience also suggests that there are significant age-related reductions in the dose requirements for thiopental as well as virtually all other agents that depress consciousness.<sup>84,85</sup> Nevertheless, pharmacologic data for the effect of aging on the dose requirements for opioids, barbiturates, and benzodiazepines are less consistent than those for inhalational anesthetics. Most studies suggest that aging increases brain sensitivity to narcotics, but the effects of aging on the pharmacodynamics of barbiturates or etomidate are less impressive.<sup>86-89</sup> Plasma drug concentrations immediately after intravenous injection are usually higher in elderly than in young adults.<sup>90</sup> Consequently, there remains considerable controversy as to whether the clinically apparent age-related increase in the potency of these drugs is truly a pharmacodynamic phenomenon or whether it simply reflects age-related changes in the “alpha” or early phase redistribution pharmacokinetics of injected agents.

In any case, the concentrations of short-acting IV agents in plasma change so rapidly and in such a complex manner that the two-compartment pharmacokinetic model used in traditional pharmacokinetic studies may be of little value for studying the early or “alpha-phase” behavior of these drugs and their subsequent redistribution in elderly subjects.<sup>91</sup> Because the interaction between subtle changes in both pharmacodynamics

and redistribution pharmacokinetics is sufficiently complex and unpredictable, some researchers believe that it must be characterized for each drug to predict the implications of aging on intravenous drug dosage.<sup>92</sup>

The net effect of age-related structural and functional changes within the nervous system on pain-related neurologic function remains controversial. The study of the amplification, modulation, and selectivity of afferent input within the spinal cord, thalamus, and other locations within the aging nervous system does not yet permit broad generalizations regarding aging and perception of pain.<sup>93,94</sup> In addition, optimizing postoperative pain management in older adults may be further complicated by cognitive impairment and by unrealistic fear of opioid side effects.<sup>95</sup> Perceived intensity of perioperative pain also appears to be far more dependent on anxiety, personality, and the prospect of long-term debility or disfigurement than on age itself.<sup>96</sup> Nevertheless, the classic observation that opiate requirements are inversely related to patient age and essentially independent of body weight remains a useful and valid general guideline.<sup>97</sup> When a fixed dose and volume of local anesthetic is used, higher levels of sensory blockade are also achieved in elderly patients undergoing spinal anesthesia.<sup>98</sup> Segmental dose requirements for epidural analgesia are similarly reduced with increasing age, although the differences because of aging may be clinically insignificant.<sup>99,100</sup>

Although the elderly have reduced skeletal muscle mass, disseminated neurogenic atrophy at the neuromus-

cular junction allows proliferation of extrajunctional cholinergic receptors. An increased density of cholinergic receptors at the muscle endplate implies that increased concentrations of neuromuscular blocking drugs are needed to produce competitive blockade. In fact, the median effective dose ( $ED_{50}$ ) and steady-state plasma concentration required for half-maximal neuromuscular blocking effect (median effective concentration [ $EC_{50}$ ]) remain virtually unchanged, or may actually increase slightly, in the elderly patient.<sup>101</sup> Maximal relaxant effect is delayed in onset relative to that produced in young adults, and duration of blockade is prolonged for relaxants with hepatic or renal elimination because plasma clearance declines with increasing age.<sup>102-105</sup> Relaxants, such as cisatracurium, that do not require organ-based elimination may provide more consistent duration of clinical effects in older patients.<sup>106,107</sup> However, antagonism of the effects of neuromuscular blocking drugs and recovery of neuromuscular transmission is unchanged if the pharmacokinetics of relaxant elimination are favorable.<sup>108</sup>

## COMMON COMORBID DISEASE STATES

The functional capacity of organs reduces with age, resulting in decreased reserve, decreased compensation for stress, and increased incidence of coexisting diseases.<sup>109</sup> Coexisting diseases further depress organ function, leading to even greater risk with surgical procedures.<sup>109</sup> It is useful to review the common diseases encountered in the elderly.

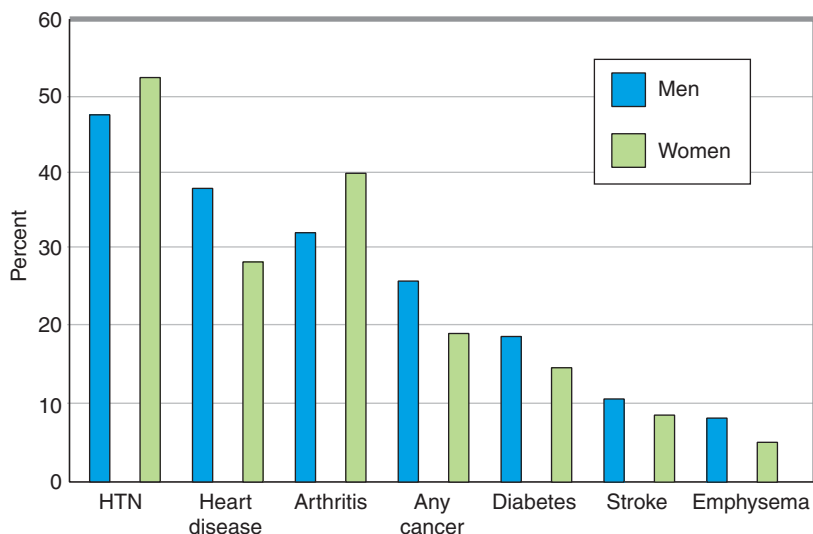
### Cardiovascular Disease

The elderly patient is likely to suffer from altered cardiovascular function. Common disease states include coronary artery disease, cardiac valvular disease, congestive heart failure and diastolic dysfunction, abnormal heart rhythm, systolic hypertension, and peripheral vascular disease.

#### Coronary Artery Disease

The presence of coronary artery disease (CAD) increases with age. Anatomic coronary artery disease can be detected in more than 50% of people older than 70 years of age (Fig. 20-12).<sup>110</sup> CAD in the aged is more severe and





**FIGURE 20-12.** The percentage of chronic disease in a non-institutionalized adult population older than 65 years of age (data averaged from 2000–2002). (Adapted from Centers for Disease Control and Prevention, National Center for Health Statistics, National Health Interview Survey. Available at: <http://www.agingstats.gov/chartbook2004/healthstatus.html>. Last accessed June 19, 2006.)

diffuse than in younger patients.<sup>111-113</sup> There are differences in prevalence by gender: at 65 years of age, CAD is more prevalent in men than in women; by age 80, the prevalence of symptomatic congestive heart disease is nearly equivalent in men and women.<sup>113,114</sup> Despite the high prevalence of anatomic CAD, only 10–20% of people older than 65 years of age carry a diagnosis of active CAD.<sup>113</sup> This may be a result of misdiagnosis, lack of clinical symptoms because of inactivity, or lack of recognition of risk factors leading to diagnosis. One study reported that 37% of elderly patients had subclinical CAD, making it as common as clinically overt CAD in older adults.<sup>115</sup> Furthermore, in this study, the presence of subclinical CAD was significant as it strongly predicted overt CAD, stroke, and mortality, even after adjustment for traditional cardiovascular risk factors.<sup>15</sup> Despite the high prevalence of CAD, over the last 30 years in the United States, the CAD mortality rate has decreased significantly. This includes reduced recurrent myocardial infarction and increased postmyocardial infarction survival.<sup>116</sup>

### Cardiac Valvular Disease

**Aortic Valve** Fibrotic thickening and increased opacity of the mitral and aortic valves occurs with age. Furthermore, one-third of patients older than 70 years of age have calcium deposits in the mitral or aortic valve.<sup>116</sup> Common causes of valvular

heart disease in the elderly are degenerative calcification, myxomatous degeneration, papillary muscle dysfunction, and infective endocarditis.<sup>116</sup>

The most frequent valvular lesion in the elderly is degenerative calcified aortic stenosis, with a prevalence of 2.5% at the age of 75 years and of almost 8% at 85 years.<sup>117</sup> Aortic regurgitation, mostly mild, was found in 29% of the entire study cohort.<sup>117</sup> The severity of aortic stenosis in the elderly is often underestimated because its progression is so gradual and because symptoms may be attributed to normal aging. Common causes of aortic valve stenosis are calcification of a congenital bicuspid aortic valve and degenerative aortic stenosis. Rheumatic heart disease is the cause in 20%; mitral valve disease often coexists.

**Mitral Valve** Mitral valve disorders are common in the elderly, but the symptoms of mitral valve disease may be masked or exacerbated by coexistent coronary artery disease, pulmonary disease, hypertension, and other systemic disorders that commonly occur in older adults.<sup>118</sup> Chronic mitral regurgitation is the most common type of mitral valve disease in the elderly. Rarely, isolated chronic mitral regurgitation occurs as a consequence of papillary muscle dysfunction after myocardial infarction. Chronic mitral regurgitation may also be a result of mitral annular calcification, myxomatous valve degeneration (with mitral valve prolapse), chordal rupture, and

rheumatic heart disease. Mitral annular calcification occurs in approximately 6% of people older than 60 years of age, predominantly in women. The incidence of myxomatous valvular degeneration increases with age.

Mitral stenosis is a disease of younger patients because severe mitral stenosis usually leads to surgery or death before 65 years of age.<sup>116</sup> If present, mitral stenosis is usually a result of rheumatic heart disease, a common condition when the current elderly population was young. Less commonly, mitral stenosis develops because of progressive mitral annular calcification.

**Tricuspid Valve** Tricuspid regurgitation is usually a result of annular dilation caused by right ventricular failure (usually resulting from left-sided heart failure) or pulmonary hypertension. Unlike in younger patients, infective endocarditis is a less-common cause. Tricuspid stenosis is rare in the elderly.

**Pulmonic Valve** Pulmonic valve disease as a consequence of primary valve dysfunction is rare but is usually secondary to pulmonary hypertension.

**Concurrent Valvular Disease** Concomitant mitral and aortic valve disease is common in the elderly. About one-half of patients with rheumatic mitral regurgitation have associated aortic valve disease, usually aortic regurgitation. In one study, concurrent mitral regurgitation found in elderly patients undergoing isolated aortic valve replacement (AVR) was found to be an independent risk factor for long-term survival.<sup>119</sup>

### Systolic Hypertension, Diastolic Dysfunction, and Congestive Heart Failure

As reviewed earlier, diastolic dysfunction and systolic hypertension are common and increase with aging. Ninety percent of Americans still having a healthy blood pressure at 55 years of age have hypertension when they reach 75 years of age.<sup>120,121</sup> Another common problem in the elderly is chronic heart failure, which can be divided into two broad categories: systolic heart failure and diastolic heart failure.<sup>122</sup> Diastolic heart failure occurs more frequently in the elderly, in women, and in those with systolic hypertension, but is less associated with concurrent CAD than systolic heart failure.<sup>122</sup>

### Peripheral Vascular Disease

Peripheral vascular disease is not a normal consequence of aging but is associated with systemic atherosclerosis and other risk factors for CAD, many of which are commonly found in the aging patient. The prevalence of peripheral arterial disease increases with age and has a variable presentation: asymptomatic, associated with intermittent claudication, or associated with critical limb ischemia.<sup>123</sup>

### Abnormal Heart Rhythm

Age-related changes in atrial chamber size and pressure, in left ventricular mass, and in catecholamine levels, in addition to increased incidence of CAD, contribute to a higher incidence of arrhythmias and conduction disturbances in the elderly. Common arrhythmias are atrial fibrillation, ectopic beats, and heart block.

**Atrial Fibrillation** Atrial fibrillation is among the most common arrhythmias seen in the general population.<sup>124</sup> The prevalence of this condition is increasing and increases with age; it occurs in 5.9% of people older than 65 years of age as compared with its occurring in 2.3% of people between 40 and 65 years of age.<sup>125</sup> In all age groups, men are more affected than women. It is believed that by 2050, more than 5.6 million people will suffer atrial fibrillation and that more than 50% of those older than 85 years of age will have this condition.<sup>126</sup> There are multiple conditions that predispose to atrial fibrillation, most commonly structural heart disease. Other contributory conditions include hypertension, coronary artery disease, heart failure thyrotoxicosis, sick sinus syndrome, and amyloidosis.

**Heart Block** There is a striking increase in the incidence of bradydysrhythmias and conduction abnormalities associated with progressive fibrosis in both the sinus node and atrioventricular conduction system in the elderly; sinoatrial pacemaker cells decrease progressively from 60 years of age such that approximately 10% of the cells are still present at age 75.<sup>116,127</sup> The sinoatrial node is also subject to fat accumulation, which may serve to separate nodal tissue from the atria musculature.<sup>116</sup> Bradydysrhythmias may be present preoperatively but can initially present as unexpected heart block under general anesthesia.<sup>128</sup>

### Pulmonary Disease

Pulmonary emphysema and chronic pulmonary obstructive disease are not associated with normal aging but are the consequences of exposure to environmental toxins, such as tobacco, which may vary among populations. One study from Norway estimated that in people older than 70 years of age, 11% reported having at least one current obstructive pulmonary disease, 8% reported daily wheezing, and 12% reported significant dyspnea.<sup>129</sup> However, they noted that the only respiratory symptom or disorder to show any clear age-related pattern was dyspnea, which increased through 89 years of age before decreasing.

As noted, because of declines in immunologic function, the elderly person is more prone to pneumonia than is a younger person. Furthermore, there may be an increased risk of aspiration pneumonia as a result of other conditions such as gastrointestinal sphincter malfunction or altered mental status.

As is expected in an aging population, the absolute number of patients with lung cancer is increasing.<sup>130</sup> Historically, there has been a reluctance to aggressively treat elderly lung cancer patients because of a lack of supportive data and concern for potential toxicity. However, the bulk of evidence suggests that healthy elderly patients can benefit from therapy in all stages of non-small cell lung cancer and that the decision to offer therapy should be based on comorbidities and performance status rather than age.<sup>130</sup>

### Gastrointestinal Disease

Although most gastroenterologic disorders that develop in younger people may also develop in the elderly, the presentation, treatment, and prognosis may be different.<sup>131</sup> Disorders that may have a higher incidence in the elderly include peptic ulcer, ischemic complications of vascular abnormalities, drug-induced disorders, malignancies, and passive reflux. Important to consider in the perioperative patient is the high likelihood of a gastrointestinal side effect of a medication such as a nonsteroidal antiinflammatory agent.<sup>132</sup> Furthermore, there may be an increased risk of constipation and bowel obstruction with opioids in the elderly.

### Renal Disease

Known decreases in renal function and glomerular filtration rate lead to a high

incidence of mild chronic renal insufficiency. Progression to chronic kidney disease is associated with a high risk of renal failure, cardiovascular disease, and death.<sup>133</sup> Many common comorbid disease states contribute to the increased incidence of renal dysfunction, including systemic hypertension, systemic arteriosclerotic disease, and chronic congestive heart failure. Regardless of the cause, the severity of chronic kidney disease can be classified by glomerular filtration rate (GFR): stage 1, kidney damage with a normal or increased GFR; stage 2, kidney damage with a mild decrease in GFR (60–100 mL/min/1.73 m<sup>2</sup>); stage 3, a moderate decrease in GFR (30–59 mL/min/1.73 m<sup>2</sup>); stage 4, a severe decrease in GFR (15–30 mL/min/1.73 m<sup>2</sup>); and stage 5, kidney failure (<15 mL/min/1.73 m<sup>2</sup> or conditions requiring dialysis).<sup>134</sup> Albuminuria is also used for diagnosis of renal dysfunction. This is a common problem, as 18% of people older than 60 years of age have albuminuria, and 7% have an estimated GFR of less than 60 mL/min/1.73 m<sup>2</sup>.<sup>133,135</sup> In people 70 years of age or older, those percentages increase to 30% and 26%, respectively.<sup>133,135</sup>

The diagnosis of renal dysfunction is indirect as GFR is estimated from the serum creatinine concentration or with creatinine-based estimations.<sup>133,134</sup> One should not rely on creatinine alone; equations for GFR estimation should incorporate additional demographic and clinical variables.<sup>133</sup>

Other problems to consider include urinary tract obstruction, common in elderly patients with an increased rate of benign prostatic hypertrophy, and urinary incontinence.

### Musculoskeletal Disease

The known decreases in the musculoskeletal system lead to predictable disorders, including tears of stiffer tendons and ligaments, especially in the rotator cuff, biceps tendon, and quadriceps tendon insertion to the patella, Achilles tendon, and posterior tibial tendon.<sup>136</sup> A large study in the United Kingdom identified the odds ratio of an Achilles tendon rupture to be 6.4% in patients ages 60 to 70 years and 20.4% in patients age 80 years or older.<sup>137</sup> There is also an increased incidence of osteoarthritis with age.<sup>138</sup> Less clearly associated with aging but with a high incidence in the elderly patient is rheumatoid arthritis.<sup>139</sup> These

conditions are associated with known problems with airway manipulation and positioning. Spinal column intervertebral disc degeneration with disc herniation and osteophyte formation is progressive in the elderly and may lead to cauda equina or nerve root impingement and symptoms of spinal stenosis.<sup>136,140,141</sup> Other conditions include polymyalgia rheumatica, gout, and pseudogout.

### Endocrine Disease

Most significant endocrine functions do not decline specifically with aging with a few exceptions. Among these are thyroid disorders, diabetes, and androgen deficiency.<sup>142</sup> Glucose intolerance is especially important to assess, and thyroid disease is an underappreciated cause of morbidity in the elderly patient. A study of 3233 individuals age 65 years or older showed an association between subclinical hyperthyroidism and development of atrial fibrillation.<sup>143</sup> However, this study did not support the hypothesis that unrecognized subclinical hyperthyroidism or subclinical hypothyroidism is associated with other cardiovascular disorders or mortality.

### Neurologic and Mental Status Disease

Starting with middle age, there is a progressive decrease in learning and memory, a factor to consider when assessing the ability of an elderly person to cooperate with perioperative care. An interesting hypothesis is that this is not caused by loss of the ability to generate new neurons, but rather to a reduction in the decline of growth factors (fibroblast growth factor-2, insulin-like growth factor-1, and vascular endothelial growth factor) necessary for new neuron growth.<sup>144</sup> There is also an increased occurrence of all forms dementia, including Alzheimer dementia and neurologic disorders such as Parkinson disease.<sup>145</sup>

The risk of suffering a stroke increases linearly with age and is associated with other forms of cardiovascular disease, especially atrial fibrillation. For example, the proportion of strokes with atrial fibrillation in the United States is 6.2% for patients who are 50–59 years of age, 7.3% for patients 60–69 years of age, 16.5% for patients 70–79 years of age, and 30.8% for patients 80–89 years of age.<sup>146,147</sup> Other causes of stroke are hypertension, cerebrovascular disease,

myocardial infarction, structural heart disease, and cardiomyopathy.

Depression is very common in the elderly, with fewer reported symptoms than in younger people.<sup>148</sup> Up to 35% of hospitalized elderly patients may suffer from depression.<sup>149</sup> Not only does depression lead to increased symptoms from medical illness and increased use of healthcare resources, but it may affect the patient's ability to cooperate with preoperative conditioning and postoperative rehabilitative care. Interestingly, depression may be related to disturbances in other systems, such as the hypothalamic–pituitary–adrenal axis, the cerebrovascular disease, inflammatory conditions, and nutrient deficiencies.<sup>148,150</sup> Another condition to be aware of is alcoholism in the elderly with implications for perioperative withdrawal and malnutrition.<sup>151</sup>

### Ophthalmologic Disease

Visual impairment is common in elderly and aged patients.<sup>152</sup> The most common causes include presbyopia, macular degeneration, cataract formation, diabetic retinopathy, and glaucoma.<sup>153</sup> Untreated, visual impairment leads to physical handicap, increased incidence of falls, depression, social isolation, and dependency.<sup>153</sup> Visual diseases and the medications used to treat them must be considered with the choice of anesthetic agents. Furthermore, perioperative disorientation or delirium may be in part a result of declines in visual stimuli.

### Hearing Impairment

Hearing loss occurs linearly with age, but the variation in hearing thresholds is large. Possible explanations include precipitating medical conditions, coexisting diseases, prior environmental exposure (especially occupational), and undefined genetic contributions.<sup>154,155</sup> Hearing impairment may also contribute to postoperative delirium.

### Oncologic Disorders

In developed countries, more than 50% of all cancers and approximately 70% of cancer deaths occur in patients age 70 years and older.<sup>156,157</sup> A contributing factor may be the known decreased immune responsiveness and specificity. Common cancers in the elderly include prostate, breast, bladder, and colon, in addition to lymphoma. Treatment of this age group is complicated

by age-related changes in cardiovascular, gastrointestinal, pulmonary, and renal physiology, all of which effect cancer treatment and chemotherapy toxicity in the elderly.<sup>158</sup> Furthermore, difficult decisions about treatment necessitate planning treatment only for those who will benefit with respect to quality or quantity of life.<sup>159</sup>

## COMMON PROCEDURES IN THE ELDERLY

Currently, more than 20% of people older than 60 years of age undergo surgery and anesthesia as compared with only 12% of those ages 45–60 years. These proportions are expected to increase in the future.<sup>160</sup> Despite the higher numbers of elderly patients having surgery, mortality and morbidity rates have been declining.<sup>160</sup>

Because all types of surgical operations are being offered to increasingly older people, it is important to differentiate the effects of aging from the pathology of individual disease processes and to control for comorbid conditions.<sup>161,162</sup> In general, preoperative testing is not determined on the basis of age but in consideration of the procedure, the coexistent disease states, and the overall condition of the patient. However, it is reasonable to search for common, but perhaps asymptomatic, comorbid problems, such as subclinical cardiac disease or glucose intolerance. Common procedures in the elderly are briefly reviewed below.

### Cardiac Surgery

All types of cardiac procedures, including coronary artery bypass grafting (CABG), valvular repair or replacement, and ventricular assist device placement, are being offered to patients older than 65 years of age, and increasingly to patients older 80 years of age. The morbidity and mortality of these procedures increase with age, but the benefits are a greater life expectancy as well as a better quality of life.

In-hospital mortality for CABG is approximately 8% for patients older than age 80 years and is similar in highly selected patients older than age 90 years.<sup>163</sup> Although there are limited studies, the data appear to suggest that elderly patients at higher risk have better outcomes with revascularization than with medical therapy alone.<sup>163</sup>

AVR combined procedures (AVR and CABG) and, to a lesser extent, mitral valve surgery are increasingly offered to the elderly. The risk appears to be similar to CABG alone, as two authors have reported in-hospital mortality rates of 7.9% and 8.5% for mitral and aortic valve surgery, respectively.<sup>164,165</sup> Certainly age and comorbid disease states play a role both in morbidity and mortality but also in the choice of valve repair versus the type of prosthetic valve used.<sup>118</sup>

### Vascular Surgery

The prevalence of vascular disease is high in the elderly population, with major vascular procedures most commonly performed to treat the effects of peripheral vascular disease and carotid artery atherosclerosis. This means that many elderly patients undergo procedures such as aortic repair (open and endovascular), femoral-to-popliteal bypass grafting, and carotid endarterectomy. In general, the morbidity and mortality of many vascular operations are not different between a *healthy* elderly patient and a younger patient, but the elderly are often not diagnosed until late in the disease process, leading to higher-risk procedures with higher mortality rates.<sup>166</sup> Endovascular interventions have made vascular surgery less invasive; a recent comparison of aortic endovascular repair to open repair revealed a reduced incidence of perioperative complications compared with open vascular surgery.<sup>167</sup> However, long-term followup determined that the incidence of cardiac mortality and myocardial infarction was similar.

### Cardiac Conduction Procedures

With the significant increase in conduction abnormalities, CAD, and congestive heart failure in the elderly, it is logical to anticipate an increased incidence of procedures to treat these abnormalities. In fact, one-half of all pacemakers implanted in the United States are for patients age 75 years and older.<sup>168</sup> Currently, the benefits of alternative pacing modes, the indications for biventricular pacing in heart failure, and the indications for cardioverter-defibrillator implantation are being investigated for the elderly.

### Thoracic Procedures

The choice to undertake thoracic procedures must be carefully weighed

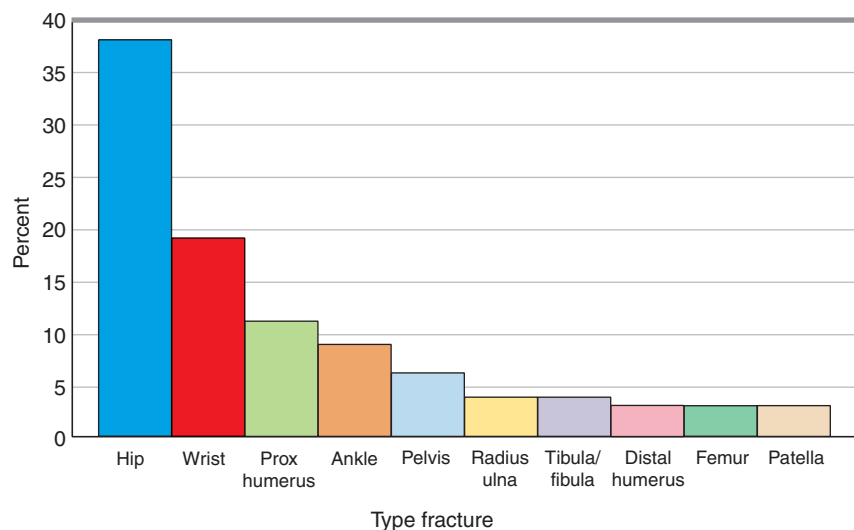
against the risks and benefits in an elderly population. For example, an oncologic indication for a procedure may carry more weight than a quality-of-life indication (e.g., surgery for emphysema) in this higher-risk population. A study of 356 patients older than 70 years of age after lung resection found a 33–48% 30-day morbidity and a 4–69% 30-day mortality rate.<sup>169</sup> Independent predictors for postoperative complications included a low predicted postoperative forced expiratory volume in 1 second (FEV<sub>1</sub>), concurrent CAD, and extended resection. Others have found that post-lung resection morbidity is predicted by a reduction in the ability to carry out activities of daily living, decreased cognition, and length of surgery.<sup>170</sup> Brunelli et al. suggested that a simple screening test for surgical fitness is the ability to climb stairs because it was determined that concomitant cardiac disease and a low stair height climbed preoperatively predicted cardiopulmonary complications in the elderly after lung resection.<sup>171</sup> The type of procedure contemplated may also affect the decision to offer a surgical intervention, in that a minimally invasive procedure may lead to less immediate morbidity, although the overall long-term mortality may be similar. There appear to be fewer age-related concerns for other types of smaller thoracic procedures such as bronchoscopies, mediastinoscopies, and esophagoscopies.

### Orthopedic Procedures

As osteoarthritis and rheumatoid arthritis increase with age, so do the procedures to treat these conditions, primarily knee and hip replacements. Furthermore, the high prevalence of skeletal disease, combined with an increased predisposition to fall, leads to a high incidence of fractures (especially of the hips, the vertebrae, and the wrists) in older people who then present for treatment on an emergency basis (Fig. 20–13).<sup>136</sup>

### Hip Replacement

Hip replacement and repair of hip fracture are exceedingly common operations in the elderly and aged populations. For example, in 2002–2003, the National Health Service in the United Kingdom admitted 78,554 hip fracture patients, 96% of whom were older than 65 years of age.<sup>172</sup> A Cochrane review of the treatment of evidence-based best practices for elderly hip fracture patients revealed that spinal anesthesia, pressure-relieving mattresses, perioperative antibiotics, and deep venous thromboses prophylaxes were beneficial, whereas preoperative traction was not beneficial, and types of surgical management, postoperative wound drainage, and even “multidisciplinary” care lacked sufficient evidence to determine either benefit or harm.<sup>173</sup> A large study of 2390 patients older than 60 years of age with hip fracture found a 9.6% 30-day mortality and a 33% 1-year mortality after hip fracture surgery; preoperative vari-



**FIGURE 20–13.** The most common types of fractures found in Medicare beneficiaries for the 1 year between July 1991 and June 1992. (Data from Grecula MJ, Caban ME. Common orthopaedic problems in the elderly patient. *J Am Coll Surg* 2005;200:774–783.)



ables that predicted mortality included 3 or more comorbid conditions, preexisting chest infection, and concurrent malignancy.<sup>174</sup>

### **Knee Replacement**

Total knee replacement (TKR) is primarily a surgery for the elderly, with younger patients less likely to be referred for surgery than older patients.<sup>175</sup> As the population ages, TKR is now almost as common as total hip replacement. Long-term results in patients older than 70 years of age are excellent, but infection and loosening and malpositioning of the implants are common complications.<sup>175,176</sup>

### **Genitourinary Treatment**

Elderly men are subject to abnormalities of the urethra primarily related to benign prostatic hypertrophy and prostate cancer; these conditions lead to the common need for a transurethral prostate procedure. In contrast, elderly women are prone to bladder and vaginal relaxation with urinary incontinence and prolapse symptoms. Thus, many urethral and urethrovaginal procedures are performed on patients older than 65 years of age. In one study, preexisting cardiovascular disease increased the risk perioperative complications in elderly women undergoing urogynecologic surgery, but the overall perioperative morbidity rate was low.<sup>177</sup> Procedures to treat benign prostatic hypertrophy are commonly performed and usually well tolerated in the elderly. Older patients undergoing radical retropubic prostatectomy for prostate cancer have survival rates similar to those of younger counterparts, suggesting that surgical intervention is appropriate in the elderly.<sup>178</sup>

### **Abdominal Surgery**

Abdominal procedures are undertaken in the elderly for a variety of reasons. As surgical and anesthesia techniques have developed, age is no longer considered a contraindication to an abdominal procedure. Furthermore, the increased use of minimally invasive techniques for abdominal procedures has led to low morbidity and mortality rates in older patients.<sup>179</sup>

### **Eye Surgery**

As visual impairment conditions increase with age, so do corrective surgical procedures to restore sight; elderly

patients represent the majority of the surgical population scheduled for ophthalmologic surgery.<sup>180</sup> Eye surgery is usually minimally invasive and is performed as day-case surgery despite the high comorbidity of these patients.<sup>180</sup>

### **Overall Surgical Risk**

Overall surgical risk is related to physiologic organ system age, comorbid diseases, and the risks of the procedure to be undertaken. In general, an otherwise healthy elderly patient can expect a good outcome with continued quality of life. However, there are known overall risks for surgery in the elderly. Emergency procedures have especially high mortality in the elderly.<sup>160</sup> An example is a study of 48-hour emergency surgery mortality rates in 795 patients in which patients older than 90 years of age had a mortality of 7.8% as compared with a 0.6% for age-matched patients undergoing elective surgery.<sup>181,182</sup> These findings prompted one author to state that “if surgical condition is allowed to progress to the point of urgent or emergency status, elderly patients tolerate surgical treatment very poorly.”<sup>183</sup> The risk of major cardiac complications (e.g., myocardial infarction, pulmonary edema, ventricular fibrillation) is relatively higher after abdominal, noncardiac thoracic, and suprainguinal vascular procedures in individuals 50 years of age or older.

The type and number of coexisting diseases are exceedingly important as it has been proposed that the effects from coexisting disease outweigh the effects of age alone on anesthesia outcome.<sup>160</sup> When age and severity of illness are compared, the number of coexisting diseases is more significant. Additionally, the albumin level may serve as a marker for preoperative health status of the elderly patient, as albumin level has been linked to perioperative mortality.<sup>184</sup>

Of elderly patients undergoing surgery, 10–40% develop a postoperative complication that can lead to serious adverse events.<sup>185</sup> According to a recent study, even seemingly mild initial complications may profoundly alter postoperative prognosis, beginning a cascade of other complications that result in death.<sup>185</sup> Silber et al. examined Pennsylvania Medicare claims and determined that the odds of an elderly patient dying within 60 days after surgery increased 3.4-fold in

patients with complications compared with those without complications.<sup>186</sup> Certain complications increased the risk substantially, such as respiratory compromise, associated with a 7.2-fold increase in the risk of dying, and congestive heart failure, resulting in a 5-fold risk in the odds of dying compared with patients without any perioperative complications.

### **Altered Perioperative Mental Status**

Perioperative delirium is common in high-risk surgery and is associated with age, education, preoperative cognitive functioning, preexisting medical conditions, and postoperative complications. In addition, the pathophysiology is poorly understood. As well as being linked to narcotics, sedatives, and anticholinergics, delirium is associated with urinary tract infection, pneumonia, hypoxia or hypercarbia, fever, blood loss, and electrolyte disturbances. For example, 102 patients between 41 and 88 years of age underwent elective open abdominal aortic aneurysm surgery. Delirium occurred in 33% of the patients during the first 6 days after surgery. With multivariate analysis, the most powerful preoperative predictors of delirium were *number of pack years smoked*, mental status scores, and number of perioperative psychoactive medications.<sup>187</sup> Longer duration of delirium was related to lower education, preoperative depression, and greater preoperative psychoactive medication use. Unrelated variables were characteristics of the surgery and hospital stay.

Others have sought to determine whether the type of anesthesia (general or regional) plays a role in the development of cognitive impairment in elderly patients during the immediate postoperative period. Forty-seven patients older than 60 years of age who were undergoing major surgery were randomly allocated to receive either regional or general anesthesia. Overall, elderly patients subjected to general anesthesia displayed more frequent cognitive impairment during the immediate postoperative period in comparison with those who received a regional technique.<sup>188</sup>

However, several studies have failed to demonstrate any long-term differences in postoperative cognitive function between general and regional anesthesia. Williams-Russo et al. examined 262

patients older than the age of 40 years who were undergoing total knee arthroplasty, randomly assigned to either epidural or general anesthesia.<sup>189</sup> No differences were found between the patients for either cognitive or cardiovascular outcome. Rather, at 1 week postoperatively, both anesthetic groups had significant decreases from their preoperative neurocognitive tests scores. At 6 months postoperatively, both groups improved, but the incidence of long-term postoperative cognitive deficit remained at 5% regardless of anesthesia group. Rasmussen and colleagues also examined patients older than 60 years of age randomly allocated to general or regional anesthesia for major noncardiac surgery.<sup>190</sup> They demonstrated that a substantial proportion of patients experienced postoperative cognitive dysfunction at 1 week and 3 months post-surgery (incidence: 10–20%). There was no significant difference in the incidence of postoperative cognitive dysfunction between the groups at 3 months after surgery. The authors concluded that the choice of anesthesia should be based on an open discussion of patients' preferences, general postoperative complications, and the experience of the anesthesiologist.

### Pain Management

It is generally supported in the literature that the elderly have unique needs for analgesia compared with younger patients, including the problem of increased sensitivity to opioids.<sup>191</sup> However, this should not be interpreted to mean that elderly patients do not need pain medication, as some have withheld analgesics for fear of prolonged action or increased side effects.<sup>192</sup> To care for the elderly patient in pain, one must also consider the coexisting diseases and their effects on the distribution of analgesics, elimination of analgesics, and the potential for exacerbated or unique side effects from analgesic medications in the elderly. Furthermore, the high incidence of postoperative confusion, delirium, or altered mental status may complicate the assessment and communication of postoperative pain. Consideration should be given to the use of nonopioid analgesics, reduced doses of opioid analgesics, and alternate routes of analgesic administration. One solution is to use regional anesthetic techniques with local anesthetics so that opioids are avoided.

### Type of Anesthetic

Multiple studies have demonstrated that the type of anesthesia (general vs. regional anesthesia) has no substantial effect on perioperative morbidity and mortality.<sup>193</sup> However, it intuitively makes sense that elderly patients benefit from an anesthesia technique that allows for minimal cognitive depression with excellent postoperative pain control.<sup>193</sup> It is essential to recognize that many factors influence the outcome; the quality of the anesthetic administered rather than the type of anesthetic is most important.<sup>193</sup>

### Quality of Care

We know that improved quality of care (QOC) received by patients is strongly associated with better survival among community-dwelling vulnerable older adults.<sup>194</sup> Attention to the surgical QOC in elderly patients is of great importance because of the increasing number of older adults undergoing operations.<sup>195</sup> QOC indicators have been developed in 7 domains—comorbidity assessment (cardiopulmonary disease); elderly issues (cognition); medication use (polypharmacy); patient-to-provider discussions (life-sustaining preferences); intraoperative care (preventing hypothermia); postoperative management (preventing delirium); and discharge planning (home healthcare)—with the majority of indicators rated addressing processes of care not routinely performed in younger surgical populations.<sup>195</sup> However, to address these varied goals, interdisciplinary team care has been applied successfully in hospital, outpatient, home, and nursing-home settings.<sup>196</sup> It has been stated that the best outcomes are achieved in the elderly patient when clinical care is multidisciplinary and integrated beginning with preoperative assessment and continuing through to supportive care after discharge.<sup>162</sup>

### SUMMARY

The elderly are the fastest-growing segment of the world's population and have unique medical and surgical needs. Decrements in organ function decline combined with increases in organ system disease lead to challenges in surgical and anesthetic care. Forethought about comorbid conditions and physiologic reserve with planning for the most efficacious ap-

proach to surgical care can lead to excellent outcomes from a variety of procedures in most elderly and aged patients.

### ACKNOWLEDGMENT

Many thanks to Terri Monk, MD, Professor of Anesthesiology at the Durham Veteran's Administration Medical Center in North Carolina for manuscript review, collaborations, guidance, and bringing authors together!

### KEY REFERENCES

1. Beliveau MM, Multach M. Perioperative care for the elderly patient. *Med Clin North Am* 2003;87:273–289.
2. Rosenthal RA, Kavic SM. Assessment and management of the geriatric patient. *Crit Care Med* 2004; 32:S92–S105.
3. Loran DB, Hyde BR, Zwischenberger JB. Perioperative management of special populations: the geriatric patient. *Surg Clin North Am* 2005;85:1259–1266.
4. Brody JA, Grant MD. Age associated diseases and conditions: Implications for decreasing late life morbidity. *Aging* 2001;13:1364.
5. Sieber JAD. Age associated issues: geriatrics. *Anesth Clin North Am* 2004;22:45–58.
6. Even seemingly mild complications after surgery may radically alter an elderly person's risk of dying. Available at: <http://www.ahrq.gov/RESEARCH/may05/0505RA22.htm>. Last accessed April 2, 2006.
7. Papaioannou A, Fraidakis O, Michaloudis D, et al. The impact of the type of anaesthesia on cognitive status and delirium during the first postoperative days in elderly patients. *Eur J Anaesthesiol* 2005;22: 492–499.

### REFERENCES

1. Nascher IL. Geriatrics. *N Y Med J* 1909; 90:358–359.
2. Wachtel R, Dexter F. Differentiating among hospitals performing physiologically

- complex operative procedures in the elderly. *Anesthesiology* 2004;100:1552–1561.
3. Rovenstine EA. Geriatric anesthesia. *Geriatrics* 1946;1:46–53.
  4. Beliveau MM, Multach M. Perioperative care for the elderly patient. *Med Clin North Am* 2003;87:273–289.
  5. Genova ML, Pich MM, Bernacchia A, et al. The mitochondrial production of reactive oxygen species in relation to aging and pathology. *Ann N Y Acad Sci* 2004;1011:86–100.
  6. Wei YH, Lee HC. Oxidative stress, mitochondrial DNA mutation, and impairment of antioxidant enzymes in aging. *Exp Biol Med* 2002;227:671–682.
  7. Ozawa T. Genetic and functional changes in mitochondria associated with aging. *Physiol Rev* 1997;77:425.
  8. Huang H, Manton KG. The role of oxidative damage in mitochondria during aging: a review. *Front Biosci* 2004;9:1100–1117.
  9. Ravagnan L, Roumier T, Kroemer G. Mitochondria, the killer organelles and their weapons. *J Cell Physiol* 2002;192:131–137.
  10. Kapahi P, Boulton ME, Kirkwood TB. Positive correlation between mammalian life span and cellular resistance to stress. *Free Radical Biol Med* 1999;26:495.
  11. Trifunovic A, Wredenberg A, Falkenberg M, et al. Premature ageing in mice expressing defective mitochondrial DNA polymerase. *Nature* 2004;429:417.
  12. Lieber MR, Karanjawala ZE. Ageing, repetitive genomes and DNA damage. *Nat Rev Mol Cell Biol* 2004;5:69–75.
  13. Sugiyama S, Hattori K, Hayakawa M, et al. Quantitative analysis of age-associated accumulation of mitochondrial DNA with deletion in human hearts. *Biochem Biophys Res* 1991;180:894–899.
  14. Maklashina E, Ackrell BA. Is defective electron transport at the hub of aging? *Aging Cell* 2004;3:21–27.
  15. Davidovic M, Erceg P, Trailov D, et al. The privilege to be old. *Gerontology* 2003;49:335–339.
  16. Rosenthal RA, Kavic SM. Assessment and management of the geriatric patient. *Crit Care Med* 2004;32:S92–S105.
  17. Barrows CH, Kokkonen GC. Relationship between nutrition and aging. *Adv Nutr Res* 1977;1:253–298.
  18. Tzankoff SP, Norris AH. Effect of muscle mass decrease on age-related MR changes. *J Appl Physiol* 1977;43:1001–1006.
  19. Klausen B, Toubro S, Astrup A. Age and sex effects on energy expenditure. *Am J Clin Nutr* 1997;65:895–907.
  20. Piers LS, Soares MJ, McCormack LM, et al. Is there evidence for an age-related reduction in metabolic rate? *J Appl Physiol* 1998;85:2196–2204.
  21. Fulop T Jr, Worum I, Csongor J, et al. Body composition in elderly people. *Gerontology* 1985;31:6.
  22. Kurz A, Plattner O, Sessler DI, et al. The threshold for thermoregulatory vasoconstriction during nitrous oxide/isoflurane anesthesia is lower in elderly than in young patients. *Anesthesiology* 1993;79:465.
  23. Frank SM, Beattie C, Christopherson R, et al. Epidural versus general anesthesia, ambient operating room temperature, and patient age as predictors of inadvertent hypothermia. *Anesthesiology* 1992;77:252.
  24. Carli F, Gabrielyczuk M, Clark MM, et al. An investigation of factors affecting postoperative rewarming of adult patients. *Anaesthesia* 1986;41:363.
  25. Davis PJ. Ageing and endocrine function. *Clin Endocrinol Metab* 1979;8:603–619.
  26. Davidson MB. The effect of aging on carbohydrate metabolism; a review of the English literature and a practical approach to the diagnosis of diabetes in the elderly. *Metabolism* 1979;28:688.
  27. Weisfeldt ML. Presbycardia. *Johns Hopkins Med J* 1981;149:203–208.
  28. Folkow B, Svanborg A. Physiology of cardiovascular aging. *Physiol Rev* 1993;73:725.
  29. Irich P, Cerami A. Protein glycation, diabetes, and aging. *Recent Progr Horm Res* 2001;56:1–21.
  30. Hattori K, Tanaka M, Sugiyama S, et al. Age-dependent decrease in mitochondrial DNA in the human heart: possible contributory factor to presbycardia. *Am Heart J* 1991;121:1735–1742.
  31. Pagel PS, Grossman W, Haering JM, et al. Left ventricular diastolic function in the normal and diseased heart. Perspectives for the anesthesiologist. *Anesthesiology* 1993;79:836, 1104.
  32. Alexopolous D, Machac J, Arora RR, et al. Exercise-induced pulmonary blood volume changes and diastolic dysfunction of the aged heart. *Clin Cardiol* 1989;12:209–213.
  33. Strandell T. Circulatory studies on healthy old men. *Acta Med Scand* 2005;414(Suppl 1–44):1964.
  34. Leithe ME, Hermiller JB, Magorien RD, et al. The effect of age on central and regional hemodynamics. *Gerontology* 1984;30:240–246.
  35. Aronow WS, Stein PD, Sabbah HN, et al. Resting left ventricular ejection fraction in elderly patients without evidence of heart disease. *Am J Cardiol* 1989;63:368.
  36. Rodeheffer RJ, Gerstenblith G, Becker LC, et al. Exercise cardiac output is maintained with advancing age in healthy human subjects: cardiac dilatation and increased stroke volume compensate for diminished heart rate. *Circulation* 1984;69:203–213.
  37. Buskirk ER, Hodgson JL. Age and aerobic power: the rate of change in men and women. *Fed Proc* 1987;46:1824–1829.
  38. Priebe HJ. The aged cardiovascular risk patient. *Br J Anaesth* 2000;85:763–778.
  39. Laurent S, Boutouyrie P, Benetos A. Pathophysiology of hypertension in the elderly. *Am J Geriatr Cardiol* 2002;11:34–39.
  40. Gonza ER, Marble AE, Shaw A, et al. Age-related changes in the mechanics of the aorta and the pulmonary artery in man. *J Appl Physiol* 1974;36:407–411.
  41. Nichols WW, O'Rourke MF, Avolio AP, et al. Ventricular/vascular interaction in patients with mild systemic hypertension and normal peripheral resistance. *Circulation* 1986;74:455.
  42. Dauchot PJ, Graber RG. The aging respiratory system. *Prob Anesth* 1997;9:498.
  43. John R, Thomas J. Chemical compositions of elastins isolated from aortas and pulmonary tissues of humans of different ages. *Biochem J* 1972;127:261–269.
  44. Zaugg M, Lucchinetti E. Respiratory function in the elderly. *Anesthesiol Clin North Am* 2000;18:47–58.
  45. Allen SJ. Respiratory considerations in the elderly surgical patient. *Clin Anaesthesiol* 1986;4:899.
  46. Renwick DS, Connolly MJ. Prevalence and treatment of chronic airways obstruction in adults over the age of 45. *Thorax* 1996;51:164–168.
  47. Wahba WM. Influence of aging on lung function—clinical significance of changes from age twenty. *Anesth Analg* 1983;62:764.
  48. Holland J, Milic-Emili J, Macklem PT, et al. Regional distribution of pulmonary ventilation and perfusion in elderly subjects. *J Clin Invest* 1968;47:81–92.
  49. Marshall BE, Cohen PJ, Klingensmaier CH, et al. Pulmonary venous admixture before, during, and after halothane-oxygen anesthesia in man. *J Appl Physiol* 1969;27:653–657.
  50. Tolep K, Kelsen SG. Effect of aging on respiratory skeletal muscles. *Clin Chest Med* 1993;14:363.
  51. Rose DK, Cohen MM, Wigglesworth DF, et al. Critical respiratory events in the postanesthesia care unit. *Anesthesiology* 1994;81:410.
  52. Peterson DD, Pack AI, Silage DA, et al. Effects of aging on ventilatory and occlusion pressure responses to hypoxia and hypercapnia. *Am Rev Res Dis* 1981;124:387.
  53. Bolton JWR, Weiman DS, Haynes JL, et al. Stair climbing as an indicator of pulmonary function. *Chest* 1987;92:783–788.
  54. Olsen GN, Bolton JWR, Weiman DS, et al. Stair climbing as an exercise test to predict the postoperative complications of lung resection. Two years' experience. *Chest* 1991;99:587–590.
  55. Schmucker DL. Liver function and phase I drug metabolism in the elderly: a paradox. *Drugs Aging* 2001;18:837–851.
  56. Zoli M, Iervese T, Abbati S, et al. Portal blood velocity and flow in aging man. *Gerontology* 1989;35:61.
  57. Schmucker DL, Mooney JS, Jones AL. Age related changes in the hepatic endoplasmic reticulum: a quantitative analysis. *Science* 1977;197:1005–1008.



58. Thompson EN, Williams R. Effect of age on liver function with particular reference to bromsulphalein excretion. *Gut* 1965;6:266-269.
59. Fabbri A, Marchesini G, Bianchi G, et al. Kinetics of hepatic amino-nitrogen conversion in ageing man. *Liver* 1994;14:288-294.
60. Marchesini G, Bua V, Brunori A, et al. Galactose elimination capacity and liver volume in aging man. *Hepatology* 1988;8:1079-1083.
61. Young VR, Steffee WP, Pencharz PB, et al. Total human body protein synthesis in relation to protein requirements at various ages. *Nature* 1975;253:192-194.
62. Swift CG, Homeida M, Halliwell M, et al. Antipyrine disposition and liver size in the elderly. *Eur J Clin Pharmacol* 1978;14:149.
63. Carli F, Emery PW, Freemantle CAJ. Effect of perioperative normothermia on postoperative protein metabolism in elderly patients undergoing hip arthroplasty. *Br J Anaesth* 1989;63:276-282.
64. Urban L, Bessenyei B, Marka M, et al. On the role of aging in the etiology of autoimmunity. *Gerontology* 2002;48:179-184.
65. Goidl EA, Thorbecke GJ, Weksler ME, et al. Production of auto-idiotypic antibody during the normal immune response: changes in the auto-anti-idiotypic antibody response and the idiotype repertoire associated with aging. *Proc Natl Acad Sci U S A* 1980;77:6788-6792.
66. Fraker PJ, Lill-Elghanian DA. The many roles of apoptosis in immunity as modified by aging and nutritional status. *J Nutr Health Aging* 2004;8:56-63.
67. Miller RA. The aging immune system: primer and prospectus. *Science* 1996;273:70.
68. Tornetta P, Mostafavi H, Riina J, et al. Morbidity and mortality in elderly trauma patients. *J Trauma* 1999;46:702.
69. Magri F, Muzzoni B, Cravello L, et al. Thyroid function in physiological aging and in centenarians: possible relationships with some nutritional markers. *Metabolism* 2002;51:105-109.
70. Ziegler MG, Lake CR, Kopin IJ. Plasma noradrenaline increases with age. *Nature* 1976;261:333.
71. Vestal RE, Wood AJJ, Shand DG. Reduced adrenoceptor sensitivity in the elderly. *Clin Pharmacol Ther* 1979;26:181.
72. Seals DR, Taylor JA, Ng AV, et al. Exercise and aging: autonomic control of the circulation. *Med Sci Sports Exerc* 1994;26:568.
73. Loran DB, Hyde BR, Zwischenberger JB. Perioperative management of special populations: the geriatric patient. *Surg Clin North Am* 2005;85:1259-1266.
74. Tonner PH, Kampen J, Scholz J. Pathophysiological changes in the elderly. *Best Pract Res Clin Anaesthesiol* 2003;17:163-177.
75. Montamat SC, Cusack B. Overcoming problems with polypharmacy and drug misuse in the elderly. *Clin Geriatr Med* 1992;8:143-158.
76. Schechter BM, Erwin WG, Gerbino PP. The role of the pharmacist. In: Abrams WB, Berkow R, eds. *The Merck Manual of Geriatrics*. Rahway, NJ: Merck Sharp & Dohme, 1990:193-199.
77. Larson EB, Kukull WA, Buchner D, et al. Adverse drug reactions associated with global cognitive impairment in elderly persons. *Ann Intern Med* 1987;107:169-173.
78. Muravchick S. The effects of aging on anesthetic pharmacology. *Acta Anaesthesiol Belg* 1998;49:79-84.
79. Gold MI, Abello D, Herrington C. Minimum alveolar concentration of desflurane in patients older than 65 years. *Anesthesiology* 1993;79:710.
80. Nakajima R, Nakajima Y, Ikeda K. Minimum alveolar concentration of sevoflurane in elderly patients. *Br J Anaesth* 1993;70:273.
81. Hartman PS, Ishii N, Kayser EB, et al. Mitochondrial mutations differentially affect aging, mutability and anesthetic sensitivity in *Caenorhabditis elegans*. *Mech Ageing Dev* 2001;122:1187.
82. Morgan PG, Hoppel CL, Sedensky MM. Mitochondrial defects and anesthetic sensitivity. *Anesthesiology* 2002;96:1268.
83. Wong J, Song D, Blanshard H, et al. Titration of isoflurane using BIS index improves early recovery of elderly patients undergoing orthopedic surgeries. *Can J Anaesth* 2002;49:13.
84. Christensen JH, Andreassen F. Individual variation in response to thiopental. *Acta Anaesth Scand* 1978;22:303-313.
85. Muravchick S. Effect of age and premedication on thiopental sleep dose. *Anesthesiology* 1984;61:333.
86. Scott JC, Stanski DR. Decreased fentanyl and alfentanil dose requirements with increasing age. A simultaneous pharmacokinetic and pharmacodynamic evaluation. *J Pharmacol Exp Ther* 1987;240:159.
87. Minto CF, Schnider TW, Egan TD, et al. Influence of age and gender on the pharmacokinetics and pharmacodynamics of remifentanyl. *Anesthesiology* 1997;86:10.
88. Homer TD, Stanski DR. The effect of increasing age on thiopental disposition and anesthetic requirement. *Anesthesiology* 1985;62:714-724.
89. Arden JR, Holley FO, Stanski DR. Increased sensitivity to etomidate in the elderly: initial distribution versus altered brain response. *Anesthesiology* 1986;65:19.
90. Singleton MA, Rosen JI, Fisher DM. Pharmacokinetics of fentanyl in the elderly. *Br J Anaesth* 1988;60:619-622.
91. Hull CJ. How far can we go with compartmental models? *Anesthesiology* 1990;72:399.
92. Bjorkman S, Wada DR, Stanski DR. Application of physiologic models to predict the influence of changes in body composition and blood flows on the pharmacokinetics of fentanyl and alfentanil in patients. *Anesthesiology* 1998;88:657.
93. Melding PS. Is there such a thing as geriatric pain? *Pain* 1991;46:119.
94. Fine PG. Pharmacological management of persistent pain in older patients. *Clin J Pain* 2004;20:220-226.
95. Karani R, Meier DE. Systemic pharmacologic postoperative pain management in the geriatric orthopaedic patient. *Clin Orthop Rel Res* 2004;425:26-34.
96. Hapidou EG, DeCatanaro D. Responsiveness to laboratory pain in women as a function of age and childbirth pain experience. *Pain* 1992;48:177.
97. Bellville JW, Forrest WH, Miller E, et al. Influence of age on pain relief from analgesics: a study of postoperative patients. *JAMA* 1971;217:1835.
98. Cameron AE, Arnold RW, Ghoris MW, et al. Spinal analgesia using bupivacaine 0.5% plain: variation in the extent of block with patient age. *Anaesthesia* 1981;36:318.
99. Sharrock NE. Epidural dose responses in patients 20 to 80 years old. *Anesthesiology* 1978;49:425.
100. Curatolo M, Orlando A, Zbinden AM, et al. A multifactorial analysis of the spread of epidural analgesia. *Acta Anaesth Scand* 1994;38:646.
101. Shanks CA. Pharmacokinetics of the nondepolarizing neuromuscular relaxants applied to calculation of bolus and infusion dosage regimens. *Anesthesiology* 1986;64:72.
102. Koscielniak-Nielsen ZJ, Bevan JC, Popovic V, et al. Onset of maximum neuromuscular blockade following succinylcholine or vecuronium in four age groups. *Anesthesiology* 1993;79:229.
103. Sarooshian SS, Stafford MA, Eastwood NB, et al. Pharmacokinetics and pharmacodynamics of cisatracurium in young and elderly adult patients. *Anesthesiology* 1996;84:1083.
104. Lien CA, Matteo RS, Ornstein E, et al. Distribution, elimination, and action of vecuronium in the elderly. *Anesth Analg* 1991;73:39.
105. Matteo RS, Ornstein E, Schwartz AE, et al. Pharmacokinetics and pharmacodynamics of rocuronium (Org 9426) in elderly surgical patients. *Anesth Analg* 1993;77:1193.
106. Cope TM, Hunter JM. Selecting neuromuscular-blocking drugs for elderly patients. *Drugs Aging* 2003;20:125-140.
107. Arain SR, Ebert TJ, Ruehlow RM. Variability of non-depolarizing neuromuscular blockers in the elderly. *Anesthesiology* 2003;99:A1142.
108. Marsh RHK, Chmielewski AT, Goat VA. Recovery from pancuronium. A comparison between young and old patients. *Anaesthesia* 1980;35:1193-1196.
109. Jin F, Chung F. Minimizing perioperative adverse events in the elderly. *Br J Anaesth* 2001;87:608-624.



110. Sugiura M, Hiraoka K, Ohkawa S. Severity of coronary sclerosis in the aged: a pathological study in 968 consecutive autopsy cases. *Jpn Heart J* 1976;17:471-478.
111. Stone PH, Thompson B, Anderson HV, et al. Influence of race, sex, and age on management of unstable angina and non-Q-wave myocardial infarction: the TIMI III registry. *JAMA* 1996;275:1104-1112.
112. Williams MA, Fleg JL, Ades PA, et al. Secondary prevention of coronary heart disease in the elderly (with emphasis on patients 75 years of age): an American Heart Association scientific statement from the Council on Clinical Cardiology Subcommittee on Exercise, Cardiac Rehabilitation, and Prevention. *Circulation* 2002;105:1735.
113. Blazing MA, O'Connor CM. Coronary heart disease in the elderly: risk factors, presentation and evaluation. Available at: <http://patients.uptodate.com/topic.asp?file=chd/50920#references>. Last accessed March 5, 2006.
114. Lerner DJ, Kannel WB. Patterns of coronary heart disease morbidity and mortality in the sexes: a 26-year follow-up of the Framingham population. *Am Heart J* 1986;111:383-390.
115. Chaves PH, Kuller LH, O'Leary DH, et al. Cardiovascular Health Study. Subclinical cardiovascular disease in older adults: insights from the Cardiovascular Health Study. *Am J Geriatr Cardiol* 2004;13:137-151.
116. Beers MH, Jones TV, Berkwitz M, et al. Valvular heart disease. In: Beers MH, Jones TV, Berkwitz M, et al., eds. *The Merck Manual of Geriatrics*. 3d ed. Available at: <http://www.merck.com/mrkshared/mmg/home.jsp>. Last accessed March 12, 2006.
117. Lindroos M, Kupari M, Heikilla J. Prevalence of aortic valve abnormalities in the elderly: an echocardiographic study of a random population sample. *J Am Coll Cardiol* 1993;21:1220-1225.
118. Segal BL. Valvular heart disease, part 2: mitral valve disease in older adults. *Geriatrics* 2003;58:26-31.
119. Barreiro CJ, Patel ND, Fitton TP, et al. Aortic valve replacement and concomitant mitral valve regurgitation in the elderly: impact on survival and functional outcome. *Circulation* 112:I-443-I-447.
120. Vasan RS, Beiser A, Seshadri S, et al. Residual lifetime risk for developing hypertension in middle-aged women and men: The Framingham Heart Study. *JAMA* 2002;287:1003-1010.
121. Kaplan NM, Opie LH. Controversies in hypertension. *Lancet* 2006;367:168-176.
122. Zile MR, Baicu CF, Bonema DD. Diastolic heart failure: definitions and terminology. *Progr Cardiovasc Dis* 2005;47:307-313.
123. Aronow WS. Management of peripheral arterial disease of the lower extremities in elderly patients. *J Gerontol A Biol Sci Med Sci* 2004;59:172-177.
124. Chatap G, Giraud, K Vincent J-P. Atrial fibrillation in the elderly, facts and management. *Drugs Aging* 2002;19:819-846.
125. Feinberg WM, Blackshear J, Laupacis A, et al. Prevalence, age distribution and gender of patients with atrial fibrillation. *Arch Intern Med* 1995;155:469-473.
126. Go AS, Hylek EM, Phillips KA, et al. Prevalence of diagnosed atrial fibrillation in adults. *JAMA* 2001;285:2370-2375.
127. Kusumoto FM, Phillips R, Goldschlager N. Pacing therapy in the elderly. *Am J Geriatr Cardiol* 2002;11:305-316.
128. Sieber JA. Age associated issues. *Geriatr Anesth Clin North Am* 2004;22:45-58.
129. Hardie JA, Vollmer WM, Buist AS, et al. Respiratory symptoms and obstructive pulmonary disease in a population aged over 70 years. *Respir Med* 2005;99:186-195.
130. Ng R, de Boer R, Green MD. Undertreatment of elderly patients with non-small-cell lung cancer. *Clin Lung Cancer* 2005;7:168-174.
131. Hong WS. Clinically important gastroenterologic disorders in Korean elderly. *Korean J Gastroenterol* 2003;42:257-266.
132. Egan LJ. Drug interactions in gastroenterology: mechanisms, consequences, and how to avoid. *Clin Gastroenterol Hepatol* 2004;2:725-730.
133. Stevens LA, Levey AS. Chronic kidney disease in the elderly—how to assess risk. *N Engl J Med* 2005;352:2122-2124.
134. Stevens LA, Levey AS. Clinical implications for estimating equations for glomerular filtration rate. *Ann Intern Med* 2004;141:959-961.
135. National Kidney Foundation. K/DOQI clinical practice guidelines for chronic kidney disease: evaluation, classification, and stratification. *Am J Kidney Dis* 2002;39:(Suppl 1):S1-S266.
136. Grecula MJ, Caban ME. Common orthopaedic problems in the elderly patient. *J Am Coll Surg* 2005;200:774-783.
137. van der Linden PD, Sturkenboom MC, Herings RM, et al. Increased risk of Achilles tendon rupture with quinolone antibiotic use, especially in elderly patients taking oral corticosteroids. *Arch Intern Med* 2003;163:1801-1807.
138. Neshar G, Moore TL. Clinical presentation and treatment of arthritis in the aged. *Clin Geriatr Med* 1994;10:659-675.
139. Tutuncu Z, Kavanaugh A. Rheumatic disease in the elderly: rheumatoid arthritis. *Clin Geriatr Med* 2005;21:513-525.
140. Garfin R, Herkowitz HN, Mirkovic S. Spinal stenosis. *Instr Course Lect* 2000;49:361-374.
141. Sasaki K. Magnetic resonance imaging findings of the lumbar root pathway in patients over 50 years old. *Eur Spine J* 1995;4:71-76.
142. Miller M. Endocrine disorders: new technology allows quick, accurate diagnosis. *Geriatrics* 1996;51:52-54, 57-58.
143. Cappola AR, Fried LP, Arnold AM, et al. Thyroid status, cardiovascular risk, and mortality in older adults. *JAMA* 2006;295:1033-1041.
144. Shetty AK, Hattiangady B, Shetty GA. Stem/progenitor cell proliferation factors FGF-2, IGF-1, and VEGF exhibit early decline during the course of aging in the hippocampus: role of astrocytes. *Glia* 2005;51:173-186.
145. Brody JA, Grant MD. Age associated diseases and conditions: implications for decreasing late life morbidity. *Aging* 2001;13:1364.
146. Kelley RE, Minagar A. Cardioembolic stroke: an update. *South Med J* 2003;96:343-349.
147. Wolf PA, Abbott RD, Kannel WB. Atrial fibrillation: a major contributor to stroke in the elderly—the Framingham Study. *Arch Intern Med* 1987;147:1561-1564.
148. Gareri P, De Fazio P, De Sarro G. Neuropharmacology of depression in aging and aging-related diseases. *Aging Res Rev* 2002;1:113-134.
149. Blazer D. Depression in the elderly. *N Engl J Med* 1989;320:164-166.
150. Tiemeier H. Biological risk factors for late life depression. *Eur J Epidemiol* 2003;18:745-750.
151. Rigler SK. Alcoholism in the elderly. *Am Fam Physician* 2000;61:1710-1716, 1883-1888.
152. Quillen DA. Common causes of visual loss in elderly patients. *Am Fam Physician* 1999;60:99-108.
153. Loh KY, Ogle J. Age related visual impairment in the elderly. *Med J Malaysia* 2004;59:562-568.
154. Reuben DB, Walsh K, Moore AA. Hearing loss in community-dwelling older persons. National prevalence data and identification using simple questions. *J Am Geriatr Soc* 1999;46:1008-1011.
155. Fransen E, Lemkens N, Van Laer L, et al. Age-related hearing impairment (AR-HI): environmental risk factors and genetic prospects. *Exp Gerontol* 2003;38:353-359.
156. Extermann M. Geriatric assessment with focus on instrument selectivity for outcomes. *Cancer J* 2005;11:474-480.
157. Terret C, Albrand G, Jeanton M, et al. What's new in geriatric oncology? *Bull Cancer* 2006;93:119-123.
158. Sawhney R, Sehl M, Naeim A. Physiologic aspects of aging: impact on cancer management and decision making, part I. *Cancer J* 2005;11:449-460.
159. Gosney MA. Clinical assessment of elderly people with cancer. *Lancet Oncol* 2005;6:790-797.
160. Liu LL, Leung JM. Perioperative complications in elderly patients. Available at: [http://www.asahq.org/clinical/geriatrics/peri\\_comp.htm](http://www.asahq.org/clinical/geriatrics/peri_comp.htm). Last accessed April 10, 2006.
161. Sieber JAD. Age associated issues: geriatrics. *Anesth Clin North Am* 2004;22:45-58.
162. Watters JM. Surgery in the elderly. *Can J Surg* 2002;45:104-108.

163. Scheidt S. Treatment of stable angina: medical and invasive therapy—implications for the elderly. *Am J Geriatr Cardiol* 2005;14:183–192.
164. Tanigawa K, Eishi K. Mitral valve disease in elderly patients. *Kyobu Geka* 2005;58:663–669.
165. Chiappini B, Camurri N, Loforte A, et al. Outcome after aortic valve replacement in octogenarians. *Ann Thorac Surg* 2004;78:85–89.
166. Bockler D, Schumacher H, Allenberg JR. Vascular surgery in the elderly. *Chirurg* 2005;76:113–125.
167. Schouten O, van Waning VH, Kertai MD, et al. Perioperative and long-term cardiovascular outcomes in patients undergoing endovascular treatment compared with open vascular surgery for abdominal aortic aneurysm or iliaco-femoro-popliteal bypass. *Am J Cardiol* 2005;96:861–866.
168. Vlietstra RE, Jahangir A, Shen WK. Choice of pacemakers in patients aged 75 years and older: ventricular pacing mode vs. dual-chamber pacing mode. *Am J Geriatr Cardiol* 2005;14:35–38.
169. Brunelli A, Fianchini A, Refai MA, et al. A model for internal evaluation of quality of care after lung resection in the elderly. *Eur J Cardiothorac Surg* 2004;25:884.
170. Fukuse T, Satoda N, Hijjiya K, et al. Importance of a comprehensive geriatric assessment in prediction of complications following thoracic surgery in elderly patients. *Chest* 2005;127:886–891.
171. Brunelli A, Monteverde M, Al Refai M, et al. Stair climbing test as a predictor of cardiopulmonary complications after pulmonary lobectomy in the elderly. *Ann Thorac Surg* 2004;77:266–270.
172. Department of Health. Hospital episode statistics. Available at: <http://www.hesonline.nhs.uk>. Last accessed October 10, 2005.
173. Beaupre LA, Jones CA, Saunders LD, et al. Best practices for elderly hip fracture patients. A systematic overview of the evidence. *J Gen Intern Med* 2005;20:1019–1025.
174. Roche JJW, Renn RT, Sahota O, et al. Effects of comorbidities and postoperative complications on mortality after hip fracture in elderly: prospective observational cohort study *BMJ* 2005;331:1374.
175. Carr AJ, Thompson PW, Kirwan JR. Outcomes in rheumatology: quality of life measures. *Br J Rheumatol* 1996;35:275–281.
176. Fritschy D, Leyvraz PF. Knee replacement revue. *Rev Med Suisse* 2005;1:2966–2968.
177. Stepp KJ, Barber MD, Yoo EH, et al. Incidence of perioperative complications of urogynecologic surgery in elderly women. *Am J Obstet Gynecol* 2005;192:1630–1636.
178. Siddiqui SA, Sengupta S, Slezak JM, et al. Impact of patient age at treatment on outcome following radical retropubic prostatectomy for prostate cancer. *J Urol* 2006;175:952–957.
179. Degiuli M, Mineccia M, Bertone A, et al. Outcome of laparoscopic colorectal resection. *Surg Endosc* 2004;18:427–432.
180. Kubitz JC, Motsch J. Eye surgery in the elderly. *Best Pract Res Clin Anaesthesiol* 2003;17:245–257.
181. Adkins RB Jr, Scott HW Jr. Surgical procedures in patients aged 90 years and older. *South Med J* 1984;77:1357–1364.
182. Hosking MP, Warner MA, Lobdell CM, et al. Outcomes of surgery in patients 90 years of age and older. *JAMA* 1989;261:1909–1915.
183. Anton Sharapov. Geriatric patient: implications for surgery. Available at: <http://www.med.mun.ca/surgery/presentations/Geriatics.htm>. Last accessed April 2, 2006.
184. Gibbs J, Cull W, Henderson W, et al. Preoperative serum albumin level as a predictor of operative mortality and morbidity: results from the National VA Surgical Risk Study. *Arch Surg* 1999;134:36–42.
185. Even seemingly mild complications after surgery may radically alter an elderly person's risk of dying. Available at: <http://www.ahrq.gov/RESEARCH/may05/0505RA22.htm>. Last accessed April 2, 2006.
186. Silber JH, Rosenbaum PR, Trudeau ME, et al. Changes in prognosis after the first postoperative complication. *Med Care* 2005;43:122–131.
187. Benoit AG, Campbell BI, Tanner JR, et al. Risk factors and prevalence of perioperative cognitive dysfunction in abdominal aneurysm patients. *J Vasc Surg* 2005;42:884–890.
188. Papaioannou A, Fraidakis O, Michaloudis D, et al. The impact of the type of anaesthesia on cognitive status and delirium during the first postoperative days in elderly patients. *Eur J Anaesth* 2005;22:492–499.
189. Williams-Russo P, Sharrock NE, Mattis S, et al. Cognitive effects after epidural vs. general anesthesia in older adults. *JAMA* 1995;274:44–50.
190. Rasmussen LS, Johnson T, Kuipers HM, et al. Does anaesthesia cause postoperative cognitive dysfunction? A randomized study of regional versus general anaesthesia in 438 elderly patients. *Acta Anaesthesiol Scand* 2003;47:260–266.
191. Schecter WP, Farmer D, Horn JK, et al. Special considerations in postoperative pain management: audiovisual distraction, geriatrics, pediatrics, pregnancy. *J Am Coll Surg* 2005;201:612–618.
192. Aubrun F. Management of postoperative analgesia in the elderly. *Reg Anesth Pain Med* 2005;30:363–379.
193. Tsui B, Wagne A, Finucanen B. Regional anaesthesia in the elderly: a clinical guide. *Drugs Aging* 2004;21:895–910.
194. Higashi T, Shekelle PG, Adams JL, et al. Quality of care is associated with survival in vulnerable older patients. *Ann Intern Med* 2005;143:274–281.
195. McGory ML, Shekelle PG, Rubenstein LZ, et al. Developing quality indicators for elderly patients undergoing abdominal operations. *J Am Coll Surg* 2005;201:870–883.
196. American Geriatrics Society Core Writing Group of the Task Force on the Future of Geriatric Medicine. *J Am Geriatr Soc* 2005;53:S245.
197. Jazwinski SM. Longevity, genes, and aging. *Science* 1996;273:54–59.

# CHAPTER 21

## Evaluation of the Pregnant Patient

Robert Gaiser, MD

358

Caring for the pregnant patient is one of the most challenging and the most rewarding aspects of anesthesia because it involves two patients, the mother and the fetus. Both patients must be considered when making decisions. The mother is the primary patient, with the fetus secondary. Generally, optimal care of the mother provides good care of the fetus. Pregnancy alters maternal physiology. These changes must be considered when evaluating the pregnant patient.

### PHYSIOLOGIC CHANGES OF PREGNANCY

#### Cardiac

Pregnancy results in an increase in cardiac output to meet the increased demands of oxygen consumption. Cardiac output increases 40% during pregnancy, with most of the increase occurring during the first trimester. The increase in cardiac output allows a 10- to 20-fold increase in uterine blood flow. The increase in cardiac output is multifactorial, resulting from increases in both stroke volume and heart rate (an increase of 10–20 beats/min).<sup>1,2</sup> Despite the increase in cardiac output, systolic, diastolic, and mean blood pressures decrease. Central venous pressure and pulmonary artery pressures do not change with pregnancy and are similar to the values in the nonpregnant state.

Maternal blood volume increases by 35% during pregnancy. The increase begins early in gestation and continues throughout pregnancy. Two theories exist for the increase in blood volume. In the overfill hypothesis, increased mineralocorticoid levels lead to sodium and water retention. The intravascular space expands to accommodate the increase in volume. In the underfill hypothesis, the intravascular space expands due to hormonal-induced vasodilatation. Fluid retention increases to accommodate the in-

creased intravascular space. The increased blood volume during pregnancy allows parturients to tolerate normal blood loss of delivery (approximately 400 mL during vaginal delivery and 700 mL during cesarean section).<sup>3</sup> The uterus contracts at delivery, resulting in autotransfusion of approximately 500 mL. Blood volume returns to prepregnancy levels within 7–14 days after delivery. As blood volume increases, total peripheral vascular resistance decreases.

Normal parturients are less responsive to vasopressors and chronotropic agents.<sup>4,5</sup> This decrease in response may be related to downregulation of  $\alpha$ - and  $\beta$ -receptors. As such, one may need to increase the amount of vasopressor administered to a parturient as compared to a non-pregnant individual.

In the supine position, up to 15% of pregnant patients develop nausea, hypotension, and vomiting (supine hypotension syndrome).<sup>6</sup> The supine po-

sition allows the gravid uterus to compress the inferior vena cava and aorta. Caval compression results in decreased venous return to the right atrium and, hence, cardiac output. Anesthetic drugs or techniques that cause venodilation further decrease venous return with caval obstruction. A decrease in blood pressure results in a decrease in uterine perfusion. Further decreases in uterine blood flow occur if the uterus compresses the aorta, because the uterine artery is a branch of the hypogastric artery, which emerges distal to the level of aortic compression. Studies performed with pregnant women in the lateral position have not noted major decreases in cardiac output.<sup>7,8</sup> By tilting the patient to the left, the uterus is displaced off the vena cava and the aorta. As such, pregnant women should not lie supine after 20 weeks of gestation; the uterus should be tilted to the left by placing a wedge underneath the right hip.

### KEY POINTS

1. Unlike other operations wherein the patient is primarily concerned with him or herself, the pregnant woman usually is concerned for her baby's welfare.
2. The anesthesia provider must be aware of the various physiologic changes of pregnancy and incorporate them into the anesthetic plan.
3. These physiologic changes have implications for various diseases and must be considered.
4. The central nervous system effects of pregnancy include a reduced local anesthetic requirement when these agents are given intrathecally or epidurally.
5. Pregnant patients are at increased risk for aspiration during general anesthesia.
6. There is some suggestion that surgery during the first trimester is linked to central nervous defects during surgery.
7. Fetal heart rate monitoring is possible during some surgical procedures but is not universally used in the United States.
8. Preterm delivery remains the leading cause of perinatal morbidity and mortality in the United States. Preterm labor is difficult to control with medication; the most promising medications are the calcium channel-blocking drugs. Magnesium sulfate is frequently used and is associated with prolonged depolarizing and nondepolarizing neuromuscular blockade.
9. The etiology of preeclampsia remains to be elucidated but is believed to be triggered by a paternal antigen in a susceptible mother.
10. Magnesium sulfate is the most effective medication for the prevention of seizures in women with preeclampsia.
11. Labetalol is the preferred medication for the control of blood pressure in mothers with preeclampsia.
12. The two causes of antepartum hemorrhage are placenta previa and placental abruption. Associated with the increase in cesarean sections is a high risk of placenta accreta in patients with placenta previa.
13. Perinatal transmission of HIV is low if the viral load is  $<1,000$  copies/mL, and patients with these levels do not require cesarean section. If the viral load is greater, cesarean section may decrease the risk of perinatal transmission.



Physical examination of pregnant women typically reveals a point of maximal cardiac impulse that is displaced cephalad and leftward from its location prepregnancy. Diaphragmatic elevation displaces the heart leftward so that it may appear enlarged on chest radiographs. The electrocardiogram shows left axis deviation. A small pericardial effusion may develop in healthy asymptomatic women during the third trimester of pregnancy.<sup>9</sup>

## Respiratory System

Various changes occur in the maternal airway during gestation. Vascular engorgement of the airway results in edema of the oral and nasal pharynx, larynx, and trachea.<sup>10</sup> When airways of parturients were examined at 12 weeks of gestation and then again at 36 weeks of gestation, the percentage of patients with a Mallampati class IV airway had doubled.<sup>11</sup> This airway edema can make intubation of the trachea difficult. Of the maternal deaths in the United States, approximately half occur because of failed intubation.<sup>12</sup> For oral tracheal intubation, the likelihood of edema in the false cords mandates the use of smaller endotracheal tubes. A size 6.0 cuffed endotracheal tube should be ready and available for every case. Exacerbation of these changes may occur in patients with upper respiratory tract infections or preeclampsia. The mucous membranes are very friable. Manipulation, such as nasal intubation or insertion of a nasogastric tube, may result in excessive bleeding.

The gravid uterus results in a 4-cm elevation of the diaphragm. Despite this elevation, total lung capacity changes little as the chest expands in the anteroposterior and transverse diameters to compensate. The diaphragmatic elevation does cause a 20% decrease in functional residual capacity (FRC) at term. This decrease in FRC is a result of decreases in both residual volume and expiratory reserve volume. Oxygen consumption increases by 20% as a result of increased metabolism and increased work of breathing.<sup>13</sup> The parturient compensates for this increased oxygen consumption in two ways: (1) increasing alveolar ventilation and (2) shifting the oxyhemoglobin dissociation curve to the right, thus facilitating unloading of oxygen at the cellular level. The  $P_{50}$  increases from 26 to 30

mm Hg. The shift is caused by an increase in 2,3-diphosphoglycerate.

The decrease in FRC and increased oxygen consumption make parturients very vulnerable to hypoxia. After complete denitrogenation by breathing 100% oxygen, nonpregnant patients tolerate 9 minutes of apnea before oxygen saturation is <90%, whereas parturients can tolerate only 2–3 minutes.

Alveolar ventilation increases by 70%. This increase results primarily from increased tidal volume and secondarily from a small increase in respiratory rate.  $Paco_2$  decreases to 32 mm Hg as a result of increased ventilation, and  $PaO_2$  increases 5–10 mm Hg. Decreased serum bicarbonate from 26 to 22 mm Hg results in a partially compensated respiratory alkalosis.

From 60–70% of healthy pregnant women have mild, intermittent dyspnea. The cause is not clear, but the dyspnea may be related to alterations in chest wall proprioceptors or progesterone-induced hyperventilation.<sup>14</sup> Diaphragmatic elevation may result in increased lung marking, mimicking mild congestive heart failure, on the chest radiographs of healthy pregnant women.

## Gastrointestinal Changes

The enlarged gravid uterus displaces the stomach cephalad. This displacement changes the angle of gastroesophageal junction, decreasing competence of the gastroesophageal sphincter. The uterus also displaces the pylorus upward and posteriorly, resulting in delayed gastric emptying. Elevated concentrations of progesterone decrease gastrointestinal motility and food absorption. These changes facilitate the occurrence of gastric reflux and heartburn in as many as 70% of pregnant women.<sup>15</sup> These changes also place pregnant women at major risk for regurgitation and aspiration of gastric contents during induction or maintenance of general anesthesia or any other loss of consciousness. Given these changes, many anesthesia care providers believe that all pregnant women should be considered as having full stomachs and receive rapid sequence induction. It is prudent to use good clinical judgment, weighing the risks of rapid sequence induction (failed intubation, tachycardia, hypertension) against the risks of aspiration in an asymptomatic parturient.

## Hepatic Changes

Little or no change in hepatic blood flow occurs during normal pregnancy. Healthy pregnant women frequently have increased levels of serum aspartate aminotransferase, lactic dehydrogenase, alkaline phosphatase, or cholesterol. Colloid oncotic pressure decreases as a result of decreased total protein and decreased albumin-to-globulin ratio. Colloid oncotic pressure decreases further after delivery, regardless of method of delivery or anesthesia administered.<sup>16</sup>

Pseudocholinesterase activity is decreased by 24% before delivery and by 33% on the third postpartum day.<sup>16,17</sup> It returns to normal 2–6 weeks postpartum. The decreased cholinesterase activity usually is not sufficient to result in clinically relevant prolonged paralysis after a single dose of succinylcholine.

## Hematologic Changes

Plasma volume increases 45%, but the red cell mass increases only 20%, leading to the physiologic (dilutional) anemia of pregnancy. A maternal hemoglobin concentration <11 g/dL is abnormal. The most common cause of anemia during pregnancy is iron deficiency.

Platelet count usually is elevated, but a modest decrease can be seen without any other hematologic pathology. Gestational thrombocytopenia is believed to be an exaggerated normal response in which platelets are consumed.<sup>18</sup> Pregnancy produces a hypercoagulable state. All coagulation factors, except factors XI and XIII, increase in concentration. Fibrinolytic activity decreases during the third trimester as a result of decreased plasminogen activator concentrations. These changes, combined with rapid contraction of the uterus after placental separation, help protect women from major hemorrhage. Unfortunately, this hypercoagulability also predisposes pregnant women to thromboembolic complications. Parturients are at greatest risk for deep venous thrombosis and pulmonary embolism immediately after delivery.

## Endocrine

Mean blood glucose concentration remains within the normal range, although in some women glucose concentrations may be lower than before pregnancy. Parturients become insu-



lin resistant as a result of human placental lactogen, which causes increased release of insulin.<sup>19</sup>

The thyroid gland enlarges 50–70% during pregnancy. Concentrations of thyroid-binding globulin and total thyroxine increase, but concentrations of free thyroxine and triiodothyronine do not change.

## Renal

Renal plasma flow and glomerular filtration rate (GFR) increase during the first trimester to 50% above normal by the fourth month. During the third trimester, both slowly return to normal. The increases in renal plasma flow and GFR result in increased creatinine clearance, with decreased blood urea nitrogen (BUN) and creatinine (Cr) levels.<sup>20</sup> BUN decreases 40% to 8–9 mg/dL, and Cr decreases to 0.4–0.5 mg/dL. A BUN of 15 mg/dL, serum Cr level of 1.0 mg/dL, and Cr clearance of 100 mL/min suggest abnormal renal function in pregnant women who are near term. Glucosuria may occur in healthy pregnant women because tubular glucose reabsorption may not keep up with increased GFR. Proteinuria (up to 300 mg/d) is common.

Maternal progesterone, which is a smooth muscle relaxant, causes dilation of renal calyces, pelvis, and ureters. After midpregnancy, the enlarged uterus compresses the ureters of the pelvic brim, exacerbating ureteral dilation. Urinary stasis predisposes pregnant women to urinary tract infections.

## Central Nervous System

The minimum alveolar concentration (MAC) for inhaled anesthetics is decreased up to 40% in pregnancy.<sup>21</sup> This decrease also occurs with the newer inhalation agents sevoflurane and desflurane.<sup>22,23</sup> The mechanism is unclear but may be related to progesterone (which has sedative activity) and endorphins. A concentration of an inhalation agent that may not produce loss of consciousness in nonpregnant patients may render pregnant women unconscious, placing the parturient at risk for aspiration. For this reason, inhalation agents for labor analgesia are not desirable.

Pregnant women require less local anesthetic volume to produce the same level of epidural or spinal block.<sup>24</sup> In the epidural space, the lesser anesthetic volume required may be

partly due to epidural vein engorgement, thus decreasing the volume of the epidural space. However, this decreased requirement is seen in the first trimester, well before significant mechanical changes have occurred. Acid–base changes in cerebrospinal fluid or hormonal changes of pregnancy may cause increased sensitivity to local anesthetics.<sup>25</sup>

## Reproductive Tract

The uterus weighs 50–70 g in the nonpregnant state and increases to 1.0–1.5 kg in pregnant women at term. Total uterine blood flow increases from 50 mL/min in nonpregnant women to 700 mL/min in pregnant women at term, representing approximately 10% of the cardiac output. The majority of the uterine blood flow perfuses the intervillous space; the remainder of the blood flow perfuses the enlarged myometrium.

The uterine vasculature appears maximally dilated in healthy pregnant women; therefore, uterine blood flow decreases parallel with maternal arterial pressure. Little or no autoregulation of uterine blood flow occurs during pregnancy. Any factor that decreases venous return and cardiac output will decrease uterine blood flow. Uterine contractions also decrease uterine blood flow. No known drugs specifically or directly increase uterine blood flow.

## MONITORING THE FETUS

Use of electronic fetal monitoring for assessing fetal well-being has become universal, used by both physicians and nurses.<sup>26</sup> Monitoring the fetal heart rate is used to determine adequate cerebral oxygenation of the fetus. As the brain modulates the heart, a decrease in fetal heart rate is believed to reflect inadequate fetal cerebral oxygenation. External fetal heart rate monitors use a Doppler detective device with computerized logic to interpret and count the Doppler signals, whereas internal fetal heart rate monitors involve placement of an electrode on the fetal scalp. The presence of fetal heart tones as well as their rate and rhythm are well-recognized indicators of fetal well-being.<sup>27</sup> A normal fetal heart rate tracing reveals a rate of 110–160 beats/min with minimal to moderate beat-to-beat variability with

or without accelerations.<sup>28</sup> A preterm fetus is expected to have a more rapid rate with little or no beat-to-beat variability and no accelerations (an increase in fetal heart rate over baseline, usually occurring with fetal movement).<sup>29</sup> The goal of antepartum fetal surveillance is to document fetal well-being, allowing the pregnancy to continue without concern for fetal death. Several antepartum techniques in use include fetal movement, nonstress test, contraction stress test, biophysical profile, and umbilical artery Doppler flow velocimetry.

Fetal movement is the easiest means for documenting fetal well-being. The mother can perceive fetal movements, which serve as a basis for assessment. A diminution in the perception of fetal movement often precedes fetal death.<sup>30</sup> Perception of 10 distinct movements in a period of up to 2 hours is considered reassuring.

Heart rate reactivity is thought to be a good indicator of normal fetal autonomic function. Loss of reactivity is associated most commonly with fetal sleep but also may result from any central nervous system depression. A nonstress test involves connecting the mother to the fetal heart rate monitor and observing. Nonstress test results can be categorized as reactive or nonreactive. The nonstress test is considered *reactive* (normal) if two or more fetal heart rate accelerations are observed within a 20-minute period. The nonstress test is considered *nonreactive* when no accelerations are observed over a 40-minute period.<sup>31</sup>

The contraction stress test is based on the response of the fetal heart rate to uterine contractions. During a uterine contraction, fetal oxygenation worsens as a result of uterine artery compression. In the suboptimally oxygenated fetus, this further decrease in oxygenation is not tolerated, leading to the fetal heart rate pattern of late decelerations. Three contractions in a 10-minute period are required. Contractions are produced by either oxytocin infusion or nipple stimulation.<sup>32</sup> The contraction stress test is interpreted according to the presence or absence of late fetal heart rate decelerations, which are defined as decelerations that reach the nadir after the peak of the contraction and persist beyond the end of the contraction.<sup>33</sup> The presence of late decelerations suggests that the fetus is compromised and must be de-

TABLE 21-1.

**Ultrasound Components of the Biophysical Profile**

Fetal breathing movements ( $>1$ episode of rhythmic fetal breathing movements of $\geq 30$ sec within 30 min)
Fetal movement ( $\geq 3$ discrete body or limb movements within 30 min)
Fetal tone ( $>1$ episode of extension of a fetal extremity with return to flexion, or opening or closing of a hand)
Determination of the amniotic fluid volume (single vertical pocket of amniotic fluid exceeding 2 cm)

livered, usually by cesarean section. The results of the contraction stress test are negative if no late or significant variable decelerations occur after 50% or more of contractions.

The biophysical profile was developed as a method for integrating real-time observations of the fetus directly in its environment. It is used as an assessment tool for both acute and chronic fetal conditions in the antepartum period. The biophysical profile consists of a nonstress test combined with four observations made by ultrasonography (Table 21-1).<sup>34</sup> Each of the five components is assigned a score of either 2 (normal) or 0 (abnormal). A composite score of 8–10 is normal, a score of 6 is considered equivocal, and a score of 4 or less is abnormal. The biophysical profile is frequently performed in the labor suite, necessitating a basic understanding by the anesthesiologist. The ability of the biophysical profile to predict cesarean delivery or admission to the neonatal intensive care unit was studied prospectively in 100 normal singleton pregnancies. A biophysical profile of 6 or lower was highly predictive of cesarean delivery and admission to the neonatal ICU.<sup>35</sup>

Umbilical artery Doppler flow velocimetry is based on the observation that flow velocity waveforms in the umbilical artery of normally growing fetuses differ from those of growth-restricted fetuses. The umbilical flow velocity waveform of normally growing fetuses is characterized by high-velocity diastolic flow, whereas in fetuses with intrauterine growth restriction, umbilical artery diastolic flow is reduced.<sup>36</sup> When using Doppler, the angle be-

tween the beam and the vessel should be  $< 30^\circ$ . Clearly, this angle is difficult to obtain accurately. As such, a variety of angle-independent indices have been developed to characterize flow velocity waveforms. Indices rely on systolic, diastolic, and mean velocities. These indices do not measure the volume of blood flow. Commonly measured flow indices based on peak systolic frequency shift (S), end-diastolic frequency shift (D), and mean peak frequency shift over the cardiac cycle (A). Systolic velocities are peak velocities that result from cardiac contraction. Diastolic velocities result from a combination of factors: peak flows, vessel compliance, heart rate, and vascular impedance. This allows for the following calculations to be obtained: systolic to diastolic ratio (S/D), resistance index (S-D/S), and pulsatility index (S-D/A). To maximize interpretability, multiple waveforms should be assessed, and the filter settings should be set low enough to avoid masking diastolic flow. Initial testing at 32–34 weeks of gestation is appropriate for most pregnancies at risk for stillbirth.

Future routine monitors may include the transabdominal fetal pulse oximeter. The depth of the fetal head from the maternal abdomen is determined on ultrasound; the distance between the optodes must be twice the depth of the fetus. Using this device, oxygen saturations between 50% and 74% have been obtained and are similar to those obtained transvaginally.<sup>37</sup> This monitor provides measures of both the fetal heart rate and the oxygen saturation of the fetal blood. The value of this monitor is evident because not all cases of decreased fetal heart rate variability are the result of decreased oxygenation. The transabdominal fetal pulse oximeter allows for differentiation between normal fetal sleep and decreased oxygen content.

**PRETERM LABOR**

Preterm birth is one of the major health problems in the United States. Approximately 11–12% of all births occur preterm ( $< 37$  weeks of gestation), and the rate has increased approximately 19% since 1990.<sup>38</sup> The concern with preterm labor and birth is its outcome: it accounts for approximately 70% of all neonatal deaths and

50% of the long-term neurologic disabilities.<sup>39</sup> Almost one fifth of all very preterm infants do not survive the first year of life. Of the smallest infants, handicaps occur in approximately half of survivors.<sup>40</sup> Healthcare costs resulting from preterm birth are staggering. The cost to the U.S. economy is estimated at \$5 billion annually.<sup>41</sup> Risk factors for preterm labor are listed in Table 21-2.

The prediction and prevention of preterm labor and delivery continue to be a major focus of intense investigation. The major conclusion of the research is that preterm labor and birth are complex and multifactorial. In the last decade, it has become increasingly clear that infection has a prominent role in preterm birth. An estimated 80% of preterm births are associated with chorioamnionitis or organisms in the placental membrane.<sup>42</sup> For women at risk for preterm delivery based on their history and who have bacterial vaginosis, evidence supports that treatment with metronidazole decreases the risk of preterm birth by 25–75%.<sup>43,44</sup> The other major advance in the prediction of preterm birth comes from genomics. Genomics is the study of gene expression at the messenger RNA level to provide an integrated view of the relationship among the host genome, gene expression, and disease outcome. Several studies have demonstrated a link between nucleotide polymorphisms and preterm birth.<sup>45,46</sup>

Tocolysis has been a prominent component of efforts to prevent preterm labor and delivery. The premise behind tocolysis is that administration of medication will reduce uterine con-

TABLE 21-2.

**Risk Factors for Preterm Labor and Birth**

History of preterm birth
Current multifetal pregnancy
Infection
Diabetes mellitus
Hypertension
Asthma
Lack of prenatal care
Smoking
Alcohol
Cocaine
Stress
Long work hours with long periods of standing

tractility, thus allowing retention of the fetus in utero. However, consensus is increasing among obstetricians that only a minority of patients benefit from tocolysis. Literally, hundreds of trials have evaluated medications for the prevention of preterm birth. Acute tocolysis occurs at the initial presentation for preterm labor, which differs from maintenance after successful acute tocolysis.

The  $\beta$ -mimetics, such as terbutaline or ritodrine, have been increasingly falling from favor as a first-line tocolytic agent because of the high incidence of maternal adverse effects, such as hypokalemia, hyperglycemia, tachycardia, decreased systemic vascular resistance, and increased risk of pulmonary edema. In fact,  $\beta$ -mimetics have been linked to at least 25 maternal deaths from pulmonary edema.<sup>47</sup> A meta-analysis included nine trials of primary tocolytic agents compared to placebo.<sup>48</sup> For  $\beta$ -mimetics, only one trial found an increase in the length of pregnancy, one found a prolongation measured in days, and the rest found no benefit. In 2003, the American College of Obstetricians and Gynecologists (ACOG) concluded, "It would appear, on the basis of currently available evidence, very difficult to support the use of betamimetics, which have a high incidence of side effects. Although these drugs do delay delivery in the short term, there is no demonstrable benefit for the newborn."<sup>49</sup>

The use of magnesium sulfate as a tocolytic varies by location. It is rarely used in Europe but is widely used in the United States, where it continues to be used because of its high safety profile. Magnesium sulfate results in blurry vision and maternal weakness. It potentiates the nondepolarizing muscle relaxants, necessitating a major reduction in dose of these medications. A 2004 review found no benefit of magnesium for short- or long-term delay in delivery.<sup>50</sup> However, magnesium sulfate may be beneficial for neuroprotection in the preterm newborn when administered prior to delivery.<sup>51</sup>

Calcium channel blockers relax the myometrium. The most recent study included a total of 1024 patients and found that calcium channel blockers were more effective than  $\beta$ -mimetic agents in prolonging pregnancy for 7 days or longer, were much less likely to cause maternal side effects, and were associated with reduced neonatal

morbidity.<sup>52</sup> The most commonly used drugs are nifedipine, followed by nicardipine. These drugs should not be used in women with cardiovascular disease or those who are hemodynamically unstable.

The discovery that prostaglandins play a role in the initiation of labor led to the study of prostaglandin synthetase inhibitors as agents for treating preterm labor and preventing preterm birth. Studies suggest that indomethacin is more effective than placebo in prolonging pregnancy.<sup>53</sup> The concern with the use of indomethacin is its fetal effects. Premature closure of the ductus arteriosus and oligohydramnios have been associated with maternal administration of indomethacin.

A recent development was the discovery of oxytocin antagonists. Labor is clearly accompanied by an increase in oxytocin receptors. It stood to reason that the administration of an antagonist to oxytocin would be beneficial. Atosiban is the only oxytocin antagonist to date that has undergone extensive studies. Atosiban has several advantages in that it is a specific inhibitor of myometrial contractility with little transplacental passage. A multicenter trial compared atosiban to placebo in 501 women with preterm labor. No difference in length of labor or neonatal outcome was noted.<sup>54</sup> A disadvantage of atosiban is that it must be administered intravenously. Furthermore, the agent is much more expensive than the calcium channel blockers.

Multiple studies have failed to show a benefit to maintenance of tocolysis for preventing the recurrence of preterm labor or improving neonatal outcome.<sup>55</sup> Because of its associated high neonatal morbidity and mortality, physicians feel obligated to do something when a parturient presents in preterm labor. At the present, most interventions fail to demonstrate benefits. The safest agent currently used for tocolysis appears to be nifedipine, although ACOG has not identified a tocolytic of choice.

## PREECLAMPSIA

Preeclampsia is a multisystem disorder unique to human pregnancy. Because no good animal model exists, investigation of the etiology of preeclampsia has been difficult. It is char-

acterized by an abnormal vascular response to the placenta that is associated with increased systemic vascular resistance, enhanced platelet aggregation, activation of the coagulation system, and endothelial cell dysfunction.<sup>56</sup> Parturients with preeclampsia develop edema, raised blood pressure, and proteinuria. Preeclampsia typically occurs after week 20 of gestation, except when associated with a hydatidiform mole, but rarely occurs before week 24 of gestation. ACOG has defined preeclampsia as a blood pressure of at least 140 mm Hg (systolic) or at least 90 mm Hg (diastolic) on at least two occasions at least 4–6 hours apart.<sup>57</sup> Table 21–3 lists the possible abnormal laboratory values in preeclampsia. In general, maternal and perinatal outcomes are good in patients with mild preeclampsia developing after 36 weeks of gestation. If preeclampsia develops in patients before 33 weeks of gestation or in patients with preexisting medical disorders, the outcome is less favorable.<sup>58</sup> Preeclampsia usually abates within 48 hours of termination of the pregnancy. Eclampsia is preeclampsia with central nervous system involvement leading to seizures or grand mal convulsions not related to other cerebral conditions. The diagnosis of severe preeclampsia requires the presence of end-organ disease (Table 21–4).

The incidence of preeclampsia ranges from 2–7% of nulliparous patients.<sup>59</sup> Higher frequency and greater severity occur in patients with multifetal gestations, previous preeclampsia, and chronic hypertension. Several risk factors for preeclampsia have been identified (Table 21–5). Preeclampsia tends to occur at both extremes of reproductive age. The greatest risk factor is a

TABLE 21–3.

### Abnormal Laboratory Values in Preeclampsia

Proteinuria
Elevated hemoglobin level
Elevated creatinine level
Elevated blood urea nitrogen level
Thrombocytopenia
Elevated uric acid level
Elevated prothrombin time and partial thromboplastin time
Elevated liver enzyme levels
Microangiopathic hemolytic anemia

TABLE 21-4.

## Clinical Criteria for Severe Preeclampsia

One of the following criteria will make the diagnosis of severe preeclampsia necessitating delivery in the preeclamptic parturient:

Systolic blood pressure  $\geq 160$  mm

Hg

Diastolic blood pressure  $\geq 110$  mm

Hg

Proteinuria  $\geq 5$  g/24 h

Oliguria  $\leq 400$  mL/24 h

Cerebral visual disturbances

Headache

Pulmonary edema

Hemolysis, elevated liver enzymes, low platelets (HELLP) syndrome

Epigastric pain

first pregnancy. Long-term sperm exposure with the same partner has a protective effect. The risk of preeclampsia is increased in a multiparous parturient if she has a different partner.<sup>60</sup> The importance of the father in causing preeclampsia was highlighted in a study examining the Medical Birth Registry of Norway. If a woman becomes pregnant by a man who has already fathered a preeclamptic pregnancy in a different woman, her risk of developing preeclampsia is increased 1.8 (95% confidence interval [CI], 1.2–2.6). There is also a genetic component. Using the same birth registry, the authors demonstrated that daughters of women who had preeclampsia during pregnancy had double the risk of developing preeclampsia themselves. The same did not apply to the sons who fathered children.<sup>61</sup>

During pregnancy, the placenta exerts a significant influence on maternal

blood pressure because of the interaction of its various hormones, vasoactive substances, and structure. In a normal pregnancy, peripheral vascular resistance decreases, resulting in a lower blood pressure. Maternal blood pressure decreases as early as 7 weeks of gestation. After 28 weeks of gestation, the blood pressure increases, reaching nonpregnant values toward the end of the third trimester. Also, in a normal pregnancy, all fluid compartments expand. In patients with preeclampsia, the exact opposite occurs, with an increase in blood pressure and a decrease in the fluid compartments.

The cause of preeclampsia is unknown, but the disease seems to begin at implantation, well before the clinical manifestations allow the diagnosis to be made. The likely culprit in preeclampsia is the placenta. Preeclampsia is seen in patients with molar pregnancies (thus it cannot be a result of the fetus) and in patients with abdominal pregnancies (thus it cannot be a result of the uterus). There are two theories regarding the role of the placenta. One theory is that inadequate placental implantation results in placental ischemia leading to oxidative stress. The other theory is immunologic maladaptation to a paternal antigen.<sup>62,63</sup>

Anticonvulsants were introduced for women with preeclampsia in the belief that the drugs would prevent eclampsia and improve outcome. Predicting who is at risk for eclampsia is difficult, and only 1–2% of those with preeclampsia develop eclampsia. However, prophylactic anticonvulsants are used in all parturients with preeclampsia. A variety of anticonvulsants have been proposed and evaluated, but the most widely used drug is magnesium sulfate. Other agents used include diazepam and phenytoin. Evidence continues to support the use of magnesium sulfate for the prevention of seizures, and it appears to be superior to phenytoin or nimodipine.<sup>64,65</sup> The largest study that examined magnesium sulfate was a multicenter trial that included centers from the United Kingdom, South America, and South Africa. A total of 10,110 patients were randomized to receive magnesium sulfate (5055 patients) or placebo (5055 patients). A greater incidence of side effects, such as flushing, hot flashes, and blurry vision, was observed in the magnesium sulfate group. The magnesium

sulfate group also had a 58% lower risk of eclampsia; this lower risk did not affect maternal mortality.<sup>66</sup> Magnesium does not prevent the progression of the disease to severe preeclampsia. In 222 women with mild preeclampsia, 109 patients received intravenous magnesium. There was no difference in the groups with regard to the progression to severe disease.<sup>67</sup> Magnesium sulfate does relax the uterus. The use of magnesium sulfate in parturients with preeclampsia does not slow labor, but the need for oxytocin is greater. There is no difference in the incidence of postpartum hemorrhage.<sup>68</sup>

It was hoped that low-dose aspirin would be beneficial in preventing preeclampsia. Low-dose aspirin reduces thromboxane production by selective inhibition of platelet thromboxane production without affecting prostacyclin production by the vascular endothelium. The largest study randomized 2539 women to receive either low-dose aspirin (60 mg) or placebo.<sup>69</sup> The use of low-dose aspirin did not affect the incidence of preeclampsia. A meta-analysis of aspirin studies identified 14 trials that met specific criteria. Aspirin was effective only in women with known risk factors. It was not beneficial for the general population.<sup>70</sup>

Treatment of acute hypertension is intended to prevent potential cerebrovascular complications (the most common cause of morbidity in patients with preeclampsia). It is important to note that antihypertensives prevent cerebrovascular problems; they do not alter the course of the disease. A Cochrane review supports this conclusion.<sup>71</sup> Intravenous hydralazine or labetalol or oral nifedipine are the most commonly used drugs. Originally hydralazine was believed to be the drug of choice because it preserves uterine blood flow. In a meta-analysis comparing hydralazine to labetalol or nifedipine, hydralazine was associated with more maternal hypotension, more cesarean sections, more adverse effects on the fetal heart rate, and lower 1-minute Apgar scores. It was also associated with less maternal bradycardia compared to labetalol.<sup>72</sup> This analysis supports the use of labetalol for the control on maternal hemodynamics.

In an earlier review of hypertension in pregnant women, Lindheimer and Katz<sup>73</sup> concluded: "Epidural block

TABLE 21-5.

## Risk Factors for Preeclampsia

Maternal age ( $<20$  y or  $>40$  y)

Multiple births

Hypertension before pregnancy

First pregnancy

Previous pregnancy with preeclampsia

Diabetes mellitus

Asthma

Kidney disease

Lupus

Scleroderma

Obesity



should be avoided, since in preeclampsia it is associated with sudden falls of blood pressure and on occasion with vascular collapse." The literature does not support this stance.<sup>74,75</sup> Studies have demonstrated the stability of maternal cardiac output after administration of epidural anesthesia in patients with severe preeclampsia. Epidural anesthesia provides excellent analgesia during labor and allows patients to remain awake and alert during vaginal or cesarean delivery. Epidural anesthesia has at least three specific advantages in parturients with preeclampsia. It reduces circulating concentrations of catecholamines in laboring women, facilitating control of blood pressure and improving intervillous blood flow.<sup>76,77</sup> It allows better control of systemic and pulmonary arterial pressures during cesarean section.<sup>78</sup> Finally, epidural anesthesia does not require laryngoscopy and intubation, which might be hazardous or difficult because of pharyngeal edema.<sup>79</sup>

Platelet turnover and function are often altered in preeclampsia. Normal platelets are disk-shaped cells (2–4  $\mu\text{m}$  in diameter) that lack a nucleus. Platelets are formed in the bone marrow from giant cells called megakaryocytes. At any moment, approximately 80% of the platelets are circulating and 20% are localized in the spleen. Platelets participate in coagulation factor reactions leading to thrombin formation by providing a lipoprotein surface on which coagulation enzymes and substrates interact. The bone marrow does not contain a substantial reserve of platelets. If circulating plates are rapidly destroyed or lost, thrombocytopenia persists for several days until enough platelets are formed to correct the condition.

Pitkin and Witte<sup>80</sup> measured platelet counts every 4 weeks in 23 pregnant women and found that platelet counts dropped from  $322 \times 1000/\mu\text{L}$  in the first trimester to  $278 \times 1000/\mu\text{L}$  in the third trimester. In a study of 30 women, O'Brien<sup>81</sup> found a progressive decline in platelet counts. This decrease is caused by increased destruction. Preeclampsia is accompanied by endothelial injury, leading to increased platelet activation with consumption in the microvasculature. Platelet consumption is a late finding in preeclampsia, but increased platelet turnover may be an early marker of preeclampsia. Thrombocytopenia is the most

common hematologic abnormality in patients with preeclampsia. Its incidence depends upon the severity of the disease and the presence or absence of abruption placenta. A platelet count  $<150 \times 1000/\mu\text{L}$  was found in 50% of the women and a count  $<100 \times 1000/\mu\text{L}$  in 36% of women with preeclampsia.<sup>82</sup> Roberts et al.<sup>83</sup> retrospectively studied 292 patients with low platelet counts. Patients were divided into two groups: those with platelet counts  $<50 \times 1000/\mu\text{L}$  and those with platelet counts of  $50\text{--}100 \times 1000/\mu\text{L}$ . Bleeding was likely only if the platelet count was  $<40 \times 1000/\mu\text{L}$ . The only therapy for the thrombocytopenia of preeclampsia is delivery. Epidural analgesia has been successfully placed in individuals with platelet counts  $<100 \times 1000/\mu\text{L}$  in the absence of any other existing coagulopathy.

### ANTEPARTUM HEMORRHAGE

The two major causes of antepartum hemorrhage are placenta previa and placental abruption. Hemorrhage is the third leading cause of maternal mortality in the United States.<sup>84</sup> Hemorrhage can be quite severe, with uterine blood flow of 500–700 mL/min at term.

Placenta previa is present when the placenta overlies the cervical os. Placenta previa varies in degree and may be complete (37% of cases), partial (27%), or low-lying (46%). Risk factors for placenta previa are listed in Table 21–6. The main sign of placenta previa is painless vaginal bleeding. The bleeding usually stops spontaneously but may recur suddenly at any time. The recurrent bleeding usually is severe. If the diagnosis of placenta previa is suspected, ultrasonography is performed. The accuracy of this technique is 95%.<sup>85</sup> The double setup technique in which a cervical examination is performed in the operating room with preparation to perform an immediate cesarean section should bleeding occur is no longer performed. Before term gestation, the patient with placenta previa usually is managed conservatively with bedrest if the patient is not actively bleeding. If bleeding occurs, emergency cesarean section is required. Occasionally, the placenta implants directly to the myometrium, giving rise to three situations: placenta accreta (the placenta attaches to the myometrium), placenta increta (the

TABLE 21–6.

#### Risk Factors for Placenta Previa

- Uterine fibroids
- Multiple gestation
- Previous placenta previa
- Previous cesarean section
- Cocaine use
- History of abortion

placenta invades the myometrium but does not penetrate it fully), or placenta percreta (the placenta penetrates the entire thickness of the myometrium and may attach to other structures in the pelvis). In the general obstetric population, the incidence of placenta accreta is approximately 1:2,500. In patients with placenta previa and no prior cesarean section, the incidence is 5–7%. The risk of placenta accreta in patients with placenta previa who have undergone a prior cesarean section is much higher. With one prior uterine incision, the incidence of placenta accreta reportedly is between 24% and 31%; with two or more prior uterine incisions, the incidence rises to approximately 50%.<sup>86</sup> In patients with placenta previa and previous cesarean section, the anesthesia provider should be prepared for massive hemorrhage. Large-bore intravenous access and the immediate availability of blood products are mandatory.

Placental abruption refers to separation of the placenta after 20 weeks of gestation but before the birth of the fetus. The incidence ranges from 0.2–2.4%, depending upon the population studied. From 1979–2001, the rate of placental abruption increased 92% among black women and 15% among white women.<sup>87,88</sup> A high infant mortality rate is associated with placental abruption. Risk factors for placental abruption are listed in Table 21–7. The primary etiology of placental abrup-

TABLE 21–7.

#### Risk Factors for Placental Abruption

- History of placental abruption
- High blood pressure
- Preeclampsia
- Trauma
- Cocaine
- Diabetes mellitus
- Advanced maternal age
- Multiple pregnancies
- Smoking

tion is unknown. It begins with hemorrhage into the decidua basalis, causing a split in the decidua and subsequent hematoma formation. This expanding hematoma causes additional separation, compression, and ultimately destruction of the adjacent placental tissue. The classic signs of placental abruption are vaginal bleeding, abdominal pain, uterine tenderness, and contractions. Bleeding is either through the vagina or concealed in the uterus. If the blood is concealed, underestimating blood loss is common. Unlike placenta previa, abruption cannot be ruled out by a negative ultrasound examination, as ultrasound evidence of hemorrhage is present in only 50% of patients.<sup>89</sup> Anesthetic management of the parturient with placental abruption requires volume resuscitation. The anesthesia provider must also be prepared to manage a coagulopathic patient because placental abruption is associated with disseminated intravascular coagulation.

## SURGERY DURING PREGNANCY

From 1–2% of pregnant women require anesthesia for surgery unrelated to delivery. The anesthesia provider should consider possible fetal effects of the maternal disease process. Protection of the mother is paramount, but other goals of anesthetic management include maintenance of uterine blood flow and fetal oxygenation, avoidance of teratogenic drugs, and prevention of preterm labor.

Perhaps the greatest concern of pregnant women is whether anesthetics or anesthesia may increase the risk of congenital anomalies. Shnider and Webster<sup>90</sup> evaluated the medical records of 9073 women who delivered infants between July 1959 and August 1964. Of these women, 147 (1.6%) had surgery during pregnancy. There was no increased incidence of congenital anomalies in the surgical group, but the authors noted that most of the patients received anesthetics during the second or third trimester, after organogenesis. Brodsky et al.<sup>91</sup> mailed questionnaires to 287 women who had surgery during pregnancy. Among the women, 187 had surgery during the first trimester. There was no major increase in congenital anomalies in infants born to women who had sur-

gery during pregnancy compared with a control group of pregnant women who did not have surgery. Duncan et al.<sup>92</sup> used health insurance data from 1971 to 1978. They matched 2565 women undergoing surgery during pregnancy to women of similar height and weight who did not. There was no difference in the rate of congenital anomalies. There was an increased risk of spontaneous abortion in women undergoing surgery with general anesthesia in the first or second trimester, especially in those undergoing gynecologic surgery. Mazze and Kallen<sup>93</sup> obtained data from three Swedish health-care registries to evaluate the risk of adverse reproductive outcomes after anesthesia administration and surgery in pregnant women between 1973 and 1981. They identified 5405 women who underwent surgery during the first trimester. Among these women, 65% received general anesthesia, and 35% received regional or local anesthesia. There was no increased incidence of congenital anomalies. Another approach to this question is to examine anomalies and see if there is a link to anesthesia and surgery.<sup>94</sup> Of the 20,830 pregnant women who had offspring with a congenital anomaly, 31 patients had operations with anesthesia. This fraction did not differ from the 35,727 women who had babies without defects and 73 who had surgery during pregnancy. There was no higher rate of surgery and anesthesia in any congenital anomaly group.

However, this finding is not universal. Mazze and Kallen<sup>93</sup> reexamined their database and noted six infants with neural tube defects (an expected incidence of 2.5). Of these six infants, the mothers of five of the infants had surgery during gestational weeks 4–5, the period of neural tube formation.<sup>95</sup> This group was not the only one to note a link. Infants born with central nervous system defects in Atlanta between 1968 and 1980 were matched to controls by race, birth hospital, and period of birth.<sup>96</sup> Of the 694 mothers of infants with central nervous system defects, 12 reported first trimester anesthesia exposure (34/2984 control mothers reported such exposure). There was an increased risk for hydrocephalus (odds ratio = 9.6, 95% CI, 3.8–24.6). The strongest association was for hydrocephalus and eye defects (odds ratio = 39.6, 95% CI, 7.5 – 209.2). In the past, anesthesia providers told

patients that there was only a theoretical risk that exposure to anesthesia in the first trimester increased the risk of teratogenesis. These two studies suggest that a small risk may exist. When discussing the risk of anesthesia with pregnant women scheduled for surgery, the anesthesia care provider should remind the patient that there is a 3% baseline incidence of fetal anomalies among all pregnant women.

The use of fetal monitoring during maternal surgery is a hotly debated subject. After 18–20 weeks of gestation, the fetal heart rate can be monitored. The argument for intraoperative fetal monitoring is that it can improve fetal outcome. Changes in the fetal heart rate may signal fetal compromise, allowing the anesthesia care provider to take steps to improve uteroplacental perfusion and fetal oxygenation. These may include increasing left uterine displacement, higher concentration of inspired oxygen, adjustment of maternal ventilation, augmentation of maternal circulating blood volume, or pharmacologic management of hypotension. Despite these benefits, the use of fetal monitoring during surgery is not universally applied. Hospitals in the United States were surveyed regarding monitoring.<sup>97</sup> Of the 184 respondents, 60% routinely used fetal monitors, and 40% did not. ACOG recognized that there are no data regarding monitoring during surgery<sup>98</sup>: “It is important for physicians to obtain obstetric consultation before performing nonobstetric surgery because obstetricians are uniquely qualified to discuss aspects of maternal physiology and anatomy that may affect intraoperative maternal-fetal well-being. The decision to use fetal monitoring should be individualized and if used, may be based on gestational age, type of surgery, and facilities available. Ultimately, each case warrants a team approach for optimal safety of the woman and her baby.” Anesthetic care of parturient requiring nonobstetric surgery is discussed in Chapter 61.

## EVALUATING THE PARTURIENT WITH COEXISTING DISEASE

### Cardiac Disease

The cardiovascular changes of pregnancy place a major stress on the maternal heart and circulatory system. These changes may even result in

death of the mother. In an attempt to quantify this risk, 562 pregnant women with cardiac disease (either congenital or acquired) were followed prospectively in 13 Canadian hospitals.<sup>99</sup> The study followed these women through pregnancy and for 6 months after delivery. Neonatal morbidity, preterm labor, and “small for gestational age” births occurred in 20% of these patients. Maternal complications included pulmonary edema, stroke, and tachyarrhythmia. The most significant predictor of morbidity and mortality was the presence of left ventricular dysfunction prior to the pregnancy, with an odds ratio of 11 (95% CI, 4–34). The best predictor of maternal outcome is the New York Heart Association functional class (Table 21–8). In a study of 482 pregnancies, cardiovascular morbidity was less in mothers with Class I as compared to other function classes.<sup>100</sup> The higher the functional class, the greater the incidence of morbidity and mortality.<sup>101</sup>

Valvular lesions in pregnant patients are decreasing because of the decrease in rheumatic heart disease. In general, the parturient with valvular incompetence does better than the parturient with stenotic lesions. The reduced systemic vascular resistance of pregnancy improves forward flow, thus limiting the effects of regurgitation. In contrast, stenotic valvular lesions create a fixed impediment to the required increase in cardiac output of pregnancy, precipitating heart failure. Mitral stenosis is the most common valvular lesion encountered in the parturient.<sup>102</sup> There is an increased incidence of atrial fibrillation, leading to heart failure. Balloon mitral commissurotomy is a nonsurgical option for treatment of mitral stenosis and is an option for parturients with mitral stenosis.<sup>103</sup> Aortic stenosis is infrequently encountered and usually is the result of a congenitally abnormal valve. Hypertrophic cardiomyopathy is a genetically transmitted cardiac disease characterized by left ventricular hypertrophy and reduced left ventricular size and compliance. Reduction of preload and afterload results in an increase in the outflow gradient and reduction of left ventricular filling. One hundred parturients with hypertrophic cardiomyopathy were compared with the general population. There were two pregnancy-related deaths, both in women with severe

TABLE 21–8.

### New York Heart Association Functional Classification of Cardiovascular Disease

**Class I:** No limitation of physical activity. Ordinary activity does not precipitate cardiovascular symptoms.

**Class II:** Slight limitation of physical activity. Ordinary physical activity will precipitate cardiovascular symptoms.

**Class III:** Less than ordinary physical activity precipitates symptoms that markedly limit physical activity. Patients are comfortable at rest.

**Class IV:** Patients are unable to perform any physical activity without discomfort. Cardiovascular symptoms may be present at rest.

disease.<sup>104</sup> If the patient was asymptomatic prior to the pregnancy, the progression of symptoms, atrial fibrillation, and syncope were uncommon.

Congenital heart disease is increasingly prevalent in women of childbearing age because of the advances in diagnosis and treatment of these conditions. In 74 patients with congenital heart disease, 144 pregnancies occurred.<sup>105</sup> Congenital heart disease was divided into two groups: those with acyanotic lesions and those with cyanotic lesions. Patients with cyanotic lesions developed significantly more congestive heart failure and deteriorated more often than those with acyanotic lesions. Women with obstructive lesions had a higher incidence of pregnancy-induced hypertension. In the cyanotic group, the mean birthweight was approximately 1 kg less than in the acyanotic group. Acyanotic conditions include atrial or ventricular septal defects or persistent ductus arteriosus with small or moderate left-to-right shunts. Cyanotic lesions include tetralogy of Fallot and transposition of the great vessels in women who underwent the Fontan procedure. In cyanotic lesions, the increase in cardiac output and decrease in systemic vascular resistance lead to greater right-to-left shunting, worsening the cyanosis and hypoxemia.

Peripartum cardiomyopathy is a rare form of heart failure with no identifiable cause that occurs within the last month of pregnancy or within 5 months after delivery. The incidence is 1:4000. Risk factors include advanced

maternal age, multiparity, multiple gestation, black population, obesity, and preeclampsia. There is a high morbidity and mortality: approximately 20% of those who develop the condition die<sup>106</sup>; the rest recover partially or completely. The largest series of patients with the disorder and a subsequent pregnancy consisted of 44 women.<sup>107</sup> Twenty-eight pregnancies occurred in women who recovered completely, and 16 pregnancies occurred in women who had persistent left ventricular dysfunction. All deaths occurred in patients with persistent left ventricular dysfunction (19%), and these patients were also twice as likely to present with congestive heart failure (44% vs. 21%). These patients also had a greater frequency of premature deliveries.

Acute myocardial infarction is rare in pregnant patients, with an incidence of 1:10,000 pregnancies. However, the incidence is increasing, most likely reflecting the trend toward an older maternal age.<sup>108</sup> Mortality is approximately 40%, with the greatest risk occurring if the infarction occurs late in the pregnancy. Cardiac troponin is unaffected by pregnancy, allowing for the diagnosis of ischemic infarction.

Pulmonary hypertension is defined as a mean pulmonary artery pressure >25 mm Hg associated with a pulmonary capillary wedge pressure <12 mm Hg. Primary pulmonary hypertension is a rare disease that affects young women of childbearing age. Pulmonary hypertension may be secondary to other causes, such as congenital heart disease, thromboembolic disease, and connective tissue disorders. The most common cause on pulmonary hypertension in the parturient involves the late consequences of a large cardiac shunt (e.g., Eisenmenger syndrome). Pulmonary hypertension is tolerated poorly during pregnancy because of insufficient adaptation of the right heart to increases in cardiac output and a poorly compliant pulmonary vasculature. In a series of 14 parturients with severe pulmonary hypertension (4 primary and 10 secondary), two patients died before delivery and three died postpartum.<sup>109</sup> Because of the small sample size, it was not possible to determine whether parturients with primary pulmonary hypertension fared better than patients with secondary pulmonary hypertension.

TABLE 21–9.

## Classification for Severity of Asthma

	Medication Use	Symptoms	FEV <sub>1</sub>
Intermittent	No daily medications Bronchodilator PRN	≤2×/w	≥80%
Mild persistent	One medication	>2×/w but <1×/d	≥80%
Moderate persistent (no nocturnal symptoms)	Two medications	Daily	>60%
Severe (nocturnal symptoms)	Three medications	Daily	≤60%

FEV<sub>1</sub>, forced capacity expiratory volume in 1 second.

## Asthma

Asthma is a disease of chronic airway inflammation with acute episodes of bronchospasm. Asthma severity is classified according to its clinical features (Table 21–9). Approximately 7% of pregnant women are affected by asthma.<sup>110</sup> A number of physiologic changes of pregnancy affect the course of asthma in the parturient. Airway closure that results from decreased FRC during tidal breathing might lead to exacerbation of the disease.<sup>111</sup> To determine the effect of pregnancy and stage of pregnancy on asthma, six electronic databases were searched for prospective studies of asthmatic women during pregnancy.<sup>112</sup> This review demonstrated that asthma improves in 70% of parturients and worsens in 30%. This improvement peaked in the second trimester and reverted to baseline after delivery. Harirah et al.<sup>113</sup> studied the effect of gestational age on peak expiratory flow rate in normal parturients. The peak expiratory flow rate declined significantly throughout gestation, returning to normal at 6 weeks postpartum.

Parturients with asthma are at a higher risk for developing complications during pregnancy. Parturients with poorly controlled asthma had double the risk for spontaneous preterm labor.<sup>114</sup> Asthma is also associated with the development of preeclampsia.<sup>115</sup> Frequency of asthmatic symptoms during pregnancy was strongly associated with preeclampsia. Fetal hypoxia has been suggested as the mechanism for the association between asthma and preeclampsia as well as between asthma and intrauterine growth retardation.<sup>116</sup> Parturients

with asthma have a greater risk of developing chorioamnionitis, most likely because of premature rupture of membranes coupled with immunosuppressive therapy of asthma.<sup>117</sup>

The treatment of asthma combines allergen avoidance, smoking cessation, pharmacotherapy, and education. Pregnancy is not considered a contraindication for treatment. In fact, the management in pregnant women should follow the same guidelines as for nonpregnant patients, with inhaled steroids being the first line of therapy.<sup>118</sup> Parturients are not treated with systemic glucocorticosteroids because of their teratogenic effect (the increased risk of orofacial cleft).<sup>119</sup> Inhaled steroids are not associated with this risk. Further, treatment with inhaled steroids as compared to theophylline resulted in a greater improvement in forced expiratory volume in 1 second (FEV<sub>1</sub>) in the parturient.<sup>120</sup> The mainstay for treatment of an acute attack is inhaled albuterol. Albuterol is a relatively selective  $\beta_2$ -adrenergic bronchodilator that has been shown to have no effect on maternal and fetal circulations.<sup>121</sup>

## Back Pain

Back pain during pregnancy is a frequent problem. A cohort of 200 consecutive women was followed throughout pregnancy.<sup>122</sup> Of these participants, none reported back pain at the start of the study. However, at 12 weeks of gestation, 19% of the study population complained of a backache. The incidence increased to 47% at 24 weeks of gestation and peaked at 49% at 36 weeks of gestation. After delivery, the prevalence of back pain declined to 9.4%. Interestingly, despite a relatively high prevalence, it appears that only 32% of women with low back

pain during pregnancy report this problem to their physician, and only 25% of providers recommend a specific therapy.<sup>123</sup>

The etiology of the back pain is multimodal. One popular theory is that the exaggerated lumbar lordosis to compensate for the enlarging uterus places significant mechanical strain on the lower back. There is also a hormonal component. Relaxin is a polypeptide hormone of ovarian origin of the insulin-like growth factor family. Relaxin is associated with remodeling of collagen fibers and pelvic connective tissue. The primary source of circulating relaxin is the corpus luteum. The placenta is another major source of relaxin. Serum levels of relaxin measured in parturients both with and without back pain best explained the differences in back pain.<sup>124</sup>

Patients who develop low back pain during pregnancy may avoid subsequent pregnancy to prevent recurrence of the back pain. Women with low back pain during pregnancy have an extremely high risk for experiencing a new episode during a subsequent pregnancy.<sup>125</sup>

The majority of patients with low back pain during pregnancy respond to activity and postural modification. Exercise to increase the strength of the abdominal and back muscles is helpful. Scheduled rest periods with elevation of the feet to flex the hips and decrease the lumbar lordosis help to relieve muscle spasm and pain.<sup>126</sup>

## Diabetes Mellitus

Diabetes mellitus complicates 3–5% of all pregnancies.<sup>127</sup> Type 1 diabetes results from primary failure of endogenous insulin production, whereas type 2 diabetes represents a relative insulin deficiency. The precise etiology of type 1 diabetes is unknown. For an individual to develop type 1 diabetes mellitus, it appears that he or she must have genetic susceptibility and an environmental insult, which leads to an autoimmune attack against the insulin-producing pancreatic islet  $\beta$  cells.

During normal pregnancy, the parturient develops an insulin resistance that begins near midpregnancy and progresses through the third trimester. The insulin resistance appears to result from a combination of increased maternal adiposity and of hormones excreted by the placenta, such as human placental lactogen and progesterone. The fact



that insulin resistance rapidly abates following delivery (important to remember when managing diabetic parturients in the labor suite) suggests that the major contributor to this insulin resistance is placental hormones.

Glucose control is important for both maternal and fetal well-being during pregnancy. Studies have consistently shown a significant positive correlation between ambient serum glucose concentration during organogenesis and the incidence of spontaneous abortion.<sup>128</sup> When glycosylated hemoglobin levels were <8.5%, the fetal malformation rate (cardiac defects, sacral agenesis, renal agenesis, polycystic kidneys, anencephaly, meningocele) was 3.4%, but when the glycosylated hemoglobin level was >9.5%, the rate of fetal malformations approached 22%.<sup>129</sup> Glucose crosses the placenta; fetal levels reflect maternal levels. Insulin does not cross the placenta. Maternal hyperglycemia produces fetal hyperglycemia, causing stimulation of fetal cells and fetal hyperinsulinemia. Insulin is the major fetal growth hormone and produces excessive fetal growth, especially in the fat. The fetus of a poorly controlled diabetic mother is likely to be large, especially in the shoulders and chest, increasing the risk of shoulder dystocia at delivery. Increased insulin levels in the fetus delay fetal lung maturity. Diabetic parturients also have an increased risk of developing preeclampsia. In 1949, White<sup>130</sup> proposed a system of classifying diabetes in obstetric patients. The White classification (Table 21–10) is still used today for predicting pregnancy out-

come and as a means of conveying to others the severity of the disease process. Parturients in class A have less severe disease than those in class C or D. Classes R, F, H, and T imply end-organ damage. The more severe the disease, the poorer the outcome.

The management of diabetes in pregnancy includes a careful combination of diet, exercise, and insulin. Fasting glucose level should be maintained near 90 mg/dL, and 1-hour postprandial glucose level should be 140 mg/dL. During the night, glucose levels should not fall below 60 mg/dL. Glycosylated hemoglobin level should be no higher than 6%.<sup>131</sup>

Gestational diabetes mellitus is defined as glucose intolerance with the onset or first detection during pregnancy. Risk factors include advanced maternal age, family history of diabetes, and obesity. In low-risk populations, the incidence is approximately 2%, but the risk can be as high as 5–6% in the high-risk population.<sup>132,133</sup> In women with gestational diabetes, the insulin response to a glucose load is reduced compared to the response in a normal parturient. This occurs because of  $\beta$ -cell dysfunction in patients with chronic insulin resistance. Long-term followup of patients with gestational diabetes indicates that the majority progress to diabetes after pregnancy.<sup>134</sup> Very few have diabetes soon after delivery; the incidence appears to increase 10 or more years after delivery. The focus of treatment antepartum is to return glucose levels to normal. After pregnancy, the main focus of clinical care should be on reducing the risk of diabetes and treating it if it develops.

Much debate has focused on the role of oral hypoglycemic agents for the management of diabetes during pregnancy. These drugs are routinely used in nonpregnant adults with type 2 diabetes. They have recently been proposed for the treatment of gestational diabetes. The most promising agent is the second-generation sulfonylurea glyburide. It does not cross the placenta, thus avoiding possible teratogenicity. It has an onset of action of 4 hours and a duration of 10 hours. In a study of 404 women, glyburide was similar to insulin in regard to glucose control, with a lower incidence of hypoglycemia in the glyburide group.<sup>135</sup>

### Thyroid Disease

Thyroid disease is more common in women, with a female-to-male ratio of 12:1. Thyroid autoimmunity is by far the most frequent cause of hypothyroidism in women of reproductive age.<sup>136</sup> The prevalence of hypothyroidism in the general population of reproductive age is 2%. The incidence of hyperthyroidism in pregnant women is estimated at 0.2%, with the most common cause being Graves disease (autoimmune-induced thyroxine overproduction). During pregnancy, normal thyroid activity undergoes significant changes, including a 2- to 3-fold increase in thyroxine-binding globulin concentrations, increased serum thyroglobulin levels, and increased renal iodide clearance. In addition, human chorionic gonadotropin (hCG) has mild thyroid stimulating activity.<sup>137</sup>

Hypothyroidism in women may cause infertility. This is not surprising because thyroid hormones have direct effects on granulosa cells, luteal cells, and oocytes. With mild hypothyroidism, pregnancy may occur, but the resulting pregnancies often are associated with abortion, stillbirth, or prematurity.<sup>138</sup> For the fetus, maternal thyroid hormones are transferred across the placenta. This transfer is important in early gestation because the fetal thyroid gland becomes operational only after midgestation. Maternal hypothyroidism is associated with neurologic disorders in the newborn because thyroid hormonal levels are important for fetal brain development.<sup>139</sup> Systematic screening for hypothyroidism, administration of L-thyroxine in selected cases, and monitoring of thyroid function have proved to be helpful in the management of these patients.

TABLE 21–10.

White Classification of Diabetes in Pregnancy

Class	Age at Onset	Duration	Complications	Insulin Requirement
<b>Gestational Diabetes</b>				
A1	Any	Any	—	No
A2	Any	Any	—	Yes
<b>Pregestational Diabetes</b>				
B	>20 y	<10 y	—	Yes
C	10–19 y	10–19 y	—	Yes
D	<10 y	>20 y	Benign retinopathy	Yes
F	Any	Any	Nephropathy	Yes
R	Any	Any	Proliferative retinopathy	Yes
T	Any	Any	Renal transplant	Yes
H	Any	Any	Cardiac	Yes

Hyperthyroidism during pregnancy is less common than is hypothyroidism. Hyperthyroidism can cause miscarriage, neonatal death, preterm delivery, and intrauterine growth retardation. Two pregnancy-specific conditions, hyperemesis gravidarum and trophoblastic disease, can cause hyperthyroidism in the mother.<sup>140,141</sup> Hyperemesis gravidarum is characterized by severe vomiting that begins approximately at 6 weeks of gestation and usually resolves by 20 weeks of gestation. The etiology of transient hyperthyroidism in hyperemesis gravidarum is unclear. In trophoblastic disease, there is an increase in hCG that increases thyroid function. In select cases, propylthiouracil may be required.

### Human Immunodeficiency Virus

AIDS was first reported in women in 1981. The percentage of AIDS cases involving women has increased thereafter, accounting for an estimated 26% of new AIDS diagnoses in 2002. Since 1998, deaths among women with AIDS have remained stable. Of the women with human immunodeficiency virus (HIV), 31% were of childbearing age.<sup>142</sup> Pregnancy does not affect HIV or disease progression; viral load is not increased by pregnancy but may rebound during the immediate postpartum period.<sup>143</sup> As such, the challenge with HIV in pregnant patients is preventing transmission of HIV to the child.

The first major discovery in the prevention of transmission of virus to the neonate was the demonstration that treatment of the mother with zidovudine during pregnancy and labor and of the neonate for the first 6 weeks after birth could reduce the transmission rate from 25% to 8%.<sup>144</sup> The introduction of this practice had a dramatic effect on perinatal transmission.<sup>145</sup> However, use of a single agent now is considered obsolete, and most patients receive combination therapy. Combination therapy generally consists of two nucleoside reverse transcriptase inhibitors and a nonnucleoside reverse transcriptase inhibitor or protease inhibitor. Combination antiretroviral therapy has proved effective in reducing maternal HIV-1 RNA levels to <500 copies/mL, which minimizes the risk of perinatal transmission and improves the health of the mother.<sup>146</sup>

Early studies suggested an association between vaginal delivery and

fetal transmission of the virus, with a decreased likelihood of transmission with cesarean delivery.<sup>147,148</sup> In 1999, the International Perinatal HIV Group published a meta-analysis of 15 prospective cohort studies that examined the mode of delivery and the risk of vertical transmission.<sup>149</sup> This meta-analysis included only those studies of at least 100 mother-child pairs and defined elective cesarean section as that performed before the onset of labor. The number of patients in the final analysis was 7800 mother-child pairs. The study concluded that the likelihood of maternofetal transmission of HIV decreased by approximately 50% with elective cesarean section as compared with other modes of delivery. The addition of antiretroviral therapy during prenatal, intrapartum, and neonatal periods to women undergoing cesarean section reduced the risk of maternofetal transmission by approximately 87%. The problem with this analysis was that the majority of studies were performed prior to the use of highly active antiretroviral therapy and without any data concerning maternal viral load. Given these data, ACOG published a committee opinion, which can be summarized as follows:

1. In patients with HIV who did not take antiretroviral therapy, the risk of vertical transmission is 25%.
2. The addition of zidovudine decreases the risk to 5–8%.
3. If a cesarean section is performed, the risk is approximately 2%.
4. A similar risk of 2% or less is seen among women with viral loads <1000 copies/mL. Women whose viral loads are >1000 copies/mL should be counseled regarding the potential benefit of scheduled cesarean section.

Viral load should be measured to assist the obstetrician in planning the route of delivery.<sup>150</sup>

### Cocaine Abuse

The consequences of acute and chronic cocaine abuse must be considered in the obstetric population because of the prevalence of abuse in women of childbearing age. Overall approaches to the perioperative management of substance abuse are provided in Chapter 23; this brief review focuses on the special concerns that affect the parturient and potentially her child. Cocaine is derived from the *Erythroxylon*

*coca* plant. It is taken intravenously, intranasally, or orally. “Crack” is a form of cocaine that is smoked. Cocaine produces sympathetic stimulation by blocking the presynaptic reuptake of norepinephrine, dopamine, and serotonin. This pathophysiology explains the hypertension and tachycardia frequently seen following acute use. In fact, it is difficult to differentiate preeclampsia from acute cocaine use based upon physiologic variables.<sup>151</sup> Urine testing for protein differentiates the two. The reported use of cocaine in the United States is approximately 1% but may be as high as 10% in an inner-city population.<sup>152</sup> In addition to its cardiovascular effects, maternal ingestion of cocaine is associated with premature labor, placental abruption, nonreassuring fetal heart rate, and uterine rupture.<sup>153</sup> Cocaine rapidly crosses the placenta, resulting in a high incidence of fetal anomalies.<sup>154</sup> Cocaine use is associated with thrombocytopenia.<sup>155</sup> Propranolol is contraindicated in patients with hypertension from acute cocaine use because of unopposed  $\alpha$ -adrenergic stimulation. Labetalol or hydralazine is acceptable.<sup>156</sup> The American Heart Association recommends nitroglycerin and benzodiazepines as first-line agents for patients experiencing cocaine-related myocardial ischemia.<sup>157</sup> For hypotension, ephedrine may not be effective because of depletion of catecholamines. Phenylephrine would be effective.<sup>158</sup>

### PUTTING IT ALL TOGETHER

Unlike other patients, evaluation of the parturient involves two patients, the mother and the fetus. Optimal care of the mother provides the best care for the fetus. The parturient undergoes various physiologic changes that vary depending upon gestation. These changes must be considered when devising an anesthetic plan. These changes also must be considered when the parturient has an underlying disease. These diseases and conditions can worsen during pregnancy, ultimately resulting in deterioration of the mother's health. These changes also have implications in the pharmacologic management. The anesthesia provider must clearly understand that pregnant patients are at increased risk for aspiration of gastric contents. Preterm labor does not en-

tail increased risk to the mother; rather, it carries significant risk to the fetus. However, the use of tocolytic agents places the mother at risk. Magnesium sulfate remains the cornerstone of seizure prophylaxis in patients with preeclampsia. It potentiates depolarizing and nondepolarizing muscle relaxants. Although one of the most challenging aspects of anesthesia is the parturient, it is also one of the most rewarding.

## KEY REFERENCES

1. Ananth CV, Oyelese Y, Yeo L, et al. Placental abruption in the United States, 1979 through 2001: temporal trends and potential determinants. *Am J Obstet Gynecol* 1998; 261:193.
2. Berkman ND, Thorp JM Jr, Lohl KN, et al. Tocolytic treatment for the management of preterm labor: a review of the evidence. *Am J Obstet Gynecol* 2002;186:587.
3. Bonnin M, Mercier FJ, Sitbon O, et al. Severe pulmonary hypertension during pregnancy. *Anesthesiology* 2005;102:1133.
4. Czeizel AE, Pataki T, Rockenbauer M. Reproductive outcome after exposure to surgery under anesthesia during pregnancy. *Arch Gynecol Obstet* 1998;261:193.
5. Kain ZN, Mayes LC, Ferris CA, et al. Cocaine-abusing parturients undergoing cesarean section: a cohort study. *Anesthesiology* 1996;85: 1028.
6. Kwon H, Belanger K, Bracken B. Effect of pregnancy and stage of pregnancy on asthma severity: a systematic review. *Am J Obstet Gynecol* 2004;104:65.
7. Lie RT, Rasmussen S, Brumborg H, et al. Fetal and maternal contributions to risk of preeclampsia: population based study. *BMJ* 1998; 316:1343.
8. Macones GA, Parry S, Elsousy M, et al. A polymorphism in the promoter region of TNF and bacterial vaginosis: preliminary evidence of gene-environment interaction in the etiology of spontaneous preterm birth. *Am J Obstet Gynecol* 2004;190:1504.

9. Pilkington S, Carli F, Dakin MJ, et al. Increase in Mallampati score during pregnancy. *Br J Anaesth* 1995;74:638.

10. Siu SC, Sermer M, Colam JM, et al. Prospective multicenter study of pregnancy and outcomes in women with heart disease. *Circulation* 2001;104:515.

11. Wang SM, Sexinno P, Maranets I, et al. Low back pain during pregnancy: prevalence, risk factors, and outcomes. *Obstet Gynecol* 2004; 104:65.

## REFERENCES

1. Capeless EL, Clapp JF. Cardiovascular changes in early phase of pregnancy. *Am J Obstet Gynecol* 1989;161:1449.
2. Clapp JF. Maternal heart rate in pregnancy. *Am J Obstet Gynecol* 1985;152:659.
3. Sarfat R, Maechaud M, Magnin G. Comparison of blood loss during cesarean section and during vaginal delivery with episiotomy. *J Gynecol Obstet et Biol Reprod* 1999;28:48.
4. Leighton BL, Norris MC, DeSimone CA, et al. Pre-eclamptic and healthy term pregnant patients have different chronotropic responses to isoproterenol. *Anesthesiology* 1990;72:392.
5. Gant NF, Daley GL, Chand S, et al. A study of angiotensin II pressor response throughout primigravid pregnant. *J Clin Invest* 1973;52:2682.
6. Howard BK, Goodson JH, Mengert WF. Supine hypotension syndrome in late pregnancy. *Obstet Gynecol* 1953;1:371.
7. Lees MM, Taylor SH, Scott DB, et al. A study of cardiac output at rest throughout pregnancy. *J Obstet Gynaecol Br Commonw* 1967;74:319.
8. Uleland K, Novy MJ, Peterson EN, et al. Maternal cardiovascular dynamics. IV. The influence of gestational age on the maternal cardiovascular response to posture and exercise. *Am J Obstet Gynecol* 1969;104: 856.
9. Enein M, Zina AA, Kassem M, et al. Echocardiography of the pericardium in pregnancy. *Obstet Gynecol* 1987;69:851.
10. Dobb G. Laryngeal oedema complicating obstetric anaesthesia. *Anaesthesia* 1978;33:839.
11. Pilkington S, Carli F, Dakin MJ, et al. Increase in Mallampati score during pregnancy. *Br J Anaesth* 1995;74:638.
12. Ezri T, Szmuk P, Evron S, et al. Difficult airway in obstetric anesthesia: a review. *Obstet Gynecol Survey* 2001;56:631.
13. Archer GW, Marx GF. Arterial oxygen tension during apnoea in parturient women. *Br J Anaesth* 1974;46:358.
14. Varner MW. Physiologic changes in normal pregnancy. *Iowa Perinatol Lett* 1985;6:1.
15. Cotton DB, Gonik B, Spillman T, et al. Intrapartum post-partum changes in colloid osmotic pressure. *Am J Obstet Gynecol* 1984;149:174.
16. Shnider SM. Serum cholinesterase activity during pregnancy, labor, and puerperium. *Anesthesiology* 1965;26:335.
17. Leighton BL, Cheek TG, Gross JB, et al. Succinylcholine pharmacodynamics in peripartum patients. *Anesthesiology* 1986; 64:202.
18. Hellgren M. Hemostasis during normal pregnancy and puerperium. *Semin Thromb Hemost* 2003;29:125.
19. Bernasko J. Contemporary management of type I diabetes mellitus in pregnancy. *Obstet Gynecol Surv* 2004;59:628.
20. Cararach V, Carmona F, Monleon FJ, et al. Pregnancy after renal transplantation: 25 years experience in Spain. *Br J Obstet Gynaecol* 1993;100:122.
21. Palahniuk RJ, Shnider SM, Eger EI. Pregnancy decreases the requirements for inhaled anesthetic agents. *Anesthesiology* 1974;41:82.
22. Abboud TK, Zhu J, Richardson M, et al. Desflurane: a new volatile anesthetic for cesarean section. Maternal and neonatal effects. *Acta Anaesthesiol Scand* 1995;39: 723.
23. Preckel B, Bolten J. Pharmacology of modern volatile anaesthetics. *Best Pract Res Clin Anaesthesiol* 2005;19:331.
24. Datta S, Lambert DH, Gregus J, et al. Differential sensitivities of mammalian nerve fibers during pregnancy. *Anesth Analg* 1983;62:1070.
25. Fagraeus L, Urban B, Bromage P. Spread of epidural analgesia in early pregnancy. *Anesthesiology* 1983;58:184.
26. Curtin SC. Recent changes in birth attendant, place of birth, and the use of obstetric interventions: United States, 1989-1997. *J Nurse Midwifery* 1999;44:349.
27. Goodlin RC. History of fetal monitoring. *Am J Obstet Gynecol* 1979;133:323.
28. Kelso IM, Parsons RJ, Lawrence GF, et al. An assessment of continuous fetal heart rate monitoring in labor: a randomized trial. *Am J Obstet Gynecol* 1978;131:526.
29. Luthy DA, Shy KK, Van Belle G, et al. A randomized trial of electronic fetal monitoring in preterm labor. *Obstet Gynecol* 1987;69:687.
30. Pearson JF, Weaver JB. Fetal activity and fetal well-being: an evaluation. *BMJ* 1976;1:1305.
31. Evertson LR, Gauthier RJ, Schiffrin BS, et al. Antepartum fetal heart rate testing: evolution of the nonstress test. *Am J Obstet Gynecol* 1979;133:29.
32. Huddleston JF, Sutliff G, Robinson D. Contractions stress test by intermittent nipple stimulation. *Obstet Gynecol* 1984;63:669.



33. Freeman RK, Anderson G, Dorchester W. A prospective multi-institutional study of antepartum fetal monitoring. Risk of perinatal mortality and morbidity according to antepartum fetal heart rate tests. *Am J Obstet Gynecol* 1982;143:771.
34. Manning FA, Morrison I, Lange IR, et al. Fetal biophysical profile scoring: selective use of the nonstress test. *Am J Obstet Gynecol* 1987;156:709.
35. Kim SY, Shandelwal M, Gaughan JP, et al. Is the intrapartum biophysical profile useful. *Obstet Gynecol* 2003;102:471.
36. Reuwer PJ, Bruinse HW, Stoutenbeek T. Doppler assessment of the fetoplacental circulation in normal and growth-retarded fetuses. *Eur J Obstet Gynecol Reprod Biol* 1984;18:199.
37. Vintzileos AM, Nioka S, Lake M, et al. Transabdominal fetal pulse oximetry with near-infrared spectroscopy. *Am J Obstet Gynecol* 2005;192:129.
38. Martin JA, Hamilton BE, Sutton PD, et al. Births: Final Data for 2002; National Vital Statistics Reports, Vol. 52, No 10. Hyattsville, MD: National Center for Health Statistics, 2003.
39. Hack M, Fanaroff AA. Outcomes of extremely immature infants: a perinatal dilemma. *N Engl J Med* 1993;329:1649.
40. McCormick MC. The contribution of low birth weight to infant mortality and childhood morbidity. *N Engl J Med* 1985;312:82.
41. St. John EB, Nelson KG, Cliver SP, et al. Cost of neonatal care according to gestational age at birth and survival status. *Am J Obstet Gynecol* 2000;182:170.
42. Goldenberg RL, Hauth JC, Andrews WW. Intrauterine infection and preterm delivery. *N Engl J Med* 2000;342:1500.
43. Hauth JC, Goldenberg RL, Andrews WW, et al. Reduced incidence of preterm delivery with metronidazole and erythromycin in women with bacterial vaginosis. *N Engl J Med* 1995;333:1732.
44. McDonald HM, O'Loughlin JA, Vignoswaran L, et al. Impact of metronidazole therapy on preterm birth in women with bacterial vaginosis flora: a randomized, placebo controlled trial. *Br J Obstet Gynaecol* 1997;104:139.
45. Macones GA, Parry S, Elsouly M, et al. A polymorphism in the promoter region of TNF and bacterial vaginosis: preliminary evidence of gene-environment interaction in the etiology of spontaneous preterm birth. *Am J Obstet Gynecol* 2004;190:1504.
46. Romero R, Kuivaniemi H, Tromp G. Functional genomics and proteomics in term and preterm parturition. *J Clin Endocrinol Metab* 2002;87:2431.
47. Ingemarrson I, Lamont RF. An update on the controversies of tocolytic therapy for the prevention of preterm birth. *Acta Obstet Gynecol Scand* 2003;82:1.
48. Berkman ND, Thorp JM Jr, Lohr KN, et al. Tocolytic treatment for the management of preterm labor: a review of the evidence. *Am J Obstet Gynecol* 2002;186:587.
49. ACOG Practice Bulletin No 43: Management of preterm labor, vol. 101. *Obstet Gynecol* 2003;5:1039.
50. Crowther CA, Hiller JE, Doyle LW. Magnesium Sulphate for Preventing Preterm Birth in Preterm Labour. The Cochrane Library 2004, Issue 3. Chichester, UK: John Wiley & Sons, 2004.
51. Crowther CA, Hiller JE, Doyle WW, Hakan RR. Effect of magnesium sulphate given for neuroprotection before preterm birth: a randomized controlled trial. *JAMA* 2003;290:2669.
52. King TF, Flenady V, Papatsonis D, et al. Calcium channel blockers for inhibiting preterm labour: a systematic review of the evidence and a protocol for administration of nifedipine. *Aust N Z J Obstet Gynaecol* 2003;43:192.
53. Moise KJ. The effect of advancing gestational age on the frequency of ductal constriction secondary to maternal indomethacin use. *Am J Obstet Gynecol* 1993;168:1350.
54. Romero R, Sibai BM, Sanchez-Ramos L, et al. An oxytocin receptor antagonist (atosiban) in the treatment of preterm labor: a randomized, double blind, placebo-controlled trial with tocolytic rescue. *Am J Obstet Gynecol* 2000;182:1173.
55. Sanches Ramos L, Kiunitz AM, Gauder Fl, et al. Efficacy of maintenance therapy after acute tocolysis: a meta-analysis. *Am J Obstet Gynecol* 1999;181:484.
56. Sibai B, Dakker G, Kupferminc M. Preeclampsia. *Lancet* 2005;365:785.
57. Report of the National High Blood Pressure Education Program. Working group report on high blood pressure in pregnancy. *Am J Obstet Gynecol* 2000;183:S1.
58. Hauth JC, Ewell MG, Levine RL, et al. Pregnancy outcomes in healthy nulliparous women who subsequently developed hypertension. *Obstet Gynecol* 2000;95:24.
59. Sibai BM. Diagnosis and management of gestational hypertension and preeclampsia. *Obstet Gynecol* 2003;102:181.
60. Lie RT, Rasmussen S, Brumborg H, et al. Fetal and maternal contributions to risk of preeclampsia: population based study. *BMJ* 1998;316:1343.
61. Skjaerven R, Vatten LJ, Wilcox AJ, et al. Recurrence of preeclampsia across generations: exploring fetal and maternal genetic components: a population based cohort. *BMJ* 2005;331:877.
62. Redman CWG, Sargent IL. Preeclampsia, the placenta, and the maternal systemic inflammatory response—a review. *Placenta* 2003;24:S21.
63. Wang JX, Knottnerus AM, Schuit G, et al. Surgically obtained sperm and risk of gestational hypertension and preeclampsia. *Lancet* 2002;359:673.
64. Lucas MJ, Leveno KJ, Cunningham FG. A comparison of magnesium sulfate with phenytoin for the prevention of eclampsia. *N Engl J Med* 1995;333:201.
65. Belfort M, Anthony J, Saade G, et al. A comparison of magnesium sulfate and nifedipine for the prevention of eclampsia. *N Engl J Med* 2003;348:304–311.
66. Magpie Trial Collaborative Group. Do women with preeclampsia and their babies benefit from magnesium sulfate? The Magpie Trial: a randomized placebo-controlled trial. *Lancet* 2002;359:1877.
67. Livingston JC, Livingston LW, Ramsey R, et al. Magnesium sulfate in women with mild preeclampsia: a randomized controlled trial. *Obstet Gynecol* 2003;101:217.
68. Witlin AG, Friedman SA, Sibai BM. The effect of magnesium sulfate on the duration of labor in women with mild preeclampsia: a randomized double blind placebo controlled trial. *Am J Obstet Gynecol* 1997;176:623.
69. Caritis S, Sibai B, Lindheimer MD, et al. Low dose aspirin to prevent preeclampsia in women at high risk. *N Engl J Med* 1998;338:701.
70. Coomarasamy A, Honest H, Papacoanou S, et al. Aspirin for prevention of preeclampsia in women with historical risk factors: a systematic review. *Obstet Gynecol* 2003;101:1319.
71. Abalos E, Duley L, Steyn DW, et al. Antihypertensive drug therapy for mild to moderate hypertension during pregnancy. *Cochrane Database Syst Rev* 2001;1:2252.
72. Magee LA, Chen C, Waterman EJ, et al. Hydralazine for treatment of severe hypertension in pregnancy: meta-analysis. *BMJ* 2003;327:955.
73. Lindheimer MD, Katz AI. Current concepts: hypertension in pregnancy. *N Engl J Med* 1985;313:675.
74. Graham C, Goldstein A. Epidural analgesia and cardiac output in severe preeclampsia. *Anaesthesia* 35:709 1980.
75. Newsome LR, Bramwell Rs, Curling PE. Severe preeclampsia: hemodynamic effects of lumbar epidural anesthesia. *Anesth Analg* 1986;65:31.
76. Jouppila P, Jouppila R, Hollmen A, et al. Lumbar epidural analgesia to improve intervillous blood flow during labor in severe preeclampsia. *Obstet Gynecol* 1982;59:158.
77. Abboud T, Artal R, Sarkis F, et al. Sympathoadrenal activity: maternal, fetal, and neonatal responses after epidural anesthesia in the preeclamptic patient. *Am J Obstet Gynecol* 1982;144:915.
78. Hodgkinson R, Husain FJ, Hayashi RH. Systemic and pulmonary blood pressure during caesarean section in parturients with gestational hypertension. *Can Anaesth Soc J* 1980;27:389.
79. Heller PJ, Scheider EP, Marx GP. Pharyngolaryngeal edema as a presenting symptom in preeclampsia. *Obstet Gynecol* 1983;62:523.
80. Pitkin R, Witte D. Platelet and leukocyte counts in pregnancy. *JAMA* 1979;242:2696.



81. O'Brien JR. Platelet count in normal pregnancy. *J Clin Pathol* 1976;29:174.
82. Rakocai I, Tallian R, Bagdany S, et al. Platelet life-span in normal pregnancy and pre-eclampsia as determined by a non-radioisotope technique. *Thromb Res* 1979;15:553.
83. Roberts WE, Perry KG Jr, Woods JB, et al. The intrapartum platelet count in patients with HELLP (hemolysis, elevated liver enzymes, and low platelets) syndrome: is it predictive of later hemorrhagic complications? *Am J Obstet Gynecol* 1994;171:799.
84. Chang J, Elam-Evans LD, Berg CJ. Pregnancy-related mortality surveillance—United States, 1991–1999. *MMWR Surveill Summ* 2003;52:1.
85. Pahlavan P, Nezhat C, Nezhat C. Hemorrhage in obstetrics and gynecology. *Curr Opin Obstet Gynecol* 2001;13:419.
86. Mousa HA, Alfirevic Z. Major postpartum haemorrhage. *Curr Opin Obstet Gynecol* 2001;13:595.
87. Ananth CV, Oyelese Y, Yeo L, et al. Placental abruption in the United States, 1979 through 2001: temporal trends and potential determinants. *Am J Obstet Gynecol* 2005;192:191.
88. Witlin AG, Saade GR, Mattar F, et al. Risk factors for abruption placentae and eclampsia: analysis of 445 consecutively managed women with severe preeclampsia and eclampsia. *Am J Obstet Gynecol* 1999;180:1322.
89. Nyburg DA, Cyn DR, Mack LA, et al. Sonographic spectrum of placental abruption. *AJR Am J Roentgenol* 1987;148:161.
90. Shnider SM, Webster GM. Maternal and fetal hazards of surgery during pregnancy. *Am J Obstet Gynecol* 1965;92:891.
91. Brodsky JB, Cohen EN, Brown BW Jr, et al. Surgery during pregnancy and fetal outcome. *Am J Obstet Gynecol* 1980;138:1165.
92. Duncan PG, Pope WD, Cohen MM, et al. Fetal risk of anesthesia and surgery during pregnancy. *Anesthesiology* 1986;64:790.
93. Mazze RI, Kallen B. Reproductive outcome after anesthesia and operation during pregnancy: a registry study of 5405 cases. *Am J Obstet Gynecol* 1989;161:1178.
94. Czeizel AE, Pataki T, Rockenbauer M. Reproductive outcome after exposure to surgery under anesthesia during pregnancy. *Arch Gynecol Obstet* 1998;261:193.
95. Kallen B, Mazze RI. Neural tube defects and first trimester operations. *Teratology* 1990;41:717.
96. Sylvester GC, Khoury MJ, Lu X, et al. First trimester anesthesia exposure and the risk of central nervous system defects: a population-based case-control study. *Am J Public Health* 1994;84:1757.
97. Kendrick JM, Woodard CB, Cross SB. Surveyed use of fetal and uterine monitoring during maternal surgery. *AORN J* 1995;62:360.
98. ACOG: Committee Opinion #284. Non-obstetric surgery in pregnancy. *Obstet Gynecol* 2003;102:431.
99. Siu SC, Sermer M, Colam JM, et al. Prospective multicenter study of pregnancy outcomes in women with heart disease. *Circulation* 2001;104:515.
100. Whittemore R, Hobbins J, Engle M. Pregnancy and its outcome in women with and without surgical treatment of congenital heart disease. *Am J Cardiol* 1982;50:641.
101. Siu SC, Sermer M, Harrison DA, et al. Risk and predictors for pregnancy-related complications in women with heart disease. *Circulation* 1997;96:2789.
102. Siu SC, Colman JM. Heart disease and pregnancy. *Heart* 2001;85:710.
103. Ben Farhet M, Ganra H, Betbout F, et al. Percutaneous balloon mitral commissurotomy during pregnancy. *Heart* 1997;1997;77:564.
104. Autore C, Conte MR, Piccininno M, et al. Risk associated with pregnancy in hypertrophic cardiomyopathy. *J Am Coll Cardiol* 2002;40:1864.
105. Shime J, Mocarski EJ, Hastins D, et al. Congenital heart disease in pregnancy: short- and long-term implications. *Am J Obstet Gynecol* 1987;156:313.
106. Veille JC. Peripartum cardiomyopathies: a review. *Am J Obstet Gynecol* 1984;148:805.
107. Elkayam U, Tummala PP, Rao K, et al. Maternal and fetal outcomes of subsequent pregnancies in women with peripartum cardiomyopathy. *N Engl J Med* 2001;344:1567.
108. Chaithiraphan V, Gowda RM, Khan IA, et al. Peripartum acute myocardial infarction: management perspective. *Am J Ther* 2003;10:75.
109. Bonnin M, Mercier FJ, Sitbon O, et al. Severe pulmonary hypertension during pregnancy. *Anesthesiology* 2005;102:1133.
110. Schatz M. The efficacy and safety of asthma medications during pregnancy. *Semin Perinatol* 2001;25:145.
111. Schatz M. Interrelationships between asthma and pregnancy: a literature review. *J Allergy Clin Immunol* 1999;103:S330.
112. Kwon H, Belanger K, Bracken B. Effect of pregnancy and stage of pregnancy on asthma severity: a systematic review. *Am J Obstet Gynecol* 2004;190:1201.
113. Harirah HM, Donia S, Masrallah F, et al. Effect of gestational age and position on peak expiratory flow: a longitudinal study. *Obstet Gynecol* 2005;105:372.
114. Sorensen TK, Dempsey JC, Xiao R, et al. Maternal asthma and risk of preterm delivery. *Ann Epidemiol* 2003;13:267.
115. Triche E, Saftlas A, Belanger K, et al. Association of asthma diagnosis, severity, symptoms, and treatment with risk of preeclampsia. *Obstet Gynecol* 2004;104:585.
116. Schatz M. Asthma during pregnancy: interrelationships and management. *Ann Allergy* 1992;68:123.
117. Liu S, Wen SW, Demissie L, et al. Maternal asthma and pregnancy outcomes: a retrospective cohort study. *Am J Obstet Gynecol* 2001;184:90.
118. Gluck JC, Cluck PA. Asthma controller therapy during pregnancy. *Am J Obstet Gynecol* 2005;192:369.
119. Busse WW. National Heart, Lung, and Blood Institute, National Asthma Education and Prevention Program, Asthma and Pregnancy Working Group. NAEP expert panel report. Managing asthma during pregnancy: recommendations for pharmacologic treatment—2004 update. *J Allergy Clin Immunol* 2005;115:34.
120. Dombrowski MP, Schatz M, Wise A, et al. Randomized trial of inhaled beclomethasone dipropionate versus theophylline for moderate asthma during pregnancy. *Am J Obstet Gynecol* 2004;190:737.
121. Rayburn WF, Atkinson BP, Gilbert D, et al. Short-term effects of inhaled albuterol on maternal and fetal circulations. *Am J Obstet Gynecol* 1994;171:770.
122. Kristiansson P, Svaerdsudd K, von Schoultz B. Back pain during pregnancy: a prospective study. *Spine* 1996;21:702.
123. Wang SM, Dexinno P, Maranets I, et al. Low back pain during pregnancy: prevalence, risk factors, and outcomes. *Obstet Gynecol* 2004;104:65.
124. Kristiansson P, Nilsson-Wikmar K, Von Schoultz B, et al. Back pain in in-vitro fertilized and spontaneous pregnancies. *Hum Reprod* 1998;91:182.
125. Bryhildsen J, Hansson A, Persson A, et al. Follow-up of patients with low-back pain during pregnancy. *Obstet Gynecol* 1998;91:182.
126. Borg-Stein J, Dugan S, Gruber J. Musculoskeletal aspects of pregnancy. *Am J Physical Med Rehabil* 2005;84:180.
127. Engalgau MM, Herman WH, Smith PJ, et al. The epidemiology of diabetes and pregnancy in the United States, 1988. *Diabetes Care* 1995;18:1029.
128. Mills JL, Simpson JL, Driscoll SG, et al. Diabetes in early pregnancy study: incidence of spontaneous abortion among normal women and insulin-dependent diabetic women whose pregnancies were identified within 21 days of conception. *N Engl J Med* 1988;319:1617.
129. Miller E, Hare JW, Cloherty JP, et al. Elevated maternal hemoglobin A1c in early pregnancy and major congenital anomalies in infants of diabetic mothers. *N Engl J Med* 1981;304:1331.
130. White P. Pregnancy complicating diabetes. *Am J Med* 1949;7:609.
131. Dewitt DE, Hirsch IB. Outpatient insulin therapy in type 1 and type 2 diabetes mellitus. *JAMA* 2003;289:2254.
132. Magee MS, Walden CE, Benedetti TJ, et al. Influence of diagnostic criteria on the incidence of gestational diabetes and perinatal morbidity. *JAMA* 1993;269:609.
133. Solomon CG, Willett WC, Carey VJ, et al. A prospective study of pregravid determinants of gestational diabetes mellitus. *JAMA* 1997;1997;278:1078.

134. Kim C, Newton KM, Knopp RH. Gestational diabetes and the incidence of type 2 diabetes. *Diabetes Care* 2002;25:1862.
135. Langer O, Conway DL, Berkus MD, et al. A comparison of glyburide and insulin in women with gestational diabetes mellitus. *N Engl J Med* 2000;343:1134.
136. Vanderpump MP, Tunbridge WM, French JM, et al. The incidence of thyroid disorders in the community: a twenty-year follow-up of the Wickham Survey. *Clin Endocrinol* 1995;43:55.
137. Fantz CR, Dagogo-Jack S, Ladenson JH, et al. Thyroid function during pregnancy. *Clin Chem* 1999;45:2250.
138. Davis LE, Leveno KJ, Cunningham FG. Hypothyroidism complicating pregnancy. *Obstet Gynecol* 1988;72:108.
139. Poppe K, Glinioer D. Thyroid autoimmunity and hypothyroidism before and during pregnancy. *Hum Reprod Update* 2003;9:149.
140. Goodwin TM, Montoro M, Mestman JH. Transient hyperthyroidism and hyperemesis gravidarum: clinical aspects. *Am J Obstet Gynecol* 1992;167:648.
141. Carranza-Lira S, Hernandez F, Sanchez M, et al. Prolactin secretion in molar and normal pregnancy. *Int J Gynaecol Obstet* 1998;60:137.
142. Center for Disease Control. Impact of HIV on women in the United States. Available at: <http://www.cdc.gov/ncidod>.
143. Watts DH. Effect of pregnancy. *J Acquir Immune Defic Syndr* 2005;38:S36.
144. Connor EM, Sperling RS, Gelber R, et al. Reduction of maternal-infant transmission of human immunodeficiency virus type 1 with zidovudine treatment. Pediatric AIDS clinical trials group protocol 076 study group. *N Engl J Med* 1994;331:1173.
145. Cooper ER, Nugent RP, Diaz C, et al. After AIDS clinical trial 076: the changing pattern of the zidovudine use during pregnancy and the subsequent reduction in vertical transmission of human immunodeficiency virus in a cohort of infected women and their infants. *J Infect Dis* 1996;174:1207.
146. Cooper ER, Charurat M, Mofenson L, et al. Combination antiretroviral strategies for the treatment of pregnant HIV-1 infected women and prevention of perinatal HIV-1 transmission. *J Acquir Immune Defic Syndr* 2002;29:484.
147. Kind C, Rudin C, Siegrist CA, et al. Prevention of vertical HIV transmission: additive protective effect of elective cesarean section and zidovudine prophylaxis. *AIDS* 1998;12:205.
148. Madelbrot L, Le Chenadec J, Berrebi A, et al. Perinatal HIV-1 transmission: interaction between zidovudine prophylaxis and mode of delivery in the French Perinatal Cohort. *JAMA* 1998;280:55.
149. The International Perinatal HIV Group. The mode of delivery and the risk of vertical transmission of human immunodeficiency virus type 1. *N Engl J Med* 1999;340:977.
150. The American College of Obstetricians and Gynecologists. Scheduled cesarean delivery and the prevention of vertical transmission of HIV infection. Committee opinion #234. Washington, DC: American College of Obstetricians and Gynecologists, 2000.
151. Mater C, Warren WB, Moomgy M, et al. Prevalence of use of cocaine and other substances in the obstetric population. *Am J Obstet Gynecol* 1990;63:797.
152. Towers CV, Pircon RA, Nageotte MP, et al. Cocaine intoxication presenting as preeclampsia and eclampsia. *Obstet Gynecol* 1993;81:545.
153. Moore TR, Sorg J, Miller J, et al. Hemodynamic effects of intravenous cocaine on the pregnant ewe and fetus. *Am J Obstet Gynecol* 1986;155:883.
154. Krishna RB, Levitz M, Cancis J. Transfer of cocaine by the perfused human placenta: the effect of binding to serum proteins. *Am J Obstet Gynecol* 1993;169:1418.
155. Abramowicz JS, Sherer DM, Woods JR Jr. Acute transient thrombocytopenia associated with cocaine abuse in pregnancy. *Obstet Gynecol* 1991;78:499.
156. Gay GR, Loper KA. The use of labetalol in the management of cocaine crisis. *Ann Emerg Med* 1988;17:282.
157. Anonymous. Guidelines 2000 for cardiopulmonary resuscitation and emergency cardiovascular care. Part 8. Advanced challenges in resuscitation: section 2; toxicology in ECC. The American Heart Association in collaboration with the International Committee on Resuscitation. *Circulation* 2000;102(S):1223.
158. Kain ZN, Mayes LC, Ferris CA, et al. Cocaine-abusing parturients undergoing cesarean section: a cohort study. *Anesthesiology* 1996;85:1028.

## CHAPTER 22

## Evaluation of the Obese Patient

Babatunde O. Ogunnaike, MD,  
and Charles W. Whitten, MD

374

## EVALUATION OF THE OBESE PATIENT

The worldwide epidemic of obesity is a key factor in the increased incidence of type 2 diabetes mellitus, and cardiovascular diseases, such as high blood pressure, and stroke.<sup>1</sup> Obesity is characterized by an abnormally high percentage of body weight as fat. Overweight is an increase in weight relative to a standard. Approximately 65% or two of every three adults in the United States is overweight or obese.<sup>2</sup>

The foundation for obesity usually is laid during childhood. At age 4, approximately 20% of obese adults probably were obese, and a morbidly obese adolescent has an up to 80% likelihood of being a morbidly obese adult.<sup>3</sup> Approximately 85% of the economic burden of obesity can be accounted for by obesity-related diseases (coronary artery disease, stroke, type 2 diabetes mellitus, hypertension, hyperlipidemia) and prescription drugs.<sup>4</sup> Obese people have a markedly decreased life expectancy.<sup>5</sup> Weight gain of more than 1 kg per year or more than 10 kg overall is associated with an increased risk to health.<sup>6</sup>

The anatomic distribution of body fat is associated with varying pathophysiologic consequences. Android (central) obesity is commonly seen in men and is associated with increased oxygen consumption and increased incidence of cardiovascular disease with a truncal or upper body distribution of the adipose tissue. Visceral fat is particularly associated with cardiovascular disease and ventricular dysfunction. Alcohol encourages deposition of central (android pattern) body fat. Gynecoid (peripheral) obesity, which typically is seen in women, locates adipose tissue predominantly in the hips, buttocks, and thighs. The adiposity of the gynecoid pattern is less closely associated with cardiovascular

disease because it is less metabolically active. Waist circumference (WC), waist-to-stature ratio (WSR), and waist-to-hip ratio (WHR) are body circumference (anthropometric) indices that identify patterns of obesity and correlate strongly with mortality and the

development of obesity-related diseases. Central adiposity contributes greatly to cardiovascular risk.<sup>7</sup> WC generally represents abdominal fat and is an independent predictor of disease. WC is best measured at either the umbilicus or at the narrowest circumference

## KEY POINTS

1. Expiratory reserve volume is the most sensitive indicator of the effect of obesity on pulmonary function testing.
2. Obesity is an independent risk factor for ischemic heart disease and eventual heart failure. Cardiovascular disease is strongly associated with central (android) distribution of fat. Angina may actually be a direct symptom of obesity because a significant number of obese patients with angina do not have demonstrable coronary artery disease.
3. Plasminogen activator inhibitor-1 (PAI-1), which is secreted by the endothelium, vascular smooth muscle cells, hepatocytes, and adipocytes is associated with visceral obesity and inhibits the fibrinolytic system. PAI-1 decreases fibrinolysis and increases the risk of coronary artery disease.
4. Gastric emptying is delayed in obese patients because of increased abdominal mass that causes antral distension, gastrin release, and a decrease in pH with parietal cell hypersecretion. However, emptying has been documented to be faster with high-energy-content intake such as fat emulsions, but residual volume is increased because of their larger gastric volume (up to 75% larger).
5. Rhabdomyolysis has been documented in morbidly obese patients undergoing prolonged procedures. Elevations in serum creatinine and creatine phosphokinase levels unexplained by other reasons and complaints of buttock, hip, or shoulder pain in the postoperative period should raise the suspicion of rhabdomyolysis.
6. Postoperative polyneuropathy, known as acute post-gastric reduction surgery neuropathy, could result from vitamin and nutrient deficiencies. Patients present with protracted postoperative vomiting, hypoflexia, and muscular weakness.
7. The magnitude of body mass index does not have much influence on the difficulty of laryngoscopy. Such difficulty correlates better with increased age, male sex, temporomandibular joint pathology, Mallampati classes 3 and 4, history of obstructive sleep apnea, and abnormal upper teeth. Neck circumference has been identified as the single biggest predictor of problematic intubation in morbidly obese patients.
8. Forearm blood pressure is a fairly good predictor of upper arm blood pressure in most patients; however, forearm measurements with a standard cuff may overestimate both systolic and diastolic blood pressures in obese patients.
9. Preoxygenation in the head-up or sitting position is more effective and provides the longest safe apnea period during induction of anesthesia in obese patients.
10. The head-elevated laryngoscopy position, or “ramped” position, significantly elevates the obese patient’s head, neck, upper body, and shoulders above the chest to a point where an imaginary horizontal line can be drawn from the sternal notch to the external ear to better improve laryngoscopy and intubation.
11. Positive end-expiratory pressure is the only ventilatory parameter that has consistently been shown to improve respiratory function in obese subjects, but it decreases venous return, cardiac output, and subsequent oxygen delivery.
12. The 400 J of energy on regular defibrillators is sufficient for the morbidly obese because their chest wall usually is not much thicker, but the higher transthoracic impedance from the fat may obligate several attempts.

TABLE 22-1.

## Disease Risk According to Waist Circumference

Body Mass Index (kg/m <sup>2</sup> )	Waist Circumference/Risk	
	Male: <102 cm Female: <88 cm Average Increased High Very high Extremely high	Male: ≥102 cm Female ≥88 cm Average Increased Very high Very high Extremely high
18.5–24.9		
25.0–29.9		
30.0–34.9		
35.0–39.9		
>40		

seen anteriorly. WC >102 cm (40 in) in men and 88 cm (35 in) in women increases the risk of obesity-related diseases, including cardiovascular diseases, diabetes mellitus, and dyslipidemia (Table 22-1). WHR >0.9 in women and >1.0 in men is associated with a higher risk of morbidity and mortality than is a more peripheral pattern of body fat distribution (WHR <0.75 in women and <0.85 in men). WSR is a simple yet effective anthropometric index in predicting a wide range of cardiovascular risk factors and related health conditions. It is recommended that a person's WC not exceed half the stature to minimize the incidence of these diseases.<sup>8</sup>

Ideal body weight (IBW) is the weight associated with the lowest mortality rate for a given height and gender. It is estimated using the Broca index: IBW (kg) = height (cm) - x, where x = 100 for adult males and 105 for adult females. Body mass index (BMI) is more appropriate for clinical use. It estimates the degree of obesity using the following equation:

$$\text{BMI} = \frac{\text{Weight (kg)}}{\text{Height (m)} \times \text{Height (m)}}$$

or

$$\text{BMI} = \frac{\text{Weight (lb)}}{\text{Height (in)} \times \text{Height (in)} \times 703}$$

BMI of 18.5–24.9 is within the normal weight range, BMI of 25.0–29.9 is overweight, and BMI >30 and >40 kg/m<sup>2</sup> are considered obesity and extreme obesity, respectively (Table 22-2). BMI reliably measures body fat, but it cannot distinguish overweight from overfat because heavily muscled people can be easily classified as overweight using BMI. A simplified formula that reverses the BMI equation can be used to estimate IBW by relating the “normal” BMI average of 22 (nor-

mal = 18.5–24.9) to a known height. The equation can then be rearranged to read: IBW = 22 × Height<sup>2</sup>. This equation yields weights that fall midway within the range of values obtained with other IBW formulae.<sup>9</sup>

## PATHOPHYSIOLOGY OF OBESITY (TABLE 22-3)

### Respiratory System

Morbidly obese patients have an increased work of breathing as a result of reduced chest wall compliance associated with accumulation of fat on the chest wall, diaphragm, and abdomen. There is some contribution from obesity-related respiratory muscle dysfunction. Decreases in functional residual capacity (FRC) and expiratory reserve volume (ERV) are the most commonly reported abnormalities of pulmonary function in obese subjects.<sup>10</sup> Decreased respiratory compliance leads to decreased FRC, vital capacity (VC), and total lung capacity (TLC). These parameters are significantly lower in individuals with upper body fat distribution (central obesity). The reduction in FRC is the result of decreased ERV. Reduction in ERV is the result of encroachment of abdominal contents on the diaphragm, de-

crease in respiratory system compliance by chest wall fat, and impairment of respiratory muscle strength. ERV is the most sensitive indicator of the effect of obesity on pulmonary function testing. Each kilogram of weight gained results in an approximately 26-mL reduction in VC.<sup>11</sup> Residual volume remains normal. Decreased FRC can result in lung volumes below closing capacity during normal tidal ventilation, leading to small airway closure, ventilation/perfusion mismatch, right-to-left shunting, and hypoxemia (Figure 22-1). Anesthesia worsens the situation such that up to a 50% reduction in FRC occurs in the obese anesthetized patient compared with 20% in the nonobese. Reduction in FRC impairs the ability of obese patient to tolerate even minimal periods of apnea, hence the rapid desaturation after induction of anesthesia despite adequate preoxygenation.

Obesity increases total oxygen consumption and carbon dioxide production even at rest. This is the result of metabolic activity of excess body fat and increased workload on supportive tissues. Minute ventilation needs to be increased to meet these requirements. The body increases cardiac output and alveolar ventilation in an attempt to meet these metabolic demands. Basal metabolic activity in relation to body surface area usually is within normal limits, and an increase in minute ventilation usually maintains normocapnia. The increase in minute ventilation requires an increase in oxygen consumption because most obese patients retain their normal response to hypoxemia and hypercapnia. Morbidly obese patients do extra work to maintain their augmented ventilation; therefore, they must dedicate a high percentage of their total oxygen utilization to perform respiratory work even during regular respiration.<sup>12</sup>

TABLE 22-2.

## Classifications of Obesity

Body Mass Index (kg/m <sup>2</sup> )	Description	Obesity Class
<18.5	Underweight	
18.5–24.9	Normal	
25.0–29.9	Overweight	
30.0–34.9	Obesity	I
35.0–39.9	Morbid Obesity	II
>40	Extreme obesity	III



TABLE 22-3.

## Medical Consequences of Obesity

System	Pathology
Respiratory	Obstructive sleep apnea, obesity hypoventilation syndrome, asthma, pulmonary hypertension
Cardiovascular	Arrhythmias, atherosclerosis, cardiac failure, coronary artery disease, peripheral vascular disease, sudden cardiac death, systemic hypertension, thromboembolism, varicose veins
Gastrointestinal	Colon cancer, gallbladder disease, gastroesophageal reflux disease, hernias, nonalcoholic fatty liver disease, nonalcoholic steatohepatitis
Endocrine/metabolic	Diabetes mellitus, dyslipidemia, hyperinsulinemia, hypothyroidism, insulin resistance, metabolic syndrome
Genitourinary	End-stage renal disease, macrosomia, menorrhagia, pre-eclampsia and eclampsia, prostate cancer, urinary incontinence
Neurologic	Carpal tunnel syndrome, pseudotumor cerebri, stroke
Hematology	Hypercoagulability, polycythemia
Musculoskeletal	Acanthosis nigricans, gout, osteoarthritis, rheumatoid arthritis
Psychology/psychiatry	Depression, reduced self-esteem, social stigma

Dynamic lung volumes, including the forced expiratory volume in 1 second ( $FEV_1$ ) and the forced vital capacity (FVC), decline with increasing body mass, resulting in an unchanged ratio of  $FEV_1/FVC$ . Significant hypoxemia is attributed in part to closure of depen-

dent airways within the range of normal tidal ventilation. Substantial weight loss results in gas exchange improvement as evidenced by an increase in  $PaO_2$ . Morbid obesity is associated with reductions in forced expiratory flow during midexpiratory phase ( $FEF_{25-75\%}$ ) and maximum voluntary ventilation (MVV), whereas the diffusing capacity remains normal.<sup>13</sup> MVV, an index of respiratory muscle strength, is decreased in extreme obesity. Respiratory muscle efficiency is suboptimal in obese patients. Inefficiency is suggested by a sharper increase in oxygen consumption during exercise when compared to nonobese patients. Supine position reduces FRC because of cephalad displacement of the diaphragm. This effect is exaggerated in the obese, leading to a further reduction in FRC, further small airway closure, and increased work of breathing. Clinically significant increases in intrapulmonary shunting and oxygen consumption have been documented in obese patients while they are changing from the sitting to the supine position. Chest wall and lung compliance both are decreased by fat accumulation on the thorax and abdomen. Increased pulmonary blood volume, which is part of an overall increase in total blood volume, partially explains the decreased lung compliance. Chronic hypoxemia causes polycythemia, which contributes to the increased blood volume. Morbidly obese patients who are breathing room

air have lower arterial oxygen tensions ( $PaO_2$ ) than that predicted for similarly aged nonobese subjects in both sitting and supine positions. Chronic hypoxemia eventually can lead to pulmonary hypertension and cor pulmonale.

### Obstructive Sleep Apnea

Many obese patients manifest the upper airway obstruction syndrome during sleep, which can be classified into three categories: obstructive sleep apnea, obstructive sleep hypopnea, and upper airway resistance. Features common to all three include disruption of sleep because of increased ventilatory effort in response to upper airway closure and daytime somnolence.

Obstructive sleep apnea (OSA) is defined as cessation of airflow for more than 10 seconds, five or more times per hour of sleep, despite continuous respiratory effort against a closed glottis, in combination with a decrease in arterial oxygen saturation of greater than 4% (Figure 22-2). Obstructive sleep hypopnea is a >50% decrease in airflow for >10 seconds, occurring  $\geq 15$  times per hour of sleep; it usually is associated with snoring and arterial oxygen desaturation >4%. The upper airway resistance syndrome is characterized by arousal in response to increased upper airway resistance without an elevated apnea-hypopnea index (AHI). AHI is the total number of apneas and hypopneas per hour and is used to quantify the severity of OSA.<sup>14</sup>

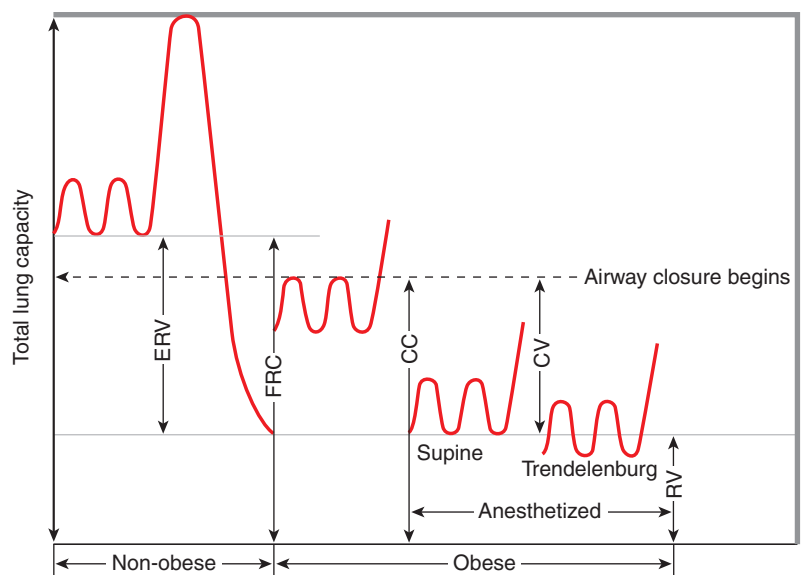
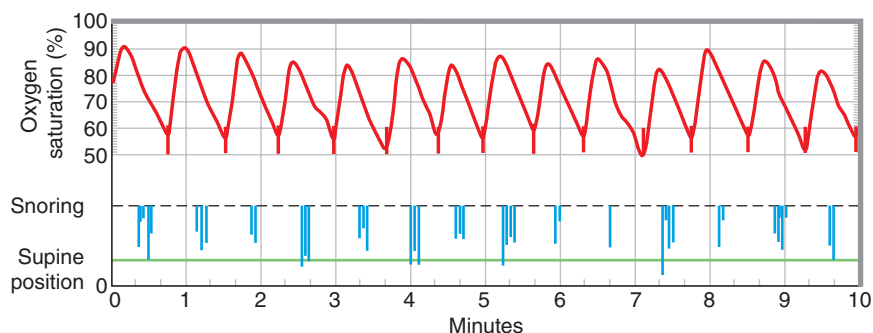


FIGURE 22-1. Effects of obesity, positioning, and anesthesia on lung volumes. CC, closing capacity; CV, closing volume; ERV, expiratory reserve volume; FRC, functional residual capacity; IRV, inspiratory reserve volume; RV, residual volume. (Modified from Ogunnaike and Whitten<sup>97</sup> with permission.)



**FIGURE 22–2.** Pattern of oxygen saturation in a patient with severe sleep apnea. The vertical lines below the oxygen saturation values indicate respiratory disturbances. Episodes of snoring are shown. Patient is in the supine position. (Flemons WW. Obstructive sleep apnea. *N Engl J Med* 2002;347:498. Copyright 2002, Massachusetts Medical Society. All rights reserved.)

AHI >30 signifies severe OSA, AHI of 5–15 defines mild OSA, and AHI of 16–30 defines moderate OSA. The total arousal index (AI) is the total number of arousals per hour. The sum of AHI and total AI is known as the respiratory disturbance index (RDI).

OSA is characterized by frequent episodes of apnea or hypopnea during sleep, snoring, and daytime somnolence, fatigue, reduced cognition, reduced intellectual function, impaired concentration, memory problems, personality and behavioral problems, and morning headaches. Predisposing factors to OSA include male gender, middle age, and obesity. Alcohol consumption or night sedation worsens the situation. BMI >30 kg/m<sup>2</sup> and collar size >16.5 inches correlate with severe OSA. Resulting physiologic abnormalities include hypoxemia, hypercapnia, and generalized (pulmonary and systemic) vasoconstriction. Secondary polycythemia as a result of recurrent hypoxemia increases the risk of cerebrovascular and ischemic heart disease. Right ventricular failure is a potential consequence of chronic hypoxic pulmonary vasoconstriction. The electrocardiographic (ECG) pattern of right ventricular hypertrophy (RVH) or echocardiographic evidence of hypofunction may be seen. Initially, respiratory acidosis occurs only during sleep, with return to normal homeostasis when awake. Hypoxemia during apnea can lead to bradycardia, long sinus pauses, second-degree heart block, and ventricular dysrhythmias with markedly increased severity if arterial oxygenation decreases below 60%. The higher incidence of nocturnal angina and myocardial infarction in OSA patients may be explained by the increased incidence of arrhyth-

mias in these patients. Up to 50% of OSA patients have diurnal systemic and pulmonary hypertension that likely is the result of repetitive increases in sympathetic tone accompanying each hypoxemic-hypercapnic arousal event which likely accounts for the high incidence of RVH and left ventricular hypertrophy (LVH) seen in OSA patients.<sup>15</sup> Activation of the sympathetic nervous system occurs in response to hypoxemia as a result of apneic and hypopneic events, which may explain the increased incidence of hypertension in obese OSA patients. Clinical diagnosis of OSA is made in a patient with obesity, snoring, apnea during sleep, periodic snorting, and apparent arousal (extremity movement, turning, and vocalization) and daytime somnolence or fatigue. Definitive diagnosis can be made only with a sleep study.

There is an inverse relationship between obesity and the pharyngeal area. The decreased pharyngeal area results from deposition of adipose tissue into pharyngeal tissues, including the uvula, tonsils, tonsillar pillars, tongue, aryepiglottic folds, and lateral pharyngeal walls (Figure 22–3). Fat deposition is most pronounced in the lateral pharyngeal walls, and its volume correlates with the severity of OSA. Weight loss improves the pharyngeal and glottic function of patients with OSA.<sup>15</sup> Decreased patency of the pharynx from increased fat deposition increases the likelihood that relaxation of the upper airway muscles will result in collapse of the soft-walled oropharynx between the uvula and the epiglottis. In obese patients, the upper airway can be compressed externally by superficially located fat masses, which increase the pharyngeal extraluminal

pressure. This situation is evidenced by a significantly larger neck in the obese patient with OSA when compared to those without OSA and the fact that the severity of OSA correlates better with larger neck circumference than with general obesity. Weight loss significantly reduces the severity of OSA.

Central depressant anesthetic drugs (benzodiazepines, opioids, and induction agents such as thiopental and propofol) reduce the action of pharyngeal dilator muscles, causing severe pharyngeal collapse in obese patients. Small precurarizing doses of muscle relaxants and nitrous oxide also reduce their action. Addition of opioids will depress ventilation and result in poor response to the ensuing hypoxemia and hypercapnia. OSA is associated with difficult mask ventilation and difficult laryngoscopy, which, when combined with decreased FRC and reduced oxygen stores, requires anticipation and preparation for airway difficulty.

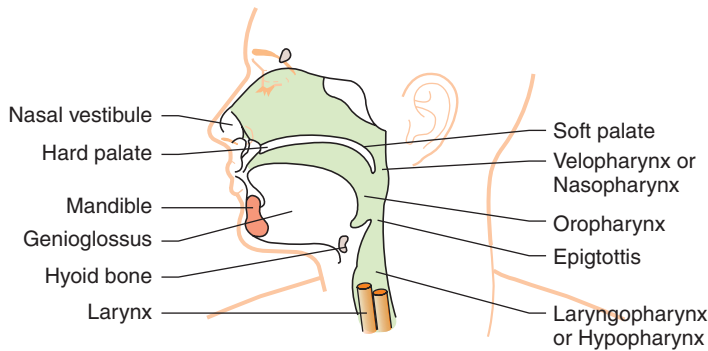
High leptin levels have been detected in patients with OSA independent of body fat content, which suggests that OSA may be associated with leptin resistance.<sup>16</sup> Leptin is a peptide secreted by white adipose tissue. It crosses the blood-brain barrier to reach the hypothalamus, where it modulates the neuroendocrine and autonomic nervous systems to decrease food intake and energy expenditure.

### Obesity-Hypoventilation Syndrome

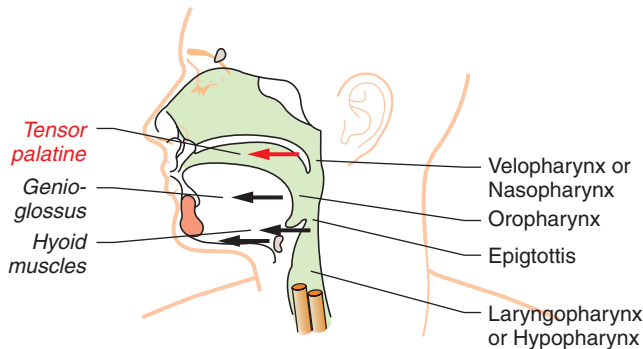
Obesity hypoventilation syndrome (OHS) is a combination of obesity and chronic hypoventilation that ultimately results in pulmonary hypertension and cor pulmonale.<sup>17</sup> It also can be defined as a combination of obesity (BMI >30 kg/m<sup>2</sup>) and awake arterial hypercapnia (Paco<sub>2</sub> >45 mm Hg) in the absence of known causes of hypoventilation. OHS is seen in up to 10% of morbidly obese patients. Clinical features are similar to those seen with OSA and include excessive daytime somnolence, fatigue, and morning headaches. In addition, daytime hypercapnia and hypoxemia are associated with pulmonary hypertension and right-sided congestive heart failure (cor pulmonale), resulting in substantial morbidity and mortality.<sup>18</sup>

OHS patients have an increased sensitivity to the respiratory depressant effects of general anesthetics. Epi-

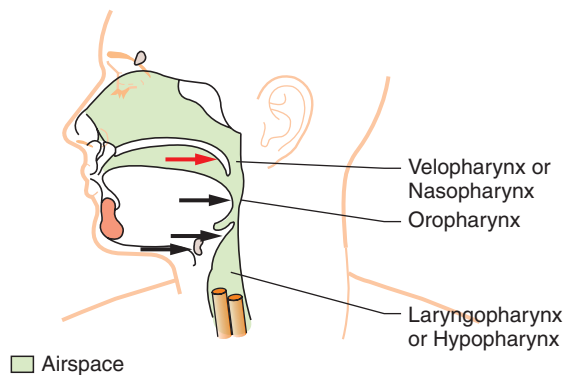
### Upper Airway Anatomy



### Action of the Upper Airway Dilator Muscles



### Sites of Obstruction During Sleep Apnea



**FIGURE 22-3.** Airway obstruction during sleep apnea. (Reprinted from Benumof JL. Obstructive sleep apnea in the adult obese patient: implications for airway management. *J Clin Anesth* 2001; 13:144, with permission from Elsevier.)

sodes of central apnea from progressive desensitization of respiratory centers to hypercapnia initially are limited to sleep but eventually leads to a progressive reliance on hypoxic drive for ventilation. Pickwickian syndrome,<sup>19</sup> characterized by obesity, hypersomnolence, hypoxia, hypercapnia, right ventricular failure, and polycythemia, is the end result of OHS. Pulmonary, metabolic, neuromuscular, and genetic diseases should

be excluded before making the diagnosis of OHS. Daytime hypoxemia and increased alveolar oxygen gradient found in these patients suggest that ventilation/perfusion inequalities as well as alveolar hypoventilation are an intrinsic part of this condition. Chronic daytime hypoxemia may be a better predictor of pulmonary hypertension and cor pulmonale than the presence and severity of OSA.<sup>20</sup> There is a strong correlation between increasing

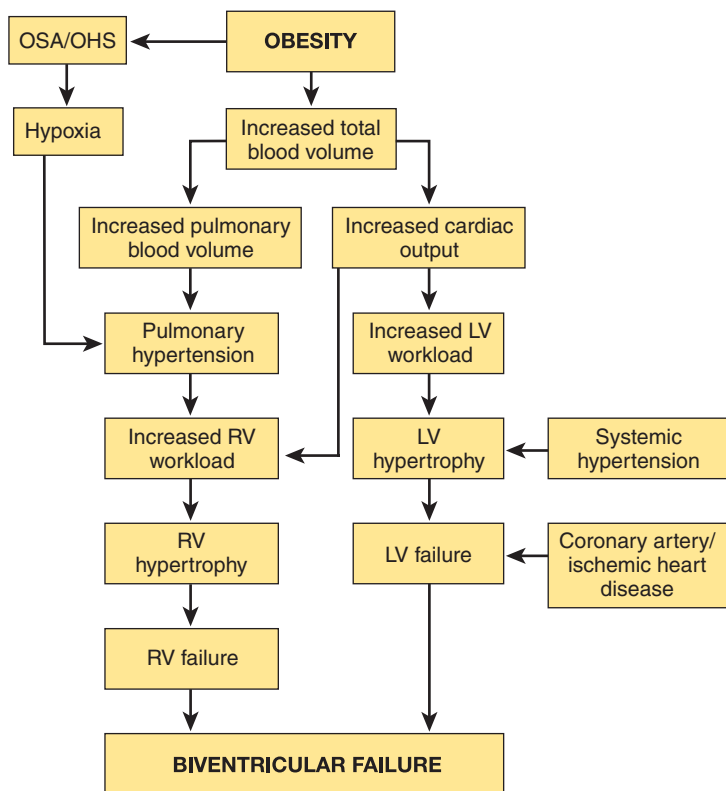
BMI > 40 kg/m<sup>2</sup> and the likelihood of developing OHS.<sup>21</sup> Many obese patients with OHS also have OSA, but the reverse is not always true, suggesting that OHS is an autonomous disorder.<sup>22</sup>

Arterial blood gas (ABG) analysis should be obtained in any morbidly obese patient with unexplained hypoxemia or features of cor pulmonale, because pulse oximetry detects oxyhemoglobin desaturation without considering contribution from hypercapnia. This results in inappropriate treatment with supplemental oxygen alone that does not reverse the hypoventilation.<sup>17</sup> An ABG confirms the presence of daytime hypercapnia and usually reveals compensated respiratory acidosis and hypoxemia. Elevated bicarbonate level is consistent with chronic hypercapnia.

Treatment of OHS with weight reduction, tracheostomy, or nocturnal positive-pressure support improves daytime hypercapnia and hypoxia without changing the abnormal ventilatory responses.

### Cardiovascular System

The increased morbidity and mortality of obesity largely result from cardiovascular problems, including hypertension, ischemic heart disease, cardiac failure, cardiomyopathy, arrhythmias, dyslipidemia, and sudden cardiac death.<sup>23</sup> Total blood volume is increased in the obese but is less than in nonobese individuals when compared on a volume-to-weight basis (50 mL/kg compared to 70 mL/kg). Most of the extra blood volume supplies adipose tissue. Excess adiposity requires an increase in cardiac output to parallel the increase in oxygen consumption, leading to a systemic arteriovenous oxygen difference that remains normal or slightly above normal. Cardiac output increases with increasing weight (20–30 mL/kg of excess adipose tissue) because of ventricular dilation and an increase in stroke volume. Left ventricular dilation results in increased left ventricular wall stress leading to eccentric hypertrophy that leads to reduced left ventricular compliance, impairment of left ventricular filling (diastolic dysfunction), elevation of left ventricular end-diastolic pressure (LVEDP), and eventual pulmonary edema. The dilated left ventricle has a limited capacity to hypertrophy so, when left ventricular wall thickening fails to keep pace with dilation, systolic dysfunction (“obe-



**FIGURE 22-4.** Interrelationship of cardiovascular and pulmonary sequelae of obesity. LV, left ventricle; OHS, obesity hypoventilation syndrome; OSA, obstructive sleep apnea; RV, right ventricle. (From Ogunnaike and Whitten<sup>97</sup> with permission.)

sity cardiomyopathy”) results with eventual biventricular failure (Figure 22-4). Increased workload on the heart is suggested by an increase in cardiac weight with increasing BMI. The increased cardiac work may result in cardiomyopathy and cardiac failure, independent of other coexisting diseases such as hypertension, diabetes mellitus, or atherosclerosis. Cardiac weight decreases with weight loss. Obese subjects compensate for the increased workload by utilizing cardiac reserve, especially in the presence of hypertension. Systemic vascular resistance (SVR) usually is within normal limits in morbidly obese patients, suggesting that hypertension and obesity can coexist with a normal SVR.

Obesity accelerates atherosclerosis; however, because of reduced mobility, morbidly obese patients appear asymptomatic in the face of significant cardiovascular disease; symptoms such as angina and exertional dyspnea occur only during periods of significant physical activity.<sup>24</sup> Cardiac output rises faster in response to exercise in the morbidly obese and often is associated with a rise in LVEDP and pulmonary capillary wedge pressure. Increase in cardiac output during exercise is achieved

by increases in heart rate without a concomitant increase in stroke volume or ejection fraction but with an increase in filling pressures. Similar changes occur during the perioperative period. The expanded blood volume of the obese patient is distributed between the peripheral and central circulations, with both ventricles distended at end-diastole leading to the increase in stroke volume. This situation accounts for the increased cardiac output and the consistent increase in left ventricular stroke work. With the exception of renal and splanchnic blood flows, which increase with obesity, organ blood flow does not change significantly because the additional cardiac output is diverted to perfuse excess fat. Blood volume and cardiac output are approximately twice the values predicted for those with IBW, but when they are normalized for body surface area, they are within normal limits or slightly below normal. The chronically elevated preload causes dilation and hypertrophy of the left ventricle (eccentric hypertrophy). Systolic performance as well as compliance will suffer as workload of the heart increases correspondingly. Chronical-

ly increased cardiac output and blood volume may cause SVR to increase over time. A high SVR and high preload combination may lead to early left ventricular dysfunction and congestive heart failure.

Obesity is an independent risk factor for ischemic heart disease (IHD) and eventual heart failure. Cardiovascular disease is strongly associated with central (android) distribution of fat. Angina may actually be a direct symptom of obesity given that a significant number of obese patients with angina do not have demonstrable coronary artery disease.<sup>25</sup> The risk of heart failure increases by 5% for men and 7% for women for every 1 kg/m<sup>2</sup> increment in BMI.<sup>26</sup> Coronary blood flow reserve in obese patients is limited because of ventricular mass and metabolic demands of the myocardium. Weight loss reduces left ventricular volume and diastolic pressures during exercise and at rest. Body oxygen consumption, blood volume, cardiac output, stroke volume, and blood pressure also decrease. Intraoperative cardiac failure can occur from rapid intravenous fluid administration (indicating left ventricular diastolic dysfunction), negative inotropy of anesthetic agents, or pulmonary hypertension precipitated by hypoxia or hypercapnia.

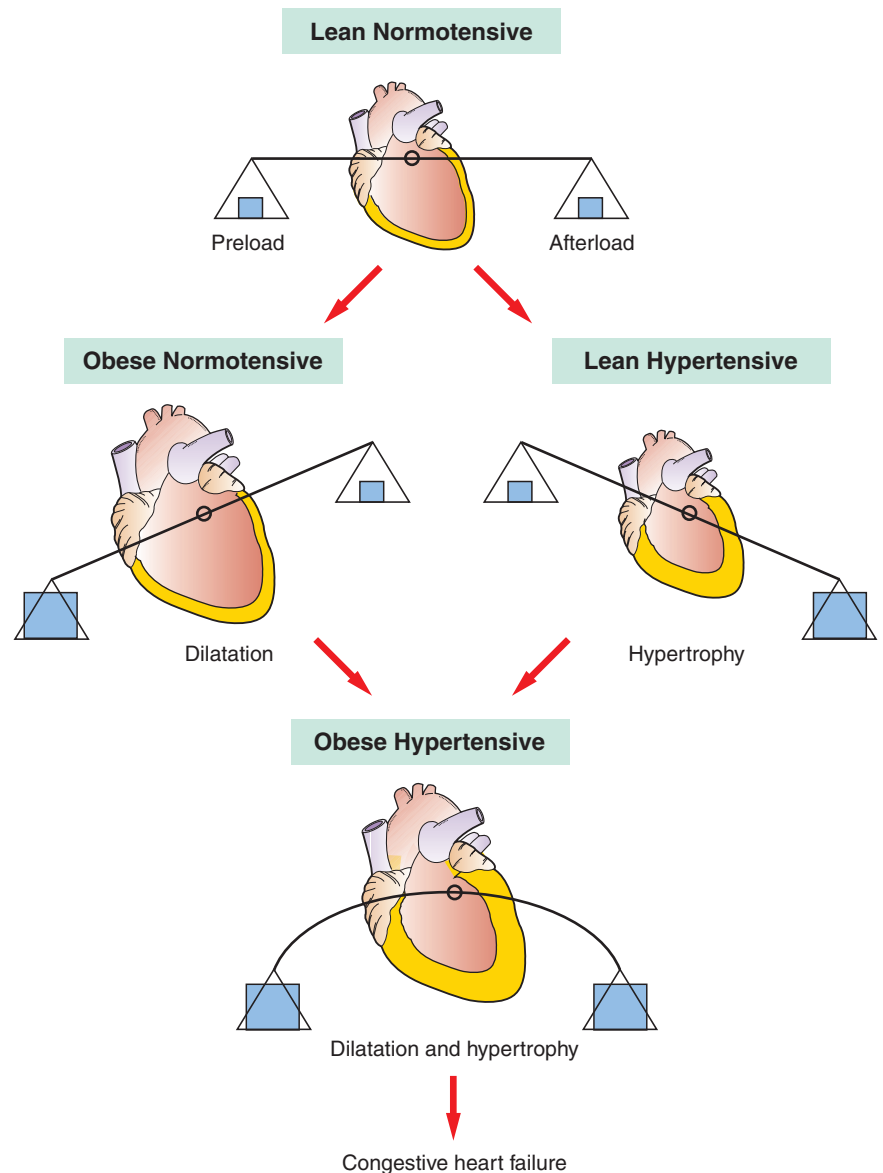
Cardiac arrhythmias can be precipitated by fatty infiltration of the conduction system, hypoxia, hypercapnia, electrolyte imbalance, coronary artery disease, increased circulating catecholamines, OSA, and myocardial hypertrophy. ECG findings frequently seen in morbidly obese patients include low QRS voltage, multiple criteria for LVH and left atrial enlargement, and T-wave flattening in the inferior and lateral leads.<sup>27</sup> In addition, there is a leftward shift of the P-wave, QRS complex, and T-wave axes, lengthening of the corrected QT interval, and prolonged QT interval duration. Substantial weight reduction can reverse many of these ECG abnormalities by shifting the mean P-wave, QRS, and T-wave axes rightward, significant reduction in the frequency of low QRS voltage, lower frequency of LVH, and marked decrease in T-wave flattening in the inferior and lateral leads.<sup>28</sup> Echocardiography usually shows increased cardiac output, increased LVEDP, and LVH in otherwise healthy obese subjects.

Mild to moderate hypertension is common in obese patients. Hyperten-



sion leads to a significant increase in cardiovascular mortality, especially in those with hypercholesterolemia or diabetes.<sup>29</sup> There is a 3–4 mm Hg increase in systolic arterial pressure and a 2 mm Hg increase in diastolic arterial pressure for every 10 kg of weight gained. Their expanded blood volume causes increased cardiac output with a lower calculated SVR for the same level of arterial blood pressure. The renin–angiotensin–aldosterone system (RAAS) has been implicated in the hypertension of obesity. Circulating levels of angiotensinogen, aldosterone, and angiotensin-converting enzyme (ACE) increase. As little as 5% reduction in body weight leads to a significant reduction in activity of the RAAS in both plasma and adipose tissue, contributing to a reduction in blood pressure.<sup>30</sup> With obesity, most tissues have a normal to increased level of sympathetic nervous system activity. An increased basal level of sympathetic activity predisposes to insulin resistance, dyslipidemia, and hypertension.<sup>31</sup> Obesity-induced insulin resistance enhances the pressor activity of norepinephrine and angiotensin II.<sup>29</sup> Hyperinsulinemia further activates the sympathetic nervous system causing sodium retention and contributing to the hypertension of obesity.<sup>32</sup> Hypertension causes concentric hypertrophy of the ventricle in normal-weight individuals but causes eccentric dilation in obese subjects.<sup>33</sup> It is associated with increased preload and stroke work. The combination of obesity and hypertension causes left ventricular wall thickening and a larger heart volume and, therefore, increased likelihood of cardiac failure (Figure 22–5).

A hypofibrinolytic and hypercoagulable state predisposes the obese patient to cardiovascular disease.<sup>34</sup> Obese patients have higher levels of fibrinogen (a marker for the inflammatory process of atherosclerosis), factor VII, factor VIII, von Willebrand factor, and plasminogen activator inhibitor-1 (PAI-1).<sup>34</sup> Increased fibrinogen, factor VII, and factor VIII levels and hypofibrinolysis as a result of increased PAI-1 levels are associated with hypercoagulability in obese patients. Significant decrease in fibrinogen concentration requires substantial (>40%) weight loss.<sup>35</sup> High factor VIII coagulant activity levels are associated with increased cardiovascular mortality.



**FIGURE 22–5.** Adaptation of the heart to obesity and hypertension. (Reprinted from Messerli FH. Cardiovascular effects of obesity and hypertension. *Lancet* 1982;1:1165, with permission from Elsevier.)

High fasting triglyceride levels also correlate with increased factor VII concentrations, whereas postprandial lipemia causes activation of factor VII. Factor VII levels are decreased by weight loss via a decrease in plasma triglyceride levels. Visceral (abdominal) fat is associated with increased levels of factor VIII and von Willebrand factor. Endothelial dysfunction induced by insulin increases von Willebrand factor and factor VIII levels, predisposing to fibrin formation. PAI-1 is secreted by the endothelium, vascular smooth muscle cells, hepatocytes, and adipocytes. Increased secretion of PAI-1 is associated with visceral obesity and inhibits the fibrinolytic system.

PAI-1 is a significant cardiovascular risk factor because it decreases fibrinolysis and increases the risk of coronary artery disease.<sup>36</sup>

### Gastrointestinal/Hepatic System

Gastric volume and acidity are increased, hepatic function altered, and drug metabolism adversely affected by obesity. A significant number of fasted morbidly obese patients have gastric volumes >25 mL and gastric pH <2.5, which are the generally accepted volume and pH indicative of high risk for pneumonitis in the event of regurgitation and aspiration. Gastric emptying can be delayed in obese

patients because of increased abdominal mass that causes antral distension, gastrin release, and a decrease in pH with parietal cell hypersecretion; however, emptying has been documented to be faster with high-energy-content intake such as fat emulsions, but residual volume is increased because of their larger gastric volume (up to 75% larger). Both faster gastric emptying and larger gastric volume can be partially reversed by weight loss.<sup>37</sup> Accelerated gastric emptying induces hunger and frequent eating by reducing the negative feedback satiety signal produced by the presence of nutrients inside the stomach, thus precipitating a feeling of hunger and shortening the interval between consecutive meals.<sup>38</sup>

An increased incidence of hiatal hernia and gastroesophageal reflux increases aspiration risk. Fasting, nonpremedicated, nondiabetic obese surgical patients who have no significant gastroesophageal pathology are not more likely to have high-volume, low-pH gastric contents than are lean patients at the time of general anesthetic induction after routine preoperative fasting.<sup>39</sup> They should follow the same guidelines as those used for nonobese patients and be allowed to drink clear liquids (up to 300 mL) until 2 hours before elective surgery, a quantity that has been shown not to adversely affect gastric pH and volume at induction of anesthesia.<sup>40</sup> There is a positive correlation between obesity and frequent gastroesophageal reflux disease (GERD) symptoms and between obesity and esophageal erosions.<sup>41</sup> One mechanism by which obesity increases the risk of GERD is via mechanical factors whereby abdominal obesity increases intragastric pressure, increasing the frequency of transient lower esophageal sphincter relaxation and/or formation of hiatal hernia. The risk of GERD symptoms, erosive esophagitis, and esophageal adenocarcinoma is increased with obesity when compared with normal BMI.<sup>42</sup> The increased risk of GERD with obesity is such that a  $>3.5$  kg/m<sup>2</sup> increase in BMI is associated with a 2.7-fold increase in risk for developing new reflux symptoms.<sup>43</sup> Weight loss, including that through surgery, significantly improves GERD symptoms.<sup>44</sup> The combination of hiatal hernia, gastroesophageal reflux, and delayed gastric emptying, coupled with increased intraabdominal pressure and a high-volume, low-pH gastric con-

tent, puts the obese at risk for increased incidence of severe pneumonitis should aspiration occur.

Peculiar morphologic and biochemical abnormalities of the liver associated with obesity include fatty infiltration, inflammation, focal necrosis, and cirrhosis. Fatty infiltration reflects the duration rather than the degree of obesity. Histologic and liver function test abnormalities are relatively common in the obese, but clearance usually is not reduced. Abnormal liver function tests are seen in up to one third of obese patients who have no evidence of concomitant liver disease; increased alanine aminotransferase (ALT) is most frequently seen. Weight loss results in sustained improvement in liver enzymes in direct proportion to the extent of weight reduction.<sup>45</sup> Despite these histologic and enzymatic changes, no clear correlation exists between routine liver function tests and the capacity of the liver to metabolize drugs.<sup>46</sup> Hepatic decompensation can occur after Roux-en-Y gastric bypass, which necessitates careful assessment for preexisting liver disease in candidates scheduled to undergo this procedure because of a high prevalence (63%) of nonalcoholic fatty liver disease (NAFLD) and cirrhosis.<sup>47</sup> Obesity is a major risk factor for NAFLD and nonalcoholic steatohepatitis (NASH). NAFLD is a group of liver abnormalities associated with obesity and insulin resistance. Hepatomegaly, elevated liver enzyme levels, and abnormal liver histology (including steatosis, steatohepatitis, fibrosis, and cirrhosis) are intrinsic components of this disease.<sup>48</sup> NAFLD is the most common liver disease worldwide. The more progressive forms of NAFLD, NASH, and associated hepatic fibrosis are strongly associated with obesity and the metabolic syndrome.<sup>49</sup> Up to 95% of morbidly obese patients have NASH.<sup>50</sup> NASH is an aggressive form of NAFLD that can progress to cirrhosis or hepatocellular carcinoma. Insulin resistance and features of metabolic syndrome are good predictors of NASH.<sup>51</sup> Fatty liver disease often represents the hepatic component of the metabolic syndrome characterized by obesity, hyperinsulinemia, peripheral insulin resistance, diabetes mellitus, hypertriglyceridemia, and hypertension.<sup>52</sup> Massive weight loss in nondiabetic, nonalcoholic morbidly obese subjects leads to significant improvement in NASH and

liver fibrosis.<sup>53</sup> Major improvements have been demonstrated in the biochemical and histologic features of liver disease associated with obesity and metabolic syndrome after surgical weight loss. Those with metabolic syndrome have greater initial histologic abnormalities and greater improvement with weight loss.<sup>54</sup>

The incidence of gallbladder disease, including cholelithiasis, is significantly increased in morbidly obese subjects; the relative risk appears to be positively correlated with increasing BMI.<sup>55</sup> Obesity, particularly in male patients, results in earlier onset of biliary disease and an increase in its prevalence.<sup>55</sup> After intestinal bypass surgery, patients have a particularly high prevalence of hepatic dysfunction and cholelithiasis; abnormal cholesterol metabolism is partially to blame.

### Renal, Endocrine, and Metabolic Systems

Impaired glucose tolerance in the morbidly obese is reflected by a high prevalence of type 2 diabetes mellitus as a result of the resistance of peripheral fatty tissues to insulin. The severity of diabetes mellitus depends on the degree and duration of the obesity. A significant number of obese patients have an abnormal glucose tolerance that predisposes them to wound infection and an increased risk of myocardial infarction.<sup>56</sup> Exogenous insulin may be required perioperatively to oppose the catabolic response to the stress of surgery, even in obese patients on oral hypoglycemic agents. Abnormal serum lipid profiles may explain the high prevalence of ischemic heart disease. Gastric bypass surgery improves or even cures type 2 diabetes mellitus by substantially improving insulin resistance through an unknown mechanism. Marked improvement in insulin resistance or complete loss of insulin resistance has been seen as early as 6 days following gastric bypass surgery; suggesting that bypass of the stomach and duodenum results in physiologic changes that either inhibit the stress response to surgery, or more likely, alleviate insulin resistance to such an extent that postsurgical insulin resistance is not manifest.<sup>57</sup>

Subclinical hypothyroidism occurs in approximately 25% of all morbidly obese patients.<sup>58</sup> Thyroid-stimulating hormone (TSH) levels are frequently elevated, suggesting the possibility that

obesity leads to a state of thyroid hormone resistance in peripheral tissues.<sup>59,60</sup> Hypothyroidism should be considered in any obese patient who displays perioperative cardiovascular or respiratory instability. Hypoglycemia, hyponatremia, and impaired hepatic drug metabolism are other adverse consequences of hypothyroidism. Reduction of thyroxine requirements is seen with a decrease in BMI.<sup>61</sup>

Obesity is a major risk factor for end-stage renal disease (ESRD) and essential hypertension. It induces high blood pressure through increased renal tubular sodium reabsorption, impaired pressure natriuresis, volume expansion resulting from activation of the sympathetic nervous system and renin-angiotensin system, and physical compression of the kidneys, especially when visceral obesity is present. Renal vasodilatation and glomerular hyperfiltration initially serve as compensatory mechanisms to maintain sodium balance in the face of increased tubular reabsorption. These changes, plus the increased systemic arterial pressure, create a hemodynamic burden on the kidneys leading to glomerular injury.<sup>62</sup> Chronic obesity results in increasing urinary protein excretion and gradual loss of nephron function that worsens with time and exacerbates hypertension. Kidney disease progresses much faster when type 2 diabetes mellitus and other metabolic problems supervene. Weight loss is an essential first step in managing the hypertension and renal disease of obesity. Obesity-related glomerular hyperfiltration decreases after weight loss, which decreases the incidence of overt glomerulopathy.<sup>63</sup> Up to a 10-fold increase in the biopsy incidence of obesity-related glomerulopathy has been documented.<sup>64</sup> Obesity-related glomerulopathy is defined as focal segmental glomerulosclerosis and glomerulopathy or glomerulopathy alone. Increased BMI in men is associated with an increased risk of development of ESRD, independent of blood pressure and proteinuria; maintenance of optimal body weight reduces the risk of ESRD.<sup>65</sup> Despite the negative association of obesity and kidney disease, a “reverse epidemiology” model has been documented in obese patients undergoing maintenance hemodialysis for ESRD whereby the association of obesity and renal disease occurs in the opposite direction, with obesity

conferring survival advantages to hemodialysis patients.<sup>66</sup>

### The Metabolic Syndrome

Obesity plays a major role in the development of the metabolic syndrome, a clinical entity resulting from the interaction of genetic, hormonal, and lifestyle factors. Components of the syndrome include insulin resistance, diabetes mellitus (or impaired glucose tolerance), hypertension, coronary artery disease, peripheral vascular disease, stroke, and hyperlipidemia.<sup>67</sup> The metabolic syndrome can be perceived as a prediabetes state because it takes into account the two major outcomes: cardiovascular disease and type 2 diabetes mellitus.<sup>68</sup> According to the International Diabetes Federation, a person diagnosed with metabolic syndrome must have central obesity (defined as WC >94 cm for men and >80 cm for women) plus any two of the following four factors<sup>69</sup>:

1. Raised serum triglyceride level ( $\geq 1.7$  mmol/L)
2. Reduced serum high-density lipoprotein (HDL) cholesterol level ( $< 1.03$  mmol/L in males and  $< 1.29$  mmol/L in females)
3. Raised blood pressure (systolic blood pressure  $\geq 130$  mm Hg or diastolic blood pressure  $\geq 85$  mm Hg) or treatment of previously diagnosed hypertension
4. Abnormal fasting plasma glucose level (fasting plasma glucose level  $\geq 5.6$  mmol/L) or previously diagnosed type 2 diabetes mellitus

The metabolic syndrome represents a cluster of the most dangerous heart attack risk factors, including diabetes (or prediabetes), abdominal obesity, changes in cholesterol level, and high blood pressure. People with this syndrome have up to a 5-fold greater risk of developing type 2 diabetes mellitus (if not already present). They are twice as likely to die from and three times more likely to have a heart attack or stroke compared to people without the syndrome.

Insulin resistance is associated with elevated plasma leptin levels independent of body fat mass. Leptin is a hormone secreted by the adipose tissue that binds to receptors in the hypothalamus to influence the normal regulation of body weight and energy expenditure. Obesity has been sug-

gested to be a leptin-resistant state given that leptin levels are elevated in most obese individuals.<sup>70</sup>

### PHARMACOLOGY

The pharmacokinetics of drugs in obese patients are significantly influenced by differences in tissue distribution, hemodynamics, and blood flow to adipose, splanchnic, and other tissues, plasma composition, or liver and kidney function.<sup>71</sup> The effect of obesity on the pharmacokinetic parameters of anesthetic drugs depends on lipid solubility and diffusion through body compartments and tissues. General pharmacokinetic principles dictate that drug dosing should take into consideration the volume of distribution ( $V_d$ ) for administration of the loading dose and the clearance for the maintenance dose.<sup>72</sup> The loading dose for a drug that is mainly distributed to lean tissues should be calculated based on IBW, whereas dosing should be calculated based on total body weight (TBW) if the drug is equally distributed between adipose and lean tissues. For maintenance, the maintenance dose for a drug with similar clearance values in both obese and nonobese individuals should be calculated based on IBW, whereas the maintenance dose for a drug whose clearance increases with obesity should be calculated according to TBW.

Changes in  $V_d$  correlate well with drug lipophilicity. Drugs with a high affinity for fat have an increased  $V_d$ , whereas drugs with low partition coefficients do not have significant alteration in  $V_d$ . The volume of the central compartment in which drugs are first distributed remains unchanged in obese patients, but absolute body water content is decreased and lean body adipose tissue mass is increased, affecting lipophilic and polar drug distribution. The  $V_d$  in obese patients is affected by reduced total body water, increased total body fat, increased lean body mass (LBM), altered protein binding, increased blood volume, increased cardiac output, increased serum concentrations of free fatty acids, triglycerides, cholesterol, and  $\alpha_1$ -acid glycoprotein, lipophilicity of the drug, and organomegaly.<sup>73</sup> Increased distribution of a drug prolongs its elimination half-life whether clearance remains the same or is increased. In general, more

lipophilic compounds are affected by obesity to a greater extent than are hydrophilic compounds. Lipophilic compounds are associated with increases in  $V_d$  with some exceptions, such as digoxin, procainamide, and cyclosporine, which are highly lipophilic substances but have comparable volumes of distribution in obese and nonobese subjects.<sup>73</sup>

Changes in concentration of plasma proteins or alterations in their affinity for substrate affect movement of drugs into tissue compartments.<sup>73</sup> The major plasma proteins are albumin (primarily responsible for binding acidic drugs),  $\alpha_1$ -acid glycoprotein (primarily responsible for binding basic drugs), and lipoproteins. Plasma protein binding of acidic drugs may decrease in an obese patient because of the obesity-associated decrease in albumin levels and an increase in concentration of  $\alpha_1$ -acid glycoprotein. Hyperlipidemia and an increased concentration of  $\alpha_1$ -acid glycoprotein affect protein binding and lead to a reduction in free drug concentration. Drugs that are primarily bound to albumin (e.g., thiopentone, phenytoin) show no significant changes in protein binding in obese individuals, whereas binding of drugs to  $\alpha_1$ -acid glycoprotein increases. Lipoprotein levels may be elevated in obese individuals because of higher triglyceride and cholesterol levels. Overall evidence suggests that plasma protein binding affinity may change in obesity without changes in protein concentrations.

As earlier mentioned, histologic and liver function abnormalities are common in the obese with concomitant deranged liver function tests; however, metabolism and clearance usually are not adversely affected. Drugs that undergo phase I metabolism (oxidation, reduction, hydrolysis) and acetylation (a phase II reaction) are generally unaffected by obesity-induced changes, whereas other phase II reactions (sulfation and glucuronidation) are enhanced. Renal clearance, glomerular filtration rate, and tubular secretion are increased, with tubular secretion disproportionately enhanced compared to glomerular filtration. Therefore, drugs that depend on the kidneys for elimination face consistently higher clearance rate in obese patients.<sup>74</sup> Orally administered medications are expected to have decreased bioavailability in obese patients because of increased splanchnic blood

flow, but no evidence suggests a significant difference in the absorption and bioavailability of orally administered drugs when comparing obese to nonobese subjects. Hemodynamic and regional blood flow changes resulting from obesity impact drug pharmacokinetics. Reduced cardiac performance from obesity itself further compromises tissue perfusion.<sup>72</sup>

Increase in LBM accounts for approximately 20–40% of an obese patient's increase in TBW; therefore, adding 20% to the estimated IBW is sufficient to include the extra lean mass. Nondepolarizing muscle relaxants can be dosed in this manner. Increased blood volume in the obese patient decreases the plasma concentrations of rapidly injected intravenous drugs. Fat, however, has poor blood flow; therefore, doses calculated on actual body weight could lead to excessive plasma concentrations. A reasonable approach is to calculate the initial doses based on IBW and subsequent doses determined by pharmacologic response to the initial dose. Repeated injections accumulate in fat, leading to prolonged response as a result of subsequent release from this large fat depot.

### SPECIFIC INTRAVENOUS AGENTS (TABLE 22-4)

#### Thiopental

Thiopental is highly lipophilic and has a larger  $V_d$  in obese patients; prolonged somnolence is expected. Increased blood volume, cardiac output, and muscle mass necessitate an increase in the initial induction dose. Thiopental pharmacokinetics are consistent, with easy and fast penetration through different tissue barriers and ultrashort-acting and high potency. The  $V_d$  is larger in obese than in nonobese patients, although elimination half-life is significantly longer in the obese. Obese patients require much less thiopental per body weight for induction than do nonobese patients. Both the terminal half-life and steady-state volume of distribution are increased. They are more sensitive to the effects of thiopental dosed according to TBW. Obese people should receive induction doses of thiopental adjusted to IBW.<sup>75</sup> Continuous infusion results in longer elimination half-life because of a larger  $V_d$ ; however, clearance remains unaltered.

#### Propofol

Propofol rapidly redistributes into inactive tissue depots, such as fat and muscle, after its initial rapid crossover into the blood-brain barrier and redistribution to the central nervous system. Both the  $V_d$  and clearance of propofol in obese and nonobese subjects correlate well with TBW without signs of accumulation and prolongation of action because the half-life is similar in obese and nonobese subjects as a result of the increase in both  $V_d$  and clearance.<sup>76</sup> These properties and the pharmacokinetic behavior of propofol suggest that both the induction and maintenance dosing for propofol in both obese and nonobese individuals should be based on TBW. However, the negative cardiovascular effects of large doses of propofol combined with the negative physiologic effects of obesity on the cardiovascular system should prompt a somewhat reduced total dose.

#### Midazolam

Significant increase in both  $V_d$  and elimination half-life has been demonstrated in obese patients, with good correlation between lipid solubility and distribution profile in adipose tissue. Midazolam is relatively shorter acting compared to other benzodiazepines; therefore, the intensity and duration of its sedative side effects after a single intravenous dose correlate better with the extent of distribution of the drug than on the rate of elimination and clearance.<sup>77</sup> The total  $V_d$  and elimination half-life of midazolam in the obese is up to three times larger and three times prolonged than in nonobese subjects with no difference in the clearance rates, suggesting that adiposity per se does not alter the capacity of the liver to metabolize midazolam. A single intravenous dose of midazolam should therefore be administered based on TBW, but continuous infusion dosing should be adjusted according to IBW rather than TBW. Even though midazolam is considered short acting, it has the potential to accumulate and cause prolonged sedation in obese patients because larger initial doses are required to achieve adequate serum concentrations.

#### Neuromuscular Blocking Agents

Muscle relaxants are polar and hydrophilic drugs that are distributed poorly



TABLE 22–4.

## Intravenous Drug Dosing in Obesity

Drug	Dosing	Comments
Thiopental	IBW (somewhat increased)	Increased $V_d$ , increased blood volume, cardiac output, and muscle mass. Increased absolute dose. Prolonged duration of action. Longer elimination half-life. Adjust loading/induction dose accordingly.
Propofol	Induction: TBW (somewhat reduced) Maintenance: TBW	Highly lipophilic. Total clearance and $V_d$ at steady state correlate well with TBW. Keep in mind negative cardiovascular effects. High affinity for well-perfused organs.
Midazolam	Loading dose: TBW (somewhat reduced) Maintenance infusion: IBW	Significant increase in $V_d$ and elimination half-life. Sedative effect correlates better with distribution than elimination/clearance. Prolonged sedation because higher loading dose is needed to achieve adequate serum concentration.
Succinylcholine	TBW	Larger extracellular fluid compartment in the obese. Pseudocholinesterase activity increases with increasing weight.
Rocuronium	IBW	Faster onset and longer duration when dosed according to TBW. Pharmacokinetics and pharmacodynamics not altered in obese subjects.
Vecuronium	IBW	Prolonged action when dosed according to TBW. Obesity does not alter distribution or elimination of the drug.
Atracurium	TBW	$V_d$ , absolute clearance, and elimination half-life unchanged by obesity. Unchanged dose per unit body weight prolongation of recovery because of organ-independent elimination.
Cisatracurium	IBW	Pharmacokinetics similar to atracurium but prolonged duration of action when dosed according to TBW.
Fentanyl	Derived “pharmacokinetic (PK) mass”	Measured total body clearance has a non-linear relationship to TBW. Fentanyl dosing based on pharmacokinetic mass correlates better with clearance. Dosing based on TBW overestimates dose requirements in the obese.
Sufentanil	Loading dose: TBW Maintenance: IBW	Increased $V_d$ and prolonged elimination half-life, which correlates with degree of obesity. Clearance similar in obese and nonobese. Overestimation of plasma concentration occurs in the morbidly obese range (BMI >40 kg/m <sup>2</sup> ).
Remifentanyl	IBW	Pharmacokinetics similar in obese and non-obese subjects. Systemic clearance and $V_d$ corrected per kg of TBW is significantly smaller in the obese. Consider age and lean body mass for dosing.
Dexmedetomidine	TBW	Lacks significant effect on respiration. Ideally suitable as an analgesic adjuvant in morbidly obese subjects in whom opioid-induced respiratory depression may be catastrophic.

BMI, body mass index; IBW, ideal body weight; TBW, total body weight;  $V_d$ , volume of distribution.

into excess adipose tissue. Obese individuals have a larger absolute LBM in conjunction with extra adipose tissue and a decreased proportion of muscle mass and body water when compared to nonobese subjects.<sup>46</sup> Drugs with weak or moderate lipophilicity have fairly predictable effects in obese patients because of their distribution mainly into lean tissues; therefore, they should be dosed based on IBW rather than TBW with the exception of succinylcholine.<sup>78</sup>

### Succinylcholine

Succinylcholine should be dosed based on TBW. Larger extracellular fluid compartment and a linear increase in pseudocholinesterase activity with weight gain necessitate an increase in succinylcholine dosage in obese patients. The potency estimates for succinylcholine in obese adolescents with BMI >30 kg/m<sup>2</sup> are similar to those of nonobese adolescents in the same age group when calculated based on TBW.<sup>79</sup>

### Nondepolarizing Muscle Relaxants

Nondepolarizing muscle relaxants should be administered according to LBM to prevent delayed recovery because of increased  $V_d$  and impaired hepatic clearance. The effects of obesity on the pharmacodynamics of nondepolarizing relaxants vary with the composition and distribution of body fat. There is no alteration in the pharmacokinetics of rocuronium in obese female patients when compared to normal weight patients; similarly, the  $V_d$ , distribution and elimination half-lives, plasma clearance, and mean residence are not different. Pharmacodynamic parameters of rocuronium, including onset time, duration, and recovery times, also are comparable.<sup>78</sup> The duration of action of rocuronium in obese patients is significantly longer when dosed according to TBW, prompting the recommendation that rocuronium be administered to morbidly obese patients on the basis of IBW.<sup>80</sup> Vecuronium pharmacokinetics and pharmacodynamics in obese patients are consistent with dosing on the basis of IBW because the  $V_d$ , plasma clearance, and elimination half-life of vecuronium are not different between obese and nonobese patients.<sup>81</sup> However, vecuronium action is prolonged when dosed according to TBW because of the excess dose administered; obesity does not alter the distribution or elimination of the drug. The

$V_d$ , absolute clearance, and elimination half-life of atracurium are unchanged by obesity. However, if dosed according to TBW, atracurium concentrations are higher in obese patients than in the nonobese with no increase in recovery times. The median effective dose is higher; therefore, dosing can be based on TBW with some reduction in the total dose.<sup>82</sup> The duration of action of cisatracurium is prolonged in the morbidly obese when dosed according to TBW, suggesting that dosing based on IBW is optimal in this group of patients.<sup>83</sup>

## Opioids

All synthetic opioids are highly lipophilic drugs. Application of non-weight-based pharmacokinetic models for fentanyl derived from normal-weight patients overestimates the plasma concentration of fentanyl as body weight increases from normal to morbid obesity. Fentanyl dosing based on a derived "pharmacokinetic mass" (derived pharmacokinetic body weight for dosing) is clinically more useful than that based on TBW because of the strong linear correlation between this derived mass and total body clearance.<sup>84</sup> Administration of fentanyl according to TBW overestimates fentanyl dose requirements in obese patients. Pharmacokinetic mass is the dosing weight for fentanyl that reflects the influence of TBW on clearance.<sup>84</sup> Fentanyl dosing for postoperative analgesia also correlates with pharmacokinetic mass.<sup>85</sup> Sufentanil is highly lipid soluble and distributes extensively in excess body fat as well as in lean tissues. It has an increased  $V_d$  and a prolonged elimination half-life that correlates positively with the degree of obesity. However, plasma clearance is similar in obese and nonobese patients; therefore, loading dose should account for total body mass, whereas maintenance and infusion dosing should be reduced and dosed according to IBW. Pharmacokinetic parameters derived from nonobese subjects accurately predict plasma sufentanil concentrations in morbidly obese subjects, but overestimation of plasma sufentanil concentration rises in patients with BMI >40 kg/m<sup>2</sup>.<sup>86</sup> Remifentanyl is a fentanyl congener that is hydrolyzed by blood and tissue esterases, leading to rapid metabolism and inactive products. No difference has been reported in the estimates of

$V_d$  of remifentanyl between obese and nonobese subjects, but the  $V_d$  is less than expected for lipid-soluble molecules with only modest distribution into body tissues.<sup>87</sup> Remifentanyl pharmacokinetics is more closely related to LBM than to TBW; therefore, dosing should be based on IBW.<sup>87</sup>

## Dexmedetomidine

Dexmedetomidine is a highly specific  $\alpha_2$ -adrenergic agonist with an eight times higher affinity than clonidine for the  $\alpha_2$ -adrenoceptor.<sup>88</sup> It has sedative-hypnotic, anesthetic-sparing, analgesic, and sympatholytic properties. Dexmedetomidine lacks significant effects on respiration, making it ideally suitable as an analgesic adjuvant in morbidly obese subjects in whom opioid-induced respiratory depression may be catastrophic.<sup>89</sup>  $\alpha_2$ -Agonists produce transient hypertension at higher doses; therefore, slow intravenous loading over 10–20 minutes is recommended to reduce these effects on heart rate and blood pressure. At infusion rates of 0.2–0.7  $\mu\text{g}/\text{kg}/\text{h}$ , dexmedetomidine produces clinically effective sedation with decreased analgesic and anesthetic requirements.

## MEDICAL AND SURGICAL THERAPY FOR OBESITY

Antiobesity medications are formulated to reduce energy intake, increase energy utilization, or decrease absorption of nutrients. Indications for drug treatment include BMI  $\geq 30$  kg/m<sup>2</sup> or BMI between 27 and 29.9 kg/m<sup>2</sup> in conjunction with an obesity-related medical complication. The combination of phentermine and fenfluramine (Phen-Fen) previously was popular for obesity treatment until evidence indicated its association with valvular heart disease and pulmonary hypertension. Sibutramine and orlistat are recently approved antiobesity medications for long-term use that have not yet been associated with such detrimental side effects. Sibutramine inhibits the reuptake of both serotonin and norepinephrine to increase satiety after the onset of eating rather than reduce appetite; it does not promote the release of serotonin, unlike fenfluramine and dexfenfluramine, which primarily increase the release of serotonin in brain synapses and also inhibits reup-

take to produce anorexia. Sibutramine does not deplete the neural synapses of catecholamines; therefore, dangerous hypotension that is unresponsive to indirectly acting vasopressors, seen with fenfluramine and dexfenfluramine, does not occur. Orlistat blocks the absorption and digestion of dietary fat by binding lipases in the gastrointestinal tract. It improves cardiovascular risk factors associated with obesity, such as hypertension, WC, fasting blood glucose levels, and lipid profile.<sup>90</sup> Low-density lipoprotein (LDL) and total cholesterol levels also decrease. An increase in the anticoagulant effect of warfarin is seen with chronic dosing of orlistat because of its side effect of decreasing absorption of fat-soluble vitamins, including vitamin K.<sup>91</sup> This results in an abnormal plasma thromboplastin time (PTT) because of deficiency of clotting factors II, VII, IX, and X.

Obesity (bariatric) surgery is generally classified into malabsorptive, restrictive, or combined. Malabsorptive procedures, which include jejunoileal bypass and biliopancreatic diversion, are rarely used today. Restrictive procedures include the vertical banded gastroplasty and the adjustable gastric banding. The Roux-en-Y gastric bypass combines gastric restriction with a minimal degree of malabsorption. Roux-en-Y gastric bypass is the most commonly performed bariatric procedure in the United States today. It involves anastomoses of the proximal gastric pouch to a segment of the proximal jejunum, bypassing most of the stomach and the entire duodenum. It is the most effective bariatric procedure for achieving safe short- and long-term weight loss in morbidly obese patients. Patients who have undergone Roux-en-Y gastric bypass lose an average of 50–60% excess body weight and decrease their BMI by approximately 10 kg/m<sup>2</sup> during the first 12–24 postoperative months. Type 2 diabetes mellitus resolves in >90% of patients after Roux-en-Y gastric bypass.<sup>92</sup> Adjustable gastric banding requires placement of an adjustable inflatable band around the proximal stomach to limit stomach capacity. Adjustments can be made to meet a patient's individual needs by adding to or removing saline from the silicone band, making it tighter or looser. All of these procedures can be performed under laparoscopy.

Rhabdomyolysis has been documented in morbidly obese patients undergoing prolonged procedures such as laparoscopic bariatric surgery; the main risk factor is prolonged duration of surgery. Elevations in serum creatinine and creatine phosphokinase (CPK) levels unexplained by other reasons and complaints of buttock, hip, or shoulder pain in the postoperative period should raise the suspicion of rhabdomyolysis.<sup>93</sup>

## PREOPERATIVE EVALUATION

Evaluation of the cardiovascular and pulmonary systems is important because obese patients have significant derangement of these systems. Previous experiences as detailed by the patient and anesthetic records are useful sources of information. Explanation of perioperative anesthetic problems associated with morbid obesity has a significant effect on the type of anesthesia chosen by most obese patients. The majority (>50%) of patients would choose to attempt to lose weight before elective surgery if given the choice, rather than be subjected to the increased risk of anesthesia.<sup>94</sup>

Obese patients should be evaluated for systemic and pulmonary hypertension, signs of right and/or left ventricular or congestive cardiac failure, and ischemic heart disease. Excess adiposity may make signs of congestive cardiac failure difficult to elucidate. The chronicity of pulmonary impairment, including OSA and OHS, makes pulmonary hypertension common in morbidly obese patients. Tricuspid regurgitation noted on echocardiography is the most useful confirmatory test of pulmonary hypertension but should be combined with clinical features such as exertional dyspnea, fatigue, and syncope, which reflect inability to increase cardiac output in response to activity.<sup>95</sup> Features of RVH, such as tall precordial R waves, right axis deviation, and right ventricular strain pattern may be seen on ECG. Sensitivity of the ECG features correlates well with the degree of pulmonary hypertension. Chest radiographs may show evidence of underlying lung disease and prominent pulmonary arteries.

Patients who have previously undergone bariatric surgery should be screened for long-term metabolic and

nutritional abnormalities during their preoperative visit. Common deficiencies include vitamin B<sub>12</sub>, iron, calcium, and folic acid. A collective form of postoperative polyneuropathy, known as acute post-gastric reduction surgery (APGARS) neuropathy, could result from these deficiencies.<sup>96</sup> Patients with APGARS neuropathy present with protracted postoperative vomiting, hyporeflexia, and muscular weakness. Differential diagnoses of this disorder include thiamine deficiency (Wernicke encephalopathy, beriberi), vitamin B<sub>12</sub> deficiency, and Guillain-Barré syndrome. Because of the associated hyporeflexia and muscular weakness, close attention should be paid to dosing and monitoring of neuromuscular blocking agents.<sup>97</sup> Electrolyte and coagulation indices should be checked before surgery, particularly in patients who have been chronically taking diuretics and weight loss medications and in those who are acutely ill or poorly compliant with vitamin and nutritional supplements. Chronic vitamin K deficiency can result in coagulation abnormalities requiring vitamin K analogue or fresh-frozen plasma.

Evidence for OSA and OHS should be sought during the preoperative visit because these conditions are frequently associated with difficult laryngoscopy and intubation. Inquiry should be made about snoring or apnea during sleep, frequent arousals, and daytime somnolence. History of hypertension or neck circumference >40 cm correlates with an increased probability of OSA. OSA is a legitimate reason to delay elective surgery in order to obtain a proper workup.<sup>15</sup> A formal sleep study may be indicated for quantifying its severity. Patients requiring general anesthesia should be treated as having severe OSA. Regional anesthesia should be considered if it is technically feasible. OSA patients should generally be treated as inpatients; however, outpatient surgery can be considered in the following circumstances: mild OSA, local or regional anesthesia with minimal or no sedation, 23-hour observation in the postanesthesia care unit (PACU) following surgery, and patients taking oral medication at the time of discharge. Patients on continuous positive airway pressure device (CPAP) at home should be encouraged to bring the device to the hospital because it may be needed postoperatively. The

possibility of invasive monitoring, prolonged endotracheal intubation, and postoperative mechanical ventilation should be discussed during the preoperative evaluation. Specialized tests such as pulmonary function tests and liver function tests need not be routinely obtained because they are not cost effective in asymptomatic morbidly obese patients. Blood glucose abnormalities should be corrected if present.

## Preoperative Medications

All current medications should be continued until the time of surgery; with the possible exception of insulin and oral hypoglycemic agents. Antibiotic prophylaxis is important because of an increased incidence of wound infection in obese patients partly as a result of a decrease in tissue oxygenation.<sup>98</sup> Both bariatric and general elective surgeries carry an equivalent risk of postoperative wound infection in morbidly obese patients.<sup>99</sup> Oral benzodiazepines are reliable for anxiolysis and mild sedation; intravenous midazolam can be titrated in small doses during the immediate preoperative period. Prophylaxis against both aspiration pneumonia and deep venous thrombosis (DVT) should be addressed during the preoperative period. H<sub>2</sub>-receptor antagonists, nonparticulate antacids, and proton pump inhibitors all reduce gastric volume, acidity, or both, reducing the risk and severity of aspiration pneumonia.

Obesity is a major independent risk factor for DVT and subsequent morbidity and mortality from postoperative pulmonary embolism.<sup>100,101</sup> Mini-dose subcutaneous heparin 5000 IU administered before surgery and repeated every 8–12 hours until the patient is fully mobile reduces this risk. The incidence of clinically evident DVT after laparoscopic Roux-en-Y gastric bypass is low when the procedure is accomplished in a relatively short time, with the initiation of calf-length pneumatic compression hose before induction of anesthesia and with routine early ambulation.<sup>102</sup> Meeting these conditions precludes any form of mandatory heparin anticoagulation except in patients with a history of prior DVT, those with a known hypercoagulable state, or with a significant family history of DVT. Preoperative inferior vena cava (IVC) filter placement is recommended for bariatric

surgery patients with prior pulmonary embolus, prior DVT, evidence of venous stasis, or hypercoagulable state.<sup>103</sup> Four important risk factors are significant in the development of postoperative venous thromboembolism: venous stasis disease, BMI  $\geq 60$ , truncal obesity, and obesity hypoventilation/sleep apnea syndrome. If all of these factors are present, prophylactic IVC filter placement is highly recommended.<sup>104</sup> Many bariatric surgeons prefer low-dose unfractionated heparin as their primary method of thromboprophylaxis.<sup>105</sup> The use of a protocol for heparin dosing in gastric bypass patients as opposed to a fixed dose is the preferred method. Dose calculations based initially on height and weight and later adjusted according to peak anti-factor Xa activity result in better thromboprophylaxis and fewer side effects.<sup>106</sup> Low-molecular-weight heparins (LMWHs) have become popular for thromboembolism prophylaxis in bariatric surgery patients because of their bioavailability when injected subcutaneously. Subcutaneous enoxaparin, 40 mg every 12 hours, decreases the incidence of postoperative DVT without increasing bleeding complications.<sup>107</sup> Other authors have recommended that enoxaparin dosing in obese patients be varied according to age and LBM.<sup>108</sup>

## AIRWAY

History obtained from the obese patient and examination of previous anesthetic records may divulge previous airway management difficulties. Anatomic changes of obesity that contribute to a potentially difficult airway include limitation of movement of the atlantoaxial joint and cervical spine by upper thoracic and low cervical fat pads, excessive tissue folds in the mouth and pharynx, short thick neck, suprasternal, presternal, and posterior cervical fat, and a very thick submental fat pad. Obese patients with OSA are significantly more difficult to intubate than patients without OSA; however, there is no relationship between the severity of sleep apnea and the occurrence of difficult intubation.<sup>109</sup> A short thick neck is significantly more related to difficult intubation, whereas obesity and a short thick neck are significantly related to each other, in addition to both being related to OSA.

Patients with OSA have excess adipose tissue deposits in their pharyngeal area, including the tonsils, tonsillar pillars, uvula, tongue, aryepiglottic folds, and lateral pharyngeal walls.<sup>15</sup> This fat deposition is most pronounced in the lateral pharyngeal walls and may not be noticed during routine airway examination. Even with the presence of these anatomic changes and pathology, the magnitude of BMI does not correlate with the difficulty of laryngoscopy. Such difficulty correlates better with increased age, male sex, temporomandibular joint pathology, Mallampati classes 3 and 4, history of OSA, and abnormal upper teeth.<sup>110</sup> Neck circumference has been identified as the single biggest predictor of problematic intubation in morbidly obese patients.<sup>111</sup> A larger neck circumference is associated with the male sex, higher Mallampati score, grade 3 views at laryngoscopy, and OSA. The probability of a problematic intubation is approximately 5% with a 40-cm neck circumference compared with a 35% probability with a 60-cm neck circumference.<sup>111</sup>

## PSYCHOLOGY OF THE OBESE

The general public often stigmatizes obesity. The belief that weight can be controlled and that obesity is a manifestation of character deficits makes the general public openly unkind to the obese. Obese people demonstrate poor well-being associated with psychological problems mainly because of discrimination. Increased anxiety, symptoms of depression, and a lower positive mental attitude toward life are some of the psychological problems. The health-related quality of life is worse in the severely obese than in other groups of patients with chronic diseases.<sup>112</sup>

Bariatric surgery is currently the most viable option for successful weight loss and maintenance; however, postsurgical drastic weight loss and alleviation of medical risks are accompanied by remarkable psychosocial changes.<sup>113</sup> Not all morbidly obese patients seeking surgery have elevated levels of psychopathology; however, postoperative improvements in mood have been consistently found despite the lack of preoperative psychopathology findings.<sup>113</sup> A positive correlation exists between presurgical severity of

depression and 1-year success at weight loss after bariatric surgery.<sup>114</sup> More depressed individuals tend to lose more weight compared to less depressed individuals. Depression, anxiety, and poor self-esteem are prominent psychosocial symptoms that are part of the etiologic factors of obesity; however, the obese population generally does not manifest more severe psychopathology than does the nonobese population, and psychological symptoms are more likely a result of obesity rather than its cause.<sup>115</sup>

## OBESE AND AMBULATORY ANESTHESIA

The Royal College of Surgeons of England issued guidelines in 1992 that deemed patients with BMI  $> 30$  kg/m<sup>2</sup> unsuitable for ambulatory surgery.<sup>116</sup> Subsequent evaluation of adherence to these guidelines discovered that  $> 85\%$  of ambulatory surgery units in England and a significant number in other countries continued to routinely anesthetize patients with BMI  $> 30$  kg/m<sup>2</sup>.<sup>117,118</sup> More than 75% of anesthesiologists responding to a survey believe that morbidly obese patients with comorbidities and no patient escort will be unsuitable for ambulatory anesthesia because many of them are in suboptimal health.<sup>119</sup> The presence of cardiovascular or respiratory comorbidity significantly reduces the willingness of anesthesiologists to provide ambulatory care to the obese.<sup>119</sup> An excess of adverse cardiovascular events has not been found in obese patients undergoing ambulatory surgery despite a prevalence of cardiovascular disease in this patient population; however, adverse intraoperative and postoperative respiratory events, including arterial oxygen desaturation and bronchospasm, are common.<sup>120</sup> Individual evaluation is the most prudent way to choose which obese patients can undergo ambulatory anesthesia and surgery. If an obese patient will require ambulatory anesthesia, the proper equipment and procedures for positioning and monitoring, including difficult airway and resuscitation equipment, should be readily available. Arrangements for transfer to a 23-hour observation unit or full admission unit should be in place. Ambulatory anesthesia for morbidly obese patients without significant comorbidities does



not increase risk. Obese patients do not have a higher incidence of contact with healthcare professionals after discharge from the ambulatory surgery unit; neither do they have a higher postambulatory surgery unplanned hospital admission rate than does the general population.<sup>121</sup> Although obesity is associated with higher regional block failure and complication rates during ambulatory regional anesthesia, the rates of successful blocks and overall satisfaction are high, enough that obese patients should not be excluded from ambulatory regional anesthesia procedures.<sup>122</sup>

## INTRAOPERATIVE CONSIDERATIONS

### Positioning

Obese patients may require specially designed tables or two regular operating tables for safe anesthesia and surgery. Regular operating tables have a maximum weight limit of approximately 205 kg, but wider and higher-capacity operating tables that can hold up to 450-kg patients and accommodate the extra girth are available. Electrically operated or motorized tables facilitate maneuvering into various surgically favorable positions. Use of belts, straps, and malleable bean bags helps keep obese patients from falling off the operating table. Pressure areas on the body should be protected with care to avoid neural injuries and possible pressure necrosis. Brachial plexus and lower-extremity nerve injuries are frequent. A documented association between ulnar neuropathy and increasing BMI quoted a >30% incidence of ulnar neuropathy in patients with BMI  $\geq 38$  kg/m<sup>2</sup> compared with only 1% in the control group.<sup>123</sup> Peripheral neuropathy occurs more frequently after bariatric surgery than after other abdominal surgery. Intraoperative neural compression or stretching from improper positioning is one of the most common etiologies. Malnutrition may be an important contributing factor; inflammation and altered immunity also play some role.<sup>124</sup> Other associated risk factors include greater absolute weight loss, a faster rate of weight loss, lower serum albumin and transferrin concentrations, prolonged postoperative gastrointestinal symptoms (nausea and vomiting, diarrhea, and dumping syn-

drome), and reduced vitamin and calcium supplementation.<sup>124</sup> Attention to patient positioning and duration of immobility during surgery helps to reduce the incidence of compression injuries and rhabdomyolysis during bariatric surgery. Micronutrient deficiencies (e.g., vitamins B<sub>6</sub>, B<sub>12</sub>, D, and E, folate) and mineral deficiencies (e.g., calcium, magnesium, phosphorus, selenium, and copper) contribute to nonmechanical peripheral neuropathies, especially in nutritionally noncompliant patients undergoing postbariatric surgery procedures.<sup>125</sup> Nerve compression injury is more likely to occur in patients with micronutrient deficiencies.

Supine positioning of the obese patient causes aortic and IVC compression and leads to ventilatory impairment with further decrease in FRC and oxygenation. Trendelenburg positioning, further worsens FRC and should be avoided whenever possible. A simple change of the obese patient from the supine to sitting position causes a significant increase in cardiac output, oxygen consumption, and pulmonary artery pressure. The head-up (semirecumbent) or reverse Trendelenburg (semi-Fowler) position unloads the weight of the intraabdominal contents from the diaphragm, leading to increased pulmonary compliance and improved FRC and oxygenation. Both intraoperative positive end-expiratory pressure (PEEP) and reverse Trendelenburg position significantly decrease alveolar-arterial oxygen tension difference and increase total respiratory compliance to a similar degree in the obese, but reverse Trendelenburg position results in lower airway pressures. However, both maneuvers decrease cardiac output significantly, which partially counteracts their beneficial effects on oxygenation.<sup>126</sup> Prone positioning in the obese patient should be correctly performed with freedom of abdominal movement to prevent detrimental effects on lung compliance, ventilation, and arterial oxygenation. Prone positioning increases intraabdominal pressure, worsening IVC and aortic compression and further decreasing FRC. Lateral decubitus positioning allows for good diaphragmatic excursion during mechanical ventilation because the panniculus is displaced off the abdomen, reducing intraabdominal pressure.<sup>127</sup> Changing from sitting to lateral decubitus posi-

tion after placing an epidural catheter may cause catheter dislodgment, resulting in inadequate analgesia because movement from sitting to lateral position increases the distance from the skin to the epidural space.<sup>128</sup>

### Monitoring

Noninvasive blood pressure measurements can be falsely elevated if a cuff is too small for the limb. The blood pressure cuff bladder should encircle a minimum of 75% of the upper arm circumference or, preferably, the entire arm. Forearm blood pressure is a fairly good predictor of upper arm blood pressure in most patients; however, forearm measurements with a standard cuff may overestimate both systolic and diastolic blood pressures in obese patients.<sup>129</sup> Invasive arterial pressure monitoring is not always necessary but may be indicated for the morbidly obese with severe cardiopulmonary disease and for those with poor fit of the noninvasive blood pressure cuff. Central venous and pulmonary artery catheters may be indicated in patients undergoing extensive surgery in whom significant fluid shifts are anticipated and in those with significant cardiopulmonary impairment. Perioperative intravenous access can be problematic in this patient population and is another indication for central venous catheterization. Routine insertion of a central venous catheter is not necessary in obese patients because insertion of peripheral lines almost always is successful.<sup>130</sup>

### Induction, Intubation, and Maintenance

Obese patients desaturate rapidly after loss of consciousness because of increased oxygen consumption and decreased FRC; therefore, adequate preoxygenation is vital prior to the induction of anesthesia. Application of positive-pressure ventilation during preoxygenation decreases atelectasis formation and improves oxygenation in morbidly obese patients.<sup>131</sup> Four vital capacity breaths with 100% oxygen within 30 seconds have been suggested as superior to the usually recommended 3 minutes of 100% preoxygenation in obese patients.<sup>132</sup> Preoxygenation in the head-up or sitting position is more effective and significantly extends the tolerance to apnea in obese patients when compared with



**FIGURE 22-6.** “Stacking” using towels and blankets. (From Ogunnaiké and Whitten<sup>97</sup> with permission.)

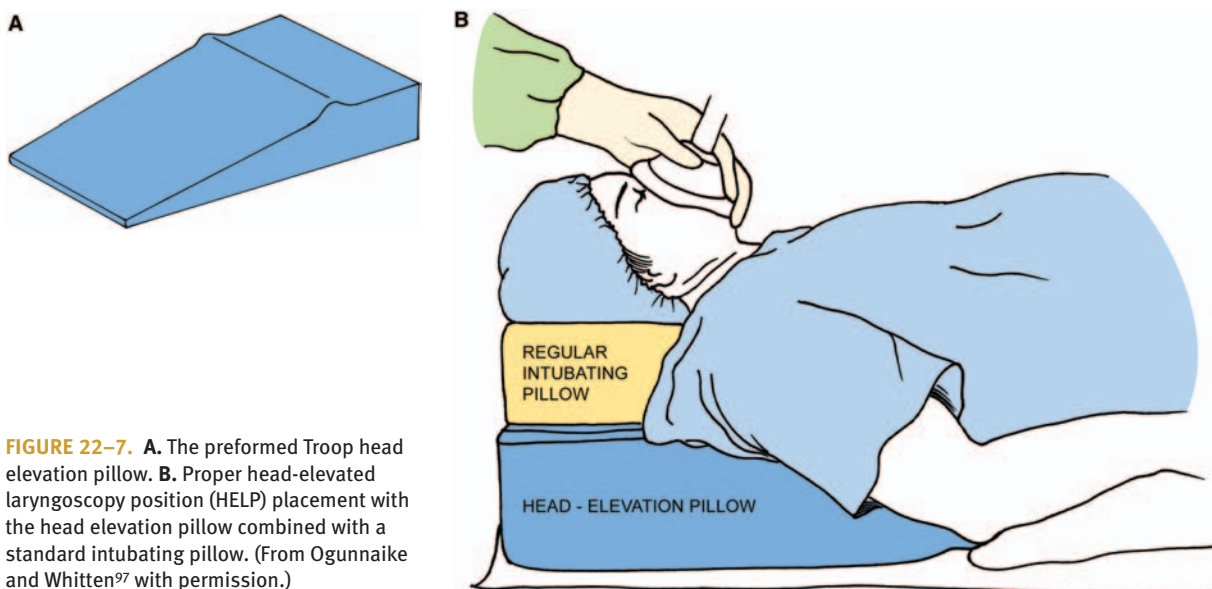
the supine position.<sup>133,134</sup> This position provides the longest safe apnea period during induction of anesthesia.<sup>135</sup> The extra time gained helps preclude hypoxemia if intubation is delayed.

Obese patients may require larger doses of induction agents because blood volume, muscle mass, and cardiac output increase linearly with the degree of obesity. However, cardiovascular and respiratory depression may result from larger doses. Any of the intravenous induction agents is suitable after considering problems peculiar to individual patients. An increased dose of succinylcholine is necessary because of an increase in pseudocholinesterase activity. Myalgia following succinylcholine is not frequently seen in morbidly obese patients; therefore, succinylcholine is highly recommended for tracheal intu-

bation.<sup>136</sup> If difficult intubation is anticipated, awake intubation under topical or regional anesthesia is a prudent approach. During awake intubation, sedative-hypnotic medications should be reduced to a minimum on order to prevent cardiorespiratory depression. An experienced colleague who is immediately available or, better still, is present in the room during induction and airway management can help with mask ventilation or further attempts at intubation. During endotracheal intubation under general anesthesia, hypoxia and aspiration of gastric contents should be prevented at all costs. Preparation should be made for the possibility of difficult intubation, and a surgeon capable of surgically accessing the airway should be readily available. Towels or folded blankets under the shoulders and head can compensate

for the exaggerated flexed position of posterior cervical fat (Figure 22-6). The object of this maneuver, known as “stacking,” is to position the patient so that the tip of the chin is at a higher level than the chest to facilitate laryngoscopy and intubation. The head-elevated laryngoscopy position (HELP), or “ramped” position,<sup>137,138</sup> is a step beyond “stacking.” It significantly elevates the obese patient’s head, neck, upper body, and shoulders above the chest to a point where an imaginary horizontal line can be drawn from the sternal notch to the external ear to better improve laryngoscopy and intubation. To facilitate proper HELP placement, the preformed Troop Head Elevation Pillow (C&R Enterprises, Frisco, TX, USA) in combination with a standard intubation pillow can be used in place of folded towels or blankets (Figure 22-7). The advantage of the preformed pillow is that it can be prepositioned, inserted, and removed much faster with less effort than that required to build and dismantle a ramp made from blankets and towels.<sup>139</sup>

Continuous infusion of a short-acting intravenous agent such as propofol, any of the inhalational agents, or a combination can be used to maintain anesthesia. Desflurane, sevoflurane, and isoflurane are minimally metabolized and therefore are useful choices in obese patients. Desflurane may provide better hemodynamic stability.<sup>140</sup> Sevoflurane provides rapid recovery, good hemodynamic control, prompt regaining of psychological and physical functioning, and infrequent incidence of nausea and



**FIGURE 22-7.** A. The preformed Troop head elevation pillow. B. Proper head-elevated laryngoscopy position (HELP) placement with the head elevation pillow combined with a standard intubating pillow. (From Ogunnaiké and Whitten<sup>97</sup> with permission.)

vomiting when compared to isoflurane.<sup>141</sup> A bispectral index (BIS)-guided study demonstrated an insignificant difference between sevoflurane and desflurane with respect to emergence and cognitive psychomotor recovery characteristics when careful anesthetic titration was used.<sup>142</sup> Obese patients have been found to awake significantly faster after desflurane than after sevoflurane anesthesia; desflurane also resulted in higher oxygen saturation on arrival in the PACU.<sup>143</sup> Propofol-nitrous oxide anesthesia adjusted to a BIS level of approximately 60 combined with thoracic epidural analgesia provides intraoperative hemodynamic stability and prompt recovery during laparotomy for gastric bypass surgery.<sup>144</sup> Overall, the evidence on significant delayed recovery and awakening from all currently available volatile anesthetic agents in obese patients when compared to the nonobese is conflicting. Metabolism of volatile anesthetics is greater in obese than in normal-weight patients, which is reflected by a greater increase in serum inorganic fluoride level, including during anesthesia with sevoflurane, whose biotransformation has not been shown to result in significant differences in plasma fluoride levels or in differences in preoperative and postoperative liver function and renal function tests between obese and nonobese patients.<sup>145</sup> In obese patients, a potentially hepatotoxic reductive pathway metabolizes halothane, resulting in an increased incidence of "halothane hepatitis." Fortunately, halothane is rarely needed in modern practice. Rapid elimination and analgesic properties make nitrous oxide an attractive choice for anesthesia in obese patients, but high oxygen demand in this patient population limits its use. This high oxygen demand is the result of excess metabolically active fat tissue and an increased workload on muscles and other supportive tissue that significantly increases mean oxygen consumption. Short-acting opioids such as remifentanyl at the lowest possible dose, combined with a low-solubility inhalation anesthetic, facilitates a more rapid emergence without increasing opioid-related side effects.<sup>146</sup> Cisatracurium possesses an organ-independent elimination profile and is a favorable nondepolarizing muscle relaxant for maintenance of anesthesia in the obese patient with high prevalence of renal and hepatic compromise. Vecuronium and rocuronium are other use-

ful choices.<sup>147</sup> Dexmedetomidine, an  $\alpha_2$ -agonist with sedative and analgesic properties, provides hemodynamic stability without myocardial depression. It has no clinically significant adverse effects on respiration, which makes it an attractive agent for use as an anesthetic adjunct in obese patients. Furthermore, it reduces the postoperative opioid analgesic requirements and their subsequent detrimental respiratory depressant effects.<sup>89</sup>

Ventilatory tidal volumes >13 mL/kg offer no added advantages during ventilation of morbidly obese patients during anesthesia. Increasing the tidal volumes further only increases airway pressures and lung compliance without significantly improving arterial oxygen tension but results in severe hypocarbia that increases shunt fraction at  $Paco_2 < 30$  mm Hg.<sup>148</sup> Arterial oxygenation during laparoscopy in morbidly obese patients is affected mainly by body weight and not by body position, pneumoperitoneum, or mode of ventilation. Oxygenation is not significantly improved by increasing either the respiratory rate or tidal volume.<sup>149</sup> PEEP is the only ventilatory parameter that has consistently been shown to improve respiratory function in obese subjects.<sup>150</sup> However, PEEP may decrease venous return, cardiac output, and subsequent oxygen delivery.

Excess adipose tissue may mask peripheral perfusion, making fluid balance difficult to assess. Blood loss usually is greater in the obese than in the nonobese for the same type of surgery because technical difficulties in accessing the surgical site necessitate larger incisions and more extensive dissection. Early infusion of colloids and blood products may be necessary because obese patients are less able to compensate for small volumes lost, but rapid infusion of excessive amounts should be avoided because of high prevalence of preexisting congestive cardiac failure.

### Regional Anesthesia

A regional anesthetic technique is a useful alternative to general anesthesia in the morbidly obese because it may help avoid potential intubation difficulties. However, it can be technically difficult given the inability to identify usual bony landmarks because of masking by excess fat. A peripheral nerve stimulator with an insulated needle helps with regional nerve blocks.

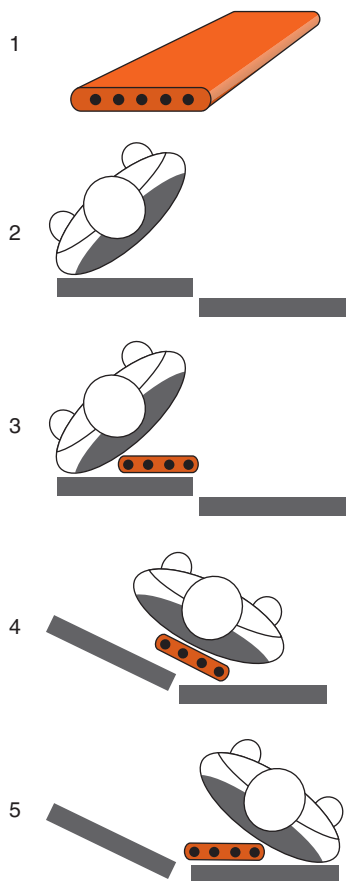
Neuraxial block is easier in the lumbar region because the midline in this area has a thinner layer of fat than do other areas of the spinal column. Longer needles and the sitting position are other useful tools that facilitate induction of neuraxial anesthesia. Ultrasound<sup>151</sup> and fluoroscopy<sup>152,153</sup> can be used to guide a needle or continuous infusion catheter into the spinal or epidural space. Low-current electrical stimulation through an epidural catheter to achieve trunk or limb movement also can be used for confirmation of epidural catheter placement.<sup>154</sup> Epidural vascular engorgement and fatty infiltration reduce the volume of the space, making dose requirements of local anesthetics for epidural anesthesia 20–25% less in obese patients. Subarachnoid blocks are not technically as difficult as epidural blocks, but the height of a subarachnoid block in obese patients can be unpredictable because it may spread considerably cephalad within a short time, causing cardiovascular and respiratory compromise. Continuous catheter subarachnoid block is an attractive technique that allows careful titration of the local anesthetic to desired effect and level, thus avoiding the unpredictability of the single-shot technique.<sup>155</sup> Combined epidural and balanced general anesthesia allows for better titration of anesthetic drugs, use of larger oxygen concentration, and optimal muscle relaxation. It also allows for postoperative analgesia through the same catheter used to provide surgical anesthesia, thereby facilitating early postoperative mobilization.

## POSTOPERATIVE CONSIDERATIONS

### Emergence

Prompt extubation prevents the morbidly obese patient, who may have underlying cardiopulmonary disease, from becoming ventilator dependent. Tracheal extubation should be considered only when there is complete reversal of neuromuscular blockade and full recovery from the effects of anesthetics. Preferably, the patient should be extubated in the semirecumbent position, which has less adverse effects on the respiratory system. Supplemental oxygen should be administered after extubation. Lifting devices such as the HoverMatt (Patient Handling Technologies, Allentown, PA,





**FIGURE 22-8.** Illustration of the Walter Henderson maneuver. **1**, Patient Transfer Device (PTD, also known as patient roller); **2**, patient tilted to slip roller under; **3**, roller slipped under patient; **4**, table tilted to roll patient downhill onto bed; **5**, patient rolled onto bed. (From Ogunnaiké and Whitten<sup>156</sup> with permission.)

USA) and the Patient Transfer Device (Alimed, Dedham, MA, USA), are useful for transporting morbidly obese patients onto or off the operating table. The Walter Henderson Maneuver (Figure 22-8) can be used to safely and gently transfer obese patients onto their postoperative beds.<sup>156</sup>

Risk of airway obstruction at extubation is increased in the obese OSA patient; up to 5% incidence of life-threatening postextubation obstruction is seen. Negative-pressure pulmonary edema can result from postextubation obstruction and is best treated by reintubation, which can be difficult in a patient with OSA. Extubation in the fully awake state is advocated. Any regional technique, if instituted for postoperative analgesia, should be operative at the time of extubation.

Patients on preoperative CPAP should continue on it postoperatively. CPAP pneumatically splints the pharynx and protects against airway obstruction dur-

ing sleep. CPAP should not be immediately applied to obese OSA patients upon arrival in the PACU because it impairs access to suctioning and dealing with postoperative nausea and vomiting; it also impairs communication between patient and caregiver, and it interferes with monitoring of facial color. Intraoperative and postoperative events, such as facial edema, may change mask fit, and CPAP requirements may change significantly because CPAP is meant to be used for natural, not drug-induced, sleep.<sup>15</sup> Another indication for CPAP is to counter the increased incidence of postoperative atelectasis in morbidly obese patients after general anesthesia.<sup>157</sup> Postoperative CPAP does not increase the incidence of major anastomotic leakage after gastric bypass surgery despite the theoretical risk of anastomotic injury from pressurized air delivered by CPAP.<sup>158</sup> The obese patient may avoid taking deep breaths because of the pain after abdominal surgery. Adequate analgesia and a properly fitted elastic binder for abdominal support may encourage patients to cooperate with early ambulation and deep breathing exercises with the aid of incentive spirometry. Pulse oximetry and ABG analysis should be monitored appropriately.

### Postoperative Analgesia

Perioperative use of regional anesthesia and analgesia reduces the incidence of postoperative respiratory complications. Epidural analgesia with local anesthetics, opioids, or both is an effective analgesic technique. Intrathecal opioid is another viable option. Potential advantages of epidural analgesia in obese patients include prevention of DVT, improved analgesia, and earlier recovery of intestinal motility. Lesser oxygen consumption and decreased left ventricular stroke work are other benefits. Morphine-based patient-controlled analgesia (PCA) has been deemed equivalent to low thoracic/high lumbar continuous infusions of bupivacaine/fentanyl epidural analgesia in morbidly obese patients undergoing gastric bypass surgery with regard to the quality of pain control at rest, frequency of nausea and pruritus, time to ambulation, time to return of gastrointestinal function, and length of hospital stay.<sup>159</sup> Incisional local anesthetic infiltration plus PCA was found to produce lower pain scores when compared to epidural anesthesia and

analgesia and postoperative PCA for gastric bypass surgery. In addition, infiltration analgesia as part of a multimodal regimen offers a simple, safe, and inexpensive alternative to epidural analgesia alone.<sup>160</sup> A combination of intraoperative nonopioid analgesics and anesthetic adjuvants (ketorolac, clonidine, ketamine, lidocaine, magnesium sulfate, and methylprednisolone) that produce analgesia by mechanisms different from opioids decreases sedation during recovery from anesthesia and reduces postoperative morphine requirements when compared to intraoperative fentanyl anesthesia in morbidly obese patients.<sup>161</sup> Delayed respiratory depression is one of the known complications of neuraxial opioids. When this is coupled with a potentially difficult airway in the obese patient, closer monitoring in a step-down or intensive care unit is a wise choice until this complication is no longer a threat. Increased analgesic requirements during the first 3 postoperative days increase the danger of life-threatening apnea during drug-induced sleep. This stage is followed by the next 3 days of deep rapid eye movement (REM) sleep rebounds, which also increase the danger of natural sleep-induced apnea. Therefore, the first postoperative week is a period of increased risk of prolonged apnea during sleep for the postoperative obese patient, especially those with OSA.<sup>15</sup>

### RESUSCITATION

The need for cardiopulmonary resuscitation during anesthesia for the morbidly obese is always a possibility. Of concern are the equipment and technical aspects of resuscitation. Chest compressions may not be effective when improperly performed. Mechanical compression devices may be required. The maximum 400 J of energy on regular defibrillators is sufficient for the morbidly obese, because their chest wall usually is not much thicker, but the higher transthoracic impedance from the fat may obligate several attempts.<sup>162</sup> Mask ventilation is more difficult because of poor mask fit, redundant oropharyngeal tissues, and reduced chest wall compliance. Limited neck mobility and mouth opening and a short thick neck may make intubation difficult. The gum-elastic bougie is a useful tool that aids suc-



cessful intubation in the obese patient during emergency situations. The intubating and ProSeal laryngeal mask airways (LMAs) and the esophageal tracheal Combitube are useful temporary supraglottic airway devices. An increased risk of aspiration may be associated with the classic LMA. Trans-tracheal jet ventilation and retrograde wire intubation may be difficult to establish because of the difficulty in palpating anatomic landmarks. Tracheostomy and percutaneous cricothyrotomy should be reserved as final options and should be performed by experienced practitioners.<sup>163</sup> Pulse oximetry may be unreliable because of increased finger thickness; the earlobe may be a better choice.

### KEY REFERENCES

1. Benumof JL. Obesity, sleep apnea, the airway and anesthesia. *Curr Opin Anaesthesiol* 2004;17:21.
2. Adams JP, Murphy PG. Obesity in anaesthesia and intensive care. *Br J Anaesth* 2000;85:91.
3. Fraley MA, Bircham JA, Senkottaiyan N, et al. Obesity and the electrocardiogram. *Obes Rev* 2005;6:275.
4. Bray GA. Medical consequences of obesity. *J Clin Endocrinol Metab* 2004;89:2583.
5. Xing J, Chen JD. Alterations in gastrointestinal motility in obesity. *Obes Res* 2004;12:1723.
6. Liberopoulos EN, Mikhailidis DP, Elisaf MS. Diagnosis and management of the metabolic syndrome in obesity. *Obes Rev* 2005;6:283.
7. Casati A, Putzu M. Anesthesia in the obese patient: pharmacokinetic considerations. *J Clin Anesth* 2005;17:134.
8. Brodsky JB, Lemmens HJ, Brock-Utne JG, et al. Morbid obesity and tracheal intubation. *Anesth Analg* 2002;94:732.
9. Ogunnaike BO, Jones SB, Jones DB, et al. Anesthetic considerations for bariatric surgery. *Anesth Analg* 2002;95:1793.
10. Brunette DD. Resuscitation of the obese patient. *Am J Emerg Med* 2004;22:40.
11. Chopra M, Galbraith S, Damton-Hill I. A global response to a global problem: the epidemic of overnutrition. *Bull World Health Organ* 2002;80:952.
12. Flegal KM, Carroll MD, Ogden CL, et al. Prevalence and trends in obesity among US adults, 1999–2000. *JAMA* 2002;288:1723.
13. Wylie R. Obesity in childhood: an overview. *Curr Opin Pediatr* 2005;17:632.
14. National Institutes of Health. Clinical guidelines on the identification, evaluation, and treatment of overweight and obesity in adults: the incidence report. *Obes Surg* 1998;6:51S.
15. Fontaine KR, Redden DT, Wang C, et al. Years of life lost due to obesity. *JAMA* 2003;289:187.
16. Bray GA. Evaluation of obesity. Who are the obese? *Postgrad Med* 2003;114:19.
17. Thomas GN, Ho SY, Lam KS, et al. Impact of obesity and body fat distribution on cardiovascular risk factors in Hong Kong Chinese. *Obes Res* 2004;12:1805.
18. Ho SY, Lam TH, Janus ED, et al. Waist to stature ratio is more strongly associated with cardiovascular risk factors than other indices. *Ann Epidemiol* 2003;13:683.
19. Lemmens HJ, Brodsky JB, Bernstein DP. Estimating ideal body weight—a new formula. *Obes Surg* 2005;15:1082.
20. Jubber AS. Respiratory complications of obesity. *Int J Clin Pract* 2004;58:573.
21. Chen Y, Horne SL, Dosman JA. Body weight and weight gain related to pulmonary function decline in adults: a six year follow up study. *Thorax* 1993;48:375.
22. Kress JP, Pohlman AS, Alverdy J, et al. The impact of morbid obesity on oxygen cost of breathing (VO<sub>2</sub> RESP) at rest. *Am J Respir Crit Care Med* 1999;160:883.
23. Biring MS, Lewis MI, Liu JT, et al. Pulmonary physiologic changes of morbid obesity. *Am J Med Sci* 1999;318:293.
24. Flemons WW. Obstructive sleep apnea. *N Engl J Med* 2002;347:498.
25. Benumof JL. Obesity, sleep apnea, the airway and anesthesia. *Curr Opin Anaesthesiol* 2004;17:21.
26. Phillips BG, Kato M, Narkiewicz K, et al. Increases in leptin level, sympathetic drive, and weight gain in obstructive sleep apnea. *Am J Physiol Heart Circ Physiol* 2000;279:H234.
27. Olson AL, Zwillich C. The obesity hypoventilation syndrome. *Am J Med* 2005;118:948.
28. Nowbar S, Burkart KM, Gonzales R, et al. Obesity-associated hypoventilation in hospitalized patients: prevalence, impact, and outcome. *Am J Med* 2004;116:1.
29. Burwell CS, Robin ED, Whaley RD, et al. External obesity is associated with alveolar hypoventilation—a Pickwickian syndrome. *Am J Med* 1956;25:815.
30. Blankfield RP, Hudgel DW, Tapolyai AA, et al. Bilateral leg edema, obesity, pulmonary hypertension, and obstructive sleep apnea. *Arch Intern Med* 2000;160:2357.
31. Akashiba T, Kawahara S, Kosaka N, et al. Determinants of chronic hypercapnia in Japanese men with obstructive sleep apnea syndrome. *Chest* 2002;121:415.
32. Kessler R, Chaouat A, Schinkewitch P, et al. The obesity-hypoventilation syndrome revisited: a prospective study of 34 consecutive cases. *Chest* 2001;120:369.
33. Howard BV, Ruotolo G, Robbins DC. Obesity and dyslipidemia. *Endocrinol Metab Clin North Am* 2003;32:855.
34. Adams JP, Murphy PG. Obesity in anaesthesia and intensive care. *Br J Anaesth* 2000;85:91.
35. Manson JE, Colditz GA, Stampfer MJ, et al. A prospective study of obesity and risk of coronary heart disease in women. *N Engl J Med* 1990;322:882.
36. Kenchaiah S, Evans JC, Levy D, et al. Obesity and the risk of heart failure. *N Engl J Med* 2002;347:305.
37. Fraley MA, Bircham JA, Senkottaiyan N, et al. Obesity and the electrocardiogram. *Obes Rev* 2005;6:275.
38. Alpert MA, Terry BE, Hamm CR, et al. Effect of weight loss on the ECG of normotensive morbidly obese patients. *Chest* 2001;119:507.
39. Thomas F, Bean K, Pannier B, et al. Cardiovascular mortality in overweight subjects. The key role of associated risk factors. *Hypertension* 2005;46:654.
40. Engeli S, Böhnke J, Gorzelniak K, et al. Weight loss and the renin-angiotensin-aldosterone system. *Hypertension* 2005;45:356.
41. van Baak MA. The peripheral sympathetic nervous system in human obesity. *Obes Rev* 2001;2:3.
42. Wolf C, Tanner M. Obesity. *West Med J* 2002;176:23.
43. Bray GA. Medical consequences of obesity. *J Clin Endocrinol Metab* 2004;89:2583.
44. Mertens I, Van Gaal LF. Obesity, haemostasis and the fibrinolytic system. *Obes Rev* 2002;3:85.
45. Primrose JN, Davies JA, Prentice CR, et al. Reduction in factor VII fibrinogen and plasminogen activator inhibitor-1 activity after surgical treatment of morbid obesity. *Thromb Haemost* 2002;68:396.
46. Birgel M, Gottschling-Zeller H, Röhrig K, et al. Role of cytokines in the regulation of plasminogen activator inhibitor-1 expression and secretion in newly differentiated subcutaneous human adipocytes. *Arterioscler Thromb Vasc Biol* 2000;20:1682.
47. Tosetti C, Corinaldesi R, Stranghellini V, et al. Gastric emptying of solids in morbid obesity. *Int J Obes Relat Metab Disord* 1996;20:200.
48. Xing J, Chen JD. Alterations in gastrointestinal motility in obesity. *Obes Res* 2004;12:1723.

39. Harter RL, Kelly WB, Kramer MG, et al. A comparison of the volume and pH of gastric contents of obese and lean surgical patients. *Anesth Analg* 1998;86:147.
40. Maltby JR, Pytko S, Watson NC, et al. Drinking 300 ml of clear fluid two hours before surgery has no effect on gastric fluid volume and pH in fasting and non-fasting obese patients. *Can J Anaesth* 2004;51:111.
41. El-Serag HB, Graham DY, Satia JA, et al. Obesity is an independent risk factor for GERD symptoms and erosive esophagitis. *Am J Gastroenterol* 2005;100:1243.
42. Hampel H, Abraham NS, El-Serag HB. Meta-analysis: obesity and the risk of gastroesophageal reflux disease and its complications. *Ann Intern Med* 2005;143:199.
43. Nilsson M, Johnsen R, Ye W, et al. Obesity and estrogen as risk factors for gastroesophageal reflux symptoms. *JAMA* 2003;290:66.
44. Frezza EE, Ikramuddin S, Gourash W, et al. Symptomatic improvement in gastroesophageal reflux disease (GERD) following laparoscopic Roux-en-Y gastric bypass. *Surg Endosc* 2002;16:1027.
45. Hickman IJ, Jonsson JR, Prins JB, et al. Modest weight loss and physical activity in overweight patients with chronic liver disease results in sustained improvements in alanine aminotransferase, fasting insulin, and quality of life. *Gut* 2004;53:413.
46. Cheymol G. Effects of obesity on pharmacokinetics: implications for drug therapy. *Clin Pharmacokinet* 2000;39:215.
47. Cotler SJ, Vitello JM, Guzman G, et al. Hepatic decompensation after gastric bypass surgery for morbid obesity. *Dig Dis Sci* 2004;49:1563.
48. Matteoni C, Younossi ZM, McCullough A. Non alcoholic fatty liver disease: a spectrum of clinical pathological severity. *Gastroenterology* 1999;116:1413.
49. Dixon JB, Bhathal PS, O'Brien PE. Non-alcoholic fatty liver disease: predictors of nonalcoholic steatohepatitis and liver fibrosis in the severely obese. *Gastroenterology* 2001;121:91.
50. Shalhub S, Parsee A, Gallagher SF, et al. The importance of routine liver biopsy in diagnosing nonalcoholic steatohepatitis in bariatric patients. *Obes Surg* 2004;14:54.
51. Boza C, Riquelme A, Ibanez L, et al. Predictor of nonalcoholic steatohepatitis (NASH) in obese patients undergoing gastric bypass. *Obes Surg* 2005;15:1148.
52. Cuadrado A, Orive A, García-Suárez C, et al. Non alcoholic steatohepatitis (NASH) and hepatocellular carcinoma. *Obes Surg* 2005;15:442.
53. Stratopoulos C, Papakonstantinou A, Terzis I, et al. Changes in liver histology accompanying massive weight loss after gastroplasty for morbid obesity. *Obes Surg* 2005;15:1154.
54. Dixon JB, Bhathal PS, Hughes NR, et al. Non alcoholic fatty liver disease: improvement in liver histological analysis with weight loss. *Hepatology* 2004;39:1647.
55. Dittrick GW, Thompson JS, Campos D, et al. Gallbladder pathology in morbid obesity. *Obes Surg* 2005;15:238.
56. Rosenberg DE, Jabbour SA, Goldstein BJ. Insulin resistance, diabetes and cardiovascular risk: approaches to treatment. *Diabetes Obes Metab* 2005;7:642.
57. Wickremesekera K, Miller G, Naotunne TD, et al. Loss of insulin resistance after Roux-en-Y gastric bypass surgery: a time course study. *Obes Surg* 2005;15:474.
58. Moulin de Moraes CM, Mancini MC, de Melo ME, et al. Prevalence of subclinical hypothyroidism in a morbidly obese population and improvement after weight loss induced by Roux-en-Y gastric bypass. *Obes Surg* 2005;15:1287.
59. Reinehr T, Andler W. Thyroid hormones before and after weight loss in obesity. *Arch Dis Child* 2002;87:320.
60. Douyon L, Schteingart DE. Effect of obesity and starvation on thyroid hormone, growth hormone, and cortisol secretion. *Endocrinol Metab Clin North Am* 2002;31:173.
61. Raftopoulos Y, Gagné DJ, Pappasavas P, et al. Improvement in hypothyroidism after laparoscopic Roux-en-Y gastric bypass for morbid obesity. *Obes Surg* 2004;14:509.
62. Hall JE, Henegar JR, Dwyer TM, et al. Is obesity a major cause of chronic kidney disease? *Adv Ren Replace Ther* 2004;11:41.
63. Chagnac A, Weinstein T, Herman M, et al. The effects of weight loss on renal function in patients with severe obesity. *J Am Soc Nephrol* 2003;14:1480.
64. Kambham N, Markowitz GS, Valeri AM, et al. Obesity-related glomerulopathy: an emerging epidemic. *Kidney Int* 2001;59:1498.
65. Iseki K, Ikemiya Y, Kinjo K, et al. Body mass index and the risk of development of end-stage renal disease in a screened cohort. *Kidney Int* 2004;65:1870.
66. Kalantar-Zadeh K, Abbott KC, Salahudeen AK, et al. Survival advantages of obesity in dialysis patients. *Am J Clin Nutr* 2005;81:543.
67. Liberopoulos EN, Mikhailidis DP, Elisaf MS. Diagnosis and management of the metabolic syndrome in obesity. *Obes Rev* 2005;6:283.
68. Wilson PWF. Estimating cardiovascular disease risk and the metabolic syndrome: a Framingham view. *Endocrinol Metab Clin N Am* 2004;33:467.
69. Zimmet PZ, Alberti KG, Shaw E. Mainstreaming the metabolic syndrome: a definitive diagnosis. *Med J Aust* 2005;183:175.
70. Friedman JM. The function of leptin in nutrition, weight, and physiology. *Nutr Rev* 2002;60:S1.
71. Sharma AM. Managing weighty issues on lean evidence: the challenges of bariatric medicine. *CMAJ* 2005;172:30.
72. Casati A, Putzu M. Anesthesia in the obese patient: pharmacokinetic considerations. *J Clin Anesth* 2005;17:134.
73. Blouin RA, Warren GW. Pharmacokinetic considerations in obesity. *J Pharm Sci* 1999;88:1.
74. Henegar JR, Bigler SA, Henegar LK, et al. Functional and structural changes in the kidney in the early stages of obesity. *J Am Soc Nephrol* 2001;12:1211.
75. Wada DR, Björkman S, Ebling WF, et al. Computer simulation of the effects of alterations in blood flows and body composition on thiopental pharmacokinetics in humans. *Anesthesiology* 1997;87:884.
76. Servin F, Farinotti R, Haberer JP, et al. Propofol infusion for maintenance of anesthesia in morbidly obese patients receiving nitrous oxide. A clinical and pharmacokinetic study. *Anesthesiology* 1993;78:657.
77. Whitwam JG. Flumazenil and Midazolam in anaesthesia. *Acta Anaesthesiol Scand* 1995;108:S15.
78. Pühringer FK, Keller C, Kleinsasser A, et al. Pharmacokinetics of rocuronium bromide in obese patients. *Eur J Anaesthesiol* 1999;16:507.
79. Rose JB, Theroux MC, Katz MS. The potency of succinylcholine in obese adolescents. *Anesth Analg* 2000;90:576.
80. Leykin Y, Pellis T, Lucca M, et al. The pharmacodynamics effects of rocuronium when dosed according to real body weight or ideal body weight in morbidly obese patients. *Anesth Analg* 2004;99:1086.
81. Schwartz AE, Matteo RS, Ornstein E, et al. Pharmacokinetics and pharmacodynamics of vecuronium in the obese surgical patient. *Anesth Analg* 1992;74:515.
82. Kirkegaard-Nielsen H, Helbo-Hansen HS, Lindholm P, et al. Anthropometric variables as predictors for duration of action of atracurium-induced neuromuscular block. *Anesth Analg* 1996;83:1076.
83. Leykin Y, Pellis T, Lucca M, et al. The effects of cisatracurium on morbidly obese women. *Anesth Analg* 2004;99:1090.
84. Shibusaki K, Inchiosa MA Jr, Sawada K, et al. Accuracy of pharmacokinetic models for predicting plasma fentanyl concentrations in lean and obese surgical patients: derivation of dosing weight ("pharmacokinetic mass"). *Anesthesiology* 2004;101:603.
85. Shibusaki K, Inchiosa MA Jr, Sawada K, et al. Pharmacokinetic mass of fentanyl for postoperative analgesia in lean and obese patients. *Br J Anaesth* 2005;95:377.
86. Slepchenko G, Simon N, Goubaux B, et al. Performance of target-controlled sufentanil infusion in obese patients. *Anesthesiology* 2003;98:65.
87. Egan TD, Huizinga B, Gupta SK, et al. Remifentanyl pharmacokinetics in obese vs lean patients. *Anesthesiology* 1998;89:562.
88. Coursin DB, Coursin DB, Maccioli GA. Dexmedetomidine. *Curr Opin Crit Care* 2001;7:221.
89. Hofer RE, Sprung J, Sarr MG, et al. Anesthesia for a patient with morbid obesity using dexmedetomidine without narcotics. *Can J Anaesth* 2005;52:176.

90. Krempf M, Louvet JP, Allanic H, et al. Weight reduction and long-term maintenance after 18 months treatment with orlistat for obesity. *Int Obes Relat Metab Disord* 2003;27:591.
91. McWalter RS, Fraser HW, Armstrong KM. Orlistat enhances warfarin effect. *Ann Pharmacother* 2003;37:510.
92. Rubino F, Gagner M, Gentileschi P, et al. The early effect of Roux-en-Y gastric bypass on hormones involved in body weight regulation and glucose metabolism. *Ann Surg* 2004;240:236.
93. Mognol P, Vignes S, Chosidow D, et al. Rhabdomyolysis after laparoscopic bariatric surgery. *Obes Surg* 2004;14:19.
94. Coe AJ, Saleh T, Samuel T, et al. The management of patients with morbid obesity in the anesthetic assessment clinic. *Anesthesia* 2004;59:570.
95. Elliot C, Kiely DG. Pulmonary hypertension: diagnosis and treatment. *Clin Med* 2004;4:211.
96. Chang C, Adams-Huet B, Provost DA. Acute post-gastric reduction surgery (APGARS) neuropathy. *Obes Surg* 2004;14:182.
97. Ogunnaike BO, Whitten CW. Anesthesia and obesity. In Barash PG, Cullen BF, Stoelting RK, eds. *Clinical Anesthesia*. 5th ed. Philadelphia: Lippincott, Williams, & Wilkins, 2006:1040.
98. Kabon B, Nagele A, Reddy D, et al. Obesity decreases perioperative tissue oxygenation. *Anesthesiology* 2004;100:274.
99. Topaloglu S, Avsar FM, Ozel H, et al. Comparison of bariatric and non-bariatric elective operations in morbidly obese patients on the basis of wound infection. *Obes Surg* 2005;15:1271.
100. Edmonds MJ, Crichton TJ, Runciman WB, et al. Evidence-based risk factors for postoperative deep vein thrombosis. *Aust N Z J Surg* 2004;74:1082.
101. Mantilla CB, Horlocker TT, Schroeder DR, et al. Risk factors for clinically relevant pulmonary embolism and deep venous thrombosis in patients undergoing primary hip or knee arthroplasty. *Anesthesiology* 2003;99:552.
102. Gonzalez QH, Tisher DS, Plata-Munoz JJ, et al. Incidence of clinically evident deep venous thrombosis after laparoscopic Roux-en-Y gastric bypass. *Surg Endosc* 2004;18:1082.
103. Keeling WB, Haines K, Stone PA, et al. Current indications for inferior vena cava filter insertion in patients undergoing surgery for morbid obesity. *Obes Surg* 2005;15:1009.
104. Sapala JA, Wood MH, Schuhknecht MP, et al. Fatal pulmonary embolism after bariatric operations for morbid obesity: A 24-year retrospective analysis. *Obes Surg* 2003;13:819.
105. Wu EC, Barba CA. Current practices in the prophylaxis of venous thromboembolism in bariatric surgery. *Obes Surg* 2000;10:7.
106. Shepherd MF, Rosborough TK, Schwartz ML. Heparin thromboprophylaxis in gastric bypass surgery. *Obes Surg* 2003;13:249.
107. Scholten DJ, Hoedema RM, Scholten SE. A comparison of two different prophylactic dose regimens of low molecular weight heparin in bariatric surgery. *Obes Surg* 2002;12:19.
108. Green B, Duffull SB. Development of a dosing strategy for enoxaparin in obese patients. *Br J Clin Pharmacol* 2003;56:96.
109. Siyam MA, Benhamou D. Difficult endotracheal intubation in patients with sleep apnea syndrome. *Anesth Analg* 2002;95:1098.
110. Ezri T, Medalion B, Weisenberg M, et al. Increased body mass per se is not a predictor of difficult laryngoscopy. *Can J Anaesth* 2003;50:179.
111. Brodsky JB, Lemmens HJ, Brock-Utne JG, et al. Morbid obesity and tracheal intubation. *Anesth Analg* 2002;94:732.
112. Larsson U, Karlsson J, Sullivan M. Impact of overweight and obesity on health-related quality of life—a Swedish population study. *Int J Obes Relat Metab Disord* 2002;26:417.
113. Bocchieri LE, Meana M, Fisher BL. A review of psychological outcomes of surgery for morbid obesity. *J Psychosom Res* 2002;52:155.
114. Averbukh Y, Heshka S, El-Shoreya H, et al. Depression score predicts weight loss following Roux-en-Y gastric bypass. *Obes Surg* 2003;13:833.
115. Friedman MA, Brownell KD. Psychological correlates of obesity: moving to the next research generation. *Psychol Bull* 1995;117:3.
116. Commission on the Provision of Surgical Services. Guidelines for Day Case Surgery. A Report of the Royal College of Surgeons of England. Rev ed. London: Royal College of Surgeons of England, 1992.
117. Atkins M, White J, Ahmed K. Day surgery and body mass index: results of a national survey. *Anaesthesia* 2002;57:169.
118. Bryson GL, Chung F, Cox RG, et al. Patient selection in ambulatory anesthesia—an evidence-based review: part II. *Can J Anaesth* 2004;51:782.
119. Friedman Z, Chung F, Wong DT. Ambulatory surgery adult patient selection criteria—a survey of Canadian anesthesiologists. *Can J Anaesth* 2004;51:437.
120. Chung F, Mezei G, Tong D. Pre-existing medical conditions as predictors of adverse events in day-case surgery. *Br J Anaesth* 1999;83:262.
121. Davies KE, Houghton K, Montgomery JE. Obesity and day-case surgery. *Anaesthesia* 2001;56:1112.
122. Nielsen KC, Guller U, Steele SM, et al. Influence of obesity on surgical regional anesthesia in the ambulatory setting: an analysis of 9038 blocks. *Anesthesiology* 2005;102:181.
123. Warner MA, Warner ME, Martin JT. Ulnar neuropathy: incidence, outcome and risk factors in sedated anesthetized patients. *Anesthesiology* 1994;81:1332.
124. Thaisetthawatkul P, Collazo-Clavell ML, Sarr MG, et al. A controlled study of peripheral neuropathy after bariatric surgery. *Neurology* 2004;63:1462.
125. Koffman BM, Greenfield LJ, Ali II, et al. Neurologic complications after surgery for obesity. *Muscle Nerve* 2006;33:166.
126. Perilli V, Sollazzi L, Modesti C, et al. Comparison of positive end-expiratory pressure with reverse Trendelenburg position in morbidly obese patients. *Obes Surg* 2003;13:605.
127. Brodsky JB. Positioning the morbidly obese patient for anesthesia. *Obes Surg* 2002;12:751.
128. Hamza J, Smida M, Benhamou D, et al. Parturient's posture during epidural puncture affects the distance from skin to epidural space. *J Clin Anesth* 1995;7:1.
129. Pierin AM, Alavarce DC, Gusmao JL, et al. Blood pressure measurement in obese patients: comparison between upper arm and forearm measurements. *Blood Press Monit* 2004;9:101.
130. Juvin P, Blarel A, Bruno F, et al. Is peripheral line placement more difficult in obese than in lean patients? *Anesth Analg* 2003;96:1218.
131. Coussa M, Proietti S, Schnyder P, et al. Prevention of atelectasis formation during the induction of general anesthesia in morbidly obese patients. *Anesth Analg* 2004;98:1491.
132. Goldberg ME, Norris MC, Larjani GE, et al. Preoxygenation in the morbidly obese: a comparison of two techniques. *Anesth Analg* 1989;68:520.
133. Altermatt FR, Muñoz HR, Delfino AE, et al. Pre-oxygenation in the obese patient: effects of position on tolerance to apnoea. *Br J Anaesth* 2005;95:706.
134. Dixon BJ, Dixon JB, Carden JR, et al. Preoxygenation is more effective in the 25 degrees head-up position than in the supine position in severely obese patients. *Anesthesiology* 2005;102:1110.
135. Boyce JR, Ness T, Castroman P. A preliminary study of the optimal positioning for the morbidly obese patient. *Obes Surg* 2003;13:4.
136. Lemmens HJ, Brodsky JB. The dose of succinylcholine in morbid obesity. *Anesth Analg* 2006;102:438.
137. Levitan RM, Mechem CC, Ochroch EA, et al. Head-elevated laryngoscopy position: improving laryngeal exposure during laryngoscopy by increasing head elevation. *Ann Emerg Med* 2003;41:322.
138. Collins JS, Lemmens HJ, Brodsky JB, et al. Laryngoscopy and morbid obesity: a comparison of the “sniff” and “ramped” positions. *Obes Surg* 2004;14:1171.
139. Rich JM. Use of an elevation pillow to produce the head-elevated laryngoscopy



- position for airway management in morbidly obese and large-framed patients. *Anesth Analg* 2004;98:264.
140. De Baerdemaeker LE, Struys MM, Jacobs S, et al. Optimization of desflurane administration in morbidly obese patients: a comparison with sevoflurane. *Br J Anaesth* 2003;91:638.
141. Torri G, Casati A, Albertin A, et al. Randomized comparison of isoflurane and sevoflurane for laparoscopic banding in morbidly obese patients. *J Clin Anesth* 2001;13:565.
142. Arain SR, Barth CD, Shankar H, et al. Choice of volatile anesthetic for the morbidly obese patient: sevoflurane or desflurane. *J Clin Anesth* 2005;17:413.
143. Strum EM, Szenohradszki J, Kaufman WA, et al. Emergence and recovery characteristics of desflurane versus sevoflurane in morbidly obese adult surgical patients: a prospective, randomized study. *Anesth Analg* 2004;99:1848.
144. Pandazi A, Bourlioti A, Kostopanagiotou G. Bispectral index (BIS) monitoring in morbidly obese patients undergoing gastric bypass surgery: experience in 23 patients. *Obes Surg* 2005;15:58.
145. Frink EJ, Malan TP, Brown EA, et al. Plasma inorganic fluoride levels with sevoflurane anesthesia in morbidly obese and nonobese patients. *Anesth Analg* 1993;76:1333.
146. Song D, Whitten CW, White PF. Remifentanyl infusion facilitates early recovery for obese outpatients undergoing laparoscopic cholecystectomy. *Anesth Analg* 2000;90:1111.
147. Ogunnaike BO, Jones SB, Jones DB, et al. Anesthetic considerations for bariatric surgery. *Anesth Analg* 2002;95:1793.
148. Bardoczky GI, Yernault JC, Houben JJ, et al. Large tidal volume ventilation does not improve oxygenation in morbidly obese patients during anesthesia. *Anesth Analg* 1995;81:385.
149. Sprung J, Whalley DG, Falcone T, et al. The effects of tidal volume and respiratory rate on oxygenation and respiratory mechanics during laparoscopy in morbidly obese patients. *Anesth Analg* 2003;97:268.
150. Yoshino J, Akata T, Takahashi S. Intraoperative changes in arterial oxygenation during volume-controlled mechanical ventilation in modestly obese patients undergoing laparotomies with general anesthesia. *Acta Anaesthesiol Scand* 2003;47:742.
151. Grau T, Leipold RW, Fatehi S, et al. Real time ultrasonic observation of combined spinal-epidural anaesthesia. *Eur J Anaesthesiol* 2004;21:25.
152. Eidelman A, Shulman MS, Novak GM. Fluoroscopic imaging for technically difficult spinal anesthesia. *J Clin Anesth* 2005;17:69.
153. Johnson TW, Morgan R, Smalley P. Radiographic guided epidural placement. *Anaesthesia* 2003;58:485.
154. Tsui BC, Gupta S, Finucane B. Confirmation of epidural catheter placement using nerve stimulation. *Can J Anaesth* 1998;45:640.
155. Michaloudis D, Fraidakis O, Petrou A, et al. Continuous spinal anesthesia/analgesia for perioperative management of morbidly obese patients undergoing laparotomy for gastroplastic surgery. *Obes Surg* 2000;10:220.
156. Ogunnaike BO, Whitten CW. Bariatric surgery and the prevention of postoperative respiratory complications (in reply). *Anesth Analg* 2004;98:1809.
157. Eichenberger A, Proietti S, Wicky S, et al. Morbid obesity and postoperative pulmonary atelectasis: an underestimated problem. *Anesth Analg* 2002;95:1788.
158. Huerta S, DeShields S, Shpiner R, et al. Safety and efficacy of postoperative continuous positive airway pressure to prevent pulmonary complications after Roux-en-Y gastric bypass. *J Gastrointest Surg* 2002;6:354.
159. Charchi R, Backman S, Christou N, et al. Patient controlled IV analgesia is an acceptable pain management strategy in morbidly obese patients undergoing gastric bypass surgery. A retrospective comparison with epidural analgesia. *Can J Anaesth* 2003;50:672.
160. Schumann R, Shikora S, Weiss JM, et al. A comparison of multimodal perioperative analgesia to epidural pain management after gastric bypass surgery. *Anesth Analg* 2003;96:469.
161. Feld JM, Laurito CE, Beckerman M, et al. Non-opioid analgesia improves pain relief and decreases sedation after gastric bypass surgery. *Can J Anaesth* 2003;50:336.
162. DeSilva RA, Lown B. Energy requirement for defibrillation of a markedly overweight patient. *Circulation* 1978;57:827.
163. Brunette DD. Resuscitation of the obese patient. *Am J Emerg Med* 2004;22:40.



## CHAPTER 23

## Evaluation of the Patient with Alcohol or Drug Addiction

Paul S. Pagel, MD, PhD,  
Judith A. May, MD, and  
David C. Warltier, MD, PhD

396

The lifetime prevalence of alcohol and drug addiction is estimated to be approximately 14% and 7%, respectively, of the U.S. population.<sup>1</sup> These data confirm that addiction is a major public health problem in the United States. The literature describing the evaluation and treatment of patients with addiction is exhaustive. A large number of peer-reviewed medical journals are dedicated to the study of addiction, two divisions of the National Institutes of Health (Alcoholism and Alcohol Abuse, Drug Abuse) are responsible for providing major federal funding for basic science and clinical research on addiction, and several major textbooks have been authored by world-renowned experts in addiction medicine that thoroughly describe the salient features of substance abuse disorders and their treatment. The American Society of Addiction Medicine was founded in 1954 and currently has more than 2700 members dedicated to the treatment of patients with addiction. It is not our intention to comprehensively review addiction medicine and its complex relationship to the practice of anesthesiology. Nevertheless, it is important that anesthesiologists be very familiar with basic concepts, including the pathophysiology of the addiction, the medical consequences of substance abuse, and the process of recovery, so as to provide appropriate care for patients suffering from this very common disease. For the purposes of this chapter, the terms *alcohol* and *ethanol* are used interchangeably.

## ADDICTION: DEFINITIONS AND NEUROBIOLOGY

Addiction is defined by loss of control over an abusable substance, including an inability to voluntarily self-regulate

drug use, compulsive preoccupation with obtaining or using a drug, and continued use despite of adverse consequences.<sup>2</sup> Addiction is a multifaceted medical illness that develops as a result of interactions between the availability, cost, and pharmacology of a drug of abuse, environmental and psychosocial factors (e.g., occupation, peer group), genetic predisposition, comorbid psychiatric disorders, and drug exposure. Addiction has a highly variable clinical course. Initial drug use is voluntary behavior, and most users do not develop drug-dependence. However, repetitive drug exposure in a susceptible individual appears to cause fundamental changes in central nervous system function that produce the disease. Experimental evidence collected to date suggests that genetic predisposition to addiction may be related to alterations in neurocircuitry that enhance sensitivity to the reinforcing effects of drugs of abuse, thus overwhelming cognitive control of behavior.<sup>3</sup> A patient may enter recovery with abstinence and treatment, but

once present, addictive disease is regarded as permanent. However, addiction may be managed successfully as a chronic disease, and many patients respond positively to treatment with long periods of abstinence.<sup>4</sup>

The neurobiology of addiction is summarized in a number of excellent reviews and textbook chapters, and is not discussed in detail here.<sup>3,5</sup> Three concepts may be inferred from this large body of literature that have immediate bearing on the anesthesiologist caring for the patient with addiction: uniform drug reward and reinforcement, cross-addiction, and disease permanence. The mesocorticolimbic dopamine system is central to the pathophysiology of addiction.<sup>5</sup> This neurocircuitry involves the ventral tegmental area of the midbrain where dopaminergic neurons originate and the basal forebrain, the nucleus accumbens, and the amygdala to which these neurons project. All drugs abused by humans have been shown in animals to interact with this system to produce reinforcement.<sup>3</sup> Different pharmaco-

## KEY POINTS

1. Addiction is a very common medical illness. It is characterized by loss of control over an abusable substance, including an inability to voluntarily self-regulate drug use, compulsive preoccupation with obtaining or using a drug, and continued use despite adverse consequences.
2. Addiction may be managed successfully as a chronic disease, and many patients respond positively to treatment with long periods of abstinence.
3. Consultation with an addiction medicine specialist is encouraged when providing care for active or recovering alcohol or drug abusers during the perioperative period.
4. Preoperative assessment of all patients presenting for surgery should include a routine evaluation for alcohol or drug abuse.
5. Establishing a supportive, nonjudgmental but firm approach to the patient with active alcoholism or drug addiction is vital for successful care.
6. Preoperative history, physical examination, and laboratory testing should be guided by the known medical consequences of alcohol and drug addiction.
7. A blood alcohol concentration and a urine drug screen should be obtained in all active and most recovering alcohol or drug abusers.
8. Polysubstance abuse is common among alcohol or drug users.
9. Infectious diseases are epidemic in injection drug users.
10. Alcohol abuse has extensive medical consequences that impact every major organ system and is a major risk factor for perioperative morbidity and mortality.
11. Abuse of sedative-hypnotics, opioids, cocaine, amphetamines, hallucinogens, and inhalants is associated with a wide variety of drug-specific medical complications.
12. Withdrawal is commonly encountered during the perioperative period in alcohol or drug abusers, and prophylaxis against withdrawal should be instituted before surgery.
13. Recovery involves abstinence in combination with a series of personal changes to maintain sobriety.

logic classes of drugs of abuse, including many of those routinely used by anesthesiologists, may initially activate different locations within the reinforcement cascade by several mechanisms, but all lead to reward stimulation.<sup>5</sup> As a result, exposure to one drug may mimic the reinforcing effects of another, a process known as *cross-addiction*. Permanent alterations in reinforcement neurocircuitry also appear to persist despite long-term abstinence and support the clinical notion of addiction as a chronic, incurable disease.<sup>4</sup> These latter data are particularly important to the recovering patient as drugs commonly used during and after anesthesia (e.g., sedative-hypnotics, opioids) may reactivate addiction regardless of the relative length of abstinence.

## APPROACH TO PREOPERATIVE EVALUATION

Medical and psychiatric diseases are very common in patients with addiction, and several factors that contribute to the higher risk of many diseases in this patient population have been identified. Drugs of abuse produce direct toxic effects on a variety of organ systems that have immediate consequences or may also contribute to or exacerbate preexisting medical conditions. Addiction may be responsible for personal behavior (e.g., sharing injection equipment, high-risk sexual activity) that markedly increase risk to infectious diseases such as endocarditis, hepatitis, and AIDS. Depressed socioeconomic conditions (e.g., unemployment, reliance on housing in shelters, homelessness) may also pose an enhanced risk of other infectious diseases such as community-acquired pneumonia and tuberculosis. Access to and delivery of routine and preventive healthcare to many patients with addiction are often incomplete or ineffective. In those patients who receive regular healthcare, active abuse of alcohol or drugs may reduce prescription medication compliance and substantially curtail attendance at followup appointments with physicians. Nevertheless, it has been convincingly demonstrated that many of these patients benefit from routine healthcare, particularly when it is linked to substance abuse treatment.<sup>6</sup> Such an integration of service delivery significant-

ly improves patient outcome and also is an important goal during the perioperative period.

Preoperative assessment of all patients presenting for surgery should include a routine evaluation for alcohol or drug addiction. Previously undiagnosed alcoholism is present in many hospitalized patients,<sup>7</sup> and physicians often fail to detect it.<sup>8</sup> These data provided compelling evidence that the anesthesiologist may play a pivotal role in the primary diagnosis of addiction and the initiation of interventions to treat the disease. The CAGE and Michigan Alcohol Screening Test (MAST) questionnaires are brief but extensively validated screening instruments that may be used to detect the presence of a substance abuse disorder.<sup>9</sup> The simple four-question CAGE test is particularly useful as a screening tool for the anesthesiologist precisely because of its brevity and predictive value:

C—Have you ever felt you ought to Cut down on your drinking (drug use)?

A—Have people Annoyed you by criticizing your drinking (drug use)?

G—Have you ever felt bad or Guilty about your drinking (drug use)?

E—Have you ever had a drink (or used a drug) first thing in the morning (“Eye-opener”) to steady your nerves or get rid of a hangover?

Two or more positive responses to the CAGE questionnaire strongly imply the presence of addiction and a single affirmative answer indicates that further assessment should be conducted. Corroborating history, including evidence of alcohol- or drug-related amnesia (“blackouts”), chronic marital or family difficulties, habitual criminal activity, homelessness, multiple detoxifications or previous rehabilitation attempts, and recurrent unemployment, also suggest the diagnosis of a substance abuse disorder.<sup>10</sup> A blood alcohol concentration and a urine drug screen should be obtained in the patient with a known history of addiction, a positive preoperative screening evaluation, or, when indicated by other clinical conditions (e.g., trauma, altered mentation, obtundation). These data definitively identify the pharmacologic class of drugs currently abused by the patient, alert the anesthesiologist to the likelihood of withdrawal, and allow the anes-

thesiologist to anticipate potential interactions between the drugs of abuse and those used for anesthesia and pain management. A positive laboratory test also provides important corroborative evidence of the presence of a substance abuse disorder that may encourage the previously undiagnosed patient to seek treatment. More frequently, a positive test provides the anesthesiologist with the opportunity to challenge denial (a nearly universal response of the patient with addiction when first confronted about the disease), facilitates an initial discussion about treatment alternatives between the physician and the patient, and affords a strong rationale for immediate consultation with an addiction medicine specialist.

Establishing a supportive, nonjudgmental but firm approach to the patient with alcoholism or drug addiction is vital for successful care and cannot be overemphasized. This strategy is especially important for the anesthesiologist because previous evidence has revealed that patients with addiction often encounter physicians during the perioperative period whose attitudes about and treatment of these patients may be prejudicial.<sup>11</sup> For example, general surgeons were shown to possess the weakest educational background and the least desire to learn about resources for substance abuse management as compared to psychiatrists and internists.<sup>12</sup> Anesthesiologists also display more negative attitudes about patients with substance abuse disorders than primary care physicians who routinely care for this patient population.<sup>13</sup> Lack of educational background in addiction and continued identification of addiction within a “moral” model or as a secondary consequence of other underlying psychopathology are frequent causes of negative physician attitudes about the disease. Discrimination against the patient by the physician, cynicism about the potential for long-term recovery, anger about continuing alcohol or drug use, frustration over relapse, and lack of compassion represent common examples of negative attitudes that may directly interfere with a meaningful therapeutic relationship between the anesthesiologist and the patient with addiction. Such negative attitudes may be especially destructive in these patients because diminished self-esteem, shame, and anxiety are characteristic features of the disease.

Thus, it is imperative that the anesthesiologist establish trust and reassure the patient that addiction will be appropriately managed as part of the perioperative plan. The establishment of such a positive relationship between the anesthesiologist and the patient facilitates more comprehensive assessment about specific drugs of abuse, the duration and patterns of drug abuse, the number and severity of previous withdrawal episodes, periods of abstinence, previous treatment attempts, and other relevant past medical and psychiatric history related to substance abuse for which the patient may have received treatment. In addition, a positive rapport in the setting of an acute surgical intervention allows the anesthesiologist to strongly encourage the active alcoholic or drug user to seek treatment for addiction.

Providing reassurance about prompt and effective treatment of acute and chronic pain to the patient with addiction deserves emphasis during the preoperative evaluation. Chronic pain resulting from a variety of alcohol- or drug abuse-related medical illnesses was previously identified in as many as 60% of chemically dependent patients enrolled in methadone maintenance programs or residential treatment facilities.<sup>14</sup> Opioid addicts may also display hyperalgesia, in part as a result of drug tolerance.<sup>15</sup> However, even well-intentioned and informed physicians may be hesitant to provide adequate doses of opioid analgesics to the patient with addiction because of fears about contributing to the disease process. Other physicians may intentionally withhold or restrict opioid analgesics because they are anxious about adverse consequences imposed by federal or state regulatory agencies,<sup>15</sup> are concerned that patient requests for these drugs may represent manipulative, addictive behavior,<sup>16</sup> or have negative, moral attitudes about addiction. These factors contribute to inadequate treatment of pain in patients with addiction,<sup>17</sup> and result in these patients harboring suspicions that they will be deliberately abused by physicians or nursing staff. This situation may be further complicated by the recognition that patients with addiction are known to self-medicate or manipulate prescribed drugs to treat pain. Thus, an environment of “mutual mistrust” concerning the treatment of acute or chronic pain

using opioid analgesics may exist between patients with substance abuse disorders and their physicians.<sup>16</sup> The potential for such a conflict should be acknowledged and honestly addressed by the anesthesiologist and surgeon during the preoperative evaluation. Guidelines for pain management in patients with addiction have been established that urge consultation with an addictionologist, meticulous observation of adherence with and clinical response to prescribed opioids, and continuous assessment of function.<sup>18</sup>

### HISTORY, PHYSICAL EXAMINATION, AND DIAGNOSTIC TESTING

In addition to the chief complaint that led to the original surgical referral and other pertinent past medical history, the preoperative history and physical examination should be guided by the known medical consequences of alcohol and drug abuse, the common occurrence of polysubstance abuse, and the presence of other coexisting diseases. A thorough review of systems should be based on the identity of abused drugs obtained in honest dialogue with the patient, concomitant with laboratory determination of blood alcohol concentration and the results of a urine drug analysis. Importantly, the recognition that constitutional complaints or new presenting symptoms may or may not indicate drug use or withdrawal is a critical feature of the history and physical examination that deserves special emphasis. For example, alcohol or opioid withdrawal is typically characterized by fever, myalgia, tachycardia, hypertension, and gastrointestinal symptoms, but such generic complaints may also indicate the presence of an underlying infectious disease. Weight loss because of malnutrition is a very common finding in drug abusers, but infectious diseases, human immunodeficiency virus (HIV), and occult malignancy must also be considered in the differential diagnosis. Similarly, a seizure certainly suggests the presence of alcohol or opioid withdrawal in the patient with a recent history of heavy abuse, but other causes of seizure cannot be immediately excluded. Thus, a presumptive diagnosis of an alcohol- or drug-related complication may often be inferred based on the history, but the anesthesiologist

must remain vigilant to the possibility that other disease states contribute to the presentation independent of alcohol or drug abuse.

The complete physical examination of the alcohol or drug abuser is primarily directed toward the medical ramifications of documented abused substances, but routine investigation of other coexisting diseases and the potential for complications arising from polysubstance abuse should not be overlooked. Examination of the skin may reveal evidence of acute or chronic infection (e.g., cellulitis, abscess), repetitive injection drug use (“track” marks), or peripheral venous thrombosis. The presence of such findings suggest that the ability of the anesthesiologist to successfully place intravenous or intraarterial catheters before surgery may be limited. Skin examination may also reveal the stigmata of advanced liver disease. Diffuse lymphadenopathy strongly suggests the presence of systemic infection, tuberculosis, or HIV. Poor dentition, oral-pharyngeal carcinoma, or nasal septum damage may be detected during examination of the airway. Such findings may have potentially important implications for airway management. Wheezing, rhonchi, rales, or evidence of pulmonary consolidation detected during the lung examination suggests the presence of reactive airway disease, acute or chronic bronchitis, heart failure, or pneumonia that may be directly or indirectly related to alcohol or drug abuse and merit further investigation. A cardiac murmur in the drug abuser strongly suggests that active or healed endocarditis may be present. An abdominal examination directed specifically toward the liver is indicated in this patient population because most drugs of abuse are associated with the development of hepatic disease. Lastly, the neurologic examination may reveal evidence of altered mental status, cerebrovascular accident, head trauma, central nervous system infection, or sensory-motor peripheral neuropathy.

Standard recommendations for obtaining preoperative laboratory and diagnostic tests in healthy individuals are often inadequate in patients with a history of alcohol or drug abuse. As in healthy patients, the preoperative laboratory and diagnostic evaluation of alcohol or drug abusers should be guided by the results of the history

and physical examination. Nevertheless, the anesthesiologist should maintain a high level of suspicion about the potential existence of other subclinical medical complications of alcohol or drug abuse that may have a substantial impact on perioperative management and obtain laboratory or diagnostic tests accordingly. For example, hepatic dysfunction resulting from drug toxicity or infection is very common in alcohol and injection-drug abusers, and obtaining liver function tests, a coagulation panel, and viral hepatitis testing is certainly warranted even if these patients are apparently asymptomatic. Similarly, a tuberculin skin test and a chest radiograph should be performed because subclinical tuberculosis may be present. Serum electrolyte, blood urea nitrogen, and serum creatinine concentrations and a urinalysis should also be obtained in this patient population because renal insufficiency resulting from viral hepatitis or HIV infection commonly occurs. After obtaining informed consent, routine screening for HIV should be performed, especially in alcohol or drug abusers who acknowledge high-risk behavior. A positive HIV screen facilitates further diagnostic testing to confirm the presence of active infection, allows the early initiation of medical treatment for the disease, and also alerts the surgical team to the potential for transmission of the virus during the perioperative period.

## INFECTIOUS DISEASE IN INJECTION-DRUG USERS

Infectious diseases are epidemic in injection-drug users.<sup>19</sup> The majority of hospital admissions of injection-drug users are related to acute infection, and the presence of chronic infectious diseases (e.g., hepatitis C, HIV) frequently complicates the perioperative management of many of these patients. Drug users may develop infections because of direct injection of pathologic organisms, high-risk sexual behavior or injection activity, immunosuppression resulting from chronic disease or malnutrition, and compromise of protective reflexes during intoxication or withdrawal. As a result of these factors, the clinical presentation of many infectious diseases may be profoundly different in injection-drug users as compared to patients from the

general population. Self-medication with illicit opioid analgesics or illegally obtained antibiotics and the presence of acute intoxication or drug withdrawal may also complicate the diagnosis and treatment of infection in injection users. This section focuses on the infectious diseases that are most relevant to the practice of anesthesiology (Table 23-1).

### Skin and Soft Tissue

Skin and soft-tissue infections (e.g., cellulitis, abscess, ulcer) are frequently responsible for hospital admission of injection-drug users, and may also be initially diagnosed by the anesthesiologist during the preoperative evaluation. Skin and soft-tissue infections are observed in as many as one third of all active users,<sup>20</sup> and may be further complicated by the development of necrotizing fasciitis. *Staphylococcus aureus* and  $\beta$ -hemolytic streptococci are the most frequently identified pathogens responsible for skin and soft-tissue infections,<sup>19</sup> although geographical variations in organism identity are regularly reported. This latter observation was dramatically emphasized in small groups of heroin addicts from the United Kingdom and California who suffered major neurologic complications and mortality related to soft-tissue infection with *Clostridium* species (e.g., tetanus, botulism) as a result of drug contamination with bacteria.<sup>21</sup> Injection of drugs mixed with saliva or licking of needles immediately before administration also predisposes the injection-drug user to polymicrobial infections resulting from a variety of aerobic and anaerobic oral flora. The route of administration of injected drugs, the presence of concomitant HIV infection, the frequency of injection, and the combined use of heroin and cocaine (known as a “speedball”) have been identified as risk factors for abscess development. For example, a higher prevalence of abscess formation has been observed in users who injected drugs subcutaneously or intramuscularly (termed “skin popping” or “muscling,” respectively) as compared to those who use an intravenous route of administration. Ranked in descending order of occurrence, arms, legs, buttocks, deltoids, and neck are the most common locations for abscess formation and correlate with typically used injection sites.<sup>22</sup> Injection of vasoactive drugs such as cocaine may pro-

TABLE 23-1.

### Infectious Complications of Alcohol and Drug Abuse

<b>Skin and muscle</b>
Cellulitis
Abscess
Ulcer
Cutaneous or muscular necrosis (cocaine or amphetamines)
Pyomyositis
Thrombophlebitis
Necrotizing fasciitis
<b>Cardiovascular</b>
Endocarditis (right > left)
Septic embolization
Hematoma
Ischemic vasculitis (cocaine or amphetamines)
Vascular thrombosis
Mycotic aneurysm
<b>Pulmonary</b>
Septic pulmonary embolism (tricuspid valve endocarditis)
Community-acquired pneumonia
Tuberculosis
Pneumocystis pneumonia (HIV)
<b>Neurologic</b>
Brain or spinal cord abscesses
Cerebral infarction
Cerebral mycotic aneurysm
Meningitis
Encephalopathy
Vertebral osteomyelitis
Botulism
Tetanus
<b>Hepatic/gastrointestinal</b>
Viral hepatitis (all forms)
Hepatic abscess
Hepatic granulomatosis (talc)
Spontaneous bacterial peritonitis
<b>Renal</b>
Nephrotic syndrome (hepatitis B, HIV)
Nephritic syndrome (hepatitis C)
Rhabdomyolysis
<b>Immunologic</b>
HIV/AIDS

duce cutaneous or muscular ischemic necrosis at the injection site and contribute to the development of superinfection or ulcer formation. Infections of large skeletal muscles (pyomyositis), most often produced by *S. aureus*, are also associated with injection drug use in patients with HIV. Treatment of abscess, ulcer, or pyomyositis usually requires the combination of intrave-



nous antibiotics and surgical incision and drainage. Necrotizing fasciitis is associated with substantial morbidity and mortality, and aggressive surgical intervention is required to effectively manage this devastating complication of injection drug use.

### Cardiovascular System

A common complication of injection drug abuse is endocarditis.<sup>23</sup> The frequency of injection and the presence of simultaneous HIV infection are risk factors for the development of infective endocarditis. Interestingly, concomitant alcohol abuse may actually reduce the risk of the disease. Mortality in patients with infective endocarditis resulting from injection drug abuse may exceed 35%,<sup>24</sup> and is probably higher in immunocompromised patients. The overall incidence of infective endocarditis has been estimated at 1.5–20 cases per thousand person-years among active injection-drug users.<sup>25</sup> Endocarditis may affect any heart valve, but infection of right- as compared to left-heart valves is more frequent and also is associated with lower mortality.<sup>26</sup> In patients from the general population, infective endocarditis most often develops as a result of transient bacteremia seeding a preexisting left-heart valvular abnormality resulting from congenital, rheumatic, or myxomatous disease. In contrast, injection drug use more commonly produces infection of structurally normal right-heart valves. The tricuspid valve is most often affected in injection-drug users. The reasons for this clinical presentation appear to be multifactorial and include toxic effects of a drug or its contaminants on valvular endothelium, an enhanced susceptibility of right-heart valves to particular skin organisms, and preexisting thickening of the tricuspid valve leaflets.<sup>25</sup> *Streptococcus viridans* and enterococci are typically identified as the bacteria responsible for endocarditis in patients without a history of substance abuse, but more virulent species, most notably *S. aureus* (with or without methicillin-resistance), are most often implicated in injection-drug users with endocarditis. A higher incidence of endocarditis resulting from gram-negative bacilli and fungi also occurs in patients who use injection drugs as compared to those who do not.

Endocarditis is characterized by the presence of persistent bacteremia, and

the diagnosis of the disease follows standard criteria.<sup>27</sup> Transthoracic or transesophageal echocardiography is commonly used during evaluation of the patient with suspected endocarditis to provide direct visual evidence of a vegetation that consists of platelets, fibrin, and sequestered bacteria usually located on the valve surface. Notably, a normal echocardiogram alone does not definitively exclude the diagnosis. The clinical presentation of endocarditis is typified by persistent fever, a variety of cardiac abnormalities (e.g., new murmur, valvular insufficiency, congestive heart failure, intraventricular conduction defects), evidence of septic embolization from the affected valve, bacterial seeding of other organ systems (e.g., meningitis, brain abscess, osteomyelitis), and immune complex-related complications (e.g., glomerulonephritis, Roth spots, Osler nodes). In contrast to findings in the general population, injection-drug users with endocarditis often present with cough, pleuritic chest pain, and bilateral pulmonary infiltrates that occur as a consequence of septic embolization from the tricuspid valve. Necrotizing or cavitory pulmonary defects produced by these septic thromboemboli may also be complicated by bronchopleural fistulae, hemoptysis, pneumothorax, empyema, or invasion of a major bronchial structure. Primary treatment of endocarditis with organism-specific antibiotics or antifungal drugs also may require simultaneous surgical intervention to manage the cardiovascular or neurologic sequelae of the disease.

Vascular infections frequently occur in injection-drug users. Contaminated injection equipment, hematoma surrounding a direct vascular injury, local ischemic damage from vasoactive drug injection (e.g., cocaine, amphetamine), or thrombosis may contribute to the development of thrombophlebitis or the formation of arteriovenous fistulae. Intravenous drug administration using contaminated supplies may also produce thrombophlebitis and septic embolization. When such emboli lodge in the vasa vasorum of an arterial wall, a mycotic aneurysm may be produced. Right- or left-heart valve endocarditis-induced septic embolization is the most frequent cause of pulmonary or brain mycotic aneurysm formation, respectively. Regardless of the embolic source, the vast majority

of these infected, mushroom-shaped, arterial defects resolve with intravenous antibiotic treatment directed against the primary underlying organism. Nevertheless, some patients with mycotic aneurysms may develop signs and symptoms despite appropriate antibiotic treatment. The clinical presentation of a mycotic aneurysm is typified by the presence of a painful, pulsatile mass accompanied by a bruit, thrill, surrounding cellulitis or abscess formation, or frank rupture. In many cases, surgical excision is required for definitive treatment of the infection or to prevent rupture.

### Lung

Community-acquired pneumonia is very common in injection-drug users and is a major cause of hospital admission in this patient population. Several factors contribute to this enhanced susceptibility including increased aspiration risk resulting from drug-induced depression of airway protective mechanisms, poor nutritional status, diminished immunologic responses, and compromised mucociliary and phagocytic function associated with tobacco smoking.<sup>28</sup> Residence in homeless shelters or incarceration in the penal system may also predispose drug users to developing pneumonia because of more frequent exposure to other infected individuals. Injection drug users with HIV are particularly susceptible to community-acquired pneumonia and have a risk of developing the disease that is approximately five times greater than drugs users who do not have HIV.<sup>29</sup> *Streptococcus pneumoniae* and *Haemophilus influenzae* are the most frequently identified pathogens responsible for pneumonia in injection-drug users with or without HIV infection. Other bacteria, including *Legionella* species, *Chlamydia pneumoniae*, *Pseudomonas aeruginosa*, and *S. aureus*, are also more commonly encountered in injection-drug users with pneumonia as compared to the general population. HIV-positive patients with AIDS are especially susceptible to opportunistic pulmonary infection with *Pneumocystis carinii*, *Mycobacterium tuberculosis*, *Mycobacterium avium intracellulare*, and cytomegalovirus.

Tuberculosis is also common in injection-drug users, especially in those users who are coinfecting with HIV.<sup>30</sup> Injection-drug users have a prevalence of latent tuberculosis infection that is

3–5-fold higher than that observed in the general population (approximately 5%). The mechanism responsible for reactivation of tuberculosis or whether active drug use plays a role in this reactivation remains unknown. It appears highly likely that many of the previously discussed factors that predispose injection-drug users to develop other infectious diseases may also contribute to the reactivation of latent tuberculosis. The immunosuppression that characterizes advanced HIV infection promotes reactivation of latent tuberculosis and contributes to the development of extrapulmonary manifestations of the disease including vertebral osteomyelitis, meningitis, and empyema that may occur in as many as 80% of these patients. Notably, reduced delayed hypersensitivity responses to tuberculin are also observed in immunocompromised patients that complicate interpretation but do not necessarily preclude use of these important diagnostic skin tests. Standardized treatment of tuberculosis has been established and usually involves drug therapy with isoniazid, rifampin, ethambutol, and pyrazinamide.<sup>31</sup> Rifampin stimulates methadone metabolism, and opioid addicts in methadone maintenance programs often require dosing adjustments to avoid withdrawal.<sup>32</sup> This drug interaction between rifampin and methadone also has potentially important ramifications for the anesthesiologist when using opioids during the perioperative period. Rifampin and pyrazinamide have also been reported to exacerbate preexisting hepatitis or contribute to the development of severe liver dysfunction in injection-drug users with tuberculosis.

### Central and Peripheral Nervous System

Signs and symptoms of acute intoxication or withdrawal often complicate the diagnosis of neurologic infection in injection-drug users. Meningitis, brain abscess resulting from septic embolization, cerebral infarction, or rupture of a mycotic aneurysm may occur in as many as 40% of injection-drug users with endocarditis. These central nervous system consequences of endocarditis may be accompanied by bacteremia-induced vertebral osteomyelitis with extension into the epidural space. The resulting epidural abscess may compromise spinal cord integrity. Al-

ternatively, central nervous system infections may be produced by bacterial invasion from ear, sinus, or mastoid infections, bacteremia resulting from another infectious source, or traumatic injury. Management of most of these bacterial complications requires appropriate antibiotic therapy and surgical intervention. Immunosuppressed injection-drug users infected with HIV are particularly susceptible to central nervous system infections produced by unusual pathogens such as tuberculosis, *Cryptococcus*, *Aspergillus*, and *Toxoplasma gondii*. Viral hepatitis may also produce encephalopathy independent of liver dysfunction.

Injection drug users are also susceptible to the development of two major neurotoxin-mediated infectious diseases. Botulinum toxin is released by subcutaneous or intramuscular injection sites infected with *Clostridium botulinum* and produces blurred vision, dysphagia, descending bilateral flaccid paralysis, and respiratory failure as a result of irreversible inhibition of acetylcholine release. Treatment with antitoxin may limit the progression of the disease until regeneration of axons occurs. Several cases of wound botulism were recently reported in drug abusers from California who had injected black tar heroin. Injection drug use is also a major risk factor for the development of tetanus. Tetanolysin produced by the anaerobic bacterium *Clostridium tetani* irreversibly blocks release of inhibitory transmitters in spinal motor neurons, and as a result, causes spastic paralysis characterized by trismus, dysphagia, hydrophobia, and profound, unrelenting muscle contraction in the upper and lower extremities. Neutralization of circulating tetanus toxin with hyperimmune globulin precedes surgical debridement so as to avoid the release of additional tetanolysin from the infected injection site. Like botulism, recovery of neural function from tetanus requires axonal regeneration.

### Hepatitis

Drug abuse is strongly associated with the development of all known forms of viral hepatitis. Collectively, these diseases have potentially devastating consequences for drug users and also pose substantial risks of transmission to anesthesiologists and other health professionals who are responsible for their care. Hepatitis A virus (HAV) is

the most common form of viral hepatitis in the United States, and drug abuse has been identified as a major risk factor for the transmission of the virus. Antibodies directed against the HAV are present as many as 60% of injection-drug users. Fecal-oral transmission of the RNA-based HAV may occur in drug users by inhalation, intranasal, or oral routes of administration, or by sharing of contaminated injection equipment. Under most circumstances, hepatitis A is a self-limited disease characterized by fever, fatigue, gastrointestinal complaints, jaundice, hepatosplenomegaly, and nonspecific abnormalities in liver function tests concomitant with the presence of IgE followed by IgG anti-HAV antibodies that confer immunity against subsequent infection. In contrast to the findings in many patients with hepatitis B virus (HBV) infection, a carrier state does not occur with HAV infection, extrahepatic manifestations of the disease are unusual, and most cases require only supportive care. However, acute HAV infection has been reported to cause fulminant hepatic failure and death in a subset of patients who are coinfecting with hepatitis C virus (HCV) or those affected by other chronic hepatic pathology.<sup>33</sup>

Transmission of the DNA-based HBV among drug abusers most often occurs as a result of sharing contaminated injection supplies or high-risk sexual activity. Drug abuse is responsible for as many as 20% of new HBV cases that are reported annually in the United States, and HBV antibodies are present in between 50% and 80% of all injection-drug users. The duration of injection drug use is strongly correlated with the presence of HBV infection, but infection with the virus most often occurs relatively early in the history of injection drug use. Acute infection with HBV has a widely variable clinical course. Many patients infected with HBV remain completely asymptomatic, and less than half develop the classical signs of jaundice, hepatosplenomegaly, and elevated serum transaminases. Although the vast majority of these patients require only supportive care, a very small number (<0.1%) develop fulminant hepatic failure. The time-dependent progression of specific HBV antigens and their respective antibodies during the course of acute HBV infection is well known and is not reviewed in detail here. The pres-

ence of antibodies directed against the HBV surface and core antigens that occur with the resolution of acute infection confers protection against subsequent infection in most patients with the disease. Unlike HAV, chronic HBV infection also occurs in a small percentage of patients (5–10%), and is characterized by the continued presence of HBV surface or e antigen, variable degrees of hepatic inflammation and dysfunction, and persistent infectivity. Importantly, chronic HBV infection is associated with the subsequent development of cirrhosis and hepatocellular carcinoma. Treatment with interferon- $\alpha$  and lamivudine (3TC) may reduce the development of these morbid complications in patients who are chronically infected with the HBV. Membranous nephropathy and renal insufficiency may also occur during HBV infection as a result of HBV e antigen deposition in glomerular capillaries.

As many as 80% of injection-drug users who are chronically infected with HBV are coinfecting with the incomplete RNA hepatitis D virus (HDV), which requires the presence of HBV for activity. The mechanisms of HDV transmission are similar to those previously described for HBV. The incidence of fulminant hepatic failure is substantially greater during coinfection with HDV and HBV as compared to HBV alone. HDV superinfection of patients who are chronic HBV carriers also portends to more rapid development of end-stage liver failure. Notably, injection-drug users who were coinfecting with HDV and HBV demonstrated accelerated deterioration of hepatic histology and function as compared to those infected with these viruses who did not inject drugs. The presence of antibodies directed against HDV is required to establish the diagnosis of HDV during acute or chronic HBV infection.

Injection-drug use is the major route of transmission of HCV in the United States today. The vast majority of injection-drug users demonstrate evidence of HCV exposure. As observed in epidemiologic studies of HAV and HBV transmission, frequency of drug injection, use of contaminated injection supplies, incarceration, and coincident participation in high-risk sexual behavior have been identified as major risk factors for the transmission of HCV. Most injection-drug users devel-

op the HCV shortly after beginning injection activity. The initial presentation of HCV infection is usually subclinical. A small minority of patients with acute HCV infection will completely eliminate the virus, but as many as 85% proceed to develop a persistent infection. Recent estimates suggest that more than 4 million Americans are chronically infected with HCV.<sup>34</sup> Serum antibodies directed against the virus concomitant with the presence of HCV RNA establish the diagnosis of chronic infection. Ominously, as many as 20% of patients with chronic HCV develop cirrhosis, and hepatic failure resulting from this complication is currently the most common indication for liver transplantation in this country. Older patients who abuse alcohol or those coinfecting with HIV appear to be particularly susceptible to more rapid progression of end-stage liver disease resulting from chronic HCV infection.<sup>35</sup> The combination of peginterferon (interferon with a polyethylene side chain) and ribavirin is currently the most efficacious drug regimen for the treatment of chronic HCV infection, may be continued for as long as 12 months depending on the viral load response, and appears to substantially reduce the incidence of cirrhosis and hepatic failure.<sup>36</sup> Chronic HCV infection is also associated with membranoproliferative glomerulonephritis with or without cryoglobulinemia in injection-drug users. This combined nephrotic-nephritic syndrome is characterized by proteinuria, hematuria, hypertension, and renal insufficiency. A membranous glomerulonephropathy produced by the deposition of virus core protein has also been described in injection-drug users with chronic HCV infection. Lastly, injection-drug users with hepatitis-induced cirrhosis are at risk of developing bacterial hepatic superinfections or spontaneous bacterial peritonitis. Gram-negative enteric bacilli are the most common cause of these frequently fatal complications.

### Human Immunodeficiency Virus

Injection-drug use is a major risk factor for the transmission of HIV. The Centers for Disease Control and Prevention identified injection-drug use as the presumed route of transmission in 31% of adults with newly diagnosed HIV infection.<sup>37</sup> Injection-drug use

was also implicated as the primary cause of 39% of reported cases of maternal-fetal transmission of the virus. The use of highly active antiretroviral therapy (HAART) has profoundly altered the natural history of HIV infection, substantially prolonged survival in patients infected with the virus, and reduced annual mortality resulting from AIDS. When combined with intensive public health emphasis on reducing transmission risk and treatment of HIV-positive patients by specialists knowledgeable about the disease, widespread use of HAART, rapid development of new drugs to treat HIV/AIDS, and evidence-based drug prophylaxis directed against opportunistic AIDS-related infections (e.g., *P. carinii* pneumonia, *T. gondii* encephalitis, disseminated *M. tuberculosis* and *M. avium intracellulare*) has transformed HIV infection from a “death sentence” diagnosis into a manageable chronic illness. The initial HIV infection is usually characterized by a variety of nonspecific signs and symptoms (e.g., fever, pharyngitis, lymphadenopathy) that typically occur within 4 weeks of exposure. The vast majority of patients display positive serology for the virus within 6 months of infection. Viral replication within the lymphatic system occurs rapidly during this latent phase of the disease, and prognosis is strongly correlated with viral load after the initial replication has stabilized. The clinical diagnosis of HIV is usually not established until several years after the initial transmission in many patients, often in conjunction with the appearance of manifestations of immunocompromise. The presence of HIV RNA and at least two specific HIV antigens are required for the diagnosis to be made. Progression of HIV infection from the latent phase to AIDS is characterized by continued viral replication and release from lymph node reservoirs accompanied by an insidious decrease in CD4 cell number. Without treatment, most patients with HIV die approximately 10 years after initial infection, although a small subset with persistently elevated CD4 cell counts and depressed viral load has also been identified in whom longer life expectancy occurs. HIV-induced nephropathy often complicates management of black patients infected with the virus and primarily occurs at later stages of HIV disease. HIV-nephropathy pre-

sents as a clinical nephrotic syndrome histologically characterized by focal and segmental glomerulosclerosis, and rapidly leads to dialysis-dependent renal failure in the absence of antiretroviral treatment. The pathophysiology of HIV-induced nephropathy remains unclear despite extensive study, but appears to involve direct viral infection of the kidney.

HIV treatment is very complex and is not reviewed in detail here. In general, medical management of HIV follows well-established guidelines<sup>38</sup> based on CD4 cell number, viral load, drug resistance, and the prevention or treatment of AIDS-related opportunistic infections. The combination of a protease inhibitor with nucleoside and nonnucleoside reverse transcriptase inhibitors forms the basis of antiretroviral therapy in HIV infection and is tailored to produce sustained reductions in viral load and enhanced immunologic function. The use of this HAART strategy has substantially prolonged life expectancy and improved quality of life for patients with the disease. Despite the optimism provided by promising developments in HIV treatment, injection-drug users continue to suffer a higher incidence of HIV-related complications and more rapid progression to AIDS as compared to those infected with the virus who do not use injection drugs. As a result, a disproportionate number of AIDS cases occur in injection-drug users in major United States cities.<sup>39</sup> Active drug abuse contributes to reduced adherence with HAART (which often requires taking multiple daily doses of several medications with significant side-effect profiles on differing schedules) as does the presence of coexisting psychiatric disease (most notably, depression), marginalized socioeconomic conditions, and important drug interactions between antiretroviral drugs and methadone. This latter caveat is particularly important to recognize because several protease inhibitors (e.g., ritonavir, nelfinavir, lopinavir) and nonnucleoside reverse transcriptase inhibitors (e.g., efavirenz, nevirapine) are known to increase methadone metabolism, and recovering opioid addicts enrolled in methadone maintenance programs may either discontinue HAART or resume illicit opioid abuse because of withdrawal symptoms.<sup>40</sup> Such drug interactions between antiretroviral therapy and opioids may also have important

ramifications for the anesthesiologist caring for the patient with HIV during the perioperative period.

## DRUG-SPECIFIC MEDICAL COMPLICATIONS OF ABUSE

### Alcohol

Alcohol abuse has profound and extensive medical consequences that impact every organ system (Table 23–2). Heavy alcohol use (defined as at least 5 drinks per day on more than 5 days of the week) has been documented in 7% of the U.S. population and is even more prevalent in patients presenting for medical or surgical evaluation. Alcohol abuse is a major risk factor for perioperative morbidity and mortality,<sup>41</sup> and yet many clinicians often fail to recognize the disease. Achieving preoperative abstinence before elective surgery substantially reduces the incidence of postoperative complications.<sup>42</sup>

Blood ethanol concentrations as low as 0.05 mg/dL produce acute hemodynamic effects that may have potentially important consequences for patients with heart disease. Mildly intoxicating doses of ethanol decrease myocardial contractility in vitro and cause left ventricular systolic and diastolic dysfunction in vivo. Such actions may result in further reductions in global cardiac performance in patients with preexisting cardiomyopathy. The mechanisms responsible for ethanol-induced myocardial depression remain unclear despite extensive study. Ethanol may produce toxicity by attenuating the availability of calcium for activation of the contractile apparatus and inhibiting myofilament calcium sensitivity or by adversely affecting myocardial metabolism of free fatty acids and proteins. The direct myocardial depressant actions of small amounts of ethanol may not be readily apparent because the drug and its major metabolites (e.g., acetaldehyde, acetate) dilate cutaneous and splanchnic arteriolar resistance vessels. Thus, ingestion of alcohol increases cardiac output in healthy individuals concomitant with a reduction in systemic vascular resistance despite a modest decline in intrinsic contractile function. Conversely, ethanol and its metabolites also indirectly enhance sympathetic nervous system activity and thereby produce tachycardia and hypertension mediated by stimulation of cardiac  $\beta_1$ -adrenoceptors, arterial vaso-

constriction, and attenuation of baroreceptor reflex control of the circulation.<sup>43</sup> These actions combine to produce increases in myocardial oxygen consumption and may contribute to the development of myocardial ischemia or infarction in heavy ethanol users with coronary artery disease. In fact, a higher incidence of acute myocardial ischemia has been previously reported after ingestion of large quantities of ethanol in these patients, often in the absence of classical anginal symptoms that are frequently obscured by the presence of the drug. Myocardial ischemia or infarction may also occur during ethanol withdrawal in patients with coronary artery disease as a result of exaggerated sympathetic nervous system activity or coronary vasospasm.

There is a strong cause-and-effect relationship between alcohol abuse and hypertension.<sup>44</sup> The combination of repetitive, heavy ethanol use and withdrawal enhance centrally mediated sympathetic nervous system activity and produce hypertension by overwhelming the direct but transient vasodilatory effects of the drug and its metabolites.<sup>43</sup> This alcohol-induced hypertension is mediated by activation of vascular smooth muscle  $\alpha_1$ -adrenoceptors, is reversible with abstinence, and rapidly recurs with relapse. The “pressor” effect of ethanol is also characterized by prominent blood pressure responses to other forms of physiologic stress that have also been observed in alcoholics after prolonged abstinence. Alcohol-induced hypertension is dose related, occurs more frequently in white men and postmenopausal women, and is exaggerated by the presence of underlying essential hypertension.

Heavy alcohol use is linked to the development of coronary atherosclerosis and is associated with increased morbidity and mortality resulting from coronary artery disease.<sup>45</sup> These adverse effects of alcohol abuse may be attributed to the presence of longstanding hypertension and increases in blood homocysteine concentrations. Conversely, consumption of modest amounts of alcohol produces significant myocardial protection against ischemic injury.<sup>46</sup> Several large-scale epidemiologic studies provide compelling evidence that chronic consumption of small amounts of ethanol reduces cardiovascular mortality, decreases the in-



TABLE 23-2.

## Medical Complications of Alcohol and Drug Abuse

Drug	Cardiovascular	Pulmonary	Neurologic	Hepatic/GI	Renal	Other
Alcohol	LV dysfunction Myocardial ischemia or infarction Coronary artery disease Hypertension Cardioprotection (modest doses) Cardiomyopathy Reduced systemic vascular resistance (hepatic cirrhosis) Atrial and ventricular arrhythmias (“holiday heart”) Sudden cardiac death	Respiratory depression/failure Aspiration Exacerbation of asthma Reduced functional vital capacity (ascites) Hypoxemia Hepatopulmonary syndrome Pulmonary hypertension Community-acquired pneumonia	Seizures during use or withdrawal Ischemic or hemorrhagic stroke Cerebral protection against ischemia (modest doses) Impaired cognition Compression neuropathy Peripheral polyneuropathy	Alcoholic fatty liver Alcoholic hepatitis GERD Upper GI bleeding Pancreatitis (acute or chronic)	Renal tubular dysfunction Renal tubular acidosis Hepatorenal syndrome	Myelopathy Alcoholic ketoacidosis ↓Potassium ↓Magnesium ↓Phosphate ↓Vitamin K-dependent coagulation factors Pancytopenia Malnutrition Immunosuppression
Sedative-hypnotics		Respiratory depression Atelectasis Aspiration	Sedation, obtundation, and coma			
Opioids	Reduced LV preload Bradycardia Cardioprotection Endocarditis	Talc granulomatosis Septic pulmonary emboli Mycotic pulmonary aneurysm Pulmonary hypertension/RV failure Pneumo-, hemo-, chylothorax Empyema Mucosal damage Bronchospasm Barotrauma Emphysema Respiratory depression/failure Aspiration pneumonitis Noncardiogenic pulmonary edema Pneumonia Hypersensitivity pneumonitis	Seizures (meperidine, pentazocine) Ischemic or hemorrhagic stroke Myelopathy Guillain-Barré syndrome Encephalopathy	Ileus Intestinal pseudoobstruction Hepatic granulomatosis	Heroin nephropathy(?) Nephropathy related to infectious disease	Malnutrition Immunosuppression
Cocaine	Sympathetic nervous system activation Myocardial ischemia/infarction	Pulmonary vasoconstriction Reduced diffusion capacity	Ischemic stroke Hemorrhagic stroke	Bowel ischemia/infarction Bowel obstruction or drug toxicity (body “packing” or “stuffing”)	Infectious disease-related nephropathies Renal ischemia/infarction	Malnutrition Immunosuppression

*continued*

TABLE 23-2.

## Medical Complications of Alcohol and Drug Abuse (Continued)

Drug	Cardiovascular	Pulmonary	Neurologic	Hepatic/GI	Renal	Other
	Coronary vasospasm Accelerated atherosclerosis Hypertension Ventricular arrhythmias Sudden cardiac death Dilated cardiomyopathy Pulmonary edema Aortic or coronary dissection Peripheral vascular insufficiency	Alveolar hemorrhage Noncardiogenic pulmonary edema Eosinophilic hypersensitivity pneumonitis (“crack lung”) Mucosal injury Sinusitis Burns (“freebasing”)	Cognitive dysfunction Seizures	Cocaine hepatitis	Renal insufficiency caused by hypertension Rhabdomyolysis Thrombotic microangiopathy	
Amphetamines	Similar to cocaine Necrotizing vasculitis	Similar to cocaine Pulmonary hypertension	Ischemic and hemorrhagic strokes Seizures associated with drug toxicity Paranoia/psychosis	Hepatic failure (MDMA) Hepatitis A (methamphetamine)	Accelerated hypertensive renal disease Necrotizing vasculitis Rhabdomyolysis	Iatrogenic hyponatremia Malnutrition Immunosuppression
Marijuana	Myocardial ischemia/infarction (patients with CAD) Ventricular ectopy	Chronic bronchitis Emphysema CO-hemoglobinemia Fungal pneumonia Hypersensitivity pneumonitis				
Hallucinogens	Similar to cocaine and amphetamines		Hallucinations, delusions, paranoia Seizures Myoclonus Ischemic or hemorrhagic stroke	Hepatic necrosis	Rhabdomyolysis	Profound hyperthermia
Inhalants		Respiratory depression Bronchospasm Hemoptysis Aspiration Barotrauma Asphyxiation Methemoglobinemia (amyl nitrate)	Dementia (toluene) Lead encephalopathy (gasoline) Polyneuropathy (hexane)			Metabolic acidosis (toluene)

Abbreviations: CAD, coronary artery disease; CO, carbon monoxide; GERD, gastroesophageal reflux disease; GI, gastrointestinal; LV and RV, left and right ventricular, respectively; MDMA, 3, 4-methylenedioxymethamphetamine.

idence of coronary artery disease, and improves survival during acute myocardial infarction. Favorable alterations in lipid metabolism, direct antioxidant

effects, inhibition of platelet aggregation, antifibrinolytic actions, and arterial vasodilatation mediated by release of nitric oxide have been proposed as po-

tential mechanisms for these beneficial effects. More recently, a growing body of experimental evidence suggests that chronic, moderate ethanol consump-

tion activates many of the endogenous signal transduction pathways that were previously implicated in cardioprotection produced by classical and delayed ischemic preconditioning.<sup>46</sup> These findings suggest a molecular basis for myocardial protection by chronic ingestion of modest amounts of alcohol. Small quantities of specific alcoholic beverages (e.g., red wine, beer) may further reduce the incidence of and complications related to coronary artery disease by exerting antioxidant effects or augmenting vitamin B<sub>6</sub> metabolism. Despite these convincing data suggesting that small amounts of alcohol may produce favorable cardiovascular effects, substantial individual variability in ethanol-induced myocardial protection may exist, and “rebound” phenomena that theoretically increase the risk of cardiovascular complications have also been described with abrupt cessation of alcohol intake. This latter caveat may be of particular importance as temporary abstinence from alcohol consumption is required during the perioperative period.

Alcohol abuse is associated with a dilated cardiomyopathy characterized by myocardial hypertrophy, biatrial and biventricular dilation, interstitial fibrosis concomitant with loss of actin and myosin proteins, profound disruption of myocyte organelle structure, and severe contractile dysfunction culminating in congestive heart failure and death.<sup>47</sup> The development of alcoholic cardiomyopathy requires prolonged alcohol abuse, and patients with this disorder are typically older, heavier alcohol abusers than alcoholics who maintain relatively normal cardiac geometry and performance. Alcoholic cardiomyopathy occurs independent of the malnutrition that frequently accompanies alcohol addiction, is most often observed in black men, and is most likely unrelated to preservatives or other substances that may be added to alcoholic beverages by manufacturers. The mechanisms responsible for alcoholic cardiomyopathy are unknown, but direct toxicity of the drug or its metabolites has been proposed as a major etiology of the disorder. Left ventricular systolic dysfunction in patients with alcoholic cardiomyopathy may be further accelerated by the sustained increases in afterload that result from the alcohol-induced hypertension. Notably, alcoholic cardiomyopathy may often be

detected in clinically asymptomatic alcoholics using noninvasive techniques (e.g., echocardiography, cardiac magnetic resonance imaging) and may be reversible with abstinence at this early stage in the natural history of the disease.

Advanced hepatic cirrhosis resulting from alcohol abuse produces alterations in systemic hemodynamics that may obscure the presence of alcoholic cardiomyopathy. Decompensated cirrhosis is characterized by increases in cardiac output that occur in response to marked decreases in systemic vascular resistance.<sup>48</sup> A correlation between the degree of hepatic dysfunction and the magnitude of reduction in systemic vascular resistance was previously established.<sup>48</sup> The abnormal arterial-venous shunting that accompanies chronic hepatic dysfunction does not appear to be primarily responsible for the hyperdynamic circulatory responses. Instead, enhanced production of nitric oxide has been implicated as a likely cause of cirrhosis-induced declines in peripheral resistance,<sup>49</sup> as nitric oxide synthase inhibitors abolished increases in basal forearm blood flow in patients with alcoholic liver disease. Notably, the presence of ascites and consequent reductions in left ventricular preload may stimulate compensatory sympathetic nervous system-mediated vasoconstriction that attenuates cirrhosis-induced vasodilatation.

Atrial or ventricular arrhythmias are frequently observed in alcohol abusers, and develop most often after a binge-drinking episode. This “holiday heart” syndrome usually occurs in otherwise healthy individuals in the absence of demonstrable heart disease or abnormalities in serum electrolyte concentrations. However, the sudden appearance of a new arrhythmia may also suggest the presence of alcoholic cardiomyopathy in a small minority of patients. Atrial fibrillation is the most commonly encountered arrhythmia associated with alcohol, and the unanticipated presentation of atrial fibrillation suggests that the diagnosis of alcohol abuse should be entertained. The mechanisms by which alcohol precipitates atrial fibrillation remain unclear despite extensive study. An increased risk of sudden cardiac death has also been reported in alcohol abusers with or without coronary artery disease, presumably as a result of malignant

ventricular arrhythmias.<sup>50</sup> Hypokalemia and hypomagnesemia are common in patients with alcohol addiction, and these electrolyte abnormalities may play an important contributing role to the development of ventricular arrhythmias. Other potential etiologies for alcohol-induced sudden cardiac death include acute myocardial ischemia, coronary vasospasm, or withdrawal-induced increases in sympathetic nervous system activity.

Alcohol abuse produces a wide variety of pulmonary complications that are related to the acute and chronic effects of the drug.<sup>51</sup> Ethanol is a potent depressant of centrally mediated respiratory activity, and acute intoxication may be associated with hypoxemia, hypercarbia, respiratory acidosis, atelectasis, and respiratory failure. Such complications may be more pronounced in patients with preexisting respiratory pathology (e.g., chronic obstructive or restrictive pulmonary disease, obstructive sleep apnea, upper airway neoplasm). Aspiration pneumonia complicated by adult respiratory distress syndrome may occur during acute intoxication as a result of an altered level of consciousness and compromise of airway protective reflexes. Ingestion of ethanol is known to exacerbate bronchospastic lung disease, especially in patients with histamine-sensitive asthma. Acetaldehyde-induced mast cell degranulation with the subsequent release of histamine, leukotrienes, and other inflammatory mediators has been implicated as a potential mechanism of alcohol-induced bronchospasm. Conversely, other patients with asthma have described symptomatic improvement with alcohol ingestion, suggesting that the acute effects of ethanol on airway reactivity may be difficult to predict.

Several important pulmonary complications of chronic alcohol abuse occur in patients with cirrhosis. The presence of large quantities of ascitic fluid substantially reduces vital and functional residual capacities, resulting in atelectasis, tachypnea, dyspnea, and rapid arterial oxygen desaturation during induction of general anesthesia. This clinical picture may be further exacerbated by pleural effusion resulting from negative intrathoracic pressure-mediated movement of ascitic fluid across the diaphragm to the pleural space. Hypoxemia may also develop in patients with alcoholic cirrhosis

because of abnormal pulmonary arterial-venous shunts. This “hepatopulmonary syndrome” is characterized by markedly reduced pulmonary vascular resistance and is observed in as many as 15% of patients with cirrhosis.<sup>52</sup> Enhanced production of nitric oxide and altered hepatic metabolism of estrogen and progesterone have been proposed as potential etiologies for hepatopulmonary syndrome. Conversely, a small minority of patients with alcoholic cirrhosis develop pulmonary hypertension, most likely because the unopposed actions of circulating vasoactive substances that normally are metabolized by the liver. Notably, the diagnosis of this “portal” pulmonary hypertension may be overlooked because many of the signs and symptoms of right ventricular failure mimic those of chronic hepatic dysfunction. In fact, portal pulmonary hypertension that is unresponsive to pulmonary vasodilators is a relative contraindication to liver transplantation in patients with alcoholic cirrhosis. Lastly, chronic alcohol abuse is associated with enhanced susceptibility to pneumonia caused by a variety of pathologic organisms including *Klebsiella* and *Streptococcus pneumoniae* and *M. tuberculosis*. Depression of immunologic function, concomitant tobacco abuse, and malnutrition probably contribute to the increased incidence of community-acquired pneumonia in this patient population.

Seizures and cerebrovascular accidents are common neurologic complications observed in alcohol abusers. In the absence of other possible causes (e.g., past history of epilepsy, central nervous system infection or trauma, cerebrovascular accident), alcohol-induced seizures are most often associated with drug withdrawal and are either single, grand mal events or occur in brief clusters of global epileptiform activity. Status epilepticus or focal seizure activity are infrequently observed during alcohol withdrawal seizures. The exclusion of other potential seizure etiologies in conjunction with a history of abrupt cessation of heavy alcohol consumption within 48 hours of the event is required for the diagnosis to be established. Anticonvulsant medications are usually not required for the treatment of alcohol withdrawal seizures, as these events are typically self-limited. Seizures may also occur during active alcohol consumption in-

dependent of withdrawal. The mechanisms responsible for seizures under these conditions are unclear, but alcohol may stimulate central nervous system excitability *via* its actions on glutamate metabolism and *N*-methyl-D-aspartate (NMDA) receptor activity. Similar to previously reported reductions in cardiovascular risk associated with moderate alcohol consumption, many epidemiologic studies suggest that daily ingestion of small quantities of alcohol may reduce the risk of cerebrovascular accidents.<sup>53</sup> It appears highly likely that many of the factors implicated in alcohol-induced cardioprotection are responsible for these beneficial actions against stroke. In contrast, chronic alcohol abuse is strongly associated with an increased incidence of hemorrhagic and ischemic strokes. The presence of hypertension, concomitant cardiovascular disease, direct vasoconstriction of cerebral arterioles, and a prothrombotic state contribute to the enhanced risk of stroke in alcohol abusers.

Sustained impairment of cognitive function frequently occurs in chronic alcohol abusers and may be observed as a consequence of closed cranial trauma, infection, hepatic encephalopathy, or malnutrition. Dementia occurs in as many as 10% of patients with alcohol addiction. Severe alterations in cognitive function produced by alcohol abuse may jeopardize the ability of the anesthesiologist or surgeon to obtain informed consent and may also undermine compliance with treatment during the perioperative period. Thiamine deficiency precipitated by alcohol-induced malnutrition produces Wernicke encephalopathy, and if inadequately treated, causes Korsakoff syndrome. Characterized by confusion, memory and attention deficits, nystagmus, and ataxia, Wernicke encephalopathy is initially fully reversible with appropriate thiamine replacement. In contrast, Korsakoff syndrome is identified by irreversible memory deficits, amnesia, inability to recall new information, and confabulation. Nutritional deficiency of nicotinic acid also occurs in alcohol abusers and causes pellagra. A reversible encephalopathy, characterized by cognitive impairment, delusion, hallucination, and delirium, is the major neurologic complication of pellagra. A more ominous cause of alcohol-induced impaired cognition is Marchiafava-Bignami disease, a rapidly

progressing neurologic disorder that is histologically characterized by segmental demyelination of the corpus callosum.

Myopathy and neuropathy are frequently observed in alcohol abusers. The clinical spectrum of alcoholic myelopathy ranges from an isolated increase in blood creatine kinase concentration in the absence of symptoms to severe muscle wasting that resembles polymyositis. Peripheral compression nerve palsies, rhabdomyolysis, and compartment syndromes commonly occur because alcohol abusers may lose consciousness and remain immobile for prolonged periods. A sensory-motor polyneuropathy has also been described in alcohol abusers characterized by progressive distal extremity sensory deficits, weakness, and pain with or without autonomic nervous system dysfunction. Like alcoholic cardiomyopathy, alcohol-induced myelopathy and polyneuropathy most likely occur as a direct result of drug toxicity, although malnutrition may also play an important contributing role.

Alcoholic liver disease is perhaps the most well-recognized complication of alcohol abuse. The importance of this disorder should not be overlooked, as hepatic failure resulting from alcohol abuse is responsible for more than 25,000 deaths annually in the United States.<sup>54</sup> Until it was surpassed by chronic HCV, alcohol-induced hepatic cirrhosis was the most common indication for liver transplantation in this country. The total amount of alcohol ingested per day and the duration of alcohol abuse are major risk factors for the development of alcoholic liver disease. Female gender, malnutrition, coexisting HBV or HCV infection, obesity, and genetic predisposition also have been identified as risk factors for the development of alcoholic liver disease. Abuse of alcohol produces three important hepatic manifestations that represent a continuum of progressive disease but may also simultaneously coexist. Fatty liver may be observed in chronic alcohol abusers but may also occur after several days of binge drinking in healthy individuals. Clinical signs and symptoms of alcohol-induced fatty liver include nausea, vomiting, anorexia, and right upper quadrant pain concomitant with preserved or mildly elevated liver function tests. The relative perioperative risk associat-



ed with alcoholic fatty liver has not been rigorously evaluated, but it is probably prudent to delay elective surgery until abstinence is achieved and clinical symptoms resolve.

The presentation of alcoholic hepatitis is similar to that of viral hepatitis, and is characterized by fever, jaundice, abnormal liver function tests, and right upper quadrant pain. Severe alcoholic hepatitis is associated with high mortality, is often accompanied by ascites, encephalopathy, and coagulopathy, and represents a contraindication to elective surgery.<sup>55</sup> Portal hypertension, ascites, esophageal varices, hepatic encephalopathy, spontaneous bacterial peritonitis, and coagulopathy resulting from decreased synthesis of coagulation factors and thrombocytopenia typify end-stage liver disease resulting from cirrhosis. In addition to clinical signs and symptoms, the diagnosis of alcoholic liver disease is established on the basis of a history of sustained alcohol abuse concomitant with characteristic abnormalities in liver function tests. Markedly increased blood gamma-glutamyl transpeptidase concentrations are accompanied by elevations in aspartate aminotransferase (AST) that usually exceed those of alanine aminotransferase (ALT), hyperbilirubinemia, hypoalbuminemia, and prolonged prothrombin time. Surgical risk in patients with alcoholic cirrhosis depends on the severity of the disease. For example, one study quoted mortality rates for alcohol abusers with the Child classifications A, B, and C hepatic disease undergoing abdominal surgery as 10%, 31%, and 76%, respectively.<sup>56</sup> The evaluation of patients with liver disease and its consequences for anesthetic management are discussed in further detail in Chapter 56.

A number of gastrointestinal complications have potential implications for anesthesiologists who are caring for patients with alcohol addiction. Gastroesophageal reflux frequently occurs in association with acute alcohol ingestion because of reductions in lower esophageal sphincter tone. Chronic alcohol use also reduces maximal lower esophageal sphincter pressure. These actions predispose the alcohol abuser to the risk of acid aspiration. The presence of upper gastrointestinal bleeding also increases aspiration risk during induction of general anesthesia. Upper gastrointestinal hemorrhage may occur as a re-

sult of direct alcohol-induced esophageal, gastric, or duodenal mucosal injury, esophageal varices, or tears of the gastroesophageal junction produced by vomiting (i.e., Mallory-Weiss syndrome). Clearly, severe upper gastrointestinal bleeding may cause profound hypovolemia requiring aggressive volume replacement with blood products and often compels immediate endoscopic or surgical intervention in order to successfully manage. Active upper gastrointestinal hemorrhage or the presence of esophageal varices also represent relative contraindications to the use of intraoperative transesophageal echocardiography. Alcohol abuse is a major risk factor for the development of acute and chronic pancreatitis. Acute pancreatitis resulting from alcohol abuse is characterized by inflammation of the organ that may also involve surrounding structures and presents with severe abdominal pain, nausea and vomiting, and hyperamylasemia concomitant with a history of prolonged alcohol consumption. Acute alcoholic pancreatitis may be complicated by respiratory insufficiency, renal failure, and sepsis. Enzymatic autodigestion of the pancreas and the release of cytotoxic reactive oxygen intermediates have been implicated in the pathogenesis of alcohol-induced acute pancreatitis. Pain and variable degrees of endocrine and exocrine dysfunction are typical features of chronic pancreatitis and are exacerbated by further alcohol abuse. Chronic administration of opioids or celiac plexus neurolytic blocks are often required for pain management in patients with alcohol-induced chronic pancreatitis.

Hepatorenal syndrome is the most devastating renal complication of chronic alcohol abuse and is almost always fatal without liver transplantation. Hepatorenal syndrome is characterized by profound hepatic dysfunction, splanchnic vasodilatation, and intense renal arterial vasoconstriction.<sup>57</sup> The diagnosis of hepatorenal syndrome requires the exclusion of other causes of nephrotoxicity and is distinguished by progressive oliguric renal failure and reduced glomerular filtration rate that are unresponsive to volume administration concomitant with a gradual increase in serum creatinine concentration and a markedly reduced urine sodium concentration. The diagnosis of hepatorenal syn-

drome may initially be difficult to establish because reduced muscle mass resulting from chronic malnutrition is commonly observed in alcohol abusers, and increases in serum creatinine and blood urea nitrogen concentrations may not become apparent until late in the natural history of the disease. Hepatorenal syndrome may occur in conjunction with a major complication of alcohol-induced end-stage liver disease (e.g., sepsis, upper gastrointestinal hemorrhage), but also may develop insidiously without an apparent underlying cause.

Alcohol abuse produces several important acid-base and electrolyte derangements as a result of the combination of gastrointestinal losses and malnutrition. Perhaps the frequent severe metabolic complication in this regard is alcoholic ketoacidosis. This anion gap acidosis may be profound, usually occurs in alcohol abusers after binge drinking, and results from enhanced lipolysis and attenuated gluconeogenesis associated with profound carbohydrate malnutrition. Chronic diarrhea or renal tubular damage may cause nonanion gap metabolic acidosis in alcohol abusers as well. Hypokalemia is very common in alcohol abusers, occurs as a consequence of losses from the gastrointestinal tract combined with secondary hyperaldosteronism, and unless corrected, may exacerbate preexisting hepatic encephalopathy or precipitate rhabdomyolysis. Other common electrolyte abnormalities in alcohol abusers are hypomagnesemia and hypophosphatemia. Gastrointestinal loss, malnutrition, and alcohol-induced renal tubular dysfunction combine to produce these deficiencies in alcohol abusers. Notably, hypomagnesemia worsens hypokalemia, and treatment of potassium deficits requires simultaneous administration of magnesium. Alcohol abuse-induced hypophosphatemia is also associated with an increased risk of rhabdomyolysis and encephalopathy.

Ethanol causes direct bone marrow toxicity and produces pancytopenia that may be further exacerbated by splenic sequestration concomitant with portal hypertension. Iron and folate deficiency with or without acute or chronic blood loss and hemolysis resulting from fragility of red blood cell membranes also contribute to anemia in alcohol abusers. Because alcohol-induced anemia is often multifactorial

in nature, evaluation of mean corpuscular volume may not accurately reflect the underlying etiology. Leukopenia is also a common finding in alcohol abusers and substantially elevates infection risk on the basis of both reduced number and activity of polymorphonuclear leukocytes. Alcohol-induced thrombocytopenia may be profound, and in combination with reduced synthesis of vitamin K-dependent coagulation factors, substantially increases the risk of bleeding associated with gastrointestinal causes, traumatic injury, or surgical intervention.

### Sedative–Hypnotics

The clinical pharmacology of barbiturates and benzodiazepines are discussed in Chapter 39. Briefly, barbiturates, benzodiazepines (including the ultrashort-acting agent flunitrazepam, known as the “date rape” drug), and the  $\gamma$ -aminobutyric acid (GABA) derivative  $\gamma$ -hydroxybutyrate (GHB, termed “liquid Ecstasy”) act through GABA receptors to exert anxiolytic, anticonvulsant, amnestic, and sedative effects.<sup>58</sup> The major complications associated with abuse of these drugs are respiratory depression and overdose, especially in the presence of alcohol or opioids. Barbiturate or benzodiazepine abuse produces sedation, obtundation, or coma with eventual loss of airway protective reflexes and contributes to progressive alveolar hypoventilation, hypoxemia, hypercarbia, respiratory acidosis, and death. In the past, death from barbiturate abuse-mediated respiratory depression was not uncommon, but the clinical use of these drugs in the treatment of anxiety disorders has been largely usurped by benzodiazepines or specific selective serotonin reuptake inhibitors (SSRIs) that display a substantially greater margin of safety. Nevertheless, death resulting from benzodiazepine overdose has been reported, although most often in conjunction with the abuse of other drugs.

### Opioids

Heroin is the most commonly abused opioid in the United States. The Office of National Drug Control Policy estimates that more than 900,000 individuals in this country suffer from heroin addiction.<sup>59</sup> Heroin and other opioid abusers have markedly elevated risk for developing a wide variety of potentially devastating medical complica-

tions. The clinical pharmacology of opioids is very well known to anesthesiologists and is reviewed in detail in Chapter 41. This section instead focuses on pathology specifically associated with opioid abuse. Cardiovascular stability is a hallmark of administration of opioids, and even large quantities of opioids (such as those used during cardiac anesthesia) typically produce only minor alterations in systemic hemodynamics. Most naturally occurring and synthetic opioids dilate venous capacitance and splanchnic arteriolar vessels, causing small reductions in arterial pressure independent of the histamine release that may occur with some opioids (e.g., heroin, morphine). It is precisely these actions of opioids on ventricular loading conditions that make these drugs especially useful for the clinical treatment of heart failure complicated by acute pulmonary edema. Opioids also produce modest reductions in heart rate but do not substantially affect myocardial contractility or cardiac output under most clinical conditions. Opioids exert cardioprotective effects against infarction<sup>60</sup> and may also produce antiarrhythmic actions in ischemic myocardium. As a result, opioid abuse usually produces few, if any, direct cardiovascular consequences, in contrast to stimulants such as cocaine or amphetamines. As discussed earlier, endocarditis is the major cardiovascular complication associated with opioid abuse.

Opioid-induced pulmonary complications are diverse and are responsible for as much as 20% of all hospital admissions related to the abuse of these drugs. Intravenous abuse of opioids may produce acute or chronic pulmonary consequences associated with substances that contaminate the drug or those related to the route of administration. For example, magnesium silicate (talc) is frequently used in oral preparations manufactured by pharmaceutical companies or may be mixed with an illicit opioid to dilute the drug. Injection or inhalation of magnesium silicate or other contaminants may cause pulmonary granulomatosis, a form of diffuse micronodular interstitial fibrosis characterized by dyspnea on exertion, cough, and diminished diffusion capacity. The clinical presentation of “talc granulomatosis” is similar to sarcoidosis and may be complicated by frank occlusion of

pulmonary arterial branches by granulomas, pulmonary hypertension, and right ventricular failure. Chronic hypoxemia and reactive pulmonary arterial vasoconstriction resulting from interstitial fibrosis may also contribute to the development of pulmonary hypertension or cor pulmonale under these conditions. Bullous emphysema has been reported as another chronic complication of talc granulomatosis in intravenous opioid abusers. As discussed earlier, septic pulmonary embolism is a frequent complication of injection drug abuse that may occur as a result of thrombophlebitis at the injection site or more commonly, tricuspid valve endocarditis. Mycotic aneurysms also occur as a consequence of seeding of the pulmonary vasculature with septic thromboemboli, and rupture of a pulmonary mycotic aneurysm may cause life-threatening hemoptysis. Broken needle fragments may embolize to the lung parenchyma, but do not typically require removal unless complicated by infection or hemorrhage. Pneumothorax, hemothorax, chylothorax, and empyema are also well-known complications associated with attempted opioid injection into the internal jugular or subclavian vein (termed “pocket shooting”).

Smoking or nasal inhalation of opioids is also associated with several pulmonary complications. Particulate substances are distributed throughout the bronchial tree depending on size, and contribute to mucosal irritation, inflammation, fibrosis, and granulomatosis. Chemical compounds produced by ignition of drugs or solvents also produce mucosal damage. Thus patients who use inhaled opioids are susceptible to the development of bronchospasm, bronchitis, airway injury, or hemoptysis. Barotrauma (e.g., pneumothorax, pneumomediastinum) may occur during inhaled opioid abuse as a result of intense breath-holding performed to enhance the actions of the drug. Such a sustained Valsalva maneuver produces lung hyperinflation and pronounced negative intrathoracic pressure that may result in peribronchial dissection of air or rupture of alveolar blebs. Barotrauma may also occur if smoke is forcefully exhaled from one user into the lungs of another (known as “shotgunning”). Lastly, chronic abuse of inhaled opioids is associated with the development of emphysema.

Pulmonary complications may also result from the direct actions of opioids on central nervous system control of respiration, airway reactivity, pulmonary arterial vascular tone, and immunological response to infectious agents. Opioids bind to  $\mu_2$  receptors in the pons and medulla, thereby attenuating respiratory automaticity, inhibiting centrally mediated airway protective reflexes, and reducing the influence of carbon dioxide on respiratory drive in a dose- and route of administration-dependent manner. These actions produce respiratory depression culminating in apnea, a major cause of mortality associated with opioid overdose.<sup>61</sup> Loss of airway reflexes combined with a diminished level of consciousness also predisposes the opioid abuser to aspiration pneumonitis and its associated complications (e.g., hypoxemia, respiratory insufficiency requiring mechanical ventilation, superimposed bacterial pneumonia). Opioid-induced release of histamine from mast cells may precipitate bronchospasm in drug abusers with asthma. Histamine release by opioids may occur as a result of direct activation of  $\mu$  opioid receptors or via an IgE-mediated mechanism.

Noncardiogenic pulmonary edema occurs in up to one-half of all patients presenting with opioid overdose and is associated with substantial mortality. Pulmonary edema has been described with either intravenous or inhalational opioid abuse and appears to be dose related. Pulmonary edema has also been reported in first-time opioid abusers independent of dose. The mechanisms responsible for opioid-induced pulmonary edema remain unclear. Opioids may directly increase pulmonary capillary permeability, thereby facilitating accumulation of protein and fluid in the alveoli by hydrostatic forces. A neurogenic component to pulmonary edema has also been proposed in which opioids precipitate a pronounced centrally mediated efferent response that causes pulmonary venoconstriction and increases pulmonary capillary permeability.<sup>62</sup> Histamine release by opioids may also produce constriction of pulmonary veins and enhance permeability of pulmonary capillary membranes. Aspiration pneumonitis and secondary bacterial pneumonia often complicate the management of patients with opioid-induced pulmonary edema. A hypersensitivity pneumonitis characterized by

dyspnea, cough, and bilateral pulmonary infiltrates appearing several days after nasal inhalation has been described in heroin users. Opioid abuse attenuates phagocytosis by neutrophils and macrophages, reduces T-cell and killer cell activity, decreases CD4 cell count, promotes leukocyte apoptosis (programmed cell death), depresses white blood cell chemotaxis, and curtails delayed hypersensitivity reactions.<sup>63</sup> These profound effects on the immune response to pulmonary pathogens markedly increase the risk of infection in the chronic opioid abuser.

Opioid abuse is associated with several important neurologic consequences. Seizures are a rare side effect of heroin or morphine abuse or withdrawal, and the occurrence of seizures in patients who have abused these opioids should prompt the clinician to investigate other potential etiologies (e.g., infection, trauma, cerebrovascular accident, toxicity or withdrawal related to other drugs of abuse). In contrast to the findings with heroin and morphine, meperidine abuse is associated with the development of seizures because of the epileptogenic properties of normeperidine, a major meperidine metabolite.<sup>64</sup> Seizures have also been reported after intravenous abuse of the mixed opioid agonist-antagonist pentazocine in combination with the antihistamine tripeleminamine (known as "T's and Blues"). Heroin abuse is reported to cause ischemic cerebrovascular accidents independent of other causes of stroke. Ischemic strokes may occur as a result of embolization of pulverized oral medication after injection, severe hypotension after overdose, or cerebral vasculitis. In contrast, hemorrhagic strokes usually occur in opioid abusers concomitant with infectious disease-related complications or renal failure. A myelopathy characterized by sensory loss, paraparesis, and urinary retention has been described in heroin abusers that may be related to spinal cord infarction or vasculitis. Immunologically mediated Guillain-Barré syndrome and brachial or lumbar plexopathies have also been reported in heroin addicts. Lastly, a profoundly debilitating and often fatal leukoencephalopathy is described in heroin abusers who inhaled drug vapors produced by heating on metal foil (known as "chasing the dragon").

Heroin use is associated with the development of focal and segmental

glomerulosclerosis concomitant with hypertension and progressive renal insufficiency. Initially, heroin nephropathy was attributed to drug impurities and the presence of contaminants. However, clinical description of heroin nephropathy has declined significantly because of its close resemblance to HIV and HCV nephropathies.<sup>65</sup> Thus it appears highly likely that heroin nephropathy is probably a manifestation of coincident HIV or HCV infection and is not mediated by the drug itself or other substances that contaminate it.

## Cocaine

More than 3.6 million Americans are chronic cocaine users.<sup>66</sup> The vast majority of the cocaine-induced medical consequences are related to pharmacologic properties of the drug<sup>67</sup> or infectious diseases associated with its use. In addition to its well-known local anesthetic effects, cocaine produces intense vasoconstriction in nearly all vascular beds as a result of inhibition of presynaptic reuptake of norepinephrine, enhanced actions of circulating endogenous catecholamines, and augmented centrally mediated sympathetic nervous system activity. From a cardiovascular perspective, these actions produce tachycardia and hypertension, and as a result, pronounced increases in myocardial oxygen consumption. The acute hemodynamic effects of cocaine ingestion are associated with direct coronary vasoconstriction, vasospasm, and prothrombotic effects (e.g., increased platelet adhesion and aggregation) whose combined actions may produce myocardial ischemia and infarction.<sup>68</sup> This pathophysiology was dramatically emphasized by Mittelman et al., who reported that the risk of myocardial infarction was increased by greater than 20-fold during the first hour after cocaine use as compared to other times.<sup>69</sup> In fact, cocaine ingestion may be responsible for as much as 25% of acute myocardial infarctions in younger patients (ages 18–45 years),<sup>70</sup> independent of route or frequency of administration, drug quantity, or plasma concentration. With the exception of smoking, other classical risk factors for coronary artery disease are typically absent and angiographically documented coronary stenoses are present in only 50% of these patients.<sup>68</sup> Cocaine inhibits sarcolemmal  $\text{Na}^+$ , voltage-dependent  $\text{Ca}^{2+}$ , and  $\text{K}^+$  channel conductance, attenuates  $\text{Ca}^{2+}$ -induced

Ca<sup>2+</sup> release from the sarcoplasmic reticulum, and reduces myofilament Ca<sup>2+</sup> sensitivity.<sup>71</sup> When combined with the sympathomimetic and vagolytic actions of the drug, these important alterations in cardiac electrophysiology may precipitate malignant ventricular arrhythmias and sudden cardiac death independent of myocardial ischemia or other preexisting heart disease.

Accelerated coronary atherosclerosis has been observed in chronic cocaine abusers that may contribute to the risk of myocardial ischemia or infarction.<sup>72</sup> The mechanisms responsible for this accelerated atherosclerosis are unclear, but release of inflammatory cytokines, repeated exposure to elevated circulating catecholamines, enhanced vascular endothelial permeability permitting intimal diffusion of atherogenic lipoproteins, and chronic vasospasm have been implicated as potential contributing factors. Repeated cocaine abuse is also associated with focal myocarditis and necrosis, pathologic findings that are very similar to those observed during chronically elevated levels of circulating catecholamines (e.g., pheochromocytoma). Cocaine-induced hypertension may contribute to the development of left ventricular hypertrophy, dilated cardiomyopathy with left ventricular systolic and diastolic dysfunction, and acute pulmonary edema, especially in patients with preexisting hypertension or concomitant alcohol abuse. Severe hypertension after cocaine ingestion may also contribute to the development of acute aortic or coronary artery dissection. In addition, the pronounced arterial vasoconstriction associated with cocaine ingestion may result in acute peripheral vascular insufficiency and limb ischemia. Notably, a greater risk of aortic or mitral valve endocarditis has also been suggested in cocaine as compared to heroin or amphetamine abusers.<sup>68</sup>

The pulmonary complications of cocaine abuse most often occur as a consequence of inhalation of the drug and are exacerbated by habitual tobacco or marijuana smoking. Like other inhaled drugs of abuse, inhalation of cocaine may be associated with bronchospasm, chronic bronchitis, barotrauma, hemoptysis, or pulmonary fibrosis.<sup>73</sup> As a result of its sympathomimetic properties, inhaled cocaine produces intense pulmonary vasoconstriction and in-

creases vascular permeability. These actions contribute to an acute and marked reduction in diffusion capacity similar to that observed in chronic tobacco smokers. More ominously, the effects of inhaled cocaine on the pulmonary circulation may produce diffuse alveolar hemorrhage or noncardiogenic pulmonary edema resulting from elevated pulmonary capillary permeability.<sup>73</sup> Other noncardiogenic mechanisms for cocaine-induced pulmonary edema have also been described, including a high negative intrathoracic pressure etiology during inhalation and a neurogenic cause based on marked increases in sympathetic nervous system activity in the pulmonary circulation.<sup>73</sup> Despite the acute pulmonary vascular effects of cocaine use, frank infarction of lung parenchyma has only been infrequently reported. Nevertheless, irreversible pulmonary hypertension may occur in cocaine addicts resulting from pulmonary arterial medial hypertrophy and the frequent development of interstitial fibrosis mediated by the deposition of talc, silica, or other substances used to “cut” the drug.<sup>73</sup> Inhalation of cocaine may predispose the patient to the development of infection, as the drug not only suppresses B- and T-lymphocyte function, but also substantially impairs the activity of alveolar macrophages. A delayed eosinophilic hypersensitivity pneumonitis that bears many similarities to Loeffler disease has also been described after cocaine inhalation. This “crack lung” syndrome typically occurs hours after a period of intense abuse and is associated with pleuritic chest pain, hemoptysis, diffuse infiltrates, hypoxemia, fever, and eosinophilia.<sup>74</sup> Upper airway complications, including mucosal irritation and burns, are common among cocaine abusers. Vasoconstriction produced by a nasal route of administration of the drug may result in septal perforation, acute or chronic sinusitis, epiglottitis, airway obstruction, or an upper airway vasculitis that is similar to Wegener granulomatosis.<sup>73</sup> Severe upper airway burns may also occur as a result of “freebasing,” a potentially explosive chemical process in which a highly flammable solvent is used to transform cocaine from a salt to a base and increase the potency of the drug. A higher prevalence of tuberculosis has also been reported in drug users who smoke crack cocaine as compared to those who inhale other drugs of abuse.

Two major acute neurologic complications associated with cocaine abuse are cerebrovascular accidents and seizures. Cocaine-induced stroke may occur as a consequence of a cardiac event (e.g., myocardial infarction, ventricular arrhythmias) or an infection (e.g., meningitis, intracranial septic emboli), but these etiologies are not responsible for cerebrovascular accidents in many patients. Ischemic strokes, including transient ischemic attacks and cerebral infarction, constitute approximately half of all cocaine-induced cerebral vascular accidents and are attributed to the potent actions of cocaine as a cerebral vasoconstrictor concomitant with its prothrombotic effects. In fact, direct cerebral vasoconstriction was observed during administration of cocaine using magnetic resonance angiography in volunteers.<sup>75</sup> Hemorrhagic strokes resulting from cocaine abuse most often occur in conjunction with pronounced arterial hypertension, and are frequently associated with the presence of a previously unrecognized cerebral aneurysm or arteriovenous malformation. Cognitive dysfunction has also been reported in chronic cocaine abusers consistent with a form of multiinfarct dementia. Cocaine-induced seizures are usually single, grand mal events that most often resolve without the need for therapeutic intervention. Notably, seizures produced by cocaine abuse may occur without signs or symptoms of systemic drug toxicity. Seizures most often occur in direct association with inhalational or intravenous and less frequently intranasal cocaine abuse, but may also develop several hours after exposure, presumably because the major product of cocaine metabolism (benzoylecgonine) also has epileptogenic effects.

Specific gastrointestinal and hepatic complications of cocaine use have been described. Large or small intestinal ischemia, infarction, or perforation and resulting peritonitis may occur as a consequence of the combination of cocaine-induced mesenteric vasoconstriction and direct toxic effects on intestinal mucosa. Bowel obstruction or acute drug toxicity has been reported with the intentional ingestion of wrapped packages of cocaine (known as “stuffing” or “packing”) that is performed to either illegally smuggle the drug into the United



States or avoid imminent arrest when in its possession.<sup>76</sup> These complications often require immediate surgical management. Cocaine hepatitis is a relatively uncommon disorder caused by the combination of hepatic vasoconstriction and the presence of toxic oxidative metabolites generated through cytochrome P450 3A1, a secondary route of cocaine metabolism. Cocaine hepatitis develops shortly after drug use, is most often associated with other signs and symptoms of systemic toxicity, and may also occur in conjunction with simultaneous alcohol abuse that induces P450 enzymatic activity. Cocaine-induced hepatotoxicity may also occur in patients with reduced plasma pseudocholinesterase activity (the major route of cocaine metabolism) because the P450 3A1 pathway assumes a greater role for drug metabolism under these conditions. Centri- or panlobular hepatic necrosis and marked elevations in serum aminotransferase activity are characteristic findings in patients with cocaine hepatitis.

Acute and chronic renal diseases are quite common in patients who abuse cocaine. Many of the renal consequences of cocaine use are related to infectious diseases, especially in intravenous users. Nephrotic syndrome is associated with HIV or hepatitis nephropathy, glomerulonephritis may occur as a result of bacterial endocarditis or sepsis, and a mixed nephritic–nephrotic syndrome is most often observed with chronic HCV infection. Abuse of cocaine in particular may produce renal insufficiency as a result of infarction, accelerated hypertension, rhabdomyolysis, or thrombotic microangiopathy.<sup>77</sup> The pronounced sympathomimetic actions of cocaine and its prothrombotic effects cause direct renal arterial vasoconstriction and thrombosis, similar to the findings in myocardium. These actions produce acute renal ischemia and infarction. As previously discussed, cocaine abuse may produce severe hypertension, and such sustained elevations in arterial blood pressure may contribute to exacerbation of preexisting renal insufficiency. Acute tubular necrosis resulting from rhabdomyolysis has also been described in patients who abuse cocaine. Another cause of cocaine-induced acute renal insufficiency is thrombotic microangiopathy that may occur in conjunction with

hemolytic uremic syndrome or renal infarction.<sup>78</sup>

## Amphetamines

Drugs in the amphetamine class, including *d,l*-amphetamine, methylphenidate, methamphetamine, and 3,4-methylenedioxy methamphetamine (MDMA, known as “Ecstasy”), are commonly abused and cause a wide variety of acute and chronic medical consequences that may substantially influence perioperative management. In recent years, abuse of MDMA and methamphetamine has increased dramatically, attracting the attention of federal regulatory agencies and the national media. Similar to the actions of cocaine, amphetamines produce sympathetic nervous system activation, inhibit the presynaptic reuptake and potentiate the actions of biogenic amines, and exert direct agonist actions on peripheral  $\alpha$ - and  $\beta$ -adrenoceptors to varying degrees, depending on minor structural variations in their  $\beta$ -phenylethylamine chemistry. As a result of these sympathomimetic effects, amphetamines cause dose-related hypertension that may be sustained for several hours because of the pharmacokinetics of these drugs. Tachycardia may be more commonly observed with methylphenidate and MDMA, presumably because these drugs produce relatively greater activation of  $\beta_1$ -adrenoceptors than other amphetamines. These hemodynamic effects increase myocardial oxygen consumption and are associated with acute myocardial ischemia and infarction, left ventricular dilation, malignant ventricular arrhythmias, and sudden cardiac death. Notably, the cardiovascular effects of amphetamines are known to be markedly potentiated by strenuous physical activity, and deaths attributed to MDMA at night clubs or dance parties (such as “raves”) may be related to this apparent hemodynamic synergism.<sup>79</sup> As observed in cocaine abusers, pathologic examination of hearts from amphetamine abusers revealed focal myocarditis and necrosis consistent with chronic catecholamine exposure. Amphetamines produce arterial vasospasm and promote thrombosis as a result of their sympathomimetic effects, and these actions probably contribute to myocardial damage as well. Methamphetamine abuse has been linked to the development of necrotiz-

ing angiitis, a vascular disease of the intima and media that is very similar to polyarteritis nodosa.

Similar to the findings with inhaled opioids and cocaine, inhalation of amphetamine may be associated with barotrauma, mucosal irritation and hemoptysis, and the development of cardiogenic and noncardiogenic pulmonary edema.<sup>73</sup> Amphetamine overdose may cause central nervous system depression or seizures, and aspiration of stomach contents is quite common under these conditions. In contrast to cocaine, amphetamines are sequestered within pulmonary parenchyma. When combined with the potent pulmonary arterial vasoconstriction produced by these drugs, this action may contribute to the well-known relationship between amphetamines and pulmonary hypertension. Inhaled methamphetamine and intravenous methylphenidate were shown to cause pulmonary hypertension in patients who chronically abused these drugs. Epidemiology studies also suggested a strong link between the amphetamine derivative fenfluramine and the subsequent development of pulmonary hypertension in many patients who had been prescribed this drug as an appetite suppressant.<sup>80</sup> Amphetamines may also reduce immune function and increase the risk of bacterial, viral, or fungal pneumonia. For example, inhaled amphetamine caused the expression of immunosuppressive cytokines and reduced CD4 cell number, actions that may predispose the patient with HIV to pulmonary infection.

Cerebrovascular accidents in amphetamine abusers may be ischemic or hemorrhagic in origin. Similar to cocaine, amphetamine-induced ischemic strokes may occur as a direct consequence of cerebral vasoconstriction. Unlike the findings with cocaine, however, necrotizing or small-vessel hypersensitivity vasculitis was also implicated as an underlying etiology of ischemic stroke in patients who abuse amphetamines.<sup>81</sup> Hemorrhagic strokes resulting from amphetamines, including MDMA, are most frequently caused by a hypertensive crisis. In contrast to seizures produced by cocaine, those associated with amphetamine abuse most often occur concomitant with clinical signs and symptoms of drug toxicity. Amphetamine abuse is associated with symptoms of exaggerated

paranoia and withdrawal from these drugs often leads to prolonged clinical depression as a result of the absence of stimulant effects.

Fulminant hepatic failure resulting in the need for urgent liver transplantation has been reported in MDMA abusers.<sup>82</sup> Hepatotoxicity may occur independent of drug dose and is accompanied by jaundice, pruritus, severe hyperbilirubinemia, and elevated transaminases (AST > ALT). MDMA-induced hepatic injury may be associated with acute drug toxicity or may occur days or even weeks after ingestion, possibly because of delayed drug metabolism by cytochrome P450 2D6 in susceptible patients with reduced enzymatic activity or as a result of an immunologically mediated mechanism. The clinical presentation of hepatic failure is often associated with hypovolemia, hyperthermia, and rhabdomyolysis. Methamphetamine use is associated with the development of HAV.

Amphetamine abuse alters kidney perfusion by virtue of the actions of these drugs on arterial blood pressure and may produce acute and chronic renal failure. Accelerated hypertension and acute renal failure have been observed in methamphetamine and MDMA abusers. Necrotizing vasculitis with microaneurysm formation and thrombosis mimicking polyarteritis nodosa has also been reported in patients who abuse amphetamine that contributes to ischemia and chronic renal insufficiency. Rhabdomyolysis and acute tubular necrosis often accompany MDMA abuse, especially in the presence of hyperthermia and hypovolemia induced by intense physical activity. Interestingly, many MDMA abusers recognize the risk of developing acute hypernatremia under these conditions and attempt to prevent this complication by ingesting large quantities of water, thereby inadvertently causing neurologically significant hyponatremia.

## Marijuana

Marijuana or hashish use is associated with increases in heart rate and cardiac output, reductions in systemic vascular resistance, and relative maintenance of arterial blood pressure. These hemodynamic effects occur in parallel to plasma concentrations of  $\Delta^9$ -tetrahydrocannabinol (the psychoactive drug in marijuana and hashish), are more pronounced following inhalation as compared to

other routes of administration, and may be accompanied by the occurrence of premature ventricular ectopy. The cardiovascular actions of marijuana are usually well-tolerated by healthy individuals, but may have important consequences for patients with heart disease. Marijuana-induced tachycardia enhances myocardial oxygen consumption, and elevated levels of carboxyhemoglobin resulting from smoking the drug also reduce myocardial oxygen supply. Thus, patients with coronary artery disease may be at risk of developing myocardial ischemia or infarction in association with marijuana abuse. In fact, the incidence of acute myocardial infarction was reported to be approximately 5-fold higher within the first hour after marijuana use as compared to other times.<sup>83</sup> Disruption of myocardial oxygen supply-demand relations may also compromise cardiac performance in marijuana users with heart failure resulting from ischemic cardiomyopathy.

Marijuana smoking is associated with several pulmonary complications that are similar to those produced by tobacco smoking. Chronic bronchitis and emphysema have been reported in marijuana smokers, and concomitant tobacco smoking further contributes to the development of these chronic pulmonary diseases. Marijuana smoking results in greater tar deposition and substantially higher concentrations of carboxyhemoglobin than tobacco smoking,<sup>84</sup> effects that are partially related to deep, sustained inhalation and intense breath-holding performed to maximize drug delivery. Similar to the findings in tobacco smokers, pulmonary defenses against pathologic organisms are compromised by marijuana smoking as indicated by alveolar macrophage dysfunction, reduced cytokine formation, and diminished ability to combat oxidative stress. Chronic, heavy marijuana smoking may also precipitate the development of lung or oropharyngeal cancer. Marijuana is often contaminated with fungi (e.g., *Aspergillus*) or actinomycetes, and inhalation of these substances during smoking may cause infections or hypersensitivity reactions. Immunosuppressed marijuana users (such as those with advanced HIV infection) appear to be particularly susceptible to aspergillosis pneumonia.

## Hallucinogens

Phencyclidine and lysergic acid diethylamide (LSD) cause cardiovascular sym-

pathomimetic effects, and complications similar to those produced by cocaine and amphetamines are associated with abuse of these drugs. Thus, phencyclidine or LSD ingestion may be associated with myocardial ischemia and infarction resulting from increased myocardial oxygen consumption, coronary vasoconstriction or vasospasm, and prothrombotic effects. Severe hypertension, left ventricular hypertrophy, and malignant ventricular arrhythmias have also been observed in phencyclidine and LSD abusers. Notably, the mechanisms by which phencyclidine and LSD stimulate the sympathetic nervous system are at least partially distinct from those responsible for the sympathomimetic actions of cocaine or amphetamines, and as a result, cardiovascular cross-tolerance between phencyclidine or LSD and these other stimulants may not occur. In addition to cardiovascular consequences, phencyclidine and LSD abuse also produce several important neurologic complications. Like ketamine, phencyclidine causes an acute dissociative state that bears striking similarity to schizophrenia. Thus, the phencyclidine abuser may present in a highly agitated state characterized by delusions, hallucination, and paranoia, or, conversely, may demonstrate frank catatonia. LSD also produces hallucinations that may compromise patient compliance with treatment. LSD users often report “flashbacks” (i.e., recurrence of hallucinations that are temporally remote to the original abuse event). Abuse of large quantities of phencyclidine, LSD, or other hallucinogens (e.g., mescaline) may produce seizures, myoclonus, and coma. Phencyclidine or LSD abuse is also associated with ischemic or hemorrhagic stroke concomitant with cerebral vasoconstriction or hypertensive crisis, respectively. A syndrome of pronounced hyperthermia accompanied by acute submassive liver necrosis that resembles the clinical presentation of malignant hyperthermia has been described in conjunction with phencyclidine use.<sup>85</sup> Rhabdomyolysis and acute tubular necrosis has also been reported in phencyclidine abusers.

## Inhalants

Inhalants are volatile hydrocarbons (e.g., hexane, xylene, toluene) contained in a wide variety of common products including paints, solvents, and adhesives. Because they are readily commercially available, inhalants

are frequently abused by teenagers. Inhalants may be directly sniffed or forcefully inhaled using an airtight container (termed “huffing”), producing rapid intoxication. Inhalant abuse is associated with several respiratory complications. In addition to respiratory depression resulting from sedation, inhalant abuse may contribute to the development of bronchospasm in the presence or absence of preexisting asthma, airway mucosal irritation, hemoptysis, hypersensitivity pneumonitis, aspiration, and barotrauma.<sup>86</sup> Methemoglobinemia and the cyanosis that it precipitates may occur in association with abuse of amyl nitrate or related compounds (termed “poppers”). Asphyxiation resulting from respiratory depression or suffocation on a plastic bag used as a container for the inhalant has also been reported. Toluene inhalation may result in a white matter dementia characterized by extrapyramidal signs and symptoms, cerebellar ataxia, and oculomotor effects. Inhaled toluene also causes a nonanion gap metabolic acidosis and hypokalemia that occurs as a consequence of generation of hippuric acid, a product of toluene metabolism. Lead encephalopathy has also been described in individuals who inhale gasoline. A progressive sensory-motor polyneuropathy (“glue sniffer’s neuropathy”) may occur in conjunction with inhalation of hexane-containing adhesives.

## ALCOHOL AND DRUG WITHDRAWAL

Signs and symptoms of withdrawal are commonly encountered during the perioperative period in alcohol or drug abusers, and prophylaxis against withdrawal should be instituted before surgery in patients with a history of recent heavy use. Alcohol withdrawal is associated with substantial increases in postoperative morbidity and mortality.<sup>87</sup> Alcohol withdrawal typically begins within 24 hours after the last drink and produces a wide spectrum of clinical consequences. Interestingly, the severity of withdrawal does not appear to be correlated with the total quantity of alcohol ingested or duration of alcohol consumption. Early alcohol withdrawal is characterized by constitutional complaints including headache, anxiety, nausea, vomiting,

diarrhea, and sleep disturbances (Table 23–3). These symptoms are frequently associated with physical signs, including fever, diaphoresis, tachycardia, hypertension, hyperreflexia, and tremor. Visual, auditory, or tactile hallucinations may also be present, but the patient may initially be able to recognize that these hallucinations do not reflect reality. In the vast majority of patients, alcohol withdrawal resolves spontaneously without advancing to seizures or delirium (also known as *delirium tremens* or DTs). As discussed previously, alcohol withdrawal seizures are usually single grand mal events, correlate closely with maximal increases in electroencephalographic activity, and occur in between 10% and 33% of alcohol abusers in the absence of prophylactic treatment with benzodiazepines.<sup>88</sup> Alcohol withdrawal-induced status epilepticus occurs in less than 3% of patients who develop seizures.<sup>89</sup> Notably, the incidence of alcohol withdrawal seizures increases in patients who have experienced multiple episodes of abuse and withdrawal. Delirium tremens usually occurs 3–4 days after the last drink and is characterized by exaggerated signs and symptoms of withdrawal concomitant with vivid hallucinations that cannot be discerned from reality, profound confusion, disorientation, and marked agitation. Alcohol withdrawal delirium usually resolves after 2–3 days, is more frequent in older patients, and continues to carry a mortality rate of approximately 1% because of delayed or inadequate treatment and the presence of coexisting diseases.

Comprehensive descriptions of the pathophysiology and treatment of alcohol withdrawal are beyond the scope of this chapter. Briefly, alcohol abuse is hypothesized to chronically stimulate inhibitory GABA-mediated neurotransmission and attenuate autonomic nervous system sensitivity. In response, an upregulation of GABAergic and central and peripheral adrenergic receptors occurs. Thus, anxiety, tremor, hyperreflexia, and a reduction in seizure threshold occur alcohol withdrawal because GABA receptors are no longer stimulated and central nervous system excitatory neurotransmission is relatively unopposed. In addition, sudden abstinence from alcohol consumption causes rebound activation of the sympathetic nervous system, producing

TABLE 23–3.

### Common Signs and Symptoms of Alcohol or Drug Withdrawal

General
Fever
Chills
Headache
Diaphoresis
Myalgias
Fatigue
Piloerection (opioids)
Cardiovascular
Tachycardia
Hypertension
Gastrointestinal
Nausea
Anorexia
Vomiting
Diarrhea
Ophthalmologic
Lacrimation (opioids)
Pupillary dilation (opioids)
Otolaryngologic
Rhinorrhea (opioids)
Neurologic
Anxiety, irritability, and agitation
Mood disorders
Depression (cocaine, amphetamines)
Drug Craving
Sleep disturbances
Insomnia (alcohol, sedative-hypnotics, marijuana)
Hypersomnolence (cocaine, amphetamines, hallucinogens)
Hyperreflexia
Tremor
Disorientation (alcohol, sedative-hypnotics)
Delusion (alcohol, sedative-hypnotics)
Hallucination (alcohol, sedative-hypnotics)
Seizure (alcohol, sedative-hypnotics)
Delirium (alcohol, sedative-hypnotics)
Coma and death (alcohol, sedative-hypnotics)

the characteristic findings of fever, diaphoresis, tachycardia, and hypertension observed during withdrawal. Benzodiazepines (e.g., lorazepam, chlordiazepoxide, oxazepam) are the primary drugs used to treat alcohol withdrawal because these agents activate GABA receptors and thereby en-

hance inhibitory neurotransmission. Beta<sub>1</sub>- (e.g., metoprolol) or  $\alpha_2$ -adrenoceptor (e.g., clonidine) agonists may also be used to control the clinical manifestations of increases in sympathetic nervous system tone. Frequent evaluation of the signs and symptoms of alcohol withdrawal using a previously validated instrument such as the revised Clinical Institute Withdrawal Assessment Scale for Alcohol should be used to guide pharmacologic management and supportive care.

The clinical ramifications of sedative-hypnotic withdrawal are very similar to those observed during alcohol withdrawal, largely because the primary site of action of these drugs is also the GABA receptor. Abrupt discontinuation of benzodiazepines or barbiturates is characterized by fever, tachycardia, hypertension, gastrointestinal complaints (e.g., nausea, vomiting, diarrhea), and evidence of neurologic excitability (e.g., anxiety, agitation, tremor, hyperreflexia). More severe withdrawal from these drugs is associated with hallucinations, seizures, delirium, and death. The onset of the withdrawal syndrome is dependent upon the elimination half-life of the abused drug. The type, dose, potency, and duration of sedative-hypnotic use are the major factors that determine the severity of withdrawal. In contrast to the findings during alcohol withdrawal, the duration of sedative-hypnotic withdrawal may be very prolonged, often extending from several weeks to months. Barbiturates and benzodiazepines are frequently abused by patients who are addicted to alcohol or other drugs, and signs and symptoms of sedative-hypnotic withdrawal are exaggerated by simultaneous withdrawal from other substances of abuse. Other factors that contribute to the severity of sedative-hypnotic withdrawal include coexisting psychiatric conditions (particularly anxiety disorders and depression), family history of alcohol abuse, age, and female gender. The addition of an acute surgical stress response may also increase the severity of benzodiazepine or barbiturate withdrawal. As a result, continued use of the abused sedative-hypnotic or initiation of an equivalent dose of a cross-tolerant alternative drug is recommended throughout the perioperative period so as to avoid withdrawal.

Prompt recognition and appropriate treatment of opioid withdrawal are

important clinical objectives during the perioperative period in the opioid abuser. In contrast to alcohol or sedative-hypnotic withdrawal, mortality rarely occurs during opioid withdrawal unless significant comorbid medical conditions are present. Nevertheless, the signs and symptoms of withdrawal are so intensely uncomfortable that untreated opioid abusers will often leave the hospital against medical advice in order to seek and abuse illicit opioids. In fact, many opioid addicts report that continued drug use is at least partially motivated by a strong desire to avoid withdrawal symptoms, and not because of a specific euphoric effect per se. Acute opioid withdrawal is characterized by fever, anxiety, irritability, intense drug craving, altered thermoregulation, rhinorrhea, piloerection, pupillary dilation, and gastrointestinal complaints (e.g., nausea, vomiting, diarrhea). Hypertension and tachycardia also occur in response to activation of the sympathetic nervous system. The onset of acute opioid withdrawal is dependent on the elimination half-life of the abused drug. For example, signs and symptoms of opioid withdrawal usually occur within 6 hours after heroin abuse, but the onset of withdrawal may be delayed if the patient abuses methadone or a sustained-release opioid (e.g., oxycodone, morphine). Similarly, the pharmacokinetics of the abused opioid are also responsible for the total duration of the withdrawal syndrome. The duration of abuse, dose of drug, and route of administration (intravenous > inhaled) are the major determinants of the severity of opioid withdrawal.

The pharmacologic management of opioid detoxification and withdrawal is complex, and several approaches have been proposed that are not reviewed in detail here. During the perioperative period, the easiest and most effective strategy for managing opioid withdrawal is methadone substitution therapy<sup>90</sup> using a validated withdrawal evaluation tool to guide treatment. Briefly, an oral or intravenous loading dose of methadone is administered at the onset of withdrawal, and subsequent doses are titrated until symptoms are adequately controlled and a stable daily dose is established. This methadone dose may either be continued unchanged throughout the hospital course or gradually reduced as signs and symptoms of opioid with-

drawal improve. Notably, methadone substitution therapy for acute opioid withdrawal should not be confused with pain management. Perioperative opioid withdrawal may also be treated independent of substitution therapy using the combination of a benzodiazepine and an  $\alpha_2$ -adrenoceptor agonist administered on a scheduled basis to control anxiety and sympathetic nervous system activation, respectively. Regardless of the approach, consultation with an addictionologist is strongly recommended to guide perioperative therapy and establish plans for postoperative addiction treatment.

Cocaine or amphetamine withdrawal is characterized by drug craving, depression, anhedonia, and hypersomnolence.<sup>91</sup> These symptoms of abrupt discontinuation of stimulant abuse are usually self-limited but may initially be severe (known as a “crash”), usually may be treated with supportive care alone, and most often do not require pharmacologic intervention. Notably, the appearance of cocaine or amphetamine withdrawal symptoms (particularly hypersomnolence) during the perioperative period may be confused with a neurologic complication. Abrupt cessation of marijuana use is associated with anxiety, irritability, insomnia, and gastrointestinal complaints in a minority of patients. Treatment of these symptoms is primarily supportive, but antidepressant medications (e.g., trazodone) may benefit some patients. Specific phencyclidine or hallucinogen withdrawal syndromes also have not been described, but a minority of patients report constitutional complaints, including anxiety, fatigue, hypersomnolence, depression, and anhedonia. These acute symptoms and the delayed psychiatric sequelae (“flashbacks”) of phencyclidine or hallucinogen abuse most often respond to supportive care, but some patients with severe manifestations may benefit from a trial of benzodiazepines or specific serotonin reuptake inhibitor antidepressants.

## GENERAL PRINCIPLES OF PERIOPERATIVE MANAGEMENT

A detailed description of the perioperative management that is unique to each of the substances that might be abused by the active alcohol or drug



abuser is beyond the scope of this chapter. Rather, the broad pharmacologic diversity of drugs of abuse combined with the wide range of complications that accompany substance abuse requires that the anesthesiologist have a firm understanding of ramifications of substance abuse, and apply this understanding to the specifics of each perioperative experience. As in the case of any patient affected by a chronic disease, the anesthetic approach to the patient with addiction varies depending on the type, location, and duration of the anticipated surgical procedure and the presence, severity, and relative stability of alcohol- or drug-related comorbidities. However, several general principles should guide the perioperative care of the patient with active substance abuse (Table 23–4). Historical evidence of abstinence from alcohol and other drugs of abuse, confirmed by timely laboratory evidence to assure the validity of the historical information, is strongly recommended before a patient undergoes elective surgery because of the well-recognized increases in the rate and severity of perioperative complications and the potentially life-threatening consequences of unanticipated withdrawal perioperatively. Cessation of drug use before elective surgery also promotes stabilization of many abuse-related medical complications and may increase the probability that the patient will comply with postoperative instructions upon discharge (e.g., followup appointments, wound care, physical therapy). In some patients, abstinence before elective surgery may be facilitated by frank discussions with the anesthesiologist and surgeon regarding the consequences of continued abuse preoperatively. Other patients may require the assistance of an addiction medicine specialist in order to achieve abstinence before an elective procedure. Unfortunately, attaining preoperative abstinence may be an unrealistic goal for many alcohol or drug abusers, especially those who are undergoing urgent or emergent surgery. Under such circumstances, perioperative alcohol or drug withdrawal must be anticipated, and appropriate measures (e.g., drug prophylaxis guided by history and laboratory tests, anticipated admission to an intensive care unit) should be instituted well before the expected onset of withdrawal signs and symptoms. Vigilance about the poten-

TABLE 23–4.

#### General Recommendations for Perioperative Management

##### Preoperative

- Supportive, nonjudgmental but firm approach
- Obtain a urine drug screen and blood ethanol concentration
- Achieve abstinence and stability of medical comorbidity before elective surgery
- Anticipate and treat alcohol or drug withdrawal, especially in alcohol or drug abusers undergoing urgent or emergent surgery
- Consult an addiction medicine specialist
- Assure that anxiety and pain are appropriately treated

##### Intraoperative

- Consider regional or local anesthesia or nerve blocks if possible
- Anticipate hyperalgesia, especially in opioid abusers
- Use general anesthesia or opioids as clinically indicated

##### Postoperative

- Plan postoperative analgesia including alternative approaches before surgery
- Use continuous local anesthesia, nonopioid analgesics, or alternative pain approaches if possible, but do not avoid opioids if clinically indicated
- Use scheduled but not “as needed” administration of opioids
- Frequently assess behavioral and functional responses to pain therapy
- Integrate initiation for addiction into the discharge plan

tial for drug withdrawal is essential for all patients with a history of recent substance abuse, and the benefits of proactive intervention cannot be overemphasized.

A straightforward, nonjudgmental approach to the patient by physicians and nursing personnel will often encourage the alcohol or drug abuser to cooperate with the treatment plan. Patients should be assured repeatedly that withdrawal symptoms, anxiety, and pain will be addressed appropriately. A clear plan for postoperative pain management should be discussed before surgery. Use of continuous local

anesthesia, nerve blocks, nonopioid analgesics, neuraxial techniques, or alternative analgesic modalities may be employed for postoperative pain management, but opioids administered on a scheduled basis should be used as clinically indicated. As discussed previously, it is critically important that pain be promptly and adequately treated so as to avoid the development of a “mutual mistrust” relationship between the alcohol or drug abuser and healthcare providers.<sup>16</sup> The anesthesiologist and other clinicians must recognize that hyperalgesia is common in patients with substance abuse disorders, and all must be prepared to manage pain accordingly. A continuous evaluation of the adequacy of pain management, based on the behavioral and functional responses of the patient, should be conducted throughout the perioperative period.

The active participation of an addiction medicine specialist throughout the entire hospital course is strongly advised because the addictionologist may contribute substantially to the evaluation and treatment of alcohol- or drug-related coexisting diseases, provide guidance about the management of perioperative alcohol or drug withdrawal, and serve as an additional resource for pain management strategies. Perhaps most importantly, the addictionologist also facilitates the transition to addiction treatment during postoperative discharge planning. The anesthesiologist and surgeon should recognize that the perioperative experience provides a unique opportunity to intervene in cases of substance abuse, and to facilitate the initiation of a plan for treatment of patient's addictive disease.

## THE RECOVERING PATIENT

Recovery is a complex process requiring intense, continuous personal effort that not only involves abstinence but also requires a series of changes to maintain sobriety (Table 23–5). Successful recovery requires acquisition of knowledge about substance abuse disorders, renewal of self-esteem and personal responsibility, development of sober living abilities and social interactions, identification with sources of inspiration, and a unified approach to guide these changes.<sup>92</sup> The terms “cured,” “former,” “recovered,” and “ex-”

TABLE 23–5.

## Therapeutic Objectives in Addiction Management

## Affective

- Manage anxiety, depression, shame, and guilt
- Increase coping skills
- Increase emotional awareness of negative consequences of use

## Behavioral

- Eliminate drug use behaviors
- Expand healthy behaviors

## Cognitive

- Reduce denial
- Enhance personal awareness of addictive disease in self and others
- Increase recognition of negative consequences of use

## Physiological

- Treat withdrawal symptoms and medical consequences of alcohol or drug abuse
- Encourage healthy activities
- Reestablish personal responsibility for health

## Social

- Increase personal responsibility
- Increase honesty, reliability, and trustworthiness
- Establish sober social networks
- Increase social coping skills

## Spiritual

- Increase self-esteem and reduce self-loathing
- Reestablish personal values
- Increase appreciation of transcendence

Adapted with permission from May JA, White HC, Leonard-White A, et al. The patient recovering from alcohol or drug addiction: special issue for the anesthesiologist. *Anesth Analg* 2001;92:1604, Table 1.

alcoholic or addict are inappropriate to describe the *recovering* patient. The incidence of relapse appears to be inversely related to the duration of recovery, but return to use has been observed in patients with decades of recovery. Abstinence alone does not constitute recovery because effective skills for coping with stress independent of drug ideation (e.g., craving) or use may not have been developed. Whether an abstinent individual has more difficulty coping with the perioperative experience than a patient in a well-established recovery program is unknown, however. Mutual-help orga-

nizations including Alcoholics Anonymous (AA) and other twelve-step programs, individual psychotherapy, behavioral modification, and pharmacologic therapy may all be effective in the management of addictive disease. The standard of care in addiction treatment in the United States is based on the Minnesota model,<sup>93</sup> a multidisciplinary approach that includes involvement in a twelve-step program, individual and group psychotherapy, patient and family education, vocational rehabilitation, and spiritual renewal. Treatment within the Minnesota model relies primarily on the experience of other recovering patients. Alcoholics Anonymous and related groups are fellowships of recovering patients who help each other maintain sobriety. The twelve steps are the central tenet of the Alcoholics Anonymous program that serve as guidelines for recovery. Other components of recovery within Alcoholics Anonymous include regular meeting attendance and sponsorship that increase the probability of maintaining sobriety.

Several medications are presently used in sobriety maintenance therapy that may have important implications for the anesthesiologist (Table 23–6). Strategies include alteration of a drug's metabolic consequences (e.g., disulfiram in alcoholism), reduction of drug reward (e.g., acamprosate in alcoholism), receptor antagonism (e.g., naltrexone in opioid addiction), and drug substitution therapy (e.g., methadone in refractory opioid addiction). Several drugs have documented efficacy in the treatment of patients with alcohol or opioid addiction, but effective pharmacologic therapy for addiction to other drugs of abuse has yet to be demonstrated. A more frequent incidence of anxiety, psychotic, and affective disorders is also observed in recovering patients. Psychoactive drugs used to treat these concurrent disorders reduce the incidence of relapse by decreasing self-medication of psychiatric symptoms, and may also have anesthetic consequences that are reviewed elsewhere.

Disulfiram is an alcohol-sensitizing drug that is still occasionally used in the treatment of alcoholism. Disulfiram inhibits aldehyde dehydrogenase, leading to acetaldehyde accumulation and a severe aversive reaction when alcohol is ingested. Disulfiram also irreversibly inhibits other sulfhydryl-

based enzyme systems responsible for drug metabolism. Inhibition of dopamine  $\beta$ -hydroxylase by disulfiram reduces presynaptic neuronal synthesis of norepinephrine and may produce an attenuated cardiovascular response to indirect-acting sympathomimetic amines. Disulfiram also reduces the clearance of diazepam, midazolam, and chlordiazepoxide, and interferes with the metabolism of barbiturates, tricyclic antidepressants, phenytoin, and warfarin by inhibiting hepatic microsomal enzymes. Calcium carbimide is another alcohol-sensitizing drug used clinically in Europe and Canada that reversibly inhibits alcohol dehydrogenase and may cause less-pronounced drug interactions. The  $\mu$  opioid receptor antagonists, naltrexone and nalmefene, reduce alcohol ideation and decrease the incidence of relapse in recovering alcoholics.<sup>94</sup> Clinical experience with naltrexone and nalmefene has been less successful in opioid addiction, but may be used as “insurance” in abstinence-based recovery. Naltrexone and nalmefene increase the threshold dose of opioid required to produce euphoria. The recovering patient who continues to receive an opioid antagonist during the perioperative period will have an increased requirement for opioid analgesics. Conversely, the  $\mu$  receptor is upregulated during chronic opioid antagonist treatment, and withdrawal of naltrexone or nalmefene is associated with increased sensitivity to opioid agonists.

Acamprosate is an amino acid derivative that substantially reduces ideation<sup>95</sup> and improves treatment retention in recovering alcoholics. Acamprosate decreases neuronal hyperexcitability caused by chronic alcohol abuse by altering GABA- and glutamate-mediated neurotransmission. These actions reduce drug craving, a major cause of relapse in recovering alcohol abusers. To date, the anesthetic implications of acamprosate have not been described. Antiepileptics (e.g., carbamazepine, valproate, gabapentin) also attenuate alcohol- or opioid-mediated drug craving.<sup>96</sup> Carbamazepine and other antiepileptics hasten recovery from intermediate- and long-acting nondepolarizing muscle relaxants by enhancing the clearance of these drugs, increasing plasma concentrations of  $\alpha_1$ -acid glycoprotein, and producing proliferation of postsynaptic acetylcholine receptors. Selective serotonin reuptake inhibitors appear to reduce

TABLE 23–6.

## Pharmacological Therapy in Relapse Prevention

Medication	Drug of Abuse	Pharmacology	Mechanism of Action	Anesthetic Implications
Disulfiram; calcium carbimide	Alcohol	Enzyme inhibition	Adverse side effects	Altered response to sympathomimetics; alerted drug metabolism; discontinue disulfiram 10 days before surgery
Naltrexone; nalmefene	Alcohol	Modulation of drug reward	Decrease drug ideation	Altered response to opioid agonists; discontinue 3 days before surgery
	Opioids	Direct receptor antagonist	Decrease euphoric threshold to opioids	
Acamprosate	Alcohol	Modulation of drug reward	Decrease drug ideation	Unknown
SSRIs	Alcohol? Benzodiazepines? Barbiturates?	Modulation of drug reward	Decrease drug ideation; decrease consumption in active users	Rare; may cause hypotension and bradycardia
Antiepileptics	Alcohol; opioids	Reduce neuronal excitability	Decrease drug ideation	Prolonged duration of neuromuscular blockers
Methadone; LAAM; buprenorphine	Opioids	Direct receptor agonist	Decrease drug ideation, positive reward, and withdrawal symptoms	Continue maintenance dose

Abbreviations: LAAM, levomethadyl acetate; SSRIs, selective serotonin reuptake inhibitors.  
 Reproduced with permission from May JA, White HC, Leonard-White A, et al. The patient recovering from alcohol or drug addictions; special issue for the anesthesiologist. *Anesth Analg* 2001;92:1604, Table 3.

drinking in alcoholics with depression and may also prevent relapse in recovering patients with anxiety or affective disorders.<sup>97</sup> Profound bradycardia and severe hypotension during anesthesia have been rarely reported in patients treated with these drugs.

Methadone, the long-acting  $\mu$  agonist levo- $\alpha$ -acetyl-methadol (LAAM), and the partial agonist buprenorphine have been used effectively in the treatment of patients with opioid addiction as substitution pharmacotherapy in combination with behavioral interventions. Methadone, LAAM, and buprenorphine decrease withdrawal symptoms, inhibit drug ideation, and attenuate the positive reward associated with subsequent opioid use. Clearly, patients chronically treated with methadone, LAAM, or buprenorphine remain physically dependent on opioids despite attenuation of addictive behavior. Thus, verification of the dose of methadone, LAAM, or buprenorphine with the patient's addiction specialist before surgery and unconditional administration of the drug throughout the perioperative period to prevent withdrawal are required. Patients receiving opioid substitution therapy may experience exaggerated pain responses to nociceptive stimuli because of drug tolerance.<sup>15</sup> These patients often require

large quantities of additional opioids for the control of surgical pain, and may benefit from alternative pain control modalities. Substituting a new opioid for methadone, LAAM, or buprenorphine for maintenance therapy during the perioperative period is inappropriate. Increasing the dose or frequency of administration of these drugs to manage acute pain is also not recommended because the boundaries between treatment of addiction and pain may be obscured.

Anesthesia and surgery may expose the recovering patient to several potential obstacles that increase the possibility of relapse. Numerous anecdotal descriptions of profound drug craving or frank relapse have been reported after brief perioperative exposure to sedatives or opioids in recovering patients with years of sobriety, but the precise incidence of such phenomena has not been defined. Anxiety about the perioperative experience may be heightened in the recovering patient because of concerns about the possibility for relapse and the fear that pain will not be adequately treated because of the history of addiction. Anxiety and pain have been identified as important precipitants of relapse, and inadequate treatment of pain precipitates drug ideation.<sup>98</sup> Recovering

patients may also display abnormal behavioral responses to stress that increase the risk of relapse.<sup>99</sup> Similar to the active alcohol or drug abuser, the recovering patient may encounter surgeons or anesthesiologists during the perioperative period who remain cynical about the sincerity or efficacy of the recovery process. Conversely, other apparently well-intentioned physicians may withhold or restrict pain medication from the recovering patient, fearing that a relapse will be inadvertently provoked. The recovering patient may be left inadequately treated, a situation that may be further complicated if justified requests for additional analgesics are misinterpreted as addictive behavior.

The preoperative evaluation allows the anesthesiologist to obtain a detailed history of addiction and recovery and provides an opportunity to reduce anxiety about the operative experience. Many patients will openly disclose their addictive disease and recovery, but others may be reticent to acknowledge this history because they are apprehensive about the stigma that is still associated with the disease. Under these circumstances, the history of addiction and recovery may be elicited by tactfully asking direct questions in response to negative answers to routine

inquiries about alcohol or drug use. The history of alcohol or drug abuse, type and quality of and compliance with a recovery program, and participation in mutual-help groups are important components of the past medical history. Involvement of an addictionologist, rehabilitation counselor, or sponsor in the patient's recovery should be noted, the duration and relative success of recovery explored, and the history of and apparent factors responsible for triggering relapse episodes identified. Encouraging the patient to intensify the practices of their recovery program has been recommended because the patient's support system is a powerful defense against relapse during periods of stress.<sup>98</sup>

Much of the end-organ damage that occurs as a result of chronic substance abuse is reversible with long-term abstinence, but some permanent pathology that requires further evaluation or stabilization before surgery might remain. A urine drug screen may be indicated to exclude drug use and identify the need for further referral. Most recovering patients are aware that many drugs used for premedication have abuse potential and may refuse premedicants on these grounds. Patients familiar with biofeedback, guided imagery, or meditation may want to use these relaxation techniques instead of drug therapy. Euphoria-associated premedication before surgery may theoretically stimulate drug ideation, but use of anxiolytics to control anxiety may be more important because apprehension and exaggerated stress responses are common in the recovering patient. Twelve-step meetings and increased sponsor contact may also be useful anxiolytics for the recovering patient.

Clear strategies for the conduct of anesthesia and the management of postoperative pain should be established with the recovering patient before surgery. Reassurance that the history of addiction will not be an obstacle to anesthetic technique and the adequate treatment of postoperative pain should be provided. The anesthesiologist's broad expertise in pain management also deserves strong emphasis during preoperative discussion with the recovering patient. The anesthesiologist should also discuss evaluation of the recovering patient's behavioral responses to pain management with the nursing staff before surgery. This dis-

ussion should emphasize that abnormal attitudes or conduct that signify drug ideation or loss of control over pain medications needs to be immediately identified and reported. However, unusual behavior specifically related to pain therapy may instead indicate the presence of pseudoaddiction, a phenomenon that refers to drug-seeking behavior related to inadequate analgesia. In contrast to true addiction, pseudoaddiction is characterized by extinction of aberrant behavior when adequate analgesia is achieved.

Analgesics without abuse potential may initially be proposed for the relief of postoperative pain. These drugs may be used with or without continuous regional local anesthesia or selective nerve blocks in some recovering patients to provide adequate pain control and may also serve to reduce opioid analgesic requirements. Alternative pain modalities might also be considered. Importantly, the potential benefits of these methods must be weighed against the risk of inadequate analgesia, a significant factor in precipitating relapse. Opioids remain the most efficacious clinically available analgesics for treatment of surgical pain. Use of opioids should be guided by specific clinical indications. The selection of the specific type of opioid and the route of administration may be less important than the scheduling of administration. Mixed opioid agonist-antagonists theoretically offer a reduced risk of abuse than pure  $\mu$  agonists, but these drugs are not completely devoid of abuse potential and do not provide clear benefits over  $\mu$  agonists for postoperative analgesia. Neuraxial administration of opioids has been advocated because of theoretical reductions in the incidence of euphoria and the potential for associated drug craving, but this hypothesis has not been rigorously investigated. Scheduled administration of opioids or patient-controlled analgesia (administered by intravenous or epidural routes) may provide benefits over intermittent dosing in the recovering patient by simplifying the pain management plan for nursing staff, reducing delays in drug administration that contribute to inadequate analgesia, and eliminating patient requests for opioids that may be misinterpreted as addictive behavior. However, the use of patient-controlled analgesia in recovering patients is controversial be-

cause of the dynamics of self-administration. Prescription of opioids solely on an "as-needed" basis is not recommended in order to reduce associations between pain symptoms and the administration of a reinforcing drug that may increase overall pain perception and inappropriately justify greater drug use.

## KEY REFERENCES

1. McLellan AT, Lewis DC, O'Brien CP, Kleber HD. Drug dependence, a chronic medical illness. Implications for treatment, insurance, and outcomes evaluation. *JAMA* 2000; 284:1689-1695.
2. Kitchens JM. Does this patient have an alcohol problem? *JAMA* 1994;272:1782-1787.
3. Rosenblum A, Joseph H, Fong C, Kipnis S, Cleland C, Portenoy RK. Prevalence and characteristics of chronic pain among chemically dependent patients in methadone maintenance and residential treatment facilities. *JAMA* 2003;289: 2370-2378.
4. Cherubin CE, Sapira JD. The medical complications of drug addiction and the medical assessment of the intravenous drug user: 25 years later. *Ann Intern Med* 1993; 119:1017-1028.
5. Havlir DV, Barnes PF. Tuberculosis in patients with human immunodeficiency virus infection. *N Engl J Med* 1999;340:367-373.
6. Des Jarlais DC, Diaz T, Perlis T, et al. Variability in the incidence of human immunodeficiency virus, hepatitis B virus, and hepatitis C virus infection among young injecting drug users in New York City. *Am J Epidemiol* 2003;157:467-471.
7. Spies C, Tonnesen H, Andreasson S, Helander A, Conigrave K. Perioperative morbidity and mortality in chronic alcoholic patients. *Alcohol Clin Exp Res* 2001;25:164S-70S.
8. Qureshi AI, Suri MF, Guterman LR, Hopkins LN. Cocaine use and the likelihood of nonfatal myocardial infarction and stroke: data from the Third National Health and



Nutrition Examination Survey. *Circulation* 2001;103:502–506.

9. Pantaleo G, Demarest JF, Schacker T, et al. The qualitative nature of the primary immune response to HIV infection is a prognosticator of disease progression independent of the initial level of plasma viremia. *Proc Natl Acad Sci U S A* 1997;94:254–258.

10. Albertson TE, Walby WF, Derlet RW. Stimulant-induced pulmonary toxicity. *Chest* 1995;108:1140–1149.

11. Linden CH. Volatile substances of abuse. *Emerg Med Clin North Am* 1990;8:559–578.

12. Savage SR. Addiction in the treatment of pain: significance, recognition, and management. *J Pain Symptom Manage* 1993;8:265–278.

## REFERENCES

1. Kessler RC, McGonagle KA, Zhao S, et al. Lifetime and 12-month prevalence of DSM-III-R psychiatric disorders in the United States. Results from the National Comorbidity Survey. *Arch Gen Psychiatry* 1994;51:8–19.
2. Diagnostic and Statistical Manual of Mental Disorders. DSM-IV. 4th ed. Washington, DC: American Psychiatric Association, 1994.
3. Nestler EJ. Molecular basis of neural plasticity underlying addiction. *Nat Rev Neurosci* 2001;2:119–128.
4. McLellan AT, Lewis DC, O'Brien CP, Kleber HD. Drug dependence, a chronic medical illness. Implications for treatment, insurance, and outcomes evaluation. *JAMA* 2000;284:1689–1695.
5. Gardner EL. Brain-reward mechanisms. In: Lowinson JH, Ruiz P, Millman RB, Langrod JG, eds. *Substance Abuse. A Comprehensive Textbook*. 4th ed. Philadelphia: Lippincott Williams & Wilkins, 2005:48–97.
6. Laine C, Hauck WW, Gourevitch MN, Rothman J, Cohen A, Turner BJ. Regular outpatient medical and drug abuse care and subsequent hospitalization of persons who use illicit drugs. *JAMA* 2001;285:2355–2362.
7. Moore RD, Bone LR, Geller G, Mamon JA, Stokes EJ, Levine DM. Prevalence, detection, and treatment of alcoholism in hospitalized patients. *JAMA* 1989;261:403–407.
8. Kitchens JM. Does this patient have an alcohol problem? *JAMA* 1994;272:1782–1787.
9. Schorling JB, Buchsbaum D. Screening for alcohol and drug abuse. *Med Clin North Am* 1997;81:845–865.
10. Chiang PP. Perioperative management of the alcohol-dependent patient. *Am Fam Physician* 1995;52:2267–2273.

11. Perry SW. Irrational attitudes toward addicts and narcotics. *Bull N Y Acad Med* 1985;61:706–727.

12. Bander KW, Goldman DS, Schwartz MA, Rabinowitz E, English JT. Survey of attitudes among three specialists in a teaching hospital toward alcoholics. *J Med Educ* 1987;62:17–24.

13. May JA, Warltier DC, Pagel PS. Attitudes of anesthesiologists about addiction and its treatment: a survey of Illinois and Wisconsin members of the American Society of Anesthesiologists. *J Clin Anesth* 2002;14:284–289.

14. Rosenblum A, Joseph H, Fong C, Kipnis S, Cleland C, Portenoy RK. Prevalence and characteristics of chronic pain among chemically dependent patients in methadone maintenance and residential treatment facilities. *JAMA* 2003;289:2370–2378.

15. Compton P, Charuvastra VC, Kintaudi K, Ling W. Pain responses in methadone-maintained opioid abusers. *J Pain Symptom Manage* 2000;20:237–245.

16. Merrill JO, Rhodes LA, Deyo RA, Marlatt GA, Bradley KA. Mutual mistrust in the medical care of drug users: the keys to the “narc” cabinet. *J Gen Intern Med* 2002;17:327–333.

17. Breitbart W, Rosenfeld BD, Passik SD, McDonald MV, Thaler H, Portenoy RK. The undertreatment of pain in ambulatory AIDS patients. *Pain* 1996;65:243–249.

18. Gilson AM, Joranson DE. U.S. policies relevant to the prescribing of opioid analgesics for the treatment of pain in patients with addictive disease. *Clin J Pain* 2000;18:S91–S98.

19. Cherubin CE, Sapira JD. The medical complications of drug addiction and the medical assessment of the intravenous drug user: 25 years later. *Ann Intern Med* 1993;119:1017–1028.

20. Binswanger IA, Kral AH, Bluthenthal RN, Rybold DJ, Eldin BR. High prevalence of abscesses and cellulitis among community-recruited injection drug users in San Francisco. *Clin Infect Dis* 2000;30:579–581.

21. Passaro DJ, Werner SB, McGee J, MacKenzie WR, Vugia DJ. Wound botulism associated with black tar heroin among injecting drug users. *JAMA* 1998;279:859–863.

22. Takahashi TA, Merrill JO, Boyko EJ, Bradley KA. Type and location of injection drug use-related soft tissue infections predict hospitalization. *J Urban Health* 2003;80:127–136.

23. Bayer AS, Bolger AF, Taubert KA, et al. Diagnosis and management of infective endocarditis and its complications. *Circulation* 1998;98:2936–2948.

24. Von Reyn CF, Levy BS, Arbeit RD, Friedland G, Crumpacker CS. Infective endocarditis: an analysis based on strict case definitions. *Ann Intern Med* 1981;94:505–518.

25. Frontera JA, Gradon JD. Right-side endocarditis in injection drug users: review of

proposed mechanisms of pathogenesis. *Clin Infect Dis* 2000;30:374–379.

26. Hecht SR, Berger M. Right-sided endocarditis in intravenous drug users. Prognostic features in 102 episodes. *Ann Intern Med* 1992;117:560–566.

27. Li JS, Sexton DJ, Mick N, et al. Proposed modifications to the Duke criteria for the diagnosis of infective endocarditis. *Clin Infect Dis* 2000;30:633–638.

28. Boschini A, Smacchia C, Di Fine M, et al. Community-acquired pneumonia in a cohort of former injection drug users with or without human immunodeficiency virus infection: incidence, etiologies, and clinical aspects. *Clin Infect Dis* 1996;23:107–113.

29. Scheidegger C, Zimmerli W. Incidence and spectrum of severe medical complications among hospitalized HIV-seronegative and HIV-seropositive narcotic drug users. *AIDS* 1996;10:1407–1414.

30. Havlir DV, Barnes PF. Tuberculosis in patients with human immunodeficiency virus infection. *N Engl J Med* 1999;340:367–373.

31. Centers for Disease Control and Prevention: Targeted tuberculin testing and treatment of latent tuberculosis infection. American Thoracic Society. *MMWR Recomm Rep* 2000;49:1–51.

32. Kreek MJ, Garfield JW, Gutjahr CL, Giusti LM. Rifampin-induced methadone withdrawal. *N Engl J Med* 1976;294:1104–1106.

33. Vento S, Garofano T, Renzini C, et al. Fulminant hepatitis associated with hepatitis A virus superinfection in patients with chronic hepatitis C. *N Engl J Med* 1998;338:286–290.

34. Alter MJ, Kruszon-Moran D, Nainan OV, et al. The prevalence of hepatitis C virus infection in the United States, 1988 through 1994. *N Engl J Med* 1999;341:556–562.

35. Thomas DL, Astemborski J, Rai RM, et al. The natural history of hepatitis C virus infection: host, viral, and environmental factors. *JAMA* 2000;284:450–456.

36. Backmund M, Meyer K, Von Zielonka M, Eichenlaub D. Treatment of hepatitis C infection in injection drug users. *Hepatology* 2001;34:188–193.

37. Centers for Disease Control and Prevention (CDC). HIV/AIDS. *MMWR Surveill Summ* 2000;12:1–41.

38. Centers for Disease Control and Prevention (CDC). Guidelines for the use of anti-retroviral agents in HIV-infected adults and adolescents. Department of Health and Human Services and Henry J. Kaiser Family Foundation. *MMWR Recomm Rep* 1998;47:43–82.

39. Holmberg SD. The estimated prevalence and incidence of HIV in 96 large U.S. metropolitan areas. *Am J Public Health* 1996;86:642–654.

40. Gourevitch MN, Friedland GH. Interactions between methadone and medications

- used to treat HIV infection: a review. *Mt Sinai J Med* 2000;67:429–436.
41. Spies C, Tonnesen H, Andreasson S, Helander A, Conigrave K. Perioperative morbidity and mortality in chronic alcoholic patients. *Alcohol Clin Exp Res* 2001;25:164S-70S.
  42. Tonnesen H, Rosenberg J, Nielsen HJ, et al. Effect of preoperative abstinence on poor postoperative outcome in alcohol misusers: randomised controlled trial. *BMJ* 1999;318:1311–1316.
  43. Randin D, Vollenweider P, Tappy L, Jequier E, Nicod P, Scherrer U. Suppression of alcohol-induced hypertension by dexamethasone. *N Engl J Med* 1995;332:1733–1737.
  44. Clark LT, Friedman HS. Hypertension associated with alcohol withdrawal: assessment of mechanisms and complications. *Alcohol Clin Exp Res* 1985;9:125–130.
  45. Serdula MK, Koong SL, Williamson DF, et al. Alcohol intake and subsequent mortality: findings from NHANES I follow-up study. *J Stud Alcohol* 1995;56:233–239.
  46. Pagel PS, Kersten JR, Warltier DC. Mechanisms of myocardial protection produced by chronic ethanol consumption. *Pathophysiology* 2004;10:121–129.
  47. Brigden W, Robinson J. Alcoholic heart disease. *Br Med J* 1964;2:1283–1289.
  48. Friedman HS, Cirillo N, Schiano F, et al. Vasodilatory state of decompensated cirrhosis: relation to hepatic dysfunction, ascites and vasoactive substances. *Alcohol Clin Exp Res* 1995;19:123–129.
  49. Campillo B, Chabrier PE, Pelle G, et al. Inhibition of nitric oxide synthase in the forearm arterial bed of patients with advanced cirrhosis. *Hepatology* 1995;22:1423–1429.
  50. Lithell H, Aberg H, Selinus I, Hedstrand H. Alcohol intemperance and sudden death. *Br Med J (Clin Res Ed)* 1987;294:1456–1458.
  51. Heinemann HO. Alcohol and the lung. A brief review. *Am J Med* 1977;63:81–85.
  52. Fallon MB, Abrams GA. Pulmonary dysfunction in chronic liver disease. *Hepatology* 2000;32:859–865.
  53. Sacco RL, Elkind M, Boden-Albala B, et al. The protective effect of moderate alcohol consumption on ischemic stroke. *JAMA* 1999;281:53–60.
  54. Dufour MC. Chronic liver disease and cirrhosis. In: Everhart JE, ed. *Digestive Diseases in the United States: Epidemiology and Impact*. Washington, DC: National Institutes of Health, 1994:615–646.
  55. Patel T. Surgery in the patient with liver disease. *Mayo Clin Proc* 1999;74:593–599.
  56. Garrison RN, Cryer HM, Howard DA, Polk HC Jr. Clarification of risk factors for abdominal operations in patients with hepatic cirrhosis. *Ann Surg* 1984;199:648–655.
  57. Gines P, Arroyo V. Hepatorenal syndrome. *J Am Soc Nephrol* 1999;10:1833–1839.
  58. Charney DS, Mihic SJ, Harris RA. Hypnotics and sedatives. In: Hardman JG, Limbird LE, Gilman AG, eds. *Goodman and Gilman's The Pharmacological Basis of Therapeutics*. 10th ed. New York: McGraw-Hill, 2001:399–427.
  59. Office of National Drug Control Policy. *National Drug Control Strategy*. Washington, DC: ONDCP, Executive Office of the President, The White House, 2000.
  60. Schultz JE, Hsu AK, Gross GJ. Morphine mimics the cardioprotective effect of ischemic preconditioning via a glibenclamide-sensitive mechanism in the rat heart. *Circ Res* 1996;78:1100–1104.
  61. Sporer KA. Acute heroin overdose. *Ann Intern Med* 1999;130:584–590.
  62. Smith WS, Matthay MA. Evidence for a hydrostatic mechanism in human neurogenic pulmonary edema. *Chest* 1997;111:1326–1333.
  63. Yin D, Mufson RA, Wang R, Shi Y. Fas-mediated cell death promoted by opioids. *Nature* 1999;397:218.
  64. Hershey LA. Meperidine and central neurotoxicity. *Ann Intern Med* 1983;98:548–549.
  65. Friedman EA, Tao TK. Disappearance of uremia due to heroin-associated nephropathy. *Am J Kidney Dis* 1995;25:689–693.
  66. U.S. Department of Health and Human Services. *NIDA Research Report Series. Cocaine Abuse and Addiction*. NIH publication No. 99-4342. Rockville, MD: National Institutes of Health, 1999.
  67. Kloner RA, Hale SH, Alker K, Rezkalla S. The effects of acute and chronic cocaine use on the heart. *Circulation* 1992;85:407–419.
  68. Lange RA, Hillis LD. Cardiovascular complications of cocaine use. *N Engl J Med* 2001;345:351–358.
  69. Mittleman MA, Mintzer D, Maclure MT, Tofler GH, Sherwood JB, Muller JE. Triggering of myocardial infarction by cocaine. *Circulation* 1999;99:2737–2741.
  70. Qureshi AI, Suri MF, Guterman LR, Hopkins LN. Cocaine use and the likelihood of nonfatal myocardial infarction and stroke: data from the Third National Health and Nutrition Examination Survey. *Circulation* 2001;103:502–506.
  71. Egashira K, Morgan KG, Morgan JP. Effects of cocaine on excitation-contraction coupling of aortic smooth muscle from the ferret. *J Clin Invest* 1991;87:1322–1328.
  72. Dressler FA, Malekzadeh S, Roberts W. Quantitative analysis of amounts of coronary arterial narrowing in cocaine addicts. *Am J Cardiol* 1990;65:303–308.
  73. Albertson TE, Walby WF, Derlet RW. Stimulant-induced pulmonary toxicity. *Chest* 1995;108:1140–1149.
  74. Kissner DG, Lawrence WD, Selis JE, Flint A. Crack lung: pulmonary disease caused by cocaine abuse. *Am Rev Respir Dis* 1987;136:1250–1252.
  75. Kaufman MJ, Levin JM, Ross MH, et al. Cocaine-induced vasoconstriction detected in humans with magnetic resonance angiography. *JAMA* 1998;279:376–380.
  76. McCarron MM, Wood JD. The cocaine “body packer” syndrome: diagnosis and treatment. *JAMA* 1983;250:1417–1420.
  77. Nzerue CM, Hewan-Lowe K, Riley LJ Jr. Cocaine and the kidney: a synthesis of pathophysiologic and clinical perspectives. *Am J Kidney Dis* 2000;35:783–795.
  78. Volcy J, Nzerue CM, Oderinde A, Hewan-Lowe K. Cocaine-induced acute renal failure, hemolysis, and thrombocytopenia mimicking thrombotic thrombocytopenic purpura. *Am J Kidney Dis* 2000;35:E3–E7.
  79. Milroy CM, Clark JC, Forrest AR. Pathology of deaths associated with “Ecstasy” and “Eve” misuse. *J Clin Pathol* 1996;49:149–153.
  80. Fishman AP. Aminorex to fen/phen: an epidemic foretold. *Circulation* 1999;99:156–161.
  81. Brust JC. Vasculitis owing to substance abuse. *Neurol Clin* 1997;15:945–957.
  82. Brauer RB, Heidecke CD, Nathrath W, et al. Liver transplantation for the treatment of fulminant hepatic failure induced by the ingestion of ecstasy. *Transpl Int* 1997;10:229–233.
  83. Mittleman MA, Lewis RA, Maclure M, Sherwood JB, Muller JE. Triggering of myocardial infarction by marijuana. *Circulation* 2001;103:2805–2809.
  84. Wu TC, Tashkin DP, Djahed B, Rose JE. Pulmonary hazards of smoking marijuana as compared with tobacco. *N Engl J Med* 1988;318:347–351.
  85. Armen R, Kanel G, Reynolds T. Phencyclidine-induced malignant hyperthermia causing submassive liver necrosis. *Am J Med* 1984;77:167–172.
  86. Linden CH. Volatile substances of abuse. *Emerg Med Clin North Am* 1990;8:559–578.
  87. Jensen NH, Dragsted L, Christensen JK, Jorgensen JC, Qvist J. Severity of illness and outcome of treatment in alcoholic patients in the intensive care unit. *Intensive Care Med* 1988;15:19–22.
  88. Mayo-Smith MF. Pharmacological management of alcohol withdrawal: a meta-analysis and evidence-based practice guideline. American Society of Addiction Medicine working Group on Pharmacologic Management of Alcohol Withdrawal. *JAMA* 1997;278:144–151.
  89. Alldredge BK, Lowenstein DH. Status epilepticus related to alcohol abuse. *Epilepsia* 1993;34:1033–1037.
  90. Mitra S, Sinatra RS. Perioperative management of acute pain in the opioid-dependent patient. *Anesthesiology* 2004;101:212–227.
  91. Coffey SF, Dansky BS, Carrigan MH, Brady KT. Acute and protracted cocaine abstinence in an outpatient population: a

prospective study of mood, sleep, and withdrawal symptoms. *Drug Alcohol Depend* 2000;59:277–286.

92. Vaillant GE. Natural history of addiction and pathways to recovery. In: Graham AW, Schultz TK, Mayo-Smith MF, Ries RK, Wilford BB, eds. *Principles of Addiction Medicine*. 3rd ed. Chevy Chase, MD: American Society of Addiction Medicine, 2003:3–16.

93. Goodwin DW. Inpatient treatment of alcoholism—new life for the Minneapolis plan. *N Engl J Med* 1991;325:804–806.

94. O'Malley SS, Jaffe AJ, Chang G, et al. Six-month follow-up of naltrexone and psychotherapy for alcohol dependence. *Arch Gen Psychiatry* 1996;53:217–224.

95. Littleton J. Acamprosate in alcohol dependence: how does it work? *Addiction* 1995;90:1179–1188.

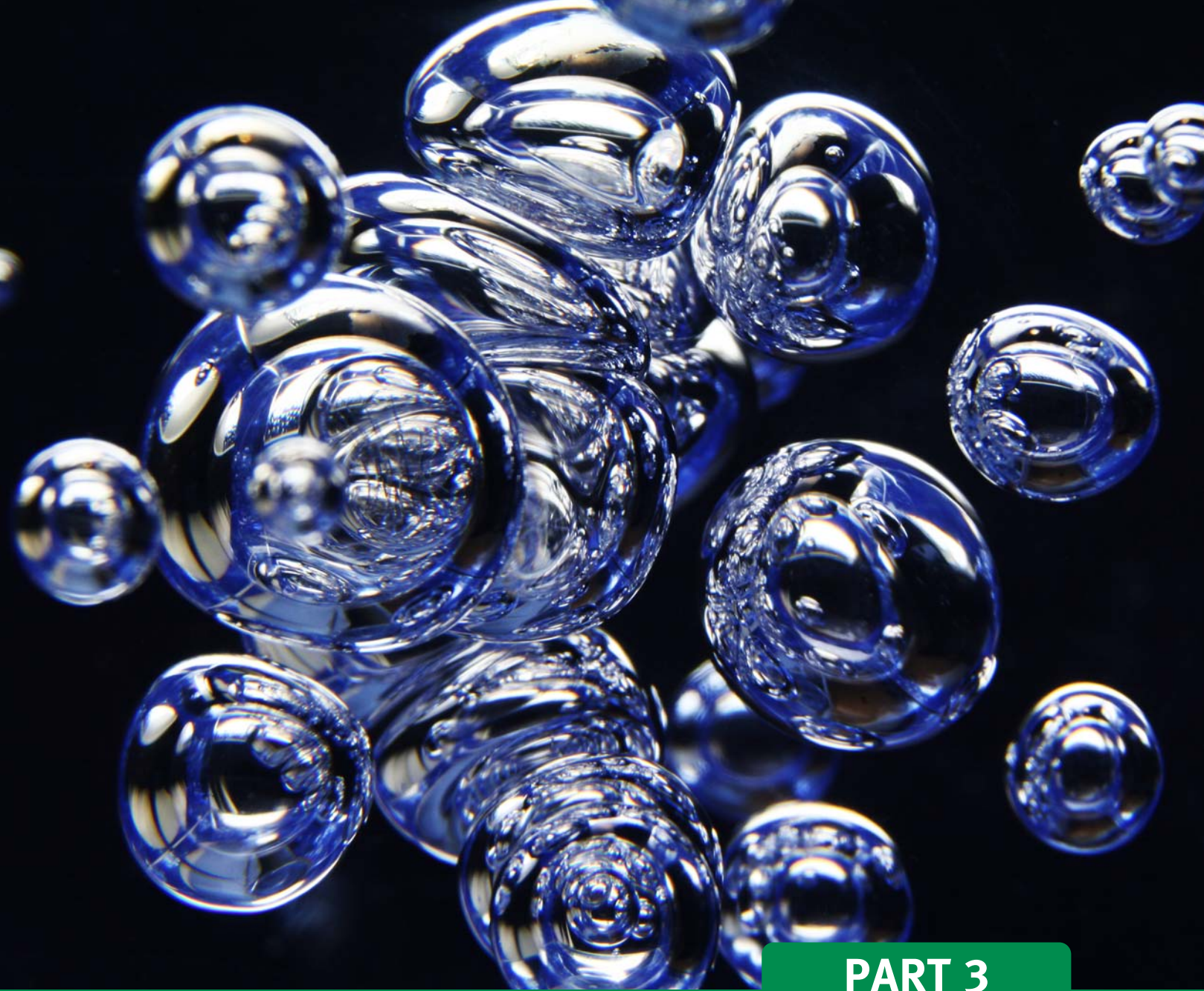
96. Mueller TI, Stout RL, Rudden S, et al. A double-blind, placebo-controlled pilot study of carbamazepine for the treatment of alcohol dependence. *Alcohol Clin Exp Res* 1997;21:86–92.

97. Kranzler HR, Burleson JA, Korner P, et al. Placebo-controlled trial of fluoxetine as an adjunct to relapse prevention in alcoholics. *Am J Psychiatry* 1995;152:391–397.

98. Wesson DR, Ling W, Smith DE. Prescription of opioids for treatment of pain in patients with addictive disease. *J Pain Symptom Manage* 1993;8:289–296.

99. Piazza PV, Le Moal M. The role of stress in drug self-administration. *Trends Pharmacol Sci* 1998;19:67–74.





## PART 3

### SAFETY AND RISK REDUCTION IN ANESTHESIA PRACTICE



# CHAPTER 24

## Anesthesia Risk

Fredrick K. Orkin, MD, MBA,  
MSc, and David E. Longnecker,  
MD, FRCA

“What is the risk of anesthesia?” patients often wonder. Their concern really is multipart. First, how likely is something to go wrong? then, what “bad things” could happen? and finally, what can be done to reduce the risk to me and to others following me in the future?

Anesthesia care providers try to allay patients' concerns by noting that most anesthesia side effects are common and may be annoying, but fortunately they are transient. Serious, life-threatening complications now are uncommon, if not rare. Whereas such comments may offer comfort, they do little to specify the magnitude and types of risks that a given individual faces, nor do they indicate that we know how to reduce the risks. Yet both have been active topics of ongoing research and efforts to improve anesthesia safety.

What lends poignancy to an otherwise arcane consideration of anesthesia risk is the recognition that an anesthetic usually confers no therapeutic benefit to the patient but rather facilitates other therapeutic or diagnostic interventions. This facilitation results from one of the most widely heralded humanitarian achievements of modern medicine, yet anesthesia care is accompanied by an ever-present possibility of harm. The potential for harm is expressed quantitatively by a variety of risk metrics, most commonly as the incidence rate for an adverse event. These metrics allow investigators to estimate the contributions of various aspects of anesthesia care (e.g., anesthesia methods and drugs, clinical care sites, temporal periods) to overall anesthetic risk. These findings allow clinicians to formulate approaches to care that are built on knowledge gained from past experience and to benchmark the impact of changes in care using quantitative metrics.

Anesthesia risk has been a critical concern since the first demonstrations of clinical anesthesia 160 years ago, when anesthesia was particularly hazardous. Over decades, interest in identifying, characterizing, and decreasing anesthesia-related harm has increased. These efforts have included inquests, case reports, case series, study commissions, registries, cohort studies (some with multi-institutional and geographically diverse data), clin-

ical trials, clinical practice guidelines and standards, establishment of the multidisciplinary Anesthesia Patient Safety Foundation (emulated in Australia and elsewhere), and use of simulation for clinical training, among other initiatives (see Chaps. 3 and 25 for additional information).

The intensity of these myriad efforts illustrates the specialty's commitment to decreasing the occurrence of adverse events and thereby improving

### KEY POINTS

1. Anesthesia risk estimates are wholly dependent on the circumstances in which they are generated; estimates developed in one clinical setting or selected population may not be relevant to other settings or specific patients.
2. The risk of death related primarily to anesthesia is estimated to be as low as approximately 1:200,000 anesthetics in large populations.
3. Such a very low anesthesia-attributable mortality rate reflects improvement of perhaps two orders of magnitude over more than 50 years.
4. Despite the very low anesthesia-attributable mortality rate, the very large and increasing number of anesthetics engenders a substantial burden of mortality and morbidity, much of which may be preventable.
5. Approximately 75% of risk actually relates directly to patient-specific characteristics, including age, gender, and comorbidity; 20% to surgical issues, such as experience and judgment; and the remaining 5% to anesthesia factors, including experience, board certification, pharmacologic issues, and overall management of care.
6. The overall anesthesia-attributable mortality rate is now so low that demonstrating further improvement is no longer logistically feasible. However, there are opportunities for meaningful advances in selected subpopulations of high-risk patients or high-risk procedures.
7. The very low anesthesia-attributable mortality should not be a cause for complacency but rather an impetus toward a wider emphasis on improving anesthesia-related morbidity in selected populations and even broader outcomes of care.
8. Although randomized clinical trials have rightly become the “gold standard” for establishing efficacy in clinical research, randomized clinical trials have a limited role in studying anesthesia risk, particularly because they cannot conveniently, efficiently, and at reasonable cost unravel the confounding clinically relevant variables.
9. Whereas much of what has been learned about both anesthesia risk and studying risk comes from large prospective cohort studies of mortality, such studies cannot fully capture the multidimensionality of anesthesia risk and risk-related nuances that require adoption of a broader definition of anesthesia care and often the study of large observational datasets.
10. The study of observational data requires rigorous attention to methodology, lest bias enter to impair the risk estimates, and multivariable statistical modeling to deal with confounding among clinically relevant variables.
11. The American Society of Anesthesiologists physical status classification correlates with risk for mortality and morbidity, but it is somewhat subjective and, without embellishment with other clinical information, is not as strong a predictor of poor outcomes than other, morbidity-specific measures.
12. Well-conducted studies of observational clinical data reveal that anesthesia risk is influenced much more by *how* the anesthesiologist provides care rather than specifically *what* methods are used.

anesthesia safety. An almost 100-fold decrease in estimates of anesthesia-attributable mortality among studies over the past 5 decades documents the specialty's high level of professionalism and leadership toward ever-greater patient safety, which has been cited by the Institute of Medicine as a model for the rest of healthcare.<sup>1</sup>

The risk of death related primarily to anesthesia has been estimated to be as low as approximately 1:200,000 anesthetics in large populations.<sup>2</sup> (This chapter emphasizes that such estimates vary greatly depending on circumstances of the given study, and that no rate can be considered representative of all clinical settings.) Yet the now very frequent administration of anesthesia—almost 48 million surgical procedures<sup>3</sup> in the United States plus an uncertain number of diagnostic procedures undertaken with anesthesia—engenders several hundred anesthesia-associated deaths each year. Many more—perhaps 10–15 times as many—perioperative deaths occur in circumstances where perioperative anesthesia management, surgical care factors, and/or patient-specific characteristics jointly contribute to poor outcomes. Moreover, an even greater prevalence of anesthesia-associated morbidity poses a substantial burden of individual suffering and societal costs. Thus, despite substantial improvement in anesthesia safety, potentially preventable anesthesia-associated mortality and morbidity remain “of sufficient magnitude to constitute a public health problem,” as Beecher and Todd<sup>4</sup> noted more than 50 years ago.

The effort to decrease anesthesia risk has been a major focus of scholarly activity, resulting in more than 3000 English-language, MEDLINE bibliographic citations on “anesthesia risk” since 1966 and many more citations relating to the risk of specific morbidities. As might be expected, this literature can be unwieldy, confusing, sometimes contradictory, and often uneven in scientific quality, leaving the practitioner little guidance about what can be applied in practice or conveyed to patients with confidence.

Rather than exploring those studies in detail, this chapter surveys the factors that must be considered when evaluating the literature on anesthesia risk. We review the definition of risk, the special problems in studying anesthesia risk, the relevant study designs,

and the salient findings from selected studies of mortality and morbidity that inform us about anesthesia risk analysis. We see how characteristics of the system of care, including the patient, the procedure, and the clinical setting, may influence outcomes, and where opportunities for further risk reduction may lie. The goal is to inform and educate the practitioner so that anesthesia practice can be guided by an understanding of the principles of anesthesia risk, without great reliance on equations and statistical formulas that are the basis of epidemiology and risk analysis.

We see how our understanding of anesthesia-associated risk has developed historically and intuitively, from a single-minded focus on the risk of death associated with anesthetic administration to the multifaceted potential role of anesthesia in a continuum of care management that includes myriad healthcare factors that act collectively to influence patient outcomes, all with the goal of improving care.

## WHAT IS ANESTHESIA RISK?

A seemingly simple concept, risk often is misunderstood, perhaps in part because of inconsistent and imprecise usage of the terms “risk” and “risk factors.”<sup>5,6</sup> The resultant confusion is not trivial, given the recent controversy regarding *when* the celebrated decrease in anesthesia risk may have occurred<sup>7,8</sup> and even *whether* it actually occurred.<sup>9,10</sup> Thus, it is appropriate first to define risk.

*Risk* is a probabilistic term that expresses the likelihood of an outcome. Risk is a ubiquitous, natural part of life, because everything we do, including doing nothing, poses an uncertain outcome. In common usage, *anesthesia risk* connotes an undesirable or negative occurrence, such as death or injury. However, colloquially, in addition to referring to the chance of an outcome (e.g., *risk* of death during anesthesia), we occasionally use the term to refer to the outcome itself (e.g., *death* as one risk of anesthesia). A detailed analysis of the many possible anesthesia-associated adverse outcomes is beyond the scope of this chapter. Thus, this chapter focuses on developing an understanding of the probabilistic concept of risk, which may be applied either broadly or in

subspecialty areas. Risk is defined as *the probability of an outcome within a population.*<sup>5,6</sup>

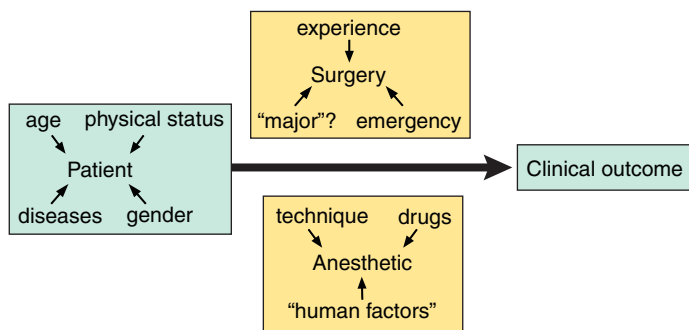
This definition quantifies the occurrence of a *specific* outcome within a *specified* population that is exposed to a *specific* hazard (e.g., anesthesia, air travel, etc.) under *specific* conditions. For example, the population receiving general anesthesia might share “exposure” to a hazard (e.g., loss of protective airway reflexes) during the period of observation; however, only some among the population develop the adverse outcome (e.g., aspiration pneumonia) that is associated with this hazard. (Note the distinction between hazard and risk: *hazard* is a characteristic of the system, whereas *risk* is a statistical probability; thus the terms cannot be used interchangeably.) Although the definition of risk is precise, differences in risk estimates among reports that purport to have studied the same outcome can vary widely to the casual observer. These differences usually result from differences in study design, not from differing definitions of risk. Careful reading of a report often reveals possible sources of the differences (Box 24–1).

Although the bulk of the anesthesia risk literature relates to estimates of risk (including identification of risk factors), an important subset of our risk literature relates to the other, less

### BOX 24–1.

#### Common Sources of Differences in Anesthesia Risk Estimates Across Studies

- Characteristics of study population (e.g., age, gender, comorbidities, genomics)
- Magnitude or duration of the exposure
- Definition of the outcome
- Sensitivity and specificity of the diagnostic methods used to identify the outcome
- Surveillance interval following exposure
- Method of attributing outcome to anesthesia management
- Characteristics of the healthcare setting
- Sampling variation (especially with small sample size)
- Other factors that might affect the likelihood of the occurrence of the outcome



**FIGURE 24-1.** Traditional model of the determinants of the patient's clinical outcome after surgery and anesthesia care. (Modified from Orkin,<sup>158</sup> Fig. 1.)

common usage of *risk*: descriptions of specific adverse outcomes. Examples include case reports, case series (e.g., critical incident studies<sup>11</sup>), and registries such as the American Society of Anesthesiologists (ASA) Closed Claims Project.<sup>12</sup> Because such reports do not include information on the “at-risk” or “exposed” population, incidence rates cannot be estimated and risk factors for the occurrence of the outcomes cannot be identified. Yet such reports are widely used to alert us to possible, but still unquantified, risks, and they have been especially useful in developing initiatives to improve safety (see Chaps. 3 and 25).

### How Does Anesthesia Risk Differ from Anesthesia Safety?

*Risk* and *safety* often are discussed colloquially as if they were closely related, yet they are not. Whereas *risk* is an objective, probabilistic term, *safety* connotes personal and/or social value judgment about the acceptability of a given level of risk.<sup>13,14</sup> We generally regard as safe that which poses an acceptable level of risk, given that nothing is risk-free.<sup>14,15</sup> The acceptability of a given risk level is a function of each individual's *risk tolerance*, which, in turn, is influenced by factors characterizing the adverse outcome, exposure, and perceptions of the individual evaluating the risk (Box 24-2).<sup>13,16</sup>

The perceptions of risk, and the tolerance for risk, vary considerably among individuals and over time. Some might consider the risks of space flight as unacceptable, whereas astronauts and recent space tourists do not. Similarly, many Americans reassessed their risk tolerance for commercial aviation immediately after the events of September 11, 2001, with many preferring to drive even though commercial

air travel posed lower risk. Some even purchased firearms, although evidence indicates that the risks from firearm accidents are far greater than the chance of being killed by a terrorist.<sup>16</sup> Not surprisingly, parents are generally much more concerned about the safety of anesthesia for their children than for themselves, even though the risk of injury is generally similar.

## HOW IS ANESTHESIA RISK MEASURED?

### Models for Studying Anesthesia Risk

The perspective taken in studying anesthesia risk may be narrow or broad—the latter approach has evolved more recently. Most investigators who published before the late 1980s probably were guided by the more restrictive model depicted in Fig. 24-1. In this approach, a population of patients is “exposed” to the dual “hazards” of anesthesia and surgery, and the model counts clinical outcomes (deaths, adverse events) that result from this experience.

A revisionist model (Fig. 24-2), consistent with studies of anesthesia risk undertaken since the latter 1980s, recognizes that anesthesia care and surgery occur in a complex matrix of administrative, cultural, and clinical processes, all of which can add hazards to the system.

The revisionist model also includes a far broader array of outcomes, well beyond those purely clinical (Box 24-3). Although most of the anesthesia risk literature focuses on clinical outcomes, such as death or morbidity, it also is important to explore the influence of anesthesia care on other outcomes, such as cost, patient performance (e.g.,

## BOX 24-2.

### Factors Associated with Decreased Tolerance for Risk

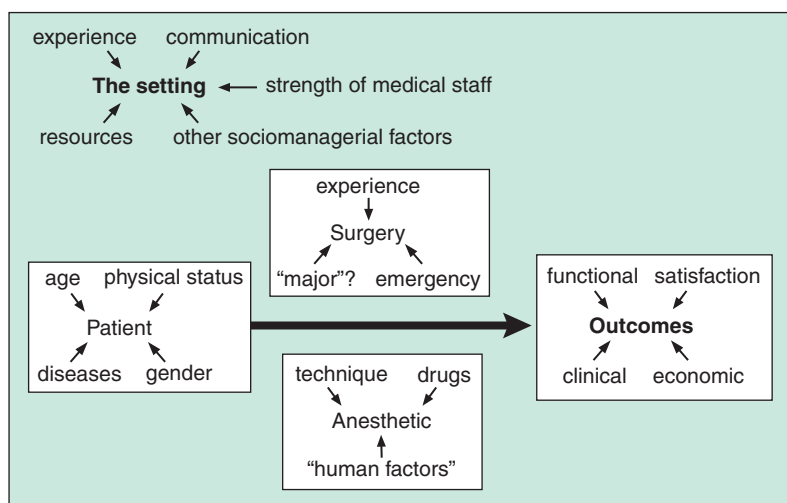
- A. Features of the adverse outcome
  1. Greater versus lesser severity
  2. Permanence versus reversibility
  3. High versus low frequency
  4. “Dread disease,” especially social and economic implications
  5. Immediate versus delayed onset
  6. Occurrence in all people versus only in sensitive people
  7. Relationship to intervention known with certainty versus not well established
- B. Characteristics of exposure (intervention)
  1. Optional (e.g., cosmetic services, treatment for self-limited disease) versus essential (e.g., therapy for life-threatening disease)
  2. Related to exposure versus its absence
  3. Alternatives available versus only available intervention
  4. Imposed versus voluntarily assumed
  5. Misuse is likely versus unlikely
- C. Perceptions of evaluator regarding circumstances of exposure
  1. New versus established
  2. Synthetic or imposed versus natural
  3. Greater uncertainty versus highly predictable result
  4. Less knowledge of situation
  5. Less personal control versus more control
  6. Less trust in the circumstances versus greater trust
  7. Relates to one's child versus one-self versus a stranger

Modified from Strom BL. *Pharmacoepidemiology*, ed 4. Copyright © 2005, John Wiley & Sons Ltd. Reproduced with permission; and Ropeik and Gray.<sup>16</sup>

quality of life), quality of service, and patient satisfaction. These assume greater importance now with the growing call throughout medicine for greater patient-centered care (see Chap. 3).

## Quantifying Anesthesia Risk

If exposure to a “hazard” increases the likelihood of an adverse outcome, then duration (or dose) of exposure should be a better predictor of development of the outcome than just occurrence of exposure. Indeed, this intuitive notion



**FIGURE 24–2.** Revisionist model of the determinants of the patient's outcomes after surgery and anesthesia care. This model acknowledges that the outcomes are far broader than purely clinical and that the care setting also has diverse influences on the care and its results. (Modified from Orkin,<sup>158</sup> Fig. 2.)

is the basis for the investigative approach in toxicologic and epidemiologic studies of health hazards. Time-related exposure risks (e.g., 1-year odds) of real-world health hazards have been tabulated.<sup>16</sup> Runciman and Moller<sup>17</sup> applied this notion to quantify the mortality risk of anesthesia and complex surgery in relation to a variety of real-world hazards (Box 24–4). Although the mortality rates they present for various hazards are only approximations, the relative risks are informative for both providers and patients: having anesthesia is as risky as being hospitalized, 20 times more hazardous than commercial flight, but 10 times safer than parachute jumping!

Despite the intuitive appeal and potential empirical value, examples of anesthesia risk studies examining time-related hazards are few. This may reflect both lack of interest in time-related hazards, as several well-conducted studies suggested that outcome differences among general anesthetics are minimal, if any,<sup>18,19</sup> and historically the lack of equipment for detecting and recording time- and dose-related delivery of anesthetics (e.g., minimum alveolar concentration-hours of desflurane). Many studies note an association between greater duration of anesthesia (or surgery) and poorer outcome, but longer duration of anesthesia is not necessarily equivalent to a greater total anesthetic dose and probably reflects longer surgery, among other factors discussed when considering sources of risk.

However, Monk et al.<sup>20</sup> have reported that greater cumulative deep hyp-

notic time—estimated as the time when the bispectral index is < 45—was independently associated with greater 1-year postoperative mortality. Hopefully, this report will encourage other investigators, especially those in settings with computer-based record-keeping technology that captures duration and weighted-average dose of inhalation agents, to validate and further elucidate this and other possible effects related to the cumulative total dose of anesthesia.

In the absence of time-related risk data, anesthesia risk is commonly summarized as an incidence rate that is computed, in its simplest form, as the quotient of the number of cases and the overall population:

$$\text{Risk} = \text{Incidence Rate} = \frac{\text{Persons with Outcome}}{\text{Population Exposed to Hazard}}$$

Four important features of this simple relationship are apparent. First, a risk cannot be estimated without knowing the size of the population from which the cases (i.e., those with the outcome) arose. Thus, the absence of the denominator precludes estimating risk in studies using case series and registry data. Second, risk estimates can span a remarkably wide range. The calculated risk value is bounded by 0, in which circumstance no one experiences the outcome, and 1, in which everyone suffers the outcome. Depending on the outcome studied, anesthesia risk estimates span much of this range, from death primarily related to

### BOX 24–3.

#### Taxonomy of Outcomes

- I. Clinical outcomes
  - A. Clinical endpoints
    1. Symptoms (e.g., nausea, cough)
    2. Laboratory values (especially abnormal values)
  - B. Complications and adverse events (e.g., dental injury, pulmonary aspiration, arrhythmia, cardiac arrest)
  - C. Death
- II. Functional health status (health-related quality of life)
  - A. Physical
  - B. Mental (including psychological and well-being)
  - C. Social
  - D. Role
- III. Patient satisfaction
  - A. Patient-based assessment of care
    1. Quality (e.g., satisfaction with pain control)
    2. Convenience
    3. Access to care
    4. Adequacy of information (e.g., education)
- IV. Economic consequences
  - A. Length of stay (hospital, intensive care unit)
  - B. Utilization of specific healthcare resources (e.g., drugs, tests, procedures)
  - C. Institutional performance
    1. Readmission of discharged patients
    2. Unplanned admissions from ambulatory surgery
    3. Other institutional implications of errors and complications (“rework”)
  - D. Costs
    1. Direct costs
    2. Indirect costs (e.g., lost wages, lost productivity, disability)

anesthesia care in large, unselected populations (e.g., as low as 0.000005) to postoperative nausea in especially susceptible individuals under specific circumstances (e.g., as high as 0.8). Because decimal values can be unwieldy (and thus error-prone) and awkward in conversation, we commonly refer to risks >0.01 in their percentage form (e.g., the risk of perioperative death in relation to cardiac surgery is “3.0%” rather than “0.03”). For smaller



## BOX 24-4.

## Average Fatal Accident Incidence Rates (Deaths per 100 Million Hours of Exposure)

Being pregnant	1
Traveling by train	5
Working at home	8
Working in agriculture	10
Testing positive for human immunodeficiency virus after receiving one unit of blood	10
Being in traffic (overall, in any capacity)	50
Working in the construction industry	67
Flying in a commercial aircraft	100
Being a patient in an Australian hospital	2,000
Being anesthetized	2,000
Parachute jumping	20,000
Having elective abdominal aortic surgery	200,000
Having emergent abdominal aortic surgery	2,000,000

Modified from Runciman and Moller,<sup>17</sup> Table 1.17.

risk values, we often express the risk in either the scientific notation (e.g.,  $5 \times 10^{-6}$  rather than 0.000005) or, more commonly, the ratio of 1 to the smallest number of individuals whose exposure to the hazard would result in one case (e.g., risk of death primarily related to anesthesia is “1 in 200,000” or “1:200,000” rather than “0.000005”).

Third, by definition, the calculated risk is the risk faced by the population under study, whereas we are often interested in the risk faced by a particular individual or perhaps a specific group of individuals who were not part of the study population and may have special characteristics that might place them at greater or lesser risk. Thus, risk estimates in the literature, especially some very low mortality rates widely touted in public media, may not relate well to the person(s) we are concerned about. Again, risk estimates are very much the products of the circumstances in which they are generated (Box 24-1).

Fourth, this simple and common risk calculation is but one approach to expressing the magnitude of risk. The magnitude of risk can be expressed in alternative ways, some of which are

## TABLE 24-1.

Risk Metrics and the Epidemiologist's  $2 \times 2$  Table

Exposure	Outcome	
	Present	Absent
Present	a	b
Absent	c	d
Risk Metric	Definition	Calculation
Relative risk (RR)	Proportion of original risk present with new intervention	$\frac{a/(a+b)}{c/(c+d)}$
Relative risk reduction (RRR)	Proportion of outcome risk removed by intervention	$\frac{c/(c+d) - a/(a+b)}{c/(c+d)}$
Absolute risk reduction (ARR)	Proportion of persons spared outcome by intervention	$\frac{c}{c+d} - \frac{a}{a+b}$
Number needed to treat (NNT)	Number of persons treated with intervention to save one	$\frac{1}{ARR}$
Odds ratio (OR)	Ratio of proportion of persons with outcome to those without outcome	$\frac{a/b}{c/d}$

Modified from Jaeschke R, Guyatt G, Barratt A, et al. Therapy and understanding the results: measures of association, In: Guyatt G, Rennie D, eds. Users' Guides to the Medical Literature: A Manual for Evidence-Based Clinical Practice. Chicago: AMA Press, 2002:351. Copyright 2002, American Medical Association. All rights reserved.

particularly useful in understanding clinical trial results and comparing treatment benefit or harm across studies (Table 24-1).<sup>21</sup> Such risk metrics are easily computed from summary results presented in the literature (Box 24-5).<sup>22</sup>

## Risk Values Are Estimates

If 5 of a 10-patient cohort receiving a new antiemetic regimen experience postoperative vomiting, we conclude that the emesis rate is 0.5. To increase our confidence in the results, we study another

## BOX 24-5.

## Calculating Risk Metrics

Often, we can extract greater risk-related information from studies, particularly clinical trials, by calculating a set of risk metrics (Table 24-1).<sup>21</sup> The first step is to express the study results in an epidemiologist's “ $2 \times 2$  table” and then compute a set of risk metrics. The computations are simple but error-prone. An interactive, Internet-based calculator is available.<sup>22</sup>

**Example 1:** How effective is intensive insulin therapy in intensive care?

Van den Berghe et al.<sup>23</sup> reported that an intensive insulin regimen was associated with a 48% decrease ( $P = 0.005$ ) in mortality among those receiving more than 5 days' intensive care. Such a decrease certainly appears very meaningful, yet we recognize that a small  $P$  value is not a measure of *clinical* significance and is influenced by sample size. Creating a  $2 \times 2$  table from their results ( $a = 22$ ,  $b = 208$ ,  $c = 49$ ,  $d = 243$ ), we can calculate the risk metrics, including a number needed to treat (NNT) of 13.6. Such a very low NNT value indicates that the intensive insulin regimen is a very potent intervention.

**Example 2:** Reconciling perioperative, prophylactic atenolol recommendations.

Mangano et al.<sup>24</sup> recommended prophylactic, perioperative atenolol for all patients at risk for coronary artery disease, but more recently Lindenauer et al.<sup>25</sup> have suggested that  $\beta$ -blocker use be reserved for patients at high risk because lower-risk patients are harmed. Can we reconcile the two recommendations? One hypothesis is that Mangano et al. studied higher-risk patients. From a  $2 \times 2$  table constructed from Mangano's principal results ( $a = 9$ ,  $b = 90$ ,  $c = 12$ ,  $d = 89$ ), we calculate risk metrics, including an NNT of 36 and odds ratio of 0.74. These risk metrics approximate those for the highest-risk patients studied by Lindenauer et al., thus supporting our hypothesis.

cohort of 10 patients. Naively, we expect the same rate as the circumstances are unchanged. The second cohort's rate is 0.6. Still seeking confirmation, we study a third and fourth cohort, whose rates are 0.2 and 0.5. Now we are confused!

Our experience teaches us four important additional lessons about studying risk in small clinical studies. First, the clinical experience of each 10-patient cohort is but a sample of the experiences of a universe of patients whom we rarely can study. The observed adverse-event rate in any sample is only an estimate of the true adverse-event rate in the much larger population. If the true emesis rate in the population receiving this anesthetic regimen is 0.5, we are likely to observe this rate in many cohorts, but we may not because of sampling variation.

The second lesson is that the rates calculated from small samples can vary greatly. Thus, for our sample of 10 patients, there is a finite set of possible rates (i.e., 0, 0.1, 0.2, ... 0.9, 1.0). Related is our third lesson: with larger samples, the set of possible rates grows, with the values closer to each other (e.g., for a sample of 20 patients, the possible rates are 0, 0.05, 0.10, 0.15, etc.).

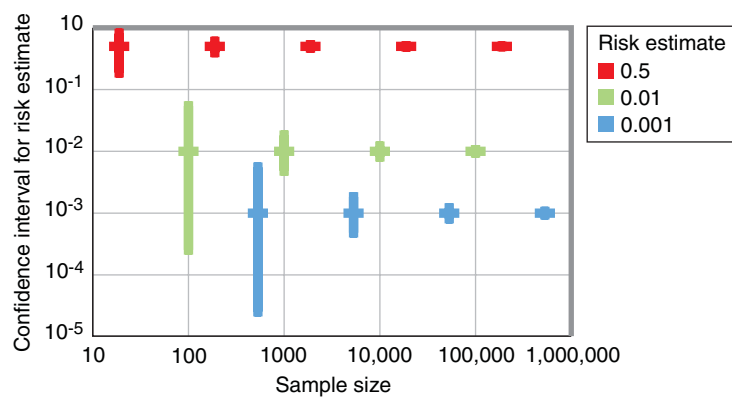
The fourth and most informative lesson is that rates calculated for successive cohorts hover around the population's rate and that one may compute a likely range (confidence interval [CI]) for the rates calculated for successive cohorts. As the cohort's sample size increases, the CI for the rate narrows, enhancing the precision of the rate estimate (Fig. 24-3 and Box 24-6).<sup>26</sup> Thus, other things being equal, we intuitively regard rates calculated from larger cohorts as more reliable than those from smaller studies, and the statistics support our intuition.

## WHAT ARE THE CHALLENGES IN ESTIMATING ANESTHESIA RISK?

### Generic Challenges in Studying Anesthesia Risk

#### Identifying the Outcomes of Interest

**Diagnostic Problems** Diagnosing or identifying an adverse event is critical to the assessment of risk and is not a trivial problem. Identifying the occurrence of death might seem inordinately simple, but postanesthesia death may not be recognized if the defined surveillance interval is brief, such as the first



**FIGURE 24-3.** Span of 95% confidence interval (vertical bar) as a function of risk estimate (horizontal line in vertical bar) and sample size. Smaller risk estimates require sharply increasing sample size for precision.

48 hours postoperatively or during hospitalization only. This “ascertainment bias” results in underestimation of the true mortality rate.

Even greater challenges are posed by specific adverse events, such as pulmo-

nary aspiration, pulmonary edema, myocardial ischemia, or myocardial infarction (MI), which often present in a graded fashion, from barely detectable to life-threatening. This raises the possibility that differences in the observed

### BOX 24-6.

#### Calculating Confidence Intervals

When perusing medical literature, physicians hone in on *P* values, looking specifically for values “less than 0.05” that are commonly accepted to denote “statistical significance.” The latter is not the same as *clinical* significance, and a smaller *P* value does not indicate a stronger basis for clinical decision making. Indeed, the *P* value tells whether the study result could have happened by chance (not necessarily of great relevance to the clinician), and the size of the *P* value is itself sensitive to the study's sample size (i.e., smaller *P* value for same “effect size” with larger sample size).

Instead, recognizing that study results vary, the clinician is most interested in knowing the range in which the study result is likely to lie, were the study to be repeated. The 95% confidence interval (CI) is the range in which the result would lie in 95 of the next 100 repeat studies.<sup>26</sup>

A special situation arises when an outcome of interest (e.g., a complication) does not occur, in which case the rate obviously is 0. But we can have little confidence that the true rate is 0%. Clearly, the lower limit of the confidence interval is 0%, but what is the upper limit? Although we can resort to statistical software or tables, there is a handy “Rule of 3” for computing an estimate of the upper limit of the 95% CI: the quotient of 3 divided by the sample size in which no event was observed.<sup>27</sup> (Similarly, there is a “Rule of 5” for estimating the upper limit of the 99% CI.)

*Example 1:* Among 9152 gastroenterologic endoscopies in an ambulatory surgery center where nurses administered propofol sedation, using an anesthesiologist-furnished protocol, there were 7 (0.08%) cases of “respiratory compromise” (3 prolonged apnea, 3 laryngospasm, 1 aspiration requiring hospitalization).<sup>28</sup> What is the likely variation about this rate? Using statistical software, we compute the 95% CI to be 0.03–0.16%, suggesting that these important complications are likely to continue to be rare.

*Example 2:* A clinical trial of gastroenterologist-administered sedation for advanced upper endoscopy compared propofol in 38 patients to meperidine/midazolam in 37 patients.<sup>29</sup> Apart from brief, transient respiratory depression monitored by capnography, no major complications occurred. How confident can we be about the risk of major complications? Using the Rule of 3, we compute the upper limit of the 95% CI as approximately 8% (statistical software: 9.5% and 9.3%, respectively). Thus, with the risk of a severe complication as high as 1:11, this small trial does not instill a sense of safety.

risk (incidence rate) of these and other outcomes might be influenced greatly by the prevalent diagnostic methods or definitions. For example, the observed rate of myocardial ischemia is greater if the diagnosis is made by continuous Holter monitoring than by clinical symptoms such as angina. Such imprecision constitutes an important source of systematic error (ascertainment bias, information bias) that can lead to failure to recognize outcome occurrences (misclassification bias) and inaccurate risk estimates.

Diagnostic challenges often are compounded by problems with the definitions and classifications that are inherent in clinical information systems and administrative databases. Institutional clinical information systems may use nonstandard definitions for data elements, such as adverse events, diagnoses, surgical procedures, and thresholds for abnormalities among laboratory values. Administrative databases, which classify the diagnoses, complications, and surgical procedures relating to care in a standard procedure coding system, typically have few anesthesia-specific categories [e.g., “E” codes in the *International Classification of Diseases, Ninth Revision, Clinical Modification (ICD-9-CM)* system], and some can be quite arcane (e.g., ICD-9-CM code 968.3: poisoning by intravenous anesthetics).

**Surrogate End Points** Even if the outcome of interest (e.g., death, specific adverse event) can be identified accurately, it may occur so infrequently that the proposed study may not be feasible. (We consider the statistical basis later.) Not unexpectedly, investigators have opted for alternative end points that are surrogates or intermediate variables—symptoms, signs, clinical events, laboratory values, and even process variables—which occur more often than the outcome and are believed to be linked to that outcome. Thus, blood pressure is used as an end point in clinical trials because high blood pressure is a known risk factor for stroke and MI; similarly, myocardial ischemia is commonly used as a surrogate for MI.

Such approaches are appropriate only if the surrogate end point truly predicts the occurrence of the outcome. However, this requirement is often not met, possibly because the outcome may occur via some pathway(s) not mediated by the surro-

gate.<sup>30</sup> Among recent examples is ventricular ectopy as the surrogate end point in the evaluation of drugs to prevent sudden death. Food and Drug Administration approval of a new class of antiarrhythmic drugs followed clinical trials demonstrating their efficacy in treating ventricular ectopy, but a subsequent trial revealed a *greater* risk for sudden death among those receiving the new drugs, and the drugs were withdrawn.<sup>31</sup> Problematic surrogate end points in anesthesia have included the interval to eye opening after general anesthesia, which does not correlate well with earlier discharge after ambulatory surgery, lower rate of unplanned hospital admission after ambulatory surgery, greater patient satisfaction, and overall lower cost of care.<sup>32</sup>

**Broadened Array of Outcomes** The end points of interest have expanded from “clinical outcome,” such as mortality or specific adverse events or complications,<sup>18,33–35</sup> to a broader and more comprehensive set of “outcomes” that reflect many facets of the care process, including the results of the care particularly from the patient’s perspective, or administrative end points such as the cost of services (Box 24–3). Studies of anesthesia risk already include some nonclinical outcomes, such as unplanned hospital admission after ambulatory surgery<sup>36,37</sup> and poorer quality of immediate postoperative recovery.<sup>38</sup>

Undoubtedly, more studies will include measures of what has been termed “health-related quality of life,”<sup>39,40</sup> increasingly termed “patient-reported outcome measures.”<sup>41</sup> As the terminology suggests, the patient is the direct source of the information. These measures take the form of a large number of generic health scales (e.g., Medical Outcome Study’s SF-36 Health Survey<sup>42</sup>) and disease- and condition-specific scales (e.g., Visual Analog Scale for Pain,<sup>43</sup> McGill Pain Questionnaire<sup>44</sup>). Such instruments have been validated in large populations, typically with chronic disease, for use in longitudinal and cross-sectional studies,<sup>45</sup> and are beginning to be used in settings such as chronic pain clinics. Apart from their possible use as outcome measures, patient-reported measures may also be used as patient descriptors (e.g., quantitating severity of a symptom or disability).

### **Patient-Specific Descriptive Data**

Risks are not distributed randomly. Some individuals are more likely to experience health problems as a result of diverse factors, including genetics, coexisting disease, personal health behaviors (e.g., smoking, diet, exercise), socioeconomic status, and environmental setting. Thus, estimating anesthesia risk requires accurate information to characterize each patient, including nonclinical information. Such information enables categorizing patients by likelihood of poor outcome (risk stratification) and “risk adjusting” their data for outcome comparisons.<sup>46</sup>

The ASA physical status classification originally was advanced to standardize terminology and group patients in six categories for review of clinical outcome.<sup>47</sup> Subsequently, it was reformatted to five categories by Dripps et al.<sup>48</sup> and adopted by the ASA.<sup>49</sup> Only later was it found to correlate with clinical outcomes.<sup>18,33–36</sup> In addition, the Charlson Comorbidity Score,<sup>50</sup> a disease-specific classification system, is increasingly used in anesthesia risk studies. (We consider these metrics in detail when exploring the patient’s role in risk.)

With growing interest in healthcare disparities, noting the patient’s race and ethnicity accurately will be important. Although multiple formats are available for recording such information, the prevailing guidance is that the patient’s self-designated race and ethnicity be noted, using categories from the US Census Bureau (White; Black or African American; Hispanic or Latino; Asian or Pacific Islander; or American Indian or Alaskan Native).<sup>51</sup>

### **Duration of the Surveillance Interval**

Intuitively, we know that the longer we watch for problems, the more likely we are to capture all such occurrences. Too short a surveillance interval risks missing some occurrences and, thus, can lead to systematically underestimating risk (ascertainment bias). Yet, as the time between the “exposure” (e.g., administration of anesthesia) and event increases, the greater the chance that the occurrence may be associated with circumstances partially or totally independent of the exposure. These other circumstances might include even chance patient-specific factors (e.g., MI that might have occurred 2 weeks preoperatively



while walking the dog). This dualism of comprehensiveness versus precision plagues most cohort studies in the anesthesia risk literature.

Variation in length of the surveillance interval is especially apparent in the early studies of anesthetic-associated mortality. Bodlander,<sup>52</sup> Harrison,<sup>53</sup> Tiret et al.,<sup>54</sup> and Dornette and Orth<sup>55</sup> considered a death eligible for further evaluation as possibly “anesthesia-related” only if it occurred during or within 24 hours of administration of the anesthetic or after failure of the patient to regain consciousness after anesthesia. Turnbull, et al.<sup>56</sup> Hovi-Viander,<sup>57</sup> Lunn and Mushin,<sup>58</sup> Marx et al.,<sup>59</sup> Cohen et al.,<sup>19</sup> Dripps et al.,<sup>48</sup> Monk et al.,<sup>20</sup> and Mangano et al.<sup>24</sup> extended the surveillance interval progressively to 48 hours, 3 days, 6 days, 7 days, 30 days, 1 year, and 2 years, respectively. Beecher and Todd<sup>4</sup> adopted an empirical approach, using the duration of the surgical hospitalization.

Extending the surveillance interval captures the delayed deaths from complications that may have their origin with anesthetic care, such as MI, which historically has occurred most commonly several days postoperatively, or pulmonary aspiration with subsequent pneumonia and terminal respiratory failure days or weeks after our care, and thus would escape our recognition if the surveillance interval were short. Even the approach of Beecher and Todd<sup>4</sup> using the duration of the surgical hospitalization can be problematic if the patient dies shortly after an early discharge. Of note, Warner et al.<sup>60</sup> found that 39% of major morbidity occurred more than 2 days but within 30 days after ambulatory surgery among 45,090 adults, including 2 of 5 cases of respiratory failure, 5 of 14 cases of MI, and 3 of 5 cases of pulmonary embolism. Their study population was not sufficiently large to differentiate observed adverse-event rates from those estimated in the catchment population; however, it is clear that substantial numbers of events would have been missed had the surveillance interval been limited to the immediate postoperative period.

Although there are no formal guidelines on duration of the surveillance interval, a 6-week period had been used in the National Halothane Study,<sup>61</sup> 30 days has been adopted by the Veterans Affairs (VA) National Surgical Quality Improvement Project

(NSQIP) database,<sup>62</sup> and 30 days is commonly used with Medicare data. At least for most procedures, this interval represents a reasonable compromise between too short an interval (which overlooks adverse events that may be temporally related to surgical and anesthesia care), and too long an interval (which introduces significant logistic problems for followup and perhaps captures adverse events unrelated to the hazards of surgery and anesthesia).

Although one might naïvely expect that the derived mortality rates would increase uniformly with the surveillance interval, such a facile relationship often does not exist, presumably because multiple technical differences among studies (Box 24-1).

### Assessing the Relationship with Anesthesia Care

**Problem of Attribution** The late Emanuel Papper, an esteemed, mid-20th century leader of American anesthesiology, fondly recounted that, as chair of a preeminent department, he was often asked to personally administer anesthesia to notables. One such morning, as he was about to induce anesthesia, he was interrupted by a colleague summoning him to an urgent phone call in his office. Apologizing to the patient and others eager to get underway, Dr. Papper excused himself, and, when he returned 15 minutes later, cardiopulmonary resuscitation was underway!

Attributing causation is inherently problematic. Most cohort studies of anesthesia-associated mortality have included a panel of blinded case reviewers who were asked to attribute the death to one of several possible causes. Was anesthesia care the *primary cause* of death? Or was anesthesia management a *contributory cause* (along with patient- and surgery-related factors) to the death? Or was the poor outcome unrelated to anesthesia care? Panels were often composed mostly or wholly of anesthesiologists. However, recognizing the complexity of the care process and the multifactorial etiology of many adverse events, some study panels have been more balanced. The review committee used by Holland<sup>63</sup> had six anesthesiologists, three surgeons, an obstetrician, a general practitioner, and a medical administrator. Holland assigned cases to one of four categories: wholly related to anesthesia or anesthetic management; probably re-

lated to anesthesia or anesthetic management; related to both anesthesia and surgery; or entirely due to surgery. Lunn and Devlin<sup>2</sup> sent a questionnaire to the patient's anesthesiologist and surgeon; the forms were reviewed by blinded assessors who adjudicated differences of opinion and obtained further information if needed to make assignments of attribution.

**Unmasking Biases** Even without close proximity to care, the mere occurrence of a poor outcome that *may* be related to anesthesia management can bias our judgments regarding quality and appropriateness of care.<sup>64</sup> As Keats<sup>65</sup> noted more than 25 years ago, an underlying assumption in much of the anesthesia risk literature has been the belief that a poor outcome is presumptive evidence of error on the part of anesthesia providers. He emphasized that high interrater reliability in peer review does not assure that judgments are accurate. Review panel determinations are necessarily products of their collective current knowledge of practice at the particular time, as well as numerous other biases that result from inadequate study designs, limited statistical capabilities, and the complexity of phenomena being studied. Despite these limitations and the resulting widely ranging risk estimates, many important insights about risk, and the study of risk, evolved from this literature.

### Characterizing the Population

Our discussion thus far has focused largely on patients experiencing an outcome of interest (becoming “cases”) after exposure to a “hazard.” However, if we do not give due consideration to the larger “at-risk” population from which these cases emerge, we have only a set of cases and cannot quantify the risk. Fortunately, the intellectual basis for estimating anesthesia risk developed in tandem with the early development of anesthesiology. Pioneers in establishing what would become the field of epidemiology recognized the importance of relating the cases to the larger population to estimate risk and compare estimates across different populations (Box 24-7).<sup>66</sup>

**Ecology of Care** Later investigators extended the interest in characterizing the at-risk population by noting that a large population is not homogeneous with regard to health status or the



## BOX 24-7.

**Epidemiologic Pioneers in Developing Mortality Rates**

Victorian England had become infatuated with the potential use of statistics to help solve diverse societal problems by the 1830s. Three individuals emerged—in close proximity to each other and to the embryonic field of anesthesiology—to provide what would become foundations of epidemiology.<sup>66</sup> Shortly before the demonstration of clinical anesthesia, William Farr began collecting what we now term *vital statistics* (e.g., births, deaths) and undertook Britain's first census. He classified people according to age and occupation groups, and diseases according to crude etiologies.

Farr's early example of health data collection and classification undoubtedly aided pioneer anesthesiologist John Snow (who administered chloroform obstetrical anesthesia to Queen Victoria) in his parallel interest in fighting the British cholera epidemics of 1849 and 1853. He classified cholera cases by London district, juxtaposed the populations of those districts, and calculated cholera death rates as the quotient of the cases and "exposed" populations. The resultant district-specific death rates enabled identification of "high-risk" districts. He then focused on water supply to those districts, particularly in relation to locations of cholera cases. When he noted the association of the highest mortality on Broad Street with service by the water company with especially high rates, he famously curtailed the epidemic by removing the handle of the Broad Street water pump, as well as proved his hypothesis that a water-borne agent was responsible for cholera transmission.

At the same time, Florence Nightingale, another Farr collaborator, was nursing the wounded during the Crimean War. She used similar data collection to develop mortality rate estimates, coupled with innovative analyses and graphics, to lobby successfully for British Army healthcare reform by showing that mortality rates relating to infectious disease, poor nutrition, and unsanitary conditions were greater for English soldiers than for civilians.

need for healthcare services. In describing "the ecology of healthcare," they noted a hierarchy in which the need for health services and, by implication, poorer health status or greater patient acuity, increases sequentially in the spectrum from the unselected general population to outpatient care settings to community hospital settings, and finally to the academic medical center (Fig. 24-4A).<sup>67</sup> Surgical care is delivered in a similar spatial distribution (Fig. 24-4B). Thus, risk estimates derived in one setting may differ from those in another environment (Berkson fallacy).<sup>68</sup> Recognizing these relationships can help reconcile seemingly disparate risk estimates from studies undertaken in widely differing clinical settings.

### Statistical Problems in Studying Anesthesia Risk

#### Dealing with Low-Incidence Phenomena

Although some anesthesia-related events may occur frequently (e.g., postoperative nausea), most severe adverse events do not. The incidence rates may be so low that estimating

rates of occurrence with acceptable precision (i.e., narrow CI) or demonstrating meaningful differences in occurrence (e.g., comparisons of drug regimens or sites of care) can be problematic (Fig. 24-5 and Box 24-8).

The most obvious remedy is merely using a larger sample size. Yet, even when feasible, a larger sample usually connotes a longer patient accrual period, during which other countervailing circumstances may arise (e.g., deterioration in quality of data collection because of study team turnover or loss of enthusiasm, emergence of better technology that obviates study, information that alters or invalidates earlier results, changes in concurrent care processes that affect the event being studied). Other options include using a more sensitive end point, repeated measurements, matched cases and controls, multiple controls, lower statistical certainty ("power"), a higher-risk population, or concurrent multicenter trials.

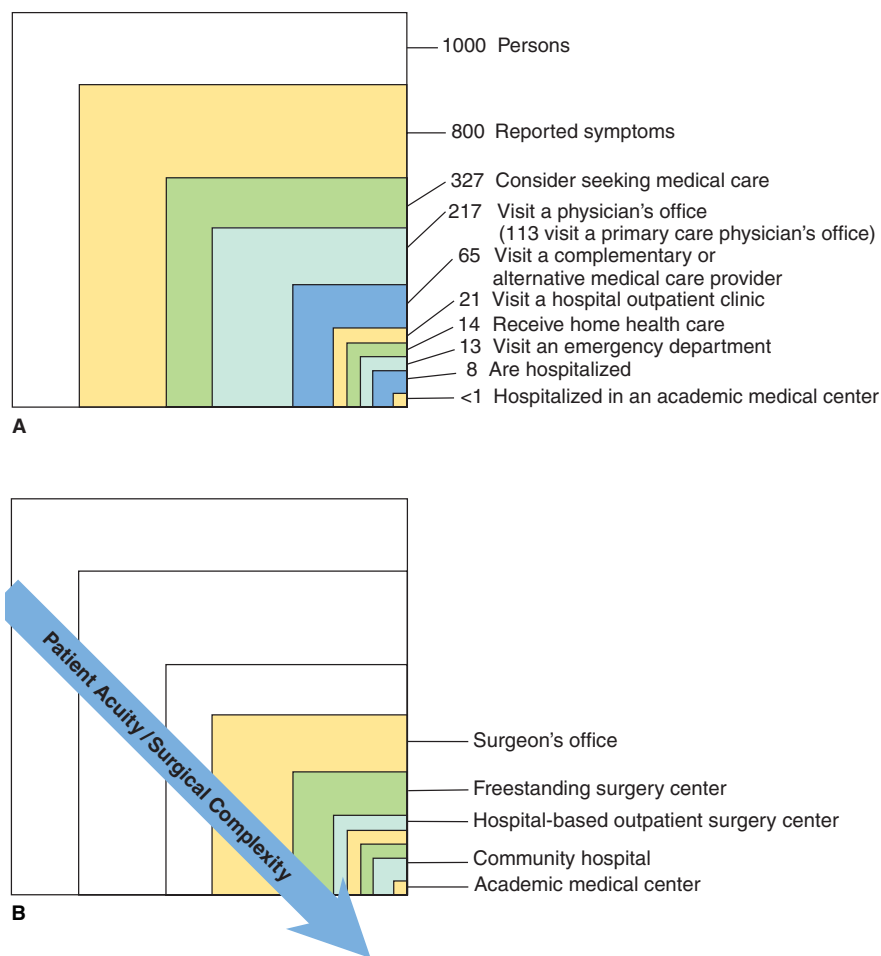
Multiinstitutional studies, such as the 10-hospital Beecher-Todd study,<sup>4</sup> 34-hospital National Halothane Study,<sup>61</sup> or the 460-hospital study by Tiret et al.<sup>54</sup> in France, offer the added benefit of enhancing the external va-

lidity (applicability to other settings, termed "generalizability" in epidemiology) of the results, particularly if the cooperating institutions have different patient populations, surgical mixes, and/or administrative characteristics. Yet multiinstitutional designs may introduce additional logistical and managerial challenges, to assure that the study is conducted the same way in each setting, and a sufficiently large sample size may be too costly.

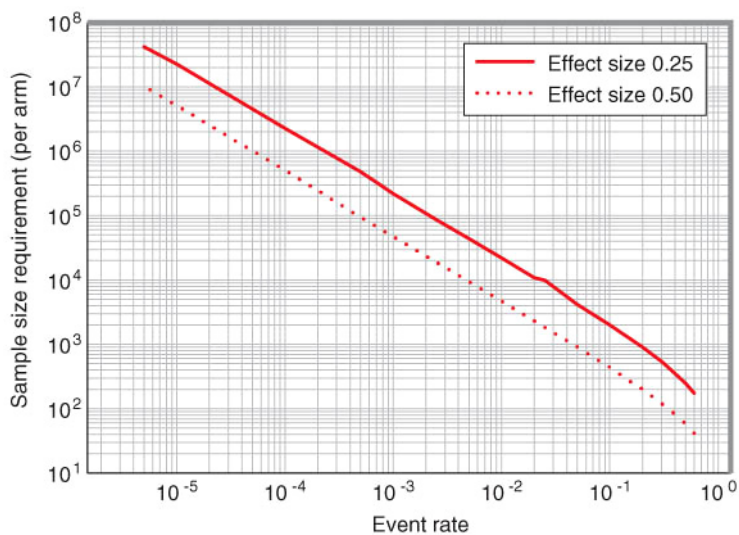
Alternatively, investigators may opt to study the occurrence of a surrogate end point (e.g., myocardial ischemia) that is associated with the outcome of interest (e.g., MI) but occurs more frequently. As noted earlier, the linkage between the surrogate and outcome may not be sufficiently tight for reliable, meaningful, or even valid results.<sup>30,32</sup>

One especially productive approach involves consortia that jointly collect large amounts of data prospectively for purposes other than a single study. Mangano's Multicenter Study of Perioperative Ischemia Group comprises more than five dozen hospitals throughout the developed world, each contributing the same data elements to a growing database on patients having cardiac and noncardiac surgery. For more than 15 years, this group has studied important perioperative risk topics, including the long-term risk of cardiovascular events,<sup>70</sup> atrial fibrillation after cardiac surgery,<sup>71</sup> mortality reduction with prophylactic use of  $\beta$ -adrenergic blocking agents,<sup>24</sup> aspirin-related mortality from cardiac surgery,<sup>72</sup> and risks related to use of aprotinin in cardiac surgery.<sup>73</sup>

Similarly, in the early 1990s, the dozen US Department of Veterans Affairs hospitals that performed cardiac surgery joined to create a common database,<sup>74</sup> which became the model for an expanded project covering all major surgery in more than 120 VA hospitals, the VA NSQIP.<sup>75</sup> This database has contributed greatly to risk assessment and acquisition of clinical data for measuring outcomes and quality of care<sup>62,75,76</sup> and has been adopted by the American College of Surgeons for national use. Anesthesia-specific data elements are few and limited (e.g., principal anesthesia method); however, the VA NSQIP database includes prospectively defined comorbidities and postoperative complications for thousands of patients having each surgical procedure and is begin-



**FIGURE 24-4.** **A.** Ecology of care, with the site of US healthcare utilization for each 1000 persons in the year 2001. (Adapted with permission from Green LA, Fryer GE Jr, Yawn BP, et al: The ecology of medical care revisited. *N Engl J Med* 344:2021, 2001. Copyright ©2001 Massachusetts Medical Society. All rights reserved.) **B.** Analogous spatial distribution of surgical care, with different types of surgical sites reflecting different strata of patient acuity and surgical complexity.



**FIGURE 24-5.** Sample size requirement for clinical studies comparing risk estimates as a function of adverse-event rate and magnitude of outcome difference (“effect size”) sought, with a probability of finding such a difference (“power”) of 0.80 and of falsely concluding that no difference exists (“type I error”) of 0.05.

ning to enhance our understanding of preoperative risk assessment and choice of anesthesia method.<sup>77-80</sup>

Ultimately, as clinical information systems become ubiquitous, data from customary clinical care will routinely become part of vast institutional databases that will create innumerable opportunities for observational studies not even imagined by the early pioneers who first used computers to develop crude estimates of anesthesia risk.<sup>59</sup> Challenges awaiting those exploiting such clinical treasure troves include assuring that the information systems use standard terminology for diagnoses, surgical procedures, complications, and other clinical information; adequate software to merge data from different databases in real time; availability of sufficiently robust risk-adjustment methods for meaningful and valid comparisons; and user-friendly software to facilitate use of such databases without reliance on computer technicians.

Ever larger administrative databases have developed as a byproduct of the payment system for healthcare; the Medicare Provider Analysis and Review (MEDPAR) inpatient (“Part A”) file is frequently used. Besides dealing with a dataset that often includes millions of patient encounters and the challenges of merging this hospital file with other files (e.g., physician or “Part B” file), numerous coding issues, including very limited clinical detail as well as inconsistency and imprecision (e.g., is a given coded disorder a comorbidity or complication?), plague efforts to risk adjust outcomes data.<sup>46</sup> Nonetheless, Medicare data have been used to explore risk in relation to a variety of topics, including the influence of medical direction of anesthesia care,<sup>81</sup> board certification of the anesthesiologist,<sup>82</sup> and location of surgical care.<sup>37,83</sup> Such data have also enabled identification of patient and hospital characteristics that influence anesthesia time for common major operations.<sup>84</sup>

### Dealing with Covariates and Confounding

Clearly, anesthesia care occurs in a multivariable setting. The outcome of each episode of anesthesia care—whether administration of anesthesia in the operating room, critical care in an intensive care unit, pain management, or other care—ultimately reflects the interaction of various patient characteristics (“covariates”), includ-

## BOX 24–8.

## Estimating Sample Size Requirements for Risk Studies

Among important steps in planning a study comparing interventions is estimating the minimum sample size needed to demonstrate a true difference, if it exists. Studying too many subjects takes more time, wastes other resources, and potentially puts individuals at unnecessary risk. Studying too few may result in not finding a statistically significant difference—and not knowing whether that reflects an inadequate sample size or the intervention’s true lack of benefit.<sup>69</sup> Thus, institutional review boards now require an explicit sample-size determination in study protocols; in the current environment, proceeding in its absence may be construed to be unethical.

Generically, the estimate is obtained by considering the smallest difference that the investigator believes is *clinically* important or beneficial (“effect size”), the desired level of certainty about the result (“statistical power” or “power”), the risk of accepting a false result ( $\alpha = 0.05$ ), and numerical value(s) with which the intervention is compared (mean and standard deviation as a measure of variation, for continuous variables; proportion, for binary data). By consulting a statistical table, working through a cumbersome formula, or using statistical computing software, one can determine the minimal sample size to detect a given effect size (e.g., “small” = “0.25” for 25% change, “moderate” = “0.50” for 50% change) at a specified statistical certainty or “power” (e.g., minimum = 0.80, with more conservative power being 0.85 or 0.90). The smaller the effect size and/or the smaller the event rate, the greater the sample size needed to demonstrate a meaningful difference with a given power. The sample-size requirement rises in an accelerating fashion as the event rate decreases (Fig. 24–5), placing a severe burden on investigators studying low-incidence events.

**Example 1:** A new antiemetic drug is being tested to reduce the nausea associated with laparoscopic cholecystectomy. Half of patients have emetic symptoms (rate = 0.5); the investigator believes that a clinically beneficial drug would halve that rate (effect size = 0.5). The comparison involves a “two-sided test” of statistical significance, to identify the possibility that the intervention raises rather than lowers the rate. Assuming minimal power (0.80), the sample-size requirement is 58 patients in each arm of the clinical trial.

**Example 2:** Another investigator studying the same drug, under the same clinical circumstances, believes that nausea is so distressing that a meaningful clinical effect would be a 25% decrease in symptoms (effect size = 0.25). Assuming minimal power (0.80), the sample size needed is 247 patients in each arm.

**Example 3:** Recent studies suggest that the anesthesia-attributable death rate associated with anesthesia care may be as low as approximately 1:200,000 (rate = 0.000005). An investigator wishes to study a new configuration of patient monitoring devices and believes that a meaningful clinical benefit would be a 50% decrease in this rate (effect size = 0.50). Assuming minimal power (0.80), the sample size needed is 10,202,941 patients in each arm of the trial!

ing age, gender, ASA physical status, and presence of specific comorbidities, as well as factors relating to the particular situation (e.g., surgery, obstetric delivery).

When complications occur among elderly men, are the poor outcomes related to the age or gender of the patients as well as the care? Might advanced age merely be common in the study sample? Or perhaps advanced age is a proxy for some underlying severe comorbidity (e.g., coronary artery disease) that happens to be more common in older men? Only by disentangling these myriad relation-

ships can we truly understand anesthesia risk and begin to target remedial efforts to the appropriate factor(s) (see Chap. 25).

Underlying this complexity is the reality that covariates may be *confounding variables* that share two properties: they may be associated with the exposure (the care) because an older or sicker person is more likely to have the care, *and* they also may be independent risk factors for poor outcome (i.e., morbidity begets a poor outcome by itself unrelated to the care). Thus, covariates may “confound” the relationship between the exposure and

outcome, resulting in an anesthesia risk estimate that mixes the risk due to anesthesia care with that due to the confounding variable.

Such *confounding* can be controlled in the study design by randomization and inclusion criteria in a clinical trial or by matching (e.g., assuring that a specified covariate is present in the study sample in the same proportion as the population).

**Stratification** If confounding has not been controlled in the study design, as would be the case in an observational design, *stratification* can be used. An anesthesia risk estimate can be calculated for men and women separately, then compared to the rate for the combined study sample, thereby revealing the influence, if any, of gender. Almost all cohort studies of anesthesia-associated death attempted stratification, even if they did not use the term. Indeed, the earliest such study by Beecher and Todd<sup>4</sup> contains dozens of tables presenting bivariate relationships, in which mortality is tabulated by anesthesia method, by anesthesia drugs, by year, etc. The reader gains an appreciation of how unevenly mortality is distributed across study groups, but there are far too many confounding variables for this rudimentary stratification to control.

**Multivariable Modeling** When more than a few confounding variables are present, multivariable modeling is used to both control confounding and determine the independent contributions of different factors. (Strictly defined, *multivariate modeling* refers to simultaneously predicting multiple outcomes, whereas *multivariable modeling* involves predicting a single outcome at a time.)

In developing the “model,” the outcome is viewed as a numerical result of a mathematical function that is composed of risk factors identified by prior research on the selected outcome, candidate variables of special interest to the investigators, and any variables that may potentially confound the relationships between risk factors and outcome. The particular mathematical form of the model is set by the type of outcome. Most commonly, dichotomous outcomes (e.g., death vs. survival) typically are modeled using logistic regression analysis, yielding a set of odds ratios (ORs). As in bivariate circumstances (Table 24–1), the OR is the



ratio of the probability (odds) of the outcome in the “exposed” group to that in the nonexposed group; however, the multivariable modeling yields a set of “adjusted” ORs that reflect the ORs for each variable (covariate) with the influence of other variables held constant. If time to event is believed important in genesis of the outcome, the relationship is modeled with a proportional hazards model, yielding equivalent hazards ratios; the study by Monk et al.<sup>20</sup> identifying cumulative deep hypnotic time as a predictor of 1-year mortality is an example.

Although intuitive as one’s “chance” of experiencing the outcome, ORs often are less useful in estimating the risk faced by a given individual, even one from the study sample, because several predictors (e.g., male gender and advanced age) may be relevant for some individuals. For example, should OR values for each relevant predictor be added or multiplied? Alternatively, Sinclair et al.,<sup>85</sup> among others, demonstrated the usefulness of the logistic regression equation, a part of the analytic output not typically presented in study reports, in estimating patient-specific risk of postoperative nausea by substituting into the equation the patient’s particular numerical values for the independent predictors.

**Propensity-Score Matching** Generally, modeling controls confounding adequately; however, confounding and related bias is ever present and often undetected.<sup>86</sup> One particular type of confounding that is an especially problematic source of bias is *confounding by indication*, where clinical features prompt use of a given intervention that is also related to the patient’s outcome. An example is the predilection of anesthesia providers for decades to administer spinal anesthesia preferentially to “poor-risk” patients, believing that this method poses a lesser physiologic trespass. Not surprisingly, many early outcome comparisons noted that spinal anesthesia, sick patients, and often higher mortality were associated! Because conscientious physicians will naturally opt to “do what’s right” for their patients, confounding by indication is a frequent problem with observational data.

A special approach for dealing with the selection bias underlying confounding by indication is propensity-score matching. This method uses logistic regression first to identify from

the observational data matched patient pairs that, based on their covariates, are equally likely to receive the intervention.<sup>87,88</sup> Then, using the matched-pairs subgroup, logistic regression analysis identifies independent predictors for the outcome. This approach has been applied to diverse risk-related topics, including pulmonary artery catheter use in critical care,<sup>89</sup> anesthesia choice for hip fracture repair,<sup>90</sup> medical direction of anesthesia care,<sup>81</sup> and anesthesiologist’s board certification.<sup>82</sup> This approach is now commonly applied where observational data are used because a clinical trial is either logistically difficult or not feasible. As with modeling generally, the propensity-score approach cannot control for confounding by covariates that are unknown or overlooked in the analysis; such oversight itself is unlikely to be detected.<sup>91</sup>

**Recursive Partitioning** An alternate approach for studying risk amid confounding avoids fitting data to a mathematical regression equation and instead uses the covariates to repetitively partition the study population into “high-risk” and “low-risk” subgroups with regard to the outcome. “Recursive partitioning” (also termed “data mining”) exploits lack of homogeneity among the study population to yield a tree-like graphic that depicts how each subject fared with regard to the outcome. This classification approach has been used to identify MI risk among emergency room patients presenting with chest pain,<sup>92</sup> poor credit risks for financial services, and, most recently, genotypes in genomic analysis, but it is only beginning to find use in studying anesthesia risk.<sup>93</sup>

## HOW DO WE INTERPRET ANESTHESIA RISK STUDIES?

### Study Designs for Anesthesia Risk

#### Taxonomy of Study Designs

Interpreting anesthesia risk literature requires an appreciation of the strengths and limitations of study designs. Box 24-9 presents a taxonomy of study designs used in anesthesia risk studies. An initial distinction is whether the study reflects an experimental (e.g., clinical trial) or a nonexperimental design; in the latter, the investigator observes what is often a

#### BOX 24-9.

##### Taxonomy of Study Designs for Studying Anesthesia Risk

- I. Experimental designs
  - A. Randomized clinical trial (RCT)
  - B. Nonrandomized clinical trial
- II. Nonexperimental (observational) designs
  - A. Person-level observation
    1. Longitudinal measurements
      - a. Cohort study
      - b. Case-control study
    2. Cross-sectional measurements
    3. Case aggregations (case series, registry)
  - B. Aggregate-level observation (ecology)

natural or unplanned experiment, hence the alternative name, “observational design.”

An often misunderstood distinction is whether the design is *prospective* or *retrospective*. When the exposure (intervention) and outcome(s) occur before data collection has started, the study is termed *retrospective*; otherwise it is *prospective*. This distinction is important because prospective data more likely rely on uniform definitions of all design components e.g., patients, intervention, outcome(s) that suit the research objectives (e.g., specified diagnostic criteria for identifying adverse cardiovascular events), resulting in more reliable data. In contrast, retrospective studies typically involve generic definitions that may have been created for other purposes (e.g., billing) and, in practice, may provide vague and less reliable data for the proposed research.<sup>94,95</sup> However, a retrospective design is not per se less reliable and may be the only approach when a prospective design is too costly or infeasible because of technical or ethical issues, such as when the intervention of interest has become standard care and cannot be randomly allocated to subjects.

Experimental designs are, by their nature, prospective, whereas nonexperimental (observational) designs may be prospective, retrospective, and even use both types of data. Most anesthesia risk reports have been retrospective, although prospective designs have been more prevalent in recent studies.

Among nonexperimental designs, an important distinction is whether the



TABLE 24-2.

Comparison of Study Designs for Studying Anesthesia Risk

Design Attribute	Study Design		
	Randomized Clinical Trial	Cohort Study	Case-Control Study
Purpose	Establish efficacy of an intervention or study effects of an exposure	Study $\geq 1$ outcomes after an exposure	Study $\geq 1$ exposure resulting in an outcome
Basic design	Experimental	Observational	Observational
Study perspective	Prospective	Prospective	Retrospective
Clinical setting	Ideal clinical practice	Customary clinical practice	Customary clinical practice
Role of subjects	Allocated to exposure groups usually via randomized process	Classified in groups based on exposure status	Sampled from source population based on outcome status
Measurement perspective	Prospective	Prospective or retrospective	Retrospective (for measurements); retrospective or prospective (for disease)
Risk metrics	Incidence, and absolute and relative risks	Incidence, and absolute and relative risks	Odds ratio (which can yield relative risk)
Benefit	Minimizes bias	External validity (generalizability)	External validity (generalizability)
Disadvantage	Possibly limited external validity (generalizability)	Possibly unknown biases	Possibly unknown biases

data collection describes individuals (person-level) or groups of individuals (aggregate-level), because the strength of associations is stronger with the former and may not even be valid with the latter. Most anesthesia risk studies have used person-level data, yet many commentators have invoked group or ecologic characteristics when attempting to explain the decrease in anesthesia-attributable deaths, by citing greater prevalence of patient monitoring devices, adoption of patient monitoring standards, greater attention to risk management, better training and trainees entering the specialty, and a growing and more adequate supply of anesthesiologists, among other trends affecting anesthesia practice generally (see Chaps. 3 and 25). These aggregate associations often seem logical and intuitive, but direct cause-and-effect relationships often are lacking for a variety of reasons (e.g., it would be unethical to have a control group who did not receive mandated standard monitoring, to validate causal relationships between monitoring and outcomes).

Finally, there is a distinction within person-level designs between studies using longitudinal measurements that are made over time and others using cross-sectional measurements that resemble snapshots capturing one time period. Here, too, anesthesia risk studies fall almost wholly in the longitudinal category. Although they cannot provide probabilistic risk estimates because they present information on only affected individuals, case aggregation

designs (e.g., registry, case series<sup>12</sup>) are shown in the design taxonomy. The adverse-event cases presented in such aggregations usually are not representative of the universe of such cases because they tend to reflect the worse outcomes, unusual outcomes, or those that are particularly timely (i.e., current “hot issues”) rather than systematic observations (selection bias). Thus, such data may lead to skewed or erroneous conclusions about the universe of patients suffering adverse events.<sup>96</sup> Yet those reports can provide highly detailed descriptions of individual adverse events and associated circumstances, which may lead to hypotheses regarding etiology and, in turn, more definitive research using population-based, quantitative approaches.

Ranked in order of reliability of results, the clinical trial is first, followed by well-conducted prospective cohort studies, other cohort studies, case-control studies, and case aggregations.<sup>97</sup> When similar results are obtained from studies using different designs, we gain confidence in those results. The salient features of the three principal designs used in anesthesia risk studies are compared in Table 24-2 as an aid to surveying examples that inform us about anesthesia risk.

**Randomized Clinical Trial** The randomized clinical trial (RCT) is the “gold standard” experimental design for assessing efficacy in clinical research because it minimizes *bias*, or systematic error that leads to incorrect

conclusions. This protection results from randomly allocating patients to the intervention or control group; blinding the investigators to the intervention allocation; prospectively defining explicit patient inclusion and exclusion criteria; and using formal treatment protocols and end points. However, reducing bias is achieved at a cost: omission often of certain patient populations (e.g., women of childbearing age, children), limited comorbidities that may occur in wider unselected patient populations, and limited practice settings (typically academic medical centers) that may not be representative of the larger universe of patients and practitioners.

RCTs may pose practical considerations (e.g., high cost, logistics) and, for many potential applications, ethical concerns. Randomization has been especially problematic in studies of technology that achieved widespread application in clinical practice (e.g., pulmonary artery catheter, fetal heart rate monitoring) before efficacy and effectiveness were established, as well as for common care that patients and healthcare providers customarily expect. Even when an RCT has been completed, its results are necessarily average effects for the population studied, and applying global evidence to individual patients or groups who might differ from the population average may be inappropriate.<sup>98</sup>

The RCT is generally not applicable to studies of anesthesia-associated mortality, because very large populations

are required to achieve sufficient statistical certainty (“power”) when studying low-incidence events (Fig. 24–5 and Box 24–8). However, the RCT can be used to compare different anesthetic drugs and methods with regard to morbidity, which occurs much more frequently than death and thus can be studied with feasible patient populations.

In 1992, Forrest et al.<sup>18</sup> reported no material differences in severe postoperative morbidity rates “up to 7 days” following then-common general anesthetic regimens (enflurane, halothane, isoflurane, fentanyl) in a multicenter RCT of 17,201 patients, to which multivariable modeling was applied. This report confirmed the findings of Cohen et al.,<sup>19</sup> who had used similar modeling to study 7-day postoperative mortality among a prospective cohort of 100,007 patients treated in one university hospital over a 9-year period. Principal anesthetic method had no independent predictive power once patient- and surgery-specific factors had been entered into the statistical model. These “negative” results for specific anesthesia techniques are important, given early studies<sup>4,48,59</sup> of anesthesia-associated mortality in which specific anesthetic methods and drugs had been implicated, based on study designs and statistical methods that were incapable of controlling confounding.

In addition to comparing anesthetic methods, RCTs can help determine whether a putative risk factor has a true causal relationship with an outcome, or whether there is only an association with that outcome. Both postoperative tachycardia<sup>99</sup> and hypothermia with shivering<sup>100</sup> were known from cohort studies to be associated with perioperative cardiac morbidity and mortality, but whether these were associations or causal relationships was unknown. In RCTs, prophylactic use of a  $\beta$ -adrenergic blocking drug (atenolol)<sup>24</sup> and maintenance of perioperative normothermia<sup>101</sup> each was shown to reduce the risk (incidence) of perioperative severe cardiac events, implying a causal relationships in each case.

RCTs, which typically test the efficacy of one intervention, often leave clinicians without guidance for the management of less controlled, multifactorial situations that are common in customary clinical practice. (If studies show that drug A alone is beneficial and drug B alone is beneficial, there is no assurance that the combination of

drugs A plus B will be beneficial or even will be without harm.) However, a large multisite RCT that uses a factorial design can test several interventions (singly and in combination) efficiently, providing a systematic approach that can give rise to development of clinical practice guidelines, as demonstrated for the prophylaxis of postoperative nausea.<sup>102,103</sup>

**Prospective Cohort Study** The next best study design for the study of anesthesia risk is the cohort study, a nonexperimental observational design in which the investigator follows one or more designated groups (i.e., surgical population) through an “exposure” (i.e., anesthesia and surgery) and over time for occurrence of disease, broadly defined to include adverse events and complications. Because this type of study is done in a customary clinical setting, the results are expected to have external validity and thus be generalizable to other clinical settings.

This description clearly mirrors the model presented in Fig. 24–1 but is difficult to conduct well. The challenges include prospectively defining all components of the model with the same rigor as in an RCT; indeed, this design is analogous to a nonrandomized clinical trial. Among the definitional challenges shared with the RCT is the need to capture all relevant information (i.e., patient characteristics, surgery factors, outcomes) with precision and accuracy. Thus, there must be explicit criteria for data being collected, and all investigators at all study sites must adhere to those definitions, lest important clinical outcomes be systematically overrepresented or underrepresented in the data (information bias; misclassification bias).<sup>104</sup>

Omission of important variables is an ever-present possibility. If they are not included in the data collection, their relationships to outcomes cannot be evaluated. Other challenges include tracking patients closely so that none are lost to followup, thereby introducing further error (ascertainment bias), and making the cohort as inclusive as possible so that the results have external validity.

Among exemplary examples of prospective cohort studies are those of Cohen et al.<sup>105</sup> Their initial study, conducted in one teaching hospital, relied on an anesthetic record designed for the study, which included check boxes

for explicit, specific information from the preanesthetic assessment, anesthesia management, operation, and postoperative adverse events. Consistent definitions of data elements were developed through discussions with physicians and nurses in the setting; then informational sessions on the study and its data form were held for anesthesia providers and nursing personnel. Data collection on the same form continued in the postanesthesia care unit as well as on the ward for up to 7 days. A specially trained anesthesia nurse reviewed all records, following 112,000 patients during the study’s 9-year duration; indeed, the study ended when that nurse retired!

Patient- and surgery-related risk factors identified in that and a subsequent study<sup>19</sup> were used by Cohen et al.<sup>106</sup> to risk-adjust rates of anesthesia-associated adverse events to characterize quality of care in four hospitals in which 27,184 anesthetics were administered over a 15-month period. Despite the modeling, there were large variations (2- to 5-fold) in rates of minor adverse events but smaller variations in major morbidity and mortality rates across the hospitals. Although one hospital had a lesser mortality rate, it had greater rates for all major events. Physician reviewers were unable to attribute any of the deaths, partially or wholly, to anesthesia care. The investigators concluded that measuring quality of anesthesia care using the incidence of major adverse events is unsatisfactory because of the uncertain contribution of anesthesia care to the events, as well as the fact that the incidence variations may reflect institutional differences over which anesthesia personnel have no control. They suggested greater attention to reducing the large variation among rates of minor adverse events, particularly those of concern to patients (e.g., nausea).

**Case-Control Study** This is a targeted, highly efficient, nonexperimental, observational design that is ideal for studying risk for low-incidence events in busy clinical settings. Its advantages accrue from avoiding the large samples and often long followup of subjects needed in cohort designs. In contrast to the cohort design, where large populations are studied but only a small fraction develop the outcome of interest, the case-control design emphasizes the outcome. Properly used, this de-

sign provides information similar to that from the cohort design, but more quickly and at lower cost. Remarkably, this design remains underused.

The investigator defines the outcome of interest and identifies from a log or an institutional database patients (“cases”) who meet the definition. Patients not experiencing the outcome (“controls”), who had care at about the same time, are identified in the same institutional source; typically one or a few controls are randomly selected and matched with a case. For both cases and controls, a dataset is created that includes all patient-, procedure-, and perhaps institution-specific information believed relevant to the outcome occurrence. Alternatively, a case-control study can be developed within a completed cohort study (nested case-control study); the “controls” are sampled randomly from the cohort. Logistic regression analysis is used to identify independent predictors of the outcome. Although this study design does not yield the most common risk metrics (e.g., incidence rate), the ORs (really the ratio of incidence rates) provide valuable insights relating to the outcomes and can yield relative risk.

Despite its many advantages, the case-control design poses many potential challenges that may increase bias. Among the most critical requirements is that all data elements must be defined explicitly, because ad hoc decisions made during data collection may introduce bias. Also, control patients should be selected without regard to their covariate values (e.g., age, gender, ASA physical status); usually this is not a problem if cases are matched only on temporal period of care and if the controls are selected randomly.

A most informative application is the study by Gold et al.,<sup>36</sup> seeking predictors of unplanned hospital admission after ambulatory surgery. They identified 100 patients (“cases”) admitted from a university hospital’s ambulatory surgery unit during a 3-year period in the mid-1980s and, for each case, four patients not admitted (“controls”) during the same 6-month period. The dataset created from review of the medical record included patient-specific information, surgical information, anesthesia information, and postoperative symptoms. Using conditional logistical regression analysis that compares each case to its matched controls, the investigators

identified independent predictors associated with hospital admission: anesthetic method (general anesthesia), surgical site (abdominal), postoperative emesis, and duration of surgery. The identification of several modifiable factors provided guidance in managing patient selection, case scheduling, and anesthetic management to reduce unplanned admissions.

**Retrospective Cohort Study** A particularly instructive example is a late 1970s study of predictors of respiratory failure after thymectomy, a complication then occurring in up to half of patients with myasthenia gravis who had this potentially curative operation via a then-common transsternal incision. Leventhal et al.<sup>107</sup> sought to create a clinical prediction rule,<sup>108</sup> similar to that for cardiac risk,<sup>33</sup> that would assist clinicians in making postoperative ventilatory decisions.

Leventhal et al.<sup>107</sup> identified in a university referral site’s medical record log 24 patients who had a thymectomy, of whom eight had not responded to a standardized postoperative extubation strategy. They extracted data elements believed important in the literature on respiratory failure in myasthenia. Using discriminant analysis—a multivariable predictive method that predates logistic regression analysis—they computed integer “points” that captured the relative importance of critical variables in independently predicting risk of postoperative respiratory failure. Using this tool, a busy clinician could tally “points” for those clinical attributes present; if a patient had more than a specified threshold number of points, then respiratory failure was predicted.

Scaled conservatively so that no patient was predicted incorrectly to tolerate extubation, the prediction rule had a sensitivity of 1.0 and a specificity of 0.88, with an overall correct classification of 91%. Seeking validation, they applied the model to another 18 patients whose charts had been unavailable. They noted a lesser but adequate performance (78% correct),<sup>109</sup> which is common when prediction rules are validated in a different sample.<sup>110</sup>

Subsequent validations emphasized the importance of clinical nuances in influencing results in anesthesia risk studies. Leventhal et al.<sup>107</sup> envisioned this when they noted that their prediction rule was not intended to be absolute but rather to be used as a guide to help

the clinician focus on important patient characteristics and as an example of a general approach to rationalizing clinical decision making. They ended the study when the management of myasthenia changed to include preoperative plasmapheresis and immunotherapy as well as less invasive surgical approaches. Thus, it was of little surprise that Grant and Jenkins<sup>111</sup> found that the prediction rule had “some value” for patients undergoing thymectomy (74% correct), although their population included some patients who had the less invasive transcervical incision and their overall management was not standardized; however, the rule had “no value” when applied to hysterectomy. Similarly, Eisenkraft et al.<sup>112</sup> noted the prediction rule performed poorly when applied to transcervical thymectomy.

## Mortality As a Risk of Anesthesia

### Early “Anesthesia Deaths”

In 1848, only 15 months after William Morton’s successful demonstration of clinical anesthesia in Boston, an Edinburgh medical journal reported the inquest held after the death of Hannah Greener, a 15-year-old British girl who had a toenail removed under chloroform anesthesia, some 4 months after she had a similar procedure performed with diethyl ether anesthesia.<sup>113</sup> This first report of a death associated with anesthesia not only initiated a decades-long debate over the relative safety of ether versus chloroform but also indicated that the seemingly reversible state of anesthesia, “administered in order to allay sensibility while undergoing a painful surgical operation,” could be fatal. Similar case reports followed.

Were these “anesthesia deaths” common, rare, or perhaps occasional? Although case reports and subsequent case series provided descriptions of the fatal events and even clues to possible etiologies, they could not quantitate the frequency of these catastrophes and allow an estimate of the risk in undergoing anesthesia. Anesthesia risk measurement benefited from the early epidemiologic work of anesthesiologist John Snow (Box 24–7).

### Cohort Studies of Anesthesia-Associated Mortality

Table 24–3 presents the principal results of international studies in which

TABLE 24-3.

## Estimates of Mortality Attributable to Surgical Anesthesia Care

Investigator(s)	Time Period	Location	No. of Hospitals	No. of Anesthetics	Primary Cause	Primary and Associated Causes
Dornette and Orth <sup>55</sup>	1943–1954	Madison, Wisconsin	1	63,105	1:2427	1:1343
Beecher and Todd <sup>4</sup>	1948–1952	United States	10	599,548	1:2680	1:1560
Dripps et al. <sup>48</sup>	1949–1957	Philadelphia	1	33,224	1:852	1:415
Minuck <sup>114</sup>	1949–1965	Canada	1	121,786	1:6766	1:3291
Schapiro et al. <sup>115</sup>	1952–1956	New York, New York	1	22,177	1:1232	1:821
Phillips et al. <sup>116</sup>	1953–1959	Baltimore, Maryland	Multiple	Unstated	(1:7692)	(1:2500)
Clifton and Hotten <sup>117</sup>	1952–1962	Australia	1	205,640	1:6048	1:3955
Greene et al. <sup>118</sup>	1956–1959	Connecticut	Multiple	120,935	1:3901	1:3183
Memery <sup>119</sup>	1955–1964	Springfield, Massachusetts	1	69,291	1:3139	1:1082
Gebbie <sup>120</sup>	1958–1964	Canada	1	129,336	—	1:6158
Harrison <sup>121</sup>	1956–1960	Cape Town, South Africa	1	177,928	—	1:3068
	1963–1966					
Holland <sup>63,122</sup>	1960–1968	New South Wales, Australia	Multiple	(300,000)	(1:5500)	—
Marx et al. <sup>59</sup>	1965–1969	New York, New York	1	34,145	—	1:1265
Bodlander <sup>52</sup>	1963–1972	Sydney, Australia	1	211,130	1:14,075	1:1703
Harrison <sup>53</sup>	1967–1976	Cape Town, South Africa	1	240,483	—	1:4537
Holland <sup>122</sup>	1970–1979	New South Wales, Australia	Multiple	(400,000)	(1:10,250)	—
Hovi-Viander <sup>57</sup>	1975	Finland	100	338,934	1:5059	1:1412
Turnbull et al. <sup>56</sup>	1973–1977	Vancouver, Canada	1	195,232	1:5138	—
Tiret et al. <sup>54</sup>	1978–1982	France	460	198,103	1:13,207	1:3810
Pitt-Miller <sup>123</sup>	1976–1987	Port-of-Spain, Trinidad	1	129,107	1:6795	1:1956
Eichhorn <sup>7</sup>	1976–1985	Boston, Massachusetts	9	757,000 <sup>a</sup>	1:151,400	—
	1985–1988	Boston, Massachusetts	9	244,000 <sup>a</sup>	0	—
Chopra et al. <sup>124</sup>	1978–1987	Leiden, The Netherlands	1	113,074	—	1:16,250
Pausawasdi <sup>125</sup>	1981–1984	Bangkok, Thailand	1	45,362	—	1:1296
Holland <sup>122</sup>	1983–1985	New South Wales, Australia	Multiple	(550,000)	(1:26,000)	—
Tan and Delilkan <sup>126</sup>	1980–1992	Malaysia	1	155,000	—	1:25,833
Lunn and Devlin <sup>2</sup>	1987	United Kingdom	100	485,850	1:185,056	1:1351
Tikkanen and Hovi-Viander <sup>127</sup>	1987	Finland	69	325,585	1:66,700	1:16,279
Pedersen et al. <sup>128</sup>	1986–1987	Herlev, Denmark	1	7306	—	1:2500
Cohen et al. <sup>106</sup>	1988–1989	Toronto Canada	4	27,184	0	0
Warden et al. <sup>129</sup>	1984–1990	New South Wales, Australia	Multiple	(493,000)	—	(1:20,000)
Coetzee <sup>130</sup>	1988–1992	Stellenbosch, South Africa	1	94,945	1:9090	1:2941
Eagle and Davis <sup>131</sup>	1990–1995	Western Australia	Multiple	(84,000)	—	(1:40,000)
Lagasse <sup>10</sup>	1992–1994	New York, New York	1 <sup>b</sup>	37,924	—	1:12,641
	1995–1999	New York, New York	1 <sup>c</sup>	146,548	—	1:13,322
Lienhart et al. <sup>132</sup>	1999	France	Multiple	(7,756,121)	(1:145,500)	(1:18,500)

“Multiple” indicates that the study involved many hospitals, but the actual number is unspecified.

Parenthetical values reflect circumstances in which the number of anesthetics was estimated.

<sup>a</sup>ASA physical status 1 and 2 patients only.

<sup>b</sup>Suburban community hospital.

<sup>c</sup>Urban teaching hospital.

the mortality risk of surgical anesthesia was studied. These studies were major, often pioneering efforts, with most performed before the advent of modern information technology that facilitates aggregating and analyzing vast data and before epidemiology and biostatistics had reached their current level of sophistication. Despite these limitations, their reports provide estimates

for surgery-related, anesthesia-attributable mortality and, in many, morbidity.

### Crude Anesthesia-Attributable Mortality Estimates

In surveying the unadjusted or crude mortality estimates listed in Table 24-3, we are immediately impressed by a wide variation in rates. Undoubtedly much of the variation is due to different

study designs and other factors listed in Box 24-1. Yet there is a suggestion of improved outcome over time, especially in well-developed countries.

Holland<sup>63,122</sup> documented a 5-fold decrease in anesthesia-attributable mortality in one Australian region over 25 years, much of which he attributed to enhanced risk management education of practitioners. Similarly, Lienhart et



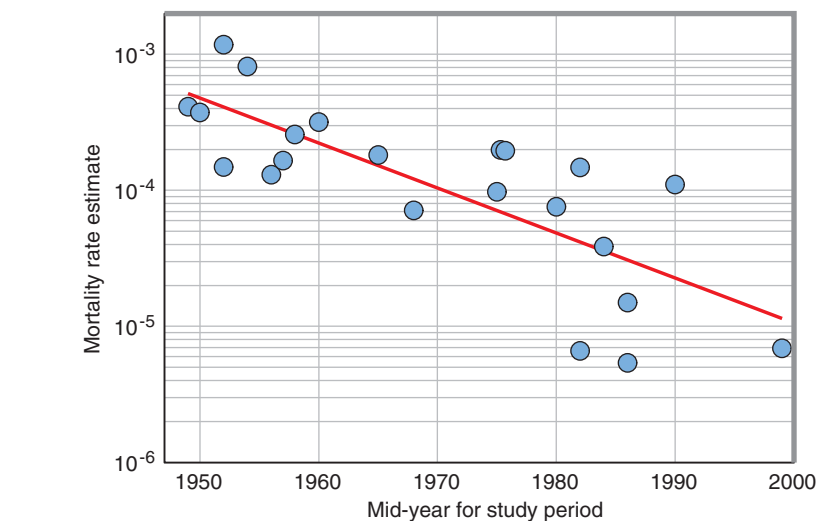
al.<sup>132</sup> noted an 11-fold decrease in anesthesia mortality over 15 years in France when repeating (albeit with different methodology) the study by Tiret et al.,<sup>54</sup> which noted poor outcomes in relation to lack of postanesthesia care units.

Moreover, although we might regard the study results listed in Table 24-3 akin to a collection of mixed fruit, a plot of the primary-cause mortality estimates in those studies span almost two orders of magnitude (or a near 100-fold decrease) over 5 decades, and the putative improvement trend predates the vigorous US patient safety initiatives of the mid-1980s (Fig. 24-6). A bubble plot that visually emphasizes the widely varying study population sizes is even more suggestive that a meaningful decrease has occurred (Fig. 24-7), even if we might be uncomfortable concluding that any specific amount of “improvement” has occurred.

However, even if an apparent trend is wholly an artifact of differing methodologies, as some argue,<sup>10</sup> the clinical terrain has changed dramatically over the past half-century. Concerned in 1959 that mortality statistics were unchanged from those decades earlier, the National Academy of Sciences’ Committee on Anesthesia invited Chauncey Starr from the National Academy of Engineering to comment. “Well, that is exactly the way it is in farming,” he related as he began to discuss the Tractor Principle<sup>133</sup>: the rate of farming accidents remained high despite many safety improvements in tractors (e.g., wider wheel base, roll bars, seat belts). Seeking an understanding, Starr made site visits during which he learned that improved tractor design enabled farmers to plow on steeper inclines! The same is true in medicine, where we now routinely perform major, “high-risk” operations on patients who as recently as 30 years ago were “too sick” to be regarded as surgical candidates. Thus, even stable mortality rates in the face of increasing severity of illness could reflect improved clinical outcome.

### Sources of Mortality and Morbidity Risk

Our literature abounds with attempts to allocate perioperative mortality and morbidity risk to specific characteristics of the patient, anesthetic, operation, or clinical setting. An important reference point is the perioperative



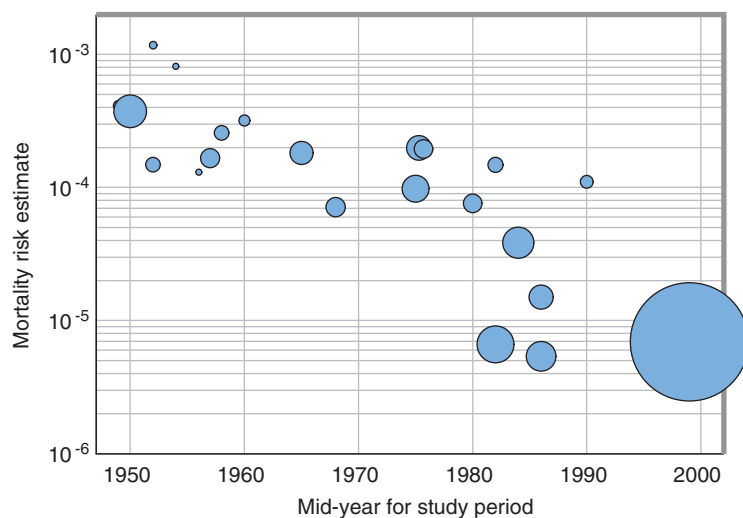
**FIGURE 24-6.** Rate of perioperative mortality primarily attributable to anesthesia care by the mid-point year of various international studies, from 1948–1999, as listed in Table 24-3.

mortality rate that was estimated to be 1.43% (or 1:70) for US hospital-based surgery in 2004<sup>134</sup> and has been relatively stable over several decades. Comparable mortality estimates based on individual cohort studies have ranged from 1:256 to 1:53,<sup>4,19,35,48,59,135</sup> without any apparent temporal trend.

The earliest attempt to identify specific sources of mortality risk appeared in Beecher and Todd’s mid-20th century study,<sup>4</sup> which noted a perioperative mortality rate of 1:75 and ascribed 78% of deaths (1:95) to the patient’s disease, 18% (1:420) to surgical management, and 3% (1:2680) solely to anesthesia management. They attributed approximately 5% (1:1560) to anesthesia when considering it as both a contributing and a primary cause. Subsequent studies attributed somewhat greater pro-

portions of mortality to surgical and anesthesia causes, as understanding of the pathophysiology of disease and the physiologic effects of anesthesia and surgical intervention increased.<sup>2,19,35,48</sup>

However, substantial confounding underlies such seemingly simple categorizations. Being male, being elderly, and being in poorer condition (i.e., ASA physical status  $\geq 3$ ) each individually augments the risk of a given surgical procedure. An early (and still valid) effort to model perioperative mortality is that of Cohen et al.,<sup>19</sup> who identified the relative importance of patient characteristics (advanced age and ASA physical status, male gender), surgery-related factors (invasiveness, whether emergent), and anesthesia management (method and drug choice; Table 24-4).



**FIGURE 24-7.** Bubble plot of Fig. 24-6, in which the size of the bubble is proportional to the number of patients in each study.

TABLE 24-4.

## Factors Associated with Mortality Within 7 Days of Surgery

Factor <sup>a</sup>	Odds Ratio <sup>b</sup>	95% Confidence Interval
Patient related		
Age, 60–79 vs. <60 y	2.32	1.70–3.17
Age, ≥80 vs. <60 y	3.29	2.18–4.96
Gender, female vs. male	0.77	0.59–1.00
ASA physical status score, 3–4 vs. 1–2	10.65	7.59–14.85
Surgery related		
Major vs. minor procedure	3.82	2.50–5.93
Intermediate vs. minor procedure	1.76	1.24–2.50
Length of anesthesia, ≥2 vs. <2 h	1.08	0.77–1.50
Emergent vs. elective procedure	4.44	3.38–5.83
Other factors		
Years of operation, 1975–1979 vs. 1980–1984	1.75	1.32–2.31
Complication in operating room vs. none	1.42	1.06–1.89
Anesthesia related		
Experience of anesthesia-provider, >600 cases for ≥8 y vs. <600 procedures for <8 y	1.06	0.82–1.37
Inhalation agent with narcotic vs. inhalation alone	0.76	0.51–1.55
Narcotic anesthesia alone vs. inhalation alone	1.41	1.01–2.00
Narcotic with inhalation vs. inhalation alone	0.79	0.47–1.32
Spinal anesthesia vs. inhalation alone	0.53	0.29–0.98
Number of anesthetic drugs, 1–2 vs. ≥3	2.94	2.20–3.84

<sup>a</sup>Factors were evaluated in logistic regression analysis of data from 100,007 patients performed the five most frequently used anesthesia methods (inhalation alone, inhalation with narcotic, narcotic anesthesia alone, narcotic anesthesia with inhalation, spinal anesthesia).

<sup>b</sup>All odds ratios whose 95% confidence intervals do not include the value 1.0 are statistically significant.

Modified from Cohen MM, Duncan PG, Tate RB. Does anesthesia contribute to operative mortality? JAMA 1988;260:2859. Copyright 1998, American Medical Association. All rights reserved.

Although definitive allocation of the components of perioperative risk, and specifically of anesthesia risk, is lacking, what follows is an attempt to dissect some of these relationships, with the goal of offering guidance to practitioners as well as identifying improvement opportunities.

### The Patient

**Importance of Comorbidity** Intuition tells us that sick patients tend to do poorly. Among the many studies<sup>4,10,18,19,33–36,48,50,54,58,59,62,70,71,74–77,83</sup> documenting this truism is Pedersen's prospective cohort study<sup>35</sup> of 6307 patients, in whom the extent of comorbidity was associated with greater complication and mortality rates (Table 24-5).

### Modeling Outcome with Patient Characteristics

Although the general principle is now well established, capturing the precise quantitative relationship between comorbidity and clinical outcome remains elusive. The venerable ASA physical status classification, never designed as a risk metric, has long been known to correlate with perioperative outcome,<sup>10,19,34,59,135</sup> with mortality rising sharply with ad-

vanced physical status (Tables 24-4 and 24-6). ASA physical status interacts with age, becoming a much more potent predictor of major complications beyond middle age (Fig. 24-8).

Yet there is substantial subjectivity and variability in use of middle ASA physical status categories, even in settings where payment for services is unrelated to this classification.<sup>136–139</sup> Prediction improves when this metric is used in combinations in multivariable modeling with other covariates, such as age and/or the presence of specific morbidities.<sup>18–20,24,33–36,62,70,76–79,83,106,140,141</sup> Concerns about subjectivity of the ASA physical status metric may also be addressed in risk modeling studies by including the Charlson Comorbidity Score,<sup>50</sup> a morbidity-specific metric that has been at least as good an outcome predictor in several studies<sup>20,90,142–144</sup>; the Acute Physiology Score (APS) of the Acute Physiology and Chronic Health Evaluation (APACHE) II score, a metric commonly used in critical care<sup>145</sup>; or perhaps the Sickness at Admission Scale Score.<sup>146</sup>

Alternatively, there have been embryonic efforts to reduce the subjectivity in ASA physical status scoring by enhanc-

ing its specificity, thereby enhancing its precision and predictive power: Barbeito et al.<sup>139</sup> suggested adding a “G” to the scoring of parturients (e.g., “2-G” to indicate the gravid status), and Holt and Silverman<sup>147</sup> proposed a superscripted notion to indicate specific morbidity (e.g., “3<sup>RESP</sup>” to indicate the affected organ system). Emphasizing the confounding of physical status by surgical complexity, Pasternak<sup>148</sup> suggested a preoperative assessment scale that includes both. These await further development and validation. The Charlson Comorbidity Score was developed to predict 1-year mortality among hospitalized *medical* patients,<sup>50</sup> and it is surprising that a similar morbidity-specific scoring system for predicting surgical mortality has not been developed.

Several simple scoring systems for organ- or operation-specific complications are available. The Cardiac Risk Index of Goldman et al.<sup>33</sup> provided an early model that was improved by Detsky et al.,<sup>149</sup> by adding angina to the risk factors. Lee et al.<sup>150</sup> developed and validated a Revised Cardiac Index that specified six independent predictors: history of ischemic heart disease,

TABLE 24-5.

## Factors Associated with Perioperative Complications and Death

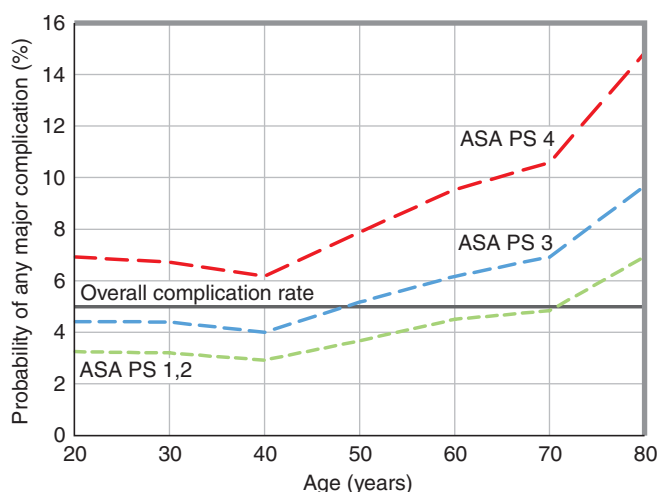
Factor	Cardiovascular Complications		Pulmonary Complications		In-Hospital Mortality	
	%	OR	%	OR	%	OR
Gender						
Female	4.9		3.7		0.7	
Male	8.8 <sup>a</sup>	1.8	6.6 <sup>a</sup>	1.8	2.2 <sup>a</sup>	3.2
Age (yr)						
<50	2.6		2.3		0.3	
50-69	8.2		6.7		1.8	
70-79	14.3 <sup>a</sup>		8.9		2.9 <sup>a</sup>	
≥80	16.7 <sup>a</sup>		10.2 <sup>a</sup>		5.8 <sup>a</sup>	
Ischemic heart disease	29.1 <sup>a</sup>	6.5	8.7	1.9	2.9	2.5
Myocardial infection						
>1 y since	20.8 <sup>a</sup>		7.7		4.0 <sup>a</sup>	
≤1 y since	38.5 <sup>a</sup>		10.4 <sup>a</sup>		7.7 <sup>a</sup>	
Chronic heart failure	35.2 <sup>a</sup>		15.1 <sup>a</sup>	3.8	9.0 <sup>a</sup>	9.9
Hypertension	11.8 <sup>a</sup>	2.1	7.1 <sup>a</sup>	1.6	1.3	1.1
Hypotension (SBP ≤90mm Hg)	16.5 <sup>a</sup>	2.5	17.3 <sup>a</sup>	4.0	9.4 <sup>a</sup>	9.8
Chronic obstructive lung disease	12.4 <sup>a</sup>	2.1	12.4	3.0	5.0 <sup>a</sup>	4.7
Renal failure	14.4 <sup>a</sup>	2.2	11.8 <sup>a</sup>	2.4	5.9 <sup>a</sup>	5.2
Diabetes mellitus	9.2	1.5	7.1	1.5	2.1 <sup>a</sup>	1.8
Neurologic disease	5.9	1.0	8.8 <sup>a</sup>	1.9	2.9	2.4
Cancer	7.0	1.1	5.5	1.2	1.1	1.0
Cancer, abdominal	19.8 <sup>a</sup>	3.2	19.4 <sup>a</sup>	4.3	5.0 <sup>a</sup>	5.4
Emergent surgery	7.4 <sup>a</sup>	1.3	6.3 <sup>a</sup>	3.0	2.8	3.2
Duration of anesthesia (min)						
<30	1.2		0.6		0.1	
30-179	6.8		4.5		1.3	
180-299	17.9 <sup>a</sup>		13.4 <sup>a</sup>		3.2 <sup>a</sup>	
≥300	20.4 <sup>a</sup>		30.2 <sup>a</sup>		4.9 <sup>a</sup>	
Minor surgery	3.2		1.8		0.3	
Major surgery	13.0 <sup>a</sup>	4.1	10.6	5.8	3.1 <sup>a</sup>	4.9
Total study population	6.3		4.8		1.2	

<sup>a</sup>Statistically significantly higher rate compared to total study population.  
OR, Odds ratio; SBP, systolic blood pressure.  
From Pederson<sup>35</sup> with permission.

TABLE 24-6.

## Relationship of ASA Physical Status Classification to Perioperative Mortality

	Author(s)	Perioperative Mortality				
		Vacanti et al. <sup>135</sup>	Marx et al. <sup>59</sup>	Cohen et al. <sup>19</sup>	Lagasse <sup>10</sup>	
	<b>Study Period</b>	1964-1966	1965-1969	1975-1984	1992-1994	1995-1999
	<b>Surveillance Period</b>	48 hours	7 days	7 days	48 hours	48 hours
<b>ASA Physical Status Class</b>	1	1:1179	1:1665	1:1389	0	1:8756
	2	1:371	1:212	1:508	1:7813	1:3084
	3	1:55	1:23	1:87	1:1360	1:644
	4	1:13	1:4	1:13	1:86	1:136
	5	1:11	1:2	1:3	1:4	1:5
<b>Overall</b>		1:256	1:53	1:140	1:332	1:632



**FIGURE 24-8.** Probability of a severe perioperative respiratory or cardiovascular complication as a function of both American Society of Anesthesiologists physical status class and patient age, computed from the logistic regression equation developed in the clinical trial of inhalation anesthesia drugs conducted among 17,201 patients by Forrest et al.<sup>18</sup> (From Muravchick S. *Anesthesia for the elderly*. In: Healy TEJ, Knight PR, eds. *Wylie and Churchill-Davidson's A Practice of Anesthesia*. 7th ed. London: Arnold, 2003:990. Reproduced with permission of Edward Arnold, Ltd.)

history of congestive heart failure, history of cerebrovascular disease, preoperative treatment with insulin, preoperative serum creatinine >2.0 mg/dL, and high-risk surgical procedure. Similar clinical prediction rules have been developed for early outcome after coronary artery bypass surgery.<sup>151</sup>

Even in the absence of simple, comprehensive risk scoring systems, multivariable modeling of several large cohorts has identified a common set of independent risk factors for severe complications and death (Tables 24-4 and 24-5, and Box 24-10). Differences in the risk associated with specific morbidities among studies probably are explained, in part, by differences in how disorder-specific acuity of illness is measured.<sup>152</sup> Racial and socioeconomic characteristics, possibly proxies for unadjusted underlying comorbidity and/or problems with access to care, also influence outcome.<sup>83,153,154</sup>

#### BOX 24-10.

##### Independent Risk Factors for Severe Complications and Death

Male gender<sup>19,35,83</sup>

Advanced age<sup>18,19,33,35,83,149</sup>

Advanced American Society of Anesthesiologists physical status class<sup>18,19,33,62,76</sup>

Moderate and severe specific comorbidity<sup>18,24,33,35,62,76,149,150</sup>

**Failure to Rescue** Building on the relationship between patient health status and clinical outcome, Silber et al.<sup>155,156</sup> developed a novel outcome metric, failure to rescue. Using multivariable modeling, they showed that patient characteristics (e.g., age, gender, comorbidities) predict complications better than they predict death; whether a complication turns into a death reflects the capability of the facility to rescue the patient. The rescue capability itself is dependent on hospital characteristics that include proportion of board-certified anesthesiologists and ratios of nurses to patients.<sup>82,155,157</sup> Subsequently validated in many studies, this metric is included among quality indicators used by the Agency for Healthcare Quality and Research, National Quality Forum, University HealthSystem Consortium, and independent healthcare researchers.

#### The Healthcare Setting

##### Unexplained Variation in Outcomes

Long before investigators had tools to identify the source of risk differences, they began to document variations in patient outcomes for ostensibly similar surgery.<sup>158</sup> Buried in the 1948 to 1952 Beecher-Todd study<sup>4</sup> is an unexplained, 3-fold difference in mortality across the 10 participating university hospitals. A decade later, the mortality variation was so great in the 34-hospital National Halothane Study (0.27–6.40%) that its statisti-

cians concluded, “Such variation in so important an outcome of surgery compels attention.”<sup>159</sup> Even after adjusting their data for age, ASA physical status, and surgical procedure, an unexplained, 3-fold variation remained.

##### Emergence of an Ill-Defined “Provider”

Intrigued, one investigator joined with sociologists and statisticians to explore nonclinical factors, including structural characteristics of hospitals, as potential explanatory variables for the postoperative mortality variation among 1224 hospitals using a chart abstracting service in the early 1970s.<sup>160,161</sup> Despite similar case-mix adjustments, 3- to 4-fold variations remained for the 15 major surgical procedures studied in this Institutional Differences Study. Probing deeper in a 17-hospital subset with detailed institutional data, they explored the influence of the individual surgeon, anesthesia-provider type, and various measures of hospital structure and medical staff organization.<sup>162,163</sup> Although such factors were weak predictors of outcome, the mere presence of such relationships heralded the beginning of our understanding of the multifaceted role of an ill-defined “provider” in surgical outcomes. (Here, *provider* is a comprehensive term indicating not only the clinicians but also the facility, its associated staff, organizational structure, and policies.)

##### Role of Sociomanagerial Factors

The Institutional Differences Study<sup>161,163</sup> identified diverse sociomanagerial factors that are associated with better surgical outcomes, including teaching-hospital status, greater number of residency programs, higher hospital expense per day, stringent medical-staff admission requirements, power over senior surgeons, higher proportion of surgeons' practices at the study hospital, and board certification of physicians. Subsequent studies have validated the influence of teaching-hospital status and board certification,<sup>155,164-166</sup> although research has not explored the full array of care.<sup>167,168</sup> Silber et al.<sup>155</sup> specifically identified a low proportion of board-certified anesthesiologists on the anesthesia staff as an important hospital characteristic associated with “failure to rescue” the surgical patient who experienced a complication. Generally, overall hospital characteristics are stronger predictors of clinical outcome than are surgeons' characteristics.<sup>162,163</sup>



As a natural extension, investigators explored whether mortality after high-risk surgery was influenced by provider experience. Studying procedures of varying complexity in the mid-1970s in 1498 hospitals using a chart abstracting service, Luft et al.<sup>169</sup> found an inverse relationship between mortality and procedure volume for high-risk procedures; a volume–outcome relationship existed for lesser-risk surgery but was weaker at low volumes. What underlies this phenomenon: a team effect in the hospital, expertise of individual surgeons, or regional referral patterns? Research has been more equivocal, in part, because of technical issues, such as low statistical power in comparisons of lower total-case volume and a statistical association (collinearity) affecting hospital and surgeon-specific volumes.<sup>170,171</sup> Yet accruing literature documents better outcomes for high-risk surgery performed at high-volume sites and suggests that a more experienced team may underlie the phenomenon.<sup>172–174</sup> As a result, performing high-risk surgery at high-volume sites has become a principle that guides contracting for services of some organizations (e.g., the Leapfrog Group) and third-party payers.

Certain aspects of critical care medicine are also associated with better surgical outcomes. Pronovost et al.<sup>175,176</sup> showed that the presence of a dedicated intensive care physician making daily rounds, a nurse-to-patient ratio of at least 1.2, a monthly case conference, and tracheal extubation in the critical care unit rather than the operating room are associated with better outcomes after abdominal aortic surgery. The implications of not having a dedicated critical care physician are so grave (OR for in-hospital mortality, 3.0; 95% CI, 1.9–4.9) that this has also become a Leapfrog Group standard. The contribution of nurse staffing ratios for good outcomes echoes the studies of general hospital nursing by Aiken et al.<sup>157</sup>

Delivering good outcomes in complex settings also requires effective team functioning, an essential part of an effective patient-safety climate.<sup>1</sup> Higher scores on the Safety Attitudes Questionnaire are associated with fewer medication errors, lower ventilator-associated pneumonia rates, and decreased risk-adjusted mortality.<sup>177</sup> Makary et al.<sup>178</sup> have developed a “teamwork culture” metric that is sensitive to operating room caregivers’

perceptions and awaits validation for use in improvement work. Awad et al.<sup>179</sup> have shown that a preprocedural operating room briefing improves teamwork climate, including coordination among caregivers (see Chap. 3 for a more thorough discussion of team performance).

Mortality risk appears to be influenced by the facility in which the procedure is performed (i.e., a “provider” effect). Fleisher et al.<sup>83</sup> studied outcomes of Medicare patients having surgery in a hospital outpatient unit, freestanding surgery center, or surgeon’s office. Although death rates on the day of operation were not different, there were differences among the rates for 7-day mortality (1:2000, 1:4000, and 1:2856, respectively) and 7-day hospital admission (1:48, 1:119, and 1:110, respectively). The readmission rates resembled those in other studies, but the authors could not exclude the likelihood that the differences across sites in both readmission and mortality rates reflected patient referral patterns (selection bias), with sicker patients treated in the more intensive settings (Fig. 24–4B).

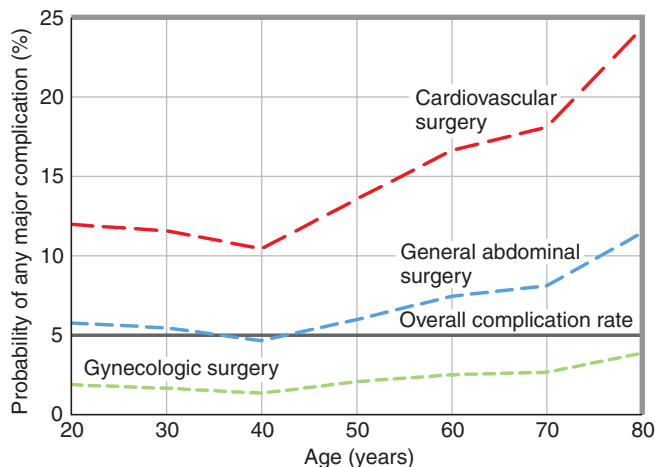
### The Surgeon and the Operation

**The Surgeon’s Characteristics** The surgeon’s board certification,<sup>155,163,165</sup> experience,<sup>163,165</sup> and case volume<sup>163,165,170,172,173</sup> each is associated with clinical outcome when comparing different hospitals, although these relationships may be weak when comparing individ-

ual surgeons at the same site. However, outcome variation has been demonstrated among individual surgeons for complex procedures.<sup>180</sup> Lunn and Devlin<sup>2</sup> have called attention to the association of poor outcomes from surgery and anesthesia care provided by unsupervised and undersupervised trainees at night.

Outcomes associated with individual surgeons are confounded by diverse hospital characteristics, such as teaching-hospital status,<sup>163,167,168</sup> total hospital expenditures,<sup>163</sup> total case volume,<sup>163,170,173</sup> team culture,<sup>177,178</sup> critical care organizational characteristics,<sup>175,176</sup> and general nurse-to-patient ratio.<sup>157</sup>

**The Operation** The surgeon’s influence on outcome is confounded by important characteristics of the operation. In most cohort studies, invasiveness of the surgical procedure (i.e., “major” vs. “minor” surgery) and whether the operation is undertaken emergently are potent independent determinants of both mortality and morbidity (Tables 24–4 and 24–5).<sup>19,33,35,36,149</sup> Underlying these relationships undoubtedly are the implications of the extent of physiologic derangement and the limited preparatory care before emergent surgery. Procedure invasiveness interacts with age, becoming a much more potent predictor of major complications beyond middle age, particularly for the more invasive procedures (Fig. 24–9).<sup>18</sup> Invasiveness (or complexity) of operation is so potent a predictor of outcome that it has been



**FIGURE 24–9.** Probability of a severe perioperative respiratory or cardiovascular complication as a function of both type of surgical procedure and patient age, computed from the logistic regression equation developed in the clinical trial of inhalation anesthesia drugs conducted among 17,201 patients by Forrest et al.<sup>18</sup> (From Muravchick S. Anesthesia for the elderly. In: Healy TEJ, Knight PR, eds. Wylie and Churchill-Davidson’s A Practice of Anesthesia. 7th ed. London: Arnold, 2003:990. Reproduced with permission of Edward Arnold, Ltd.)

included in several proposals for modifications of the ASA physical status classification or new approaches to preoperative patient assessment.<sup>78,148</sup>

An especially problematic procedure-related factor is duration of operation (or anesthesia). Consistent with the notion that increasing exposure to a potentially hazardous intervention risks a poorer outcome, duration of operation (or anesthesia) is associated with increased mortality and morbidity<sup>19,35,37</sup> (Tables 24-4 and 24-5) and hospital admission after ambulatory surgery.<sup>36,37</sup> Greater procedure duration may be a proxy for more extensive (perhaps unrecognized) surgical disease, lesser surgical skill, or the occurrence of intraoperative anesthesia and surgical complications, any of which may independently determine the postoperative outcome. Cohen et al.<sup>19</sup> specifically included occurrence of intraoperative complications among candidate predictor variables and found that such complications, rather than procedure duration, was an independent predictor of outcome (Table 24-4). Thus, unless the study has included occurrence of intraoperative complications in the outcome modeling, procedure duration alone should be regarded as a possibly “tainted” variable.

### **The Anesthesia Provider and the Anesthesia Care**

**The Anesthesiologist's Characteristics** Board certification seems an even more important predictor of outcome with the anesthesiologist than with the surgeon.<sup>82,155</sup> Using sophisticated modeling, Silber et al.<sup>155,156</sup> showed that a lesser proportion of board-certified anesthesiologists on the anesthesia staff is associated with a greater likelihood of “failure to rescue.” In a direct comparison of mortality among Medicare patients treated by mid-career anesthesiologists with and without board certification, Silber et al.<sup>82</sup> showed that absence of board certification is associated with greater likelihood of “failure to rescue” (OR 1.13, 95% CI 1.01–1.27) and higher mortality (OR 1.13; 95% CI 1.00–1.26). So confounded are the outcome predictors, however, that they noted that the poorer outcomes of noncertified practitioners may reflect hospital characteristics as well.

Apart from board certification, the effect of the anesthesiologist's experience on outcome is less clear. In a comparison of anesthesia providers at

the Massachusetts General Hospital in the mid-1970s, Gilbert<sup>181</sup> detected slightly better outcomes only when anesthesia was administered directly by a senior anesthesiologist. Cohen et al.<sup>19</sup> were unable to detect an outcome difference among anesthesiologists with greater time in the specialty and greater case volumes (Table 24-4). Lunn and Devlin<sup>2</sup> noted the association between poor outcomes of surgery and anesthesia care and unsupervised and undersupervised trainees at night. Exploring the linkage between myocardial ischemia and MI in anesthesia for coronary bypass, Slogoff and Keats<sup>182</sup> famously identified Anesthesiologist 7, whose cases had a greater proportion of intraoperative ischemia and much greater postoperative infarction than did others in the group practice. They implied this was due to individual skill factors, but analysis was superficial and without risk adjustment of the clinical data.

**Anesthesia Provider Type** More extensive efforts to explore outcome differences by type of anesthesia provider also have been indeterminate, perhaps because of design flaws. Gilbert<sup>181</sup> found no outcome differences when comparing anesthesiologists providing direct care, anesthesiology residents medically directed by faculty anesthesiologists, and nurse anesthetists similarly medically directed. However, a fully trained anesthesiologist was involved in every case, the data were only partially risk adjusted (*note*: the physicians likely received the more difficult cases), and patients were not randomly allocated to providers. Similar flaws are present in an analysis based on the Institutional Differences Study. In one portion of the study, they compared “(nine) hospitals in which anesthesiologists primarily were the providers...and (seven) hospitals in which nurse anesthetists were primarily the providers.”<sup>183</sup> Outcomes were the same in both groups, yet anesthesiologists were involved in all care.

Multiple design flaws also plague an analysis of postoperative deaths in North Carolina during the period 1969–1976, in which half of the anesthetics were administered by nurse anesthetists medically directed by the surgeon and the other half by anesthesiologists working alone or a team of a nurse anesthetist and an anesthesiologist.<sup>184</sup> Anesthesia-related death rates were

similar across the three provider types; yet, unlike the studies by Gilbert<sup>181</sup> and Forrest,<sup>183</sup> there was no attempt to adjust the data for case-mix differences (e.g., age, ASA physical status) and type of operation (e.g., emergent vs. elective, major vs. minor). Because nurse anesthetists working without anesthesiologists (then and now) are located typically in smaller, often rural hospitals, the two other provider types (with anesthesiologists) likely were treating sicker patients having more complex procedures. Also, as with the other studies, there had been no random allocation of patients to provider type, resulting in likely selection bias.

The most recent provider-type comparison, although much more sophisticated, also suffers from serious design flaws. Pine et al.<sup>185</sup> compared mortality of Medicare patients having one of eight common surgical procedures, whose anesthesia was provided by nurse anesthetists working without anesthesiologists, anesthesiologists providing direct care, or an anesthesia care team of a nurse anesthetist medically directed by an anesthesiologist. After stratification by procedure and adjustment for patient characteristics, the mortality rates were similar across the three provider types. However, 80% of the cases in which nurse anesthetists worked without anesthesiologists were performed in rural hospitals; thus, those nurse anesthetists were most assuredly caring for a lower-risk population (severe selection bias). Direct comparison of outcomes in this circumstance is likely to be misleading, because patients in the three groups would be expected to differ markedly in measured *and unmeasured* risk factors and thus their likelihood of poor outcome.

Silber et al.<sup>81</sup> demonstrated in a matched-pair, propensity score analysis (addressing selection bias) that lack of medical direction by an anesthesiologist is associated with a higher failure-to-rescue rate (OR 1.10, 95% CI 1.01–1.18) and higher 30-day postoperative mortality (OR 1.08, 95% CI 1.00–1.15). They estimated that the higher mortality rate engenders 2.5 excess deaths per 1000 patients, which represents a number needed to treat (NNT) of 400 (Table 24-1). Although an NNT of 400 reflects a modest effect, anesthesiologist's medical direction gains enormous power because of the tens of millions of anesthetics administered each year.

**The Anesthesia Care** Outcome comparisons of specific anesthesia drugs and methods have not identified a single ideal approach to anesthesia but rather have emphasized characteristics, typically pharmacologic, that can be regarded as tradeoffs among different options. Keats<sup>65</sup> suggested that anesthesia agents are “inherently toxic” and that, as our knowledge grows, anesthesia risk diminishes. Past controversies about specific drugs were resolved by either learning how to use them safely or discarding those that were problematic, usually on a pharmacologic basis (e.g., methoxyflurane with dose-related nephrotoxicity). Thus, Beecher and Todd<sup>4</sup> attributed “intrinsic toxicity” to curare (a generic term applied to muscle relaxants) before it was appreciated that postanesthesia residual paralysis could be both hazardous and avoided with pharmacologic antagonism. That drug class now is a mainstay of anesthesia practice (see Chap. 33).

Perhaps expectedly, well-conducted studies have failed to identify important risk differences among anesthesia options. Cohen et al.<sup>19</sup> noted that anesthesia-related factors (e.g., principal anesthesia method) added negligibly to the contributions of patient- and surgery-related factors in accounting for mortality risk (Table 24-4). However, they did find markedly greater mortality if a single-agent anesthetic rather than “balanced anesthesia” with multiple drugs was used (OR 4.85, 95% CI 1.97–11.96). Although their inability to identify benefits of specific anesthesia methods arguably could result from selection bias (confounding by indication), Forrest et al.<sup>18</sup> were unable to detect meaningful morbidity differences among inhalation agents in a clinical trial that would minimize biased selection.

However, in support of a long-held belief that it is more important *how* rather than specifically *what* one does, Arbous et al.<sup>186</sup> showed that there are multiple opportunities to decrease anesthesia risk by adopting a set of good practices in the management of anesthesia care (Table 24-7). Although the efficacy of most of the practices identified by Arbous et al. are well documented in the literature (e.g., epidural opiates for postoperative pain management rather than intramuscular or intravenous narcotic administration; antagonism of nonme-

TABLE 24-7.

Anesthesia Management Factors Associated with 24-Hour Mortality and Coma

Factor <sup>a</sup>	Odds Ratio <sup>b</sup>	95% Confidence Interval
<b>Preoperative Period</b>		
Equipment check with protocol and checklist (vs. none or incomplete)	0.640	0.432–0.948
Documentation of equipment check (vs. none)	0.607	0.399–0.923
<b>Intraoperative period</b>		
Availability of and access to attending anesthesiologist (direct vs. indirect)	0.455	0.313–0.662
No intraoperative change of anesthesiologist (vs. change)	0.444	0.199–0.990
Presence of full-time anesthesia nurse (vs. part-time)	0.408	0.236–0.704
Presence of attending anesthesiologist at emergence and termination of anesthesia (2 practitioners vs. 1)	0.687	0.474–0.996
Reversal of opiates (vs. none)	0.636	0.100–4.027
Reversal of muscle relaxants (vs. none)	0.101	0.032–0.314
Reversal of opiates and muscle relaxants (vs. none)	0.290	0.175–0.482
<b>Postoperative period</b>		
Postoperative pain medication: opiate (vs. none)	0.165	0.108–0.254
Postoperative pain medication: local anesthetics (vs. none)	0.061	0.009–0.400
Postoperative pain medication: combination (vs. none)	0.324	0.140–0.752
Postoperative opiate route: epidural (vs. IV)	0.226	0.057–0.887
Postoperative opiate route: intramuscular (vs. IV)	0.130	0.074–0.335

<sup>a</sup>All factors adjusted for characteristics of patient (age, gender, ASA physical status classification); surgical procedure (time, duration, whether emergent, type, complexity); principal anesthetic method (inhalation, total intravenous, combined technique; regional [type]; or combination); and hospital (type, size).

<sup>b</sup>All odds ratios whose 95% confidence intervals do not include the value 1.0 are statistically significant.

IV, intravenous route of administration.

Modified from Arbous et al.<sup>186</sup> with permission.

tabolized muscle relaxants at conclusion of anesthesia), these practices continue to require support and encouragement toward full adoption. Their results emphasize the inadequacy of viewing anesthesia care as merely the administration of drugs and use of certain methods and devices. We may infer that anesthesia risk studies that consider patient characteristics and their clinical outcomes—but omit intraoperative detail relating to the anesthesiologist’s clinical practices—provide an incomplete and possibly misleading perspective. We also might speculate that the beneficial practices identified are likely to be among those that underlie the anesthesiologist’s beneficial influence detected by the failure-to-rescue metric.

## HOW DO WE INTERPRET ANESTHESIA RISK TO PATIENTS?

As if the evolving story of anesthesia risk were not sufficiently complex, communicating effectively with patients about anesthesia risk is even more challenging. Basic concepts of risk are confusing, if not foreign, to patients, and they are likely to be wary of risk-related statements, given the many prominent public reversals about the benefits and safety of common drugs (e.g., hormone replacement therapy, cyclooxygenase-2 analgesics).

### Creating an Effective Message

Because the hallmark of effective communication is understanding the audi-

ence, we should tailor risk-related discussions to the specific patient's needs and knowledge, recognizing that a brief, targeted disclosure is likely to be mutually satisfying. We can allay their general concerns by noting that anesthesia care has never been safer, that it may be among the least hazardous parts of overall patient care, that common postanesthesia problems tend to be transient, that serious complications have become very uncommon, and that our expanding perspective on anesthesia care (e.g., postoperative pain management) means that they are also likely to be more comfortable and satisfied with their care. We can convey to patients that as a result of myriad improvements, anesthesia methods are more similar than different with regard to risk, and often their anesthesia preferences can be honored.

### Problems with Risk Numeracy

We should avoid placing undue emphasis on specific risk estimates, in part because they are based on the experiences of large populations and may not predict well an given individual's clinical outcome (Box 24-1). Although patient-specific risks can be estimated from regression equations and patients often want to know their "chances" (even if they do not ask), the more problematic issue is that quantitative information about risk is meaningful only to the small minority having facility with probabilities and numerical concepts.<sup>187-189</sup> Rather than regarding an outcome occurring 1:100 as "common" and 1:1000 as "uncommon," patients tend to focus on the numerator almost to the exclusion of the denominator (i.e., odds are less important than the possibility that an event can occur). Framing is also a barrier to communicating risk, with 90% survival perceived as better than 10% mortality. Evolving guidance for enhancing effective risk communication includes understanding the patient's experience and expectations, presenting *relative* risks of competing options rather than risk estimates in isolation, using graphics ("decision aids") to help the presentation, encouraging a balanced discussion of options and uncertainties, developing recommendations informed by clinical judgment and patient preferences, and continually checking for understanding and agreement.<sup>190,191</sup> For some patients, comparing the risks of anesthesia to other well-known events, such as parachute

jumping or flying in commercial aircraft, may be helpful (Box 24-4), but both the clinician and the patient must recognize that these broad generalities may not apply to any given patient.

### HOW DO WE ACHIEVE FURTHER REDUCTION IN ANESTHESIA RISK?

The foregoing dissection of sources of risk emphasizes the need to move beyond the former narrow definition of anesthesia care as the use of drugs, methods, and devices, to embrace a far broader perspective of the overall anesthesia care process, from preoperative assessment to postoperative care, and its role in the overall system of care (see Chap. 3 for a discussion of the system of anesthesia care, within a larger system of overall care). A real benefit to adopting a more comprehensive view of anesthesia care has already been demonstrated by the mortality and morbidity risk reduction achieved by modulating the sympathetic nervous system by administering  $\beta$ -adrenergic blockers<sup>24</sup> and preventing hypothermia<sup>100,101</sup>; decreasing surgical wound infections by administering perioperative supplemental oxygen<sup>192</sup>; and decreasing perioperative mortality by adopting clinical practice patterns<sup>186</sup> and by having an anesthesiologist directing the anesthesia care.<sup>81</sup> The identification of an association between higher cancer recurrence- and metastasis-free survival rates and use of anesthesia approaches known to reduce stress<sup>193</sup> suggests that perhaps only our formerly narrow notions of "anesthesia" risk are preventing further decreases in anesthesia risk.

### KEY REFERENCES

1. Arbous MS, Meursing AEE, van Kleef JW, et al. Impact of anesthesia management characteristics on severe morbidity and mortality. *Anesthesiology* 2005;102:257.
2. Beecher HK, Todd DP. A study of deaths associated with anesthesia and surgery: based on a study of 599,548 anesthetics in ten institutions 1948-1952, inclusive. *Ann Surg* 1954;140:2.
3. Cohen MM, Duncan PG, Tate RB. Does anesthesia contribute to oper-

ative mortality? *JAMA* 1988;260:2859.

4. Forrest JB, Rehder K, Cahalan MK, et al. Multicenter Study of General Anesthesia: III. Predictors of severe perioperative adverse outcomes. *Anesthesiology* 1992;76:3.

5. Gold BS, Kitz DS, Lecky JH, et al. Unanticipated admission to the hospital following ambulatory surgery. *JAMA* 1989;262:3008.

6. Katz MH. *Multivariable Analysis: A Practical Guide for Clinicians*. 2nd ed. New York: Cambridge University Press, 2006.

7. Kraemer HC, Lowe KK, Kupfer DJ. *To Your Health: How to Understand What Research Tells Us About Risk*. New York: Oxford University Press, 2005.

8. Lunn JN, Devlin HB. Lessons from the confidential enquiry into perioperative deaths in three NHS regions. *Lancet* 1987;2:1384.

9. Mangano DT, Layug EL, Wallace W, et al. Effect of atenolol on mortality and cardiovascular morbidity after noncardiac surgery. *N Engl J Med* 1996;335:1713.

10. Rothman KJ, Greenland S. *Modern Epidemiology*. 2nd ed. Philadelphia: Lippincott-Raven, 1998.

11. Silber JH, Williams SV, Krakauer H, et al. Hospital and patient characteristics associated with death after surgery: a study of adverse occurrence and failure to rescue. *Med Care* 1992;30:615.

12. Silber JH, Kennedy SK, Even-Shoshan O, et al. Anesthesiologist direction and patient outcomes. *Anesthesiology* 2000;93:152.

13. Silber JH, Kennedy SK, Even-Shoshan O, et al. Anesthesiologist board certification and patient outcomes. *Anesthesiology* 2002;96:1039.

### REFERENCES

1. Kohn LT, Corrigan JM, Donaldson MS, eds. *To Err is Human: Building a Safer Health System*. Washington, DC: National Academy Press, 1999:32.
2. Lunn JN, Devlin HB. Lessons from the confidential enquiry into perioperative deaths in three NHS regions. *Lancet* 1987;2:1384.



3. Estimate based on data in Tables 2.4, 3.1, and 3.4 in Trend Watch Chartbook 2006. Chicago: American Hospital Association, 2006.
4. Beecher HK, Todd DP. A study of deaths associated with anesthesia and surgery: based on a study of 599,548 anesthetics in ten institutions 1948–1952, inclusive. *Ann Surg* 1954;140:2.
5. Kraemer HC, Kazdin AE, Offord DR, et al. Coming to terms with the terms of risk. *Arch Gen Psychiatr* 1997;54:337.
6. Kraemer HC, Lowe KK, Kupfer DJ. *To Your Health: How to Understand What Research Tells Us About Risk*. New York: Oxford University Press, 2005.
7. Eichhorn JH. Prevention of intraoperative anesthesia accidents and related severe injury through safety monitoring. *Anesthesiology* 1989;70:572.
8. Orkin FK. Patient monitoring as a problem in technology assessment. In: Saidman LJ, Smith NT, eds. *Monitoring in Anesthesia*. 3rd ed. Boston: Butterworth-Heinemann, 1993:439.
9. Cooper JB, Gaba D. No myth: anesthesia is a model for addressing patient safety. *Anesthesiology* 2002;97:1335.
10. Lagasse RS. Anesthesia safety: model or myth? A review of the published literature and analysis of current original data. *Anesthesiology* 2002;97:1609.
11. Cooper JB, Newbower RS, Long CD, et al. Preventable anesthesia mishaps: a study of human factors. *Anesthesiology* 1978;49:399.
12. Cheney FW. The American Society of Anesthesiologists Closed Claims Project: what we have learned, how it has affected practice, and how will affect practice in the future. *Anesthesiology* 1999;91:552.
13. Strom BL. When should one perform pharmacoepidemiology studies? In: Strom BL, ed. *Pharmacoepidemiology*. 4th ed. Hoboken, NJ: Wiley, 2005:59.
14. Starr C. Social benefit versus technological risk: what is our society willing to pay for safety? *Science* 1969;165:1232.
15. Lowrance WW. *Of Acceptable Risk*. Los Altos, CA: Kaufmann, 1976.
16. Ropeik D, Gray G. *Risk: A Practical Guide to Deciding What's Really Safe and What's Really Dangerous in the World Around You*. Boston: Houghton Mifflin, 2002.
17. Runciman WB, Moller JJ. Iatrogenic Injury in Australia. Adelaide: Australian Patient Safety Foundation, 2001, Table 1. Available at: <http://www.apsf.net.au>. Last accessed April 1, 2006.
18. Forrest JB, Rehder K, Cahalan MK, et al. Multicenter Study of General Anesthesia: III. Predictors of severe perioperative adverse outcomes. *Anesthesiology* 1992;76:3.
19. Cohen MM, Duncan PG, Tate RB. Does anesthesia contribute to operative mortality? *JAMA* 1988;260:2859.
20. Monk TG, Saini V, Weldon BC, et al. Mortality after noncardiac surgery. *Anesth Analg* 2005;100:4.
21. Jaeschke R, Guyatt G, Barratt A, et al. Therapy and understanding the results: measures of association. In: Guyatt G, Rennie D, eds. *Users' Guides to the Medical Literature: A Manual for Evidence-Based Clinical Practice*. Chicago: AMA Press, 2002:351.
22. Interactive risk-metrics calculator. Available at: [http://Denison.uchsc.edu/SG/defs/therapy\\_swf.html](http://Denison.uchsc.edu/SG/defs/therapy_swf.html). Accessed January 30, 2007.
23. Van den Berghe G, Wouters P, Weekers F, et al. Intensive insulin therapy in critically ill patients. *N Engl J Med* 2001;345:1359.
24. Mangano DT, Layug EL, Wallace W, et al. Effect of atenolol on mortality and cardiovascular morbidity after noncardiac surgery. *N Engl J Med* 1996;335:1713.
25. Lindenauer PK, Pekow P, Wang K, et al. Perioperative beta-blockade therapy and mortality after major noncardiac surgery. *N Engl J Med* 2005;353:349.
26. Guyatt G, Walter S, Cook D, et al. Therapy and understanding the results: confidence intervals. In: Guyatt G, Rennie D, eds. *Users' Guides to the Medical Literature: A Manual for Evidence-Based Clinical Practice*. Chicago: AMA Press, 2002:339.
27. Hanley JA, Lippman-Hand A. If nothing goes wrong, is everything all right? Interpreting zero numerators. *JAMA* 1983;249:1743.
28. Walker JA, McIntyre RD, Schleinitz PF, et al. Nurse-administered propofol sedation without anesthesia specialists in 9152 endoscopic cases in an ambulatory surgery center. *Am J Gastroenterol* 2003;98:1744.
29. Vargo JJ, Zuccaro G Jr, Dumot JA, et al. Gastroenterologist-administered propofol versus meperidine and midazolam for advanced upper endoscopy: a prospective, randomized trial. *Gastroenterology* 2002;123:8.
30. Fleming TR, DeMets DL. Surrogate end points in clinical trials: are we being misled? *Ann Intern Med* 1996;125:605.
31. Echt DS, Liebson PR, Mitchell LB, et al. Mortality and morbidity in patients receiving encaainide, flecainide, or placebo. *N Engl J Med* 1991;324:781.
32. Fisher DM. Surrogate end points: are they meaningful? *Anesthesiology* 1994;81:795.
33. Goldman L, Caldera DL, Nussbaum SR, et al. Multifactorial index of cardiac risk in noncardiac surgical procedures. *N Engl J Med* 1977;297:845.
34. Cohen MM, Duncan PG. Physical status score and trends in anaesthetic complications. *J Clin Epidemiol* 1988;41:83.
35. Pedersen T. Complications and death following anaesthesia: a prospective study with special reference to the influence of patient-, anaesthesia-, and surgery-related risk factors. *Dan Med Bull* 1994;41:319.
36. Gold BS, Kitz DS, Lecky JH, et al. Unanticipated admission to the hospital following ambulatory surgery. *JAMA* 1989;262:3008.
37. Fleisher LA, Pasternak LR, Lyles A. A novel index of elevated risk of inpatient hospital admission immediately following outpatient surgery. *Arch Surg* 2007;142:263.
38. Wu CL, Rowlingson AJ, Partin AW, et al. Correlation of postoperative pain to quality of recovery in the immediate postoperative period. *Reg Anesth Pain Med* 2005;30:516.
39. Guyatt GH, Feeney DH, Patrick DL. Measuring health-related quality of life. *Ann Intern Med* 1993;118:622.
40. Wilson IB, Cleary PD. Linking clinical variables with health-related quality of life: a conceptual model of patient outcomes. *JAMA* 273:59,1995.
41. Patient-Reported Outcome Measures: Use in Medical Product Development to Support Labeling Claims. Draft Guidance. Washington, DC: Food and Drug Administration, 2006. Available at: <http://www.fda.gov/cder/guidance/5460dft.pdf>. Last accessed April 19, 2006.
42. Stewart AL, Ware JE Jr, eds. *Measuring Function and Well-Being: The Medical Outcomes Study Approach*. Durham, NC: Duke University Press, 1996.
43. Huskisson EC. Measurement of pain. *Lancet* 1974;2:1127.
44. Melzack R. The McGill Pain Questionnaire: major properties and scoring properties. *Pain* 1975;1:277.
45. McDowell I, Newell C. *Measuring Health: A Guide to Rating Scales and Questionnaires*. 3rd ed. New York: Oxford University Press, 2006.
46. Iezzoni LI. Reasons for risk adjustment. In: Iezzoni LI, ed. *Risk Adjustment for Measuring Health Outcomes*. 3rd ed. Chicago: Health Administration Press, 2003:1.
47. Saklad M. Grading of patients for surgical procedures. *Anesthesiology* 1941;2:281.
48. Dripps RD, Lamont A, Eckenhoff JE. The role of anesthesia in surgical mortality. *JAMA* 1961;178:261.
49. New classification of physical status. *Anesthesiology* 1963;24:111.
50. Charlson ME, Pompei P, Ales KL, et al. A new method of classifying prognostic comorbidity in longitudinal studies: development and validation. *J Chronic Dis* 1987;40:373.
51. Hasnain-Wynia R, Baker DW. Obtaining data on patient race, ethnicity, and primary language in health care organizations: current challenges and proposed solutions. *Health Serv Res* 2006;41:1501.
52. Bodlander FMS. Deaths associated with anaesthesia. *Br J Anaesth* 1975;47:36.
53. Harrison GG. Deaths attributable to anaesthesia: a 10-year survey, 1967–1976. *Br J Anaesth* 1978;50:1041.
54. Tiret L, Desmonts JM, Hatton F, et al. Complications associated with anaesthesia: a prospective survey in France. *Can Anaesth Soc J* 1986;33:336.
55. Dornette WHL, Orth OS. Death in the operating room. *Anesth Analg* 1956;35:545.

56. Turnbull KW, Fancourt-Smith PF, Banting GC. Death within 48 hours of anaesthesia at the Vancouver General Hospital. *Can Anaesth Soc J* 1980;27:159.
57. Hovi-Viander M. Deaths associated with anaesthesia in Finland. *Br J Anaesth* 1980;52:483.
58. Lunn JN, Mushin WW. *Mortality Associated with Anaesthesia*. London: Nuffield Provincial Hospitals Trust, 1982.
59. Marx GF, Matteo CV, Orkin LR. Computer analysis of postanesthetic deaths. *Anesthesiology* 1973;39:54.
60. Warner MA, Shields SE, Chute CG. Major morbidity and mortality within 1 month of ambulatory surgery and anesthesia. *JAMA* 1993;270:1437.
61. Subcommittee on the National Halothane Study of the Committee on Anesthesia, National Academy of Sciences–National Research Council: Summary of the National Halothane Study: possible association between halothane anesthesia and postoperative hepatic necrosis. *JAMA* 1966;197:775–788.
62. Khuri SF, Daley J, Henderson W, et al. Risk adjustment of the postoperative mortality rate for the comparative assessment of the quality of surgical care: results of the National Veterans Affairs Surgical Risk Study. *J Am Coll Surg* 1997;185:315.
63. Holland R. Special committee investigating deaths under anaesthesia: report on 745 classified cases, 1960–1968. *Med J Aust* 1970;1:573.
64. Caplan RA, Posner KL, Cheney FW. Effect of outcome on physician judgments of appropriateness of care. *JAMA* 1991;265:1957.
65. Keats AS. What do we know about anesthetic mortality? *Anesthesiology* 1979;50:387.
66. Stolley PD, Lasky T. *Investigating Disease Patterns: The Science of Epidemiology*. New York: Scientific American, 1995:23–49.
67. Green LA, Fryer GE Jr, Yawn BP, et al. The ecology of medical care revisited. *N Engl J Med* 2001;344:2021.
68. Berkson J. Limitations of the application of fourfold table analysis to hospital data. *Biometrics Bull* 1946;2:47.
69. Freeman JS, Chalmers TC, Smith H Jr, et al. The importance of beta, the type II error and sample size in the design and interpretation of the randomized clinical trial: survey of 71 “negative” trials. *N Engl J Med* 1978;299:690.
70. Mangano DT, Browner WS, Hollenberg M, et al. Long-term cardiac prognosis following noncardiac surgery. *JAMA* 1992;268:233.
71. Matthew JP, Parks R, Savino JS, et al. Atrial fibrillation following coronary artery bypass graft surgery: predictors, outcomes, and resource utilization. *JAMA* 1996;276:300.
72. Mangano DT. Aspirin and mortality from coronary bypass surgery. *N Engl J Med* 2002;347:1309.
73. Mangano DT, Tudor IC, Dietzel C, et al. The risk associated with aprotinin in cardiac surgery. *N Engl J Med* 2006;354:353.
74. Grover FL, Shroyer AL, Hammermeister KE. Calculating risk and outcome: the Veterans Affairs database. *Ann Thorac Surg* 1996;62(Suppl 5):S6.
75. Khuri SF, Daley J, Henderson W, et al. The Department of Veterans Affairs’ NSQIP. The first national, validated, outcome-based, risk-adjusted, and peer-controlled program for the measurement and enhancement of the quality of surgical care. National VA Surgical Quality Improvement Program. *Ann Surg* 1998;228:491.
76. Daley J, Khuri SF, Henderson W, et al. Risk adjustment of the postoperative morbidity rate for the comparative assessment of the quality of surgical care: results of the National Veterans Affairs Surgical Risk Study. *J Am Coll Surg* 1997;185:328.
77. Davenport DL, Henderson WG, Khuri SF, et al. Preoperative risk factors and surgical complexity are more predictive of costs than postoperative complications: a case study using the National Surgical Quality Improvement Program (NSQIP) database. *Ann Surg* 2005;242:463.
78. Aust JB, Henderson W, Khuri S, et al. The impact of operative complexity on patient risk factors. *Ann Surg* 2005;241:1024.
79. Davenport DL, Bowe EA, Henderson WG, et al. National Surgical Quality Improvement Program (NSQIP) risk factors can be used to validate American Society of Anesthesiologists Physical State Classification (ASA PS) levels. *Ann Surg* 2006;243:636.
80. Singh N, Sidawy AN, Dezee K, et al. The effects of the type of anesthesia on outcomes of lower extremity infrainguinal bypass. *J Vasc Surg* 2006;44:964.
81. Silber JH, Kennedy SK, Even-Shoshan O, et al. Anesthesiologist direction and patient outcomes. *Anesthesiology* 2000;93:152.
82. Silber JH, Kennedy SK, Even-Shoshan O, et al. Anesthesiologist board certification and patient outcomes. *Anesthesiology* 2002;96:1039.
83. Fleisher LA, Pasternak LR, Herbert R, et al. Inpatient hospital admission and death after outpatient surgery in elderly patients: importance of patient and system characteristics and location of care. *Arch Surg* 2004;139:67.
84. Silber JH, Rosenbaum PR, Zhang X, et al. The influence of patient and hospital characteristics on anesthesia time in Medicare patients undergoing general and orthopedic surgery. *Anesthesiology* 2007;106:356.
85. Sinclair DR, Chung F, Mezei G. Can postoperative nausea and vomiting be predicted? *Anesthesiology* 1999;91:109.
86. Christenfeld NJS, Sloan RP, Carroll D, et al. Risk factors, confounding, and the illusion of statistical control. *Psychosom Med* 2004;66:868.
87. Rubin DB. Estimating causal effects from large data sets using propensity scores. *Ann Intern Med* 1997;127:757.
88. Weitzen S, Lapane KL, Toledano AY, et al. Principles for modeling propensity scores in medical research: a systematic literature review. *Pharmacoepidemiol Drug Saf* 2004;13:841.
89. Connors AF, Speroff T, Dawson NV, et al. The effectiveness of right-heart catheterization in the initial care of critically ill patients. *JAMA* 1996;276:889.
90. O’Hara DA, Duff A, Berlin JA, et al. The effect of anesthetic technique on postoperative outcomes in hip fracture repair. *Anesthesiology* 2000;92:947.
91. Weitzen S, Lapane KL, Toledano AY, et al. Weaknesses of goodness-of-fit tests for evaluating propensity score models: the case of the omitted confounder. *Pharmacoepidemiol Drug Saf* 2005;14:227.
92. Goldman L, Cook EF, Brand DA, et al. A computer protocol to predict myocardial infarction in emergency department patients with chest pain. *N Engl J Med* 1988;318:797.
93. Orkin FK, Dohlmans LE. Recursive-partitioning analysis provides a more patient-centric perspective on predicting adverse-event occurrence than logistic regression analysis. *Eur J Anaesth* 2005;22(Suppl 34):7.
94. Iezzoni LI. Coded data from administrative sources. In: Iezzoni LI, ed. *Risk Adjustment for Measuring Health Outcomes*. 3rd ed. Chicago: Health Administration Press, 2003:86.
95. Iezzoni LI. Clinical data from medical records or providers. In: Iezzoni LI, ed. *Risk Adjustment for Measuring Health Outcomes*. 3rd ed. Chicago: Health Administration Press, 2003:139.
96. Orkin FK. Statistical indiscretions in papers from the ASA Closed Claims Project. *Anesthesiology* 2006;104:615.
97. Guyatt GH, Sackett DL, Sinclair JC, et al. *Users’ guides to the medical literature*. IX. A method for grading health care recommendations. *JAMA* 1995;274:1800.
98. Kravitz RL, Duan N, Braslow J. Evidence-based medicine, heterogeneity of treatment effects, and the trouble with averages. *Milbank Quart* 2004;82:661.
99. Rao TLK, Jacobs KH, El-Etr AA. Reinfarction following anesthesia in patients with myocardial infarction. *Anesthesiology* 1983;59:499.
100. Frank SM, Beattie C, Christopherson R, et al. Unintentional hypothermia is associated with postoperative myocardial ischemia. The Perioperative Ischemia Randomized Anesthesia Trial Study Group. *Anesthesiology* 1993;78:468.
101. Frank SM, Fleisher LA, Breslow MJ, et al. Perioperative maintenance of normothermia reduces the incidence of morbid cardiac events. A randomized clinical trial. *JAMA* 1997;277:1127.
102. Apfel CC, Korttila K, Abdalla M, et al. A factorial trial of six interventions for prevention of postoperative nausea and vomiting. *N Engl J Med* 2004;350:2441.
103. Korttila K, Apfel CC. Factorial design provides evidence to guide practice of ana-

- esthesia. *Acta Anaesthesiol Scand* 2005;49:927.
104. Jansen AC, van Aalst-Cohen ES, Hutten VA, et al. Guidelines were developed for data collection from medical records for use in retrospective analyses. *J Clin Epidemiol* 2005;58:269.
105. Cohen MM, Duncan PG, Pope WDB, et al. A survey of 112,000 anaesthetics at one teaching hospital (1975–1983). *Can J Anaesth* 1987;33:22.
106. Cohen MM, Duncan PG, Pope WDB, et al. The Canadian four-centre study of anaesthetic outcomes: II. Can outcomes be used to assess the quality of anaesthesia care? *Can J Anaesth* 1992;39:430.
107. Leventhal SR, Orkin FK, Hirsh RA. Prediction of the need for postoperative mechanical ventilation in myasthenia gravis. *Anesthesiology* 1980;53:26.
108. Laupacis A, Sekar N, Stiell IG. Clinical prediction rules: a review and suggested modifications of methodological standards. *JAMA* 1997;177:488–494.
109. Orkin FK, Leventhal SR, Hirsh RA. Predicting respiratory failure following thymectomy. *Ann N Y Acad Sci* 1981;377:862.
110. Charlson ME, Ales KL, Simon R, et al. Why predictive indexes perform less well in validation studies: is it magic or methods? *Arch Intern Med* 1987;147:2155.
111. Grant RP, Jenkins LC. Prediction of the need for postoperative mechanical ventilation in myasthenia gravis: thymectomy compared to other surgical procedures. *Can Anaesth Soc J* 1982;29:112.
112. Eisenkraft JB, Papatestas AE, Kahn CH, et al. Predicting the need for postoperative mechanical ventilation in myasthenia gravis. *Anesthesiology* 1986;65:79.
113. Section on Legal Medicine: fatal application of chloroform. *Edinburgh Med Surg J* 1848;69:498.
114. Minuck M. Death in the operating room. *Can Anaesth Soc J* 1967;14:197.
115. Schapira M, Kepes ER, Hurwitt ES. An analysis of deaths in the operating room and within 24 hours of surgery. *Anesth Analg* 1960;39:149.
116. Phillips OC, Frazier TM, Graff TD, et al. The Baltimore Anesthesia Study Committee: review of 1,024 postoperative deaths. *JAMA* 1960;174:2015.
117. Clifton BS, Hotten WIT. Deaths associated with anaesthesia. *Br J Anaesth* 1963;35:250.
118. Greene NM, Bannister WK, Cohen B, et al. Survey of deaths associated with anaesthesia in Connecticut: a review of 120,935 anaesthetics. *Conn Med* 1959;23:512.
119. Memery HN. Anaesthesia mortality in private practice: a ten-year study. *JAMA* 1965;194:1185.
120. Gebbie D. Anaesthesia and death. *Can Anaesth Soc J* 1966;13:390.
121. Harrison GG. Anaesthetic contributory death: its incidence and causes. Part I. Incidence. *S Afr Med J* 1968;42:514.
122. Holland R. Anaesthetic mortality in New South Wales. *Br J Anaesth* 1987;59:834.
123. Pitt-Miller P. Deaths with 24 hours of surgical procedures at the Port-of-Spain General Hospital (January 1976 to December 1987). *West Indian Med J* 1989;38:148.
124. Chopra V, Bovill JG, Spierdijk J. Accidents, near accidents and complications during anaesthesia: a retrospective analysis of a 10-year period in a teaching hospital. *Anaesthesia* 1990;45:3.
125. Pausawasdi S. Morbidity and mortality of anaesthesia in Thai patients. *J Med Assoc Thailand* 1986;69:407.
126. Tan I, Delilkan A. Anaesthetic contribution to deaths in the operating theatre at the University Hospital Kuala Lumpur: a retrospective survey. *Med J Malaysia* 1993;48:397.
127. Tikkanen J, Hovi-Viander M. Death associated with anaesthesia and surgery in Finland in 1986 compared to 1975. *Acta Anaesthesiol Scand* 1995;39:262.
128. Pedersen T, Eliassen K, Henriksen E. A prospective study of mortality associated with anaesthesia and surgery: risk indicators of mortality in hospital. *Acta Anaesthesiol Scand* 1990;34:176.
129. Warden JC, Borton CL, Horan BF. Mortality associated with anaesthesia in New South Wales, 1984–1990. *Med J Aust* 1994;161:585.
130. Coetzee A. Mortality associated with anaesthesia. *S Afr Med J* 1996;86:973.
131. Eagle CC, Davis NJ. Report of the Anaesthetic Mortality Committee of Western Australia 1990–1995. *Anaesth Intensive Care* 1997;25:51.
132. Lienhart A, Auroy Y, Pequignot F, et al. Survey of anaesthesia-related mortality in France. *Anesthesiology* 2006;105:1087.
133. Comments by Chauncey Starr, as cited by Bendixen HH. What are the important questions regarding the delivery of anaesthesia care and how should we go about answering them? In: Hirsh RA, Forrest WH Jr, Orkin FK, et al., eds. *Health Care Delivery in Anesthesia*. Philadelphia: George F. Stickley, 1980:183.
134. US national estimate for Year 2004 based on US Agency for Healthcare Research and Quality's HCUP Nationwide Inpatient Sample. Available at: <http://hcup.ahrq.gov/HCUPnet>. Accessed January 30, 2007.
135. Vacanti CJ, Van Houten RJ, Hill RC. A statistical analysis of the relationship of physical status to postoperative mortality in 68,388 cases. *Anesth Analg* 1978;49:233.
136. Owens WD, Felts JA, Spitznagel EL Jr. ASA physical status classifications: a study of consistency of ratings. *Anesthesiology* 1978;49:239.
137. Haynes SR, Lawler PGP. An assessment of the consistency of ASA physical status classification allocation. *Anaesthesia* 1995;50:195.
138. Mak PH, Campbell RC, Irwin MG. The ASA Physical Status Classification: inter-observer consistency. *Anaesth Intensive Care* 2002;30:633.
139. Barbeito A, Muir HA, Gan TJ, et al. Use of a modifier reduces inconsistency in the American Society of Anesthesiologists Physical Status Classification in parturients. *Anesth Analg* 2006;102:1231.
140. Wolters U, Wold T, Stützer H, et al. ASA classification and perioperative variables as predictors of postoperative outcome. *Br J Anaesth* 1996;77:217.
141. Cullen DJ, Apolone G, Greenfield S, et al. ASA Physical Status and age predict morbidity after three surgical procedures. *Ann Surg* 1994;220:3.
142. Froehner M, Koch R, Litz R, et al. Comparison of the American Society of Anesthesiologists Physical Status classification with the Charlson score as predictors of survival after radical prostatectomy. *Urology* 2003;62:698.
143. Boruk M, Chernobilsky B, Rosenfeld RM, et al. Age as a prognostic factor for complications of major head and neck surgery. *Arch Otolaryngol Head Neck Surg* 2005;131:605.
144. Carson JL, Duff A, Berlin JA, et al. Perioperative blood transfusion and postoperative mortality. *JAMA* 1998;279:199.
145. Knaus WA, Draper EA, Wagner DP, et al. APACHE II. A severity of disease classification system. *Crit Care Med* 1985;13:818.
146. Keeler ER, Kahn EL, Draper D, et al. Changes in sickness at admission following the introduction of the prospective payment system. *JAMA* 1990;264:1962.
147. Holt NF, Silverman DG. Modeling perioperative risk: can numbers speak louder than words? *Anesthesiol Clin North America* 2006;24:427.
148. Pasternak LR. Preoperative assessment: guidelines and challenges. *Acta Anaesthesiol Scand* 1997;111(Suppl):318.
149. Detsky AS, Abrams HB, Forbath N, et al. Cardiac assessment for patients undergoing noncardiac surgery: a multifactorial clinical risk index. *Arch Intern Med* 1986;146:2131.
150. Lee TH, Marcantonio ER, Mangione CM, et al. Derivation and prospective validation of a simple index for prediction of cardiac risk of major noncardiac surgery. *Circulation* 1999;100:1043.
151. O'Connor GT, Plume SK, Olmstead EM, et al. Multivariate prediction of in-house mortality associated with coronary artery bypass graft surgery. *Circulation* 1992;85:2110.
152. Iezzoni LI, Ash AS, Shwartz M, et al. Predicting who dies depends on how severity is measured: implications for evaluating patient outcomes. *Ann Intern Med* 1995;123:763.
153. Epstein AM, Stern RS, Tognetti J, et al. The association of patients' socioeconomic characteristics with the length of hospital



- stay and hospital charges within diagnosis-related groups. *N Engl J Med* 1988;318:1579.
154. Liu JH, Zingmond DS, McGory ML, et al. Disparities in the utilization of high-volume hospitals for complex surgery. *JAMA* 2006;296:1973.
155. Silber JH, Williams SV, Krakauer H, et al. Hospital and patient characteristics associated with death after surgery: a study of adverse occurrence and failure to rescue. *Med Care* 1992;30:615.
156. Silber JH, Rosenbaum PR, Ross RN. Comparing the combinations of groups of predictors: which outcomes vary with hospital rather than patient characteristics? *J Am Stat Assoc* 1995;90:7.
157. Aiken LH, Clarke SP, Sloane DM, et al. Hospital nurse staffing and patient mortality, nurse burnout, and job satisfaction. *JAMA* 2002;288:1987.
158. Orkin FK. Patient outcome following anesthesia care: role of the provider. *Probl Anesth* 1992;6:212.
159. Moses LE, Mosteller F. Institutional differences in postoperative death rates: commentary on some of the findings of the National Halothane Study. *JAMA* 1968;203:492.
160. Scott WR, Forrest WH Jr, Brown BW. Hospital structure and postoperative mortality and morbidity. In: Shortell SM, Bown M, eds. *Organizational Research in Hospitals*. Chicago: Inquiry (Blue Cross Association), 1972:72.
161. Staff of the Stanford Center for Health Care Research. Comparison of hospitals with regard to outcomes of surgery. *Health Serv Res* 1976;11:112.
162. Flood AB. Hospital organization and outcomes of care. In: Hirsh RA, Forrest WH Jr, Orkin FK, et al., eds. *Health Care Delivery in Anesthesia*. Philadelphia: George F. Stickley, 1980:105.
163. Flood AB, Scott WR, eds. *Hospital Structure and Performance*. Baltimore: Johns Hopkins University Press, 1987.
164. Brennan TA, Horwitz RI, Duffy FD, et al. The role of physician specialty board certification status in the quality movement. *JAMA* 2004;292:1038.
165. Prystowsky JB, Bordage G, Feinglass JM. Patient outcomes for segmental colon resection according to surgeon's training, certification, and experience. *Surgery* 2002;132:663.
166. Kohatsu ND, Gould D, Ross LK, et al. Characteristics associated with physician discipline: a case-control study. *Arch Intern Med* 2004;164:653.
167. Rosenthal GE, Harper DL, Quinn LM, et al. Severity-adjusted mortality and length of stay in teaching and nonteaching hospitals: results of a regional study. *JAMA* 1997;278:485.
168. Ayanian JZ, Weissman JS. Teaching hospitals and quality of care: a review of the literature. *Milbank Q* 2002;80:569.
169. Luft HS, Bunker JP, Enthoven AC. Should operations be regionalized? The empirical relation between surgical volume and mortality. *N Engl J Med* 1979;30:1364.
170. Luft HS, Garnick DW, Mark DH, et al. Hospital Volume, Physician Volume, and Patient Outcomes: Assessing the Evidence. Ann Arbor, MI: Health Care Administration Press, 1990.
171. Dimick JB, Welch HG, Birkmeyer JD. Surgical mortality as an indicator of hospital quality: the problem with small sample size. *JAMA* 2004;292:847.
172. Jenkins KJ, Newberger JW, Lock JE, et al. In-hospital mortality for surgical repair of congenital heart defects: preliminary observations of variation by hospital case-load. *Pediatrics* 1995;95:323.
173. Begg CB, Cramer LD, Hoskins WJ, et al. Impact of hospital volume on operative mortality for major cancer surgery. *JAMA* 1998;280:1747.
174. Birkmeyer JD, Siewers AE, Finlayson EV, et al. Hospital volume and surgical mortality in the United States. *N Engl J Med* 2002;346:1128.
175. Pronovost PJ, Jenckes MW, Dorman T, et al. Organizational characteristics of intensive care units related to outcomes of abdominal aortic surgery. *JAMA* 1999;281:1310.
176. Pronovost PJ, Dang D, Dorman T, et al. Intensive care unit nurse staffing and the risk for complications after abdominal aortic surgery. *Eff Clin Pract* 2001;4:199.
177. Sexton JB, Thomas EJ, Helmreich RL. Error, stress, and teamwork in medicine and aviation: cross sectional surveys. *BMJ* 2000;320:745.
178. Makary MA, Sexton JB, Freischlag JA, et al. Operating room teamwork among physicians and nurses: teamwork in the eye of the beholder. *J Am Coll Surg* 2006;202:746.
179. Awad SS, Fagan SP, Bellows C, et al. Bridging the communication gap in the operating room with medical team training. *Am J Surg* 2005;190:770.
180. McArdle CS, Hole D. Impact of variability among surgeons on postoperative morbidity and mortality and ultimate survival. *BMJ* 1991;302:1501.
181. Gilbert J. Outcome: experience and training of the anesthetist. In: Hirsh RA, Forrest WH Jr, Orkin FK, et al., eds. *Health Care Delivery in Anesthesia*. Philadelphia: George F. Stickley, 1980:143.
182. Slogoff S, Keats AS. Does perioperative myocardial ischemia lead to postoperative myocardial infarction? *Anesthesiology* 1985;62:107.
183. Forrest WH Jr. Outcome: the effect of the provider. In: Hirsh RA, Forrest WH Jr, Orkin FK, et al., eds. *Health Care Delivery in Anesthesia*. Philadelphia: George F. Stickley, 1980:137.
184. Bechtoldt AA Jr. Committee on anesthesia study: anesthetic-related deaths: 1969-1976. *N C Med J* 1981;42:253.
185. Pine M, Holt KD, Lou YB. Surgical mortality and type of anesthesia provider. *AANA J* 2003;71:109.
186. Arbus MS, Meursing AEE, van Kleef JW, et al. Impact of anesthesia management characteristics on severe morbidity and mortality. *Anesthesiology* 2005;102:257.
187. Lipkus IM, Samsa G, Rimer BK. General performance on a numeracy scale among highly educated samples. *Med Decis Making* 2001;21:37.
188. Woloshin S, Schwartz LM, Welch HG. Patients and medical statistics: interest, confidence, and ability. *J Gen Intern Med* 2005;20:1071.
189. Weinfurt KP, Depuy V, Castel LD, et al. Understanding of an aggregate probability statement by patients who are offered participation in Phase I clinical trials. *Cancer* 2005;103:140.
190. Edwards A, Elwyn G, Mulley A. Explaining risks: turning numerical data into meaningful pictures. *BMJ* 2002;324:827.
191. Epstein RM, Alper BS, Quill TE. Communicating evidence for participatory decision making. *JAMA* 2004;291:2359.
192. Belda FJ, Aguilera L, Garcia de la Asuncion J, et al. Supplemental perioperative oxygen and the risk of surgical wound infection: a randomized controlled trial. *JAMA* 2005;294:2053.
193. Exadaktylos AK, Buggy DJ, Moriarty DC, et al. Can anesthetic technique for primary breast cancer surgery affect recurrence of metastasis? *Anesthesiology* 2006;105:660.



## CHAPTER 25

### Approaches to Quality Improvement in Anesthesia Care

David S. Smith, MD, PhD,  
and Lee A. Fleisher, MD

There has been a dramatic increase in the public's concern about the quality of patient care and the determination of the extent with which errors occur during the provision of that care since the 1999 publication of the Institute of Medicine monograph *To Err is Human*.<sup>1</sup> This concept of quality includes ensuring that the care is both beneficial and cost-effective and has placed unprecedented demands on all health-care providers to prove the safety and value of the care they deliver.

Until recently, the autonomy of the individual practitioner to provide care in a manner in which they deemed best was paramount. In the hospital setting, the quality of care was ensured by preemployment credentialing with casual periodic renewal and episodic case conferences with the primary reliance on the individual professionalism of each practitioner. This no longer suffices. Groups, regardless of specialty, are being asked to identify potential sources of error both within their practices and within the entire healthcare system. It is now assumed by hospital chief executives and medical officers that groups will establish procedures and protocols to minimize risk and to collaborate with other professional groups within a health system. For example, it is expected that anesthesiologists will collaborate with surgeons and nurses to cross-check and confirm correctness at certain critical points in a patient's care (e.g., time-out before incision or checking transplantation organ compatibility). As part of the continued support of a group, they are expected to document the approaches being used to evaluate and improve the quality and safety of the care provided.

These concerns about patient safety are being driven at many levels (Table

25-1). In addition to traditional accrediting agencies, hospital boards of directors and credentialing committees, state boards of medicine, legislatures, the federal government, including Congress, and even the courts are increasingly involved. Patient safety and quality improvement is an area that is rapidly changing, the terminology often cryptic, and the sources of information outside those that are usually consulted by anesthesiologists. This chapter demystifies the processes related to quality improvement and discusses several available toolsets that provide quality assurance, including the approach in use at the University of Pennsylvania Health System. Questions addressed include: How does one determine the quality of care provided by a group of anesthesiologists? How does one identify errors in care? What is meant by a critical incident? How does one establish a pro-

cess to improve the quality and safety of care provided? How should this process be documented?

#### TERMINOLOGY

A variety of terms are used to define aspects of patient safety, risk reduction, and quality of care. Some of these terms are duplicative. For a number of terms the meaning has changed over time. The following are terms and their definitions as used by the Joint Commission on Accreditation of Healthcare Organizations (JCAHO) in its recent standards and reporting documentation.

#### Medical Error

This is defined as an unintended act, whether by omission or commission, or an act that does not achieve its intended outcome. This is clearly a very broad definition. With regard to

#### KEY POINTS

1. There is significant public dissatisfaction with the level of safety associated with medical care in the United States. This issue has been taken up by many legislative and governmental regulatory bodies at both federal and state level.
2. The demand for greater patient safety (i.e., error reduction) has created multiple new levels of regulation and demands for accountability that go well beyond the traditional.
3. The traditional approach of practitioner accountability is giving way to approaches that additionally emphasize systems redesign and group managed processes.
4. The demands for accountability requires that individual practitioners, groups of practitioners, hospitals, and entire health systems implement methods that allow documentation of outcome and process.
5. Relying on review systems such as the case conference and focusing on the individual patient is inadequate for the level of error remediation demanded. New approaches that allow examination of aggregate performance across a hospital or health system need to be developed and implemented. This is particularly challenging for perioperative anesthesia care considering the already low level of adverse outcomes.
6. For many practitioners, reimbursement in the future will be linked to both outcome and demonstrated compliance with process variables such as perioperative antibiotic administration. Systems that allow documentation at the individual patient level need to be developed or reimbursement and accreditation may be compromised.
7. The level of sophistication with respect to outcome and process evaluation in the intensive care unit has increased significantly more than that in the operating room. A significant body of work exists to guide the improvement of care and to decrease the error rate in this subspecialty of anesthesia practice.
8. Safety and evaluation of outcome for acute pain therapy lags. Part of this may be related to the fact that decisions about acute pain therapy are often split between multiple groups. In addition, there is little definition of what are adequate levels of acute pain relief, how to accurately measure adequacy of pain relief, and how to monitor to prevent the complications of opioid-based pain therapy.

**TABLE 25-1.**

**Organizations with an Interest in the Quality of Medical Care and Patient Safety**

- Agency for Healthcare Research and Quality (AQRH, part of the United States Department of Health and Human Services)
- American Medical Association (AMA)
- Anesthesia Patient Safety Foundation (APSF)
- American Society of Anesthesiologists (ASA)
- Centers for Medicare and Medicaid Services (CMS, part of the United States Department of Health and Human Services)
- Food and Drug Administration (FDA, part of the United States Department of Health and Human Services)
- Institute of Medicine of the National Academies (IOM)
- Joint Commission International Center for Patient Safety
- Joint Commission on Accreditation of Healthcare Organizations
- National Quality Forum (NQF)
- World Health Organization (WHO)
- Consumers of healthcare
- Legislative bodies both state and federal
- Local law enforcement organizations
- Purchasers of healthcare
- State boards of medicine

unintended acts, it is important to recognize that activities that were once considered appropriate care may now be considered a medical error and vice versa.

**Sentinel Events**

As defined by the JCAHO, a sentinel event is “an unexpected occurrence involving death or serious physical or psychological injury, or the risk thereof. Serious injury specifically includes loss of limb or function. The phrase ‘risk thereof’ includes any process variation for which a recurrence would carry a significant chance of a serious event outcome.” The JCAHO notes that the term *sentinel* reflects an event that requires immediate investigation and response. At a leadership level, the JCAHO requires an integrated patient safety program that includes in part (a) a definition of the types of occurrences to be addressed; (b) a mecha-

**TABLE 25-2.**

**Joint Commission on Accreditation of Healthcare Organizations’ Sentinel Events That Might Be Related to Anesthesia Care<sup>a</sup>**

- Abduction
- Delivery of radiotherapy to the wrong body region or >25% above the planned radiotherapy dose.
- Discharge of an infant to the wrong family
- Events that result in an unanticipated death or major permanent loss of function and are unrelated to the natural course of the patient’s illness or underlying condition
- Hemolytic transfusion reactions because of major blood group incompatibilities
- Prolonged fluoroscopy with a cumulative dose of >1500 rads to a single field
- Rape
- Severe neonatal hyperbilirubinemia
- Suicide during treatment or within 72 hours of discharge
- Surgery on the wrong patient or body part regardless of magnitude of procedure
- Unanticipated death of a full-term infant
- Unintended retention of a foreign body after surgery or other procedure

<sup>a</sup>Though some of these events may seem remote from the experiences of anesthesiologists whose practices are confined to the operating room, those doing interventional pain therapy, block placement with fluoroscopic guidance or intensive care need to be concerned with the broader range of these events.

Adapted from the Joint Commission on Accreditation of Healthcare Organizations. Sentinel event policy and procedures; updated June 2005. [www.jointcommission.org](http://www.jointcommission.org)

nism to ensure that all relevant areas of the healthcare organization participate and that their activities are integrated; (c) a procedure of immediate response including care of the affected patient, containment of the risk to others, preservation of information for future review; (d) a clear system for internal and external reporting; (e) a defined mechanism for responding to various types of occurrences; and (f) reporting at least yearly on occurrence of errors and efforts to improve patient safety both proactively and in response to

actual occurrences. Thus reporting, categorizing, and review of serious events is required and mechanisms need to be established to accomplish this goal (Table 25-2).

In addition to the JCAHO, other organizations have begun to require the documentation and reporting the equivalent of the JCAHO sentinel event. Currently in the United States (2007), about 25 states require reporting (Table 25-3). Although the specific events and terminology may vary, there are common concepts that tend to follow the JCAHO descriptions. For example, New Jersey requires reporting “every serious preventable adverse event, defined as an adverse event that is preventable and results in a patient death, loss of body part, disability, or loss of bodily function lasting for more than seven days or still present at the time of discharge (Interim Mandatory Patient Safety Reporting Requirements for General Hospitals, New Jersey Department of Health and Human Services, 2004). Preventable event means an event that could have been anticipated and prepared against, but occurs because of an error or other system failure.” In the case of New Jersey, reporting is due within 2 days, but no later than 5 days after the event. Specifically delineated events that might be associated with perioperative anesthetic care include hemolytic reactions from administration of ABO-incompatible blood or blood products, electric shock, burns, injuries from the use of restraints, malfunction of ventilators or infusion pumps, surgery on the wrong body part, wrong patient,

**TABLE 25-3.**

**States with Adverse Event Reporting Rules**

California	Colorado
Connecticut	Florida
Georgia	Illinois
Indiana	Kansas
Maine	Maryland
Massachusetts	Minnesota
New Jersey	Nevada
New York	Ohio
Oregon	Pennsylvania
Rhode Island	South Carolina
South Dakota	Tennessee
Texas	Utah
Washington	

and wrong surgical procedure. They also include intraoperative or postoperative (within 12 hours) coma, death, or other serious preventable adverse event for any American Society of Anesthesiologists (ASA) physical status (PS) 1 inpatient or any same-day-surgery patient regardless of ASA physical status. Other states, such as Pennsylvania, are less prescriptive. The Pennsylvania statute, Medical Care Availability and Reduction of Error (MCARE) Act (Act 13 of 2002), does not use the “sentinel event” terminology but rather defines a *serious event* as an event, occurrence or situation involving the clinical care of a patient in a medical facility that results in death or compromises patient safety and results in an unanticipated injury that required the delivery of additional healthcare services to the patient. The act further defines the term *incident* as an event that could have produced unexpected injury to a patient in a way similar to that defined under serious event. Several investigators have begun using state databases of reported events to determine the safety of different practices such as office-based anesthesia care.

### Near Miss

This is defined as a “process variation” that did not affect the outcome, but for which recurrence carries a significant chance of a serious adverse outcome. These events are not subject to review by the JCAHO but need to be appropriately reviewed and changes made to decrease the risk of the event happening again.

### Hazardous Conditions

These are defined as circumstances (not including the disease or condition for which the patient is being treated) that significantly increase the likelihood of a serious adverse outcome. A wet floor, for example, presents a hazardous condition that might increase the risk of a patient fall. The JCAHO has now made prevention of patient falls a national patient safety goal, thus identification of both those at risk and hazardous conditions for those who are at risk are a national priority.

### Sentinel Event Alerts

The JCAHO introduced this mechanism to bring attention to situations that might lead to sentinel events. Among the many events are a number that potentially involve the practice of

anesthesia or intensive care, including high concentrations of potassium chloride; wrong-side surgery; restraint deaths; high-alert medications; operative and postoperative complications; infusion pump malfunction; look-alike sound-alike drugs; medical gas mix-ups; needles and sharps injuries; dangerous abbreviations; ventilator-related events; delays in treatment; nosocomial infections; surgical fires; anesthesia awareness; and patient-controlled analgesia. Once an alert occurs, it is important that it is disseminated throughout the organization.

The specialty of anesthesiology has recently addressed one of these sentinel alerts in a more formal manner. On October 6, 2004, the JCAHO issued an alert on *Preventing and Managing the Impact of Anesthesia Awareness*. The alert stated that

To overcome the limitations of current methods to detect anesthesia awareness, new methods are being developed that are less affected by the drugs typically used during general anesthesia. These devices measure brain activity rather than physiological responses. These electroencephalography (EEG) devices (also called level-of-consciousness, sedation-level and anesthesia-depth monitors) include the Bispectral Index (BIS), spectral edge frequency (SEF), and median frequency (MF) monitors. These devices may have a role in preventing and detecting anesthesia awareness in patients with the highest risk, thereby ameliorating the impact of anesthesia awareness. A body of evidence has not yet accumulated to definitely define the role of these devices in detecting and preventing anesthesia awareness; the Joint Commission expects additional studies on these subjects to emerge. In its review of the Bispectral Index (BIS) monitor, the Food and Drug Administration determined that “Use of BIS monitoring to help guide anesthetic administration may be associated with the reduction of the incidence of awareness with recall in adults during general anesthesia and sedation.”

The JCAHO recommended that healthcare organizations which perform procedures under general anesthesia develop and implement an anesthesia awareness policy. Because many practitioners were concerned

that a particular monitoring device was being endorsed, they developed a sample departmental policy on intraoperative awareness that is available to members. It is important to recognize that there are resources available to help address some of these alerts.

## QUALITY OF CARE INDICATORS

A broad definition for reportable events such as those found for sentinel events or serious events presented earlier may be difficult for practitioners to use on a day to day basis to decide what should or should not be reported. Without detracting from the need to report at a broad level, defining specific reporting indicators provides operational definitions that speeds this decision making. The quality of care indicators in Table 25-4 are those in use by the Department of Anesthesiology and Critical Care at the University of Pennsylvania. They are based on material developed initially by an Anesthesia Care Task Force convened by the JCAHO in 1987, although they have been updated and adapted to meet the needs of the Department.<sup>2</sup> These are outcome indicators and do not include newly developed process indicators such as on-time antibiotic administration or time-out documentation.

Reporting of adverse events needs to be encouraged. The aviation industry has used self-reporting for a number of years to detect situations at risk for serious events (for an overview, see ref. 3). This reporting is nonpunitive, whereas failure to report may compromise one’s employment position. An environment in which reporting is encouraged can only be created if the act of reporting does not create negative repercussions. Anonymous reporting may be helpful, but compromises the ability to followup and determine events at the level of detail that might be required. There has been debate about whether or not voluntary reporting is adequate and a number of institutions have reported their experiences with scanning of anesthesia records for vital sign excursions beyond predefined boundaries. Others have used chart review by sampling a portion of the anesthetics performed. Given the relative rarity of many of the most serious anesthesia-related incidents and events, sampled chart reviews may miss critical cases. Chart scanning for acceptable vital sign boundaries might



TABLE 25-4.

## Quality Improvement Indicators Related to Anesthesia

Awareness under anesthesia
Blood or blood product transfusion reactions
Can't ventilate, Can't intubate
Cancellation of surgery after induction of anesthesia
Central nervous system complication <sup>a</sup> (stroke, failure to regain consciousness, etc.)
Code call related (includes failure to respond, inappropriate interaction, failure to establish an airway, etc.)
Death <sup>a</sup>
Dental injury
Myocardial infarction <sup>a</sup> (regardless of mildness, any postoperative troponin increase triggers review)
Perioperative cardiac arrest
Peripheral nervous system complications <sup>a</sup> (paresthesia, neuropathies, etc.)
Physical injury except for dental injury
Reintubation in postanesthesia care unit or operating room (unplanned, excludes predefined trials of extubation)
Severe anesthesia-related drug reactions (includes anaphylactic or phylactoid reactions; errors in drug administration with respect to drug given, dose given, or route given; idiosyncratic reactions; etc.)
Significant patient dissatisfaction with anesthesia care
Vascular injury (typically related to placement of central catheters; for example, carotid puncture with large-bore sheath)
Other (anything not covered above)

<sup>a</sup>Review cut off is 48 hours post operatively. These are the indicators currently used in the Department of Anesthesiology and Critical Care at the University of Pennsylvania, Philadelphia, PA.

generate more false positives than can be reasonably reviewed, depending on the patient population of a particular institution. "Buy in" for voluntary reporting provides the ability to identify the uncommon but serious events. Voluntary reporting need not be limited to members of an anesthesia department. We have found that observations by others, such as nurses and surgical house staff, can be valuable additions to the quality improvement process.

## ASSESSMENT OF PATIENT QUALITY OF CARE INFORMATION

## Peer Review

Peer review has been a part of anesthesia practice for more than 70 years. One of the earliest documented uses of peer review for anesthesia-related mortality was by Ruth, in 1935, when he helped establish the first anesthesia study commission to analyze perioperative deaths.<sup>4</sup> The commission relied on voluntary submission of cases and determined the cause of death by majority vote. The peer review process actually approaches the analysis of care in a much more systematic way today, but clearly there is a long tradition in the field of trying to identify those cases in which the actions of the anesthesiologist contributes to mortality. It is also common today for perioperative deaths (and major complications) to be reviewed by multiple individuals who were not directly responsible for the care of the patient. For example, the reviewers may include a quality assurance officer in the anesthesia department, but may also include individuals in surgery, nursing, and pharmacy.

## Mortality and Morbidity Conferences

Mortality and morbidity conferences (Table 25-5) are a common occurrence in surgical departments, although less commonly used in anes-

thesia departments. In brief, all cases of mortality and morbidity that occur during a defined period are briefly presented to the rest of the department and the etiology of the complication and potential means of improving care in the future are discussed. Despite their long use and honored place in medical training and performance evaluation, these types of conferences have not produced the levels of safety currently expected. In many departments they tend to focus on technical aspects of the care provided and often digress into discussions of how, not whether, a particular intervention should have been done. In addition, they have had little impact on important issues of patient identification and wrong-side surgery. Because they tend to focus on the individual case they tend to fail in recognizing infrequent events. The single-case approach slights trends and risks that can only be detected by grouping events and performing various types of data analyses. Although this type of conference still has a place, as a tool to improve patient safety it has been less than optimal and other approaches need to be implemented as well.

One approach to using the morbidity and mortality conference effectively at the University of Pennsylvania is through the joint conferences with other departments. Specifically, we periodically present cases to a joint group of surgeons and anesthesiologists. There is a focus on cases in

TABLE 25-5.

## Comparing Traditional Mortality and Morbidity Conferences to Systems-Oriented Conferences

Traditional	Systems-Oriented
Absolute individual practitioner responsibility	Examines the role of the "system" in contributing to error without diminishing the need for individual responsibility
Focuses on individual care	Allows for examination across larger patient groups, often beyond individual practitioner
Does not adequately recognize the role of groups and group interaction	Emphasizes group contributions toward common goal of patient safety and error reduction
Exhortation to "do better" key route for problem solution	Explores possible changes in the "system" to reduce probability of error
Continued high rate of medical error despite long history of this approach to improving patient care	Too new to know if there will be a significant reduction in error
"Shame" and "blame" may make discussions less than forthcoming	Emphasis on totality of risk may allow better discussion



which more effective teamwork or communication could have led to better outcomes. This joint multispecialty conference has proven to be a very effective method for obtaining more widespread buy-in to quality assurance processes. Senior faculty members and the respective departmental leaders have been very willing to participate. The concept has expanded from joint conferences with general surgery and anesthesia to conferences with other surgical specialties and even with our colleagues in perioperative nursing.

## Root Cause Analysis

Root cause analysis is a more structured process than traditional peer review for identifying the causal or contributing factors leading to major morbidity or mortality (see [www.patientsafety.gov/rca.html](http://www.patientsafety.gov/rca.html)). A root cause analysis must include the following:

1. Determination of human and other factors
2. Determination of related processes and systems
3. Analysis of underlying cause-and-effect systems through a series of “why?” questions
4. Identification of risks and their potential contributions
5. Determination of potential improvement in processes or systems

The approach demands that bad outcomes not be attributed to the first error discovered, but rather that it is important to review all of the potential sources of error or systems problems that led to the adverse event. A systems approach allows one to discover all of the potential areas that can lead to an adverse event. Reason<sup>5</sup> popularized the concept of latent error; that is, risks associated with, but not manifest with, a process. Usually multiple latent errors are required before an adverse event occurs. For example, an anesthesiologist may give the wrong medication but contributing factors may be containers with similar size and lettering, low light levels in an operating room, a distressingly high level of music, and a malfunctioning inspiratory valve, the correction of which has created a distraction. Typically, these factors do not all occur at once and the patient receives the correct medication. Focusing only on the last error (the giving of the wrong

medication) will not correct the underlying cause of the error nor will it decrease the probability of avoiding a similar error in the future.

## Failure Modes and Effects Analysis

Failure modes and effects analysis (FMEA) is a systematic method of evaluating a process to identify where and how it may fail. Whereas root cause analysis assesses cause after an event has occurred, the goal of FMEA is to anticipate risks, alter processes and thus avoid adverse events. According to the Institute for Healthcare Improvement, FMEA includes review of the following:

- Steps in the process
- Failure modes (What could go wrong?)
- Failure causes (Why would the failure happen?)
- Failure effects (What would be the consequences of each failure?)

Tools have been developed to perform a FMEA. Each failure mode gets a numeric score that quantifies (a) likelihood that the failure will occur, (b) likelihood that the failure will be detected, and (c) the amount of harm or damage the failure mode may cause to a person or to equipment. The product of these three scores is the risk priority number (RPN) for that failure mode. The sum of the RPNs for the failure modes is the overall RPN for the process.

For example, FMEA can be used to look at blood bank processes even if no adverse event occurred. It can also be used by groups of clinicians to test or simulate a process before it is incorporated into routine clinical care. This may lead to improvements in the process. Paradoxically, a proposed “improvement in care” may be found to increase the RPN rather than decrease it and therefore should not be implemented. The RPN can also be used to determine if implemented process changes actually resulted in lower potential risk.

## AN APPROACH TO QUALITY OF CARE IMPROVEMENT

### Data Acquisition

#### Observer Reporting

Acquiring information about patient outcomes, adverse events, and inci-

dents that might have led to adverse events is the first step for any quality review process. Event reporting by the caregivers or observers has been contrasted to chart review. Manual chart review can be labor intensive and the yield may be low for the infrequent events of most interest to anesthesiologists. Chart review may be complementary to incident reporting and in fact may identify different populations of patients.<sup>6</sup> Reporting by those involved needs to be encouraged. Ease of reporting,<sup>7</sup> comfort providing reports, and the feeling that reporting may lead to useful evaluation and change may contribute to higher reporting rates. A process that leads to retribution for error will decrease reporting.

Whether or not caregiver incident reporting produces adequate response rates is a topic for debate. Sanborn et al. suggested that in their institution there was a low level of compliance with voluntary reporting of defined intraoperative incidents.<sup>8</sup> In contrast, Lagasse described a program claiming a near 100% response rate with a nonthreatening quality assurance system.<sup>9,10</sup> Katz and Lagasse reported on incidents captured after 37,924 anesthetics by self-reporting, chart reviews, and an incident report process.<sup>11</sup> They found that self-reporting for events resulting in disabling patient injury was very high. They found no significant benefit to chart review compared to self-reporting.

### Automated Data Acquisition

Over the past decade there has been a marked acceleration of the implementation of hospital information systems and continuing refinement of intraoperative data record keepers or anesthesia information management systems (AIMS). The AIMS have the ability to capture and identify multiple outcomes of interest and intraoperative events (e.g., blood pressure changes, drugs). Data from individual patients can be aggregated and linked to pre-defined clinical and/or resource use outcomes. Although there is concern about the accuracy of the information obtained from the AIMS related to the potential “smoothing” of intraoperative data, studies in this area have reported a higher degree of accuracy than data obtained from a traditional “hand written” record or self-reporting.<sup>12,13</sup> Of greatest concern in the potential use of these large databases

is the potential for “data mining.” It is important to recognize that the associations that might be found from these types of analyses are just associations, and when a large number of variables are examples, there is a good statistical probability that these associations will be found. Thus it is important to recognize that these are hypothesis generating, rather than hypothesis confirming or disproving. Nonetheless, the increasing implementation of AIMS should lead to an improved ability to identify morbidity and mortality and to reconstruct the potential factors that led to the complications.

### **Computer-Assisted Data Acquisition**

Computers can assist in the acquisition of incident and event information. In the fourth quarter of 2002 our institution went online with a computerized report-entry system. Embedded within the system are the quality improvement indicators that we had been following for anesthesia-related events. The system is accessible from any computer within the medical center's domain, which includes every operating room, strategic locations outside the operating room, postanesthesia care units, intensive care units, and all faculty offices. Prior to this system going online, we would typically receive about 50–100 reports per year regarding patient-related events. Most of these came from anesthesia faculty and residents. The year after the computer system went online, 250 events were logged in, with at least half coming from nonanesthesia observers. Currently we receive about 300 reports per year of events or incidents that might be related to the activities of anesthesiologists. The system has greatly improved our capture of potential issues. In addition, there is faster access to these reports than was possible when a paper-based system was in use.

### **Data Verification**

The medical record is the ultimate source of data verification. With respect to serious events, discussions with those involved before memory fades and review of the anesthesia record and other associated records are critical. We have found that single reports may be inaccurate or the reporter unaware of the entire clinical situation. Thus reports are a start, and depending on the nature of the event, more investigation may be required.

In some situations, we undertake these reviews internally. When there appears to be significant multidisciplinary issues, we ask our medical center risk management group to conduct a formal root cause analysis.

### **Database Entry**

The data obtained often contains patient identifiers and information of a sensitive nature. Clearly, basic precautions to avoid theft of this data or its publication need to be taken. Password protection of computer files using strong passwords and possibly encryption appear necessary. Paper records should be kept in locked offices or filing cabinets. We do not store any of our patient safety data on portable computers. We store the data on medical center servers that are routinely backed up and maintained behind a firewall. Patient records are not removed from the medical center, as records of this nature have been, for example, stolen from automobiles and briefcases have been mislaid in restaurants. We attempt to maintain all of our patient safety/quality improvement data within the peer review system to decrease the risk of discoverability during any medicolegal process.

Consideration must also be given to the personnel entrusted with database entry. Diversion of records from their intended purposes by clerks and others has occurred. We also make sure that the records are not left out on desks when those doing data entry leave the area.

### **Review of Data Moving Beyond the Assessment of a Single Case**

The single case, unless intensively studied, may provide little information. Aggregating the data provides information about trends and special risks, depending on the frequency of event occurrence and the time over which the data is accumulated. Particularly for rare events, such as anesthesia-related deaths, occurrence and cause may not at all be evident without some sort of data accumulation. However, the key first step is to review the incident to determine its relevance to the anesthetic care provided.

### **Database Management and Incident Analysis Programs**

Systematic data review can be done reasonably well using a computerized spreadsheet. Data entry and simple

analysis, such as frequency, changes over time, and events based on practitioner, type of surgery, or other variables of interest, are relatively easily obtained. However, there is at least one product available that might simplify this task. Mention of this program is not an endorsement as we have not used it. The ASA has made available a program from Quality Assurance Research called QA/PDX. The program is available to ASA members; for information, see the ASA website at: [www.asahq.org/qmdaform.htm](http://www.asahq.org/qmdaform.htm). According to the information provided by the developers, the program is a relational database that can be used on virtually any computer that uses a Microsoft operating system including DOS legacy machines. The program has a defined data entry format as well as preconfigured reports.

### **Computer-Assisted Reporting Programs**

Even though many large centers have developed their own reporting systems, a number of reporting systems are available for purchase. The advantages of using a computer-based (as opposed to a paper-based) system for the entire institution (in contrast to a single department) were mentioned earlier (see Computer-Assisted Data Acquisition). Although we have not had personal experience with any of these programs, each has been installed and recommended in a general way by a current user. These programs include Risk MonitorPro; WEBagent by Peminic; Quantros Occurrence report management system; and International Developers Healthcare Management System, which includes modules for incident and complaint management, and quality and peer-review management, as well as other process management programs.

### **Feedback**

Obtaining and analyzing data actually may be easier than developing mechanisms to feed back this information to the involved practitioners and to other stakeholders. Our impression is that this part of the patient safety and quality improvement processes is the most difficult. In teaching departments, the normal turnover of residents, and in many cases, junior faculty, means that the “institutional” memory is short. The intervals required to review or reteach this information may be difficult to determine, as is maintaining an up-to-date

list of “what needs to be relearned.” Because many of the issues relating to patient safety appear very basic, administrative, or bureaucratic, many department members are uninterested in learning about or implementing changes in their practice. For example, universal precautions during central line insertion appear to many anesthesiologists as an impediment rather than a process to be embraced and transmitted. We have found that a variety of approaches are needed to reach a majority of those who need to receive specific patient safety messages. We use conferences, e-mail—both in the form of a periodic “newsletter” and individual e-mail—individual conversation, and policy development to transmit the needed information to those who need it. We have found that developing policies that can alter processes at the level of the operating nurse or those who prepare the operating room between cases can often effect that change faster than working through physicians. Generally, residents are more receptive than faculty to change and getting resident “buy-in” can produce change reasonably quickly. The need for both repetition and followup suggests that in larger departments resources should be devoted to the education component of the patient safety and quality improvement processes. Several examples may be helpful. Intraoperative cardiac arrest related to potassium was not finally eliminated until concentrated potassium solutions were removed from the operating room. Virtually 100% compliance with operating room central line placement guidelines was achieved when a sterile gown, drape, and towel pack specifically for central line placement was developed and provided each time a central line kit was requested. In addition, the circulating nurse and scrub nurse have become actively involved, virtually forcing compliance.

### AGGREGATED PATIENT OUTCOME AND SAFETY DATA IMPROVES ANESTHESIA CARE

One of the first reports in which anesthesia-related patient care data was aggregated was by Beecher and Todd, who studied anesthetic death in 10 institutions and published their work in 1954.<sup>14</sup> Their study included 599,548 instances of anesthesia. The cause of mortality was determined at the local

institution by consensus of a surgeon and the chief anesthetist of the institution. Each death was characterized as having one primary cause, and may also have had multiple secondary causes. This approach allowed a more thorough analysis of the causes of mortality beyond a primary one.

Dripps and colleagues at the University of Pennsylvania surveyed their experience during the 10-year period from 1947–1957.<sup>15</sup> They noted 1285 operative deaths (death within 30 days) in approximately 120,000 instances of anesthesia, for a gross mortality rate of 1.1%. This definition includes late deaths, as opposed to the many studies that focus on the intraoperative period or the first 48 postoperative hours. After review of the hospital records, they determined whether anesthesia was definitely or possibly contributory to death. This approach allowed the authors to identify systematic issues that could be addressed.

Clifton and Hotton reported on 162 deaths associated with anesthesia in 205,640 operations performed in the Royal Prince Alfred Hospital in Sydney, Australia between 1952 and 1962.<sup>16</sup> One cause of postoperative mortality was respiratory insufficiency. These authors argued that many of these complications would have been prevented by the use of a recovery unit. The potential safety advantage of a postanesthesia care unit (PACU) was a general theme in these reports from the 1960s and this quality assurance process led to the routine availability of a PACU.

Numerous other groups have examined the incidence and etiology of perioperative morbidity and mortality over the years. For example, Tiret and colleagues carried out a prospective survey of complications associated with anesthesia in France from 1978 to 1982 in a representative sample of 198,103 instances of anesthesia chosen at random from hospitals throughout the country in a study done under the direction of the French Ministry of Health.<sup>17</sup> The investigators evaluated both deaths or coma within 24 hours of surgery. The French survey confirmed previous findings that major complications occurred more frequently in older patients, in patients who were undergoing emergent operations, and in patients with more extensive comorbidity, as measured by the ASA physical status classification.

One of the most important findings of the survey was that postanesthesia

respiratory depression was the largest cause of death and coma that was wholly attributable to anesthesia. Almost all of the patients with respiratory depression leading to a major complication had received narcotics and muscle relaxants that had not been reversed. They also reported a high incidence of “anaphylactoid shock.” The authors contended that this was primarily a result of Althesin and succinylcholine. Importantly, there was no category of drug overdose, which may have been a more appropriate label for some of these cases.

The need to look into perioperative morbidity and mortality on a national level was recognized in England. The pioneering work of Lunn and others led to the development of the Confidential Enquiry into Perioperative Deaths (CEPOD) study, which assessed nearly a million cases of anesthesia during a 1-year period in 1987 in three large regions of the United Kingdom.<sup>18,19</sup> Unique to this study was the establishment of “crown privilege” by the government to allow total confidentiality: “The Secretary of State is satisfied that the disclosure of documents about individual cases prepared for the Enquiry into Perioperative Deaths would be against the public interest and would undermine the whole basis of a confidential study. Therefore, the data/information sent to the Confidential Enquiry into perioperative deaths is protected from subpoena....”

Deaths within 30 days of surgery were included in the study. Anesthesia was considered the sole cause of death in only 3 individuals, for a rate of 1/185,000 cases, and anesthesia was contributory in 410 deaths, for a rate of 7/10,000. An important aspect of the CEPOD study was that it established both anesthesia- and surgical-related factors that contributed to mortality. Of the 410 perioperative deaths, there were 9 cases of aspiration or vomit and 18 cases of cardiac arrest.

These types of publications add greatly to understanding the cause of rare outcomes and provide individual clinicians with areas to focus their attention.

### ASA CLOSED CLAIMS STUDY

Studies similar to the CEPOD study have not been performed in United States, most likely because of the legal



system. Consequently, potential causes (and treatments) of perioperative mortality had to be obtained from other sources. This led the Professional Liability Committee of the American Society of Anesthesiologists to conduct a nationwide survey of closed insurance claims for major anesthetic mishaps, which has resulted in a series of publications over the past several decades. The closed claims study allowed analysis of very rare events and potential treatments.

One example involved unexpected cardiac arrest during spinal anesthesia, which was observed in 14 healthy patients from the initial 900 claims.<sup>20</sup> The cases were analyzed in detail in order to identify patterns of management that may have led to the event. Two patterns were identified; overseparation leading to respiratory insufficiency and inappropriate resuscitation of high spinal sympathetic blockade. In another example, Caplan et al. reviewed the closed claims study for respiratory events.<sup>21</sup> They identified inadequate ventilation, esophageal intubation, and difficult tracheal intubation as the primary causes of respiratory events. Most of the outcomes were thought by the investigators to be preventable with better monitoring. Much of this work formed part of the basis for the American Society of Anesthesiologists Difficult Airway Guidelines and algorithm.<sup>22</sup>

### VETERANS ADMINISTRATION (VA) HEALTH SYSTEM'S APPROACH TO QUALITY

Based on concern about quality of care within our Veterans Administration, Congress mandated the development of the National Veterans Administration Surgical Risk Study (NVASRS) in 1986. Between October 1, 1991 and December 31, 1993, the NVASRS was conducted in 44 VA Medical Centers and developed a risk-adjustment model for predicting 30-day outcome. Based upon the NVASRS, the National Veterans Administration Surgical Quality Improvement Program (NSQIP) was established in January 1994.<sup>23,24</sup> NSQIP collects data on 40 preoperative clinical risk factors (e.g., diabetes and heart disease), 20 categories of 30-day postoperative morbidity (e.g., venous thrombosis, wound infections, and pneumonia), and 30-

day postoperative mortality on patients having major operations under general, spinal, or epidural anesthesia. During the past decade, the NSQIP group has published numerous articles demonstrating the factors associated with poor outcome and medical errors.<sup>25</sup> As of 2002, the 30-day postoperative mortality after major surgery in the VA has decreased by 27%, and the 30-day morbidity by 45%.

### INVOLVEMENT OF THE PATIENT AND FAMILY

As part of some of the national patient safety initiatives, a critical component has been the involvement of the patient and family. For example, the JCAHO and the Institute for Healthcare Improvement (IHI) have both advocated advising patients to ask their physicians and other healthcare providers to wash their hands. This may seem like a simple request, but multiple observations suggest that handwashing is not a routine activity between patient encounters. Similarly, the Surgical Care Improvement Project (SCIP) has developed patient "tip sheets" to advise patients about appropriate questions and best practices which should be adopted at the individual hospital. For example, patients who are taking  $\beta$ -blockers are advised to ask about the use of protocols to maintain perioperative  $\beta$ -blockade and of other protocols to prevent deep vein thromboses. It is the authors' belief that this will become a more common practice in the future and the clinicians should be prepared for an educated public who questions their practices.

### NATIONAL PATIENT SAFETY GOALS AS THEY RELATE TO ANESTHESIA PRACTICE

Over the past several years, a series of national patient safety goals have been advocated which are based on sentinel events and other sources of medical errors that have occurred in the past. Table 25-6 represents a list of those goals that have been adopted, and Table 25-7 is a list of those goals under consideration for 2007. The operating room is a high-risk area and adoption of systems to reduce this risk is critical.

### EVIDENCE-BASED PRACTICES

On a national level, the ability to disseminate best practices has taken the form of standards and guidelines produced by national associations and the federal government. Practice policies or guidelines are the summation by clinicians of the available evidence about the benefits and risks of a treatment plan. Guidelines are a method of codifying recommendations regarding the use of a given technology or practice. There are several types of recommendations that fall into the general category of a practice parameter. A standard implies that a therapy or practice should be performed on patients with a particular condition. Standards are only approved if an assessment of the probabilities and utilities of the group indicate that the decision to choose the treatment or a strategy would be virtually unanimous. If a particular therapy or strategy is considered a standard, it should also be cost-effective. Standards are intended to be applied rigidly. The American Society of Anesthesiologists first adopted Standards for Intraoperative Monitoring in 1986, which were developed from safety guidelines adopted at the Harvard hospital system. Guidelines are intended to be more flexible than standards, but they should be followed in most cases. Depending on the patient, setting, and other factors, guidelines can and should be tailored to fit individual needs. Like standards, guidelines should be cost-effective. The American Society of Anesthesiologists has developed a series of guidelines, which it terms Practice Parameters or Practice Guidelines on a number of issues such as pulmonary artery catheter use and blood transfusions.<sup>26-28</sup> Similarly, the American Heart Association/American College of Cardiology has established *Guidelines for Perioperative Cardiovascular Evaluation for Noncardiac Surgery*.<sup>29</sup> Local practices can then be benchmarked against these national norms and local performance improvement initiatives can be developed. One example is the development of  $\beta$ -blocker protocols for patients who present to the hospital currently taking  $\beta$ -blockers. As more high-quality studies of best practices become available, practice guidelines will be used to disseminate these practices.



TABLE 25–6.

## Joint Commission on Accreditation of Healthcare Organizations' Patient Safety Goals as They Apply to the Perioperative Period (2003–2006)

Standards and goals vary depending on the healthcare setting. The ones in this list apply to hospital and critical access hospital programs.

**Goal 1:** Improve accuracy of patient identification: 1A—Use at least two patient identifiers prior to giving medication or blood products, providing treatment or procedures.

**Goal 2:** Improve effectiveness of communication among caregivers: 2A—"Read-back" verbal orders or verbal test results; 2B—Standardize a list of abbreviations that are not to be used; 2E—Implement a standardized approach to "hands off" communications including an opportunity to ask and respond to questions.

**Goal 3:** Improve the safety of using medications: 3A—Remove concentrated electrolytes from patient care units (includes potassium chloride and sodium chloride greater than 0.9%); 3B—Standardize and limit the number of drug concentrations available within the organization; 3C—Identify a list of look-alike/sound-alike drugs used in the organization, and take action to prevent errors involving the interchange of these drugs; 3D—Label all medications, medication containers, or other solutions on and off the sterile field in perioperative and other procedural settings.

**Goal 4:** Eliminate wrong-site, wrong-patient, wrong-procedure surgery: Protocol-driven pre-operative verification process; mark the operative site; conduct a "time-out" before starting the procedure.

**Goal 5:** Improve safety of using infusion pumps.

**Goal 6:** Improve effectiveness of clinical alarm system: Assure that alarms are activated with appropriate settings; assure adequate level of audibility.

**Goal 7:** Reduce risk of healthcare-associated infections: 7A—Comply with Centers for Disease Control and Prevention hygiene guidelines; 7B—Manage as sentinel events all identified cases of unanticipated death or major permanent loss of function associated with a healthcare-associated infection.

**Goal 8:** Medication reconciliation: 8A—Develop a process for obtaining a complete list of patient's current medications; 8B—Develop a process for communicating the complete medication list to the next provider outside or within the organization.

Adapted from the Joint Commission website ([www.jointcommission.org](http://www.jointcommission.org)).

TABLE 25–7.

## Draft Candidate 2007 Joint Commission on Accreditation of Healthcare Organizations National Patient Safety Goals as They Apply to the Perioperative Period

These are proposed standards and may be modified prior to adoption. Some may not be adopted. This list is based on material released November 2005.

**Goal 3E:** Reduce likelihood of patient harm associated with the use of anticoagulant therapy: strategies include the use of premixed heparin solutions, use of programmable pumps and independent double-checks for IV anticoagulants, dosing protocols based on patient weight, elimination of heparin flush in peripheral intravenous lines.

**Requirement 15B:** Prevent healthcare-associated pressure ulcers. Assess and periodically reassess each patient's risk for developing a pressure ulcer and take action to address any identified risks: strategies include maintaining and improving tissue tolerance to pressure, protecting against the adverse effects of external mechanical forces by reducing skin injury from friction and shear forces, repositioning, or mechanical loading and support surfaces.

**Goal 16:** Discourage disruptive behavior: Implementation strategies include developing a code of behavior, identifying unacceptable behaviors, staff reporting using a nonretributive process, education, programs to manage unacceptable behavior, and developing programs to manage stresses associated with the healthcare work environment.

**Goal 18:** Improve recognition and response to changes in patient's condition: Key strategy involves development of an early response team whose composition varies depending on the needs of the organization. The goal is to provide a route for healthcare staff members to obtain direct assistance when a patient's condition appears to be worsening.

In the absence of strong evidence to support a given practice, expert opinion can help define best practice. For example, there is little high-quality randomized data to support the decision to perform a routine laboratory test prior to surgery. After reviewing the data, the American Society of Anesthesiologists Task Force on Preoperative Evaluation chose to develop a practice advisory.<sup>30</sup> A practice advisory uses expert opinions and survey-of-practice results to help inform clinicians.

## PROCESS MEASUREMENT AS PART OF THE QUALITY IMPROVEMENT PROCESS

Most of the discussion has dealt with outcome measurements, such as death or myocardial infarction. For anesthesia-related complications, however, outcome requires a fairly large sample size and may be hard to separate from other factors such as underlying disease or the surgical intervention. Easier to implement and measure are process-based indicators such as antibiotic administration,  $\beta$ -blocker administration or other processes that have been demonstrated to lead to improved outcome.<sup>31,32</sup> The key issue here is the relationship between the process being measured and outcome. In addition, meeting process mandates alone may not guarantee an acceptable outcome, thus the previously discussed patient safety and quality improvement processes cannot be abandoned. Of concern is the use of process variables to institute "pay-for-performance" compensation paradigms and whether or not the processes mandated will in fact correlate with improved patient care.

## PATIENT SAFETY AND QUALITY IMPROVEMENT IN INTENSIVE CARE UNITS

As summarized by Wu et al., in the United States, ICUs account for approximately 10% of inpatient acute care beds.<sup>33</sup> ICU mortality has been estimated to be between 8% and 10%, which accounts for about 400,000–500,000 deaths each year.<sup>34</sup> Errors and adverse events appear to be common in ICUs and may be on the order of 1.7 errors per patient per day.<sup>35</sup> Consequently, many researchers have thought that

ICUs present an ideal area to study the effects of patient safety initiatives on outcome.<sup>33</sup>

Communication errors may contribute to as much as 67% of adverse events in the intensive care setting.<sup>36</sup> Pronovost et al. described several tools, including “the morning briefing” and the concept of “daily goals,” that have improved certain measured outcomes.<sup>36,37</sup> The morning briefing approach highlights those patients with the most critical issues; it helps determine the order of rounding and provides focus for the day’s activity. The morning briefing form asks three questions: “What happened overnight that I need to be aware of? Where should I begin rounds? What are your concerns regarding potential problems for today?” The authors note that this approach provides an immediate overview of the totality of care requirements in the ICU and allows a more rational allocation of resources. They also note, anecdotally, that the approach results in enhanced teamwork, better identification of defects, and an improved admissions/discharge process.

The “daily goals” is a second approach. It is “low tech” but has decreased ICU length of stay in the studied ICU from a mean of 2.2 to 1.1 days and allowed an additional 670 patients to be cared for during the year.<sup>37</sup> According to the authors, this approach allows explicit delineation of the goals for each patient and improved communication with nurses, house staff, and families.

The frequency of ICU-based incidents and their deleterious effect on patient outcome has led to considerable effort to define relevant variables that alter outcome. Berenholtz et al. described outcome variables such as ICU mortality rate, average days on mechanical ventilation, and suboptimal management of pain; process variables such as appropriate use of blood transfusion and appropriate peptic ulcer disease prophylaxis; access variables such as delayed admissions and rate of delayed discharges; and complication variables such as rate of unplanned ICU readmission and the rate of resistant infections as a starting point to determine which factors seemed the most relevant to improving patient outcomes in the ICU.<sup>38</sup>

Others have described various processes for data collection of adverse

events, including collaborative, multi-institutional Internet-based reporting systems.<sup>33,39</sup> Approaches to encourage reporting within institutions include the trigger tool described by Resar et al., which is a mix of process and outcome variables that lead to further review.<sup>40</sup> Triggers in this series include chest tube insertion, positive blood cultures, death, and renal failure, among others. The selection was empirical. The authors determined a prevalence of 11.3 adverse events per 100 ICU days. Schuerer et al. describe an error-reporting system involving the use of pre-prepared cards listing various reporting indicators.<sup>41</sup> They noted that reporting increased with this system compared to the previous online system. This was attributed mostly to ease of reporting, although the attention paid to reporting, including in-service sessions, may have been a factor.

Other types of data acquisition besides reporting have been attempted. Beckman et al. compared incident reporting to a medical card review.<sup>42</sup> Even though the incident reporting and medical chart review often found similar events, they found that medical chart review seemed to detect infections, pain management problems, and myocardial infarction that were missed by the incident-reporting system. The authors believe that the two systems are complementary, but that the medical chart review requires a greater investment of resources.

Adverse events also occur while patients are being moved from other areas of the hospital to the ICU. Gillman et al., for example, determined that during a 6-month period 66 of 290 (23%) patients transferred from the emergency department to the ICU experienced some type of adverse event during the transfer process; these range from incorrect identification bands to hypertension, hypotension, hypothermia, and transport equipment problems.<sup>43</sup> Thus any program developed for ICU-related patient care quality needs to also account for patients coming into and leaving the unit.

Despite great efforts by a number of institutions, monitoring for patient safety and improving outcomes in the ICU setting is still in the developmental stage. Curtis et al. provides the most up-to-date summary.<sup>44</sup> However, they note that performance measures

still need to be tested. For efficacy, Pronovost and Holzmueller note that quality improvement and patient safety within the ICU setting is multidisciplinary.<sup>45</sup> They emphasize the need to develop a culture that emphasizes these aspects of patient care. They note that developing work processes that reduce complexity, standardize, and automate may be most helpful in reducing error.

## ACUTE PAIN MANAGEMENT

Quality and safety standards with respect to acute pain appear to be the least developed. Part of this relates to the fragmentation of acute pain care between surgeons, nurses, and anesthesiologists that occurs in many institutions. It is also related to philosophical differences among the participants toward the treatment of acute pain and the lack of a quantitative measure outside of patient observation. Practice guidelines from the American Society of Anesthesiologists emphasize that a single approach to pain management may not be appropriate for all types of patients and that multimodality approaches tailored to the patient’s clinical conditions and therapeutic requirements have the greatest probability of producing adequate pain relief with the least risk of undesirable side effects.<sup>46</sup> The JCAHO has published specific pain-management standards that may help to increase the resources devoted to this often-ignored aspect of patient care.<sup>47</sup> The basic underpinning for determining the efficacy and safety of pain control efforts is the requirement that patient pain needs to have appropriate assessment and management. There are two problems, however, as regards this underpinning. First, many institutions have not yet implemented appropriate pain assessment and control programs. The American Pain Society guidelines were formulated in 1995 and provide a very precise approach to instituting an effective approach to acute pain care.<sup>48</sup> Second, and the focus of this section, is once an acute pain care plan is in place, how does one organize for monitoring it for safety and efficacy?

Garnerin et al. discuss a single event related to a pump error and the process of root cause analysis related to that error.<sup>49</sup> Karlsten et al. found that over a 3-year period the assessment of

pain according to the set protocols improved with repeated staff training, meetings and audits.<sup>50</sup> Bardiau et al. reported improved pain relief as indicated by Visual Analogue Scale (VAS) scores with the implementation of a multimodal pain therapy approach, routine VAS measurement, and nurse training.<sup>51</sup> Sartain and Barry reported improved pain control with the institution of an acute pain service.<sup>52</sup> Miaskowski et al. described the results of a prospective, multisite study involving 5837 patients of whom 49% were cared for by an anesthesia-based pain service.<sup>53</sup> Patients cared for by the acute pain service had significantly lower pain scores, they also had a lower level of complications. Meissner et al. described an ongoing benchmarking protocol for quality assessment.<sup>54</sup> This approach used a specialized pain nurse who interviewed patients on the surgical wards for quality of pain relief. Benchmarks included pain at rest, pain with ambulation, and maximal pain intensity since surgery. Specific side effects such as nausea, vomiting, and sedation were also determined. Other potential quality indicators might include the documentation of VAS, the frequency of VAS documentation, the appropriateness of pain medication for the expected level of pain, efficiency of transition from one pain modality to another and complications.<sup>55</sup> The large number of patients being treated for pain allows the construction of control charts based on type of surgery, pain therapy modality, and physical condition of the patient. This might allow determination of the success of pain control efforts and better determination of which approaches are the most effective in a particular patient population.

## IMPEDIMENTS TO REVIEW OF QUALITY OF CARE ISSUES

Many physicians are concerned about the confidentiality and discoverability of discussions of patient outcome. Most states provide protection for discussions held within the purview of peer review committees. The degree of protection varies, but tends to protect the members of the committee, those who testify before the committee, and the written work product of the committee. Original patient records are, of course, discov-

erable even if taken into the “protected” environment of the peer review committee. Discussions outside the committee environment may be discoverable in legal proceedings. In general, case conferences and mortality and morbidity conferences avoid many of these issues by avoiding the use of specific patient identifiers.

## THE FUTURE

### Changing Patient Expectations

Patient expectations are changing. Many want greater involvement in their care process. Some demand input into the exact drugs used and evidence significant dissatisfaction with the care provided when their desires are not met. Many also want a near-risk-free experience and have little tolerance for what many of us view as relatively minor events, such as small degrees of hematoma or bruising, intravenous infiltration, and delays in start of surgery. “Service recovery,” measures taken to satisfy the patient or the patient’s family when care expectations are not met, has long been used to compensate patients for dental injury. It is now being expanded at our institution to reimburse the copay or uninsured portions of postoperative consultations related to certain aspects of anesthesia care, such as ophthalmology consults in the case of eye irritation, plastic surgery consultation for intravenous infiltration, or otorhinolaryngologic consultation for voice changes or persistent sore throat.

### Changing Payer Expectations

Payers for medical care expect better outcomes and are willing to pay for these better outcomes through the use of incentives, for example, pay-for-performance. There are two different philosophic approaches to pay-for-performance: (a) focusing on the outcomes themselves and (b) focusing on care processes that are associated with the improved outcomes. An example of an outcome-oriented program is the National Surgical Quality Improvement Program. The American College of Surgeons has recently adapted NSQIP (ACS-NSQIP) to the private sector and allowed private hospitals to send a standard set of data to a national center and obtain observed versus expected mortality.

The process-variable approach is best exemplified by the SCIP. SCIP represents a partnership that was formed in 2003 and included representatives from the American Hospital Association, the American College of Surgeons, the American Society of Anesthesiologists, the Association of Perioperative Registered Nurses, the JCAHO, the IHI, the Department of Veterans Affairs (VA), the Agency for Healthcare Research and Quality (AHRQ), the Centers for Medicare and Medicaid Services (CMMS), and the Centers for Disease Control and Prevention (CDC) (see [www.medqic.org/scip](http://www.medqic.org/scip)). In 2005, the group set as a goal the reduction in number of surgical complications by 25% by the year 2010. Four major areas of surgical complications were identified: prevention of surgical site infections, perioperative myocardial infarction, postoperative pneumonia, and venous thromboembolism (pulmonary embolism and deep vein thrombosis).

The partnership has used expert panels composed of members from the steering committee and from more than 20 additional organizations to identify best practices supported by the literature or that are identified as class I recommendations in guidelines developed by the appropriate organizations. For example, the recommendations for perioperative  $\beta$ -blockade were restricted to class I recommendations of the American College of Cardiology/American Heart Association *Guidelines for Perioperative Cardiovascular Evaluation*. In fact, the *Focused Update on Perioperative Beta Blockade* was published in part to ensure that the SCIP measures would be consistent with the most current evidence. The measures for venous thromboembolism are based on recommendations from the American College of Chest Physicians. The best-described measures are those related to the prevention of surgical site infections. Both timing and appropriateness of perioperative antibiotics were incorporated from the previously commissioned Surgical Infection Project (SIP). Additional measures, such as perioperative normothermia in colon surgery and perioperative glucose control in cardiac surgery, were also part of this “module.” At the time of the writing of this manuscript, the SCIP measures are voluntary. Hospitals can report on any one of the four major areas, but they



must report on all of the measures in that area. The IHI has also included the SCIP project in its national agenda. However, the antibiotic measures of SCIP, which were incorporated in SIP, are part of the new pay-for-reporting (P4R), initiative incorporated into the Medicare reimbursement policy. Many private insurers and states are also incorporating this measure; eventually, the overall performance on this measure may effect payment (pay-for-performance) rather than just reporting.

Although the U.S. Congress has clearly identified pay-for-performance as an important approach to controlling healthcare costs and improve quality, several investigators are concerned that better performance on process variables (e.g., antibiotic timing) may not lead to improvement in outcome. Werner and Bradlow found that hospital performance measures only predict small differences in hospital risk-adjusted mortality rates.<sup>56</sup> Despite these concerns, it seems likely that these trends of pay-for-performance and pay-for-results will be widely adopted. In fact, separate measures are being developed for physicians, through the American Medical Association Physician Consortium for Performance Improvement. The Consortium is comprised of more than 100 national medical specialties and state medical societies; the Council of Medical Specialty Societies; American Board of Medical Specialties and its member boards; experts in methodology and data collection; the Agency for Healthcare Research and Quality; and the Centers for Medicare and Medicaid Services. It is committed to the development, testing, and maintenance of evidence-based clinical performance measures and measurement resources for physicians. The measures are then proposed to the National Quality Forum (NQF) and will become those measured included in the pay-for-performance measures for CMMS.

### Changing Hospital Expectations

Medical centers increasingly are expecting members of their clinical staff to actively participate in programs to improve patient outcomes and safety. Two of the areas for active participation of anesthesiologists are in the patient safety time-out process and in the proper identification of organ transplantation blood types. Requests to par-

ticipate in multidisciplinary process-planning groups are increasing. There is an increasing concern with patient satisfaction and clinician groups are being increasingly asked to review processes that produce less-than-optimal outcomes, significant patient dissatisfaction, or have higher costs. This will only increase and a good understanding of the sources of patient dissatisfaction and poorer outcomes within the context of a specific practice will become increasingly necessary.

### SUMMARY AND CONCLUSIONS

A robust quality assurance system is essential to ensure that we provide our patients with the highest quality of care. The history of the specialty of anesthesiology has been marked by a focus on patient safety and assessment of outcomes. Anesthesiology has been lauded as the specialty which has focused on achieving a 6-sigma approach to quality. Numerous national projects have attempted to identify factors that contribute to perioperative morbidity and mortality and have proposed systems to reduce complications through the publications of guidelines. These guidelines are now being converted into pay-for-performance initiatives to ensure that all practitioners practice according to the best evidence. Despite these national efforts, each individual provider and group of providers should develop its own system to both identify the causes of complications and to disseminate practices to reduce these same complications.

### KEY REFERENCES

1. Reason JT. *Human Error*. Cambridge: UK Cambridge University Press, 1990.
2. O'Neil AC, Petersen LA, Cook EF, et al. Physician reporting compared with medical-record review to identify adverse medical events. *Ann Intern Med* 1993;119:370-376.
3. Sanborn KV, Castro J, Kuroda M, Thys DM. Detection of intraoperative incidents by electronic scanning of computerized anesthesia records. Comparison with volun-

tary reporting. *Anesthesiology* 1996;85:977-987.

4. Rubin HR, Pronovost P, Diette GB. The advantages and disadvantages of process-based measures of health care quality. *Int J Qual Health Care* 2001;13:469-474.

5. Wu AW, Pronovost P, Morlock L. ICU incident reporting systems. *J Crit Care* 2002;17:86-94.

6. American Pain Society Quality of Care Committee. Quality improvement guidelines for the treatment of acute pain and cancer pain. *JAMA* 1995;274:1874-1880.

7. Miaskowski C, Crews J, Ready LB, et al. Anesthesia-based pain services improve the quality of postoperative pain management. *Pain* 1999;80:23-29.

### REFERENCES

1. Kohn LT, Corrigan JM, Donaldson MS. *To Err Is Human: Building a Safer Health System*. Washington DC: Institute of Medicine, 2000.
2. Gabel RA. Evolution of joint commission anesthesia clinical indicators. *ASA News* 1994;58:24-28.
3. Helmreich RL, Merritt AC. *Culture at Work in Aviation and Medicine: National, Organizational and Professional Influences*. Aldershoot, England: Ashgate, 1998.
4. Ruth HS. Anesthesia study commissions. *JAMA* 1945;127:514.
5. Reason JT. *Human Error*. Cambridge, UK: Cambridge University Press, 1990.
6. O'Neil AC, Petersen LA, Cook EF, et al. Physician reporting compared with medical-record review to identify adverse medical events. *Ann Intern Med* 1993;119:370-376.
7. Vigoda MM, Gencorelli F, Lubarsky DA. Changing medical group behaviors: increasing the rate of documentation of quality assurance events using an anesthesia information system. *Anesth Analg* 2006;103:390-395.
8. Sanborn KV, Castro J, Kuroda M, Thys DM. Detection of intraoperative incidents by electronic scanning of computerized anesthesia records. Comparison with voluntary reporting. *Anesthesiology* 1996;85:977-987.
9. Lagasse RS, Steinberg ES, Katz RI, Saubermann AJ. Defining quality of perioperative care by statistical process control of adverse outcomes. *Anesthesiology* 1995;82:1181-1188.
10. Lagasse RS. Self-reporting can be a reliable means of tracking adverse perioperative events. *Anesthesiology* 1997;87:722-725.



11. Katz RI, Lagasse RS. Factors influencing the reporting of adverse perioperative outcomes to a quality management program. *Anesth Analg* 2000;90:344–350.
12. Dirksen R, Lerou JG, van Daele M, et al. The clinical use of the Ohmeda Automated Anesthesia Record Keeper integrated in the Modulus II Anesthesia System. A preliminary report. *Int J Clin Monit Comput* 1987; 4:135–139.
13. Gravenstein JS. The automated anesthesia record. *Anaesthesiol Reanim* 1991; 16:23–30.
14. Beecher HK, Todd DP. A study of deaths associated with anesthesia and surgery. *Ann Surg* 1954;140:2–34.
15. Dripps RD, Lamont A, Eckenhoff JE. The role of anesthesia in surgical mortality. *JAMA* 1961;178:261–266.
16. Clifton BS, Hotten WIT. Deaths associated with anaesthesia. *Br J Anaesth* 1963;35: 250–259.
17. Tiret L, Desmouts JM, Hatton F, Vourc'h G. Complications associated with anaesthesia—a prospective survey in France. *Can Anaesth Soc* 1986;33:336–344.
18. Lunn JN, Devlin HB. Lessons from the confidential enquiry into perioperative deaths in three NHS regions. *Lancet* 1987;2: 1384–1386.
19. Buck N, Devlin HB, Lunn JL. Report of a Confidential Enquiry into Perioperative Deaths. London: The King's Fund Publishing House, 1987.
20. Caplan RA, Ward RJ, Posner K, Cheney FW. Unexpected cardiac arrest during spinal anesthesia: a closed claims analysis of predisposing factors. *Anesthesiology* 1988; 68:5–11.
21. Caplan RA, Posner KL, Ward RJ, Cheney FW. Adverse respiratory events in anesthesia: a closed claims analysis. *Anesthesiology* 1990;72:828–833.
22. Anonymous. Practice guidelines for management of the difficult airway. A report by the American Society of Anesthesiologists Task Force on Management of the Difficult Airway. *Anesthesiology* 1993;78: 597–602.
23. Khuri SF, Daley J, Henderson W, et al. Risk adjustment of the postoperative mortality rate for the comparative assessment of the quality of surgical care: results of the National Veterans Affairs Surgical Risk Study. *J Am Coll Surg* 1997;185:315–327.
24. Khuri SF, Daley J, Henderson W, et al. The National Veterans Administration Surgical Risk Study: risk adjustment for the comparative assessment of the quality of surgical care. *J Am Coll Surg* 1995;180:519–531.
25. Best WR, Khuri SF, Phelan M, et al. Identifying patient preoperative risk factors and postoperative adverse events in administrative databases: results from the Department of Veterans Affairs National Surgical Quality Improvement Program. *J Am Coll Surg* 2002;194:257–266.
26. Arens JF. A practice parameters overview. *Anesthesiology* 1993;78:229–230.
27. Practice guidelines for pulmonary artery catheterization: an updated report by the American Society of Anesthesiologists Task Force on Pulmonary Artery Catheterization. *Anesthesiology* 2003;99:988–1014.
28. Practice guidelines for perioperative blood transfusion and adjuvant therapies: an updated report by the American Society of Anesthesiologists Task Force on Perioperative Blood Transfusion and Adjuvant Therapies. *Anesthesiology* 2006;105:198–208.
29. Eagle KA, Berger PB, Calkins H, et al. ACC/AHA guideline update for perioperative cardiovascular evaluation for noncardiac surgery—executive summary a report of the American College of Cardiology/American Heart Association Task Force on Practice Guidelines (Committee to Update the 1996 Guidelines on Perioperative Cardiovascular Evaluation for Noncardiac Surgery). *Circulation* 2002;105:1257–1267.
30. Practice advisory for preanesthesia evaluation: a report by the American Society of Anesthesiologists Task Force on Preanesthesia Evaluation. *Anesthesiology* 2002;96:485–496.
31. Rubin HR, Pronovost P, Diette GB. The advantages and disadvantages of process-based measures of health care quality. *Int J Qual Health Care* 2001;13:469–474.
32. Rubin HR, Pronovost P, Diette GB. From a process of care to a measure: the development and testing of a quality indicator. *Int J Qual Health Care* 2001;13:489–496.
33. Wu AW, Pronovost P, Morlock L. ICU incident reporting systems. *J Crit Care* 2002;17:86–94.
34. Angus DC, Linde-Zwirble WT, Sirio CA, et al. The effect of managed care on ICU length of stay: implications for medicare. *JAMA* 1996;276:1075–1082.
35. Donchin Y, Gopher D, Olin M, et al. A look into the nature and causes of human errors in the intensive care unit. *Crit Care Med* 1995;23:294–300.
36. Thompson D, Holzmüller C, Hunt D, et al. A morning briefing: setting the stage for a clinically and operationally good day. *Jt Comm J Qual Patient Saf* 2005;31:476–479.
37. Pronovost P, Berenholtz S, Dorman T, et al. Improving communication in the ICU using daily goals. *J Crit Care* 2003;18:71–75.
38. Berenholtz SM, Dorman T, Ngo K, Pronovost PJ. Qualitative review of intensive care unit quality indicators. *J Crit Care* 2002;17:1–12.
39. Holzmüller CG, Pronovost PJ, Dickman F, et al. Creating the web-based intensive care unit safety reporting system. *J Am Med Inform Assoc* 2005;12:130–139.
40. Resar RK, Rozich JD, Simmonds T, Haraden CR. A trigger tool to identify adverse events in the intensive care unit. *Jt Comm J Qual Patient Saf* 2006;32:585–590.
41. Schuerer DJ, Nast PA, Harris CB, et al. A new safety event reporting system improves physician reporting in the surgical intensive care unit. *J Am Coll Surg* 2006;202:881–887.
42. Beckmann U, Bohringer C, Carless R, et al. Evaluation of two methods for quality improvement in intensive care: facilitated incident monitoring and retrospective medical chart review. *Crit Care Med* 2003; 31:1006–1011.
43. Gillman L, Leslie G, Williams T, et al. Adverse events experienced while transferring the critically ill patient from the emergency department to the intensive care unit. *Emerg Med J* 2006;23:858–861.
44. Curtis JR, Cook DJ, Wall RJ, et al. Intensive care unit quality improvement: a “how-to” guide for the interdisciplinary team. *Crit Care Med* 2006;34:211–218.
45. Pronovost PJ, Holzmüller CG. Partnering for quality. *J Crit Care* 2004;19:121–129.
46. Practice guidelines for acute pain management in the perioperative setting: an updated report by the American Society of Anesthesiologists Task Force on Acute Pain Management. *Anesthesiology* 2004;100: 1573–1581.
47. Phillips DM. JCAHO pain management standards are unveiled. JCAHO on Accreditation of Healthcare Organizations. *JAMA* 2000;284:428–429.
48. Quality improvement guidelines for the treatment of acute pain and cancer pain. American Pain Society Quality of Care Committee. *JAMA* 1995;274:1874–1880.
49. Garnerin P, Huchet-Belouard A, Diby M, Clergue F. Using system analysis to build a safety culture: improving the reliability of epidural analgesia. *Acta Anaesthesiol Scand* 2006;50:1114–1119.
50. Karlsten R, Strom K, Gunningberg L. Improving assessment of postoperative pain in surgical wards by education and training. *Qual Saf Health Care* 2005;14:332–335.
51. Bardiau FM, Taviaux NF, Albert A, et al. An intervention study to enhance postoperative pain management. *Anesth Analg* 2003;96:179–185, table of contents.
52. Sartain JB, Barry JJ. The impact of an acute pain service on postoperative pain management. *Anaesth Intensive Care* 1999; 27:375–380.
53. Miaskowski C, Crews J, Ready LB, et al. Anesthesia-based pain services improve the quality of postoperative pain management. *Pain* 1999;80:23–29.
54. Meissner W, Ullrich K, Zwacka S. Benchmarking as a tool of continuous quality improvement in postoperative pain management. *Eur J Anaesthesiol* 2006;23:142–148.
55. Tsui SL, Irwin MG, Wong CM, et al. An audit of the safety of an acute pain service. *Anaesthesia* 1997;52:1042–1047.
56. Werner RM, Bradlow ET. Relationship between Medicare's hospital compare performance measures and mortality rates. *JAMA* 2006;296:2694–2702.

# CHAPTER 26

## Positioning of Patients for Operation

Vijaya Gottumukkala, MB, BS, MD (Anes)

### POSITIONING OF PATIENTS

The term *surgical posture* or “*positioning*” in the perioperative context denotes the body position in which a patient is placed for the surgical procedure. The main purpose of “positioning” is to maximize anatomic exposure for the surgical procedure. The world’s oldest known medical text on surgery (known as the Edwin Smith Papyrus), written approximately 1600 B.C., described different battlefield injuries. However, no mention was made about positioning. The first allusion to surgical positioning is believed to come from the Hippocratic Oath: “I will not cut for stone (i.e., lithotomy), even for patients in whom the disease is manifest...” In *Epidemics, Book I, Second Constitution*, Hippocrates advised *primum non nocere*, “to first do no harm.” Thus, intraoperative positioning should be optimized for surgical exposure, ensuring patient safety at all times. Although anesthesia-related morbidity secondary to inadequate ventilation and oxygenation have improved as a result of better physiologic monitoring and the American Society of Anesthesiologists (ASA) standards on minimum monitoring, complications secondary to positioning are on the rise. Many problems arising from positioning, such as peripheral nerve injuries, fall under the legal doctrine of “*Res ipsa loquitur*.” This Latin phrase literally means “the thing speaks for itself” and implies that the injury sustained is so evident that it would not have occurred without negligence from someone else. Thus, the plaintiff needs only to prove the injury. In cases of *res ipsa loquitur*, the burden of proof falls on the healthcare providers to prove their innocence, that is, that the care provided was not negligent. Therefore, safe intraopera-

tive patient positioning is crucial, and a clear protocol must be in place and followed by all members of the perioperative team.

This chapter discusses the positions that are commonly used during surgical procedures (supine, lithotomy, sitting, head-down, prone, and lateral decubitus). The rationale and technique for safe establishment of each of these positions are described, followed by the associated pathophysiologic changes and the potential complications particular to each position. With advances in technology and the advent of new surgical therapeutic options, various modifications of the standard positions are continuously being added. It still is possible to minimize positioning-related injury to the patient even in these challenging situations by adhering to the basic principles.

### Supine (Horizontal Dorsal Decubitus Position)

Because the majority of surgical procedures involve patients in the supine position, a clear understanding of the pathophysiologic effects of this position is necessary for the perioperative

team. A significant portion of our life is spent in the supine position, and this position is not usually considered to pose significant physiologic stress on the body. However, patients with morbid obesity, mediastinal masses, or poor cardiac function and term parturients prone to aortocaval compression do not easily tolerate this position.

In the traditional supine position, the patient is placed on his/her back with some degree of neck flexion. The arms are either padded and restrained in a neutral position alongside the body or abducted on padded armboards. A pillow usually is placed under the knees to reduce the degree of lumbar lordosis and prevent excessive strain on the lumbar spine. This is an important consideration in the elderly and in those with mechanical low back pain.

### Pathophysiology of the Supine Position

**Cardiovascular** Moving from erect posture to the supine position increases central blood volume considerably. As a result of this increased blood volume, compensatory stretch and baroreceptors in the central circula-

### KEY POINTS

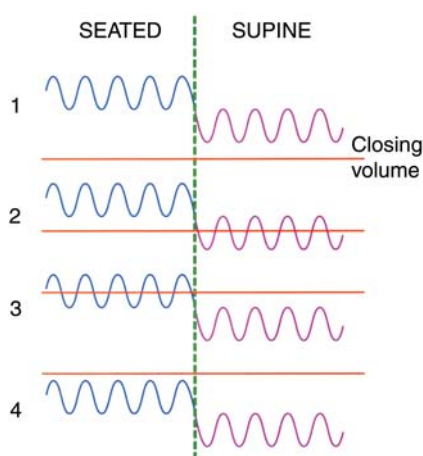
1. Proper positioning of the patient during the operative period is important for optimal surgical exposure and outcome.
2. Understanding the pathophysiologic changes and special considerations associated with each position helps in reducing positioning-related morbidity.
3. Improper positioning during surgery could lead to postoperative peripheral neuropathies, muscular sprain injuries, ischemic injury to skin and muscles, and visual loss.
4. Perioperative peripheral nerve injuries are the second most common cause of professional liability among anesthesiologists.
5. Male gender, extremes of body habitus, and prolonged hospitalization are considered risk factors for postoperative peripheral neuropathies.
6. Thorough assessment of risk factors for complications related to positioning should be an integral part of the preoperative evaluation.
7. As part of the informed consent, risks and benefits associated with positioning should be discussed with the patients.
8. Description of intraoperative positioning techniques and measures taken to prevent injury should be documented in the anesthetic record.
9. Familiarity and understanding of the American Society of Anesthesiologists (ASA) Task Force on Prevention of Perioperative Peripheral Neuropathies may help minimize the problems associated with positioning during the perioperative period.
10. Special attention needs to be paid to minimizing the potential for visual injuries in high-risk patients during the perioperative period.
11. A report by the ASA Task Force on Perioperative Blindness is an excellent source of current information and consensus expert opinion on this devastating problem.

tion initiate reflex responses that usually maintain blood pressure within narrow limits in healthy adults. Ward et al.<sup>1</sup> studied the overall hemodynamic changes during supine positioning and noted that MAP, heart rate (HR), and peripheral vascular resistance decrease whereas cardiac output and stroke volume increase in healthy adults. Although these changes are well tolerated by healthy subjects, an increase in myocardial oxygen consumption is noted in patients with coronary artery disease and poor myocardial function.

**Pulmonary** In the erect position, breathing normally is a function of muscles of the rib cage. In the supine position, however, muscles of the abdominal wall and diaphragm assume the predominant role. Significant changes in the anatomy of the upper airway and abdominothoracic areas occur in the supine position. These changes affect the cross-sectional area of the upper airway, ventilatory mechanics, and blood flow to the lungs, contributing to significant alterations in lung volumes and ventilation-perfusion matching.<sup>2</sup>

Cephalad displacement of the posterior diaphragm in the awake supine position allows for improved ventilation in basal portions of the lungs. Because regional blood flow in the lungs is determined by the vertical distance of the capillaries from the pulmonary hilum, there is increased perfusion in the basal segments in the supine position. Froese et al.<sup>3</sup> studied regional ventilation in awake spontaneously breathing patients as well as in those who are anesthetized (spontaneously breathing or paralyzed) and concluded that a more uniform ventilation per unit lung volume and an overall improvement of ventilation-perfusion matching occur in the supine position in healthy patients.

Functional residual capacity (FRC) decreases under anesthesia, with most of the reduction occurring immediately after induction of general anesthesia.<sup>4</sup> The relationship between closing volume (CV) and FRC reflects the degree of atelectasis, and therefore hypoxemia, during tidal ventilation. Closing volume (CV) is defined as the fraction of the total lung capacity below which airway closure occurs when external pressures overcome natural elastic recoil.<sup>5</sup> The relationship between CV and FRC in erect and



**FIGURE 26-1.** Classification of subjects into groups (1–4) according to the relationship of closing volume (CV) to functional residual capacity (FRC) in the seated and supine positions. Group 1: FRC > CV in both positions; Group 2: FRC > CV in seated position only; Group 3: CV in the breathing range in seated position and exceeded in supine position; Group 4: CV above breathing range in both positions. (From Craig et al.<sup>6</sup> with permission.)

supine patients can be divided into four groups (Fig. 26-1).<sup>6</sup> Craig et al.<sup>6</sup> showed that a conscious patient between the ages of 30 and 40 years can have basilar atelectasis upon assuming the supine position because CV exceeds FRC. Induction of anesthesia exaggerates these changes, which are further pronounced in obese patients and during procedures involving head-down positioning.

### Complications

Excluding peripheral neuropathies, the main complications in the supine position are backache and ischemic pressure injuries. Pressure point changes and alopecia result from ischemia to the tissues overlying bony prominences and the hair follicles, respectively. These complications can be minimized by maintaining tissue perfusion pressure and adequate padding of pressure points in the dependent regions of the body.

Backache in patients under supine position for long periods results from loss of normal lordotic curvature of the lumbar spine because of reduced tone of paraspinal muscles and ligaments. This problem may be exacerbated in the elderly and in patients with preexisting lower back pain problems or lumbar spinal stenosis. Using the lawn chair position or placing a pillow under the knees in the standard

supine position may reduce the incidence of back ache.

**Lawn Chair Position** This is a modification of the standard supine position in which the lower and upper halves of the body are slightly elevated in relationship to the hips. This position results in improved tissue perfusion and hemodynamic status because of the better balance between the venous return from the lower half of the body and the perfusion pressure gradient to major organs. An additional advantage of this position is the greater degree of abdominal musculature relaxation, which is facilitated by the shortened distance from the xiphoid process to symphysis pubis.<sup>7</sup>

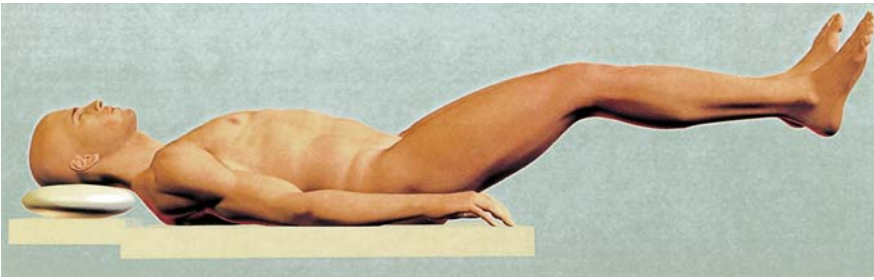
### Lithotomy Position

This position is most often used for genitourinary, gynecologic, and colorectal procedures. The standard lithotomy position is achieved when the patient's legs are abducted from the midline, and the hips and knees are flexed so that the lower legs are parallel to the floor. It is prudent that both lower extremities be raised and lowered simultaneously while using this position to avoid rotational stress on the lumbar spine. To minimize the risk of injury to the patient, it is important to understand the advantages and limitations of the various supporting devices (candy cane, knee crutch, calf support, cushioned dorsal boot, adjustable knee and foot support) for the lower extremities. Improper use of these devices can lead to postoperative neuropathies, musculoskeletal strain to the lower spine, and ischemic injuries to the skin and muscles. Because many variations of the lithotomy position are currently used, Martin and Warner have proposed a standardized classification (low, standard, high, hemi, exaggerated, and tilted) to prevent miscommunication among members of the operating team (Figs. 26-2 through 26-7).<sup>7</sup>

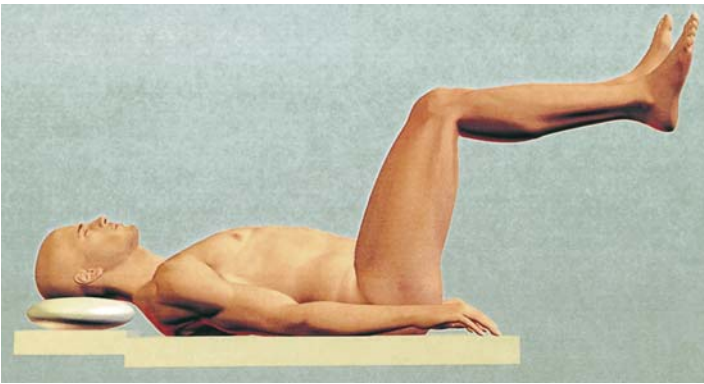
### Pathophysiology of the Lithotomy Position

The physiology of a patient in the lithotomy position is no different from that of a supine patient except for the physiologic consequences of leg elevation on the central blood volume, the effects of antigravity on tissue perfusion in elevated legs, and the deleterious ventilatory effects of excessive flexion at the hip joints.





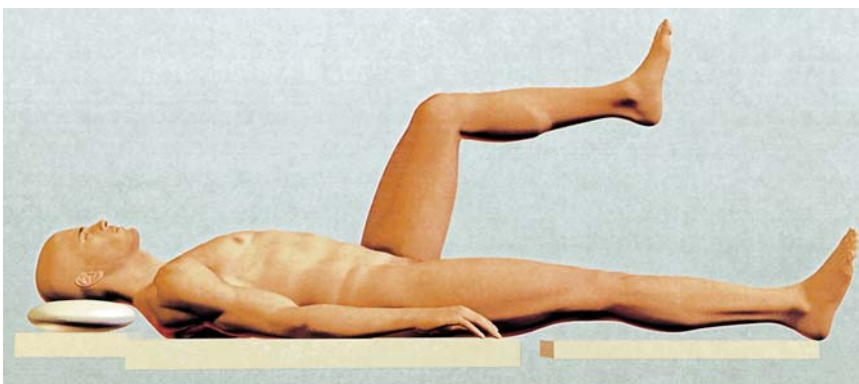
**FIGURE 26-2.** Low lithotomy position. (Redrawn from Martin and Warner<sup>7</sup> with permission.)



**FIGURE 26-3.** Standard lithotomy position. (Redrawn from Martin and Warner<sup>7</sup> with permission.)



**FIGURE 26-4.** High lithotomy position. (Redrawn from Martin and Warner<sup>7</sup> with permission.)



**FIGURE 26-5.** Hemilithotomy position. (Redrawn from Martin and Warner<sup>7</sup> with permission.)

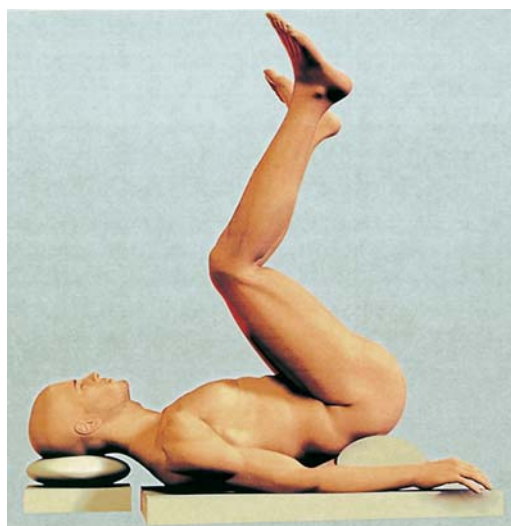
As the legs are elevated, a significant amount of intravascular volume is added to the central circulation. Normal vascular compensatory reflexes tend to compensate for these transient increases in atrial filling pressures, increased intracranial blood volume, and internal carotid blood flow. In disease states, however, these changes may cause significant alterations to the cerebral and cardiac function. Kopman and Sandza<sup>8</sup> showed that patients with coronary artery disease poorly tolerate head-down tilts  $>10^\circ$  and lithotomy position. Because lithotomy position is frequently combined with head-down tilt for improved surgical access, the cardiopulmonary status of the patient must be taken into consideration to minimize cardiac decompensation.

The mean arterial pressure (MAP) at a measurement site varies by 2 mm Hg with each vertical inch above or below the atrium. Enderby<sup>9</sup> clearly demonstrated the variations in MAP with positional changes (Fig. 26-8). This is particularly important in older patients (with peripheral vascular disease, diabetes, and hypertension) when compressive stockings are used and the patient is situated in lithotomy position for a prolonged period. Inadequate perfusion pressure to the lower extremities in such a situation can lead to ischemic complications of the skin and muscles, resulting in skin necrosis and myoglobinuria.

Under general anesthesia, with the assumption of the lithotomy position the tidal volume decreases by 3%. With a  $10^\circ$  head-down tilt, tidal volume decreases another 14%.<sup>10</sup> Although conscious patients usually can compensate and tolerate this change in tidal volume because of improved resting position of the diaphragm, anesthetized patients breathing spontaneously may develop basilar atelectasis and hypoxia. Patients with obesity, hiatal hernia, and gastroesophageal reflux disease may have decreased lower esophageal sphincter tone and barrier pressure, increasing the risk for regurgitation and aspiration of gastric contents in the lithotomy position.

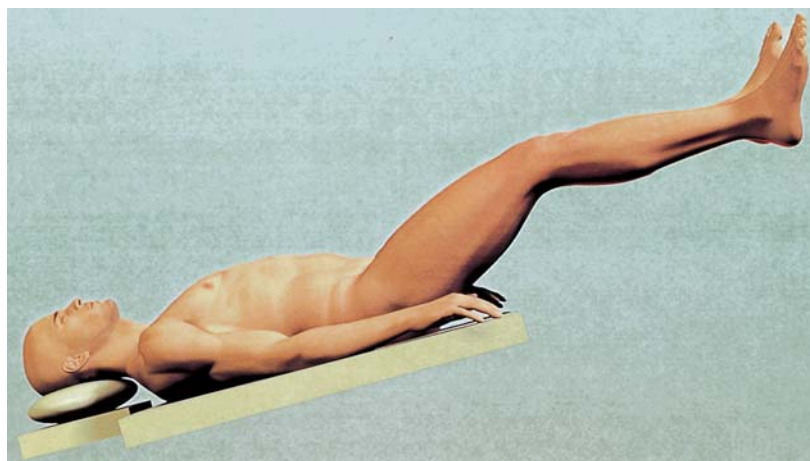
Compartment syndromes have been associated with use of the lithotomy position lasting  $>5$  hours.<sup>11</sup> Anatomic compartments are relatively rigid osseofascial partitions in the extremities comprised of muscles, nerves, blood vessels, and connective and ad-



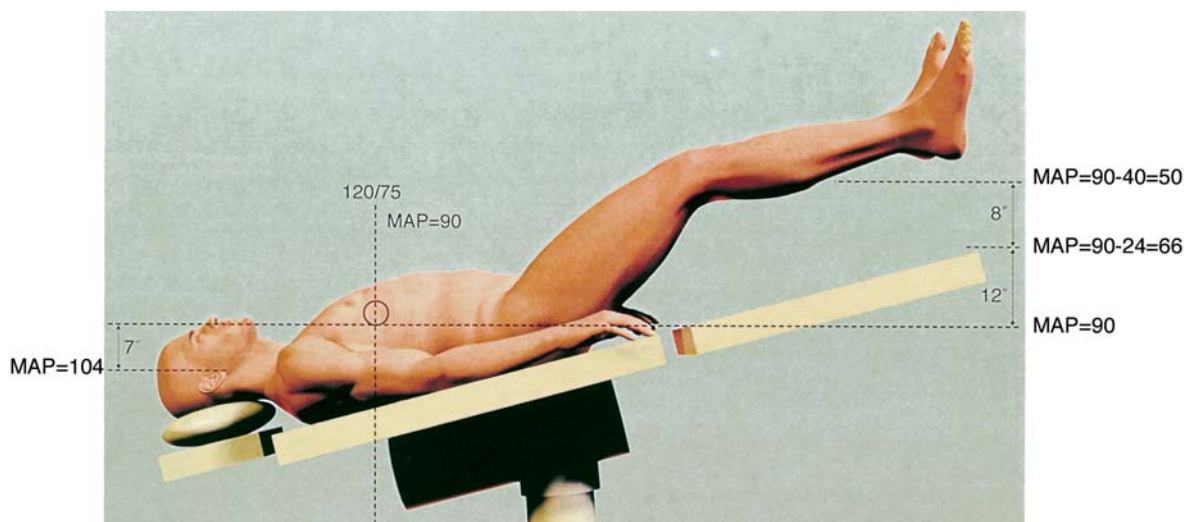


468

**FIGURE 26-6.** Exaggerated lithotomy position. (Redrawn from Martin and Warner<sup>7</sup> with permission.)



**FIGURE 26-7.** Tilted lithotomy position. (Redrawn from Martin and Warner<sup>7</sup> with permission.)



**FIGURE 26-8.** Effects of gravity on perfusion pressure in the lithotomy position. MAP, mean arterial pressure. (Redrawn from Martin<sup>11</sup> with permission.)

ipose tissues. A certain amount of perfusion pressure, 9–15 mm Hg in the lower extremity,<sup>12</sup> is required for normal perfusion of tissues in these compartments. If the pressure in the compartment rises as a result of external forces (dependent pressure, casts, stockings, tight dressings) or internally by edema/bleeding, the vascular driving pressure (MAP) must increase concurrently to prevent ischemic complications. Inadequate tissue perfusion and ischemia of the contents of these compartments lead to varying degrees of injury (endothelial injury, tissue necrosis, and myoglobinuria) that potentially could result in death. Because pain is the most specific symptom for diagnosis of compartment syndromes, a high index of suspicion should be maintained for patients at risk while receiving regional analgesia.

The respiratory complications of the lithotomy position are similar to those of the supine position. The lithotomy position can be an additional factor when diaphragmatic excursion is restricted as a result of excessively flexed thighs or a steep head-down tilt. The duration of the use of the lithotomy position and the body mass index of the patient are reliable predictors for complications pertaining to nerve injuries, respiratory problems, and the compartment syndromes.<sup>11</sup>

### Sitting Position

An operative surgical site is intentionally elevated above the level of the heart

to decrease bleeding in the operative field and to provide better surgical conditions. Although popular in the 1980s and early 1990s for posterior fossa neurosurgical procedures, sitting position now is commonly used for surgical procedures on the shoulder. Advantages of the sitting position to the anesthesiologist include easier ventilation because of unimpeded diaphragmatic excursion, easier access to the endotracheal tube and airway, unimpeded access to the chest wall for resuscitative measures, and unobstructed view of the face for monitoring cranial nerve function. Disadvantages include the need for a coordinated effort from the operating team (nursing, surgical, and anesthesia) to establish this position safely, hypotension and venous air embolism (VAE), consequences of excessive neck flexion (kinking of endotracheal tube and swelling of face and tongue), nerve injuries, pneumocephalus, and blindness.

### Pathophysiology of the Sitting Position

Gravity and anesthetic agents have significant effects on cardiovascular function in the sitting position. In a healthy adult patient, stroke volume and cardiac output are decreased by approximately 12–20%, and cerebral perfusion pressure reduces by 15% without much change in HR.<sup>13</sup>

There is an overall increase in ventilation with increased VC and FRC. However, with positive-pressure ventilation and relative hypovolemia there is reduced perfusion in the nondependent lung fields leading to an increase in physiologic dead space.

During neurosurgical procedures, loss of cerebrospinal fluid (CSF) occurs upon opening of the arachnoid membrane. The loss of CSF allows air to enter the intracranial CSF pathway, leading to pneumocephalus and downward displacement of the brain. Although this gravitation of the brain may be tolerated in most patients, those with thin cerebral mantles may suffer from subdural hematoma.<sup>6</sup>

While positioning the patient, care should be exercised with the following basic principles: maintaining normal body alignment, protecting and padding all pressure points, avoiding placement of rigid oropharyngeal airways and excessive flexion of the neck, exercising care with extremities so that their limits of passive range of motion are not exceeded, establishing

final position slowly to allow time for hemodynamic compensation, and exercising extreme caution with the horseshoe frame if used for support of the head (Fig. 26–9).

**Complications** The frequent and most common complications are related to the hemodynamic and ventilatory effects as described in the section on Lithotomy. Neurologic complications pertaining to neuropathies and blindness are detailed at the end of this chapter.

**Venous air embolism** The incidence of VAE in posterior fossa surgery in the sitting position is reported to be 41–45% with routine monitoring.<sup>14</sup> However, with the use of Doppler ultrasound the reported incidence is as high as 42–85%.<sup>15</sup> VAE often is clinically undetected and frequently not of serious concern in a healthy patient if the volume and rate of air entrainment are minimal. The amount of entrained air that is reported to be lethal in humans is approximately 300 mL.<sup>16</sup> Children generally have greater clinically significant hemodynamic derangement from VAE than do adults.

Significant morbidity and mortality from VAE is now <1%,<sup>17</sup> predominantly as a result of better monitoring techniques, early detection, and prompt intervention. VAE has significant effects on the cardiopulmonary system, resulting in elevated pulmonary artery pressures, decreased cardiac output, systemic hypotension, and increased dead space ventilation. These physiologic changes result from mechanical effects of obstructed pulmonary blood flow from the air pocket in cardiac chambers and chemical medi-

ator release from air–blood interface. The appearance of dysrhythmias can signal the presence of intracardiac air; therefore, a high index of suspicion is warranted.

Paradoxical air embolus occurs whenever there is a communication between the right and the left sides of the heart. Although left-sided pressures are generally higher than the right, right-sided pressures can exceed the left in pathologic conditions (pulmonary hypertension, pulmonic stenosis) and in healthy subjects during certain phases of the cardiac cycle. Thus, increased right-sided cardiac pressures could result in the appearance of the entrained air in the arterial circulation with its associated complications. Therefore, sitting position is contraindicated in patients with documented intracardiac defects or arteriovenous malformations. Patent foramen ovale is the most common congenital defect associated with a paradoxical air embolus.

### Head-Down Tilt Position

The head-down position as introduced by Trendelenburg in the mid-19th century is still routinely used in genitourinary and colorectal procedures. Anesthesiologists also use this position for cannulation of central veins in the upper half of the body. Head-down tilt usually is combined with lithotomy to achieve optimal surgical conditions for genitourinary and colorectal procedures, but this combination has special physiologic consequences of which anesthesia providers must be aware. Steep head-down tilt is frequently used for laparoscopic gynecologic and urologic procedures.

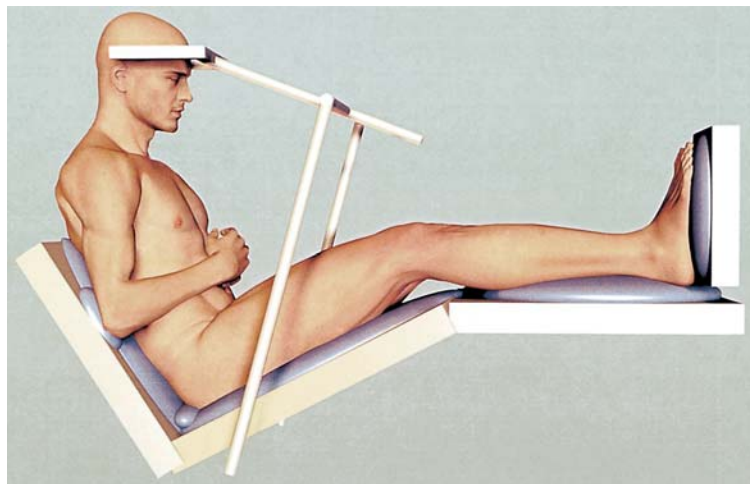


FIGURE 26–9. Sitting position. (Redrawn from Martin and Warner<sup>7</sup> with permission.)

Steep head-down position has significant deleterious effects on the cardiovascular, respiratory, and nervous systems. Although young healthy patients may tolerate this position for short periods without major sequelae, those with obesity, cardiovascular dysfunction, obstructive airway disease, and intracranial pathology may decompensate when placed in this position. Abdominal insufflation exaggerates and adds to the deleterious physiologic effects of this position. Therefore, special attention is needed for laparoscopic procedures in steep head-down tilt position. The earlier custom of head-down position to treat “shock” or hypotension has been disputed by Weil et al.<sup>18</sup> and Sibbald et al.<sup>19</sup>

### Pathophysiology of Head-Down Tilt

Upon instituting head-down position, the central blood volume increases by approximately 1000 mL in an adult patient, increasing cardiac output and systolic blood pressure. However, an immediate systemic vasodilatation secondary to reflex barostimulation leads to decreased stroke volume, reduced cardiac output, and diminished perfusion of vital organs. The brain is particularly vulnerable to decreased perfusion (reduced cerebral perfusion pressure) because of increased venous and CSF pressure. Shenkin et al.<sup>20</sup> studied the effects of head-down tilt on cerebral hemodynamics in healthy adults and showed consistent decrease in cerebral blood flow in spite of increased mean carotid pressure. Increased cerebral venous pressure from the head-down position can result in increased intraocular tension, leading to ocular venous thrombosis and retinal detachment. These effects are particularly significant in patients with glaucoma. The occurrence of these complications can be minimized by using a less steep tilt and by decreasing the mean airway pressure.

Sing et al.<sup>21</sup> studied the effects of head-down tilt on hemodynamic indices in hypovolemic postoperative patients in an intensive care unit. All hemodynamic variables and indices were measured supine and at 10 minutes after the head-down tilt position. MAP, pulmonary capillary wedge pressure, and systemic vascular resistance increased, whereas cardiac index, oxygen delivery, and consumption remain unchanged. They concluded that the immediate increase in blood pressure

was not accompanied by a similar improvement in tissue oxygenation.

Johannsen et al.<sup>22</sup> studied the cardiorespiratory effects of head-down position and intraperitoneal insufflation in healthy women undergoing elective diagnostic laparoscopies. They reported an approximately 42% reduction in stroke index and cardiac index, a 50% increase in systemic vascular resistance, and no significant changes in HR or MAP. These changes in cardiovascular variables remained abnormal until the patient was returned to the supine position and the abdomen was deflated. Therefore, the anesthesiologist must be particularly diligent in maintaining normal intravascular volume status when this position is used during surgery.

Current literature does not support the use of head-down tilt for treatment of hypovolemic shock. In such a situation, lawn chair position is ideal because it gently elevates the head as well as the legs on torso. The advantage of this position is that cerebral congestion is minimized and peripheral venous return is augmented, thereby augmenting cardiac output and cerebral oxygenation.

Atelectasis occurs when an anesthetized patient is placed in this position. The main reason for atelectasis and hypoxemia is decreased FRC (with induction of anesthesia, increased central blood volume, cephalad displacement of the diaphragm, and the weight of the abdominal contents impeding diaphragmatic excursion). As a result of these changes, increased impedance to the chest wall and lung

inflation lead to decreased total compliance and increased work of breathing (if the patient is breathing spontaneously). The cardiopulmonary effects of these changes can be minimized by maintaining intravascular volume, minimizing the time spent in this position, ventilating the patient with larger tidal volumes, and adding positive end-expiratory pressure (PEEP). However, the effects of these ventilatory adjustments on cardiovascular indices and cerebral circulation must be taken into consideration so that oxygen delivery to the brain and vital organs is optimized. Position of the endotracheal tube must be checked frequently when the patient is placed in the head-down tilt position. Cephalad movement of the diaphragm and compression of the lung bases can shift the carina relative to the fixed endotracheal tube, resulting in endobronchial intubation. These changes are exaggerated with abdominal insufflation.

### Prone Position

Prone, ventral decubitus, or ventral recumbent position is a posture in which the patient is resting “face down” upon the operating table. The prone position may be comfortable and even common for some individuals during normal sleep. However, when anesthetized in this position, potential complications can result from loss of active reflexes that normally protect from atelectasis, compressive ischemia, and skeletal stress (Figs. 26–10 and 26–11).

In the classic or horizontal prone position, the patient lies face down, resting on the ventral aspects of the

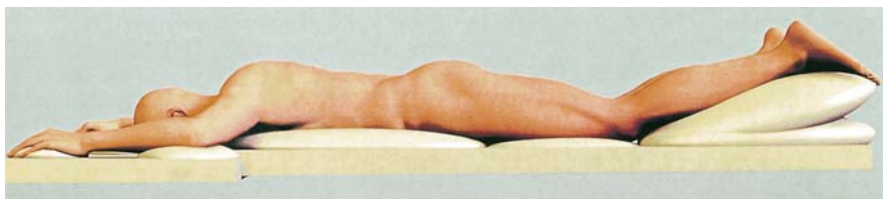


FIGURE 26–10. Prone position. (Redrawn from Martin and Warner<sup>7</sup> with permission.)



FIGURE 26–11. Prone position. (Redrawn from Martin and Warner<sup>7</sup> with permission.)



torso with legs extended and arms raised beside the head or tucked alongside the body. Care should be exercised during positioning of the arms to avoid stretch injury to the neurovascular structures. In the former position (arms raised beside the head), the shoulders and forearms should be ventral to the horizontal axis of the torso. In the latter situation (arms tucked beside the torso), excessive elevation or drooping of the shoulders should be avoided. In all variations of this position, pressure points (e.g., nipples and genitalia) should be carefully padded and care exercised to avoid any compressive ischemic injury. The patient's torso usually is bolstered or supported to avoid abdominal compression (to minimize undesirable effects on ventilation, venous return, and engorgement of epidural venous plexus) and to allow unimpeded chest wall expansion with ventilation. It is vital that the patient's face (eyes, tip of the nose), mouth, and endotracheal tube be visualized and accessible at all times.

The operating room table is generally angled or varied (crouching or kneeling) from the classic prone position when used to straighten the spine or decrease the lumbar lordosis for procedures on the dorsal lumbar spine. Numerous devices, such as the Tarlov seat, Andrews frame, and Hastings frame, are also used to help position the patient for surgical procedures on the dorsal spine. Each of these devices has the potential to cause further injury if care is not exercised during positioning and securing of the patient. Coordinated team effort during positioning and constant vigilance throughout the procedure is vital to minimize the risk of injury. It is extremely important to be diligent in supporting the head and to avoid any injury to the face during the prolonged spine procedures. Various devices for head support are commercially available. Some have a mirror attached to the base that allows visualization of the face at all times. Irrespective of the device used, it is the constant vigilance and monitoring of dependent areas and pressure points that may prevent any potential ischemic injury. It is widely believed that the most stable holder for the prone head is the three-pin C-shaped skull fixation frame. Patients with an unstable cervical spine must be managed in such a manner so that spinal

cord function during and after the positioning process can be monitored.

The prone jackknife position is often used for anorectal surgery. The patient is first placed prone, and all pressure points are padded. The patient is situated on the table such that when the table is anteflexed the apex of the inverted "V" is at the patient's inguinal region. The final position must be achieved in graded steps to avoid sudden hypotension from venous pooling in dependent lower extremities and venous compression in the groin. A supportive pad usually is placed beneath the pelvis to prevent direct compression to the neurovascular bundle in the inguinal region. Care should be exercised in securing the patient after the desired position is achieved.

The anesthesia team should have a plan to manage the ventilation, invasive monitoring catheters and cables, intravenous lines, ostomy bags, and urinary catheter during the positioning process.

### **Pathophysiology of the Prone Position**

It is unusual for a healthy adult patient to have significant hemodynamic disturbances during the positioning process if major venous compression is avoided. However, if pressure is exerted on the major vessels (aortocaval and iliac compression), decreased venous return leads to decreased cardiac output. In the presence of abdominal compression (compression of inferior vena cava), blood from the lower half of the body is diverted through other (perivertebral, intercostal, and lumbar veins) low-pressure venous systems to the right atrium, leading to congestion of vertebral venous plexuses. Engorgement of venous plexuses can lead to increased blood loss during surgical procedures on the spine if positioning is not optimized. Hemodynamic effects of the commonly used supporting devices in the prone position have been studied by various authors. The single most important factor that is consistently shown to have deleterious effect on hemodynamic function is the effect of the device on abdominal and thoracic compression.

Douglas et al.<sup>23</sup> showed an increase in FRC and arterial oxygen partial pressures with no change in respiratory mechanics after patients were placed prone and properly positioned. The relationship between transpulmonary and airway opening pressures is

an important factor in determining the degree of atelectasis. In the supine position, transpulmonary pressures are less than airway opening pressures, leading to atelectasis in the dorsal lung units. Lamm et al.<sup>24</sup> showed that, in the prone position, the transpulmonary pressure generated in the dorsal lung units exceeded the airway closing pressures in dogs subjected to oleic acid-induced acute lung injury. This may explain the transient improvement in oxygenation in the prone position by increased homogeneity in the gravity-dependent ventilation-perfusion ratios in the dorsal lung regions without adversely affecting ventral lung regions.

No significant changes in cerebral hemodynamics occur if the head of the healthy prone patient is at the level of the heart and is not laterally flexed or rotated. If the head is positioned below the level of the heart in a healthy patient, cerebral blood pressure and vascular resistance in the carotid arterial system increase proportionally to maintain constant perfusion pressure and blood flow. In the presence of intracranial pathology, cerebral autoregulation is impaired; therefore, the patient's head should not be positioned below the level of the heart to prevent a pressure-dependent (gravity-induced) increase in cerebral blood flow. Severe rotation ( $>60^\circ$ ) of the head and neck can have significant deleterious effects on the flow patterns in cerebral circulation. Complete obstruction of the contralateral vertebral blood flow with rotation of the head  $>80^\circ$  in humans has been reported.<sup>25</sup> Care must be exercised during rotation of the head because patients can have significant asymptomatic occlusive cerebral vascular disease and/or congenital variations in cerebral vascular anatomy (circle of Willis). Exaggerated rotational movements in such situations can compromise blood flow in the region of the vertebrobasilar systems, leading to neurologic dysfunction.

Other complications related to prone positioning include injury to the eyes, ocular edema and blindness, compressive ischemic injuries to facial structures, compartment syndrome, VAE, breast and genital injuries, thoracic outlet syndrome, neuropathies, ostomy injuries, and hypothermia.

### **Lateral Decubitus Position**

Lateral decubitus positions are described as right or left, depending on



the side of the body on which the patient lies. For example, patients are said to be positioned in right lateral decubitus position when they lie with their right side down.

In the classic lateral decubitus position, the patient is positioned on the side with his/her back perpendicular to the surface of the table. The head is supported such that the cervical spine is properly aligned with the rest of the body, and a supportive device (axillary roll or chest pad) is placed under the dependent thorax just caudad to the axilla to prevent compression and injury to the axillary neurovascular bundle. The dependent lower extremity is flexed at the hip and knee joints, and the nondependent leg is straightened in such a manner that the pelvis is stabilized and ventral tilt (forward roll) of the torso is avoided. Adequate padding is ensured to protect all the pressure points (pillow between the legs, foam for the dependent greater trochanter, fibular head and lateral malleolus) of the lower extremities. The dependent arm is flexed and supported on a padded arm board while the nondependent arm is slightly abducted and flexed at the shoulder and elbow joints such that the scapula is drawn away from the thorax (Fig. 26–12). Once the patient is positioned optimally, care should be exercised to avoid injuries related to restraint devices (bean bag, hook and loop straps).

The “kidney position” is a variation of the lateral decubitus position that is commonly used for renal procedures. In this version of the lateral decubitus position, the patient’s dependent ilium is placed over the flexion point between the torso and thigh sections of the table. The table is then flexed, and the transverse elevating bar of the table (kidney bar) is raised until the lateral flexion has caused the muscles of the upper flank to become tight. During and immediately after the final position, all measures must be taken

to avoid inferior vena caval and dependent rib cage compression.

### **Pathophysiology of the Lateral Decubitus Position**

For the most part, the lateral decubitus position has minimal effects on major organ function when the patient is carefully positioned.

Sudden postural changes are poorly tolerated by deeply anesthetized and hypovolemic patients because of dose-dependent depression of carotid and baroreceptor function under general anesthesia. Gentle changes in position with frequent monitoring of blood pressure is indicated in elderly, hypovolemic, and hypertensive patients. Mediastinal shift to the dependent hemithorax and rotation of the heart on its longitudinal axis in the lateral position could impair venous return and decrease cardiac output. Impediment of venous return usually is not a problem except in lateral jackknife (venous pooling in lower extremities) or kidney positions (caval compression). The right lateral decubitus position appears to have greater propensity for caval compression and reduced venous return with kidney rest because of the closer proximity of the vena cava to the right flank.

Vital capacity in normal awake subjects decreases by a comparable 10% in the lateral and supine positions compared to the erect posture. The kidney position can decrease the vital capacity by another 5–10%. Most of this decrease is thought to result from reduced movement of the ribs and diaphragm. Although vital capacity and FRC are reduced, better ventilation–perfusion matching results from increased perfusion in the dependent lung and corresponding increase in ventilation from the stretched dependent hemidiaphragm. However, general anesthesia with or without spontaneous ventilation in the lateral decubitus position causes an increased mismatch

in ventilation–perfusion ratios compared to that in awake subjects. This is further complicated by the institution of paralysis and mechanical ventilation, addition of PEEP, opening of the pleura in thoracic procedures, pathologic processes in the dependent and nondependent lung, and use of medications (vasodilators) that affect hypoxic pulmonary vasoconstriction.

Complications from the lateral decubitus position include pressure injuries (ischemic), muscular and ligamentous strain, whiplash-like injury to the cervical spine, neurologic injuries, and ocular complications (corneal abrasions, pressure effects, dependent edema, and blindness).

### **Nerve Injuries Associated with Positioning**

Perioperative peripheral nerve injuries are a significant source of morbidity for the patient and unfortunately will be encountered by even the most conscientious anesthesia provider. It is the second most common cause (after death) of professional liability among anesthesiologists, accounting for 16% of claims in the ASA closed claims database.<sup>26</sup> The claims secondary to nerve injuries have steadily increased in the last decade, and unfortunately the relationship between current conventional perioperative care with positioning and development of postoperative nerve injury is poorly understood.

Injuries to the ulnar nerve, brachial plexus, and lumbosacral roots account for most of the claims, with ulnar being the most commonly reported nerve injury during the perioperative period. Cited mechanisms for nerve injury during the perioperative period include compression, stretch, ischemia, direct trauma, and laceration. Although injuries to the brachial plexus and lumbosacral roots may be secondary to stretch or compression with malpositioning of the patient, those to ulnar nerve usually are unexplained and often puzzling. Ulnar nerve injury may occur despite protective padding and careful positioning. In fact, 27% of cases of ulnar nerve injury in the ASA closed claims database occurred despite documentation of adequate padding at the elbow.<sup>26</sup>

A retrospective review from the Mayo Clinic reported a 0.04% incidence of persistent ulnar neuropathy in noncardiac surgery, with 9% of



**FIGURE 26–12.** Lateral decubitus position. (Redrawn from Martin and Warner<sup>7</sup> with permission.)

reported injuries in this study being bilateral.<sup>27</sup> Initial symptoms in most cases were noted only after a 24-hour period, and the distribution of sensory-only and mixed sensory and motor loss injuries was equal. More recent prospective data from the same authors report a higher incidence (approximately 0.5%) of perioperative ulnar neuropathies.<sup>28</sup> The incidence may be even higher in patients undergoing cardiac surgery. The most consistent risk factors appear to be male gender, prolonged hospitalization, and extremes of body habitus.<sup>27</sup> Morell et al. reported significant changes in ulnar nerve sensory thresholds with elbow flexion in human volunteers. In the flexed position, nearly all volunteers reported ulnar nerve paresthesias. All the volunteers reporting paresthesias had a significant increase in C fiber sensory threshold without any change in either A $\alpha$  or A $\beta$  fiber function. It could be that most hospitalized patients spend a considerably greater time with their elbows flexed, accounting for the finding that prolonged hospitalization is an independent risk factor for nerve injuries. Prielipp et al.<sup>29</sup> studied the effects of arm positioning on the pressure exerted at the elbow. They showed that the pressure exerted over the ulnar nerve was greatest when the forearm was pronated. It was also noted that up to 50% of male volunteers who experienced pressure on the ulnar nerve sufficient to impair electrophysiologic function did not perceive concurrent paresthesia in that nerve distribution. Thus, a significant number of male patients could be at increased risk for failure to respond to potentially damaging compression injury over the ulnar nerve during the perioperative period. An additional risk factor may be the sedated state of patients in the immediate postoperative period as a result of residual effects of anesthetics and narcotic medications.

Injury to the brachial plexus is the second most common perioperative nerve injury, with an estimated incidence of 0.2–0.6%.<sup>30</sup> The anatomy of the brachial plexus—long and mobile course of its components through the limited space between the first rib and the clavicle—makes it susceptible to stretch and compressive injury. Careful attention to arm positioning during supine position (abduction <90°), steep head-down tilt (avoiding should-

er braces for support), prone positioning (avoiding improper placement of chest roll and positioning of arms), and lateral decubitus position (properly placed axillary roll) can help minimize the risk of injury.

Perioperative lower-extremity neuropathies have a clearer relationship with positioning when compared to upper-extremity nerve injuries. Warner et al.<sup>31</sup> reported an overall 1.5% incidence in all patients undergoing surgery in the lithotomy position. The risk increases with the duration (>2 hours) in the lithotomy position, and almost all of the reported injuries were sensory in nature. Paresthesia in the affected nerve distribution was the most common complaint. Symptoms in all of their patients were noted within 4 hours. The obturator was the most commonly affected nerve, with lateral femoral cutaneous, sciatic, and peroneal nerve injuries following in order. Sciatic nerve injury is most common after lithotomy positioning or some variant of it. Hyperflexion of the hip with extension at the knee along with external rotation of the thigh during positioning of the legs can produce excessive stretch of the sciatic nerve and result in injury. The common peroneal nerve is particularly vulnerable to compression injury because it wraps around the head of the fibula. Femoral neuropathy is more commonly associated with surgical factors, although ischemic injury could result from extreme abduction and external rotation of the thighs during lithotomy positioning.

Anesthesiologists should be familiar with and follow the recommendations of the ASA practice advisory for prevention of perioperative neuropathies (Box 26–1). For particularly long procedures, consideration should be given to minimizing the time spent in a position that amplifies physiologic perturbations or injury to the patient. It may be advisable to look for and document symptoms of nerve dysfunction preoperatively in high-risk patients (those with risk factors for perioperative neuropathies or those coming for high-risk surgery, i.e., long procedures or surgical positions at risk for injury). A description of the intraoperative positioning and measures taken to prevent injury should be documented in the anesthetic record at the beginning of the procedure and thereafter on a regular basis.

## Visual Injury

Postoperative visual complications constitute a broad group ranging from temporary loss of visual acuity to devastating permanent loss of visual function. Corneal abrasions, periorbital and conjunctival edema, ocular hemorrhage, vitreous loss, retinal detachment, central retinal artery occlusion, and ischemic optic neuropathy are the range of complications that are encountered in the perioperative period.

The reported incidence of perioperative visual injury varies widely (< 0.06–25.6%). The American Association of Nurse Anesthetists (AANA) Foundation closed malpractice claims study<sup>32</sup> reports an incidence of 3.3%, and the ASA closed claims analysis<sup>33</sup> reports a similar 3.47% for all types of eye injury. In both closed claims projects, corneal abrasions are the most common complications encountered. Patient movement, chemical irritation from prep solutions, direct trauma from face mask, pressure from the laryngoscopic blade, pressure effects on the globe from lateral and prone positioning, prolonged procedures on the spine in prone position, intraoperative hypotension, and anemia all have been implicated as the reasons.

Lateral, prone, and Trendelenburg positions increase the risk for visual complications during the perioperative period. In all these positions, venous pressure in the eye can increase from direct pressure, edema, and/or stasis, leading to decreased choroidal perfusion and increased risk for ischemic optic neuropathy. Other associated factors for visual complications during the perioperative period include prolonged operations on the spine, large-volume blood loss, significant decreases in hemoglobin levels, and intraoperative hypotension. Contributing patient comorbid conditions include hypertension, diabetes, obesity, smoking history, hypercholesterolemia, alcohol abuse, atherosclerosis, anemia, Graves disease, and renal transplantation.<sup>34</sup> Shaw et al.<sup>35</sup> reported that 40 of their 312 patients scheduled for coronary artery bypass grafting procedures had preexisting ophthalmologic abnormalities on examination. Currently, preoperative screening ophthalmologic examination of surgical patients to predict postoperative visual complications is not common practice.

## BOX 26-1.

## Summary of ASA Task Force Consensus on Prevention of Perioperative Peripheral Neuropathies

## Preoperative assessment

- When judged appropriate, it is helpful to ascertain that patients can comfortably tolerate the anticipated operative position.

## Upper-extremity positioning

- Arm abduction should be limited to 90° in supine patients; patients who are positioned prone may comfortably tolerate arm abduction >90°.
- Arms should be positioned to decrease pressure on the postcondylar groove of the humerus (ulnar groove). When arms are tucked at the side, a neutral forearm position is recommended. When arms are abducted on armboards, either supination or a neutral forearm position is acceptable.
- Prolonged pressure on the radial nerve in the spiral groove of the humerus should be avoided.
- Extension of the elbow beyond a comfortable range may stretch the median nerve.

## Lower-extremity positioning

- Lithotomy positions that stretch the hamstring muscle group beyond a comfortable range may stretch the sciatic nerve.
- Prolonged pressure on the peroneal nerve at the fibular head should be avoided.
- Neither extension nor flexion of the hip increases the risk of femoral neuropathy.

## Protective padding

- Padded armboards may decrease the risk of upper-extremity neuropathy.
- Use of chest rolls in laterally positioned patients may decrease the risk of upper-extremity neuropathies.
- Padding at the elbow and at the fibular head may decrease the risk of upper- and lower-extremity neuropathies, respectively.

## Equipment

- Properly functioning automated blood pressure cuffs on the upper arms do not affect the risk of upper-extremity neuropathies.
- Shoulder braces in steep head-down positions may increase the risk of brachial plexus neuropathies.

## Postoperative assessment

- Simple postoperative assessment of extremity nerve function may lead to early recognition of peripheral neuropathies.

## Documentation

- Charting specific positioning actions during the care of patients may result in improvements of care by (a) helping practitioners focus attention on relevant aspects of patient positioning; and (b) providing information that continuous improvement processes use can lead to refinements in patient care.

From Practice advisory for the prevention of perioperative peripheral neuropathies: a report by the American Society of Anesthesiologists Task Force on Prevention of Perioperative Peripheral Neuropathies. *Anesthesiology* 2000;92:1168–1182. Reprinted with permission of publisher.

Therefore, it is imperative for anesthesia providers to be highly cognizant of the potential for visual complications in high-risk patients. Anesthesia providers should pay special attention to avoid pressure effects on the globe and to maintain adequate oxygen delivery to the optic disk and retinal structures. A report by the ASA Task Force on Perioperative Blindness is an excellent source of current information and consensus expert opinion on this devastating problem (approved by the ASA house of delegates October 2005).<sup>36</sup>

## KEY REFERENCES

1. Martin JT, Warner MA. Positioning in Anesthesia and Surgery. 3rd ed. Philadelphia: WB Saunders, 1997. (Highly recommended)
2. Lumb AB, Nunn JF. Respiratory function and ribcage contribution to ventilation in body positions commonly used during anesthesia. *Anesth Analg* 1991;73:422–426.
3. Warner MA, Warner ME, Martin JT. Ulnar neuropathy. Incidence,

outcome, and risk factors in sedated or anesthetized patients. *Anesthesiology* 1994;81:1332–1340.

4. Prielipp RC, Morell RC, Walker FO, et al. Ulnar nerve pressure: influence of arm position and relationship to somatosensory evoked potentials. *Anesthesiology* 1999;91:345–354.

5. Warner MA, Warner DO, Harper CM, et al. Lower extremity neuropathies associated with lithotomy positions. *Anesthesiology* 2000;93:938–942.

6. Rupp-Montpetit K, Moody ML. Visual loss as a complication of nonophthalmologic surgery: a review of the literature. *AANA J* 2004;72:285–292.

7. Cheney FW, Domino KB, Caplan RA, et al. Nerve injury associated with anesthesia: a closed claims analysis. *Anesthesiology* 1999;90:1062–1069.

8. A report by the American Society of Anesthesiologists Task Force on Perioperative Blindness. Chicago: American Society of Anesthesiologists, 2005.

## REFERENCES

1. Ward RJ, Danziger F, Bonica JJ, et al. Cardiovascular effects of change of posture. *Aerosp Med* 1966;37:257–259.
2. Pae EK, Lowe AA, Sasaki K, et al. A cephalometric and electromyographic study of upper airway structures in the upright and supine positions. *Am J Orthod Dentofacial Orthop* 1994;106:52–59.
3. Froese AB, Bryan AC. Effects of anesthesia and paralysis on diaphragmatic mechanics in man. *Anesthesiology* 1974;41:242–255.
4. Lumb AB, Nunn JF. Respiratory function and ribcage contribution to ventilation in body positions commonly used during anesthesia. *Anesth Analg* 1991;73:422–426.
5. Fairley HB. Airway closure. *Anesthesiology* 1972;36:529–532.
6. Craig DB, Wahba WM, Don HF, et al. "Closing volume" and its relationship to gas exchange in seated and supine positions. *J Appl Physiol* 1971;31:717–721.
7. Martin JT, Warner MA. Positioning in Anesthesia and Surgery. Philadelphia: WB Saunders, 1997.
8. Kopman EA, Sandza JG Jr. Hemodynamic effects of head-down lithotomy position in patients with coronary artery disease. *Obstet Gynecol* 1979;53:237–240.

9. Enderby GE. Postural ischaemia and blood-pressure. *Lancet* 1954;266:185–187.
10. Jones JR, Jacoby J. The effect of surgical positions on respiration. *Surg Forum* 1954;5:686–691.
11. Martin JT. Compartment syndromes: concepts and perspectives for the anesthesiologist. *Anesth Analg* 1992;75:275–283.
12. Reneman RS. The anterior and the lateral compartmental syndrome of the leg due to intensive use of muscles. *Clin Orthop Relat Res* 1975;113:69–80.
13. Marshall WK, Bedford RF, Miller ED. Cardiovascular responses in the seated position—impact of four anesthetic techniques. *Anesth Analg* 1983;62:648–653.
14. Young ML, Smith DS, Murtagh F, et al. Comparison of surgical and anesthetic complications in neurosurgical patients experiencing venous air embolism in the sitting position. *Neurosurgery* 1986;18:157–161.
15. Gildenberg PL, O'Brien RP, Britt WJ, et al. The efficacy of Doppler monitoring for the detection of venous air embolism. *J Neurosurg* 1981;54:75–78.
16. Gottlieb JD, Ericsson JA, Sweet RB. Venous air embolism: a review. *Anesth Analg* 1965;44:773–779.
17. Matjasko J, Petrozza P, Cohen M, et al. Anesthesia and surgery in the seated position: analysis of 554 cases. *Neurosurgery* 1985;17:695–702.
18. Weil MH, Shubin H, Rosoff L. Fluid repletion in circulatory shock: central venous pressure and other practical guides. *JAMA* 1965;192:668–674.
19. Sibbald WJ, Paterson NA, Holliday RL, et al. The Trendelenburg position: hemodynamic effects in hypotensive and normotensive patients. *Crit Care Med* 1979;7:218–224.
20. Shenkin HA, Scheuerman WG, et al. Effect of change of position upon the cerebral circulation of man. *J Appl Physiol* 1949;2:317–326.
21. Sing RF, O'Hara D, Sawyer MA, et al. Trendelenburg position and oxygen transport in hypovolemic adults. *Ann Emerg Med* 1994;23:564–567.
22. Johannsen G, Andersen M, Juhl B. The effect of general anaesthesia on the haemodynamic events during laparoscopy with CO<sub>2</sub>-insufflation. *Acta Anaesthesiol Scand* 1989;33:132–136.
23. Douglas WW, Rehder K, Beynen FM, et al. Improved oxygenation in patients with acute respiratory failure: the prone position. *Am Rev Respir Dis* 1977;115:559–566.
24. Lamm WJ, Graham MM, Albert RK. Mechanism by which the prone position improves oxygenation in acute lung injury. *Am J Respir Crit Care Med* 1994;150:184–193.
25. Toole JF. Effects of change of head, limb and body position on cephalic circulation. *N Engl J Med* 1968;279:307–311.
26. Cheney FW, Domino KB, Caplan RA, et al. Nerve injury associated with anesthesia: a closed claims analysis. *Anesthesiology* 1999;90:1062–1069.
27. Warner MA, Warner ME, Martin JT. Ulnar neuropathy. Incidence, outcome, and risk factors in sedated or anesthetized patients. *Anesthesiology* 1994;81:1332–1340.
28. Warner MA, Warner DO, Harper CM, et al. Ulnar neuropathy in medical patients. *Anesthesiology* 2000;92:613–615.
29. Prielipp RC, Morell RC, Walker FO, et al. Ulnar nerve pressure: influence of arm position and relationship to somatosensory evoked potentials. *Anesthesiology* 1999;91:345–354.
30. Cooper DE, Jenkins RS, Bready L, et al. The prevention of injuries of the brachial plexus secondary to malposition of the patient during surgery. *Clin Orthop Relat Res* 1988;228:33–41.
31. Warner MA, Warner DO, Harper CM, et al. Lower extremity neuropathies associated with lithotomy positions. *Anesthesiology* 2000;93:938–942.
32. Jordan LM, Kremer M, Crawforth K, et al. Data-driven practice improvement: the AANA Foundation closed malpractice claims study. *AANA J* 2001;69:301–311.
33. Gild WM, Posner KL, Caplan RA, et al. Eye injuries associated with anesthesia. A closed claims analysis. *Anesthesiology* 1992;76:204–208.
34. Rupp-Montpetit K, Moody ML. Visual loss as a complication of nonophthalmologic surgery: a review of the literature. *AANA J* 2004;72:285–292.
35. Shaw PJ, Bates D, Cartlidge NE, et al. Neuro-ophthalmological complications of coronary artery bypass graft surgery. *Acta Neurol Scand* 1987;76:1–7.
36. A report by the American Society of Anesthesiologists Task Force on Perioperative Blindness. Chicago: American Society of Anesthesiologists, 2005.



## CHAPTER 27

## Electricity, Electrical Safety, and Instrumentation in the Operating Room

Robert H. Stiefel, MS and  
Julian M. Goldman, MD

The role of technology in medicine has steadily increased during the past few decades, and there is every indication that this will continue. Most of this technology has been in the form of new electronic equipment. Safety has sometimes been overlooked; at other times, specific aspects of safety (notably, electrical safety) are overemphasized. This chapter describes the principles and practices of the safe use of medical equipment.

The safe use of modern medical technology depends first on an understanding of the operating principles of the technology. An understanding of electrical hazards also is necessary to operate electrical equipment safely. Such knowledge is based on an understanding of electricity and electronics. The first section of this chapter reviews the basic concepts of electricity and electronics. The second section of this chapter describes and explains the hazards of medical equipment use.

Standards and regulations for the use of medical equipment have been promulgated to avoid hazards to patients and personnel. The third section of this chapter describes the organizations that set standards, tells how and why they develop standards and gives an overview of some more important standards. From this information it becomes clear that proper use of standards is to provide safe, and safe use of, medical technology.

These three sections of this chapter provide the basis for development of an equipment safety program. The need to understand and apply electrical engineering principles to analyze and avoid equipment hazards, and to apply equipment safety standards, has spawned a new profession in healthcare known as *clinical engineering*. This field, practiced

by biomedical and clinical engineers and technicians in hospitals, is described in the fourth section. This section concludes with a discussion of *technology management*—the term used to describe the involvement of clinicians, engineers, and administrators in planning and implementing the use of medical technology in the most effective manner.

An understanding and respect for the safe use of medical equipment is particularly important for anesthesiologists. Of the major disciplines of modern medicine, none depends more on technology for direct patient care and safety than does anesthesiology. Many of the devices used at the bedside for diagnosis and treatment of patients were developed first in the operating room by anesthesiologists. Anesthesiologists use the widest variety of medical equipment and routinely use it in the most precarious situations of any of the medical disciplines.

## ELECTRICITY

*Current* is the flow of electric charge, with electrons being the most common charge carrier. The unit of measure of current is the *ampere* or amp, abbreviated A. One ampere is the flow of 1 coulomb per second, and 1 coulomb is  $6.2420 \times 10^{18}$  units of electric charge. An electron has one unit of negative electric charge. The symbol for current is *I*; the symbol for charge (in coulombs) is *Q*.

*Voltage*, also called *potential difference* or *electromotive force* (EMF), is the amount of potential energy available to move electrons (i.e., available for work). It also is the difference in potential energy between two points caused by differences in electrical charge or the energy released when electrons move from higher to lower potential. The unit of measure of voltage is the volt, and the symbol for voltage is V (or sometimes E). One volt represents the amount of power or work per unit of time to move 1 coulomb. The zero potential reference point is called *ground* or *earth*. Besides being a reference point, ground plays a major role in electrical safety. Hazard currents can be safely drained by connection to ground, as will be discussed later.

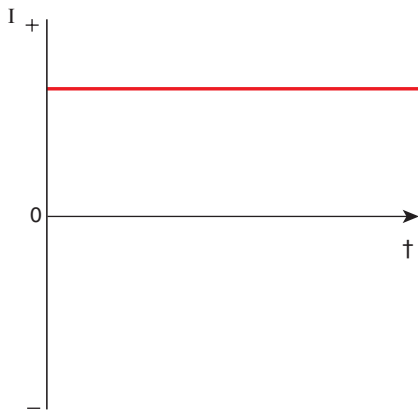
A *conductor* is a material through which electrons move easily (e.g., copper), and an *insulator* is a material through which electrons move poorly (e.g., glass). A *semiconductor* is a material that normally is an insulator but acts like a conductor when certain conditions are met (e.g., silicon crystals with a particular impurity added).

## Direct Current

*Direct current* (DC) is unidirectional current and is constant in magnitude. Batteries provide a constant DC. By convention, the direction of current is from the more positive to the more negative voltage (Fig. 27-1). This was based on a guess by Benjamin Franklin when he needed to assign algebraic signs in equations describing electrical

## KEY POINTS

1. Hazards to patients from medical equipment include fibrillation and burns, equipment failure, and misuse. Electrical safety concerns originating in the 1960s have led to the development of safety and performance standards, improved equipment designs, and in-house clinical engineering programs.
2. Medical equipment standards are promulgated by a variety of national and international organizations. Understanding and complying with these standards requires clinical engineering expertise.
3. Clinical engineering departments in hospitals help to ensure the safety and performance of medical equipment by providing evaluations, testing, maintenance, and training programs.
4. Safe and effective use of medical equipment involves the cooperation of clinicians, administrators, support staff, and manufacturers. A clinical engineer usually is best able to orchestrate these efforts.
5. A hospital-wide technology management program combines individual equipment programs and improves efficiency and quality.


**FIGURE 27-1.** Direct current.

charges and forces. Unfortunately, his guess was incorrect. Electrons actually flow from negative to positive, opposite to the convention for current that was accepted before the discovery of electrons.

*Resistance* is the opposition to the flow of current. The unit of measure of resistance is the ohm, abbreviated  $\Omega$ , and the symbol for resistance is R. A *resistor* is an electrical component designed to provide a specific value of resistance. Voltage, current, and resistance are related by Ohm's law, which states that voltage is directly proportional to current and to resistance (Fig. 27-2).

*Power* is work per unit time or the rate at which electrical energy is used. Its unit of measure, the watt (abbreviated W), is equivalent to 1 joule per second. The symbol for power is P, and it is calculated  $P$  equals  $IV$  equals  $I^2R$ .

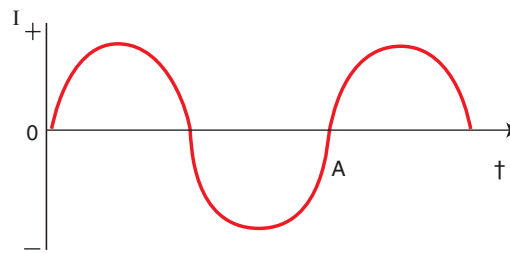
## Alternating Current

*Alternating current* (AC) differs from DC in that its polarity reverses periodically. As a result, its magnitude is constantly changing. A cycle is one complete wave pattern (from 0–A in Fig. 27-3). A *period* is the time of one cycle. The average value of AC for one period is zero. *Frequency* (f) is the number of cycles per second (cps) and is the inverse of the period. The unit of measure is the hertz, abbreviated Hz. By

Ohm's law (for direct current):

$$V = I \times R$$

where V = voltage (volts)  
I = current (amps)  
R = resistance (ohms)

**FIGURE 27-2.** Ohm's law (for direct current).

**FIGURE 27-3.** Alternating current.

definition, 1 Hz is equal to 1 cps. There are  $360^\circ$  in one cycle, and the *phase* is the number of degrees between two AC waveforms at the same time.

Common household voltage (that available at electrical receptacles in the home) and the voltage at most hospital receptacles is nominally 120 volts AC (VAC) and has a 60-Hz sinusoidal waveform (period of 16.7 ms). (In most of Europe, Asia, and Africa, 50 Hz and 220 V are used.) The voltage given is the root mean square (RMS) value, which is 0.707 ( $1/\sqrt{2}$ ) of the peak value or 0.354 of the peak-to-peak value of the voltage waveform (Fig. 27-4). The RMS value of AC voltage provides the same wattage as the same value of DC voltage. DC and AC are additive. Combinations of DC and AC can make virtually any desired waveform. Conversely, any electrical waveform can be described as a series of sine waves, each at a single frequency; this technique is called *Fourier analysis*.

AC adds a number of refinements (or complications) to the management of electricity. In contrast to DC, resistance is no longer the only opposition to AC. *Reactance* is the opposition to current that varies with frequency (resistance is constant). Together, resistance and reactance are called *impedance*. Impedance is measured in ohms, but its symbol is Z. *Reactance* also is composed of two parts: capacitive reactance and inductive reactance. Reactance has the symbol X; capacitive reactance is  $X_C$ , and inductive reactance is  $X_L$ . Impedance is calculated as follows:

$$Z = R^2 + (X_L - X_C)^2,$$

and Ohm's law becomes:

$$V = I \times Z.$$

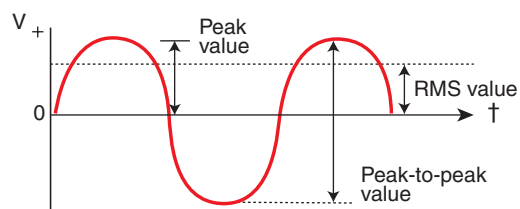
A *capacitor* is an electrical component designed to provide a specific value of capacitance, which is the property of storing separated charges when a voltage is present between conductors. In construction, a capacitor is two conductive plates separated by an insulating material called a *dielectric*. The symbol for capacitance is C. Capacitance is measured in farads, abbreviated F. More often, values are given in microfarads (microfarads =  $\mu\text{F}$ , although mF also is used). Capacitance is related to current and voltage by the following formula:

$$I = C [dV/dt].$$

An *inductor* is an electrical component designed to provide a specific value of inductance, which is the property of a varying electric current to induce a voltage in a circuit. An inductor is a coil of wire, often around a metallic core. The symbol for inductance is L, and the unit of measure is the henry, abbreviated H. Inductance is related to current and voltage by the following formula:

$$V = L [di/dt].$$

An important application of inductance is in transformers. A transformer is constructed by placing two coils close to each other. An AC source is applied to one coil, and a current is induced in the other. Voltage can be


**FIGURE 27-4.** Root mean square (RMS) voltage.

adjusted up or down by selecting the ratio of turns of wire in the two coils:

$$V_1/V_2 = N_1/N_2,$$

where  $N$  is the number of turns of wire (Fig. 27-5). AC is used for transmission from electrical generators because transformers can convert AC voltages but not DC voltages. Increasing and decreasing high voltages is practical only with transformers. High voltage is more efficiently transmitted over long distances. If current is cut in half, the voltage must be doubled to transmit the same power (recall that  $P = IV$ ). This reduces the power loss in the transmission lines to one quarter ( $I^2R$ , where  $R$  is the resistance of the transmission line).

### AC versus DC

Sixty hertz was chosen for AC frequency for engineering reasons. Transformers work efficiently at 60 Hz. At higher frequencies, transmission losses increase. At lower frequencies, lights would flicker perceptibly. Unfortunately, 60 Hz also is in the middle of the range of frequencies to which muscles and nerves are most susceptible (see Hazards of Electricity below).

An interesting historical note on the selection of AC rather than DC involves William Kemmler, the first man legally electrocuted.<sup>1</sup>

In 1879, Thomas Edison invented the electric light. He then developed a DC distribution system, most of which was installed in the 1880s. George Westinghouse developed an AC distribution system late in the 1880s. Edison and Westinghouse waged an economic battle over whether AC or DC would become the standard for electrical distribution systems. The advantage of AC was that it could be transmitted at a high voltage for long distances without the unacceptably high losses that AC and DC suffer at low voltage, and then it could be dropped to a lower, safer voltage with a transformer for local distribution. Edison and others could show that AC was more dangerous. In animal experiments, AC voltages of 200 V were lethal, but DC was relatively safe at that level.

On June 4, 1888, Governor David Hill of New York signed a law making electrocution the method of execution for capital crimes committed after January 1, 1889. Electrocution had been selected by a commission assigned the

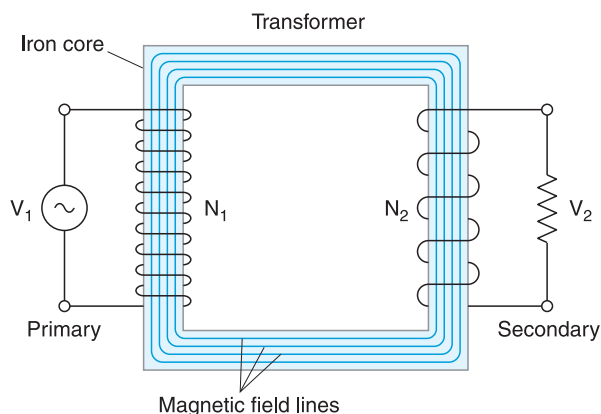


FIGURE 27-5. Example of a transformer.

task of finding an effective, humane means of execution to replace hanging. In March 1889, an electrical engineer, Harold Brown, was contracted to provide execution systems for the Auburn, Sing Sing, and Clinton prisons. Brown previously had published reports on the dangers of AC and the comparative safety of DC. He naturally chose Westinghouse AC generators, although he had to purchase them to prevent him from obtaining them (Westinghouse did not want his name associated with electrocution). The first system was installed in Auburn state prison in central New York State in June 1889.

Meanwhile, on March 29, 1889, in Buffalo, New York, William Kemmler killed his girlfriend after a drunken argument. On May 10, a jury found him guilty, and on May 14, he was sentenced to death by electrocution. Kemmler's attorney appealed on the grounds of cruel and unusual punishment. Hearings were conducted in New York City and Buffalo during July 1889. The defense attempted to prove that death by electric current was uncertain because people recovered after being struck by lightning. Brown testified on behalf of the State, describing his electrocution experiments on ani-

mals. Edison also was called by the State to testify. He opined that death by electrocution should be instantaneous. Kemmler's appeals ultimately were denied, and he was electrocuted on August 6, 1890.

### Circuits

A *circuit* is any connection of electrical components. A *complete circuit* is one that starts and ends at the same point and is required for current to flow (Fig. 27-6). A *series circuit* has two-terminal components connected end to end, and the total current in the circuit passes through each component (i.e., the current is constant through a series circuit). If one light bulb in a series of bulbs burns out, they all go dark. A *parallel circuit* has two-terminal components connected side by side. The current divides between the components, but the voltage drop across each component is the same (i.e., the voltage is constant across a parallel circuit; Fig. 27-7). If one light bulb in a parallel circuit burns out, the others will be unaffected.

### Semiconductors

Electricity becomes more interesting and useful—and more complicated—with semiconductors. Resistors, capacitors, and inductors are two-terminal,

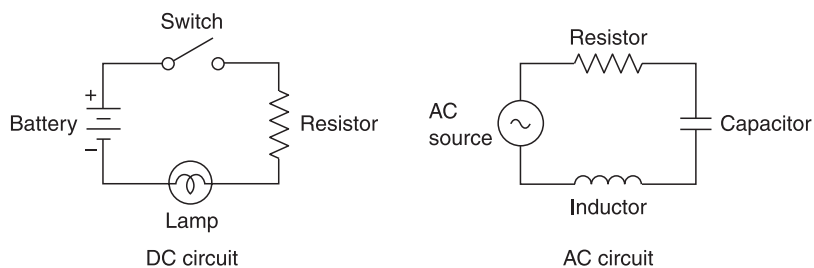


FIGURE 27-6. Direct current (DC) circuit and an alternating current (AC) circuit.

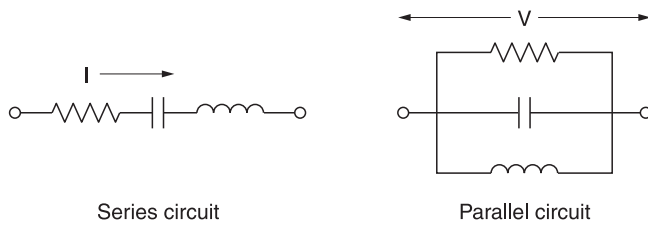


FIGURE 27-7. Series and parallel circuits.

linear, passive devices. In a linear device, a change in the input signal produces a proportional change in the output signal. A passive device is one with no built-in power source. A junction diode is the simplest semiconductor. It is a two-terminal, passive component, but it is nonlinear. It allows current in one direction and blocks current in the other (Fig. 27-8). This characteristic is used to convert AC to DC—*rectification*. A *zener diode* is a diode that can conduct in the reverse direction when a sufficiently large reverse voltage is applied (Fig. 27-9). This voltage is called a *zener point*, and a zener diode is used as a voltage regulator, which establishes a fixed voltage.

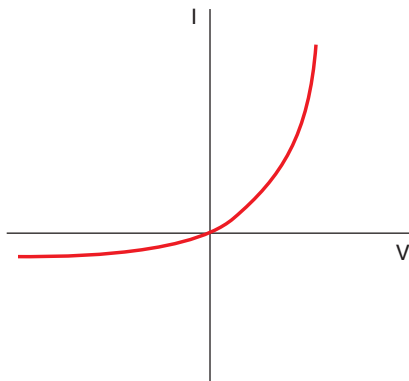


FIGURE 27-8. Current versus voltage in a junction diode.

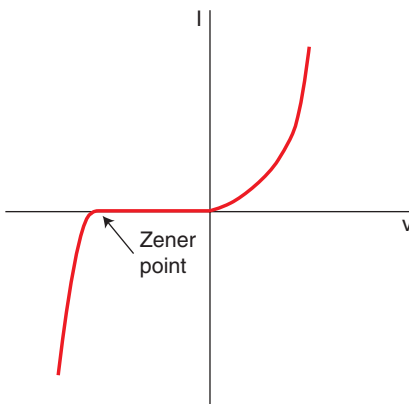


FIGURE 27-9. Current versus voltage in a zener diode.

A *transistor* is a three-terminal, nonlinear, active device. Active means that the output can have more power than the input. This characteristic permits amplification of signals. The extra power comes from an external power supply. Characteristics that are controlled by transistor circuits are input and output impedances, current and voltage gains, and phase and frequency responses. Types of transistors include bipolar-junction transistors and field-effect transistors. The symbols for resistors, capacitors, inductors, diodes, and transistors (as they appear in schematic drawings) are shown in Fig. 27-10.

*Integrated circuits* (ICs) are single semiconductor “chips” into which numerous transistors and passive components have been etched. A single IC can be a complete amplifier, a chip capable of storing thousands of bytes of digital memory, a computer’s microprocessor, or any of hundreds of different analog or digital circuits. ICs account for the miniaturization of instruments and computers and for their phenomenal speed and versatility. For example, the IC that serves as the central processing unit of a modern personal computer contains over 1,000,000,000 transistors. Their reduced power requirements are another important advantage.

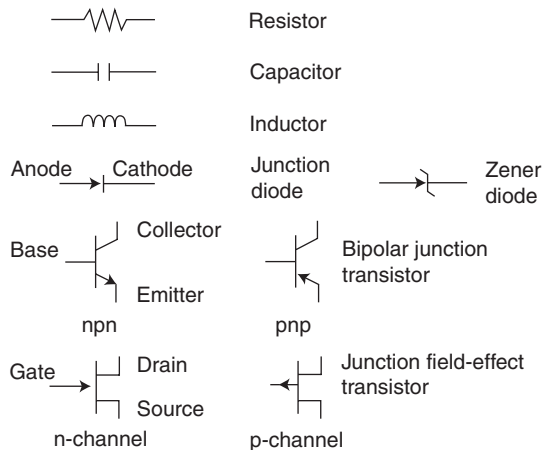


FIGURE 27-10. Electronic symbols.

## Analog and Digital Circuits

Circuits that manipulate continuous waveform voltages are called *analog circuits*. Signals can have a range of magnitudes. Natural phenomena typically are analog. Bipolar digital circuits have only two discrete voltage values, called *high* and *low* (or 1 and 0). Analog data can be converted to digital, and vice versa, by analog-to-digital (A/D) and digital-to-analog (D/A) converters. Data need to be in digital form to be used by digital computers. Digital data also have greater immunity to electrical noise. Spurious voltages added to an analog signal will alter the signal’s value. Digital low and high signals need only be within 1.5 V of their nominal values of 0–5 V to be dependably interpreted.

## Leakage Current

An unavoidable and undesirable side effect of electrical circuitry is leakage current. It is virtually impossible to contain all electrical energy within the wiring and components of electrical equipment. The primary source of leakage current is stray capacitance. Two conductors separated by insulation and air act like a capacitor, and AC current is conducted between them. The electrical power cord usually has the greatest amount of stray capacitance because of the length and proximity of the wires. Interestingly, leakage current will flow in the ground wire of a power cord even when a device is not turned on because AC voltage is present in the power cord as long as it is plugged in.

There also is resistive leakage because insulation is less than perfect. Although resistive leakage current is a



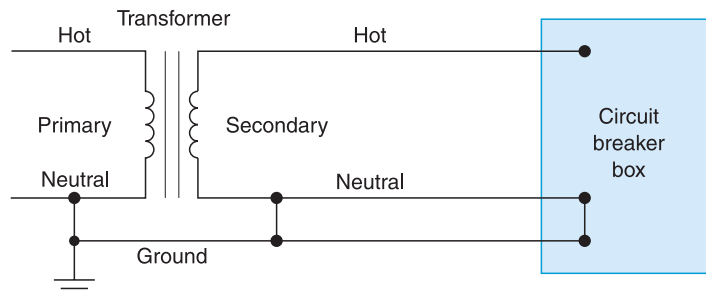
minor source, it tends to increase as equipment ages. In addition to the degradation of insulation, there can be a buildup of dirt, dust, and moisture inside the equipment.

The ground wire in a three-wire power cord conducts leakage current from the chassis of equipment to ground. It also shunts fault currents (caused by damaged insulation, wiring, or components) to ground. If a fault current is large enough, it will cause a fuse or circuit breaker to open, preventing shocks to patients or operators and further damage to equipment. If a ground wire is missing or broken, leakage current or fault current energizes the chassis until it finds an alternative path to ground. This alternative path can be a patient or an operator. This is one of the more important considerations in electrical hazards, which is the topic of the section on Hazards of Electricity.

### Isolated Power

In a conventional power distribution system, three wires feed into a circuit breaker box. These three wires are called *hot*, *neutral*, and *ground*. (This discussion is limited to 120 VAC systems.) The hot wire supplies current at 120 VAC, and the neutral wire provides the return path. The ground wire is for safety (i.e., for shock and fire protection from electrical faults). The circuit breaker box distributes power to branch circuits through individual circuit breakers. Each branch circuit feeds electrical receptacles, overhead lighting, or installed equipment (e.g., radiograph view box; Fig. 27-11).

An isolated-power system (or floating system) is a more specialized type of power distribution system. In an isolated-power system, the hot and neutral wires are *not* ground referenced. An isolation transformer and a line-isolation monitor (LIM) are installed directly in front of the circuit breaker box (Fig. 27-12A). Neither of the output leads from the isolation transformer is connected to ground. The output leads are referred to as *line 1* and *line 2*. Isolated-power sometimes is called *ungrounded*, but it is important to realize that a ground wire still is used. In this context, ungrounded simply means that neither of the power lines is connected to ground. The LIM monitors the degree of isolation of the isolated-power system by measuring the amount of current that would flow



**FIGURE 27-11.** Conventional power distribution system. Note the connections of neutral wires to ground terminals on both sides of the transformer and in the circuit breaker box.

to ground if either power line were connected directly to ground (total hazard current). If this current exceeds a preset limit, the monitor lights and sounds an alarm (Fig. 27-12B). If adding a device to the circuit triggers an alarm, the hazard current display can be used to assist troubleshooting by measuring the contribution of a device to the total hazard current as the device is added and removed from the circuit.

In a conventional power distribution system, a ground fault (a short circuit from the hot conductor to ground) allows a large current to flow until the circuit breaker opens (circuit breakers typically are rated at 15 or 20 A). An ideal isolation transformer would not allow any current to flow from either power line to ground. A direct fault from either power line to ground would merely convert the isolated-power system to a conventional power distribution system. A second fault, from the other power line to ground, would be required for a large current to flow to ground.

No isolation transformer is ideal. Capacitance between the transformer wiring creates a high-impedance path to ground. Additional high-impedance paths to ground exist within the LIM and the power distribution wiring. Altogether, these allow up to 1.5 mA of leakage current. Each device connected to the system contributes its own inherent leakage current (generally <math><100\ \mu\text{A}</math> each). Because of this, the alarm point of the LIM usually is set at 1.7–2.0 mA. This limits the shock and fire hazards resulting from ground faults. In 1978, the total hazard current limit was increased from 2 to 5 mA to reduce nuisance alarms. Isolated-power systems originally were used in hospitals to eliminate sparks that could cause an explosion in the presence of flammable anesthetics. In the

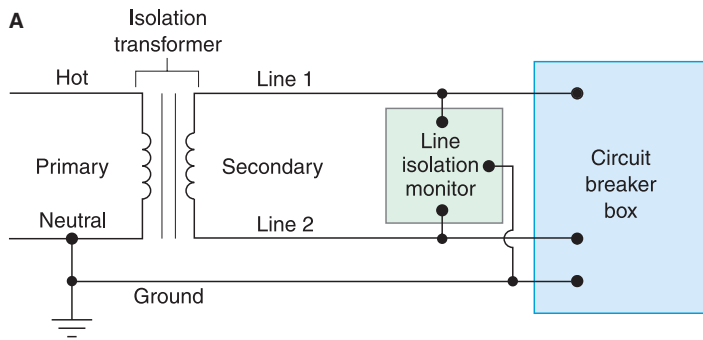
1960s and early 1970s when electrical safety first became a major concern, isolated-power systems were touted as panaceas for shock hazards. The virtual elimination of flammable anesthetics and realistic, cost-effective electrical safety measures have minimized the use of isolated-power systems for shock and fire protection.

The remaining safety factor provided by isolated-power systems is branch circuit protection. In the event of a ground fault in a device connected to an isolated-power system, the LIM will activate audible and visible alarm signals. These alert the operator to the fault and do no worse than convert the isolated-power system to conventional power (i.e., one power line is grounded). This allows the branch circuit to remain energized and the equipment to continue operating. The circuit breaker does not open because the only additional current that flows is limited to the previous value that the LIM was measuring. This benefit also is minimized by more realistic electrical safety measures applied to the design, construction, and maintenance of modern medical equipment.

Isolated-power systems formerly were required in anesthetizing locations and were strongly recommended in heavily instrumented areas (e.g. critical care units). They are expensive, more than \$2,000 for the hardware, plus extra costs for installation. Since 1984, isolated-power systems no longer have been required in nonflammable anesthetizing locations, but they still are allowed and continue to be included in the design of most operating rooms.

### Ground Fault Circuit Interrupters

Ground fault circuit interrupter (GFCI) protection systems are used in wet locations in the home, where contact



**FIGURE 27-12. A.** Isolated-power system. Note that neither side of the secondary of the transformer is connected to ground terminals, either at the transformer or at the circuit breaker box. **B.** Old and new (digital) line-isolation monitor status indicators. Digital panel indicates a total hazard current of 1.8 mA.



with a grounded surface is likely. A GFCI monitors the current flowing in both the hot and neutral lines. If an imbalance of current flow of  $>6$  mA is detected, indicating that current from the hot conductor is returning to ground via any other pathway—including a potential victim of electrocution—the GFCI immediately interrupts the circuit. The GFCI reaction time varies inversely with the leakage current. For example, Underwriters Laboratories (UL) standard 943 specifies that at a leakage current of 250 mA, the GFCI must activate in  $<20$  msec. (The threshold is 5 mA in the United States but may vary throughout the world.)

The GFCI effectively protects both grounded and ungrounded circuits from delivering a shock, but this protection comes with a price. Once activated, the GFCI interrupts all current flow from the circuit protected by the GFCI. Therefore, GFCI protection is reasonable only when interruption of electrical power is acceptable. GFCI activation may occur unpredictably, as

very small, relatively harmless, leakage currents, which may be generated by capacitive coupling in electrical wiring systems, may activate the GFCI.

One must assess the utility of a GFCI in the context of the hazard introduced by loss of electrical power. ECRI Institute (formerly Emergency Care Research Institute) recommends never using a GFCI with “life-support or critical equipment,”<sup>2</sup> and the National Electrical Code (NEC) recommends against the use of GFCIs if “interruptions cannot be tolerated.”<sup>3</sup> Despite the apparent clarity around the choice of protection, there is a significant practical problem. Currently, the choice of using a LIM or GFCI for protection is left to the institution. According to NFPA 99, GFCIs must be used in wet locations.<sup>4</sup> However, hospitals determine what they consider to be wet locations (with the exception of hydrotherapy tanks and pools, which are always considered wet locations).<sup>2</sup> Although operating rooms are not necessarily wet locations, one may encoun-

ter GFCI protected circuitry in modern operating rooms.<sup>2</sup>

## Isolation Amplifiers

Amplifiers increase the magnitude of an electrical signal or modify the signal to filter unwanted noise or other effects. It is desirable to isolate electrical connections between instruments and patients from ground (discussed later in Electrical Hazards to Patients). To accomplish this, isolation amplifiers are used. They have the advantage of isolating the input connections from any AC-powered circuit. There are three basic design techniques used by isolation amplifiers.

- Optical isolation amplifiers work by using light to transmit the signal. A light-emitting diode (LED) puts out light with intensity proportional to the strength of the signal. A photodiode then picks up the light signal and converts it back to an electrical signal.
- The transformer isolation amplifier uses a transformer to couple the

input signal with the rest of the circuitry. Because transformers cannot amplify DC signals, to make the instrument usable down to DC levels, the input signal modulates a high-frequency carrier signal. After the transformer-coupling stage, the signal has to be demodulated before further processing.

- Capacitively coupled isolation amplifiers also need a high-frequency carrier signal to transmit the signal to be isolated across isolating capacitors. Again, the desired signal subsequently is removed via a demodulator circuit.

## Interference

Electrical *interference* is any disturbance of the desired electrical signal. There are many possible sources of electrical interference, which sometimes may be hard to find or eliminate. The types of equipment most susceptible to electrical interference are physiologic monitors—equipment designed to detect generally low-level signals from a patient. Sources of interference include the following:

- Muscle artifact: muscle contractions produce electrical signals
- Broken input wires: open or intermittent circuits produce noisy signals
- Poor connections to the patient (e.g., dry electrodes)
- Electrical power distribution system: electric and magnetic fields produced by power lines can produce interference
- Ground loops: current created when two devices are electrically grounded to points that are not at the same electrical potential and then are connected to each other (e.g., through a patient); this current subsequently can interfere with the physiologic signal to be monitored
- Electromagnetic interference: transmitted signals picked up by circuitry (especially patient lead wires) and by the patient, which act like antennas; common sources include high-power, high-frequency equipment, such as electrosurgical units and x-ray machines, and portable communication equipment, such as two-way radios and cellular telephones.
- Triboelectric interference: generated by friction (including flexion) of insulation-covered wires

## HAZARDS OF ELECTRICITY

The hazards of electricity for the human body can be divided into four categories:

- Ventricular fibrillation
- Respiratory arrest
- Thermal burns
- Electrolytic burns

All of these result from unwanted electric current flowing through the body. In addition, there can be hazards caused by the electrical distribution system and connected equipment:

- Fire and explosion
- Electrical distribution system failure
- Electrical equipment failure

Finally, a broad category can be added to the list of hazards—misuse.

## Electrical Hazards to Patients

The human body is predominantly composed of conductive electrolyte solutions enclosed in a skin of high resistance. The skin's resistance varies depending on its condition. Dry, intact skin has a resistance of approximately one megohm (1 M $\Omega$ ). Moisture (e.g., perspiration) reduces resistance to approximately 15 kilohms (15 k $\Omega$ ). Electrode paste reduces skin resistance to approximately 1,000 ohms (1 k $\Omega$ ) by a combination of electrolytic action and mechanical abrasion. If the skin's resistance is breached by needles or catheters, resistance drops to a few hundred ohms.

*Macroshock* is the term used for current applied at the body's surface. *Microshock* describes current applied directly to the heart, and an electrically susceptible patient is one with a di-

rect, conductive path to the heart (e.g., pacing catheter, fluid-delivery catheter). The effect of electricity on the human body varies depending on a number of factors, including the magnitude, density, and frequency of the current; its path through the body; the weight of the subject; the duration of exposure; and the variability of response between subjects.

Fig. 27–13 shows the physiologic effects of a 60-Hz, 1- to 3-second duration current of varying magnitudes applied to the hands of a 70-kg man.<sup>5,9–12,36</sup> The threshold of perception is the minimum current that a subject can feel.<sup>13</sup> As the current increases, the effect increases from a tingling sensation to pain. Additional increases cause muscular contractions that prevent the subject from releasing his or her grasp—the *let-go current*. Just above the range of currents that prevents releasing the grip is the range that causes sustained contraction of the respiratory muscles. If the current is removed promptly, normal respiration resumes; if not, asphyxia can result. Ventricular fibrillation occurs when a critical number of myocardial cells are excited by a current of sufficient magnitude. This condition is not reversed when the current is removed. If a current that causes sustained myocardial contraction is removed, normal cardiac activity resumes. This is an effect similar to defibrillation (the return of rhythmicity after an abrupt excitation and subsequent depolarization of a large portion of the myocardium). Skin burns occur at high currents resulting from heating of the high resistance of the skin (analogous to the heating of a high-resistance filament in a light bulb). High currents can cause muscle contractions so strong that tendons tear away

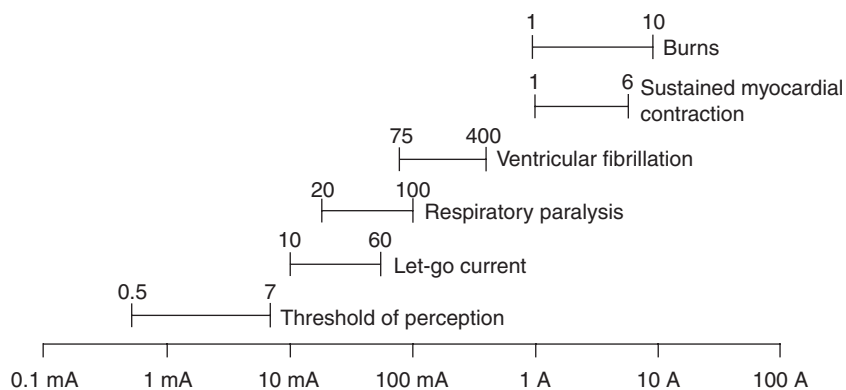


FIGURE 27–13. Threshold ranges of different effects for 1- to 3-second application of 60-Hz current.

from bones. Nervous tissue, including the brain, ceases all activity when subjected to high currents. Of these effects, ventricular fibrillation is the most dangerous to patients. For this reason, electrical safety in hospitals concentrates almost exclusively on preventing hazards that can cause ventricular fibrillation.

The path that the current takes through the body is important because it is only the percentage of the total current that passes through the heart that has the potential for causing fibrillation.<sup>5,11</sup> For example, if the two points of contact of the current source are on the same hand, there is little chance of fibrillation. A greater percentage of the current passes through the heart if it is applied between an arm and a leg rather than between both arms.

The longer the duration of the applied current, the less the magnitude of the current required to cause ventricular fibrillation.<sup>10,11,14</sup> There is a marked increase in the current required when the duration is reduced to <1 second. It can take 10 times as much current to cause fibrillation at 100 msec as it does at 1 second, but the current required at 5 seconds may be only about half that required at 1 second.

The frequency of the applied current has an interesting effect on the susceptibility of the body.<sup>10,15</sup> The body is most susceptible to frequencies between 10 Hz and 1 kHz. The frequency at which the minimum current is required to induce fibrillation is 50–60 Hz, the frequencies used for AC around the world. Below 10 Hz and above 1 kHz, the currents required to cause the same effects increase sharply. Studies of fibrillation thresholds have been conducted on dogs, pigs, sheep, and ponies. These studies have shown a direct relation between body weight and current, but the variability between subjects of the same weight is even greater.

There are two primary mechanisms for keeping equipment electrically safe: minimizing leakage current and grounding exposed conductive surfaces. Both are tested routinely as part of an electrical safety program, but there is no guarantee that either or both could not fail between equipment inspections.<sup>16</sup>

Leakage current can increase because of degradation of a single-layer insulation or because of a buildup of dust or other residue inside the instrument. Fault currents occur when something goes wrong—typically, a short circuit to the device's chassis. If there is only a partial short, one in which the current that can flow to ground is limited, the device continues to operate. This is likely when the fault is a result of a failed component or a frayed wire, wherein only a few strands of wire may be touching the chassis. A direct short of the hot wire of the power cord to ground or neutral would cause the instrument's fuse or circuit breaker or the circuit breaker in the distribution system's branch circuit to open. The former is more likely because the amperage rating of the instrument's fuse or breaker is much lower than that of the branch circuit.

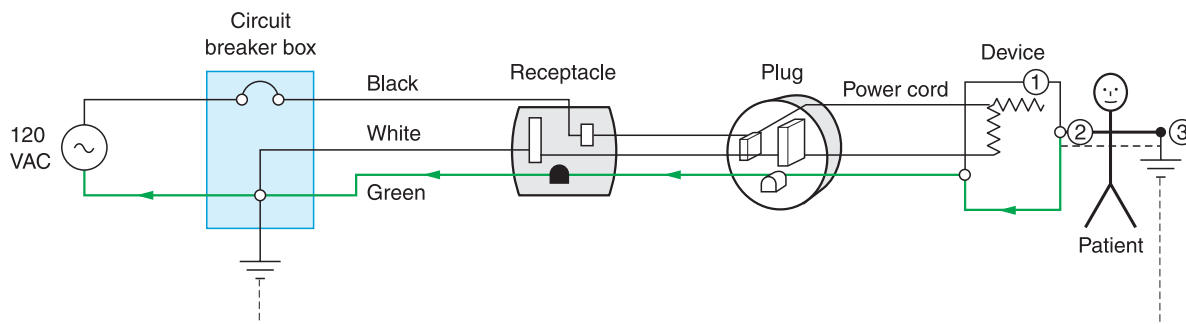
Grounding the chassis of an instrument shunts leakage current or fault current safely to earth ground and away from patients and personnel. Grounding can fail inside the instrument, the power cord, the electrical plug, or the electrical receptacle. As in the case of excessive leakage current or a partial short, if an instrument loses its ground connection, it will continue to operate.

It is a fundamental principle in modern electrical equipment design that the equipment must remain "single-fault" safe, which means that failure of a single safety mechanism will not create a safety hazard. For example, a device may be protected both by hav-

ing a chassis ground connected to a grounded power cord and by being designed with a low leakage current. If the power cord ground wire breaks, the low leakage current on the chassis surface will not present a new shock hazard. Similarly, an internal insulation failure that makes the chassis hot would not present a shock hazard because the current would be conducted to the power line ground, which would cause the panel circuit breaker to open. Because of this principle, equipment is designed with either basic insulation and grounding (as in the example above) or double (also called reinforced) insulation.

Fig. 27-14 illustrates the protection normally provided by grounding. In the event of a fault to the chassis (1), the fault current is safely shunted to ground (arrowheads). If the ground continuity is broken at any point between the device and the circuit breaker box, the chassis of the device becomes electrically energized. If a patient contacts or is connected to the device (2) and a grounded surface (3), such as an electric hospital bed, he or she becomes part of the circuit for the fault current (dashed line).

This discussion of electrical hazards to patients has concentrated on macroshock—current applied to the surface of the body. Electrically susceptible patients—those with a conductive path to the heart—are at risk for an additional hazard termed microshock. When all of the hazard current passes through the heart, much lower levels can cause ventricular fibrillation<sup>17</sup> There is no unanimous agreement on the minimum level of microshock current that can cause ventricular fibrillation in humans, but 100–200  $\mu\text{A}$  is most commonly cited.<sup>18–22</sup> As little as 20 mA has caused fibrillation in a dog, using 60-Hz current, applied for 15 seconds through a 0.224-mm<sup>2</sup> contact area.<sup>19</sup>

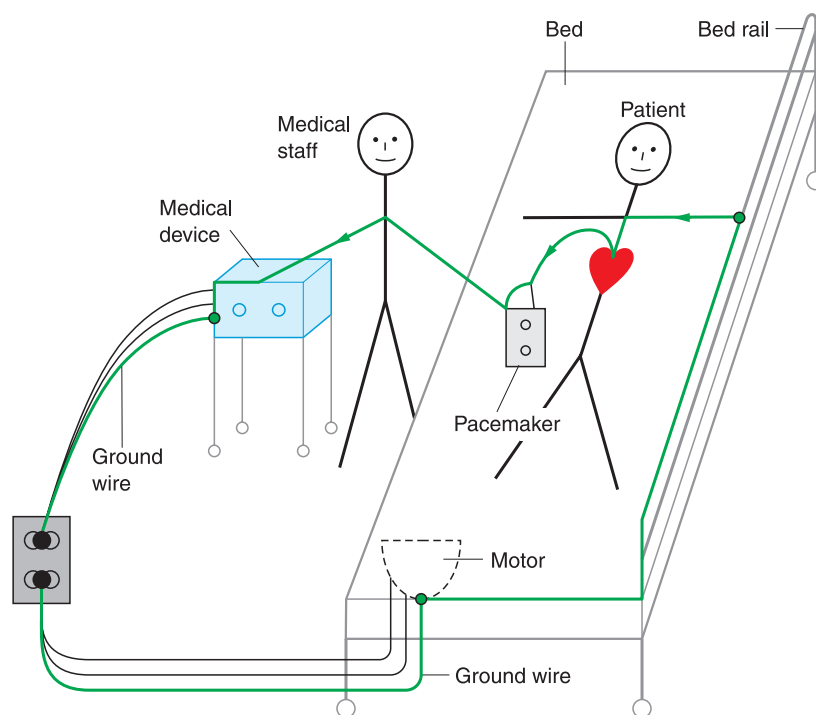


**FIGURE 27-14.** Arrows indicate safe path for leakage or fault current. If ground continuity were broken, leakage or fault current would follow an alternate path, which includes the patient, indicated by the dashed line.



Because the magnitude of the current that poses a microshock hazard is so small—roughly three orders of magnitude less than a macroshock hazard that can cause ventricular fibrillation—the problem of preventing it originally was more difficult. Temporary external pacemakers were AC powered, and the catheters and connectors were not protected from casual contact. Electrocardiographic (ECG) monitors had the right leg (RL) lead connected to chassis ground. Blood pressure transducers had metal cases that also were connected to ground. A variety of older equipment still was in use that had excessive leakage current or two-wire power cords. There was a lack of appreciation for the importance of relatively small differences in electrical potential between grounds in the patient's environment. The importance of electrical safety programs was not acknowledged at all hospitals.

Although virtually all of these initial problems have been eliminated in modern hospitals and very few accidental shocks or electrocutions in hospitals have ever been documented, a brief review of the hazards is worthwhile. It serves to reinforce the need for electrical safety programs, care in the design and selection of equipment, and avoidance of practices that may be hazardous to electrically susceptible patients. Fig. 27-15 illustrates just one of many scenarios that would allow the leakage current of one device to flow through a patient's heart. If the ground wire of the bed were broken, the leakage current of the bed would flow through the bed rail, the patient's

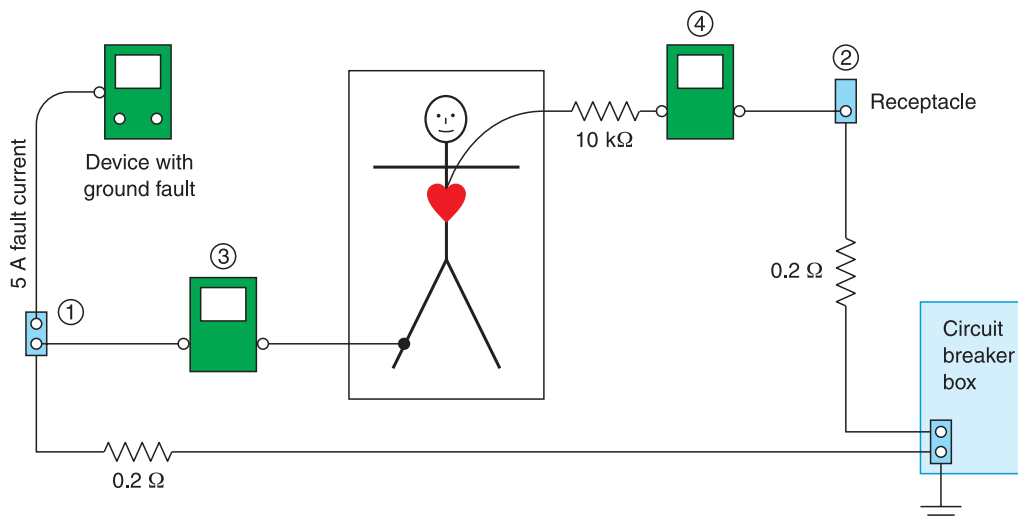


**FIGURE 27-15.** Electrically susceptible patient is at risk for microshock if either the ground wire of the bed or the ground wire of the device is broken. Arrows indicate current path through operator and patient.

arm and heart, the pacing catheter, the nurse or doctor handling the catheter, and the grounded medical device. If the ground of the device were broken, the device's leakage current would follow the same path in the opposite direction.

Another different scenario is shown in Fig. 27-16. In this figure, only the ground wiring of the power distribution system is drawn. There are two receptacles on separate branch circuits. A device with a ground fault,

allowing a 5-A fault current, is connected to the receptacle (1). Another device (3) grounds the patient via an RL connection (this may be an electrosurgical unit with a grounded return electrode). The patient also has a cardiac catheter with a relatively high resistance of 10 k $\Omega$  to ground. The resistance between the ground pins of each receptacle and the ground connection of the circuit breaker box is 0.2  $\Omega$ . The 5-A fault current through the 0.2- $\Omega$  ground resistance puts the ground of



**FIGURE 27-16.** A 5-A fault current increases the ground at receptacle (1) to 1 V above the ground at receptacle (2). The patient is grounded via device (3) and has a fluid-filled cardiac catheter connected to device (4). Up to 100  $\mu$ A can flow through the patient's heart (see text for analysis).

receptacle (1) at 1 V above the ground of receptacle (2). This potential, across the 10 k $\Omega$  of the cardiac catheter (other resistances in the path, including the patient, are not important), allows 100  $\mu$ A to flow through the patient's heart.

These types of events are unlikely to occur because reasonable effective steps have been taken to prevent them. In particular, pacing catheters are protected from casual contact by the design of their connections and by precautions taken in their handling. Other catheters typically are effectively isolated from ground. It is possible that there can be broken ground wires or fault currents in equipment, although they are less likely to occur because of generally higher-quality components and construction. Perhaps the most important reasons that electrical shock incidents are so unlikely to occur are that electrical safety standards and tests (as part of an equipment inspection program) are so well established. Electrical safety standards and tests are measurements of the same parameters—grounding resistance and leakage current. Grounding resistance is measured as the electrical resistance from the ground pin of a device's power plug to exposed conductive surfaces of the device. Leakage current (sometimes called *risk current* by standards organizations) is measured as the current that flows under specified conditions and between specified test points through a circuit (test load) that simulates a body's electrical resistance.

Leakage current is measured at a variety of sites: from the surface of the device to ground (enclosure leakage current); in the ground conductor of the power cord (earth leakage current); from patient connections to ground, to the surface of the device, and to other patient connections (patient applied leakage current); and into patient connections with line voltage (120 VAC) applied to the patient connections (patient-isolated leakage current). Leakage current is measured under normal operating conditions and under a set of single-fault conditions. Normal operating conditions include every combination of power on and off, normal and reversed power polarity, and patient grounded and not grounded. Single-fault conditions include open power ground connection, a short circuit of either level of double insulation, and the failure of any component that can

affect leakage current. The allowable leakage current varies, depending on the use (in the vicinity of patient or not), design (isolated patient connections or not), and condition (normal or single-fault) of the equipment.

Thermal burns result from resistive heating of tissue. This type of heating is called *joule heating*. The amount of heat produced, in joules, is proportional to current, resistance, and time:  $H = I^2RT$ . The threshold current for causing burns depends on a number of factors. The smaller the contact area, the greater the current density and the greater the heating for a given current. From the equation for joule heating, it is clear that the longer the current is applied, the greater the heating. This is further affected by the ability of the tissue to dissipate heat. Well-vascularized tissue is able to carry away heat more effectively than can poorly vascularized tissue. The higher the resistance of the tissue, the greater the heat production of a given current. Tissue resistance increases in the following order: nerves, blood vessels, muscles, skin, tendons, fat, and bone. Although the joule heating of tissue is independent of frequency, the path taken by the current is not. This is because the impedance of different tissues varies at different frequencies. At DC and low AC frequencies, current distributes itself throughout the body. Skin tissue exhibits a combination of high resistance and low capacitance. Therefore, at frequencies >10 kHz, more current flows along the surface of the body (i.e., through the skin). This makes skin more susceptible to burns at radiofrequency (RF) currents from electrosurgical units, which operate from 500 kHz to 3 MHz.

DC causes burns at low potentials and currents by electrolytic action. Saline in the body is converted to chlorine gas at the anode (positive) connection and sodium hydroxide and hydrogen at the cathode (negative) connection. Burns can occur at both connections but will be more severe at the cathode because of the caustic action of the sodium hydroxide.

Two points about electric shock hazards warrant emphasis. The first is that leakage current is an important hazard parameter, not voltage. One reason for this is that current density has the physiologic effect. The other reason is that the source impedance (the impedance "seen" when looking

back into the leakage source) usually is much higher than the load (i.e., the patient). Thus, there will be a relatively low current through the load compared with the open circuit voltage (typically, 120 VAC).

The second point is that there historically has been an overreaction to potential or theoretic electric shock hazards, which has, without a doubt, resulted in wasted resources.<sup>23</sup> Time has been wasted looking for escaping microamperes, and money has been wasted on multiple layers of redundant electrical safety hardware. There simply has not been enough of a real danger to justify these expenditures. Equipment and user performance problems (as discussed later in Hazards of Misuse) are more frequent and at least as serious. The overemphasis on electrical safety has detracted from attention to more important concerns to the extent that some in-house equipment inspection programs test only safety and ignore performance measures.

### Hazards of Electrical Distribution Systems and Equipment

Hazards with electrical distribution systems and equipment generally are more straightforward than the effects of electricity on patients. Despite (or perhaps because of) this, such hazards are more likely to occur. This section describes hazards associated with the use of electricity other than those that occur with the direct application of current to the body.

Historically, flammable anesthetics were the major explosion hazard. Now, nonflammable anesthetics are used exclusively, at least in the United States. Therefore, the risk of explosion in operating rooms has been dramatically reduced. Other flammable liquids or aerosols may be used, including some germicides and alcohol-based skin preparations. Use of such chemicals should be minimized. Alcohol-based prep must be permitted to air-dry prior to covering with surgical drapes, and pooling of prep solution must be avoided. Finding a suitable substitute probably is easier than eliminating sources of ignition (e.g., electrical equipment, static electricity) or being sure to eliminate remnants of the liquid or its vapors.

Fire hazards are more difficult to avoid entirely than are explosion hazards. Fires can start under a variety of

circumstances. Electrical fires can start from the overheating of worn insulation, deteriorated components, excessive friction of moving parts, dirt or dust buildup on hot assemblies, and a variety of other possibilities. In the operating room, the situation is exacerbated by the likelihood of increased oxygen or nitrous oxide concentrations, especially during head and neck surgery. Oxygen not only increases the intensity of fire, but it also reduces the temperature necessary for ignition. New technologies also can introduce new fire hazards. For example, lasers used for tracheal and oropharyngeal procedures have ignited endotracheal tubes in patients' airways. The oxygen-enriched atmosphere produces a fearsome fire that obviously is life threatening. Sloppy or thoughtless techniques also are a fire hazard (as well as being a surgical risk). Fires started by careless use of electrosurgical units continue to occur too frequently.

Likewise, there are many ways that the electric distribution system can fail. If there is a failure outside the hospital, the hospital should have an emergency alternative source of power. According to the National Fire Protection Association's standard, *Standard for Health Care Facilities* (NFPA 99),<sup>4</sup> hospitals should have an on-site generator(s) capable of powering what are defined as "essential electrical systems." This standard also has sections that provide detailed and specific requirements for wiring distribution, circuit breakers, and grounding to reduce the potential for shocks, fires, and loss of power. This topic is discussed further in the Standards section. It should be obvious that for the electrical system to be safe and dependable, it must be designed and installed properly. In addition, the electrical system should be inspected and tested periodically. This, too, is described in detail in the section on standards of the National Fire Protection Association.

Many of the hazards attendant to the use of medical equipment already have been mentioned. Electric shock has been described in terms of its effects on the body, and it has been shown how patients can be at risk for either macroshock or microshock. Operators can be equally at risk of macroshock—perhaps even more than patients—because they handle more equipment, more often, and under less-controlled conditions. Operators

have the additional hazard of a startle reaction to a shock that can lead to a secondary accident as they jerk or jump. Defective equipment—in particular, improperly grounded equipment, poses a serious shock hazard.

Loss of power can immediately threaten a patient if equipment is sustaining his or her life. The best examples are heart–lung machines and ventilators, although compressed gas also can be a power source. The loss of oxygen to an anesthesia machine or ventilator can be just as life threatening as the loss of AC power. AC and compressed gas from a central source are fairly dependable and, at least with life support equipment, usually have some backup source. The same is not necessarily true for equipment that has a self-contained power source. External (temporary) pacemakers and portable ventilators are examples; the former depend on batteries and the latter on oxygen cylinders. Equipment with self-contained power sources can be especially dangerous if power fails because patients may not be under direct observation by clinicians or may be in locations where adequate backup support is not readily available (e.g., transport in an elevator).

A less common hazard is RF interference. Some pieces of equipment generate RF signals that "escape" from their intended circuitry. The electrosurgical unit is the classic example. A powerful RF generator, such as an electrosurgical unit, can conduct RF interference back through the power line and radiate it through the air, much like a radio transmitter. The former can be controlled by circuits called *RF filters*. The latter can be controlled by a combination of circuit design, physical layout, and shielding via the enclosure of subassemblies and the entire device. Devices also can be susceptible to RF interference. Devices with digital circuitry, including microprocessor-controlled devices, are particularly susceptible. Equipment that is susceptible to RF interference will have RF filters built in to protect it. Unless properly designed, a characteristic of simple RF filters is that they allow unacceptable leakage current to ground.<sup>6</sup> Although modern medical equipment incorporates RF filters that do not have this flaw, older medical equipment (especially older physical therapy diathermy units) and any pieces of equipment not intended for

medical applications have RF filters that cause high leakage current. An example of the latter is the personal computer. Often, an RF filter can be replaced with one designed for medical equipment. If not, a dedicated isolation transformer may have to be installed—a more expensive and cumbersome solution.

More recently, the extent to which the electromagnetic environment interacts with medical equipment has garnered attention. A variety of malfunctions resulting from electromagnetic interference (EMI) with devices such as powered wheelchairs, apnea monitors, and ventilators have been reported.<sup>24</sup> Television and radio transmission antennas, at some distance from a hospital, can cause erratic behavior of equipment.<sup>25</sup> Miniaturization of electronics has allowed the development of increasingly complex medical devices. They typically consume less power than older equipment but often are more sensitive to EMI. There also has been a concomitant development and proliferation of communications devices, such as cellular telephones and wireless computer links. Unforeseen problems may result from the interactions between communications devices and medical devices.<sup>26</sup> Neither the full extent of the problems nor the appropriate levels of precautions and standards have been completely defined.

Fire and explosion hazards were described first and separately because they were a concern before the use of electrical equipment. They still are hazards that are not limited to electrical equipment. Patients also can receive thermal injuries directly from equipment. Sustained skin contact with a good thermal conductor at 42–44°C can burn the skin. As the temperature increases, the time required to burn falls rapidly. Hypothermia/hyperthermia machines, blood warmers, and infant radiant warmers are devices intended to help maintain a patient's temperature. All of these should have safety (backup) thermostats, but they can overheat a patient if circuitry fails or if they are set improperly. The patient and the equipment both should be monitored. A malfunctioning heated humidifier in a ventilator circuit can burn a patient's airway or present a fire hazard. A patient also can be burned inadvertently by a laser or an electrosurgical unit. These are not the-

oretical hazards; they occur regularly in operating rooms as a result of even the slightest carelessness.

Moisture in equipment can reduce the insulating properties of wires, components, and printed circuit boards, resulting in a malfunction, a shock hazard, or a fire. The most common cause of moisture entry into equipment is spillage of a container of liquid that had “conveniently” been placed on top of the equipment. Some equipment is built with holes or slots in the top to allow cooling. This is a poor design, usually compounded by a top that is horizontal. It is much better to design equipment so that it does not require holes in the top and so that the top is at any angle to prevent its use as a shelf.

Patients and staff can suffer mechanical injury from equipment. A sharp corner or projection on a piece of equipment is almost a guarantee that someone will run into it. A top-heavy piece of equipment can fall onto a person as easily as onto the floor. A portable IV pole with small casters, a narrow wheel base, and two or three pumps clamped to the upper half can easily be knocked over. Overloaded or poorly installed shelves eventually will fail. Loose brackets or locking assemblies may lead to the collapse of a bed, operating room table, or wheelchair. What this also should indicate is that even if no human injury results, the equipment will be damaged such that the damaged equipment is not available and possibly subject to expensive repair or early retirement.

## Hazards of Misuse

Misuse of equipment is given many names that also indicate the breadth of this category: human or operator error, accidental activation, incorrect setting, confusing controls, misinterpreted displays, abuse, and so on. The types of hazards that can result from misuse are essentially the same as those previously described. It is too easy, especially for a clinical engineer, to claim clinicians do not have enough respect for medical equipment. It is more useful to list steps to prevent misuse.

Anyone who operates medical equipment should read the operator's manual and understand the operating principles of the equipment, the function of all controls and displays, and any warnings. A copy of the manual should be available in a known, convenient location (with the equipment, or on an

institutional intranet, if possible). An abbreviated instruction label on the instrument often is useful. Operators should receive training, which may have to be repeated periodically, especially if the operators are only “occasional” users. New equipment should have undergone a careful selection process, ideally a comparative evaluation based on existing standards and an objective set of technical and clinical criteria. Trained technicians should periodically inspect and maintain the equipment. Malfunctioning or damaged equipment should be serviced promptly.

For the most critically important equipment, plans or provisions for the eventuality of a failure should be in place. If there is sufficient justification, a backup unit is the best solution. There should be a long-range plan for how and when equipment should be considered for retirement and replacement. Criteria should include not only age and repair costs, but also functionality.

Common sense is most important. Psychologist Edward Titchener said, “Common sense is the very antipodes of science.” This negative remark obviously is meant as sarcastic humor. More accurately and more to the point, the physician Peter Latham said, “Common sense is, in medicine, the master workman.”

## STANDARDS

In a nation of rules, regulations, and recommendations, healthcare (including medical device manufacturers, hospitals, clinics, and other providers) is arguably one of the more regulated aspects of our society. The list of organizations that promulgate or enforce healthcare standards reads like a veritable alphabet soup of acronyms: FDA, NFPA, JCAHO, UL, ANSI, IEC, AAMI, ECRI, and so on. This section covers those organizations that have the most impact on the use of medical equipment. It describes the various groups, their standards, and the differences between their standards.

### National Fire Protection Association

The National Fire Protection Association (NFPA) is a nonprofit organization that produces scores of different fire safety-related codes and standards. Interestingly, none of them carry the

force of law unless they are adopted by a state or local governing body. The two of most import to electrical safety in hospitals are the *National Electrical Code* (NFPA 70),<sup>3</sup> commonly known as the NEC, and *Standard for Health Care Facilities* (NFPA 99).<sup>4</sup> As with all NFPA standards, these codes are under constant review. Revisions appear, on the average, every 3 years. “Article 517” in the NEC pertains to electrical construction and installation in healthcare facilities. In its seven parts, it prescribes design, installation, and performance criteria of electrical distribution systems for general care, intensive care, and anesthetizing locations (including use of flammable and nonflammable anesthetics); electrical supplies for x-ray equipment; and low-voltage systems for communications, data, fire alarms, and so on. Two of the parts cover applications that are unique to hospitals. Emergency electrical power systems must provide continuous electrical service to specified areas of the hospital in the event of a disruption of normal electrical service. Isolated-power systems are required only in areas designated as hazardous anesthetizing locations (i.e., areas in which flammable anesthetics are used or stored).

*Standard for Health Care Facilities* combines what used to be 13 separate standards. Its companion, *Health Care Facilities Handbook*,<sup>27</sup> provides guidance and commentary on the standard. This standard addresses fire, explosion, and electrical hazards in healthcare facilities. It covers performance, use, and maintenance of the physical facilities and equipment as they relate to hazards. Chapter 13 on “Hospital Requirements” has several standards that cover electrical, gas, and vacuum systems and equipment; this chapter deals specifically with requirements on anesthetizing locations that are intended to protect against explosion, shock, or mechanical injury hazards associated with the use of inhalation anesthetics. Some changes have occurred in this section during the past few years. In particular, isolated power is no longer required “in facilities that have a written policy prohibiting the use of flammable inhalation anesthetizing agents.”

The electrical distribution system includes power to essential areas and functions for which alternate sources of power should be available in the



event of disruption of normal supply. The electrical distribution system in patient care areas is to be tested according to criteria listed. Grounding voltage and impedance are to be tested in new construction before it is accepted and in existing construction before it has been altered (annual inspections are recommended).

Electrical equipment in hospitals includes fixed and portable patient care and non-patient care equipment. Of these, portable patient care equipment deserves the most attention. It is to be tested at least annually in general care areas and semiannually in critical care areas, unless the hospital can justify longer periods based on inspection history. Testing includes and should be in the order of physical inspection, grounding, and leakage current. Equipment should have an appropriate plug, power cord, and strain relief at the chassis. The chassis leakage current of portable patient care equipment was increased from 100  $\mu\text{A}$  to 300  $\mu\text{A}$  in 1993. This change finally occurred after a decade-long debate of patient safety versus a desire to correlate more closely with international standards (Table 27-1). This current was further increased to 500  $\mu\text{A}$  in 2005 with the adoption of the third edition of IEC 60601-1 in the United States and the subsequent withdrawal of AAMI ES-1. Also, leakage current is measured as the RMS value from DC to 1 kHz. Leakage current limits increase to 10 mA proportional to frequency.

There are additional restrictions for equipment used in anesthetizing locations. There must be a storage device (e.g., cord wrap hooks) for the power

cord of portable equipment to prevent damage during storage. Switches are not allowed in the power cord, except for splash-proof foot switches. Equipment must be plugged into a fixed receptacle (i.e., not an extension cord). Allowable exceptions to this requirement are multiple-outlet strips permanently attached to a rack, table, or pedestal, and overhead (ceiling-drop) receptacles supplied by a flexible cord.

There are also some important administrative requirements. Only isolated input equipment is allowed to be connected to conductive catheters or pacemaker leads connected to a patient's heart. Equipment purchase orders are to require manuals that include operating, testing, and maintenance instructions. There is to be a scheduled inspection and preventive maintenance program. Electrical equipment for use with oxygen delivery equipment is to be listed for such use.

The hazards with centrally piped medical gas and vacuum systems include gases that intensify combustion (e.g., oxygen and nitrous oxide) being piped throughout the hospital, gas cylinder storage, pipe leaks, cross-connection of gases, and poor performance or failure of the system. Most of these hazards can be prevented by proper design and installation of medical gas and vacuum systems. In particular, care must be taken with oxygen and nitrous oxide, which are used with anesthesia equipment and (oxygen only) with respiratory therapy equipment. For example, after components of the gas supply are serviced, oxygen flowmeters and the oxygen flush valve must be tested to confirm that only

oxygen is being delivered. Almost all of the medical gas and vacuum requirements in NFPA 99 apply only to new installations, and all apply exclusively to centrally piped systems.

### Joint Commission

The Joint Commission (formerly Joint Commission on Accreditation of Healthcare Organizations [JCAHO]) is another private, nonprofit organization. It was formed in 1951 to improve the quality of healthcare to the public. The Joint Commission develops standards of quality in collaboration with health professionals and others. They publish and annually revise 10 accreditation manuals for different segments of healthcare, including the *Comprehensive Accreditation Manual for Hospitals* (CAMH).<sup>28</sup> Compliance with the requirements of the CAMH is, in principle, voluntary. In practice, compliance is considered virtually mandatory. Medicare and Medicaid, many state health departments, and various other licensure organizations accept or require Joint Commission accreditation as part of their own requirements.

In 2003, the Joint Commission introduced new National Patient Safety Goals, standards that address specific areas of patient safety. These standards are evaluated and updated annually. In 2004, the Joint Commission implemented its latest major changes to their accreditation system, Shared Visions-New Pathways, with even greater emphasis on patient safety and quality of care. Among the many changes was a new survey process based upon a "patient tracer methodology." In 2006, all accreditation surveys became unan-

**TABLE 27-1.**

**Comparison of Electrical Safety Standards, Patient Care Equipment Ungrounded**

Specification	ANSI/AAMI 60601-1:2005	NFPA 99	UL 60601-1	IEC 60601-1
Ground impedance, plug to chassis	Not applicable	0.5 $\Omega$	0.2 $\Omega$	0.2 $\Omega$
Leakage current, chassis to ground	300 $\mu\text{A}$	300 $\mu\text{A}$	300 $\mu\text{A}$ AC 420 $\mu\text{A}$ DC	500 $\mu\text{A}$
Leakage current, nonisolated patient connection	100 $\mu\text{A}$	100 $\mu\text{A}$	50 $\mu\text{A}$ AC 70 $\mu\text{A}$ DC	500 $\mu\text{A}$
Leakage current, isolated patient connection	50 $\mu\text{A}$	50 $\mu\text{A}$	10 $\mu\text{A}$ AC 14 $\mu\text{A}$ DC	50 $\mu\text{A}$
Leakage current, line voltage applied to isolated patient connection	50 $\mu\text{A}$	20 $\mu\text{A}$	20 $\mu\text{A}$	50 $\mu\text{A}$

ANSI/AAMI 60601-1:2005, American national standard, safe current limits for electromedical apparatus; IEC 60601-1, medical electrical equipment; NFPA 99, standard for health care facilities; UL 60601-1, medical electrical equipment, part 1: general requirements for safety; AC, alternating current; DC, direct current.

nounced, emphasizing the need for hospitals to be in continuous compliance with accreditation standards.

The accreditation standards that uniquely pertain to medical equipment appear in the chapter on “Management of the Environment of Care.” Standard EC.6.10 describes how hospitals must manage medical equipment risks, and standard EC.6.20 describes how medical equipment must be maintained. However, the Joint Commission standards are interdisciplinary; that is, the roles of many departments and functions affect and are affected by standards throughout the CAMH. Standards that affect medical equipment appear in chapters on leadership, human resources, information technology, human resources, and infection control, as well as in other parts of the chapter on environment of care.<sup>29</sup>

### Food and Drug Administration

Government regulation of medical devices is the responsibility of the Food and Drug Administration (FDA). Within the FDA, device regulation is the responsibility of the Center for Devices and Radiological Health (CDRH). The first federal law to protect the public from adulterated or misbranded food and drugs was The Food and Drugs Act, passed in 1906. In 1938, a new law The Federal Food, Drug, and Cosmetic Act established the FDA and expanded the authority to regulate food, drugs, and cosmetics. In May 1976, the Medical Device Amendments established the Bureau of Medical Devices and the Bureau of Radiological Health<sup>30</sup> (In 1982, the FDA combined these two bureaus into the CDRH.) The 1976 amendments gave the FDA specific authority for the regulation of medical devices. Before this, the FDA's ability to regulate medical devices was severely hampered because the FDA had to work within regulations intended for drugs. The 1976 amendments differentiated medical devices from drugs by defining that the latter group works primarily through chemical action, whereas the former does not.

The 1976 amendments also established a classification system for medical devices. Class I (“General Controls”) devices require minimal regulation; they do not require performance standards or premarket approval. General controls require that manufacturers register annually with the FDA, follow published Good Manufacturing Prac-

es (GMP) for establishing and documenting quality assurance practices, and comply with other labeling and documentation requirements of the Medical Device Amendments. Class II (“Performance Standards” cleared by premarket notification or 510(k)) devices must meet FDA-established standards that address safety and effectiveness or be compared to devices that were on the market in May 1976 (or devices that have been cleared via this process since then). To date, the FDA has created very few performance standards for specific devices. (Voluntary standards have been established by other organizations, and manufacturers almost invariably comply with them.) Examples of class II devices include ventilators, monitors, and infant incubators. Class III (“Premarket Approval”) devices should be demonstrated as safe and effective, typically via clinical testing. They include life support and implantable devices and devices that have a potential unreasonable risk of illness or injury. Examples include implantable pacemakers and heart valves.

The FDA has been actively reviewing consensus standards for optional use by manufacturers to support claims of safety or effectiveness. The document *Recognition and Use of Consensus Standards; Final Guidance for Industry and FDA (2001)*, represents the FDA's current thinking on this topic.

The Safe Medical Devices Act of 1990 (SMDA) was signed into law on November 28, 1990. Effective November 28, 1991, users are required by law to report to manufacturers if a device contributed to a patient's or staff member's serious injury or illness. If a device contributed to a death, the user must report to the manufacturer and the FDA. Users include virtually all medical facilities except physicians' offices. A *device* is broadly defined as an apparatus used to diagnose or treat a disease or function of the body. Reports must be submitted within 2 weeks of the time the user became aware of the incident. A serious illness or injury is one that is life threatening, results in permanent impairment, or requires immediate intervention to prevent permanent impairment. This law represents the first time that the FDA has directly regulated users of medical equipment. The user-reporting requirements of the SMDA are only one of the 18 parts of this law. The other sections pertain to new or

expanded regulations for manufacturers, including more authority for the FDA to require recalls of products.<sup>31</sup>

### Underwriters Laboratories and Nationally Recognized Testing Laboratories

The Underwriters Laboratories (UL) is an independent, nonprofit organization that develops safety standards. It tests materials, devices, and systems against these standards and “lists” (approves) products that meet the standards. The UL probably is the most widely recognized safety testing organization in the United States. It was founded in 1894 as a result of fire insurance companies' (underwriters') concerns for the number of electrical fires occurring at the 1893 Columbian Exposition in Chicago. UL is a Nationally Recognized Testing Laboratory (NRTL). Whereas at one time UL was the only NRTL, today more than a dozen different testing organizations for testing electrical equipment are recognized. Manufacturers seek NRTL listing to independently verify the safety of their products and, in many cases, to reduce their product liability insurance costs. Some areas of the United States require UL listing of products (e.g., Chicago, Oregon, and North Carolina).<sup>32</sup> Hospitals require their electrical equipment to carry NRTL listing so that they can comply with the federal Occupational Safety and Health Administration (OSHA) regulations, that is, so that they maintain a safe workplace.

The original UL standard for electrical medical equipment was UL 544, *Standard for Medical and Dental Equipment*.<sup>8</sup> Its various sections addressed construction, hazards to patients and users, electrical performance characteristics (including grounding impedance and leakage current; Table 27-1), and labeling requirements. It required chassis leakage of 100  $\mu$ A for patient care equipment.

In 1994, UL adopted UL 2601-1, *Medical Electronic Equipment, Part 1: General Requirements for Safety*.<sup>32</sup> This standard started with International Electrotechnical Commission (IEC) 60601-1 and its two amendments.<sup>33</sup> It was modified in a section of “US Deviations.” In general these deviations were from the UL 544 standards, when these standards were more stringent than the corresponding IEC 601-1 standards. For example, the chassis leakage was 300  $\mu$ A for patient

care equipment, rather than 500  $\mu\text{A}$  of IEC 60601-1, which is used in the rest of the world. In 2005, IEC approved the third edition of 60601-1, and in 2006 the United States adopted it without the 300- $\mu\text{A}$  chassis leakage deviation.<sup>21a</sup>

### Association for the Advancement of Medical Instrumentation

The Association for the Advancement of Medical Instrumentation (AAMI) is a private, nonprofit, professional membership organization. Members include engineers technicians, physicians, nurses, and administrators. Membership categories include individual, institutional, and manufacturers. One of the primary activities of AAMI is the writing of voluntary standards for medical devices. These standards are unique in that they include more than safety; they also include performance. To date, the AAMI has published 68 standards and a number of “recommended practices” and “technical information reports.” AAMI standards include *Electrosurgical Devices*, *Diagnostic Electrocardiographic Devices*, *Electronic or Automated Sphygmomanometers*, and *Cardiac Defibrillator Devices*.<sup>34</sup> Their standards are developed by a consensus process, in which manufacturers, users, researchers, consultants, and the FDA typically participate. AAMI standards are submitted to the American National Standards Institute (ANSI; see ANSI section) for approval as a national standard. In addition, AAMI represents ANSI in the development of international standards for medical equipment with the IEC and International Organization for Standardization (ISO). It is the intention of the U.S. medical device standards writing organizations—including FDA, ANSI, and AAMI “to adopt IEC and ISO standards if at all possible or to adapt them with minimal changes.”

The AAMI’s electrical safety standard was ES-1, *American National Standard, Safe Current Limits for Electromedical Apparatus*.<sup>35</sup> It specified four classes of medical equipment: those with isolated patient connection, nonisolated patient connection, likely to contact patient (but no patient connection), and no patient contact. The 1993 revision of this standard increased leakage current limits from the previous editions. The limits were more compatible, although not identical, with the IEC standard (discussed later in International Standards; Table

27–1). The leakage current from a patient care device to ground was raised from 100 to 300  $\mu\text{A}$ , not only to bring the AAMI standard closer to the IEC standard but also based on a study by Levin.<sup>13</sup> The leakage current limits are for frequencies from DC to 1 kHz. From 1 to 100 kHz, the limit increases proportionately to the frequency (i.e., at 100 kHz, the limit is 100 times the 1-kHz limit). Above 100 kHz, the limit remains constant. This standard was withdrawn in 2006 and replaced by IEC 60601-1.<sup>33</sup>

### American National Standards Institute

The American National Standards Institute (ANSI) is a private, nonprofit organization that coordinates most other U.S. organizations that promulgate standards, including NFPA, AAMI, and ASTM International. It administers voluntary consensus standards for virtually every type of product. These standards do not carry the force of law unless they are adopted and enforced by some other agency. ANSI also is the official U.S. representative to the IEC and ISO (see International Standards below). Within ANSI, the Medical Device Standards Board coordinates standards approved specifically for medical equipment.

### ASTM International

ASTM International (formerly the American Society for Testing and Materials) also is a private, nonprofit organization that promulgates standards. It was founded in 1898 and currently has approximately 134 committees that write standards for materials, products, systems, and services. The F4 Committee writes standards for medical and surgical materials and devices, the F29 Committee writes for anesthetic and respiratory equipment, and the F30 Committee writes for emergency medical devices. Of ASTM’s 68 volumes of standards, Volume 13.01 (Medical Devices) contains the ASTM standards for medical equipment, materials and supplies, and services. Examples include tracheal tubes, anesthesia workstations, pediatric trauma facilities, and fixation pins and wires.

### International Standards

International standards are assuming increasing importance because of the European Community (EC). A major

provision of the EC is the adoption of standards that will replace national standards of member countries. For any manufacturer to be able to market equipment in the EC, it has to comply with these standards. This is important to manufacturers because the EC represents a large market, second only to the United States.

The International Electrotechnical Commission (IEC) writes standards for electrical devices, and the International Organization for Standardization (ISO) writes standards for everything else. The IEC Technical Committee No. 62, which is responsible for standards on electrical equipment, publishes IEC 60601-1 *Medical Electrical Equipment*. Part I, “The General Requirements for Safety,” is the starting point for all IEC medical equipment standards. Part II, “Particular Requirements,” supplements (and amends as necessary) the general requirements to cover the characteristics of specific types of equipment. There currently are approximately 60 Part II Particular Requirements from IEC and more than 15 from ISO. Like the AAMI standards, the IEC and ISO Particular Requirements cover safety and performance

The leakage current limit from the surface of a patient care device to ground is 500  $\mu\text{A}$ . The upper limits for leakage current pertain to frequencies up to 1 kHz. For frequencies between 1 and 100 kHz, these values are multiplied by the frequency in kilohertz, to an upper limit of 10 mA.

### ECRI Institute

Since 1968, ECRI Institute (formerly Emergency Care Research Institute) has been studying the safety and performance of medical equipment. ECRI Institute is a private, nonprofit organization that is the medical equipment analogue of Consumers Union. Their primary publication, *Health Devices*, presents comparative evaluations of equipment and disposables and provides analysis and advice on technology and management issues relevant to healthcare. Although they do not publish standards per se, they develop tests and performance criteria for the devices that they evaluate and for recommended inspection procedures. For years, their publication of these criteria and their direct involvement and interaction with organizations that promulgate standards have had a major impact on medical device standards.

## SAFE USE OF EQUIPMENT

### Hazards: A Reality Check

The hazards of medical equipment have been described in the previous sections of this chapter. These hazards still exist, and new wrinkles on old types of problems continuously appear as new technologies are introduced. The frequency of equipment-related hazards is reduced with understanding and experience. In addition, as more hospitals obtain the assistance of sophisticated clinical engineering departments, risk management and quality assurance functions improve. The current interest extends beyond risk management and quality control to quality improvement.

The first reported instance of a fatal electric shock caused by a medical device appeared in *Lancet* on April 16, 1960.<sup>7</sup> A patient died on the operating table when he was connected to a faulty cardiac monitor. Descriptions of electrical hazards in hospitals were published throughout the 1960s. Carl Walter, in 1970, claimed that 1,200 patients per year were being electrocuted in U.S. hospitals.<sup>36</sup> This figure gained widespread notoriety when Ralph Nader<sup>37</sup> repeated it in *Ladies Home Journal* in 1971. This figure was never documented. Nevertheless, it led to a period of great, if often misplaced, activity that ultimately resulted in an understanding and appreciation of electrical safety. The design and construction of modern medical equipment combined with the practices used in electrical safety programs have almost eliminated electrical shock incidents. Although electrical safety concerns should not be ignored, perhaps their most important contribution is that engineers and technicians now have regular opportunities to test medical equipment. The most important aspect of equipment inspections is performance testing.

Fires and resulting burn injuries caused by anesthetic gases have been eliminated because flammable anesthetic gases are no longer used in the United States. Fires and burns still occur as a result of the use of electro-surgical units and lasers. Precautions still are necessary. It is important to keep sources of fuel, oxidizing gas, and ignition separated. Most of the time, use of common sense and reasonable caution prevents fires. Additional precautions are necessary, in particular,

for head and neck surgery. Basically, these precautions involve using non-flammable materials when possible, preventing the buildup of higher concentrations of oxidizing gases (especially from nasal cannulas), and knowing where electro-surgical sparks or lasers are directed.

Burns also occur as a direct result of electro-surgical currents. Unintended burns may result from carelessness or improper technique with either the active or the return (or “dispersive”) electrode. The active electrode should never be left on the patient when not in use. Inadvertent activation of the electro-surgical unit can cause a spark or current through layers of surgical drapes. Some electro-surgical units allow connection of more than one active electrode and may not always provide a means for selective activation. It becomes especially important that one active electrode not be lying on the patient when the other is activated because current will be available from both. Burns at the site of the return electrode occur when there is inadequate electrical contact with the site, which may result if the electrode’s conductive gel dries out. Gel can dry out in the package if left open too long before application, or even during a particularly long surgical procedure. (Some return electrodes do not use electrode gel; they use either a conductive adhesive or capacitive coupling to the skin.) Another problem with electrical contact occurs if not enough of the electrode is in contact with the skin. The entire surface should be firmly pressed to the skin. Bony areas should be avoided because they make it difficult to maintain good contact. In addition, wrinkled electrodes, or “tenting” of the electrode over the skin, should be prevented. Poor electrical contact results in higher current densities, which can be sufficient to cause burns. Newer return electrode designs incorporate two separate electrodes to continuously monitor skin-to-electrode impedance to detect poor skin contact.

Burns can occur at alternate sites. Contact with other conductive surfaces, such as ECG electrodes or the operating table, can cause the electro-surgical current to divide between return paths. This contact can be resistive or capacitive. At the frequencies used by electro-surgical units, capacitive coupling can occur, with surfaces that

would not appreciably conduct lower frequency currents. Two approaches are taken to prevent this. One is to always place the return electrode as close as possible to the surgical site. The other is, via the design of the electro-surgical unit, to ensure that all of the output current is returned to the electro-surgical unit through the return electrode. This can be accomplished by using an isolated output (analogous to isolated-power distribution systems) that does not allow current to return through alternate paths. Another technique is to compare the output current with the return current. If they are not the same, the electro-surgical unit deactivates the output and alarms (audible and visible).

It may be difficult to identify all contributing factors to a burn or burn-like injury. There often are multiple factors, any one of which by itself would not have caused an injury. Thermal burns can result from direct contact or radiant heat. Hyperthermia units can cause the former, and radiant warmers or high-intensity lights can cause the latter. Ischemia resulting from pressure or surgery can exacerbate the problem because circulating blood is an effective means for dissipating heat. Mechanical injuries can appear to be burns. Shearing forces, which result from changing the position of the operating table, can cause mechanical injury. Chemical burns can result from the application of some skin preparation agents (e.g., acetone, alcohol, iodine, or merthiolate). Injury is more likely if the agent is in constant contact with the skin and if heat or pressure is applied. Ethylene oxide, if not completely aerated from the chambers of a re-sterilized anesthesia mask or hyperthermia blanket, may cause skin injury, especially if the skin is moist. Electrical burns can result from the unintended flow of electrical current. Not only electro-surgical units, but virtually any device that has an electrical output, can cause a burn if the current density is allowed to get too high. For example, nerve stimulators for testing the degree of muscle paralysis have caused burns when used with inappropriate electrodes.

Outright failure of medical equipment accounts for only a small percentage of patient injuries. Generally, a complete failure is obvious, and the real problem is the lack of availability



of the device. A more insidious problem occurs if the device is inaccurate. This can lead to inappropriate treatment, either directly because of an incorrect output (e.g., defibrillator) or indirectly because of an inaccurate measurement (e.g., pressure monitor).

Although not many device-related patient injuries occur, more result from human error (referred to as *use error*) than device failure. This probably is because when a device fails, an operator is likely to discover it, whereas when use error occurs, it may go unnoticed. Use error can take the form of misinterpretation, oversight, or misapplication. Any of these can result from, at least in part, the equipment design. Confusing or ambiguous controls and indicators increase the opportunities for mistakes. In addition, human error is likely to occur if operators do not receive adequate training or if a variety of models of equipment are used interchangeably for the same applications. A new standard has been developed, IEC 62366:2007, which will require manufacturers to minimize use error.<sup>21a</sup>

### Aspects of Equipment Safety

Attention should be given to all aspects of equipment safety to provide the proper measure of safety. Two broad categories should be considered: care of the equipment and care of the users.

Care of equipment requires conscientious application of engineering and management principles. Care of equipment also requires care of physical facilities; the former cannot work properly unless the latter also works properly. To provide this care, clinical and plant engineering departments not only have to do their own jobs, they have to cooperate.

The clinical engineering department typically has responsibility for most electronic and pneumatic equipment that has a role in patient care. The major functions of clinical engineering departments are inspections, repairs, and user assistance. Every clinical engineering department should provide these services. Biomedical equipment technicians are specially and specifically trained to provide these services.

Equipment inspections and preventive maintenance must be done according to appropriate schedules and procedures. Developing the schedule depends on judgment and experience. Consideration is given to the likelihood of problems occurring, the seriousness

of the consequences, and the manufacturer's specifications and recommendations. The procedures are developed from a combination of the manufacturer's procedures in the service manual, independently published standards and guidelines, and practical experience. Inspection procedures must include safety (mechanical and electrical) and performance tests. The latter should be considered more important. Performance failures may or may not be more serious than safety failures, but they are more likely to occur. A successful inspection depends on two other aspects as well: appropriate test equipment and cooperative equipment users. The former is obvious; the latter too often is not. To locate equipment and ensure its availability, biomedical equipment technicians should have help from equipment users. New radio-frequency identification (RFID) systems may help locate equipment and track maintenance history. Finally, the inspection program must be documented, including the schedule, procedures, and results.

Medical equipment repair is a technical skill that depends on education and experience. Users can help in two important ways. The first is to take the time to explain the nature of the problem and to make a reasonable assessment of the priority of the equipment. The second is to give the technician time to concentrate on troubleshooting and repair. Documentation of repairs is important to the clinical engineering department in order to track trends with equipment and users. Such documentation also should be available to the users for their review.

Other functions provided by more versatile clinical engineering departments include equipment evaluations, equipment-related incident investigations, in-service education, and design and fabrication of new or modified equipment. These services are best done by engineers or experienced technicians with a demonstrated ability for these functions.

Plant engineering departments also provide inspections, preventive maintenance, and repairs, although they typically do not provide user assistance to clinicians. The equipment for which they are responsible is predominantly nonmedical, but it is just as critical as medical equipment is to clinicians and patients. The medical equipment for which plant engineer-

ing departments are responsible may include patient beds, operating tables, operating room lights, nurse call systems, and mechanical items such as stretchers and wheelchairs. However, as this equipment becomes more versatile and more complex, responsibility often is transferred to the clinical engineering department.

Clinical engineering and plant engineering departments must cooperate, particularly in areas where their responsibilities overlap. Examples include the installation of equipment for patient monitoring, dialysis water treatment, and imaging, and for other equipment having unique installation or operational requirements. Likewise, clinical engineering and information technology departments must cooperate.<sup>38</sup> Increasingly, the lines separating their equipment responsibilities is blurring, as medical equipment is networked and data from medical equipment are added to electronic patient records.<sup>39,40</sup>

Arguably the most important facet of the safe and effective use of medical equipment is the end user. The end user usually is a nurse or a physician but may be an engineer, technician, or therapist. The most vital component for user success is training. The end user can be so skilled that he or she can even overcome shortcomings of particular equipment or so unskilled as to make the best of equipment hazardous. Training can and should be available from the manufacturer, directly from its representatives and from its operator's manual, from the clinical engineering staff, and from other knowledgeable users. Users should understand the operating principles of the equipment, the operation of controls and indicators, and the applications for which the equipment is intended. They should observe the setup and preuse checks prescribed by the manufacturer. They have the right and the duty to insist that equipment be properly maintained and in proper working order. Finally, they should be observant and conscientious during the actual use of the equipment.

Another, occasionally overlooked, aspect of medical equipment use is cooperation with others in healthcare who are involved with the acquisition and use of medical technology. The institution's administration is responsible for planning, budgeting, and complying with a myriad of standards

and regulations. They cannot be completely successful without the cooperation of clinicians. Support services, from housekeeping and nutrition departments to plant and clinical engineering departments, cannot successfully complete their responsibilities without cooperation from clinicians. All clinical areas have similar requirements. It often is just as important to share the availability of clinical equipment as it is to share clinical information to provide optimal patient care.

## Technology Management

It is an oversimplification, but still useful, to categorize the approximately 40-year history of clinical engineering by decades. The 1960s were primarily concerned with electrical safety, the 1970s with performance assurance, and the 1980s with productivity and quality assurance. The 1990s were concerned with technology management, incorporating quality improvement. Now we are addressing software reliability, firmware upgrades, connectivity of medical devices to the hospital information system, and the absence of standards-based interoperability. The intention is for everyone involved in the acquisition and use of technology to cooperate to improve this process and patient care within the constraints (primarily financial) imposed on healthcare.

Technology management is a complex subject, still in its infancy at least as far as its acceptance and application in healthcare institutions.<sup>41</sup> To bring a measure of order out of what often is a seemingly chaotic situation, technology management can be described as a five-step cycle (Fig. 27-17).

Appropriately enough, the first step is planning. New technology should be approached with equal measures of promise and caution. It takes time and objectivity to determine whether the new technology actually will improve healthcare, what the total cost will be, whether the cost is affordable, and whether the new technology fits properly with the mission and other plans of

the individual institution. Replacement of equipment also is involved in planning. Justification for replacement should include consideration of dependability and safety, operating and maintenance factors (including cost), and performance. Another consideration in planning is the quantity of equipment needed to satisfy peak demands and for backup. Related to this is the support for new equipment: trained users, installation requirements, supplies, and maintenance requirements.

If the decision is made to acquire new equipment, the second step is selection. Unless the technology is new, there probably will be more than one source or more than one model or configuration. Technical and clinical criteria should be determined, based on available literature, the experience of other users, and the institution's unique needs. A comparative evaluation should be conducted.<sup>42</sup> An engineer should test equipment samples to compare performance versus the established criteria, any available standards, and the manufacturer's specifications. Acceptable equipment then should undergo a clinical trial that is long enough to expose the equipment to a representative sample of potential uses and users. Current users of each model at other institutions should be contacted for their reactions and opinions. Where possible, the institution should standardize on one model of a particular type of device, especially if users are likely to encounter different pieces of the same type of equipment. Finally, the institution should protect its negotiating position with vendors by not making its final decision (or at least letting it be known) until competitive bids are received and reviewed.

Implementation follows selection. The time to include all requirements and specifications to protect the investment is during order placement. Considerations for inclusion in negotiation and ultimate order are operator and service training, warranty, supplies and accessories, price protection for future purchases, upgrades (especially software), and provision for maintenance, including parts and backups. This also is the time to consider installation requirements such as special space or services, and who will perform to installation. Acceptance of, and payment for, the equipment should be contingent on a successful initial inspection to be provided by personnel of the

institution's choosing. Before the new equipment is put into use, users should be trained. Ongoing training, for new users and as reinforcement for others, should be available as needed. The need for training simply cannot be overlooked or overemphasized.

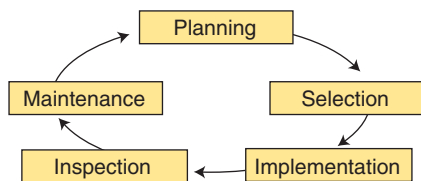
Ongoing use of equipment requires an inspection program. As described previously, an inspection program should be performed according to an established schedule, with procedures and test equipment that cover safety and performance aspects. Some equipment requires routine preventive maintenance (e.g., regular parts replacement or calibration). The inspection program must be properly documented, including the schedule, procedures, and results. Based on trends discovered by analyzing inspection results, it may be appropriate to adjust the technology management program. If the equipment is not meeting expectations, it may be necessary to involve the manufacturer. If something was overlooked in the acquisition, the oversight not only should be corrected, but the selection and implementation processes adjusted to prevent such occurrences in the future. As a result of trends, it may be necessary to increase the inspection frequency or to possibly reduce it.

Ongoing use of equipment requires maintenance. During the warranty period, a final decision can be made about whether service will be provided by the manufacturer, an independent service organization, or an in-house department. Before the warranty expires, arrangements can be made so that there is no lapse in service. Again, documentation is necessary for, among other things, determining whether there are any trends in service problems that could be corrected. In addition, the service history of the equipment should be used to help decide on future purchases (e.g., buying more of the same device and repair or replacement choices). This leads back to step 1—planning.

Technology management is intended to combine and refine individual equipment programs, to make them work more efficiently, and to be directly involved in improving quality in general and patient care in particular (Box 27-1).

## CONCLUSION

Medical technology is vital to modern healthcare. Its contributions to patient



**FIGURE 27-17.** Cycle of technology management.

## BOX 27-1.

**Technology Management Program Components**

Equipment control program: documentation, inspection schedule, procedures

Outside service contracts: negotiate; monitor performance

Inspection and repair records evaluation: identify problems; advise on inspection schedules and procedures; advise on equipment replacement

Device evaluations (including disposables)

Device recalls and alerts program

Risk management and quality assurance program

User training program

Expansion of in-house service (e.g., personal computers, home-care program devices)

Hazardous materials management program

Research, design, and fabrication of clinical equipment

care and its rate of progress are awe inspiring. The practice of anesthesiology largely depends on medical technology. Equipment increases the anesthesiologist's ability to fulfill patient responsibilities, but it certainly does not replace it. The anesthesiologist should know how to apply technology safely and effectively as part of these responsibilities.

This chapter provides a background for the principles and requirements of the safe use of medical equipment. Historically, scare tactics were used to convince clinicians to follow specific guidelines for the safe use of medical equipment. The better approach is to explain the problems and the solutions so that guidelines are understood and applied objectively. For example, medical device standards—when used as their originators intended—generally are a help and not a hindrance to providing safe and effective patient care. It also is valuable for clinicians to understand the principle of operation of each device sufficiently to produce a “conceptual model” to aid safe use and troubleshooting.

This chapter provides a review of basic electricity so that electrical hazards to patients can be understood. In response to such hazards, medical device standards have been developed.

To apply these standards, electrical safety programs were instituted in hospitals. Experience with electrical safety programs showed the need for other safe practices in the application of technology. Technology management programs currently are being developed to acquire and implement new technology effectively.

Medical technology is remarkable, but so are the people who use it safely and effectively. Two factors may not be intuitively obvious: (1) safe and effective application of medical technology requires cooperation among clinical staff, support services, and administration, and (2) justification for and application of medical technology aims for improvement of the quality of patient care.

**KEY REFERENCES**

1. Bruner JMR, Leonard PF. Electricity, Safety, and the Patient. St. Louis: Mosby-Year Book, 1989.
2. Dalziel CF. Reevaluation of lethal electric currents. *IEEE Trans Industry Gen Appl* 1968;IGA-4(5):467.
3. ECRI. Special report on technology management: preparing your hospital for 1990s. *Health Technol* 1989;3:1.
4. Joint Commission. 2007 Comprehensive Accreditation Manual for Hospitals. Oakbrook Terrace, IL: Joint Commission, 2006.
5. National Fire Protection Association. *Health Care Facilities Handbook* 2005 Edition. Quincy, MA: National Fire Protection Association, 2004.
6. ECRI. Guidance article, electrical safety Q&A, a reference guide for the clinical engineer. *Health Devices* 2005;34:56-75.

**REFERENCES**

1. Bernstein T. A grand success, the first legal electrocution was fraught with controversy which flared between Edison and Westinghouse. *IEEE Spectrum* 1973;February:54.
2. ECRI. Guidance article, electrical safety Q&A, a reference guide for the clinical engineer. *Health Devices* 2005;34:56-75.

3. National Fire Protection Association. *NFPA 70: National Electrical Code*, 2005 Edition. Quincy, MA: National Fire Protection Association, 2004.
4. National Fire Protection Association. *NFPA 99: Standard for Health Care Facilities*, 2005 Edition. Quincy, MA: National Fire Protection Association, 2004.
5. Dalziel CF, Lee WR. Lethal electric current. *IEEE Spectrum* 1969;6:44.
6. McNulty SE, Cooper M, Staudt S. Transmitted radiofrequency current through a flow directed pulmonary artery catheter. *Anesth Analg* 1994;78:587-589.
7. Medicine and the law: fatal shock from a cardiac monitor. *Lancet* 1960;1:872.
8. Underwriters Laboratories, Inc. *Standard for Medical and Dental Equipment UL 544*. 2nd ed. Northbrook, IL: The Laboratories, 1993.
9. Bruner JMR. Hazards of electrical apparatus. *Anesthesiology* 1967;28:396.
10. Dalziel CF. Reevaluation of lethal electric currents. *IEEE Trans Industry Gen Appl* 1968;IGA-4(5):467.
11. Geddes LA, Cabler P, Moore AG, et al. Threshold 60-Hz current required for ventricular fibrillation in subjects of various body weights. *IEEE Trans Biomed Eng* 1973;20:465.
12. Dalziel CF. *The Effects of Electric Shock on Man*. Washington, DC: U.S. Atomic Energy Commission, Office of Health and Safety, 1956.
13. Levin M. Perception of chassis leakage current. *Biomed Instrum Technol* 1991;25:135-140.
14. Dalziel CF. Threshold 60-cycle fibrillating currents. *AIEE Trans (Power Apparatus Systems)* 1960;79:667.
15. Kouwenhoven WB, Knickerbocker GG, Chestnut RW, et al. A-C shocks of varying parameters affecting the heart. *AIEE Trans (Communication Electronics)* 1959;78:163.
16. Litt L, Ehrenwerth J. Electrical safety in the operating room: important old wine, disguised new bottles. *Anesth Analg* 1994;78:417-419.
17. Swerdlow CD, Olson WH, O'Connor ME, et al. Cardiovascular collapse caused by electrocardiographically silent 60-Hz intracardiac leakage current. Implications for electrical safety. *Circulation* 1999;99:2559-2564.
18. Noordijk JA, Oey FTI, Tebra W. Myocardial electrodes and the danger of ventricular fibrillation. *Lancet* 1961;1:975.
19. Roy OZ, Scott JR, Park GC. 60-Hz ventricular fibrillation and pump failure thresholds versus electrode area. *IEEE Trans Biomed Eng* 1976;23:45.
20. Starmer CF, Whalen RE. Current density and electrically induced ventricular fibrillation. *Med Instrum* 1973;7:158.
21. Watson AB, Wright JS, Loughman, J. Electrical thresholds for ventricular fibrillation in man. *Med J Aust* 1973;1:1179.

- 21a. IEC62366. 2007 Medical Devices—Application of Usability Engineering to Medical Device. Geneva, Switzerland: International Electrotechnical Commission, 2007.
22. Whalen RE, Starmer CF, McIntosh HD. Electrical hazards associated with cardiac pacemaking. *Ann N Y Acad Sci* 1964;111:922.
23. Bruner JMR, Leonard P. *Electricity, Safety, and the Patient*. Chicago: Year Book Medical Publishers, 1989, reprinted 1994:172.
24. Silberberg JL. Performance degradation of electronic medical devices due to electromagnetic interference. *Compliance Eng* 1993;10:25–40.
25. Segal B, Retfalvi S, Pavleseck T. “Silent” malfunction of a critical-care device caused by electromagnetic interference. *Biomed Instrum Technol* 1995;29:350–354.
26. Soto RG, Chu LF, Goldman JM, et al. Communication in critical care environments: mobile telephones improve patient care. *Anesth Analg* 2006;102:535–541.
27. National Fire Protection Association. *Health Care Facilities Handbook*, 2005 Edition. Quincy, MA: National Fire Protection Association, 2004.
28. Joint Commission. *2007 Comprehensive Accreditation Manual for Hospitals*. Oakbrook Terrace, IL: 2007 Joint Commission, 2007.
29. Stiefel RH. *Medical Equipment Management Manual 2005 Edition*. Arlington, VA: Association for the Advancement of Medical Instrumentation, 2005.
30. US Department of Health and Human Services. *The Medical Device Amendments of 1976*. Rockville, MD: Public Health Service, Food and Drug Administration, Center for Devices and Radiological Health, 1984.
31. Stiefel RH. *The Safe Medical Devices Act of 1990: Implications for Health Care Personnel*. Arlington, VA: Association for the Advancement of Medical Instrumentation, 1991.
32. Underwriters Laboratories, Inc. *Medical Electrical Equipment, Part 1: General Requirements for Safety UL 2601-1*. Northbrook, IL: The Laboratories, 1994.
33. International Electrotechnical Commission. *International Standard Medical Electrical Equipment. Part 1. General Requirements for Safety*. 2nd ed. Geneva, Switzerland: Bureau Central de la Commission Electrotechnique International, 1988. Amendment 1, 1991. Amendment 2, 1995.
34. Association for the Advancement of Medical Instrumentation. *AAMI Standards on CD, The Comprehensive Collection*. Arlington, VA: Association for the Advancement of Medical Instrumentation, 2007.
35. Association for the Advancement of Medical Instrumentation. *AAMI Standards and Recommended Practices, Vol. 1, Biomedical Equipment*. Arlington, VA: Association for the Advancement of Medical Instrumentation, 1994.
36. Walter CW. *Electric Hazards in Hospitals, Proceedings of a Workshop*. Washington, DC: National Academy of Sciences, 1970.
37. Nader R. Ralph Nader's most shocking expose. *Ladies Home Journal* 1971;March: 98.
38. Grimes SL. The challenge of integrating the healthcare enterprise. *IEEE Eng Med Biol Mag* 2005;24:122, 124.
39. Goldman JM, Schrenker RA, Jackson JL, et al. Plug-and-play in the operating room of the future. *Biomed Instrum Technol* 2005;39:194–199.
40. Goldman JM. Medical device connectivity for improving safety and efficiency. *ASA Newsletter* 2006;70:6.
41. ECRI. Special report on technology management: preparing your hospital for the 1990s. *Health Technol* 1989;3:1.
42. Stiefel RH, Rizkalla E. The elements of complete product evaluation. *Biomed Instrum Technol* 1995;29:482–488.



*This page intentionally left blank*



## PART 4

### MANAGING ANESTHESIA CARE

## SECTION A

## MONITORING THE ANESTHESIA PATIENT

## CHAPTER 28

## Perioperative Information Management Systems

J.P. Abenstein, MSEE, MD

In the 1950s and 1960s, digital computers, in the form of mainframe systems, first made their way out of government laboratories and into the corporate world. They soon found their way into hospitals, generally as accounting tools. Over time, computer technology was offered as a solution to many real and perceived problems in the hospital, including medical record keeping, patient data analysis, and materials management to name just a few. In spite of the expenditure of significant resources, both monetary and personnel, few real clinical solutions were successfully introduced. This was disappointing to both investors and computer advocates. The reasons for these failures are many but often were based on the fact that the proposed clinical solutions were more complex and demanding than was technically or fiscally feasible to solve. Often the solution was far more expensive than the problem.

The last 10–15 years have seen truly dramatic changes in computing. Desktop and server hardware are remarkably powerful. Advances in network technology allow for the integration of thousands of machines. Storage solutions make it possible to store and retrieve information stored

on hundreds of terabytes. The Internet has demonstrated that large amounts of information can be transmitted and displayed in new and creative ways. Finally, and most importantly, advances in computer science, particularly programming tools and computational theory, now allow for

the introduction of clinically important computing technology in the medical environment.

Interest in the perioperative information management system (PIMS) is increasing. This interest is based on a variety of issues, including the following:

## KEY POINTS

1. The question of whether medical records will be electronic has been answered. All medical records will be entered and accessed on computer systems, including anesthesia and critical care documentation. Resistance is futile; you will be assimilated.
2. Anesthesiologists can either embrace this new technology and have a say in how it will be manifested in their work environment, or they can wait until another physician or administrators decides for them how they will document their clinical care.
3. Configuring and installing a perioperative information management system (PIMS) is a significant task. Careful project management is required. This includes:
  - a. Production of a scope document that defines the expected functionality of the PIMS.
  - b. Rigid control over the project to prevent scope creep. No additional functionality should be allowed unless it is vital to the overall success of the project.
  - c. Contracting the defined functionality in the scope document if that functionality is not critical and proves to be delaying the project.
  - d. Departmental leadership must keep ownership of the project. Careful delineation must be made between project decisions (how to program functionality) and practice decisions (how will clinicians use the PIMS). Practice decisions must be made by the leadership, NOT the project.
4. Additional functionality can and should be added to the PIMS after installation. New functionality that focuses on patient safety and practice efficiency is most common.
5. The business case for a PIMS can be made from both direct and indirect benefits. Direct benefits include improved billing, decreased lost charges from incomplete records, and decreased risk from regulatory and payer audits. Indirect benefits include legible records and ubiquitous access to medical information instantly throughout a medical center.
6. Objections to adoption have proved to be unwarranted. These include concerns with cost (see business case), artifacts, and the impact on workflow. In particular, the concern with increased risks during litigation have proved to be completely unfounded. Both the experience at Mayo Clinic and that reported in the literature show that risk during litigation is decreased with a PIMS.
7. The PIMS database can be used for practice management, quality assurance, and research. Use of electronic data to produce information and knowledge is in its infancy.



1. Physiologic data are not recorded in a timely fashion, particularly during critical incidents that demand all of a clinician's attention.<sup>1</sup> The anesthesia provider, either unconsciously or purposely, "smooths" the physiologic information prior to recording.<sup>2-4</sup>
2. Serious legal consequences may be generated by the lack of accurate records.<sup>5-7</sup>
3. The explosive growth in monitoring devices and laboratory data generates so much data that the process of recording information diminishes a clinician's ability to care for his/her patient.<sup>8</sup>
4. Increasing demands by regulatory agencies for quality assurance (QA) reviews consume too much time and money. The ability to generate a database should allow for automated screening of perioperative records.<sup>9</sup>
5. Use of computer-generated databases will reduce the difficulty in determining the safety and efficacy of new technologies and therapeutic interventions. PIMS has been offered as a solution for these and many other perceived problems.

Counter-arguments opposing the introduction of a PIMS are strong<sup>10-16</sup>:

1. An unacceptable number of artifacts will appear on the official anesthesia record. Artifacts potentially could mislead clinicians as to the course of the anesthetic and potentially generate medicolegal difficulties.
2. The anesthesia provider will be forced to spend too much time generating the anesthesia record and will neglect the patient.
3. The clinician will not look at the current state of the monitors because there is no need to write the values down, thereby leading to a lack of vigilance.<sup>17</sup>
4. The expense and added complexity far outweigh the unproven small improvement in record keeping and practice.

Despite the ongoing controversy over PIMS, the number of institutions installing such systems continues to grow. Initially, these systems were designed and built by the users. Several academic departments have spent substantial resources developing these

systems, with mixed results.<sup>18-20</sup> In the last several years, a number of commercial products have been released. These systems vary in their degree of automation, complexity, networking capability, and cost.

Pragmatically, the debate on whether to embrace electronic anesthesia records is essentially over. Not because of any breakthroughs in computing technology or the development of the "perfect" anesthesia system but because of the fact that the decision to use electronic medical records (EMRs) has already been made by hospital systems, external payers, and regulatory groups. Whether or not anesthesiologists accept electronically based documentation, the facilities in which anesthesiologists work, the payers whom they send bills to, and virtually the entire external medical regulatory structure have made it clear that EMRs will not be preferred, they will be required. Therefore, anesthesiologists are left with the decision either to choose and implement a PIMS that best fits their needs or to wait for a physician in another specialty or hospital administrator (i.e., individuals who do not know where the operating rooms are, much less how an operative practice functions) to pick one for them.

Unfortunately, little has been written on the routine use of PIMS. This reflects the small number of systems that have been installed and the difficulty in objectively evaluating the use of automatic record keeping. Therefore, most decisions on purchasing a PIMS are based on preconceived notions and the assurances of equipment vendors. This chapter attempts to delineate the major issues associated with choosing, implementing, and using a PIMS in a clinical practice.

## THE MEDICAL RECORD IN CONTEXT

Physicians, nurses, allied health staff, and others are caring for increasingly ill patients undergoing ever more complex and risky procedures in operating and nonoperative procedural suites. The primary tool used to manage these patients is the information found in the medical record. Starting with basic patient demographics (i.e., name, hospital number, height, weight,) the medical record is the repository of information concerning the patient's medical histo-

ry, current condition, laboratory and diagnostic test results, and all other information associated with the current episode of care. Unfortunately, the vast amount of information about the patient is rarely available in a format that allows caregivers to find the pertinent information in a timely manner. This problem has worsened as patients and the healthcare system that cares for them have grown in complexity. The suggestion that physicians and nurses will continue to search through often random collections of mismatched illegible pieces of paper in order to piece together the current status of a surgical patient is unacceptable. Lost time and information is the rule. Not uncommonly, patients submit to expensive and potentially dangerous diagnostic tests, and the results of those tests are not used by their physicians merely because the results are effectively lost. Today, the paper medical record is broken beyond repair.

In the operating room, rapid access to vital information often can mean the difference between a successful intervention and a disaster. Information technology offers a solution to this problem. A number of centers, including Mayo Clinic, are in the process of developing comprehensive EMRs. From the perspective of the operating suite, a subset of these tools and information is most important:

- Interfacing and display of physiologic monitoring
- Interfacing and display of mechanical support devices
- Periprocedural events (e.g., airway management)
- Medications
- Fluids
  - Input and output calculations
- Infusions
- Stat laboratory results
  - Arterial blood gases (ABGs)
  - Electrolytes
  - Hemoglobin
  - Coagulation studies
- Recent diagnostic studies
  - Cardiac catheterization
  - Echocardiography
  - Laboratory results
  - Radiographic images and interpretation



- Electrocardiographic and electroencephalographic tracings and interpretation
- Recent history and physical examination
  - Patient problem list
  - Current pathophysiologic state
  - Summary of progress notes
  - Current medications
  - Allergies

This information is found in the electronic tool used by an anesthesiology practice to document its patient care activities, the PIMS. With this collection of integrated tools, a collated summary of information is produced that reflects the patient care and response to care during the perioperative period.

Automated anesthesia record keeping systems (AARKS) have been commercially available for a number of years. The total market share of this technology is small but is growing rapidly. Today, a number of commercially available systems have been successfully implemented outside of research and development environments. These companies include (but are not limited to) the following:

- CareFX, Scottsdale, AZ
- Caresuite, Picis, Wakefield, Massachusetts
- Centricity, GE Medical, Fairfield, CT
- CompuRecord, Philips Medical, Andover, MA
- Innovian Anesthesia, Dragger Medical, Germany
- Surginet—Cerner Corporation, Kansas City, MO

I believe that EMRs have reached the “tipping point.” Although this technology has downsides, including the substantial cost of implementation, they are outweighed by its benefits. As stated earlier, outside forces are making it next to impossible to avoid EMRs, both in and out of the operating suite.

It is reasonable to extrapolate the success of computer-based anesthesia records to the additional information gathered and recorded in the operating suite. The additional benefit of eliminating multiple, often conflicting, documentation of the same information and the elimination of transcription errors will improve efficiency and distribution of appropriate patient information to all the medical profes-

sionals in the operating suite. Finally, the process of introducing this technology can spur medical organizations to rethink what information really needs to be recorded. It is fair to say that a portion of the information we dutifully record each day is never read or used to care for our patients. If it is not used, why enter the information? Manifesting a PIMS in the operating suite is vital to the continued success of this enterprise.

The rest of this chapter focuses on the selection, configuration, implementation, and evaluation of a PIMS in a clinical environment. I will use the Mayo Clinic experience as the basic template for this discussion.

## SELECTION OF A PIMS PRODUCT

An automated anesthesia record keeping system had been used in the cardiothoracic and vascular surgery operating rooms at Mayo Clinic since 1983. This system was based on the Hewlett Packard Patient Data Management System (PDMS). It used a minicomputer for processing and interfaced with custom physiologic monitors, mass spectrometer, blood bank, cardiac catheterization laboratory, radiology department, and blood gas laboratory. The user in the operating room entered information via a command-line interface. The anesthesia record was produced in real time with a color X-Y plotter. Over the life of the system, more than 75,000 anesthetics had been recorded and archived.

By early 1996 it became evident that the system was reaching the end of its useful life. Hardware failures were increasing, and the vendors had made it known that spare parts would no longer be available. In addition, the software had reached the limit of functionality, and the ongoing process of modifying the software as the practice evolved was no longer possible. A search was begun to find a replacement for the cardiac system with the intention of expanding the use of automated anesthesia record keeping to the entire anesthesia practice and to incorporate information from preoperative care, intraoperative nursing, procedural data, and postoperative care.

At the 1996 American Society of Anesthesiologists (ASA) Annual Meeting, a team of anesthesiologists and

information services staff examined all the PIMS-related products presented at the meeting. Four manufacturers were invited to present their systems in greater depth at Mayo. They were asked to demonstrate the ability of their products to chart both complex (aortic valve replacement and coronary artery bypass graft) and short (myringotomy with tubes) procedures. The systems were evaluated for their clinical utility, ease of use, and completeness, as well as technical compatibility with the installed base of clinical instrumentation and networked information systems. The initial four products were culled to two. Further evaluation was done, including site visits, visits to research and development facilities, detailed technical review by our engineers and programmers, further clinical simulations of detailed anesthetic scenarios, and fiduciary review. After an extensive 6-month evaluation, the decision was made to purchase a replacement system for the cardiothoracic and vascular practice, which consisted of 14 operating rooms, and if successful to expand the implementation to the entire anesthesiology practice of approximately 150 anesthetizing locations, 75 postanesthesia recovery beds, 60 preprocedural waiting beds, potentially the nonoperative procedural practice, and the ICUs.

The initial replacement project was carefully defined to manifest only the functionality of the existing system. Attempting to expand functionality would add too much complexity to the project and could prevent successful implementation prior to failure of the existing system.

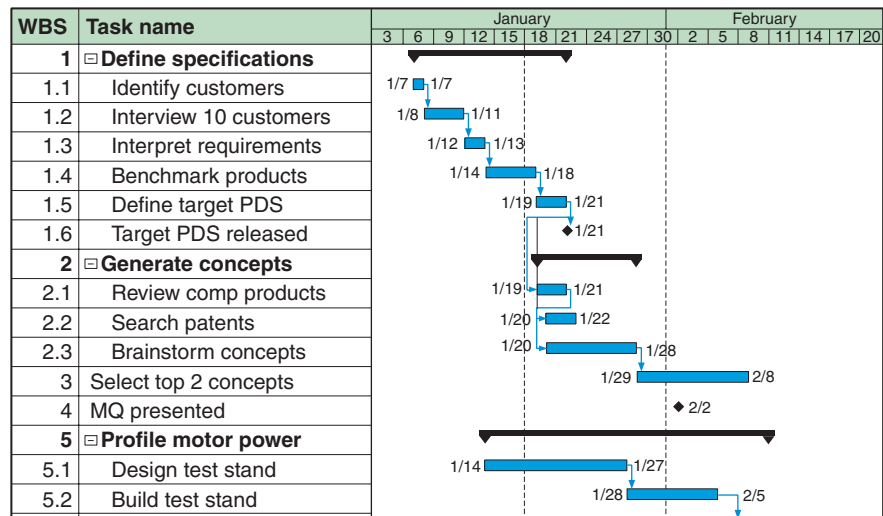
A detailed scope document was produced to fully define the expected functionality, the steps necessary to manifest the project, and the project time line. Production of a Gantt chart was an integral part of the scope document. A Gantt chart breaks the project into small parts, with expected time line and dependencies. A simplistic example of a Gantt chart is shown in Fig. 28-1. The importance of the scope document cannot be overstated. Without a scope document, successful management of the project would be impossible. The stated operational philosophy of the project was to design and implement a system that was consistent with the clinical practice. It is considered paramount not to expect the practice to change in order to use

the new system but to modify the system to fit the practice. Another critical project management strategy was the careful delineation of project decisions and practice decisions. Aspects of the new system that would directly impact the clinical practice (e.g., how attending physicians would sign the chart, or whether to block patient transfer if the chart was not complete) were taken to the clinical leadership. Assuring that the clinical leadership had a direct sense of ownership of this project was an important part of the project's success.

The project was strictly managed in order to prevent scope creep (i.e., the addition of new functionality as the project progressed). If proposed new functionality was not in the scope document and the argument could not be made that the new functionality was absolutely vital (e.g., lack of the functionality would lead to patient harm, system failure, or regulatory noncompliance), it was not considered. In fact, some expected functionality was deferred when it became apparent that continued development would lead to unacceptable delays in the project. It is vital to carefully define the functionality of the PIMS, document the functionality in a scope document, rigidly stick to the functionality defined in the scope document while implementing the PIMS, and contract the functionality if implementation is negatively impacted by aspects of the defined functionality.

## DESIGN AND CONFIGURATION OF A PIMS

The first part of the project was to configure the software. This consisted of building a variety of database tables that listed every fluid, medication, procedure, personnel, and text-based patient care documentation (i.e., "events"). These lists had already been partially created on the existing system, but because the new product was built around a relational database the tables had to be constructed in more detail than the previous system. The level of detail must be carefully considered. It is attractive to document every possible variation of a clinical activity. For example, an intravenous line placement can include the size, length, specific location, and use of local anesthesia. The events for one IV



**FIGURE 28–1.** Simplistic example of a Gantt chart. Note each line item has a start date and an end date. Arrows show dependency. For example, 1.1, "Identify customers," starts and ends on 1/7. 1.2, "Interview 10 customers," requires 1.1 to be complete before this task can begin. When 1.2 is completed then 1.3 begins, and so on. Other tasks can be performed simultaneously.

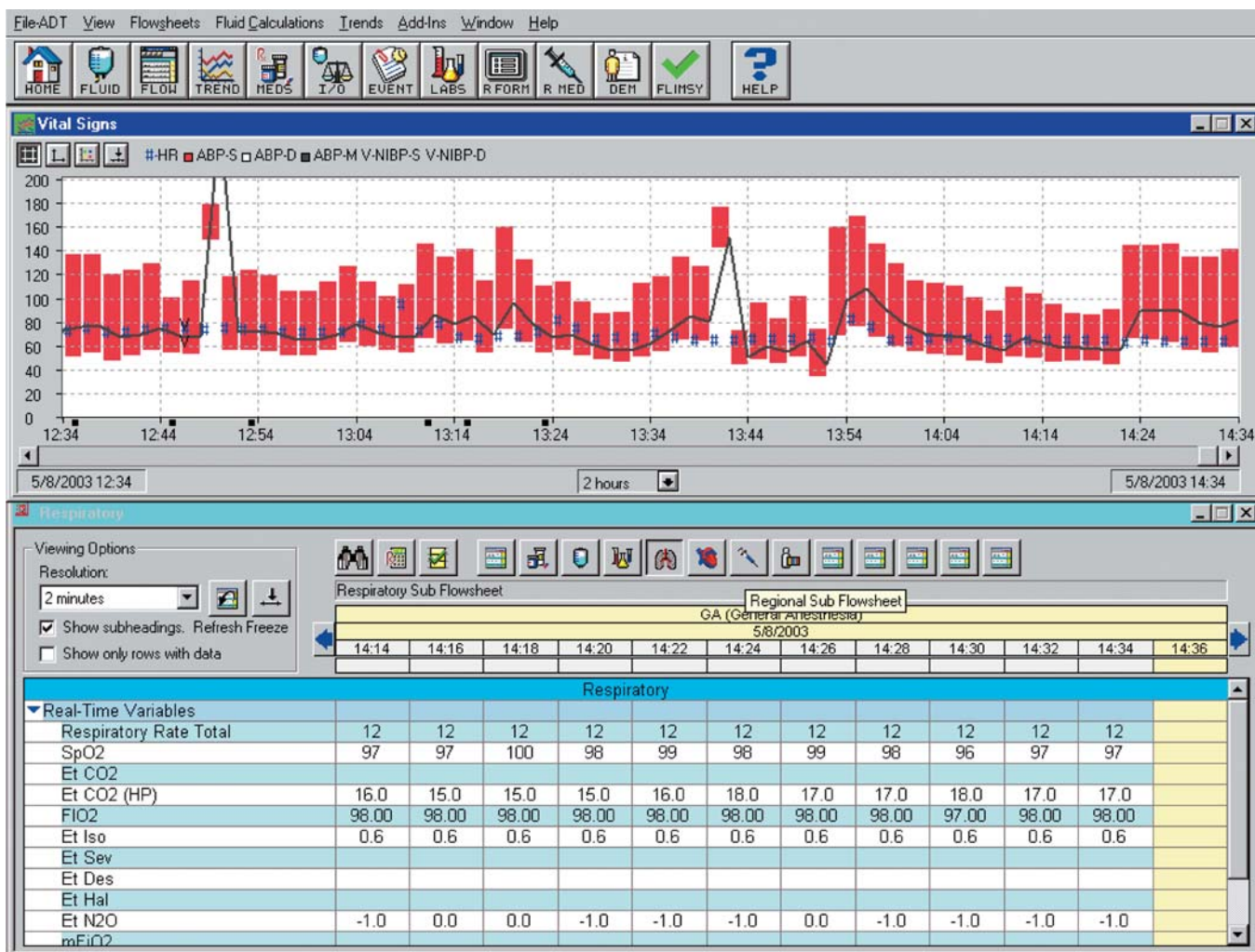
could then read: 18G, 5 cm, IV, 0.5 cc, 1% lidocaine, left, dorsal, forearm. This would require the clinician to potentially pick as many as seven different events to document the placement of one IV. The number of possible choices for each and every action can quickly add to a very large number. Therefore, when one considers the number of activities done during one case, the decision on the level of detail or granularity that will be documented becomes critical. It is strongly recommended to apply great restraint in filling event, procedure, fluids, and

medication lists. An example of an event list is shown in Fig. 28–2. Complete and detailed documentation is attractive, but the system must be useable in a clinical context.

The design of the different screens (e.g., events, flowsheet(s), fluids, medications,...) also had to be configured. The home screen was modified repeatedly. At first, we thought that maximizing the information content of the home screen would be ideal, but when the project team and clinical users interacted with mockups of the system, we realized that the content was

Events			
5/7/2003	11:08	JXH02	Transfer to ANES
5/7/2003	12:34	JXH02	Transfer from ANES
5/7/2003	12:36	JXH02	Transfer to ANES
5/8/2003	13:18	JXH02	Identify Patient
5/8/2003	13:18	JXH02	Anesthesia Start
5/8/2003	13:18	JXH02	Machine Checked
5/8/2003	13:18	JXH02	Infection Precautions
5/8/2003	13:18	JXH02	Procedure Verified
5/8/2003	13:18	JXH02	NPO Status Verified
5/8/2003	13:19	JXH02	ASA I
5/8/2003	13:19	JXH02	General Anesthesia
5/8/2003	13:19	JXH02	Discussed with Patient/Legal Guardian
5/8/2003	13:19	JXH02	Eval and Approved for Anes
5/8/2003	13:19	JXH02	Discuss Risk/Option/Alternative
5/8/2003	13:19	JXH02	Discuss +/- Blood Tx
5/8/2003	13:19	JXH02	Consultant in Room -SIGNATURE
5/8/2003	13:19	JXH02	Discharge When PACU IC Criteria Met
5/8/2003	13:19	JXH02	Immediate Pre-anes/sed Evaluation Completed
5/8/2003	13:19	JXH02	Present for Minor Procedure
5/8/2003	13:19	JXH02	I Was Present at Induction

**FIGURE 28–2.** Example of an event list. Note that each event is timed and dated, and the author is identified by user name (i.e., JXH02). This list consists of events documented at the beginning of a procedure. The event "Consultant in Room—SIGNATURE" is the legal signature of the attending physician and must be documented under the login name and password of an attending physician.



**FIGURE 28-3.** PIMS home screen. Top. Graphical recording of invasive blood pressure (red bars), mean blood pressure (line), and heart rate (plus signs). Bottom. Numerical output of respiratory parameters (e.g., respiratory rate, end-tidal carbon dioxide).

too complex and information was difficult to visually extract from the screen. The final version of the home screen only presented a graphical representation of the vital signs (i.e., blood pressure and heart rate) and the most recent output of the pulse oximeter and mass spectrograph (i.e., inhaled oxygen, exhaled carbon dioxide, and inhalation anesthetic concentrations; Fig. 28-3). After using this home screen in the clinical setting, the respiratory gas data were decided to be of little use, and the screen was replaced with the events window. Details such as physician signature and other time and security sensitive documentation also were solved. The billing and legal departments were consulted to assure that the electronic documentation would fulfil payer and regulatory requirements.

Macros were programmed to speed documentation of complex portions of the anesthetic, such as induction and

emergence. A number of activities (e.g., anesthesia start, on bypass) required the same documentation. In order to decrease the charting workload, a number of preprogrammed charting macros were designed. Some of these subroutines simply accomplished a preset documentation task (e.g., the same events, medications, fluids). Other macros pause and ask the user to pick one or more items (e.g., size of the endotracheal tube, patient position) and then the macro continues. These preprogrammed tasks have the efficiency of the charting process.

The final portion of configuration consisted of designing the printed anesthesia record. This was a complex task because the practice was very focused on retaining an anesthetic record that remained essentially in the same format as the traditional handwritten record. This task was made more difficult by the limitations of

font size, readability, and paper size. The final product was very close to the handwritten format, but the minimum size for any anesthetic was two pages. The computer-generated anesthetic record is shown in Fig. 28-4, with detailed close-up views shown in Figs. 28-5 to 28-7.

## HARDWARE DESIGN

While the configuration team was doing its work, the project's computer scientists and engineers went about the process of interfacing the system with the clinical instrumentation and networked systems. The system has a thick client-server architecture, meaning that the PIMS software runs on the computer in the operating room and sends data to the central server, in this case, every 5 minutes. The benefit of this architecture is that if the computer in the operating room crashes, even



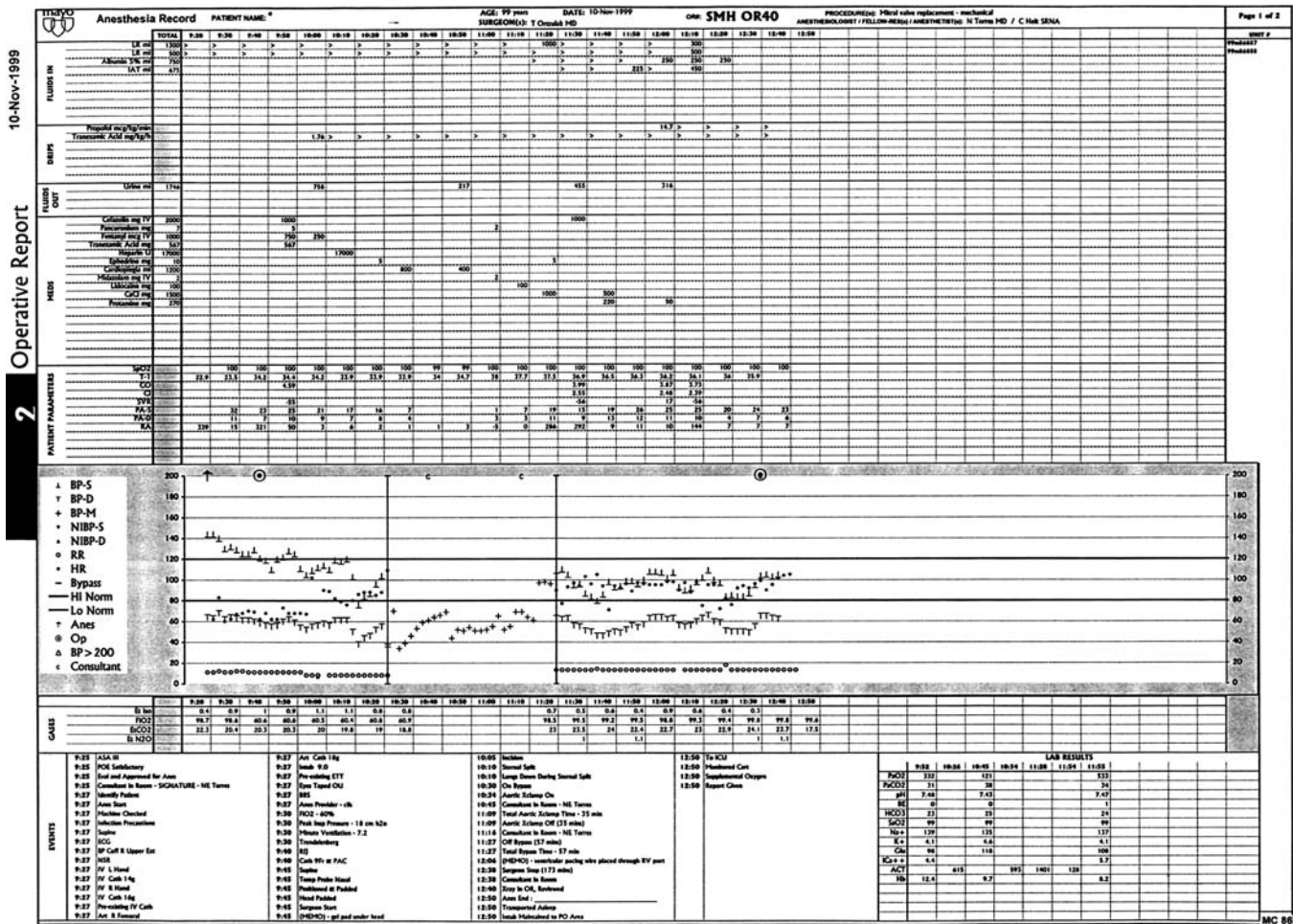


FIGURE 28-4. PIMS paper output—printed anesthesia record. Graphic vital signs with numeric vital signs above (e.g., central venous pressure, cardiac output). Drugs and fluids above vital signs. Text events on bottom left. Blood gas results on bottom right.

with a unrecoverable hard drive failure, all of the anesthetic records, except for the last 5 minutes, are retained on the server. Conversely, if the server goes down, the anesthetic record can continue to be recorded in the operating room. The vendor's architecture

was further enhanced by installing fully redundant servers and hard drives. The system runs on two servers that are in geographically separated locations (i.e., across town from each other). Each server has mirrored hard drive arrays. If one server goes down,

the entire load is automatically switched to the remaining server. The same hold true for the hard drives. Finally, the entire database is mirrored on a third, nonproduction server that is used for ongoing development and off-line database queries. This high-reliability architecture design provides for a stable (i.e., <8 hours of unscheduled downtime per year, measured against a 24-hour-per-day, 7-day-per-week calendar) robust computing environment.

The system also had to be interfaced with the Hospital Information System (HIS). Specifically, patient demographics from the Admit, Discharge, and Transfer System (ADT) had to be forwarded and documented in the PIMS. New laboratory values had to be captured from Laboratory Medicine. This proved to be somewhat difficult because the outputs, for example, from the different ABG analyzers labeled their output values somewhat differently. This initially caused multiple rows containing the same values (e.g., a row labeled as PO<sub>2</sub> and another

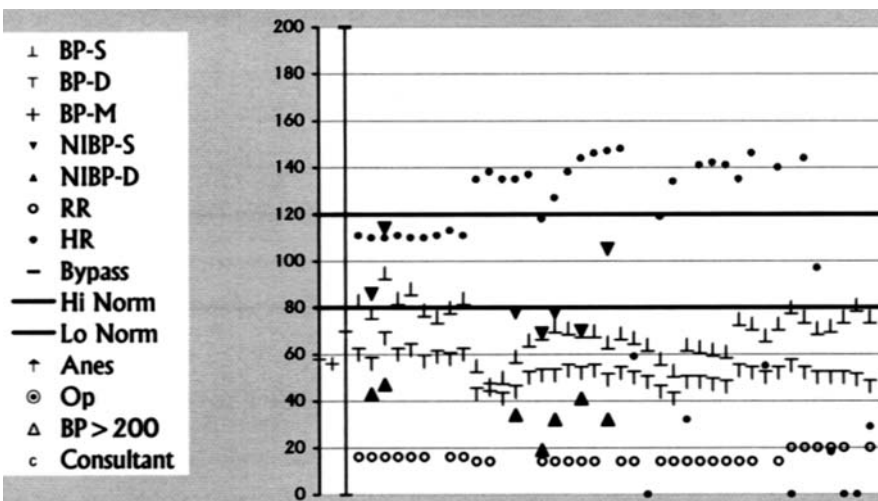


FIGURE 28-5. Close-up of the graphical display of vital signs on the PIMS printout.



mayo		Anesthesia Record		PATIENT NAME:							
		TOTAL	11:20	11:30	11:40	11:50	12:00	12:10	12:20	12:30	12:40
FLUIDS IN	LR ml	800									
	LR ml	700									
	LR ml	250									
	NaCl.9 ml	>	>	>	>	>	>	>	>	>	
	NaCl.9 ml	>	>	>	>	>	>	>	>	>	
	Albumin 5% ml	1250	250	>	>	>	>	>	>	>	>
	RBC ml	500	>	>	>	250	>	>	>	>	>
	FFP ml						>	>	>	>	>
	Platelets ml							>	>	>	>
	IAT ml	225					>	>	225	>	>
DRIPS	Dopamine mcg/kg/min	>	>	>	>	>	>	>	>	>	
	Dobutamine mcg/kg/min	>	>	>	>	>	>	>	>	>	
	Isoproterenol mcg/kg/min	>	0.03	>	>	>	0.03	>	>	>	
	Nitroglycerine mcg/kg/min	>	0.06	>	>	>	0.52	>	>	>	
	Epinephrine mcg/kg/min	>	0.04	>	>	>	>	>	>	>	
	Nitroprusside mcg/kg/min	>	0.52	>	>	>	>	>	>	>	
	Phenylephrine mcg/min	>	>	X							
FLUIDS OUT	Urine ml	1150		492			86		158	80	

FIGURE 28-6. Close-up of the fluid portion of the PIMS printout. Note that fluid totals are in the left most column directly next to fluid name.

MEDS	Midazolam mg IV	10								
	Ephedrine mg	35	20	10						
	Fentanyl mcg IV	3000				1000				
	Pancuronium mg	12								
	Succinylcholine mg	120								
	Ketamine mg IM	50								
	Cefazolin mg IV	2000							1000	
	Heparin U	23000								
	Aprotinin mg	1.4								
	Phenylephrine mcg	1100				100				
	Furosemide mg IV	320								20
	Lidocaine mg	200								
	Magnesium Sulfate gm	2								
	CaCl mg	3500					1000			500
	Amlodarone mg IV	150					150			
	Esmolol mg	40					40			
	Protamine mg	230							230	
Methylprednisolone mg	500								500	

FIGURE 28-7. Close-up of the medication portion of the PIMS printout. Note that medication totals are in the left most column directly next to medication name.

labeled as AO<sub>2</sub>) to be generated in the anesthetic record. The project had to implement an application that would translate these differently labeled outputs to only one label per value and then forward these translated results to the PIMS. Each interface with different electronic systems in the hospital had to be developed, debugged, validated, and, at times, had to clean up the forwarded information prior to being recorded on the PIMS.

The initial workstations used in the operating room consisted of Intel P3 processors at 300 MHz and 128 MB of random access memory (RAM). The operating system was Windows NT,

v.4.5. The majority of information was transmitted via an Ethernet connection to the institutional network. Information from the operating room was archived to a server every 5 minutes in order to assure data redundancy. The interfacing with the physiologic monitor initially was via a serial card in the operating room computer. This proved to be somewhat unreliable, so the physiologic monitors then were interfaced, via an optical cable, to the institutional Intranet, which then forwarded the information to the operating room computer. This architecture offers the added advantage of being able to see the real-time values and

waveforms from any workstation in the medical center. This interface is dependent on fixed computers and monitors; therefore, they cannot be moved from room to room. A number of hardware and software have been upgraded since the initial installation of the system. Currently, the PIMS runs on 3.0-GHz machines running Windows XP.

The placement of the computer system in the operating room was carefully considered. It was recognized early on that the system could not be too far away from the patient in order for the clinician to be able to care for the patient as well as chart on the PIMS.



**FIGURE 28-8.** Anesthesia cart in the cardiovascular operating room. Physiologic monitor and anesthetic gas analyzer on right. Computer screen and keyboard on left. Computer itself is mounted on the back of the cart.

Because the initial implementation of the system was in the cardiovascular and thoracic operating rooms, we had the luxury of fairly large operating rooms. The previous system had occupied a large cart, which included not only the computer but also the physiologic monitor, respiratory gas analysis, as well as other equipment. Therefore,

it was straightforward and consistent with the current practice to replicate this footprint for the new PIMS. This hardware configuration is shown in Fig. 28-8. The luxury of the large cardiovascular operating rooms was not found elsewhere in the practice. Not only did we have to consider the much smaller general operating rooms, but we also



**FIGURE 28-9.** Mounting of the PIMS hardware in general purpose operating room. Flat screen monitor and keyboard mounted via an articulating arm on right of anesthesia machine. Computer is below on a custom shelf affixed to right side of the machine.

had to deal with the fact that the location of the anesthesia equipment commonly changed in many operating rooms. This required as compact a hardware configuration as possible and the installation of multiple Ethernet sockets and sources of A/C power. After a number of false starts, the general operating room configuration decided upon is shown in Fig. 28-9.

## VALIDATION AND IMPLEMENTATION OF A PIMS

After design, configuration, system architecture, interfacing, and hardware installations were completed, the system had to be validated prior to implementation. The project would have a short grace period with the clinicians, particularly those who had no involvement with the development of the PIMS. In order to gain acceptance, we would roll out an anesthesia charting system that was

- Accurate—the information on the electronic anesthesia record accurately captures and records information from the physiologic monitors, anesthesia machine, and ventilator, and laboratory and other information from the Hospital Information System and that entered by the clinician.
- Reliable—the PIMS is up and running each and every time an anesthetic needs to be documented (i.e., 24 hours per day, 7 days per week).
- Useable—charting the anesthetic course on the PIMS can be performed simultaneously with caring for a patient. That charting does not degrade the quality of care secondary to either time or concentration demands.
- Readable—the anesthetic record is useable during administration of the anesthetic to track the course of care and facilitate clinical decision making. The anesthetic record is readable and useable after the procedure by both anesthesia and nonanesthesia clinicians.

In order to achieve these goals, validation and implementation of the PIMS was accomplished in well-defined stages.

The first step consisted of the production of a number of clinical scenarios where every step of documentation was scripted. This information was en-

tered into the PIMS, in a remote computer laboratory, when the system was interfaced and gathering data from a networked monitor in an operating room. These clinical scripts were run repeatedly until all the automated and manual information entered was correct and the printed anesthesia record was complete and error free. Once the computer laboratory portion of validation was accomplished, the system was brought into the operating room for further testing. This testing consisted of the computer programmers entering the information into the system, during operative procedures, and then comparing the output to the handwritten record.

While the system was being tested in the computer laboratory, the configuration of the PIMS was also being tested in the usability laboratory. Clinicians who had no involvement in the project were brought to the usability laboratory where a mockup of an operating room, including all the routine anesthesia equipment and the prototype PIMS, was installed. The clinicians were asked to perform a number of charting tasks while a simulated anesthetic was occurring. They were observed via a one-way mirror, videotaped, and their interaction on the computer recorded. They were debriefed after the tasks were completed. The information gathered via the usability laboratory was used to modify the configuration of the PIMS (e.g., screens, icons, lists of events,...) to improve the user interface and usability of the PIMS, particularly in a clinical context.

Once all the bugs were identified and corrected in the computer and usability laboratories, the system was turned over to the clinical staff. After training, the staff first used the system in the “background.” One clinician would care for the patient and produce the handwritten record, while another clinician would chart on the computer system. When the project team was satisfied that the electronic record accurately matched that of the handwritten record, the clinical validation process then consisted of charting in the “foreground.” The clinician caring for the patient would chart on the computer record while a second clinician would produce the handwritten record for inclusion in the medical record. This last step was considered most important because it was vital to deter-

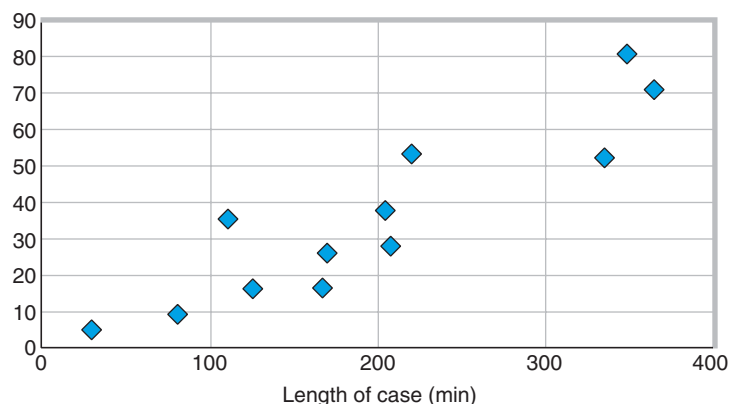
mine, prior to using the PIMS to produce the official anesthetic record, that using the system and simultaneously caring for an anesthetized patient in a manner consistent with the clinical practice was possible.

The final step was implementation of the PIMS as a production system. As with the rest of the project, this was done in an orderly stepwise manner. The entire clinical staff, physicians and nurses, was trained on use of the system. These classes consisted of 4 hours of hands-on training. The go-live process started with only four operating rooms. Each room had a clinical user paired with a “super user” who was part of the project team. The system was used for charting the anesthetic course by the primary clinician while the project team member(s) solved problems and answered questions. After 3 days, the four rooms were successfully implemented, and an additional four rooms were brought online in the same manner. This process continued until all 14 rooms were implemented. Once all 14 rooms were up and running, one to two project team members remained in the operating room suite, during the day, for 2 weeks. They remained available to answer questions and promptly solve problems. In addition, one team member, who had remote access to the operating room computers from home, was on call every night to solve problems with the PIMS. Most of the problems were educational in nature and could be solved remotely.

Postimplementation review determined that the system worked well in the context of the cardiothoracic and vascular anesthesiology practice. As part of the evaluation process, observ-

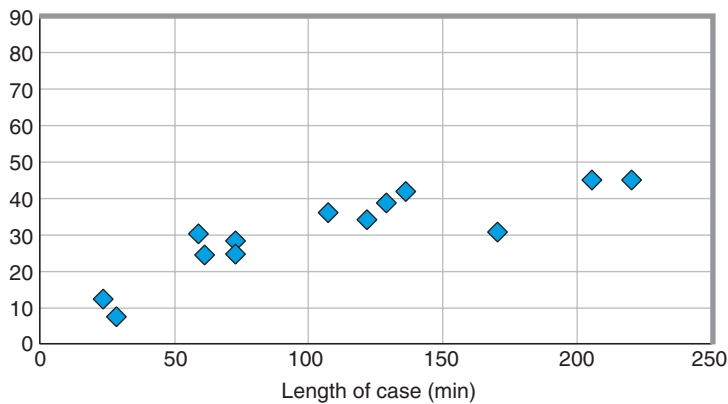
ers recorded the time spent documenting the anesthetic course on handwritten records and, after 3 months of use, on the PIMS. The results showed that the time spent charting the anesthetic course was about the same for the first 90 minutes of a case. After 90 minutes, the time spent charting by hand continued to increase in a linear manner whereas the time spent charting on the PIMS did not increase. Therefore, in short cases, computer charting took no longer compared to hand charting, but for cases longer than 90 minutes charting on the PIMS took less time. These results are shown in Figs. 28–10 and 28–11. These results are consistent with a time-motion study of anesthesia record keeping and transesophageal echocardiography from the University of California–San Diego.<sup>21</sup> This study also observed anesthesia personnel charting an anesthetic record manually and electronically during cardiac surgical procedures. The authors reported that there was no time difference between the two modalities, although when the clinicians charted was different. The authors also noted that little, if any, charting was done at the beginning of a case and that during paper-based charting the physiologic data and other details had to be reconstructed well after the fact. In contrast, the objective data all were recorded contemporaneously with the electronic record. Ours and Weinger’s results are consistent with earlier reports.<sup>22,23</sup>

The new system was stable and produced an acceptable anesthesia record. Further refinements were made once the system was fully operational in the cardiovascular and thoracic anesthesiology practice and the



**FIGURE 28–10.** Results of anesthesia charting timing study for manual charting on a paper record. Time devoted to charting increases as length of case increases.





**FIGURE 28-11.** Results of anesthesia charting timing study for charting on PIMS. Time devoted to charting increases for first hour of anesthesia. For cases lasting >1 hour, charting the anesthesia record takes 30–45 minutes for any length of case.

clinical users had the opportunity to evaluate the system and provide feedback to the project team about any problems encountered or enhancements needed. Based on this experience, the decision was made to expand the use of the system to the entire anesthesia practice at Mayo Clinic.

Further configuration was needed to incorporate the specific documentation needs of the rest of the practice. This was particularly true for procedure listing and patient care events. As with the cardiothoracic and vascular rollout, further implementation was done in a planned stepwise process. Currently, 105 operating rooms, 85 nonoperative procedural rooms (e.g., cardiac catheterization laboratory, invasive radiology, GI laboratory), 10 recovery rooms, and 24 ICU and stepdown units are using the PIMS software that has been configured for the specific use of a procedural suite or critical care practice.

## EXPANDING FUNCTIONALITY

Almost immediately after the PIMS was installed, there were demands for improvements. In the more than 7 years since the PIMS has been used in the clinical setting, the demands for changes and refinements have not slackened. What has become clear is that a project of this nature and scope is never completed because of the constant change in the clinical practice (e.g., new medications, fluids, procedures) and the fact that the system is being used by bright people who are constantly thinking of how to do their job more effectively and efficiently. The demands for additional function-

ality outstrips available resources (i.e., programmers, administrative, clinical support, and engineers). This is consistent with our experience with the original cardiovascular anesthetic record, other parts of the Mayo EMR, and reports from other institutions that also have embraced electronic charting. To successfully manage these demands required the development of a change management process. All requests for added functionality must be documented (i.e., a phone call expressing a want is not adequate). The requests are first evaluated by the technical team to determine how much work (e.g., programmer time, other technical resources) and money the request will require. The clinical team evaluates the request for its importance to the practice and assigns a priority. The impact on current projects is assessed. The technical team projects how much delay there will be in other projects time lines by adding the new request to the workload (i.e., more work to be done by a fixed number of personnel). This information is brought to the project management team, which reviews the request, decides whether to move forward on the request, and if so whether to add it to the current active projects or to add it to the queue of pending projects. If the request is added to the queue, a 1–5 priority score is assigned to guide the team as to when to activate a queued request. Finally, the clinical leadership (i.e., department and division chairs) is kept informed as to the decisions of the project group, and at times the practice will overrule the decisions of the project team (e.g., the practice may decide that a newly requested

change in the PIMS takes priority over currently pending projects).

## Projects to Improve Usability and Charting Accuracy

As soon as the PIMS was rolled out beyond the confines of the cardiovascular practice, there were demands for automated charting aids. This was particularly true in those parts of the practice that delivered anesthesia services for very short procedures (e.g., electroconvulsive therapy [ECT], bone marrow transplant, pediatric surgery). Users reported difficulty in documenting the anesthetic while caring for patients during these short procedures. The solution was to produce a set of icons that, when selected, would document a predefined set of charting actions. The image of the icons would change after they were selected to remind the user that this set of documentation had already been accomplished. Fig. 28-12 shows an example of this icon/button set that is used in the ECT suite. The first three icons—start, treat, and stop—document those events associated with the start of the anesthetic, beginning of treatment, and end of treatment. The last icon—transfer—charts the events associated with the end of the anesthetic course and transfers the patient's chart to the postanesthesia care unit (PACU). In addition to these icons, each practice area had its most commonly used fluids and medications automatically added to each anesthetic record when the case was started. These additions to the PIMS improved its functionality.

Documentation of perioperative procedures (e.g., regional anesthetics, placement of invasive catheters, and airway management) demands signifi-



**FIGURE 28-12.** Close-up of part of the icon bar in PIMS as used in the electroconvulsive therapy (ECT) suite. When these icons are selected, a predefined set of charting actions is triggered. “Start” documents the beginning of the anesthetic. “Treat” documents the beginning of the ECT treatment. “Stop” documents the end of the ECT treatment. “Trans” documents the end of the anesthetic and transfer of the patient to the recovery room.



**FIGURE 28–13.** PIMS regional anesthesia form. Instead of picking from a long event list (Figure 28–2), the clinician chooses from short pull-down menus (e.g., CSE-Epidural Block, Betadine) or clicks on radio button. This form allows for rapid documentation with more granularity than offered by event lists.

cant granularity in order to accurately and completely document what was done to the patient. In addition, specific documentation is required by third party payers for reimbursement (e.g., that the regional anesthesia block was placed for postoperative pain management). Choosing from a long event list became problematic for charting these procedures, and the consequence was an unacceptable rate of incomplete charts and delivered services that were unbillable. The solution was to create electronic forms that could be completed in a more timely manner and could mandate completion of required documentation. Fig. 28–13 shows the regional anesthesia form. It is completed by selecting items by clicking on radio buttons or selecting items from short pull-down menus. The information is stored in the same database with the rest of the PIMS data, making queries straightforward. When the anesthetic record is printed, this documentation is in a separate section of the record and not stuck in the middle of a long list of events.

The same strategy was used for documenting the placement of invasive lines (e.g., arterial catheters, central lines, pulmonary artery catheters).

This project was completed several years after the regional anesthesia project and was programmed using Microsoft's .NET technology. The programming effort required to manifest this form was much less than for the regional anesthesia form. As shown in Fig. 28–14, this form requires only one click for each data element. When a selection is made, the next list is opened, which can be different depending on a previous selection. When the documentation is saved, the information is stored in the PIMS database, documented on the anesthesia record, and forwarded as structured text to the hospital progress notes. This facilitates passing the information to other caregivers. For example, when the critical care service is determining when a central line must be replaced to prevent line sepsis, it is much faster to review sequential progress notes than to decipher an anesthetic record.

### Projects to Improve Billing and Regulatory Compliance

In the paper environment, only a manual audit process assures that documentation is complete, that it fulfills billing requirements, or that it has all the details demanded by different reg-

ulatory agencies. The PIMS has the ability to automatically query the anesthesia record to determine if all the necessary documentation is present.

One of the early additions to the PIMS functionality was to automate documentation of anesthesia time. As with most anesthesia practices, there had been variability among clinicians as to how anesthesia start and stop were documented. With the initiation of the PIMS project, we were able to standardize this documentation. When the patient comes into the operating room and the PIMS is launched, the event "anesthesia start" is documented. At the end of the case, the patient is transferred electronically out of the operating room, and the patient is transported to the next unit, generally the recovery room or intensive care unit. When the patient is admitted to the receiving unit, the system documents "anesthesia end." If the clinician spends an extended amount of time rendering care in the receiving unit, he or she can edit "anesthesia end" to reflect this additional time. With the introduction of this electronic charting tied to admission and discharge, we now have reproducible and defensible anesthesia time documentation.

Clear All Selections... Automate Selections

- Hand Hygiene
  - Yes
  - No
- Aseptic Technique
  - Yes
  - No
- Skin Prep
  - Alcohol
  - Betadine
  - Hibiclens
  - Other
  - Chlorhexidine/Alcohol
- Sterile Drape
  - Yes
  - No
- SQ Local Infiltration
  - Lidocaine 1%
  - EMLA Cream
  - Other

**FIGURE 28–14.** PIMS invasive monitoring form. In contrast to the regional anesthesia form (Figure 28–13), this form was produced using Microsoft.NET technology. This allows for rapid form development and decreases maintenance. The clinician picks from a short event list (e.g., picks Betadine in the skin prep list). This action automatically opens the subsequent list. As with the regional anesthesia form, this form allows for rapid documentation with the required granularity.

With paper record keeping, billing information had to be documented separately from the anesthesia record. The content of these forms was commonly different from what had been documented on the anesthesia record. At times, billing forms were lost or simply not filled out by busy clinicians. We added electronic billing and QA to the PIMS. At the end of a procedure, triggered by patient transfer, a subset of the anesthetic record is electronically generated and forwarded to the billing and QA offices. The

only way to enter billing or QA information is via the anesthetic record; there is no possibility of conflicting information between the medical record and what is being billed. The same holds true with the QA data. With the introduction of this process, lost billings are a thing of the past. This one process change has improved anesthesia billing 5–10%.

Completeness of critical documentation is required by the Medicare program and other payers. At the end of the procedure, also triggered by the

transfer process, the PIMS electronically reviews the documentation and determines whether the required events (i.e., anesthesia start and stop, procedure start and stop, attending physician signature, and ASA physical status) have been entered into the record and are in the correct order. Fig. 28–15 shows the screen that informs the user whether the required documentation is complete and correct. Only when the documentation is complete will the PIMS allow for the transfer. This process has also improved the accuracy of our record keeping. We must be careful not to make the number of required documentation events too long because this complicates the charting process, particularly at the busiest time of the case, which can lead to “crashed” records when users force quit the application, thereby bypassing the chart check process.

### Projects to Improve Patient Safety and Quality of Care

One of the most exciting aspects of a PIMS is the potential to use computer-based tools to directly improve patient safety and quality of care. Initially, we held the view that simple reminders (i.e., warning windows) would be a straightforward means by which to accomplish this goal. It soon became evident that clinicians found these electronic alerts to range from being annoying to interfering with their ability to get their work done. When the clinicians were observed in the operating room, they routinely clicked on the “OK” button in the warning window, took no action, and continued on with the current task. We saw no measurable improvements in safety but noted unnecessarily expended resources, and we began to alienate the clinical staff.

Instead of depending on warning windows to remind clinicians of what they should do, we changed direction and focused on transmitting information in a reliable manner. In addition, we tried to decrease dependence on human beings, who have a remarkable ability to see and hear what they expect to see and hear and to use computer-based processes that reliably produce the same output when given the same input.

Our initial projects were consistent with our general strategy—small. For example, feedback from the critical

Personnel	Events	Time
Abenstein, John (MD)	Anesthesia Start	5/18/2001 14:01:00
	Surgeon/Procedure Start	5/18/2001 14:05:00
	Surgeon/Procedure Stop	5/18/2001 14:05:00
	Anesthesia End	5/18/2001 14:05:00
	ASA	MISSING

Height: 100 cm Weight: 100 kg Visit Status: Inpatient

**FIGURE 28–15.** PIMS chart completeness screen. This application is launched at the end of an anesthetic course when the clinician chooses to transfer the patient’s anesthesia record. The application determines if the required documentation (i.e., anesthesia start, procedure start, procedure end, attending signature, and American Society of Anesthesiologists [ASA] status) has been entered into the record. In the example shown, ASA status is missing.

<b>EVENTS</b>	8:37	<b>Intub Difficulty 0</b>	5:38	Consultant in Room—SIGNATURE—Aberstein
	5:31	Machine Checked	5:38	Emergency
	5:31	Infection Precautions	5:38	ASA V
	5:31	Identify Patient	5:40	IV L Arm
	5:31	Anes Start	5:40	IV Cath 14g
	5:31	Anes Provider	5:40	IV R Arm
	5:31	O2 per NC	5:40	IV Cath 14g
	5:31	ECG	5:40	IV Fluids Through Warmer
	5:31	BP Cuff R Upper Ext	5:45	Art L Radial
	5:31	Monitors Applied	5:45	Art Cath 20g
	5:31	Supine	6:02	Trendelenberg
	5:31	AV Paced	6:16	LEJ
	5:32	Vent Paced	6:16	Cath 8Fr 16cm Quad
	5:38	Discussed with Patient	6:17	Ox PA Cath
	5:38	POE Satisfactory	6:23	Supine
	5:38	Eval and Approved for Anes	6:28	(MEMO)—Picc line flushed, capped
	5:38	Discuss Risk/Option/Alternative	7:03	Aortic Xclamp On—donor heart
	5:38	Discuss +/- Blood Tx	8:15	Consultant in Room—rdb signout from jpa

**FIGURE 28-16.** Close-up of events on the PIMS printout. Note that all the events are documented in time order except for the first event, which is always intubation difficulty. This event is also printed in a larger font, which is bolded. This was considered an important patient safety feature.

care service made it clear that teasing out difficult intubations from the anesthetic record, which could have >100 documented lines of text, proved difficult. In the paper environment, intubation difficulty was documented in a specific location on the anesthesia record, and the clinician circled a “0,” “1,” or “2.” This linear analog score had proved useful over the years and was replicated in the electronic record, but it now was just one more event in what appeared to be an endless list of events. The solution was to force intubation difficulty to the top of the event list (Fig. 28-16). In addition, if a difficult intubation was documented on the preoperative assessment, this would be carried forward to all subsequent evaluations (i.e., it would be automatically documented as a difficult intubation on every future pre-anesthetic evaluation), and a warning window would be displayed when the assessment was opened. Unfortunately, this safety solution was short lived because the PIMS migrated away from printing a paper anesthetic record to the information being available only electronically. The solution to this problem was found with the use of another electronic form, very similar to the invasive line form discussed earlier (Fig. 28-14). An airway management form was developed that not only has the advantages of additional granularity to more fully document how the patient's airway was managed, but when the documentation is complete and saved, the system generates a structured text message that is forwarded to the electronic progress notes. This way, every clinician can easily find and read the details of airway management during the pa-

tient's anesthetic course by merely accessing the progress notes. This has proved very useful for downstream users, particularly the critical care service when they are deciding on when to wean and extubate a patient.

A more difficult problem was seen with spinal and epidural opioids. Initially, the regional anesthesia form (Fig. 28-13) required that the clinician document whether neuraxial opioids were administered and, if so, via what route (Fig. 28-17). The regional anesthesia form cannot be saved or exited without documentation of whether neuraxial opioids were delivered and, if so, by which route. This was then printed, always in the same location, on the anesthesia record. Unfortunately, some patients who had received neuraxial opioids were missed by the service and/or nursing, received additional parenteral narcotics, and had respiratory depression requiring intervention. Several solutions were attempted, including changing the location of the information on the anesthesia record and automated e-mails triggered by patient transfer. None of these solutions worked. Finally, a hospital-specific Internet site was created that listed every patient who had received opioids in the last 48 hours and included the patient's medical identification (ID) number and the time, date, and route of administration. This site is accessed throughout the day by the acute pain service, and it is their responsibility to see every patient and ensure that appropriate pain medication orders are written. This example highlights the fact that although computer-based solutions can be very powerful, they will not work unless they are coupled with achievable policies and procedures and that the solu-

tions are evaluated to determine whether they are working (i.e., postimplementation review).

A major problem in all medical centers is difficulty errors in correctly identifying patients, particularly in environments where patients cannot speak for themselves. This is particularly true in the operating room where the patient not only is unable to answer questions but, after surgical preparation and draping, cannot even be visually identified. The traditional solution is to place an armband on the patient, but this solution is only as good as the individuals who are comparing the armband to another piece of documentation. Another safety project made use of a bar code reader and the addition of a bar code on the patient's armband. Currently, prior to entry into the operating room, the PIMS is launched, and the patient's name and medical ID number are entered into the system. The software compares the entered name and ID number via an interface with the hospital information system to determine if the name and number match. If the name and number are correctly linked, the PIMS starts recording vital signs and other objective data, but no charting may be done. When the patient arrives in the operating room or procedure room, a bar code reader inputs the information on the armband bar code, which consists of the patient's medical ID number (Fig. 28-18). If the medical ID number on the armband matches the information that had been entered into the system, the PIMS launches the anesthesia record and documents anesthesia start, and

**\*Neuroaxial  
Opioid Given:**

No

Spinal

Epidural

**FIGURE 28-17.** Close-up of the regional anesthesia form (Figure 28-13), which documents whether neuraxial opioids were administered and, if so, by which route (i.e., spinal or epidural). One of the three choices must be picked before the form can be saved and the clinician returned to the PIMS.





**FIGURE 28-18.** Bar code identification of the patient. When the patient enters the operating room, the bar code, which consists of the patient's medical ID number, is read with a hand-held device. This number is compared to the medical ID number the clinician entered earlier, which was confirmed to match the patient's name.



**FIGURE 28-19.** Bar code identification of blood products. The clinician reads the bar code on the blood product bag, which consists of the medical ID number of the intended recipient, with a hand-held device. This is compared to the confirmed medical ID number of the patient on the operating room table.

charting is enabled. This process ensures that the EMR on the computer is actually that of the patient on the operating table.

Unfortunately, this process does not always work. Some patients come to the operating room from the emergency department without identification. Some armbands are unreadable because the ink has worn off. Sometimes the patient has taken the armband off. These are just a few examples of how the system can be defeated. Therefore,

the system allows the clinician to bypass the bar code identification but requires the user to document the reason for the bypass and to attest to the fact that he or she used other reliable means of identifying the patient. This bypass proved to be the source of several incorrect patient identifications, usually when there was a rush of getting the patient into the room, the bar code was not working for whatever reason, and the anesthesia personnel was assured of the



**FIGURE 28-20.** Screen displayed by the PIMS if the bar code identification of a blood product matches that of the patient on the operating room table.

identity of the patient. After a few near misses, the bar code ID bypass was refined. The system now has two requirements: (1) the clinician who is in the room must sign in with his/her name and password and document as performed previously, and (2) an anesthesia supervisor, either an attending physician or senior nurse, must enter the operating room and document that correct identification has been done.

A similar process was added to the PIMS for positive blood product identification. The blood identification process also makes use of bar code identification. When blood products are brought into the operating room, the clinician scans a bar code on the blood product bag (Fig. 28-19). Like the patient's armband, the bar code on the blood product bag contains the intended recipient's medical ID number. The system compares the ID number on the blood product to that of the patient, who had been identified earlier via a bar coding process. If the medical ID number of the patient matches that of the blood product, the system clearly informs the clinician of the fact, both via text and color (i.e., green; Fig. 28-20). If there is a mismatch between the patient and the blood product, the clinician is also informed via text and color (i.e., red; Fig. 28-21). Since the bar code blood product identification system was installed, no patient has received an incorrect unit of any blood product, although the rare near miss (i.e., wrong blood product is brought into the operating room) does occur.

The various patient safety projects demonstrate the fundamental fact that the failure to correctly communicate (i.e., transfer information from one clinician to another) is commonly the





**FIGURE 28–21.** Screen displayed by the PIMS if the bar code identification of a blood product does not match that of the patient on the operating room table.

foundation upon which error and, at times, patient harm occur. The various safety projects that a PIMS allows decrease the opportunity for those errors of communication to occur. For example, if the patient in the operating room is not the same patient the clinician believes was brought in to the OR (i.e., the patient the clinician initially entered into the PIMS), the system does not allow charting to occur, clearly communicating that the wrong patient is in the operating room. Part of the solution to these kinds of medical errors is taking the human brain out of the process, because human neurophysiology is structured to draw rapid conclusions based on incomplete datasets, thus leading clinicians to see what they expect to see (e.g., patient and blood ID). These procedures are a subset of the ongoing efforts to leverage the electronic environment to decrease the opportunities for clinicians to draw wrong conclusions that lead to errors and harm.

## RETURN ON INVESTMENT

There is an understandable concern that EMRs broadly, and PIMS specifically, may not be worth the cost. These systems are expensive, with estimates between \$20,000–\$40,000 per bed. This cost includes the software, hardware, interfacing, furniture, and so on. The return on this investment can be difficult to tease out of the complex dynamics within a medical facility. Nonetheless, we can point to a number of significant benefits associated with the introduction of EMRs.

One of the most obvious benefits of EMRs is availability. With paper records, the paper chart must accompany a patient arriving on the ward or in the operating suite. In the context of an inpatient episode of care, the current chart commonly is placed on a clipboard or other device that holds the pieces of paper together. When the patient is moved, it is a simple task to merely place the chart on the gurney or to have the patient hold the record on his/her lap while the wheelchair is pushed. This becomes more complicated in an outpatient context and even more difficult when the patient has pertinent medical records from a previous episode of care. When the record is not with the patient, it must be sent for. This generates a time delay as well as an expense. The internal estimates at Mayo Clinic assessed a \$7 cost every time a record was sent for or moved (i.e., cost of having a clerk find the record and then transport it), and it was twice as expensive to access a radiology image. If the chart is not in the expected location but instead is on another physician's desk (e.g., to be summarized or reviewed for research purposes), the time delay often can be substantial, if the record can be found at all. The consequence of these delays not only is less efficient care delivery but also possibly less effective care. Depending on the medical situation of the individual patient as well as the time demands on the clinician, decisions may be made without access to important medical information. When we analyzed our critical care practice more than a decade ago, we concluded that as much as 25% of laboratory and radiographic results were never seen by clinicians because they either could not find the results or were unaware that the studies had been done.

Once a fully integrated EMR is installed, there is virtually no delay in accessing current and historic medical information, although there is a transition period when the legacy, paper chart will be accessed. The access to old records decreases fairly rapidly over time as their value erodes and the electronic records increasingly contain historic information. Instead of having to call for a chart or waiting until a colleague has completed his/her charting task, all a clinician has to do is access a computer terminal, enter his/her ID information, and then access

the patient's medical record. This ready access also assists in the direct delivery of care because clinicians can discuss cases while they have access to the record. The clinician who receives a phone call from an ICU nurse is not constrained by what the nurse sees on the record or the monitor. The clinician can access the record from a distant location and discuss the patient's management while having access to the patient's real-time physiologic data. Although we initially had worked very hard to produce a printed anesthesia record that was as similar as possible to the handwritten record, once the rest of the medical center was up and running, we were able to abandon the printout entirely. The advantages to the anesthesia team of having complete access to a patient's medical record, particularly previous anesthesia records, everywhere in the medical center are substantial.

Having this kind of ready access to medical information is associated with a real economic advantage. An immediate cost savings is associated with not having to store and transport paper records. The efficiencies gained from virtually immediate access to medical information can be translated into improved access to medical care and the ability to evaluate and treat more patients per day. Not only does an electronic record provide near immediate access, anywhere in the medical center, to the patient's medical record, it provides that information in a legible form. Fig. 28–22 shows an example of a handwritten record. It is both difficult (some would say impossible) and time consuming to obtain information from handwritten records. At times the difficulty in reading a handwritten record is an even greater barrier to understanding a patient's medical history than is the impact of a delay in obtaining the record. For an anesthesiology department, rapid electronic access to legible medical information means faster and more comprehensive preanesthesia assessments. It also increases the likelihood that preexisting conditions that could complicate the perioperative course (e.g., difficult intubation, pseudocholinesterase deficiency) are identified and the associated complications prevented. New findings in an electronic format are available more rapidly. For example, digital radiology can make images available as soon as they taken. Preventing periop-

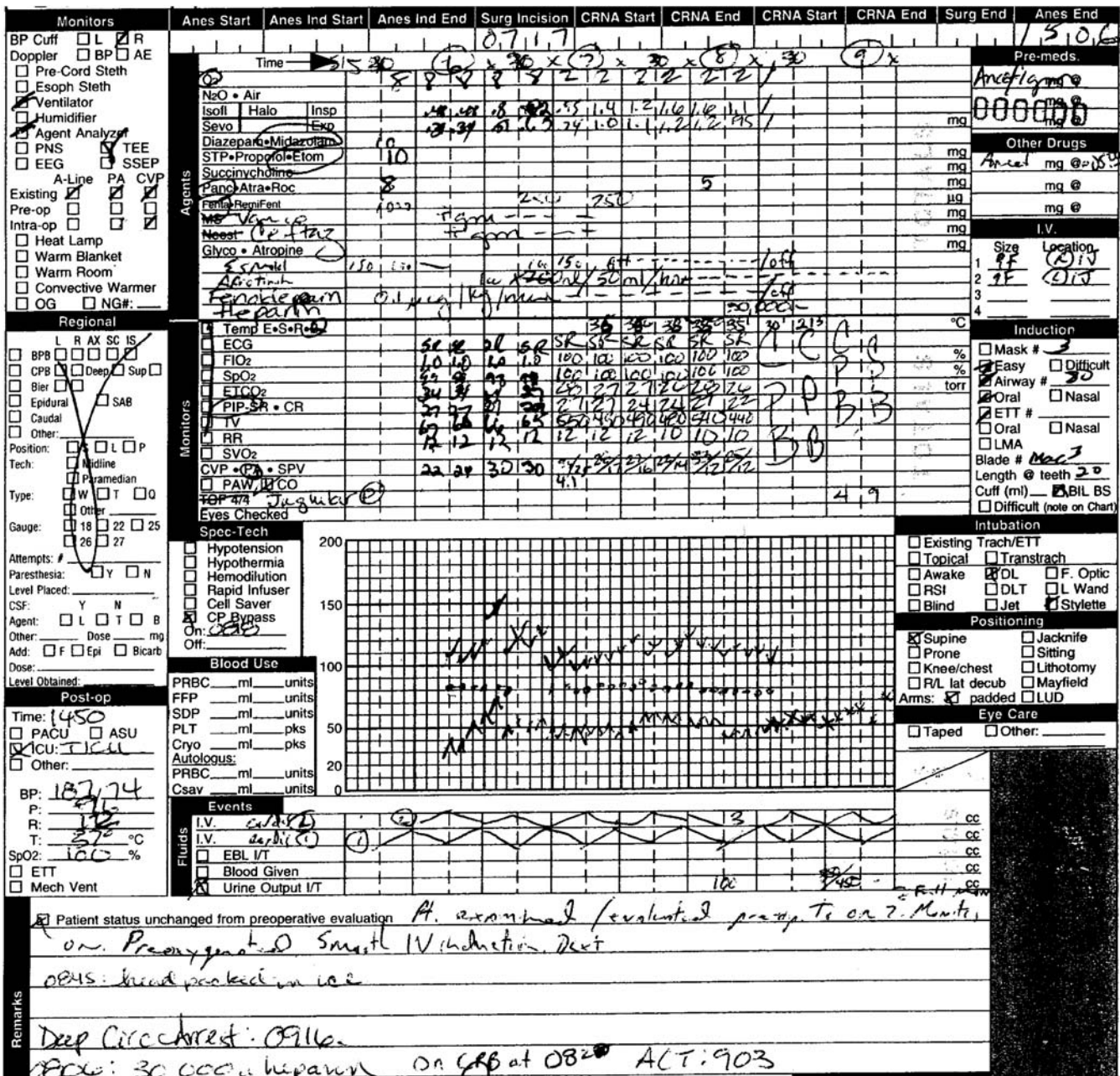


FIGURE 28-22. Example of a handwritten anesthesia record.

erative complications offers significant cost savings, and holding down costs is imperative in an environment of bundled pricing for procedures.

As noted earlier, the PIMS communicates directly with the billing office at the end of every anesthetic procedure. The information forwarded is a subset of the anesthetic record, and the system determines whether all the required information for billing has been provided. If any required item is missing or incomplete, the system blocks transfer of the patient until the required documentation has been entered. Our estimate is that anesthesia

billing has increased 5-10% with this electronic process. Billing for reimbursable procedures (e.g., central line placement, postoperative regional analgesia) has also improved with the addition of electronic forms that ensure that these procedures are documented with adequate granularity, thereby allowing for appropriate billing and reimbursement. This process decreases opportunities for incomplete documentation, which has given us confidence that we not only are complying with the various billing requirements but we also are compliant with regulatory requirements. This substan-

tially reduces the economic risks associated with regulatory audits. Considering the fact that each incidence of noncompliance could be fined as high as \$10,000, the value of mitigating such a risk is significant.

These are just a few examples of the business case for a PIMS. Rapid access to a patient's medical information that is presented in a legible form is of unquestionable value. EMRs decrease costs by eliminating the need to store and transfer paper records. Care is delivered in a more efficient manner because there are no delays in accessing information. Care is delivered



more effectively because all information about a patient is available and legible. System design facilitates the clinician's ability to identify critical information, thereby decreasing the likelihood of avoidable perioperative complications, whether secondary to misidentifying the patient, blood products, previous complications, or critical underlying pathophysiology. A PIMS allows for electronic transfer of billing information that is complete and comprehensive. This allows the organization to receive reimbursement for all delivered services. Finally, the PIMS ensures that the records are complete with regard to regulatory requirements. Therefore, an EMR, including a PIMS, decreases the costs of delivering care, increases productivity, increases revenues, and mitigates regulatory risks.

## BARRIERS TO ADOPTION

One of the most important issues hindering adoption of a PIMS is cost. As discussed earlier, the business case can clearly be made and the return on investment can be substantial, depending on the specific issues a PIMS can improve in the medical center. Nonetheless, the capital costs are substantial. As a general statement, a PIMS almost always will be part of a larger EMR project that is supported and funded at the institutional level. Although some anesthesiology practices may decide to go it alone in order to obtain the benefits of an electronic record for their practice, this model will be the exception and not the rule. The benefits of a standalone project can make a PIMS project worth pursuing (e.g., mitigation of litigation and regulatory risks, improved billing), but a more comprehensive project allows for greater benefit and broadens the risk across the medical facility.

Concern with artifacts is a common reason for opposing a PIMS. Physicians and nurses express the fear that inaccurate recordings of physiologic parameters (e.g., blood pressure, oxygen saturation) not only will produce an inaccurate record that may mislead clinicians carrying for the patient but also could put them at increased risk during litigation. We have found these concerns to be unfounded. Although artifacts do occur (e.g., arterial blood pressure >300 when arterial line is

flushed), they almost always are obviously artifactual and of no concern. The reason these incorrect data are transparently artifactual is human physiology. The PIMS records information every minute and records in the database every 30 seconds. For example, it is impossible for the blood pressure to be steady at 120/70 for many minutes, then briefly >300 (flushing) or <10 (transducer open to air), and then instantly return to 120/70, all the while with no change in heart rate, oxygen saturation, or end-tidal carbon dioxide concentration. At times, information that does not reflect the patient's physiologic state is recorded. If the information is of brief duration, the PIMS data can be manually corrected, and users will commonly enter the correct information. More commonly, the physiologic data on the monitor is incorrect (e.g., low blood pressure or oxygen saturation secondary to low perfusion state). This situation is best handled by writing a memo into the PIMS or progress note explaining the clinical situation. In a study of a clinical information system used in an ICU setting, Ward<sup>24</sup> reported a <0.1% error rate for verified vital signs (i.e., oxygen saturation, heart rate, and respiratory rates).

There is also objection to a PIMS because of concerns that computer-based record keeping will take the clinician away from the patient's bedside, and critical events will be missed. As discussed earlier and as reported by Weinger et al.,<sup>21</sup> the time dedicated to electronic charting is no worse than that for paper record keeping. An added advantage of PIMS is that the system records monitored data in real time; this negates the requirement with paper records keeping to recreate, from faulty memory, what had occurred in the past. This allows clinicians to concentrate on patient care and to document during low-intensity maintenance periods of the procedure. The potential problem with automated record keeping is not taking the clinician away from the patient, but that the PIMS may take the clinician away from the record. Except for the beginning and end of a procedure, there is very little to do in terms of record keeping during the bulk of a procedure. Therefore, there is no need to examine the record every 5 minutes, as required for paper record. This could lead to the missing of trends.

Although we have no identified incidences, we are examining whether processing of real-time data to identify adverse trends and to warn clinicians would be a value-added to the PIMS in the operative setting.

Finally is the concern commonly voiced that PIMS will significantly increase litigation risk. The reasons given include documentation of artifacts, erroneous entry secondary to typographic errors, purposeful misunderstanding of the content of automated records, and the risk associated with accurate documentation of vital signs (e.g., hypotension and tachycardia during induction of anesthesia). The issue of artifacts was discussed earlier. Incorrect manual documentation is just as likely with an electronic record as with a paper record. Because computer-based medical record keeping is, by definition, legible, it seems more likely that fewer errors will occur with a PIMS as compared to a paper record because an illegible entry is effectively an error or even missing information. Although increased variations of vital signs are noted on a PIMS, this merely reflects the normal increase and decrease of blood pressure, heart rate, and other physiologic parameters that occur during an anesthetic procedure. It is well documented that clinicians smooth vital signs on a paper record.<sup>1-4,25</sup> Therefore, if questions arise as to the variability of the vital signs during a procedure, accessing the literature as well as other anesthetic records to establish the fact that the observed variability is normal and expected is a straightforward process. Litigation concerns that a PIMS accurately records the vital signs hopefully reflects the views of a minority within the medical community. If the purpose of the medical record is not to document what had occurred during a procedure but instead is to obfuscate the patient's medical care, then a PIMS certainly could put a clinician at increased risk. The literature as well as our experience clearly shows that PIMS records are much more accurate and complete records compared to the paper paradigm.

In contrast to the concerns expressed regarding litigation risk, our experience has been quite different. Since the introduction of the PIMS, first in the cardiovascular and thoracic operating rooms in the early 1980s and then wall to wall in the late 1990s,

every time we have been challenged by litigation the electronic documentation has served to bolster our defense. During legal review, no challenges were made regarding documentation of artifacts, physiologic variability, or unsmoothed data. The fact that the objective data (e.g., physiologic parameters, laboratory results) were recorded electronically without the possibility of human interference added weight to their veracity. The completeness of the records gave confidence that the record reflected what really occurred. The legibility of the medical record has decreased opportunities for disagreements on what the record meant. We now are confident that the PIMS is a critical element of accurate record keeping that will aid us in the event of legal challenge. Our experience is consistent with that reported by Feldman,<sup>26</sup> who surveyed 55 anesthesia departments regarding their experience with electronic record keeping and malpractice cases. Twenty-four departments reported a total of 41 malpractice events where the anesthetic record was documented electronically. In none of these cases did the respondents claim that the electronic record caused problems with their defense. Thirty of the cases were dropped prior to trial, and 11 either were settled or went to litigation. Eighteen departments believed that their PIMS helped with their risk management, and three departments believed that the PIMS was a critical element to this endeavor. Based on our experience and the results of Feldman's survey, it is reasonable to conclude that a PIMS would decrease the risk of adverse legal review.

When the details of most objections to a PIMS are examined, it is clear that the objections are not well grounded. Although the capital expenditure is nontrivial, over time improved billing, more efficient and effective medical care, decreased complications, and decreased regulatory risk will substantially make up the expense. Concerns with artifacts and the associated time required to chart on an electronic record are, in fact, nonissues. Artifacts will occur, but they are transparently obvious, are correctable (although our experience shows this is rarely done), and have not been demonstrated to be problematic, either during the course of care or afterward. PIMS has been shown to, at worst, demand the same

time for charting activities as a paper record, but it has the advantage of automatically charting much of the objective information automatically while the clinician is engaged in patient care activities. Objections that an electronic system will chart what really occurred and that this could put the clinician at risk are correct, but the purpose of a medical record is to document what occurred and not to serve as an obfuscating shield to protect clinicians. Finally, our experience and that of other facilities has shown that a PIMS helps, not hinders, the defense in a medical malpractice case. In summary, the objections commonly offered to the installation of a PIMS are not supportable.

## PRACTICE MANAGEMENT

One of the many claims made by proponents of a PIMS is that the collected data from many patients, records can be used to generate new medical knowledge. It is widely believed that electronic records will allow researchers to determine which medical strategies work and which do not. Unfortunately, until now these claims have been thinly demonstrated.

Once information about the patient, the course of care, and resource utilization is entered into a database, it can be processed and displayed as a tool to improve both the quality and the efficiency of practice in the operating suite. This kind of analysis is a major value-added with the implementation of a PIMS. For example, examining the relationship of a variety of physiologic variables to adverse outcomes can identify easily solvable problems. Close attention to the economic as well as the medical impact of new pharmacologic agents can assist in the appropriate use of new drugs. Analysis of laboratory testing with practice decisions helps to identify which tests are really needed for clinical management. Comparing the practices of physicians to that of their peers allows for identification of "best practices" as well as problematic issues. The ability to carefully examine one's practice offers the possibility of accelerating practice improvements and improving patient outcomes.

In our experience, the data made available by the PIMS has been used primarily for practice management

purposes. We have created a number of automated reports to assist the management of our clinical and education enterprise, including the following:

- Productivity reports, tracking the cases of each physician and nurse.
- After hours reports, tracking both emergency and scheduled procedures performed after hours.
- Concurrency reports, tracking the number of concurrent cases each anesthesiologist is responsible for and the status of the clinician being supervised (i.e., resident physician, anesthesiologist assistants, nurse anesthetist, or student nurse anesthetist).
- QA reports, tracking anesthesia morbidity and mortality. These reports are broken down by clinical area (e.g., neurosurgery, cardiac catheterization laboratory), clinician, patient comorbidity, and so on.
- Education reports, tracking the number, kind of cases, invasive lines, and regional anesthetics of resident physicians. Similar reports are generated for the nurse anesthesia program.

The demands for practice management reports are ongoing. As with requests for changes to the PIMS, the reports must be prioritized. Currently, the work to produce these reports falls on the shoulders of the information technology team of programmers who must put aside work to upgrade the PIMS in order to generate these reports. The system currently is at the point where we are examining whether we can transfer responsibility for report generation and maintenance to another group, possibly an expanded research group that has the necessary technical and statistical skills.

The literature is beginning to see the results of different groups of investigators making use of the data available in their respective PIMS databases. These reports include the following:

An investigation from the Mount Sinai School of Medicine in New York, which examined the relationship between postinduction hypotension and the patient's preoperative history and pharmacologic management.<sup>27</sup> The authors reviewed more than 5000 electronic records and showed that propofol was associated with clinically significant hypotension in patients who were older than 50 years and had



an ASA physical status greater than II. This hypotension was associated with greater length of stay and higher mortality rates.

Investigators at Duke University reported that they used the data generated from their electronic anesthesia record to determine the cost of anesthetic medications used on a per case and per clinician basis.<sup>28</sup> This information was used as feedback to the clinical staff, and the department saw an associated cost saving in excess of \$1 million per year.

The University of Miami reported that use of a PIMS in conjunction with education, workflow integration, and user feedback improved their QA completion rate from a baseline of 48% to 94%.<sup>29</sup>

Researchers at the University Hospital in Giessen, Germany, analyzed the data in their PIMS database to determine if certain patient characteristics could predict significant hypotension after spinal anesthesia. Using sophisticated statistical analysis, the authors reported a statistically significant association between post-spinal anesthesia hypotension and chronic alcohol consumption, emergency procedures, and a history of hypertension.<sup>30</sup>

The same investigators examined their data for an association between patient and anesthetic characteristics and antiemetic rescue treatment. They reported that patients who were smokers, female, younger than 40 years, or had received opioids, nitrous oxide, or propofol were at increased risk.<sup>31</sup>

These are early examples of the potential use of data in a PIMS database to improve the quality of patient care. It is too early to predict the degree to which this kind of analysis will be used to change how anesthesia care is delivered. However, it appears reasonable that as PIMS gains a greater share of the anesthesia marketplace, investigators will make increasing use of the data and hopefully will discover information within the sea of data.

## MANAGEMENT OF AN ESTABLISHED PIMS

Installation of a PIMS requires a dedicated staff. In our project, we assigned a

full-time nurse anesthetist, 20% of a physician's time, five to seven information technology staff, and three administrative staff. This does not include the significant time and effort of the clinical and administrative staff in the department of anesthesiology that also contributed to making the project a success. Although this allocation of personnel may appear to be overly generous, it is not inconsistent with what other institutions have used to configure and install their systems, particularly when scaled to the size of the respective institutions. Some manufacturers include configuration and installation of their system as part of the cost of their software, but experience has shown that significant institutional resources are required to successfully install such a system.

After the go-live period is complete and the PIMS appears to be stable and functioning, the project team's job has just begun. Ongoing issues include PIMS support for the clinical staff. This consists of onsite support during the workday, help desk support, and 24-hour-per-day, 7-day-per-week on-call support from programming and engineering staff. As the system expands to a greater number of clinical sites, a greater demand is placed on the network and the different servers supporting the system.

The complex issue of user expectations and demands must be engaged. The ongoing demands for added functionality and customization are an expected outgrowth of computer-based documentation. A formal process to review these requests and to determine which changes are appropriate and cost-effective, and when and to what degree to develop the requested added functionality must be developed. With this process in place, the PIMS is positioned to evolve with the clinical practice.

Such a process requires ongoing dedicated personnel to the PIMS project, including clinical, information technology, and administrative staff. The business software systems that a hospital administration must use for accounting, inventory control, and human resources require in-house information technology staff support to ensure the systems are up and running and are upgraded to meet ever changing requirements. Clinical systems must have similar support. Without the ability to update or add refinement to a PIMS, the usefulness of the

system will rapidly degrade. This issue should be considered nonnegotiable. If a medical organization is considering moving its medical records from a paper format to an electronic system, information technology staff must be part of the package. Too many facilities have failed in their attempt to introduce an EMR because they were unwilling to hire the necessary support staff. When time constraints and intensity of clinical tasks are considered, the need for information technology staff is more important with a PIMS than with almost any other clinical system. Appropriate personnel—clinical, information technology, and administrative—must be part and parcel of a PIMS, for configuration, installation, and maintenance.

## SUMMARY

After a relatively slow start, particularly when compared to other industries, computer technology is beginning to be used at the patient bedside, broadly referred to as the electronic medical record (EMR). One important part of the EMR is the perioperative information management system (PIMS). The PIMS consists of the electronic tools used to document the preanesthetic evaluation, the intraprocedural anesthetic record, and the postanesthesia care. It also consists of a database that stores all the data on perioperative care. This database then can be used to reconstruct an individual's record for medical or administrative purposes (e.g., billing or regulatory review). It also can be used to evaluate aspects of rendered care to a large number of patients (e.g., track how many cases have been done, determine which proportion of patients with coronary disease received  $\beta$ -blockers).

There are many reasons to move from a paper to an electronic record. Some of the most important issues addressed by a PIMS are the realities that paper records are sometimes illegible and inaccurate, are time consuming to produce and maintain, and generate difficulties with payers, regulators, and during legal review. EMRs solve most of these problems. Paper records can be lost or spoiled. Electronic records allow clinicians in a medical facility virtually instant access to a patient's medical record. Electronic record keeping has downsides, particularly the ex-

pense and complexity of such a project. Certain objections to a PIMS have proved to be unfounded, including concerns with artifacts, which are easily identified and discounted; that electronic charting is too time consuming, which has been shown to be no worse than paper record keeping; and that a PIMS-generated record could put clinicians at increased risk during litigation, which in our experience and that of others has shown no increased risk—in fact, an electronic record may decrease litigation risk.

Currently a number of companies offer a PIMS. These include CareFX, Picis Caresuite, GE Centricity, Philips CompuRecord, Dragger Innovian, and Cerner Surginet. As expected, each vendor has its advantages and proponents. In my opinion, which product an organization chooses is less important than how the organization manifests and manages the system. It is clear that the medical specialty of anesthesiology will have to embrace EMRs, and most likely will be in the best interest of individual groups to actively engage such a project. Waiting for one's institution to make a decision, or delaying institution of electronic records as long as possible, will put an anesthesiology department at risk for having the decision made for them by individuals with little or no knowledge of an operative practice. It is better to retain control of a department's clinical tools. With regard to electronic record keeping, taking a proactive stance will make it more likely that the department will retain control of its medical records.

The process of configuring and manifesting a PIMS can be complex. The entire process of patient care must be analyzed and broken into its component parts. The first step in the process should be the creation of a scope document that details the expected functionality of the PIMS and the various tasks that must be accomplished in order to accomplish such a project. The scope document then becomes the project's bible, and fairly rigid management is required to prevent scope creep. Once the PIMS functionality is agreed to, no additional functionality should be allowed until after the system is installed, unless a serious error is identified. The project team must continue to engage the department's leadership for decisions that impact the clinical practice. Deci-

sions such as mandatory documentation should be made by the clinical leadership and not by the PIMS project team. This keeps the leadership engaged in the project, ensures that the leadership retains ownership of the project, and prevents the PIMS team from becoming marginalized.

The necessary steps of configuring and installing a PIMS include detailing every aspect of the process (e.g., lists of medications to be documented, size of intravenous lines that may be placed), interfacing the different devices (e.g., monitors and ventilators) that will feed information into the PIMS, and installing computer systems in each anesthetizing location. As the PIMS takes shape, each aspect must be tested and verified. Most of this work can be done in a testing site outside of the clinical spaces. It is vitally important to ensure that the PIMS works as expected prior to use by the clinical staff.

Once the project team is reasonably sure that the system is ready for clinical use, the system must be tested in the clinical setting. For the first few locations, it is prudent to consider charting on the PIMS in parallel with manual documentation. The two records can be compared and the accuracy of the electronic record clinically validated. The next step is to determine whether the PIMS can be used by clinicians concurrently with patient care tasks. A paper record should be recorded during this testing, and again the PIMS should be validated. Finally, once the clinical accuracy and usability of the PIMS have been demonstrated, a staged rollout process should occur. This stepwise approach allows the practice to be assured that the new record-keeping system will not interfere with the practice's ability to care for patients and that their record will accurately reflect the clinical care they delivered.

When the PIMS is installed, the project team will be faced with endless requests for refinements to make charting easier, added functionality, and various database reports. Examples of postimplementation projects include bar code identification of patients and blood products, charting shortcuts for rapid turnover cases, increased charting granularity by use of forms for regional anesthesia and invasive line placement, mandatory charting for billing and regulatory compliance, and for-

warding of clinical information, such as neuraxial opioids, to downstream clinicians. The large number of requests requires the development of a change management process. Request for changes and additions to the PIMS must be documented and then reviewed and prioritized by the project team. Disagreements are adjudicated by the departmental leadership. This process has allowed steady but controlled improvements to the PIMS that do no disrupt the clinical practice.

An anesthesiology practice will see positive returns on its investment in a PIMS in terms of time and money. Because billing information is electronically generated in the PIMS, no forms can be inaccurately filled out or lost. It is not unreasonable to expect a 5–10% improvement in billing with an integrated PIMS. Clinically, the utility of electronic access to all patients' medical information is a clear benefit. Avoiding complications secondary to missing information can be expected to lower costs. The PIMS facilitates regulatory compliance, including concurrency issues and pay-for-performance demands. Improved patient safety is an external demand of payers and regulators. It is also a growing expectation of patients. A PIMS will improve the economics of delivering anesthesia care and decrease the risks associated with the practice.

A PIMS is an integral part of modern practice management. It can be used to track productivity, complications, and drug administration. The literature is beginning to publish reports of a PIMS database used to improve the management of an operating suite, to improve a QA program, or to determine the best way to handle specific medical conditions. Our understanding of the downstream utility of these electronic tools is just in its infancy, and it is reasonable to expect that this knowledge base will grow rapidly as more systems are installed.

There is no question that EMRs and PIMs will become ubiquitous. The only question is when any one particular practice will embrace this new technology. Although complex and expensive, the advantages of electronically based documentation far outweigh the disadvantages. Improvements in access to medical information secondary to legible and available charts, accuracy of documentation, billing, payer, and regulatory compliance, patient

safety and quality of care, and decreased litigation risks are just a few of the advantages of these systems. Perioperative information management is in the future of every anesthesiology practice.

## KEY REFERENCES

1. Devitt JH, et al. The anesthetic record: accuracy and completeness. *Can J Anaesth* 1999;46:122–128.
2. Vigoda MM, Lubarsky DA. The medicolegal importance of enhancing timeliness of documentation when using an anesthesia information system and the response to automated feedback in an academic practice. *Anesth Analg* 2006;103:131–136.
3. Abenstein JP, et al. Eight year's experience with automated anesthesia record keeping: lessons learned—new directions taken. *Int J Clin Monit Comput* 1992;9:117–129.
4. Weinger MB, Herndon OW, Gaba DM. The effect of electronic record keeping and transesophageal echocardiography on task distribution, workload, and vigilance during cardiac anesthesia. *Anesthesiology* 1997;87:144–155; discussion 29A–30A
5. Ward NS. The accuracy of clinical information systems. *J Crit Care* 2004;19:221–225.
6. Feldman JM. Do anesthesia information systems increase malpractice exposure? Results of a survey. *Anesth Analg* 2004;99:840–843.

## REFERENCES

1. Devitt JH, et al. The anesthetic record: accuracy and completeness. *Can J Anaesth* 1999;46:122–128.
2. Cook RI, McDonald JS, Nunziata E. Differences between handwritten and automatic blood pressure records. *Anesthesiology* 1989;71:385–390.

3. Block FE Jr. Normal fluctuation of physiologic cardiovascular variables during anesthesia and the phenomenon of "smoothing." *J Clin Monit* 1991;7:141–145.
4. Lerou JG, et al. Automated charting of physiological variables in anesthesia: a quantitative comparison of automated versus handwritten anesthesia records. *J Clin Monit* 1988;4:37–47.
5. Gaba DM. The present and future medicolegal importance of record keeping in anesthesia and intensive care: the case for automation. *J Clin Monit* 1990;6:338–339.
6. Gibbs RF. The present and future medicolegal importance of record keeping in anesthesia and intensive care: the case for automation. *J Clin Monit* 1989;5:251–255.
7. Vigoda MM, Lubarsky DA. The medicolegal importance of enhancing timeliness of documentation when using an anesthesia information system and the response to automated feedback in an academic practice. *Anesth Analg* 2006;103:131–136.
8. Smith NT. Perioperative anesthetic data—what to do with them? The role of the automated anesthetic record. In 65th Congress of the International Anesthesia Research Society March 8–12, 1991: IARS.
9. Gravenstein JS. The uses of the anesthesia record. *J Clin Monit* 1989;5:256–265.
10. Heinrichs W. Automated anaesthesia record systems, observations on future trends of development. *Int J Clin Monit Comput* 1995;12:17–20.
11. Heinrichs W, Monk S, Eberle B. Automated anesthesia record systems. *Anaesthesist* 1997;46:574–582.
12. Eichhorn JH. Disadvantages of the automated anesthesia record. In Gravenstein JS, Holzer JF, eds. *Safety and Cost Containment in Anesthesia*. Boston: Butterworth, 1988:223–232.
13. Gravenstein JS, et al., eds. *The Automated Anesthesia Record and Alarm Systems*. Boston: Butterworth, 1987.
14. Zollinger RM, Kreul JF Jr, Schneider AJ. Man-made versus computer-generated anesthesia records. *J Surg Res* 1977;22:419–424.
15. Lees DE. Computerized anesthesia records may have drawbacks. *Anesthesiology* 1985;63:236–237.
16. Vigoda MM, Lubarsky DA. Failure to recognize loss of incoming data in an anesthesia record-keeping system may have increased medical liability. *Anesth Analg* 2006;102:1798–1802.
17. Noel TA 2nd. Computerized anesthesia records may be dangerous. *Anesthesiology* 1986;64:300.
18. Block FE Jr, et al. The computer-based anesthetic monitors: the Duke Automatic

Monitoring Equipment (DAME) system and the microDAME. *J Clin Monit* 1985;1:30–51.

19. Abenstein JP, et al. Eight year's experience with automated anesthesia record keeping: lessons learned—new directions taken. *Int J Clin Monit Comput* 1992;9:117–129.
20. Lanza V. Automatic record keeping in anaesthesia—a nine-year Italian experience. *Int J Clin Monit Comput* 1996;13:35–43.
21. Weinger MB, Herndon OW, Gaba DM. The effect of electronic record keeping and transesophageal echocardiography on task distribution, workload, and vigilance during cardiac anesthesia. *Anesthesiology* 1997;87:144–155; discussion 29A–30A
22. Edsall DW, et al. Computerized patient anesthesia records: less time and better quality than manually produced anesthesia records. *J Clin Anesth* 1993;5:275–283.
23. Allard J, et al. Effect of automatic record keeping on vigilance and record keeping time. *Br J Anaesth* 1995;74:619–626.
24. Ward NS. The accuracy of clinical information systems. *J Crit Care* 2004;19:221–225.
25. Benson M, et al. Comparison of manual and automated documentation of adverse events with an Anesthesia Information Management System (AIMS). *Stud Health Technol Inform* 2000;77:925–929.
26. Feldman JM. Do anesthesia information systems increase malpractice exposure? Results of a survey. *Anesth Analg* 2004;99:840–843.
27. Reich DL, et al. Intraoperative hemodynamic predictors of mortality, stroke, and myocardial infarction after coronary artery bypass surgery. *Anesth Analg* 1999;89:814–822.
28. Lubarsky DA, et al. Using an anesthesia information management system as a cost containment tool. Description and validation. *Anesthesiology* 1997;86:1161–1169.
29. Vigoda MM, Gencorelli F, Lubarsky DA. Changing medical group behaviors: increasing the rate of documentation of quality assurance events using an anesthesia information system. *Anesth Analg* 2006;103:390–395.
30. Hartmann B, et al. The incidence and risk factors for hypotension after spinal anesthesia induction: an analysis with automated data collection. *Anesth Analg* 2002;94:1521–1529.
31. Junger A, et al. The use of an anesthesia information management system for prediction of antiemetic rescue treatment at the postanesthesia care unit. *Anesth Analg* 2001;92:1203–1209.



# CHAPTER 29

## Hemodynamic Monitoring

Shahar Bar-Yosef, MD,  
Rebecca A. Schroeder, MD,  
and Jonathan B. Mark, MD

One can ascribe the birth of hemodynamic monitoring to the British anesthesiologist Joseph T. Clover, MD (1825–1882), who has emphasized the need to have one's finger on the pulse when giving chloroform anesthesia (Fig. 29–1).<sup>1</sup> The word *monitor* originated in the Latin word *monere*, meaning “to warn.” Indeed, one of the more commonly associated roles of monitoring devices is to alert the anesthetist of changes in patient's conditions. However, an additional goal of “monitoring” relates to regulation and control: the anesthetist uses information gleaned from the monitors to modify therapeutic interventions, and then uses the monitors again to gauge the effect of these interventions, and so on in a continual feedback-control loop.<sup>2</sup> It becomes clear, then, that for the patient to gain benefit from the monitor used, several conditions must be fulfilled. First, the data needs to be correctly interpreted; both the technical and physiologic aspects of the monitor need to be perfectly understood by the physician-user. Second, effective clinical interventions should exist to treat the underlying problem. Third, risks associated with the monitor itself should be recognized and minimized. It is important to emphasize that physiologic information not followed by effective interventions will not benefit the patient and information that is mistakenly interpreted can even lead to patient harm by prompting wrong interventions.<sup>3</sup>

This chapter describes the technical and physiologic principles behind the more commonly used monitors in the perioperative period, presents existing data regarding their accuracy and usefulness, and suggests a cognitive framework for employing these monitors to answer specific clinical questions.

### ARTERIAL BLOOD PRESSURE MONITORING

Blood pressure is the vital sign that describes the driving force for perfusion of all tissues and is the major determinant of left ventricular afterload. Accurate, reliable, and timely measurement of arterial blood pressure (ABP) is crucial for the responsible care of critically ill patients and those undergoing surgical procedures. ABP can be measured accurately with invasive and noninvasive methods, but both are subject to artifacts that could lead to inappropriate therapy and patient injury unless correctly identified and interpreted.

#### Noninvasive Arterial Blood Pressure Measurement

Current auscultatory methods for measuring ABP are based on the work of Korotkoff, who described the series of distinct sounds produced by the return of blood flow through the artery during cuff deflation. This method has a variety of limitations, including its reliance on pulsatile blood flow and its

tendency to significantly underestimate blood pressure in states of extreme vasodilatation, or overestimate blood pressure in cases of severe arterial vasoconstriction.<sup>4</sup>

Automated noninvasive ABP measurement has been based on the oscillometric technique, in which the point of maximal cuff pressure fluctuation corresponds to mean arterial pressure (MAP).<sup>5</sup> The technique whereby systolic and diastolic pressures are determined varies somewhat between device manufacturers, but in general, systolic and diastolic pressures correspond to the points of rapidly increasing and decreasing oscillations, respectively (Fig. 29–2). Unfortunately, when compared to direct ABP measurement, oscillometry tends to overestimate ABP during hypotension and underestimate it during hypertension.<sup>6</sup>

#### Invasive Arterial Blood Pressure Measurement

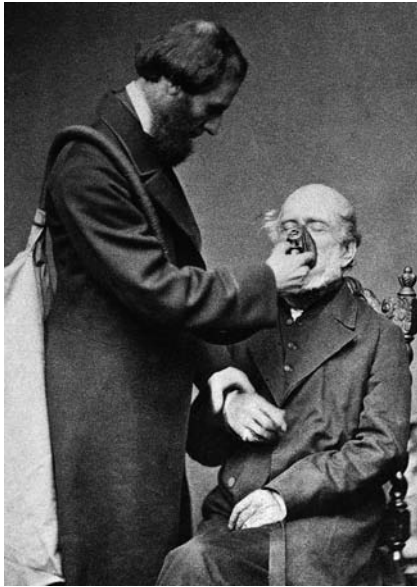
##### Theory and Background

Direct ABP measurement remains the gold standard despite its increased cost and the additional expertise and

### KEY POINTS

1. When interpreting invasive hemodynamic pressures, consideration should be given to technical aspects including the zero reference level, dynamic response of the monitoring system, and the effects of changes in intrathoracic pressures.
2. Much diagnostic information can be gleaned from the analog waveform of directly measured pressures, both arterial blood pressure and cardiac filling pressures.
3. The interpretation of filling pressures like central venous pressure (CVP) and pulmonary artery occlusion pressure (PAOP) is confounded by many variables, notably changes in ventricular compliance, valvular abnormalities, and positive pressure ventilation.
4. Use of the pulmonary artery catheter for monitoring without a structured therapeutic intervention protocol has generally been found not to be beneficial in most perioperative and critical care settings. It might still be justified in very-high-risk patients or in critically ill patients who do not respond to empiric therapy.
5. There are no accepted “gold standards” for cardiac output measurement. With this in mind, it is more clinically useful to follow trends in cardiac output rather than consider absolute values.
6. Functional indices based on respiratory variation in hemodynamic parameters are better predictors of fluid responsiveness compared to static filling pressures or volumetric indices.
7. Metabolic indices like lactate, base excess, and venous oxygen saturation should be included in the hemodynamic monitoring of the critically ill patient.
8. Preemptive goal directed therapy, aimed at optimization of hemodynamic goals before and during surgery, has been found to decrease mortality in high-risk surgical patients and decrease morbidity in moderate-risk patients.



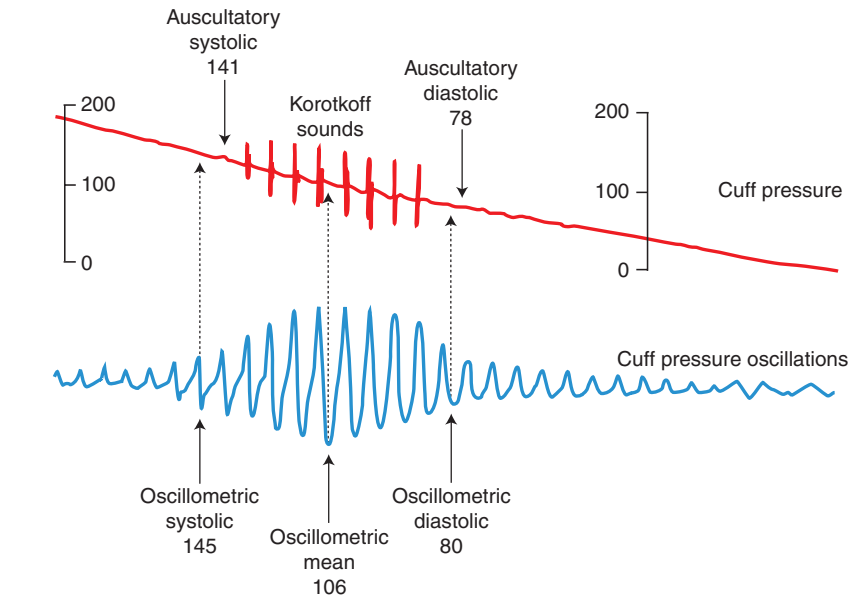


**FIGURE 29-1.** Joseph T. Clover (1825–1882), a pioneer of monitoring during anesthesia. (Reproduced with permission from the Wellcome Library, London.)

520

risk involved. A small catheter is placed within an arterial vessel and connected through fluid-filled tubing to an electromechanical transducer. The dynamic response of this system is best characterized by two physical properties: natural frequency and damping coefficient. Natural frequency describes how rapidly a system oscillates after it is set in motion, and the damping coefficient refers to how rapidly it comes to rest after such a disturbance. With a low natural frequency, the system will resonate and pressure waves displayed on the monitor will be greatly exaggerated versions of the true ABP, a phenomenon known as overshoot or ringing. Underdamped systems exaggerate high- and low-pressure values and produce artificial peaks and troughs in the displayed waveform. In contrast, overdamped systems display waveforms devoid of detail with attenuated peaks and troughs.

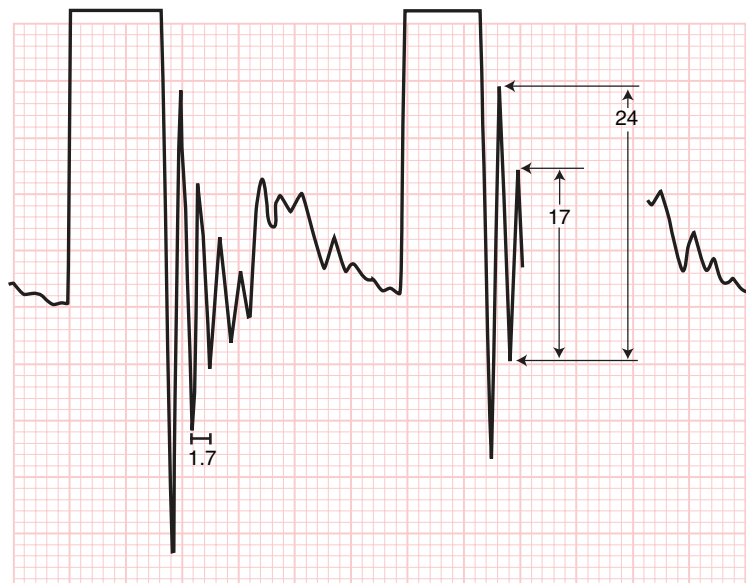
The dynamic response of the monitoring system can be quickly assessed with the “fast flush test” (Fig. 29-3).<sup>7</sup> Although accurate quantitative evaluation of natural frequency and damping coefficient is possible, in clinical use a satisfactory flush test will appear as one large and one small oscillation and then a return to baseline. Based on the fast-flush test, one can determine whether changes in the monitoring system (e.g., reducing the length



**FIGURE 29-2.** Noninvasive measurement of blood pressure. In the auscultatory method, systolic and diastolic pressures are decided based on the beginning and end of Korotkoff sounds. In the oscillometric technique, the mean blood pressure is the primary measured variable, determined as the point of maximal oscillations in cuff pressure. The exact algorithm used to decide upon the systolic and diastolic pressures varies. (Reproduced with permission of the author from Geddes LA. *Cardiovascular Devices and Their Applications*. New York: John Wiley, 1984: Fig. 3–6.)

of extension tubing, removing stopcocks, removing clots or air bubbles) would likely improve natural frequency and decrease resonance of the system. For all invasive pressure moni-

toring systems, a zero reference value should be set, usually at the upper border of the heart estimated as 5 cm below the sternal border in the fourth intercostal space in a supine patient.<sup>8</sup>



**FIGURE 29-3.** The “flush test” used to estimate natural frequency and damping coefficient of an invasive pressure monitoring system. A square-wave artifact is created by temporarily opening the flushing system, then allowing the monitoring system to return to “resting” state. Natural frequency is calculated as the recording paper speed (25 mm/sec) divided by the length of 1 cycle between two adjacent pressure oscillation peaks (1.7 mm in this example, resulting in a natural frequency of 14.7 Hz). The damping coefficient is reflected by the ratio between the amplitude of two adjacent oscillation peaks—the higher the ratio, the smaller the amount of damping exists. (Modified with permission from Gardner RM. *Direct blood pressure measurement—dynamic response requirements*. *Anesthesiology* 1981;54(3):227–236.)

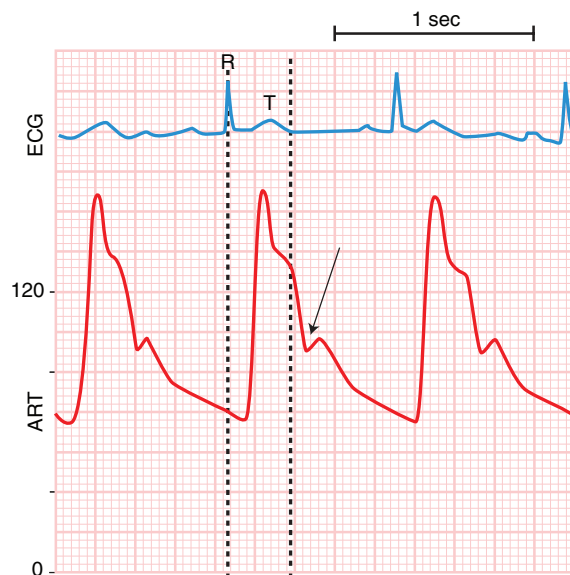
## The Arterial Blood Pressure Waveform

The systemic arterial pressure waveform results from forceful ejection of blood from the left ventricle during systole, runoff into the peripheral vessels during diastole and reflectance of waveform energy from the peripheral circulation (Fig. 29-4).<sup>9</sup> As a consequence, ABP waveform morphology differs as the monitoring site moves distally, a phenomenon known as distal pulse amplification. Compared with aortic pressure waveforms, more distal site tracings show wider pulse pressure, delayed upstroke, delayed, slurred diastolic notch, and more prominent diastolic wave. Beyond these normal physiologic variations, large gradients may exist between central and peripheral sites in patients in shock and following cardiopulmonary bypass, when central ABP is greater than peripheral ABP.<sup>10,11</sup>

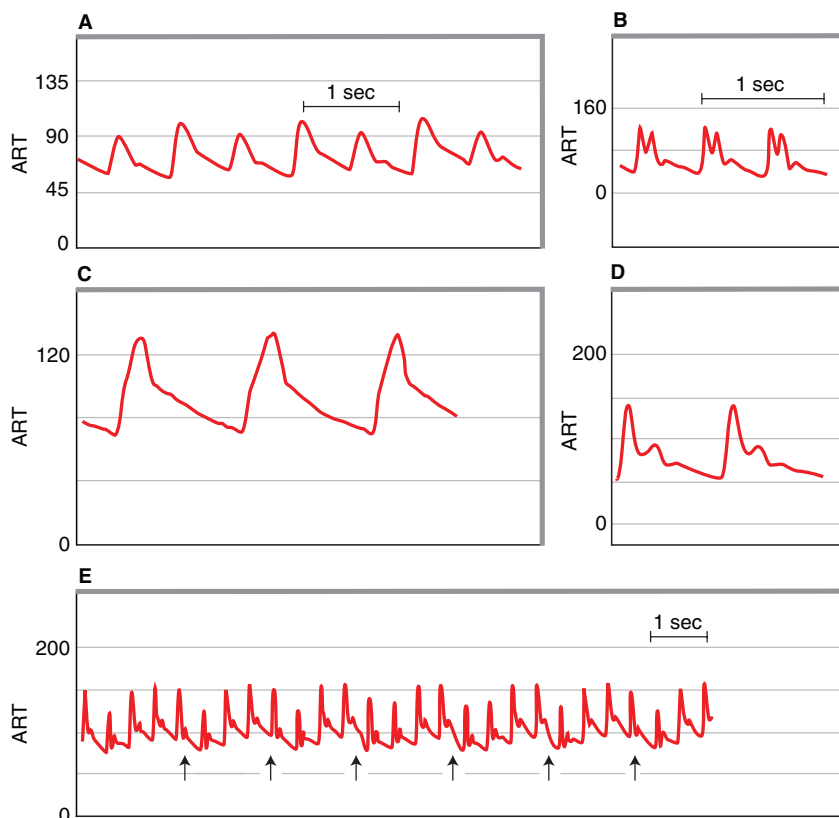
Specific waveform patterns have been described and may provide useful diagnostic information in several pathologic states (Fig. 29-5). Additional information that can be gleaned from the arterial waveform includes systolic pressure variation, an important indicator of hypovolemia.<sup>12,13</sup>

### Insertion Technique

The most common site for monitoring ABP in clinical practice is the radial artery because of its ease of access and low complication rate. The process of cannulating any palpable peripheral artery is similar. The site is immobilized so the extremity is secure but the pulse is still palpable. In the case of the radial artery, the hand is mildly dorsiflexed perhaps with the thumb extended. The skin is prepared with alcohol or chlorhexidine, and a local anesthetic is injected into the skin and around the artery, both to anesthetize the site and reduce the risk of arterial spasm. Integrated needle-guidewire-catheter assemblies are frequently used in adults. The angle of needle entry should be shallow and in line with the course of the artery. When blood flows into the reservoir, the wire is advanced into the artery, and the catheter then passed over the wire. The wire should thread with no resistance, and the catheter should pass smoothly and painlessly. Some practitioners prefer to place arterial lines without the use of a guidewire, threading the catheter directly into the vessel upon appearance of the flash through the needle hub.<sup>14</sup> If



**FIGURE 29-4.** Normal arterial pressure waveform with sharp systolic upstroke, a peak and a well-defined diastolic notch (arrow). Note that the upstroke follows the R-wave on the electrocardiogram (ECG) trace as a result of the short delay between electrical and mechanical systole.



**FIGURE 29-5.** Pathologic arterial waveforms. **A.** *Pulsus alternans*—alternating higher and lower systolic peaks, commonly associated with large pericardial effusion or severely depressed ventricular function. **B.** *Pulsus bisferiens*—characterized by a double systolic peak, low diastolic pressure, and a wide pulse pressure, usually indicating severe aortic regurgitation. **C.** *Pulsus tardus*—slurred upstroke with a delayed systolic peak, characteristic of severe aortic stenosis. **D.** *Spike-and-dome configuration* characteristic of hypertrophic obstructive cardiomyopathy, with a normal systolic upstroke but wide, delayed diastolic notch and prolonged ejection phase. **E.** *Pulsus paradoxus*—cycles of increasing and decreasing systolic blood pressure correlating to respiratory cycle (arrows point to spontaneous breaths). In this example, the degree of variation is approximately 35–40 mm Hg. (Reproduced with permission from Mark JB. *Atlas of Cardiovascular Monitoring*. New York: Churchill Livingstone, 1998: Figs. 17.22, 17.24, 18.10.)

smooth passage into the vessel lumen does not occur, a through-and-through method may salvage the procedure. The needle-catheter assembly is advanced through the back wall of the vessel, the needle removed, and the catheter pulled back slowly until brisk pulsatile flow is obtained through the catheter. At this point, the catheter may be advanced into the artery or a guidewire inserted and a catheter advanced over the wire. Gentle spinning or rotation of the catheter facilitates advancement into the vessel. If the radial artery cannot be cannulated successfully, an alternative site must be sought. One should be extremely cautious using the ipsilateral ulnar artery. Many have raised concerns about cannulation of the brachial artery owing to the lack of collateral circulation to the arm, but this has not been confirmed by clinical studies.<sup>15</sup> Other possible targets include the dorsalis pedis, axillary, and femoral arteries.

### Indications for Invasive Arterial Blood Pressure Monitoring

Current standards for intraoperative monitoring require measurement of the blood pressure at least every 5 minutes.<sup>16</sup> Despite traditional teaching that intraoperative blood pressure lability does not result in worse outcome following elective surgery, some clinical evidence indicates that, especially in longer surgery, intraoperative deviations greater than 20% from preoperative levels are associated with postoperative complications.<sup>17,18</sup>

Direct invasive monitoring of ABP is indicated in cases when large moment-to-moment blood pressure changes are anticipated, or when coexisting medical conditions, abrupt blood loss, or large fluid shifts are likely to cause sudden cardiovascular changes. Occasionally, invasive ABP monitoring is performed when noninvasive methods are unreliable or technically difficult. These situations include morbid obesity, burn or trauma patients who have no suitable site for cuff placement, or a patient whose dysrhythmias preclude adequate function of automated noninvasive blood pressure devices. A frequent need to measure arterial blood gases is another indication for invasive arterial cannulation.

### Complications of Blood Pressure Monitoring

Even a monitoring modality as seemingly innocuous as noninvasive ABP

measurement is not without risk although reported complications are relatively rare. Most complications have followed high frequency or prolonged periods of cuff cycling, or have occurred in patients receiving anticoagulation therapy, and have resulted in either local trauma or impaired perfusion to the distal extremity.<sup>19</sup> Likewise, peripheral arterial cannulation has been shown to be relatively safe, with a risk of ischemic complications of less than 0.1%. The Allen test, which examines the integrity of the ulnar collateral circulation, is not considered a reliable positive or negative predictor of ischemic complications.<sup>20</sup> Other possible complications include air or catheter embolism, blood loss from tubing disconnection, and inadvertent arterial injection of drugs.<sup>21</sup>

## CENTRAL VENOUS PRESSURE MONITORING

### Theory and Background

Central venous pressure (CVP) provides an indicator of intravascular volume, and the waveform details can provide additional information about specific cardiac pathology and dysrhythmias. By understanding the physiologic phenomena responsible for these waveforms, one can appreciate the mechanisms underlying other hemodynamic waveforms (hepatic vein, pulmonary artery), and their relation to Doppler ultrasound spectral velocity patterns obtained with echocardiography.

#### The Normal CVP

Central venous pressure, or right atrial pressure (RAP), is ideally measured at the junction of the superior vena cava (SVC) and the right atrium (RA), and reflects the balance between intravascular volume, venous capacitance, and right ventricular (RV) function. In a healthy, spontaneously breathing subject, normal mean CVP ranges between 1 and 7 mm Hg. Figure 29-6 displays a normal CVP waveform. It is comprised of three waves and two descents: the c wave, x descent, and v wave occur during cardiac systole, and the y descent and a wave occur during cardiac diastole (Table 29-1). Identification of each wave is easiest when the CVP trace is aligned with the electrocardiogram and the electrocardiogram (ECG) R wave is marked to indi-

cate the end of diastole. Use of the ABP trace to identify the CVP waves may lead to confusion as a result of the delay between electrical depolarization and onset of the systolic upstroke. Note that flow from the vena cavae into the RA is greatest when RAP is the lowest (i.e., during the x and y descents). This relationship is responsible for the pattern seen when the hepatic veins are examined with spectral Doppler echocardiography. A similar relationship between left atrial pressure and pulmonary venous flow velocity also exists for the left side of the heart.

#### The Abnormal CVP

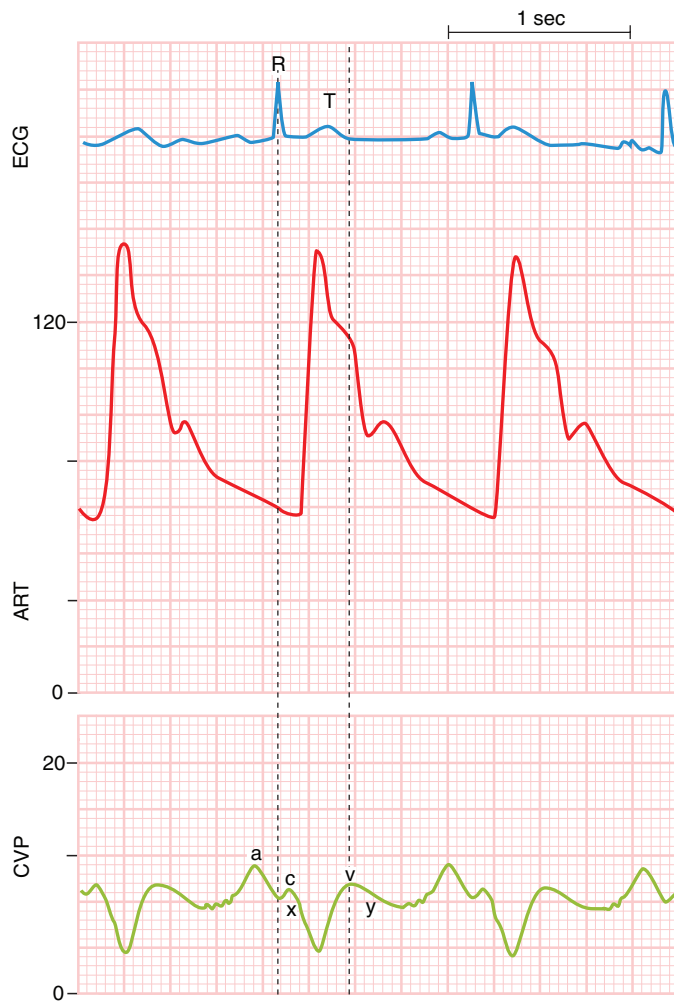
Analysis of the CVP waveform can assist in identification of a variety of clinical diagnoses. Specific dysrhythmias cause unique patterns that are easily interpreted when the underlying physiologic disturbance is kept in mind (Fig. 29-7). Atrial fibrillation is recognizable by the absence of the a wave and a prominent c-v wave. Atrioventricular (AV) nodal rhythms can result in cannon a waves that result from retrograde conduction of the cardiac impulse from the AV node to the atrium, producing contraction of the atrium against a closed tricuspid valve during ventricular systole. Similar cannon waves may be detected during any form of AV dissociation, including ventricular pacing. Effective restoration of AV synchrony with atrial or AV pacing can be confirmed by documentation of a normal CVP trace.

Disorders of the tricuspid valve can also affect the CVP waveform (Fig. 29-8). Severe tricuspid regurgitation results in a broad, tall, systolic c-v wave (often termed a regurgitant v wave), resembling a RV pressure waveform. In contrast, tricuspid stenosis produces a tall, end-diastolic a wave and an attenuated, early diastolic y descent.

In combination with data from the pulmonary artery catheter, the CVP waveform is also useful for diagnosis of other conditions, including right ventricular ischemia, cardiac tamponade, and constrictive pericarditis.

### Insertion Technique

Cannulation of the central veins is necessary for measurement of CVP and for placement of a pulmonary artery catheter or transvenous pacing wire. A variety of sites are available, including femoral, subclavian, internal and external jugular, and even the



**FIGURE 29-6.** Normal central venous pressure (CVP) and arterial pressure waveforms. The systolic (a and c waves, x descent) and diastolic (v wave, y descent) components of the CVP waveform are noted. Clear identification of the a and v waves is aided by the electrocardiogram (ECG) waveform as the electrical R wave immediately follows the CVP a wave. (Reproduced with permission from Mark JB. *Atlas of Cardiovascular Monitoring*. New York: Churchill Livingstone, 1998: Fig. 2.5.)

large antecubital veins. Amongst anesthesiologists, the internal jugular vein (IJV) approach is the most common because of its ease of access in the operating room and its optimal positioning for placement of a pulmonary artery catheter. In contrast, the subclavian vein approach is often preferred for long-term access or in the intensive care unit because of increased patient comfort and lower infection rate.<sup>22</sup>

During IJV cannulation, one must rely on either superficial anatomical landmarks or imaging techniques to locate the vessel, which usually lies lateral and slightly superficial to the carotid artery. To approach the right IJV, the patient is positioned supine, with mild Trendelenburg tilt, and with the head turned slightly to the left. Ultrasound studies have shown that rotation of the head greater than 40°

increases overlap of IJV and carotid artery, increasing the risk of arterial puncture.<sup>23</sup> Appropriate aseptic technique is important with a wide preparation area; full body draping for the

patient, and mask, gown, gloves, and cap for the operator.<sup>22</sup>

There are a variety of approaches to the IJV, with the anterior being the most common and reliable.<sup>24</sup> The carotid artery is palpated with the fingertips of the left hand. The skin is then anesthetized near the apex of the triangle formed by the two heads of the sternocleidomastoid muscle. A small-bore finder needle may be used to locate the vessel, beginning at the apex of the triangle, angled at approximately 30° to the skin, and directed toward the ipsilateral nipple. It is important to keep the carotid pulsation under the left fingertips, but to avoid compression of the pliable jugular vein. If no blood flash is obtained on forward motion of the needle, it should be withdrawn slowly with constant, gentle aspiration. It is common to get the “flash” of blood on withdrawal of the needle rather than on forward movement as a result of compression of the vessel by the advancing needle. If the vein is not located on the first pass, it is reasonable to make a small number of repeat attempts, as long as the carotid pulsation remains medial to the path of the needle. However, the needle should be withdrawn periodically to check patency and to reassess the anatomy.

After locating the vein with the finder needle, the vein is approached with an 18-gauge thin-walled needle attached to a syringe, directed along the same trajectory, with constant aspiration. On entering the vessel, the syringe is removed, a guidewire is inserted through the needle, and the needle removed. The electrocardiogram should be monitored for dysrhythmias during wire manipulation that may cause atrial or ventricular

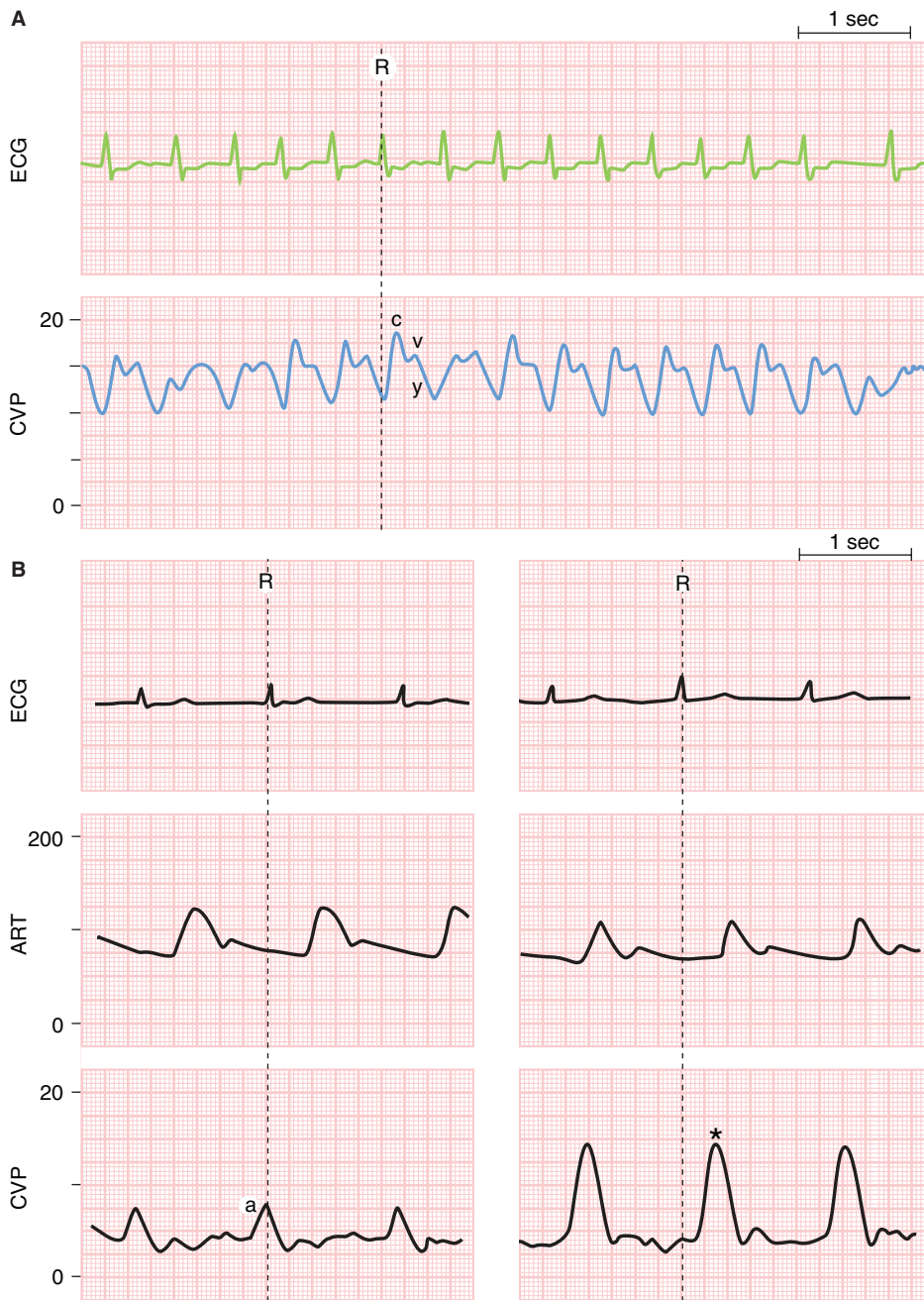
**TABLE 29-1.**

**Components of the Normal Central Venous Pressure Waveform**

Waveform Component	Cardiac Cycle Phase	Causative Mechanical Event
a wave	End diastole	Atrial contraction
c wave	Early systole	Isovolumic ventricular contraction
x descent	Mid systole	Atrial relaxation and descent of the base of the heart
v wave	Late systole	Systolic filling of the atrium
y descent	Early diastole	Opening of the atrioventricular valve

Modified with permission from Mark JB.<sup>40</sup>





**FIGURE 29-7.** Effect of dysrhythmias on the central venous pressure (CVP) waveforms. **A.** *Atrial fibrillation*—irregular R-R interval leads to an inconsistent CVP value and while there is no a wave there is a prominent c-v-wave complex. **B.** *Atrioventricular dissociation*—early systolic cannon waves (marked by \*) result from atrial contraction against a closed tricuspid valve. (Reproduced with permission from Mark JB. *Atlas of Cardiovascular Monitoring*. New York: Churchill Livingstone, 1998: Figs. 14.1 and 14.5.)

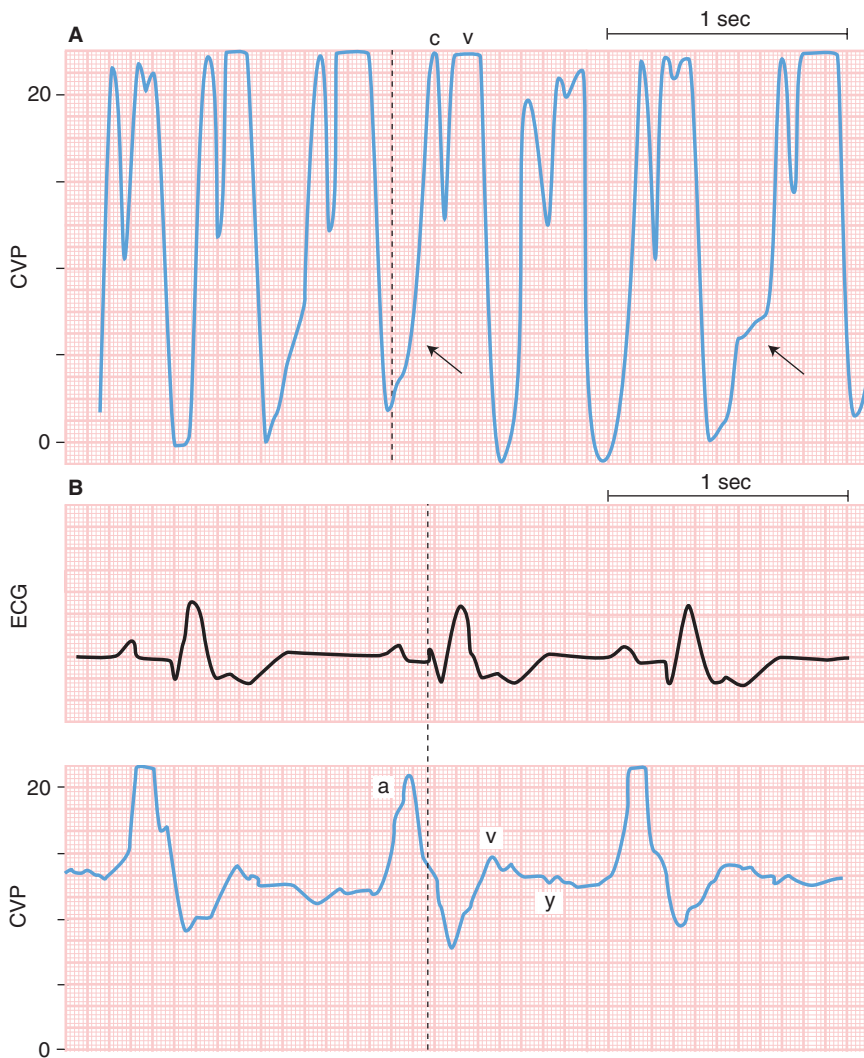
irritation. As an alternative to the thin-walled needle, a 2-inch 18-gauge catheter may be used to enter the vessel. With this technique, the catheter is threaded into the vessel, the needle removed, and the guidewire inserted through the catheter. Confirmation of venous rather than arterial cannulation may be accomplished in one of several ways. Detection of pulsatile blood through the thin-walled needle identifies unintended cannula-

tion of an artery. In addition, when using the 18-gauge catheter to cannulate the IJV vein, attachment of a length of intravenous tubing to measure the intravascular pressure prior to placement of the guidewire is a common and effective safety check.

After confirmation of venous cannulation, the skin, subcutaneous tissues, and vessel opening are dilated, and the catheter is placed. A small skin incision eases passage of the catheter itself

and prevents damage to its leading edge. However, care should be taken with passage of the vessel dilator, as it is large, stiff, and capable of perforating or tearing the vessel.

The most recent innovation in central venous cannulation has been the development of small portable ultrasound devices for vessel localization. These devices have made it possible to image the great veins of the neck either prior to or during line place-



**FIGURE 29-8.** Effect of tricuspid valve pathology on the central venous pressure (CVP) waveform. **A.** *Tricuspid regurgitation*—high mean CVP with tall c-v-wave complex (arrows), minimal x descent, and sometimes absent a wave as a consequence of the presence of atrial fibrillation. **B.** *Tricuspid stenosis*—high mean CVP but with prominent a wave and deep x descent with minimal v wave or y descent. (Reproduced with permission from Mark JB. *Atlas of Cardiovascular Monitoring*. New York: Churchill Livingstone, 1998: Figs. 17.3 and 17.5.)

ment. A variety of studies show that their use decreases the incidence of failed catheter placement, as well as the complication rate.<sup>25,26</sup> Routine use has been recommended, although the importance of maintenance of skills and training in the traditional landmark method has been emphasized by some authors.<sup>25</sup> Obese patients and patients with neck scarring might be especially suitable candidates for using ultrasound guidance.

### Indications for Central Venous Catheterization

Box 29-1 lists the indications for central venous catheterization. The main indication for monitoring CVP is as a guide for volume status assessment and fluid

resuscitation. Once in place, it may be used for additional purposes such as for obtaining repeated blood samples.

### Complications of Central Venous Catheterization

Complications arising from a central venous catheter can generally be separated into those arising from the placement of the catheter itself and those that develop while the catheter is in place and in use (Box 29-2). Type of complication will vary somewhat between locations. For example, pneumothorax is more common when using the subclavian vein approach. However, for all central vein cannulation sites, vascular injury is the most common complication and can result

#### BOX 29-1.

##### Indications for Central Venous Line Placement

###### Monitoring

- Central venous pressure monitoring
- Pulmonary artery catheterization

###### Therapeutic Intervention

- Hemodialysis
- Temporary transvenous pacing
- Aspiration of air emboli (e.g., sitting position craniotomy)
- Infusion of vasoactive drugs or total parenteral nutrition
- Need for repeated blood sampling
- Cannulae placement (e.g., venovenous bypass, portosystemic shunt)
- Inadequate peripheral venous access (obesity, burns, postchemotherapy)

in a wide range of clinical sequelae, ranging from undetectable hematoma to life-threatening cardiac tamponade following perforation of the intrapericardial portion of the superior vena cava or right atrium. Risk for this complication can be minimized by ensuring the catheter tip is located at the

#### BOX 29-2.

##### Complications of Central Venous Catheterization

###### Secondary to catheter placement:

- Airway or lung injury (pneumothorax, subcutaneous or mediastinal emphysema)
- Bleeding (subcutaneous hematoma, hemothorax)
- Chylothorax
- Arterial injury/cannulation
- Air embolism
- Nerve injury
- Catheter shearing/embolism
- Dysrhythmias

###### Secondary to in-situ catheter:

- Dysrhythmias
- Hydrothorax/hydropneumothorax
- Thromboembolism (superior vena cava syndrome, pulmonary embolism)
- Infections (cellulitis, bacteremia, sepsis, endocarditis)
- Vascular/cardiac perforation (arteriovenous or venobronchial fistula, cardiac tamponade)

## BOX 29–3.

## Recommended Measures to Decrease Catheter-Related Infections

- Adequate training of physicians and nurses.
- Avoiding femoral vein catheterization.
- Use of full sterile technique for catheter insertion (including cap, mask, gown, sterile gloves and drapes).
- Chlorhexidine rather than povidone-iodine for skin preparation.
- Use of heparin-bonded catheters.
- Removal of catheters as early as possible.

level of the carina or higher on a chest x-ray.<sup>27</sup> Delayed presentation of aortovenous and even aortobronchial fistulas have been reported, although rare.<sup>28</sup> Inadvertent placement of any large-bore catheter into a central artery should prompt evaluation by a vascular surgeon for management to avoid a variety of long-term complications. Respiratory compromise can develop from several sources, including embolism of air or clot, pneumothorax, direct airway injury from the advancing needle, or airway compression from arterial bleeding and expanding hematoma. Catheter-related infectious complications range from local site infection to life-threatening sepsis and endocarditis. In an attempt to decrease infectious complications, specific recommendations have been published by the Centers for Disease Control (Box 29–3).<sup>22</sup> Routine scheduled replacement of central venous catheters, either on guidewire or to a new site, does not decrease the infection risk. Rather, central catheters should be removed as early as clinically feasible. The incidence of many of these complications can be decreased with use of ultrasound technology prior to or during central line placement.<sup>25,26</sup>

## THE PULMONARY ARTERY CATHETER

A landmark article in 1970 described the clinical use of a balloon-tipped, flow-directed pulmonary artery catheter (PAC) for treatment of patients with acute myocardial infarction.<sup>29</sup> Use of the PAC rapidly spread as an important monitoring tool for treatment of

## TABLE 29–2.

## Hemodynamic Parameters Measured by the Pulmonary Artery Catheter

Measured Parameter	Normal Values	Normal Values Indexed to Body Surface Area
Cardiac output	4–6 L/min	2.8–4.2 L/min/m <sup>2</sup>
Central venous pressure	2–7 mm Hg	n/a
Pulmonary artery pressure (systolic/diastolic)	15–30/6–15 mm Hg	n/a
Pulmonary artery occlusion pressure	5–12 mm Hg	n/a
Right ventricular ejection fraction	40–60%	n/a
Mixed venous oxygen saturation	70–75%	n/a
n/a, Not applicable.		

high-risk surgical and critically ill patients. Various modifications of the PAC allow measurement of intracardiac pressures, cardiac output, mixed venous oxygen saturation, and RV ejection fraction (Table 29–2 lists normal values). From these measured values, various hemodynamic indices can be calculated, including systemic and pulmonary vascular resistances (SVR and PVR), stroke volume (SV), right and left ventricular stroke work indices, right ventricular end-diastolic volume, and shunt fraction (Table 29–3). It should be emphasized that calculated parameters inherit measurement inaccuracies of each of the constituent directly measured parameters; consequently, these calculated indices may have magnified errors. Numerous studies show that standard clinical measurements such as heart rate, blood pressure, and urine output do not always allow early identification of inadequate perfusion states; moreover, experienced clinicians are often wrong in their assessment of the circulatory profile of critically ill patients.<sup>30</sup> Therefore, monitoring using the PAC often reveals new information that should be helpful in diagnosis and management of various hemodynamic disturbances, guiding fluid and vasoactive drug therapy. However, continuous debate still exists regarding the clinical usefulness of the PAC and whether its use improves patient outcome.<sup>31,32</sup>

Monitoring cannot be expected to benefit patient outcome unless the clinician collects the data accurately and interprets and applies it correctly. This has proven especially problematic for the PAC; studies have demonstrated deficiencies in interpretation of the

raw hemodynamic waveform even by experienced physicians.<sup>33</sup> Other studies have found that even when given the processed PAC data, different intensivists make different, sometimes opposing or even harmful, choices for therapeutic interventions.<sup>3,34</sup> These studies have led to increasing emphasis on training requirements by the American Society of Anesthesiologists (ASA), Society of Critical Care Medicine, and the National Institutes of Health.<sup>35–37</sup> Widespread difficulties with interpretation and application of PAC data confounds evaluation of PAC clinical outcome studies and might explain in part the discrepant results and failure to show benefit in many trials.<sup>32</sup> Correct insertion technique, awareness of indications and possible complications, and understanding of the physiologic principles involved, are all prerequisites for gaining any clinical benefit from the use of the PAC.

## Insertion Technique

The current PAC for use in adult patients is 110 cm in length, contains 3 or 4 lumens, and has an embedded thermistor and a 1.5-mL balloon at the tip. The long and pliable catheter has a relatively low natural frequency, which might contribute to error in measuring transmitted pressures when the damping coefficient is unusually high or low. The catheter is inserted through a one-way valve on a large-bore introducer placed into a central vein.

The right internal jugular vein affords the most direct path for inserting the PAC into the right-heart chambers. The left subclavian vein is an alternative choice as the catheter fol-

TABLE 29-3.

## Hemodynamic Calculations Derived from Pulmonary Artery Catheter Measurements

Parameter	Formula	Normal Values	Normal Values Indexed to BSA
Stroke volume	$\frac{\text{Cardiac output}}{\text{Heart rate}}$	60–90 mL	40–60 mL/m <sup>2</sup>
Systemic vascular resistance	$\frac{(\text{MAP} - \text{CVP}) \times 80}{\text{Cardiac output}}$	900–1500 dyne × sec/cm <sup>5</sup>	1600–2400 dyne × sec × m <sup>2</sup> /cm <sup>5</sup>
Pulmonary vascular resistance	$\frac{(\text{mPAP} - \text{PAOP}) \times 80}{\text{Cardiac output}}$	150–200 dyne × sec/cm <sup>5</sup>	225–320 dyne × sec × m <sup>2</sup> /cm <sup>5</sup>
Left ventricular stroke work	$(\text{MAP} - \text{PAOP}) \times \text{stroke volume} \times 0.0136$	60–110 g × m	50–68 g/m
Right ventricular stroke work	$(\text{mPAP} - \text{CVP}) \times \text{stroke volume} \times 0.0136$	8–16 g × m	5–10 g/m
Right ventricular end-diastolic volume	Stroke volume/right ventricular ejection fraction	100–160 mL	60–100 mL/m <sup>2</sup>
Oxygen delivery	Cardiac output × CaO <sub>2</sub> × 10	850–1050 mL/min	500–600 mL/min/m <sup>2</sup>
Oxygen consumption	Cardiac output × (CaO <sub>2</sub> – CvO <sub>2</sub> ) × 10	200–250 mL/min	120–160 mL/min/m <sup>2</sup>
Pulmonary shunt fraction	$\frac{(\text{Pulmonary capillary oxygen content} - \text{CaO}_2)}{(\text{Pulmonary capillary oxygen content} - \text{CvO}_2)}$	<5%	n/a

CaO<sub>2</sub>, arterial oxygen content; CvO<sub>2</sub>, mixed venous oxygen content; CVP, central venous pressure; MAP, mean arterial pressure; mPAP, mean pulmonary artery pressure; PAOP, pulmonary artery occlusion pressure.

lows the natural curve of the brachiocephalic vein into the superior vena cava. Other routes, including more peripheral sites such as the femoral vein, or even a large arm vein, can be used, but catheter positioning might be more difficult and limited intraoperative access will hinder needed adjustments. Once the catheter is inserted through the introducer to a depth of 20 cm, the balloon at the tip is filled with 1.5 mL of air to help float the catheter into the pulmonary artery. Although catheter guidance depends both on balloon flotation and blood-flow direction, the former is by far the more important.<sup>38</sup> Consequently, patient positioning can influence the ease with which the catheter passes through the heart. A combination of head elevation with patient tilt to the right places the right ventricular infundibulum and pulmonary valve in a nondependent position, and aids flotation across the valve.<sup>39</sup> The catheter tip also has a curve that can help in maneuvering across the tricuspid and pulmonary valves. Optimizing patient positioning and direction of the catheter curve are more important in clinical situations in which the right atrium or ventricle are enlarged or cardiac output is low.

Identification of correct catheter positioning depends primarily on monitoring changes in pressure transduced from the distal port of the PAC (Fig. 29-9). When the PAC is introduced from the right internal jugular vein, the right atrium is encountered at 20–25 cm from the edge of the introducer's hub, right ventricle at 30–35 cm, pulmonary artery at 40–45 cm, and the wedge position at approximately 50 cm.<sup>40</sup> By keeping these estimated distances in mind, the clinician can avoid excessive catheter insertion that may lead to catheter coiling or knotting within the heart.

The PAC balloon should not be kept inflated for more than a few seconds at a time because of the risks of pulmonary infarction or pulmonary artery rupture. If the pulmonary artery occlusion pressure (PAOP) waveform appears when less than 1 mL of air is added to the balloon, the PAC tip has migrated into a small pulmonary artery branch and the catheter should be immediately withdrawn to a point where this does not occur.

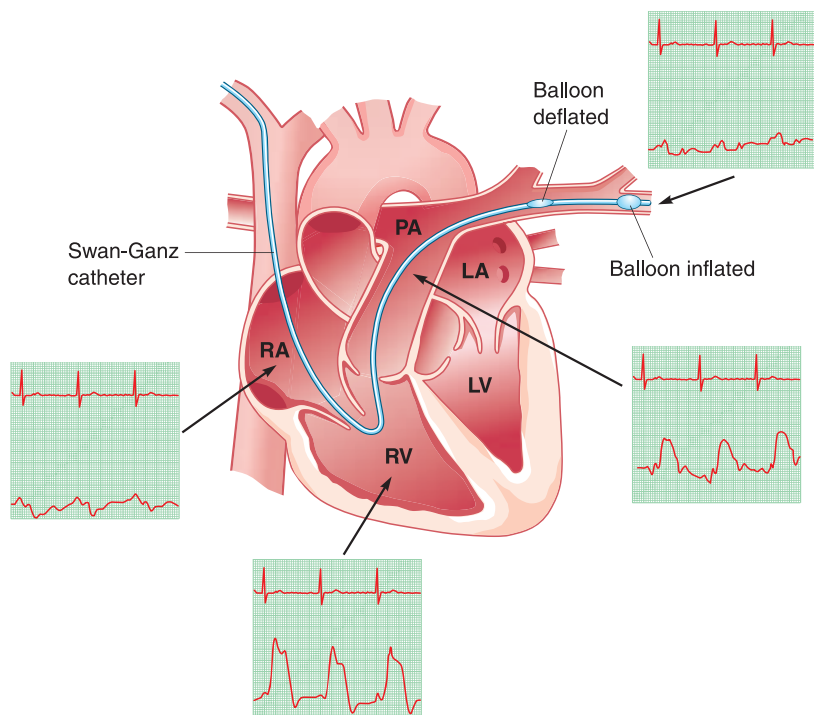
Fluoroscopy has been used to aid PAC insertion and localization in difficult cases, or when using the femoral or arm veins as entry sites. More recently, the use of transesophageal

echocardiography (TEE) has been described to help with visualizing the PAC during insertion.<sup>41</sup> The midesophageal right ventricle inflow-outflow view is especially suitable for this purpose (Fig. 29-10).

### PAC-Derived Pressure Measurements

Once the PAC is in place, several physiologic parameters can be measured, calculated, and derived (Tables 29-2 and 29-3). The most important measurements are cardiac output, an index of global perfusion, and PAOP, an index of left ventricular (LV) preload. Additional useful pressure recordings are measured from the right atrium (CVP) and pulmonary artery. Right ventricular pressure can be measured as the catheter tip is advanced or retracted. To measure PAOP, the balloon is slowly inflated so that pulmonary blood flow carries the catheter to a “wedged” position. At this point, the balloon obstructs forward blood flow through a medium-sized pulmonary artery branch, and a static column of blood is created, connecting the catheter tip to a junction point where flow resumes in the pulmonary veins near the left atrium.<sup>42</sup> Because resistance to flow in the large

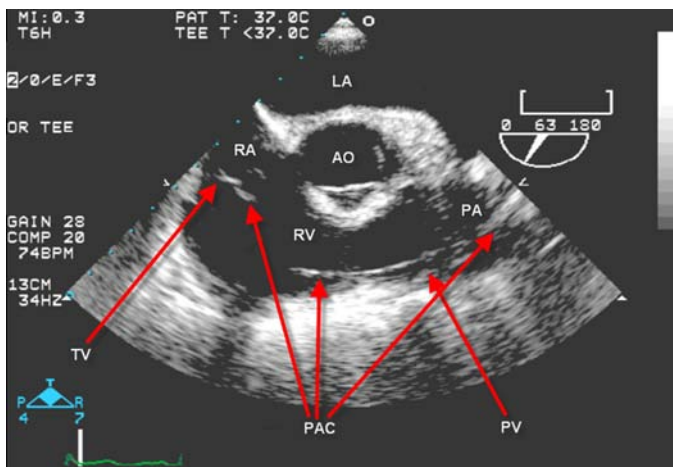




**FIGURE 29-9.** Pressure waveforms measured by the pulmonary artery catheter. As the catheter is advanced from the venous cannulation site, the first waveform recorded will be the central venous pressure trace. Passage of the catheter from the right atrium (RA) into the right ventricle (RV) is accompanied by marked increase in “systolic” pressure. As the catheter tip enters the pulmonary artery (PA), a dicrotic notch may appear in the systolic wave and the diastolic pressure will increase in magnitude and will be down-sloping, in contrast to the up-sloping diastolic pressure in the right ventricle. With further advancement of the catheter, the balloon will occlude blood flow and the tip will record the pulmonary artery occlusion pressure, characterized by disappearance of the “systolic” pressure wave and reappearance of venous a, c, and v waves. (Modified with permission from Mark JB. *Atlas of Cardiovascular Monitoring*. New York: Churchill Livingstone, 1998: Fig. 3.1.)

pulmonary veins is low, the PAOP should provide an accurate estimate of left atrial pressure (LAP). Similar in morphology to the CVP trace, the PAOP waveform has a and v waves

that reflect a LAP waveform that is slightly delayed and damped by the interposed pulmonary vascular bed. Although the PAOP is usually reported as a single mean value, the PAOP a



**FIGURE 29-10.** Midesophageal right ventricle inflow-outflow transesophageal echocardiography view demonstrating the pulmonary artery catheter (PAC) in the right atrium (RA), right ventricle (RV), and pulmonary artery (PA), traversing the tricuspid valve (TV) and pulmonary valve (PV). Also shown are the left atrium (LA) and aorta (AO).

wave, which just follows the ECG R wave, better reflects left ventricular end-diastolic pressure (LVEDP), particularly in patients with left ventricular dysfunction,<sup>43</sup> and is therefore a more accurate predictor of left ventricular preload. The mean PAOP, however, is a better estimate of the hydrostatic back pressure that influences pulmonary edema formation. Even though the terms PAOP and pulmonary capillary pressure (PCP) are sometimes used interchangeably, these pressures do not reflect the same physiologic measurement. Because direction of blood flow is from the pulmonary capillaries to the pulmonary veins and thence to the left atrium, true PCP is slightly higher than PAOP and may be significantly higher when either pulmonary venous resistance is elevated, as in acute respiratory distress syndrome (ARDS), or when blood flow is increased.<sup>42</sup>

### Factors Affecting Data Validity and Interpretation

A primary reason for PAC monitoring is to provide an estimate of left ventricular preload. Physiologically, true preload is the length of the ventricular muscle sarcomere at end-diastole. In the three-dimensional heart, left ventricular end-diastolic volume (LVEDV) can be considered a global measure of LV preload; however, measurement of this parameter is not readily available clinically. LVEDP can be measured by left-heart catheterization, although its relationship to LVEDV depends on left ventricular compliance. Under normal physiologic conditions, upstream pressure measurements of LAP, PAOP, and pulmonary artery diastolic pressure (PADP), should provide accurate surrogates for LVEDP. Use of PAC-derived pressures (PAOP and PADP) to estimate preload is predicated on these assumptions. However, there are many pathophysiologic conditions in which these surrogate measures of LVEDV are subject to error. These are discussed below and are summarized in Table 29-4.<sup>42,44</sup>

**Artifacts** Motion of the PAC tip from ventricular contraction or valve leaflet movements can produce artifactual spikes or troughs in the pressure waveform, termed *catheter whip*. “Overwedging” appears when balloon inflation produces a gradually rising, nonpulsatile pressure, which results from the catheter tip being forced against the

TABLE 29-4.

## Factors Causing Under- and Overestimation of Left Ventricular End-Diastolic Volume

Condition	Site of Discrepancy	Cause of Discrepancy
<b>Underestimation</b>		
Decreased left ventricular compliance	LVEDV < LVEDP	Change in pressure–volume relation
Aortic regurgitation	LAP < LVEDP	Ventricular filling continues after mitral valve closure
Decreased pulmonary vascular bed	PAOP < LAP	Balloon inflation significantly decreases right ventricular blood flow
Pulmonic regurgitation	PADP < PAOP	Bidirectional runoff for pulmonary artery blood flow
Right bundle-branch block	PADP < PAOP	Delayed pulmonary valve opening allows continued fall of PADP
<b>Overestimation</b>		
Positive pressure ventilation	LVEDP > transmural EDP	Ignoring intrapericardial pressure
Mitral stenosis/left atrial myxoma	LAP > LVEDP	Obstruction to flow across mitral valve
Mitral regurgitation	Mean LAP > LVEDP	Retrograde systolic v wave
Ventricular septal defect	Mean LAP > LVEDP	Antegrade systolic v wave
Tachycardia	PADP > PAOP = LAP > LVEDP	Short diastole creates pressure gradients
Positive end-expiratory pressure	PAOP > LAP	Expansion of West lung zones 1 or 2
Overwedging	PAOP > LAP	Occlusion of distal catheter lumen
Pulmonary venous hypertension	PADP > PAOP	Increased pressure gradient over pulmonary circulation

EDP, end diastolic pressure; LAP, left atrial pressure; LVEDP, left ventricular end-diastolic pressure; PADP, pulmonary artery diastolic pressure; PAOP, pulmonary artery occlusion pressure.

arterial wall, occluding the distal lumen of the PAC.

**Ventricular Compliance** Because the pressure-volume relationship of the left ventricle is curvilinear, the same change in ventricular volume can produce either a small or large change in LVEDP, depending on the position on the compliance curve over which the left ventricle is operating. Also, conditions causing a marked shift in the compliance curve may result in pressure and volume changing in opposite directions, that is, increased LVEDP associated with decreased LVEDV (Fig. 29-11). In the perioperative period, myocardial ischemia, right ventricular failure causing interventricular septal shift, and inotropic drug effects, can all induce rapid changes in ventricular compliance.

**Catheter-Tip Position** West et al. divided the lung into three zones according to gravity-dependent differences in perfusion and ventilation that affect the relationship of pulmonary arterial pressure (Pa), alveolar pressure (Palv), and pulmonary venous pressure (Pv).<sup>45</sup> The PAC tip needs to reside in zone 3 (Pa > Pv > Palv) so that a continuous column of blood exists and the pressure measured by the catheter tip will reflect vascular rather than alve-

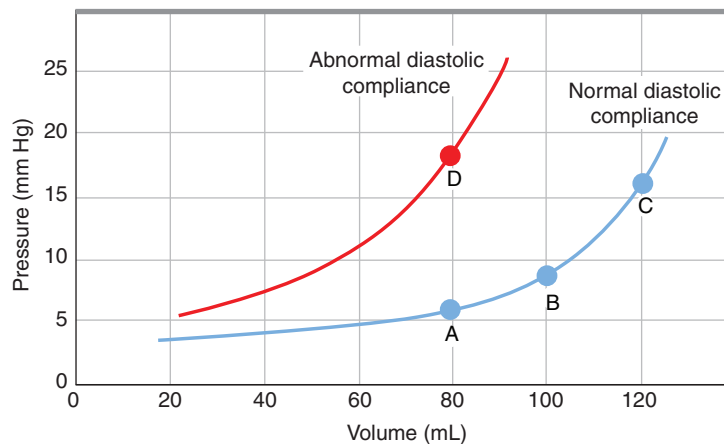
olar pressure. In a supine, spontaneously breathing subject, this is rarely a problem. However, with hypovolemia (low Pv) or positive-pressure ventilation (high Palv), zone 2 or zone 1 conditions might appear. This may be suspected when the PAOP trace demonstrates excessive respiratory variation in the pressure waveform (Fig. 29-12).<sup>46</sup>

Changes in body position will also influence the distribution of lung blood

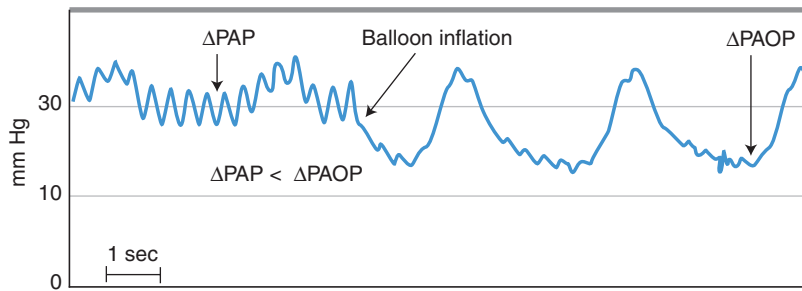
flow and the anatomic locations of the different lung zones. This may be an important consideration in a patient who has a PAC inserted while supine, but later is positioned in the lateral, prone, or steep head-up or head-down positions.

### Ventilatory Pressure Influences

With large cyclic variations in intrathoracic pressure, as occurs during labored



**FIGURE 29-11.** The effect of change in left ventricular compliance on pressure–volume relationship. The normal relationship (*light blue curve*) is curvilinear. Depending on the starting point, the same change in the true preload, that is, end-diastolic volume, will cause a markedly different change in left ventricular end-diastolic pressure, and hence in the pulmonary artery occlusive pressure (A to B vs. B to C). When ventricular compliance decreases (*red curve*), an increase in filling pressures (from A to D) does not necessarily reflect increased end-diastolic volume. (Modified with permission from Mark JB. *Atlas of Cardiovascular Monitoring*. New York: Churchill Livingstone, 1998: Figs. 15.1 and 15.2.)



**FIGURE 29-12.** Pressure trace recorded during positive pressure mechanical ventilation from a pulmonary artery catheter located in West lung zone 1. Pressure swings in the pulmonary artery occlusion pressure ( $\Delta$ PAOP) reflect changes in airway pressure and are significantly higher than swings in pulmonary artery pressure ( $\Delta$ Pa), which result from changes in pleural pressure. (Modified with permission from Teboul JL, Pinsky MR, Mercat A, et al. Estimating cardiac filling pressure in mechanically ventilated patients with hyperinflation. *Crit Care Med* 2000;28(11):3631–3636.)

respiration, coughing, Valsalva maneuver, or positive-pressure ventilation, both intracardiac and intrapericardial pressures are affected. The PAC will reflect the increased intracardiac pressures, although the true transmural pressure which determines cardiac preload, has not been changed.<sup>47</sup> Consequently, the PAOP should be measured at end-expiration, a time point when intrathoracic pressure approximates atmospheric pressure, whether the patient is breathing spontaneously or mechanically ventilated. Visual inspection of the waveform display is more accurate than reliance on digital display for identifying end-expiratory pressures. During spontaneous breathing, inspiratory pressures are negative and the end-expiration point corresponds to the higher vascular pressure values. The opposite is true under positive-pressure ventilation.

Application of positive end-expiratory pressure (PEEP) will also alter intrathoracic pressure and hence PAOP measurements at end-expiration. The magnitude of these effects depends on the level of PEEP used and the pulmonary and chest wall compliance.<sup>42</sup> As a simple rule of thumb, the increase in measured PAOP is usually less than one-half the value of the PEEP applied. As lung compliance deteriorates, however, the transmission of airway pressure to the pleural space is attenuated. Therefore the effect of high PEEP, commonly employed in these situations, is minimized.<sup>48</sup>

### Diagnostic Use of the PAC-Derived Pressure Waveform

In addition to the quantitative hemodynamic data provided by pressure measurements and cardiac output, the

analog pressure waveform can be diagnostic of several pathologic cardiovascular conditions. Although echocardiography has mostly supplanted the PAC for clinical diagnosis of most of these disorders, initial clinical clues can be provided by PAC monitoring (Fig. 29-13).<sup>49</sup>

### Complications of PAC Monitoring

Complications associated with PAC arise from central venous cannulation (Box 29-2), initial PAC placement and positioning, and from continued presence and use of the catheter within the body. Frequency varies greatly between various reports and most complications have been described only in case reports or small case series.<sup>35</sup> Although minor complications occur in up to 50% of cases, recent practice guidelines concluded that the incidence of serious life-threatening complications is much lower, and estimated to be 0.1–0.5%.<sup>35</sup> Two large, prospective registries of PAC complications in surgical patients support this estimated risk, showing major morbidity in 0.12–0.16% and mortality of 0.016% of catheterized patients.<sup>50,51</sup> Factors suggested as important to minimize complications include the expertise and experience of the attending physician, close supervision of trainees, and attention to detail during pulmonary artery catheterization and usage.

### Dysrhythmias

Transient dysrhythmias, most commonly premature ventricular contractions (PVCs), accompany passage of the PAC through the heart in up to 70% of patients.<sup>50</sup> PVCs can also occur during removal of the catheter. Clinically signifi-

cant dysrhythmias, such as complete heart block, ventricular tachycardia and ventricular fibrillation, are much rarer—approximately 3% of patients.<sup>50,52</sup>

Transient right bundle-branch block occurs in up to 5% of patients during PAC insertion.<sup>53</sup> Therefore, patients with preexisting left bundle-branch block are at risk of developing complete heart block.<sup>54</sup> In these patients, a margin of safety can be provided by using a PAC with a pacing port, having transcutaneous pacing readily available, or, rarely, a prophylactic placement of a transvenous pacing wires.

In patients with severe aortic stenosis and other conditions associated with severe left ventricular hypertrophy, effective external cardiac massage is hard to achieve. When cardiac surgery is performed in these patients, many anesthesiologists delay flotation of the PAC until after sternotomy, which enables open cardiac massage to be performed in the event of a life-threatening dysrhythmia.

### Catheter Knotting

Possible risk factors for looping and knotting of catheters within the heart include low cardiac output states, right-heart dilation, and excessive length of catheter inside the heart.<sup>55</sup> The PAC might also become entangled with intracardiac pacing wires or anatomic structures such as chordae tendinae.<sup>56,57</sup> If knots occur, they can usually be disentangled under fluoroscopic guidance. Alternatively, the knot may be pulled tight and the catheter removed with its sheath.<sup>58</sup>

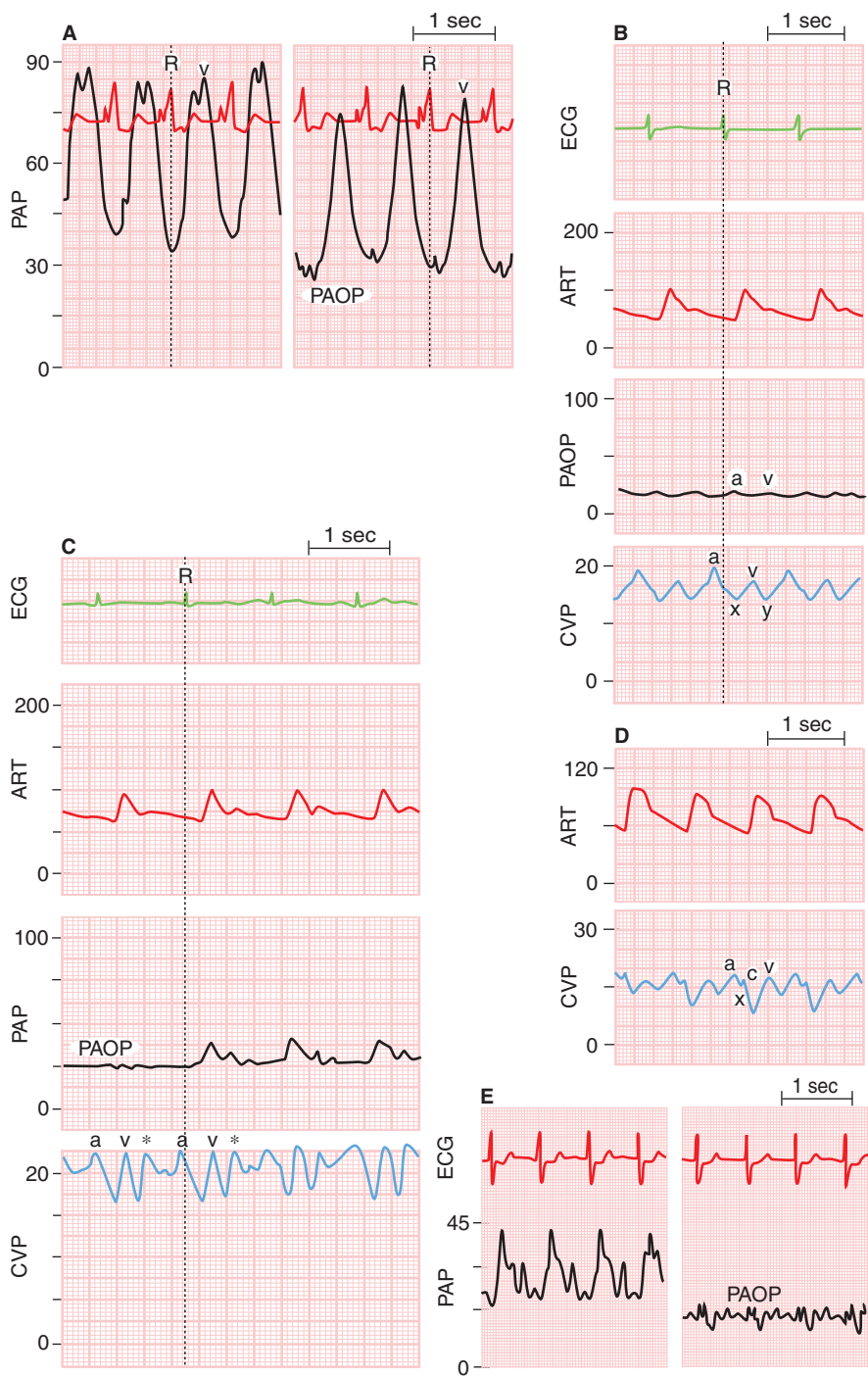
### Thromboembolism and Pulmonary Infarction

Minor thrombi associated with the PAC were almost universal in the past, but became uncommon with the use of heparin-coated catheters.<sup>59</sup> Major pulmonary embolism associated with PAC use has been reported in 0.9% of patients receiving PAC versus none in the control group.<sup>60</sup> Pulmonary infarction following PAC can also result from prolonged balloon inflation or distal catheter migration.<sup>61</sup>

### Catheter-Related Infections

For central venous catheters and PACs alike, catheter-related infections usually result from skin organisms colonizing the introducer sheath.<sup>22</sup> Heparin-coated PACs and regular central venous catheters carry a similar risk of





**FIGURE 29-13.** Pressure waveform morphology in various clinical situations. **A.** *Acute mitral regurgitation*—giant v waves are seen in the pulmonary artery occlusion pressure (PAOP) trace, as well as distorting the nonwedged pulmonary artery pressure (PAP) trace. While the wedged (PAOP) pressure can be mistaken to be a PAP trace, the timing of the main pressure wave relative to the electrocardiographic T wave can help in correct identification. **B.** *Right ventricular infarction*—note prominent CVP waves with increased mean value (16 mm Hg) almost equal the PAOP pressure (18 mm Hg). **C.** *Constrictive pericarditis*—equilibration of end-diastolic pressures across the heart: PAOP, diastolic Pa, and CVP a wave, all about 25 mm Hg. Also note the W-shaped CVP trace with the mid-diastolic plateau wave (marked by \*). **D.** *Cardiac tamponade*—relatively low blood pressure (84/55 mm Hg) and elevated CVP with dominant x descent but attenuated y descent. **E.** *Pulmonary hypertension*—increased pulmonary pressure (42/20 mm Hg) with markedly lower PAOP (13 mm Hg), caused by increased pulmonary vascular resistance. (Reproduced with permission from Mark JB. *Atlas of Cardiovascular Monitoring*. New York: Churchill Livingstone, 1998: Figs. 17.11, 12.15, 18.1, 18.5, and 6.11.)

infectious complications (2.6 infections per 1000 catheter days), whereas non-heparin-coated PACs carry a 2-fold increased risk.<sup>22</sup> Leaving the PAC in place for more than 5–7 days also increases the risk of infection.

### Valvular Damage and Endocarditis

Case reports have described PAC-associated injury of the tricuspid valve<sup>62</sup> and the pulmonary valve,<sup>63</sup> but these injuries appear to be very rare events. The PAC balloon must be completely deflated prior to catheter withdrawal to avoid valvular injury. Even with proper catheter management, endocarditis, either septic or thrombotic, has been described in autopsy studies, probably representing occult endocardial injury.<sup>64</sup>

### Pulmonary Vascular Injury

Pulmonary vascular injury and pulmonary artery rupture are rare, life-threatening complications of pulmonary artery catheterization. Pulmonary artery rupture has an incidence of 0.02–2.0% but carries a mortality of 40–70%.<sup>60,65,66</sup> Risk factors for this catastrophic complication include patient characteristics (advanced age, female gender, hypothermia, anticoagulation therapy, and pulmonary hypertension) as well as operator errors (overdistension of the balloon, unrecognized distal migration of the catheter, and balloon inflation when the catheter tip is wedged).<sup>65,66</sup> In patients with risk factors, consideration should be given to using the PADP as an estimate for PAOP and avoiding repeated balloon inflation.

Sudden hemoptysis is the most common presentation of pulmonary artery rupture. Other signs include hemothorax, hypoxemia, and cardiovascular collapse.<sup>65,66</sup> Maintaining oxygenation and achieving rapid control of bleeding are initial therapeutic goals. Endobronchial intubation with a double-lumen tube or intentional mainstem intubation allows selective lung ventilation and isolation of the bleeding segment.<sup>67</sup> Ancillary treatment includes lowering pulmonary artery pressure, reversing anticoagulation, and performing bronchoscopy for endobronchial toilet and identification of the bleeding site. Definitive control of bleeding may be achieved by transcatheter selective pulmonary artery embolization,<sup>68</sup> but surgical lung resection is required when more conserva-



## BOX 29–4.

**Common Indications for Pulmonary Artery Catheterization**

- Hemodynamic monitoring in high-risk patients undergoing major surgery, including preoperative optimization
- Differential diagnosis and management of shock (hypovolemic, septic, cardiogenic)
- Diagnostic evaluation of major cardiopulmonary disorders (e.g. myocardial ischemia, pulmonary hypertension, intracardiac shunt, pulmonary edema)
- Titration of therapy in unstable hemodynamic conditions (e.g. hypervolemic therapy in subarachnoid hemorrhage, management of eclampsia)
- Optimization of ventilatory support (PEEP titration)

532

tive treatments fail or if life-threatening bleeding develops.<sup>65,66</sup>

### Indications for Use and the Controversy Surrounding Pulmonary Artery Catheterization

Box 29–4 summarizes the common indications for the PAC. However, studies show that factors other than medical indications affect the decision to use the PAC, including institutional, geographical, organizational, demographic, and individual preferences.<sup>69,70</sup>

In 1996, Connors et al., in a retrospective study in critically ill patients, concluded that PAC use is associated with a 20% increased mortality.<sup>71</sup> This study ignited a major controversy regarding the role of the PAC in clinical medicine.<sup>31,32</sup> Although earlier studies shared problems of inadequate methodology, unequal case mix and small sample size,<sup>35,36</sup> several more recent, large, well-designed clinical trials have been published and have helped to better define the role of the PAC in perioperative medicine. In patients undergoing major noncardiac surgery, a large observational study showed that PAC use was associated with a 2.2-fold increase in risk of cardiac complications,<sup>72</sup> and a large randomized study found no benefit for PAC-guided goal-directed therapy compared to standard care without PAC.<sup>60</sup> In moderate-risk vascular surgery, both ran-

domized controlled studies<sup>73</sup> and a meta-analysis<sup>74</sup> demonstrated no benefit associated with routine use of the PAC. Lastly, a large prospective randomized trial in patients undergoing coronary artery bypass surgery compared routine use of PAC versus CVP monitoring, and showed no difference in outcome.<sup>75</sup>

Several recent, large, randomized studies also have been performed in nonsurgical populations, including patients with severe congestive heart failure,<sup>76</sup> patients with acute lung injury,<sup>77</sup> and ICU patients with early shock or multiorgan failure.<sup>52,78,79</sup> All found no therapeutic advantage for use of the PAC.

However, most randomized studies have looked at the routine use of the PAC in large sequential cohorts of patients with relatively moderate risk of death.<sup>80</sup> In most of these clinical trials, specific therapeutic protocols were not mandated and management was left to the physician's discretion. Patients whose physicians considered them to be too sick to avoid having a PAC placed were also usually excluded.<sup>81</sup> In contrast, several recent large, nonrandomized studies suggest that PAC use may benefit especially high-risk patients characterized by age > 65 years, significant physiologic disturbances (i.e., large base deficit) and a high level of disease acuity or injury severity.<sup>82–84</sup> In addition, use of the PAC as a “rescue” monitor in patients who remain hemodynamically unstable despite empirical therapy has received little investigation.

Several expert panels have been convened to provide guidelines to help standardize clinical practice.<sup>35–37</sup> Specifically focused on the perioperative period, the ASA task force practice guidelines for PAC use suggest that preemptive PAC insertion in patients deemed at high-risk is a justifiable practice because of the delay associated with PAC placement once complications have developed, as well as possibly increased vascular and infectious complications related to hasty catheter insertion under suboptimal clinical conditions.<sup>35</sup> The guidelines emphasize the role of operator's experience in preventing PAC-associated complications, and underscore the importance of training and education to improve physician's knowledge and understanding of cardiopulmonary physiology. According to the ASA guidelines,

the use of the PAC is considered necessary only in high-risk patients undergoing high-risk surgery, and even then is contingent upon a favorable practice environment (i.e., knowledgeable and experienced physicians and ICU nurses). The term *high-risk patient* generally refers to an ASA class 4 or 5 patient with significant cardiovascular disease, pulmonary dysfunction, renal insufficiency, sepsis, or trauma. High-risk surgery includes procedures commonly associated with large fluid shifts or hemodynamic derangements and high predicted mortality. As new monitoring modalities become clinically available, the need for PAC is expected to decrease even further.

### Special Types of Pulmonary Artery Catheter

#### Pacing Pulmonary Artery Catheter

Two types of PAC have pacing capability. One has 5 electrodes incorporated in the catheter that allow bipolar atrial, ventricular, or atrioventricular sequential pacing. A second type has an extra lumen through which a pacing wire can be placed into the right ventricle. An obvious target population for these catheters are patients undergoing cardiac surgery using cardiopulmonary bypass, where pacing is frequently required postoperatively for a short period. Other candidates are patients with left bundle-branch block, in whom placing a PAC puts them at risk of developing complete heart block. Successful pacing with these catheters is usually achieved intraoperatively in anesthetized patients,<sup>85</sup> but capture becomes less reliable when patients start to move postoperatively. As a result, these catheters are not widely used.

#### Continuous Mixed Venous Oximetry

Measurement of mixed venous oxygen content in the pulmonary artery blood provides an assessment of the balance between total body oxygen supply and consumption.<sup>86</sup> Assuming the contribution of dissolved oxygen is negligible, the mixed venous oxygen saturation can be expressed by rearrangement of the Fick equation (Box 29–5). This relationship highlights that venous saturation increases when arterial oxygen saturation, hemoglobin concentration, and cardiac output increase, and decreases when oxygen consumption increases.

## BOX 29-5.

## Mixed Venous Oxygen Saturation

$$SvO_2 = SaO_2 - \left( \frac{\dot{V}O_2}{CO \times 1.36 \times Hgb} \right) \times 100$$

Where	= mixed venous oxygen saturation (%)
$SvO_2$	= arterial oxygen saturation (%)
$SaO_2$	= oxygen consumption (mL $O_2$ /min)
$\dot{V}O_2$	= hemoglobin concentration (g/mL)
Hgb	= cardiac output (mL/min)
CO	= the amount of oxygen carried by hemoglobin (mL/g)
1.36	

Hence, under conditions where oxygen consumption, hemoglobin concentration, and arterial oxygenation remain stable, mixed venous oxygen saturation continuously reflects changes in cardiac output.

Mixed venous oxygen saturation can be measured intermittently using a PAC by sampling blood from the distal pulmonary artery lumen. Cooximetry should be used to directly measure saturation rather than calculate it from the blood oxygen partial pressure owing to the steep hemoglobin-oxygen saturation curve at partial pressures normally seen in venous blood. Continuous measurement of mixed venous saturation can be achieved using oximetric PACs that employ "reflectance spectrophotometry": transmitting light through a fiberoptic bundle, measuring the light reflected from the blood, and calculating the amount of light absorbed by the hemoglobin. Similar to plethysmography, this technique is based on the differential absorption of various wavelengths of light by oxyhemoglobin and deoxyhemoglobin. Oximetric PACs have several technical limitations that should be recognized. They may show a drift artifact, requiring recalibration every 24 hours with a pulmonary artery blood sample, and they may be inaccurate at venous oxygen saturations below 50%. Other technical problems include thrombus formation on the catheter tip or excessive proximity to the vessel wall that may result in inaccurate readings. Most systems will warn of a reduction in light signal quality under these conditions. Last, if

the catheter is wedged, arterialized blood with high oxygen saturation will be sampled rather than mixed venous blood.

Although continuously monitoring venous oximetry can reliably reflect changes in cardiac output during cardiac surgery,<sup>87</sup> this is not the case in situations associated with rapid changes in oxygen consumption, like graft reperfusion during liver transplantation,<sup>88</sup> aortic cross-clamp removal,<sup>89</sup> and high-dose therapy with catecholamines.<sup>90</sup>

Two recent studies, performed in patients with early sepsis<sup>91</sup> and in patients undergoing cardiac surgery,<sup>92</sup> demonstrated that therapeutic interventions aimed at achieving venous oxygen saturation above 70% result in improved outcome. This contrasts with negative results of an older study performed in critically ill patients,<sup>93</sup> supposedly emphasizing the importance of early monitoring and therapy.

Recently developed oximetric central venous catheters allow continuous measurement of central venous oxygen saturation in the superior vena cava. Because the brain normally is the major oxygen consumer, central venous oxygen saturation (70–75%) is usually slightly lower than mixed venous oxygen saturation (75%).<sup>86</sup> With hypoperfusion, splanchnic blood flow suffers before cerebral blood flow, and oxygen saturation in the inferior vena cava decreases first. Under these situations, central venous saturation will be higher than mixed oxygen saturation by approximately 5–8%.<sup>94</sup> Despite these complicated relationships, central venous oximetry does correlate with severity of injury and blood loss in trauma patients with otherwise stable hemodynamic parameters,<sup>95</sup> and has been used successfully to guide therapy in early sepsis.<sup>91</sup> Experience with this type of catheter in the perioperative period has been very limited to date.

### Right Ventricular Ejection Fraction PAC

This modification of the PAC allows measurement of right ventricular ejection fraction (RVEF) using a fast-response thermistor that measures beat-to-beat changes in pulmonary artery blood temperature.<sup>96</sup> Similar to the continuous cardiac output PAC, the RVEF PAC incorporates a heating filament that delivers a thermal bolus into the bloodstream. Distal temperature is measured in the pulmonary artery,

and from the beat-to-beat temperature decay curve and successive diastolic temperature plateaus, RVEF is computed. Right ventricular end-diastolic volume (RVEDV) can be calculated from RVEF and stroke volume, and this derived variable has been used as an index of cardiac preload. Studies demonstrate acceptable accuracy of the thermal technique for RVEF measurement compared to radionuclide ventriculography.<sup>97</sup>

Right ventricular dysfunction may result from right ventricular ischemia or acute pulmonary hypertension. These events are not rare during cardiac surgery, especially after weaning from cardiopulmonary bypass (CPB) and protamine neutralization of heparin. Indeed, RVEF monitoring in patients following CPB can identify patients with significant right ventricular dysfunction.<sup>98</sup> In patients with septic shock, depressed RVEF better predicts prognosis than does cardiac output or cardiac filling pressures,<sup>99</sup> as well as indicating the need for inotropic support rather than fluid resuscitation alone.<sup>100</sup>

## CARDIAC OUTPUT MONITORING

Cardiac output is determined by cardiac preload, afterload, contractility, and heart rate. As such, cardiac output is a global index of circulatory status. Using cardiac output and other hemodynamic measurements, a variety of useful parameters can be derived, including vascular resistances, oxygen delivery to the tissues, and oxygen consumption (Table 29-3). Measurement of cardiac output and its response to therapeutic interventions are commonly employed therapeutic protocols in critically ill patients. While thermodilution cardiac output (TDCO) using the PAC is generally considered the gold standard in both clinical medicine and research, studies comparing it with the Fick method have not shown good agreement.<sup>101</sup> For clinical purposes, however, the absolute cardiac output might be less important than changes in cardiac output and assessing its adequacy in terms of oxygen supply and demand.<sup>102</sup>

Even though TDCO measurement remains the reference method, other less invasive cardiac output measurement techniques are gaining in popularity.<sup>103</sup> Like the PAC, each of these newer

## BOX 29–6.

**The Modified Stewart-Hamilton Equation for Calculation of Cardiac Output**

$$CO = \frac{V_i \times (T_B - T_i) \times K}{\int_0^{\infty} \Delta T_B(t) dt}$$

Where CO	= cardiac output (L/min)
$V_i$	= injected volume (mL)
$T_B$	= blood temperature
$T_i$	= injectate temperature
K	= computation constant
$\int_0^{\infty} \Delta T_B(t) dt$	= integral of temperature change over time

The computation constant adjusts for characteristics of the injectate (volume, specific heat capacity, and density) and catheter (specific heat capacity, dead space).

monitoring modalities requires education and training for effective use.

**The Thermodilution Technique**

TDCO measurement is based on the indicator dilution principle, wherein a known amount of substance is injected into the circulation and its concentration measured over time at a downstream site. For TDCO, a thermal bolus is used as the indicator and a thermistor incorporated into the catheter 4 cm proximal to the tip measures the change in pulmonary artery blood temperature. Based on these measurements, cardiac output is calculated using the modified Stewart-Hamilton equation (Box 29–6).<sup>104</sup> TDCO, therefore, measures right ventricular output, which, at steady-state conditions and in the absence of intracardiac shunts, equals left ventricular output.

The computation constant adjusts for characteristics of the injectate (volume, specific heat capacity, and density) and catheter (specific heat capacity, dead space).

In clinical practice, 10 mL of room temperature saline or D<sub>5</sub>W (0.15 mL/kg in children)<sup>105</sup> is injected rapidly and uniformly through the proximal port of the PAC into the SVC or right atrium. The injectate temperature should be measured at the point of injection, to obviate the influence of injectate rewarming in the syringe. The results from 2–3 consecutive measurements are usually averaged, deleting measurements varying more than 10%. The reproducibility of the TDCO

technique is not high; therefore at least 15% change in cardiac output between two time points is required to be considered clinically significant.<sup>104</sup> When comparing TDCO results derived with different cardiac output computers, the measurement variability is even higher, in the range of 20%.<sup>106</sup>

Right and left ventricular loading conditions, as well as pulmonary artery blood temperature, all vary considerably during the respiratory cycle.<sup>107</sup> While synchronizing cardiac output measurement to end-inspiration or end-expiration might decrease measurement variation and increase reproducibility, a more truly representative mean value for cardiac output is obtained by averaging multiple measurements performed throughout the respiratory cycle.<sup>108</sup> Similarly, while using ice-cold rather than room-temperature injectate can increase the signal-to-noise ratio of the thermal bolus, this has not been shown to be clinically significant.<sup>109</sup>

Technical errors during TDCO measurement are common and may go unrecognized. A real-time display of the pulmonary artery blood temperature curve is an important aid to identify spurious measurements (Fig. 29–14).<sup>104</sup> Fluid boluses, given either peripherally or through the PAC introducer sheath, behave as additional positive or negative thermal sources and will affect TDCO measurement accuracy.<sup>110</sup> In the immediate postcardiopulmonary bypass period, both a rapid drift and an exaggerated respiratory variation of the pulmonary artery blood temperature can introduce clinically significant errors in TDCO measurement.<sup>111,112</sup> Right-sided valvular regurgitation, especially tricuspid regurgitation, can have a significant and unpredictable effect on the accuracy of TDCO measurement by causing recirculation of the thermal bolus.<sup>113</sup> Because positive pressure ventilation with high levels of PEEP can either induce or exacerbate tricuspid regurgitation,<sup>114</sup> this may limit the accuracy of TDCO measurement in a large group of critically ill patients. It is also important to remember that intracardiac shunts invalidate TDCO as a measure of systemic cardiac output, because under these conditions right and left ventricular outputs are not equal. Additionally, either recirculation (in left-to-right shunts) or injectate bypassing the thermistor (in right-to-left shunts) will in-

troduce errors in the calculation of cardiac output. Lastly, in low flow states, TDCO might overestimate true cardiac output owing to excessive heat loss from slow transit of the injectate.<sup>115</sup>

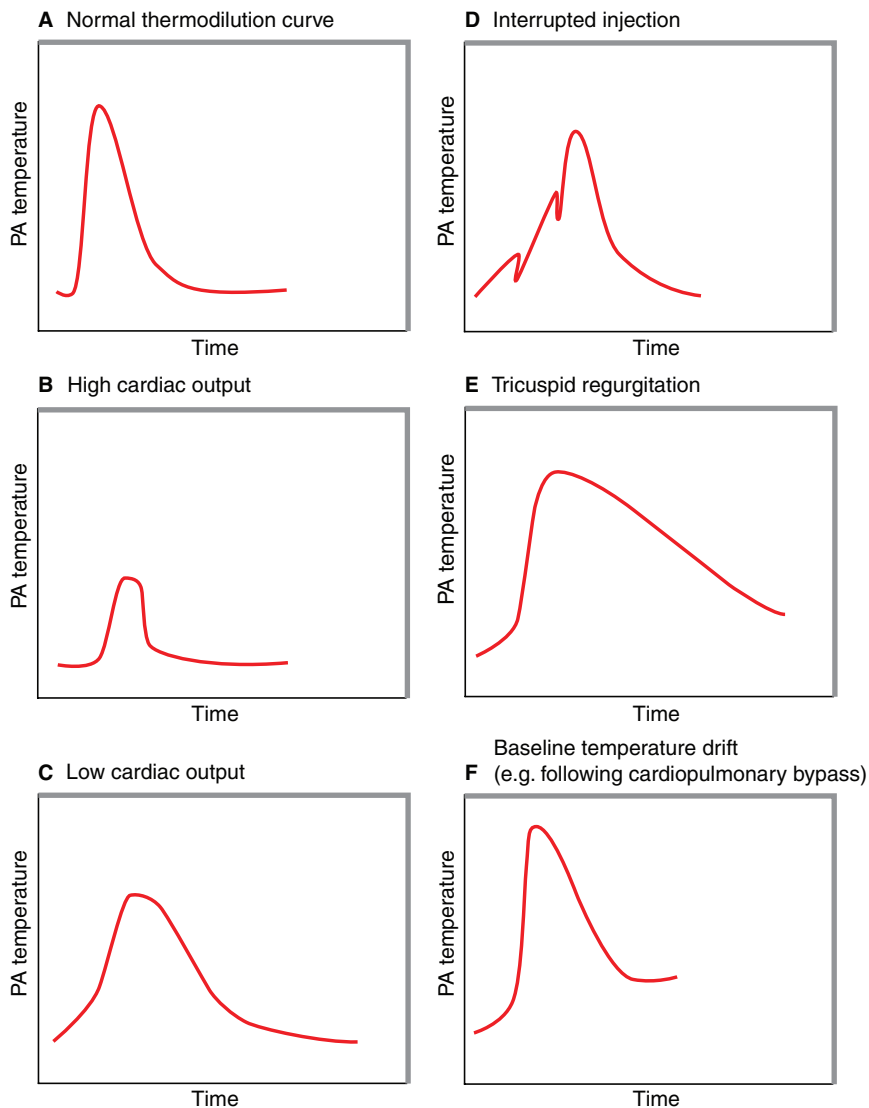
Notwithstanding its limitations, the TDCO technique is simple to perform repeatedly and quickly, does not require blood sampling, and uses a non-toxic, nonrecirculating, and nonaccumulating indicator. For these reasons, TDCO is extensively used as the preferred method in a variety of clinical settings. However, because TDCO measurement requires pulmonary artery catheterization, it is a highly invasive monitoring technique.

**Transpulmonary Thermodilution Cardiac Output Measurement**

Transpulmonary thermodilution replaces the PAC with a special thermistor-tipped arterial catheter that measures blood temperature change in the systemic circulation (either femoral or axillary artery) following bolus administration of ice-cold injectate through a central venous line.<sup>116</sup> Unlike standard TDCO measurement, this technique requires iced injectate owing to higher thermal noise and greater thermal loss from the longer path that the thermal bolus must traverse from venous injection to systemic arterial detection. Compared to TDCO, this measurement is made over a longer time period, which eliminates the problem of respiratory variation in cardiac output.<sup>117</sup> Both in patients after cardiac surgery and in critically ill patients, transpulmonary thermodilution cardiac output agreed well with standard TDCO, although the transpulmonary values tended to be about 0.3–0.5 L/min higher, possibly reflecting loss of heat during transfer through the lungs.<sup>118,119</sup>

**Lithium Dilution Cardiac Output Measurement**

Another indicator dilution technique employs intravenously injected ionized lithium as the indicator. The dilution curve is built by drawing blood from a standard arterial line over a lithium-sensitive electrode.<sup>120</sup> Similar to transpulmonary thermodilution, respiratory influences are eliminated with this method because cardiac output is measured over several respiratory cycles. Another advantage of this technique is that the injection



**FIGURE 29-14.** Thermodilution curves recorded from the thermistor at the tip of the pulmonary artery catheter after injection of cold saline. Because the injectate temperature is usually colder than body temperature, the temperature along the y axis is decreasing. The cardiac output is inversely related to the area under the curve, as demonstrated by curves A to C. Curve D shows the effect of a nonsmooth injection. In tricuspid regurgitation (curve E), incomplete mixing of the indicator within the right ventricle and subsequent recirculation between the right atrium and right ventricle will distort the descending limb of the thermodilution curve, usually leading to an increased area under the curve and underestimation of cardiac output. After discontinuation of cardiopulmonary bypass (curve F), blood temperature gradually decreases as blood flow resumes to body parts that are cold (e.g., the lungs). The drift in baseline temperature will decrease the area under the curve and lead to an overestimation of cardiac output.

of the lithium indicator can be done through a peripheral vein, removing even the requirement for central venous catheterization.<sup>121</sup> In small children, lithium-dilution cardiac output compares favorably with transpulmonary thermodilution cardiac output.<sup>122</sup> In several studies that compared lithium-dilution cardiac output with TDCO in postoperative patients in the critical care unit, a good agreement was found,

although the lithium-dilution technique tends to underestimate TDCO by 0.2–0.5 L/min.<sup>120,121</sup>

The lithium-dilution technique has several limitations. It cannot be used in patients who are allergic to or receiving lithium. Nondepolarizing neuromuscular blocking agents can interfere with the lithium electrode, which requires a 15–30-minute wait period before measuring cardiac output.

## Partial CO<sub>2</sub> Rebreathing

This noninvasive method employs a modification of the Fick principle to measure cardiac output in mechanically ventilated patients. In the modified Fick partial rebreathing method, CO<sub>2</sub> production and end-tidal CO<sub>2</sub> are measured at baseline and during brief periods of rebreathing, which allows calculation of pulmonary capillary blood flow.<sup>123</sup> The rebreathing is achieved by intermittently diverting exhaled gas through a loop connected to the ventilatory circuit. While this technique does not involve invasive vascular catheterization, it generally requires a tracheally intubated, mechanically ventilated patient. It provides a semi-continuous cardiac output measurement, as the rebreathing period can be automatically repeated. A major theoretical drawback of the technique is that it only measures blood that participates in gas exchange, ignoring shunted blood. To account for this, the CO<sub>2</sub> rebreathing measurements can be adjusted by estimating shunt fraction based on FiO<sub>2</sub> (fraction of inspired oxygen) and either arterial oxygen partial pressure or saturation.

Clinical studies of the partial rebreathing method in surgical patients have been mainly limited to patients undergoing or recovering from coronary artery bypass grafting (CABG). These small trials have generally shown acceptable bias and precision compared to TDCO,<sup>124</sup> although accuracy at higher cardiac output is reduced.<sup>125</sup> Newer software versions allow use of the partial rebreathing method in modes of ventilation that allow spontaneous breathing and might improve its performance in patients in the intensive care unit.

Because arterial PCO<sub>2</sub> increases 2–5 mm Hg during each rebreathing measurement period, the use of the CO<sub>2</sub> rebreathing technique is relatively contraindicated in neurosurgical patients who have increased intracranial pressure.

## Continuous Thermodilution Cardiac Output Measurement

The continuous thermodilution PAC incorporates a thermal filament around the right ventricular portion of the catheter, approximately 20 cm from the tip. This filament is intermittently warmed to about 111.2°F (44°C), and a thermodilution curve is recorded by the thermistor at the tip of the PAC in



the pulmonary artery. Because this warm thermal signal is much smaller than the cold thermal signal of standard TDCO measurement, a stochastic system controls filament heating, switching it on and off with pseudorandom timing, thereby enhancing the signal-to-noise ratio.<sup>126</sup> The displayed cardiac output is updated every 30 seconds and represents the averaged measurement over the previous 3–6 minutes, eliminating respiratory variations. Current commercial systems have a “fast” mode that displays the result of each measurement cycle as it is performed, allowing earlier detection of acute changes, but at the price of accentuated random variations and errors. Because of the very small thermal signal involved, this method is more susceptible to interference by other sources of heat, such as rapid intravenous fluid infusion or the temperature changes that occur immediately following cardiopulmonary bypass.<sup>127</sup>

Continuous thermodilution has been quite extensively validated against standard TDCO, mainly in patients undergoing cardiac surgery.<sup>119,128</sup> Although this method is termed *continuous thermodilution*, current devices only provide semicontinuous measurement that is averaged over a several-minute interval, and therefore have an oblige delay of approximately 10 minutes in identifying acute hemodynamic changes.<sup>129</sup> However, compared to TDCO measurements performed only every several hours, continuous thermodilution might still allow earlier recognition of hemodynamic problems.<sup>130</sup> Thus far, no studies have demonstrated that patient outcome is improved by using these more expensive continuous cardiac output catheters.

### Pulse Contour-Derived Cardiac Output

Pulse contour methods calculate stroke volume from the area under the arterial pressure waveform. The pressure waveform as measured in the large arteries is a combination of a forward pressure wave produced by the contraction of the heart and a backward pressure wave reflected from arterial branch points and arterial-arteriolar junctions. The magnitude of wave reflection is affected by changes in arterial resistance and compliance and needs to be taken into account in the calculation algorithm.<sup>131,132</sup> Available

commercial devices are based upon different models of the circulation, and generally require intermittent (every 4–8 hours) calibration with a cardiac output reference to establish accurate monitoring in an individual patient, by accounting for differences in vascular resistance, compliance, impedance, and wave reflectance.<sup>133</sup> While the pulse contour method only requires an arterial line for monitoring, the needed calibration methods might require additional invasive procedures. Reliable pulse contour measurement requires a reasonably well-defined arterial pressure waveform, in part because the dicrotic notch is often used to identify end-systole. Conversely, it appears that pulse contour cardiac output monitoring remains accurate across arterial pressure-monitoring systems that have a wide range of dynamic response characteristics.<sup>134</sup> Other limitations of this technique include the presence of frequent dysrhythmias or severe tachycardia leading to a variable or low stroke volume, respectively. Some investigators have shown that large fluctuations in systemic vascular resistance affect vessel compliance and wave reflectance and require recalibration to maintain accuracy of the pulse contour measurements,<sup>134</sup> whereas other studies have shown preserved accuracy despite acute changes in systemic vascular resistance.<sup>135</sup>

Notwithstanding these shortcomings, the pulse contour method provides a true continuous beat-to-beat measurement of cardiac output, which has acceptable agreement with TDCO and a small mean bias of 0.1–0.3 L/min.<sup>119,132,134</sup> In addition, pulse contour methods can calculate the beat-to-beat variation in stroke volume induced by positive pressure ventilation, which can be used to evaluate volume status.

### Esophageal Doppler

Ultrasound waves reflected from a moving target change their frequency, which allows calculation of the direction and velocity of movement using the Doppler equation (Box 29-7). For cardiac output calculation, circulating red blood cells are used as the moving target.

Current Doppler cardiac output technique employs an esophageal probe, similar in size to a standard orogastric tube, which is inserted into the lower esophagus, approximately 35–40 cm from the incisor teeth.<sup>136</sup> This position

#### BOX 29-7.

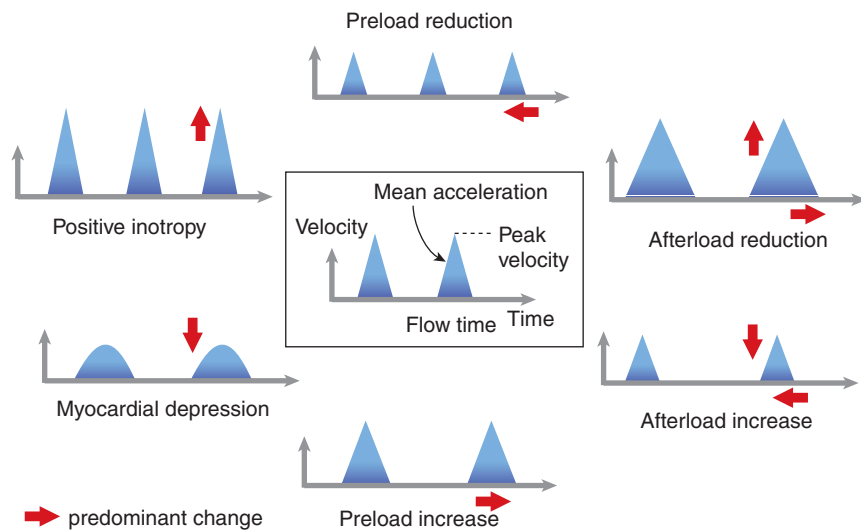
##### The Doppler Equation

$$V = \frac{\Delta f \cdot c}{2f_0 \cdot \cos \theta}$$

Where V	= blood velocity
$\Delta f$	= change of ultrasound frequency
$f_0$	= transmitted ultrasound frequency
$\theta$	= angle between the ultrasound beam and velocity vector
c	= velocity of ultrasound in blood (1540 m/sec)

provides a suitable acoustic window to the descending thoracic aorta, because the aorta and esophagus are almost parallel at this anatomic location. With this method, descending thoracic aorta blood flow is calculated from the area under the velocity-time curve and the aortic cross-sectional area. The latter is either derived from a nomogram or continuously measured during the cardiac cycle with a dedicated M-mode echo transducer incorporated into the probe to measure aortic diameter. As might be expected, measuring the aortic diameter gives more accurate results than using the nomogram.<sup>137</sup> Because the flow in the descending aorta is only a proportion of total cardiac output, some devices report an estimate of total cardiac output that is derived by multiplying descending thoracic aortic flow by an empirical constant of 1.4.<sup>136</sup> In addition to providing a minimally invasive, continuous beat-to-beat estimate of cardiac output, Doppler cardiac output monitors can provide valuable information regarding cardiac preload, contractility, and afterload, all derived from the shape of the velocity-time spectral Doppler waveform (Fig. 29-15).<sup>136</sup> The respiratory variation in aortic blood flow velocity can also be used to evaluate preload, similar to systolic blood pressure variation.<sup>138</sup>

One shortcoming of the esophageal Doppler monitor is its restriction to tracheally intubated, deeply sedated patients. Relative contraindications include patients with esophageal pathology or severe coagulopathy. In addition, frequent repositioning of the Doppler probe is needed, particularly in ICU patients who are not paralyzed,



**FIGURE 29–15.** Spectral Doppler tracings of descending aorta blood flow recorded using esophageal Doppler cardiac output monitoring. Changes in the velocity–time waveform shape result from alterations in contractility (mainly affect peak velocity and mean acceleration), preload (mainly affect systolic flow time corrected for heart rate [FTc]), and afterload (which affect FTc, mean acceleration and peak flow velocity). (Modified with permission from Singer M. Esophageal Doppler monitoring of aortic blood flow: beat-by-beat cardiac output monitoring. *Int Anesthesiol Clin* 1993;31(3):99–125.)

anesthetized, and immobile. Additional concerns involve the underlying assumptions on which the technique is based: a fixed ratio between descending aortic blood flow and total cardiac output, a constant thoracic aortic cross-sectional area during systole, a uniform flow profile across the aorta, and absence of significant diastolic antegrade aortic flow. It is unsurprising that esophageal Doppler cardiac output measurements tend to underestimate total cardiac output measured by other methods, although in some trials, the bias was small enough to be clinically insignificant and generally changes in cardiac output over time were reliably tracked.<sup>139</sup>

Despite all the theoretical concerns regarding the accuracy of the technique, Doppler-derived cardiac output monitoring is one of the few monitoring modalities that have been tested and found to be clinically effective for resuscitating critically ill and surgical patients. Several studies, both in cardiac and noncardiac surgery, used esophageal Doppler monitoring to guide fluid therapy for maximizing cardiac output, and have shown a reduced incidence of perioperative complications and a shorter hospital length of stay.<sup>140–144</sup>

### Gastric Tonometry

Gastric tonometry is a unique monitoring modality, which instead of directly

measuring total cardiac output, measures gastric  $\text{PCO}_2$ , serving as a surrogate measure of regional blood flow and tissue perfusion. As gastric mucosal blood flow decreases,  $\text{CO}_2$  clearance is reduced. With further reduction in blood flow and oxygen delivery,  $\text{CO}_2$  production increases from titration of  $\text{H}^+$  ions generated by anaerobic metabolism.<sup>145</sup> Increased mucosal tissue levels will be reflected by increased  $\text{CO}_2$  levels in the gastric lumen because  $\text{CO}_2$  diffuses freely across membranes. The gastric tonometer monitor consists of a modified gastric tube with a balloon at the tip, which is filled with either saline or air. Carbon dioxide in the balloon equilibrates over time with the gas in the gastric lumen, and samples are intermittently aspirated for measurement using either an arterial blood gases machine (for saline tonometry) or infrared spectroscopy (for air tonometry).<sup>146</sup> Calculating the gap between gastric  $\text{PCO}_2$  and arterial  $\text{PCO}_2$  controls for the effect of respiratory acidosis on gastric  $\text{CO}_2$ . Most devices can also calculate gastric pH (intracellular hydrogen ion concentration [pHi]) when the arterial bicarbonate level is measured and entered into the monitor. A pHi value below 7.32 is considered abnormal, but the  $\text{PCO}_2$  gap (gastric  $\text{PCO}_2$  – arterial  $\text{PCO}_2$ ) is currently considered to be a better measure of tissue perfusion.<sup>147</sup>

During low perfusion states, splanchnic blood flow is the first to be compromised, as the body diverts blood flow to the brain, heart, and kidneys.<sup>148</sup> Consequently, gastric  $\text{PCO}_2$  has been considered to be an early monitor of hypoperfusion. Studies of experimental graded hemorrhage,<sup>149</sup> as well as clinical studies in trauma patients,<sup>150</sup> support this concept. The effects of gut ischemia may be protean, as it can contribute to bacterial translocation, inflammatory response, and the development of multiorgan failure, independent of the mechanism that caused the ischemia in the first place.<sup>151</sup> Indeed, intraoperative gastric hypercarbia was shown to correlate with increased complications, length of stay and mortality after both cardiac and noncardiac surgery.<sup>152,153</sup> Lastly, several studies in ICU patients and in patients undergoing noncardiac surgery suggest that therapy guided by gastric  $\text{PCO}_2$  can reduce morbidity and mortality.<sup>154,155</sup>

Gastric tonometry is contraindicated in patients with esophageal abnormalities and the measurements might be affected by feeding, gastric insufflation or suctioning and the use of  $\text{H}_2$  blockers. Finally, not all studies have found gastric tonometry to be useful.<sup>156,157</sup>

### PROBLEM-ORIENTED HEMODYNAMIC MONITORING

For clinicians, monitoring choices should always stem from a clinical diagnostic or therapeutic question. Consequently, it is essential to discuss and compare the various existing monitoring modalities in terms of their usefulness in answering specific clinical questions.

#### Assessment of Acute Ischemia

Several studies confirm the association of perioperative myocardial ischemia with postoperative cardiac complications, mainly myocardial infarction and cardiac death.<sup>158,159</sup> This highlights the importance of early diagnosis of ischemia in the surgical patient. The most commonly used methods to diagnose ischemia perioperatively are ECG monitoring and echocardiography. Some physicians, however, advocate the use of the PAC to monitor for ischemia.<sup>160</sup>

Myocardial ischemia typically impairs diastolic relaxation, which leads

to decreased ventricular compliance and increased ventricular end-diastolic pressure.<sup>161</sup> This leads to an increased amplitude of the a wave of the PAOP, reflecting left atrial contraction against a nonrelaxed ventricle. Less prominent increases in mean PAOP and PADP can also be seen. When systolic dysfunction occurs, reduced stroke volume, left ventricular stroke work, and arterial blood pressure may ensue. If acute mitral regurgitation occurs as a result of either ischemia-induced geometric changes in the left ventricle or papillary muscle dysfunction, a tall c-v wave can be observed in the PAOP trace.

The main limitation of using PAC monitoring for diagnosis of ischemia is that no threshold values have been set as diagnostic criteria. In a study where ischemia was defined as wall motion abnormalities seen on TEE, mean PAOP increased by  $3.5 \pm 4.8$  mm Hg.<sup>162</sup> However, a threshold of 3 mm Hg had only a 25% sensitivity and a 15% positive predictive value for ischemia. Another study in patients undergoing CABG used myocardial lactate production to diagnose ischemia and found that a 5-mm Hg increase in mean PAOP had almost 100% specificity, but only 1.6% sensitivity.<sup>163</sup> Interestingly, ECG monitoring had only 17.5% sensitivity, demonstrating the lack of a clinically reliable and useful ischemia monitor. Given the numerous factors that can affect PAC pressure measurements, these results are unsurprising. Also, ischemia in small areas of the myocardium might not induce a large enough change in global myocardial compliance to be detected by the PAC. Lastly, the PAOP cannot be continuously monitored because of the risk of pulmonary infarction.

To summarize, PAC monitoring should probably not be employed for the sole purpose of diagnosing perioperative ischemia. However, other currently available monitors, namely ECG and TEE, are also limited in their diagnostic usefulness. Information collected from the PAC can help to corroborate the diagnosis of ischemia, evaluate its hemodynamic significance and guide therapy.

### Assessment of Pulmonary Edema

Pulmonary edema results from the interplay of two different processes: increased pulmonary capillary hydro-

static pressure and increased pulmonary capillary permeability. The critical forces driving edema formation are described by the Starling equation (Box 29–8). Pulmonary edema formation is reduced as pulmonary capillary hydrostatic pressure is lowered (e.g., by diuresis), but at a certain point left ventricular preload reduction will reduce cardiac output without any further benefit in terms of pulmonary edema. In normal alveolar–capillary permeability states, a pulmonary capillary pressure of 18–20 mm Hg is considered to be the threshold beyond which alveolar flooding is promoted.<sup>164</sup> Accordingly, pulmonary edema in the presence of a PAOP below 18 mm Hg has traditionally been classified as noncardiogenic edema.<sup>165</sup>

### The Usefulness of the PAOP

Clinical reliance on absolute PAOP values such as these can be, however, misleading. First, increased hydrostatic pressure might be transient, as in acute ischemic left ventricular dysfunction or acute neurogenic pulmonary edema. Following such an event, it might already be significantly lower. Second, the PAOP is used as a surrogate for pulmonary capillary pressure, assuming negligible pulmonary venous resistance. However, in conditions of increased cardiac output or increased pulmonary venous resistance (e.g., pulmonary fibrosis, late-stage ARDS, high-altitude pulmonary edema, vasopressor therapy), true pulmonary capillary pressure might be significantly higher than the measured PAOP.<sup>166</sup> In these patients, pulmonary vasodilators might be beneficial for treating pulmonary edema. Third, positive-pressure ventilation may increase the PAOP while simultaneously increasing the interstitial tissue pressure, resulting in no net increase in the filtration pressure gradient. Last, in patients with acute lung injury and increased capillary permeability, the Starling equation indicates that pulmonary capillary pressure might play even a greater role in edema formation because as  $K_d$  decreases, protein concentration in the interstitium increases and the oncotic pressure gradient decreases (Box 29–8). Under these conditions, pulmonary capillary pressures less than 18 mm Hg might still promote formation of pulmonary edema. Indeed, pulmonary capillary pres-

### BOX 29–8.

#### Starling's Equation for Fluid Flux across Membranes

$$\text{Fluid flux} = K_{fc} \times (P_{\text{capillary}} - P_{\text{interstitium}}) - K_d \times (\pi_{\text{capillary}} - \pi_{\text{interstitium}})$$

Where: P =	hydrostatic pressure
$\pi$ =	oncotic pressure
$K_{fc}$ =	capillary filtration coefficient
$K_d$ =	reflection coefficient

sure is a major determinant of fluid flux across the alveolar capillary membrane regardless of the degree of capillary permeability. The “safe” level of PAOP in patients with increased alveolar capillary permeability remains elusive.<sup>167</sup> However, a large randomized study in patients with acute lung injury has found some clinical advantage to a restrictive fluid therapy (aiming at PAOP < 8 mm Hg or CVP < 4 mm Hg) compared to liberal fluid management (PAOP 14–18 mm Hg or CVP 10–14 mm Hg).<sup>168</sup>

### Measuring Extravascular Lung Water

A different approach to assess pulmonary edema involves quantification of extravascular lung water (EVLW), which can be measured using transpulmonary thermodilution.<sup>169</sup> Studies conducted in critically ill patients demonstrate that EVLW has prognostic value.<sup>170</sup> Also, trials in patients with acute lung injury found that compared to care guided by PAOP monitoring, therapy guided by EVLW monitoring results both in a reduction in the amount of administered fluid and in an improvement in clinically significant end points such as ventilator days, ICU length of stay, and mortality.<sup>167</sup> A more recent study suggests that monitoring EVLW can be used to guide fluid challenges in septic patients at risk for pulmonary edema.<sup>171</sup> Only little data, however, exist regarding EVLW monitoring during the perioperative period, and its usefulness in the operating room remains uncertain.

### Assessment of Ventricular Contractility

Contractility, the force of muscle contraction, can be defined as the velocity of myocardial fiber shortening during systole. Together, contractility, pre-

load, afterload, and heart rate are the four determinants of cardiac output.

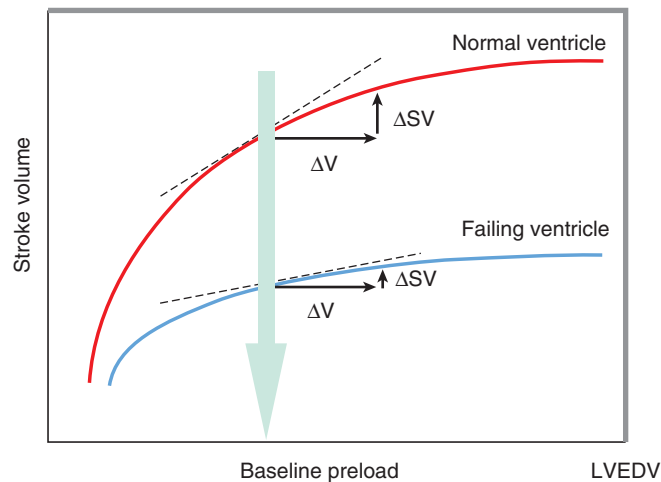
Direct assessment of intrinsic ventricular contractility, independent of loading conditions, is possible under laboratory or research conditions, but is not easily available clinically. Instead, several indices of integrative “pump” function can be used, attempting to take into consideration the effects of loading conditions. Under a range of loading conditions, these indices can still give reasonably accurate estimate of ventricular contractility.<sup>172</sup>

### Cardiac Function Curve

A classical study on the use of the PAC in the setting of myocardial infarction defined cardiogenic shock as the combination of low cardiac index ( $<2.2$  L/min/m<sup>2</sup>) and high PAOP ( $>18$  mm Hg).<sup>173</sup> As a rough guide, this combination is commonly used clinically to decide upon the need for inotropic support, for example, following weaning from cardiopulmonary bypass. However, significant ventricular dysfunction may be present in a variety of clinical conditions when measured cardiac output is in the normal range, yet inadequate for the bodily needs. Also, cardiac output might be preserved despite low stroke volume because of increased heart rate, or stroke volume might be preserved despite reduced contractility because of reduced afterload. Similarly, PAOP can be abnormally increased from a variety of other causes besides systolic left ventricular dysfunction. Rather than focusing clinically on absolute values for PAOP or stroke volume, “fluid responsiveness” might serve as a better indicator of ventricular function. When a fluid bolus does not lead to a significant increase in stroke volume, while at the same time the PAOP does rise significantly, this can be construed as a sign of a failing left ventricle that is operating on the “flat portion” of its Starling curve (Fig. 29–16).<sup>174</sup> Obviously, a flat portion also exists in a normal ventricle, however at a relatively very high stroke volume.

### Ventricular Stroke Work

Another measure of pump function is ventricular stroke work, which is the energy consumed by the ventricle while transferring the stroke volume from the atrium to the pulmonary artery or aorta.<sup>175</sup> The higher the pressure differential between the filling



**FIGURE 29–16.** Lack of fluid responsiveness as a marker of ventricular dysfunction. Starting from the same left ventricular end-diastolic volume (LVEDV, yellow arrow), a similar preload augmentation ( $\Delta V$ ) leads to a much smaller increase in stroke volume ( $\Delta SV$ ) in the failing ventricle, operating on a much flatter Starling curve (the slope is marked by the dotted line). Therefore, assessment of baseline preload, whether in pressure terms (e.g., pulmonary artery occlusion pressure) or in volume terms (LVEDV) cannot predict the cardiac output response to preload augmentation. (Modified with permission of Springer Science and Business Media from Michard F, Reuter DA. Assessing cardiac preload or fluid responsiveness? It depends on the question we want to answer. *Intensive Care Med* 2003;29(8):1396.)

pressure and the mean arterial blood pressure (pulmonary or systemic), the higher is the ventricular work. A failing ventricle, as a result of a contractility–afterload mismatch, will display a smaller stroke work index.<sup>176</sup>

### Echocardiography

Echocardiography has become a widely used monitor to evaluate ventricular function.<sup>177</sup> The most widely used index for assessing left ventricular function is the ejection fraction, usually estimated from the observed change in ventricular two-dimensional cross-sectional area, although techniques do exist for more accurate calculation. Regardless of calculation technique, it, again, should be emphasized that the ejection fraction is both preload and afterload dependent. Because of the nongeometric shape of the right ventricle, calculation of right ventricular ejection fraction is usually abandoned in favor of a more qualitative evaluation of contractility, based mainly on inward movement of the ventricular wall during systole.

The rate of pressure rise during systole,  $dP/dt$ , is classically measured using intraventricular pressure manometers. In patients with mitral regurgitation, a similar parameter can be measured using echocardiography from the mitral regurgita-

tion jet Doppler envelope. As this index is measured during the isovolumic contraction phase, it is afterload independent, although it is still preload dependent.

### Newer Monitors

Newer monitoring modalities offer new indices of contractility. From the esophageal Doppler time–velocity waveform, the peak flow velocity as well as the slope of the velocity–time envelope (i.e., mean acceleration) can be calculated (Fig. 29–15).<sup>178</sup> These are analogous to the  $dP/dt$  index mentioned previously.

The transpulmonary thermodilution supplies the cardiac function index, defined as the cardiac index divided by the global end-diastolic volume index, which is a preload index. The resulting quotient is supposed to be a preload-independent index of contractility.<sup>179</sup>

Right ventricular ejection fraction can be directly measured using the RVEF PAC. In the presence of right ventricular dysfunction, as a result of either ischemia<sup>98</sup> or sepsis,<sup>100</sup> fluid loading may cause further hemodynamic deterioration by increasing right ventricular end-diastolic volume, inducing leftward shift of the interventricular septum, thereby decreasing left ventricular compliance and preload.<sup>180</sup> This might be diagnosed by



RVEF PAC monitoring, prompting inotropic support of the right ventricle.

### Assessment of Volume Status

Fluid management is a major responsibility of the anesthesiologist or critical care physician in the perioperative period. Goals for fluid administration are maintenance of effective intravascular volume and optimization of tissue perfusion and cellular oxygenation. Inadequate intravascular volume resuscitation initially impairs nonvital organ perfusion, but eventually leads to a state of shock with inadequate oxygen delivery to all tissues. Volume expansion is expected to increase stroke volume and cardiac output. However, excessive volume administration can result in pulmonary and intestinal edema, exacerbation of cor pulmonale, hemodilution and functional anemia, hyperchloremic acidosis from administration of normal saline, and coagulation abnormalities, all of which may increase morbidity and mortality.<sup>181</sup>

The inflammatory response to surgical trauma, ischemia/reperfusion injury or sepsis increases vascular permeability, greatly increasing fluid losses from the vascular space.<sup>182</sup> Even without additional pathology, general anesthesia alone has been shown to increase interstitial fluid three-fold compared to conscious controls.<sup>183</sup> Hence, perioperative and critically ill patients are often relatively hypovolemic. Unfortunately, not always is volume expansion able to improve organ perfusion; several investigators have shown that up to one half of critically ill patients fail to respond to fluid administration.<sup>184,185</sup> The challenge for resuscitation of critically ill patients is to identify individuals who are hypovolemic and who will respond favorably to volume expansion.

### Clinical Evaluation

Most commonly, and in the absence of invasive monitors, standard clinical signs and symptoms are used to guide fluid administration in the operating room. Formulae for calculating volume deficits are based on the length of fasting period, estimates of insensible losses during the operation, blood loss, and third-spacing of fluid. Tachycardia and hypotension are most considered to indicate hypovolemia. Assessing peripheral perfusion including capillary refill and tactile warmth of the extremities can add information. Several lab-

oratory findings may suggest hypovolemia, including inappropriately high hematocrit, hypernatremia, high levels of blood urea nitrogen (BUN), increased ratio of BUN to creatinine, or elevated base deficit (i.e., metabolic acidosis). In patients with relatively normal renal function, urine output and composition (osmolarity, fractional excretion of sodium) can provide some information concerning intravascular volume. However, many of these signs actually evaluate perfusion, which may be inadequate despite normal or even increased volume status, for example, in face of severe vasoconstriction or cardiogenic shock. Additionally, many other processes common in the perioperative period can affect these signs, including hypothermia, anxiety, increased antidiuretic hormone or hyperchloremic metabolic acidosis. Several studies show the lack of sensitivity or specificity of the clinical examination and laboratory indices to assess volume status.<sup>186,187</sup>

One of the best methods to determine the adequacy of volume resuscitation is to administer a fluid challenge and assess the desired physiologic response, such as improved blood pressure, increased urine output, or clearance of a metabolic acidosis: 250–500 mL of crystalloid or colloid solution are given over 30 minutes and the response is monitored. Even simpler, passive leg raising can induce transient autotransfusion and increase blood pressure in patients who are volume responsive.<sup>188</sup> In contrast to respiratory variation-based dynamic indices, the passive leg-raising test is also useful in patients with dysrhythmia or spontaneous breathing.<sup>189</sup> In severely hypovolemic patients, however, the amount of blood in the legs might be too low to significantly change hemodynamics. In patients who have failed to respond to these simple measures, or in whom a fluid challenge carries greater risk, more sophisticated assessment requires additional hemodynamic monitoring.

### The Usefulness of Filling Pressures

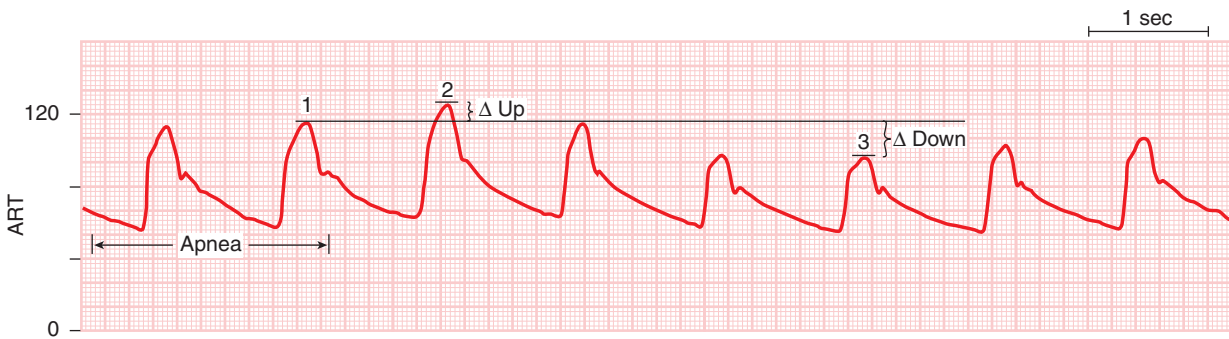
Static pressure measurements, mainly CVP and PAOP, traditionally have been used as preload indicators to guide fluid administration. However, the relationships between intravascular blood volume, end-diastolic ventricular volumes, and cardiac filling pres-

ures are complex and affected by many factors. Both right and left ventricular compliances are frequently abnormal in critically ill patients. Nonlinear ventricular diastolic compliance (Fig. 29-11) also confounds the direct pressure-volume relationship, as do myriad other factors, including changes in pulmonary vascular resistance, decreased chest wall or abdominal compliance, increased pericardial pressure, increased intrathoracic pressure from mechanical ventilation or auto-PEEP, and the use of vasoactive drugs. In fact, even in healthy volunteers no predictable relationship between CVP or PAOP and volumetric measures of preload or cardiac performance can be demonstrated.<sup>190</sup> In a critical review of 12 studies, marked overlap in CVP or PAOP measurements did not allow identification of patients who would respond to volume expansion.<sup>184</sup> Because PAOP, and not end-diastolic ventricular volume, represents the hydrostatic force for development of edema in the lung, monitoring PAOP during fluid resuscitation can still be important, especially in patients who are at risk for development of pulmonary edema.<sup>171</sup>

One approach to trying to cope with the lack of predictive ability of baseline filling pressures is to administer a fluid challenge and evaluate the change in pressures. An increase of no more than 3 mm Hg in the CVP or in the PAOP indicates a state of hypovolemia, and additional fluid challenges are given until a higher increase in pressures is observed. In a goal-directed therapy study in patients with femoral neck fractures, volume was infused to achieve sustained increases of CVP of  $\geq 3$  mm Hg in order to maintain blood pressure within 20% of baseline. This was associated with improvements in postoperative outcomes, demonstrating the possible usefulness of such an approach.<sup>141</sup> Another type of dynamic test involves the decrease in CVP that accompanies spontaneous, negative pressure inspiration: a decrease of more than 1 mm Hg was found to predict fluid responsiveness.<sup>191</sup>

### Volumetric Indices

Another approach for assessing preload involves volumetric measurements. Fast-response RV ejection fraction PAC are able to calculate RVEDV. As a direct measure of right ventricular preload, it has been found to be a



**FIGURE 29–17.** Systolic pressure variation visible on an arterial pressure trace. Note that  $\Delta_{up}$  and  $\Delta_{down}$  are measured from an apneic baseline. In this example,  $\Delta_{up}$  is approximately 9 mm Hg, whereas  $\Delta_{down}$  is approximately 18 mm Hg, for a total SPV of 27 mm Hg.

better index of fluid responsiveness than PAOP,<sup>192,193</sup> though some studies found the opposite.<sup>194</sup> RVEDV monitoring might be especially useful in patients requiring mechanical ventilation, where elevated intrathoracic pressures confound interpretation of cardiac filling pressures.<sup>195</sup>

The transpulmonary thermodilution technique allows measurement of a parameter called global end-diastolic volume (GEDV) which represents the volume of blood inside both right and left heart chambers at end-diastole. From the GEDV, another parameter, intrathoracic blood volume, can be calculated. Several small studies in septic patients,<sup>196</sup> and during cardiac<sup>197</sup> or lung transplant surgery,<sup>198</sup> have found these indices better indicators of volume status compared to pressure measurements.

Echocardiography can be used to measure and derive a number of cardiac volumes and parameters that can help to evaluate preload. Not surprisingly, ventricular end-diastolic area has been found a better index of preload compared to filling pressures.<sup>199</sup> In healthy volunteers, echocardiographic volume indices also correlated with cardiac output response to volume expansion,<sup>190</sup> interestingly, however, studies in patients could not generally identify threshold values able to predict response to volume challenge.<sup>184,185</sup>

In contrast, the degree of superior or inferior vena cava collapsibility during inspiration in ventilated septic patients was found predictive of the increase in cardiac output in response to volume infusion.<sup>200,201</sup> Unfortunately, the time, training, cost, and equipment involved in use of bedside echocardiography in the critical care setting often limit its use and effectiveness.

### Respiratory Variation-Based Dynamic Indices

As an alternative to static preload measurements, a variety of dynamic measures have been proposed to identify hypovolemic patients who will respond to volume expansion by increase in cardiac output. These are based on the cyclic changes in left ventricular preload induced by changes in intrathoracic pressure during positive-pressure mechanical ventilation. In fluid-responsive (i.e., preload-dependent) patients, cyclic changes in stroke volume and blood pressure will ensue.<sup>202</sup>

**Systolic Pressure Variation** Increases in systolic pressure variation (SPV; Fig. 29–17) beyond 8–10 mm Hg have been found to reflect the degree of blood loss and consequent hypovolemia, as well as to correlate with response to volume infusion.<sup>12,203</sup> SPV has two distinct components. An early systolic increase of 2–4 mm Hg immediately follows the end-expiratory pressure baseline and is caused by blood squeezing out of the lungs during inspiration,<sup>204</sup> and from decreased left ventricular afterload.<sup>205</sup> The second component is a pressure decrease of approximately 5–6 mm Hg which reflects a decrease in venous return to the heart caused by positive pressure.<sup>206</sup> The second pressure change is termed the delta-down component ( $\Delta_{down}$ ), and may be a more sensitive indicator of volume responsiveness compared to total SPV.<sup>185</sup>

**Pulse Pressure Variation** Pulse pressure variation (PPV) is defined as the difference between the maximal and the minimal pulse pressure values during a single mechanical breath, divided by the mean of these two values (Fig. 29–18). Some clinical data suggest that PPV might be a more accu-

rate predictor of fluid responsiveness compared to SPV,<sup>207,208</sup> although both are affected by both  $\Delta_{up}$  and  $\Delta_{down}$ , and therefore might be misleading in conditions of hypovolemia or cardiac failure.

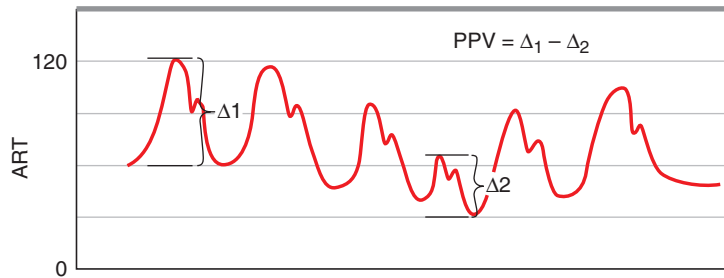
**Stroke Volume Variation** Stroke volume variation (SVV) is defined analogously to PPV, and can be calculated from arterial pulse contour cardiac output monitors. A SVV greater than 10% is a good predictor of fluid responsiveness in patients undergoing neurosurgical or cardiac procedures.<sup>209,210</sup> A major theoretical concern regarding the use of SVV is whether the changes in arterial tone and impedance induced by positive-pressure ventilation affect its accuracy.<sup>211</sup>

Respiratory variation in peak blood flow velocity in the descending aorta can be measured using esophageal Doppler. A variation in excess of 18% identified those patients who would benefit from volume infusion.<sup>138</sup>

### Limitations of Dynamic Indices

Dynamic preload indices are simple to use, minimally invasive, and accurately reflect the cardiac output response to fluid loading. However, they require the patient to be intubated and ventilated using a controlled mode of ventilation to ensure uniform tidal volume, generally larger than 8 mL/kg.<sup>13,212</sup> The arterial pressure waveform should be inspected and the signal optimized if needed.<sup>213</sup> Dynamic indices cannot be used in patients with significant dysrhythmias, notably atrial fibrillation, because nonuniform diastolic filling time will induce its own beat-to-beat stroke volume variation.

The respiratory systolic variation test has been suggested to eliminate the effects of  $\Delta_{up}$  and tidal volume variation on SPV (Fig. 29–19).<sup>214</sup> A



**FIGURE 29–18.** In this example of pulse pressure variation, maximal pulse pressure is approximately 62 mm Hg, while minimal pulse pressure is near 36 mm Hg. The resulting PPV of 26 mm Hg is larger than 12% of the mean of the two values (49 mm Hg), and as such indicates fluid responsiveness or hypovolemia.

slope greater than 0.5 mm Hg/cm H<sub>2</sub>O was found to have the best predictive power for fluid responsiveness.<sup>214</sup> The usefulness of this test in patients with abnormal lung compliance has not been addressed yet.

### Summary

A conclusion that may be drawn from the review of these techniques and clinical trials is the superiority of dynamic measures over static measures in identifying patients who would benefit from volume expansion.

There are, however, two important issues to consider. First is the idea that preload, as measured by either volume or pressure variables, is fundamentally different from fluid responsiveness. Hypovolemic patients might fail to respond to volume expansion for a host of reasons like right or left ventricular failure (Fig. 29–16) or increased venous or arterial compliance. Also, fluid administration causes hemodilution and thereby decreases left ventricular afterload. This can increase stroke volume as a consequence of a decreased left ventricular end-systolic volume with no or minimal change in end diastolic volume.<sup>215</sup>

A second important issue is defining the clinical goal. Simply being fluid responsive does not necessarily indicate that fluid should be administered. Actually, fluid responsiveness is a characteristic of normal cardiovascular physiology.<sup>190</sup> The primary question the physician should ask himself is whether hypoperfusion exists, and only if the answer to this question is positive, should evaluation of preload responsiveness be performed and acted upon.<sup>213</sup>

### Assessment of Perfusion

Ensuring adequate perfusion of major body organs is the main hemodynamic

goal of the anesthesiologist in the perioperative period. Tissue hypoperfusion is the defining characteristic of circulatory shock, but can occur long before other signs and symptoms become apparent. Unfortunately, most currently employed monitoring modalities provide only indirect measures of organ perfusion. Regional perfusion variability adds to the monitoring challenge since some organs, like the splanchnic bed, might be hypoperfused while more vital organs, like the brain and heart, remain adequately perfused.<sup>216</sup>

### Clinical Evaluation

A variety of traditional clinical indices have been used to judge the adequacy

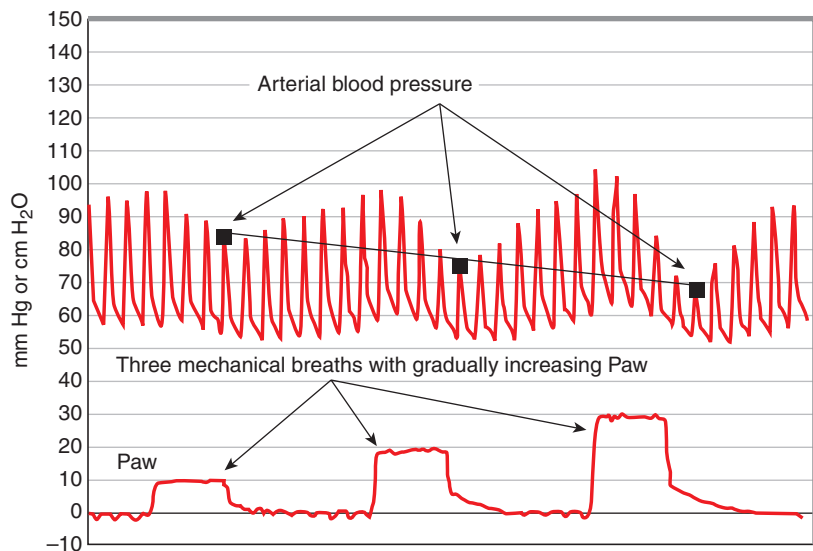
of tissue perfusion. These clinical signs and symptoms include the level of consciousness, urine output, heart rate, capillary refill, and skin temperature and color. All, however, may be unreliable in the perioperative period owing to the many confounding effects encountered during this time; as a result, hemodynamic monitors were developed to fill this patient care need.

### Pressure-Based Indices

The simplest of these monitors are pressure-based measurements, mainly systemic blood pressure and cardiac-filling pressures. Perfusion of major body organs is pressure independent over a wide range of pressures, because of autoregulation. In addition, compensatory mechanisms help to defend blood pressure, so that in many circumstances, arterial hypotension is a late sign of hypovolemia or shock.<sup>149</sup> Studies in different patient populations demonstrate the coexistent of normal vital signs despite occult shock as demonstrated by continuing anaerobic metabolism.<sup>217</sup>

### Flow-Based Indices

The next level of hemodynamic monitoring involves flow-based measurements, namely cardiac output, stroke volume, and oxygen delivery. Several studies suggest that these indices do



**FIGURE 29–19.** Respiratory systolic variation test—the steeper the slope of the line created by plotting minimal systolic blood pressures during the standardized protocol, the greater the predicted response to fluid resuscitation. (Reproduced by permission of Oxford University Press/British Journal of Anaesthesia from Preisman S, Kogan S, Berkenstadt H, Perel A. Predicting fluid responsiveness in patients undergoing cardiac surgery: functional haemodynamic parameters including the respiratory systolic variation test and static preload indicators. *Br J Anaesth* 2005; 95(6):746–755.)

TABLE 29–5.

## Positive Randomized Controlled Studies of Goal-Directed Therapy in the Perioperative Period

Study	Patient Population	Number (n)	Monitoring Modality	Therapeutic Goals	Interventions	Mortality (Control vs. Treatment Group) <sup>a</sup>
Bishop, 1995 <sup>241</sup>	Severe trauma	115	PAC	CI >4.5 L/min/m <sup>2</sup> DO <sub>2</sub> >600 mL/min/m <sup>2</sup> VO <sub>2</sub> >170 mL/min/m <sup>2</sup>	Fluids, blood, dobutamine	37% vs. 18%
Boyd, 1993 <sup>242</sup>	High-risk non-cardiac surgery	107	PAC	DO <sub>2</sub> >600 mL/min/m <sup>2</sup>	Dopexamine	22.7% vs. 5.7%
Wilson, 1999 <sup>243</sup>	Major elective noncardiac surgery	138	PAC	PAOP >12 mm Hg Hb >11 g/dL SaO <sub>2</sub> > 94% DO <sub>2</sub> >600 mL/min/m <sup>2</sup> DO <sub>2</sub> >600 mL/min/m <sup>2</sup>	Fluid, blood, oxygen, adrenalin/dopexamine	17% vs. 3%
Lobo, 2000 <sup>244</sup>	Major elective surgery	37	PAC	DO <sub>2</sub> >600 mL/min/m <sup>2</sup>	Dobutamine	50% vs. 15.7%
Berlauk, 1991 <sup>245</sup>	Peripheral vascular surgery	89	PAC	CI >2.8 L/min/m <sup>2</sup> SVR <1100 dyne*s/cm <sup>5</sup> PAOP 8–15 mm Hg SvO <sub>2</sub> >70% Lactate <2 mmol/L	Fluid, afterload reduction, positive inotropes	9.5% vs. 1.5% (p borderline significant at 0.08)
Polonen, 2000 <sup>92</sup>	Cardiac surgery	403	PAC		Fluids, dobutamine	3% vs. 1% (p nonsignificant, but significantly shorter hospital stay and fewer complications)
Pearse, 2005 <sup>246</sup>	High-risk non-cardiac surgery	122	Lithium dilution	Maximize stroke volume DO <sub>2</sub> >600 mL/min/m <sup>2</sup>	Fluids, dopexamine	9.7% vs. 10% (p nonsignificant, but significantly shorter hospital stay and fewer complications)
Mythen, 1995 <sup>142</sup>	Cardiac surgery	60	Esophageal Doppler	Maximize stroke volume	Fluids	Not reported, but significantly shorter hospital stay and fewer complications
Sinclair, 1997 <sup>143</sup>	Femur neck fracture	40	Esophageal Doppler	Maximize stroke volume	Fluids	10% vs. 5% (p nonsignificant, but shorter hospital stay)
Gan, 2002 <sup>140</sup>	Noncardiac surgery with estimated blood loss >500 mL	100	Esophageal Doppler	Maximize stroke volume	Fluids	Not reported, but shorter hospital stay

CI, cardiac index; DO<sub>2</sub>, oxygen delivery; Hb, hemoglobin concentration; PAC, pulmonary artery catheter; PAOP, pulmonary artery occlusive pressure; SaO<sub>2</sub>, arterial oxygen saturation; SvO<sub>2</sub>, mixed venous oxygen saturation; SVR, systemic vascular resistance; VO<sub>2</sub>, oxygen consumption.  
<sup>a</sup>For all results, p is significant at 0.05 levels unless stated otherwise.

have a prognostic value,<sup>218</sup> and many studies of goal-directed therapy demonstrate their clinical usefulness (Table 29–5). However, these studies also demonstrate that the “optimal” level of cardiac output or oxygen delivery in the perioperative period is not necessarily the “normal” level. With the changes in oxygen requirements resulting from anesthesia on the one hand, or the systemic inflammatory response on the other hand, the same

oxygen delivery might be too high, too low, or just right. The development of “oxygen debt” after major surgery is associated with both survival and the incidence of complications.<sup>219</sup>

### Metabolic Indices

Considering the shortcomings of flow-based monitoring methods, metabolic indices might supply the required information about the adequacy of oxygen delivery or cardiac output. These

metabolic markers include either global measures such as base excess, blood lactate level, and venous oxygen saturation, or regional perfusion measures, such as cerebral oximetry and gastric tonometry.

**Lactic Acidosis** Elevated blood lactate and metabolic acidosis indicate anaerobic metabolism, presumably related to hypoperfusion leading to tissue ischemia. Indeed, various studies



confirm the prognostic significance of serial lactate and base deficit measurements,<sup>220,221</sup> and the potential of using lactate level as a guide for directing therapy.<sup>92,222</sup> Several pitfalls need to be acknowledged. Lactate levels may increase as a consequence of isolated organ damage such as limb ischemia or mesenteric thrombosis, where surgical intervention, rather than medical therapy to increase oxygen delivery, is warranted. Also, because there are various other etiologies for both hyperlactatemia and metabolic acidosis, lactic acidosis is probably a more specific index for hypoperfusion than either measure alone.<sup>223</sup>

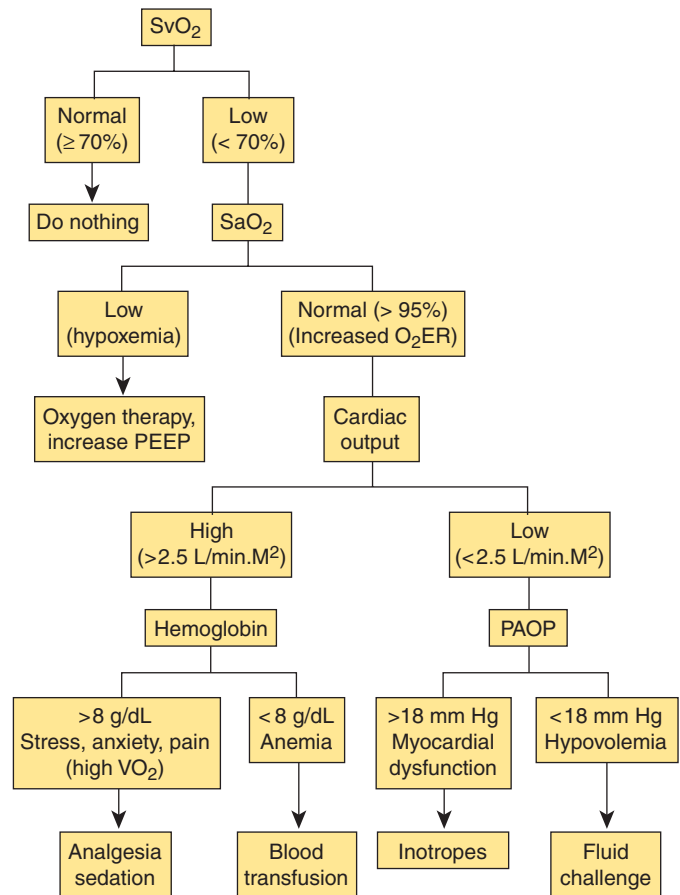
**Venous Oximetry** Because increased oxygen extraction can initially compensate for reduced oxygen delivery, anaerobic metabolism usually does not occur before venous oxygen saturation has decreased to 30–40%.<sup>224</sup> Therefore, monitoring venous oximetry, in either mixed pulmonary or central venous blood, might allow early detection of hypoperfusion before tissue ischemia develops. Reduced venous oxygen saturation better predicts adverse outcome after cardiac surgery than does cardiac output or oxygen delivery,<sup>225</sup> while treating low cardiac output in patients with a normal venous oxygen saturation might be counterproductive.<sup>226</sup> Indeed, venous oxygen saturation may be one of the more important monitors for judging the adequacy of the hemodynamic status and determining whether the measured pressure- and flow-based indices are acceptable, in the context of the individual patient's oxygen requirements.<sup>227</sup>

#### Regional versus Global Perfusion

A major drawback of lactate, base deficit, and venous oxygen saturation is their global nature. Lactate production and increased oxygen extraction induced by ischemia in an isolated organ might be diluted and therefore masked when whole-body lactate or mixed venous oximetry are measured. Consequently, a place exists for also monitoring regional perfusion, the best example being gastric tonometry. Other regional monitors include jugular bulb oximetry, sublingual capnography, near-infrared light spectroscopy, tissue oxygen electrodes, and cytoscan imaging.<sup>228,229</sup>

To summarize, a systematic approach to hemodynamic monitoring that combines relatively easily measured metabolic indices with classical

#### Resuscitate to a mean arterial pressure of > 65 mm Hg



**FIGURE 29–20.** A systematic approach to assessment and treatment of hypoperfusion. Perfusion assessment by measuring mixed venous oxygen saturation (SvO<sub>2</sub>) starts after restoration of perfusion pressure (which can be done using fluids and vasopressors). O<sub>2</sub>ER, oxygen extraction ratio; SaO<sub>2</sub>, arterial oxygen saturation; VO<sub>2</sub>, systemic oxygen consumption. (Reproduced with permission from Pinsky MR, Vincent JL. Let us use the pulmonary artery catheter correctly and only when we need it. *Crit Care Med* 2005;33(5):1119–1122.)

hemodynamic measurements might allow early detection of tissue hypoperfusion and undertaking of appropriate corrective measures (Fig. 29–20).

#### Preemptive Goal-Directed Therapy

Monitoring alone cannot influence patient outcome unless it is used to guide effective therapeutic interventions. Usually, these interventions are ill-defined and highly variable between practitioners, contributing to the difficulty in assessing the usefulness of various monitoring modalities, most notably the PAC.<sup>3,32</sup> The “goal-directed therapy” approach, in contrast, defines a priori a set of interventions aimed at achieving specific values for monitored physiologic parameters. In an early retrospective trial in high-risk surgical patients, mostly trauma vic-

tims, survivors were found to achieve higher levels of cardiac output (>4.5 L/min/m<sup>2</sup>), oxygen delivery (>600 mL/min/m<sup>2</sup>), and oxygen consumption (>170 mL/min/m<sup>2</sup>) compared to nonsurvivors.<sup>218</sup> This was followed by a successful prospective interventional trial aimed at treating patients to achieve these “supranormal” values preoperatively through use of fluids, blood transfusion, and vasoactive drugs.<sup>230</sup> Many similar trials followed, and most of them confirmed a significantly decreased morbidity and mortality in the goal-directed treatment group (Table 29–5). However, a recent, large, multicenter, randomized study tested early goal-directed therapy in surgical patients and did not find any benefit.<sup>60</sup> This study, however, included relatively low-risk patients (mortality in the control group was

only 7.7%), the goals chosen differed from those in previous positive studies, most patients did not achieve the therapeutic goals prior to surgery, and the interventions were not rigorously defined.

In contrast to perioperative management of surgical patients or treatment of patients in early stages of sepsis,<sup>91</sup> goal-directed therapy has been less successful when applied to critically ill medical and surgical patients who have an established systemic inflammatory response syndrome, sepsis, or multiorgan failure.<sup>93,231</sup> The main early pathophysiologic disturbance in trauma and perioperative patients is occult hypovolemia, which can be ameliorated with fluids alone.<sup>232</sup> In contrast, the pathophysiologic disturbances in critically ill septic patients with multiorgan failure may be much more profound and involve abnormalities at the level of the microcirculation and mitochondria. These critically ill patients might not be able to increase oxygen use regardless of oxygen delivery.<sup>233,234</sup>

Goal-directed therapy in the perioperative period is still an area of ongoing research and considerable uncertainty. Several retrospective studies suggest that the large fluid volumes required for increasing cardiac index and oxygen delivery to supranormal values might result in congestive heart failure<sup>72</sup> and increased abdominal pressure leading to gastric hypoperfusion and acute renal failure.<sup>235</sup> Positive inotropic agents might increase systemic oxygen consumption owing to their thermogenic effect, hence paradoxically decreasing venous oxygen saturation despite increased cardiac output.<sup>90</sup> Increasing myocardial oxygen consumption might also trigger acute ischemic events.<sup>72</sup>

For perioperative goal-directed therapy to have a beneficial effect on mortality, treated patients need to be at a very high-risk group (at least 15–20% predicted mortality, according to a recent meta-analysis<sup>236</sup>). Older patients (above 65 years) with coexisting cardiorespiratory diseases may be one such group.<sup>237</sup> A low anaerobic threshold on preoperative cardiopulmonary exercise testing or a clinical assessment of the ability to climb 2 flights of stairs might also help identify patients who will not be able to increase oxygen delivery perioperatively without aggressive therapeutic interventions.<sup>238,239</sup> Patients with lower mor-

tality risk might still benefit from goal-directed therapy by having a reduced complication rate or shortened hospital length of stay.

To provide any benefit, hemodynamic goals must be achieved early, either pre- or intraoperatively. In most patients, optimization of volume status is all that is required. Patients with known cardiac dysfunction may require inotropic therapy in addition to fluid resuscitation, guided either by cardiac output or venous oxygen saturation. Clinical attention to development of fluid overload and increased oxygen consumption may reduce potential complications of goal directed therapy. When performed properly and applied to appropriate patient cohorts, perioperative hemodynamic optimization may not only improve outcome, but also may prove to be a cost-effective intervention as the reduction in complications compensates for the increased monitoring costs and ICU use.<sup>240</sup>

### Discrepant Clinical Data and Troubleshooting Monitoring Problems

One of the more important roles played by the anesthesiologist in the care of the critically ill patient is to determine that the monitored data are accurate and, based on these data and the rest of the patient's history, physical findings, and testing results, to arrive at a clinical diagnosis. A common challenge arises when monitoring results provide discrepant data or are otherwise inconsistent with the clinical condition of the patient and the working clinical diagnosis. In these circumstances, a methodical approach is helpful, one that is based upon a good understanding of monitoring equipment and patient physiology. Box 29–9

#### BOX 29–9.

##### Standard Steps for Troubleshooting Unexpected Monitored Values

- Recognize clinical urgency
- Address technical considerations
- Confirm digital values with accompanying waveforms
- Confirm measurements using another technique
- Cross validate measurements with another monitored variable
- Consider physiologic and pathophysiologic explanations
- Consider iatrogenic causes

summarizes the recommended steps in the evaluation of discrepant data. These steps can be performed rapidly and some even simultaneously. Although less common, there are certainly clinical situations wherein apparently normal monitored values are in fact spurious. Recognition of these problems begins with knowledge of the clinical condition of the patient and the clinical context in which the monitored value is observed.

### KEY REFERENCES

1. Mark JB. Central venous pressure monitoring: clinical insights beyond the numbers. *J Cardiothorac Vasc Anesth* 1991;5:163–173.
2. O'Quin R, Marini JJ. Pulmonary artery occlusion pressure: clinical physiology, measurement, and interpretation. *Am Rev Respir Dis* 1983;128:319–326.
3. Pinsky MR. Pulmonary artery occlusion pressure. *Intensive Care Med* 2003;29:19–22.
4. Bloos F, Reinhart K. Venous oximetry. *Intensive Care Med* 2005;31:911–913.
5. Nishikawa T, Dohi S. Errors in the measurement of cardiac output by thermodilution. *Can J Anaesth* 1993;40(2):142–153.
6. Michard F. Changes in arterial pressure during mechanical ventilation. *Anesthesiology* 2005;103(2):419–428.
7. Siegemund M, van Bommel J, Ince C. Assessment of regional tissue oxygenation. *Intensive Care Med* 1999;25:1044.
8. Davies SJ, Wilson RJ. Preoperative optimization of the high-risk surgical patient. *Br J Anaesth* 2004;93:121–128.

### REFERENCES

1. Cope DK. Monitoring in the 19th century: from blood-letting to blood-flow measurements. *ASA Newsl* 2002;66(9):6–8.
2. Young D, Griffiths J. Clinical trials of monitoring in anaesthesia, critical care and acute ward care: a review. *Br J Anaesth* 2006;97(1):39–45.

3. Jain M, Canham M, Upadhyay D, Corbridge T. Variability in interventions with pulmonary artery catheter data. *Intensive Care Med* 2003;29(11):2059–2062.
4. Cohn JN. Blood pressure measurement in shock. Mechanism of inaccuracy in auscultatory and palpatory methods. *JAMA* 1967;199:972–976.
5. Borow KM, Newburger JW. Noninvasive estimation of central aortic pressure using the oscillometric method for analyzing systemic artery pulsatile blood flow: comparative study of indirect systolic, diastolic, and mean brachial artery pressure with simultaneous direct ascending aortic pressure measurements. *Am Heart J* 1982;103:879–886.
6. Gravlee GP, Brockschmidt JK. Accuracy of four indirect methods of blood pressure measurement, with hemodynamic correlations. *J Clin Monit* 1990;6:284–298.
7. Gardner RM. Direct blood pressure measurement—dynamic response requirements. *Anesthesiology* 1981;54(3):227–236.
8. Courtois M, Fattal PG, Kovacs SJ, Tiefenbrunn AJ, Ludbrook PA. Anatomically and physiologically based reference level for measurement of intracardiac pressures. *Circulation* 1995;92:1994–2000.
9. O'Rourke MF, Gallagher DE. Pulse wave analysis. *J Hypertension* 1996;14(5):S147–S157.
10. Chauhan S, Saxena N, Mehrotra S, Rao BH, Sahu M. Femoral artery pressures are more reliable than radial artery pressures on initiation of cardiopulmonary bypass. *J Cardiothorac Vasc Anesth* 2000;14(3):274–276.
11. Dorman T, Breslow MJ, Lipsett PA, et al. Radial artery pressure monitoring underestimates central arterial pressure during vasopressor therapy in critically ill surgical patients. *Crit Care Med* 1998;26(10):1646–1649.
12. Coriat P, Vrillon M, Perel A, et al. A comparison of systolic blood pressure variations and echocardiographic estimates of end-diastolic left ventricular size in patients after aortic surgery. *Anesth Analg* 1994;78(1):46–53.
13. Rooke GA, Schwid HA, Shapira Y. The effect of graded hemorrhage and intravascular volume replacement on systolic pressure variation in humans during mechanical and spontaneous ventilation. *Anesth Analg* 1995;80(5):925–932.
14. Tegtmeyer K, Brady G, Lai S, Hodo R, Braner D. Videos in clinical medicine. Placement of an arterial line. *N Engl J Med* 2006;354(15):e13.
15. Barnes RW, Foster EJ, Janssen GA, Boutros AR. Safety of brachial arterial catheters as monitors in the intensive care unit—prospective evaluation with the Doppler ultrasonic velocity detector. *Anesthesiology* 1976;44(3):260–264.
16. Anonymous. Standards for Basic Anesthesia Monitoring. ASA Standards, Guidelines and Statements. Park Ridge, IL: American Society of Anesthesiologists, 1993:4–5.
17. Charlson ME, MacKenzie CR, Gold JP, Ales KL, Topkins M, Shires GT. Intraoperative blood pressure. What patterns identify patients at risk for postoperative complications? *Ann Surg* 1990;212(5):567–580.
18. Reich DL, Bennett-Guerrero E, Bodian CA, Hossain S, Winfree W, Krol M. Intraoperative tachycardia and hypertension are independently associated with adverse outcome in noncardiac surgery of long duration. *Anesth Analg* 2002;95(2):273–277.
19. Alford JW, Palumbo MA, Barnum MJ. Compartment syndrome of the arm: a complication of noninvasive blood pressure monitoring during thrombolytic therapy for myocardial infarction. *J Clin Monit Comput* 2002;17(3-4):163–166.
20. Wilkins RG. Radial artery cannulation and ischaemic damage: a review. *Anaesthesia* 1985;40(9):896–899.
21. Singleton RJ, Webb RK, Ludbrook GL, Fox MA. The Australian Incident Monitoring Study. Problems associated with vascular access: an analysis of 2000 incident reports. *Anaesth Intensive Care* 1993;21(5):664–669.
22. O'Grady NP, Alexander M, Dellinger EP, et al. Guidelines for the prevention of intravascular catheter-related infections. Centers for Disease Control and Prevention. *MMWR Recomm Rep* 2002;51(RR-10):1–29.
23. Sulek CA, Gravenstein N, Blackshear RH, Weiss L. Head rotation during internal jugular vein cannulation and the risk of carotid artery puncture. *Anesth Analg* 1996;82(1):125–128.
24. Daily PO, Griep RB, Shumway NE. Percutaneous internal jugular vein cannulation. *Arch Surg* 1970;101(4):534–536.
25. Hind D, Calvert N, McWilliams R, et al. Ultrasonic locating devices for central venous cannulation: meta-analysis. *BMJ* 2003;327(7411):361.
26. The National Institute for Clinical Excellence. The Effectiveness and Cost-Effectiveness of Ultrasound Locating Devices for Central Venous Access. Sheffield, UK: Trent Institute for Health Services Research, 2002:1–98.
27. Albrecht K, Nave H, Breitmeier D, Panning B, Troger HD. Applied anatomy of the superior vena cava—the carina as a landmark to guide central venous catheter placement. *Br J Anaesth* 2004;92(1):75–77.
28. Ezri T, Szmuk P, Cohen Y, et al. Carotid artery-internal jugular vein fistula: a complication of internal jugular vein catheterization. *J Cardiothorac Vasc Anesth* 2001;15(2):231–232.
29. Swan HJ, Ganz W, Forrester J, Marcus H, Diamond G, Chonette D. Catheterization of the heart in man with use of a flow-directed balloon-tipped catheter. *N Engl J Med* 1970;283(9):447–451.
30. Mimoso O, Rauss A, Rezik N, Brun-Buisson C, Lemaire F, Brochard L. Pulmonary artery catheterization in critically ill patients: a prospective analysis of outcome changes associated with catheter-prompted changes in therapy. *Crit Care Med* 1994;22(4):573–579.
31. Dalen JE, Bone RC. Is it time to pull the pulmonary artery catheter? *JAMA* 1996;276:916–918.
32. De Backer D. Hemodynamic assessment: the technique or the physician at fault? *Intensive Care Med* 2003;29(11):1865–1867.
33. Iberti TJ, Fischer EP, Leibowitz AB, Panacek EA, Silverstein JH, Albertson TE. A multicenter study of physicians' knowledge of the pulmonary artery catheter. Pulmonary Artery Catheter Study Group. *JAMA* 1990;264(22):2928–2932.
34. Squara P, Bennett D, Perret C. Pulmonary artery catheter: does the problem lie in the users? *Chest* 2002;121(6):2009–2015.
35. Roizen M, Berger D, Gabel R, et al. Practice guidelines for pulmonary artery catheterization: an updated report by the American Society of Anesthesiologists Task Force on Pulmonary Artery Catheterization. *Anesthesiology* 2003;99(4):988–1014.
36. Pulmonary artery catheter consensus conference: consensus statement. *Crit Care Med* 1997;25(6):910–925.
37. Bernard GR, Sopko G, Cerra F, et al. Pulmonary artery catheterization and clinical outcomes: National Heart, Lung, and Blood Institute and Food and Drug Administration Workshop Report. Consensus statement. *JAMA* 2000;283(19):2568–2572.
38. Parlow JL, Milne B, Cervenka FW. Balloon flotation is more important than flow direction in determining the position of flow-directed pulmonary artery catheters. *J Cardiothorac Vasc Anesth* 1992;6:20–23.
39. Szabo Z. A simple method to pass a pulmonary artery flotation catheter rapidly into the pulmonary artery in anaesthetized patients. *Br J Anaesth* 2003;90(6):794–796.
40. Mark JB. Atlas of Cardiovascular Monitoring. New York: Churchill Livingstone, 1998.
41. Tempe DK, Datt V, Banerjee A, et al. Case 5-2004: Transesophageal echocardiography-guided insertion of a pulmonary artery catheter. *J Cardiothorac Vasc Anesth* 2004;18(5):657–662.
42. Pinsky MR. Pulmonary artery occlusion pressure. *Intensive Care Med* 2003;29(1):19–22.
43. Falicov RE, Resnekov L. Relationship of the pulmonary artery end-diastolic pressure to the left ventricular end-diastolic and mean filling pressures in patients with and without left ventricular dysfunction. *Circulation* 1970;42:65–73.
44. O'Quin R, Marini JJ. Pulmonary artery occlusion pressure: clinical physiology, measurement, and interpretation. *Am Rev Respir Dis* 1983;128(2):319–326.
45. West JB, Dollery CT, Naimark A. Distribution of blood flow in isolated lung: relation to vascular and alveolar pressures. *J Appl Physiol* 1964;19:713–724.



46. Teboul JL, Pinsky MR, Mercat A, et al. Estimating cardiac filling pressure in mechanically ventilated patients with hyperinflation. *Crit Care Med* 2000;28(11):3631–3636.
47. Marini JJ, O'Quin R, Culver BH, Butler J. Estimation of transmural cardiac pressures during ventilation with PEEP. *J Appl Physiol* 1982;53(2):384–391.
48. Jardin F, Delorme G, Hardy A, Auvert B, Beauchet A, Bourdarias JP. Reevaluation of hemodynamic consequences of positive pressure ventilation: emphasis on cyclic right ventricular afterloading by mechanical lung inflation. *Anesthesiology* 1990;72(6):966–970.
49. Sharkey SW. Beyond the wedge: clinical physiology and the Swan-Ganz catheter. *Am J Med* 1987;83(1):111–122.
50. Shah KB, Rao TL, Laughlin S, El-Etr AA. A review of pulmonary artery catheterization in 6,245 patients. *Anesthesiology* 1984;61(3):271–275.
51. Procaccini B, Clementi G. [Pulmonary artery catheterization in 9071 cardiac surgery patients: a review of complications]. *Ital Heart J* 2004;5(12):891–899.
52. Harvey S, Harrison DA, Singer M, et al. Assessment of the clinical effectiveness of pulmonary artery catheters in management of patients in intensive care (PAC-Man): a randomised controlled trial. *Lancet* 2005;366(9484):472–477.
53. Luck JC, Engel TR. Transient right bundle-branch block with "Swan-Ganz" catheterization. *Am Heart J* 1976;92(2):263–264.
54. Sprung CL, Elser B, Schein RM, Marcial EH, Schrager BR. Risk of right bundle-branch block and complete heart block during pulmonary artery catheterization. *Crit Care Med* 1989;17(1):1–3.
55. Fibuch EE, Tuohy GF. Intracardiac knotting of a flow-directed balloon-tipped catheter. *Anesth Analg* 1980;59(3):217–212.
56. Kranz A, Mundigler G, Bankier A, Daneschvar H, Pacher R, Siostrzonek P. Knotting of two central venous catheters: a rare complication of pulmonary artery catheterization. *Wien Klin Wochenschr* 1996;108(13):404–406.
57. Schwartz KV, Garcia FG. Entanglement of Swan-Ganz catheter around an intracardiac structure. *JAMA* 1977;237(12):1198–1199.
58. Dumesnil JG, Proulx G. A new nonsurgical technique for untying tight knots in flow-directed balloon catheters. *Am J Cardiol* 1984;53(2):395–396.
59. Randolph AG, Cook DJ, Gonzales CA, Andrew M. Benefit of heparin in central venous and pulmonary artery catheters: a meta-analysis of randomized controlled trials. *Chest* 1998;113(1):165–171.
60. Sandham JD, Hull RD, Brant RF, et al. A randomized, controlled trial of the use of pulmonary-artery catheters in high-risk surgical patients. *N Engl J Med* 2003;348(1):5–14.
61. Foote GA, Schabel SI, Hodges M. Pulmonary complications of the flow-directed balloon-tipped catheter. *N Engl J Med* 1974;290(17):927–931.
62. Boscoe MJ, de Lange S. Damage to the tricuspid valve with a Swan-Ganz catheter. *Br Med J (Clin Res Ed)* 1981;283(6287):346–347.
63. O'Toole JD, Wurtzbacher JJ, Wearer NE, Jain AC. Pulmonary-valve injury and insufficiency during pulmonary-artery catheterization. *N Engl J Med* 1979;301(21):1167–1168.
64. Ehrie M, Morgan AP, Moore FD, O'Connor NE. Endocarditis with the indwelling balloon-tipped pulmonary artery catheter in burn patients. *J Trauma* 1978;18(9):664–666.
65. Hartmann G, Steib A, Ludes B, Ravanello J. [Perforation of the pulmonary artery following Swan-Ganz catheterization]. *Ann Fr Anesth Reanim* 1988;7(6):486–493.
66. Kearney TJ, Shabot MM. Pulmonary artery rupture associated with the Swan-Ganz catheter. *Chest* 1995;108(5):1349–1352.
67. Klafta JM, Olson JP. Emergent lung separation for management of pulmonary artery rupture. *Anesthesiology* 1997;87(5):1248–1250.
68. Tayoro J, Dequin PF, Delhommais A, Alison D, Perrotin D. Rupture of pulmonary artery induced by Swan-Ganz catheter: success of coil embolization. *Intensive Care Med* 1997;23(2):198–200.
69. Rapoport J, Teres D, Steingrub J, Higgins T, McGee W, Lemeshow S. Patient characteristics and ICU organizational factors that influence frequency of pulmonary artery catheterization. *JAMA* 2000;283(19):2559–2567.
70. Vincent JL, Dhainaut JF, Perret C, Suter P. Is the pulmonary artery catheter misused? A European view. *Crit Care Med* 1998;26(7):1283–1287.
71. Connors AF Jr, Speroff T, Dawson NV, et al. The effectiveness of right heart catheterization in the initial care of critically ill patients. SUPPORT Investigators. *JAMA* 1996;276(11):889–897.
72. Polanczyk CA, Rohde LE, Goldman L, et al. Right heart catheterization and cardiac complications in patients undergoing non-cardiac surgery: an observational study. *JAMA* 2001;286(3):309–314.
73. Valentine RJ, Duke ML, Inman MH, et al. Effectiveness of pulmonary artery catheters in aortic surgery: a randomized trial. *J Vasc Surg* 1998;27(2):203–211.
74. Barone JE, Tucker JB, Rassias D, Corvo PR. Routine perioperative pulmonary artery catheterization has no effect on rate of complications in vascular surgery: a meta-analysis. *Am Surg* 2001;67(7):674–679.
75. Tuman KJ, McCarthy RJ, Spiess BD, et al. Effect of pulmonary artery catheterization on outcome in patients undergoing coronary artery surgery. *Anesthesiology* 1989;70(2):199–206.
76. Binanay C, Califf RM, Hasselblad V, et al. Evaluation study of congestive heart failure and pulmonary artery catheterization effectiveness: the ESCAPE trial. *JAMA* 2005;294(13):1625–1633.
77. Wheeler AP, Bernard GR, Thompson BT, et al. Pulmonary-artery versus central venous catheter to guide treatment of acute lung injury. *N Engl J Med* 2006;354(21):2213–2224.
78. Rhodes A, Cusack RJ, Newman PJ, Grounds RM, Bennett ED. A randomised, controlled trial of the pulmonary artery catheter in critically ill patients. *Intensive Care Med* 2002;28(3):256–264.
79. Richard C, Warszawski J, Anguel N, et al. Early use of the pulmonary artery catheter and outcomes in patients with shock and acute respiratory distress syndrome: a randomized controlled trial. *JAMA* 2003;290(20):2713–2720.
80. De Backer D, Creteur J, Vincent JL. Perioperative optimization and right heart catheterization: what technique in which patient? *Crit Care* 2003;7(3):201–202.
81. Shah MR, Hasselblad V, Stevenson LW, et al. Impact of the pulmonary artery catheter in critically ill patients: meta-analysis of randomized clinical trials. *JAMA* 2005;294(13):1664–1670.
82. Kavarana MN, Azimuddin K, Agarwal A, Balsano N, Cayten CG, Agarwal N. Hemodynamic monitoring in the elderly undergoing elective colon resection for cancer. *Am Surg* 2003;69(5):411–415.
83. Chittock DR, Dhingra VK, Ronco JJ, et al. Severity of illness and risk of death associated with pulmonary artery catheter use. *Crit Care Med* 2004;32(4):911–915.
84. Friese RS, Shafi S, Gentilello LM. Pulmonary artery catheter use is associated with reduced mortality in severely injured patients: a National Trauma Data Bank analysis of 53,312 patients. *Crit Care Med* 2006;34(6):1597–1601.
85. Zaidan JR, Freniere S. Use of a pacing pulmonary artery catheter during cardiac surgery. *Ann Thorac Surg* 1983;35(6):633–636.
86. Bloos F, Reinhart K. Venous oximetry. *Intensive Care Med* 2005;31(7):911–913.
87. Inomata S, Nishikawa T, Taguchi M. Continuous monitoring of mixed venous oxygen saturation for detecting alterations in cardiac output after discontinuation of cardiopulmonary bypass. *Br J Anaesth* 1994;72(1):11–16.
88. Spiess BD, Tuman KJ, McCarthy RJ, et al. Oxygen consumption and mixed venous oxygen saturation monitoring during orthotopic liver transplantation. *J Clin Monit* 1992;8(1):7–11.
89. Powelson JA, Maini BS, Bishop RL, Sottile FD. Continuous monitoring of mixed venous oxygen saturation during aortic operations. *Crit Care Med* 1992;20(3):332–336.
90. Teboul JL, Graini L, Boujdaria R, Berton C, Richard C. Cardiac index vs oxygen-



derived parameters for rational use of dobutamine in patients with congestive heart failure. *Chest* 1993;103(1):81-85.

91. Rivers E, Nguyen B, Havstad S, et al. Early goal-directed therapy in the treatment of severe sepsis and septic shock. *N Engl J Med* 2001;345(19):1368-1377.
92. Polonen P, Ruokonen E, Hippelainen M, Poyhonen M, Takala J. A prospective, randomized study of goal-oriented hemodynamic therapy in cardiac surgical patients. *Anesth Analg* 2000;90(5):1052-1059.
93. Gattinoni L, Brazzi L, Pelosi P, et al. A trial of goal-oriented hemodynamic therapy in critically ill patients. SvO<sub>2</sub> Collaborative Group. *N Engl J Med* 1995;333(16):1025-1032.
94. Reinhart K, Kuhn HJ, Hartog C, Bredle DL. Continuous central venous and pulmonary artery oxygen saturation monitoring in the critically ill. *Intensive Care Med* 2004;30(8):1572-1578.
95. Scalea TM, Hartnett RW, Duncan AO, et al. Central venous oxygen saturation: a useful clinical tool in trauma patients. *J Trauma* 1990;30(12):1539-1543.
96. Vincent JL, Thirion M, Brimiouille S, Lejeune P, Kahn RJ. Thermodilution measurement of right ventricular ejection fraction with a modified pulmonary artery catheter. *Intensive Care Med* 1986;12(1):33-38.
97. Kay HR, Afshari M, Barash P, et al. Measurement of ejection fraction by thermal dilution techniques. *J Surg Res* 1983;34(4):337-346.
98. Boldt J, Kling D, Moosdorf R, Hempelmann G. Influence of acute volume loading on right ventricular function after cardiopulmonary bypass. *Crit Care Med* 1989;17(6):518-522.
99. Vincent JL, Gris P, Coffernils M, et al. Myocardial depression characterizes the fatal course of septic shock. *Surgery* 1992;111(6):660-667.
100. Redl G, Germann P, Plattner H, Hammerle A. Right ventricular function in early septic shock states. *Intensive Care Med* 1993;19(1):3-7.
101. Dhingra VK, Fenwick JC, Walley KR, Chittock DR, Ronco JJ. Lack of agreement between thermodilution and Fick cardiac output in critically ill patients. *Chest* 2002;122(3):990-997.
102. Singer M. What's in a beat? *Intensive Care Med* 2003;29(10):1617-1620.
103. Chaney JC, Derdak S. Minimally invasive hemodynamic monitoring for the intensivist: current and emerging technology. *Crit Care Med* 2002;30(10):2338-2345.
104. Nishikawa T, Dohi S. Errors in the measurement of cardiac output by thermodilution. *Can J Anaesth* 1993;40(2):142-153.
105. Wyse SD, Pfitzner J, Rees A, Lincoln JC, Branthwaite MA. Measurement of cardiac output by thermal dilution in infants and children. *Thorax* 1975;30(3):262-265.

106. Matthew EB, Vender JS. Comparison of thermodilution cardiac output measured by different computers. *Crit Care Med* 1987;15(10):989.
107. Moise SF, Sinclair CJ, Scott DH. Pulmonary artery blood temperature and the measurement of cardiac output by thermodilution. *Anaesthesia* 2002;57(6):562-566.
108. Jansen JR, Versprille A. Improvement of cardiac output estimation by the thermodilution method during mechanical ventilation. *Intensive Care Med* 1986;12(2):71-79.
109. Pearl RG, Rosenthal MH, Nielson L, Ashton JPA, Brown BW. Effect of injectate volume and temperature on thermodilution cardiac output determination. *Anesthesiology* 1986;64(6):798-801.
110. Wetzel RC, Latson TW. Major errors in thermodilution cardiac output measurement during rapid volume infusion. *Anesthesiology* 1985;62(5):684-687.
111. Bazaral MG, Petre J, Novoa R. Errors in thermodilution cardiac output measurements caused by rapid pulmonary artery temperature decreases after cardiopulmonary bypass. *Anesthesiology* 1992;77(1):31-37.
112. Latson TW, Whitten CW, O'Flaherty D. Ventilation, thermal noise, and errors in cardiac output measurements after cardiopulmonary bypass. *Anesthesiology* 1993;79(6):1233-1243.
113. Heerdt PM, Blessios GA, Beach ML, Hogue CW. Flow dependency of error in thermodilution measurement of cardiac output during acute tricuspid regurgitation. *J Cardiothorac Vasc Anesth* 2001;15(2):183-187.
114. Artucio H, Hurtado J, Zimet L, de Paula J, Beron M. PEEP-induced tricuspid regurgitation. *Intensive Care Med* 1997;23(8):836.
115. van Grondelle A, Ditchey RV, Groves BM, Wagner WW Jr, Reeves JT. Thermodilution method overestimates low cardiac output in humans. *Am J Physiol* 1983;245(4):H690-H692.
116. Hoefl A. Transpulmonary indicator dilution: an alternative approach for hemodynamic monitoring. In: Vincent J, ed. *Yearbook of Intensive Care and Emergency Medicine*. Berlin: Springer, 1995:593-605.
117. von Spiegel T, Wietasch G, Bursch J, Hoefl A. [Cardiac output determination with transpulmonary thermodilution. An alternative to pulmonary catheterization?]. *Anaesthesist* 1996;45(11):1045-1050.
118. Segal E, Katzenelson R, Berkenstadt H, Perel A. Transpulmonary thermodilution cardiac output measurement using the axillary artery in critically ill patients. *J Clin Anesth* 2002;14(3):210-213.
119. Mielck F, Buhre W, Hanekop G, Tirilomis T, Hilgers R, Sonntag H. Comparison of continuous cardiac output measurements in patients after cardiac surgery. *J Cardiothorac Vasc Anesth* 2003;17(2):211-216.

120. Linton R, Band D, O'Brien T, Jonas M, Leach R. Lithium dilution cardiac output measurement: a comparison with thermodilution. *Crit Care Med* 1997;25(11):1796-1800.
121. Garcia-Rodriguez C, Pittman J, Cassell CH, et al. Lithium dilution cardiac output measurement: a clinical assessment of central venous and peripheral venous indicator injection. *Crit Care Med* 2002;30(10):2199-2204.
122. Linton RA, Jonas MM, Tibby SM, et al. Cardiac output measured by lithium dilution and transpulmonary thermodilution in patients in a paediatric intensive care unit. *Intensive Care Med* 2000;26(10):1507-1511.
123. Jaffe MB. Partial CO<sub>2</sub> rebreathing cardiac output—operating principles of the NICO system. *J Clin Monit Comput* 1999;15(6):387.
124. Osterlund B, Gedeon A, Krill P, Johansson G, Reiz S. A new method of using gas exchange measurements for the noninvasive determination of cardiac output: clinical experiences in adults following cardiac surgery. *Acta Anaesthesiol Scand* 1995;39(6):727-732.
125. van Heerden PV, Baker S, Lim SI, Weidman C, Bulsara M. Clinical evaluation of the non-invasive cardiac output (NICO) monitor in the intensive care unit. *Anaesth Intensive Care* 2000;28(4):427-430.
126. Yelderman M. Continuous measurement of cardiac output with the use of stochastic system identification techniques. *J Clin Monit* 1990;6(4):322-332.
127. Bottiger BW, Rauch H, Bohrer H, et al. Continuous versus intermittent cardiac output measurement in cardiac surgical patients undergoing hypothermic cardiopulmonary bypass. *J Cardiothorac Vasc Anesth* 1995;9(4):405-411.
128. Botero M, Kirby D, Lobato EB, Staples ED, Gravenstein N. Measurement of cardiac output before and after cardiopulmonary bypass: comparison among aortic transit-time ultrasound, thermodilution, and noninvasive partial CO<sub>2</sub> rebreathing. *J Cardiothorac Vasc Anesth* 2004;18(5):563.
129. Siegel LC, Hennessy MM, Pearl RG. Delayed time response of the continuous cardiac output pulmonary artery catheter. *Anesth Analg* 1996;83(6):1173-1177.
130. Lichtenthal PR, Wade LD. Continuous cardiac output measurements. *J Cardiothorac Vasc Anesth* 1994;8(6):668-670.
131. Wesseling KH, Jansen JR, Settels JJ, Schreuder JJ. Computation of aortic flow from pressure in humans using a nonlinear, three-element model. *J Appl Physiol* 1993;74(5):2566-2573.
132. Linton NW, Linton RA. Estimation of changes in cardiac output from the arterial blood pressure waveform in the upper limb. *Br J Anaesth* 2001;86(4):486-496.
133. van Lieshout JJ, Wesseling KH. Continuous cardiac output by pulse contour analysis? *Br J Anaesth* 2001;86(4):467-469.
134. Pittman J, Bar-Yosef S, Sum-Ping J, Sherwood M, Mark J. Continuous cardiac

- output monitoring with pulse contour analysis: a comparison with lithium indicator dilution cardiac output measurement. *Crit Care Med* 2005;33(9):2015–2021.
135. Weissman C, Ornstein EJ, Young WL. Arterial pulse contour analysis trending of cardiac output: hemodynamic manipulations during cerebral arteriovenous malformation resection. *J Clin Monit* 1993;9(5):347–353.
136. Singer M. Esophageal Doppler monitoring of aortic blood flow: beat-by-beat cardiac output monitoring. *Int Anesthesiol Clin* 1993;31(3):99–125.
137. Odenstedt H, Aneman A, Oi Y, Svensson M, Stenqvist O, Lundin S. Descending aortic blood flow and cardiac output: a clinical and experimental study of continuous oesophageal echo-Doppler flowmetry. *Acta Anaesthesiol Scand* 2001;45(2):180–187.
138. Monnet X, Rienzo M, Osman D, et al. Esophageal Doppler monitoring predicts fluid responsiveness in critically ill ventilated patients. *Intensive Care Med* 2005;31(9):1195–1201.
139. Dark PM, Singer M. The validity of trans-esophageal Doppler ultrasonography as a measure of cardiac output in critically ill adults. *Intensive Care Med* 2004;30(11):2060–2066.
140. Gan TJ, Soppitt A, Maroof M, et al. Goal-directed intraoperative fluid administration reduces length of hospital stay after major surgery. *Anesthesiology* 2002;97(4):820–826.
141. Venn R, Steele A, Richardson P, Poloniecki J, Grounds M, Newman P. Randomized controlled trial to investigate influence of the fluid challenge on duration of hospital stay and perioperative morbidity in patients with hip fractures. *Br J Anaesth* 2002;88(1):65–71.
142. Mythen MG, Webb AR. Perioperative plasma volume expansion reduces the incidence of gut mucosal hypoperfusion during cardiac surgery. *Arch Surg* 1995;130(4):423–429.
143. Sinclair S, James S, Singer M. Intraoperative intravascular volume optimisation and length of hospital stay after repair of proximal femoral fracture: randomised controlled trial. *BMJ* 1997;315(7113):909–912.
144. Wakeling HG, McFall MR, Jenkins CS, et al. Intraoperative oesophageal Doppler guided fluid management shortens postoperative hospital stay after major bowel surgery. *Br J Anaesth* 2005;95(5):634–642.
145. Schlichtig R, Bowles SA. Distinguishing between aerobic and anaerobic appearance of dissolved CO<sub>2</sub> in intestine during low flow. *J Appl Physiol* 1994;76(6):2443–2451.
146. Kolkman JJ, Otte JA, Groeneveld AB. Gastrointestinal luminal PCO<sub>2</sub> tonometry: an update on physiology, methodology and clinical applications. *Br J Anaesth* 2000;84(1):74–86.
147. Schlichtig R, Mehta N, Gayowski TJ. Tissue-arterial PCO<sub>2</sub> difference is a better marker of ischemia than intramural pH (pHi) or arterial pH-pHi difference. *J Crit Care* 1996;11(2):51–56.
148. Adar R, Franklin A, Spark RF, Rosoff CB, Salzman EW. Effect of dehydration and cardiac tamponade on superior mesenteric artery flow: role of vasoactive substances. *Surgery* 1976;79(5):534–543.
149. Hamilton-Davies C, Mythen MG, Salmon JB, Jacobson D, Shukla A, Webb AR. Comparison of commonly used clinical indicators of hypovolaemia with gastrointestinal tonometry. *Intensive Care Med* 1997;23(3):276–281.
150. Ivatury RR, Simon RJ, Havriliak D, Garcia C, Greenbarg J, Stahl WM. Gastric mucosal pH and oxygen delivery and oxygen consumption indices in the assessment of adequacy of resuscitation after trauma: a prospective, randomized study. *J Trauma* 1995;39(1):128–134.
151. Mythen MG, Webb AR. The role of gut mucosal hypoperfusion in the pathogenesis of post-operative organ dysfunction. *Intensive Care Med* 1994;20(3):203–209.
152. Bennett-Guerrero E, Panah MH, Bodian CA, et al. Automated detection of gastric luminal partial pressure of carbon dioxide during cardiovascular surgery using the Tonocap. *Anesthesiology* 2000;92(1):38–45.
153. Lebuffe G, Vallet B, Takala J, et al. A European, multicenter, observational study to assess the value of gastric-to-end tidal PCO<sub>2</sub> difference in predicting postoperative complications. *Anesth Analg* 2004;99(1):166–172.
154. Gutierrez G, Palizas F, Doglio G, et al. Gastric intramucosal pH as a therapeutic index of tissue oxygenation in critically ill patients. *Lancet* 1992;339(8787):195–199.
155. Poeze M, Takala J, Greve JW, Ramsay G. Pre-operative tonometry is predictive for mortality and morbidity in high-risk surgical patients. *Intensive Care Med* 2000;26(9):1272–1281.
156. Pargger H, Hampl KF, Christen P, Staender S, Scheidegger D. Gastric intramucosal pH-guided therapy in patients after elective repair of infrarenal abdominal aneurysms: is it beneficial? *Intensive Care Med* 1998;24(8):769–776.
157. Gomersall CD, Joynt GM, Freebairn RC, Hung V, Buckley TA, Oh TE. Resuscitation of critically ill patients based on the results of gastric tonometry: a prospective, randomized, controlled trial. *Crit Care Med* 2000;28(3):607–614.
158. Landesberg G, Mosseri M, Zahger D, et al. Myocardial infarction after vascular surgery: the role of prolonged stress-induced, ST depression-type ischemia. *J Am Coll Cardiol* 2001;37(7):1839–1845.
159. Mangano DT, Browner WS, Hollenberg M, London MJ, Tubau JF, Tateo IM. Association of perioperative myocardial ischemia with cardiac morbidity and mortality in men undergoing noncardiac surgery. The Study of Perioperative Ischemia Research Group. *N Engl J Med* 1990;323(26):1781–1788.
160. Kaplan JA, Wells PH. Early diagnosis of myocardial ischemia using the pulmonary arterial catheter. *Anesth Analg* 1981;60:789–793.
161. McLaurin LP, Rolett EL, Grossman W. Impaired left ventricular relaxation during pacing-induced ischemia. *Am J Cardiol* 1973;32:751–757.
162. van Daele MERM, Sutherland GR, Mitchell MM, et al. Do changes in pulmonary capillary wedge pressure adequately reflect myocardial ischemia during anesthesia: a correlative preoperative hemodynamic, electrocardiographic, and transesophageal echocardiographic study. *Circulation* 1990;81:865–871.
163. Hall RI, O'Regan N, Gardner M. Detection of intraoperative myocardial ischemia—a comparison among electrocardiographic, myocardial metabolic, and haemodynamic measurements in patients with reduced ventricular function. *Can J Anaesth* 1995;42(6):487–494.
164. Pinsky MR. Clinical significance of pulmonary artery occlusion pressure. *Intensive Care Med* 2003;29(2):175–178.
165. Bernard GR, Artigas A, Brigham KL, et al. The American-European Consensus Conference on ARDS. Definitions, mechanisms, relevant outcomes, and clinical trial coordination. *Am J Respir Crit Care Med* 1994;149(3 Pt 1):818–824.
166. Nunes S, Ruokonen E, Takala J. Pulmonary capillary pressures during the acute respiratory distress syndrome. *Intensive Care Med* 2003;29(12):2174–2179.
167. Mitchell JP, Schuller D, Calandrino FS, Schuster DP. Improved outcome based on fluid management in critically ill patients requiring pulmonary artery catheterization. *Am Rev Respir Dis* 1992;145(5):990–998.
168. Wiedemann HP, Wheeler AP, Bernard GR, et al. Comparison of two fluid-management strategies in acute lung injury. *N Engl J Med* 2006;354(24):2564–2575.
169. Michard F, Schachtrupp A, Toens C. Factors influencing the estimation of extravascular lung water by transpulmonary thermodilution in critically ill patients. *Crit Care Med* 2005;33(6):1243–1247.
170. Sakka SG, Klein M, Reinhart K, Meier-Hellmann A. Prognostic value of extravascular lung water in critically ill patients. *Chest* 2002;122(6):2080–2086.
171. Matejovic M, Krouzecky A, Rokyta R Jr, Novak I. Fluid challenge in patients at risk for fluid loading-induced pulmonary edema. *Acta Anaesthesiol Scand* 2004;48(1):69–73.
172. Kass DA, Maughan WL, Guo ZM, Kono A, Sunagawa K, Sagawa K. Comparative influence of load versus inotropic states on indexes of ventricular contractility: experimental and theoretical analysis based on

- pressure-volume relationships. *Circulation* 1987;76(6):1422-1436.
173. Forrester JS, Diamond G, Chatterjee K, Swan HJ. Medical therapy of acute myocardial infarction by application of hemodynamic subsets (first of two parts). *N Engl J Med* 1976;295(24):1356-1362.
174. Michard F, Reuter DA. Assessing cardiac preload or fluid responsiveness? It depends on the question we want to answer. *Intensive Care Med* 2003;29(8):1396.
175. Ramsey JD, Tisdale LA. Use of ventricular stroke work index and ventricular function curves in assessing myocardial contractility. *Crit Care Nurse* 1995;15(1):61-67.
176. Ognibene FP, Parker MM, Natanson C, Shelhamer JH, Parrillo JE. Depressed left ventricular performance. Response to volume infusion in patients with sepsis and septic shock. *Chest* 1988;93(5):903-910.
177. Poortmans G, Schupfer G, Roosens C, Poelaert J. Transesophageal echocardiographic evaluation of left ventricular function. *J Cardiothorac Vasc Anesth* 2000;14(5):588-598.
178. Thys DM, Hillel Z. Left ventricular performance indices by transesophageal Doppler. *Anesthesiology* 1988;69(5):728-737.
179. Wisner-Eutenier, Lichtwarck-Aschoff M, Zimmermann G, Blumel G, Pfeiffer U. Evaluation of the cardiac function index as a new bedside indicator of cardiac performance. *Intensive Care Med* 1994;20(Suppl 2):S21.
180. Moore TD, Frenneaux MP, Sas R, et al. Ventricular interaction and external constraint account for decreased stroke work during volume loading in CHF. *Am J Physiol Heart Circ Physiol* 2001;281(6):H2385-H2391.
181. Holte K, Sharrock NE, Kehlet H. Pathophysiology and clinical implications of perioperative fluid excess. *Br J Anaesth* 2002;89(4):622-632.
182. Grocott MP, Mythen MG, Gan TJ. Perioperative fluid management and clinical outcomes in adults. *Anesth Analg* 2005;100(4):1093-1106.
183. Connolly CM, Kramer GC, Hahn RG, et al. Isoflurane but not mechanical ventilation promotes extravascular fluid accumulation during crystalloid volume loading. *Anesthesiology* 2003;98(3):670-681.
184. Michard F, Teboul JL. Predicting fluid responsiveness in ICU patients: a critical analysis of the evidence. *Chest* 2002;121(6):2000-2008.
185. Tavernier B, Makhotine O, Lebuffe G, Dupont J, Scherpereel P. Systolic pressure variation as a guide to fluid therapy in patients with sepsis-induced hypotension. *Anesthesiology* 1998;89(6):1313-1321.
186. McGee S, Abernethy WB 3rd, Simel DL. The rational clinical examination. Is this patient hypovolemic? *JAMA* 1999;281(11):1022-1029.
187. Kellen M, Aronson S, Roizen MF, Barnard J, Thisted RA. Predictive and diagnostic tests of renal failure: a review. *Anesth Analg* 1994;78(1):134-142.
188. Boulain T, Achard JM, Teboul JL, Richard C, Perrotin D, Ginies G. Changes in BP induced by passive leg raising predict response to fluid loading in critically ill patients. *Chest* 2002;121(4):1245-1252.
189. Monnet X, Rienzo M, Osman D, et al. Passive leg raising predicts fluid responsiveness in the critically ill. *Crit Care Med* 2006;34(5):1402-1407.
190. Kumar A, Anel R, Bunnell E, et al. Pulmonary artery occlusion pressure and central venous pressure fail to predict ventricular filling volume, cardiac performance, or the response to volume infusion in normal subjects. *Crit Care Med* 2004;32(3):691-699.
191. Magder S, Georgiadis G, Cheong T. Respiratory variations in right atrial pressure predict the response to fluid challenge. *J Crit Care* 1992;7:76-85.
192. Reuse C, Vincent JL, Pinsky MR. Measurements of right ventricular volumes during fluid challenge. *Chest* 1990;98(6):1450-1454.
193. Chang MC, Blinman TA, Rutherford EJ, Nelson LD, Morris JA Jr. Preload assessment in trauma patients during large-volume shock resuscitation. *Arch Surg* 1996;131(7):728-731.
194. Wagner JG, Leatherman JW. Right ventricular end-diastolic volume as a predictor of the hemodynamic response to a fluid challenge. *Chest* 1998;113(4):1048-1054.
195. Cheatham ML, Nelson LD, Chang MC, Safcsak K. Right ventricular end-diastolic volume index as a predictor of preload status in patients on positive end-expiratory pressure. *Crit Care Med* 1998;26(11):1801-1806.
196. Michard F, Alaya S, Zarka V, Bahloul M, Richard C, Teboul JL. Global end-diastolic volume as an indicator of cardiac preload in patients with septic shock. *Chest* 2003;124(5):1900-1908.
197. Wiesenack C, Prasser C, Keyl C, Rodig G. Assessment of intrathoracic blood volume as an indicator of cardiac preload: single transpulmonary thermodilution technique versus assessment of pressure preload parameters derived from a pulmonary artery catheter. *J Cardiothorac Vasc Anesth* 2001;15(5):584-588.
198. Della Rocca G, Costa GM, Coccia C, Pompei L, Di Marco P, Pietropaoli P. Preload index: pulmonary artery occlusion pressure versus intrathoracic blood volume monitoring during lung transplantation. *Anesth Analg* 2002;95(4):835-843.
199. Thys DM, Hillel Z, Goldman ME, Mindich BP, Kaplan JA. A comparison of hemodynamic indices derived by invasive monitoring and two-dimensional echocardiography. *Anesthesiology* 1987;67(5):630-634.
200. Vieillard-Baron A, Chergui K, Rabiller A, et al. Superior vena caval collapsibility as a gauge of volume status in ventilated septic patients. *Intensive Care Med* 2004;30(9):1734-1739.
201. Barbier C, Loubieres Y, Schmit C, et al. Respiratory changes in inferior vena cava diameter are helpful in predicting fluid responsiveness in ventilated septic patients. *Intensive Care Med* 2004;30(9):1740-1746.
202. Michard F. Changes in arterial pressure during mechanical ventilation. *Anesthesiology* 2005;103(2):419-428.
203. Perel A, Pizov R, Cotev S. Systolic blood pressure variation is a sensitive indicator of hypovolemia in ventilated dogs subjected to graded hemorrhage. *Anesthesiology* 1987;67(4):498-502.
204. Vieillard-Baron A, Chergui K, Augarde R, et al. Cyclic changes in arterial pulse during respiratory support revisited by Doppler echocardiography. *Am J Respir Crit Care Med* 2003;168(6):671-676.
205. Preisman S, DiSegni E, Vered Z, Perel A. Left ventricular preload and function during graded haemorrhage and retransfusion in pigs: analysis of arterial pressure waveform and correlation with echocardiography. *Br J Anaesth* 2002;88(5):716-718.
206. Vieillard-Baron A, Augarde R, Prin S, Page B, Beauchet A, Jardin F. Influence of superior vena caval zone condition on cyclic changes in right ventricular outflow during respiratory support. *Anesthesiology* 2001;95(5):1083-1088.
207. Michard F, Boussat S, Chemla D, et al. Relation between respiratory changes in arterial pulse pressure and fluid responsiveness in septic patients with acute circulatory failure. *Am J Respir Crit Care Med* 2000;162(1):134-138.
208. Kramer A, Zygun D, Hawes H, Easton P, Ferland A. Pulse pressure variation predicts fluid responsiveness following coronary artery bypass surgery. *Chest* 2004;126(5):1563-1568.
209. Berkenstadt H, Margalit N, Hadani M, et al. Stroke volume variation as a predictor of fluid responsiveness in patients undergoing brain surgery. *Anesth Analg* 2001;92(4):984-989.
210. Hofer CK, Muller SM, Furrer L, Klaghofer R, Genoni M, Zollinger A. Stroke volume and pulse pressure variation for prediction of fluid responsiveness in patients undergoing off-pump coronary artery bypass grafting. *Chest* 2005;128(2):848-854.
211. Pinsky MR. Probing the limits of arterial pulse contour analysis to predict preload responsiveness. *Anesth Analg* 2003;96(5):1245-1247.
212. De Backer D, Heenen S, Piagnerelli M, Koch M, Vincent JL. Pulse pressure variations to predict fluid responsiveness: influence of tidal volume. *Intensive Care Med* 2005;31(4):517-523.



213. Michard F. Volume management using dynamic parameters: the good, the bad, and the ugly. *Chest* 2005;128(4):1902-1903.
214. Perel A, Minkovich L, Preisman S, Abiad M, Segal E, Coriat P. Assessing fluid-responsiveness by a standardized ventilatory maneuver: the respiratory systolic variation test. *Anesth Analg* 2005;100(4):942-945.
215. Kumar A, Anel R, Bunnell E, et al. Preload-independent mechanisms contribute to increased stroke volume following large volume saline infusion in normal volunteers: a prospective interventional study. *Crit Care* 2004;8(3):R128-R136.
216. Uusaro A, Ruokonen E, Takala J. Splanchnic oxygen transport after cardiac surgery: evidence for inadequate tissue perfusion after stabilization of hemodynamics. *Intensive Care Med* 1996;22(1):26-33.
217. Rady MY, Rivers EP, Martin GB, Smithline H, Appelton T, Nowak RM. Continuous central venous oximetry and shock index in the emergency department: use in the evaluation of clinical shock. *Am J Emerg Med* 1992;10(6):538-541.
218. Bland RD, Shoemaker WC, Abraham E, Cobo JC. Hemodynamic and oxygen transport patterns in surviving and nonsurviving postoperative patients. *Crit Care Med* 1985;13(2):85-90.
219. Shoemaker WC, Appel PL, Kram HB. Role of oxygen debt in the development of organ failure sepsis, and death in high-risk surgical patients. *Chest* 1992;102(1):208-215.
220. Kaplan LJ, Kellum JA. Initial pH, base deficit, lactate, anion gap, strong ion difference, and strong ion gap predict outcome from major vascular injury. *Crit Care Med* 2004;32(5):1120-1124.
221. Cheifetz IM, Kern FH, Schulman SR, Greeley WJ, Ungerleider RM, Meliones JN. Serum lactates correlate with mortality after operations for complex congenital heart disease. *Ann Thorac Surg* 1997;64(3):735-738.
222. Rossi AF, Khan DM, Hannan R, Bolivar J, Zaidenweber M, Burke R. Goal-directed medical therapy and point-of-care testing improve outcomes after congenital heart surgery. *Intensive Care Med* 2005;31(1):98-104.
223. De Backer D. Lactic acidosis. *Intensive Care Med* 2003;29(5):699-702.
224. Ronco JJ, Fenwick JC, Tweeddale MG, et al. Identification of the critical oxygen delivery for anaerobic metabolism in critically ill septic and nonseptic humans. *JAMA* 1993;270(14):1724-1730.
225. Polonen P, Hippelainen M, Takala R, Ruokonen E, Takala J. Relationship between intra- and postoperative oxygen transport and prolonged intensive care after cardiac surgery: a prospective study. *Acta Anaesthesiol Scand* 1997;41(7):810-817.
226. Yu M, Burchell S, Hasaniya NW, Takanishi DM, Myers SA, Takiguchi SA. Relationship of mortality to increasing oxygen delivery in patients > or = 50, years of age: a prospective, randomized trial. *Crit Care Med* 1998;26(6):1011-1019.
227. Vincent JL, De Backer D. Cardiac output measurement: is least invasive always the best? *Crit Care Med* 2002;30(10):2380-2382.
228. Siegemund M, van Bommel J, Ince C. Assessment of regional tissue oxygenation. *Intensive Care Med* 1999;25(10):1044.
229. Toledo Maciel A, Creteur J, Vincent J-L. Tissue capnometry: does the answer lie under the tongue? *Intensive Care Med* 2004;30(12):2157.
230. Shoemaker WC, Appel PL, Kram HB, Waxman K, Lee TS. Prospective trial of supranormal values of survivors as therapeutic goals in high-risk surgical patients. *Chest* 1988;94(6):1176-1186.
231. Hayes MA, Timmins AC, Yau EH, Palazzo M, Hinds CJ, Watson D. Elevation of systemic oxygen delivery in the treatment of critically ill patients. *N Engl J Med* 1994;330(24):1717-1722.
232. Takala J, Meier-Hellmann A, Eddleston J, Hulstaert P, Sramek V. Effect of dexamethasone on outcome after major abdominal surgery: a prospective, randomized, controlled multicenter study. European Multicenter Study Group on Dexamethasone in Major Abdominal Surgery. *Crit Care Med* 2000;28(10):3417-3423.
233. Alia I, Esteban A, Gordo F, et al. A randomized and controlled trial of the effect of treatment aimed at maximizing oxygen delivery in patients with severe sepsis or septic shock. *Chest* 1999;115(2):453-461.
234. Hayes MA, Timmins AC, Yau EH, Palazzo M, Watson D, Hinds CJ. Oxygen transport patterns in patients with sepsis syndrome or septic shock: influence of treatment and relationship to outcome. *Crit Care Med* 1997;25(6):926-936.
235. Balogh Z, McKinley BA, Cocanour CS, et al. Supranormal trauma resuscitation causes more cases of abdominal compartment syndrome. *Arch Surg* 2003;138(6):637-642.
236. Kern JW, Shoemaker WC. Meta-analysis of hemodynamic optimization in high-risk patients. *Crit Care Med* 2002;30(8):1686-1692.
237. Cook TM, Day CJ. Hospital mortality after urgent and emergency laparotomy in patients aged 65 yr and over. Risk and prediction of risk using multiple logistic regression analysis. *Br J Anaesth* 1998;80(6):776-781.
238. Older P, Hall A, Hader R. Cardiopulmonary exercise testing as a screening test for perioperative management of major surgery in the elderly. *Chest* 1999;116(2):355-362.
239. Girish M, Trayner E Jr, Dammann O, Pinto-Plata V, Celli B. Symptom-limited stair climbing as a predictor of postoperative cardiopulmonary complications after high-risk surgery. *Chest* 2001;120(4):1147-1151.
240. Fenwick E, Wilson J, Sculpher M, Claxton K. Pre-operative optimisation employing dexamethasone or adrenaline for patients undergoing major elective surgery: a cost-effectiveness analysis. *Intensive Care Med* 2002;28(5):599-608.
241. Bishop MH, Shoemaker WC, Appel PL, et al. Prospective, randomized trial of survivor values of cardiac index, oxygen delivery, and oxygen consumption as resuscitation endpoints in severe trauma. *J Trauma* 1995;38(5):780-787.
242. Boyd O, Grounds RM, Bennett ED. A randomized clinical trial of the effect of deliberate perioperative increase of oxygen delivery on mortality in high-risk surgical patients. *JAMA* 1993;270(22):2699-2707.
243. Wilson J, Woods I, Fawcett J, Whall R, Morris C, McManus E. Reducing the risk of major elective surgery: randomised controlled trial of preoperative optimisation of oxygen delivery. *BMJ* 1999;318:1099-1103.
244. Lobo SM, Salgado PF, Castillo VG, et al. Effects of maximizing oxygen delivery on morbidity and mortality in high-risk surgical patients. *Crit Care Med* 2000;28(10):3396-3404.
245. Berlauck JF, Abrams JH, Gilmour IJ, O'Connor SR, Knighton DR, Cerra FB. Preoperative optimization of cardiovascular hemodynamics improves outcome in peripheral vascular surgery. A prospective, randomized clinical trial. *Ann Surg* 1991;214(3):289-297.
246. Pearse R, Dawson D, Fawcett J, Rhodes A, Grounds M, Bennet D. Early goal directed therapy reduces morbidity and length of hospital stay following high-risk surgery. *Crit Care* 2005;9(Suppl 1):P45.



# CHAPTER 30

## Intraoperative Transesophageal Echocardiography: A Systematic Approach

Larry C. Field, MD,  
George D. Lappas, MD,  
Angus A. Christie, MD,  
Andrew Green, MD,  
Steven T. Morozowich, MD,  
Tamas Szabo, MD, Ph D,  
Qin Zhang, MD,  
Stephen P. Murphy, MD,  
Ravi Bissessar, MD, and  
Solomon Aronson, MD

Intraoperative echocardiography now is considered an essential part of modern cardiac surgery. It can be performed using transesophageal, epicardial, epiaortic, and transthoracic approaches. Its clinical applications are numerous, including assessment of left ventricular (LV) and right ventricular (RV) function, assessment of preload, measurement of cardiac output, detection of myocardial ischemia, assessment of valvular function, detection and assessment of various congenital heart diseases, and evaluation of aortic atheromatous disease prior to cannulation. Intraoperative echocardiography serves as an important diagnostic tool, as well as a monitor, for cardiac surgical patients.

### INDICATIONS FOR PERIOPERATIVE TRANSESOPHAGEAL ECHOCARDIOGRAPHY

Since 1996, when evidence-based practice guidelines for perioperative transesophageal echocardiography (TEE) initially were published (see Fig. 30-1), support for the superiority of intraoperative TEE over other techniques

(e.g., electrocardiograms or pulmonary artery catheters) for specific diagnostic information has steadily increased. The indications for a TEE examination should be based on each patient's condition rather than a specific surgical procedure. In addition, the dynamics of each case should dictate when a TEE examination may reduce critical diagnostic work or distract from it. Table 30-1 provides some published recommendations.

### LIMITATIONS TO AND CONTRAINDICATIONS FOR TEE

One of the most important limitations to performing an intraoperative TEE examination is the expertise or attention of the physician. Substantial patient harm can result from inappropriate fixation of the anesthesiologist's attention on the TEE examination rather than on the patient. Although performing a useful TEE examination while simultaneously caring for the patient often is possible, a more appropriate practice would be having a colleague perform the TEE examination while the primary anesthesiologist focuses on caring for the patient (especially if a more comprehensive TEE examination is desired or the patient is unstable).

There are few absolute contraindications to performing a TEE examination in an anesthetized patient. A history of dysphagia, esophageal varices, severe gastroesophageal reflux disease, odynophagia, unstable cervical spine injuries, prior mediastinal radiation, and upper airway pathology should be sought prior to probe insertion and are considered relative contraindications. Although TEE has been proven safe, it should be undertaken only by experienced operators in cases with a clear indication for TEE use. In anesthetized patients, the probe can be inserted blindly or with laryngoscopic visualization. It is

helpful to have an assistant support the probe during insertion. A bite guard should always be used to protect the patient as well as the probe. Proper insertion of the probe requires skill and judgment. Major complications of TEE are rare (0.2-0.6% of insertion attempts in prospective studies),<sup>1-3</sup> and most examples are based on published case reports. The transducer should never be forced through resistance upon entry into or during passage through the esophagus. Insertion and manipulation of the TEE probe can result in oral, esophageal, or pharyngeal trauma and arrhythmias. Another important danger of performing a TEE examination is misrepresenting a finding as abnormal when it is actually a normal variant (Table 30-2). Understanding the normal variants will enable better diagnostic accuracy when detecting abnormal structures. Significant clinical experience is required for the echocardiographer to be able to confidently make this distinction.

### TERMINOLOGY

Table 30-3 lists the terminology used to describe probe manipulation, with the patient lying supine, with reference to the heart.

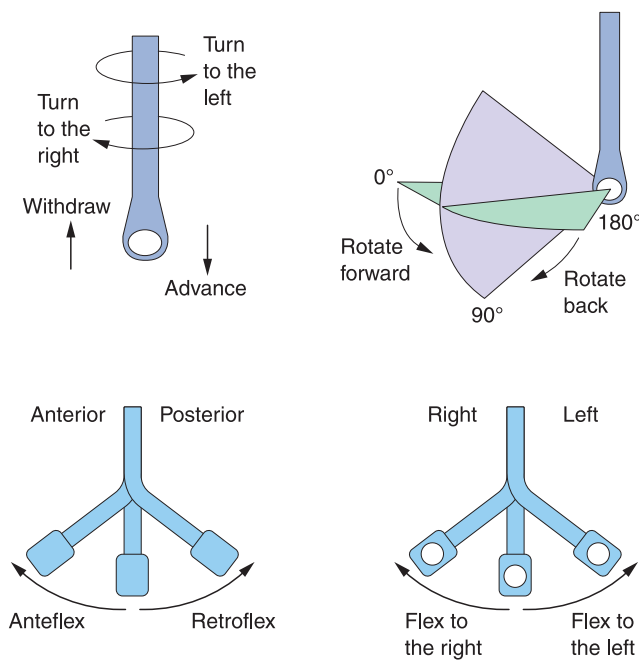
### BASIC PRINCIPLES OF ECHOCARDIOGRAPHY

Two-dimensional (2D) echocardiography displays the intensity of reflected ultrasound waves as brightness along the axis of the scan plane to reconstruct a representative 2D image. This is useful for identifying tissue structures but does not allow for full assessment of hemodynamics.

Doppler ultrasound, however, can be used to assess hemodynamics. Doppler ultrasound uses the principle of

### KEY POINTS

1. TEE is an essential component of cardiac anesthesia care.
2. A complete diagnostic examination should include the standard set of views (at a minimum) suggested by the ASE/SCA guidelines.
3. Intraoperative evaluation of acute persistent and life threatening hemodynamic disturbances in which ventricular function is uncertain and unresponsive to treatment is a Category I indication for TEE.



**FIGURE 30–1.** Probe manipulation of guidelines modified from “ASE/SCA guidelines for performing a comprehensive intraoperative multiplane transesophageal echocardiography examination: recommendations of the American Society of Echocardiography Council for Intraoperative Echocardiography and the Society of Cardiovascular Anesthesiologists Task Force for Certification in Perioperative Transesophageal Echocardiography.”<sup>4</sup>

Doppler effect to display the velocities of moving structures (red blood cells or myocardium). When ultrasound is reflected from a moving target, the ultrasound frequency is slightly changed from the transmitted frequency (i.e., Doppler shift). Red blood cells moving toward the probe return a slightly increased frequency of ultrasound waves, and those moving away from the probe return a slightly decreased frequency of ultrasound waves. The magnitude of Doppler shift is proportional to the velocity of the moving structure. These velocity measurements can be translated into the pressure differences that generate them (Bernoulli equation), allowing for hemodynamic assessments.

Modified Bernoulli:

$$\Delta P = 4(V_2^2 - V_1^2).$$

Simplified Bernoulli:

$$\Delta P = 4V_2^2 \text{ (assuming } V_1 < 1.5 \text{ m/s)}.$$

Because the Doppler effect only measures the velocity component moving directly toward or away from the probe, oblique angles will underestimate the true velocity. Therefore, all Doppler measurements should be made with the sampling beam as parallel as possible to the assumed blood

flow. This necessitates using specific views to obtain accurate measurements, as will be described.

Color flow Doppler (CFD) displays the mean velocity of the red blood cells in a sample area according to a color map, assigning different shades of color to their respective velocities and different colors to different directions. This velocity information is overlaid on top of the 2D image, allowing the echocardiographer to visualize the velocity flow patterns of blood through the various structures. The velocity data for the CFD sample area is actually made up of many pulsed-wave Doppler (PWD) areas, which reduces the frame rate of the image displayed. Decreasing the lateral area covered by CFD will result in less PWD sampling and a faster frame rate.

PWD displays the mean velocity of a much smaller sample area versus time, resulting in velocity waveforms of that sample. This allows more accurate measurement of velocity waveforms in specific areas with a high sampling rate but without the 2D structural information. Because of the pulsed nature of this Doppler, it can measure velocities only within a given range determined by how long the

transducer listens for ultrasound reflections before repeating the pulses. Velocities outside this given range are assigned incorrect velocities, termed *aliasing*. The aliasing velocity (the highest velocity accurately displayed) often can be increased by decreasing the pulse repetition frequency, but this degrades the temporal resolution. Of course, because PWD is used to construct CFD images, CFD suffers from the same velocity and temporal resolution limitations.

Continuous-wave Doppler (CWD) displays all the blood velocities along a beam of ultrasound rather than at a particular location. The continuous nature of this mode allows for display of the complete range of velocities at the highest temporal resolution. However, this mode cannot determine where along the ultrasound beam the particular velocities originated. This limitation of CWD is termed *range ambiguity*. Often, the echocardiographer will be able assume where the peak velocities should be originating (e.g., a narrowed valve orifice).

## SYSTEMATIC APPROACH TO A TEE EXAMINATION

The American Society of Echocardiography and the Society of Cardiovascular Anesthesiologists have suggested a set of standard views and the nomenclature for those views.<sup>4</sup> This nomenclature should be followed whenever possible to minimize confusion. Generally, a combination of these views will allow for a complete diagnostic examination. However, deviation from these standard views may be necessary to obtain images appropriate to the individual patient. It is beneficial to be flexible about the order the views are obtained to allow focusing on a specific clinical question in a timely manner. Each echocardiographer should develop a systematic order for routine diagnostic TEE. This not only allows for increased speed and efficiency but also ensures that an important finding will not be missed simply because a view was forgotten.

Many echocardiographers prefer to order the examination such that they collect multiple views focusing on many different structures from each probe position or depth prior to moving to the next probe location. This

TABLE 30–1.

## Recommended Indications for Transesophageal Echocardiography

**Category I Indications:** Supported by the strongest evidence or expert opinion: TEE is frequently useful in improving clinical outcomes in these settings and is often indicated, depending on individual circumstances (e.g., patient risk and practice setting).

- Intraoperative evaluation of acute, persistent, and life-threatening hemodynamic disturbances in which ventricular function and its determinants are uncertain and have not responded to treatment
- Intraoperative use in valve repair
- Intraoperative use in congenital heart surgery for most lesions requiring cardiopulmonary bypass
- Intraoperative use in repair of hypertrophic obstructive cardiomyopathy
- Intraoperative use for endocarditis when preoperative testing was inadequate or extension of infection to perivalvular tissue is suspected
- Preoperative use in unstable patients with suspected thoracic aortic aneurysms, dissections, or disruption who need to be evaluated quickly
- Intraoperative assessment of aortic valve function in repair of aortic dissections with possible aortic valve involvement
- Intraoperative evaluation of pericardial window procedures
- Use in intensive care unit for unstable patients with unexplained hemodynamic disturbances, suspected valve disease, or thromboembolic problems (if other tests or monitoring techniques have not confirmed the diagnosis or patients are too unstable to undergo other tests)

**Category II Indications:** Supported by weaker evidence and expert consensus; TEE may be useful in improving clinical outcomes in these settings, depending on individual circumstances, but appropriate indications are less certain.

- Perioperative use in patients with increased risk of myocardial ischemia or infarction
- Perioperative use in patients with increased risk of hemodynamic disturbances
- Intraoperative assessment of valve replacement
- Intraoperative assessment of repair of cardiac aneurysms
- Intraoperative evaluation of removal of cardiac tumors
- Intraoperative detection of foreign bodies
- Intraoperative detection of air emboli during cardiotomy, heart transplant operations, and upright neurosurgical procedures
- Intraoperative use during intracardiac thrombectomy
- Intraoperative use during pulmonary embolectomy
- Intraoperative use for suspected cardiac trauma
- Preoperative assessment of patients with suspected acute thoracic aortic dissections, aneurysms, or disruption
- Intraoperative use during repair of thoracic aortic dissections without suspected aortic valve involvement
- Intraoperative detection of aortic atheromatous disease or other sources of aortic emboli
- Intraoperative evaluation of pericardiectomy, pericardial effusions or evaluation of pericardial surgery
- Intraoperative evaluation of anastomotic sites during heart and/or lung transplantation
- Monitoring placement and function of assist devices

**Category III Indications:** Little current scientific or expert support; TEE is infrequently useful in improving clinical outcomes in these settings, and appropriate indications are uncertain.

- Intraoperative evaluation of myocardial perfusion, coronary artery anatomy, or graft patency
- Intraoperative use during repair of cardiomyopathies other than hypertrophic obstructive cardiomyopathy
- Intraoperative use for uncomplicated endocarditis during noncardiac surgery
- Intraoperative monitoring for emboli during orthopedic procedures
- Intraoperative assessment of repair of thoracic aortic injuries
- Intraoperative use for uncomplicated pericarditis
- Intraoperative evaluation of pleuropulmonary diseases
- Monitoring placement of intraaortic balloon pumps, automatic implantable cardiac defibrillators, or pulmonary artery catheters
- Intraoperative monitoring of cardioplegia administration

TEE, Transesophageal echocardiography.  
Modified from Daniel et al.<sup>31</sup>

allows for increased efficiency and decreases the total probe manipulation necessary for a complete examination. Alternatively, the echocardiographer may focus on one structure or chamber at a time. This results in duplicated views, as many structures usually can be seen within single

views, and increased probe manipulation, as each structure is interrogated from different vantage points and angles.

### Left Atrium

Because the left atrium (LA) lies just anterior to the esophagus in most pa-

tients, the LA can be seen in the near field (i.e., at the top) of most midesophageal (ME) images of the heart (probe tip is approximately 35 cm from teeth and anteriorly oriented). Evaluation of the LA usually starts from an ME four-chamber view (Fig. 30–2A; multiplane angle at 0–20° with transducer slightly

TABLE 30–2.

## Normal Structures That May Be Mistaken for Abnormal Cardiac Masses

Left atrium	Tissue ridge between the superior pulmonary vein and left atrial appendage (“Coumadin ridge”) Atrial suture line after cardiac transplant
Left ventricle	Papillary muscle Chordae variant (redundancy) Prominent apical trabeculation
Right atrium	Chiari network Eustachian valve Crista terminalis Lipomatous hypertrophy of interatrial septum or lateral tricuspid valve annulus Right atrial appendage trabeculations
Right ventricle	Pulmonary artery catheter, pacer wire Moderator band Pulmonary artery catheter, pacer wire
Aortic valve	Nodules of Arantius Lambl excrescences
Mitral valve	Myxomatous mitral valve tissue Lambl excrescences
Pericardium	Epicardial adipose tissue

TABLE 30–3.

## TEE Probe Manipulation

Terminology	Definition
Superior	Toward the head
Inferior	Toward the feet
Anterior	Toward the sternum
Right and left	Patient’s right and left sides
Advancing the transducer	Pushing the tip of the probe deeper into the esophagus or the stomach
Withdrawing the transducer	Pulling the tip of the probe up the esophagus toward the head.
Turning to the right	Moving the tip of the probe clockwise within the esophagus (scan plane moving toward the patient’s right if the transducer is oriented anteriorly)
Turning to the left	Moving the tip of the probe counterclockwise
Rotating forward	Rotation of the multiplane angle from 0° toward 180° (using the electronic toggle switch)
Rotating back	Rotation of the multiplane angle in the opposite direction toward 0°
Anteflexing	Flexing the tip of the probe anteriorly (clockwise rotation of the large control wheel when oriented anteriorly)
Retroflexing	Flexing the tip posteriorly (counterclockwise rotation)
Flexing to the right	Laterally flexing the tip of the probe to the patient’s right (clockwise rotation of the small control wheel). (Fig. 30–1)
Flexing to the left	Flexing the tip to the patient’s left. (Fig. 30–1)

retroflexed from the neutral position). It can be evaluated further as the multiplane angle sweeps from 0–120°. Within the LA, a tissue ridge (“Coumadin ridge”) separates the LA appendage and left upper pulmonary vein (Figs. 30–2B and 30–2C). This atrial tissue can accumulate fat, creating a mass-like appearance. Because the majority of LA thrombi are located within the LA appendage, this structure should always be interrogated. The normal LA appendage is lined with ridges of pectinate muscle, which may be difficult to differentiate from small thrombi. Thrombi are generally more rounded and often fill the appendage.

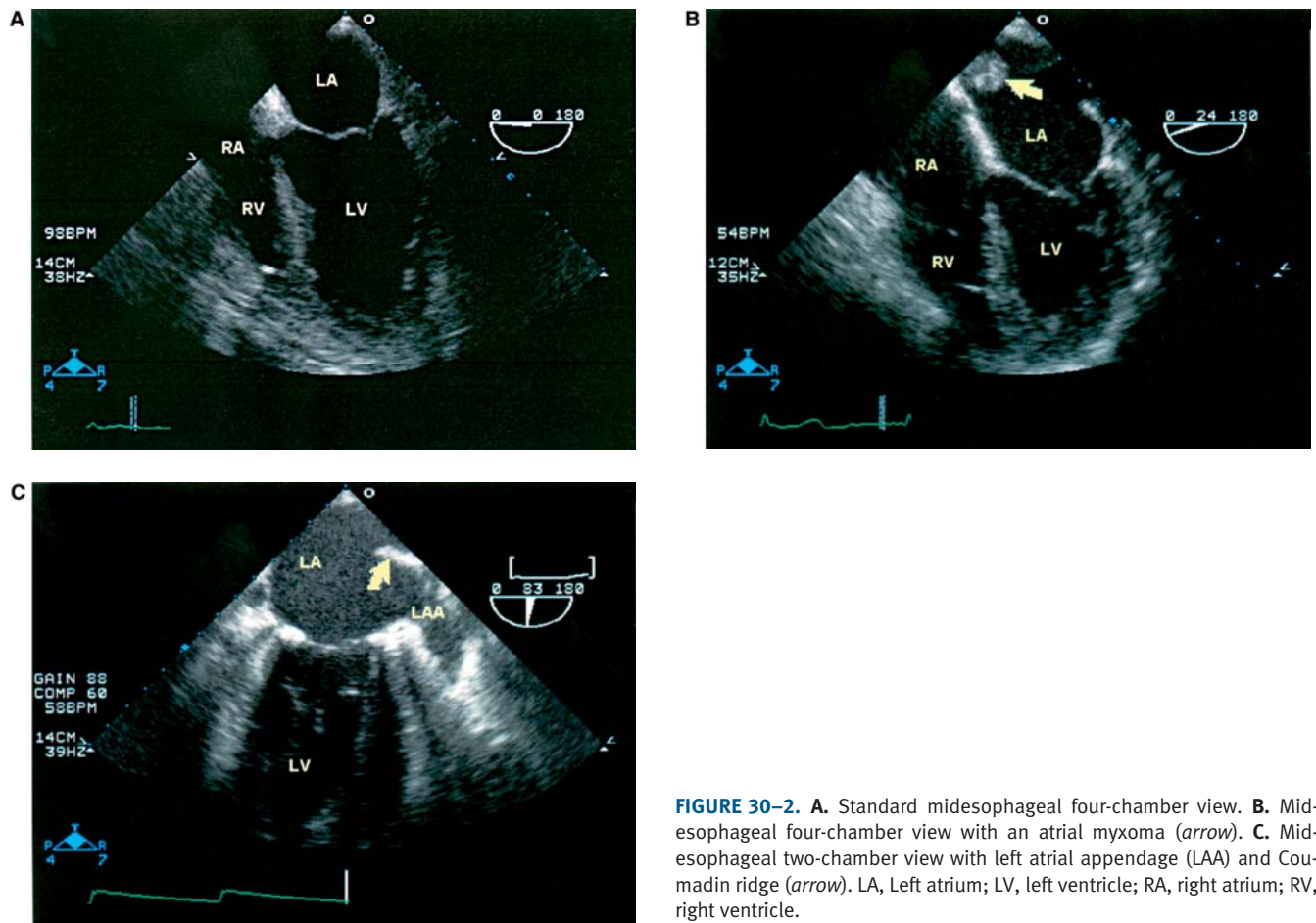
LA thrombus usually is associated with high-risk structural and functional heart disease, most commonly atrial fibrillation, mitral stenosis, mitral valve (MV) prosthesis, or LA enlargement resulting from LV dysfunction. These structural and functional cardiac abnormalities tend to be associated with blood stasis within the LA, which facilitates thrombus formation. Mitral regurgitation (MR) may decrease LA stasis and protect against LA thrombus formation. Aortic stenosis (AS), or an aortic prosthesis, usually does not result in significant LA stasis unless accompanied by LV dysfunction. Thrombus usually is homogeneous in appearance, more echogenic than the underlying myocardium, appears in multiple imaging planes, and moves in concert with the underlying myocardium.

TEE is superior to transthoracic echocardiography for detection of LA thrombus. This is partly because of the large percentage of LA thrombi that are found in the LA appendage, which can be well delineated by TEE. LA appendage thrombi can be evaluated by keeping the atrial appendage centered in the image and rotating the multiplane angle from 0–180°. Spontaneous echo contrast, seen as a slowly swirling “smoke” pattern, indicates low-flow velocities. It is strongly associated with LA thrombus. Doppler interrogation of the LA appendage also may be helpful, as lower blood flow velocities identify patients at higher risk.

### Right Atrium

Evaluation of the right atrium (RA) can be approached from the ME four-chamber view, ME bicaval view (Fig. 30–3A; probe turned to patient’s right with multiplane angle of 110–120°), ME RV





**FIGURE 30-2.** A. Standard mid-esophageal four-chamber view. B. Mid-esophageal four-chamber view with an atrial myxoma (arrow). C. Mid-esophageal two-chamber view with left atrial appendage (LAA) and Coumadin ridge (arrow). LA, Left atrium; LV, left ventricle; RA, right atrium; RV, right ventricle.

inflow–outflow view (Fig. 30-3B; 40–60°), and transgastric (TG) RV inflow view (rotating the angle to 90° and turning the probe to the right from the TG short-axis [SAX] view). The RA is a thin-walled structure. The superior vena cava (SVC) and inferior vena cava (IVC) entering the RA posteriorly and medially, respectively. Remnant embryonic structures should be distinguished from thrombi and other masses. The eustachian valve is an elongated, membranous projection at the junction of the RA and IVC. The Chiari network, a delicate, mobile structure often arising from the eustachian valve and stretching to the interatrial septum (IAS), may be misdiagnosed as an atrial mass. The crista terminalis is a vertical ridge of muscle originating at the junction of the RA and SVC. It runs toward the IVC and has also been misinterpreted as an intracardiac mass. Central venous catheters, pulmonary artery catheters, and pacing wires often can be seen as they course through the right heart and should not be confused as pathologic

masses. RA thrombi typically are associated with indwelling catheters or pacemaker leads.

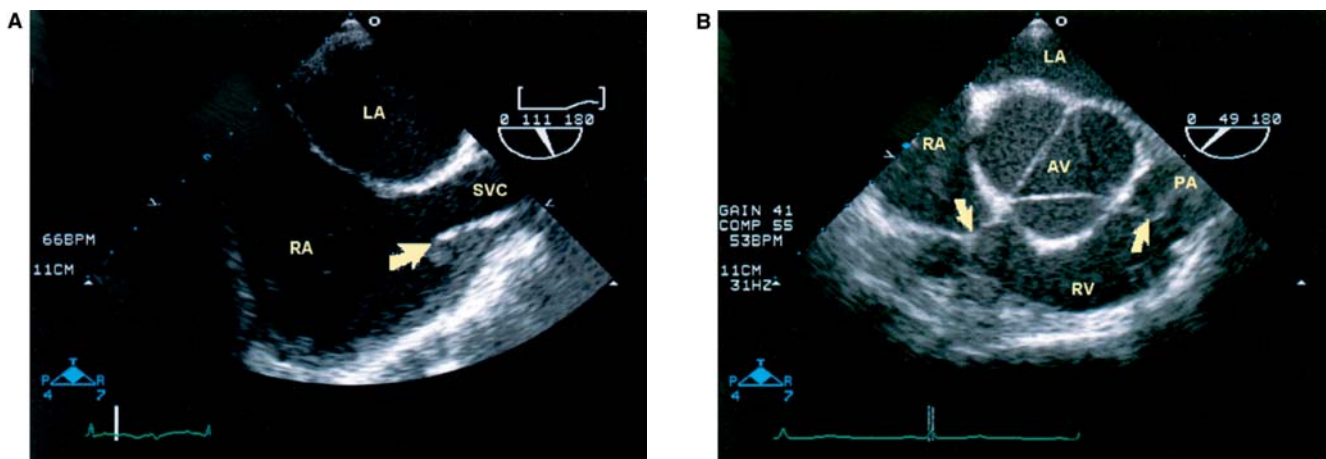
### Interatrial Septum

The IAS consists of the thin fossa ovalis centrally and thicker limbus regions anteriorly and posteriorly. The IAS should be examined with CFD to detect interatrial shunts.

Structural atrial septal defects can be divided anatomically into defects at the fossa ovalis (ostium secundum type), defects occurring inferior to the fossa ovalis (ostium primum type), and defects occurring superior to the fossa ovalis (sinus venosus type). The most common defect is the ostium secundum type, in which the posterior atrial wall may be totally absent. The ostium primum type usually can be seen inferior to the fossa ovalis in the ME four-chamber view. It is associated with other endocardial cushion defects, such as ventricular septal defects, atrioventricular canal defects, and tricuspid or MV abnormalities. The sinus venosus type of atrial septal

defect lies superior to the fossa ovalis close to the opening of the SVC. It may be best seen from an ME bicaval view.

A patent foramen ovale (PFO) is a flap-like opening between the atrial septa primum and secundum at the location of the fossa ovalis that persists after age 1 year. In utero, the foramen ovale serves as a physiologic conduit for right-to-left shunting. PFO is a common functional secundum atrial septal defect that results from failure of the septa primum and secundum to completely fuse (Fig. 30-4A), allowing an interatrial shunt to occur under certain hemodynamic conditions. TEE is the diagnostic standard for detecting PFO, which is present in approximately 20% of adults. The ME bicaval view often is best for detecting this lesion. CFD interrogations of the IAS and contrast echocardiography both have high sensitivity and specificity for detecting PFO. Intravenous injection of agitated saline often is used intraoperatively to produce a contrast effect (Fig. 30-4C). Simultaneous release of a breath-hold-



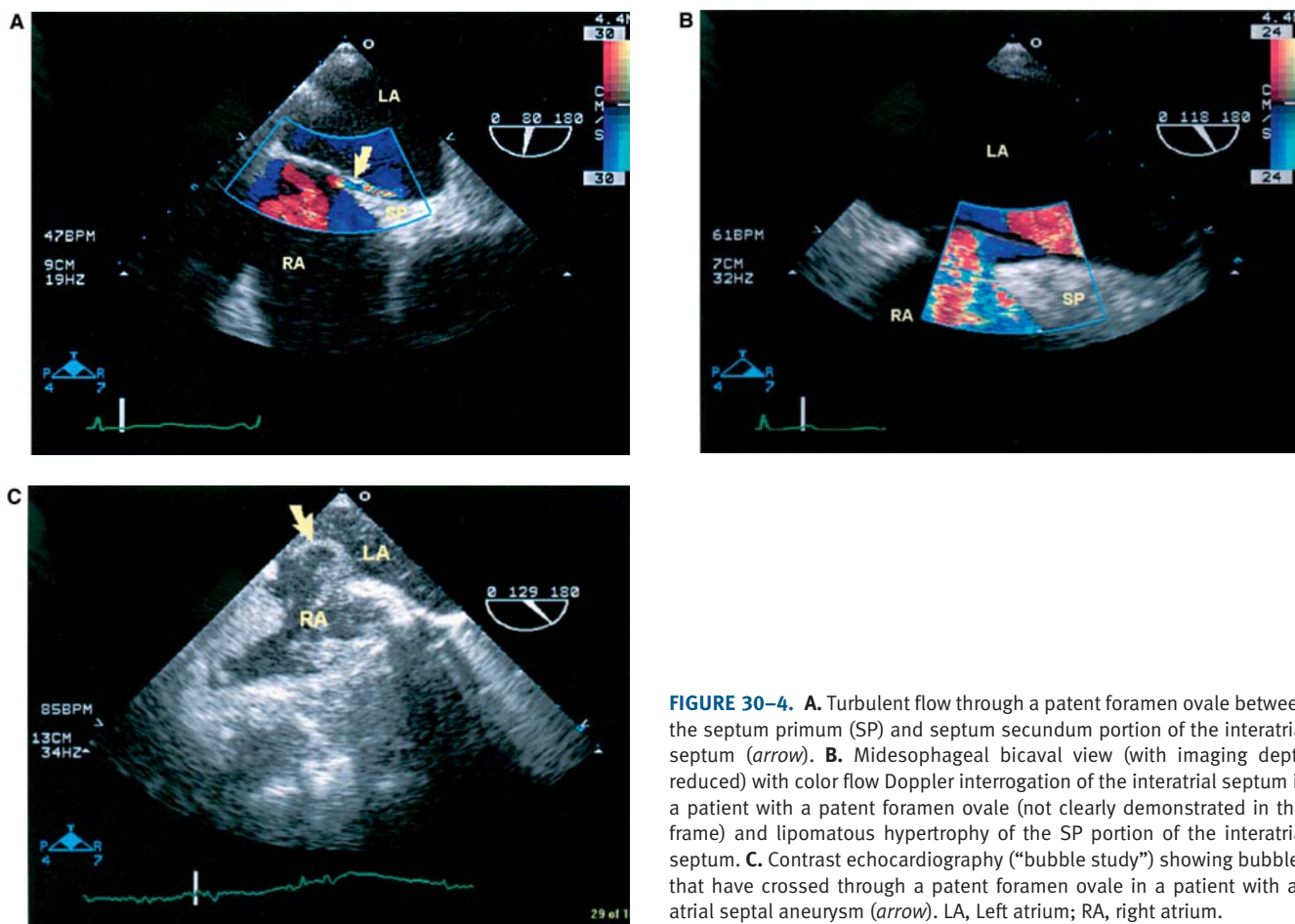
**FIGURE 30-3.** **A.** Standard midesophageal bicaval view with crista terminalis (*arrow*) visualized. **B.** Standard midesophageal right ventricular inflow-outflow view in a patient with a large aortic valve. Down arrow indicates tricuspid valve; up arrow indicates pulmonic valve. AV, Aortic valve; LA, left atrium; PA, pulmonary artery; RA, right atrium; RV, right ventricle; SVC, superior vena cava.

ing maneuver will increase RA pressures relative to LA pressures and may open a functionally closed PFO.

In the presence of an atrial septal defect with left-to-right shunting, the LA usually appears normal while the

RA and RV enlarge from volume overload. As pulmonary hypertension occurs, the RV wall becomes hypertrophied. With an atrial septal defect, the pulmonary vasculature dilates and can be as wide as the aorta.

An atrial septal aneurysm is an out-pouching of thin, mobile, redundant tissue in the region of the fossa ovalis (Fig. 30-4C). The atrial septum is considered to be aneurysmal when a portion at least 15 mm wide has an



**FIGURE 30-4.** **A.** Turbulent flow through a patent foramen ovale between the septum primum (SP) and septum secundum portion of the interatrial septum (*arrow*). **B.** Midesophageal bicaval view (with imaging depth reduced) with color flow Doppler interrogation of the interatrial septum in a patient with a patent foramen ovale (not clearly demonstrated in this frame) and lipomatous hypertrophy of the SP portion of the interatrial septum. **C.** Contrast echocardiography (“bubble study”) showing bubbles that have crossed through a patent foramen ovale in a patient with an atrial septal aneurysm (*arrow*). LA, Left atrium; RA, right atrium.

interatrial excursion of at least 15 mm. Atrial septal aneurysm formation may be secondary to raised interatrial pressure gradients, producing a bulging septal shift toward the low-pressure side. An atrial septum aneurysm must be considered in the differential diagnosis of atrial cysts and tumors and has been related to atrial arrhythmias, systemic and pulmonary embolism, MV prolapse, and atrial septal defect.

Lipomatous hypertrophy of the atrial septum is a peripherally thickened septum surrounding the thin fossa ovalis (Fig. 30-4B). It results from fat deposits in the atrial septum and should not be confused with intraatrial masses such as myxomas.

## Cardiac Tumors

Metastatic cardiac tumors are more common than primary cardiac tumors. Metastatic disease may result from contiguous extension, lymphangitic spread, or hematogenous spread from the primary tumor. It tends to involve the pericardium and myocardium rather than the valves and endocardium. Extension of tumor thrombus via the IVC into the RA is a well-recognized complication of advanced renal cell carcinoma.

Myxomas, the most common primary cardiac tumors, account for approximately 50% of all primary cardiac tumors. Myxomas can cause obstruction and embolization, making prompt surgical removal mandatory. Myxomas usually are solitary and are found most commonly within the LA (Fig. 30-2A), originating from the IAS (often the fossa ovalis). Myxomas characteristically have hemorrhagic cystic spaces and possibly areas of calcification.

## Left Ventricle

### Systolic Function

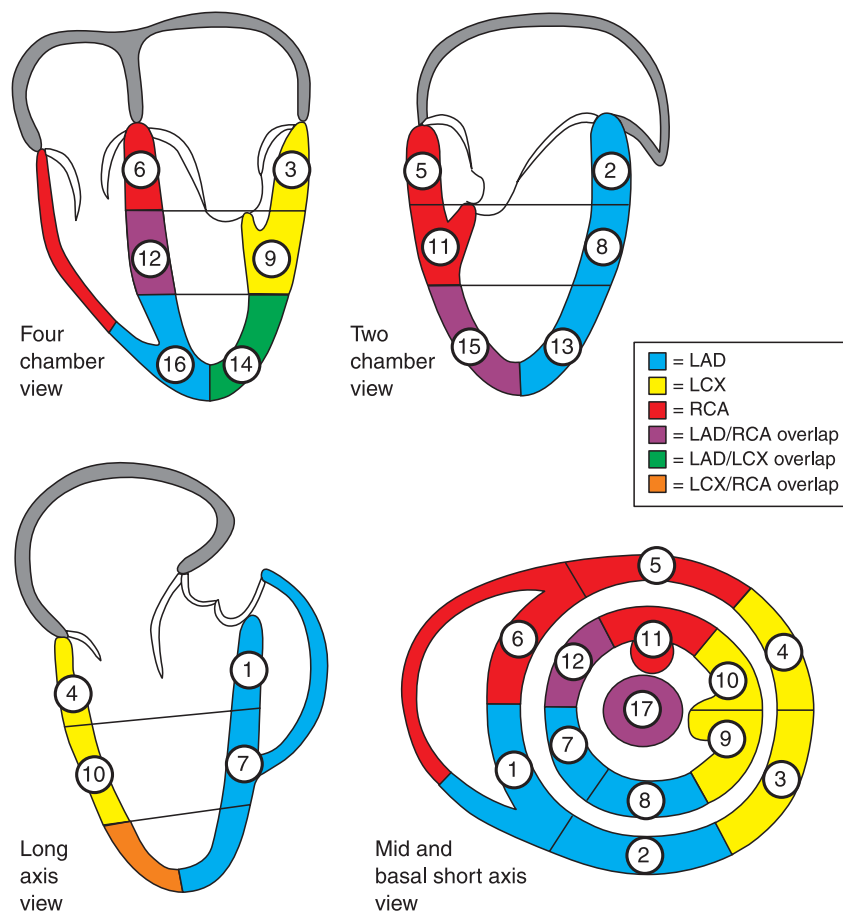
Assessment of regional and global systolic LV function often is the primary indication for perioperative echocardiography. TEE is well suited to providing accurate evaluation and monitoring of ventricular filling and systolic function during hemodynamic instability. For purposes of identifying wall-motion abnormalities, the American Society of Echocardiography divides the LV into 17 segments (Fig. 30-5).<sup>5</sup> The basal and midlevels of the LV each have inferior, inferolateral (formerly termed posterior), anterolateral, anterior, anteroseptal, and infer-

oseptal segments. The apical level has inferior, lateral, anterior, and septal segments. The apical cap is the final segment. All segments (except the apical cap) can be visualized from either an ME or TG probe location. If wall-motion abnormalities are observed, the typical blood supply patterns (or actual blood supply patterns from a previous angiogram) to these segments can help identify the compromised coronary artery or graft.

A wall-motion description should be assigned for each segment. *Mild hypokinesis* refers to a decrease in inward wall movement and a 10–30% increase in endocardial systolic thickening (normal is >30%). *Severe hypokinesis* refers to only slight wall movement and <10% thickening. *Akinesis* refers to lack of both movement and endocardial thickening (indicating severe ischemia or infarct). *Dyskinesis*

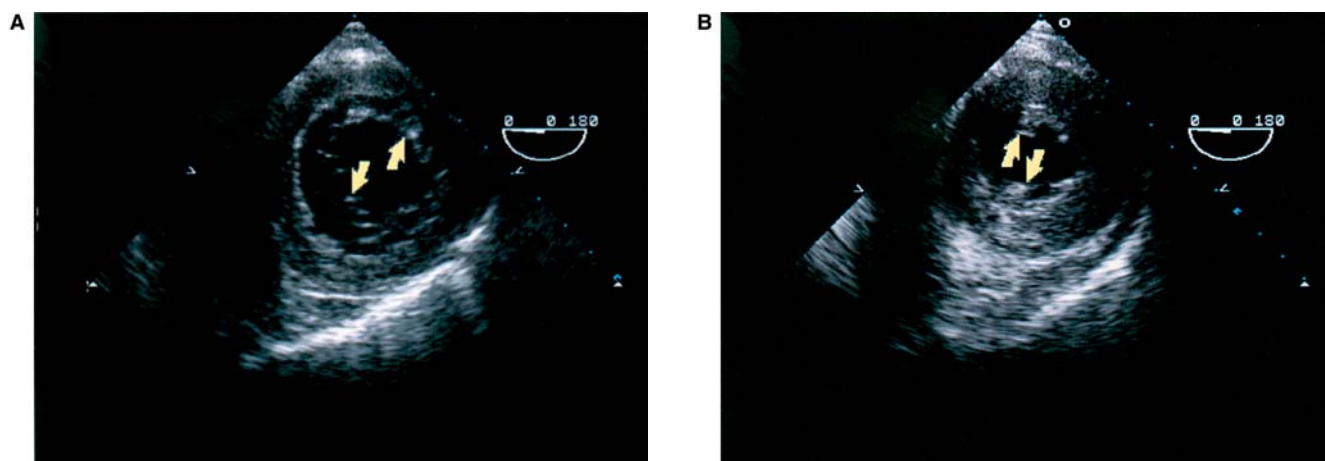
refers to outward wall movement and endocardial thinning during systole (indicating old infarct). As movement may be passive because of contraction of adjacent segments or translational movement of the heart, thickening is believed to be more reliable than wall movement in determining wall-motion abnormalities. If scaled scores are assigned to each type of wall-motion abnormality, the average of those scores from each segment provides a semiquantitative assessment of global ventricular function, termed the *wall-motion index*. The wall-motion index can be converted in order to estimate ejection fraction (EF) and results in good agreement with other measures of EF.<sup>6</sup>

Many other measures of global ventricular function can be made; only the most common are discussed here. Fractional area change (FAC) can be



**FIGURE 30-5.** Depiction of the American Society of Echocardiography's 17 left ventricular wall segments, with color coding according to normal variations of coronary blood flow. **1**, Basal anteroseptal; **2**, basal anterior; **3**, basal anterolateral; **4**, basal inferolateral; **5**, basal inferior; **6**, basal inferoseptal; **7**, mid anteroseptal; **8**, mid anterior; **9**, mid anterolateral; **10**, mid inferolateral; **11**, mid inferior; **12**, mid inferoseptal; **13**, apical anterior; **14**, apical lateral; **15**, apical inferior; **16**, apical septal; **17**, apical cap (apex).





**FIGURE 30-6.** A. Basal transgastric short-axis view showing open mitral valve. Posterior (*up arrow*) and anterior (*down arrow*) mitral leaflets. B. Midpapillary transgastric short-axis view. Posteromedial papillary muscle (*up arrow*) and anterolateral papillary muscle (*down arrow*).

obtained from the TG SAX view (“donut view”). It is simply the proportion of diastolic area of the LV chamber in the midpapillary SAX view (Fig. 30-6B) that is reduced during systole:

$$\text{FAC\%} = (\text{End-diastolic area} - \text{End-systolic area}) / \text{End-diastolic area} * 100.$$

Although FAC often is estimated visually, the chamber circumference can be traced in both systole and diastole to provide the areas for more accurate calculation. Because FAC is measured in only one plane, it may miss significant wall-motion abnormalities outside that plane and therefore has limited accuracy in the assessment of overall ventricular function. Oblique planes of view also may reduce accuracy.

EF, which includes the volume change of the whole ventricle rather than the area change of a  $\text{EF\%} = (\text{End-diastolic volume} - \text{End-systolic volume}) / \text{End-diastolic volume} * 100.$

Normal EF is 55–75%.

Generating accurate three-dimensional (3D) volumes from 2D echocardiography can be a source of error. Multiple geometric methods have been developed that assume the ventricle fits a stereotypical ellipsoidal shape. They include the single-plane ellipsoid method, cylinder-hemi-ellipsoid method, and area-length method; all of these methods estimate volume from diameter and length measurements in one or two planes. These geometric assumptions limit the accuracy of EF estimation when segmental wall-motion abnormalities or unusual ventricular shapes are present. If the plane of measurement does not in-

clude the true apex, termed a *foreshortened view*, then the volumes and EF will be unreliable.

The modified Simpson method, also known as the *disk summation method*, is considered the best method for deriving ventricular volumes and EF from 2D echocardiography. For this method, the endocardial border is traced in two orthogonal planes (e.g., ME four-chamber and two-chamber views). Computer software then models the ventricle as a series of 20 or more stacked elliptical disks (Fig. 30-7). The volume of each disk then is calculated from the thickness of the disk and the diameters of each ellipsoid disk (Fig. 30-7C), and all of the individual disk volumes are summed to yield the total volume of the ventricle. Similar cylindrical disks or rotating ellipsoid models can be generated from a single tomographic view, but with reduced accuracy. This biplane disk summation method allows for variably shaped ventricles. It also can account for significant regional wall-motion abnormalities but still may be limited by image quality or foreshortened views. To reduce foreshortening errors, the two orthogonal views should not be combined if the chamber lengths appear to differ by >20%.

In clinical practice, simple visual estimation by the echocardiographer often is the source of the reported EF. The reliability of visual estimation of EF by an experienced echocardiographer appears to be similar to wall-motion index and EF calculations using the Simpson rule.<sup>6</sup> New image

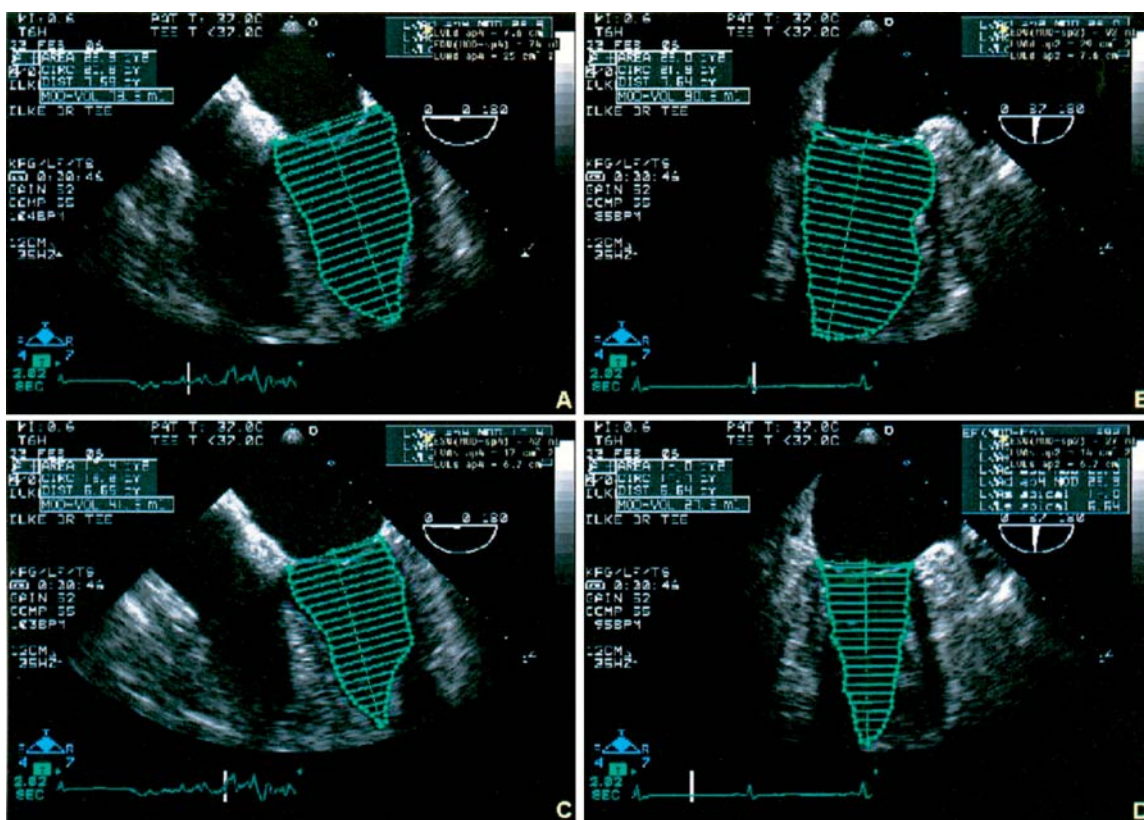
processing modes, such as secondary harmonic imaging, Doppler tissue imaging, and contrast agents, can help delineate subendocardial borders and improve the image. Volumes may soon be obtained from real-time 3D echocardiography with automated border detection programs.

Neither FAC nor EF is a pure index of myocardial contractility because both are dependent upon loading conditions, especially at the extremes of preload and afterload.

Attempts have been made to measure load-independent indices of ventricular function. Generation of pressure-volume loops at different loading conditions results in a linear end-systolic relationship, the slope of which is termed *end-systolic elastance*. The area within pressure-volume loops is *stroke work*, which can be plotted against the corresponding end-diastolic volumes to obtain preload-recruitable work. These measures are much more complex and include measuring intraventricular pressures or their surrogates and thus are principally used for research purposes at this time.

Less load-dependent measures that are easier to obtain, although rarely reported, include the peak systolic pressure-end systolic volume ratio and cardiac power. *Mean cardiac power* is the product of stroke volume, mean arterial pressure, and heart rate. Peak instantaneous power also can be calculated. These measures can be corrected for end-diastolic volume to make them load independent. If MR is present,  $dP/dt$  of the MR jet is a relatively load-independent measure of





**FIGURE 30-7.** Ejection fraction calculated using the disk summation method from four-chamber end-diastole (A), two-chamber end-diastole (B), four-chamber end-systole (C), and two-chamber end-systole (D) tracings. E. Depiction of a single Simpson disk with elliptical diameters measured from midesophageal four-chamber and two-chamber views. Using the software package of the transesophageal echocardiography machines, the volume of each theoretical disk is automatically calculated separately in this way and then summed together to obtain the left ventricular volume in both end-diastole and end-systole, allowing for calculation of ejection fraction.

contractility, which is otherwise difficult to assess when ventricular work is lost into the lower-pressure LA. *Myocardial performance index* is the sum of isovolumic contraction time and isovolumic relaxation time, divided by ejection time. It combines systolic and diastolic function into one easily obtainable and reproducible index that has good prognostic value.<sup>7</sup> All of these measures have the benefit of being independent of ventricular geometry and the subjective determination of endocardial borders.

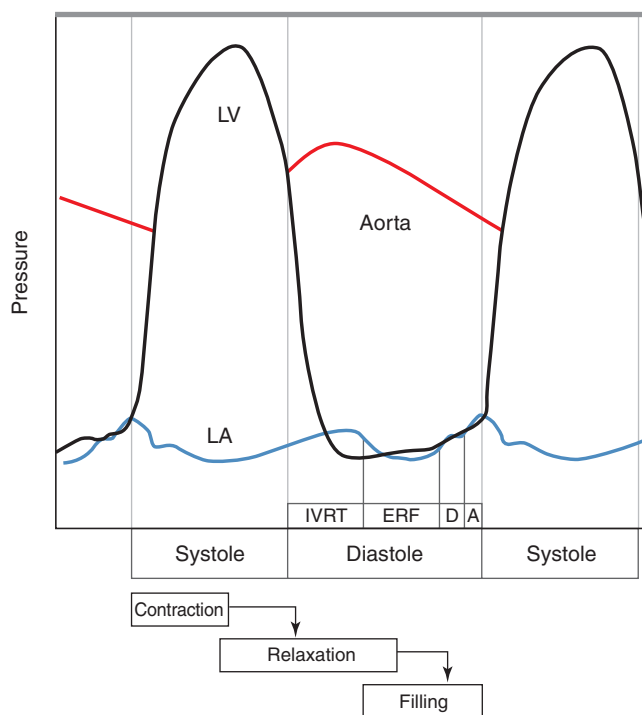
### Diastolic Function

Diastole is divided into four distinct phases: isovolumic relaxation, early rapid filling, diastasis, and atrial contraction (Fig. 30-8). Isovolumic relax-

ation begins with closure of the aortic valve (AV). The chamber relaxes, and the pressure within the chamber decreases. Once the pressure falls below the pressure in the atrium, the MV opens, ending the period of isovolumic relaxation. Isovolumic relaxation is an active, energy dependent process; therefore, abnormalities in systolic function usually are accompanied by abnormalities in isovolumic relaxation. Blood flowing through the MV initiates the early rapid filling phase. The rapid filling of the chamber (early diastole) is dependent on both LV relaxation (an active process) and chamber compliance (a passive property). As volume fills the ventricle, the pressures between the atrium and the ventricle equalize, and the flow begins to

slow. This period is referred to as *diastasis* because there is little blood flow between the chambers. The MV leaflets remain in an open position, and the duration of diastasis is dependent on heart rate and chamber compliance. With the onset of atrial contraction, atrial pressures become greater than ventricular pressures, so again there is a net flow of blood into the ventricle. In normal individuals, atrial contraction contributes approximately 20% to the end-diastolic ventricular volume. The atrial contraction phase is dependent on the chamber compliance, LA function, and the electrical conduction system.

From the preceding discussion, one can conclude that flow is driven primarily by pressure gradients between



**FIGURE 30-8.** Pressure tracings from a normal cardiac cycle. Pressure differences (which cannot be measured directly by transesophageal echocardiography) between chambers drive the corresponding flow velocities (which we measure with transesophageal echocardiography to calculate pressure differences). A, Atrial contraction; D, diastasis; ERF, early rapid filling; IVRT, isovolumic relaxation time; LA, left atrium; LV, left ventricle.

the atrium and the ventricle. For a given pressure, if LV relaxation is brisk, the result is a large, early pressure gradient (often even a suction effect) that drives filling during early diastole. This results in less filling in late diastole. On the other hand, if ventricular relaxation is sluggish, early diastolic filling declines and a greater proportion of diastolic filling is seen in late diastole. In the latter situation, there is a greater dependence on atrial contraction for filling.

It follows, then, that a decrease in LV relaxation and/or compliance will lead to a compensatory increase in LA pressures to maintain end-diastolic ventricular volume. Because the rate of LV relaxation and increase of LA pressures is a continuum, many different transmitral pressure gradients and LV filling patterns are possible. This leads to a challenge in quantifying diastolic dysfunction over the continuum of varying patient conditions.

Doppler echocardiography, by virtue of its ability to evaluate flow patterns across valves and in large blood vessels, allows the clinician to diagnose diastolic dysfunction. Two-dimensional echocardiographic inspection of

the ventricular systolic function may provide an alternative cause for a patient's heart failure or suggest that diastolic dysfunction is likely. For example, if a patient with the clinical picture of heart failure is found to have normal ventricular systolic function and volumes but LV hypertrophy (end-diastolic wall thickness  $>1.1$  cm) is present, diastolic heart failure is likely. Combined systolic and diastolic failure may be present, or a patient may have ventricular hypertrophy without measurable diastolic abnormalities. Therefore, 2D findings are neither sensitive nor specific for diastolic dysfunction, and further investigation is warranted. Two-dimensional echocardiography, then, is most useful in helping to quantify systolic function and to differentiate isolated diastolic dysfunction from combined systolic–diastolic dysfunction. To fully assess diastolic function, use of Doppler echocardiography techniques is necessary.

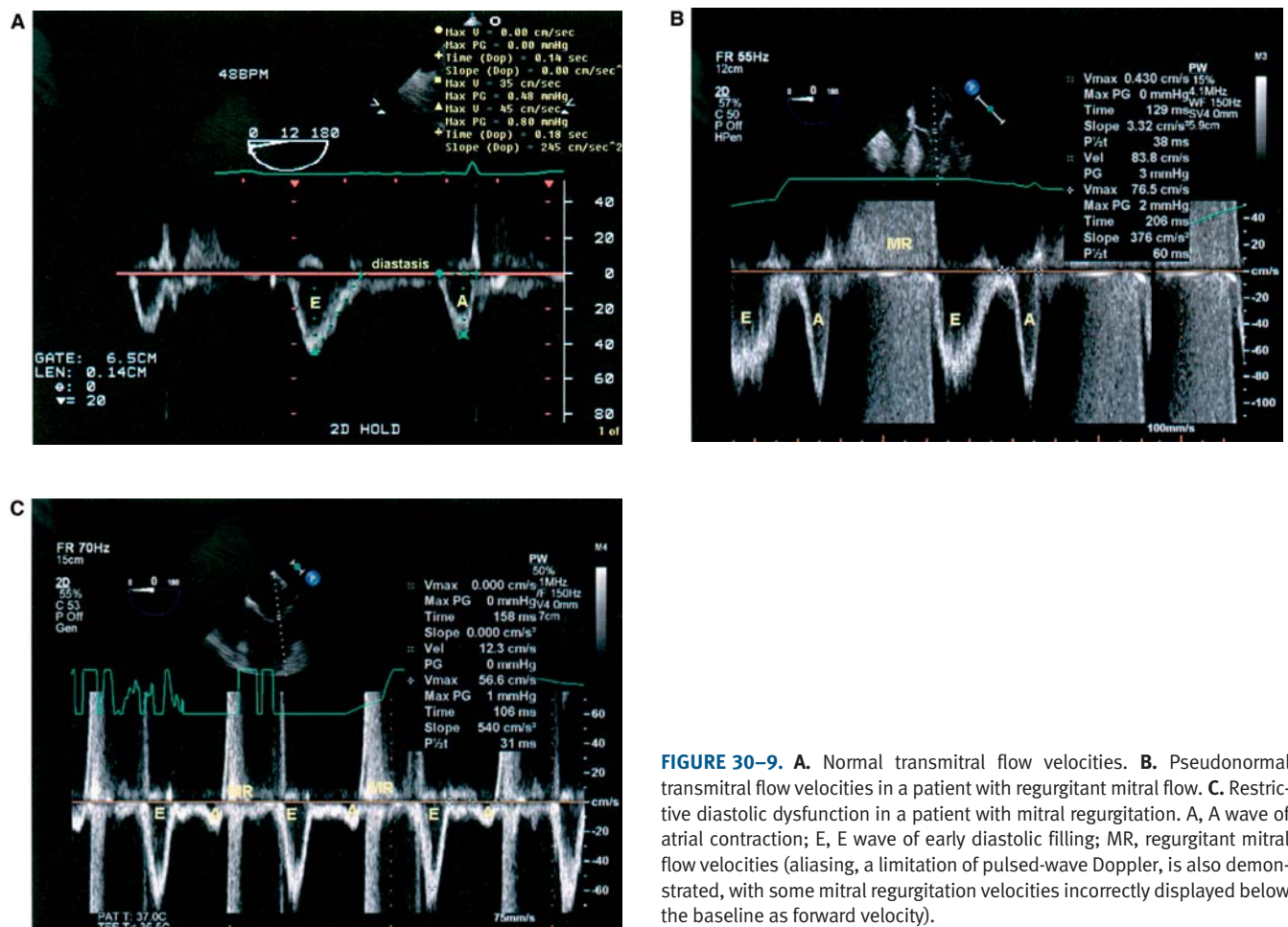
The period required for isovolumic relaxation (first phase of diastole) is the isovolumic relaxation time (IVRT). IVRT is measured as the time interval from closure of the AV to opening of

the MV. IVRT can be obtained from the deep TG long-axis (LAX) view (multiplane angle at  $90^\circ$ ) with a PWD sample at (or CWD through) the junction of the MV inflow and the LV outflow tract (LVOT). Normally, IVRT lasts 60–90 msec and reflects the rate of myocardial relaxation. Impaired relaxation delays the drop in ventricular pressure below that of the atrium, resulting in prolonged IVRT. It probably is the most sensitive Doppler index for detecting impaired relaxation because it is the first to become abnormal, but it is dependent on afterload and heart rate.

If a PWD sample is acquired near the coaptation point of the MV leaflets, transmitral flow velocities can be mapped and measured, corresponding to early diastolic filling. Flow at this time is directed away from the transducer (below the baseline). This wave is the *early* or *E wave*. The time required for the flow velocity to return to zero (from the peak of the E wave back to the baseline) is the *deceleration time*. For a brief time, there is no flow across the MV, and the velocities will remain zero (diastasis). Soon after, the LA contracts, and flow once again begins. Plotting these velocities versus time will yield the *atrial* or *A wave*. The total duration of the A wave (from the end of diastasis to the return of zero flow) is termed *A-wave duration* ( $A_{dur}$ ).

Normally, most diastolic filling occurs in early diastole so that the E/A ratio is  $>1$  (Fig. 30-9A). However, mitral flow velocity curves vary with loading conditions, age, and heart rate. In healthy young patients, the E/A ratio may be as high as two. As people get older, LV relaxation slows; there is a gradual decrease of the peak E-wave velocity and an increase of the A-wave component. In most individuals, E and A become approximately equal in the sixth decade of life. Because relaxation is impaired beyond what is “normal” for age, early diastolic filling decreases.

With diastolic dysfunction, the volume that remains in the atrium at the end of the early filling phase increases, and a progressively vigorous compensatory atrial contraction (“atrial kick”) occurs. This results in a reversed E/A ratio ( $E/A < 0.75$ , delayed relaxation pattern). In this case, deceleration time is increased ( $>220$  msec) and IVRT is increased ( $>100$  msec).



**FIGURE 30-9.** **A.** Normal transmitral flow velocities. **B.** Pseudonormal transmitral flow velocities in a patient with regurgitant mitral flow. **C.** Restrictive diastolic dysfunction in a patient with mitral regurgitation. A, A wave of atrial contraction; E, E wave of early diastolic filling; MR, regurgitant mitral flow velocities (aliasing, a limitation of pulsed-wave Doppler, is also demonstrated, with some mitral regurgitation velocities incorrectly displayed below the baseline as forward velocity).

With further diastolic dysfunction, LV compliance is even lower, and filling pressures begin to increase. This leads to a compensatory increase of LA atrial pressure that results in increased early filling velocities despite impaired relaxation. The filling pattern appears relatively normal (termed *pseudonormalization*), and the E/A ratio returns to approximately 1 (Fig. 30-9B). Pseudonormalization represents abnormalities of both relaxation and compliance and can be distinguished from normal filling by a shortened deceleration time.

In patients with severely decreased LV compliance, LA pressure is markedly elevated and drives vigorous early diastolic filling velocities despite impaired relaxation. This restrictive filling pattern (E/A > 1.5) is consistent with an abnormal rise in LV diastolic pressure and an abrupt deceleration of early diastolic flow (deceleration time < 150 msec) with little additional filling during mid-diastole and atrial contraction (Fig. 30-9C). In the extreme

case, the change in pressure in the ventricle exceeds LA pressure so that MR in mid-diastole may occur.

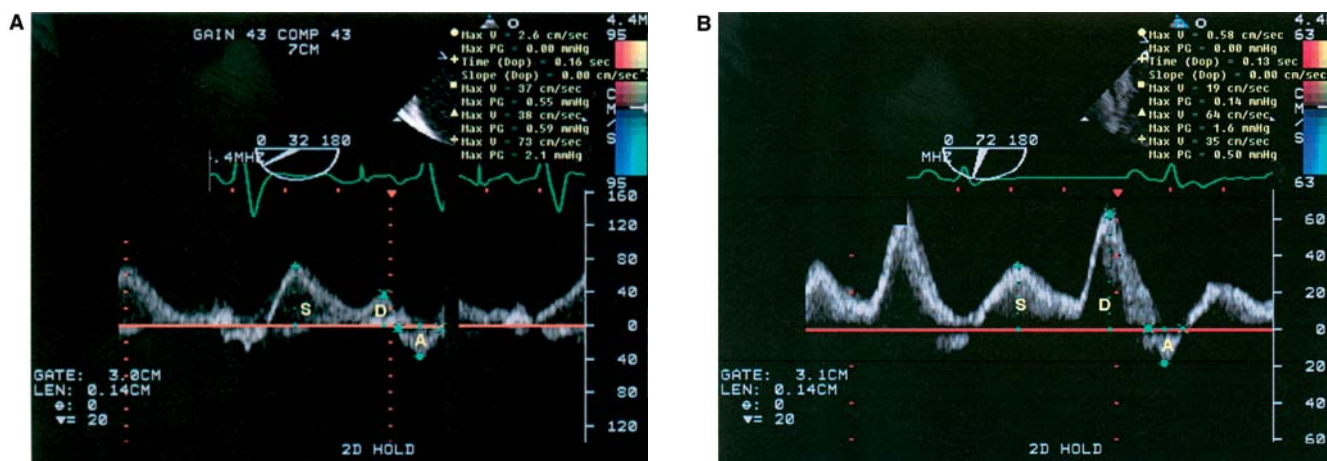
Analysis of pulmonary venous filling patterns provides additional information about LV diastolic function. PWD is used to sample pulmonary venous flow approximately 1.5–2.0 cm within the left upper pulmonary vein (or alternatively the right upper pulmonary vein). Flow from the pulmonary veins into the LA atrium occurs in three phases: systolic phase (S wave), diastolic phase (D wave), and retrograde flow with atrial contraction (A wave). Under normal conditions (LA pressure is normal and the MV is competent), most of the flow into the atrium occurs during ventricular systole (S-wave velocity > D-wave velocity) as the MV annulus is pulled downward (Fig. 30-10A). During diastole, additional blood flows from the pulmonary veins into the LA, which is simultaneously emptying into the LV. During atrial contraction, blood is ejected into the LV, with a small amount of retrograde flow into

the pulmonary veins. The smaller A wave is in the opposite direction to the S and D waves.

As pressure in the LA increases (compensating for advancing diastolic dysfunction), systolic flow decreases (decreased S-wave velocity) and flow occurs predominantly in diastole (increased D-wave velocity; Fig. 30-10B). The absolute values of the S and D waves do not necessarily provide any additional information. Because they are dependent on the volume status of the patient, the absolute values of the S and D waves can vary significantly even under normal conditions.

Pulmonary venous flow patterns help to differentiate normal transmitral filling patterns from pseudonormal patterns. In the pseudonormal pattern, the atrium contracts against an increased afterload in the LV due to an elevated diastolic filling pressure and a stiff LV. More blood will be ejected along the “path of least resistance” back into the pulmonary veins. As a result, the A wave in pseudonor-





**FIGURE 30-10.** A. Normal pulmonary venous flow velocities (S wave > D wave). B. Abnormal pulmonary venous flow velocities (D wave > S wave) from diastolic dysfunction. A, Retrograde atrial flow wave; D, diastolic phase wave; S, systolic phase wave.

mal diastolic dysfunction is tall (often >0.35 m/s) and prolonged.

Both transmitral and pulmonary venous flow patterns are affected by the patient's volume status. Color M-mode Doppler echocardiography is a relatively new modality that can be used to assess diastolic function in a preload-independent manner. When using color M-mode, an "ice pick" scan line is used to display color Doppler velocity information versus time. By placing the scan line through the mitral inflow jet of the LV, two distinct flow profiles are obtained. The displayed profiles correspond to the E and A waves from PWD. The slope of the first (E) wave's aliasing velocity is the propagation velocity ( $V_p$ ), which is an indication of the velocity at which blood travels from the mitral annulus to the apex during early ventricular filling (Fig. 30-11).  $V_p$  correlates to the degree of diastolic dysfunction and is independent of preload and heart rate. Another advantage of color M-mode Doppler echocardiography is that it provides a superior combination of temporal, spatial, and velocity resolution. Propagation velocities <45 cm/s are consistent with diastolic dysfunction in older (>30 years) persons, whereas  $V_p$  <55 cm/s is abnormal in younger patients.

Doppler tissue imaging is another relatively new ultrasound imaging modality that measures the velocity of the actual myocardium during the cardiac cycle. Myocardial tissue Doppler shifts typically are higher in amplitude and lower in frequency than the traditional blood flow measurements. PWD tissue imaging provides the capability of

recording the low velocities of a moving wall structure with a relatively high sampling rate. A PWD sample is taken at the lateral MV annulus, and the peak early diastolic myocardial velocity ( $E'$ ) is measured. In contrast to blood flow velocity profiles that are below the baseline (away from the TEE transducer), Doppler tissue imaging profiles are above the baseline as the MV annulus recoils toward the transducer in diastole.

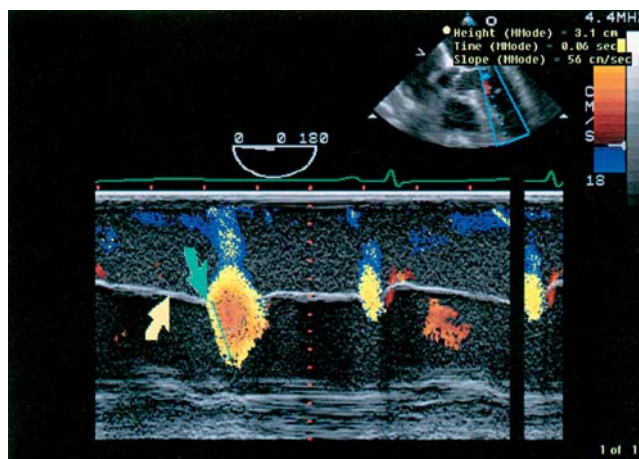
During diastole, motion of the mitral annulus shows two distinct movements toward the atrial side in patients with sinus rhythm (Fig. 30-12A). During the early diastolic period, the onset of  $E'$  coincides with the beginning of mitral inflow. The  $E'$  peak velocity precedes the peak velocity of the transmitral E wave. Unlike transmitral inflow veloci-

ties, where measured parameters are preload dependent,  $E'$  is a good index of LV relaxation and appears to be less sensitive to alterations in preload.

$E' < 8$  cm/s is consistent with diastolic dysfunction (Fig. 30-12B). In addition, a peak early transmitral inflow velocity to peak early diastolic myocardial velocity ratio ( $E/E'$ ) >10 is consistent with diastolic dysfunction.  $E/E'$  then can be used to differentiate normal from pseudonormal transmitral flow pattern.  $E/E' > 15$  has been shown to be highly specific for elevated LA pressures, whereas  $E/E' < 8$  is highly sensitive for normal LA pressures (Fig. 30-13 and Table 30-4).

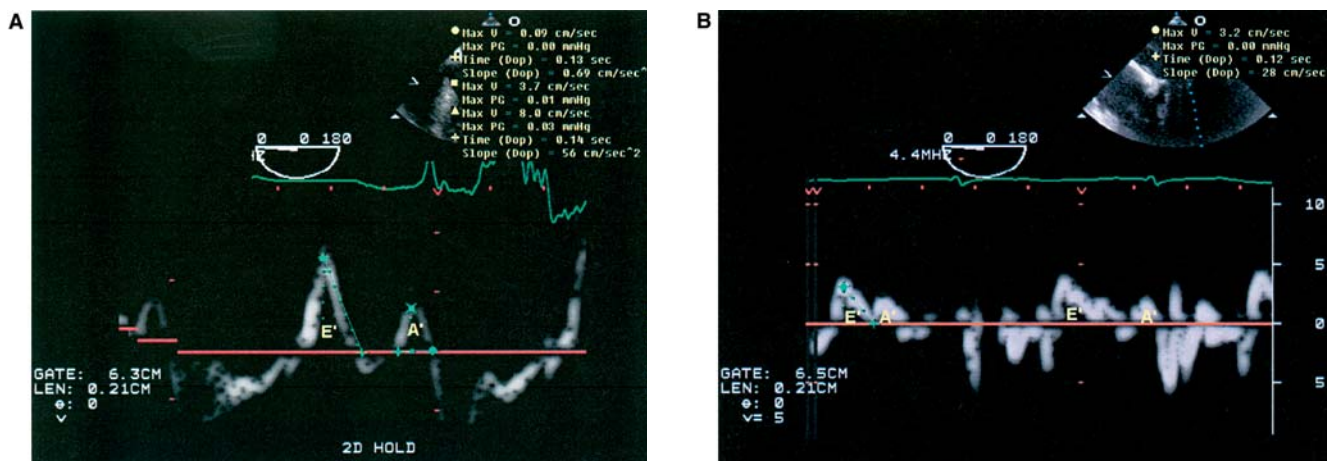
### Mitral Valve

The MV lies in close proximity to the esophagus and is separated from the



**FIGURE 30-11.** Normal propagation velocity measured using color M-mode Doppler. Yellow arrow indicates closed mitral valve. Green arrow indicates beginning of transmitral early diastolic flow as mitral valve opens.





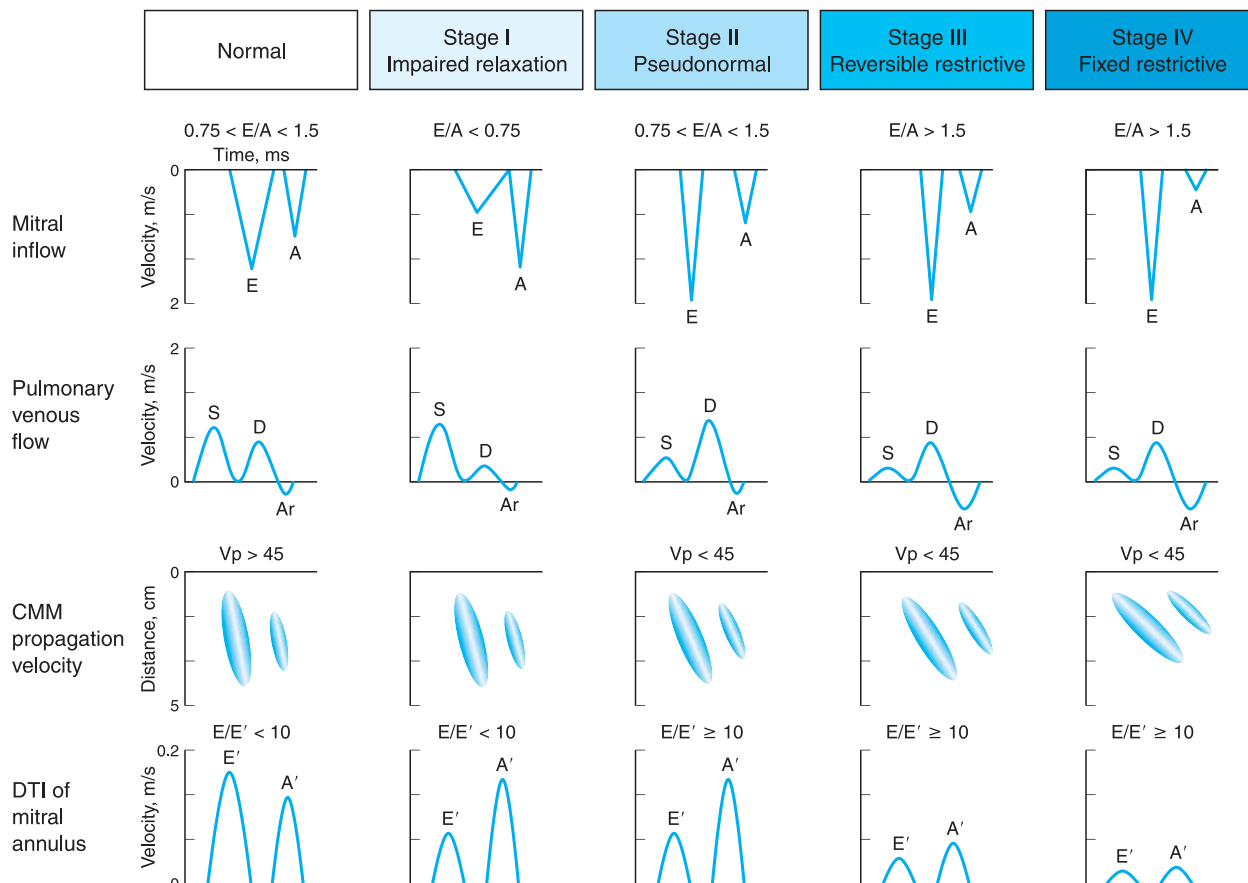
**FIGURE 30-12.** **A.** Normal mitral valve annulus tissue Doppler velocities. A', Atrial contraction myocardial velocity; E', early diastolic myocardial velocity. **B.** Mitral valve tissue Doppler showing restrictive diastolic dysfunction. A', Atrial contraction (late diastolic) myocardial velocity; E', early diastolic myocardial velocity.

TEE probe by the excellent acoustic window offered by the blood-filled LA. The MV is attached to a fibrous ring and consists of two leaflets, one anterior and one posterior. Although morphologically different, the surface areas of the anterior and posterior MV

leaflets are nearly identical and together exceed the area of the mitral annulus in a >2:1 relationship.<sup>8,9</sup> The mitral annulus is a 3D, saddle-shaped, ellipsoid structure that changes shape and decreases in area as it descends during systole (Fig. 30-14). Coaptation

of the two leaflets is curvilinear, and both leaflets join at the anterolateral and posteromedial commissures (Fig. 30-15).

The subvalvular apparatus consists of two papillary muscles and chordae tendineae. The anterolateral papillary



**FIGURE 30-13.** Transesophageal evaluation of diastolic dysfunction. A, Peak late diastolic transmitral flow velocity; A', peak late diastolic tissue velocity; Ar, peak pulmonary venous (PV) atrial reversal flow velocity; D, peak diastolic PV flow velocity; E, peak early diastolic transmitral flow velocity; E', peak early diastolic myocardial velocity; S, peak systolic PV flow velocity; Vp, flow propagation velocity.

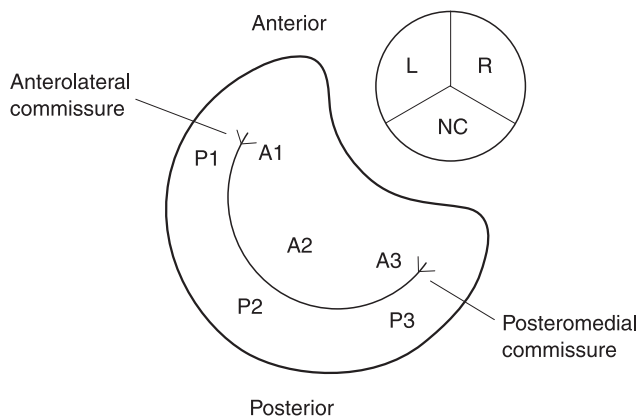
TABLE 30-4.

## Normal Doppler Values

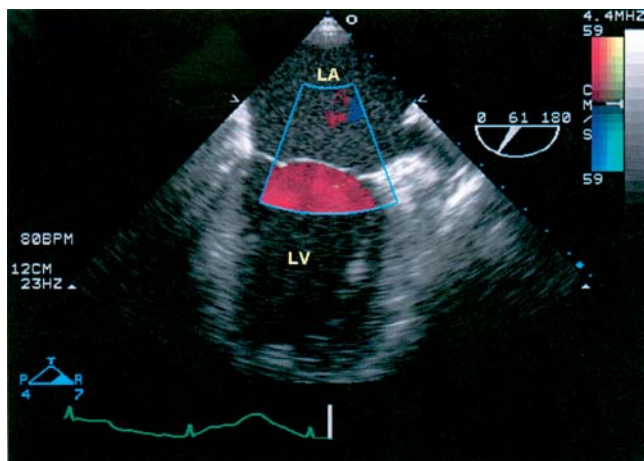
Parameters	Adults <41 y	Adults >55y
Peak mitral flow velocity (E) (cm/s)	76 ± 13	63 ± 11
Peak mitral filling rate (A) (cm/s)	38 ± 8	52 ± 9
Mitral E/A	2.1 ± 0.6	1.3 ± 0.3
Mitral E deceleration time	184 ± 24	
Isovolumetric relaxation time (ms)	74 ± 26	
Peak pulmonary venous AR wave (cm/s)	18 ± 3	25 ± 5
Peak pulmonary venous S wave (cm/s)	41 ± 10	60 ± 10
Peak pulmonary venous D wave (cm/s)	53 ± 10	38 ± 10

E/A, E wave/A wave ratio.

Reprinted from Rakowski H, Appleton C, Chan, KL, et al. Canadian consensus recommendations for the measurement and reporting of diastolic dysfunction by echocardiography: from the Investigators of Consensus on Diastolic Dysfunction in Echocardiography. *J Am Soc Echocardiogr* 1996;9:736-760, with permission from Elsevier.



**FIGURE 30-14.** Anatomic view of the mitral valve viewed from the base of the heart looking toward the left ventricular apex. Orientation of the leaflets and commissures is shown using the Carpentier naming system for mitral segments. The left (L), right (R), and noncoronary (NC) aortic valve leaflets are shown.



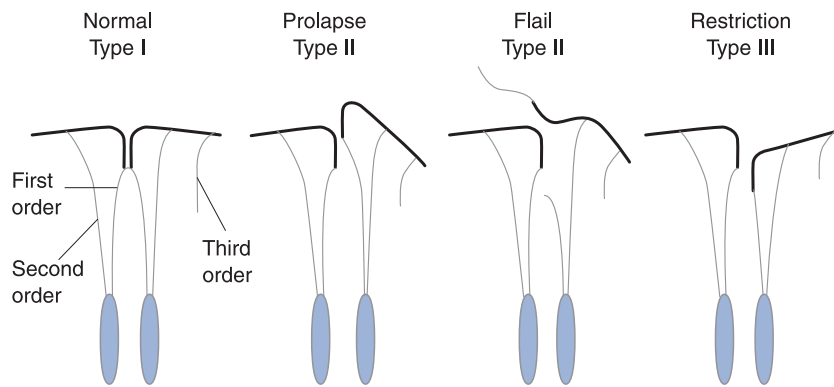
**FIGURE 30-15.** Midesophageal commissural view of a normal mitral valve. A2 segment of anterior leaflet is seen between the commissures, with P1 and P3 segments lateral to commissures. LA, Left atrium; LV, left ventricle.

muscle supplies chordae to the anterior aspect of both the anterior and posterior mitral leaflets; the posteromedial papillary muscle supplies chordae to the posterior aspect of both valve leaflets. Three groups of chordae exist, named in accordance with their insertion points on the MV leaflets (Figs. 30-16 and 30-17). *First-order chordae* attach to the free edge of the leaflets, *second-order chordae* attach to the body of the leaflets, and *third-order chordae* attach near the base of the posterior leaflet only.<sup>10</sup> More than 120 chordal tendons subdivide as they project from each papillary muscle to attach to the free edge and body of both MV leaflets.<sup>8</sup> The subvalvular apparatus is responsible for maintaining valve integrity during systole and plays a crucial role in preserving the overall structure-function relationship of the LV. The MV shares a close anatomic, and at times pathophysiologic, relationship with the AV. In particular, the fibrous skeleton of the heart that gives rise to the anterior MV annulus is intimately associated with both the left and non-coronary cusps of the AV.

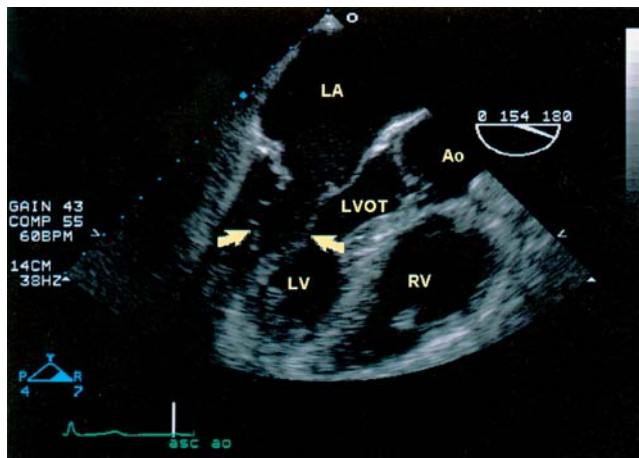
In order to accurately diagnose MV pathology, it is crucial to be able to relate TEE images of this valve to specific anatomic regions. Three approaches to 2D examination of the MV by TEE have been published. Although these approaches all have strengths and limitations, they all emphasize the importance of concise, systematic 2D evaluation of the MV in multiple scan planes and from multiple points of view.

### Mitral Regurgitation

In the early 1980s, Carpentier introduced a functional classification of mitral insufficiency (Fig. 30-16).<sup>11</sup> Type I MR has normal motion of the leaflets, with MR due to leaflet perforation, usually from endocarditis, or annular dilation, often accompanying LV dysfunction. Type II MR has increased leaflet motion, typically from myxomatous change, leading to either leaflet prolapse or a flail leaflet. Leaflet prolapse, a result of leaflet redundancy and chordal elongation, is defined as doming of the leaflet body above the level of the mitral annulus in systole with the leaflet tip still directed toward the LV. With myxomatous change, the annulus often is significantly dilated in addition to the defect in leaflet tip coaptation. This regur-



**FIGURE 30-16.** Normal, prolapsed, flail, and restricted mitral leaflets. The classification of chordae tendineae is also shown.



**FIGURE 30-17.** Midesophageal long-axis view showing subvalvular chordae (arrows). Ao, Aorta; LA, left atrium; LV, left ventricle; LVOT, left ventricular outflow tract; RV, right ventricle.

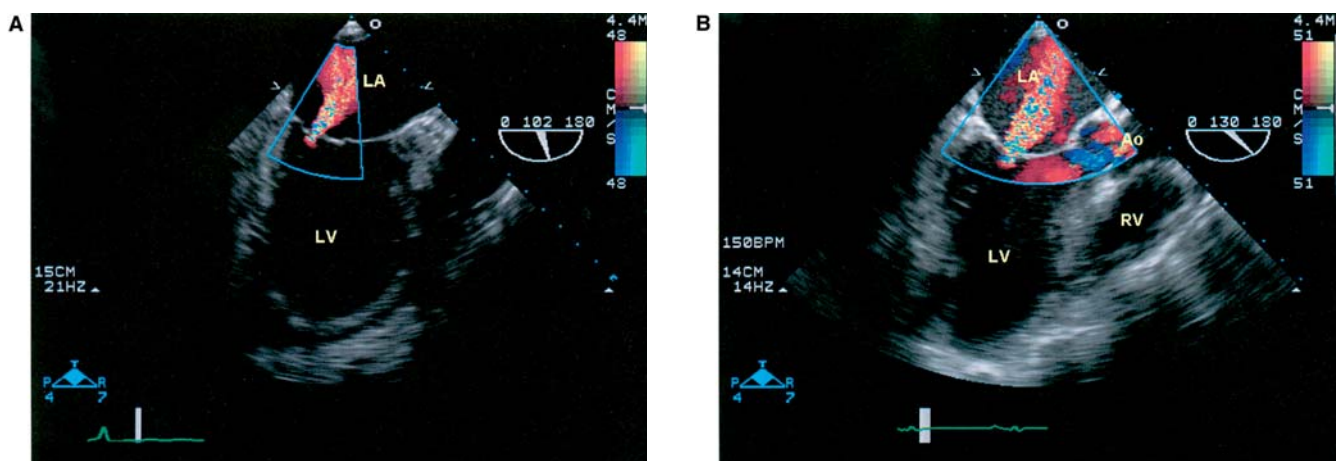
gitant lesion usually evolves slowly and ranges in scale from trivial to severe. A flail leaflet has a leaflet tip directed toward the LA throughout systole. This regurgitant lesion usually is severe with abrupt onset and is

poorly tolerated by the patient. Type III MR is characterized by restricted leaflet motion. Type IIIa dysfunction involves restricted leaflet motion during diastole and systole due to rheumatic changes. Type IIIb dysfunction

correlates to restricted leaflet motion during systole secondary to papillary muscle displacement in ischemic or dilated cardiomyopathy.

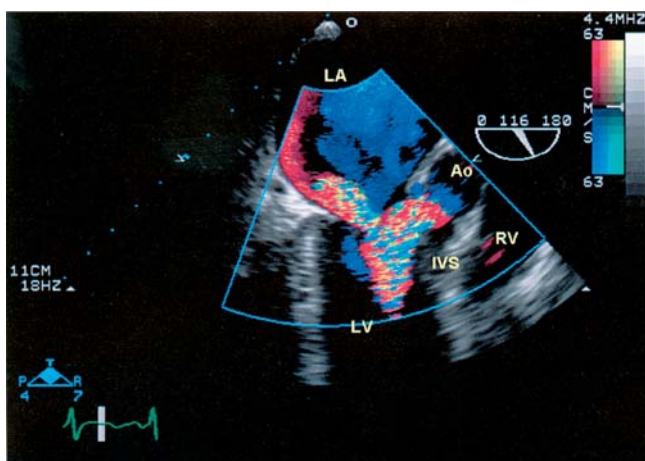
Mitral insufficiency due to global LV dysfunction appears to result from a distorted geometric relationship between the MV leaflets and the papillary muscles. At the gross level, the LV is seen to transform from its usual ellipsoid shape into that of a sphere, causing widening of the interpapillary angle and restriction or tethering of leaflet motion.<sup>12</sup> The valve may appear morphologically normal on 2D imaging, but with loss of the usual systolic leaflet overlap or with a visible coaptation defect. With dilated cardiomyopathy, the regurgitant jet usually is central (Fig. 30-18). Dilation of the annulus may contribute to regurgitation, most notably in the region of the P2 segment, but in most cases is not the major mechanism of regurgitation.

With ischemic MR, dilation of specific areas of myocardium may lead to asymmetric tethering and an eccentric regurgitant jet. Papillary muscle rupture, which most frequently affects the posteromedial muscle, is an occasional complication of myocardial infarction and can result in severe bileaflet regurgitation. The papillary muscle and chordae tips can often be seen flinging into and out of the LA. In hypertrophic obstructive cardiomyopathy, the regurgitant jet usually is directed posteriorly as the anterior leaflet is pulled into the LVOT (systolic anterior motion of the anterior leaflet), resulting in a coaptation defect (Fig. 30-19).



**FIGURE 30-18.** **A.** Midesophageal two-chamber view with color flow Doppler showing mild mitral regurgitation from left ventricular dilation. **B.** Midesophageal long-axis view with color flow Doppler showing moderate mitral regurgitation. Ao, aorta; LA, left atrium; LV, left ventricle; RV, right ventricle.





**FIGURE 30-19.** Midesophageal long-axis view with color flow Doppler revealing mitral regurgitation caused by hypertrophic obstructive cardiomyopathy. Ao, Aorta; IVS, interventricular septum (hypertrophied); LA, left atrium; LV, left ventricle; RV, right ventricle.

MV endocarditis can affect native valves and result in regurgitation because of perforation or deformation of the valve leaflets (Fig. 30-20). Vegetations commonly arise on the upstream side of a valve, which are generally areas of slower flow and therefore are usually seen in the LA. The finding of MV endocarditis mandates careful inspection of the other heart valves to rule out their involvement. Leaflet perforation is identified by the appearance of one or more regurgitant jets that do not seem to arise from the coaptation line. A clue to this particular pathology is the presence of multiple convergence zones on color Doppler.

Echocardiographic examination of the insufficient MV should involve inspection of other structures in the heart that may be altered as a result of the regurgitant process. LA dilation is commonly found in chronic MR of at least moderate severity but is not a feature of acute MR. Left-to-right bowing of the IAS due to elevated LA pressure often can be appreciated in the ME four-chamber or ME bicaval view. Signs of pulmonary hypertension, such as RV and RA enlargement, often accompany progressive MR.

As a significant portion of the systolic volume is unloaded into the LA with severe MR, normal systolic function should appear like a hypercontractile LV. Therefore, an LV with apparently normal systolic function may actually have significant systolic dysfunction. Spherical enlargement of the LV with eccentric hypertrophy signifies long-standing MR in which the compensatory processes of the ventricle are failing.

The severity of MR can be assessed with TEE in a number of ways. One caveat that must be emphasized is that such severity often can be difficult to interpret in the intraoperative period because of the relatively deranged hemodynamic profile of the patient undergoing general anesthesia. Altered loading conditions and cardiac contractility can lead to varying degrees of MR that may be different from those seen in the awake, physiologically normal state. Furthermore, application of severity estimation methods is dependent on the technical expertise of the imaging staff, the complexity involved with the measurement technique, associated limitations with the individual method, and time constraints.

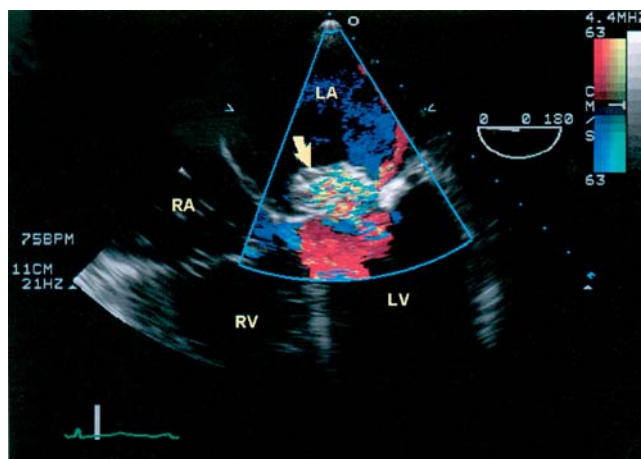
A number of grading systems using CFD have been described, including

regurgitant jet length, jet area, jet area as a percentage of LA area, and width of the vena contracta (narrowest diameter of the regurgitant jet at the site of jet formation). The vena contracta is considered the most useful CFD grading system because it effectively estimates the diameter of the regurgitant jet orifice.<sup>13</sup> A vena contracta  $\geq 6$  mm identifies angiographically severe MR with sensitivity of 95% and specificity 98%. Eccentric regurgitant jets imaged by CFD commonly appear to occupy less overall area compared to jets of similar flow rates directed centrally within the LA.<sup>14</sup> An eccentric jet has a different observed morphology compared to free jets secondary to limited expansion because of impingement of the jet along the atrial wall. Consideration of jet morphology in the CFD assessment is important to avoid underestimating the degree of regurgitation.

A proximal isovelocity surface area (PISA) may be seen on the LV side of the MV during systole as blood flow accelerates toward the regurgitant orifice, causing aliasing with CFD. The product of PISA and the aliasing velocity provides the flow rate through the valve during the measurement. According to the continuity principle, dividing the peak flow rate by the peak regurgitant velocity, as measured by CWD, provides quantitative assessment of the effective regurgitant orifice (ERO):

$$\text{ERO} = \text{PISA}_{\text{MR}} * (\text{Aliasing velocity}) / (\text{Peak regurgitant velocity}),$$

where  $\text{PISA}_{\text{MR}} = 2\pi r^2$ , and  $r$  = radius of semicircular shell of color change at the set Nyquist limit.



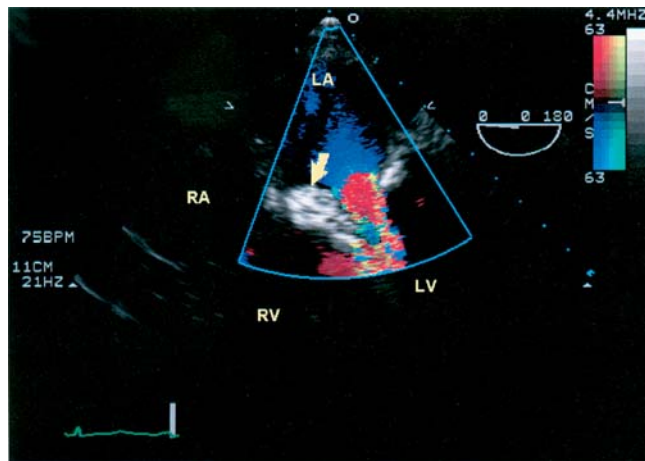
**FIGURE 30-20.** Midesophageal four-chamber view with color flow Doppler demonstrating mitral regurgitation caused by mitral valve endocarditis (arrow). LA, Left atrium; LV, left ventricle; RA, right atrium; RV, right ventricle.



The continuity principle also can be used to derive regurgitant fractions by determining stroke volumes through various other sites in the heart (notably the LVOT, AV, and pulmonic valve). Stroke volume is calculated as the product of the velocity-time integral (VTI) through an orifice and the calculated orifice area at the same location.

Alterations in the pulmonary venous Doppler profile are useful in quantifying the severity of MR. Trivial or mild regurgitation is generally associated with a normal flow velocity pattern (peak S wave > peak D wave), moderate regurgitation is associated with systolic blunting (peak S wave < peak D wave), and severe regurgitation is associated with S-wave reversal (S wave directed away from transducer as regurgitant blood flows retrograde into the pulmonary vein).<sup>15</sup> It is advisable to interrogate at least one pulmonary vein from each side of the LA because regurgitant jets may preferentially affect the pulmonary venous profile of one side over the other.

Peak E-wave velocity is another parameter that can be used to qualitatively assess the degree of MR. When the degree of MR increases, the added regurgitant volume across the MV increases the pressure gradient between the LA and the LV. This increase in pressure gradient subsequently increases early mitral inflow velocity. E-wave velocity >1.2 m/s identified patients with severe MR with sensitivity of 86%, specificity 86%, positive predictive value 75%, and negative predictive value 92%.<sup>16</sup>



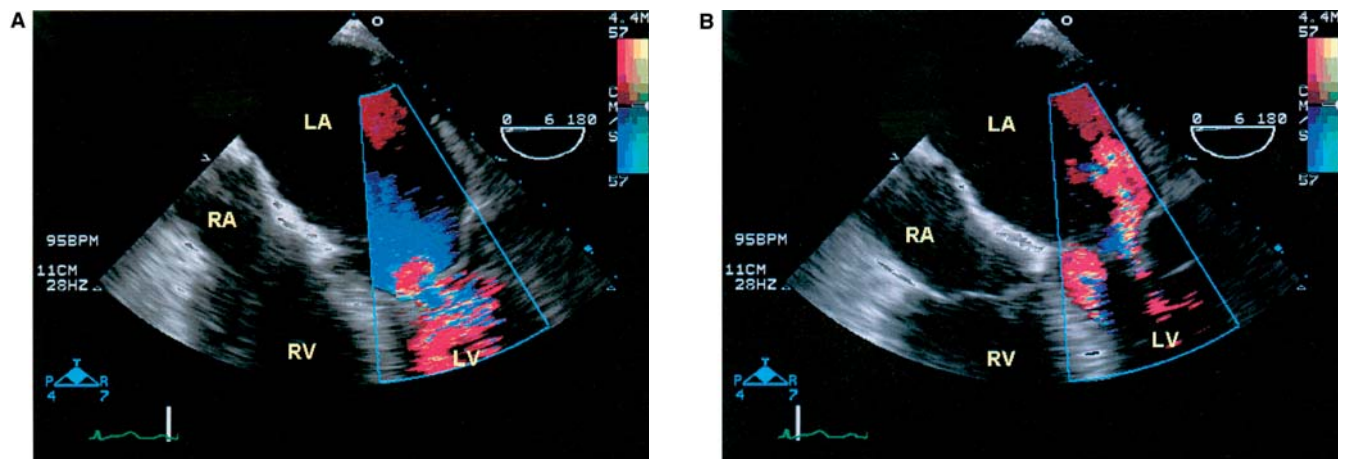
**FIGURE 30-21.** Midesophageal four-chamber view with color flow Doppler demonstrating mitral stenosis from mitral valve endocarditis (arrow). LA, Left atrium; LV, left ventricle; RA, right atrium; RV, right ventricle.

### Mitral Stenosis

Most cases of hemodynamically significant native MV stenoses are due to rheumatic heart disease. Uncommon causes include severe mitral annular calcification, obstructing lesions such as LA tumors and endocarditis vegetations (Fig. 30-21), and congenital deformities such as parachute MV or cor triatriatum. Surgical correction can involve either open commissurotomy or valve replacement. In addition to confirming the severity of the stenosis, it is equally if not more important to evaluate the heart for evidence of LA thrombus (particularly within the LA appendage), RV and LV function, presence and severity of tricuspid regurgitation (TR), and degree of residual stenosis or regurgitation following valve repair or replacement.

Common echocardiographic findings of rheumatic MV stenosis (Fig. 30-22A) include leaflet thickening and calcification, leaflet restriction, and subvalvular involvement (shortening, tethering, and calcification of the chordae). The resulting failure of leaflet coaptation causes a regurgitant jet that is directed toward the side of the lesion (Fig. 30-22B). These leaflet changes are best seen in the ME four-chamber and long-axis (LAX) views. Subvalvular involvement usually is best visualized from the TG two-chamber view. The TG basal SAX view may reveal calcification in the region of the commissures. Rheumatic heart disease also may involve the pericardium, myocardium, and other heart valves.

Associated findings in mitral stenosis include atrial dilation, pronounced



**FIGURE 30-22.** A. Midesophageal four-chamber view with turbulent flow through a stenotic rheumatic mitral valve. B. Midesophageal four-chamber view with color flow Doppler demonstrating mitral regurgitation in a patient with rheumatic heart disease. LA, Left atrium; LV, left ventricle; RA, right atrium; RV, right ventricle.

left-to-right bowing of the IAS, spontaneous echo contrast in the LA (with or without atrial thrombus), and signs of pulmonary hypertension (right-heart dysfunction).

A number of methods are available to the echocardiographer for assessing the severity of mitral stenosis. Mean transmitral pressure gradients are easily estimated from the transmitral CWD profiles using the simplified Bernoulli equation:

$$\text{Mean pressure difference} = 4(\text{Mean transmitral velocity})^2.$$

Severe MV stenosis is associated with mean transvalvular gradients >12 mm Hg.

The pressure half-time denotes the rate of diastolic pressure decline across the MV, specifically the time required to reach 50% of the peak pressure gradient. Normally the diastolic E wave undergoes rapid deceleration due to the abrupt fall in transmitral pressure gradient as the LV fills during early systole. However, in mitral stenosis, the pressure gradient is sustained much later in diastole, giving rise to a greatly prolonged E-wave deceleration and thus longer pressure half-time. Angiographic experiments have shown that an MV area of 1 cm<sup>2</sup> corresponds to a pressure half-time of 220 ms; thus, the area of the stenotic orifice can be estimated by dividing 220 by the pressure half-time in milliseconds.<sup>17</sup>

The continuity equation can be used in conjunction with the peak transmitral E-wave velocity and PISA measurements to estimate the stenotic orifice area. Providing there is no significant aortic or pulmonary regurgitation or interventricular shunts, the continuity equation also can use stroke volumes of the LVOT, AV or pulmonary valve, and the measured VTI of transmitral inflow to estimate the area of the stenotic mitral orifice.

### Aortic Valve

High-resolution images of the AV are provided by TEE because the valve and probe are separated by the LA, which acts as an excellent acoustic window. The AV is composed of three leaflets or cusps that are suspended from the aortic wall along three crescent-shaped lines. The junctions of the free edges of the cusps are called the *aortic commissures*. Behind each leaflet is the respective sinus of Valsalva, a pouch-like dilation of the aortic root. The leaflets and sinuses are named

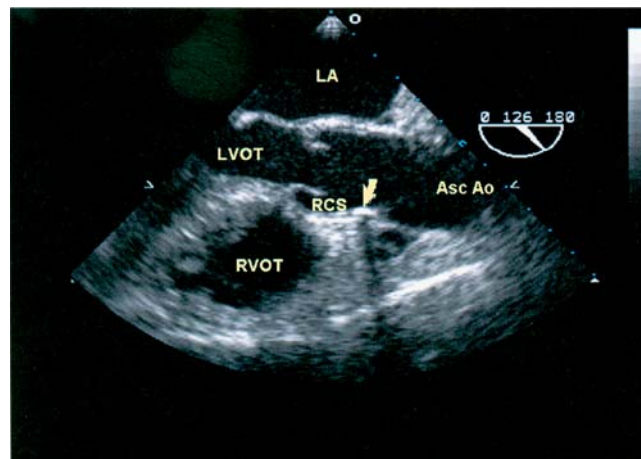
according to the adjacent coronary artery (i.e., left, right, and noncoronary cusps and sinuses).

Four standard views allow examination of the AV and LVOT. Beginning with the imaging depth set at 10–12 cm, the ME AV SAX view is obtained by advancing or withdrawing the probe with a multiplane angle of 30–50° until the AV appears in the center of the screen (Fig. 30–23). All three cusps should be seen symmetrically by rotating the multiplane angle and slightly anteflexing the probe. The general morphology of the AV (bicuspid, tricuspid) is noted as well as the thickness and mobility of the leaflets. CFD is applied to detect flow disturbances indicating aortic regurgitation or stenosis. The AV orifice may be traced to measure valve area.

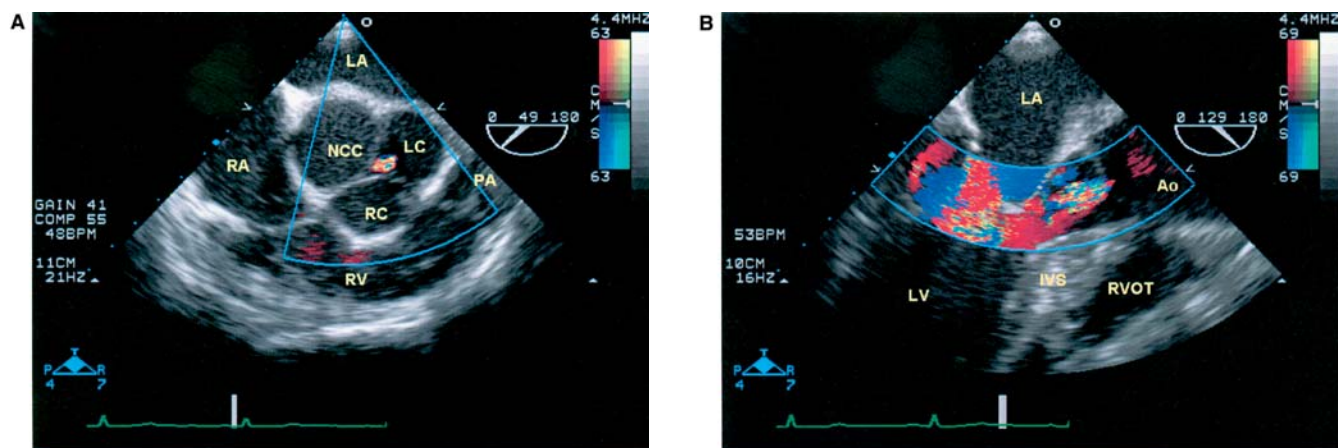
The ME AV LAX view is obtained by rotating the multiplane angle forward 90° from the ME AV SAX to visualize the LVOT, AV, and proximal ascending aorta in long axis (Fig. 30–24). The AV leaflets appear as two thin lines opening parallel to the aortic walls. The right coronary cusp, being farthest from the probe, is visualized toward the bottom of the display. The left or noncoronary cusp (depending on the imaging plane), located closer to the probe, is seen toward the top of the display. The diameters of the LVOT, aortic annulus, sinotubular junction, and ascending aorta can be measured in this view. The annulus is measured where the leaflets insert into the aorta. The proximal ascending aorta should be evaluated for calcification, atheroma, intimal flap or dissec-

tion, and aneurysmal dilation. CFD is again applied to detect the flow pattern through the LVOT, AV, and ascending aorta. Turbulent LVOT flow in this view should prompt further evaluation for hypertrophic obstructive cardiomyopathy or another obstruction to LVOT flow. Systolic anterior motion of the MV (often a fluttering motion into the LVOT, but sometimes apparently occluding the LVOT), associated MR, premature AV closure, and thickened interventricular septum (>1.2 cm, disproportionate from the free wall) confirm hypertrophic obstructive cardiomyopathy.

The deep TG LAX view can be obtained by advancing the probe tip deep into the stomach and then anteflexing to create an imaging plane originating from the LV apex with the AV appearing in the far field. Alternatively, the TG LAX view is obtained from the TG midpapillary SAX view by rotating the angle forward to 90–110° until the AV comes into view in the far field to the right side of the image. Both of these TG views allow for parallel alignment of the ultrasound beam through the AV, making them most useful for measuring Doppler flow velocities through the LVOT and AV rather than visualizing anatomy. Positioning the PWD sample volume in the center of the LVOT allows Doppler flow measurement in the outflow tract. Flow velocity through the AV is measured with CWD. Either or both of these TG views may be difficult to obtain in some patients, and a severely stenotic AV may make Doppler interrogation difficult. CFD may be helpful in detecting



**FIGURE 30–23.** Midesophageal aortic valve long-axis view. Arrow indicates sinotubular junction. Asc Ao, Ascending aorta; LA, left atrium; LVOT, left ventricular outflow tract; RCS, right coronary sinus behind right cusp of aortic valve; RVOT, right ventricular outflow tract.



**FIGURE 30-24.** A. Midesophageal aortic valve short-axis view with color flow Doppler showing central aortic insufficiency in a dilated aortic valve. B. Midesophageal aortic valve long-axis view with color flow Doppler demonstrating aortic insufficiency. Ao, Aorta; IVS, hypertrophied interventricular septum; LA, left atrium, LC, left aortic valve cusp; LV, left ventricle, NCC, noncoronary aortic valve cusp, PA, pulmonary artery, RA, right atrium, RC, right aortic valve cusp, RV, right ventricle, RVOT, right ventricular outflow tract.

flow through the stenotic orifice, facilitating appropriate placement of the Doppler beam.

### Aortic Insufficiency

Acute or chronic regurgitation may result from abnormalities of the AV and the aortic root (Fig. 30-23). Aging, rheumatic heart disease, endocarditis, or congenital bicuspid or unicuspid AV all may lead to aortic regurgitation. Dilation of the aorta resulting from connective tissue diseases (Marfan syndrome, Ehlers-Danlos syndrome), sinus Valsalva aneurysm, aortic root abscess, and hypertension are other causes of aortic insufficiency (AI).

Two-dimensional imaging should be applied in the ME AV SAX and LAX views to detect congenital abnormalities or acquired defects such as myxomatous degeneration and vegetations. The aortic root should be assessed for dilation, and measurements of the LVOT, AV annulus, sinotubular junction, and ascending aorta should be obtained. The area of the end-diastolic gap between the aortic cusps, measured by planimetry, correlates with the severity of AI (mild  $<0.2 \text{ cm}^2$ , moderate  $0.2\text{--}0.4 \text{ cm}^2$ , severe  $>0.4 \text{ cm}^2$ ).

The vena contracta should be measured by CFD in the ME LAX view with the imaging depth reduced. A vena contracta  $<0.3 \text{ cm}$  indicates mild AI, whereas a value  $>0.6 \text{ cm}$  signifies severe AI. The ratio of the regurgitant jet area to the LVOT area also can be measured by CFD in the ME LAX view. Similarly, the width of the regurgitant jet can be compared to the width of the LVOT. Values  $>60\%$  and

$>65\%$  for area and width, respectively, indicate severe AI.

The pressure half time (PHT), described previously to grade mitral stenosis, can be applied to grade the severity of AI. The more severe the AI, the shorter the PHT because the aortic diastolic pressure gradient declines more rapidly. PHT is best obtained in the TG LAX or deep TG LAX views with CWD. PHT  $>500 \text{ msec}$  indicates mild AI, whereas PHT  $<200 \text{ msec}$  is compatible with severe AI. PHT measurements can be misleading in patients with elevated LV end-diastolic pressure (diastolic dysfunction). In these instances, the gradient will dissipate rapidly, and the true severity of regurgitation may be overestimated.

Early diastolic flow reversal in the descending aorta, measured with PWD, may be a normal finding. However, holodiastolic flow reversal in the proximal abdominal aorta/distal thoracic aorta indicates severe AI.

### Aortic Stenosis

Calcific degeneration of the AV, the most common cause of AS, is characterized by restricted leaflet motion and calcification along the free edges of the leaflets. Patients with calcific degeneration usually become symptomatic in their sixth to seventh decade of life.

Rheumatic AS typically is seen in middle-aged immigrants. The tips of the leaflets are thickened and calcified and the commissures are fused, producing a characteristic “doming” during systole. The orifice may become circular instead of the normal triangular shape. Rheumatic AS almost al-

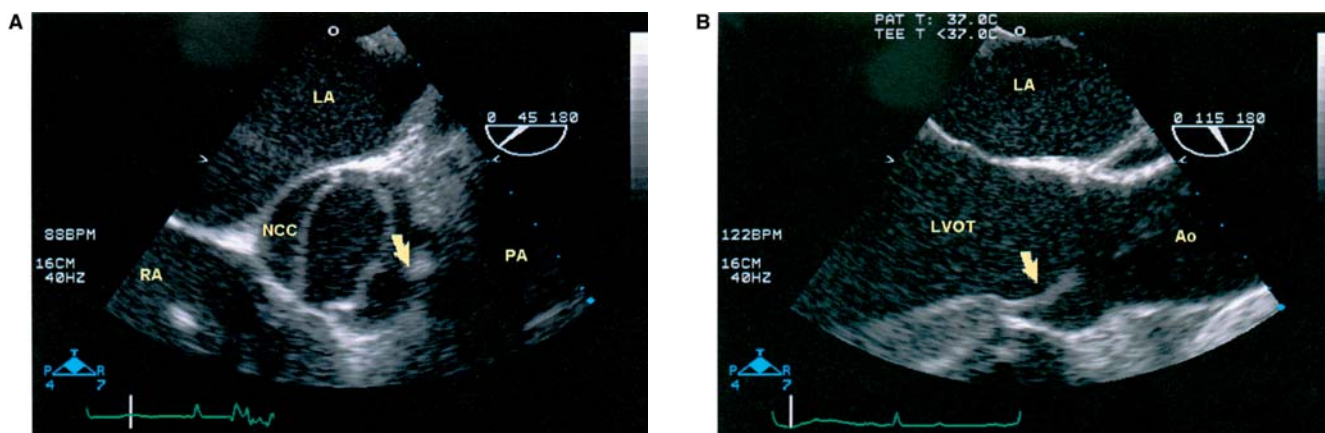
ways is associated with rheumatic involvement of the MV.

Congenital abnormalities of the AV may lead to AS. Bicuspid AV is the most common form, occurring in approximately 2% of the normal population, and symptoms usually occur in the fourth to sixth decades of life. The bicuspid AV orifice is elliptical, and a calcified raphe is often present on one of the leaflets, giving the false impression of a trileaflet valve (Fig. 30-25).

TEE interrogation should start with 2D imaging in the ME AV SAX and LAX views. Thin and mobile AV leaflets without calcification usually exclude severe AS. Thickening, calcification, and restricted leaflet motion are seen in all cases of AS. Commissural fusion is seen in rheumatic valvulitis. Poststenotic dilation of the aortic root and the proximal ascending aorta may be present. The AV area can be measured by planimetry in the ME AV SAX view using the zoom mode to magnify the frozen image. The inner edges of the distal leaflets should be traced in systole during their greatest excursion. Severe thickening and calcification of the leaflets, shadowing, accentuated cardiac motion, and the inability to obtain a true SAX view near the leaflet tips all may make planimetry difficult and inaccurate. In the ME AV LAX view, leaflet morphology, mobility, calcification, and thickening also can be evaluated. The LVOT can be examined for subaortic pathology.

Turbulent, high-velocity flow can be seen in the proximal ascending aorta with severe AS. Pressure gradients and transvalvular velocity should be measured. To accomplish this, the CWD





**FIGURE 30–25.** **A.** Midesophageal aortic valve short-axis view showing the elliptical opening of a bicuspid aortic valve. Arrow indicates calcification along raphe where right and left aortic valve cusps appear fused into a single cusp. **B.** Midesophageal aortic valve long-axis view showing bowing of the restricted bicuspid aortic valve leaflet (arrow). Ao, Aorta; LA, left atrium; LVOT, left ventricular outflow tract; NCC, noncoronary aortic valve cusp; PA, pulmonary artery; RA, right atrium.

beam is positioned across the AV in the TG LAX or deep TG LAX views (Fig. 30–26), and the edge of the spectrum is traced to obtain the peak and mean pressure gradients and flow velocities. Severe AS corresponds to a peak velocity  $>4$  m/s (Fig. 30–27A). The VTI of the traced spectrum is calculated and corresponds to the distance traveled by a column of blood during the stroke cycle. This allows use of the continuity principle to calculate the effective AV cross-sectional area ( $CSA_{AV}$ ). The continuity principle is based on the conservation of flow over time between two conduits within a closed circuit (AV and LVOT in this example). Because flow is the product of the cross-sectional area of the conduit and the VTI through the conduit:

$$CSA_{LVOT} \times VTI_{LVOT} = CSA_{AV} \times VTI_{AV},$$

where  $CSA = \pi r^2$ , and  $r$  = radius of the respective conduit.

The radius of the LVOT can be measured in the ME LAX view.  $VTI_{LVOT}$  can be obtained in the TG LAX or deep TG LAX views using PWD.  $VTI_{AV}$  can be directly measured with CWD from the deep TG view. Alternatively, a “double-envelope” technique can be used to simultaneously measure LVOT and AV VTIs by CWD in the TG LAX or deep TG LAX views (Fig. 30–27C). Because the velocity of flow through the smaller AV must accelerate from that of the larger-diameter LVOT, the larger envelope must correspond to the VTI of the AV, and the smaller, but denser, envelope represents the VTI of the LVOT.

## Aorta

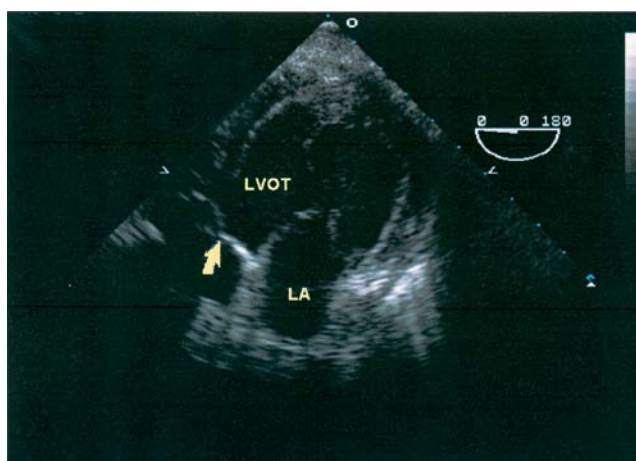
The aorta is the largest artery in the body with a normal diameter up to 3.5

cm. It is divided anatomically into four segments: ascending aorta, transverse aortic arch, descending thoracic aorta, and abdominal aorta. The ascending aorta begins at the level of the aortic annulus and the aortic valve. Just distal to the aortic annulus, the ascending aorta dilates to form a segment known as the *aortic sinus of Valsalva*, which includes the respective left coronary, right coronary, and noncoronary sinuses. Distal to the aortic sinuses, the aorta has a brief segment with a reduced diameter called the *sinotubular junction*.

In adults, the ascending aorta is approximately 5 cm in length. After originating from the AV annulus, the ascending aorta extends rightward around the main pulmonary trunk and crosses the right pulmonary artery anteriorly. It then ascends rightward and anteriorly until it meets the aortic arch at the origin of the innominate artery

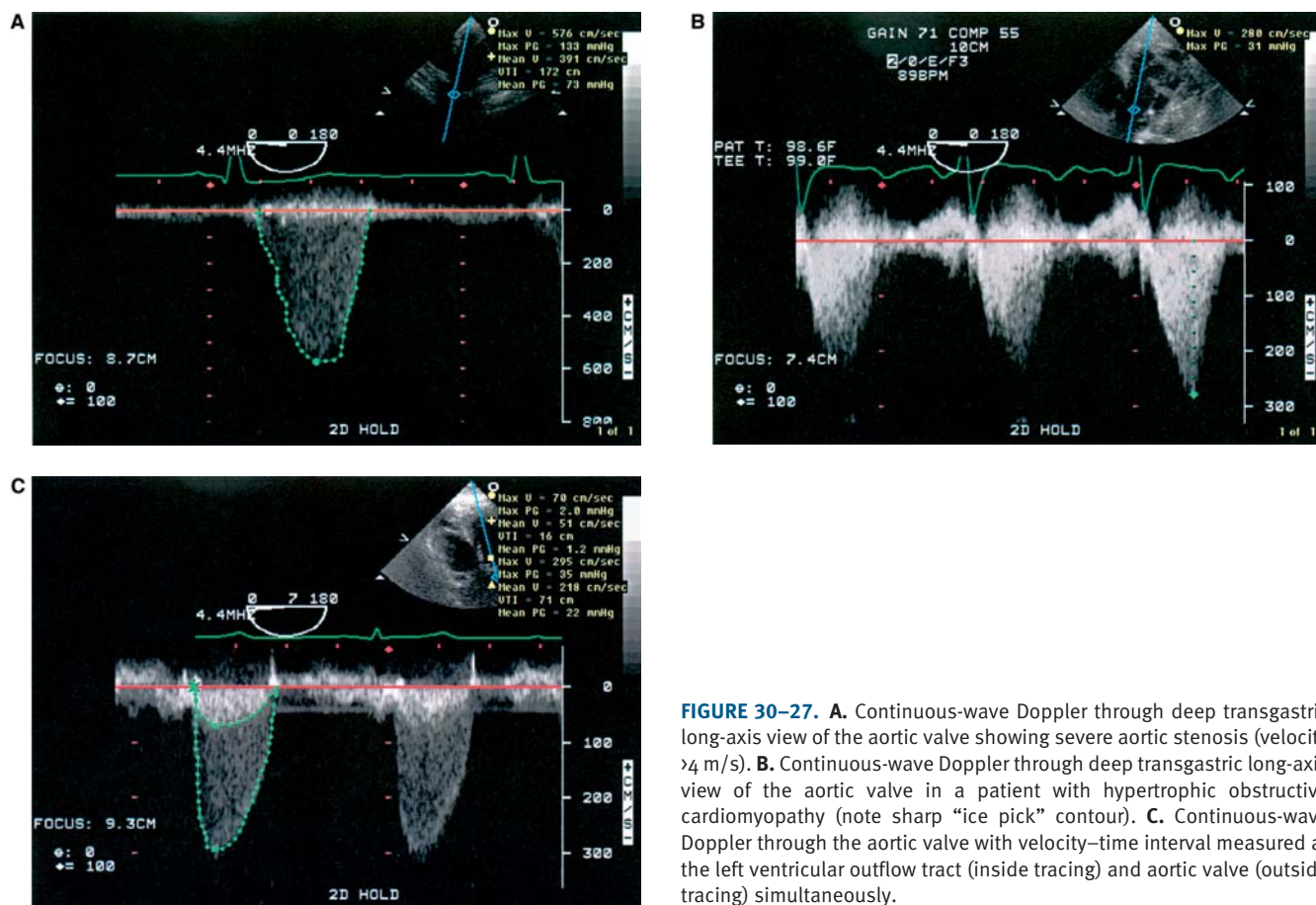
(at the level of the second intercostal space). The proximal or near aortic arch is poorly visualized with TEE because of the anatomic interposition of the trachea between the esophagus and the aorta at this level. Whereas the innominate and left common carotid arteries are in close proximity to the trachea, the left subclavian artery lies to the left of the trachea and can be visualized more easily with TEE.

The descending thoracic aorta begins distal to the left subclavian artery at the level of the ligamentum arteriosus. This is an area of narrowing referred to as the *aortic isthmus*. The ligamentum arteriosus is a fibrous connection between the pulmonary artery and the aorta, a remnant of the ductus arteriosus during fetal life. Inferior to the isthmus, the descending aorta courses to the left lateral side of the body of the fourth thoracic vertebrae. The descending aorta is relative-



**FIGURE 30–26.** Deep transgastric long-axis view with aortic valve leaflets (arrow) seen on the left. LA, Left atrium; LVOT, left ventricular outflow tract.





**FIGURE 30-27. A.** Continuous-wave Doppler through deep transgastric long-axis view of the aortic valve showing severe aortic stenosis (velocity  $>4$  m/s). **B.** Continuous-wave Doppler through deep transgastric long-axis view of the aortic valve in a patient with hypertrophic obstructive cardiomyopathy (note sharp “ice pick” contour). **C.** Continuous-wave Doppler through the aortic valve with velocity–time interval measured at the left ventricular outflow tract (inside tracing) and aortic valve (outside tracing) simultaneously.

ly transfixed to the vertebral column here. Therefore, deceleration injuries often occur at the level of the isthmus. The descending aorta continues along a slightly anterior and rightward path as it approaches the diaphragm, where it lies directly posterior to the esophagus. Therefore, at the level of the lower esophageal sphincter, the heart and the aorta are on opposite sides of the esophagus.

The Society of Cardiovascular Anesthesiologist and the American Society of Echocardiography have defined six views for interrogating the thoracic aorta by TEE.<sup>4</sup> Multiple imaging planes from within similar views may be necessary to accurately define aortic pathology.

The ME ascending aorta SAX view is obtained in the 0–30° imaging plane with the probe approximately 25 cm from the lips. In this view, an SAX view of the ascending aorta along with the main pulmonary artery, right pulmonary artery, and SVC is obtained. Qualitative analysis of the aortic anatomy and wall thickness can be obtained in this view.

The ME ascending aorta LAX view is obtained between 110° and 140°. This

view is easily obtained after starting with the ME AV SAX view (“Mercedes-Benz” view), which is easily recognized at the ME level with the multiplane angle at 20–50°. Once the “Mercedes-Benz” view is obtained, rotating the imaging plane forward an additional 90° and withdrawing the probe slightly yields the ME ascending aorta LAX view (Fig. 30–28). This view is useful in defining wall thickness, aortic dimensions, and blood flow patterns in the ascending aorta.

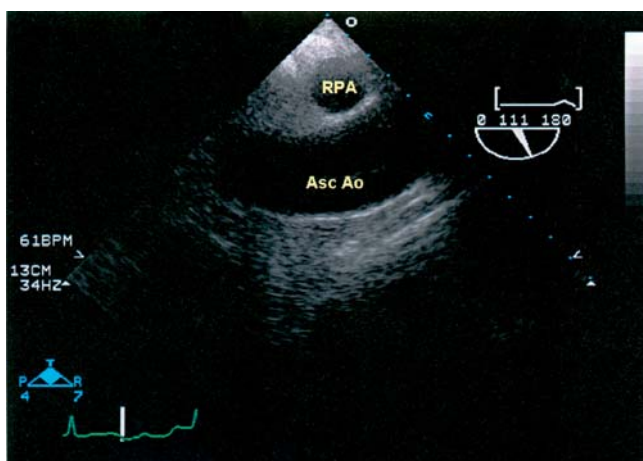
From the ME ascending aorta views, turning the probe to the left with a multiplane angle of 0° produces an SAX image through the descending aorta. Once the aorta is visualized, the depth of the image should be optimized so that the aorta is in the center of the screen. Inserting the probe to the level of the diaphragm (where the image disappears) and then slowly withdrawing the probe allows scanning of the entire descending thoracic aorta. The SAX view is useful for defining wall thickness, determining atherosclerotic severity, and measuring aortic dimensions (Fig. 30–29A).

From the SAX view, rotating the plane to 90° produces an LAX view of

the descending aorta (Fig. 30–29B). These views are useful for defining spatial relationships of SAX findings, interrogating aortic flow patterns, and identifying branch vessels.

With the scan plane at 0°, withdrawal of the probe following the aorta to an upper esophageal window with a rightward rotation produces an LAX view of the aortic arch. This view is used to define aortic dimensions, wall contour, and branch vessels. Advancing the multiplane angle to 90° in the upper esophagus produces an SAX view of the arch. At the proximal arch, the main pulmonary artery and right pulmonary artery may be seen if the depth is sufficient (Fig. 30–33A). At the distal arch, multiple views of the arch and its branch vessels may be obtained.

Even using all of these views, TEE does not image the entire thoracic aorta. A “blind spot” in the distal ascending/proximal arch is created by the trachea. The aorta also is subject to echocardiographic artifacts and dropout caused by calcifications. With every image, the examiner should describe the morphology, dimensions, and integrity of the aortic wall. Evalu-



**FIGURE 30-28.** Midesophageal ascending aorta long-axis view. Asc Ao, Ascending aorta; RPA, right pulmonary artery.

ation for spontaneous echocardiographic contrast or turbulent flow also is recommended. Any fluid collection should be noted.

The association between atherosclerosis of the aorta and systemic embolization is prevalent in the literature. Katz et al.<sup>18</sup> showed a link between the severity of atherosclerotic atheroma and the incidence of perioperative stroke. In addition, atherosclerosis of the ascending aorta is an independent predictor of long-term neurologic outcomes and morbidity following cardiac surgery.<sup>19</sup> If atheroma is not detected by TEE examination of the aorta, then significant atheroma in the ascending aorta (where cannulation, cross-clamping, and most aortic manipulation occurs for cardiopulmonary bypass) is unlikely.<sup>20</sup> Conversely, if significant atheroma is found in the thoracic aorta upon TEE examination, then there is a 34% chance of significant atheroma in the ascending aorta,

and epiortic scanning should be strongly considered.

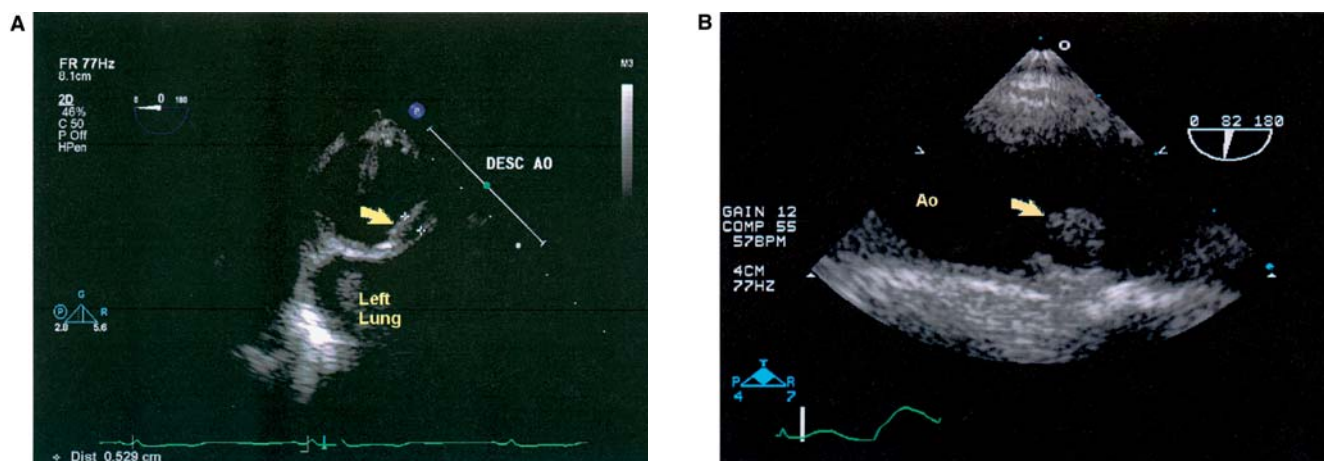
Many different classification systems for aortic atheroma severity have been proposed. The most widely used system was proposed by Katz et al.,<sup>18</sup> consisting of a five-grade classification system. A grade I atheroma has minimal or no intimal thickening. A grade II atheroma has severe intimal thickening without a protruding element. A grade III atheroma has intimal thickening protruding <5 mm into the lumen. A grade IV atheroma protrudes >5 mm into the lumen. A grade V lesion is any atheroma with a mobile component. Although currently there is no consensus as to the size of plaque that should warrant alteration of the surgical procedure, large atheromas and atheromas with mobile elements should warrant discussion with the surgeon.

Direct ultrasound of the aorta via a high-frequency probe placed directly

on the aorta (epiaortic scanning) can be used to gain additional information during procedures that use a sternotomy. An epiaortic probe is guided into a sterile sleeve on the operating field. Gel or water is used to create a stand-off from the probe to the aorta in order to visualize the anterior wall of the aorta. The aorta is best visualized in both the LAX and SAX views. The image should be optimized so that the aorta is in the center of the screen. The cross-clamp site and antegrade cardioplegia site should be interrogated. These sites often fall in the region of the aorta that is difficult to image with TEE because of the interposed trachea. If atherosclerotic lesions that could be embolic sources are present, manipulation of these areas should be avoided.

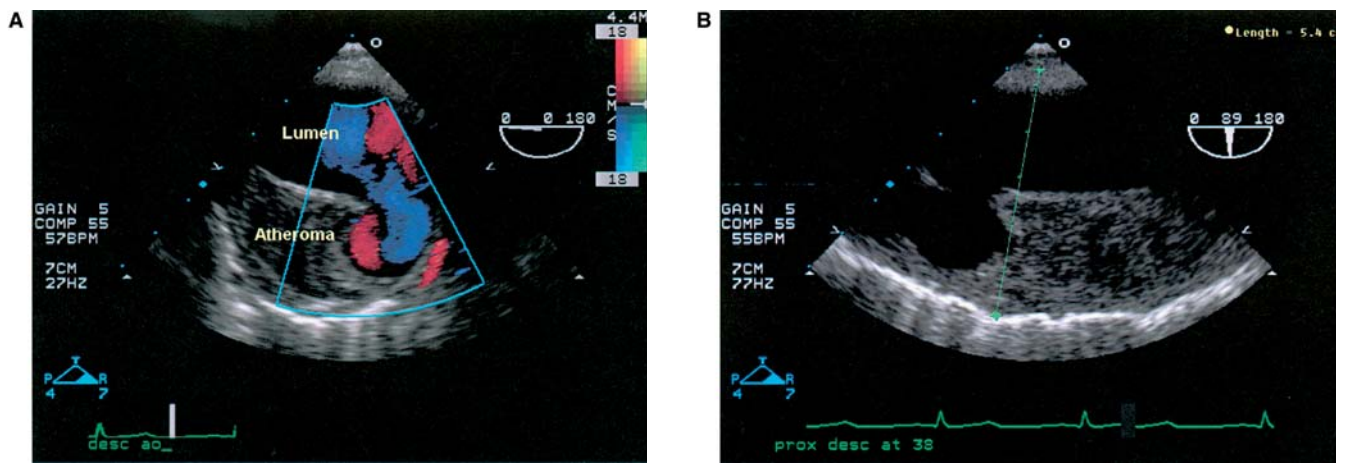
TEE is useful for diagnosis and classification of thoracic and abdominal aneurysms (Fig. 30-30). An aneurysm of the aorta involves an increase in the luminal diameter of all three layers of the aorta. A pseudoaneurysm involves an interruption of the intima and media at the level of the aneurysmal sac and its communication with the native aorta. An ascending aortic diameter >4 cm, descending thoracic aneurysm >6 cm, or abdominal aortic aneurysm >5 cm in diameter is considered an indication for surgical intervention.

Dissection of the aorta is a process in which the intima separates from the adventitial layer. It is characterized by the presence of an intimal flap and resulting false and true lumens. Aortic dissection can result from intimal rupture followed by cleavage formation and propagation of the dissection into the media. Additionally, aortic dissec-



**FIGURE 30-29.** A. Descending aorta short-axis view with atheroma (arrow). B. Descending aorta long-axis view with atheroma (arrow). Ao, Lumen of aorta.





**FIGURE 30-30.** Short-axis (A) and long-axis (B) views of a descending thoracic aorta aneurysm with ulcerated atheroma.

tion can result from intramural hemorrhage and hematoma formation in the media, subsequently followed by perforation of the intima. The presence of an intimal flap is the most characteristic feature of aortic dissection. The pathogenesis of dissection is complex. Medial degeneration tends to be more extensive in older individuals and in patients with hypertension, Marfan syndrome, and bicuspid AVs.<sup>21</sup> The true lumen diameter typically is smaller than the false lumen diameter (Fig. 30-31A), and spontaneous contrast can often be seen in the false lumen. However, PWD should be used to confirm forward flow in the presumed true lumen during systole (Fig. 30-31B).

Aortic dissection is divided into acute and chronic types, depending on the duration of symptoms. Acute aortic dissection is present when the diagnosis is made within 2 weeks after the initial onset of symptoms. Approxi-

mately one third of patients with aortic dissection fall into the chronic category, in which symptom duration is >2 weeks. The most common site of initiation of aortic dissection is the ascending aorta (50%), followed by aortic regions in the vicinity of the ligamentum arteriosum.

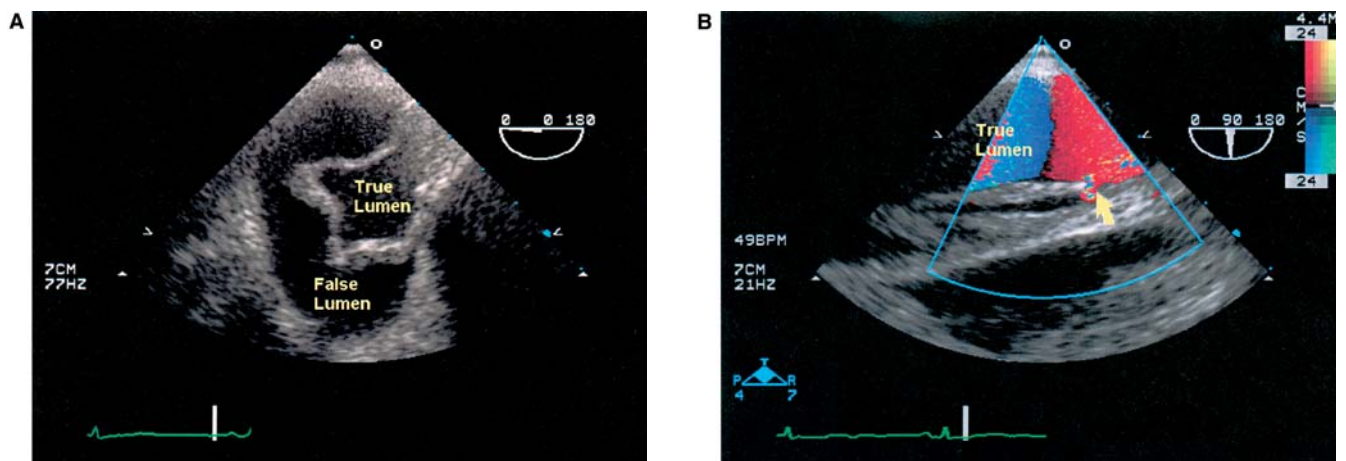
Anatomically, aortic dissection has been classified by two schemes. The DeBakey classification consists of the three types: type I includes both the ascending and the descending aorta, type II includes only the ascending aorta, and type III includes only the descending aorta. The Stanford classification consists of two types: type A involves the ascending aorta regardless of the entry site location, and type B involves the aorta distal to the origin of the left subclavian artery. Any dissection involving the ascending aorta (DeBakey types I and II or Stanford type A) is an indication for repair, whereas dissections confined to the

descending aorta can be medically managed, at least initially.

Endovascular repair of the aorta has gained popularity as a reliable alternative to conventional repair. TEE is used to supplement intraoperative angiography in guiding placement of thoracic endografts. During endovascular repair, TEE is the most sensitive imaging modality currently available for diagnosing endoleaks immediately after graft deployment. The ability to use intraoperative TEE for visualizing the thoracic and abdominal aorta and monitoring cardiac function makes it an invaluable tool during these procedures.<sup>22</sup>

## Right Ventricle

The RV is crescent shaped, thin walled, and compliant. It is less contractile compared to the LV. Its oxygen requirements are lessened by its reduced muscle mass and lower afterload. The right coronary artery (RCA)



**FIGURE 30-31.** A. Descending aorta short-axis view of an aortic dissection. B. Descending aorta long-axis view of an aortic dissection at the level of an intimal tear (arrow).

supplies the RV free wall, the posterior descending artery supplies the inferior RV wall, and the anterior RV wall has a dual blood supply from the conus branch from the RCA and the moderator branch from the left anterior descending artery.<sup>23</sup> The RV is a low-pressure system, with an average pressure of 20/5 mm Hg. Therefore, coronary flow to the RV from the aorta follows this favorable pressure gradient, resulting in perfusion during both diastole and systole, unlike the high-pressure LV, which is perfused only during diastole.<sup>24,25</sup> RV contraction resembles peristaltic motion, which functions to prolong ejection time by ejecting blood even as proximal RV pressures decline, thus minimizing end-diastolic pressure and promoting venous return.<sup>26</sup> RV ejection results primarily from RV free wall inward motion, with a smaller contribution from descent of the base of the heart.

The RV is sensitive to changes in afterload and susceptible to coronary air embolism because of the anterior location of the RCA takeoff. Furthermore, the RV is difficult to protect during cardiac surgery. Evaluation of the RV is a necessary part of a comprehensive TEE examination because RV dysfunction in cardiac surgery correlates with mortality.<sup>27</sup> However, because of its anterior position far from the TEE probe and its geometric complexity due to its crescent shape and twisting contraction, assessment of the RV with TEE is more challenging than that of the LV.

TEE examination of the RV is primarily performed qualitatively by as-

sessing the RV in long axis with the ME four-chamber (Figs. 30–2B and 30–32B) and TG RV inflow views, as well as in short axis with TG mid-SAX (Fig. 30–34) and ME RV inflow-outflow views (Fig. 30–3B). The RV free wall is best viewed from the ME four-chamber and TG mid SAX views. When assessing RV function, RV dilation, presence of interatrial and/or interventricular septal shift to the left, RV wall-motion abnormalities, significant tricuspid insufficiency, and IVC engorgement indicate dysfunction.<sup>28–30</sup> *RV hypertrophy* is defined as end-diastolic free wall thickness >0.5 cm (or greater than half the thickness of the LV).

RV dilation is indicated by an RV diastolic diameter that exceeds the LV diastolic diameter in the TG mid-SAX view. RV dilation also can be graded from the ME four-chamber view. The normal-sized RV will not form part of the heart apex. If the apex of the heart includes the RV apex, then moderate RV dilation is present; if the apex is entirely formed by the RV, then severe dilation is present.<sup>31</sup>

Semiquantitative assessment of RV systolic function is described by the RV fractional area of contraction in the ME four-chamber view and the tricuspid annular plane systolic excursion (descent of the tricuspid annulus) in the ME four-chamber view. In a retrospective study, RV fractional area of contraction <35% was associated with poorer outcomes.<sup>32</sup> Tricuspid annular plane systolic excursion >25 mm correlates with normal RV EF.<sup>33</sup> However, because of the complexity of the RV anatomy, these measurements may be

inaccurate, so a comprehensive qualitative assessment must be performed.

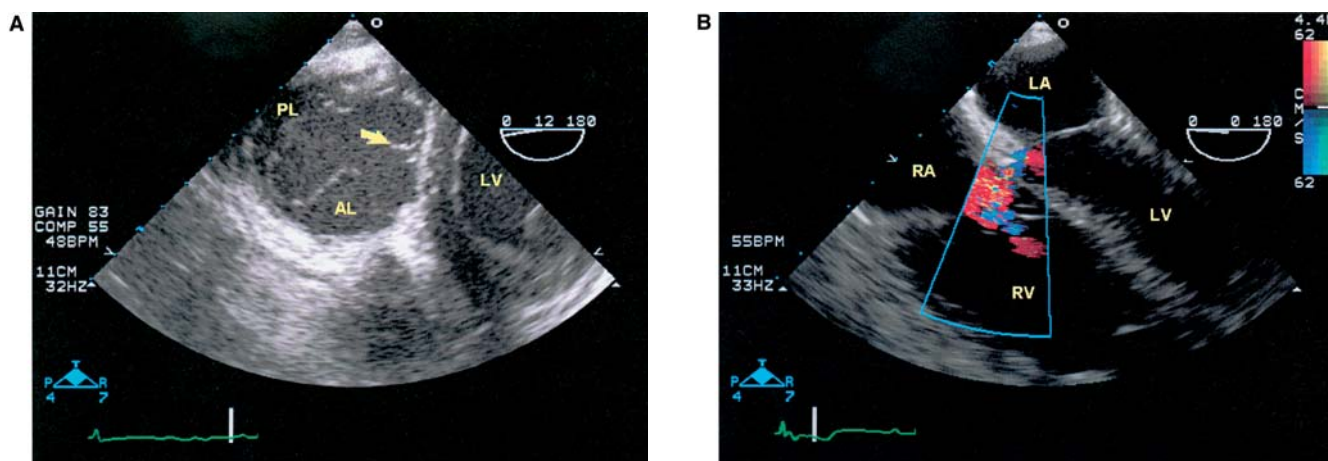
## Tricuspid Valve

The tricuspid valve (TV) consists of anterior, posterior, and septal leaflets; the largest is the septal leaflet (Fig. 30–32A). In the presence of normal leaflets, TR is termed *functional* and is commonly due to RV dilation and/or dysfunction. In contrast, TR due to leaflet abnormalities is rare.

Like the RV, the TV lies in the far field, making 2D imaging difficult. In the ME four-chamber view, the anterior (or sometimes posterior) and septal leaflets are seen. In the ME RV inflow-outflow view, the posterior and anterior leaflets are seen on the left and right of the image screen, respectively (Fig. 30–3B). In the TG RV inflow view, the posterior leaflet is in the near field, and the anterior leaflet is in the far field.

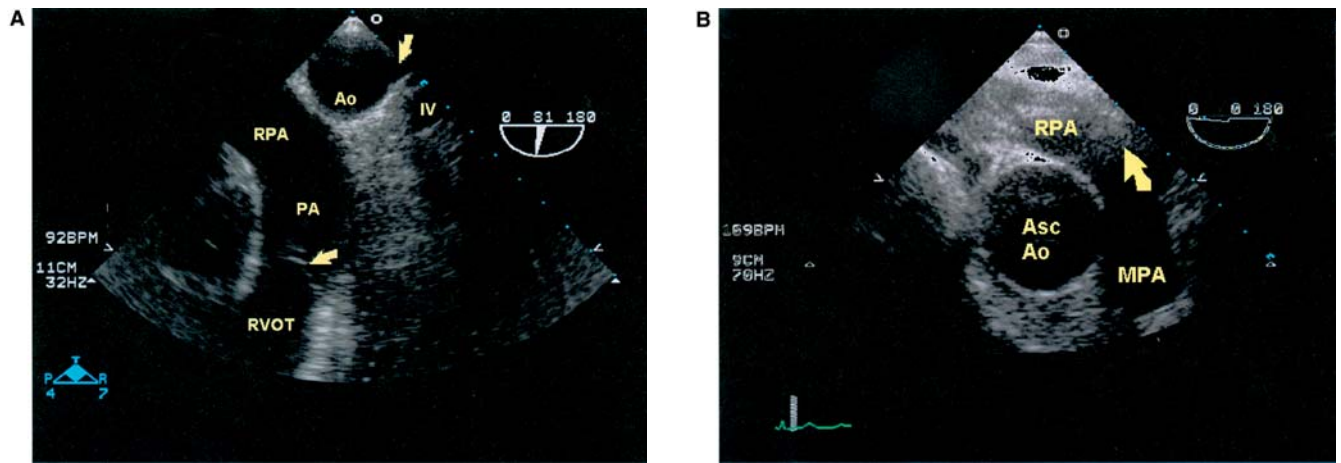
Grading TR should consider many factors, including RA and RV size, hepatic flow patterns, vena contracta, and jet area. Severe TR correlates well with systolic flow reversal in the hepatic veins, a vena contracta measuring >6.5 mm in the apical four-chamber view, and TR jet area more than two thirds of RA area.<sup>34,35</sup> In addition, TV annulus >4 cm and tricuspid inflow velocity >1 m/s by CWD is associated with severe TR.<sup>36</sup>

In the absence of pulmonic stenosis, the pulmonary artery systolic pressure can be estimated if TR is present. To accomplish this, the peak pressure gradient is calculated and added to the measured central venous pressure. To



**FIGURE 30–32.** **A.** Transgastric short-axis view with rightward rotation at the level of the tricuspid valve leaflets. Arrow indicates septal tricuspid leaflet poorly visualized in this plane. **B.** Midesophageal four-chamber view showing severe right ventricular dilation and associated tricuspid regurgitation. AL, Anterior tricuspid leaflet; LA, left atrium; LV, left ventricle; PL, posterior tricuspid leaflet; RA, right atrium; RV, right ventricle.





**FIGURE 30-33.** **A.** Upper esophageal aortic arch short-axis view with pulmonary artery and pulmonary valve in the far field. *Leftward arrow* indicates pulmonic valve. *Ao*, Aorta with branch vessel (*downward arrow*); *PA*, main pulmonary artery. Left pulmonary artery and branch point are not within this two-dimensional ultrasound plane. **B.** Upper esophageal ascending aorta short-axis view at level of pulmonary artery branch point. *Asc Ao*, Ascending aorta; *IV*, innominate vein; *MPA*, main pulmonary artery; *RPA*, right pulmonary artery; *RVOT*, right ventricular outflow tract.

obtain the peak pressure gradient across the TV, the modified Bernoulli equation is applied to the peak TR jet velocity measured by CWD.

With regard to tricuspid stenosis, a mean inflow pressure gradient  $<2$  mm Hg is considered mild, 2–6 mm Hg is moderate, and  $>6$  mm Hg is severe. CWD is used to measure TV inflow velocities, which are used to determine pressure gradients. Multiple views should be interrogated to obtain the best alignment with diastolic inflow and, therefore, more accurate measurements.

### Pulmonic Valve

The pulmonic valve is trileaflet, consisting of anterior, left, and right leaflets. Significant pulmonic disease in the adult without congenital heart disease is rare. As with the other right-sided structures, the pulmonic valve is anterior and difficult to image with TEE. The best views for visualizing the pulmonic valve are the ME RV inflow-outflow view (Fig. 30-3B) and upper esophageal aortic arch SAX view (Fig. 30-33A).

In the adult, pulmonic regurgitation usually is due to pulmonary hypertension and annular dilation. The examination should include the regurgitant jet vena contracta, jet length, RV size, and degree of CWD flow deceleration. Holodiastolic flow reversal in the main pulmonary artery (measured with PWD in the upper esophageal aortic arch SAX view) is indicative of significant pulmonic insufficiency.

Pulmonic stenosis is rare in the adult and is classified as valvular, sub-

valvular, or supra-valvular. CWD is used in the upper esophageal aortic arch SAX view to obtain a peak pressure gradient (mild stenosis  $<30$  mm Hg, moderate 30–64 mm Hg, severe  $>64$  mm Hg).

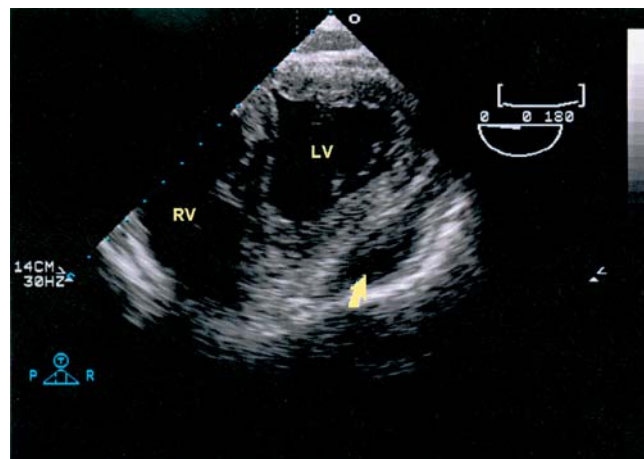
### Pulmonary Artery

Evaluation of the main and right pulmonary arteries is performed from the upper esophageal ascending aorta SAX view. The left pulmonary artery is difficult to image because it usually is obscured by air in the left mainstem bronchus. In the adult, the main pulmonary artery is approximately 5 cm in length. The normal main and right pulmonary artery dimensions are 0.9–2.9 cm and 1.2–2.2 cm, respectively. TEE has 80% sensitivity and 100% specificity for the diagnosis of pulmo-

nary embolus, but its low negative predictive value of 53% makes this modality unsuitable for ruling out pulmonary embolus.<sup>37</sup>

### Pericardium

The pericardial sac is a potential space between visceral and parietal pericardium. Pericardial effusion is a syndrome in which fluid accumulates in the pericardial sac. A wide variety of disease processes can lead to pericardial effusion. Depending on the size and speed of accumulation, a pericardial effusion can compromise venous return and lead to low cardiac output. Tamponade occurs when pericardial pressure exceeds the distending pressure of the cardiac chambers, resulting in impaired diastolic cardiac filling. Echocardiography is helpful for diag-



**FIGURE 30-34.** Transgastric short-axis view revealing a significant pericardial effusion (*arrow*). The right ventricle (RV) is enlarged, and the D-shaped left ventricle (LV) indicates elevated right ventricular pressures.

nosing pericardial effusion and cardiac tamponade, but cardiac tamponade ultimately is a clinical diagnosis.

Pericardial effusions can be visualized as an echolucent space surrounding the echogenic external border of the heart chambers (Fig. 30–34). A thorough TEE examination, including ME four-chamber, ME two-chamber, ME LAX, and TG basal SAX views, should be performed for evaluation of pericardial cavity and surrounding structures. Effusions that separate the visceral pericardium from the parietal pericardium by <0.5 cm are small, and those with >2-cm separation are large.

Characteristic echocardiographic findings of cardiac tamponade are RA systolic collapse, RV diastolic collapse, abnormal ventricular septal motion, and reciprocal respiratory variation in ventricular volumes. RA systolic collapse usually develops before RV diastolic collapse. Because of the tethering effect of the pulmonary veins, LA collapse is rare and implies the presence of a large effusion. PWD of mitral inflow velocity and pulmonary vein flow velocity also show a pronounced respiratory variation pattern in cardiac tamponade.

## CONCLUSION

Intraoperative echocardiography has rapidly evolved over the last 3 decades since its introduction in the early 1970s and has become a standard of practice for cardiac anesthesia care. In addition, it now holds a place as an important and increasingly routine adjunct to noncardiac anesthesia practice. Whereas modalities such as 3D, tissue Doppler, and contrast have enabled expanded application of this diagnostic imaging technique for intraoperative anatomic, physiologic, and hemodynamic capabilities, new systems that are less expensive, portable, and user friendly have enabled the expansion of intraoperative echocardiography to a greater variety of settings. Today, hand-held as well as portable systems allow for use of ultrasound in the preoperative clinic, postanesthesia care unit, and ICU and have stimulated a new generation of ultrasound uses.

It is our hope that this chapter with its systematic approach to TEE examination will help grow and stimulate further use of this unique and important modality.

## KEY REFERENCES

1. Daniel WG, Erbel R, Kasper W, et al. Safety of transesophageal echocardiography. A multicenter survey of 10, 419 examinations. *Circulation* 1991;83:817.

2. Shanewise JS, Cheung AT, Aronson S, et al. ASE/SCA guidelines for performing a comprehensive intraoperative multiplane transesophageal echocardiography examination: recommendations of the American Society of Echocardiography Council for Intraoperative Echocardiography and the Society of Cardiovascular Anesthesiologists Task Force for Certification in Perioperative Transesophageal Echocardiography. *J Am Soc Echocardiogr* 1999;12:884–900.

3. Katz ES, Tunick PA, Rusinek H, et al. Protruding aortic atheromas predict stroke in elderly patients undergoing cardiopulmonary bypass: experience with intraoperative transesophageal echocardiography. *J Am Coll Cardiol* 1992;20:70–77.

4. Swaminathan M, Lineberger CK, McCann RL, et al. The importance of intraoperative transesophageal echocardiography in endovascular repair of thoracic aortic aneurysms. *Anesth Analg* 2003;97:1566–1572.

5. Daniel MT, Martin A, Bruce AB, et al. Practice guidelines for perioperative transesophageal echocardiography. A report by the American Society of Anesthesiologists and the Society of Cardiovascular Anesthesiologists Task Force on Transesophageal Echocardiography. *Anesthesiology* 1996;84:986–1006.

## REFERENCES

- Chan KL, Cohen GL, Sochowski RA, Baird MG. Complications of transesophageal echocardiography in ambulatory adult patients: analysis of 1500 consecutive examinations. *J Am Soc Echocardiogr* 1991;4:577.
- Daniel WG, Erbel R, Kasper W, et al. Safety of transesophageal echocardiography. A multicenter survey of 10, 419 examinations. *Circulation* 1991;83:817.
- Stevenson JG. Incidence of complications in pediatric transesophageal echocar-

diography: experience in 1650 cases. *J Am Soc Echocardiogr* 1999;12:527.

4. Shanewise JS, Cheung AT, Aronson S, et al. ASE/SCA guidelines for performing a comprehensive intraoperative multiplane transesophageal echocardiography examination: recommendations of the American Society of Echocardiography Council for Intraoperative Echocardiography and the Society of Cardiovascular Anesthesiologists Task Force for Certification in Perioperative Transesophageal Echocardiography. *J Am Soc Echocardiogr* 1999;12:884–900.

5. Cerqueira MD, Weissman NJ, Dilsizian V, et al. Standardized myocardial segmentation and nomenclature for tomographic imaging of the heart: a statement for healthcare professionals from the Cardiac Imaging Committee of the Council on Clinical Cardiology of the American Heart Association. *Circulation* 2002;105:539.

6. McGowan JH, Cleland JGF. Reliability of reporting left ventricular systolic function by echocardiography: a systematic review of 3 methods. *Am Heart J* 2003;146:388–397.

7. Poulsen SH, Jensen SE, Nielsen JE, et al. Serial changes and prognostic implications of a Doppler-derived index of combined left ventricular systolic and diastolic myocardial performance in acute myocardial infarction. *Am J Cardiol* 2000;85:19–25.

8. Roberts W, Perloff J. Mitral valve disease: a clinicopathologic survey of the conditions causing the mitral valve to function abnormally. *Ann Intern Med* 1972;77:939–975.

9. Perloff J, Roberts W. The mitral apparatus. Functional anatomy of mitral regurgitation. *Circulation* 1972;XLVI:227–239.

10. Cheitlin MD, Finkbeiner WE. Cardiac anatomy. In Chatterjee K, Cheitlin MD, Karliner J, et al., eds. *Cardiology: An Illustrated Text*. Philadelphia: JB Lippincott, 1991:1.9–1.10.

11. Carpentier A. Cardiac valve surgery—the “French correction.” *J Thorac Cardiovasc Surg* 1983;86:323.

12. Otsuji Y, Handschumacher MD, Schwammenthal E, et al. Insights from three-dimensional echocardiography into the mechanism of functional mitral regurgitation: direct in vivo demonstration of altered leaflet tethering geometry. *Circulation* 1997;96:1999–2008.

13. Grayburn PA, Fehske W, Omran H, et al. Multiplane transesophageal echocardiography assessment of mitral regurgitation by Doppler color flow mapping of the vena contracta. *Am J Cardiol* 1994;74:912–917.

14. Chen C, Thomas J, Anconina J, et al. Impact of impinging wall jet on color Doppler quantification of mitral regurgitation. *Circulation* 1991;84:712–720.

15. Enriquez-Sarano M, Dujardin KS, Tribouilloy CM, et al. Determinants of pulmonary venous flow reversal in mitral regurgitation and its usefulness in determining the severity of regurgitation. *Am J Cardiol* 1999;83:535–541.

16. Thomas L, Foster E, Schiller N. Peak mitral inflow velocity predicts mitral regurgitation by Doppler color flow imaging: angiographic and hemodynamic correlations. *J Am Coll Cardiol* 1989;13:585-590.
17. Hatle L, Angelsen B. Pulsed and continuous wave Doppler in diagnosis and assessment of various heart lesions. In Hatle L, Angelsen B, eds. *Doppler Ultrasound in Cardiology: Physical Principles and Clinical Applications*. Philadelphia: Lea & Febiger; 1982:76-89.
18. Katz ES, Tunick PA, Rusinek H, et al. Protruding aortic atheromas predict stroke in elderly patients undergoing cardiopulmonary bypass: experience with intraoperative transesophageal echocardiography. *J Am Coll Cardiol* 1992;20:70-77.
19. Davila-Roman VG, Kouchoukos NT, Schechtman KB, et al. Atherosclerosis of the ascending aorta is a predictor of renal dysfunction after cardiac operations. *J Thorac Cardiovasc Surg* 1999;117:111-116.
20. Konstadt SN, Reich DL, Kahn R, et al. Transesophageal echocardiography can be used to screen for ascending aortic atherosclerosis. *Anesth Analg* 1995;81:225-228.
21. Khan IA, Nair CK. Clinical, diagnostic, and management perspectives of aortic dissection. *Chest* 2002;122:311-328.
22. Swaminathan M, Lineberger CK, McCann RL, et al. The importance of intraoperative transesophageal echocardiography in endovascular repair of thoracic aortic aneurysms. *Anesth Analg* 2003;97:1566-1572.
23. Forman MB, Goodin J, Phelan B, et al. Electrocardiographic changes associated with isolated right ventricular infarction. *J Am Coll Cardiol* 1984;4:640-643.
24. Lee FA. Hemodynamics of the right ventricle in normal and disease states. *Cardiol Clin* 1992;10:59-67.
25. Lowensohn HS, Khouri EM, Gregg DE, et al. Phasic right coronary artery blood flow in conscious dogs with normal and elevated right ventricular pressures. *Circ Res* 1976;39:760-766.
26. Mebazaa A, Karpati P, Renaud E, Algotsen L. Acute right ventricular failure—from pathophysiology to new treatments. *Intensive Care Med* 2004;30:185-196.
27. Reichert CL, Visser CA, van den Brink RB, et al. Prognostic value of biventricular function in hypotensive patients after cardiac surgery as assessed by transesophageal echocardiography. *J Cardiothorac Vasc Anesth* 1992;6:429-432.
28. D'Arcy B, Nanda NC. Two-dimensional echocardiographic features of right ventricular infarction. *Circulation* 1982;65:167-173.
29. Goldberger JJ, Himelman RB, Wolfe CL, et al. Right ventricular infarction: recognition and assessment of its hemodynamic significance by two-dimensional echocardiography. *J Am Soc Echocardiogr* 1991;4:140-146.
30. Vieillard-Baron A, Prin S, Chergui K, et al. Echo-Doppler demonstration of acute cor pulmonale at the bedside in the medical intensive care unit. *Am J Respir Crit Care Med* 2002;166:1310-1319.
31. Daniel MT, Martin A, Bruce AB, et al. Practice guidelines for perioperative transesophageal echocardiography. A report by the American Society of Anesthesiologists and the Society of Cardiovascular Anesthesiologists Task Force on Transesophageal Echocardiography. *Anesthesiology* 1996;84:986-1006.
32. Maslow AD, Regan MM, Panzica P, et al. Precardiopulmonary bypass right ventricular function is associated with poor outcome after coronary artery bypass grafting in patients with severe left ventricular systolic dysfunction. *Anesth Analg* 2002;95:1507-1518.
33. Rafferty T, Durkin M, Harris S, et al. Transesophageal two-dimensional echocardiographic analysis of right ventricular systolic performance indices during coronary artery bypass grafting. *J Cardiothorac Vasc Anesth* 1993;7:160-166.
34. Shapira Y, Porter A, Wurzel M, et al. Evaluation of tricuspid regurgitation severity: echocardiographic and clinical correlation. *J Am Soc Echocardiogr* 1998;11:652-659.
35. Tribouilloy CM, Enriquez-Sarano M, Bailey KR, et al. Quantification of tricuspid regurgitation by measuring the width of the vena contracta with Doppler color flow imaging: a clinical study. *J Am Coll Cardiol* 2000;36:472-478.
36. Moukarbel GV, Ayoub CM, Abchee AB. Valvular regurgitation. In Mathew JP, Ayoub CM, eds. *Clinical Manual and Review of Transesophageal Echocardiography*. New York: McGraw-Hill, 2005:137-161.
37. Pruszczyk P, Torbicki A, Kuch-Wocial A, et al. Diagnostic value of transoesophageal echocardiography in suspected haemodynamically significant pulmonary embolism. *Heart* 2001;85:628-634.



# CHAPTER 31

## Monitoring Respiratory Function

Dean R. Hess, PhD, RRT, and  
Robert M. Kacmarek, PhD, RRT

Monitoring is the continuous, or nearly continuous, evaluation of the physiologic function of a patient in real time to guide diagnosis and management decisions, including when to make therapeutic interventions and assessment of those interventions.<sup>1</sup> Many physiologic parameters can be monitored during mechanical ventilation, including both invasive and noninvasive monitoring. Respiratory monitoring is an integral part of the care of mechanically ventilated patients in the operating room and in the intensive care unit. Arterial blood gases are also commonly used to assess respiratory function. This chapter reviews the use of blood gases and monitors for assessment of respiratory function.

### ARTERIAL BLOOD GASES

Arterial blood gases refer to measurements of  $PCO_2$  and  $PO_2$ . The measurement of pH is also included with blood gases. Measured hemoglobin saturation with oxygen ( $O_2Hgb$ ), carboxyhemoglobin ( $COHgb$ ), and methemoglobin ( $metHgb$ ) may be included. Many laboratories also report calculated values of oxygen saturation, bicarbonate concentration, and base excess. These measurements assess oxygenation, ventilation, and acid-base status.

### Oxygenation

*Hypoxemia* results from decreased delivery of oxygen from the atmosphere to the arterial blood, and *hypoxia* refers to decreased delivery of oxygen to the tissues (Table 31-1). Oxygen content is a combination of dissolved oxygen and that bound to hemoglobin. The amount dissolved in plasma is small and directly related to  $PO_2$ . The normal range of arterial  $PO_2$  ( $PaO_2$ ) is 80–100 mm Hg in healthy young

adults breathing air at sea level.  $PaO_2$  normally decreases with increasing age and increasing altitude. Hypoxemia occurs when the lungs fail to adequately oxygenate arterial blood.  $PaO_2$  is often a reflection of lung function and not of hypoxia per se. Hypoxia can occur without hypoxemia and vice versa. Adequate  $PaO_2$  in acutely ill patients is unknown, but most clinicians agree that  $PaO_2 > 60$  mm Hg usually is acceptable.

### Alveolar Gas Equation

The alveolar  $PO_2$  ( $PAO_2$ ) is calculated from the alveolar gas equation:

$$PAO_2 = (FIO_2 \times EBP) - (Paco_2 \times [FIO_2 + (1 - FIO_2)/R]), \quad (31-1)$$

where  $FIO_2$  = fraction of inspired oxygen,  $EBP$  = effective barometric pressure (barometric pressure minus water vapor pressure), and  $R$  = respiratory quotient. For calculation of  $PAO_2$ ,  $R = 0.8$  is commonly chosen. For  $FIO_2 \geq 0.6$ , the effect of  $R$  on the alveolar gas equation becomes the following:

$$PAO_2 = (FIO_2 \times EBP) - (Paco_2). \quad (31-2)$$

For  $FIO_2 < 0.6$ , the alveolar gas equation becomes the following:

$$PAO_2 = (FIO_2 \times EBP) - (1.2 \times Paco_2). \quad (31-3)$$

An increased difference between alveolar  $PO_2$  ( $PAO_2$ ) and  $PaO_2$ , the  $P(A-a)O_2$  gradient, can be due to shunt,  $\dot{V}/\dot{Q}$  mismatch, or a diffusion defect.  $P(A-a)O_2$  normally is  $\leq 10$  mm Hg breathing air and  $\leq 50$  mm Hg breathing 100% oxygen. The ratio of  $PaO_2$  to  $PAO_2$  ( $PaO_2/PAO_2$ ) also can be calculated as an index of lung function and normally is  $> 0.75$  at any  $FIO_2$ .  $PaO_2/FIO_2$  is the easiest of the indices of oxygenation to calculate. The acute respiratory distress syndrome (ARDS) is associated with  $PaO_2/FIO_2 < 200$ , and acute lung injury (ALI) is associated with  $PaO_2/FIO_2 < 300$ . The oxygenation index (OI) is calculated from  $FIO_2$ , mean airway pressure ( $\bar{P}_{aw}$ ), and  $PaO_2$ :

$$OI = (FIO_2 \times \bar{P}_{aw} \times 100)/PaO_2. \quad (31-4)$$

OI is commonly calculated for neonates but is seldom used in the care of adults. In neonates,  $OI > 40$  with maximal therapy is often used as a criterion for severe hypoxemia requiring extracorporeal life support.

### Oxyhemoglobin Dissociation Curve

The oxygen saturation of hemoglobin is determined by the oxyhemoglobin dissociation curve (Fig. 31-1), where oxygen saturation is a function of  $PO_2$ . The affinity of hemoglobin for oxygen is high at high saturations and less at lower

### KEY POINTS

1. Arterial blood gases are used to assess oxygenation, ventilation, and acid-base balance.
2. The right-to-left shunt fraction is the gold standard index of oxygenation efficiency in the lungs.
3. Dead space is that portion of the minute ventilation that does not participate in gas exchange.
4. Acid-base balance is explained by the Henderson-Hasselbalch equation or the strong ion difference.
5. Arterial blood gases primarily reflect lung function, whereas venous blood gases reflect the adequacy of tissue oxygenation and tissue carbon dioxide clearance.
6. Pulse oximeters pass two wavelengths of light through a pulsating vascular bed to measure arterial oxygen saturation.
7. Capnometry is the measurement of  $CO_2$  at the airway opening during the ventilatory cycle.
8. Transcutaneous  $PO_2$  is measured with a Clark electrode and transcutaneous  $PCO_2$  is measured using a Severinghaus electrode.
9. Pulmonary mechanics is the expression of lung function through measurements of pressure and flow; from these measurements a variety of derived indices can be determined, such as volume, compliance, resistance, and work of breathing.
10. The decision to monitor, like any other clinical decision, should be based on achieving therapeutic objectives in a safe and cost-effective manner.



TABLE 31-1.

## Causes of Hypoxemia and Hypoxia

## Hypoxemia

- Decreased inspired oxygen: altitude
- Hypoventilation: respiratory center depression, neuromuscular disease, respiratory failure
- Shunt: pulmonary (e.g., atelectasis, pneumonia, pulmonary edema, acute respiratory distress syndrome) or cardiac (patent foramen ovale)
- $\dot{V}/\dot{Q}$  mismatch: airway secretions, bronchospasm

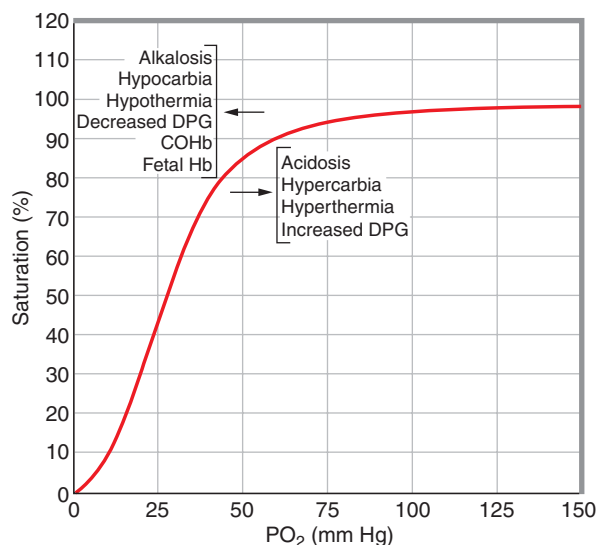
## Hypoxia

- Hypoxemic hypoxia: lower than normal PaO<sub>2</sub> (hypoxemia)
- Anemic hypoxia: decreased red blood cell count, carboxyhemoglobin, methemoglobin, hemoglobinopathy
- Circulatory hypoxia: decreased cardiac output, decreased local perfusion
- Affinity hypoxia: decreased release of oxygen from hemoglobin to the tissues
- Histotoxic hypoxia: cyanide poisoning

saturations. This effect facilitates oxygen loading in the lungs (where PO<sub>2</sub> is high) and oxygen unloading to the tissues (where PO<sub>2</sub> is low). The position of the oxyhemoglobin dissociation curve is not fixed. Factors that shift the curve to the left increase the affinity of hemoglobin for oxygen, and factors that shift the curve to the right decrease the affinity of hemoglobin for oxygen. The oxygen saturation of hemoglobin is also altered by conditions such as COHgb and metHgb. Carbon monoxide attaches to the oxygen binding sites of hemoglobin with a high affinity and decreases the ability of hemoglobin to carry oxygen. Thus, the hemoglobin oxygen saturation cannot be >70% if the COHgb level is 30%. Methemoglobin is produced when the iron in the hemoglobin molecule is converted from its common reduced state (Fe<sup>2+</sup>) to its oxidized state (Fe<sup>3+</sup>). Hemoglobin can carry oxygen only if the iron is in the reduced state. Thus, metHgb decreases the ability of hemoglobin to transport oxygen.

## Shunt

The right-to-left shunt fraction is the gold standard index of oxygenation efficiency in the lungs. It is calculated from the shunt equation:



**FIGURE 31-1.** Oxyhemoglobin dissociation curve. Physiologic conditions that shift the curve to the left and to the right are indicated. Note that a shift to the left increases oxygen saturation for a given PO<sub>2</sub> (increased affinity) and a shift to the right decreases oxygen saturation for a given PO<sub>2</sub> (decreased affinity).

$$Q_s/Q_T = (C\bar{V}O_2 - CaO_2)/(C\bar{V}O_2 - C\bar{V}O_2), \quad (31-5)$$

where  $C\bar{V}O_2$  = pulmonary capillary oxygen content (mL/dL),  $CaO_2$  = arterial oxygen content, and  $C\bar{V}O_2$  = mixed venous oxygen content. Oxygen content is calculated as follows:

$$CO_2 = (1.34 \times Hgb \times HgbO_2) + (0.003 \times PO_2). \quad (31-6)$$

To calculate  $C\bar{V}O_2$ , the pulmonary capillary PO<sub>2</sub> is assumed to equal the alveolar PO<sub>2</sub>, and the pulmonary capillary hemoglobin oxygen saturation is assumed to be 100%. If measured when the patient is breathing 100% oxygen,  $Q_s/Q_T$  represents shunt (i.e., blood that flows from the right heart to the left heart without passing gas-exchanging alveoli). If measured at FIO<sub>2</sub> < 1.0, then  $Q_s/Q_T$  represents both shunt fraction and  $\dot{V}/\dot{Q}$  mismatch. A shunt >50% represents severe respiratory failure, whereas 5% approximates the normal value.

## Ventilation

Arterial PCO<sub>2</sub> (Paco<sub>2</sub>) reflects the balance between carbon dioxide production ( $\dot{V}CO_2$ ) and alveolar ventilation ( $\dot{V}_A$ ):

$$Paco_2 = \dot{V}CO_2/\dot{V}_A. \quad (31-7)$$

Thus, Paco<sub>2</sub> varies directly with carbon dioxide production and inversely with alveolar ventilation. Note that

Paco<sub>2</sub> is determined by alveolar ventilation and not total minute ventilation per se. Minute ventilation affects Paco<sub>2</sub> only to the extent that it affects alveolar ventilation. Clinical causes of hypoventilation (increased Paco<sub>2</sub>) and hyperventilation (decreased Paco<sub>2</sub>) are listed in Table 31-2. Because alveolar ventilation is determined by minute ventilation ( $\dot{V}_E$ ) and the ratio of dead space to total ventilation ( $V_D/V_T$ ), the relationship can be derived as follows:

$$Paco_2 = \dot{V}CO_2/[\dot{V}_E \times (1 - V_D/V_T)]. \quad (31-8)$$

TABLE 31-2.

## Clinical Causes of Hypoventilation and Hyperventilation

## Hypoventilation

- Respiratory center depression: pathologic, iatrogenic
- Disruption of neural pathways affecting respiratory muscles: neuropathy, trauma
- Neuromuscular blockade: disease, paralyzing agents
- Respiratory muscle weakness: fatigue, disease

## Hyperventilation

- Respiratory center stimulation: hypoxia, anxiety, central nervous system pathology
- Metabolic acidosis
- Iatrogenic: mechanical ventilation

$P_{aCO_2}$  increases with an increase in  $V_D/V_T$ , an increase in  $\dot{V}CO_2$ , and a decrease in  $\dot{V}_E$  (Fig. 31–2). Although a goal of mechanical ventilation traditionally has been to normalize  $P_{aCO_2}$ , at times an elevated  $P_{aCO_2}$  (permissive hypercapnia) may be more desirable than the high alveolar pressure required to normalize  $P_{aCO_2}$  in patients with acute respiratory failure.

## Dead Space Ventilation

Dead space is that portion of the minute ventilation that does not participate in gas exchange.<sup>2–4</sup> It consists of anatomic dead space and alveolar dead space. Dead space is calculated using the Bohr equation:

$$V_D/V_T = (P_{aCO_2} - P_{E}CO_2)/P_{aCO_2} \quad (31-9)$$

where  $V_D/V_T$  = fraction of total ventilation that is dead space, and  $P_{E}CO_2$  is the partial pressure of  $CO_2$  in mixed exhaled gas. The normal value of  $V_D/V_T$  ranges from 0.2 to 0.4. Causes of an increased  $V_D/V_T$  include pulmonary embolism, positive-pressure ventilation, pulmonary hypoperfusion, and high-rate, low-tidal-volume ventilation. Increased  $V_D/V_T$  has been associated with a high mortality rate in patients with ARDS.<sup>5</sup> Increased  $V_D/V_T$  also has been associated with a lower rate of weaning from mechanical ventilation.<sup>6</sup>

The traditional method for determining  $P_{E}CO_2$  was to collect mixed exhaled gas in a large bag for 5 to 15 minutes. During the gas collection, the patient is undisturbed, with a stable  $\dot{V}_E$ , and an arterial blood sample is obtained to assess  $P_{aCO_2}$  during this time. Many current-generation mechanical ventilators have a constant bias gas flow through the circuit, which complicates the collection of mixed exhaled gas to calculate  $V_D/V_T$ . In this case,  $P_{E}CO_2$  can be calculated from  $\dot{V}CO_2$  and  $\dot{V}_E$ :

$$P_{E}CO_2 = (\dot{V}CO_2/\dot{V}_E) \times P_B \quad (31-10)$$

Because dead space determinations require a leak-free system, they cannot be measured in patients with a bronchopleural fistula or with a leaking uncuffed tracheostomy tube. From the exhaled  $CO_2$ ,  $\dot{V}_E$ , and barometric pressure ( $P_B$ ),  $\dot{V}_A$  can be calculated as follows:

$$\dot{V}_A = \dot{V}_E \times P_{E}CO_2/P_B \quad (31-11)$$

$\dot{V}_A$  also can be calculated from  $V_D/V_T$  as follows:

$$\dot{V}_A = \dot{V}_E - (\dot{V}_E \times V_D/V_T) \quad (31-12)$$

## Acid–Base Balance

Acid–base balance is explained by the Henderson-Hasselbalch equation:

$$pH = 6.1 + \log[HCO_3^-]/(0.03 \times PCO_2) \quad (31-13)$$

Metabolic acid–base disturbances are those that affect the numerator of the Henderson-Hasselbalch equation, and respiratory acid–base disturbances are those things that affect the denominator. The pH is normal (7.40) whenever the ratio  $[HCO_3^-]/(0.03 \times P_{aCO_2})$  is 20:1. The metabolic component of acid–base interpretation usually is given as  $[HCO_3^-]$ . The metabolic component also can be expressed as base excess (BE). BE can be estimated as:  $BE = [HCO_3^-] - 24$ . In other words,  $[HCO_3^-] < 24$  mmol/L corresponds with a negative BE, and  $[HCO_3^-] > 24$  mmol/L corresponds with a positive BE. Clinical causes of metabolic acid–base disturbances are listed in Table 31–3, and the degree of compensation for acid–base disturbances is given in Table 31–4.

The strong ion difference (SID) is a method of evaluating acid–base disturbances based on the Stewart physiochemical approach to acid–base chemistry.<sup>7</sup> Using this approach, the only variables that affect pH are  $PCO_2$ , SID, and the concentration of unmeasured strong ions. The normal value for SID is 40 mmol/L and is calculated as follows:

$$SID = [HCO_3^-] + 0.28 \times [\text{Albumin (g/L)}] + [\text{Inorganic phosphate (mmol/L)}] \quad (31-14)$$

Metabolic acidosis is associated with a decreased SID, and metabolic alkalosis is associated with an increased SID (Table 31–5).

The anion gap is useful to differentiate causes of metabolic acidosis. Metabolic acidosis can be associated with a normal anion gap (hyperchloremic acidosis) or with an increased anion gap (normochloremic acidosis). The anion gap is calculated as follows:

$$\text{Anion gap} = [Na^+] - ([Cl^-] + [HCO_3^-]) \quad (31-15)$$

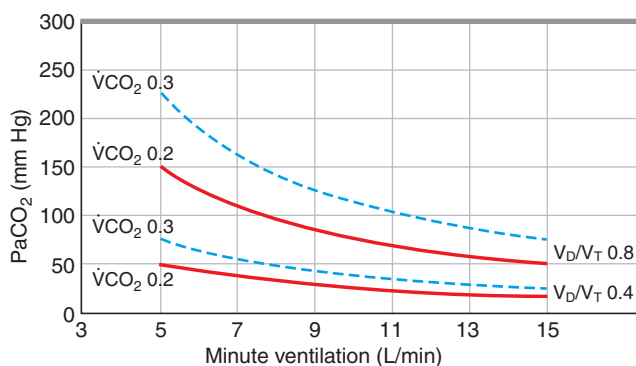


FIGURE 31–2. Relationship between  $P_{aCO_2}$ , minute ventilation,  $V_D/V_T$ , and  $\dot{V}CO_2$ .

TABLE 31–3.

### Clinical Causes of Metabolic Acidosis and Metabolic Alkalosis

#### Metabolic Acidosis

- Lactic acidosis (e.g., hypoxia)
- Ketoacidosis (e.g., uncontrolled diabetes)
- Uremic acidosis (e.g., renal failure)
- Loss of base from lower gastrointestinal tract (e.g., diarrhea)
- Loss of base from kidneys (e.g., acetazolamide, renal tubular acidosis)
- Poisons (e.g., methanol, ethylene glycol, aspirin)

#### Metabolic Alkalosis

- Hypokalemia
- Loss of acid from upper gastrointestinal tract (e.g., vomiting, gastric suction)
- Bicarbonate administration

TABLE 31-4.

## Expected Compensation for Acid-Base Disturbances

Respiratory acidosis:	$\Delta\text{HCO}_3^- = 0.10 \times \Delta\text{Paco}_2$ (acute)
	$\Delta\text{HCO}_3^- = 0.35 \times \Delta\text{Paco}_2$ (chronic)
Respiratory alkalosis:	$\Delta\text{HCO}_3^- = 0.2 \times \Delta\text{Paco}_2$ (acute)
	$\Delta\text{HCO}_3^- = 0.5 \times \Delta\text{Paco}_2$ (chronic)
Metabolic acidosis:	$\text{Paco}_2 = 1.5 \times \text{HCO}_3^- + 8$
Metabolic alkalosis:	$\text{Paco}_2 = 0.9 \times \text{HCO}_3^- + 15$

If the acid-base status exceeds the expected level of compensation, a mixed acid-base disturbance is present.

A normal anion gap is 8–12 mmol/L. Causes of metabolic acidosis with an increased anion gap include lactic acidosis, diabetic ketoacidosis, and azotemic (renal) acidosis. Causes of metabolic acidosis with a normal anion gap include loss of bicarbonate from the gastrointestinal tract (e.g., diarrhea), acetazolamide (Diamox) therapy, and excessive chloride administration (e.g., HCl,  $\text{NH}_4\text{Cl}$ ). The osmolality (osmol gap) is the difference between the measured osmolality of the plasma and that calculated as follows:

$$\text{Osmolality} = 2 [\text{Na}^+] + [\text{Glucose}]/18 + [\text{BUN}]/2.8 + [\text{Ethanol}]/4.6, \quad (31-16)$$

where BUN = blood urea nitrogen. If the measured osmolality is >10 mOsm/L above the calculated value (osmol gap >10 mOsm/L), osmotically active particles whose metabolites may be organic acid may present. Metabolic acidosis with an osmol gap is consistent with the presence of the toxins methanol, ethanol, and ethylene glycol.

### Temperature Correction of Blood Gases

Blood gases and pH are measured in the laboratory at 37°C. If the patient's temperature is abnormal, the in vivo blood gas and pH values will differ from those measured and reported by the blood gas laboratory. Using empiric equations, the blood gas analyzer can adjust the measured values to the patient's body temperature. Two ven-

TABLE 31-5.

## Classification of Acid-Base Disturbances Using the Steward Approach

	Acidosis	Alkalosis
Respiratory	$\uparrow\text{PCO}_2$	$\downarrow\text{PCO}_2$
Metabolic		
Water excess or deficit	$\downarrow\text{SID}, \downarrow\text{Na}^+$	$\uparrow\text{SID}, \uparrow\text{Na}^+$
Chloride excess or deficit	$\downarrow\text{SID}, \uparrow\text{Cl}^-$	$\uparrow\text{SID}, \downarrow\text{Cl}^-$
Unmeasured strong ion excess	$\downarrow\text{SID}, \uparrow\text{unmeasured ions}$	

SID, strong ion difference.

tilation strategies for hypothermic acid-base management have been suggested (usually during cardiopulmonary bypass)<sup>8-13</sup> During  $\alpha$ -stat management,  $\text{Paco}_2$  is maintained at 40 mm Hg when measured at 37°C. Thus, the dissociation fraction of the imidazole moiety of histidine is constant, whereas pH changes parallel to the neutral pH point of water. During pH-stat management,  $\text{Paco}_2$  is corrected to the patient's actual body temperature. Because of increased gas solubility during hypothermia, the  $\alpha$ -stat strategy results in relative hyperventilation. This issue is becoming increasingly important with the use of induced hypothermia after cardiac arrest and in the treatment of focal cerebral ischemia. Animal studies suggest that pH-stat management, as compared with  $\alpha$ -stat management, results in improved cerebral blood flow and neurologic outcomes. The pH-stat approach allows differentiation of temperature-related changes from physiologic changes. Temperature-adjusted values should be used to compare blood gas levels with exhaled gas values (e.g., end-tidal  $\text{PCO}_2$  [ $\text{PETCO}_2$ ]) and to calculate oxygen content indices (e.g., right-to-left shunt) or tension indices [e.g.,  $\text{P(A-a)O}_2$ ].

### Point-of-Care Measurement of Blood Gases

Point-of-care blood gas monitoring is performed near the site of patient care (e.g., operating room, intensive care unit). Point-of-care analyzers are available to measure blood gases and pH. These analyzers also can make other important useful measurements at the bedside, including levels of electrolytes, glucose, lactate, urea nitrogen, and hematocrit, and clotting studies [activated clotting time (ACT), prothrombin time (PT), and partial thromboplastin time (PTT)]. Point-of-care an-

alyzers are small and portable (some are hand-held), they require minute blood volumes (several drops), and they provide rapid reporting of results (a few minutes). They are relatively easy to use (e.g., self-calibrating) and typically incorporate a disposable cartridge that contains the appropriate biosensors. The cost-benefit of these devices is unclear. Further, appropriate documentation for compliance with hospital standards is necessary. This requires appropriate quality control checks and instrument maintenance.

### Venous Blood Gases

Arterial blood gases primarily reflect lung function, whereas venous blood gases reflect the adequacy of tissue oxygenation and tissue carbon dioxide clearance. A low mixed venous  $\text{PO}_2$  level (<35 mm Hg) reflects tissue hypoxia and may be the result of decreased oxygen delivery or increased tissue oxygen uptake. Venous  $\text{PO}_2$  typically is much lower than arterial  $\text{PO}_2$ , and there is often little relationship between the two. For example, the mixed venous  $\text{PO}_2$  may be low and the arterial  $\text{PO}_2$  may be high when cardiac output is reduced, lung function is normal, and  $\text{FIO}_2$  is high. Normally, the mixed venous  $\text{PCO}_2$  is only slightly greater than the arterial  $\text{PCO}_2$ . However, the venous  $\text{PCO}_2$  depends on blood flow (cardiac output), and, in cases of low blood flow (e.g., cardiac arrest), the mixed venous  $\text{PCO}_2$  may be high despite a normal or decreased arterial  $\text{PCO}_2$ . When venous blood gases are used to assess acid-base balance, mixed venous or central venous blood samples are preferable to peripheral venous samples. Interest in central venous oxygen saturation has increased with the use of goal-directed treatment of sepsis, in which  $\text{SvO}_2 > 70\%$  was reported to be associated with a survival benefit.<sup>14</sup>

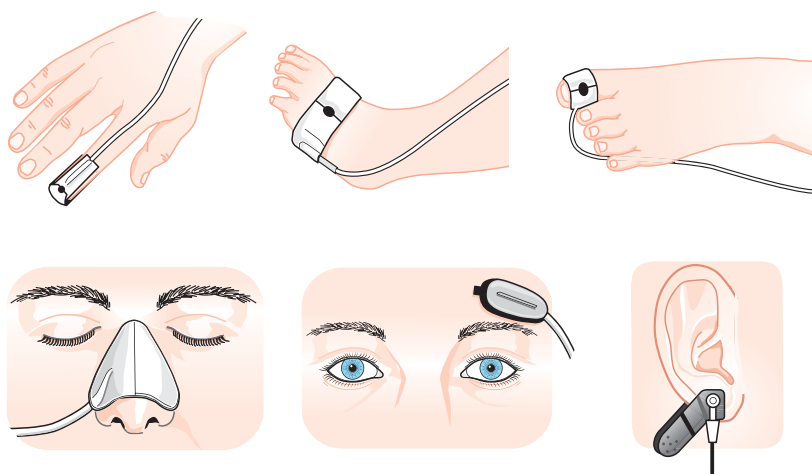


FIGURE 31-3. Examples of pulse oximetry probes. (Adapted from materials provided by Nellcor.)

## PULSE OXIMETRY

Pulse oximetry, a technology unavailable until the mid-1980s, is now in widespread use. Continuous pulse oximetry is the standard of care in the operating room and for treatment of critically ill patients. A probe passes two wavelengths of light (660 and 940 nm) through a pulsating vascular bed. Although most pulse oximeters commonly use transmission oximetry (i.e., the light emitted from the light-emitting diodes [LEDs] is transmitted through the tissue and a photodetector is opposite the LEDs), other designs use reflectance oximetry (i.e., the light from the LEDs is reflected from the tissue, and the photodetector is on the same side of the tissue as the LEDs). The pulse oximeter probe can be placed on a number of sites, including the finger, toe, earlobe, nose, and forehead. In infants, the probe can be placed on the hand or foot (Fig. 31-3).

A number of limitations of pulse oximetry should be recognized, appreciated, and understood by everyone who uses pulse oximetry data.

- **Accuracy:** Most pulse oximeter errors can be explained by too little signal (e.g., low tissue perfusion levels, improper probe placement) or too much noise (e.g., motion, high levels of ambient light). Pulse oximeters use empirical calibration curves developed from studies of healthy volunteers. At saturations >80%, the accuracy of pulse oximetry is approximately  $\pm 4$ –5%. Below 80%, their accuracy is far worse, but the clinical importance of this is questionable.

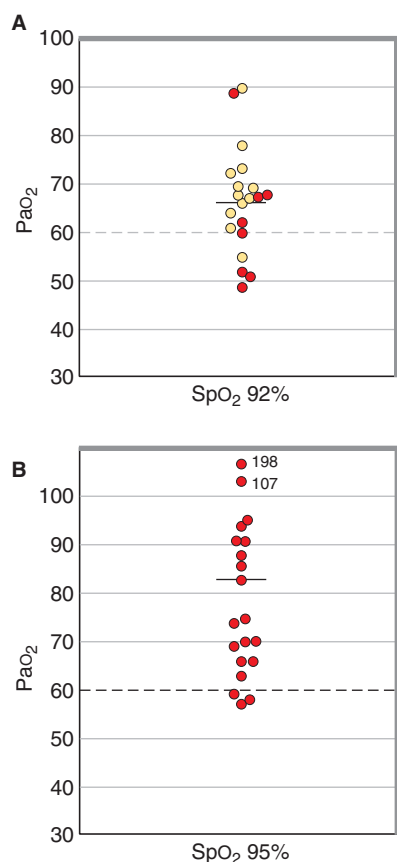
To appreciate the implications of the limits of accuracy of pulse oximetry, one must consider the oxyhemoglobin dissociation curve. If the pulse oximeter displays an  $SpO_2$  of 95%, the true saturation could be as low as 90% or as high as 100%. If the true saturation is 90%, the  $P_{aO_2}$  will be approximately 60 mm Hg. If the true saturation is 100%, however, one does not know how high the  $P_{aO_2}$  might be. Also, a shift of the oxyhemoglobin dissociation curve can change the  $SpO_2$ , although no change in  $P_{aO_2}$  has occurred.

- **Misunderstanding by those who use pulse oximetry:** Although pulse oximetry is commonly used, it may be misunderstood by those using it. For example, it has been reported that a large percentage of junior physicians and staff nurses lacked knowledge and made serious errors in the interpretation of  $SpO_2$ .<sup>15</sup> However, this problem may have improved in recent years.<sup>16</sup>
- **Differences between devices and probes:** The pulse oximeter is unique in that it requires no user calibration. However, manufacturer-derived calibration curves programmed into the software vary from manufacturer to manufacturer and can vary among pulse oximeters from a given manufacturer. Moreover, the output of the LEDs can vary from probe to probe.
- **Penumbra effect:** If the finger pulse oximeter probe does not fit correctly, light can be shunted from the LEDs directly to the photodetector. This will cause a falsely low  $SpO_2$  if

$SpO_2 > 85\%$  and a falsely elevated  $SpO_2$  if  $SpO_2 < 85\%$ .

- **Dyshemoglobinemias:** Because traditionally available pulse oximeters use only two wavelengths of light, they are only able to evaluate oxyhemoglobin ( $O_2Hgb$ ) and deoxyhemoglobin ( $HHgb$ ). Abnormal elevations of carboxyhemoglobin ( $COHgb$ )<sup>17</sup> and methHgb<sup>18</sup> both result in significant inaccuracy in pulse oximetry, and pulse oximetry should not be used when elevated levels of these abnormal hemoglobins are present. It is noteworthy that a new pulse oximeter design that measures  $COHgb$  and methHgb in addition to  $O_2Hgb$  now is available. This design should be useful for patients with suspected elevations in  $COHgb$  and methHgb. Fetal hemoglobin<sup>19</sup> and sickle cell anemia<sup>20</sup> do not affect the accuracy of pulse oximetry.
- **Endogenous and exogenous dyes and pigments:** Intravascular dye administration can affect the accuracy of pulse oximetry, with methylene blue having the greatest effect.<sup>21</sup> Nail polish also can affect the accuracy of pulse oximetry and should be removed before pulse oximetry is begun.<sup>22</sup> Hyperbilirubinemia does not appear to affect the accuracy of pulse oximetry.<sup>23</sup>
- **Skin pigmentation:** Several studies have found that the accuracy and performance of pulse oximeters are affected by deeply pigmented skin.<sup>24–26</sup>
- **Perfusion:** Pulse oximeters require a pulsating vascular bed to function correctly. Under conditions of low flow (e.g., cardiac arrest or severe peripheral vasoconstriction), pulse oximetry becomes unreliable. Under these conditions, an ear probe may be more reliable than a finger probe.
- **Anemia:** Although pulse oximeters are generally reliable over a wide range of hemoglobin levels, they become less accurate and reliable with conditions of severe anemia (hematocrit < 24 g/dL at low saturations, and hematocrit < 10% at all saturations).<sup>27</sup>
- **Motion:** Motion of the probe can produce considerable artifact and unreliable and inaccurate pulse oximetry readings. This problem can sometimes be corrected by using a more stable probe site (e.g., the ear or toe rather than the finger).





**FIGURE 31-4.** **Top.** In white patients (open circles), SpO<sub>2</sub> ≥92% is reliable in predicting PaO<sub>2</sub> ≥60 mm Hg. **Bottom.** In black patients, SpO<sub>2</sub> ≥95% was required to reliably predict PaO<sub>2</sub> ≥60 mm Hg.

- **High-intensity ambient light:** Because the photodetector of the pulse oximeter is nonspecific, high-intensity ambient light can produce interference. This problem can be corrected by wrapping the probe with a light barrier.
- **Abnormal pulses:** Venous pulses and a large dicrotic notch may affect the accuracy of pulse oximetry.
- **Safety:** Pulse oximetry is generally considered safe. However, burns as the result of defective probes and pressure necrosis can rarely occur.

Jubran and Tobin<sup>26</sup> evaluated the use of pulse oximetry in titrating supplemental oxygen in 54 critically ill ventilator-dependent patients (Fig. 31-4). In white patients, they found that an SpO<sub>2</sub> of 92% was reliable in predicting PaO<sub>2</sub> ≥60 mm Hg. In black patients, however, an SpO<sub>2</sub> of 95% was required. Although this method is useful for titrating a level of arterial oxygenation that does not produce hypoxemia, it does not eliminate the need

for periodic arterial blood gas measurements. When pulse oximetry is used to titrate the FIO<sub>2</sub>, the final FIO<sub>2</sub> setting should be confirmed by an arterial blood gas measurement.

If pulse oximetry is to be clinically useful, it must have a low failure rate. Intraoperative pulse oximeter failure was evaluated by Freund et al.<sup>28</sup> Overall, they found a failure rate <5%. Pulse oximetry failures tended to be greater in older patients, sicker patients, and during longer surgical procedures. Failure of pulse oximetry in other settings has not been reported. Perhaps the most frequent cause of pulse oximetry failure in the ICU is accidental disconnection or misplacement of the probe.

Motion artifact and low perfusion are common causes of pulse oximetry errors.<sup>29-36</sup> Manufacturers of pulse oximeters have developed improved software algorithms to calculate SpO<sub>2</sub> in an attempt to eliminate motion artifacts from the pulse signal. Three such devices on the market are the FAST (Fourier Artifact-Suppression Technology, Philips Medical Systems, Andover, MA), SET (Signal-Extraction Technology, Masimo, Irvine, CA), and Oxismart N-3000 (Nellcor, Pleasanton, CA). A comprehensive review concluded that the clinical performance of all of the new-generation pulse oximeters was better than that of earlier devices.<sup>30</sup> Although several studies have evaluated the performance of these new designs,<sup>32-36</sup> there was no strong and convincing evidence that

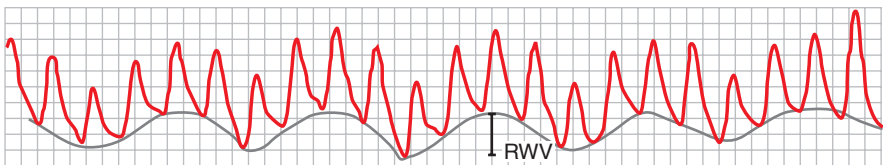
the performance of any single new-generation device was superior to that of any other new-generation device.

Although it allows early detection of hypoxemia and related events, the impact of pulse oximetry on patient outcomes is unclear.<sup>37</sup> A large study (>20,000 patients) of pulse oximetry use during anesthesia and postanesthesia care found no difference in outcome.<sup>38,39</sup> Pulse oximetry is indicated in unstable patients likely to desaturate, in patients receiving a therapeutic intervention that is likely to produce hypoxemia (e.g., bronchoscopy), and in patients having interventions likely to produce changes in arterial oxygenation [i.e., changes in FIO<sub>2</sub> or positive end-expiratory pressure (PEEP)].

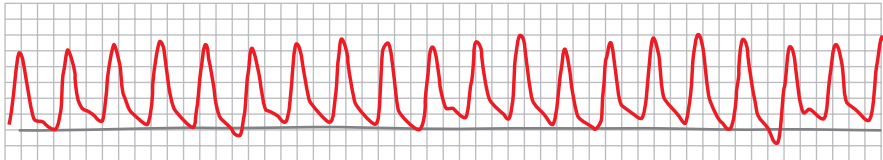
There may be important nonoxygenation monitoring applications for pulse oximetry. For example, Hartert et al.<sup>40</sup> reported the effect of pulsus paradoxus, and therefore the severity of air trapping in obstructive airway disease, on the pulse oximetry plethysmographic (POP) waveform (Fig. 31-5). They reported that, in patients with obstructive lung disease and elevated pulsus paradoxus, an altered pulse oximetry baseline tracing manifested as the respiratory waveform variation. Pulsus paradoxus was significantly correlated with the degree of respiratory waveform variation of the pulse oximetry tracing and the amount of auto-PEEP.

Respiratory variations in POP waveform amplitude has been shown to be useful in predicting fluid responsive-

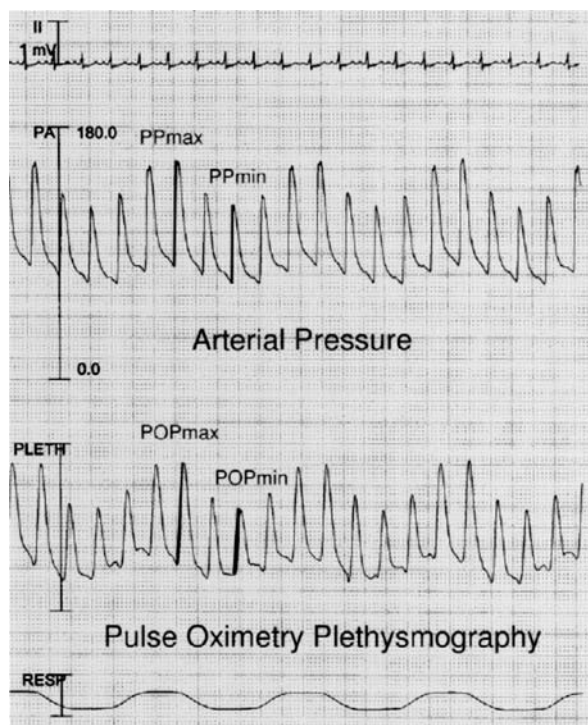
Panel A



Panel B



**FIGURE 31-5.** Pulse oximeter tracings from a 60-year-old woman with exacerbation of chronic obstructive pulmonary disease who was admitted to the ICU in ventilatory failure. **A.** Patient's pulse oximetry tracing at the time of admission reveals respiratory variability in the pulse oximeter plethysmography tracing. Measured pulsus paradoxus at this time was 16 mm Hg. **B.** Patient's pulse oximetry tracing after 12 hours of aggressive therapy. Pulsus paradoxus at this time was 8 mm Hg. Note the absence of respiratory waveform variation (RWV) in the baseline of the oximeter tracing after clinical improvement in airflow and resolution of elevated pulsus paradoxus. (From Hartert et al.<sup>40</sup> with permission.)



**FIGURE 31-6.** Comparison between invasive arterial pressure and pulse oximeter plethysmography recordings. Simultaneous recording of electrocardiographic lead (II), systemic arterial pressure (PA), pulse oximetry plethysmography (PLETH), and respiratory signal (RESP) in one illustrative patient. POP, pulse oximetry plethysmographic; PP, pulse pressure.

ness. POP waveform amplitude is measured on a beat-to-beat basis as the vertical distance between peak and preceding valley trough in the waveform (Fig. 31-6). Maximal POP ( $POP_{max}$ ) and minimal POP ( $POP_{min}$ ) are determined over the same respiratory cycle.  $\Delta POP$  is calculated using the following formula:

$$\Delta POP (\%) = 100 \times \frac{[POP_{max} - POP_{min}]}{[(POP_{max} + POP_{min})/2]} \quad (31-17)$$

The results of one study suggest that  $\Delta POP > 15\%$  is predictive of fluid responsiveness in mechanically ventilated patients with circulatory failure.<sup>41</sup>

## CAPNOGRAPHY

Capnometry is the measurement of  $CO_2$  at the airway opening during the ventilatory cycle.<sup>42</sup> Most capnometers measure  $CO_2$  by infrared absorption, analyzing the absorption peak of  $CO_2$  at  $4.26 \mu m$ . Mass spectrometry and Raman spectrometry can also be used. A portable nonelectronic single-patient-use device is commonly used to produce a color change (colorimet-

ric end-tidal  $CO_2$  detection) in the presence of exhaled  $CO_2$  (i.e., tracheal intubation). The color changes from purple with a low  $CO_2$  concentration to yellow with  $CO_2$  concentration of 2.0–5.0%.

Capnometers can be configured as mainstream or sidestream devices. With the mainstream capnometer, the measurement chamber is placed di-

rectly at the airway. With the sidestream capnometer, gas from the airway is aspirated through fine-bore tubing to the measurement chamber inside the device. Some devices (e.g., colorimetric capnometers) can only be used as mainstream devices, whereas other devices (e.g., Mass and Raman spectrometers) can only be used as sidestream devices. Infrared capnometers can be configured as either mainstream or sidestream devices. Each approach has advantages and disadvantages (Table 31-6). A new capnography technology, Microstream, has been introduced, which uses molecular correlation spectroscopy that operates at room temperature and emits only  $CO_2$  specific radiation.<sup>43</sup> It features low flow rates, reduced dead space, and lack of moisture-associated occlusion problems.

## Time-Based Capnography

For applications in the operating room and critical care unit, the time-based capnogram is often displayed (Fig. 31-7). Unlike the volume-based capnogram, the time-based capnogram has an inspiratory segment and an expiratory segment.  $PCO_2$  usually is zero during the inspiratory phase. At the beginning of exhalation,  $PCO_2$  remains zero as gas from the anatomic dead space leaves the airway (phase I). The capnogram then rises sharply as alveolar gas mixes with dead space gas (phase II). The curve then forms an alveolar plateau during most of exhalation (phase III).  $PCO_2$  at the end of the alveolar plateau is the  $P_{ET}CO_2$ . The

**TABLE 31-6.**

### Mainstream and Sidestream Capnometers

#### Advantages

##### Mainstream Capnometer

- Sensor at patient's airway
- Fast response (crisp waveform)
- Short lag time (real-time readings)
- No sample flow to reduce tidal volume

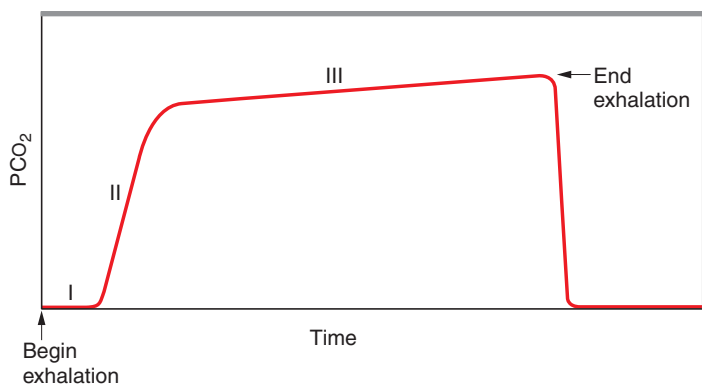
##### Sidestream Capnometer

- No bulky sensors or heaters at airway
- Ability to measure  $N_2O$
- Disposable sample line
- Can be used with nonintubated patients

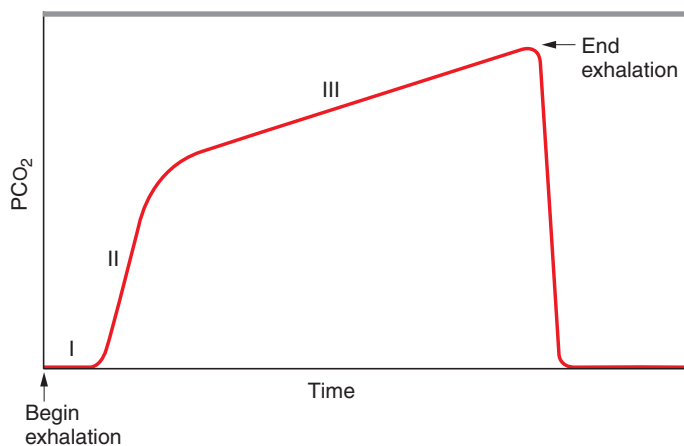
#### Disadvantages

- Secretions and humidity block sensor
- Sensor heated to prevent condensation
- Bulky sensor at patient's airway
- Does not measure  $N_2O$
- Difficult to use with nonintubated patients
- Cleaning and sterilization of reusable sensor

- Secretions block sample tubing
- Water trap required
- Slow response to  $CO_2$  changes
- Sample flow may decrease tidal volume



**FIGURE 31-7.** Time-based capnogram. I, anatomic dead space; II, transition from anatomic dead space to alveolar plateau; III, alveolar plateau.

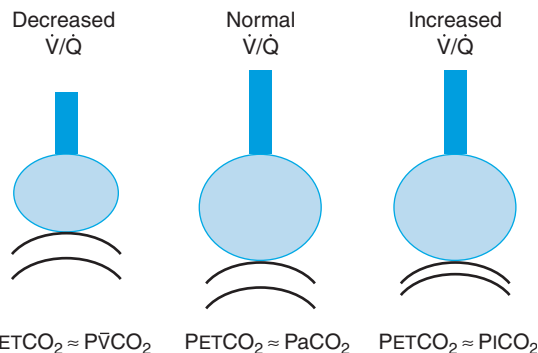


**FIGURE 31-8.** Capnogram produced with airflow obstruction.

capnogram with airflow obstruction is characterized by an increased slope of phase III (Fig. 31-8). This occurs because of the  $\dot{V}/\dot{Q}$  heterogeneities that result from airflow obstruction.<sup>44</sup> In asthmatic patients with acute bronchospasm, the slope of phase III has been shown to correlate with peak expiratory flow rate, and this slope normalizes with  $\beta$ -agonist therapy.<sup>45,46</sup>

Carbon dioxide homeostasis is affected by  $\dot{V}CO_2$ ,  $CO_2$  transport from the tissues to the lungs, and  $\dot{V}_A$ . Conditions that increase  $\dot{V}CO_2$  include fever, activity, sepsis, hyperthyroidism, trauma, burn injuries, and a high-carbohydrate diet. Conditions that decrease  $\dot{V}CO_2$  include hypothyroidism, hypothermia (when shivering is blocked), sedation, and paralysis. Carbon dioxide from tissue metabolism diffuses into the circulation, producing a mixed venous  $PCO_2$  ( $P\bar{V}CO_2$ ) of approximately 45 mm Hg. The  $PCO_2$  of an individual lung unit depends upon the  $\dot{V}/\dot{Q}$  (Figure 31-9). Without perfusion (pure dead space;  $\dot{V}/\dot{Q} = \infty$ ),  $PCO_2$  is similar to inspired  $PCO_2$  (i.e., zero). With a

normal  $\dot{V}/\dot{Q}$  unit,  $PACO_2$  is the same as arterial  $PCO_2$  (i.e., 40 mm Hg). With a low  $\dot{V}/\dot{Q}$  unit,  $PACO_2$  increases toward  $P\bar{V}CO_2$  (i.e., 45 mm Hg).  $PACO_2$ , and thus  $PETCO_2$ , must always remain between zero and  $P\bar{V}CO_2$ .  $PETCO_2$  normally is several millimeters of mercury less than  $PACO_2$ . However, the relationship between the  $PACO_2$  and  $PETCO_2$  will vary depending upon the relative contributions of various  $\dot{V}/\dot{Q}$  units composing the lungs.<sup>44</sup>



**FIGURE 31-9.**  $PETCO_2$  with low  $\dot{V}/\dot{Q}$ , normal  $\dot{V}/\dot{Q}$ , and high  $\dot{V}/\dot{Q}$ .

Theoretically,  $PETCO_2$  could be as low as inspired  $PCO_2$  (zero) or as high as  $P\bar{V}CO_2$  (but not higher than this value). An increased or decreased  $PETCO_2$  can result from changes in  $\dot{V}CO_2$  and carbon dioxide delivery to the lungs, changes in alveolar ventilation, or equipment malfunction (Table 31-7). However, because of homeostasis, compensatory changes may occur so that  $PETCO_2$  does not change despite some of these changes. For example, if  $\dot{V}CO_2$  increases (such as with fever) and alveolar ventilation increases proportionately (the normal homeostatic response), then  $PETCO_2$  may not change. Thus,  $PETCO_2$  is a nonspecific indicator of cardiopulmonary homeostasis and often does not indicate the presence of any specific problem or abnormality.

If  $PACO_2$  is measured, the gradient between  $PACO_2$  and  $PETCO_2$  [ $P(a-ET)CO_2$ ] can be calculated. This gradient normally is small, usually <5 mm Hg. With dead space-producing disease (high  $\dot{V}/\dot{Q}$ ),  $PETCO_2$  may be considerably less than  $PACO_2$  (Table 31-8).<sup>47-52</sup> Although right-to-left blood shunting may result in a large gradient between  $PAO_2$  and  $PaO_2$ , it will have only a small effect on  $P(a-ET)CO_2$ . On occasion,  $PETCO_2$  may be greater than  $PACO_2$ . The reason for  $PETCO_2 > PACO_2$  is not well understood and may be related to low (but finite)  $\dot{V}/\dot{Q}$  regions within the lung that empty at end-exhalation.  $P(a-ET)CO_2$  may decrease when measured at maximal exhalation in patients with airway obstruction.<sup>53</sup>

Perioperative measurement of  $PETCO_2$  is a standard of care to determine proper endotracheal tube position.<sup>54-60</sup> Lack of exhaled  $CO_2$  is consistent with an esophageal intubation. Capnography has also been reported useful for verifying feeding tube placement.<sup>61,62</sup> In the case of trache-

TABLE 31-7.

Causes of Increased and Decreased  $P_{ET}CO_2$ Increased  $P_{ET}CO_2$ 

**Increased  $CO_2$  production and delivery to the lungs:** fever, sepsis, bicarbonate administration, increased metabolic rate, seizures

**Decreased alveolar ventilation:** respiratory center depression, muscular paralysis, hypoventilation, chronic obstructive pulmonary disease

**Equipment malfunction:** rebreathing, exhausted  $CO_2$  absorber, leak in ventilator circuit

Decreased  $P_{ET}CO_2$ 

**Decreased  $CO_2$  production and delivery to the lungs:** hypothermia, pulmonary hypoperfusion, cardiac arrest, pulmonary embolism, hemorrhage, hypotension

**Increased alveolar ventilation:** hyperventilation

**Equipment malfunction:** ventilator disconnect, esophageal intubation, complete airway obstruction, poor sampling, leak around endotracheal tube cuff

al placement of the feeding tube,  $CO_2$  is detected in the gas aspirated from the feeding tube.  $P_{ET}CO_2$  may also be useful for assessing the adequacy of cardiopulmonary resuscitation (CPR). The onset of cardiac arrest results in a decrease of  $P_{ET}CO_2$  to zero. With the initiation of CPR,  $P_{ET}CO_2$  increases and has been reported to increase immediately with return of spontaneous circulation.<sup>63-66</sup> In one study, patients successfully resuscitated following cardiac arrest had a  $P_{ET}CO_2$  of  $15 \pm 4$  mm Hg during CPR, whereas patients who could not be resuscitated had a  $P_{ET}CO_2$  of only  $7 \pm 5$  mm Hg.<sup>67,68</sup>

A common clinical cause of increased dead space is pulmonary embolism, and there has been interest in the use of capnography in this setting.<sup>69-71</sup>  $P(a-ET)CO_2$  usually is increased when pulmonary embolism is present, but the gradient also is increased for a variety of other causes when pulmonary embolism is not present (e.g., any dead space-producing disease). Extrapolation of

phase III of the volumetric capnogram to determine  $PCO_2$  at 15% of the predicted total lung capacity has been reported to be useful in the diagnosis of pulmonary embolism (Fig. 31-10). With maximal exhalation, the gradient approaches zero in patients with obstructive lung disease but remains high in patients with pulmonary embolism.<sup>71</sup>

## Volume-Based Capnography

The volume-based capnogram is displayed with  $PCO_2$  on the ordinate and volume on the abscissa. Airway dead space volume (anatomic dead space), physiologic dead space fraction ( $V_D/V_T$ ),

and the volume of exhaled  $CO_2$  ( $\dot{V}CO_2$ ) can be determined from the volume-based capnogram (Fig. 31-11). If  $\dot{V}CO_2$  is known, it is possible to calculate the metabolic rate:

$$REE = \dot{V}CO_2 \times 5.52 \times 1440, \quad (31-18)$$

where REE = resting energy expenditure (kcal/d),  $\dot{V}CO_2$  is given in L/min, 5.52 = caloric equivalent for  $CO_2$ , and 1440 = number of minutes in a day.

Volumetric capnography can also be used to measure  $V_D/V_T$ <sup>72-75</sup> because  $P_{ET}CO_2$  can be calculated from  $\dot{V}CO_2$  and  $\dot{V}_E$ :

$$\dot{V}CO_2 = \dot{V}_E \times P_{ET}CO_2 / P_B \text{ or } P_{ET}CO_2 = (\dot{V}CO_2 / \dot{V}_E) \times P_B. \quad (31-19)$$

$V_D/V_T$  can then be calculated in the usual manner:

$$V_D/V_T = (PaCO_2 - P_{ET}CO_2) / PaCO_2. \quad (31-20)$$

Cardiac Output Using Partial  $CO_2$  Rebreathing

Using volume-based capnography, it is possible to noninvasively measure cardiac output with the partial  $CO_2$  rebreathing technique (Fig. 31-12).<sup>76-85</sup>  $\dot{V}CO_2$  is calculated on a breath-by-breath basis, and the Fick equation is applied to establish the relationship between  $\dot{V}CO_2$  and cardiac output ( $\dot{Q}$ ):

TABLE 31-8.

Causes of Increased  $P(a-ET)CO_2$ 

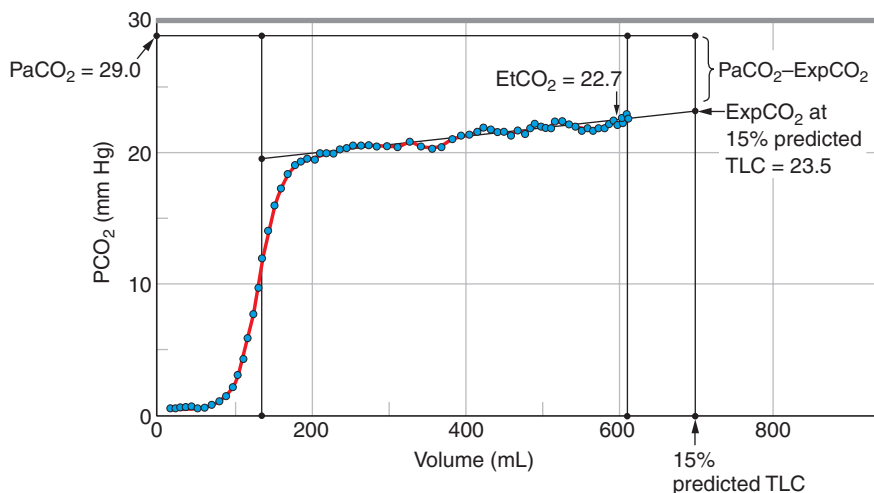
Pulmonary hypoperfusion

Pulmonary embolism

Cardiac arrest

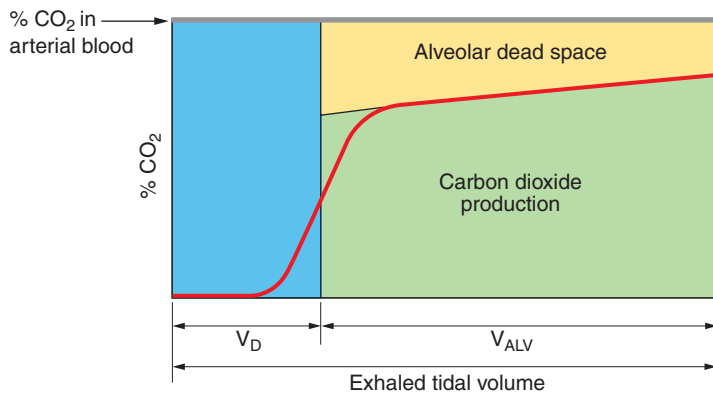
Positive-pressure ventilation (especially positive end-expiratory pressure)

High-rate, low-tidal volume ventilation



**FIGURE 31-10.** Capnogram in a patient diagnosed with pulmonary embolism. This patient had  $V_T$  of 612 mL.  $PaCO_2$  was 29 mm Hg,  $P_{ET}CO_2$  was 22.7 mm Hg, and 15% of the predicted total lung capacity was calculated to be 699 mL.  $P_{ET}CO_2$  at this volume was 23.5 mm Hg after extrapolation of phase III. This relatively high percentage theoretically separates a patient with pulmonary embolism from a healthy patient or a patient with chronic obstructive pulmonary disease.





**FIGURE 31-11.** Components of volume-based capnogram.  $V_D$ , anatomic dead space;  $V_{ALV}$ , alveolar gas volume.

$$\dot{V}CO_2 = \dot{Q} \times (C\bar{V}CO_2 - CaCO_2), \quad (31-21)$$

where  $C\bar{V}CO_2$  =  $CO_2$  content of mixed venous blood, and  $CaCO_2$  =  $CO_2$  con-

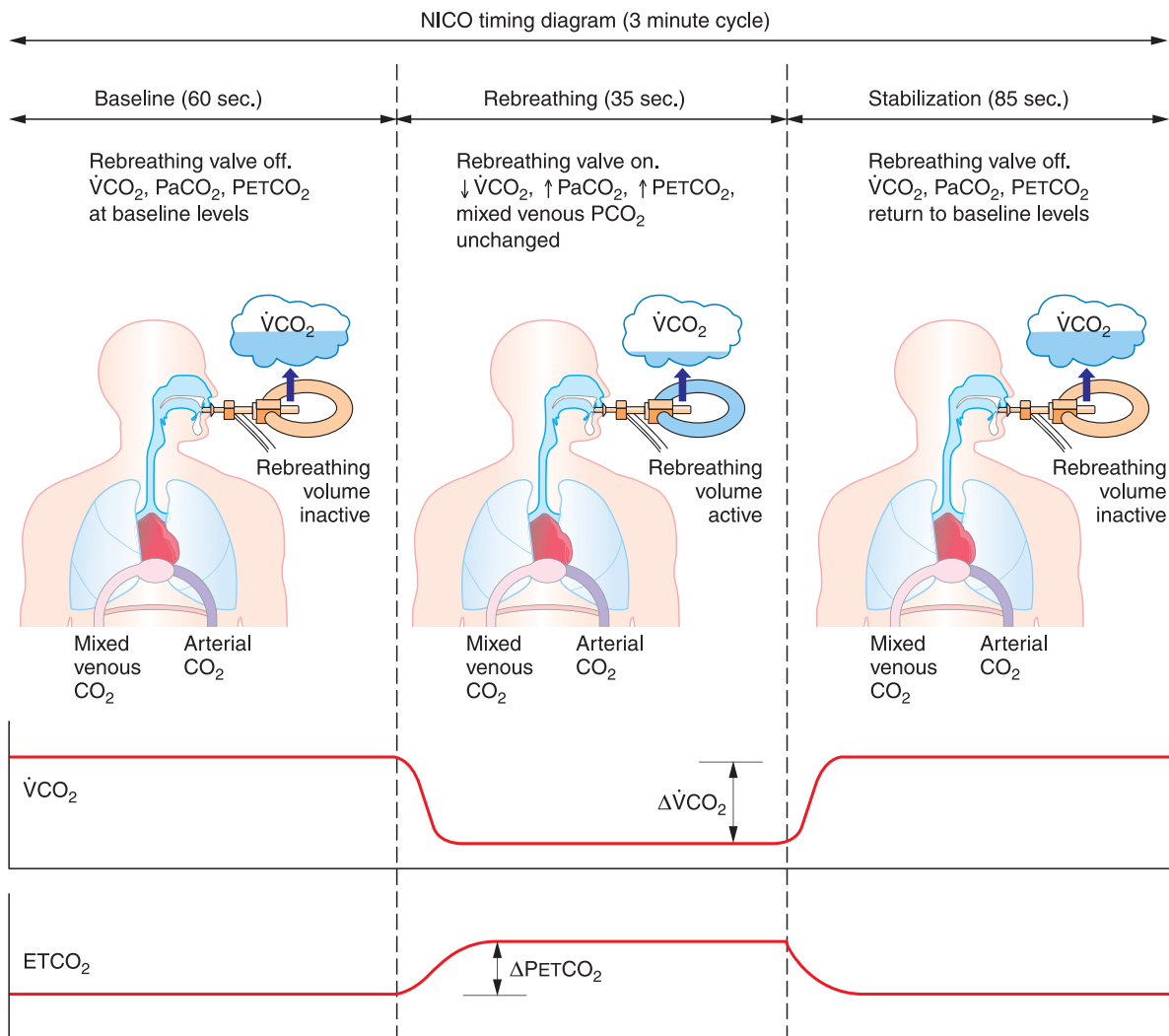
tent of arterial blood.  $CO_2$  rebreathing is performed for 35 seconds every 3 min. Assuming that  $\dot{Q}$  remains constant during the rebreathing procedure yields the following:

$$\Delta\dot{V}CO_2 = \dot{Q} \times (\Delta C\bar{V}CO_2 - \Delta CaCO_2), \quad (31-22)$$

where  $\Delta\dot{V}CO_2$  = change in  $\dot{V}CO_2$  between normal breathing and rebreathing,  $\Delta C\bar{V}CO_2$  = change in mixed venous carbon dioxide content, and  $\Delta CaCO_2$  = change in arterial carbon dioxide content. If  $C\bar{V}CO_2$  remains constant during rebreathing, the following equation is used:

$$\Delta\dot{V}CO_2 = \dot{Q} \times (-\Delta CaCO_2). \quad (31-23)$$

When end-capillary content ( $CcCO_2$ ) is used in place of  $CaCO_2$ , pulmonary capillary blood flow (PCBF), the blood flow that participates in alveolar gas exchange, is measured rather than  $\dot{Q}$ , and the following equation is used:



**FIGURE 31-12.** Rebreathing cycle used by Respiration Noninvasive Cardiac Output (NICO) monitor to measure cardiac output using the partial rebreathing technique.

$$\Delta \dot{V}CO_2 = PCBF \times (-CcCO_2 - CcCO_2). \quad (31-24)$$

Assuming that  $-CcCO_2$  is proportional to  $\Delta P_{ET}CO_2$ , the following equation can be used:

$$PCBF = \Delta \dot{V}CO_2 / (S \times \Delta P_{ET}CO_2), \quad (31-25)$$

where  $\Delta P_{ET}CO_2$  = change in  $P_{ET}CO_2$  between normal breathing and rebreathing, and  $S$  = slope of the carbon dioxide dissociation curve from hemoglobin. Because cardiac output is the sum of PCBF and intrapulmonary shunt flow:

$$\dot{Q} = PCBF / (1 - \dot{Q}_s / \dot{Q}_T). \quad (31-26)$$

The noninvasive method for estimating  $\dot{Q}_s / \dot{Q}_T$  is adapted from Nunn's iso-shunt plots, which are a series of continuous curves indicating the relation between arterial oxygen pressure ( $P_{aO_2}$ ) and  $FIO_2$  at different levels of right-to-left shunt.  $P_{aO_2}$  is noninvasively estimated using a pulse oximeter.

There are several potential limitations of partial rebreathing for the measurement of cardiac output. In nonparalyzed patients, rebreathing increases the respiratory rate, which reduces the magnitude of the signal and limits the ability to detect changes in  $P_{ET}CO_2$  and  $\dot{V}CO_2$ .

Noise is increased by respiratory pattern irregularities that produce an unstable  $P_{ET}CO_2$  and  $\dot{V}CO_2$ , and these may impair accuracy. Additional cardiac output not calculated because of shunt fraction is estimated from  $SpO_2$  and  $FIO_2$ , and these also may introduce errors.

### Capnometry during Spontaneous Ventilation

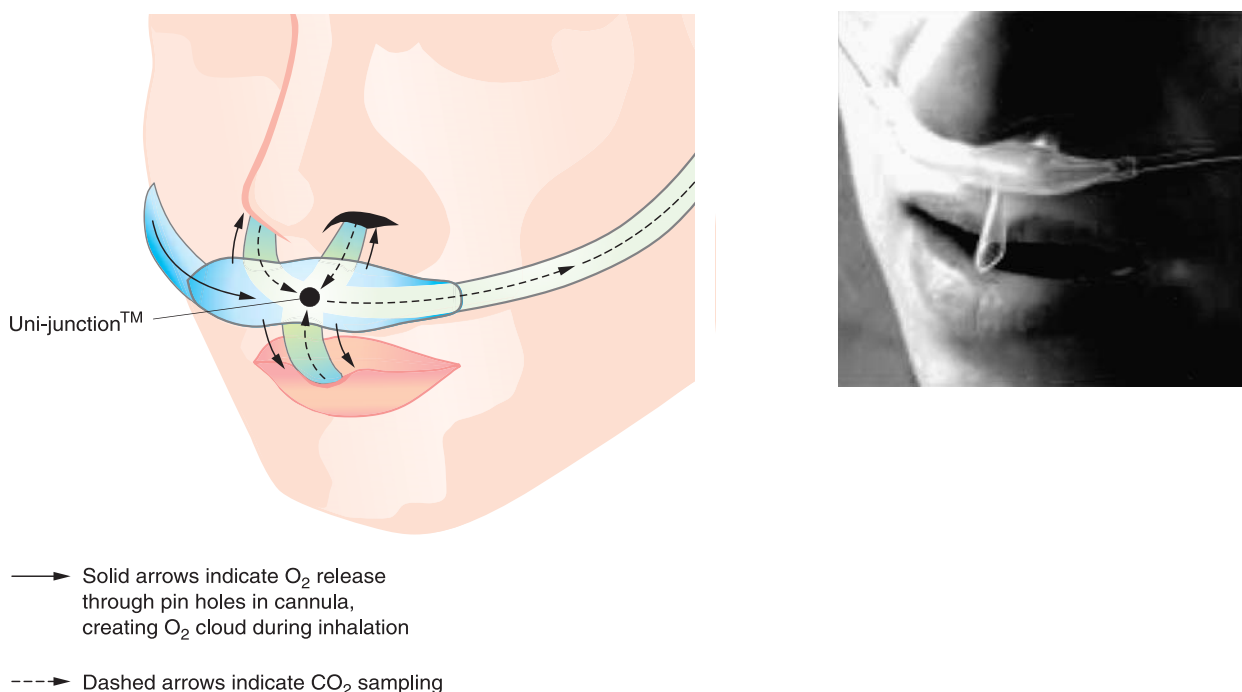
Although capnometry is most often used with intubated and mechanically ventilated patients, techniques are available to measure  $P_{ET}CO_2$  during spontaneous breathing. Nasal cannulae are commercially available for capnometry (Figure 31-13). When a capnometer is used with a nasal cannula, it is important that the sample is not contaminated with room air or oxygen flow, which will result in significant underestimation of  $P_{ET}CO_2$ . Although it can be technically difficult to accurately perform capnometry in nonintubated patients,  $P(a-ET)CO_2$  values that are similar during both spontaneous breathing and intubation have been reported.<sup>86-91</sup>

### TRANSCUTANEOUS $PO_2$ AND $PCO_2$

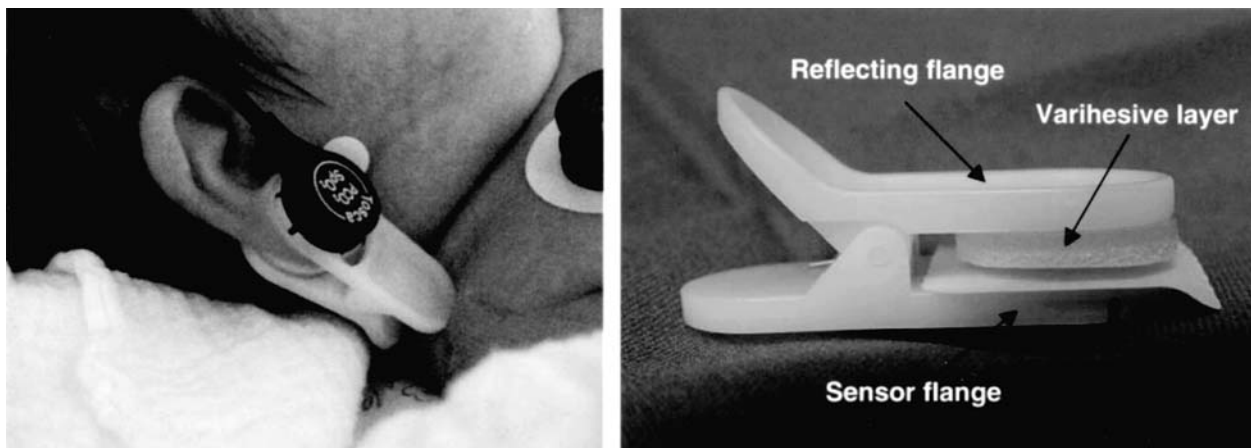
The transcutaneous  $PO_2$  ( $P_{tCO_2}$ ) electrode uses the polarographic principle

(Clark electrode). To produce a  $P_{tCO_2}$  approximating the  $P_{aO_2}$ , the electrode must be heated to approximately 44°C. The relationship between  $P_{aO_2}$  and  $P_{tCO_2}$  is the result of a complex set of physiologic events. Simply stated, the increase in  $PO_2$  caused by heating roughly balances the decrease in  $PO_2$  caused by skin oxygen consumption and the diffusion of oxygen across the skin. It should be recognized that the close relationship between  $P_{aO_2}$  and  $P_{tCO_2}$  that occurs in neonates probably is more coincidental than physiologic. In adults, the  $P_{tCO_2}$  value frequently is less than the directly measured  $P_{aO_2}$ .  $P_{tCO_2}$  is also affected by perfusion and may reflect the quantity of oxygen delivered to the skin under the electrode (the product of cardiac output and arterial oxygen content).  $P_{tCO_2}$  has been used in adults to monitor the results of vascular surgery, with the intent of evaluating perfusion rather than  $P_{aO_2}$  per se.

Transcutaneous  $PCO_2$  ( $P_{tCO_2}$ ) is measured using a Severinghaus electrode. Unlike the  $P_{tCO_2}$  electrode, a reasonably good correlation with  $P_{aCO_2}$  can be obtained at a temperature of 37°C. Because  $P_{tCO_2}$  is consistently greater than  $P_{aCO_2}$ , manufacturers incorporate a correction factor so that the  $P_{tCO_2}$  that is displayed approxi-



**FIGURE 31-13.** Nasal cannula designed for  $CO_2$  sampling and oxygen administration (Smart CapnoLine, Oridion). The cannula samples  $CO_2$  from both the nares and the mouth while oxygen is delivered through pinholes directed toward both the nose and mouth.



**FIGURE 31-14.** Disposable low-pressure adhesive attachment clip for transcutaneous sensor placement at the earlobe. The clip consists of two clip jaws connected by a coil spring. One of the jaws to be placed at the outside of the earlobe provides a retainer ring for inserting the sensor. This jaw also has a hole in the middle, in which a drop of contact gel has to be applied before inserting the sensor. The sensor can be rotated in the retainer ring for finding a position in which the sensor cable is not stretched or twisted. (From Bernet-Buettiker et al.<sup>92</sup> with permission.)

mates the  $P_{aCO_2}$ . Like  $P_{tCO_2}$ , the proximity with which  $P_{tcCO_2}$  approximates  $P_{aCO_2}$  is the result of a complex set of physiologic events; thus it is incorrect to believe that  $P_{tcCO_2}$  is the  $P_{aCO_2}$ . For example, decreased tissue perfusion causes  $P_{tcCO_2}$  to increase.

A miniaturized single sensor combining the measurement of pulse oximetry ( $SpO_2$ ) and  $P_{tcCO_2}$  (TOSCA, Linde Medical Sensors) recently become available (Fig. 31-14). The TOSCA measurement system is based on a heated Severinghaus electrode combined with a pulse oximetry sensor and is attached to the earlobe with an attachment clip. The pressure exerted by the attachment clip to the skin is approximately 12 mm Hg. According to the manufacturer's data, the in vitro 90% response time for  $PCO_2$  is <50 seconds. The sensor is calibrated in vitro using a one-point dry gas calibration with 7%  $CO_2$  when the sensor is placed in its calibration chamber. The calibration takes 2 minutes, allowing rapid repositioning every 8 hours. The sensor is heated to 42°C to induce local vasodilatation and enhance skin permeability for  $CO_2$  to improve gas diffusion at the site of measurement. The sensor is cleaned with alcohol and dried before each application. One drop of contact gel is applied on the skin in the center of the attachment clip before the sensor is applied. The sensor is removed after 8 hours, recalibrated, and fixed on the other earlobe. Several studies have reported the accuracy of this device compared to  $P_{aCO_2}$ .<sup>92-96</sup>

## LUNG MECHANICS AND GRAPHICS

Pulmonary mechanics is the expression of lung function through measurements of pressure and flow.<sup>97-99</sup> From these measurements, a variety of derived indices can be determined, such as volume, compliance, resistance, and work of breathing. Pulmonary graphics are derived when one of the parameters of pulmonary mechanics is plotted as a function of time or as a function of one of the other parameters. This produces scalar pressure-time, flow-time, and volume-time graphics as well as flow-volume and pressure-volume loops. Current-generation critical care and anesthesia ventilators provide monitoring of pulmonary mechanics and graphics in real time.

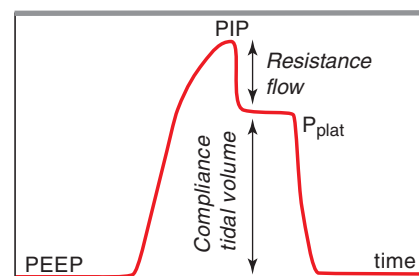
Airway pressure is universally measured during mechanical ventilation. Peak airway pressure is predicted mathematically by the Equation of Motion, which describes the relationship between proximal airway pressure ( $P_{aw}$ ), the pressure generated by the respiratory muscles ( $P_{mus}$ ), respiratory system compliance ( $C$ ), tidal volume ( $V_T$ ), airways resistance ( $R$ ), flow ( $\dot{V}$ ), and the level of PEEP:

$$P_{aw} + P_{mus} = V_T/C + R \times \dot{V} + PEEP. \quad (31-27)$$

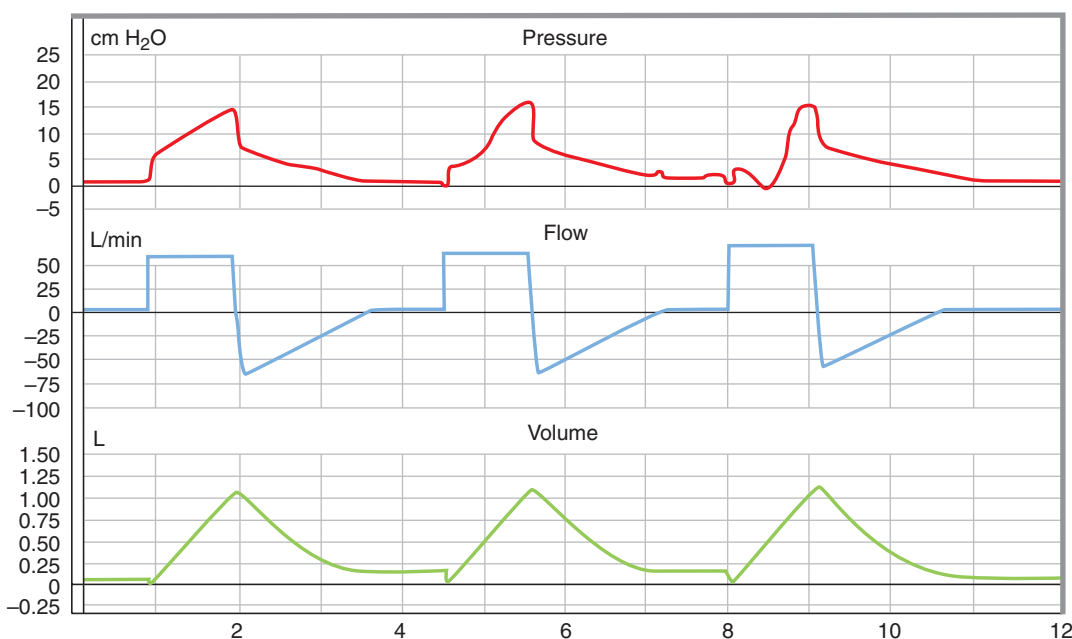
The Equation of Motion predicts that proximal airway pressure will increase with a higher tidal volume, lower respiratory system compliance,

higher airway resistance, higher inspiratory flow, higher PEEP, and presence of auto-PEEP.

Because of airway resistance, proximal airway pressure will always be greater than alveolar pressure during inspiration when flow is present. During volume-controlled ventilation, plateau pressure ( $P_{plat}$ ) is measured by applying an end-inspiratory breathhold for 0.5–2 seconds, during which pressure equilibrates throughout the respiratory system so that the pressure measured at the proximal airway approximates the peak alveolar pressure (Fig. 31-15).  $P_{plat}$  cannot be accurately measured during active breathing and thus cannot be measured with ventilator modes such as pressure support ventilation. During pressure-controlled



**FIGURE 31-15.** Schematic representation of a pressure waveform during volume-controlled ventilation. The difference between peak inspiratory pressure (PIP) and plateau pressure ( $P_{plat}$ ) is determined primarily by airway resistance and flow. The difference between  $P_{plat}$  and the level of PEEP is determined by compliance and tidal volume.



**FIGURE 31-16.** Example of patient–ventilator dyssynchrony in a patient on volume-controlled ventilation. Note the breath-to-breath changes in airway pressure waveform. (From Nilsestuen and Hargett<sup>100</sup> with permission.)

ventilation, the flow may decrease to zero before the end of the inspiratory phase, in which case peak inspiratory pressure (PIP) and  $P_{plat}$  are equal. Breath-to-breath variability of airway pressure occurs with patient–ventilator dyssynchrony (Fig. 31-16).<sup>100,101</sup>

$P_{plat}$  is determined by tidal volume and respiratory system compliance:

$$P_{plat} = V_T/C. \quad (31-28)$$

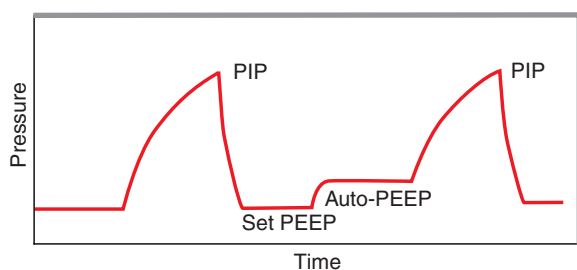
$P_{plat}$  indicates the risk of alveolar overdistension during mechanical ventilation and should be maintained at  $\leq 30$  cm H<sub>2</sub>O.<sup>102</sup> The lower the  $P_{plat}$ , the lower is the risk of ventilator-induced lung injury.<sup>103</sup> However, a higher  $P_{plat}$  may be safe (and necessary) if intrapleural pressure is elevated (e.g., ab-

dominal distension, decreased chest wall compliance).

Incomplete emptying of the lungs occurs if the expiratory phase is terminated prematurely. When this occurs, alveolar pressure does not equilibrate with proximal airway pressure at end-exhalation, and gas trapping results. The pressure produced by this trapped gas is called auto-PEEP or intrinsic PEEP. Auto-PEEP increases the end-expiratory lung volume (hyperinflation). It is measured by applying an end-expiratory pause for 0.5–2 seconds (Fig. 31-17). The pressure measured at the end of this maneuver that is in excess of the PEEP set on the ventilator is auto-PEEP.<sup>104–108</sup> For a valid measurement, the patient must be relaxed and breathing in synchrony with the ventilator. Many patients with chronic ob-

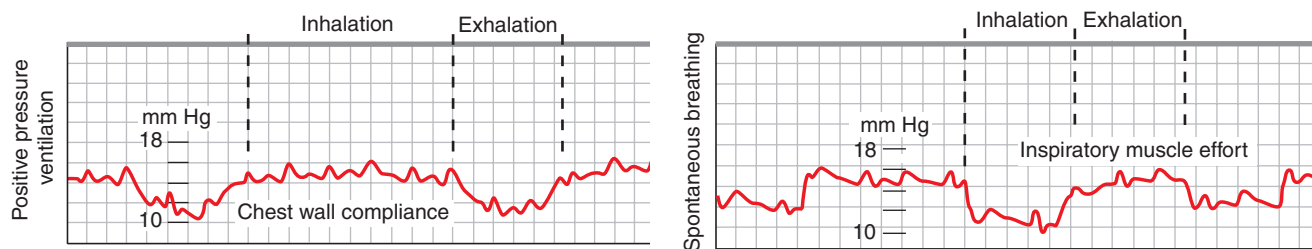
structive pulmonary disease (COPD) contract their abdominal muscles during exhalation. This is an important determinant of auto-PEEP for these patients but does not produce hyperinflation. It has also been shown that the end-expiratory pause method can underestimate auto-PEEP with complete airway closure during exhalation, as may occur during mechanical ventilation of patients with severe asthma.<sup>108</sup> The risk of auto-PEEP is greater with increased resistance and compliance (e.g., chronic obstructive lung disease), increased respiratory rate or increased inspiratory time (both decrease expiratory time), and at increased tidal volume. It follows that auto-PEEP can be reduced by decreasing minute ventilation (rate or tidal volume), increasing expiratory time, or decreasing the airways resistance (e.g., bronchodilator administration). During mechanical ventilation, set-PEEP may counterbalance auto-PEEP in patients with flow limitation, and thus auto-PEEP should be measured at PEEP = 0.

Esophageal pressure is measured with a balloon inflated with a small volume of air (<1 mL) that is placed into the lower esophagus.<sup>109</sup> Esophageal pressure changes reflect changes in pleural pressure. However, the absolute esophageal pressure does not reflect the absolute pleural pressure. Changes in esophageal pressure can be used to assess respiratory effort and



**FIGURE 31-17.** Measurement of auto-positive end-expiratory pressure (PEEP) with an end-expiratory pause maneuver. The difference between the pause pressure and the set PEEP level is the amount of auto-PEEP.





**FIGURE 31-18.** Left. During positive-pressure ventilation in a relaxed patient, the increase in central venous pressure (CVP) during the inspiratory phase is determined by chest wall compliance. Right. During spontaneous breathing, the decrease in CVP during the inspiratory phase is determined by inspiratory muscle effort.

work of breathing during spontaneous breathing, to assess chest wall compliance during full ventilatory support, and to assess auto-PEEP during spon-

aneous breathing. If an esophageal balloon is not present, changes in pleural pressure can be crudely estimated by observing the respiratory

variability of the central venous pressure (Fig. 31-18).<sup>110</sup>

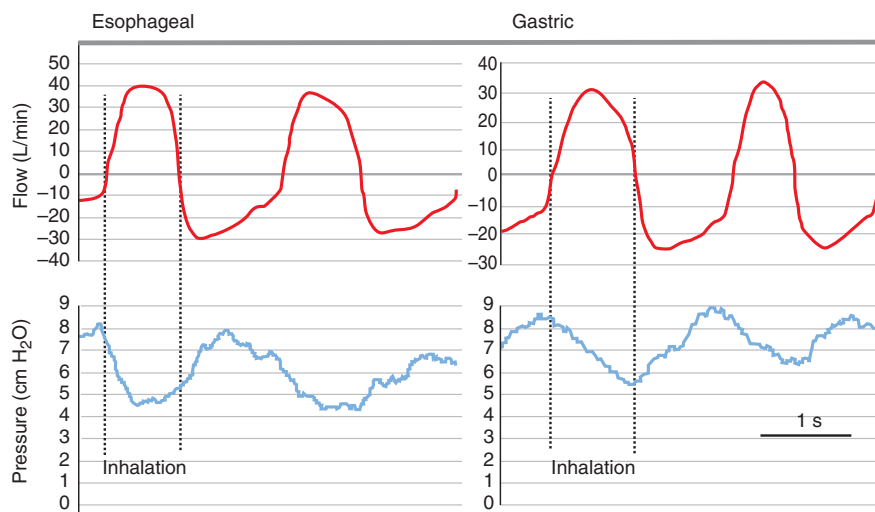
Gastric pressure can be measured with a balloon inserted into the stomach. Gastric pressure reflects intraabdominal pressure. Measures of phasic gastric pressure during spontaneous breathing usually reflect diaphragmatic function. Normally, gastric pressure (intraabdominal pressure) should increase during inhalation. If the gastric pressure decreases during a spontaneous inhalation, this is consistent with diaphragmatic paralysis (Fig. 31-19).<sup>111</sup> In the absence of a gastric balloon, respiratory variation of bladder pressure can be used.

If exhalation is passive, the change in esophageal pressure required to reverse flow at the proximal airway (i.e., trigger the ventilator) reflects the amount of auto-PEEP. Negative esophageal pressure changes that produce no flow at the airway indicate failed respiratory triggering efforts (Fig. 31-17). Clinically, this is recognized as a patient respiratory rate that is greater than the trigger rate on the ventilator (readily observed by inspecting chest wall movement).<sup>112</sup>

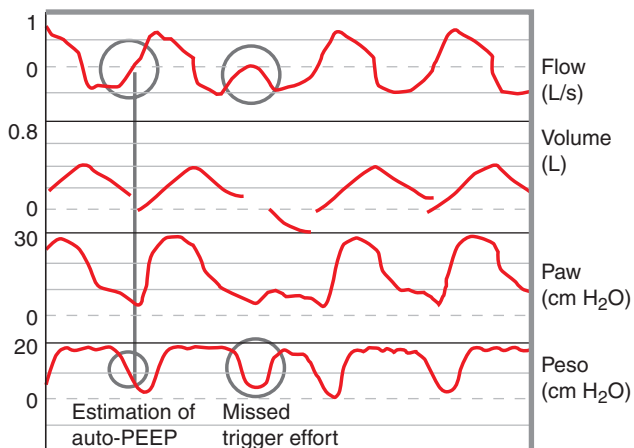
A useful application of the airway flow waveform is for detection of auto-PEEP. If the expiratory flow does not return to baseline, this indicates the presence of auto-PEEP. Although the flow waveform is useful for detecting auto-PEEP, it does not quantitatively indicate the amount of auto-PEEP. Dips in expiratory flow indicate trigger efforts in which the patient's inspiratory effort was insufficient to overcome auto-PEEP and trigger the ventilator (Fig. 31-20).

Respiratory system compliance ( $C_{rs}$ ) is assessed in mechanically ventilated patients as the tidal volume divided by the pressure required to deliver that volume:

$$C_{rs} = \Delta V / \Delta P = V_T / (P_{plat} - PEEP). \quad (31-29)$$



**FIGURE 31-19.** Esophageal and gastric pressure changes in a patient with diaphragmatic paralysis. Note that both esophageal and gastric pressures have negative deflections during the inspiratory phase. (From Lecamwasam et al.<sup>111</sup> with permission.)



**FIGURE 31-20.** Esophageal pressure measurements in a patient with auto-positive end-expiratory pressure (auto-PEEP). Note that an esophageal pressure drop of approximately 10 cm H<sub>2</sub>O is necessary to trigger the ventilator. This represents an auto-PEEP level of approximately 10 cm H<sub>2</sub>O. Also note an inspiratory effort that is not great enough to overcome auto-PEEP and trigger the ventilator. Expiratory pressure does not return to zero before the subsequent breath is initiated.

Respiratory system compliance typically is 50–100 mL/cm H<sub>2</sub>O in mechanically ventilated patients and is determined by the compliance of the lungs and chest wall. Chest wall compliance is calculated from the change in esophageal pressure (pleural pressure) during passive inflation. Chest wall compliance normally is 200 mL/cm H<sub>2</sub>O and can be decreased by abdominal distension, chest wall edema, chest wall burns, thoracic deformities (e.g., kyphoscoliosis), and an increase in muscle tone (e.g., a patient who is “bucking” the ventilator). Chest wall compliance is increased with flail chest and paralysis. Lung compliance is calculated using the transpulmonary pressure; in other words, the difference between alveolar pressure ( $P_{\text{plat}}$ ) and pleural pressure (esophageal). Normal lung compliance is 100 mL/cm H<sub>2</sub>O and will be decreased by pulmonary edema (cardiogenic or noncardiogenic), pneumothorax, lung consolidation, atelectasis, pulmonary fibrosis, pneumonectomy or lung resection, mainstream intubation, and hyperinflation. Lung compliance is increased with emphysema.

During volume-controlled ventilation, inspiratory airways resistance can be estimated:

$$R_1 = (PIP - P_{\text{plat}}) / \dot{V}_I \quad (31-30)$$

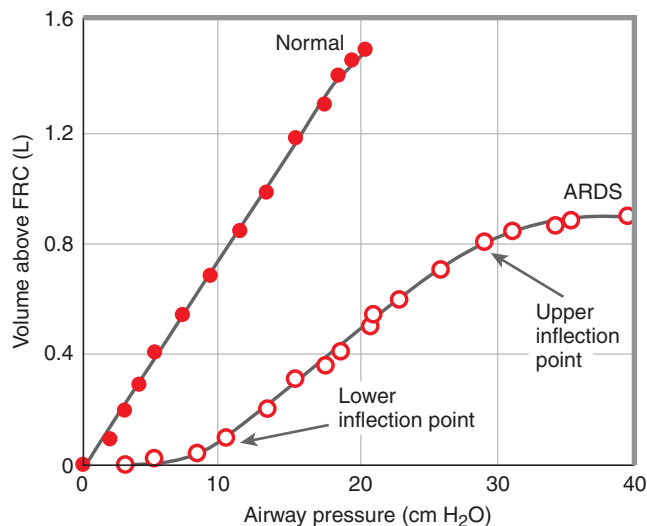
where  $\dot{V}_I$  = end-inspiratory flow. A simple way to make this measurement is to set the ventilator for a constant

inspiratory flow of 60 L/min (1 L/s). Using this approach, the inspiratory airways resistance is  $PIP - P_{\text{plat}}$ . Common causes of increased airway resistance are bronchospasm, secretions, and a small inner-diameter endotracheal tube. For intubated and mechanically ventilated patients, airways resistance should be < 10 cm H<sub>2</sub>O/L/s at a flow of 1 L/s. Expiratory airway resistance typically is greater than inspiratory airway resistance.

The pressure–volume curve represents the static relationship between pressure and volume of the respiratory system (lungs, abdomen, rib cage, and respiratory muscles). It can be constructed using a number of techniques that measure pressure as the lungs are inflated or deflated.<sup>113</sup> This requires a completely relaxed chest wall; thus, the patient must be paralyzed for the best results. The respiratory system pressure–volume curve can be separated into the lung and chest wall curves by estimating pleural pressure with an esophageal balloon. In the normal respiratory system, the shape of the pressure–volume curve is nearly linear above the resting volume. The inflation and deflation curves demonstrate differences in their shape and pressure for a given volume (hysteresis). The inflation curve with ALI begins with a flat portion followed by a transition to a steeper more compliant region (Fig. 31-21). This transition has been called the lower inflection point ( $P_{\text{Flex}}$ ). The curve continues with a linear progression and at its upper end undergoes

another transition to a flat region. This transition has been called the upper inflection point. On deflation, a similar shape is achieved but at a lower pressure than the inflation curve. The lower  $P_{\text{Flex}}$  has been equated with the closing volume, and the upper  $P_{\text{Flex}}$  has been equated with overdistension. Determination of inflection points often is arbitrary and inaccurate. Methods have ranged from eyeball approximation to graphical curve-fitting methods. Interobserver variability in the determination of  $P_{\text{Flex}}$  has been reported.<sup>114</sup> Methods based on curve-fitting equations may provide more accurate estimates of the inflection points.

There has been enthusiasm for use of pressure–volume curves to optimize ventilator settings by setting PEEP above  $P_{\text{Flex}}$  and setting  $P_{\text{plat}}$  below the upper  $P_{\text{Flex}}$ . Recent observations and analysis of the pressure–volume curve in ARDS have changed its interpretation and implications for management. The chest wall affects  $P_{\text{Flex}}$  and determination of the upper inflection point.<sup>115,116</sup> These observations imply that the pressure–volume curve should be measured with an esophageal balloon to determine the inflection points for the lung alone. Because the pressure–volume curve represents the sum behavior of all ventilated lung units and given the heterogeneity of lung injury, it might not be possible to determine ideal points of recruitment or overdistension. Mathematical modeling suggests that PEEP settings based on  $P_{\text{Flex}}$  may not be adequate to ensure an “open lung.”<sup>117,118</sup>



**FIGURE 31-21.** Pressure–volume curve during mechanical ventilation. Note that the curve is nearly linear in the normal condition. In acute respiratory distress syndrome, the curve demonstrates a lower inflection point and an upper inflection point.

## MONITORING IN PERSPECTIVE

How much monitoring is needed? This is an important question for both clinicians and administrators. Clinicians often want to monitor everything possible, with a “more is better” attitude. On the other hand, administrators and managed care providers become concerned with the costs and complexity associated with monitoring.

The presence of many monitors at the bedside can be distracting to clinicians. Many monitoring systems tend to beep, buzz, and blink constantly, attracting attention excessively. Bentt et al.<sup>119</sup> found that a pulse oximeter alarm was present up to 47% of the time (28 min/h) in a 10-bed surgical

ICU, and that many of these were false alarms that required no intervention. During anesthesia monitoring, Kestin et al.<sup>120</sup> found that 75% of all alarms that sounded were spurious, and only 3% indicated a risk to the patient. In an adult ICU, monitor alarms were present 20% of the time, with an average peak sound level of nearly 80 dBA (decibels measured using the A weighting filter); the Environmental Protection Agency (EPA) recommends that noise levels in hospitals not exceed 45 dBA.<sup>121</sup> Monitoring is often useful in patient care. However, monitoring should not be done just because it is technically feasible. Technical capability must be balanced against clinical usefulness, cost effectiveness, and safety. The decision to monitor, like any other clinical decision, should be based on achieving therapeutic objectives in a safe and cost-effective manner.

### KEY REFERENCES

1. Lucangelo U, Blanch L. Dead space. *Intensive Care Med* 2004;30:576–579.
2. Fencel V, Jabor A, Kazda A, Figue J. Diagnosis of metabolic acid-base disturbances in critically ill patients. *Am J Respir Crit Care Med* 2000;162:2246–2251.
3. Kiziltan HT, Baltali M, Bilen A, Seydaoglu G, et al. Comparison of alpha-stat and pH-stat cardiopulmonary bypass in relation to jugular venous oxygen saturation and cerebral glucose-oxygen utilization. *Anesth Analg* 2003;96:644–650.
4. Pedersen T, Møller AM, Pedersen BD. Pulse oximetry for perioperative monitoring: systematic review of randomized, controlled trials. *Anesth Analg* 2003;96:426–431.
5. Hess DR. Capnometry. IN: Tobin MJ. *Principles and practice of intensive care monitoring*. McGraw-Hill, New York, 1998.
6. Araujo-Preza CE, Melhado ME, Gutierrez FJ, et al. Use of capnometry to verify feeding tube placement. *Crit Care Med* 2002;30:2255–2259.
7. Blanch L, Romero PV, Lucangelo U. Volumetric capnography in the

mechanically ventilated patient. *Minerva Anestesiol* 2006;72:577–585.

8. Yem JS, Tang Y, Turner MJ, et al. Sources of error in noninvasive pulmonary blood flow measurements by partial rebreathing. A computer model study. *Anesthesiology* 2003;98:881–887.

9. Rodriguez P, Lellouche F, Aboab J, et al. Transcutaneous arterial carbon dioxide pressure monitoring in critically ill adult patients. *Intensive Care Med* 2006;32:309–312.

10. Hess DR. Monitoring during mechanical ventilation. In Mosenifar Z, Soo Hoo GW, ed. *Practical Pulmonary and Critical Care Medicine. Respiratory Failure. Lung Biology in Health and Disease*, Volume 213. Taylor & Francis, New York, 2006.

### REFERENCES

1. Hess D. An overview of noninvasive monitoring in respiratory care: present, past, and future. *Respir Care* 1990;35:482–499.
2. Lucangelo U, Blanch L. Dead space. *Intensive Care Med* 2004;30:576–579.
3. Drummond GB, Fletcher R. Editorial II. Deadspace: invasive or not? *Br J Anaesth* 2006;96:4–7.
4. Tang Y, Turner MJ, Baker AB. A new equal area method to calculate and represent physiologic, anatomical, and alveolar dead spaces. *Anesthesiology* 2006;104:696–700.
5. Nuckton TJ, Alonso JA, Kallet RH, et al. Pulmonary dead-space fraction as a risk factor for death in the acute respiratory distress syndrome. *N Engl J Med* 2002;346:1281–1286.
6. Hubble CL, Gentile MA, Tripp DS, et al. Dead-space to tidal volume ratio predicts successful extubation in infants and children. *Crit Care Med* 2000;28:2034–2040.
7. Fencel V, Jabor A, Kazda A, Figue J. Diagnosis of metabolic acid-base disturbances in critically ill patients. *Am J Respir Crit Care Med* 2000;162:2246–2251.
8. Ali MS, Harmer M, Vaughan RS, Dunne JA, et al. Changes in cerebral oxygenation during cold (28 degrees C) and warm (34 degrees C) cardiopulmonary bypass using different blood gas strategies (alpha-stat and pH-stat) in patients undergoing coronary artery bypass graft surgery. *Acta Anaesth Scand* 2004;48:837–844.
9. Acsell JR. pH-stat ventilation management: a simple method of achieving this regimen. *J Extra Corpor Technol* 2003;35:287–289.
10. Kiziltan HT, Baltali M, Bilen A, Seydaoglu G, et al. Comparison of alpha-stat and pH-stat cardiopulmonary bypass in relation to jugular venous oxygen saturation and cerebral glucose-oxygen utilization. *Anesth Analg* 2003;96:644–650.
11. Laussen PC. Optimal blood gas management during deep hypothermic paediatric cardiac surgery: alpha-stat is easy, but pH-stat may be preferable. *Paediatr Anaesth* 2002;12:199–204.
12. Kofstad J. Blood gases and hypothermia: some theoretical and practical considerations. *Scand J Clin Lab Invest Suppl* 1996;224:21–26.
13. Ye J, Li Z, Yang Y, et al. Use of a pH-stat strategy during retrograde cerebral perfusion improves cerebral perfusion and tissue oxygenation. *Ann Thorac Surg* 2004;77:1664–1670.
14. Rivers E, Nguyen B, Havstad S, et al. Early goal-directed therapy in the treatment of severe sepsis and septic shock. *N Engl J Med* 2001;345:1368–1377.
15. Giuliano KK, Liu LM. Knowledge of pulse oximetry among critical care nurses. *Dimens Crit Care Nurs* 2006;25:44–49.
16. Stoneham MD, Saville GM, Wilson IH. Knowledge about pulse oximetry among medical and nursing staff. *Lancet* 1994;344:1339–1342.
17. Hampson NB. Pulse oximetry in severe carbon monoxide poisoning. *Chest* 1998;114:1036–1041.
18. Barker SJ, Tremper KK, Hyatt J. Effects of methemoglobinemia on pulse oximetry and mixed venous oximetry. *Anesthesiology* 1989;70:112–117.
19. Rajadurai VS, Walker AM, Yu VY, et al. Effect of fetal haemoglobin on the accuracy of pulse oximetry in preterm infants. *J Paediatr Child Health* 1992;28:43–46.
20. Kress JP, Pohlman AS, Hall JB. Determinants of hemoglobin saturation in patients with acute sickle chest syndrome. A comparison of arterial blood gases and pulse oximetry. *Chest* 1999;115:1316–1320.
21. Scheller MS, Unger RJ, Kelner MJ. Effects of intravenously administered dyes on pulse oximeter readings. *Anesthesiology* 1986;65:550–552.
22. Cote CJ, Goldstein EA, Fuchsman WH, et al. The effect of nail polish on pulse oximetry. *Anesth Analg* 1989;67:683–686.
23. Veyckemans F, Baele P, Guillaume JE, et al. Hyperbilirubinemia does not interfere with hemoglobin saturation measured by pulse oximetry. *Anesthesiology* 1989;70:118–122.
24. Bickler PE, Feiner JR, Severinghaus JW. Effects of skin pigmentation on pulse oximeter accuracy at low saturation. *Anesthesiology* 2005;102:715–719.
25. Zeballos RJ, Wiesman IM. Reliability of noninvasive oximetry in black subjects during exercise and hypoxia. *Am Rev Respir Dis* 1991;144:1240–1244.
26. Jubran A, Tobin MJ. Reliability of pulse oximetry in titrating supplemental oxygen therapy in ventilator-dependent patients. *Chest* 1990;97:1420–1425.

27. Severinghaus JW, Koh SO. Effect of anemia on pulse oximeter accuracy at low saturation. *J Clin Monit* 1990;6:85–88.
28. Freund PR, Overand PT, Cooper J, et al. A prospective study of intraoperative pulse oximetry failure. *J Clin Monit* 1991;7:253–258.
29. Plummer JL, Ilsley AH, Fronsco RRL, et al. Identification of movement artefact by the Nellcor N-200 and N-3000 pulse oximeters. *J Clin Monit* 1997;13:109–113.
30. Gehring H, Nornberger C, Matz H, et al. The effects of motion artifact and low perfusion on the performance of a new generation of pulse oximeters in volunteers undergoing hypoxemia. *Respir Care* 2002;47:48–60.
31. Goldman JM, Petterson MT, Kopotic RJ, et al. Masimo signal extraction pulse oximetry. *J Clin Monit* 2000;16:475–483.
32. Barker SJ. “Motion-resistant” pulse oximetry: a comparison of new and old models. *Anesth Analg* 2002;95:967–972.
33. Durbin CG, Rostow SK. More reliable oximetry reduces the frequency of arterial blood gas analyses and hastens oxygen weaning after cardiac surgery: a prospective, randomized trial of the clinical impact of a new technology. *Crit Care Med* 2002;30:1734–1740.
34. Robertson FA, Hoffman GM. Clinical evaluation of the effects of signal integrity and saturation on data availability and accuracy of Masimo SE and Nellcor N-395 oximeters in children. *Anesth Analg* 2004;98:617–622.
35. Giuliano KK, Higgins TL. New-generation pulse oximetry in the care of critically ill patients. *Am J Crit Care* 2005;14:26–37.
36. Richards NM, Giuliano KK, Jones PG. A prospective comparison of 3 new-generation pulse oximetry devices during ambulation after open heart surgery. *Respir Care* 2006;51:29–35.
37. Pedersen T, Møller AM, Pedersen BD. Pulse oximetry for perioperative monitoring: systematic review of randomized, controlled trials. *Anesth Analg* 2003;96:426–431.
38. Moller JT, Pedersen T, Rasmussen LS, et al. Randomized evaluation of pulse oximetry in 20,802 patients. I. Design, demography, pulse oximetry failure rate, and overall complication rate. *Anesthesiology* 1993;78:436–444.
39. Moller JT, Johannessen NW, Espersen K, et al. Randomized evaluation of pulse oximetry in 20,802 patients. II. Perioperative events and postoperative complications. *Anesthesiology* 1993;78:445–453.
40. Hartert TV, Wheeler AP, Sheller JR. Use of pulse oximetry to recognize severity of airflow obstruction in obstructive airway disease: correlation with pulsus paradoxus. *Chest* 1999;115:475–481.
41. Cannesson M, Besnard C, Durand PG, et al. Relation between respiratory variations in pulse oximetry plethysmographic waveform amplitude and arterial pulse pressure in ventilated patients. *Crit Care* 2005;9:R562–R568.
42. Hess DR, Capnometry IN, Tobin MJ. Principles and Practice of Intensive Care Monitoring. New York: McGraw-Hill, 1998.
43. Colman Y, Krauss B. Microstream capnography technology: a new approach to an old problem. *J Clin Monit* 1999;15:403–409.
44. Hoffbrand BI. The expiratory capnogram: a measure of ventilation-perfusion inequalities. *Thorax* 1966;21:518–523.
45. Yaron M, Padyk P, Hutsiniller M, et al. Utility of expiratory capnogram in the assessment of bronchospasm. *Ann Emerg Med* 1996;28:403–407.
46. You B, Peslin R, Duvivier C, et al. Expiratory capnography in asthma: evaluation of various shape indices. *Eur Respir J* 1994;7:318–323.
47. Yamanaka MK, Sue DY. Comparison of arterial-end-tidal PCO<sub>2</sub> difference and dead space/tidal volume ratio in respiratory failure. *Chest* 1987;92:832–835.
48. Jones NL, McHardy GJR, Naimark A, et al. Physiological dead space and alveolar-arterial gas pressure differences during exercise. *Clin Sci* 1966;31:19–29.
49. Nunn JF, Hill DW. Respiratory dead space and arterial to end-tidal CO<sub>2</sub> tension difference in anesthetized man. *J Appl Physiol* 1960;15:383–389.
50. Severinghaus JW, Stupfel MA, Bradley AF. Alveolar dead space and arterial to end-tidal carbon dioxide differences during hypothermia in dog and man. *J Appl Physiol* 1957;10:349–355.
51. Fletcher R, Jonson B, Cumming G, et al. The concept of deadspace with special reference to the single breath test for carbon dioxide. *Br J Anaesth* 1981;53:77–88.
52. Fletcher R, Jonson B. Dead-space and the single breath test for carbon dioxide during anaesthesia and artificial ventilation. *Br J Anaesth* 1984;56:109–119.
53. Tulou PP, Walsh PW. Measurement of alveolar carbon dioxide tension at maximal expiration as an estimate of arterial carbon dioxide tension in patients with airway obstruction. *Am Rev Respir Dis* 1970;102:921–926.
54. Birmingham PK, Cheney FW, Ward RJ. Esophageal intubation: a review of detection of techniques. *Anesth Analg* 1986;65:886–891.
55. Guggenberger H, Lenz G, Federle R. Early detection of inadvertent oesophageal intubation: pulse oximetry vs. capnography. *Acta Anaesthesiol Scand* 1989;33:112–115.
56. Holland R, Webb RK, Runciman WB. The Australian Incident Monitoring Study. Oesophageal intubation: an analysis of 2000 incident reports. *Anaesth Intensive Care* 1993;21:608–610.
57. Linko K, Paloheimo M, Tammisto T. Capnography for detection of accidental oesophageal intubation. *Acta Anaesthesiol Scand* 1983;27:199–202.
58. Murray IP, Modell JH. Early detection of endotracheal tube accidents by monitoring carbon dioxide concentration in respiratory care. *Anesthesiology* 1983;59:344–346.
59. Szekely SM, Webb RK, Williamson JA, et al. Problems related to the endotracheal tube: an analysis of 2000 incident reports. *Anaesth Intens Care* 1993;21:611–616.
60. Vaghadia H, Jenkins LC, Ford RW. Comparison of end-tidal carbon dioxide, oxygen saturation and clinical signs for the detection of oesophageal intubation. *Can J Anaesth* 1989;36:560–564.
61. Burns SM, Carpenter R, Truweit JD. Report on the development of a procedure to prevent placement of feeding tubes into the lungs using end-tidal CO<sub>2</sub> measurements. *Crit Care Med* 2001;29:936–939.
62. Araujo-Preza CE, Melhado ME, Gutierrez FJ, et al. Use of capnometry to verify feeding tube placement. *Crit Care Med* 2002;30:2255–2259.
63. Garnett AR, Ornato JP, Gonzalez ER, et al. End-tidal carbon dioxide monitoring during cardiopulmonary resuscitation. *JAMA* 1987;257:512–515.
64. Falk JL, Rackow EC, Weil MH. End-tidal carbon dioxide concentration during cardiopulmonary resuscitation. *N Engl J Med* 1988;318:607–611.
65. Sanders AB, Kern KB, Otto CW, et al. End-tidal carbon dioxide monitoring during cardiopulmonary resuscitation. A prognostic indicator for survival. *JAMA* 1989;262:1347–1351.
66. Levine RL, Wayne MA, Miller CC. End-tidal carbon dioxide and outcome of out-of-hospital cardiac arrest. *N Engl J Med* 1997;337:301–306.
67. Hatle L, Rokeseth R. The arterial to end-expiratory carbon dioxide tension gradient in acute pulmonary embolism and other cardiopulmonary diseases. *Chest* 1974;66:352–357.
68. Nutter DO, Massumi RA. The arterial-alveolar carbon dioxide tension gradient in diagnosis of pulmonary embolus. *Dis Chest* 1966;50:380–387.
69. Chopin C, Fesard P, Mangalaboyi J, et al. Use of capnography in diagnosis of pulmonary embolism during acute respiratory failure of chronic obstructive pulmonary disease. *Crit Care Med* 1990;18:353–357.
70. Eriksson L, Wollmer P, Olsson C, et al. Diagnosis of pulmonary embolism based upon alveolar dead space analysis. *Chest* 1989;96:357–362.
71. Verschuren F, Liistro G, Coffeng R, et al. Volumetric capnography as a screening test for pulmonary embolism in the emergency department. *Chest* 2004;125:841–850.
72. Riou Y, Leclerc F, Neve V, et al. Reproducibility of the respiratory dead space measurements in mechanically ventilated children using the CO<sub>2</sub>SMO monitor. *Intensive Care Med* 2004;30:1461–1467.



73. Kallet RH, Daniel BM, Garcia O, et al. Accuracy of physiologic dead space measurements in patients with acute respiratory distress syndrome using volumetric capnography: comparison with the metabolic monitor method. *Respir Care* 2005;50:462-467.
74. Blanch L, Romero PV, Lucangelo U. Volumetric capnography in the mechanically ventilated patient. *Minerva Anestesiol* 2006;72:577-585.
75. Blanch L, Lucangelo U, Lopez-Aguilar J, et al. Volumetric capnography in patients with acute lung injury: effects of positive end-expiratory pressure. *Eur Respir J* 1999;13:1048-1054.
76. Tachibana K, Imanaka H, Takeuchi M, et al. Noninvasive cardiac output measurement using partial carbon dioxide rebreathing is less accurate at settings of reduced minute ventilation and when spontaneous breathing is present. *Anesthesiology* 2003;98:830-837.
77. Tachibana K, Imanaka H, Miyano H, et al. Effect of ventilatory settings on accuracy of cardiac output measurement using partial CO<sub>2</sub> rebreathing. *Anesthesiology* 2002;96:96-102.
78. Yem JS, Tang Y, Turner MJ, et al. Sources of error in noninvasive pulmonary blood flow measurements by partial rebreathing. A computer model study. *Anesthesiology* 2003;98:881-887.
79. de Abreu MG, Geiger S, Winkler T, et al. Evaluation of a new device for noninvasive measurement of nonshunted pulmonary capillary blood flow in patients with acute lung injury. *Intensive Care Med* 2002;28:318-323.
80. Odenstedt H, Stenqvist O, Lundin S. Clinical evaluation of a partial CO<sub>2</sub> rebreathing technique for cardiac output monitoring in critically ill patients. *Acta Anaesthesiol Scand* 2002;46:152-159.
81. Mielck F, Buhre W, Hanekop G, et al. Comparison of continuous cardiac output measurements in patients after cardiac surgery. *J Cardiothoracic Vasc Anesth* 2003;17:211-216.
82. Maxwell RA, Gibson JB, Slade JB, et al. Noninvasive cardiac output by partial CO<sub>2</sub> rebreathing after severe chest trauma. *J Trauma* 2001;51:849-853.
83. Brandi LS, Bertolini S, Pieri M, et al. Comparison between cardiac output measured by thermodilution technique and calculated by O<sub>2</sub> and modified CO<sub>2</sub> Fick methods using a new metabolic monitor. *Intensive Care Med* 1997;23:908-915.
84. Murias GE, Villagra A, Vatua S, et al. Evaluation of a noninvasive method for cardiac output measurement in critical care patients. *Intensive Care Med* 2002;28:1470-1474.
85. de Abreu MG, Winkler T, Pahlitzsch T, et al. Performance of the partial CO<sub>2</sub> rebreathing technique under different hemodynamic and ventilation/perfusion matching conditions. *Crit Care Med* 2003;31:543-551.
86. Bowe EA, Boysen PG, Broome JA, et al. Accurate determination of end-tidal carbon dioxide during administration of oxygen by nasal cannulae. *J Clin Monit* 1989;5:105-110.
87. McNulty SE, Roy J, Torjman M, et al. Relationship between arterial carbon dioxide and end-tidal carbon dioxide when a nasal sampling port is used. *J Clin Monit* 1990;6:93-98.
88. Roy J, McNulty SE, Torjman MC. An improved nasal prong apparatus for end-tidal carbon dioxide monitoring in awake, sedated patients. *J Clin Monit* 1991;7:249-252.
89. Bongard F, Wu Y, Lee TS, et al. Capnographic monitoring of extubated postoperative patients. *J Invest Surg* 1994;7:259-264.
90. Barton CW, Wang ES. Correlation of end-tidal CO<sub>2</sub> measurements to arterial PaCO<sub>2</sub> in nonintubated patients. *Ann Emerg Med* 1994;23:560-563.
91. Liu SY, Lee TS, Bongard F. Accuracy of capnography in nonintubated surgical patients. *Chest* 1992;102:1512-1515.
92. Bernet-Buettiker V, Ugarte MJ, Frey B, et al. Evaluation of a new combined transcutaneous measurement of PCO<sub>2</sub>/pulse oximetry oxygen saturation ear sensor in newborn patients. *Pediatrics* 2005;115:e64-e68.
93. Senn O, Clarenbach CF, Kaplan V, et al. Monitoring carbon dioxide tension and arterial oxygen saturation by a single earlobe sensor in patients with critical illness or sleep apnea. *Chest* 2005;128:1291-1296.
94. Rodriguez P, Lellouche F, Aboab J, et al. Transcutaneous arterial carbon dioxide pressure monitoring in critically ill adult patients. *Intensive Care Med* 2006;32:309-312.
95. Lagerkvist AL, Sten G, Redfors S, et al. Repeated blood gas monitoring in healthy children and adolescents by the transcutaneous route. *Pediatr Pulmonol* 2003;35:274-279.
96. Kocher S, Rohling R, Tschupp A. Performance of a digital PCO<sub>2</sub>/SpO<sub>2</sub> ear sensor. *J Clin Monit Comput* 2004;18:75-79.
97. Lucangelo U, Bernabe F, Blanch L. Respiratory mechanics derived from signals in the ventilator circuit. *Respir Care* 2005;50:55-65.
98. Fernandez-Perez ER, Hubmayr RD. Interpretation of airway pressure waveforms. *Intensive Care Med* 2006;32:658-659.
99. Hess DR. Monitoring during mechanical ventilation. In Mosenifar Z, Soo Hoo GW, eds. *Practical Pulmonary and Critical Care Medicine. Respiratory Failure. Lung Biology in Health and Disease, Volume 213.* Taylor & Francis, New York, 2006.
100. Nilsestuen JO, Hargett KD. Using ventilator graphics to identify patient-ventilator asynchrony. *Respir Care* 2005;50:202-234.
101. Georgopoulos D, Prinianakis G, Kondili E. Bedside waveforms interpretation as a tool to identify patient-ventilator asynchronies. *Intensive Care Med* 2006;32:34-47.
102. Anonymous. Ventilation with lower tidal volumes as compared with traditional tidal volumes for acute lung injury and the acute respiratory distress syndrome. *N Engl J Med* 2000;342:1301-1308.
103. Hager DN, Krishnan JA, Hayden DL, et al. Tidal volume reduction in patients with acute lung injury when plateau pressures are not high. *Am J Respir Crit Care Med* 2005;172:1241-1245.
104. Dhand R. Ventilator graphics and respiratory mechanics in the patient with obstructive lung disease. *Respir Care* 2005;50:246-261.
105. Ranieri VM, Grasso S, Fiore T, et al. Auto-positive end-expiratory pressure and dynamic hyperinflation. *Clin Chest Med* 1996;17:379-394.
106. Lessard MR, Lofaso F, Brochard L. Expiratory muscle activity increases intrinsic positive end-expiratory pressure independently of dynamic hyperinflation in mechanically ventilated patients. *Am J Respir Crit Care Med* 1995;15:562-569.
107. Ninane V, Yerault J, de Troyer A. Intrinsic PEEP in patients with chronic obstructive pulmonary disease. Role of expiratory muscles. *Am Rev Respir Dis* 1993;148:1037-1042.
108. Leatherman JW, Ravenscraft SA. Low measured auto-positive end-expiratory pressure during mechanical ventilation of patients with severe asthma: hidden auto-positive end-expiratory pressure. *Crit Care Med* 1996;24:541-546.
109. Benditt JO. Esophageal and gastric pressure measurements. *Respir Care* 2005;50:68-77.
110. Chieveley-Williams S, Dinner L, Puddicombe A, et al. Central venous and bladder pressure reflect transdiaphragmatic pressure during pressure support ventilation. *Chest* 2002;121:533-538.
111. Lecamwasam HS, Hess D, Brown R, et al. Diaphragmatic paralysis after endovascular stent grafting of a thoracoabdominal aortic aneurysm. *Anesthesiology* 2005;102:690-692.
112. Kress JP, O'Connor MF, Schmidt GA. Clinical examination reliably detects intrinsic positive end-expiratory pressure in critically ill, mechanically ventilated patients. *Am J Respir Crit Care Med* 1999;159:290-294.
113. Harris RS. Pressure-volume curves of the respiratory system. *Respir Care* 2005;50:78-99.
114. Harris RS, Hess DR, Venegas JG. An objective analysis of the pressure-volume curve in the acute respiratory distress syndrome. *Am J Respir Crit Care Med* 2000;161:432-439.

115. Ranieri VM, Brienza N, Santostasi S, et al. Impairments of lung and chest wall mechanics in patients with acute respiratory distress syndrome. *Am J Respir Crit Care Med* 1997;156:1082–1091.
116. Mergoni M, Martelli A, Volpi A, et al. Impact of positive end-expiratory pressure on chest wall and lung pressure-volume curve in acute respiratory failure. *Am J Respir Crit Care Med* 1997;156:846–854.
117. Hickling KG. The pressure-volume curve is greatly modified by recruitment. *Am J Respir Crit Care Med* 1998;158:194–202.
118. Hickling KG. Best compliance during a decremental, but not incremental, positive end-expiratory pressure trial is related to open-lung positive end-expiratory pressure: a mathematical model of acute respiratory distress syndrome lungs. *Am J Respir Crit Care Med* 2001;163:69–78.
119. Benti LR, Santora TA, Laverle BJ, et al. Accuracy and utility of pulse oximetry in the surgical intensive care unit. *Curr Surg* 1990;47:267–268.
120. Kestin IG, Miller BR, Lockhart CH. Auditory alarms during anesthesia monitoring. *Anesthesiology* 1988;69:106–109.
121. Kahn DM, Cook TE, Carlisle CC, et al. Identification and modification of environmental noise in an ICU setting. *Chest* 1998;114:535–540.

## CHAPTER 32

## Intraoperative Neurologic Monitoring

John C. Keifer, MD, and  
Cecil O. Borel, MD

Intraoperative neurologic monitoring is based on measuring changes in neurologic function that reflect injury to the nervous system. Neurologic function can be assessed intraoperatively either by repeated neurologic physical examinations or by inducing observable responses through electrical or magnetic stimulation of the nervous system. Because much of intraoperative neurophysiologic monitoring depends on some measurement of the electroencephalogram (EEG), this chapter starts with a brief overview of the cellular mechanisms responsible for the genesis of the EEG. Phenomena that modify electrical brain function and electrical activity are considered in order to appreciate the possibilities and limitations of electrical monitoring in guiding anesthesia administration and safeguarding the integrity of the nervous system. The use of anesthetic techniques that minimize interference with monitored neurophysiologic function are presented, as are techniques that allow for rapid emergence enabling intraoperative neurologic testing, immediate postoperative assessment, and continuous postoperative assessment in the ICU.

## ELECTRICAL METHODS

## EEG

The EEG was first measured in 1875 by Richard Caton, who noted the electrical oscillations on the exposed cortical surface of animals. The physiologic mechanisms and cortical morphology responsible for generating the EEG are presented by Martin,<sup>1</sup> and some essential features are summarized here.

**Neural Basis of the EEG****The EEG is Derived from Postsynaptic Potentials on Pyramidal Cells**

The two major classes of cortical neurons are pyramidal and nonpyramidal. Pyramidal cells derive their name from their distinctive shape and are notable as the only neurons that project axons out of the cerebral cortex and locally as well. Their apical dendritic spines are oriented perpendicular to the cortical surface and extend through the lamina of the cortex, enabling connection with all of the nonpyramidal cortical cells. Nonpyramidal cells modulate pyramidal cell output through stimulation (glutamate alteration of postsynaptic potential) or inhibition [ $\gamma$ -aminobutyric acid (GABA) alteration of postsynaptic potentials; Fig. 32-1 and Table 32-1].

**Collective Voltage of Cortical Neuron Ensembles are Measurable at the Scalp**

The parallel orientation of the pyramidal cells enables measurement of the constructive addition of polarity from each cell at the surface of the cerebral cortex (Fig. 32-2).

Because postsynaptic potentials last for a relatively long time and are geometrically aligned, it is possible for the potentials to summate to a sufficiently large magnitude that they can be measured by electrodes placed on the scalp. Action potentials, which are of a much

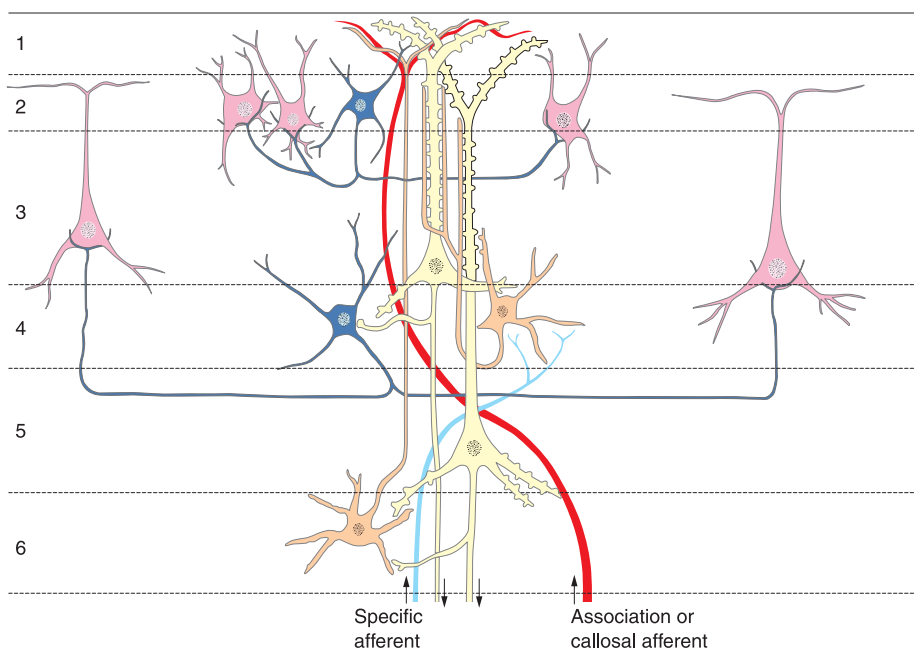
larger magnitude than are postsynaptic potentials, are too brief to enable summation and therefore do not contribute to the EEG. Similar mechanisms for generation of the EEG are presented by Rampil,<sup>2</sup> Lukatch and Greenwald,<sup>3</sup> and McPherson.<sup>4</sup> The EEG is an electrical potential versus time measurement that measures cortical voltages at the scalp resulting from the collective postsynaptic potentials of ensembles of cortical pyramidal cells.

**Synchronous versus Desynchronous EEG Patterns**

This cellular mechanism forms the conceptual basis of two basic patterns of EEG, synchronous and desynchronous EEG. A synchronous EEG is composed of large-amplitude peaks with slow-frequency oscillations. Referring to the basic mechanism presented previously, a synchronous EEG results when an ensemble of many cortical dendrites is polarized in synchrony. The voltage amplitude is large because the individual depolarizations are additive. The thalamus serves as the orchestrator of pyramidal cell depolarization during EEG synchrony, and the frequency of thalamic stimulation determines the slow rate of cortical polarization/depolarization.<sup>5</sup> A desynchronous EEG results when cortical dendrites are polarized by a less circumscribed group of afferent nerves. The consequence of

## KEY POINTS

1. Anesthetic strategies to enhance intraoperative monitoring of the nervous system include techniques that minimize interference with neurophysiologic modalities as well as techniques that preserve neurocognitive function during structure and function mapping in the awake patient.
2. The cellular basis of a normal electroencephalogram (EEG) reveals a variety of pathways that produce alterations of electrical and neurocognitive function.
3. Synchronous EEG is seen with sleep, sedation and anesthesia, and cerebral ischemia.
4. Processed EEG algorithms can aid with objective assessment of EEG changes. Given an understanding of the EEG features analyzed by these algorithms, pitfalls leading to inaccurate assessment can be avoided.
5. Achieving reliability with evoked potential monitoring depends on minimizing anesthetic effect, maintaining a constant anesthetic level, and assuring adequate nervous tissue perfusion.
6. Intraoperative wakefulness for cortical mapping has been achieved by a variety of techniques. For a procedure to be successful, any techniques used must address the maintenance of effective ventilation during craniotomy and a balance of clear sensorium and sufficient analgesia to enable effective patient participation during cortical mapping.
7. Subarachnoid block for placement of epidural stimulating electrodes allows for maintained patient perception of electrode stimulation while providing effective anesthesia for laminotomy.



**FIGURE 32-1.** Schematic of cortical pyramidal, basket, and interneurons. (Data from Martin JH. The collective electrical behavior of cortical neurons: The electroencephalogram and the mechanisms of epilepsy. In: Kandel ER, Schwartz JH, Jessel TM, eds. *Principles of Neural Science*. 3rd ed. Appleton & Lange, 1991:777–91.)

diverse sources of polarizations is a faster frequency of oscillation. The polarizations are not additive and therefore are of lower amplitude. Drawing from this conceptual framework, certain patterns are evident in the normal waking and sleeping EEG (Fig. 32-3). A normal EEG from an awake alert person is characterized by irregular EEG oscillations with a variable frequency >12 (cycles/sec) and relatively small amplitude. Low-amplitude, high-frequency EEG activity, the hallmark of desynchronous EEG, is the typical EEG pattern of the awake and dreaming brain (the consciously perceiving brain). Departures from normal waking consciousness during sleep are characterized by a slowing of the oscillation frequency and an increase in

amplitude of the voltage oscillation. Neuronal discharge is no longer subject to the ambient environmental stimulus–response characteristics of wakefulness. Orchestration of neuronal discharge now is directed by central pattern generators (presumably located in the thalamus).<sup>5</sup> The constructive interference of these waves is evidenced by large-amplitude, slow-frequency EEG traces, the hallmark of the synchronized EEG of the sleeping brain.

#### **Desynchronous EEG: Wakefulness and Rapid Eye Movement Sleep**

One of the early findings in sleep research was that the EEG reverted from a synchronous pattern (low frequency, large amplitude) to a

desynchronous pattern when a subject passed from non-rapid eye movement (non-REM) sleep to REM sleep. Because subjects were able to report dreams (cognitive activity) at the conclusion of these episodes and awake patients also demonstrated a desynchronous EEG, the notion developed that EEG desynchrony was the electrical correlate of a cognitively functioning brain. Conversely, EEG synchrony was the hallmark of the unconscious brain. The transition from desynchronous EEG to synchronous EEG during sleep onset is characterized by the gradual appearance of slow oscillations in the EEG. The tendency for an EEG to develop a synchronous pattern is also known as *slowing*.

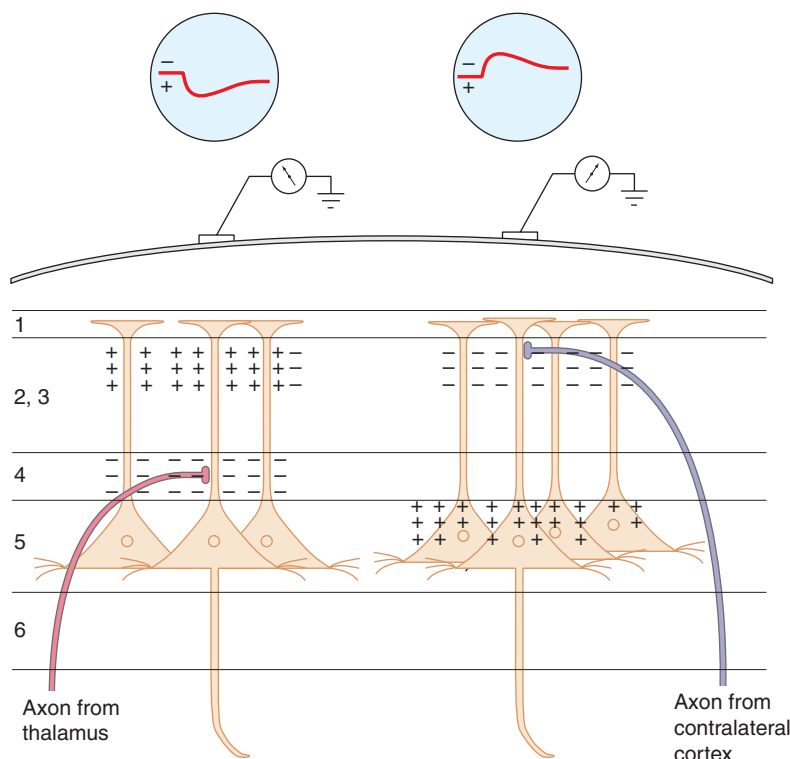
**TABLE 32-1.**

#### **Cortical Neurons Contributing to Generation of the Electroencephalogram**

Neuron	Cytologic Features	Synapses with	Neurotransmitter	Stimulates or Inhibits Target Neuron
Pyramidal cell	Spiny dendrites	Only output neurons of the cortex	Glutamate	Stimulates
Interneuron	Stellate shape, no dendritic spines	Pyramidal cell dendrites	Glutamate	Stimulate
Basket cell	Envelop the soma of postsynaptic cell bodies, hence the name basket	Pyramidal cell bodies, hence the name basket	$\gamma$ -Aminobutyric acid	Inhibits pericolumnar inhibition, enabling neurons in a given cortical column to function in relative isolation from neighboring columns

(Martin JH. The collective electrical behavior of cortical neurons: The electroencephalogram and the mechanisms of epilepsy. In: Kandel ER, Schwartz JH, Jessel TM, eds. *Principles of Neural Science*. 3rd ed. Appleton & Lange, 1991:777–91.)





**FIGURE 32–2.** Scalp voltage potential depend on perpendicular orientation of pyramidal cells and the polarity of the apical dendrites. (Martin JH. The collective electrical behavior of cortical neurons: The electroencephalogram and the mechanisms of epilepsy. In: Kandel ER, Schwartz JH, Jessel TM, eds. Principles of Neural Science. 3rd ed. Appleton & Lange, 1991:777–91.)

**Synchronous EEG: Natural Sleep, Drug-Induced Sedation, “Light” Anesthesia, and Cerebral Ischemia** All of these states usually are marked by an alteration of consciousness. But all of these states are not equivalent in terms of the degree of altered wakefulness, nor are they equivalent in terms of the likelihood of return to normal consciousness. However, for all of these states, a return to normal waking consciousness is associated with a return of a desynchronized EEG pattern. In summary, the synchronous EEG does not specifically identify the cause of EEG synchrony (and its associated alteration of consciousness). Therefore, synchronous EEG will be less than specific in predicting the consequences.<sup>6</sup>

“The following four points, while highly simplified, represent key concepts in EEG generation. (1) EEG signals recorded at the skull surface represent the summated post synaptic potential of hundreds of thousands to millions of pyramidal neurons. (2) While EEG rhythms recorded at the skull surface are generated by neocortical neurons, these rhythms may originate either in the neocortex itself, or they may be ‘imposed on’ the neocortex by subcorti-

cal structures which ‘pace’ the activity of neocortical neurons. (3) Multiple neurotransmitter systems can be involved in generating different types of EEG activity. (4) EEG activity within individual frequency bands (i.e., delta, theta, alpha, beta or gamma) likely represents more than one phenomenon.”<sup>3</sup>

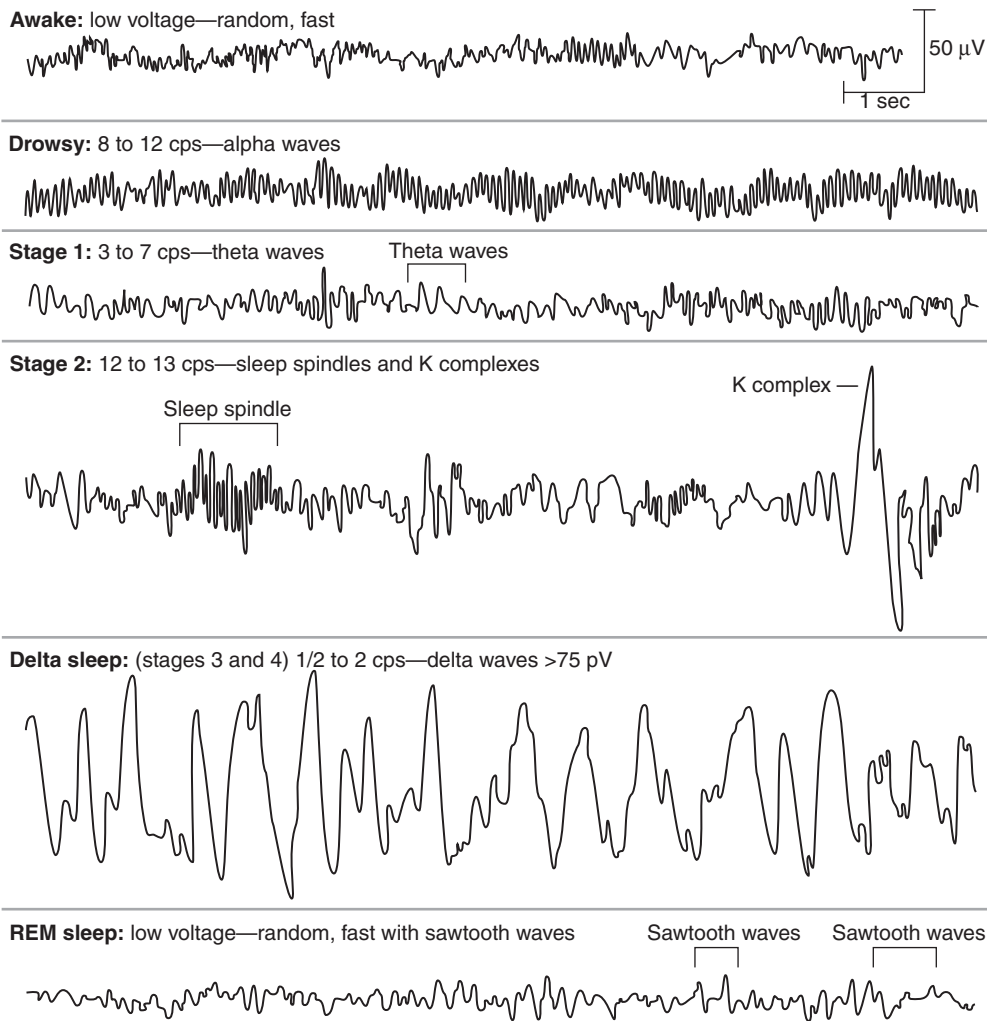
**Studies Suggesting the Cellular Mechanisms for EEG Synchrony: How Sleep, Anesthesia, and Cerebral Lesions Slow the EEG**

Amzica and Steriade<sup>5</sup> review the evidence for the cellular mechanisms of slow wave generation during natural sleep. Their summary describes three different oscillations that “coalesce into the polymorphic wave of slow wave EEG sleep” (Fig. 32–4). Salient points from their review include the following. (1) Cellular discharge data are obtained from cats anesthetized with ketamine and xylazine. Therefore, there is a leap of faith that the mechanism of slowing from sleep versus anesthesia is the same. (2) Human data during natural sleep are not obtained from single cells but from scalp EEG. Therefore, there is an assumption that cellular data from anesthetized cats can be extrapolated to unmeasured cellular phenomena of

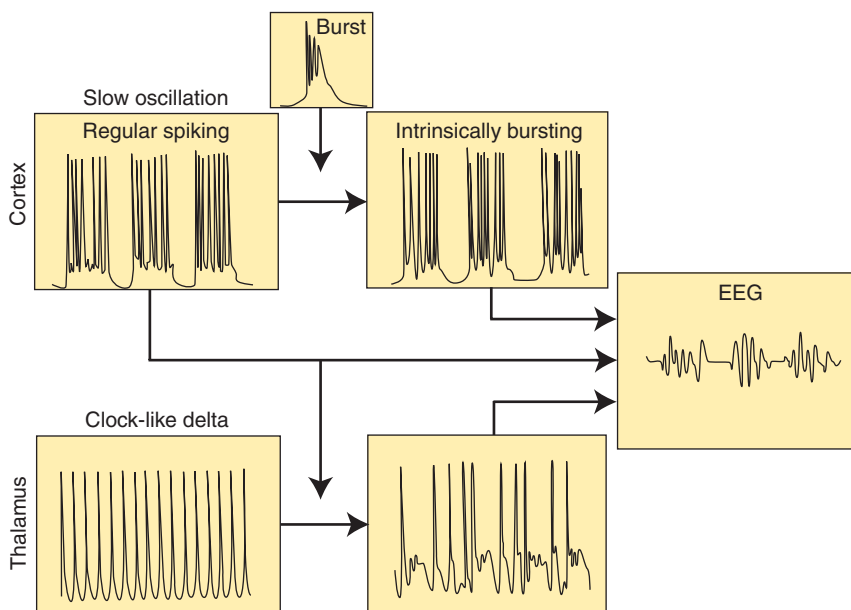
sleeping humans because of a similarity of the EEG from both groups. (3) Deafferented cortex (cortex disconnected from thalamic input by surgical prep or tumor) tends to reveal a slow wave pattern.

The *EPITIDE* (Enhanced Phasic Inhibition, Tonic Inhibition and Depressed Excitation) theory of anesthetic action on patterned brain activity proposes that anesthetic-induced prolongation of inhibitory currents may slow EEG activity by limiting neuronal discharge frequencies of EEG-generating neurons. Lukatch and Greenwald<sup>3</sup> propose that the EEG rhythms arise in neocortical neurons and may also be “imposed” on neocortical neurons by subcortical structures that “pace” the cortex. Multiple neurotransmitter systems are involved, and EEG activity within individual frequency bands likely represents more than one phenomenon. The anesthetic effect on EEG is not a simple transition from the desynchronized EEG to the synchronous EEG but involves an initial EEG activation at sub-anesthetic concentrations (perhaps an EEG correlate of the clinical excitement phase of subanesthetic levels during induction and emergence). At greater anesthetic exposure the EEG evolves into a synchronous pattern of slowing, followed at even greater exposure by isoelectric EEG with bursts of oscillation. It is hypothesized that at the network level, this cellular effect could produce a state in which low-frequency EEG oscillations (e.g.,  $\delta$  activity) are supported by the network, whereas higher-frequency oscillations are filtered out (much like the activity of a low-pass filter in an electronics circuit). Lukatch and Greenwald state that the theory relies on an anesthetic effect on the cortical networks to explain the EEG effect. The theory does not address the role of subcortical networks of cortical slowing proposed for the mechanism of natural sleep-related EEG slowing. Further observations are required for confirmation.

EEG changes induced by a variety of insults include EEG slowing, burst suppression, and isoelectric activity. Neuronal electrophysiologic changes responsible for these EEG changes were explored by Rabinovici et al.<sup>7</sup> This study used an in vitro rat brain slice model, which enabled the measurement of single-cell discharge and simultaneous cortical field potential (analogous to EEG) resulting from exposure to



**FIGURE 32-3.** Electroencephalographic patterns from wakefulness (desynchrony) to sleep (synchrony) to dreaming (desynchrony). (From Brown LW. Power Point presentation on Sleep and Epilepsy in Childhood. Used with permission of Lawrence W. Brown).



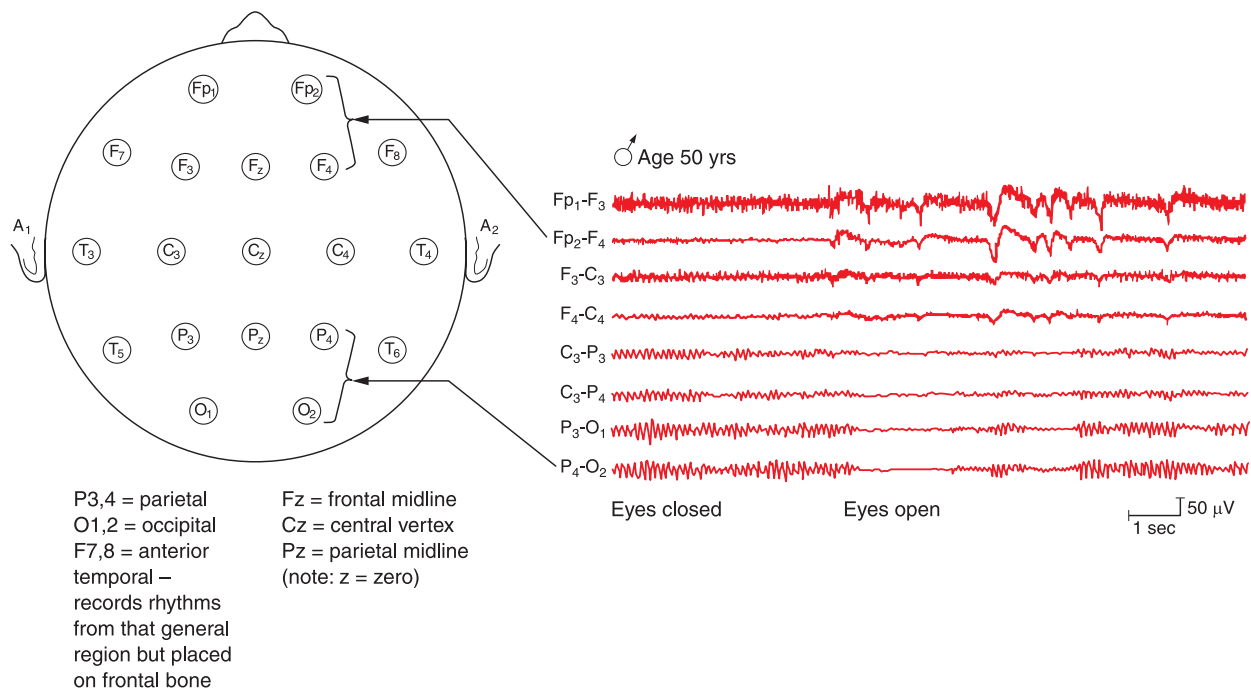
**FIGURE 32-4.** Cortical and thalamic depolarization leading to  $\delta$  slow waves. Reprinted from Amzica F, Steriade M. Electrophysiological correlates of sleep delta waves. *Electroencephalogr Clin Neurophysiol* 1998;107:69–83, with permission from the International Federation of Clinical Neurophysiology.

the brain slice to hypoxia, ischemia, and hypoglycemia. The findings show that EEG slowing, burst suppression, and isoelectric EEG occur with varying patterns depending on the lesion, and that some patterns of damage occur with recovery from the insult. This study did not specifically address the role of subcortical structures (i.e., thalamus) in the generation of slowed EEG, suggesting that thalamic mechanisms may not be necessary for the genesis of a slowed EEG in response to cerebral insult.

The work of Amzica and Steriade, Lukatch and Greenwald, and Rabinovici et al. illustrate that ischemia, hypoxia, hypoglycemia, and anesthesia produce cortical EEG slowing by a variety of cellular electrophysiologic mechanisms that may not be distinguishable from the macroscopic EEG.

### **Intraoperative EEG Uses**

The foregoing discussion indicates that a variety of “natural,” pharmaco-



**FIGURE 32–5.** Heterogeneous appearance of electroencephalogram recorded simultaneously from many sites on the scalp. Reprinted and modified from Mahla M, Black S, Cucchira R. Neurologic monitoring. In: Miller RD, ed. Miller's Anesthesia. 6th ed. Philadelphia: Churchill Livingstone, 2005: 1511–1550, with permission from Elsevier.

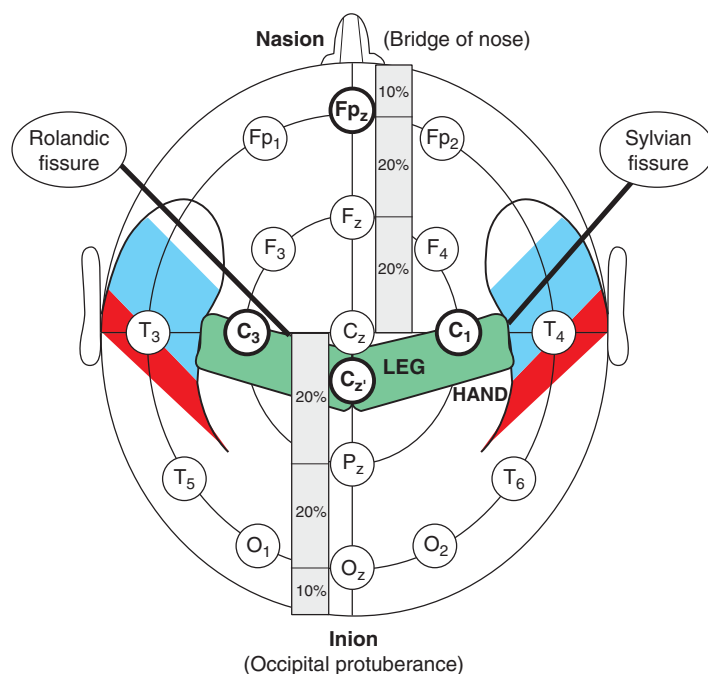
logic, and pathologic causes alter conscious brain function and the associated EEG. This overlap points to the necessity of obtaining confirmatory data to determine the cause and treatment of such EEG changes.

**Ischemia Monitor** The EEG is not homogeneous throughout the skull (Fig. 32–5). EEG activity varies considerably depending on the location of the electrode pair being monitored. Therefore, a standardized scheme of electrode application, the 10–20–20 system, has been developed to more reliably position EEG sensing electrodes using surface landmarks of the head for reference points. This reference system enables placement of electrodes at positions that are likely to detect EEG changes due to alteration of local perfusion or evoked EEG changes due to stimulation of a particular extremity (Fig. 32–6).

Doubt has been cast that the standard 10–20–20 system has sufficient spatial sensitivity to determine small areas of cerebral ischemia.<sup>8</sup> However, the EEG is symmetric about the midline, with EEG activity on one hemisphere generating a “mirror image” of the same area on the other side of the midline. This feature adds a benefit of internal control when assessing changes in an area of EEG activity. If the mirror image area of one hemisphere

does not mimic the change on the other side, then the change is focal and likely due to a change in the activity of the area under monitoring. Symmetric changes of activity in both hemispheres noted in EEG suggest a global source of altered neural activity

and therefore more likely due to global changes (i.e., blood pressure, oxygenation, anesthetic depth). The converse is also true. Focal changes in EEG activity over one portion of the brain may not be detected over another portion of the same brain. This fact



**FIGURE 32–6.** 10–20–20 system highlighting position of electrodes to underlying cortical anatomy. (Reprinted from Keifer JC. Somatosensory evoked potentials. In Russel GB, Rodichok LD, eds. Intraoperative Neurophysiologic Monitoring. Boston: Butterworth-Heinemann, 1995:125–133, with permission from Elsevier.)

TABLE 32-2.

## Summary of Electroencephalographic Changes in 36 of 367 (9.8%) Endarterectomy Patients

Group	Decreased Voltage	Decreased Frequency	Ipsilateral	Bilateral	Immediate	Delayed
I	X		X		X	
II	X			X	X	
III		X	X		X	
IV	X	X	X		X	
V	X	X		X	X	
VI						X

Data from Chiappa et al.<sup>9</sup>

has consequence when attempting to describe a global change in cerebral activity from one focal electrode pair.

The ischemic effect of carotid cross-clamping was reported by Chiappa et al.<sup>9</sup> in 1970 (Table 32-2). A variety of postclamping patterns were noted. The changes were not global but reflected local changes in activity, underscoring the importance of a symmetric array of electrodes in detecting changes over one hemisphere versus the other. EEG changes were sometimes observed over the cerebral hemisphere opposite to the clamped side, suggesting an interruption of collateral circulation.

A Cochrane meta-analysis reviewed two prospective randomized studies (composed of 590 patients) that compared routine selective shunting strategy versus no shunt strategy for carotid endarterectomy (CEA).<sup>10</sup> The analysis reviewed a third study that explored the potential benefit of intraoperative EEG monitoring for identifying CEA patients who would benefit from shunting. The authors concluded “There is still insufficient evidence from randomized controlled trials to support or refute the use of routine or selective shunting during carotid endarterectomy. Further, there is little evidence to support the use of one form of monitoring over another in selecting patients requiring a shunt.”

“As regards the method of monitoring in selective shunting, until the efficacy of shunting has been demonstrated, further trials of the method of monitoring are probably not merited.”<sup>10</sup> This Cochrane analysis does not address the use of other potential strategies for brain protection during endarterectomy, including hypothermia, burst suppression, induced hypertension, and techniques performed on an

awake patient (either endovascular carotid angioplasty or transcutaneous endarterectomy performed under local anesthesia).

Once the decision is made to monitor the EEG for cerebral ischemic changes during any surgery, then comes the problem of determining whether a change in EEG is due to focal hypoperfusion, generalized hypoperfusion (from low systemic blood pressure), or an anesthetic effect. These possibilities guide the anesthesiologist toward a strategy of anesthetic management during procedures that may result in ischemia:

1. Rely on anesthetic agents that have the least effect on EEG activity (short-acting narcotics, benzodiazepine; Table 32-3).
2. Maintain a constant anesthetic level throughout the procedure, especially during critical periods.
3. Be prepared to raise and lower blood pressure with nonanesthetic agents (inotropes, chronotropes, vasoactive drugs, and volume).
4. Be prepared to use alternate ischemia monitors [i.e., somatosensory evoked potential (SSEP) if burst suppression will be used for “cerebral protection”].
5. Perform the carotid surgery with the patient awake.

### USING EEG TO MONITOR BURST SUPPRESSION

The human data regarding burst suppression as a guide for administering anesthetics for cerebral protection is mixed. Patients in whom focal iatrogenic ischemia is induced during middle cerebral artery (MCA) aneurysm clip

ligation have a significant advantage compared with those receiving isoflurane when they are given pentobarbital as the primary neuroprotective agent or when they receive propofol or etomidate titrated to achieve EEG burst suppression.<sup>11</sup> Melgar et al.<sup>12</sup> propose the use of EEG to identify CEA patients who develop ischemic changes following carotid cross-clamp that are refractory to induced hypertension. To these patients, they administer etomidate to achieve burst suppression and proceed with endarterectomy without shunting. Bush et al.<sup>13</sup> conclude that “Percutaneous carotid stenting with neuroprotection provides comparable clinical success to CEA performed under local anesthetic.”

However, a multicenter study of the protective effects of propofol-induced burst suppression during cardiac valve replacement showed no effect.<sup>14</sup> Burst suppression achieved through various means (barbiturate or isoflurane) resulted in different effects on cerebral blood flow and calculated cerebral requirement for oxygen,<sup>15</sup> demonstrating that the balance of oxygen delivery to consumption is altered differently by these two agents at equivalent degrees of burst suppression. Therefore, the use of burst suppression as a guide to anesthetic administration during procedures that place the cortex at risk must take account of the anesthetic agent used for the burst suppression, the surgical procedure for which it is intended, as well as the other hemodynamic and ventilatory parameters effecting oxygen delivery to the cortex.

### STATE OF ANESTHESIA MONITOR

#### Why Process an EEG?

The characteristics of the EEG associated with consciousness and unconsciousness are EEG synchrony and desynchrony. Synchronous EEG is obtained in natural sleep, sedation, anesthesia, and cerebral ischemia. Desynchronous EEG is observed during wakefulness and REM sleep (associated with dreaming). The degree of synchrony and desynchrony of the EEG varies. It is difficult for the human observer to reliably measure this feature by inspecting the unprocessed EEG. Therefore, methods for objec-



TABLE 32-3.

## Intravenous and Inhalational Anesthetic Effect on Somatosensory Evoked Potential and Electroencephalogram

Drug/Dosage	Effect of Intravenous Anesthetics on Somatosensory Evoked Potentials		
	Latency	Amplitude	Subcortical Waveform
			Early Cortical Waveform <sup>d</sup>
Thiopental			
2.5–5.0 mg/kg	<10% ↑	5%–30% ↓	Negligible
75 mg/kg	15% ↑	60% ↓	Negligible
Pentobarbital			
Up to 20 mg/kg	≈10% ↑	45% ↓	None (latency), 20% ↓ in amplitude
Ketamine			
0.5 mg/kg	No effect	No effect	No effect
2–3 mg/kg + 2 mg × kg <sup>-1</sup> × h <sup>-1</sup>	No effect	0%–30% ↑	Negligible
Etomidate			
0.3–0.4 mg/kg + 2 mg × kg <sup>-1</sup> × h <sup>-1</sup>	<10% ↑	40%–180% ↑	None (latency), 50% ↓ in amplitude
1 mg/kg	10% ↑	150% ↑	Negligible
Propofol			
2.5 mg/kg	<10% ↑	No change	Negligible
Propofol			
2.5 mg/kg, then 10 mg × kg <sup>-1</sup> × h <sup>-1</sup>	10%–15% ↑	50%	NA
+			
Sufentanil			
0.5 μg/kg, then 0.25 μg × kg <sup>-1</sup> × h <sup>-1</sup>			
Midazolam			
0.1–0.3 mg/kg <sup>a</sup>	<5% ↑	25%–40% ↓	Negligible
Diazepam			
0.1–0.25 mg/kg	Minimal	↓	NA
Morphine			
0.25 mg/kg	<10% ↑	≈20% ↓	NA
Lidocaine			
1.5 mg/kg, then 3 mg × kg <sup>-1</sup> × h <sup>-1</sup>	5% ↑	25%–30% ↓ <sup>b</sup>	Negligible
Fentanyl			
2.5 μg/kg + N <sub>2</sub> O	5%–10% ↑	Variable <sup>c</sup>	No change
25–100 μg/kg	<10% ↑	10%–30% ↓	Negligible
Sufentanil			
Sufentanil + N <sub>2</sub> O + 0.5% isoflurane/1 μg/kg + infusion	5%–10% ↑	≈50% ↓	No change
5 μg/kg Sufentanil (alone)	≈5% ↑	≈40% ↓	No change (latency), 40% ↓ in amplitude
1 μg/kg + Sufentanil propofol	5%–10% ↑	No change	NA
Remifentanyl (with 0.4 MAC isoflurane)			
1 μg/kg + 0.2 μg × kg <sup>-1</sup> × min <sup>-1</sup>	NA	15%–30% ↓	NA
2.5 μg/kg + 0.5 μg × kg <sup>-1</sup> × min <sup>-1</sup>		30%–40% ↓	
5.0 μg/kg + 1.0 μg × kg <sup>-1</sup> × min <sup>-1</sup>		≈40% ↓	
Clonidine			
2–10 μg/kg	No effect	No effect	No effect (latency), 10% ↓ in amplitude
Alfentanil			
10 μg/kg alone	NA	50% ↓	NA
100 μg/kg + 2 with N <sub>2</sub> O	No effect	40% ↓	NA
Dexmedetomidine			
Low sedative dose	NA	≈10% ↓	≈20% ↓ in amplitude
High sedative doses	NA	≈30% ↓	≈10% ↓ in amplitude

(continued)

TABLE 32-3.

Intravenous and Inhalational Anesthetic Effect on Somatosensory Evoked Potential and Electroencephalogram (Continued)

Anesthetic Drug/Concentration	Effect of Inhaled Anesthetics on Somatosensory Evoked Potentials		
	Latency	Amplitude	Subcortical Waveform <sup>i</sup>
<b>Halothane</b>			
0.5 MAC + 60% N <sub>2</sub> O	<10% ↑	≈60% ↓	Negligible
1.0 MAC + 60% N <sub>2</sub> O	<10% ↑	≈70% ↓	Negligible
1.5 MAC + 60% N <sub>2</sub> O	10%–15% ↑	≈80% ↓	Negligible
1.5 MAC (alone)	10%–15% ↑	≈70% ↓	Negligible
<b>Isoflurane</b>			
0.5 MAC + 60% N <sub>2</sub> O	<10% ↑ <sup>g</sup>	50%–70% ↓	Negligible
0.5 MAC (alone)	<15% ↑	<30% ↑	Negligible
1.0 MAC + 60% N <sub>2</sub> O	10%–15% ↑	50%–75% ↓	Negligible
1.0 MAC (alone)	15% ↑	≈50% ↓	Negligible
1.5 MAC + 60% N <sub>2</sub> O <sup>e</sup>	>15% ↑	>75% ↓	5% ↑ in latency
1.6 MAC (alone) <sup>e</sup>	15%–20% ↑	60%–70% ↓	5% ↑ in latency 20% ↓ in amplitude
<b>Enflurane</b>			
0.5 MAC + 60% N <sub>2</sub> O	<10% ↑	≈50% ↓	Negligible
0.2–0.6 MAC (alone)	<10% ↑	<20% ↓	NA
1.0 MAC + 60% N <sub>2</sub> O <sup>e</sup>	20% ↑	≈85% ↓	Negligible
1.5 MAC + 60% N <sub>2</sub> O	Not recordable	Not recordable	Negligible
1.5 MAC (alone) <sup>e</sup>	>25% ↑	≈85% ↓	Negligible
<b>Sevoflurane</b>			
0.5 MAC + 66% N <sub>2</sub> O	<5% ↑	38% ↓	Negligible
1.0 MAC + 66% N <sub>2</sub> O	<10% ↑	≈45% ↓	Negligible
1.5 MAC + 66% N <sub>2</sub> O	<10% ↑	≈50% ↓	Negligible
1.7–2.5 MAC	10%–15% ↑	≈100% ↓ <sup>h</sup>	NA
<b>Desflurane</b>			
0.5 MAC	<5% ↑	<20% ↓	Negligible
1.0 MAC	3%–8% ↑	30%–40% ↓	Negligible
1.5 MAC	≤10% ↑	<50% ↓	Negligible
Any with 65% N <sub>2</sub> O <sup>f</sup>	≥15% ↑	>60% ↓	Negligible
<b>Nitrous oxide</b>			
60%–65%	No effect	50%–55% ↓	Negligible

MAC, minimum alveolar concentration; NA, data not available; negligible, <5% change in latency; N<sub>2</sub>O, nitrous oxide; ↑, increase; ↓, decrease. All data are from humans; percent changes are synthesized from multiple sources and based on reported changes in mean values.

<sup>a</sup>In several studies, <10 μg/kg fentanyl was added. <sup>b</sup>In isolated cases, bolus administration of 1–1.5 mg/kg resulted in loss of severe attenuation of the cortical somatosensory evoked potential (SSEP) with preservation of subcortical components. <sup>c</sup>At times, amplitude depression was severe. <sup>d</sup>For example, N-20 for median nerve SSEPs. <sup>e</sup>In a substantial fraction of patients, waveforms were not attainable at this concentration. <sup>f</sup>Complete loss of waveform observed only with 1.5 minimum alveolar concentration (MAC) desflurane plus 65% nitrous oxide (N<sub>2</sub>O). <sup>g</sup>Up to 15% in children. <sup>h</sup>Fusion to a single early cortical high-amplitude wave with abolition of all later wave components. Not proven reliable for intraoperative monitoring. <sup>i</sup>For example, N-20 for median nerve somatosensory evoked potentials (SSEPs) and P-40 for posterior tibial nerve SSEPs. From Banoub et al.<sup>26</sup> with permission.

tively quantifying the frequency and amplitude characteristics of the EEG have been developed.<sup>2,16</sup> Two methods currently in clinical use are the bispectral index (BIS) and entropy.<sup>17,18</sup>

### The Processed EEG

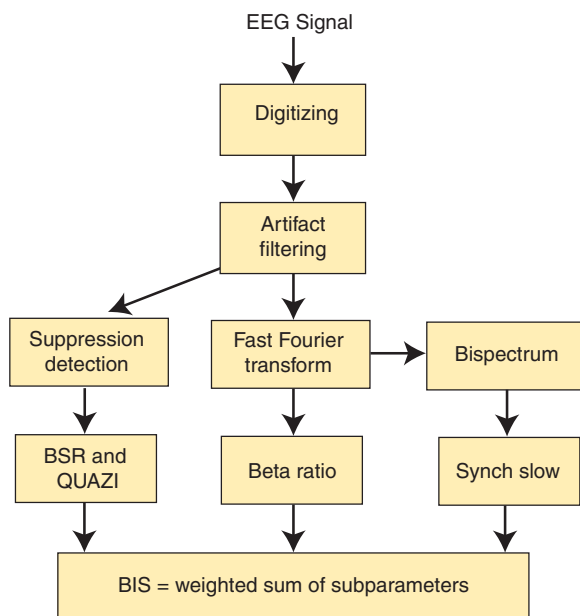
EEG voltage oscillation is sufficiently irregular so that the voltage measured at one instant does not enable an exact prediction of voltage for the next instant. However, EEG voltage oscillation

is not completely random. Knowing the voltage at a particular instant allows for prediction of the next voltage with some probability of certainty. The EEG signal is stochastic (from the Greek *stokhos*, meaning to aim), that is, it can be analyzed statistically but may not be predicted precisely. The stochastic nature of the EEG requires that the signal be described in terms of probability. The Fourier transformation of the EEG has been used to provide this summary

and is the initial step used in both the bispectral and the entropy methods of EEG signal processing.

### Bispectral Array

The three-pronged strategy underlying the analysis of “raw” EEG to derive the BIS is described by Sigl and Chamoun<sup>16</sup> and Rampil<sup>2</sup> (Fig. 32-7). This strategy includes the following: (1) determining the slow wave content of the signal (beta ratio); (2) determining the bico-

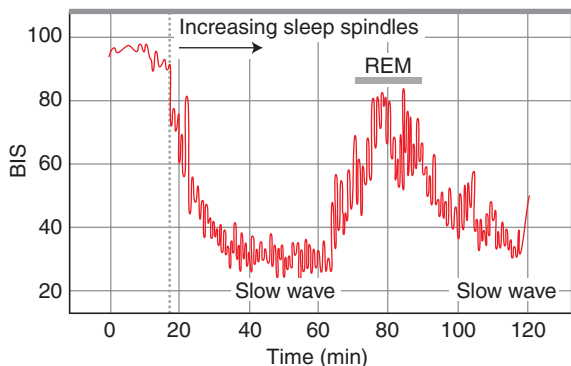


**FIGURE 32-7.** Three-pronged strategy for generating the bispectral index. (From Rampil<sup>2</sup> with permission.)

herence all frequency pairs derived from a Fourier transformation (synch slow); and (3) quantifying the amount of burst suppression present in the EEG (burst suppression ratio). These three features are combined in an unspecified, weighted fashion to derive the BIS.

Because the synchronous activity of EEG (slow frequency, large-amplitude

oscillations) occurs during progression from wakefulness to natural sleep, does the BIS identify this as well? Sleight answered this question in a study of human volunteers undergoing natural sleep. The results, summarized in the accompanying figure and table (Fig. 32-8), show that the BIS algorithm will assign low BIS numbers to



Values of EEG indices at the start of each sleep stage

	BIS	SEF*	EMG	Delta	Alpha
Awake	92 ± 3	21 ± 3	85 ± 12	50 ± 5	52 ± 8
Light sleep	81 ± 9	17 ± 2	88 ± 6	50 ± 5	49 ± 6
Slow wave sleep	59 ± 10	12 ± 2	94 ± 5	50 ± 4	46 ± 7
REM	83 ± 6	14 ± 4	66 ± 14	59 ± 4	44 ± 3

Values are mean + SD.

Data are from 28 sleep stage transitions in five subjects.

BIS = bispectral index, SEF = spectral edge frequency, EMG = power in the low EMG waveband (70–110 Hz), EEG = electroencephalogram.

\*The units of spectral power are decibels.

**FIGURE 32-8.** Bispectral index obtained from human volunteers during natural non-rapid eye movement and rapid eye movement sleep. (Modified from Sleight JW, Andrzejowski J, Steyn-Ross A, et al. The bispectral index: a measure of depth of sleep? *Anesth Analg* 1999;88:659–661, with permission.)

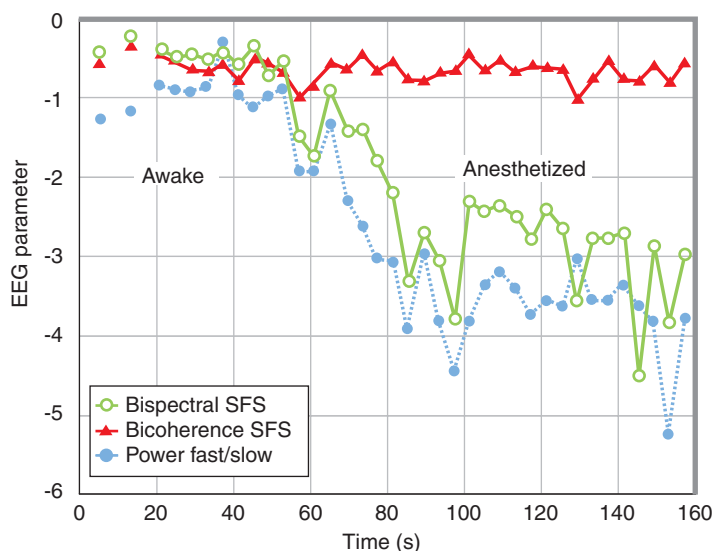
EEGs from naturally sleeping volunteers. A return of desynchronous EEG (i.e., dreaming) is also identified by an increase in BIS number. The BIS shows a low number during physiologic sleep based on the prevalence of slow EEG activity during that time. The BIS assumption is that this slow EEG activity also corresponds to a deep state of anesthesia. The BIS algorithm does not uniquely identify an anesthetized EEG.

Phase coupling, which is measured by the bicoherence portion of the algorithm, may be the least useful component of the algorithm.<sup>19</sup> In a study of processed EEG obtained from human subjects undergoing induction of anesthesia, Miller et al.<sup>19</sup> conclude that although the power content of a slow-frequency EEG increases as subjects progress from wakefulness to anesthesia, the degree of phase coupling remains unchanged (Fig. 32-9).

These results show that bispectral analysis did not provide any more information than power spectral-based analysis, and that most of the changes in bispectral values result from a decrease in the relative high-frequency content of the EEG caused by anesthesia.<sup>19</sup>

### Entropy Monitors

Entropy is a concept related to the amount of “disorder” within a system<sup>18</sup> and has been applied to thermodynamics and information theory by Shannon and Weaver and to power spectrums by Johnson and Shore in 1984. The entropy of a signal in the time domain or frequency domain can be computed in a variety of ways. The algorithm implemented by Datex-Ohmeda uses a combination of time and frequency domain approaches (Fig. 32-10). This approach allows for explicit separation of the contributions to entropy from any frequency. The computations are constructed such that the length of the time window for each individual frequency is individually chosen in order to optimize response times. To summarize the algorithm: the raw EEG (signal) is transformed to a power spectrum by fast Fourier transformation (Fig. 32-10, step 1). A Shannon function is performed on each integer frequency to determine the contribution of each frequency to the overall entropy (Fig. 32-10, step 2). The total amount of entropy is determined by summing all the entropy contributions from each integer frequency (Fig. 32-10, step 3). Entropy ranges from 0 (order) to 1 (complete randomness).



**FIGURE 32-9.** Wakefulness to anesthesia: comparative change in slow wave content and bicoherence of the electroencephalogram. Miller A, Sleigh JW, Barnard J, et al. Does bispectral analysis of the electroencephalogram add anything but complexity? *Br J Anaesth* 2004;92:8–13. © The Board of Management and Trustees of the British Journal of Anesthesia. Reproduced by permission of Oxford University Press/British Journal of Anesthesia.

### State Entropy and Response Entropy

State entropy (SE) is computed over the frequency range from 0.8–32 Hz. It includes the EEG-dominant part of the spectrum and therefore primarily reflects the cortical state of the patient. The time windows for SE are chosen optimally for each particular frequency component and range from 60–15 seconds. Response entropy (RE) is computed over a frequency range from 0.8–47 Hz. It includes both the EEG-dominant and electromyogram (EMG)-dominant parts of the spectrum. The time windows for RE are chosen optimally for each frequency.<sup>18</sup> A study by White et al.<sup>20</sup> comparing the entropy monitor and BIS of 30 laparoscopic patients showed that both the BIS and RE parameters increased after reversal of cisatracurium paralysis. However, the study was not designed to determine the ability of the RE monitor to function as an early predictor of emergence in a muscle-relaxed patient.

Wheeler et al.<sup>21</sup> studied RE in patients who were induced and paralyzed and found that RE increased in a portion of patients undergoing arterial catheter placement or head pin placement before recovery from paralysis. “We conclude that increased RE during painful stimulation was not dependent on recovery from paralysis but was seen more often in patients anesthetized with 0.8% compared with 1.4% isoflurane. This suggests that RE reflects frontal electromyography (FEMG) and may

be useful to identify inadequate anesthesia and patient arousal during painful stimuli.”

### Entropy: Clinical Studies Anesthesia versus Sedation

The study by White et al.<sup>20</sup> concluded that “the changes in SE and RE values followed a similar pattern to the BIS values during the perioperative period. Analogous to the BIS, the entropy indices display a high degree of sensitivity and specificity in assessing consciousness during the induction of and emergence from anesthesia and were able to detect changes associated with administration of IV (propofol) and volatile (desflurane) anesthetics during the maintenance period. Finally, the Entropy module experienced less interference with the displayed indices during use of the electrocautery unit than the BIS monitor.”

### How Does an Entropy Monitor Handle Burst Suppression?

Periods of zero EEG voltage have zero entropy because the EEG value is constant. Burst suppression patterns contain variable amounts of entropy because a variable amount of the signal is composed of bursts of oscillations. Therefore the entropy algorithm has been successful in identifying and quantifying the degree of burst suppression.

**Conclusion: Bispectral and Entropy Processing of the Raw EEG** Whatever method is used—bispectral analysis or entropy—the

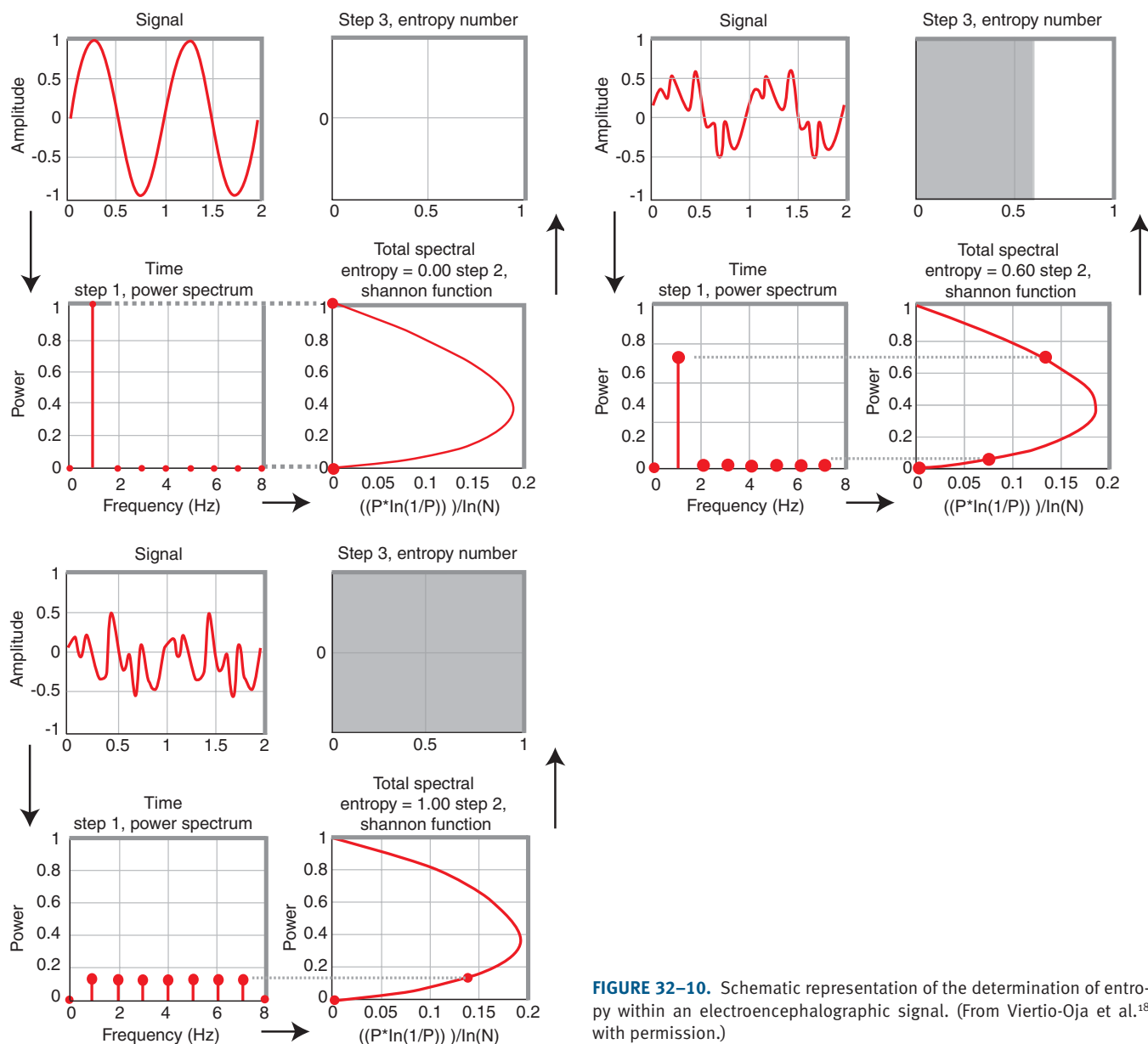
strategy still seems to address the issue of identifying a synchronous versus a desynchronous EEG. The entropy method uses electrical frequencies in the EMG range in an attempt to use muscle activity as a gauge to anesthetic depth. Those strategies are useful if a number of dictums are kept in mind:

1. There are multiple ways to generate a synchronous EEG including ischemia, natural sleep, and anesthetic. Therefore, a synchronous EEG may not be predictive of the patient's response to stimulation or the time for change from a synchronous to a desynchronous EEG.
2. Although a synchronous EEG may imply a nonperceiving brain, it does not guarantee that state. Nor does it define absolute cutoffs for achieving a nonperceiving state.
3. The use of synchrony/desynchrony evaluation of EEG is effectively done when one looks for a change in the EEG pattern in response to stimulus. An absence of change during noxious stimulation may add confidence that cerebral arousal did not occur (retrospective), but it does not add confidence that noxious-induced activation will not occur (prospective). However, if noxious event-related changes in synchrony to desynchrony do occur, the patient might be at risk for a more overt response to noxious stimulus (in the form of gross movement or recollection of the event).

### EVOKED EEG AND EVOKED MUSCLE RESPONSE

Intraoperative evoked potential monitors have received the greatest clinical usage in monitoring integrity of the spinal cord during surgery to correct spinal column deformities, to remove spinal cord tumors and vascular malformations, and to correct vascular lesions that jeopardize the spinal cord vascular supply. The decision to use monitoring is based on the risk and the magnitude of possible deficit versus the predictive value (positive and/or negative) of the monitor in a given operative setting. Except for a few exceptions (i.e., facial nerve monitoring during acoustic neuroma resection),<sup>22</sup> there are no mandatory uses of this monitoring even though a body of evidence supports its use in a variety of circumstances, including the follow-





**FIGURE 32-10.** Schematic representation of the determination of entropy within an electroencephalographic signal. (From Viertio-Oja et al.<sup>18</sup> with permission.)

ing: (1) peripheral nerve or plexus surgery; (2) spinal cord surgery (deformity correction, traumatic spinal fracture repair, tumor removal); (3) brain-stem surgery (posterior fossa tumor removal); (4) cerebrovascular surgery (CEA, aneurysm repair); or (5) identification of the sensory portion of the sensorimotor cortex (central sulcus identification or cortical mapping).<sup>23</sup>

## How to Evoke a Cortical Response: Anatomy

### Site of Stimulation

SSEPs are elicited by stimulation of a peripheral nerve at a distal site, typically the median or ulnar nerves at the wrist for acquiring SSEPs from the upper extremities and the posterior tibial nerves at the ankle or the peroneal nerves at

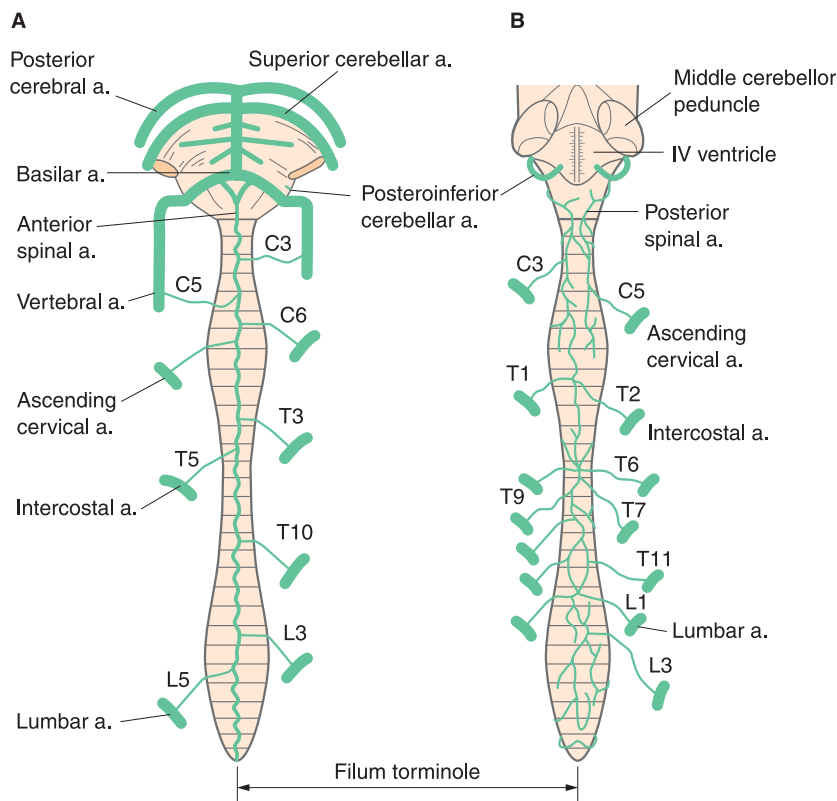
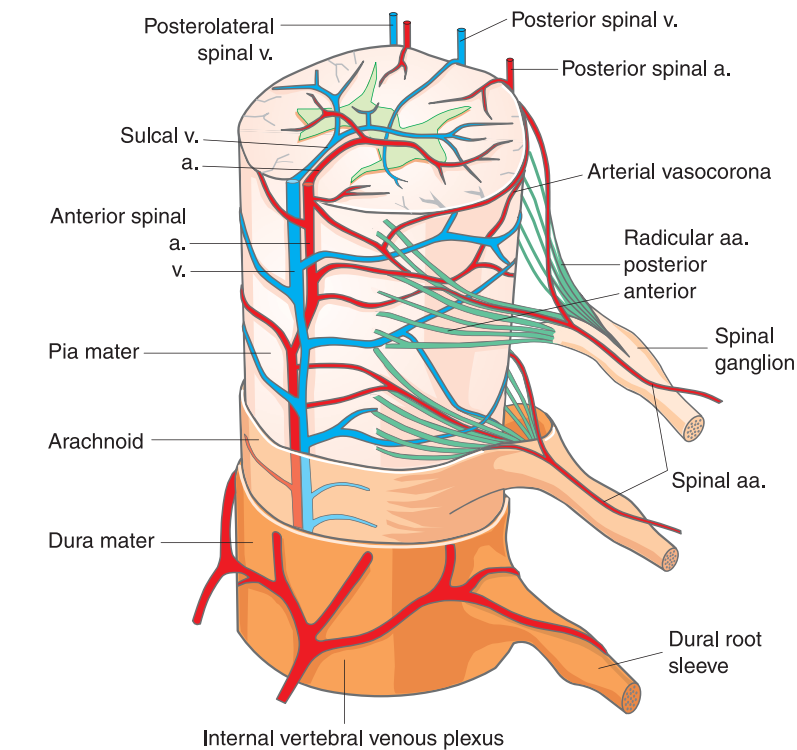
the fibular head for acquiring SSEPs from the lower extremities. Stimulation typically is delivered by adhesive electrodes or fine needle electrodes.

### Pathway of the Response Through the Spinal Cord

The SSEP signal enters the spinal cord through dorsal nerve roots and ascends the spinal cord via multiple pathways.<sup>24,25</sup> The posterior column spinal pathways, which decussate at the cervicomedullary junction, primarily mediate the SSEPs. Other pathways, such as the dorsal spinocerebellar tracts and the anterolateral columns, which decussate near the nerve root entry level, may contribute to the early SSEP responses that are used for monitoring purposes.<sup>23</sup>

### Implications of Vascular Supply to Cord

The blood supply for nourishing the posterior column pathways that mediate SSEPs is generally thought to be the posterior spinal arteries (Fig. 32-11). The anterior spinal artery is generally believed to provide the primary blood supply to the anterior and anterolateral portions of the spinal cord, which constitute the remaining two thirds of the spinal cord. Motor pathway function is mediated by spinal cord pathways that receive their blood supply from the anterior spinal artery. Therefore, loss of motor function as a result of compromise of the blood supply to the anterior spinal artery may be associated with little or no loss of the sensory function, which is mediated



**FIGURE 32-11.** Vascular supply of the spinal cord. (Reprinted from Marshal WK, Mostrom JL. Neurosurgical diseases of the spine and spinal cord: anesthetic considerations. In Cottrell JE, Smith DS, eds. *Anesthesia and Neurosurgery*. 3rd ed. St. Louis: Mosby, 1994:569–603, with permission from Elsevier.)

by the dorsal column pathways (anterior cord syndrome).

### Global Cerebral Blood Flow

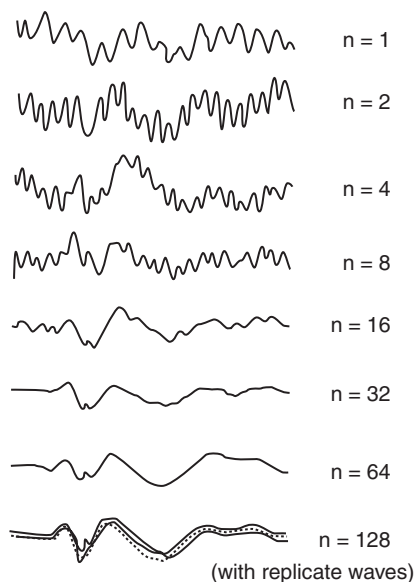
When cerebral perfusion drops to approximately 18 mL/min per 100 g of tissue, electrical activity of the brain decreases, and SSEPs begin to diminish in amplitude. When perfusion drops to 15 mL/min per 100 g of tissue, electrical activity of the brain drops still further, and SSEPs are generally not recordable. Further drops in blood flow to the brain, particularly if they are sustained, will result in cellular damage and irreversible changes in electrical activity.<sup>23</sup> These responses are dependent upon the blood supply to the brain and brainstem and the specific arterial branches that provide this supply. Perforating branches of the basilar artery and the vertebral artery supply the brainstem. The middle cerebral artery provides the blood supply to the area of the cortex, which mediates upper-extremity SSEPs, whereas the anterior cerebral artery provides the blood supply to the area of the brain that mediates lower-extremity SSEPs.

### What Is the Response and How Is It Quantitated?

According to Banoub et al., “The single cortical sensory evoked response has a low amplitude (1–2 microV) compared with the much larger electroencephalogram waves (50–100 microV). Therefore, the EP wave has to be extracted from concurrent spontaneous electroencephalogram activity by repetitive stimulation and computer-signal averaging techniques” (Fig. 32-12).<sup>26</sup> “The EP waveform consists of a series of peaks and valleys presented as a graph of voltage over time and described in terms of amplitude, latency, and morphology. Amplitude is commonly measured as the waves’ peak-to-peak voltage difference. Latency is the time from stimulus to the peak of the response. Interpeak latency is the interval between the peaks of interest” (Fig. 32-13).<sup>26</sup>

### Anesthetic Effect on SSEP: Implication of Synapses Among Peripheral Nerve Sites, Brainstem, and Cortex

General anesthetics do not affect ascending SSEP responses up to the level of the medullary nuclei (nucleus cuneatus and nucleus gracilis). These early subcortical responses are predominantly a reflection of the integrity of spinal cord white matter and provide little

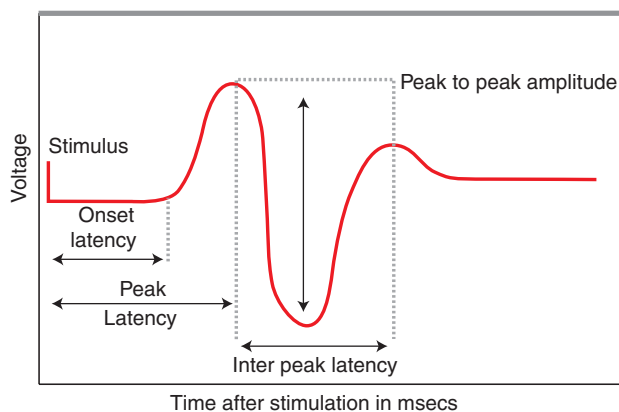


**FIGURE 32-12.** Evolution of somatosensory evoked potential from the electroencephalogram (EEG) following repetitive peripheral nerve stimulations and signal averaging of EEG epochs synchronized to each stimulus. This article was published in McPherson R. Intraoperative neurologic monitoring. In: Longnecker D, Tinker J, Morgan E, eds. *Principles and Practice of Anesthesiology*. St. Louis: Mosby, 1998: 883–906, with permission from Elsevier.

direct information about the condition of spinal cord gray matter. The short latency evoked responses from these “subcortical” structures are useful for determining the integrity of the monitoring system (i.e., is the stimulator working?, is electrode impedance sufficiently low to enable peripheral nerve stimulation?) and for distinguishing “real problems” in spinal cord integrity from “false positive problems” due to anesthetic-induced decrement of cortical SSEPs. Anesthetic effects on sensory responses are more pronounced in regions where synaptic transmission is prominent. Therefore, the effects are more pronounced in the EEG and cortically generated SSEP peaks. Responses of the brainstem, spinal cord, and peripheral nerve are markedly less affected because fewer synapses occur in these pathways. Anesthetic effects are clearly dose related. However, many agents have a disproportionate effect at low doses. Therefore, during periods of acute neural risk, a steady state of anesthesia is important.<sup>27</sup>

### Choosing an Anesthetic Plan for SSEP Monitoring<sup>26</sup>

1. Criteria for significant changes are difficult to establish and therefore are empiric. A significant change in



**FIGURE 32-13.** Amplitude and latency of somatosensory evoked potential. (From Banoub et al.<sup>26</sup> with permission.)

SSEP, reflecting loss of integrity of peripheral nerve or spinal cord, usually is taken as a 50% decrease in peak amplitude and a 10% increase in peak latency, provided these changes are not caused by anesthetic or temperature.

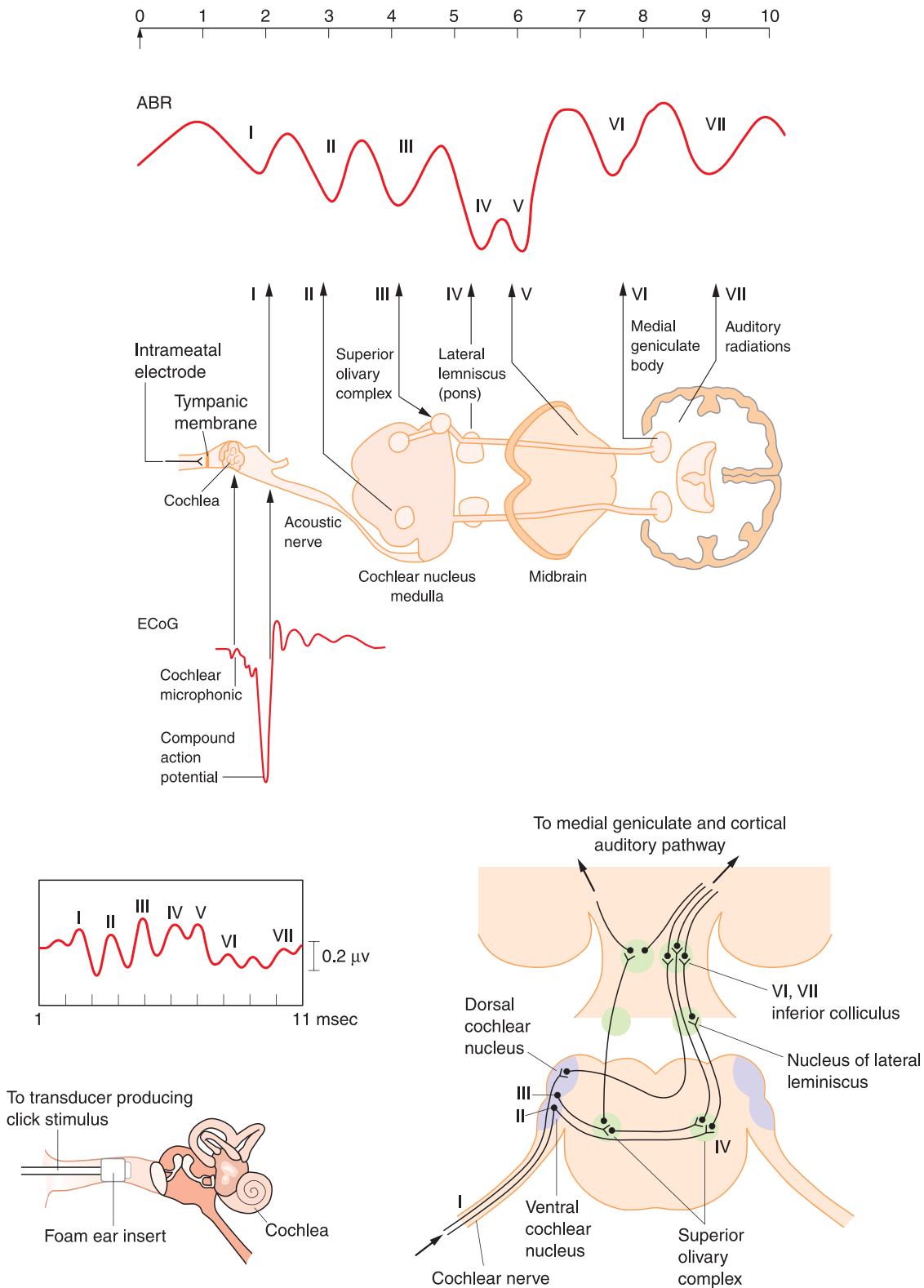
- “General anesthesia has an inhibitory effect on neurotransmission and, therefore, on the EP. The effect of anesthetics is greater on synaptic transmission than on axonal conduction. For this reason, responses recorded from polysynaptic pathways (e.g., cortical recordings) are affected by anesthesia to a much greater extent than those recorded from oligosynaptic pathways (e.g., spinal cord and subcortical recordings).”<sup>26</sup>
- “All volatile anesthetics produce a dose-dependent increase in SSEP latency and a decrease in amplitude. All volatile anesthetics, even at concentrations above 1.0 MAC, only minimally affect the sub-cortical waveform, resulting in high recordability and reliability.”<sup>26</sup>
- “The effect of volatile anesthetics on cortical SSEP amplitude is compounded by nitrous oxide.”<sup>26</sup>
- “Intravenous anesthetics generally affect SSEPs less than inhaled anesthetics do.”<sup>26</sup>
- Etomidate and ketamine increase SSEP amplitude.<sup>26</sup>
- Propofol, midazolam, and barbiturates have a moderate depressant effect on SSEP amplitude. In a normothermic individual, SSEP monitoring can detect cerebral ischemia during barbiturate anesthesia at doses that induce burst suppression.<sup>27–29</sup>
- “Most authors report minimal to no effect of opioids on SSEP amplitude.”<sup>26</sup>

- “Clonidine can be used as an anesthetic adjuvant without compromising SSEP monitoring. Dexmedetomidine affects SSEP amplitude minimally at sedative doses. During isoflurane anesthesia, dexmedetomidine blunts the effect of isoflurane on SSEP amplitude.”<sup>26</sup>

### Application of Evoked Potentials

SSEP monitoring is generally used to assess intraoperative spinal cord, brainstem, and regional cortical function. In the spinal cord, SSEP monitoring is used during spinal cord manipulation (e.g., spinal distraction and rod placement, intramedullary tumor and vascular malformation removal). In the brainstem, SSEPs are useful for monitoring lesions at the cervicomedullary junction, particularly below the entrance of the eighth cranial nerve to the brainstem, such as clivus chordoma resection. In the cortex, SSEPs are used for monitoring function in the anterior cerebral artery or middle cerebral artery distributions during procedures that place those areas at risk for ischemic damage (e.g., vascular surgery or tumor resection).

The brainstem auditory evoked response (BAER) is derived in similar fashion to the SSEP, but in this application the stimulus is an audible click delivered to the tympanic membrane through earphones. The evoked stimulus traverses the auditory nerve and brainstem tracts and arrives at the auditory cortex. The response of the EEG is summed in similar fashion to the SSEP, and a characteristic pattern of evoked peaks is generated (Fig. 32-14), corresponding to synapses that occur between the eighth nerve



**FIGURE 32-14.** Schematics of auditory neural pathways.( From Mullatti et al.<sup>39</sup> with permission.)

and the cortex. BAERs typically are used during operations involving the eighth nerve (especially removal of acoustic neuromas) or procedures involving the brainstem or posterior cranial fossa to ensure integrity of neural structures in this area.

The use of mechanically evoked motor potentials has taken various forms: (1) identifying muscles that may be rendered paralyzed during dissection of a tethered spinal cord or meningocele; (2) monitoring facial nerve function during head and

neck operations that place the facial nerve at risk; and (3) determining that the application of a pedicle screw has not come in close contact to the nerve root contained in a neural foramen. Motor evoked potentials (MEPs), stimulated over the motor cortex and mea-



TABLE 32–4.

## Specific Procedures for Evoked Potential Monitoring

Procedure	Monitoring	Comments	Reference
Spinal decompression	SSEP MEP or NMEP		64
Scoliosis surgery	EMG SSEP MEP or NMEP	EMG for transpedicular screw placement Patient prepared for intraoperative wake-up for motor testing	55, 56
Acoustic neuroma excision	BAER		22, 43, 66
Facial EMG	Facial EMG		
Facial nerve decompression for tic douloureux	Electrocochleogram BAER Facial nerve EMG Compound action potential of eighth nerve BAER 8th nerve decompression		67
Aortic cross-clamping, coarctation, aneurism	SSEP MEP		68–70
Spinal tumor excision	SSEP MEP Spinal cord mapping		71, 72
Brachial plexus exploration	EMG		44–46
Acetabular osteotomy	Continuous electromyographic monitoring		47
Pelvic fracture	SSEP MEP		73
Tethered cord	EMG		40
Intracranial aneurysm clipping	Raw EEG SSEP	EEG for ischemia monitoring and burst suppression SSEP for ischemia monitoring after burst suppression	42, 74, 75
Carotid endarterectomy	Raw EEG SSEP	EEG for ischemia monitoring and burst suppression SSEP for ischemia monitoring after burst suppression	13

BAER, brainstem auditory evoked potential; EMG, electromyogram; MEP, motor evoked potential; NMEP, nonmotor evoked potential; SSEP, somatosensory evoked potential.

sured at the peripheral muscle, enable monitoring of motor tract integrity and are thought to provide more comprehensive scrutiny of the spinal cord when combined with SSEP monitoring.

### Specific Cases and Use of Electrophysiologic Monitoring

A variety of surgical procedures and monitoring modalities that have been used productively is listed in Table 32–4.<sup>23</sup>

- Before starting the case, get on the same page with both the surgeon and the neurophysiologist. What is the procedure? What is the tissue at risk? How is it at risk (tissue perfusion mechanical injury, etc.)? When is it at risk—beginning, middle, end, postoperatively? What modality will be used to monitor tissue at risk? Are baseline measurements required preoperatively? Can the anesthetic plan be adjusted such that the predictive value of the monitor is enhanced? Usually this is achieved by limiting the use of potent agents and nitrous oxide, but above all by keeping exposure levels as constant as is possible. Is the monitoring enhanced through use of muscle relaxants, or does the use of relaxants impede detection of an evoked motor response? Do monitoring techniques that require an unparalyzed but immobile patient rely on rapidly reversible deep narcotics and/or neuroleptic adjuncts such as dexmedetomidine? Are there alternatives in case of monitor failure (i.e., intraoperative wake-up)?
- Constant communication among anesthesiologist, neurophysiologist, and surgeon regarding any significant changes in vital signs or administered anesthetic is essential. The neurophysiologist must relay assessment regarding the adequacy of monitoring and any change in monitoring parameters so that the cause and effect relationship can be identified.
- Tailor the anesthetic plan to maximize a reliably timed and clear wake-up to enable rapid postoperative as-

assessment of tissue at risk, which enables timely corrective action.

### **What Is the Effect of Anesthetic Agents on Spontaneous and Evoked EEG?**

Banoub et al.<sup>26</sup> present a succinct summary of anesthetic effect on SSEP.<sup>26</sup>

To summarize:

1. All potent inhaled agents prolong SSEP latency in a dose-dependent fashion.
2. All potent inhaled agents diminish SSEP amplitudes in a dose-dependent fashion.
3. Sole use of 60% nitrous oxide decreases SSEP amplitude but does not affect latency.
4. Additive use of nitrous oxide with a potent agent further decreases SSEP amplitude but does not increase latency more than that seen with the potent agent alone.

### **Troubleshooting a Change in SSEP**

Because evoked potential monitoring is highly sensitive and relatively less specific, a fair frequency of “false-positive” changes in the amplitude and/or latency of evoked responses during surgical procedures can be expected. All three participants in the monitoring process (neurophysiologist, surgeon, and anesthesiologist) should have a consistent strategy for dealing with these events in order to determine whether the SSEP is a “false positive” (i.e., SSEP changes caused by monitor artifact or anesthetic effect impeding the ability to monitor the nervous system). Some preliminary points to consider are the use of preprocedural monitoring in an already damaged nerve tract. If preanesthetic testing is abnormal, then the likelihood of improvement with anesthesia and surgery is low, and monitoring of that tract should not be attempted. The neurophysiologist will be adept at determining false-positive signs to faulty electrode application by performing impedance checks and determining if the elicited responses are altered in redundant locations along the peripheral nerve/spinal cord/brainstem/cortex circuit. Global changes in SSEP will be explored to determine whether there is a problem with generalized electrical interference from electrocautery or other electrical monitors. While these causes are being eliminated, the anesthesiologist can ensure that the two main features of anesthesia-controllable

effects—anesthetic depth and tissue perfusion—are optimal. If all these maneuvers do not improve the SSEP, then plan for rapid wake-up and testing. This part of the plan involves patient preparation for responding to commands to move appropriate extremities.<sup>23</sup>

### **Auditory Evoked Responses**

The genesis of auditory evoked responses (auditory evoked potentials [AEPs]) has similarities with SSEPs. They are electrical cortical potentials, evoked through repetitive stimulation of a peripheral nerve, and are identified and measured by summing numerous brief (milliseconds) stimulus synchronized EEG epochs recorded from electrodes placed on the vertex and ear lobe. Cranial nerve VIII is stimulated by presenting audible clicks to the cochlea by earphones placed within the auditory canal. AEPs are grouped based on their respective latencies. Brainstem auditory evoked potentials (BAEP), also called auditory brainstem responses (ABRs), are composed of short-latency waves (approximately 2–10 msec) and are numbered I through VII. The purported neural structures that serve as the substrate for these short-latency waves are displayed in (Figure 32-14).<sup>30</sup> Procedures that have been monitored effectively include resection of acoustic neuroma, decompression of facial nerve for hemifacial spasm (which carries a large risk of hearing loss), posterior fossa work where the brainstem is at risk, clipping of basilar artery aneurysms, and sectioning of cranial nerve VIII for intractable tinnitus.

Midlatency AEPs (MLAEPs) have a poststimulus latency on the order of 20–100 msec and are generated from the medial geniculate and primary auditory cortex.<sup>31</sup> Although their amplitude is correlated with increasing indicators of anesthetic depth, MLAEPs are not a perfect monitoring modality because of poor agreement among experts as to what determines a good peak necessary for analysis.<sup>32</sup> Also, by determining the prediction probability ( $P_K$ )<sup>33</sup> of the midlatency BAER, Alpiger et al.<sup>34</sup> showed that end-expiratory sevoflurane concentration was a better predictor and may prove to be more useful in the clinical setting. Long-latency AEPs (also called auditory late responses [ALRs]) have a latency of 50–250 msec<sup>35</sup> and are generated from the frontal cortex and association areas.<sup>31</sup>

The early-latency BAEPs appear to be an exquisitely sensitive monitor for

pathologic events during surgery. Because anesthetics and mild hypothermia have minimal effects, they are specific monitors as well. MLAEPs show promise as evoked responses for monitoring awareness and depth of anesthesia. When the concentration of anesthetics is increased, the amplitudes of MLAEP peaks are decreased and their latencies are elongated. Further testing will determine if these AEP-based monitors are superior to processed EEGs in detecting the transition from unconsciousness to consciousness.<sup>31</sup>

### **MEPs**

An MEP is an electrical potential evoked from a muscle (myogenic response) or from a motor nerve (neurogenic response) by stimulating the motor cortex, spinal cord, or peripheral nerve. The source of stimulation can be either electrical or magnetic. MEP monitoring is primarily used to ensure the integrity of the motor tracts of the spinal cord during spinal cord or spinal column surgery. MEPs also are used to determine the positioning of epidural motor strip electrodes for chronic pain treatment.<sup>36–39</sup>

### **Why Obtain an MEP?**

The review by Sala et al.<sup>40</sup> contains an extensive list of operations that can be monitored with MEPs:

1. Monitor anterior cord during spinal tumor removal, spinal vascular surgery (i.e., arterio-venous malformation [AVM], and spinal column distraction (scoliosis surgery)
2. Identify motor strip for analgesic electrode placement<sup>36–39,41</sup>
3. Monitor brainstem and thalamus for ischemia during basilar artery aneurysm surgery<sup>42</sup>
4. Facial nerve EMG during posterior fossa surgery<sup>22,43</sup>
5. Upper-arm EMG for surgery within the brachial plexus<sup>44–46</sup>
6. Lower-extremity EMG for myelomeningocele repair and release of tethered cord<sup>40</sup>
7. EMG during acetabular surgery in which epidural was used with passive EMG<sup>47</sup>

### **Why Spinal Cord Stimulation Differs from Transcranial Stimulation**

Rose<sup>48</sup> and Toleikis et al.<sup>49</sup> show that neurogenic monitoring following direct spinal cord stimulation may not

specifically evaluate anterior spinal cord function. Measured impulses over the peripheral motor nerve may be due to antidromic stimulation of  $\alpha_1$  spindle afferents, which stimulate motor neurons. They believe that similar “contamination” may occur with transcranial stimulation. They offer a “collision” method of stimulation to circumvent this problem.<sup>48,49</sup>

**MEP Monitoring during Anesthesia**

Anesthetics decrease transcranial MEPs in a dose-dependent fashion, likely due to inhibition of the motor neuron because motor potentials evoked from direct stimulation of the spinal cord are maintained even at 1.5 MAC concentrations.<sup>50,51</sup> Intraoperative transc-

ranial motor stimulation can be evoked through the use of total intravenous anesthesia (TIVA) with propofol and remifentanyl. Multiple stimulation techniques may improve the quality of weak responses.<sup>51-54</sup>

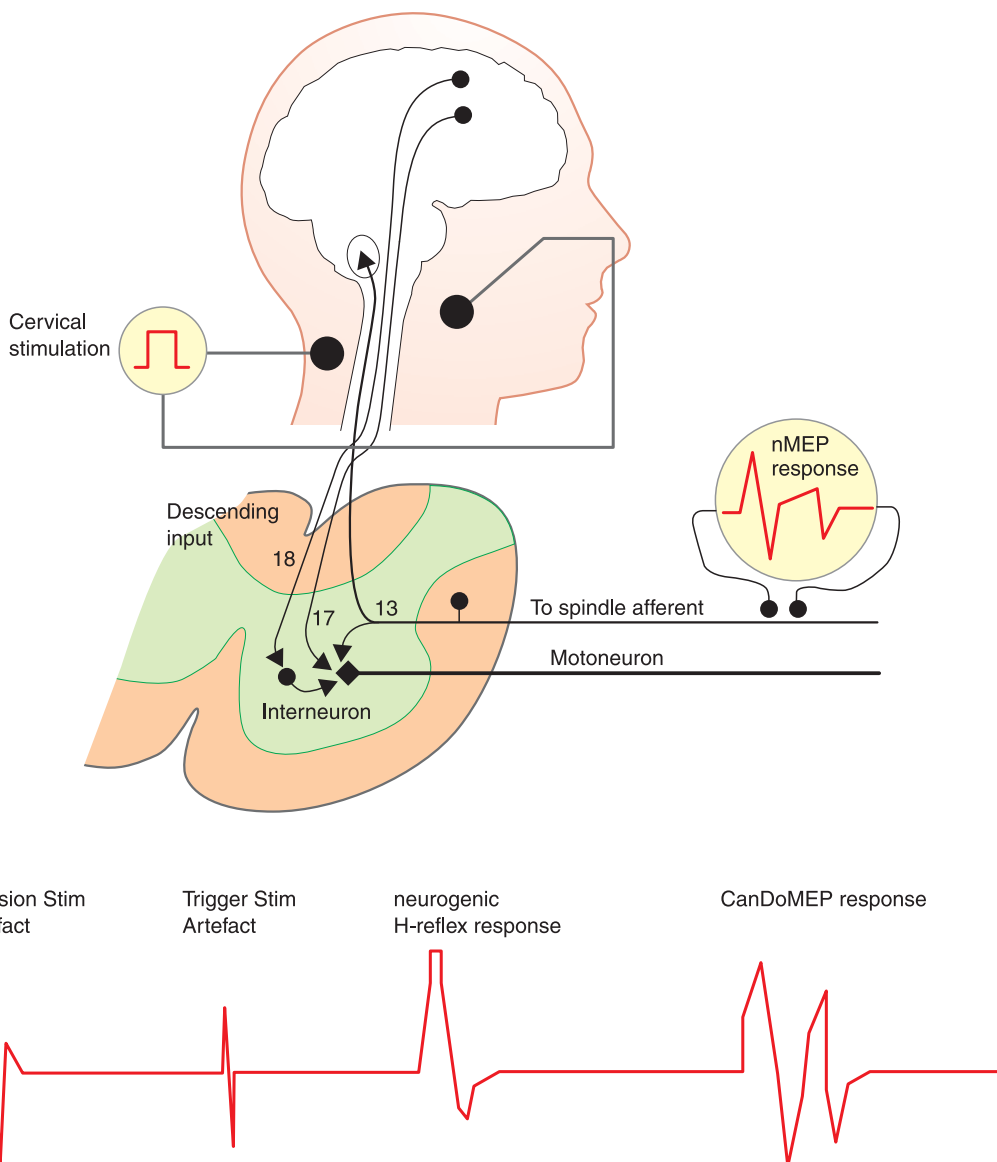
Direct comparison of administration of an inhaled anesthetic with desflurane and nitrous oxide to a TIVA technique showed successful motor evoked monitoring with both techniques.<sup>55</sup> Tanaka et al.<sup>56</sup> propose a method for compensation of transcranial MEP that easily and accurately removes the effects of muscle relaxants.

The advent of MEP monitoring is a landmark in progress. MEP monitoring is the most appropriate technique for assessing the functional integrity of descending motor pathways in the

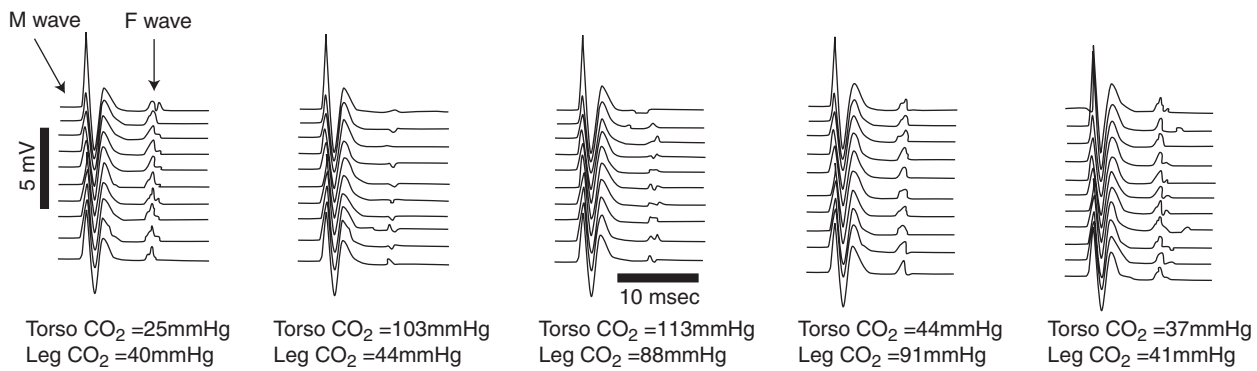
brainstem and, foremost, in the spinal cord. Mapping of the corticospinal tract at the level of the cerebral peduncle as well as mapping of the VII, IX-X, and XII cranial nerve motor nuclei on the floor of the fourth ventricle is valuable for identifying “safe entry zones” into the brainstem (Figures 32-15 to 32-17).<sup>57</sup>

**EMG**

Elicited responses to motor nerve stimulation are measured as compound muscle action potentials (CMAPs) from intramuscular needle electrodes or surface electrodes adhered over the muscle of interest. Stimulation of these responses can be either passive or active. Passive stimulation is used to alert surgeons that a dissection has



**FIGURE 32-15.** Schematic of neural circuit responsible for motor evoked potential waveform H reflex. Reprinted from Rose RD. Removing the antidromically driven sensory component from cervically evoked motor potentials. *Med Hypotheses* 1998;50:147-154. Copyright Elsevier 1998.



**FIGURE 32-16.** F wave and M wave. (From Dominguez C, Carstens E, Antognini JF. Carbon dioxide depresses the F wave by a central, not peripheral, mechanism during isoflurane anesthesia. *Anesth Analg* 2005;100:398–403.)

trespassed on a peripheral nerve by mechanically stimulating a motor fiber resulting in a muscle twitch. Active stimulation is used to electrically stimulate tissue of interest to determine which muscles are innervated by the nerve of interest. This strategy is used for brachial plexus exploration or for identifying nerve roots during meningomyelocele repair or release of tethered cord. The National Institutes of Health Consensus Conference on Acoustic Neuroma<sup>22</sup> recommended that facial nerve monitoring<sup>43</sup> be used in all patients undergoing surgical resection of an acoustic neuroma.

### Intraoperative Wake-Up Test

Historically, before the use of electrophysiologic spinal cord monitoring, the functional integrity of the complete motor system (upper and lower motor neurons and peripheral musculature) was confirmed after spinal distraction for treatment of scoliosis by means of intraoperative emergence from anesthesia and demonstration of voluntary leg movement. This technique, the

Stagnara wake-up test (named after one of its originators), was introduced in 1973 by Vazuelle et al.<sup>58</sup> and described by Owens.<sup>59</sup> Careful preoperative patient preparation is necessary to determine that the patient understands what is required and is able to comply. Muscle relaxation and anesthesia are reversed intraoperatively while the narcotic level is maintained. The patient emerges to a level of consciousness at which point the patient is asked to follow commands. The commands include hand grip and movement of feet. Use of the upper extremities assures that the patient is sufficiently awake to follow commands. If quadriplegia is a possibility, the patient can be asked to open the mouth or to grimace to determine that he or she is sufficiently awake.

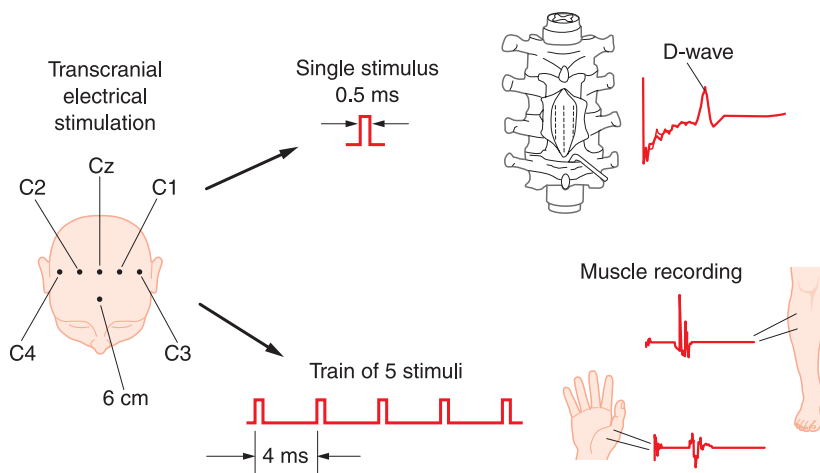
The Stagnara wake-up test has a number of limitations. It is a test of gross motor function and cannot precisely assess specific muscle group or nerve root function. It is not a test of sensory function; therefore, a patient could have a significant sensory deficit

in the presence of grossly normal motor tract function. The test is time consuming, requires reversal of anesthetic agents, and poses some risks to the patient, including aggressive patient movement resulting in trauma or extubation. Test administration can be difficult in patients with reduced capacities (e.g., mental retardation, deafness, inadequate language skills, insufficient emotional capacity). Repeated administration is difficult and not often undertaken. In most cases, the test is administered at the completion of all corrective maneuvers. This single administration can reduce its sensitivity to the onset of a neurologic injury and the subsequent efficacy of intervention. However, the wake-up test can be useful to further evaluate the veracity of a change in neurophysiologic monitoring parameters in a patient under general anesthesia.

## CONSCIOUS INTRAOPERATIVE NEUROLOGIC TESTING

### Awake Craniotomy

The “silent cortex” is so named because lesions of these cortical regions are not evident by simple neurologic testing. In distinction, lesions in the “eloquent cortex” are identified by alterations in normal neurologic function, including speech and motor and sensory function. Intraoperative monitoring of eloquent cortical function can be effectively performed through use of cortical mapping. Mapping is performed intraoperatively by transiently inducing functional ablation of small portions of the cortex with stimulating electrodes. Correlation of structure and function requires an awake patient who is capable of performing the neurologic function under surveillance



**FIGURE 32-17.** Obtaining a D wave. (From Sala et al.<sup>40</sup> with permission.)



(i.e., speech or directed movement) so that a cortical stimulation of a particular portion of cortex can be linked with interruption of that function (i.e., aphasia or uncontrolled contraction of a muscle group). Anesthetic techniques that enable this testing vary. “Awake craniotomy” relies on local anesthetic blocks of scalp, periosteum, and dura supplemented by a “neurolept anesthetic.”<sup>60</sup> More recently, general anesthetic for craniotomy followed by intraoperative emergence for cortical testing followed by reinduction of general anesthesia (the so called asleep-awake-asleep technique) have gained wide acceptance. Challenges of any method include issues of airway control (assuring sufficient airway patency and ventilatory drive to maintain acceptable oxygenation and carbon dioxide level) and minimizing coughing and Valsalva in a patient with an open cranium. These challenges are met through use of various airway adjuncts, including nasal trumpets and laryngeal mask airways. Significant reflux risk can be addressed by endotracheal intubation followed by extubation at the time of emergence for intraoperative testing. Another challenge is maintaining sufficient balanced analgesia and anxiolysis during the awake portion of the case in order to enable patient participation. A variety of intravenous anesthetic techniques have been used and tend to rely on quickly titratable and reversible narcotic (i.e., remifentanyl) and anesthesia provided by infusion of propofol or infusion of dexmedetomidine.<sup>61</sup> A drawback to propofol is the respiratory depression associated with concomitant narcotic use. A relatively brief exposure to propofol infusion is associated with a brief predictable emergence time. However, because of context sensitivity, a more prolonged exposure is associated with a longer, less predictable emergence. Dexmedetomidine infusion in conjunction with a narcotic infusion provides dose-related deep sedation as well as maintenance of ventilatory drive during craniotomy. However, airway patency is not assured at higher doses, and emergence times are not as brisk. However, a low dose of  $\alpha_2$ -agonist may be beneficial as a “rescue” medication for patients who, after emergence, demonstrate significant anxiety and hypertension that may preclude cortical testing.

## Spinal Anesthesia for Epidural Placement of Spinal Cord Stimulating Electrodes

Accurate placement of spinal cord stimulating electrodes for treatment of chronic pain requires patient responsiveness in order to determine that the patient perceives the stimulating current in the same region as the perceived pain. Because electrodes placement may also require a laminotomy in order to introduce the electrode into the epidural space, the anesthetic challenge is to provide sufficient anesthesia for laminotomy and electrode placement while the patient is in a lateral or prone position. A combination of local anesthetic and conscious sedation is feasible. However, this technique runs the risk of airway loss. Additionally, prolonged deep sedation can impair patient response, which may hinder optimal electrode placement. A technique that involves the use of subarachnoid bupivacaine has been described. Spinal block is performed with the patient in the prone position, and hypobaric bupivacaine is introduced. Complete dermatomal anesthesia through blockade of the spinal nerve roots enables performance of a painless laminotomy. However, because spinal anesthetic does not completely block sensory tracts within the spinal cord, patient perception of stimulation from the epidural electrodes is maintained.<sup>62</sup>

## SUMMARY

Surgery on and around the nervous system is safer when the functional integrity of the nervous system can be assured. Anesthetic agents, by definition and design, decrease neurologic function. Therefore, monitoring nervous system function during anesthesia can be challenging. The techniques discussed in this chapter offer a standardized approach to assessing intraoperative neurologic function. Much work is needed to improve the impact of anesthetics on intraoperative neurologic monitoring and surely will evolve.

## KEY REFERENCES

1. Data from Martin JH. The collective electrical behavior of cortical neurons: the electroencephalogram

and the mechanisms of epilepsy. In Kandel ER, Schwartz JH, Jessel TM, eds. *Principles of Neural Science*. 3rd ed. New York: Elsevier, 1991: 777–791.

2. Rampil IJ. A primer for EEG signal processing in anesthesia. *Anesthesiology* 1998;89:980–1002.

3. Toleikis JR. Intraoperative monitoring using somatosensory evoked potentials. A position statement by the American Society of Neurophysiological Monitoring. *J Clin Monit Comput* 2005;19:241–58.

4. Sala F, Krzan MJ, Deletis V. Intraoperative neurophysiological monitoring in pediatric neurosurgery: why, when, how? *Childs Nerv Syst* 2002;18:264–87.

5. Owen JH. The application of intraoperative monitoring during surgery for spinal deformity. *Spine* 1999;24:2649–62.

6. Lind G, Meyerson BA, Winter J, et al. Implantation of laminotomy electrodes for spinal cord stimulation in spinal anesthesia with intraoperative dorsal column activation. *Neurosurgery* 2003;53:1150–1153; discussion 1153–1154.

## REFERENCES

1. Data from Martin JH. The collective electrical behavior of cortical neurons: the electroencephalogram and the mechanisms of epilepsy. In Kandel ER, Schwartz JH, Jessel TM, eds. *Principles of Neural Science*. 3rd ed. New York: Elsevier, 1991:777–791.
2. Rampil IJ. A primer for EEG signal processing in anesthesia. *Anesthesiology* 1998;89:980–1002.
3. Lukatch H, Greenwald S. Cerebral cortex-anesthetic action on the electroencephalogram. In Antognini J, Carstens E, Raines D, eds. *Neural Mechanisms of Anesthesia*. Totowa, NJ: Humana Prss, 2003:93–112.
4. McPherson R. Intraoperative neurologic monitoring. In Longnecker D, Tinker J, Morgan E, eds. *Principles and Practice of Anesthesiology*. St. Louis: Mosby, 1998:883–906.
5. Amzica F, Steriade M. Electrophysiological correlates of sleep delta waves. *Electroencephalogr Clin Neurophysiol* 1998;107: 69–83.
6. Sebel PS, Lang E, Rampil IJ, et al. A multicenter study of bispectral electroencephalogram analysis for monitoring anesthetic effect. *Anesth Analg* 1997;84:891–899.
7. Rabinovici GD, Lukatch HS, MacIver MB. Hypoglycemic and hypoxic modulation of

- cortical micro-EEG activity in rat brain slices. *Clin Neurophysiol* 2000;111:112–121.
8. Luu P, Tucker DM, Englander R, et al. Localizing acute stroke-related EEG changes: assessing the effects of spatial undersampling. *J Clin Neurophysiol* 2001;18:302–317.
  9. Chiappa KH, Burke SR, Young RR. Results of electroencephalographic monitoring during 367 carotid endarterectomies. Use of a dedicated minicomputer. *Stroke* 1979;10:381–388.
  10. Bond R, Rerkasem K, Rothwell PM. Routine or selective carotid artery shunting for carotid endarterectomy (and different methods of monitoring in selective shunting). *Stroke* 2003;34:824–825.
  11. Lavine SD, Masri LS, Levy ML, et al. Temporary occlusion of the middle cerebral artery in intracranial aneurysm surgery: time limitation and advantage of brain protection. *J Neurosurg* 1997;87:817–824.
  12. Melgar MA, Mariwalla N, Madhusudan H, et al. Carotid endarterectomy without shunt: the role of cerebral metabolic protection. *Neurol Res* 2005;27:850–856.
  13. Bush RL, Kougiass P, Guerrero MA, et al. A comparison of carotid artery stenting with neuroprotection versus carotid endarterectomy under local anesthesia. *Am J Surg* 2005;190:696–700.
  14. Roach GW, Newman MF, Murkin JM, et al. Ineffectiveness of burst suppression therapy in mitigating perioperative cerebrovascular dysfunction. Multicenter Study of Perioperative Ischemia (McSPI) Research Group. *Anesthesiology* 1999;90:1255–1264.
  15. Newman MF, Croughwell ND, White WD, et al. Pharmacologic electroencephalographic suppression during cardiopulmonary bypass: a comparison of thiopental and isoflurane. *Anesth Analg* 1998;86:246–251.
  16. Sigl JC, Chamoun NG. An introduction to bispectral analysis for the electroencephalogram. *J Clin Monit* 1994;10:392–404.
  17. Vanluchene AL, Vereecke H, Thas O, et al. Spectral entropy as an electroencephalographic measure of anesthetic drug effect: a comparison with bispectral index and processed midlatency auditory evoked response. *Anesthesiology* 2004;101:34–42.
  18. Viertio-Oja H, Maja V, Sarkela M, et al. Description of the Entropy algorithm as applied in the Datex-Ohmeda S/5 Entropy Module. *Acta Anaesthesiol Scand* 2004;48:154–161.
  19. Miller A, Sleight JW, Barnard J, et al. Does bispectral analysis of the electroencephalogram add anything but complexity? *Br J Anaesth* 2004;92:8–13.
  20. White PF, Tang J, Romero GF, et al. A comparison of state and response entropy versus bispectral index values during the perioperative period. *Anesth Analg* 2006;102:160–167.
  21. Wheeler P, Hoffman WE, Baughman VL, et al. Response entropy increases during painful stimulation. *J Neurosurg Anesthesiol* 2005;17:86–90.
  22. Anonymous. National Institutes of Health Consensus Development Conference Statement on Acoustic Neuroma, December 11–13, 1991. The Consensus Development Panel. *Arch Neurol* 1994;51:201–207.
  23. Toleikis JR. Intraoperative monitoring using somatosensory evoked potentials. A position statement by the American Society of Neurophysiological Monitoring. *J Clin Monit Comput* 2005;19:241–258.
  24. York DH. Somatosensory evoked potentials in man: differentiation of spinal pathways responsible for conduction from the forelimb vs hindlimb. *Prog Neurobiol* 1985;25:1–25.
  25. Powers SK, Bolger CA, Edwards MS. Spinal cord pathways mediating somatosensory evoked potentials. *J Neurosurg* 1982;57:472–482.
  26. Banoub M, Tetzlaff JE, Schubert A. Pharmacologic and physiologic influences affecting sensory evoked potentials: implications for perioperative monitoring. *Anesthesiology* 2003;99:716–737.
  27. Sloan TB. Anesthetic effects on electrophysiologic recordings. *J Clin Neurophysiol* 1998;15:217–226.
  28. Huotari AM, Koskinen M, Suominen K, et al. Evoked EEG patterns during burst suppression with propofol. *Br J Anaesth* 2004;92:18–24.
  29. Drummond JC, Todd MM, Schubert A, et al. Effect of the acute administration of high dose pentobarbital on human brain stem auditory and median nerve somatosensory evoked responses. *Neurosurgery* 1987;20:830–835.
  30. Mullatti N, Coakham HB, Maw AR, et al. Intraoperative monitoring during surgery for acoustic neuroma: benefits of an extratympanic intrameatal electrode. *J Neurol Neurosurg Psychiatry* 1999;66:591–599.
  31. Morimoto Y, Sakabe T. [Auditory evoked potentials]. *Masui* 2006;55:314–321.
  32. Schneider G, Nahm W, Kochs EF, et al. Quality of perioperative AEP—variability of expert ratings. *Br J Anaesth* 2003;91:905–908.
  33. Smith WD, Dutton RC, Smith NT. Measuring the performance of anesthetic depth indicators. *Anesthesiology* 1996;84:38–51.
  34. Alpiger S, Helbo-Hansen HS, Vach W, et al. Efficacy of A-line AEP monitor as a tool for predicting acceptable tracheal intubation conditions during sevoflurane anaesthesia. *Br J Anaesth* 2005;94:601–606.
  35. Hall JW. Overview of auditory evoked responses: past, present and future. In Hall J, ed. *Handbook of Auditory Evoked Responses*. Boston: Allyn and Bacon, 1992:3–40.
  36. Drouot X, Nguyen JP, Peschanski M, et al. The antalgic efficacy of chronic motor cortex stimulation is related to sensory changes in the painful zone. *Brain* 2002;125:1660–1664.
  37. Lefaucheur JP. Transcranial magnetic stimulation in the management of pain. *Suppl Clin Neurophysiol* 2004;57:737–748.
  38. Nguyen JP, Lefaucheur JP, Le Guerinel C, et al. Motor cortex stimulation in the treatment of central and neuropathic pain. *Arch Med Res* 2000;31:263–265.
  39. Brown JA, Pilitsis JG. Motor cortex stimulation for central and neuropathic facial pain: a prospective study of 10 patients and observations of enhanced sensory and motor function during stimulation. *Neurosurgery* 2005;56:290–297; discussion 290–297.
  40. Sala F, Krzan MJ, Deletis V. Intraoperative neurophysiological monitoring in pediatric neurosurgery: why, when, how? *Childs Nerv Syst* 2002;18:264–287.
  41. Nguyen JP, Lefaucheur JP, Decq P, et al. Chronic motor cortex stimulation in the treatment of central and neuropathic pain. Correlations between clinical, electrophysiological and anatomical data. *Pain* 1999;82:245–251.
  42. Quinones-Hinojosa A, Alam M, Lyon R, et al. Transcranial motor evoked potentials during basilar artery aneurysm surgery: technique application for 30 consecutive patients. *Neurosurgery* 2004;54:916–924; discussion 924.
  43. McElveen JT Jr, Belmonte RG, Fukushima T, et al. A review of facial nerve outcome in 100 consecutive cases of acoustic tumor surgery. *Laryngoscope* 2000;110:1667–1672.
  44. Belzberg AJ, Dorsi MJ, Storm PB, et al. Surgical repair of brachial plexus injury: a multinational survey of experienced peripheral nerve surgeons. *J Neurosurg* 2004;101:365–376.
  45. Xu JG, Gu YD, Hu SN, et al. Electrophysiologic study of influence on C7 innervated muscles after transection of different C7 fascicles. *Microsurgery* 2004;24:147–150.
  46. Balakrishnan G, Kadadi BK. Clinical examination versus routine and paraspinale electromyographic studies in predicting the site of lesion in brachial plexus injury. *J Hand Surg [Am]* 2004;29:140–143.
  47. Pring ME, Trousdale RT, Cabanela ME, Harper CM. Intraoperative electromyographic monitoring during periacetabular osteotomy. *Clin Orthop Relat Res* 2002;400:158–164.
  48. Rose RD. Removing the antidromically driven sensory component from cervically evoked motor potentials. *Med Hypotheses* 1998;50:147–154.
  49. Toleikis JR, Skelly JP, Carlvin AO, et al. Spinally elicited peripheral nerve responses are sensory rather than motor. *Clin Neurophysiol* 2000;111:736–742.
  50. Zentner J, Albrecht T, Heuser D. Influence of halothane, enflurane, and isoflurane on motor evoked potentials. *Neurosurgery* 1992;31:298–305.
  51. Nathan N, Tabaraud F, Lacroix F, et al. Influence of propofol concentrations on multipulse transcranial motor evoked potentials. *Br J Anaesth* 2003;91:493–497.
  52. Sakamoto T, Kawaguchi M, Inoue S, et al. Suppressive effect of nitrous oxide on motor evoked potentials can be reversed by train

stimulation in rabbits under ketamine/fentanyl anaesthesia, but not with additional propofol. *Br J Anaesth* 2001;86:395–402.

53. Hargreaves SJ, Watt JW. Intravenous anaesthesia and repetitive transcranial magnetic stimulation monitoring in spinal column surgery. *Br J Anaesth* 2005;94:70–73.

54. Costa P, Bruno A, Bonzanino M, et al. Somatosensory- and motor-evoked potential monitoring during spine and spinal cord surgery. *Spinal Cord* 2007;45:86–91.

55. Lo YL, Dan YF, Tan YE, et al. Intraoperative motor-evoked potential monitoring in scoliosis surgery: comparison of desflurane/nitrous oxide with propofol total intravenous anesthetic regimens. *J Neurosurg Anesthesiol* 2006;18:211–214.

56. Tanaka S, Kobayashi I, Sagiuchi T, et al. Compensation of intraoperative transcranial motor-evoked potential monitoring by compound muscle action potential after peripheral nerve stimulation. *J Clin Neurophysiol* 2005;22:271–274.

57. Sala F, Lanteri P, Bricolo A. Motor evoked potential monitoring for spinal cord and brain stem surgery. *Adv Tech Stand Neurosurg* 2004;29:133–169.

58. Vauzelle C, Stagnara P, Jouvinroux P. Functional monitoring of spinal cord activity during spinal surgery. *Clin Orthop Relat Res* 1973;173–178.

59. Owen JH. The application of intraoperative monitoring during surgery for spinal deformity. *Spine* 1999;24:2649–2662.

60. Keifer J. Anesthesia for craniotomy with intraoperative speech testing. *Curr Rev Clin Anesth* 2001;21:283–290.

61. Keifer JC, Dentshev D, Little K, et al. A retrospective analysis of a remifentanyl/propofol general anesthetic for craniotomy before awake functional brain mapping. *Anesth Analg* 2005;101:502–8, table of contents.

62. Lind G, Meyerson BA, Winter J, et al. Implantation of laminotomy electrodes for spinal cord stimulation in spinal anesthesia with intraoperative dorsal column activation. *Neurosurgery* 2003;53:1150–1153; discussion 1153–1154.

63. Mahla M, Black S, Cucchira R. Neurologic monitoring. In Miller RD, ed. *Miller's Anesthesia*. 6th ed. Philadelphia: Churchill Livingstone, 2005:1511–1550.

64. Toleikis JR, Skelly JP, Carlvn AO, et al. The usefulness of electrical stimulation for assessing pedicle screw placements. *J Spinal Disord* 2000;13:283–289.

65. MacDonald DB, Al Zayed Z, Khoudair I, et al. Monitoring scoliosis surgery with combined multiple pulse transcranial electric motor and cortical somatosensory-evoked potentials from the lower and upper extremities. *Spine* 2003;28:194–203.

66. Mullatti N, Coakham HB, Maw AR, et al. Intraoperative monitoring during surgery for acoustic neuroma: benefits of an extratympanic intrameatal electrode. *J Neurol Neurosurg Psychiatry* 1999;66:591–599.

67. Mustafa MK, van Weerden TW, Mooij JJ. [Hemifacial spasms caused by neurovascular compression]. *Ned Tijdschr Geneesk* 2003;147:273–277.

68. Weigang E, Hartert M, Sircar R, et al. Setup of neurophysiological monitoring with tcMEP/SSEP during thoracoabdominal

aneurysm repair. *Thorac Cardiovasc Surg* 2005;53:28–32.

69. Jacobs MJ, Mess WH. The role of evoked potential monitoring in operative management of type I and type II thoracoabdominal aortic aneurysms. *Semin Thorac Cardiovasc Surg* 2003;15:353–364.

70. Faberowski LW, Black S, Trankina MF, et al. Somatosensory-evoked potentials during aortic coarctation repair. *J Cardiothorac Vasc Anesth* 1999;13:538–543.

71. Quinones-Hinojosa A, Lyon R, Ames CP, et al. Neuromonitoring during surgery for metastatic tumors to the spine: intraoperative interpretation and management strategies. *Neurosurg Clin N Am* 2004;15:537–547.

72. Nuwer MR. Spinal cord monitoring. *Muscle Nerve* 1999;22:1620–1630.

73. Arrington ED, Hochschild DP, Steinagle TJ, et al. Monitoring of somatosensory and motor evoked potentials during open reduction and internal fixation of pelvis and acetabular fractures. *Orthopedics* 2000;23:1081–1083.

74. Debatisse D, Pralong E, Dehdashti AR, et al. Simultaneous multilobar electrocorticography (mEcoG) and scalp electroencephalography (scalp EEG) during intracranial vascular surgery: a new approach in neuromonitoring. *Clin Neurophysiol* 2005;116:2734–2740.

75. Young WL, Lawton MT, Gupta DK, et al. Anesthetic management of deep hypothermic circulatory arrest for cerebral aneurysm clipping. *Anesthesiology* 2002;96:497–503.

# CHAPTER 33

## Monitoring and Managing Neuromuscular Blockade

Richard M. Pino, MD, PhD, and  
Hassan H. Ali, MD

Muscle relaxation can be achieved by direct central nervous system depression with volatile inhalation anesthetics or by neural blockade either at the peripheral nerve or with drugs that act at the neuromuscular junction. Neuro-muscular blocking drugs (NMBDs) are essential in anesthetic practice to facilitate endotracheal intubation and provide optimum surgical conditions for a variety of procedures. Although volatile anesthetic agents can be used for muscle relaxation, the addition of NMBD significantly reduces the concentration of volatile anesthetics required to provide adequate analgesia and amnesia with rapid postoperative recovery. NMBDs have no inherent analgesic or amnestic properties, and their use is contraindicated if artificial ventilation is not possible.

### HISTORICAL PERSPECTIVE

In 1850, Pelouze and Bernard demonstrated that curare, the arrow poison used by certain South American Indian tribes, abolished the effect of nerve stimulation on muscle but did not affect the excitability of either nerve or muscle. Curare and nicotine were thought to act directly on muscle through “receptive substances” rather than by action on axonal endings until stimulation of the vagus nerve was demonstrated to produce a substance, later identified as acetylcholine (ACh), that was the transmitter at the myoneuronal junction of voluntary muscle.

### CELL BIOLOGY OF MUSCLE CONTRACTION

#### Basic Myoneural Structure

A motor unit is a series of muscle fibers that is innervated by the same

motor nerve.<sup>1</sup> This nerve enters skeletal muscle and ramifies to an extent that depends upon the function of the specific muscle. Muscles involved in fine control are innervated by a high ratio of neurons to muscle fibers, such as the extraocular muscles with a 1:1 ratio of neuron to muscle fibers. In contrast, muscles that contract for more coarse activities (e.g., maintenance of posture) have multiple fascicles that are innervated by a single nerve fiber.

Stimulation of a single motor nerve leads to contraction of all the muscle fibers contained within the particular motor unit. As the axons terminate in troughs on the surface of the muscle fibers, their myelin sheaths are lost. The neuromuscular junction is the synapse that is formed at the endplate region of the muscle membrane and bare terminal of the motor nerve (Fig. 33-1). The synaptic cleft is a 50-nm-wide extracellular space that spans the short distance between the neuronal and muscle cell membranes.

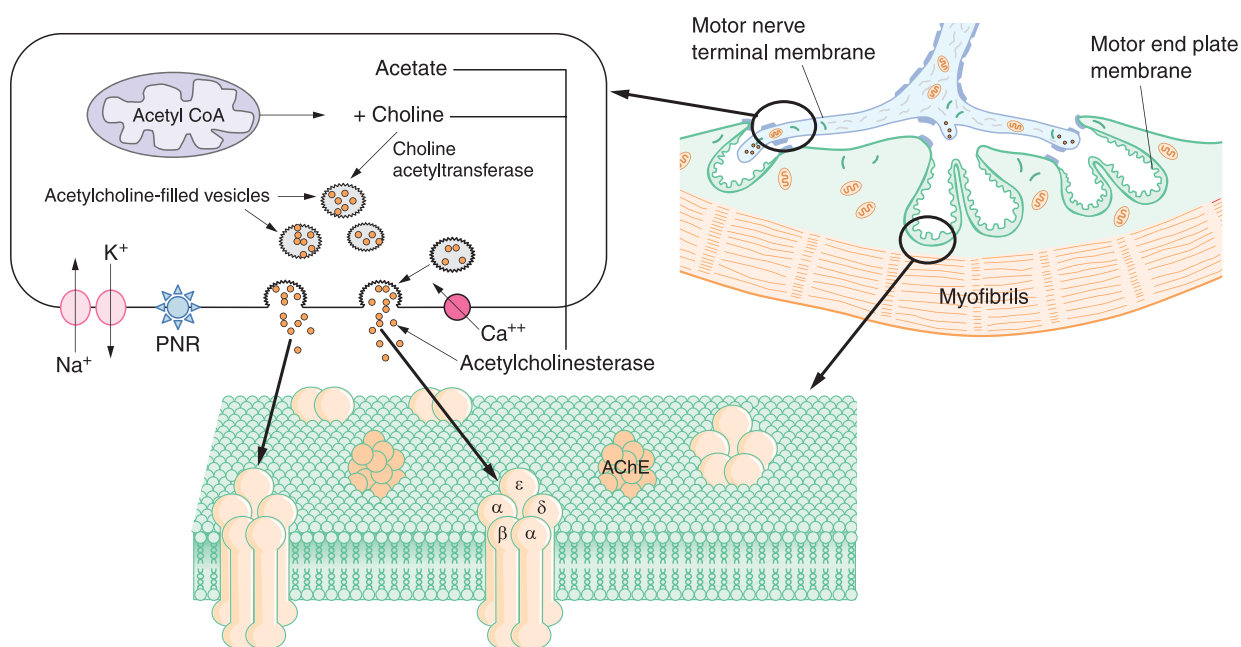
### Synthesis of ACh

Neuromuscular transmission begins with synthesis of the enzyme choline acetyltransferase in the organelle-rich cell body of the axon, followed by distal intracellular transport to the nerve terminal where it is concentrated. The choline acetyltransferase catalyzes the synthesis of ACh from acetyl-coenzyme A (acetyl-CoA) and choline. Hydrolysis of ACh in the junctional cleft is the primary source of choline. Most of the ACh (approximately 60%) is stored in the 5–10,000 synaptic vesicles of the nerve terminal. These vesicles are arranged in a triangular pattern, with the apex of each triangle close to a thickened area of the prejunctional membrane. This so-called active zone may be part of a system that orients and controls the site of release of ACh from the synaptic vesicles. The remainder of neural ACh is free in the cytoplasm. In the absence of nerve impulses, spontaneous release of small amounts of ACh depolarizes the postjunctional membrane to a

### KEY POINTS

1. Muscle response can be measured by mechanomyography, electromyography, acceleromyography, and direct palpation.
2. Commonly used patterns of stimulation are single twitch, train of four, double burst, tetanic, and posttetanic count.
3. Clinical criteria, in addition to evoked responses, should be used to assess recovery of neuromuscular blockade.
4. Pharmacokinetics is the mathematical description of the relationship between time and the plasma concentration of a drug and its metabolites. Pharmacodynamics is the measurement of what the drug does in the body.
5. Reversal agents increase the concentration of acetylcholine in the junctional clefts to compete with the neuromuscular blocking drug (NMBD) to restore muscle activity.
6. Succinylcholine, the depolarizing NMBD, is metabolized by plasma cholinesterase. Atypical pseudocholinesterases cannot metabolize pseudocholinesterase at a normal rate, and prolonged neuromuscular blockade may result.
7. Immobility, prolonged use of NMBDs, and upper and lower motor neuron disease may cause the proliferation of extrajunctional receptors. These receptors affect severe hyperkalemia when stimulated with succinylcholine.
8. Nondepolarizing NMBDs are benzylisoquinoline (mivacurium, atracurium, cisatracurium, doxacurium) and steroidal molecules (vecuronium, rocuronium, pancuronium, pipecuronium).
9. The degradation of atracurium, cisatracurium, and mivacurium is independent on organ-specific elimination.
10. Pancuronium and vecuronium are metabolized in the liver to derivatives that are cleared by the kidney and that exhibit neuromuscular blocking activities. These derivatives accumulate with prolonged administration and renal insufficiency.





**FIGURE 33-1.** Schematic representation of the nerve terminal and myoneural junction. See text for details. PNR, prejunctional nicotinic receptor.

small extent. These 0.5- to 1.5-mV depolarizations, called *miniature end-plate potentials* (MEPPs), are approximately 0.01 the magnitude of a standard endplate potential (EPP) and are not significant enough to trigger muscle contraction. According to the quantum theory,<sup>2</sup> calcium-mediated fusion of synaptic vesicles with the presynaptic membrane simultaneously releases approximately 200 to 400 quanta of ACh into the synaptic cleft. Each quantum contains 500–25,000 molecules of ACh. Motor neuron action potentials propagate via voltage-responsive ion channels that, in turn, open channels in the nerve terminal that serve as pathways for the influx of ionized calcium at the active zone.

### ACh Receptors

The postsynaptic membrane is highly folded, increasing its surface area to allow a high concentration of nicotinic postjunctional receptors. Each receptor is composed of five integral linear protein subunits arranged as a rosette in the membrane: two alpha ( $\alpha$ ), and one each of beta ( $\beta$ ), delta ( $\delta$ ), and epsilon ( $\epsilon$ ). Each subunit contains four helical domains. The sites of binding for ACh and NMBDs are on the extracellular  $\alpha$ -subunits, although the receptors span the entire muscle cell membrane contacting both extracellular and intracellular spaces. The binding sites for ACh on the two  $\alpha$ -subunits are not identical and can be characterized into high- and low-affinity sites

based on their binding of competitive antagonists. Both sites must be occupied by ACh in order to propagate a muscle cell depolarization. After ACh binds to the active site of both  $\alpha$ -subunits, the receptor undergoes a conformational change, opening a central channel within the five subunits. The structure of this channel permits the transit of sodium, potassium, and calcium ions while blocking anions and larger cations. When nondepolarizing NMBDs bind to either  $\alpha$ -subunit, the channels cannot open, and a neuromuscular blockade occurs.

### Depolarization and Muscle Contraction

Most of the released ACh molecules cross the synaptic clefts, bind to postjunctional receptors, and induce depolarization of the muscle cell. Depolarizations are created by the influx of sodium through specific channels, decreasing the membrane potential from  $-90$  to  $+50$  mV. During depolarization, as the membrane potential approximates 0 mV, potassium channels open and sodium channels close to limit the voltage flux to  $+10$  mV. The action potential is self-propagating through a decrease in the adjacent membrane potential of approximately 15 mV, which opens sodium channels and depolarizes the membrane.

Depolarization is an all-or-none phenomenon. Once begun after the threshold is achieved, it continues until the entire membrane has depolar-

ized. Therefore, the strength of individual contractions does not depend upon the amplitudes of the individual action potentials but is dependent on the sum of repetitive, additive, and fused contractions of different motor units. Calcium is released from the sarcoplasmic reticulum of the muscle upon depolarization to activate actin–myosin coupling within myofibrils resulting in contraction. Upon completion of depolarization, the ionic gradient is restored via an  $\text{Na}^+/\text{K}^+$ -dependent adenosine triphosphates (ATPase) to repolarize the membrane, and a refractory period follows during which time depolarization is not possible. Once depolarization is completed, the concentration of ACh markedly decreases in the synaptic cleft by diffusion through the postjunctional receptor. ACh is further reduced by degradation into acetate and choline by acetylcholinesterase, a key enzyme that is concentrated in the basal lamina of the muscle cell.

### Prejunctional Receptors

The response of muscle contraction is also modulated by prejunctional receptors of the motor neuron. It is theorized that released ACh interacts with prejunctional nicotinic, and possibly muscarinic, receptors to further augment transmitter release. These receptors are believed to control a sodium-specific ion channel in contrast to the nonspecific cation channels of the postjunctional receptors. Sodium is essential for the synthesis

and mobilization of ACh, but it is not directly involved in the release process. Therefore, nondepolarizing NMBDs can bind to these ion channels, decrease the mobilization of ACh, and reduce its release from nerves that are stimulated with high-frequency stimuli. The clinical equivalent is seen in the fade to tetanic and train-of-four (TOF) stimulation.

### Extrajunctional Receptors

Muscle cells can also exhibit a variable number of extrajunctional receptors that are embryologic remnants of the muscle cell membrane. In the fetus, these receptors are found throughout the muscle cell membrane. With maturation, extrajunctional receptors become markedly reduced while junctional receptors predominate. In addition to differences in their location, the extrajunctional receptor has a gamma ( $\gamma$ )-subunit substituted for the epsilon ( $\epsilon$ )-subunit of the junctional receptor. Extrajunctional receptors also have short half-lives of <1 day compared with the >1-week half-lives of junctional receptors. Compared with junctional receptors, they are less sensitive to stimulation by ACh but have channels that remain open approximately four times longer than the postjunctional receptors. The clinical significance of extrajunctional receptors becomes evident when they proliferate in response to upper and lower neuron damage, muscular injury and disease (some muscular dystrophies, disuse atrophy, even cast immobilization), and trauma associated with major burns.<sup>3</sup>

### TECHNIQUES USED TO MONITOR NEUROMUSCULAR BLOCKADE

We have described the basic mechanisms controlling the contraction of a single muscle fiber. This knowledge must be extrapolated to the bedside analysis of the contraction of anatomically distinct muscles to assess the patient's degree of neuromuscular blockade.

Objectives of clinical monitoring are as follows:

- Titration of NMBD doses to the desired level of paralysis
- Detection of unusual sensitivity, resistance, or altered clearance of a relaxant in the course of the anesthetic

- Evaluation of whether neuromuscular blockade can be pharmacologically reversed
- Assessment of the adequacy of reversal to assure that residual neuromuscular blockade is not present

The depth of neuromuscular blockade often is assessed by a measurement of the contraction of the adductor pollicis muscle as elicited by stimulation of the ulnar nerve at the wrist with surface electrodes.<sup>4</sup> When the ulnar nerve is not accessible, stimulation of several other peripheral nerves is useful (Fig. 33-2). The stimulus used to evoke muscle contraction usually is a rectangular waveform of 0.2-msec duration.<sup>5</sup> It is important to adequately clean and lightly abrade the skin for optimum adherence of surface electrodes and to minimize the impedance of the skin to prevent reduction of the applied current intensity.

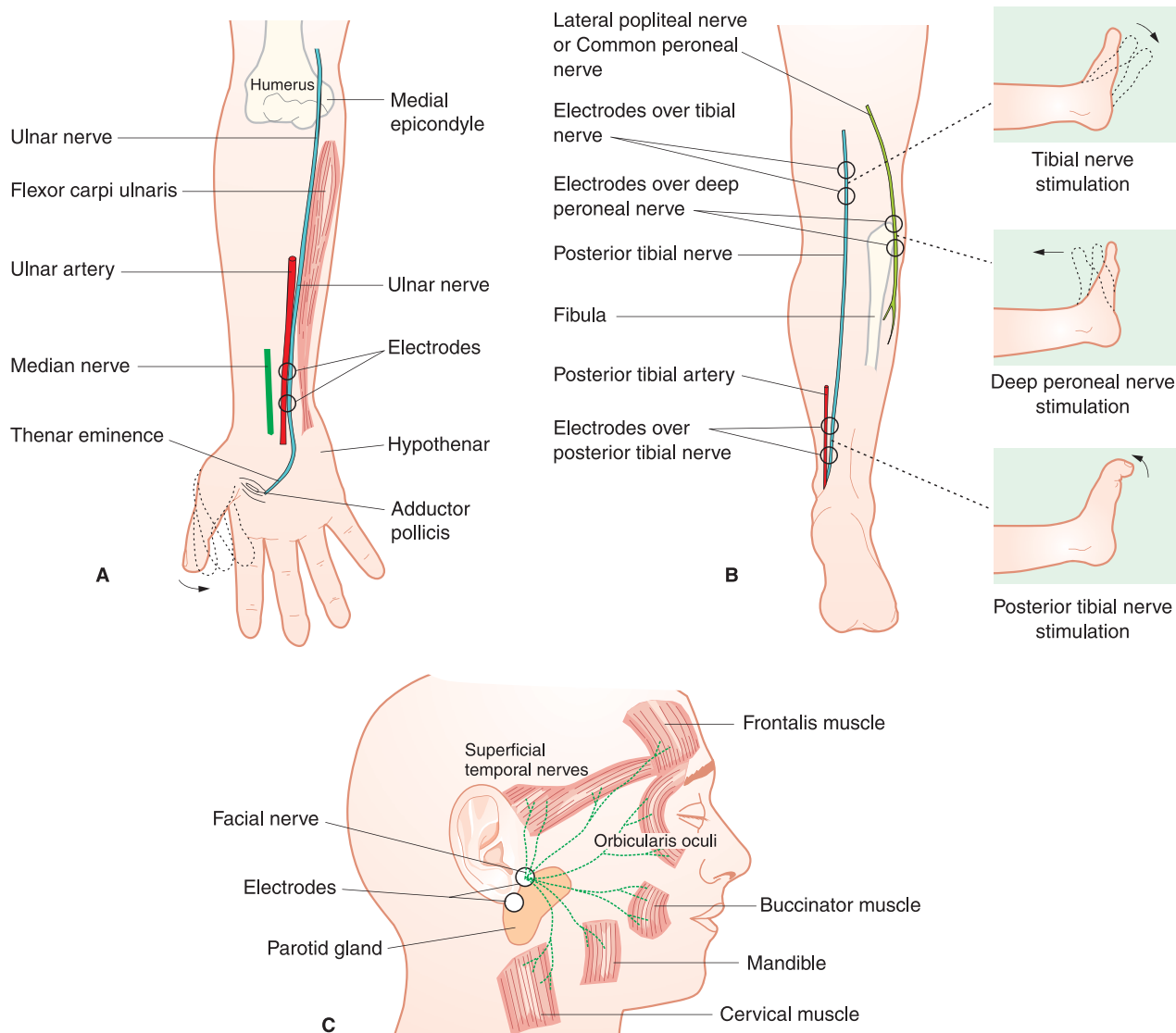
### Patterns of Stimulation

There are five patterns of stimulation.

1. *Single-twitch stimulus* (Fig. 33-3) usually is given at a frequency of 0.1 Hz, that is, one stimulus every 10 seconds.<sup>6</sup> The current is incrementally increased until a maximum twitch height is obtained. A current that is slightly greater than that used to achieve maximum twitch height is called the *supramaximal stimulus*. After an NMBD is administered, the decrements in twitch height are compared as percentages of the control twitch. This stimulus pattern is most often used to establish the basic pharmacodynamic properties of an NMBD. For example, the ED<sub>95</sub> is the dose at which the twitch height is depressed by 95% of maximal height. The primary shortcoming of a single-twitch stimulus is the requirement for a control response prior to the administration of the NMBD.
2. *TOF stimulation* (TOF; Fig. 33-4) is the most commonly used stimulus.<sup>7,8</sup> Each train consists of four stimuli at 2 Hz (four stimuli in 2 seconds) that are again repeated every 10–12 seconds. In the absence of neuromuscular blockade, the TOF will evoke four twitches of equal strength when the abducted thumb is palpated after stimulation of the ulnar nerve. Because the strength of the first twitch ( $T_1$ ) is compared with the second, third,

and fourth twitches, control twitches are not required. With the onset of neuromuscular blockade, release of ACh by the first stimulus often evokes an adequate contraction. However, the ability of neurons to replenish and release ACh progressively diminishes with each stimulus of the TOF in the successive train. This can be manifested in two ways. First, with the onset of neuromuscular blockade, the amplitude of the fourth twitch ( $T_4$ ) will decrease with successive stimuli. Second, within each TOF, there is a clear decrement between  $T_4$  and  $T_1$ . The  $T_4/T_1$  ratio can be easily compared if objectively measured. In clinical practice, when the strength of the first twitch is reduced to 75% of the maximal height, only three twitches will be demonstrable. With increased neuromuscular blockade to a  $T_1$  of 20%, two twitches will be observed. At 90% suppression of  $T_1$ , only one twitch will be perceptible. These patterns are reversed as muscle activity returns and can be used with other clinical criteria to help determine the patient's suitability for extubation. Initial studies demonstrated that at  $T_4/T_1 = 0.75$ , awake patients can sustain a 5-second head lift, generate a vital capacity of 15–20 mL/kg with an inspiratory force of -25 cm H<sub>2</sub>O, and cough effectively.<sup>9</sup>

3. *Tetanic stimulation* is used in conjunction with the TOF. When a profound depth of neuromuscular blockade has been established, the twitch response to TOF stimulation will be abolished.<sup>6</sup> With stimulation at a tetanic frequency of 50 Hz for 5 seconds, increased quanta of ACh are released into the synaptic cleft. The increased ACh causes a sustained muscle contraction during the duration of the stimulus and also augments its own subsequent release if a single TOF stimulus follows. This enhanced response after tetanic stimulation is called *posttetanic potentiation* (Fig. 33-3). Instead of a posttetanic TOF, a stimulation of 1 Hz can be applied 3 seconds after tetanus. The number of twitches then observed is termed the *posttetanic count*. A posttetanic count of 10 has been found to coincide with the appearance of the first twitch



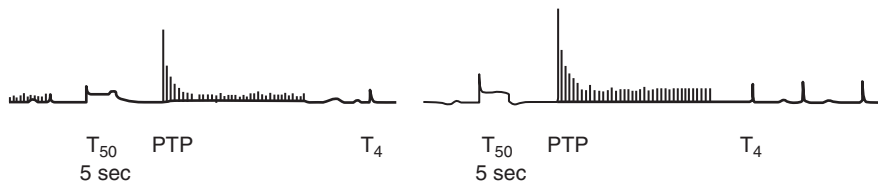
**FIGURE 33-2.** Diagram of sites suitable for nerve stimulation. **A.** Ulnar nerve. **B.** Tibial, deep peroneal, and posterior tibial nerves. **C.** Facial nerve. (Reprinted and modified from Ali HH. Monitoring neuromuscular function. *Semin Anesth* 1989;8:158, with permission from Elsevier.)

of the TOF. A posttetanic count of 1 indicates that the first twitch of the TOF should appear in approximately 30 minutes when pancuronium is used or 8 minutes with vecuronium and atracurium.<sup>10</sup> In the absence of a posttetanic twitch, the blockade is sufficiently profound to suggest that immediate

administration of reversal agents will not be effective.

4. *Double-burst stimulation (DBS)* was devised to increase the manual perception of fade.<sup>11,12</sup> DBS consists of two short bursts of three stimuli at 50 Hz separated by 750 msec. The responses to each burst are close

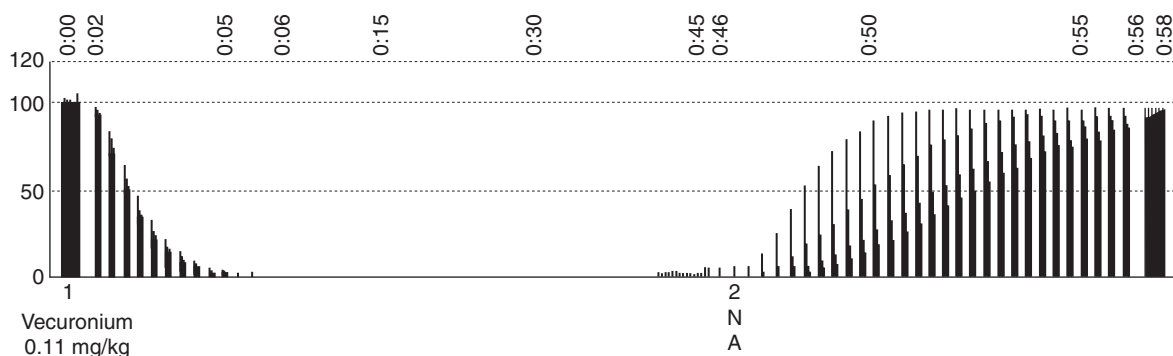
enough to be palpated as a strong single muscle contraction. Any fade that is manifested with a partial blockade may be easier to detect between the sets of stimuli with DBS than with TOF. In the absence of fade to DBS, there is a 90% chance that TOF is  $\geq 0.6$  and a 75% chance that TOF is  $< 0.6$  when fade is present.



**FIGURE 33-3.** Evoked thumb adduction in response to single-twitch stimulation of 0.1 Hz before and after tetanic stimulation at 50 Hz for 5 seconds. Note the tetanic fade and posttetanic potentiation (PTP).

### Methods Used to Quantify Muscle Responses<sup>13</sup> (Fig. 33-5)

*Mechanomyography* is an extremely accurate method that has been used for research on the basic pharmacodynamics properties of NMBDs. An isometric tension of a known preload is placed on the thumb. The thumb is attached to a transducer that measures



**FIGURE 33-4.** Integrated evoked electromyographic response to train-of-four (TOF) stimulation shows the response to vecuronium 0.11 mg/kg. At 47 minutes, the first response to TOF recovered spontaneously to 10% of control. Note during the onset there is minimal fade compared with that during recovery. Neostigmine (N) 4.0 mg and atropine (A) 1.5 mg were administered. Note the development of  $T_2$ ,  $T_3$ , and  $T_4$  and the progressive increase in TOF ratio, which reached 0.8 after 11 minutes of reversal.

the force of contraction of the adductor pollicis brevis muscle.

*Electromyography* (EMG) monitors compound motor unit action potentials that are generated a few milliseconds after the stimulus is delivered to a nerve. Two sensing electrodes are placed over a specific muscle and a ground electrode applied between the stimulating and sensing electrodes. The thenar, hypothenar, and first dorsal interosseous muscles of the hand are usually studied. Although each muscle cell responds in an all-or-none fashion, the amplitude of the EMG signal is proportional to the number of individual action potentials. In principle, the advantage of EMG is that it is closest to direct assessment of function of the neuromuscular junction.

Acceleromyography measures the isotonic acceleration across a joint with a small piezoelectric transducer.<sup>14</sup> This technique considers that the acceleration of a muscle is directly proportional to the force of contrac-

tion (assuming the muscle mass is constant). Acceleromyography is simple to perform and is clinically useful. One disadvantage is the inconsistency of the response.

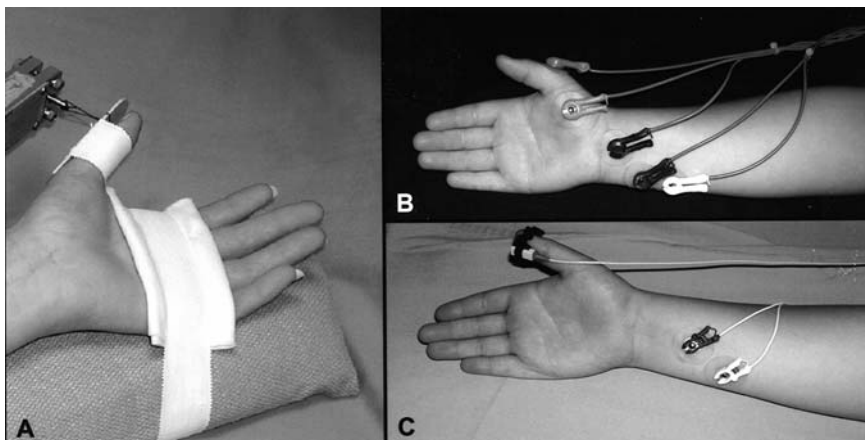
*Direct palpation* of an abducted thumb during contractions evoked by ulnar nerve stimulation is the most common method used to assess neuromuscular blockade. With palpation, the clinician is measuring both the force of isometric contraction and the force of acceleration. Although it is a subjective assessment of neuromuscular blockade and has a considerable margin of error even in the hands of experienced clinicians,<sup>15</sup> direct palpation with TOF remains the gold standard in routine clinical practice.

## PHARMACOLOGY OF NMBDS

Pharmacokinetics and pharmacodynamics are two important concepts pertinent to understanding the pharmacology of NMBDs.

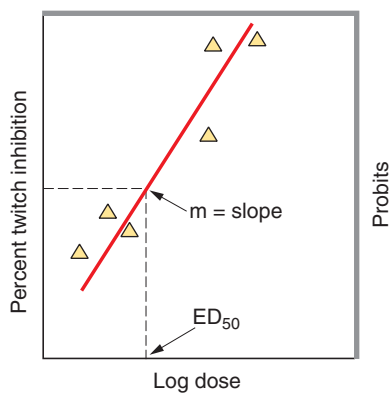
## Pharmacokinetics

Pharmacokinetics is the mathematical description of the plasma concentration of the drug over time. The plasma concentration of a drug is initially high after an intravenous (IV) bolus and is followed by a rapid decline toward equilibrium during the distribution phase as a result of transfer between blood and tissue compartments. The initial volume of distribution ( $V_1$ ) is the distribution space of the vessel-rich organs in contrast to the volume of distribution at steady state ( $V_{d_{ss}}$ ), which is the apparent volume needed to explain the drug concentration after equilibrium between blood and the various tissues. The distribution half-life ( $t_{1/2\alpha}$ ) defines the time needed for the blood concentration to decline by 50% and occurs before the elimination phase begins. This is quantified from the slope of the natural log of the blood concentration–time curve in the distribution phase. The  $t_{1/2\alpha}$  is 2–10 minutes for the nondepolarizing NMBD. During the elimination phase, plasma levels of a relaxant decline at a slower rate than during the distribution phase because of excretion of the drug or its metabolite via the kidneys and/or the liver, spontaneous degradation, or a combination of both. The elimination half-life ( $t_{1/2\beta}$ ) is computed from the slope of the natural log of the blood concentration–time curve for the elimination phase and is the time required for the plasma drug concentration to decrease by 50%. The  $t_{1/2\beta}$  is sensitive to changes in either the volume of distribution at steady state or the clearance ( $C_L$ ). The latter is defined as the volume of blood that is completely cleared of the drug per unit time. The  $t_{1/2\beta}$  can range from 2.5 minutes (mivacurium) to approximately 2 hours (pancuronium),



**FIGURE 33-5.** Methods used to quantify muscle responses to stimulation. **A.** Mechanomyography. **B.** Electromyography. **C.** Acceleromyography.





**FIGURE 33-6.** Log dose-probit transformation allows calculation of  $ED_{50}$ , estimation of  $ED_{95}$ , and comparison of potencies and mechanisms between different neuromuscular blocking drugs.

whereas  $C_L$  can vary from 2–100 mL/kg/min.

### Pharmacodynamics

Pharmacodynamics is the principle of pharmacology that is most applicable to the clinical use of NMBDs. Pharmacodynamics includes the characterization of the therapeutic, pharmacologic, and toxic effects of the drug as well as the mechanism of drug action at the receptor. Dose–response studies of NMBD have established the relationship between increasing doses of a drug and the extent of neuromuscular blockade (Fig. 33-6). When a dose is simply plotted against response, comparisons of one NMBD with another become difficult. In order to estimate the 95% blocking dose ( $ED_{95}$ ) of a relaxant and determine appropriate doses for intubation, a straight-line dose–response curve is needed. A log-dose probit analysis assigns an arbitrary number (probit) to each level of blockade (including 0% response and 100% response) to generate a straight line and facilitate the determination of the extent of blockade versus dose. The potency of different NMBDs then can be compared by examining the slope and parallelism of these straight lines. Different slopes and the absence of parallelism may indicate different mechanisms of blockade.

Although it is desirable to know the concentration–response relationships at the site of drug action, it usually is not possible to do so. An assumption is that a close relationship exists between the concentration of the drug in the plasma and the concentration at postjunctional receptors. This type of relationship for NMBDs is determined

during continuous infusions at steady-state conditions, and comparisons between relaxants are noted by concentration in plasma at steady state and 50% paralysis ( $C_{pss_{50}}$ ). Dose–response relationships ( $ED_{50}$ ) and concentration–response relationships ( $C_{pss_{50}}$ ) are altered by disease states, normal differences in physiology, and drug interactions and are reflected in differing dose requirements or plasma levels required to achieve the desired degree of blockade.

### Onset of Neuromuscular Blockade

The onset time of neuromuscular blockade after administration of an NMBD is inversely related to potency.<sup>16,17</sup> Rapid plasma clearance contributes to a fast onset because the maximum drug effect occurs when the concentrations in the plasma and at the neuromuscular junction are equal. As the plasma concentration is decreasing, the effective concentration at the neuromuscular junction is increasing. Recovery from neuromuscular blockade begins immediately after both the plasma and junctional concentrations of the NMBD decrease. Therefore, when NMBDs have both equal potencies and equilibration rates, the drug with the faster clearance will cause a neuromuscular blockade more rapidly and of lesser magnitude than the NMBD with the slower clearance. A rapid onset and greater peak effect can be obtained by increasing the dose of the more rapidly cleared NMBD as long as there are no side effects with the increased dose. Thus, high-potency, low-clearance drugs have slow onset, whereas low-potency, rapid-clearance drugs have fast onset. Succinylcholine (SCh) has the fastest onset time to maximum effect. The onset times for the nondepolarizing NMBDs are rocuronium (shortest onset) < mivacurium < vecuronium < atracurium < cisatracurium.

Mivacurium is the only exception to these principles because it is a relaxant with both a high potency and a high clearance rate. Although mivacurium is assumed to have an intermediate potency, its high potency is demonstrable in patients with atypical plasma cholinesterase, and its rapid clearance is partly based on destruction of the compound as well as its distribution. Because these characteristics are antagonistic, mivacurium has a slower onset than expected.

Finally, nondepolarizing relaxants have a faster onset time, a less intense effect, and a more rapid recovery at the diaphragm and intrinsic muscles of the larynx than at the adductor pollicis.<sup>18,19</sup> This characteristic allows tracheal intubation at less intense degrees of neuromuscular blockade than evidenced at the adductor pollicis, provided adequate anesthesia is present. This is especially important for mivacurium. It is possible to have appropriate relaxation of laryngeal muscles while the adductor pollicis (and other muscles) still exhibit a marked twitch response. Furthermore, when the adductor pollicis twitch is abolished using small doses of mivacurium ( $\leq 0.15$  mg/kg), the laryngeal muscles may already be recovering, and intubation may be difficult.

### MUSCLE RELAXATION FOR TRACHEAL INTUBATION

The most common use for neuromuscular blocking agents is to facilitate endotracheal intubation during general anesthesia. This is especially important during a rapid sequence induction to swiftly intubate the trachea in order to protect the lungs from gastric contents. The standard drug for such rapid intubation remains SCh. When SCh is contraindicated, either an awake intubation can be performed or nondepolarizing relaxants can be administered. Conditions appropriate for intubation can be achieved within 2 minutes after administration of large doses of rocuronium, pancuronium, and cisatracurium, although the duration of neuromuscular blockade will be prolonged. In order to minimize unwanted cardiovascular side effects that may be produced with high doses of pancuronium, atracurium, or mivacurium, a divided dose technique may be used. The rationale for the divided dose technique is the initial binding of a large number of postjunctional receptors by a subparalytic dose of a nondepolarizing relaxant, called the “priming dose,” which is insufficient to produce cardiovascular side effects. The balance of receptors subsequently are blocked to facilitate intubation within a short time after administration of the second dose of the NMBD.<sup>20</sup> For example, using the divided dose technique for mivacurium,<sup>21</sup> excellent intubation conditions were achieved

TABLE 33-1.

## Pharmacodynamics of Succinylcholine

	Dose (mg/kg)	Onset (min)	Time to 25% Recovery (min)	Time to 95% Recovery
ED <sub>95</sub>	0.2–0.25	1	8	12
Routine intubation	0.5–1.0	45 sec	10	12–15
Rapid intubation	1.0	4 sec	10	12–15
Pretreated intubation	1.5	1.5	10	12–15
d-Tubocurarine (3 mg)				
Pancuronium (1 mg)				
Vecuronium (1 mg)				
Infusion (mg/kg/min)	60–100	—	6 <sup>a</sup>	15–30 <sup>a</sup>

<sup>a</sup>After infusion stopped.

by 90 seconds and were identical to those obtained after rocuronium was administered at three (0.9 mg/kg) and four (1.2 mg/kg) times the ED<sub>95</sub>.<sup>22</sup>

There are several caveats for the priming principle.<sup>23</sup> In some studies, the priming and intubating doses were determined after induction of anesthesia<sup>24–26</sup> and may not be appropriate for an urgent anesthetic when the patient has a full stomach. Individual patients differ in their sensitivity and response to relaxants. Some patients are not adequately relaxed after 90 seconds, and during light anesthesia they may cough, jerk, vomit, or have laryngospasm. Many patients have diplopia from the priming dose, and in some patients more troublesome effects of neuromuscular blockade develop, such as difficulty swallowing, airway obstruction, or inadequate ventilation. Without exception, after a priming dose is given, constant monitoring for these adverse effects is mandatory. Any comorbidity that impairs muscle blood flow (e.g., decreased blood volume or decreased cardiac output) will delay delivery of the NMBD to the neuromuscular junction and slow the onset of neuromuscular blockade.<sup>27</sup>

## SUCCINYLCOLINE

SCh is the only depolarizing NMBD in current use (Table 33-1).<sup>3</sup> Because it is structurally two molecules of acetylcholine linked together via the acetyl moieties (Fig. 33-7), SCh reacts with nicotinic receptors at the neuromuscular junction and also in autonomic ganglia. Additional SCh binding to muscarinic postganglionic receptors in the heart, secretory glands, and smooth

muscle is responsible for many of this drug's side effects. The customary dose for intubation is 1.0 mg/kg (Table 33-1). It has been suggested that a dose of 0.6 mg/kg is efficacious while the time to a return to spontaneous ventilation is decreased.<sup>28</sup>

The rapid onset and brief duration of action of SCh are this drug's major advantages. They result from rapid metabolism of SCh in plasma to succinylmonocholine (a metabolite of minimal potency). The enzyme responsible for this activity is butyrylcholinesterase, usually referred to as *plasma cholinesterase*. The rapid metabolism of SCh by plasma cholinesterase is responsible for its brief duration of action, as relatively few of the injected molecules survive intact to reach the motor endplate. However, SCh molecules that reach the endplate are very resistant to metabolism by acetylcholinesterase, and neuromuscular blockade ends as SCh diffuses away from the neuromuscular junction (Table 33-2).

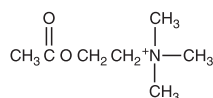
Two alleles control the quantity and quality of plasma cholinesterase. The normal gene is homozygous in 96% of patients. The activity of SCh is moderately prolonged in the 4% of patients

who are heterozygous with one normal and one atypical gene. It is greatly prolonged in the remainder of patients who are homozygous for the atypical gene. A clinical test for assessing these genetic differences uses the local anesthetic dibucaine, which inhibits the activity of normal, but not the atypical, plasma cholinesterase. A dibucaine number >80 (showing marked inhibition of the enzyme) indicates normal pseudocholinesterase, a dibucaine number <30 indicates a homozygote for the atypical enzyme, and dibucaine numbers between these values indicate heterozygotes. A more recent approach has been genotyping plasma cholinesterase variants and correlating the results with enzyme activity.<sup>29</sup>

Rare genes code for two additional atypical plasma cholinesterases.<sup>30</sup> The fluoride-resistant gene produces an atypical plasma cholinesterase that is not inhibited in vitro by the addition of a fluoride ion. The extremely poor degradation of SCh by this enzyme results in a greatly prolonged neuromuscular blockade. Another atypical enzyme produced by the "silent gene" is incapable of metabolizing SCh.

Decreased amounts of plasma cholinesterase that cause prolonged responses to SCh occasionally are problematic in patients with severe liver disease or in peripartum patients. Inhibition of plasma cholinesterase by echothiophate eyedrops, anticholinesterases, organophosphate insecticides, hexafluorenum, phenelzine, and some cytotoxic tumor agents also prolong the duration of SCh's neuromuscular blockade. In the absence or inhibition of SCh metabolism, the drug is eliminated from plasma by redistribution and slow renal elimination.

### Acetylcholine



### Succinylcholine (diacetylcholine)

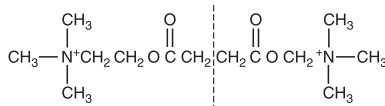


FIGURE 33-7. Chemical structures of acetylcholine and succinylcholine.

TABLE 33–2.

## Plasma Cholinesterase Genotypes and Expected Response to Succinylcholine

Genotype	Incidence	Esterase Activity	Dibucaine Number	Fluoride Number	Response
N : N	96%	Normal	80	60	Normal
N : A	1:25	Moderately low	40–70	45	S <sub>1</sub> prolongation
N : F	1:200	S <sub>1</sub> low	75	50	S <sub>1</sub> prolongation
N : S	1:190	Moderately low	80	60	S <sub>1</sub> prolongation
A : F	1:20,000	Moderately low	45	35	Moderate prolongation
F : S	1:150,000	Very low	60	35	Moderate prolongation
F : F	1:150,000	Moderately low	70	30	Moderate prolongation
A : A	1:2500	Very low	20	20	Very prolonged
A : S	1:29,000	Very low	20	35	Very prolonged
S : S	1:100,000	None	None	None	Very prolonged

A, atypical gene; F, fluoride-resistant gene; N, normal gene; S, silent gene.

Modified from Whittaker M. Plasma cholinesterase variants and the anaesthetist. *Anaesthesia* 1980;35:174.

### Phase I and Phase II Blockade (Table 33–3)

Because of its structural similarity to ACh, SCh's interaction with the post-junctional receptors creates an initial depolarization that spreads to adjacent membranes, causing disorganized contractions of motor units called *fasciculations*. Because SCh is not metabolized in

the junctional cleft, the receptors and membranes remain depolarized and unresponsive to further stimuli, and paralysis ensues. After SCh diffuses away from the receptors, the membranes repolarize and once again become responsive to normal neuromuscular transmission. This sequence of events is known as *depolarization blockade* or *phase I blockade*. It is characterized by (1) fasciculations, (2) decreased response to single nerve stimuli, (3) absence of fade to tetanus, (4) minimal fade to TOF, (5) no posttetanic facilitations, (6) enhancement of block by anticholinesterase agents, and (7) rapid recovery. However, given prolonged exposure of the neuromuscular junction to SCh, there is a conformational change at the receptors. The block that results, termed *phase II block*, resembles that obtained with nondepolarizing NMBD. This level of paralysis is characterized by (1) marked fade of tetanus and TOF (>50% fade), (2) posttetanic potentiation, (3) tendency toward prolonged recovery in at least 50% of patients, and (4) the ability to reverse with anticholinesterases once plasma levels of SCh have been allowed to decrease (wait at least 10 minutes).

The establishment of a phase II blockade depends upon the dose of SCh and the duration of SCh exposure. When inhalation agents are used to maintain anesthesia, a phase II block usually is heralded by a tachyphylaxis to SCh over a cumulative dose range between 10 and 12 mg/kg. The identification of >50% fade on the TOF

alerts the practitioner to the presence of phase II block, allows recovery to be followed over time, and permits the assessment of reversal after a plateau in recovery has been reached in patients in whom phase II blockade is prolonged.

### Side Effects

**Hyperkalemia.** In normal patients, the depolarization induced by SCh administration causes an increase in serum potassium level of 0.5–1.0 mEq/L. In some patients with elevated baseline serum potassium levels, this modest increase in potassium level after SCh administration will not cause a cardiac dysrhythmia.<sup>31</sup> However, the rapid rise of potassium from normal levels after SCh administration can be life-threatening in patients with burns, massive tissue trauma, disuse atrophy, hemiparesis, spinal cord trauma, and neuromuscular disorders, such as Guillain-Barré disease, amyotrophic lateral sclerosis, and Friedreich ataxia.<sup>3</sup> Possible mechanisms for SCh-induced hyperkalemia re (1) loss of motor nerve control over motor endplates that results in a proliferation of extrajunctional receptors, (2) damaged muscle membranes, and (3) defective muscle membranes in certain muscle diseases. In the acutely injured state, the critically dangerous period begins after a grace period of 48–72 hours. With burns and trauma, this period of SCh susceptibility can persist until recovery is well underway even for months. Patients with neuronal inju-

TABLE 33–3.

### Characteristics of Neuromuscular Blockade

#### Depolarizing (Phase I) Block

Muscle fasciculation preceding the onset of neuromuscular blockade

Absence of posttetanic potentiation

Lack of fade to frequent stimulation (e.g., tetanus, train of four, or double burst)

Block antagonized by nondepolarizing drugs

Block potentiated by acetylcholinesterase inhibitors

#### Nondepolarizing and Phase II Block

Absence of muscle fasciculation

Presence of posttetanic potentiation

Fade with frequent stimulation

Possible synergism between various groups of nondepolarizing relaxants

Phase II block and nondepolarizing block potentiate each other

Block may be reversed by acetylcholinesterase inhibitors

ries, such as spinal cord trauma, can have exaggerated responses for more than 6 months. The use of SCh in children is justified only for rapid sequence inductions. It is not warranted for routine pediatric use based on the increased risk of hyperkalemia in children with as yet undiagnosed congenital myopathies.

**Increased intraocular pressure.** SCh can increase the intraocular pressure (IOP). Increased IOP reaches a maximum approximately 2 minutes after SCh is administered and disappears in approximately 6 minutes. This increased IOP traditionally has been considered important for the patient with an open eye injury wherein an increased IOP may cause irreversible loss of vitreous or global contents. However, studies from institutions with great experience with acute eye injuries have not shown adverse effects from use of SCh.<sup>32–34</sup> Pretreatment with a nondepolarizing relaxant, followed by deep anesthetic induction and SCh for intubation, may prevent an increase in IOP. Alternatively, conditions for rapid endotracheal intubation can be obtained using large doses of nondepolarizing NMBD (two or three times ED<sub>95</sub>), with the understanding that neuromuscular blockade will be greatly prolonged.

**Increased intragastric pressure** of approximately 40 cm H<sub>2</sub>O occurs after SCh administration. This is blunted by pretreatment using a nondepolarizing drug followed by a larger dose of SCh (1.5 mg/kg) to achieve good intubating conditions. However, this increased gastric pressure is not believed to be clinically relevant because it is counterbalanced by an even greater increase in lower esophageal sphincter tone. Therefore, SCh is the most widely used drug for rapid sequence induction of patients with a suspected full stomach.

**Increased intracranial pressure** can occur via muscle fasciculations, creating a venous pressure elevation in epidural and jugular veins, and also through increased cerebral blood flow. Pretreatment with a nondepolarizing relaxant prevents this increase. However, an insufficient depth of anesthesia and hypercapnia are even more significant factors increasing intracranial pressure than the minor effects of SCh.

SCh will produce muscle contraction rather than relaxation in patients with myotonia congenita or myotonia dystrophica that can be severe enough to pre-

vent intubation and ventilation. These contractures usually are self-limited and are not inhibited by nondepolarizing agents. Rhabdomyolysis and myoglobinuria can occur with SCh administration in some susceptible patients (e.g., myopathies, glycogen storage diseases). Finally, SCh is a triggering agent to be avoided in patients susceptible to malignant hyperthermia.

## NONDEPOLARIZING NMBDS

### Classification

Nondepolarizing NMBDs are classified by their duration of action and their chemical composition. The approximate duration of neuromuscular blockade provided by a single dose of these drugs may be short (<20 minutes), intermediate (45–60 minutes), or long (>1 hour). The currently available NMBDs are either steroidal molecules or benzylisoquinolines. The benzylisoquinolines are based on the structure of D-tubocurarine (curare [dTC]), a naturally occurring substance obtained from the vine *Chondodendron tomentosum* found in the Amazon Jungle. Curare is no longer commercially available. Pancuronium, the parent chemical of the steroidal NMBDs, was formulated from the compound malouetine, used by African tribesmen as arrowhead poison. Pancuronium is still used in clinical practice.

A brief discussion of the clinical pharmacology of commonly used nondepolarizing NMBDs is provided, beginning with the benzylisoquinolines in order of the duration of their neuromuscular blockade. Factors associated with either increased resistance or increased sensitivity to nondepolarizing relaxants are summarized in Tables 33–4 and 33–5.

### Benzylisoquinolines (Fig. 33–8) Mivacurium (Short-Acting)

Mivacurium is a bisquaternary benzylisoquinoline diester with ED<sub>95</sub> = 0.08 mg/kg, onset of 3.5 minutes, recovery time to 25% of baseline twitch of 15 minutes, and total duration of approximately 25 minutes (Tables 33–6 and 33–7).<sup>35</sup> At comparable doses, mivacurium has twice the duration of SCh and half the duration of intermediate drugs such as atracurium and vecuronium. The onset time can be shortened to 2 minutes by increasing the dose 3-fold. This will increase the du-

TABLE 33–4.

#### Factors Associated with Resistance to Nondepolarizing Relaxants

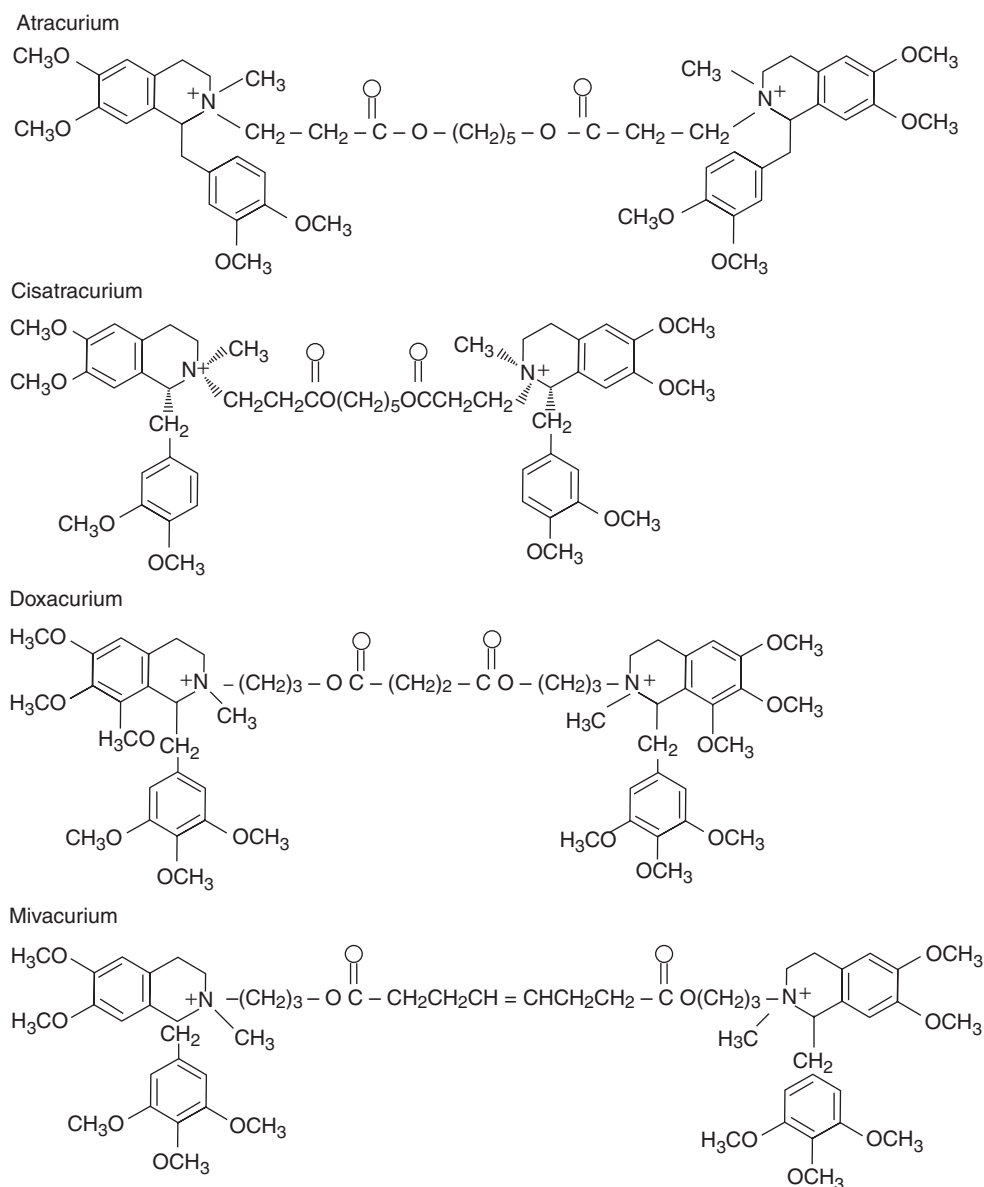
- Presence of extrajunctional receptors
- Burns
- Trauma (massive)
- Upper motor neuron lesions
- Lower motor neuron lesions
- Demyelinating lesions (end-stage lesions may be very sensitive)
- Prolonged immobilization
- Aminophylline
- Theophylline
- Corticosteroids
- Phenytoin

TABLE 33–5.

- Neuromuscular diseases
- Myasthenia gravis
- Muscular dystrophies
- Inhalation anesthetics
- Respiratory acidosis
- Neonatal state
- Hypokalemia
- Hypocalcemia
- Hypernatremia
- Hypermagnesemia
- Antibiotics
- Local anesthetics
- Calcium channel blockers
- Steroids
- Diuretics
- Immunosuppressants
- Antineoplastic agents

ration of the block by 20%.<sup>35</sup> Mivacurium can cause histamine release when large doses are given by IV bolus.<sup>36</sup> In approximately 50% of patients, histamine is released when three times the ED<sub>95</sub> of mivacurium (0.25 mg/kg) is given within <30 seconds. However, when mivacurium was administered in a divided dose regimen of 0.15 mg/kg followed by 0.1 mg/kg 30 seconds later, histamine release did not occur, and good to excellent intubation conditions were achieved 90 seconds after the initial dose.<sup>21,22</sup> Mivacurium-induced blockade can be maintained by continuous infusion without alteration in its recovery characteristics.





**FIGURE 33-8.** Chemical structures of the benzylisoquinoline neuromuscular blocking drugs.

The short duration of block produced by mivacurium is the result of rapid metabolism by plasma cholinesterase at approximately 70–80% the rate of SCh hydrolysis.<sup>37</sup> Biochemical

genetic analysis has shown that the K variant of the plasma cholinesterase gene prolongs recovery from mivacurium.<sup>38</sup> Mivacurium consists of three stereoisomers—*cis-trans* (35–40%), *trans-*

*trans* (50–60%), and *cis-cis* (4–8%)—that differ in their relaxant potency and pharmacokinetics.<sup>39</sup> The *cis-trans* and *trans-trans* isomers are 13 times more potent than the *cis-cis* isomer

**TABLE 33-6.**

**Pharmacodynamics of Mivacurium**

	Dose (mg/kg)	Onset (sec)	Time to 25% Recovery (min)	Time to 95% Recovery
ED <sub>95</sub>	0.08	3.8 ± 0.5	13	21
Routine intubation	0.015/0.01 <sup>a</sup>	1.5–2.0	23	34
Rapid intubation				
Primed intubation	0.015/.0135 <sup>b</sup>	1.6		
Infusion (μg/kg/min)	8.3		4.0–6.5 <sup>c</sup>	13.6–16.6 <sup>c</sup>

<sup>a</sup>Initial dose followed by a second dose at 30 seconds with intubation 60 seconds later.

<sup>b</sup>Priming dose followed in 5 minutes by second dose.

<sup>c</sup>After infusion stopped.

TABLE 33-7.

## Pharmacokinetics of Mivacurium

	Vd <sub>ss</sub> (mL/kg)	Clearance (mL/kg/min)	Elimination Half-Life (min)
Normal	112	55	2.32
Renal failure	150	76.6	
Hepatic failure	124	33.3	
Cirrhosis			11.1

and have elimination half-lives of approximately 2 minutes and clearances of 100 and 60 mL/kg/min, respectively. The *cis-cis* isomer has a half-life of 53 minutes and a clearance rate of 4.6 mL/kg/min. After long duration (hours) infusions of mivacurium, the recovery characteristics do not change, and, importantly, the plasma concentrations of the *cis-cis* isomer do not increase.

Mivacurium is metabolized by plasma cholinesterase.<sup>35,37</sup> As a nondepolarizing agent, it is competitively reversed by anticholinesterases by augmenting the concentration of ACh at the neuromuscular junction.<sup>35</sup> However, recovery may be slowed following reversal with neostigmine in the presence of a dense block (the absence of a twitch or one twitch on TOF stimulation). This delayed recovery is the result of a concomitant inhibition of plasma cholinesterase slowing the hydrolysis of mivacurium by 20–60 minutes and markedly prolonging neuromuscular block in patients with low baseline levels of plasma cholinesterase. Therefore, before attempting reversal of mivacurium with anticholinesterases, there should be an evidence of recovery manifested by the

appearance of at least two twitches in response to TOF stimulation. Edrophonium may be a better choice of anticholinesterase to reverse the action of mivacurium because it inhibits plasma cholinesterase to a lesser degree than does neostigmine.

The recovery after a mivacurium infusion has been compared to recovery after infusions of atracurium, vecuronium, and Sch. Mivacurium blockade recovers from 5–95% approximately 15 minutes after stopping an infusion, regardless of the duration of infusion.<sup>35</sup> It has half the duration of recovery of atracurium and vecuronium<sup>40</sup> and equals the best of phase II-type recoveries of Sch<sup>41</sup> given by infusion. Because mivacurium does not depend on organ metabolism for elimination, there is no tendency toward accumulation. It behaves consistently across age groups and in patients with comorbid disease states having normal plasma cholinesterase activity and hepatic synthetic function.

**Atracurium and Cisatracurium**

Atracurium and cisatracurium are bisquaternary benzylisoquinoline diesters with similar intermediate dura-

tions of action that produce 95% blockade.<sup>42,43</sup> They are unique nondepolarizing blocking drugs that were specifically synthesized to degrade spontaneously and are independent of organ elimination. At physiologic temperature and pH, the Hofmann elimination reaction breaks down both drugs to produce a tertiary amine, laudanosine, and a monoacrylate compound.<sup>43,44</sup> Laudanosine at high plasma levels can cause cerebral excitation and seizure activity in animals, but this has not been a clinical problem in humans. Atracurium is additionally metabolized by nonspecific plasma esterases to a quaternary alcohol and acid.<sup>45</sup>

*Atracurium* has an elimination half-life of approximately 20 minutes, and its plasma clearance rate is 5–6 mL/kg/min.<sup>46</sup> This elimination half-life is approximately seven times shorter than that of long-acting relaxants, with a clearance rate approximately four times faster. The pharmacodynamics and pharmacokinetics of atracurium (Tables 33-8 and 33-9) are relatively unaltered in patients with renal failure<sup>47</sup> or hepatic failure,<sup>46</sup> in infants and children,<sup>45,48</sup> in the elderly,<sup>49</sup> and when given by continuous infusion.<sup>50</sup> Repeated administration or infusion shows no tendency for accumulation as evidenced by increased recovery times.<sup>42</sup> Atracurium causes release of histamine and hypotension when administered at doses >2.5 times its ED<sub>95</sub>, especially when given as a rapid bolus (<15 seconds). When doses <0.5 mg/kg are given or when a large dose of atracurium (>0.6 mg/kg) is given slowly over 15–75 seconds, few patients elicit histamine release and hypotension (Fig. 33-9).<sup>51</sup>

TABLE 33-8.

## Pharmacodynamics of Atracurium

	Dose (mg/kg)	Onset (min)	Time to 25% Recovery (min)	Time to 95% Recovery
ED <sub>95</sub>	0.2	3–5	30–40	45–60
Routine intubation	0.3–0.4	2–3	40–50	50–70
Rapid intubation	0.5	2	45–60	60–90
Primed intubation	0.5	1.5	45–60	60–90
Prime: 0.05 mg/kg				
Time: 3–5 min				
Infusion (μg/kg/min)	7–10	—	12–15 <sup>a</sup>	25 <sup>a</sup>

All doses for balanced anesthesia.  
<sup>a</sup> After infusion stopped.

TABLE 33-9.

## Pharmacokinetics of Atracurium

	Vd <sub>ss</sub> (mL/kg)	Clearance (mL/kg/min)	Elimination Half-Life (min)
Normal	182	6.1	20.6
Renal failure	224	6.7	23.7
Hepatic failure	210	6.5	22
Cirrhosis	—	—	—
Biliary obstruction	—	—	—
Elderly	199	5.4	23.1
Neonates	177–210	5.1–7.9	14–20
Children	129–139	5.1–6.8	17–19

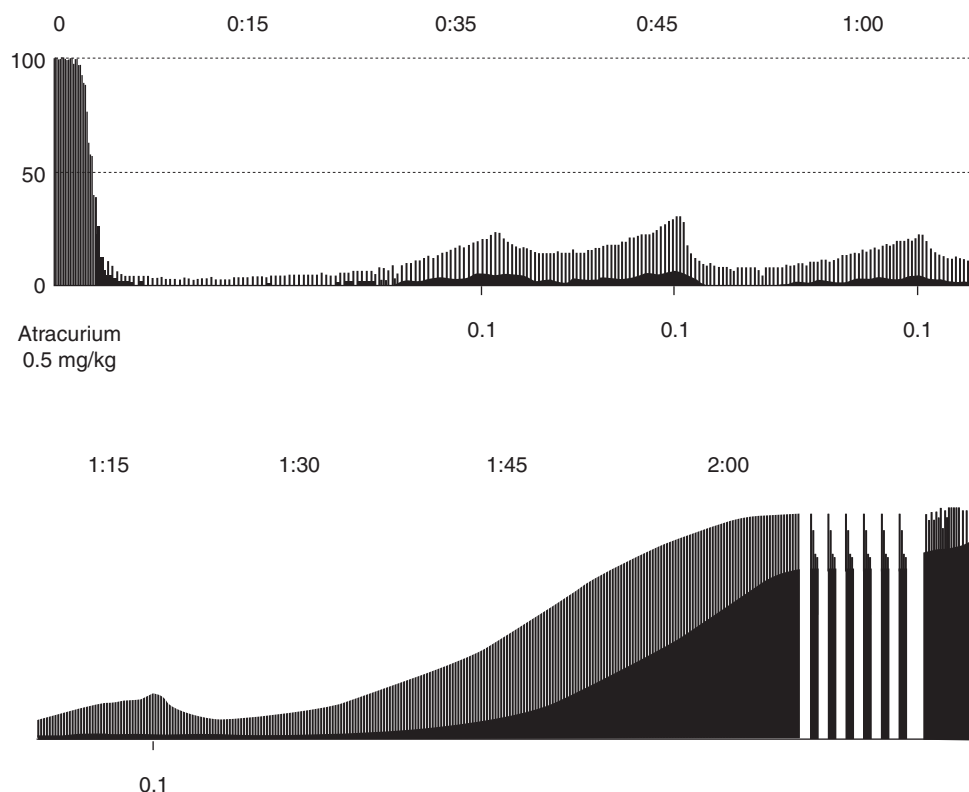
*Cisatracurium* is one of the 1*R*-*cis*,1'*R*-*cis* configurations of one of the 10 isomers of atracurium and is approximately four times as potent as atracurium. The ED<sub>95</sub> is 0.05 mg/kg, with an onset time of 7.5 minutes to complete blockade (2 minutes longer than atracurium), a clinical duration of 45 minutes, and a time to >70% TOF ratio of 67 minutes (Tables 33-10 and 33-11).<sup>44</sup> Cisatracurium recovery indices are unaffected by total dose of relaxant or method of administration. In contrast

to atracurium, doses of cisatracurium as great as eight times the ED<sub>95</sub> have been administered rapidly without any evidence of histamine release.

**Doxacurium**

Doxacurium is a long-acting bisquaternary benzylisoquinoline diester that is poorly metabolized by plasma cholinesterase. Its ED<sub>95</sub> is 25–30 μg/kg.<sup>52</sup> Unlike the other benzylisoquinolines, organ elimination is required for its metabolism. This drug is excreted by

the kidney as the major pathway of elimination, and its action is prolonged in renal failure.<sup>53</sup> It also is excreted unchanged in the bile.<sup>53</sup> Doxacurium exhibits no dose-related cardiovascular side effects. It is useful in long cases wherein extubation is not needed immediately postoperatively, in patients who would benefit from its lack of cardiovascular effects, and perhaps as an adjunct to permit ventilation for short periods in sedated patients in the ICU.



**FIGURE 33-9.** Initial dose of atracurium was 0.5 mg/kg, followed by four increments of 0.1 mg/kg every 15 minutes. Note when T<sub>1</sub> spontaneously recovered to control height and train-of-four ratio was 0.74 and increased to 0.85 in the next 4 minutes. (From Ali HH, Miller RD. Monitoring of neuromuscular function. In Miller RD, ed. Anesthesia, vol. 2. 2nd ed. New York: Churchill-Livingstone, 1986, with permission from Elsevier. Copyright 1996.)

TABLE 33–10.

## Pharmacodynamics of Cisatracurium

	Dose (mg/kg)	Onset (min)	Time to 25% Recovery	Time to 95% Recovery
ED <sub>95</sub>	0.05	7.6 ± 1.4		
Routine intubation	0.2	2.7 ± 0.1	68.3 ± 2.4	87 ± 4.3
Rapid intubation	0.4	2.7 ± .01	91.3 ± 3.3	121 ± 5.9
Primed intubation	—	—	—	—
Infusion (μg/kg/min)	1.6 <sup>a</sup>			33.2 ± 1.8 <sup>b</sup>

<sup>a</sup>After 0.1 mg/kg bolus.  
<sup>b</sup>After infusion stopped.

TABLE 33–11.

## Pharmacokinetics of Cisatracurium

	Vd <sub>ss</sub> (mL/kg)	Clearance (mL/kg/min)	Elimination Half-Life (min)
Normal	121 ± 22	4.66 ± 0.67	25.5 ± 4.1
Renal failure	—	—	—
Hepatic failure	195 ± 38	6.6 ± 1.1	24.4 ± 2.9
Cirrhosis	—	—	—
Biliary obstruction	—	—	—
Elderly	190 (141–238)	4.55	28.4
Neonates	—	—	—
Children	—	—	—

All doses for balanced anesthesia.

## Steroidal Muscle Relaxants (Fig. 33–10)

## Vecuronium

Vecuronium (Tables 33–12 and 33–13, Fig. 33–4) is the monoquaternary analogue of the steroidal relaxant pancuronium.<sup>54</sup> Vecuronium is a more potent NMBD than pancuronium,<sup>55</sup> with half to one third of its duration of action by demethylation at the 2-position of the D ring, the position of the steroidal nucleus that is responsible for its potency. It is a lipophilic compound that is easily absorbed by the liver and excreted into the bile mostly as the unchanged drug, the predominant method of elimination.<sup>55</sup> The action of this drug can be prolonged in patients with liver disease.<sup>56</sup> Vecuronium is metabolized in the liver to 3-desacetylvecuronium, 17-desacetylvecuronium, and 3,17-desacetylvecuronium.<sup>57</sup> The 3-desacetylvecuronium has neuromuscular blocking properties at approximately half the potency of vecuronium. This metabolite is eliminated by the kidneys, which may account

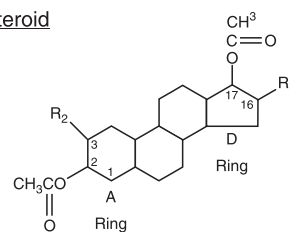
for the prolonged block when vecuronium is given as a continuous infusion to facilitate mechanical ventilation of patients in the ICU who have compromised renal function.<sup>58,59</sup> Recovery times are increased in infants younger than 1 year, based on their increased sensitivity to vecuronium and larger volume of distribution and decreased clearance rate.<sup>60</sup>

Vecuronium does not have effects on heart rate and blood pressure through modification of the A ring of the steroidal nucleus.<sup>61</sup> At doses >0.1 mg/kg, it may inhibit the enzyme histamine-N-methyltransferase,<sup>62</sup> which may contribute to occasional reports of histamine-like reactions to vecuronium.<sup>63,64</sup> This may be a concern especially when other drugs that release histamine (e.g., the antibiotic vancomycin) are administered or when histamine-rich organs are manipulated during a surgical procedure.<sup>62</sup>

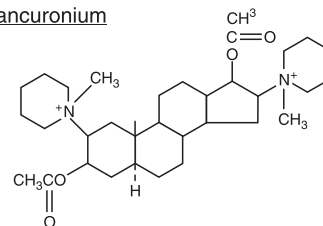
## Rocuronium

Rocuronium (Tables 33–14 and 33–15) is the 2-morpholino, 3-desacetyl 16-N-

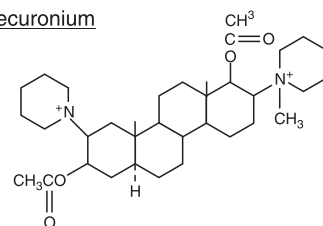
## Steroid



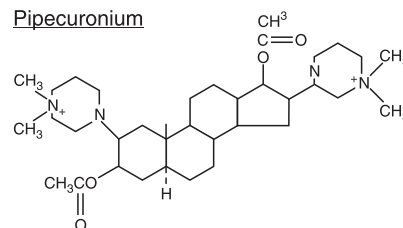
## Pancuronium



## Vecuronium



## Pipecuronium



## Rocuronium

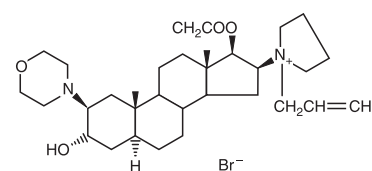


FIGURE 33–10. Chemical structure of steroidal class neuromuscular blocking drugs.

allylpyrrolidino derivative of vecuronium.<sup>65</sup> It was developed specifically to have a rapid onset of action. It achieves this effect partly by being approximately six times less potent than vecuronium and by having a similar molecular weight.<sup>16</sup> This results in a larger number of molecules reaching the neuromuscular junction per circulation time and may contribute to the more rapid development of its neuromuscular blockade. Rocuronium undergoes rapid uptake by the liver because of its relative lipophilicity. Unchanged rocuronium has been found in the urine (8.7%) and in the bile (>50%), indicating dual pathways for its elimination.<sup>66</sup> The rapid redistribution of rocuronium from the



TABLE 33-12.

## Pharmacodynamics of Vecuronium

	Dose (mg/kg)	Onset (min)	Time to 25% Recovery (min)	Time to 95% Recovery
ED <sub>95</sub>	0.05	3.5	30–40	50–60
Routine intubation	0.08–0.1	2.3	45–60	60–80
Rapid intubation	0.2	1.5–2.0	60–80	80–120
Primed intubation	0.1–0.15	1.5	45–80	60–120
Prime: 0.01 mg/kg Time: 4 min				
Infusion (μg/kg/min)	1–2	—	12–15 <sup>a</sup>	30 <sup>a</sup>

All doses for balanced anesthesia.  
<sup>a</sup>After infusion stopped.

TABLE 33-13.

## Pharmacokinetics of Vecuronium

	Vd <sub>ss</sub> (mL/kg)	Clearance (mL/kg/min)	Elimination Half-Life (min)
Normal	190	3.0	79.5
Renal failure <sup>a</sup>	240	2.5	97.1
	(295)	(2.1 vs 4.3)	(148 vs 84)
Hepatic failure <sup>a</sup>	(232)	(3.6 vs 54.1)	(70 vs 49)
Cirrhosis	300	2.7	84
Biliary obstruction	290	2.4	98
Elderly	180	3.7	58
Neonates	357	(5.6 vs 5.2)	(64.7 vs 70) <sup>b</sup>
Children	204	(5.9 vs 5.2)	(41.0 vs 70) <sup>b</sup>

<sup>a</sup>Values in parentheses include 3-desacetyl vecuronium metabolite.  
<sup>b</sup>Mean residence time: 66 minutes for infants, 34 minutes for children, vs 52 minutes for adults.

TABLE 33-14.

## Pharmacodynamics of Rocuronium

	Dose (mg/kg)	Onset (sec)	Time to 25% Recovery (min)	Time to 95% Recovery
ED <sub>95</sub>	0.30	210 ± 55	20(14–28)	
Routine intubation	0.60	89 ± 33	37 (23–75)	
Rapid intubation	1.2	55 ± 14	73 (38–150)	
Primed intubation				
Infusion	10 <sup>a</sup>		13 ± 4 <sup>b</sup>	46 ± 19 <sup>b</sup>

All doses for balanced anesthesia.  
<sup>a</sup>After 0.45 mg/kg bolus.  
<sup>b</sup>After infusion stopped.

neuromuscular junction contributes to its intermediate duration of action at lower doses. The pharmacokinetics of this drug have been reported to be altered in patients with major renal<sup>67</sup> and hepatic<sup>68</sup> disease. In both infants and elderly patients, the changes in the pharmacokinetics of rocuronium increases the duration of action.<sup>69</sup> Rocuronium does not produce alterations in heart rate and blood pressure.<sup>70</sup>

The ED<sub>95</sub> of rocuronium is 0.3 mg/kg, with a recovery index of 8 minutes and a clinical duration of <20 minutes. Mean onset times at 2× ED<sub>95</sub> (0.6 mg/kg), 3× ED<sub>95</sub> (0.9 mg/kg), and 4× ED<sub>95</sub> (1.2 mg/kg) are approximately 90, 75, and 55 seconds, respectively, with ranges of 48–156, 48–144, and 36–84 seconds.<sup>71</sup> These are the most rapid onset times at equipotent doses of any nondepolarizing relaxant currently available. It has been suggested that this drug in appropriate doses may be useful as an alternative to SCh for rapid intubation of the trachea.<sup>71</sup> Because rocuronium depends on organs of elimination for its termination of action,<sup>72</sup> it has a dose-related escalation of clinical duration. At 2×, 3×, and 4× the ED<sub>95</sub> dose, expected durations to 25% recovery are 37 (range 23–75), 53 (range 25–88), and 73 (range 38–150) minutes, respectively.<sup>71</sup> In addition, recovery from lengthy rocuronium infusions is markedly slower than from single doses of moderate quantity (e.g., 0.6 mg/kg).

### Pancuronium

Pancuronium (Tables 33-16 and 33-17) is predominantly eliminated by the kidney and has a prolonged duration of neuromuscular blockade in patients with renal insufficiency. Clearance of pancuronium is minimally altered in patients with obstructive hepatic disease, whereas the volume of distribution at steady state is increased.<sup>73</sup> This implies that in patients with hepatic disease, greater doses may be needed to establish neuromuscular blockade that might be prolonged. In elderly patients, the duration of action is prolonged secondary to compromised clearance of the drug. Approximately 10–20% of the injected dose of pancuronium is metabolized in the liver to three metabolites: 3-hydroxypancuronium, 17-hydroxypancuronium, and 3,17-dihydroxypancuronium. The 3-hydroxy metabolite is about half as

TABLE 33-15.

## Pharmacokinetics of Rocuronium

	Vd <sub>ss</sub> (mL/kg)	Clearance (mL/kg/min)	Elimination Half-Life (min)
Normal	207 ± 14	2.89 ± 0.25	70.9 ± 4.7
Renal failure	264 ± 19	2.89 ± 0.25	97.2 ± 17.3
Hepatic failure			
Cirrhosis	234 ± 50	2.41 ± 0.57	96 ± 36.8
Biliary obstruction			
Elderly	399 ± 122 <sup>a</sup>	3.67 ± 1	97.6 ± 69.1
Neonates			
Children	224	2.67	46 <sup>b</sup> – 55 <sup>c</sup>

<sup>a</sup>Vd<sub>ss</sub> was 552.9 [+/-] 279 for normal subjects.  
<sup>b</sup>For 20 kg.  
<sup>c</sup>For 50 kg.

TABLE 33-16.

## Pharmacodynamics of Pancuronium

	Dose (mg/kg)	Onset (min)	Time to 25% Recovery (min)	Time to 95% Recovery
ED <sub>95</sub>	0.07	3–5	80–90	120
Routine intubation	0.08–0.10	2–3	90–100	120–150
Rapid intubation	0.2	1.5–2.0	120–150	180–300
Primed intubation	0.15	1.5–2.0	120–150	180–300
Prime: 0.02 mg/kg				
Time: 3 min				

All doses for balanced anesthesia.

TABLE 33-17.

## Pharmacokinetics of Pancuronium

	Vd <sub>ss</sub> (mL/kg)	Clearance (mL/kg/min)	Elimination Half-Life (min)
Normal	150–340	1.0–1.9	100–132
Renal failure	240–330	0.3–0.9	257–289
Hepatic failure	190	0.57	303
Cirrhosis	350	1.5	208
Biliary obstruction	310–430	1.1–1.5	270
Elderly	250	0.8–1.3	168–204
Neonates	—	—	—
Children	—	—	—

potent as the parent compound and is cleared by the kidney.

Pancuronium has a tendency to increase heart rate, blood pressure, and cardiac output through a vagolytic action at muscarinic receptors in the autonomic nervous system and via in-

hibition of catecholamine reuptake at sympathetic nerve terminals.

**Pipecuronium**

Pipecuronium is a potent steroidal class relaxant that is slightly more potent than pancuronium, with an ED<sub>95</sub> of 40

μg/kg.<sup>74</sup> There is essentially no organ metabolism of pipecuronium, and it is entirely eliminated in the urine by renal excretion. In patients with renal failure, excretion is delayed, clearance is decreased, elimination half-life is lengthened, and the duration of the neuromuscular blockade may be prolonged.<sup>41</sup> Because the quaternary nitrogen groups are distant from the 3,17-acetoxy substitutions in the steroid nucleus, pipecuronium is not vagolytic and does not block autonomic ganglia in the clinically used dose range.<sup>75</sup>

**MAINTENANCE OF NEUROMUSCULAR BLOCKADE BY INFUSION**

Intermittent intravenous bolus doses of nondepolarizing NMBDs to maintain adequate levels of surgical paralysis are readily accomplished by giving one fifth to one third the original dose titrated against some objective criteria (e.g., number of twitches in the TOF, clinical evaluation of abdominal relaxation). This process usually is necessary every 40–60 minutes, although more frequent supplemental doses are needed with the short- and intermediate-acting agents. An appropriate option for maintaining more constant and prolonged neuromuscular blockade is a continuous infusion to achieve steady-state plasma levels of drug within a therapeutic window. The infusion of NMBD can be titrated to achieve a stable depth of neuromuscular blockade (usually one or two responses to TOF) permitting a rapid reversal when needed, for example, for daily assessment of a patient's neurologic status.

SCh has been given in the past by IV infusion for maintenance of neuromuscular blockade but is no longer routinely used for this purpose. During infusion of SCh, neuromuscular blockade can change from phase I to phase II block in approximately two thirds of patients receiving a nitrous-narcotic anesthetic, with an extremely variable time of onset. Approximately half of these patients recover rapidly (5–95% recovery in 15 minutes). The remaining half recover to approximately 75% in roughly 30 minutes and require reversal with an anticholinesterase drug.<sup>76</sup> Inhalational anesthetics hasten the onset of phase II block, which usually is heralded by tachy-

phylaxis. The key to successful use of SCh as a continuous infusion is to recognize the presence of phase II block (TOF fade >50%) and to not attempt to reverse until a plateau of recovery has been reached.

Vecuronium and rocuronium by infusion have been used with considerable success. After maintaining steady-state paralysis of approximately 95% and then discontinuing the infusion, mean recovery time to 25% is approximately 13 minutes, and mean 5–95% recovery times are approximately 32 minutes.<sup>77</sup> However, there is an age-dependent decrease in the steady-state drug infusion requirement and an increased recovery time required for patients older than 60 years.<sup>58</sup> These and other findings suggest that disease states or age that alter organ elimination generally decrease maintenance drug infusion requirements and slow the speed of recovery to some extent with vecuronium. This is especially true for long-term infusions in patients with renal failure, because the 3-desacetyl metabolite of vecuronium, which is a potent neuromuscular blocking compound, is eliminated by the kidney.<sup>59,78</sup>

Atracurium and cisatracurium have similar recovery characteristics after infusions in healthy patients. The 25% recovery time after infusion is approximately 12.5 minutes, and the 5–95% mean recovery time is 26.6 minutes during oxygen/nitrous oxide/narcotic anesthesia. Unlike vecuronium, atracurium and cisatracurium show no tendency toward prolonged recovery in disease states, such as renal failure, cirrhosis, and hepatic failure, or at the extremes of age because of its spontaneous degradation by the Hofmann elimination reaction and metabolism by nonspecific plasma cholinesterases.

Mivacurium, because of its metabolism by human plasma cholinesterase at 70% the rate of SCh, has significant clinical potential for maintenance of blockade by continuous infusion. During balanced anesthesia, the time from discontinuing the infusion of mivacurium to 25% recovery was 5.7 minutes, with a 5–95% recovery time of 13.6 minutes.<sup>40</sup> Its recovery characteristics are much shorter than those of atracurium, cisatracurium, vecuronium, and rocuronium and compare favorably with the short recovery times achieved with SCh.

## RELAXANTS IN THE INTENSIVE CARE UNIT

NMBDs in the intensive care unit can be valuable adjuncts for managing intubated and mechanically ventilated patients.<sup>79</sup> Neuromuscular blockade may be helpful for diminishing the risk of barotrauma by reducing peak airway pressures, minimizing oxygen consumption in hypothermic patients by preventing shivering, decreasing intra-abdominal pressure, and stopping respiratory activity that is asynchronous with the ventilatory cycle when all other treatments have failed. NMBD also can be given to help mechanically ventilated patients with unusual problems (status epilepticus, tetanus, botulism) that are resistant to conventional methods of treatment. The use of NMBD in critically ill patients must be balanced with the most serious side effect of severe myopathy.<sup>59,79–81</sup> This critical illness myopathy is characterized by marked atrophy of type I and type II muscle fibers, little evidence of inflammation, and sparing of the motor and sensory nerves.<sup>82</sup> Although the steroidal muscle relaxants have been implicated because the myopathy associated with their use is similar to the myopathy caused by exogenous corticosteroid administration,<sup>59,83</sup> all classes of NMBD contribute to myopathy. In the ICU, the underlying complex systemic disease processes (including sepsis and burns), prolonged immobility, ventilator dependence, use of various drugs that may affect the neuromuscular system, and the initial more frequent use of the steroidal muscle relaxants as compared with the benzyloquinolines in ICU patients have confounded studies of myopathy caused by prolonged neuromuscular blockade.<sup>79</sup>

*Atracurium* and *cisatracurium* can be given to critically ill patients with renal failure.<sup>84</sup> The epileptogenic effects of laudanosine, a metabolite of the Hofmann degradation, have not been reported in patients receiving atracurium infusions. The highest plasma concentrations of laudanosine measured in human plasma during continuous infusions in the ICU are <6 µg/mL, far lower than the 17 µg/mL needed to produce seizures in animals.<sup>85</sup>

*Pancuronium*, because it is the NMBD in longest use, frequently was given to ICU patients prior to the

availability of the benzyloquinoline NMBD and sedatives, such as propofol, to facilitate mechanical ventilation. Because of its cardiovascular effects, pancuronium may be a poor choice for patients in whom dysrhythmias and tachycardia would be detrimental. Furthermore, because pancuronium is primarily excreted by the kidneys, patients with compromised renal function may experience a prolonged duration of effect, causing confusion over the patient's neurologic status.

*Vecuronium* is eliminated primarily by biliary clearance and only minimally by renal clearance. When vecuronium was administered as an infusion to maintain approximately 80% blockade in patients with renal and respiratory failure, recovery to control twitch height after stopping the infusion took from 6–37 hours compared with an approximately 1-hour recovery for cisatracurium.<sup>59</sup> A prolonged recovery may occur secondary to accumulation of the 3-desacetyl metabolite of vecuronium that has approximately 50% of the parent compound's neuromuscular blocking activity and is cleared by the kidney.

## RESIDUAL NEUROMUSCULAR BLOCKADE

Residual neuromuscular blockade is observed occasionally in patients admitted to the postanesthesia care unit (PACU).<sup>86–89</sup> "Recurarization" is the term that initially was coined for patients who were reparable after seemingly adequate reversal of neuromuscular blockade in the operating room. Recurarization is clearly a misnomer: what we observe in the PACU is failure to adequately reverse the action of neuromuscular blockade. One long-standing guide for the clinician has been a return to TOF ratio = 0.7 as a reliable indicator for the return of sufficient muscular function to permit endotracheal extubation.<sup>6,90</sup> If we base recovery on the level of pharyngeal function at rest and during swallowing in partially paralyzed subjects, recovery to TOF ratios >0.9 has been advocated.<sup>91</sup> The return of TOF toward baseline should be considered only one criterion in concert with the sum total of multiple clinical observations such as respiratory function and the ability to follow com-

TABLE 33–18.

## Criteria of Adequate Recovery

Criteria used depend on whether the patient is awake or somnolent.

## Patient Is Awake

Opens eyes widely to command and denies diplopia

Sustains tongue protrusion

Swallows effectively

Sustains a head lift for 5 seconds

Sustains a firm hand grip

Has an effective cough

Has a vital capacity of at least 15 mL/kg

Can generate an inspiratory force of at least 30 cm H<sub>2</sub>O

## Patient Is Somnolent

Can generate an inspiratory force of at least 30 cm H<sub>2</sub>O

Responds to nerve stimulator appropriately, including sustained tetanic response to 50 Hz for 5 seconds

TOF or DBS stimulus yields ratio >0.7 or no discernible fade of fully abducted thumb

DBS, double-burst stimulation; TOF, train of four.

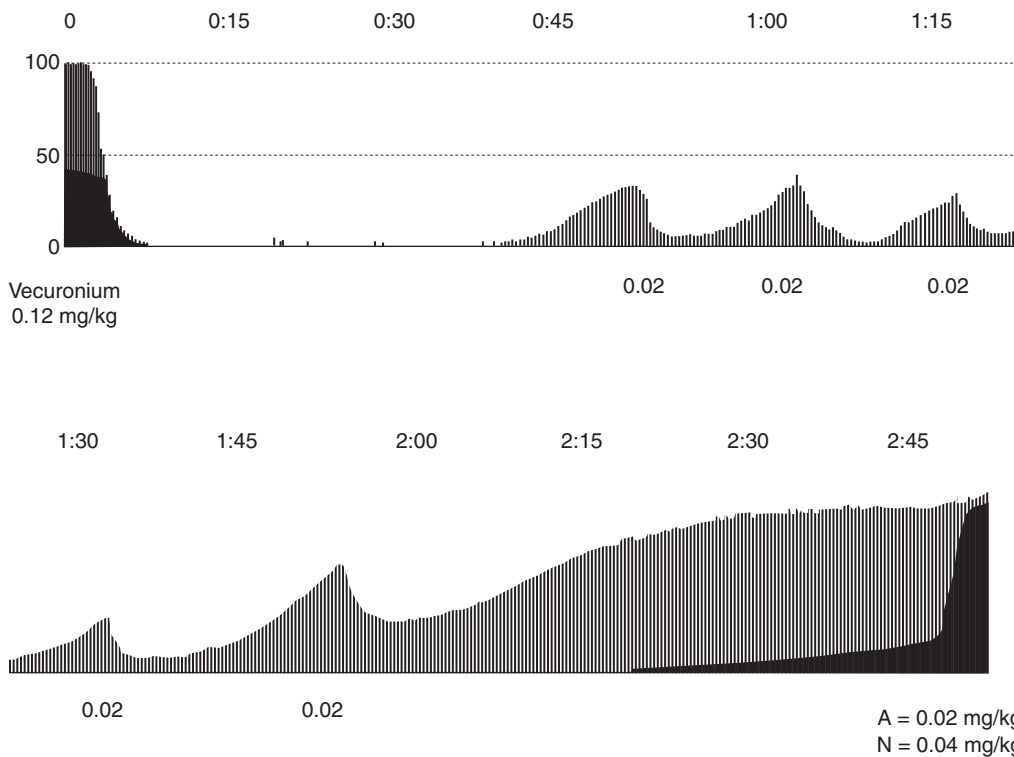
mands (Table 33–18) as an indication of adequate recovery from neuromuscular blockade.

Reversal of neuromuscular blockade by the administration of an anticholinesterase (e.g., neostigmine or edrophonium) is routinely needed in the operating room or PACU (Fig. 33–11). Through inhibition of acetylcholinesterase activity, the concentration of ACh will increase and be available to compete with the nondepolarizing NMBD. A muscarinic antagonist is simultaneously administered to limit any untoward effects of ACh (bradycardia, bronchospasm, or gastrointestinal hyperactivity). Because the anticholinesterase and muscarinic antagonist should have similar durations, the usual drug pairs that are commonly given are neostigmine/glycopyrrolate or edrophonium/atropine. The timing of the administration of anticholinesterases is important. Profound neuromuscular blockade with NMBD that is dependent on organ elimination may require up to 80 minutes for full recovery.<sup>92–94</sup> In routine clinical practice, upon return of the TOF to a single twitch, adequate recovery from neuromuscular blockade

to allow successful extubation usually is present within 20 minutes. In lieu of acetylcholinesterase inhibitors, drug-specific cyclodextrins may provide reversal of neuromuscular blockade in the future. A  $\gamma$ -cyclodextrin, sugammadex, has been synthesized to reverse a profound neuromuscular blockade after rocuronium administration.<sup>95,96</sup> This is accomplished by encapsulating rocuronium, decreasing its free concentration in the plasma, and thereby removing this NMBD from the neuromuscular junction. The sugammadex-rocuronium complex is cleared by the kidney. Although sugammadex is specific for rocuronium, it is tempting to speculate that similar encapsulating agents for the other steroidal and benzyloisoquinoline NMBD will be synthesized.

## KEY REFERENCES

1. Ali HH. Criteria of adequate clinical recovery from neuromuscular block. *Anesthesiology* 2003;98:1278.



**FIGURE 33–11.** Tracing of an evoked thenar electromyography after administration of vecuronium. After the initial dose, supplemental vecuronium was given in 15-minute increments. Spontaneous recovery of the first train-of-four (TOF) response to control height took approximately 30 minutes. The fourth response to the TOF occurred 15 minutes later (dark shadow) and required reversal with neostigmine and atropine to achieve a ratio of 0.9.



2. Ali HH, Savarese JJ, Lebowitz PW, et al. Twitch, tetanus and train-of-four as indices of recovery from nondepolarizing neuromuscular blockade. *Anesthesiology* 1981;54:294.
3. Bevan DR, Smith CE, Donati F. Postoperative neuromuscular blockade: a comparison between atracurium, vecuronium, and pancuronium. *Anesthesiology* 1988;69:272.
4. Debaene B, Plaud B, Dilly MP, et al. Residual paralysis in the PACU after a single intubating dose of nondepolarizing muscle relaxant with an intermediate duration of action. *Anesthesiology* 2003;98:1042.
5. Eriksson LI, Sundman E, Olsson R, et al. Functional assessment of the pharynx at rest and during swallowing in partially paralyzed humans: simultaneous videomanometry and mechanomyography of awake human volunteers. *Anesthesiology* 1997;87:1035.
6. Hayes AH, Mirakhor RK, Breslin DS, et al. Postoperative residual block after intermediate acting neuromuscular blocking drugs. *Anaesthesia* 2001;56:312.
7. Martyn JA, Richtsfeld M. Succinylcholine-induced hyperkalemia in acquired pathologic states. Etiologic factors and molecular mechanisms. *Anesthesiology* 2006;104:158.
8. Naguib M, Flood P, McArdle JJ, et al. Advances in neurobiology of the neuromuscular junction: implications for the anesthesiologist. *Anesthesiology* 2002;96:202.
9. Schow AJ, Lubarsky DA, Olson RP, et al. Can succinylcholine be used safely in hyperkalemic patients? *Anesth Analg* 2002;95:119.
10. Watling SM, Dasta JF. Prolonged paralysis in intensive care unit patients after the use of neuromuscular blocking agents: a review of the literature. *Crit Care Med* 1994;22:884.

## REFERENCES

1. Naguib M, Flood P, McArdle JJ, et al. Advances in neurobiology of the neuromuscular junction: implications for the anesthesiologist. *Anesthesiology* 2002;96:202.
2. Katz RL. Neuromuscular effects of d-tubocurarine, edrophonium and neostigmine in man. *Anesthesiology* 1967;28:327.
3. Martyn JA, Richtsfeld M. Succinylcholine-induced hyperkalemia in acquired pathologic states. Etiologic factors and molecular mechanisms. *Anesthesiology* 2006;104:158.
4. Ali HH. Monitoring of neuromuscular function. *Middle East J Anesthesiol* 1989;10:261.
5. Ali HH, Savarese JJ. Stimulus frequency and dose-response curve to d-tubocurarine in man. *Anesthesiology* 1980;52:36.
6. Ali HH, Savarese JJ, Lebowitz PW, et al. Twitch, tetanus and train-of-four as indices of recovery from nondepolarizing neuromuscular blockade. *Anesthesiology* 1981;54:294.
7. Ali HH, Utting JE, Gray TC. Quantitative assessment of residual antidepolarizing block. I. *Br J Anaesth* 1971;43:473.
8. Ali HH, Utting JE, Gray TC. Quantitative assessment of residual antidepolarizing block. II. *Br J Anaesth* 1971;43:478.
9. Ali HH. Criteria of adequate clinical recovery from neuromuscular block. *Anesthesiology* 2003;98:1278.
10. Viby-Mogensen J, Howardy-Hansen P, Chraemmer-Jorgensen B, et al. Posttetanic count (PTC): a new method of evaluating an intense nondepolarizing neuromuscular blockade. *Anesthesiology* 1981;55:458.
11. Drenck NE, Ueda N, Olsen NV, et al. Manual evaluation of residual curarization using double burst stimulation: a comparison with train-of-four. *Anesthesiology* 1989;70:578.
12. Engbaek J, Ostergaard D, Viby-Mogensen J. Double burst stimulation (DBS): a new pattern of nerve stimulation to identify residual neuromuscular block. *Br J Anaesth* 1989;62:274.
13. Pino R, Ali HH. Monitoring neuromuscular blockade. *Curr Opin Anesth* 1995;8:348.
14. Eikermann M, Groeben H, Husing J, et al. Accelerometry of adductor pollicis muscle predicts recovery of respiratory function from neuromuscular blockade. *Anesthesiology* 2003;98:1333.
15. Viby-Mogensen J, Jensen NH, Engbaek J, et al. Tactile and visual evaluation of the response to train-of-four nerve stimulation. *Anesthesiology* 1985;63:440.
16. Bartkowski RR, Witkowski TA, Azad S, et al. Rocuronium onset of action: a comparison with atracurium and vecuronium. *Anesth Analg* 1993;77:574.
17. Kopman AF. Pancuronium, gallamine, and d-tubocurarine compared: is speed of onset inversely related to drug potency? *Anesthesiology* 1989;70:915.
18. Donati F, Meistelman C, Plaud B. Vecuronium neuromuscular blockade at the adductor muscles of the larynx and adductor pollicis. *Anesthesiology* 1991;74:833.
19. Donati F, Meistelman C, Plaud B. Vecuronium neuromuscular blockade at the diaphragm, the orbicularis oculi, and adductor pollicis muscles. *Anesthesiology* 1990;73:870.
20. Mehta MP, Choi WW, Gergis SD, et al. Facilitation of rapid endotracheal intubations with divided doses of nondepolarizing neuromuscular blocking drugs. *Anesthesiology* 1985;62:392.
21. Ali HH, Lien CA, Witkowski T, et al. Efficacy and safety of divided dose administration of mivacurium for a 90-second tracheal intubation. *J Clin Anesth* 1996;8:276.
22. Pino RM, Ali HH, Denman WT, et al. A comparison of the intubation conditions between mivacurium and rocuronium during balanced anesthesia. *Anesthesiology* 1998;88:673.
23. Miller RD. The priming principle. *Anesthesiology* 1985;62:381.
24. Mak PH, Irwin MG. The effect of cisatracurium and rocuronium on cisatracurium precurarization and the priming principle. *J Clin Anesth* 2004;16:83.
25. Naguib M, Abdulatif M, Gyasi HK, et al. Priming with atracurium: improving intubating conditions with additional doses of thiopental. *Anesth Analg* 1986;65:1295.
26. Schwarz S, Ilias W, Lackner F, et al. Rapid tracheal intubation with vecuronium: the priming principle. *Anesthesiology* 1985;62:388.
27. Taboada JA, Rupp SM, Miller RD. Refining the priming principle for vecuronium during rapid-sequence induction of anesthesia. *Anesthesiology* 1986;64:243.
28. Naguib M, Samarkandi AH, Abdullah K, et al. Succinylcholine dosage and apnea-induced hemoglobin desaturation in patients. *Anesthesiology* 2005;102:35.
29. Levano S, Ginz H, Siegemund M, et al. Genotyping the butyrylcholinesterase in patients with prolonged neuromuscular block after succinylcholine. *Anesthesiology* 2005;102:531.
30. Whittaker M. Plasma cholinesterase variants and the anaesthetist. *Anaesthesia* 1980;35:174.
31. Schow AJ, Lubarsky DA, Olson RP, et al. Can succinylcholine be used safely in hyperkalemic patients? *Anesth Analg* 2002;95:119.
32. Donlon JV. Succinylcholine and open eye injuries. *Anesthesiology* 1986;65:526.
33. Libonati M, Leahy J, Ellson V. The use of succinylcholine in open eye surgery. *Anesthesiology* 1986;64:517.
34. Vachon CA, Warner DO, Bacon DR. Succinylcholine and the open globe. Tracing the teaching. *Anesthesiology* 2003;99:220.
35. Savarese JJ, Ali HH, Basta SJ, et al. The clinical neuromuscular pharmacology of mivacurium chloride (BW B1090U). A short-acting nondepolarizing ester neuromuscular blocking drug. *Anesthesiology* 1988;68:723.

36. Savarese JJ, Ali HH, Basta SJ, et al. The cardiovascular effects of mivacurium chloride (BW B1090U) in patients receiving nitrous oxide-opiate-barbiturate anesthesia. *Anesthesiology* 1989;70:386.
37. Cook DR, Stiller RL, Weakly JN, et al. In vitro metabolism of mivacurium chloride (BW B1090U) and succinylcholine. *Anesth Analg* 1989;68:452.
38. Gatke MR, Viby-Mogensen J, Ostergaard D, et al. Response to mivacurium in patients carrying the k variant in the butyrylcholinesterase gene. *Anesthesiology* 2005;102:503.
39. Basta SJ. Clinical pharmacology of mivacurium chloride: a review. *J Clin Anesth* 1992;4:153.
40. Ali HH, Savarese JJ, Embree PB, et al. Clinical pharmacology of mivacurium chloride (BW B1090U) infusion: comparison with vecuronium and atracurium. *Br J Anaesth* 1988;61:541.
41. Caldwell JE, Heier T, Kitts JB, et al. Comparison of the neuromuscular block induced by mivacurium, suxamethonium or atracurium during nitrous oxide-fentanyl anaesthesia. *Br J Anaesth* 1989;63:393.
42. Basta SJ, Ali HH, Savarese JJ, et al. Clinical pharmacology of atracurium besylate (BW 33A): a new non-depolarizing muscle relaxant. *Anesth Analg* 1982;61:723.
43. Hughes R, Chapple DJ. The pharmacology of atracurium: a new competitive neuromuscular blocking agent. *Br J Anaesth* 1981;53:31.
44. Lien CA, Schmith VD, Belmont MR, et al. Pharmacokinetics of cisatracurium in patients receiving nitrous oxide/opioid/barbiturate anesthesia. *Anesthesiology* 1996;84:300.
45. Fisher DM, Canfell PC, Spellman MJ, et al. Pharmacokinetics and pharmacodynamics of atracurium in infants and children. *Anesthesiology* 1990;73:33.
46. Ward S, Neill EA, Weatherley BC, et al. Pharmacokinetics of atracurium besylate in healthy patients (after a single i.v. bolus dose). *Br J Anaesth* 1983;55:113.
47. Fahey MR, Rupp SM, Fisher DM, et al. The pharmacokinetics and pharmacodynamics of atracurium in patients with and without renal failure. *Anesthesiology* 1984;61:699.
48. Brandom BW, Stiller RL, Cook DR, et al. Pharmacokinetics of atracurium in anaesthetized infants and children. *Br J Anaesth* 1986;58:1210.
49. Kent AP, Parker CJ, Hunter JM. Pharmacokinetics of atracurium and laudanosine in the elderly. *Br J Anaesth* 1989;63:661.
50. d'Hollander AA, Luyckx C, Barvais L, et al. Clinical evaluation of atracurium besylate requirement for a stable muscle relaxation during surgery: lack of age-related effects. *Anesthesiology* 1983;59:237.
51. Scott RP, Savarese JJ, Basta SJ, et al. Atracurium: clinical strategies for preventing histamine release and attenuating the haemodynamic response. *Br J Anaesth* 1985;57:550.
52. Basta SJ, Savarese JJ, Ali HH, et al. Clinical pharmacology of doxacurium chloride. A new long-acting nondepolarizing muscle relaxant. *Anesthesiology* 1988;69:478.
53. Dresner DL, Basta SJ, Ali HH, et al. Pharmacokinetics and pharmacodynamics of doxacurium in young and elderly patients during isoflurane anesthesia. *Anesth Analg* 1990;71:498.
54. Savage DS, Sleigh T, Carlyle I. The emergence of ORG NC 45, 1-[2 beta,3 alpha,5 alpha,16 beta,17 beta]-3, 17-bis(acetyloxy)-2-(1-piperidinyl)-androstan-16-yl]-1-methylpiperidinium bromide, from the pancuronium series. *Br J Anaesth* 1980;52(Suppl 1):3S.
55. Fahey MR, Morris RB, Miller RD, et al. Clinical pharmacology of ORG NC45 (Norcuron™): a new nondepolarizing muscle relaxant. *Anesthesiology* 1981;55:6.
56. Duvaldestin P, Saada J, Berger JL, et al. Pharmacokinetics, pharmacodynamics, and dose-response relationships of pancuronium in control and elderly subjects. *Anesthesiology* 1982;56:36.
57. Marshall IG, Gibb AJ, Durant NN. Neuromuscular and vagal blocking actions of pancuronium bromide, its metabolites, and vecuronium bromide (Org NC45) and its potential metabolites in the anaesthetized cat. *Br J Anaesth* 1983;55:703.
58. d'Hollander A, Massaux F, Nevelsteen M, et al. Age-dependent dose-response relationship of ORG NC 45 in anaesthetized patients. *Br J Anaesth* 1982;54:653.
59. Segredo V, Caldwell JE, Matthey MA, et al. Persistent paralysis in critically ill patients after long-term administration of vecuronium. *N Engl J Med* 1992;327:524.
60. Fisher DM, Castagnoli K, Miller RD. Vecuronium kinetics and dynamics in anaesthetized infants and children. *Clin Pharmacol Ther* 1985;37:402.
61. Morris RB, Cahalan MK, Miller RD, et al. The cardiovascular effects of vecuronium (ORG NC45) and pancuronium in patients undergoing coronary artery bypass grafting. *Anesthesiology* 1983;58:438.
62. Futo J, Kupferberg JP, Moss J. Inhibition of histamine N-methyltransferase (HNMT) in vitro by neuromuscular relaxants. *Biochem Pharmacol* 1990;39:415.
63. Durrani Z, O'Hara J. Histaminoid reaction from vecuronium priming: a case report. *Anesthesiology* 1987;67:130.
64. Lavery GG, Hewitt AJ, Kenny NT. Possible histamine release after vecuronium. *Anaesthesia* 1985;40:389.
65. Mayer M, Doenicke A, Hofmann A, et al. Onset and recovery of rocuronium (Org 9426) and vecuronium under enflurane anaesthesia. *Br J Anaesth* 1992;69:511.
66. Khuenl-Brady KS, Pomaroli A, Puhring-er F, et al. The use of rocuronium (ORG 9426) in patients with chronic renal failure. *Anaesthesia* 1993;48:873.
67. Szenohradszky J, Fisher DM, Segredo V, et al. Pharmacokinetics of rocuronium bromide (ORG 9426) in patients with normal renal function or patients undergoing cadaver renal transplantation. *Anesthesiology* 1992;77:899.
68. Khalil M, D'Honneur G, Duvaldestin P, et al. Pharmacokinetics and pharmacodynamics of rocuronium in patients with cirrhosis. *Anesthesiology* 1994;80:1241.
69. Matteo RS, Ornstein E, Schwartz AE, et al. Pharmacokinetics and pharmacodynamics of rocuronium (Org 9426) in elderly surgical patients. *Anesth Analg* 1993;77:1193.
70. McCoy EP, Maddineni VR, Elliott P, et al. Haemodynamic effects of rocuronium during fentanyl anaesthesia: comparison with vecuronium. *Can J Anaesth* 1993;40:703.
71. Magorian T, Flannery KB, Miller RD. Comparison of rocuronium, succinylcholine, and vecuronium for rapid-sequence induction of anesthesia in adult patients. *Anesthesiology* 1993;79:913.
72. Khuenl-Brady K, Castagnoli KP, Canfell PC, et al. The neuromuscular blocking effects and pharmacokinetics of ORG 9426 and ORG 9616 in the cat. *Anesthesiology* 1990;72:669.
73. Duvaldestin P, Agoston S, Henzel D, et al. Pancuronium pharmacokinetics in patients with liver cirrhosis. *Br J Anaesth* 1978;50:1131.
74. Stanley JC, Mirakhor RK. Comparative potency of pipecuronium bromide and pancuronium bromide. *Br J Anaesth* 1989;63:754.
75. Stanley JC, Carson IW, Gibson FM, et al. Comparison of the haemodynamic effects of pipecuronium and pancuronium during fentanyl anaesthesia. *Acta Anaesthesiol Scand* 1991;35:262.
76. Ramsey FM, Lebowitz PW, Savarese JJ, et al. Clinical characteristics of long-term succinylcholine neuromuscular blockade during balanced anesthesia. *Anesth Analg* 1980;59:110.
77. Shanks CA, Fragen RJ, Ling D. Continuous intravenous infusion of rocuronium (ORG 9426) in patients receiving balanced, enflurane, or isoflurane anesthesia. *Anesthesiology* 1993;78:649.
78. Miller DR, Wherrett C, Hull K, et al. Cumulation characteristics of cisatracurium and rocuronium during continuous infusion. *Can J Anaesth* 2000;47:943.
79. Pino RM. Neuromuscular blockade studies of critically ill patients. *Intensive Care Med* 2002;28:1695.
80. Hansen-Flaschen J, Cowen J, Raps EC. Neuromuscular blockade in the intensive care unit. More than we bargained for. *Am Rev Respir Dis* 1993;147:234.
81. Watling SM, Dasta JF. Prolonged paralysis in intensive care unit patients after the use of neuromuscular blocking agents: a review of the literature. *Crit Care Med* 1994;22:884.
82. Gooch JL, Suchyta MR, Balbierz JM, et al. Prolonged paralysis after treatment with

neuromuscular junction blocking agents. *Crit Care Med* 1991;19:1125.

83. Giostra E, Magistris MR, Pizzolato G, et al. Neuromuscular disorder in intensive care unit patients treated with pancuronium bromide. Occurrence in a cluster group of seven patients and two sporadic cases, with electrophysiologic and histologic examination. *Chest* 1994;106:210.

84. Prielipp RC, Coursin DB, Scuderi PE, et al. Comparison of the infusion requirements and recovery profiles of vecuronium and cisatracurium 51W89 in intensive care unit patients. *Anesth Analg* 1995;81:3.

85. Chapple DJ, Miller AA, Ward JB, et al. Cardiovascular and neurological effects of laudanose. Studies in mice and rats, and in conscious and anaesthetized dogs. *Br J Anaesth* 1987;59:218.

86. Bevan DR, Smith CE, Donati F. Postoperative neuromuscular blockade: a comparison between atracurium, vecuronium, and pancuronium. *Anesthesiology* 1988;69:272.

87. Debaene B, Plaud B, Dilly MP, et al. Residual paralysis in the PACU after a single intubating dose of nondepolarizing

muscle relaxant with an intermediate duration of action. *Anesthesiology* 2003;98:1042.

88. Hayes AH, Mirakhor RK, Breslin DS, et al. Postoperative residual block after intermediate-acting neuromuscular blocking drugs. *Anaesthesia* 2001;56:312.

89. Murphy GS, Szokol JW, Franklin M, et al. Postanesthesia care unit recovery times and neuromuscular blocking drugs: a prospective study of orthopedic surgical patients randomized to receive pancuronium or rocuronium. *Anesth Analg* 2004;98:193.

90. Brand J, Cullen D, NE W, et al. Spontaneous recovery from nondepolarizing neuromuscular blockade: correlation between clinical and evoked response. *Anesth Analg* 1977;56:55.

91. Eriksson LI, Sundman E, Olsson R, et al. Functional assessment of the pharynx at rest and during swallowing in partially paralyzed humans: simultaneous videomanometry and mechanomyography of awake human volunteers. *Anesthesiology* 1997;87:1035.

92. Kirkegaard H, Heier T, Caldwell JE. Efficacy of tactile-guided reversal from cisatracurium-induced neuromuscular block. *Anesthesiology* 2002;96:45.

93. Kopman AF, Chin WA, Moe J. Dose-response relationship of rocuronium: a comparison of electromyographic vs. acceleromyographic-derived values. *Acta Anaesthesiol Scand* 2005;49:323.

94. Magorian TT, Lynam DP, Caldwell JE, et al. Can early administration of neostigmine, in single or repeated doses, alter the course of neuromuscular recovery from a vecuronium-induced neuromuscular blockade? *Anesthesiology* 1990;73:410.

95. de Boer HD, van Egmond J, van de Pol F, et al. Reversal of profound rocuronium neuromuscular blockade by sugammadex in anesthetized rhesus monkeys. *Anesthesiology* 2006;104:718.

96. Sorgenfrei IF, Norrild K, Larsen PB, et al. Reversal of rocuronium-induced neuromuscular block by the selective relaxant binding agent sugammadex: a dose-finding and safety study. *Anesthesiology* 2006;104:667.

# CHAPTER 34

## Monitoring and Managing Perioperative Electrolyte Abnormalities, Acid–Base Disorders, and Fluid Replacement

Patrick J. Neligan, MD, and  
Jiri Horak, MD

The human body is an aqueous soup containing carbohydrates, protein, fat, ions, and trace elements bundled into and around cellular structures built on an exoskeleton. Fundamental to the structure and function of the body are the chemical properties of water. Patients who are undergoing surgery or suffering with critical illness undergo dramatic changes in the volume, distribution, and composition of body water. Patients undergoing the most minor of procedures will undertake a period of fasting, rehydration with intravenous fluids and neurohormonal changes in fluid distribution. To understand strategies and implications of perioperative fluid administration, it is important that one understands the homeostatic mechanisms by which the body maintains its internal milieu.

Homeostasis refers to the capacity of the human body to maintain a stable constant condition by means of constant dynamic equilibrium adjustments controlled by a medley of interconnected regulatory mechanisms. The concept dates from the foundations of scientific medicine, specifically the work of Claude Bernard (1813–1878). Multiple systems exist in the body to test and control deviations from the normal range in vital functions, including the autonomic nervous system, the renin–angiotensin–aldosterone–vasopressin axis, and the hypothalamic–pituitary–adrenal axis. The body thus self-regulates to maintain a variety of physiologic and metabolic variables in the state of equilibrium, despite a staggering range

### KEY POINTS

1. Water is the single most abundant compound in the body, constituting approximately 50–70% of body weight.
2. One third of body water is extracellular, representing approximately 20% of body weight. Of this one third is located within the intravascular compartment, and two thirds is extravascular or interstitial.
3. Electrolytes are characterized by their degree of dissociation (strong or weak ions), the number of particles present (millimoles), the number of electrical charges per unit (milliequivalents), and the number of active molecules per unit volume (milliosmoles).
4. Although osmolality is equal through each of the body's compartments, electrolyte composition varies. Sodium and chloride are principally extracellular. Potassium, phosphate, magnesium, and calcium are principally intracellular.
5. Perioperative patients undergo a predictable “stress” response during which there is significant fluid and electrolyte flux. The magnitude and timing of these changes are key to management strategies.
6. Changes in extracellular sodium concentrations often, but not always, reflect body water composition. Hyponatremia is indicative of free water overload, whereas hypernatremia is indicative of dehydration.
7. Depletion of serum concentration of principally intracellular ions (potassium, phosphate, magnesium, and calcium) reflects significant total body electrolyte depletion.
8. All acid–base abnormalities can be explained in terms of strong ion difference, weak acid concentration,  $\text{PaCO}_2$  and extracellular free water.
9. The six primary acid–base abnormalities are acidosis because of increased  $\text{PaCO}_2$ , acidosis because of reduced strong ion difference (SID), acidosis because of increased  $A_{\text{TOT}}$ , alkalosis associated with reduced  $\text{PaCO}_2$ , alkalosis because of increased SID, and alkalosis because of reduced  $A_{\text{TOT}}$ .
10. A variety of tools are available for interpreting acid–base abnormalities. These include the base deficit excess, the corrected anion gap, the strong ion gap, and the base deficit–excess gap.
11. Treatment of acid–base abnormalities should be directed at correcting the underlying cause.
12. Initial perioperative or emergency fluid resuscitation strategies involve crystalloid resuscitation to replace insensible loss and restore interstitial volume, lost as a consequence of transcapillary refill.
13. Upper GI losses should be replaced with isotonic saline. Lower GI and extracellular fluid losses should be replaced with balanced salt solutions. Blood loss can be initially be replaced with crystalloid in a 1:3–5 ratio, but as blood loss increases, the volume of crystalloid required increases geometrically.
14. Overresuscitation with crystalloid may lead to poor perioperative outcomes. “Normal saline” solution, given in significant volume, causes metabolic acidosis and hyperchloremia may reduce splanchnic blood flow.
15. Colloid solutions restore circulating volume more rapidly than crystalloid, with less tissue edema. Their use remains controversial.
16. Volume replacement strategies for major surgery should not be formula based, but dynamic and goal directed, using volume- and flow-monitoring devices.
17. Patient outcomes appear to be optimal when the patient is resuscitated fully on the day of surgery or injury and resuscitation efforts rapidly decelerate.
18. Consideration should be given to postoperative fluid restriction, in particular in patients undergoing lower intestinal resection.



of variations in the level of human activities and externalities. A key part of homeostasis is maintenance of body water in terms of circulating volume, volume distribution, and composition. The systems involved in homeostasis are dedicated to maintaining the delicate balance of homeostatic function despite externalities such as tissue trauma or surgery. The anesthesiologist is in a unique position to manipulate these systems for the good of the patient.

Key to the understanding of homeostasis is the role of water and ions in body fluids. Changes in water and electrolyte distribution lead to significant physiologic upset, often manifest as acid–base abnormalities. Acid–base abnormalities all result from changes in carbon dioxide tension, water and electrolyte distribution, and extracellular protein concentration. Intravenous fluids, administered to the majority of perioperative patients have significant effects on water and electrolyte distribution and also impact acid–base balance. Initial perioperative or emergency fluid resuscitation strategies involve crystalloid resuscitation to replace insensible loss and restore interstitial volume. Overresuscitation with crystalloid may lead to poor perioperative outcomes. “Normal saline” solution causes metabolic acidosis and the associated hyperchloremia may reduce splanchnic blood flow.

A careful dynamic or goal-directed approach to fluid administration is supplanting traditional formulaic approaches. Furthermore, widely established practices such as fluid administration to replace third space losses and postoperative maintenance fluid administration are undergoing rigorous evaluation. This chapter sequentially reviews these concepts.

## WATER AND IONS

### Physical Chemistry of Water

The human body is composed principally of water. Water is a simple triatomic molecule composed of 2 molecules of oxygen and 1 molecule of hydrogen, bound covalently. There is an unequal charge distribution; oxygen nuclei have a particularly strong attraction for electrons. This results in a H–O–H bond angle of 105°. Thus water behaves like a charged molecule, a dipole, with a negative oxygen and positive hydrogen end. This polar-

ity—molecules clumping together—is responsible for important chemical properties of water. Water has a high surface tension, low vapor pressure, high specific-heat capacity, high heat of vaporization, and a high boiling point. These factors have enabled life on this planet. Water is a powerful ionizing solvent—substances dissolved in water separate into component parts. Water is slightly ionized: when molecules collide, enough energy is produced to transfer a proton from one water molecule to another. Thus water slightly dissociates into a negatively charged hydroxylated (OH) ion and positively charged protonated (H<sub>n</sub>O<sup>+</sup>) ion.<sup>1</sup> All metabolic activity in the body occurs in this aqueous medium. Thus compounds ingested or administered to the body are impacted by the chemical properties of water.

### Water Distribution in Body Compartments

Water is the single most abundant compound in the body, constituting approximately 50–70% of body weight. Males contain relatively more water (on average 60%) than do females (on average 50%). There is an inverse relationship between total body fat and total body water (TBW). Females have less skeletal muscle and have more subcutaneous fat, thus lower TBW. TBW varies dramatically, depending on the age of the individual. Neonates have very high TBW (70–80%). Conversely, elderly patients have relatively lower TBW (52% for males, 45% for females). Body water is neither liquid nor easily accessible. It is divided into two separate compartments: the intracellular and the extracellular compartments (or spaces). Two-thirds of body water is intracellular, principally in skeletal muscle. One-third of body water is extracellular, representing approximately

20% of body weight. Of this one third is located within the intravascular compartment, and two thirds is extravascular or interstitial. To place this in context, a 75-kg male has a TBW of 45 L, of which 15 L is extracellular and 5 L is intravascular (Fig. 34–1). The interstitial fluid contains ultrafiltrated plasma (intravascular water), transudated plasma, and fluid and electrolytes actively pumped out of cells (transcellular fluids). Water freely moves from the intracellular to the extracellular space, but dissolved ions cannot do so. Consequently, the clinician should be aware that administration of electrolyte-rich solutions may have a dramatic impact on extracellular ionic composition and, indeed, on acid–base chemistry.<sup>2,3</sup>

Most of the fluid in the interstitium is derived from filtration and diffusion from the capillaries. The extracellular space is a matrix made up of collagen fiber bundles and proteoglycan filaments. Fluid is entrapped in the minute spaces between the filaments, taking the form of a gel (“tissue gel”). Fluid does not flow easily through this gel. Indeed, fluid diffuses through the gel, molecule by molecule. There is little “free fluid” in the interstitium. Free fluid exists only as small rivulets that course along the collagen fibers or cells. When there is significant extravascular fluid expansion, such as in volume overload or congestive heart failure, these rivulets turn into pockets, then rivers, of free flowing water. As a consequence, tissues feel boggy or edematous.

### Ionic Constituents of Body Compartments

#### Charge

Compounds introduced into aqueous solutions dissociate into their component parts, depending on the ion dissociation constant (pK<sub>a</sub>).<sup>4</sup> This describes the tendency of the molecule or ion to

Major Body Fluid Compartments in a 75 kg Male

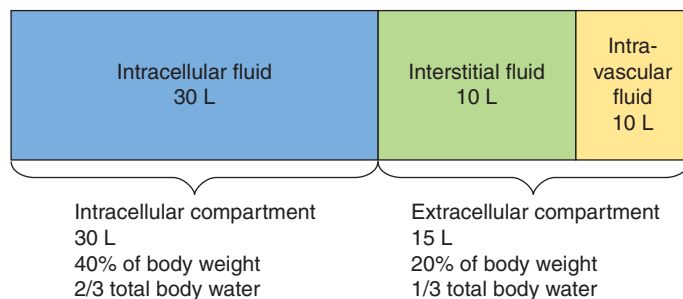


FIGURE 34–1. Body fluid compartments.

keep a proton at its ionization center. Strong ions, characterized by low  $pK_a$ , rapidly split into their component parts. Examples of strong ions include sodium ( $Na^+$ ), chloride ( $Cl^-$ ), potassium ( $K^+$ ), magnesium ( $Mg^{2+}$ ) and lactate.

The physiologic and chemical activity, and thus the importance, of electrolytes depend on several variables. These include the number of particles present per unit volume (in terms of moles or millimoles), the number of electrical charges per unit volume (in equivalents or milliequivalents), and the number of osmotically active molecules per unit volume (in osmoles or milliosmoles). It is important that the clinician be aware of these properties and distinguishes each from the others when managing and monitoring fluids and electrolytes in perioperative care. It is also important to be aware of the physiologic functions of the most important ions.

The chemical composition of the body's various fluids is described in terms of chemical combining activity or chemical "equivalents." When the concentrations of different ions within each fluid compartment are expressed in this way, the sum of all positive ions (cations) exactly equals the sum of all negative ions (anions). This is the law of electrical neutrality.

The atomic weight of an element is approximately the sum of protons and electrons in the nucleus: the weight of 1 atom of oxygen is 16. The weight of 1 atom of hydrogen is 1. The molecular weight of a compound can be determined by the chemical formula of the compound, and then adding together the atomic weights of all the elements constituting that compound.

One mole (1 mol) of any substance is its molecular weight expressed in grams (i.e., gram-molecular weight) and contains  $6.023 \times 10^{23}$  molecules (the Avogadro number). A millimole (mmol) of a substance is 1/1000 of a mole, or the substance's weight expressed in milligrams. In addition, 1 mol of any gas (e.g., oxygen, carbon dioxide) under standard conditions occupies a constant volume of 22.4 L and 1 mmol/L of gas occupies 22.4 mL. Regardless of whether a substance is ionized or nonionized, organic or inorganic, the terms *mole* and *millimole* are applicable.

Electrolytes combine with each other strictly in proportion to their ionic valencies. Originally, oxygen was chosen

as the standard of reference; 8 g of oxygen will combine with 1 g atomic weight of hydrogen. By convention, the chemical standard of reference for combining power is the electric charge (+) of 1 atomic weight (1 g) of hydrogen. Thus 1 equivalent (1 Eq) of an ion is that amount that can combine with 1 g of hydrogen and thus is chemically equivalent to 1 g of hydrogen.

One equivalent of hydrogen consists of  $6.023 \times 10^{23}$  particles, weighs 1 g, and carries a positive charge. This quantity of hydrogen ions neutralizes or balances 1 Eq of hydroxyl ions, which consists of  $6.023 \times 10^{23}$  particles, weighs 17 g, and carries a negative electric charge. The result of this neutralization is the formation of 1 mol of water weighing 18 g. Such ions are termed univalent and balance each other in a 1:1 ratio. For all univalent ions, 1 Eq equals 1 mol.

Certain ions (e.g., calcium  $Ca^{2+}$ , magnesium  $Mg^{2+}$ , sulfate  $SO_4^{2-}$ ) are divalent and carry either 2 positive charges (divalent cations) or 2 negative charges (divalent anions). These multivalent ions have greater chemical-combining power than do univalent ions. As electrochemical neutrality must be maintained in all reactions, 1 divalent cation (e.g.,  $Ca^{2+}$ ) will react with 2 univalent anions (e.g.,  $2 \times Cl^-$ ). In other words, 1 mol of divalent cation ( $6.023 \times 10^{23}$  particles) supplies 2 Eq and will offset 2 mol (1 Eq each) of univalent anion.

The ionic concentrations present in body fluids are relatively small and are expressed in terms of milliequivalents (mEq) rather than equivalents. In the case of univalent ions, 1 mEq is equal to 1/1000 of the gram-atomic weight (i.e., atomic weight expressed in mg); is the same as 1 mmol of the ion in question; and consists of  $6.023 \times 10^{20}$  particles. For divalent ions, 1 mEq consists of  $3.012 \times 10^{20}$  particles and weighs 1/2000 of the gram-atomic weight. One mmol of divalent ions equals 2 mEq. An equivalent (or milliequivalent) of any ion is its atomic weight expressed in grams (or milligrams) divided by the valence. Electrolytes do not combine gram for gram or milligram for milligram; they combine equivalent for equivalent or milliequivalent for milliequivalent of opposite polarity. Therefore, in any given fluid compartment or intravenous solution, the number of milliequivalents of cations is balanced by precisely the same number of milliequivalents of anions.

### Distribution

There are different electrolyte concentrations in each body fluid compartment; Table 34-1 lists the average values. In the extracellular compartment, the major cation is sodium and the principal anions are chloride and bicarbonate. Sodium and chloride are free in solution, but appreciable fractions of calcium and magnesium are

TABLE 34-1.

Ion Distribution in Different Compartments

Electrolyte	Plasma (mEq/L)	Plasma Water (mEq/L)	Interstitial Fluid (mEq/L)	Intracellular Fluid (mEq/kgL)
<b>Cations</b>				
Sodium	142	152	145	10
Potassium	4	4	4	156
Calcium	5	5	3	3
Magnesium	3	3	1	26
Total	154	164	153	195
<b>Anions</b>				
Chloride	103	109	114	2
Bicarbonate	27	29	30	10
Phosphate	2	2	2	108
Sulfate	1	1	1	20
Organic acids	5	6	5	
Protein	16	17	1	55
Total	154	164	153	195

bound to protein. Interstitial fluid represents a partial ultrafiltrate of plasma devoid of platelets and erythrocytes and with a lower concentration of protein. The principal plasma protein, albumin, carries a significant negative charge at pH 7.4, and its diffusion across capillary endothelium is restricted. Consequently, because of the greater protein content (i.e., organic anions) in plasma, the total plasma concentration of cations is greater and the concentration of inorganic anions is less than in the interstitial fluid. Electroneutrality is maintained within each fluid compartment, but because of protein distribution, there is an asymmetry of ion distribution between plasma and the interstitium. Within each fluid compartment, the total cations must equal the total anions, but a greater number of diffusible ions reside in the compartment containing the most organic anions. As a result, a slight osmotic pressure gradient is established, which, under normal conditions, is counterbalanced by capillary hydrostatic forces. This is an example of the Gibbs-Donnan principle, which describes the unequal distribution of diffusible ions on either side of the cell membranes bordering these fluid compartments.

The ionic concentrations for plasma water differ from those of plasma because of the exclusion of solids, notably lipids and large proteins, which total approximately 7%. Plasma proteins occupy a volume far out of proportion to the few milliequivalents of anion they represent. One liter of plasma contains about 940 mL of water. The remaining volume is occupied, for the most part, by protein. Ions are generally dissolved in the aqueous phase of plasma, so that concentrations in plasma water exceed those in whole plasma by a factor of 1000/940. Clinical laboratories usually report electrolyte values as the ionic concentration in a given volume of whole plasma or serum, and, although slightly inaccurate, this is generally accepted. However, if the lipid or protein content of plasma is significantly increased, there will be a corresponding decrease in the reported concentration of ions per liter of plasma (e.g., pseudohyponatremia). The volume of water in the sample may be significantly less than the total volume; therefore the ionic concentrations will be underestimated.

Within the intracellular compartment, potassium and magnesium are the predominant cations, whereas phosphate, sulfate, and protein are the most abundant anions. There is a marked difference between intracellular and extracellular water in terms of ionic concentrations. The ratio of intracellular to extracellular potassium is almost 30:1. Likewise, sodium and chloride are portioned along a steep concentration gradient in the opposite direction. There are more ions in the intracellular compartment than the extracellular compartment. Significant proportions of intracellular ions are bound to protein or cellular constituents and are osmotically inactive.

Many biologic processes are dependent on the presence of transcellular impediments to ion transport. Large polyvalent protein and organic phosphate anions are confined intracellularly because of their absolute membrane impermeability. For smaller ions, maintaining different ionic concentrations across cell membranes is in part, dependent on the active accumulation and extrusion of certain ions from within cells. Active, energy-dependent "ion pumps" (contained within cell membranes) generate the ionic concentration gradients observed among the various fluid compartments. For example, the tendency for sodium ions to diffuse from extracellular fluid (high concentration) into cells (low concentration) is opposed by the active transport of sodium ions out of cells. Similarly, the tendency for potassium ions to diffuse along a concentration gradient from the intracellular fluid (high concentration) to the extracellular fluid (low concentration) is opposed by an active accumulation process. For the anesthesiologist this means that when fluids are administered perioperatively, sodium and chloride remain in the extracellular space.

Ionic distribution results in electrical polarization across cells. Sodium is predominantly extracellular and cells are far more permeable to potassium than to sodium. Thus, potassium ions tend to diffuse down a concentration gradient and out of a cell. The result is an increasing negative charge within the cell that tends to counteract this diffusion, restraining further potassium movement. Membrane polarization is largely a function of the difference in potassium concentration on either side of the membrane. For most

cells under normal conditions, the resting transmembrane potential difference is 60 to 90 mV. Alterations in the distribution of ions, particularly in the extracellular space, can result in a change in this resting potential and cellular dysfunction. Hypoxia, in particular, destroys this delicate charge balance and leads to unopposed diffusion of ions along concentration gradients. This results in cellular swelling, a result of sodium and water entering cells, and hyperkalemia, as a result of outward leakage of potassium.

### Concentration of Ions

By convention, the concentrations of most intravenous solutions are expressed as percentages (usually weight in grams or milligrams per 100 mL of solution). For example, 0.9% saline solution (normal saline) represents 0.9 g sodium chloride/100 mL water. In the United States, laboratory measurements of, for example, glucose, albumin, and creatinine, continue to be expressed as milligrams percent (i.e., mg/100 mL of blood, serum, or plasma). The major limitation of this measurement technique is the impact of temperature on substance volume.

Internationally, molality and molarity are widely used to describe concentration. Molality is the number of moles of solute per 1000 g of solvent. It is independent of temperature. A molal solution of saline will contain 58.5 g of sodium chloride dissolved in 1000 g of water. The molar concentration is the number of moles of solute per 1000 mL of solution (usually water) at a specified temperature. In clinical practice, millimoles are used. Thus, we use millimoles per kilogram of solution (millimolal [mmol]) and millimoles per liter of solution (millimolar [mM]).

### Water Distribution and Movement

Cell membranes are permeable to water. Water molecules continuously move between fluid compartments in the body. Water movement is governed by hydrostatic and osmotic pressures. Hydrostatic pressure is dynamic and results from pulsatile blood flow. This pressure gradually reduces from a mean in the aorta of 90–95 mm Hg, to a mean of 30–40 mm Hg in the capillaries. Hydrostatic pressure is higher in the lower limbs in the erect patient. The capillary network is fe-

nestrated, and the hydrostatic pressure within the capillary is sufficient to push fluid through these fenestrations into the interstitium. Once in the capillary system, however, osmotic forces are more important than hydrostatic forces. Osmosis is the movement of water thru a semipermeable membrane from a location in which solute is in low concentration to a location in which solute is in high concentration. The membrane is permeable to solvent, not solute, resulting in a pressure gradient. Osmotic pressure is the hydrostatic pressure that must be applied to the solution of greater concentration to prevent water movement across the membrane.

Osmotic pressure is dependent on the number of osmotically active molecules in solution and not their molecular weight, electric charge, or valence number. Small numbers of large molecules are less osmotically active than large numbers of small molecules. One gram molecular weight (i.e., 1 mol) of a nondissociating compound (e.g., glucose, urea) consists of  $6.023 \times 10^{23}$  molecules and is termed 1 osmole (Osm). For nondissociating compounds, 1 mmol is equivalent to 1 mOsm; 1 mOsm of any solute dissolved in 1 kg of water will decrease the activity of water by 17 mm Hg. Ionized substances tend to dissociate in solution and thereby generate more osmotically active particles. For example, 1 gram-molecular weight of sodium chloride (NaCl)—consisting of  $6.023 \times 10^{23}$  molecules—dissociates into twice this number of ions in solution and exerts an osmotic effect of approximately 2 Osm. One mole of sodium sulfate ( $\text{Na}_2\text{SO}_4$ ) results in 4 Eq ( $2 \text{ Na}^+$ ,  $\text{SO}_4$ ) but dissociates so as to exert an osmotic effect approaching 3 Osm ( $\text{Na}$ ,  $\text{Na}$ ,  $\text{SO}_4$ ).

Osmolarity is the number of osmoles of solute per liter of solvent plus solute. Osmolality, on the other hand, is the solute concentration per kilogram of solvent (water). Osmolality is more widely used in clinical practice, as its value is unaffected by the presence of fat and protein in plasma. Osmolality is generally measured with a freezing point osmometer.

Extracellular osmolality is approximately  $290 \pm 10$  mOsm/kg  $\text{H}_2\text{O}$ , and, presumably, the intracellular osmolality level is identical. As 1 mOsm/kg  $\text{H}_2\text{O}$  exerts an osmotic effect equivalent to 17 mm Hg, the osmotic pres-

sure of most body fluids is approximately  $300 \times 17$ , or 5100 mm Hg.

Quantitatively, osmotic pressures greatly exceed any hydrostatic pressure in the body. The magnitude of these osmotic forces can be appreciated when one realizes that an osmotic pressure difference of only 6 mOsm/L, across a semipermeable membrane, can move as much water as the entire hydrostatic pressure generated by the heart.

Osmotic forces throughout the body (with the exception of the renal medulla) are equal, as water can readily cross cell membranes. Thus the osmolality of the intracellular and extracellular spaces equalize, despite differing compositions. This has significant impact in health and disease. Loss of extracellular fluid (ECF) volume leads to increased ECF osmolality and subsequent cellular dehydration.

Sodium, chloride, and bicarbonate account for 90–95% of the osmotic activity present in plasma and interstitial fluid. Other ions and organic compounds (e.g., glucose, urea, amino acids) account for most of the remainder. Plasma proteins provide negligible osmotic effect. The major intracellular osmotic solutes are potassium, magnesium phosphate, and protein. Total body osmotic solute is portioned such that two thirds is contained within the intracellular fluid (ICF) compartment and one third resides in the ECF compartment. This localization of total body solute in turn explains the overall distribution of body water.

In most situations, the concentrations of certain osmotically active substances can be combined to provide a remarkably accurate (within 10%) estimate of serum osmolality ( $S_{\text{osm}}$ ):

$$S_{\text{osm}} \text{ (mOsm/kg H}_2\text{O)} \\ = (2 \times [\text{Na}] + [\text{K}]) + ([\text{glucose}]/18) + \\ ([\text{BUN}]/2.8)$$

where glucose and blood urea nitrogen (BUN) concentrations are expressed in mg/dL and sodium concentration  $[\text{Na}^+]$  is in mEq/L. The calculations for BUN and glucose resolve the results into mmol/L.

Occasionally, osmotically active compounds are present in the extracellular fluids that are not accounted for by the above calculation. When osmolality is measured, and then calculated, a gap between the two figures becomes evident (osmolal gap). This gap is nor-

mally less than 10 mOsm/kg  $\text{H}_2\text{O}$ . Pharmacologically, the gap is increased by the administration of mannitol or alcohol. Pathologically, the gap may be widened by poisoning with ethylene glycol, propylene glycol, or isopropyl alcohol.

Tonicity describes the relative osmolality of solutions. A solution is said to be isotonic when it is isoosmotic (i.e., the same osmotic pressure) with the body fluids. Intravenous fluids that are formulated as balanced salt solutions (Normosol-R or Plasma-Lyte) are isotonic with respect to plasma. Normal saline (0.9% NaCl) is slightly hypertonic to plasma. Lactated Ringer solution is slightly hypotonic. However, functionally, these fluids act as isoosmotic solutions and do not impact the size of erythrocytes. Administration of hypertonic fluids (e.g., 3% or 7.5% NaCl, 7.5% sodium bicarbonate, 10% mannitol) leads to a dramatic increase in ECF osmolality and cellular dehydration. Often this is intentional, such as the administration of mannitol or hypertonic saline to head-injured patients. Occasionally, hyperosmolality occurs pathologically, as in diabetes insipidus, diabetic ketoacidosis (caused by ketones and glucose) or nonketotic hyperosmolar syndrome (caused by glucose), and acute renal failure (caused by urea and other nitrogenous waste products).

Hypotonic solutions (e.g., 0.45% NaCl) have fewer osmotically active particles per volume compared with the reference solution and tend to produce cellular swelling.

Finally, although the terms *tonicity* and *osmolality* are frequently used interchangeably, an alteration in one does not necessarily lead to an alteration in the other. The classic example of this is urea. Urea is freely permeable throughout the body water. It does not affect tonicity, but will cause an increase in extracellular osmolality.

## ALTERATIONS IN FLUID AND ELECTROLYTE DISTRIBUTION

### Impact of Surgical Stress Response on Perioperative Fluid Distribution Insensible Losses

Perioperative care is characterized by dramatic changes in fluid and electrolyte content and distribution in the various fluid spaces in the body. These



changes are predictable and follow a characteristic pattern described by Cuthbertson<sup>5</sup> and Moore,<sup>6,7</sup> widely known as the “stress response.” An understanding of this process is central to understanding the dynamics of fluid and electrolyte flux in the perioperative period and is helpful in guiding therapy.

The stress response has traditionally been considered a biphasic “ebb and flow” phenomenon. After an injury or surgical incision, initially there is significant peripheral vasoconstriction, shunting of blood from the periphery to the midline (to preserve vital organs), and a drop in body temperature. Simultaneously, there is a fall in capillary hydrostatic pressure, promoting a rapid shift of protein-free fluid from the interstitium into the capillaries.<sup>8</sup> This is known as “transcapillary refill” and it includes mobilization of fluid from the splanchnic circulation, in particular the splanchnic veins.<sup>9</sup> This induces a state of absolute hypovolemia in the extracellular space. There is a dramatic increase in the release of vasopressin (antidiuretic hormone) and activation of the renin-angiotensin-aldosterone axis to conserve salt and water.

The second phase, the hypermetabolic or “flow” phase, occurs within hours, characterized by a dramatic increase in cardiac output, driven by catecholamines, vasodilatation, increased capillary permeability and an increase in temperature. A generalized catabolic state ensues, characterized by insulin resistance, hypercortisolism, and protein breakdown. Thus the patient develops tachycardia, leucocytosis, hyperthermia, hyperglycemia, and tissue edema. The magnitude of this response is proportionate to the degree of injury or extent of surgery. Significant intracellular fluid deficit may be incurred to maintain circulating volume. A period of fluid sequestration occurs, as a result of extravasation of fluid consequent of widespread capillary leak, urinary output falls, and tissue edema may become evident. Vasodilatation and relative intravascular hypovolemia occurs. During this period, patients typically require administration of resuscitation fluids to maintain blood pressure and circulating volume. Weight gain ensues.

Eventually a state of equilibrium arrives, usually day 2 after a procedure, when active sequestration stops. This is followed by a phase of diuresis during which the patient mobilizes

fluid and recovers. Initially there is a precipitous drop in serum albumin. Restoration of albumin levels is associated with recovery. Moreover, intracellular fluid volume returns to normal. Inward shift of fluid from the extracellular to the intracellular space is associated with intracellular movement of ions such as potassium, magnesium, and phosphate. Hence hypophosphatemia, hypomagnesemia, and, in particular, hypokalemia are usually evident on a serum chemistry panel at this time.

The practicing clinician must be aware of the stages of the stress response when deciding whether or not to administer fluid and electrolytes. For example, early in the flow phase, significant intracellular and interstitial fluid depletion may exist, despite the appearance of “normal” cardiovascular measurements (blood pressure, cardiac output, stroke volume). This requires repletion with free water and isotonic crystalloid. During the vasodilatory, hypermetabolic phase, the circulating volume requires support, taking into account the large volume of distribution of administered crystalloid. During the equilibrium phase, the administration of intravenous fluid is dependent on the objective of the clinician. The clinician may choose to continue fluid administration, to keep organs well hydrated, or to stop administering fluid, preventing the formation of further tissue edema. During the diuretic phase, the major objective of the clinician is to allow the patient to return to baseline body weight, and to aggressively replete electrolytes.

It can be argued that the administration of anesthesia significantly reduces the ebb or shock phase. Nevertheless, patients undergoing surgery are usually dehydrated secondary to fasting, bowel lavage, or their primary disease (e.g., esophageal cancer). Consequently, the perioperative period should be viewed as follows: (a) dehydration phase, (b) shock phase, (c) relative and absolute hypovolemic phase (as a consequence of vasodilatation, fluid sequestration, and blood loss), (d) equilibrium phase, and (e) diuresis phase. Certain operations are associated with greater blood loss because of overt or microvascular bleeding (vascular surgery); other operations are associated with greater tissue injury because of, for example, bowel handling. Thus, within this paradigm, a “one-formula-

fits-all” approach is neither scientific nor effective. Where extensive fluid shifts are to be expected in the perioperative period, it is worthwhile to obtain a preoperative weight so as to have a baseline goal for the patient’s postoperative diuresis.

## Hypovolemia

There is little excess water-storage capacity in the human body. With the exception of congestive heart failure, perioperative patients are more than likely to present in a state of relative or absolute hypovolemia. This may be mild dehydration, as a consequence of fasting, or severe dehydration, because of the administration of purgatives (for bowel lavage), persistent diarrhea, nasogastric suctioning, fistula drainage, or the inability to consume water and electrolytes. Clinical findings that may alert the clinician to dehydration include confusion, loss of skin turgor, longitudinal furrowing of the tongue, dry mucus membranes, sunken eyes, collapsed veins, cold extremities, and highly concentrated urine. A 15–30% loss of intravascular volume will lead to resting tachycardia. Blood pressure is usually maintained despite a volume loss of up to 40%, caused by intense vasoconstriction and transcapillary refill. In addition cardiac output and cardiac index remain within normal limits and the only hemodynamic indication of hypovolemia is a reduction in stroke volume.<sup>10</sup>

On evaluation of the patients’ chemistry panel, a high urea to creatinine ratio (>10:1), hypernatremia, and metabolic (contraction) alkalosis (caused by increased strong ion difference, a consequence of free water deficit) should alert the clinician to an ECF volume deficit. An ECF volume deficit can be confirmed by a urine specimen (assuming normal renal function) that is significantly concentrated (e.g., 500–1400 mOsm/kg H<sub>2</sub>O) and that has a high specific gravity and low sodium content (<20 mEq/L).

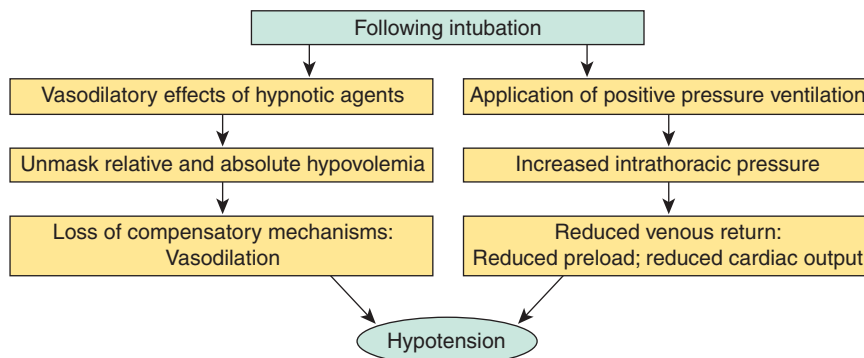
Of particular importance is the problem of relative hypovolemia. Typically, this occurs in patients who are being treated with vasodilator drugs such as angiotensin-converting enzyme inhibitors, angiotensin receptor blockers,  $\alpha_1$ -receptor antagonists (e.g., phenoxybenzamine) and  $\alpha_2$ -adrenergic agonists (e.g., clonidine). Administration of anesthetic agents typically causes widespread vasodilatation and rela-

tive hypovolemia; in patients who are treated with these drugs, severe hypotension may ensue. Likewise, in patients who present with acute shock as a result of volume loss or vasoplegia, such as occurs with sepsis, the administration of an anesthesia induction agent (propofol or thiopental), followed by the application of positive-pressure ventilation, may result in life-threatening hypotension (Fig. 34-2).

The decision to rehydrate patients prior to and during induction of anesthesia must be guided by the clinical assessment, quantification of preoperative fluid deficits and the nature of the surgery. Preoperative fasting of 12 hours or more may result in a fluid deficit of more than 1 L, consisting principally of free water. Ambulatory patients who are administered 30 mL/kg of fluid have significantly less dizziness and postoperative nausea and vomiting than those who are given less fluid or none at all.<sup>11-13</sup> It is unclear whether prehydration should involve hypotonic crystalloid or balanced salt solution. The administration of dextrose-containing fluids is associated with increased pain, thirst, and blood glucose compared with patients given dextrose-free balanced salt solutions.<sup>14</sup> For patients who have pre-existing gastrointestinal fluid losses, significant electrolyte depletion is to be anticipated. For upper gastrointestinal losses, for example, secondary to nasogastric suctioning, vomiting, or gastroparesis, hypochloremia is to be anticipated; “normal” saline is the replacement fluid of choice. For patients with lower gastrointestinal system losses, significant losses of sodium and potassium are to be anticipated, and balanced salt solution should be administered. Subsequent to surgical incision, administered fluids should be isotonic because of the 50-100-fold increase in antidiuretic hormone (ADH) activity that persists for the duration of the stress response. Large-volume resuscitation with hypotonic fluid may result in acute severe hyponatremia, cerebral edema, and seizures.

### Hypervolemia

Signs of preoperative hypervolemia include a cardiac gallop rhythm, jugular venous distension, ankle and/or sacral edema, an enlarged liver, and pulmonary edema. Although there are no pathognomonic laboratory signs of hy-



**FIGURE 34-2.** Hemodynamic consequences of induction, intubation, and positive-pressure ventilation.

pervolemia, hyponatremia, below-normal values of urea and creatinine, and low serum osmolality, may be indicative of free water overload.

Postoperative hypervolemia is an inevitable consequence of current fluid administration strategies that has generally been considered benign. Traditionally, generous volumes of intravenous fluid are administered in the operating room to replete fasting deficits, maintenance requirements, and third space fluid losses. The consequence is an inevitable weight gain of 4-6 kg for major surgery.<sup>15</sup> This approach has been challenged because of emerging evidence of adverse outcomes associated with perioperative fluid overload.<sup>16</sup>

The concept of “third space” fluid loss or functional extracellular fluid deficit derived originally from work by Shires et al.<sup>17</sup> The hypothesis behind third spacing is that as a consequence of trauma, hemorrhage, tissue injury, or tissue handling, extracellular fluid becomes sequestered in nonfunctional tissue spaces, presumably the injured tissue, the bowel lumen, and other potential spaces, such as the pleura and peritoneum. This fluid serves no physiologic purpose and may lead to organ hypoperfusion and, in particular, acute renal failure. Proponents point to the dramatic difference in the incidence of acute renal failure during the Vietnam War, in which liberal fluid management strategies were used, versus the Korean War, where fluid restriction was the norm. A small body of subsequent work investigated extracellular fluid volume in the perioperative period with a series of radiolabeled tracers. Brandstrup et al. systematically evaluated this literature and found significant flaws in the methodology.<sup>18</sup> Indeed, there is little

or no published evidence that significant third space fluid loss occurs in clinical practice. Fluid resuscitation strategies based on this premise are associated with an elevated incidence of acute lung injury, abdominal compartment syndrome, prolonged ileus, myocardial ischemia, extensive tissue edema, impaired wound healing, and delayed discharge from hospital.<sup>16,19,20</sup>

Large-volume fluid resuscitation leads to significant sequestration of fluid in lax tissues, the splanchnic veins, and the peritoneum. Following resolution of the stress response, this fluid is mobilized into the intravascular space and the patient usually undergoes rapid diuresis. However, in cases of diastolic dysfunction or congestive heart failure (CHF), the patient may develop acute pulmonary edema (“flash pulmonary edema”) or acute myocardial ischemia. This process has been termed “deresuscitation.” Gentle preemptive administration of furosemide may increase venous capacitance and induce earlier diuresis.

### Sodium Physiology

Sodium is the most abundant extracellular ion, and is responsible for maintenance of the extracellular volume.

There is a dynamic relationship between total body water and extracellular sodium concentration. This water balance is influenced by intakes and outputs, antidiuretic hormone, renin-angiotensin-aldosterone, and serum osmolality. As sodium ion is excluded from the intracellular space and is the predominant osmotically active substance in the ECF, isolated changes in water volume are generally reflected by inverse changes in the serum sodium concentration and serum osmolality. Hyponatremia generally indicates an expansion in free water volume as

compared with normal. Hyponatremia generally indicates a reduction in free water concentration.

Total body sodium concentration averages 60 mEq/kg of body weight in a healthy adult male (i.e., 4200 mEq in a 70-kg man). Approximately 2000–2200 mEq is dissolved in the ECF. Another 1800 mEq resides within the skeletal system, which constitutes 15–16% of body weight. Thus, total body sodium is proportioned as follows: approximately 50% is extracellular, 40% is in bone, and 10% or less is intracellular.

Body sodium is often considered in terms of exchangeable and nonexchangeable moieties. Nonexchangeable sodium is that fraction adsorbed on hydroxyapatite crystals contained deep within the long bones of the skeleton. It amounts to approximately 18 mEq/kg of the total body sodium concentration. More important clinically is the exchangeable sodium, which represents 42 mEq/kg of total body sodium. This exchangeable fraction includes all sodium within the ECF and ICF, and about half of the bone sodium. Exchangeable sodium is in diffusion equilibrium with plasma (serum) sodium and is reflected in the normal ECF concentration of sodium (i.e., 136–145 mEq/L). This exchangeable reservoir serves to mitigate concentration changes when sodium is either lost (e.g., sweat, diarrhea) or retained (e.g., cirrhosis, CHF). As a result, the concentration of sodium may provide little useful information about the total body sodium content.

The daily adult requirement for sodium averages 1–2 mEq/kg/d. Normal dietary intake ranges between 100 and 200 mEq/d. The kidney is the principal site of sodium regulation, through changes in the rates of glomerular filtration and tubular resorption. Approximately 180 L of water and 24,000 mEq of sodium are filtered and resorbed by the kidneys each day. This is modulated by the interaction of a variety of neurohormonal modulators, including the sympathetic nervous system, the renin–angiotensin–aldosterone system, atrial natriuretic peptide, and antidiuretic hormone. Diseases or drugs that impact the normal renal or neuroendocrine function impact the normal sodium–water homeostasis. For example, congestive heart failure is characterized by adrenergic activation, release of renin–angiotensin–aldosterone, retention of both salt and water in the renal

tubules, and hypervolemia. The administration of angiotensin-converting enzyme inhibitors results in vasodilation, lowering the blood pressure, diuresis, and natriuresis.

### Hyponatremia

Hyponatremia exists when the serum (or plasma) sodium concentration is below 135 mEq/L. It may occur in an isotonic, hypertonic, or hypotonic state (Fig. 34–3). If the blood is hypoosmolar in relation to the brain, water enters the brain and can cause acute cerebral edema, particularly in patients who are euvolemic. This may occur with large-volume administration of hypotonic fluids and in patients who develop “TURP” syndrome, which is caused by intravasation of hypotonic fluid during transurethral resection of the prostate gland (TURP). This may lead to a spectrum of neurologic upsets ranging from confusion, to seizures, to coma, to brainstem herniation. Rapid correction of low sodium can lead to osmotic demyelination of the brain/brainstem because of rapid shrinkage of the brain.

Serum osmolality is governed by contributions from all molecules in the body that cannot easily move between the intracellular and extracellular space. Sodium is the most abundant electrolyte, but glucose, urea, plasma proteins, and lipids are also important. A patient with diabetic ketoacidosis may have hyponatremia, but normal osmolality, because

of hyperglycemia, hypertriglyceridemia, and increased plasma ketones. Each of these compounds is osmotically active. Patients with acute renal failure may have hyponatremia as a result of uremia, which is characterized by the accumulation of urea and other nitrogenous waste products.

*Hypotonic hyponatremia* is when a patient has hyponatremia with low measured and calculated serum osmolality. If serum osmolality is normal or high, this is *isotonic* or *hypertonic hyponatremia* or *pseudohyponatremia*.

Serum osmolality is calculated as follows:

$$2(\text{Na} + \text{K}) + \text{BUN}/2.8 + \text{glucose}/16$$

(in mEq/L)

or in SI units (mmol/L)

$$2(\text{Na} + \text{K}) + \text{urea} + \text{glucose}$$

Classically, we divide pseudohyponatremia into conditions in which the measured and calculated serum osmolalities are the same—hyperglycemia or uremia—and those in which there is an osmolar gap; some osmoles are clearly present as measured by serum osmolality but not identified by standard blood tests. The source of unmeasured osmoles may be endogenous (lipids or proteins), or exogenous (alcohols: ethanol, ethylene glycol, methanol, or isopropyl alcohol). The recognition of pseudohyponatremia is important because therapy for the de-

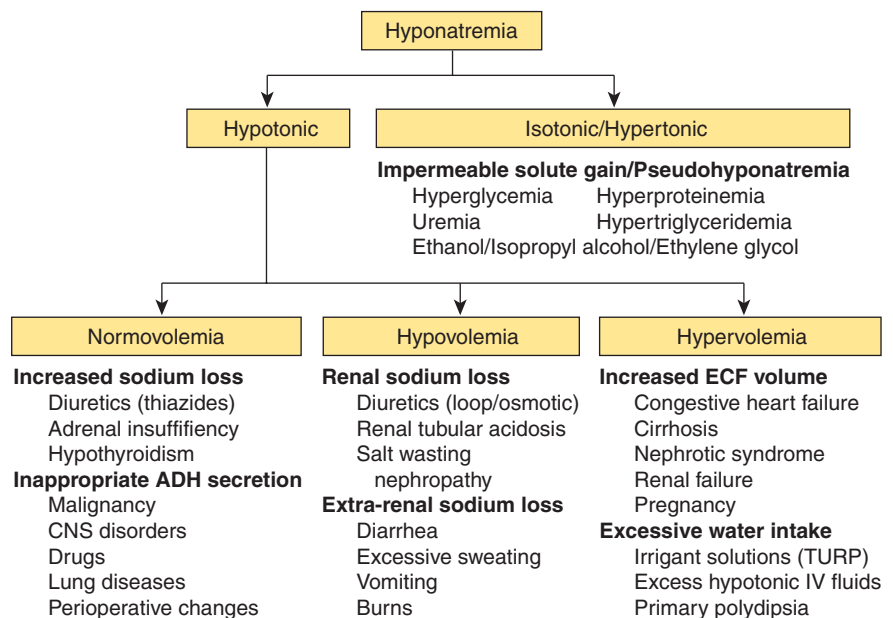


FIGURE 34–3. Hyponatremia.

creased serum sodium concentration is not indicated.

Hypertonic hyponatremia occurs when a decreased serum sodium concentration coexists with an increased serum osmolality. An increase in concentration of any osmotically active substance, which is confined predominantly to the ECF (e.g., glucose, glycerol, mannitol), will result in water movement out of cells along the osmolar gradient. The osmolar load usually evokes an osmotic diuresis, leading to urinary loss of both sodium and water. These losses may, in turn, potentiate both the hypertonicity and the hyponatremia. Clinically, the most frequent cause of this water and electrolyte disturbance is the occurrence of significant hyperglycemia in uncontrolled or poorly controlled diabetes mellitus. The measured serum sodium concentration decreases approximately 1.6 mEq/L for each 100 mg/dL increment of blood glucose.

True hyponatremia may result from increased total body water, associated with edema (liver failure, congestive heart failure, renal failure, or nephrotic syndrome), hypotonic fluid overload, or sodium loss in excess of free water. Total body sodium concentration is increased and there is a concomitant defect in the excretion of solute-free water. Water retention is proportionately greater than sodium retention, resulting in hypervolemic hyponatremia. This may be associated with extensive tissue edema. Despite the dramatic increase in extracellular fluid volume, there is a tendency toward venous pooling and accumulation of fluid in lax tissues and the peritoneum. Consequently, the plasma volume and, indeed, stroke volume, may be reduced, leading to renal hypoperfusion and activation of volume defence mechanisms by way of the juxtaglomerular apparatus and renin-angiotensin-aldosterone axis. This leads to a vicious cycle of hypervolemia, characteristically associated with congestive heart failure.

Dehydration associated with hyponatremia (hypovolemic hyponatremia) may be of renal or extrarenal origin. Renal losses are identified by a urinary sodium of  $>40$  mEq/L, and are characterized by the inability of the body to retain sodium. This may be caused by loop, thiazide, or osmotic diuretics, carbonic anhydrase inhibitors, primary aldosterone deficiency (Addison disease or adrenal insufficiency), or cere-

bral salt wasting (associated with subarachnoid hemorrhage). If the urinary sodium is less than 20 mEq/L, then the site of sodium loss is outside the kidney, usually the lower gastrointestinal tract, and associated with diarrhea. The mechanism of hyponatremia is the inbuilt priority of preservation of volume over osmolality. Hence, in this situation there is a dramatic increase in plasma ADH levels.

A number of diseases and drugs cause abnormal release of antidiuretic hormone, either as a consequence of ectopic production of ADH (ADH-se-

creting tumors) or increased release of this compound from the posterior pituitary gland (Table 34-2). The result is a paradoxically concentrated urine with dilute blood (the urinary osmolality is higher [ $>300$  mOsm] than the serum osmolality [ $<300$  mOsm]). The result is a state of hypervolemic or euvoletic hyponatremia. The syndrome of inappropriate antidiuretic hormone secretion (SIADH) is easily confused with the cerebral salt wasting syndrome: the SIADH improves with fluid restriction, whereas the cerebral salt wasting syndrome does not.

**TABLE 34-2.**

**Syndrome of Inappropriate Antidiuretic Hormone (ADH) Secretion**

*Increased hypothalamic production of ADH*

**1. Neuropsychiatric disorders**

Infections: meningitis, encephalitis, brain abscess

Vascular: thrombosis, subarachnoid or subdural hemorrhage, temporal arteritis, cavernous sinus thrombosis, stroke

Neoplasm: primary or metastatic

Skull fracture, traumatic brain injury

Psychosis, delirium tremens

Other: Guillain-Barré syndrome, acute intermittent porphyria, autonomic neuropathy, postpituitary surgery, multiple sclerosis, epilepsy, hydrocephalus, lupus erythematosus

**2. Drugs**

Intravenous cyclophosphamide

Carbamazepine

Vincristine or vinblastine

Thiothixene

Thioridazine, other phenothiazines

Haloperidol

Amitriptyline, other tricyclic antidepressants or serotonin-reuptake inhibitors

Monoamine oxidase inhibitors

Bromocriptine

Lorcainide

Clofibrate

General anesthesia

Narcotics, opiate derivatives

Nicotine

**3. Lung diseases and interventions**

Pneumonia

Tuberculosis

Lung abscess, empyema

Acute respiratory failure

Positive pressure ventilation

**4. Perioperative period—associated with the stress response to injury and pain**

*Ectopic (nonhypothalamic) production of ADH*

**Cancer**

Small cell carcinoma of lung (67% patients with small cell have impaired water excretion), bronchogenic, duodenum, pancreas, thymus, olfactory neuroblastoma, bladder, prostate, uterus

Lymphosarcoma, reticulum cell sarcoma, mesothelioma, Ewing sarcoma

Hodgkin disease, leukemia

Pulmonary tuberculosis



Several factors in perioperative medicine can contribute to functional SIADH, including emotional stress, anxiety, nausea, pain, the administration of opiates, and mechanical ventilation. Obstetric patients frequently receive oxytocin in order to increase uterine contractility. Indeed, the acute stress response should be seen as a state of free water retention, and for that reason large-volume resuscitation hypotonic fluids should be avoided. Conversely, SIADH as a result of other causes (Table 32-1) is treated, initially, with water restriction (Table 34-3). Chronic SIADH may be treated by inducing a state of nephrogenic diabetes insipidus, for example, by administering drugs such as lithium and demeclocycline.

A potentially fatal cause of hyponatremia, particular to perioperative medicine is TURP syndrome. This procedure requires continuous irrigation of the operative field to improve visibility and distend the bladder or prostatic urethra. The systemic absorption of these irrigating solutions can produce acute and sometimes dramatic hyponatremia. To prevent current dispersion from the resectoscope, the irrigating fluids cannot contain electrolytes; consequently, distilled water solutions containing isotonic glycine, mannitol, and/or sorbitol are usually used. During TURP, systemic absorption of the irrigating solutions is influenced by the duration of exposure, the number and size of venous sinuses opened, extravasation of the fluid into tissues outside the bladder or prostatic capsule, and the hydrostatic pressure of the fluid. The majority of patients undergoing TURP probably intravasate some hypotonic fluid, and there are few sequelae. However, when large volumes are absorbed, severe hyponatremia leading to cerebral edema may ensue. Consequently, urologists routinely administer furosemide when resection is complete. On occasion, it is necessary to administer hypertonic fluids to replete a sodium deficit.

If hypertonic saline is to be used, the sodium deficit must be calculated (the normal serum sodium is 140 mEq/L) as follows:

Step 1: Determine the patient's weight in kilograms prior to illness.

Step 2: Calculate the sodium deficit.

It is usual to correct only half the

sodium deficit (NaD) (hence the deficit/2):

$$\text{NaD} = (\text{desired sodium} - \text{patient's sodium})/2$$

If the patient's weight is 70 kg, and the serum sodium is 120 mEq/L, then the desired change is 10 mEq/L.

Total body deficit (TD) of sodium is the sodium deficit  $\times$  TBW:

$$\text{NaD} \times (\text{weight in kg} \times 0.6) = \text{TD}$$

The formula is applied as follows:

$$10 \times (70 \times 0.6) = 420 \text{ mEq}$$

Step 3: Calculate the rate of replacement.

Most physicians replace the deficit at a rate of replacement (RoR) of no more than 0.5 mEq/h. The patient has a deficit of 10 mEq, so at this rate (0.5 mEq/h), the deficit will be replaced over 20 hours (10/0.5).

$$\text{RoR in hours} = \text{NaD}/0.5$$

Step 4: Replace the sodium deficit with the fluid of your choice.

Because the amount of fluid required depends on the sodium content of that fluid (Table 34-4):

$$\text{TD}/[\text{Na fluid}/\text{mL}]/\text{RoR} = \text{per hour fluid replacement}$$

For example, if one is using 3% saline in this 70-kg male patient who has a serum sodium of 120 mEq/L, the calculation is as follows:

$$(420/0.513)/20 = 41 \text{ mL/h}$$

That is, after 20 hours, assuming no other fluids are given, the patient's serum sodium will rise to 130 mEq/L

TABLE 34-3.

## Management of Hyponatremia

If Na concentration is  $>125$ , the treatment is water restriction, 500–1000 mL/d

If Na concentration is  $<125$ , or water restriction is not possible, furosemide 40–80 mg IV, repeated as necessary, with replacement of electrolyte losses

If this strategy is unsuccessful at raising serum sodium, treatment with hypertonic saline may be necessary: NaCl 0.9% contains 1 mEq of Na in 6.5 mL (i.e., 0.154 mmol/mL), NaCl 1.8%, contains approximately 1 mEq Na per 3.25 mL, 3% NaCl contains approximately 1 mEq Na per 2 mL

If the cause is syndrome of inappropriate diuretic hormone secretion, and the patient does not respond to fluid restriction, then loop diuretics may be helpful; an alternative treatment is to cause a nephrogenic diabetes insipidus, by administering demeclocycline 300–600 mg BID

L. If 0.9% saline is given, the calculation is as follows:

$$(420/0.13)/20 = 160 \text{ mL/h}$$

Care must be taken when repleting sodium deficits to avoid the problem of osmotic demyelination (central pontine myelinolysis). Rapid correction of hyponatremia may trigger demyelination of pontine or extrapontine neurons, leading to neurologic dysfunction that may include quadriplegia, pseudobulbar palsy, seizures, coma, and even death.<sup>21</sup> For that reason serum sodium is raised slowly and only 50% of the deficit is corrected.

TABLE 34-4.

## Sodium Content of Various Intravenous Fluids

Fluid (Infusate)	Na Content (mEq/L)	Sodium Concentration per mL
Lactated Ringer solution	130	0.13 mEq/mL
0.9% NaCl	154	0.154 mEq/mL
1.8% NaCl	308	0.38 mEq/mL
3% NaCl	513	0.513 mEq/mL
5% NaCl	855	0.855 mEq/mL

## Hypernatremia

A serum sodium of  $>145$  mEq/L represents a hypertonic and hyperosmolar state. There is a net deficit of water in relation to sodium. This implies neither an increase in total body sodium nor a deficit in total body water. Hypernatremia is rarely encountered in routine perioperative patients; however, it is not an uncommon finding in the intensive care unit and, consequently, in patients traveling to the operating room from the ICU for subsequent procedures. When the serum osmolality exceeds 305–310 mOsm/kg  $H_2O$ , ADH secretion is stimulated and the urine becomes severely concentrated (i.e., osmolality greater than 800–1000 mOsm/kg  $H_2O$ ). The thirst response is activated in an attempt to stem cellular dehydration. Hypertonicity and hypernatremia rarely develop in the presence of an intact thirst mechanism and access to water. However, critically ill patients are often too sedated to express thirst and/or unable to drink water.

The imbalance between TBW and sodium that occurs in the hypernatremia may develop from either water loss or sodium gain (Fig. 34-4 and Table 34-5).<sup>22</sup> This may result from pure dehydration, the presence of a free water deficit (hypovolemic hypernatremia) such as occurs with administration of loop or osmotic diuretics, excessive evaporative losses (nonhumidified breathing systems), or diabetes insipidus (either cranial or nephrogenic). Patients with diabetes insipidus may present to the operating room in three circumstances. First, patients with traumatic brain injury complicated by diabetes insipidus may present for neurosurgery, for example, for decompressive craniectomy. Second, a patient who has undergone devastating brain injury, either traumatic or hemorrhagic, complicated by diabetes insipidus, may present for organ harvest, following brain death. Finally, a patient who has been chronically treated with lithium, for bipolar disorder, complicated by diabetes insipidus, may present for routine surgery. In each of these situations, the major risk to the patient (or to the patient's organs) is not hypernatremia but hypovolemia, and the anesthesiologist must be careful to replenish perioperative urinary losses.

Hypernatremic hypernatremia is associated with sodium gain, in the

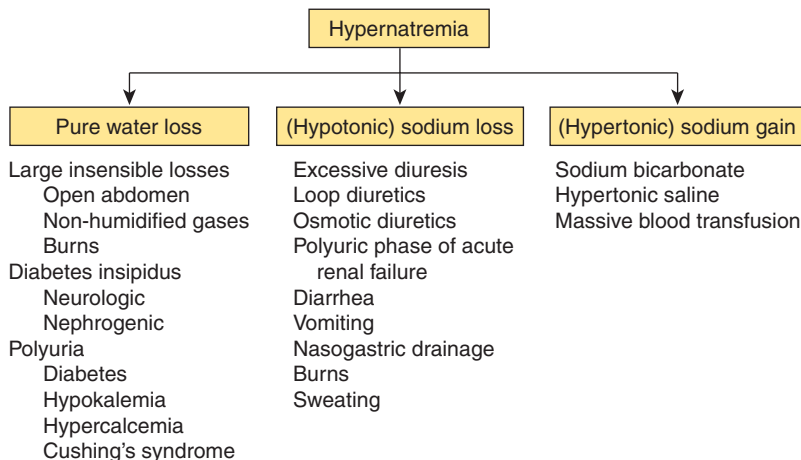


FIGURE 34-4. Hypernatremia.

presence of either euvoolemia or hypervolemia. This may result from administration of hypertonic saline, sodium bicarbonate, blood transfusion (sodium citrate), or parenteral nutrition (sodium acetate). Hypernatremia may be accompanied by metabolic alkalosis associated with an increase in the strong ion difference, from either dehydration of sodium gain.

Hypernatremia can be associated with significant neurologic sequelae; initially, the brain shrinks as a consequence of volume depletion, which makes the blood vessels vulnerable to rupture. The brain adapts to dehydration by expressing more solute, which may lead to cerebral edema, neurologic deficit, or convulsions.

The clinical approach to the management of the hypernatremic patient is to identify and treat the source, and replace the free water deficit. To correct hypernatremia, fluid and electrolyte losses must be restored. The rate of correction depends on the duration of hypernatremia. In general, for critically ill patients, correction at a rate of 1 mEq Na/L/h is appropriate; if hypernatremia is prolonged, the 0.5 mEq Na/L/h is more advisable (to reduce the risk of rebound cerebral edema).

For young males, the free water deficit is calculated as follows:

$$\text{free water deficit} = 0.6 \times \text{patient's weight in kg} \times \left[ \frac{\text{patient's sodium}}{140} - 1 \right]$$

where  $0.6 \times \text{weight}$  = estimated body water and 140 = desired sodium. (To calculate the free water deficit for females and elderly males multiply the weight in kg by 0.5.) Thus for a 70-kg

young male with a serum sodium of 150 mEq/L, the free water deficit equals 3 L.

Either isotonic or hypotonic fluid can be used to replace the free water loss. However, the more hypotonic the fluid administered, the more rapidly the deficit will be replaced.

In the example above, if one wished to reduce the patient's serum sodium by 10 mEq/L, how much of what fluid does one use? This depends on the amount of sodium in the chosen fluid,

TABLE 34-5.

### Causes of Hypernatremia

#### Pure water loss

Large insensible losses: no humidifier on mechanical ventilator

Diabetes insipidus

Neurologic—associated with head injury, brain hemorrhage, or meningitis

Nephrogenic—caused by lithium, demeclocycline, amphotericin B, heavy metal poisoning, hypokalemia, and hypercalcemia

#### Hypotonic fluid loss

Excessive diuresis with loop of osmotic diuretics

Polyuric phase of acute renal failure

Diarrhea

Vomiting

Nasogastric drainage

Burns

Sweating

#### Hypertonic sodium gain

Sodium bicarbonate infusion

Hypertonic saline administration

TABLE 34-6.

## Sodium Content of Fluids Used to Treat Hyponatremia

Fluid (Infusate)	Na Content (mEq/L)	Change per Liter in 70 kg Male with Na 150 mEq/L
Dextrose 5% in water	0	-3.5 mEq Na/L
0.2% NaCl in D <sub>5</sub> W	34	-2.7 mEq Na/L
0.45% NaCl	77	-1.7 mEq Na/L
Lactated Ringer solution	130	-0.5 mEq Na/L

and then applying this figure to the formula below (Table 34-6):

$$\text{change in serum Na per liter} = \frac{\text{infusate Na} (\text{serum Na} / [(\text{weight in kg} \times 0.6) - 1])}{}$$

If one chose D<sub>5</sub>W (dextrose 5% in water) and planned to correct this patient's sodium at a rate of 1 mEq/L/h, because each 1 L will correct 3.5 mEq, the rate of fluid infusion would be 1000 mL/3.5 = 285 mL/h.

Clearly, for simple hyponatremia, the choice of fluid determines the volume required to correct the sodium abnormality (a much larger volume of lactated Ringer solution than of D<sub>5</sub>W is required). The administration of free water, for example, via the enteral route, is probably the most effective method for replenishing extracellular water deficit.

### Potassium Physiology

Potassium is the major intracellular cation in the body and has several roles, the most important being the generation of the resting cell membrane potential and the action potential, as well as protein synthesis, acid-base balance and maintenance of intracellular osmolality.

The total body potassium content ranges from 50–55 mEq/kg body weight. Potassium is an intracellular cation, and approximately 98% of the body stores are located within the ICF compartment (i.e., only a total of 60–70 mEq exists in the ECF). A huge concentration gradient exists between the ICF and ECF compartments (150 mEq/L and 3.5–5.5 mEq/L, respectively). The primary mechanism for establishing and maintaining this concentration gradient is the sodium-potassium-activated adenosine triphosphatase (ATPase) “pump,” which is located in the plasma membrane of all body cells. These membrane-bound ionic transport pumps and the selective

permeability characteristics of cell membranes are responsible for the transmembrane electrical potential difference found in all living cells. Potassium is the ion responsible for generating cellular electrical activity. Hence, hypo- and hyperkalemia result in significant neuromuscular dysfunction.

The total amount of potassium present in the body is approximately 3200 mEq, 90% of which is intracellular, which is regulated by a variety of homeostatic mechanisms. Of total body potassium, approximately 135–150 mEq/L is intracellular, compared to plasma levels of 3.5–5.5 mEq/L. The daily requirement is about 1 mEq/kg/d absorbed from the small intestine. Potassium excretion exactly matches intake and body stores are quantitatively stable. Potassium balance is predominately governed by urinary loss. The kidney can adjust urinary potassium excretion from less than 1 mEq/L to greater than 100 mEq/L. In addition, there is some secretion of potassium in the colon.

Two factors impact renal handling of potassium: renal tubular fluid flow and aldosterone. The majority of filtered potassium is reabsorbed in the proximal tubule. The distal tubules then secrete potassium. This is influenced by the intracellular potassium concentration, the rate of urinary flow, and the anionic charge of the urine. As the rate of flow increases, there is a significant increase in potassium excretion. This explains hypokalemia associated with diuresis. Conditions that increase distal tubular sodium delivery promote potassium excretion and sodium reabsorption, particularly in the presence of aldosterone.

One of the most important roles of potassium is the resting membrane potential and in the repolarization phase of action potentials. The normal cell membrane is relatively permeable to potassium ions, and impermeable to sodium and anions. The anions generate a negative intracellular potential.

Potassium is held intracellularly against the electrochemical gradient by the action of the Na<sup>+</sup>-K<sup>+</sup> ATPase pump that maintains the resting membrane potential. The relative ratio for intracellular to extracellular potassium is responsible for electrochemical activity. Hence abnormalities of potassium concentration directly impact neuromuscular activity.

### Hyperkalemia

Hyperkalemia is generally defined as a serum potassium concentration of greater than 5.5 mEq/L. There are numerous conditions, diseases, and drugs that produce hyperkalemia by disrupting the normal external and/or internal potassium balance (Table 34-7). Factitious hyperkalemia is associated with hemolysis of the blood sample.

Several factors may produce a transient increase in serum potassium concentration as a result of transcellular shift. This includes administration of succinylcholine (0.3–0.5 mEq/L in normal subjects), burns, diabetes, metabolic acidosis, and nonselective β-blockers.

Succinylcholine may be associated with significant hyperkalemia in certain

TABLE 34-7.

## Causes of Hyperkalemia

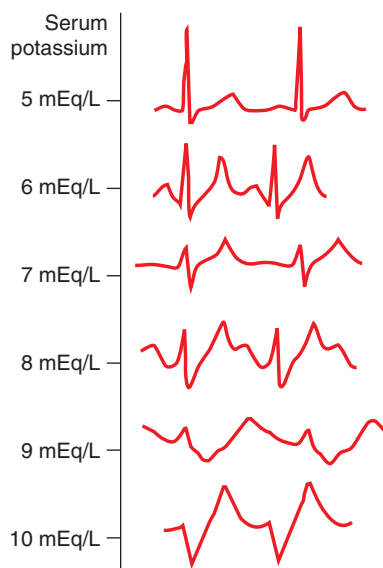
Increased exogenous potassium load
Potassium supplements including TPN
Enteral potassium administration
Red blood cell transfusion
Penicillin G administration
Increased endogenous potassium load
Rhabdomyolysis
Impaired excretion
Acute or chronic renal failure
ACE inhibitors
Potassium-sparing diuretics
Congestive heart failure
Heparin
Tacrolimus of cyclosporine
Trimethoprim
Amphotericin
Heparin
Intracellular to extracellular exchange
Hyperglycemia
Metabolic acidosis
β-Blockers
Succinylcholine
Digoxin

ACE, angiotensin-converting enzyme; TPN, total parenteral nutrition.

circumstances, such as conditions where there is muscle membrane degeneration (e.g., trauma, burns, or primary muscle disorders) or neural denervation (e.g., stroke, multiple sclerosis, Guillain-Barré syndrome or spinal cord injuries). Impaired potassium excretion is associated with acute and chronic renal failure, adrenal insufficiency, hypoaldosteronism (for any reason), and the use of angiotensin-converting enzyme (ACE) inhibitors.

In hyperkalemia the resting membrane potential is decreased toward the threshold potential (Fig. 34-5). With mild hyperkalemia (i.e., a serum potassium concentration of less than 6–7 mEq/L) there is increased automaticity as reflected by atrial and/or ventricular ectopy. Progressive hyperkalemia enhances rapid repolarization (phase 3), which causes shortening of the T-wave interval and symmetrical peaking of the T wave. If the serum potassium concentration continues to increase, the inward movement of sodium (phase 0) and calcium (phase 2) will diminish; the PR interval becomes prolonged and, eventually, the P waves (atrial phase 0) will disappear. Within the ventricular muscle mass, both conduction velocity and the height of the action potential are reduced. The net result is a widened QRS complex and reduced contractility. If the hyperkalemia progresses, the QRS complex will become smooth, wide, and sinusoidal as it merges with the T wave (serum potassium concentration of >10 mEq/L). Without treatment, ventricular fibrillation will ensue.

Emergency treatment is aimed at quickly stabilizing the myocardium and restoring normal transmembrane electrical potentials; 10–30 mL of 10% calcium gluconate can be administered over 3–5 minutes (or 5–10 mL calcium chloride may be substituted). Calcium reduces both the threshold potential and the excitability of cell membranes. The duration of action is roughly 30–60 minutes; a second dose may be necessary. Alternative temporizing measures include administration of sodium bicarbonate, nebulized albuterol, or insulin and dextrose in combination. Each has the impact of sending potassium into cells. One unit of regular insulin is recommended for each 2 g of dextrose. For example, 1 ampule of D50 (i.e., 50 mL of 50% dextrose) would be immediately followed by 12 units of regular insulin.



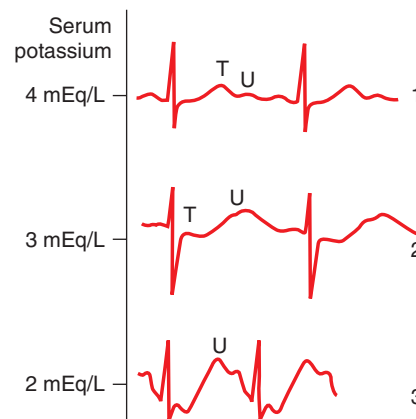
**FIGURE 34-5.** Electrocardiogram (ECG) changes associated with progressive hyperkalemia.

More definitive treatment of hyperkalemia can be achieved by administering exchange resins administered orally or rectally. These include calcium or sodium polystyrene sulfonate in combination with sorbitol, that facilitates potassium excretion through colonic exchange of calcium or sodium for potassium. If this approach fails, hemodialysis may be required.

### Hypokalemia

Hypokalemia is typically considered a potassium level of less than 3.5 mmol/L, although patients may be asymptomatic until the level is less than 2.5 mmol/L. Although the relative fall in extracellular potassium may appear small (1–2 mEq/L) this represents a significant total body deficit of potassium, up to 500 mEq. On average, plasma potassium decreases by 0.3 mmol/L for each 100-mmol reduction in total body stores.

Acute hypokalemia is associated with either inadequate intake or absolute loss of potassium from the body, governed by the law of mass conservation, or transcellular movement (Fig. 34-6 and Table 34-8). Causes of absolute loss include vomiting, diarrhea, bowel fistulae, loop and osmotic diuretics, and the diuretic phase of acute renal failure. Causes of intracellular potassium shifting include metabolic alkalosis, use of  $\beta_2$ -adrenergic agonists, hyperadrenergic states (including the acute stress response), administration of insulin, and hypothermia. Chronic causes of hypokale-



**FIGURE 34-6.** Electrocardiogram (ECG) changes associated with progressive hypokalemia. Strip 1: normal ECG; strip 2: flattened T wave, prominent U wave; strip 3: prolonged PR interval, prolonged QRS, ST-segment depression, heightened U waves, and prolonged QT interval.

mia include malnutrition, malabsorption, diuretic usage, corticosteroid administration, and Conn syndrome (primary hyperaldosteronism).

Potassium depletion causes muscle weakness. The ratio of intracellular to extracellular potassium increases, thereby reducing the resting potential (phase 4) and creating a state of hyper-

**TABLE 34-8.**

### Causes of Hypokalemia

Altered transcellular (internal) balance
Metabolic alkalosis
Insulin
$\beta_2$ -Adrenergic agonists
Following resolution of stress response
Anabolism
Periodic paralysis
Altered external balance
Decreased intake
Inadequate content in intravenous fluids
Malabsorption
Malnutrition
Increased renal excretion
Diuretics
Polyuria
Hyperaldosteronism
Hypomagnesemia
Renal tubular acidosis
High-dose penicillins
Increased gastrointestinal loss
Vomiting
Nasogastric suctioning
Diarrhea



polarization. When the action potential is initiated (phase 0), it is of super-normal magnitude. The time allotted for calcium entry (phase 2) is shortened, and repolarization (phase 3) is prolonged, leading to a greater relative refractory period. The diminished calcium entry affects skeletal muscle and may lead to myalgia, cramps, and weakness. The smooth muscle components of the bladder, gastrointestinal tract and the peripheral vasculature are also affected leading to urinary retention, ileus, and postural hypotension. The ensuing vasoplegia may be catecholamine insensitive.

Hypokalemia impacts cardiac conduction and contractility. Progressive electrocardiographic changes are typical (see Fig. 34–6): T-wave amplitude decreases, QT interval lengthens, the U wave appears or becomes broader and taller, the ST segment sags, and P-wave amplitude and QRS duration increase. Cardiac arrhythmias are relatively common. The most common dysrhythmias are atrial fibrillation and premature ventricular systoles, but supraventricular tachycardia, junctional tachycardia, and Mobitz type I second-degree atrioventricular block may also occur. Hypokalemia may induce digitalis toxicity (Fig. 34–6).

It is probably unnecessary to administer potassium supplements to a patient with mild hypokalemia. If moderate to severe hypokalemia (<3.0 mEq/L) is present, intravenous potassium chloride or potassium phosphate is usually administered. The maximal recommended rate of infusion is 0.5–0.7 mEq/kg/h. The repletion of total body potassium stores requires approximately 200 mEq for each 1 mEq/L reduction in the serum potassium concentration. Magnesium is an essential cofactor for transcellular sodium–potassium ion pumps. If hypomagnesemia coexists, magnesium supplements should be administered to ensure intracellular potassium repletion.

### Calcium Physiology

Calcium is an essential inorganic element that plays a crucial role in many biologic functions. It is the single most abundant electrolyte in the human body. A normal adult contains between 1000 and 1400 g of calcium, of which 99% is located in bone, where it is the primary structural component. Approximately 1% of the total calcium pool resides in the soft tissues and the

ECF compartment. Circulating calcium exists in three forms: a free ionized fraction (50%), a fraction bound to protein (mostly albumin) (40%), and a diffusible, nonionized fraction (10%) in which calcium is chelated with circulating anions (e.g., bicarbonate, phosphate, citrate). The ionized fraction is the calcium that is physiologically active, and it is the concentration of this fraction that is closely regulated by parathyroid hormone, vitamin E, and calcitonin. These substances alter the resorption of calcium from various target organs, including the skeletal system, the gastrointestinal tract, and the kidneys.

A measurement of total serum calcium (the analysis most often performed when a calcium level is requested) reflects the quantitative contribution of all three forms of circulating calcium. The normal value will vary depending on the particular laboratory but is generally in the range of 8.5–10.5 mg/dL (4.5–5.5 mEq/L or 0.96–1.27 mmol/L). The reported quantity may be misleading because of albumin binding, and calcium concentration measured in this way must be corrected for albumin concentration. Modern laboratories have the capability of directly measuring ionized calcium. The normal values for this measurement usually range from 4–5 mg/dL (2.1–2.6 mEq/L or 1.17–1.29 mmol/L).

Calcium has a number of important physiologic functions. As an essential component in neuromuscular transmission, calcium is involved in myocardial contractility by way of voltage-sensitive calcium channels in the myocardium. Calcium is involved in both depolarization and the magnitude of muscle contraction. Calcium is stored in the sarcoplasmic reticulum. Neurochemical activation leads to an increase in cytoplasmic calcium concentration. Calcium binds to troponin C and this complex binds to tropomyosin, which facilitates the interaction between actin and myosin, resulting in cardiac muscular contraction. Increased intracellular calcium is associated with increased contractility, inotropy, and cardiac output. Calcium is removed by reuptake into the sarcoplasmic reticulum and by extrusion via the  $\text{Ca}^{2+}$ - $\text{Na}^{+}$  pump located in the plasma membrane. This results in relaxation. Calcium is also an essential component in both skeletal muscle and smooth muscle contractility.

Calcium is an important cofactor for blood coagulation. The cytoplasm of platelets contains contractile filaments of actin and myosin that enable activated platelets to change their shape and release the contents of their granules. This process is driven by intracellular calcium. Calcium is important in the activation of thrombin, acting as a cofactor with factors VII, IX, and X.

Calcium is absorbed by the small intestine under the influence of calcitriol, a derivative of vitamin D. Calcitriol also facilitates absorption of phosphate from the intestine and the nephron, and influences bone formation and osteoclastic activity. The major control hormone for calcium metabolism is parathyroid hormone (PTH). This hormone causes release of calcium and phosphate from bone. It also enables renal calcium reabsorption and renal phosphate excretion, and activates calcitriol. Calcitonin has the opposite impact on serum calcium to PTH. It inhibits renal reabsorption of calcium and inhibits osteoclastic bone formation.

### Hypercalcemia

Hypercalcemia is associated with numerous conditions and disorders, including hyperparathyroidism, immobilization, chronic renal failure, adrenal insufficiency, thyrotoxicosis, sarcoidosis, and various drugs (Table 34–9, Fig. 34–7).

The most common cause of hypercalcemia is hyperparathyroidism. Anesthesiologists encounter these patients because they are frequently scheduled for parathyroidectomy. The second most common cause of acute hypercalcemia is malignancy, either secondary to bone destruction by metastases or as a consequence of secretion of calcemic factors by the tumor. This problem is most frequently encountered in breast cancer, myeloma, bronchogenic, and renal cell carcinoma.

A wide variety of clinical symptoms are characteristic of hypercalcemia, often described as “bones, stones, groans, and moans.” Patients develop bony pain, renal calculi, abdominal symptoms, and neuropsychiatric problems. Abdominal problems include nausea and vomiting, constipation, and acute and chronic pancreatitis. Hypercalcemia may impact cardiac electrical conduction by progressive shortening of the QT interval, leading to arrhythmias and possible cardiac

TABLE 34–9.

## Causes of Hypercalcemia

Hyperparathyroidism
Malignancy
Adrenal insufficiency
Sarcoidosis
Thyrotoxicosis
Immobilization
Drugs
Thiazide diuretics
Exogenous calcium or vitamin D
Furosemide
Tamoxifen
$\beta$ -Adrenergic agonists

arrest. Hypertension as a consequence of contraction of vascular smooth muscle is commonplace. Hypercalcemia has varying effects on the kidney. It may cause polyuria and polydipsia (mimicking diabetes mellitus) by interfering with ADH activity on the collecting ducts. It may reduce renal blood flow and glomerular filtration. It may cause nephrocalcinosis, interstitial nephritis and urolithiasis. In the central nervous system, hypercalcemia may cause anxiety, depression, irritability, lethargy, confusion, and psychosis.

The mainstay of therapy is hydration, either with or without the use of loop diuretics such as furosemide. Renal clearance of sodium and chloride are closely linked, so the coadministration of salt solutions and diuretics al-

lows rehydration and natriuresis. Other alternative therapies include chelators (e.g., phosphates and ethylenediaminetetraacetic acid [EDTA]), osteoclast inhibitors (e.g., mithramycin, glucocorticoids, calcitonin, diphosphonates), and calcium channel blockers (verapamil).

**Hypocalcemia**

Ionized hypocalcemia develops when there is significant calcium loss from the body. In perioperative medicine, this may be associated with massive blood transfusion, massive crystalloid resuscitation, or following parathyroidectomy (Table 34–10). Other causes include acute and chronic renal failure, vitamin D deficiency, hypomagnesemia, rhabdomyolysis, malnutrition, burns, sepsis, and acute pancreatitis. Critically ill patients are frequently hypocalcemic. During massive transfusion, the presence of citrate in the blood may result in significant hypocalcemia. The hallmark of hypocalcemia is neuromuscular irritability, with symptoms ranging from paresthesia to tetany and seizures. In addition, hypocalcemia may augment the neuromuscular blockade caused by nondepolarizing muscle relaxants. Mild hypocalcemia (ionized calcium levels of 3.2–3.9 mg/dL), even in critically ill patients, usually does not evoke symptoms. Patients who are undergoing parathyroidectomy may develop acute postoperative hypocalcemia, requiring supplementation.



**FIGURE 34–7.** Sclerosing peritonitis. A 77-year-old female with chronic renal failure and secondary hypercalcemia, who is on chronic peritoneal dialysis with abdominal pain. Axial noncontrast CT image through the pelvis demonstrates thick calcification of the peritoneum (*arrows*) and of the serosa of small bowel loops (*white arrowheads*). Note also extensive vascular calcification (*black arrowheads*). Source: Both figures courtesy of Diane Bergin, MD, Thomas Jefferson University Hospital.

TABLE 34–10.

## Causes of Hypocalcemia

Overhydration with calcium-free intravenous fluids
Massive blood transfusion
Hypoparathyroidism
Postoperative parathyroid surgery
Hypomagnesemia
Metabolic alkalosis
Chronic renal failure
Vitamin D deficiency
Osteomalacia
Sepsis/critical illness
Burns
Anticonvulsant therapy

Table 34–11 lists the clinical features of acute hypocalcemia. Acute hypocalcemia is associated with increased neuromuscular irritability. In mild hypocalcemia the patient may complain of paraesthesia of the fingers and toes and numbness (and burning) around the lips and mouth. With more severe hypocalcemia (ionized Ca < 1.0 mmol/L) the patient may complain of painful

TABLE 34–11.

## Clinical Features of Hypocalcemia

Neurologic
Paraesthesias
Muscle cramps
Tetany
Muscle weakness
Hyperactive reflexes
Convulsions
Respiratory
Laryngeal spasm
Bronchospasm
Cardiovascular
Hypotension
Impaired contractility
Bradycardia
Arrhythmias
Digitalis insensitivity
Cardiac arrest
ECG changes
QT and ST prolongation
T-wave inversion
Psychiatric
Anxiety
Confusion
Irritability
Depression
Psychosis
Dementia

muscle spasms, particularly of the fingers and thumb (carpal spasm). The term *tetany* has been used to describe this process, in which there is repetitive neuromuscular discharge after a single stimulus. Tetany can be elicited by tapping over the facial nerve, proximal to the auricle; this leads to twitching of the ipsilateral facial muscles particularly around the eyes and mouth (the Chvostek sign). Carpal spasm can be elicited by inflating a blood pressure cuff around the arm for several minutes, presumably causing mild ischemia and provoking muscle contraction (the Trousseau sign). Pain, anxiety, and hyperventilation may precipitate muscular spasms in postoperative patients. This has the potential to cause stridor or laryngospasm.

Acute symptomatic hypocalcemia is a medical emergency that warrants the intravenous administration of calcium. Therapy should not be withheld, even if the cause of the hypocalcemia is unclear. In adults, the recommended treatment is a 100-mg bolus of elemental calcium (over 5–10 minutes), followed by a continuous infusion administered at a rate of 0.5–2 mg/kg/h. Note that a bolus dose of calcium will only increase the ionized calcium concentration for 1–2 hours. Consequently, repeated boluses or an infusion is required.

Two different calcium salt preparations are readily available for intravenous administration: calcium chloride and calcium gluconate. Calcium chloride 10% contains 27.2 mg of elemental calcium in 10 mL. Calcium gluconate contains 9.3 mg of elemental calcium per 10 mL. Calcium chloride is very irritating to the peripheral vasculature and should be administered directly into the central venous circulation, if at all possible. In addition, the chloride salt is acidifying and theoretically should not be used when acidemia coincides with hypocalcemia. Thus, in the presence of significant metabolic acidosis, calcium gluconate should be used.

### Magnesium Physiology

Magnesium is the fourth most abundant cation within the body and is the second most prevalent intracellular cation next to potassium. Within the body, magnesium is distributed such that 50–60% resides in the skeletal system and another 20% is located within muscle tissue. The ICF to ECF

concentration ratio is about 15:1. At any one time, less than 1% of total body magnesium circulates within the intravascular fluid compartment, and thus serum levels do not reflect total body stores.

Depending on the particular laboratory, the normal total serum magnesium concentration ranges from 1.5–2.0 mEq/L. Similar to calcium, the circulating magnesium consists of three components: a chelated fraction (5%), a protein-bound fraction (33%), and an ionized, diffusible fraction (62%). Ionized magnesium is physiologically active and carefully regulated to maintain homeostasis. Because laboratories cannot report ionized magnesium, total magnesium is used.

Magnesium is a cofactor for more than 300 enzymatic reactions involving energy metabolism and nucleic acid synthesis. It is also involved with hormone receptor binding, calcium channel gating, transmembrane ion flux, regulation of adenylate cyclase, muscle contraction, neuronal activity, vasomotor tone, cardiac excitability, and neurotransmitter release.<sup>23</sup> From many perspectives, magnesium can be viewed as a physiologic calcium antagonist.

Both parathyroid hormone and vitamin D have regulatory influences on renal and gastrointestinal magnesium absorption. In turn, the ionized magnesium concentration influences parathyroid hormone secretion. The circulating ionized magnesium is primarily regulated by the kidney; the majority of filtered magnesium is conserved through proximal tubular resorption. Renal magnesium wasting occurs with hypermagnesemia, hypercalcemia, hypophosphatemia, hypercalciuria, loop diuretics, ACE inhibitors, aminoglycosides, amphotericin, cyclosporine, and cisplatin. Hypomagnesemia is almost universal in patients undergoing major surgery. Hypomagnesemia may also result from malnutrition, malabsorption, inadequate administration (including ECF dilution), diarrhea, laxatives, vomiting, and diabetes (Table 34–12).

Hypomagnesemia is associated with a variety of clinical manifestations, that involve the neuromuscular and cardiovascular systems (Table 34–13). One interesting manifestation of hypomagnesemia is a cardiac arrhythmia known as *torsade de pointes*. This is derived from a French ballet expres-

TABLE 34–12.

### Causes of Hypomagnesemia

Perioperative
Overhydration with calcium free intravenous fluids
Massive blood transfusion
Recovery phase of the stress response
Administration of epinephrine
Acute respiratory alkalosis
Cardiopulmonary bypass
Gastrointestinal
Diarrhea
Malabsorption
Gastrointestinal fistulae
Malnutrition
Alcoholism
Endocrine
Hyperaldosteronism
Hyperparathyroidism
Syndrome of inappropriate diuretic hormone secretion
Diabetes
Ketoacidosis (diabetes/alcoholism/starvation)
Drugs
Loop diuretics
Laxatives
Digitalis
Aminoglycosides
Amphotericin
Cyclosporine
Cisplatin

sion for “twisting of the points.” It refers to a specific polymorphous ventricular tachyarrhythmia in which the morphology of the QRS complexes varies from beat to beat. The ventricular rate varies from 150–250 beats/min. The arrhythmia is effectively treated with potassium and magnesium boluses.

In cases of hypomagnesemia, the total deficit is often greater than anticipated, as this is primarily an intracellular cation. The deficit of magnesium is often 1–2 mEq/kg and effective repletion may require a total dose of elemental magnesium in the range of 2–4 mEq/kg (given over several days). For mild acute hypomagnesemia, 4–6 g of magnesium can be added into intravenous fluids and infused over 30 minutes. Rapid infusion is associated with an unpleasant hot flash, and may induce acute hypotension. A continuous maintenance infusion of magnesium sulfate should then be administered for

TABLE 34-13.

## Clinical Manifestations of Hypomagnesemia (1.2 mg/dL)

Neuromuscular (symptoms and signs similar to hypocalcemia)
Muscle weakness
Difficult reversal from neuromuscular blockade
Tetany
Positive Chvostek and Trousseau signs
Muscle cramps
Muscle fasciculations and tremor
Neurologic
Nystagmus
Apathy
Delirium
Convulsions
Coma
Cardiovascular
Supraventricular arrhythmias
Ventricular arrhythmias
Torsade de pointes
Digitalis toxicity
Electrolyte disturbances
Hypokalemia
Hypocalcemia

4 to 7 days. This maintenance fluid should contain a total daily dose of 600 to 900 mg of elemental magnesium. In emergency situations the loading dose can be infused more rapidly, so long as continuous electrocardiogram (ECG) monitoring is performed and the rate of administration does not exceed 15 mg/min of elemental magnesium. For the duration of intravenous magnesium therapy, patients should be carefully monitored for evidence of magnesium toxicity and frequent assessment of the total serum magnesium concentration is mandatory.

Hypermagnesemia results from magnesium-containing antacids, enemas, total parenteral nutrition, acute renal failure, adrenal insufficiency, hypothyroidism, and nephrogenic diabetes insipidus.

Hypermagnesemia impairs neuromuscular function and produces progressive neuromuscular blockade. There is a heightened sensitivity to both depolarizing and nondepolarizing muscle relaxants. Magnesium has significant cardiac and hemodynamic effects. As a functional calcium channel blocker, magnesium may cause vasodilatation and hypotension.

Magnesium has been used in a variety of clinical situations, including perioperative care, to control blood pressure, and to prevent seizures in preeclampsia (Table 34-14). Magnesium may be used to control heart rate in ventricular and supraventricular arrhythmias, particularly when hypokalemia coexists. It has been used to treat torsade de pointes and digitalis toxicity. Magnesium has been used to reduce the adrenergic response to induction of anesthesia and intubation.<sup>24</sup> It has been used therapeutically as a smooth muscle relaxant in acute severe asthma.<sup>25</sup> Other therapeutic roles for magnesium in perioperative medicine and critical illness include perioperative analgesia, treatment of myocardial infarction, and treatment of tetanus.<sup>26</sup> The analgesic properties of magnesium appear to be associated with its antagonistic properties on *N*-methyl-D-aspartate (NMDA) receptors and calcium channel blockade. Calcium channel blockers are antinociceptive and potentiate the effects of morphine.<sup>26</sup>

The clinical manifestations of hypermagnesemia correlate well with the total serum magnesium concentration. These include somnolence, hypoventilation, postural hypotension, and at higher doses, respiratory and cardiac arrest. In patients who are treated with high-dose magnesium, and in obstetric patients with preeclampsia and eclampsia, for example, careful monitoring of neuromuscular function must be performed to avoid devastating neuromuscular blockade, which leads to respiratory arrest.

Treatment for hypermagnesemia is to enhance urinary excretion, principally by combining saline infusion and furosemide. Direct antagonism of toxic effects can be provided by intravenous calcium, although the duration of action is relatively short. In circumstances in which reversal of effect is not possible because of acute renal failure, hemodialysis is required.

### Phosphate Physiology

Phosphorous is the most abundant intracellular anion, its concentration is approximately 100 mmol/L. One-hundredth of the body's mass is made up of phosphate, most of which is stored as hydroxyapatite crystals in the bone matrix; only 15% is metabolically active and 1% is present in the blood. The average diet provides 800–1400 mg of phosphorous daily. Of this, 70%

TABLE 34-14.

## Therapeutic Uses of Magnesium

Cardiovascular
Supraventricular arrhythmias (associated with hypokalemia)
Torsade de pointes
Digitalis toxicity
Acute myocardial infarction (reperfusion, antiarrhythmia, coronary vasodilatation)
Pulmonary
Acute severe asthma
Obstetrics
Blood pressure control in preeclampsia
Anticonvulsant in preeclampsia
Anesthesia
Antiadrenergic therapy for intubation
Prevention of succinylcholine-induced muscular pain
Reduction in postoperative pain (NMDA antagonism)
Neuromuscular blockade (including treatment of tetanus)
NMDA, <i>N</i> -methyl-D-aspartate.

is absorbed through the gut, mainly by passive transport, but there is also some active transport, stimulated by vitamin D metabolites. Normal plasma range is between 2.8 and 4.5 mg/dL. The main organ of regulation of phosphate is the kidney. Phosphorous is filtered by the nephron, and mostly reabsorbed in the proximal tubule in cotransport with sodium. This cotransport is regulated by phosphorous intake (i.e., serum phosphorous levels) and PTH. PTH inhibits the cotransport mechanism, and increases urinary excretion of phosphorous. In the blood, phosphate is present in multiple forms—as phospholipids, as  $\text{PO}_4^{3-}$ , as  $\text{H}_2\text{PO}_4^-$ , and  $\text{HPO}_4^{2-}$ .

Every metabolic action in the body requires chemical energy, principally in the form of adenosine triphosphate (ATP). The high energy bonds in ATP are derived from phosphate. This is essential for muscle contractility, neuronal transmission, and electrolyte transport. Phosphate is a key building block for many essential intracellular compounds, including nucleic acids, phospholipids, enzymes, and nucleoproteins. Many of the intracellular messenger chemicals employ phosphate, these include cyclic adenosine monophosphate and cyclic guanosine



monophosphate. Phosphate has an essential role in both aerobic and anaerobic metabolism, and in 2,3-DPG (diphosphoglycerate), which is involved with hemoglobin-oxygen interactions at the tissue level. Phosphate is involved in cascades within the coagulation and immune systems. Finally, phosphate is the main intracellular buffer in the body, and is a component of the extracellular weak acid buffering system ( $A_{TOT}$ ).

Hypophosphatemia is caused by inadequate intake, excessive loss or redistribution within the body (Table 34–15). Inadequate intake may result from malnutrition or malabsorption (short-bowel syndrome, tropical sprue,

celiac and Crohn disease, radiation enteritis). Agents that bind with phosphate may reduce its absorption. These include magnesium and aluminum antacids and sucralfate (which contains aluminium).

Excessive loss of phosphate is associated with diuresis and dialysis. Osmotic diuretics and hyperglycemia cause increase urinary loss, as do theophylline and acetaminophen in overdose. The most phosphaturic diuretics are carbonic anhydrase inhibitors. Hypophosphatemia can rapidly occur during intermittent and continuous renal replacement therapies.

Hypophosphatemia may result from intracellular redistribution, during administration of catecholamines or  $\beta$ -adrenergic agonists, insulin surges (hyperglycemia), and alkalosis for any reason.

In general, muscles do not function well in hypophosphatemic states (Table 34–16). This relates to the importance of phosphate as the body's source of chemical energy. Hypophosphatemic causes weakness of respiratory muscles, particularly the diaphragm, and causes a leftward shift of the oxyhemoglobin dissociation curve (increasing the tendency for hemoglobin to cling to oxygen). Patients who are hypophosphatemic may be slow to wean from mechanical ventilation.<sup>27,28</sup> As one would expect, hypophosphatemia causes skeletal muscle weakness, which may mimic myopathy. In addition, low serum phosphate may interfere with blood cell function and cause increased red cell fragility.

Hypophosphatemia may cause myocardial dysfunction,<sup>29</sup> and may make the myocytes less sensitive to the stimulatory effects of catecholamines. This effect is reversible. Table 34–16 lists other complications of hypophosphatemia.

A particularly important cause of hypophosphatemia is the “refeeding syndrome.” Severely malnourished individuals develop a total body depletion of phosphorous; serum phosphorous levels are maintained by redistribution from the intracellular space. The body uses endogenous fuel stores as its main source of energy. Fat and protein (from muscle) are metabolized. Glucose delivery, either enterally or parenterally, as part of a feeding strategy, leads to a dramatic increase in circulating insulin levels. This results in rapid uptake of glucose, potassium, phosphate and magnesium into cells.

The serum concentration of these species falls dramatically. Simultaneously, there is a dramatic increase in extracellular fluid volume. There is an increase in cardiac workload, with increased stroke work, heart rate, and oxygen consumption. This sudden increase in demand for nutrients and oxygen may outstrip supply. Moreover, in patients with cardiovascular disease, the sudden increase in cardiac work and circulating fluid can precipitate acute heart failure. The sudden administration of carbohydrates exerts a considerable strain on the respiratory system, whose musculature may well be atrophied because of starvation. There is an increase in  $CO_2$  production and  $O_2$  consumption, and a resultant increase in the respiratory quotient. The consequence of this is an increase in minute ventilation, leading to dyspnea and tachypnea, and possibly to acute respiratory failure.

The serum phosphorous level falls precipitously with refeeding, as a consequence of a shift of phosphate from the extracellular to the intracellular compartment. This results from increased intracellular demand for the synthesis of phosphorylated com-

TABLE 34–15.

## Causes of Hypophosphatemia

Decreased absorption
Malnutrition
Phosphate binding antacids
Malabsorption syndromes
Crohn disease
Celiac disease
Gastrointestinal fistulae
Phosphate-binding agents
Magnesium and aluminum antacids
Sucralfate
Vitamin E deficiency
Increased loss
Volumn expansion
Diuretics
Dialysis
Steroids
Alcoholism
Renal transplantation
Hyperparathyroidism
Metabolic acidosis
Pancreatitis
Burns
Redistribution
Shifts from serum into cells
Recovery from the stress response
Carbohydrate infusions
Hyperglycemia
Hormonal effects
Catecholamines (epinephrine, dopamine, terbutaline, albuterol)
Insulin
Glucagon
Calcitonin
Respiratory alkalosis
Refeeding syndrome
Leukemic blast cell crises
Hungry bone syndrome

TABLE 34–16.

## Clinical Manifestations of Hypophosphatemia

Musculoskeletal
Chronic myopathy
Rhabdomyolysis
Osteopenia
Osteomalacia
Cardiovascular
Cardiomyopathy
Arrhythmias (ventricular)
Pulmonary
Respiratory failure
Failure to wean
Neurologic
Delirium
Seizures
Encephalopathy
Hallucinations
Peripheral neuropathy
Hematologic
Impaired oxygen release
Hemolysis
Leucocyte dysfunction
Metabolic
Metabolic acidosis
Glucose intolerance

TABLE 34–17.

## Preparations Available for Phosphate Repletion

Intravenous Preparations	Phosphate Concentration	Sodium Concentration	Potassium Concentration
Neutral sodium potassium PO <sub>4</sub>	1.1 mmol/mL	0.2 mEq/mL	0.02 mEq/mL
Neutral sodium PO <sub>4</sub>	0.09 mmol/mL	0.2 mEq/mL	0
Sodium PO <sub>4</sub>	3.0 mmol/mL	4.0 mEq/mL	0
Potassium PO <sub>4</sub>	3.0 mmol/mL	0	4.4 mEq/mL

pounds. This may result in respiratory failure, cardiac failure, cardiac arrhythmias, rhabdomyolysis, seizures, coma, and red cell and leucocyte dysfunction.

Perioperative patients are vulnerable to hypophosphatemia because of the catecholamine surge associated with the stress response. If severe malnutrition is suspected, the anesthesiologist should avoid the administration of glucose-containing intravenous fluids and aggressively supplement intracellular ions, potassium, magnesium, calcium, and phosphate (Table 34–17).

Hyperphosphatemia is caused by increased administration or absorption, decreased loss, or increased production (Table 34–18). Increased intake can occur as a result of excessive intravenous administration or oral supplementation or vitamin D intoxication. Occasionally, hyperphosphatemia results from recurrent administration of phosphate-containing enemas. There is reduced excretion in renal failure, hypoparathyroidism, and hypomagnesemia. Increased serum phosphate levels may result from diseases that cause widespread cell destruction: tumor lysis syndrome, rhabdomyolysis, bowel ischemia, hemolysis, and malignant hyperthermia. Pseudohyperphosphatemia may occur as a result of hypertriglyceridemia.

Acute hyperphosphatemia is associated with hypocalcemia, muscle weakness, and tetany. In chronic hyperphosphatemia, as occurs in chronic renal failure, calcium may be deposited in the tissues (ectopic/metastatic calcification). The treatment for acute hyperphosphatemia is administration of phosphate binding salts—calcium, magnesium, and aluminum.

### Chloride Physiology

Chloride is the second most abundant extracellular ion, and the most important extracellular anion. Chloride is ab-

sorbed in roughly equimolar concentrations with sodium in the small bowel. In addition, chloride is actively secreted into the gastric lumen with potassium that is subsequently pumped back into the parietal cell. The consequence is a significant fall in pH (gastric acidity). Chloride has a wide variety of other functions in the body. It represents one third of extracellular osmoles; it is involved in volume homeostasis, regulation of pH in the kidney, organic solute transport, and cell migration, proliferation, and differentiation.

Chloride channels are abundant in the body.<sup>30</sup> These are involved in a variety of functional roles in diverse processes, such as blood pressure regulation, cell cycle and apoptosis, muscle tone, volume regulation, synaptic transmission, and cellular excitability.<sup>31</sup> The benzodiazepine receptor gates a chloride channel, a key element in anesthesia pharmacology. A significant number of diseases appear to result from chloride channel abnormalities (Table 34–19). Mutations that result in a loss of function of the voltage-gated chloride channel, CLC-5, are associated with Dent disease, which is characterized by low-molecular-weight proteinuria, hypercalciuria, nephrolithiasis, and renal failure.<sup>32</sup> Mutations of another voltage-gated chloride channel, CLC-Kb, are associated with a form of Bartter syndrome, whereas other forms of Bartter syndrome are caused by mutations in the bumetanide-sensitive sodium-potassium-chloride cotransporter (NKCC2) and the potassium channel, ROMK. Mutations of the thiazide-sensitive sodium-chloride cotransporter (NCCT) are associated with Gitelman syndrome.<sup>32</sup> Mutations of chloride transport proteins are responsible for cystic fibrosis, renal tubular acidosis, neuromuscular disorders, and some forms of epilepsy.

The role of chloride in acid-base chemistry is discussed in Acid-Base

TABLE 34–18.

## Causes of Hyperphosphatemia

Increased intake
Intravenous infusion
Oral supplementation
Vitamin D intoxication
Phosphate-containing enemas
Acute phosphorus poisoning
Increased production/release
Tumor-lysis syndrome
Rhabdomyolysis
Bowel infarction
Malignant hyperthermia
Hemolysis
Acid-base disorders (lactic acidosis, diabetic ketoacidosis, respiratory acidosis)
Reduced loss
Renal failure
Hypoparathyroidism
Acromegaly
Tumoral calcinosis
Vitamin D intoxication
Bisphosphonate therapy
Magnesium deficiency
Pseudohyperphosphatemia
Multiple myeloma
Hemolysis in vitro
Hypertriglyceridemia

Chemistry below. Essentially hyperchloremia is associated with metabolic acidosis; hypochloremia is associated with metabolic alkalosis. Chloride has an important role in renal function.<sup>32</sup> Thiazide diuretics may modulate blood pressure by controlling serum chloride concentration by way of a sodium-chloride cotransporter. Hyperchloremia produces progressive renal vasoconstriction and a fall in glomerular filtration.<sup>33</sup> In addition, hy-

TABLE 34–19.

## Known Disorders That Result from Chloride Channel Abnormalities

Myotonia congenital
Myotonic dystrophy
Bartter syndrome
Renal tubular acidosis
Dent disease (hypercalciuria)
Gitelman syndrome
Nephrogenic diabetes insipidus (mouse)
Cystic fibrosis
Epilepsy
Osteopetrosis

perchloremia results in splanchnic hypoperfusion.<sup>34</sup> Administration of chloride rich solutions such as 0.9% saline may result in hyperchloremia, renal dysfunction, nausea and vomiting and hyperventilation.

### Physiology of Albumin

Albumin is the most abundant extracellular protein. It is a single polypeptide with 585 amino acids and a molecular weight range of 65,000 daltons (Da) to 69,000 Da. Thus a medium-size compound (IgG, e.g., is 150,000 Da), in addition to being highly soluble, is small enough to pass through fenestrated endothelium, such as in the nephron. Proteinuria does not occur in normal individuals because of the strong negative charge (17 mEq) carried by albumin that rebuts the protein in the glomerulus. Albumin is a weak acid whose concentration significantly impacts extracellular buffering capacity.

Albumin is manufactured in the liver at a rate of 9–12 g/d. The normal serum albumin is 30–50 g/L (3–5 g/dL). There is no storage, no reserve. Being the major source of oncotic pressure in health, the rate of production of albumin is controlled by changes in osmotic pressure and osmolality of extravascular perihepatic space. There is limited capacity to increase production. Increased synthesis is driven by the neuroendocrine system, chiefly by insulin, thyroid hormones, and cortisol.

Albumin is catabolized at a rate of 9–12 g/d (the same rate as it is produced) by pinocytosis in cells adjacent to the vascular endothelium. Albumin is not catabolized in starvation—under these circumstances, protein is derived from muscle, following exhaustion of fat stores.

Although albumin is perceived as intravascular protein, the total extravascular albumin actually exceeds the total intravascular amount by 30%.<sup>35</sup> The ratio of albumin to water is, however, higher in the intravascular space (the extracellular fluid is two-thirds interstitial and one-third intravascular), hence the colloidal effect. Albumin cyclically leaves the circulation, through the endothelial barrier at the level of the capillaries, passes into the interstitium, and returns to the bloodstream through the lymph system via thoracic duct. The circulation half-time for this process is 16–18 hours. Of the total intravascular albu-

min, 4–5% extravasates in this way per hour. This rate of movement is known as the transcapillary escape rate (TER), which is determined by capillary and interstitial free albumin concentration, capillary permeability to albumin, movements of solvent/solute, and the electrical charges across the capillary wall. The concentration of albumin in lymph protein content is approximately 80% that of plasma.

Albumin has a variety of physiologic and pharmacologic roles (Table 34–20). Albumin binds drugs and ligands, and reduces the serum concentration of these compounds (Table 34–20). An example is the serum calcium, the free (ionized) concentration of which needs to be corrected for albumin. There are four binding sites on albumin with varying specificity for different substances. Competitive binding of drugs may occur at the same site or at different sites (conformational changes). The drugs that have important albumin binding are warfarin, digoxin, nonsteroidal antiinflammatory drugs, midazolam, and thiopental. The relevance of a low albumin and drug binding is unknown.

Albumin is a major source of sulfhydryl groups; these “thiols” scavenge free radicals (nitrogen and oxygen species). The anticoagulant and antithrombotic effects of albumin are poorly understood.

Low serum albumin is a nonspecific marker of disease. A fall in the albumin concentration indicates deterioration, whereas a rise appears to reflect recovery. Very low levels of albumin appear to reflect a poor outcome. The relevance of low albumin on ligand binding is unknown.

In critical illness there is a reduction in the production of albumin, because of favored hepatic production of acute-phase proteins such as globulins, fibrinogen, and haptoglobin. Other proteins whose levels fall in this situation include prealbumin, retinal-binding protein, transferrin, and somatomedin C. This process is known as “hepatic reprioritization.” During conditions of stress or tissue injury, such as major surgery, trauma, or critical illness, there develops a generalized increase in vascular permeability, associated with release of cytokines and cytotoxic material. This leads to leakage of protein rich fluid into the interstitium (capillary leak). Aggressive volume resuscitation with crystalloid, gelatins,

**TABLE 34–20.**

#### Physiologic Roles of Albumin

Maintenance of the colloid osmotic pressure (COP)
Binding and transport
Drugs
Benzodiazepines (including midazolam)
Thiopental
Nonsteroidal antiinflammatory agents
Warfarin
Tacrolimus
Indomethacin
Digitalis
Furosemide
Chlorpropamide
Penicillins
Thyroxine
Calcium
Magnesium
Free radical scavenging
Acid–base balance
Pro- and anticoagulant effects
Inhibits platelet aggregation
Enhances the inhibition of factor Xa by antithrombin III
Effects on vascular permeability

or hydroxyethyl starch significantly reduces albumin concentration by a dilutional effect. Hence hypoalbuminemia during the stress and systemic inflammatory response is a result of hemodilution, redistribution, and hepatic reprioritization. Low serum albumin (and prealbumin) represents a negative acute-phase response.

In critical illness, there is a stronger correlation with colloid oncotic pressure and total protein than with serum albumin concentration. In these patients, the decreased albumin is compensated for by an increase in acute-phase proteins.<sup>36</sup> Nonetheless, there is increased leakage of albumin that drags fluid into the extravascular space. The overall fluid flux is less than would be predicted if albumin was the only protein responsible for oncotic pressure in the Starling equation. Thus low serum albumin does not necessarily mean low plasma oncotic pressure, and does not always cause edema.

Hypoalbuminemia is associated with various disease states (Table 34–21), including liver dysfunction, nephropathies (in particular nephrotic

TABLE 34–21.

## Causes of Decreased Plasma Albumin

Decreased synthesis
Increased catabolism (very slow)
Increased loss
Nephrotic syndrome
Exudative loss in burns
Hemorrhage
Gut loss
Redistribution
Hemodilution
Increased capillary permeability (leakage into the interstitium)
Decreased lymph clearance

syndrome), preeclampsia and eclampsia, and burns. Hypoalbuminemia in preoperative patients is indicative of severe malnutrition and is a known indicator of poor surgical outcomes. Preoperative nutrition targeting an increase in albumin improves outcomes.<sup>37</sup> In critically ill patients, there is a strong relationship between the dynamic fall in serum albumin concentration and patient outcomes.<sup>38</sup> The lower the serum albumin plunges, the greater the mortality, morbidity, length of stay, and complication rate. Blunt et al. showed that nonsurvivors in intensive care had lower mean albumin concentrations than did survivors, and there was, significantly, no difference between the colloid oncotic pressures of the two groups.<sup>39</sup> Finally, changes in albumin concentration have significant impact on acid–base balance, which is discussed in detail in the following section.

## ACID–BASE CHEMISTRY

## Primary Principles

Acid–base chemistry refers to the study of the relative ratio of hydrogen to hydroxyl ions in extracellular fluid, particularly in arterial blood. Intracellular hydrogen ion concentration, or pH (its negative logarithm), is equivalent to the pH of water at body temperature, and varies little despite significant changes in extracellular pH. The body carefully controls the relative concentrations of hydrogen and hydroxyl ions in the extracellular and intracellular spaces. Alterations in this “balance” lead to significant cardiovascular problems because of dysfunction of transcellular ion pumps. The anes-

thesiologist is expected to identify changes in acid–base chemistry, determine their origins, and treat them. However, the tools available, based on traditional methods derived from epidemiologic studies of respiratory cripples and extrapolation of the Henderson-Hasselbalch equation, are often unhelpful in perioperative medicine. These approaches, the “Boston” approach of Schwartz and Brackett, and the “Copenhagen” approach of Siggaard-Anderson, frequently fail to identify perioperative acid–base abnormalities, particularly when multiple abnormalities are present simultaneously. Moreover, these approaches do not provide guidance with regard to the source of the anomaly.<sup>40</sup> In general, the cause of acid–base disturbances is more clinically relevant than the acid–base anomaly itself. The majority of causes of such perturbations are easily explained, but some, such as dilutional and hyperchloremic acidosis, previously eluded description.

The “modern” physical–chemical approach, originally introduced by Peter Stewart<sup>41</sup> and subsequently refined by several investigators,<sup>42–44</sup> has significantly enhanced our understanding of these problems and simplified the clinical application.<sup>4,45</sup> This approach has gained widespread acceptance in perioperative medicine and critical care, and is the basis of this segment of the chapter.<sup>46</sup>

## Acids, Bases, and Water

Water is a highly ionizing solvent that autodissociates into a negatively charged hydroxylated (OH) ion and positively charged protonated (H<sub>n</sub>O<sup>+</sup>) ion.<sup>47</sup> Conventionally, this self-ionization of water is written as follows:



The symbol H<sup>+</sup> is convenient because, even though protons dissociating from water have many aliases (such as H<sub>3</sub>O<sup>+</sup>, H<sub>5</sub>O<sub>2</sub><sup>+</sup> and H<sub>9</sub>O<sub>4</sub><sup>+</sup>), most physicians and chemists refer to them as hydrogen ions. Indeed, the concept of “free hydrogen ions” referred to in texts is metaphorical. Water dissociation is constant (K<sub>w</sub>), and is governed by changes in temperature, dissolved electrolytes, and cellular components:

$$K_w = [\text{H}^+][\text{OH}^-]$$

In other words, if [H<sup>+</sup>] increases, then [OH<sup>-</sup>] decreases by the same mag-

nitude. The self-ionization of water is miniscule. In pure water at 77°F (25°C), the [H<sup>+</sup>] and [OH<sup>-</sup>] are 1.0 × 10<sup>7</sup> mEq/L.<sup>48</sup> Using the Sorenson negative logarithmic pH scale, this is a pH of 7.0. Water becomes alkaline with falling temperature (at 32°F [0°C] pH is 7.5) and acidic with increasing temperature (at 212°F [100°C] pH is 6.1). Physiologic pH, that at which the body resides, differs between the intracellular (pH 6.9) and compartment (pH 7.4) and between venous (pH 7.5) and arterial (pH 7.4) blood. Conventionally, acid–base balance refers to changes in hydrogen ion concentration in ECF from 7.4. This is reasonable as cells are relatively impervious to ionic materials, and the ECF is rapidly influenced by changes in fluids, electrolytes, and carbon dioxide tension. Thus acidosis (an increase in hydrogen ion concentration) occurs when the pH is less than 7.3, and alkalosis (a decrease in hydrogen ion concentration) occurs when pH is greater than 7.5.

One reason for the confusion regarding the concept of acids and bases is the variety of apparently conflicting theories that define acidity versus alkalinity. This results, in a particular fixation with the concept of an acid being a “proton donor” (Brønsted-Lowry definition) and a base being a “proton acceptor.” However, as all acid–base changes in physiology are derived from alterations in water dissociation,<sup>49</sup> it is simpler to define an acid as a substance that increases hydrogen ion concentration when added to a solution. A base is a substance that decreases hydrogen ion (and increases hydroxyl ion) concentration, when added to a solution. This definition, although closer to Arrhenius’ theory, is entirely consistent with Brønsted-Lowry,<sup>4,50</sup> and more easily understood.

The extracellular fluid is an ionic soup containing uncharged cells and particles, dissolved gases (oxygen and carbon dioxide), and fully and partially dissociated ions. Many of these factors influence water dissociation, dependent on chemical charge, quantity, and degree of dissociation.<sup>51</sup> In addition, ionized particles, particularly sodium and chloride, as we have seen, exert a significant osmotic effect. Thus physical chemistry and extracellular fluid volume are interconnected. These particles obey three distinct laws<sup>45</sup>: (a) electrical neutrality—the net positive charge must equal the net nega-



tive charge; (b) mass conservation—the total quantity of a substance in the extracellular space is constant unless added, removed, generated, or destroyed; (c) dissociation equilibria for all incompletely dissociated substances (albumin, phosphate, and carbonate) must be obeyed at all times. Thus, to determine the acid–base status of a fluid, all substances to which these rules might be applied must be accounted for. These include fully dissociated ("strong") ions, partially dissociated ("weak") acids, and volatile acid species.

Stewart determined that the relative concentration of hydrogen and hydroxyl ions in health and disease is determined by three independent variables: the strong ion difference (SID), the total concentration of weak acids ( $A_{TOT}$ ), and the partial pressure of carbon dioxide ( $PCO_2$ ; Table 34–22).<sup>4,41</sup> Hydrogen, hydroxyl ions, and bicarbonate are dependent variables. Because their concentration is entirely dependent on independent variables, isolated loss of hydrogen ions or bicarbonate from the gut or kidney cannot induce a change in acid–base balance.

### Strong Ions

Strong ions are completely dissociated at physiologic pH. The most abundant strong ions in the extracellular space are sodium ( $Na^+$ ) and chloride ( $Cl^-$ ). Other important strong ions include  $K^+$ ,  $SO_4^{2-}$ ,  $Mg^{2+}$ , and  $Ca^{2+}$ . Each applies a direct electrochemical and osmotic effect.

In the extracellular space—the difference between the charge carried on strong cations and strong anions—is calculated as follows:

$$SID = ([Na^+] + [K^+] + [Ca^{2+}] + [Mg^{2+}]) - ([Cl^-] + [\text{other strong anions: A}]) = 40\text{--}44 \text{ mEq}$$

This excess of positive charge, called the *strong ion difference* by Peter Stewart,<sup>41</sup> is always positive, and is balanced by an equal amount of "buffer base," principally in the form of phosphate, albumin, and bicarbonate.<sup>52</sup> SID independently influences water dissociation, determined by electrical neutrality and mass conservation. If all other factors ( $PCO_2$ , albumin, and phosphate) are kept constant, an increase in SID will decrease hydrogen ion liberation from water (and increase hydroxyl ion liberation), causing alkalosis (Fig. 34–8). A de-

TABLE 34–22.

### What Determines pH?

Using a physiochemical approach, it is possible to determine the effect of carbon dioxide, completely dissociated ions, and partially dissociated ions on water dissociation, and, hence, hydrogen ion concentration. Six simultaneous equations can be constructed and solved for  $[H^+]^{4,40}$ :

- |  |  |
|--|--|
| 1. Water dissociation equilibrium        | $[H^+] \times [OH^-] = K_w$                                    |
| 2. Weak acid dissociation equilibrium    | $[H^+] \times [A^-] = K_A \times [HA]$                         |
| 3. Conservation of mass for weak acids   | $[HA] + [A^-] = [A_{TOT}]$                                     |
| 4. Bicarbonate ion formation equilibrium | $[H^+] \times [HCO_3^-] = K_C \times PCO_2$                    |
| 5. Carbonate ion formation equilibrium   | $[H^+] \times [CO_3^{2-}] = K_3 \times [HCO_3^-]$              |
| 6. Electrical neutrality                 | $[SID] + [H^+] - [HCO_3^-] - [A^-] - [CO_3^{2-}] - [OH^-] = 0$ |

Interestingly, there are 6 independent simultaneous equations, and just 6 unknown, dependent variables determined by them:  $[HA]$ ,  $[A^-]$ ,  $[HCO_3^-]$ ,  $[CO_3^{2-}]$ ,  $[OH^-]$  &  $[H^+]$ . There are 3 known independent variables:  $[SID]$ ,  $[A_{TOT}]$ , and  $PCO_2$ . Although the above equations look relatively simple, fourth-order polynomials are required for the resolution.

Solving equations for  $[H^+]$ :

$$[SID] + [H^+] - K_C \times P_C / [H^+] - K_A \times [A_{TOT}] / (K_A + [H^+]) - K_3 \times K_C P_C / [H^+]^2 - K_w / [H^+]$$

In order words,  $[H^+]$  is a function of  $SID$ ,  $A_{TOT}$ ,  $PCO_2$ , and a number of constants. All other variables, most notably  $[H^+]$ ,  $[OH^-]$ , and  $[HCO_3^-]$  are dependent, and thus cannot independently influence acid–base balance. Hence, it is possible to resolve all acid–base abnormalities into a problem of one or more of these three variables.

crease in SID increases hydrogen ion liberation, to maintain electrical neutrality, causing acidosis.

The chief determinant of SID is the relationship between the relative concentration of sodium, chloride and free water in ECF. The normal ratio of sodium to chloride is approximately 1.4:1. Any process that reduces that ratio reduces SID and leads to acidosis (sodium loss, chloride gain, or free water gain). Any process that increases that ratio increases SID and leads to alkalosis (sodium gain, chloride loss, or free water gain).

### Weak Acids

Albumin and phosphate are weak acids, whose degree of dissociation is related to temperature and pH. Weak

acids, represented by the symbol  $A_{TOT}$ , independently influence acid–base balance, depending on absolute quantity and dissociation equilibria.<sup>41,53</sup>

The principal limitation of traditional approaches to acid–base balance has been the limited attention paid to changes in  $A_{TOT}$ .<sup>54</sup> Although this may be valid in otherwise healthy patients, perioperative care and critical illness cause hypoalbuminemia as a result of crystalloid administration, hepatic prioritization, and capillary leak.<sup>55</sup> A reduction in serum albumin or phosphate leads to metabolic alkalosis.<sup>43</sup> Hypophosphatemia is associated with malnutrition, refeeding, diuresis, and hemodilution. Hyperphosphatemia occurs in renal failure. Hyperphosphatemia leads to metabolic acidosis.

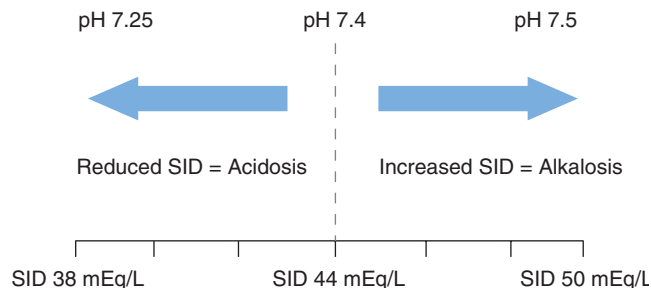


FIGURE 34–8. Impact of changes in strong ion difference on pH. Increased SID causes metabolic alkalosis. Decreased SID causes metabolic acidosis.

## Carbon Dioxide

Aerobic metabolism results in the production of large quantities of carbon dioxide. Carbon dioxide is hydrated by carbonic anhydrase in red cell erythrocytes to carbonic acid. This liberates the equivalent of 12,500 mEq of  $H^+$  per day. Hydrogen ions bind to histidine residues on deoxyhemoglobin, and bicarbonate is actively pumped out of the cell. Carbon dioxide exists in four forms: carbon dioxide [denoted  $CO_2(d)$ ], carbonic acid ( $H_2CO_3$ ), bicarbonate ions ( $HCO_3^-$ ), and carbonate ions  $CO_3^{2-}$ . The principal mechanism of excretion is through alveolar ventilation, although some  $CO_2$  is excreted from the kidney as bicarbonate as part of a sodium-chloride cotransporter.

Chronic respiratory acidosis is associated with increase in total body  $CO_2$  content, reflected principally by an increase in serum bicarbonate. Mathematically  $\Delta HCO_3^- = 0.5 \Delta PaCO_2$ .<sup>40</sup> It is important that this not be confused with metabolic compensation for hypercarbia, a relatively slow process that reduces SID by increasing urinary chloride excretion.<sup>56</sup>

## Acid-Base Disturbances

### Overview

Acid-base disturbances are an important part of clinical and laboratory investigation of perioperative and critically ill patients.

There are 6 primary acid-base abnormalities (Table 34-23):

1. Acidosis as a result of increased  $PaCO_2$
2. Acidosis as a result of decreased SID: increased chloride (hyperchloremic), reduced sodium (dilutional)/increased free water
3. Acidosis as a result of increased  $A_{TOT}$ : hyperphosphatemia, hyperproteinemia
4. Alkalosis as a result of decreased  $PaCO_2$
5. Alkalosis as a result of increased SID: decreased chloride (hypochloremic), increased sodium/decreased free water (contractional)
6. Alkalosis as a result of decreased  $A_{TOT}$ : hypophosphatemia, hypoalbuminemia

### Acute Respiratory Acidosis and Alkalosis

Acute respiratory acidosis results from hypoventilation, which is caused by

TABLE 34-23.

### Classification of Acid-Base Abnormalities

	Acidosis	Alkalosis
Respiratory	Increased $PCO_2$	Decreased $PCO_2$ $\uparrow SID \downarrow [Cl^-]$
Metabolic		
1. Abnormal SID <sup>+</sup>		
a. Because of water	Water excess = dilution $\downarrow SID^+ \downarrow [NA^+]$	Water deficit = contraction $\uparrow SID^+ \uparrow [NA^+]$
b. Because of electrolytes	Chloride excess $\downarrow SID^+ \uparrow [Cl^-]$	Chloride deficit $\uparrow SID^+ + \downarrow [Cl^-]$
Others (unmeasured anions), e.g., lactate, ketoacids	$\downarrow SID \uparrow [A^-]$	—
2. Abnormal $A_{TOT}$		
a. Albumin [Alb]	$\uparrow [Alb^-]$ (intravenous albumin)	$\downarrow [Alb^-]$
b. Phosphate [Pi]	$\uparrow [Pi^-]$	$\downarrow [Pi^-]$

loss of respiratory drive, neuromuscular or chest wall disorders, or rapid shallow breathing, and which increases the fraction of dead space ventilation. Acute respiratory acidosis is often associated with a precipitous reduction in pH as a result of the absence of a rapid buffering system for large quantities of carbon dioxide. Acute respiratory alkalosis (pH >7.5) is caused by hyperventilation, as a result of either anxiety, central respiratory stimulation (as occurs early in salicylate poisoning), or excessive artificial ventilation. Acute respiratory alkalosis usually accompanies acute metabolic acidosis (pH <7.35), in which case the reduction in  $PCO_2$  from baseline (usually 40 mm Hg) is equal to the magnitude of the base deficit. For example, in a patient with lactic acidosis, with a lactate of 10 mEq/L, the base deficit should be 10, and the  $PCO_2$  should be 30 mm Hg. If the  $PCO_2$  is higher than expected, there is a problem with the respiratory apparatus. This is seen, for example, in a multitrauma patient, in whom there is massive blood loss, causing lactic acidosis, plus a flail chest, causing respiratory acidosis.

### Acute Metabolic Acidosis

Acute metabolic acidosis is caused by an alteration in SID or  $A_{TOT}$ . SID is changed by an alteration in the relative quantity of strong anions to strong cations. This can be caused by anion gain, as occurs with lactic-, renal-, keto-, and hyperchloremic acidosis, or cation loss, as occurs with severe diar-

rhea. Acidosis also results from increased free water relative to strong ions—dilutional acidosis—which results from excessive hypotonic fluid intake, certain poisonings (methanol, ethylene glycol, and isopropyl alcohol), or hyperglycemia (Fig. 34-9).

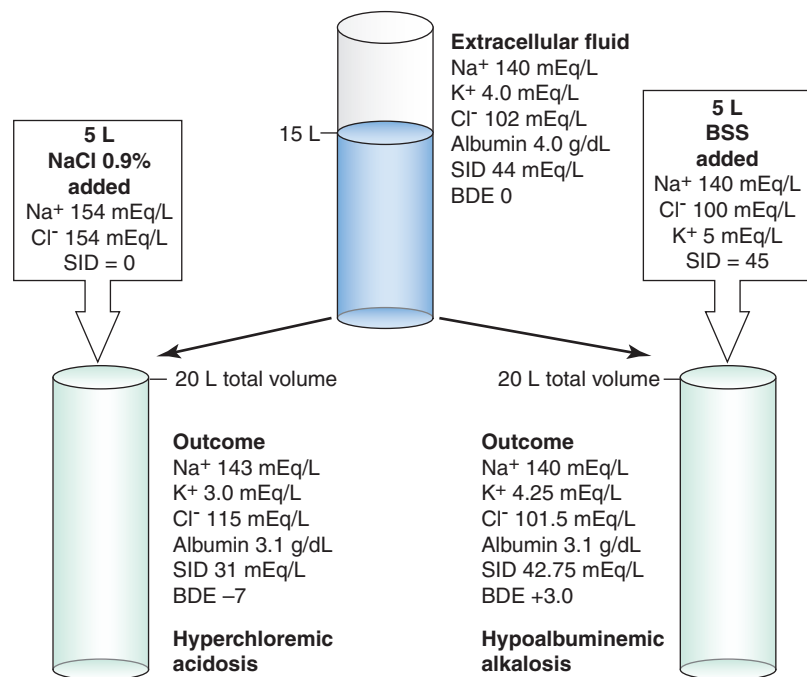
In acute metabolic acidosis, three diagnoses should be immediately investigated: lactic acidosis (send a serum lactate as it should mirror the magnitude of base deficit), ketoacidosis as a consequence of diabetes (the patient should be hyperglycemic and have positive urinary ketones), and acute renal failure demonstrated by high serum urea and creatinine and low total  $CO_2$ . The latter is a diagnosis of exclusion. The presence of a low serum sodium (>135 mEq/L) should alert the clinician to the possibility of a dilutional acidosis caused by alcohol poisoning. Alcohols such as ethanol, methanol, isopropyl alcohol, and ethylene glycol are osmotically active molecules that expand extracellular water (glucose and mannitol have the same effect but also promote diuresis, as the molecules are small enough to be filtered by the kidney). Suspicion of alcohol poisoning is raised by the presence of an osmolar gap—a difference between the measured and calculated serum osmolality greater than 12 mOsm demonstrates the presence of unmeasured osmoles. Toxicology laboratories can investigate for the presence of various toxic alcohols.

Renal acidosis is caused by accumulation of strong ion products, such as

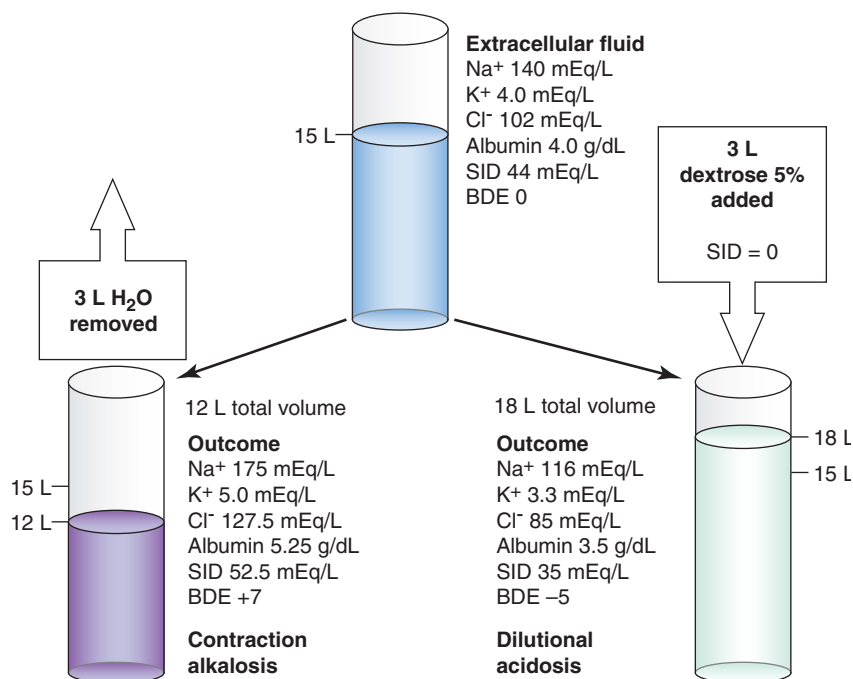
sulphate and formate, of metabolism excreted exclusively by the kidney. In addition, there is accumulation of a weak acid, phosphate.

The administration of intravenous fluids to patients has significant impact on acid–base balance. There are changes in free water volume, SID, and  $A_{TOT}$  (principally albumin). “Dilutional acidosis” results from administration of pure water to extracellular fluid (which is alkaline). This can occur with large-volume administration of any fluid whose SID is 0, for example, 5% dextrose, 0.9% saline (contains 154 mEq of both  $Na^+$  and  $Cl^-$ ), and other hypotonic saline infusions. Dilutional acidosis results from a reduction in serum sodium or an increase in chloride relative to sodium. This “hyperchloremic acidosis” is frequently seen in the operating suite following large-volume administration of 0.9% saline solution or 6% hetastarch (both formulated in normal saline) (Fig. 34–10).<sup>57,58</sup> In an experimental model of sepsis, Kellum<sup>59</sup> showed that dogs treated with 5% hydroxyethyl starch diluted in lactated Ringer solution (Hextend) and lactated Ringer solution (both with a SID of 20) had less acidosis and longer survival than those treated with normal saline.

What is the relevance of hyperchloremic acidosis? Brill et al. found that acidosis caused by hyperchloremia was associated with better outcomes than either lactic acidosis or ketoacidosis.<sup>60</sup> This supports the contention that it is the underlying problem that increases patient risk. Nonetheless, metabolic acidosis, regardless of origin, can depress myocardial contractility and reduce cardiac output and tissue perfusion. Acidosis inactivates membrane calcium channels and inhibits the release of norepinephrine from sympathetic nerve fibers, leading to vasodilatation and maldistribution of blood flow. Additionally, metabolic acidosis is associated with an increased incidence of post-operative nausea and emesis.<sup>61</sup> Plasma chloride levels affect afferent arteriolar tone through calcium-activated chloride channels and modulate the release of rennin.<sup>62</sup> Hyperchloremia can reduce renal blood flow and glomerular filtration rate.<sup>63</sup> Hyperchloremia reduces splanchnic blood flow.<sup>34</sup> In a study of healthy volunteers, normal saline was associated with reduced urinary output compared with lactated Ringer solution.<sup>64</sup> Finally, in a study of fluid prehydration to prevent contrast nephropathy



**FIGURE 34–9.** Impact of extracellular fluid (ECF) expansion with NaCl 0.9% versus an idealized balanced salt solution (balanced salt solutions) on acid–base chemistry. Note the impact of the fluid on both SID and on albumin concentration ( $A_{TOT}$ ). In both of these examples the contribution of albumin dilution to base deficit excess is approximately 3 mEq/L. ECF expansion with NaCl, with a SID of 0, leads to hyperchloremic acidosis; the magnitude of acidosis is less than would be predicted by the change in SID. ECF expansion with the idealized balanced salt solutions is alkalinizing because of albumin dilution.



**FIGURE 34–10.** Impact of loss and gain of free water on acid–base chemistry. In the left-side example, removal of 3 L of water leads to increased SID and increased albumin. The former is alkalinizing, the latter acidifying and the result is a contraction alkalosis. In the right panel the ECF is diluted with 3 L dextrose 5% (SID 0, a physiologic method of delivering free water). Note the impact of the fluid on both SID and on albumin concentration ( $A_{TOT}$ ). The main impact of hemodilution with free water is reduced SID; this is dilutional acidosis.

thy, the use of sodium bicarbonate was associated with a 11.9% absolute reduction in the risk of renal injury (defined as a 25% increase in creatinine).<sup>65</sup>

### Acute Metabolic Alkalosis

Perioperative metabolic alkalosis is usually of iatrogenic origin. Hyperventilation of patients with chronic respiratory failure results in acute metabolic alkalosis because of chronic compensatory alkalosis associated with chloride loss in urine. More frequently, metabolic alkalosis is associated with increased SID caused by sodium gain. This occurs as a result of administration of fluids in which sodium is “buffered” by weak ions, citrate (in blood products), acetate (in parenteral nutrition), and, of course, bicarbonate.

The most frequent single disturbance in acid–base chemistry in perioperative and critically ill patients is hypoalbuminemia.<sup>66</sup> This is ubiquitous, causes an unpredictable metabolic alkalosis, and may mask significant alterations in SID, such as lactic acidemia. All intravenous fluids that do not contain albumin are alkalinizing (see Fig. 34–10). Thus, all patients who receive significant volumes of intravenous fluid in the operating room develop a hypoalbuminemic alkalosis. It is unknown whether this anomaly has any clinical significance.

Critically ill patients are vulnerable to significant changes in SID and free water. Nasogastric suctioning causes chloride loss; diarrhea leads to sodium and potassium loss. Surgical drains placed in tissue beds may remove fluids with varying electrolyte concentrations (the pancreatic bed, e.g., secretes fluid rich in sodium). Fever, sweating, oozing tissues, and inadequately humidified ventilator circuits lead to large-volume insensible loss and contraction alkalosis. Loop diuretics and polyuric renal failure may be associated with significant contraction alkalosis as a consequence of loss of chloride and free water.

Parenteral infusions may be responsible for stealth alterations in serum chemistry. Many antibiotics, such as piperacillin-azobactam, are diluted in sodium-rich solutions. Others, such as vancomycin, are administered in large volumes of free water (5% dextrose). Lorazepam is diluted in propylene glycol, large volumes of which will cause metabolic acidosis similar to that seen with ethylene glycol.<sup>67</sup>

Continuous renal replacement therapy is used in critical illness to hemofiltrate and hemodialyze patients who are hemodynamically unstable. Rocktaschel et al.<sup>68</sup> demonstrated that continuous renal replacement therapy resolves the acidosis of acute renal failure by removing strong ions and phosphate. However, metabolic alkalosis ensued as a consequence of the unmasking of metabolic alkalosis caused by hypoalbuminemia.

### Regulation of Acid–Base Balance

Carbon dioxide tension is controlled principally by chemoreceptors in the medulla and peripherally in the carotid body and aortic arch. An increase in the  $PCO_2$  or in the acidity of cerebrospinal fluid stimulates the breathing center to increase alveolar ventilation. When respiratory failure occurs, the principal  $CO_2$  buffering system, hemoglobin, becomes overwhelmed, leading to the rapid development of acidosis. In response, the kidney excretes an increased chloride load, using  $NH_4^+$ , a weak cation, for electrochemical balance. Thus ECF osmolality is maintained.

“Metabolic” acid is buffered principally by increased alveolar ventilation, producing respiratory alkalosis and extracellular weak acids, which include plasma proteins, phosphate and bicarbonate. The bicarbonate buffering system (92% of plasma buffering and 13% overall) is, probably, the most important extracellular buffer. The  $pK_a$  of bicarbonate is relatively low (6.1), but the system derives its importance because of the enormous quantity of carbon dioxide in the body. The coupling of bicarbonate and  $H_2O$  produces carbon dioxide, which is excreted through the lungs. There is an increase in alveolar ventilation.

In metabolic acidosis, chloride is preferentially excreted by the kidney. Indeed, this is the resting state of renal physiology, as sodium and chloride are absorbed in the diet in relatively equal quantities.<sup>69</sup> In metabolic alkalosis, chloride is retained, and sodium and potassium are excreted.

Abnormalities in the renal handling of chloride may be responsible for several inherited acid–base disturbances. In renal tubular acidosis, there is inability to excrete Cl in proportion to  $Na^+$ .<sup>70</sup> Similarly, pseudohypoaldosteronism appears to be caused by high

reabsorption of chloride.<sup>71</sup> Bartter syndrome is caused by a mutation in the gene encoding the chloride channel—CLCNKB—which regulates the Na-K-2Cl cotransporter (NKCC2).<sup>72</sup>

### Analytic Tools Used in Acid–Base Chemistry

Abnormalities of acid–base balance provide valuable information regarding changes in respiratory function, electrolyte chemistry and underlying disease processes. Although blood gas analysis is ubiquitous, it provides only partial information regarding acid–base chemistry. Abnormalities of pH, base deficit excess (BDE) or bicarbonate concentration reflect effect (and not always accurately), but not always cause. Measurement of each of the strong and weak ions that influence water dissociation, although cumbersome, is essential.<sup>42</sup>

This section considers some of the tools that have evolved over the past 50 years to assist our interpretation of acid–base conundrums. None are entirely accurate, and each has a dedicated group of followers.<sup>73</sup> Clinicians often confuse mechanisms of interpretation with the underlying causes of acid–base abnormalities. For example, a fall in serum bicarbonate during metabolic acidosis reflects hyperventilation and the activity of the carbonate system as an extracellular buffer. The acidosis is not caused by depletion or dilution of bicarbonate; instead, it is caused by decreased SID (usually by unmeasured anions [UMAs]) or increased  $A_{TOT}$ . We deal with each of these approaches chronologically and discuss the merits and demerits of each.

### $CO_2$ -Bicarbonate (Boston) Approach

Schwartz et al., at Tufts University in Boston, developed an approach to acid–base chemistry using acid–base maps and the mathematical relationship between carbon dioxide tension and serum bicarbonate (or total  $CO_2$ ), derived from the Henderson-Hasselbalch equation, to predict the nature of acid–base disturbances.<sup>74</sup> A number of patients with known acid–base disturbances, at steady states of compensation, were evaluated. The degree of compensation from what was considered normal was measured for each disease state. The investigators were able to describe 6 primary states of acid–base imbalance, using linear equa-



tions or maps, relating hydrogen ion concentration to  $\text{PCO}_2$  for respiratory disturbances, and  $\text{PCO}_2$  to  $\text{HCO}_3^-$  concentration for metabolic disturbances (Table 34–24). For any given acid–base disturbance, an expected  $\text{HCO}_3^-$  concentration was determined. The major drawback of this approach is that it treats  $\text{HCO}_3^-$  and  $\text{CO}_2$  as independent rather than interdependent variables.

### Base Deficit/Excess (Copenhagen) Approach

Singer and Hastings pioneered an alternative approach to acid–base chemistry in 1948, by moving away from the Henderson-Hasselbalch equation toward quantifying the metabolic component.<sup>52</sup> They proposed that the whole-blood buffer base could be used for this purpose. The buffer base represented sum of the bicarbonate and the nonvolatile buffer ions (essentially the serum albumin, phosphate, and hemoglobin). Applying the law of electrical neutrality, the buffer base was forced to equal the electrical charge difference between strong (fully dissociated) ions. Thus, normally

$$\text{buffer base} = [\text{Na}^+] + [\text{K}^+] - [\text{Cl}^-]$$

Alterations in buffer base represented, essentially, changes in strong ion concentrations (which could not be easily measured in 1948). Buffer base increases metabolic alkalosis and decreases metabolic acidosis. The major drawback of the use of buffer base measurements is the potential for changes in buffering capacity associated with alterations in hemoglobin concentration.

Siggard-Anderson and colleague, in 1958, developed a simpler measure of metabolic acid–base activity, the base deficit excess.<sup>75</sup> They defined BDE as the amount of strong acid or base required to return the pH of 1 L of blood to 7.4, assuming a  $\text{PCO}_2$  of 40 mm Hg, and temperature of 100.4°F (38°C). The initial use of whole-blood base excess was criticized because of the dynamic activity of red cells within the acid–base paradigm, that is, the gas and electrolyte exchange. This approach was modified in the 1960s to use only serum base excess, and the calculation became the *standardized* base excess. Current algorithms for computing the standardized base excess are derived from the Van Slyke equation (1977).<sup>76</sup> The BDE approach

TABLE 34–24.

Changes in  $\text{PCO}_2$  and  $[\text{HCO}_3^-]$  in Response to Acute and Chronic Acid–Base Disturbances

Disturbance	$\text{HCO}_3^-$ vs $\text{PaCO}_2$
Acute respiratory acidosis	$\Delta\text{HCO}_3^- = 0.2 \Delta\text{PaCO}_2$
Acute respiratory alkalosis	$\Delta\text{HCO}_3^- = 0.2 \Delta\text{PaCO}_2$
Chronic respiratory acidosis	$\Delta\text{HCO}_3^- = 0.5 \Delta\text{PaCO}_2$
Metabolic acidosis	$\Delta\text{PaCO}_2 = 1.3 \Delta\text{HCO}_3^-$
Metabolic alkalosis	$\Delta\text{PaCO}_2 = 0.75 \Delta\text{HCO}_3^-$

Modified from Narins RB, Emmet M. Simple and mixed acid–base disorders: a practical approach. *Medicine* 1980; 59:161–187.

TABLE 34–25.

Changes in Standardized Base Deficit or Excess (BDE) in Response to Acute and Chronic Acid–Base Disturbances

Disturbance	BDE vs $\text{PaCO}_2$
Acute respiratory acidosis	$\Delta\text{BDE} = 0$
Acute respiratory alkalosis	$\Delta\text{BDE} = 0$
Chronic respiratory acidosis	$\Delta\text{BDE} = 0.4 \Delta\text{PaCO}_2$
Metabolic acidosis	$\Delta\text{PaCO}_2 = \Delta\text{BDE}$
Metabolic alkalosis	$\Delta\text{PaCO}_2 = 0.6 \Delta\text{BDE}$

to acid–base chemistry was validated by Schlittig<sup>77</sup> and Morgan.<sup>78</sup>

Simple mathematical rules can be applied using the BDE in each of the common acid–base disturbances (Table 34–25). For example, in acute respiratory acidosis or alkalosis, BDE does not change. Conversely, in acute metabolic acidosis, the magnitude of change of the  $\text{PCO}_2$  (in mm Hg), is the same as that of the BDE (in mEq/L), and the change in BDE represents the overall sum total of all acidifying and alkalinizing effects. This makes interpretation of acid–base abnormalities simple, but misleading.

The base deficit approach has two significant limitations: First, it does not account for changes in acid–base chemistry associated with hypoproteinemia; indeed, the Van Slyke equation assumes normal serum proteins, which is not the case in critical illness. The second limitation is that this approach does not distinguish between metabolic acidosis associated with hyperchloremia and that associated with unmeasured anions.

### Anion Gap Approach

To address the primary limitation of the Boston and Copenhagen approaches, the anion gap was developed by

Emmit and Narins in 1975.<sup>79</sup> The anion gap approach is based on the law of electrical neutrality and is entirely consistent with the work of Stewart and Fencl. The sum of the difference in charge of the common extracellular ions reveals an unaccounted for “gap” of 12 to 16 mEq/L (Fig. 34–11):

$$\text{anion gap} = (\text{Na}^+) - (\text{Cl}^- + \text{HCO}_3^-)$$

If the patient develops a metabolic acidosis, and the gap “widens” to, for example, 20 mEq/L, then the acidosis is caused by unmeasured anions, either lactate or ketone. If the gap does not widen, then the anions *are* being measured, and the acidosis has been caused by hyperchloremia (bicarbon-

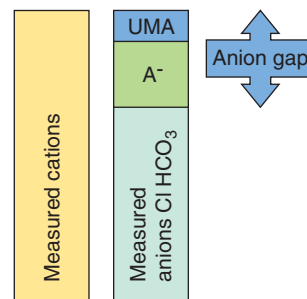
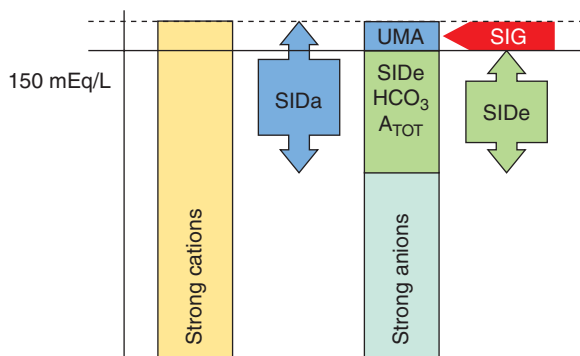


FIGURE 34–11. The anion gap. A<sup>-</sup>, phosphate and albumin; UMA, unmeasured anions.



**FIGURE 34–12.** The strong ion gap (SIG). SIDa, apparent SID; SIDE, effective SID; UMA, unmeasured anions.

ate cannot independently influence acid–base status). Although this is a useful tool, it is weakened by the assumption of what is or is not a “normal gap.”<sup>80</sup> The majority of critically ill patients are hypoalbuminemic, and many are also hypophosphatemic.<sup>44</sup> Consequently, the gap may be normal in the presence of unmeasured anions. Fencl and Figge developed a variant known as the *corrected anion gap*<sup>81</sup>:

$$\begin{aligned} \text{anion gap corrected (for albumin)} = \\ \text{calculated anion gap} + 2.5 \\ (\text{normal albumin g/dL} - \text{observed} \\ \text{albumin g/dL}) \end{aligned}$$

A second weakness with this approach is the use of bicarbonate in the equation. An alteration is  $[\text{HCO}_3]$  concentration, which can occur for reasons independent of metabolic disturbance, for example, hyperventilation. The base deficit and anion gap frequently underestimate the extent of the metabolic disturbance.<sup>42</sup>

### Stewart-Fencl Approach

A more accurate reflection of true acid–base status can be derived using the Stewart-Fencl approach.<sup>4,45</sup> Like the anion gap, the Stewart-Fencl approach is based on the concept of electrical neutrality. There exists in plasma a SID  $[(\text{Na}^+ + \text{Mg}^{2+} + \text{Ca}^{2+} + \text{K}^+) - (\text{Cl} + \text{A})]$  of 40–44 mEq/L, balanced by the negative charge on bicarbonate and  $\text{A}_{\text{TOT}}$  (the buffer base). There is a small difference between SIDa (apparent SID) and weak acid buffers (SIDE [effective SID]). This represents a strong ion gap (SIG), which quantifies the amount of unmeasured anion present (Fig. 34–12).

$$\text{SIDa} = ([\text{Na}^+] + [\text{K}^+] + [\text{Mg}^{2+}] + [\text{Ca}^{2+}]) - [\text{Cl}]$$

$$\text{SIDE} = [\text{HCO}_3] + [\text{charge on albumin}] + [\text{charge on Pi}] \text{ (in mmol/L)}$$

Pi is inorganic phosphate. The degree of weak acid ionization is pH dependent, so one must calculate for this:

$$[\text{alb}] = [\text{alb g/L}] \times (0.123 \times \text{pH} - 0.631)$$

$$[\text{Pi}] \text{ (in mg/dL)} = [\text{Pi}]/10 \times \text{pH} - 0.47$$

$$\text{SIG} = \text{SIDa} - \text{SIDE}$$

The BDE and SIG approaches are consistent with one another, and can be derived from a master equation.<sup>82</sup> The Stewart approach,<sup>45</sup> refined by Figge,<sup>43,83</sup> Fencl,<sup>4,42</sup> and others, more accurately measures the contribution of charge from weak acids, which change with temperature and pH.

The weakness of this system is that the SIG does not necessarily represent unmeasured strong anions, merely all anions that are unmeasured. Furthermore, SID changes quantitatively in absolute and relative terms when there are changes in plasma water concentration. Fencl<sup>42</sup> addressed this by correcting the chloride concentration for free water ( $\text{Cl corr}$ ) using the following equation:

$$[\text{Cl}]_{\text{corr}} = [\text{Cl}]_{\text{observed}} \times \frac{([\text{Na}^+]_{\text{normal}}/[\text{Na}^+]_{\text{observed}})}$$

This corrected chloride concentration can then be inserted into the SIDa equation above. Likewise, the derived value for UMAs should also be corrected for free water using UMA instead of Cl in the above equation.<sup>42</sup> In a series of 9 normal subjects, Fencl estimated the “normal” SIG as  $8 \pm 2$  mEq/L.<sup>42</sup>

Although accurate, the SIG approach is cumbersome and expensive, requiring measurement of multiple

ions and albumin. An alternative approach, used by Gilfix et al.,<sup>84</sup> and subsequently by Balasubramanian et al.<sup>85</sup> and Story and Bellomo<sup>86</sup> is to calculate the BDE gap. This allows recalculation of BDE using strong ions, free water, and albumin. The resulting BDE gap should mirror the SIG and the anion gap.

We find the simplified calculation of Story et al. to be most useful.<sup>87</sup> They use two equations to calculate the BDE for sodium/chloride/free water ( $\text{BDE}_{\text{NaCl}}$ ) and for albumin (Table 34–26). Figure 34–13 presents a unified approach to solving acid–base problems.

**TABLE 34–26.**

### Calculation of Base Deficit-Excess of Sodium Chloride-Free Water and Albumin<sup>a</sup>

$$\text{BDE}_{\text{NaCl}} = ([\text{Na}^+] - [\text{Cl}^-]) - 38$$

$$\text{BDE}_{\text{Alb}} = 0.25 (42 - \text{albumin g/L})$$

$$\text{BDE}_{\text{NaCl}} - \text{BDE}_{\text{Alb}} = \text{BDE}_{\text{calc}}$$

$$\text{BDE} - \text{BDE}_{\text{calc}} = \text{BDE gap} = \text{the effect of unmeasured anions or cations}$$

These calculations simplify the framework for “eyeballing” a chemistry series:

Normal Na = 140

–For every 1 mEq/L increase in Na from 140, base excess increases by +1

(Na 150 = BDE + 10 = contraction alkalosis)

–For every 1 mEq/L decrease in Na from 140, base deficit increases by –1

(Na 130 = BDE – 10 = dilutional acidosis)

Normal Cl = 102

–For every 1 mEq/L increase in Cl from 102, base deficit increases by +1

(Cl 110 = BDE – 8 = hyperchloremic acidosis)

–For every 1 mEq/L decrease in Cl from 102, base excess increases by +1

(Cl 90 = BDE + 12 = hypochloremic, chloride sensitive, alkalosis)

Normal albumin = 4.2 g/dL or 4.2 g/dL

–For every 0.4 g/dL decrement in albumin from 4.0, there is a 1.0 mEq/L increase in base excess.

<sup>a</sup>This approach involves calculating the base deficit excess (BDE) for sodium, chloride, and free water ( $\text{BDE}_{\text{NaCl}}$ ), and that for albumin ( $\text{BDE}_{\text{Alb}}$ ). The result is the calculated BDE ( $\text{BDE}_{\text{calc}}$ ). This is subtracted from the measured BDE to find the BDE gap.

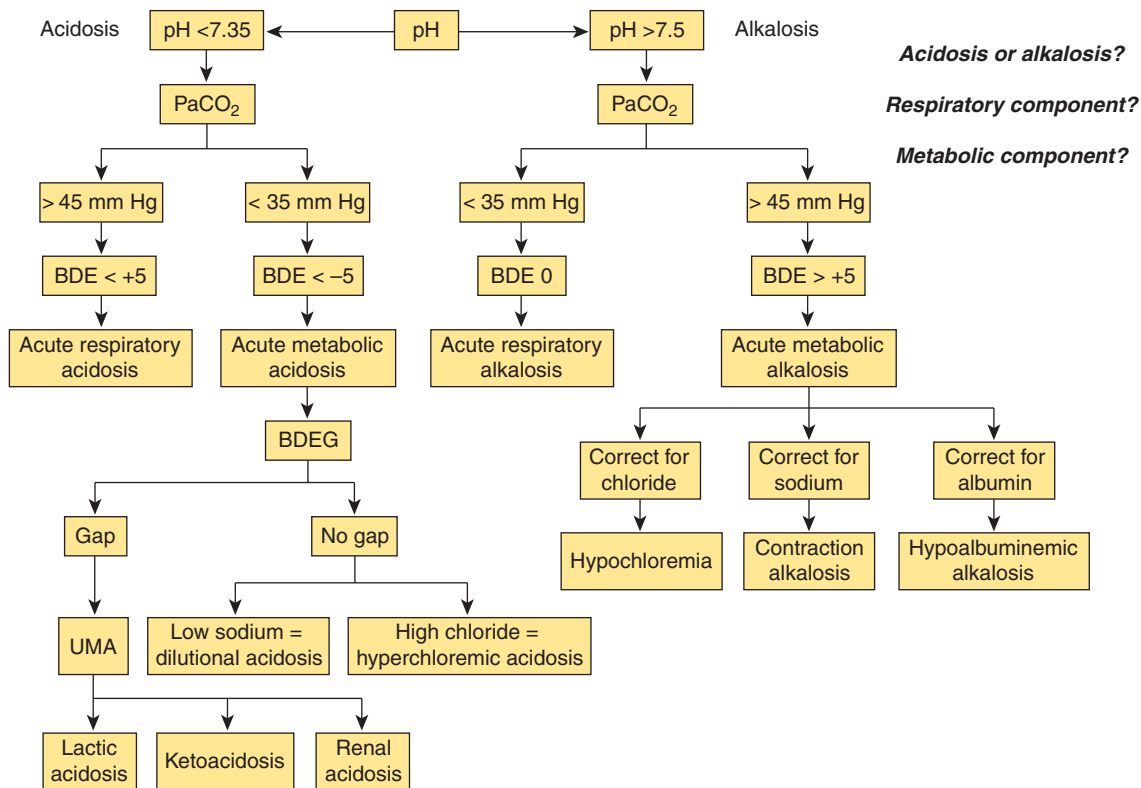


FIGURE 34-13. Mechanism for solving an acid–base problem. BDE, base deficit or excess; BDEG, base deficit excess gap.

## Treating Acid–Base Disturbances

Therapeutic treatment of acid–base disturbances is controversial; many regard it as “window dressing” rather than addressing the cause. This refers particularly to the use of sodium bicarbonate in the treatment of lactic acidosis.<sup>88</sup> Therapeutic use of sodium bicarbonate has three effects: (a) volume expansion, as the 7.5% solution is hypertonic (hence the often remarked improvement in cardiovascular performance); (b) increased SID as a consequence of the administration of sodium without accompanying strong anion,<sup>89</sup> and (c) increased CO<sub>2</sub> generation. There is no evidence that sodium bicarbonate administration improves outcomes in circulatory shock.<sup>88</sup> Much discussion has focused on bicarbonate inducing intracellular acidosis,<sup>90</sup> but this is probably clinically insignificant.<sup>88,91</sup> Lactic acidosis is treated with volume resuscitation and source control; diabetic ketoacidosis is treated with volume resuscitation and insulin.

Hyperchloremic or dilutional acidosis is treated by increasing the SID of infused fluids, for example, by infusing sodium without chloride. Although no such fluid is available commercially, such a fluid can be constructed by

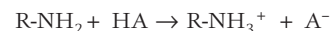
using sodium bicarbonate or sodium acetate.

Sodium gain is “chloride sensitive” alkalosis, treated by administration of net loads of chloride—0.9% NaCl, potassium chloride, calcium chloride, and, occasionally, hydrogen chloride. It is important to correct chloride-sensitive alkalosis, as the normal compensatory measure is hypoventilation, increasing PaCO<sub>2</sub>, which may lead to CO<sub>2</sub> narcosis or failure to liberate from mechanical ventilation. There is no specific treatment for hypoalbuminemic alkalosis.

Renal acidosis is treated with dialysis, which removes fixed acids. However, alteration in SID using sodium bicarbonate or sodium acetate can be used, for patient comfort, as a bridge to dialysis.

There has been significant interest in hypercapnic acidosis over the past decade following the introduction of “permissive hypercapnia” in acute respiratory distress syndrome, to prevent ventilator-associated lung injury.<sup>92</sup> There is accumulating evidence that hypercapnia has a lung-protective effect, and that reversing the acidosis may have adverse effects.<sup>93</sup> Nevertheless, in patients with hypercapnic acidosis and associated cardiovascular instability we recommend the use of

*Tris*(hydroxymethyl)-aminomethane (THAM).<sup>94</sup> THAM titrates hydrogen ions (e.g., lactic acid or CO<sub>2</sub>) according to the following reaction:



THAM is a proton acceptor that generates NH<sub>3</sub><sup>+</sup>/HCO<sub>3</sub><sup>-</sup> without generating CO<sub>2</sub>, and the protonated R-NH<sub>3</sub><sup>+</sup>, along with chloride, is eliminated by the kidneys. THAM has the significant advantage of buffering acidosis without increasing serum sodium or generating more carbon dioxide.

## Monitoring Blood Gases: Alpha Stat versus pH Stat

Water dissociation is temperature dependent. Thus extracellular pH varies with body temperature, becoming more alkalotic with progressive hypothermia and more acidotic with hyperthermia. Hence patients presenting in a state of hypothermia, or induced hypothermia (for cardiac surgery), would be expected to exhibit significant metabolic alkalosis on a blood gas. Blood gas machines heat the blood sample to an idealized 98.6°F (37°C), enabling the clinician to make inferences regarding the presence or absence of respiratory or metabolic abnormalities from a con-

stant perspective. This “alpha-stat” approach is widely used in perioperative medicine. An unfortunate drawback of this approach is that many clinicians are unaware of the impact of temperature on pH. Incumbent in this hypothesis is that, despite temperature changes, the body is capable of maintaining homeostatic function, and intracellular enzymes and transcellular ion pumps will continue to function.

Intracellular pH is 6.8 at 98.6°F (37°C), which is neutral pH at that temperature. Extensive animal investigation has established that intracellular pH remains neutral across a wide array of body temperatures. The reason that this occurs appears to relate to the constant buffering capacity, across pH, of intracellular histidine moieties.<sup>95</sup> This neutrality has the effect of maintaining intracellular enzymatic activity. Carbon dioxide becomes more soluble in blood as temperature drops. Moreover, hypothermia is associated with reduced metabolic activity. Consequently, hypothermia results in respiratory alkalosis and reduced cerebral blood flow.

Some clinicians believe that pH should be kept constant, despite changes in temperature (the pH-stat hypothesis). Thus, when measuring a blood gas, the patient's current body temperature is entered into the machine and a series of calculations corrects the blood gas to that temperature. Thus if a patient has a temperature of 82.4°F (28°C), the pH will be reported, for example, at 7.65 and the PCO<sub>2</sub> at 22 mm Hg.

Poikilothermic animals (reptiles) use an alpha-stat system of pH control, and can function over a broad range of temperatures.<sup>96</sup> Hibernating animals, however, use a pH-stat strategy, induced by hypoventilation. The consequent increase in intracellular CO<sub>2</sub> content reduces cellular metabolism and may have a protective effect.<sup>97</sup>

Clinicians that adopt a pH-stat approach will correct the blood pH by adding carbon dioxide during cardiopulmonary bypass. The resulting respiratory acidosis is thought to improve neurologic outcomes in cardiac surgery. For example, cerebral blood flow decreases 40% during cardiopulmonary bypass at 78.8°F (26°C) using alpha-stat management but remains similar to baseline with pH-stat management.<sup>98</sup>

The higher PCO<sub>2</sub> in pH stat approaches is thought to improve neuro-

logic outcomes by (a) inducing a rightward shift of the oxyhemoglobin dissociation curve promoting O<sub>2</sub> unloading to tissues, (b) reducing the cerebral metabolic rate of oxygen and increasing neuronal tolerance to ischemia, and (c) modulating the N-methyl-D-aspartate receptor that limits the neurotoxic effects of excitatory amino acids.<sup>99</sup> There is little data to support the use of the pH-stat approach in adults, and benefit, if it exists at all, is probably confined to infants who are undergoing cardiac surgery.<sup>99</sup> We do not recommend the adoption of the pH-stat approach for the majority of perioperative patients.

## ESTIMATING PERIOPERATIVE FLUID REQUIREMENTS

Traditional approaches to perioperative fluid management have focused on rigorous calculation of fluid deficits; the administration of “maintenance” fluids, calculated on body weight and metabolic activity; repletion of insensible losses and third space losses (dependent on the anatomical region of surgery); and replacement of blood loss with crystalloid (in a 1:3 ratio) or colloid (in a 1:1 ratio). There are many limitations to this approach; chief among them is the potential for significant weight gain and fluid overload. Additionally, the actual presence of third space fluid loss has been questioned. Nevertheless, these approaches continue to be widely advocated in practice and a short description follows.

### Preoperative Deficits

In adults who are undergoing elective surgery, despite guidelines that water is permissible up to 2 hours preoperatively,<sup>100</sup> oral intake is usually restricted for up to 12 hours before the procedure. This period of restricted oral intake may be considerably longer when surgery is scheduled late in the day. The resulting fluid deficit is primarily because of water loss.

The traditional approach involves calculating the hourly maintenance fluid rate and multiplying that by the time of restricted fluid intake. The maintenance fluid is calculated using a 4–2–1 system (4 mL/kg/h for the first 10 kg body weight, 2 mL/kg/h for the next 10 kg body weight, and 1 mL/kg/h

beyond that body weight). An alternative system is to administer 1.5 mL/kg. Of this total, 50% of this deficit volume is replaced over the first hour of intravenous fluid therapy and 25% is replaced during each of the ensuing 2 hours. The entire deficit is replaced in 3 hours, which is accomplished by adding the fluid deficit to the basal infusion rate of the maintenance fluids. Simultaneously, account must be taken for insensible losses during and after surgery. This is associated with, for example, evaporation at the site of surgery, hyperventilation, fever, sweating, denuded skin, burns, and the use of non-humidified oxygen therapy administered at high flow rates. Again, much of this loss is in water not extracellular fluid.

Additional preoperative deficits may also occur. The most common is volume loss through the bowel as a consequence of preoperative administration of purgatives (“bowel preparations”). This leads to an absolute deficit of water and electrolytes, principally sodium and potassium, but also chloride as a result of renal compensatory loss. This requires replacement with a balanced salt solution. There is no clear published guideline for the absolute volume that must be replaced to overcome bowel preparation losses, but the majority of anesthesiologists estimate this at 1000–2000 mL. Other preoperative causes of absolute hypovolemia with associated electrolyte loss include vomiting, gastric suction, diarrhea, and ostomy output. Upper gastrointestinal losses should be repleted with chloride-rich solutions, preferably 0.9% saline. Lower gastrointestinal losses should be repleted with balanced salt solutions.

Internal losses are volume deficits that cannot be easily quantified as they represent redistribution of fluid within the body. Traditionally these are considered “relocation” losses into cavities and third spaces, but also represent expansion of the extracellular fluid space secondary to capillary leak. The cavitory losses (e.g., pleural, ascitic, and pericardial fluid) are simple transudates of plasma that often require a relatively prolonged period to accumulate in significant quantities. Consequently, the impact on the ECF volume is generally minor, as there is usually some degree of compensation for this redistribution of vascular fluid. Although significant cavitory fluid ac-



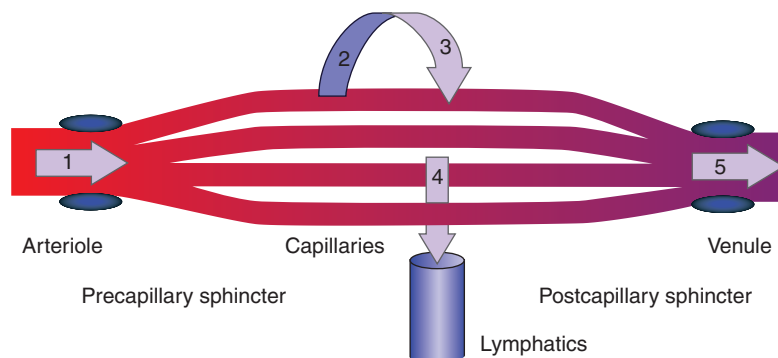
cumulation does occur in hypervolemic states, the most important variant of this genre is ascites. Ascitic fluid, secondary to cirrhosis, ovarian cancer, or carcinomatosis, once drained, inevitably reaccumulates, leading to massive fluid shifts and the potential for significant intravascular dehydration.

There are many other causes of fluid redistribution losses in perioperative medicine. These usually involve significant edema in conjunction with injured tissue (as may occur with obstructed, ischemic, or dead bowel), in particular when compartment syndromes occur, and when secretory fluid becomes trapped in obstructed bowel. These “third space” and cavity losses create a new ECF pool that is sequestered and essentially nonfunctional.

Internal blood loss also diminishes the ECF volume. Such losses may be significant when associated with retroperitoneal hematoma, leaking aneurysm, pseudoaneurysm or vascular anastomosis, pelvic or femoral fracture, or splenic rupture. Depending on the acuteness of the hemorrhage, some degree of compensation may have occurred. Typically, this involves transcapillary refill (Figs. 34–14 and 34–15), the movement of extracellular fluid into the vascular space to maintain perfusion of fight-or-flight organs (midline structures and skeletal muscle). Although this may lead to a small drop in the hemoglobin concentration, it is essential to understand that in situations of acute isovolemic blood loss, hemoglobin remains essentially unchanged despite massive blood loss. This may lead to false reassurance, particularly in young patients who have tremendous compensatory capacity through tachycardia and intense vasoconstriction.

Clearly, estimation of fluid deficits and ongoing fluid losses differs depending on the nature of the patients and the type of surgery. Emergency procedures are often associated with significant fluid shifts that must be accounted for.

Fluid used to replace pure volume losses should be nearly isotonic with respect to plasma and should also contain sodium and chloride. In general, a polyvalent, balanced salt solution (e.g., mildly hypotonic, lactated Ringer solution) is used. Ideally, both internal and external preoperative fluid deficits should undergo total correction before the administration of an anesthetic.



1. Precapillary sphincters are relaxed, and blood flows into the capillary bed
2. Fluid is filtered on the arterial side and returns
3. On the venous side or
4. Through lymphatics
5. Blood returns through the postcapillary sphincters to the venous system

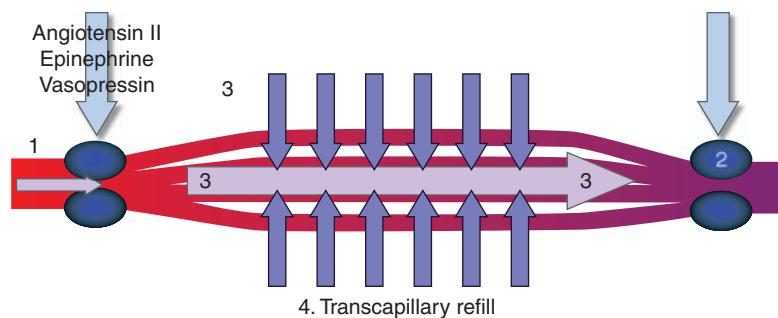
FIGURE 34–14. The normal microcirculation.

However, an urgent need for surgery may preclude replacement of the entire deficit. Relatively small volume deficits (i.e., less than 20% of the blood volume) can often be replaced with an isotonic or balanced salt solution administered over a period of 15 minutes or less. Although most patients will tolerate this amount of acute intravascular volume expansion, care must be taken in patients with a history of hypertension or diastolic dysfunction. In this case, rapid volume administration may precipitate acute pulmonary edema. Importantly, 40–60% of the infused solution will redistribute to the extracellular compartment within 15–30 minutes, and 80% will redistribute by 1 hour (Fig. 34–16). If the patient has significant extracellular fluid deficit, this is an effective method of resuscitating that space. However, if blood loss is the problem, significant tissue

edema will result from large-volume crystalloid resuscitation to maintain hemodynamic goals.

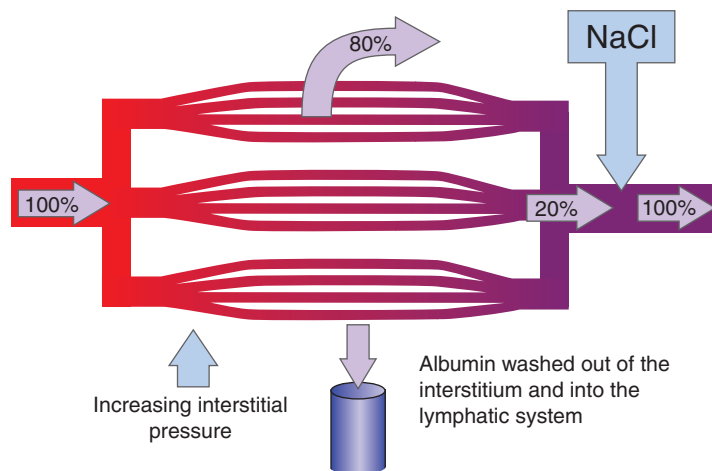
### Intraoperative Fluid Losses

Intraoperative fluid losses (similar to preoperative losses) can be categorized as either internal or external. Traditional approaches to intraoperative fluid management involve estimation of distribution volume deficits and repletion of this apparent ECF volume loss with isotonic fluids. Significant volume is lost or sequestered into “third” spaces. It is assumed that the volume of fluid sequestered is proportional to the amount of surgical trauma. Thus major orthopedic procedures, surgery within the chest cavity, bowel resections, and hysterectomies are examples in which a significant quantity of third spacing occurs (i.e., perhaps 4–5% of body weight). The



1. The blood pressure falls, reflex vasoconstriction follows
2. The pre-capillary and post-capillary sphincters contract
3. This reduces the volume and increases the velocity of blood passing through
4. Fluid is sucked back into the circulation by the flow of blood, this process is called “transcapillary refill,” and allows remobilization of fluid

FIGURE 34–15. Compensation for hypovolemia.



**FIGURE 34–16.** Crystalloid extravasation. When isotonic crystalloid fluids are administered to the perioperative patient, up to 80% of the infused volume extravasates into the interstitium.

exact quantity of sequestered fluid is impossible to ascertain, and replacement of these third-space losses is an approximation.

Conservative approaches to third space fluid replacement, based on the amount of tissue exposure and degree of tissue trauma, are as follows: minimal trauma, 2–4 mL/kg/h; moderate trauma, 4–6 mL/kg/h; extensive trauma, 6–12 mL/kg/h. This volume replacement is in addition to maintenance fluids and repletion of preoperative losses.

External fluid losses during surgery are predominantly a result of insensible or evaporative losses and blood loss. Significant evaporative losses may occur when either the peritoneal or pleural surfaces are exposed to ambient conditions, depending on the relative humidity of the air in the operating room and the rate of exchange of air within the room. This is free water loss that is almost impossible to quantify. Traditional approaches involve the administration of 1–4 mL/kg/h of fluid to replete these losses, with higher volumes administered depending on the cavity or tissue surface exposed. Patients with extensive burns have massive insensible volume losses, and volume repletion is formula driven, based on the surface area burned.

Intraoperative blood loss may lead to significant tissue hypoperfusion and organ injury. It is, however, difficult to quantify as a result of, for example, accumulation in drains, drapes, suction canisters, and administration of lavage fluid. The estimated blood loss almost always underestimated true blood loss. Administration of crystalloid or colloid to fixed hemodynamic

goals will progressively deplete the hemoglobin concentration, providing a useful index of blood loss. However, underresuscitation of the patient is often associated with a falsely reassuring hemoglobin concentration.

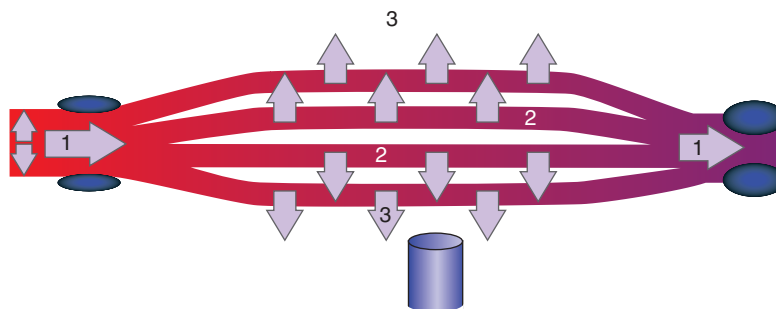
Traditional approaches to blood replacement have identified a 3:1 ratio of crystalloid to blood loss. This is incorrect.<sup>101</sup> With increasing volumes of crystalloid administration the extracellular space becomes progressively more compliant, resulting in a geometric increase in transcapillary leakage that volume replacement for blood loss parallels.<sup>102</sup> This process is known as cytopempsis and principally reflects the progressive hypoalbuminemia associated with volume replacement.<sup>10</sup> In his original animal study, Moss described a 5:1 ratio of crystalloid replacement to blood loss when losses reached 35% of blood volume, reaching an inflection point at this level, with subsequent ratios increas-

ing geometrically. At 75% blood loss the ratio reaches 16:1.<sup>10</sup> Consequently, consideration should be given to replete blood losses with colloid solutions or blood component therapy.

### Postoperative Fluid Losses

Both internal and external fluid losses continue into the postoperative period. Depending on the patient's preoperative status, intraoperative management, and surgical procedure, combinations of volume, concentration, and composition disturbances are not infrequent. Over the first 24–36 hours after a procedure, fluid continues to be sequestered into the extracellular space, principally as a result of capillary leakage (Fig. 34–17).<sup>103</sup> Evidence of end-organ hypoperfusion may become apparent, in particular oliguria. Recurrent boluses of fluid may be required to restore organ function. On postoperative day 2, a steady state appears to be reached, followed by fluid mobilization and diuresis. Patients lose up to 1000 mL of water per day in insensible losses, but also gain water from metabolic activity. Although traditional teaching emphasizes the administration of hypotonic glucose-containing intravenous fluids to prevent dehydration and ketosis, there is very little support for this position in the literature. Indeed the controversy of “dry” versus “wet” has existed for as long as intravenous fluid therapy has been available.<sup>104</sup> Furthermore, postoperative clear fluid administration may be associated with worse outcomes, and dextrose administration is associated with undesirable hyperglycemia.

External losses may persist into the postoperative period as a result of, for example, continued bleeding, nasogas-



1. There is widespread vaso- and venodilatation
2. The endothelium becomes porous
3. Protein-rich fluid leaks out into the extracellular space causing edema

**FIGURE 34–17.** Extravasation of fluid into the extracellular space due to capillary leak.

TABLE 34–27.

Composition of Commonly Used Crystalloid Solutions

Solution	Osmolarity (mOsm/L)	Na <sup>+</sup> (mEq/L)	Cl <sup>-</sup> (mEq/L)	K <sup>+</sup> (mEq/L)	Ca <sup>2+</sup> (mEq/L)	Mg <sup>2+</sup> (mEq/L)	Glucose (g/L)	Lactate (mEq/L)	Gluconate (mEq/L)	Acetate (mEq/L)
NaCl 0.45% & dextrose 5%	406	77	77				50			
NaCl 0.9% & dextrose 5%	560	154	154				50			
NaCl 0.9%	308	154	154							
Lactated Ringer	273	130	109	4	3			28		
Lactated Ringer & dextrose 5%	525	130	109	4	3		50			
Dextrose 5%	252						50			
Dextrose 50%	2520						500			
Plasmalyte 148	294	140	98	5		3			23	27
Normosol	294	140	98	5		3			23	27

tric suctioning, surgical drains, diarrhea, and evaporative losses. It is imperative that the clinician quantify these losses and replenish them with fluids appropriate for the site of loss (e.g., balanced salt solutions for ECF loss, normal saline for upper GI losses).

## FLUID REPLACEMENT CRYSTALLOIDS

### Nature and Makeup of Crystalloid Solutions

Crystalloid solutions are intravenous fluids that involve electrolytes or dextrose dissolved in sterile water (Table 34–27). Crystalloid solutions may be hypotonic, isotonic, or hypertonic. They may have a SID of 0 (dextrose solutions or NaCl 0.9%) or a SID that approximates plasma (balanced salt solutions, e.g., lactated Ringer solution, Normosol, Plasmalyte). Dextrose-based fluids distribute evenly across total body water. Hypotonic fluids distribute across body water in proportion to electrolyte content. Isotonic fluids, being electrolyte based, distribute evenly through the extracellular fluid, but remain extracellular (Fig. 34–18). Hypertonic fluids remain in the compartment into which they are injected (bloodstream) and expand that compartment by dragging fluid from the intracellular and extracellular space along the osmotic gradient. The choice of intravenous fluids, used therapeutically, is determined by the clinical indication and prevailing conditions. For example, hypotonic fluids are typically used to replace free water deficits. Isotonic fluids are used to

replace extracellular fluid losses. Slightly hypotonic balanced salt solutions, such as lactated Ringer solution, replace free water and extracellular fluid losses. Hypertonic fluids are typically used as plasma expanders, used in acute resuscitation, but may reduce edema volume. Hypertonic saline is typically used in traumatic brain injury. Table 34–26 is a comprehensive list of crystalloid solutions. The following section addresses the most commonly administered formulations.

### Dextrose 5%

Water cannot be administered into the intravascular space because red cell lysis results. Dextrose as a 5% solution is isosmotic with plasma, but rapidly becomes free water as the glucose content is metabolized. Consequently, free water therapy has traditionally taken the form of dextrose solutions. Alternative “hypotonic fluids” include 0.45% NaCl + dextrose 5% and 0.25% NaCl. Water, administered as dextrose, distributes to the total body water. Thus when 1000 mL of dextrose is delivered, two-thirds of it enters the

intracellular space and a tiny fraction remains intravascular. Consequently, dextrose, and all hypotonic fluids, should be avoided when intravascular volume expansion is desired. Dextrose has been used traditionally to treat dehydration losses before and after surgery. However, the caloric content of dextrose is problematic (200 kcal/L). Glucose cannot be used as fuel in perioperative patients. Administration of glucose results in hyperglycemia as a result of stress catecholamine release and insulin resistance, during the stress response. Perioperative hyperglycemia is associated with increased risk of death, myocardial ischemia, and stroke.<sup>105–107</sup> Thus the traditional postoperative fluid regimens, which emphasize the use of glucose to prevent ketosis and replenish free water deficits, require reevaluation.

### “Normal” Saline

“Normal” saline consists of an equimolar solution of sodium (154 mEq/L) and chloride (154 mEq/L). The solution has an osmolality of 308 mOsm, slightly hypertonic to plasma, and a

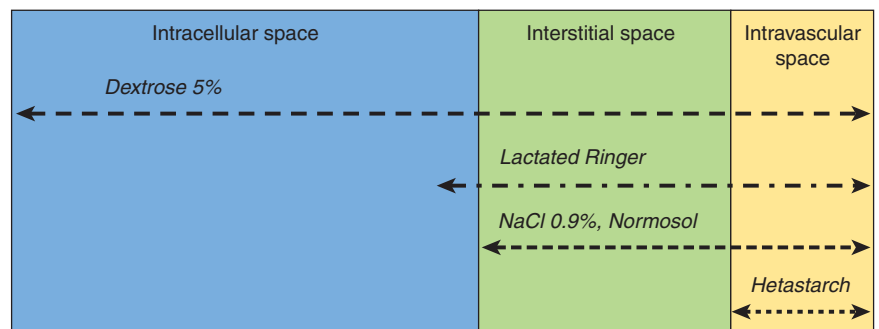


FIGURE 34–18. Volume of distribution of crystalloid solutions.

SID of 0. Consequently, administration of moderate to large quantities of this fluid is associated with mild hypernatremia, progressive hyperchloremia, and metabolic acidosis (see Fig. 34–10).

Saline continues to be widely used in hospital practice, particularly in neurosurgery, where it is used as a component of osmotic therapy. The widely accepted use of this solution in patients with renal failure has been questioned. Traditionally balanced salt solutions were avoided in this patient population because of concerns regarding accumulation of potassium in renal failure. However, a study by O'Malley et al. demonstrated a 20% absolute risk increase (number needed to treat: 5) for hyperkalemia in patients undergoing renal transplantation who were administered saline rather than lactated Ringer solution.<sup>108</sup> Moreover, there was a 30% incidence of metabolic acidosis, requiring treatment, in the saline group, versus 0% in the lactated Ringer group.

Although not widely recognized, chloride ion excretion is a primary role of the kidney, as sodium and chloride are absorbed in roughly equimolar concentrations in the diet; a net excretion of chloride over sodium is necessary. Chloride is involved with regulation of renal vascular tone.<sup>109</sup> Hansen demonstrated that  $K^+$ -induced contraction of smooth muscle cells in the afferent arteriole is highly sensitive to chloride.<sup>110</sup> Thus chloride is a functional renal vasoconstrictor. Hyperchloremia has been shown to produce dose dependent renal vasoconstriction and a reduction in glomerular filtration rate.<sup>111,112</sup> In addition hyperchloremia may be associated with an increased risk of acute renal failure in vulnerable patients, such as those receiving radiographic contrast dye.<sup>113</sup>

Wilkes et al. demonstrated that, compared with balanced salt solutions, patients who received intraoperative saline-based solutions had significantly reduced splanchnic blood flow,<sup>34</sup> as estimated using gastric tonometry. Williams et al. randomized healthy volunteers to 0.9% saline versus an equal volume of lactated Ringer solution. Saline administration was associated with lower pH and longer time to first urination.<sup>64</sup> This tendency toward fluid retention may result from the higher chloride content or the higher osmolality of the solution that induces inappropriate ADH secretion by “fool-

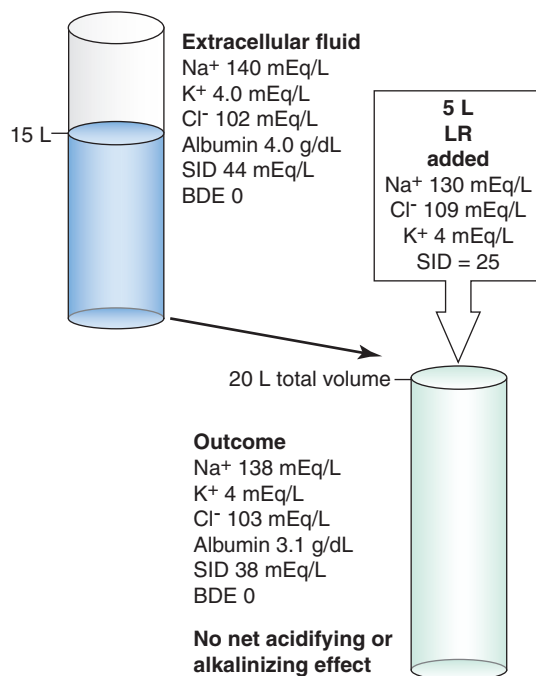
ing” the midbrain that the patient is dehydrated.<sup>64</sup>

Crystalloid solutions of any type enhance coagulation as measured by thrombelastograph analysis and routine coagulation studies.<sup>114,115</sup> When patients were hemodiluted up to 30% with saline, coagulation parameters increased.<sup>116</sup> The most likely mechanism is an imbalance between the naturally occurring anticoagulants and activated procoagulants, with a reduction in antithrombin III probably being the most important.<sup>117</sup> This effect lowers the threshold above which positive feedback into the intrinsic coagulation pathway occurs, leading to the enhanced coagulation. Although it has been suggested that resuscitation with 0.9% normal saline is associated with increased risk of bleeding versus balanced salt solutions,<sup>118</sup> there is minimal human data to support this claim. One study of 0.9% saline versus lactated Ringer solution in aortic aneurysm surgery showed no difference in outcome variables, but a higher perioperative blood loss in the saline group.<sup>119</sup>

### Lactated Ringer Solution

Lactated Ringer solution is the most widely used balanced salt solution, and is recommended as part of ad-

vanced trauma life support. Although balanced, it does not fully reflect the electrolyte distribution of the extracellular fluid. The sodium component is relatively low (130 mEq/L) and the chloride level high (109 mEq/L), making the SID significantly lower than plasma. Nevertheless, perioperative patients tend to lose more water than sodium as a result of insensible losses, and as all intravenous fluids dilute albumin, a slightly hyperchloremic solution is favored (Fig. 34–19). Hence studies that looked at the acid–base changes associated with lactated Ringer solution have reported few abnormalities.<sup>34,64</sup> The slight hypotonicity may worsen cerebral edema in patients with traumatic brain injury, although this has never been proven. In that circumstance, lactated Ringer solution is generally avoided. Because bicarbonate is unstable in electrolyte solutions, lactated Ringer solution is buffered in lactate. Lactate is metabolized by the liver to carbon dioxide and water. Care must be taken with this fluid in end-stage liver disease because the patient cannot metabolize lactate, which then functions as a strong ion, leading to metabolic acidosis. In addition, lactate may be converted to glucose, leading to hyperglycemia; consequently, this solution is



**FIGURE 34–19.** Extracellular fluid dilution with lactated Ringer solution. Although moderate volumes of this fluid have both acidifying effects (low strong ion difference) and alkalinizing effects (dilution of albumin), these effects offset each other and the net acid–base change is negligible.



rarely administered during diabetic crises.

An important issue with the use of lactated Ringer solution concerns its interaction with packed red cells for transfusion. First, lactated Ringer solution contains calcium, which may lead to clotting of the blood before it enters the bloodstream. Second, there is the theoretical concern that mixing this hypotonic fluid with blood will lead to hemolysis.

### Balanced Salt Solutions

A variety of balanced salt solutions are available that attempt to mimic extracellular fluid content. The solutions available in North America are Normosol-R and Plasma-Lyte 148, which are essentially identical. Although attractive in conception, there is little published data to suggest that any of these fluids is superior to lactated Ringer solution. Plasma-Lyte comes in a number of different formulations and different buffering solutions. Normosol is buffered in acetate and gluconate, both weak anion buffers; this suggests a better acid-base profile in liver failure. Both Normosol and Plasma-Lyte 148 contain 140 mEq/L Na, 98 mEq/L Cl, and 5 mEq/L K, with a SID of 47. Administration of either of these solutions leads to progressive metabolic alkalosis (see Fig. 34–10). As calcium is not a component of either of these solutions, Normosol and Plasma-Lyte can be safely administered alongside blood.

In choosing a crystalloid solution to administer to a patient, the clinician must take into account the patient's hydration status, anticipated volume of crystalloid to be administered, and the potential side effects. For the majority of patients, a balanced salt solution such as lactated Ringer (Hartmann) solution should be administered. This has the advantages of relative isotonicity, an electrolyte composition similar to extracellular fluid, minimal impact on acid-base chemistry, universal familiarity, low cost, and a strong safety profile. Concerns about hyperkalemia and renal failure are probably overstated. Lactated Ringer solution is an excellent choice for both resuscitation and rehydration, resulting in neither hypernatremia nor hyperchloremia. Isotonic saline solutions should not be administered in large volume. If blood is to be administered through the same intravenous line as the crystalloid, Normosol-

R or Plasma-Lyte 148 should be substituted for lactated Ringer solution.

### Hypertonic Saline

Normal plasma osmolality is 280–295 mOsm/L. Any solution whose osmolality exceeds 310 mOsm/L is a hypertonic fluid. In practical terms, this refers to hypertonic saline and sodium bicarbonate solutions (Table 34–28). A variety of different hypertonic saline (HS) solutions are commercially available, the most commonly used are 1.8% HS, 3% HS, 7.5% HS, and 23.4% HS. The latter is not generally used as an intravenous fluid, but is, for example, injected into hydatid cysts.

There are two well-defined uses of hypertonic fluids. The first is intravascular volume expansion in patients in hypovolemic shock, as a means of low-volume high-impact resuscitation. The second is a corollary—intracellular volume depletion. This approach is widely used in neurosurgery and neurocritical care to reduce cerebral volume and intracranial pressure.

Hypertonic saline dramatically increases the osmotic pressure in the compartment into which it is injected. Water flows along the osmotic gradient into the compartment, expanding its volume for several hours. In the intravascular space, HS causes endothelial cell shrinkage, arteriolar dilation and reduced viscosity, thereby increasing flow.<sup>120</sup> It may also increase myocardial contractility, although there are conflicting data on this issue. The metabolic consequences of HS are hypernatremia, hyperosmolality, and hyperchloremic acidosis.<sup>121</sup> The degree of hypernatremia and hyperosmolality is lower than one

would expect because of the relatively low volume administered.<sup>122</sup>

The logic behind the use of HS in shocked states is based on two observations: (a) isotonic crystalloids are very inefficient plasma volume expanders and result in significant tissue edema; and (b) hypertonic solutions expand the plasma volume by a significantly greater amount than the volume administered. Consequently, significant hemodynamic benefit accrues from relatively low volumes of fluid administered. This may be of particular use in combat situations, where the weight and size of medical supplies of great importance.

Numerous small studies and case reports suggest that patients have better hemodynamic profiles when given HS than if administered isotonic crystalloid.<sup>123</sup> No study of prehospital administration of HS has shown an overall statistically significant benefit. Indeed, published benefits accrue in statistically weaker subgroup analysis. For example Mattox et al. studied 422 patients in a randomized, double-blind, multicenter trial of prehospital HS with dextran versus an equal volume of isotonic crystalloid.<sup>124</sup> Patients who had been administered HS with dextran and who required surgery had improved survival. Wade et al. reported improved survival in patients with penetrating trauma who were administered HS.<sup>125</sup> A meta-analysis by the same group failed to demonstrate a benefit to using HS in trauma patients.<sup>126</sup> A more recent large clinical trial failed to demonstrate improved clinical outcomes at 6 months.<sup>127</sup> Currently, HS is not used in this setting. The major controversy in trauma is

TABLE 34–28.

Characteristics of Hypertonic Solutions

Fluid	Sodium Concentration (mEq/L)	Chlorine Concentration (mEq/L)	Bicarbonate Concentration (mEq/L)	Osmolality (mOsm/L)
0.9% NaCl	154	154	—	308
1.7% NaCl	291	291	—	582
3% NaCl	513	513	—	1026
7.5% NaCl	1283	1283	—	2566
10% NaCl	1712	1713	—	3424
23.4% NaCl	4004	4004	—	8008
Mannitol	—	—	—	1098
7.5% NaHCO <sub>3</sub>	900	—	900	1600
8.4% NaHCO <sub>3</sub>	1000	—	1000	2000

not the usefulness of HS, but the timing of use.

Hypertonic saline has been used in the perioperative care of cardiac surgical patients. To date, data has revealed only that HS reduces perioperative weight gain and has a diuretic effect.<sup>128</sup> HS may be an effective component of a goal-directed approach to fluid resuscitation, but this has yet to be studied.

The most frequent indication for HS use has been in traumatic brain injury.<sup>129</sup> Death from brain injury is primary, as a direct result of the event, or secondary, because of ischemic brain injury, cerebral edema, and brain herniation. Intracranial hypertension is the clinical manifestation of secondary brain injury. Under normal conditions, the blood-brain barrier limits bulk flow of fluid from cerebral capillaries into brain parenchyma by forming a semi-permeable membrane, which is moderately permeable to water and relatively impermeable to small solutes and proteins. The balance of Starling forces (the transcapillary hydrostatic pressure gradient that is counterbalanced by an osmotic pressure gradient) determines the magnitude of flow into the brain substance.<sup>128</sup> In areas where the blood-brain barrier is disrupted, this balance disappears, facilitating the flow of proteins and electrolytes across the membrane.<sup>129</sup> Hydrostatic pressure becomes the dominant driving force for fluid movement from the intravascular space to brain tissue. This leads to brain swelling with an increase in intracranial pressure, a decrease in cerebral perfusion pressure, cerebral hypoxia, and secondary brain injury. Interruption of this continuing cycle of injury is the basis of treatment in traumatic brain injury.<sup>130</sup> Osmotherapy using mannitol has been the therapy of choice in traumatic brain injury for a generation. However, mannitol has several limitations, including hyperosmolality, osmotic diuresis leading to hypotension, and accumulation in brain tissue leading to reverse osmotic effects.

Hypertonic saline has reemerged over the past decade as an alternative to mannitol. Permeability of the blood-brain barrier to sodium is low. HS produces a significant osmotic gradient, leading to shrinkage of brain tissue (assuming that the blood-brain barrier is intact) and reduces intracranial pressure. HS improves overall sys-

temic perfusion and, presumably, oxygen delivery, and may modulate the inflammatory response.<sup>131</sup>

## FLUID REPLACEMENT COLLOIDS

### Colloids and Colloid Oncotic Pressure

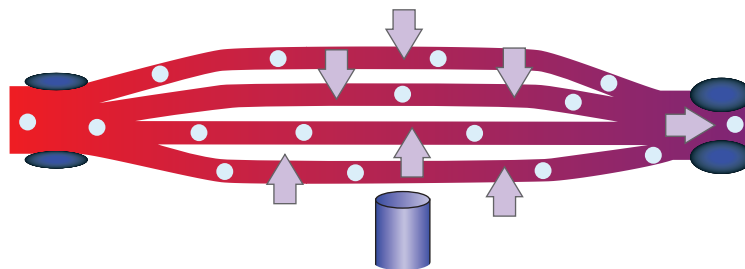
For the majority of patients undergoing surgery and anesthesia, gentle hydration with crystalloid repletes dehydration losses and mild blood losses. However, significant tissue injury (including major surgery) leads to a slightly different paradigm that involves classic inflammatory stress response associated with increased capillary permeability. This facilitates the extravasation of intravascular fluid into the extracellular space (see Fig. 34-17). Fluid sequestered in this way does not remobilize until the stress response resolves. In these circumstances, up to 80% of crystalloid solutions used as volume replacement collect in extravascular tissues (see Fig. 34-16). This leads to weight gain and tissue edema, particularly in lax tissues and in the abdomen. Oxygen delivery is reduced and the cumulative effect may be worsened perioperative outcomes.<sup>16</sup> In addition to increased capillary permeability, there is a reduction in plasma oncotic pressure in surgery, trauma, and critical illness as a result of reduced circulating albumin concentrations, because of dilution, extravasation, and reduced hepatic production (negative acute-phase response).

High-molecular-weight solutions are used widely as plasma substitutes. These have the purported advantages of remaining in the intravascular space, plugging leaky capillaries and increasing colloid oncotic pressure, thus expanding intravascular volume.

As compared to crystalloid solutions, lower volumes are required to achieve hemodynamic goals.<sup>16</sup>

Colloids are homogenous noncrystalline substances, consisting of large molecules or ultramicroscopic particles of one substance dispersed through a second substance.<sup>132</sup> Colloid solutions remain in the intravascular space because of their large molecular size, which leads to relative membrane impermeability (Fig. 34-20). The principal biologic colloids are plasma proteins, primarily albumin and globulin. These proteins impart two distinct forces: an osmotic pressure and a Gibbs-Donnan effect. This refers to an electrochemical effect of the protein: the protein is negatively charged and positively charged cations are held in plasma. The combined effect is a pressure that draws water out of the interstitium and into the plasma: the colloid oncotic pressure (COP). The COP is approximately 50% greater than would be expected from the plasma proteins alone.

Albumin, with a molecular weight of 69,000 kDa and a significant negative charge, normally accounts for nearly two-thirds of the plasma COP. Serum albumin falls in the perioperative period and during inflammation from tissue injury or sepsis. Many clinicians mistakenly ascribe hypoalbuminemia as the cause of the edema of critical illness. However, edema occurs secondary to increased capillary permeability and fluid overload. In addition, albumin production falls as a consequence of “hepatic reprioritization” toward inflammatory proteins. The result is maintenance of COP despite low levels of albumin.<sup>39</sup> Thus serum or plasma protein concentration is an unreliable predictor of COP. Globulins are larger molecules than albumin, and impart significantly less osmotic effects. COP can be measured



**FIGURE 34-20.** Colloid therapy. Colloids are hypothesized to remain intravascular despite the presence of widespread capillary leak. Fluid (represented by pink arrows) is drawn back into the circulation as a consequence of increased colloid oncotic pressure.

in a laboratory using a colloid osmometer (i.e., oncometer); however, this is rarely measured in modern clinical practice.

It is important to note that although colloids have an important role in maintaining intravascular volume, the oncotic effect is significantly less important vis-à-vis extracellular volume than the osmotic effect of electrolytes, such as sodium or chloride. This is a result of the significantly lower total number of osmotically active particles involved. The COP is only one of several factors that determine the fluid flux across a vascular membrane. The Starling equation describes the movement of fluid across the capillary endothelium:

$$Q_f = k_1[(P_c - P_i) - \delta(\pi_c - \pi_i)]$$

where  $Q_f$  indicates transcapillary fluid flux,  $k_1$  is the fluid filtration coefficient,  $P_c$  indicates capillary hydrostatic pressure,  $P_i$  indicates interstitial hydrostatic pressure,  $\pi_c$  indicates intravascular oncotic pressure,  $\pi_i$  indicates interstitial oncotic pressure, and  $\delta$  is the reflection coefficient.

The reflection coefficient in the Starling equation is a function of the permeability and surface area of the capillary bed. The numeric value varies from 0 to 1. For example, the reflection coefficient of the pulmonary endothelium is normally 0.7, but may fall to 0.3 or 0.4 in conditions that increase microvascular permeability.

### Increased Capillary Permeability

The forces responsible for normal or abnormal fluid flux are the net colloid and hydrostatic pressures on either side of the capillary membrane (Fig. 34-21). The capillary hydrostatic pressure is the driving force for fluid moving out of the intravascular compartment. Because the interstitial hydrostatic pressure is usually negative or zero, the plasma COP is the force primarily responsible for counterbalancing the capillary hydrostatic pressure. Any increment in the forces that enhance filtration may induce changes that then retard further transcapillary fluid loss (e.g., increased tissue hydrostatic pressure, increased plasma COP, and decreased tissue COP). In addition, the lymphatic system provides a means for returning filtered capillary water and protein back to the intravascular compartment. The

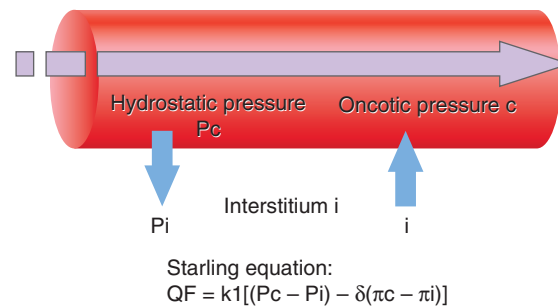


FIGURE 34-21. The Starling hypothesis.

rate of lymphatic flow appears linked to the filtration characteristics of the capillary wall and interstitium, and the net flow of transcapillary fluid. When these protective adaptations are overwhelmed, the rate of interstitial fluid accumulation may surpass the rate of lymphatic drainage and edema will result.

During tissue injury, sepsis, or surgery, there is a significant increase in capillary permeability, with leakage of protein-rich fluid into the interstitial space (see Fig. 34-17). Thus the reflection coefficient of the Starling equation changes and fluid accumulates in lax tissues, leading to edema. The rate of edema formation varies linearly with the volume of crystalloid administered. Colloidal solutions (Table 34-29) are purported to remain intravascular in conditions of widespread capillary leak (see Fig. 34-20). There is some evidence to support this contention.<sup>133,134</sup> This leads to more rapid achievement of hemodynamic goals, volume expansion equal to or greater than the volume administered, and reduction in tissue edema.

Despite these logical arguments there is a strong counterargument that colloid solutions are expensive, probably leak into the extracellular space,

and impact blood coagulation. Three influential meta-analyses were published in the late 1990s that suggested that colloid solutions may actually worsen patient outcomes.<sup>135-137</sup> There is reason to be skeptical of the results of these reviews. A myriad of compounds labelled "colloid" were included, many no longer administered. The studies accrued data over a 30-year period during which fundamental changes occurred in the practices of anesthesia, trauma, and critical care. Moreover, the end points listed in the reviews (principally mortality) were not necessarily end points measured in the studies. The majority of these studies were not carried out in the controlled operating room environment, did not use specific goals for resuscitation, and tended to compare isolated crystalloid resuscitation with isolated colloid resuscitation, not in combination. Most studies of colloids have compared one agent against another, rather than against crystalloid solutions.

There is an emerging body of evidence to support the limited use of colloid solutions in perioperative medicine. These data are discussed in the final section of this chapter. The following sections review the most frequently prescribed colloid solutions.

TABLE 34-29.

#### Properties of Colloid Solutions

Fluid	Weight (Average Molecular Weight)	Number (Average Molecular Weight)	Colloid Osmotic
5% Albumin	69,000	69,000	19
25% Albumin	69,000	69,000	78
Plasma	119,000	88,000	21
6% Hetastarch	450,000	70,000	30
10% Pentastarch	264,000	63,000	40
6% Pentafraction	280,000	120,000	28
10% Dextran 40	40,000	26,000	148
6% Dextran 70	70,000	41,000	60

## Intravenous Albumin

Albumin is commercially available in concentrations of 5% (250-mL and 500-mL vials) and 25% (50-mL and 100-mL vials). These monodisperse solutions are derived from pooled human blood, serum, or plasma, and have been pasteurized at 140 °F (60 °C) for 10 hours. In addition, these preparations contain no clinically important antibodies and may be administered without regard to the recipient's blood group or Rh factor. The more frequently used 5% solution contains 50 mg of albumin per milliliter of physiologic salt solution, whereas the 25% solution has an albumin concentration of 250 mg/mL. All commercial albumin products contain 130–160 mEq of sodium per liter of solution. The 5% solution is isoncotic with respect to human plasma; the 25% solution is 4–5 times more oncologically active than is an equivalent volume of normal plasma. Albumin has a very low incidence of allergic reactions (0.5–1%) and these are usually mild (rash, fever, chills, nausea). Albumin solutions do not appear to directly alter blood coagulation.

Albumin administration is associated with a rapid but unpredictable expansion of the plasma volume. In profoundly hypovolemic patients the interstitial compartment should be resuscitated first so the use of albumin should follow initial administration of crystalloid. Albumin has been widely used to minimize weight gain, prevent pulmonary edema, diminish ascites and reduce tissue edema. There is some evidence that this agent may have some impact on improving organ function and facilitating enteral nutrition.<sup>138</sup> Beyond this there is no evidence that albumin reduces mortality. Previous concerns that albumin may increase mortality,<sup>139</sup> appear to be unfounded. The Saline vs. Albumin Fluid Evaluation (SAFE) study, an Australian randomized controlled trial that recruited >7000 patients, showed no differences in outcome between patients treated with 4% albumin as their resuscitation fluid and those receiving saline.<sup>140</sup>

## Dextrans

Dextrans are high-molecular-weight *d*-glucose polymers joined largely by  $\alpha$ -1,6 bonds into linear-branched macromolecules. They are biosynthesized commercially from sucrose by the B512 strain of *Leuconostoc mesenteroides*, using the enzyme dextran sucrose

For clinical purposes, dextrans are designated by their weight-average molecular weights, because these solutions are polydisperse colloids containing both large and small molecules. Dextran 40, with a weight-average molecular weight of 40,000 Da (range: 10,000–90,000 Da), is available in 0.9% sodium chloride or 5% dextrose, as is dextran 70, which has a weight-average molecular weight of 70,000 Da (range: 20,000–200,000 Da). Dextrans have a strong colloidal osmotic effect: 1 g of dextran 40 retains 30 mL of fluid.

Following administration, the lower-molecular-weight particles are rapidly cleared by the kidney. The threshold for the renal excretion of dextran is a molecular weight of roughly 50,000 Da. Particles weighing less than 15,000 Da are rapidly filtered and not reabsorbed. The remainder are excreted through the gut or phagocytosed by cells of the reticuloendothelial system. Within 24 hours after infusion, approximately 70% of dextran 40 and 50% of dextran 70 is excreted unchanged in the urine. Severe renal dysfunction (creatinine clearance <30 mL/min) prolongs the intravascular half-life and causes an accumulation of the smaller dextran molecules.

In most instances the dextran preparations produce an expansion of plasma volume that is approximately equal to the volume of solution infused. Acutely, dextran 40 will produce a greater increment in plasma volume as compared with dextran 70, because of the greater number of molecules and the more powerful osmotic effect. Intravascular volume expansion is generally more prolonged with dextran 70.

Dextrans are known to have a significant impact on coagulation. When more than 1.5 g/kg is administered, bleeding time is prolonged. The observed hemostatic abnormality is similar to that seen in von Willebrand syndrome. Dextran also impairs the polymerization of fibrin. Dextrans have been traditionally used for postoperative thromboembolic prophylaxis in vascular and plastic and reconstructive surgery.

Dextran 40 may interfere with the cross-matching of blood if a proteolytic enzyme technique is employed. Dextran 70 can induce erythrocyte aggregation and rouleaux formation that may also impede cross-matching. Both solutions can produce a factitious hy-

perglycemia, and the lower-molecular-weight dextran solution can increase serum transaminase (aspartate aminotransferase and alanine aminotransferase) levels. Dextran 40 can produce highly viscous urine that may actually obstruct the renal tubules and cause acute renal failure.

Dextrans are associated with a relatively high incidence of anaphylactoid and anaphylactic reactions. Anaphylactoid reactions are caused by dextran-reactive immunoglobulin G antibodies.<sup>141</sup> The best available data suggests that the risk of a major anaphylactoid reaction is 13 per 100,000 doses sold for dextran 40 and 25 per 100,000 doses sold for dextran 70.<sup>142</sup> Severe anaphylactoid reactions can nearly always be prevented by preinfusing dextran 1 (Promit, Meda AB Pharmaceuticals, Solna, Sweden), a low-molecular-weight (1000 Da) dextran moiety.<sup>141</sup> Dextran 1 acts to prevent severe anaphylactoid reactions by competitively inhibiting dextran from binding to IgG antibodies.

## Hydroxyethyl Starches

Hydroxyethyl starches (hetastarch) are modified natural polysaccharides, derived from amylopectin, that structurally resemble glycogen. Solutions of starch are unstable as they are rapidly hydrolyzed by  $\alpha$ -amylase. The solution is stabilized by hydroxyethylation. This results in hydroxyethyl substitutions, predominantly at carbon 2 (c2), but also at c3 and c6, in the glucose ring (Fig. 34–22). The pharmacokinetics of these starches is determined by the degree and type of hydroxylation. A higher c2/6 substitution ratio results in slower enzymatic degradation. The molecular weight of the compound impacts its side effects. The main route of elimination is urinary. A fraction is taken up by the reticuloendothelial system from whence it is slowly eliminated. Hetastarches contain molecules of variable molecular weights, the average weight is usually that listed. After infusion of hetastarch the dispersion of molecular weights changes: first the small molecules are rapidly eliminated, then the large molecules are partially hydrolyzed to middle-size molecules.

Hetastarch products can be divided into three classes by their weight-averaged molecular weight: high molecular weight (450–480 kDa), medium molecular weight (approximately 200 kDa),



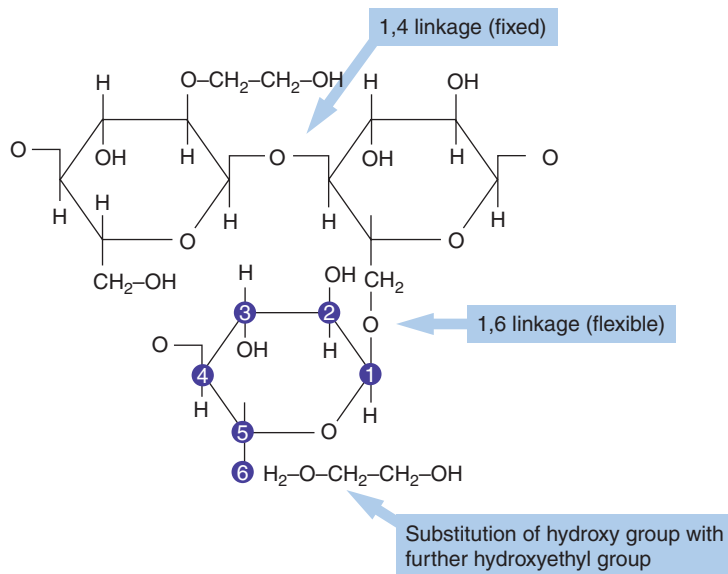


FIGURE 34–22. Hydroxyethyl starch structure.

and low molecular weight (70–130 kDa). Examples of commercially available starches are 6% high-molecular-weight hetastarch in saline (Hespan), 6% high-molecular-weight hetastarch in balanced electrolytes (Hextend), medium-molecular-weight pentastarch in saline (Pentastarch, EloHAES, HAES-steril), and low-molecular-weight tetrastarch in saline (Voluven).

The most commonly used hydroxyethyl starch in the United States, Hespan, is a high-molecular-weight hetastarch, with an average molecular weight of 450,000 Da and a number-average molecular weight of 70,000 Da; 80% of the polymers fall in the range of 30,000–2,400,000 Da. This hetastarch is usually formulated in 0.9% sodium chloride. The COP of this solution is approximately 30 mm Hg, and each gram of hetastarch has a water-binding capacity of 20 mL. On average, 46% and 64% of the dose is excreted in the urine within 2 and 8 days, respectively. Average terminal half life is 17 days. Plasma volume expansion persists for at least 48 hours,<sup>143</sup> with 40% of the peak effect persisting after 24 hours. Hetastarch produces a significantly greater increase in plasma COP than does an equal volume of 5% albumin.

Serum amylase may increase significantly after infusion of hetastarch because of the formation of a stable hetastarch-amylase complex that retards amylase excretion. Allergic reactions to hetastarch are uncommon.

Hetastarch solutions have varying effects on coagulation that are dependent

on the molecular weight of the polypeptide molecule. This appears to occur principally with high-molecular-weight hetastarches that dilute coagulation factors and induce abnormalities on thromboelastography, but not standard coagulation tests. Hetastarch appears to induce an abnormality of platelet function by impairing von Willebrand factor and factor VIIIc. The effect on hemostasis appears to be dose related. Large volumes of hetastarch in vitro and in vivo produce progressive abnormalities in thromboelastogram studies. However, it is unclear if this translates into an increased risk of perioperative bleeding. Many clinicians assert that the dose of hetastarch should be limited to 20 mL/kg/d. Lower-molecular-weight hetastarch and pentastarch solutions appear to be associated with a reduced risk of coagulopathy,<sup>144</sup> as does formulation in balanced salt solution rather than saline.<sup>145</sup>

### Gelatins

Gelatin solutions are widely used in Europe, in particular in the British Isles. Currently, no gelatin is licensed for administration in the United States. The colloidal compounds are derived from hydrolysis of bovine collagen. Gelatins are medium-size compounds, with a molecular weight of 30,000–40,000 Da. The two most common preparations are succinylated gelatin (Gelifusin), presented in a carrier solution of Na 154 mmol and Cl 120 mmol, and urea-linked gelatin (Hemaccel), presented in a carrier solution of isotonic saline plus K 5.1 mmol

and Ca 6.25 mmol/L. Care should be used when administering the latter product in patients who require blood transfusion. The presence of calcium in the fluid-giving set may cause blood coagulation. Administration of gelatin is followed by intravascular volume expansion of an equivalent volume, although after 4 hours, up to 50% of the volume expansion will have been lost. Thus use of gelatins is limited to cases in which rapid volume expansion is required, but the source of the problem is rapidly reversible. An example of this situation would be acute vasoplegia associated with epidural analgesia.

The pharmacokinetics of gelatins are not well understood. Gelatins are cleared principally by glomerular filtration, but may also be broken down by proteases in the reticuloendothelial system. The impact of these compounds on coagulation is unclear; however, urea-bridge gelatins may result in a reduction of platelet aggregation. The incidence of allergic reactions is relatively high compared with hydroxyethyl starches. The bovine origin of these products has led to significant discussion about the risk of transmission of bovine spongiform encephalopathy to humans.<sup>146</sup> However, there are no reported cases of new variant Creutzfeldt-Jakob disease associated with pharmaceutical-grade gelatins to date.

## MONITORING FLUID REPLACEMENT

### Limitations of Crystalloid Resuscitation

Traditional approaches to perioperative fluid management had emphasized the use of careful calculation of fasting fluid deficits, insensible losses, and maintenance requirements. Fluid replacement regimens have been formulaic, centered on crystalloid resuscitation in the belief that dehydration and excessive third space loss will lead to adverse outcomes. However, there is an emerging movement that questions these assumptions.<sup>16</sup> For example, the human body evolved many processes to sustain itself in the face of inadequate hydration. Hence the renin-angiotensin-aldosterone-vasopressin axis developed to maintain homeostasis until a source of water became

available. Conversely, the human body does not appear to be able to store water. Consequently, few mechanisms appear to be in place to deal with significant hypervolemia. Moreover, advocates of aggressive crystalloid resuscitation have tended to ignore the impact of this fluid on tissue compartments (a dramatic increase in interstitial fluid volume), water dissociation (acid-base balance), electrolyte composition, colloid balance, and coagulation. Proponents of an alternative system for perioperative fluid balance, goal-directed resuscitation, use dynamic flow-directed physiologic end points that emphasize timing rather than total volume for fluid administration.

Resuscitation with crystalloid fluids may actually reduce oxygen delivery and tissue perfusion. Funk et al.<sup>147</sup> undertook a laboratory experiment of isovolemic hemodilution of awake Syrian golden hamsters. The hamsters were given either lactated Ringer solution or dextran 60 to replace blood loss. Four times the volume of blood loss was replaced with lactated Ringer solution to maintain mean arterial pressure, central venous pressure, and heart rate. Tissue perfusion and  $P_{aO_2}$  were unchanged in the colloid group, but reduced by 62% and 58%, respectively, in the crystalloid group. Lang et al. investigated the impact of colloid fluid replacement versus crystalloid therapy on tissue oxygen tension in major abdominal surgery.<sup>148</sup> Forty-two patients were randomized to receive 6% hydroxyethyl starch plus lactated Ringer solution or lactated Ringer solution alone for 24 hours targeted to a central venous pressure of 8–12 mm Hg. The investigators measured tissue oxygen tension in the deltoid muscle: a LICOX oxygen monitoring device was placed after induction of anesthesia. Patients in the crystalloid group had received significantly more fluid by the end of surgery (5940 mL  $\pm$  1910 mL vs. 3920 mL  $\pm$  1350 mL,  $p < 0.05$ ) and at the end of 24 hours (11,740  $\pm$  2630 mL vs. 5950 mL  $\pm$  800 mL,  $p < 0.05$ ). The patients in the combined crystalloid-colloid group had significantly greater tissue perfusion (oxygen tension increased from baseline) than did the crystalloid-only group (oxygen tension reduced from baseline).

An ideal resuscitative fluid would maintain intravascular volume without expanding the interstitial space.

Ernest et al. investigated the volume of distribution of NaCl 0.9% versus albumin 55 in cardiac surgical patients.<sup>149</sup> Plasma and extracellular fluid volumes were measured by dilution of radiolabeled albumin and sodium. Administration of isotonic saline increased plasma volume by  $9 \pm 23\%$  of the volume infused. Administration of 5% albumin increased plasma volume by  $52 \pm 84\%$  of the volume infused. Albumin increased cardiac index significantly more than saline, and had an equal impact of hemoglobin dilution. In the saline treatment group, the mean net fluid balance (fluid infusion + fluid losses) was approximately double the mean increase in extracellular fluid volume, which on average was distributed equally between the plasma volume (PV) and interstitial fluid volume (ISFV). In contrast, in the albumin treatment group, the net fluid balance approximated the mean increase in extracellular fluid volume, which approximated the mean increase in PV.

The tendency for crystalloids to extravasate may lead to relative hypoperfusion. Wilkes et al. studied saline-based intravenous fluids (crystalloid and hetastarch) versus balanced salt solution-based fluids (crystalloid and hetastarch) on acid-base status and gut perfusion, which were estimated using gastric tonometry.<sup>34</sup> Patients who received saline were significantly more acidotic and had a lower gastric mucosal pH (indicative of gut perfusion), compared with the patients receiving balanced salt solutions. This was strongly related to increases in serum chloride.

### Pro- and Antiinflammatory Effects of Intravenous Fluids

Conventional wisdom holds that intravenous fluids impart adverse effects consequent of increases in hydrostatic pressure, leading to pulmonary edema, tissue edema, and interference with oxygen perfusion into tissues. However, there is emerging evidence that intravenous fluids may have indigenous pro- and antiinflammatory properties. In a pig model of volume-controlled hemorrhagic shock, Rhee et al. demonstrated a significant increase in neutrophil activation and oxidative burst activity, associated with the administration of lactated Ringer solution.<sup>150</sup> This solution activated inflammation regardless of whether blood

was shed or not. This did not occur when volume was replaced with whole blood or 7.5% hypertonic saline. Similar findings were reported with isotonic saline, dextran, and hydroxyethyl starch but not with albumin (5% or 25%), blood, or anesthesia.<sup>151</sup>

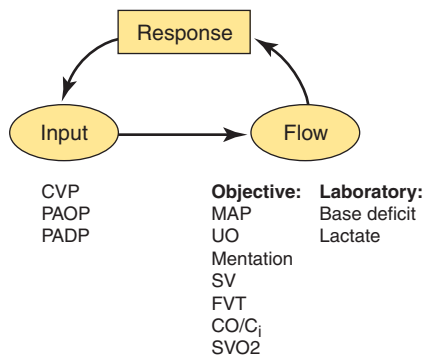
Lactated Ringer solution administration was associated with expression of adhesion molecules that were increased in lung and spleen whether or not hemorrhage took place. This was not seen if the animal was either not resuscitated or was resuscitated with fresh blood.<sup>152</sup> However, when preceded by shock, lactated Ringer resuscitation was associated with histologic evidence of pulmonary edema and inflammation.<sup>152</sup>

Ketone-buffered intravenous fluids such as ethyl pyruvate may have opposite antiinflammatory effects. In a rat model, the use of ethyl pyruvate versus lactated Ringer solution resulted in significantly less pulmonary cellular apoptosis.<sup>151</sup>

### Flow/Goal-Directed Volume Resuscitation

As a result of significant limitations regarding formulaic approaches to fluid resuscitation, concerns about overresuscitation, and the need for a scientific approach based on the dynamics of the stress response, there is an emerging body of evidence supporting the use of goal-directed volume resuscitation that combines crystalloid and colloid in perioperative medicine and critical illness.<sup>153</sup> The modern approach to goal-directed volume resuscitation involves the use of specific “normal” end points of blood flow and tissue perfusion.

The goal-directed approach involves the use of specific monitors that measure input (fluid loading), tissue blood flow, and response (Fig. 34–23). Arterial and central lines are placed and goals for resuscitation are set: these include a central venous pressure (CVP) of 8–12 cm  $H_2O$ , a mean arterial pressure (MAP) of  $> 65$  mm Hg, and, if the appropriate device(s) is(are) placed, a mixed venous oxygen saturation of  $> 70\%$  and a stroke volume of between 0.7 and 1.0 mL/kg (ideal body weight). The purpose of stroke volume monitoring is to construct Starling curves, using one of a variety of surrogates of end-diastolic volume as an index of cardiac preload. These include central venous pressure, pulmonary artery oc-



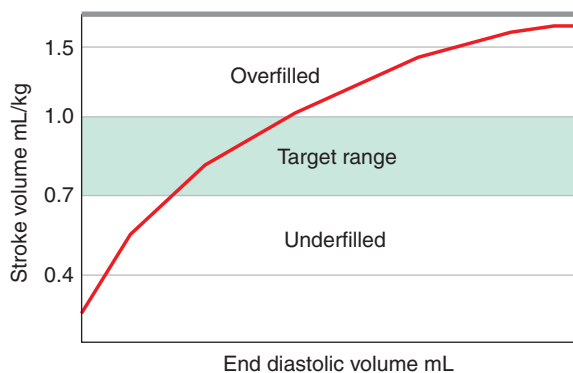
**FIGURE 34–23.** Principles of goal-directed resuscitation. Ci, cardiac index; CO, cardiac output; CVP, central venous pressure; FVT, flow velocity time; MAP, mean arterial pressure; PADP, pulmonary artery diastolic pressure; PAOP, pulmonary artery occlusion pressure; UO, urinary output; SV, stroke volume; SVO<sub>2</sub>, mixed venous oxygen saturation.

clusion pressure, and pulmonary artery diastolic pressure (Fig. 34–24). Changes in stroke volume are more sensitive to changes in circulating volume than changes in cardiac output or cardiac index.<sup>10</sup>

A variety of other devices that measure surrogates of stroke volume or cardiac output are available. These include esophageal Doppler monitors, lithium dilution cardiac output, Fick principle CO<sub>2</sub> rebreathing cardiac output (noninvasive cardiac output), bioimpedance cardiac output, and echocardiography. An alternative approach is to directly measure tissue perfusion, or measure surrogates of blood flow. This includes gastric tonometry and tissue oxygen monitoring probes, such as LICOX.

Central venous pressure can be used to ensure precise perioperative hydration. Moretti et al.<sup>154</sup> randomized 90 patients who were undergoing major elective (noncardiac surgery) to receive either 6% hetastarch in normal saline, 6% hetastarch in balanced salt solution, or lactated Ringer solution on the basis of a resuscitation algorithm. CVP was used for therapeutic goals (Fig. 34–25). Patients who received colloid received significantly less fluid than did those who received crystalloid alone and had significantly lower incidence of postoperative nausea and vomiting, requirement for rescue antiemetics, severe pain, periorbital edema, and double vision.

A number of studies have used esophageal Doppler monitoring (EDM) stroke volume to guide perioperative fluid administration. Mythen and



**FIGURE 34–24.** Stroke volume monitoring.

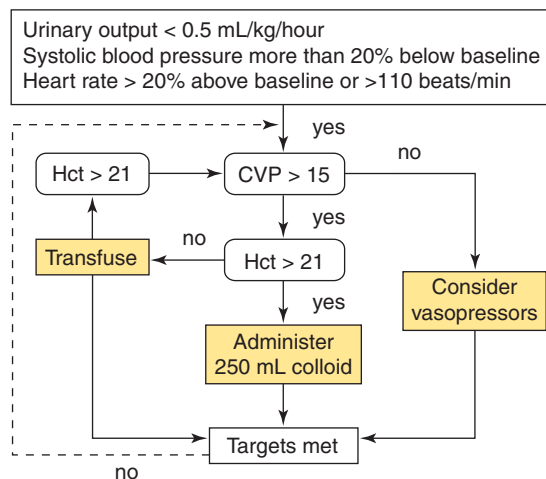
Webb<sup>155</sup> studied 60 patients who were undergoing cardiac surgery and randomly assigned to a protocol that included 200-mL boluses of colloid throughout to specified stroke volume using EDM or control. The volume administration approach in the control group was at the anesthesiologist’s discretion. Patients in the EDM group had higher splanchnic perfusion, and at the end of surgery, fewer major complications and shorter intensive care and hospital stays.

Gan et al.<sup>156</sup> studied 100 patients who were undergoing major elective surgery with an anticipated blood loss of greater than 500 mL and who were randomly assigned to a control or protocol group. The protocol included EDM-guided plasma volume expansion (with colloid) to maximize stroke volume. The protocol group had a significantly shorter duration of hospital stay, tolerated solid oral food earlier, and had significantly less postoperative nausea and vomiting.

Venn et al.<sup>157</sup> randomized 90 patients into three groups: one that received conventional fluid management (based on formulae), a second that received colloid fluid challenges with a CVP line, and a third that received colloid fluid challenges with EDM. Patients were deemed medically fit for discharge more rapidly in the esophageal Doppler monitored group than in the CVP group, and in the CVP group than in the conventional fluid management group.

Sinclair and Singer<sup>158</sup> randomized 40 patients who were undergoing repair of proximal femoral fracture to receive conventional fluid management versus EDM and colloid fluid challenges, again to a specific stroke volume goal. Patients in the esophageal Doppler monitored group were deemed medically fit for discharge earlier than those in the conventional therapy group.

Wakeling et al.<sup>159</sup> randomized 128 consecutive patients who were undergoing colorectal surgery to EDM-guid-



**FIGURE 34–25.** Use of central venous pressure as part of goal-directed volume resuscitation.

ed or CVP-based (conventional) intraoperative fluid management. The CVP-guided protocol aimed at a CVP of 12–15 mm Hg. There was a significant reduction in postoperative stay, shorter time to resuming full diet, and lower incidence of gastrointestinal morbidity in the patients randomized to EDM-guided therapy.

Noblett et al.<sup>160</sup> recruited 108 patients who were undergoing elective colorectal resection and inserted esophageal Doppler monitors in all. The patients were randomized into fluid therapy that was at the discretion of the anesthesiologist versus protocolized fluid therapy that included colloid boluses. The intervention group had a reduced postoperative hospital stay, fewer intermediate or major postoperative complications, and tolerated diet earlier. In addition, there was a reduced rise in perioperative level of the cytokine interleukin 6 in the intervention group.

An alternative approach to flow monitoring, derived from the seminal work of Shoemaker,<sup>161</sup> is to use oxygen consumption (or its surrogate, mixed venous oxygen saturation [ $SVO_2$ ]) to determine tissue oxygen flow. Low  $SVO_2$  is indicative of excessive extraction per unit volume, which is strongly suggestive of hypovolemia. Rivers et al.<sup>162</sup> studied early goal-directed therapy in sepsis, in 263 patients who were randomized to “standard” therapy versus aggressive goal-directed therapy that included the use of an oximetric central venous pressure line. This measured  $SVO_2$  in the superior vena cava distribution. The patients in the study group received significantly more fluid than did patients in the control group in the first 6 hours, more red cell transfusions overall, and an equivalent volume of intravenous fluid over the first 72 hours. There was a 16% decrease in 28-day mortality (number needed to treat: 6). The implication of this study is that early aggressive volume resuscitation ensures tissue blood flow. Once goals are met, further resuscitation is not helpful and may be harmful (Fig. 34–26).

Taking these data together, it appears that perioperative patients who are undergoing major nonvascular surgery, require early, aggressive, goal-targeted volume resuscitation. Stroke volume monitoring appears to be more effective than CVP, which appears to be more effective than the use

of standard formulaic approaches. Patients appear to do better if resuscitated on the day of surgery, and if colloids are administered to achieve volume goals (Fig. 34–27).

### Fluid Restriction

One question that arises from these data is whether the convention of administering postoperative maintenance fluids to patients who have undergone major abdominal surgery is helpful or hurtful. Brandstrup et al.<sup>163</sup> performed a randomized, observer-blinded, multicenter trial (8 Danish Hospitals) that included 172 patients randomized to restrictive or standard perioperative fluid regimen. All of the patients underwent colorectal surgery. The restrictive therapy received no volume preloading, no adjustment for third space loss, and hetastarch or blood to replace blood losses. Postoperative fluid management was adjusted to prevent weight gain of more than 1 kg. The standard therapy group received formula-driven volume replacement. There was a significant reduction in postoperative (including cardiopulmonary and wound healing) complications in the restrictive therapy group.

In another study, 152 patients, with an American Society of Anesthesiologists physical status of I–III who were undergoing elective intraabdominal surgery, were randomized to receive intraoperatively either liberal or restrictive amounts of lactated Ringer so-

lution.<sup>164</sup> The liberal protocol group received 10 mL/kg followed by 12 mL/kg/h. The restrictive protocol group received 4 mL/kg/h and no bolus. The majority of patients underwent lower gastrointestinal surgery. The median volume of fluid administered to the restrictive group was 1230 mL versus 3670 mL in the liberal group. The number of complications was lower in the restrictive protocol group. Return of bowel function was later in that group and their hospital stay was longer.

Another group randomized 10 patients who were undergoing surgery for colonic cancer to receive liberal postoperative fluids ( $\leq 3$  L water and 154 mmol sodium per day) and 10 to receive a restricted intake ( $\leq 2$  L water and 77 mmol sodium per day). Patients in the fluid-restriction group, that is, a weight gain of less than 3 kg, had an earlier return of gastrointestinal function and shorter duration of hospital stay. A similar study by Tambyraja et al. demonstrated a significant relationship between postoperative sodium and water gain and complications after colonic surgery.<sup>165</sup>

### Summary

Perioperative fluid management is a complex process that must take into account the patient's preexisting disease, preoperative volume status, physiologic reserve, degree of perioperative stress, and perioperative fluid losses.

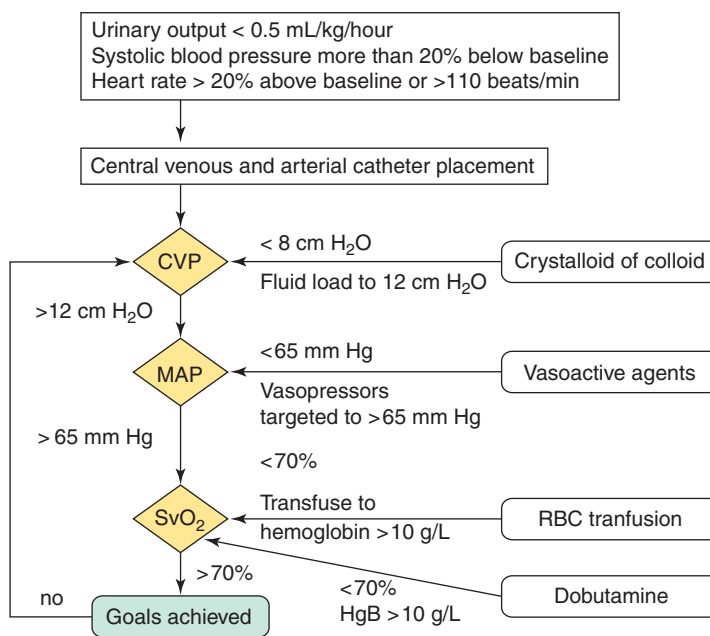
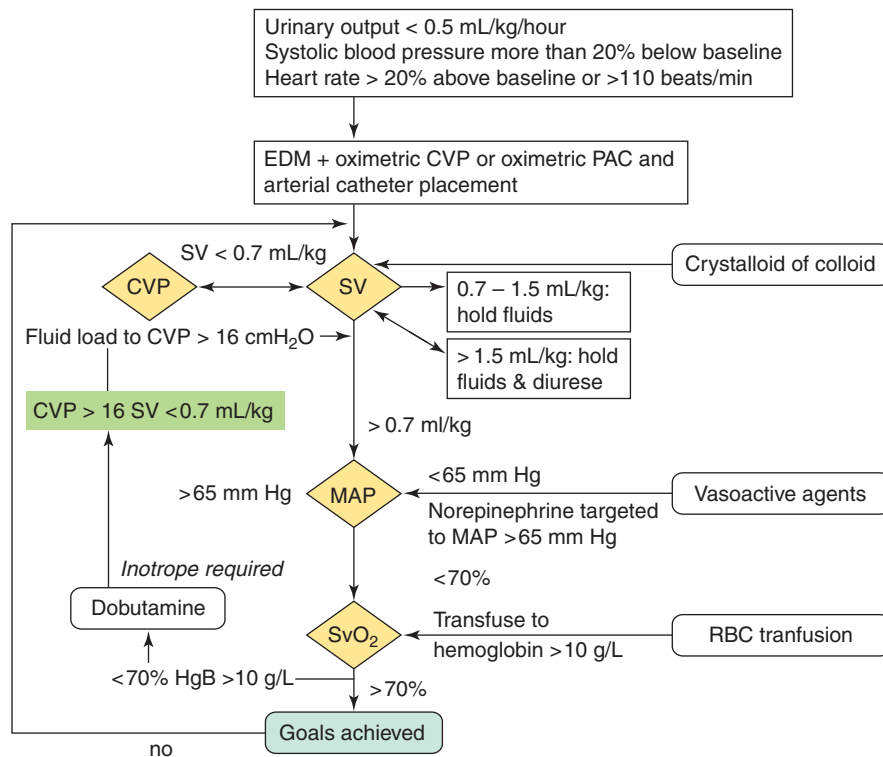


FIGURE 34–26. Use of  $SVO_2$  (mixed venous oxygen saturation) as part of goal-directed resuscitation.





**FIGURE 34–27.** Use of stroke volume and  $\text{SvO}_2$  (mixed venous oxygen saturation) as part of goal-directed resuscitation. CVP, central venous pressure; EDM, esophageal Doppler monitor; MAP, mean arterial pressure; PAC, pulmonary artery catheter; SV, stroke volume.

For the majority of patients, prehydration with 2 mL/kg/h fasting or 30 mL/kg crystalloid, prior to or at the time of induction, will reduce postoperative nausea, vomiting, pain, and lightheadedness. For patients who are undergoing minor surgery or ambulatory surgery without appreciable blood loss, this is all the intravenous fluid that is required. There is little data available with respect to youthful patients with low American Society of Anesthesiologists physical status scores. A formula-based approach to perioperative fluid management appears reasonable for low-risk patients who are undergoing moderately traumatic surgery (e.g., laparoscopic operations, peripheral vascular surgery, neurosurgery). However, management of patients who are undergoing extensive or high-risk surgery requires a more elegant approach. Patients who underwent bowel resection appear to have worse outcomes when overresuscitated with crystalloid. Patients who underwent major vascular surgery, hip surgery, or extensive upper abdominal operations appear to benefit from a dynamic, flow-based, goal-directed approach to volume resuscitation. This can be achieved (in increasing order of inva-

siveness) using CVP (volume responsiveness; see Fig. 34–25); CVP and mixed venous oxygen saturation (volume responsiveness and tissue flow; see Fig. 34–26) or stroke volume and mixed venous oxygen saturation (dynamic volume responsiveness and tissue flow; see Fig. 34–27). In the latter approach, stroke volume is targeted to 0.7–1 mL/kg of ideal body weight. A stroke volume in excess of 1.0 mL/kg is indicative of overresuscitation and fluids are withheld until the stroke volume drifts back into normal range. If the stroke volume exceeds 1.5 mL/kg, serious consideration should be given to the administration of diuretics. Respiratory pulse pressure variation is gaining popularity and may emerge as a simple surrogate for stroke volume.<sup>166</sup> Intraoperative blood loss should be replaced 1:1 with blood or colloid or with 4:1 with crystalloid; crystalloid requirements to replace blood increase geometrically as blood loss continues. Patient outcomes appear to be optimal when the patient is resuscitated fully on the day of surgery or injury and resuscitation efforts rapidly decelerate.

Postoperative fluid management remains a controversial area. Although

transcompartmental fluid sequestration continues for a day or two following surgery or injury (longer if a septic source remains uncontrolled), continued administration of crystalloid leads to increasing tissue edema and weight gain. Conversely, intravascular dehydration may lead to hypoperfusion organ injury, particularly to the kidney. A prudent approach to postoperative fluid administration is recommended. Maintenance fluids are probably unnecessary, unless the period of fasting is prolonged. Evidence of tissue hypoperfusion, as evidenced by low urinary output, low  $\text{SVO}_2$ , or low stroke volume, should be treated with fluid boluses, keeping in mind that lower volumes of colloid are required to achieve the same hemodynamic goals. Once spontaneous diuresis commences, continuous fluid infusions should be discontinued and attention directed toward repletion of intracellular ions, potassium, magnesium, and phosphate. A reasonable goal for perioperative fluid management is restoration of normal body weight by day 7 postoperatively.

## KEY REFERENCES

1. Adroque HJ, Madias NE. Hypernatremia. *N Engl J Med* 2000;342:1493–1499.
2. Adroque HJ, Madias NE. Hyponatremia. *N Engl J Med* 2000;342:1581–1589.
3. Aguilera IM, Vaughan RS. Calcium and the anaesthetist. *Anaesthesia* 2000;55:779–790.
4. Bugg NC, Jones JA. Hypophosphataemia. Pathophysiology, effects and management on the intensive care unit. *Anaesthesia* 1998;53:895–902.
5. Dube L, Granry JC. The therapeutic use of magnesium in anesthesiology, intensive care and emergency medicine: a review. *Can J Anaesth* 2003;50:732–746.
6. Fencel V, Leith DE. Stewart's quantitative acid-base chemistry: applications in biology and medicine. *Respir Physiol* 1993;91:1–16.
7. Grocott MPW, Mythen MG, Gan TJ. Perioperative fluid management and clinical outcomes in

adults. *Anesth Anal* 2005;100:1093–1106.

8. Holte K, Sharrock NE, Kehlet H. Pathophysiology and clinical implications of perioperative fluid excess. *Br J Anaesth* 2002;89:622–632.

9. Lafrance JP, Leblanc M. Metabolic, electrolytes, and nutritional concerns in critical illness. *Crit Care Clin* 2005;21:305–327.

10. Moore FD. Some observations on the metabolic requirement in surgical patients. *Bull N Engl Med Center* 1949;11:193–201.

11. Moss G. Fluid distribution in prevention of hypovolemic shock. *Arch Surg* 1969;98:281–286.

12. Nicholson JP, Wolmarans MR, Park GR. The role of albumin in critical illness. *Br J Anaesth* 2000;85:599–610.

13. Pope A, Longnecker DE, eds. *Fluid Resuscitation: State of the Science for Treating Combat Casualties and Civilian Injuries*. Institute of Medicine 1999. Available at: <http://newton.nap.edu/books/0309064813/html/R1.html>. Last accessed May 2007.

14. Stewart PA. Modern quantitative acid-base chemistry. *Can J Physiol Pharmacol* 1983;61:1444–1461.

15. Wilmore DW. Metabolic response to severe surgical illness: overview. *World J Surg* 2000;24:705–711.

6. Moore FD. Some observations on the metabolic requirement in surgical patients. *Bull N Engl Med Center* 1949;11:193–201.

7. Moore FD. Common patterns of water and electrolyte change in injury, surgery and disease. *N Engl J Med* 1958;258:277–285.

8. Drucker WR, Chadwick CD, Gann DS. Transcapillary refill in hemorrhage and shock. *Arch Surg* 1981;116:1344–1353.

9. Marty AT, Zweifach BW. Splanchnic contribution to transcapillary refill after hemorrhagic shock. *Ann Surg* 1971;174:131–136.

10. Moss G. Fluid distribution in prevention of hypovolemic shock. *Arch Surg* 1969;98:281–286.

11. Holte K, Kehlet H. Compensatory fluid administration for preoperative dehydration—does it improve outcome? *Acta Anaesth Scand* 2002;46:1089–1093.

12. Maharaj CH, Kallam SR, Malik A, Hassett P, Grady D, Laffey JG. Preoperative intravenous fluid therapy decreases postoperative nausea and pain in high risk patients. *Anesth Anal* 2005;100:675–682.

13. Magner JJ, McCaul C, Carton E, Gardiner J, Buggy D. Effect of intraoperative intravenous crystalloid infusion on postoperative nausea and vomiting after gynaecological laparoscopy: comparison of 30 and 10 mL/kg(1). *Br J Anaesth* 2004;93:381–385.

14. McCaul C, Moran C, O’Cronin D, et al. Intravenous fluid loading with or without supplementary dextrose does not prevent nausea, vomiting and pain after laparoscopy. *Can J Anaesth* 2003;50:440–444.

15. Brandstrup B. Fluid therapy for the surgical patient. *Best Pract Res Clin Anaesthesiol* 2006;20:265–283.

16. Holte K, Sharrock NE, Kehlet H. Pathophysiology and clinical implications of perioperative fluid excess. *Br J Anaesth* 2002;89:622–632.

17. Shires T, Williams J, Brown F. Acute change in extracellular fluids associated with major surgical procedures. *Ann Surg* 1961;154:803–810.

18. Brandstrup B, Svensen C, Engquist A. Hemorrhage and operation cause a contraction of the extracellular space needing replacement—evidence and implications? A systematic review. *Surgery* 2006;139:419–432.

19. Brandstrup B, Tonnesen H, Beier-Holgersen R, et al. Effects of intravenous fluid restriction on postoperative complications: comparison of two perioperative fluid regimens: a randomized assessor-blinded multicenter trial. *Ann Surg* 2003;238:641–648.

20. Holte K, Jensen P, Kehlet H. Physiologic effects of intravenous fluid administration in healthy volunteers. *Anesth Anal* 2003;96:1504–1509.

21. Adrogue HJ, Madias NE. Hyponatremia. *N Engl J Med* 2000;342:1581–1589.

22. Adrogue HJ, Madias NE. Hyponatremia. *N Engl J Med* 2000;342:1493–1499.

23. Fawcett WJ, Haxby EJ, Male DA. Magnesium: physiology and pharmacology. *Br J Anaesth* 1999;83:302–320.

24. Gupta K, Vohra V, Sood J. The role of magnesium as an adjuvant during general anaesthesia. *Anaesthesia* 2006;61:1058–1063.

25. Blitz M, Blitz S, Beasley R, et al. Inhaled magnesium sulfate in the treatment of acute asthma. *Cochrane Database Syst Rev* 2005;CD003898.

26. Dube L, Granry JC. The therapeutic use of magnesium in anesthesiology, intensive care and emergency medicine: a review [L’usage thérapeutique du magnésium en anesthésiologie, réanimation et médecine d’urgence]. *Can J Anaesth* 2003;50:732–746.

27. Agusti AG, Torres A, Estopa R, Agustividal A. Hypophosphatemia as a cause of failed weaning: the importance of metabolic factors. *Crit Care Med* 1984;12:142–143.

28. Aubier M, Murciano D, Lecocguic Y, et al. Effect of hypophosphatemia on diaphragmatic contractility in patients with acute respiratory failure. *N Engl J Med* 1985;313:420–424.

29. Zazzo JF, Troche G, Ruel P, Maintenant J. High incidence of hypophosphatemia in surgical intensive care patients: efficacy of phosphorus therapy on myocardial function. *Intensive Care Med* 1995;21:826–831.

30. Nilius B, Droogmans G. Amazing chloride channels: an overview. *Acta Physiol Scand* 2003;177:119–147.

31. Jentsch TJ. Chloride channels are different. *Nature* 2002;415:276–277.

32. Thakker RV. Chloride channels in renal disease. *Adv Nephrol Necker Hosp* 1999;29:289–298.

33. Wilcox CS. Regulation of renal blood flow by plasma chloride. *J Clin Invest* 1983;71:726–735.

34. Wilkes NJ, Woolf R, Mutch M, et al. The effects of balanced versus saline-based hetastarch and crystalloid solutions on acid-base and electrolyte status and gastric mucosal perfusion in elderly surgical patients. *Anesth Analg* 2001;93:811–816.

35. Nicholson JP, Wolmarans MR, Park GR. The role of albumin in critical illness. *Br J Anaesth* 2000;85:599–610.

36. Soni N. Human albumin administration in critically ill patients. Validity of review methods must be assessed. *BMJ* 1998;317:883–884.

37. Perioperative total parenteral nutrition in surgical patients. The Veterans Affairs Total Parenteral Nutrition Cooperative Study Group. *N Engl J Med* 1991;325:525–532.

38. Goldwasser P, Feldman J. Association of serum albumin and mortality risk. *J Clin Epidemiol* 1997;50:693–703.

39. Blunt MC, Nicholson JP, Park GR. Serum albumin and colloid osmotic pressure in survivors and nonsurvivors of prolonged critical illness. *Anaesthesia* 1998;53:755–761.

## REFERENCES

1. Geissler PL, Dellago C, Chandler D, Hutter J, Parrinello M. Autoionization in liquid water. *Science* 2001;291:2121–2124.

2. Haskins SC, Hopper K, Rezende ML. The acid–base impact of free water removal from, and addition to, plasma. *J Lab Clin Med* 2006;147:114–120.

3. Scheingraber S, Rehm M, Sehmisch C, Finsterer U. Rapid saline infusion produces hyperchloremic acidosis in patients undergoing gynecologic surgery. *Anesthesiology* 1999;90:1265–1270.

4. Fencl V, Leith DE. Stewart’s quantitative acid–base chemistry: applications in biology and medicine. *Respir Physiol* 1993;91:1–16.

5. Cuthbertson D, Tilstone WJ. Metabolism during the postinjury period. *Adv Clin Chem* 1969;12:1–55.

40. Narins R, Emmett M. Simple and mixed acid-base disorders: a practical approach. *Medicine (Baltimore)* 1980;59:161–187.
41. Stewart PA. Independent and dependent variables of acid-base control. *Respir Physiol* 1978;33:9–26.
42. Fencel V, Jabor A, Kazda A, Figge J. Diagnosis of metabolic acid-base disturbances in critically ill patients. *Am J Respir Crit Care Med* 2000;162:2246–2251.
43. Figge J, Rossing TH, Fencel V. The role of serum proteins in acid-base equilibria. *J Lab Clin Med* 1991;117:453–467.
44. Wilkes P. Hypoproteinemia, strong-ion difference, and acid-base status in critically ill patients. *J Appl Physiol* 1998;84:1740–1748.
45. Stewart PA. Modern quantitative acid-base chemistry. *Can J Physiol Pharmacol* 1983;61:1444–1461.
46. Kellum JA. Diagnosis and treatment of acid-base disorders. In: Shoemaker W, ed. *Textbook of Critical Care Medicine*. 4th ed. Philadelphia: WB Saunders, 2000:839–853.
47. Geissler PL, Dellago C, Chandler D, Hutter J, Parrinello M. Autoionization in liquid water. *Science* 2001;291:2121–2124.
48. Chaplin MF. A proposal for the structuring of water. *Biophys Chem* 2000;83:211–221.
49. Rini M, Magnes BZ, Pines E, Nibbering ETJ. Real-time observation of bimodal proton transfer in acid-base pairs in water. *Science* 2003;301:349–352.
50. Marx D, Tuckerman ME, Hutter J, Parrinello M. The nature of the hydrated excess proton in water. *Nature* 1999;397:601–604.
51. Chaplin MF. A proposal for the structuring of water. *Biophys Chem* 2000;83:211–221.
52. Singer RB, Hastings AB. An improved clinical method for the estimation of disturbances of the acid-base balance of human blood. *Medicine* 1948;10:242.
53. Rossing TH, Maffeo N, Fencel V. Acid-base effects of altering plasma protein concentration in human blood in vitro. *J Appl Physiol* 1986;61:2260–2265.
54. Corey HE. Stewart and beyond: new models of acid-base balance. *Kidney Int* 2003;64:777–787.
55. Goldwasser P, Feldman J. Association of serum albumin and mortality risk. *J Clin Epidemiol* 1997;50:693–703.
56. Alfaro V, Torras R, Ibanez J, Palacios L. A physical-chemical analysis of the acid-base response to chronic obstructive pulmonary disease. *Can J Physiol Pharmacol* 1996;11(74):1229–1235.
57. Rehm MO, Scheingraber S, Kreimeier U, Brechtelsbauer H, Finsterer U. Acid-base changes caused by 5% albumin versus 6% hydroxyethyl starch solution in patients undergoing acute normovolemic hemodilution: a randomized prospective study. *Anesthesiology* 2000;93:1174–1183.
58. Waters J, Gottlieb A, Schoenwald P, Popovich M. Normal saline versus lactated Ringer's solution for intraoperative fluid management in patients undergoing abdominal aortic aneurysm repair: an outcome study. *Anesth Analg* 2001;93:817–822.
59. Kellum JA. Fluid resuscitation and hyperchloremic acidosis in experimental sepsis: improved short-term survival and acid-base balance with Hextend compared with saline. *Crit Care Med* 2002;30:300–305.
60. Brill SA, Stewart TR, Brundage SI, Schreiber MA. Base deficit does not predict mortality when secondary to hyperchloremic acidosis. *Shock* 2002;17:459–462.
61. Tournadre JP, Allaouchiche B, Malbert CH, Chassard D. Metabolic acidosis and respiratory acidosis impair gastropyloric motility in anesthetized pigs. *Anesth Analg* 2000;90:74–79.
62. Hansen PB, Jensen BL, Skott O. Chloride regulates afferent arteriolar contraction in response to depolarization. *Hypertension* 1998;32:1066–1070.
63. Wilcox CS. Regulation of renal blood flow by plasma chloride. *J Clin Invest* 1983;71:726–735.
64. Williams EL, Hildebrand KL, McCormick SA, Bedel MJ. The effect of intravenous lactated Ringer's solution versus 0.9% sodium chloride solution on serum osmolality in human volunteers. *Anesth Analg* 1999;88:999–1003.
65. Merten GJ, Burgess WP, Gray LV, et al. Prevention of contrast-induced nephropathy with sodium bicarbonate: a randomized controlled trial. *JAMA* 2004;291:2328–2334.
66. Story DA, Poustie S, Bellomo R. Quantitative physical chemistry analysis of acid-base disorders in critically ill patients. *Anaesthesia* 2001;56:530–533.
67. Tayar J, Jabbour G, Saggi SJ. Severe hyperosmolar metabolic acidosis due to a large dose of intravenous lorazepam. *N Engl J Med* 2002;346:1253–1254.
68. Rocktaschel J, Morimatsu H, Uchino S, Ronco C, Bellomo R. Impact of continuous venovenous hemofiltration on acid base balance. *Int J Artif Organs* 2003;26:19–25.
69. Kellum JA. Diagnosis and treatment of acid-base disorders. In: Shoemaker W, ed. *Textbook of Critical Care Medicine*. 4th ed. Philadelphia: WB Saunders, 2000:839–853.
70. Rodriguez-Soriano J. New insights into the pathogenesis of renal tubular acidosis—from functional to molecular studies. *Pediatr Nephrol* 2000;14:1121–1136.
71. Choate KA, Kahle KT, Wilson FH, Nelson-Williams C, Lifton RP. WNK1 a kinase mutated in inherited hypertension with hyperkalemia, localizes to diverse Cl-transporting epithelia. *Proc Natl Acad Sci U S A* 2003;100:663–668.
72. Shaer AJ. Inherited primary renal tubular hypokalemic alkalosis: a review of Gitelman and Bartter syndromes. *Am J Med Sci* 2001;322:316–332.
73. Severinghaus JW. Acid-base balance nomogram—a Boston-Copenhagen detente. *Anesthesiology* 1976;45:539–541.
74. Schwartz WB, Relman AS. A critique of the parameters used in the evaluation of acid-base disorders. “Whole-blood buffer base” and “standard bicarbonate” compared with blood pH and plasma bicarbonate concentration. *N Engl J Med* 1963;268:1382–1388.
75. Siggaard-Anderson O. The acid-base status of the blood. 1st ed. Copenhagen: Munksgard, 1963:134.
76. Siggaard-Anderson O. The van Slyke equation. *Scand J Clin Lab Invest Suppl* 1977;37:15–20.
77. Schlichtig R, Grogono AW, Severinghaus JW. Human PaCO<sub>2</sub> and standard base excess compensation for acid-base imbalance. *Crit Care Med* 1998;26:1173–1179.
78. Morgan TJ, Clark C, Endre ZH. Accuracy of base excess—an in vitro evaluation of the Van Slyke equation. *Crit Care Med* 2003;28:2932–2936.
79. Emmett M, Narins RG. Clinical use of the anion gap. *Medicine (Baltimore)* 1977;56:38–54.
80. Salem MM, Mujais SK. Gaps in the anion gap. *Arch Intern Med* 1992;152:1625–1629.
81. Figge J, Jabor A, Kazda A, Fencel V. Anion gap and hypoalbuminemia. *Crit Care Med* 1998;26:1807–1810.
82. Wooten EW. Analytic calculation of physiological acid-base parameters in plasma. *J Appl Physiol* 1999;86:326–334.
83. Figge J, Mydosh T, Fencel V. Serum proteins and acid-base equilibria: a follow-up. *J Lab Clin Med* 1992;120:713–719.
84. Gilfix BM, Bique M, Magder S. A physical chemical approach to the analysis of acid-base balance in the clinical setting. *J Crit Care* 1993;8:187–197.
85. Balasubramanian N, Havens PL, Hoffman GM. Unmeasured anions identified by the Fencel-Stewart method predict mortality better than base excess, anion gap, and lactate in patients in the pediatric intensive care unit. *Crit Care Med* 1999;27:1577–1581.
86. Story DA, Morimatsu H, Bellomo R. Strong ions, weak acids and base excess: a simplified Fencel-Stewart approach to clinical acid-base disorders. *Br J Anaesth* 2004;92:54–60.
87. Story DA, Morimatsu H, Bellomo R. Strong ions, weak acids and base excess: a simplified Fencel-Stewart approach to clinical acid-base disorders. *Br J Anaesth* 2004;92:54–60.
88. Forsythe SM, Schmidt GA. Sodium bicarbonate for the treatment of lactic acidosis. *Chest* 2000;117:260–267.
89. Rehm M, Finsterer U. Treating intraoperative hyperchloremic acidosis with sodium bicarbonate or tris-hydroxymethyl aminomethane: a randomized prospective study. *Anesth Analg* 2003;96:1201–1208, table.
90. Goldsmith DJ, Forni LG, Hilton PJ. Bicarbonate therapy and intracellular acidosis. *Clin Sci (Lond)* 1997;93:593–598.



91. Nielsen HB, Hein L, Svendsen LB, Secher NH, Quistorff B. Bicarbonate attenuates intracellular acidosis. *Acta Anaesth Scand* 2002;46:579-584.
92. Hickling KG. Permissive hypercapnia. *Respir Care Clin N Am* 2002;8:155-169, v.
93. Laffey JG, Engelberts DORE, Kavanagh BP. Buffering hypercapnic acidosis worsens acute lung injury. *Am J Respir Crit Care Med* 2000;161:141-146.
94. Holmdahl MH, Wiklund L, Wetterberg T, et al. The place of THAM in the management of acidemia in clinical practice. *Acta Anaesthesiol Scand* 2000;44:524-527.
95. Reeves RB. An imidazole alaphastat hypothesis for vertebrate acid-base regulation: tissue carbon dioxide content and body temperature in bullfrogs. *Respir Physiol* 1972;14:219-236.
96. Rahn H, Reeves RB, Howell BJ. Hydrogen ion regulation, temperature, and evolution. *Am Rev Respir Dis* 1975;112:165-172.
97. Laffey JG, Kavanagh BP. Carbon dioxide and the critically ill—too little of a good thing? *Lancet* 1999;354:1283-1286.
98. Murkin JM, Farrar JK, Tweed WA, McKenzie FN, Guiraudon G. Cerebral autoregulation and flow/metabolism coupling during cardiopulmonary bypass: the influence of PaCO<sub>2</sub>. *Anesth Anal* 1987;66:825-832.
99. Hogue CW Jr, Palin CA, Arrowsmith JE. Cardiopulmonary bypass management and neurologic outcomes: an evidence-based appraisal of current practices. *Anesth Anal* 2006;103:21-37.
100. American Society of Anesthesiologist Task Force on Preoperative Fasting. Practice guidelines for preoperative fasting and the use of pharmacologic agents to reduce the risk of pulmonary aspiration: application to healthy patients undergoing elective procedures. *Anesthesiology* 1999;90:896-905.
101. Dillon J, Lynch LJ Jr, Myers R, Butcher HR Jr. The treatment of hemorrhagic shock. *Surg Gynecol Obstet* 1966;122:967-978.
102. Skillman JJ, Awwad HK, Moore FD. Plasma protein kinetics of the early transcapillary refill after hemorrhage in man. *Surg Gynecol Obstet* 1967;125:983-996.
103. Fleck A, Raines G, Hawker F, et al. Increased vascular permeability: a major cause of hypoalbuminaemia in disease and injury. *Lancet* 1985;1:781-784.
104. Fisher M. Postoperative intravenous therapy. *Anaesth Intensive Care* 1977;5:339-346.
105. Van den Berghe G, Wouters P, Weekers F, et al. Intensive insulin therapy in critically ill patients. *N Engl J Med* 2001;345:1359-1367.
106. Capes SE, Hunt D, Malmberg K, Gerstein HC. Stress hyperglycaemia and increased risk of death after myocardial infarction in patients with and without diabetes: a systematic overview. *Lancet* 2000;355:773-778.
107. Bochicchio GV, Sung J, Joshi M, et al. Persistent hyperglycemia is predictive of outcome in critically ill trauma patients. *J Trauma* 2005;58:921-924.
108. O'Malley CM, Frumento RJ, Hardy MA, et al. A randomized, double-blind comparison of lactated Ringer's solution and 0.9% NaCl during renal transplantation. *Anesth Anal* 2005;100:1518-1524, table.
109. Hansen PB, Jensen BL, Skott O. Chloride regulates afferent arteriolar contraction in response to depolarization. *Hypertension* 1998;32:1066-1070.
110. Hansen PB, Jensen BL, Skott O. Chloride regulates afferent arteriolar contraction in response to depolarization. *Hypertension* 1998;32:1066-1070.
111. Wilcox CS. Regulation of renal blood flow by plasma chloride. *J Clin Invest* 1983;71:726-735.
112. Lobo DN, Bostock KA, Neal KR, Perkins AC, Rowlands BJ, Allison SP. Effect of salt and water balance on recovery of gastrointestinal function after elective colonic resection: a randomised controlled trial. *Lancet* 2002;359:1812-1818.
113. Merten GJ, Burgess WP, Gray LV, et al. Prevention of contrast-induced nephropathy with sodium bicarbonate: a randomized controlled trial. *JAMA* 2004;291:2328-2334.
114. Boldt J. New light on intravascular volume replacement regimens: what did we learn from the past three years? *Anesth Anal* 2003;97:1595-1604.
115. Ruttman TG, James MFM, Finlayson J. Effects on coagulation of intravenous crystalloid or colloid in patients undergoing peripheral vascular surgery. *Br J Anaesth* 2002;89:226-230.
116. Ng KF, Lam CC, Chan LC. In vivo effect of haemodilution with saline on coagulation: a randomized controlled trial. *Br J Anaesth* 2002;88:475-480.
117. Ruttman TG, Jamest MF, Lombard EH. Haemodilution-induced enhancement of coagulation is attenuated in vitro by restoring antithrombin III to pre-dilution concentrations. *Anaesth Intensive Care* 2001;29:489-493.
118. Healey MA, Davis RE, Liu FC, Loomis WH, Hoyt DB. Lactated ringer's is superior to normal saline in a model of massive hemorrhage and resuscitation. *J Trauma* 1998;45:894-899.
119. Waters JH, Gottlieb A, Schoenwald P, Popovich MJ, Sprung J, Nelson DR. Normal saline versus lactated Ringer's solution for intraoperative fluid management in patients undergoing abdominal aortic aneurysm repair: an outcome study. *Anesth Anal* 2001;93:817-822.
120. Mazzoni MC, Borgstrom P, Intaglietta M, Arfors KE. Capillary narrowing in hemorrhagic shock is rectified by hyperosmotic saline-dextran reinfusion. *Circ Shock* 1990;31:407-418.
121. Bruegger D, Bauer A, Rehm M, et al. Effect of hypertonic saline dextran on acid-base balance in patients undergoing surgery of abdominal aortic aneurysm. *Crit Care Med* 2005;33:556-563.
122. Oliveira RP, Weingartner R, Ribas EO, Moraes RS, Friedman G. Acute haemodynamic effects of a hypertonic saline/dextran solution in stable patients with severe sepsis. *Intensive Care Med* 2002;28:1574-1581.
123. Nolan J. Fluid resuscitation for the trauma patient. *Resuscitation* 2001;48:57-69.
124. Mattox KL, Maningas PA, Moore EE, et al. Prehospital hypertonic saline-dextran infusion for post-traumatic hypotension. The U.S.A. Multicenter Trial. *Ann Surg* 1991;213:482-491.
125. Wade CE, Grady JJ, Kramer GC. Efficacy of hypertonic saline dextran fluid resuscitation for patients with hypotension from penetrating trauma. *J Trauma* 2003;54:S144-S148.
126. Wade CE, Kramer GC, Grady JJ, Fabian TC, Younes RN. Efficacy of hypertonic 7.5% saline and 6% dextran-70 in treating trauma: a meta-analysis of controlled clinical studies. *Surgery* 1997;122:609-616.
127. Cooper DJ, Myles PS, McDermott FT, et al. Prehospital hypertonic saline resuscitation of patients with hypotension and severe traumatic brain injury: a randomized controlled trial. *JAMA* 2004;291:1350-1357.
128. Jarvela K, Kaukinen S. Hypertonic saline (7.5%) decreases perioperative weight gain following cardiac surgery. *J Cardiothorac Vasc Anesth* 2002;16:43-46.
129. White H, Cook D, Venkatesh B. The use of hypertonic saline for treating intracranial hypertension after traumatic brain injury. *Anesth Anal* 2006;102:1836-1846.
130. Klatzo I. Presidential address. Neuro-pathological aspects of brain edema. *J Neuropathol Exp Neurol* 1967;26:1-14.
131. Schmoker JD, Shackford SR, Wald SL, Pietropaoli JA. An analysis of the relationship between fluid and sodium administration and intracranial pressure after head injury. *J Trauma* 1992;33:476-481.
132. Grocott MPW, Mythen MG, Gan TJ. Perioperative fluid management and clinical outcomes in adults. *Anesth Anal* 2005;100:1093-1106.
133. Rittuo D, Gosling P, Burnley S, et al. Randomized study comparing the effects of hydroxyethyl starch solution with Gelo-fusine on pulmonary function in patients undergoing abdominal aortic aneurysm surgery. *Br J Anaesth*, 2004;92:61-66.
134. Zikria BA, King TC, Stanford J, Freeman HP. A biophysical approach to capillary permeability. *Surgery* 1989;105:625-631.
135. Choi PT, Yip G, Quinonez LG, Cook DJ. Crystalloids vs. colloids in fluid resuscitation: a systematic review. *Crit Care Med* 1999;27:200-210.
136. Roberts I, Alderson P, Bunn F, Chinnock P, Ker K, Schierhout G. Colloids versus crystalloids for fluid resuscitation in



critically ill patients. *Cochrane Database Syst Rev* 2004;CD000567.

137. Velanovich V. Crystalloid versus colloid fluid resuscitation: a meta-analysis of mortality. *Surgery* 1989;105:65–71.

138. Dubois MJ, Orellana-Jimenez C, Melot C, et al. Albumin administration improves organ function in critically ill hypoalbuminemic patients: a prospective, randomized, controlled, pilot study. *Crit Care Med* 2006;34:2536–2540.

139. Cochrane Injuries Group Albumin Reviewers. Human albumin administration in critically ill patients: systematic review of randomised controlled trials. *BMJ* 1998;317:235–240.

140. The SS, I. A comparison of albumin and saline for fluid resuscitation in the intensive care unit. *N Engl J Med* 2004;350:2247–2256.

141. Zinderman CE, Landow L, Wise RP. Anaphylactoid reactions to dextran 40 and 70: reports to the United States Food and Drug Administration, 1969 to 2004. *J Vasc Surg* 2006;43:1004–1009.

142. Ljungstrom KG, Renck H, Strandberg K, Hedin H, Richter W, Widerlov E. Adverse reactions to dextran in Sweden 1970–1979. *Acta Chir Scand* 1983;149:253–262.

143. Yacobi A, Stoll RG, Sum CY, Lai CM, Gupta SD, Hulse JD. Pharmacokinetics of hydroxyethyl starch in normal subjects. *J Clin Pharmacol* 1982;22:206–212.

144. Treib J, Haass A, Pindur G, et al. Influence of low molecular weight hydroxyethyl starch (HES 40/0.5–0.55) on hemostasis and hemorheology. *Haemostasis* 1996;26:258–265.

145. Gan TJ, Bennett-Guerrero E, Phillips-Bute B, et al. Hextend, a physiologically balanced plasma expander for large volume use in major surgery: a randomized phase III clinical trial. *Anesth Anal* 1999;88:992–998.

146. Bedforth NM, Hardman JG. Mad colloid disease? *Anaesthesia* 1997;52:389–390.

147. Funk W, Baldinger V. Microcirculatory perfusion during volume therapy. A comparative study using crystalloid or colloid

in awake animals. *Anesthesiology* 1995;82:975–982.

148. Lang K, Boldt J, Suttner S, Haisch G. Colloids versus crystalloids and tissue oxygen tension in patients undergoing major abdominal surgery. *Anesth Anal* 2001;93:405–409.

149. Ernest D, Belzberg AS, Dodek PM. Distribution of normal saline and 5% albumin infusions in septic patients. *Crit Care Med* 1999;27:46–50.

150. Rhee P, Burris D, Kaufmann C, et al. Lactated Ringer's solution resuscitation causes neutrophil activation after hemorrhagic shock. *J Trauma* 1998;44:313–319.

151. Alam HB, Stanton K, Koustova E, Burris D, Rich N, Rhee P. Effect of different resuscitation strategies on neutrophil activation in a swine model of hemorrhagic shock. *Resuscitation* 2004;60:91–99.

152. Deb S, Martin B, Sun L, et al. Resuscitation with lactated Ringer's solution in rats with hemorrhagic shock induces immediate apoptosis. *J Trauma* 1999;46:582–588.

153. Shoemaker WC, Montgomery ES, Kaplan E, Elwyn DH. Physiologic patterns in surviving and nonsurviving shock patients. Use of sequential cardiorespiratory variables in defining criteria for therapeutic goals and early warning of death. *Arch Surg* 1973;106:630–636.

154. Moretti EW, Robertson KM, el Moalem H, Gan TJ. Intraoperative colloid administration reduces postoperative nausea and vomiting and improves postoperative outcomes compared with crystalloid administration. *Anesth Analg*, 2003;96:611–617, table.

155. Mythen MG, Webb AR. Perioperative plasma volume expansion reduces the incidence of gut mucosal hypoperfusion during cardiac surgery. *Arch Surg* 1995;130:423–429.

156. Gan TJ, Soppitt A, Maroof M, et al. Goal-directed intraoperative fluid administration reduces length of hospital stay after major surgery. *Anesthesiology* 2002;97:820–826.

157. Venn R, Steele A, Richardson P, Poloniecki J, Grounds M, Newman P. Randomized controlled trial to investigate influence

of the fluid challenge on duration of hospital stay and perioperative morbidity in patients with hip fractures. *Br J Anaesth* 2002;88:65–71.

158. Sinclair S, James S, Singer M. Intraoperative intravascular volume optimisation and length of hospital stay after repair of proximal femoral fracture: randomised controlled trial. *BMJ* 1997;315:909–912.

159. Wakeling HG, McFall MR, Jenkins CS, et al. Intraoperative oesophageal Doppler guided fluid management shortens postoperative hospital stay after major bowel surgery. *Br J Anaesth* 2005;95:634–642.

160. Noblett SE, Snowden CP, Shenton BK, Horgan AF. Randomized clinical trial assessing the effect of Doppler-optimized fluid management on outcome after elective colorectal resection. *Br J Surg* 2006;93:1069–1076.

161. Shoemaker WC, Appel PL, Kram HB. Tissue oxygen debt as a determinant of lethal and nonlethal postoperative organ failure. *Crit Care Med* 1988;16:1117–1120.

162. Rivers E, Nguyen B, Havstad S, et al. Early goal-directed therapy in the treatment of severe sepsis and septic shock. *N Engl J Med* 2001;345:1368–1377.

163. Brandstrup B, Tonnesen H, Beier-Holgersen R, et al. Effects of intravenous fluid restriction on postoperative complications: comparison of two perioperative fluid regimens: a randomized assessor-blinded multicenter trial. *Ann Surg* 2003;238:641–648.

164. Nisanevich V, Felsenstein I, Almog G, Weissman C, Einav S, Matot I. Effect of intraoperative fluid management on outcome after intraabdominal surgery. *Anesthesiology* 2005;103:25–32.

165. Tambyraja AL, Sengupta F, MacGregor AB, Bartolo DC, Fearon KC. Patterns and clinical outcomes associated with routine intravenous sodium and fluid administration after colorectal resection. *World J Surg* 2004;28:1046–1051.

166. Solus-Biguenet H, Fleyfel M, Tavernier B, et al. Non-invasive prediction of fluid responsiveness during major hepatic surgery. *Br J Anaesth* 2006;97:808–816.

## SECTION B

## MANAGING THE AIRWAY

## CHAPTER 35

## Airway Management

P. Allan Klock, Jr., MD, and  
Andranik Ovassapian, MD

The airway conducts gases between the atmosphere and the alveoli. Effective airway management keeps the airway free of secretions, contamination, and obstruction while minimizing complications. Critical illness often causes weakness and obtundation sufficient to impair air exchange. The sedative, narcotic, anesthetic, and relaxant drugs that facilitate surgery predictably compromise airway patency and protection. The Closed Claims Study of the American Society of Anesthesiologists (ASA) Committee on Professional Liability reveals that tragic and costly complications of anesthesia frequently are tied to problematic airway management.<sup>1</sup> Some of the most important roles of the anesthesiologist include ensuring that the patient is adequately oxygenated and ventilated and that airway patency is maintained.

Mastery of the airway demands familiarity with normal and variant anatomy and the alterations caused by abnormal states. Essential attributes for the expert airway manager include knowledge, sound judgment, skills for a range of techniques, and planning for conceivable contingencies.<sup>2,3</sup>

## APPLIED ANATOMY OF THE AIRWAY

To ensure adequate gas exchange, anesthesiologists must continually as-

sess the patency and alignment of the air passages and their ability to accommodate airway devices. Key are the relationships of the pharynx to surrounding structures, the architecture of the larynx, and the mobility of the tissues.

## The Pharynx

Extending from the sphenoid bone to C6, the pharynx parallels the vertebrae, which are covered by the anterior longitudinal ligament and fascial layers beneath the mucosa and constrictor muscles.<sup>3,4</sup> Between the more

## KEY POINTS

1. Tracheal intubation can be accomplished using a direct visual (rigid laryngoscopy), indirect visual (fiberoptic laryngoscopy), guided blind (laryngeal mask airway, retrograde, lightwand), or a complete blind (blind nasal) technique. Each technique has its preferred indication and risks and benefits.
2. Airway management without tracheal intubation is becoming more popular with the introduction of the laryngeal mask airway.
3. General anesthesia and muscle relaxants are used to facilitate tracheal intubation. A rapid-acting muscle relaxant is used during rapid sequence induction and intubation.
4. Soft-tissue upper airway obstruction is common after induction of anesthesia. Oropharyngeal airway insertion and application of jaw thrust often are successful for overcoming soft-tissue airway obstruction.
5. Securing the airway under topical anesthesia with or without sedation (an “awake intubation”) provides the optimal approach for patients with severely compromised or difficult airways.
6. Awake intubation should be encouraged, taught, and practiced regularly so that anesthesiologists are comfortable and skilled with the elements of this technique.
7. The availability of a difficult airway cart should be assured for every anesthetizing location.
8. Major anesthetic complications are frequently associated with airway mismanagement, including inadequate ventilation or oxygenation and unrecognized esophageal intubation.
9. Laryngospasm is common with patient stimulation during light anesthesia. Stridor indicates partial blockade of the airway. Lack of stridor may indicate complete closure of the larynx with no air exchange.
10. In patients in whom the upper airway is obstructed, establishing emergency ventilation through the use of a laryngeal mask airway, Combitube, cricothyrotomy, or transtracheal jet ventilation is a must and should be applied as soon as possible to prevent brain injury and death.
11. Esophageal intubation to establish emergency ventilation is more likely to succeed since the introduction of the Combitube.
12. Trauma to laryngeal structures can leave patients with vocal cord paralysis and major voice dysfunction.
13. Airway compromise has been reported during patient extubation. Planned and prepared extubation is a must to minimize airway-related complications.

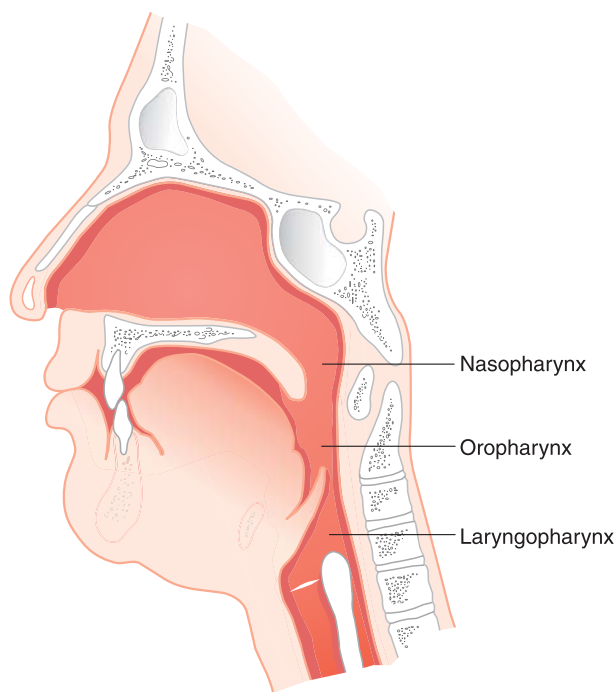
superficial buccopharyngeal fascia and the prevertebral fascia, the retropharyngeal space permits free movement of the pharynx during deglutition. Retropharyngeal abscesses may infiltrate through this space and enter the superior mediastinum.

The anterior communications of the pharynx give names to its subdivisions (Fig. 35-1). The nasopharynx extends from the skull base to the soft palate at the caudal aspect of the atlas (C1). From here to the caudal aspect of C3 lies the oropharynx, whose forward limit is the junction between the anterior two thirds and posterior third of the tongue. The laryngopharynx or hypopharynx merges at C6 with the esophagus (Fig. 35-2). There, the cricopharyngeus (lower fibers of the inferior constrictor), originating on the cricoid cartilage, encircles the esophagus to form its upper sphincter. In anesthetized patients, the same function is mimicked by pressing the cricoid ring against C6 (Sellick maneuver).<sup>5</sup>

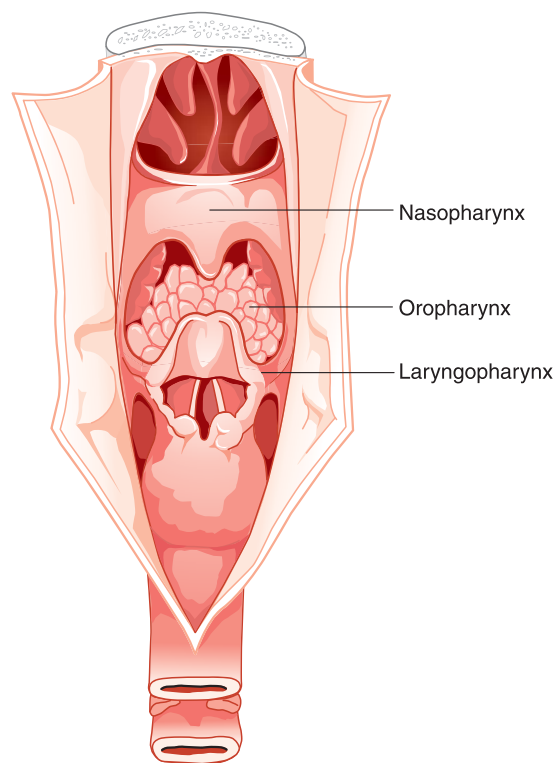
### Nasopharynx and Nose

The pharyngobasilar fascia anchors the pharynx superiorly to the occipital and the sphenoid bones. In the presence of basilar skull fractures, passage of nasotracheal and nasogastric tubes may result in their entry into the cranium. Superficial to these bones that roof the pharynx and C1 lies the pharyngeal tonsil (called *adenoids* when hypertrophied), a site of potential obstruction or hemorrhage during nasal intubation. In patients whose large tongues fill their oral cavities, face mask ventilation permits entry of gas through the nasopharynx into the lungs, but the soft palate, posterior pharyngeal wall, and tongue often form a unidirectional valve that blocks exhalation. Exhalation block is prevented by periodic release of the mandible or by insertion of an artificial airway.

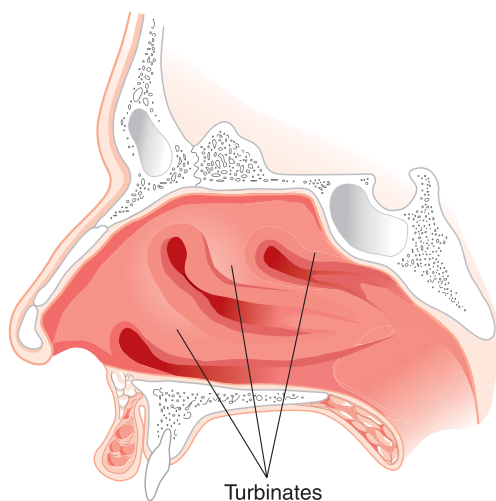
Anteriorly, the nasopharynx opens through the choanae, nasal passages, and nostrils. Consequent to septal deformity or mucosal congestion, one passage is commonly smaller than the other. The filtration and humidification functions of the nose are well served by the convoluted surfaces of the three turbinates on each lateral wall (Fig. 35-3). Their fragility assures that intubation attempts will cause epistaxis unless the tube is guided parallel and adjacent to the hard palate and perpendicular to the face



**FIGURE 35-1.** Diagram of sagittal section of the pharynx illustrating the three subdivisions of the pharynx. (Reprinted from Finucane BT, Santora AH. *Principles of Airway Management*. 2ed. St. Louis: Mosby Year Book, Inc., 1996, with permission from Elsevier.)



**FIGURE 35-2.** Posterior view of the pharynx showing subdivisions of the pharynx. (Reprinted from Finucane BT, Santora AH. *Principles of Airway Management*. 2ed. St. Louis: Mosby Year Book, Inc., 1996, with permission from Elsevier.)



**FIGURE 35-3.** Lateral wall of the nasal cavity demonstrating the superior, middle, and inferior conchae (turbinate bones). (Reprinted from Finucane BT, Santora AH. *Principles of Airway Management*. 2ed. St. Louis: Mosby Year Book, Inc., 1996, with permission from Elsevier.)

through the channel beneath the inferior turbinate.

### Oropharynx and Mouth

The posterior third of the tongue, muscular for mastication and deglutition, forms the anterior wall of the oropharynx. In the sleeping or anesthetized patient in the supine position, muscle relaxation combined with gravity moves the base of the tongue toward the posterior oropharyngeal wall, causing varying degrees of airway obstruction. Partial airway obstruction is aggravated by negative inspiratory pressure collapsing the loose pharyngeal walls inward. Much of successful airway management amounts to preventing airway obstruction at this level.

In the absence of artificial airways, airway patency may be improved by extending the neck or subluxing the mandible anteriorly. This anterior displacement, through stretching of the mylohyoid, genioid, and genioglossus muscles, indirectly relieves oropharyngeal obstructions (Fig. 35-4). Mandibular mobility depends in turn on the hinging and gliding motions of the temporomandibular joint. Successful rigid laryngoscopy requires anterior displacement of the tongue to allow visualization of the larynx.

The oropharynx opens to the oral cavity at the palatoglossal folds, marking the division between the anterior two thirds and posterior one third of the tongue. The palatoglossal folds and the more posterior palatopharyngeal

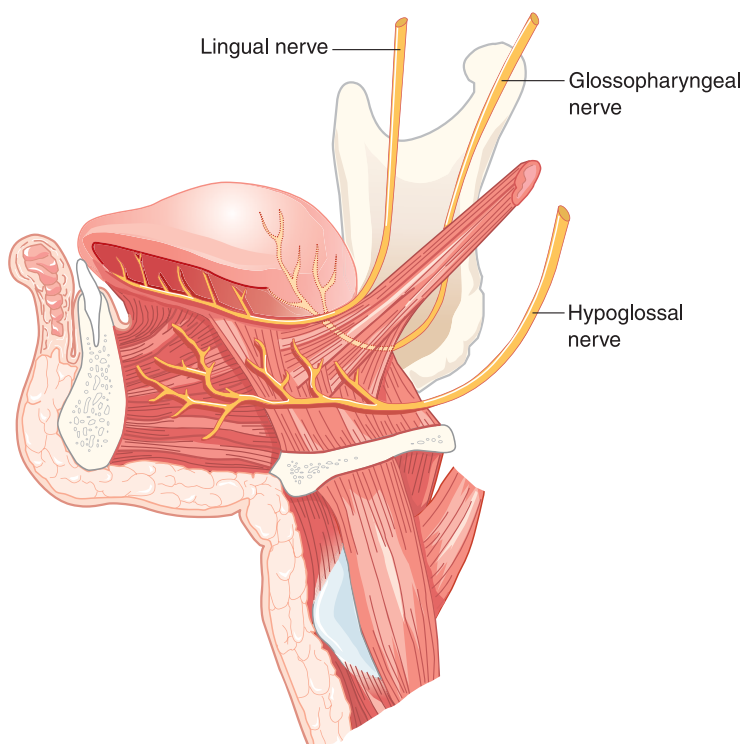
folds form bilateral triangles, called the *fauces*, which contain the tonsils. Hypertrophy of the tonsils and their confluence with the adjacent soft palate, uvula, and tongue base can challenge an anesthesiologist attempting mask ventilation or intubation. Full visualization of all structures at the faucal

isthmus between the oropharynx and oral cavity, in the seated patient with tongue protruding, suggests easy direct laryngoscopic intubation.

Anterior to the fauces is the oral cavity proper, separated from the vestibule by the teeth and gums. Maxillary teeth, especially if prominent, bucked, or capped, can interfere with laryngoscopy and intubation.

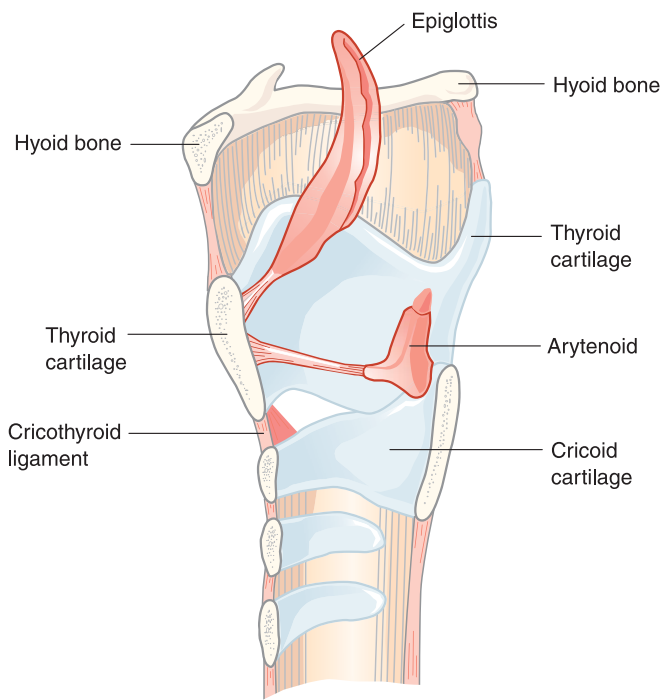
### Laryngopharynx and Larynx

Three single cartilages (epiglottis, thyroid, cricoid) and six smaller, paired cartilages (arytenoid, corniculate, cuneiform) and their mucosal coverings shape the larynx (Fig. 35-5). Presenting the appearance of an obliquely cut vent pipe originating out of a steep roof, the larynx protrudes into the laryngopharynx. The laryngeal inlet or aditus is formed by the cephalad border of the epiglottis, the aryepiglottic fold, and the mucous membranes covering the cuneiform and corniculate cartilages. The rima glottidis is the elongated opening between the true vocal folds (anteriorly) and the arytenoid cartilages (posteriorly). The term *glottis* (vocal apparatus of the larynx) refers to the true vocal folds and the opening between them. Be-



**FIGURE 35-4.** Sagittal section of the mouth to illustrate the tongue and its innervation. (Reprinted from Finucane BT, Santora AH. *Principles of Airway Management*. 2ed. St. Louis: Mosby Year Book, Inc., 1996, with permission from Elsevier.)

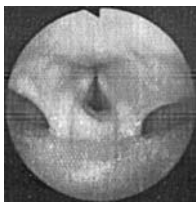




**FIGURE 35-5.** Diagrammatic illustration of sagittal section of the larynx. The epiglottis, thyroid, cricoid, and arytenoid cartilages and the position of the vocal cord ligaments are demonstrated. (Reprinted from Finucane BT, Santora AH. *Principles of Airway Management*. 2ed. St. Louis: Mosby Year Book, Inc., 1996, with permission from Elsevier.)

tween the false and true vocal cords lie the laryngeal ventricles. The laryngeal vestibule includes the laryngeal inlet and the false vocal folds. The aryepiglottic folds curve caudally and medially into the larynx to form the vestibular folds or false cords.

To each side of the larynx and inferior to the aryepiglottic folds are the piriform recesses, which are separated by a prominence in the anterior laryngopharyngeal wall created by the lamina of the cricoid cartilage (Fig. 35-6).<sup>3</sup> The properly positioned laryngeal mask airway (LMA) seals against the cricoid cartilage and cricopharyngeus muscle inferiorly, the base of the tongue superiorly, and the piriform recesses laterally.<sup>6</sup> The superior laryn-



**FIGURE 35-6.** Fiberoptic endoscopic view of the larynx. The piriform recesses are represented by the deepest part of the hypopharynx lateral to aryepiglottic folds bilaterally. (From Ovassapian<sup>3</sup> with permission.)

geal nerves, submucosal in these recesses, can be blocked with local anesthetic-soaked pledgets applied to the piriform sinuses. During blind nasal or lightwand intubation, tubes caught in the piriform recesses should be withdrawn a few centimeters and rotated to enter the larynx.

The hyoid (Greek, "U-shaped") bone at C4 suspends the thyroid cartilage by the thyrohyoid membrane, which is penetrated when performing superior laryngeal nerve blocks (Fig. 35-7). Gentle lateral movements by the thumb and index finger applied to opposite sides of the hyoid allow palpation of the cornua of the bone. At C5, at the superior aspect of the 3-cm high thyroid cartilage, is the thyroid notch and laryngeal prominence (Adam's apple), an important landmark that may be subtle in women. The thyroid (Greek, "shield") cartilage sends superior cornua cephalad toward the hyoid bone and inferior cornua to articulate with the cricoid (Greek, "ring") cartilage. The cricoid cartilage resembles a graduation ring with its narrower portion facing posteriorly. In the midline at C6, the cricothyroid membrane (ligament) provides an easily palpated and avascular site for emergency cricothyrotomy or

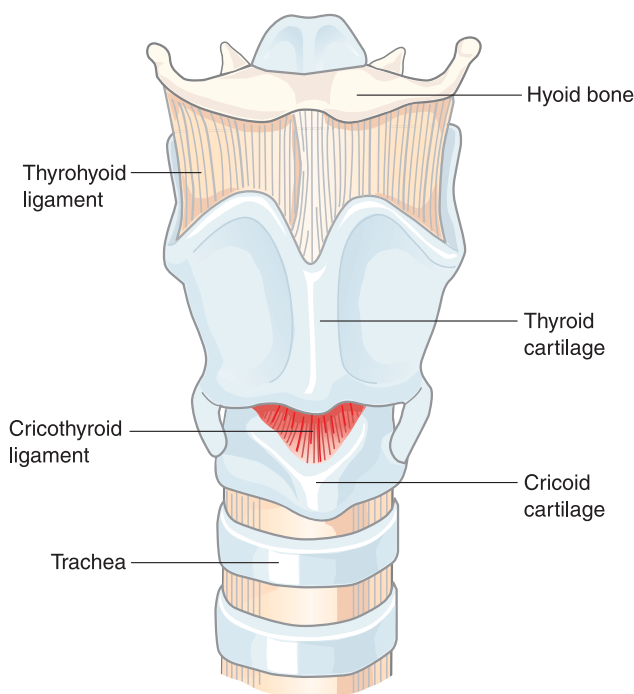
cannulation for instillation of local anesthetics, jet ventilation, or retrograde wire-guided intubation.

The vocal ligaments of the true cords attach anteriorly to the medial aspect of the thyroid cartilage, just 1 cm superior to the cricothyroid ligament, and posteriorly to the vocal processes of the arytenoid cartilages (Fig. 35-5).<sup>3,4</sup> Just superior to the anterior attachment of the vocal ligaments, the epiglottic cartilage is attached to the medial aspect of the thyroid cartilage. The superior edge of the epiglottis blends with the aryepiglottic folds. The tip of a curved (Macintosh) laryngoscope blade fits into the glossoepiglottic reflection. Two lateral valleculae in this reflection are created by the hyoepiglottic ligament, which keeps the resting epiglottis out of the laryngeal vestibule. Tracheal tubes caught in the valleculae during blind nasal or lightwand intubations may be directed into the larynx by changing their angle of approach or by pulling the epiglottis anteriorly with traction on the tongue. The epiglottic cross-section, crescent-shaped in adults, is more curved (omega-shaped) in infants.

Superior to the posterior cricoid lamina sit the paired arytenoid (Greek, "ladle") cartilages with superior, anterior, and lateral projections. The superior projections support the corniculate (Latin, "little horn") cartilages, and the anterior and lateral projections attach to the vocal cords and various intrinsic laryngeal muscles, respectively (Fig. 37-5). Corniculate and cuneiform cartilages embedded in the aryepiglottic fold form two prominences on the posterior part of rima glottidis. These prominences, commonly referred to as "the arytenoids," serve as important landmarks for intubation during suboptimal laryngoscopy.

### Normal Vocal Cord Movements and Laryngeal Nerve Palsies

Normal vocal cord movements include abduction during inspiration, partial adduction during exhalation, and full adduction during phonation. All intrinsic muscles of the larynx are adductors or tensors, with the exception of the posterior cricoarytenoid muscles, which are the sole abductors. All intrinsic muscles of the larynx are innervated by the recurrent laryngeal nerve, with the exception of the cricothyroid, a tensor innervated by the external branch of the superior laryn-



**FIGURE 35-7.** Diagrammatic illustration of the anterior view of the larynx. The larynx is suspended from the hyoid bone by the thyrohyoid ligament. The cricothyroid ligament provides easy and fast access to the larynx. Translaryngeal injection of local anesthetics and transtracheal jet ventilation are performed through this ligament. (Reprinted from Finucane BT, Santora AH. Principles of Airway Management. 2ed. St. Louis: Mosby Year Book, Inc., 1996, with permission from Elsevier.)

geal nerve. Laryngeal nerve palsies are classified as central or peripheral and unilateral or bilateral.<sup>7</sup> Simultaneous malfunction of the superior and recurrent laryngeal branches implies a central lesion or a high interruption of the vagus nerve. Central causes include posterior fossa surgery or brainstem infarctions. Peripheral lesions are more commonly caused by neck or cardiothoracic surgery than by endotracheal (ET) tube cuff pressure on the larynx. Damage to the superior laryngeal nerve or its external branch results in an inability to sound a high-pitched C note, but the inability improves over time as the contralateral muscle compensates. During phonation, the aryepiglottic folds and glottis are asymmetric. A complete unilateral recurrent laryngeal nerve injury causes hoarseness and a motionless cord that is joined during phonation by the contralateral cord crossing the midline. Brain infarction or a complete vagus nerve interruption causes the cord to assume a flaccid, wavy, partially abducted, or “cadaveric” position more commonly seen as a result of administering muscle relaxants.

Incomplete bilateral recurrent laryngeal nerve palsies result in a glottic

opening so small that an emergency surgical airway may be needed. Bilateral complete recurrent laryngeal nerve palsies result in severe hoarseness, but because the cords neither adduct nor abduct, a safe glottic opening may remain. Paradoxical movement of vocal cords, often seen in young anxious female patients, may mimic vocal cord paralysis. Both vocal cords move, but they approximate during inspiration, closing the larynx and causing stridor and airway obstruction.<sup>8</sup>

### Glottic and Laryngeal Closure

Three forms of laryngeal airway closure can be distinguished. First, during light anesthesia or phonation, the intrinsic laryngeal muscles approximate the vocal cords during exhalation, causing expiratory stridor or moaning. Second, if the vocal cords are edematous or are resting close together (encountered in some anxious patients), the Bernoulli effect draws the cords together during rapid inhalation, resulting in inspiratory stridor.<sup>9</sup>

The third kind of closure involves the entire larynx instead of simply the glottis; the thyrohyoid and other strap muscles contract in a forceful, longitudinal compression of the larynx.<sup>10</sup> Dur-

ing deglutition, Valsalva, or laryngeal spasm, the thyroid cartilage and hyoid bone approximate, bulging the epiglottis caudal into the vestibule against the false cords in a ball-valve fashion. Muscle relaxants and maneuvers to elongate the larynx (application of the sniff position, neck extension, and jaw thrust) tend to counteract such closure; in contrast, face mask positive pressure may expand the piriform recesses and compress the aryepiglottic folds, compounding laryngeal closure.

### The Lower Airway

The lower airway includes the subglottic larynx, trachea, and bronchi. The subglottic larynx is 2 cm in length and extends from the true vocal folds to the lower border of the cricoid ring. The trachea extends from the lower border of the cricoid ring at C6 to the carina at T5, posterior to the angle of Louis (manubriosternal junction).<sup>4</sup>

A lightwand-fitted tracheal tube can be positioned with its tip at midtrachea by advancing the transilluminated spot to the sternal notch.<sup>11</sup> Neck flexion will advance an ET tube in a caudad direction, whereas Trendelenburg position or laparoscopic pneumoperitoneum can move the carina in a cephalad direction. All of these maneuvers can cause a properly located ET tube to move into a bronchus.<sup>12</sup> False reassurance that a tube tip is not in a bronchus often is given by a radiograph taken with the head transiently thrown into extension by removing the pillow while supporting the chest with a film cassette.

During fiberoptic examination, the trachea is distinguished from bronchi by its flat, muscular posterior wall, lending a D-shaped cross-section.

The right mainstem bronchus is approximately half as long as the 5-cm left mainstem bronchus. Being wider and more in line with the trachea, the right mainstem bronchus is more likely than the left bronchus to be unintentionally intubated. Also, foreign bodies, aspirated material, and suction catheters preferentially wind up in the right bronchus. Tracheobronchial anatomy and other features of the airway differ between infants and adults (Table 35-1).<sup>4</sup>

### EVALUATION OF THE AIRWAY

A difficult airway can present as difficult mask ventilation, difficult rigid

TABLE 35-1.

## Comparison of the Infant and Adult Airways

Feature	Infant (birth to 1 year)	Adult $\geq 8$ years)
Cricoid–carina distance (cm)	5–6	10–20
Trachea–right bronchus angle	30°	20°
Trachea–left bronchus angle	45°	45°
Narrowest portion of airway	Cricoid cartilage	Glottis
Level of glottis	C3–4 interspace	C5
Inclination of vocal cords	Anteroinferior	Horizontal
Protrusion of corniculate and cuneiform tubercles into laryngeal aditus	Prominent	Minimal
Epiglottic cross-section	Omega-shaped	Crescent-shaped or flat
Glottic–epiglottic angle	Small	Large
Ease of mobilizing epiglottis to expose cords	Generally awkward, especially with curved blade	Usually easy with curved or straight blade
Height of thyrohyoid and cricothyroid ligaments	Almost nonexistent	Several millimeters
Preferred breathing route	Nasal	Nasal or oral
Prominence of occiput	Large (no headrest needed to attain the “sniff” position)	Small (headrest needed)

laryngoscopic intubation, difficult tracheostomy, or combination of all three. The major task during preoperative airway evaluation is to identify patients at risk for a “cannot intubate, cannot ventilate” situation, which is caused by congenital or acquired anatomic variations or by abnormal afflictions of the upper and lower airway (Box 35-1).<sup>13,14</sup> A search for these includes reviewing old records, taking a ventilatory history, examining the patient with reference to the normal and desired mobility of airway structures, and reviewing relevant laboratory and radiologic studies.<sup>14</sup> Inability to ventilate is a more urgent problem than is inability to intubate with adequate mask ventilation. Independent risk factors for difficult mask ventilation include age  $>55$  years, body mass index  $>26$  kg/m<sup>2</sup>, facial hair, missing teeth, and a history of snoring.<sup>15</sup> Special attention should be paid to syndromes associated with a problematic airway. Details of the airway evaluation are given in Chapter 8.

It is important to have an airway management plan that addresses whether the patient will require an airway device such as a supraglottic airway or an ET tube. It also is important to consider whether the airway

will be instrumented while the patient is awake or after induction of the anesthetic.

Despite a thorough evaluation of the airway, anatomic variants, including supraepiglottic cysts<sup>16</sup> and lingual tonsillar hypertrophy,<sup>17,18</sup> can lead to an unexpected difficult ventilation and/or intubation. In addition, the ever present possibility of instrument failure requires backup plans and familiarity with algorithms for handling unanticipated challenges.

## VENTILATION DURING ANESTHESIA

Alveolar ventilation should deliver the oxygen (O<sub>2</sub>) consumed by tissues while removing metabolic carbon dioxide (CO<sub>2</sub>). The average anesthetized adult consumes approximately 250 mL/min of O<sub>2</sub> and produces 200 mL/min of CO<sub>2</sub>. Because the normal alveolar effluent contains 5% (1/20) CO<sub>2</sub>, removing 200 mL of CO<sub>2</sub> each minute requires 4 L/min (20  $\times$  200 mL/min = 4000 mL/min) of alveolar ventilation. Because one third of minute ventilation is dead space (does not participate in gas exchange), the required total minute ventilation to maintain nor-

BOX 35-1.

### Some Causes of Difficult Airway Management

#### Anatomic Features

Short, muscular neck  
Limited neck mobility  
Prominent maxillary incisors  
Awkwardly placed, incomplete dentition  
Long, highly arched palate with narrow mouth  
Small mouth opening  
Receding chin

#### Abnormal States

Anaphylactic airway edema  
Arthritis and ankylosis  
Cervical spine  
Temporomandibular joint  
Larynx  
Congenital syndromes  
Klippel-Feil (short, fused neck)  
Pierre Robin (micrognathia, cleft palate, glossoptosis)  
Treacher Collins (mandibulofacial dysostosis)

#### Endocrinopathies

Obesity  
Acromegaly  
Hypothyroid macroglossia  
Goiter

#### Infections

Ludwig’s angina (floor of the mouth abscess)  
Peritonsillar abscess  
Retropharyngeal abscess  
Epiglottitis

#### Mediastinal masses

Myopathies demonstrating myotonia or trismus

#### Scarring from burns or radiation

Trauma and hematomas

#### Tumors and cysts

#### Technical and Mechanical Factors

Body cast  
Halo fixation or cervical collar  
Airway foreign bodies  
Leaks around a face mask  
Edentulous  
Flat bridge of nose  
Large face and head  
Whiskers, beard  
Nasogastric tube  
Poor technique, inexperience, or haste

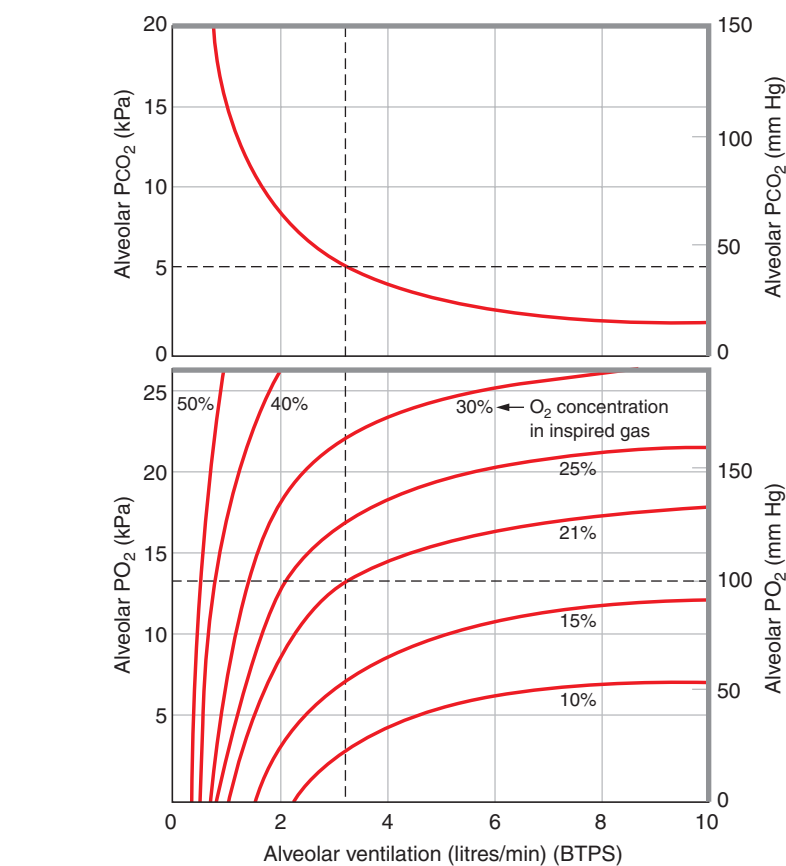
mocapnia is 6000 mL/min, or approximately 90 mL/kg/min. Unless the metabolic rate is reduced, alveolar hypoventilation results in hypercapnia.

Arterial oxygenation can be sustained during hypoventilation by increasing the fraction of inspired oxygen ( $FIO_2$ ).

In the presence of opioids, sedatives, and inhaled anesthetics, the brain's normal compensatory responses to hypercapnia and hypoxemia are blunted. Thus, the spontaneously breathing patient during general anesthesia will become hypercapnic, although surgical stimuli offset ventilatory depression and tend to return  $Paco_2$  toward normal. Spontaneous ventilation is acceptable during general anesthesia when muscle relaxants are avoided and airway patency is properly maintained.

The anesthesiologist assists ventilation by timing the compression of the reservoir bag to the patient's spontaneously initiated breaths, a task requiring considerable practice.<sup>19</sup> Assisted ventilation can test the quality of a face mask or laryngeal mask seal and offset the mechanical loading caused by partial airway obstruction. In the anesthetized patient, apnea may result either from hyperventilation until the  $Paco_2$  drops below the apneic threshold or from a series of breaths large enough to elicit the Hering-Breuer inspiratory reflex. It has been shown that assisting breathing enough to lower the  $Paco_2$  by 5 mm Hg reduces it below the apneic threshold. For this reason, assisted ventilation cannot generally reverse hypercapnia to a meaningful extent without becoming controlled ventilation. In the presence of muscle relaxants, unfavorable position, critical illness, or a requirement for hyperventilation, the anesthesiologist may choose to initiate controlled ventilation.

An inhalation induction is performed by allowing a patient to breathe volatile anesthetics, starting with concentrations low enough to avoid airway irritation and gradually increasing as the central effects of the vapors begin to depress cough reflexes. As alveolar ventilation drops off, breaths are assisted with increasing frequency, until ventilation is manually controlled. Inhalation inductions, popular for children, have some merit in adults when the ability to ventilate the patient after induction of anesthesia is uncertain.<sup>19</sup> If worsening of airway obstruction is encountered during inhalation induction, the anesthetic can be turned off, thereby awakening the patient. Historically, a well-performed



**FIGURE 35-8.** Dependency of alveolar oxygenation on alveolar ventilation at low  $FIO_2$  values. Supplemental  $O_2$  largely frees the  $PaO_2$  of its dependency on alveolar ventilation. For example, the broken vertical line shows that a patient breathing room air with an alveolar ventilation of 3.2 L/min has a  $PaO_2$  of 100 mm Hg, which would decrease to 50 mm Hg should the alveolar ventilation decrease by 50%. Yet even at the lower alveolar ventilation, increasing the  $FIO_2$  to 0.4 elevates the  $PaO_2$  to 200 mm Hg. (Reprinted from Nunn JF. *Applied Respiratory Physiology*. 3d ed. Boston: Butterworth, 1987, with permission from Elsevier.)

inhalation induction was even used in patients at increased risk for regurgitation to deepen them enough to obliterate the vomiting reflex while preventing inspiratory attempts against a closed glottis.

### Hypoventilation

Hypoventilation, consequent to depressed ventilatory drive, laryngeal spasm, or most commonly supraglottic soft-tissue airway obstruction, results in hypercapnia and hypoxemia. Normally, although room air is 21%  $O_2$ , alveolar gas has an  $O_2$  concentration of 16% because of the presence of water vapor and  $CO_2$ . Arterial  $O_2$  desaturation of hypoventilating patients breathing room air occurs in part because increasing alveolar  $CO_2$  displaces alveolar  $O_2$ . Small increases in  $FIO_2$  elevate alveolar  $O_2$  enough to maintain an acceptable arterial  $O_2$  saturation in the presence of hypoventila-

tion; large increments in  $FIO_2$  can maintain close to normal arterial  $O_2$  saturation despite profound hypoventilation (Fig. 35-8).

During apnea, arterial oxygenation can be sustained by apneic oxygenation.<sup>20</sup> In this technique, the patient breathes 100%  $O_2$  long enough to wash nitrogen from the alveoli, leaving only  $O_2$ ,  $CO_2$ , and 6% water vapor (47 mm Hg vapor pressure at 37°C). If 100%  $O_2$  continues to be available to a patent airway, it will be drawn into the alveoli during apnea. Without exhalation, the alveolar  $CO_2$  concentration increases 5 or 6 mm Hg the first minute (equilibration between venous and alveolar  $PCO_2$ ) and 3 to 6 mm Hg/min thereafter (metabolic production). Ten minutes into apneic oxygenation that began with normocapnia, the alveolar composition of gases would be 47 mm Hg of water vapor, 72 mm Hg of  $CO_2$ , and 641 mm Hg of  $O_2$ . In the absence



**BOX 35-2.****Conditions Aggravated by Hypercapnia**

Preexisting metabolic acidosis  
(e.g., lactic acidosis, uremia)  
Hyperkalemia  
Elevated intracranial pressure  
Pulmonary hypertension  
Right-to-left cardiac shunts  
Cardiac dysrhythmia  
Poor myocardial contractility

of metabolic acidosis, the pH would be approximately 7.24.

In general, it is the risk of hypoxia that threatens to permanently harm the hypoventilating patient. This realization justifies the popularity of supplemental O<sub>2</sub> to lessen the likelihood of hypoxemia during hypoventilation. Except in selected conditions, the consequences of hypercapnia are well tolerated or reversible (Box 35-2).

**Denitrogenation**

Because it is impossible to assure the ability to ventilate any patient about to receive general anesthesia, proper preanesthetic denitrogenation should be undertaken. The 80% of the average 2.5-L adult functional residual capacity (FRC) that starts out as N<sub>2</sub> is replaced with O<sub>2</sub>.<sup>21</sup> Should ventilation become impossible, this extra 2 L of O<sub>2</sub> may sustain vital organs for up to 8 minutes, which is enough time to establish another means of oxygenation.

Because it may make the difference between life and death for the patient, proper denitrogenation (Box 35-3) should be a top priority for an anesthesiologist preparing to induce a general anesthetic.<sup>21,22</sup>

**BOX 35-3.****Proper Denitrogenation****Technique**

High flow of O<sub>2</sub>  
Fully open pop-off valve  
Leak-free mask fit to prevent entraining room air  
Tidal breathing for 2-3 minutes or a series of four vital capacity breaths

**Confirmatory Observations**

Reservoir bags empties and refills  
End-tidal CO<sub>2</sub> approaches 40 mm Hg  
End-tidal O<sub>2</sub> approaches 85-90%

**MONITORING THE ADEQUACY OF VENTILATION AND OXYGENATION**

The gold standard for assessing the adequacy of ventilation and oxygenation is the measurement of the partial pressures of CO<sub>2</sub> and O<sub>2</sub> in sampled blood, that is, arterial blood gases. Because of cost and delay, a number of alternative technologies have become popular since 1980. Clinical observations remain invaluable to the anesthesiologist, who should constantly monitor the validity of pulse oximetric and capnographic data.

**Clinical Observation**

Airway management demands constant awareness of the patient's physiologic status, obtained through observations of skin color, vital signs, chest and abdominal movements, and use of accessory muscles. Even before arterial blood gases deteriorate, anesthesiologists usually are able to detect problems and make adjustments to maintain airway patency and gas exchange (Table 35-2).<sup>4,19</sup>

**Pulse Oximetry**

In the majority of patients, pulse oximetry affords reliable but noninvasive measurement of the arterial O<sub>2</sub> saturation. Provided that hemoglobin concentration and organ perfusion are acceptable, satisfactory arterial O<sub>2</sub> saturation makes organ hypoxia unlikely. The reassurance offered by pulse oximetry allows the anesthesiologist to proceed carefully instead of hurrying during intubation.<sup>23</sup> Pulse oximetry is not sensitive to hypoventilation in the presence of a high FIO<sub>2</sub> and gives late notification of esophageal intubation after denitrogenation.<sup>24</sup>

Most failures of pulse oximetry (e.g., movement artifact, vasoconstriction) are obvious. The anesthesiologist may incorrectly assume adequate oxygenation during carbon monoxide poisoning or illumination of the pulse oximeter's probe by lights of unusual wavelength.

**Capnometry**

Capnometry, using one of several detection methods, continuously displays the waveform of end-tidal PCO<sub>2</sub> (PETCO<sub>2</sub>)

**TABLE 35-2.****Reassuring and Worrisome Signs and Their Implications during Airway Management**

Reassuring	Worrisome	Implication of Worrisome Sign
Concurrent pectoral and subcostal rising, alternating with falling	Stepwise expansion of subcostal region	Stomach filling with gas or unidirectional expiratory obstruction
No retractions	Subcostal expansion with concurrent pectoral collapse	Partial upper airway obstruction or intercostal weakness
No tug	Subcostal rocking with no chest expansion	Complete airway obstruction
Breathing without accessory muscles	Submandibular, intercostal, or supraclavicular retractions	Partial or complete upper airway obstruction
Normal breathing sounds heard with pretracheal stethoscopy	Inspiratory tracheal tug	Intercostal weakness with preserved diaphragmatic strength
Normal vital signs	Use of sternocleidomastoid and trapezius muscles	Respiratory muscle fatigue or weakness
Rebreathing bag quickly refills during exhalation	Stertor (snoring)	Soft-tissue obstruction
Volumeter indicates appropriate tidal volumes	Stridor (harsh, high pitched)	Laryngeal obstruction
Sequential fogging and clearing of plastic mask	Audible phonation or palpable purring	Light anesthesia or partial airway obstruction

sampled at the patient end of the breathing circuit. When the tidal volume is large enough, alveolar gas reaches the CO<sub>2</sub> sampling site, and the displayed PETCO<sub>2</sub> closely approximates PaCO<sub>2</sub>, affording a noninvasive, breath-by-breath method to judge the adequacy of ventilation. In patients with normal cardiopulmonary physiology, expiratory gas has a PCO<sub>2</sub> that is 2–5 mm Hg less than the arterial PCO<sub>2</sub>.

Significant and common clinical events create PCO<sub>2</sub> gradients (arterial to alveolar) so that the PaCO<sub>2</sub> is normally higher than that displayed on the capnometer measured (Box 35–4). In most patients, end-tidal CO<sub>2</sub> suggests better alveolar ventilation than actually exists, resulting from significant amounts of CO<sub>2</sub>-free inspired gas diluting the sample. For example, during spontaneous face mask ventilation of a patient with elevated intracranial pressure, the peak measured PCO<sub>2</sub> displayed by the capnometer may be only 18 mm Hg, but the first few breaths after tracheal intubation may show a PCO<sub>2</sub> of 30 mm Hg. The rapid,

shallow ventilatory pattern prior to intubation prevented transport of undiluted alveolar gas to the capnometer.

An important application of capnometry is the confirmation of an intratracheal tube position by the appearance of stable CO<sub>2</sub> concentrations in sequential breaths immediately after intubation, as mandated, by the ASA Standards for Basic Anesthetic Monitoring.<sup>25,26</sup> Despite tracheal intubation, the expected levels of CO<sub>2</sub> may fail to appear if delivery of CO<sub>2</sub> to the lungs is limited by low cardiac output, hypovolemia, gas embolization, or cardiac arrest.

## AIRWAY MANAGEMENT WITHOUT TRACHEAL INTUBATION

The majority of airway-related deaths and severe neurologic morbidity result not from a failure to intubate the trachea but rather from a failure to ventilate and oxygenate.<sup>1</sup> Resourceful anesthesiologists command an array of techniques for ventilation without tracheal intubation when the latter is not indicated or has failed. These include face mask ventilation, oral airways, and supraglottic devices such as LMAs or esophageal devices.<sup>4,19,27</sup>

### Face Mask Ventilation

#### Positioning to Facilitate Face Mask Ventilation

When the patient is in the supine position, gravity draws the relaxed tongue and epiglottis into configurations that can obstruct the airway. Patients recovering from anesthesia or obtunded and intoxicated emergency room patients may be best observed in a semilateral position, with the dependent leg straight and the other leg bent, the dependent arm flexed, and the dependent cheek on the bed (the tonsillar position). Gravity will draw the tongue away from the posterior pharyngeal wall, and blood or vomitus can drain out the mouth before being aspirated.

If the anesthesiologist suspects that gastric contents have entered the pharynx, he or she should turn the patient's head to the side and quickly position the table head down to maximize drainage while attempting to clear the pharynx with a Yankauer suction catheter.

Students of basic life support are taught to overcome upper airway obstruction by extending the head and

neck and by anterior mandibular displacement with jaw thrust. Although these maneuvers move the hyoid and attached structures anteriorly, their effectiveness can be limited by two factors. Some vertebral columns can bow anteriorly and impinge on pharyngeal patency. More commonly, the forceful cervicooccipital extension tightens the strap muscles sufficiently to limit the anterior mobility of the larynx and the mandible. For these reasons, anesthesiologists often favor the sniffing position, in which the occiput rests on a firm pad approximately 10 cm anterior to the scapula. Atlantooccipital extension and jaw thrust maneuvers then are superimposed. The sternomental distance shrinks, so the hyoid and its attached structures can be moved away from the posterior pharynx without tightening the strap muscles. Greater comfort for the awake patient and preparedness for laryngoscopy are additional advantages of the sniffing position. It is provided naturally by the large occiput of infants and small children, obviating the need for a pad.

In some patients, the best airway patency is achieved by rotating the head to either side. Airway visualization and manipulation seem easier when the operating room table is elevated so that the patient's forehead is brought to the level of the anesthesiologist's xiphoid.

#### Achieving a Seal

The skill of sealing a mask to the face develops only after months of anesthesiology residency training. Although masks consist of a few basic designs, facial contours assume an endless variety (Fig. 35–9). Clear plastic masks with large-volume, low-pressure cushions seal easily to most faces (including patients with a flat nasal bridge) while affording a view of ventilatory condensation and evaporation cycles and early detection of regurgitated gastric contents. Being disposable, they are relatively expensive per use, provide little bracing for the mandible, and can be hard to seal on the furrowed face of an edentulous patient.

Black rubber anatomic masks have a formable body between their 22-mm connectors and inflatable cushions. A mask strap hooks around the connectors. These opaque masks may delay the recognition of regurgitation, albeit a rare event. As reusable items, they are inexpensive per use but require individual cleaning and high-level dis-

### BOX 35–4.

#### Increased Gradient between PaCO<sub>2</sub> and PETCO<sub>2</sub>

##### Arterial-to-End-Tidal Gradients

PaCO<sub>2</sub> increases, whereas PETCO<sub>2</sub> decreases (decreased perfusion relative to ventilation)

##### Decreased perfusion

Embolization

Pulmonary thromboembolism

Air embolism

CO<sub>2</sub> embolism (laparoscopic insufflation)

##### Hypovolemic shock

##### Right-to-left intracardiac shunting

##### Sudden increase in ventilation-to-perfusion ratio

Bronchial intubation

##### PETCO<sub>2</sub> > PaCO<sub>2</sub> (reversed gradients)

Chronic obstructive pulmonary disease

##### Alveolar-to-Sampled Gradient

##### Anatomic or apparatus dead space

Rapid, shallow breaths

Apparatus dead space (face mask)

##### Dilution at the sampling site of exhaled gas by fresh air

##### Sampled-to-Measured Gradients

##### Calibration errors

Slow capnometer response time with rapid breaths



**FIGURE 35-9.** Face masks. Three adult universal masks on the left. The Rendell-Baker pediatric mask is shown on the far right.

infection between uses. Masks are only half of an ensemble that includes a mask strap, which is essential for achieving and sustaining a good fit (Box 35-5).

Concern of excessive apparatus dead space in patients with tiny tidal volumes led Rendell-Baker and Soucek to develop pediatric masks without cushions and made from molds of infants'

faces. In contrast with the racial and ethnic variability displayed in later life, infants share uniformity of facial contours. Their full cheeks can be pulled up and around the rims of these masks. Undue submandibular pressure by the anesthesiologist's fingers tends to worsen airway obstruction. When providing mask ventilation for children, it is particularly important to ensure that the anesthesiologist's third through fifth fingers engage only the mandible and do not compress the soft tissues overlying the tongue.

Beards or broad mustaches may hinder a good mask seal, making controlled ventilation simply impossible. For edentulous patients too alert to tolerate airways, the lower margin of the mask can be placed against the mucosal reflection in the vestibule of the mouth while drawing the lower lip over the mask. By inserting an oropharyngeal airway, anesthesiologists can minimize the furrows in the cheeks of edentulous patients. Inserting an oral airway lengthens the distance between the suprarenal depression and the nasal bridge, necessitating substitution for the next larger mask size. For this reason, it is essential that small, medium, and large masks be available.<sup>4,19</sup>

### Applying Positive Pressure

A functioning breathing system (a backup self-inflating resuscitation bag should be present at all anesthetizing locations) and a leak-free mask seal are essential for applying positive airway pressure. Anesthesiologists learn to adjust the pop-off valve and speed of reservoir bag compression to keep airway pressures below the 20–25 cm H<sub>2</sub>O associated with gastric inflation.

Fit patients can tolerate generous doses of intravenous (IV) induction drugs without hypotension. An opioid, benzodiazepine, and hypnotic agent in combination act synergistically and generally render the airway nonreac-

tive for several minutes, during which inhaled anesthetics can be introduced. Large vigorous breaths and rapid escalations in inspired anesthetic concentrations may precipitate hiccups, coughing, breathholding, laryngospasm, and delay induction. Increasing sevoflurane or desflurane vaporizer settings in 0.5% increments every five breaths allows depression of airway reflexes before irritating inspired concentrations are reached. Intubating doses of neuromuscular blockers eliminate upper airway reactivity in short intervals.

Positive pressure not only facilitates ventilation but may overcome minor degrees of soft-tissue obstruction of the airway. In a spontaneously breathing patient who is too lightly anesthetized to accept insertion of an airway, 5–15 cm H<sub>2</sub>O of continuous positive airway pressure achieved by partially closing the “pop-off” valve may relieve airway obstruction and increase the minute ventilation. Well-synchronized intermittent positive-pressure breaths can achieve the same result. Inflation of the stomach with respiratory gases should be avoided because it decreases thoracic compliance and increases the risk of regurgitation.

### Pharyngeal Airways

An inability to ventilate with a face mask despite proper positioning, jaw thrust, and a good mask seal may be caused by laryngeal spasm in response to light anesthesia or by soft-tissue upper airway obstruction resulting from deepening anesthesia and the onset of muscle relaxation (Box 35-6).<sup>2,3</sup> If an assessment suggests simple supraglottic obstruction, insertion of pharyngeal airway to separate soft tissues from the posterior pharyngeal wall is a logical next step (Fig. 35-10). Success confirms that the soft tissue had been obstructing the airway, whereas persisting or worsening obstruction often is indicative of active closure of the larynx that may be relieved by administering muscle relaxants or deepening the anesthetic depth with intravenous agents. The anesthesiologist should minimize the trap created by the pathologic causes of obstruction that may be worsened by the loss of muscle tone.

Until the arrival of the LMA and esophageal devices, oropharyngeal or nasopharyngeal airways were the best ways to relieve simple supraglottic obstructions. They remain inexpensive,

#### BOX 35-5.

##### Achieving a Seal with a Face Mask

1. Place the mask strap beneath the occiput.
2. Apply the mask's nasal groove to the low point of the nasal bridge to avoid pressure on the eyes.
3. Grip the left mandible with the third and fourth fingers of the left hand.
4. Lower the mask so that its inferior rim contacts the face between the lower lip and the mental prominence.
5. If there is a leak between the mask and the cheeks, consolidate the seal by dragging mobile tissue of the left cheek toward and under the mask cushion, stabilizing the tissue with the ulnar margin of the left hand.
6. Bracing the mentum against the mask, pull the mandible up and forward with the third through fifth fingers, while the thumb and index finger grip the mask above and below the connector.
7. Maintaining the left-sided seal, tilt the mask toward the right cheek, consolidating the seal by dragging the mobile tissue forward to the cushion and by keeping it there with one limb of the mask strap.
8. The other limbs of the mask strap may improve the seal, especially for anesthesiologists with small hands. Crossing the lower limbs of the mask strap prevents the mask from riding up the face.



**BOX 35-6.****Causes of Inability to Ventilate**

Laryngeal spasm or vocal cord adduction  
 Light anesthesia  
 Supraglottic soft-tissue relaxation (obstruction)  
 Soft palate and pharyngeal walls  
 Tongue  
 Epiglottis  
 Chest wall rigidity  
 Breathholding  
 Narcotic-induced  
 Pathologic, glottic, and subglottic  
 Foreign body  
 Enlarged lingual tonsil  
 Edema  
 Infection  
 Tumor and hematoma  
 Congenital  
 Superior vena cava syndrome  
 Bilateral vocal cord palsy  
 Tracheal stenosis  
 Tracheal and bronchial compression  
 Great vessel anomalies  
 Mediastinal mass  
 Equipment failure  
 Selector valve accidentally in the “ventilator” position

safe, and generally effective.<sup>19,27</sup> Trial and error often are necessary for even the experienced anesthesiologist to select an oropharyngeal airway long enough to anteriorly displace the base of the tongue without pushing the epiglottis into the laryngeal inlet. The forward portion of the oropharyngeal airway separates the teeth or gums; its flange keeps the device from dropping into the hypopharynx. Displacing the tongue into the hypopharynx is avoid-

ed by drawing it anteriorly with a tongue blade held in the left hand while the right hand opens the mouth and inserts the oropharyngeal airway.

The onset of soft-tissue relaxation and airway obstruction usually heralds depression of cough and gag reflexes sufficient to tolerate pharyngeal stimulation. Swallowing or gagging triggered by a tongue blade or airway touching the base of the tongue suggests deferring insertion pending greater obtundation; the stimulus itself often restores airway patency. Coughing and breathholding after uneventful placement of an oropharyngeal airway suggest airway irritation by anesthetic vapors and may remit with turning down the vaporizer and temporarily abandoning attempts at positive-pressure ventilation or deepening the depth of anesthesia with intravenous agents.

A nasopharyngeal airway can be inserted in a patient with a clenched jaw, a need that often occurs when soft-tissue obstruction complicates premature extubation. Unfortunately, unless precautions are taken (Box 35-7), epistaxis may complicate the hasty introduction of an airway through the nasal passages. Because of alignment with the glottic opening, blind tracheal suctioning may be possible by passing a catheter through a nasopharyngeal airway, although the need for and tolerance of repeated tracheal suctioning usually are indications for intubation.

**Laryngeal Mask Airway**

Developed in the 1980s by Dr. Archie Brain,<sup>6</sup> the classic LMA (Fig. 35-11) has achieved great popularity for addressing simple, supraglottic airway obstruction in a variety of contexts.<sup>28-30</sup> Its unique capabilities (Boxes 35-8 and

**BOX 35-7.****Precautions for Introducing Nasopharyngeal Airways**

Prepare the larger nasal passage with a vasoconstrictor  
 Choose a soft, blunt-tipped nasopharyngeal airway  
 Soften it by warming (not applicable for some materials)  
 Lubricate the airway  
 To protect the turbinates, point the bevel medially  
 Direct the device directly posteriorly, parallel to the hard palate and beneath the inferior turbinate  
 If resistance is encountered, withdraw, rotate 90°, and re-advance with gentle, steady pressure  
 Ease difficult passage by using a soft suction catheter as an introducer

35-9), relative ease of use, and low incidence of serious complications has assured the LMA a place in the anesthesiologist's armamentarium.<sup>31-34</sup> Several studies have indicated that trained but inexperienced resuscitators are more likely to be successful at proper placing an LMA than at tracheal intubation.<sup>35</sup> Lacking an experienced mentor, practitioners can initiate their own LMA experience based on the instructional videotape and manual that accompany the product.

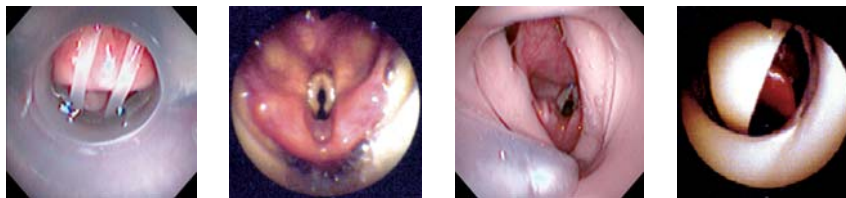
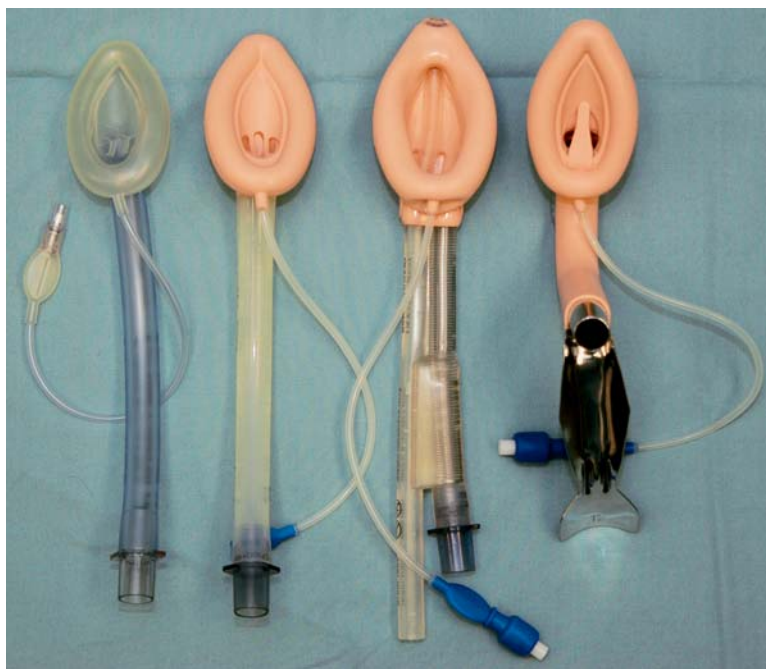
Becoming adept at proper LMA insertion requires consideration of anatomy, patience, and practice.<sup>29,36</sup> Even when using suboptimal insertion technique, providers will have a high success rate with the LMA, allowing many practitioners to develop poor habits. Adherence to proper technique will maximize success and reduce complications. The LMA should be deflated with finger pressure on the dorsal aspect of the cuff so that the totally flattened cuff curves away from the aperture (Fig. 35-12). Water-soluble lubricant smeared on the dorsal surface of the cuff should be kept from drying. The recommended technique for LMA placement is summarized in Figure 35-13.<sup>37</sup> When the epiglottis is dragged downward, the aperture bars of the LMA prevent impaction of epiglottis into the LMA and possible obstruction.

Obstacles to LMA insertion include the soft palate, uvula, tonsillar fauces, oropharyngeal angle, tongue, and epiglottis. These areas are negotiated by the sniffing position with marked cervi-



**FIGURE 35-10.** Artificial oropharyngeal and nasopharyngeal airways.





**FIGURE 35-11.** Various laryngeal mask airways and endoscopic views of them. Shown from left to right are the LMA Unique, Classic, ProSeal, and Fastrach. The two epiglottic bars of the LMA Unique and Classic prevent entry of epiglottis inside the lumen of LMA. The LMA ProSeal does not have epiglottic bars, but the drain tube supports the epiglottis and prevents it from impacting inside the LMA tube. In the LMA Fastrach, the epiglottic bar elevates epiglottis as the endotracheal tube passes into the trachea.

cooccipital extension, permitting laryngeal structures to move forward and accommodate the mask. A gloved hand flattens the tip of the mask against the hard palate to start it on a path that will not engage the epiglottis. Intravenous propofol doses of 2–2.5 mg/kg usually provide an appropriate depth of anesthesia for LMA insertion, but insertion can proceed during *any* adequately deep general anesthetic or after topical anesthesia in conscious patients.

Although careful placement, cuff inflation, and adaptation time improve the seal, leakage often occurs at 20 cm H<sub>2</sub>O airway pressure with the classic LMA. Obesity, head-down tilt, abdominal insufflation, airway obstruction, or any other conditions necessitating ventilation with high airway pressures increase the risk of hypoventilation, gastric insufflation, and regurgitation.

The *LMA Classic* is particularly well suited for the lightly anesthetized, spontaneously breathing ambulatory pa-

tient. Compared with face mask or endotracheal anesthesia, there seems to be less need for deep anesthesia beyond that required for the surgery itself.<sup>29</sup> Patients seem to tolerate a lighter depth of anesthesia with less chance of coughing, breathholding, stridor, or laryngeal spasm.<sup>38</sup> Increasing anesthetic depth usually manages episodes of movement, tachypnea, or hyperpnea. Finally, patients tolerate a return to consciousness with the ability to follow commands while the inflated LMA is still in place. Positive-pressure ventilation can be applied through the LMA; however, the tidal volume, respiratory rate, and inspiratory to expiratory ratio (I:E) should be adjusted to avoid high airway pressures. Newer anesthesia ventilators that can provide synchronized positive-pressure breaths are particularly well suited for use in the patient with a supraglottic airway in place.

The *LMA ProSeal* is an advanced form of the LMA Classic consisting of two

### BOX 35-8.

#### Clinical Use of Laryngeal Mask Airway

##### Indications

- Surgical anesthesia without intubation
- Repeated anesthetics
- Emergency ventilation when intubation has failed
- Improving airway seal without tracheal intubation
- Patient with facial hair
- Edentulous
- Assisting tracheal intubation
- Providing a patent airway with minimal changes in blood pressure, heart rate, intraocular or intracranial pressure, or bronchial tone

##### Contraindications

- High risk of aspiration (relative contraindication)
- Glottic or subglottic obstruction
- Supraglottic pathology interfering with its placement
- Extremely limited mouth opening or neck extension
- Prone position (relative contraindication)
- Need for high airway pressure ventilation

### BOX 35-9.

#### Benefits and Limitations of Laryngeal Mask Airway (LMA)

##### Benefits

- Permits ventilation when face mask and intubation have failed
- Permits lighter anesthesia and faster emergence
- Facilitates blind or fiberoptic tracheal intubation
- Provides better airway for fiberoptic bronchoscopy
- Easier to learn than tracheal intubation

##### Limitations

- Proper position of the LMA may be difficult to achieve
- Probably gas leak with LMA Classic when airway pressure >20 cm H<sub>2</sub>O
- Limited protection against aspiration
- No protection against laryngospasm

tubes; an airway tube and a drain tube.<sup>39</sup> When properly positioned, the drain tube communicates with the upper esophageal sphincter and permits insertion of a gastric tube to decompress the stomach. The LMA ProSeal also has a second posterior cuff that provides a

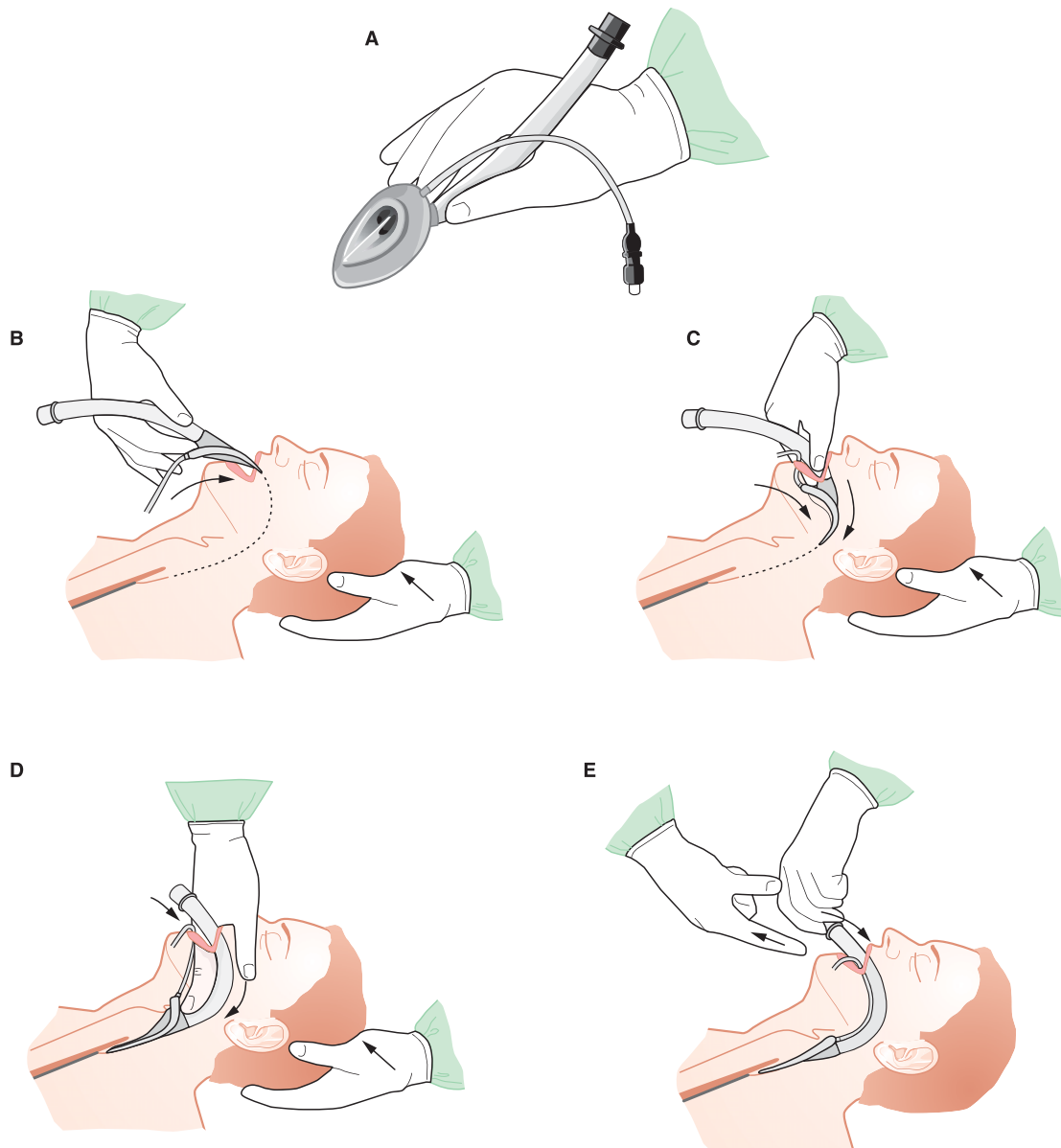


**FIGURE 35–12.** Diagram of a deflated laryngeal mask airway. The cuff of the laryngeal mask airway is deflated before its insertion. The rim of the cuff should evenly face away from mask aperture, with no folds near the tip.

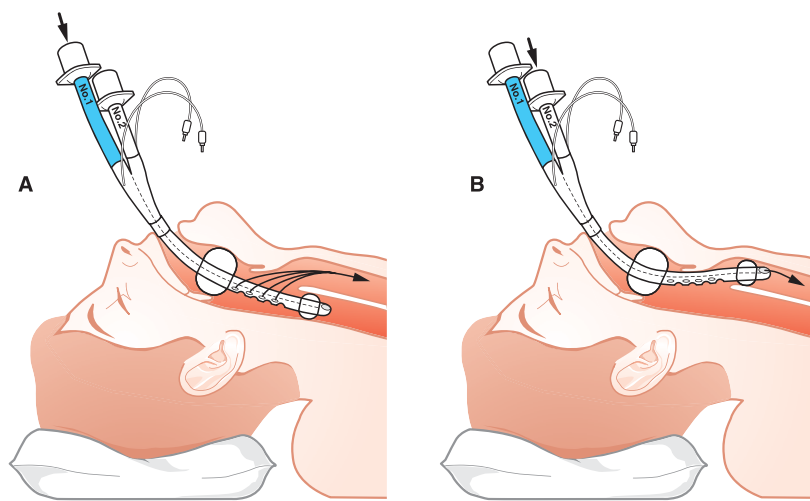
better seal between the LMA and the larynx, allowing for positive-pressure ventilation with higher airway pressures than the LMA Classic.<sup>29</sup> The LMA ProSeal introducer is provided to aid insertion of the LMA ProSeal without the need to place fingers in the mouth. The technique of LMA ProSeal placement with the introducer is similar to LMA Fastrach placement.

Whereas the LMA Classic can be used with low-pressure positive-pressure ventilation, the LMA ProSeal has

been designed for use with positive-pressure ventilation at higher airway pressures. The drain tube will direct the regurgitated fluid to the outside, minimizing the risk of aspiration of gastric contents.<sup>29,40</sup> One of the best emergency uses of the LMA ProSeal is to establish ventilation and to decompress the distended stomach when intubation has failed and the stomach is distended because of difficult face mask ventilation. The anesthetic can be continued with the ProSeal, or the



**FIGURE 35–13.** Technique for placing a laryngeal mask airway (LMA) described by Brain. **A.** The LMA is held by the index finger and the thumb facing the bowl of LMA caudally toward the larynx. The index finger is positioned between the shaft of the LMA and the deflated cuff. The occiput is stabilized with the left hand. **B.** The deflated and lubricated LMA is placed into the open mouth pressed against the hard palate. **C.** The LMA is advanced behind the tongue and into the oropharynx using the index finger. **D.** The LMA is pushed further down deep into the hypopharynx using the tip of the index finger. **E.** The index finger is removed. The LMA is pushed farther down to its final position by holding the tube of the LMA with the left hand. Without holding the tube of the LMA, the cuff is inflated with the recommended volume of air. The LMA may protrude slightly on inflation of the cuff. Final position of the LMA with cuff inflated. A bite block made of sponges is placed between molars and taped to the LMA tube to prevent patient biting. (LMA Airway Instruction Manual. San Diego: LMA North America, 2005. Courtesy of LMA.)



**FIGURE 35-14.** Combitude. **A.** Combitude positioned in the esophagus. Ventilation is performed via the blue lumen, marked number 1. **B.** Combitude positioned in the trachea. Ventilation is performed via the clear lumen, marked number 2. (From Ovassapian<sup>3</sup> with permission.)

device can be exchanged for an ET tube.

Using the LMA in an unfavorable setting increases the likelihood of unfortunate results. The LMA does not protect as effectively as an ET tube against pulmonary aspiration of gastric contents.<sup>41,42</sup> The incidence of aspiration with the laryngeal mask is reported to be similar to that of mask anesthesia and very close to that of ET intubation.<sup>29,43</sup> Application of cricoid pressure impedes placement of the LMA.<sup>44</sup> Reported but rare complications include twelfth cranial nerve paralysis,<sup>45</sup> unilateral hypoglossal nerve paralysis,<sup>46</sup> and transient bilateral vocal cord paralysis.<sup>47</sup>

### Esophageal–Tracheal Airway

The esophageal–tracheal Combitude (ETC; Fig. 35-14) is intended for establishing emergency ventilation when there is simple, supraglottic obstruction or when the operator lacks the skills for face mask ventilation or tracheal intubation.<sup>48–50</sup> This device differs from the earlier esophageal obturator airway in that it permits ventilation whether it enters the esophagus or the trachea.

When the lubricated ETC is passed through the pharynx of a comatose or anesthetized patient, a neutral position or slight flexion of the neck generally directs the device to follow the posterior pharyngeal wall and into the esophagus. Approximately 4–6% of the time, the ETC enters the trachea. A large 100-mL balloon seals the oropharynx, and a smaller balloon seals the esophagus. The ETC has two channels. One lumen is open at the tip of

the ETC. If the ETC enters into the esophagus, this channel can be used to decompress the stomach. If the ETC enters the trachea, this lumen can be used to ventilate the patient, avoiding the necessity of removal and reinsertion. The second lumen opens into multiple pharyngeal ports and is used to ventilate the patient during the more common scenario when the tip of the ETC is placed in the esophagus. Lifesaving ventilation has been provided by this device.<sup>48</sup>

### Other Extraglottic Airways

After successful introduction of the LMA, several other extraglottic airway devices have been introduced. Some are commercially available, but none have been studied as extensively as the LMA. Examples are the laryngeal tube airway (VBM Medizintechnik, GmbH, Sulz, Germany), the streamlined pharyngeal airway liner, the intubation laryngeal airway developed by Cook-gas, and the Cobra (see reference 29).

### Complications of Nonintubated Airway Management

Improperly conducted and monitored airway management can result in hypercapnia and/or hypoxic organ damage, although supplemental oxygen and pulse oximetry reduce the incidence of the latter.<sup>1</sup> Hypercapnia is nearly always well tolerated; however, in rare situations hypercapnia can cause morbidity (Box 35-2).

Laryngeal spasm is an airway reflex that presents as a sustained, disinhibit-

#### BOX 35-10.

##### Progression of Steps to Manage Difficulty in Ventilating a Patient

- Confirm that the machine's selector valve is set to "bag" and that the reservoir is not twisted
- Without exceeding 25 cm H<sub>2</sub>O, increase airway pressure while intensifying jaw thrust and observing for ventilation or gastric distension
- If blood pressure is adequate and if awakening the patient is unnecessary, deepen anesthesia with a rapidly acting IV drug (e.g., thiopental, propofol)
- If depth of anesthesia is judged adequate, insert an oropharyngeal or nasopharyngeal airway
- If O<sub>2</sub> saturation decreases, maximize FIO<sub>2</sub>
- Consider whether it would be safest to awaken the patient
- Administer 5–20 mg of IV succinylcholine
- Consider the wisdom of a full dose of relaxant to facilitate tracheal intubation
- Consider using laryngeal mask airway or Combitude
- Consider establishing a transcricothyroid airway

ed glottic closure resulting from insufficient anesthesia and precipitated by instrumentation, fluid irritation, or ill-timed stimulation of the larynx or other body parts (e.g., moving or examining the patient at a light plain of anesthesia). The anesthesiologist should consider a wide variety of causes (Box 35-6) when treating a patient who is difficult to ventilate (Box 35-10).

Although anesthesia deep enough to obliterate airway reflexes eliminates active vomiting, passive regurgitation can occur anytime during the care of the anesthetized or critically ill patient. Repeated inspiratory efforts against an obstructed airway and gastric distension by air are predisposing factors to regurgitation.<sup>51,52</sup> When regurgitation occurs, liquids should be removed from the pharynx by rapidly lowering the head, turning it to the side, and suctioning with a rigid-tipped (e.g., Yankauer) catheter. Subsequent pulmonary aspiration of fluid, solid, or acid may result in bronchospasm and O<sub>2</sub> desaturation, tracheobronchial obstruction, and/or chemical pneumoni-



**BOX 35–11.****Indications for Tracheal Intubation****Anesthesia**

- Controls the airway
- Provides an unobstructed leak-free airway for prolonged ventilation
- Minimizes aspiration risk
- Facilitates resuscitation of the moribund patient
- Permits attention to complex diagnostic and therapeutic matters
- Has preemptive utility if it is feared that ventilation and intubation may later become impossible
- Ventilates with thoracoabdominal surgery
- Permits flexible positioning
- Affords the anesthesiologist distance from the head
- Allows full range of positions (e.g., prone, sitting, lateral, head down)
- Keeps blood and secretions out of the trachea during airway surgery

**Critical Care**

- Establishes airway patency
- Protects against pulmonary aspiration
- Facilitates tracheobronchial toilet
- Provides a route for airway pressure therapy (e.g., IPPV, IMV)

IPPV, Intermittent positive pressure ventilation; IMV, Intermittent mandatory ventilation.

tis. Although the ASA Closed Claims Study indicates that aspiration is rare in modern anesthetic practice, the consequences are significant enough to require that the possibility of aspiration be considered in every patient and that thoughtful planning and preparation be undertaken.<sup>1</sup>

Using a face mask with straps presents risk of traumatic pressure to the eyes or branches of the facial nerve. Upper airway laceration may precipitate mucosal bleeding severe enough to render laryngoscopy impossible.

**AIRWAY MANAGEMENT WITH TRACHEAL INTUBATION**

Tracheal intubation is undertaken for reasons of physiology, pathology, or convenience (Box 35–11). Reflecting an appreciation of the consequences of hypoventilation, hypoxia, and aspiration and the desire to free the anesthesiologist's hands for other tasks, the prevalence of tracheal intubation during anesthesia had increased until

the introduction of the LMA in the 1980s, leading to a reduction in the proportion of anesthetics used with ET intubation.

Visualization of the pharyngeal and glottic structures assures the greatest likelihood of successful tracheal intubation. Tracheal intubation is optimally undertaken after setup in an operating room or critical care area with custom-stocked carts (Box 35–12). Alternative techniques of intubation and ventilation may be lifesaving when suboptimal circumstances prevent visualized tracheal intubation.

**Endotracheal Tubes**

Most ET tubes are disposable and made of clear, bioinert polyvinyl chloride (PVC) that molds to the contour of the airway after softening at body temperature. Lengths are marked in centimeters, and internal diameters are indicated in millimeters. Implantation testing in animals has shown these materials to be nonirritating by the standards of the American Society for Testing and Materials' Committee F-29 on Anesthetic and Respiratory Equipment. Because combustion of PVC in the presence of supplemental O<sub>2</sub> during airway laser surgery produces hydrochloric acid and other pulmonary toxins, tubes in this setting tend to be made of metal, metal-wrapped red rubber or silicone.<sup>53</sup>

Although the resistance of a small ET tube can impair the ventilatory weaning of a critically ill patient, it generally is not necessary in the operating room to use the largest possible tube. In many cases, a 7.0- or 7.5-mm internal diameter ET tube is chosen for female patients and an 8.0-mm ET tube is used for men. The clinical setting dictates even smaller tubes for patients with airway edema (e.g., preeclamptic), nasal intubation, and blind intubation. Pediatric ET tube sizes are predicted by an age-related formula and tested for leaks in situ. Use of cuffs often is avoided in children until they are 8 to 9 years old, when the cricoid ring ceases to be the narrowest, edema-prone portion of the airway. Cutting ET tubes renders them less obtrusive and easier to handle, but 26 cm of length should be sufficient for adult oral tubes, allowing 3 cm more for nasal tubes. The 15-mm adapter can be firmly affixed by wiping it with alcohol and twisting it firmly into place in the ET tube.

**BOX 35–12.****Preparation for Tracheal Intubation****Skilled assistance**

- Equipment for face mask ventilation
- Source of positive-pressure oxygen
- Anesthesia machine
- Self-inflating bag
- Tongue blade and oropharyngeal or nasopharyngeal airways

**Bright laryngoscope**

- Straight blade(s)
- Curved blade(s)

**Stiff (tonsil-style) suction device****Position and environment**

- Access to patient's head
- Patient's face near anesthesiologist's xiphoid
- Occipital elevation (sniffing position)
- Adequate light
- Monitors

**Intubation stylet or introducers****Local anesthetics**

- Injectable
  - Nerve block
  - Laryngotracheal spray
  - Transcricothyroid spray

**Topical**

- Spray
- Ointment for tongue
- Viscous
- Nebulized

**IV access for**

- Sedation or anesthetic induction
- Neuromuscular blockers
- Relaxants
- Volume administration
- Cardioactive drugs (e.g., antiarrhythmic)

**Intubating (Magill) forceps****Backup equipment for unanticipated difficult intubation or ventilation (difficult airway cart)**

High-volume cuffs contact the trachea over a broad area, minimizing the pressure on the mucosa and improving the seal, which helps minimize aspiration risk. The pressure in the cuff is estimated by squeezing the pilot balloon, or the pressure is set to <25 cm H<sub>2</sub>O when measured by a manometer. With longer periods of intubation, it becomes important to minimize cuff overinflation by periodically measuring pressure or by injecting only 1 additional cc of air after the audible air leak has been sealed. A cuff initially inflated with air merits periodic checks to detect overinflation



TABLE 35-3.

## Special Tracheal Tubes and Their Applications

Description	Use
Embedded wire (armored or anode) Endotrol with an intrinsic cable to flex the tip J-shaped laryngectomy	Minimize chance of kinking Facilitate entry into the glottis  Fit into a tracheal stoma without enter- ing the bronchus
Laser-adapted Lumen-containing	Minimize change of ignition Sample airway gas or medicate the air- way (e.g., with lidocaine)
Micro-laryngeal 4- to 6-mm inner diame- ter with adult length and cuff (micro- laryngeal tube [MLT])	Pass a narrowed stretch of the airway
Preformed oral or nasal (Ring-Adair- Elwyn [RAE]) Uncuffed	Avoid the field during head and neck surgery Prevent subcuticoid edema in patients aged <8 years
Double lumen Univent bronchial blocker	Lung separation Lung separation

when nitrous oxide is used during an anesthetic course because nitrous oxide may enter the cuff and lead to increasing pressures.

The standard ET tube has a bevel that opens toward the patient's left when the concavity of the tube's curve faces anteriorly. The Murphy eye is a fenestration in the tip of the tube opposite the bevel, added to protect against

obstruction. A variety of ET tubes are available for specific applications (Table 35-3, and Figs. 35-15 and 35-16).

### Laryngoscopes

These instruments are designed to create a line of sight for passage of the ET tube by displacing the tongue and epiglottis anteriorly.<sup>53</sup> A battery-operated bulb may sit near the tip of the blade

or in the handle itself, in which case illumination is directed by a fiberoptic bundle to the laryngeal structures. Blade-mounted bulbs will operate erratically if their contacts are not corrosion-free.

Laryngoscope blades require appropriate disinfection to kill vegetative organisms but do not necessarily need to be sterilized. They should be soaked and brushed clean in an enzyme detergent before disinfection. Autoclaving or soaking in glutaraldehyde will corrode the contact between the bulb and blade over time. Gas sterilization is effective but time consuming. Disposable plastic covers keep handles and blades free of saliva and blood and minimize cross-contamination.

Although innumerable laryngoscope blade designs have been used, only two remain popular: the straight Miller, which lifts the epiglottis directly, and the curved Macintosh, which does so with traction on the glossoepiglottic and hyoepiglottic ligaments (Fig. 35-17).

### Stylets

Because of the position of the tongue and epiglottis, a glottic opening not exposed by routine laryngoscopy seems to hide anteriorly. Stylets are blunt-tipped, flexible tools used to give a different shape to the ET tube in order to facilitate tracheal intubation. Stylets are lu-



**FIGURE 35-15.** Varieties of tracheal tubes. Shown from left to right are the armored laryngectomy tube, laser tube, and laryngeal mask airway flexible nondisposable tube used for Fastrach intubation.



**FIGURE 35-16.** Varieties of tracheal tubes. From left to right: Regular tube, preformed tube for nasotracheal use (Ring-Adair-Elwyn [RAE]; National Catheter Corporation), preformed tube for orotracheal use (National Catheter Corporation-RAE).



**FIGURE 35-17.** From top to bottom: Straight blade (Miller), curved (Macintosh) blade, laryngoscope battery handle.

bricated and inserted in the ET tube but are not intended to protrude out of the tube (the distal tip of the stylet should be positioned inside the ET tube). The tip of the ET tube and stylet are often bent approximately 5 cm from the tip to achieve a “hockey stick” shape. The ET tube is passed beneath the epiglottis, and an assistant removes the stylet as the ET tube enters the trachea. Excessively stiff, carelessly placed, and improperly used stylets can cause life-threatening complications. A stylet that is used repeatedly may fracture during intubation.

## Introducers

Introducers, exemplified by the angle-tipped Eschmann gum elastic bougie, can guide an ET tube into the trachea. Longer and less rigid than stylets, they are used to facilitate difficult intubation. The gum elastic bougie tip is guided into the trachea first, and the ET tube is threaded over it into the trachea.

A soft, flexible introducer can serve as tracheal tube exchanger and guide the blind insertion of a new tube if an exchange of tubes is necessary. Dedicated tube changers include models with Luer-Lok or 15-mm male adapters at the proximal end for oxygenating with jet ventilation until a new tube can be placed. An ET tube is least likely to hang up on the epiglottis or aryepiglottic folds if its internal diameter is not much larger than the introducer.

## TRACHEAL INTUBATION

Tracheal intubation usually is performed after induction of anesthesia and muscle paralysis, but it is also

### BOX 35-13.

#### Techniques of Tracheal Intubation

##### Visualized

- Rigid laryngoscope (direct)
- Fiberoptic laryngoscope (indirect)
- Bullard laryngoscope (indirect)

##### Guided Blind

- Retrograde wire
- Lightwand
- Laryngeal mask
- Bougie
- Augustine guide

##### Blind Nasal

##### Combination of techniques

##### Surgical

- Cricothyrotomy
- Tracheostomy

easily accomplished in conscious patients. In some patients, muscle relaxants are avoided, and intubation is performed during general anesthesia with the patient breathing spontaneously.

An ET tube can be passed orotracheally, nasotracheally, or through a tracheostomy. Although passage of an ET tube through a mature tracheostomy requires no special instruments, intubating through the mouth or nose can be extremely difficult or impossible.

Many techniques exist to assist routine and difficult tracheal intubation (Box 35-13).<sup>3,4,51</sup> They vary in their level of sophistication, invasiveness, tendency for blood and secretions to obscure visualization, and potential for complications. In selecting a technique, the anesthesiologist weighs risks against the likelihood of success, keeping in mind a backup plan to deal with unexpected failure. Importantly, expertise may vary depending on when the anesthesiologist trained. For example, recent American trainees may not have extensive experience in blind nasal intubation (BNI), whereas those of an earlier vintage may be less comfortable with fiberoptic techniques. The ideals against which a technique can be judged are summarized in Box 35-14. Fiberoptic bronchoscopy scores high as a technique to manage difficult airways. Its shortcomings include its size, cost, potential for equipment damage, and susceptibility to obliteration of the view by blood and secretions. Compact, battery-powered light sources for bronchoscopes have proven advantageous when portability, compact size, or low weight are important.

### BOX 35-14.

#### Desired Features of an Intubation Technique

##### Primary

- High success rate in those with difficult airways
- Useful for upper and lower airway problems
- Useful for oral and nasal intubations
- Allows ventilation during intubation
- Performed with visual guidance
- Allows application of topical anesthesia
- Devoid of technique-specific complications
- Head and neck manipulation not crucial for success
- Useful in combination with other techniques
- Blood and secretions do not interfere with its use

##### Secondary

- Avoids dental trauma
- Equipment easily cleaned and stored
- Portable
- Easily learned and mastered
- Cost-effective

## TECHNIQUES OF INTUBATION

### Rigid Laryngoscopy

Rigid laryngoscopy retains its popularity because of its simplicity, high success rate, and good visualization.<sup>4,19,51</sup> In adults, it is critical to elevate the occiput on a pad to flex the neck while permitting the atlantooccipital extension that will align the pharynx with the mouth and larynx (Fig. 35-18). If the patient has been given muscle relaxants, a neuromuscular blockade monitor is the best means to assure sufficient paralysis. Although succinylcholine provides the most rapid onset of relaxation, the effect of nondepolarizing relaxants can be hastened by using either large doses or the priming principle.

The left hand grasps the open laryngoscope with the fifth finger just above the blade. Although simply extending the neck adequately opens some mouths, the best access is achieved by pushing on the right mandibular premolar with the right thumb while stabilizing the maxillary teeth with the third finger. With barrel-chested or obese patients, extra elevation of the head and shoulders or directing the laryngoscope handle to the left (rather than keeping it in a sagittal plane) avoids

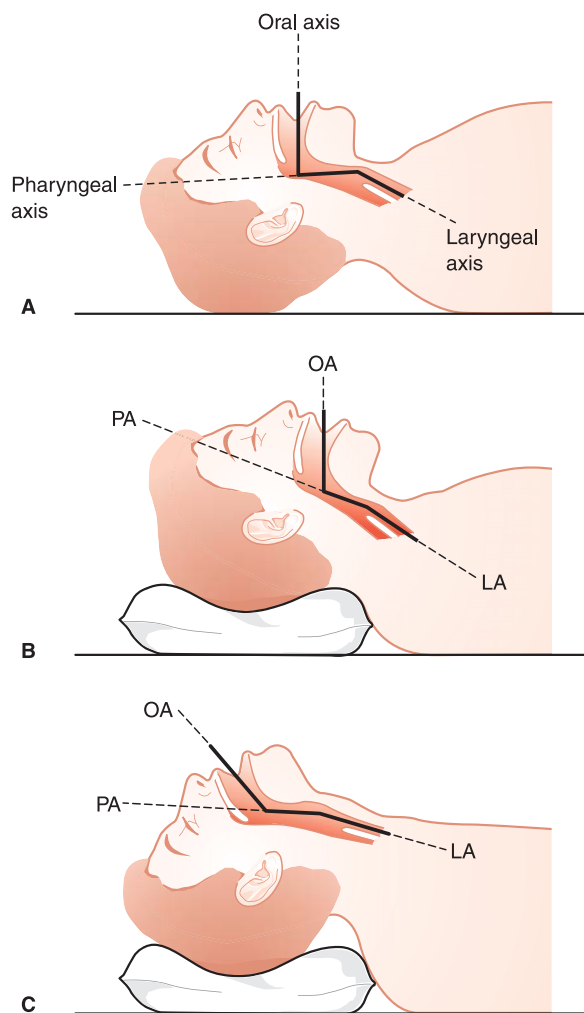
interference from the sternum while inserting the blade in the mouth. The laryngoscope blade can then be slid along the right side of the tongue so that its flange displaces the tongue leftward. Passing the right fauces, the blade is directed medially to the epiglottis, a key landmark. The tip of a curved blade, placed in the midline of the glossoepiglottic reflection, will be able to maximally lift the epiglottis to expose the glottis. Straight blades are slid beneath the epiglottis to lift it directly (Fig. 35–19). Elevation of the tongue and epiglottis is accomplished with the left hand pulling up and away from the anesthesiologist, keeping the left elbow close to the anesthesiologist's side. Levering the laryngoscope with the maxillary teeth as a fulcrum is to be avoided. The view of the glottis

may be improved by applying the right thumb and index finger to the thyroid cartilage to provide either lateral or backward, upward, and rightward pressure (the BURP maneuver).<sup>51</sup> Initiated by the laryngoscopist, laryngeal pressure can be maintained by an assistant during intubation. In small children, the relatively large occiput eliminates the need for a pad, and the more cephalad glottis increases the importance of laryngeal pressure.

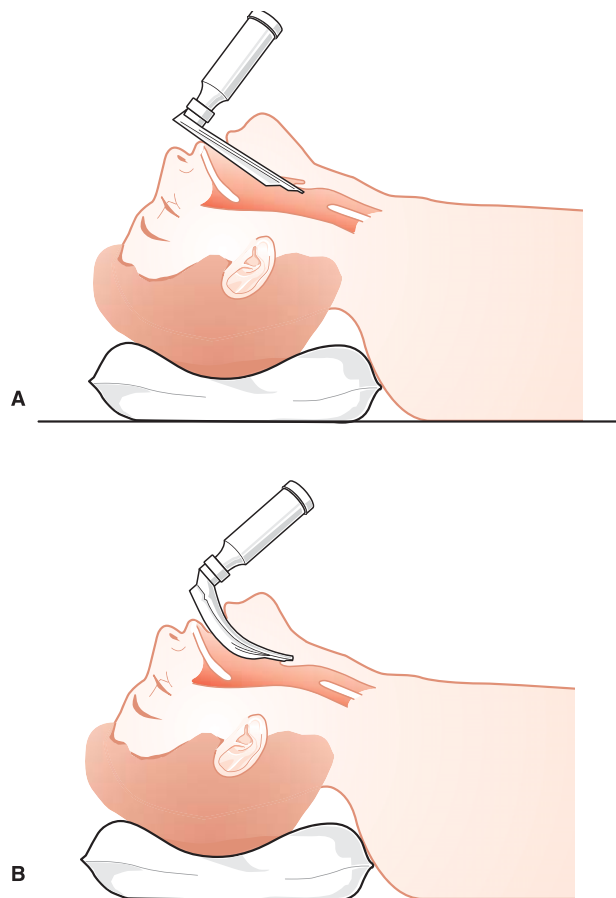
Common avoidable causes of difficult visualization during laryngoscopy include improper positioning of the head, inadequate opening of the mouth, selecting the wrong blade, allowing the tongue to hang over the right side of the blade, applying leverage rather than traction, and obscuring the line of vision with the ET tube

during its insertion. If the epiglottis is not seen, the blade may have been inserted too far, providing a view of the esophagus. Slowly withdrawing the laryngoscope may let the epiglottis drop into view. Selecting too short a blade will prevent the tip from reaching the glossoepiglottic reflection.

Particular situations may call for either a straight or a curved blade. The Macintosh curved blade with its effective flange and panoramic exposure of the anatomic features is recommended to those learning intubation. It does a good job retracting large tongues and prominent lips of edentulous patients. Because a curved blade avoids contacting the sensitive laryngeal surface of the epiglottis, it is well suited for intubation in conscious patients. In patients with micrognathia, a floppy epi-



**FIGURE 35–18.** Intubating position during rigid laryngoscopy. **A.** Supine patient without headrest. **B.** Head elevation and neck flexion bring the pharyngeal and laryngeal axes into line. **C.** Extension of head at atlantooccipital joint aligns the oral axis with the other two axes. (Reprinted from Ovassapian A, Meyer R. Airway Management. In: Longnecker DE, Murphy FL, eds. Introduction to Anesthesia. 9th ed. Philadelphia: WB Saunders, 1996, with permission from Elsevier.)



**FIGURE 35–19.** **A.** The straight blade is placed under the epiglottis to lift the epiglottis up to expose the glottis. **B.** The curved blade is positioned in the vallecula during rigid laryngoscopy. (Reprinted from Ovassapian A, Meyer R. Airway Management. In: Longnecker DE, Murphy FL, eds. Introduction to Anesthesia. 9th ed. Philadelphia: WB Saunders, 1996, with permission from Elsevier.)

glottis, or an anteriorly hidden glottis, the ability of the straight blade to lift the epiglottis affords a superior view of the larynx. The Miller straight blade, with its small cross-section, is especially useful in the right corner of the mouth in patients with prominent maxillary teeth or limited temporomandibular mobility.

Nasotracheal intubation guided by rigid laryngoscopy can be used in oral and maxillofacial surgery or in the intensive care setting. Introduced through the right corner of the mouth so as not to block laryngoscopic visualization, a Magill intubating forceps directs the tip of the ET tube to the glottis while an assistant advances the tube on command.<sup>51,54</sup> The tube commonly hangs up on the anterior laryngeal structures and may require twisting or occipitocervical flexion for it to enter the trachea.

### **Intubation in the Conscious Patient**

In patients who have a difficult airway or are at high risk for aspiration, serious consideration should be given to securing the airway before inducing anesthesia.<sup>2,3</sup> Intubation in the conscious patient is certainly the choice when both risk of aspiration and difficult airway factors coexist. To assure maximum cooperation, preanesthetic preparation should include an explanation of the procedure and appropriate premedication.

Sedation to an extent that apnea or airway obstruction is produced should be avoided. Opioid-induced analgesia and depression of airway reflexes increase the risk of aspirating gastric contents but facilitate oropharyngeal instrumentation while permitting the patient to follow commands. Protective reflexes remain more active when a benzodiazepine is used, but the patient may be less cooperative and reacting more vigorously to instrumentation. A combination of fentanyl and midazolam (1.5 µg/kg and 30 µg/kg, respectively in divided doses) has been used successfully.<sup>55</sup> To assure that these synergistic drugs have reached their peak effect, 3–5 minutes is allowed to elapse between doses. Continually asking the patient to take deep breaths helps avoid oversedation and hypoxemia.

Glycopyrrolate 0.2–0.3 mg IV minimizes secretions and improves the effectiveness of topical anesthetics. Pa-



**FIGURE 35–20.** Proper application of cricoid pressure during rapid sequence induction and intubation to prevent passive regurgitation of gastric contents.

tients may benefit from medications that increase gastric fluid pH or enhance gastric emptying.

Topical anesthesia is achieved by an oropharyngeal spray of 4% lidocaine and translaryngeal injection of 3 mL of 4% lidocaine.<sup>56,57</sup> Topical anesthesia with lidocaine begins to work within 30 seconds after its application and is fully active within 2 minutes, but it lasts only 20–30 minutes. For nasotracheal intubation, 4% cocaine or a 3-mL mixture of 4% lidocaine with 1 mL of 1% phenylephrine more commonly used today provides anesthesia while shrinking mucosae.<sup>58</sup> Use of lidocaine jelly before application of other anesthetics to normal mucosa increases patient satisfaction.<sup>59</sup>

During rigid laryngoscopy in the conscious patient, the anesthesiologist continually instructs and reassures the patient while proceeding gently. Time may be required to spray more topical anesthetic on the tongue base or epiglottis. Laryngeal pressure by an assistant is particularly helpful, and lingual nerve block may decrease refractory gagging.

### **Rapid Sequence Induction and Intubation**

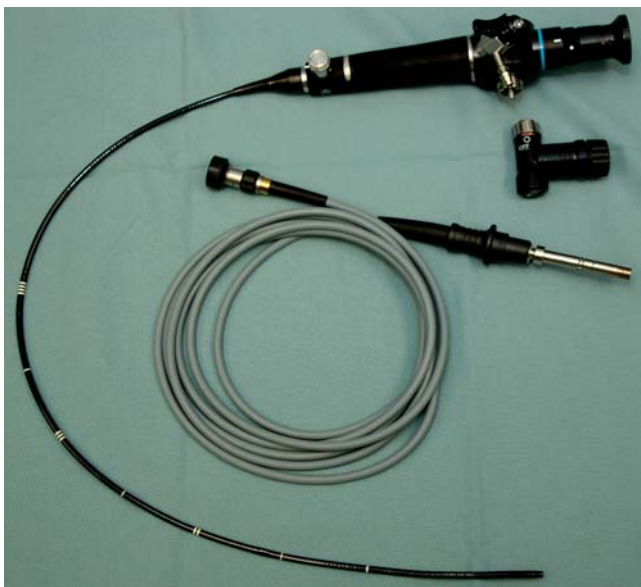
Preoxygenation, avoidance of mask ventilation, and compression of the cricoid cartilage (Sellick maneuver; Fig. 35–20) to resist passive regurgitation of gastric contents into the oropharynx are elements of a traditional rapid sequence induction.<sup>5,19,51</sup> The anesthetic begins with a rapid injection of propofol or thiopental, followed by succinylcholine and intuba-

tion as soon as muscle relaxation is confirmed. An assistant maintains cricoid pressure from the onset of hypnosis until tracheal intubation is confirmed, and the cuff is inflated. Other induction agents and nondepolarizing muscle relaxants are alternatives for induction.

Appropriate cricoid pressure, as described by Sellick, should be firm enough to prevent the esophagus from slipping laterally but not so firm as to obstruct ventilation.<sup>5,60</sup> This may be difficult to attain because the 30-N force currently recommended may obstruct the view of the larynx.<sup>61</sup> Sellick also described neck extension, but pursuing such extension at the expense of the sniffing position sacrifices the goal of smooth easy tracheal intubation. Application of cricoid pressure is a safe and effective maneuver, with one reported case of esophageal rupture in the presence of vomiting. Complete anesthesia and paralysis, confirmed with a blockade monitor, eliminates the chance of active vomiting. With this knowledge, the anesthesiologist can be confident in having the assistant maintain cricoid pressure until the tracheal position of the tube is certain.

Should intubation fail, the anesthesiologist should keep in mind that the risk of asphyxia may exceed the risk of aspiration. Mask ventilation with maintained cricoid pressure was described by Sellick<sup>5</sup> in 1961. If mask ventilation proves difficult, the patient should be placed in 5° of head-down tilt and the cricoid pressure decreased incrementally until it is released. If





**FIGURE 35-21.** Olympus LF-GP bronchoscope. This bronchoscope can use a battery-powered, self-contained, or standard halogen light source.

mask ventilation is improved, intubation may proceed without cricoid pressure. If mask ventilation is impossible, the possibility of airway obstruction caused by improperly applied cricoid pressure<sup>60</sup> or previously unsuspected pathology (e.g., hypertrophic lingual tonsils) should be considered.

Any factor that increases the intra-gastric to esophageal pressure gradient predisposes to regurgitation of stomach contents. Factors that elevate this pressure gradient include inflation of the stomach with air, steep head-down position, high intraabdominal pressure, and spontaneous respiratory efforts against a fully or partially obstructed airway (which lowers the intraesophageal pressure). Airway pressures <15 cm H<sub>2</sub>O during mask ventilation rarely inflate the stomach, whereas in adults without cricoid pressure, the minimum airway pressure required to push air into the stomach is reported to be 20 cm H<sub>2</sub>O.

In infants and children, appropriate application of cricoid pressure prevents gastric gas insufflation during



**FIGURE 35-22.** Advanced carcinoma of the larynx.

mask ventilation with an airway pressure up to 40 cm H<sub>2</sub>O.<sup>62</sup> Complete airway obstruction is one of the complications of improperly applied cricoid pressure and is more likely to occur in infants and children because of their more pliable trachea.

### Fiberoptic Intubation

A fiberoptic (Fig. 35-21) can be used for routine and challenging intubations in patients with airway tumors or infections or cervical spine fractures or fixation (Fig 35-22).<sup>3,63-68</sup> Indications for fiberoptic tracheal intubation are summarized in Box 35-15.

Fiberoptic intubation is easier in the conscious patient because the tongue and epiglottis are less likely to obscure the vocal cords, and the patient can assist by phonating or protruding the tongue. Haste is unnecessary given that the patient is breathing. The patient with a history of failed intubation, upper airway abnormality, or expected difficult intubation may benefit from an awake fiberoptic intubation. Proper topical anesthesia and sedation ease the task.

With experience, topical anesthesia of the larynx and trachea can be achieved by spraying local anesthetic through the working channel of the fiberoptic. Inhalation of nebulized lidocaine may minimize coughing.

### Oral Fiberoptic Approach

After applying topical anesthetic to the tongue and oropharynx, a special oropharyngeal airway is inserted to pre-

### BOX 35-15.

#### Indications for Fiberoptic Intubation

- Routine intubation (teaching and learning)
- Difficult intubation
  - Anticipated
    - History of difficult intubation
    - Physical evidence of difficult intubation
  - Unanticipated
- Compromised airway
  - Upper airway abnormality
  - Tracheal stenosis and compression
- Extension of neck to be avoided
  - Unstable neck
  - Vertebral artery insufficiency
- High risk of dental damage
  - Poor, loose, or fragile teeth
  - Extensive dental restoration
- Conscious intubation

vent biting on the fiberoptic, to keep the instrument in the midline, and to restrain the tongue (Fig. 35-23).<sup>3</sup> The oropharynx is suctioned, and the lubricated ET tube is placed 4–5 cm inside the airway. The fourth and fifth fingers of the right hand stabilize the ET tube, while the index finger and thumb insert the fiberoptic through it (Fig. 35-24). If the fiberoptic is accidentally passed through the Murphy eye of the ET tube, it will prevent subsequent intubation, even after the fiberoptic is successfully guided into the trachea.

As the fiberoptic is advanced toward the oropharynx, the soft palate and uvula come into view. With entry into the oropharynx, the tip is deflected anteriorly to expose the epiglottis and vocal cords. To separate a floppy epiglottis from the posterior pharyngeal wall, extending the head at the atlantooccipital joint or applying tongue traction or a jaw thrust is effective. In obese patients and in those with a difficult airway, the sitting position has merit.

After the glottis is exposed, it is maintained in the center of the field of view by fine manipulations of the control lever. The fiberoptic is advanced into the midtrachea, as confirmed by observation of the carina and flat posterior wall (Fig. 35-25). The ET tube is slipped over the fiberoptic and advanced with a twisting motion into the trachea. The tip of the ET tube is positioned 3–4 cm above the carina.

In many patients, even though the fiberoptic has entered the trachea, the



**FIGURE 35-23.** Ovassapian fiberoptic intubating airway.

ET tube catches on laryngeal structures and cannot pass.<sup>69</sup> The ET tube is pulled back, twisted until the leading ledge of the bevel is oriented anteriorly, and readvanced during a deep inspiration. In some patients, this maneuver may have to be repeated two or three times, particularly when a large discrepancy exists between the size of the fiberoptic and the ET tube. Using a larger size fiberoptic,<sup>70</sup> an anode tube,<sup>71</sup> or a special tube with tapered tip,<sup>72</sup> such as the tube used to intubate through the LMA Fastrach (Fig. 35-26), minimizes the incidence of difficult advancement of the tube through the larynx.

Laryngospasm may prevent ET tube advancement. Additional topical anesthesia applied through the fiberoptic usually remedies this problem.

### Nasal Approach

In the conscious patient, fiberoptic nasotracheal intubation often is easier than an oral approach.<sup>3</sup> Minimal pressure on the base of the tongue leads to less gagging, and the patient cannot bite the tube. By creating a “straight shot,” passing the fiberoptic through the nose facilitates locating the glottis and advancing the fiberoptic and tube into the larynx. A warmed, softened, lubricated tube, advanced into the pharynx through a nasal passage prepared with anesthetic with or without a vasoconstrictor, serves as a channel to suction the pharynx and to find the glottis with a fiberoptic. Laryngeal anesthesia and intubation proceed as described for the oral approach. The gag reflex is not stimulated by nasal intu-

bation, so no oropharyngeal topical anesthesia is needed. If the tube does not make the bend, it is pulled back, rotated 90°, and reintroduced. If this maneuver fails, the ET tube is withdrawn to allow the lubricated fiberoptic to guide it into the oropharynx.

It is important to avoid passing the tube too far into the oropharynx because this may direct the fiberoptic into the esophagus or away from the midline, preventing laryngeal exposure. The oropharynx is suctioned thoroughly through the ET tube before the lubricated fiberoptic is inserted through it. In most patients, the epiglottis and vocal cords are seen immediately with minimal manipulation of the fiberoptic tip. In heavily sedated or edentulous patients, the tongue and pharyngeal tissues may block exposure of the glottis, necessitating head extension, jaw thrust, or tongue traction. The fiberoptic is advanced into the midtrachea, followed by the ET tube.

### Asleep Fiberoptic Intubation

Fiberoptic oral and nasal intubation in the anesthetized patient require an assistant to monitor the patient and apply jaw thrust.<sup>3</sup> Intubation attempts are interrupted to ventilate the patient as needed. With oral and nasal approaches, the ET tube is loaded on the fiberoptic before intubation is attempted. The fiberoptic then is passed through the nostril or intubating airway in the mouth and advanced through the glottis into the trachea. The ET tube then is advanced over the fiberoptic into the trachea (Fig. 35-27).

Failed rigid laryngoscopic intubation, during a rapid sequence induction, leaves the patient vulnerable to aspiration. If the patient can be ventilated via face mask, then oral fiberoptic intubation, while maintaining cricoid pressure, is an effective technique that should be seriously considered. The ability to perform rapid fiberoptic intubation may play an important role in preventing airway problems. Repeated unsuccessful attempts at BNI or rigid laryngoscopy traumatize the airway, converting a manageable airway into one that is difficult to ventilate.

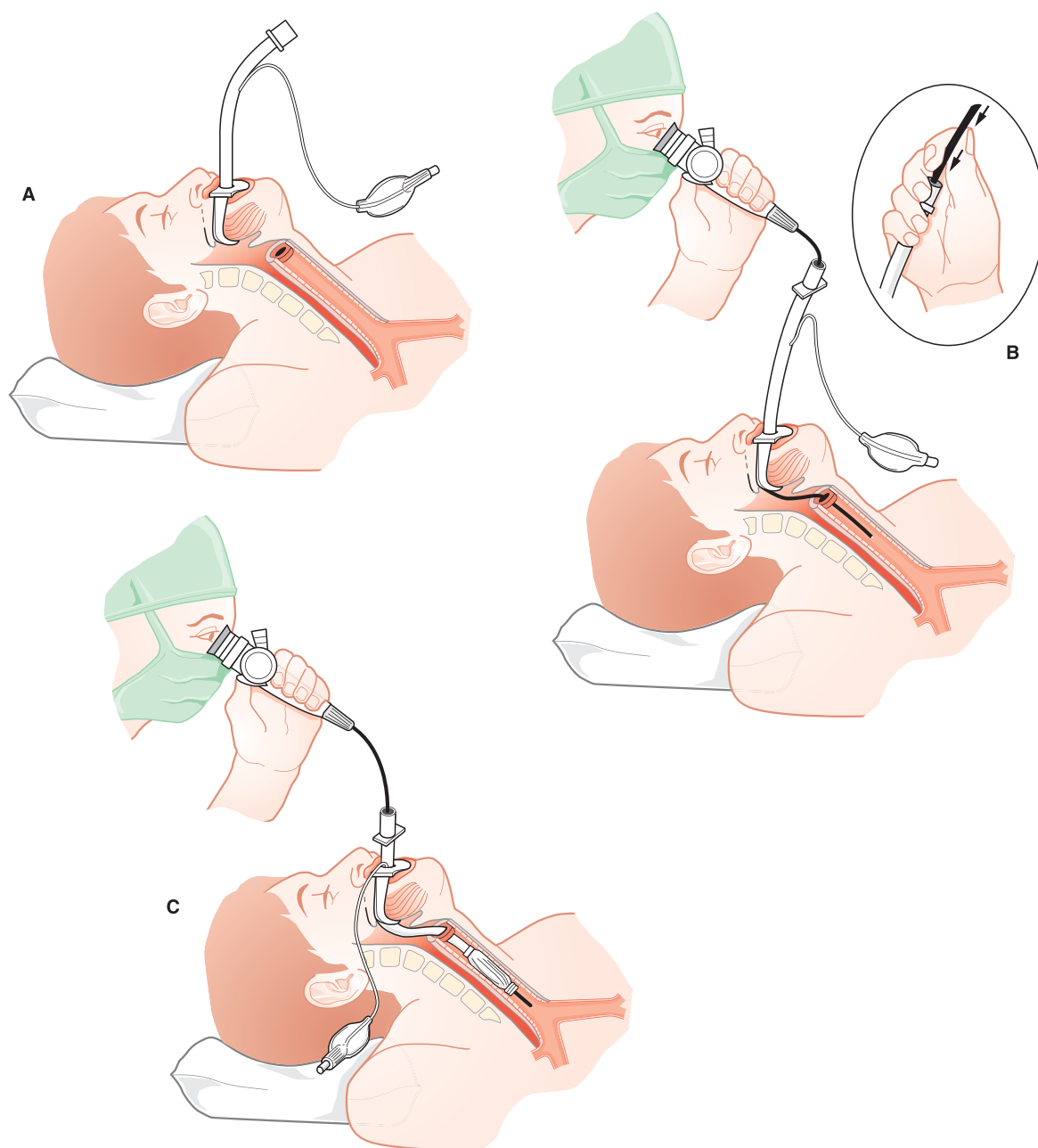
In a rapid sequence induction incorporating fiberoptic intubation, one assistant maintains cricoid pressure while another applies jaw thrust (Fig. 35-28). Excessive cricoid compression may block the endoscopist's view of the glottis by folding the epiglottis posteriorly.

### Intubation Through an LMA

The LMA Classic can be used to manage a “cannot intubate, cannot ventilate” situation or to facilitate tracheal intubation.<sup>73-76</sup>

Three distinct techniques exist for tracheal intubation through the LMA Classic or LMA Unique: blind passage of a 6.0-mm inner diameter or smaller ET tube,<sup>29</sup> blind insertion of a guide to facilitate the threading of a large ET tube after LMA removal,<sup>75</sup> or fiberoptic-assisted tracheal intubation through the LMA. With ideal LMA position, the aperture lies opposite the glottic inlet, allowing blind insertion of an ET tube or guide. When the epiglottis partially blocks the laryngeal inlet, fiberoptic assistance is needed. The Aintree intubation catheter (Cook Critical Care, Bloomington, IN) has a 4.7-mm internal diameter and a 56-cm length. It is specifically designed to facilitate intubation when an LMA is in place. A fiberoptic bronchoscope is placed through the catheter. The scope and catheter are directed through the LMA into the trachea. With the catheter left in place, the fiberoptic scope is removed, and the LMA is removed over the catheter. The trachea is then intubated over the catheter.

The distance from LMA aperture bars to the vocal cords is 3.5 cm.<sup>77</sup> If the length of a 6-mm ET tube is limited to 26 cm, the cuff of the ET tube will be positioned inside the larynx just beyond the vocal cords, which may increase the possibility of a laryngeal nerve palsy.



**FIGURE 35-24.** Fiberoptic orotracheal intubation during sedation and topical anesthesia. **A.** After sedation and application of topical anesthesia, an Ovassapian intubating airway is placed, and the oropharynx is suctioned. **B.** The endotracheal tube is removed from a warm water bath, lubricated, and placed inside the airway. The fiberscope is advanced through the endotracheal tube into the oropharynx, under the epiglottis, and inside the trachea. Care should be exercised to avoid passing the fiberscope through the Murphy eye. **C.** The endotracheal tube is slipped over the fiberscope into the trachea. The distance between carina and tip of the endotracheal tube is measured using the fiberscope before it is removed. (From Ovassapian<sup>3</sup> with permission.)

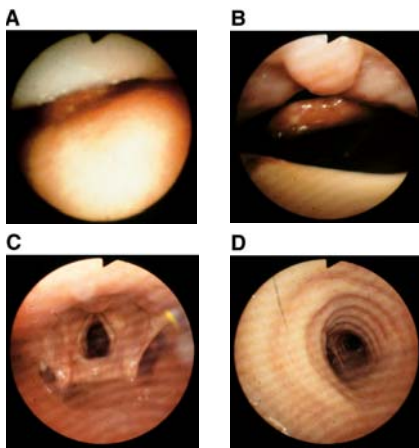
The Fastrach intubating LMA (LMA North America, San Diego, CA) is unique among airway management tools because it is the only device designed to assist with ventilation and intubation.<sup>78</sup> The Fastrach LMA was introduced as an intubation device in 1997. It is designed to facilitate blind or fiberoptic-aided tracheal intubation with a large size ET tube while maintaining the ventilatory properties of

the classic LMA. It is available in three sizes and has a rigid anatomically curved tube made of stainless steel with a standard 15-mm connector and an epiglottic elevating bar. The caudal end of the epiglottic elevating bar is not fixed, allowing it to elevate the epiglottis when an ET tube is passed through the aperture. The tube is large enough to accept a cuffed 8-mm ET tube and is short enough to ensure

passage of the cuff of the ET tube beyond the vocal cords. The tube is fitted with a rigid handle to facilitate one-handed insertion, removal, and adjustment of the device's position during intubation.

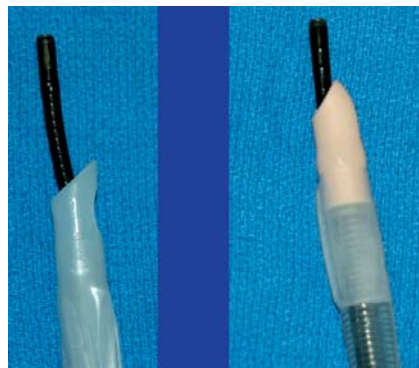
The Fastrach LMA permits single-handed insertion without moving the head and neck from a neutral position. Because a direct line of sight is not required, the person performing the





**FIGURE 35-25.** Endoscopic view during orotracheal intubation. **A.** As the fiberscope enters the intubating airway, the white laryngeal surface of the Ovassapian airway is seen at the top of the circle. The soft palate is visualized in the lower half of the slide. **B.** When the tip of the fiberscope is advanced to the oropharynx, the distal end of the Ovassapian airway can be seen covering the base of the tongue, and the epiglottis is in the center of the view. **C.** With the tip of the fiberscope passed beneath the tip of the epiglottis, the glottic opening is visualized. **D.** The tip of the fiberscope is located in the lower third of the trachea, revealing the carina.

intubation does not need to be behind the patient's head, an advantage when the patient is contained in a small space or is in unusual position, such as



**FIGURE 35-26.** Endotracheal tubes over a 4.0-mm flexible bronchoscope. The tube designed for intubation through the Fastrach LMA (right) has a curved tip, which eases passage of the tube into the trachea.

victim trapped in a motor vehicle accident. Ventilation and oxygenation can be continued during intubation to prevent desaturation.

Tracheal intubation has been achieved successfully under many difficult situations, including in patients with cervical spine diseases. One series of 254 patients with difficult to manage airways showed that 96.5% of patients had successful blind intubation via the LMA. The remaining patients were intubated using a flexible bronchoscope placed through the LMA.<sup>79</sup>

The most recent development in the evolution of the LMA is the introduction of the LMA CTrach (LMA North America; Figure 35-29). The general shape of the device is similar to the Fastrach but has added features of fiberoptic light and image transmission bundles and a small monitor that is mounted on the CTrach to display the view of the larynx during intubation.

### Light Wand

This technique uses a lighted stylet to transilluminate the anterior neck, guiding an ET tube into the trachea. The Trachlight light wand has a bright light and stylet long enough to be used with an uncut ET tube. A clip holds the ET tube in place. The Trachlight has been used successfully in patients with routine or difficult oral intubations.<sup>80</sup>

The light wand is lubricated and inserted into the distal tip of the ET tube. The stylet is bent proximal to the cuff at a 90° angle. After induction of anesthesia and muscle relaxation, the tongue is grasped with a sponge and pulled forward. The light wand is introduced into the mouth and posterior to the tongue in the midline.

When light is seen in the anterior neck above the thyroid notch, the tip of the tube is in the vallecula. If the tube enters the esophagus, the light



**FIGURE 35-27.** Fiberoptic orotracheal intubation during general anesthesia. **A.** The patient is paralyzed, the intubating airway is in place, and the oropharynx has been suctioned. The operator receives the fiberscope from an assistant and inserts the tip of the fiberscope inside the intubating airway. **B.** The assistant applies a jaw thrust as soon as the fiberscope has been passed to the operator. The operator looks through the fiberscope and advances the insertion cord through the airway and vocal cords into the trachea. The tube is rotated 45–90° if resistance is encountered during advancement through the vocal cords. Note the position of the endoscopist's right hand.





**FIGURE 35–28.** Fiberoptically aided rapid sequence induction and intubation. The first assistant on the right side of the operator applies cricoid pressure before induction of anesthesia. The second assistant on the left of the operator administers the induction agents, passes the fiberscope to the operator, and then applies jaw thrust.

dims or disappears. Off-midline transillumination indicates the tip is in a piriform recess, requiring withdrawal and rotation into the midline. When the tip of the tube enters the larynx, the light is visible below the cricoid cartilage, at which time the stylet is withdrawn to allow the tube to be threaded into the trachea.

The light wand orotracheal intubation technique has been used successfully in patients with unstable cervical vertebrae, burn strictures of the neck, and congenital airway problems, such as Treacher Collins and Pierre Robin syndromes.

### Retrograde Intubation

Retrograde intubation involves passing a guidewire through a needle percutaneously inserted into the larynx and delivering the wire through the mouth or nose to serve as a guide for the ET.<sup>81–83</sup> Dedicated kits (Cook Retrograde Intubation Set, Bloomington, IN) are available for pediatric and adult use.

The supine patient is placed in the sniffing position. The oropharynx is

topically anesthetized. An 18-gauge needle attached to a syringe containing 2 mL of 4% lidocaine is inserted through the cricothyroid membrane in a cephalad direction into the larynx. Aspiration of air confirms correct placement of the needle, and the local anesthetic is injected into the larynx. The guidewire is threaded through the needle into the pharynx, and the tip is delivered through the mouth.

A guide is passed over the wire through the mouth, cords, and into the trachea. Then the ET tube is advanced over the guide into the trachea (Fig. 35–30).

A fiberscope loaded with an ET tube can be advanced over the guidewire or next to the guidewire to assist retrograde intubation.<sup>81,82</sup> A technique that involves passing the guidewire through the suction channel of the fiberscope has greatly improved the success rate of retrograde intubation.

The most common complication with the retrograde technique is bleeding in and around the airway. Bleeding usually is minor and does not require special treatment. Other complications

are trauma to the airway, pneumomediastinum, and failed intubation.<sup>83</sup>

### Blind Nasal Intubation

BNI is a valuable technique in the patient who is uncooperative, unable to open the mouth, or has a fair amount of secretions or blood in the airway.<sup>51,84,85</sup> The nasal mucosa is prepared with a cocaine or a mixture of vasoconstrictor and local anesthetic. If sedation is needed, ketamine, which allows maintenance of an airway with spontaneous ventilation, has been used to provide sedation or induce general anesthesia to facilitate BNI.

The head is placed in the sniffing position, and a lubricated ET tube is advanced gently into the oropharynx. If resistance is encountered when entering the oropharynx, the tube is withdrawn approximately 2 cm, rotated 90°, and readvanced. If still unsuccessful, a suction catheter or a nasogastric tube passed through the ET tube into the oropharynx serves as a guide. The intensity of breath sounds and bulging produced in the neck guide maneuvers.<sup>84</sup> As the tube is advanced toward



**FIGURE 35-29.** Latest addition to laryngeal mask airway families, the LMA CTTrach. Views observed on the monitor during intubation. Shown from left to right are the glottic view showing the green epiglottic elevator bar pushing the epiglottis up and the endotracheal tube passed through the larynx.

the larynx, the breath sounds become louder. To help pass through the cords, the patient is encouraged to breathe deeply and rapidly, and the tube is advanced quickly during inspiration. Successful intubation is confirmed by continued breath sounds through the tube and the patient's inability to pho-

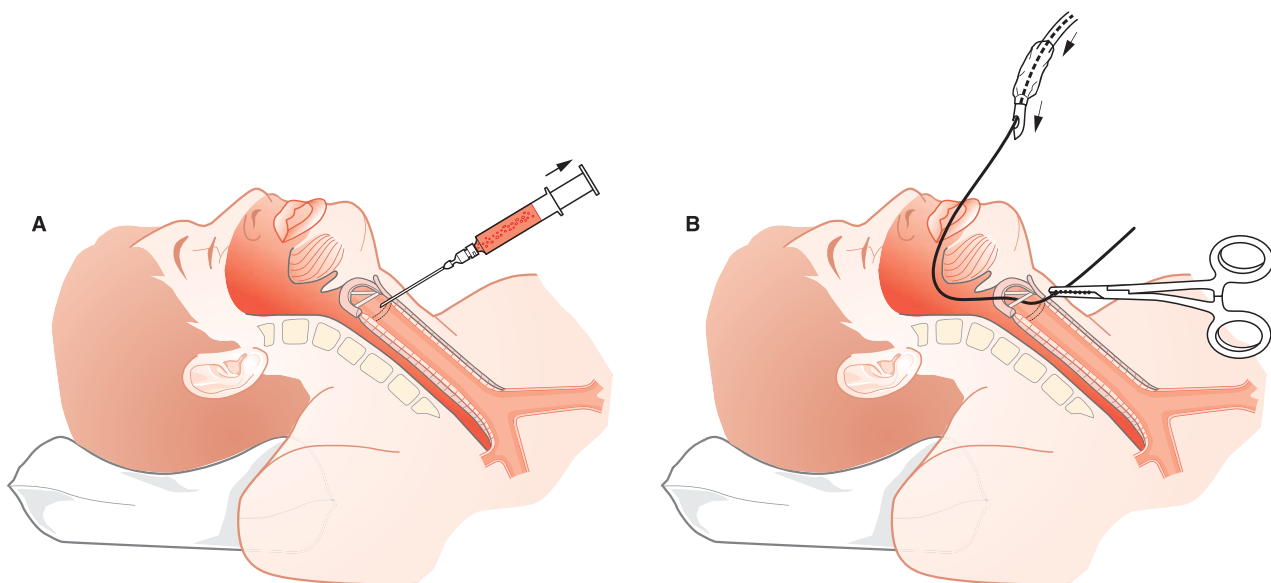
nate. Coughing is common when topical anesthesia is omitted.

If breath sounds are lost, the tube has not entered the trachea. It may be in the esophagus, valleculae, or one of the piriform recesses. A loss of breath sounds without resistance to passage indicates esophageal placement. In this

case, the tube should be withdrawn and readvanced after further elevating and extending the patient's head. Inflating the tracheal tube cuff with 15 mL of air may accomplish the identical end.<sup>85</sup> The tube is advanced 1–3 cm before the cuff is deflated and advanced further into the trachea. Entry into a piriform recess is corrected by withdrawal and rotation. Obstruction by the epiglottis necessitates neck flexion and jaw thrust or application of traction on the tongue.

Success rates between 86% and 97% have been reported for BNI. Success rates in emergency room patients have been reported as approximately 90%.<sup>86</sup> BNI is less successful when the larynx is distorted by a mass, edema, or scarring from previous surgery. Contraindications to BNI include nasal pathology, coagulopathy, thrombocytopenia, severe midface trauma, and prior transphenoidal surgery; the latter two contraindications may allow the ET tube to pass into the cranium in some patients.

Complications of BNI include trauma to the nasopharyngeal mucosa, entering the submucosal plane of the pharynx, dislodging nasal polyps, pushing foreign bodies into the larynx, and nasal bleeding.<sup>84,86</sup> Difficulty advancing the tracheal tube into the oropharynx may be a result of septal deviation, a turbinate spur, hypertrophied inferior turbinates, or nasopharyngeal lymph nodes. Use of a smaller tube or of the other nostril may remedy these problems.



**FIGURE 35-30.** Retrograde intubation. **A.** Needle attached to a syringe filled with lidocaine is passed through the cricothyroid membrane into the larynx. Free aspiration of air confirms correct placement of the needle. Lidocaine is injected to provide topical anesthesia of the airway. **B.** The guidewire is passed into the needle, retrograde through the larynx, and up into the oropharynx. The guidewire is retrieved through the mouth using a hook or forceps. The endotracheal tube is advanced over the guidewire into the trachea. (From Ovassapian<sup>3</sup> with permission.)

## Cricothyrotomy and Tracheostomy

In patients with upper airway obstruction or failed tracheal intubation, surgical establishment of the airway through the anterior neck is indicated. Cricothyrotomy involves entering the larynx through the cricothyroid membrane, allowing passage of a small ET tube or a special cricothyrotomy tube into the trachea. Cricothyrotomy is preferred to tracheostomy when an airway must be established promptly. Cricothyrotomy is faster, is easier to perform, and is farther away from the mediastinum than tracheostomy. Several kits are available for percutaneous cricothyrotomy including the Melker cricothyrotomy system (Cook Critical Care). Applying the Seldinger technique for cricothyrotomy is easy for nonsurgeons faced with a patient who has a difficult airway.<sup>87</sup> Cricothyrotomy usually is performed during emergency situations and in less than optimal conditions, increasing the chances for laryngeal injury. Once the patient is stabilized, the wound and the larynx should be examined.

## Percutaneous Transtracheal Jet Ventilation

Placement of a large-bore catheter through the cricothyroid membrane (needle cricothyrotomy) into the trachea provides rapid access to the airway and can be lifesaving when mask ventilation and tracheal intubation have failed.<sup>88,89</sup>

The incidence of malfunctioning of thin-walled 16- or 14-gauge IV catheters caused by kinking or dislodgment is high and can cause major complications. This problem is more likely to occur in an awake, struggling patient. The Arndt emergency cricothyrotomy catheter set (Cook Critical Care) may minimize these problems. The set features a 3-mm, kink-resistant catheter with a 15-mm Luer-Lok connector. A hollow, tapered-tip dilator is provided to assist with placement of the catheter into the trachea. Once in place, the airway catheter and its 15-mm adaptor can be connected to the common gas outlet of the anesthesia machine or Ambu bag, or directly to a jet ventilator through the Luer-Lok adaptor. The relatively large size tracheal catheter permits effective high-pressure jet ventilation. Bag-valve manual ventilation provides some oxygen delivery but ineffective ventila-

tion with a progressive increase in CO<sub>2</sub> concentration.

Rupture of the lungs may produce a pneumomediastinum, pneumothorax, or other complications. In the event of total upper airway obstruction, percutaneous transtracheal jet ventilation requires establishment of an exit airway. Inadequate exhalation time or inability of gas to escape can lead to “breath stacking” or pulmonary tamponade. The resultant impairment of venous return can lead to hypotension and even pulseless electrical activity similar to that seen with a tension pneumothorax. It is prudent to practice the technique initially on a mannequin and gain expertise during controlled patient care conditions before applying it to emergency situations.

Percutaneous transtracheal jet ventilation has been used as an interim means of oxygenation during a difficult intubation.<sup>89</sup>

## CARE AFTER TRACHEAL INTUBATION

### Confirmation of Tracheal Intubation

Visually observing the position of the ET tube between the cords after passage is a reliable indicator of tracheal intubation. Immediately after intubation, the cuff is inflated, and the anesthesiologist should observe the sequential rise and fall of the chest while auscultating over each midaxillary line and the epigastrium to assure that the trachea, not the esophagus or bronchi, has been intubated. Because breath sounds have misled even skilled clinicians, the ASA's intraoperative monitoring standards mandate confirming tracheal intubation by detecting consistent levels of exhaled CO<sub>2</sub> in successive breaths.<sup>25,26</sup> Carbon dioxide can be sampled while ventilating the esophagus, but exhaled CO<sub>2</sub>

concentrations fall after a few breaths (Fig. 35–31).<sup>26</sup> During circulatory shock, exhaled CO<sub>2</sub> levels may be very low despite proper tracheal tube position. If no sustained CO<sub>2</sub> levels are detected and the patient has a perfusing rhythm, the tracheal tube should be removed and the lungs ventilated by mask, particularly if there is a low risk for aspirating gastric contents.

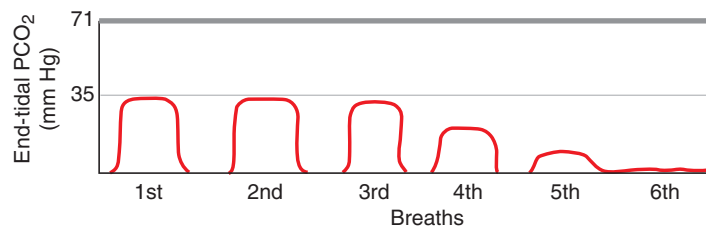
The self-inflating bulb (Ambu TubeChek B, Ambu Inc., Glen Burnie, MD) relies on anatomy rather than the physiology of CO<sub>2</sub> in exhaled gases. The device reinflates within 5 seconds if the tube is in the trachea but should remain collapsed if the tube is in the esophagus. (Fig. 35–32).<sup>90</sup>

When an ET tube is ideally positioned, the tip of the ET tube is placed 3–4 cm above the carina and the tube cuff is positioned below the cricoid ring. The practice of taping the ET tube at 21 cm in women and 23 cm in men at the teeth level may place the tube cuff inside the larynx in some patients and should be discouraged. To avoid endolaryngeal placement of the ET tube cuff, the superior border of the ET tube cuff should pass 2.5–3 cm beyond the level of the true vocal cords. Some ET tubes identify this depth by placing a black dot or circle on the tube 2.5–3 cm above the tube cuff. Nasotracheal tubes should be inserted 3 cm deeper.

### Maintaining the Tracheal Tube

To avoid tracheal mucosal ischemia, many clinicians fill the cuff so that there is a small audible leak at peak airway pressure. During prolonged intubation, regular checks are conducted to prevent overinflation.

Tracheal tubes usually are secured with adhesive tape. Tincture of benzoin or other skin adhesives may improve stability. An oropharyngeal airway or roll of gauze sponges placed between the teeth keeps the patient from biting



**FIGURE 35–31.** CO<sub>2</sub> waveform after esophageal intubation. The first three breaths may look like normal waves but will decrease in amplitude quickly. With tracheal intubation, the CO<sub>2</sub> level remains constant. (From Sum Ping<sup>26</sup> with permission.)





**FIGURE 35-32.** Self-inflating bulb fitted with a standard 15-mm adapter used as an esophageal detector device. Disposable CO<sub>2</sub> detector showing the green color change to yellow color with CO<sub>2</sub> exposure.

the tube. Nasotracheal tubes should be taped securely while avoiding pressure on the nares. The position of the tube should be verified each time the patient's position changes.<sup>12</sup>

## MANAGING THE DIFFICULT AIRWAY AND THE ASA DIFFICULT AIRWAY ALGORITHM

Patients difficult to intubate often can be ventilated by face mask. When intubation has failed but ventilation is adequate, the anesthesiologist should weigh the available options, assuring that each new maneuver represents a logical, substantive change from steps that have failed. Repeated rigid laryngoscopy may cause bleeding and rapidly evolving airway edema that frustrate subsequent attempts and may render mask ventilation difficult.<sup>91</sup> Therefore it is essential to anticipate patients at risk so that they can benefit from a controlled awake intubation. Proper preparation includes optimal positioning, thorough denitrogenation, glycopyrrolate pretreatment, and ensuring the presence of proper tools and personnel. Only two or three rigid laryngoscopy attempts generally are indicated before changing techniques.<sup>2,3,91</sup> A simple algorithm for tracheal intubation using two attempts at direct laryngoscopy with a Macintosh blade and fiberoptic intubation has been reported to have a 99.96% success rate when the two techniques are used regularly.<sup>92</sup> A return to spontaneous ventilation may be the wisest course. Experienced assistance is invaluable.

Morbidity and mortality related to airway management prompted the ASA's Difficult Airway Task Force to develop a management algorithm (Fig. 35-33).<sup>91</sup> Subsequent to the publication of the ASA guidelines, other orga-

nizations have published guidelines for airway management.<sup>93,94</sup>

Key features of the ASA guidelines include three management choices made before initiating the anesthetic: (1) Should the airway be secured with the patient awake or after induction of general anesthesia; (2) Should the initial technique be noninvasive or should it include invasive elements? (3) Should spontaneous ventilation be maintained or abolished? If problems are encountered after induction of general anesthesia, the algorithm distinguishes between difficult ventilation (life-threatening) and difficult intubation (rarely life-threatening). The LMA plays a prominent role in the 2003 revision of these guidelines because it can be used to establish or maintain ventilation and oxygenation, and it may also facilitate intubation.<sup>91</sup>

Because any patient may unexpectedly prove difficult to intubate or ventilate, proper denitrogenation before induction of general anesthesia should be routine. Maintaining skills at techniques of ventilation without tracheal intubation and mastering a variety of methods for tracheal intubation are a must for every anesthesiologist.<sup>2,3</sup> Each anesthetizing location should have rapid access to a difficult airway cart, including equipment to deal with a cannot ventilate, cannot intubate scenario.

## EXTUBATING THE TRACHEA

### The Routine Airway

Extubation of the easily intubated patient who did not undergo airway surgery is performed as soon as extubation criteria are met (Box 35-16).<sup>4,19,51</sup> Breathholding and coughing elevate pulse, blood pressure, intracranial pressure, and intraocular pressure (Box 35-17).<sup>95,96</sup> Intravenous lidocaine

and esmolol are popular adjuncts to minimize coughing and the cardiovascular responses to laryngeal stimulation by the ET tube during emergence from anesthesia.<sup>97</sup>

Extubation of the trachea during deep anesthesia minimizes the cardiovascular response,<sup>98</sup> although ventilatory depression, upper airway obstruction, and difficulty with mask ventilation may be problematic. In patients who were difficult to intubate or in those at high risk for aspiration, extubation during deep anesthesia usually is contraindicated. Even properly treated asthmatic patients tolerate conscious extubation.

Laryngospasm and airway obstruction may occur after extubation, especially in children.<sup>99</sup> Although mild laryngeal spasm presents with stridor, a severe episode results in complete airway obstruction and silence. Management of laryngeal spasm includes applying positive-pressure oxygen, suctioning oropharyngeal secretions, and providing jaw thrust. In patients with severe episodes, intravenous succinylcholine 0.1 mg/kg will relieve the spasm, permitting mask ventilation without apnea.<sup>100</sup> On rare occasions, reintubation may be necessary.

Laryngeal edema should be suspected when postextubation inspiratory stridor develops within 30–60 minutes after extubation.<sup>101</sup> Laryngeal edema caused by intubation is uncommon in adults. Overhydration, prolonged Trendelenburg position, and an allergic reaction to medications given before or during surgery should be considered. Management includes the head-up position, humidified oxygen, racemic epinephrine, dexamethasone, and reintubation.

Acute pulmonary edema may complicate tracheal extubation when severe airway obstruction coexists with vigorous spontaneous attempts at inspiration.<sup>99,102</sup> The negative intrathoracic pressure and possibly associated hypoxemia contribute to the development of pulmonary edema. Management consists of relieving the obstruction and administration of supplemental oxygenation while the congestion resolves.

Tracheomalacia caused by thyroid disease may cause airway obstruction after extubation.<sup>101,103</sup>

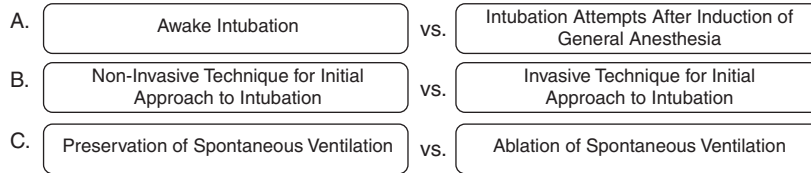
### The Difficult Airway

A closed claims analysis showed that since the introduction of the ASA

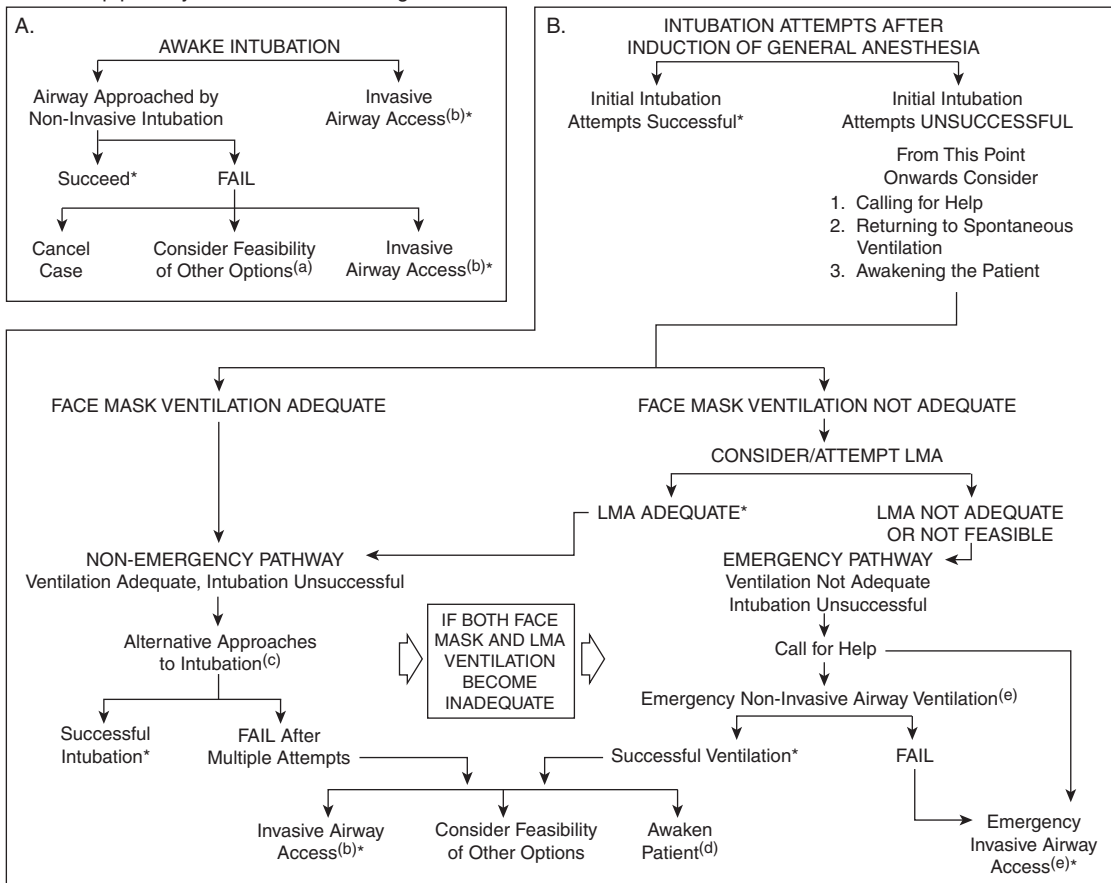


## DIFFICULT AIRWAY INTUBATION

1. Assess the likelihood and clinical impact of basic management problems:
  - A. Difficult Ventilation
  - B. Difficult Intubation
  - C. Difficulty with Patient Cooperation or Consent
  - D. Difficult Tracheostomy
2. Actively pursue opportunities to deliver supplemental oxygen throughout the process of difficult airway management
3. Consider the relative merits and feasibility of basic management choices:



4. Develop primary and alternative strategies:



\*Confirm ventilation, tracheal intubation, or LMA placement with exhaled CO<sub>2</sub>.

a. Other options include (but are not limited to): surgery utilizing face mask or LMA anesthesia, local anesthesia infiltration or regional nerve blockade. Pursuit of these options usually implies that mask ventilation will not be problematic. Therefore, these options may be of limited value if this step in the algorithm has been reached via the Emergency Pathway.

b. Invasive airway access includes surgical or percutaneous tracheostomy or cricothyrotomy.

c. Alternative non-invasive approaches to difficult intubation include (but are not limited to): use of different laryngoscopic blades, LMA as an intubation conduit (with or without fiberoptic guidance), fiberoptic intubation, intubating stylet or tube changer, light wand, retrograde intubation, and blind oral or nasal intubation.

d. Consider re-preparation of the patient for awake intubation or canceling surgery.

e. Options for emergency non-invasive airway ventilation include (but are not limited to): rigid bronchoscope, esophageal-bracheal combitube ventilation, or transtracheal jet ventilation.

**FIGURE 35-33.** The American Society of Anesthesiologist's difficult airway algorithm. (From American Society of Anesthesiologists Task Force on Management of the Difficult Airway<sup>91</sup> with permission.)

practice guidelines for management of difficult airways in 1993, there has been a reduction in airway-related claims associated with the induction of anesthesia. However, there has

been no change in the rate of claims related to airway misadventures during the maintenance, emergence, or recovery from an anesthetic. The authors call for the development of ad-

ditional management strategies during these phases.<sup>104</sup>

Patients who were difficult to intubate, who had major head and neck operations, or in whom airway access is

**BOX 35–16.****Tracheal Extubation in Patients with Uncomplicated Airways****Criteria for Extubation**

No indication to keep patient intubated

Spontaneous ventilation is adequate

Muscle relaxant is fully reversed

(demonstrated with strong head lift or hand grip)

Airway reflexes are recovered

Patient follows commands

**Technique of Extubation**

Suction oropharynx before patient is reactive

Administer 100% oxygen for several minutes

Remove tape

Deflate the cuff

Apply positive pressure to the breathing bag, and gently remove the tracheal tube

Suction again if secretions are present

Apply mask with high-flow oxygen

Check for airway patency and adequacy of ventilation

restricted are at high risk after extubation. The timing of extubation, equipment availability, and presence of a skilled anesthesiologist are vital in these patients. Should emergent reintubation be required, these patients are likely to be hypoxic, hypercapnic, and uncooperative, with gastric distension from failed ventilatory attempts (Box 35–18).<sup>105</sup>

Possible approaches to these patients include extubating them when fully awake, extubating after edema or hematoma has resolved, extubating after assuring a leak around a deflated cuff (cuff-leak test),<sup>54</sup> or extubating over an introducer, fiber scope, or jet stylet.<sup>106–108</sup> The presence of a leak around a deflated ET tube cuff usually predicts that glottic edema will not complicate extubation in adult patients. Exchange for an LMA or extubation in front of an LMA likely will be the most common technique to bridge to extubation (Fig. 35–34).<sup>109,110</sup>

LMA-assisted extubation is beneficial in several situations. Some examples include prevention of upper airway obstruction in obese patients; in head and neck operations to avoid severe hypertension and bleeding; for head and neck free flap and skin graft operations to avoid damage to the new flap; in intraocular operations to prevent pres-

**BOX 35–17.****Complications Related to Extubation****During Extubation**

Hypertension, tachycardia, arrhythmias

Coughing, breathholding, cyanosis

Difficult extubation

**Postextubation**

Laryngospasm

Airway obstruction

Soft-tissue obstruction

Laryngeal edema

Edema of stenotic trachea

Vocal cord malfunction

Bilateral palsy

Unilateral palsy

Dysfunctional vocal cords (paradoxical adduction during inspiration)

External compression

Hematoma

Bleeding

Laryngotracheomalacia

Negative-pressure pulmonary edema

Aspiration of gastric contents

Ventilatory depression

Laryngeal incompetence

Dysphonia, aphonia

Dislocation of arytenoid

Laryngotracheal stenosis

Sore throat

sure on the eye caused by face mask ventilation; and to provide a conduit for fiberoptic assessment of the vocal cord function after thyroidectomy. The exchange is performed while the patient is anesthetized and before the muscle relaxant effect is reversed. The ET tube tape is moved to the lower lip, and a size 3 or 4 deflated LMA Classic is placed behind the ET tube. It is advanced to its position using either the standard finger technique or by bringing the shaft to parallel to the chest and advancing the LMA against the hard palate in a cephalad and downward direction. Anesthesia is then discontinued, and the ET tube is removed as soon as spontaneous ventilation has begun. The LMA is removed when the patient is fully awake and responds to the LMA. At this stage, patients usually maintain good air exchange and do not require any airway support after the device is removed.

**Extubation Over a Jet Stylet**

The jet stylet, an airway exchange catheter, or a bougie can be left in the

**BOX 35–18.****Challenges of Immediate Reintubation**

Known difficult airway

Surgical distortion

Limited access

Edema

Uncooperative, combative patient

Emergent nature

Blood and secretions

Hematoma

Cervical immobilization or instability

Maxillomandibular fixation

Head and neck dressing

Halo vest

Inadequate experience

Difficult mask ventilation

Risk of aspiration

Poor oxygenation and ventilation

Poor topical anesthesia as a result of secretions

Occurrence during transportation

Unavailability of equipment

trachea to facilitate reintubation.<sup>106,108</sup> Should reintubation fail, the jet stylet can be used to oxygenate and ventilate patients.<sup>106</sup> The jet stylet can be positioned in the lower trachea using centimeter markings along its length. Tissue trauma from catheter whip or direct injury from the air jet is a major concern. Side holes placed along its distal 5 cm help minimize tissue trauma from these causes.

**The Difficult Extubation**

Iatrogenic causes and mechanical failure on rare occasions can render extubation difficult or impossible.<sup>108,111,112</sup> Extubation may be difficult in patients with laryngeal abnormalities or in those who bite the ET tube. Difficult extubation with a deflated cuff has been reported, resulting from folding of the ET tube cuff below the vocal cords and from laryngeal edema caused by difficult intubation. Persistent fixation of the tra-



**FIGURE 35–34.** Endoscopic view of the LMA Classic positioned behind the endotracheal tube.

## BOX 35–19.

## Complications of Tracheal Intubation

## Physiologic Responses to Laryngotracheal Stimulation

## Cardiovascular

Tachycardia, hypertension, myocardial ischemia

Reflex bradycardia

Bronchospasm and bronchorrhea

Intracranial hypertension

Intraocular hypertension or extrusion of vitreous humor

## Trauma

Abrasion of the cornea

Laceration of the lips, gums, tongue, pharynx

Epistaxis

Perforation of pharyngeal or esophageal mucosa

Chipping or avulsion of teeth or dental appliances

Persisting subluxation of the mandible

Laryngotracheal penetration with subcutaneous emphysema

Pneumothorax

Injury to the vocal cords and arytenoid cartilages

## Tube Malposition

Prolonged or failed intubation

Insufficient insertion

Bronchial intubation

## Airway Foreign Bodies

Teeth

Laryngoscope bulbs

Stylets

## During Tracheal Tube Maintenance

Unintended extubation

Obstruction

Unrecognized disconnection

Changes in position

## With Extubation

Physiologic responses (same as previous)

Difficult or impossible extubation

Laryngeal spasm

Negative-pressure pulmonary edema

## Common Sequelae of a Mild Nature and Lasting &lt;48 Hours

Hoarseness

Sore throat

## Complications of Prolonged Intubation

Infections

Laryngotracheobronchitis

Sinusitis

Pneumonia

Laryngeal ulceration

Vocal cord granuloma

Tracheomalacia

Tracheal stenosis

Vocal cord paralysis

cheal tube with surgical wires, sutures, and screws also has been reported.

## FOLLOWUP OF A DIFFICULT AIRWAY

For optimal airway management in the future, patients with proven difficult airways should be informed and identified. Immediate application of a temporary wristband or flagging the medical record will alert healthcare providers to these patients' special requirements.

A written statement with pertinent airway management information should be given to the patient, with a copy of the statement filed in the patient's medical record.

For future reference and availability of information for other healthcare organizations, the patient with a difficult airway can be enrolled in the Medic Alert Difficult Airway/Intubation Registry.<sup>113</sup>

## COMPLICATIONS OF INTUBATION

The difficulties and complications related to tracheal intubation are numerous and can be related to the act of intubation, maintenance of the ET tube, or extubation (Box 35–19).<sup>7,114–117</sup> A closed claims analysis found that the larynx, pharynx, and esophagus were the most common sites of airway injuries. Pharyngoesophageal perforation injuries were the most severe. Early signs of perforation were present in only 51% of the claims. The authors recommend that patients in whom tracheal intubation has been difficult should be observed for and instructed to watch for signs and symptoms of retropharyngeal abscess, mediastinitis, or both.<sup>115</sup>

## KEY REFERENCES

1. Practice guidelines for management of the difficult airway: an updated report by the American Society of Anesthesiologists Task Force on Management of the Difficult Airway. *Anesthesiology* 2003; 98:1269–1277.
2. Benumof JL. Management of the difficult airway: with special em-

phasis on awake tracheal intubation. *Anesthesiology* 1991;75:1087.

3. Benumof JL. *Airway Management: Principles and Practice*. St. Louis: Mosby-Year Book, 1996.

4. Birmingham PK, Cheney FW, Ward RJ. Esophageal intubation: a review of detection techniques. *Anesth Analg* 1986;65:886–891.

5. Brimacombe JR. *Laryngeal Mask Anesthesia: Principles and Practice*. 2d ed. Sydney: Saunders, 2005.

6. Caplan RA, Posner KL, Ward RJ, et al. Adverse respiratory events in anesthesia: a closed claims analysis. *Anesthesiology* 1990;72:828–833.

7. Finucane BT, Santora AH. *Principles of Airway Management*. 3d ed. New York: Springer-Verlag, 2003.

8. Gravenstein N, Kirby RR. *Complications in Anesthesiology*. 2d ed. Philadelphia: Lippincott-Raven, 1996.

9. Hartley M, Vaughan RS. Problems associated with tracheal extubation. *Br J Anaesth* 1993;71:561–568.

10. Ovassapian A. *Fiberoptic endoscopy and the Difficult Airway*. 2d ed. New York: Lippincott-Raven, 1996.

## REFERENCES

1. Caplan RA, Posner KL, Ward RJ, et al. Adverse respiratory events in anesthesia: a closed claims analysis. *Anesthesiology* 1990;72:828–833.
2. Benumof JL. Management of the difficult airway: with special emphasis on awake tracheal intubation. *Anesthesiology* 1991; 75:1087.
3. Ovassapian A. *Fiberoptic Endoscopy and the Difficult Airway*. 2d ed. New York: Lippincott-Raven, 1996.
4. Finucane BT, Santora AH. *Principles of Airway Management*. 3d ed. New York: Springer-Verlag, 2003.
5. Sellick BA. Cricoid pressure to control regurgitation of stomach contents during induction of anaesthesia. *Lancet* 1961;2: 404.
6. Brain AU. The laryngeal mask: a new concept in airway management. *Br J Anaesth* 1983;55:801.
7. Cavo JW. True vocal cord paralysis following intubation. *Laryngoscope* 1985;95: 1352.

8. Hayes JP, Nolan MT, Brennan N, et al. Three cases of paradoxical vocal cord adduction followed up over a 10-year period. *Chest* 1993;104:678.
9. Fink B, Demarest R. *Laryngeal Biomechanics*. Cambridge, MA: Harvard University Press, 1978.
10. Williamson JA, Webb RK, Spekely S, et al. Difficult intubation: an analysis of 2000, incident reports. *Anaesth Intensive Care* 1993;21:602.
11. Stewart RD, LaRosee A, Stoy WA, et al. Use of a lighted stylet to confirm correct endotracheal tube placement. *Chest* 1987;92:900.
12. Conrardy PA, Goodman LR, Laing F, et al. Alteration of endotracheal tube position: flexion and extension of the neck. *Crit Care Med* 1976;4:8.
13. Cone AM, Scott S. Intermittent airway obstruction during anesthesia in a patient with an undiagnosed anterior mediastinal mass. *Anaesth Intensive Care* 1994;22:204.
14. Shenkman Z, Shir Y, Brodsky JB. Perioperative management of the obese patient. *Br J Anaesth* 1993;70:349.
15. Langeron O, Masso E, Huraux C, et al. Prediction of difficult mask ventilation. *Anesthesiology* 2000;92:1229–1236.
16. Mason DG, Wark KJ. Unexpected difficult intubation. Asymptomatic epiglottic cysts as a cause of upper airway obstruction during anesthesia. *Anaesthesia* 1987;42:407.
17. Jones DH, Cohle SD. Unanticipated difficult airway secondary to lingual tonsillar hyperplasia. *Anesth Analg* 1993;77:1285.
18. Ovassapian A, Glassenberg R, Randel GI, et al. The unexpected difficult airway and lingual tonsil hyperplasia. A case series and a review of the literature. *Anesthesiology* 2002;97:124–132.
19. Ovassapian A, Meyer R. Airway management. In Longnecker DE, Murphy FL, eds. *Introduction to Anesthesia*. 9th ed. Philadelphia: WB Saunders, 1996:137–158.
20. Frumin MJ, Epstein RM, Cohen G. Apneic oxygenation in man. *Anesthesiology* 1959;20:789.
21. Norris MC, Dewan DM. Preoxygenation for cesarean section: a comparison of two techniques. *Anesthesiology* 1985;62:827.
22. Gambee AM, Hertzka RE, Fisher DM. Preoxygenation techniques: comparison of three minutes and four breaths. *Anesth Analg* 1987;66:468.
23. Severinghouse JW, Kelleher JF. Recent developments in pulse oximetry. *Anesthesiology* 1992;76:1018.
24. Guggenberger J, Lenz G, Federle R. Early detection of inadvertent oesophageal intubation: pulse oximetry vs. capnography. *Acta Anaesth Scand* 1989;33:112.
25. Birmingham PK, Cheney FW, Ward RJ. Oesophageal intubation: a review of detection techniques. *Anesth Analg* 1986;65:886.
26. Sum Ping ST, Mehta MP, Symreng T. Reliability of capnography in identifying oesophageal intubation with carbonated beverage or antacid in the stomach. *Anesth Analg* 1991;73:333–337.
27. McGee JP, Vender JS. Nonintubation management of the airway: mask ventilation. In Benumof J, ed. *Airway Management: Principles and Practice*. St. Louis: Mosby-Year Book, 1996:228–254.
28. Brain AIJ. The laryngeal mask airway: a possible new solution to airway problems in the emergency situation. *Arch Emerg Med* 1984;1:229–232.
29. Brimacombe JR. *Laryngeal Mask Anesthesia: Principles and Practice*. 2d ed. Sydney: Saunders 2005.
30. Verghese C, Smith TG, Young E. Prospective survey of the use of the laryngeal mask airway in 2359 patients. *Anaesthesia* 1993;48:60.
31. Cork R, Monk JE. Management of a suspected and unsuspected difficult laryngoscopy with the laryngeal mask airway. *J ClinAnesth* 1992;4:230.
32. Divatia JV, Sareen R, Upadhye SM, et al. Anaesthetic management of tracheal surgery using the laryngeal mask airway. *Anaesth Intensive Care* 1994;22:69.
33. George SL, Blogg CE. Role of the LMA in tracheal extubation? *Br J Anaesth* 1994;72:610.
34. Harris TM, Johnston DF, Collins SRC, et al. A new general anaesthetic technique for use in singers: the brain laryngeal mask airway versus endotracheal intubation. *J Voice* 1990;4:81.
35. Martin PD, Cyna AM, Hunter WAH, et al. Training nursing staff in airway management for resuscitation. A clinical comparison of the face mask and laryngeal mask. *Anaesthesia* 1993;48:33.
36. Brimacombe J, Berry A. Insertion of the laryngeal mask airway—a prospective study of four techniques. *Anaesth Intensive Care* 1993;21:89.
37. *LMA Airway Instruction Manual*. San Diego, CA: LMA North America, 2005.
38. Pennant JH, Walker MB. Comparison of the endotracheal tube and laryngeal mask in airway management by paramedical personnel. *Anesth Analg* 1992;74:531.
39. Brain AIJ, Verghese C, Strube PJ. The LMA “ProSeal”: a laryngeal mask with an oesophageal vent. *Br J Anaesth* 2000;84:650–654.
40. Awan R, Nolan JP, Cook TM. Use of Pro-Seal laryngeal mask airway for airway maintenance during emergency Cesarean section after failed tracheal intubation. *Br J Anaesth* 2004;92:144–146.
41. Barker P, Langton JA, Murphy PJ, et al. Regurgitation of gastric contents during general anaesthesia using the laryngeal mask airway. *Anaesthesia* 1992;69:314.
42. Rabey PG, Murphy PJ, Langton JA, et al. Effect of the laryngeal mask airway on lower oesophageal sphincter pressure in patients during general anaesthesia. *Br J Anaesth* 1992;69:341.
43. Brimacombe J, Berry A. The incidence of aspiration associated with the laryngeal mask airway: a meta-analysis of published literature. *Clin Anesth* 1995;7:297.
44. Asai T, Barclay K, Power I, et al. Cricoid pressure impedes placement of the laryngeal mask airway and subsequent tracheal intubation through the mask. *Br J Anaesth* 1994;72:47.
45. King C, Street MK. Twelfth cranial nerve paralysis following use of a laryngeal mask airway. *Anaesthesia* 1994;49:786.
46. Nagai K, Sakuramoto C, Goto F. Unilateral hypoglossal nerve paralysis following the use of the laryngeal mask airway. *Anaesthesia* 1994;49:603.
47. Inomata S, Nishikawa T, Suza A, et al. Transient bilateral vocal cord paralysis after insertion of a laryngeal mask airway. *Anesthesiology* 1995;82:787.
48. Davis DP, Valentine C, Ochs M, et al. The Combitube as a salvage airway device for paramedic rapid sequence intubation. *Ann Emerg Med* 2003;42:697–704.
49. Frass M, Frenzer R, Zdrahal F, et al. The oesophageal tracheal combitube: preliminary results with a new airway for CPR. *Ann Emerg Med* 1987;16:768.
50. Ovassapian A, Liu S, Krejcie T. Fiberoptic tracheal intubation with combitube in place. *Anesth Analg* 1993;75:S315.
51. Benumof JL. *Airway Management: Principles and Practice*. St. Louis: Mosby-Year Book, 1996.
52. Warner MA, Warner ME, Weber JG. Clinical significance of pulmonary aspiration during the perioperative period. *Anesthesiology* 1993;78:56.
53. Dorsch JA, Dorsch SE. *Understanding Anesthesia Equipment*. 4th ed. Baltimore: Williams & Wilkins, 1999.
54. Fisher MM, Raper RF. The “cuff-leak” test for extubation. *Anaesthesia* 1992;47:10.
55. Ovassapian A. Flexible bronchoscopic intubation of awake patients. *J Bronchol* 1994;1:240.
56. Graham DR, Hay JG, Clague J, et al. Comparison of three different methods used to achieve local anesthesia for fiberoptic bronchoscopy. *Chest* 1992;102:704–707.
57. Webb AR, Fernando SS, Dalton HR, et al. Local anaesthesia for fiberoptic bronchoscopy: transcrioid injection or the “spray as you go” technique? *Thorax* 1990;45:474–477.
58. Gross JB, Hartigan ML, Schaffer DW. A suitable substitute for 4% cocaine before blind nasotracheal intubation: 3% lidocaine-0.25% phenylephrine nasal spray. *Anesth Analg* 1984;63:915.
59. Randell T, Yli-Hankala A, Valli H, et al. Topical anesthesia of the nasal mucosa for fiberoptic airway endoscopy. *Br J Anaesth* 1991;66:164.
60. Georgescu A, Miller IN, Lecklinter ML. The Sellick maneuver causing complete airway obstruction. *Anesth Analg* 1992;74:457.



61. Haslam N, Parker L, Duggan JE. Effect of cricoid pressure on the view at laryngoscopy. *Anaesthesia* 2005;60:41–47.
62. Moynihan RJ, Brock-Utne JG, Archer JH, et al. The effect of cricoid pressure on preventing gastric insufflation in infants and children. *Anesthesiology* 1993;78:652.
63. Bullingham A, Hampson-Evans D, Palazzo M. An impaled neck. Management of difficult airway access. *Anaesthesia* 1984;49:866.
64. Neuman GG, Weingarten AE, Abramowitz RM, et al. The anesthetic management of the patient with an anterior mediastinal mass. *Anesthesiology* 1984;60:144.
65. Ovassapian A, Yelich SJ, Dykes MHM, et al. Fiberoptic nasotracheal intubation—incidence and causes of failure. *Anesth Analg* 1983;62:692.
66. Ovassapian A, Krejcie TC, Yelich SJ, et al. Awake fiberoptic intubation of the patient at high risk of aspiration. *Br J Anaesth* 1989;62:13.
67. Ovassapian A, Land P, Schafer MF, et al. Anesthetic management for surgical correction of severe flexion deformity of the cervical spine. *Anesthesiology* 1983;58:370.
68. Ovassapian A, Tuncbilek M, Weitzel EK, et al. Airway management in adult patients with deep neck infections: a case series and review of the literature. *Anesth Analg* 2005;100:585.
69. Asai T, Shingu K. Difficulty in advancing a tracheal tube over a fiberoptic bronchoscope: incidence, causes and solutions. *Br J Anaesth* 2004;92:870–881.
70. Hakala P, Randell T. Comparison between two fiberscopes with different diameter insertion cords for fiberoptic intubation. *Anaesthesia* 1995;50:735.
71. Brull SJ, Wiklund R, Ferris C, et al. Facilitation of fiberoptic orotracheal intubation with a flexible tracheal tube. *Anesth Analg* 1994;78:746.
72. Jones HE, Pearce AC, Moore P. Fiberoptic intubation. Influence of tracheal tube tip design. *Anaesthesia* 1993;48:672.
73. American Society of Anesthesiologists Task Force on Management of the Difficult Airway. Practice guidelines for management of the difficult airway. *Anesthesiology* 1993;78:597.
74. Benumof JL. Laryngeal mask airway and the ASA difficult airway algorithm. *Anesthesiology* 1996;84:686.
75. Heath ML, Allagain J. Intubation through the laryngeal mask. A technique for unexpected difficult intubation. *Anaesthesia* 1991;46:545.
76. Parmet JL, Colonna-Romano P, Horrow JC, et al. The laryngeal mask airway reliability rescue ventilation in cases of unanticipated difficult tracheal intubation along with difficult mask ventilation. *Anesth Analg* 1988;87:661–665.
77. Asai T, Latto IP, Vaughan RS. The distance between the grille of the laryngeal mask airway and the vocal cords. Is conventional intubation through the laryngeal mask safe? *Anaesthesia* 1993;48:667–669.
78. Brain AIJ, Verghese C, Addy EV, et al. The intubating laryngeal mask. II. a preliminary clinical report of a new means of intubating the trachea. *Br J Anaesth* 1997;79:704–709.
79. Ferson DZ, Rosenblatt WH, Johansen MJ, et al. Use of the intubating LMA-Fastrach in 254 patients with difficult-to-manage airways. *Anesthesiology* 2001;95:1175–1181.
80. Hung OR, Pytka S, Morris I, et al. Clinical trial of a new lightwand device (Trachlight) to intubate the trachea. *Anesthesiology* 1995;83:509.
81. Audenart SM, Montgomery CL, Stone B, et al. Retrograde-assisted fiberoptic tracheal intubation in children with difficult airways. *Anesth Analg* 1991;73:660.
82. Bissinger U, Guggenberger H, Lenz G. Retrograde-guided fiberoptic intubation in patients with laryngeal carcinoma. *Anesth Analg* 1995;81:408.
83. Sanchez A, Pallares V. Retrograde intubation techniques. In Benumof J, ed. *Airway Management: Principles and Practice*. St. Louis: Mosby-Year Book, 1996:320–341.
84. Gold MI, Buechel DR. A method of blind nasal intubation for the conscious patient. *Anesth Analg* 1960;39:257.
85. Gorback MS. Inflation of the endotracheal tube cuff as an aid to blind nasal endotracheal intubation. *Anesth Analg* 1987;66:916.
86. Tintinalli JE, Claffey J. Complications of nasotracheal intubation. *Ann Emerg Med* 1981;10:142.
87. Bainton CR. Cricothyrotomy: new concepts in airway management. *Int Anesth Clin* 1994;32:95.
88. Benumof JL, Scheller MS. The importance of transtracheal jet ventilation in the management of the difficult airway. *Anesthesiology* 1989;71:769.
89. McLellan I, Gordon P, Khawaja S, et al. Percutaneous transtracheal high frequency jet ventilation as an aid to difficult intubation. *Can J Anaesth* 1988;35:404.
90. Wee MYK. The esophageal detection device: assessment of a method to distinguish oesophageal from tracheal intubation. *Anaesthesia* 1988;43:27.
91. American Society of Anesthesiologists Task Force on Management of the Difficult Airway. Practice guidelines for management of the difficult airway: an updated report. *Anesthesiology* 2003;98:1269–1277.
92. Heidegger T, Gerig HJ, Ulrich B, et al. Validation of a simple algorithm for tracheal intubation: daily practice is the key to success in emergencies—an analysis of 13248 intubations. *Anesth Analg* 2001;92:517–522.
93. Crosby ET, Cooper RM, Douglas MJ, et al. The unanticipated difficult airway with recommendations for management. *Can J Anaesth* 1998;45:757–76.
94. Henderson JJ, Popat MT, Latto IP, et al. Difficult Airway Society guideline for management of the unanticipated difficult intubation. *Anaesthesia* 2004;59:675–694.
95. Hartley M, Vaughan RS. Problems associated with tracheal extubation. *Br J Anaesth* 1993;71:561.
96. Miller KA, Harkin CP, Bailey PL. Postoperative tracheal extubation. *Anesth Analg* 1995;80:149.
97. Helfman SM, Gold MI, DeLisser EA, et al. Which drug prevents tachycardia and hypertension associated with tracheal intubation: lidocaine, fentanyl, or esmolol? *Anesth Analg* 1991;72:482.
98. Pounder DR, Blackstock D, Steward DJ. Tracheal extubation in children: halothane versus isoflurane, anesthetized versus awake. *Anesthesiology* 1991;74:653.
99. Lang SA, Duncan PG, Shephard DAE, et al. Pulmonary oedema associated with airway obstruction. *Can J Anaesth* 1990;37:210.
100. Chung DC, Rowbottom SJ. A very small dose of suxamethonium relieves laryngospasm. *Anaesthesia* 1993;48:229.
101. Nakagawa H, Komatsu R, Hayashi K, et al. Fiberoptic evaluation of the difficult extubation. *Anesthesiology* 1995;82:785.
102. Maroof M, Bonsu A, MacInnis E. Pulmonary oedema due to upper airway obstruction caused by a Foley catheter. *Anaesth Intensive Care* 1994;22:605.
103. Geelhoed GW. Tracheomalacia from compressing goiter: management after thyroidectomy. *Surgery* 1988;104:1100.
104. Peterson GN, Domino KB, Caplan RA, et al. Management of the difficult airway. A closed claims analysis. *Anesthesiology* 2005;103:33–39.
105. Mathew JP, Rosenbaum SH, O'Connor T, et al. Emergency tracheal intubation in the postanesthesia care unit: physician error or patient disease? *Anesth Analg* 1990;71:691–697.
106. Bedger RC, Chang JL. A jet-stylet endotracheal catheter for difficult airway management. *Anesthesiology* 1987;66:221.
107. deLima LGR, Bishop MJ. Lung laceration after tracheal extubation over a plastic tube changer. *Anesth Analg* 1991;73:350.

108. Robles B, Hester J, Brock-Utne JG. Remember the gum-elastic bougie at extubation. *J Clin Anesth* 1993;5:329.
109. Patel P, Verghese C. Delayed extubation facilitated with the use of a laryngeal mask airway (LMA) on the intensive care unit (ICU). *Anaesthesia* 2000;55:396.
110. Takita K, Yamane M, Morimoto Y, et al. The ED<sub>95</sub> of end-tidal sevoflurane concentration for the smooth exchange of the tracheal tube for a laryngeal mask airway is 2.97%. *Can J Anesth* 2003;50:184.
111. Akers JA, Riley RH. Failed extubation due to "sutured" double-lumen tube. *Anaesth Intensive Care* 1990;18:577.
112. Asai T. Difficult tracheal extubation in a patient with an unsuspected congenital subglottic stenosis. *Anaesthesia* 1995;50:243.
113. Mark U, Beattie C, Lee Ferrell C, et al. The difficult airway: mechanisms for effective dissemination of critical information. *J Clin Anaesth* 1992;4:247.
114. Burton JF, Baker AB. Dental damage during anaesthesia and surgery. *Anaesth Intensive Care* 1987;15:262.
115. Domino KB, Posner KL, Caplan RA, et al. Airway injury during anesthesia: a closed claims analysis. *Anesthesiology* 1999;91:1703–1711.
116. Gamlin F, Caldicott LD, Shah MV. Mediastinitis and sepsis syndrome following intubation. *Anaesthesia* 1994;49:883.
117. Lee TS, Jordan JS. Pyriform sinus perforation secondary to traumatic intubation in a difficult airway patient. *J Clin Anesth* 1994;6:152.

## SECTION C

## ANESTHESIA DRUGS AND DRUG DELIVERY SYSTEMS

## CHAPTER 36

## Mechanisms of General Anesthetic Action

Max B. Kelz, MD, PhD,  
Jay Yang, MD, PhD, and  
Roderic G. Eckenhoff, MD

General anesthetics were formally introduced into medical practice more than 160 years ago and have been hailed as one of the most significant medical advances of all time. Yet there is still considerable mystery about how the drugs work and how to characterize the state that they produce. This should not be too surprising, because a description of the transition from consciousness to unconsciousness necessarily requires an understanding of the former, and the neurobiology of consciousness is still in its infancy. Nevertheless, considerable progress has been made toward the characterization of anesthesia and the potential mechanisms of the drugs that produce it. In this chapter, we summarize the current body of evidence for the mechanism(s) of general anesthesia, with emphasis on the inhaled anesthetics because they are used most commonly. Excellent and comprehensive reviews summarize current knowledge of the molecular, cellular, and in vivo pharmacology,<sup>1,2</sup> so we have selected only a few of the putative molecular targets to illustrate the principles and to support the notion that alteration of a neurophysiologic process, rather than the activity of an individual protein, is responsible for the state of general anesthesia.

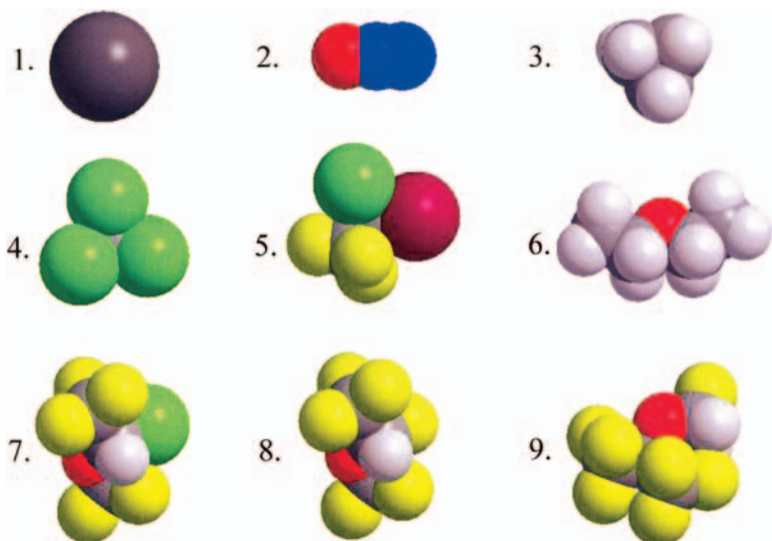
## GENERAL ANESTHESIA

Mechanistic searches are greatly aided by clear physiologic or behavioral end points. Those associated with anesthesia, however, often are ambiguous and arbitrary. Most people associate anesthesia with unconsciousness or “sleep,” but the transition to this state often is not apparent to the observer, so the lack of physical movement in response to a noxious stimulus is the most common end point associated with the term *anesthesia*. This is essentially the same end point used in Boston more than 160 years ago. But it is immediately apparent that many pathways can lead to such an end point, most notably paralysis, which itself is at the end of many pathways. Nevertheless, the mobility end point is well entrenched and has been useful as a practical comparison of the potency of different drugs. After all, surgery is greatly facilitated

by a motionless patient. Thus was born the concept of minimum alveolar concentration (MAC; see Chapter 37), a useful tool for practitioners. Investigators, on the other hand, were hampered by such a concept and only now are starting to break the state of anesthesia into its many components in an attempt to relate them to the underlying targets and pathways. For example, most acknowledge the presence of hypnosis, amnesia, excitement, weakness, and analgesia in the state of anesthesia. These are distinct from the many arbitrarily assigned “side” effects of the drugs, including alterations in vascular, cardiac, respiratory, metabolic, and renal function. Also produced are a series of “toxic” effects, which might be unique, or simply an enhancement of the primary or the side effects. This disassembly of effects is likely to facilitate the linkage with molecular targets and with their reassembly to the final in vivo state of

## KEY POINTS

1. The mechanisms by which the inhaled general anesthetics work are not fully understood. No single molecular target has been proven to transduce anesthesia.
2. Correlation of the physicochemical character of anesthetics with their potency suggests target sites are dominantly hydrophobic, with a small degree of polarity and chirality. Internal protein cavities best fit this description.
3. Inhaled anesthetic binding site character is not highly specific, predicting more than a few anesthetic binding targets. The interaction at some of these targets may not contribute significantly to anesthetic action.
4. Use of the lipid membrane as a direct target for inhaled anesthetics has been dismissed prematurely. Some components of anesthetic action may occur via this interaction.
5. Many potential protein targets in the synapse have been identified, suggesting that inhaled anesthetic action results from disruption of the specific process of synaptic transmission rather than from a receptor-like interaction with a single molecular target.
6. Anesthetic effects on a process, such as synaptic transmission, may have a different system-level effect depending on placement in the neural circuitry. The circuits that regulate sleep and arousal are well positioned to mediate the hypnotic properties of anesthetics.



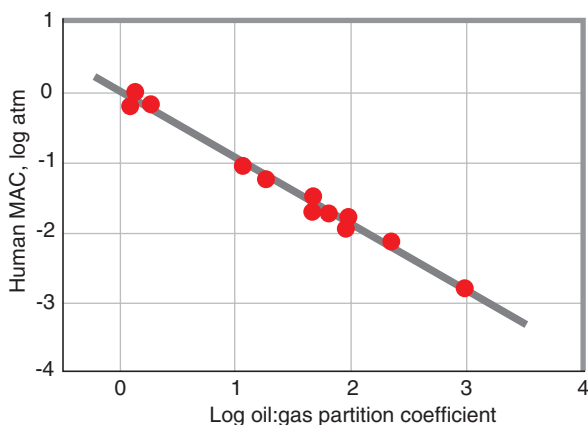
**FIGURE 36-1.** Space-filling representation of some inhaled general anesthetics. 1, xenon; 2, nitrous oxide; 3, cyclopropane; 4, chloroform; 5, halothane; 6, diethyl ether; 7, isoflurane; 8, desflurane; 9, sevoflurane. Atoms are color coded: light gray, carbon; white, hydrogen; blue, nitrogen; red, oxygen; green, chlorine; yellow, fluorine; magenta, bromine; dark gray, xenon.

anesthesia. At the very least, it facilitates the formation and testing of critical hypotheses. We return to these ideas toward the end of this chapter.

## GENERAL ANESTHETICS

Mechanistic searches are aided by clear structural motifs among the drugs that produce the end point. This permits a search for the complementary motif on the target macromolecules. Here too, general anesthetics fall short of the mark. A **structurally diverse** range of molecules is capable of producing a state of anesthesia (Fig. 36-1). Nonetheless, certain physicochemical features appear to be important. For

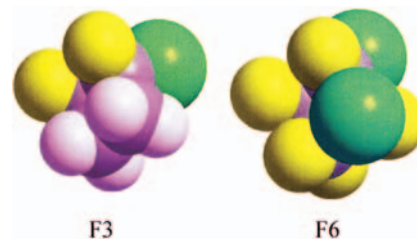
example, **hydrophobicity** correlates exceedingly well with anesthetic potency, with only a few exceptions (Fig. 36-2). Although impressive, this only suggests that the domain(s) producing the effects is hydrophobic, limiting the choices to most proteins and all lipid membranes. Other more subtle features of the drugs seem to be important. Most inhaled anesthetics have an asymmetric distribution of hydrogen atoms, giving the molecule enough of a dipole moment to interact favorably with more polar environments. The few **nonimmobilizer** drugs (Fig. 36-3), introduced to allow for selection of relevant targets,<sup>3,4</sup> lack this feature and therefore are extremely insoluble in water.<sup>4</sup> Although the mechanism of



**FIGURE 36-2.** Log/log plot of the oil/water partition coefficient against human minimum alveolar concentration (MAC) in atmospheres for 12 inhaled anesthetics. Note the tight correlation over almost five orders of magnitude, strongly suggesting that the anesthetic site(s).

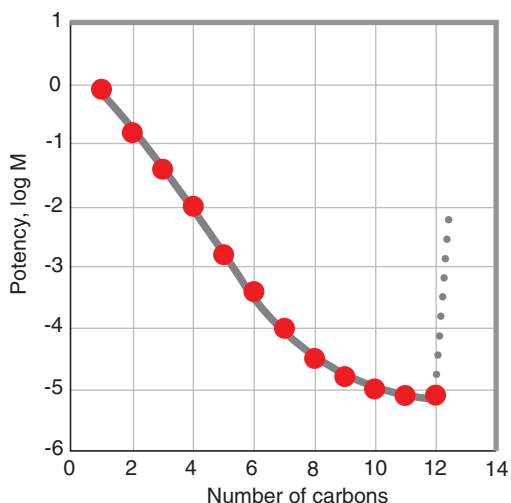
their failure to cause anesthesia is not clear, it likely is related to their low dipole and poor solubility in water and therefore, lower occupancy in targets. Also, there is a clear relationship between potency and the presence of halogens (and their size) on the anesthetic molecule. Given that the halogens are uncharged atoms, then polarizability must be important, another indication that the sites responsible for anesthesia are relatively polar. That the focus is beginning to narrow on protein as the target still cannot exclude lipid because the general head group region has both polar and hydrophobic character.

Related to hydrophobicity is the **cutoff effect** (Fig. 36-4). In a homologous series of compounds, for instance, *n*-alcohols, anesthetic potency increases progressively as the hydrocarbon chain lengthens, until a certain length is reached and then anesthetic potency is abruptly lost. This typically occurs at 10–14 carbons, depending on assay and end point, and has been used to implicate specific molecular targets.<sup>5</sup> Interpretation of this phenomenon has varied, but is conventionally viewed as indicating the geometric capacity of a binding site—a molecular ruler. Of course, this interpretation requires that the alcohol actually bind to the target in question, a requirement that is almost never tested. In the one case where it was, a cutoff effect was observed with no apparent loss in binding affinity,<sup>6</sup> suggesting that cutoff is due to mechanisms other than steric hindrance, perhaps (like the nonimmobilizers) to the extremely low solubility of the



**FIGURE 36-3.** Two nonclinical molecules used for research purposes. The molecule on the left [chlorotrifluorocyclobutane (F<sub>3</sub>)] has anesthetic properties similar to isoflurane, whereas the molecule on the right [dichlorohexafluorocyclobutane (F<sub>6</sub>)] is devoid of anesthetic activity, despite being very soluble in oil. Because F<sub>6</sub> is much less soluble in water than F<sub>3</sub>, this suggests the anesthetic site(s) on molecular targets transducing the minimum alveolar concentration (MAC) end point has some polar character in addition to being hydrophobic.



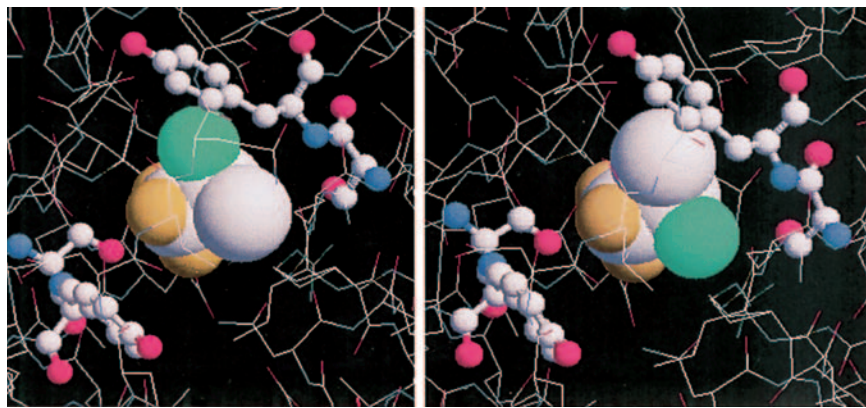


**FIGURE 36-4.** The cutoff effect. As one ascends a homologous series of compounds, such as the *n*-alkanols, anesthetic activity increases until about C12, where activity is abruptly lost with the addition of just one more carbon. The cutoff point is different for different chemical series, in different *in vitro* systems, and in different organisms. Long interpreted as reflecting the dimensions of the anesthetic site on an important molecular target, a form of molecular ruler, the progressive decline in water solubility of the long-chain molecules suggests that occupancy of sites may decline for reasons unrelated to site dimensions. This suggests that the mechanism for failure of long hydrocarbons and nonimmobilizer molecules to produce immobility is similar.

long compounds in water. The final blow to the cutoff effect being useful as a molecular ruler of important protein binding sites was the demonstration that polyhydric alcohols (essentially *n*-alcohol polymers) retained anesthetic activity at molecular sizes in large excess of the *n*-alcohol cutoff.<sup>7</sup>

The final drug feature that has been used to aid the search for targets is **enantioselectivity**. Many of the inhaled anesthetics have chiral carbons, indicating that mirror image molecules are possible (Fig. 36-5). Such pairs are identical from a physico-

chemical standpoint but have a different arrangement of atoms in space, which would be expected to interact with a unique spatial distribution of atoms in a protein binding site, for example, more specifically than in a more fluid-like assembly of lipid molecules. Small differences in the immobilizing potency of the isoflurane enantiomers were found,<sup>8</sup> and in at least one species for the halothane enantiomers.<sup>9</sup> Although this has the potential for selecting relevant targets, the small degree of enantioselectivity (~20%), combined with the fact that



**FIGURE 36-5.** Stereoselective binding of halothane enantiomers. Binding of racemic halothane in hydrophobic cavity of apoferritin revealed a 2:1 preference for the *S*-enantiomer over the *R*-enantiomer. This provides credibility that the small degree of enantioselectivity observed *in vivo* is transduced through protein targets.

many proteins display enantioselectivity for inhaled anesthetics, renders the potential small. It is even possible that the few chiral molecules in phospholipid bilayers (i.e., cholesterol), or that very general and conserved chiral features of proteins (such as L- $\alpha$ -amino acids and uniquely handed helices), contribute to this small degree of selectivity.

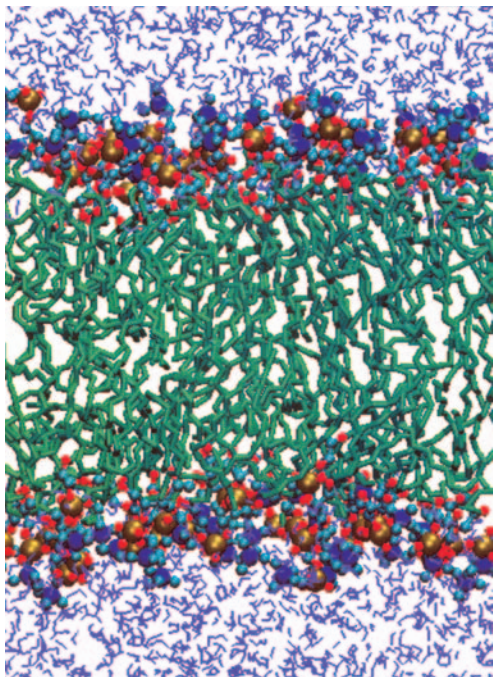
Thus, in general, drug features have given us only general clues to the identity of important anesthetic targets and the underlying mechanisms of their dysfunction.

## ANESTHETIC TARGETS

### Lipid Bilayers

The dramatic correlation of hydrophobicity with anesthetic potency predated an understanding of protein interiors, so initial focus fell on the obvious oily candidate: the lipid bilayer (Fig. 36-6). The idea was that solubilization of the hydrophobic anesthetic into the thin lipid membrane altered a property sensed by the cell or by proteins wholly or partially embedded in the lipid. The crucial property was (and still is) unclear, so surrogate properties that could be easily measured, such as the gel-liquid phase transition, were studied extensively. Changes induced by the anesthetics in these properties could be demonstrated, but several features gradually emerged that diminished enthusiasm in the lipid membrane as an important transducer of anesthetic effects. First, measurable changes in phase transition at clinical concentrations of anesthetic were small, mimicked by only 1–2°C. Second, other compounds that dissolved well and produced similar effects in these bilayers (e.g., nonimmobilizers) did not produce anesthesia. Finally, the emergence of protein-centered theories shifted attention away from the lipid bilayer.

A shift in attention, however, does not suffice to eliminate the potential for an important contribution. New theories, coupled with improved understanding of the lipid bilayer and its interaction with anesthetics and membrane protein, call for a return to the lipid bilayer at some point to test whether anesthetic modulation contributes to *in vivo* anesthetic effects. For example, it is clear that phase transitions are not a relevant feature



**FIGURE 36-6.** Snapshot of a lipid membrane in a molecular dynamics simulation. This gives an idea of the complexity and organization of this essential and widely distributed structure. Our poor understanding of its communication with proteins embedded in it, and of effects of solutes distributed in it, have conspired to make it difficult to eliminate the lipid bilayer as a viable potential target for transducing some anesthetic effects.

of biologic membranes, so conclusions based on their measurement must be viewed cautiously. It now is clear that anesthetics distribute in the lipid bilayer heterogeneously, less in the center (acyl trough) and more toward the outer edges. This asymmetric distribution can influence lipid properties not easily measured, such as lateral pressure (Fig. 36-7), but posited to have a potent effect on membrane protein conformational transitions.<sup>10</sup> Interestingly, even though nonimmobilizers partition well into the lipid bilayer, the distribution within the bilayer is very different than that of an anesthetic,<sup>11</sup> yet again opening the door for lipid theories. Furthermore, lipid microdomains exist (e.g., lipid rafts) that appear to organize specific proteins into functional groups may have a higher affinity for inhaled anesthetics (because of unique lipids or unique proteins), increasing the opportunity for anesthetic effects on signaling pathways.<sup>12</sup> Finally, in most assays of membrane protein activity (e.g., ion channels), protein is functionally inseparable from the lipid. For example, mutagenesis of membrane protein by itself cannot be directly used to implicate a protein target because the mutation also might influence the interac-

tion with lipid. Thus, it is premature to rule out the biologic lipid membrane as an important direct target for the inhaled anesthetics.

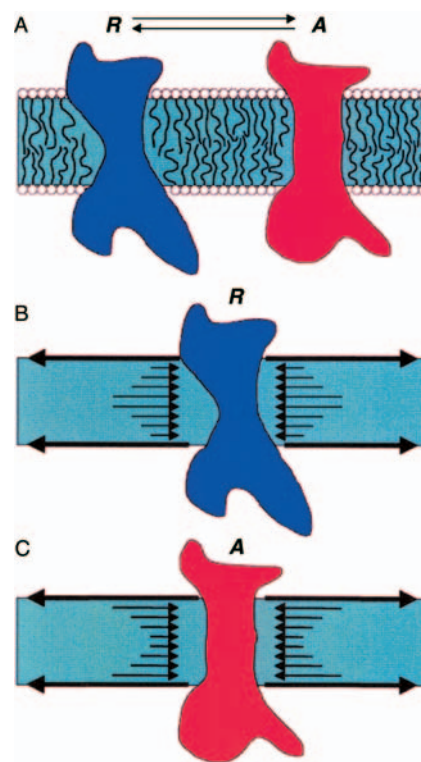
### Proteins

Proteinaceous components of the cell as targets for anesthetics were first proposed by Claude Bernard in 1875 but did not gain favor until the demonstration that the activity of lipid-free preparations of protein were reversibly influenced by anesthetics, and in a way that reproduced the correlation with hydrophobicity.<sup>13</sup> Because this paralleled the understanding that the interior of proteins are as hydrophobic as that of lipid membranes, this association should not have been surprising. When combined with enantioselectivity and an ability to measure and alter protein function, especially in ion channels, protein-centered theories rapidly became favored. Many protein targets have been proposed and studied, and we review some of them briefly. *However, at this time it is safe to conclude that not a single protein target, or even class or family of protein targets, has been proven to play the central role in inhaled anesthetic action.* This is not to say, however, that favored candidates have not emerged, especially for

the injectable induction agents. We first review some essential basics of protein–ligand interactions as they relate to anesthetics and then present the evidence for specific targets.

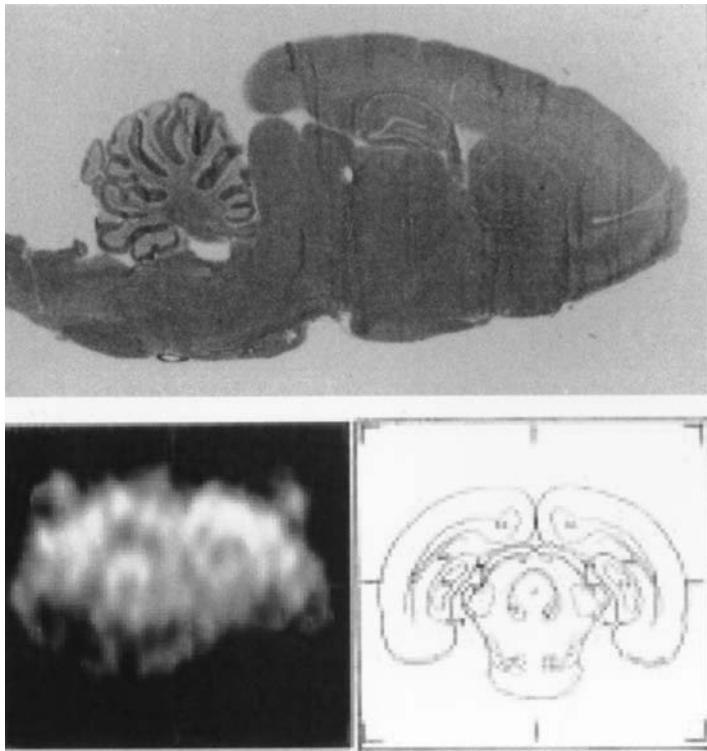
### Binding

The submolecular mechanism by which the anesthetic causes a change in protein function or activity must first involve a binding event—formation of drug–target complex. This often is the initial criterion for establishing the relevance of any proposed drug target but has not been used for inhaled anesthetics because the affinity for protein targets is low, and they appear to be fairly promiscuous, binding to many targets. Both nuclear magnetic resonance spectroscopy and photolabeling have sug-



**FIGURE 36-7.** Lateral pressure hypothesis of membrane–protein communication. **A.** Membrane protein in two conformations: R for resting, and A for activated. The A conformer requires some expansion in the membrane center. **B.** Membrane lateral profile of vectors that favors the R state. **C.** Pressure profile that favors the A conformer. A solute that distributes unevenly across the membrane will, of necessity, alter this lateral pressure profile, resulting in a modulation of conformational state and therefore of activity. Molecular dynamics simulations predict that anesthetic molecules do distribute unevenly across the lipid bilayer. (Used by permission,<sup>104</sup> Copyright 2001 American Society for Pharmacology and Experimental Therapeutics.)





**FIGURE 36-8.** Top. Autoradiogram of rat brain sagittal section photoaffinity labeled with  $^{14}\text{C}$ -halothane. The degree of halothane binding is indicated by the level of darkness; no other stain has been applied to this section. There appears to be no regional preference, and excess unlabeled halothane reduces incorporation by ~70% (image not shown), indicating that this distribution represents specific binding. Bottom left.  $^{19}\text{F}$ -Nuclear magnetic resonance coronal section of in vivo rat brain after equilibration with sevoflurane. Bottom right. Orientation of the left panel. Both experiments demonstrate widespread anesthetic distribution in mammalian brain. (Fig. 36-8B used by permission.<sup>105</sup> Copyright 1995 Lippincott Williams & Wilkins.)

gested a large number of protein binding targets (27) and no particular regional preference in the brain (Fig. 36-8).<sup>14</sup> This renders untenable the conventional radioligand binding approach for discovering targets. Whether anesthetics also significantly alter the function of a large number of proteins is not clear, but even if only a minority of the binding target pool, the number of contributing targets is still large.

**Nature of the Binding Site** Until recently, the nature of anesthetic binding sites has been inferred from correlations with anesthetic structural or physicochemical features. For example, the Overton-Meyer relationship suggested that sites are in the hydrophobic interior of proteins, and the relationship of halogen size and asymmetric hydrogens with potency suggested that polar amino acids must contribute to these sites. High-resolution structures of a clinically used inhaled anesthetic complexed to a protein target have been revealed for two protein models: serum albumin<sup>15</sup> and apoferritin (Fig. 36-9).<sup>16</sup> Although

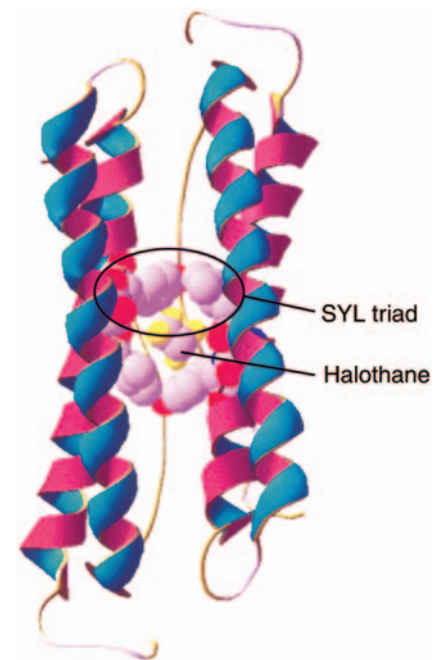
unlikely to transduce important effects of anesthesia, the affinity of both proteins (see later) suggests substantial occupancy at clinical concentrations of anesthetic (~0.2 mmol/L), and thus the binding site architecture is likely to bear resemblance to those in targets underlying effects relevant to anesthesia. Both structures show occupancy of preexisting internal packing defects, also known as *cavities*. The apoferritin example goes further to suggest that a packing density of just over half full represents an optimal balance between enthalpic and entropic forces. Finally, both examples suggest that polar (but uncharged) amino acids contribute to the strength of binding. In the apoferritin cavity, two SYL (serine-tyrosine-leucine) triads interact with either halothane or isoflurane atoms to produce the highest affinity binding yet described for these compounds (Fig. 36-9). The stringency of these features is not yet clear, but preliminary estimates based on current entries in the Protein Data Bank (<http://www.rcsb.org/pdb>) suggest that <1% of the proteome (~3000 proteins) have

comparable binding sites for volatile anesthetics.

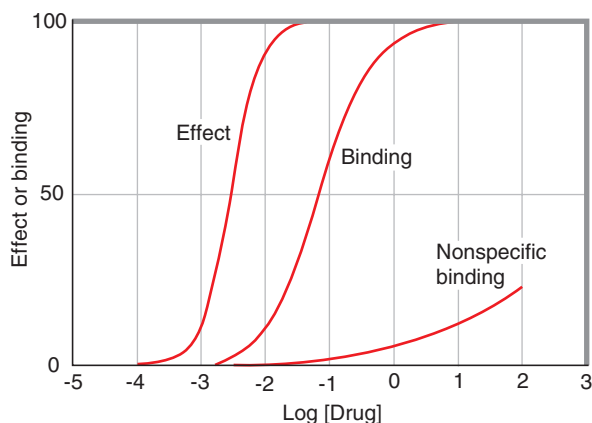
### Affinity and Stoichiometry

Affinity of a drug for a site, indicated by the association constant ( $K_a$ ) or, more commonly, the dissociation constant ( $K_d = 1/K_a$ ), is experimentally defined as the drug concentration at which half the sites are occupied. It is more properly called “apparent” affinity, because other aspects of the mixture can modify the true affinity of the ligand–site complex. Relevant to this is whether the binding event “causes” a conformational change (see later) in the protein to which it binds. If so, the apparent affinity will be lowered by the amount of free energy used to change the protein conformation (Fig. 36-10). Thus, a set of binding site features that produces a 10  $\mu\text{mol/L}$  absolute  $K_d$  with an anesthetic perhaps will have an *apparent*  $K_d$  of 1 mmol/L, if approximately 2 kcal/mol of free energy is required to change the protein conformation.

The slope of the relationship between drug concentration and occu-



**FIGURE 36-9.** High-resolution structure of the high-affinity anesthetic binding site in an interface between two subunits of apoferritin. The halothane is shown in the middle, coordinated by two SYL triads (see text for details). Note that the parallel helical bundle motif of this binding domain is found in the transmembrane region of the ligand-gated ion channel subunits and in many receptors (see Figs. 36-14 and 36-15).



**FIGURE 36-10.** Sigmoid-shaped dose–response curve for a typical anesthetic-like drug. The effect curve often is most left shifted is the steepest. The binding effects that underlie the effect usually is shifted to the right, and may or may not have the same slope, depending on the number targets, the number of sites per target, and whether the sites interact (cooperativity). This indicates that molecular sites underlying a specific effect do not necessarily need to be fully occupied to reach full (saturation) effect. Nonspecific binding (that generally not associated with the primary effect) is most right shifted and may appear to be linear in many experiments.

pancy, the Hill slope, is an indication of both the number of sites on a target and whether they interact. For example, a single site should always have a Hill slope of 1, reflecting a relationship where the site goes from 0–100% occupancy over an approximately 100-fold change in drug concentration (Fig. 36-10). Multiple sites on a single target also can demonstrate a Hill slope of 1, or they can “cooperate,” increasing the slope. In other words, if occupancy of the first site enhances occupancy of the second (as in oxygen binding by hemoglobin), the slope will rise, although rarely over 2 or 3. Although difficult to measure as indicated, anesthetic  $K_d$  values in model proteins typically are approximately 1 mmol/L, and Hill slopes are generally 1 or slightly greater, even though more than one binding site has been found in most proteins studied. Serum albumin has at least six sites,<sup>15</sup> apoferritin 12,<sup>16</sup> and the intact nicotinic acetylcholine receptor (nAChR) 15–20.<sup>17–19</sup> As might be deduced from the preceding paragraph, occupancy of multiple sites is a potentially powerful method of donating free energy to the protein in order to alter its conformation. Occupancy of only one additional binding site in a protein produces as much free energy as an approximately 10-fold increase in affinity.

An issue frequently causing confusion has been what affinity an important anesthetic target should display for anesthetics. Prevailing logic has suggested that, for a target to be relevant to a

particular end point, for example, immobility, the dissociation constant for the anesthetic–target complex should approximate that achieved at MAC. However, this logic holds only if one assumes that this target is alone capable of producing the end point, an assumption that rarely is valid. Furthermore, even if the target is wholly responsible for the end point, it is difficult to know the expected  $K_d$  because drug efficacy at this target is not known. It is rare for the relationship between receptor occupancy and median effective concentration ( $EC_{50}$ ) to be linear; thus, predicting that more than some degree of occupancy should be anticipated at clinical concentrations is difficult. As our discussion on Hill slopes indicates, this limits the expected  $K_d$  to an approximately 100-fold range.

### Coupling Mechanism

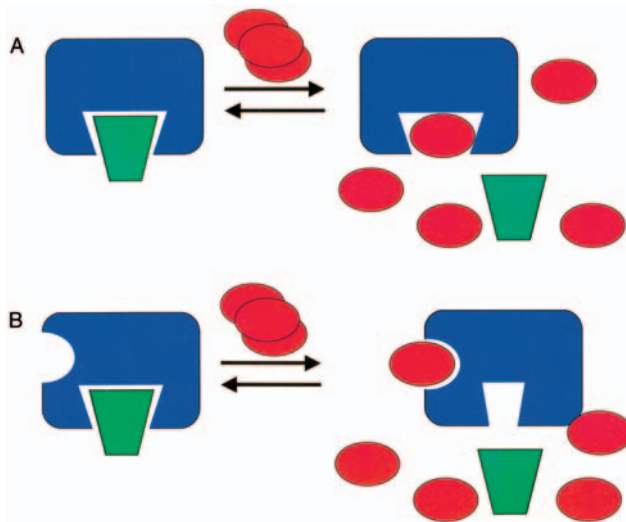
As discussed earlier, the anesthetic can only alter the protein’s activity through a contribution of binding energy—through either the affinity or the stoichiometry of the complex. This binding energy alters protein activity through at least three potential, and partially overlapping, mechanisms. The first mechanism, **competition**, occurs when the drug–protein complex is strong enough to compete with the binding of an endogenous ligand, therefore inhibiting the associated effect (Fig. 36-11). This was the mechanism initially proposed for anesthetic inhibition of firefly luciferase.<sup>13</sup> The two forms of competition are isosteric and allosteric. In isosteric competition, the drug occupies the same

binding site as the endogenous ligand, physically preventing binding. An anesthetic example is halothane occupancy of the retinal cavity in the G-protein coupled receptor (GPCR) rhodopsin.<sup>20</sup> In allosteric competition, the drug binds elsewhere in the protein, altering the structure sufficiently to disfavor ligand binding in its otherwise unoccupied site. Clear examples of this have not emerged, but there are examples of a closely related form of allosterism, **cooperativity**. In this case, allosteric binding of anesthetic favors a conformation that binds the endogenous ligand more tightly. In firefly luciferase, for example, the binding of adenosine triphosphate (ATP) and anesthetic is cooperative.<sup>21</sup> Cooperative effects of agonist and anesthetic in some receptors may also be due to binding cooperativity.<sup>19,22</sup>

The second general category of drug–effect coupling is **ensemble modulation** (Fig. 36-12). Functional proteins exist in an ensemble of conformations, each of which is associated with some aspect of activity. Resting, active, desensitized, etc., all describe states of activity with a specific underlying protein conformation. Some conformers may possess binding sites for anesthetics that are more attractive than others and therefore are populated to a greater extent when the anesthetic is present. The anesthetic changes protein activity by selecting the most favorable conformer for binding and increasing its prevalence. One can immediately see the overlap with allosterism. Like allosterism, ensemble modulation can explain either an enhancement or an inhibition in protein activity, depending on which conformer has the most attractive anesthetic binding sites.

The final general mechanism for coupling binding to a change in protein function is **oligomerization modulation** (Fig. 36-13). Much protein activity and signaling is controlled by interactions with other proteins. In general, these interactions are highly specific but relatively weak so that they can be readily reversed. The protein–protein interface may include features attractive to an anesthetic, such as cavities. If these features are optimal when the proteins are linked, then the anesthetic will enhance the interaction or oligomerization; if they are optimal when separated, anesthetics will disfavor oligomerization. Examples of the former appear to be the sarcoplasmic reticular calcium adenosine triphosphatase (AT-





**FIGURE 36-11.** **A.** Example of isosteric competition, where the anesthetic (red oval) achieves a high enough concentration to actually replace the endogenous ligand (green trapezoid) in its site of action. **B.** Example of allosteric competition, where the anesthetic binds preferentially to a conformer that disfavors binding of the endogenous ligand, but at a distant site.

Pase)<sup>23</sup> and of the latter the PSD-95 PDZ domain proteins (see later).<sup>24</sup> The synaptic vesicle machinery is highly dependent on these oligomerization events, and components that might be modulated by anesthetics in this way have been identified.<sup>25</sup> It should be apparent that this mechanism has important implications as to the number of potential effects these drugs might have. Whereas the set of all proteins expressed—the proteome—is very large (~300,000 proteins), the number of protein-protein interactions, the so-called *interactome*, is much larger. Thus,

anesthetic effects at the interactome level, produced by effects at the interface, could dwarf those at the individual protein level.

An important caveat in this discussion is that all binding interactions do not necessarily result in an important change in protein activity. It is possible that an anesthetic binding site is precisely preserved across the entire conformation or oligomerization ensemble, in which case anesthetic binding will not alter the distribution of conformers and therefore will have no effect on activity. How commonly this

form of “unproductive” binding occurs is not clear.

### Summary

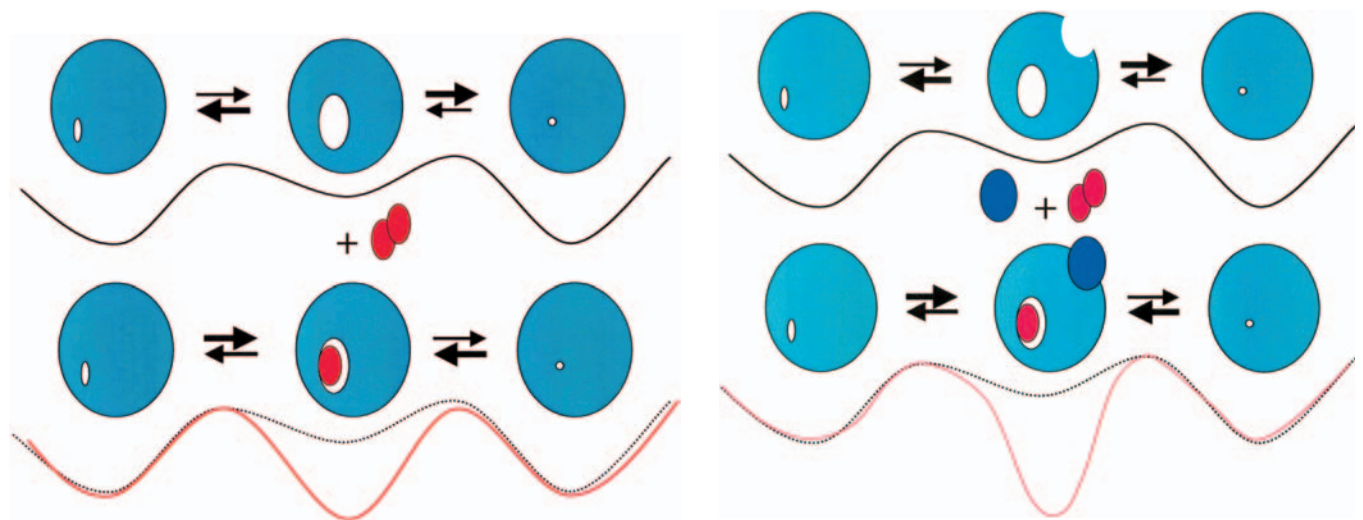
Any or all of these general coupling mechanisms may be involved in anesthetic-induced protein dysfunction. The distinction often is difficult but is important if we are to intelligently modify the drugs to favor or disfavor specific interactions.

### Potential Protein Targets

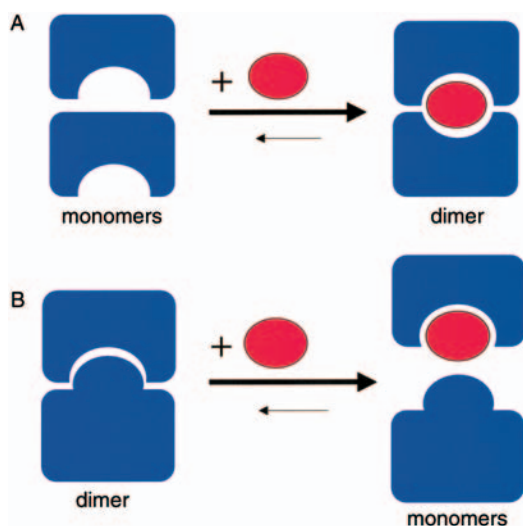
As suggested earlier, the anesthetic sensitivity of a number of protein systems has been studied over the past few decades, and, remarkably, many are altered within only a 10-fold range of clinical concentrations. We briefly review some of these systems and the evidence for inclusion. This discussion is not intended to be a comprehensive list of those proteins studied; many have come and gone. Rather, we focus on some of the more recent and compelling candidates, especially those with associated *in vivo* evidence for a contribution.

### Soluble

As pointed out earlier, proteins have domains as hydrophobic as those of the lipid bilayer, and it now is clear that anesthetics bind to and influence the activity of many soluble proteins. Much of the published work involved model systems, such as firefly luciferase, serum albumin, and apoferritin, which are un-



**FIGURE 36-12.** Simple ensemble of protein conformers, with the relative free energy shown beneath. **A.** Anesthetic favors the conformer with the most attractive cavities, lowering its free energy (red line) and increasing its concentration. **B.** Same cartoon demonstrating cooperativity, but in this case the anesthetic-preferred conformer also preferentially binds an endogenous ligand. Thus, free energy is lowered even further in the presence of both ligands, more dramatically enhancing the population and therefore activity associated with this conformer. (Fig. 36-12A used by permission.<sup>104</sup> Copyright 2001 American Society for Pharmacology and Experimental Therapeutics.)



**FIGURE 36–13.** Example of oligomerization modulation. **A.** Anesthetic binding site is created by dimerization of a monomer that otherwise has no binding site. Thus, the anesthetic will be observed to increase the population of dimer. **B.** On the other hand, occupancy of an anesthetic site in the monomer disfavors binding of the second protein because of a steric clash. In this case, the anesthetic will be observed to decrease the population of dimer. Although both mechanisms may occur in vivo, the situation shown in A probably is more likely.

likely to contribute directly to anesthesia. However, plausible candidates, centrally located in signal transduction cascades or cellular machinery, have emerged. For example, protein kinase C (PKC) transduces receptor activation to phosphorylation of key membrane proteins, such as certain ion channels and other receptors, and has been shown to bind general anesthetics.<sup>26</sup> Alteration of its activity by anesthetics would be expected to have generalized and widespread cellular effects that might contribute to anesthesia, although controversy exists as to both the expected and observed directions of effect (reviewed by Rebecchi and Pentylala<sup>27</sup> and Gomez et al.<sup>28</sup>). Initially thought to be inhibited by general anesthetics, later studies performed under physiologic conditions showed PKC to be activated. This one system demonstrates the complexity of sorting out anesthetic targets and effects. The observed effects in this relatively simple physiologic assay can result from anesthetic effects on membrane lipid, stimuli–kinase coupling, kinase–target coupling, or the phosphorylated target itself. Anesthetics might interact with any component. Studies in intact, genetically altered animals are in progress but to date have not provided unambiguous answers. Further studies on PKC isoform distribution and activity are required to sort out the influence of anesthetics and potential contribution to the anesthetic state.

Another attractive anesthetic target would be any of the components of the cellular cytoskeleton, motility apparatus, and vesicle transport systems. These systems subserve a variety of basic cellular functions, the alteration of which would manifest as a decrease in cellular activity or communication. For example, tubulin forms microtubules, which are crucial elements of cellular scaffolding and motility. Assembly of the monomer into the large tubular oligomer apparently is altered by anesthetics, albeit at high concentration.<sup>29</sup> Entire mechanisms for general anesthesia based on microtubular dynamics and organization have been proposed,<sup>30</sup> and some experimental support has been reported.<sup>31</sup> Oligomerization of actin, a protein acting with myosin and other proteins to subserve cellular motion, is inhibited by anesthetics and is another relatively unexplored potential general mechanism of anesthesia.<sup>32</sup>

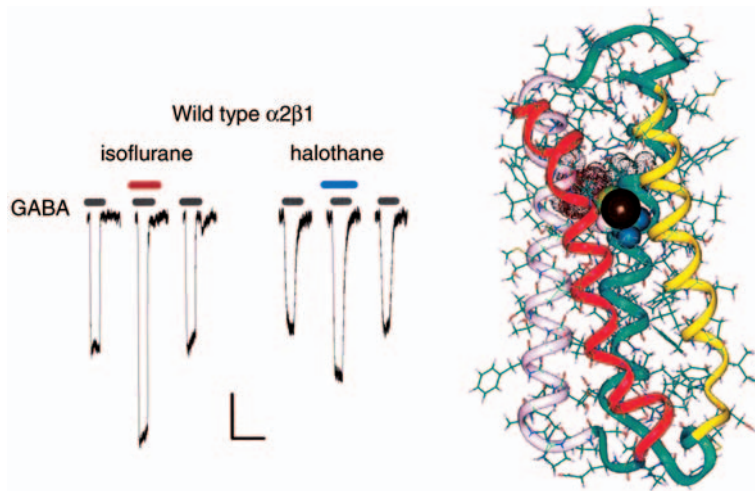
Anesthetics also affect the synaptic vesicle machinery. A decrease in synaptic transmission is generally agreed to accompany general anesthesia; therefore, inhibition of synaptic vesicle transport, fusion, and release is a plausible general mechanism of central nervous system (CNS) dysfunction. Evidence comes from several disparate sources. In a genetic screen of the nematode *Caenorhabditis elegans*, mutations in the vesicle fusion soluble N-ethylmaleimide sensitive attachment factor (SNARE)

proteins were found to produce resistance to some anesthetic end points.<sup>25</sup> Furthermore, one component, syntaxin, and various SNARE assemblies have been shown to bind isoflurane using nuclear magnetic resonance approaches.<sup>33</sup> Transcript profiling<sup>34</sup> in mammals has shown an upregulation of synaptotagmin, another vesicle release protein. The latter does not necessarily implicate synaptotagmin as a direct anesthetic target, but it lends credence to the idea that synaptic vesicle release is inhibited during general anesthesia. Other synaptic targets implicated are the PDZ domain proteins. These domains are responsible for fusion events (oligomerization) between proteins and are intimately involved in synaptic vesicle trafficking. Work has shown that anesthetics disrupt the oligomerization, and the probable binding site responsible has been identified in a truncated version of PSD-95.<sup>24</sup>

## Membrane

**Ion Channels** A variety of proteins embedded in, and dependent on, the lipid bilayer for their activity are altered by general anesthetics in *in vitro* assays. Most studied are the ion channels, due in large part to the availability of electrophysiologic approaches for measurement of function. Of the ion channels, most emphasis has been placed on the ligand-gated cys-loop receptor–channel complex, the prototype of which is the nAChR. These proteins are transmembrane heterooligomers of five subunits arranged around a central ion channel. A variety of anesthetics inhibit this excitatory channel, perhaps by promoting the desensitized state via cooperative binding with acetylcholine; the probable basis for the muscle relaxation associated with many general anesthetics. Volatile anesthetics bind this receptor specifically, and a site underlying cooperative binding behavior has been tentatively identified.<sup>17,19</sup> The nAChRs are also found in the brain, adding credibility to the possibility that alterations in their activity contribute to anesthesia. *In vivo* support of an important role for these receptors is still lacking.

$\gamma$ -Aminobutyric acid (GABA)ergic neurotransmission was identified 20 years ago as a plausible substrate for anesthetic effects,<sup>35</sup> so recent emphasis has been placed on the inhibitory GABA type A (GABA<sub>A</sub>) and glycine receptor–ion channel complex as potential contributors to at least the sed-



**FIGURE 36-14.** Enhancement of activity of  $\gamma$ -aminobutyric acid type A ( $GABA_A$ ) chloride conductance by isoflurane and halothane. In both cases, the effect of an endogenous ligand, GABA, is significantly enhanced by the presence of the anesthetic. The probable basis for this is shown in Fig. 36-12B, and the region of the protein thought to transduce this effect is shown on the right by the hypothetical placement of an anesthetic in the interhelical space. Note the similarity of this hypothetical structural motif and binding site to the crystal structure shown in Fig. 36-9. (Fig. 36-14 used by permission.<sup>106</sup> Copyright 2001 by the Society for Neuroscience.)

ative or amnestic component of general anesthesia. Like the nAChR, many general anesthetics (most volatile ones and alcohols) probably bind cooperatively with agonist (either GABA or glycine). However, because these receptors undergo desensitization more slowly than the nAChR, the final effect is enhanced agonist-stimulated currents instead of inhibition (Fig. 36-14). These ion channels are inhibitory (produce hyperpolarization), so enhancement of their activity is expected to inhibit synaptic transmission. The difficulty of isolating or expressing sufficient  $GABA_A$  receptor of any subunit composition for biochemical studies so far has precluded the demonstration of specific volatile anesthetic binding.

Most studies to date have focused on the action of volatile anesthetics on  $GABA_A$  receptors mediating rapid synaptic transmission. However, volatile anesthetics also act on  $GABA_A$  channels mediating tonic inhibition. Tonic  $GABA_A$  channels are found in many areas of the nervous system, including the hippocampus and the spinal cord interneurons. Although the precise receptor subunits composing the tonic  $GABA_A$  channels remain unknown, the  $\alpha_5$ - and  $\delta$ -subunits likely are involved because tonic currents inhibited by bicuculline are not seen in null-mutant mice devoid of these subunits. These  $GABA_A$  channels are more sen-

sitive to agonist than the rapid type, requiring only low micromolar concentrations of GABA for opening, concentrations found in even extrasynaptic regions of a nerve cell. Similarly, tonic  $GABA_A$  channels are more sensitive to volatile anesthetics than those mediating rapid synaptic transmission.<sup>36</sup> Because of this sensitivity and expression in the hippocampus, it is reasonable to hypothesize that these channels mediate the amnestic component of volatile anesthetic action. A thorough characterization of the volatile anesthetic effects on the various tonic  $GABA_A$  null mutant mice has not been reported.

In an attempt to both find sites of action as well as to implicate anesthetic targets, site-directed mutagenesis has been coupled with electrophysiology. For example, an asparagine to methionine mutation at position 265 in the  $GABA_A \beta_3$  subunit largely eliminated enflurane enhancement of GABA action in vitro, but the knock-in mouse, in which the wild-type  $\beta_3$ -subunit was replaced by the point mutant, had minimally altered righting reflex sensitivity or MAC.<sup>37,38</sup> Greater success was obtained with the injectable general anesthetics (induction agents) in this same model. For example, like enflurane, etomidate and propofol failed to enhance GABA-evoked currents in vitro, but in this case, the whole animal sensitivity to both inject-

able drugs was significantly diminished. The technology of mutant receptor knock-in is far superior to an overall elimination of the receptor produced by the knock-out technology because the normal cellular process that regulates expression of the wild-type receptor is preserved. Based on structure-activity studies demonstrating the role of both  $\alpha$ - and  $\beta$ - $GABA_A$  subunits<sup>39</sup> as well as other ligand-gated channels in determining volatile anesthetic responsiveness in in vitro expressed receptors, a multiple knock-in mutant mouse in which many sites are simultaneously altered is more likely to exhibit relative resistance to the volatile anesthetics.

Another hypothesis is that the two-pore domain family of background K (KCNK) channels is involved in volatile anesthetic action. This gene family encodes for  $K^+$ -selective ion channels with a common structural feature of two protein domains putatively lining the ion channel and four transmembrane domains. Two two-pore domain proteins are thought to assemble as a dimer, creating a complete protein complex with a functional  $K^+$ -permeable ion channel normally open at all physiologic membrane potentials, thus contributing to the background leak K channel critical in determining the resting membrane potential and regulating neuronal excitability.<sup>40</sup> Opening of channels encoded by two members of the KCNK family, TREK-1 and TREK-2, and more recently a third member, TRESK, are enhanced by volatile anesthetics, thereby hyperpolarizing the cell membrane. However, the enhancement is not seen in all the family because the channel activity of a closely related member, TRAAK, is not affected. As in the case for  $GABA_A$  receptors, the hypothesis that the anesthetic-responsive KCNK channels play a role in the general anesthetic action at the whole animal level was examined and confirmed in TREK-1 knock-out mice. For example, mice without the TREK-1 gene were approximately 20% less sensitive to halothane, sevoflurane, desflurane, and chloroform (but not pentobarbital) as defined by the loss of righting reflex (LORR) and withdraw to tail clamp. Interestingly, an invertebrate analogue of this channel<sup>41</sup> was discovered a decade earlier in the pond snail,<sup>42</sup> pointing out the importance of information derived regardless of the model organism used.



Calcium channels have been studied for years because of the central role of calcium in intracellular signaling. Because of its importance, intracellular calcium is tightly controlled via many systems, including voltage- and ligand-gated channels, exchangers, ATPases, and soluble binding proteins. Many of these systems have been shown to be influenced by anesthetics, although in general the magnitude of effect is modest at clinical concentrations.<sup>43</sup> Nevertheless, small effects on calcium signaling may have large intracellular consequences<sup>44</sup> (see later discussion on relevance), so a summary here is justified. The effects of volatile anesthetics on even one subset of calcium channels, the voltage-gated calcium channels (CaVs), are variable, probably reflecting the molecular heterogeneity of the CaVs. Of the functionally characterized CaV, the N- and P-type channels, which are putative presynaptic channels regulating neurotransmitter release, were inhibited by inhaled anesthetics.<sup>45,46</sup> The best evidence supporting a possible role of inhibition of N-type CaV in the pharmacology of inhaled anesthetics comes from the observation that N-type CaV knock-out mice exhibited increased sensitivity to halothane,<sup>47</sup> although as noted elsewhere in this chapter, this is an extremely common observation regardless of the target manipulated. The T-type CaV channels, although not involved in synaptic neurotransmitter release, play an important role in generating spontaneous oscillatory bursting of groups of neurons in the thalamus thought to be involved in regulating the state of arousal and sleep. The T-type channels are significantly blocked by clinically relevant concentrations of the inhaled anesthetics.<sup>48</sup> The molecular mechanism of how these drugs inhibit the CaV channels is not known but appears to involve acceleration of channel inactivation and slowing of the recovery from this nonconducting state.<sup>49</sup> There is no evidence of anesthetic binding to these targets, so whether this electrophysiologic effect is mediated via anesthetic interactions with lipid or protein is uncertain.

Voltage-gated sodium channels (NaVs) play a key role in regulating neuronal excitability and therefore are a plausible target for the inhaled volatile anesthetics. However, NaVs were largely dismissed as a relevant target because initial studies indicated that high concentrations were required for inhibition in squid axons (reviewed by Elliott et

### BOX 36-1.

#### Isoform and State Dependence of Anesthetic Action

It now is clear that voltage-gated sodium channels (NaVs) constitute a family of closely related proteins with distinct physiologic and pharmacologic properties, although which isoforms are present in the presynaptic terminal remains unknown. Systematic comparison of the sensitivity of different NaV isoforms to isoflurane confirmed the differential sensitivity of the different isoforms to this volatile anesthetic.<sup>53</sup> Of curiosity is the observation that volatile anesthetics had no effect on the NaV1.8 tetrodotoxin-resistant isoform predominantly expressed in the primary afferent neurons thought to play a critical role in pain signaling, which could explain why volatile anesthetics exhibit no analgesic property. An additional confounder that may explain some of the inconsistencies reported in the literature is the fact that halothane inhibition of NaV was dependent on coexpression of protein kinase C.<sup>41</sup> Therefore, both the state of the NaV itself (resting vs inactivated) and the presence or absence of other modulatory proteins most likely influence the effect of volatile anesthetics on NaVs.

al.<sup>50</sup>). However, later studies of mammalian brain NaVs indicated that these channels are significantly inhibited by lower, more clinically relevant concentrations of volatile anesthetics.<sup>51</sup> In fact, these anesthetics displace specific ligand binding to GABA<sub>A</sub> receptors and the NaVs with approximately equal potency,<sup>52</sup> and rank-order effects appears to qualify the presynaptic NaV as a feasible target for contributing to general anesthesia (Box 36-1).

**Receptors** The dominant receptor type in the brain is the GPCR. This enormous family includes most of the neurotransmitter and sensory receptors, whether small molecule, peptide, or lipid. These receptors are monomeric and have seven transmembrane domains arranged like an envelope around a central cleft, or cavity. On the cytoplasmic face, GPCRs couple to the heterotrimeric (three different subunits) G-protein messenger systems. The native ligand binding site tends to be at various depths in the interhelical cavity, and although some features are conserved, the site can accommodate a wide variety of

ligand structure and chemistry (Fig. 36-15). Ligands range from small molecules (volatile odorants, catecholamines) to small peptides (endogenous opioids). That anesthetics act on these receptors is suggested by the anesthetic-sparing effect of agonists for the dopamine and  $\alpha_2$ -adrenergic receptors, in addition to alterations of activity of the eicosanoid receptors.<sup>54</sup> Finally, volatile anesthetics have been shown to bind the conserved agonist site in many of these receptors (Fig. 36-15),<sup>20</sup> producing either inhibition or excitation.<sup>55</sup> Effects downstream of these receptors (e.g., on the G-protein transduction pathway) are also possible. Evidence is ample for anesthetic effects on G-protein mediated signaling<sup>27,54</sup> and the importance to function in vivo. For example, *C. elegans* with diminished Go activity (a negative modulator of synaptic activity) was 2-fold resistant to isoflurane.<sup>56</sup> These effects probably are related to effects on the receptor, or the receptor-G interface, as evidence for



**FIGURE 36-15.** Structure of the prototypical G-protein coupled receptor (mammalian rhodopsin, PDB No. 1F88) showing the anesthetic binding site (blue object) located through photolabeling experiments. Occupancy of this interhelical hydrophobic site competes with native ligand (retinal), a mechanism shown in Fig. 36-10A. The general motif of an interhelical site in a parallel bundle (see Figs. 36-9 and 36-14) is retained. (Used by permission.<sup>20</sup> Copyright 2002 American Society for Pharmacology and Experimental Therapeutics.)



direct binding to any G-protein subunit or the heterotrimeric complex has not yet emerged.<sup>27</sup> This work is highly intricate because of the multiple complexes and states and at this time is unresolved.

**Mitochondria** Mitochondria have long been suspected as contributing to anesthetic action because of their obvious role in cellular energy production. However, the anesthetic concentrations required for inhibition of ATP production and the apparently slow kinetics for ATP depletion seemed to obviate their role. Recent evidence has renewed interest in the mitochondrion. First, signaling and feedback between mitochondria and cellular consumers of ATP is considerably more precise and rapid than originally thought, effectively eliminating the kinetic argument against their contribution to the anesthetic state. Second, mitochondrial genes have been implicated in unbiased genetic screens in simple organisms (see later). For example, mutations in a mitochondrial complex I subunit gene dramatically increased sensitivity to halothane, enflurane, and isoflurane. As expected, mitochondria isolated from this mutant had a reduced rate of oxidative phosphorylation in the presence of halothane.<sup>57</sup> Furthermore, several subunits of the oxidative phosphorylation complexes, including complex I, were found to bind halothane specifically.<sup>58</sup> Perhaps most importantly, children with biopsy-proven complex I disease were found to be extraordinarily sensitive to the anesthetic sevoflurane,<sup>59</sup> rendering this anesthetic target the only to date that has supportive evidence from the gene, the binding interaction, to the human. The underlying mechanism for how the altered mitochondrial function affects anesthetic sensitivity is unclear, but given the recent evidence that mitochondria modulates synaptic transmission through the regulation of presynaptic  $Ca^{2+}$  dynamics,<sup>60</sup> it is possible that the gas-1 mutation affects synaptic transmission. Another potential mitochondrial target is the VDAC-1, an anion channel also related to mitochondrial steroid synthesis and synaptic activity and implicated through halothane and neurosteroid binding assays.<sup>58,61</sup>

## Summary

A wide variety of molecular candidates have been examined, and although several are compelling, proof

for involvement in the in vivo anesthesia end point is still lacking. But how does one determine the relevance of a molecular interaction to the in vivo effect, especially when it is as complex as consciousness?

## MOLECULES TO BEHAVIOR

### How to Determine Relevance of In Vitro Assays

The plethora of potential targets, the imprecise definitions of anesthesia, the variable end points, and the low-affinity drugs have conspired to make it difficult to judge the contribution of molecular targets to drug behavior, an already difficult task. As a start, two broad concepts of anesthetic action have been proposed; one favors a single molecular target site (the “unitary” hypothesis), whereas the other proposes that anesthesia results from the combination of actions at many molecular targets (distributed hypothesis). Lipid theories are an example of unitary theories, as are those that focused on the  $GABA_A$  receptor. Distributed action hypotheses will require careful dissection of more molecular targets. Historically, the hunt for the volatile anesthetic targets has taken two general approaches: the study of effects on a well-defined and functionally or physically isolated target (bottom-up approach), and those that start with the anesthetic effect on an organism with the goal of defining the target responsible for the observed effect using either genetic or pharmacologic probes (top-down approach). Although both approaches have merits and limitations, it is the complex, dynamic coupling between “top” and “bottom” that has so far made clear conclusions difficult. Next, we discuss how information derived from one approach might contribute to testable hypotheses in the other, and how, when taken together, support for a neurophysiologic process (the “middle”) rather than an individual protein or behavior, emerges as a likely anesthetic target. It is important to realize that disruption of a process might have multiple contributing, and perhaps synergistic, molecular events.

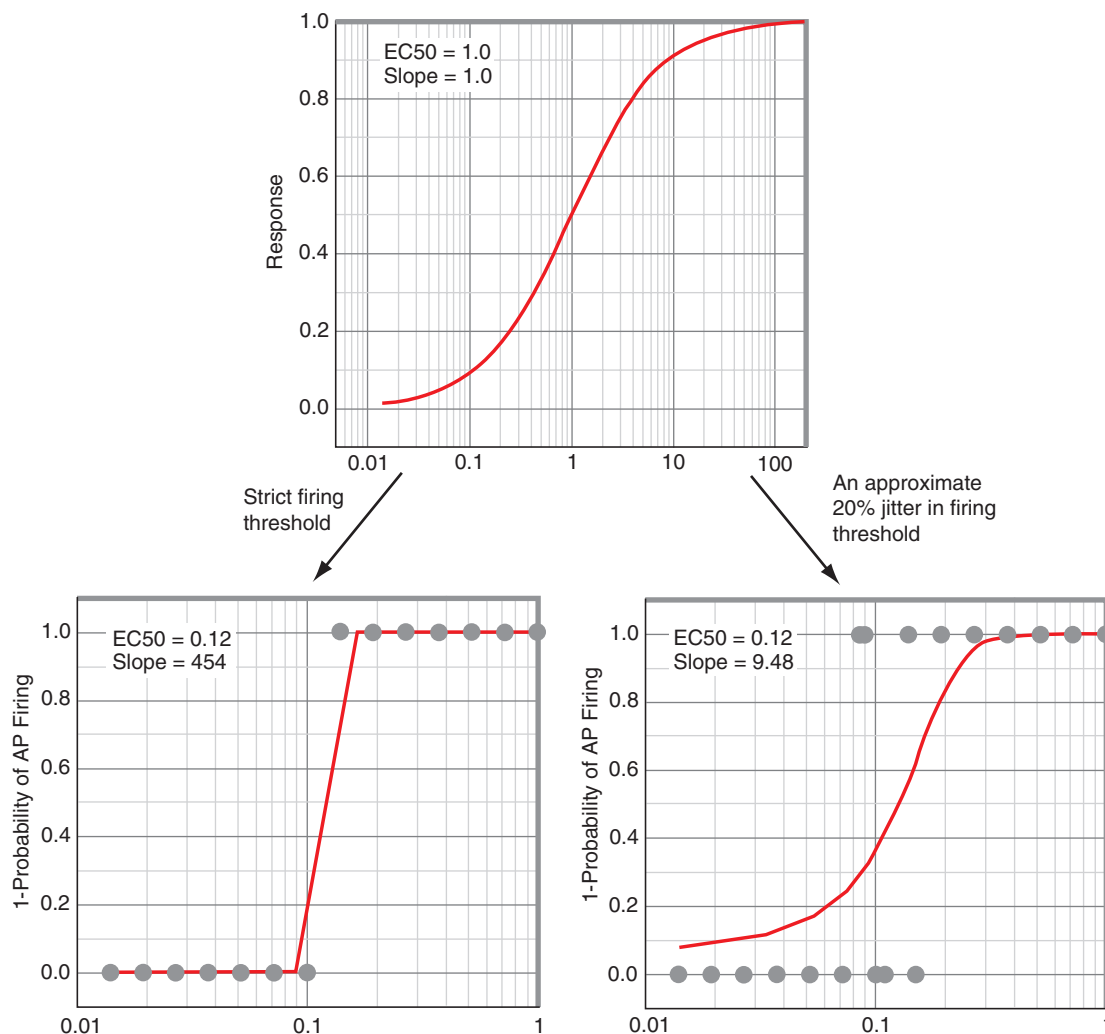
### “Bottom-Up” Approach

This approach has dominated much of the literature on the mechanism of general anesthetic action. Examples are studies of the biochemistry of an-

esthetic action on a specific signaling cascade, such as activation of a G-protein coupled pathway, studies on the structural nature of anesthetic binding sites in synthetic proteins, and electrophysiology of heterologously expressed ion channels. An important weakness of this approach is that it requires the identification of a system for study based on the inherently biased criterion, plausibility.

Plausibility has driven studies on the effects of anesthetics on the electrophysiology of ion channels expressed in heterologous systems such as the *Xenopus* oocyte. Such electropharmacologic studies have demonstrated effects (enhancement or inhibition) of anesthetics on essentially all the ion channels examined, albeit some requiring higher concentrations of anesthetics than others. Herein lies the principal weakness of the bottom-up approach. How do we determine whether a given effect on a given target contributes to a particular behavioral end point? Discrepancy between the anesthetic concentration required for the effect on a given target protein and the clinical MAC (either positive or negative) has led to a call for dismissal of some putative targets as biologically irrelevant.<sup>62</sup> As we discussed for the relationship between  $K_d$  and  $EC_{50}$ , the relationship between  $EC_{50}$  and MAC is not likely to be linear. The nervous system is complex, and inclusion of even one simple nonlinear process, such as generation of an action potential in a synaptic transmission (a threshold effect), can easily shift an apparently irrelevant in vitro concentration–response relationship to one that is quantitatively consistent with clinical MAC (Fig. 36–16).<sup>44</sup> Even at the single synapse level, spatial and temporal integration of postsynaptic currents contributing to the generation of action potentials will interpose further nonlinear processes between a drug action at a receptor and an observable output. A simple cascading of multiple processes, each well described by a conventional continuous concentration–response curve (i.e., Hill equation), will further shift the composite concentration–response curve to the left with an increase in the Hill slope.<sup>63,64</sup> Thus, a quantitative discrepancy in the experimentally and clinically observed concentration–response relationship cannot discredit the biologic relevance of a putative anesthetic target.

Given the apparent difficulty of linking molecular events and behavior, other



**FIGURE 36-16.** Effects of a single nonlinear threshold process on a continuous concentration–response relationship describing a volatile anesthetic (VA) action. **Top.** Simulated continuous concentration–response relationship of a VA action on a response described by  $\text{Response} = [\text{VA}] / ([\text{VA}] + 1)$ , yielding  $\text{EC}_{50} = 1.0$  and slope = 1.0. Suppose the response represents enhancement of  $\gamma$ -aminobutyric acid (GABA)ergic inhibitory post-synaptic current (IPSC) decay rate and that initiation of an action potential is inhibited by a 10% increase in the IPSC duration. If the threshold for action potential (AP) firing is set at exactly 10% with no variability, we obtain an effective concentration response described by a logistic equation with  $\text{EC}_{50} = 0.1$  and slope = 454. **Bottom left.** If we incorporate an approximate 20% jitter in the AP firing so that on occasion IPSC prolongation slightly  $> 10\%$  fails to inhibit and likewise a VA-induced event slightly  $< 10\%$  inhibits AP firing, we obtain the relationship on the right, described by  $\text{EC}_{50} = 0.1$  and slope = 9.48. **Bottom right.** Further cascading of more threshold events in between the continuous concentration–response, such as those obtained in *in vitro* studies, and the final anesthetic end point, such as immobility to noxious stimulus surely to be present in even the simplest neural pathway, will result in a large transformation of the overall concentration–response relationship, giving little credence to using the sensitivity or the slope of a concentration–response relationship to include or exclude a putative VA target.

“litmus test” criteria have emerged. For a target to be seriously considered as a candidate, most agree that the anesthetic must actually occupy a binding site in or on the target (see earlier). Thus, it is remarkable how many candidates are being favored in the complete absence of binding data. Other criteria used to establish relevance are Overton-Meyer behavior (correlation of potency with lipid solubility), enantioselectivity, sensitivity (correlation of *in vitro*  $\text{EC}_{50}$  with MAC), lack of response to nonimmobilizer compounds, hydrostatic pressure reversal, cutoff, and plausibility. For example, if differences in potency exist in the intact

organism for the enantiomers of a given anesthetic, then the targets responsible for this anesthetic effect also should exhibit this difference in potency *in vitro*. If the organism fails to lose consciousness with a particular compound (e.g., F6 or F8), then any related molecular target also should remain unaffected.<sup>65</sup> However, this litmus test logic assumes that a single target can produce anesthesia, and now that several molecular targets have emerged that satisfy many of these criteria, such criteria should be viewed with considerable skepticism.

A final means of establishing linkage of the molecular event with the behav-

ior involves use of specific pharmacologic probes. For example, concentration–effect experiments with anesthetics can be performed in the presence of other sedative drugs, and then the interaction can be characterized as synergistic, additive, or antagonistic through isobolographic analysis. If the second drug is known to be highly specific for a given molecular target, then some insight might be gained into the targets used by anesthetic. Although this approach has identified many potential targets for the inhaled anesthetics, its use has been somewhat reduced by the fact that the second drug rarely produces the same

end point as that of the anesthetics. For example, the opioids and the benzodiazepines, unless given in very high doses, do not produce the MAC end point, whereas this is the standard end point for the volatile anesthetics. Yet in both cases, the second drug decreases the volatile anesthetic MAC by 10–50%. Agonism at the GPCR  $\alpha_2$ -adrenergic receptors reduces anesthetic requirements by as much as 90%,<sup>66</sup> although whether synergistic or additive cannot be clear because these agents cannot independently reach this end point. Finally, this pharmacologic approach is further confounded by the fact that the effects are global, and it now is recognized that the same targets may have important influences only regionally (see later).

**Summary** Bottom-up studies allow for well-controlled experiments with well-defined end points (e.g., examination of the extent of anesthetic potentiation of GABA<sub>A</sub> receptors) and for straightforward subsequent genetic manipulation of the target protein through conventional site-directed mutagenesis of the complementary DNA encoding the protein of interest expressed *in vitro*. However these approaches are primarily useful for generating *testable hypotheses*, where the biologic relevance of the putative target can be proposed and then examined in a more intact system, such as with targeted pharmacologic or knock-out, knock-in, or knock-down genetic approaches.

### “Top-Down” Approach

An alternative approach to determining the sites and mechanisms of drug action is a “top-down approach” where the starting point is an individual or a population of intact organisms. Populations typically harbor random mutations in their genome, and thus individuals with high or low sensitivity to volatile anesthetics can be identified through standard potency experiments and the potential molecular basis hypothesized based on the discovered genetic differences. For example, strain differences in mice have been demonstrated<sup>67</sup> but are small (< 50%), and the underlying genetics appear to be complex. This approach is limited, however, because it requires that considerable variability exist within the population of organisms in order to clearly select for the differences. The Hill slopes of 20 in the human population suggest that sufficient variability in the response does not exist in order for this to be a productive approach, unless enormous numbers of individuals can be tested.

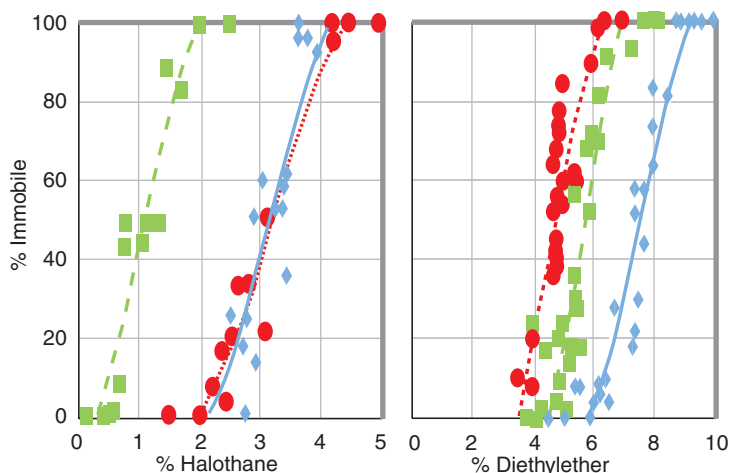
Although difficult in human studies, such numbers can be easily studied in simple organisms, such as the fruit fly *Drosophila melanogaster* or the worm *C. elegans*. These systems give the added advantage of relatively easy identification of the genetic defect from the selected population, an approach called “forward genetic” screening. The primary advantage of such a system lies in the possibility of revealing a direct correlation between a genetic target and a complex behavior involving no a priori assumptions or biases. Furthermore, the natural prevalence of mutations often can be considerably enhanced by chemicals or ultraviolet light in these simple systems, greatly increasing the odds of finding interesting alterations. On the other hand, the fundamental limitation of simple model systems lies in the definition of the anesthetic state or the behavioral end point used and its relevance to the state of general anesthesia in higher organisms. For example, the yeast *Saccharomyces cerevisia* is an enormously useful eukaryote for genetic studies, but how can one possibly define anesthesia in the absence of behavior? Is anesthetic-induced immobility in a nematode analogous to anesthesia? Should similar end points be chosen across species, *immobility* for example, independent of the anesthetic concentration dependence, or should arbitrary end points be chosen that happen to have similar concentration–response relationships across species? Will determining the genetic basis for anesthetic-induced growth inhibition in the yeast, or escape behavior in the fly, tell us anything about how anesthetics work in a human? Although such questions are legitimate and vexing, conservation of biologic processes throughout phylogeny has been proven time after time, and a fundamental biologic mechanism operating in simple organisms is likely to have a homologous mechanism in the more complex organisms. Research using the forward genetic approach to seek the volatile anesthetic site of action in simple organisms has yielded several exciting potential targets.

Similar to humans, nematodes have different behaviors that demonstrate different sensitivity to anesthetics. For example, complex behaviors such as mating, chemotaxis, and coordinated movement are inhibited at halothane concentrations similar to human MAC values,<sup>25</sup> whereas immobility occurs

only at concentrations approximately eight times higher (Fig. 36–17).<sup>68</sup> The top-down screening of a *de novo* mutagenized population using immobility as the end point has identified genes encoding the worm homologues of two mammalian proteins as the genetic basis for increased sensitivity to anesthetics (resistant organisms for the immobility end point have not been discovered): a subunit of mitochondrial complex I protein (see earlier) and stomatin, a transmembrane protein enriched in the lipid raft microdomains. Interestingly, these studies have clearly documented that these mutations do not affect sensitivity to all volatile anesthetics, the first solid evidence against a unitary hypothesis of volatile anesthetic action. A very powerful tool in these simple creatures is that suppressors (i.e., strains with additional mutations that negate the phenotype of the original mutation) can be sought. Identification and function of the suppressor then can be reconciled with that of the original mutation to provide validation and further understanding of the underlying pathways and mechanisms. For example, a suppressor of the worm mitochondrial complex I mutation was found that increased the capacity for oxidative phosphorylation in isolated mitochondria and partially restored-wild type anesthetic sensitivity in the intact worm.<sup>69</sup> This strengthens the association between anesthetic sensitivity and mitochondrial function.

A similar screening of *C. elegans* mutants using the loss of more complex behaviors, such as coordinated movement, as the behavioral end point identified the syntaxin-1A gene, mentioned earlier,<sup>25</sup> as being associated with anesthetic resistance (up to 6-fold). Further work, including binding studies and suppressors, has provided evidence for the involvement of syntaxin-1A in anesthetic action and has led to the attractive and intuitive hypothesis that anesthetics interfere with the release of neurotransmitters at the presynaptic terminal, producing a general reduction in synaptic transmission (see later).<sup>70</sup> Again, these simple creatures have provided compelling hypotheses for testing in higher organisms.

Moving up the complexity and evolutionary scale, studies in *D. melanogaster* have documented that specific ion channels can contribute to volatile anesthetic sensitivity (Fig. 36–18). For example, forward genetic screening has succeeded in isolating a putative



**FIGURE 36–17.** “Worm” model. *Caenorhabditis elegans* is only 1 mm long, but the short generation time, the ease of manipulation, the fully understood genome, and the presence of complex behaviors have made it a popular model for anesthetic studies. **Right.** Anesthetic dose–response curves for the wild-type and for more sensitive mutants (shifted to the left). (Graphs used by permission.<sup>107</sup> Copyright 1990 National Academy of Sciences.)

ion channel resembling the voltage-gated sodium and calcium channels as important for anesthetic-induced immobility.<sup>71</sup> As in the worm, the different ion channels show variable sensitivity to different volatile anesthetics, suggesting that multiple neurophysiologic mechanisms mediate the action of different anesthetics even in simple organisms.

A final related approach that avoids investigator bias is assaying for the genes or proteins whose expression is altered during or after exposure to volatile anesthetics. This approach carries the tenuous assumption that the organism will choose to alter the expression of those targets directly affected by the anesthetic in an attempt at homeostasis. In some published studies, the expression of many genes or proteins is altered.<sup>72,73</sup> However, using a more (perhaps overly) rigorous statistical approach, a study found only a modest transcriptional response after considerable exposure to either halothane or isoflurane in both animals and cells.<sup>34</sup> It is still too early to summarize this approach because the methodology, analysis, and interpretation are evolving.

Taken together with the evidence presented, observations from both bottom-up and top-down studies clearly suggest that a search for a small number of targets for volatile anesthetic action in a complex organism is overly simplistic and unlikely to yield a satisfactory or interpretable answer. However, future studies using novel methods for confirming a critical role of a given genetic defect in determining

the inhaled anesthetic sensitivity may yet prove that our arguments against the unitary hypothesis are erroneous.

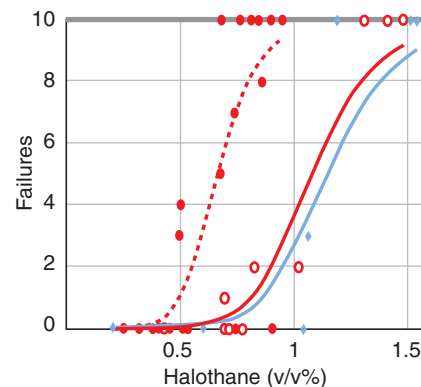
### Integration of Molecular Responses

If anesthesia is an integrated response to a large number of molecular events, then validation at the molecular level, or in translational attempts of single candidates, will be difficult. For example, the most popular means of testing hypotheses from both bottom-up and top-down approaches is to produce genetically altered animals (usually mice). As mentioned for GABA<sub>A</sub> receptors, this form of validation suffers from at least two weaknesses. First, in a knock-out (null mutant) animal, developmental compensation may occur in multiple associated pathways, possibly providing new mechanisms for anesthetic-induced perturbations. However, this does argue against highly specific “unitary” targets because the likelihood that such adaptation in other components of the pathway will produce similarly unique and functionally active binding sites seems rather small. The second weakness, for both knock-out and knock-in strategies, is that the physiologic alteration may be of sufficient magnitude to render end point evaluation difficult (e.g., seizures, lethality). Consistent with these concerns, this means of testing individual targets has generally yielded ambiguous results.

A large number of targets does not rule out a unitary mechanism of action, however. Such a mechanism might be found at a higher level of resolution,

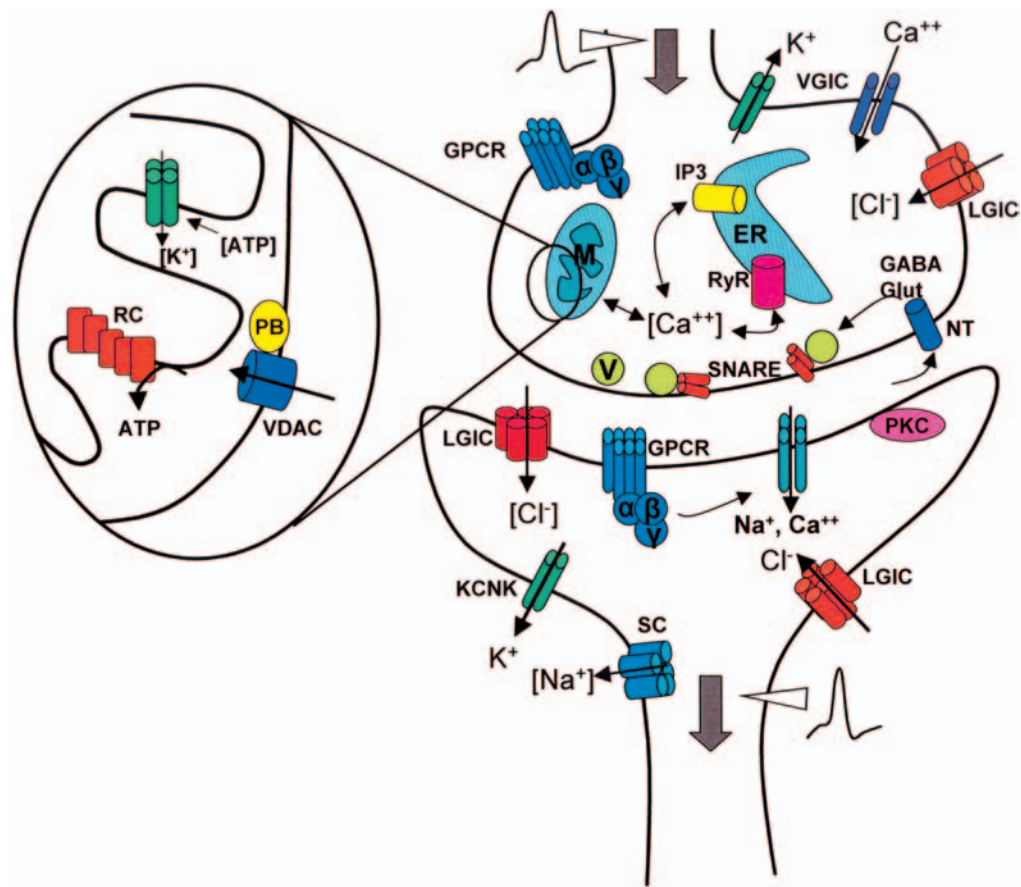
such as at the level of a neurophysiologic process. Candidates at this level are numerous but could include transcription or translation, mitochondrial activity, membrane resting potential, action potential conduction, and synaptic transmission. Each process has multiple and overlapping molecular contributors.

Decades of study have implicated the *synapse* as a key neurophysiologic substrate affected by volatile anesthetics.<sup>74</sup> This idea initially was based on the simple observation that axonal conduction of action potentials was more resistant to volatile anesthetics than synaptic transmission. Insight gained from the large number of bottom-up and top-



**FIGURE 36–18.** “Fly” model. *Drosophila melanogaster* is a similarly popular organism for anesthetic studies for the same reasons as is the worm but is a somewhat more complex organism. EC<sub>50</sub> concentrations in this assay are more analogous to those required for immobility in mammals and shown are hypersensitive mutants. (Used by permission.<sup>108</sup> Copyright 2001 Lippincott Williams & Wilkins.)





**FIGURE 36–19.** Some potential targets of inhaled anesthetics in the synapse. Synaptic transmission is a likely neurophysiologic process targeted by the inhaled anesthetics. On the presynaptic side, interference with calcium channels or mobilization of intracellular calcium<sup>109</sup> will reduce neurotransmitter release and perhaps cause synaptic failure. Interference with vesicle trafficking and fusion proteins<sup>110</sup> would clearly add to this effect. Heterotrimeric G-protein and G-protein coupled receptors (GPCRs) also are likely to affect anesthetic sensitivity, as already demonstrated in *Caenorhabditis elegans* and other systems. Thus, the seemingly unrelated putative protein targets of volatile anesthetics already revealed by both the bottom-up and top-down studies may play a key role in the presynaptic events of transmission. So too are the dynamics of transmitter concentrations in the synaptic cleft. The activity of all the major neurotransmitter transporters is altered by volatile anesthetics, either raising or lowering synaptic cleft concentrations. This is important because of the apparent cooperativity with anesthetics in some postsynaptic receptors [ligand-gated channels (LGIC)] or the competition with others (some GPCRs). Finally, the effects on many postsynaptic receptors already alluded to are thought to contribute to anesthetic action. Likewise, increased “shunting” of the postsynaptic charge due to enhancement of the KCNK leakage channels or tonic  $\gamma$ -aminobutyric acid type A (GABA<sub>A</sub>) channels will limit depolarization of the postsynaptic membrane and likely preclude the generation of postsynaptic action potentials. Anesthetic action on other lipophilic proteins, such as stomatin and others residing in lipid rafts enriched in signaling proteins, could disrupt the signaling initiated by neurotransmitter activation of the myriad of metabotropic receptors regulating synaptic transmission. Presynaptic: GPCR (blue), G-protein coupled receptor with associated heterotrimeric G-protein ( $\alpha\beta\gamma$ ); VGIC (green and purple), voltage-gated ion channels, either calcium (Ca) or potassium (K); LGIC (orange), tonic ligand-gated ion channels; NT (dark blue), neurotransmitter transporters; SNARE (orange), synaptic vesicle transport and fusion proteins; V (light green), synaptic vesicles; ER, endoplasmic reticulum, containing ryanodine receptors (magenta) and inositol-trisphosphate channels (yellow); M, mitochondria, containing ATP-gated potassium channels (green), the respiratory complexes (RC, orange), and the voltage-dependent anion channel (VDAC, dark blue) with its associated peripheral benzodiazepine receptor (PB, yellow). Postsynaptic: LGIC (red), ligand-gated ion channels such as GABA<sub>A</sub>, AMPA/KA, nicotinic cholinergic, 5HT<sub>3</sub>; GPCRs, neurotransmitter G-protein coupled receptors; PKC, protein kinase C; KCNK, tandem pore potassium channels (TREK, TASK, etc.); SC, sodium channels; LGIC (orange), tonic ligand-gated channels.

down studies of volatile anesthetics has supported and refined the notion that synaptic transmission is the most likely neurophysiologic process targeted by these drugs (Fig. 36–17).

Synaptic transmission, although the most fundamental unit of intercellular information transfer in the nervous system, is a highly complex process in itself (Fig. 36–19). When an action potential arrives at the presynaptic terminal, an increase in presynaptic Ca<sup>2+</sup> concentration via voltage-gated calcium channels and release from intra-

cellular stores activates the synaptic vesicle release machinery orchestrated by, and consisting of, a myriad of proteins. After release into the synaptic cleft, the concentration of transmitter available to the postsynaptic receptor is influenced by neurotransmitter uptake pumps and degradative enzymes for some synapses. On activation of the postsynaptic receptor (G-protein coupled or ligand-gated channel) and the consequent influx of ions and activation of cellular signaling molecules, the change in charge distribution may pro-

duce depolarization of the postsynaptic membrane and formation of an action potential if the threshold is exceeded. Thus, it should be clear that anesthetics can and do have an effect at each of the many points in the process.

Given a focus on synaptic transmission as a key process targeted by volatile anesthetics, some predictions can be made on the anesthetic phenotype of some mice not yet examined. For example, the null-mutant mice for the various calcium channels or release mechanisms that regulate presynaptic

## BOX 36-2.

## Further Definition of Targets within the Process

Despite the logical appeal of a forward genetic approach to identifying volatile anesthetic sites of action, a well-defined population of mouse mutants amenable to this approach is not presently available, relegating the genetic approach to volatile anesthetic site-of-action research to a painstaking testing of a specific mouse mutant. However, a true forward genetic screening to allow identification of volatile anesthetic sensitive-gene products in mice may be possible in the near future. A concerted effort using state-of-art techniques, including gene targeting, gene trapping, and RNA interference to produce mouse mutants on a large scale with the ultimate goal of creating knock-outs covering a substantial portion of the entire genome, is under way.<sup>76,77</sup> Of course we must be cognizant of the usual caveats of the inherent strain differences in anesthetic sensitivity<sup>67</sup> and genetic compensation in the traditional global knock. A combination of gene trapping and site-specific DNA inversion methods<sup>78</sup> may allow large-scale production of conditional knock-out mice in animals from a uniform background that could overcome these limitations. The technical ingenuity of all these approaches is that the genetic basis for any observed phenotype can be traced back with relative ease because the site of gene disruption is traceable, much like in the fruit fly and the worm model systems. Such projects envision a systematic hierarchical phenotyping of every mutant, starting with a low-cost tier I screen (home-cage observation, physical examination, blood hematologic and chemistry profiles, and skeletal radiographs), followed by a more specialized tier II screening with all results publicly available. In order for the general anesthesia research community to take advantage of these upcoming international scientific resources, an inexpensive large-scale screening of volatile anesthetic sensitivity in mice must be developed. Integration of results garnered from the bottom-up approach and the top-down approach, particularly in mice, while cognizant of a “neurophysiologic process” as the true target for the complex action of volatile anesthetic, is likely to provide a clearer picture of how these clinically essential drugs produce clinical general anesthesia.

calcium dynamics, all with impaired synaptic transmission, should demonstrate increased sensitivity to volatile anesthetics. In contrast, mouse mutants with enhanced synaptic transmission, which may result from mutations increasing neurotransmitter concentration in the synapse, should exhibit decreased sensitivity to anesthetics. If we assume that the state of clinical general anesthesia is a manifestation of all the downstream consequences of the failure of synaptic transmission, there will be many more, yet unidentified target proteins and processes contributing to this complex drug action. However, interpretation of the anesthetic phenotype of any gene-targeted mice must take into consideration the likely redundancy built into any complex system and the possibility of compensatory changes in the conventional null-mutant mice.

A model where a process is altered by widely distributed and perhaps small input effects also predicts difficulty in altering the output with isolated input manipulations. Analogy may be found on the Internet, where many coordinated small and essentially undetectable influences on router function (colluding routers) can have a considerably larger effect on Internet “function” than a few large and easily detected router “meltdowns.”<sup>75</sup> A small-effects-at-multiple-targets model leads to predictions that so far have been largely verified. For example, altered plausible molecular targets with clear alteration of anesthetic effects in isolation, when

introduced in a system or process context, produce little, if any effect, on anesthetic sensitivity. Although in biologic systems this is complicated by the principle of homeostasis and compensation, this observation appears to be consistent. In no case has a mutation of an individual target, or highly specific drug, altered anesthetic potency by > 20–50%. Furthermore, the facts that antagonists have not emerged, that there is little biologic variability, and that there is no adaptation, even when the drugs are given continuously for weeks, all argue for a highly distributed, redundant molecular effect. Redundancy is often used in systems design to produce reliability, a feature synonymous with low variation. Reliability of anesthetic action is a clinical feature we cannot afford to ignore, but its foundation in a distributed mechanism is a scientific feature that will be difficult to sort out.

### Neuroanatomic Substrates

A process may be widely distributed within the nervous system (e.g., synaptic transmission), but the influence of its dysfunction could be sensed and exhibited regionally. Although there is no evidence for regional binding of anesthetic (Fig. 36-8), binding targets may be positioned within networks and pathways that rely on their neurotransmitter types and regional interactions for higher functions, such as behavior. Thus, GABAergic enhancement in the spinal cord or the cerebellum may have very different functional effects than

enhancement in the hippocampus. The different functional components of general anesthesia likely arise from such regionality (Box 36-2).

Thus, volatile anesthetics produce a composite state that can be subdivided into functional components, which include amnesia, unconsciousness, analgesia, muscle atonia, and autonomic nervous system modulation. Each may represent specific interactions of general anesthetics upon discrete neuronal loci. Just as the search for molecular targets of anesthetic action have revealed multiple sites of modulation, so too has the hunt for cellular sites of anesthetic action. In this section, we focus upon different features of the anesthetic state that arise from anesthetic actions in various parts of the CNS.

### Anesthetics and Immobility

The MAC end point (see Chapter 37) is defined as the minimum alveolar concentration of an agent that is required to suppress movement in response to a defined noxious stimulus. It should not be surprising, then, that anesthetics appear to exert their immobilizing effects most sensitively through interactions within the spinal cord. For example, transection of the brain at the level of the inferior colliculus does not alter MAC of inhaled anesthetics in mammals.<sup>79</sup> Although such lesions ablate ascending and descending forebrain and midbrain communications with the spinal cord, they do not impair spontaneous ventilatory efforts because brainstem respiratory groups are left intact. This works sug-

gests that MAC is primarily determined by a direct action of anesthetics upon the CNS at a level caudal to the brainstem—the spinal cord. Further work in multiple species supports this hypothesis. Surgical isolation of brain and spinal cord blood flow in goats (which lack significant cerebral perfusion from vertebral arteries) allowed independent determination of MAC. Delivery to the brain required a > 2-fold higher concentration than did whole animal MAC, suggesting that immobility is produced via direct interactions within the spinal cord.<sup>80,81</sup> In vitro evidence of anesthetic effects upon spinal cord has also been obtained. All volatile anesthetics tested to date appear to suppress the excitability of spinal motor neurons; however, even within the spinal cord different anesthetics exert their effects at multiple sites. For example, halothane reduces noxious-evoked movement via depression of dorsal horn neurons, whereas isoflurane appears to have smaller effects upon these sensory neurons yet produces an identical inhibition of movement by exerting a relatively greater suppression of anterior horn motor neurons or interneurons.<sup>82</sup>

### **Anesthetics and Hypnosis**

Although the neural substrate responsible for generating consciousness remains unknown, much has been learned about the systems responsible for its nightly loss and subsequent return during the normal process of sleep. The physiologic changes associated with unconsciousness induced by both anesthesia and sleep are strikingly similar. They include decreased minute ventilation, blood pressure, heart rate, core body temperature, motor tone, and, most importantly, responsiveness to external stimuli. Positron emission tomography, used to study cerebral blood flow during both sleep and anesthesia, has confirmed that similar alterations in regional cerebral blood flow, metabolism, and regional neuronal activity occur during both sleep and general anesthesia.<sup>83</sup> These similarities and others (documented in the following) have led to the speculation that sleep and general anesthesia share an underlying neural substrate. Consistent with this hypothesis is the observation that an individual's underlying state of arousal alters anesthetic sensitivity. In rodents, loss of consciousness typically is assessed by the LORR behavioral assay, in which animals turned from supine to prone are unable to right themselves. Using this end point,

Einon et al.<sup>84</sup> noted that the hypnotic duration of pentobarbital was prolonged when the drug was administered to rats during their sleeping hours compared with their normally wakeful hours. Sleep deprivation acts synergistically with anesthetics, reducing the dose of anesthetic required for hypnosis and allowing recovery from sleep deprivation.<sup>85</sup>

Further linkage between sleep and anesthesia derives from pharmacologic studies. Endogenous somnogens such as adenosine, which can induce sleep, also potentiate the hypnotic effects of inhaled and intravenous anesthetics and delay emergence from anesthesia.<sup>86</sup> Moreover, anesthetic exposure appears to affect levels of endogenous somnogens, such as prostaglandin D<sub>2</sub>.<sup>87</sup>

Despite these overlapping features, it is clear that sleep and general anesthesia have important differences. The most notable is that sleep is readily reversed through external stimuli, whereas anesthesia is reversed only upon discontinuation of the anesthetic drugs. Another primary difference is that anesthetics appear to inhibit systems required for rapid eye movement (REM) sleep as well as cortical arousal.<sup>88</sup> Hence, general anesthesia has been likened to a form of non-rapid eye movement (non-REM) sleep from which one cannot be easily aroused.<sup>83</sup>

The similarities between non-REM sleep and general anesthesia extend to various measures of the electroencephalogram (EEG). For example, both power spectrum analysis and the bispectral index<sup>89</sup> show a high degree of similarity between non-REM sleep and general anesthesia. EEG entropy, a measure of the disorder inherent in the EEG, declines during deep non-REM sleep and during general anesthesia.<sup>90,91</sup> In both instances, as non-REM sleep or anesthetic depth increase, the EEG becomes more ordered, further reducing EEG entropy.

### **Neural Circuitry of Arousal**

Similarities between general anesthesia and non-REM sleep have led to the speculation that the two states share a common underlying neural network. The degree of arousal is determined by the coordinated activity of several nuclei within the brain. One such region, the ventral lateral preoptic (VLPO) nucleus located in the anterior hypothalamus, was found to contain the only group of cells specifically active during non-REM sleep.<sup>92</sup> Subsequent studies in rodents using *in vivo*

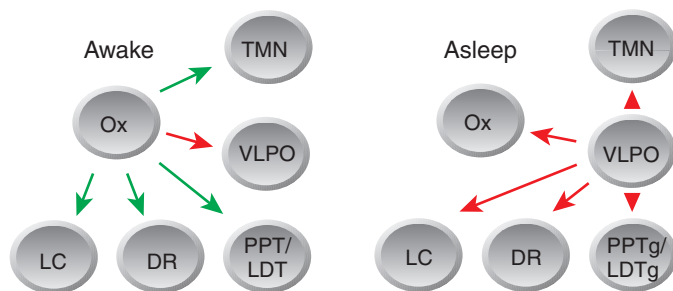
electrophysiologic recordings together with polysomnography have proved that VLPO neurons are sleep active, firing rapidly during sleep while being inhibited during wakefulness. VLPO neurons send projections to the orexinergic and all of the monoaminergic wake-active centers in the brain<sup>93</sup> (Fig. 36-18) and express the inhibitory neurotransmitters GABA and galanin. Hence, through GABA-mediated signaling, VLPO neurons inhibit wake-active centers responsible for regulating vigilance and cortical arousal and thereby favor sleep.

The major arousal centers, located in the hypothalamus and brainstem, consist of the orexinergic neurons (Ox) concentrated around the perifornical and lateral hypothalamus as well as the histaminergic cells in the tuberomammillary nucleus (TMN), the noradrenergic cells in the locus caeruleus (LC), the serotonergic cells in the dorsal raphe nucleus (DR), and the cholinergic mesopontine neurons in the lateral dorsal tegmentum (LDT) and pedunclopontine tegmentum (PPT). As a group, the TMN, LC, and DR (monoaminergic neurons) as well as the orexinergic neurons are maximally active during wakefulness, decrease their firing rate during non-REM sleep, and are virtually silent during REM sleep. These neuronal groups send diffuse projections that innervate the entire neuraxis. The cholinergic brainstem arousal system also displays state-dependent activity. However, unlike the orexinergic and monoaminergic groups, the brainstem cholinergic neurons show highest activity during both wakefulness and REM sleep and virtual quiescence during non-REM sleep.<sup>93</sup>

### **Anesthetic Effects on Arousal Centers**

As is the case for natural sleep, early pharmacologic, lesion, and more recent gene knock-out studies indicate that the hypnotic component of general anesthesia is modestly affected by modulation of any of the monoaminergic, orexinergic, or cholinergic wake-active systems. Thus, at the systems level, general anesthetics produce unconsciousness in part by inhibiting arousal. Disruption of cholinergic neurotransmission, in particular, appears to participate in the hypnosis associated with halothane, isoflurane, sevoflurane, propofol, opioids, and ketamine. Consistent with this is the observation that physostigmine, an acetylcholinesterase





**FIGURE 36–20.** Endogenous arousal neural circuitry. Mutual antagonism between VLPO and hypothalamic orexinergic neurons influences state of arousal along with contributions from other members of the reticular activating system: TMN, LC, DR, PPT, and LDT. During non-rapid eye movement (NREM) sleep, VLPO activity predominates, inhibiting firing of TMN, LC, DR, PPTg, LDTg, and Ox neurons. Conversely, during wakefulness, orexinergic neuronal activity inhibits VLPO and excites other members of the reticular activating system. Excitatory connections are shown in green. Inhibitory connections shown in red. DR, dorsal raphe; LC, locus caeruleus; Ox, orexin neurons; PPTg/LDTg, pedunculopontine and lateral dorsal tegmentum, respectively; TMN, tuberomammillary nucleus; VLPO, ventrolateral preoptic nucleus.

inhibitor that crosses the blood–brain barrier, partially antagonizes sevoflurane or propofol hypnosis<sup>94</sup> In addition to interacting with other wake- and sleep-active groups, cholinergic brainstem nuclei such as the LDT and PPT project to the thalamus and cortex. When these brainstem centers are activated, desynchrony of the EEG typical of wakefulness or REM sleep occurs (reviewed by Jones<sup>95</sup>). Conversely, when cholinergic output of the LDT and PPT is inhibited, as occurs with general anesthesia (see discussion of anesthetic effects on nAChRs), EEG activity in the cortex assumes a striking similarity to that seen during non-REM sleep.

Similar to the cholinergic centers, monoaminergic centers are most active during wakefulness. The noradrenergic LC has long been known as a region of brain associated with vigilance. Independent excitation of the LC enhances an individual's state of arousal, whereas reduction of the LC firing rate decreases alertness.<sup>96</sup> Inhibition of the LC appears to be a primary mechanism of action through which the  $\alpha_2$ -adrenergic agonist dexmedetomidine exerts its strong hypnotic effect.<sup>97</sup> Inhibition of the LC further destabilizes wakefulness by releasing inhibition of the sleep center VLPO. Classic pharmacologic studies over the past 5 decades have demonstrated that increasing central adrenergic output from the LC is associated with an increased anesthetic requirement, a fact known to any anesthesiologist caring for a patient who recently ingested cocaine, amphetamines, or similar psychostimulants. Conversely, decreasing catecholaminergic output reduces MAC, as evidenced by reserpine or  $\alpha$ -methyl dopa

depletion experiments and by isolated destruction of the LC.

Modulation of serotonergic output from the DR also affects anesthetic sensitivity. As with the LC, lesion and pharmacologic inhibition of serotonergic signaling reduces MAC. Blockade of 5-hydroxytryptamine 2A (5-HT<sub>2A</sub>) receptors with the two different antagonists has been shown to reduce the MAC of isoflurane and halothane. When combined with in vitro data demonstrating that inhaled anesthetics such as isoflurane inhibit signal transduction mediated through G-protein coupled 5-HT<sub>2A</sub> receptors, these data suggest that 5-HT<sub>2A</sub> receptors are in the neural circuitry influencing MAC.<sup>98</sup>

Like other aminergic nuclei, the histaminergic neurons of the TMN are part of a phylogenetically ancient arousal system, conserved across vertebrates. The TMN is reciprocally connected to, and tonically inhibited by, other neurons of the VLPO. In brain slice studies, norepinephrine inhibits GABAergic activity in the TMN and thus releases inhibition. Serotonin and orexin depolarize the TMN through activation of an electrogenic sodium/calcium (Na/Ca) exchanger, suggesting that the TMN is excited by increased activity of the other wake-active arousal centers. Moreover, activity of TMN neurons has been linked to hibernation as well as to the hypnotic component of general anesthetic action.<sup>99,100</sup> As discussed earlier, one molecular mechanism shared by many (but not all) anesthetics is their ability to potentiate inhibitory GABAergic signaling. Nelson et al.<sup>100</sup> establish the TMN as an important neuronal site mediating the sedation of propofol, pentobarbital, and the

classic GABA<sub>A</sub> agonist muscimol because the anesthetic facilitation of GABA<sub>A</sub> receptor signaling inhibits the tonic TMN inhibition of VLPO activity.

Orexinergic neurons release the neuropeptides orexin-A and orexin-B (also called hypocretin), thereby coordinating and stabilizing the activity of the entire reticular activating system during wakefulness. Orexinergic neurons are ideally positioned to be the master regulator of arousal. They send dense excitatory projections to all other monoaminergic as well as cholinergic arousal nuclei.<sup>101</sup> Thus, increased firing of orexinergic neurons stimulates activity of the other arousal nuclei and inhibits VLPO neurons, thereby driving the system toward wakefulness (Fig. 36–20). Mutual antagonism between VLPO and orexinergic neurons creates a bistable switch<sup>93</sup> that drives an organism either toward wakefulness (low VLPO activity in conjunction with increased orexinergic activity) or toward sleep (high VLPO activity in conjunction with decreased orexinergic activity).

Orexin receptors are GPCRs that, because of the binding and functional results discussed earlier, are reasonable direct anesthetic targets. Moreover, several reports suggest that modulation of orexinergic neurotransmission alters anesthetic responsiveness. Using the LORR behavioral assay as an end point, intrathecal administration of an orexin-A agonist and antagonist were shown to reduce and prolong, respectively, the duration of barbiturate induced hypnosis.<sup>102</sup> Direct evidence for orexin modulation of anesthetic hypnosis was also obtained when intracerebroventricular administration of orexin-A produced cortical arousal, opposing the depressive effects of 1.0 and 1.5 MAC of isoflurane.<sup>103</sup> But, as with other catecholaminergic systems, a direct effect of anesthetics upon orexin-mediated signal transduction remains unproven. However, the fact that pharmacologic and genetic interference with orexin signaling reduces wakefulness, motor tone, cardiovascular, respiratory, and thermoregulatory parameters, coupled with the demonstration that anesthetics bind specifically to sensory GPCRs, suggests that direct interactions between anesthetics and orexinergic neurons contribute to the clinical state of anesthesia.

### Anesthetics and Other End Points

Although the majority of research on the mechanisms of anesthetic action



has been focused at the molecular level, the interpretation of these findings in the context of the whole animal requires knowledge of the neuronal networks upon which anesthetics exert their site-specific effects to produce different behavioral end points. Toward that end, elegant and sophisticated studies are clarifying and standardizing end points for quantitative application and qualitative association with the networks. Using these approaches, future studies promise to unravel the neuroanatomic loci that mediate many anesthetic actions, both desired and undesired.

## SUMMARY

Despite their importance and widespread application in medicine, the general inhalational anesthetics still defy a comprehensive description of their action. A rational explanation for this state of affairs is that inhalational anesthesia relies on a multitude of targets, a proposal well aligned with the results of binding, *in vitro* functional studies, and behavioral phenomenology. Nevertheless, substantial progress at the molecular level has allowed a pool of protein candidates to be proposed and a detailed understanding of the submolecular mechanisms of anesthetic action. Progress has been made in the linkage of specific end points to underlying targets and neuronal circuitry.

However, little progress has been made toward developing novel inhaled molecules with a more favorable therapeutic ratio. A reason for this lack of progress may be a fundamental dissociation between the pharmacology and the application. To date, the development of anesthetic molecules has been guided by more practical goals: fast kinetics to facilitate rapid induction, emergence, and patient throughput; enhanced stability to reduce metabolic degradation and its associated toxicity and to prolong shelf-life; and operating room safety (i.e., absence of flammability or toxicity from inhalation of trace amounts in the ambient air). These goals may have had the unintended consequence of actually reducing specificity for molecular targets and may not have achieved a lower toxic potential. It is clear that greater molecular complexity will be necessary to enhance specificity, but this may come at

the price of slower kinetics, lower and less predictable efficacy, and a less "complete" anesthetic. Such an outcome predicts that combination drug therapy will assume a greater role in anesthetic care in the future.

## RECENT REVIEWS

1. Campagna JA, Miller KW, Forman SA. Mechanisms of actions of inhaled anesthetics. *N Engl J Med* 2003;348:2110-2114.
2. Eckenhoff RG, Johansson JS. Molecular interactions between inhaled anesthetics and proteins. *Pharmacol Rev* 1997;49:343-367.
3. Rudolph U, Antkowiak B. Molecular and neuronal substrates for general anaesthetics. *Nat Rev Neurosci* 2004;5:709-720.
4. Lydic R, Baghdoyan HA. Sleep, anesthesiology, and the neurobiology of arousal state control. *Anesthesiology* 2005;103:1268-1295.

## REFERENCES

1. Campagna JA, Miller KW, Forman SA. Mechanisms of actions of inhaled anesthetics. *N Engl J Med* 2003;348:2110.
2. Rudolph U, Antkowiak B. Molecular and neuronal substrates for general anaesthetics. *Nat Rev Neurosci* 2004;5:709.
3. Koblin DD, Chortkoff BS, Laster MJ, et al. Polyhalogenated and perfluorinated compounds that disobey the Meyer-Overton hypothesis. *Anesth Analg* 1994;79:1043.
4. Raines DE. Anesthetic and nonanesthetic halogenated volatile compounds have dissimilar activities on nicotinic acetylcholine receptor desensitization kinetics. *Anesthesiology* 1996;84:663.
5. Peoples RW, Weight FF. Cutoff in potency implicates alcohol inhibition of N-methyl-D-aspartate receptors in alcohol intoxication. *Proc Natl Acad Sci U S A* 1995;92:2825.
6. Eckenhoff RG, Tanner JW, Johansson JS. Steric hindrance is not required for n-alkanol cutoff in soluble proteins. *Mol Pharmacol* 1999;56:414.
7. Mohr JT, Gribble GW, Lin SS, et al. Anesthetic potency of two novel synthetic polyhydric alkanols longer than the n-alkanol cutoff: evidence for a bilayer-mediated mechanism of anesthesia? *J Med Chem* 2005;48:4172.
8. Eger EI, Koblin DD, Laster MJ, et al. Minimum alveolar anesthetic concentration values for the enantiomers of isoflu-

rane differ minimally. *Anesth Analg* 1997;85:188.

9. Sedensky MM, Cascorbi HF, Meinwald J, et al. Genetic differences affecting the potency of stereoisomers of halothane. *Proc Natl Acad Sci U S A* 1994;91:10054.
10. Cantor RS. The lateral pressure profile in membranes: a physical mechanism of general anesthesia. *Biochemistry* 1997;36:2339.
11. Koubi L, Tarek M, Bandyopadhyay S, et al. Effects of the nonimmobilizer hexafluoroethane on the model membrane dimyristoylphosphatidylcholine. *Anesthesiology* 2002;97:848.
12. Sedensky MM, Siefker JM, Koh JY, et al. A stomatin and a degenerin interact in lipid rafts of the nervous system of *Caenorhabditis elegans*. *Am J Physiol Cell Physiol* 2004;287:C468.
13. Franks NP, Lieb WR. Do general anaesthetics act by competitive binding to specific receptors? *Nature* 1984;310:599.
14. Eckenhoff MF, Eckenhoff RG. Quantitative autoradiography of halothane binding in rat brain. *J Pharmacol Exp Ther* 1998;285:371.
15. Bhattacharya AA, Curry S, Franks NP. Binding of the general anesthetics propofol and halothane to human serum albumin. High resolution crystal structures. *J Biol Chem* 2000;275:38731.
16. Liu R, Loll PJ, Eckenhoff RG. Structural basis for high-affinity volatile anesthetic binding in a natural 4-helix bundle protein. *FASEB J* 2005;19:567.
17. Eckenhoff RG. An inhalational anesthetic binding domain in the nicotinic acetylcholine receptor. *Proc Natl Acad Sci U S A* 1996;93:2807.
18. Xu Y, Seto T, Tang P, et al. NMR study of volatile anesthetic binding to nicotinic acetylcholine receptors. *Biophys J* 2000;78:746.
19. Chiara DC, Dangott LJ, Eckenhoff RG, et al. Identification of nicotinic acetylcholine receptor amino acids photolabeled by the volatile anesthetic halothane. *Biochemistry* 2003;42:13457.
20. Ishizawa Y, Pidikiti R, Liebman PA, et al. G protein-coupled receptors as direct targets of inhaled anesthetics. *Mol Pharmacol* 2002;61:945.
21. Eckenhoff RG, Tanner JW, Liebman PA. Cooperative binding of inhaled anesthetics and ATP to firefly luciferase. *Proteins* 2001;42:436.
22. Harrison NL, Kugler JL, Jones MV, et al. Positive modulation of human gamma-aminobutyric acid type A and glycine receptors by the inhalation anesthetic isoflurane. *Mol Pharmacol* 1993;44:628.
23. Kutchai H, Geddis LM, Jones LR, et al. Differential effects of general anesthetics on the quaternary structure of the Ca-ATPases of cardiac and skeletal sarcoplasmic reticulum. *Biochemistry* 1998;37:2410.
24. Fang M, Tao YX, He F, et al. Synaptic PDZ domain-mediated protein interactions

- are disrupted by inhalational anesthetics. *J Biol Chem* 2003;278:36669.
25. van Swinderen B, Saifee O, Shebester L, et al. A neomorphic syntaxin mutation blocks volatile-anesthetic action in *Caenorhabditis elegans*. *Proc Natl Acad Sci U S A* 1999;96:2479.
26. Das J, Addona GH, Sandberg WS, et al. Identification of a general anesthetic binding site in the diacylglycerol-binding domain of protein kinase C $\delta$ . *J Biol Chem* 2004;279:37964.
27. Rebecchi MJ, Pentylala SN. Anaesthetic actions on other targets: protein kinase C and guanine nucleotide-binding proteins. *Br J Anaesth* 2002;89:62.
28. Gomez RS, Guatimosim C, Gomez MV. Mechanism of action of volatile anesthetics: role of protein kinase C. *Cell Mol Neurobiol* 23:377, 2003;.
29. Hinkley RE, Jr. Microtubule-macro-tubule transformations induced by volatile anesthetics. Mechanism of macro-tubule assembly. *J Ultrastructure Res* 1976;57:237.
30. Hameroff S, Nip A, Porter M, et al. Conduction pathways in microtubules, biological quantum computation, and consciousness. *Biosystems* 2002;64:149.
31. Samain E, Bouillier H, Rucker-Martin C, et al. Isoflurane alters angiotensin II-induced Ca $^{2+}$  mobilization in aortic smooth muscle cells from hypertensive rats: implication of cytoskeleton. *Anesthesiology* 2002;97:642.
32. Kaeck S, Brinkhaus H, Matus A. Volatile anesthetics block actin-based motility in dendritic spines. *Proc Natl Acad Sci U S A* 1999;96:10433.
33. Nagele P, Mendel JB, Placzek WJ, et al. Volatile anesthetics bind rat synaptic snare proteins. *Anesthesiology* 2005;103:768.
34. Pan JZ, Wei H, Hecker JG, et al. Rat brain DNA transcript profile of halothane and isoflurane exposure. *Pharmacogenet Genomics* 2006;16:171.
35. Cheng SC, Brunner EA. Inducing anesthesia with a GABA analog, THIP. *Anesthesiology* 1985;63:147.
36. Caraiscos VB, Newell JG, You T, et al. Selective enhancement of tonic GABAergic inhibition in murine hippocampal neurons by low concentrations of the volatile anesthetic isoflurane. *J Neurosci* 2004;24:8454.
37. Jurd R, Arras M, Lambert S, et al. General anesthetic actions in vivo strongly attenuated by a point mutation in the GABA(A) receptor beta3, subunit. *FASEB J* 2003;17:250.
38. Liao M, Sonner JM, Jurd R, et al. Beta3-containing gamma-aminobutyric acidA receptors are not major targets for the amnesic and immobilizing actions of isoflurane. *Anesth Analg* 2005;101:412.
39. Mihic SJ, Ye Q, Wick MJ, et al. Sites of alcohol and volatile anaesthetic action on GABA(A) and glycine receptors. *Nature* 1997;389:385.
40. Franks NP, Honore E. The TREK K2P channels and their role in general anaesthesia and neuroprotection. *Trends Pharmacol Sci* 2004;25:601.
41. Patel AJ, Honore E, Lesage F, et al. Inhalational anesthetics activate two-pore-domain background K $^{+}$  channels. *Nat Neurosci* 1999;2:422.
42. Franks NP, Lieb WR. Volatile general anaesthetics activate a novel neuronal K $^{+}$  current. *Nature* 1988;333:662.
43. Gomez RS, Guatimosim C. Mechanism of action of volatile anesthetics: involvement of intracellular calcium signaling. *Curr Drug Targets CNS Neurol Disord* 2003;2:123.
44. Gottschalk A, Haney P. Computational aspects of anesthetic action in simple neural models. *Anesthesiology* 2003;98:548.
45. White IL, Franks NP, Dickinson R. Effects of isoflurane and xenon on Ba $^{2+}$  currents mediated by N-type calcium channels. *Br J Anaesth* 2005;94:784.
46. Study RE. Isoflurane inhibits multiple voltage-gated calcium currents in hippocampal pyramidal neurons. *Anesthesiology* 1994;81:104.
47. Takei T, Saegusa H, Zong S, et al. Increased sensitivity to halothane but decreased sensitivity to propofol in mice lacking the N-type Ca $^{2+}$  channel. *Neurosci Lett* 2003;350:41.
48. Joksovic PM, Bayliss DA, Todorovic SM. Different kinetic properties of two T-type Ca $^{2+}$  currents of rat reticular thalamic neurons and their modulation by enflurane. *J Physiol* 2005;566:125.
49. Kameyama K, Aono K, Kitamura K. Isoflurane inhibits neuronal Ca $^{2+}$  channels through enhancement of current inactivation. *Br J Anaesth* 1999;82:401.
50. Elliott JR, Elliott AA, Harper AA, et al. Effects of general anaesthetics on neuronal sodium and potassium channels. *Gen Pharmacol* 1992;23:1005.
51. Ouyang W, Wang G, Hemmings HC Jr. Isoflurane and propofol inhibit voltage-gated sodium channels in isolated rat neurohypophysial nerve terminals. *Mol Pharmacol* 2003;64:373.
52. Lingamaneni R, Hemmings HC Jr. Differential interaction of anaesthetics and antiepileptic drugs with neuronal Na $^{+}$  channels, Ca $^{2+}$  channels, and GABA(A) receptors. *Br J Anaesth* 2003;90:199.
53. Shiraishi M, Harris RA. Effects of alcohols and anesthetics on recombinant voltage-gated Na $^{+}$  channels. [erratum appears in *J Pharmacol Exp Ther* 2004;310:843]. *J Pharmacol Exp Ther* 2004;309:987.
54. Hollmann MW, Strumper D, Herroeder S, et al. Receptors, G proteins, and their interactions. *Anesthesiology* 2005;103:1066.
55. Peterlin Z, Ishizawa Y, Araneda R, et al. Selective activation of G-protein coupled receptors by volatile anesthetics. *Mol Cell Neurosci* 2005;30:506.
56. van Swinderen B, Metz LB, Shebester LD, et al. G $\alpha$  regulates volatile anesthetic action in *Caenorhabditis elegans*. *Genetics* 2001;158:643.
57. Tseng YY, Liang J. Are residues in a protein folding nucleus evolutionarily conserved? *J Mol Biol* 2004;335:869.
58. Xi J, Liu R, Asbury GR, et al. Inhalational anesthetic-binding proteins in rat neuronal membranes. *J Biol Chem* 2004;279:19628.
59. Morgan PG, Hoppel CL, Sedensky MM. Mitochondrial defects and anesthetic sensitivity. *Anesthesiology* 2002;96:1268.
60. Hollenbeck PJ. Mitochondria and neurotransmission: evacuating the synapse. *Neuron* 2005;47:331.
61. Darbandi-Tonkabon R, Hastings WR, Zeng C-M, et al. Photoaffinity labeling with a neuroactive steroid analogue. *J Biol Chem* 2003;278:13196.
62. Eger EI, Fisher DM, Dilger JP, et al. Relevant concentrations of inhaled anesthetics for in vitro studies of anesthetic mechanisms. *Anesthesiology* 2001;94:915.
63. Urban BW, Friederich P. Anesthetic mechanisms in-vitro and in general anesthesia. *Toxicol Lett* 1998;100-101:9.
64. Eckenhoff RG, Johansson JS. On the relevance of "clinically relevant concentrations" of inhaled anesthetics in in vitro experiments. *Anesthesiology* 1999;91:856.
65. Raines DE, Miller KW. On the importance of volatile agents devoid of anesthetic action. *Anesth Analg* 1994;79:1031.
66. Hayashi Y, Maze M. Alpha 2, adrenoceptor agonists and anaesthesia. *Br J Anaesth* 1993;71:108.
67. Sonner JM, Gong D, Li J, et al. Mouse strain modestly influences minimum alveolar anesthetic concentration and convulsivity of inhaled compounds. *Anesth Analg* 1999;89:1030.
68. Morgan PG, Sedensky MM. Mutations conferring new patterns of sensitivity to volatile anesthetics in *Caenorhabditis elegans*. *Anesthesiology* 1994;81:888.
69. Kayser EB, Morgan PG, Sedensky MM. Mitochondrial complex I function affects halothane sensitivity in *Caenorhabditis elegans*. *Anesthesiology* 2004;101:365.
70. Hawasli AH, Saifee O, Liu C, et al. Resistance to volatile anesthetics by mutations enhancing excitatory neurotransmitter release in *Caenorhabditis elegans*. *Genetics* 2004;168:831.
71. Nash HA, Scott RL, Lear BC, et al. An unusual cation channel mediates photic control of locomotion in *Drosophila*. *Curr Biol* 12:2152, 2002;.
72. Sergeev P, da Silva R, Lucchinetti E, et al. Trigger-dependent gene expression profiles in cardiac preconditioning: evidence for distinct genetic programs in ischemic and anesthetic preconditioning. *Anesthesiology* 100:474, 2004;.
73. Futterer CD, Maurer MH, Schmitt A, et al. Alterations in rat brain proteins after desflurane anesthesia. *Anesthesiology* 2004;100:302.
74. Richards CD. Anaesthetic modulation of synaptic transmission in the mammalian CNS. *Br J Anaesth* 2002;89:79.

75. Subramaniam L. Security and Predictability: two missing pieces in BGP. Available at: <http://www.net.informatik.tu-muenchen.de/wired/position/lakme.pdf> 2003. Last accessed August 16, 2007.
76. Adams DJ, Biggs PJ, Cox T, et al. Mutagenic insertion and chromosome engineering resource (MICER). *Nat Genet* 2004; 36:867.
77. Austin CP, Battey JF, Bradley A, et al. The knockout mouse project. *Nat Genet* 2004;36:921.
78. Xin HB, Deng KY, Shui B, et al. Gene trap and gene inversion methods for conditional gene inactivation in the mouse. *Nucleic Acids Res* 2005;33:e14.
79. Rampil IJ. Anesthetic potency is not altered after hypothermic spinal cord transection in rats. *Anesthesiology* 1994;80:606.
80. Antognini JF, Carstens E, Atherley R. Does the immobilizing effect of thiopental in brain exceed that of halothane? *Anesthesiology* 2002;96:980.
81. Antognini JF, Schwartz K. Exaggerated anesthetic requirements in the preferentially anesthetized brain. *Anesthesiology* 1993;79:1244.
82. Jinks SL, Martin JT, Carstens E, et al. Peri-MAC depression of a nociceptive withdrawal reflex is accompanied by reduced dorsal horn activity with halothane but not isoflurane. *Anesthesiology* 2003;98:1128.
83. Alkire MT, Haier RJ, Fallon JH. Toward a unified theory of narcosis: brain imaging evidence for a thalamocortical switch as the neurophysiologic basis of anesthetic-induced unconsciousness. *Conscious Cogn* 2000;9:370.
84. Einon D, Stewart J, Atkinson S, et al. Effect of isolation on barbiturate anaesthesia in the rat. *Psychopharmacology (Berl)* 1976;50:85.
85. Tung A, Bergmann BM, Herrera S, et al. Recovery from sleep deprivation occurs during propofol anesthesia. *Anesthesiology* 2004;100:1419.
86. Tanase D, Baghdoyan HA, Lydic R. Dialysis delivery of an adenosine A<sub>1</sub> receptor agonist to the pontine reticular formation decreases acetylcholine release and increases anesthesia recovery time. *Anesthesiology* 2003;98:912.
87. Sato T, Araki I, Kushikata T, et al. Decreased hypothalamic prostaglandin D<sub>2</sub> and prostaglandin E<sub>2</sub> contents during isoflurane anaesthesia in rats. *Can J Anaesth* 1995;42:1031.
88. Keifer JC, Baghdoyan HA, Lydic R. Pontine cholinergic mechanisms modulate the cortical electroencephalographic spindles of halothane anesthesia. *Anesthesiology* 1996;84:945.
89. Tung A, Lynch JP, Roizen MF. Use of the BIS monitor to detect onset of naturally occurring sleep. *J Clin Monit Comput* 2002;17:37.
90. Gallez D, Babyloyantz A. Predictability of human EEG: a dynamical approach. *Biol Cybern* 1991;64:381-391.
91. Sleight JW, Donovan J. Comparison of bispectral index, 95% spectral edge frequency and approximate entropy of the EEG, with changes in heart rate variability during induction of general anaesthesia. *Br J Anaesth* 1999;82:666-671.
92. Sherin JE, Shiromani PJ, McCarley RW, et al. Activation of ventrolateral preoptic neurons during sleep. *Science* 1996;271:216.
93. Saper CB, Chou TC, Scammell TE. The sleep switch: hypothalamic control of sleep and wakefulness. *Trends Neurosci* 2001;24:726.
94. Plourde G, Chartrand D, Fiset P, et al. Antagonism of sevoflurane anaesthesia by physostigmine: effects on the auditory steady-state response and bispectral index. *Br J Anaesth* 2003;91:583.
95. Jones BE. From waking to sleeping: neuronal and chemical substrates. *Trends Pharmacol Sci* 2005;26:578.
96. Berridge CW, Foote SL. Effects of locus coeruleus activation on electroencephalographic activity in neocortex and hippocampus. *J Neurosci* 1991;11:3135.
97. Correa-Sales C, Rabin BC, Maze M. A hypnotic response to dexmedetomidine, an alpha 2, agonist, is mediated in the locus coeruleus in rats. *Anesthesiology* 1992;76:948.
98. Zhang Y, Laster MJ, Eger EI, et al. Blockade of 5-HT<sub>2A</sub> receptors may mediate or modulate part of the immobility produced by inhaled anesthetics. *Anesth Analg* 2003;97:475.
99. Haas H, Panula P. The role of histamine and the tuberomammillary nucleus in the nervous system. *Nat Rev Neurosci* 2003;4:121.
100. Nelson LE, Guo TZ, Lu J, et al. The sedative component of anesthesia is mediated by GABA(A) receptors in an endogenous sleep pathway. *Nat Neurosci* 2002;5:979.
101. Sutcliffe JG, de Lecea L. The hypocretins: setting the arousal threshold. *Nat Rev Neurosci* 2002;3:339.
102. Kushikata T, Hirota K, Yoshida H, et al. Orexinergic neurons and barbiturate anesthesia. *Neuroscience* 2003;121:855.
103. Yasuda Y, Takeda A, Fukuda S, et al. Orexin a elicits arousal electroencephalography without sympathetic cardiovascular activation in isoflurane-anesthetized rats. *Anesth Analg* 2003;97:1663.
104. Eckenhoff RG. Promiscuous ligands and attractive cavities: how do the inhaled anesthetics work? *Mol Interv* 2001;1:258.
105. Xu Y, Tang P, Zhang W, et al. Fluorine-19, nuclear magnetic resonance imaging and spectroscopy of sevoflurane uptake, distribution, and elimination in rat brain. *Anesthesiology* 1995;83:766.
106. Jenkins A, Greenblatt EP, Faulkner HJ, et al. Evidence for a common binding cavity for three general anesthetics within the GABA<sub>A</sub> receptor. *J Neurosci* 2001;21:RC136.
107. Morgan PG, Sedensky M, Meneely PM. Multiple sites of action of volatile anesthetics in *Caenorhabditis elegans*. *Proc Natl Acad Sci U S A* 1990;87:2965.
108. Walcourt A, Scott RL, Nash HA. Blockage of one class of potassium channel alters the effectiveness of halothane in a brain circuit of *Drosophila*. *Anesth Analg* 2001; 92:535.
109. Collin T, Marty A, Llano I. Presynaptic calcium stores and synaptic transmission. *Curr Opin Neurobiol* 2005;15:275.
110. Weimer RM, Jorgensen EM. Controversies in synaptic vesicle exocytosis. *J Cell Sci* 2003;116:3661.



# CHAPTER 37

## Pharmacology of Inhalational Anesthetics

Stuart A. Forman, MD, PhD,  
and George A. Mashour,  
MD, PhD

Experimentation with inhalation of gases and vapors for the purpose of obtunding the distress associated with surgery began in the 19th century. The administration of inhaled anesthetics spread rapidly following the successful public demonstration of ether anesthesia by William T. G. Morton on October 16, 1846 at Massachusetts General Hospital.

Inhaled agents were the sole means of reliably inducing general anesthesia until the development of intravenous delivery techniques and drugs. Inhalants continue to be used in a large fraction of general anesthetics because of their ease of use and predictable effects. The inhalational route of administration is always available, and the same route is used for drug removal. Thus, inhaled anesthetics require no metabolic clearance (indeed, metabolism is associated with toxicity). Modern equipment for administration of inhaled anesthetics is simple and robust, providing an elegant method for inducing, maintaining, and reversing general anesthesia. Furthermore, monitoring anesthetic concentrations in end-tidal expired gases (see Chapters 27 and 31) provides an estimate of drug concentrations in the circulating blood and central nervous system (CNS). This ability to assess drug concentrations in the body reduces pharmacokinetic uncertainty when determining how much inhaled vapor to administer.

### ANESTHETIC DOSE–RESPONSE CONCEPTS

Varying the amount of delivered anesthetic will alter the physiologic functions of the patient. An understanding

### KEY POINTS

- Inhaled anesthetics are delivered and eliminated via pulmonary ventilation. The most useful definition of “dose” for these drugs is the partial pressure in alveolar gases, which is readily monitored in end-tidal expired gases.
- Some early inhaled anesthetic alkanes and ethers were flammable. Halogenation reduces flammability. Fluorination tends to decrease metabolic breakdown.
- All halogenated anesthetics break down, releasing carbon monoxide and heat when they contact *desiccated* alkaline chemicals, such as those in common carbon dioxide (CO<sub>2</sub>) adsorbents. Potential harm to patients from this breakdown can be prevented by proper use and maintenance of anesthesia equipment and by use of less alkaline CO<sub>2</sub> adsorbents.
- Biophysical properties of inhaled anesthetics, including blood/gas partition coefficients and tissue–blood partition coefficients, determine the speed of drug uptake, distribution among tissue groups, and elimination.
- Low blood solubility of inhaled anesthetics is associated with rapid uptake and elimination via the lungs.
- The rate at which the alveolar anesthetic concentration (FA or P<sub>alv</sub>) approaches the inspired (circuit) concentration (FI or P<sub>circ</sub>) depends on minute alveolar ventilation (increased ventilation accelerates FA/FI), cardiac output (increased output slows FA/FI rise), and the blood/gas partition coefficient of the anesthetic (high solubility slows FA/FI rise).
- The concentration (partial pressure) of anesthetic in highly perfused tissues (brain, spinal cord, heart, liver, kidney) equilibrates rapidly with that in alveoli.
- Nitrous oxide diffuses into air-filled spaces in the body, causing expansion and/or increased pressure. This action may impair regional or total body blood flow.
- General anesthesia is a state that includes hypnosis (loss of awareness), amnesia (loss of memory), and immobility (lack of motor responses to pain). These primary effects of anesthetics are mediated in the central nervous system.
- Minimum alveolar concentration (MAC) is the alveolar concentration of anesthetic that blocks movement in half of subjects in response to a surgical incision. MAC is influenced by age, pharmacologic and physiologic factors (e.g., temperature), and genetic factors.
- MAC–awake is the alveolar concentration of anesthetic causing loss of response to verbal commands in half of subjects.
- Amnesia can be produced by anesthetic concentrations lower than MAC–awake.
- Awareness and explicit recall of intraoperative events is due to inadequate delivery of anesthetics for the patient’s needs. Awareness during anesthesia occurs in about one in 1000 to 2000 patients and may cause psychological disturbances leading to post-traumatic stress disorder.
- Anesthetists should know the risk factors associated with awareness and strategies for preventing it. Ideally, all patients should be interviewed postoperatively to elicit reports of awareness during general anesthesia.
- All potent volatile anesthetics in current use decrease mean arterial pressure in a dose-dependent manner.
- Severe cardiovascular and respiratory depression can occur even at low volatile anesthetic concentrations in elderly, hypovolemic, or critically ill patients and at only 2–3 × MAC in healthy patients. Prevention of severe depression requires vigilant monitoring and anticipation of anesthetic requirements.
- Nitrous oxide augments sympathetic activity and tends to oppose the hypotensive action of coadministered volatile agents.
- Volatile anesthetics may increase heart rate, both by a baroreceptor reflex in response to decreased arterial pressure and by a direct vagolytic effect on the heart.
- Volatile anesthetics tend to increase respiratory rate, decrease tidal volume, and blunt ventilatory responses to hypercapnia and hypoxia.

*Continued*



*Key Points—continued*

20. Desflurane is very pungent, and its use can be associated with airway irritability, bronchoconstriction, and laryngospasm during induction. Sevoflurane causes the least amount of subjective airway irritation.
21. Volatile anesthetics vasodilate cerebral vessels, increasing blood flow while reducing cerebral metabolic oxygen consumption. Cerebral vascular responses to altered  $p\text{CO}_2$  are maintained in the presence of volatile anesthetics. Nitrous oxide increases cerebral metabolism.
22. Volatile anesthetics reduce both hepatic and renal blood flow, whereas nitrous oxide does not.
23. Halothane undergoes the most hepatic metabolism of the inhaled agents. Enflurane, isoflurane, and sevoflurane also are metabolized in the liver, whereas desflurane and nitrous are minimally metabolized.
24. Oxidative metabolism of halothane and other volatile agents can induce a severe immune-mediated hepatitis.
25. All potent volatile agents may trigger malignant hyperthermia in susceptible individuals.

of inhaled anesthetic pharmacology must begin with clear definitions of both the drug amount (dosage) and important effects (response).

The “dose” of an inhaled anesthetic can be a confusing concept. The dosage of inhaled anesthetic documented in an anesthetic record is most often the *delivered gaseous concentration* (in percent of total gas) in the vaporizer outflow (i.e., fresh gas). Dosage also may be defined as the *inspired concentration* of inhaled anesthetic in the breathing circuit or, analogous to injected drugs, as the *amount absorbed* by the body via the lungs. These definitions are of limited use because several factors, including ambient atmospheric pressure, fresh gas flow (FGF) rate, minute ventilation, and rate of uptake into the blood via the lungs, determine how these various “doses” affect patients. The most useful and practical definition of dosage for inhaled anesthetic drugs is the partial pressure in alveolar gas. The partial pressure of an inhaled drug is directly proportional to its fractional concentration in a gas mixture and is measured on an absolute scale of pressure (see Chemical and Physical Properties of Inhaled Anesthetics below).

The common effects induced by all general anesthetics are hypnosis (loss of perceptive awareness), amnesia (anterograde loss of memory), and ablation of movement in response to pain (inhibition of nociceptive reflexes).<sup>1</sup> These therapeutic actions, which define the state of general anesthesia, all are mediated by the CNS (brain and spinal cord). Some anesthetics can provide additional therapeutic actions, such as analgesia, attenuation of autonomic reflexes, and protection of the

heart and brain from ischemia and reperfusion. In addition, nontherapeutic effects of anesthetics (side effects) must be considered, because these often influence the choice of anesthetic drug and dosage depending on the specific clinical setting.

## PURPOSE AND SCOPE OF THIS CHAPTER

This chapter describes the chemical and biophysical properties of commonly used inhaled anesthetics and relates these properties to the clinical pharmacology. Various properties of inhaled drugs influence their chemical stability, rate of pulmonary uptake/elimination, and metabolism (pharmacokinetics), as well as clinically important differences among their therapeutic actions and toxicities (pharmacodynamics). Understanding these pharmacologic relationships is crucial for the safe and effective delivery of inhaled anesthetics.

### Chemical and Physical Properties of Inhaled Anesthetics

The structures of various inhaled anesthetics, in three chemical categories, are depicted in Fig. 37-1. The chemical and physical properties of the gaseous and volatile anesthetics currently available for clinical use (nitrous oxide [ $\text{N}_2\text{O}$ ], isoflurane, enflurane, halothane, desflurane, and sevoflurane) are summarized for comparison in Table 37-1.

### Nitrous Oxide

$\text{N}_2\text{O}$  was one of three inhaled anesthetics, along with diethyl ether and chloroform, that was used in the 19th centu-

ry. In the early 20th century, more inhaled anesthetics were identified, including ethylene, ethyl chloride, and cyclopropane. Of these, only  $\text{N}_2\text{O}$  remains in use. All the others are combustible, a characteristic that can lead to infrequent catastrophic outcomes for both patients and caregivers.<sup>2</sup>

$\text{N}_2\text{O}$  is a simple linear inorganic compound that is in the gas phase at normal ambient temperature and pressure and is chemically stable.  $\text{N}_2\text{O}$  has no odor or taste. The boiling point of  $\text{N}_2\text{O}$  is  $-88.5^\circ\text{C}$ . At room temperature,  $\text{N}_2\text{O}$  condenses into a liquid at 745 psi (50 atm), making the storage and transport of large quantities in pressurized cylinders economical. A room-temperature cylinder will display a pressure near 745 psi as long as liquid  $\text{N}_2\text{O}$  remains. The pressure will fall only when the tank is completely depleted of liquid and is nearly empty. Pressure within the cylinder may drop during rapid delivery of  $\text{N}_2\text{O}$  as vaporization absorbs heat, cooling the tank and its contents. The weight of the tank, not the pressure, is the only reliable guide to assessing how much  $\text{N}_2\text{O}$  remains.  $\text{N}_2\text{O}$  can support combustion, so inhalation of  $\text{N}_2\text{O}$  during surgery with electrocautery or lasers does not prevent the ignition of flammable materials.

$\text{N}_2\text{O}$  has a low potency as an anesthetic. It must be delivered at nearly 0.7 atm (530 mm Hg) to ablate awareness in half of patients and at over 1 atm in most patients to prevent movement during an incision. Therefore,  $\text{N}_2\text{O}$  is frequently used in combination with other inhaled or intravenous anesthetic agents.

### Halothane

In the mid-20th century, efforts to develop safer inhaled anesthetics focused on reducing flammability by halogenation (adding bromine, chlorine, and fluorine) of alkanes and ethers.<sup>3</sup> Halothane is a halogenated alkane ( $\text{CF}_3\text{CHBrCl}$ ) and became clinically available in 1956. It has a pleasant, nonpungent odor, and it is tolerated well during inhalation. Halothane is a liquid at normal temperature and pressure, and its high vapor pressure (243 mm Hg at  $20^\circ\text{C}$ ) is many-fold higher than that needed to induce anesthesia. Clinically used concentrations of halothane are not flammable, but higher concentrations (in anesthesia machines) can ignite. Halothane is slightly unstable, decomposing in the presence of light and oxygen. To prevent photo-oxidative breakdown, hal-

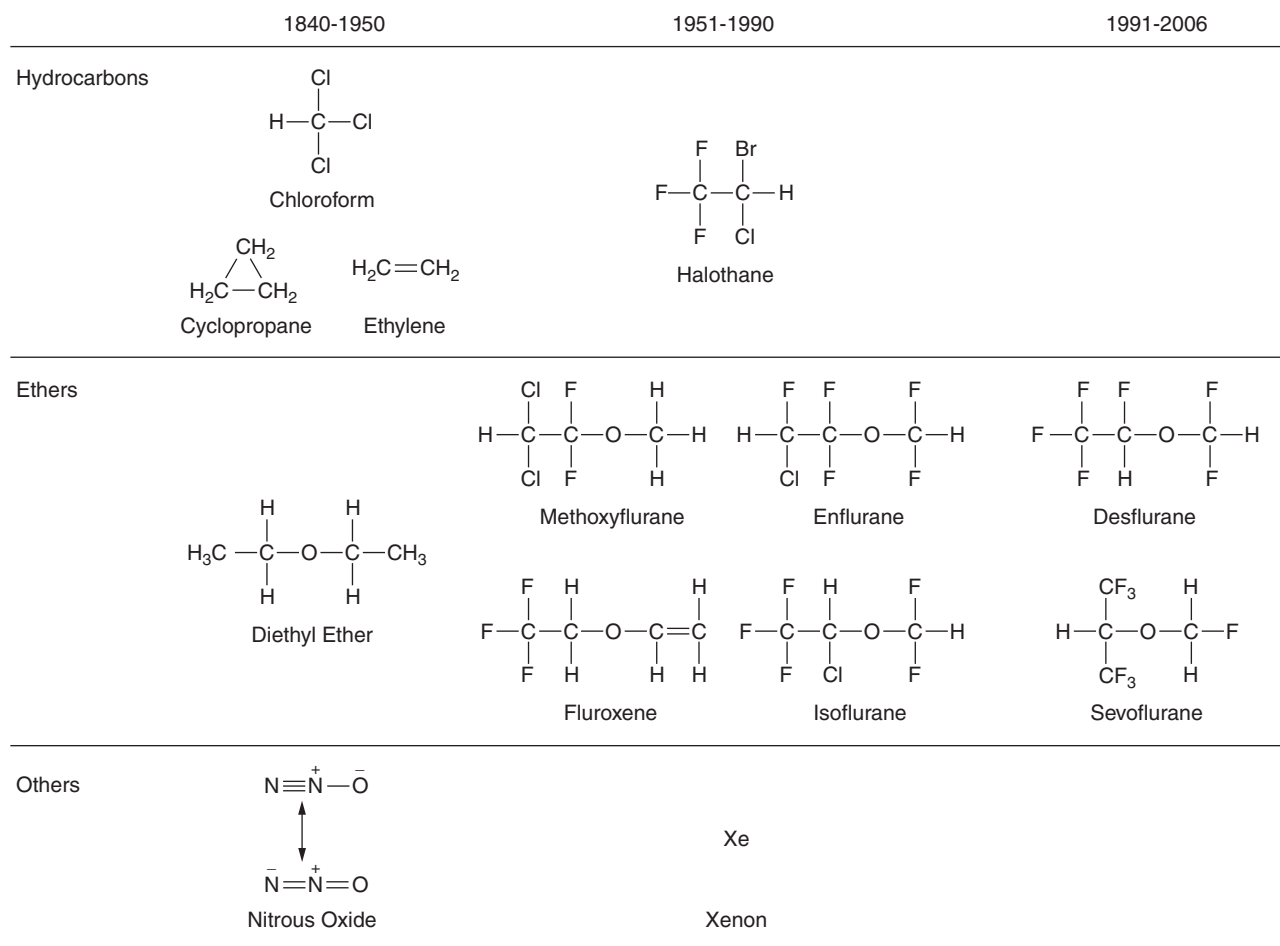


FIGURE 37-1. Structures of inhaled anesthetics. Three different classes of inhaled anesthetics were identified in the 19th century.

othane is stored in dark glass bottles containing 0.01% thymol. Newer halogenated volatile anesthetics do not require such chemical stabilizers.

### Enflurane and Isoflurane

Enflurane and its isomer isoflurane were introduced into clinical practice in the 1970s. They are halogenated ethers that undergo much less metabolism and have faster onset/offset in comparison to halothane.

Enflurane is a halogenated ether ( $\text{CHFClCF}_2\text{OCHF}_2$ ) and is more pun-

gent than halothane, but it is reasonably well tolerated for inhalation induction. It is a clear liquid with a vapor pressure of 172 mm Hg at 20°C.

Isoflurane is a halogenated ether and an isomer of enflurane ( $\text{CF}_3\text{CHClOCHF}_2$ ). It is a clear liquid with a vapor pressure of 238 mm Hg at 20°C. It is pungent and frequently stimulates coughing during inhalation induction.

### Desflurane and Sevoflurane

Desflurane and sevoflurane, introduced in the 1990s, both are less potent

and less blood soluble than other halogenated anesthetics. Low blood solubility provides rapid pulmonary uptake and elimination, which are highly desirable in clinical settings where rapid emergence from anesthesia is valued.

Desflurane is a highly fluorinated ether ( $\text{CF}_3\text{CHFOCHF}_2$ ) that is extremely resistant to biodegradation. Desflurane has a high vapor pressure of 664 mm Hg at 20°C and boils at 22.8°C (73°F). To prevent boiling, desflurane is stored in special bottles with valves that open only when fitted into

TABLE 37-1.

#### Physicochemical Properties of Inhaled Anesthetics

Property	$\text{N}_2\text{O}$	Isoflurane	Enflurane	Halothane	Desflurane	Sevoflurane
Molecular weight	44	184.5	184.5	197.4	168	200.1
Boiling point (°C/°F)	-88.5/-127.3	48.5/119.3	56.5/133.7	50.2/122.4	22.8/74.3	58.6/137.5
Density (g/mL)	$1.84 \times 10^{-3}$ (gas)	1.5	1.52	1.86	1.45	1.50
Vapor pressure at 20°C (mm Hg)	43,879 (gas)	238	175	243	664	157
Oil/gas partition coefficient at 37°C	1.3	90.8	96.5	197	19	47-54

the filling port of a vaporizer. The unique desflurane vaporizer heats the anesthetic to 39°C to control its vapor pressure and delivery rate.<sup>4</sup> Desflurane vapor is extremely pungent, and coughing and autonomic stimulation are frequently produced during inhalation induction.

Sevoflurane is a highly fluorinated ether [(CF<sub>3</sub>)<sub>2</sub>CHOCH<sub>2</sub>F]. It is a clear liquid with a vapor pressure of 157 mm Hg at 20°C. Sevoflurane has a pleasant odor and low pungency, making it well tolerated for inhalation induction of anesthesia.

## BIOPHYSICAL PROPERTIES OF INHALED ANESTHETICS

The concepts of partial pressure and partition coefficients are central to understanding how gases distribute among various compartments in the body.

### Partial Pressure

Partial pressure is the pressure exerted by one component of a gas mixture, where the sum of all the partial pressures equals the total pressure. For example, air contains approximately 79% nitrogen (fraction of N<sub>2</sub> = FN<sub>2</sub> = 0.79) and 21% oxygen (FO<sub>2</sub> = 0.21), so at 1 standard atmosphere barometric pressure (P<sub>Bar</sub> = 1 atm = 760 mm Hg), the partial pressure of N<sub>2</sub> (PN<sub>2</sub>) = 0.79 atm = 600 mm Hg and PO<sub>2</sub> = 0.21 atm = 160 mm Hg. Near sea level, where atmospheric pressure is approximately 760 mm Hg, the fractional concentration of a gas differs insignificantly from its partial pressure (in atm), and the two terms can be used synonymously. At high altitudes, where ambient pressure is lower, air contains the same fractional concentrations of nitrogen and oxygen, whereas their partial pressures are reduced relative to those at sea level. For example, in Denver (P<sub>Bar</sub> = 630 mm Hg), PN<sub>2</sub> = 500 mm Hg and PO<sub>2</sub> = 130 mm Hg. Similarly, gaseous anesthetics such as N<sub>2</sub>O, when used at high altitudes, will exert a lower partial pressure (and have a subsequently reduced anesthetic effect) relative to the same fractional concentration at sea level.

### Vapor Pressure

Volatile anesthetic vapor pressure is the gaseous partial pressure at the liquid-gas interface, such as that in a vaporizer. Vapor pressure remains in-

dependent of total ambient pressure and is solely a property of the anesthetic agent and its temperature. Thus, in relation to carrier gases, the fractional concentration of a saturated volatile anesthetic in a vaporizer will be higher at high altitude (Fig. 37-2). When working at ambient pressures that differ significantly from sea level, anesthetists must adjust the delivered oxygen concentrations and vaporizer settings appropriately.

Partial pressure is the driving force for the diffusion of gases across permeable barriers into other gases, liquids, or tissues. At equilibrium, the partial pressure of any gas is equal in all intercommunicating compartments within a closed system. In the operating room, intercommunicating compartments include the anesthesia machine, the breathing circuit, and the patient's body, which is further compartmentalized. The partial pressure of an inhaled anesthetic is directly proportional to its concentration in liquid (i.e., blood) or tissue phases (e.g., brain), where concentration usually is defined as the weight, volume, or moles of drug per volume of liquid or tissue. Importantly, different liquids (e.g., blood or cerebrospinal fluid) and tissues may contain remarkably different drug concentrations at the same partial pressure, depending on the solubility of the gas in each liquid or tissue. The concentrations in two different compartments define a partition coefficient.

### Partition Coefficients

A *partition coefficient* is defined as the ratio of concentrations of a drug in one compartment (gas, blood, or tissue) versus another intercommunicating compartment at equilibrium (i.e., equal partial pressure in both compartments). Therefore, partition coefficients have no units. Another useful concept is that the partition coefficient represents the number of volumes of the reference phase (e.g., gas) that contains the same amount of anesthetic as the second phase (e.g., blood), which we call the *effective volume* (or relative volume) of the second phase (Fig. 37-3 and Table 37-2). The effective volume concept is similar to the distribution volume of injected drugs when calculating metabolic or renal clearance and helps illustrate why drug equilibration in different tissues takes vastly different amounts of time.

Both blood/gas partitioning and tissue/blood partitioning (Table 37-2) determine the distribution of inhaled anesthetics within the body.

### Blood/Gas Partitioning

The *blood solubility* of inhaled anesthetics is another term for the blood/gas partition coefficient ( $\lambda_{b/g}$ ). At equilibrium, the concentration (i.e., volume drug per volume = v/v) of most inhaled anesthetics is higher in blood than in surrounding gases. That is,  $\lambda_{b/g} > 1.0$  (Table 37-2). Two notable exceptions are N<sub>2</sub>O and desflurane, which have the lowest blood solubilities of the commonly used inhaled anesthetics. Blood/gas partitioning varies depending on temperature, hematocrit, and the lipid content of blood. The solubility of most gases, including inhaled anesthetics, increases as the temperature of a liquid, such as blood, decreases.<sup>5</sup> Blood cells and plasma contain protein and lipids, which provide a higher capacity for anesthetics. Thus, hemodilution (decreased cell mass) reduces, whereas hypertriglyceridemia increases, the blood solubility of inhaled anesthetics. Elevated levels of blood lipids after a fatty meal increase anesthetic solubility relative to that after fasting.<sup>6</sup>

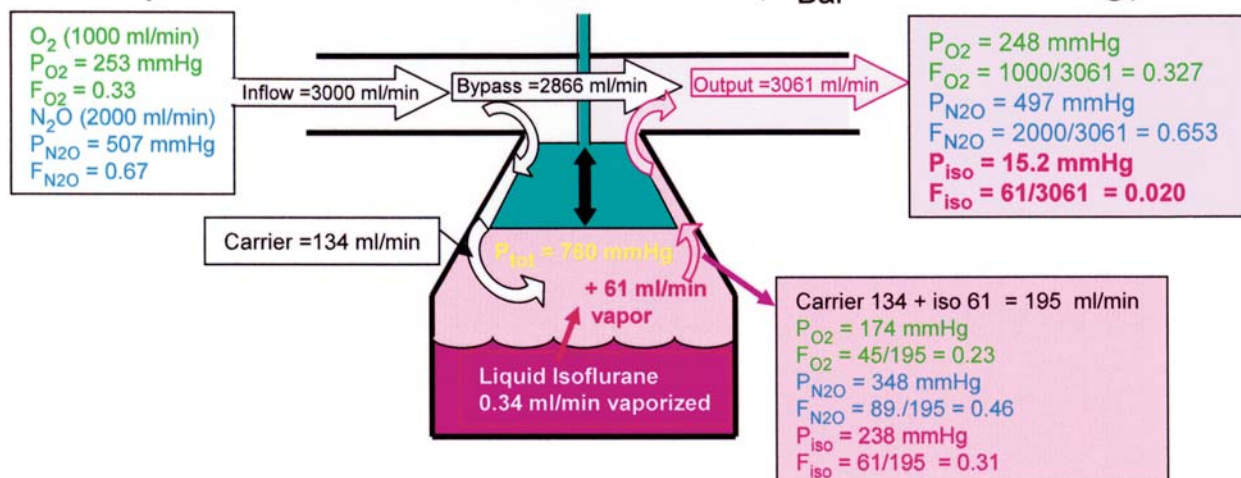
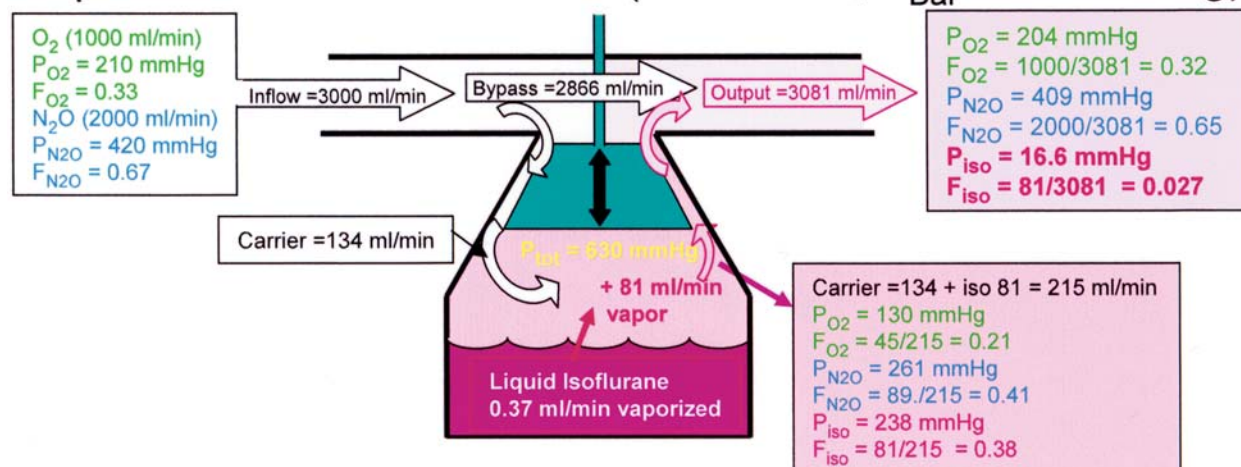
### Tissue/Blood Partitioning

In general, the solubility of inhaled anesthetics in tissues depends on the fraction of tissue that is lipid,<sup>7</sup> because most anesthetics are highly lipophilic. Thus, the more potent volatile anesthetics, which also are the most oil soluble (based on the Meyer-Overton correlation), tend to partition avidly into fatty tissues (Table 37-2).

## PHARMACOKINETICS: INHALED ANESTHETIC UPTAKE AND DISTRIBUTION

### Multicompartmental Kinetic Model

The inflows to and the outflows between the anesthesia machine circuit and the patient's lungs, blood and tissues can be depicted as a cyclical multicompartmental system wherein the anesthetic partial pressure in one compartment is the upstream partial pressure driving anesthetic into downstream compartment(s) (Fig. 37-4). These compartments have different phases: gas in the anesthetic circuitry

Vaporizer set at 2% at Sea Level ( $P_{\text{Bar}} = 760 \text{ mm Hg}$ )Vaporizer set at 2% in Denver (Alt. 5280 ft,  $P_{\text{Bar}} = 630 \text{ mmHg}$ )

**FIGURE 37–2.** Vapor pressure, partial pressure, and concentration of inhaled anesthetics. Impact of atmospheric pressure on vaporizer output. Top. Variable bypass vaporizers are calibrated at 20°C and 1 atm (standard temperature and pressure). The partial pressure of isoflurane in the vaporization chamber is its vapor pressure, 238 mm Hg. Isoflurane vapor adds to the carrier gases ( $\text{O}_2$  and  $\text{N}_2\text{O}$ ), and the sum of the partial pressures equals atmospheric pressure ( $\approx 760 \text{ mm Hg}$  at sea level) at all points in the flow path. With fresh gas flow = 3 L/min and the vaporizer set at 2.0%, the carrier flow through the vaporization chamber is 134 mL. Approximately 61 mL/min of isoflurane vapor (0.34 mL/min liquid) is added to the carrier gases so that the output of the vaporizer after dilution is 3061 mL/min at 2.0% isoflurane ( $P_{\text{iso}} = 15.2 \text{ mm Hg}$ ). Bottom. With the same flow and vaporizer settings in Denver (elevation 5280 ft ambient, pressure 630 mm Hg), isoflurane composes a larger portion of the carrier gas mixture, and, after dilution, the output of the vaporizer is 3081 mL/min at approximately 2.6% isoflurane. Thus, in Denver the *delivered concentration* of isoflurane is 30% higher than that at sea level. However, the delivered *partial pressure* of isoflurane in Denver is 16.7 mm Hg, only 10% higher than at sea level. Similarly, liquid isoflurane is vaporized at 0.37 mL/min in Denver, approximately 10% more than at sea level. Because its partial pressure directly determines the uptake and effect of isoflurane on patients, only minor changes in vaporizer settings are required at high altitudes. Partial pressures of  $\text{N}_2\text{O}$  and  $\text{O}_2$  carrier gases in Denver will be approximately 17% lower than at sea level. Thus, at similar carrier gas flows, nitrous oxide will have a significantly reduced anesthetic action in Denver *versus* sea level. Moreover, the inspired  $\text{O}_2$  concentration in Denver should be increased to reduce the risk of hypoxia, so increasing the  $\text{N}_2\text{O}$  concentration may not be possible.

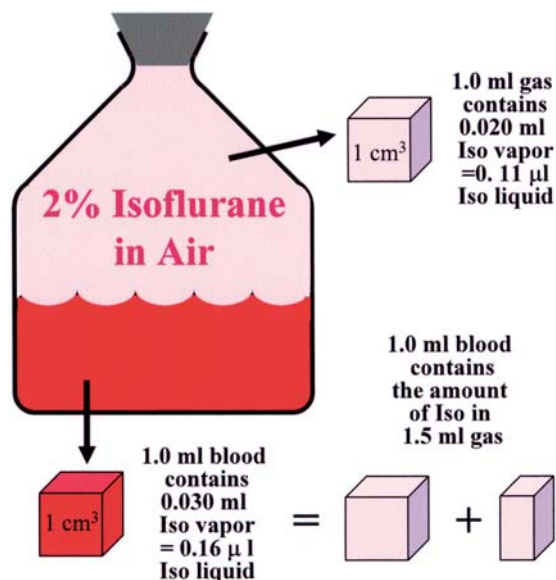
and airspace of the lung, liquid in blood, and mixed liquid/solid in organs.<sup>8</sup> The model depicted in Fig. 37–4 is complex and requires computer assistance to calculate how the anesthetic partial pressure in various compartments changes over time (for details, see Fig. 37–4 legend). However, it is

relatively easy to understand how an anesthetic moves between one upstream compartment and one downstream compartment (a two-compartment system).

Transfer of anesthetic gas from one compartment to another (e.g., from a vaporizer to the breathing circuit) is

proportional to both the bulk carrier flow (FGF in this example) and the partial pressure difference ( $P_{\text{delivered}} - P_{\text{circ}}$ ). As more anesthetic gas is transferred, the partial pressure difference between the compartments becomes smaller, and the transfer rate slows. The time it takes a given compart-





**FIGURE 37-3.** Blood/gas partitioning of isoflurane. After equilibrating a sealed container containing blood and isoflurane in air, a sample of blood will contain 1.5 times the amount of isoflurane as an equal volume of air.

ment to equilibrate with upstream anesthetic partial pressure is determined by its volume (or effective volume) and the bulk flow carrying anesthetic to that compartment.

Equilibration between two compartments is quantitatively described by an exponential equation (Equation 37-1), which is characterized by the time constant  $\tau$ . After each time constant,

the difference between upstream and downstream concentrations is reduced by approximately 63%. A general equation describing this relationship is as follows:

$$P_{\text{downstream}} = P_{\text{upstream}} \times (1 - e^{-t/\tau}) \quad (37-1)$$

where  $t$  = elapsed time measured from when the anesthetic is turned on during induction. The time constant is directly proportional to the downstream compartment volume ( $V$ ): if the volume of the receiving compartment doubles,  $\tau$  doubles and it takes twice as long for equilibration to occur. The time constant  $\tau$  is inversely proportional to carrier flow ( $F$ ): if the delivery flow doubles,  $\tau$  halves and equilibration occurs twice as fast.

$$\tau(\text{min}) = \frac{V(\text{L})}{F(\text{L/min})} \quad (37-2)$$

After five time constants have elapsed, the difference between upstream and downstream compartments diminishes to approximately 1%. At equilibrium, the compartments

**TABLE 37-2.**

**Biophysical and Pharmacokinetic/Pharmacodynamic Properties of Inhaled Anesthetics**

Property	N <sub>2</sub> O	Isoflurane	Enflurane	Halothane	Desflurane	Sevoflurane
$\lambda_{\text{blood/gas}}$ at 37°C <sup>a</sup>	0.47	1.4	1.8	2.5	0.45	0.65
Blood V <sub>eff</sub> (L) <sup>b</sup>	2.4	7.5	9.0	12.5	2.3	3.3
$\lambda_{\text{brain/blood}}$ at 37°C <sup>a</sup>	1.1	1.6	1.4	1.9	1.3	1.7
Brain V <sub>eff</sub> (L) <sup>b</sup>	1.5	2.2	2.0	2.7	1.8	2.4
$\tau_{\text{brain/blood}}$ (min) <sup>c</sup>	2.1	3.0	2.6	3.5	2.4	3.2
$\lambda_{\text{muscle/blood}}$ at 37°C <sup>a</sup>	1.2	2.9	1.7	3.4	2	3.1
Muscle V <sub>eff</sub> (L) <sup>b</sup>	36	87	51	102	60	93
$\tau_{\text{muscle/blood}}$ (min) <sup>c</sup>	62	147	87	174	103	159
$\lambda_{\text{fat/blood}}$ at 37°C <sup>a</sup>	2.3	45	36	51	27	48
Fat V <sub>eff</sub> (L) <sup>b</sup>	29.7	580	464	658	348	619
$\tau_{\text{fat/blood}}$ (min) <sup>c</sup>	126	2470	1976	2800	1482	2635
MAC in O <sub>2</sub> (%/mm Hg) <sup>d</sup>	105/800	1.28/9.7	1.58/12.0	0.75/5.7	6.0/45.6	2.05/15.6
MAC in 70% N <sub>2</sub> O/30% O <sub>2</sub> (%/mm Hg) <sup>d</sup>	—	0.56/4.26	0.57/4.33	0.29/2.20	2.5/19	0.66/5.02
MAC-Awake (%/mm Hg) <sup>e</sup>	71/540	0.43/3.27	0.51/3.88	0.41/3.21	2.4/19	0.63/4.79
Metabolism (%)	0.0	0.2	2.4	20	0.02	2-5

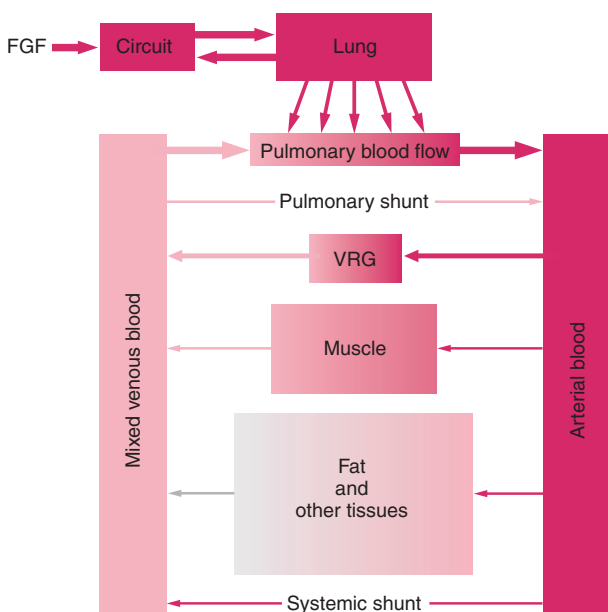
<sup>a</sup>Partition coefficient at 37°C.

<sup>b</sup>Effective volumes and time constants were calculated based on a 70-kg adult with blood volume = 5.0 L, brain volume = 1.4 L, brain blood flow = 0.75 L/min, muscle volume = 30 L, muscle blood flow = 0.59 L/min, fat volume = 12.9 L, and fat blood flow = 0.24 L/min. After Kennedy et al.<sup>211</sup>

<sup>c</sup>Time constants ( $\tau$ ) are for equilibration between the blood and the specified tissue, calculated using Equation 37-2 and V<sub>eff</sub>.

<sup>d</sup>Minimum alveolar concentration (MAC) is the anesthetic concentration inhibiting motor responses to skin incision in half of subjects.

<sup>e</sup>Minimum alveolar concentration-awake (MAC-Awake) is the anesthetic concentration that inhibits appropriate motor responses to spoken commands in half of subjects.



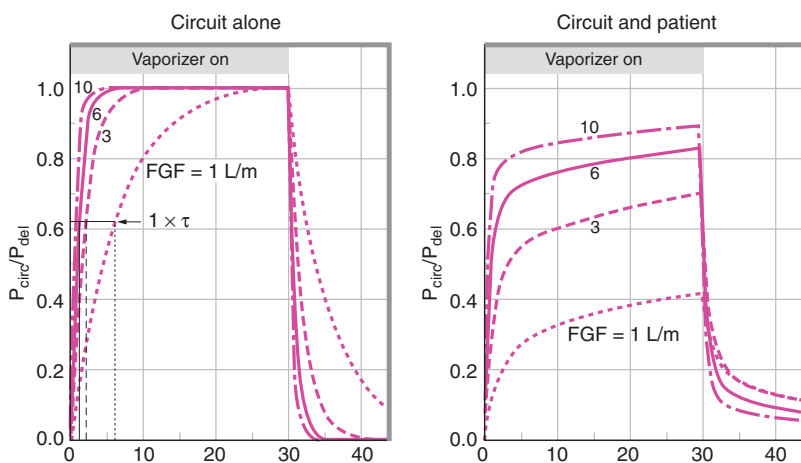
**FIGURE 37-4.** Model for uptake and distribution of inhaled anesthetics. Scheme depicts the flow of anesthetic gas from vaporizer to the breathing circuit, its transfer into blood via the lungs, and distribution to various tissues. The size of tissue compartments are drawn in general proportion to their effective volumes ( $V_{\text{eff}} = V_{\text{anatomic}} \times \lambda_{\text{tissue/blood}}$ ), and arrows of different width indicate relative blood flows. A variety of mathematical models have been devised to quantitatively illustrate anesthetic flow and distribution, and most are elaborations on the model introduced in 1963 by Mapleson.<sup>212</sup> The model shown here is not intended to replicate reality, although it approximates it and serves as a simple way of illustrating how the various input parameters (fresh gas flow [FGF], type of agent, vaporizer setting, minute ventilation, and cardiac output) affect the rate of gas uptake. The following differential equations were used to generate the uptake and clearance data displayed in figures throughout this chapter ( $\dot{V}$  = minute ventilation,  $Q$  = cardiac output, and  $\dot{q}$  = tissue perfusion). The anesthetic partial pressure in the breathing circuit:

$$dP_{\text{circ}}/dt = \text{FGF}/V_{\text{circ}} \times (P_{\text{delivered}} - P_{\text{circ}}) - \dot{V}/V_{\text{circ}} \times (P_{\text{circ}} - P_{\text{alv}}). \quad (37-3)$$

$$\text{The anesthetic partial pressure in alveolar gas } dP_{\text{alv}}/dt = \dot{V}/V_{\text{lung}} \times (P_{\text{circ}} - P_{\text{alv}}) - \frac{(Q \times \lambda_{\text{b/g}})/V_{\text{lung}} \times (P_{\text{alv}} - P_{\text{mv}})}{.} \quad (37-4)$$

$$\text{Uptake into a specific tissue (i): } dP_i/dt = \dot{q}_i / (\dot{V}_i \times \lambda_{i/b}) \times (P_{\text{alv}} - P_i). \quad (37-5)$$

$$\text{The anesthetic partial pressure in mixed venous blood: } P_{\text{mv}} = \frac{\sum_{i=1}^n P_i \times q_i}{Q}. \quad (37-6)$$



**FIGURE 37-5.** Impact of fresh gas flow on the anesthetic concentration in the breathing circuit. **Left.** Rise of anesthetic partial pressure follows a single exponential when there is only a single downstream compartment (the circuit). Anesthetic clearance from the circuit follows the same time course as its rise, depending on fresh gas flow. **Right.** Rise of the inspired anesthetic (isoflurane in this example) partial pressure is slowed by uptake into the patient.

have the same partial pressure of anesthetic, and no net anesthetic transfer between compartments occurs, even though carrier flow continues.

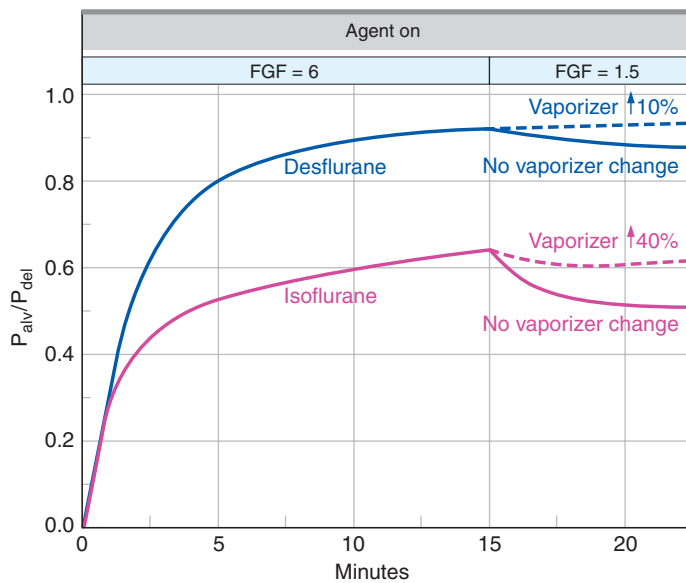
Equilibration time is independent of the source partial pressure if this pressure is small (see Concentration Effect and Second Gas Effect below). However, the time to reach a target partial pressure in the downstream compartment (i.e., to reach a specific depth of anesthesia) will be shorter if the upstream partial pressure is higher. A common practice is to deliver potent volatile anesthetics at two to three times the target partial pressure (*overpressure*) in order to reduce the induction time. Once the desired depth of anesthesia has been achieved, the vaporizer is set to a lower concentration to prevent the toxic effects of overdosage.

### Inspired Partial Pressure of Anesthetic Gas

The example cited can be used to illustrate how long it takes to “prime” a breathing circuit with anesthetic, as is done before a single-breath induction. The upstream source is the output from a vaporizer ( $P_{\text{delivered}}$ ), the drug carrier is FGF, and the breathing circuit volume is  $V_{\text{circ}}$ . The delivery of anesthetic is determined by the product of FGF and  $P_{\text{delivered}}$ . The time needed to equilibrate the circuit with the delivered gas is determined by the ratio of  $V_{\text{circ}}$  to FGF. High FGFs and low circuit volume, such as that in an open-circuit delivery system, enable rapid control of the anesthetic concentration in the circuit that is inhaled by the patient (Fig. 37-5).

The most common breathing circuit configuration is a circle system that allows rebreathing of exhaled anesthetic gases while scavenging carbon dioxide ( $\text{CO}_2$ ). These circuits have total gas volumes of 6–8 L. If  $V_{\text{circ}} = 6$  L and  $\text{FGF} = 6$  L/min, then  $\tau = 1$  minute, and it will take approximately 5 minutes for the anesthetic concentration in the circuit to closely approach the concentration delivered by the vaporizer. However at  $\text{FGF} = 1$  L/min,  $\tau = 6$  minutes, and it will take up to 30 minutes to fully equilibrate the circuit (Fig. 37-5, left).

To illustrate the impact of additional compartments in our model, consider what happens if a patient is breathing circuit gases when the vaporizer is turned on. In this case, uptake of



**FIGURE 37-6.** Lowering fresh gas flows after induction. After the initial rapid uptake of anesthetic, fresh gas flow can be dropped, reducing both drug delivery and waste. The drop in anesthetic concentration that results is larger for highly soluble agents.

anesthetic into the patient's body reduces the rate of rise of the partial pressure of anesthetic in the circuit (Fig. 37-5, right). These examples illustrate why a high FGF is most useful when rapid changes in inspired anesthetic concentration are needed, such as during induction and emergence. After the induction period, the rate of uptake of anesthetic into the patient slows, and, if a rebreathing circuit is used, FGF can be reduced, usually in

the range from 1–3 L/min. After FGF is reduced, modestly increasing the delivered anesthetic concentration will help maintain drug delivery to match the uptake of anesthetic into the body (Fig. 37-6). Reducing FGF has economic, environmental, and medical benefits. Lower quantities of inhaled gases are used, resulting in reduced cost and less environmental pollution with waste gases. The patient's airway humidity is maintained,

improving the clearance of bronchopulmonary secretions.

The extreme of low FGF is “closed-circuit” anesthesia, wherein almost all inhaled gases are rebreathed and fresh gas is delivered with only sufficient oxygen to replace that metabolized by the patient ( $\approx 0.25$  L/min for a typical normothermic 70-kg adult), and anesthetic vapor is added to match uptake and maintain the level of anesthesia. The practice of closed-circuit anesthesia should be based on detailed knowledge of anesthetic gas uptake into patients (for a more thorough description, see Baum<sup>9</sup>).

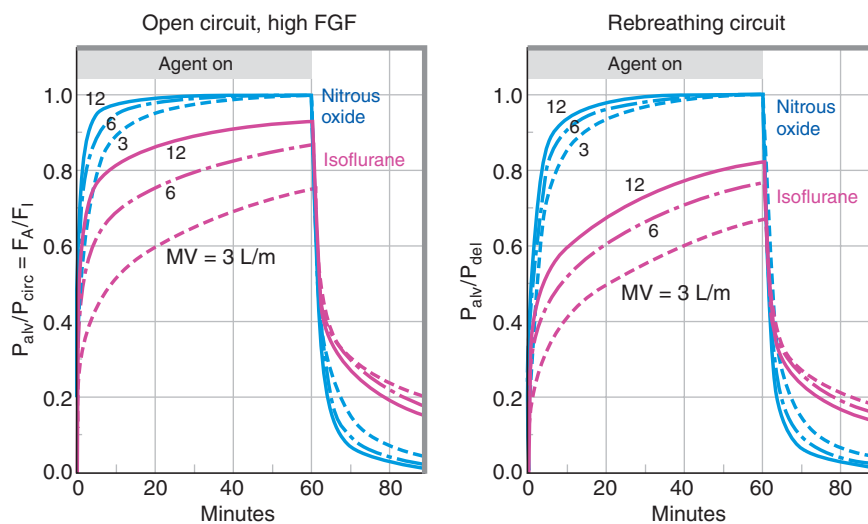
### Alveolar Partial Pressure of Anesthetic Gas

The alveolar anesthetic partial pressure ( $P_{alv}$ ) is important because it is the upstream source or driving pressure that rapidly equilibrates with the blood, brain, and other highly perfused tissues (see Distribution of Inhaled Anesthetics in Body Tissues) and because its level can be monitored in end-tidal expired gases.

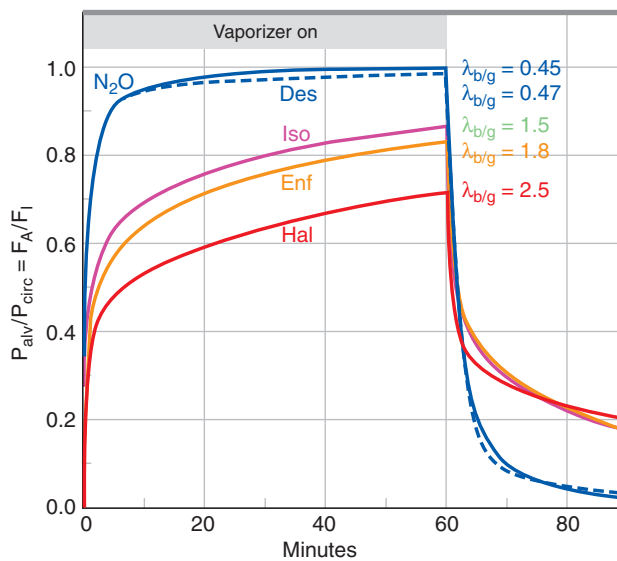
### Transfer of Anesthetic from the Breathing Circuit to Alveoli

The transfer of inhaled anesthetic from the breathing circuit into the lungs depends on the minute alveolar ventilation rate and the difference between the partial pressures in the circuit ( $P_{circ}$ ) and the lung ( $P_{alv}$ ). Thus, hyperventilation enables the rapid adjustment of  $P_{alv}$ , which provides the upstream driving pressure for transfer of anesthetic to and from other body tissues. The impact of varying minute alveolar ventilation is illustrated in Fig. 37-7.

It is traditional to illustrate uptake with  $P_{alv}$  normalized to  $P_{circ}$  (inspired), which represents the case of high-flow, open-circuit anesthesia, wherein  $P_{circ} \approx P_{delivered}$ . However, with a rebreathing circuit, as we have described,  $P_{circ}/P_{delivered}$  is not constant (Fig 37-5). In this instance, a clearer illustration of how  $P_{alv}$  varies over time is obtained by normalizing to  $P_{delivered}$ , which is held constant in our uptake model calculations. The difference between open-circuit and rebreathing models is illustrated in Fig. 37-7. Comparing the two panels, it is apparent that  $P_{alv}$  increases more slowly with moderate FGF and a rebreathing circuit, whereas the impact of changing minute ventilation is similar in both cases. For simplicity, we have adopted the traditional open-circuit model to illustrate the impact of other physiologic variables



**FIGURE 37-7.** Impact of minute ventilation on the alveolar anesthetic concentration. **Left.** Rise of  $P_{alv}$  is shown in the traditional manner, normalized to inspired concentration ( $P_{circ}$ ), which is constant only with very high fresh gas flows and no rebreathing. Increased minute ventilation accelerates the rise of  $P_{alv}$  and also increases clearance after delivery stops. **Right.**  $P_{alv}$  is shown normalized to the constant delivered anesthetic concentration. This illustration better reflects the rise of  $P_{alv}$  during a typical induction, where rebreathing occurs (fresh gas flow = 6 L/min).



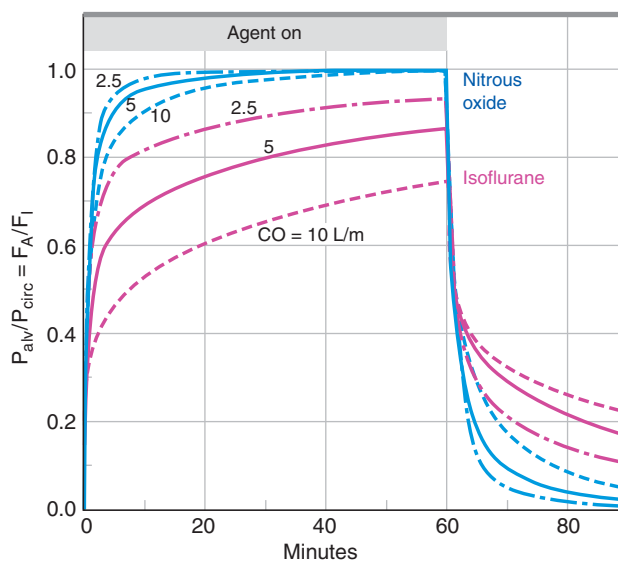
**FIGURE 37-8.** Impact of blood solubility on the alveolar anesthetic concentration. During induction, high blood solubility (high  $\lambda_{b/g}$ ) results in a slow rise of  $P_{alv}$ , because a large fraction of alveolar anesthetic is taken up into blood. Conversely, low blood solubility results in rapid equilibration between alveolar and inspired anesthetic concentrations. The impact of  $\lambda_{b/g}$  on anesthetic clearance mirrors that on uptake.

on anesthetic uptake (for washout in these figures, we have normalized to either  $P_{delivered}$  or  $P_{circ}$  just before the agent is turned off).

### Anesthetic Uptake into Pulmonary Blood

Pulmonary blood rapidly takes up alveolar anesthetic gases. The uptake into blood depends on blood solubility (the blood/gas partition coefficient  $\lambda_{b/g}$ ),

the rate of pulmonary blood flow (usually near the cardiac output), and the difference between the anesthetic partial pressure in the lung and that of mixed venous blood entering the lung. The more blood-soluble anesthetics produce a slower rise of  $P_{alv}$  relative to the inspired concentration ( $P_{circ}$ ) because more vapor needs to be transferred into blood before the blood compartment is “filled” (Fig. 37-8).



**FIGURE 37-9.** Impact of cardiac output on the alveolar anesthetic concentration. During induction, increased cardiac output (pulmonary blood flow) results in a slower rise of  $P_{alv}$ , because uptake from the alveoli into pulmonary blood is accelerated. The dependence of the  $P_{alv}$  rate of rise on cardiac output is greatest for highly soluble anesthetics and minimal for insoluble drugs such as nitrous oxide. The impact of cardiac output on anesthetic clearance is similar to that on uptake.

Stated another way, the effective blood volume is larger for the more soluble anesthetics (Table 37-2).

Increased cardiac output (pulmonary blood flow) slows the rise in  $P_{alv}$  by more rapidly removing the anesthetic agent from alveolar gases, whereas decreasing cardiac output accelerates the rise in  $P_{alv}$ . This effect is most significant for the highly blood-soluble anesthetics, for which the rate of rise of  $P_{alv}$  is reduced more by vapor uptake into blood. Changes in cardiac output cause smaller changes in the rate of rise of  $P_{alv}$  for the blood-insoluble anesthetics such as  $N_2O$  and desflurane (Fig. 37-9).

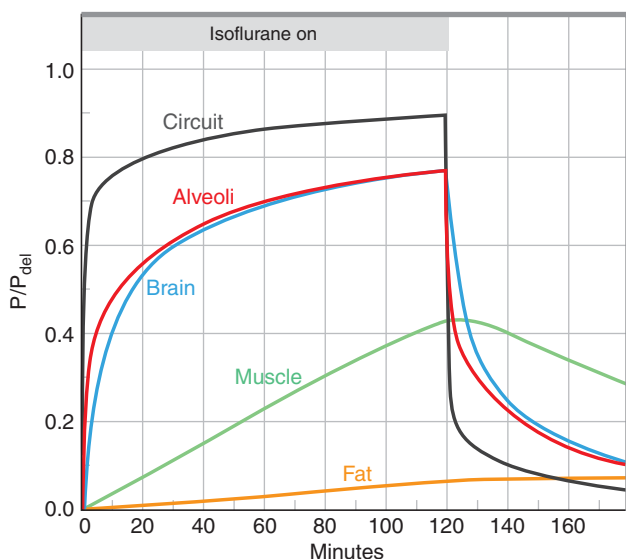
The role of cardiac output in inhaled anesthetic uptake (and therefore inhalation induction) can seem counterintuitive. Increased cardiac output results in more rapid delivery of anesthetic to the major sites of action in the nervous system, suggesting that anesthesia induction is faster, not slower. The key to untangling this conundrum is to understand that during induction,  $P_{alv}$  is the driving force for drug entry into the blood and nervous system. Because  $P_{alv}$  rises more slowly when cardiac output increases, partial pressure in the brain and spinal cord also will rise more slowly. What happens to the “extra” anesthetic that is taken up via the lung at an elevated cardiac output? The brain and other highly perfused tissues (see Distribution of Inhaled Anesthetics in Body Tissue) equilibrate rapidly with  $P_{alv}$ . However, muscle and fat tissue, which typically take hours to equilibrate with  $P_{alv}$ , are absorbing most of the additional anesthetic agent.

In summary, the rate of equilibration between the alveolar partial pressure ( $P_{alv}$ ) and the inspired anesthetic partial pressure ( $P_{circ}$ ) is dependent on three factors. (1) *Minute alveolar ventilation*: As minute alveolar ventilation increases, the lung more rapidly equilibrates with the circuit. (2) *Cardiac output*: As cardiac output increases, uptake from the pulmonary airspace into the blood and tissues slows the rate at which  $P_{alv}$  rises. (3) *Blood/gas partitioning*: High  $\lambda_{b/g}$  increases uptake into blood, removing a higher fraction of anesthetic from the pulmonary airspace and slowing the rate at which  $P_{alv}$  rises.

### Distribution of Inhaled Anesthetics in Body Tissues

Mixed venous blood entering the pulmonary capillary bed rapidly equilibrates with the alveolar partial pressure of an





**FIGURE 37-10.** Uptake of anesthetics into different tissues. The partial pressure of isoflurane in different tissue beds is depicted during induction with fresh gas flow = 6 L/min,  $\dot{V} = 5$  L/min, and  $\dot{Q} = 5$  L/min. Note that the isoflurane partial pressure in highly perfused tissues (brain) closely matches that in alveoli, except when  $P_{alv}$  is changing very rapidly. Also note that the partial pressure of anesthetic in fat continues to rise after discontinuing isoflurane delivery, as long as  $P_{alv} > P_{fat}$ .

inhaled anesthetic ( $P_{alv}$ ) so that blood exiting from the pulmonary vein has a partial pressure close to  $P_{alv}$ . Anesthetic then is distributed to various tissues via systemic arterial blood. Delivery of anesthetic to each tissue is determined by its blood flow rate, its anatomic volume, and its tissue/blood partition coefficient (Table 37-2). The effective volume ( $V_{eff}$ ) for uptake of anesthetic in a given tissue is the product of its anatomic volume and  $\lambda_{tissue/blood}$ . The time it takes for anesthetic partial pressure in a given tissue to equilibrate with  $P_{alv}$  is decreased when tissue perfusion is high and increased when  $V_{eff}$  is large.

*Highly perfused tissues* include the brain, spinal cord, kidney, liver, and heart, which compose less than 10% of an adult body's mass while receiving approximately 70% of the normal cardiac output. Highly perfused tissues equilibrate within a few minutes with the arterial (alveolar) anesthetic partial pressure (Fig. 37-10 and Table 37-2). As a result, the alveolar partial pressure of anesthetic, which can be measured in end-tidal gases, usually is close to the brain and spinal cord partial pressures (unless the anesthetic concentration in alveolar gas is changing rapidly).

*Muscle* represents a large anatomic volume (average 35–40% of body mass) and the muscle/blood partition coefficient for all inhaled agents ranges from 1.2–3.1. Because muscle nor-

mally receives only approximately 10% of cardiac output at rest, the anesthetic partial pressure in muscle rises slowly, and equilibration with  $P_{alv}$  takes hours for most anesthetics used clinically (Table 37-2).

*Fat* receives approximately 13% of cardiac output and represents approximately 25% of body mass in the average adult, with considerable variation. In addition, the potent volatile agents partition highly into fat ( $\lambda_{fat/blood}$  range 27–51) so that the effective volume for uptake of volatiles into fat is extremely large (Table 37-2). For the volatile anesthetics, uptake into fat is so slow that equilibration of the partial pressure with  $P_{alv}$  never occurs under normal clinical conditions. The only commonly used inhaled anesthetic with a low fat solubility is  $N_2O$  ( $\lambda_{fat/blood} = 2.3$ ), for which the equilibration time constant is approximately 2 hours.

The *vessel-poor group of tissues* include skin, ligaments, tendons, cartilage, and cortical bone. These tissues represent approximately 14% of the average adult's body mass and receive less than 2% of cardiac output. As a result, their contribution to anesthetic uptake is negligible.

### Other Factors Affecting Uptake and Distribution of Inhaled Anesthetics

*Intrapulmonary right-to-left shunts* (per-fused but nonventilated lung regions)

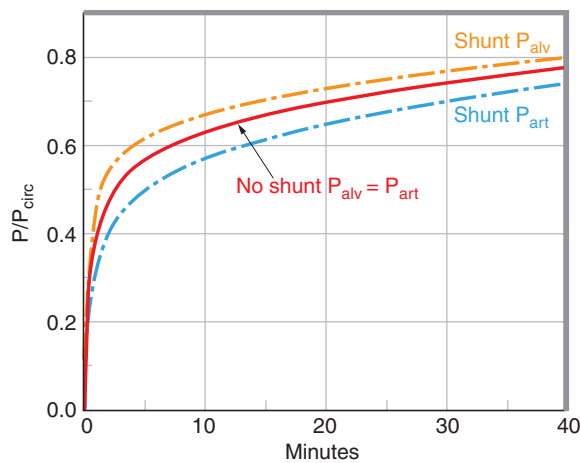
do not participate in anesthetic uptake. They slow the rate of uptake into blood and make  $P_{alv}$  rise more quickly, especially for the more blood-soluble anesthetics. At the same time, pulmonary shunting results in an arterial admixture of mixed venous blood with blood from gas-exchanging lung regions. As the fraction of pulmonary blood flow passing through right-to-left shunts rises,  $P_{art}$ , the direct upstream anesthetic pressure source for the nervous system, drops relative to  $P_{alv}$ . For the highly soluble anesthetics, the increased  $P_{alv}$  somewhat compensates for admixing, and  $P_{art}$  rises only slightly slower than normal (Fig. 37-11). With insoluble agents, the impact of shunt on uptake from lung ( $P_{alv}$ ) is smaller and there is less compensation for admixing.

*Anatomic and physiologic dead space* (ventilated but nonperfused lung regions) effectively reduces alveolar ventilation relative to minute ventilation. Therefore, the impact of increasing dead space on anesthetic uptake is equivalent to reducing minute ventilation of lung regions without dead space. An increased dead space reduces agent delivery to alveoli and results in a slower rate of  $P_{alv}$  rise.

*Systemic arteriovenous (left-to-right) shunting* causes the anesthetic partial pressure in mixed venous blood to increase rapidly, slowing the uptake of anesthetic agent from alveolar gas. Therefore, alveolar anesthetic partial pressure rises more rapidly, compensating for the reduced uptake rate. Overall, the impact of arteriovenous shunting is to modestly increase the rate of rise in  $P_{alv}$  and the highly perfused tissues.

Systemic right-to-left shunting, like that in the lung, causes downstream arterial admixing. Thus, intracardiac shunts, such as patent foramen ovale or patent ductus arteriosus, result in regional  $P_{art}$  lower than  $P_{alv}$ . Patent ductus arteriosus shunting may result in different anesthetic partial pressures delivered to the brain and spinal cord. The overall effect of shunting can be difficult to predict because total cardiac output may also increase to compensate for the shunt.

*Anesthetic-induced changes in cardiac and respiratory function* affect the rate of anesthesia induction with volatile anesthetics. When spontaneous ventilation is maintained, the uptake of inhaled drug is reduced as anesthetic is absorbed and minute ventilation



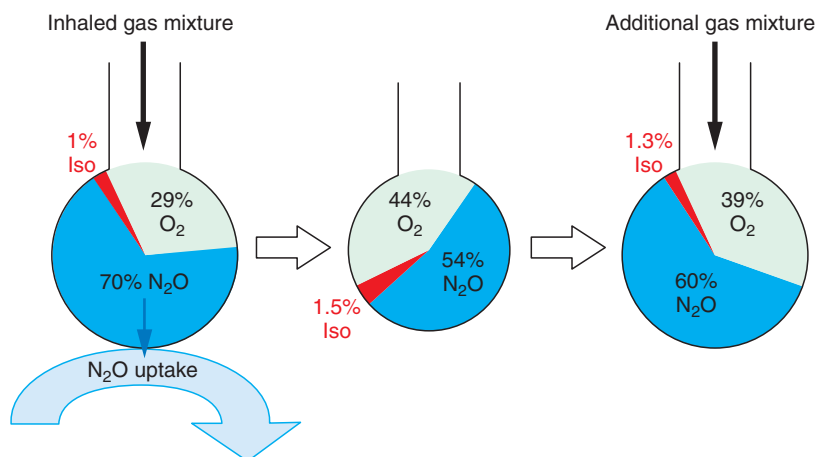
**FIGURE 37-11.** Impact of pulmonary right-to-left shunting on alveolar and arterial anesthetic concentrations. The impact of a 30% left-to-right shunt was calculated using a modified model from Figure 37-4. Pulmonary right-to-left shunting reduces alveolar uptake, increasing  $P_{alv}$ , and mixing of shunted blood results in a lower  $P_{art}$ . However, the increased  $P_{alv}$  compensates for admixing so that, compared with the zero shunt model,  $P_{art}$  is only approximately 10% reduced by the 30% shunt.

falls. Anesthetic depression of cardiac output is another dynamic factor that alters both uptake and distribution of anesthetic (see Anesthetic Uptake into Pulmonary Blood and Fig. 37-9).

### Concentration Effect and Second Gas Effect

$N_2O$  represents a special case in clinical anesthesia, because it is often the major constituent of the inhaled gas mixture. As a result, uptake of  $N_2O$  from the alveolar space into blood produces significant shifts of alveolar gas volume.<sup>10</sup> As alveolar gas volume

diminishes, the concentration of  $N_2O$  is maintained (the *concentration effect*), and the concentrations of other gases increase (the *second gas effect*). Consider a single breath of a gas mixture of 70%  $N_2O$ , 29%  $O_2$ , and 1% isoflurane (Iso) near the start of an anesthetic when mixed venous blood does not contain  $N_2O$  (Fig. 37-12). When half of the alveolar  $N_2O$  is taken up into blood, the remaining alveolar gas volume will be 65% of the original volume with relative concentrations of 35  $N_2O$ :29  $O_2$ :1 Iso = 54%  $N_2O$ :45%  $O_2$ :1.5% Iso. Because of the reduction in



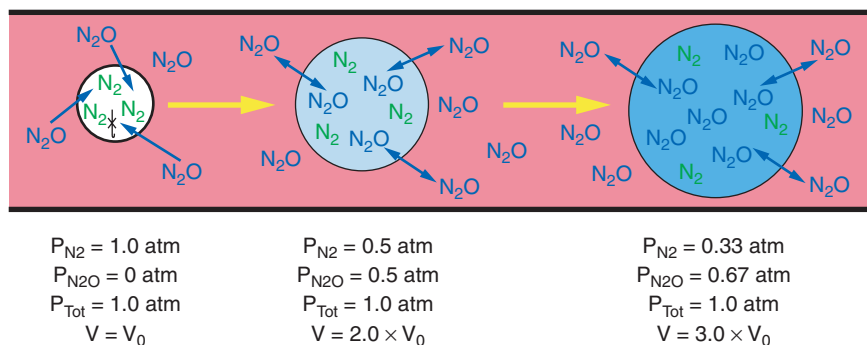
**FIGURE 37-12.** Concentration and second gas effects. When nitrous oxide is inspired at high concentrations, transfer from the lung into pulmonary blood causes the volume of alveolar gas to drop, drawing in more of the gas mixture and concentrating the remaining gases. This *concentration effect* on nitrous oxide itself results in a sustained alveolar driving pressure and more rapid uptake. The alveolar concentration of other gases, such as isoflurane and oxygen, become higher than the inspired concentrations, which increases their uptake as well—the *second gas effect*.

alveolar gas volume, the alveolar  $N_2O$  concentration (and partial pressure) is more than half its original concentration (if 100%  $N_2O$  were inhaled, uptake would not reduce the alveolar concentration at all). Therefore, the concentration effect maintains the pressure gradient for uptake and increases the rate of rise of  $P_{alv}$  for  $N_2O$  toward the inspired concentration. The second gas effect is illustrated in Fig. 37-12. With  $N_2O$  uptake, the alveolar concentrations of both oxygen and isoflurane will become higher than the inspired concentration, accelerating their uptake into blood.<sup>11</sup>

### Nitrous Uptake into Airspaces in the Body

Inhalation of  $N_2O$  at high concentrations leads to important effects on airspaces within the body. Airspaces usually contain mostly nitrogen (79% of air), which has a low solubility in blood ( $\lambda_{b/g} = 0.015$ ), such that bulk transfer of trapped nitrogen gas cannot occur on the time scale of most anesthetics.  $N_2O$  ( $\lambda_{b/g} = 0.45$ ) is delivered to airspaces 30 times faster than nitrogen leaves. As  $N_2O$  diffuses into the preexisting airspace, the volume and/or pressure in the airspace increases. In most cases, both airspace volume and pressure will rise, but examples where one or the other effect dominates are useful for illustration.

A compliant airspace, such as a small air embolus or pneumothorax, can increase its volume with minimal pressure change. It will continue to expand until the partial pressure of  $N_2O$  within the airspace equals that in surrounding blood. Theoretically, at 50% inspired  $N_2O$ , the preexisting volume of the gas bubble would double (half of its gas volume would then consist of  $N_2O$ ). Similarly, 67%  $N_2O$  could lead to a tripling of volume, and 75%  $N_2O$  could quadruple the volume (Fig. 37-13). Small venous air emboli then may become easier to detect with Doppler and echocardiographic monitors but may create more physiologic problems by obstructing blood vessels.<sup>12,13</sup> A small pneumothorax could expand to compress mediastinal structures and impair oxygenation or create hemodynamic compromise. The rate of airspace expansion depends on the volume, geometry, and compliance of the airspace as well as the blood flow delivering  $N_2O$  to it. Small venous air emboli may expand within seconds,



**FIGURE 37-13.** Expansion of venous air emboli by nitrous oxide. Nitrous oxide enters air pockets far faster than nitrogen leaves (because of low blood nitrogen-carrying capacity), causing airspace expansion. Expansion continues until the partial pressure of  $N_2O$  inside the air bubble matches that in surrounding blood. Thus, at 50%  $N_2O$  ( $P_{N_2O} = 0.5 \text{ atm}$ ), air emboli can double in volume, and at 67%  $N_2O$  ( $P_{N_2O} = 0.67 \text{ atm}$ ), they can triple in volume. Expansion of small venous air emboli can lead to occlusion of pulmonary capillaries, compromising both blood flow and gas exchange.

and a pneumothorax can expand toward equilibrium in less than 1 hour, whereas airspaces in bowel take may considerably longer to expand.

$N_2O$  diffusion into noncompliant airspaces can create clinical problems. In a noncompliant space, volume does not change, so pressure increases as  $N_2O$  enters. For example, following intravitreal injection of sulfur hexafluoride ( $SF_6$ ) or perfluoropropane ( $C_3F_8$ ) gases,  $N_2O$  administration can result in rapid increases of intraocular pressure, compromising retinal blood flow.<sup>14,15</sup> Intracranial air bubbles (after craniectomy or pneumoencephalography) and the inner ear also represent airspaces in noncompliant body compartments.

Other commonly used inhaled anesthetics also diffuse into airspaces, but their low concentrations in clinical settings result in negligible impact upon airspace volume and pressure. Xenon is an experimental anesthetic inhaled at high concentrations (60–70%) and, like  $N_2O$ , is associated with airspace expansion.<sup>16</sup>

### Elimination of Inhaled Anesthetics via Ventilation

Removal of inhaled anesthetics via the lungs is essentially the reverse of uptake, and many of the factors that affect induction also affect elimination rates. High FGF promotes faster washout of anesthetic from the circuit, enhancing the gradient for removal from the lung (Fig. 37-5). High minute ventilation clears alveolar anesthetic, reducing  $P_{alv}$  and providing a gradient for movement of anesthetic from the blood to the alveoli (Fig. 37-7). Highly blood soluble

anesthetics are retained longer than insoluble drugs because the effective volume of blood is higher as  $\lambda_{b/g}$  increases (Fig. 37-8). Similarly, increasing the cardiac output retards recovery. Increased delivery of anesthetic from tissues to the lung tends to maintain  $P_{alv}$ , which reduces the gradient for removal from the blood (Fig. 37-9).

Some aspects of anesthetic elimination do not mirror the uptake during anesthetic induction. The use of overpressure to accelerate anesthetic induction has no parallel during recovery, because the delivered concentration or partial pressure of anesthetic agent cannot fall below zero. Also, prior to induction the inhaled anesthetic partial pressure in all tissues is zero, whereas different tissues will typically have reached different partial pressures when anesthetic delivery is discontinued. In particular, the partial pressures in muscle and fat may be far lower than  $P_{alv}$  after a brief anesthetic. Because anesthetic will continue to be transferred into tissue as long as  $P_{alv} > P_{tissue}$ , these compartments may continue to absorb drug even after delivery ceases. This effect is illustrated in Fig. 37-10, where fat continues to take up isoflurane from blood long after delivery is discontinued, until  $P_{alv} < P_{fat}$ . This uptake helps reduce the anesthetic partial pressure within the highly perfused tissues and can reduce recovery time.

The longer anesthesia is maintained, the more drug is absorbed into muscle and fat, which are characterized by a slow uptake and release of agent. Thus, clearance of inhaled an-

esthetics is context sensitive: the longer the anesthetic, the slower the clearance. If fat and muscle reach high partial pressures (after many hours for most potent agents), recovery from anesthesia may be significantly delayed. Therefore, obese patients and those with a higher than normal muscle mass are at risk for slowed emergence after long exposures to soluble anesthetics.

## PHARMACODYNAMICS OF INHALED ANESTHETICS

### Therapeutic Effects and Anesthetic Depth

Although general anesthesia results in a multitude of physiologic alterations, there is no consensus among clinicians and researchers as to which actions are essential to the state of general anesthesia.<sup>17</sup> Our view is that the common desired outcomes of general anesthesia include hypnosis (loss of awareness), amnesia (loss of memory), and immobility (suppression of movement in response to pain). Some have argued that analgesia is also an essential component.<sup>18</sup> Pain is unquestionably a critical consideration in perioperative care, but the potent sedative/hypnotic effects of most general anesthetics confound the assessment of pain. Hypnosis and amnesia are produced via drug effects on neural networks within the brain, whereas immobility is primarily mediated by the spinal cord. In short, the major therapeutic actions of volatile anesthetics take place in the CNS. Beneficial and toxic effects of inhaled anesthetics on other physiologic systems (e.g., cardiovascular function, respiration) thus can be regarded as secondary. In this section, we discuss various measurements of anesthetic effects in the nervous system, as well as their limitations.

Because general anesthesia is defined as the loss of normal responses to environmental stimuli, anesthetic depth is most rigorously defined by stimulus-response testing using stimuli that range from benign (e.g., spoken commands) to noxious (e.g., laryngoscopy or surgical incision).<sup>19</sup> In addition, certain consistent pharmacologic effects of anesthetics that are stimulus independent are useful signs of anesthetic depth. Traditionally, both

TABLE 37-3.

## Classic Stages and Planes of Inhalational Anesthesia

*Stage 1* is defined as the time between normal waking state and the loss of consciousness (*hypnosis*) due to an anesthetic agent. There is also mild *analgesia* in Stage 1 anesthesia.

*Stage 2* is associated with loss of awareness and recall (*amnesia*). Stage 2 is associated with the undesired effects of cardiovascular instability excitation, dysconjugate ocular movements, and emesis.

*Stage 3* is defined as surgical anesthesia, a state where *movement in response to pain is suppressed*. Various planes of anesthesia were described by Guedel, based on additional physiologic signs:

*Plane 1* is associated with deep respiration, coordinated thoracic and diaphragmatic muscular activity, and papillary constriction.

*Plane 2* is associated with diminished respiration, as well as fixed midline and dilated pupils.

*Plane 3* is associated with continued diaphragmatic movement, diminished thoracic movement, and further papillary dilation.

*Plane 4* is associated with thoracic immobility and diminished diaphragmatic movement.

*Stage 4* is associated with cessation of spontaneous respiration and medullary cardiac reflexes and may lead to death.

desired and undesired clinical effects have been associated with the various stages and planes of anesthesia introduced by Snow<sup>20</sup> and modified by Guedel.<sup>21</sup> These descriptions (Table 37-3) were developed during the era of ether and chloroform anesthesia and therefore are not fully applicable to modern practice.

### Minimum Alveolar Concentration, Minimum Alveolar Concentration–Awake, and Minimum Alveolar Concentration for Blockade of Autonomic Responses

#### Minimum Alveolar Concentration

In 1965, Eger introduced the concept of minimum alveolar concentration (MAC) as a stimulus–response meas-

ure of anesthetic potency.<sup>22,23</sup> MAC is the alveolar concentration of inhaled anesthetic that prevents movement in half of subjects in response to a surgical incision. Thus, MAC is the equivalent of a median effective dose (ED<sub>50</sub>) for inhibition of movement in response to a specific noxious stimulus. If different noxious stimuli (e.g., varying point pressures or electric shocks) are used, the concentration of inhaled anesthetic required to suppress movement increases with stimulus intensity. Thus, MAC is most useful for comparing potency among different inhaled agents under the same conditions, with potency being inversely related to MAC. During measurement of MAC, equilibrium between the alveolar compartment and the nervous system must first be established. Other drugs that modulate pain sensation (e.g., opioids) or movement (muscle relaxants) cannot be present. MAC as originally defined depends on atmospheric pressure, but when agent concentration is expressed as a partial pressure, MAC becomes independent of ambient pressure. The MAC values of common inhaled agents in oxygen (Table 37-2) show that N<sub>2</sub>O is least potent, followed by desflurane, sevoflurane, enflurane, isoflurane, and halothane. By definition, an exclusively inhalational anesthetic to a level of 1 × MAC is inadequate to prevent movement in half of patients. The ED<sub>95</sub>, which is approximately 1.3 × MAC, may be a more clinically useful value. The ED<sub>95</sub> corresponds to 0.9% for hal-

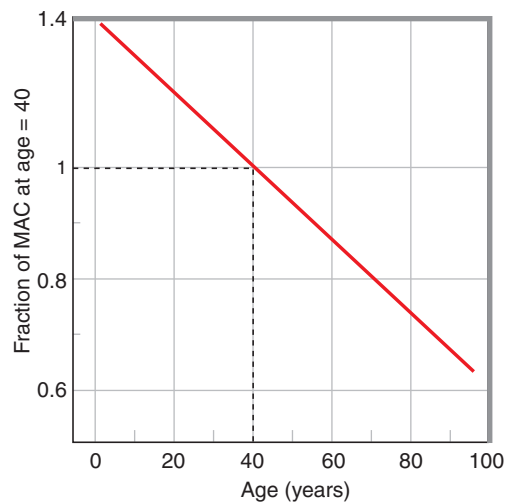
othane, 1.68% for isoflurane, and 1.88% for enflurane.

Physiologic, genetic, and pharmacologic conditions may alter MAC. MAC decreases with age (Fig. 37-14). MAC was first measured in patient populations with an average age of approximately 40 years. Further studies showed that MAC is highest within the first year of life (age 6–12 months) and decreases with advancing age.<sup>24,25</sup>

*Physiologic factors such as temperature influence MAC.* For each 1 °C decrease in core temperature, anesthetic requirements decrease by 5%. Other physiologic extremes that affect CNS function (hypoxia, hypercapnia, acidosis, hypotension) also decrease MAC.

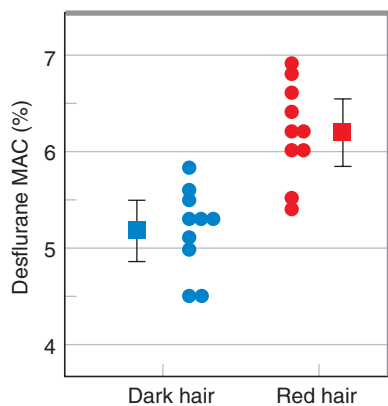
Whether MAC is affected by gender is controversial. Elderly Japanese women require 26% less xenon than do elderly Japanese men. In young men and women, however, MAC for desflurane does not significantly differ.<sup>26</sup> MAC is reduced in the parturient.<sup>27</sup> Increases in either progesterone or endogenous opiates (endorphins) during pregnancy have been proposed to account for increased anesthetic sensitivity, but these theories have not been substantiated by experiments.

*Pharmacogenomic factors play a role in determining MAC.* Mice of varying genomic backgrounds are differentially susceptible to volatile anesthetics such as halothane, isoflurane, and sevoflurane.<sup>28</sup> In humans, natural redheads have a significantly higher desflurane MAC than do other patients (Fig. 37-15).<sup>29</sup> Ninety percent of the



**FIGURE 37-14.** Minimum alveolar concentration (MAC) varies with age. MAC is maximal in the first year of life and drops with age. The figure shows the relationship on a semilogarithmic scale. The equation of the line is  $MAC/MAC_{40} = 1.32 \times 10^{-0.00303Age}$ , or a 6.7% drop in MAC per decade (Eger<sup>24</sup>).





**FIGURE 37-15.** Minimum alveolar concentration (MAC) values are increased in natural redheads. On average, redheads require about 20% higher alveolar concentrations of desflurane to prevent movement. Anesthetic requirements for individuals are represented by circles; means are represented by squares; bars indicate 95% confidence intervals. (From Liem et al.<sup>29</sup> with permission.)

redheads tested had mutations reducing expression of the melanocortin-1 receptor gene. Genetically altered (knock-out) mice lacking the melanocortin-1 receptor gene also display a modest increase in MAC for desflurane, isoflurane, sevoflurane, and halothane.<sup>30</sup>

**Pharmacologic factors alter MAC.** The addition of 70% N<sub>2</sub>O reduces the anesthetic requirements of other inhaled agents by 55–70% (Table 37-2). MAC is an additive phenomenon when two or more inhaled agents are combined.<sup>31</sup> Adjunct opiate or benzodiazepine administration reduces MAC. Acute alcohol intoxication reduces MAC, whereas chronic intake of alcohol or sedatives can increase resistance to anesthetics, a phenomenon known as *cross-tolerance*.<sup>32</sup>

**MAC reflects the effects of inhaled anesthetics in the spinal cord.** In animal models, MAC has been shown to be primarily dependent on anesthetic effects on the spinal cord and not on the brain.<sup>33,34</sup> Anesthetic-induced immobility is likely due to suppression of spinal motor neuron function, observed as a diminished Hoffmann reflex (H-reflex) and F-wave amplitudes.<sup>35,36</sup> Suppression of movement and H-reflex amplitude by sevoflurane follow similar dose-response relationships in humans.<sup>37</sup>

### Minimum Alveolar Concentration-Awake

*Minimum alveolar concentration-awake (MAC-awake) is the concentration of inhaled anesthetic that inhibits appropriate*

*responses to spoken commands in half of patients.*<sup>24</sup> MAC-awake has been measured both during induction of anesthesia (loss of response) and during emergence from anesthesia (recovery of response). The ratio of MAC-awake to MAC is not uniform for all inhaled agents. It is fairly constant for the halogenated volatiles ( $\approx 0.35 \times \text{MAC}$ ) and significantly higher for N<sub>2</sub>O,<sup>38</sup> which likely reflects differing mechanisms of action (see Chapter 36).

Functional recovery from anesthesia is determined by MAC-awake for the specific agent as well as by its elimination kinetics. Therefore, the time needed to wake up after an anesthetic, especially a long one, depends on what concentration of anesthetic was inhaled relative to its MAC-awake. If the inhaled concentration was  $2 \times \text{MAC-awake}$ , then only a 50% reduction in P<sub>alv</sub> will be needed before the patient awakens, which usually is rapidly achieved for most agents. If higher concentrations were inhaled, then recovery may be more than proportionately slowed because the slower phases of agent elimination will have a more dominant effect (see Elimination of Inhaled Anesthetics via Ventilation above).

Like MAC, MAC-awake is reduced in the elderly, by hypothermia, and by the presence of other drugs with hypnotic activity (ethanol, benzodiazepines, anticonvulsants, antidepressants).<sup>24</sup> MAC-awake also is reduced by neuraxial blockade (spinal or epidural), despite intact cranial nerve function.<sup>39-42</sup> This effect is believed to be due to diminished ascending signals from the spinal cord, which stimulate cortical arousal via the brainstem. MAC-awake is decreased by high doses of opiates, but this effect is smaller than the reduction of MAC.<sup>43</sup>

MAC-awake (hypnosis) is associated with volatile anesthetic effects on the cerebral cortex,  $\gamma$ -range (40-Hz) signals from different cortical regions become desynchronized during the transition from conscious to unconscious states.<sup>44</sup> Synchrony among widespread cortical networks is believed to be associated with higher cognitive function, and its interruption may account for loss of consciousness.<sup>45</sup> Loss of “functional connectivity” among different cortical networks during anesthesia has been demonstrated by functional brain imaging studies.<sup>46,47</sup>

Low concentrations of inhaled anesthetics block memory more than aware-

ness.<sup>38</sup> When inhaling agents at MAC-awake, only a small fraction of “aware” experimental subjects (those responding to spoken commands) can recall events.<sup>48</sup> Amnesia is likely due to effects on the limbic network, including the amygdala and hippocampus. Lesions in the basolateral amygdala produce resistance to the amnesic effects of sevoflurane in animals.<sup>49</sup> Volatile anesthetics both attenuate hippocampal activity and inhibit long-term potentiation of hippocampal synapses that is associated with memory formation.<sup>50,51</sup>

### Minimum Alveolar Concentration for Blockade of Autonomic Responses

*Minimum alveolar concentration for blockade of autonomic responses (MAC-BAR) is the alveolar anesthetic concentration that suppresses cardiovascular responses to surgical incision in half of patients.*<sup>52</sup> MAC-BAR typically is greater than MAC. For example, MAC-BAR for desflurane is  $1.66 \times \text{MAC}$ .<sup>52</sup> Like MAC and MAC-awake, MAC-BAR is reduced by opiates.<sup>19</sup>

### Limitations on Traditional Anesthetic Depth Measurements

Stimulus-response testing usually is impractical in clinical settings. Neuromuscular blocking drugs ablate motor responses to both painful (MAC) and benign (MAC-awake) stimuli. Techniques for maintaining a motor response capability are laborious. As a result, autonomic signs such as blood pressure, heart rate, diaphoresis, tearing, and pupillary responses often are the only accessible data for assessing depth of anesthesia. These signs are valuable but unreliable guides to anesthetic depth. They also are confounded by drugs and diseases that impair cardiac and/or autonomic nervous system functions.

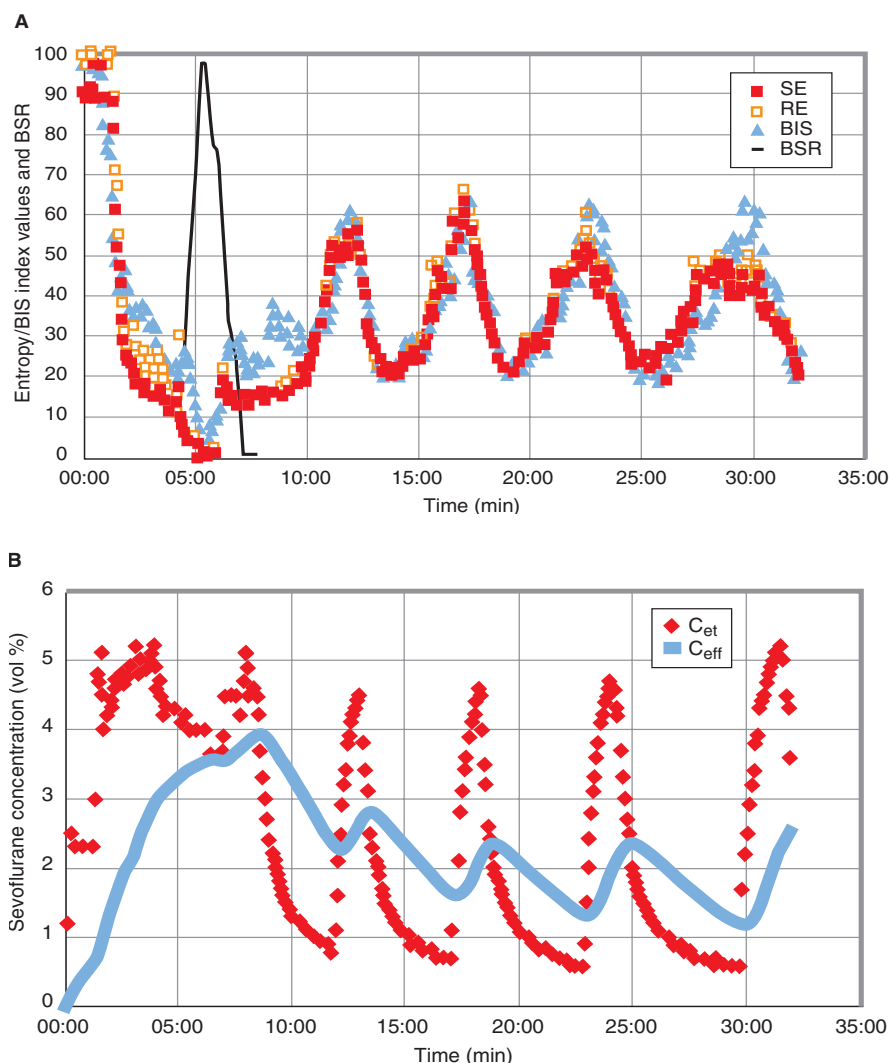
Numerous factors affect anesthetic sensitivity (including unknown genetic factors), resulting in widely varying individual anesthetic requirements. Too little anesthetic puts patients at risk for intraoperative awareness (see Intraoperative Awareness and Recall). Conversely, deep anesthesia ( $> 1.5 \times \text{MAC}$ ) for all patients is neither feasible nor advisable. Deep inhalational general anesthesia in patients with cardiac disease, hypovolemia, and critical illnesses predictably causes profound hypotension and organ hypoperfusion. Healthy patients may tolerate deep anesthesia, but this practice results in slow emergence

and a high incidence of side effects. Research also suggests that excessively deep general anesthesia may accelerate the pathogenesis of neurodegenerative diseases such as Alzheimer's dementia<sup>53</sup> and may be associated with increased late mortality.<sup>54</sup> The delivery of sufficient but not excessive anesthesia together with optimal surgical conditions represents a central challenge facing the anesthetist.

### Electroencephalographic Measurement of Anesthetic Depth

Given that the modern practice of general anesthesia frequently includes neuromuscular blockade to provide immobility, narcotics to provide analgesia, and other drugs to control autonomic activity, the essential therapeutic effects of general anesthetics are hypnosis and amnesia (ablation of awareness and memory). These effects, which are mediated in the brain, are the most difficult to assess clinically. Monitors that analyze electrical signals from the brain can provide anesthetists with more data to individualize the titration of general anesthetics to achieve these end points.

A number of techniques based on electroencephalography (EEG) have been developed and used. Fourier transformation of raw EEG data enables the derivation of median power and spectral edge frequencies.<sup>55</sup> Other EEG analyses assess bispectral phase relationships, burst suppression, and entropy. The bispectral index (BIS; Aspect Medical Systems, Natick, MA) is a proprietary algorithm based on burst suppression, near burst suppression,  $\alpha$ -band power, and phase relationships between  $\delta$  and  $\theta$  waves.<sup>56</sup> The patient state index (PSI; Physiometrix, Inc., North Billerica, MA) is based on EEG component relationships between the frontal and occipital regions.<sup>57</sup> Entropy monitors (e.g., S/5, Instrumentarium Corp. [Datex-Ohmeda], Helsinki, Finland) analyze entropy (randomness in frequency and phase relationships) using both EEG and frontal electromyography.<sup>58</sup> Some of these monitors are available for intraoperative use for assessing hypnosis and detecting undesired consciousness. The concentration-dependent effects of volatile anesthetics correlate with EEG indexes such as BIS and spectral entropy (Fig. 37-16).<sup>59</sup> Auditory evoked potentials (a stimulus-response method) also have been used to assess anesthetic-induced



**FIGURE 37-16.** Correlation between processed electroencephalographic (EEG) parameters and volatile anesthetic concentration. **A.** Time course of state entropy (SE), response entropy (RE), bispectral index (BIS), and burst suppression ratio (BSR) of a single patient. Each symbol represents an EEG parameter of a 5-second epoch. **B.** End-tidal sevoflurane concentration (C<sub>et</sub>) and calculated effect site concentration (C<sub>eff</sub>) during the same time course in the same patient. (From Ellerkmann et al.<sup>59</sup> with permission.)

unconsciousness and can be used in conjunction with other EEG parameters.<sup>60,61</sup> Nonetheless, all of these monitors have important limitations. Further research in identifying neural and EEG correlates of consciousness may improve their utility to assess the depth of anesthesia.

### INTRAOPERATIVE AWARENESS AND RECALL

The variability in patient sensitivities to general anesthetics and the uncertainty in clinical assessment of anesthetic depth inevitably result in some patients receiving either supratherapeutic or subtherapeutic doses of anes-

thetic agents. Inadequate anesthesia can result in awareness and explicit recall of intraoperative events, a problem that is a subject of clinical, public, and scientific attention.<sup>62</sup>

### Incidence of Awareness with Recall during General Anesthesia

Large studies in both Sweden<sup>63</sup> and the United States<sup>64</sup> have used multiple postoperative interviews (Table 37-4) to elicit reports of intraoperative awareness. In a total of 31,360 combined patients, 40 cases of "definite" and "probable" awareness with recall were identified, an incidence of 0.13%. Assuming 30 million general anesthetics are administered, the number of patients experiencing

TABLE 37-4.

## Modified Brice Interview

1. What is the last thing you remember before anesthesia?
2. What is the first thing you recall after waking up?
3. Do you recall anything in between?
4. Did you have any dreams during surgery?
5. What was the worst thing about your surgery and anesthesia?

Data from Brice DD, Hetherington RR, Utting JE. A simple study of awareness and dreaming during anaesthesia. *Br J Anaesth* 1970;42:535-42.

awareness with recall is approximately 40,000 per year in the United States.

### Patient Reports and Posttraumatic Stress Disorder after Intraoperative Awareness

Spontaneous reports by patients of intraoperative awareness are rare, emphasizing the need to ask about these events using a structured interview.<sup>65</sup> Patients report a variety of intraoperative experiences following general anesthesia. A high proportion of these experiences are vague and dreamlike, whereas others are explicit recollections of intraoperative events. Explicit recollections may include hearing conversations among operating room personnel, pain associated with intubation or surgery, and extreme anxiety, particularly in paralyzed patients. These experiences can lead to postoperative psychological problems, the most severe being posttraumatic stress disorder (PTSD). PTSD is characterized by recurrent episodes of anxiety, irritability, anger, and vigilance, often associated with flashbacks or nightmares, avoidance of cues related to the trauma, and sleep disturbances.<sup>66</sup> The incidence of PTSD following intraoperative awareness is not known, but it is likely dependent on the length of the awareness episode and on the presence of pain, anxiety, and preexisting psychological problems. In a small study of 16 postawareness patients, more than 50% developed symptoms of PTSD requiring psychotherapy.<sup>67</sup>

### Risk Factors for Awareness During General Anesthesia

The factors that contribute to intraoperative awareness include the use of mus-

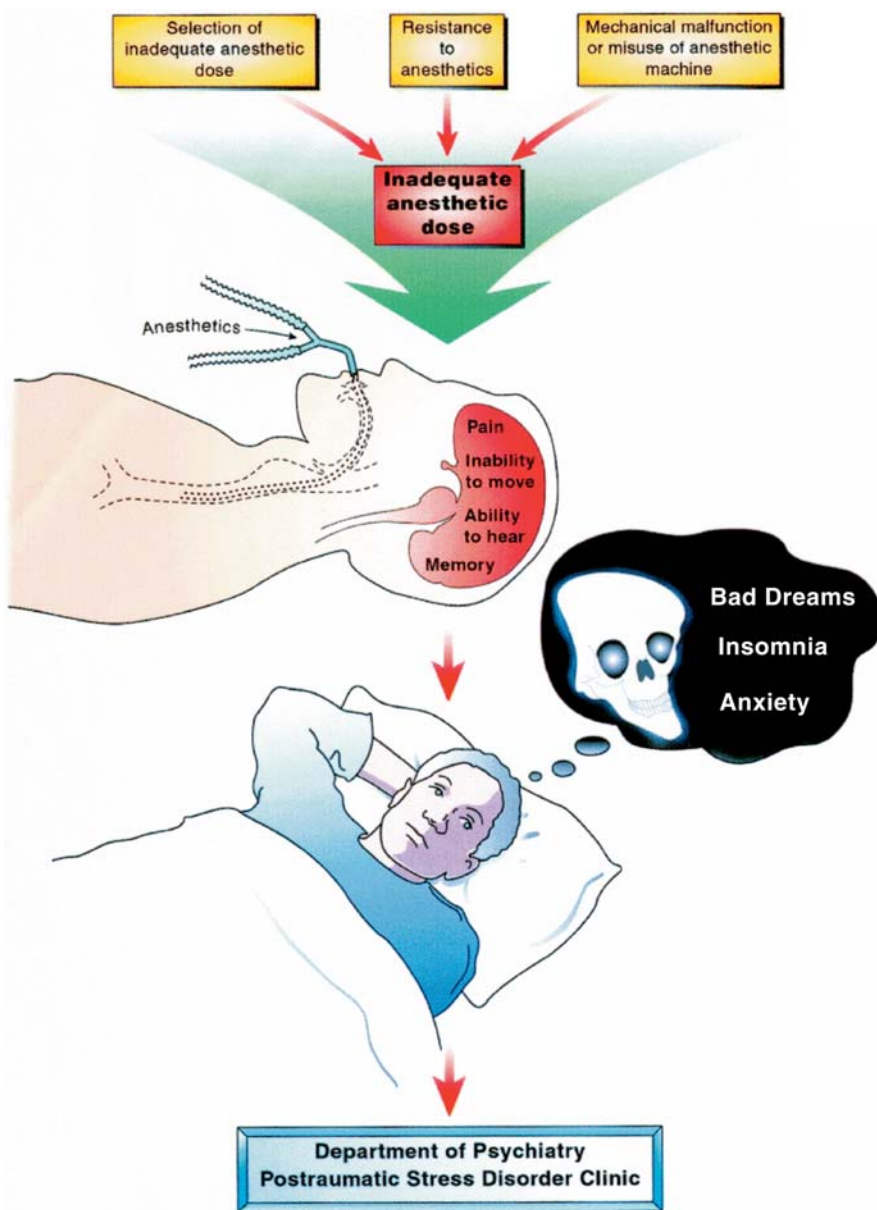


FIGURE 37-17. Causes and consequences of awareness during anesthesia. (From Ghoneim<sup>68</sup> with permission.)

cle relaxants, patient resistance to anesthetics, surgical situations where “light” anesthesia typically is used, and errors by the anesthesia care team (Fig. 37-17).<sup>68</sup> Awareness with recall has been reported in patients who were anesthetized without muscle relaxants, but these cases are rarer than in patients in whom muscle relaxants were given.<sup>69</sup> Furthermore, severe psychological problems seem to develop primarily in patients who experience “awake paralysis” with anxiety and pain.<sup>70</sup> Patients receiving chronic therapy with sedatives, opiates, and some anticonvulsants can develop tolerance (resistance) to anesthetic drugs and require higher

than normal anesthetic doses. Pharmacogenomic factors are likely to play a role, and patients with either a personal or a family history of awareness during general anesthesia may be at increased risk. Surgical procedures associated with high incidences of intraoperative awareness include major trauma, thoracoabdominal, and cardiac surgery. In these settings, hemodynamic instability often precludes the use of sufficient anesthetic agent concentrations to block awareness, resulting in reported incidences of awareness ranging from 1–40%.<sup>71,72</sup> Caesarean section under general anesthesia, where a “light” anesthetic is provided to reduce depression



of the newborn, also is associated with a high incidence of awareness (0.4%).<sup>73</sup> Inadequate dosing, misuse of equipment, and distraction of the care team can lead to patient awareness. Many cases of awareness appear to occur during prolonged attempts at airway intubation, when the hypnotic effect of intravenous induction agents wears off before muscle relaxants. Other reports have described awareness when vaporizers were empty or when drug pumps were not delivering proper doses of hypnotic agents. Reviews of awareness during general anesthesia incidents report that most cases were preventable.<sup>74</sup>

### EEG Monitoring for Intraoperative Awareness

To date, use of one EEG-based monitoring technique (BIS) has been evaluated for its ability to reduce the incidence of awareness. In a follow-up to Sandin et al.,<sup>63</sup> Ekman et al.<sup>75</sup> interviewed 4945 patients who received BIS-guided general anesthesia with intubation and/or muscle relaxants. Two cases of awareness (0.04%) were found, an incidence 80% below that of the historical control group. Myles et al.<sup>76</sup> conducted a prospective, randomized, double-blinded, multicenter trial of 2463 patients at high risk for awareness with recall, who were assigned to either a standard care or a BIS-guided anesthesia group. Postoperative interviews identified two patients (0.16%) who experienced awareness with recall in the BIS-guided group and 11 (0.9%) in the high-risk control group. Of note, use of the BIS monitor in this study did not reduce the total number of reports of intraoperative experiences in the subjects tested (including reports judged as “possible awareness” or “no awareness”) but only those with “confirmed” awareness with recall.

A number of confounding factors can affect the BIS, resulting in the possibility of reassuring monitor values with concomitant awareness. These factors include electrical artifact from electrocautery devices, physiologic alterations such as hypoglycemia, low-voltage EEG due to genetic variation or drugs, and neurologic abnormalities such as Alzheimer's dementia.<sup>77</sup> A common confounding factor that can alter BIS and spectral entropy values is electromyographic (muscle) activity and its reduction with neuromuscular blockade.<sup>78,79</sup> Furthermore, as with any monitor, ap-

propriate interpretation and response are required for efficacy. In an incidence study by Sebel et al.,<sup>64</sup> approximately 40% of patients underwent BIS monitoring, yet this subset of patients did not have a reduced incidence of awareness reports.

### Prevention and Management of Intraoperative Awareness

Preventing intraoperative awareness with recall begins with recognizing and addressing known risk factors. Caregivers must be familiar with their equipment, and they must maintain and use it properly. Amnestics, such as benzodiazepines, can reduce the incidence of awareness with recall and should be considered as premedication for most patients and in intraoperative circumstances where “light” anesthesia is unavoidable. Muscle relaxants should be used judiciously to provide adequate relaxation for surgery and avoided whenever possible. N<sub>2</sub>O relaxant anesthesia should be supplemented with adequate (1.5–2 × MAC-awake) volatile anesthetics or intravenous hypnotic agents. When intubation is delayed or multiple attempts are required, consider supplementing the induction bolus with additional inhaled or intravenous agents. *All patients should be routinely informed of the risk of awareness during general anesthesia.* High-risk patients should be monitored using an EEG-based monitor when feasible. EEG monitoring, if used, should be performed according to manufacturer's guidelines, and monitor values suggesting inadequate anesthesia should result in increased dosage of hypnotic agents, unless other circumstances make this inadvisable.

Ideally, all patients should be interviewed in the postoperative period and asked specific questions (Table 37–4) to elicit reports of intraoperative awareness. When awareness is detected, the case should be treated like any complication that results in harm or potential harm to patients. A thorough debriefing of the patient is warranted, and the details of the patient's experiences should be reported in the medical record. Other members of the operative team should be informed, and patient recollections should be corroborated as thoroughly as possible. The incident should be reported to the departmental Quality Assurance Committee and possibly the hospital legal counsel. A patient reporting awareness during anes-

thesia should be reassured that his/her experience is valid, and an explanation of why and how the intraoperative awareness occurred should be offered. Expressions of sympathy and regret for the patient's suffering can help maintain a therapeutic relationship, and the patient should be offered professional psychological evaluation and therapy if he/she experiences uncomfortable emotional reactions to the experience. Maintaining contact with the patient with daily visits to his/her hospital room or phone calls can reduce malpractice risk.

## SYSTEMIC ACTIONS OF INHALED ANESTHETICS

In this section, we summarize both the therapeutic and toxic secondary effects of inhaled anesthetics on important physiologic systems.

### Central Nervous System Cerebrovascular and Metabolic Effects

The effects of anesthetics on cerebral metabolism and vascular tone are summarized in Table 37–5. Normal cerebral blood flow (CBF) is tightly autoregulated and coupled to cerebral metabolic demands. Volatile anesthetics interrupt this autoregulation by acting as direct vasodilators of the cerebral vasculature.<sup>80</sup> Volatile anesthetics dose dependently increase middle cerebral artery blood flow velocity, with sevoflurane causing less vasodilatation than isoflurane or desflurane.<sup>81,82</sup> Both K<sup>+</sup> channels<sup>83</sup> and neuronal nitric oxide synthase<sup>84</sup> have been linked to these direct actions of anesthetics.

Volatile anesthetics also decrease the cerebral metabolic rate (CMR) of oxygen consumption.<sup>17,80</sup> Cerebral metabolism is decreased by halothane, isoflurane, sevoflurane, and desflurane.<sup>85</sup> The extent to which flow and metabolism are altered depends on the choice of agent. For example, halothane may increase CBF by almost 200%, but reduce CMR by only 10%.<sup>86</sup> In contrast, isoflurane increases CBF by approximately 20% but reduces CMR by 45%.<sup>87,88</sup> Volatile agents also partially uncouple flow–metabolism relationships and CO<sub>2</sub> reactivity.<sup>89,90</sup> These agents have not been shown to increase intracranial pressure in normocapnic adults undergoing supratentorial brain tumor resection without a



TABLE 37-5.

## Inhaled Anesthetic Effects on Central Nervous System Physiology

Effect	Nitrous Oxide	Desflurane	Sevoflurane	Isoflurane	Halothane
Cerebral blood flow	↑	↑	↑	↑	↑
Cerebral perfusion pressure	↓	↓	↓	↓	↓
Intracranial pressure	↑	↔/↑	↔/↑	↔/↑	↔/↑
Metabolic demands	↑	↓	↓	↓	↓
CO <sub>2</sub> reactivity	↔	↔	↔	↔	↔

preoperative midline shift.<sup>91</sup> In children, isoflurane, sevoflurane, and desflurane all have been shown to increase intracranial pressure.<sup>92</sup> N<sub>2</sub>O is distinguished from the potent volatile anesthetics in that it increases CBF and CMR and may increase intracranial pressure.<sup>93,94</sup> This is partly attributable to its sympathomimetic effects.<sup>95</sup>

**EEG Effects**

Volatile anesthetics alter the cortical EEG, decreasing high-frequency ( $\gamma$ -band) activity and increasing slower frequencies. Quantitative EEG analysis demonstrates that power shifts anteriorly.<sup>44</sup> In comparison, N<sub>2</sub>O has little effect or increases the frequency of the cortical EEG.<sup>96-98</sup> Indeed, EEG-based monitors do not reliably detect the hypnotic effects of N<sub>2</sub>O alone or in combination with other anesthetics.<sup>99,100</sup> Deep volatile anesthesia (1.5–2 × MAC) leads to burst suppression or isoelectric EEG patterns. Although all volatile anesthetics have been used to suppress seizures, both enflurane and sevoflurane have been reported to augment epileptic brain activity and may induce EEG patterns associated with epilepsy in normal patients.<sup>101-103</sup> Enflurane and sevoflurane may be useful during cortical mapping for ablation of seizure foci but should otherwise be avoided in patients with seizure disorders.

The effects of anesthetics that are thought to produce the state of general

anesthesia are discussed in this chapter and in more detail in Chapter 36. The long-term effects of anesthetics on cognitive function are reviewed in Chapter 87.

**Cardiovascular System**

The effects of volatile anesthetics on the cardiovascular system are of paramount clinical importance intraoperatively, particularly in patients at risk for end-organ ischemia. They are summarized in Table 37-6.

**Mean Arterial Pressure**

Volatile anesthetics decrease mean arterial pressure (MAP) in a dose-dependent manner by direct vascular and autonomic nervous effects.<sup>85</sup> Volatile anesthetics reduce MAP by decreasing systemic vascular resistance, increasing vascular compliance (the change in circulatory volume with changes in pressure), and inhibiting myocardial contractility. Halothane depresses myocardial contractility more than other volatile anesthetics. Isoflurane and desflurane decrease systemic vascular resistance, although halothane, isoflurane, and sevoflurane increase arterial compliance (Table 37-7).<sup>104</sup> Desflurane has been found to stimulate sympathetic nervous system activity (especially with rapid increases in vapor concentration), which may account for its minor effect on vascular compliance.<sup>105</sup>

N<sub>2</sub>O raises sympathetic activity and systolic blood pressure<sup>106</sup> and thus counters the vasodilatory and hypotensive effects of coadministered volatile agents.<sup>107</sup>

**Heart Rate**

Volatile anesthetics increase heart rate, both by a baroreceptor reflex in response to decreased arterial pressure and by a direct vagolytic effect on the heart. In dogs, desflurane increases heart rate the most, followed by sevoflurane, isoflurane, and halothane.<sup>108</sup> Rapid increases in the alveolar concentration of desflurane are associated with increased heart rate and blood pressure (Fig. 37-18),<sup>109,110</sup> which are attributed to stimulation of sympathetic activity.<sup>105</sup> The minimal effect of halothane on heart rate is associated with its block of the baroreceptor reflex.<sup>111</sup> N<sub>2</sub>O is associated with only modest transient increases in heart rate,<sup>112</sup> which reflect its sympathetic effects and preservation of MAP.

**Myocardial Contractility**

Volatile anesthetics cause myocardial depression, in part by inhibiting calcium ion influx in cardiac muscle.<sup>113</sup> Halothane causes marked dose-dependent inhibition of myocardial contractility and reduces cardiac output.<sup>114,115</sup> Isoflurane, sevoflurane, and desflurane have lesser effects on myocardial contractility. In dogs, all these anes-

TABLE 37-6.

## Effects of Inhaled Anesthetics on Cardiovascular Physiology

Effect	Nitrous Oxide	Desflurane	Sevoflurane	Isoflurane	Halothane
Mean arterial pressure	↔/↑	↓	↓	↓	↓
Systemic vascular resistance	↔/↑	↓	↔	↓	↔
Heart rate	↔/↑	↑	↑	↑	↔
Myocardial function	↓	↓	↓	↓	↓
Epinephrine-induced arrhythmia	↑	↔	↔	↔	↑

TABLE 37-7.

## Inhaled Anesthetic Effects on Vascular Resistance and Compliance Comparison to Sodium Nitroprusside

Effect	Desflurane	Sevoflurane	Isoflurane	Halothane	Sodium Nitroprusside
Total arterial resistance	↓	↔	↓	↔	↓
Total arterial compliance	↔	↑	↑	↑	↑

Modified from Lowe et al.<sup>104</sup> with permission.

thetics depress myocardial contractility, delay cardiac chamber relaxation, reduce chamber stiffness, and impair left atrial–left ventricular coupling.<sup>116,117</sup> N<sub>2</sub>O administration also decreases intracellular calcium levels and depresses myocardial contractility.<sup>118,119</sup> Thus, although N<sub>2</sub>O minimally affects blood pressure and heart rate, it has negative inotropic effects similar to those of potent volatile agents.

### Cardiac Rhythm and Conduction

Volatile anesthetics affect the function of cardiac ion channels, increasing the risk of arrhythmias.<sup>120</sup> Halothane sensitizes the heart to the arrhythmogenic effects of epinephrine,<sup>121</sup> although isoflurane, desflurane, and sevoflurane do not.<sup>122,123</sup> Halothane, isoflurane, desflurane, and sevoflurane all pro-

long the QT interval.<sup>124,125</sup> In dental outpatients, halothane produced more ventricular arrhythmias than did isoflurane.<sup>126,127</sup> In pediatric dental outpatients receiving halothane anesthesia, 48% had ventricular dysrhythmias compared to 8–16% of those inhaling sevoflurane.<sup>128</sup> Furthermore, sevoflurane-induced arrhythmias were primarily single supraventricular ectopic beats, although ventricular tachycardia was observed in 12% of patients receiving halothane. N<sub>2</sub>O may induce atrioventricular junctional rhythms<sup>129</sup> and can lower the threshold for epinephrine-induced arrhythmias in conjunction with halothane.<sup>130</sup>

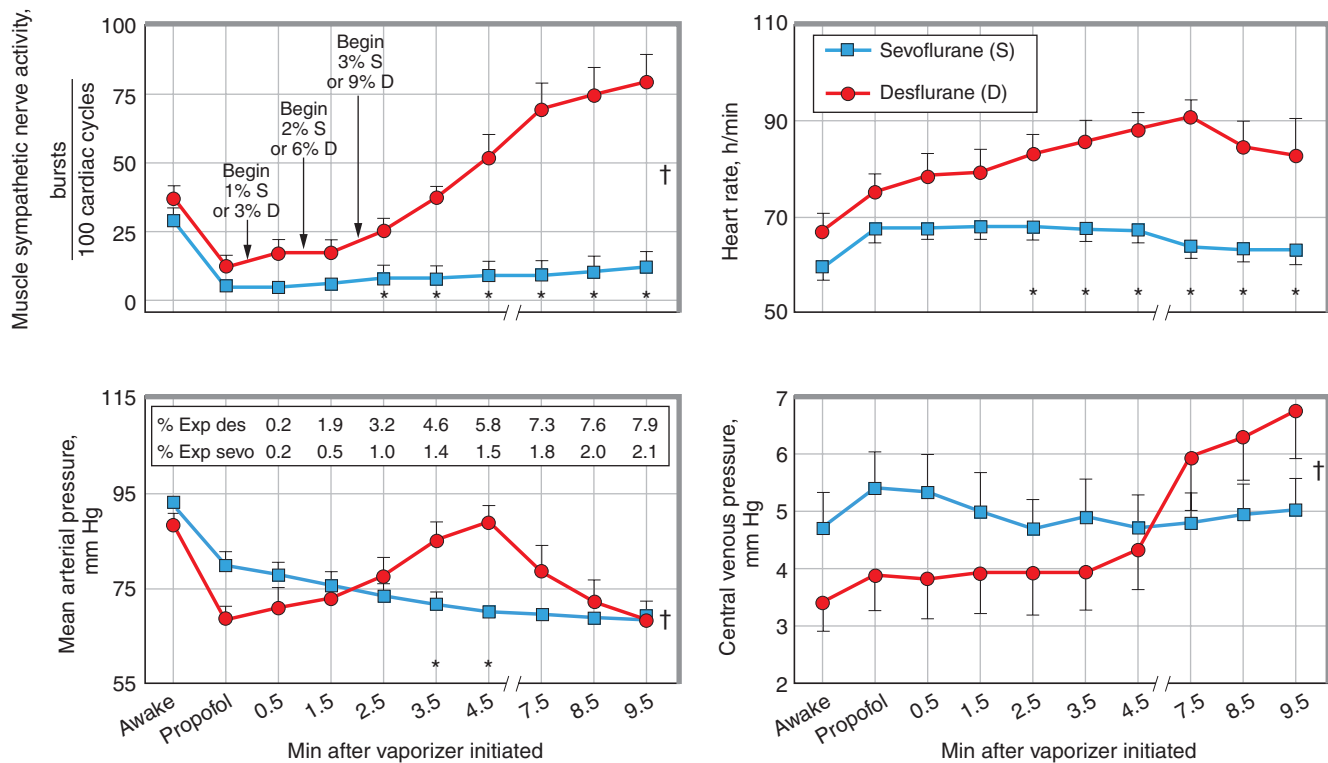
### Coronary Artery Perfusion

Isoflurane is a coronary vasodilator and thus can potentially create “coro-

nary steal,” a diversion of blood flow away from fixed stenotic lesions.<sup>131</sup> The clinical significance of this phenomenon appears to be mostly theoretical. Isoflurane has been found to be safe in patients with coronary artery disease as long as adequate perfusion is maintained. Isoflurane also provides beneficial effects via ischemic preconditioning.<sup>132</sup> Desflurane and sevoflurane do not cause coronary steal.<sup>133,134</sup>

### Respiratory System Ventilation

Volatile anesthetics depress respiration through both central medullary and peripheral muscular effects. In general, inhaled anesthetics decrease tidal volume and increase respiratory rate. Halothane, isoflurane, desflurane,



**FIGURE 37-18.** Effects of desflurane and sevoflurane on basic cardiovascular parameters in human subjects. Consecutive measurements of neurocirculatory variables (mean  $\pm$  SEM) during induction of anesthesia with propofol and subsequent mask administration of sevoflurane or desflurane for a 10-minute period. The subsequent administration of sevoflurane did not alter heart rate or sympathetic nerve activity but led to a progressive decline in mean arterial pressure. In contrast, desflurane resulted in significant increases in neurocirculatory variables that persisted throughout the 10-minute mask administration period. (From Ebert et al.<sup>110</sup> with permission.)

and sevoflurane dose dependently reduce tidal volume. The concomitant increase in respiratory rate is more pronounced with halothane, desflurane, and sevoflurane than with isoflurane.<sup>133,135–137</sup> Compensatory tachypnea maintains minute ventilation with desflurane up to alveolar concentrations of  $1.6 \times \text{MAC}$ . Nonetheless, alveolar ventilation is reduced by all volatile anesthetics, resulting in an increased  $\text{Paco}_2$ .  $\text{N}_2\text{O}$  also causes tachypnea and decreased tidal volume, but alone it causes minimal changes in  $\text{Paco}_2$ .  $\text{N}_2\text{O}$  depression of ventilation is additive when given in combination with other inhalational agents.<sup>138</sup>

Factors that contribute to hypoxia and hypercarbia during inhalational anesthesia include hypoventilation, atelectasis, airway closure, decreased functional residual capacity, and ventilation-perfusion ( $\dot{V}/\dot{Q}$ ) mismatch.<sup>139</sup> Volatile anesthetics blunt hypoxic and hypercarbic respiratory drive, increasing the risk of severe hypoxia and hypercarbia in spontaneously breathing patients.<sup>140–142</sup> Depression of hypoxic and hypercarbic ventilatory drives occurs even at subanesthetic doses.  $\text{N}_2\text{O}$  blunts the respiratory drive to hypoxia and hypoventilation, but its clinical effects are minimal because of its low potency.<sup>143</sup> After terminating delivery, rapid elimination of  $\text{N}_2\text{O}$  from blood dilutes alveolar gases and, if supplemental oxygen is not supplied, can lead to *diffusion hypoxia*.<sup>144,145</sup>

### Hypoxic Pulmonary Vasoconstriction

Hypoxic pulmonary vasoconstriction (HPV) is a pulmonary vascular mechanism that diverts blood flow away from poorly ventilated areas of the lung, minimizing  $\dot{V}/\dot{Q}$  mismatch. The mechanisms underlying HPV are not fully understood, but cyclooxygenase,

calcium channels, and potassium channels appear to be involved.<sup>146</sup>  $\text{N}_2\text{O}$  has been shown *in vivo* to inhibit HPV.<sup>147</sup> In isolated lung models, halothane, isoflurane, sevoflurane, desflurane, and  $\text{N}_2\text{O}$  all dose dependently inhibit HPV.<sup>148–150</sup> In many animal studies, however, clinical concentrations of halothane, isoflurane, sevoflurane, and desflurane have not been found to inhibit HPV.<sup>151–154</sup> In a few studies of chronically instrumented dogs, isoflurane was found to attenuate HPV.<sup>155</sup> The conflicting data regarding isoflurane effects on HPV may be due to different flow conditions in the pulmonary vasculature during different experiments.

### Bronchial Tone

Most volatile anesthetics, including halothane, enflurane, isoflurane, and sevoflurane, are bronchodilators that decrease respiratory resistance and increase dynamic compliance (Table 37–8).<sup>156</sup> At equi-MAC concentrations, respiratory resistance is reduced by sevoflurane > halothane > isoflurane.<sup>157</sup> In contrast to the other volatile anesthetics, desflurane is associated with either no bronchodilatory effects or with bronchoconstrictor effects at higher concentrations.<sup>158</sup> Inhalational induction with desflurane is associated with coughing and increased risk of laryngospasm, which likely is due to its pungency. Sevoflurane causes the least amount of subjective airway irritation and is well tolerated during inhalational induction.<sup>159</sup>  $\text{N}_2\text{O}$  has no effect on respiratory resistance.<sup>157</sup>

## Hepatic and Renal Systems

### Liver

Volatile anesthetics reduce overall hepatic perfusion by altering portal venous and/or hepatic arterial inflows. Most agents decrease portal

venous flow. Isoflurane has the least overall effect on hepatic perfusion because of compensatory increases in hepatic artery flow.<sup>160</sup> In contrast, halothane causes hepatic artery vasoconstriction and decreases overall hepatic blood flow,<sup>161</sup> hepatic oxygen delivery, and hepatic vein blood oxygen saturation.<sup>162</sup>  $\text{N}_2\text{O}$  causes minimal circulatory effects on the liver.

Transient modest increases in liver enzymes are not uncommon following exposure to volatile anesthetics (halothane, desflurane, sevoflurane, and isoflurane). This effect is independent of surgical intervention and almost always is clinically insignificant.<sup>163,164</sup> The increase in liver enzyme levels after halothane administration may be due to anaerobic reductive metabolism that generates free radicals.<sup>165</sup> More severe hepatic injury (halothane hepatitis) is described in the section on Breakdown of Inhaled Anesthetics and Toxicity of Byproducts.

### Kidney

Volatile anesthetic agents cause dose-dependent decreases in renal blood flow, glomerular filtration rate, and urine output, which can be minimized with preoperative hydration.<sup>166–168</sup> Autoregulation of renal blood flow is preserved during halothane anesthesia.<sup>167</sup> Decreases in renal blood flow during inhalational anesthesia reflect a reduction in effective circulating volume secondary to increased vascular capacitance. Anesthetics do not directly stimulate antidiuretic hormone (ADH) release, but diminished urine production due to ADH is associated with surgical stress.<sup>169</sup>  $\text{N}_2\text{O}$  causes minimal effects on renal blood flow and function. Nephrotoxicity can be associated with breakdown of volatile anesthetics (see Breakdown of Inhaled Anesthetics and Toxicity of Byproducts below).

TABLE 37–8.

### Effects of Inhaled Anesthetics on Respiratory Physiology

Effect	Nitrous Oxide	Desflurane	Sevoflurane	Isoflurane	Halothane
Tidal volume	↓	↓	↓	↓	↓
Respiratory rate	↑	↑	↑	↑	↑
Hypoxic hypercarbic responses	↓	↓	↓	↓	↓
Hypoxic pulmonary vasoconstriction (in vitro)	↓	↓	↓	↓	↓
Airway resistance	↔	↑	↓	↓	↓

## Other Systemic and Adverse Effects

### Muscular System

Volatile anesthetics potentiate neuromuscular blockade via direct effects on the neuromuscular junction.<sup>170</sup> The muscle relaxant effect of volatile agents is stronger than that of intravenous anesthetics; N<sub>2</sub>O has no relaxant action. In animal models of isolated diaphragmatic muscle, enflurane and sevoflurane enhance fatigability at high concentrations.<sup>171,172</sup> This may be mediated in part by cyclic adenosine monophosphate, as administration of the phosphodiesterase inhibitor olprinone attenuates the effects of volatile anesthetics on diaphragmatic muscular fatigue.

### Malignant Hyperthermia

Malignant hyperthermia is a life-threatening clinical myopathy triggered by all potent volatile anesthetics and/or succinylcholine. It is a pharmacogenetic disorder associated with autosomal dominant transmission of genes encoding mutant forms of the skeletal muscle calcium release channel (ryanodine receptor protein or RyR1).<sup>173</sup> Upon exposure to the triggering drugs, patients with malignant hyperthermia develop an exaggerated increase of intracellular calcium resulting in sustained skeletal muscular contracture, which is not affected by neuromuscular blocking agents. Sustained contracture produces a hypermetabolic state, leading to increased CO<sub>2</sub> production and eventually hyperthermia. This condition is fatal unless treated aggressively and rapidly with intravenous dantrolene.

### Methionine Synthase Inhibition by N<sub>2</sub>O

N<sub>2</sub>O irreversibly oxidizes the cobalt atom of vitamin B<sub>12</sub>, which inhibits the cobalamin-dependent enzyme methionine synthase. This pathway is essential for homocysteine breakdown, nerve myelination, methyl substitutions of neurotransmitters, and DNA synthesis. Most patients are unaffected by temporary inactivation of vitamin B<sub>12</sub> after N<sub>2</sub>O. Nonetheless, this reaction can result in pathology in patients with poor nutrition, preexisting vitamin B<sub>12</sub> deficiency, or other metabolic diseases that converge on the same metabolic pathways. N<sub>2</sub>O exposure has led to “anesthesia paresthetica,” which is characterized by paresthesias, ataxias, and poor manual

dexterity.<sup>174</sup> In one infant with a pre-existing deficiency of 5,10-methylene-tetrahydrofolate reductase, another enzyme in the methionine synthetic pathway, it was thought that superimposed exposure to N<sub>2</sub>O resulted in neuronal damage, status epilepticus, and death.<sup>175</sup>

### Endocrine Function

Halothane and enflurane impair glucose tolerance in animal models by reducing both insulin secretion and receptor sensitivity. Isoflurane has been shown to increase endogenous glucose production and decrease glucose utilization.<sup>85,176</sup> The selection of anesthetic may also play a role in modulating stress responses to surgery. In a study of 20 women requiring laparoscopic surgery for ovarian cystectomy, sevoflurane was associated with less increase of cortisol and adrenocorticotrophic hormone levels compared to isoflurane.<sup>177</sup>

### Immune Function

Potent inhalational anesthetics can alter immune cell functions in various ways, which in turn may affect recovery from surgery or tumor viability. Halothane depresses the neutrophil oxidative response to inflammatory mediators of infection, whereas desflurane, sevoflurane, and isoflurane have smaller effects.<sup>178</sup> Sevoflurane impairs transcription factors in human lymphocytes, which may reduce the inflammatory response.<sup>179</sup> Volatile anesthetics can induce apoptosis in human T-cells in vitro<sup>180</sup> and may affect cytokine function.<sup>181</sup>

### Ischemic Preconditioning

Volatile anesthetics induce cellular responses that protect against ischemia and biochemical stress mediators. For example, sevoflurane decreases markers of myocardial and renal damage after coronary artery bypass grafting.<sup>182</sup> Animal models of renal ischemic injury demonstrate differential preconditioning, with desflurane demonstrating less protective effects against tubular necrosis than sevoflurane, isoflurane, or halothane.<sup>183</sup> Volatile anesthetics can protect against neural ischemia in animal models, through pathways involving both nitric oxide metabolism<sup>184</sup> and potassium channels.<sup>185</sup>

### Genotoxicity and Teratogenicity

Halogenated hydrocarbons and ethers can cause DNA damage. Halothane

and isoflurane produce genotoxicity in proliferating blood lymphocytes in vitro, whereas sevoflurane does not appear to be cytotoxic in an animal model.<sup>186</sup> The potential for anesthetic-induced teratogenicity has been studied. Prolonged N<sub>2</sub>O exposure is teratogenic in a number of embryonic animal models.<sup>187</sup> N<sub>2</sub>O inhibition of B<sub>12</sub>-dependent DNA synthesis is the likely cause. Because of potential genetic damage after chronic exposure to inhaled anesthetics, it is currently recommended that operating room air contain less than 25 parts per million (ppm) of N<sub>2</sub>O and less than 2 ppm of halogenated anesthetics. Under these conditions, there is little evidence of significant risk from workplace exposure to inhaled anesthetics.<sup>188</sup> Furthermore, approximately 75,000 pregnant women undergo nonobstetric surgery each year. Although there was once controversy over the effects of surgery and anesthesia in this population, volatile anesthesia appears to be safe for both the parturient and the fetus.<sup>189</sup>

## BREAKDOWN OF INHALED ANESTHETICS AND TOXICITY OF BYPRODUCTS

Inhaled anesthetics represent a class of drugs that are eliminated largely via nonmetabolic pathways—for the most part, they leave the body as they entered, unaltered and via ventilatory gas exchange. Undesirable effects directly associated with anesthetics are summarized above (see Systemic Actions of Inhaled Anesthetics), whereas others are caused indirectly by chemical decomposition of inhaled anesthetics into toxic byproducts. The breakdown of volatile anesthetics into potentially harmful chemicals can occur in the presence of CO<sub>2</sub> adsorbents or via enzymatic biotransformation in the body. In general, greater breakdown of inhaled anesthetics leads to greater toxicity.

### Nonmetabolic Decomposition of Inhaled Anesthetics

Whereas inhaled anesthetics are chemically stable under normal storage conditions (including within vaporizers), decomposition can occur under certain environmental conditions.

### Sevoflurane Breakdown and Compound A

When sevoflurane contacts CO<sub>2</sub> adsorbents containing a strong base (Bara-



lyme and soda lime), chemical decomposition occurs, releasing volatile breakdown products.<sup>190</sup> The major degradation product, compound A [fluoromethyl-2-2-difluoro-1-(trifluoromethyl) vinyl ether], was shown to cause renal injury and death in rats when inhaled at high levels.<sup>191</sup> Renal injury is both dose and time dependent, with a threshold for detectable injury in laboratory animals of 150–300 ppm hours. Nonetheless, in human volunteer and clinical studies, blood urea nitrogen and creatinine levels remain unchanged after exposures that sometimes exceed 300 ppm hours. It is thought that humans sustain less renal injury than rats after compound A exposure because of lower levels of renal cysteine conjugated  $\beta$ -lyase enzyme activity.<sup>192,193</sup> Special laboratory markers for subtle renal tubular damage in humans are elevated after 300 ppm hours of compound A exposure, and levels normalize within a few days.<sup>194</sup> In clinical settings, the inhaled concentration of compound A is proportional to the sevoflurane concentration and inversely related to FGFs. Low gas flows allow compound A to accumulate in the breathing circuit, unlike high gas flows which wash out compound A with waste gases. At FGF  $\geq 2$  L/min, concentrations of compound A are low enough that the conservative exposure threshold of 150 ppm hours is unlikely to be reached. Sevoflurane package labeling guidelines should be heeded. There is little evidence that sevoflurane is harmful to patients with preexisting renal disease, but other anesthetic agents are more prudent choices.

### **Volatile Anesthetic Breakdown and Desiccated CO<sub>2</sub> Adsorbents**

All the halogenated volatile anesthetics degrade in the presence of dry alkaline CO<sub>2</sub> adsorbents in rebreathing circuits (only sevoflurane breaks down in the presence of moist adsorbent). Decomposition in the presence of dry CO<sub>2</sub> adsorbents releases carbon monoxide (CO), formaldehyde, methanol, and heat. These exothermic reactions have resulted in the ignition of breathing circuit components<sup>195</sup> and in acute respiratory distress syndrome in patients.<sup>196</sup> They also can lead to significant carboxyhemoglobin levels in patients.<sup>197</sup> These problems are preventable and arise only when the CO<sub>2</sub> adsorbent is desiccated (e.g., if flushed

overnight with high-flow oxygen) and depend on the type and quantity of strong base in the adsorbent [in descending order of reactivity: KOH > NaOH > > Ba(OH)<sub>2</sub>]. Sevoflurane releases more heat than does desflurane or isoflurane,<sup>198</sup> whereas CO production is highest with desflurane > enflurane > isoflurane > sevoflurane > halothane.<sup>199,200</sup>

### **Photochemical Breakdown of Anesthetic Waste Gases**

Waste gases scavenged from anesthesia machines enter the atmosphere, where they are exposed to solar radiation and other gases.<sup>201,202</sup> Ultraviolet light catalyzes the reaction between N<sub>2</sub>O and O<sub>2</sub>, producing the free radical nitric oxide, which in turn destroys atmospheric ozone. Waste N<sub>2</sub>O from medical uses is less than 2% of the total added to the atmosphere (the majority results from agriculture and combustion of fossil fuels). All halogenated volatile gases break down when exposed to ultraviolet light to form halogen free radicals, which can deplete atmospheric ozone. Volatile anesthetic waste gases represent only a small portion of total atmospheric chlorofluorocarbons.

### **Biotransformation of Inhaled Anesthetics**

#### **Hepatic Drug Metabolism**

In the liver, enzymes can transform volatile anesthetics by oxidation, reduction, and conjugation. These reactions convert hydrophobic substrates into more hydrophilic metabolites that are excreted via the kidneys. Of these, the most important pathways for volatile anesthetics are oxidative, and the enzymes responsible are various members of the large cytochrome P450 (CYP) family. Neonates lack some enzymes that are present in older humans, and diverse other factors, such as genetic variation, can alter individual metabolic activities. Intrinsic liver disease or hepatic congestion due to heart failure may result in diminished enzymatic capacity, and intrahepatic blood flow shunting may reduce the efficiency with which drugs are enzymatically cleared. CYP enzyme activities may be inhibited by drugs such as cimetidine and amiodarone, or they may be enhanced by prolonged exposure to “inducers” such as phenobarbital, phenytoin, and a

wide range of other compounds, including inhaled anesthetics.

### **Halothane Hepatitis**

Among the currently available agents, halothane undergoes the most hepatic metabolism (20–25%) and is associated most frequently with significant toxicity. Usually, less than 1% of halothane metabolism is reductive. Oxidative metabolism of halothane by CYP enzymes generates trifluoroacetic acid, bromide, and an intermediate metabolite, trifluoroacetyl chloride, which can covalently modify proteins. Acetylation primarily occurs within the liver, and these modified proteins can act as neoantigens that stimulate the immune system to attack hepatocytes, resulting in fulminant hepatic necrosis. “Halothane hepatitis” occurs in 1:6000 to 1:35,000 adults following halothane anesthesia and is fatal in 50–75% of these cases.<sup>203</sup> Genetic factors likely are involved, and females are affected about twice as frequently as males. Many cases of hepatic necrosis occur following multiple exposures to halothane, consistent with an amplified secondary immune response. Halothane hepatitis has been reported in pediatric patients, but its incidence in children is 10–20 times lower than in adults.

Other inhaled anesthetics are metabolized by CYP enzymes to reactive acetyl intermediates that can modify hepatic proteins. Rare cases of fulminant hepatic injury following enflurane, isoflurane, and desflurane have been reported, and the incidence for each compound is related to the relative degree of metabolism (2.5%, 0.2%, and 0.02%, respectively).<sup>204</sup>

### **Fluoride Nephrotoxicity**

Metabolism of some inhaled anesthetics releases inorganic fluoride ions (F<sup>-</sup>), which can cause polyuric renal failure and increased mortality. Clinical findings include hypernatremia, hyperosmolarity, and increased blood urea nitrogen and creatinine. This problem is primarily associated with methoxyflurane, a very blood- and tissue-soluble anesthetic that is no longer used. Metabolic release of fluoride is clearly linked to methoxyflurane nephrotoxicity by dose-relationships and experiments in animals. Renal injury after methoxyflurane is rare at fluoride blood levels below 50  $\mu$ mol/L, whereas moderate injury is seen at 50–80  $\mu$ mol/L

and severe injury at higher levels. In rats, clinical and pathologic changes similar to those seen in human fluoride nephrotoxicity can be produced by intravenous administration of fluoride at similar levels.

Other fluorinated anesthetics, particularly enflurane and sevoflurane, release readily detectable amounts of fluoride when metabolized in the liver. However, nephrotoxicity is rarely associated with these drugs. Serum fluoride levels during and after enflurane anesthesia usually are below 50  $\mu\text{mol/L}$ , whereas levels during and after sevoflurane anesthesia often peak above 50  $\mu\text{mol/L}$ . However, sevoflurane is much less soluble in blood and tissue than is methoxyflurane. Sevoflurane is eliminated rapidly at the end of anesthesia, which halts fluoride production. In contrast, methoxyflurane is retained in tissues, and fluoride concentrations continue to rise after delivery is halted, reaching peak levels 2–3 days after anesthesia (for review, see Anders<sup>205</sup>). Methoxyflurane, more than sevoflurane, is decomposed to fluoride within the kidney, so intrarenal fluoride levels are higher than those detected in blood samples.<sup>206</sup>

## INERT GASES: FUTURE ANESTHETICS?

Although the safety and speed of inhaled anesthetics have improved greatly since the 19th century, all of the currently used agents are far from ideal because of their toxic effects on various physiologic systems (Table 37–9). The inert gas xenon was shown to produce anesthesia in 1951, and further study has revealed a pharmacokinetic and pharmacodynamic profile that approaches the ideal for an inhalational anesthetic.<sup>207,208</sup> Xenon is an odorless, tasteless, nonflammable, nonexplosive gas. Like other noble gases (helium, neon, argon, krypton, and radon), it is entirely chemically inert, undergoes no metabolic transformation, and has no direct negative environmental effects. Xenon does not cause airway irritation, and its blood/gas partition coefficient is 0.14, which makes inhalation induction significantly faster than with  $\text{N}_2\text{O}$  or desflurane. Xenon, like  $\text{N}_2\text{O}$ , produces minimal cardiovascular or respiratory depression. It produces no direct systemic organ toxicity, and there is evidence that xenon has neuroprotective effects,<sup>209</sup> including attenuation of cog-

**TABLE 37–9.**

### Advantages and Disadvantages of Inhaled Anesthetics

Anesthetic	Advantages	Disadvantages
Nitrous oxide	No odor, taste, pungency Rapid uptake and elimination Analgesic effect Minimal cardiovascular depression Minimal biotransformation	Airspace expansion $\uparrow$ Nausea/vomiting Inhibits methionine synthase Environmental pollutant Supports combustion
Halothane	Inexpensive Nonpungent	Myocardial depression Arrhythmias Halothane hepatitis risk Very slow uptake and elimination
Enflurane	Good muscle relaxation Stable heart rate	Pungent Slow uptake and elimination Epileptogenic
Isoflurane	Good muscle relaxation Maintains cardiac output Low biotransformation Inexpensive	Pungent Slow uptake and elimination
Desflurane	Rapid uptake and elimination Very low biotransformation	Airway irritant Sympathetic stimulant Requires electric vaporizer Breakdown to carbon monoxide in circuit Expensive
Sevoflurane	Rapid uptake and elimination Nonpungent	Breakdown to compound A in circuit Potentially nephrotoxic Expensive
Xenon	No odor, taste, pungency Very rapid uptake and elimination Analgesic effect Minimal cardiovascular depression No toxic metabolites Environmentally safe Inhibits combustion	Limited worldwide supply Expensive Airspace expansion

nitive dysfunction after cardiopulmonary bypass in an animal model.<sup>210</sup> Because MAC for xenon is approximately 0.7 atm, its use as a sole anesthetic agent is possible. One of its few negative physiologic effects is, like  $\text{N}_2\text{O}$ , airspace expansion. Xenon has analgesic effects, which likely are due to inhibition of *N*-methyl-D-aspartate (NMDA)-sensitive glutamate receptors. Unlike ketamine, an intravenous anesthetic that also acts on NMDA receptors, xenon is not associated with emergence delirium.

The main barrier to routine use of xenon is its limited worldwide supply and the prohibitive cost of isolating and concentrating it. Xenon cannot be

synthesized, so these factors are unlikely to change unless new sources are discovered. Energy expended in collecting xenon creates secondary negative environmental impacts. Methods for conserving (closed-circuit delivery) and reclaiming xenon from waste gases may make xenon more economically viable in the future.

## KEY REFERENCES

1. Campagna JA, Miller KW, Forman SA. Mechanisms of actions of inhaled anesthetics. *N Engl J Med* 2003;348:2110–2124.

2. Eger EI. Uptake of inhaled anesthetics: the alveolar to inspired anesthetic difference. In: Eger EI, ed. *Anesthetic Uptake and Action*. Baltimore: Williams & Wilkins, 1974: 77–96.
3. Baum JA. *Low Flow Anaesthesia: The Theory and Practice of Low Flow, Minimal Flow and Closed System Anaesthesia*. 2nd ed. Boston: Butterworth-Heinemann, 2001.
4. Stoelting RK, Eger EI 2nd. An additional explanation for the second gas effect: a concentrating effect. *Anesthesiology* 1969;30:273–277.
5. Eger EI 2nd. Age, minimum alveolar anesthetic concentration, and minimum alveolar anesthetic concentration-awake. *Anesth Analg* 2001;93:947–953.
6. Sebel PS, Bowdle TA, Ghoneim MM, et al. The incidence of awareness during anesthesia: a multicenter united states study. *Anesth Analg* 2004;99:833–839.
7. Myles PS, Leslie K, McNeil J, et al. Bispectral index monitoring to prevent awareness during anaesthesia: the b-aware randomised controlled trial. *Lancet* 2004;363:1757–1763.
8. Kenna JG, Jones RM. The organ toxicity of inhaled anesthetics. *Anesth Analg* 1995;81:S51–S66.
9. Anders MW. Formation and toxicity of anesthetic degradation products. *Annu Rev Pharmacol Toxicol* 2005;45:147–176.

## REFERENCES

1. Campagna JA, Miller KW, Forman SA. Mechanisms of actions of inhaled anesthetics. *N Engl J Med* 2003;348:2110–2124.
2. Keys TE. *The History of Surgical Anesthesia*. Chicago, Wood Library Museum of Anesthesiology, 1996.
3. Artusio JF Jr. Rationale and history of the development of halothane. *Clin Anesth* 1968;1:1–10.
4. Weiskopf RB, Sampson D, Moore MA. The desflurane (tec 6) vaporizer: design, design considerations and performance evaluation. *Br J Anaesth* 1994;72:474–479.
5. Munson ES, Eger EI 2nd. The effects of hyperthermia and hypothermia on the rate of induction of anesthesia: calculations using a mathematical model. *Anesthesiology* 1970;33:515–519.
6. Munson ES, Eger EI 2nd, Tham MK, et al. Increase in anesthetic uptake, excretion, and blood solubility in man after eating. *Anesth Analg* 1978;57:224–231.
7. Levitt DG. Pkquest: volatile solutes—application to enflurane, nitrous oxide, halothane, methoxyflurane and toluene pharmacokinetics. *BMC Anesthesiol* 2002;2:5.
8. Eger EI. Uptake of inhaled anesthetics: the alveolar to inspired anesthetic difference. In: Eger EI, ed. *Anesthetic Uptake and Action*. Baltimore: Williams & Wilkins, 1974:77–96.
9. Baum JA. *Low Flow Anaesthesia: The Theory and Practice of Low Flow, Minimal Flow and Closed System Anaesthesia*. 2nd ed. Boston: Butterworth-Heinemann, 2001.
10. Stoelting RK, Eger EI 2nd. An additional explanation for the second gas effect: a concentrating effect. *Anesthesiology* 1969;30:273–277.
11. Taheri S, Eger EI 2nd. A demonstration of the concentration and second gas effects in humans anesthetized with nitrous oxide and desflurane. *Anesth Analg* 1999;89:774–780.
12. Losasso TJ, Black S, Muzzi DA, et al. Detection and hemodynamic consequences of venous air embolism. Does nitrous oxide make a difference? *Anesthesiology* 1992;77:148–152.
13. Losasso TJ, Muzzi DA, Dietz NM, et al. Fifty percent nitrous oxide does not increase the risk of venous air embolism in neurosurgical patients operated upon in the sitting position. *Anesthesiology* 1992;77:21–30.
14. Hart RH, Vote BJ, Borthwick JH, et al. Loss of vision caused by expansion of intraocular perfluoropropane (c(3)f(8)) gas during nitrous oxide anesthesia. *Am J Ophthalmol* 2002;134:761–763.
15. Seaberg RR, Freeman WR, Goldbaum MH, et al. Permanent postoperative vision loss associated with expansion of intraocular gas in the presence of a nitrous oxide-containing anesthetic. *Anesthesiology* 2002;97:1309–1310.
16. Grocott HP, Sato Y, Homi HM, et al. The influence of xenon, nitrous oxide and nitrogen on gas bubble expansion during cardiopulmonary bypass. *Eur J Anaesthesiol* 2005;22:353–358.
17. Urban BW, Bleckwenn M. Concepts and correlations relevant to general anaesthesia. *Br J Anaesth* 2002;89:3–16.
18. Woodbridge PD. Changing concepts concerning depth of anesthesia. *Anesthesiology* 1957;18:536–550.
19. Daniel M, Weiskopf RB, Noorani M, et al. Fentanyl augments the blockade of the sympathetic response to incision (MAC-bar) produced by desflurane and isoflurane: desflurane and isoflurane MAC-bar without and with fentanyl. *Anesthesiology* 1998;88:43–49.
20. Snow J. *On the Inhalation of the Vapour of Ether in Surgical Operations*. London: John Churchill, 1847.
21. Guedel A. *Inhalation Anaesthesia: A Fundamental Guide*. New York: Macmillan, 1937.
22. Eger EI 2nd, Saidman LJ, Brandstater B. Minimum alveolar anesthetic concentration: a standard of anesthetic potency. *Anesthesiology* 1965;26:756–763.
23. Eger EI 2nd. A brief history of the origin of minimum alveolar concentration (MAC). *Anesthesiology* 2002;96:238–239.
24. Eger EI 2nd. Age, minimum alveolar anesthetic concentration, and minimum alveolar anesthetic concentration-awake. *Anesth Analg* 2001;93:947–953.
25. Nickalls RW, Mapleson WW. Age-related iso-MAC charts for isoflurane, sevoflurane and desflurane in man. *Br J Anaesth* 2003;91:170–174.
26. Wadhwa A, Durrani J, Sengupta P, et al. Women have the same desflurane minimum alveolar concentration as men: a prospective study. *Anesthesiology* 2003;99:1062–1065.
27. Gin T, Chan MT. Decreased minimum alveolar concentration of isoflurane in pregnant humans. *Anesthesiology* 1994;81:829–832.
28. Stekiel TA, J Contney S, Bosnjak ZJ, et al. Reversal of minimum alveolar concentrations of volatile anesthetics by chromosomal substitution. *Anesthesiology* 2004;101:796–798.
29. Liem EB, Lin CM, Suleman MI, et al. Anesthetic requirement is increased in redheads. *Anesthesiology* 2004;101:279–283.
30. Xing Y, Sonner JM, Eger EI 2nd, et al. Mice with a melanocortin 1 receptor mutation have a slightly greater minimum alveolar concentration than control mice. *Anesthesiology* 2004;101:544–546.
31. Eger EI 2nd, Xing Y, Laster M, et al. Halothane and isoflurane have additive minimum alveolar concentration (MAC) effects in rats. *Anesth Analg* 2003;96:1350–1353.
32. Firestone LL, Korpi ER, Niemi L, et al. Halothane and desflurane requirements in alcohol-tolerant and -nontolerant rats. *Br J Anaesth* 2000;85:757–762.
33. Rampil IJ. Anesthetic potency is not altered after hypothermic spinal cord transection in rats. *Anesthesiology* 1994;80:606–610.
34. Antognini JF, Schwartz K. Exaggerated anesthetic requirements in the preferentially anesthetized brain. *Anesthesiology* 1993;79:1244–1249.
35. Zhou HH, Jin TT, Qin B, Turndorf H. Suppression of spinal cord motoneuron excitability correlates with surgical immobility during isoflurane anesthesia. *Anesthesiology* 1998;88:955–961.
36. Zhou HH, Mehta M, Leis AA. Spinal cord motoneuron excitability during isoflurane and nitrous oxide anesthesia. *Anesthesiology* 1997;86:302–307.
37. Rehberg B, Grunewald M, Baars J, et al. Monitoring of immobility to noxious stimuli.



- lation during sevoflurane anesthesia using the spinal h-reflex. *Anesthesiology* 2004;100:44–50.
38. Dwyer R, Bennett HL, Eger EI 2nd, et al. Effects of isoflurane and nitrous oxide in subanesthetic concentrations on memory and responsiveness in volunteers. *Anesthesiology* 1992;77:888–898.
39. Ben-David B, Vaida S, Gaitini L. The influence of high spinal anesthesia on sensitivity to midazolam sedation. *Anesth Analg* 1995;81:525–528.
40. Tverskoy M, Shifrin V, Finger J, et al. Effect of epidural bupivacaine block on midazolam hypnotic requirements. *Reg Anesth* 1996;21:209–213.
41. Hodgson PS, Liu SS. Epidural lidocaine decreases sevoflurane requirement for adequate depth of anesthesia as measured by the bispectral index monitor. *Anesthesiology* 2001;94:799–803.
42. Hodgson PS, Liu SS, Gras TW. Does epidural anesthesia have general anesthetic effects? A prospective, randomized, double-blind, placebo-controlled trial. *Anesthesiology* 1999;91:1687–1692.
43. Katoh T, Ikeda K. The effects of fentanyl on sevoflurane requirements for loss of consciousness and skin incision. *Anesthesiology* 1998;88:18–24.
44. John ER, Pritchep LS. The anesthetic cascade: a theory of how anesthesia suppresses consciousness. *Anesthesiology* 2005;102:447–471.
45. Mashour GA. Consciousness unbound: toward a paradigm of general anesthesia. *Anesthesiology* 2004;100:428–433.
46. Peltier SJ, Kerssens C, Hamann SB, et al. Functional connectivity changes with concentration of sevoflurane anesthesia. *Neuroreport* 2005;16:285–288.
47. Alkire MT, Haier RJ, Fallon JH. Toward a unified theory of narcosis: brain imaging evidence for a thalamocortical switch as the neurophysiologic basis of anesthetic-induced unconsciousness. *Conscious Cogn* 2000;9:370–386.
48. Kerssens C, Klein J, Bonke B. Awareness: monitoring versus remembering what happened. *Anesthesiology* 2003;99:570–575.
49. Alkire MT, Nathan SV. Does the amygdala mediate anesthetic-induced amnesia? Basolateral amygdala lesions block sevoflurane-induced amnesia. *Anesthesiology* 2005;102:754–760.
50. Uchida S, Nakayama H, Maehara T, et al. Suppression of gamma activity in the human medial temporal lobe by sevoflurane anesthesia. *Neuroreport* 2000;11:39–42.
51. Simon W, Hapfelmeier G, Kochs E, et al. Isoflurane blocks synaptic plasticity in the mouse hippocampus. *Anesthesiology* 2001;94:1058–1065.
52. Roizen MF, Horrigan RW, Frazer BM. Anesthetic doses blocking adrenergic (stress) and cardiovascular responses to incision-MAC bar. *Anesthesiology* 1981;54:390–398.
53. Eckenhoff RG, Johansson JS, Wei H, et al. Inhaled anesthetic enhancement of amyloid-beta oligomerization and cytotoxicity. *Anesthesiology* 2004;101:703–709.
54. Monk TG, Saini V, Weldon BC, et al. Anesthetic management and one-year mortality after noncardiac surgery. *Anesth Analg* 2005;100:4–10.
55. Rampil IJ. A primer for EEG signal processing in anesthesia. *Anesthesiology* 1998;89:980–1002.
56. Rosow C, Manberg PJ. Bispectral index monitoring. *Anesthesiol Clin North America* 2001;19:947–966, xi.
57. Dressler O, Schneider G, Stockmanns G, et al. Awareness and the EEG power spectrum: analysis of frequencies. *Br J Anaesth* 2004;93:806–809.
58. Vakkuri A, Yli-Hankala A, Talja P, et al. Time-frequency balanced spectral entropy as a measure of anesthetic drug effect in central nervous system during sevoflurane, propofol, and thiopental anesthesia. *Acta Anaesthesiol Scand* 2004;48:145–153.
59. Ellerkmann RK, Liermann VM, Alves TM, et al. Spectral entropy and bispectral index as measures of the electroencephalographic effects of sevoflurane. *Anesthesiology* 2004;101:1275–1282.
60. Scheller B, Schneider G, Dauderer M, et al. High-frequency components of auditory evoked potentials are detected in responsive but not in unconscious patients. *Anesthesiology* 2005;103:944–950.
61. Schneider G, Hollweck R, Ningler M, et al. Detection of consciousness by electroencephalogram and auditory evoked potentials. *Anesthesiology* 2005;103:934–943.
62. Joint Commission on Accreditation of Hospital Organizations (JCAHO). Preventing, and managing the impact of anesthesia awareness. Sentinel event alert 6, Oct 2004; 32.
63. Sandin RH, Enlund G, Samuelsson P, et al. Awareness during anaesthesia: a prospective case study. *Lancet* 2000;355:707–711.
64. Sebel PS, Bowdle TA, Ghoneim MM, et al. The incidence of awareness during anesthesia: a multicenter united states study. *Anesth Analg* 2004;99:833–839.
65. Brice DD, Hetherington RR, Utting JE. A simple study of awareness and dreaming during anaesthesia. *Br J Anaesth* 1970;42:535–542.
66. Osterman JE, van der Kolk BA. Awareness during anesthesia and posttraumatic stress disorder. *Gen Hosp Psychiatry* 1998;20:274–281.
67. Osterman JE, Hopper J, Heran WJ, et al. Awareness under anesthesia and the development of posttraumatic stress disorder. *Gen Hosp Psychiatry* 2001;23:198–204.
68. Ghoneim MM. Awareness during anesthesia. *Anesthesiology* 2000;92:597–602.
69. Sandin R. Relax, be aware, and know what you are doing. *Acta Anaesthesiol Scand* 2002;46:343–344.
70. Lennmarken C, Bildfors K, Enlund G, et al. Victims of awareness. *Acta Anaesthesiol Scand* 2002;46:229–231.
71. Phillips AA, McLean RF, Devitt JH, et al. Recall of intraoperative events after general anaesthesia and cardiopulmonary bypass. *Can J Anaesth* 1993;40:922–926.
72. Bogetz MS, Katz JA. Recall of surgery for major trauma. *Anesthesiology* 1984;61:6–9.
73. Lyons G, Macdonald R. Awareness during caesarean section. *Anaesthesia* 1991;46:62–64.
74. Bergman IJ, Kluger MT, Short TG. Awareness during general anaesthesia: a review of 81 cases from the anaesthetic incident monitoring study. *Anaesthesia* 2002;57:549–556.
75. Ekman A, Lindholm ML, Lennmarken C, et al. Reduction in the incidence of awareness using BIS monitoring. *Acta Anaesthesiol Scand* 2004;48:20–26.
76. Myles PS, Leslie K, McNeil J, et al. Bispectral index monitoring to prevent awareness during anaesthesia: the B-Aware randomised controlled trial. *Lancet* 2004;363:1757–1763.
77. Dahaba AA. Different conditions that could result in the bispectral index indicating an incorrect hypnotic state. *Anesth Analg* 2005;101:765–773.
78. Messner M, Beese U, Romstock J, et al. The bispectral index declines during neuromuscular block in fully awake persons. *Anesth Analg* 2003;97:488–491.
79. Liu N, Chazot T, Huybrechts I, et al. The influence of a muscle relaxant bolus on bispectral and Datex-Ohmeda entropy values during propofol-remifentanyl induced loss of consciousness. *Anesth Analg* 2005;101:1713–1718.
80. Sloan TB. Anesthetics and the brain. *Anesthesiol Clin North America* 2002;20:265–292.
81. Matta BF, Heath KJ, Tipping K, et al. Direct cerebral vasodilatory effects of sevoflurane and isoflurane. *Anesthesiology* 1999;91:677–680.
82. Bedforth NM, Hardman JG, Nathanson MH. Cerebral hemodynamic response to the introduction of desflurane: a comparison with sevoflurane. *Anesth Analg* 2000;91:152–155.
83. Iida H, Ohata H, Iida M, et al. Isoflurane and sevoflurane induce vasodilation of cerebral vessels via ATP-sensitive K<sup>+</sup> channel activation. *Anesthesiology* 1998;89:954–960.
84. Staunton M, Drexler C, Schmid PG 3rd, et al. Neuronal nitric oxide synthase mediates halothane-induced cerebral microvascular dilation. *Anesthesiology* 2000;92:125–132.
85. Preckel B, Bolten J. Pharmacology of modern volatile anaesthetics. *Best Pract Res Clin Anaesthesiol* 2005;19:331–348.
86. Wollman H, Alexander SC, Cohen PJ, et al. Cerebral circulation of man during halothane anesthesia: effects of hypocarbia



and of d-tubocurarine. *Anesthesiology* 1964;25:180-184.

87. Lenz C, Rebel A, van Ackern K, et al. Local cerebral blood flow, local cerebral glucose utilization, and flow-metabolism coupling during sevoflurane versus isoflurane anesthesia in rats. *Anesthesiol* 1998; 89:1480-1488.
88. Oshima T, Karasawa F, Okazaki Y, et al. Effects of sevoflurane on cerebral blood flow and cerebral metabolic rate of oxygen in human beings: a comparison with isoflurane. *Eur J Anaesthesiol* 2003;20:543-547.
89. Mielck F, Stephan H, Buhre W, et al. Effects of 1 MAC desflurane on cerebral metabolism, blood flow and carbon dioxide reactivity in humans. *Br J Anaesth* 1998;81: 155-160.
90. Mielck F, Stephan H, Weyland A, Sonntag H. Effects of one minimum alveolar anesthetic concentration sevoflurane on cerebral metabolism, blood flow, and CO<sub>2</sub> reactivity in cardiac patients. *Anesth Analg* 1999;89:364-369.
91. Fraga M, Rama-Maceiras P, Rodino S, et al. The effects of isoflurane and desflurane on intracranial pressure, cerebral perfusion pressure, and cerebral arteriovenous oxygen content difference in normocapnic patients with supratentorial brain tumors. *Anesthesiology* 2003;98:1085-1090.
92. Sponheim S, Skraastad O, Helseth E, et al. Effects of 0.5 and 1.0 MAC isoflurane, sevoflurane and desflurane on intracranial and cerebral perfusion pressures in children. *Acta Anaesthesiol Scand* 2003;47: 932-938.
93. Pelligrino DA, Miletich DJ, Hoffman WE, et al. Nitrous oxide markedly increases cerebral cortical metabolic rate and blood flow in the goat. *Anesthesiology* 1984;60:405-412.
94. Henriksen HT, Jorgensen PB. The effect of nitrous oxide on intracranial pressure in patients with intracranial disorders. *Br J Anaesth* 1973;45:486-492.
95. Nakanishi O, Ishikawa T, Imamura Y, et al. Inhibition of cerebral metabolic and circulatory responses to nitrous oxide by 6-hydroxydopamine in dogs. *Can J Anaesth* 1997;44:1008-1013.
96. Kaieda R, Todd MM, Warner DS. The effects of anesthetics and PaCO<sub>2</sub> on the cerebrovascular, metabolic, and electroencephalographic responses to nitrous oxide in the rabbit. *Anesth Analg* 1989;68:135-143.
97. Baughman VL, Hoffman WE, Miletich DJ, et al. Cerebrovascular and cerebral metabolic effects of N<sub>2</sub>O in unrestrained rats. *Anesthesiology* 1990;73:269-272.
98. Yli-Hankala A, Lindgren L, Porkkala T, et al. Nitrous oxide-mediated activation of the EEG during isoflurane anaesthesia in patients. *Br J Anaesth* 1993;70:54-57.
99. Anderson RE, Jakobsson JG. Entropy of EEG during anaesthetic induction: a comparative study with propofol or nitrous oxide as sole agent. *Br J Anaesth* 2004;92: 167-170.

100. Barr G, Jakobsson JG, Owall A, et al. Nitrous oxide does not alter bispectral index: study with nitrous oxide as sole agent and as an adjunct to I.V. anaesthesia. *Br J Anaesth* 1999;82:827-830.
101. Neigh JL, Garman JK, Harp JR. The electroencephalographic pattern during anesthesia with ethrane: of depth of anesthesia, PaCO<sub>2</sub>, and nitrous oxide. *Anesthesiology* 1971;35:482-487.
102. Iijima T, Nakamura Z, Iwao Y, et al. The epileptogenic properties of the volatile anesthetics sevoflurane and isoflurane in patients with epilepsy. *Anesth Analg* 2000; 91:989-995.
103. Hilty CA, Drummond JC. Seizure-like activity on emergence from sevoflurane anesthesia. *Anesthesiology* 2000;93:1357-1359.
104. Lowe D, Hettrick DA, Pagel PS, et al. Influence of volatile anesthetics on left ventricular afterload in vivo. Differences between desflurane and sevoflurane. *Anesthesiology* 1996;85:112-120.
105. Pac-Soo CK, Ma D, Wang C, et al. Specific actions of halothane, isoflurane, and desflurane on sympathetic activity and A delta and C somatosympathetic reflexes recorded in renal nerves in dogs. *Anesthesiology* 1999;91:470-8.
106. Ebert TJ, Kampine JP. Nitrous oxide augments sympathetic outflow: direct evidence from human peroneal nerve recordings. *Anesth Analg* 1989;69:444-449.
107. Smith NT, Eger EI 2nd, Stoelting RK, et al. The cardiovascular and sympathomimetic responses to the addition of nitrous oxide to halothane in man. *Anesthesiology* 1970;32:410-421.
108. Picker O, Scheeren TW, Arndt JO. Inhalation anaesthetics increase heart rate by decreasing cardiac vagal activity in dogs. *Br J Anaesth* 2001;87:748-754.
109. Weiskopf RB, Moore MA, Eger EI 2nd, et al. Rapid increase in desflurane concentration is associated with greater transient cardiovascular stimulation than with rapid increase in isoflurane concentration in humans. *Anesthesiology* 1994;80:1035-1045.
110. Ebert TJ, Muzi M, Lopatka CW. Neurocirculatory responses to sevoflurane in humans. A comparison to desflurane. *Anesthesiology* 1995;83:88-95.
111. Ebert TJ, Kotrly KJ, Vucins EJ, et al. Halothane anesthesia attenuates cardiopulmonary baroreflex control of peripheral resistance in humans. *Anesthesiology* 1985; 63:668-674.
112. Kawamura R, Stanley TH, English JB, et al. Cardiovascular responses to nitrous oxide exposure for two hours in man. *Anesth Analg* 1980;59:93-99.
113. Hannon JD, Cody MJ, Sun DX, et al. Effects of isoflurane and sevoflurane on intracellular calcium and contractility in pressure-overload hypertrophy. *Anesthesiology* 2004;101:675-686.
114. Goldberg AH, Ullrick WC. Effects of halothane on isometric contractions of iso-

lated heart muscle. *Anesthesiology* 1967; 28:838-845.

115. Eger EI 2nd, Smith NT, Stoelting RK, et al. Cardiovascular effects of halothane in man. *Anesthesiology* 1970;32:396-409.
116. Gare M, Schwabe DA, Hettrick DA, et al. Desflurane, sevoflurane, and isoflurane affect left atrial active and passive mechanical properties and impair left atrial-left ventricular coupling in vivo: analysis using pressure-volume relations. *Anesthesiology* 2001;95:689-698.
117. Bartunek AE, Claes VA, Housmans PR. Effects of volatile anesthetics on stiffness of mammalian ventricular muscle. *J Appl Physiol* 2001;91:1563-1573.
118. Price HL. Myocardial depression by nitrous oxide and its reversal by Ca<sup>++</sup>. *Anesthesiology* 1976;44:211-215.
119. Carton EG, Wanek LA, Housmans PR. Effects of nitrous oxide on contractility, relaxation and the intracellular calcium transient of isolated mammalian ventricular myocardium. *J Pharmacol Exp Ther* 1991;257:843-849.
120. Huneke R, Fassl J, Rossaint R, et al. Effects of volatile anesthetics on cardiac ion channels. *Acta Anaesthesiol Scand* 2004;48:547-561.
121. Sumikawa K, Ishizaka N, Suzuki M. Arrhythmogenic plasma levels of epinephrine during halothane, enflurane, and pentobarbital anesthesia in the dog. *Anesthesiology* 1983;58:322-325.
122. Navarro R, Weiskopf RB, Moore MA, et al. Humans anesthetized with sevoflurane or isoflurane have similar arrhythmic response to epinephrine. *Anesthesiology* 1994;80:545-549.
123. Moore MA, Weiskopf RB, Eger EI 2nd, et al. Arrhythmogenic doses of epinephrine are similar during desflurane or isoflurane anesthesia in humans. *Anesthesiology* 1993;79:943-947.
124. Guler N, Kati I, Demirel CB, et al. The effects of volatile anesthetics on the Q-Tc interval. *J Cardiothorac Vasc Anesth* 2001; 15:188-191.
125. Yildirim H, Adanir T, Atay A, et al. The effects of sevoflurane, isoflurane and desflurane on qt interval of the ECG. *Eur J Anaesthesiol* 2004;21:566-570.
126. Rodrigo MR, Moles TM, Lee PK. Comparison of the incidence and nature of cardiac arrhythmias occurring during isoflurane or halothane anaesthesia. *Studies during dental surgery. Br J Anaesth* 1986; 58:394-400.
127. Cripps TP, Edmondson RS. Isoflurane for anaesthesia in the dental chair. A comparison of the incidence of cardiac dysrhythmias during anaesthesia with halothane and isoflurane. *Anaesthesia* 1987; 42:189-191.
128. Blayney MR, Malins AF, Cooper GM. Cardiac arrhythmias in children during outpatient general anaesthesia for dentistry: a prospective randomised trial. *Lancet* 1999; 354:1864-1866.

129. Roizen MF, Plummer GO, Lichtor JL. Nitrous oxide and dysrhythmias. *Anesthesiology* 1987;66:427-431.
130. Liu WS, Wong KC, Port JD, et al. Epinephrine-induced arrhythmias during halothane anesthesia with the addition of nitrous oxide, nitrogen, or helium in dogs. *Anesth Analg* 1982;61:414-417.
131. Wilton NC, Knight PR, Ullrich K, et al. Transmural redistribution of myocardial blood flow during isoflurane anesthesia and its effects on regional myocardial function in a canine model of fixed coronary stenosis. *Anesthesiology* 1993;78:510-523.
132. Agnew NM, Pennefather SH, Russell GN. Isoflurane and coronary heart disease. *Anaesthesia* 2002;57:338-347.
133. Warltier DC, Pagel PS. Cardiovascular and respiratory actions of desflurane: is desflurane different from isoflurane? *Anesth Analg* 1992;75:S17-S29.
134. Kersten JR, Brayer AP, Pagel PS, et al. Perfusion of ischemic myocardium during anesthesia with sevoflurane. *Anesthesiology* 1994;81:995-1004.
135. Fourcade HE, Stevens WC, Larson CP Jr, et al. The ventilatory effects of Forane, a new inhaled anesthetic. *Anesthesiology* 1971;35:26-31.
136. Doi M, Ikeda K. Respiratory effects of sevoflurane. *Anesth Analg* 1987;66:241-244.
137. Lockhart SH, Rampil IJ, Yasuda N, et al. Depression of ventilation by desflurane in humans. *Anesthesiology* 1991;74:484-488.
138. Hornbein TF, Martin WE, Bonica JJ, et al. Nitrous oxide effects on the circulatory and ventilatory responses to halothane. *Anesthesiology* 1969;31:250-260.
139. Hedenstierna G. Gas exchange pathophysiology during anesthesia. In Breen P, ed. *Respiration in Anesthesia*. Philadelphia: WB Saunders, 1998:113-128.
140. Hirshman CA, McCullough RE, Cohen PJ, et al. Depression of hypoxic ventilatory response by halothane, enflurane and isoflurane in dogs. *Br J Anaesth* 1977;49:957-963.
141. Knill RL, Gelb AW. Ventilatory responses to hypoxia and hypercapnia during halothane sedation and anesthesia in man. *Anesthesiology* 1978;49:244-251.
142. Groeben H, Meier S, Tankersley CG, et al. Influence of volatile anaesthetics on hypercapnoic ventilatory responses in mice with blunted respiratory drive. *Br J Anaesth* 2004;92:697-703.
143. Yacoub O, Doell D, Kryger MH, et al. Depression of hypoxic ventilatory response by nitrous oxide. *Anesthesiology* 1976;45:385-389.
144. Sheffer L, Steffenson JL, Birch AA. Nitrous-oxide-induced diffusion hypoxia in patients breathing spontaneously. *Anesthesiology* 1972;37:436-439.
145. Einarsson S, Stenqvist O, Bengtsson A, et al. Nitrous oxide elimination and diffusion hypoxia during normo- and hypoventilation. *Br J Anaesth* 1993;71:189-193.
146. Liu R, Ueda M, Okazaki N, et al. Role of potassium channels in isoflurane- and sevoflurane-induced attenuation of hypoxic pulmonary vasoconstriction in isolated perfused rabbit lungs. *Anesthesiology* 2001;95:939-946.
147. Lejeune P, Deloef T, Leeman M, et al. Multipoint pulmonary vascular pressure/flow relationships in hypoxic and in normoxic dogs: effects of nitrous oxide with and without cyclooxygenase inhibition. *Anesthesiology* 1988;68:92-99.
148. Marshall C, Lindgren L, Marshall BE. Effects of halothane, enflurane, and isoflurane on hypoxic pulmonary vasoconstriction in rat lungs in vitro. *Anesthesiology* 1984;60:304-308.
149. Ishibe Y, Gui X, Uno H, et al. Effect of sevoflurane on hypoxic pulmonary vasoconstriction in the perfused rabbit lung. *Anesthesiology* 1993;79:1348-1353.
150. Loer SA, Scheeren TW, Tarnow J. Desflurane inhibits hypoxic pulmonary vasoconstriction in isolated rabbit lungs. *Anesthesiology* 1995;83:552-556.
151. Benumof JL, Wahrenbrock EA. Local effects of anesthetics on regional hypoxic pulmonary vasoconstriction. *Anesthesiology* 1975;43:525-532.
152. Mathers J, Benumof JL, Wahrenbrock EA. General anesthetics and regional hypoxic pulmonary vasoconstriction. *Anesthesiology* 1977;46:111-114.
153. Kerbaul F, Bellezza M, Guidon C, et al. Effects of sevoflurane on hypoxic pulmonary vasoconstriction in anaesthetized piglets. *Br J Anaesth* 2000;85:440-445.
154. Kerbaul F, Guidon C, Stephanazzi J, et al. Sub-MAC concentrations of desflurane do not inhibit hypoxic pulmonary vasoconstriction in anesthetized piglets. *Can J Anaesth* 2001;48:760-767.
155. Lennon PF, Murray PA. Attenuated hypoxic pulmonary vasoconstriction during isoflurane anesthesia is abolished by cyclooxygenase inhibition in chronically instrumented dogs. *Anesthesiology* 1996;84:404-414.
156. Dikmen Y, Eminoglu E, Salihoglu Z, et al. Pulmonary mechanics during isoflurane, sevoflurane and desflurane anaesthesia. *Anaesthesia* 2003;58:745-748.
157. Rooke GA, Choi JH, Bishop MJ. The effect of isoflurane, halothane, sevoflurane, and thiopental/nitrous oxide on respiratory system resistance after tracheal intubation. *Anesthesiology* 1997;86:1294-1299.
158. Goff MJ, Arain SR, Ficke DJ, et al. Absence of bronchodilation during desflurane anesthesia: a comparison to sevoflurane and thiopental. *Anesthesiology* 2000;93:404-408.
159. TerRiet MF, DeSouza GJ, Jacobs JS, et al. Which is most pungent: isoflurane, sevoflurane or desflurane? *Br J Anaesth* 2000;85:305-307.
160. Frink EJ Jr, Morgan SE, Coetzee A, et al. The effects of sevoflurane, halothane, enflurane, and isoflurane on hepatic blood flow and oxygenation in chronically instrumented greyhound dogs. *Anesthesiology* 1992;76:85-90.
161. Gatecel C, Losser MR, Payen D. The postoperative effects of halothane versus isoflurane on hepatic artery and portal vein blood flow in humans. *Anesth Analg* 2003;96:740-745.
162. Vollmar B, Conzen PF, Kerner T, et al. Blood flow and tissue oxygen pressures of liver and pancreas in rats: effects of volatile anesthetics and of hemorrhage. *Anesth Analg* 1992;75:421-430.
163. Tiainen P, Lindgren L, Rosenberg PH. Changes in hepatocellular integrity during and after desflurane or isoflurane anaesthesia in patients undergoing breast surgery. *Br J Anaesth* 1998;80:87-89.
164. Holt C, Csete M, Martin P. Hepatotoxicity of anesthetics and other central nervous system drugs. *Gastroenterol Clin North Am* 1995;24:853-874.
165. Spracklin DK, Hankins DC, Fisher JM, et al. Cytochrome P450 2E1 is the principal catalyst of human oxidative halothane metabolism in vitro. *J Pharmacol Exp Ther* 1997;281:400-411.
166. Eger E. Isoflurane (Forane). A Compendium and Reference. Madison: Anaquest, 1986.
167. Bastron RD, Perkins RM, Pyne JL. Autoregulation of renal blood flow during halothane anesthesia. *Anesthesiology* 1977;46:142-144.
168. Kenna JG, Jones RM. The organ toxicity of inhaled anesthetics. *Anesth Analg* 1995;81:S51-S66.
169. Philbin DM, Coggins CH. The effects of anesthesia on antidiuretic hormone. *Contemp Anesth Pract* 1980;3:29-38.
170. Wulf H, Hauschild S, Proppe D, et al. [Augmentation of the neuromuscular blocking effect of mivacurium during inhalation anesthesia with desflurane, sevoflurane and isoflurane in comparison with total intravenous anaesthesia]. *Anaesthesiol Reanim* 1998;23:88-92.
171. Uesugi T, Mikawa K, Nishina K, et al. Effects of phosphodiesterase-iii inhibitors on sevoflurane-induced impairment of rat diaphragmatic function. *Acta Anaesthesiol Scand* 2005;49:819-826.
172. Nishina K, Mikawa K, Kodama S, et al. The effects of enflurane, isoflurane, and intravenous anesthetics on rat diaphragmatic function and fatigability. *Anesth Analg* 2003;96:1674-1678.
173. Priori SG, Napolitano C. Cardiac and skeletal muscle disorders caused by mutations in the intracellular Ca<sup>2+</sup> release channels. *J Clin Invest* 2005;115:2033-2038.
174. Kinsella LJ, Green R. "Anesthesia parasthetica": nitrous oxide-induced cobalamin deficiency. *Neurology* 1995;45:1608-1610.
175. Selzer RR, Rosenblatt DS, Laxova R, Hogan K. Adverse effect of nitrous oxide in a child with 5,10-methylenetetrahydro-

folate reductase deficiency. *N Engl J Med* 2003;349:45–50.

176. Geisser W, Schreiber M, Hofbauer H, et al. Sevoflurane versus isoflurane-anaesthesia for lower abdominal surgery. Effects on perioperative glucose metabolism. *Acta Anaesthesiol Scand* 2003;47:174–179.

177. Marana E, Annetta MG, Meo F, et al. Sevoflurane improves the neuroendocrine stress response during laparoscopic pelvic surgery. *Can J Anaesth* 2003;50:348–354.

178. Frohlich D, Rothe G, Schwall B, et al. Effects of volatile anaesthetics on human neutrophil oxidative response to the bacterial peptide FMLP. *Br J Anaesth* 1997;78:718–723.

179. Loop T, Scheiermann P, Doviakue D, et al. Sevoflurane inhibits phorbol-myristate-acetate-induced activator protein-1 activation in human T lymphocytes in vitro: potential role of the p38-stress kinase pathway. *Anesthesiology* 2004;101:710–721.

180. Loop T, Dovi-Akue D, Frick M, et al. Volatile anesthetics induce caspase-dependent, mitochondria-mediated apoptosis in human T lymphocytes in vitro. *Anesthesiology* 2005;102:1147–1157.

181. Giraud O, Mollieux S, Rolland C, et al. Halogenated anesthetics reduce interleukin-1beta-induced cytokine secretion by rat alveolar type II cells in primary culture. *Anesthesiology* 2003;98:74–81.

182. Julier K, da Silva R, Garcia C, et al. Preconditioning by sevoflurane decreases biochemical markers for myocardial and renal dysfunction in coronary artery bypass graft surgery: a double-blinded, placebo-controlled, multicenter study. *Anesthesiology* 2003;98:1315–1327.

183. Lee HT, Ota-Setlik A, Fu Y, et al. Differential protective effects of volatile anesthetics against renal ischemia-reperfusion injury in vivo. *Anesthesiology* 2004;101:1313–1324.

184. Kapinya KJ, Lowl D, Futterer C, et al. Tolerance against ischemic neuronal injury can be induced by volatile anesthetics and is inducible no synthase dependent. *Stroke* 2002;33:1889–1898.

185. Xiong L, Zheng Y, Wu M, et al. Preconditioning with isoflurane produces dose-dependent neuroprotection via activation of adenosine triphosphate-regulated potassium channels after focal cerebral ischemia in rats. *Anesth Analg* 2003;96:233–237.

186. Szyfter K, Szulc R, Mikstacki A, et al. Genotoxicity of inhalation anaesthetics:

DNA lesions generated by sevoflurane in vitro and in vivo. *J Appl Genet* 2004;45:369–374.

187. Fujinaga M, Mazze RI, Baden JM, et al. Rat whole embryo culture: an in vitro model for testing nitrous oxide teratogenicity. *Anesthesiology* 1988;69:401–404.

188. Burm AG. Occupational hazards of inhalational anaesthetics. *Best Pract Res Clin Anaesthesiol* 2003;17:147–161.

189. Kuczkowski KM. Nonobstetric surgery during pregnancy: what are the risks of anesthesia? *Obstet Gynecol Surv* 2004;59:52–56.

190. Fang ZX, Kandel L, Laster MJ, et al. Factors affecting production of compound a from the interaction of sevoflurane with Baralyme and soda lime. *Anesth Analg* 1996;82:775–781.

191. Gonsowski CT, Laster MJ, Eger EI 2nd, et al. Toxicity of compound a in rats. Effect of a 3-hour administration. *Anesthesiology* 1994;80:556–565.

192. Iyer RA, Anders MW. Cysteine conjugate beta-lyase-dependent biotransformation of the cysteine s-conjugates of the sevoflurane degradation product compound a in human, nonhuman primate, and rat kidney cytosol and mitochondria. *Anesthesiology* 1996;85:1454–1461.

193. Sheffels P, Schroeder JL, Altuntas TG, et al. Role of cytochrome P4503A in cysteine S-conjugates sulfoxidation and the nephrotoxicity of the sevoflurane degradation product fluoromethyl-2,2-difluoro-1-(trifluoromethyl)vinyl ether (compound A) in rats. *Chem Res Toxicol* 2004;17:1177–1189.

194. Eger EI 2nd, Koblin DD, Bowland T, et al. Nephrotoxicity of sevoflurane versus desflurane anesthesia in volunteers. *Anesth Analg* 1997;84:160–168.

195. Wu J, Previte JP, Adler E, et al. Spontaneous ignition, explosion, and fire with sevoflurane and barium hydroxide lime. *Anesthesiology* 2004;101:534–537.

196. Fatheree RS, Leighton BL. Acute respiratory distress syndrome after an exothermic Baralyme-sevoflurane reaction. *Anesthesiology* 2004;101:531–533.

197. Berry PD, Sessler DI, Larson MD. Severe carbon monoxide poisoning during desflurane anesthesia. *Anesthesiology* 1999;90:613–616.

198. Laster M, Roth P, Eger EI 2nd. Fires from the interaction of anesthetics with desiccated absorbent. *Anesth Analg* 2004;99:769–774.

199. Wissing H, Kuhn I, Warnken U, et al. Carbon monoxide production from desflurane, enflurane, halothane, isoflurane, and sevoflurane with dry soda lime. *Anesthesiology* 2001;95:1205–1212.

200. Keijzer C, Perez RS, De Lange JJ. Carbon monoxide production from five volatile anesthetics in dry sodalime in a patient model: halothane and sevoflurane do produce carbon monoxide; temperature is a poor predictor of carbon monoxide production. *BMC Anesthesiol* 2005;5:6.

201. Logan M, Farmer JG. Anaesthesia and the ozone layer. *Br J Anaesth* 1989;63:645–647.

202. Westhorpe R, Blutstein H. Anaesthetic agents and the ozone layer. *Anaesth Intensive Care* 1990;18:102–104.

203. Ray DC, Drummond GB. Halothane hepatitis. *Br J Anaesth* 1991;67:84–99.

204. Weitz J, Kienle P, Bohrer H, et al. Fatal hepatic necrosis after isoflurane anaesthesia. *Anaesthesia* 1997;52:892–895.

205. Anders MW. Formation and toxicity of anesthetic degradation products. *Annu Rev Pharmacol Toxicol* 2005;45:147–176.

206. Kharasch ED, Hankins DC, Thummel KE. Human kidney methoxyflurane and sevoflurane metabolism. Intrarenal fluoride production as a possible mechanism of methoxyflurane nephrotoxicity. *Anesthesiology* 1995;82:689–699.

207. Preckel B, Schlack W. Inert gases as the future inhalational anaesthetics? *Best Pract Res Clin Anaesthesiol* 2005;19:365–379.

208. Lynch C 3rd, Baum J, Tenbrinck R. Xenon anesthesia. *Anesthesiology* 2000;92:865–868.

209. Ma D, Hossain M, Chow A, et al. Xenon and hypothermia combine to provide neuroprotection from neonatal asphyxia. *Ann Neurol* 2005;58:182–193.

210. Ma D, Yang H, Lynch J, et al. Xenon attenuates cardiopulmonary bypass-induced neurologic and neurocognitive dysfunction in the rat. *Anesthesiology* 2003;98:690–698.

211. Kennedy RR, French RA, Spencer C. Predictive accuracy of a model of volatile anesthetic uptake. *Anesth Analg* 2002;95:1616–1621.

212. Mapleson WW. An electric analogue for uptake and exchange of inert gases and other agents. *J Appl Physiol* 1963;18:197–204.



# CHAPTER 38

## Anesthesia Delivery System

James B. Eisenkraft, MD

The anesthesia delivery system is the anesthesiologist's constant companion in the operating or procedure room. Whether a patient is to receive general anesthesia, regional anesthesia, or monitored anesthesia care, the delivery system must be checked and ready for immediate use. An understanding of the structure and function of the anesthesia delivery system is essential to the safe practice of anesthesia.

The anesthesia delivery system has evolved considerably over the past several years. The current voluntary consensus standard describing the features of a contemporary machine is that published by the American Society for Testing and Materials (ASTM) and designated F1850-00. This document, published in March 2000, is entitled *Standard specification for particular requirements for anesthesia workstations and their components*.<sup>1</sup> The term *anesthesia workstation* is defined as a system for the administration of anesthesia to patients. It consists of the anesthesia gas supply device, anesthesia ventilator, monitoring devices, and protection device(s). This standard supersedes the F1161-88 anesthesia machine standard published in 1989 by ASTM.<sup>2</sup>

The above standards represent a consensus adopted voluntarily by the machine manufacturers. Certain accrediting and licensing bodies, however, may choose to adopt such standards in whole or in part and make them requirements for machines used in that locality. The reader is referred to the source documents for more details.

The recent evolution of the anesthesia workstation and advances in technology have led to many changes in design. While all of the basic operations remain the same, the functions of many of the traditional components are now performed by more technologically advanced components. In many new models, the familiar rotameter tubes are replaced by virtual

### KEY POINTS

1. A basic understanding of the anesthesia delivery system and its components is important to the provision of safe patient care.
2. The current voluntary consensus standard describing the features of a contemporary anesthesia workstation is the American Society for Testing and Materials (ASTM) F1850-00, published in 2000.
3. A full oxygen tank (E cylinder) has a pressure of approximately 1900 psig (pounds per square inch gauge) and evolves 660 L of gaseous O<sub>2</sub> at atmospheric pressure (14.7 psia [pounds per square inch absolute], 760 mm Hg).
4. By applying Boyle's law, the pressure gauge can indicate fullness of the O<sub>2</sub> tank.
5. Tank O<sub>2</sub> supply is regulated to enter the anesthesia machine at 40–45 psig. Pipeline O<sub>2</sub> is regulated to 50–55 psig.
6. The pin-index and diameter-index safety systems ensure that the correct medical gas enters the correct part of the machine.
7. The "fail-safe" valve (pressure sensor shut-off valve, O<sub>2</sub> failure protection device) only ensures that if the O<sub>2</sub> supply pressure is adequate, nitrous oxide (N<sub>2</sub>O) and other gases may flow to their flow-control valves. This valve does not ensure O<sub>2</sub> flow.
8. N<sub>2</sub>O can exist as a liquid at room temperature.
9. N<sub>2</sub>O E cylinders have a pressure of 750 psig (the saturated vapor pressure of N<sub>2</sub>O at 20°C) as long as some liquid N<sub>2</sub>O remains.
10. Only one flow-control knob should exist for each gas emerging at the common gas outlet.
11. The O<sub>2</sub> flowmeter should be located downstream of all other gas flowmeters, that is, it should be the one closest to the common gas outlet.
12. The O<sub>2</sub> and N<sub>2</sub>O flow controls are interlinked so that a gas mixture containing 25% or greater of O<sub>2</sub> is created at the flowmeters when N<sub>2</sub>O and O<sub>2</sub> are in use. Use of a third or fourth gas may "defeat" this feature.
13. An O<sub>2</sub> analyzer in the patient circuit is essential to detect a hypoxic mixture. It should be automatically enabled and the low O<sub>2</sub> alarm set whenever the machine is capable of delivering an anesthetic gas mixture.
14. Anesthesia vaporizers create a saturated vapor concentration of the anesthetic and then dilute it to clinically useful concentrations.
15. The ideal vaporizer construction material has high specific heat and thermal conductivity.
16. Contemporary vaporizers for halothane, isoflurane, enflurane, and sevoflurane are variable-bypass, concentration-calibrated, and temperature-compensated vaporizers.
17. The volume of gas leaving a vaporizer is greater than that entering it because of the addition of anesthetic vapor.
18. The output of a variable-bypass, concentration-calibrated, agent-specific vaporizer is determined by the splitting ratio created by the dial setting. This determines what flow bypasses the vaporizing chamber (bypass flow) and what flow enters the vaporizing chamber to evolve the agent at its saturated vapor concentration.
19. Vaporizers are agent-specific. Erroneous filling should be avoided, and the use of agent-specific filling devices is encouraged.
20. Desflurane has a vapor pressure of 669 mm Hg at 20°C and boils at 22.8°C. It cannot be used in traditional designs of variable-bypass vaporizers. Desflurane is administered using the Tec 6 or D-Vapor vaporizer, in which the agent is heated to 39°C to form vapor under pressure at 1500 mm Hg and this vapor is added to the fresh gas stream. The ADU Aladin vaporizer is a hybrid variable-bypass and measured-flow design that can be used for all 5 inhaled anesthetics.
21. The anesthesia machine should be checked each day before anesthetizing the first patient and whenever any change has been made to the system. A shortened checkout should precede each administration of anesthesia. The checkout procedure should follow the directions given in the machine's operation and maintenance manual.

*Continued*



## Key Points—continued

22. Presently, a positive-pressure check for leaks is recommended for traditional Dräger Narkomed machines and a negative-pressure check for Datex-Ohmeda machines. The FDA 1993 preuse checkout recommends the negative pressure leak check for traditional machines.
23. Use of free-standing vaporizers downstream from the common gas outlet can be hazardous and should be avoided.
24. Anesthesia circuits are classified as rebreathing (no CO<sub>2</sub> absorption) or nonrebreathing (including a CO<sub>2</sub> absorber; e.g., circle system).
25. In all circuits, the higher the fresh gas flow, the closer inspired gas composition approaches that of fresh gas.
26. Anesthesia ventilators are traditionally pneumatic and of “bag-in-a-bottle” or “double-circuit” design. The bellows is the interface between the patient circuit and the driving gas circuit.
27. Datex-Ohmeda ventilators are driven by 100% O<sub>2</sub>, whereas the Dräger AV-E is driven by an air/O<sub>2</sub> mixture in the bellows housing.
28. In traditional ventilators a standing bellows design is preferred as it makes a leak in the breathing system more obvious. The bellows descend on inspiration and ascend on expiration. This design requires that the ventilator relief valve incorporate a positive end-expiratory pressure (PEEP) mechanism.
29. Having set the ventilator rate (f) and tidal volume (V<sub>T</sub>) controls, one must appreciate that patient V<sub>T</sub> is determined also by fresh gas flow (FGF), inspiratory-to-expiratory (I:E) ratio, circuit compliance, and peak inspiratory pressure:
 
$$\text{Patient } V_T = \left[ \text{Bellows } V_T + \text{FGF} \times \frac{1}{I+E} \times \frac{1}{f} \right] - (\text{circuit compliance} \times \text{peak inspiratory pressure})$$
30. New designs of ventilator use computerized compensation (ADU, Aisys, Smart Vent) or fresh gas decoupling (Apollo, Fabius GS, Narkomed 6400, Anestar) to ensure that V<sub>T</sub> is delivered as set on the ventilator.
31. Free-standing PEEP valves may be hazardous if added to the circuit incorrectly. PEEP valves are safer when designed as an integral part of the circuit. Addition of PEEP to a circle may decrease the V<sub>T</sub>; the decrease depends on the position of the PEEP valve in the circle. The ideal position is as close to the ventilator pressure relief valve as possible.
32. Waste anesthesia gases should be scavenged.
33. National Institute for Occupational Safety and Health (NIOSH) recommends that exposure of operating room workers to halogenated agents should be kept below 2 ppm. N<sub>2</sub>O levels should be controlled so that no worker is exposed at time-weighted average concentrations greater than 25 ppm. The latter guide should result in levels of approximately 0.5 ppm of the halogenated agents.
34. The ASTM F1850–00 standard calls for an integrated and prioritized alarm system, breathing pressure monitoring, and exhaled volume or ventilatory CO<sub>2</sub> monitoring.
35. In the event of a severe machine or gas delivery system malfunction, an alternative means for ventilating the patient’s lungs with O<sub>2</sub> (or room air) should be immediately available. Thus a self-inflating bag whose function has been checked should be available in each anesthetizing location.
36. Use error is the most common cause of adverse outcomes in relation to anesthesia gas delivery equipment.
37. User education must be emphasized and there must be a thorough in-service whenever there is a new user or new equipment is introduced.

flowmeters displayed on a computer screen. The gas flow-control needle valves may be replaced by electronically controlled gas-mixing devices. Because space does not permit a de-

tailed description of each model of workstation, the basic components and functions of a traditional anesthesia workstation are described. The reader should then be able to appreci-

ate some of the changes that have been made in the most recent models.

Figure 38–1 depicts the components of a contemporary basic anesthesia delivery system. These include the anesthesia machine itself, which receives the gases oxygen (O<sub>2</sub>), nitrous oxide (N<sub>2</sub>O), and perhaps a third and fourth gas (e.g., air, heliox) delivered under pressure. A controlled gas mixture in terms of concentration of O<sub>2</sub> and other gas(es), as well as total gas flow rates, is created using the gas flow controls and delivered to a concentration-calibrated vaporizer, where a measured amount of a potent inhaled anesthetic agent may be added. The resulting fresh gas mixture of known composition and metered production rate leaves the anesthesia machine at the common gas outlet and flows continuously to the patient circuit. The patient circuit represents a mini environment that allows respiratory exchange and control of anesthetic and respiratory (i.e., PO<sub>2</sub> and PCO<sub>2</sub>) gas tensions in the patient’s alveoli, blood, and tissues (e.g., brain). An anesthesia ventilator bellows (or in some recent Dräger models, a piston) may be connected to the breathing circuit, by means of which the patient’s lungs can be mechanically ventilated. Excess gases are vented from the anesthesia circuit via either the adjustable pressure-limiting (APL or “pop-off” valve) or the ventilator pressure relief valve. The vented gases enter the waste gas scavenging system and are removed from the operating room, usually through the hospital suction.

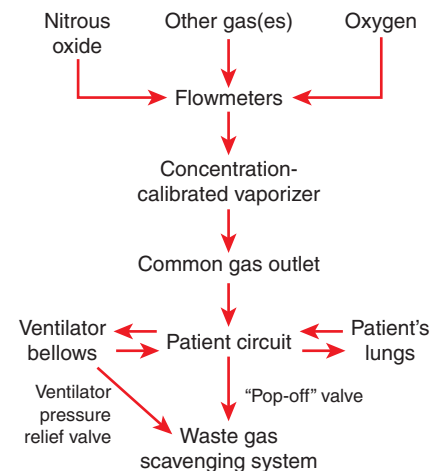


FIGURE 38–1. Schematic of generic anesthesia gas delivery system.

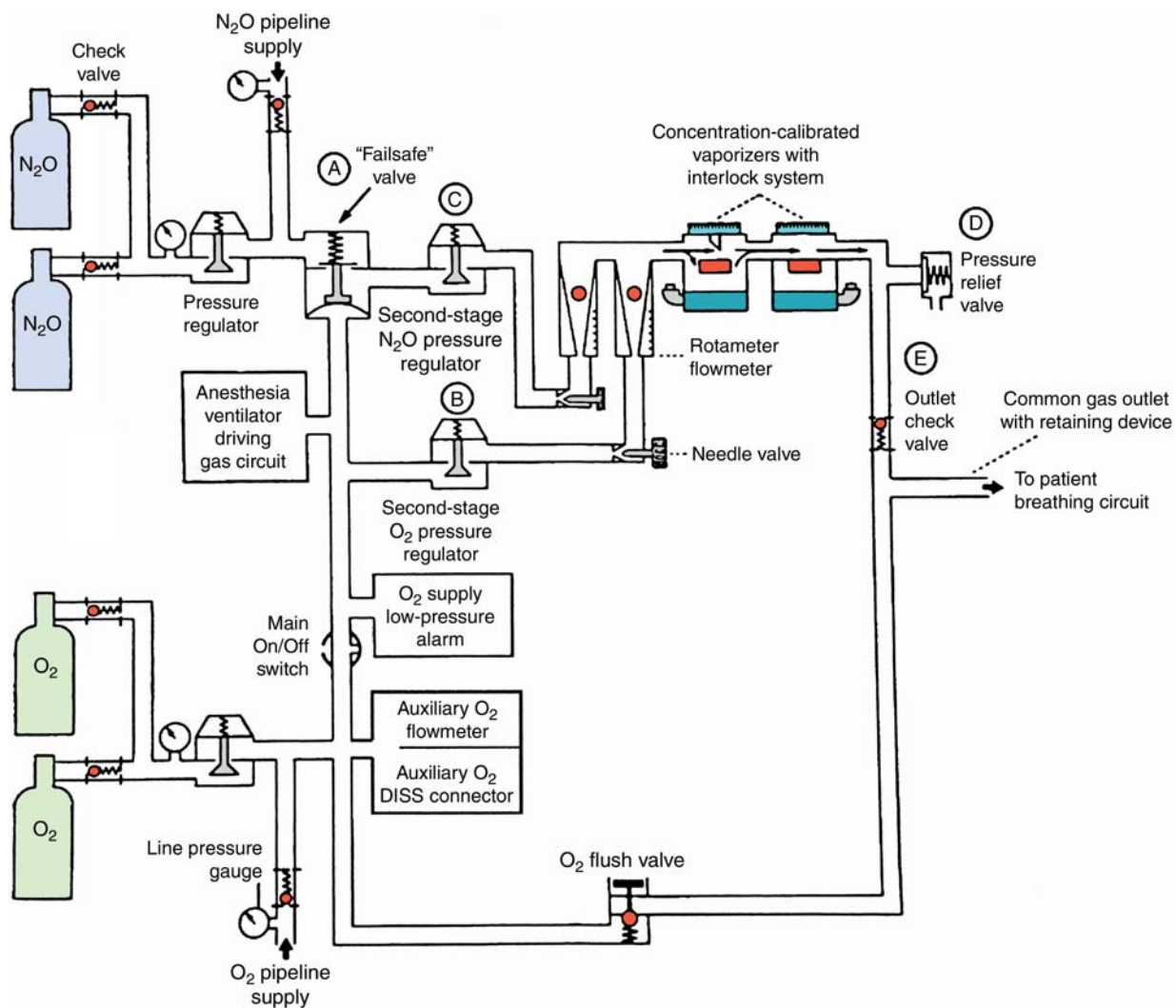
Presently, in the United States, the two largest manufacturers of anesthesia delivery systems (machines, ventilators, vaporizers, scavenging systems) are Dräger (Telford, PA) and Datex-Ohmeda (Madison, WI). Other manufacturers include Datascope, Blease, and Penlon. This chapter reviews the features of a basic anesthesia gas delivery system, referring to the product from a specific manufacturer where appropriate. The approach used is to trace the flow of gases, from their pressurized storage sources, and vapors through the various components of the delivery system,

and to understand the function of each component. In this way the reader can more readily appreciate the rationale for the various checkout procedures and have a framework from which to diagnose problems that may arise during use of the equipment. A systematic approach to problems with the delivery system is presented elsewhere.<sup>3</sup> The most comprehensive source of reference for any individual model of workstation is the workstation manufacturer's operator's and maintenance manuals, and the reader is strongly encouraged to review the manual(s) relevant to the reader's

equipment. Additionally, an alternative means for delivering O<sub>2</sub> or room air to the patient should be kept immediately available in the event of a severe workstation malfunction. Thus a self-inflating (e.g., Ambu) resuscitation bag, previously tested for correct function and, ideally, a full tank of O<sub>2</sub> should be immediately available in each anesthetizing location.

## BASIC ANESTHESIA MACHINE

Figure 38-2 depicts the flow arrangements of a basic two-gas anesthesia



**FIGURE 38-2.** Schematic of flow arrangements of contemporary anesthesia machine. "Fail-safe" valve A in Datex-Ohmeda machines is termed a *pressure sensor shutoff valve*. In Dräger machines, it is the *oxygen-failure protection device* (OFPD). Second-stage O<sub>2</sub> pressure regulator B is used in Datex-Ohmeda (but not Dräger Narkomed) machines. Second-stage N<sub>2</sub>O pressure regulator C is used in Datex-Ohmeda Modulus and Excel machines with the Link-25 Proportion Limiting Control System; this is not used in Dräger Narkomed machines. Pressure relief valve D is used in Datex-Ohmeda Modulus machines; it is not used in Dräger machines. Outlet check valve E is used in Datex-Ohmeda machines except Modulus II Plus and Modulus CD models; it is not used in Dräger machines. Datex-Ohmeda Excel machines have a pressure relief valve located downstream from the outlet check valve, between this valve and the machine common gas outlet.

machine. The machine receives each of the two basic gases, O<sub>2</sub> and N<sub>2</sub>O, from two supply sources: a tank or cylinder source and a pipeline source.

## Oxygen

Oxygen has a molecular weight of 32 and a boiling point of -183°C at a pressure of 760 mm Hg (14.7 pounds per square inch absolute pressure [psia]). (Absolute pressure is designated psia and gauge pressure is designated psig [pounds per square inch gauge pressure]. Gauges record pressure above or below existing atmospheric pressure. Thus 1 atmosphere [atm] pressure = 760 mm Hg = 14.7 psia = 0 psig.) Boiling point (the temperature at which O<sub>2</sub> changes from the liquid to the gas phase) is related to ambient pressure such that as pressure increases, so does the boiling point of O<sub>2</sub>. However, a certain critical temperature is reached above which, no matter how much pressure is applied, the liquid O<sub>2</sub> boils to a gas. The critical temperature for O<sub>2</sub> is -118°C, and the critical pressure that must be applied at this temperature to keep O<sub>2</sub> liquid is 737 psia. Because room temperature is normally around 20°C and thus well above the critical temperature, O<sub>2</sub> can exist only as a gas at room temperature. This has certain implications for understanding the contents of an O<sub>2</sub> tank.

Oxygen tanks serve as the primary source of O<sub>2</sub> if there is no pipeline in the anesthetizing location, and as a backup supply in case of pipeline failure. Machines are usually equipped with one or two E cylinders, that hang on specific O<sub>2</sub> hanger yokes. The medical gas pin-index safety system ensures that the correct medical gas tank is hung in the correct yoke. The system consists of two pins that are fixed in the yoke, and which fit into two corresponding holes in the tank valve. The two pins are in a unique configuration for O<sub>2</sub> and should never be removed from the hanger yoke. Specific pin configurations exist for each of the medical gases supplied in small cylinders in order to prevent erroneous misconnections of gas supplies. A tank should never be force-fitted to a hanger yoke.

Oxygen tanks are filled at the factory to a pressure of approximately 1900 psig (add 14.7 to convert to psia) at room temperature. Once filled, they contain a fixed number of gas mole-

cules (fixed mass of gas) that obey Boyle's law (i.e., pressure × volume = constant), provided that temperature does not change. A full E cylinder of O<sub>2</sub> at a pressure of 1900 psig will evolve 660 L of gaseous O<sub>2</sub> at 1 atm pressure (14.7 psia, or 760 mm Hg). The internal volume (V<sub>1</sub>) of an E cylinder is therefore approximately 5 L because, by Boyle's law,  $P_1 \times V_1 = P_2 \times V_2$ . Thus  $1900 \times V_1 = 14.7 \times 660$ . If the O<sub>2</sub> tank pressure is 1000 psig, the tank is 1000/1900, or 52% full, and will generate only 660 × 52%, or 340 L of gaseous O<sub>2</sub> at atmospheric pressure. If such a tank were being used at an O<sub>2</sub> flow rate of 6 L/min, it would empty in just under 1 hour (340/6 = 57 minutes). It is important to understand these principles when O<sub>2</sub> cylinders are in use to supply the machine or during patient transport. If the anesthesia machine is equipped with two E cylinders of O<sub>2</sub>, only one should be open and in use at any one time so that both tanks are not emptied simultaneously.

There is a check valve in the hanger yoke for each O<sub>2</sub> (and other medical gas) cylinder to prevent leakage of gas out through the hanger yoke if no cylinder is hanging in place and the machine is being supplied by the pipeline or from a second O<sub>2</sub> tank (Fig. 38-2). If two O<sub>2</sub> tanks are hanging, the check valve in the yoke prevents transfilling of gas from one tank to the other. However, these check valves may leak, so if a hanger yoke does not have a tank hanging in it, a yoke plug should be inserted to prevent leakage of gas in the event of an incompetent check valve. These solid plastic block yoke plugs are usually attached to the back of the machine by a chain to prevent their loss. In the Dräger Apollo workstation, the tank pressures are measured using electronic pressure transducers and the values displayed on a screen.<sup>4</sup>

In many medical facilities the O<sub>2</sub> pipeline is supplied from a bulk liquid O<sub>2</sub> source. This may be more economical for the institution, depending on rate and volume of O<sub>2</sub> used.

Liquid O<sub>2</sub> is stored at temperatures of around -160°C under pressure in a storage vessel that resembles a large vacuum (Dewar) flask. When gaseous O<sub>2</sub> is drawn from the top of the storage vessel, liquid O<sub>2</sub> boils to replace it. The boiling (change of phase) helps to keep the remaining liquid O<sub>2</sub> cold. Because the O<sub>2</sub> gas evolved is very cold, it is

first passed through a heating coil and then through a pressure regulator that maintains the hospital pipeline pressure at 50–55 psig. Alarms and safety devices, including relief valves and shut-off valves, ensure the safe functioning of the bulk O<sub>2</sub> storage and pipeline systems. Pipeline systems, although usually reliable, may fail. A recent report describes failure between the bulk liquid oxygen storage vessel and the pipeline, which resulted in the release of 8000 gallons of liquid O<sub>2</sub> into the atmosphere.<sup>5</sup> Consequently, ensuring that a backup (tank) supply is available is an important part of the preuse checkout.

Pipeline O<sub>2</sub> is available in the operating rooms usually via gas-specific and manufacturer-specific “quick connectors” or via oxygen-specific diameter-indexed safety system outlets. The operating room wall pipeline “quick-connectors” are both noninterchangeable among medical gases (so that an O<sub>2</sub> hose quick-connector cannot be connected to a N<sub>2</sub>O wall outlet) and are also manufacturer specific (e.g., Schraeder, Datex-Ohmeda, Chemetron). At the machine end of the hose that conducts O<sub>2</sub> from the wall outlet to the machine is a connector that is gas specific by a national standard. The diameter-index safety system specifies that at the machine end the medical gas connectors be of different diameter. The diameter- and pin-index safety systems are designed to ensure that the correct medical gas enters the correct part of the anesthesia machine.<sup>6</sup>

For simplicity, the anesthesia machine is described as consisting of two basic systems, a high-pressure system for each gas, and a common low-pressure system for the gas mixture. Those parts upstream of the gas flow-control (traditionally needle) valves contain gas at relatively high pressures and are considered to be the high-pressure system. Those parts downstream of the flow-control valves (Fig. 38-2) contain gas at low pressure (measured in cm H<sub>2</sub>O rather than psig) and constitute the low-pressure system. The low-pressure system extends from the flow-control valves to the machine common gas outlet. Although O<sub>2</sub> from the pipeline supply enters the machine O<sub>2</sub> high-pressure system at a pressure of approximately 50 psig, O<sub>2</sub> from a full tank enters the yoke at pressures of approximately 1900 psig. The O<sub>2</sub> tank source is therefore regu-

lated ( $O_2$  passes through a regulator valve) and enters the machine high-pressure system at a nominal pressure of 45 psig (Fig. 38-2).

A pressure regulator is a device that reduces a variable high input pressure (in this case,  $\sim 1900$  psig from the  $O_2$  tank) to a constant low-output pressure (in this case, 45 psig) for the gas whose pressure is being regulated. Because the tank supply serves as a backup in case the pipeline fails, once the tank pressures have been checked during the preuse checkout, the tank supply should be turned off if gas from the pipeline source is being used. If the  $O_2$  tank(s) remains turned on while the machine is being supplied from the pipeline,  $O_2$  is drawn preferentially from the pipeline supply (50–55 psig) because the regulator that controls flow from the  $O_2$  tanks only permits flow into the machine high-pressure system for  $O_2$  when the pressure in the machine high-pressure system falls below about 45 psig (Fig. 38-2). However, the pipeline pressure at times may fluctuate to below 45 psig, in which case  $O_2$  would be drawn from an open tank. Thus, if the machine is being supplied from the  $O_2$  pipeline, the  $O_2$  tanks on the machine should be turned off to prevent the tank  $O_2$  supply being used and the backup tank supply being unintentionally depleted.

As long as pipeline supply pressure (50–55 psig) exceeds the pressure downstream of the first-stage  $O_2$  (tank supply) regulator, the  $O_2$  tank source will not supply the machine. If one wants to use the tank  $O_2$  to supply the machine, the  $O_2$  pipeline connector should first be disconnected from the wall. Thus, if one should ever suspect that a hypoxic gas (i.e., a gas other than  $O_2$ ) is being delivered through the  $O_2$  pipeline system at 50–55 psig (e.g., because of pipeline crossover or misfilling of the bulk  $O_2$  supply tank), the machine's  $O_2$  pipeline connection must be disconnected from the wall outlet so as to permit the tank  $O_2$  supply to flow into the high-pressure system.

Having entered the machine high-pressure system for  $O_2$  at a pressure of 45–55 psig (from tank or pipeline),  $O_2$  may flow or pressurize in 7 directions (Fig. 38-2):

1. It provides the power source for a pneumatically driven anesthesia ventilator. Most anesthesia ventilators (e.g., those on Datex-Ohmeda

Modulus, Aestiva, Excel ADU, and Aisys machines; Dräger Narkomed 2, Narkomed 3, and Narkomed 4, Narkomed GS, Narkomed Mobile) use compressed oxygen as the driving gas. The driving gas is used to compress (“drive” or squeeze the ventilator bellows during the inspiratory phase of positive pressure ventilation. It is important to realize this because if the machine, and therefore ventilator, are being supplied from the tank rather than the pipeline, the tank will be depleted much more rapidly. In general, the volume of oxygen needed to drive the ventilator is at least the minute ventilation (MV) set to be delivered (e.g.,  $V_T$  500 mL, respiratory rate [RR] 10 breaths/min, gives MV of 5 L). Thus, if the pipeline oxygen supply fails during use of the ventilator and one switches to the tank supply, one should consider ways to limit the rate of use of the tank oxygen by ventilating the lungs using the reservoir bag, having the patient breathe spontaneously if possible, and using the lowest flow of oxygen necessary at the oxygen flowmeter.

2. It supplies the auxiliary oxygen flowmeter that is present on most contemporary machines. This is the separate flowmeter that is commonly used to supply a nasal cannula.
3. It supplies oxygen to an auxiliary oxygen diameter-index safety system fitting. This may be used to power a Sanders injector design of jet ventilator, or a venturi design vacuum-suction system.
4. If the oxygen flush control (valve) is opened by pressing the oxygen flush control button, oxygen flows directly (bypassing the flowmeters) to the common gas outlet of the machine at a rate of 35–75 L/min and potentially at a pressure of 50 psig. Consequently, the flush must not be activated if a patient is connected to the breathing system and there is no means for pressure relief. For example, activation of the flush during the inspiratory phase of ventilation, during which gas can enter the breathing system but cannot leave, has the potential to cause positive pressure barotrauma.
5. It pressurizes an oxygen supply pressure failure alarm system such that if oxygen pressure in the high pressure system falls (usually to

below 30 psig) an audible alarm sounds. On modern machines, a pressure-operated electrical switch ensures a continuous audible (and visual) alarm when the oxygen supply pressure falls below 30 psig. This will alert to a possible problem with the machine's oxygen supply pressure, such as pipeline failure or if the tank in use is nearing empty.

6. It pressurizes and opens the “fail-safe” valve (Fig. 38-2 item A). This is a pressure-sensitive valve that can decrease or totally interrupt the supply of nitrous oxide and other gases (e.g., heliox, and in some machines air) to their flow-control systems if the pressure of gas in the oxygen high pressure system falls below a threshold level.

In the Datex-Ohmeda machines this valve is called the pressure sensor shut-off valve (PSSV). These valves interrupt the gas supplies to the nitrous oxide and other gas flowmeters when the oxygen pressure falls below a nominal 26 psig. In the Datex-Ohmeda machines, these valves are either fully open or fully closed.

In the Dräger Narkomed 2, Narkomed 3, and Narkomed 4 machines, the “fail-safe” valve is called the oxygen-failure protection device (OFPD) and there is one interfacing the high-pressure system for oxygen with the high-pressure systems for each of the other gases supplied to the machine (e.g., nitrous oxide). Unlike the Datex-Ohmeda PSSV “fail-safe” valves, the OFPDs gradually reduce the supply pressure to the nitrous oxide and other gas flowmeters as the oxygen supply pressure decreases. The supply of other gases to their respective flowmeters is completely interrupted when the oxygen supply pressure falls below  $12 \pm 4$  psig. In this way, a hypoxic mixture arising from oxygen supply problems to the flowmeters should be prevented. Thus in Dräger Narkomed, Datex-Ohmeda, and other brands of machines, when the oxygen supply pressure is low, only 100% oxygen is delivered.

7. It passes to the oxygen flow-control valve. In traditional machines this is the needle valve that is connected to the oxygen flow-control knob used to set the oxygen flow at the oxygen flowmeter.



In Datex-Ohmeda machines (e.g., Modulus II, Modulus II Plus, Modulus CD, and Excel models), to reach the oxygen flow-control valve, oxygen in the high-pressure system must first pass through a second-stage regulator valve where the pressure is downregulated to about 16 psig. This second-stage regulator (Fig. 38-2 item B) ensures that the oxygen flowmeter is supplied at a constant pressure of 16 psig. Thus even if the oxygen supply pressure to the machine falls to below 45–50 psig, as long as it exceeds 16 psig, the oxygen flow set at the flowmeter will be maintained. Without this second-stage regulator, if the oxygen supply pressure to the machine were to fall, the oxygen flow would decrease at the flowmeter and, if nitrous oxide were being used also, a hypoxic gas mixture might result at the level of the flowmeters. In summary, in Datex-Ohmeda machines, if the oxygen supply pressure falls below 30 psig, the low-pressure supply alarm sounds (see #5 above); below 20 psig the “fail-safe” valve will interrupt the flow of other gases to their flowmeters so that only oxygen can be delivered, and the oxygen flow set on the oxygen flowmeter will not decrease until the oxygen supply pressure falls below 16 psig.

Dräger Narkomed 2, Narkomed 3, and Narkomed 4 machines do not use a second stage oxygen pressure regulator (in Fig. 38-2 item B is absent) to supply the oxygen flowmeter at constant pressure. Instead they use OFPDs (see #6 above) to continually interface the pressure of oxygen in the high-pressure system with the pressure of nitrous oxide just upstream of the nitrous oxide flowmeter. A decrease in the oxygen supply pressure causes a proportionate decrease in the pressure of nitrous oxide supplied to its flowmeter. Thus as oxygen supply pressure decreases, the flow of oxygen and that of all other supplied gases will decrease in *proportion* so as to avoid creation of hypoxic gas mixture.

### Nitrous Oxide

Like  $O_2$ ,  $N_2O$  may be supplied to the machine from the pipeline system at a pressure of approximately 50 psig or from a backup E cylinder supply on the

machine.  $N_2O$  has a molecular weight of 44 and a boiling point of  $-88^\circ C$  at 760 mm Hg (14.7 psia) pressure.<sup>7</sup> Because it has a critical temperature of  $36.5^\circ C$  (critical pressure: 1054 psig),  $N_2O$  can exist as a liquid at room temperature ( $20^\circ C$ ). E cylinders of  $N_2O$  are factory-filled to 90–95% capacity with liquid  $N_2O$ . Above the liquid in the tank is  $N_2O$  vapor. Because the liquid agent is in equilibrium with its vapor or gas phase, the pressure exerted by the gaseous  $N_2O$  is its saturated vapor pressure (SVP) at the ambient temperature. At  $20^\circ C$  the SVP of  $N_2O$  is 750 psig.<sup>7</sup>

A full E tank of  $N_2O$  generates approximately 1600 L of gas at 1 atm pressure at sea level (14.7 psia). As long as some liquid  $N_2O$  is present in the tank and the ambient temperature remains at  $20^\circ C$ , the pressure in the  $N_2O$  tank will remain at 750 psig, which is the SVP of  $N_2O$  at  $20^\circ C$ .

Unlike with  $O_2$ , the content of a  $N_2O$  tank cannot be determined by reference to the  $N_2O$  tank pressure gauge. However, the content can be determined by weighing the tank and subtracting the weight of the empty tank (tare weight) to determine the weight of the remaining  $N_2O$ . By Avogadro's volume, one gram molecular weight (i.e., 44 g) of  $N_2O$  will occupy 22.4 L at standard temperature and pressure (STP: 760 mm Hg;  $273.15^\circ K$  or  $0^\circ C$ ). Once all the liquid  $N_2O$  has been used and the tank contains only gas, Boyle's law may be applied. In this situation, where the tank pressure is 750 psig (from gas only) and the internal volume of the E cylinder is approximately 5 L (see Oxygen above), the volume of  $N_2O$  that will evolve at a pressure of 760 mm Hg (14.7 psia) can be calculated. Thus  $P_1 \times V_1 = P_2 \times V_2$ ;  $750 \times 5 = 14.7 \times V_2$ , or  $V_2 = 255$  L. At this point the  $N_2O$  tank is 255/1600, or 16%, full. At  $20^\circ C$  room temperature, an E tank of  $N_2O$  with a pressure of 400 psig would deliver  $(400/750 \times 255$  L), or 136 L of  $N_2O$  gas.

Nitrous oxide from the tank supply enters the  $N_2O$  hanger yoke at pressures of up to 750 psig (at  $20^\circ C$ ) and then passes through a regulator that reduces this pressure to 40–45 psig (Fig. 38-2). The pin-index safety system is designed to ensure that only a  $N_2O$  tank may hang in a  $N_2O$  hanger yoke. As with  $O_2$ , a check valve in each yoke prevents the back leakage of  $N_2O$  if no tank is hanging in the yoke.

The  $N_2O$  pipeline is supplied from a bulk storage container of liquid  $N_2O$  or from banks of large  $N_2O$  tanks, usually H cylinders. (Each H cylinder of  $N_2O$  evolves 16,000 L of gas at atmospheric pressure.) The pressure in the  $N_2O$  pipeline is regulated to approximately 50 psig to supply the outlets in the operating room. Having entered the anesthesia machine high-pressure system for  $N_2O$ ,  $N_2O$  must flow past the fail-safe valve to reach the  $N_2O$  flow-control (traditionally a needle) valve and flowmeter (traditionally a rotameter) (Fig. 38-2).

In Datex-Ohmeda anesthesia machines that have the Link-25 Proportion Limiting Control System (see next section), a second-stage  $N_2O$  regulator further reduces gas pressure so that  $N_2O$  is supplied to its flow-control (needle) valve at a nominal pressure of 26 psig (Fig. 38-2). The actual downstream pressure of this regulator is adjusted at the factory or by a field service representative to ensure correct functioning of the Link-25 Proportion Limiting Control System.

### Gas Flow Control Systems (Knobs, Needle Valves, Rotameters, Etc.)

The anesthesia machine is used to adjust the proportions of oxygen and nitrous oxide, as well as total gas flows delivered to the patient. For each gas (oxygen, nitrous oxide, etc.) this is achieved in a traditional machine (Fig. 38-3) by means of a control valve and a gas-flow measuring system.

The flow control knob is connected to a needle valve whereby gas flow is set and adjusted. Turning the knob counterclockwise opens the valve wider, permitting a greater flow of gas. The flow-control knob for oxygen is larger than those for the other gases, and it is fluted rather than knurled so that it is “touch-coded.” Thus, the oxygen knob feels different than the knobs for the other gases.

Traditionally, gas flows on the conventional anesthesia machine are measured using the rotameter flowmeter (Fig. 38-3). There may be one rotameter, or two rotameters in tandem for each gas. If two are present for each gas, the first permits accurate measurement of low flows (usually up to 1 L/min) and the second of flows of 1–12 L/min. In North America, the oxygen rotameter(s) is(are) positioned on the right

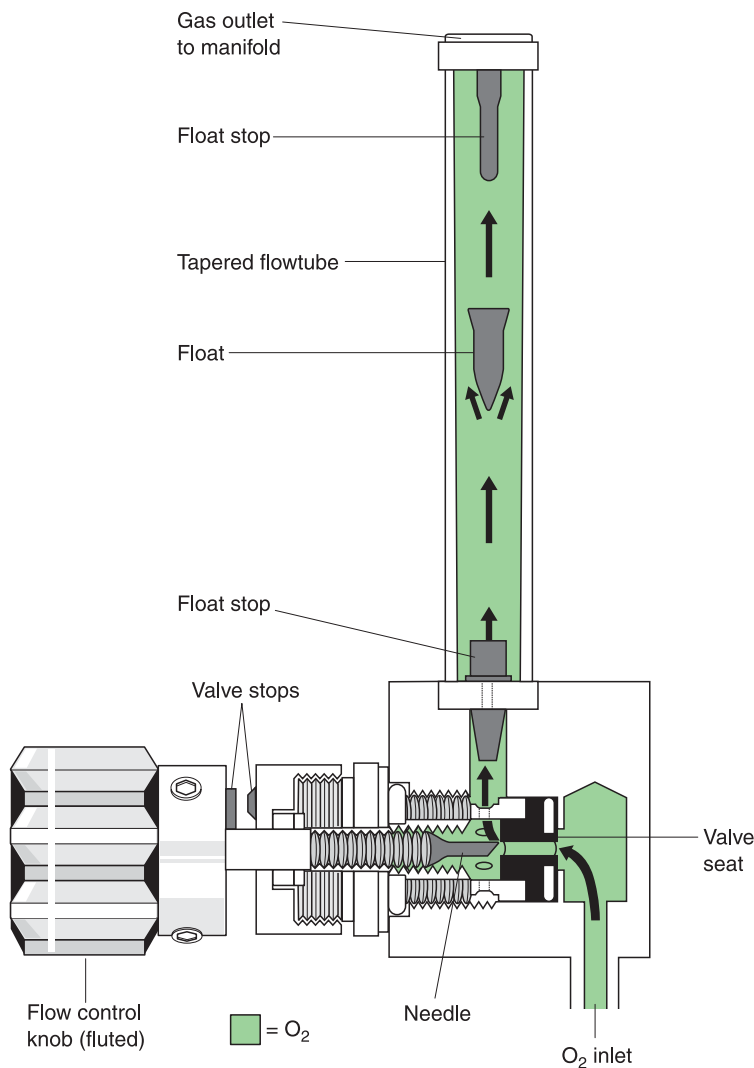


FIGURE 38-3. O<sub>2</sub> flowmeter and flow-control valve.

side of the rotameter bank. The rotameter is a constant pressure, variable orifice flowmeter, based on the Thorpe tube principle. Each rotameter consists of a vertical tapered glass tube that is of small diameter at the bottom and wider at the top, and contains a ball, float, or bobbin. The cross-sectional area between the outside of the float and the inside of the tapered glass tube represents the variable orifice. A certain pressure difference across the bobbin is required to “float” the bobbin in the upwardly flowing gas stream. As the orifice widens, increasing flows are required to create the same pressure difference across the bobbin, which floats at a higher level in the tapered glass tube. At low gas flow rates, flow is essentially laminar and Poiseuille’s law applies:

$$\text{Flow} = \frac{\pi \times P \times r^4}{8 \times \eta \times L}$$

where  $P$  is the pressure drop across the bobbin,  $r$  is the radius of the tube,  $\eta$  is the viscosity of the gas, and  $L$  is the length of the bobbin or float.

When the orificial area ( $r^2$ ) is larger and flows are greater, flow becomes turbulent, in which case:

Flow is proportional to the  $\sqrt{P}$ ,  $r^2$ , length<sup>-1</sup>, and density<sup>-0.5</sup>.

Rotameter flowmeters are precision instruments. Flow tubes are manufactured for specific gases, calibrated with a unique float, and for use within a certain range of temperatures and pressures. Flowmeters are *not* interchangeable among gases and if a gas were passed through a rotameter for which it was not calibrated, the flows shown would likely be incorrect. The-

oretical exceptions to this would be that at *low (laminar) flows*, the flow rates of gases with *similar viscosities* would be read identically (e.g., oxygen and helium have viscosities of 202 and 194 micropoise, respectively) and at *high flows* gases of *similar densities* (e.g., nitrous oxide and carbon dioxide, which both have a molecular weight of 44 atomic mass units) would be read identically. Again, it is emphasized that flow meters are not interchangeable among medical gases and are now manufactured such that they cannot be interchanged.

### Virtual Flow Meters

As mentioned in the opening paragraphs of this chapter, some of the traditional mechanical components are being replaced by more sophisticated devices. For example, in some models of contemporary anesthesia workstation (Datex-Ohmeda S5/ADU; Dräger Fabius GS), gas flows are still controlled by mechanical needle valves but flows are measured using electronic flow sensors based on the principle of the pneumotachograph. Essentially, the pressure difference is measured across a laminar flow resistor through which the gas flows. Reference to the Poiseuille formula (see Gas Flow Control Systems [Knobs, Needle Valves, Rotameters, Etc.] above) shows that if  $r$ ,  $\eta$ , and  $L$  are constant,  $P$  can be used to measure flow. Flows are therefore measured using a differential pressure transducer, and displayed on a screen in the form of a virtual graduated flow meter, together with a digital display. In the Datex-Ohmeda S5/ADU and the Dräger Apollo workstations, the virtual flow displays are color coded (e.g., green column for O<sub>2</sub>, yellow for air), whereas in the basic Dräger Fabius GS, all the flows are displayed as vertical yellow bars.

Advantages of electronic flow sensors are that they are less expensive than rotameters and the data can be used elsewhere in the workstation to record gas and agent consumption or to adjust ventilator bellows tidal volume (as in the Datex-Ohmeda ADU workstation).

An obvious concern with any electronically based system is what would happen if electrical power were totally lost. Also, many anesthesiologists are not completely comfortable unless they can see physical evidence of gas

flowing. For these reasons, the workstation manufacturers offer (e.g., as an option on the Datex-Ohmeda S5/ADU) a rotameter that is placed at the common gas outlet (CGO) of the machine and that displays the approximate total flow of gas leaving the CGO.

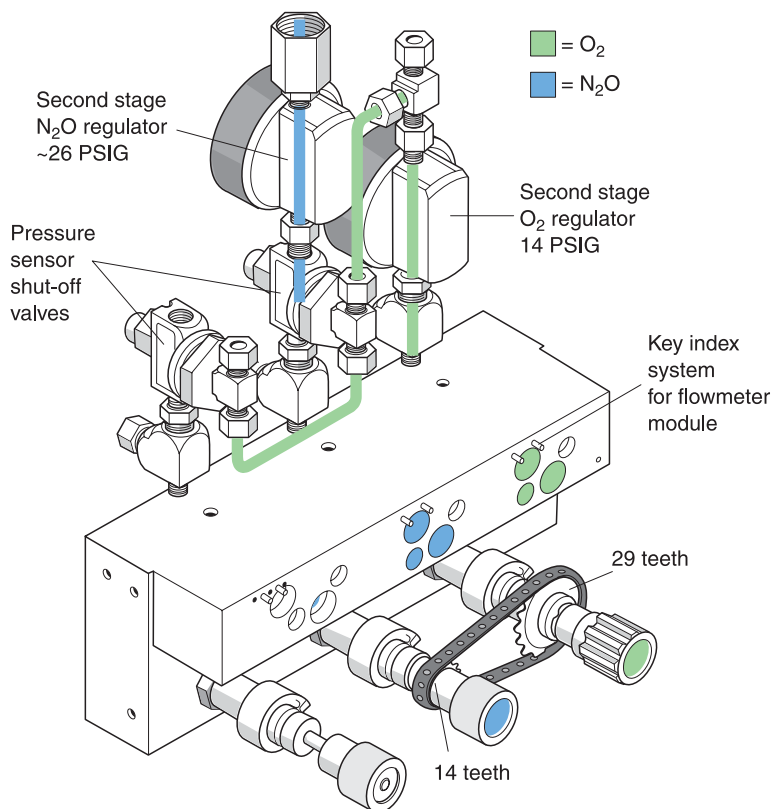
Some anesthesia workstations offer, as an option, an oxygen flow that cannot be discontinued completely because either a “stop” is provided on the oxygen flow-control valve to ensure a minimum oxygen flow of 200–300 mL/min past the needle valve (Datex-Ohmeda machines), or a gas flow resistor is provided (Dräger Narkomed 2, Narkomed 3, and Narkomed 4 machines) that permits a similar flow of 200–300 mL/min to bypass a completely closed oxygen flow-control needle valve. In the Dräger Narkomed machines, the minimum oxygen flow feature functions only in the “O<sub>2</sub>/N<sub>2</sub>O” mode but not in the “ALL GASES” mode.

### Oxygen Ratio Monitoring and Proportioning Systems

A major consideration in the design of contemporary anesthesia machines is prevention of delivery of a hypoxic gas mixture. The fail-safe system described previously only serves to interrupt (Datex-Ohmeda pressure sensor shut-off valve) or proportionately reduce and ultimately interrupt (Dräger OFPD) the supplies of N<sub>2</sub>O and (in some models) other gases (e.g., air, He) to their flowmeters if the O<sub>2</sub> supply pressure to the machine is reduced. It does not prevent the delivery of a hypoxic mixture to the common gas outlet, making the term *fail-safe* somewhat of a misnomer.

In traditional contemporary machines, N<sub>2</sub>O and O<sub>2</sub> flow controls are physically interlinked either mechanically (Datex-Ohmeda) or mechanically and pneumatically (Dräger), so that a fresh gas mixture containing at least 25% O<sub>2</sub> is delivered at the flowmeters when only N<sub>2</sub>O and O<sub>2</sub> are being used.<sup>8,9</sup>

Datex-Ohmeda anesthesia machines use the Link-25 Proportion Limiting Control System to ensure an adequate percentage of O<sub>2</sub> in the gas mixture created.<sup>8,10</sup> In this system, a gear with 14 teeth is integral with the N<sub>2</sub>O flow-control spindle, whereas a gear with 29 teeth is allowed to rotate (“float”) on a threaded O<sub>2</sub> flow-control valve spindle (Fig. 38–4). The two gears are connected together by a precision

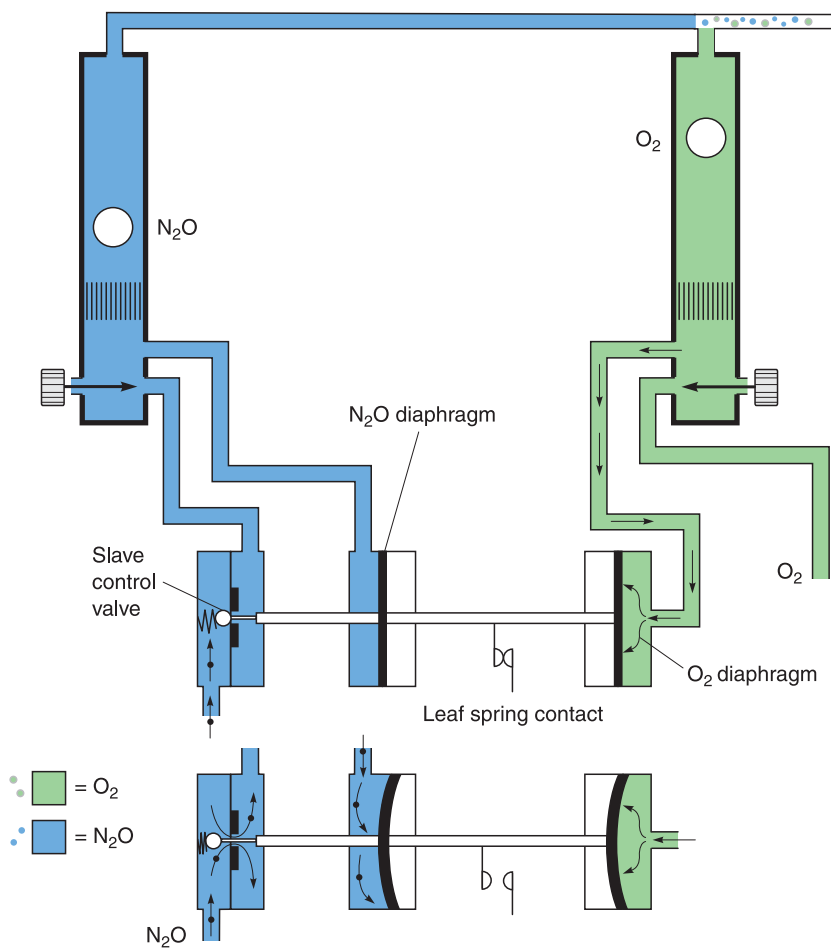


**FIGURE 38–4.** Datex-Ohmeda Link-25 Proportion Limiting Control System, which ensures at least 25% O<sub>2</sub> concentration at the level of the flowmeters when O<sub>2</sub> and N<sub>2</sub>O are being used. When supply pressure to the second-stage O<sub>2</sub> regulator falls below a nominal 26 psig, the pressure sensor shut-off valves (“fail-safe” valves) cause the supply of N<sub>2</sub>O and other gases to be shut off.

stainless steel link chain. For every 2.07 revolutions of the N<sub>2</sub>O flow-control spindle, an O<sub>2</sub> flow control, set to the lowest O<sub>2</sub> flow, rotates once because of the 14:29 ratio of gear teeth. Because the gear on the O<sub>2</sub> flow-control spindle is thread-mounted so that it can rotate on the control valve spindle like a nut on a bolt (rather than being integral with the spindle), O<sub>2</sub> flow can be increased independently of N<sub>2</sub>O. However, regardless of the O<sub>2</sub> flow set, if the flow of N<sub>2</sub>O is increased sufficiently, the gear on the O<sub>2</sub> spindle will engage with the O<sub>2</sub> flow-control knob, causing it to rotate and thereby causing O<sub>2</sub> flow to increase. If N<sub>2</sub>O flow is now reduced, the O<sub>2</sub> flow remains high unless it is deliberately decreased by the user. The 75% N<sub>2</sub>O:25% O<sub>2</sub> proportioning is completed because the N<sub>2</sub>O flow-control valve is supplied from a second-stage gas regulator, that reduces N<sub>2</sub>O pressure to a nominal 26 psig (adjusted as previously described) before it reaches the flow-control valve, whereas the O<sub>2</sub> flow-control

valve is supplied at a pressure of 14 psig from a second-stage O<sub>2</sub> regulator (Figs. 38–2 and 38–4). The Link-25 Proportion Limiting Control System permits the N<sub>2</sub>O and O<sub>2</sub> flow-control valves to be set independently of one another, but whenever a N<sub>2</sub>O concentration of more than 75% would be accidentally set, the O<sub>2</sub> flow is automatically increased to maintain at least 25% O<sub>2</sub> in the resulting mixture. This system thus increases the minimum flow of O<sub>2</sub> according to the N<sub>2</sub>O flow set. The Link-25 Proportion Limiting Control System interconnects only the N<sub>2</sub>O and O<sub>2</sub> flow-control valves. If the anesthesia machine has flow controls for other gases (e.g., He, air) (Fig. 38–4), a gas mixture containing less than 25% O<sub>2</sub> could potentially be set at the flowmeters.

In Dräger Narkomed 2, Narkomed 3, and Narkomed 4 machines the oxygen ratio monitor controller (ORMC) (Fig. 38–5) serves to limit the N<sub>2</sub>O flow according to the O<sub>2</sub> flow and create a mixture of at least 25% O<sub>2</sub> at the flow-



**FIGURE 38-5.** Dräger oxygen ratio monitor controller (ORMC). See text for details of operation.

meter level when these two gases are being used.<sup>9</sup> At O<sub>2</sub> flow rates of less than 1 L/min, even higher concentrations of O<sub>2</sub> are delivered. In addition, an alarm is activated when the ORMC is functioning to prevent a hypoxic mixture when the Narkomed machine is used in the “O<sub>2</sub>/N<sub>2</sub>O” mode, but not in the “all gases” mode (i.e., when air, helium, etc., might be switched into the system).

The ORMC works as follows: As O<sub>2</sub> flows past its flow-control needle valve and up the rotameter tube, it encounters a resistor that creates a back pressure that is applied to the O<sub>2</sub> diaphragm (Fig. 38-5). As N<sub>2</sub>O flows past its flow-control valve and up the rotameter tube, it also encounters a resistor that causes a back pressure on the N<sub>2</sub>O diaphragm. The two diaphragms are linked by a connecting shaft, the ultimate position of which depends on the relative back pressures and, therefore, flows of N<sub>2</sub>O and O<sub>2</sub>.

The left-hand end of the connecting shaft controls the orifice of a slave valve, which, in turn, controls the supply pressure of N<sub>2</sub>O to its flow-control valve. When the O<sub>2</sub> flow is high, the shaft moves to the left and opens the slave control valve (Fig. 38-5, lower). Conversely, if the N<sub>2</sub>O flow is increased excessively, the shaft moves to the right, closing the slave valve orifice and decreasing the supply pressure of N<sub>2</sub>O to, and thereby flow of N<sub>2</sub>O from, its flow-control valve. When the ORMC is acting to prevent a hypoxic mixture, the leaf spring contacts (Fig. 38-5) are closed, annunciating an alarm. This alarm is disabled if the machine is in the “all gases” mode.<sup>9</sup>

The Dräger ORMC differs from the Datex-Ohmeda Link-25 Proportion Limiting Control System in several ways. First, the ORMC does not require second-stage O<sub>2</sub> and N<sub>2</sub>O regulators. Second, the ORMC serves to limit the N<sub>2</sub>O flow according to the O<sub>2</sub> flow, whereas

the Link-25 Proportion Limiting Control System increases the O<sub>2</sub> flow as the N<sub>2</sub>O flow is increased. As with the Link-25 Proportion Limiting Control System, the ORMC functions only with N<sub>2</sub>O and O<sub>2</sub> and there is no interlinking of O<sub>2</sub> with other gases (e.g., air, He) that might also be deliverable by the machine. Thus when a third or fourth gas is in use, the proportioning systems afford no protection against a hypoxic mixture. Prevention of delivery of a hypoxic gas mixture when a third or fourth gas is supplied to the machine may be achieved by supplying that gas in a tank premixed with O<sub>2</sub> (e.g., heliox, a gas mixture of 75% He and 25% O<sub>2</sub>).

Although elegant in design, both the ORMC and the Link-25 Proportion Limiting Control Systems are subject to mechanical and pneumatic failure and should be tested according to the manufacturer’s instructions during the preuse machine checkout.<sup>9,11</sup> Furthermore, if the systems are functioning correctly, they only ensure adequacy of greater than 25% O<sub>2</sub> at the flowmeter level. An O<sub>2</sub> leak downstream from the flow-control valves (i.e., from the low-pressure system of the machine) could result in a hypoxic mixture flowing from the common gas outlet. Consequently, an oxygen analyzer in the patient circuit is essential if a hypoxic mixture is to be detected. The controlled flows of O<sub>2</sub>, N<sub>2</sub>O, and other gas or gases are mixed in the manifold at the top of the flowmeter bank, and they flow to a concentration-calibrated anesthesia vaporizer (Fig. 38-2).

## ANESTHESIA VAPORIZERS

A vapor is the gas phase of an agent that is normally a liquid at room temperature and atmospheric pressure. Vaporizers facilitate the change of a liquid anesthetic into its vapor phase and add a controlled amount of this vapor to the flow of gases passing to the patient circuit.

### Vapor, Evaporation, and Vapor Pressure

Consider isoflurane in a closed container at 1 atm pressure (760 mm Hg) and room temperature 20°C. Although most is in liquid form, some isoflurane molecules escape from the surface of the liquid to enter the space above as a vapor. Under steady-state conditions of temperature, an equilibrium is estab-



lished between the molecules in the vapor phase and those in the liquid phase. The vapor phase molecules are in constant motion, striking the walls of the container to exert a vapor pressure. If the temperature is increased, more isoflurane molecules enter the vapor phase (evaporate), resulting in an increase in vapor pressure. When the gas phase above the liquid contains all the isoflurane vapor that it can hold at that temperature, it is said to be saturated and the pressure exerted by the isoflurane is called its saturated vapor pressure (SVP) at that temperature.

The SVP exerted by the vapor phase of a potent volatile agent depends only on the volatile agent and the ambient temperature (Fig. 38–6). The temperature at which SVP becomes equal to atmospheric pressure and at which all the liquid agent changes to the vapor phase is the liquid's boiling point. The most volatile agents are those with the highest SVPs for any given temperature, and they also have the lowest boiling points (e.g., desflurane and diethyl ether boil at 22.8°C and 35°C, respectively, at an ambient pressure of 760 mm Hg). Boiling point decreases with decreasing ambient pressure, such as occurs at increasing altitude.

### Units of Vapor Concentration

Anesthetic vapor presence may be quantified either as an absolute pressure (or tension), expressed in millimeters of mercury (mm Hg), or in volumes percent of 1 atm (i.e., volumes of vapor per 100 volumes of total gas).

By applying Dalton's law, volumes percent is similar to the agent's fractional partial pressure:

$$\text{Vols \%} = \left( \frac{\text{Partial pressure of agent}}{\text{Total ambient pressure}} \right) \times 100$$

### Dalton's Law of Partial Pressures

Dalton's law states that in a mixture of gases (or vapors) the pressure exerted by each gas is the same as that it would exert if it alone occupied the container.<sup>7</sup> Each gas (or vapor) exerts its pressure independently of the pressure of the other gases present. For example, in a container of dry air at atmospheric pressure (760 mm Hg), if O<sub>2</sub> represents 21% of all gases present, the pressure exerted by the O<sub>2</sub> (its partial pressure) is 21% of 760, or 159.6 mm Hg.

Now consider air, which is fully saturated with water vapor at 37°C (normal body temperature). Vapor pressure de-

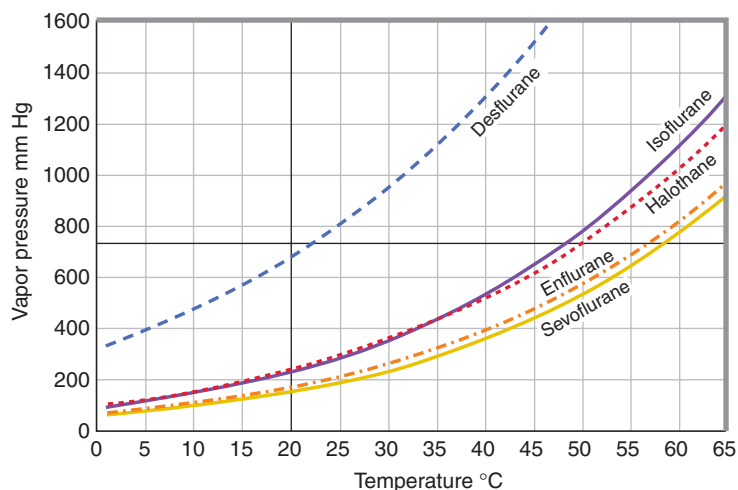


FIGURE 38–6. Vapor pressure curves for the potent inhaled anesthetics.

pends on temperature. The SVP for water at 37°C is 47 mm Hg. O<sub>2</sub> now represents 21% of what remains (i.e., 713, or 760 – 47), having a partial pressure of 21% of 713, or 149.3 mm Hg.

Volumes percent expresses the ratio of gas molecules in a mixture, whereas partial pressure is an absolute value. Anesthetic uptake and potency are directly related to partial pressure and only indirectly to volumes percent. This distinction will become more apparent when the use of vaporizers under hyperbaric and hypobaric conditions is considered in a later section (see Changes in Barometric Pressure).

### Minimum Alveolar Concentration

The minimum alveolar concentration (MAC) of a potent inhaled anesthetic agent that produces immobility in 50%

of patients undergoing a surgical incision is used as a measure of anesthetic potency or depth. MAC is typically expressed as volumes percent of alveolar (end-tidal) gas at 1 atm pressure at sea level (760 mm Hg). Table 38–1 shows how MAC in familiar volumes percent can be expressed as a partial pressure in millimeters of mercury.<sup>12</sup> The reader is encouraged to think of MAC in terms of minimum alveolar pressure (MAP) or minimum alveolar partial pressure (MAPP) rather than volumes percent because it is the partial pressure (tension) of the anesthetic in the brain that determines the depth of anesthesia.<sup>13,14</sup> The term  $P_{MAC1}$  (Table 38–1) is used to express the partial pressure of a potent inhaled agent at a concentration of 1 MAC. Thus 1 MAC of sevoflurane is equivalent to a  $P_{MAC1}$  of 16 mm Hg.

TABLE 38–1.

Expression of Minimum Alveolar Concentration of Anesthetic Agent (MAC) as Partial Pressure at Concentration of 1 MAC ( $P_{MAC1}$ ) Assuming Ambient Pressure of 760 mm Hg

Anesthetic Agent	MAC (vol %)	$P_{MAC1}$ (mm Hg)
Halothane	$0.75 \times 760$	= 5.7
Enflurane	$1.68 \times 760$	= 12.8
Isoflurane	$1.15 \times 760$	= 8.7
Methoxyflurane	$0.16 \times 760$	= 1.2
Desflurane <sup>a</sup>	$6.0 \times 760$	= 45.6
	$7.25 \times 760$	= 55.1
Sevoflurane	$2.1 \times 760$	= 16.0

<sup>a</sup>MAC of desflurane is age-dependent: 18–35 years = 7.25%; 31–65 years = 6.0%. See Rampil et al.<sup>15</sup>

Reprinted from Eisenkraft JB. Anesthesia vaporizers. In: Ehrenwerth J, Eisenkraft JB, eds. Anesthesia Equipment: Principles and Applications. St. Louis, MO: Mosby-Year Book, 1993:59, with permission from Elsevier.

## Latent Heat of Vaporization

Energy in the form of heat is needed to transfer molecules from the liquid to the vapor phase. This energy is called the *latent heat of vaporization*, and is defined as the amount of heat (calories) required to convert unit mass (grams) of the liquid into vapor.<sup>7</sup> For example, the latent heats of vaporization of volatile anesthetics at room temperature are 35 cal/g for halothane; 41 cal/g for enflurane and isoflurane; and 58 cal/g for methoxyflurane.<sup>16</sup>

The heat of vaporization is inversely related to ambient temperature so that the lower the temperature, the more heat that is required. Heat required to vaporize anesthetic agents is drawn from the remaining liquid and the surroundings. As vapor is generated, the temperatures of the vaporizer and remaining liquid fall. This causes the vapor pressure to decrease and would result in decreased vaporizer output if no compensatory mechanism were provided.

## Specific Heat

Specific heat is the quantity of heat (calories) required to raise the temperature of unit mass (grams) of a substance by 1 °C.<sup>7</sup> Heat must be supplied to the liquid anesthetic in the vaporizer to maintain its temperature while

heat is being lost in the process of evaporation.

Specific heat is also important to vaporizer construction material. Thus materials with high specific heat change temperature more gradually than those with low specific heats for the same amount of heat lost through vaporization. Thermal capacity is defined as the product of specific heat and mass and represents the total quantity of heat stored in the vaporizer body.<sup>7</sup>

The vaporizer construction material's ability to conduct heat from the environment through to the contained liquid anesthetic is also of importance. This is called thermal conductivity, defined in terms of how quickly heat is transmitted through a substance. The ideal material for vaporizer construction would have a high specific heat and high thermal conductivity. In this respect, copper comes close to the ideal (thus the Copper Kettle vaporizer). More recently, bronze and stainless steel have been used in vaporizer construction.

## Regulating Vaporizer Output: Measured Flow versus Variable Bypass

The SVPs of the four potent inhaled agents halothane, isoflurane, enflurane, and sevoflurane at room temperature

are 243, 238, 175, and 160 mm Hg, respectively, and far in excess of those required for clinical anesthesia (Fig. 38-6 and Table 38-2). Consequently, the vaporizer first creates a saturated vapor that must then be diluted by the bypass gas flow to result in clinically useful concentrations. If this were not done, a lethal concentration of agent could be delivered.

Contemporary anesthesia vaporizers for halothane, isoflurane, enflurane, and sevoflurane are concentration-calibrated and of the variable-bypass design.<sup>2</sup> The vaporizers for desflurane (Datex-Ohmeda Tec 6; Dräger D-Vapor) are of a different design and are described separately in a later section (see Desflurane and the Tec 6 Vaporizer). In a variable-bypass vaporizer (e.g., Datex-Ohmeda Tec series, Dräger Vapor 19.n series) the total fresh gas flow from the anesthesia machine flow meters passes to the vaporizer. The vaporizer splits the incoming gas flow into both a smaller flow, which enters the vaporizing chamber to emerge with the agent at its saturated vapor concentration, and a larger bypass flow, which when mixed with the vaporizing chamber output, results in the desired or "dialed-in" concentration (Fig. 38-7).

In the now rarely used measured-flow (i.e., not concentration-calibrated)

TABLE 38-2.

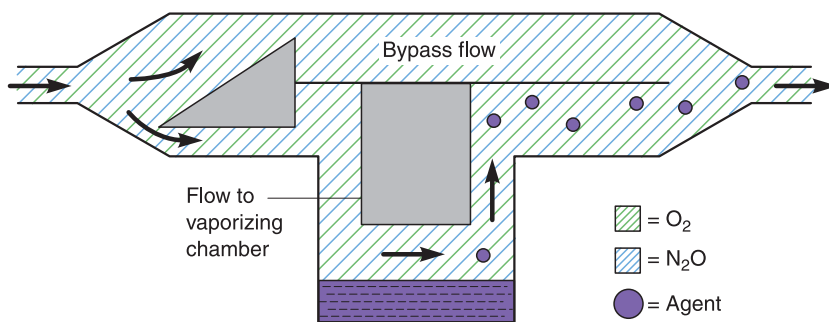
Physical Properties of Potent Volatile Agents

Parameter/Agent	Halothane	Enflurane	Isoflurane	Methoxyflurane	Sevoflurane	Desflurane
Structure	CHBrClCF <sub>3</sub>	CHFClCF <sub>2</sub> OCHF <sub>2</sub>	CF <sub>2</sub> HOCHClCF <sub>3</sub>	CHCl <sub>2</sub> CF <sub>2</sub> OCH <sub>3</sub>	CH <sub>2</sub> FOCH(CF <sub>3</sub> ) <sub>2</sub>	CH <sub>2</sub> HOCFHCFC <sub>3</sub>
Molecular weight	197.4	184.5	184.5	165.0	200	168
Boiling point at 769 mm Hg (°C)	50.2	56.5	48.5	104.7	58.5	22.9
SVP at 20°C	243	175	238	20.3	160	669
Saturated vapor concentration at 20°C and 1 atmosphere absolute (vol %)	32	23	31	2.7	21	87
MAC at 1 atmosphere absolute (vol %)	0.75	1.68	1.15	0.16	1.7	6.0–7.25 <sup>a</sup>
P <sub>MAC1</sub> (mm Hg)	5.7	12.8	8.7	1.22	12.9	46–55 <sup>a</sup>
Specific gravity of liquid at 20°C	123	130	130	145	120	143
Vapor (mL) per liquid at 20°C	226	196	195	204	182	207

<sup>a</sup>Age related; see Table 38-1.

MAC, minimum alveolar concentration; P<sub>MAC1</sub>, partial pressure at concentration of 1 MAC; SVP, saturated vapor pressure.

Reprinted from Eisenkraft JB. Anesthesia vaporizers. In: Ehrenwerth J, Eisenkraft JB, eds. Anesthesia Equipment: Principles and Applications. St. Louis, MO: Mosby-Year Book, 1993:60, with permission from Elsevier.



**FIGURE 38-7.** Variable bypass vaporizer principle. These are concentration-calibrated and are of the flow-over design (see text).

vaporizers, such as the Copper Kettle (Foregger/Puritan-Bennett) or Verni-Trol (Datex-Ohmeda), a measured  $O_2$  flow is set on a separate flowmeter to pass to the vaporizer, from which vapor at its SVP emerges. This is then diluted by a larger measured flow of gases from other (main) flowmeters on the anesthesia machine (Fig. 38-8). In this type of arrangement, several calculations are necessary to determine the anesthetic vapor concentration in the emerging gas mixture.

With either type of vaporizing arrangement, an efficient system must exist to create a saturated vapor concentration in the vaporizing chamber. This is achieved by having a large surface area for evaporation of the liquid agent. In flow-over vaporizers (e.g., Dräger Vapor series, Datex-Ohmeda Tec series) the area is increased by the use of wicks and baffles. In bubble-through vaporizers (e.g., Copper Kettle, Verni-Trol),  $O_2$  is bubbled through the

liquid agent. The tiny bubbles, which in the Copper Kettle are created by passage of  $O_2$  through a sintered bronze disk, represent large areas of liquid-gas interface over which evaporation of the liquid agent can quickly occur.

Desflurane, because of its high saturated vapor pressure at room temperature (669 mm Hg at  $20^\circ\text{C}$ ), and its low boiling point ( $22.8^\circ\text{C}$  at 1 atm), cannot be safely delivered using the vaporizing systems described in the preceding paragraphs. The physical properties of desflurane require that a special design of vaporizer (e.g., Datex-Ohmeda Tec 6; Dräger D-Vapor) be used to deliver this agent in a controlled fashion (see Desflurane and the Tec 6 Vaporizer).

### Calculation of Vaporizer Output for Agents Other Than Desflurane

Assume that room temperature is kept constant at  $20^\circ\text{C}$ . The SVPs of each agent are as follows: halothane, 243

mm Hg; isoflurane, 238 mm Hg; enflurane, 172 mm Hg; and sevoflurane, 160 mm Hg (Table 38-2). If ambient pressure is 760 mm Hg, these vapor pressures represent 243/760, or 32% for halothane; 238/760, or 31% for isoflurane; 175/760, or 23% for enflurane; and 160/760, or 21% for sevoflurane, in terms of volumes percent of each agent at 1 atm.

In a variable-bypass vaporizer, a given volume of carrier gas flowing into the vaporizing chamber over time will exit the chamber over the same period. In the vaporizing chamber, however, anesthetic vapor at its SVP constitutes a mandatory fractional volume of the atmosphere (e.g., 32% by volume in a halothane vaporizer at  $20^\circ\text{C}$  and 760 mm Hg ambient pressure). Thus the volume of carrier gas entering the vaporizing chamber constitutes the difference between 100% of the atmosphere in the vaporizing chamber and that which results from the anesthetic vapor.

With halothane at  $20^\circ\text{C}$  and ambient pressure 760 mm Hg the volume of carrier gas at any time represents 68% of the atmosphere in the vaporizing chamber. Thus if 100 mL of carrier gas enters a vaporizing chamber containing halothane, the carrier gas represents 68% (i.e.,  $100\% - 32\%$ ) of the atmosphere, and the remaining 32% is halothane vapor. By simple proportions, the latter can be calculated to be 47 mL of halothane vapor ( $[100/68] \times 32$ ).

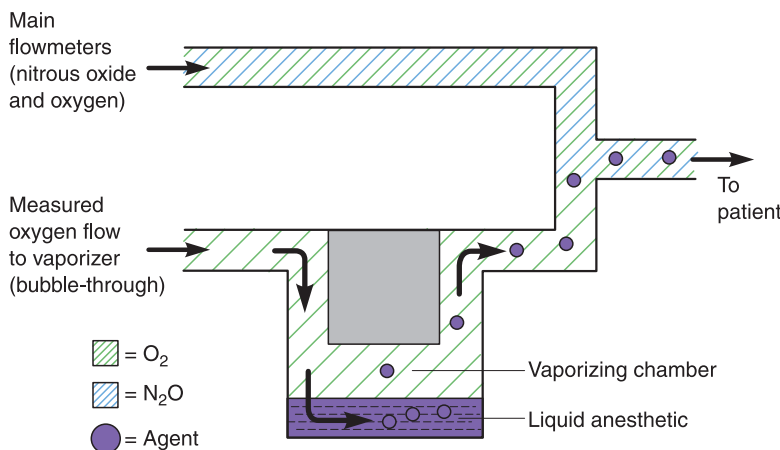
Another way of expressing this is by applying Dalton's law:

$$\frac{\text{SVP}_{\text{agent}} \text{ (mm Hg)}}{\text{Total Pressure (mm Hg)}} = \frac{\text{Agent vapor (x mL)}}{\text{Carrier gas (y mL) + Agent vapor (x mL)}}$$

For halothane in the previous example,  $y = 100 \text{ mL/min}$ . Therefore:

$$\frac{243}{760} = \frac{x}{100 + x}$$

from which  $x$  can be calculated to be 47 mL. Conversely, if  $x$  is known, the carrier gas flow ( $y$ ) can be calculated. Thus a larger total volume of gas leaves the vaporizing chamber than enters it, the additional volume being anesthetic vapor at its saturated vapor concentration.



**FIGURE 38-8.** Measured flow vaporizer principle. These are not concentration-calibrated and are of the bubble-through design (see text).

## Measured-Flow Vaporizers

Although measured-flow vaporizers are not included in the recent anesthesia machine and workstation standards,<sup>1,2</sup> it is instructive to first review the function of a measured-flow vaporizer (e.g., Copper Kettle).

Assume that 1% (vol/vol) halothane is required at a total fresh gas flow rate to the patient circuit of 5 L/min (Fig. 38-9). This requires that 50 mL halothane vapor be evolved per minute by the vaporizer (1% × 5000 mL). In the vaporizing chamber, halothane represents 32% of the atmosphere by volume, assuming temperature is kept constant at 20°C and therefore SVP is maintained at 243 mm Hg. Now if 50 mL of halothane vapor represents 32% by volume, the carrier gas (O<sub>2</sub>) must represent the other 68%, or 106 mL (50/32 × 68).

Alternatively:

$$\frac{243}{760} = \frac{50}{y + 50}$$

where  $y$  is carrier gas (O<sub>2</sub>) flow, or 106 mL. Thus if 106 mL/min of O<sub>2</sub> flows into a measured-flow vaporizer, 156 mL/min of gas emerges, of which 50 mL is halothane vapor and 106 mL is the carrier gas O<sub>2</sub> supplied to the vaporizer. This vaporizer output of 156 mL/min must be diluted by an additional fresh gas flow of 5000 – 156 = 4844 mL/min, to create a precise 1%

halothane mixture (as 50 mL of halothane diluted in a total volume of 5000 mL = 1% by volume).

In clinical practice, however, the anesthetist would likely set flows of 100 mL/min to the measured-flow vaporizer and 5 L/min of fresh gas on the main flowmeters, which results in slightly less than 1% halothane (47/5147 = 0.91%). Multiples of either of these numbers (100 mL and 5 L) are used to create other concentrations of halothane from a measured-flow vaporizing system. Thus a 100-mL/min O<sub>2</sub> flow to the vaporizer and 2500 mL/min on the main flowmeters would produce approximately 2% halothane (actually 1.78%). It is important to realize that if there is O<sub>2</sub> flow only to the vaporizer and no diluent gas flow is set on the main flowmeters, potentially lethal concentrations (approaching 32%) of halothane would be delivered to the anesthesia circuit, albeit at low flow rates.

Because halothane and isoflurane have similar vapor pressures at 20°C (Table 38-2), the gas flows required for halothane are essentially the same as those to be set for isoflurane if similar concentrations of isoflurane were to be produced from a measured-flow vaporizing system.

## Variable Bypass

In the foregoing example discussing measured-flow vaporizing systems, it was necessary to calculate both the O<sub>2</sub>

flow to the vaporizer and the total bypass gas flow needed to produce the desired output concentrations of vapor. This is inconvenient and can give rise to errors, but it is helpful to understand the principles underlying the calculations.

In the concentration-calibrated variable-bypass (“Tec-type”) design, the vaporizer splits the incoming total flow of gas arriving from the machine flowmeters between a variable-bypass and the vaporizing chamber that contains the anesthetic agent (Fig. 38-7). The ratio of these flows—the splitting ratio—depends on the anesthetic agent, the temperature, and the dial-in vapor concentration set to be delivered. Figure 38-10 shows the schematic of a contemporary concentration-calibrated vaporizer, the Dräger Vapor 19.1. Anesthetic output concentration is increased by turning the concentration dial, which raises the control cone, allowing more saturated anesthetic vapor to leave the vaporizing chamber.

Review of the previous section for accurately delivering 1% halothane from a measured-flow vaporizer reveals that 4950 mL/min of incoming total gas flow must be split so that 106 mL enters the vaporizing chamber and 4844 mL enters the bypass (Fig. 38-9). This results in a splitting ratio of 4844/106, or 46:1 (at a temperature of 20°C). A variable-bypass vaporizer (e.g., Dräger Vapor 19.1), when set to deliver 1% halothane, is, in effect, set to a splitting ratio of 46:1 (bypass flow-to-vaporizing chamber flow).

Concentration-calibrated vaporizers are agent-specific and designed to be used only with the agent for which the unit is designed and calibrated. To produce a 1% vapor concentration, an isoflurane vaporizer makes a flow split of 44:1, whereas a sevoflurane vaporizer makes a flow split of 25:1 (Table 38-3). If an empty sevoflurane vaporizer set to deliver 1% were filled with isoflurane, the concentration of the isoflurane vapor emerging would exceed 1% (44/25 = 1.7%). An understanding of splitting ratios enables fairly accurate prediction of the concentration output of an agent-specific variable-bypass vaporizer that has been erroneously filled with an agent for which it was not designed (see Incorrect Filling of Vaporizers below).

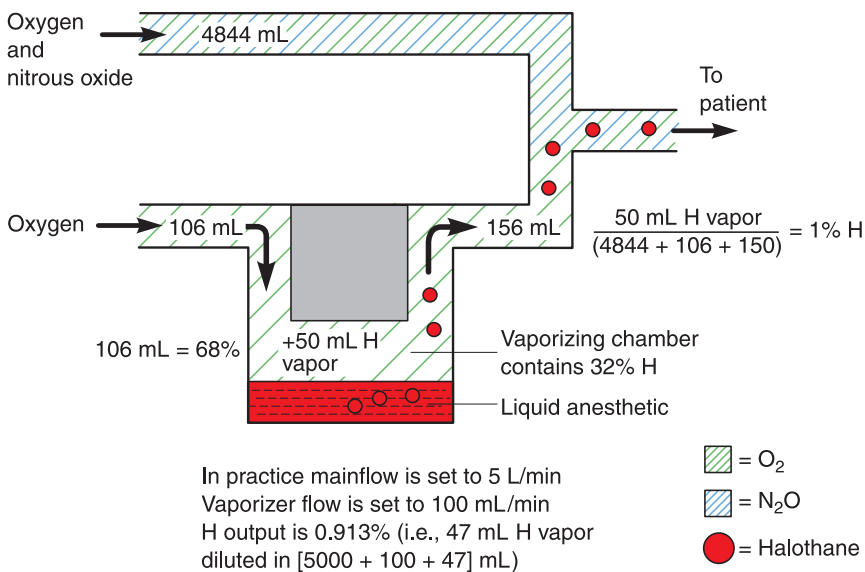
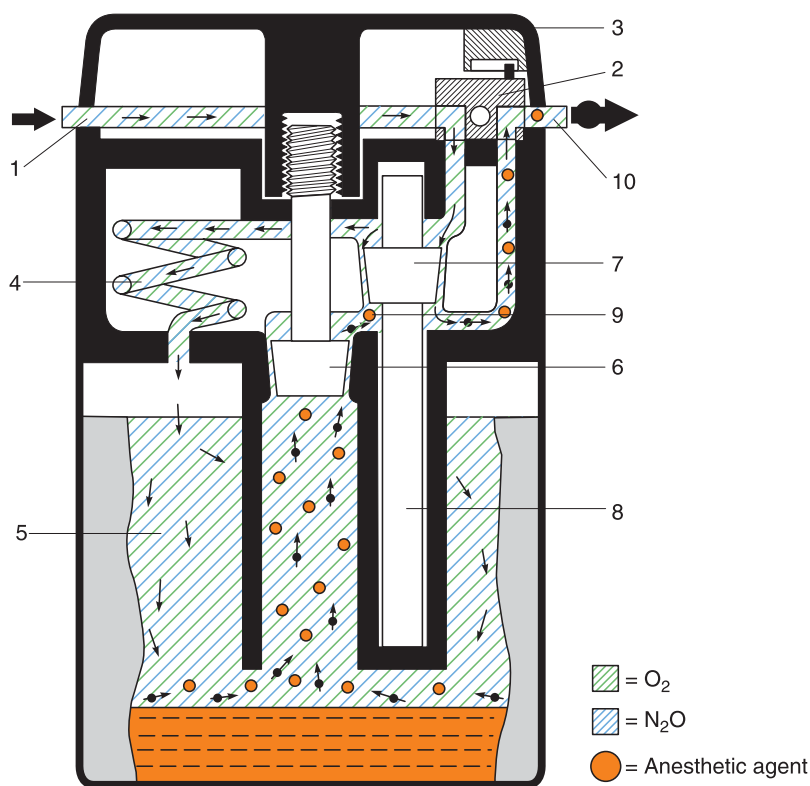


FIGURE 38-9. Preparation of 1% (vol/vol) halothane by measured-flow vaporizer.





**FIGURE 38–10.** Schematic of Dräger Vapor 19.1 vaporizer. When concentration knob (3) is in o (zero) position, on/off switch (2) is closed. Gas mixture enters vaporizer at fresh gas inlet (1) and leaves through fresh gas outlet (10) without entering the vaporizer's interior. When concentration knob (3) is turned to any volume (%) concentration above 0.2 vol%, the on/off switch (2) automatically opens and allows fresh gas to enter the vaporizer's interior. Gas is immediately divided and follows two different routes. One part of the fresh gas moves through a thermostatically controlled bypass (7), which compensates for temperature changes and maintains correct volumes percent concentration vapor output as selected with concentration knob (3). The other part of the fresh gas moves through a pressure compensator (4), which prevents pressure changes that occur upstream or downstream from the vaporizer to be transmitted into the vaporizer and thus affect volumes percent vapor output. From the pressure compensator, gas continues into vaporizing chamber (5). This chamber contains liquid anesthetic agent, which is absorbed and evaporated by a special wick assembly. As fresh gas moves through the vaporizing chamber, it is fully saturated with anesthetic vapor. Saturated gas leaves the chamber through a control cone (6). The cone is adjustable with concentration knob (3). Saturated vapor and fresh gas that did not pass through the vaporizing chamber are combined and leave through the fresh gas outlet (10). Combination of the bypass opening (7) and control cone opening (6) determines volumes percent vapor output. The expansion element (8) reduces vaporizing chamber gas flow as temperature increases.

### Efficiency and Temperature Compensation

Agent-specific, variable-bypass, concentration-calibrated vaporizers are located in the fresh gas path between the flow meters (e.g., rotameters) on the anesthesia machine and the machine common gas outlet (Fig. 38–2). The vaporizers must be efficient and produce steady concentrations of the agent over a fairly wide range of incoming gas flows. However, as the

agent is vaporized and the temperature falls, SVP also falls and vaporizing chamber output tends to decrease.

Measured-flow vaporizers (e.g., Copper Kettle, Verni-Trol) incorporate a thermometer that measures the temperature of the liquid agent in the vaporizing chamber. A lower temperature translates to a lower SVP in this chamber, and reference to the vapor pressure curves (Fig. 38–6) enables a resetting of vaporizer gas flow, bypass gas flows, or both to ensure correct

output at the ambient temperature. Such an arrangement can be tedious but if done correctly does ensure the most accurate and rapid temperature compensation.

Most of the contemporary variable-bypass vaporizers (e.g., Datex-Ohmeda Tec series, Dräger Vapor 19.1) have automatic temperature compensation achieved by a temperature-sensitive valve in the bypass gas flow. When temperature increases, the valve in the bypass opens wider to create a greater splitting ratio. More gas flows through the bypass, and less gas enters the vaporizing chamber. A smaller volume of a higher concentration of vapor emerges from the vaporizing chamber. When mixed with an increased bypass gas flow, this volume maintains a reasonably constant vaporizer output when temperature changes are gradual and not extreme.

The design of the temperature-sensitive valve varies among the different types of vaporizer. Datex-Ohmeda Tec series vaporizers use a bimetallic strip; a flap valve situated in the bypass flow composed of two different metals that have different coefficients of expansion (defined as change in length per unit length per unit change in temperature). As temperature increases, one surface of the flap expands more than the other, causing the flap to bend in such a way that the valve orifice opens wider.<sup>17</sup> The principle of differential expansion of metals is applied similarly in the Dräger Vapor 19.1 vaporizers, in which an expansion element increases bypass gas flow as temperature increases (Fig. 38–10, component 8).

The vapor pressures of the potent volatile anesthetics vary nonlinearly as a function of temperature (Fig. 38–6). The automatic temperature compensation mechanisms described are linear in terms of expansion coefficients of materials. When these affect the size of the orifice that they control, however, the compensation mechanisms also become nonlinear. The situation is complex, depending on the geometry of the valves and the nature of the gas flow through them. The result is that the vapor output concentration at any given vaporizer setting remains constant only within a certain range of temperatures. For example, the Dräger Vapor 19.1 vaporizers are specified as accu-

TABLE 38-3.

Gas Flow Splitting Ratios at 20°C<sup>a</sup>

	Halothane	Enflurane	Isoflurane	Methoxyflurane	Sevoflurane
1%	46:1	29:1	44:1	1.7:1	25:1
2%	22:1	14:1	21:1	0.36:1	12:1
3%	14:1	9:1	14:1	<sup>b</sup>	7:1

<sup>a</sup>Ratios are not given for desflurane, because the vaporizer for this agent (Datex-Ohmeda Tec 6; Drager D-Vapor) uses a different design from that used for the above agents.

<sup>b</sup>Maximum possible concentration is 2.7% at 20°C; see Table 38-2.

Reprinted from Eisenkraft JB: Anesthesia vaporizers. In: Ehrenwerth J, Eisenkraft JB, ed. Anesthesia Equipment: Principles and Applications. St. Louis, MO: Mosby-Year Book, 1993:63, with permission from Elsevier.

rate to  $\pm 15\%$  of the concentration set when used within the temperature range of 15°C to 35°C at normal atmospheric pressure.<sup>9,11</sup> At temperatures outside this range, the resulting concentration increases beyond the upper tolerance limit despite continuing compensation. The boiling point of the volatile agent must never be allowed to be reached in the current variable-bypass vaporizers designed for enflurane, halothane, isoflurane, and sevoflurane, as the vapor output concentration would otherwise be totally uncontrolled and potentially lethal.

### Incorrect Filling of Vaporizers

Modern vaporizers are agent-specific. If an empty vaporizer designed for one agent is filled with an agent for which it was not designed, the vaporizer output may be erroneous for both agent and delivered vapor concentration.

A dangerous situation would result if a vaporizer designed for methoxyflurane (very low SVP of 20.3 mm Hg at 20°C) were erroneously filled (Table 38-2). A methoxyflurane vaporizer filled with halothane and set to deliver 1% methoxyflurane (albeit 6 MAC; Table 38-2) would deliver 14.8% (20 MAC) halothane. Set to 1 MAC (0.16%) methoxyflurane, the vaporizer makes a flow split of 16:1, similar to that of a halothane or isoflurane variable-bypass vaporizer set to deliver 2.7%.

Table 38-4 lists the outputs of erroneously filled vaporizers. Erroneous filling affects the output concentration and consequently the MAC (MAP, MAPP) or potency output of the vaporizer. Thus an enflurane vaporizer set to deliver 2% (1.19 MAC) but filled with halothane at 22°C will deliver 3.21% (4.01 MAC) halothane, that is, 3.3 times the anticipated anesthetic potency output.<sup>18</sup>

TABLE 38-4.

Output in Percent and Minimum Alveolar Concentration (MAC) in O<sub>2</sub> of Erroneously Filled Vaporizers at 22°C

Vaporizer	Liquid	Setting (%)	Output (%)	Output MAC
Halothane	Halothane	1.0	1.00	1.25
	Enflurane	1.0	0.62	0.37
	Isoflurane	1/0	0.96	0.84
Enflurane	Enflurane	2.0	2.0	1.19
	Isoflurane	2.0	3.09	2.69
	Halothane	2.0	3.21	4.01
Isoflurane	Isoflurane	1.5	1.50	1.30
	Halothane	1.5	1.56	1.95
	Enflurane	1.5	0.97	0.57

Reproduced with permission from Bruce DL, Linde HW. Vaporization of mixed liquids. Anesthesiology 1984;60:342.

Erroneous filling of vaporizers can be prevented by careful attention to the specific agent and the vaporizer when filling is performed. In the United States, agent-specific keyed filling mechanisms are available as options on modern vaporizers; in Canada, keyed filling is a standard. Liquid anesthetic agents are commercially available packaged in bottles that have an agent-specific collar. One end of the agent-specific filling device fits the collar on the agent bottle, and the other end fits only the vaporizer designed for that agent. An agent-specific filling system assumes even greater importance with desflurane (see Desflurane and the Tec 6 Vaporizer and Table 38-2). Keyed filling systems also decrease contamination of the operating room atmosphere during vaporizer filling.

### Vaporization of Mixed Anesthetic Liquids

A more likely scenario is that an agent-specific variable-bypass vaporizer partially filled with correct agent is topped off with an incorrect agent.<sup>18</sup> The situation here is more complex, vaporizer output is less-easily predicted, and large errors in vapor administration can occur. Halothane, enflurane, and isoflurane, when mixed, do not react chemically but do influence the extent of each other's ease of vaporization. Halothane facilitates the vaporization of both enflurane and isoflurane and in the process is itself more likely to vaporize.<sup>19</sup> The clinical consequences depend on the potencies of each of the mixed agents as well as the delivered vapor concentrations. If a halothane vaporizer 25% full is refilled to 100% with isoflurane and set to deliver 1%, the halothane output is 0.41% (0.51 MAC) and the isoflurane output is 0.9% (0.78 MAC) (Table 38-5).<sup>18</sup> In this case, the output potency of 1.29 MAC is not far from the 1.25 MAC (1% halothane) expected.

However, an enflurane vaporizer 25% full and set to deliver 2% (1.19 MAC) enflurane that is filled to 100% with halothane has an output of 2.43% (3.03 MAC) halothane and 0.96% (0.57 MAC) enflurane (Table 38-5).<sup>19</sup> This represents a total MAC of 3.6, or more than twice that intended. In any event, it is important that erroneous filling of vaporizers be avoided, and that if suspected, the vaporizer be

TABLE 38–5.

## Vaporizer Output after Incorrectly Refilling from 25% to 100% Full

Vaporizer	Setting(%)	Refill liquid	Vaporizer Outputs						
			Halothane		Enflurane		Isoflurane		Total MAC
			%	MAC	%	MAC	%	MAC	
Halothane	1.0	Enflurane	0.33	0.41	0.64	0.38	—	—	0.79
	1.0	Isoflurane	0.41	0.51	—	—	0.90	0.78	1.29
Enflurane	2.0	Halothane	2.43	3.03	0.96	0.57	—	—	3.60
Isoflurane	1.5	Halothane	1.28	1.60	—	—	0.57	0.50	2.10

Reproduced with permission from Bruce DL, Linde HW. Vaporization of mixed anesthetic liquids. *Anesthesiology* 1984;60:342.

emptied, serviced, purged, and refilled with the correct agent.

### Filling of Vaporizers

Vaporizers should only be filled as directed in their accompanying instructions. Overfilling or tilting of a vaporizer (free-standing or by tilting the whole anesthesia machine) may result in liquid agent entering parts of the anesthesia delivery system (e.g., vaporizer bypass flow) designed for gases or vapors only and might give rise to lethal concentrations of the agent. If a vaporizer has been tilted and there is concern that liquid agent has leaked into the gas delivery system, then with no patient connected to the system, the vaporizer should be purged with a high flow rate of O<sub>2</sub> (10 L/min) from the machine flowmeter (not the O<sub>2</sub> flush, which bypasses the vaporizer) and with the vaporizer concentration dial set to the maximum concentration setting.<sup>20</sup> The most recent models of vaporizer (Datex-Ohmeda Tec 7; Dräger Vapor 2000 series) are designed with antispill mechanisms. Thus to remove a Vapor 2000 vaporizer from the mounting manifold, the concentration dial must be turned past the OFF setting to the T setting, or transport mode. In this setting, the sump that contains liquid agent is completely isolated from the other parts of the vaporizer, which can then be safely tilted.

Table 38–2 shows that 1 mL of liquid volatile anesthetic agent produces approximately 200 mL of vapor at 20 °C. Thus if small volumes of liquid agent enter parts of the delivery system intended for gas or vapor only, it is easy to see how potentially lethal concentrations of vapor could arise. For example, if 1 mL of liquid halothane entered the patient breathing system,

it would require 22.6 L of fresh gas to dilute the resulting vapor to a 1% concentration (1.3 MAC).

### Effect of Carrier Gas on Vaporizer Output

The carrier gas used to vaporize the volatile agent in the vaporizing chamber may also affect vapor output concentration. Thus when the carrier gas flow through a variable-bypass Ohio enflurane vaporizer (Fig. 38–11) was changed from N<sub>2</sub>/O<sub>2</sub> to N<sub>2</sub>O/O<sub>2</sub>, the vapor concentration decreased for about 15 minutes and then returned to normal.<sup>21</sup> Once the output concentration is stable with a carrier gas of N<sub>2</sub>O/O<sub>2</sub>, changing back to N<sub>2</sub>/O<sub>2</sub> resulted in an increase in vapor concentration for about 15 minutes.

The explanation for this observed effect is the solubility of N<sub>2</sub>O in the

liquid volatile agents. When N<sub>2</sub>O/O<sub>2</sub> first enters the vaporizing chamber, some N<sub>2</sub>O gas physically dissolves in the liquid agent, and the vaporizing chamber output decreases until the liquid has become saturated with N<sub>2</sub>O. Conversely, when N<sub>2</sub>O is discontinued as the carrier gas, the N<sub>2</sub>O gas that is dissolved in the liquid anesthetic comes out of solution and represents, in effect, additional gas flow to the vaporizing chamber. The solubility of N<sub>2</sub>O is approximately 4.5 mL per mL of liquid anesthetic. Thus 100 mL of halothane liquid, when fully saturated with N<sub>2</sub>O, can dissolve approximately 450 mL of N<sub>2</sub>O. Such a volume of N<sub>2</sub>O, being added to the vaporizing chamber flow over a brief period when N<sub>2</sub>O has been discontinued, causes the observed increase in vaporizer output concentration. This effect is not ob-

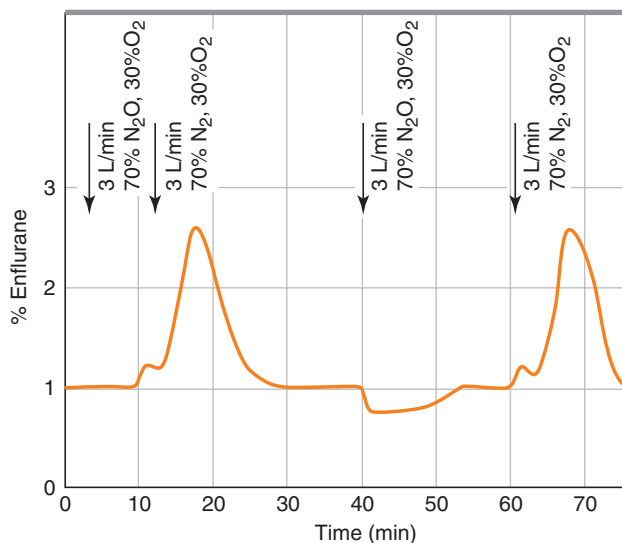
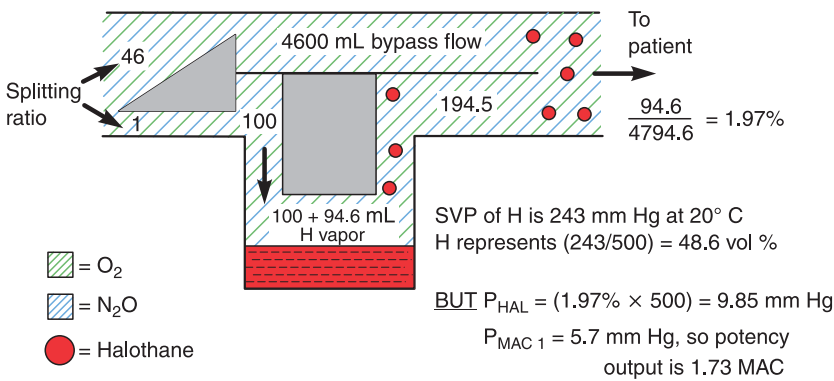


FIGURE 38–11. Effect of carrier gas composition on output of Ohio enflurane variable-bypass vaporizer (see text for details).



**FIGURE 38-12.** Use of variable-bypass halothane vaporizer under hypobaric conditions. Vaporizer is set to 1% (vol/vol) and is being used at ambient pressure of 500 mm Hg.

served with measured-flow vaporizers (e.g., Copper Kettle, Verni-Trol), as in this type of arrangement the carrier gas is always O<sub>2</sub>.<sup>21</sup>

### Changes in Barometric Pressure

Although vaporizers are most often used at ambient pressures of approximately 760 mm Hg (1 atm at sea level), they may be used under hypobaric (e.g., at increased altitude) or hyperbaric (e.g., in a hyperbaric chamber) conditions.<sup>22</sup>

#### Hypobaric Conditions

Because few reports discuss the use of vaporizers under hypobaric conditions, the theoretic considerations applying to such use are discussed here. Consider a variable-bypass vaporizer set to deliver 1% halothane (1.3 MAC at 760 mm Hg atmospheric pressure) that is being used at an ambient pressure of 500 mm Hg (equivalent to an altitude of 10,000 feet above sea level) and at a temperature of 20° C (Fig. 38-12). In the vaporizing chamber, halothane has an SVP of 243 mm Hg (at 20° C), but this now represents 243/500 = 48.6 vol%. The vaporizer, set to deliver 1% under normal conditions, creates a splitting ratio of 46:1 (Table 38-3) between bypass and vaporizing chamber flows. If the total gas flow to the vaporizer is 4700 mL/min (Fig. 38-12), 4600 mL/min enter the bypass and 100 mL/min of carrier gas enter the vaporizing chamber. This 100 mL represents 51.4% of the volume there because halothane represents the other 48.6 vol% (100% - 51.4%). Emerging from the chamber is 100 mL/min of carrier gas plus ([100/

51.4] × 48.6) = 94.6 mL/min of halothane vapor. When the vaporizing chamber and bypass flows merge, the 94.6 mL/min of halothane vapor are diluted in a total volume of 4794.6 mL/min (4600 + 100 + 94.6), giving a halothane concentration of 1.97 vol%, or approximately 2%. This would appear to be double the dialed-in concentration in terms of volumes percent.

Now consider partial pressures. If halothane represents 1.97% of the gas mixture by volume, its partial pressure in the emerging mixture is 1.97 × 500, or 9.85 mm Hg. In terms of anesthetic potency, this represents 9.85/5.7, or 1.73 MAC, because the P<sub>MAC1</sub> of halothane is 5.7 mm Hg (Table 38-1). Thus in theory, when used at an ambient pressure of 500 mm Hg, the variable-bypass halothane vaporizer set to 1% (vol/vol) would deliver twice the dialed-in concentration in terms of volumes percent but only 1.73/1.33

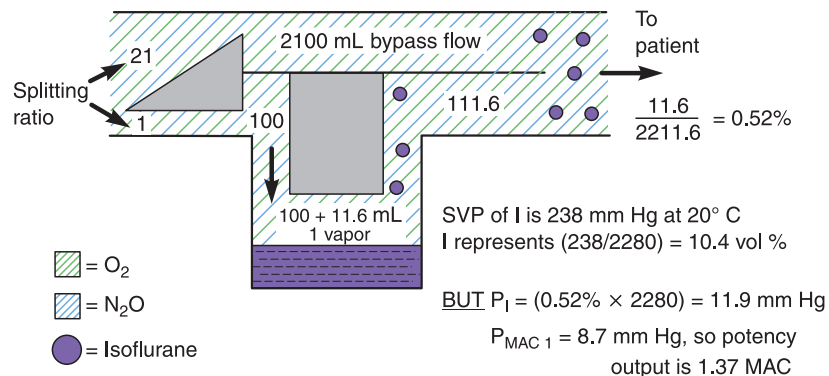
MAC, or 1.3 times the anesthetic potency expected.

#### Hyperbaric Conditions

Consider a variable-bypass isoflurane vaporizer set to deliver 2% (1.74 MAC at 760 mm Hg atmospheric pressure) isoflurane vapor used at 20° C and 3 atm (3 × 760 = 2280 mm Hg), as may exist in a hyperbaric chamber (Fig. 38-13).

In the vaporizing chamber, the SVP of isoflurane is 238 mm Hg (Table 38-2) and the isoflurane concentration is 10.4 vol% ([238/2280] × 100). A variable-bypass isoflurane vaporizer set to deliver 2% creates a splitting ratio of 21:1 for the fresh gas flow (Table 38-3). If the total gas flow to the vaporizer is 2200 mL/min, 2100 mL enter the bypass and 100 mL of carrier gas enter the vaporizing chamber per minute (Fig. 38-13). This 100 mL represents 89.6% (100 - 10.4) of the total gas there; the remainder is isoflurane vapor. The amount of isoflurane vapor evolved is ([100/89.6] × 10.4) = 11.6 mL/min. This volume, diluted in 2100 + 100 + 11.64 gives 11.6/2211.6, or 0.52% isoflurane vapor by volume. This is 0.26 (0.52/2.0) of what was set on the concentration dial in terms of volumes percent.

How about potency? The partial pressure of isoflurane in the emerging gas mixture is 11.9 mm Hg (0.52% × 2280). Dividing by the P<sub>MAC1</sub> for isoflurane of 8.7 mm Hg (Table 38-1) gives a potency output of 1.37 MAC (11.9/8.7). Thus the isoflurane vaporizer, set to deliver 1.74 MAC under conditions of 1 atm pressure, delivers 1.37 MAC at 3 atm, or about 0.80 times the anesthetic potency expected.



**FIGURE 38-13.** Use of variable-bypass isoflurane vaporizer under hyperbaric conditions. Vaporizer is set to 2% (vol/vol) and is being used at ambient pressure of 2280 mm Hg (3 atm).



These examples show that although changes in ambient pressure may have a great effect on vapor concentration output in terms of volumes percent, the anesthetic potency (MAC) output is changed less drastically. In the examples discussed, it was assumed that the set splitting ratios (Table 38–3) would be maintained constant as ambient pressure changed. In reality, changes in gas density occur with changes in ambient pressure and may affect the splitting ratios slightly. The anesthetic potency output expected for any given vaporizer setting is relatively unchanged, by ambient pressure, even though vapor concentration (vol/vol) may be altered considerably.<sup>22</sup> Again, vaporizer output concentration expressed in volumes percent is of limited value unless converted to MAC units using the concept of pressures as described in the foregoing examples.<sup>12,22</sup>

### Arrangement of Vaporizers

Old anesthesia machines had up to three variable-bypass vaporizers arranged in series such that fresh gas from the flowmeters passed through each vaporizer to reach the common gas outlet of the anesthesia machine. Without an interlock system, which permits only one vaporizer to be in use at any time, it was possible to have all three vaporizers turned on simultaneously. Apart from potentially overdosing the patient, the agent from the upstream vaporizer could contaminate the liquid agent(s) in the downstream vaporizer(s). During subsequent use, the output of the downstream vaporizer would be contaminated. The resulting concentrations in the emerging gas and vapor mixture would be indeterminate and might even be lethal.<sup>12</sup>

With modern workstations, only one vaporizer can be on at any time. The recent standards require that, to prevent cross-contamination of the contents of one vaporizer with an agent from another, a system must be provided that isolates the vaporizers from each other and prevents gas from passing through the vaporizing chamber of one vaporizer and then through that of another.<sup>1,2</sup> This specification is met by use of an interlock system. Contemporary Dräger and Datex-Ohmeda anesthesia machines incorporate manufacturer-specific interlock systems.<sup>23,24</sup>

### Calibration and Checking of Vaporizer Outputs

Vaporizers should be regularly serviced according to manufacturer's recommendations and their outputs checked to ensure that a malfunction does not exist. Thus the vaporizer dial is set to deliver a certain concentration. The actual output concentration is measured by an anesthetic agent analyzer that samples gas via a connector placed at the common gas outlet of the anesthesia machine.

### Desflurane and the Tec 6 Vaporizer

Box 38–1 lists the physical properties of desflurane. With an SVP of 669 mm Hg at 20°C and a boiling point of 22.8°C, this agent is extremely volatile. Clearly, this agent cannot be administered using the conventional variable-bypass design of vaporizer used for halothane, enflurane, isoflurane, and sevoflurane. If such a variable-bypass vaporizer were somehow filled with desflurane, an increase in temperature to above 22.8°C would result in the desflurane boiling in the vaporizing chamber and uncontrolled output from the vaporizer. The consequences of misfilling contemporary agent-specific variable-bypass vaporizers with desflurane at 22°C have been predicted.<sup>23</sup> Thus an enflurane vaporizer set to deliver 3 MAC (approximately 5% enflurane) would deliver 16 MAC (approximately 96%) desflurane at 22°C.<sup>25</sup>

Datex-Ohmeda (Steeton, UK) designed the Tec 6 concentration-calibrated vaporizer for the controlled administration of desflurane. It was designed to make the practical aspects of the clinical administration of desflurane no different from that of other potent inhaled agents using their Tec series of vaporizers (Fig. 38–14).<sup>24,25</sup>

The principle of operation of the Tec 6 is that liquid desflurane is heated in a chamber (the sump) to 39°C to produce vapor under pressure (~1500 mm Hg or 2 atm absolute) analogous to having a reservoir of compressed gas in a tank (Fig. 38–14). The vapor leaves the sump (item 9) via a variable pressure-regulating valve (item 7), the opening of which is continuously adjusted according to the output from pressure transducers (items 3 and 4) to ensure that the pressure of the desflurane vapor entering the rotary valve in the user-controlled concentra-

#### BOX 38–1.

##### Desflurane

Structure:  $\text{CHF}_2\text{OCHFCl}_3$

Molecular weight: 168

Specific gravity: 1.45

Boiling point: 22.8°C at 760 mm Hg

SVP: 669 mm Hg at 20°C

Odor: ethereal

Preservative free

MAC: 6–7.25%\* at 760 mm Hg

$P_{\text{MAC}_1}$ : 46–55 mm Hg

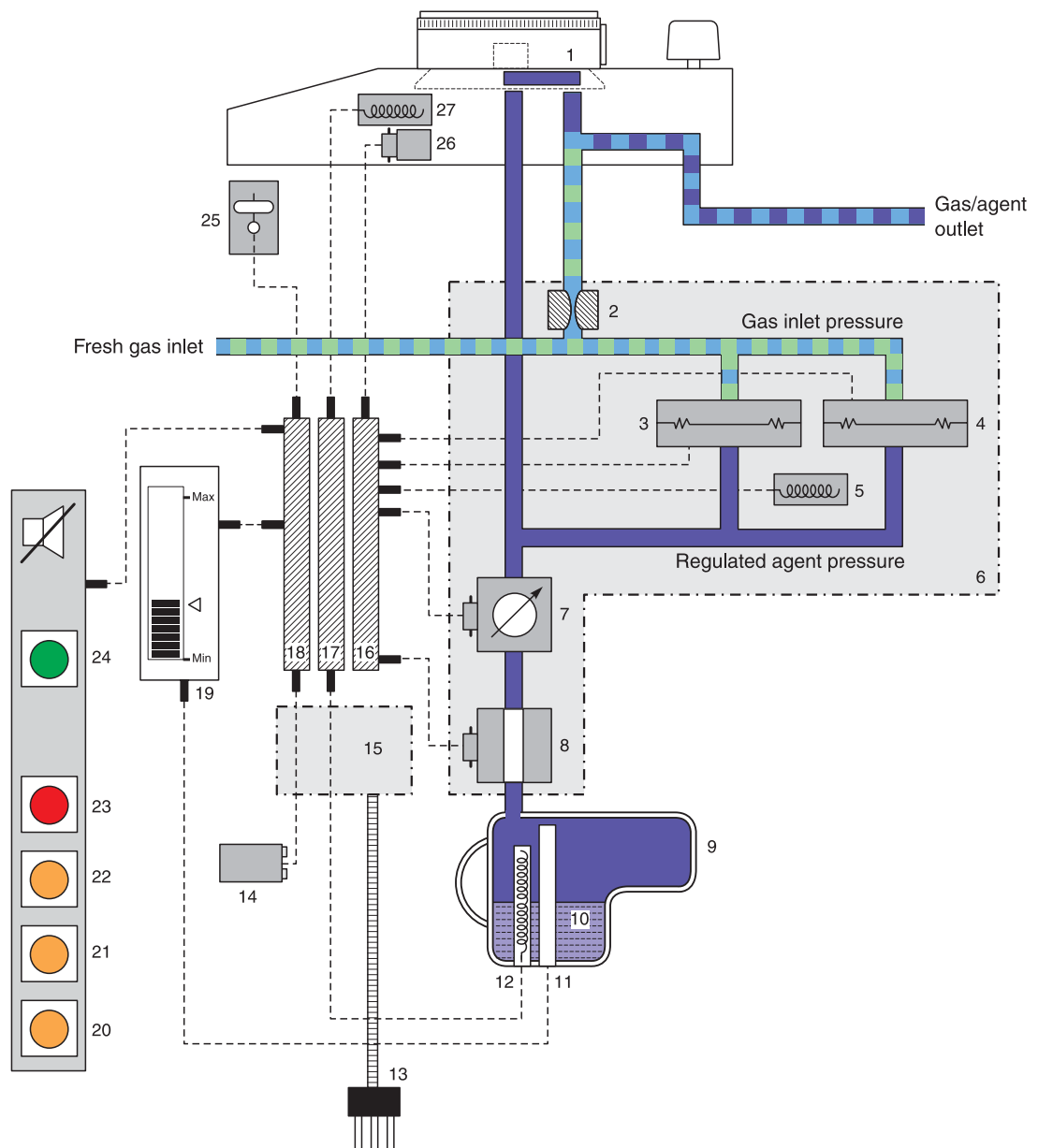
MAC, minimum alveolar concentration;

$P_{\text{MAC}_1}$ , partial pressure at concentration of 1 MAC; SVP, saturated vapor pressure.

\*Age related; see reference 15 and Table 38–1.

tion dial is the same as the pressure generated by the fresh gas inflow (from the anesthesia machine flowmeters) into a fixed restrictor. The concentration dial and rotary valve control the quantity of desflurane vapor added to the fresh gas flow so that what emerges from the vaporizer outlet is the dialed-in concentration of desflurane. Unlike other concentration-calibrated vaporizers (e.g., Datex-Ohmeda Tec 5, Dräger Vapor 19.1) which are of variable-bypass design, no fresh gas enters the desflurane sump in the Tec 6.

The Tec 6 is calibrated by the manufacturer using 100% oxygen as the fresh gas. As the oxygen enters the vaporizer it flows through a fixed restrictor (Fig. 38–14, item 2, and Fig. 38–15). This is a device that offers a fixed resistance, resistance being defined as change in pressure per unit of flow. The resistance is approximately 10 cm  $\text{H}_2\text{O}/\text{L}/\text{min}$  over a wide range of gas flows. The back pressure created by gas flowing through the fixed restrictor is therefore proportional to the main gas flow (as set on the machine flowmeters) and changes according to Poiseuille's law (see Gas Flow Control Systems [Knobs, Needle Valves, Rotameters, Etc.] above). By sensing this back pressure (via a pressure transducer) and ensuring that the pressure of the desflurane vapor entering the variable restrictor is always made equal to this pressure (via the control electronics and variable pressure control valve), the variable restrictor provides a means to control



- |                                    |                                  |
|------------------------------------|----------------------------------|
| 1 Dial and rotary valve            | 14 Battery                       |
| 2 Fixed restrictor                 | 15 Power supply                  |
| 3 Pressure control transducer      | 16 Control electronics PCB       |
| 4 Pressure monitor transducer      | 17 Heater electronics PCB        |
| 5 Heater in vapor control manifold | 18 Alarm electronics PCB         |
| 6 Vapor control manifold assembly  | 19 LCD agent level display       |
| 7 Pressure regulating valve        | 20 Alarm battery low amber light |
| 8 Shut-off valve                   | 21 Warm-up amber light           |
| 9 Sump assembly                    | 22 Low agent amber light         |
| 10 Agent                           | 23 No output red light           |
| 11 Volume sensor                   | 24 Operational green light       |
| 12 Sump heaters                    | 25 Tilt switch                   |
| 13 Mains lead                      | 26 Solenoid in interlock block   |
|                                    | 27 Heater in valve plate         |

Key

- |  |                        |
|--|------------------------|
|  | Fresh gas              |
|  | Agent vapor            |
|  | Gas/agent vapor        |
|  | Electrical connections |

**FIGURE 38-14.** Schematic of the Tec 6 vaporizer for desflurane. **1**, Dial and rotary valve; **2**, fixed restrictor; **3**, pressure control transducer; **4**, pressure monitor transducer; **5**, heater in vapor control manifold; **6**, vapor control manifold assembly; **7**, pressure regulating valve; **8**, shut-off valve; **9**, sump assembly; **10**, agent; **11**, volume sensor; **12**, sump heaters; **13**, mains lead; **14**, battery; **15**, power supply; **16**, control electronics; **17**, heater electronics PCB; **18**, alarm electronics PCB; **19**, agent level liquid crystal display; **20**, alarm battery low amber light; **21**, warm-up amber light; **22**, low agent amber light; **23**, no output red light; **24**, operation green light; **25**, tilt switch; **26**, solenoid in interlock block; **27**, heater in valve plate. For details of operation see text.

the concentration of desflurane (Fig. 38-15).

Thus,

$$\text{Resistance} = \frac{\Delta \text{ Pressure}}{\Delta \text{ Flow}} \tag{38-1}$$

For the main gas flow of oxygen entering the fixed restrictor,

$$\text{Resistance (main)} = \frac{\text{Pressure(main)}}{\text{Flow(main)}} \tag{38-2}$$

or

$$\text{Flow (main)} = \frac{\text{Pressure(main)}}{\text{Resistance(main)}} \tag{38-3}$$

But Resistance(main) is a constant, K (10 cm H<sub>2</sub>O/L/min), so Flow(main) is proportional to Pressure(main).

For the desflurane flow entering the concentration dial variable restrictor,

$$\text{Flow(des)} = \frac{\text{Pressure(des)}}{\text{Resistance(main)}}$$

$$\text{Concentrations(des)} = \frac{\text{Flow(des)}}{\text{Flow(main)} + \text{Flow(des)}} \tag{38-4}$$

If Flow(des) is small compared to Flow(main), we can ignore Flow(des) in the denominator of equation 38-4, thus:

$$\begin{aligned} \text{Concentrations(des)} &= \frac{\text{Flow(des)}}{\text{Flow(main)}} = \\ & \frac{\text{Pressure(des)} \times K}{\text{Pressure(main)} \times \text{Resistance(des)}} \end{aligned} \tag{38-5}$$

The pressure transducer, control electronics and variable pressure control valve ensure that Pressure(des) = Pressure(main), therefore:

$$\begin{aligned} \text{Concentration(des)} &= \frac{\text{Flow(des)}}{\text{Flow(main)}} \\ \text{which is approximately equal to:} & \\ & \frac{1}{\text{Resistance(des)}} \end{aligned} \tag{38-6}$$

Thus it becomes apparent that the variable restrictor in the concentration

dial [i.e., Resistance(des)], can be calibrated in terms of desflurane concentration. The calibration of the variable restrictor is not linear, however, and equation 38-6 above is an approximation because the value of Flow(des) in the denominator of equation 1 cannot always be ignored.

Some examples of vaporizer concentration dial and gas flow settings will illustrate the application of these principles.

**Example 1** Consider a Tec 6 vaporizer set to deliver 10% desflurane at a fresh gas flow of O<sub>2</sub> of 5 L/min (Fig. 38-16).

$$\begin{aligned} \text{Concentrations(des)} &= \\ & \frac{\text{Flow(des)}}{\text{Flow(main)} + \text{Flow(des)}} \\ 10\% = 0.10 &= \frac{\text{Flow(des)}}{5000 + \text{Flow(des)}} \end{aligned} \tag{38-7}$$

Thus,

$$\begin{aligned} 0.10 \times (5000 + \text{Flow(des)}) &= \text{Flow(des)} \\ 0.9 \times \text{Flow(des)} &= 500 \text{ mL} \\ \text{Flow(des)} &= \frac{500}{0.9} = 556 \text{ mL/min} \end{aligned} \tag{38-8}$$

Consequently, at a 5 L/min flow of O<sub>2</sub> and set to deliver 10% desflurane, the Tec 6 is adding 556 mL/min of desflurane vapor to the main gas flow, that is,

$$\frac{556}{5000 + 556} = \frac{556}{5556} = 0.10 = 10\% \tag{38-9}$$

Once the main flow (in this case 5 L/min O<sub>2</sub>) and the desflurane flow (calculated as above) are known, the ratio of resistances of the variable restrictor (Resistance(des), in the concentration dial) to the fixed restrictor (Resistance(main), in the main gas flow) may be calculated:

$$\begin{aligned} \text{Resistance(des)} &= \frac{\text{Pressure(des)}}{\text{Flow(des)}} \\ \text{Resistance(main)} &= \frac{\text{Pressure(main)}}{\text{Flow(main)}} \end{aligned} \tag{38-10}$$

But, Pressure(des) = Pressure(main), therefore,

$$\begin{aligned} \frac{\text{Flow(main)}}{\text{Flow(des)}} &= \frac{\text{Resistance(des)}}{\text{Resistance(main)}} = \\ \frac{5000}{556} &= 9:1 \end{aligned} \tag{38-11}$$

Resistance(des) may also be calculated as follows:

$$\begin{aligned} \text{Pressure(des)} &= \text{Pressure(main)}, \\ \text{which is } 50 \text{ cm H}_2\text{O} & \text{ (because main gas flow is 5 L/min)} \\ \text{Flow(des)} &= 556 \text{ mL/min} \\ \text{Resistance(des)} &= \frac{\text{Pressure(des)}}{\text{Flow(des)}} = \\ \frac{50}{0.556} &= 90 \text{ cm H}_2\text{O/L/min} \end{aligned} \tag{38-12}$$

**Example 2** Increase fresh gas flow to 10 L/min. Increasing Flow(main) from 5 L/min to 10 L/min causes a temporary imbalance of pressures

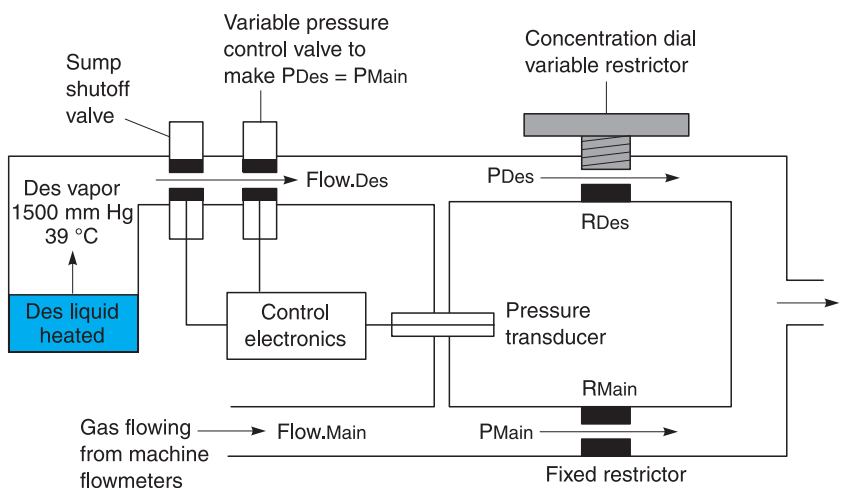


FIGURE 38-15. Tec 6 vaporizer simplified to illustrate principles. See text for details.



**FIGURE 38-16.** A. Tec 6 vaporizer (Datex-Ohmeda) for desflurane. B. Close-up to show status warning lights and LCD indicating agent level.

across the differential pressure transducer because Pressure(main) increases from 50 cm H<sub>2</sub>O to 100 cm H<sub>2</sub>O (Fig. 38-15). (Remember that Resistance(main) is 10 cm H<sub>2</sub>O/L/min.) The imbalance is sensed by the differential pressure transducer and the control electronics cause the variable pressure control valve to open wider (i.e., decrease its resistance to desflurane vapor flowing from the sump at a pressure of 1500 mm Hg) so that the pressure of desflurane vapor into the concentration dial variable restrictor increases until Pressure(des) is also 100 cm H<sub>2</sub>O. The increase in Flow(des) and, thereby, Pressure(des) ensures that the Tec 6 continues to deliver the 10% concentration as set on the dial.

**Example 3** Increase concentration dial setting from 10% to 15% while maintaining gas flow of 10 L/min. Increasing the concentration dial setting to 15% causes a decrease in Resistance(des). The resulting decrease in Pressure(des) relative to Pressure(main) is sensed by the differential pressure transducer and the control electronics cause the variable pressure control valve to open wider (i.e., decrease its resistance to desflurane vapor flowing from the sump) so that Pressure(des) is increased to once again be equal to Pressure(main). The resulting increase

in Flow(des) ensures that the vapor concentration increases to the desired greater concentration.

**Example 4** Decrease concentration dial setting from 15% to 5% at 10 L/min gas flow. Changing the concentration dial setting from 15% to 5% creates an increase in Resistance(des), which causes an increase in Pressure(des). The latter is sensed by the differential pressure transducer because Pressure(des) is now greater than Pressure(main) and the control electronics cause the variable pressure control valve to decrease its opening (i.e., increase its resistance to desflurane vapor flowing from the sump), thereby decreasing Flow(des) until Pressure(des) once again equals Pressure(main).

### Special Considerations

**Design Features of the Tec 6 (Figs. 38-14 and 38-16)** The sump, when full, contains 450 mL desflurane. Because the sump is pressurized to 1500 mm Hg, the agent level is sensed electronically and shown on a liquid crystal display (LCD), rather than the sight-glass used in variable-bypass vaporizers. When the vaporizer is energized by connecting the power cord to an electrical outlet, a heater in the sump heats the agent to 39°C and maintains that

temperature via thermostatic controls. While the agent is being heated, the sump shut-off valve is held closed, keeping the agent in the sump. During the warmup period, the vaporizer is not operational because the sump shut-off valve remains closed, and a solenoid-locking device prevents the concentration dial from being turned on. Once operational (i.e., at 39°C), the dial lock is released and when the dial is turned on, the sump shut-off valve is opened, permitting desflurane vapor to flow to the pressure regulating valve.<sup>24,25</sup>

To prevent condensation (“rain out”) of desflurane vapor, in addition to the heater in the sump, there are heaters in the rotary valve and in the vicinity of the pressure transducers that sense the back pressures caused by the main gas flow and by desflurane.

The Tec 6 thus differs considerably from variable-bypass vaporizers. None of the fresh gas flow enters the vaporizing chamber. The Tec 6 requires electrical power and incorporates sophisticated electronics to ensure normal operation and a display panel to inform the user about its operational status. It also has alarms to alert to any malfunction, in the event of which the sump shut-off valve closes (Fig. 38-16).

**Filling System** Because of its high saturated vapor pressure, desflurane is supplied in plastic-coated glass bottles



to which an agent-specific filling device is firmly attached. The vaporizer incorporates an agent-specific filling system that permits filling of the sump at any time, including when the vaporizer is in use. This may be important because of desflurane's low blood-to-gas partition coefficient.

During filling the bottle is locked to the vaporizer-filling system and the high pressure of vapor in the sump at 39°C is transmitted to the interior of the bottle, which helps to drive liquid desflurane from the bottle into the sump. When filling is complete, the bottle is disconnected from the vaporizer fill system and the valve on the bottle closes to avoid loss or spillage of agent. At this time the bottle contains vapor at 39°C and a pressure of 1500 mm Hg. As the bottle and its contents cool to room temperature, the pressure in the bottle decreases toward atmospheric (760 mm Hg at 22.8°).

Effect of fresh gas composition on performance. The Tec 6 is calibrated at the factory using 100% O<sub>2</sub>. Performance accuracy at 5 L/min oxygen is specified as ± 0.5% of delivered agent or ± 15% of dial setting, whichever is greater.<sup>24</sup>

Using Poiseuille's law, laminar flow through a resistor is determined as:

$$\text{Flow} = \frac{\pi \times P \times r^4}{8 \times \eta \times L}$$

where  $\pi = 3.142$ ,  $P$  is the pressure difference,  $r$  is the radius,  $\eta$  is the viscosity of the gas, and  $L$  is length

Thus,

$$\text{Flow} = \frac{P}{\eta}$$

or

$$P \approx \text{Flow} \times \eta$$

The Tec 6 design uses back pressure from gas flow through the fixed restrictor to infer flow (Fig. 38-15). If the viscosity of the gas flowing through the fixed restrictor were to decrease, then the same flow would result in a lower back pressure. This back pressure is used to determine the pressure of desflurane into the variable restrictor in the concentration dial. A lower pressure results in a lower flow of desflurane vapor through the variable restrictor.

Of the gases on the anesthesia machine, O<sub>2</sub> is the most viscous and N<sub>2</sub>O

the least viscous. Thus, changing the main gas flow composition from O<sub>2</sub> to O<sub>2</sub>/N<sub>2</sub>O decreases gas viscosity and the output concentration of desflurane from that setting on the dial. Differences between the actual concentration produced and the dial setting are greatest (up to 20% of dial setting) with high concentrations of N<sub>2</sub>O at low gas flow rates. The clinical implications of this are minimal, however, because the anesthetic effect lost by the decrease in desflurane is offset by the effect of the N<sub>2</sub>O.<sup>24</sup>

### Effects of Altitude on Output

The Tec 6 accurately delivers the dialed-in concentration of desflurane in terms of volumes percent, even at altitudes different than sea level. At sea level, 7% desflurane (1 MAC) creates a P<sub>des</sub> of (7% × 760 mm Hg) = 53 mm Hg (the P<sub>MAC1</sub>; Table 38-2). At altitude, if the ambient pressure were 500 mm Hg, the same 7% desflurane creates a P<sub>des</sub> of only 35 mm Hg (7% × 500), which is only 0.66 of the P<sub>MAC1</sub>. To compensate for this decrease in potency output at increased altitude, a higher concentration must be set on the dial. Conversely, at higher ambient pressures, a lower concentration dial setting would be indicated. Recommendations as to how the dial setting should be changed at altitude are provided in the operator's manual.<sup>24</sup>

**Interlock System** Although the Tec 6 is manufactured by Datex-Ohmeda and is mountable on their patented Select-a-Tec manifold on a Datex-Ohmeda anesthesia machine, a version is also available for mounting on Dräger Narkomed anesthesia workstations. Recently, Dräger introduced the D-Vapor desflurane vaporizer to its Vapor 2000 series (Fig. 38-17). The operating principles are the same as in the Datex-Ohmeda Tec 6 but it weighs significantly less. Similar to other vaporizers in their Vapor 2000 series, the D-Vapor is hermetically sealed when removed from an anesthesia system, allowing transport in any position, even when filled. The 300-mL reservoir capacity of the tank can hold the entire contents of a standard anesthetic agent bottle. Like the Tec 6, the D-Vapor is electrically powered, but it also features 5 minutes of emergency battery operation which ensures that dose settings remain constant even during a brief power failure. Penlon (UK) has also exhibited a desflurane vaporizer addition to their Sigma series of vaporizers, but at the time of writing it is not being marketed in the United States.

### Aladin Vaporizing System

Advances in technology and computerization of the workstation have led to the development of a new design of



**FIGURE 38-17.** Left: Dräger D-Vapor desflurane vaporizer. Right: Dräger Vapor 2000 sevoflurane vaporizer. Note the T position (for Transport mode) on the concentration dial.

variable-bypass, electrically powered Aladin vaporizing system that is used in the Datex-Ohmeda S5 /ADU and Aisys workstations. The principles of operation differ from those of earlier variable-bypass vaporizers and from the Tec 6 design of vaporizers discussed above.

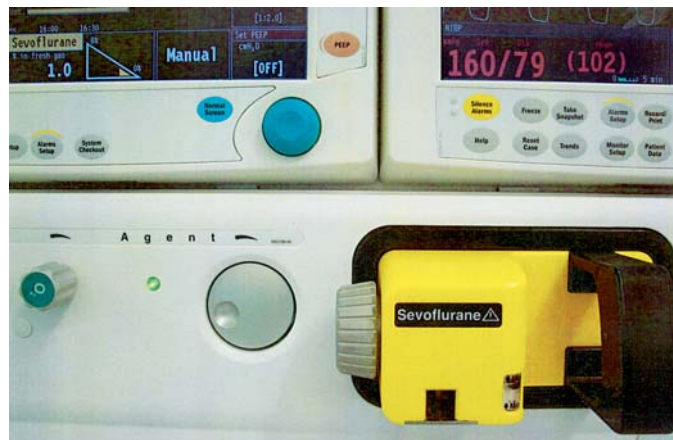
The Aladin vaporizer consists of two separate parts that must be joined to produce a functioning vaporizer. One is a sump, the detachable agent-specific Aladin cassette, that can hold up to 250 mL of liquid agent. Each anesthetic agent, including desflurane, has its own cassette made unique by means of an agent-specific fill system (e.g., Saf-T-Fil for desflurane; key fill or Quick-Fill for other agents). Thus five different cassettes are available, one for each of the presently available potent inhaled agents. The second part of the vaporizer is a component of the ADU or Aisys workstation and contains the concentration-control hardware and software. The agent-specific cassette identifies itself to the second part of the vaporizer by the arrangements of signature magnets at the top of the cassette. The ADU and Aisys workstations monitor and control gas and vapor at several points. They monitor and control flow through the  $N_2O$ ,  $O_2$  and air flowmeters and will not permit the delivered oxygen concentration to fall below 25% at the workstation's common gas outlet. Gas flow from these sources is delivered to, or bypasses, the anesthetic in the sump. The flow of agent at its saturated vapor concentration issuing from the sump, and the bypass flows are monitored and adjusted by hardware, as governed by software algorithms to produce the dialed-in concentration of anesthetic. The algorithms take into account the anesthetic agent, temperatures and gas pressures in the sump and by pass (each separately measured).

The agent wheel (an electronic control) on the front panel of the ADU or Aisys workstation is used to set the desired concentration of agent to be delivered to the breathing system (Fig. 38-18). A green light-emitting diode (LED) indicates that the vaporizer is on (Fig. 38-19). The vaporizer is controlled via a central processing unit (CPU). See Figure 38-20 for principles of operation.<sup>26</sup> The flow restrictor in the bypass causes fresh gas from the gas flow controls to be split into a bypass flow and a flow, that passes

through a unidirectional valve (which prevents backflow) to the Aladin cassette. The latter is an agent-specific cartridge that contains liquid anesthetic at its saturated vapor concentration at the ambient temperature (e.g.,  $[160/760] \times 100\% = 21$  vols% for sevoflurane at  $20^\circ C$ ). Continuous monitoring of temperature and pressure in the cassette means that the agent vapor concentration there is always known. The concentration of anesthetic vapor delivered to the common gas outlet of the machine is determined by the con-

centration of agent vapor in the cassette, and the ratio of cassette outflow to the bypass flow, both of which are measured continuously. The delivered concentration is controlled by the position of the agent proportional valve, which is set continuously according to information from the agent controller (CPU).

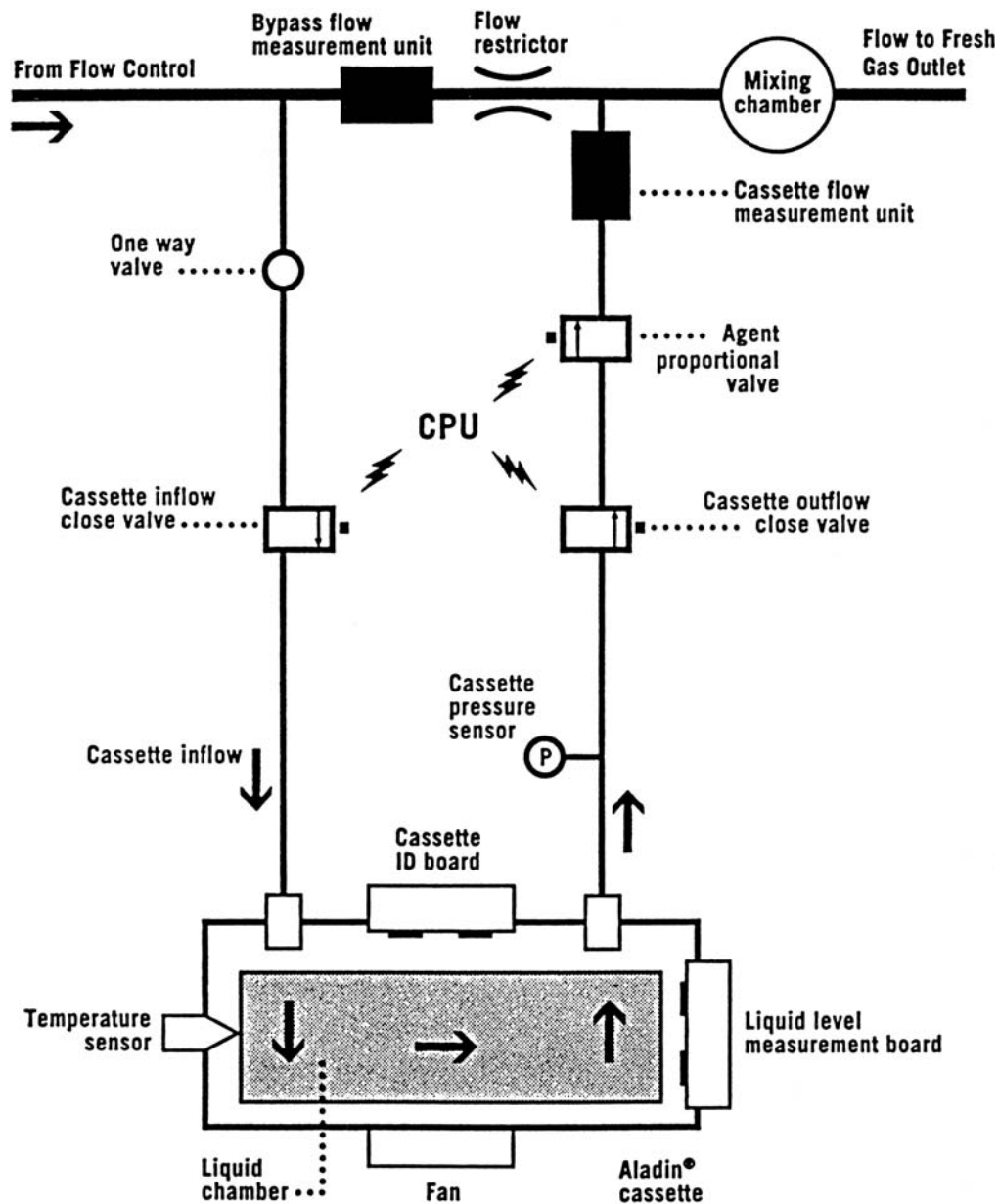
Each Aladin cassette is essentially a flow-over vaporizer because it contains liquid agent that is vaporized as fresh gas flows between the agent-soaked wicks and baffles. It is equiva-



**FIGURE 38-18.** Aladin vaporizing system shown here on a Datex-Ohmeda ADU workstation. The cassette is agent-specific (in this case sevoflurane). The dial to the left of the cassette is the concentration control. The (green) pilot light to the left of the dial indicates that the vaporizer is on. The dialed-in agent concentration is shown at the bottom of the left-hand screen.



**FIGURE 38-19.** Enlarged view of concentration dial and agent display box on screen. Although this is an electronically controlled vaporizing system, agent concentration is *increased* by turning the dial in a *counterclockwise* direction, analogous to the dial on a traditional variable-bypass vaporizer (e.g. Tec 7, Dräger Vapor 2000.)



**FIGURE 38-20.** Schematic showing principles of operation of the Aladin vaporizing system used on the Datex-Ohmeda ADU and Aisys workstations.

lent to the sump of a traditional variable-bypass vaporizer but because it does not incorporate bypass flow channels, tilting the cassette during handling, changing, or filling is not hazardous (Figs. 38-21A,B).

The Aladin cassette for desflurane incorporates an electronic liquid level measuring device so that if <10% liquid desflurane (<25 mL) remains, an alarm message is displayed. If the temperature is <22.8°C (boiling point of desflurane) fresh gas must enter the cassette for vapor to be delivered via the exit connection. If the temperature is >22.8°C, no fresh gas inflow is needed and the desflurane vapor is released by controlling the outflow valve. A fan is mounted inside the fresh gas control

unit beneath the Aladin cassette housing and is required to heat the cassette when large amounts of agent are being vaporized. The fan operates when the cassette temperature is <17°C and stops when it is >20°C.

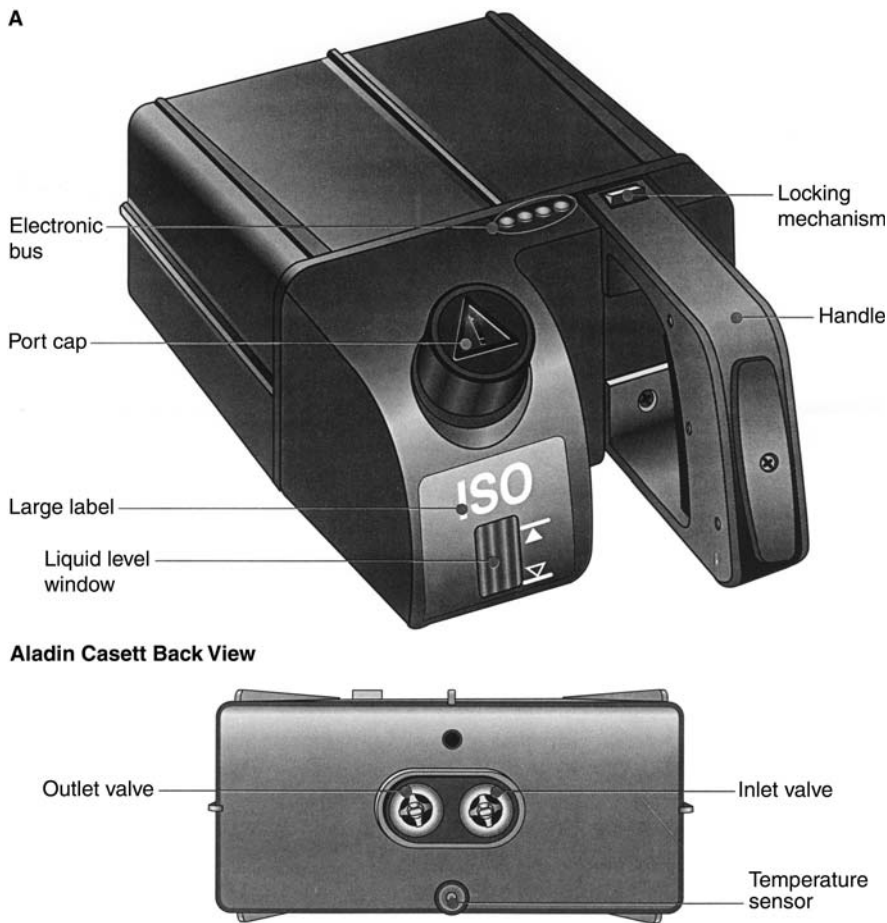
The Aladin vaporizing system offers certain advantages, the greatest of which is that the CPU can control the concentration of any of the commonly used potent inhaled anesthetic agents. Separate vaporizers (or at least their flow-splitting mechanisms) are not required for each agent. An obvious disadvantage is that in the event of a prolonged power loss (i.e., after the backup battery has been depleted) delivery of the volatile agent will cease. In contrast, conventional mechanical

Tec-type vaporizers will function as long as there is a source of compressed gas to the machine. An Aisys workstation with the Aladin system is shown in Figure 38-22.

## COMMON GAS OUTLET AND OUTLET CHECK VALVES

The fresh gas mixture produced by the settings of the flow controls for O<sub>2</sub>, N<sub>2</sub>O, and other gases, and vapor from one concentration-calibrated vaporizer exit the anesthesia machine via the common gas outlet. Situated between the vaporizer and the common gas outlet, Datex-Ohmeda Modulus I and Modulus II machines have an outlet check valve,





**FIGURE 38-21A.** A. Aladin cartridge specific for isoflurane. The electronic bus (electrical contacts) allows the agent fill status to be monitored by the CPU. (continued)

and a pressure relief valve that opens at a pressure of 120–150 mm Hg (2.3–2.9 psig) (Fig. 38-2). The pressure-relief valve, as its name suggests, prevents the buildup of excessive pressures upstream of the outlet check valve. These components are located upstream from where the O<sub>2</sub> flush flow would join to pass to the common gas outlet. The Datex-Ohmeda Excel and Aestiva machines have an outlet check valve and a pressure relief valve (opening pressure threshold: 5 psig) that is located downstream of the outlet check valve.

The purpose of the outlet check valve, where present (Datex-Ohmeda Modulus I, Modulus II, Excel and Aestiva but not Modulus II Plus or Modulus CD machines), is to prevent reverse gas flow, which would permit gas to go back into the variable-bypass (Tec-type) vaporizer if the latter did not have its own outlet check valve or specialized design. This “pumping” effect, if not prevented, could cause increased vaporizer output concentrations.<sup>27</sup>

Dräger Narkomed models 2, 3, and 4 are designed so as not to require an outlet check valve. Any pumping effect is eliminated by special design of the Vapor vaporizer (Fig. 38-10, component 4). The Datex-Ohmeda Modulus II Plus and Modulus CD machines are equipped with Datex-Ohmeda Tec 4 or Tec 5 vaporizers, which incorporate a baffle system and specially designed manifold to prevent the pumping effect, making an outlet check valve unnecessary on these machines. Nevertheless, the Datex-Ohmeda Modulus II Plus and Modulus CD machines do have a pressure-relief valve (Fig. 38-2). Dräger Narkomed 2, Narkomed 3, and Narkomed 4 machines do not require a separate pressure-relief valve.<sup>9</sup> In these machines, pressure-relief opening (threshold approximately 18 psig), if required, takes place through the specially designed Dräger Vapor vaporizers. The presence or absence of an outlet check valve and pressure-relief valve is important when considering

how to test the low-pressure system of the anesthesia machine for leaks.

The workstation standard requires that when the common gas outlet is connected to the breathing system by a fresh gas supply hose (the usual arrangement in most workstations), the common gas outlet should be provided with a manufacturer-specific retaining device. It may have a 15-mm female fitting or a 15/22-mm coaxial fitting. Machines should have only one common gas outlet. The retaining device's purpose is to help prevent disconnection or misconnections between the machine common gas outlet and the patient circuit, which could result in patient injury. Dräger Narkomed machines have a bar-type retaining device, whereas Datex-Ohmeda machines use a spring-loaded, bayonet-fitting retaining device.

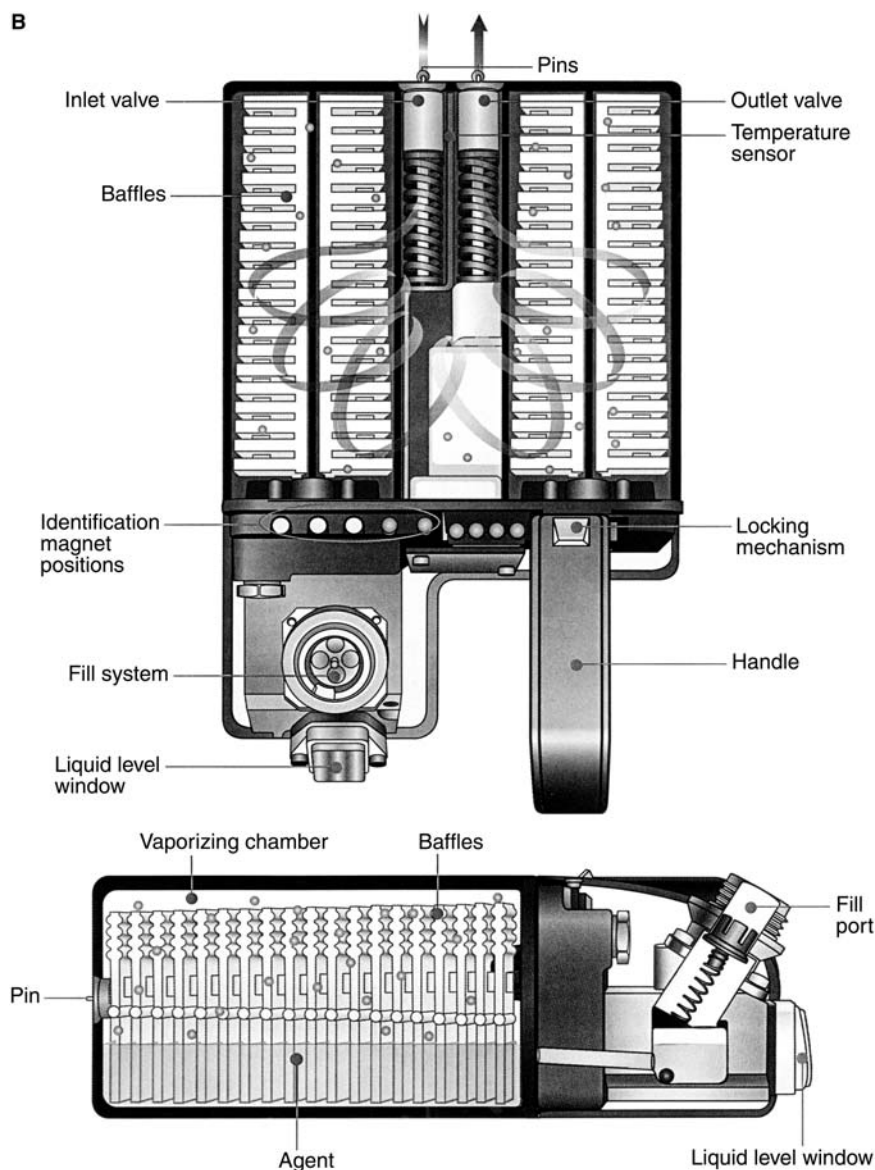
Datex-Ohmeda Aestiva and Aespire machines do not have a visible CGO and hose connection between machine and circle system. There is, however, an auxiliary CGO that can be accessed if other than a circle system is used (e.g., Bain), or to leak check the low-pressure system of the machine (see Anesthesia Machine Check-out; Testing for Leaks in the Anesthesia Machine and Breathing System).

## ANESTHESIA BREATHING SYSTEMS

The anesthesia breathing system or circuit represents a mini-environment for respiratory gas exchange. The fresh gas flow from the anesthesia machine delivers known volumes and concentrations of O<sub>2</sub>, N<sub>2</sub>O (and possibly air or helium), and potent inhaled anesthetic to the circuit, and gases are vented from the circuit to the scavenging system. In some arrangements, high fresh gas flows are used, in which case the patient's inspired gas concentrations approximate those in the fresh gas supply. Other circuits, such as the adult circle system, use lower fresh gas flows and rely on an absorption system for CO<sub>2</sub>. In the circle breathing system, when low fresh gas flows are used, the composition of the inspired gas may be quite different from that of the fresh gas inflow.

All adult anesthesia circuits are composed of corrugated 22-mm-diameter tubing, a reservoir bag, and connecting piece or elbow to the patient's airway. They may or may not also





**FIGURE 38-21B.** (Continued) **B.** Schematic cross-section of Aladin cartridge showing that it is the same as the agent specific sump of a standard variable-bypass vaporizer, with wicks and baffles to increase the surface area for evaporation of the anesthetic agent. (Courtesy of Datex-Ohmeda, a Division of GE Health Care, Madison, WI.)

include a valve or valves. How these items are arranged gives the resulting circuit its functional characteristics. Breathing systems are generally classified as rebreathing, having no  $\text{CO}_2$  absorption system (i.e., Mapleson classification circuits A to F), or nonrebreathing, having a  $\text{CO}_2$  absorber (e.g., circle system).

### Rebreathing Systems

Figure 38-23 illustrates the circuits assigned letters according to the Mapleson classification.<sup>28</sup> In circuits A, B, and C, the APL (pop-off) valve is located close to the patient, whereas circuits D,

E, and F are T-piece arrangements with gas leaving the circuit at a distance from the patient. Because there is no  $\text{CO}_2$  absorber in any of these systems, the potential exists for the patient to inhale alveolar gas that has been previously exhaled and contains  $\text{CO}_2$ . The extent of rebreathing depends on the circuit anatomy, the patient's minute ventilation, pattern of ventilation, fresh gas flow rate, and whether ventilation is spontaneous or controlled.<sup>29,30</sup>

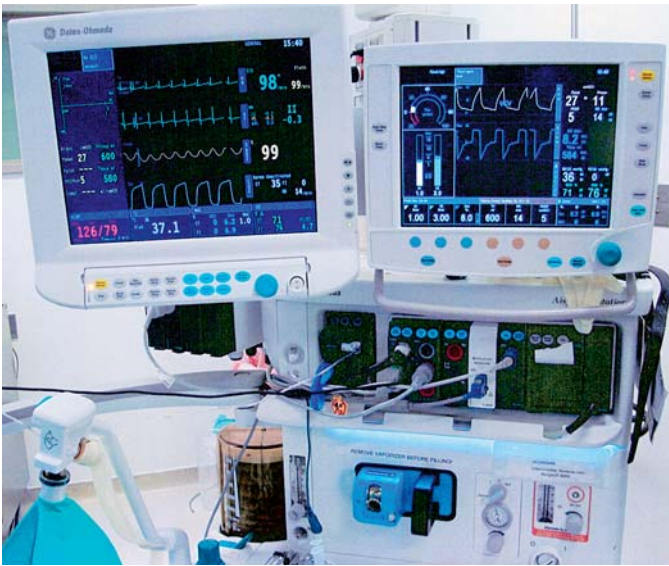
#### Mapleson A: Magill Attachment

The Magill attachment (circuit A) is illustrated in Fig. 38-23. Fresh gas from

the anesthesia machine enters at the end of the system farthest from the patient and closest to the reservoir bag and leaves via a spring-loaded adjustable pop-off valve located close to the patient. The system functions very differently during spontaneous than during controlled ventilation. During spontaneous ventilation, as the patient begins to exhale, dead space gas enters the tubing and passes toward the reservoir bag. Meanwhile, fresh gas entering the system from the machine is stored in the reservoir bag. As exhalation continues, pressure increases in the system, and the pop-off valve opens to preferentially vent alveolar gas. If the fresh gas flow rate is high, dead space gas stored in the tubing may also be vented via the pop-off valve. During the next spontaneous inspiration the patient breathes in any dead space gas stored in the tubing, followed by fresh gas from the anesthesia machine and that stored in the reservoir bag. Mapleson<sup>28</sup> calculated and others<sup>32</sup> confirmed that during spontaneous ventilation, a fresh gas flow rate equivalent to alveolar ventilation (i.e., approximately 70% of minute ventilation) will prevent rebreathing. However, as the fresh gas flow rate approaches alveolar ventilation, the system's vulnerability to producing rebreathing, as a result of an uneven ventilatory pattern, is increased.

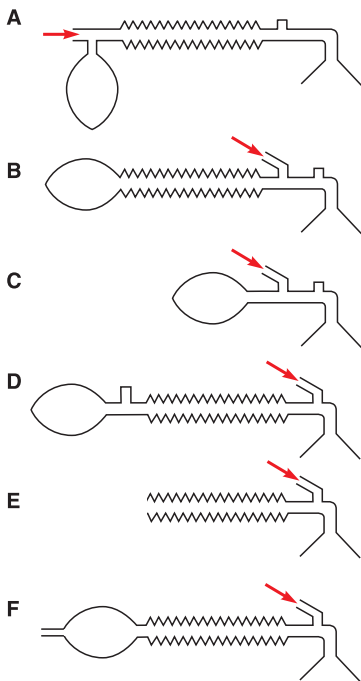
When used during controlled ventilation, the Magill attachment becomes very inefficient in terms of fresh gas requirements. During controlled inspiration, when the bag is squeezed, the pop-off valve opens, causing release of fresh gas.<sup>29</sup> Previously exhaled alveolar gas is not vented efficiently and is rebreathed. With controlled ventilation the most efficient removal of  $\text{CO}_2$  occurs with a short inspiratory-to-expiratory (I:E) ratio, a large tidal volume, and a high fresh gas flow.<sup>28,31</sup> Consequently, fresh gas flow rates of 3 times the estimated minute ventilation are recommended during controlled ventilation with the Magill attachment.<sup>32</sup> Such high flows are wasteful of anesthetic gases and pose additional problems for waste gas scavenging.

Enthusiasm for the Magill attachment resulted in potential modifications to address these problems. Thus, during controlled ventilation, the fresh gas requirement can be reduced by keeping the pop-off valve closed during inspiration. This is achieved by the



**FIGURE 38-22.** The Aladin vaporizing system is also used in the Datex-Ohmeda Aisys workstation. Note the agent-specific desflurane cassette. In this workstation, agent concentration is adjusted using the com wheel that is just below the lower right corner of the screen on the right hand side. In this workstation, agent concentration is *increased* by turning the com wheel in a *clockwise* direction.

Enclosed Magill System or the Miller modification (Fig. 38-24).<sup>33</sup> A system somewhat analogous to that used in contemporary double-circuit anesthesia ventilators (see Anesthesia Ventilators). This modified system is reported to be as efficient during controlled ventilation as the Magill attachment is during spontaneous ventilation.<sup>33,34</sup>



**FIGURE 38-23.** Mapleson classification of re-breathing systems (see text for details on A to F circuits). The Mapleson A circuit is also known as the Magill attachment.

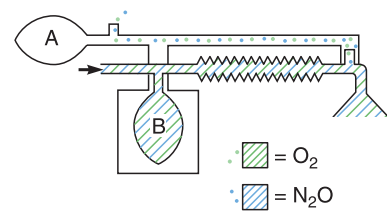
As noted, because the pop-off valve in the Magill attachment is close to the patient, waste gas scavenging is a potential problem. This is addressed in the coaxial Mapleson A or Lack Breathing System (Fig. 38-25), which is functionally similar to the Mapleson A.<sup>35</sup>

### Mapleson B and C Systems

In the Mapleson B and C systems (Fig. 38-23B and C) the site of fresh gas inflow and the pop-off valve are near the patient, whereas the circuit tubing and reservoir bag form a cul-de-sac in which a mixture of dead space, alveolar, and fresh gas may collect. The Mapleson C system, with a shorter length of tubing between patient and bag, is also known as the Waters to-and-fro system without absorber. These systems function similarly during both spontaneous and controlled ventilation. Rebreathing is prevented with fresh gas flows of at least twice the minute ventilation.<sup>28,29</sup> In contemporary anesthesia practice, the Mapleson B and C systems are rarely used.

### Mapleson D System

The Mapleson D system (Fig. 38-23D) is basically a T piece with a long expiratory limb, the end of which has a reservoir bag and a pop-off valve. During spontaneous ventilation it is less efficient than the A system, but more efficient than the B or C systems.<sup>28,29</sup> On spontaneous exhalation,



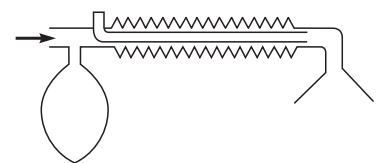
**FIGURE 38-24.** The enclosed Magill system. Squeezing reservoir bag (A) causes the pop-off valve to be held closed and results in compression of enclosed reservoir bag (B).

dead space, alveolar, and fresh gas enter the tubing, and as pressure increases, some of this gas mixture is vented. During the next spontaneous inspiration the patient inhales fresh gas from the anesthesia machine mixed with gas from the tubing, the composition of which depends on fresh gas flow, tidal volume, and duration of the patient's expiratory pause.

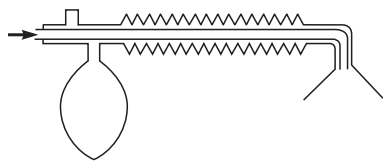
If the latter is long, the tubing is flushed with fresh gas, which is then available to be inhaled on the next inspiration. If the pause is short, less flushing occurs and rebreathing of CO<sub>2</sub> becomes more likely. Large tidal volumes result in more alveolar gas entering the tubing, which also predisposes to rebreathing. Mapleson<sup>28</sup> calculated that a fresh gas flow of at least twice the minute ventilation was required to prevent rebreathing. This has been confirmed by others.<sup>29,31</sup>

When used during controlled ventilation, gas is distributed similarly in the circuit. Thus manual compression of the reservoir bag ensures that alveolar and dead space gas is released via the pop-off valve during inspiration and that fresh gas enters the patient's airway. During exhalation, dead space gas and fresh gas tend to enter the reservoir bag first before the pop-off valve opens to vent the remaining (mainly alveolar) gas. As with spontaneous ventilation, a fresh gas flow of 2 to 3 times the minute ventilation prevents rebreathing.<sup>29,31</sup>

The Mapleson D circuit originally described is rarely used now in the United States. However, a coaxial mod-



**FIGURE 38-25.** Coaxial Mapleson A or Lack Breathing System.



**FIGURE 38–26.** Bain circuit: coaxial Mapleson D.

ification, the Bain circuit, is sometimes used in pediatric anesthesia practice.

### Bain Circuit: Coaxial Mapleson D

This system, introduced by Bain and Spoerel in 1972,<sup>36</sup> is shown in Figure 38–26. Fresh gas from the anesthesia machine enters the inner (smaller-bore) tubing and is delivered to the patient end. Exhaled gas is carried via the outer tubing to the reservoir bag and pop-off valve. Both reusable and disposable versions are available. The outer tubing is now made from transparent material so that the inner tubing can be inspected for kinking or disconnection. Clearly, if disconnection occurred at the machine end, the whole system would become apparatus dead space and result in excessive rebreathing.

The Bain system may be used for spontaneous or assisted ventilation, or the reservoir bag may be removed and an anesthesia ventilator hose attached to the bag mount for mechanical ventilation. Several studies have evaluated the fresh gas flow requirements of the Bain system. Although some have found that during spontaneous ventilation, a fresh gas flow of 100 mL/kg/min produces normocapnia at the cost of increased minute ventilation,<sup>36</sup> another study reported that a fresh gas flow of 2.5–3 times the minute ventilation prevents rebreathing during spontaneous ventilation.<sup>37</sup> The slightly higher fresh gas flow requirement of the Bain circuit compared with the basic Mapleson D system may be caused by turbulence at the patient end of the coaxial system, in turn causing failure to store fresh gas in the outer corrugated tubing. During controlled ventilation, the Bain circuit behaves more as a Mapleson D system, and a fresh gas flow of 70 mL/kg/min results in normocapnia, provided minute ventilation is adequate (120 mL/kg/min). This applies in patients weighing more than 40 kg.<sup>36</sup>

A ventilation nomogram has been produced for the Bain circuit during controlled ventilation (Fig. 38–27).<sup>37</sup> This shows that the alveolar CO<sub>2</sub> tension (and therefore PaCO<sub>2</sub>) can be

estimated from a combination of fresh gas flow and minute ventilation ( $\dot{V}_E$ ). At high fresh gas flow, PaCO<sub>2</sub> becomes independent of fresh gas flow and dependent on minute ventilation. At high minute ventilation, PaCO<sub>2</sub> is independent of minute ventilation and becomes dependent on fresh gas flow.

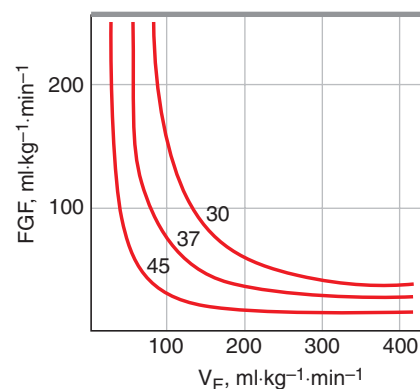
The Bain circuit can thus be used to provide controlled rebreathing with hyperventilation, resulting in normal PaCO<sub>2</sub>. Such predictive nomograms, while useful guides, have become of less importance as monitoring of end-tidal CO<sub>2</sub> by capnometry has become the standard of care. Because the pop-off valve in the Bain circuit is located close to the machine, scavenging from the Bain circuit is not a problem.

A preuse check of the Bain circuit is essential to ensure that the inner gas delivery tube has not become disconnected. If this occurred, it would lead to rebreathing. Two checkout methods have been described. In one (Pethick's method) the patient end of the whole system is occluded, the pop-off valve is closed, and the system is filled with O<sub>2</sub> until the reservoir bag is distended. The patient end is then unoccluded, and O<sub>2</sub> is flushed into the circuit via the inner tube. The high O<sub>2</sub> flow produces a Venturi effect at the patient end of the circuit. The low pressure created at the end of the outer tubing causes O<sub>2</sub> to be drawn along the outer tubing from the bag, causing the reservoir bag to deflate. If a disconnection or a leak occurs in the inner tubing, flushing the circuit with O<sub>2</sub> would allow the high pressure to be transmitted from the inner to the outer tubing, and the reservoir bag would remain inflated or distend further.

A second method (Seed's method) for checking the Bain circuit is to set 50 mL/min of flow on the O<sub>2</sub> flowmeter and then occlude the distal (patient) end of the inner tube using the plunger of a small syringe. If the inner tube is intact, this should cause the gas flow to cease and the flowmeter bobbin to fall. This (Seed's) method is preferred because if the inner tube has been omitted, Pethick's method may give no indication that anything is wrong.

### Mapleson E and F Systems

The Mapleson E and F systems are valveless, T-piece arrangements (Fig. 38–23E and F). The E system is modified from Ayre's original T-piece by the addition of corrugated tubing to



**FIGURE 38–27.** Nomogram for predicting PaCO<sub>2</sub> from given combination of fresh gas flow and minute ventilation for Bain system. Three isopleths indicate PaCO<sub>2</sub> of 30, 37, and 45 mm Hg.

the expiratory limb, which thereby becomes a reservoir of fresh gas during inspiration. During inspiration the patient breathes fresh gas from the machine and gas stored in the expiratory limb. The latter should have a capacity greater than the patient's expected tidal volume, to prevent entrainment of room air during inspiration. During exhalation, exhaled gas enters the expiratory limb; during the expiratory pause, this limb is flushed with fresh gas, which is then available for the next inspiration.

The E system may be used for either spontaneous or controlled ventilation, the latter being achieved by intermittent occlusion of the expiratory limb by a "mechanical thumb" ventilator. With the E system, rebreathing is avoided if a fresh gas flow of 3 times the minute ventilation is used.<sup>29</sup>

The Mapleson F circuit is a modification by Jackson-Rees<sup>38</sup> of the Ayre's T-piece (Mapleson E) system (Fig. 38–23E and F). In this system a two-tailed reservoir bag and a means for venting waste gases are added to the end of the expiratory limb tubing. The venting piece is usually a valve with an adjustable orifice that is connected to a waste gas scavenging system.

The Mapleson F system functions similarly to the Mapleson E, except that during exhalation a mixture of exhaled and fresh gas collects in the bag. On the next inspiration the patient inhales fresh gas from the machine and that stored in the expiratory limb. Addition of the reservoir bag to the E system provides a means to qualitatively monitor ventilation during spontaneous breathing, as well as a



means to control ventilation by manually squeezing the reservoir bag. Prevention of rebreathing is achieved using fresh gas flows of 2–3 times the minute ventilation.<sup>29</sup>

The Ayre's T-piece and Jackson-Rees' systems have been popular for pediatric anesthesia because they are simple to assemble, inexpensive, and, being valveless, offer low resistance to breathing. However, because relatively high fresh gas flows are needed, all T-piece systems are less desirable for use in adults. They also cause greater loss of moisture from the airway if dry gases are used.<sup>29,31</sup>

## Circle System

In this system, the components form a circle into which fresh gas can enter and from which excess gas can leave. Figure 38–28 shows the arrangement of the components of a contemporary circle system. Fresh gas enters just upstream from the inspiratory unidirectional valve and during inspiration passes down the circle's inspiratory limb to the Y-piece connector. During expiration, gas passes along the expiratory limb to the expiratory unidirectional valve. Just beyond the expiratory valve are the adjustable pressure limit (APL or pop-off) valve and a reservoir bag. Gas then passes through a canister containing a CO<sub>2</sub> absorbent (e.g., soda lime) and emerges to rejoin fresh gas entering the circuit from the anesthesia machine just upstream from the inspiratory valve.

In the system described, rebreathing of CO<sub>2</sub> is prevented by its absorption from exhaled gas before it is re-inspired. At high fresh gas flows, however, CO<sub>2</sub> absorption becomes unnecessary, and some older circle systems even permitted bypass of the absorber canister. At lower fresh gas flows, CO<sub>2</sub> absorption is necessary. Eger<sup>39</sup> proposed 3 basic rules for minimizing CO<sub>2</sub> rebreathing in a circle system: (1) a unidirectional valve must be present between the reservoir bag and the patient on both inspiratory and expiratory sides; (2) fresh gas must not enter the system between the expiratory unidirectional valve and the patient; and (3) the overflow (APL) valve must not be placed between the patient and the inspiratory unidirectional valve.

Unidirectional gas flow occurs only in that part of the circle between the unidirectional valves and the patient. In the part of the circuit between the

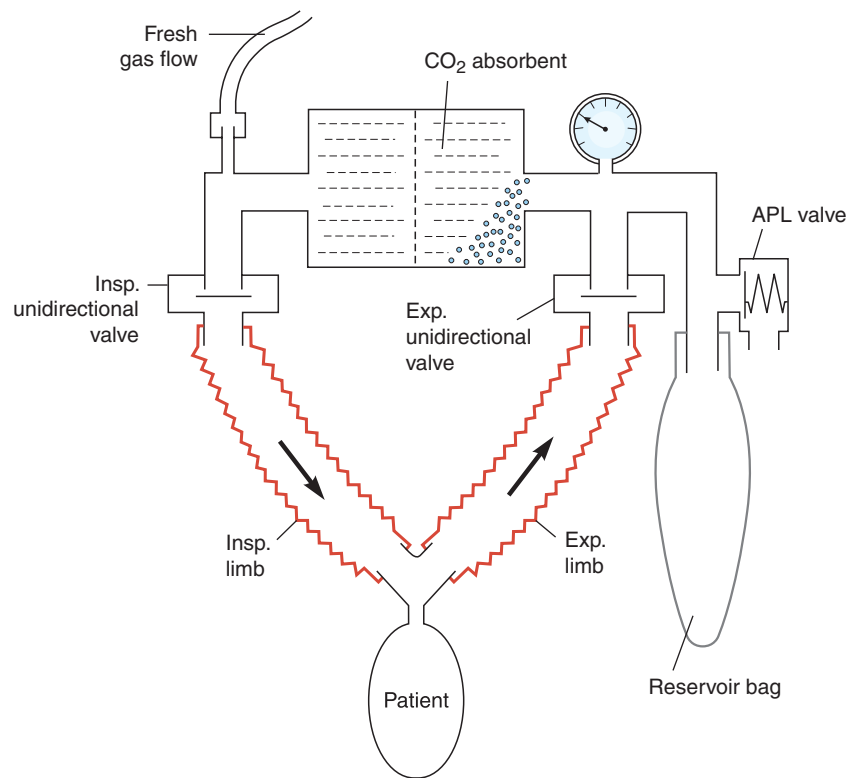


FIGURE 38–28. Contemporary anesthesia circle system arrangement.

fresh gas inlet and the APL valve, gas flow is bidirectional (Fig. 38–28). Incompetence of either unidirectional valve permits bidirectional gas flow in the corrugated patient circuit tubing, leading to rebreathing of previously exhaled CO<sub>2</sub>.

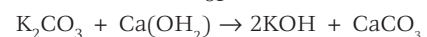
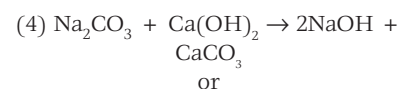
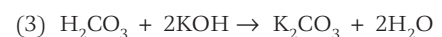
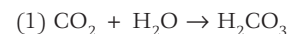
The circle system is currently the most popular anesthesia system in use in the United States. It has the advantages of permitting low fresh gas flows, reduction of operating room pollution, and conservation of heat and humidity. Disadvantages of the circle system include a somewhat complex design with multiple components that could malfunction or possibly be arranged incorrectly. It is also difficult to predict inspired gas composition within the circle, particularly if low fresh gas flows are being used. The latter may cease to be a problem as monitoring of anesthetic gas and vapor concentrations becomes more common.

## Absorption of Carbon Dioxide

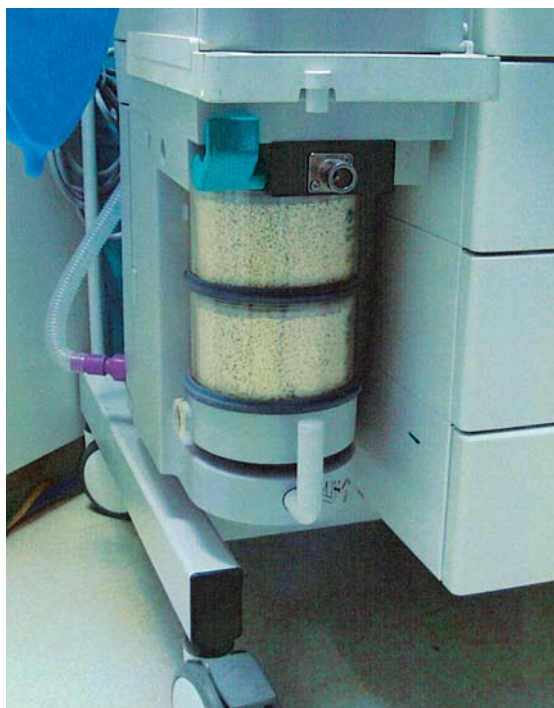
The CO<sub>2</sub> absorber is the central component in a circle system. Traditional absorber canisters are large, with a minimal gas space equal to the largest expected patient tidal volume. This design permits low gas flow rates, long dwell times, and, as a result, more

complete removal (“scrubbing”) of CO<sub>2</sub>. Traditional absorber canisters usually have 2 chambers so that half of the absorbent (that in the upstream chamber) can be completely exhausted before removal. The chambers are then reversed so that the previously downstream chamber now becomes upstream (Fig. 38–29).<sup>40</sup>

The CO<sub>2</sub> absorbent most commonly used is soda lime. The once popular absorbent Baralyme is no longer available. Soda lime consists of 4% NaOH, 1% KOH, 14–19% H<sub>2</sub>O, and the remainder Ca(OH)<sub>2</sub>.<sup>49</sup> In addition, small amounts of silica or kieselguhr are added for hardening, to reduce the formation of dust. The absorptive efficacy of soda lime is inversely related to its hardness. The reaction of CO<sub>2</sub> with soda lime is as follows<sup>40</sup>:







**FIGURE 38–29.** Traditional two-compartment absorber canister as used on a Datex-Ohmeda Aestiva machine.

796

Considerable heat is liberated during the course of this reaction. The preservation of heat and moisture within the system is considered to be a desirable feature.

Absorptive surface area and gas flow through soda lime are a function of granule size. The smaller the size, the larger the area for absorption but the greater the resistance to gas flow. Conversely, large granules decrease absorption surface area, offer less resistance to flow, and may encourage channeling of gases through the soda lime, thereby decreasing CO<sub>2</sub> absorption. The most frequently used size of soda lime granule is 4–8 mesh (i.e., 0.25-inch to 0.125-inch diameter). In theory, 100 g of CO<sub>2</sub> absorbent (soda lime) can absorb 26 L of CO<sub>2</sub>. In practice, the amount of CO<sub>2</sub> actually absorbed is less because of the channeling of gas through the absorber.

Indicators are added to the absorbent granules to show when they are becoming exhausted. These indicators are pH sensitive and are colorless when soda lime is fresh but become colored when pH decreases. The most frequently used indicator is ethyl violet, which changes to purple as absorption proceeds. It was chosen because the color change is conspicuous even under poor lighting conditions.<sup>40</sup>

Ethyl violet may be deactivated by fluorescent lighting and may possibly be temporally deactivated after a container is opened, even with storage in the dark. Such deactivation increases the hazard of using CO<sub>2</sub> absorption, but such a hazard would be offset by continuous capnography.

When using CO<sub>2</sub> absorption, the absorbent must be compatible with the anesthetic gases in use. Sevoflurane is degraded by both soda lime and the now discontinued Baralyme.<sup>41</sup>

Prolonged exposure of desflurane, enflurane, and isoflurane to desiccated CO<sub>2</sub> absorbents may result in anesthetic degradation, leading to the production of CO.<sup>42</sup> Use of dry absorbent produces more CO than standard absorbent with normal amounts of water. For any given water content, the now discontinued Baralyme produced more CO than does soda lime. Increased temperature increases CO production, as does use of higher anesthetic concentrations. Although there were no reports of patient harm resulting from CO found in the breathing system, CO is of concern because there is the potential for injury. To minimize exposure to CO from the degradation of anesthetics in the breathing system, only an absorbent with the full complement of water

should be used. Drying of the absorbent can be minimized by using low fresh gas flow rates. Liquid water may be added to the top of the absorbent; this was found to decrease degradation of the anesthetic.<sup>42</sup>

### New Absorbents and the Problems Associated with Strong Bases

Baralyme was a very popular absorbent and used safely for many years. In late 2004, Allied Health Care, the manufacturer of Baralyme, halted its distribution. This was because desiccated Baralyme acting on sevoflurane can produce great amounts of heat that could result in temperatures in excess of 400 °C, fires, and explosions.<sup>43–45</sup> Animal studies and a bench model have demonstrated fires and explosions with sevoflurane.<sup>43–45</sup> In August 2004, several reports documented fires and explosions in clinical practice with sevoflurane, but none with desflurane or isoflurane.<sup>46–49</sup> In a bench study of the action of desiccated Baralyme on potent inhaled anesthetics at 1.5 MAC, sevoflurane degradation by Baralyme produced temperatures >300 °C, and fires, whereas degradation of desflurane or isoflurane produced temperatures of approximately 100 °C and no fires.<sup>50</sup>

Monovalent bases (potassium hydroxide and sodium hydroxide) in absorbents cause the exothermic degradation of potent inhaled anesthetics to compound A and carbon monoxide. In new absorbents, such as Amsorb, Dräger-sorb, and Dräger-sorb Free,<sup>51,52</sup> the elimination of such bases (but not calcium hydroxide) minimizes compound A or CO production with both moist and desiccated absorbents (Table 38–6).<sup>51–55</sup> Although the new absorbents appear to be safer, compared to soda lime they are more expensive and absorb less CO<sub>2</sub>. It is likely that the withdrawal of Baralyme (with its high content of KOH) from clinical use will minimize or eliminate the problem of fires and explosions. Amsorb has the additional advantage that it turns from white to purple when it becomes desiccated or when its capacity to absorb CO<sub>2</sub> is exhausted. Dräger-sorb Free, which contains no monovalent bases, may not only cause less anesthetic degradation, but also may have a greater absorptive capacity for CO<sub>2</sub>.<sup>53–55</sup>

TABLE 38-6.

Absorbent Comparisons<sup>a</sup>

Company	Product Name	H <sub>2</sub> O%	NaOH%	KOH%	Ca(OH) <sub>2</sub> %	Significant Other	US Availability
Allied Healthcare/Chemetron	Baralyme	11.0–16.0	0.0	<5	73	Ba(OH) <sub>2</sub>	No longer
Allied Healthcare	Carbolime <sup>b</sup>	12.0–19.0	3	0.0	>75	—	Yes
W.R. Grace and Company	Sodasorb	15.0–17.0	3.7	—	50–100	—	Yes
Intersurgical Ltd.	Intersorb Plus	13.5–17.5	2.6	0.0	81	—	Yes
Intersurgical Ltd.	Spherasorb	13.5–17.5	1.3	0.0	78	4% Zeolite	Yes
Intersurgical Ltd.	LoFloSorb	13.5–17.5	0.0	0.0	78	6.5% Silica	Yes
Armstrong Medical Ltd.	Amsorb	13.5–16.5	0.0	0.0	79–82	CaCl <sub>2</sub>	No Longer
Armstrong Medical Ltd.	Amsorb Plus	13.0–18.0	0.0	0.0	>80	CaCl <sub>2</sub>	Yes
Dräger Medical, Inc.	Drägersorb 800	—	~2	~3	—	—	No longer
Dräger Medical, Inc.	Drägersorb 800 Plus	~16	1–3	NA	75–83	—	Yes
Dräger Medical, Inc.	Drägersorb Free	14–18	0.5–2	NA	74–82	CaCl <sub>2</sub>	Yes
Airgas/Molecular Products	Sodalime	—	<3.5	2.6	>80	—	Yes
Molecular Products	Sofnolime	12–19	<3.5	0.0	—	—	No <sup>d</sup>
GE Medical <sup>c</sup> /Molecular Products	Medisorb	—	<3.5	0.0	—	—	Yes

<sup>a</sup>This table was formulated based on information supplied by the various manufacturers. The APSF assumes no responsibility for variations in, or deviations from the formulations that are represented in this table. The table is supplied for educational and conceptual purposes.

<sup>b</sup>Manufactured by Molecular Products.

<sup>c</sup>Distributor of product manufactured by Molecular Products.

<sup>d</sup>Not available in US market as a medical product, although diving and military grades are available in the US. Medical grade is available outside the US.

More than one manufacturer reported variable absorption capacity based on canister design, shape, volume FGF, hydration, and carbon dioxide concentration. Nearly all reported price variability dependent upon marketing and type of fill.

Reproduced with permission from Anesthesia Patient Safety Foundation (APSF) Newsletter, Volume 20, No. 2, Summer 2005.

In April 2005, the Anesthesia Patient Safety Foundation (APSF) convened a conference to discuss the safety of CO<sub>2</sub> absorbents. The stated goal of the conference, was “to develop a consensus statement to share with anesthesia professionals on the use of carbon dioxide absorbents so as to reduce the risk of adverse interactions with volatile anesthetic drugs.” The conclusions of the attendees were as follows.

The APSF recommends use of carbon dioxide absorbents whose composition is such that exposure to volatile anesthetics does not result in significant degradation of the volatile anesthetic.

The APSF further recommends that there should be institutional, hospital, and/or departmental policies regarding steps to prevent desiccation of the carbon dioxide absorbent should they choose conventional carbon dioxide absorbents that may degrade volatile anesthetics when absorbent desiccation occurs.

In such circumstances of using absorbents that may degrade volatile anesthetics, conference attendees generally agreed that users could take the following steps, consistent with Emergency Care Research Institute (ECRI) recommendations:

1. Turn off all gas flow when the machine is not in use.
2. Change the absorbent regularly, on Monday morning for instance.
3. Change absorbent whenever the color change indicates exhaustion.
4. Change all absorbent, not just 1 canister in a 2-canister system.
5. Change absorbent when uncertain of the state of hydration, such as if the fresh gas flow has been left on for an extensive or indeterminate time period.
6. If compact canisters are used, consider changing them more frequently.

There was also support for the APSF to create an “Expert Task Force” to

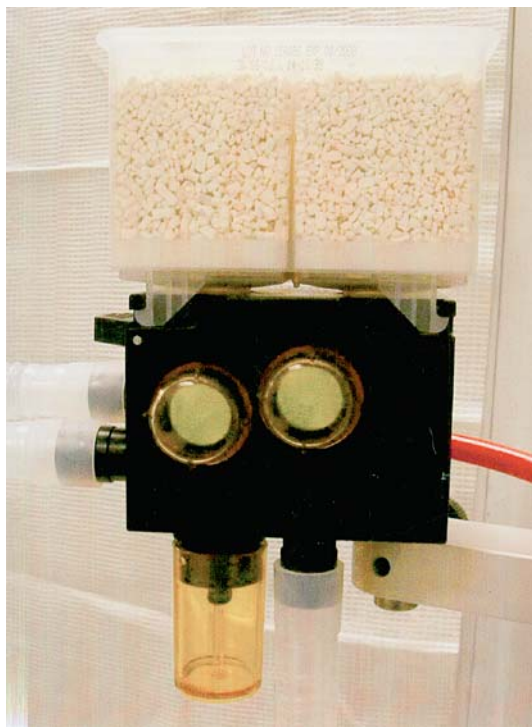
define further the characteristics of carbon dioxide absorbents that do not significantly degrade volatile anesthetics.

### Mini-Absorbers

While traditional circle systems used large absorber canisters, some recent workstations such as the Datex-Ohmeda ADU, Aisys, and Dräger Apollo workstations use smaller volume (600 mL) compact or “mini-absorbers” that contain soda lime or one of the new absorbents shown in Table 38-6. These compact absorber canisters can be replaced without causing a leak in the breathing system because the absorber mount block is self-sealing (Fig. 38-30).

## ANESTHESIA VENTILATORS

Anesthesia ventilators have evolved considerably over the last several years. The traditional anesthesia ventilator is a pneumatically powered, electronically controlled device. The visible bellows acts as a “counterlung” that



**FIGURE 38-30.** Datex-Ohmeda ADU Carestation Compact Block and mini-absorber. In this design of circle breathing system the fresh gas flow from the CGO enters the circuit *downstream* (i.e., on the patient side) of the inspiratory unidirectional valve (rather than upstream as shown in Fig. 38-28). With this design, changes in fresh gas composition are reflected more rapidly at the patient's airway. Also the dry fresh gas cannot flow back into the absorbent, which helps to prevent desiccation.

exchanges with the gas in the patient's lungs via the breathing circuit. Examples of traditional ventilators include the Dräger AV-E and the Datex-Ohmeda 7900 and ADU models. These are sometimes described as “bag-in-a-bottle” respirators. The basic principle is that the reservoir bag of the anesthesia circle system is replaced by a bellows in a bellows housing, and the APL (“pop-off”) valve is replaced by a ventilator pressure-relief valve (Fig. 38-31). Inspiration occurs when compressed (driving) gas enters the bellows housing. The bellows is compressed, and the pressure-relief valve is held closed (Fig. 38-32). Gas contained within the bellows, as well as fresh gas entering the patient circuit from the anesthesia machine, are forced into the patient's lungs. At end-inspiration the bellows housing is no longer pressurized, the bellows refills (by gravity in the case of a hanging bellows, as in Figs. 38-31 and 38-32), and the pressure-relief valve is able to open, permitting excess gas in the patient circuit to be vented to the waste gas scavenging system.

The traditional “bag-in-a-bottle” anesthesia ventilators are also described as double-circuit ventilators, one cir-

cuit being the driving gas circuit and the other the patient breathing system. The interface between these two circuits is the ventilator bellows itself.

In some recent models of Dräger anesthesia workstation (Narkomed 6400,

Apollo) the ventilator bellows, bellows housing and driving gas circuit are replaced by a piston in a cylinder. The movements of the piston are precisely controlled by a microprocessor and electric motor. This design is described in a later section (New Designs of Anesthesia Ventilator and Patient Breathing Systems).

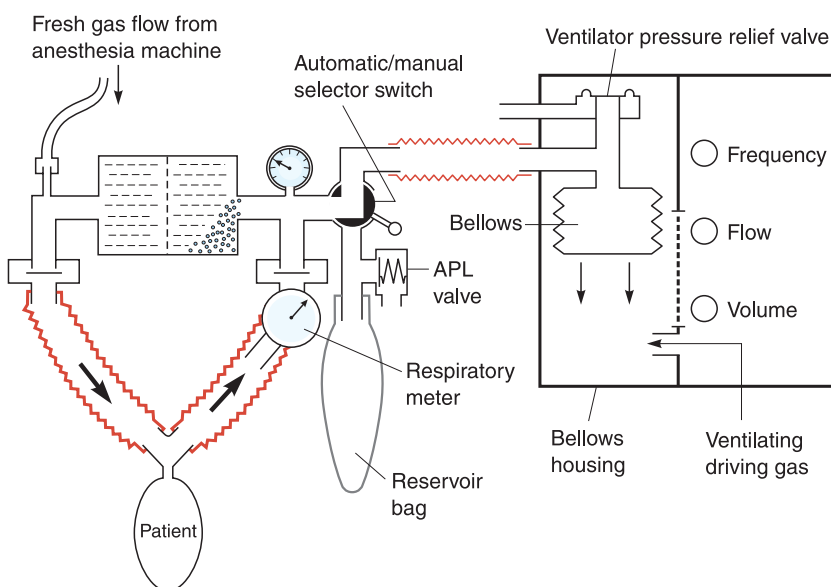
## Traditional Anesthesia Ventilators

Although the Dräger AV-E and the Datex-Ohmeda 7000 series, 7900 series, and ADU model ventilators are of the double-circuit design, their mechanisms of action differ in certain details.

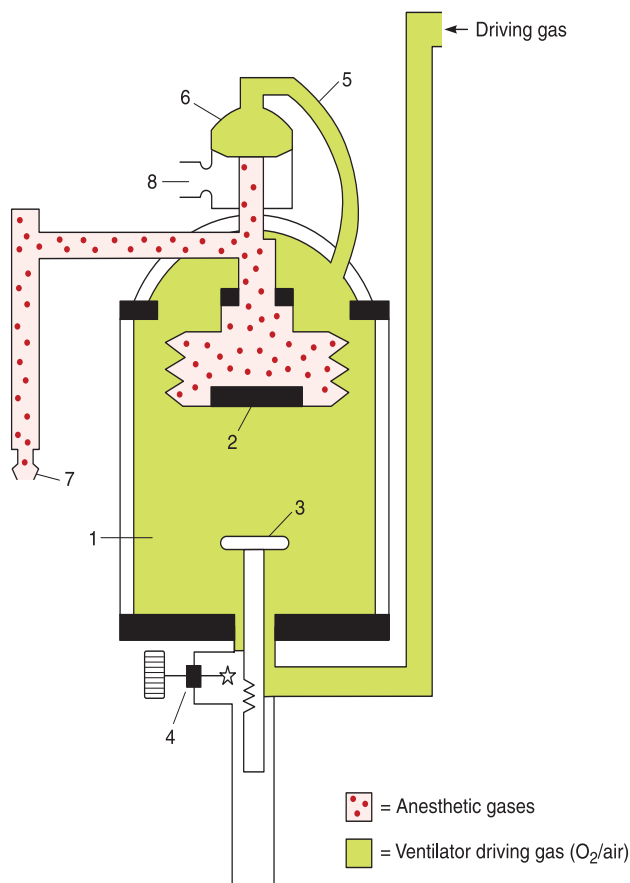
### Datex-Ohmeda 7000

The Datex-Ohmeda 7000 ventilator is shown in Fig. 38-33. It consists of two basic units: a bellows housing and assembly, and a control unit. The former may be separate from, or be mounted on, the control unit, as in Fig. 38-33. The driving gas circuit is considered first (Fig. 38-34).<sup>56</sup>

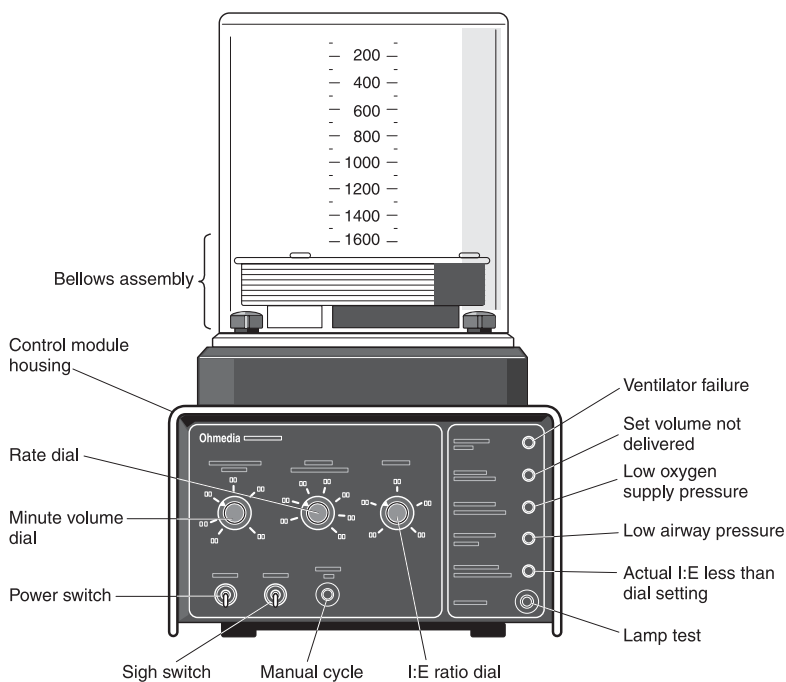
The driving gas supply of this ventilator, O<sub>2</sub> at a nominal pressure of 50 psig, passes to a pressure regulator whose output is set to 38 psig at 24 L/min of flow. From here the pressure-regulated O<sub>2</sub> flow passes to a block containing 5 solenoid flow-control valves connected in parallel. These flow-control valves are electronically opened during the inspiratory phase to



**FIGURE 38-31.** Schematic of typical “bag-in-a-bottle” double-circuit design of anesthesia ventilator. Reservoir bag and APL valve are switched out of circuit and replaced by ventilator bellows (bag) in bellows housing (bottle).



**FIGURE 38–32.** Schematic of North American Dräger AV-E hanging bellows ventilator during inspiration. *Hatched area* represents driving gas under pressure, which comes from ventilator control circuits, enters bellows housing to compress and empty the bellows, and pressurizes and thereby closes ventilator pressure-relief valve. 1, Bellows housing; 2, bellows; 3, tidal volume adjustment plate; 4, tidal volume control knob; 5, relief valve pilot line; 6, ventilator pressure-relief valve; 7, connector to patient circuit; 8, connector to waste gas scavenging system.



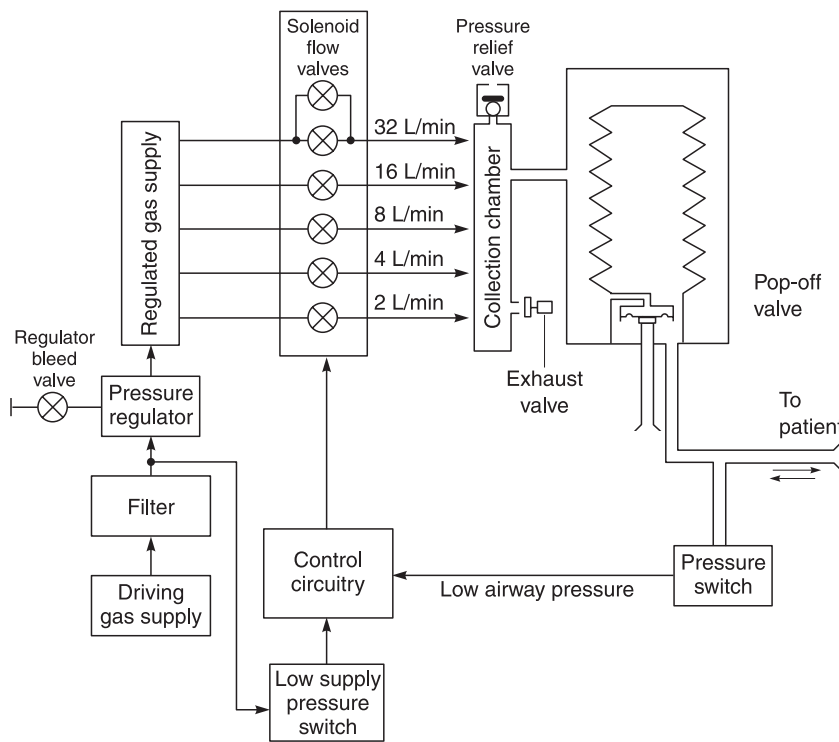
**FIGURE 38–33.** Ohmeda 7000 electronic anesthesia ventilator. (Courtesy of Datex-Ohmeda, BOC Health Care, Madison, WI.)

direct  $O_2$  flow through tuned orifices, which are calibrated for flows of 2, 4, 8, 16, and 32 L/min. The possible range for flow selection is 4–60 L/min in 2 L/min increments. By controlling the duration of opening of each of the 5 solenoid valves, the control module determines the  $O_2$  volume that passes into the collection chamber. This metered  $O_2$  volume then enters the bellows housing, where it exerts pressure on the bellows and displaces an equal volume of anesthesia gas mixture from the bellows into the patient circuit. This displaced volume is the ventilator tidal volume.

The Datex-Ohmeda 7000 ventilator uses a standing bellows. According to the settings on the ventilator panel,  $V_T$  equals set MV divided by set RR, or  $V_T = MV/RR$ ; the bellows empties until the predetermined tidal volume has been delivered. The bellows therefore does not empty completely unless a tidal volume of 1600 mL or greater is selected (Fig. 38–34). During inspiration the exhaust valve in the collection chamber (Fig. 38–34) is closed so that the driving gas does not escape. A ventilator pressure-relief valve (pop-off valve) located in the base of the bellows is held closed by the driving gas pressure during inspiration so that gas passes from within the bellows to the patient circuit (Fig. 38–35).

Exhalation begins when the driving gas exhaust valve located in the control module opens, permitting driving gas to be vented from the bellows housing. This occurs because this gas is displaced by the bellows refilling with anesthesia gases from the patient's lungs during passive exhalation, and the fresh gas flow from the anesthesia machine. During exhalation, for the bellows to refill with anesthesia gases, a slight positive pressure must be maintained in the circuit. If the circuit were kept at atmospheric pressure during exhalation, circuit gas would preferentially flow out to the scavenging system, and the bellows would not reexpand. The ventilator pressure-relief valve therefore also incorporates a positive end-expiratory pressure (PEEP) valve that exerts a pressure of about 2.5 cm  $H_2O$  on the gas contained within the patient circuit. At end-expiration, when the bellows has reached its limit of expansion and the circuit pressure has risen to greater than 2.5 cm  $H_2O$ , the ventilator pressure-relief valve opens, and





**FIGURE 38-34.** Ohmeda 7000 electronic anesthesia ventilator. Schematic of driving gas circuit. (Courtesy of Ohmeda, BOC Health Care, Madison, WI.)

excess gas from the patient circuit is vented to the waste gas scavenging system.

The pressure-relief valve in the driving gas collection chamber (Fig. 38-34) represents a safety feature such that if

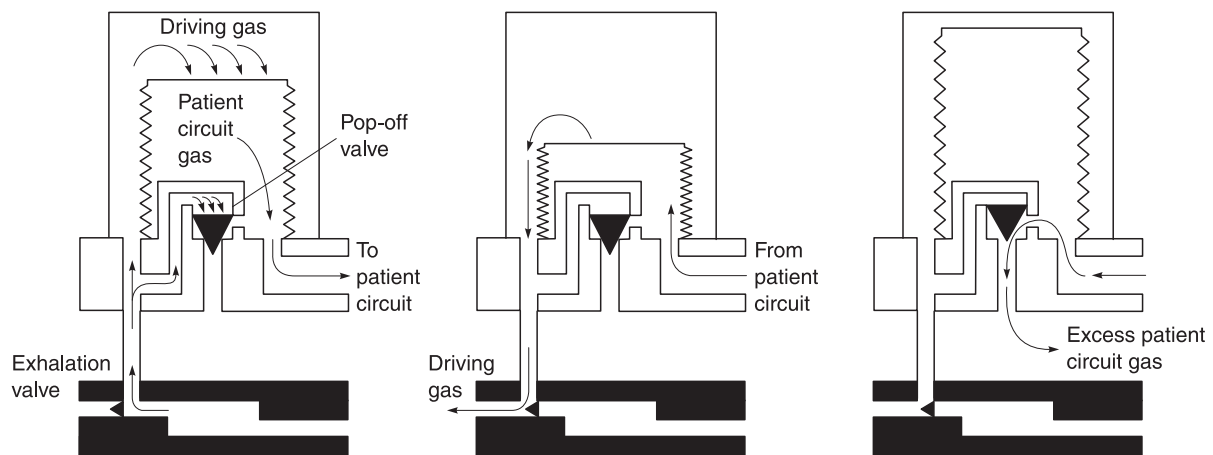
the pressure in the driving gas circuit becomes too high (greater than 65 cm H<sub>2</sub>O), the valve opens to relieve the excess pressure. This prevents such excessive pressure from being applied to the patient's airway.<sup>56</sup> The Ohmeda

7000 ventilator is electronically controlled and time cycled. Operator controls (Fig. 38-33) are for minute volume, respiratory rate (thus  $V_T = MV/RR$ ), and I:E ratio.

### **Datex-Ohmeda 7810**

The Datex-Ohmeda 7810 ventilator (Fig. 38-36) is very similar to the model 7000 but differs in certain features.<sup>57</sup> Driving gas is O<sub>2</sub> at 50 psig nominal pressure (Fig. 38-37). The O<sub>2</sub> passes to a primary regulator whose output is controlled to 26 psig. From here the O<sub>2</sub> passes to a pneumatic manifold, where its flow into the bellows housing is controlled by a flow-control valve. This sophisticated mass flow valve varies the opening of a flow orifice according to the current supplied to the valve's coil, thereby controlling O<sub>2</sub> flow. A combination of the current supplied to the coil and the time for which it is applied (valve opening size and time) is determined by the microprocessor and based on the operator control settings.

The pneumatic manifold in the model 7810 replaces the 5 solenoid valves and tuned orifices of the model 7000 (Fig. 38-34). The operator controls also differ in that the model 7810 the limits of tidal volume, rate, inspiratory flow, and inspiratory pressure (maximum, 100 cm H<sub>2</sub>O) may be set directly (Fig. 38-36). The I:E ratio, how-



Start of inspiration. Control module closes the exhalation valve and delivers driving gas to the area around the bellows.

Beginning of expiration. Exhalation valve opens and gas flow in the breathing circuit and driving-gas circuit reverses. Driving gas is released into the atmosphere as the bellows extends.

If during the expiratory cycle (when the bellows has extended completely) the pressure inside the bellows exceeds about 2.5 cm H<sub>2</sub>O, the pop-off valve opens, releasing any excess breathing system gas through the bellows assembly's exhaust port.

**FIGURE 38-35.** Ohmeda 7000 and 7810 ventilators. Schematic of function of pop-off (pressure-relief valve; ventilator pressure relief) valve in bellows during inspiration and expiration (see text for details). (Courtesy of Ohmeda, BOC Health Care, Madison, WI.)

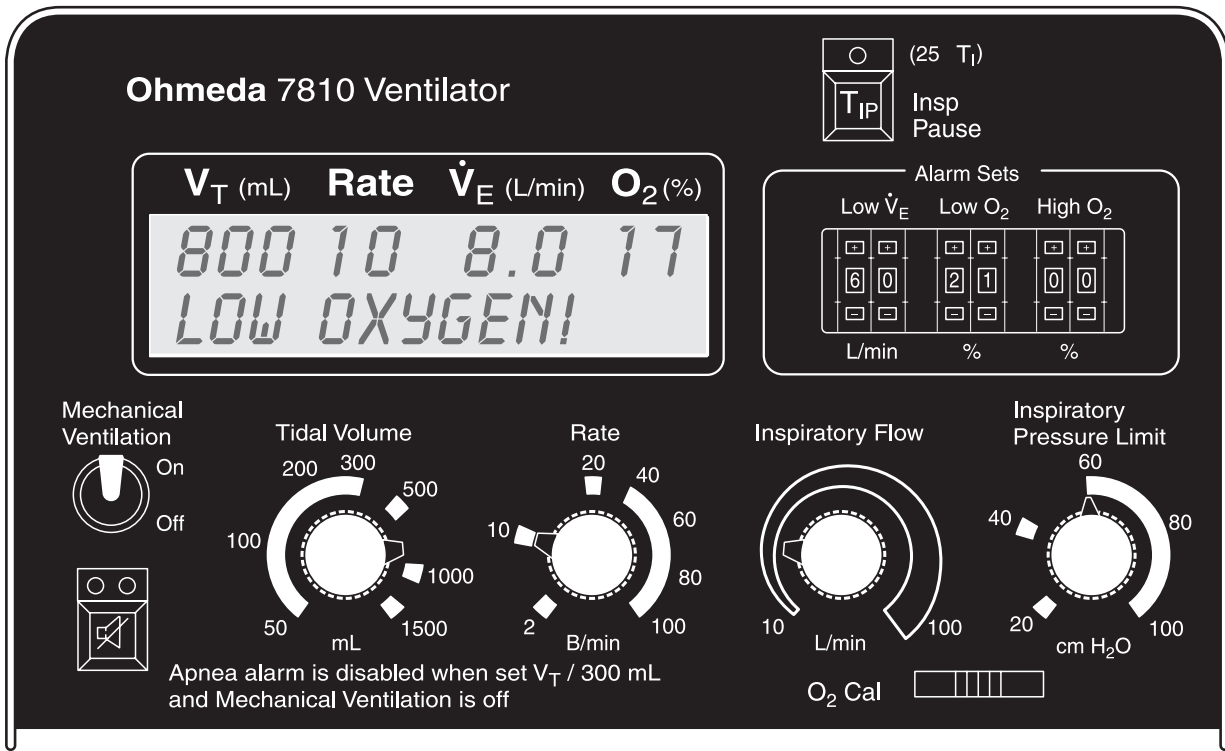


FIGURE 38–36. Datex-Ohmeda 7810 electronic anesthesia ventilator. Schematic of control panel (see text for details). (Courtesy of Datex-Ohmeda, BOC Health Care, Madison, WI.)

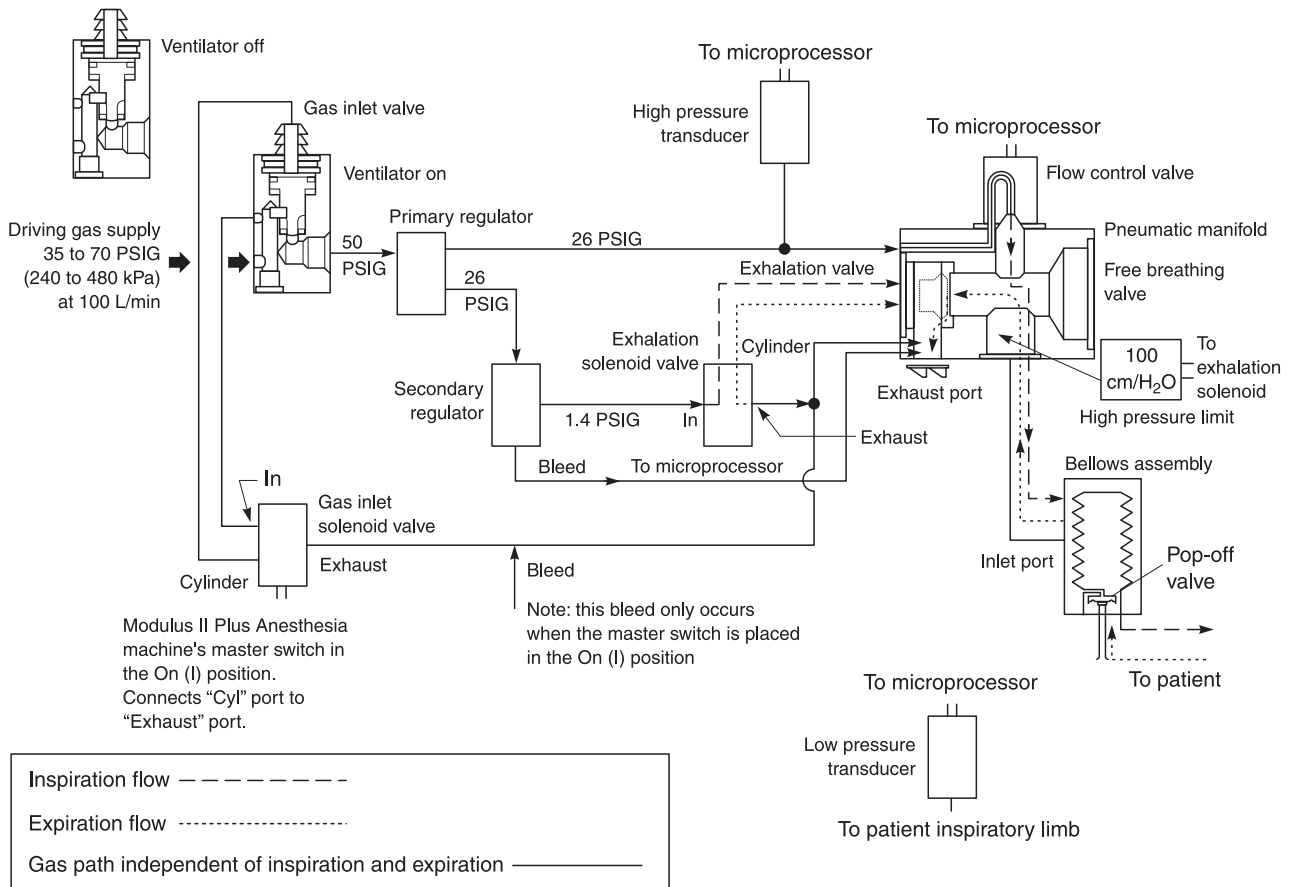
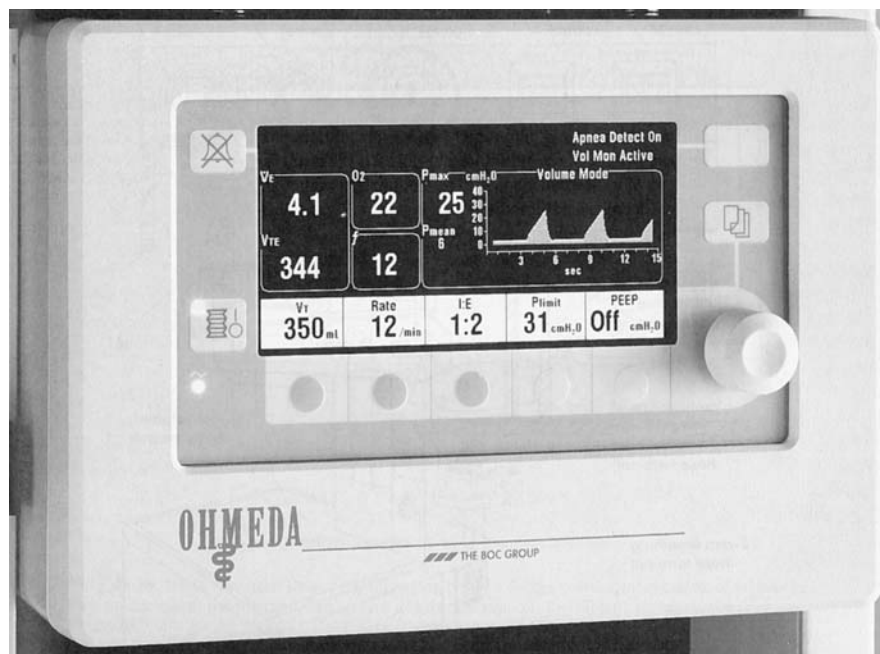


FIGURE 38–37. Datex-Ohmeda 7810 electronic anesthesia ventilator. Schematic of driving gas circuit (see text for details). (Courtesy of Ohmeda, BOC Health Care, Madison, WI.)



**FIGURE 38-38.** Datex-Ohmeda 7900 ventilator showing control panel and display. See text for more details. (Courtesy of Datex-Ohmeda, Inc., Madison, WI.)

802

ever, is not set directly but is calculated by the unit and displayed. The control unit contains an O<sub>2</sub> analyzer and displays the O<sub>2</sub> concentration sensed in the patient circuit. It also incorporates pressure and volume alarms. In other respects, the 7810 ventilator functions are similar to the model 7000.

### Datex-Ohmeda 7900

The Datex-Ohmeda 7900 ventilator is similar to the 7810 in that it consists of a control unit (Fig. 38-38) and a separate bellows housing assembly. It uses compressed oxygen and a precision control valve to control the flow and pressure of gas delivered to the patient circuit. Inspiration may be volume or pressure preset and during exhalation, the ventilator controls the PEEP by regulating the exhalation pressure at the ventilator pressure-relief valve. Using signals from pressure, flow, and oxygen sensors, microprocessor circuits in the ventilator monitor the patient breathing circuit and display the measured variables. By comparing the operator set values for ventilatory parameters with those measured by the sensors, the ventilator automatically compensates for gas losses because of compression of gases in the ventilator, ventilator circuit, and absorber system, but not for losses in the patient circuit. The system also compensates for gas gains as a result of anesthesia

machine fresh gas flow (see Tidal Volume below). Thus the user-set tidal volume is delivered to the patient circuit even when fresh gas flow, respiratory rate, or I:E ratios are altered. Some of the most recent model Datex-Ohmeda workstations (Aestiva, Aespire, Aisys) use the 7900 series ventilator.

### Dräger AV-E

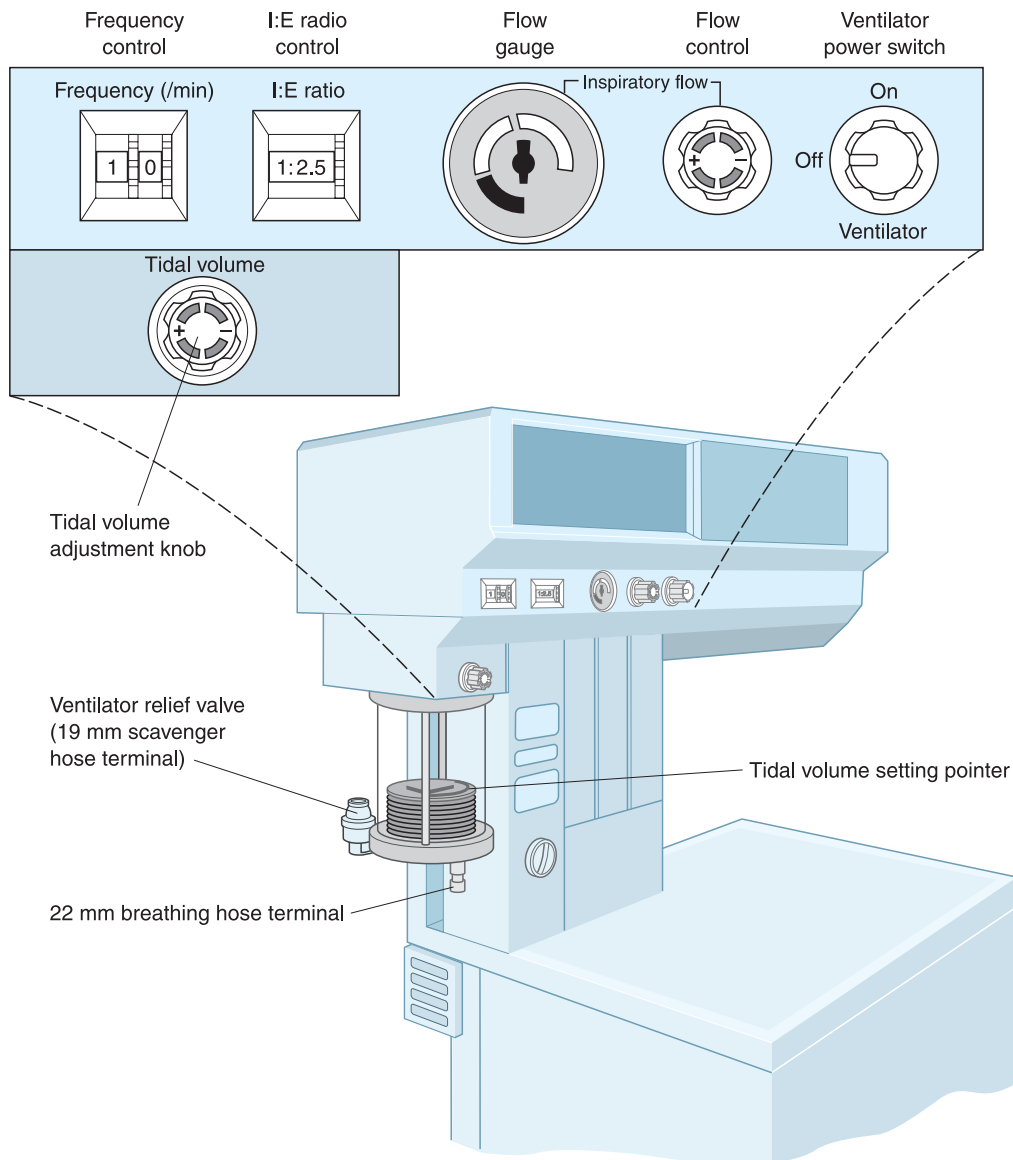
The Dräger AV-E ventilator (used on the Narkomed 2, 3, 4, GS, and Mobile machines) is also a double-circuit, pneumatically powered design.<sup>38,39</sup> It consists of a control unit mounted above the flowmeters and vaporizers on a Dräger Narkomed machine and a bellows assembly (Fig. 38-39). A schematic illustration of this ventilator is shown in Fig. 38-40. The following numbers in parentheses refer to Figs. 38-40 and 38-41. The driving gas circuit is described first.<sup>58</sup>

The ventilator is powered by O<sub>2</sub> at a driving pressure of 50 psig (2). When the ventilator on/off switch (3) is turned on, O<sub>2</sub> pressure is supplied to a 1 psig switch (4), which is activated and energizes the electronic circuit. The respiratory rate (7) and I:E ratio (6) controls (Fig. 38-39 inset) are set as desired. Inspiration (Fig. 38-40) occurs when the solenoid valve (9) receives an electrical signal from the control unit (5). This signal remains throughout inspiration and activates

the solenoid valve (9) to allow O<sub>2</sub> at 50 psig to pass through it to activate the control valve (10). Opening the control valve allows O<sub>2</sub> that has passed through the adjustable flow regulator (11) to pass through the control valve (10) to the venturi (13). The inspiratory flow rate is adjusted by the flow regulator (11) (flow-control knob, Fig. 38-39), and the flow rate is monitored on a flow indicator gauge (12). This indicator is really a pressure gauge, measuring pressure downstream from the flow regulator. The display on the gauge shows flow in three zones: high, medium, and low (Fig. 38-39). During inspiration, back pressure from the venturi (13) is conducted to a pilot actuator (15), which is held closed. As the O<sub>2</sub> flows from the venturi (13), room air is entrained through the muffler and entrainment port (14).

The mixture of O<sub>2</sub> and entrained air is directed into the bellows chamber (16). As pressure rises in the bellows chamber, the bellows is compressed. Anesthetic gases within the bellows are forced into the patient circuit via the breathing connector (22). At the same time, driving gas pressure from the bellows housing (16) is transmitted via the relief valve pilot line (20) to hold the ventilator pressure-relief valve (21) closed as long as the bellows housing is under pressure (i.e., throughout inspiration). In this ventilator the bellows is emptied completely with each inspiratory cycle. Thus tidal volume is determined by the extent to which the bellows is allowed to expand during exhalation, which in turn is adjusted by the tidal volume control knob (19) and bellows plate (18). During the inspiratory pause the O<sub>2</sub> continues to flow from the venturi (13). Because the bellows is now fully compressed, no further air is entrained, and pressure is maintained in the bellows housing by the pressure of the O<sub>2</sub> jet from the venturi. Meanwhile, the chamber (16) contains a mixture of air and O<sub>2</sub> with an average O<sub>2</sub> concentration of 33%.

Expiration (Fig. 38-41) begins when the electrical signal from the control unit (5) to the solenoid valve (9) stops. The solenoid valve is deactivated and closes, interrupting the supply of 50 psig O<sub>2</sub> to the control valve (10), which therefore also closes. The preset O<sub>2</sub> flow from the flow regulator (11) is interrupted by the control valve (10), causing a pressure drop at the venturi



**FIGURE 38–39.** Dräger AV-E anesthesia ventilator. Note the standing bellows arrangement in this diagram. Figures 38–31 and 38–40 show a hanging bellows version. (Courtesy of North American Dräger, Telford, PA.)

(13), and no back pressure is supplied to the pilot actuator (15). The latter opens to allow gas from the bellows chamber (16) to be vented through the pilot actuator (15) and the entrainment port (14) of the venturi (13). This exhausted driving gas leaves the ventilator through a muffler. A clean, dry muffler is essential for normal function of this ventilator. As the pressure falls in the bellows chamber (16), the bellows (17) begins to refill. As long as any pressure remains in the bellows chamber (16), the ventilator relief valve (2) is also pressurized and held closed.

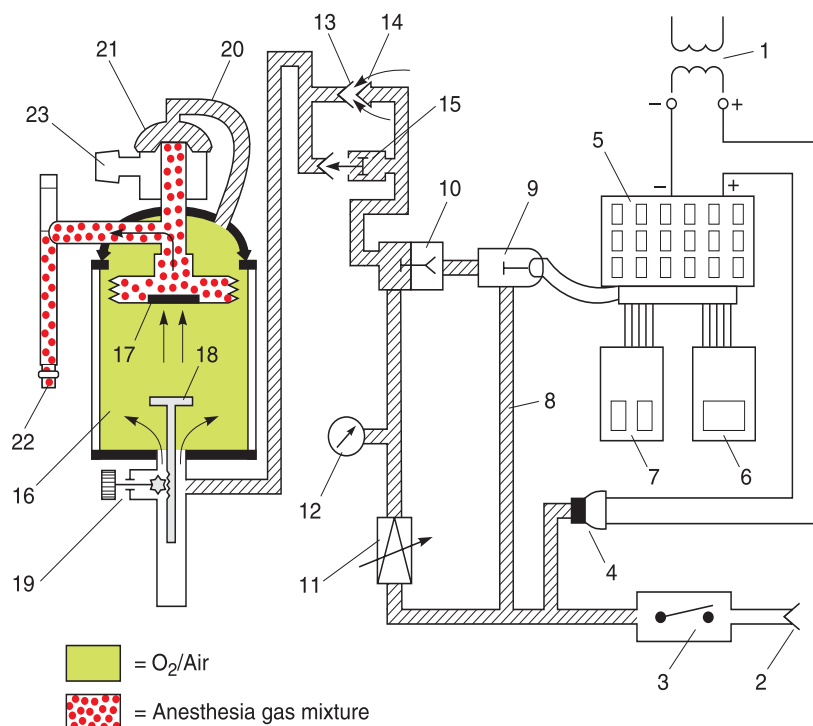
Figures 38–42 and 38–43 are schematic illustrations of the standing bel-

lows version of the Dräger AV-E during inspiration and expiration, respectively. As with the standing bellows arrangement in the Datex-Ohmeda ventilators, the Dräger AV-E ventilator relief valve applies about 2.5 cm H<sub>2</sub>O PEEP to the gas in the patient circuit. Once the standing bellows has reached its preset limit of expansion (the next tidal volume) and circuit pressure exceeds 2.5 cm H<sub>2</sub>O, the PEEP valve opens, permitting excess circuit gas to enter the waste gas scavenging system (Fig. 38–43).

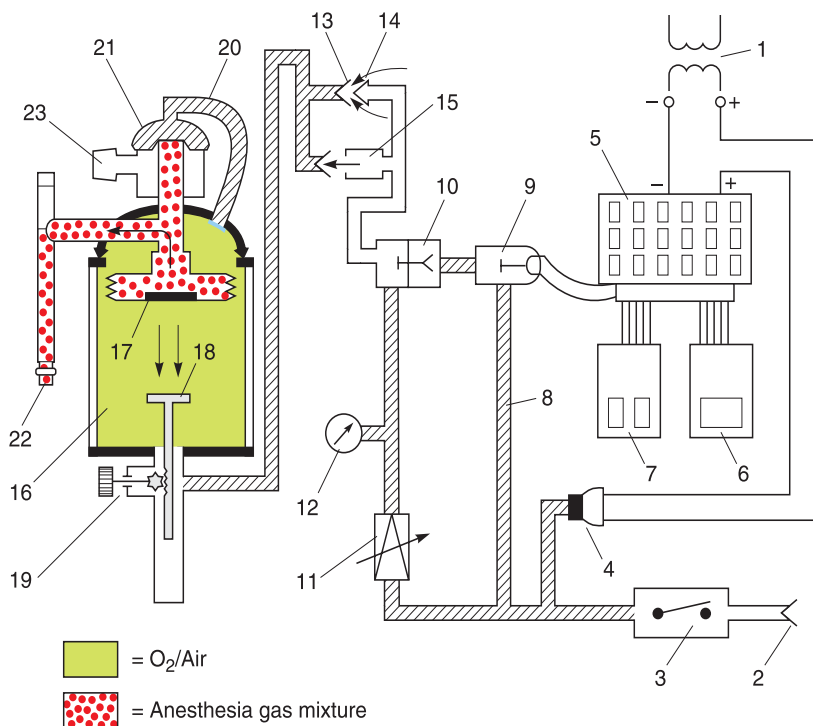
In the Dräger AV-E, the ventilator pressure-relief valve is controlled via an external relief valve pilot line (Figs. 38–40 and 38–41, item 20), which is

essentially a short length of plastic tubing. Kinking this tubing can cause ventilator malfunction. Occlusion during inspiration, when the valve is being held closed, causes it to remain closed thereafter and excess gas cannot leave the anesthesia circuit. Consequently, pressure in the circuit rises and, if not relieved, could result in barotrauma.<sup>59</sup> A circuit continuing pressure or high-pressure alarm should alert the clinician to such a situation. If the tubing is occluded during expiration when the valve is not held closed, during the next inspiratory cycle, pressure cannot be transmitted through to the valve to hold it closed. Patient circuit gas can then leak out to the scavenging system





**FIGURE 38-40.** Dräger AV-E hanging bellows design ventilator. Schematic of ventilator function during *inspiration*. See text for details of operation. **1**, Electric power supply (117 volts AC); **2**, gas supply of O<sub>2</sub> (50 psig); **3**, ventilator on/off switch; **4**, electrical supply on/off switch (1 psig pressure switch); **5**, AV-E printed circuit; **6**, I:E ratio control; **7**, frequency control; **8**, solenoid pilot pressure line; **9**, solenoid valve; **10**, control valve; **11**, flow regulator; **12**, flow indicator gauge; **13**, venturi; **14**, venturi entrainment port; **15**, pilot actuator; **16**, bellows chamber; **17**, bellows; **18**, tidal volume adjustment plate; **19**, tidal volume control; **20**, relief valve pilot line; **21**, ventilator relief valve; **22**, patient breathing system connector; **23**, waste gas scavenging system connector. (Courtesy of Dräger, Telford, PA.)



**FIGURE 38-41.** North American Dräger AV-E hanging bellows design ventilator. Schematic of ventilator function during *expiration*. See Fig. 38-39 for numbers and text for details. (Courtesy of Dräger, Telford, PA.)

rather than entering the patient circuit, which might result in hypoventilation. Incompetence of the pressure-relief valve itself may also result in hypoventilation.<sup>60</sup> Again, contemporary circuit pressure, volume, or ventilation (CO<sub>2</sub>) alarms should alert one to these situations. More recent versions of Dräger ventilator (AV 2+) incorporate a high-pressure limit control, capable of inverse I:E ratios with a built-in safety mechanism that allows application to a wider range of patient conditions.

## Differences Among Traditional Double-Circuit Ventilator Designs

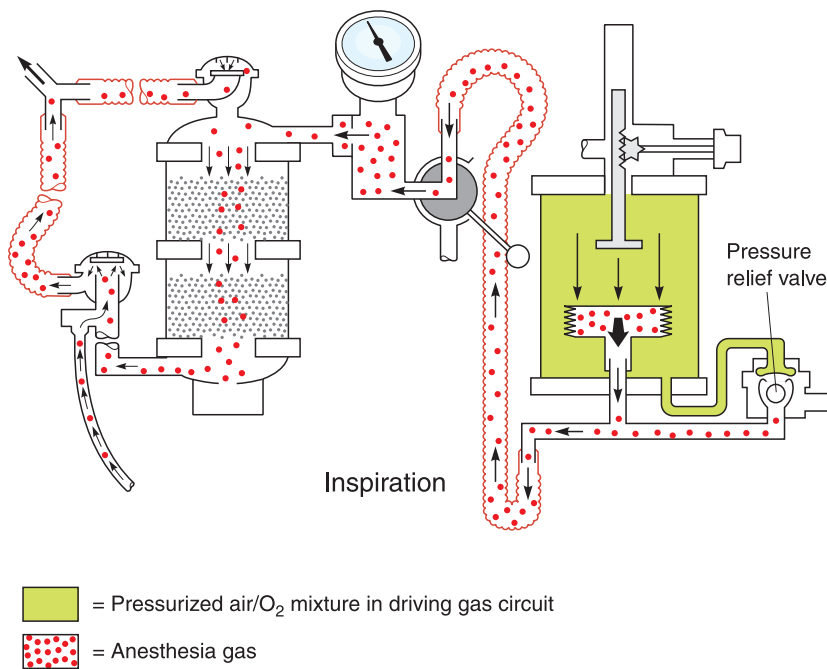
### Standing versus Hanging Bellows Ventilators

Contemporary traditional anesthesia ventilators are of the standing bellows design; that is, they rise (ascend as the bellows fills) during exhalation and descend (empty) during inspiration. With a disconnection in which circuit pressure becomes equal to atmospheric pressure, the bellows cannot refill during exhalation. Some consider this to be a desirable safety feature.

In the (older) hanging bellows design (Figs. 38-31 and 38-32), the bellows fills by gravity during exhalation so that the ventilator pressure-relief valve does not require a PEEP design. With a circuit disconnection, room air is entrained into the patient circuit via the leak and the bellows refills, emptying through the leak on the next inspiration. For this reason the standing bellows design is preferred, although it is not required by the standard describing specifications for anesthesia ventilators.<sup>61</sup> The standard states that if the ventilator incorporates a weighted descending bellows, the manufacturer shall specify the maximum negative pressure created both when the fresh gas flow to the circuit is shut off and when the patient connecting port of the delivery system is obstructed just after a tidal volume is described and the ventilator shut off.

### Dräger AV-E versus Datex-Ohmeda: Driving Gas

The gas entering the bellows housing in a Datex-Ohmeda ventilator is 100% O<sub>2</sub> (Figs. 38-33 and 38-37), whereas in the Dräger AV-E, the gas is an air/O<sub>2</sub> mixture (Fig. 38-40). With a leak (hole) in the bellows, driving gas enters the patient circuit and dilutes the



**FIGURE 38-42.** Dräger AV-E standing bellows design showing events during inspiration. (Courtesy of Dräger, Telford, PA.)

gases there. This can cause O<sub>2</sub> enrichment with a Datex-Ohmeda ventilator but a decrease in the F<sub>I</sub>O<sub>2</sub> with a Dräger AV-E if an F<sub>I</sub>O<sub>2</sub> < 0.4 were set at the machine flowmeters.

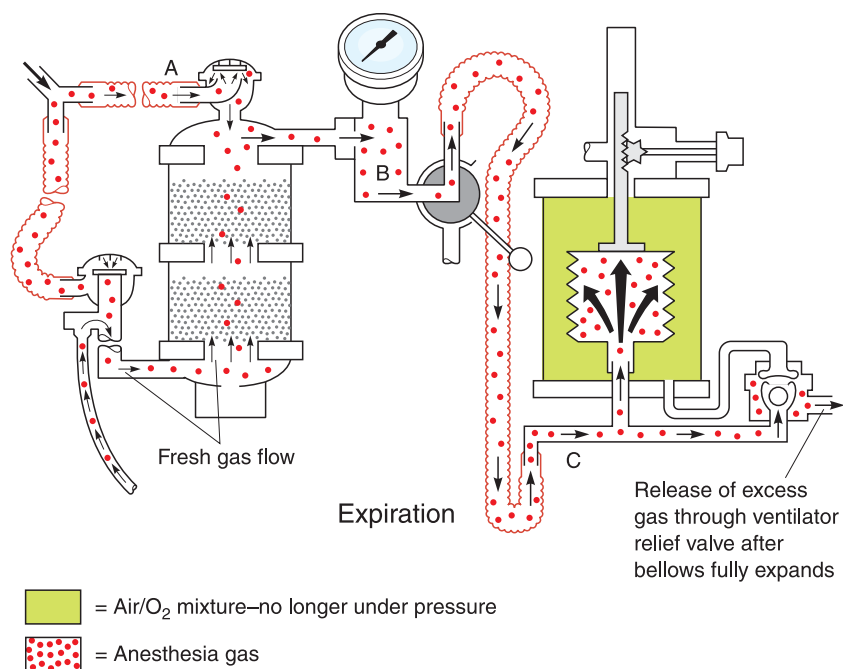
In the Dräger ventilator, the tidal volume is determined by setting the expansion limit of the bellows during expiration, because the bellows is emptied completely during inspiration. The bellows (Figs. 38-42 and 38-43) is graduated from 0 mL below to 2000 mL at the top of the housing. In the Datex-Ohmeda design, the bellows is graduated from 0 mL at the top to 1600 mL at the bottom of the bellows housing, as the tidal volume is displaced from the bellows by a metered volume of compressed O<sub>2</sub> during inspiration (Fig. 38-33).

The Dräger AV-E ventilator uses a venturi and an air/O<sub>2</sub> mixture to compress the bellows. This economizes on the use of compressed O<sub>2</sub>. In the Datex-Ohmeda ventilator, O<sub>2</sub> consumption as the driving gas is a little greater than the set minute ventilation.<sup>62</sup>

In the Datex-Ohmeda 7000 and 7800 series ventilators, the circuit pressure-relief (“pop-off”) valve is flush-mounted inside the bellows (Fig. 38-35). The design does not use a relief valve pilot line and is therefore not vulnerable to the effects of this line kinking (Fig. 38-40, item 20).<sup>59</sup> In the Datex-Ohmeda ADU

workstation, the ventilator pressure-relief valve is visible but there is a direct rather than a pilot tube connection to the driving gas circuit.

Datex-Ohmeda ventilators incorporate a pressure-relief valve in the driving gas circuit (Figs. 38-32 and 38-34).



**FIGURE 38-43.** Dräger AV-E standing bellows design showing events during expiration. A, B, and C represent possible positions for positive end-expiratory pressure (PEEP) valve placement (see text for details). (Courtesy of Dräger, Telford, PA.)

This may be preset to 65 cm H<sub>2</sub>O (as in the Datex-Ohmeda 7000 model) or may be adjustable (Fig. 38-36, Ohmeda 7810 model, “Inspiratory Pressure Limit”) as on the 7900 series. Most of the original Dräger AV-E ventilators do not have a pressure-relief valve in the driving gas circuit. Such a valve (Dräger Pressure Limit Control), with variable relief pressure settings, is available and may be retrofitted to standing bellows versions of these ventilators, thereby providing a pressure limit.<sup>63</sup> It is now standard with the more recent model, the Dräger AV 2+.

Because the Dräger AV-E ventilator venturi requires entrainment of air (Figs. 38-40 and 38-41), a clean (unoccluded) muffler is essential. If the muffler becomes blocked for any reason, room air is no longer entrained and inspiration cannot be completed. If blockage occurs during expiration, gas cannot leave the ventilator bellows housing, and the bellows remain collapsed.<sup>64</sup>

### Tidal Volume

During inspiration the anesthesia ventilator pressure-relief valve is held closed so that gas contained in the bellows enters the patient circuit rather than the scavenging system (Fig. 38-42). Meanwhile, because the anesthesia machine is a continuous flow machine, fresh gas continues to enter

the patient circuit from the anesthesia machine throughout the ventilatory cycle, according to the (O<sub>2</sub>, N<sub>2</sub>O, air) gas flow-control settings.

In the traditional design of anesthesia ventilator, when setting a certain V<sub>T</sub> to be delivered from the bellows in order to achieve a certain V<sub>T</sub> delivered to the patient's lungs, one must consider the fresh gas flow rate from the anesthesia machine to the patient circuit.<sup>65,66</sup>

Consider an anesthesia ventilator set to a frequency of 10 breaths/min, an I:E ratio of 1:2, and a fresh gas flow of 6 L/min (or 100 mL/sec) to the anesthesia circle. Each breath lasts 6 seconds (60 sec/10 breaths), with inspiration lasting 2 seconds and expiration 4 seconds (I:E = 1:2). During inspiration, the ventilator pressure-relief valve is closed so that both gas from the emptying bellows and fresh gas flow from the machine enter the patient circuit (Fig. 38–42). Because fresh gas flow is 100 mL/sec and each inspiration lasts 2 seconds, the V<sub>T</sub> set on the ventilator bellows is potentially augmented by 200 mL. Consequently, changing the fresh gas flow, respiratory rate, or I:E ratio may have a profound effect on circuit V<sub>T</sub>, alveolar ventilation, and PaCO<sub>2</sub>.<sup>65,66</sup> Figure 38–44 illustrates the effect on PaCO<sub>2</sub>.

The additional minute ventilation to the patient circuit when using an anesthesia ventilator is approximated by the formula:

$$\text{Additional ventilation} = (I/[I + E]) \times \text{fresh gas flow}$$

This is divided by the respiratory rate to determine the augmentation of each ventilator bellows V<sub>T</sub>.

In terms of V<sub>T</sub> actually delivered to the patient's airway, this formula provides an approximation only. The actual augmentation of V<sub>T</sub> also depends on the patient's total thoracic compliance compared with that of the anesthesia circuit components. If the patient's total thoracic compliance is low, additional fresh gas inflow from the machine may be accommodated mainly by compression in the circuit. Thus patient MV is given by:

$$\text{Set MV} + (\text{fresh gas flow} \times [I + E]) - (\text{gas volume compressed in circuit at peak inspiratory pressure} \times f)$$

where *f* is the respiratory rate in breaths per minute. The compressed

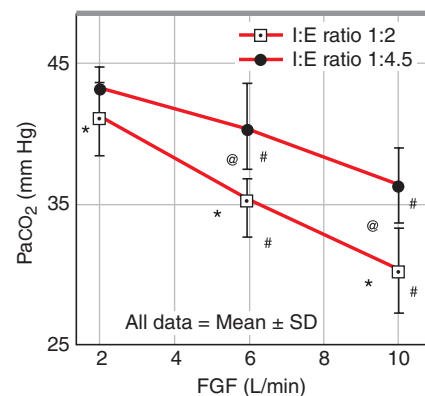
gas volume term can be calculated as the product of circuit compliance and peak inspiratory pressure. Thus volume compressed in the circuit equals compliance of circuit (mL/cm H<sub>2</sub>O) times peak inspiratory pressure. These considerations do not apply to intensive care unit ventilators, which are designed to be minute volume dividers and whose V<sub>T</sub> is not affected by fresh gas flow, I:E ratio, or rate. The Datex-Ohmeda 7900 ventilator uses the SmartVent compensation system to compensate automatically for changes in fresh gas flow, I:E ratio, and RR as far as they affect the tidal volume delivered to the patient circuit. However, because the inspiratory flow transducer (which senses the inspired volume) is located at the inspiratory connection to the circuit, compression losses experienced in the patient circuit itself are not compensated. The uncompensated loss is the product of the peak inspiratory pressure and the compliance of the patient circuit.

### Positive End-Expiratory Pressure

The deliberate application of PEEP to the patient's airway is not uncommon during anesthesia. PEEP may be applied by adding a free-standing PEEP valve between the circle system's expiratory limb and the expiratory valve (e.g., Boehringer PEEP valve, Boehringer Laboratories, Wynnwood, PA). Although free-standing PEEP valves function well when used correctly, they are occasionally used erroneously and may totally occlude the circuit if incorrectly placed in the circle's inspiratory limb.<sup>67</sup> Because of this potential hazard, the use of free-standing PEEP valves is not recommended.

The machine manufacturers, Dräger and Datex-Ohmeda, now provide PEEP valves that are an integral component of their contemporary anesthesia delivery systems. These purpose-designed valves are convenient to use and should also avoid the risk of erroneous valve placement. However, one must consider the possible effects of placement positions of a PEEP valve in the anesthesia circuit.

At end-exhalation the pressure in an anesthesia circuit during positive-pressure ventilation using a standing bellows ventilator is +2.5 cm H<sub>2</sub>O because of the PEEP effect of the ventilator pressure-relief valve (Fig. 38–43). If a 10-cm H<sub>2</sub>O PEEP valve is now added by the expiratory unidirectional valve



**FIGURE 38–44.** Effect of fresh gas flow and inspiratory-to-expiratory (I:E) ratio on arterial CO<sub>2</sub> tension (PaCO<sub>2</sub>) in patients ventilated with anesthesia ventilator set to constant tidal volume (V<sub>T</sub>). Increasing fresh gas flow or I:E ratio causes an increase in delivered V<sub>T</sub>, an increase in alveolar ventilation, and a decrease in PaCO<sub>2</sub>.

(Fig. 38–43, position A), that part of the circuit between the inspiratory and PEEP valves is at +10 cm H<sub>2</sub>O compared with pressure beyond the valve. That part of the circuit between the PEEP valve and the ventilator is at +2.5 cm H<sub>2</sub>O. On the next inspiration, gas from the compressed bellows enters the circuit and must compress that gas in the patient circuit that is at +2.5 cm H<sub>2</sub>O by an additional +10 cm H<sub>2</sub>O before any entering gas will flow past the inspiratory unidirectional valve to enter the circle's inspiratory limb. The volume of gas that leaves the ventilator bellows and is compressed in the part of the circuit that was at +2.5 cm H<sub>2</sub>O represents wasted bellows V<sub>T</sub> because it is not available to ventilate the patient's lungs. If the PEEP valve is placed close to the ventilator bellows (Fig. 38–43, position C), at end-exhalation most of the gas in the patient circuit is now at +10 cm PEEP. In this case, a much smaller volume of gas leaving the bellows during inspiration must be compressed in the circuit before the patient begins to receive a V<sub>T</sub>. Thus once a V<sub>T</sub> has been set to be delivered from an anesthesia ventilator bellows, addition of PEEP to the basic patient circuit may decrease delivered V<sub>T</sub>, depending on the position of the PEEP valve in the circuit. In Fig. 38–43, bellows V<sub>T</sub> loss would be greatest with position A and least with position C; position B is intermediate.<sup>68</sup> Decreases in V<sub>T</sub> may be reflected in spirometer readings or in other monitors of patient ventilation (e.g., PaCO<sub>2</sub>; end-tidal CO<sub>2</sub>).

Advantages of placing the PEEP valve near to the expiratory unidirectional valve (see Fig. 38–43, position A or B), however, are that in these positions PEEP may be applied during spontaneous as well as during mechanical ventilation. The decrease in patient  $V_T$  on application of PEEP at position A in Fig. 38–43 (such as would be obtained with insertion of a free-standing PEEP valve) is greatest at low bellows  $V_T$  settings.<sup>68</sup> It is also more significant with the Datex-Ohmeda design of ventilator (models 7000, 7810) than with the Dräger AV-E. This is because the Dräger AV-E bellows empties completely during each inspiration, whereas the Datex-Ohmeda bellows empties only the set  $V_T$  into the circuit. Because a Datex-Ohmeda bellows has a capacity of 1600 mL (Fig. 38–33), the compression volume in the circuit at end-inspiration is greater than in the Dräger AV-E ventilator system by a volume of [1600 mL  $V_T$ ].

Because with the Datex-Ohmeda 7900 ventilator and the ADU, the PEEP is applied at the level of the ventilator pressure relief valve, the whole circuit is at positive-end expiratory pressure and the tidal volume loss caused by application of PEEP at positions A, B, and C (shown in Fig. 38–43) does not apply. Furthermore, any deviation from the tidal volume set would be sensed by the inspiratory flow transducer and a correction would be made via the SmartVent Compensation System.

### New Designs of Anesthesia Ventilator and Patient Breathing Systems

As discussed above, there were several problems inherent in the design of the traditional anesthesia ventilator. There was often a discrepancy between what was set as  $V_T$  and what was delivered. Thus with a Datex-Ohmeda 7000 ventilator and GMS absorber system, one might set a  $V_T$  of 500 mL, observe a different value on the bellows housing graduations (which are inaccurate), and yet another value from the spirometer on the expiratory side of the circuit. The ventilators were not very accurate in small pediatric patients, where changes in fresh gas flow, I:E ratio, and RR could have profound effects that might lead to barotrauma.

Two basic approaches have been taken to compensate for unintentional changes in  $V_T$ ; computerized compensation and fresh gas decoupling. These require a more detailed discussion of some of the newer workstations.

#### Computerized Compensation: Datex-Ohmeda Anesthesia Delivery Unit (ADU) and 7900 SmartVent

The Datex-Ohmeda ADU uses conventional needle valves to control gas flows ( $O_2$ ,  $N_2O$ , air) but the flows are measured electronically and the information fed to the CPU. Information from the Aladin vaporizing system is also fed to the CPU. The total fresh gas flow and vapor leaving the CGO is therefore constantly measured. It may pass through an optional conventional rotameter that reassures the user that  $O_2$  is flowing in the event electrical power is lost.

The ADU uses a circle system with fresh gas inflow on the patient side of the inspiratory unidirectional valve. The ADU ventilator controls are integrated with the CPU so that when a  $V_T$  is set to be delivered by the ventilator, the CPU can adjust the excursion of the bellows, adjusting it accordingly if fresh gas flow, RR, or I:E ratio is changed. If a high fresh gas flow is set at the gas flow controls and a small  $V_T$  is set on the ventilator, the bellows may move only slightly because most of the  $V_T$  is now being provided by the fresh gas flow. If the fresh gas flow is decreased, this is sensed by the CPU, which automatically increases the  $V_T$  delivered from the ventilator bellows. In addition, during the automated preuse check-out the user occludes the Y-piece and the workstation measures the compliance of the breathing system so that this is also taken into account by the ventilator. The ADU Carestation achieves PEEP by controlling the ventilator pressure-relief valve.

The latest addition to the Datex-Ohmeda line is the Aisys workstation. Although it incorporates totally electronic gas flow control using a gas mixer (the user selects  $N_2O$  or air,  $F_{I,O_2}$ , and total gas flow) and Aladin vaporizer controls, the ventilator used is the Datex-Ohmeda 7900. The SmartVent feature monitors the patient's breathing system by signals from pressure, flow and  $O_2$  transducers. Inspiratory and expiratory flow sensors meas-

ure the flow of gas to and from the patient circuit. By comparing the operator set value with the actual delivered inspired  $V_T$ , the ventilator compensates for gas compression losses and contributions from fresh gas flow.

#### Fresh Gas Decoupling

Fresh gas decoupling is used in the Datascope Anestar workstation, which has a hanging bellows design. Fresh gas decoupling is also used in the Dräger Narkomed 6400, Fabius GS, and Apollo (Fig. 38–45) workstations, which use an electrically driven piston in place of the traditional gas-driven bellows.

The principle of fresh gas decoupling is that during the inspiratory cycle of positive-pressure ventilation, a decoupling valve diverts fresh gas flow into the reservoir bag of the circle system so that only gas from the ventilator (piston or bellows) flows to the patient. Figure 38–46 shows fresh gas decoupling in the Anestar circuit. During inspiration, the decoupling valve closes, bellows gas flows to the patient, and fresh gas is diverted into the reservoir bag. If the fresh gas flow is high such that the bag's capacity is exceeded, the excess flows through the absorber and is vented to the waste gas scavenging system. In other designs the bellows can be replaced in function by an electric motor-driven piston (Fig. 38–47). During the expiration phase (Fig. 38–48), the fresh gas decoupling valve opens, permitting the descending bellows to fill with fresh gas from the bag, and fresh gas flow from the machine, followed by exhaled gas that has passed through the absorber. Once the bellows has descended completely, additional exhaled gas (mainly alveolar) is vented to the scavenging system.

In the fresh gas decoupling ventilator circuits that use a piston (Fig. 38–49) or a hanging bellows, negative pressure could potentially be applied during exhalation if fresh gas flow is inadequate. This is of particular concern with the piston ventilator when the piston withdraws as it attempts to refill the cylinder. To protect against possible negative pressure barotrauma, fresh gas decoupling circuits incorporate a negative pressure relief valve through which room air can be drawn when the negative pressure exceeds approximately  $-2$  cm  $H_2O$ . When this occurs, an alarm sounds because unrecognized entrainment of room air could lead to





**FIGURE 38–45.** Dräger Apollo Anesthesia workstation. (Courtesy of Dräger, Telford, PA.)

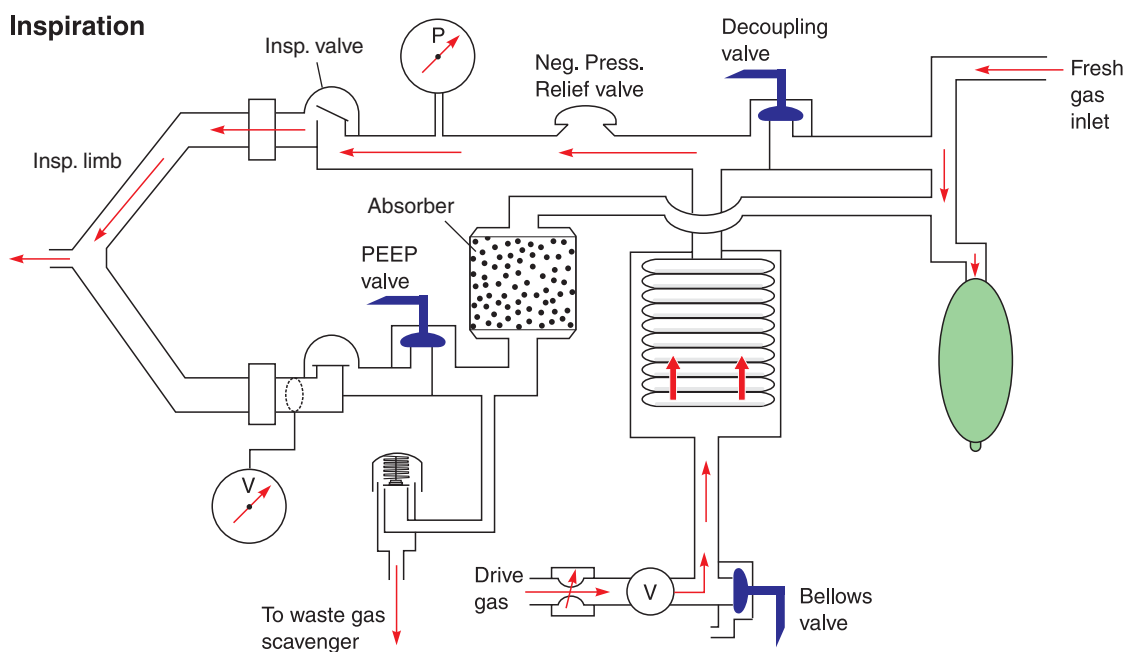
an unintended low  $F_I O_2$  and dilution of the anesthetic. Consequently, monitoring of  $F_I O_2$  and anesthetic agent concentration at the airway is of particular importance. During the preuse check-

out of the workstation the integrity of the breathing system is pressure checked for leaks. A leak could result in anesthetic gases being released into the atmosphere, as well as room air being

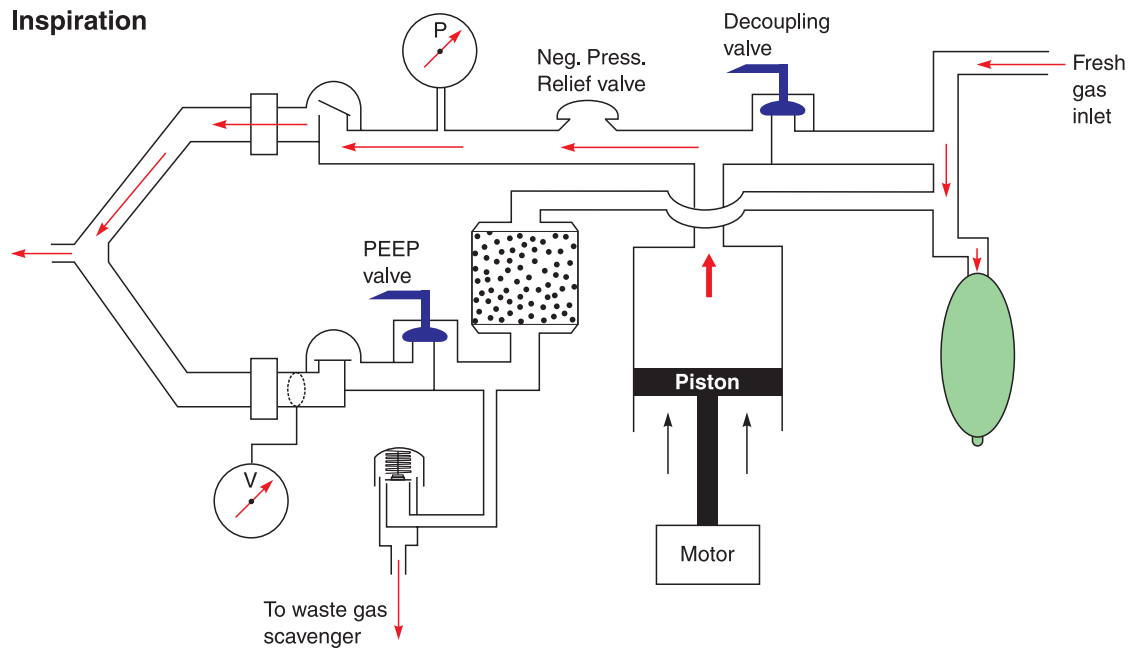
entrained as just described. In one report, the workstation was checked out correctly. The users then noted that the patient was latex allergic and so the reservoir bag was replaced with one that was latex free. It was then noted that the  $F_I O_2$  and the anesthetic agent concentration were decreasing. The users concluded that air was being entrained and a large hole was found in the latex-free bag. No alarm sounded, however, because the air entrainment was not occurring through the negative pressure relief valve (Fig. 38–49).<sup>69</sup>

## WASTE GAS SCAVENGING SYSTEMS

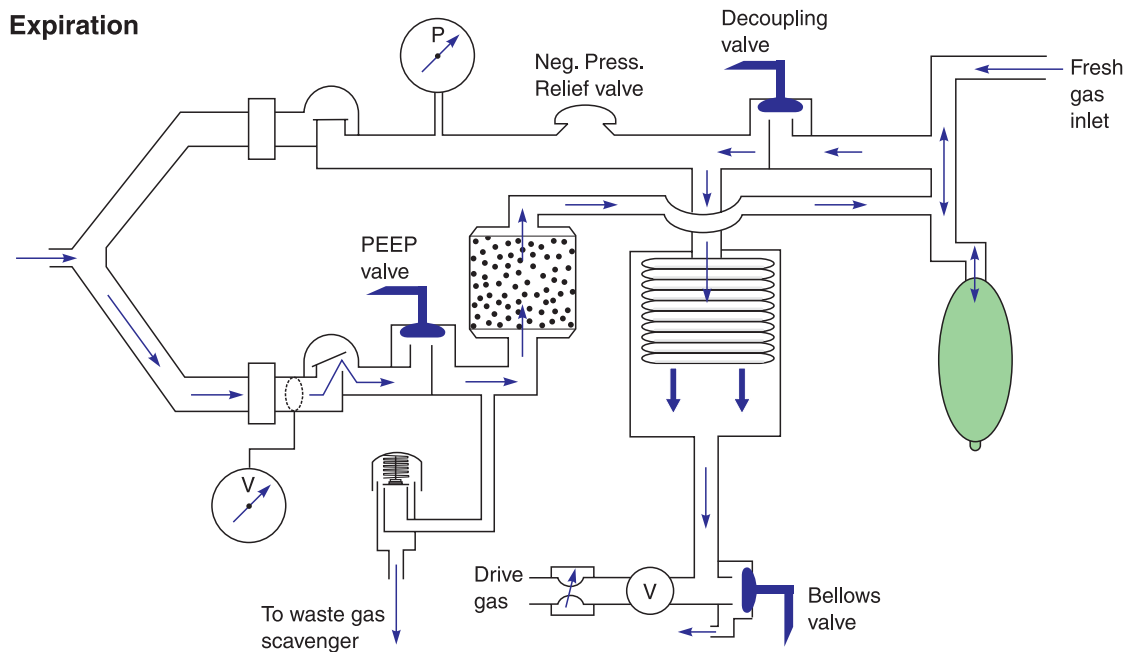
The anesthesia workstations in common use are all continuous flow devices, that is, fresh gas flows continuously from the common gas outlet to the breathing system. Because the fresh gas flow is usually more than that required either by the patient or to compensate for small leaks, the excess gas must be allowed to exit the breathing system and be scavenged by the waste gas scavenging system. Trace concentrations of anesthetic (waste) gases have neither been fully incriminated nor fully exonerated as a health hazard to operating room personnel. However,



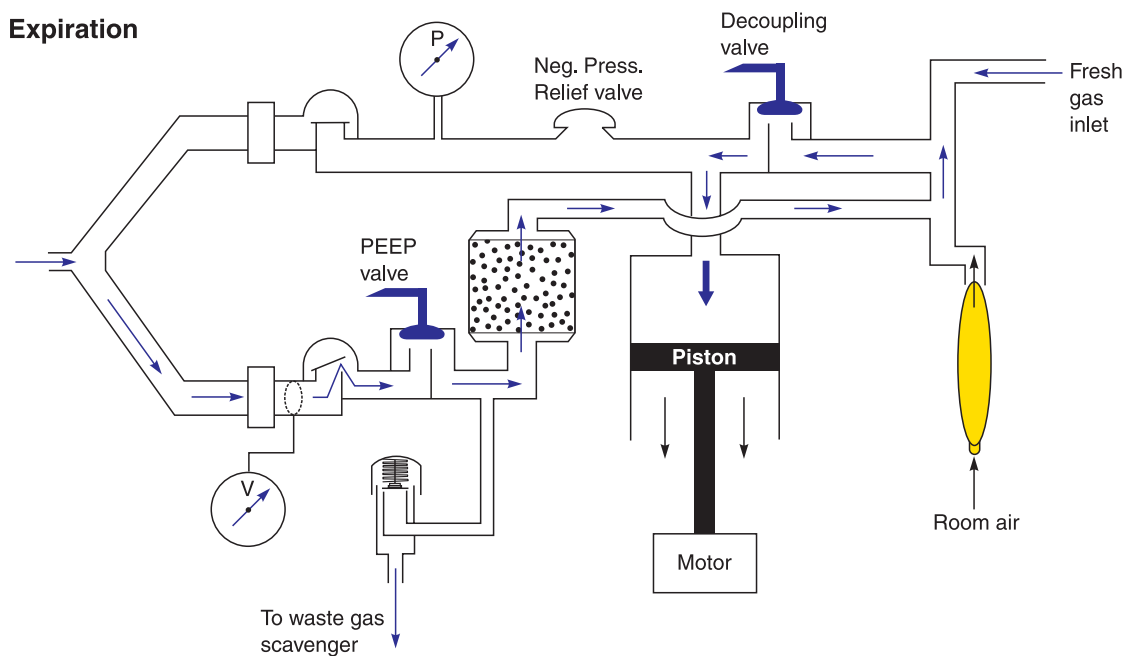
**FIGURE 38–46.** Fresh gas decoupling during the inspiratory phase of positive pressure ventilation. During this phase the decoupling valve, positive end-expiratory pressure (PEEP) valve and bellows valve are held closed. Fresh gas entering the breathing system is diverted into the reservoir bag, which therefore distends. Reproduced with permission from Abramovich A. Fresh gas decoupling minimizes complexity. APSF Newsletter 2005;20:35.



**FIGURE 38–47.** This figure shows that the function of the ventilator bellows can be performed by a piston in the same location. Piston ventilators are used in the Dräger Narkomed 6400 (Divan ventilator, horizontal piston), Fabius GS, and Apollo workstations (vertical pistons). Several advantages are afforded by a piston ventilator. Because they are driven by an electric motor there is no need for a driving gas circuit, which economizes on the use of oxygen, particularly if a cylinder supply is in use. The electric motor can control the piston very accurately and provide versatility in ventilatory modes such as offered in ICU ventilators. These ventilators are silent in operation and many anesthetists are used to the familiar sounds of a pneumatic ventilator. Some models offer variable tones to simulate inspiration and expiration. Adapted with permission from Abromovich A. *Fresh gas decoupling minimizes complexity.* APSF Newsletter 2005;20:35.



**FIGURE 38–48.** Fresh gas decoupling circuit during exhalation. The bellows refills (in this example by descending) and draws in fresh gas from the fresh gas inlet, and fresh gas that was stored in the reservoir bag during the previous inspiration. Reproduced with permission from Abromovich A. *Fresh gas decoupling minimizes complexity.* APSF Newsletter 2005;20:35.



**FIGURE 38–49.** Figure shows in principle the situation reported by Sandberg and Kaiser.<sup>69</sup> The reservoir bag that passed the machine checkout is replaced by one that has a large hole in it. During exhalation, room air is entrained into the circuit via the hole as the piston descends to refill the cylinder with anesthetic gas mixture. Because the circuit is now at atmospheric pressure (due to the hole in the bag, no air is entrained through the negative pressure relief valve and no alarm is annunciated. Adapted with permission from Abromovich A. Fresh gas decoupling minimizes complexity. APSF Newsletter 2005;20:35.

810

all the concerned agencies, such as the National Institute for Occupational Safety and Health (NIOSH), the American Hospital Association (AHA), the Joint Commission on Accreditation of Healthcare Organizations (JCAHO), and the American Society of Anesthesiologists (ASA), encourage reduction of exposure to waste gases, which includes waste gas scavenging and monitoring of measures to reduce exposure.

In a 1977 publication that to date has not been superseded, NIOSH recommended environmental limits for the upper boundary of exposure<sup>70</sup>:

Occupational exposure to halogenated anesthetic agents shall be controlled so that no worker is exposed at concentrations greater than 2 parts per million (ppm) of any halogenated anesthetic agent....When such agents are used in combination with nitrous oxide, levels of the halogenated agent well below 2 ppm are achievable. In most situations, control of nitrous oxide to a time-weighted average (TWA) concentration of 25 ppm during the anesthetic administration period will result in levels of approximately 0.5 ppm of the halogenated agent....Occupational exposure to nitrous oxide, when used as the sole anesthetic agent, shall be controlled

so that no worker is exposed at TWA concentrations greater than 25 ppm during anesthetic administration. Available data indicate that with current control technology, exposure levels of 50 ppm and less for nitrous oxide are attainable in dental offices.

These recommended exposure limits were based on two reports. Whitcher et al.<sup>71</sup> showed that these levels were readily attainable in the operating room when certain precautionary measures were taken. Bruce and Bach found no decrement in the psychomotor capacities of volunteers exposed for 4 hours at these levels.<sup>72</sup>

Because trace concentrations of anesthetic gases have never been proven to be a health hazard, the NIOSH-recommended limits were never promulgated into law and are therefore not enforceable by OSHA. In 1998, the ASA convened a Task Force on Trace Anesthetic Gases (of which this author was a member) to evaluate the status of this subject and make recommendations.<sup>73</sup> The opinion and recommendations of the Task Force are summarized as follows:<sup>73</sup>

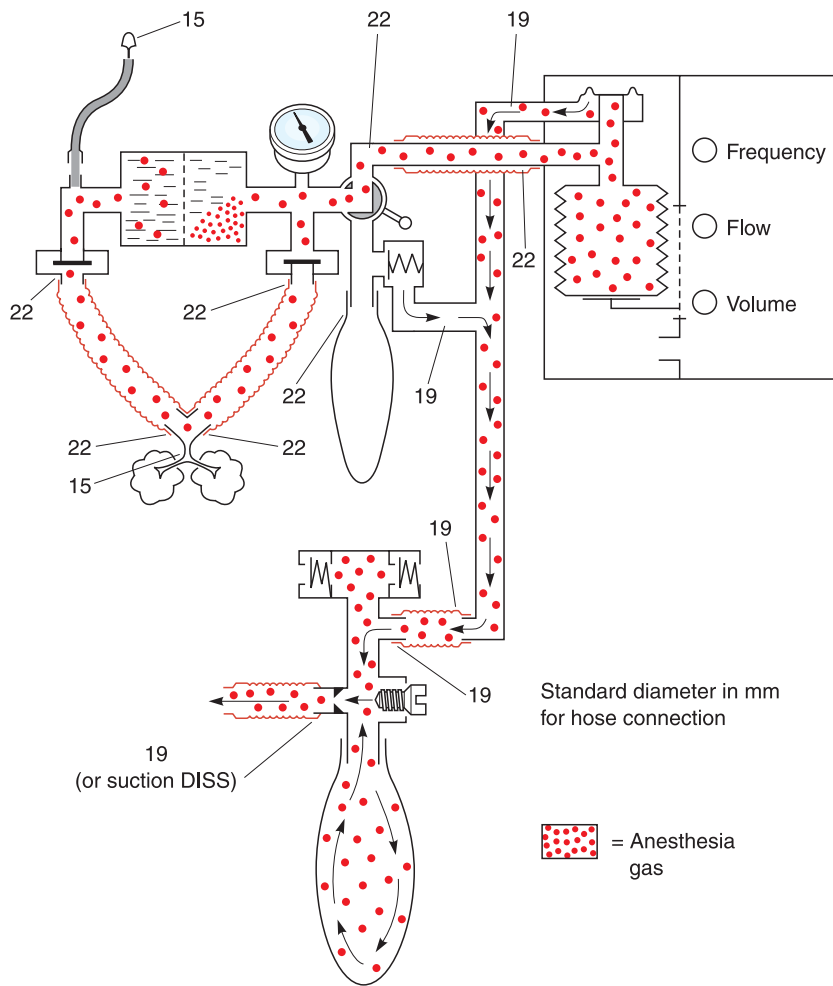
Studies have not shown an association between trace levels of waste anesthetic gases found in scavenged

anesthetizing locations and adverse health effects to personnel.

Recommendations of ASA Task Force on Waste Anesthetic Gases are:

1. Waste anesthetic gases should be scavenged.
2. Appropriate work practices should be used to minimize exposure to waste anesthetic gases.
3. Personnel working in areas where waste anesthetic gases may be present should be educated regarding current studies on health effects of exposure to waste anesthetic gases, appropriate work practices to minimize exposure, and machine checkout and maintenance procedures.
4. There is insufficient evidence to recommend routine monitoring of trace levels of waste anesthetic gases in the operating room and postanesthesia care unit.
5. There is insufficient evidence to recommend routine medical surveillance of personnel exposed to trace concentrations of waste anesthetic gases, although each institution should have a mechanism for employees to report suspected work-related health problems.

Waste gases may leave the anesthesia circuit via the APL valve or via the



**FIGURE 38–50.** Schematic of anesthesia circuit and scavenging system tubing showing diameters for hose connections. (Courtesy of Dräger, Telford, PA.)

ventilator pressure-relief valve. In either case, tubing of either a 19-mm or 30-mm internal diameter is used, as distinct from the 22-mm internal diameter with anesthesia circuit and ventilator tubing, and the 15-mm internal diameter common gas outlet and tracheal tube connector sizes (Fig. 38–50). The scavenging system interfaces the gas flow out of the patient circuit with the hospital suction system.<sup>8</sup> Scavenging systems may be open or closed.

Closed systems use spring-loaded valves to ensure that excessively high or low pressures are not applied to the patient circuit (Fig. 38–51).<sup>74,75</sup> Thus if not connected to negative pressure (suction), excess pressure in the closed interface caused by gas entering it from the circuit is vented via the positive-pressure (pop-off) relief valve, which opens at about +5 cm H<sub>2</sub>O. If excessive suction might be applied to the circuit, one (Ohmeda interface) or two (North

American Dräger closed interface, Fig. 38–50) negative-pressure relief (“pop-in”) valves (–0.25 to –1.80 cm H<sub>2</sub>O, depending on the system) would open to preferentially draw in room air. This would minimize the potential for application of negative pressure to the patient circuit.

Open-reservoir scavenging interfaces are valveless (Fig. 38–52) and use continually open relief ports to provide pressure relief.<sup>76</sup> Waste gas that exits from the breathing circuit (via the APL or ventilator pressure-relief valve) is directed to the bottom of the canister (all anesthetic gases are more dense than air), and the hospital suction system aspirates gas from the bottom of the canister. In this type of interface, the reservoir canister contains the excess waste gas and thereby accommodates a range of waste gas flow rates from the patient circuit. Because this type of interface depends on open relief ports for pressure relief,

care must be taken to ensure that these ports remain unoccluded at all times. Items 8a through 8e of the 1993 FDA checklist describe, in principle, how the scavenging system should be checked out (see Box 38–2 in Anesthesia Machine Checkout below).

In some recent models of workstation (e.g., ADU) the waste gas scavenging interface is internal to the machine and invisible to external inspection by the user. The principle of operation is that of an open reservoir system and the checkout requires that the machine’s scavenging connector is connected to the hospital vacuum and that the scavenging flowmeter indicates that flow is present. With the flowmeter indicator ball floating between the two lines, the vacuum is drawing about 25 L/min from the interface.

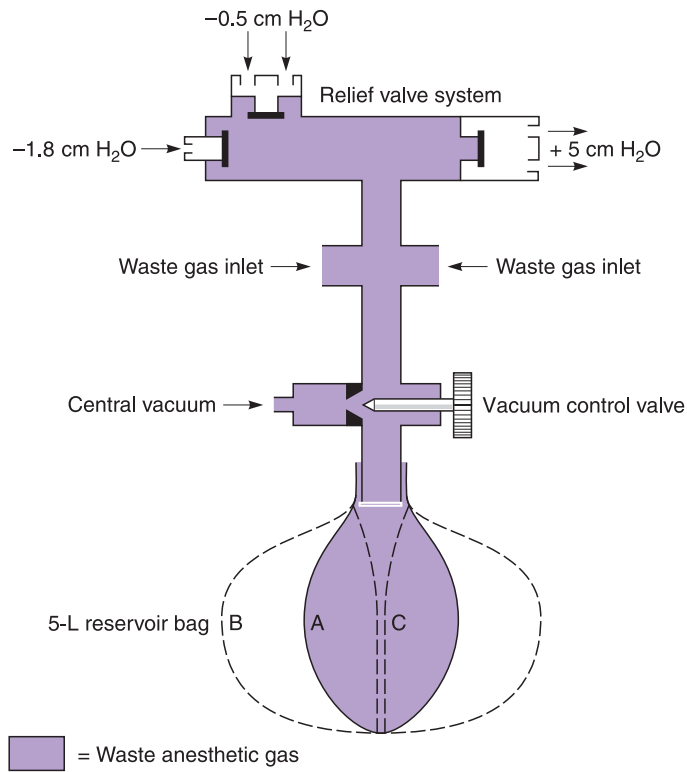
## ANESTHESIA MACHINE CHECKOUT

The anesthesia delivery system should be checked each day before administering anesthesia to the first patient and whenever any change has been made to the system. Such changes include replacing the ventilator bellows, replacing the anesthesia circuit, changing the absorbent, and moving the anesthesia workstation, even within the same operating room. Moving the machine may cause kinking or compression of tubing, which, in turn, may produce interference with gas delivery, ventilator function, or waste gas scavenging. Thus, in addition to a complete checkout at the start of each day, a shortened checkout of the delivery system should precede each administration of an anesthetic.

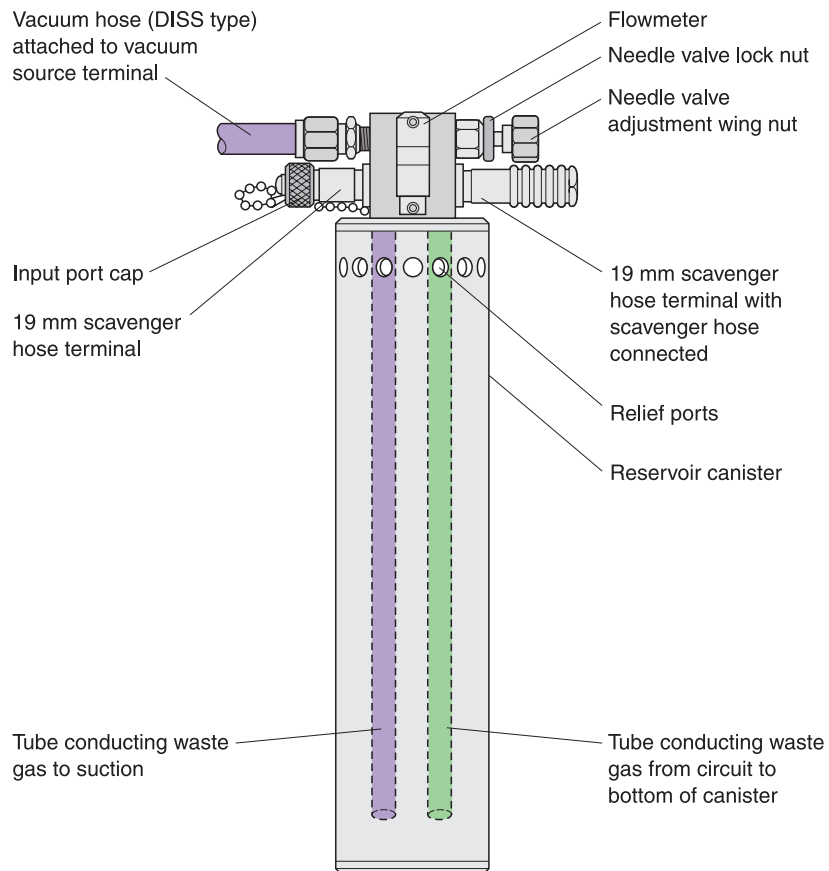
The Food and Drug Administration (FDA) first published its anesthesia apparatus checkout recommendations, which had 24 steps, in August 1986.<sup>77</sup> A subsequent study reported that the mere introduction of the FDA 1986 checklist did not improve the ability of anesthesiologists to detect anesthesia machine faults.<sup>78</sup>

A revised version of the FDA preuse checkout with 18 steps was published in 1993 (Box 38–2).<sup>79</sup> Many potential problems with the machine can be detected if the FDA checkout is performed correctly, although the best checkout is always that recommended by the manufacturer for its particular model of machine.





**FIGURE 38–51.** Dräger closed reservoir scavenger interface. **A** = Normal distention of bag, system working normally; **B** = Inadequate suction, bag distends and positive pressure relief valve opens; **C** = Excessive suction, bag collapses and negative pressure relief valves opens. (Courtesy of Dräger, Telford, PA.)



**FIGURE 38–52.** Dräger open-reservoir scavenging system. This interface uses continually open relief ports to provide positive and negative pressure relief (compare with valves in Fig. 38–51). An adjustable needle valve regulates waste gas exhaust flow, which is indicated on uncalibrated flowmeter. Flowmeter reading halfway between two white lines corresponds to suction flow rate of about 25 L/min. (Courtesy of Dräger, Telford, PA.)

## BOX 38-2.

## FDA Anesthesia Apparatus Checkout Recommendations—1993

Anesthesia Apparatus Checkout Recommendations, 1993

This checkout, or a reasonable equivalent, should be conducted before administration of anesthesia. These recommendations are only valid for an anesthesia system that conforms to current and relevant standards and includes an ascending bellows ventilator and at least the following monitors: capnograph, pulse oximeter, oxygen analyzer, respiratory volume monitor (spirometer), and breathing system pressure monitor with high and low pressure alarms. This is a guideline which users are encouraged to modify to accommodate differences in equipment design and variations in local clinical practice. Such local modifications should have appropriate peer review. Users should refer to the operator's manual for the manufacturer's specific procedures and precautions, especially the manufacturer's low pressure leak test (step #5).

*Emergency Ventilation Equipment*

\*1. Verify Backup Ventilation Equipment is Available & Functioning

*High Pressure System*

- \*2. Check Oxygen Cylinder Supply
  - a. Open O<sub>2</sub> cylinder and verify at least half full (about 1000 psi).
  - b. Close cylinder.
- \*3. Check Central Pipeline Supplies
  - a. Check that hoses are connected and pipeline gauges read about 50 psi.

*Low Pressure Systems*

- \*4. Check Initial Status of Low Pressure System
  - a. Close flow control valves and turn vaporizers off.
  - b. Check fill level and tighten vaporizers' filler caps.
- \*5. Perform Leak Check of Machine Low Pressure System
  - a. Verify that the machine master switch and flow control valves are OFF.
  - b. Attach "suction bulb" to common fresh gas outlet.
  - c. Squeeze bulb repeatedly until fully collapsed.
  - d. Verify bulb stays fully collapsed for at least 10 seconds.
  - e. Open one vaporizer at a time and repeat "c" and "d" as above.
  - f. Remove suction bulb, and reconnect fresh gas hose.

\*6. Turn On Machine Master Switch and All Other Necessary Electrical Equipment.

\*7. Test Flowmeters

- a. Adjust flow of all gases through their full range, checking for smooth operation of floats and undamaged flow tubes.
- b. Attempt to create a hypoxic O<sub>2</sub>/N<sub>2</sub>O mixture and verify correct changes in flow and/or alarm.

*Scavenging System*

\*8. Adjust and Check Scavenging System

- a. Ensure proper connections between the scavenging system and both APL (pop-off) valve and ventilator relief valve.
- b. Adjust waste gas vacuum (if possible).
- c. Fully open APL valve and occlude Y-piece.
- d. With minimum O<sub>2</sub> flow, allow scavenger reservoir bag to collapse completely and verify that absorber pressure gauge reads about zero.
- e. With the O<sub>2</sub> flush activated allow the scavenger reservoir bag to distend fully, and then verify that absorber pressure gauge reads <10 cm H<sub>2</sub>O.

*Breathing System*

- \*9. Calibrate O<sub>2</sub> Monitor
  - a. Ensure monitor reads 21% in room air.
  - b. Verify low O<sub>2</sub> alarm is enabled and functioning.
  - c. Reinstall sensor in circuit and flush breathing system with O<sub>2</sub>.
  - d. Verify that monitor now reads greater than 90%.
- 10. Check Initial Status of Breathing System
  - a. Set selector switch to "Bag" mode.
  - b. Check that breathing circuit is complete, undamaged and unobstructed.
  - c. Verify that CO<sub>2</sub> absorbent is adequate.
  - d. Install breathing circuit accessory equipment (e.g. humidifier, PEEP valve) to be used during the case.
- 11. Perform Leak Check of the Breathing System
  - a. Set all gas flows to zero (or minimum).
  - b. Close APL (pop-off) valve and occlude Y-piece.
  - c. Pressurize breathing system to about 30 cm H<sub>2</sub>O with O<sub>2</sub> flush.

d. Ensure that pressure remains fixed for at least 10 seconds.

e. Open APL (pop-off) valve and ensure that pressure decreases

*Manual and Automatic Ventilation Systems*

12. Test Ventilation Systems and Unidirectional Valves

- a. Place a second breathing bag on Y-piece.
- b. Set appropriate ventilator parameters for next patient.
- c. Switch to automatic ventilation (Ventilator) mode.
- d. Fill bellows and breathing bag with O<sub>2</sub> flush and then turn ventilator ON.
- e. Set O<sub>2</sub> flow to minimum, other gas flows to zero.
- f. Verify that during inspiration bellows delivers appropriate tidal volume and that during expiration bellows fills completely.
- g. Set fresh gas flow to about 5 L/min.
- h. Verify that the ventilator bellows and simulated lungs fill and empty appropriately without sustained pressure at end-expiration.
- i. Check for proper action of unidirectional valves.
- j. Exercise breathing circuit accessories to ensure proper function.
- k. Turn ventilator OFF and switch to manual ventilation (Bag/APL) mode.
- l. Ventilate manually and assure inflation and deflation of artificial lungs and appropriate feel of system resistance and compliance.
- m. Remove second breathing bag from Y-piece.

*Monitors*

13. Check, Calibrate, and/or Set Alarm Limits of all Monitors  
Capnometer Pulse Oximeter  
Oxygen Analyzer Respiratory Volume Monitor (Spirometer)  
Pressure Monitor with High and Low Airway Alarms

*Final Position*

- 14. Check Final Status of Machine
  - a. Vaporizers off
  - b. AFL valve open
  - c. Selector switch to "Bag"
  - d. All flowmeters to zero
  - e. Patient suction level adequate
  - f. Breathing system ready to use

\*If an anesthesia provider uses the same machine in successive cases, these steps need not be repeated or may be abbreviated after the initial checkout.

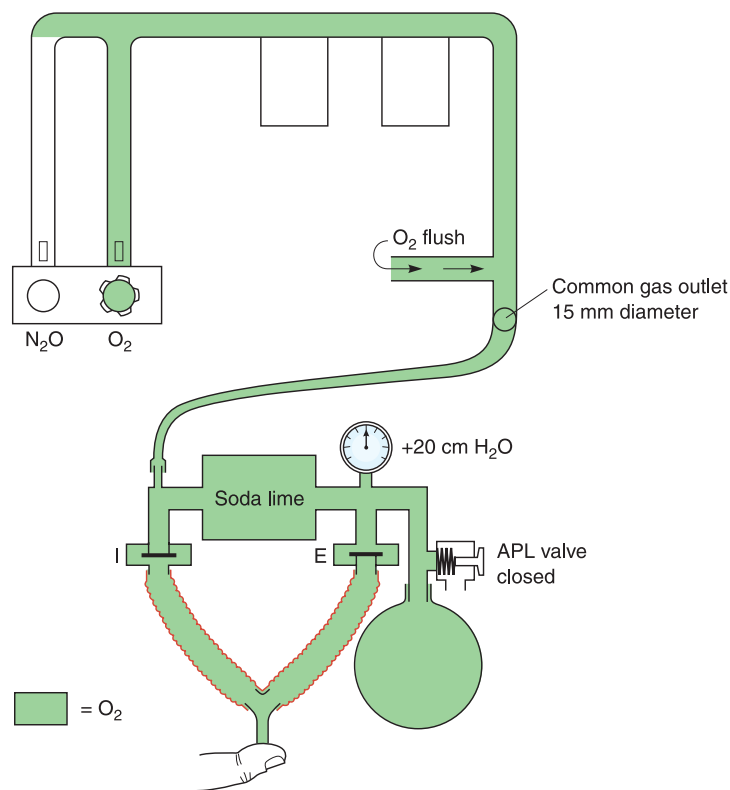
Updated May 12, 1997

## Testing for Leaks in the Anesthesia Machine and Breathing System

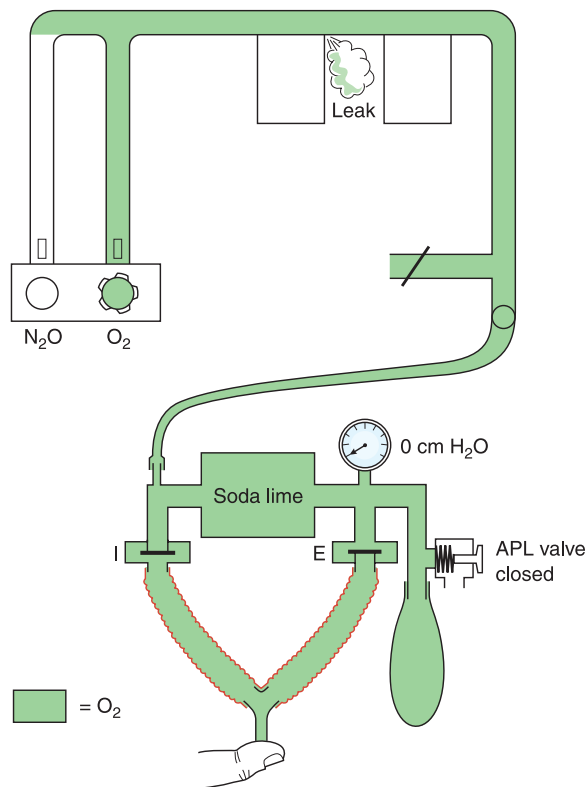
Item 5 in the 1993 FDA checkout recommendations (Box 38-2) describes how to check for leaks in the low-pressure system.<sup>79</sup> This checkout evaluates the components of the delivery system that are downstream of the gas flow control and should detect gross leaks that may result from cracked rotameter tubes, leaking gaskets, and vaporizers. This leak check evolved from that in the 1986 checkout. In the 1986 test, the APL ("pop-off") valve is closed and the patient circuit is occluded at the patient end. The system is then filled via the O<sub>2</sub> flush until the reservoir bag is just full, but negligible pressure exists in the system. Oxygen flow is set to 5 L/min and the oxygen flow is slowly decreased until pressure no longer rises above about 20 cm H<sub>2</sub>O (Fig. 38-53). This set flow is said to approximate the total gas leak rate, which should be no greater than a few hundred ml/min. The reservoir bag should then be squeezed to a pressure of about 50 cm H<sub>2</sub>O to verify that the system is gas tight. If a large enough leak is present, the circuit pressure may decrease to zero (Fig. 38-54).

The advantages of this test routine are that it can be performed quickly and that it checks the patient circuit as well as the low-pressure parts of the machine in those models without an outlet check valve. Disadvantages of this routine are that it is relatively insensitive to small leaks and that in those machines with an outlet check valve (e.g., Datex-Ohmeda Modulus I, Modulus II, Aestiva and Excel models), only the patient circuit downstream of the outlet check valve is tested for leaks (Fig. 38-55).

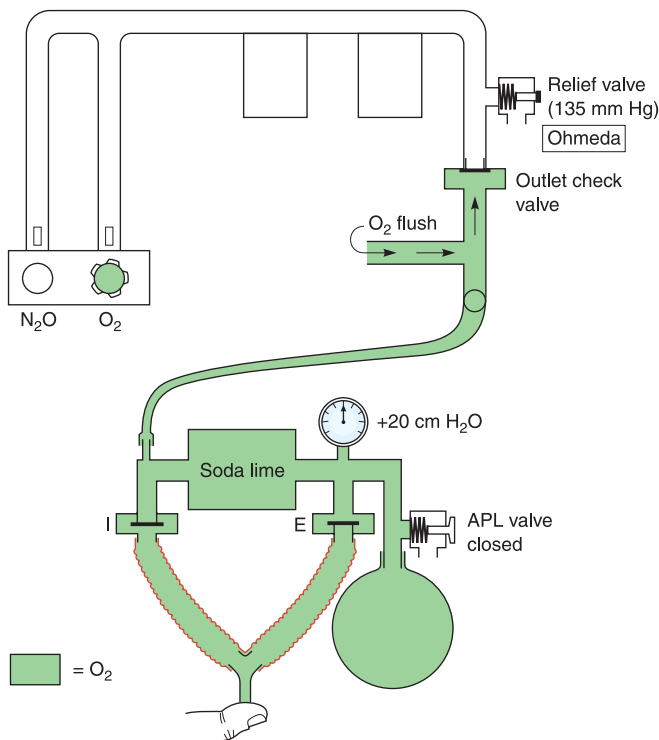
The FDA 1986 generic leak check also is insensitive because it is volume dependent. Thus in this test, a large volume of gas (i.e., that contained in the circuit tubing, absorber, and reservoir bag) is compressed, and a change in reading on the pressure gauge is sought. The term *compliance* expresses the relationship between volume and pressure and is defined as change in volume per unit change in pressure. Because of the large volume of gas compressed and the high compliance of the distensible reservoir bag, relatively large changes in volume (i.e., leaks) may exist with minimal changes in pressure. The anesthetist performing the check is seeking a pressure decrease as an indicator of gas



**FIGURE 38-53.** FDA 1986 generic leak test in a machine without an outlet check valve. In this case, a pressure of 20 cm H<sub>2</sub>O is held with no gas flow, indicating both patient circuit and low-pressure parts of machine are gas tight.



**FIGURE 38-54.** In absence of outlet check valve, a leak at the vaporizer mount results in failure of the system to hold pressure, which in this case falls to zero. Such a leak would not be detectable by this test if an outlet check valve (see Fig. 38-55) were present.



**FIGURE 38–55.** Application of generic checkout to a system with an outlet check valve. In this case, application of positive back pressure of 20 cm H<sub>2</sub>O causes the check valve to close so that only components downstream (i.e., the circuit) are being tested for leaks.

leakage, but large leaks may go undetected by this test. Such leaks may be unimportant while high fresh gas flows are used, but become more significant if gas flow rates are reduced subsequently during the maintenance of anesthesia.

The second limitation of the FDA 1986 generic checkout is related to the presence or absence of an outlet check valve, which, if present, separates the low-pressure part of the machine from the common gas outlet and circuit components downstream (Fig. 38–2). Application of the generic leak check in this situation may fail to detect leaks in components downstream of the outlet check valve (Fig. 38–55). In the past, certain anesthesia delivery systems configured by the user placed a free-standing vaporizer in series between the common gas outlet of the machine and the fresh gas inlet of the patient circuit. Some of these free-standing vaporizers incorporated their own outlet check valve to prevent a pumping effect on the vaporizer. If such an arrangement were to be used, the generic leak check would test only as far proximally as the location of this check valve in the vaporizer outlet.

The use of in-series, free-standing vaporizers is not described in the ASTM F1161–88 and subsequent stan-

dards and should be prohibited. Furthermore, because free-standing vaporizers are placed downstream of the machine's common gas outlet, use of the O<sub>2</sub> flush would deliver a "bolus" of the potent inhaled agent to the patient circuit. This assumes that the tubing connections are not disrupted by the potentially high pressures associated with use of the O<sub>2</sub> flush. A disconnect between the machine's common gas outlet and the free-standing vaporizer could also cause a low-concentration O<sub>2</sub> mixture to develop in the patient circuit during controlled ventilation (if a hanging bellows ventilator is being used), thus the current requirement for a retaining device. In addition, any vaporizer exclusion system (interlock) would be compromised with a free-standing arrangement. Again, it is emphasized that the use of a free-standing vaporizer downstream of the common gas outlet is not recommended and may be hazardous.

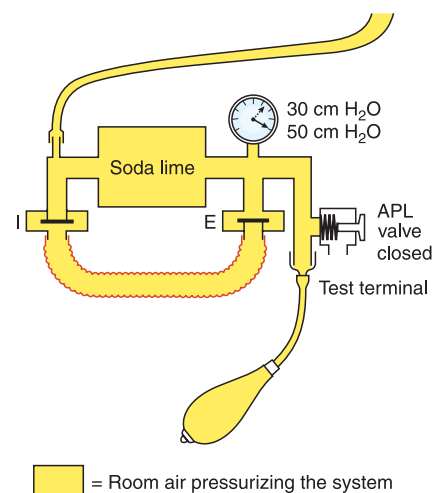
The limitations of the FDA 1986 generic leak check demand that specialized leak checks of the low-pressure system must be used and that the machine operator's manual be consulted for details. The tests described for the traditional Dräger Narkomed and Datex-Ohmeda machines are briefly re-

viewed to illustrate the differences in system design, function, and checkout.

### **Dräger Narkomed 2, Narkomed 3, Narkomed 4, and Narkomed GS Machines: No Outlet Check Valve**

Dräger recommends the following procedure for checking the anesthesia breathing system and fresh gas delivery system.<sup>11</sup> In this test, all gas flow-control (flowmeter) valves are closed, and the machine system's main power switch is turned to standby or off. This way, no gas should flow to the flowmeters or from the common gas outlet. All vaporizer concentration dials are set to zero. The inspiratory and expiratory valves are interconnected using a 22 mm-diameter circuit hose (Fig. 38–56). The shortest possible length of hose should be used to minimize contained gas volume. The "manual/automatic" selector valve is set to the manual (bag) position. The APL (pop-off) valve is closed (turned fully clockwise). The reservoir bag is removed, and the "test terminal" is attached to the bag mount. A sphygmomanometer squeeze bulb is connected to the hose barb on the test terminal.

The total volume of the circuit components has now been drastically reduced by removing the circle system tubing (a circle with each limb measuring 152 cm in length has a volume of about 1200 mL) and the reservoir bag (3 L). The sphygmomanometer bulb is then squeezed by hand until the pressure shown on the breathing system pressure gauge indicates a pressure higher than 50 cm H<sub>2</sub>O. The



**FIGURE 38–56.** Dräger Narkomed positive-pressure leak check. It should take 30 seconds or longer for the pressure to decrease from 50 to 30 cm H<sub>2</sub>O.



gauge is then observed for a pressure decrease. The manufacturer specifies that 30 seconds or longer is required for a pressure decrease from 50 to 30 cm H<sub>2</sub>O.<sup>11</sup> Because the volume of gas being compressed in this test is minimal, small gas leaks result in decreased pressure, which is observable on the circuit pressure gauge.

The positive-pressure leak check should be repeated sequentially with each vaporizer turned on and set at any concentration above 0.4%. This will check for leaks in individual vaporizers (e.g., filler caps, selector switches, vaporizer mounts).

The test specifications given in this section apply to an anesthesia breathing system without accessories (e.g., spirometer, sidestream gas analyzer, other adapters).<sup>11</sup> Test limits are exceeded when accessory items are included in the test. (The supplier of the accessory items should be contacted for leak specifications.)

Leaks in the patient circuit components can be distinguished from leaks in the low-pressure part of the Dräger Narkomed machine (no outlet check valve) as follows. If a leak has been identified using the combined circuit/machine positive-pressure leak check just described, the sphygmomanometer bulb can be connected to the machine's common gas outlet using a 15-mm connector and to a pressure gauge using a 3-way stopcock. With this arrangement, only the machine (as opposed to machine and circuit in the previous test) is pressurized to 50 cm H<sub>2</sub>O. A decrease in pressure then indicates a leak within the machine upstream of the common gas outlet. This test is possible because no outlet check valve is present in Dräger Narkomed machines.

Leaks in the patient circuit can be detected by systematically examining each component and connection in the circuit. If necessary, soap solution can be applied over joints suspected of leaking, with bubbles indicating the leakage site(s).

### **Datex-Ohmeda Machines: Outlet Check Valve Present**

In certain Datex-Ohmeda anesthesia machines (Modulus I, Modulus II, Excel, and Aestiva) an outlet check valve complicates positive-pressure testing of the machine's low-pressure system (Fig. 38–55).

Application of positive pressure downstream from the valve causes it to close, and only components down-

stream of this valve (i.e., beyond the common gas outlet) would then be checked for leaks. Positive-pressure ventilation and opening of the O<sub>2</sub> flush valve cause the check valve to close. For this reason, Datex-Ohmeda describes a negative-pressure leak test using a special suction bulb device that is supplied with each machine to which this test applies (Fig. 38–57).

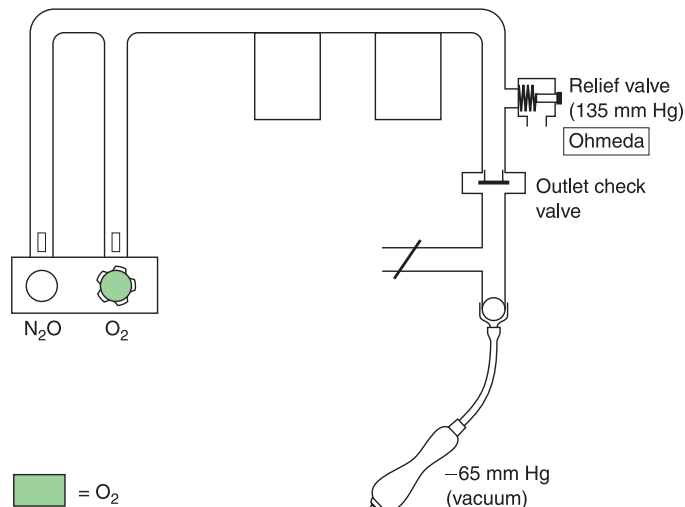
First, the adequacy of the leak-testing device should be checked by sealing the bulb's inlet connector and squeezing the bulb until it is collapsed. The bulb is then released and the time taken to reinflate observed. If reinflation occurs in less than 60 seconds, the device should be replaced.<sup>8,10,80</sup> The device is checked periodically (at times of machine servicing) to ensure that the vacuum produced by the evacuated bulb is at least –65 mm Hg (Fig. 38–57).

The device is then used to check the machine. The anesthesia machine system's master switch and all vaporizers are turned off so that no gases flow into the machine's low-pressure system. Each gas supply is then opened by turning on the cylinder valves or by connecting the pipeline supply. The flow-control valves (rotameters) are turned fully open. The negative-pressure leak-testing bulb is attached to the machine's common gas outlet via a 15-mm connector. The hand bulb is repeatedly squeezed and released until it remains collapsed. If the bulb reinflates within 30 seconds or less (Fig. 38–57), a leak of as little as 30 mL/min is present. The test procedure is repeated with each vaporizer on in turn to seek leaks in individual vaporizers. If the source is not obviously correctable, the machine should be withdrawn from service.

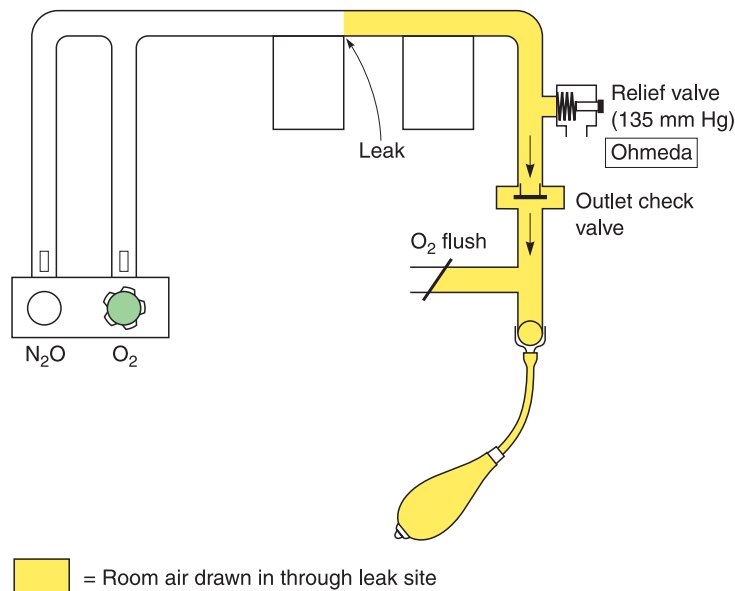
When the leak tests are completed, the negative-pressure bulb is removed from the common gas outlet, and residual vapors are purged from the machine by turning on O<sub>2</sub> flow at 1 L/min for 1 minute with all vaporizers off. Use of the O<sub>2</sub> flush control following this check does not purge vapors from the machine, because the O<sub>2</sub> flush flow enters the system downstream from the vaporizers and from the outlet check valve. Because the leak check described is conducted with all the flow-control valves open, components up to and including the machine's main on/off control switch are also tested for leaks.

The negative-pressure leak check described for Datex-Ohmeda machines results in the outlet check valve being held open by the –65 mm Hg vacuum (Fig. 38–58) and air or gas being sucked into the system through any leaks. If such leaks were present while the machine was in service, anesthesia gases would escape from the system through such leaks.

Considering the basic internal arrangement of the Datex-Ohmeda machines that have an outlet check valve, one might suggest that an internal machine leak could be detected by occluding the common gas outlet (by thumb or by clamping the fresh gas delivery tubing, as shown in Fig. 38–59). The machine is then turned on and the O<sub>2</sub> flow rate observed, which is possible at the rotameter, assuming that the O<sub>2</sub> flow rate indicates the leakage rate (compare with FDA 1986 checkout procedure). The procedure described does not necessarily indicate the true leakage rate, because these Datex-Ohmeda machines also have a pressure-relief valve located between the vaporizers



**FIGURE 38–57.** Datex-Ohmeda negative-pressure leak check. See text for details.



**FIGURE 38–58.** Datex-Ohmeda negative-pressure leak check. With a leak in the machine, the evacuated bulb reinflates. See text for details.

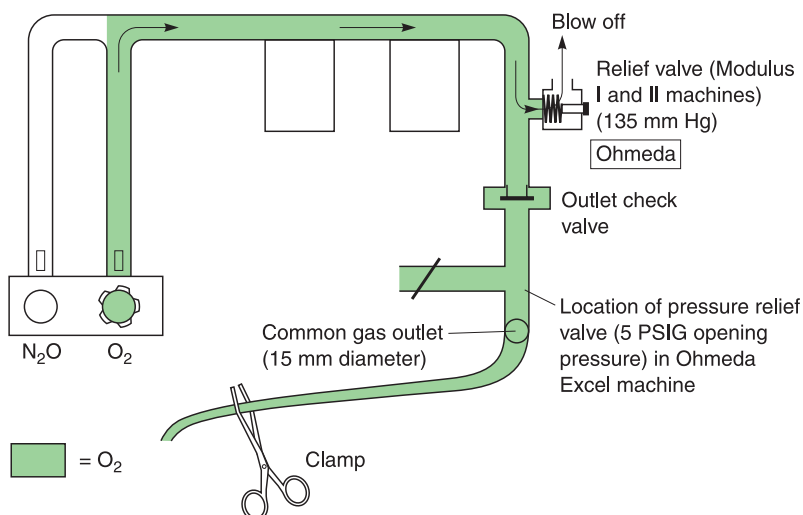
and the outlet check valve (see Figs. 38–57, 38–58, and 38–59). This pressure-relief valve opens at a pressure of  $135 \pm 15$  mm Hg (approximately 2.3–2.9 psig) to release gas and prevent pressure buildup proximal to the outlet check valve. Datex-Ohmeda Excel machines have a pressure-relief valve located downstream from the outlet check valve, between this valve and the common gas outlet. This pressure-relief valve has an opening pressure of 5 psig. A pressure-relief valve limits the use of the procedure just described to testing for machine leaks only at pressures below the pressure-relief valve's opening pressure. Consequently, only the negative-pressure test de-

scribed by Datex-Ohmeda in its operator's manual for the particular model should be used.

If, following testing, the anesthesia machine is found to have a leak, it should be withdrawn from use until an authorized agent has repaired the leak, rechecked the system, and certified that it is ready to be put back into clinical service.

#### **Datex-Ohmeda Modulus II Plus and Modulus CD Machines: No Outlet Check Valve**

Although the more recently introduced Datex-Ohmeda models (Modulus II Plus, Modulus CD) do not have an outlet check valve (Fig. 38–2), Datex-



**FIGURE 38–59.** Datex-Ohmeda system. The effect of occluding the common gas outlet and turning on the O<sub>2</sub> flowmeter is shown. Flow shown does not necessarily indicate leakage rate but may indicate rate of gas flow (blow-off) through pressure relief valve (pressure-relief valve). See text for details.

Ohmeda recommends the negative-pressure leak-test procedure previously described to check for leaks in these models.<sup>10</sup> The negative-pressure leak check device can, in principle, be used to check for leaks in a Dräger Narkomed machine, but Dräger has not provided specifications for using such a device on their products. Indeed, Myers et al. reported that the negative-pressure leak test could be used to detect leaks in all traditional anesthesia machines, whether they have an outlet check valve or not.<sup>81</sup> Item 5 of the FDA 1993 preuse checkout recommendations describes the use of the negative-pressure leak check bulb, and states that it should stay fully collapsed for at least 10 seconds.

#### **Automated Preuse Checkouts**

Although the preuse checkout of the workstation is very important, it is apparent that it is often performed inadequately. The most recently introduced anesthesia workstations (e.g., ADU, Aisys, Narkomed 6400, Apollo) use an automated checkout of many of the important functions. Advantages of an automated checkout are that it is performed correctly and alerts the user to faults and potential problems; the results are recorded in the memory of the workstation; and it enables certain parts of the checkout to be performed by an anesthesia technician so that an anesthetist who subsequently uses the workstation can see what has been checked and when.

Automated checkouts cannot, however, check all aspects of the workstation function. Certain procedures must still be performed by the user. The computerized checkout screen prompts and educates the user to perform certain checkout actions and to log that the actions have been done. For example, the user is expected to correctly assemble the breathing system and connect it to the workstation. The automated checkouts require that the Y-piece of the circuit be occluded so that the system can be pressurized to test for leaks and to measure compliance. This must be performed each time a change is made to the circuit. Thus there may not be a leak in the circuit used in the first case, but there may be a leak in the next used disposable circuit. Breathing circuit function, as opposed to integrity, can be checked by attaching a second reservoir bag to the circuit Y-piece to act as a model lung, and ventilating the bag in both manual and ventilator modes (see

Box 38–2, FDA 1993 checkout, step 12, above). This is important because the circuit may pass an automated pressure check but not a functional flow check.

With the introduction of the new workstations, the specific procedures recommended in the FDA 1993 checkout may not always be applicable, although the principles still apply. At the time of writing, an ASA subcommittee is reviewing the 1993 checkout with a view to suggest updated recommendations.

Studies of critical incidents and adverse outcomes in relation to anesthesia gas delivery equipment have consistently shown that use error is the most common cause of such incidents and outcomes.<sup>82–84</sup> Because intensive training of anesthetists improves their ability to detect problems with anesthesia equipment, educational efforts must be emphasized.<sup>85</sup> User education is a major concern and priority of the manufacturers as new and increasingly sophisticated workstations are introduced. Human patient simulation has been reported to be an effective training device to ensure that practitioners are competent to use new equipment in both straightforward and crisis situations before using the equipment with real patients.<sup>85</sup>

## SUMMARY

A basic understanding of the anesthesia delivery system and its components is important to the provision of safe patient care. The reader is encouraged to trace the flow of gases and vapors from their sources of storage, through the reader's own particular delivery system, to waste gas scavenging. One should also consider the structure and function of each component in the gas pathway. In this way, malfunctions can be more readily identified and often more easily corrected by the user.

The reader is also strongly encouraged to review the operator's manual accompanying the reader's anesthesia delivery system and, in particular, to understand the rationale behind the specific checkout procedures described.

## KEY REFERENCES

1. American Society for Testing and Materials. Standard specification for minimum performance

and safety requirements for components and systems of anesthesia gas machines. F1850.00. West Conshohocken, PA: ASTM, 2000.

2. Bowie E, Huffman LM. *The Anesthesia Machine: Essentials for Understanding*. Madison, WI: Ohmeda, BOC Health Care, 1985.

3. Cicman J, Himmelwright C, Skibo V, Yoder J. *Operating Principles of Narkomed Anesthesia Machines*. 2nd ed. Telford, PA: North American Dräger, 1993.

4. Conway CM. Anaesthetic breathing systems. *Br J Anaesth* 1985;57:649.

5. Dorsch JA, Dorsch SE. *Understanding Anesthesia Equipment*. 4th ed. Baltimore: Williams & Wilkins, 1999.

6. Ehrenwerth J, Eisenkraft JB, eds. *Anesthesia Equipment: Principles and Applications*. St. Louis, MO: Mosby-Year Book, 1993.

7. Food and Drug Administration. *Anesthesia Apparatus Checkout Recommendations*. Rockville, MD: FDA, 1993.

8. Schreiber P. *Safety Guidelines for Anesthesia Systems*. Telford, PA: North American Dräger, 1985.

9. Sykes MK. Rebreathing circuits, a review. *Br J Anaesth* 1960;40:666.

10. ASA. *Waste anesthetic gases. Information for management in anesthetizing areas and the postanesthesia care unit*. Task Force on Trace Anesthetic Gases of the ASA Committee on Occupational health of Operating Room Personnel. Park Ridge, IL: American Society of Anesthesiologists, 1999.

## REFERENCES

1. American Society for Testing and Materials. Standard specification for particular requirements for anesthesia workstations and their components. ASTM F1850–00. West Conshohocken, PA: ASTM, 2000.
2. American Society for Testing and Materials. Standard specification for minimum performance and safety requirements for components and systems of anesthesia gas machines. F1161–88. Philadelphia: ASTM, 1989.

3. Eisenkraft JB. Complications of anesthesia delivery systems. In: Schwartz AJ, ed. *ASA Refresher Courses in Anesthesiology*. Vol. 26. Philadelphia: Lippincott-Raven, 1998:45–56.

4. *Apollo Operating Instructions*. Telford, PA: Dräger Medical, 2005.

5. Schumacher SD, Brockwell RC, Andrews JJ. Bulk liquid O<sub>2</sub> supply failure. *Anesthesiology* 2004;100:186–189.

6. *Compressed Gas Cylinder Valve Outlet and Inlet Connections*. Pamphlet V-1. New York: Compressed Gas Association, 1977.

7. Davis PD, Parbrook GD, Kenny GNC. *Basic Physics and Measurement in Anesthesia*. 4th ed. Boston: Butterworth-Heinemann, 1995.

8. *Modulus II Anesthesia System Operation and Maintenance Manual*. Madison, WI: Ohmeda, BOC Health Care, 1987.

9. *Narkomed 3 Anesthesia System Technical Service Manual*. Telford, PA: North American Dräger, 1988.

10. *Modulus II Plus Anesthesia Machine Preoperative Checklists, Operation and Maintenance Manual*. Madison, WI: Ohmeda, BOC Health Care, 1988.

11. *Narkomed 3 Anesthesia System Operator's Instruction Manual*. Telford, PA: North American Dräger, 1986.

12. Eisenkraft JB. Anesthesia vaporizers. In: Ehrenwerth J, Eisenkraft JB, eds. *Anesthesia Equipment: Principles and Applications*. St. Louis, MO: Mosby-Year Book, 1992.

13. Fink BR. How much anesthetic? *Anesthesiology* 1971;34:403.

14. Fink BR. MAPP versus MAC. *Anesth Analg* 1985;64:646.

15. Rampil IJ, Lockhart SH, Eger EI II, et al. The electroencephalographic effects of desflurane in humans. *Anesthesiology* 1991;74:429.

16. Dorsch JA, Dorsch SE. *Understanding Anesthesia Equipment*. 4th ed. Baltimore: Williams & Wilkins, 1999.

17. Bowie E, Huffman LM. *The Anesthesia Machine: Essentials for Understanding*. Madison, WI: Ohmeda, BOC Health Care, 1985.

18. Bruce DL, Linde HW. Vaporization of mixed anesthetic liquids. *Anesthesiology* 1984;60:342.

19. Korman B, Ritchie IM. Chemistry of halothane–enflurane mixtures applied to anesthesia. *Anesthesiology* 1985;63:152.

20. *Vapor 19.1 Vaporizer Operating Manual*. Lübeck, Germany: Drägerwerk AG, 1986.

21. Scheller MS, Drummond JC. Solubility of N<sub>2</sub>O in volatile anesthetics contributes to vaporizer aberrancy when changing carrier gases. *Anesth Analg* 1986;65:88.

22. James MFM, White JF. Anesthetic considerations at moderate altitude. *Anesth Analg* 1984;63:1097.

23. Andrews JJ, Johnston RV Jr, Kramer GC. Consequences of misfilling contemporary vaporizers with desflurane. *Can J Anesth* 1993;40:71.

24. Tec 6 vaporizer: operation and maintenance manual. Madison, WI: Ohmeda, BOC Health Care, 1992.
25. Weiskopf RB, Sampson D, Moore MA. The desflurane (Tec 6) vaporizer. *Br J Anaesth* 1994;72:474.
26. Hendrickx JFA, De Cooman S, Deloof T, et al. The ADU vaporizing unit. A new vaporizer. *Anesth Analg* 2001;93:391-395.
27. Eisenkraft JB. Anesthesia vaporizers. In: Ehrenwerth J, Eisenkraft JB, eds. *Anesthesia Equipment: Principles and Applications*. St. Louis, MO: Mosby-Year Book, 1993:57-88.
28. Mapleson WW. The elimination of rebreathing in various semi-closed anaesthetic systems. *Br J Anaesth* 1954;26:323.
29. Sykes MK. Rebreathing circuits: a review. *Br J Anaesth* 1960;40:666.
30. Kain ML, Nunn JF. Fresh gas economics of the Magill circuit. *Anesthesiology* 1968;29:964.
31. Conway CM. Anaesthetic breathing systems. *Br J Anaesth* 1985;57:649.
32. Tyler CKG, Barnes PK, Rafferty MP. Controlled ventilation with a Mapleson A (Magill) breathing system: reassessment using a lung model. *Br J Anaesth* 1989;62:462.
33. Miller DM, Miller JC. Enclosed afferent reservoir breathing systems. *Br J Anaesth* 1988;60:469.
34. Bruce WE, Soni NC. Preliminary evaluation of the enclosed Magill breathing system. *Br J Anaesth* 1989;62:144.
35. Lack JA. Theatre pollution control. *Anaesthesia* 1976;31:259.
36. Bain JA, Spoerel WE. A streamlined anaesthetic system. *Can Anaesth Soc J* 1972;19:426.
37. Seeley HF, Barnes PK, Conway CM. Controlled ventilation with the Mapleson D system. *Br J Anaesth* 1977;49:107.
38. Jackson-Rees G. Anaesthesia in the newborn. *Br Med J* 1950;2:1419.
39. Eger EI II. Anesthetic systems: construction and function. *Anesthetic Uptake and Action*. Baltimore: Williams & Wilkins, 1974:214.
40. The Sodasorb Manual of Carbon Dioxide Absorption. New York: Dewey and Almy Chemical Division, WR Grace, 1962.
41. Tanifuji Y, Takagi MS, Kobayashi K, et al. The interaction between sevoflurane and soda lime or Baralyme [abstract]. *Anesth Analg* 1989;68:S285.
42. Fang ZX, Eger EI, Laster MJ, et al. Carbon monoxide production from degradation of desflurane, enflurane, isoflurane, halothane and sevoflurane by soda lime and Baralyme. *Anesth Analg* 1995;80:1187.
43. Steffey EP, Laster MJ, Ionescu P, Eger EI II, Gong D, Weiskopf RB. Dehydration of Baralyme increases compound A resulting from sevoflurane degradation in a standard anesthetic circuit used to anesthetize swine. *Anesth Analg* 1997;85:1382-1386.
44. Holak EJ, Mei DA, MB 3rd, et al. Carbon monoxide production from sevoflurane breakdown: modeling of exposures under clinical conditions. *Anesth Analg* 2003;96:757-764.
45. Laster M, Roth P, Eger EI II. Fires from the interaction of anesthetics with desiccated absorbent. *Anesth Analg* 2004;99:769-774.
46. Wu J, Previte JP, Adler E, Myers T, Ball J, Gunter JB. Spontaneous ignition, explosion, and fire with sevoflurane and barium hydroxide lime. *Anesthesiology* 2004;101:534-537.
47. Castro BA, Freedman LA, Craig WL, Lynch C III. Explosion within an anesthesia machine: Baralyme, high fresh gas flows and sevoflurane concentration. *Anesthesiology* 2004;101:537-539.
48. Fatheree RS, Leighton BL. Acute respiratory distress syndrome after an exothermic Baralyme-sevoflurane reaction. *Anesthesiology* 2004;101:531-533.
49. Woehlick HJ. Sleeping with uncertainty: anesthetics and desiccated absorbent. *Anesthesiology* 2004;101:276-278.
50. Laster MJ, Eger EI II. Temperatures in soda lime during degradation of desflurane, isoflurane, and sevoflurane by desiccated soda lime. *Anesth Analg* 2005;101:753-757.
51. Murray JM, Renfrew CW, Bedi A, McCrystal CB, Jones DS, Fee JPH. Amsorb. A new carbon dioxide absorbent for use in anesthetic breathing systems. *Anesthesiology* 1999;91:1342-1348.
52. Struys MM, Bouche MP, Rolly G, et al. Production of compound A and carbon monoxide in circle systems: an in vitro comparison of two carbon dioxide absorbents. *Anaesthesia* 2004;59:584-589.
53. Kobayashi S, Bito H, Morita K, Katoh T, Sato S. Amsorb Plus and Drägerorb Free, two new-generation carbon dioxide absorbents that produce a low compound A concentration while providing sufficient CO<sub>2</sub> absorption capacity in simulated sevoflurane anesthesia. *J Anesth* 2004;18:277-281.
54. Versichelen LFM, Pouche, M-PLA, Rolly G, et al. Only carbon dioxide absorbents free of both NaOH and KOH do not generate compound A during in vitro closed-system sevoflurane. *Anesthesiology* 2001;95:750-755.
55. Knolle E, Heinze G, Giloly H. Small carbon monoxide formation in absorbents does not correlate with small carbon dioxide absorption. *Anesth Analg* 2002;95:650-655.
56. Ohmeda 7000 Electronic Anesthesia Ventilator Service Manual. Madison, WI: Ohmeda, BOC Health Care, 1985.
57. Ohmeda 7810 Electronic Anesthesia Ventilator Service Manual. Madison, WI: BOC Health Care, 1989.
58. Narkomed 2A Anesthesia Machine Technical Service Manual, Operating Principles. Telford, PA: North American Dräger, 1989.
59. Eisenkraft JB. Potential for barotrauma or hypoventilation with the North American Dräger AV-E ventilator. *J Clin Anesth* 1989;1:452.
60. Sommer RM, Bhalla GS, Jackson JM, et al. Hypoventilation caused by ventilator valve rupture. *Anesth Analg* 1988;67:999.
61. American Society for Testing and Materials. Standard Specification for Ventilators Intended for Use During Anesthesia. F1101-90. Philadelphia: ASTM, 1990.
62. Klemenzson GK, Perouansky M. Contemporary anesthesia ventilators incur a significant oxygen cost. *Can J Anaesth* 2004;51:616-620.
63. Eisenkraft JB, Sommer RM. Hazards of the anesthesia delivery system. In: Ehrenwerth J, Eisenkraft JB, eds. *Anesthesia Equipment: Principles and Applications*. St. Louis, MO: Mosby-Year Book, 1993:321-349.
64. Roth S, Tweedie E, Sommer RM. Excessive airway pressure due to a malfunctioning anesthesia ventilator. *Anesthesiology* 1986;65:532.
65. Gravenstein N, Banner MJ, McLaughlin G. Tidal volume changes due to the interaction of anesthesia machine and anesthesia ventilator. *J Clin Monit* 1987;3:187.
66. Scheller MS, Jones BL, Benumof JL. The influence of fresh gas flow and I:E ratio on tidal volume and arterial PCO<sub>2</sub> in mechanically ventilated surgical patients. *J Cardiothorac Anesth* 1989;3:564.
67. Schreiber P. Safety Guidelines for Anesthesia Systems. Telford, PA: North American Dräger, 1985.
68. Elliott WR, Harris AE, Philip JH. Positive end-expiratory pressure: implications for tidal volume changes in anesthesia machine ventilation. *J Clin Monit* 1989;5:100.
69. Sandberg WS, Kaiser S. Novel breathing circuit architecture: new consequences of old problems. *Anesthesiology* 2004;100:755-756.
70. NIOSH. Criteria for a Recommended Standard—Occupational Exposure to Waste Anesthetic Gases and Vapors. Pub no. 77-140. Cincinnati, OH: US Department of Health, Education and Welfare, Public Health Service, Centers for Disease Control, National Institute for Occupational Safety and Health, 1977.
71. Whitcher C, Piziali R, Sher R. Development and Evaluation of Methods for the Elimination of Waste Anesthetic Gases and Vapors in Hospitals. No. (NIOSH) 75-137. Cincinnati, OH: US Department of Health, Education and Welfare, Public Health Service, Centers for Disease Control, National Institute for Occupational Safety and Health, 1975.
72. Bruce DL, Bach MJ. Effects of trace anaesthetic gases on behavioural performance of volunteers. *Br J Anaesth* 1976;48:871.
73. American Society of Anesthesiologists. Waste Anesthetic Gases. Information for Management in Anesthetizing Areas and the Postanesthesia Care Unit. Task Force on



Trace Anesthetic Gases of the ASA Committee on Occupational Health of Operating Room Personnel. Park Ridge, IL: American Society of Anesthesiologists, 1999.

74. American Society for Testing and Materials. Standard Specification for Anesthetic Equipment. Scavenging Systems for Anesthetic Gases. ASTM F1343-91. Philadelphia: ASTM, 1991.

75. Azar I, Eisenkraft JB. Waste gas scavenging. In: Ehrenwerth J, Eisenkraft JB, eds. Anesthesia Equipment: Principles and Applications. St. Louis, MO: Mosby-Year Book, 1993:114-139.

76. Open Reservoir Scavenger Operators Instruction Manual. Telford, PA: North American Dräger, 1986.

77. Food and Drug Administration. Anesthesia Apparatus Checkout Recommendations. Rockville, MD: FDA, 1986.

78. March MG, Crowley JJ. An evaluation of anesthesiologists' present checkout methods and the validity of the FDA checklist. *Anesthesiology* 1991;75:724-729.

79. Food and Drug Administration. Anesthesia Apparatus Checkout Recommendations. Rockville, MD: FDA, 1993.

80. Modulus II System Service Manual. Madison, WI: Ohmeda, BOC Health Care, 1985.

81. Myers JA, Good ML, Andrews JJ. Comparison of tests for detecting leaks in the low pressure system of anesthesia gas machines. *Anesth Analg* 1997;84:179.

82. Cooper JB, Newbower RS, Kitz RJ. An analysis of major errors and equipment failures in anesthesia management: considerations for prevention and detection. *Anesthesiology* 1984;60:34-42.

83. Caplan RA, Vistica MF, Posner KL, Cheney FW. Adverse anesthetic outcomes arising from gas delivery equipment: a closed claims analysis. *Anesthesiology* 1997;87:741-748.

84. Eisenkraft JB. A commentary on anesthesia gas delivery equipment and adverse outcomes. *Anesthesiology* 1997;87:731-733.

85. Olympio MA Goldstein MM, Mathes DD. Instructional review improves performance of anesthesia apparatus checkout procedures. *Anesth Analg* 1996;83:618-622.

# CHAPTER 39

## Principles of Pharmacokinetics and Pharmacodynamics: Applied Clinical Pharmacology for the Practitioner

Ken B. Johnson, MD, and  
Talmage D. Egan, MD

### CLINICAL PHARMACOLOGY: WHY BOTHER?

Clinical pharmacology is the science of predicting the magnitude and time course of drug effect. Given that anesthesiologists and other anesthesia providers spend their day administering low therapeutic index agents, clinical pharmacology is perhaps more important to anesthesiology than any other specialty. From a practical aspect, the ultimate goal of clinical pharmacology is to provide anesthesia practitioners with the information they need to make rational decisions about the selection and administration of anesthetics.

Anesthesia and reanimation necessitate a standard of precision and accuracy in drug administration not required in most areas of clinical medicine. Practitioners must profoundly depress the central nervous system in order to maintain the anesthetized state but then rapidly reanimate patients after an operation is complete. Although overdosing every patient within the constraints of acceptable hemodynamic variables is one approach to assuring the patient is adequately anesthetized, it comes at the cost of slow emergence from anesthesia, among others. Therefore, clinicians must target drug levels that are within a relatively narrow therapeutic window to achieve the competing clinical imperatives of adequate anesthesia (without toxicity) and rapid emergence.

Once an agent is selected (presumably because the agent's pharmacologic profile is well suited to the proposed

application), the next challenge is the formulation of a scientifically grounded dosing strategy. What does the anesthetist need to know? Table 39-1

catalogues some of the important considerations in determining the proper drug administration scheme in the context of anesthesia practice.

### KEY POINTS

1. The ultimate goal of *pharmacokinetic–pharmacodynamic* study is accurate prediction of the time course and magnitude of drug effect so that the clinician can answer a very simple and important question: “What is the appropriate dosing scheme for my patient?”
2. *Pharmacokinetics*, often thought of as “what the body does to the drug,” is the study of the relationship between the drug dose and the drug concentrations that are produced over time.
3. *Pharmacodynamics*, often thought of as “what the drug does to the body,” is the study of the relationship between the drug concentration and the drug effects that are produced.
4. Pharmacokinetic–pharmacodynamic models can be constructed that characterize drug behavior. These models are mathematical expressions of the relationship between drug dose and concentration (pharmacokinetics) and drug concentration and effect (pharmacodynamics). The models are composed of individual parameters (e.g., *clearance*, *distribution volume*, *effective concentration for 50% of maximal effect*, etc.). Because of the complex interaction of the parameters, drawing conclusions about drug behavior from a single parameter is difficult.
5. Because it is a mathematically based discipline, pharmacokinetics–pharmacodynamics is a distinctly unpopular subject among clinical anesthesiologists. This unpopularity is ironic considering there is no medical specialty for which accurate prediction of the time course and magnitude of drug effect is more important (anesthesiologists produce profound, potentially dangerous drug effects that must be “turned on and off” in a rapid fashion).
6. Fortunately, the clinical implications of pharmacokinetic–pharmacodynamic models can be easily understood and conveyed through the use of *computer simulation*. Using computer simulation, a proposed dosing scheme can be “input” into a pharmacokinetic–pharmacodynamic model, producing a “*picture*” of the drug levels and drug effects that are expected to occur. These pictures (i.e., computer simulations) are intuitively understandable and are easily applied to clinical situations.
7. The “*biophase*” is the theoretical site of drug action or “*effect site*” (e.g., the brain, the neuromuscular junction, the spinal cord, etc.). It is important to consider drug concentrations in the biophase (and not just the plasma) because most drugs do not exert their effect in the blood. Pharmacokinetic–pharmacodynamic models account for this problem by linking the concentrations in the blood to theoretical concentrations in the biophase.
8. Because anesthetics are rarely administered alone (i.e., anesthesia usually is at least a two-drug process consisting of an analgesic and a sedative), characterizing the interaction between drugs is also an important goal of pharmacokinetic–pharmacodynamic study. Most anesthetics commonly used in combination, such as fentanyl and propofol, interact in a profoundly synergistic way (i.e., where  $2 + 2 = 7$  or more...) so that much less of each drug is required (compared to the doses necessary when the drugs are used alone). Drug interaction models using “*response surface*” methods can be used to visualize these *synergistic interactions* and identify optimal dosing regimens.
9. Anesthesiologists have long recognized the need to adapt their anesthetic to account for differences in demographic factors and disease processes that influence drug disposition or effect. Comorbidities such as obesity, blood loss, presence of opioid tolerance, and differences in age are referred to as *covariates*. Covariates are descriptors of demographic factors or pathophysiologic states that impact anesthetic drug behavior.

TABLE 39–1.

### Questions to Consider When Formulating a Dose of Intravenous Anesthetic

1. What is an appropriate dose for my particular patient? Should I give the dose as a bolus or as a continuous infusion?
2. How soon will the intended effect start?
3. How long will it last?
4. How do the onset and duration of effect change in the presence of other anesthetics?
5. How do I minimize sedation yet optimize analgesia following surgical procedures associated with a painful postoperative course?
6. Do I know how to account for body weight, age, or other important factors that may alter dosage requirements (e.g., blood loss, heart failure, kidney failure, etc.) in how I determine the dose?
7. How can I tailor my anesthetic to account for opioid tolerance in patients who chronically consume opioids and/or benzodiazepines?

Adapted from Sheiner<sup>90</sup> with permission.

Anesthesiologists have long recognized that conventional, often simplified approaches to describing drug behavior, such as “half-life” or “peak and trough,” are not useful in answering these questions.<sup>1</sup> Perhaps no other specialty in medicine is more dependent on accurate predictions of a drug’s pharmacokinetic and pharmacodynamic profile than is anesthesiology. Most settings in clinical medicine do not require immediate onset and rapid offset of pharmacologic effect. When an internist prescribes an oral medication for treatment of hypertension, for example, the fact that several days may be required for the development of a steady-state level of drug effect is of little consequence. The anesthetist, however, must rely on drugs with rapid onset and predictable offset of effect to ensure maintenance of an anesthetic state with return of responsiveness and other vital functions at the appropriate time. In summary, an understanding of fundamental pharmacokinetic and pharmacodynamic concepts is of critical importance to the clinical practice of anesthesiology.

Modern clinical pharmacology techniques and concepts provide the scien-

tific foundation to answer the questions listed in Table 39–1. Clinical pharmacologists have created tools using principles of pharmacokinetics and pharmacodynamics to construct models that predict drug behavior. Unfortunately, the often puzzling mathematical manipulations involved in estimating pharmacokinetic and pharmacodynamic parameters and the complex mathematics required to build models that predict drug behavior have made these techniques distinctly unpopular among most practitioners. Most practitioners have been slow to integrate the intricacies of kinetics and dynamics into their clinical practice, instead relying on training and experience to determine dosing. Thus, determination of the proper dose in clinical anesthesia often is little more than a sophisticated guess based on the anesthesiologist’s gestalt impressions.

So why bother with clinical pharmacology? It is because this discipline provides the core scientific foundation for optimizing doses of intravenous anesthetics and should be a part of every practicing anesthetist’s knowledge base. Fortunately, advances in pharmacologic computer *simulation* have revolutionized the way we apply complex pharmacokinetic and pharmacodynamic models. Simulations can be used to create meaningful *pictures* of drug behavior that are useful when considering the questions given in Table 39–1. Pharmacokinetic and pharmacodynamic model simulations get beyond the clinically unappealing mathematics associated with this area, providing an intuitively interpretable picture of drug behavior that clinician can grasp and apply in day-to-day practice. Relying almost entirely on simulations (and not math), the purpose of this chapter is to empower practitioners with key concepts in pharmacokinetics and pharmacodynamics that influence the answer to the question: “What is an appropriate dose for my patient?”

## PHARMACOLOGIC MODELING

### Pharmacokinetics

To develop a *pharmacokinetic* model, clinical pharmacologists administer a drug and then repeatedly measure drug levels until the concentration is undetectable. The raw data are drug concentrations over time (Fig. 39–1).

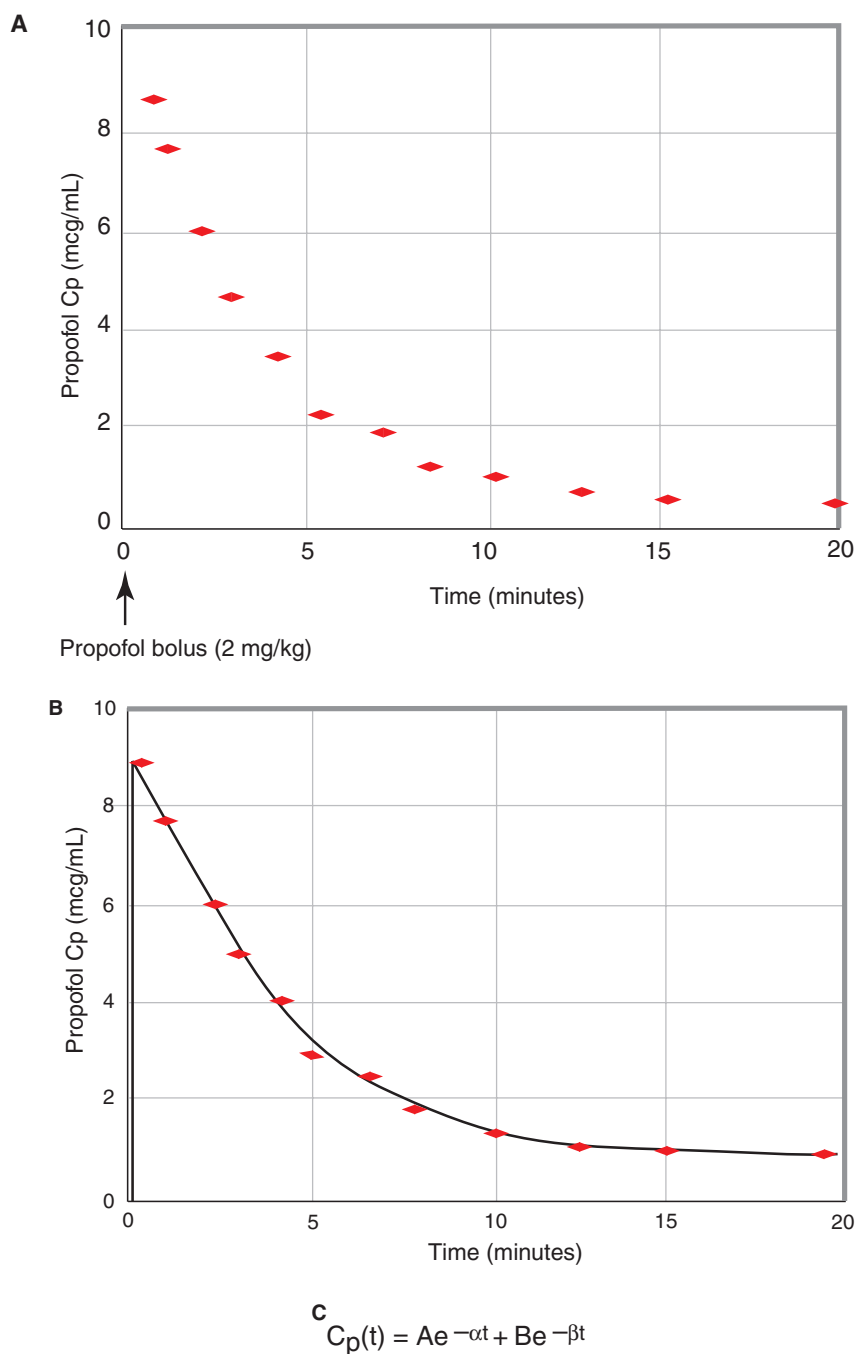
Using computerized pharmacokinetic tools, an equation is fit to the raw data. The equations used are simply a mathematical expression of the shape of the concentration versus time curve. The equations are composed of parameters such as fractional coefficients and rate constants, which are not much use to most providers.

To make parameters more meaningful, these equations often are reparameterized (converted) in terms of *distribution volumes* and *clearances* or intercompartmental *micro rate constants*. Distribution volumes and clearances are used to create compartmental models that provide a schematic representation of drug behavior (Fig. 39–2A).

### Unimportance of Individual Parameters

It is difficult for clinicians to take advantage of compartment models and the mathematical equations that represent them in a clinical setting. Consideration of individual volumes of distribution or clearance parameters in formulating a dose of anesthetic that accounts for the complex interplay of the parameters is impossible for humans to do in real time.

As an example of this complexity, consider the illustration in Fig. 39–2B. As a metaphor of a compartment model, tracking loans and bank accounts over time provides insight into what is required to estimate drug concentrations in the body over time. Consider a person with an income of \$2,900 that is deposited into his/her bank account each month. From this bank account there are two monthly withdrawals to pay for credit card debt and mortgage payments. The credit card debt has a high interest rate (18%) with a debt load of \$10,000. The mortgage has a low interest rate (5.5%) and a balance of \$100,000. The monthly payments to each are \$200 and \$900 to the credit card and mortgage companies, respectively. In addition, each month there is a monthly expenditure of \$1,000 for savings and daily living operating costs. Assuming no other expenses, how much money will be in the bank (central compartment) in 21 months? It is clear that without the use of a computer, calculating the answer to this question is impossible. Hence, using compartmental models without computer support makes them not very useful in a clinical environment.



**FIGURE 39-1.** Development of a pharmacokinetic model, using propofol as an example. **A.** Raw data. Drug levels (red diamonds) are repeatedly measured over time. **B.** Analyzed data. A drug disposition curve (black line) is fit to the raw data using an exponential equation based on a computerized nonlinear regression analysis. **C.** The equation is simply a mathematical representation of curves of the general shape that “fit” the data. The nonlinear regression “curve fitting” exercise results in a set of parameters (in this example, A, B,  $\alpha$ , and  $\beta$ ) that, when plugged into the equation, reproduces the curve through the data.  $C_p(t)$  represents the plasma propofol concentration as a function of time ( $t$ ). This is the mathematical basis of the pharmacokinetic model that clinicians need not worry about!

### Importance of Simulations

The real power from these pharmacokinetic parameters and compartment models comes through simulation. Because little insight into a drug's pharmacokinetic profile can be gleaned from simple inspection of its multicom-

partment pharmacokinetic parameters, computer simulation of the expected rise and fall of drug concentrations using a drug's pharmacokinetic parameters has assumed an important role in modern pharmacokinetic research and analysis. Making use of population

pharmacokinetic parameters estimated in research studies, computers can be programmed to simulate the concentration versus time profile that results from any combination of boluses and/or continuous infusions. Although such simulations are subject to certain limitations, they are intuitive graphic representations of the time course of drug concentration.<sup>2</sup>

For example, Fig. 39-3 illustrates a set of simulations of propofol using pharmacokinetic parameters from the literature.<sup>3</sup> In these simulations, the temporal profile of plasma propofol levels that result from various bolus doses is plotted over time. From these plots it is possible to visualize the peak plasma propofol concentration attained and the time propofol levels remain present in the plasma.

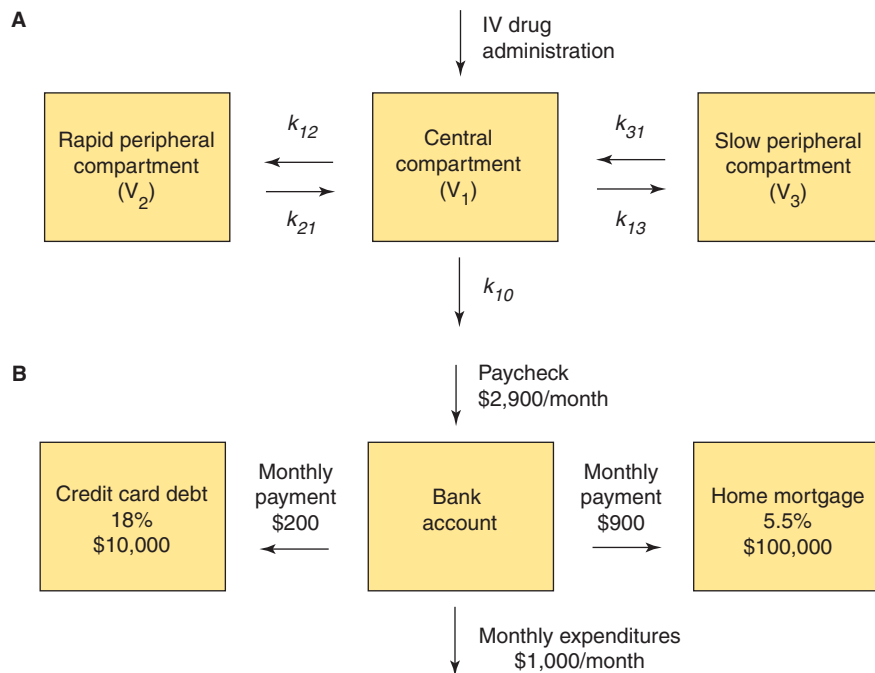
Without the aid of a computer, these simulations would be impossible. Although the simulations are limited by the quality of the original research from which the pharmacokinetic parameters were estimated and the inherent variability of pharmacokinetic parameters from patient to patient, the simulations are nonetheless a graphic representation of a drug's expected clinical pharmacokinetic profile and provide an excellent framework within which to formulate a rational dosing strategy.

### Context-Sensitive Half-Times

Computer simulation has been useful in demonstrating how estimating drug behavior based on individual kinetic parameters such as terminal half-lives can be misleading.<sup>1</sup> Clinicians have traditionally relied on terminal half-lives as a reflection of the duration of drug action when, in fact, terminal half-life alone is not a very useful pharmacokinetic parameters.<sup>4</sup> To that end, techniques have been used to predict the time necessary to achieve a 50% decrease in drug concentration after termination of variable-length continuous infusions. Approaches in simulation have been developed to provide a *context-sensitive-half time* or *50% decrement time* where “context” refers to the duration of a continuous infusion.<sup>5</sup> Such simulations are intended to provide more clinically relevant parameters than “half-life” or “volume of distribution.”<sup>6</sup>

Fig. 39-4 is a graphical representation of context sensitive half-times for selected opioids and sedatives using

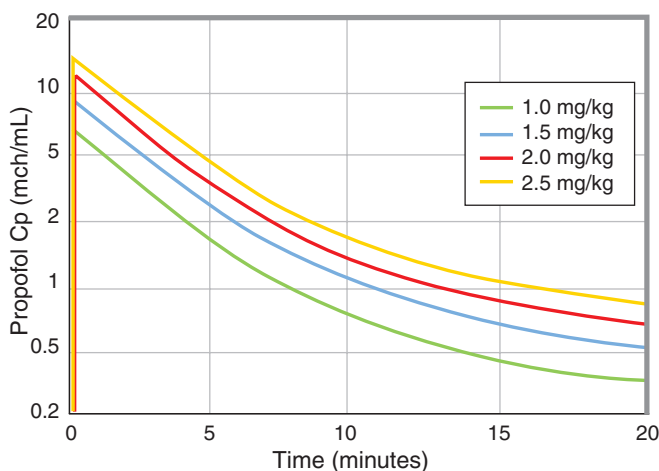




**FIGURE 39-2.** Mathematical complexity of the three-compartment model. **A.** Schematic of a three-compartment model. The  $k$  parameters represent rate constants. The  $V$  parameters represent the compartment volumes. **B.** Metaphor of a three-compartment model: cash flow through multiple accounts.

parameters from the literature.<sup>3,7-11</sup> As can be appreciated in Fig. 39-4A, clinically relevant information is easily gleaned from the plot that compares the context-sensitive half-times for propofol, etomidate, and midazolam. Here propofol and etomidate have a more rapid decrement time than midazolam for any continuous infusion of duration >30 minutes. This illustrates why a prolonged continuous infusion of midazolam is a poor choice if rapid emergence is an important anesthetic

goal. By contrast, propofol and etomidate have a much more forgiving profile for prolonged continuous infusions. Even for infusions lasting >8 hours, for example, the time required for propofol to decrease by 50% is <20 minutes. This feature of propofol makes it an attractive drug when delivering prolonged intravenous anesthetics. Although etomidate has a favorable pharmacokinetic profile for prolonged infusions in comparison to midazolam, it has other features that



**FIGURE 39-3.** Simulations of four different bolus doses of propofol ranging from 1–2.5 mg/kg. The vertical axis is on a log scale.

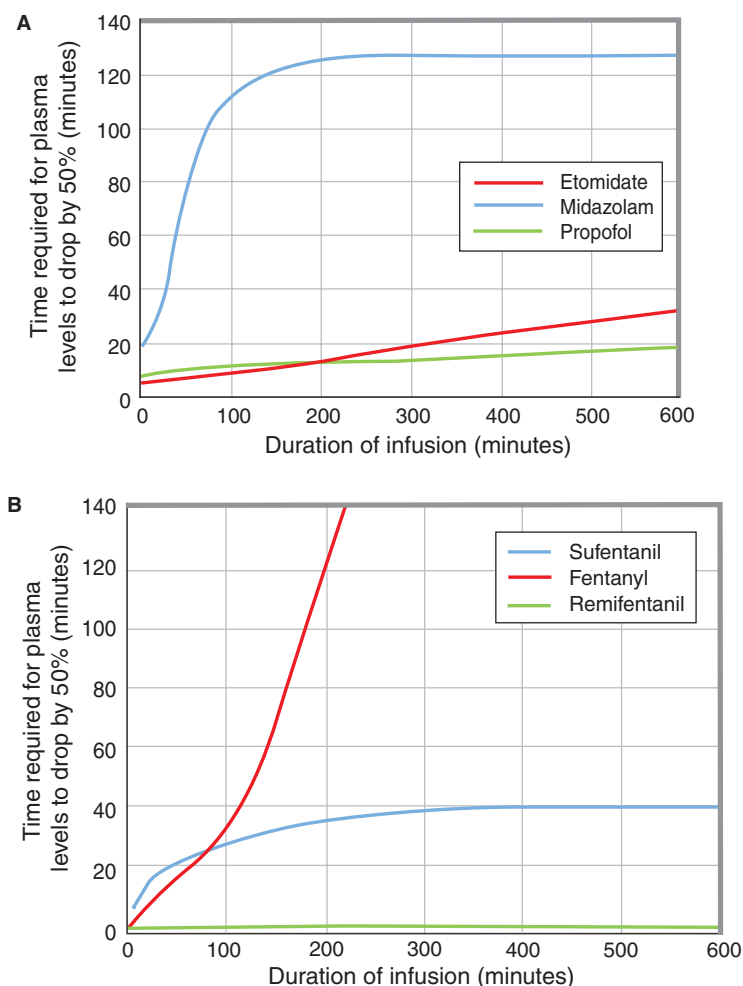
make it unattractive for prolonged use, such as nausea and vomiting, hemolysis, and adrenal suppression.<sup>12</sup>

With regard to opioids, sufentanil appears to have more favorable pharmacokinetics for infusions lasting <8 hours compared to fentanyl when the goal is to achieve a rapid 50% decrease in concentration. This difference can be explained by the fact that sufentanil's pharmacokinetic model has a large, slowly equilibrating peripheral compartment that continues to fill after termination of an infusion, thus contributing to the faster decrease in sufentanil central compartment concentration. In other words, central compartment sufentanil concentrations (which is the compartment that drives drug effect) fall rapidly after an infusion <8 hours is stopped because of continued elimination and distribution.<sup>5,13</sup>

Unlike sufentanil, fentanyl exhibits an early time-dependent increase in the context-sensitive half-time. Although fentanyl would be a poor choice for clinical situations where a rapid decrease in concentration after infusion termination is desirable, it might well be the drug of choice in clinical scenarios where prolonged opioid effect is the goal. For example, fentanyl is well suited for cases after which the patient's trachea will remain intubated for a period of time after the procedure in order to promote a gradual emergence from anesthesia and a long-lasting level of significant analgesia.

Note that for cases of very brief duration, the context-sensitive half-times for sufentanil and fentanyl are nearly identical. Thus, for brief applications, when the opioid is administered by infusion (or by frequent, small bolus doses), there would be no substantial differences among these drugs in the time to a 50% decrease in concentration after stopping a continuous infusion.

Remifentanyl, in contrast to both sufentanil and fentanyl, has a very short context-sensitive half-time for infusions of any duration. This feature may be attractive during procedures associated with varied surgical stimuli where giving longer-acting opioids such as fentanyl or sufentanil to blunt the response to noxious stimulation may prolong emergence or increase the chance of unwanted respiratory depression. Remifentanyl's short context-sensitive half-time may be useful in cases



**FIGURE 39-4.** Simulations of the context-sensitive half-life (or 50% decrement time) for selected sedatives (A) and opioids (B). The vertical axis represents the time required for plasma concentrations to decrease by 50% once a continuous infusion is terminated. The horizontal axis represents the duration of a continuous infusion.

where timely postoperative neurologic assessments are warranted to rule out developing neurologic deficits following neurosurgical procedures. Remifentanyl, on the other hand, may be a poor choice as a prolonged infusion in cases associated with significant postoperative pain (e.g., total hip arthroplasty). In this setting, once a continuous infusion of remifentanyl is terminated, without the addition of a “transition” analgesic, patients can become remarkably uncomfortable once remifentanyl plasma levels wane.

Although the 50% decrement time is an improvement compared with the use of the terminal half-life for estimating how anesthetic drugs will behave, it is not always relevant. Depending on the dose and pharmacokinetic features of a particular drug, the 50% decrement time may not adequately describe drug behavior that is of clinical interest (i.e., when will the analgesic

effect of my intravenous opioid infusion dissipate after the infusion is terminated?). To get beyond this limitation, other decrement times can be used, such as the 20% or the 80% decrement time, to tailor the pharmacokinetic description of drug behavior to a clinical end point of interest.<sup>6,13</sup>

### Importance of Biophase

*Biophase* refers to the equilibration delay between peak drug levels in the blood or plasma and peak drug effect. The time lag (or *hysteresis*) between peak concentration in the plasma and peak drug effect is a function of drug movement into and action within the effect site.<sup>14–16</sup> The effect site represents a theoretical space without any definitive anatomic analogue where drug exerts its effect. The lag time represents a summation of events that can impact the onset of pharmacologic effect, such as drug diffusion to the effect site, receptor binding,

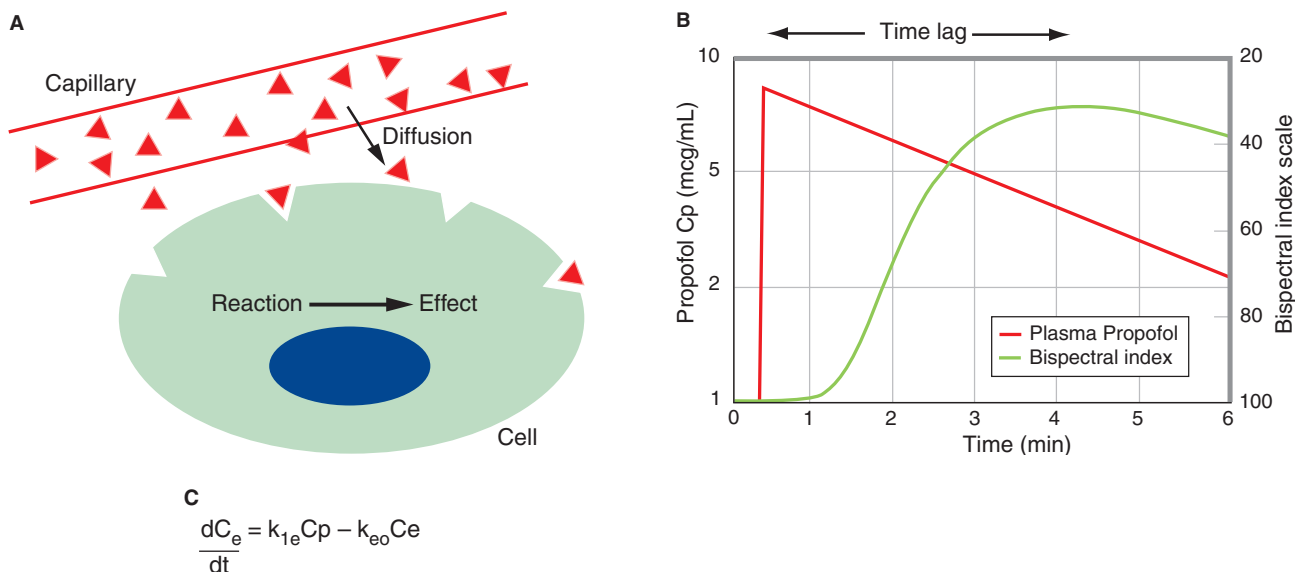
etc. (Fig. 39–5A). The hysteresis is important to account for when forecasting drug effect. It is particularly important to consider when simulating bolus injections of drug, whereas for long infusions the time lag assumes less importance because the effect site and plasma are generally closer to equilibrium.

Consider again a 2 mg/kg bolus of propofol and the observed changes in a processed electroencephalographic (EEG) parameter such as the bispectral index scale (BIS). The maximal decrease in the BIS lags behind the peak plasma propofol level (Figure 39–5B). The time delay, or hysteresis, represents the time required for propofol to go from the plasma to the site where it exerts an effect. In other words, most drugs do not work in the plasma.

For many drugs, including propofol, the equilibration delay between peak concentration in the plasma and peak effect has been characterized by estimating a parameter called  $k_{eo}$ . The  $k_{eo}$  represents the rate constant for elimination of drug from a virtual compartment called the *effect site* (Fig. 39–5C).<sup>15,17</sup> The effect site concept is schematically represented as an additional compartment in the three-compartment model (Fig. 39–6). When the  $k_{eo}$  parameter is available for a drug, theoretical effect compartment concentrations can be simulated along with plasma concentrations, thus making the effect of the time lag easily appreciated. In essence, the time course of effect site concentrations should accurately predict the time course of drug effect.

One of the useful clinical features of simulating the effect site concentration is that the time required to reach peak effect can be easily visualized. Fig. 39–7 presents simulations of the effect concentration over time for selected sedatives and opioids following commonly used doses for each drug. It is readily apparent that some intravenous anesthetics reach their peak effect site concentrations for a given dose much later than do others (Table 39–2).

Midazolam, for example, requires up to 9 minutes to reach peak effect in contrast to propofol and etomidate. This may explain why the early use of midazolam for endoscopic procedures was associated with adverse events related to excessive sedation.<sup>18–20</sup> One misleading characteristic of midazolam is that it has a rapid onset of effect (i.e., some effect is apparent soon after injection) but a latency to peak effect that is slower



**FIGURE 39-5.** Biophase concept. **A.** Schematic of drug (blue triangles) diffusion from a blood vessel to the site of action (effect site), in this case, a cell membrane. Drug interaction with a cell membrane receptor produces a biochemical reaction that leads to a drug effect. **B.** Simulation of plasma propofol levels and bispectral index scale (BIS) following a 2 mg/kg propofol bolus to a 70-kg person. The red and green lines represent the plasma propofol concentration and BIS, respectively. The right-side vertical axis for BIS has been reversed. Note the time (hysteresis) lag between the peak propofol plasma level and the peak BIS value. **C.** Mathematical expression used to compute the effect site concentration.  $k_{1e}$  and  $k_{e0}$  represent the elimination rate constants from the central (Cp) and effect site (Ce) compartments, respectively. Although important for modeling, this is another mathematical detail that the clinician need not worry about!

826

relative to some other sedatives. In instances where a desired effect has not been reached within 90 seconds, practitioners may be tempted to administer additional midazolam. This may lead to a peak effect site concentration that is excessive and, by comparison to other sedative-hypnotics, delayed in presentation. This underscores the importance of using caution when administering large doses of intravenous midazolam.

By contrast to midazolam, etomidate and propofol, given as a bolus dose under normal hemodynamic conditions, reach their peak effect within 2 minutes following administration and then quickly dissipate. With these

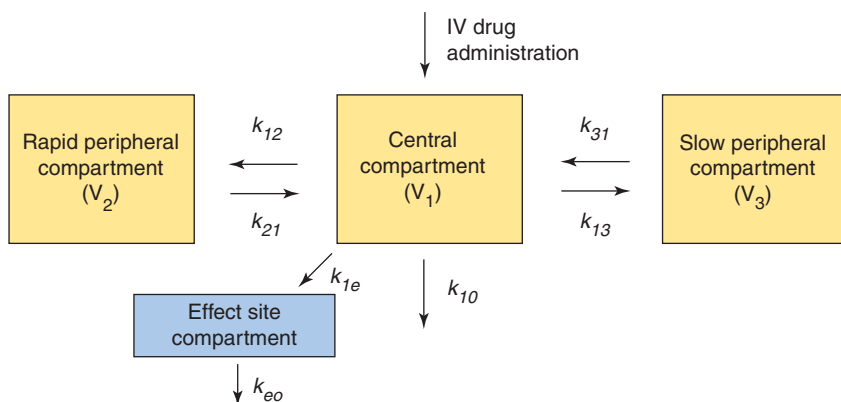
agents, if a desired effect has not been achieved within 120 seconds, practitioners may be inclined to give additional drug knowing that the previous doses are already waning.

With regard to opioids, following a bolus dose, the time required to reach peak effect site concentrations for remifentanyl is considerably quicker than that of fentanyl and sufentanyl. The clinical implications of this difference may be considerable when these drugs are administered to patients breathing spontaneously. Remifentanyl by bolus injection may lead to a more pronounced respiratory depression when compared to equipotent doses of

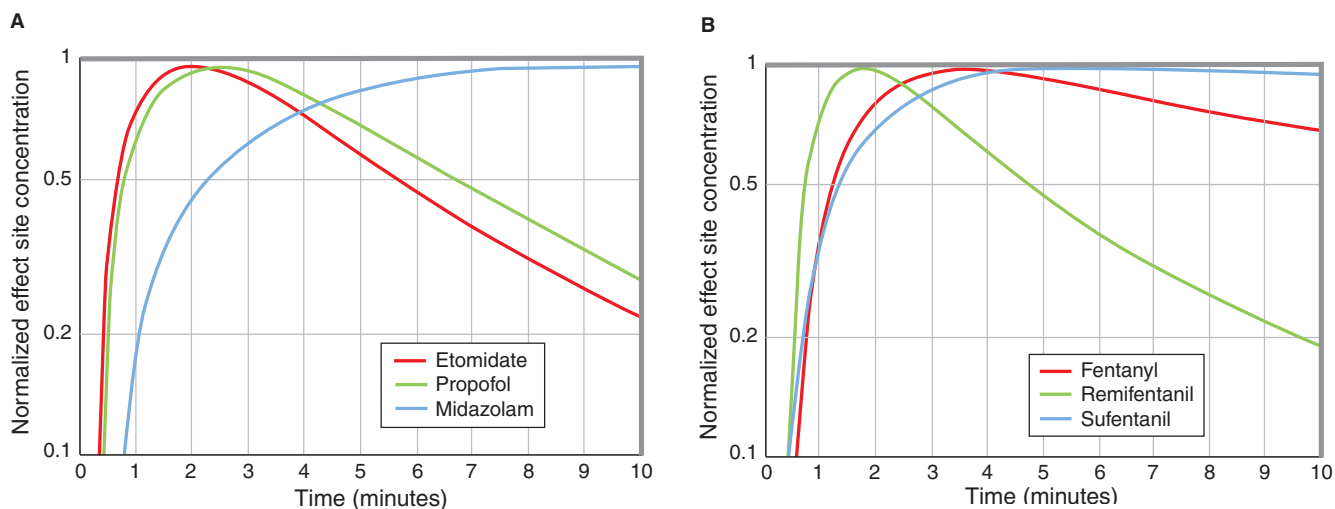
sufentanyl or fentanyl. With the slower onset of effect for fentanyl and sufentanyl, blood  $PCO_2$  levels are given time to rise, providing some offset to the respiratory depression associated with opioids. With remifentanyl, the onset of effect outpaces the accumulation of blood  $PCO_2$ , leading to more pronounced respiratory depression.<sup>21-23</sup>

## Pharmacodynamics

Pharmacodynamic models have been constructed to describe the relationship between drug effect site levels and drug effect. Some important features of pharmacodynamic models are presented in Fig. 39-8. In this figure, a schematic illustrates how drug, once it reaches the effect site, interacts with a receptor to produce effect (Fig. 39-8A). This process is typically characterized graphically using a sigmoidal curve (Fig. 39-8B). Parameters used to describe the pharmacodynamic model (i.e., the sigmoid curve) include  $C_{50}$  and  $\gamma$ .  $C_{50}$  represents the effect site concentration at which 50% of the maximal drug effect will be elicited, and  $\gamma$  represents the slope of the concentration-effect curve. The most important part of the sigmoid curve, the steep section of the curve, represents the dynamic range of drug effect. The dynamic range charts the concentration-effect relationship from  $E_0$  (baseline effect) to  $E_{max}$  (maximal ef-



**FIGURE 39-6.** Effect site compartment concept. Addition of the effect site to a three-compartment model.  $k_{1e}$  and  $k_{e0}$  (in blue) represent the elimination rate constants from the central and effect site compartments, respectively. Drug effect correlates with the concentration in the effect compartment.



**FIGURE 39-7.** Latency to peak effect site concentration. Effect site concentrations over time for selected opioids (A) and sedatives (B) following conventional doses for each drug. The vertical axis has been normalized for all drugs such that 1 indicates the maximal effect site concentration.

fect). In this region, small changes in drug concentration lead to large changes in drug effect. This is the region of particular interest to anesthesia providers. Increasing effect site concentrations beyond the dynamic range leads to minimal changes in drug effect. The mathematical expression that uses  $C_{50}$  and  $\gamma$  to estimate drug effect is presented in Fig. 39-8C.

A surfing analogy is helpful in conceptualizing the application of pharmacodynamic models to rational drug administration.<sup>24</sup> Just as a surfer attempts to ride just in front of the crest of a wave in order to slide down the front edge of the wave, practitioners attempt to maintain their anesthetic drugs at effect site concentrations near the “crest” of the concentration–effect relationship (Fig. 39-8B). In so doing, clinicians maintain significant drug effect but can “slide down” the concentration curve to promote recovery at the end of an anesthetic. From an efficacy and toxicity perspective, there is no advantage of being on the flat part of the concentration–effect relationship near  $E_{max}$ .

As an example, consider three bolus doses of propofol (0.5, 2, and 7 mg/kg). The resultant effect site concentrations for each bolus are presented in Fig. 39-9. Using a pharmacodynamic model for propofol, the effect of these boluses is plotted on a sigmoid curve. The  $C_{50}$  for this curve (1.8  $\mu\text{g/mL}$ ) represents the effect site concentration at which there is a 50% probability of loss of responsiveness.<sup>25</sup> Dosing regimens that maintain drug concentrations along the lower left portion of the sigmoid curve (i.e., below the wave) are too low to be

effective, as illustrated by the low-dose propofol bolus (0.5 mg/kg). Dosing regimens that maintain drug concentrations to the right side of the sigmoid curve (i.e., before the wave breaks) are excessive and may produce unwanted hemodynamic depression or prolonged recovery. In this region, increasing drug concentration does not increase drug effect. This phenomenon is illustrated by the 7 mg/kg bolus dose of propofol. The ideal dosing strategy targets the upper portion of the steep part of the concentration–effect relationship, a concentration that produces considerable drug effect but from which drug effect will recover quickly once drug administration is terminated as illustrated by an intermediate dose of propofol (2 mg/kg).

One practical aspect of anesthesia care that makes pharmacologic “surfing” difficult is that the concentration–effect relationship is not consistent across various stimuli. For some stim-

uli, much less drug is required to achieve a desired effect compared to other stimuli. For example, skin incision typically is less noxious than laryngoscopy.<sup>26–28</sup> In an effort to characterize how different stimuli vary, numerous pharmacodynamic models have been built for selected stimuli.

The schematic presented in Fig. 39-10 plots out the relative difference between pharmacodynamic models for opioids across various stimuli. Effect measures used to characterize opioid behavior include mild to moderate analgesia (i.e., blunting response to a noxious stimulus), respiratory depression, significant analgesia (i.e., blunting response to laryngoscopy), and suppression of EEG activity. As expected, the pharmacodynamic relationship for each stimulus is very similar (a sigmoid curve), but the  $C_{50}$  values are shifted from left to right with increasing stimulus. Several important points flow from this schemat-

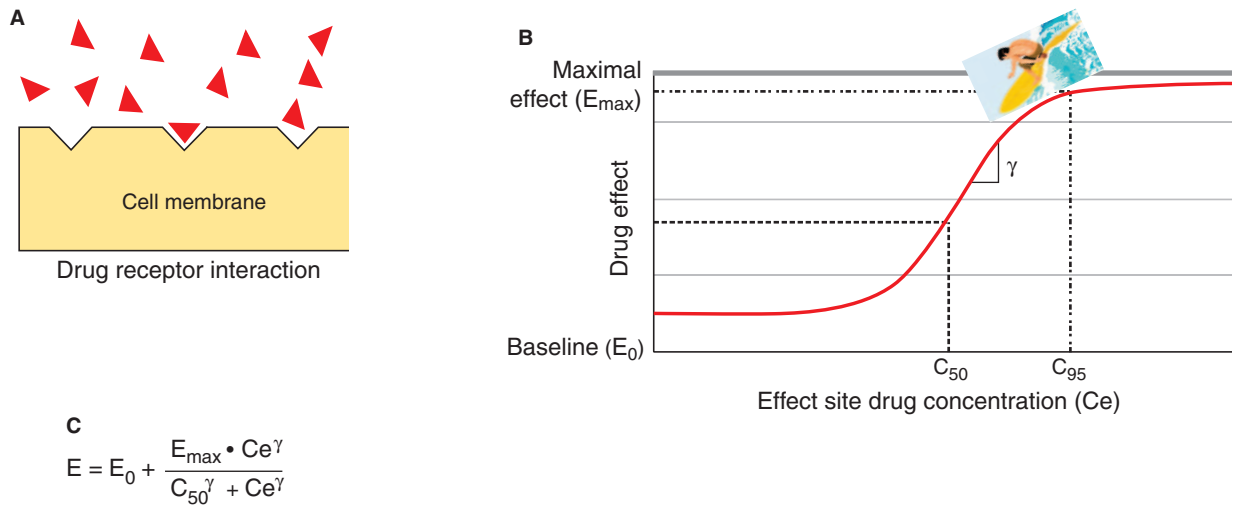
**TABLE 39-2.**

**Time to Peak Effect for Selected Opioids and Sedative–Hypnotics**

Drug	Dose	Peak Effect Site Concentration	Time Required to Reach Maximal Effication
<b>Opioids</b>			
Fentanyl	150 $\mu\text{g}$	1.5 ng/mL	39 min
Sufentanyl	15 $\mu\text{g}$	0.2 ng/mL	5.5 min
Remifentanyl	150 $\mu\text{g}$	8.6 ng/mL	1.5 min
<b>Sedatives</b>			
Propofol	2 mg/kg	4.8 $\mu\text{g/mL}$	2.3 min
Etomidate	0.2 mg/kg	0.6 $\mu\text{g/mL}$	2.0 min
Midazolam	2 mg	22.0 ng/mL	9.5 min

Simulations based on a body weight of 70 kg.





**FIGURE 39-8.** Typical pharmacodynamic model. **A.** Schematic of the pharmacodynamic process. Drug (red triangles) interact with receptors in the effect site to elicit a drug effect. **B.** Graphic expression of pharmacodynamic drug behavior.  $E$  represents drug effect,  $C_{50}$  represents the effect site concentration necessary to produce 50% of the maximal drug effect,  $E_0$  represents the baseline effect (with no drug present), and  $E_{\max}$  represents the maximal effect. The vertical axis is on the log scale. The sigmoid shape of the concentration versus effect curve is characteristic of intravenous anesthetics.  $\gamma$  represents the maximal slope of the concentration versus effect curve. A surfing analogy is useful to understand the application of the pharmacodynamic model. As the surfer rides just below the crest of a wave, anesthesia providers attempt to dose their anesthetics to achieve near maximal effect just at the point where the sigmoid curve starts to flatten out. The dashed line represents the concentration at which 50% of the maximal effect is achieved. The dash-dot-dash line represents the concentration at which 95% of the maximal effect is achieved. **C.** Mathematical expression of the pharmacodynamic model used to render the concentration versus effect curve in B. This is the mathematical basis of the pharmacodynamic model that clinicians need not worry about.

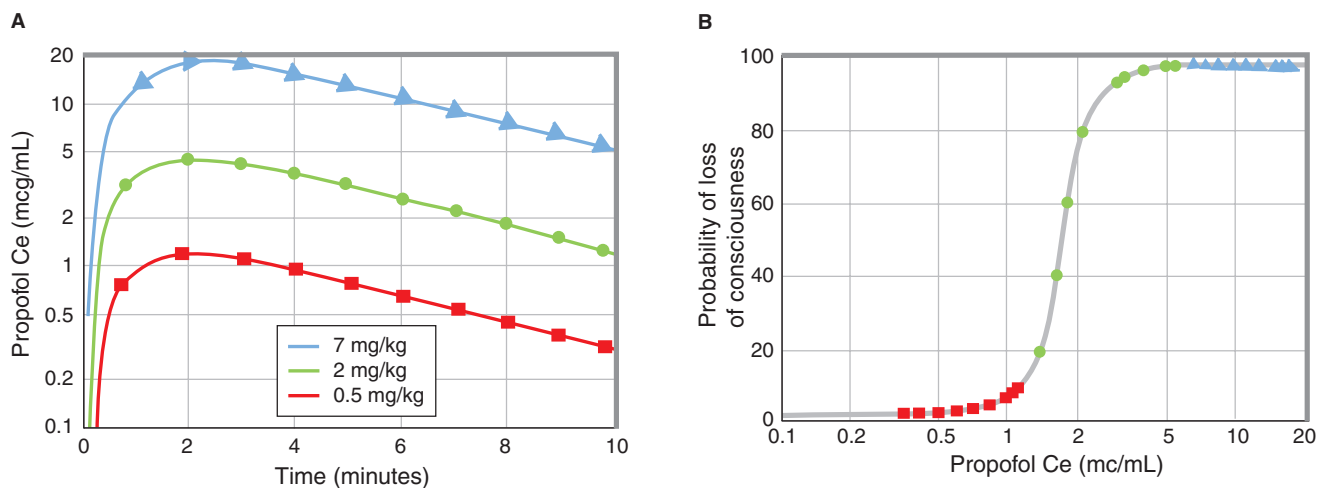
ic, especially for the meticulous clinician who seeks to “surf” near the ideal  $C_e$  and thus achieve the desired drug effect without administering a relative overdose. (1) Significant analgesia is required to blunt the response from laryngoscopy compared to other stimuli encountered in the operating room. (2) The  $C_{50}$  for the effect site concentration necessary to blunt a response to laryngoscopy is higher than the  $C_{50}$  for respiratory depression. (3) Dosing anesthetics requires an appreciation of ongoing and antici-

pated stimuli. (4) There is a window in opioid levels between which analgesia can be achieved yet excessive respiratory depression can be avoided. Investigators have demonstrated that the  $C_{50}$  for analgesia is approximately 30% of the  $C_{50}$  for respiratory depression.<sup>26</sup> This may be especially important during emergence from anesthesia.

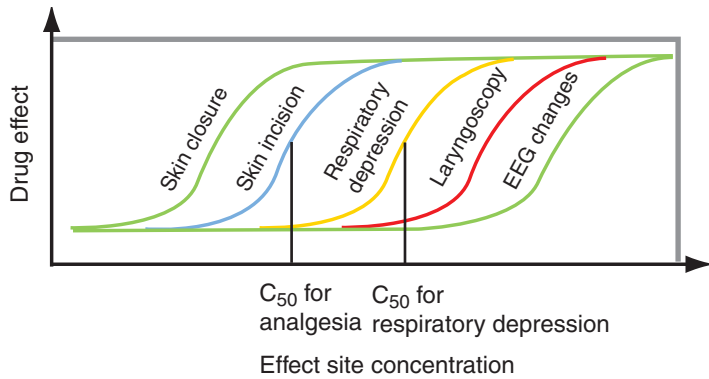
### Importance of Combining Kinetic and Dynamic Models

In order to depict a patient's response to a dose of drug, it is necessary to

combine pharmacokinetic–pharmacodynamic models and provide a quantitative description of each. Because most drugs do not act in the blood, pharmacokinetic and pharmacodynamic models must be linked so that concentrations in the plasma can be translated into effect site concentrations and thus drug effect. One approach to visualize the link between pharmacokinetics and pharmacodynamic models is to plot a horizontal line on the pharmacokinetic plot of effect site concentrations over time



**FIGURE 39-9.** Simulation integrating pharmacokinetic and pharmacodynamic models illustrating the interplay between the dose–concentration (pharmacokinetic) relationship and the concentration–effect (pharmacodynamic) relationship. **A.** Simulation of propofol effect site concentrations over time for bolus doses of 0.5 mg/kg (red squares), 2 mg/kg (green circles), and 7 mg/kg (blue triangles). **B.** Corresponding concentration versus effect of the bolus doses shown in A superimposed over a pharmacodynamic model for propofol.



**FIGURE 39–10.** Schematic of the concentration–effect relationship for various stimuli.<sup>26</sup> Anesthesia is a dynamic process that requires frequent adjustments of drug levels.

that represents the  $C_{50}$  for a desired drug effect. Two key points of interest are now easily visualized through computer simulation: (1) the time to onset of effect and (2) the duration of drug effect.<sup>4,29,30</sup>

For example, using linked pharmacokinetic and pharmacodynamic models, the simulations of propofol bolus doses ranging from 1–2.5 mg/kg presented in Fig. 39–3 can be reperformed for effect site concentrations rather than plasma concentrations (Fig. 39–11). To visualize the onset and duration of effect, the  $C_{50}$  for loss of responsiveness is overlaid on the simulations of propofol effect site concentrations. Several investigators have estimated propofol effect site concentrations required for loss of respon-

siveness with  $C_{50}$  values ranging from 1.8–2.4  $\mu\text{g}/\text{mL}$ .<sup>25,31–33</sup> For simulation and discussion purposes, the  $C_{50}$  for loss of responsiveness to be used in these simulations and throughout the remainder of this chapter is 1.8  $\mu\text{g}/\text{mL}$ . A summary of the time to onset and duration of effect for each propofol bolus dose is presented in Table 39–3. It is important to point out that this  $C_{50}$  for loss of responsiveness, like all pharmacokinetic and pharmacodynamic parameters, is a population estimate for the typical patient and as such is subject to intersubject variability and will not perfectly predict unresponsiveness in individuals.

Guided by simulations, the clinical implications of a given propofol dosing strategy become apparent. For exam-

**TABLE 39–3.**

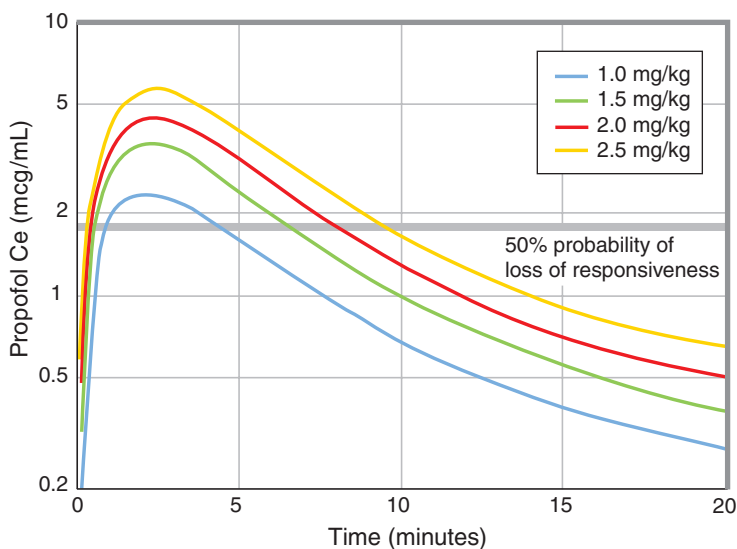
**Onset and Duration of Effect Following a Propofol Bolus**

Dose	Time to Onset	Duration of Effect
1.0 mg/kg	80 sec	3.7 min
1.5 mg/kg	50 sec	6.9 min
2.0 mg/kg	40 sec	8.0 min
2.5 mg/kg	30 sec	9.5 min

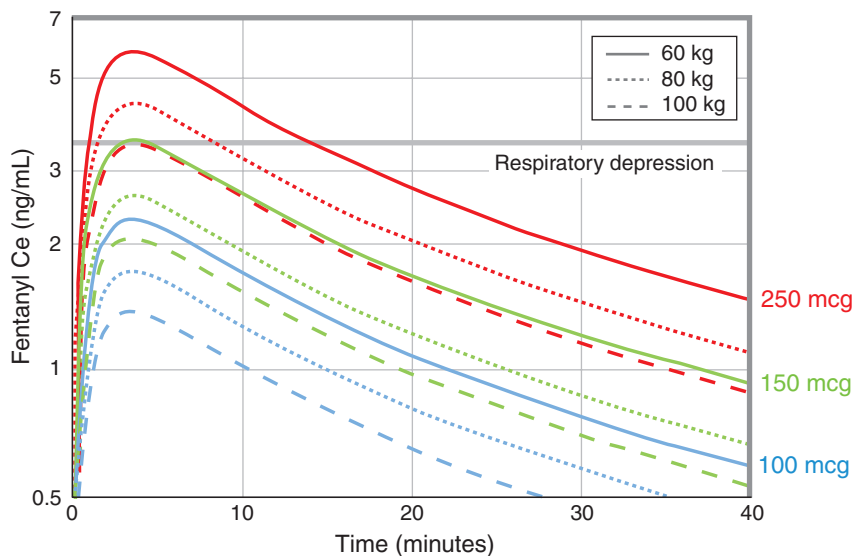
ple, using a higher dose of propofol as part of a rapid sequence induction, if hemodynamically tolerable, may prove useful in minimizing the time when the airway is unsecured because of faster onset of effect. By contrast, a lower dose may be useful when providing anesthesia for brief procedures associated with a noxious stimulus, such as a retrobulbar block, where only brief unresponsiveness is required. When using the lower dose, however, practitioners need to recognize that it will take up to 50 seconds longer to achieve loss of responsiveness.

Simulations may also be useful in illustrating how drugs behave in relation to an unwanted toxic effect. Consider a plot of fentanyl effect site concentrations for various doses of fentanyl and the concentration at which probability of substantial respiratory depression exceeds 50% (i.e., somewhere around 3.5 ng/mL) in 60-, 80-, and 100-kg people (Fig. 39–12).<sup>34</sup> In this simulation, the bolus of 100- and 150-mg fentanyl prevents respiratory depression for each weight. However, the 250- $\mu\text{g}$  bolus exceeds the effect site concentrations associated with a 50% probability of respiratory depression for people weighing 60 and 80 kg for 7 and 13 minutes, respectively. According to these simulations, persons weighing 100 kg or more briefly approach the fentanyl effect site concentration associated with a 50% probability of respiratory depression but do not exceed it.

Linked pharmacokinetic–pharmacodynamic models can provide insight into how drugs behave following termination of continuous infusions. Factors that influence the duration of effect following termination of an infusion include (1) the infusion rate and (2) the duration of the infusion. For example, consider the time required to regain responsiveness following termination of a continuous infusion of



**FIGURE 39–11.** Simulations of propofol effect site concentrations in response to bolus doses ranging from 1–2.5 mg/kg for a 70-kg person. The vertical axis is on the log scale. The gray line represents the propofol effect site concentration associated with a 50% probability of loss of responsiveness.<sup>25,31–33</sup> Note the time to loss of responsiveness and the duration of the loss of responsiveness for varying doses.



**FIGURE 39-12.** Simulations of the fentanyl effect site concentration following a 100-, 150-, and 250- $\mu\text{g}$  bolus in a 60-, 80-, and 100-kg person. The fentanyl effect site concentration associated with a 50% probability of substantial respiratory depression is plotted as a gray line (3.5 ng/mL).<sup>34</sup> The vertical axis is on a log scale. Note the implication of dose on respiratory depression.

propofol. Fig. 39-13 shows a series of simulations of the resultant propofol effect site concentration following continuous infusions at rates between 50 and 150  $\mu\text{g}/\text{kg}/\text{min}$  for 1, 2, and 3 hours. As with the previous simulations of bolus dosing of propofol, the plot also charts the propofol effect site concentration associated with a 50% probability of loss of responsiveness (1.8  $\mu\text{g}/\text{mL}$ ).<sup>25</sup>

The area of interest is the segment of time from when the infusion is terminated until the propofol effect site concentration falls below the level associated with a loss of responsiveness. The results of these simulations are summarized in Table 39-4. Once the infusion was terminated, longer propofol infusions at equivalent dosages required more time for propofol levels to drop below a level associated with unresponsiveness. As expected, once the infusion was terminated, higher propofol infusion rates required more time to drop below a level associated with unresponsiveness. With higher infusion rates, the time to regaining responsiveness can be quite long (i.e., up to 13 minutes).

Conceptualizing this clinical issue in terms of compartmental models, these simulations illustrate how during prolonged infusions propofol gradually “fills” the slowly equilibrating peripheral compartments (extravascular tissues). When the infusion is terminated, the propofol in the peripheral compartments serves as a reservoir to

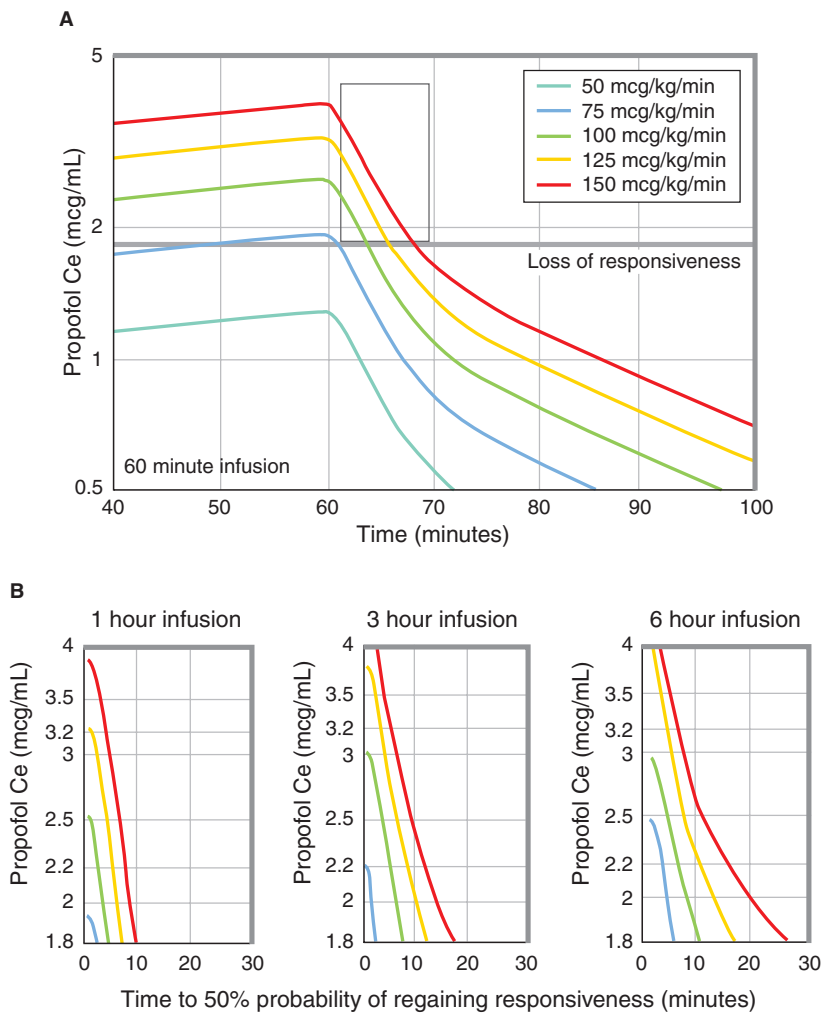
maintain plasma propofol concentrations, thereby slowing the decline in drug effect. This may be clinically evident as a delay in emergence. These simulations also suggest that running a propofol infusion at a single continuous rate throughout an anesthetic will lead to propofol effect site levels that are higher than desired. Therefore, a prudent approach to dosing prolonged propofol infusion is to reduce the infusion rate over time to minimize drug accumulation. This accumulation phenomenon emphasizes the advantage of target controlled infusions that, instead of delivering drug at a set rate (i.e., micrograms per kilogram per minute), deliver drug to achieve and maintain a set effect site concentration (i.e., 2.5  $\mu\text{g}/\text{mL}$  for propofol). In so doing, they avoid accumulation of drug yet maintain an appropriate drug level for the desired duration. These types of infusion systems are widely used throughout the world, but they have not attained regulatory approval within the United States.<sup>24</sup>

This form of analysis may be useful when exploring the duration of analgesic effect from fentanyl following surgical procedures of various durations. A common practice is to administer intermittent boluses of fentanyl starting at induction and then throughout a general anesthetic with the goal of providing perioperative analgesia during and following a stimulating procedure. Consider an anesthetic where

fentanyl, in addition to a potent inhaled agent, is given as a bolus (3  $\mu\text{g}/\text{kg}$  or approximately 200  $\mu\text{g}$  for a 70-kg patient) on induction and then intermittently (i.e., 1.5  $\mu\text{g}/\text{kg}$  or approximately 100  $\mu\text{g}$  for a 70-kg patient every 20 minutes) throughout a surgical procedure associated with significant painful stimuli.

Simulations of this fentanyl dosing regimen for anesthetics lasting 1, 2, and 3 hours reveal several clinical points of interest (Fig. 39-14). For a 1-hour anesthetic with an induction dose of 200  $\mu\text{g}$  of fentanyl followed by two supplemental 100- $\mu\text{g}$  doses during the anesthetic, the total fentanyl dose administered is 400  $\mu\text{g}$  (8 mL). With this dosing regimen, the fentanyl effect site concentration intermittently rises above the fentanyl effect site concentration associated with analgesia (1.6 ng/mL)<sup>35</sup> but rapidly drops below the analgesic level once the anesthetic is terminated.

Simulations of the 2- and 3-hour anesthetics using a similar dosing scheme result in total fentanyl doses of 700 and 1000  $\mu\text{g}$  (14 and 20 mL). With the longer duration, the fentanyl concentration rises above the effect site level associated with analgesia. In this simulation, it becomes apparent that repetitive doses increase the fentanyl concentration at the end of a 3-hour anesthetic; the resulting effect site concentration of fentanyl is much higher than after the 1-hour anesthetic. Following termination of the anesthetic, the time required for the fentanyl effect site concentrations to decrease below the level associated with analgesia was 9 and 57 minutes for a 2- and 3-hour anesthetic, respectively. Similar to what was learned from the simulations of the context-sensitive half-time for fentanyl, prolonged infusions or repetitive dosing of fentanyl over prolonged periods can lead to high fentanyl effect site concentrations. High fentanyl levels may be of clinical benefit (i.e., adequate analgesia following a painful surgical procedure) or be a detriment (prolonged respiratory depression) in the early postoperative period. These simulations demonstrate the potential benefit of visualizing fentanyl effect site concentrations in real time when caring for patients for whom the anesthetic goals upon termination of a general anesthetic include adequate analgesia yet avoidance of unwanted respiratory depression.



**FIGURE 39-13.** A. Simulation of a 60-minute infusion of propofol at rates ranging from 50–150  $\mu\text{g}/\text{kg}/\text{min}$ . At 60 minutes the infusion is terminated. Superimposed on this plot is the effect site concentration (Ce) associated with a 50% probability of loss of responsiveness (gray line).<sup>25,31–33</sup> Of interest is the time required once the infusion is terminated for the propofol effect site concentration to fall below the concentration associated with loss of responsiveness (black box). B. Plot within the black box expanded for three different infusion durations (1–6 hours). Following termination of the continuous infusion, the time on the x axis has been reset to 0 for each plot. Each plot illustrates the time required for propofol effect site levels to drop below the propofol concentration associated with a loss of responsiveness for infusion rates commonly used in clinical practice. Simulations used pharmacokinetic and pharmacodynamic parameters for propofol reported by Marsh et al.<sup>8</sup> and Kern et al.,<sup>25</sup> respectively.

**TABLE 39-4.**

Time Required for Propofol Effect Site Concentrations to Fall Below Levels Associated with Loss of Responsiveness for Various Infusion Rates Running for 1, 3, and 6 Hours

Infusion Rate (mg/kg/min)	Time Required for Propofol Ce to Fall Below Ce Associated with Loss of Responsiveness (min)		
	60-Min Infusion	180-Min Infusion	360-Min Infusion
50	—	—	—
75	1	3	4
100	4	7	9
125	6	11	17
150	9	17	23

Ce, Effect site concentration.

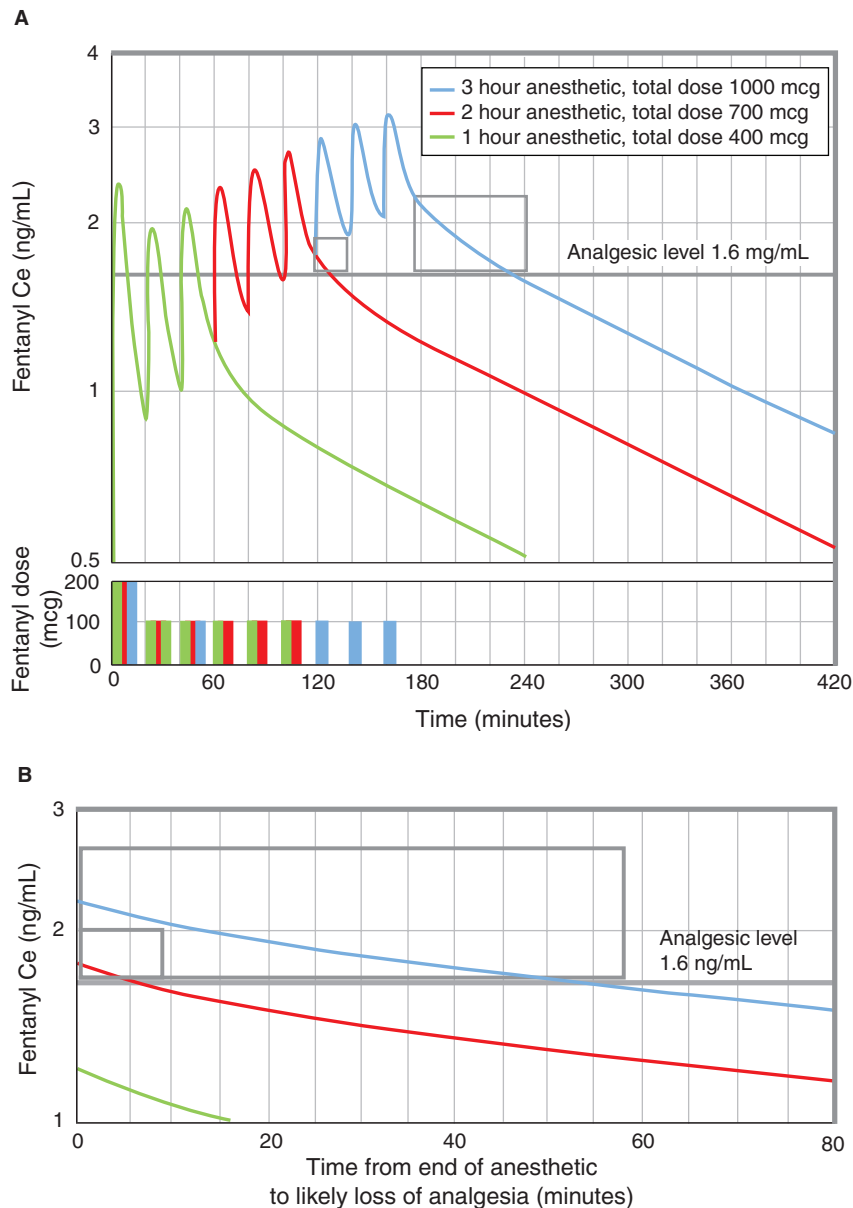
One important limitation of these simulations is that painful surgical procedures are rarely, if ever, performed with fentanyl alone. Other anesthetics, such as potent inhaled agents or intravenous sedatives, are used as well. Inhaled agents and intravenous sedatives accentuate the analgesic effect of opioids in a synergistic fashion. This limitation is addressed in Drug Synergism below. Thus, these simulations chart the effect of fentanyl alone and at best are representative of analgesic effect once other anesthetics that have been coadministered with the fentanyl have been allowed to dissipate. Hence, the segment of this simulation set reflective of the actual analgesic state is the fentanyl effect site concentrations well beyond (i.e., 20–30 minutes) the termination of the anesthetic.

### Drug Synergism

Anesthetics typically are administered as a combination of several different types of drugs to achieve a desired complete anesthetic. Anesthesiologists have long appreciated that the administration of one type of drug may enhance and prolong the effect of another type of drug. The concept of minimum alveolar concentration (MAC) reduction is well established and used to describe how the addition of an intravenous opioid reduces the amount of a potent inhaled agent required to achieve and maintain a desired MAC. This line of thinking is especially important when trying to prevent unwanted side effects associated with high doses of a single anesthetic, such as hemodynamic depression, prolonged emergence from anesthesia, and persistent respiratory depression.

As clinical pharmacologists have become more sophisticated in their approach to characterizing the interaction between different anesthetic drug types, several tools have been developed to describe drug–drug interactions. One simple tool characterizes drug–drug interactions as additive (i.e.,  $2 + 2 = 4$ ), antagonistic (e.g.,  $2 + 2 = 1$ ), or synergistic (e.g.,  $2 + 2 = 8$ ). These can be graphically illustrated to allow visualization of the extent of antagonism or synergism present between two drugs (Fig. 39-15). These drug interaction plots present the effect site concentrations for two drugs that are necessary to achieve specified

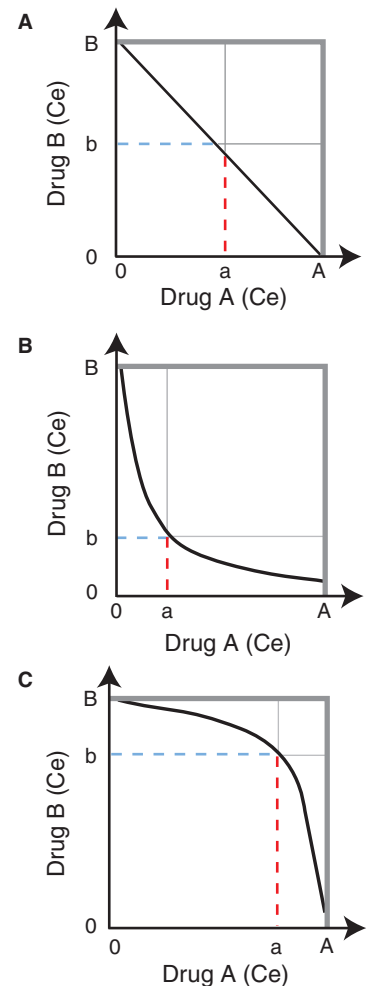




**FIGURE 39-14.** **A.** Simulation of intermittent doses of fentanyl for anesthetics lasting 1, 2, and 3 hours. The red line represents the fentanyl effect site concentration (Ce) that results from a 200-mcg bolus on induction followed by intermittent 100-mg boluses throughout the remainder of the anesthetic. The green bars just above the x axis represent the fentanyl dosing regimen. The red and blue lines represent the fentanyl Ce for similar dosing schemes that last for 2 and 3 hours, respectively. Superimposed on this plot is the Ce associated with analgesia (gray line). Of interest is the time required once the anesthetic is terminated for the fentanyl Ce to fall below the concentration associated with analgesia (gray boxes). **B.** Plots within the gray boxes have been expanded. Following termination of the anesthetic, the time on the horizontal axis has been reset to 0. This plot illustrates the time required for fentanyl Ce to drop below the fentanyl concentration associated with analgesia. These simulations used pharmacokinetic and pharmacodynamic parameters for fentanyl reported by Shafer et al.<sup>9</sup> and fentanyl Ce associated with analgesia (1.6 ng/mL) reported by Scott et al.<sup>65</sup> Simulations were based on a patient weight of 70 kg.

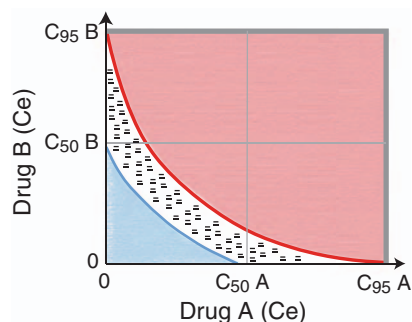
drug effects. In this schematic, a desired effect is achieved at point A on the horizontal axis and point B on the vertical axis. The points labeled a and b represent the concentrations of both drugs required to achieve a similar effect to either drug A or B alone. As can be appreciated, an infinite number of drug-drug combinations can

result in a similar drug effect. The line that runs through all the possible drug-drug concentration pairs and that connects points A and B is known as an *isobologram*. The isobologram represents drug concentration pairs that would result in the same drug effect when the two drugs are used alone or in combination.



**FIGURE 39-15.** Schematic representation of drug-drug interactions. **A.** Additive interaction. **B.** Synergistic interaction. **C.** Antagonistic interaction. The horizontal and vertical axes represent the effect site concentration (Ce) of drugs A and B, respectively. A and B represent the concentrations of each drug required to achieve a similar effect when used alone. a and b represent the concentrations of drugs A and B that result in a similar effect when combined. The black lines represent an isobologram. An *isobologram* is a plot of all the drug-drug concentration pairs that result in the same level of drug effect. These schematics are patterned after schematics originally described by Minto et al.<sup>36</sup>

With drug-drug interactions that are additive, the isobologram is a straight line indicating that as drug A increases, proportionally less of drug B is required to achieve the same degree of effect (Fig. 39-15A). With drug-drug interactions that are synergistic, the isobologram is a curved line bowing toward the origin of the graph (Fig. 39-15B), indicating that when both drugs A and B are used, much less of both is required to achieve the same degree of desired effect. Conversely, with drug-drug inter-



**FIGURE 39-16.** Schematic representation of a synergistic drug–drug interaction of drugs A and B for the probability of no response to a noxious stimulus. The red line represents the 50% isobole, and the blue line represents the 95% isobole. Area to the right of the 95% isobole (shaded red) represents drug–drug pairs that are higher than the 95% isobole. Area to the left of the 50% isobole (shaded blue) represents drug–drug pairs that are less than the 50% isobole. Area contained within the 50% and 95% isobole (black hash marks) represents drug–drug pairs that are between the two isoboles. The  $C_{50}$  and  $C_{95}$  effect site concentrations for drugs A and B are marked on the horizontal and vertical axes, respectively. Any of the infinite number of combinations of drugs A and B along the isoboles yields the same probability of drug effect.

actions that are antagonistic, the isobologram is a curved line bowing away from the origin of the graph (Fig. 39-15C), indicating that when both drugs A and B are used, much more of each is required to achieve the same degree of desired effect. Most interactions between anesthetic drugs are synergistic.

Common anesthetic goals can be characterized in terms of isobolograms. For example, isobolograms can be used to plot effect site concentration pairs necessary to achieve a 50% or 95% probability of achieving a desired drug effect (i.e., no response to laryngoscopy) or when a worrisome side effect may occur (i.e., onset of respiratory depression). Using these isobolograms, it is possible to explore through computer simulations how well an anesthetic performs in terms of meeting desired anesthetic goals.

For example, consider a schematic of a combined anesthetic technique using drug A (an opioid) and drug B (a sedative), which are known to have a synergistic interaction (Fig. 39-16). Drug delivery that yields concentration pairs to the left of the 50% isobole for no response to painful stimuli do not meet analgesic goals. With drug pairs in this region, patients most likely will respond to painful stimuli. Drug

delivery that yields concentration pairs between the 50% and 95% isoboles likely will meet analgesic goals, but some patients may respond to a painful stimulus. In this region, once the anesthetic is terminated, the analgesic effect will quickly dissipate. With drug delivery that yields concentration pairs to the right of the 95% isobole, a patient is very likely to be unresponsive to painful stimuli, and increasing the anesthetic target will not substantially increase the probability of adequate effect. A key point with regard to this region of the isobole plot is that administering additional anesthetic will not provide more analgesia but rather will only prolong the time required for drug effect to dissipate, especially if the resultant concentrations have far exceeded the 95% isobole. A prolonged duration of effect may be a desired outcome (e.g., adequate analgesia following a surgery associated with significant postoperative pain) or an undesired outcome (e.g., delayed emergence following a prolonged surgery).

Because visualization of these complex interactions currently is not feasible in the clinical setting and clinicians are justifiably more frequently concerned with preventing awareness while patients are under anesthesia or exaggerated responses to painful stimuli than they are in promoting rapid emergence from anesthesia, most anesthetic techniques target concentration pairs that are substantially above the 95% isobole. In summary, to prevent unwanted consequences of light anesthesia, most practitioners tend to administer relatively excessive doses of anesthetics. For the majority of anesthetics, this practice is well tolerated. However, in patients who are sensitive to adverse consequences of excessive anesthesia, administering an anesthetic beyond the 95% isobole may be associated with adverse consequences.

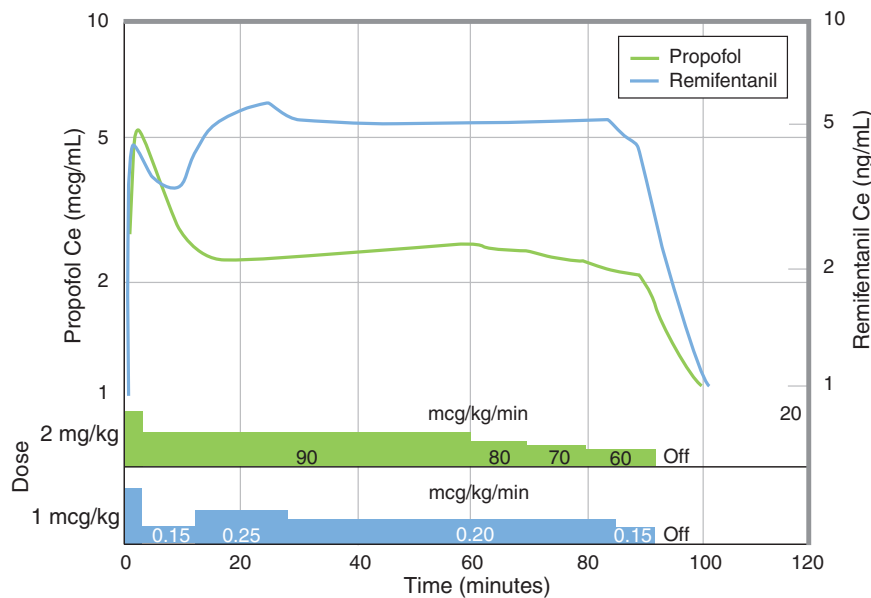
In order to visualize the concentration interaction that two drugs have on a particular drug effect, such as analgesia, work has focused on the development of three-dimensional plots called *response surfaces*. Response surfaces portray the concentration–effect relationship for each drug individually (similar to a simple pharmacodynamic model) as well as paired concentration–effect (drug–drug interaction). Plotted on these surfaces are the effect site concentrations for two drugs (i.e., an opioid and a potent inhaled agent)

over a range of concentrations of clinical interest and a measure of drug effect. The measure of drug effect typically is presented as a probability ranging from 0–1 (i.e., the probability of loss of responsiveness with a selected drug pair is 0.8). Many investigators have characterized response surfaces for a variety of drug–drug pairs and clinical relevant drug effects in human volunteers and patients. For example, surfaces have been developed for analgesia, loss of responsiveness to verbal and tactile stimulation, and laryngoscopy for propofol and remifentanyl<sup>25,31,33,36–41</sup> and sevoflurane and remifentanyl.<sup>42</sup>

To illustrate the visual power of response surfaces, consider a simulation of 90-minute total intravenous anesthetic using continuous infusions of propofol and remifentanyl (Fig. 39-17). Simulated infusion rates are consistent with dosing recommendations for each drug. The resultant effect site concentrations for both drugs are plotted over time. With a bolus dose administered prior to starting a continuous infusion, therapeutic levels for each drug are quickly achieved and then maintained throughout the anesthetic. To visualize the combined analgesic effect of remifentanyl and propofol, this anesthetic technique has been plotted out on a previously established response surface for analgesia (Fig. 39-18).<sup>25</sup>

With the concentration pairs of remifentanyl and propofol plotted for the entire anesthetic on this response surface, two important features of the anesthetic technique are easily observed. First, remifentanyl and propofol have a pronounced synergistic interaction. When given together, much less of both drugs is required to achieve a desired analgesic effect than if each drug were given individually. This is best illustrated by the 50% and 95% isoboles in Fig. 39-18B. Here, the isoboles bow inward and reveal that propofol when dosed to produce an effect site concentration of 1  $\mu\text{g}/\text{mL}$  decreases the remifentanyl needed to meet an analgesic goal by more than half. Of note, a propofol effect site concentration of 1  $\mu\text{g}/\text{mL}$  by itself typically is enough to sedate patients but is not enough to render them unconscious.

Second, the dosing used in this total intravenous technique results in a combined drug–drug analgesic effect that, for the majority of the anesthetic, exceeds the 95% isobole for analgesia. The trajectory of the dosing regimen is



**FIGURE 39-17.** Simulation of a 90-minute total intravenous anesthetic with propofol and remifentanyl. The propofol and remifentanyl dosing regimens are presented along the horizontal axis. They include the induction bolus dose (in milligrams per kilogram for propofol and micrograms per kilogram for remifentanyl) followed by the continuous infusion rates (in micrograms per kilogram per minute) for each drug. The propofol and remifentanyl effect site concentrations that result from the dosing regimens are plotted over time.

color coded into three segments: *induction* (i.e., bolus doses of both drugs), *maintenance* (continuous infusions of both drugs), and *emergence* (termination of both drug infusions). It is interesting to note that the maintenance phase of the anesthetic exclusively occupies the relatively flat region on the

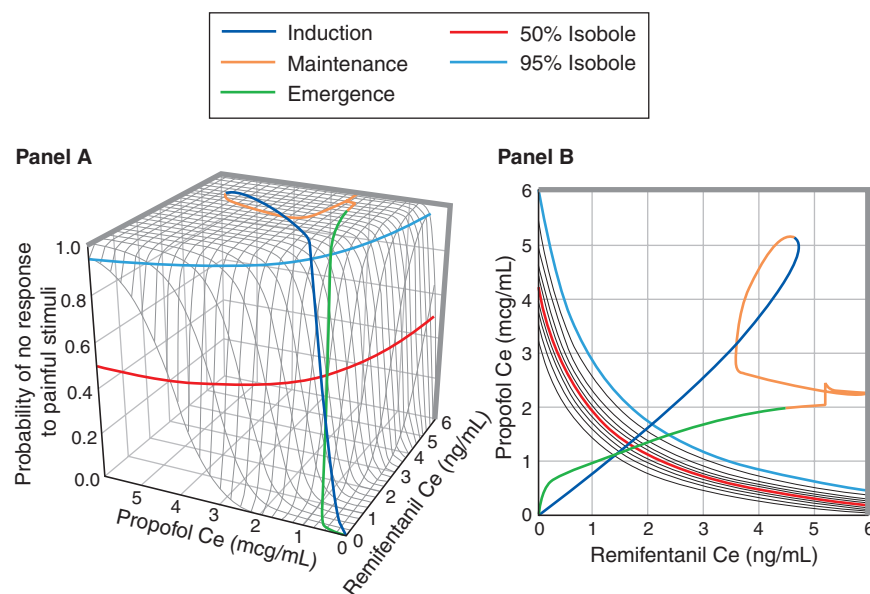
surface. Maintaining an anesthetic that is so far removed from the 95% isobole is essentially unnecessary. With regard to analgesia, in this region additional anesthetic would not be expected to increase the analgesic effect. In the case of remifentanyl and propofol, this practice may not be overly worrisome

because both drugs exhibit a rapid decline in drug effect once infusions are terminated. With other opioid–sedative drug pairs, however, overdosing an anesthetic onto the flat portion of the response surface in most instances will slow the decline of drug effect.

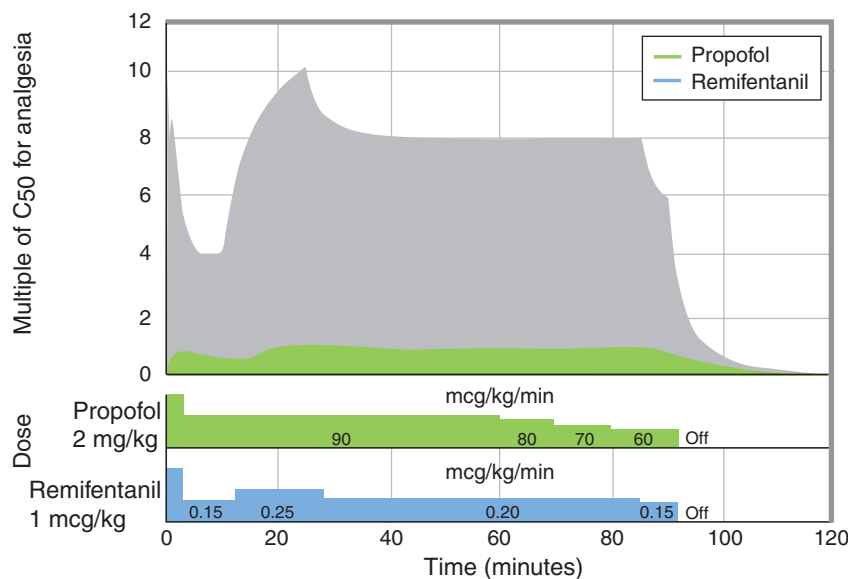
One of the challenges of drug synergism is quantifying the magnitude of drug–drug interactions in a clinically meaningful manner that will allow clinicians to reliably modify their dosing regimens to optimize a desired drug effect. Although response surfaces and isoboles provide useful tools for characterizing drug interactions, their clinical utility when delivering an anesthetic in real time has not been explored. Suspecting that anesthesia providers may have difficulty interpreting response surfaces and isoboles, investigators have explored other means of visually presenting synergistic effects in real time. Work has focused on plotting the contribution of simultaneously administered sedatives or potent inhaled agents and opioids to the overall analgesic and sedative effects over time.<sup>43</sup> With this approach, the overall analgesic effect, for example, is plotted over time as a function of the  $C_{50}$  for no response to a painful stimulus. Using this technique, the total intravenous anesthetic introduced in Fig. 39-17 has been replotted in terms of the contribution of remifentanyl alone (blue) and remifentanyl and propofol (gray) to the overall analgesic effect (Fig. 39-19).

To gain a perspective of how synergistic these two drugs are with regard to analgesia, consider the contribution of remifentanyl without propofol to analgesia. The bolus and infusion of remifentanyl rendered an effect site concentration that approached half of the effect site concentration (4–5 ng/mL) necessary to reach the  $C_{50}$  for analgesia (8.8 ng/mL).<sup>25</sup> By contrast, when added to the bolus and continuous infusion of propofol, the cumulative effect of both drugs exceeds the  $C_{50}$  for analgesia 8-fold during most of the anesthetic.

An important limitation of these simulations used to describe drug synergy is that they are inherently restricted by pharmacokinetic and pharmacodynamic parameter variability within the population that was used to estimate them.<sup>44,45</sup> Population pharmacokinetic parameters thus should be viewed as an estimate of the population's typical parameters, recognizing



**FIGURE 39-18.** **A.** Response surface for remifentanyl and propofol effect site concentration pairs and the probability of no response to a painful stimulus. **B.** Isobologram of the response surface presented in **A.** Superimposed on both plots are the remifentanyl and propofol effect site concentrations that result from the simulated total intravenous anesthetic shown in Figure 39-17. Segments of the anesthetic are color coded to depict the induction, maintenance, and termination of anesthetic delivery.



**FIGURE 39-19.** Simulation of the analgesic effect of remifentanyl (blue) and synergistic effect of remifentanyl and propofol on analgesia (gray) over time. The analgesic effect is presented as multiples of the  $C_{50}$  for analgesia (8.8 ng/mL<sup>25</sup>). The dosing regimens for propofol and remifentanyl are presented on the horizontal axis.

ing that each individual likely will vary from the population parameters to some degree.<sup>46</sup> Some patients, of course, will vary greatly from the population mean. For these patients, the simulations are admittedly of little value. For most patients, however, the prediction based on the population pharmacokinetic and pharmacodynamic parameters are a good starting point for initial therapy. Adjustments in dosing scheme are then made on the basis of patient response.

In summary, most practitioners tend to relatively overdose patients with their anesthetic technique because the current surrogate measures of anesthetic depth (e.g., changes in heart rate and blood pressure, patient movement, processed EEGs) and display tools for visualizing the time course of anesthetic drug concentrations over time are inadequate. Given that variations in surgical stimulus often are difficult to predict and that pharmacologic interpatient variability is substantial, clinical experience mandates that practitioners continue to administer generous doses of anesthetics. As pharmacokinetic and pharmacodynamic display systems become more effective at reliably communicating useful information regarding clinical end points of interest in a timely manner, perhaps anesthesiologists will be more inclined to tailor their technique to the precise needs of each

patient and the demands of a given surgical procedure or, in other words, surf the 95% isobole.

### SPECIAL POPULATIONS

Anesthesiologists have long recognized the need to adapt their anesthetic to account for differences in demographic factors and disease processes that influence drug disposition or effect. Increasingly, the scientific rationale supporting these dosing changes is taking shape. Comorbidities in these special populations, such as obesity, renal failure, heart failure, liver failure, blood loss, presence of opioid tolerance, and differences in age, are referred to as *covariates*. Covariates are descriptors of demographic factors or pathophysiologic states used to estimate the impact of these states on anesthetic drug behavior. Although a significant amount of research has been dedicated to describing covariates and how they can be used to optimize dosing, there are still many gaps in our knowledge base, making the development of guidelines and dosing recommendations for commonly used anesthetics difficult. Nevertheless, as newer intravenous anesthetics have expanded the array of drugs available to the practitioner, covariate analysis has become an increasingly useful tool for describing potential dosing pitfalls associated with these anesthetics.

The next segment of this chapter reviews the comorbidities and demographic factors that have been described, with covariate analysis for selected intravenous anesthetics (propofol, fentanyl, and remifentanyl) as an example of how to account for (1) disease states such as obesity and blood loss and (2) commonly occurring patient conditions such as advanced age and opioid tolerance when formulating a dosing regimen. Unfortunately, our pharmacologic database is incomplete and does not allow us to generalize these examples to all intravenous anesthetics. Furthermore, some of the studies were performed in animal models and therefore are difficult to translate to clinical practice. Nevertheless, this body of work does provide some insight into how intravenous anesthetics behave in the presence of commonly occurring covariates and are important to consider when formulating a dosing regimen.

### Body Weight and Intravenous Anesthetic Pharmacology: Developing Rational Dosing Strategies

The clinical relevance of accounting for differences in body mass is a result of the prevalence of obesity in western culture. Obesity is a major public health problem throughout the developed world. Since the early 1970s the proportion of the US population that is overweight has steadily increased.<sup>47</sup> Among US adults aged 20–74 years, approximately 25% are overweight, with a slightly higher prevalence among women.<sup>48</sup> Almost 5% of US adults are morbidly obese, that is, they weigh twice their ideal weight. Anesthesia providers thus frequently encounter obese patients in everyday practice.

Many investigators have explored the impact of weight on drug dosing for opioids<sup>46,49–51</sup> and sedatives<sup>52</sup> and have offered strategies on how doses should be formulated for patients who are overweight. Nonetheless, despite the high prevalence of obesity, practitioners often formulate dosage regimens for many drugs based on total body weight (TBW). However, dosing according to TBW in obese patients can lead to large doses and prolonged or toxic effect. Clinicians should recognize that most studies designed to determine appropriate doses of intravenous anesthetics have been conducted in healthy patients or in volunteers at or



TABLE 39-5.

## Ideal Body Weights for Selected Heights in Men and Women

Height	Women	Men
4 ft 9 in (145 cm)	85 lb (39kg)	
5 ft 1 in (155 cm)	105 lb (48 kg)	115 lb (52 kg)
5 ft 6 in (165 cm)	130 lb (59 kg)	140 lb (63 kg)
5 ft 9 in (175 cm)	145 lb (66kg)	155 lb (70 kg)
6 ft 1 in (185 cm)	165 lb (75 kg)	174 lb (79 kg)
6 ft 5 in (196 cm)		194 lb (88kg)

near their ideal body weight (IBW). A unique attribute of IBW is that it represents an estimate of appropriate body weight based on height only. For example, popular formulas for estimating IBW are  $IBW = 49.9 + 0.89 \times (\text{Height} - 152.4) \text{ kg}$  for men and  $IBW = 45.4 + 0.89 \times (\text{Height} - 152.4) \text{ kg}$  for women.<sup>53</sup>

To illustrate the resultant weights using these formulas, IBWs for several common heights are presented in Table 39-5. It is important to point out that when using these formulas for any given height, the IBW is the *same* regardless of weight. Formulating a dose according to the IBW for patients of equivalent height who weigh 70, 100, and 150 kg would be the same. By contrast to dosing patients according to their TBW, dosing according to the IBW has the potential for significant *underdosing*.

To get around the limitations of IBW for dosing anesthetics, investigators have used lean body mass (LBM) instead. Advantages of LBM are that it excludes weight associated with adipose tissue and accounts for patient height and TBW. For example, LBM has been used to scale pharmacokinetic parameters (i.e., volumes and clearances) for remifentanyl to predict drug

levels in lean and obese patients (Table 39-6).<sup>49</sup>

Using these weight-adjusted pharmacokinetic parameters, simulations of remifentanyl effect site concentrations in obese and lean patients can be compared when dosed according to TBW versus LBM (Fig. 39-20). This set of simulations was performed for a lean woman (125 lb) and an obese woman (220 lb) of the same height (5 feet 5 inches). The simulations used

dosing regimens typical for remifentanyl as part of a combined technique with a potent inhaled agent, nitrous oxide, or a continuous infusion of a sedative-hypnotic. The dosing scheme included a bolus dose ( $1 \mu\text{g}/\text{kg}$ ) followed by a continuous infusion at  $0.25 \mu\text{g}/\text{kg}/\text{min}$  for 20 minutes and then  $0.15 \mu\text{g}/\text{kg}/\text{min}$  for 60 minutes.

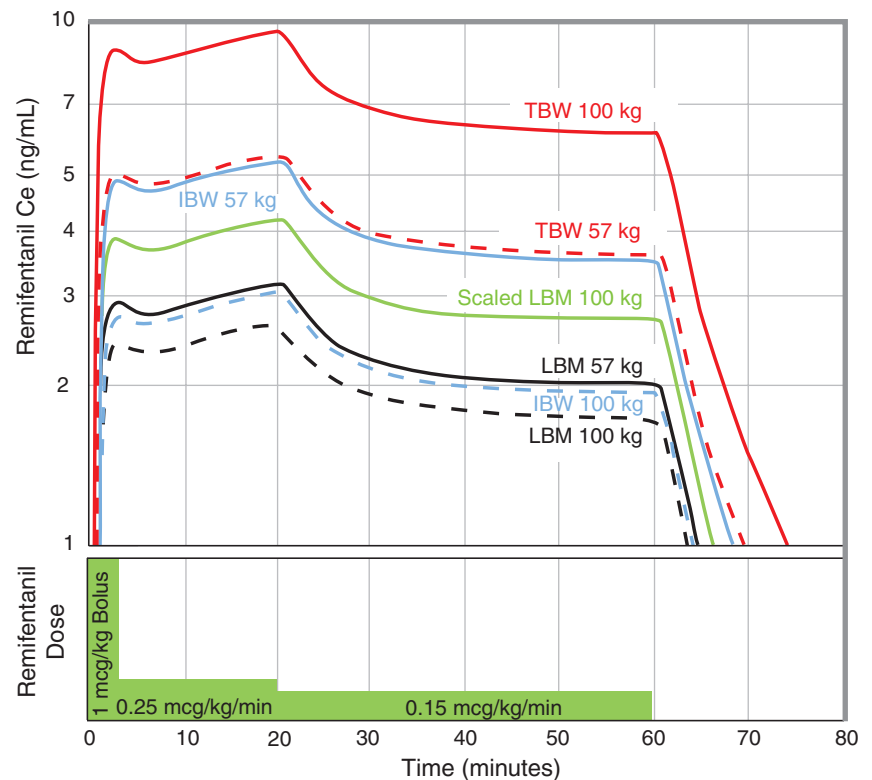
Key points illustrated by these simulations include the following. (1) Dosing obese patients according to their TBW can yield remifentanyl effect site concentrations that are substantially higher than in equivalently dosed lean patients. The peak effect site concentrations after 20 minutes of the anesthetic were 9.5 and 5.4 ng/mL for the obese and lean patient, respectively. (2) With the dosing scaled to LBM, the resultant simulated effect site concentrations for both lean and obese patients were *lower* than the effect site profile for a lean patient dosed to the TBW. These simulations suggest that dosing intravenous anesthetics to

TABLE 39-6.

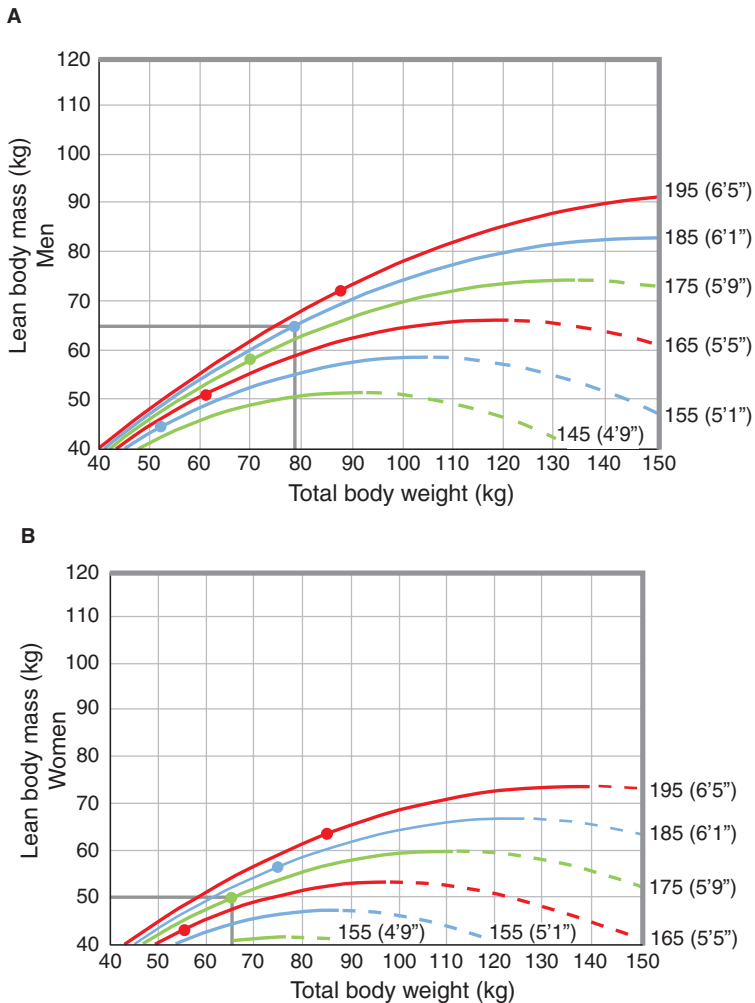
## Pharmacokinetic Population Model Scaled to Lean Body Mass

Parameter Name	Scale Pharmacokinetic Parameter
V <sub>1</sub> (L)	$(0.121 \times \text{LBM}) - 0.0731$
V <sub>2</sub> (L)	$(0.165 \times \text{LBM}) - 0.0731$
Cl <sub>1</sub> (L/min)	$(0.0185 \times \text{LBM}) - 1.88$
Cl <sub>2</sub> (L/min)	1.04

Equations used to describe lean body mass (LBM) are  $\text{LBM} = 1.1 \times \text{Weight} - 128 \times (\text{Weight}/\text{Height})^2$  for men and  $\text{LBM} = 1.07 \times \text{Weight} - 148 \times (\text{Weight}/\text{Height})^2$  for women.



**FIGURE 39-20.** Computer simulation of a remifentanyl infusion for two patients: a 5-foot 5-inch (165-cm) lean (57-kg) female, and a 5-foot 5-inch obese (100-kg) female. Solid lines represent dosing to 100 kg, and dashed lines represent dosing to 57 kg. The dosing regimen is presented along the horizontal axis. The red, blue, and black lines represent the resultant remifentanyl effect site concentration when dosed according to total body weight (TBW), ideal body weight (IBW), and lean body mass (LBM). The green line represents the resultant effect site concentration when remifentanyl is dosed according to the scaled LBM for the 100-kg patient. The effect site concentration when remifentanyl is dosed according to the scaled LBM for the lean patient is equivalent to the concentration for the lean patient dosed to TBW.



**FIGURE 39-21.** Normogram by height of the lean body mass over a range of total body weights for men (A) and women (B). The height is presented in centimeters, with feet and inches in parentheses. The dots represent the ideal body weight at each height. The solid lines illustrate the lean body mass for an ideal body weight for a 6-foot 1-inch man and a 5-foot 9-inch woman. The dashed lines represent the segment of each normogram where the formula for lean body weight begins to generate lean body masses that are smaller for increasing total body weight. Ideal body weights and lean body mass were calculated from standard formulas presented in the text.<sup>53</sup> These normograms are patterned after normograms originally described by Bouillon and Shafer<sup>54</sup> using different heights and weights.

LBM, similar to IBW, may lead to significant underdosing.

LBM has an additional limitation. In instances where the patient's weight approaches morbid obesity, dosing according to the LBM becomes increasingly inaccurate.<sup>54</sup> A unique and somewhat worrisome feature to the LBM equation is that, for any given height, there is a maximum LBM. For TBWs that are above the maximum LBM, the LBM decreases. In Fig. 39-21, an LBM normogram, the LBM estimates that correspond to TBWs where the LBM decreases with increasing TBW are plotted as a dashed line. This most likely is an artifact of the LBM equation. If not accounted for, very large patients would receive smaller doses

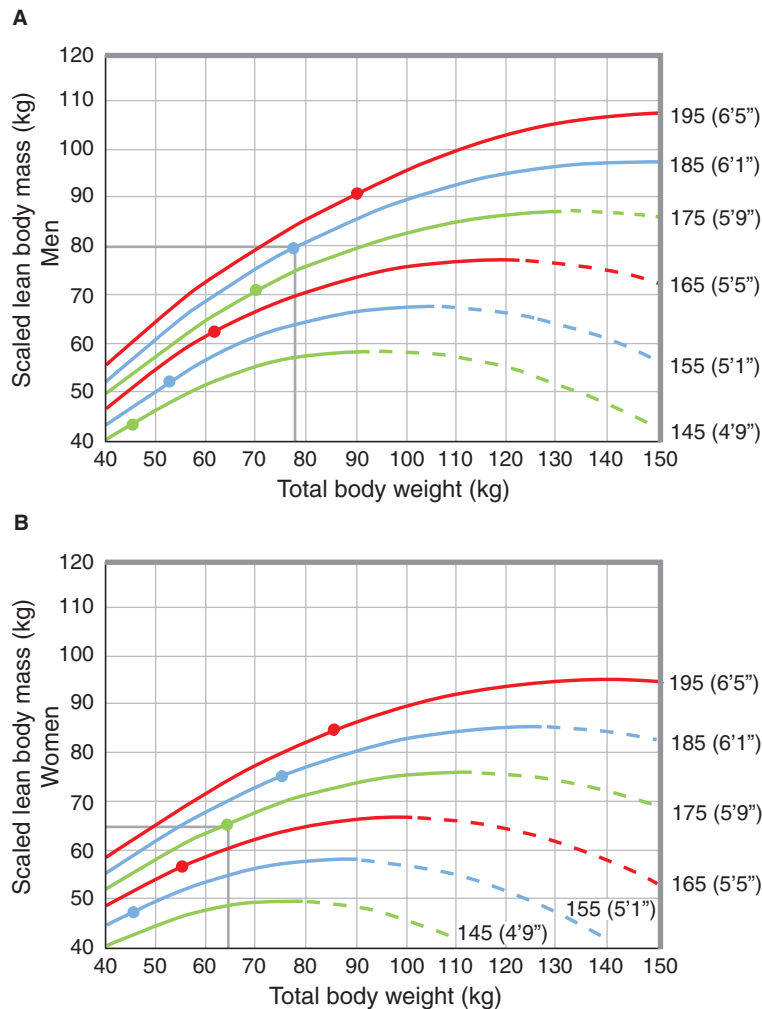
than patients of equivalent height but not as large. Another limitation of using the LBM normogram for dosing is that the LBM reports the patient mass in the absence of any fat tissue. The LBM is always lower than the IBW. This is illustrated in the normogram with solid gray lines. These lines point out the resultant LBM for an IBW for a 6-foot 1-inch man and a 5-foot 9-inch female. Because even lean people have some fat, this would suggest that using the LBM for dosing anesthetics, as observed in Fig. 39-20, results in some degree of underdosing. Hence, for clinical purposes, the LBM equation is perhaps useful only until the maximum LBM for a given height is reached, with the expectation that

many patients may require additional anesthetic.

With this limitation in mind, Bouillon and Shafer<sup>9</sup> recommend that estimates of the *ideal* dosing weight from which to formulate dosing regimen use a modified normogram of LBM. Their modified normogram uses the following guidelines. (1) Conventional LBM scales are adjusted to IBW (in other words, for a patient that is at his/her IBW, the LBM at a given height should be the IBW). In effect, this shifts the original normograms presented in Fig. 39-21 up and to the left. (2) The scaled or modified LBM normograms are truncated at the maximal estimates of LBM. This approach relies on the assumptions that recommended doses printed on package inserts are appropriate for patients who are their IBW. The scaled normogram of LBM is presented in Fig. 39-22. Again, the dashed lines represent the point where the scaled LBM decreases with increasing weight. Scaled LBM estimates in this region should not be used to estimate the proper dosing weight.

Using this scaled normogram for dosing remifentanyl when a person's weight is at or below his/her IBW is unnecessary. Using their actual weight will suffice. When a person's weight is above the IBW, using the normogram shown in Fig. 39-22 may be useful but probably is not immediately practical if it is not readily available in the clinical setting. A more simplified approach, based on the normograms presented in Fig. 39-22, is to use a patient's IBW or, if the patient is approaching morbid obesity, to consider using his/her IBW *plus* some fraction of the difference between TBW and IBW.<sup>54</sup> A simplified summary of scaled LBM normograms is presented by gender in Table 39-7. To account for height and weight, suggested scaled weights to use for dosing are presented as a function of the body mass index (BMI).

In Fig. 39-20, the green line represents the resultant remifentanyl effect site concentration when dosing the 5-foot 5-inch (165-cm), 220-lb (100-kg) patient according to the suggested dosing weight in Table 39-6. Her IBW is 57 kg. Her BMI was calculated as 37. Twenty percent of the difference between TBW and IBW is 8.6 kg. Therefore, the suggested dosing weight is 65.6 kg. The resultant effect site concentrations are between the concen-



**FIGURE 39-22.** Modified normogram by height of the *scaled* lean body mass over a range of total body weights for men (A) and women (B). This normogram represents weights that should be used when formulating a dosing regimen by weight. The normogram assumes that published dosing recommendations are correct for persons of ideal body weight. The height is presented in centimeters, with feet and inches in parentheses. The dots represent the ideal body weight at each height. Note that with the scaled normogram, the ideal body weight plotted on the horizontal axis corresponds to the same scaled lean body mass on the vertical axis. The solid lines illustrate that the scaled lean body mass and the ideal body weight for a 6-foot 1-inch man and a 5-foot 9-inch woman are the same. The dashed lines represent the segment of each normogram where the formula for scaled lean body weight begins to generate scaled lean body masses that are smaller for increasing total body weight.

trations when dosing her according to her TBW and LBM, respectively. Using this approach avoids the inherent risks of underdosing using the LBM and overdosing using the TBW, as well as the limitations of dosing according to the IBW.

### Age and Intravenous Anesthetic Pharmacology: Developing Rational Dosing Strategies

Considering the aging of the world's population, the clinical significance of age in the practice of anesthesia is obvious. Practitioners are frequently faced with the clinical challenge of

anesthetizing older adults, sometimes even patients in their ninth or tenth decade. Clinicians have long recognized that elderly patients usually require a smaller dosage of most intravenous anesthetics to produce the desired therapeutic effect while minimizing adverse effects.

Of the frequently considered patient covariates (e.g., gender, age, body weight, kidney function, hepatic function, etc.), age is perhaps one of the most valuable in terms of developing a therapeutic, nontoxic dosage strategy for many intravenous anesthetics. Age is easily measured (i.e., just ask the patient), and its influence on the pharmacokinetics and pharmacodynamics

**TABLE 39-7.**

**Estimates of Scaled Lean Body Mass and IBW and TBW**

BMI (kg/m <sup>2</sup> )	Increase of IBW as Percentage of TBW-IBW
<b>Men</b>	
≤27	IBW
28–35.1	IBW + 40% of (TBW – IBW)
36–42	IBW + 30% of (TBW – IBW)
≥43	IBW + 20% of (TBW – IBW)
<b>Women</b>	
≤27	IBW
28–33	IBW + 30% of (TBW – IBW)
>33	IBW + 20% of (TBW – IBW)

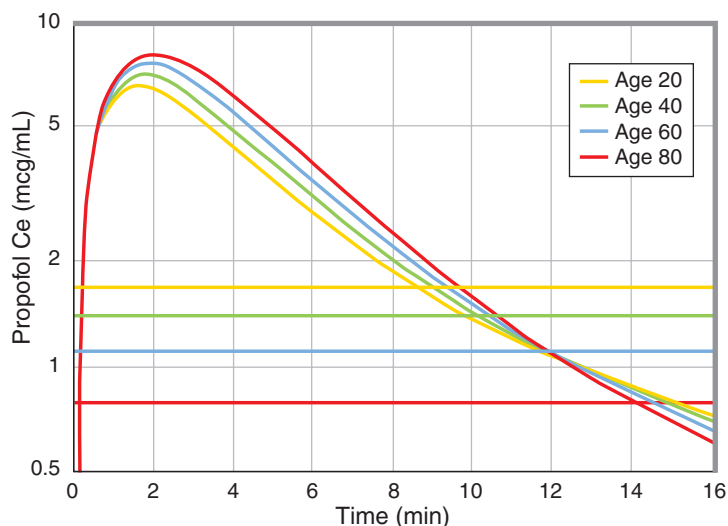
BMI, Body mass index; IBW, ideal body weight; TBW, total body weight.

of many intravenous anesthetics has been described in some detail.

With regard to age, both remifentanyl and propofol can serve as a prototype to examine the impact of age on anesthetic pharmacology. Studies specifically designed to assess the influence of age on remifentanyl and propofol pharmacokinetics and pharmacodynamics have been conducted and complex models constructed that characterize the influence of age in quantitative terms.<sup>11,32,52,54,55</sup>

With regard to remifentanyl, it is clear that the elderly do require less drug to produce the desired spectrum of opioid effects. The reduced dosage requirement is a function of both pharmacokinetic and pharmacodynamic mechanisms, although pharmacodynamic factors dominate.<sup>55</sup> The concentration of remifentanyl necessary for 50% of maximal effect as measured by the EEG is markedly decreased in the elderly ( $C_{50}$  for EEG changes); in addition, remifentanyl's clearance and volume of distribution are also decreased.<sup>11</sup> These age-related changes translate clinically into the need for a very substantial dosage reduction in the elderly that is based largely on the increased potency of remifentanyl in older patients (i.e., a pharmacodynamic difference).

Using the pharmacokinetic–pharmacodynamic parameters from age-adjust-



**FIGURE 39-23.** Plot illustrating a combined pharmacokinetic and pharmacodynamic simulation of the propofol effect site concentration that results from a 2 mg/kg bolus. The simulated patient is an 80-kg, 183-cm male. Simulations were performed for patients aged 20, 40, 60, and 80 years. The horizontal lines represent the effect site concentrations associated with a 50% probability of loss of responsiveness, which are 1.7, 1.4, 1.1, and 0.8  $\mu\text{g}/\text{mL}$  for ages 20, 40, 60, and 80 years, respectively. Pharmacokinetic and pharmacodynamic parameters for propofol by age were adapted for simulation from Schnider et al.<sup>32,52</sup>

ed pharmacologic models of propofol and remifentanyl, computer simulations can be performed to explore the suitability of various dosage schemes. Fig. 39-23 presents a set of simulations of propofol's pharmacologic behavior following an induction dose of propofol. Using age-adjusted pharmacokinetic and pharmacodynamic parameters,<sup>32,52</sup> four simulations of a 2 mg/kg propofol bolus for a 20-, 40-, 60-, and 80-year-old patient demonstrate, with the same dose, a subtle rise in the peak propofol effect site concentration and a small delay in reaching the peak with increasing age. By contrast, the concentration at which there is a 50% probability of losing unresponsiveness ( $C_{50}$  for unresponsiveness) drops by 50% from age 20 to 80 (Table 39-8). Combining the pharmacokinetic and pharmacodynamic models, the duration of propofol effect (time above the effect site concentration associated with a loss of responsiveness) substantially increases with increasing age.

Similarly Fig. 39-24 is an illustration of simulations of remifentanyl's pharmacologic behavior following a 1-hour infusion. Using age-adjusted pharmacokinetic and pharmacodynamic parameters,<sup>11,55</sup> four simulations are presented of a 1-hour continuous infusion at a rate of 0.2 mg/kg/min for a 20-, 40-, 60-, and 80-year-old patient. At the same infusion rate, the remifentanyl

effect site concentration develops a substantial increase over time with increasing age (Table 39-8). Estimates of the  $C_{50}$  for analgesia allow for prediction of the duration of analgesic effect following termination of the 1-hour infusion. In Fig. 39-24, the  $C_{50}$  for each simulated age is presented as

a horizontal line. Following termination of the infusion, the duration of analgesic effect markedly increases with age (more than 3-fold increase from age 20 to 80).

Additional simulations can be used to estimate the percent reduction in dose as a function of age for both propofol and remifentanyl. As shown in Table 39-8, to achieve equipotent doses in 20- and 80-year-old individuals requires that the 80-year-old person receive a dose that has been reduced by 55-65% of that which would be given to a 20-year-old person. These simulations emphasize the importance of considering age when formulating an appropriate dose in elderly patients.

Although the physiologic mechanism of the pharmacodynamic changes in elderly people remains largely unexplored, the pharmacokinetic changes may be due at least in part to decreased cardiac output. The lower cardiac output associated with advanced age<sup>56</sup> presumably results in slower drug mixing and therefore higher peak concentrations after a bolus dose.<sup>57-59</sup> Lower cardiac output may decrease drug delivery to metabolic organs, resulting in lower clearance for some drugs.

When generalizing to other drugs, whether reduced cardiac output is the primary underlying mechanism responsible for the pharmacokinetic

**TABLE 39-8.**

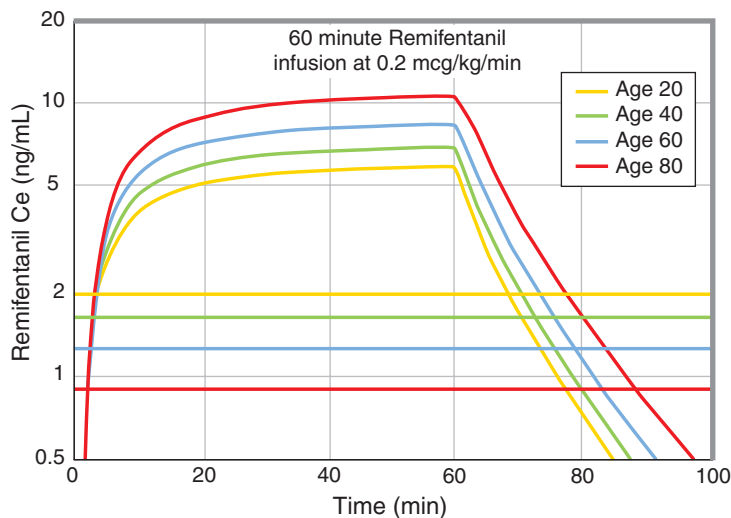
**Influence of Age on Pharmacologic Behavior of a 2 mg/kg Bolus of Propofol and 1-Hr Remifentanyl Infusion Set at 0.2 kg/min**

Age (y)	20	40	60	80
<b>Propofol</b>				
Peak propofol Ce ( $\mu\text{g}/\text{mL}$ )	6.5	7.0	7.6	8.2
Time to peak Ce (min)	1.7	1.8	2.0	2.0
$C_{50}$ for LOR ( $\mu\text{g}/\text{mL}$ )	1.7	1.4	1.1	0.8
Time above the $C_{50}$ for LOR (min)	9	10	12	14
Percent reduction in dose	0	25	56	65
<b>Remifentanyl</b>				
Remifentanyl Ce (ng/mL) upon termination of infusions	5.6	6.6	8.0	10.2
$C_{50}$ for analgesia (ng/mL)	2.0	1.6	1.3	0.9
Upon termination of infusion time above $C_{50}$ for analgesia (min)	8	13	19	29
Percent reduction in dose	0	18	37	55

Ce, effect site concentration;  $C_{50}$  for analgesia, effect site concentration associated with 50% probability of analgesia;  $C_{50}$  for LOR, effect site concentration associated with 50% probability of loss of responsiveness.

Pharmacokinetic and pharmacodynamic parameters for propofol by age were adapted for simulation from Schnider et al.<sup>32,52</sup> Pharmacokinetic and pharmacodynamic parameters for remifentanyl by age were adapted for simulation from Minto et al.<sup>11,55</sup>





**FIGURE 39–24.** Plot illustrating a combined pharmacokinetic and pharmacodynamic simulation of the remifentanil effect site concentration that results from a 1-hour infusion set at 0.2  $\mu\text{g}/\text{kg}/\text{min}$ . The simulated patient is an 80-kg, 183-cm male. Simulations were performed for patients aged 20, 40, 60, and 80 years. The horizontal lines represent the effect site concentrations associated with an analgesia. The analgesic levels are 2, 1.6, 1.3, and 0.9 ng/mL for ages 20, 40, 60, and 80 years, respectively. Pharmacokinetic and pharmacodynamic parameters for propofol by age were adapted for simulation from Minto et al.<sup>14,55</sup>

840

changes observed in the elderly, it is consistent with the observation that many intravenous anesthetics (thiopental, propofol, etomidate) appear to have a smaller distribution volume or slower clearance in the elderly.<sup>10,52,60,61</sup>

It is, however, important to point out that reduced cardiac output is not a ubiquitous finding in the elderly, particularly in the absence of heart disease in well-conditioned individuals.<sup>62</sup> This recognition perhaps has led to the common clinical notion of identifying a patient's "physiologic" age instead of relying on chronologic age alone.<sup>63,64</sup> Significant reductions in dosage may not, therefore, be necessary for physically robust elderly patients with normal body habitus and without substantial coexisting disease.

It is more difficult to generalize with regard to age-induced pharmacodynamic changes to other intravenous anesthetics. Although the elderly clearly have a "left-shifted" concentration-effect relationship for opioids (i.e., the opioids are more potent in the elderly),<sup>11,65</sup> a good deal of data suggests that the elderly are not more pharmacodynamically sensitive to the sedative-hypnotics. For example, there is no difference between old and young in terms of the EEG  $C_{50}$  for etomidate or thiopental.<sup>10,60,61</sup> On the other hand, published data suggest that both propofol and midazolam are more potent in

the elderly.<sup>32,66</sup> Thus, although there certainly is general consensus that the elderly require less medication than do younger patients, whether this reduced dosage requirement can be attributed to pharmacokinetic or pharmacodynamic mechanisms remains unclear for some individual agents.

### Blood Volume and Intravenous Anesthetic Pharmacology: Developing Rational Dosing Strategies

Dr. F. Halford,<sup>67</sup> a surgeon, wrote a letter to the editor of *Anesthesiology* after caring for several trauma victims following the attack on Pearl Harbor in 1941. He noticed that anesthesiologists had started using the intravenous anesthetic sodium pentothal. His comments are as follows:

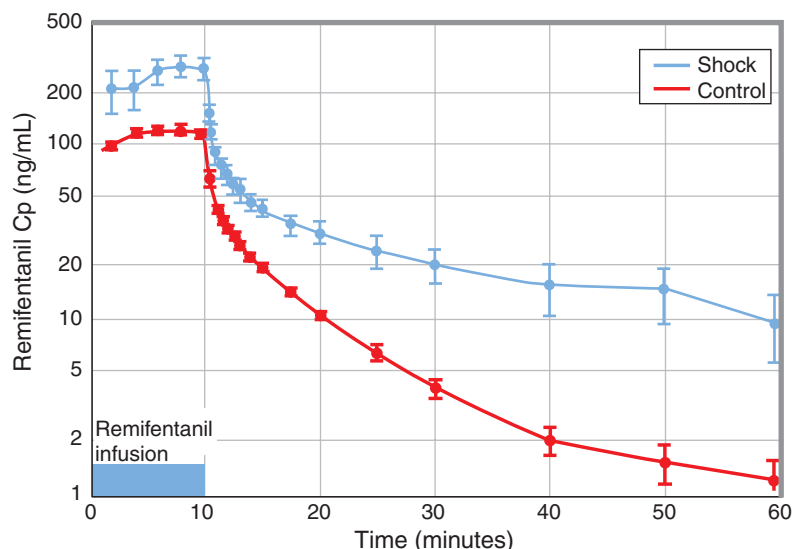
"Then let it be said that intravenous anesthesia is also an ideal form of euthanasia.... With this heterogeneous mass of emergency anesthesiologists, it is necessary to choose an anesthetic involving the *WIDEST MARGIN OF SAFETY* for the patient.... Stick with *ETHER*."

Anesthesiologists have long recognized the need to select certain IV anesthetics over others, to incrementally dose these anesthetics, and to moderate the overall dose for patients

who have significant blood loss before or during surgery. Through experience, clinicians have learned that a full dose of selected intravenous anesthetics can lead to pronounced and often unwanted side effects with potentially disastrous consequences.

In the recent past, several researchers have attempted to quantify how the extent of blood loss impacts intravenous anesthetic pharmacokinetics and pharmacodynamics to include work with opioids,<sup>68–70</sup> sedative-hypnotics,<sup>71–75</sup> benzodiazepines,<sup>76,77</sup> and local anesthetics.<sup>78</sup> The most important finding consistent throughout this body of work is that equivalent dosing leads to higher drug concentrations with severe blood loss when compared to unbled controls. In addition, although derived volumes and clearances from pharmacokinetic analyses do not reflect true organ drug distribution and clearance, they do indicate that, in severe blood loss, blood flow to muscle, gut, liver, and connective tissue is markedly decreased such that anesthetics delivered intravenously are most likely pumped straight to the brain in higher concentrations. This phenomenon leads to higher brain concentrations of anesthetic drugs and a more pronounced and/or prolonged anesthetic effect.<sup>79</sup>

As an example, Fig. 39–25 illustrates the differences in blood concentrations that result from identical doses of remifentanil in bled and unbled swine.<sup>70</sup> Following severe blood loss (42 mL/kg), resultant remifentanil blood levels were 2-fold higher during and after a 10-minute remifentanil infusion. Of note in this study, the dose (10  $\mu\text{g}/\text{kg}/\text{min}$ ) is approximately 50- to 100-fold more than a typical dose of 0.1 to 0.2  $\mu\text{g}/\text{kg}/\text{min}$ , yet all animals survived despite losing more than half of their blood. A decrease in blood volume and cardiac index (5–1.7 L/min/m<sup>2</sup>) along with compensatory changes in regional blood flow are the likely physiologic mechanisms explaining these pharmacokinetic changes. Pharmacokinetic analyses revealed that the volumes of distribution and clearances were decreased in bled animals when compared to unbled controls. Spectral edge changes in the EEG were used to measure drug effect. By contrast to the pharmacokinetic analysis, no difference was observed in the pharmacodynamics between groups. As has been observed with fentanyl<sup>69</sup> and morphine,<sup>68</sup> these findings with remifenta-

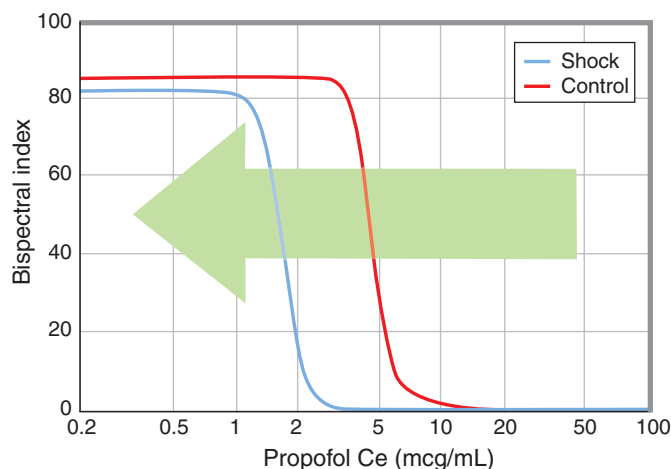


**FIGURE 39-25.** Resultant mean blood drug concentrations versus time from equivalent dosing of remifentanyl in bled (42 mL/kg) and unbled swine. The blue and green lines represent the mean levels for bled and unbled animals, respectively. The blue box at the lower left corner represents the duration of the 10  $\mu\text{g}/\text{kg}/\text{min}$  remifentanyl infusion. The error bars indicate the standard error. The vertical axis is on the log scale.

nil corroborate the relative forgiving posture of high-dose opioids on cardiovascular function even when used in the setting of hemorrhagic shock.

In contrast to opioids, blood loss has a more worrisome impact on propofol pharmacokinetics and pharmacodynamics. Similar to the experimental design used with remifentanyl described earlier, investigators have bled animals and then administered propofol. Two major differences were observed when compared to remifentanyl. First, the administration of propofol following severe hemorrhage (42 mL/kg) led to certain cardiovascular collapse. Second, the dose found to elicit a pharmacologic effect (i.e., a change in the BIS of at least 50) in unbled animals was in no way tolerated in bled animals. In order to conduct experiments in bled animals, the propofol dose had to be reduced by more than 50% and the extent of hemorrhage had to be markedly reduced to 30 mL/kg. In this case, hemorrhage led to a decrease in the cardiac index from 5 to 2.6 L/min/m<sup>2</sup>. Subsequently animals received a 10-minute propofol infusion at 200  $\mu\text{g}/\text{kg}/\text{min}$ . Of interest, with equivalent dosing, the hemorrhaged animals exhibited approximately 2-fold greater plasma concentrations of propofol throughout the study period. A pharmacokinetic analysis revealed that, similar to remifentanyl, propofol compartmental clearances and volumes were decreased in bled animals.

The BIS was used as a surrogate measure of propofol effect. As expected, changes in the BIS lagged behind the changes in plasma propofol concentrations. These data were used to estimate the  $k_{\text{eo}}$  for bled and unbled animals and to construct previously described pharmacodynamic models to include estimates of  $C_{50}$  and  $\gamma$ . Comparison of pharmacodynamic parameters between bled and unbled animals revealed a similar  $k_{\text{eo}}$  and  $\gamma$  but a 2.7-fold decrease in  $C_{50}$  (4.6  $\mu\text{g}/\text{mL}$  vs 1.7  $\mu\text{g}/\text{mL}$  for the control and shock groups, respectively). This is emphasized by the leftward shift



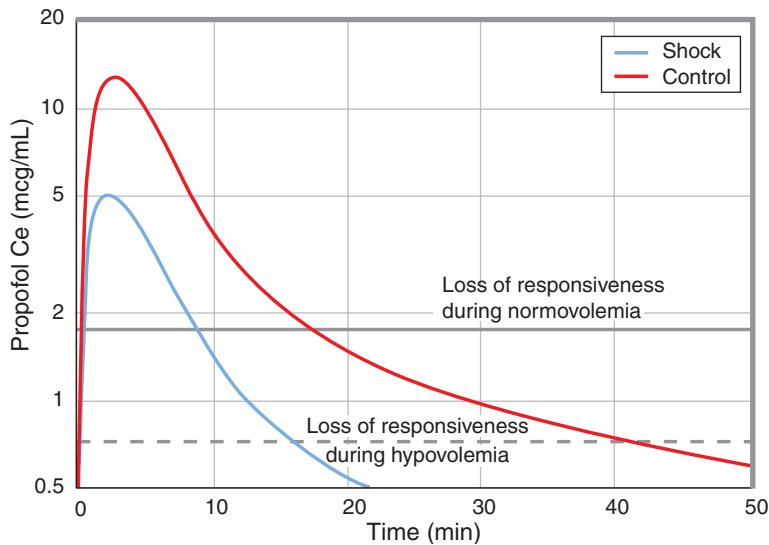
**FIGURE 39-26.** Concentration–effect relationship of propofol to the bispectral index scale (BIS) in bled (30 mL/kg) and unbled swine as characterized by a pharmacodynamic model. The red and blue lines represent the mean change in BIS over a range of propofol effect site concentrations for unbled and bled swine, respectively. The green arrow illustrates the shift in  $C_{50}$  between groups.

(green arrow) in the  $C_{50}$  for each study group (Fig. 39–26).

Perhaps one of the more dangerous uses of intravenous anesthetics is during the induction of anesthesia. Here bolus doses are used to rapidly render a patient analgesic or unconscious, but these doses can be associated with significant morbidity if dosing does not account for large changes in blood volume. For purposes of discussion, consider an induction dose of propofol. The pharmacokinetic and pharmacodynamic findings related to propofol during blood loss described earlier will be used to illustrate how blood loss impacts conventional dosing of sedative-hypnotics.

In Fig. 39–11, using pharmacokinetic parameters previously described in humans,<sup>3</sup> the onset and duration of loss of responsiveness following a propofol bolus of 2 mg/kg was 1 and 8 minutes, respectively, assuming that the necessary propofol effect site concentrations required for loss of responsiveness was near 1.8  $\mu\text{g}/\text{mL}$ .<sup>25</sup> Conducting a propofol bolus simulation following moderate blood loss (35% of the blood volume) yields a significantly different result (Fig. 39–27). Based on the impact of blood loss on propofol pharmacokinetics and pharmacodynamics, this simulation takes into account the 2.5-fold increase in effect site propofol concentration and the 2.7-fold decrease concentration required for loss of responsiveness.

With this simulation, the impact of moderate blood loss on the duration of effect is easily appreciated. Of note,



**FIGURE 39-27.** Combined pharmacokinetic and pharmacodynamic simulations of a propofol 2 mg/kg bolus dose under normal hemodynamic conditions and following moderate blood loss. The blue and red lines represent the effect site concentrations under normal and hypovolemic conditions. The gray solid and dashed lines represent the propofol effect site concentration associated with loss of responsiveness under normal and hypovolemic conditions.

with blood loss there is more than a 5-fold increase in the duration of effect (from 8 to 44 minutes). These simulations suggest that propofol should be used, if at all, with extreme caution! Estimating the dose that would provide an equivalent effect in a person suffering from severe blood loss with a person with normal cardiovascular physiology yields a propofol dose reduction of 80% (i.e., 0.4 mg/kg). Although the impact of blood loss on propofol is dramatic, it is important to recognize that this is a simulation of a single propofol bolus and does not reflect the common practice of combining propofol with an opioid during the induction of anesthesia. In this scenario, it is likely that the pronounced increase in peak effect and duration of effect would only be larger and potentially more dangerous.

Perhaps the most important consequence of blood loss on propofol behavior is the exaggerated hemodynamic response following a bolus dose. Propofol is a peripheral vasodilator and suppresses contractility.<sup>80</sup> As observed in these simulations, a propofol bolus dose yields higher effect site concentrations that remain elevated for a prolonged period of time, thus amplifying propofol's cardiovascular depression. Sodium pentothal has a similar profile of cardiovascular depression, which likely explains why Dr. Halford was so adamant about the dangers associated with the induction of anesthesia with sodium pentothal.

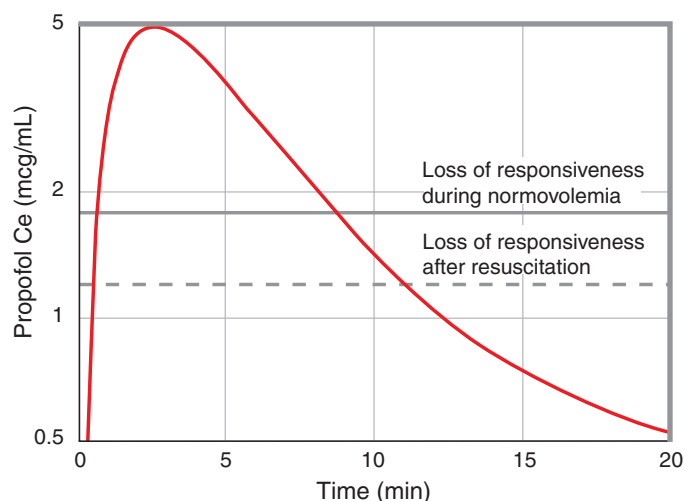
What about resuscitation? Does volume resuscitation restore drug disposition and effect to baseline? In typical clinical practice, some fluid resuscitation usually is under way prior to administration of an anesthetic. Based on the premise that resuscitation will restore cardiac output and systemic blood flow, the shock-induced pharmacokinetic and pharmacodynamic changes may be reversed. In a similar set of experiments, a comparison was made between unbled controls and bled and then partially resuscitated swine.<sup>81</sup> Hemorrhage was severe (42 mL/kg), and resuscitation constituted an infusion of crystalloid to maintain a mean arterial blood pressure of 70 mm Hg for 60 minutes. This resulted in a resuscitation volume of 59 mL/kg.

Following a 10-minute, high-dose (750  $\mu$ g/kg/min) propofol infusion, the propofol plasma concentrations were nearly identical. Resuscitation restored the shock-induced changes in propofol pharmacokinetics to near baseline values. However, the pharmacodynamic parameters remained altered. As with severe blood loss, the  $C_{50}$  was decreased 1.5-fold following hemorrhage and resuscitation. Although the mechanism for this phenomenon is not well understood, one explanation for the increase in end-organ sensitivity to propofol may be, at least in part, attributable to an unrecognized increase in unbound propofol. Thus, the leftward shift in the  $C_{50}$  of propofol

may represent an undetected *pharmacokinetic* difference between groups. Although the plasma propofol levels were similar between the bled then resuscitated animals and the unbled animals, the amount of unbound propofol available to exert a pharmacologic effect may have been increased.<sup>82</sup> After removing >50% of the estimated blood volume and replacing it with crystalloid, plasma protein content most likely would be decreased. Furthermore, alterations in organ blood flow, capillary wall integrity, and plasma pH may influence the levels of unbound propofol. Given that plasma protein content, propofol-plasma protein binding, or unbound propofol levels were not measured or estimated, the extent that changes in unbound propofol played in altering the observed differences in end-organ sensitivity remains unknown.

With this protocol, 60% of the estimated blood volume was removed, and 140% of the shed blood volume was replaced with lactated Ringer solution to maintain a near normotensive blood pressure. *The near normal blood pressure was deceiving!* Although hemodynamic function appeared near normal (i.e., central venous pressure and cardiac index were similar to values in unbled animals), the cardiovascular response to propofol remained exaggerated. During the propofol infusion, the cardiac index decreased by 1.7 L/min/m<sup>2</sup> in the shock-resuscitation group but by only 0.2 L/min/m<sup>2</sup> in the control group. The large hemodynamic changes in the shock-resuscitation group illustrate how severe blood loss followed by partial resuscitation can lead to potentially large cardiovascular changes with the administration of propofol. In fact, a significant clinical correlate from this analysis is that, despite a near normal hemodynamic profile following partial resuscitation for severe blood loss, resuscitation should continue in order to minimize the potentially severe hemodynamic depression that can be associated with the administration of propofol.

Fig. 39-28 shows a simulation of the propofol effect site concentration following a propofol bolus dose in a patient suffering from severe blood loss followed by partial resuscitation with crystalloid (1.5 mL of crystalloid per 1 mL of estimated blood loss). This simulation accounts for the pharmacodynamic changes as manifest by a 1.5-



**FIGURE 39–28.** Combined pharmacokinetic and pharmacodynamic simulation of a propofol 2 mg/kg bolus dose following severe blood loss and resuscitation. The solid and dashed blue lines represent the effect site concentrations at which there is a loss of responsiveness under normal and bled then resuscitated conditions.

fold decrease in the effect site concentration required for loss of responsiveness. The duration of effect increases from 8 to 11 minutes.

By comparison to propofol, both ketamine and etomidate have greater acceptance among clinicians who care for patients with significant blood loss. This is largely because the cardiovascular depression known to be exaggerated with propofol and sodium pentothal is not as apparent with etomidate and to an even lesser extent with ketamine. Although etomidate is known to produce mild cardiovascular depression, prior work surprisingly has revealed minimal cardiovascular change following a high-dose, brief continuous etomidate infusion<sup>73,74</sup> during moderate hemorrhagic shock (30 mL/kg). In a similar fashion, the pharmacokinetic and pharmacodynamic profile of etomidate following blood loss was minimally influenced by blood loss. This suggests that dosing requirements for etomidate do not require adjustment following moderate blood loss. This finding is in accordance with the widely held view that etomidate is a good choice in hemodynamically unstable patients.

What remains unknown is the impact of blood loss on ketamine. Preliminary work has revealed that, as with etomidate, blood loss does not significantly impact the pharmacokinetics of ketamine. Ketamine is known to increase sympathetic tone, serve as a potent analgesic, and perform favorably in patients with poor cardiovascu-

lar function. These preliminary findings support the widely held view that ketamine is an important drug to maintain in our pharmacologic armamentarium when caring for patients suffering from life-threatening blood loss.

The pharmacodynamic properties of ketamine are difficult to assess. This is largely because ketamine is a racemic mixture that, when metabolized, has an active metabolite, nor-ketamine. Hence, the contribution of both enantiomers and nor-ketamine must be considered when assessing the overall drug effect of ketamine. Another complication with measuring ketamine's drug effect is that it is difficult to identify a surrogate measure for ketamine's effect. For example, the BIS is not a reliable measure of ketamine's sedative effects.

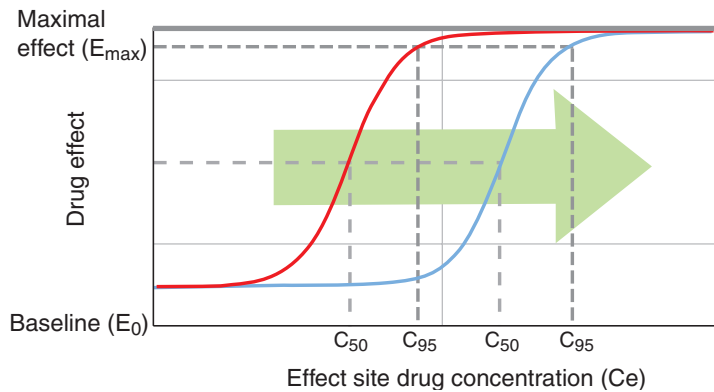
In summary, as clinicians manage patients suffering from blood loss through often perilous anesthetics, hemorrhage and even hemorrhage followed by resuscitation that appears to restore hemodynamic function to near normal can lead to dramatic alterations in the pharmacologic behavior of commonly used sedative-hypnotics and opioids. Duration of effect, peak effect site concentrations, and extent of cardiovascular depression all should be considered when selecting an intravenous anesthetic and formulating an appropriate dose. The hemodynamically compromised patient is especially susceptible to the cardiovascular suppression of selected sedative-hypnotics,

whereas other patients appear to be much safer. Propofol and sodium pentothal are an especially poor choice even after some degree of resuscitation. By contrast, ketamine and etomidate tend to be immune to the deleterious effects of moderate to severe blood loss on their pharmacokinetic profiles. Severe blood loss alters opioid pharmacokinetics, leading to higher plasma concentrations, but opioids, by contrast to propofol and sodium pentothal, enjoy a wider therapeutic margin in the presence of blood loss. What remains unexplored is the impact of blood loss on the resultant effect from simultaneous administration of multiple drugs. As illustrated in the section on Drug Synergism, opioids and sedative-hypnotics can dramatically influence one another. How this interaction behaves in the presence of intravascular volume depletion remains unknown.

### The Opioid-Tolerant Patient

One of the most vexing problems facing an anesthetist is providing care for patients who chronically consume opioids (see Chapter 23 for a general review of substance abuse and anesthesia practice). With chronic consumption of opioids, tolerance develops, and more drug is required to achieve a desired analgesic effect. This becomes especially problematic in the perioperative period when opioid dosing requirements for these patients often reach thresholds associated with significant morbidity in the nonopioid-tolerant population. Out of concern for patient safety, opioid doses often are administered in more conventional doses to avoid unwanted side effects associated with opioid toxicity leading to often dramatically poor pain control in the postoperative period. In these types of patients, the population-based pharmacodynamic models used to describe opioid concentration–effect relationships become obsolete. Performing simulations to estimate opioid behavior either alone or in combination with other types of anesthetics using pharmacodynamic models built from studies evaluating an opioid-naïve population is bound to provide a faulty estimate of drug effect in patients who chronically consume opioids. The essential problem is that the magnitude of the right shift in  $C_{50}$  and  $C_{95}$ , which are key parameters used to build the pharmacodynamic models, is unknown (Fig. 39–29).





**FIGURE 39-29.** Effect of opioid tolerance on the concentration–effect relationship characterized by pharmacodynamic modeling.  $C_{50}$  and  $C_{95}$  are shifted to the right, indicating that more drug is required to achieve the same level of drug effect.

With the widespread use of oral short-acting and time-contingent opioids, transdermal opioid delivery systems, and implantable opioid infusion pumps, opioid tolerance is recognized as a growing challenge in the perioperative environment. Nevertheless, there is a paucity of literature examining the phenomenon of opioid tolerance as a covariate in pharmacodynamic models. One potential reason for this is that opioid tolerance is a difficult feature of drug behavior to quantify and most likely varies substantially among persons based on duration of opioid consumption and opioid dose.

With this problem in mind, investigators have explored methods of identifying the concentration–effect relationship for opioid on an individual basis.<sup>83–85</sup> Using principles of pharmacokinetics and pharmacodynamics, a technique called the “fentanyl challenge” has been developed. The fentanyl challenge was designed for use in patients with a known history of chronic opioid consumption who are scheduled to undergo surgical procedures associated with significant postoperative pain that will require a general anesthetic and are of moderate to long duration (i.e., multilevel lumbar spine instrumentation). The fentanyl challenge protocol calls for administration of a rapid continuous infusion of fentanyl (2  $\mu\text{g}/\text{kg}/\text{min}$ ) until the onset of respiratory depression in the absence of any other sedatives, anxiolytics, or opioids (Fig. 39–30). The optimal setting in which to perform the challenge is just prior to the induction of general anesthesia. The onset of respiratory depression as defined within the fentanyl challenge is a respiratory rate <6 breaths/min. A criti-

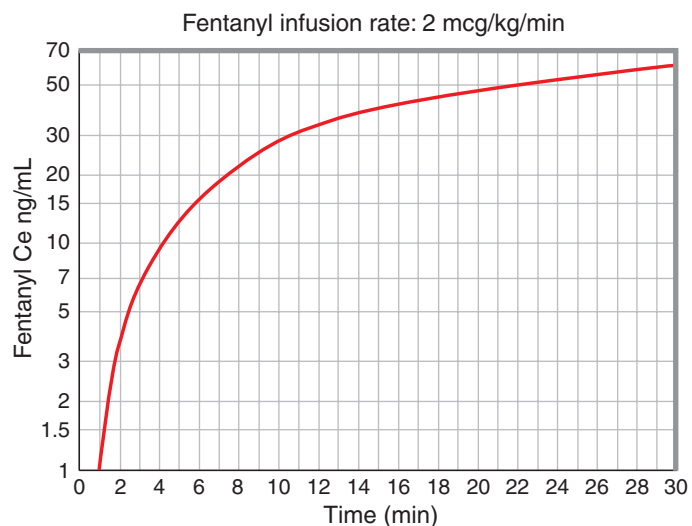
cal component of the challenge is to measure the time from the onset of fentanyl infusion until the onset of respiratory depression.

With the duration of high-dose fentanyl infusion until respiratory depression identified, a pharmacokinetic simulation of the infusion is made to identify the fentanyl effect site concentration that is associated with respiratory depression. This process redefines the pharmacodynamic relationship between fentanyl effect site concentrations and drug effect that is unique to a particular patient. A major assumption of this protocol is that more drug will be required to achieve analgesia.

As described in the Pharmacodynamics section, a series of pharmacodynamic relationships over an array of noxious

stimuli is encountered in the perioperative environment (Fig. 39–10). One interesting feature of this array of concentration relationships is that they can be quantified in terms of a percentage of the amount of drug required to elicit EEG changes.<sup>26</sup> For example, the fentanyl effect site concentration associated with  $C_{50}$  for changes in the spectral edge, a measure of EEG activity, is approximately 9 ng/mL.<sup>35,65,86,87</sup> The fentanyl effect site concentration  $C_{50}$  values associated with analgesia and respiratory depression are 1.6 and 5.4 ng/mL, respectively. Hence, the fentanyl effect site concentrations for analgesia and respiratory depression are 17% and 60%, respectively, of the  $C_{50}$  for EEG changes. Taking advantage of this linearity, the analgesic fentanyl effect site concentrations are approximately 30% of those associated with respiratory depression.<sup>88,89</sup>

Although not well established, preliminary work has indicated that the linear relationship between analgesia, respiratory depression, and EEG changes remains intact despite a rightward shift in the concentration–effect relationships associated with opioids in the chronic opioid-consuming patient.<sup>83–85</sup> Using this linearity, the fentanyl challenge is able to predict analgesic effect site concentrations from estimated concentrations of fentanyl required to produce respiratory depression. For example, the fentanyl effect site concentration associated with analgesia



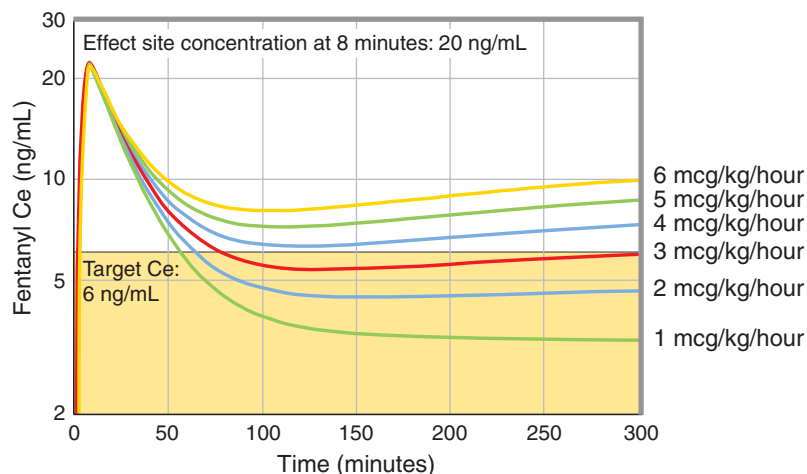
**FIGURE 39-30.** Computer simulation of the fentanyl challenge. Plot illustrates the fentanyl effect site concentration that results from a continuous infusion of 2  $\mu\text{g}/\text{kg}/\text{min}$ . Plot is used to estimate the fentanyl effect site concentration at the onset of respiratory depression. For example, if 8 minutes elapses prior to the onset of respiratory depression (i.e., respiratory rate <6 breaths/min), the associated fentanyl effect site concentration is approximately 20 ng/mL.

will be 30% of the effect site concentration associated with respiratory depression regardless of the fentanyl effect site concentration required to achieve respiratory depression.

With the analgesic effect site concentration identified as a percentage of the concentration required for respiratory depression, the next step is to develop fentanyl dosing regimens to achieve and maintain analgesia. Dosing goals may be directed at providing intraoperative analgesia as part of a combined anesthetic technique and/or postoperative analgesia until the patient is able to take oral analgesics. Additional simulations are used to identify optimal infusion rates that will produce the target analgesic effect during the course of the anesthetic and into the postoperative period.

Unique features of fentanyl pharmacokinetics that are important to consider when initiating an infusion following a fentanyl challenge include the following: (1) With prolonged continuous infusions (i.e., >2 hours), effect site concentrations continue to rise. Simulations of continuous infusions reveal that effect site concentrations do not reach near steady state for at least 24 hours. Thus, it is important to anticipate the duration of a postoperative continuous fentanyl infusion and select an infusion rate that will not exceed the effect site concentrations associated with respiratory depression. (2) Upon completion of the fentanyl challenge prior to the induction of anesthesia, a significant amount of fentanyl can be delivered, depending on the duration of the challenge. For example, an 8-minute infusion at 2  $\mu\text{g}/\text{kg}/\text{min}$  in a 90-kg patient will result in the delivery of 1440  $\mu\text{g}$  (29 mL) of fentanyl. This initial dose should be accounted for when formulating an intraoperative fentanyl infusion rate.

In Fig. 39-31, a set of simulations illustrate the fentanyl effect site concentrations that result from a fentanyl challenge. In this case, an 8-minute infusion was required to reach the onset of respiratory depression. Following the challenge are six simulations of a fentanyl infusion ranging from 1–6  $\mu\text{g}/\text{kg}/\text{h}$  for a 5-hour anesthetic. At 8 minutes, the fentanyl effect site concentration associated with respiratory depression is 20 ng/mL, giving a target effect site concentration of 6 ng/mL (i.e., 30% of 20). Using this simulation, the fentanyl infusion



**FIGURE 39-31.** Computer simulation of the fentanyl challenge (2  $\mu\text{g}/\text{kg}/\text{min}$ ) for 8 minutes, followed by continuous infusions at various rates for 5 hours. Plot is used to estimate the fentanyl infusion rate necessary to achieve analgesia. The target  $C_e$  is estimated as 30% of the fentanyl effect site concentration ( $C_e$ ) associated with the onset of respiratory depression (20 ng/mL). For a 5-hour anesthetic, a continuous infusion of 3  $\mu\text{g}/\text{kg}/\text{h}$  best achieves the target  $C_e$ .

that best approximates the target effect site concentration of 6 ng/mL is a continuous infusion at 3  $\mu\text{g}/\text{kg}/\text{h}$ .

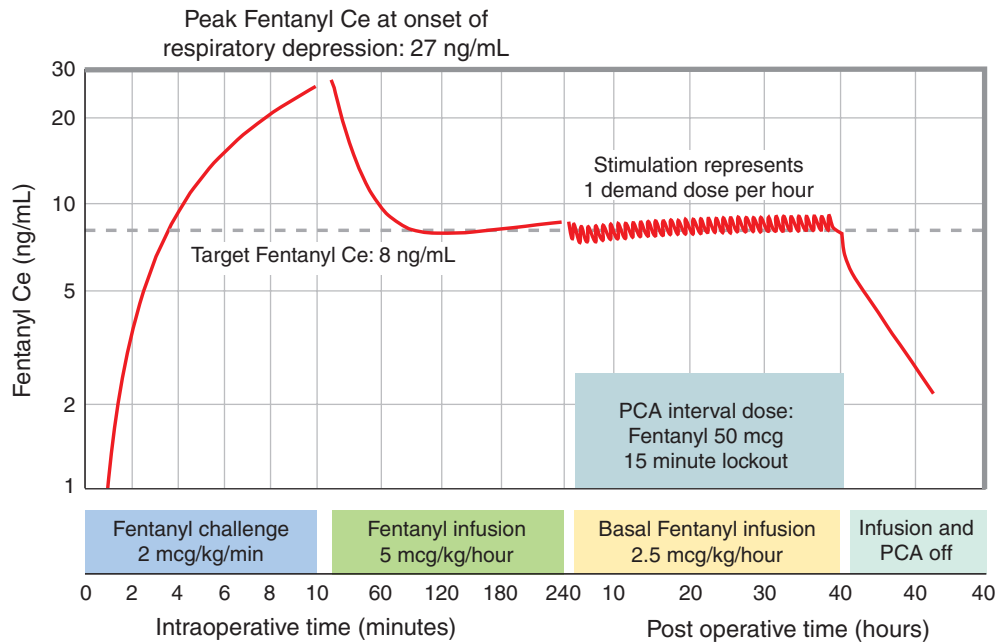
Information obtained from pharmacokinetic simulations following a fentanyl challenge can be used to improve intraoperative dosing of fentanyl to ensure adequate analgesia in the early postoperative period. This same information can be used to identify intravenous fentanyl dosing regimens for the first 24–48 hours following selected surgical procedures associated with significant postoperative pain and no or inadequate ability to use oral analgesics.

To improve intraoperative dosing of fentanyl, prior work has found that administering a continuous infusion of fentanyl that maintains the analgesic effect site concentration throughout the duration of a surgical procedure leads to an adequate level of analgesia in the early postoperative period yet allows for timely emergence from anesthesia in patients who chronically consume opioids.<sup>84</sup> With regard to postoperative dosing of fentanyl, information gained from the fentanyl challenge can be used to identify dosing regimens for patient-controlled analgesia (PCA) combined with a basal continuous infusion to maintain analgesia while avoiding respiratory depression.<sup>83–85</sup> Infusion rates (in micrograms per kg per hour) used intraoperatively to target the fentanyl concentrations associated with analgesia are divided in half. Half the infusion rate is administered as a continuous

infusion, and the other half is administered as intermittent boluses using a PCA pump.

Preliminary exploration into the efficacy and safety of this technique has been encouraging. In a cohort of patients who reported chronic consumption of opioids, a fentanyl challenge was used to identify the intraoperative and postoperative dosing regimens for fentanyl. The number of interval doses delivered via the PCA pump was used as a metric of pain control. Interval dose requirements of less than two doses or less per hour was considered to provide adequate analgesia. No use of the PCA pump over a 4-hour period was considered to be an aggressive basal infusion and was decreased by 20%. PCA pump usage more than twice per hour was considered in inadequate basal infusion and was increased by 20%. Following 24 hours of this dosing regimen, measures of respiratory function, arterial  $\text{PCO}_2$  levels, and pain control were made. In all subjects, respiratory rates and blood oxygenation were normal. Arterial  $\text{PCO}_2$  levels ranged from 40–47 mm Hg. PCA pump usage was within one to two doses per hour.

A computer simulation of a fentanyl challenge followed by the intraoperative and postoperative course is presented in Fig. 39-32. In this example, an 80-kg patient known to chronically consume opioids required 10 minutes to achieve the onset of respiratory depression. The corresponding fentanyl effect site concentration at this time



**FIGURE 39-32.** Computer simulation of the intraoperative and postoperative courses following a fentanyl challenge for an 80-kg, 180-cm patient. The fentanyl challenge (2  $\mu\text{g}/\text{kg}/\text{min}$ ) required 10 minutes to achieve respiratory depression (respiratory rate  $<6$  breaths/min). The fentanyl effect site concentration at 10 minutes was 27 ng/mL. Subsequently, a fentanyl infusion was run at 5  $\mu\text{g}/\text{kg}/\text{h}$  (8 mL/h) for 4 hours, with a target analgesic concentration of 8 ng/mL. Upon completion of the anesthetic, a basal infusion at 2.5  $\mu\text{g}/\text{kg}/\text{h}$  (4 mL/h) and a patient-controlled analgesia (PCA) pump with a 50-mg bolus dose on a 15-minute lockout were started. The average PCA dose was one bolus per hour.

was 27 ng/mL. The target effect site concentration for analgesia was 30% of 27, or approximately 8 ng/mL. Subsequently, a basal infusion of fentanyl was administered at 5  $\mu\text{g}/\text{kg}/\text{h}$  during the 4-hour intraoperative period as part of a combined technique with a potent inhaled agent. Upon completion of the intraoperative period, the patient was allowed to emerge from anesthesia. In the postoperative phase, a basal infusion was started at 2.5  $\mu\text{g}/\text{kg}/\text{h}$ . In addition to the basal infusion, the PCA pump was set to deliver a demand dose of 50  $\mu\text{g}$  every 15 minutes (2.5  $\mu\text{g}/\text{kg}/\text{h}$  if using all four doses). The basal infusion and PCA pump were used for 36 hours following the anesthetic. Average PCA pump usage was one demand dose per hour. No adjustments were made in the PCA pump.

Several points of clinical interest are illustrated by this simulation. By starting the fentanyl infusion rate at 5  $\mu\text{g}/\text{kg}/\text{h}$  immediately following the fentanyl challenge, the resultant effect site concentrations were well above the target concentration for nearly 90 minutes. This is an important feature to consider when delivering anesthetics of shorter duration. Also of interest, by the end of the 4-hour anesthetic, the effect site concentration was beginning to climb

above 8 ng/mL. Should an anesthetic require more time, perhaps a more moderate infusion rate would be prudent (i.e., 4  $\mu\text{g}/\text{kg}/\text{h}$ ). In the postoperative phase, the simulation reveals that the basal infusion rate in combination with the PCA pump maintained the target concentration well. Once turned off, the fentanyl effect site concentrations drop fairly slowly. The time required for the fentanyl effect site levels to drop by half is  $>5$  hours. This dissipation time may be important to consider when initiating oral analgesic therapy after terminating PCA pump use and basal infusion.

## KEY REFERENCES

1. Fisher DM. (Almost) everything you learned about pharmacokinetics was (somewhat) wrong! *Anesth Analg* 1996;83:901-903.
2. Krejcie TC, Avram MJ. What determines anesthetic induction dose? It's the front-end kinetics, doctor! *Anesth Analg* 1999;89:541-4.
3. Shafer SL, Stanski DR. Improving the clinical utility of anesthetic drug pharmacokinetics. *Anesthesiology* 1992;76:327-330.
4. Shafer SL, Varvel JR. Pharmacokinetics, pharmacodynamics, and rational opioid selection. *Anesthesiology* 1991;74:53-63.
5. Sheiner LB, Stanski DR, Vozeh S, et al. Simultaneous modeling of pharmacokinetics and pharmacodynamics: application to d-tubocurarine. *Clin Pharmacol Ther* 1979;25:358-371.
6. Egan TD, Shafer SL. Target-controlled infusions for intravenous anesthetics: surfing USA not! *Anesthesiology* 2003;99:1039-1041.
7. Minto CF, Schnider TW, Short TG, et al. Response surface model for anesthetic drug interactions. *Anesthesiology* 2000;92:1603-1616.
8. Minto CF, Schnider TW, Egan TD, et al. Influence of age and gender on the pharmacokinetics and pharmacodynamics of remifentanyl. I. Model development. *Anesthesiology* 1997;86:10-23.
9. Bouillon T, Shafer SL. Does size matter? *Anesthesiology* 1998;89:557-560.
10. Shafer SL. Shock values. *Anesthesiology* 2004;101:567-568.

11. Davis JJ, Swenson JD, Hall RH, et al. Preoperative "fentanyl challenge" as a tool to estimate postoperative opioid dosing in chronic opioid-consuming patients. *Anesth Analg* 2005;101:389-395.

## REFERENCES

- Fisher DM. (Almost) everything you learned about pharmacokinetics was (somewhat) wrong! *Anesth Analg* 1996;83:901-903.
- Ebling WF, Lee EN, Stanski DR. Understanding pharmacokinetics and pharmacodynamics through computer stimulation: I. The comparative clinical profiles of fentanyl and alfentanil. *Anesthesiology* 1990;72:650-658.
- Marsh B, et al. Pharmacokinetic model driven infusion of propofol in children. *Br J Anaesth* 1991;67:41-48.
- Shafer SL, Stanski DR. Improving the clinical utility of anesthetic drug pharmacokinetics. *Anesthesiology* 1992;76:327-330.
- Hughes MA, Glass PS, Jacobs JR. Context-sensitive half-time in multicompartment pharmacokinetic models for intravenous anesthetic drugs. *Anesthesiology* 1992;76:334-341.
- Youngs EJ, Shafer SL. Pharmacokinetic parameters relevant to recovery from opioids. *Anesthesiology* 1994;81:833-842.
- Boer F, et al. Pulmonary uptake of sufentanil during and after constant rate infusion. *Br J Anaesth* 1996;76:203-208.
- Marsh BJ, et al. A computer controlled infusion of propofol for induction and maintenance of anaesthesia in children. *Can J Anaesth* 1990;37(4 Pt 2):S97.
- Shafer SL, et al. Pharmacokinetics of fentanyl administered by computer-controlled infusion pump. *Anesthesiology* 1990;73:1091-1102.
- Arden JR, Holley FO, Stanski DR. Increased sensitivity to etomidate in the elderly: initial distribution versus altered brain response. *Anesthesiology* 1986;65:19-27.
- Minto CF, et al. Influence of age and gender on the pharmacokinetics and pharmacodynamics of remifentanyl. I. Model development. *Anesthesiology* 1997;86:10-23.
- Wertz E. Does etomidate cause haemolysis? *Br J Anaesth* 1993;70:490-491.
- Shafer SL, Varvel JR. Pharmacokinetics, pharmacodynamics, and rational opioid selection. *Anesthesiology* 1991;74:53-63.
- Stanski DR, et al. Pharmacokinetics and pharmacodynamics of d-tubocurarine during nitrous oxide-narcotic and halothane anesthesia in man. *Anesthesiology* 1979;51:235-241.
- Sheiner LB, et al. Simultaneous modeling of pharmacokinetics and pharmacodynamics: application to d-tubocurarine. *Clin Pharmacol Ther* 1979;25:358-371.
- Jacobs JR, Reves JG. Effect site equilibration time is a determinant of induction dose requirement. *Anesth Analg* 1993;76:1-6.
- Verotta D, Sheiner LB. Simultaneous modeling of pharmacokinetics and pharmacodynamics: an improved algorithm. *Comput Appl Biosci* 1987;3:345-349.
- Arrowsmith JB, et al. Results from the American Society for Gastrointestinal Endoscopy/US Food and Drug Administration collaborative study on complication rates and drug use during gastrointestinal endoscopy. *Gastrointest Endosc* 1991;37:421-427.
- Michalodimitrakis M, et al. Death related to midazolam overdose during endoscopic retrograde cholangiopancreatography. *Am J Forensic Med Pathol* 1999;20:93-97.
- Levy L, Pandit SK. Is midazolam a dangerous drug? *J Post Anesth Nurs* 1989;4:40-43.
- Babenco HD, Conard PF, Gross JB. The pharmacodynamic effect of a remifentanyl bolus on ventilatory control. *Anesthesiology* 2000;92:393-398.
- Bouillon T, et al. A model of the ventilatory depressant potency of remifentanyl in the non-steady state. *Anesthesiology* 2003;99:779-787.
- Richardson SP, Egan TD. The safety of remifentanyl by bolus injection. *Expert Opin Drug Saf* 2005;4:643-651.
- Egan TD, Shafer SL. Target-controlled infusions for intravenous anesthetics: surfing USA not! *Anesthesiology* 2003;99:1039-1041.
- Kern SE, et al. A response surface analysis of propofol-remifentanyl pharmacodynamic interaction in volunteers. *Anesthesiology* 2004;100:1373-1381.
- Egan TD, et al. The electroencephalogram (EEG) and clinical measures of opioid potency: defining the EEG-clinical potency relationship ("fingerprint") with application to remifentanyl. *Int J Pharm Med* 2001;15:1-8.
- Ausems ME, et al. Comparison of a computer-assisted infusion versus intermittent bolus administration of alfentanil as a supplement to nitrous oxide for lower abdominal surgery. *Anesthesiology* 1988;68:851-861.
- Ausems ME, et al. Plasma concentrations of alfentanil required to supplement nitrous oxide anesthesia for general surgery. *Anesthesiology* 1986;65:362-373.
- Egan TD. Intravenous drug delivery systems: toward an intravenous "vaporizer." *J Clin Anesth* 1996;8(3 Suppl):8S-14S.
- Ebling WF, Levy G. Population pharmacodynamics: strategies for concentration- and effect-controlled clinical trials. *Ann Pharmacother* 1996;30:12-19.
- Vuyk J, et al. Propofol anesthesia and rational opioid selection: determination of optimal EC50-EC95, propofol-opioid concentrations that assure adequate anesthesia and a rapid return of consciousness. *Anesthesiology* 1997;87:1549-1562.
- Schnider TW, et al. The influence of age on propofol pharmacodynamics. *Anesthesiology* 1999;90:1502-1516.
- Struys MM, et al. Ability of the bispectral index, autoregressive modelling with exogenous input-derived auditory evoked potentials, and predicted propofol concentrations to measure patient responsiveness during anesthesia with propofol and remifentanyl. *Anesthesiology* 2003;99:802-812.
- Mildh LH, Scheinin H, Kirvela OA. The concentration-effect relationship of the respiratory depressant effects of alfentanil and fentanyl. *Anesth Analg* 2001;93:939-946.
- Scott JC, Ponganis KV, Stanski DR. EEG quantitation of narcotic effect: the comparative pharmacodynamics of fentanyl and alfentanil. *Anesthesiology* 1985;62:234-241.
- Minto CF, et al. Response surface model for anesthetic drug interactions. *Anesthesiology* 2000;92:1603-1616.
- Minto C, Vuyk J. Response surface modelling of drug interactions. *Adv Exp Med Biol* 2003;523:35-43.
- Vuyk J. Pharmacokinetic and pharmacodynamic interactions between opioids and propofol. *J Clin Anesth* 1997;9(6 Suppl):23S-26S.
- Vuyk J. Drug interactions in anaesthesia. *Minerva Anestesiol* 1999;65:215-218.
- Vuyk J. Clinical interpretation of pharmacokinetic and pharmacodynamic propofol-opioid interactions. *Acta Anaesthesiol Belg* 2001;52:445-451.
- Bouillon TW, et al. Pharmacodynamic interaction between propofol and remifentanyl regarding hypnosis, tolerance of laryngoscopy, bispectral index, and electroencephalographic approximate entropy. *Anesthesiology* 2004;100:1353-1372.
- Manyam SC, Gupta DK, Johnson KB, et al. Opioid-volatile anesthetic synergy: a response surface model with remifentanyl and sevoflurane as prototypes. *Anesthesiology* 2006;105:267-278.
- Syroid ND, et al. Development and evaluation of a graphical anesthesia drug display. *Anesthesiology* 2002;96:565-575.
- Wood M. Plasma binding and limitation of drug access to site of action. *Anesthesiology* 1991;75:721-723.
- Wood M. Variability of human drug response. *Anesthesiology* 1989;71:631-634.
- Maitre PO, et al. Evaluating the accuracy of using population pharmacokinetic data to predict plasma concentrations of alfentanil. *Anesthesiology* 1988;68:59-67.
- Kuczmarski RJ, et al. Increasing prevalence of overweight among US adults. The National Health and Nutrition Examination Surveys, 1960 to 1991. *JAMA* 1994;272:205-211.
- Williamson DF, Pamuk ER. The association between weight loss and increased longevity. A review of the evidence. *Ann Intern Med* 1993;119(7 Pt 2):731-736.



49. Egan TD, et al. Remifentanyl pharmacokinetics in obese versus lean patients. *Anesthesiology* 1998;89:562-573.
50. Schwartz AE, et al. Pharmacokinetics of sufentanil in obese patients. *Anesth Analg* 1991;73:790-793.
51. Shibutani K, et al. Accuracy of pharmacokinetic models for predicting plasma fentanyl concentrations in lean and obese surgical patients: derivation of dosing weight ("pharmacokinetic mass"). *Anesthesiology* 2004;101:603-613.
52. Schnider TW, et al. The influence of method of administration and covariates on the pharmacokinetics of propofol in adult volunteers. *Anesthesiology* 1998;88:1170-1182.
53. Abernathy DR, et al. Alterations in drug distribution and clearance due to obesity. *J Pharmacol Exp Ther* 1981;217:681-685.
54. Bouillon T, Shafer SL. Does size matter? *Anesthesiology* 1998;89:557-560.
55. Minto CF, Schnider TW, Shafer SL. Pharmacokinetics and pharmacodynamics of remifentanyl. II. Model application. *Anesthesiology* 1997;86:24-33.
56. Fagard R, Staessen J. Relation of cardiac output at rest and during exercise to age in essential hypertension. *Am J Cardiol* 1991;67:585-589.
57. Upton RN, et al. Cardiac output is a determinant of the initial concentrations of propofol after short-infusion administration. *Anesth Analg* 1999;89:545-552.
58. Upton RN, Huang YF. Influence of cardiac output, injection time and injection volume on the initial mixing of drugs with venous blood after I.V. bolus administration to sheep. *Br J Anaesth* 1993;70:333-338.
59. Krejcie TC Avram MJ. What determines anesthetic induction dose? It's the front-end kinetics, doctor! *Anesth Analg* 1999;89:541-544.
60. Stanski DR, Maitre PO. Population pharmacokinetics and pharmacodynamics of thiopental: the effect of age revisited. *Anesthesiology* 1990;72:412-422.
61. Homer TD, Stanski DR. The effect of increasing age on thiopental disposition and anesthetic requirement. *Anesthesiology* 1985;62:714-724.
62. Rodeheffer RJ, et al. Exercise cardiac output is maintained with advancing age in healthy human subjects: cardiac dilatation and increased stroke volume compensate for a diminished heart rate. *Circulation* 1984;69:203-213.
63. Williams TF. Aging or disease? *Clin Pharmacol Ther* 1987;42:663-665.
64. Avram MJ, Krejcie TC, Henthorn TK. The relationship of age to the pharmacokinetics of early drug distribution: the concurrent disposition of thiopental and indocyanine green. *Anesthesiology* 1990;72:403-411.
65. Scott JC, Stanski DR. Decreased fentanyl and alfentanil dose requirements with age. A simultaneous pharmacokinetic and pharmacodynamic evaluation. *J Pharmacol Exp Ther* 1987;240:159-166.
66. Jacobs JR, et al. Aging increases pharmacodynamic sensitivity to the hypnotic effects of midazolam. *Anesth Analg* 1995;80:143-148.
67. Halford FA. Critique of intravenous anesthesia in war surgery. *Anesthesiology* 1943;4:67-69.
68. De Paepe P, et al. The influence of hemorrhagic shock on the pharmacokinetics and the analgesic effect of morphine in the rat. *Fundam Clin Pharmacol* 1998;12:624-630.
69. Egan TD, et al. Fentanyl pharmacokinetics in hemorrhagic shock: a porcine model. *Anesthesiology* 1999;91:156-166.
70. Johnson KB, et al. Influence of hemorrhagic shock on remifentanyl: a pharmacokinetic and pharmacodynamic analysis. *Anesthesiology* 2001;94:322-332.
71. Weiskopf RB, Bogetz MS. Haemorrhage decreases the anaesthetic requirement for ketamine and thiopentone in the pig. *Br J Anaesth* 1985;57:1022-1025.
72. De Paepe P, et al. Influence of hypovolemia on the pharmacokinetics and the electroencephalographic effect of propofol in the rat. *Anesthesiology* 2000;93:1482-1490.
73. De Paepe P, et al. Influence of hypovolemia on the pharmacokinetics and the electroencephalographic effect of etomidate in the rat. *J Pharmacol Exp Ther* 1999;290:1048-1053.
74. Johnson KB, et al. The influence of hemorrhagic shock on etomidate: a pharmacokinetic and pharmacodynamic analysis. *Anesth Analg* 2003;96:1360-1368.
75. Johnson KB, et al. The influence of hemorrhagic shock on propofol: a pharmacokinetic and pharmacodynamic analysis. *Anesthesiology* 2003;99:409-420.
76. Adams P, et al. Midazolam pharmacodynamics and pharmacokinetics during acute hypovolemia. *Anesthesiology* 1985;63:140-146.
77. Klockowski P, Levy G. Kinetics of drug action in disease states. XXV. Effect of experimental hypovolemia on the pharmacodynamics and pharmacokinetics of desmethyldiazepam. *J Pharmacol Exp Ther* 1988;245:508-512.
78. Benowitz N, et al. Lidocaine disposition kinetics in monkey and man. II. Effect of hemorrhage and sympathomimetic drug administration. *Clin Pharmacol Ther* 1973;16:99-109.
79. Shafer SL. Shock values. *Anesthesiology* 2004;101:567-568.
80. Graham MR, Thiessen DB, Mutch WA. Left ventricular systolic and diastolic function is unaltered during propofol infusion in newborn swine. *Anesth Analg* 1998;86:717-723.
81. Johnson KB, et al. Influence of hemorrhagic shock followed by crystalloid resuscitation on propofol: a pharmacokinetic and pharmacodynamic analysis. *Anesthesiology* 2004;101:647-659.
82. Hiraoka H, et al. Changes in drug plasma concentrations of an extensively bound and highly extracted drug, propofol, in response to altered plasma binding. *Clin Pharmacol Ther* 2004;75:324-30.
83. Swenson JD, Davis JJ, Johnson KB. Postoperative care of the chronic opioid-consuming patient. *Anesthesiol Clin North America* 2005;23:37-48.
84. Davis JJ, et al. Preoperative fentanyl infusion with pharmacokinetic simulation for anesthetic and perioperative management of an opioid-tolerant patient. *Anesth Analg* 2003;97:1661-1662.
85. Davis JJ, et al. Preoperative "fentanyl challenge" as a tool to estimate postoperative opioid dosing in chronic opioid-consuming patients. *Anesth Analg* 2005;101:389-395.
86. Lemmens HJ, et al. Pharmacokinetic-pharmacodynamic modeling in drug development: application to the investigational opioid trefentanyl. *Clin Pharmacol Ther* 1994;56:261-271.
87. Scott JC, Cooke JE, Stanski DR. Electroencephalographic quantitation of opioid effect: comparative pharmacodynamics of fentanyl and sufentanil. *Anesthesiology* 1991;74:34-42.
88. Peng PW, Sandler AN. A review of the use of fentanyl analgesia in the management of acute pain in adults. *Anesthesiology* 1999;90:576-599.
89. Gourlay GK, et al. Fentanyl blood concentration-analgesic response relationship in the treatment of postoperative pain. *Anesth Analg* 1988;67:329-337.
90. Sheiner LB. Learning versus confirming in clinical drug development. *Clin Pharmacol Ther* 1997;61:275-291.

# CHAPTER 40

## Pharmacology of Intravenous Anesthetics

Mark Dershwitz, MD, PhD,  
and Carl E. Rosow, MD, PhD

### HISTORY

For 90 years after the introduction of ether as a general anesthetic agent, almost all general anesthetics were administered via the inhalational route. That practice changed in 1935 following the description by Lundy<sup>1</sup> of the use of thiopental. It was soon recognized that intravenous anesthesia with thiopental required greater skill and was not as “forgiving” as general anesthesia with ether.<sup>2</sup> During World War II, both intravenous cannulation for the administration of blood products and crystalloid solutions, as well as physicians specializing in anesthesiology, became commonplace. Along with these changes in practice, thiopental was widely used during surgery for battlefield wounds. Over the next 3 decades, induction by inhalation became less and less common (with the exception of pediatric anesthesia) while additional intravenous agents were introduced to compete with thiopental.

Thiopental is an excellent intravenous anesthetic, and its introduction revolutionized the practice of anesthesiology. Newer agents such as propofol have improved upon thiopental and largely supplanted it in clinical practice. Nevertheless, thiopental and the other barbiturates are discussed first because they are the best characterized of all the intravenous anesthetics and the standard by which these newer drugs are judged. The characteristics of an “ideal” intravenous anesthetic agent are listed in Box 40-1. How each of the intravenous anesthetic agents available for use approaches this ideal is described in detail. Because not all clinical scenarios are identical, the unique characteristics of the individual agents must be considered when choosing the best drug for a particular patient.

### KEY POINTS

1. Thiopental decreases cerebral metabolic rate for oxygen and cerebral blood flow. By causing vasoconstriction of CNS blood vessels, thiopental also significantly decreases intracranial pressure.
2. When thiopental is given in advance of a planned decrease or interruption in cerebral perfusion, the likelihood or severity of CNS damage appears to be reduced.
3. Thiopental produces a dose-dependent decrease in ventilatory drive. It causes a decreased tidal volume and minute ventilation and an increased  $\text{Paco}_2$ . The ventilatory depressant effect of thiopental is exaggerated in patients with underlying chronic obstructive pulmonary disease (COPD).
4. Thiopental has a direct effect on the heart by decreasing contractility, leading to a decrease in cardiac output. It also has a direct effect on both systemic arteries and veins causing vasodilatation.
5. Coexisting factors, such as previous premedication (e.g., benzodiazepines and/or opioids), advanced age, or presence of concurrent disease (e.g., cardiac dysfunction, COPD, hypovolemia) will decrease the required dose of thiopental to produce unconsciousness. Patients with acquired tolerance because of chronic use of barbiturates or cross-tolerance to benzodiazepines, anti-convulsants, or alcohol may require higher doses of thiopental to produce unconsciousness.
6. The CNS effects of propofol are similar to those of thiopental. Propofol causes a greater decrease in blood pressure than does thiopental because of a larger reduction in systemic venous and arteriolar vascular resistance, resulting in decreases in both preload and afterload. Propofol also blunts the barostatic reflex, resulting in a slower heart rate for a given decrease in blood pressure as compared with thiopental.
7. Propofol causes the least incidence of postoperative nausea and vomiting of any general anesthetic agent, injected or inhaled. Propofol also has intrinsic antiemetic activity and has been used successfully as an antiemetic.
8. Propofol often causes pain, sometimes severe, on injection. Injecting lidocaine with a proximal tourniquet provides the highest efficacy in preventing such pain.
9. Propofol is the shortest-acting intravenous anesthetic. It accumulates to the least degree, and because of its rapid recovery characteristics following infusion, even after long-duration infusion, it is an extremely useful drug for maintaining general anesthesia.
10. The CNS effects of etomidate are similar to those of thiopental and propofol.
11. Etomidate is notable for its lack of cardiovascular effects. It has little effect on systemic arterial or venous vascular tone or on cardiac contractility, and usually little change in blood pressure or heart rate occurs. Cardiovascular stability is generally preserved in persons with hypovolemia or cardiac dysfunction.
12. Etomidate inhibits the enzyme responsible for performing the  $11\beta$ -hydroxylation reaction in cortisol synthesis. A single induction dose of 0.3 mg/kg inhibits cortisol synthesis and the normal response to adrenocorticotrophic hormone for up to 12 hours. Infusions of several days' duration in ventilated ICU patients are associated with increased mortality.
13. Sedative doses of midazolam cause patients to become sleepy and calmer and to have anterograde amnesia. The amnestic effects of midazolam are variable but usually short-lived, and they should not be relied upon to prevent recall of intraoperative events.
14. Intramuscular administration of midazolam results in reliable absorption and little injection pain. Its oral bioavailability is only approximately 15%.
15. Midazolam is synergistic with opioids or alcohol in depressing ventilatory drive. Patients with COPD are more sensitive to its ventilatory depressant effects.

*Continued*

*Key Points—continued*

16. Flumazenil is a benzodiazepine antagonist. When given to healthy volunteers, mild anxiety and symptoms resembling those that occur during a panic attack may occur. When given to patients chronically taking benzodiazepines, acute withdrawal, including seizures, may occur.
17. Ketamine produces dissociative anesthesia. Under ketamine anesthesia, the patient may move, vocalize, have eyes open, and make ocular tracking movements. Depth of anesthesia is difficult to assess. It also produces profound analgesia and salivation.
18. Ketamine usually causes an increase in blood pressure, heart rate, cardiac contractility, cardiac output, and vascular resistance. It has little effect on ventilatory drive in normal patients or in patients with COPD, and it produces bronchodilation. Protective airway reflexes are less likely to be ablated.
19. Intramuscular administration of ketamine results in reliable absorption and little injection pain.
20. Droperidol produces a neuroleptic state in which behavior is diminished and responses to stimuli are fewer, slower, and smaller in magnitude. At high doses, it can produce catatonia, although consciousness and memory are preserved.
21. At subhypnotic doses, droperidol is an excellent antiemetic.
22. Dexmedetomidine is an  $\alpha_2$ -adrenoceptor agonist that produces sedation without associated amnesia. Even at high doses, loss of consciousness does not occur.

**BARBITURATES****Chemistry**

A large number of barbiturates have been introduced into clinical medicine, but only two remain in use as intravenous anesthetics: thiopental (a thiobarbiturate) and methohexital (an oxybarbiturate; Fig. 40-1 and Table 40-1). Both of these medications are practically insoluble in water; however, they are weak acids, and their sodium salts are freely soluble in water.

The usual concentrations of the sodium salts used clinically are 2.5% thiopental and 1% methohexital. Thiopental is soluble at higher concentrations, but pain on injection is likely to occur. The 2.5% thiopental solution usually is painless when given intravenously. This solution is irritating to tissues if it extravasates because it has a pH between 10 and 11. If accidentally injected intraarterially, vasospasm and thrombosis may occur that can lead to limb loss if not treated rapidly by intraarterial injection of a vasodilator (e.g., papaverine or nitroglycerin) and an anticoagulant (e.g., heparin). The 1% methohexital solution is more likely to cause pain after intravenous injection; however, it is well tolerated after intramuscular injection and can be given via this route in a patient without intravenous access. Methohexital is hazardous if inadvertently injected intraarterially.

Both thiopental and methohexital are supplied in powdered form and usually

are reconstituted with sterile, preservative-free water (although normal saline can be used). Neither reconstituted solution is stable in the long term, and the manufacturer's package inserts state that they are stable at room temperature for 24 hours. Despite this conservative recommendation, thiopental has been shown to be both chemically stable and bacteriologically sterile for at least 1 week following reconstitution when refrigerated.<sup>3</sup> Under refrigeration, methohexital remains chemically stable and microbiologically sterile for at least 6 weeks.<sup>4</sup>

**Pharmacodynamics****Central Nervous System**

Thiopental has its primary neuronal action at the  $\gamma$ -aminobutyric acid (GABA)<sub>A</sub> receptor, a ligand-gated ion channel. The GABA<sub>A</sub> receptor is coupled to a chloride channel; as the GABA effect increases, the postsynaptic membrane becomes hyperpolarized, and thus GABA acts as an inhibitory neurotransmitter. Thiopental binds to a unique binding site and increases chloride conductance in a concentration-dependent manner. Thus thiopental potentiates the inhibitory effects of GABA. Although barbiturates allosterically affect GABA binding (and vice versa), GABA is not necessary for barbiturate action on the channel.<sup>5</sup>

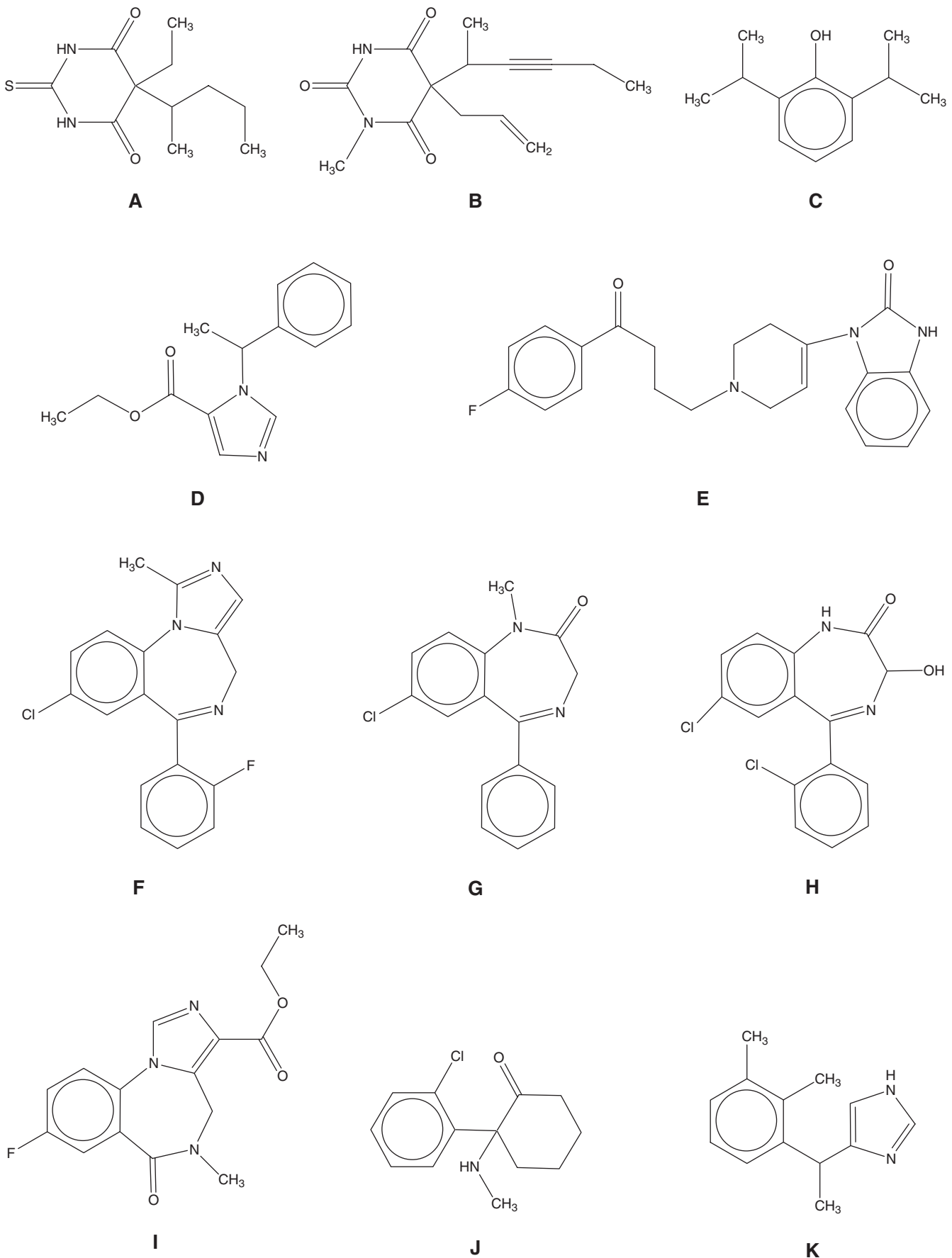
The barbiturates are classified as sedative-hypnotics; they produce dose-related depression of the central ner-

**BOX 40-1.****The "Ideal" Intravenous Anesthetic Agent**

Stable in aqueous solution  
No pain on injection, venous irritation, or tissue damage from accidental perivenous administration  
Very low potential to release histamine or precipitate hypersensitivity reactions  
Rapidly metabolized to pharmacologically inactive substances, with minimal accumulation when administered by repeated bolus doses or continuous infusion  
Rapid and smooth onset of action, without excitatory phenomena such as muscle movements, hyper-tonus, or hiccoughing  
Produces a steep dose-response relationship so that changes in the rate of administration result in rapid changes in the depth of anesthesia when administered by continuous infusion  
Rapid and smooth return of consciousness, even after prolonged administration for maintenance of anesthesia or sedation  
Produces a decrease in cerebral metabolism proportional to the decrease in cerebral blood flow and does not increase intracranial pressure  
Minimal cardiovascular and ventilatory depressant effects with no adverse effects on other organ systems  
Allows rapid recovery without postoperative side effects, such as nausea and vomiting, psychomimetic symptoms, dizziness, headache, or prolonged sedation ("hangover")

vous system (CNS) ranging from mild sedation to unconsciousness. Thiopental or methohexital rapidly produce unconsciousness, and awakening will occur in minutes unless additional drugs are given. When administered in subhypnotic doses, barbiturates can sometimes produce disinhibition and "paradoxical" excitation. These drugs are not analgesics, and suppression of movement or hemodynamic responses to painful stimuli requires plasma concentrations in excess of those needed to cause unconsciousness.

In the CNS, neuronal activity is coupled to oxygen utilization and delivery as a result of autoregulation (Table 40-2). By decreasing neuronal activity, thiopental decreases both CNS



**FIGURE 40-1.** Chemical structures of the intravenous anesthetic agents: thiopental (A), methohexital (B), propofol (C), etomidate (D), droperidol (E), midazolam (F), diazepam (G), lorazepam (H), flumazenil (I), ketamine (J), and dexmedetomidine (K).



TABLE 40-1.

## Physicochemical Properties of Anesthetic Agents

Drug Group	Drug Name	Available Solutions (pH or pK <sub>a</sub> )	Venous Irritation
Barbiturates	Thiobarbiturate	Thiopental pK <sub>a</sub> = 7.5 Sodium salt, to be diluted in water or saline to create 2.5% solution, pH >10	+++
	Oxybarbiturate	Methohexital pK <sub>a</sub> = 7.9 Sodium salt, to be diluted in water or saline to create 1% solution, pH >10	+++
Alkylphenol	Propofol	pK <sub>a</sub> = 11 1% solution in aqueous emulsion containing 10% soybean oil, 2.25% glycerol, 1.2% lecithin	++
Imidazole	Etomidate	pK <sub>a</sub> = 4.3 0.2% solution in 30% propylene glycol	+++
Benzodiazepines	Diazepam	0.5% solution in 40% propylene glycol, 10% ethanol	+
	Lorazepam	0.4% solution in 80% propylene glycol, 18% polyethylene glycol, 2% benzyl alcohol	+
	Midazolam	0.1% or 0.5% aqueous solutions, pH 3-4	-
Arylcyclohexylamine	Ketamine	pK <sub>a</sub> = 7.5 1%, 5%, or 10% aqueous solutions, pH 3.3-5.5	-

oxygen utilization, as measured by the cerebral metabolic rate of oxygen consumption (CMRO<sub>2</sub>), and cerebral blood flow (CBF). By causing vasoconstriction of CNS blood vessels, and therefore a reduction of cerebral blood volume, thiopental also significantly decreases intracranial pressure (ICP). In some instances thiopental may exert a “neu-

roprotective” effect (see two paragraphs later) in which decreased oxygen delivery to the CNS (e.g., during clamping of an intracranial artery) may be less likely to result in CNS damage because there has been a drug-induced decrease of oxygen utilization.

Because of its effects on CMRO<sub>2</sub>, CBF, and ICP, intravenous thiopental injec-

tion may produce beneficial effects in patients with intracranial space-occupying lesions or cerebral edema associated with a brain tumor, intracranial hemorrhage, or head trauma (Table 40-2). Cerebral perfusion pressure (CPP) is estimated to be the difference between the mean arterial pressure (MAP) in the carotid arteries and the ICP or, if low, the venous pressure in the jugular veins (see Chap. 10). It is significantly affected by the position of the patient with respect to gravity. The effect of thiopental on CPP in the supine patient is unpredictable. Thiopental decreases mean arterial pressure in a dose-dependent manner (see Cardiovascular System); however, if CPP is low in a patient because of an elevated ICP, the overall effect of thiopental may be beneficial.<sup>6</sup>

The ability of thiopental to produce “neuroprotection” is both variable and controversial. When thiopental is given *in advance* of a planned reduction or interruption of cerebral perfusion, the likelihood or severity of subsequent CNS damage appears to be less.<sup>7</sup> In contrast, when thiopental is given *after* the onset of cerebral ischemia, such as following a cardiac arrest, no apparent beneficial effect is seen.<sup>8</sup> Protective efficacy appears to be superior when the size of the ischemic area is smaller and when the total duration of ischemia is shorter (see Chap. 88 for detailed considerations on this topic).

Thiopental produces a dose-dependent effect on the electroencephalograph (EEG; Fig. 40-2).<sup>9</sup> At sedative doses or at doses associated with excitation or disinhibition (“stage 2” anesthesia), median EEG frequency increases because alpha waves (7-13 Hz) typical of the awake state change to beta waves (13-30 Hz). As the depth of hypnosis increases, there is a decrease in fre-

TABLE 40-2.

## Central Nervous System Effects of Intravenous Anesthetic Agents

Drug Name	CMRO <sub>2</sub>	CBF	CPP	ICP
Thiopental	--	--	±	--
Methohexital	--	--	±	--
Propofol	--	--	-	-
Etomidate	--	--	+	--
Benzodiazepines	-	±	0	-
Ketamine	+	++	±	+

CBF, cerebral blood flow; CPP, cerebral perfusion pressure; CMRO<sub>2</sub>, cerebral metabolic rate for oxygen; ICP, intracranial pressure.

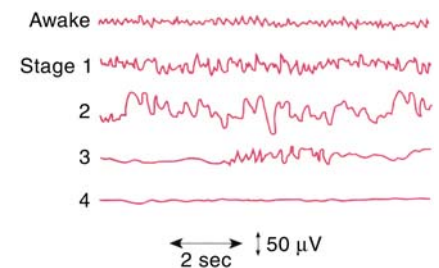


FIGURE 40-2. Changes in electroencephalographic pattern with increasing concentrations of thiopental. Loss of consciousness (hypnosis) occurs early during stage 1. (Redrawn from Hudson et al.<sup>9</sup> with permission.)

TABLE 40-3.

## Ventilatory Depressant Effects of Intravenous Anesthetic Agents

Drug Name	Healthy Patients	Patients with COPD
Barbiturates	++	+++
Propofol	++	+++
Etomidate	+	+
Benzodiazepines	+	+++
Ketamine	0	0

COPD, chronic obstructive pulmonary disease.

quency and an increase in amplitude (power) of the EEG waves. Surgical anesthesia is associated with an EEG characterized by a predominance of delta waves (0.5–3.5 Hz). Increasing the dose of thiopental further leads to burst suppression (characterized by alternating periods of delta waves and electrical inactivity) and, finally, a completely isoelectric (“flat-line”) EEG. An isoelectric or burst suppression EEG pattern is associated with a profound decrease in both  $CMRO_2$  and CBF, and this end point has been used to titrate the dose of thiopental for brain protection studies. Some studies suggest that alternative mechanisms (e.g., decrease in amino acid-induced excitotoxicity) are more important than reducing cerebral metabolic rate.<sup>10</sup>

Thiopental is an excellent anticonvulsant. The typical intravenous anesthetic induction dose of 4–7 mg/kg usually is effective in rapidly terminating seizures. Refractory status epilepticus is often treated with repeated boluses or with continuous infusion of thiopental; such patients usually also require mechanical ventilatory support and may require infusion of vasopressors (see Cardiovascular System).

In contrast to thiopental, methohexital may cause abnormal spiking activity of the EEG and may elicit seizures in patients with a seizure disorder, especially in those with psychomotor epilepsy. For this reason, methohexital has long been used as the hypnotic agent to render patients unconscious for electroconvulsive therapy. Methohexital is also associated with abnormal motor activity during induction of general anesthesia, such as myoclonic jerks, muscle tremors, and hiccoughs.

TABLE 40-4.

## Cardiovascular Effects of Intravenous Anesthetic Agents

Drug Name	MAP	HR	CO	Contractility (dP/dt)	SVR	Venous Dilatation
Thiopental	–	+	–	–	±	++
Methohexital	–	++	–	–	±	+
Propofol	--	–	–	–	--	++
Etomidate	0	0	0	0	0	0
Diazepam	0/–	±	0	0	–/0	+
Midazolam	0/–	±	0/–	0	–/0	+
Ketamine	++	++	+	± <sup>a</sup>	± <sup>a</sup>	0

<sup>a</sup>Change depends on sympathetic reserve.  
CO, cardiac output; HR, heart rate; MAP, mean arterial pressure; SVR, systemic vascular resistance.

**Respiratory System**

Thiopental produces a dose-dependent decrease in ventilatory drive, with a decreased tidal volume and minute ventilation and an increased  $Paco_2$  (Table 40-3). At the usual intravenous anesthetic induction dose of 4–7 mg/kg, most patients will become apneic for a few minutes. Accompanying this ventilatory depression is a decrease in protective airway reflexes, although overall responsiveness of the airway is increased. The incidence of coughing and laryngospasm during induction is higher with barbiturates than with most other sedative-hypnotics. The ventilatory depressant effect of thiopental is exaggerated in patients with underlying chronic obstructive pulmonary disease (COPD), and there is a synergistic effect between thiopental and opioids in decreasing ventilatory drive.

Thiopental produces an increase in the circulating concentration of histamine (see Hypersensitivity Reactions). The effect of histamine on the respiratory musculature is to cause constriction in the trachea and dilation in smaller airways. Typically no net alteration in bronchial resistance occurs.<sup>11</sup>

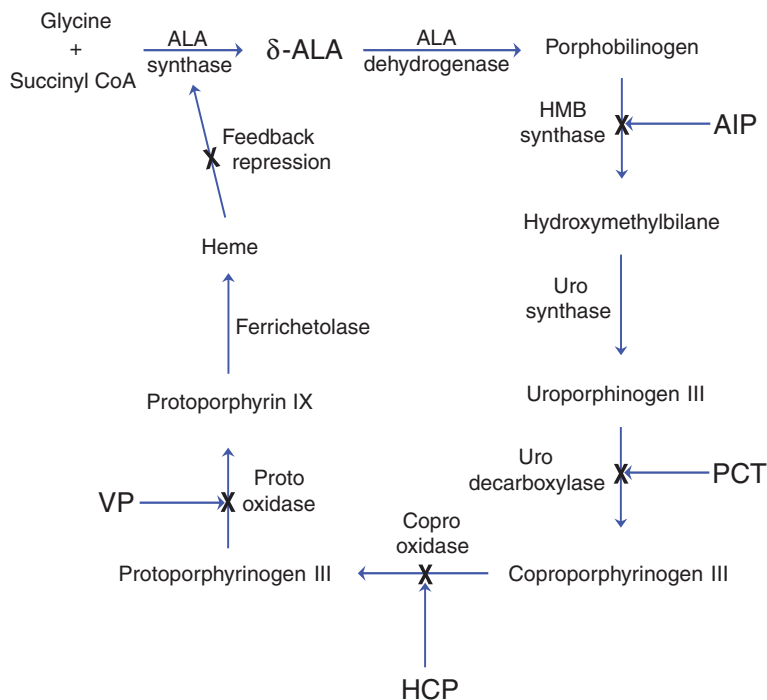
**Cardiovascular System**

Thiopental typically causes a transient, although significant, decrease in systemic blood pressure when it is administered to induce general anesthesia (Table 40-4).<sup>12</sup> This decrease in blood pressure is exaggerated in persons with preexisting cardiac dysfunction or hypovolemia, those given opioid or benzodiazepine premedication, or those receiving therapy with  $\beta$ -adrenergic blockers or vasodilators. Thiopental-induced hypotension is more pronounced in older patients and when

the drug is administered rapidly. Thiopental has a direct effect on the heart, decreasing contractility and leading to a decrease in cardiac output. It also has a direct effect on both systemic arteries and veins, causing vasodilatation. This vasodilatation results in decreased systemic arterial pressure as well as decreased venous return to the heart, the latter effect compounding the decrease in cardiac output and blood pressure. An equipotent dose of methohexital causes slightly less hypotensive effect than does thiopental. Thiopental increases the pulmonary vascular resistance in rat lung,<sup>13</sup> although this effect may not be significant in humans.<sup>14</sup>

**Adverse Effects**

**Hypersensitivity Reactions** In an *anaphylactic* reaction, there is IgE-mediated release of vasoactive and immune mediators from mast cells and basophils. An *anaphylactoid* reaction results when a drug directly causes the release of some of these mediators from mast cells or basophils. Anaphylaxis and other true immunologic reactions to barbiturates are extremely rare. They occasionally produce an *anaphylactoid* reaction by displacing vasoactive mediators from tissue mast cells or basophils. Thiopental injection increases the circulating concentration of histamine 3.5-fold, with the histamine concentration returning to baseline within 10 minutes.<sup>15</sup> This effect contributes to the overall decrease in systemic vascular resistance produced by the drug. Anaphylactic or anaphylactoid reactions to thiopental are much less common than are perioperative reactions to latex exposure or injection of muscle relaxants and antibiotics.<sup>16</sup>



**FIGURE 40-3.** Heme biosynthesis pathway. The enzyme deficiencies that result in the various forms of porphyria are indicated with an “X.” AIP, acute intermittent porphyria; ALA, aminolevulinic acid; HCP, hereditary coproporphyria; HMB, hydroxymethylbilane; PCT, porphyria cutanea tarda. (Redrawn from Desnick<sup>17</sup> with permission.)

**Porphyria** Barbiturates are the prototypical inducers of the hepatic microsomal enzyme system, including the cytochromes P450 and the glucuronyl transferases. The rate of metabolism of some medications may be increased in the postoperative period if a patient is given thiopental for anesthesia induction, although this effect is rarely of clinical consequence. Thiopental is also an inducer of the enzyme  $\delta$ -aminolevulinic acid (ALA) synthase, an enzyme that catalyzes the initial step in the biosynthesis of heme. Thiopental is absolutely contraindicated in persons with certain porphyrias (Fig. 40-3). In three of the clinically important porphyrias, there is a deficiency in a heme biosynthetic enzyme that follows ALA synthase in the pathway, and ALA, which is neurotoxic, then accumulates. These three porphyrias are acute intermittent porphyria, hereditary coproporphyria, and variegate porphyria,<sup>17</sup> and the enzyme deficiencies responsible for them are shown in Fig. 40-3. Each of these is transmitted as an autosomal dominant trait, so affected individuals usually are heterozygotes with approximately half the normal amount of enzyme. Interestingly, a fourth variety, porphyria cutanea tarda, also due

to a deficiency in a heme biosynthetic enzyme, is not a contraindication to use of a barbiturate.<sup>17</sup> Anesthetic medications generally considered safe or unsafe in persons with porphyria are listed in Box 40-2.

**Renal Effects** Thiopental decreases renal blood flow and increases the

secretion of antidiuretic hormone. The actions act together to decrease urine output.

**Other effects** In comparison to propofol (see Propofol, Nausea and Vomiting), thiopental used for anesthesia induction results in a higher incidence of postoperative nausea and vomiting. In sedative (i.e., subhypnotic) doses, thiopental causes hyperalgesia (i.e., it decreases the threshold to pain).<sup>18</sup> This effect (and thiopental's tendency to accumulate) make it a poor choice for intraoperative sedation during regional anesthesia or monitored anesthesia care. Thiopental is safe to use in patients susceptible to malignant hyperthermia.

## Pharmacokinetics

### Lipid Solubility

Thiopental is administered as the alkaline (pH 10–11) solution of its sodium salt, but it is buffered to physiologic pH immediately upon contacting the circulation. Because its  $pK_a$  is 7.5, at physiologic pH slightly >50% of the thiopental molecules are uncharged and therefore lipid soluble. Its oil/water partition coefficient of approximately 500 is more than twice that of halothane, indicating that it is highly lipid soluble. This high lipid solubility, coupled with the large fraction of the cardiac output typically delivered to the brain, is responsible for the very rapid onset of effect, typically well under 1 minute, following intravenous administration.

### BOX 40-2.

#### Safety of Anesthetic Medications in Porphyria<sup>a</sup>

Unsafe	Safe	Inadequate Data <sup>b</sup>
Alcohol	Acetaminophen	Atracurium
Barbiturates	Aspirin	Diazepam
Carbamazepine	Atropine	Halothane
Etomidate	Bupivacaine	Isoflurane
Pentazocine	Droperidol	Ketamine
Valproic acid	Nitrous oxide	Lidocaine
	Opioids	Midazolam
	Phenothiazines	Vecuronium
	Procaine	
	Propofol	
	Scopolamine	
	Succinylcholine	

These recommendations are based upon the authors' review of the available literature.

<sup>a</sup>Acute intermittent porphyria, hereditary coproporphyria, and variegate porphyria.

<sup>b</sup>These medications probably are safe in that there are no case reports that have linked them to exacerbations of porphyria; however, the number of reports suggesting that they are safe is inadequate to justify a generalized recommendation as safe.

TABLE 40-5.

## Pharmacokinetic Parameters for Intravenous Anesthetic Agents

Drug Name	Redistribution Half-Life (min)	Terminal Half-Life (h)	Clearance (mL/min)	Volume of Distribution (L)	Protein Binding (%)
Thiopental	2-4	6-12	120-180	100-200	85
Methohexital	5-6	2-5	700-900	60-80	85
Propofol	1-2	4-6	1400-2800	200-500	98
Etomidate	2-4	2-5	800-1400	200-400	75
Diazepam	10-15	20-40	15-35	60-100	98
Lorazepam	3-10	10-20	50-70	50-90	98
Midazolam	7-15	2-4	300-550	70-130	94
Ketamine	11-17	2-3	1250-1400	200-250	12

**Protein Binding**

Thiopental is approximately 85% bound to plasma protein. Protein-bound thiopental is unable to diffuse across the blood-brain barrier and produce a pharmacologic effect. In addition, the extensive binding of thiopental limits overall hepatic clearance, as only free drug is taken up by the liver to be metabolized. In clinical situations where the plasma concentration of protein is decreased (e.g., hepatic disease or hemodilution due to fluid resuscitation), the free fraction of thiopental is elevated, and lower doses of thiopental may be needed.

**Redistribution**

The redistribution half-life of a drug, often abbreviated as  $t_{1/2\alpha}$ , is the time required for the central compartment concentration of the drug to decrease by 50% as the drug is distributed to peripheral compartment(s) (see Chap. 39). For thiopental,  $t_{1/2\alpha}$  is approximately 2-4 minutes,<sup>19</sup> indicating that, following a typical bolus injection, the effect of the drug will be terminated within 3-4 half-lives or approximately 6-16 minutes (Table 40-5). Redistribution is the primary process by which the pharmacologic effects of thiopental are terminated. Unless the drug is given in very large doses (e.g., barbiturate coma), repeated doses, or by a long continuous infusion, metabolism and elimination are much less important in terminating its effect.

**Metabolism and Elimination**

The terminal half-life of a drug, often abbreviated as  $t_{1/2\beta}$  for medications fitting a two-compartment model (see Chap. 39), is a function of the processes of both metabolism and elimination. For thiopental,  $t_{1/2\beta}$  is approximately 6-12 hours.<sup>19</sup> Thiopental undergoes an interesting metabolic reaction catalyzed by cytochrome P450.

The initial step is oxidation of the sulfur atom, forming a sulfoxide derivative that spontaneously rearranges leaving oxygen in place of the sulfur in the barbiturate ring. This metabolite is the active barbiturate pentobarbital. Because of slower redistribution, pentobarbital is a longer-acting drug than thiopental. Thus, when very large doses of thiopental are given, clinically significant concentrations of pentobarbital occur. Pentobarbital contributes to the overall effect and makes thiopental appear as a much longer-acting medication.<sup>20</sup> Other inactive hydroxylated metabolites of thiopental also are produced. Methohexital has a lower volume of distribution and a higher hepatic clearance than thiopental, and it is metabolized to inactive hydroxylated metabolites (Table 40-6).

**Factors Affecting Pharmacodynamics and Pharmacokinetics**

Many factors affect the pharmacodynamics and pharmacokinetics of thiopental. For example, elderly patients require lower doses of thiopental to produce unconsciousness. This altered response is due to the decreased rate of distribution from the central compartment to the rapidly equilibrating compartment.<sup>21</sup>

The pharmacokinetics of thiopental in persons with significant impairment

of hepatic function is complex. The fraction of unbound thiopental is increased because of decreased plasma albumin concentrations, but hepatic clearance of unbound drug is decreased. Total clearance remains normal.<sup>19</sup> Persons with cardiac dysfunction typically have an exaggerated hypotensive response to thiopental. In hypovolemic shock, a lower thiopental dose is needed because a greater fraction of the cardiac output goes to the brain. The hypovolemic patient may tolerate thiopental-induced vasodilatation very poorly.

**Clinical Use****Induction of Anesthesia**

The characteristics of thiopental as an induction agent are listed in Table 40-7. An induction dose of 4-7 mg/kg is reasonable in the typical healthy patient undergoing elective surgery. Coexisting factors, such as previous premedication (e.g., with benzodiazepines and/or opioids), advanced age, or presence of concurrent disease (e.g., cardiac dysfunction, COPD, hypovolemia) will decrease the required dose of thiopental. Patients with acquired tolerance because of chronic use of barbiturates or cross-tolerance to benzodiazepines, anticonvulsants, or alcohol may require higher doses of thiopental to produce unconsciousness.

TABLE 40-6.

## Relative Hepatic Extraction Ratios for Intravenous Anesthetic Agents

Low	Intermediate	High
Diazepam: 0.01-0.025 Thiopental: 0.1-0.2	Midazolam: 0.2 Methohexital: 0.5-0.6	Etomidate: 0.7 Ketamine: 0.8 Propofol: >1



TABLE 40-7.

Induction Characteristics for Intravenous Anesthetic Agents

Drug Name	Induction Dose (mg/kg)	Onset (sec)	Duration (min)	Excitatory Activity	Injection Pain
Thiopental	4-7	<30	5-10	+	+
Methohexital	1-3	<30	5-10	++	++
Propofol	1-3	<30	3-8	+	+++
Etomidate	0.2-0.3	<30	5-10	+++	++
Diazepam	0.3-0.6	45-60	15-30	0	++
Lorazepam	0.03-0.06	60-120	60-120	0	++
Midazolam	0.2-0.4	30-60	15-30	0	0
Ketamine	1-2	45-60	10-20	++	0

If there is concern about a possibly exaggerated response to thiopental, a prudent practice would be to administer the induction dose slowly or in divided doses, using a small initial bolus as a “test dose” and waiting 1–2 minutes to evaluate the central nervous and hemodynamic responses.

After administration of the induction dose, consciousness typically is lost within 30 seconds, although this time may be longer in persons with a slow circulation time because of cardiac dysfunction. Recovery of consciousness usually occurs within 5–10 minutes; however, some degree of cognitive impairment (a “hangover”) may persist for hours.

The induction dose of methohexital is 1–3 mg/kg. Onset and awakening are similar to those with thiopental; however, the duration of cognitive impairment will be somewhat shorter.

### Maintenance of Anesthesia

General anesthesia can be maintained by either intermittent intravenous boluses or a continuous intravenous infusion of thiopental; however, a rapid recovery should not be anticipated. Giving any rapidly redistributed medication by intermittent bolus results in a series of peaks and troughs in both blood concentration and effect, typically causing alternating periods of overmedication and undermedication. A continuous infusion, typically following a loading dose, permits a more constant blood (and brain) concentration and effect (see Chap. 42).

The context-sensitive half-time (CSHT) describes the time required for the central compartment blood concentration to fall by half as a function of the duration of an infusion (of variable rate designed to maintain a constant

blood concentration).<sup>22</sup> The CSHTs for thiopental following 1- and 2-hour infusions are approximately 80 and 100 minutes, respectively (Fig. 40-4). Thus thiopental is not a good choice for a maintenance infusion when rapid emergence and recovery are desired.

Methohexital has shorter CSHT values than does thiopental. The CSHTs for methohexital following 1- and 2-hour infusions are approximately 26 and 48 minutes, respectively (Fig. 40-4). Although shorter than for thiopental, emergence and recovery following an infusion of methohexital are still prolonged.

### Sedation

Sedation during regional anesthesia or monitored anesthesia care can be achieved by the administration of intermittent boluses or a continuous infusion of a medication or medications. Frequently an opioid is given along with a sedative to relieve the discomfort that may accompany a noxious proce-

dures as well as decrease the required dose of the sedative. Intermittent bolus administration has the additional risk of causing periods of unconsciousness that may be accompanied by diminished or absent airway reflexes.

Barbiturates are infrequently used for procedural sedation (except perhaps the use of methohexital during office-based oral surgical procedures). In subhypnotic doses, thiopental has only mild suppressant effects on memory<sup>23</sup> (usually considered a desirable effect), and there may be hyperalgesia to pain.

## PROPOFOL

### Chemistry

Propofol is 2,6-diisopropylphenol, a simple derivative of phenol (Fig. 40-1 and Table 40-1). Propofol is an oil at room temperature and is essentially insoluble in water. Its initial formulation used a detergent called Cremophor, but this solubilizer was found to produce anaphylactoid reactions. Propofol subsequently was prepared as a 1% emulsion in Intralipid, a commonly used source of nutritional fat in patients receiving total parenteral nutrition. Intralipid contains 10% soybean oil, 2.25% glycerol, and 1.2% egg lecithin. The propofol emulsion readily supports bacterial growth, and the original formulation was associated with numerous cases of iatrogenic sepsis. Currently, all propofol formulations have a bacteriostatic agent added in low concentration to slow, but not prevent, bacterial growth. Depending on the manufacturer, the bacteriostatic agent

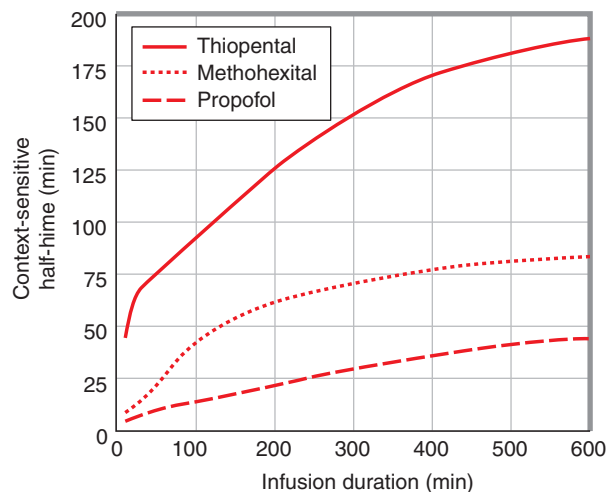


FIGURE 40-4. Context-sensitive half-times for thiopental, methohexital, and propofol as a function of the duration of infusion.

is 0.005% ethylenediaminetetraacetic acid (EDTA), 0.025% metabisulfite, or 0.1% benzyl alcohol. Propofol undergoes dimerization and oxidation to a quinone when exposed to oxygen. These chemical reactions occur at a more rapid rate in the preparation containing metabisulfite.<sup>24</sup> When the metabisulfite-containing propofol preparation is exposed to room air, it becomes visibly yellow after approximately 6 hours because of the presence of quinone. Whether this oxidation product affects safety or efficacy is unknown, but all opened vials and syringes containing propofol (irrespective of preservative) should routinely be discarded after 6 hours in order to reduce the risk of bacterial contamination.

## Pharmacodynamics

### Central Nervous System

The CNS effects of propofol are very similar to those of thiopental (Table 40–2). It is a rapid-acting hypnotic whose effects are terminated by rapid redistribution. Like thiopental, propofol exerts its CNS effects primarily via the GABA<sub>A</sub> receptor.<sup>25</sup> In vitro studies suggest that it also acts to inhibit glutamate action at N-methyl-D-aspartate (NMDA) receptors.<sup>26</sup> Propofol also decreases CMRO<sub>2</sub>, CBF, and ICP. Although it has not been studied as well as thiopental for its neuroprotective activity, it appears to share that effect with thiopental.<sup>27</sup> It must be used cautiously in this setting because it causes more hypotension than thiopental (see Cardiovascular System) and therefore is more likely to reduce CPP and thus CBF.

Like thiopental, propofol is an anti-convulsant, and it has been used to terminate status epilepticus. It probably does not produce this effect in sedative doses.<sup>28</sup> Although propofol shortens the duration of “therapeutic” seizure during electroconvulsive therapy compared with methohexital, it still can be used in this setting.<sup>29</sup>

Propofol has pharmacodynamic effects that differ from those of thiopental in several ways. It does not produce hyperalgesia in sedative doses, and it is more likely to suppress movement responses to painful stimuli at concentrations achieved during routine administration. Unlike thiopental, sedative doses of propofol can produce significant amnesia.<sup>23</sup> At sedative and hypnotic concentrations, propofol is much more effective in reducing airway responsiveness, and the incidence of

cough or laryngospasm is greatly reduced. On the other hand, induction of anesthesia with propofol often causes myoclonic movements, an effect that is much less common with thiopental. Finally, even subhypnotic concentrations of propofol have a direct antiemetic effect (see Nausea and Vomiting). In this respect it is unlike any other intravenous anesthetic agent.

### Respiratory System

The effects of propofol on respiratory control are very similar to those of thiopental (Table 40–3). Like thiopental, propofol produces a dose-dependent decrease in ventilatory drive manifested as decreased tidal volume and minute ventilation and increased Paco<sub>2</sub>. After injection of the usual anesthetic induction dose of 1–3 mg/kg, most patients will become apneic for a few minutes and have decreased airway reflexes. The ventilatory depressant effect of propofol is exaggerated in patients with underlying COPD, and there is a synergistic effect between propofol and opioids in decreasing ventilatory drive.

Unlike thiopental, propofol does not cause histamine release. Airway resistance following intubation is lower after induction with propofol than after thiopental.<sup>30</sup> Some persons with reactive airway disease become bronchospastic when exposed to sulfites in the environment, such as those found naturally in certain wines. Reports on the bronchospastic effects of the metabisulfite-containing propofol preparation are conflicting, but any such effects, if they exist, appear to be sporadic and minor.

### Cardiovascular System

Propofol causes a greater decrease in systemic blood pressure than does thiopental (Table 40–4).<sup>31</sup> Although the two drugs have similar depressant effects on cardiac contractility, propofol causes a larger reduction in venous and arteriolar systemic vascular resistance resulting in decreases of both preload and afterload. Contributing to the hypotensive effect of propofol is its action in blunting the barostatic reflex, resulting in a slower heart rate for a given decrease in blood pressure compared with thiopental.<sup>32</sup> As is seen with thiopental, the decrease in blood pressure with propofol injection is exaggerated in older persons and those with preexisting cardiac dysfunction or hypovolemia, those given

opioid or benzodiazepine premedication, or those receiving therapy with  $\beta$ -adrenergic blockers or vasodilators. Propofol does not alter the normal resting pulmonary vascular resistance in dogs; however, it potentiates the pulmonary vasoconstriction produced by phenylephrine.<sup>33</sup>

### Nausea and Vomiting

Propofol causes the least incidence of postoperative nausea and vomiting of any general anesthetic agent, injected or inhaled.<sup>34</sup> The use of propofol as a maintenance anesthetic is associated with a very low incidence of postoperative nausea and vomiting, perhaps because residual subhypnotic concentrations are antiemetic.<sup>35</sup> In addition, propofol has intrinsic antiemetic activity and has been used successfully as an antiemetic.<sup>36</sup> The mechanism of this effect is unknown, although it does not involve dopamine D<sub>2</sub> receptors such as with droperidol or metoclopramide.<sup>37</sup>

### Other Effects

Like thiopental, propofol decreases renal blood flow and causes increased secretion of antidiuretic hormone. Subhypnotic doses appear to be effective in reversing the itching produced by cholestasis or by epidural morphine.<sup>38</sup> Propofol is safe to give to patients with all types of porphyria and for those with malignant hyperthermia.

### Adverse Effects

**Pain on Injection** Propofol often causes pain, sometimes severe, on injection. The importance of this problem to the anesthesia community is indicated by the fact that, in the 20 years since the introduction of propofol, more than 300 publications have addressed this adverse effect. What is apparent when considering the published studies is that no technique is universally reliable in preventing this adverse effect, nor is there general agreement on which technique is most recommended.

Mitigating the pain on injection of propofol has involved three general approaches: modifying the vehicle in which the propofol is contained, adding a drug to the propofol emulsion, or administering a drug prior to propofol injection.

There appears to be a correlation between the incidence and severity of pain and the free concentration of propofol in the aqueous phase of the emulsion. Modifications of the emulsion

that increase the free propofol concentration (i.e., decreasing the concentration of lecithin) are associated with increases in pain. Conversely, a modified emulsion product has been developed that uses a mixture of medium-chain and long-chain triglycerides instead of egg lecithin (Propofol Lipuro). It has a lower free concentration of propofol and causes less pain on injection.<sup>39</sup> Although not available in the United States (as of 2007), it is widely used in Europe and Japan.

Free propofol may exert its painful effect by stimulating the kallikrein-kinin system, resulting in the generation of bradykinin, which stimulates intravascular nociceptors. Administration of nafamostat, an inhibitor of kallikrein, prior to propofol injection has significantly decreased the incidence and severity of pain.<sup>40</sup>

Clinicians desiring a simple and practical method for alleviating pain on injection have studied numerous medications either given prior to propofol or mixed with the propofol emulsion. A review of the published studies suggested that injecting lidocaine with a proximal tourniquet provided the highest efficacy.<sup>41</sup> The authors recommended that “IV lidocaine (0.5 mg/kg) should be given with a rubber tourniquet on the forearm, 30 to 120 seconds before the injection of propofol.” This method was superior to mixing lidocaine with propofol, which itself was superior to giving lidocaine without a tourniquet prior to injecting the propofol.

**Hypersensitivity Reactions** Propofol does not cause histamine release and is only very rarely associated with hypersensitivity reactions. Although components of the emulsion are derived from eggs and soybeans, the product contains no egg albumin or soy protein (the proteins to which hypersensitive persons are most likely to react). Persons allergic to egg albumin or soy protein have been given propofol safely.

## Pharmacokinetics

### Lipid Solubility

Propofol is one of the most lipid-soluble drugs used in medicine. Its oil/water partition coefficient of 4700 is almost 10-fold higher than that of thiopental. This high lipid solubility, coupled with the large fraction of cardiac output typically delivered to the brain, is responsible for the very rapid onset of effect, typically well under 1

minute, following intravenous administration (Table 40–7).

### Protein Binding

Protein-bound propofol is unable to diffuse across the blood–brain barrier and produce a pharmacologic effect. Propofol is approximately 98% bound to plasma protein. In clinical situations where the plasma concentration of protein is decreased, as in hepatic disease or hemorrhage that has been treated only with crystalloid solutions and/or packed red blood cells, the free fraction of propofol will be elevated compared with normal, and lower doses of propofol may be needed. Despite being an extensively bound drug, propofol has a high hepatic extraction ratio (Table 40–6). The total clearance of propofol is greater than hepatic blood flow, indicating that there is significant extrahepatic metabolism (see Metabolism and Elimination).<sup>42</sup>

### Redistribution

Propofol has a redistribution half-life  $t_{1/2\alpha}$  of approximately 1–2 minutes, indicating that the effect of a typical bolus injection will be terminated within 3–4 half-lives or approximately 3–8 minutes (Table 40–5).<sup>43</sup> This process of redistribution is the primary process by which the pharmacologic effect of propofol is terminated. Unless very large doses are given or a long infusion is given, the processes of metabolism and elimination are much less important in terminating the drug's effect.

### Metabolism and Elimination

Propofol has a terminal half-life  $t_{1/2\beta}$  of approximately 4–6 hours, substantially less than the corresponding value for thiopental.<sup>43</sup> This difference, as well as propofol's very short redistribution half-life, helps explain why propofol, given as a continuous infusion, has a substantially shorter duration than thiopental after termination of the infusion (see Maintenance of Anesthesia).

Approximately 60% of administered propofol is hydroxylated at the carbon located *para* to the existing hydroxyl group and then conjugated with either glucuronide or sulfate. The remainder is conjugated to glucuronide via the existing hydroxyl group.<sup>44</sup> In persons with normal hepatic and renal function, approximately 60% of propofol metabolism occurs in the liver and approximately 40% occurs in the kidneys.<sup>42</sup> The overall clearance of propofol is not reduced in patients with end-stage renal disease<sup>45</sup> or with cirrhosis.<sup>46</sup>

Significant propofol metabolism occurs in the lungs of some animals, but kidney rather than pulmonary metabolism of propofol may be more important in humans.<sup>42</sup>

## Factors Affecting Pharmacodynamics and Pharmacokinetics

Many factors affect the pharmacodynamics and pharmacokinetics of propofol. Like thiopental, elderly patients require lower doses of propofol to produce unconsciousness. This altered response is due to increased sensitivity of the brain to the drug's effect (pharmacodynamic alteration)<sup>47</sup> and a decreased plasma protein concentration and decreased clearance rate (pharmacokinetic alterations).<sup>48</sup>

The pharmacokinetics of propofol in persons with significant impairment of hepatic function is complex. Despite a significant increase in volume of distribution, the total clearance rate is preserved.<sup>46</sup> Persons with cardiac dysfunction typically have an exaggerated hypotensive response to propofol, to a greater degree than with thiopental. In hypovolemic shock, a lower propofol dose is needed because a greater fraction of the cardiac output goes to the brain. The hypovolemic patient tolerates propofol-induced vasodilatation very poorly.

## Clinical Use

### Induction of Anesthesia

The characteristics of propofol as an induction agent are listed in Table 40–7. An induction dose of 1–3 mg/kg is often given to the typical healthy patient undergoing elective surgery, but there is enormous variability between patients in the amount actually required. Coexisting factors, such as previous premedication (e.g., with benzodiazepines and/or opioids), advanced age, or presence of concurrent disease (e.g., cardiac dysfunction, COPD, hypovolemia), will decrease the required dose of propofol. Conversely, patients with acquired tolerance because of chronic use of medications that exhibit cross-tolerance with propofol (e.g., benzodiazepines, barbiturates, anticonvulsants, or alcohol) may require higher doses of propofol to produce unconsciousness.

If there is concern about a possibly exaggerated response to propofol and a rapid sequence induction is not planned, it may be prudent to admin-



ister the induction dose slowly or in divided doses, treating the initial bolus as a “test dose” and waiting 1–2 minutes to evaluate the effects.

After administration of the induction dose, consciousness is typically lost within 30 seconds, although this time may be longer in persons with a slow circulation time because of cardiac dysfunction. Recovery of consciousness usually occurs within 3–8 minutes; however, some degree of cognitive impairment may persist for hours. The time to awakening from propofol is faster than with thiopental, and patients in ambulatory surgical settings are able to achieve recovery “milestones” more rapidly. A portion of the rapid recovery may be due to propofol’s relative freedom from “hangover” and its tendency to cause an elevation in mood. Emergence from propofol is often accompanied by a sense of well-being,<sup>49</sup> and patients occasionally become euphoric. Occurrence of hallucinations and sexual fantasies during emergence also has been reported.

### Maintenance of Anesthesia

General anesthesia can be maintained by either intermittent intravenous boluses or continuous intravenous infusion of propofol. Following an induction bolus, infusion rates of 100–200 µg/kg/min typically are used to maintain general anesthesia in healthy patients. If nitrous oxide and/or opioids are administered concurrently, a reduction in the required propofol infusion rate by one third to half may be anticipated. To maintain a nearly constant blood (and brain) concentration of propofol during an infusion requires that the infusion rate be decreased as the infusion continues (see Target-Controlled Infusion). Use of a monitor that measures the depth of the hypnotic effect, such as the bispectral index or patient state index, facilitates titrating the infusion rate. Elderly patients and those with coexisting cardiopulmonary disease typically will require reduced infusion rates.

Because of propofol’s shorter kinetic parameters compared with thiopental, it accumulates to a much lesser degree, and its recovery characteristics following an infusion, even of very long duration, permit it to be an extremely useful drug for maintaining general anesthesia. The CSHTs for propofol following 1-, 2-, and 6-hour infusions are approximately 11, 16, and 34 minutes, respectively (Fig. 40–4). Thus, a “rule of thumb” for the CSHT for pro-

propofol would be to take the value of 11 minutes for a 1-hour infusion and add to that 4 minutes for each additional hour of infusion duration; this linear relationship remains valid for infusions up to approximately 10 hours in duration. Remember that CSHT is not the same as time to clinical recovery, which depends upon the actual concentrations achieved.

### Sedation

Propofol is commonly used for procedural sedation as well as for longer-term sedation in the intensive care unit (ICU). If loss of consciousness is to be avoided (as is the goal for most cases of procedural sedation), a loading dose of 0.5–1 mg/kg is used, followed by an infusion of 25–75 µg/kg/min. Lower infusion rates will be required in persons given benzodiazepines and/or opioids, in elderly patients, and in those with coexisting cardiopulmonary disease.

Propofol is routinely used in the ICU for long-term (i.e., weeks) sedation of patients requiring mechanical ventilation. Even in this setting, its recovery characteristics permit rapid recovery. For example, a patient who is sedated (but not rendered unconscious) for 2 weeks will recover in approximately 3 hours.<sup>50</sup> Long-term infusion of propofol may give the patient a very large amount of lipid, which has been associated with hypertriglyceridemia and pancreatitis.<sup>51</sup> Logically, propofol should be administered cautiously in patients with preexisting pancreatitis or hyperlipidemia. Long-term administration (particularly in critically ill children) has also been linked to a rare and often fatal disorder termed *propofol infusion syndrome*. The pathophysiology has not been well characterized, but typical features include rhabdomyolysis, metabolic acidosis, and cardiac and renal failure.<sup>52</sup>

### Target-Controlled Infusion

By using estimates of the pharmacokinetic parameters for propofol, it is possible to achieve and maintain a targeted blood (or brain) concentration utilizing a computer-controlled infusion pump (see Chap. 42). Such a target-controlled infusion (TCI) pump, with the pharmacokinetic constants for propofol built in, is marketed as the Diprifusor in many countries (but not in the United States). The patient’s age, body weight, and desired blood concentration are entered, and the pump delivers a pro-

propofol bolus followed by a variable-rate infusion. The rate is automatically adjusted to match predicted losses from distribution and elimination, in order to maintain a constant propofol concentration. TCI pumps have been used successfully in closed-loop delivery systems with processed EEG signals as a control variable. For scientists interested in studying TCI, several public-domain computer programs are available that facilitate this process.<sup>53</sup> Most modern infusion pumps have the ability to be controlled by a computer, so by connecting the pump to a portable computer and using one of the available programs, a TCI can be delivered. Despite more than a decade of clinical use in other parts of the world, it must be emphasized that TCI is still considered an experimental treatment in the United States.

## ETOMIDATE

### Chemistry

Etomidate is an imidazole derivative whose structure is unlike that of any other anesthetic (Fig. 40–1 and Table 40–1). Its imidazole nucleus permits it to bind to, and inhibit, certain isozymes of cytochrome P450 (see Endocrine Effects). It contains an ester linkage that is rapidly hydrolyzed to produce an inactive metabolite. With a  $pK_a$  of 4.2, it is water soluble at acidic pH and lipid soluble at physiologic pH. It is supplied as a 0.2% solution in 35% propylene glycol.

### Pharmacodynamics

#### Central Nervous System

Etomidate works via GABA<sub>A</sub> receptors to produce rapid onset of unconsciousness. It has a brief duration of effect, similar to that of thiopental and propofol. The drug has virtually no analgesic effects, so usually it must be combined with other drugs to suppress autonomic or somatic responses to painful surgical stimulation. Induction of anesthesia is frequently accompanied by myoclonic movements (Table 40–2).

#### Cardiovascular System

Etomidate is notable for its lack of cardiovascular effects, although the reasons for this remain obscure (Table 40–3).<sup>54,55</sup> At the typical induction dose of 0.3 mg/kg, it has little effect on arterial or venous vascular tone or on cardiac contractility. Following induc-



tion of general anesthesia with etomidate, usually little change in blood pressure or heart rate occurs. Cardiovascular stability usually is preserved in persons with hypovolemia or cardiac dysfunction. Etomidate does not release histamine. At the higher dose of 0.7 mg/kg needed to produce EEG burst suppression, hypotension due to vasodilatation has been reported.<sup>56</sup>

### Respiratory System

Etomidate has less of a ventilatory depressant effect than does thiopental or propofol; however, an induction dose is still likely to result in transient apnea (Table 40-4). The ventilatory depressant effect is not exaggerated in persons with COPD.

### Endocrine Effects

In 1984, Watt and Ledingham<sup>57</sup> reported a 2-fold increase in mortality among ventilated ICU patients who were given etomidate for 5 days or longer. This excess mortality subsequently was confirmed and attributed to the production of adrenal insufficiency. At clinically relevant concentrations, etomidate inhibits the mitochondrial P450 isozyme responsible for performing the 11 $\beta$ -hydroxylation reaction in cortisol synthesis. Etomidate is also able to inhibit the 17 $\alpha$ -hydroxylase isozyme, although not at the plasma concentrations achieved during clinical infusions.<sup>58</sup> The clinical relevance of this effect for perioperative use of etomidate remains controversial 20 years after its description.

The duration of suppression of cortisol synthesis by etomidate is dependent upon the cumulative dose. A single induction dose of 0.3 mg/kg inhibits cortisol synthesis and the normal response to adrenocorticotrophic hormone for up to 12 hours. However, the effects are not large, and there is no convincing evidence that this effect is deleterious in normal persons undergoing elective surgery. Even infusions of a few hours duration do not appear harmful in healthy patients. Nevertheless, fear of adrenal suppression has significantly limited the popularity of etomidate over the years (see Clinical Use).

### Other Effects

Etomidate produces changes in CMRO<sub>2</sub>, CBF, and ICP similar to those seen with thiopental and propofol. In contrast, etomidate will not likely lower, and may actually increase, CPP because it has minimal effect on blood pressure while

decreasing ICP. Etomidate may be useful in the short-term management of the neurosurgical patient in whom cardiovascular stability is desired.

Etomidate is associated with the highest incidence of postoperative nausea and vomiting among the intravenous anesthetics (30–40%, by some estimates). The propylene glycol solvent can cause pain on injection and superficial phlebitis. Excitatory phenomena, such as hiccoughs and myoclonic movements, are common during induction. The safety of etomidate in patients with porphyria is questionable. Although a few case reports have described its safe use in patients known to have porphyria, etomidate induces the synthesis of ALA synthase in rats. Etomidate is safe to give patients with malignant hyperthermia.

### Pharmacokinetics

Following an induction dose of 0.3 mg/kg, loss of consciousness and recovery will be similarly rapid as with thiopental and propofol. Because of the long duration of adrenal suppression associated with etomidate infusions, it has not been as extensively studied. Its redistribution half-life is similar to that of thiopental, whereas its terminal half-life is shorter than that of thiopental and similar to that of propofol (Table 40-5).

Etomidate is approximately 75% bound to plasma proteins, a fraction that is significant but not as high as for thiopental or propofol. Most of an administered dose of etomidate is metabolized via ester hydrolysis, yielding an inactive carboxylic acid that is excreted in the urine. Despite the presence of high concentrations of esterases throughout the body, hydrolysis of etomidate occurs primarily in the liver. It has a high extraction ratio of 0.7, so alterations in hepatic blood flow should affect clearance. Because the effects of a bolus are terminated by redistribution and repeated doses or infusions are unlikely to be given, hepatic clearance of etomidate is unlikely to play an important role in recovery (Table 40-6).

### Clinical Use

Etomidate is a popular choice for induction of anesthesia in patients compromised by cardiac dysfunction or hypovolemia (Table 40-7). Hemodynamic stability following induction with etomidate is superior to that of any alternative method of induction. In

theory, etomidate's pharmacokinetics should make it an excellent drug for use during short surgical procedures, but the high incidence of nausea and vomiting is a major disadvantage for patients undergoing same-day surgery. The occurrence of myoclonus and hiccoughs is annoying but similar in frequency to that seen with methohexital.

After more than 20 years of using etomidate, what can we conclude about the importance of adrenal suppression? When etomidate is used for induction and short-term maintenance, reduction in cortisol historically has not been a problem, although there is substantial conflict in the literature on this issue. For example, one review suggests that a single induction dose of etomidate may be hazardous in patients with established or evolving septic shock.<sup>59</sup> Another reports no harm from etomidate infusions during coronary surgery and concludes that the stress of a major operation overcomes the inhibition of cortisol synthesis.<sup>60</sup> Some investigators have proposed the concurrent administration of etomidate plus a glucocorticoid, but in the absence of a proven harmful effect, it is difficult to imagine any benefit.

Ultimately, the decision to use etomidate must rest on the proven benefits of this drug, that is, cardiovascular and respiratory stability. These benefits are most likely to be seen when higher doses are used during induction. In our opinion, there is little compelling reason to use etomidate for maintenance of anesthesia or for procedural sedation.

## BENZODIAZEPINES

### Chemistry

Three injectable benzodiazepines are used in the perioperative period: midazolam, diazepam, and lorazepam (Fig. 40-1 and Table 40-1). Diazepam and lorazepam are "classic" benzodiazepines that are lipid soluble and difficult to solubilize for injection. Diazepam injection is supplied as a 0.5% solution in 40% propylene glycol and 10% ethanol. Lorazepam is supplied as a 0.4% solution in 80% propylene glycol, 18% polyethylene glycol, and 2% benzyl alcohol. Midazolam has unique properties as a result of its substituted imidazole ring. The imidazole nitrogen has a pK<sub>a</sub> of 6.2, so it becomes protonated and water soluble when buffered in a

solution of pH 3–4 (as supplied in the vial).<sup>61</sup> At physiologic pH, >90% of the midazolam molecules exist in the unprotonated lipid-soluble form. Hydroxylation of the methyl group on this imidazole ring decreases the pharmacologic activity of midazolam and increases its clearance, permitting this drug to be shorter acting than the other injectable benzodiazepines.

The water solubility of midazolam at low pH has erroneously been attributed to opening of one of the rings in the benzodiazepine nucleus. In fact, all benzodiazepines undergo ring opening at low pH. At pH 2, 75% of the midazolam molecules are in the open-ring configuration, whereas at pH 4 that percentage decreases to 9%.<sup>61</sup> Because midazolam is supplied at a pH of 3–4 in the vial, ring opening can account for only a small percentage of its water solubility at that pH.

## Pharmacodynamics

### Central Nervous System

Benzodiazepines bind to a specific site located at the interface between the  $\alpha$  and  $\gamma$  subunits of the pentameric GABA<sub>A</sub> receptor. GABA itself appears to bind at a different site between the  $\alpha$  and  $\beta$  subunits.<sup>5</sup> Binding by endogenous benzodiazepine ligands (endopeptides) or by benzodiazepine agonists to this benzodiazepine receptor acts allosterically to increase the affinity of the GABA receptor for GABA. Thus benzodiazepines potentiate the inhibitory effects of GABA, thereby increasing chloride conductance and hyperpolarizing neuronal membranes. Unlike barbiturates, benzodiazepines cannot affect the chloride channel directly but must work via GABA. At higher doses, such as those necessary to produce hypnosis or anticonvulsant effects, benzodiazepines may be working by non-GABA mechanisms such as inhibition of adenosine reuptake<sup>62</sup> or inhibition of neuronal Ca<sup>2+</sup> currents.<sup>63</sup> Benzodiazepines also have agonist activity at the glycine receptor, an important inhibitory neurotransmitter in the spinal cord. Some of the effects of benzodiazepines, such as muscle relaxation, likely are mediated by their actions in the spinal cord. Benzodiazepine receptors in the periphery appear to regulate the initial step in the synthesis of steroid hormones from cholesterol.<sup>64</sup> The physiologic significance of this action remains unclear.

Patients who are chronically taking benzodiazepines can become tolerant

to some, but not all, of the effects. The initial drowsiness usually decreases, although some degree of psychomotor impairment seems to persist. Tolerance develops to the muscle relaxant and anticonvulsant effects, and the latter has limited the use of benzodiazepines in chronic seizure disorders. Alcohol, barbiturates, and benzodiazepines exhibit some cross-tolerance, so higher doses of these sedatives will be needed in patients with significant alcohol or barbiturate intake.

Benzodiazepines have effects on CMRO<sub>2</sub> and ICP qualitatively similar to the effects of thiopental; however, the magnitude of these effects is far less (Table 40–2). The effect of benzodiazepines on CBF and CPP is variable and is more of a function of their effects on blood pressure. Benzodiazepines are excellent anticonvulsants, although their primary use is limited to initial control of seizures and not prophylaxis. All of them raise the threshold for seizures induced by local anesthetics. Unlike thiopental and propofol, benzodiazepines, even in very high doses, do not cause burst suppression on the EEG or an isoelectric tracing, and they are not used for neuroprotection. Benzodiazepines given in subhypnotic doses produce amnesia for events following drug administration (anterograde amnesia).

Benzodiazepines are classified as “anxiolytics” because they are active in various animal models thought to represent anxiety. In patients who have chronic anxiety states, benzodiazepines can reduce anxiety at doses that are not highly sedating. Of note, the same effects may not occur in surgical patients. Many patients scheduled for surgery do not have high levels of self-rated anxiety, and the effect of midazolam is more likely to produce dizziness or sleepiness.<sup>65</sup> An occasional patient may find the feeling of drunkenness or dizziness to be unpleasant.

### Other Effects

Benzodiazepines produce much smaller cardiovascular effects than do thiopental or propofol, even when used for general anesthesia induction (Table 40–4). Some dilation of capacitance vessels leads to a decrease in venous return; however, there is little or no effect on myocardial contractility. Thus, the overall effect on blood pressure and heart rate will depend on the volume status of the patient. Elevated blood pressure in the anxious patient

is often lowered by low doses of benzodiazepines by virtue of their sedative properties (see later, Clinical Use).

Although benzodiazepines cause a dose-dependent decrease in hypoxic ventilatory drive, subhypnotic doses given alone rarely cause apnea. Doses of midazolam sufficient to induce unconsciousness produce apnea with a frequency similar to that of thiopental.<sup>66</sup> There is profound synergy in depressing ventilatory drive between benzodiazepines and opioids or ethanol. Patients with COPD are more sensitive to the ventilatory depressant effects of benzodiazepines (Table 40–3).

Benzodiazepines, given alone, have a very low risk for causing nausea and vomiting. They are safe in patients with malignant hyperthermia, but they should be used with caution in persons with acute intermittent porphyria, hereditary coproporphyrin, and variegate porphyria because some benzodiazepines induce ALA synthase in rats. Hypersensitivity reactions to benzodiazepines are rare.

## Pharmacokinetics

Following an induction dose of 0.3 mg/kg midazolam, loss of consciousness is rapid; however, awakening will be much slower and hangover more prolonged than after thiopental or propofol. Simultaneous pharmacokinetic–pharmacodynamic modeling using an EEG end point suggests that midazolam is slightly slower in onset than is diazepam. The half-time for steady state was over 4 minutes, compared to 90 seconds for diazepam.<sup>67</sup> The  $t_{1/2\alpha}$  for midazolam is 7–15 minutes, much longer than the 2–4 minutes values for thiopental or propofol. The  $t_{1/2\beta}$  for midazolam is 2–4 hours. When given by infusion, recovery following termination of the infusion will be longer than following propofol but shorter than following thiopental (Table 40–5).

Midazolam is metabolized primarily via hydroxylation of the *N*-methyl group on the imidazole ring (Table 40–6). Although this metabolite has some residual benzodiazepine activity, circulating concentrations are low because it is rapidly conjugated with glucuronic acid, yielding an inactive and rapidly excreted metabolite. Midazolam has high first-pass metabolism following oral administration, with an oral bioavailability of approximately 15%.<sup>68</sup>

Diazepam and lorazepam are metabolized and eliminated much more slowly

ly than midazolam because of a high degree of protein binding (98%) and a much lower hepatic clearance. Whereas lorazepam is metabolized to an inactive glucuronide, diazepam is metabolized to several active metabolites. The most important of these active metabolites is nordazepam, which has an extremely long terminal half-life (100 hours vs. 20 hours for diazepam). The processes of metabolism and elimination of these medications become important only when repeated doses or long infusions are given.

### Clinical Use

Midazolam is the most commonly used preoperative sedative in anesthesia (Table 40-7). It replaced diazepam largely because it does not produce pain on injection. Given as a single intravenous bolus, the effects of diazepam and midazolam are quite similar and have about the same duration. Lorazepam is slower in onset and longer in duration, and its tendency to cause prolonged amnesia may be undesirable for patients undergoing short procedures. Following administration of 1–2 mg of midazolam, most patients become sleepy and calmer and have anterograde amnesia, effects that persist for 30–60 minutes. At these doses and in the absence of other medications, there are few significant effects on cardiorespiratory parameters. Sedation can be maintained by repeating intermittent boluses of 0.5–1 mg or by giving a continuous infusion. As with barbiturates, administration of benzodiazepines can sometimes produce paradoxical excitation.

The amnestic effects of benzodiazepines are dose related and often occur in patients who remain conscious and capable of normal conversation. The amnestic effects of midazolam (when given in usual doses for premedication) are variable but usually short lived, and they should not be relied upon to prevent recall of intraoperative events. Although lorazepam has a shorter plasma half-life than does diazepam, its amnestic effects are more prolonged. This may be a function of higher affinity for benzodiazepine receptors.

Midazolam is commonly given by mouth for preoperative sedation in pediatric patients. The usual dose is 0.5–0.75 mg/kg, and a significant effect is apparent within 15–30 minutes. However, the peak effect may occur up to 1 hour following oral administration, so

there might be significant postoperative sedation following short procedures.<sup>68</sup> An official oral preparation of midazolam is unavailable in many countries. The intravenous solution can be mixed with fruit juice or flavored syrup; however, there is no completely effective way to mask the bitter taste.

Midazolam is one of only two induction agents (the other being ketamine) whose administration by the intramuscular route is well tolerated without pain and whose absorption is both reliable and predictable. Doses ranging from those that produce mild sedation up to those required to induce general anesthesia can be given intramuscularly. Doses in excess of a few milligrams should be given using the more concentrated 10 mg/mL preparation to minimize injected volume.

Diazepam is an excellent oral preoperative sedative and anxiolytic agent for patients undergoing inpatient surgery. A dose of 10–20 mg in an adult, or 0.2–0.4 mg/kg in a child, given by mouth an hour before transport to the operating room usually results in a drowsy and calm patient. Both diazepam and lorazepam are associated with significant pain when given intravenously, and the propylene glycol solvent can cause superficial phlebitis. Both medications are absorbed erratically when administered by intramuscular injection.

Midazolam can be used in higher intravenous doses (0.05–0.15 mg/kg) to induce anesthesia, or it can be given via continuous infusion during maintenance (see Chap. 42). The slower onset and offset of effect compared to propofol or thiopental are counterbalanced by midazolam's modest cardiovascular effects. The drug is not an analgesic, so it is usually administered with opioids. This significantly reduces the required dose of midazolam but usually causes a greater decrease in peripheral vascular resistance than seen with the individual drugs. This vasodilatation may be due to an increased effect on central sympathetic tone or possibly to a decrease in plasma catecholamines.<sup>69,70</sup>

The doses of midazolam and diazepam should be reduced in the elderly because of their increased sensitivity and reduced clearance. Hepatic disease or drugs that inhibit the oxidative metabolism of diazepam (e.g., cimetidine) can significantly increase the intensity and duration of sedation.<sup>71</sup> Because

midazolam has a moderately high rate of hepatic clearance, it is less susceptible to enzyme induction or inhibition. Renal disease, on the other hand, can delay the excretion of hydroxymidazolam and cause an increase in effect. Lorazepam is glucuronidated and has no active metabolites, so its effects are not markedly altered by moderate hepatic or renal disease.

### Flumazenil

Flumazenil (Fig. 40-1) is a benzodiazepine antagonist.<sup>72</sup> It has high affinity for the benzodiazepine binding site on the GABA<sub>A</sub> receptor, and flumazenil binding prevents the effects of benzodiazepines and endozepines. There is no evidence that flumazenil will reverse nonbenzodiazepine CNS depression. The usual initial dose in a patient who has been given a therapeutic dose of a benzodiazepine is 0.1–0.2 mg intravenously. The initial dose can be repeated every minute or two, up to a total dose of 1 mg to antagonize benzodiazepine-induced sedation. The various actions of benzodiazepines require different concentrations of agonist, and effects that require high doses (e.g., hypnosis) are most sensitive to flumazenil reversal. Some effects, such as depression of hypoxic ventilatory drive, appear to be incompletely antagonized (see following list on next page, second bullet).<sup>73</sup>

Reports of weak partial agonist or inverse agonist effects from flumazenil are inconsistent. Healthy volunteers given a relatively high dose (2 mg) of flumazenil alone experienced mild anxiety and symptoms resembling those that occur during a panic attack.<sup>74</sup> These symptoms are more likely to occur in patients with previously diagnosed panic attacks. These effects indicate tonic activity in some critical GABA<sub>A</sub> pathways, and flumazenil may be acting weakly as a so-called “inverse agonist” (i.e., producing an effect opposite to that of the benzodiazepine). This action likely is not clinically important in the typical anesthesia setting where flumazenil is used to reverse midazolam. Persons on chronic benzodiazepine therapy who are given flumazenil have been reported sporadically to have seizures,<sup>75</sup> sometimes progressing to status epilepticus.<sup>76</sup> This finding suggests that some patients develop physical dependence to the benzodiazepine, and flumazenil can precipitate withdrawal. A few cases of flumazenil-induced seizures in persons



not on chronic drug therapy have been reported.<sup>75</sup>

Flumazenil is rapidly cleared by hepatic metabolism, with a half-life of approximately 1 hour. Therefore, it has a shorter duration than the benzodiazepines it is used to antagonize, so repeated doses usually are necessary.

The appropriate clinical roles for flumazenil are relatively limited:

- If a patient who is receiving midazolam for sedation or monitored anesthesia care becomes disoriented or uncooperative, reversal may be helpful. In contrast, planned use of flumazenil, that is, giving excessive amounts of benzodiazepines for a procedure and then relying on reversal at the end, seems to be of little benefit. Such treatment risks ventilatory depression and loss of airway reflexes during the procedure and recurrence of depression when the effects of the short-acting antagonist decay.
- Remember that excessive sedation and ventilatory depression most often occur when benzodiazepines are combined with opioids. Flumazenil only partially reverses the depression of hypoxic ventilatory drive produced by midazolam, and it has no effect on ventilatory depression due to an opioid. In this setting, support of ventilation and administration of naloxone are more appropriate treatments.
- When flumazenil has been used empirically for treatment of suspected drug overdoses, deaths due to status epilepticus have occurred. Risk factors in such deaths include concurrent ingestion of tricyclic antidepressants and prior long-term therapy with benzodiazepines or anticonvulsants. Unless an overdose is known to be due to the acute ingestion of only a benzodiazepine, flumazenil treatment may be riskier than cardiorespiratory support of depression due to drugs.

## KETAMINE

### Chemistry

Ketamine is a derivative of aminocyclohexanone whose chemical structure is related to phencyclidine (Fig. 40-1 and Table 40-1). It is a weak base with a pK of 7.5 and is supplied in solution as the hydrochloride salt.

The three concentrations available—10 mg/mL, 50 mg/mL, and 100 mg/mL—are typically used for monitored anesthesia care, intravenous anesthesia, and intramuscular injection, respectively. Ketamine is compatible in solution with atropine or glycopyrrolate, with which it is often mixed.

The commercial preparations of ketamine contain a racemic mixture of its two isomers. The S-isomer is a more potent anesthetic with fewer adverse effects<sup>77</sup> and is available in Europe, but this enantiomer is not commercially available in the United States.

### Pharmacodynamics

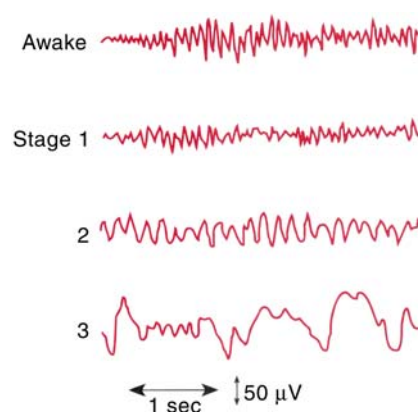
#### Central Nervous System

Whereas all the previously discussed intravenous anesthetics potentiate the inhibitory effects of GABA, ketamine produces its inhibitory effects by blocking the NMDA receptor.<sup>78</sup> The NMDA receptor is, like GABA<sub>A</sub>, a ligand-gated ion channel, but it is gated by the excitatory neurotransmitter glutamate. When open, it passes a current carried by calcium ions.

The anesthetic state induced by ketamine is called *dissociative anesthesia*. It does not resemble normal sleep; rather, patients appear to be dissociated from their environment. Under ketamine anesthesia, patients may move, vocalize, have their eyes open, and make ocular tracking movements. However, patients are anesthetized and do not respond to noxious stimuli or have any recall of events that occurred during the anesthetic. Ketamine causes profound analgesia that persists well into the postoperative period. Vivid dreams or hallucinations that may be perceived as unpleasant often accompany ketamine anesthesia, and hallucinations and/or dysphoria may occur in the postoperative period.

In contrast to the other intravenous anesthetics, ketamine produces increases in CMRO<sub>2</sub>, CBF, and ICP. Thus, ketamine is relatively contraindicated in patients with an intracranial mass or increased ICP, or who have suffered recent head trauma (Table 40-2).

Ketamine produces dose-dependent changes in the EEG that are quite different from those resulting from thiopental or propofol (Fig. 40-5).<sup>79</sup> For this reason, EEG-based monitors of the depth of anesthesia (see Chap. 32) are not accurate when ketamine is the primary anesthetic. As seen with thiopental, light anesthesia with ketamine



**FIGURE 40-5.** Progressive changes in the electroencephalogram produced by ketamine. Stages 1 to 3 are achieved with racemic ketamine and its S(+) isomer. With R(−) ketamine, stage 2 was the maximal electroencephalographic depression produced. (Redrawn from Schuttler et al.<sup>79</sup> with permission.)

is associated with an increase in EEG frequency so that beta waves predominate. As the depth of anesthesia increases, high-amplitude theta waves, with intermittent delta waves, can occur. An isoelectric EEG does not occur with ketamine anesthesia.<sup>80</sup>

#### Cardiovascular System

In contrast to the other intravenous anesthetics, ketamine usually causes an increase in blood pressure, heart rate, cardiac contractility, cardiac output, and systemic vascular resistance (Table 40-4). These are indirect effects by virtue of increased centrally mediated sympathetic tone and increased centrally mediated release of catecholamines from the adrenal medulla. In the critically ill or injured patient whose circulating catecholamine concentration has reached its maximum value, a decrease in blood pressure and cardiac output may occur when ketamine is injected because ketamine and its major metabolite have a direct negative inotropic effect. Ketamine may increase myocardial oxygen demand more than it increases oxygen delivery, and in some patients with coronary artery disease this effect may lead to ischemia.

#### Respiratory System

Ketamine differs from the other intravenous anesthetics in its respiratory effects (Table 40-3). Ketamine has little effect on ventilatory drive in normal patients or in those with COPD. It produces bronchodilation and has proved useful in patients with, or prone to, bronchospasm. Protective airway reflex-



es are less likely to be ablated by ketamine, even in the presence of surgical anesthesia, although aspiration remains a risk in a patient with ketamine-induced unconsciousness. Ketamine causes copious salivation, and its use is generally preceded by, or it is administered with, an anticholinergic drug such as glycopyrrolate.

### Other Effects

Like etomidate, ketamine is associated with a high risk for postoperative nausea and vomiting. Ketamine is safe in patients with malignant hyperthermia and, based upon a number of case reports, probably is safe in patients with porphyria.

### Pharmacokinetics

Following an intravenous induction dose of 1–2 mg/kg of ketamine, loss of consciousness is rapid; however, awakening will be much slower and the hangover more prolonged than after any other intravenous anesthetic. Ketamine has a redistribution half-life  $t_{1/2\alpha}$  of 11–17 minutes, much longer than the values for either thiopental or propofol (Table 40–5).

Ketamine is extensively metabolized, primarily by *N*-demethylation. The resulting active metabolite, norketamine, is approximately one fourth as potent. Norketamine is further metabolized to an inactive glucuronide.

In contrast to the other intravenous anesthetics, only a small fraction of circulating ketamine is bound to plasma protein. Ketamine has a high hepatic extraction ratio, and other medications or coexisting diseases that decrease hepatic blood flow would be expected to prolong its duration of action (Table 40–6). Ketamine has high first-pass hepatic metabolism following oral administration, although it is sometimes administered by this route.

### Clinical Use

Like etomidate, ketamine is most commonly used for induction of general anesthesia in patients compromised by concurrent cardiac dysfunction or hypovolemia (Table 40–7). It has been used extensively for acute and chronic treatment of burn victims. Infusions are used for analgesia and hypnosis as part of balanced anesthesia. Because increasing doses of ketamine do not produce consistent changes in hemodynamics, respiration, eye signs, or movement, the depth of anesthesia may be

difficult to assess. Unless there is maximal sympathetic tone, ketamine usually causes an increase or no change in blood pressure. Ketamine is a good choice for patients with, or prone to, bronchospasm. A slow emergence, often accompanied by hallucinations and/or dysphoria, are common adverse effects that must be balanced against the desire for a lack of cardiovascular depression. The unpleasant psychological effects may be mitigated, but not eliminated, by concurrent administration of propofol or a benzodiazepine.

In subhypnotic doses (0.15–0.3 mg/kg), ketamine is commonly used for monitored anesthesia care. It produces profound analgesia without the concurrent ventilatory depression produced by opioids. In combination with a low dose of propofol or a benzodiazepine, the unpleasant psychological effects are minimal, and the ventilatory depressant effects are much less than the combination with an opioid.

Ketamine is commonly used, either alone or in combination with midazolam, as an oral medication in children, especially as the sole agents for conscious sedation for a short but noxious procedure (e.g., upper endoscopy). Typical doses of the combination are 3–6 mg/kg of ketamine plus 0.25–0.5 mg/kg of midazolam.

Ketamine is one of only two induction agents (the other being midazolam) that have reliable and predictable absorption with minimal pain following intramuscular injection. Doses ranging from those that produce mild sedation to those required to induce general anesthesia may be given intramuscularly. The preparation containing 100 mg/mL usually is given, especially in adults, to minimize the injected volume. A rapid onset after intramuscular injection makes ketamine a frequent choice for induction of anesthesia in children and adults with mental disabilities who will not tolerate a mask or the placement of an intravenous catheter. Following intramuscular administration of 2–4 mg/kg of ketamine, the patient will lose consciousness, thus allowing placement of an intravenous catheter within approximately 5 minutes.

## ADJUNCTS

### Butyrophenones

Droperidol and the closely related antipsychotic agent haloperidol exert their

CNS effects via antagonism of the dopamine  $D_2$  receptor. Unlike their predecessors, the phenothiazines, they have less affinity at other sites, such as  $\alpha$ -adrenoceptors or muscarinic cholinergic receptors. They are classified as *neuroleptic* agents because of their distinct behavioral effects. When a neuroleptic agent is given to a “normal” individual, behavior is diminished and responses to stimuli are fewer, slower, and smaller in magnitude. In high doses, a catatonic state is induced, although consciousness and memory are preserved. These drugs should generally not be given by themselves. Patients treated this way usually appear sleepy and comfortable when drug concentrations are maximal, but they often describe an intensely dysphoric experience after the effects have worn off. This is in distinct contrast to the benzodiazepines, which often produce anterograde amnesia. When a neuroleptic agent is given to a psychotic patient, the thought disorder usually improves. In schizophrenia, the delusions and auditory or visual hallucinations become less pronounced or disappear, and thinking becomes more orderly. Even if some hallucinations remain, the patient is far more likely to recognize them as unreal.

Droperidol is a highly effective antiemetic at doses (0.625–1.25 mg) that do not cause sedation or dysphoria (see Chap. 73). In rare instances, it may be useful in higher doses for its neuroleptic effect. Droperidol is a very safe sedative, albeit one often associated with dysphoria. It causes no ventilatory depression and, in contrast to the benzodiazepines, does not potentiate the ventilatory depressant effects of opioids.<sup>81</sup> It has few cardiovascular side effects other than very mild vasodilatation due to its weak interaction with  $\alpha$ -adrenoceptors. Butyrophenones can lower the seizure threshold and cause extrapyramidal symptoms (see next paragraph), so they are generally avoided in patients with seizure disorders or Parkinson disease. Many clinicians find droperidol useful for sedation during monitored anesthesia care or regional anesthesia in patients with dementia, psychosis, or mental retardation. In addition, droperidol may be useful to facilitate procedures such as line placement or awake intubation in uncooperative and/or intoxicated trauma patients. In such cases, its overall safety renders the possible later dysphoria a tolerable adverse effect.

Like all dopamine antagonists, droperidol has the potential to cause extrapyramidal reactions. These may include involuntary facial grimacing, neck stiffness, and limb movements such as akathisia (“restless legs”). These effects usually are not seen with antiemetic doses unless they are repeated, and they can be treated by administration of diphenhydramine or trihexyphenidyl, drugs with central anticholinergic effects.

An anesthetic technique rarely used today is neuroleptanesthesia, which involves the concurrent administration of droperidol (a butyrophenone with neuroleptic activity), fentanyl (an opioid), and nitrous oxide. Anesthesia induction is accomplished via administration of 10–15 mg of droperidol and 250–500 µg of fentanyl. Loss of consciousness and a lack of awareness are unlikely unless a high concentration of nitrous oxide is also given, and even then awareness still may occasionally occur. The neuroleptanesthetic state is accompanied by cardiovascular stability, and for this reason the technique gained some popularity before the use of invasive monitoring and Intensive Care Units. The technique is associated with prolonged emergence and frequent dysphoria.

Although droperidol has been used as a neuroleptic for more than 4 decades, its ability to cause cardiac dysrhythmias has only recently been appreciated. Droperidol causes a dose-dependent prolongation of the QTc interval, and, in a subset of the population (of unknown incidence), this may lead to polymorphic ventricular tachycardia (torsade de pointes). Antiemetic doses of droperidol almost certainly are safe, but there is the possibility that larger, sedating doses may be associated with this dysrhythmia.<sup>82</sup> In the United States, droperidol is labeled with a boxed warning that mandates continuous electrocardiographic monitoring for 2–3 hours following droperidol administration.

### $\alpha_2$ -Adrenoceptor Agonists

Clonidine was the first centrally acting  $\alpha_2$ -adrenergic agonist widely used in medicine. Introduced as an antihypertensive, a common adverse effect was sedation to which the patient became tolerant after 1–2 weeks of therapy. Because one person's adverse effect may be another person's therapeutic effect, clonidine was later investigated and used as a preoperative sedative (see Chap. 5). In some studies, such use was associated with diminished

intraoperative requirements for hypnotic and analgesic medications and less intraoperative tachycardia and hypertension.

Dexmedetomidine is the first  $\alpha_2$ -adrenoceptor agonist specifically marketed as a sedative. It is considerably more selective for  $\alpha_2$ -receptors than clonidine. The primary site of its action as a sedative is in the locus ceruleus, where its effect is to mimic physiologic sleep.<sup>83</sup> Dexmedetomidine decreases inhibitory neuronal outflow from the locus ceruleus to the ventrolateral preoptic nucleus, resulting in increased GABA release from the latter. In rats, dexmedetomidine produces analgesia at the spinal cord level by activating descending inhibitory pathways originating in the midbrain, thereby reducing pain impulses that would otherwise ascend in the cord. Additionally it acts synergistically with nitrous oxide to potentiate the latter's analgesic activity in the spinal cord.<sup>84</sup>

Dexmedetomidine produces intense sedation, although it cannot reliably produce amnesia, hypnosis, or general anesthesia.<sup>85</sup> It does not have anticonvulsant properties. As would be expected, dexmedetomidine lowers blood pressure and heart rate, and dramatic decreases have occasionally occurred in patients without preexisting cardiovascular disease. Like clonidine, higher doses of dexmedetomidine can produce an initial increase in blood pressure that is believed to result from stimulation of  $\alpha_{2B}$ -adrenoceptors. Sympathetic stimulation is also responsible for the common side effect of dry mouth. In animals and humans, dexmedetomidine can markedly reduce the requirement for volatile or intravenous anesthetics and opioids. Sedative doses have very little effect on ventilation and do not appear to increase the ventilatory depressant effects of opioids.<sup>86</sup>

Although dexmedetomidine has been studied in a number of environments, currently it is only approved for sedation of mechanically ventilated adult patients, and then only for up to 24 hours. The infusion typically is started near the end of an operative procedure before the patient is transported to the ICU or shortly after arrival. A bolus dose of 10 µg/kg is given over 10 minutes, followed by an infusion of 0.2–0.7 µg/kg/h. No ventilatory depression is associated with this sedation, and patients should require less opioid for management of postoperative pain. The heart rate usual-

ly is slow, although symptomatic bradycardia occasionally occurs, and dexmedetomidine should not be given to patients with preexisting heart block. Postoperative hypertension usually is well controlled; however, some patients experience hypotension and require pressor infusion, especially if they have preexisting ventricular dysfunction.

An intriguing possibility is that perioperative administration of an  $\alpha_2$ -adrenoceptor agonist decreases cardiovascular mortality. A meta-analysis concluded that such use decreases mortality and myocardial infarction following vascular surgery.<sup>87</sup>

## FUTURE HORIZONS: EXPERIMENTAL DRUGS

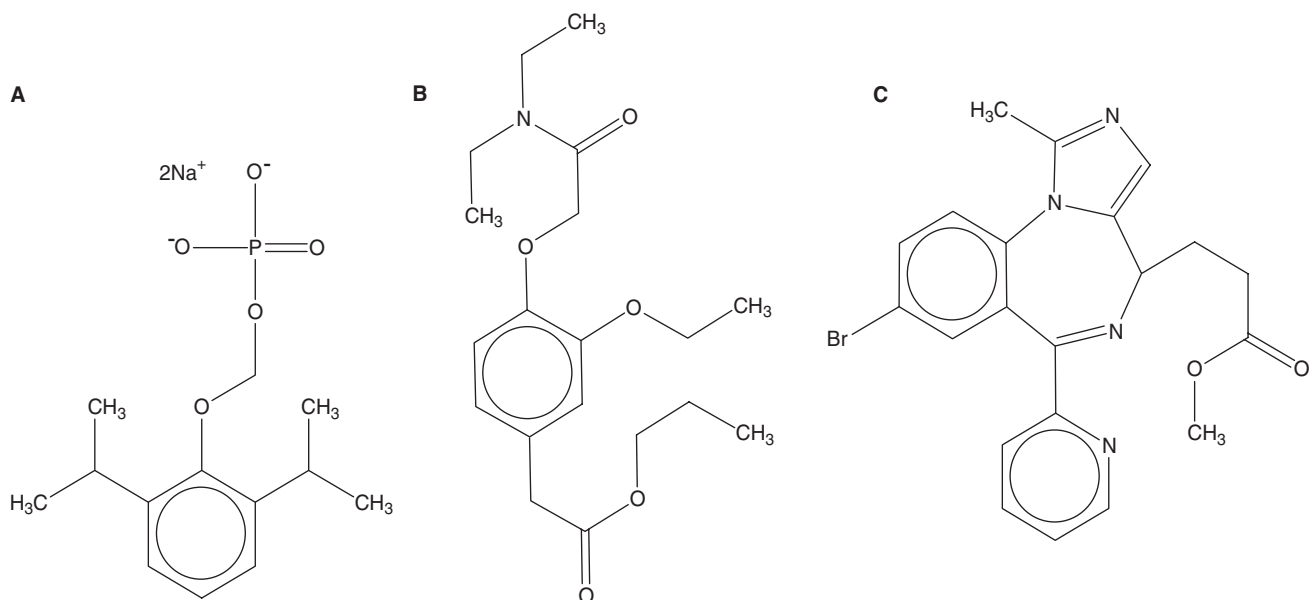
### Fospropofol Disodium

Fospropofol (Fig. 40–6) is a water-soluble prodrug of propofol that results in incomplete (20–30%) liberation of propofol into the systemic circulation by alkaline phosphatase. It is believed that most (70–80%) of the propofol liberated is further metabolized prior to entering the systemic circulation. The peak hypnotic effect occurs approximately 10 minutes following a bolus injection. The kinetic disposition of liberated propofol differs from that of an injected propofol emulsion, with the former being slower for reasons that remain unexplained.<sup>88,89</sup>

Apparent advantages of an aqueous solution of fospropofol are a reduced risk of bacterial contamination compared with a propofol emulsion and the absence of an infused lipid load that has been associated with organ toxicity during long-term infusions of a propofol emulsion. Whether the new medication will cause less pain on injection remains to be determined. The relatively slow-onset kinetics of fospropofol probably would not make it useful for induction of general anesthesia. It may find utility for sedation in the ICU, procedural sedation outside of the operating room (where its safety needs to be demonstrated), and for sedation during monitored anesthesia care or regional anesthesia during which a rapid onset is less critical.

### Propanidid Congener (TD-4756)

Propanidid was formerly used as an intravenous anesthetic in countries other than the United States. It is a



**FIGURE 40-6.** Structures of some investigational intravenous anesthetic agents: fospropofol (A), TD-4756 (B), and CNS 7056X (C).

naturally occurring constituent of clove oil and is an ester whose rapid hydrolysis by plasma cholinesterase in the circulation gives it the shortest terminal half-life of any intravenous hypnotic (approximately 6 minutes). It is insoluble in water and was formulated in Cremophor when it was marketed. Because of the occurrence of anaphylactoid reactions to the vehicle, it was withdrawn from the market.

TD-4756 (formerly called THRX-918661, Fig. 40-6) is a propanidid congener with about twice its potency. TD-4756 contains an ethoxy group at the number 3 position on the benzene ring, whereas propanidid has a methoxy group. Although not yet studied in humans, TD-4756 is much shorter acting than propofol when infused in animals. Its duration of action is independent of the duration of infusion; thus, like remifentanyl, its CSHT appears to be a constant regardless of infusion duration.<sup>90</sup> Reliance on plasma cholinesterase for metabolism likely will make the drug subject to genetic variability in clearance and possibly interactions with succinylcholine.

### Esterase-Metabolized Benzodiazepine (CNS 7056X)

CNS 7056X (Fig. 40-6) is an esterase-metabolized benzodiazepine. It is metabolized by nonspecific tissue esterases, as is remifentanyl (see Chap. 41). The carboxylic acid metabolite that results from its hydrolysis is approxi-

mately 400 times less potent than the parent medication. Although CNS 7056X has not yet been administered to human volunteers, its duration of action in animals is much less than that of midazolam following equisedating doses.<sup>91</sup>

### KEY REFERENCES

- Avram MJ, Krejcie TC, Henthorn TK. The relationship of age to the pharmacokinetics of early drug distribution: the concurrent disposition of thiopental and indocyanine green. *Anesthesiology* 1990;72:403-411.
- Brain Resuscitation Clinical Trial I Study Group. Randomized clinical study of thiopental loading in comatose survivors of cardiac arrest. *N Engl J Med* 1986;314:397-403.
- Coursin DB, Coursin DB, Maccioli GA. Dexmedetomidine. *Curr Opin Crit Care* 2001;7:221-226.
- Dershwitz M, Rosow CE, Di Biase PM, et al. Comparison of the sedative effects of butorphanol and midazolam. *Anesthesiology* 1991;74:717-724.
- Gan TJ, Glass PS, Howell ST, et al. Determination of plasma concentrations of propofol associated with 50% reduction in postoperative nausea. *Anesthesiology* 1997;87:779-784.
- Hoffman EJ, Warren EW. Flumazenil: a benzodiazepine antagonist. *Clin Pharm* 1993;12:641-656.
- Hudson RJ, Stanski DR, Saidman LJ, et al. A model for studying depth of anesthesia and acute tolerance to thiopental. *Anesthesiology* 1983;59:301-308.
- Hughes MA, Glass PS, Jacobs JR. Context-sensitive half-time in multicompartiment pharmacokinetic models for intravenous anesthetic drugs. *Anesthesiology* 1992;76:334-341.
- Jackson WJ. Should we use etomidate as an induction agent for endotracheal intubation in patients with septic shock? A critical appraisal. *Chest* 2005;127:1031-1038.
- Picard P, Tramèr MR. Prevention of pain on injection with propofol: a quantitative systematic review. *Anesth Analg* 2000;90:963-969.
- Russo H, Bressolle F. Pharmacodynamics and pharmacokinetics of thiopental. *Clin Pharmacokinet* 1998;35:95-134.
- Veselis RA, Reinsel RA, Feshchenko VA, et al. The comparative amnestic effects of midazolam, propofol, thiopental, and fentanyl at

equisedative concentrations. *Anesthesiology* 1997;87:749–64.

13. Watt I, Ledingham IM, Mortality amongst multiple trauma patients admitted to an intensive therapy unit. *Anaesthesia* 1984;39: 973–981.

## REFERENCES

- Lundy JS. Intravenous anesthesia; preliminary report of the use of two new thiobarbiturates. *Proc Staff Meet Mayo Clin* 1935;10:536–543.
- Goodman LS, Gilman AG. *The Pharmacological Basis of Therapeutics*. New York: The Macmillan Co., 1941.
- Haws JL, Herman N, Clark Y, et al. The chemical stability and sterility of sodium thiopental after preparation. *Anesth Analg* 1998;86:208–213.
- Beeman CS, Dembo J, Bogardus A. Stability of reconstituted methohexital sodium. *J Oral Maxillofac Surg* 1994;52:393–396.
- Burt DR. Reducing GABA receptors. *Life Sci* 2003;73:1741–1758.
- Shapiro HM. Intracranial hypertension: therapeutic and anesthetic considerations. *Anesthesiology* 1975;43:445–471.
- Nehls DG, Todd MM, Spetzler RF, et al. A comparison of the cerebral protective effects of isoflurane and barbiturates during temporary focal ischemia in primates. *Anesthesiology* 1987;66:453–464.
- Brain Resuscitation Clinical Trial I Study Group. Randomized clinical study of thiopental loading in comatose survivors of cardiac arrest. *N Engl J Med* 1986;314:397–403.
- Hudson RJ, Stanski DR, Saidman LJ, et al. A model for studying depth of anesthesia and acute tolerance to thiopental. *Anesthesiology* 1983;59:301–308.
- Swanson RA, Seid LL. Barbiturates impair astrocyte glutamate uptake. *Glia* 1998; 24:365–371.
- Mustafa S, Thulesius L, Thulesius O. The contractile response of thiopental in large and small ovine airways. *Acta Anesthesiol Scand* 1994;38:499–504.
- Chamberlain JH, Seed RG, Chung DC. Effect of thiopentone on myocardial function. *Br J Anaesth* 1977;49:865–870.
- Rich GF, Roos CM, Anderson SM, et al. Direct effects of intravenous anesthetics on pulmonary vascular resistance in the isolated rat lung. *Anesth Analg* 1994;78:961–966.
- Todd MM, Drummond JC, U HS. The hemodynamic consequence of high-dose thiopental anesthesia. *Anesth Analg* 1985; 64:681–687.
- Lorenz W, Doenicke A, Meyer R, et al. Histamine release in man by propanidid and thiopentone: pharmacological effects and clinical consequences. *Br J Anaesth* 1972;44:355–369.
- Laxenaire MC. Epidemiology of anesthetic anaphylactoid reactions. Fourth multicenter survey (July 1994–December 1996). *Ann Fr Anesth Reanim* 1999;18:796–809.
- Desnick RJ. The porphyrias. In: Kasper DL ed. *Harrison's Principles of Internal Medicine*. 16th ed. New York: McGraw-Hill, 2004.
- Archer DP, Ewen A, Roth SH, et al. Plasma, brain, and spinal cord concentrations of thiopental associated with hyperalgesia in the rat. *Anesthesiology* 1994;80: 168–176.
- Russo H, Bressolle F. Pharmacodynamics and pharmacokinetics of thiopental. *Clin Pharmacokinet* 1998;35:95–134.
- Cordato DJ, Mather LE, Gross AS, et al. Pharmacokinetics of thiopental enantiomers during and following high-dose therapy. *Anesthesiology* 1999;91:1693–1702.
- Avram MJ, Krejcie TC, Henthorn TK. The relationship of age to the pharmacokinetics of early drug distribution: the concurrent disposition of thiopental and indocyanine green. *Anesthesiology* 1990;72: 403–411.
- Hughes MA, Glass PS, Jacobs JR. Context-sensitive half-time in multicompartment pharmacokinetic models for intravenous anesthetic drugs. *Anesthesiology* 1992;76:334–341.
- Veselis RA, Reinsel RA, Feshchenko VA, et al. The comparative anesthetic effects of midazolam, propofol, thiopental, and fentanyl at equisedative concentrations. *Anesthesiology* 1997;87:749–764.
- Maker MT, Gregerson MS, Martin SM, et al. Free radical and drug oxidation products in an intensive care unit sedative: propofol with sulfite. *Crit Care Med* 2003; 31:787–792.
- Sanna E, Garau F, Harris RA. Novel properties of homomeric beta 1 gamma-aminobutyric acid type A receptors: actions of the anesthetics propofol and pentobarbital. *Mol Pharmacol* 1995;47:213–217.
- Orser BA, Bertlik M, Wang LY, et al. Inhibition by propofol (2,6 di-isopropylphenol) of the N-methyl-D-aspartate subtype of glutamate receptor in cultured hippocampal neurons. *Br J Pharmacol* 1995;116: 1761–1768.
- Cheng MA, Theard MA, Tempelhoff R. Intravenous agents and intraoperative neuroprotection. Beyond barbiturates. *Crit Care Clin* 1997;13:185–199.
- Samra SK, Sneyd JR, Ross DA, et al. Effects of propofol sedation on seizures and intracranially recorded epileptiform activity in patients with partial epilepsy. *Anesthesiology* 1995;82:843–851.
- Dwyer R, McCaughey W, Lavery J, et al. Comparison of propofol and methohexitone as anaesthetic agents for electroconvulsive therapy. *Anaesthesia* 1988;43:459–462.
- Eames WO, Rooke GA, Wu RS, et al. Comparison of the effects of etomidate, propofol, and thiopental on respiratory resistance after tracheal intubation. *Anesthesiology* 1996;84:1307–1311.
- Grounds RM, Twigley AJ, Carli F. The haemodynamic effects of intravenous induction. Comparison of the effects of thiopentone and propofol. *Anaesthesia* 1985;40: 735–740.
- Sato M, Tanaka M, Umehara S, et al. Baroreflex control of heart rate during and after propofol infusion in humans. *Br J Anaesth* 2005;94:577–581.
- Kondo U, Kim SO, Nakayama M, et al. Pulmonary vascular effects of propofol at baseline, during elevated vasomotor tone, and in response to sympathetic alpha- and beta-adrenoceptor activation. *Anesthesiology* 2001;94:815–823.
- Sneyd JR, Carr A, Byrom WD, et al. A meta-analysis of nausea and vomiting following maintenance of anesthesia with propofol or inhalational agents. *Eur J Anesthesiol* 1998;15:433–445.
- Gan TJ, Glass PS, Howell ST, et al. Determination of plasma concentrations of propofol associated with 50% reduction in postoperative nausea. *Anesthesiology* 1997; 87:779–784.
- DeBalli P. The use of propofol as an antiemetic. *Int Anesthesiol Clin* 2003;41: 67–77.
- Appadu BL, Strange PG, Lambert DG. Does propofol interact with D2 dopamine receptors? *Anesth Analg* 1994;79:1191–1192.
- Saiah M, Borgeat A, Wilder-Smith OH, et al. Epidural-morphine-induced pruritus: propofol versus naloxone. *Anesth Analg* 1994;78:1110–1113.
- Yamakage M, Iwasaki S, Satoh JI, et al. Changes in concentrations of free propofol by modification of the solution. *Anesth Analg* 2005;101:385–388.
- Iwama H, Nakane M, Ohmori S, et al. Nafamostat mesilate, a kallikrein inhibitor, prevents pain on injection with propofol. *Br J Anaesth* 1998;81:963–964.
- Picard P, Tramèr MR. Prevention of pain on injection with propofol: a quantitative systematic review. *Anesth Analg* 2000; 90:963–969.
- Hiraoka H, Yamamoto K, Miyoshi S, et al. Kidneys contribute to the extrahepatic clearance of propofol in humans, but not lungs and brain. *Br J Clin Pharmacol* 2005; 60:176–182.
- Schnider TW, Minto CF, Gambus PL, et al. The influence of method of administration and covariates on the pharmacokinetics of propofol in adult volunteers. *Anesthesiology* 1998;88:1170–11782.
- Kanto J, Gepts F. Pharmacokinetic implications for the clinical use of propofol. *Clin Pharmacokinet* 1989;17:308–326.
- Ickx B, Cockshott ID, Barvais L, et al. Propofol infusion for induction and maintenance of anaesthesia in patients with end-stage renal disease. *Br J Anaesth* 1998;81: 854–860.



46. Servin F, Cockshott ID, Farinotti R, et al. Pharmacokinetics of propofol infusions in patients with cirrhosis. *Br J Anaesth* 1990;65:177-183.
47. Ouattara A, Boccarda G, Lemaire S, et al. Target-controlled infusion of propofol and remifentanyl in cardiac anaesthesia: influence of age on predicted effect-site concentrations. *Br J Anaesth* 2003;90:617-622.
48. Shafer A, Doze VA, Shafer SL, et al. Pharmacokinetics and pharmacodynamics of propofol infusions during general anaesthesia. *Anesthesiology* 1988;69:348-356.
49. McDonald NJ, Mannion D, Lee P, et al. Mood elevation and outpatient anaesthesia. A comparison between propofol and thiopentone. *Anaesthesia* 1988;43(Suppl):68-69.
50. Barr J, Egan TD, Sandoval NF, et al. Propofol dosing regimens for ICU sedation based upon an integrated pharmacokinetic-pharmacodynamic model. *Anesthesiology* 2001;95:324-333.
51. Devlin JW, Lau AK, Tanios MA. Propofol-associated hypertriglyceridemia and pancreatitis in the intensive care unit: an analysis of frequency and risk factors. *Pharmacotherapy* 2005;25:1348-1352.
52. Vasile B, Rasulo F, Candiani A, et al. The pathophysiology of propofol infusion syndrome: a simple name for a complex syndrome. *Intensive Care Med* 2003;29:1417-1425.
53. Available at: <http://anaesthesia.stanford.edu/pkpd>
54. Gooding JM, Weng JT, Smith RA. Cardiovascular and pulmonary responses following etomidate induction of anaesthesia in patients with demonstrated cardiac disease. *Anesth Analg* 1979;58:40-41.
55. Scorgie B. Etomidate infusion. Its use in anaesthesia for general surgery. *Anaesthesia* 1983;38(Suppl):63-65.
56. Shapiro BM, Wendling WW, Ammaturo FJ, et al. Vascular effects of etomidate administered for electroencephalographic burst suppression in humans. *J Neurosurg Anesthesiol* 1998;10:231-236.
57. Watt I, Ledingham IM. Mortality amongst multiple trauma patients admitted to an intensive therapy unit. *Anaesthesia* 1984;39:973-981.
58. Alolio B, Dorr H, Stuttmann R, et al. Effect of a single bolus of etomidate upon eight major corticosteroid hormones and plasma ACTH. *Clin Endocrinol (Oxf)* 1985;22:281-286.
59. Jackson WJ. Should we use etomidate as an induction agent for endotracheal intubation in patients with septic shock? A critical appraisal. *Chest* 2005;127:1031-1038.
60. Crozier TA, Schlaeger M, Wuttke W, et al. TIVA with etomidate-fentanyl versus midazolam-fentanyl. The preoperative stress of coronary surgery overcomes the inhibition of cortisol synthesis caused by etomidate-fentanyl anaesthesia. *Anaesthetist* 1994;43:605-613.
61. Loftsson T, Gudmundsdóttir, Sigurjónsdóttir JF, et al. Cyclodextrin solubilization of benzodiazepines: formulation of midazolam nasal spray. *Int J Pharmaceut* 2001;212:29-40.
62. Phillis JW, O'Regan MH. The role of adenosine in the central actions of the benzodiazepines. *Prog Neuropsychopharmacol Biol Psychiatry* 1988;12:389-404.
63. MacDonald RL, McLean MJ. Anticonvulsant drugs: mechanism of action. *Adv Neurol* 1986;44:713-736.
64. Hall PF. The role of endozepine in the regulation of steroid synthesis. *Mol Neurobiol* 1995;10:1-17.
65. Dershwitz M, Rosow CE, Di Biase PM, et al. Comparison of the sedative effects of butorphanol and midazolam. *Anesthesiology* 1991;74:717-724.
66. Reves JG, Fragan RJ, Vinik HR, et al. Midazolam: pharmacology and uses. *Anesthesiology* 1985;62:310-324.
67. Bührer M, Maitre PO, Crevoisier C, et al. Electroencephalographic effects of benzodiazepines. II. Pharmacodynamic modeling of the electroencephalographic effects of midazolam and diazepam. *Clin Pharmacol Ther* 1990;48:555-567.
68. Payne K, Mattheyse FJ, Liebenberg D, et al. The pharmacokinetics of midazolam in paediatric patients. *Eur J Clin Pharmacol* 1989;37:267-272.
69. Marty J, Gauzit R, Lefevre P, et al. Effects of diazepam and midazolam on baroreflex control of heart rate and on sympathetic activity in humans. *Anesth Analg* 1986;65:113-119.
70. Tomichek RC, Rosow CE, Philbin DM, et al. Diazepam-fentanyl interaction—hemodynamic and hormonal effects in coronary artery surgery. *Anesth Analg* 1983;62:881-884.
71. Klotz U, Reimann I. Delayed clearance of diazepam due to cimetidine. *N Engl J Med* 1980;302:1012-1014.
72. Hoffman EJ, Warren EW. Flumazenil: a benzodiazepine antagonist. *Clin Pharm* 1993;12:641-656.
73. Gross JB, Weller RS, Conard P. Flumazenil antagonism of midazolam-induced ventilatory depression. *Anesthesiology* 1991;75:179-185.
74. Zedkova L, Coupland NJ, Man GC, et al. Panic-related responses to pentagastrin, flumazenil, and thyrotropin-releasing hormone in healthy volunteers. *Depress Anxiety* 2003;17:78-87.
75. Spivey WH. Flumazenil and seizures: analysis of 43 cases. *Clin Ther* 1992;14:292-305.
76. Haverkos GP, DiSalvo RP, Imhoff TE. Fatal seizures after flumazenil administration in a patient with mixed overdose. *Ann Pharmacother* 1994;28:1347-1349.
77. Himmelseher S, Pfenninger F. The clinical use of S-(+)-ketamine—a determination of its place. *Anesthesiol Intensivmed Notfallmed Schmerzther* 1998;33:764-770.
78. Davies SN, Alford ST, Coan EJ, et al. Ketamine blocks an NMDA receptor-mediated component of synaptic transmission in rat hippocampus in a voltage-dependent manner. *Neurosci Lett* 1988;92:213-217.
79. Schuttler J, Stanski DR, White PF, et al. Pharmacodynamic modeling of the EEG effects of ketamine and its enantiomers in man. *J Pharmacokinetic Biopharm* 1987;15:241-253.
80. Schwartz MS, Virden S, Scott DF. Effects of ketamine on the electroencephalograph. *Anaesthesia* 1974;29:135-140.
81. Harper MH, Hickey RF, Cromwell TH, et al. The magnitude and duration of respiratory depression produced by fentanyl and fentanyl plus droperidol in man. *J Pharmacol Exp Ther* 1976;199:464-468.
82. Dershwitz M. Is droperidol safe? Probably.... *Semin Anesth* 2004;23:291-301.
83. Nelson LE, Lu J, Guo T, et al. The  $\alpha_2$ -adrenoceptor agonist dexmedetomidine converges on an endogenous sleep-promoting pathway to exert its sedative effects. *Anesthesiology* 2003;98:428-436.
84. Dawson C, Ma D, Chow A, et al. Dexmedetomidine enhances analgesic action of nitrous oxide. *Anesthesiology* 2004;100:894-904.
85. Coursin DB, Coursin DB, Maccioli GA. Dexmedetomidine. *Curr Opin Crit Care* 2001;7:221-226.
86. Belleville JP, Ward DS, Bloor BC, et al. Effects of intravenous dexmedetomidine in humans. I. Sedation, ventilation, and metabolic rate. *Anesthesiology* 1992;77:1125-1133.
87. Wijesundera DN, Naik JS, Beattie WS. Alpha-2 adrenergic agonists to prevent perioperative cardiovascular complications: a meta-analysis. *Am J Med* 2003;114:742-752.
88. Gibiansky E, Struys MMRF, Gibiansky L, et al. Aquavan<sup>®</sup> injection, a water-soluble prodrug of propofol, as a bolus injection: a phase I dose-escalation comparison with Diprivan<sup>®</sup> (Part 1). *Anesthesiology* 2005;103:718-729.
89. Struys MMRF, Vanluchene ALG, Gibiansky E, et al. Aquavan<sup>®</sup> injection, a water-soluble prodrug of propofol, as a bolus injection: a phase I dose-escalation comparison with Diprivan<sup>®</sup> (Part 2). *Anesthesiology* 2005;103:730-743.
90. Beattie D, Jenkins T, McCullough J, et al. The in vivo activity of THRX-918661, a novel, pharmacokinetically responsive sedative/hypnotic agent. *Anaesthesia* 2003;59:101.
91. Kilpatrick GJ. New drugs for sedation and hypnosis. 2005 EuroSIVA Annual Scientific Meeting, Vienna, Austria, May 27-28, 2005.

# CHAPTER 41

## Pharmacology of Opioid Analgesics

Carl Rosow, MD, PhD, and  
Mark Dershwitz, MD, PhD

### KEY POINTS

1. An *opioid* is any natural or synthetic compound that has effects similar to those of morphine or that acts as an antagonist at the same receptors to which morphine binds.
2. Because opioid agonists relieve pain, they are classified as *analgesics*. In contrast to the local anesthetics (which interrupt the transmission of all nerve impulses, including pain), and the antiinflammatory analgesics such as aspirin (which decrease some of the pathologic processes leading to pain), the opioid analgesics act primarily to alter the *perception* of pain as a noxious entity.
3. The “classical” pharmacologic effects of morphine, like analgesia and ventilatory depression, are mediated by  $\mu$  receptors. The  $\kappa$  receptor shares a number of effects with the  $\mu$  receptor, including analgesia, sedation, and ventilatory depression. The  $\delta$  receptor is responsible for mediating some of the analgesic effects of the endogenous opioid peptides, especially in the spinal cord.
4. All opioid receptors are G-protein-coupled receptors. The actions of both  $\mu$  and  $\delta$  agonists result in overall neuronal depression, and they share several signal transduction mechanisms, including inhibition of adenylyl cyclase, activation of  $K^+$  currents, and suppression of  $Ca^{2+}$  currents.
5. Five families of endogenous opioid peptides bind to the various opioid receptors. Although some of these peptides undoubtedly function in nociceptive pathways, they also appear to play fundamental roles in processes like thermoregulation and hormone release, as well as gastrointestinal and cardiovascular control.
6. The most widely used opioid analgesics are the pure agonists, and all of these are relatively selective for  $\mu$ -opioid receptors. Unlike the volatile anesthetics, opioid agonists produce a group of highly specific depressant and stimulant effects by acting at discrete sites within the central nervous system.
7. Opioid analgesic effects result from actions at several different levels of the neuraxis. Sufficient doses of opioids will relieve almost any pain, although some types of pain are typically more responsive than others. Prolonged, burning pain, for example, is more effectively blunted than the brief, sharp pain of an incision. Neuropathic pain (e.g., pain of nerve root compression) can be very resistant to opioid treatment. Intraoperatively the opioids can produce sufficient analgesia to reduce or abolish autonomic and somatic responses to surgical stimuli.
8. In usual analgesic doses, morphine-like drugs may produce drowsiness, feelings of heaviness, and difficulty concentrating. Unlike benzodiazepines, opioids do not usually produce amnesia in subhypnotic doses. Doses of opioids that are sufficient to produce apnea and profound analgesia do not always produce sleep in healthy individuals.
9. Seizures can be produced by meperidine because its major metabolite, normeperidine, is a potent convulsant. This is most likely to occur after large doses, or if the patient has renal failure and cannot excrete the metabolite.
10. Opioids produce a dose-related depression of the ventilatory response to  $CO_2$  by a direct effect on ventilatory centers in the medulla. It is important to remember that a decrease in ventilatory rate is not a very sensitive indicator of opioid effect. A patient’s drive to breathe may be abnormal despite an apparently normal ventilatory rate and state of consciousness. Sleep further depresses the response to  $CO_2$  and potentiates the ventilatory depression caused by opioids.
11. Equianalgesic doses of all opioids produce equivalent amounts of ventilatory depression. There is no convincing evidence that any analgesic is more or less dangerous than morphine in this regard.
12. Tolerant individuals who require large amounts of opioid for relief of pain are not at a proportionately increased risk of ventilatory depression.
13. Ventilatory depression is difficult to reverse without reversing some analgesia.
14. Opioids suppress cough by depressing cough centers in the medulla. This effect apparently involves different receptor mechanisms than those mediating analgesia and ventilatory depression.
15. The pinpoint pupil is a pathognomonic sign of opioid overdose (unless hypoxia is severe enough to produce mydriasis).
16. Opioids produce complex effects on vomiting centers in the medulla. There is direct stimulation of the chemoreceptor trigger zone (CTZ) in the area postrema on the floor of the fourth ventricle. This, in turn, activates the vomiting center proper, which is a deeper structure. The emetic effects are markedly potentiated by stimulation of the vestibular apparatus, so ambulatory patients are much more likely to vomit than those patients who are lying quietly.

*Continued*

*Key Points—continued*

- 17.** Generalized hypertonus of skeletal muscle can be produced by large intravenous doses of most opioid agonists. Although morphine can produce rigidity, the problem is most commonly associated with fentanyl, alfentanil, sufentanil, and remifentanil. In its most severe form, “lead pipe” muscle rigidity can totally prevent mechanical ventilation. The difficulty is caused, in part, by loss of chest wall compliance, as well as constriction of laryngeal and pharyngeal muscles.
- 18.** At normal analgesic doses opioids produce minimal cardiovascular effects. Bradycardia and peripheral vasodilatation are seen at higher doses and when opioids are combined with other anesthetic drugs. The combination of slow heart rate, peripheral vasodilatation, minimal myocardial effects, and preservation of autonomic function makes opioid-based anesthesia particularly useful for critically ill patients with cardiac ischemia or failure.
- 19.** Some opioids, particularly morphine and meperidine, produce a nonimmunologic release of histamine from tissue mast cells. This is most often seen as local itching, redness, or hives near the site of intravenous injection. Sometimes a patient will experience generalized flushing. If sufficient histamine is liberated, it may cause decreases in systemic vascular resistance, hypotension, and tachycardia. The potent opioids fentanyl, sufentanil, alfentanil, and remifentanil do not release histamine.
- 20.** Opioids decrease the passage of fluids and solids at every level of the GI tract—so-called opioid bowel dysfunction (OBD). Opioids delay gastric emptying and increase antral tone, which may slow the absorption of oral medications that are administered concomitantly. Food might not pass into the proximal jejunum for many hours, so surgical patients given opioids preoperatively may remain at risk for aspiration despite nominal NPO status. Chronic administration of opioids usually necessitates the administration of laxatives and stool softeners to treat constipation.
- 21.** Opioids cause contraction of smooth muscle in the gall bladder and spasm of the sphincter of Oddi. In some individuals this can precipitate biliary colic.
- 22.** Opioids increase the contractions of the ureter although they relieve the pain caused by ureteral stones. They also decrease detrusor contraction in response to bladder distension (the voiding reflex) and increase the tone of the urinary sphincter by both central and peripheral mechanisms.
- 23.** Although opioids have no specific teratogenic effects, chronic opioid use by the mother can lead to physical dependence by the fetus. Neonatal withdrawal may occur shortly following delivery, and in some instances, may be life-threatening.
- 24.** When tolerance to an opioid occurs, there is simultaneous development of *cross-tolerance* to all other opioid agonists. In general, tolerance develops most rapidly to the effects we have described as depressant (analgesia, ventilatory depression, euphoria), but much less tolerance occurs to some of the stimulant effects, such as constipation or pupillary constriction.
- 25.** Morphine is the least lipophilic of the opioids, which has two important implications for its pharmacokinetics: morphine penetrates biologic membranes more slowly than lipophilic opioids, and it is less likely to accumulate in lipid membranes or fatty tissues. The plasma pharmacokinetics of morphine does *not* parallel its clinical effects. In spite of morphine’s rapid distribution and elimination from plasma, the changes in brain concentration are small and delayed. As a result, the onset and offset of analgesia are slow.
- 26.** Morphine 6-glucuronide (M6G), which may constitute 15% of total morphine metabolites, possesses morphine-like analgesic and respiratory depressant activity, although higher doses are required.
- 27.** Meperidine is significantly more lipid soluble than morphine, although its plasma pharmacokinetics is similar. The onset of analgesic effect is faster than morphine, and the duration is shorter (2–3 hours). Meperidine is rapidly *N*-demethylated to form normeperidine. Seizures have occurred in patients with renal failure (who could not excrete normeperidine) and in cancer patients who received high doses of meperidine over long periods of time.
- 28.** Patients chronically taking nonselective monoamine oxidase inhibitors who are given meperidine may suffer a serotonergic crisis manifested as clonus, agitation, hyperreflexia, and hyperthermia.
- 29.** Hydromorphone is a hydrophilic drug with an octanol–water partition coefficient only slightly higher than morphine’s. Its water solubility means that it can be prepared in concentrated solutions (up to 100 mg/mL) that are useful for highly tolerant patients or delivery with implanted infusion pumps. The low lipid solubility gives hydromorphone some of morphine’s characteristics as a selective spinal analgesic.
- 30.** Methadone is a long-lasting synthetic  $\mu$  opioid approximately equipotent with morphine. Unlike most other opioids, methadone has very high oral bioavailability (approximately 80%). Repeated oral or parenteral doses may result in substantial accumulation; subsequent doses appear to last much longer than the initial dose.
- 31.** Fentanyl is extremely fat soluble, which accounts for its rapid onset and relatively short duration. The effects of low doses (e.g., 100–200  $\mu$ g) are brief because they are terminated by rapid redistribution. After much higher doses (e.g.,  $>20$   $\mu$ g/kg) redistribution may be insufficient to bring plasma concentrations to subtherapeutic levels. In this circumstance, termination of effect depends on the much slower elimination process, and the drug appears long-acting.
- 32.** Alfentanil is a slightly less potent congener of fentanyl, and has an extremely rapid onset and short duration of effect. Peak analgesic and ventilatory depressant effects occur in less than 2 minutes, and the duration of the effects of small doses (10  $\mu$ g/kg) may last only 15 minutes.
- 33.** Sufentanil is a thienyl derivative of fentanyl that is more potent and even more fat soluble. Despite a

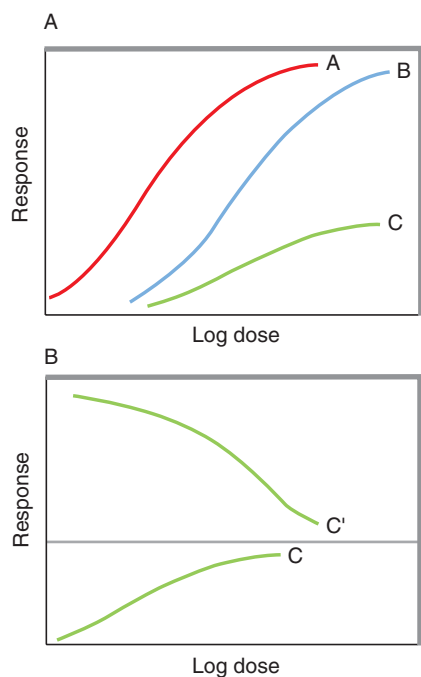
*Continued*



*Key Points—continued*

- terminal half-life of approximately 10 hours, (longer than that of fentanyl and much longer than that of alfentanil), sufentanil has the shortest context-sensitive half-time when given by infusion for up to 10 hours.
34. Pharmacodynamically, remifentanyl is similar to the other fentanyl derivatives, but it has an extremely short duration of action due to rapid metabolic inactivation. It is hydrolyzed by nonspecific esterases primarily in skeletal muscle. The context-sensitive half-life is less than 5 minutes, regardless of the duration of the infusion. There is essentially no accumulation of remifentanyl after infusions or repeated boluses. The ultrashort duration of this analgesic can be a drawback: patients who are expected to have postoperative pain should receive a longer-acting opioid *prior* to stopping remifentanyl.
  35. Clinically available preparations of tramadol contain the racemic mixture of two isomers. (+)-Tramadol is a weak agonist at  $\mu$  receptors and an inhibitor of serotonin reuptake. It is also demethylated to yield a metabolite with greater  $\mu$  opioid efficacy. (–)-Tramadol more selectively inhibits norepinephrine reuptake. The effects on neurotransmitter reuptake enhance inhibitory effects on pain transmission in the spinal cord.
  36. The first attempts at “balanced” anesthesia used curare together with thiopental and nitrous oxide, but these techniques usually failed to block autonomic responses to surgical stimuli. In 1947, Neff et al. introduced a more satisfactory anesthetic that included small doses of meperidine in combination with thiopental, curare, and nitrous oxide. Although the individual components have changed over the years, this technique is the basis for modern balanced anesthesia.
  37. The administration of opioids potentiates the hypnotic effects of barbiturates, benzodiazepines and propofol. By reducing the amount of hypnotic administered, an opioid can sometimes produce more rapid emergence. The opioids also produce a dramatic, dose-related decrease in the need for volatile anesthetics, and they are frequently used for this specific purpose.
  38. The amount of opioid analgesic required varies tremendously from patient to patient, so anesthetic “recipes” with a predetermined opioid dose are not advisable.
  39. How does one titrate an opioid intraoperatively? Decreasing ventilatory rate or depth is usually a reliable sign of increasing opioid effect if the case permits spontaneous ventilation. More commonly, the rise in blood pressure and other autonomic responses to a “painful” stimulus are gauged. This requires good clinical judgment because autonomic responses are nonspecific and may be produced by many conditions that do not involve pain. Unlike the volatile anesthetics, the opioids do not produce graded cardiovascular depression as depth increases. Normal blood pressure does not necessarily mean that the anesthetic level is appropriate, because large overdoses of most opioids are well tolerated as long as ventilation is supported.
  40. Naloxone acts as a competitive antagonist at all opioid receptors, but it has greatest affinity for  $\mu$  receptors. Small doses of naloxone reliably reverse or prevent the effects of pure opioid agonists and most mixed agonist–antagonists. The block is reversible and competitive, so it can be overcome by additional agonist. The onset of antagonist effect is extremely rapid, but the duration of action is quite brief. An IV dose of 0.4 mg will usually antagonize morphine for less than 1 hour; increasing the dose does not increase the duration appreciably. With the exception of remifentanyl, the duration of naloxone is shorter than the opioids it is used to antagonize.
  41. The agonist–antagonist opioids are synthetic and semisynthetic analgesics that are structurally related to morphine. They have been used primarily for moderate to severe acute pain, although buprenorphine has now been approved for maintenance therapy in opioid addiction. All these compounds produce some degree of competitive antagonism to morphine and the other pure agonists.
  42. Most of the clinically available agonist–antagonists bind to both  $\mu$  and  $\kappa$  receptors, but they have different intrinsic activities at each site. Nalorphine, pentazocine, butorphanol, and nalbuphine produce analgesia and sedation by a partial agonist effect at  $\kappa$  receptors. All of them are competitive antagonists at  $\mu$  receptors, and therefore reverse the effects of morphine. Buprenorphine binds to  $\mu$  receptors with extremely high affinity but has limited efficacy. When given alone, its effects are similar to those of morphine. When given after morphine, it competes with the full agonist and causes a reduction in opioid effect.
  43. The subjective effects of buprenorphine are similar to morphine throughout the dose range. The  $\kappa$ -type agonists have been described as producing “apathetic sedation.” Patients given pentazocine, nalbuphine, or butorphanol may experience floating and dissociation, but usually do not experience mood elevation. After analgesic doses these patients often appear extremely sedated, yet remain capable of surprisingly lucid conversation. With pentazocine, patients are increasingly likely to experience “weird” feelings, dysphoria, or even hallucinations as the dose is raised. These unpleasant effects occur less frequently with butorphanol or nalbuphine. Lack of a morphine-like mood effect makes these analgesics much less desirable for opioid addicts, and it is thought to be a key factor in their low abuse liability.
  44. Nalbuphine and buprenorphine are strong antagonists, and they have been used clinically for this purpose. Administration of an opioid antagonist to an opioid-dependent patient will precipitate withdrawal, and this has occurred after therapeutic doses of pentazocine, nalbuphine, and buprenorphine.
  45. There has been renewed interest in chronic sublingual administration of buprenorphine since 2002 when the FDA approved it for maintenance therapy of opioid addicts. In the event that a patient taking buprenorphine presents for surgery, treatment of acute pain may present a significant problem. These patients are highly tolerant to opioids, and residual levels of the partial agonist may antagonize other opioids for a long time.





**FIGURE 41-1.** **A.** Idealized log dose–response curves for two agonists (*A* and *B*) and a partial agonist (*C*) with an intrinsic activity of approximately 0.4. **B.** Idealized log dose–response curve for the interaction of a partial agonist with a pure agonist. Curve (*C*), the partial agonist alone; curve (*C'*), increasing doses of the partial agonist in the presence of a high concentration of pure agonist. The final level of response is  $0.4 \times$  maximum. (Reproduced with permission from Rance MJ. Multiple opiate receptors—their occurrence and significance. *Clin Anaesthesiol* 1983;1:183.)

tice. They are used as premedicants or sedatives (Chap. 68), intravenous anesthetics (Chap. 42), postoperative analgesics (Chap. 74), intraspinal analgesics (Chap. 46), and in the management of chronic pain (Chaps. 92 and 94). Unfortunately, they are also abused by patients (Chap. 23) and physicians (Chap. 96).

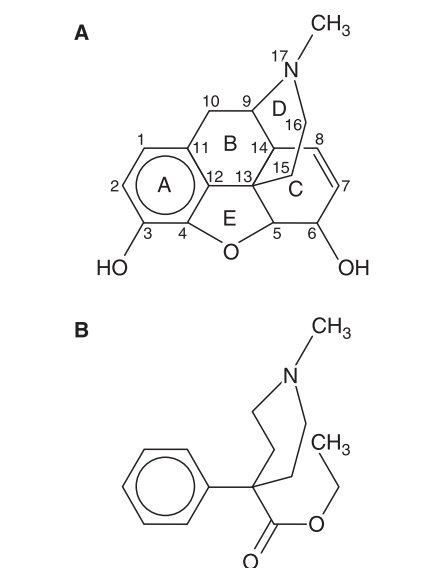
The initial suggestion that more than a single mechanism may be operative in opioid-mediated analgesia came in 1954, when Beecher and Lasagna reported that nalorphine had the characteristics of both an agonist and an antagonist. In the succeeding decade, a number of agonists and antagonists were synthesized, permitting the description of three opioid receptor types by Martin in 1967. Goldstein hypothesized the existence of endogenous opioid compounds in 1970, and 3 years later, independent research teams led by Terenius, Snyder, and Simon identified stereospecific binding sites for opioids. Hughes, Koster-

litz, Goldstein, and their respective colleagues then isolated peptide molecules having morphine-like effects from brain and pituitary gland.

For the purposes of pharmacologic discussions, the term *narcotic* is avoided. Narcotic implies sleep (which opioids surely may produce), but does not connote analgesia. Furthermore, under United States law, a narcotic is any substance deemed likely to be abused, and the class includes such obviously “nonnarcotic” agents as amphetamine, cocaine, and marijuana. Morphine and codeine are opiate analgesics—naturally occurring alkaloids obtained from the juice of the poppy *Papaver somniferum*. An opioid is any natural or synthetic compound that has effects similar to those of morphine or that acts as an antagonist at the same receptors to which morphine binds.

An opioid agonist, like morphine or fentanyl, binds to one (or more) of the opioid receptors and elicits the typical response mediated by that receptor. The opioid antagonists, such as naloxone, are competitive, meaning they produce a block of opioid effect that is surmountable when a sufficient amount of agonist is present. Some clinically used opioids, such as buprenorphine, are partial agonists. Such drugs have lower efficacy than full agonists, even when given at extremely high doses. Their dose–response curves plateau at a lower maximal effect than do those of full agonists (Fig. 41-1A). In some circumstances a partial agonist may act like an antagonist: in the presence of a full dose of an agonist, the partial agonist may displace the agonist from its receptor binding sites and reduce the overall effect (Fig. 41-1B).

Because opioid agonists relieve pain, they are classified as analgesics. In contrast to the local anesthetics (which interrupt the transmission of all nerve impulses, including pain) and the antiinflammatory analgesics such as aspirin (which decrease some of the pathologic processes leading to pain), the opioid analgesics act primarily to alter the perception of pain as a noxious entity. A patient's overall response to pain is a function of many simultaneous processes. These include the magnitude of the noxious stimulus, the patient's individual threshold for experiencing suffering in response to pain, what the patient anticipates will be the result of the

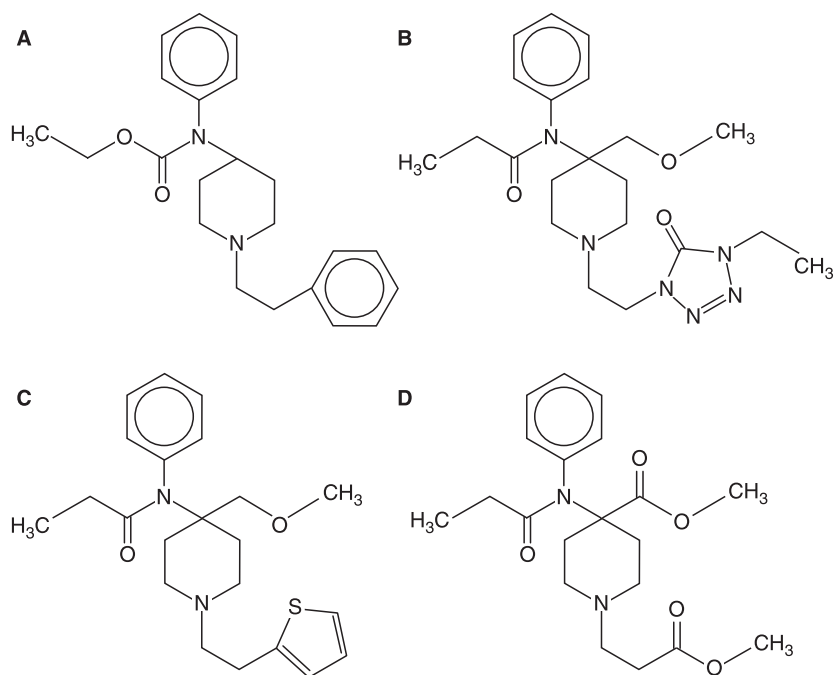


**FIGURE 41-2.** Structural formulas of morphine (**A**) and meperidine (**B**).

noxious stimulus, and the presence or absence of agents (such as opioids) capable of modulating the integration of these processes. As we shall see, the opioid analgesics are also used to decrease “pain” responses in individuals who are unconscious.

Figure 41-2A shows the structure of morphine. It is a 5-ring molecule, 3 rings of which lie in one plane, while the other 2 (labeled *C* and *D*) lie nearly perpendicularly, forming a T shape. There are two hydroxyl groups (one phenolic and one alcoholic), a quaternary carbon atom at position 13, and a piperidine ring with a methyl group on the nitrogen. Morphine is optically active, and only the levorotatory form is analgesically active. Codeine is morphine that has been *O*-methylated at position 3. The first semisynthetic opioids (heroin, hydromorphone) were made by simple substitution, but the morphine molecule may be much simplified while retaining opioid agonist activity. Meperidine (Fig. 41-2B) is a phenylpiperidine that contains only fragments of the original morphine structure. Fentanyl and its derivatives are anilidopiperidines, closely related to meperidine (Fig. 41-3). Note that when the piperidine ring is opened, the ensuing molecule is structurally analogous to tyrosine, the amino acid required to be in the terminal position for peptide opioid activity.

When the piperidine nitrogen has a bulkier chemical group (e.g., allyl, cyclopropyl, cyclobutyl), the compound often takes on opioid antagonist prop-



**FIGURE 41-3.** Structural formulas of fentanyl (A), alfentanil (B), sufentanil (C), and remifentanyl (D).

erties. For example, the *N*-allyl derivatives of morphine and oxycodone are the antagonists nalorphine and naloxone, respectively.

## OPIOID RECEPTORS

Four broad classes of opioid receptors are currently accepted, each encoded by a different gene. Most of the clinically important pharmacologic effects of opioid alkaloids are mediated by  $\mu$  or  $\kappa$  receptors. The international names for these receptors are MOP and KOP, but in this chapter we will use the Greek letter designations. Some opioid peptides are more selective for a third receptor, the  $\delta$  receptor (DOP). A fourth receptor called the nociceptin-orphanin FQ receptor (NOP) may also be involved in pain processing (see Endogenous Opioids). Older literature describes a  $\sigma$  receptor, but this is no longer considered to be a true opioid receptor.

The “classical” pharmacologic effects of morphine, like analgesia and ventilatory depression, are mediated by  $\mu$  receptors. Other  $\mu$  effects include sedation, euphoria, tolerance and physical dependence, decreased gastrointestinal motility, biliary spasm, and miosis. Studies with selective agonists and antagonists support the concept that there are many subclasses of  $\mu$  receptors, and specific functions have been ascribed to a few of these subclasses. For exam-

ple, ventilatory depression and spinal opioid analgesia are mediated by  $\mu_2$  receptors, whereas supraspinal analgesia is a  $\mu_1$ -opioid effect.<sup>108</sup> A  $\mu_3$  receptor is found in vascular tissue and in leukocytes,<sup>20</sup> and it may have roles in vascular control and immunomodulation. It is possible that a  $\mu$  subtype-specific agonist might have greater efficacy or less toxicity than morphine, but no such agent has been developed for clinical use.

All  $\mu$  receptors are encoded by a single gene, denoted OPRM1, found on chromosome 6q24-q25. Although genetic polymorphisms exist,<sup>86</sup> most receptor variants arise from posttranscriptional or posttranslational modifications.<sup>82,108</sup> The transcribed messenger ribonucleic acid (mRNA) may be modified by splicing or polyadenylation, whereas the receptor may be covalently modified by phosphorylation or conjugation to ubiquitin. There is now evidence for the existence of more than 20  $\mu$ -receptor variants. This heterogeneity may explain why opioids have variable efficacy and toxicity in different patients, and it may also account for the fact that patients who are tolerant to the effects of one  $\mu$  agonist can sometimes get relief with another.

The  $\kappa$  receptor shares a number of effects with the  $\mu$  receptor, including analgesia, sedation, and ventilatory depression. It now appears that the

ability of some opioids to cause dysphoria is caused by action at  $\kappa$  receptors. All  $\kappa$  receptors are encoded by a single gene that may theoretically produce at least 6 mRNA variants.<sup>82</sup> The  $\kappa$  receptors have been subdivided into several subclasses, two of which ( $\kappa_1$  and  $\kappa_3$ ) are relevant to the effects of drugs used in anesthesia. The  $\kappa_1$  receptor mediates spinal analgesia,<sup>148</sup> whereas activation of the  $\kappa_3$  receptor results in supraspinal analgesia,<sup>109</sup> sedation, and ventilatory depression. The  $\kappa_2$  receptor is the most prevalent opioid receptor in the brain.

The  $\delta$  receptor is responsible for mediating some of the analgesic effects of the endogenous opioid peptides, especially in the spinal cord.<sup>52,114</sup> Few of the clinically used opioid alkaloids have significant affinity for  $\delta$  receptors at usual analgesic doses. If a  $\mu$ -selective opioid is administered in a sufficiently high dose (to treat a tolerant patient, for example), the drug may be less selective and produce significant  $\delta$  effects.

All opioid receptors are G-protein coupled receptors. All have 7 transmembrane domains and significant structural homology. The actions of both  $\mu$  and  $\delta$  agonists result in overall neuronal depression, and they share several signal transduction mechanisms, including inhibition of adenylyl cyclase,<sup>116,140</sup> activation of  $K^+$  currents, and suppression of  $Ca^{2+}$  currents. Opening of the inwardly rectifying  $K^+$  channel serves to hyperpolarize neuronal membranes, and inhibition of inward calcium current limits the release of various neurotransmitters. Other mechanisms have been demonstrated, including stimulation of phospholipase C<sup>140</sup> and mitogen-activated protein kinase,<sup>59</sup> as well as blockade of L-type calcium channels.<sup>112</sup> The  $\kappa$  receptor elicits similar cellular responses,<sup>59,61,141</sup> and it may also block N-type calcium channels.<sup>146</sup>

## ENDOGENOUS OPIOIDS

Five families of endogenous opioid peptides bind to the various opioid receptors. The peptides show some binding selectivity, but there is no consistent association between a peptide family and a particular receptor mechanism. Four of the families begin as large polypeptide molecules that are subsequently cleaved to yield sev-

eral opioid (and some nonopioid) peptides. Although some of these peptides undoubtedly function in nociceptive pathways, they also appear to play fundamental roles in processes like thermoregulation and hormone release, as well as gastrointestinal and cardiovascular control.

1. The *enkephalins* are pentapeptides derived from proenkephalin A. Each molecule of proenkephalin contains four sequences of met-enkephalin (Tyr-Gly-Gly-Phe-Met), one copy of leu-enkephalin (Tyr-Gly-Gly-Phe-Leu), and some slightly larger enkephalin-like peptides. The enkephalins are moderately selective for  $\delta$  receptors and probably act as neurotransmitters released from short interneurons within the spinal cord and brainstem. They are found in the adrenal medulla and in nerve terminals that contain catecholamines. Enkephalins (and exogenous opioids) bind to presynaptic opioid receptors on nociceptive neurons containing neurotransmitters like substance P. Inhibition of substance P release is an important mechanism of opioid analgesia. The naturally occurring enkephalins are hydrolyzed extremely rapidly by peptidases in plasma. Stable analogues of the enkephalins have been synthesized, permitting *in vivo* experiments on their actions.
2. *Prodynorphin* (also called proenkephalin B) contains the sequences for dynorphin A and dynorphin B. The dynorphins are the endogenous ligands at the  $\kappa$  receptor, and their distribution is similar to that of the enkephalins. The 5 amino acids at the N-terminus of the dynorphins are identical in sequence to leu-enkephalin.
3. Proopiomelanocortin (POMC) contains a multitude of opioid and non-opioid peptides and is found in high concentrations in the anterior pituitary gland and the hypothalamus. The N-terminus of POMC is identical to met-enkephalin, although POMC is not cleaved to yield met-enkephalin. The final 31 amino acids form  $\beta$ -endorphin, the most important of the humoral endogenous opioids, and an important endogenous ligand at the  $\mu$  receptor. In addition, selective cleavage of POMC yields many nonopioid hormones including adrenocorticotrophic hormone (ACTH), several var-

ieties of melanocyte-stimulating hormone (MSH), and the lipotropins.

4. *Proorphanin* is cleaved to orphanin FQ (also called nociceptin), a peptide containing 17 amino acids. Although proorphanin has significant sequence homology with the other 3 parent opioid peptides, orphanin FQ does not bind to  $\mu$ ,  $\kappa$ , or  $\delta$  receptors. It binds to a G-protein coupled receptor (NOP) and causes cellular responses similar to other opioids, including inhibition of adenyl cyclase, opening of the inwardly rectifying potassium channel, and blocking N-type calcium channels.<sup>97</sup> Orphanin FQ is found in unusual places like hippocampus and sensory cortex. It has a supraspinal antianalgesic effect while producing spinal analgesia. Its possible roles in pain modulation, learning, and drug reward are topics for much current research.
5. The *endomorphins* appear to be endogenous agonists that have high affinity and high selectivity for the  $\mu$  receptor. A precursor molecule for the endomorphins has not yet been identified. The tetrapeptide Tyr-Pro-Trp-Phe-NH<sub>2</sub> is called endomorphin-1, and a related peptide, Tyr-Pro-Phe-Phe-NH<sub>2</sub>, is called endomorphin-2.<sup>171</sup> *In vivo* studies suggest that endomorphin-1 acts via stimulation of  $\mu_2$  receptors. Endomorphin-2 is less specific, acting at both  $\mu$  and  $\kappa$  receptors. These peptides have both *in vitro* and *in vivo* cardiovascular effects. They decrease spontaneous discharge in the rostral ventrolateral medulla (RVLM), an area important in the central control of blood pressure. Peripherally, they decrease norepinephrine release from vascular sympathetic neurons.

When nature creates an interesting and useful molecule, it is often found at work across wide expanses of the plant and/or animal kingdoms. Thyroid hormone is an excellent example of a simple, small molecule whose structure has been conserved for millions of years. Morphine, too, may be such an example. Although the poppy flower may possess the machinery to manufacture morphine in large quantities, mammalian systems may also synthesize morphine from tyrosine precursors, using apparently the same reaction scheme. The significance of endogenous morphine is unknown, but it is interesting

that arthritic rats make more morphine than do healthy ones.<sup>35,165</sup>

## OPIOID AGONISTS

### General Properties

The most widely used opioid analgesics are the pure agonists, and all of these are relatively selective for  $\mu$ -opioid receptors. Unlike the volatile anesthetics, opioid agonists produce a group of highly specific depressant and stimulant effects by acting at discrete sites within the central nervous system. For example, morphine stimulates the vagal nuclei in the medulla while depressing ventilatory centers only a few millimeters away. Box 41-1 lists the acute and chronic effects of opioids.

Given their common mechanism of action, it is easy to see why morphine, meperidine, fentanyl, and the fentanyl congeners have very similar pharmacodynamic effects. The few qualitative differences between them (e.g., histamine release) usually do not involve specific opioid receptor mechanisms. However, the various opioids differ greatly in their physicochemical properties, as well as in speed of onset and duration of action, so the clinical selection of an opioid is frequently based on pharmacokinetic considerations. Opioid pharmacokinetics are considered later in the discussion of specific agonist drugs.

#### BOX 41-1.

##### Acute and Chronic Effects of Opioids

###### Acute

Analgesia  
 Ventilatory depression  
 Sedation  
 Euphoria  
 Vasodilatation  
 Bradycardia  
 Cough suppression  
 Miosis  
 Nausea and vomiting  
 Skeletal muscle rigidity  
 Smooth muscle spasm.  
 Constipation  
 Urinary retention  
 Biliary spasm

###### Chronic

Tolerance  
 Physical dependence

TABLE 41-1.

Dose, Time to Peak Effect, and Duration of Analgesia for Intravenous Opioid Agonists and Agonist-Antagonists<sup>a</sup>

Opioid	Dose (mg) <sup>b</sup>	Peak (min)	Duration (h) <sup>c</sup>
Morphine	10	>30	3-4
Meperidine	80	5-7	2-3
Hydromorphone	1.5	10-20	2-3
Methadone	10	15-20	3-4
Tramadol <sup>d</sup>	100	<30	4-6
Fentanyl	0.1	3-5	0.5-1
Sufentanil	0.01	3-5	0.5-1
Alfentanil	0.75	1.5-2	0.2-0.3
Remifentanyl	0.1	1.5-2	0.1-0.2
Pentazocine	60	15-20	2-3
Butorphanol	2	15-20	2-3
Nalbuphine	10	15-20	3-4
Buprenorphine	0.3	<30	5-6

<sup>a</sup>Data for fentanyl derivatives are derived from intraoperative studies, the remainder from postoperative pain studies.

<sup>b</sup>Approximately equianalgesic doses (see text).

<sup>c</sup>Average duration of first, single dose.

<sup>d</sup>Intravenous tramadol not available in the United States.

## CNS Effects

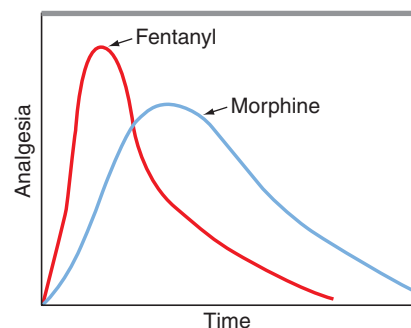
**Analgesia and Mood Effects** The opioids produce selective relief of pain at doses that do not produce sleep or impair sensation. Opioid analgesic effects result from actions at several different levels of the neuraxis. The processing of pain information is inhibited by a direct spinal effect at the dorsal horn; the rostral transmission of pain signals is decreased by activation of descending inhibitory pathways in the brainstem<sup>1</sup>; finally, the emotional response to pain is altered by opioid actions on the limbic cortex. Opioids also act at receptors located peripherally on sensory and smooth muscle motor neurons.<sup>146</sup>

Opioids affect both the perception of pain and the response to pain, but it is difficult to make the distinction in most clinical circumstances. Patients given morphine will typically report that pain is still present, but the intensity is decreased and it no longer bothers them as much. The relief of pain and anxiety will often result in sleep, but sometimes mood elevation or frank euphoria can occur. The euphoriant effect or sense of well-being produced by opioid agonists is thought to be one of the most important reasons for their abuse.

Sufficient doses of opioids will relieve almost any pain, although some types of pain are typically more re-

sponsive than others. Prolonged, burning pain, for example, is more effectively blunted than the brief, sharp pain of an incision. Neuropathic pain (e.g., pain of nerve root compression) can be very resistant to opioid treatment.<sup>33,37</sup> Intraoperatively, the opioids can produce sufficient analgesia to reduce or abolish autonomic and somatic responses to surgical stimuli. In this circumstance, they are almost always combined with other central nervous system depressants (see discussion on Intraoperative Use of Opioids).

Table 41-1 lists some commonly used opioid agonists along with their recommended doses and durations of action. The relative potencies of most older opioids have been determined in postoperative pain models, whereas those for the fentanyl series are from intraoperative studies. The doses in the table are for comparison only, and the actual doses given during administration of anesthesia will vary greatly depending on the application. "Equianalgesic" doses can be very difficult to determine when bolus doses of opioids with very different analgesic time-effect curves are being compared (Fig. 41-4). Fentanyl is often stated to have 80-100 times the potency of morphine, a figure that takes into account both the intensity and duration of effect (i.e., the area under the curve is measured). If one considered only the



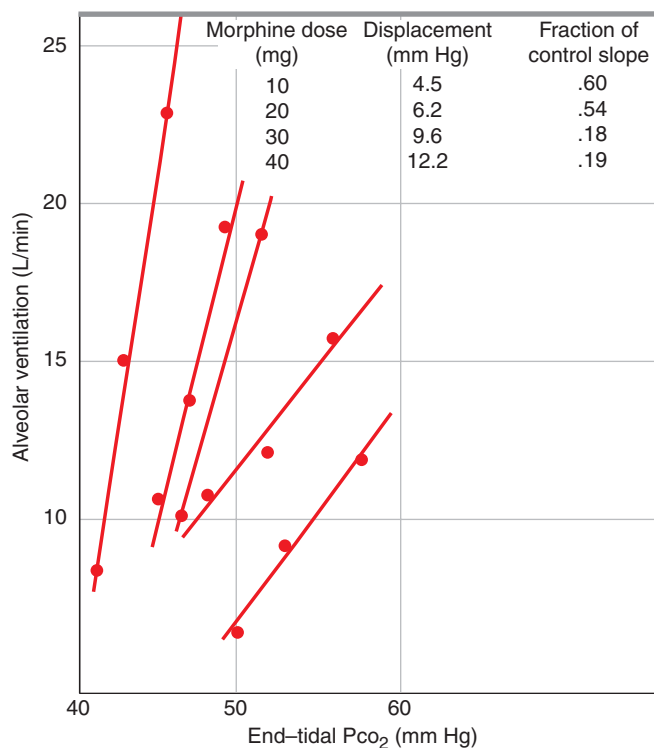
**FIGURE 41-4.** Idealized time-effect curves for fentanyl and morphine. Estimated potency of fentanyl is higher if only peak analgesia is considered and duration ignored (see text).

peak intensity of effect, fentanyl might appear to be 200 times more potent than morphine. Because the anesthesiologist typically looks for peak analgesic and toxic effects following an intravenous bolus, the latter number might be more useful.

**Sedation-Hypnosis** In usual analgesic doses, morphine-like drugs may produce drowsiness, feelings of heaviness, and difficulty concentrating. Unlike benzodiazepines, opioids do not usually produce amnesia in subhypnotic doses. At higher doses sedation becomes more pronounced, and, eventually, hypnosis may occur. Doses of opioids that are sufficient to produce apnea and profound analgesia do not always produce sleep in healthy individuals.<sup>9</sup> The use of opioids alone to produce both hypnosis and analgesia has resulted in numerous cases of intraoperative awareness. Sleep is much more likely to occur in elderly or debilitated patients or in those given small doses of benzodiazepines.<sup>138</sup> High doses of morphine, fentanyl, or its congeners produce a cortical electroencephalogram (EEG) pattern that is superficially similar to deep sleep.<sup>134</sup> The average frequency decreases, and large-amplitude delta waves predominate. Unlike the intravenous or inhaled anesthetics, high doses of opioids will not produce EEG burst suppression.

**CNS Toxicity** Dysphoria and agitation occur infrequently after analgesic doses of most opioids, although their incidence is higher with meperidine and codeine. True seizures can be produced by meperidine because its major metabolite, normeperidine, is a potent convulsant. This is most likely to occur after large doses, or if the





**FIGURE 41-5.** CO<sub>2</sub> response curves from one subject who received 4 doses of morphine 10 mg intravenously at 40-minute intervals. Reprinted, with permission, from the Annual Review of Pharmacology and Toxicology, Volume 41 © 1985 by Annual Reviews. www.annualreviews.org

patient has renal failure and cannot excrete the metabolite<sup>26</sup> (see Specific Drugs).

In laboratory animals, extremely high doses of morphine or fentanyl can produce seizure activity, but this does not occur at the concentrations achieved in clinical practice.<sup>98</sup> Opioid-induced hypertonus of skeletal muscle (see Muscle Rigidity) can sometimes lead to myoclonic movements that have been mistaken for seizures.

Administration of opioids can raise cerebrospinal fluid pressure if ventilation is not controlled, and P<sub>a</sub>CO<sub>2</sub> is allowed to rise. Opioid premedication should generally be avoided when elevated intracranial pressure (ICP) is suspected; ICP may rise further, and the opioid effects may mask changing neurologic signs. These drugs are very useful, however, during induction of anesthesia in neurosurgical patients. When ventilation is controlled, fentanyl and sufentanil have little effect on cerebral metabolic rate and blood flow, and therefore do not increase ICP.<sup>94,137</sup>

**Ventilatory Depression** Opioids produce a dose-related depression of the ventilatory response to CO<sub>2</sub> by a

direct effect on ventilatory centers in the medulla.<sup>73</sup> Morphine also blunts the response to hypoxia.<sup>161</sup> In awake subjects given an analgesic dose of morphine, the intercept of the CO<sub>2</sub> response curve is shifted to the right, and (depending on the measurement technique) there may also be a decrease in slope (Fig. 41-5).<sup>32</sup> Both the rate and the rhythm of breathing are affected: as the dose of opioid is increased, ventilatory rate will slow, but the effect of this may be partially offset by an increase in tidal volume. It is important to remember that a decrease in ventilatory rate is not a very sensitive indicator of opioid effect. A patient's drive to breathe may be abnormal despite an apparently normal ventilatory rate and state of consciousness. Sleep will further depress the response to CO<sub>2</sub> and potentiate the ventilatory depression caused by opioids.<sup>42</sup>

At usual analgesic doses the opioids rarely cause clinically significant ventilatory depression unless there is pre-existing pathology (such as hypothyroidism or pulmonary or CNS disease) or previous drug administration (alcohol, general anesthetics, or benzodiazepines). Patients with obstructive sleep apnea are at increased risk for

opioid-induced ventilatory depression, and postoperative use of opioid analgesics in such patients may warrant increased monitoring as compared to patients without sleep apnea.<sup>14,26</sup>

Very large doses of opioids will eventually result in inadequate ventilation. Breathing may become irregular or even take on a Cheyne-Stokes pattern. There may be complete inattention to breathing; otherwise responsive patients may hypoventilate to the point of cyanosis unless they are reminded to breathe. Ventilatory depression is, of course, the major toxicity of opioids and nearly always the cause of death from overdose.

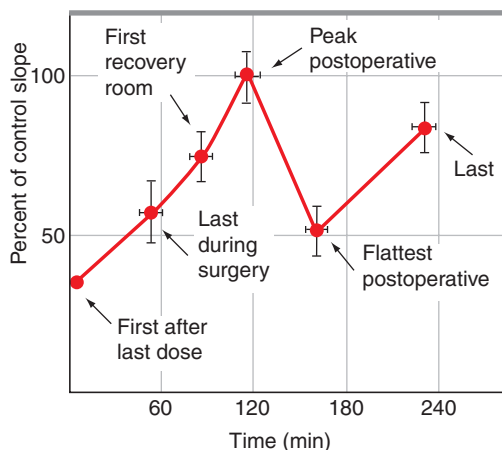
Equianalgesic doses of all opioids produce equivalent amounts of ventilatory depression. There is no convincing evidence that any analgesic is more or less dangerous than morphine in this regard. Despite experimental evidence that analgesia and ventilatory depression may be mediated by different receptor subtypes ( $\mu_1$  and  $\mu_2$ , respectively), no highly selective agonist or antagonist has been developed for clinical use.<sup>108</sup>

Both analgesia and ventilatory depression are reduced by administration of an opioid antagonist or by the development of tolerance. This has two important clinical implications:

1. Tolerant individuals who require large amounts of opioid for relief of pain are not at proportionately increased risk of ventilatory depression.
2. Ventilatory depression is difficult to reverse without reversing some analgesia (see Naloxone below).

A number of case reports have described "recurrent" or "delayed" ventilatory depression after administration of anesthetics with fentanyl or alfentanil. Becker et al.<sup>11</sup> showed that CO<sub>2</sub> sensitivity could recover after fentanyl-N<sub>2</sub>O anesthesia, only to decline once again over the next hour (Fig. 41-6). It is likely that these events are actually caused by varying levels of stimulation: opioid-induced ventilatory depression is antagonized by pain and movement during emergence and transfer to the recovery area; it may reappear if the patient goes back to sleep.

**Cough Suppression** Opioids suppress cough by depressing cough centers in the medulla. This effect apparently involves different receptor mechanisms than those mediating an-



**FIGURE 41-6.** Recurrent ventilatory depression expressed as slope of CO<sub>2</sub> response curve (percentage of awake control) vs. time. First data point obtained after last intraoperative dose of fentanyl. Response recovered, then subsequently declined when patients were no longer stimulated (see text). (Reproduced with permission from Becker LD, Paulson BA, Miller RD, et al. Biphasic respiratory depression after fentanyl-droperidol or fentanyl alone used to supplement nitrous oxide anesthesia. *Anesthesiology* 1976;44:291.)

algnesia or ventilatory depression. Some animal data suggest that peripheral opioid receptors may be involved as well. Cough is effectively suppressed by stereoisomers of opioids (e.g., dextromethorphan) that have no analgesic activity. The molecular modification that selectively increases antitussive potency is replacement of the 3-hydroxyl group on morphine with a bulkier group. Thus, cough suppression is strong with heroin (3-acetoxy-) and codeine (3-methoxy-), but weak with meperidine (no functional group).

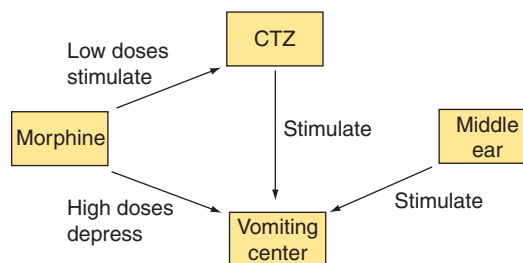
**Pupillary Constriction** Opioids stimulate the Edinger-Westphal nucleus of the oculomotor nerve to produce miosis.<sup>83</sup> The pinpoint pupil is a pathognomonic sign of opioid overdose (unless hypoxia is severe enough to produce mydriasis). Miosis is rapidly reversed with naloxone. Miosis occurs after relatively small doses of opioids, and reaches a plateau after moderate doses, so it is not a very useful way to grade the intensity of opioid effect following larger doses.<sup>32,75</sup> Absence of miosis, however, suggests absence of opioid effect.

**Nausea and Vomiting** Opioids produce complex effects on vomiting centers in the medulla (Fig. 41-7). There is direct stimulation of the chemoreceptor trigger zone (CTZ) in the area postrema on the floor of the fourth ventricle. This, in turn, activates the vomiting center proper, which is a deeper structure.<sup>157</sup> The emetic effects are markedly

potentiated by stimulation of the vestibular apparatus, so ambulatory patients are much more likely to vomit than those patients who are lying quietly. Postoperatively, patients frequently become nauseated when they have to move from stretcher to bed. Costello has shown that high doses of opioids can actually have antiemetic effects by depressing the vomiting center proper.<sup>25</sup> It is not clear at which dose a given opioid becomes antiemetic.

Tolerance can occur to the emetic effects of opioids, but treatment with antagonists may often make the symptoms worse. The emetic effects involve a complex interaction of dopaminergic, cholinergic, and serotonergic mechanisms, and opioid-induced nausea and vomiting may be treated successfully with a wide variety of antiemetic drugs that block these neurotransmitter systems.

**Muscle Rigidity** The opioids have no significant effects on nerve conduc-



**FIGURE 41-7.** Mechanisms of opioid-induced nausea and vomiting (see text for details). (Reproduced with permission from Rosow CE. *Newer synthetic opioid analgesics*. In: Smith G, Covino BG, eds. *Acute Pain*. London: Butterworths, 1985 p.74.)

tion, at the neuromuscular junction or at the skeletal muscle membrane. In animals they produce minimal depression of monosynaptic and polysynaptic spinal reflexes, but the clinical relevance of this is not known. A much more important effect is the generalized hypertonus of skeletal muscle, which can be produced by large intravenous doses of most opioid agonists. Although morphine can produce rigidity, the problem is most commonly associated with fentanyl, alfentanil, sufentanil, and remifentanyl.

Opioid-induced rigidity was originally thought to be restricted to the abdominal and thoracic musculature, but it is now known that muscles of the neck and extremities are involved as well.<sup>13</sup> The incidence and severity of the problem are greatest when large amounts of opioids are infused rapidly, but rigidity can occur with doses of only 1–2 µg/kg of fentanyl. This effect is usually seen during induction of anesthesia, just at loss of consciousness. When very large amounts of opioid have been administered (e.g., for cardiac surgery), rigidity may occur upon emergence. Rigidity is more likely to occur in older patients and when nitrous oxide is administered along with the opioid.<sup>128</sup>

In its most severe form, “lead pipe” muscle rigidity can totally prevent mechanical ventilation. The difficulty is caused, in part, by loss of chest wall compliance, as well as by constriction of laryngeal and pharyngeal muscles. Some suggest that supraglottic obstruction is the more important problem.<sup>128</sup> Substantial amounts of positive pressure are sometimes needed for effective ventilation, which can lead to decreased venous return, gastric insufflation, and so forth. Such rigidity is substantially mitigated by pretreatment with midazolam or diazepam (and to a lesser degree with thiopental).<sup>128</sup>

Opioids are believed to produce rigidity by actions at  $\mu$  receptors in the striatum. Opioids increase the rate of striatal dopamine biosynthesis and inhibit the release of the inhibitory neurotransmitter  $\gamma$ -aminobutyric acid (GABA).<sup>24</sup> Antagonism of this effect on GABA may account for the beneficial effects of sedative-hypnotics. In the rat, microinjection of opioid antagonists at certain raphe nuclei will selectively block rigidity.<sup>163</sup>

### Cardiovascular Effects

At normal analgesic doses opioids produce minimal cardiovascular effects. Bradycardia and peripheral vasodilatation are seen at higher doses and when opioids are combined with other anesthetic drugs.

Opioids produce bradycardia by a specific stimulant effect on the central nuclei of the vagus nerves. In animals, microinjection of naloxone at these sites antagonizes the bradycardia, but not the analgesia, produced by intravenous fentanyl.<sup>81</sup> The bradycardic effect is most likely to occur when large doses of opioids are administered rapidly. It may be prevented or reversed by atropine, pancuronium, and other vagolytic drugs. Opioid-induced bradycardia may be more frequent when a relaxant such as vecuronium is used because it lacks vagal blocking effects. Meperidine, which is weakly atropinic, does not usually cause bradycardia.

The opioid-induced increase in vagal tone leads to a prolongation of atrioventricular (AV) conduction. There is also evidence of a direct depressant effect on the sinoatrial (SA) node.<sup>152</sup> Morphine and fentanyl decrease central sympathetic tone, which raises the threshold for ventricular fibrillation in the dog.<sup>126</sup>

Opioids produce peripheral vasodilatation by depressing vasomotor centers in the medulla. Analgesic doses frequently cause orthostatic hypotension, and higher doses may significantly reduce venous return. The peripheral vascular effects involve both resistance and capacitance vessels.<sup>60</sup> Zelis showed that an analgesic dose of morphine increases blood flow through forearm skeletal muscle without altering systemic pressure.<sup>171</sup> This effect is thought to represent a centrally mediated lysis of sympathetic tone. Lowenstein et al. demonstrated that morphine's effect on skeletal muscle vascular resistance is neurally mediated and markedly increased under conditions of high sym-

pathetic activity.<sup>87</sup> This is consistent with the clinical observations that opioids are more apt to cause hypotension in patients with conditions that elevate the baseline level of sympathetic tone (e.g., hypovolemia, coronary artery disease, congestive failure).

A number of studies have documented a direct effect of opioids on vascular smooth muscle, but its contribution to overall hemodynamic effects is unclear.<sup>59</sup> Morphine, but not enkephalin analogues, can bind to a  $\mu_3$  receptor on arterial endothelial cells and cause vasodilatation by releasing nitric oxide.<sup>20</sup> For morphine, some vasodilatation is caused by the release of histamine.

Venodilation may lead to significant pooling of blood, especially in the splanchnic vasculature.<sup>83</sup> There is evidence in the dog that morphine causes blood to be sequestered in hepatic sinusoids.<sup>53</sup> In both humans and animals, opioid-induced venodilation seems to occur later and last longer than the effect on arterioles.<sup>60,64</sup>

At clinically relevant concentrations the opioids do not produce significant myocardial depression. Unlike the volatile anesthetics, morphine does not block arteriolar constriction in response to sympathetic nerve stimulation or circulating catecholamines.<sup>158</sup> Unlike the volatile anesthetics, fentanyl (even when combined with a benzodiazepine) does not block high- or low-pressure baroreceptor responses.<sup>36</sup> The combination of slow heart rate, peripheral vasodilatation, minimal myocardial effects, and preservation of autonomic function makes opioid-based anesthesia particularly useful for critically ill patients with cardiac ischemia or failure. When hypotension does occur, it frequently responds to simple measures like administration of intravenous fluids.

### Histamine Release

True allergic responses to opioids are very rare, although anaphylaxis to fentanyl and meperidine has been reported. Some opioids, particularly morphine and meperidine, produce a nonimmunologic release of histamine from circulating basophils and tissue mast cells. This is most often seen as local itching, redness, or hives near the site of intravenous injection. Sometimes a patient will experience generalized flushing. If sufficient histamine is liberated, it may cause decreased systemic vascular resistance, hypoten-

sion, and tachycardia.<sup>123</sup> The cardiovascular effects (but not the histamine release) may be prevented by pretreatment with  $H_1$  and  $H_2$  antagonists like chlorpheniramine and cimetidine.<sup>110</sup>

This is a nonspecific effect that depends upon competitive displacement of the amine by opioid molecules. Mast cell degranulation is more likely to occur in some sites (e.g., skin) than others (lung, GI tract).<sup>151</sup> Because the more potent opioids expose tissue mast cells to lower opioid concentrations, they are less likely to cause release. The potent opioids fentanyl, sufentanil, alfentanil, and remifentanyl do not release histamine<sup>41,124,138</sup> (Fig. 41-8). Chemical structure also influences this process, because even equimolar concentrations of fentanyl and morphine do not cause equivalent histamine release.<sup>62</sup>

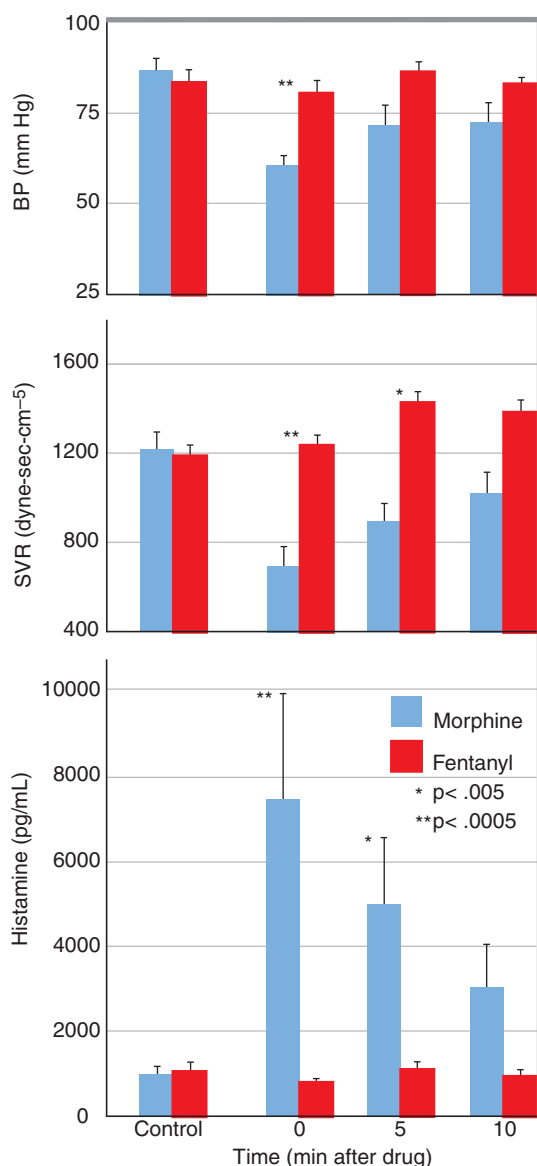
Histamine release does not usually cause bronchospasm, but opioids should still be used with great care on patients with asthma. These drugs may exacerbate preexisting bronchospasm by depressing cough and ventilatory drive, and by drying airway secretions.

### Pruritus

Patients given opioids frequently complain of itching and warmth over the neck and face, especially over the malar area. Neuraxial administration of opioids (especially intrathecal) can often produce very troublesome generalized itching.<sup>10</sup> This effect is an opioid receptor-mediated dysesthesia, and it can be produced by opioids like fentanyl that do not release histamine. The itching is not antagonized by antihistamines, but it may be reversed with opioid antagonists.

### Smooth Muscle Effects

**Intestine and Stomach** Opioids decrease the passage of fluids and solids at every level of the GI tract—so-called opioid bowel dysfunction (OBD). They delay gastric emptying and increase antral tone, and these effects may slow the absorption of oral medications that are administered concomitantly. Food may not pass into the proximal jejunum for many hours, so surgical patients given opioids preoperatively may remain at risk for aspiration despite nominal NPO status. Chronic administration of opioids usually necessitates the administration of laxatives and stool softeners to treat constipation. Meperidine and some of the agonist-antagonist opioids



**FIGURE 41-8.** Plasma histamine increases while mean arterial pressure (BP) and systemic vascular resistance (SVR) decrease in cardiac surgical patients given morphine 1 mg/kg, IV. These effects do not occur after fentanyl 50  $\mu$ g/kg, IV. (Reproduced with permission from Rosow CE, Moss J, Philbin DM, et al. Histamine release during morphine and fentanyl anesthesia. *Anesthesiology* 1982;56:93.)

are less likely to cause this effect. OBD can be reversed or prevented by the use of opioid antagonists that act peripherally (see Opioid Antagonists).

The constipating effect is caused by a combination of decreased intestinal fluid production and increased fluid absorption as the passage of intestinal contents is delayed. Opioids decrease GI secretory activity by direct effects on intestinal secretory cells and by modulation of sympathetic transmission in the enteric nervous system. The decrease in GI motility involves both CNS effects and peripheral actions on opioid receptors in the bowel.<sup>78</sup> In the small bowel, there is initial

stimulation of activity followed by atony. The stimulation produces segmenting, nonpropulsive contractions that prolong intestinal transit time. Opioids increase GI sphincter tone and cause an increase in colonic tone. The increase in resting colonic tone is especially pronounced in patients with ulcerative colitis, and opioids may predispose these patients to the development of toxic megacolon.

Opioids may also be used therapeutically in the treatment of diarrheal syndromes. Treatment of diarrhea is usually accomplished with orally administered drugs like diphenoxylate and loperamide. Therapeutic doses of

these drugs do not usually produce central effects because they are poorly absorbed, and loperamide is actively pumped from the CNS by a P-glycoprotein transporter.

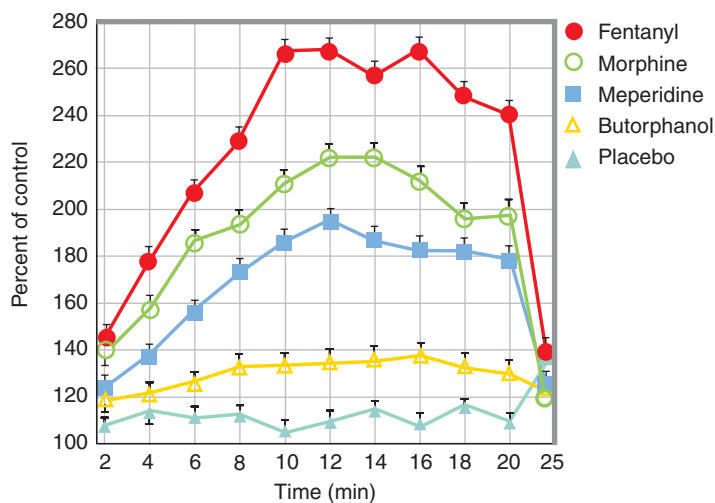
**Biliary System** Opioids cause contraction of smooth muscle in the gall bladder and spasm of the sphincter of Oddi. In some individuals this can precipitate biliary colic. Intraoperatively, the same effect has been reported to cause false-positive cholangiograms and even to prevent instrumentation of the common duct. The biliary effects may be completely antagonized by naloxone and partially reversed by glucagon, nitroglycerin, or atropine.<sup>5,119</sup> The biliary effects of full agonists (including meperidine) appear to be similar when the medications are given at equianalgesic doses, while the agonist-antagonist opioids have much smaller smooth muscle effects<sup>119</sup> (Fig. 41-9).

**Urinary Tract** Opioids increase the contractions of the ureter although they relieve the pain caused by ureteral stones. They also decrease detrusor contraction in response to bladder distension (the voiding reflex) and increase the tone of the urinary sphincter by both central and peripheral mechanisms.<sup>36</sup> This may cause a sense of urinary urgency but an inability to void. Sufficient opioid may also eliminate urgency; that is, the patient may become inattentive to the stimulus of bladder distension. Urinary retention occurs much more commonly in men, and it is an especially frequent side effect when opioids are administered into the subarachnoid or lumbar epidural spaces.

### Hormonal Effects

Morphine inhibits the release of gonadotropin-releasing hormone and corticotropin-releasing factor by acting on the hypothalamus.<sup>155</sup> The concentrations of testosterone and cortisol in plasma are decreased because the secretion of pituitary trophic hormones is inhibited.<sup>21</sup> Opioids also increase plasma levels of certain hormones such as growth hormone and prolactin. Over the short term, most of these hormonal changes are probably not clinically significant. Perhaps more importantly, surgery and pain can produce large increases in many hormones (the so-called stress response), and opioids are able to blunt or abolish these responses (see Intraoperative Use of Opioids below).





**FIGURE 41-9.** Percentage change in common bile duct pressure versus time following equianalgesic doses of several opioids. Patients were undergoing cholecystectomy with basal enflurane anesthesia. After 20 minutes, the effect was reversed by naloxone. (Reproduced with permission from Radnay PA, Duncalf D, Novakovic M, et al. Common bile duct pressure changes after fentanyl, morphine, meperidine, butorphanol and naloxone. *Anesth Analg* 1984;63:441.)

### Immune Effects

For many years there have been reports about the immunosuppressive effects of opioids. In animal models, there is evidence that opioids suppress resistance to infection and may promote metastatic spread of tumors. Heroin addicts have increased incidences of many different infections, although multiple factors are undoubtedly involved in this setting. Opioid-induced immunosuppression is probably mediated by effects on both peripheral immune cells and the central nervous system. Opioids decrease natural killer cell activity, lymphocyte proliferation, antibody production, and nuclear factor kappa B (NF- $\kappa$ B) activation in neutrophils.<sup>161</sup> Many of these effects are blocked in  $\mu$ -receptor knockout mice, and some are blocked by opioid antagonists.<sup>49</sup>

The clinical impact of all this is still unknown and it is likely to be complex. Opioid agonists do not all produce the same effects on immune cells, and untreated pain can also be immunosuppressive. This research may have important implications, particularly for patients with chronic pain, those in methadone programs, and hospitalized patients given very large doses of opioids.

### Effects on Pregnancy and the Neonate

Opioids have no specific teratogenic effects, but chronic opioid use by the mother may lead to physical dependence in the fetus. Neonatal withdraw-

al may occur shortly following delivery, and, in some instances, may be life-threatening. Parenteral opioids are commonly used to treat labor pain. Because opioids cross the placenta readily, they can cause ventilatory depression in the neonate. Morphine produces more depression in the neonate than meperidine.<sup>160</sup> The newborn infant has an incompletely developed blood-brain barrier, so a dose of morphine that is appropriate for the mother may produce excessive effects in the baby. Meperidine is more lipophilic, and its effects in mother and infant are more comparable. Opioids take time to accumulate in the fetus, so the neonate may actually be less affected if the opioid is given very close to the time of delivery. Naloxone may be required to reverse the effects of meperidine given repeatedly during a long labor.

Opioid agonist-antagonist agents like nalbuphine and butorphanol are popular for use in laboring women. Because they produce less ventilatory depression at higher doses than full agonists (See Opioid Agonist-Antagonists), they are thought to be safer for mother and child; however, convincing controlled trials are lacking.

### Tolerance

There appear to be two types of tolerance to opioid action. When a large dose is administered by bolus or rapid infusion, *acute tolerance* or *tachyphylaxis* may occur. Acute tolerance to a brief infusion of remifentanyl was report-

ed,<sup>157</sup> but this has been difficult to confirm.<sup>58,131</sup>

The more important problem of *chronic tolerance* occurs when opioids are administered frequently over longer periods of time. The first indication of tolerance is often a decrease in the duration of analgesia after each dose, but eventually the intensity of effect also declines. Tolerance may be overcome, in most cases, by an increase in the dose of the opioid. Cancer patients receiving very high doses or continuous neuraxial opioid administration can acquire profound tolerance, and huge doses may be needed to produce an adequate analgesic effect. Regional blocks and nonopioid analgesics may be necessary to produce adequate pain relief in these circumstances. In recent years, opioid tolerance has also become a common problem for mechanically ventilated ICU patients who receive fentanyl or morphine infusions for sedation.

When tolerance to an opioid occurs, there is simultaneous development of cross-tolerance to all other opioid agonists. In general, tolerance develops most rapidly to the effects we have described as depressant (analgesia, ventilatory depression, euphoria), but much less tolerance occurs to some of the stimulant effects like constipation or pupillary constriction. For example, a heroin addict who is placed on chronic methadone treatment becomes tolerant to the euphoriant effect but frequently continues to have miosis and constipation. Similarly, constipation is a common problem for the terminal cancer patient who requires large doses of morphine for relief of pain. As previously discussed, cross-tolerance among full agonists is often incomplete, perhaps because of the heterogeneity of  $\mu$ -receptor subtypes. A patient who is tolerant to one opioid can often get additional relief by switching to another—a process known as *opioid rotation*.<sup>39</sup>

The precise mechanisms of both acute and chronic tolerance are still unclear. Some of the mechanisms are similar to desensitization of other G-protein coupled receptors: receptor phosphorylation and internalization can occur, as well as activation of mitogen-activated protein kinases, adenylyl cyclase, and phosphokinase C. Confusingly, the mechanisms are not consistent for the various opioid receptors, not even for different ligands of the

TABLE 41–2.

## Physicochemical Properties of Some Opioid Agonists

Drug	pK <sub>a</sub>	% Ionized at pH 7.4	Partition Coefficient <sup>a</sup>
Morphine	7.9/9.4	76	0.7 <sup>125</sup> , 1.42 <sup>73</sup>
Meperidine	8.5	93	38.8 <sup>73</sup>
Hydromorphone	8.1 <sup>c</sup>	83	1.28 <sup>125</sup>
Fentanyl	8.4	91	717 <sup>125</sup> , 860 <sup>73</sup>
Sufentanil	8.0	80	1778 <sup>73</sup> , 2842 <sup>125</sup>
Alfentanil	6.5	11	130 <sup>73</sup>
Remifentanil	7.1	33	17.9 <sup>b</sup>

<sup>a</sup>The *n*-octanol/water partition coefficient (at 98.6°F [37°C], corrected for the percentage of drug un-ionized at pH 7.4) is a measure of lipid solubility.

<sup>b</sup>Data on file, GlaxoSmithKline Beecham Pharmaceuticals.

<sup>c</sup>Data on file, Purdue Pharma.

same receptor. Activation of glutamate (*N*-methyl-D-aspartate [NMDA]) receptors may play a role, and inhibitors of NMDA may reduce tolerance development.<sup>118</sup> A growing literature now suggests that chronic administration of opioids can actually activate some pain pathways (possible via NMDA activation and consequent nitric oxide production). This means that a part of what we term opioid “tolerance” may be a result of a hyperalgesic effect.<sup>76</sup>

### Physical Dependence

After sufficient doses have been administered for an adequate period of time, all opioids induce a state of physical dependence. Abruptly stopping the drug or administering an antagonist then causes a stereotypic withdrawal syndrome. The symptoms of withdrawal can be rapidly terminated with small doses of intravenous morphine.

Some authorities believe that medically induced physical dependence is common, and clinically imperceptible dependence may actually be present after only a few injections of a potent opioid. In most cases, “withdrawal”

may occur without the patient or physician being aware of it. Physical dependence is not the same thing as *psychological dependence* or *addiction*, which includes the dimension of compulsive drug-seeking behavior. The data of Porter and Jick suggest that addiction resulting from appropriate medical treatment is a very unusual event.<sup>114</sup> Irrational fear of causing patients to become addicted has been cited as a frequent cause for the inadequate treatment of acute pain.

When a patient with known physical dependence is to be detoxified (withdrawn), the patient is commonly switched to methadone, and the dose is reduced slowly. This produces a mild, although protracted, withdrawal syndrome. However, a person addicted to heroin or methadone who presents emergently for medical treatment is generally not an appropriate candidate for detoxification (see Chap. 23).

### Specific Drugs

As discussed previously, the onset or duration of effect is most often the basis for selection of a particular opio-

id. Chapter 39 discusses many of the pharmacokinetic properties of opioids. The clinically available opioid agonists vary greatly in their physicochemical properties and therefore in their absorption and distribution throughout the body. Table 41–2 lists important physicochemical properties of several opioids, and Table 41–3 lists pharmacokinetic parameters. It should be noted that there is tremendous variability in the published values for most of these pharmacokinetic parameters. Some of this variability reflects true differences between patient populations, whereas some is the result of sampling times and other technical aspects of measurement.

### Morphine

Morphine is the least lipophilic of the opioids listed,<sup>73,125</sup> and this has two important implications for its pharmacokinetics: morphine penetrates biologic membranes more slowly than lipophilic opioids, and it is less likely to accumulate in lipid membranes or fatty tissues. The plasma pharmacokinetics of morphine is similar to that of a fat-soluble drug. It is rapidly absorbed after intramuscular, subcutaneous, or oral administration. After an intravenous bolus, plasma concentrations decline rapidly as the drug is distributed into well-perfused tissues. Only about 25–35% is bound to plasma proteins, primarily albumin. The steady-state volume of distribution is very large, and it is probably made up of nonfatty tissues.

Morphine is a substrate for P-glycoprotein, an energy-dependent transporter molecule responsible for the efflux of many cationic compounds out of cells. What used to be called the blood-brain barrier for morphine is actually a combination of slow CNS penetration and rapid efflux. Togeth-

TABLE 41–3.

## Pharmacokinetic Properties of Some Opioid Agonists

	Morphine	Meperidine <sup>a</sup>	Hydromorphone	Fentanyl	Sufentanil	Alfentanil	Remifentanil
T <sub>1/2</sub> α (min)	1.7	7–11	1.27	1.0	1.4	0.67	0.9
T <sub>1/2</sub> β (min)	19.8	180	14.7	19	23	13	9.1
T <sub>1/2</sub> γ (min)	180	—	140–184	475	562	111	48
Vdss (L/kg)	3.2–4.7	2.8–4.2	4.1–4.4	3.2–4.2	2.5–3.0	0.4–1.0	0.2–0.3
Cl (mL/min/kg)	12.4–15.2	10.1–16.4	23–28	11.2–13.3	10–15	4–9	30–40
Protein binding (%)	30	64	8–19	84	92	92	80

Cl, clearance; T<sub>1/2</sub>, half-life; Vdss, steady state volume of distribution.

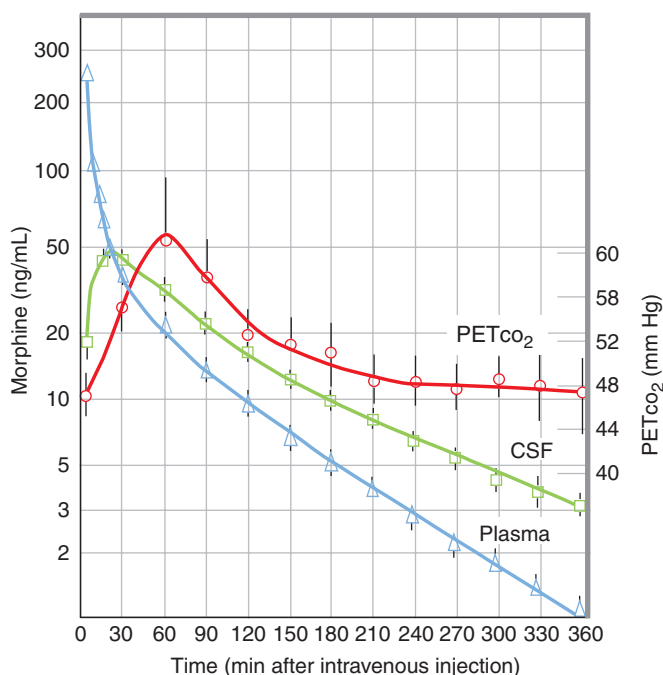
<sup>a</sup>Data fitted to two-compartment model.

er, these effects account for the relatively slow onset and low concentrations of morphine found in the brain after analgesic doses.<sup>85</sup>

Morphine is eliminated primarily by hepatic biotransformation with approximately 5–15% excreted unchanged in the urine. The rate of hepatic clearance is very high, and accounts for the relatively short 3-hour terminal half-life. The hepatic extraction of morphine is approximately 0.7; that is, 70% is cleared in 1 pass through the liver. Morphine therefore undergoes flow-dependent elimination, so factors that decrease hepatic blood flow will prolong its elimination. High hepatic clearance also means that morphine is subject to a large first-pass effect, and larger doses are required when the drug is given orally.

More than 90% of a dose of morphine is metabolized and excreted within 24 hours. The primary route of metabolism is conjugation in the liver to produce morphine 3-glucuronide and morphine 6-glucuronide. A small amount of morphine is *N*-demethylated to form normorphine.<sup>96</sup> These polar metabolites are then excreted in the urine and bile. Morphine 6-glucuronide (M6G), which may constitute 15% of total morphine metabolites, possesses morphine-like analgesic and respiratory depressant activity, although higher doses are required.<sup>121,122</sup> M6G is a substrate for a transporter protein distinct from the P-glycoprotein,<sup>140</sup> and it does not appear to contribute to the overall analgesia produced by morphine after a single or a few doses.<sup>139</sup> M6G may contribute more to the overall analgesic effect of morphine administered long-term.

The plasma pharmacokinetics of morphine does not parallel its clinical effects. In spite of morphine's rapid distribution and elimination from plasma, the changes in brain concentration are small and delayed. As a result, the onset and offset of analgesia are slow. In a study in human volunteers, the peak pupillary effect occurred 86 minutes after intravenous injection, although 90% of that effect was achieved within 22 minutes.<sup>32</sup> Hug demonstrated in dogs that peak ventilatory depression did not occur for 30–60 minutes following an intravenous bolus of morphine<sup>67</sup> (Fig. 41–10). During the recovery period, Hug showed that concentrations of morphine in cerebrospinal fluid declined more



**FIGURE 41–10.** Concentration of morphine in plasma and cerebrospinal fluid (CSF), and end-tidal CO<sub>2</sub> (PETCO<sub>2</sub>) versus time in 6 dogs given 0.3 mg/kg and allowed to breathe spontaneously (see text for details). (Reproduced with permission from Hug CC Jr, Murphy MR, Rigel EP, et al. Pharmacokinetics of morphine injected intravenously into the anesthetized dog. *Anesthesiology* 1981;54:38.)

slowly than those in plasma, and the decline in ventilatory depression was slower still.

### Meperidine

This substituted phenylpiperidine is significantly more lipid soluble than morphine, although its plasma pharmacokinetics is similar. The onset of the analgesic effect is faster than morphine, and the duration is shorter (2–3 hours). Meperidine is rapidly distributed into a large apparent volume of distribution, and it has a very high rate of clearance by hepatic biotransformation.<sup>91,156</sup> The high hepatic extraction means that meperidine undergoes significant (48–56%) first-pass metabolism. The terminal half-life has been estimated as 3–7 hours—which is similar to or longer than that of morphine. Meperidine is more highly protein bound than morphine (65–80%), and it is bound mainly to  $\alpha_1$ -acid glycoprotein.

Meperidine is rapidly *N*-demethylated to form normeperidine; the other major metabolites are meperidinic acid and normeperidinic acid. Less than 7% of a dose is excreted unchanged in the urine. The metabolism of meperidine plays a significant role in its pharmacodynamics. In the mouse, normeperidine is an analgesic with about half the potency of meperidine; unfortunately,

in both mouse and man it is a potent convulsant. Normeperidine has a terminal half-life of 8–12 hours, so significant amounts of this toxic metabolite can accumulate. Seizures have occurred in patients with renal failure (who could not excrete normeperidine) and in cancer patients who received high doses of meperidine over long periods of time.<sup>147</sup>

A large amount of data has been obtained on the correlation between meperidine plasma concentration and its pharmacodynamic effects. For meperidine, the relationship between plasma level and analgesia is both predictable and useful. Austin et al. titrated meperidine to analgesic effect in post-surgical patients. For each individual, the change from no pain relief to excellent pain relief occurred over a very narrow range of plasma concentrations, and this level was fairly consistent over a 2-day period.<sup>8</sup> In contrast, there was a large variability (40%) in meperidine requirement between individuals. These data are remarkably similar to those describing the relationship of alfentanil concentration to intraoperative analgesic response<sup>7</sup> (see Intraoperative Use of Opioids). The data on meperidine have been used to demonstrate why our traditional fixed-dosage regimens for relief of acute

pain often result in inadequate or excessive plasma concentrations.

Meperidine (or one of its metabolites) appears to have serotonin reuptake inhibitory effects.<sup>50</sup> This effect may form the basis for the well-described and potentially fatal interaction between meperidine and monoamine oxidase inhibitors. Patients chronically taking nonselective monoamine oxidase inhibitors who are given meperidine may suffer a serotonergic crisis manifested as clonus, agitation, hyperreflexia, and hyperthermia.

### Hydromorphone

Hydromorphone is an older, semisynthetic  $\mu$  agonist that has gained increasing popularity for a number of acute and chronic indications as an alternative to morphine. It is approximately 5–7 times more potent than morphine (although some data suggest as much as 10 times more potent), and it has a slightly shorter duration of action. It is cleared by hepatic glucuronidation with an approximate 62% first-pass metabolism. There is no active 6-glucuronide, but the 3-glucuronide can accumulate to produce neuroexcitation.

Hydromorphone is a hydrophilic drug with an octanol-water partition coefficient only slightly higher than that of morphine.<sup>125</sup> This probably explains the 10–20-minute delay in peak analgesic effect after an IV bolus dose, as well as the relatively poor correlation between plasma concentration and effect.<sup>23</sup> Its water solubility means that it can be prepared in concentrated solutions (up to 100 mg/mL), that are useful for highly tolerant patients or delivery with implanted infusion pumps. The low lipid solubility gives hydromorphone some of morphine's characteristics as a selective spinal analgesic. The epidural-to-parenteral equianalgesic ratio is 1:2, and the duration of a single epidural dose is estimated as being between 7.7 and 19.3 hours.<sup>102</sup> A few papers suggest that hydromorphone may produce fewer side effects (nausea, pruritus) than morphine, but the evidence for this is weak.

### Methadone

Methadone is a long-lasting synthetic  $\mu$  opioid approximately equipotent with morphine. Unlike most other opioids, methadone has very high oral bioavailability (approximately 80%). Compared to morphine, methadone is more lipid soluble and has higher tissue and plasma protein binding (to  $\alpha_1$ -

acid glycoprotein). Methadone has a very large volume of distribution and its clearance (by hepatic biotransformation) is low.<sup>68</sup> The redistribution kinetics of methadone is similar to that of morphine, so the drugs may have similar durations after single bolus doses. The terminal half-life of methadone is approximately 35 hours, and repeated oral or parenteral doses can result in substantial accumulation; subsequent doses appear to last much longer than the initial dose.

There is renewed interest in methadone for the therapy of chronic pain. The drug is available as a racemic mixture, and the *d*-isomer was long thought to have no activity. Recently *d*-methadone was demonstrated to be a noncompetitive glutamate (NMDA) antagonist in concentrations similar to those achieved with analgesic concentrations of the racemate. In animal models, *d*-methadone attenuates the development of opioid tolerance and blocks NMDA-induced hyperalgesia.<sup>69</sup> It is not known whether these benefits can be achieved in humans.

### Fentanyl

This potent synthetic opioid is extremely fat soluble, which accounts for its rapid onset and relatively short duration. After intravenous administration fentanyl is rapidly distributed to the brain, heart, and other highly perfused tissues,<sup>66</sup> and its peak effect occurs in only 3–5 minutes. Within a short time, the drug is distributed extensively throughout the body (steady-state volume of distribution is more than 4 L/kg), so plasma levels drop precipitously. Termination of effect occurs when fentanyl redistributes away from the central nervous system.

Plasma concentrations fall much more slowly during the elimination phase. Fentanyl is biotransformed in the liver to inactive metabolites, primarily norfentanyl and several hydroxylation products. Only 6–8% is excreted unchanged in the urine. The hepatic clearance of fentanyl is very high, and more than 60% is cleared in 1 pass. The large distribution volume, however, means that most of the drug remains extravascular and unavailable for biotransformation. The long terminal half-life of fentanyl (approximately 8 hours) is a function of the slow rate at which it reenters the central compartment.<sup>93</sup>

Fentanyl concentration in the plasma correlates well with cerebrospinal

fluid (CSF) concentration and pharmacodynamic effect.<sup>65</sup> Fentanyl plasma pharmacokinetics therefore predicts some of its more important pharmacodynamic properties:

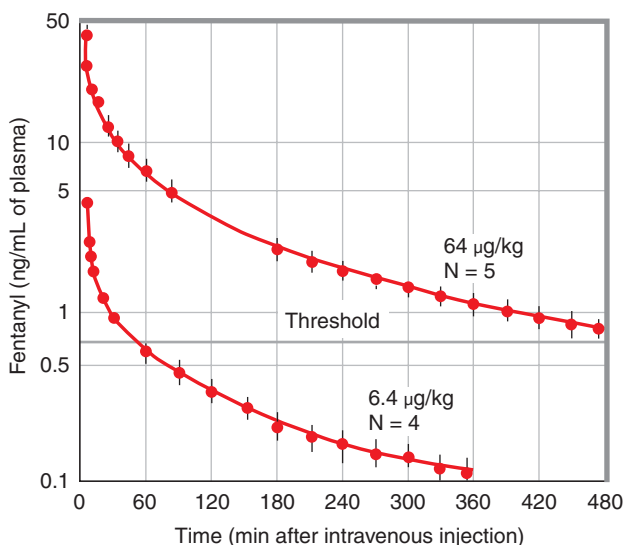
- The effects of low doses (e.g., 100–200  $\mu\text{g}$ ) are brief because they are terminated by rapid redistribution. After much higher doses (e.g., >20  $\mu\text{g}/\text{kg}$ ) redistribution may be insufficient to bring plasma concentrations to subtherapeutic levels. In this circumstance, termination of effect depends on the much slower elimination process, and the drug appears long-acting<sup>101</sup> (Fig. 41–11). The distribution and terminal half-lives do not change with dosage (fentanyl obeys first-order kinetics throughout the clinical dose range).
- A long terminal half-life means that repeated intravenous boluses of fentanyl are very likely to produce cumulative effects.
- A high hepatic extraction ratio (0.6) means the clearance of fentanyl is limited by hepatic blood flow. Factors that lower hepatic blood flow (e.g., intraabdominal surgery, cardiopulmonary bypass) can decrease elimination of fentanyl.
- Fentanyl undergoes substantial first-pass metabolism, so the oral route is inefficient. The drug is well absorbed when given transdermally, intranasally, or via the oral mucosa. These routes bypass the portal circulation and result in high blood levels of fentanyl.

### Alfentanil

Alfentanil is a slightly less potent congener of fentanyl, and has an extremely rapid onset and short duration of effect. Peak analgesic and ventilatory depressant effects occur in less than 2 minutes, and the duration of the effects of small doses (10  $\mu\text{g}/\text{kg}$ ) may last only 15 minutes. The pharmacokinetics of alfentanil is unusually well studied; Table 41–3 lists some of its more important pharmacokinetic parameters.

The pharmacokinetic behavior of fentanyl and alfentanil is qualitatively similar. A single bolus of alfentanil undergoes rapid redistribution followed by slower elimination. Termination of alfentanil effects after small doses still depends on redistribution, and the effects of larger doses (100–200  $\mu\text{g}/\text{kg}$ ) may be prolonged. Alfentanil is less lipophilic than fentanyl, and





**FIGURE 41-11.** Plasma concentration of fentanyl versus time in dogs given either 6.4 or 64 µg/kg intravenously. Threshold represents the concentration above which depression of ventilation occurs (see text for details). Effects of the lower dose are terminated by redistribution; those of the higher dose are terminated by elimination. (Reproduced with permission from Murphy MR, Olson WA, Hug CC Jr. Pharmacokinetics of  $^3\text{H}$ -fentanyl in the dog anesthetized with enflurane. *Anesthesiology* 1979;50:13.)

it has much less tendency to bind nonspecifically in muscle and fat. This is reflected in smaller initial and steady-state volumes of distribution.<sup>18</sup>

Alfentanil is rapidly metabolized by *N*-dealkylation and *O*-demethylation, and very little of the drug is excreted unchanged in the urine.<sup>18</sup> The relatively small steady-state volume of distribution is less than one fourth that of fentanyl, so the terminal half-life of alfentanil is only 1.5–2 hours in most healthy patients. Alfentanil is less likely than fentanyl to produce cumulative effects after repeated doses, and it

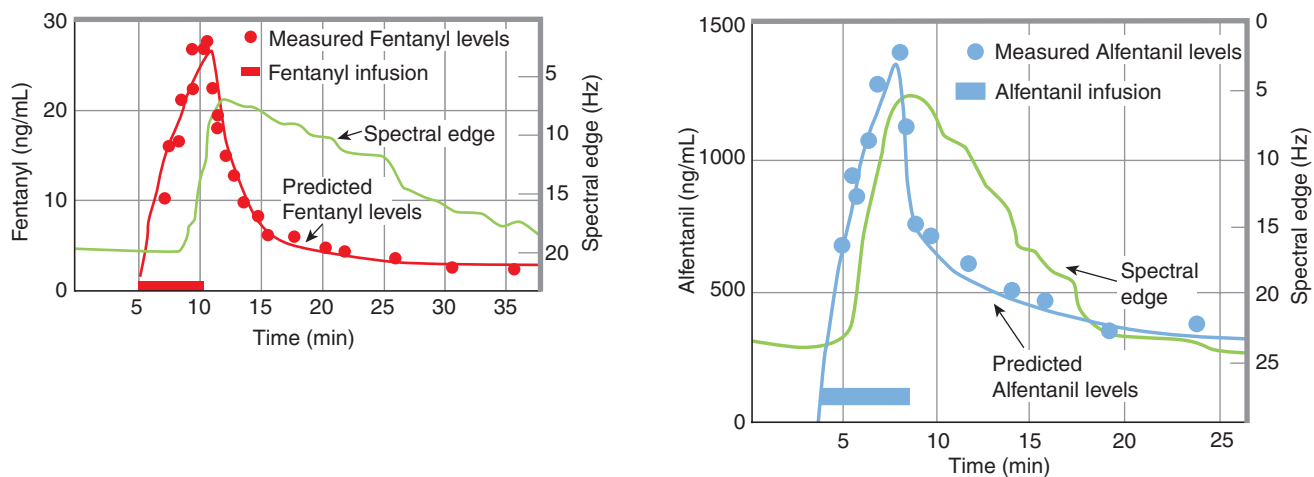
is a better choice for administration by continuous infusion.<sup>7,135</sup> For infusions of 2 hours or less, its context-sensitive half-time (see Chap. 39) is about half the infusion duration. For infusions longer than 2 hours, its context-sensitive half-time remains at approximately 1 hour.

Alfentanil was one of the very first drugs characterized by simultaneous pharmacokinetic–pharmacodynamic modeling. Scott et al. gave volunteers a brief infusion of either fentanyl or alfentanil at a sufficient rate to produce slowing of the EEG<sup>132</sup> (Fig. 41-12). Both

opioids produced a decrease in the average EEG frequency as the plasma level increased; when the infusions were terminated, the EEG reverted to normal fast frequencies. In the fentanyl group, there was a delay of 2–3 minutes before measurable slowing occurred, and the effects persisted for 20–30 minutes after the infusion was discontinued. In the alfentanil group, the onset and offset of effect were much more closely correlated to the rise and fall in plasma levels. The reasons for this remain speculative: Diffusion of alfentanil into the CNS may be faster because more of the drug is in a diffusible, nonionized form at body pH (see Table 41-2). It is also 22 times less soluble than fentanyl in rat brain.<sup>16</sup> This property may allow it to achieve more rapid effect-site equilibrium (see Chap. 39) because it undergoes less nonspecific binding in brain tissue.

### Sufentanil

This thienyl derivative of fentanyl is more potent and even more fat soluble. The drug is rapidly and extensively distributed, and the effects of small doses are terminated by redistribution. Despite a terminal half-life of approximately 10 hours (longer than that of fentanyl and much longer than that of alfentanil), sufentanil has the shortest context-sensitive half-time when given by infusion for up to 10 hours. For example, after a 2-hour infusion, the context-sensitive half-time of sufentanil is approximately 20 minutes, about a third the value for alfentanil. Hepatic clearance is greater than that of



**FIGURE 41-12.** Plasma concentration of fentanyl or alfentanil versus time with simultaneous measurement of EEG spectral edge. Volunteers were given fentanyl 150 µg/min or alfentanil 1500 µg/min. Increasing opioid effect is depicted as a decrease in average EEG frequency and spectral edge. Changes in spectral edge follow plasma concentrations more closely for alfentanil (see text for details). (Reproduced with permission from Scott JC, Ponganis KV, Stanski DR. EEG quantitation of narcotic effect: the comparative pharmacodynamics of fentanyl and alfentanil. *Anesthesiology* 1985;62:234.)

fentanyl (extraction ratio = 0.7). Sufentanil is metabolized by *N*-dealkylation and *O*-demethylation.

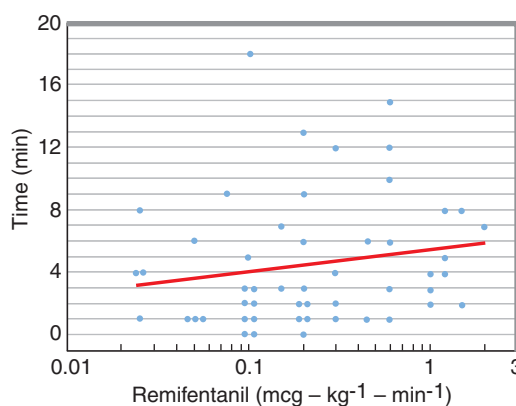
Sufentanil has had extensive use in cardiac surgery, where it has been given in very large doses (up to 30  $\mu\text{g}/\text{kg}$ ). At these doses, profound analgesia and ventilatory depression last for many hours, although extubation is usually possible earlier than with comparable doses of fentanyl. The distribution of the opioid is dramatically affected by cardiopulmonary bypass: plasma concentrations of sufentanil drop with hemodilution, but the huge amounts sequestered in lung and muscle cause a secondary increase when the bypass is discontinued.<sup>106</sup> Large amounts of sufentanil can also be bound to oxygenators and tubing in the bypass circuit.

The fat solubility of sufentanil allows it to be absorbed rapidly through intact skin and mucous membranes. Although it has been used epidurally, its rapid absorption by spinal cord and vertebral plexus gives it a very short duration.

### Remifentanyl

Remifentanyl is the newest opioid to be introduced into clinical use. Pharmacodynamically, it is similar to the other fentanyl derivatives, but it has an extremely short duration of action because of rapid metabolic inactivation. It is hydrolyzed by nonspecific esterases, primarily in skeletal muscle, and the resulting metabolite is several thousand-fold less potent as a  $\mu$ -opioid agonist. Remifentanyl is not a substrate for pseudocholinesterase, and the dose does not need to be changed for patients with pseudocholinesterase deficiency. Its redistribution half-life is similar to those of other fentanyl derivatives, but metabolism is always the predominant mechanism for clearance. The context-sensitive half-life is less than 5 minutes, regardless of the duration of the infusion.<sup>164</sup> There is essentially no accumulation of remifentanyl after infusions or repeated boluses.

Remifentanyl is more potent than alfentanil and less potent than sufentanil. In the presence of 70% nitrous oxide, infusion rates between 0.05 and 0.3  $\mu\text{g}/\text{kg}/\text{min}$  will provide adequate analgesia for most surgical procedures. Higher doses have been approved, but they are usually not needed; additionally, they may produce bradycardia and hypotension. Emergence from anesthesia is essentially



**FIGURE 41-13.** The time to spontaneous ventilation after discontinuing an infusion of remifentanyl expressed as a function of the infusion rate. (Reprinted from Dershwitz M, Rosow CE. Remifentanyl: a truly-short-acting opioid. *Semin Anesth* 1996;15:88, with permission from Elsevier.)

independent of the infusion rate or cumulative dose given (Fig. 41-13), and will occur within a few minutes of discontinuing the infusion.<sup>30</sup> The ultrashort duration of this analgesic can be a drawback: patients who are expected to have postoperative pain should receive a longer-acting opioid prior to stopping remifentanyl.

Patients with hepatic or renal failure do not experience a prolongation in effect, and the dose of remifentanyl does not need to be adjusted in such patients.<sup>31,33</sup> In fact, the dose of remifentanyl does not need to be adjusted for age or weight except at the extremes of these parameters.

### Tramadol

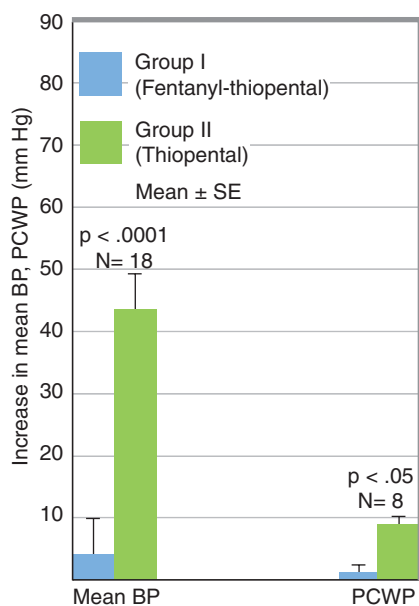
Tramadol is considered here with other opioid agonists, but it has multiple and unique mechanisms of action as an analgesic. Clinically available preparations of tramadol contain the racemic mixture of two isomers. (+)-Tramadol is a weak agonist at  $\mu$  receptors and an inhibitor of serotonin reuptake. It is also demethylated to yield a metabolite with greater  $\mu$  opioid efficacy. (-)-Tramadol more selectively inhibits norepinephrine reuptake. The effects on neurotransmitter reuptake enhance inhibitory effects on pain transmission in the spinal cord.<sup>55</sup> Tramadol is partially reversed by naloxone and exhibits incomplete cross-tolerance to opioid agonists. It does not have opioid antagonist properties and does not precipitate withdrawal when given to opioid-dependent addicts.

In the United States, tramadol is only available for oral administration, whereas a parenteral preparation is available in many other countries. Given orally, tramadol is effective in

both acute postoperative pain and neuropathic pain. Given parenterally, it has been used epidurally, as part of a balanced anesthetic, and for patient-controlled analgesia.<sup>56</sup> The drug undergoes oxidative hepatic metabolism then renal excretion of a glucuronidated metabolite. The active *O*-demethylated metabolite is formed by CYP2D6, and there is some evidence that genetic polymorphisms will influence the drug effect. Common side effects are sedation and nausea. Because it inhibits serotonin reuptake, tramadol (like meperidine) can cause a serotonergic crisis in a patient taking a monoamine oxidase inhibitor or another reuptake inhibitor like fluoxetine or paroxetine.<sup>50</sup> Its effects on ventilatory drive and its potential to be abused appear to be less than those of the typical  $\mu$ -opioid agonists.

## INTRAOPERATIVE USE OF OPIOIDS

Although opium extracts were used hundreds of years ago in “soporific sponges,” the modern concept of an opioid-based general anesthetic did not evolve until quite recently. Gray and Rees defined general anesthesia as a “triad” consisting of narcosis (i.e., hypnosis), analgesia, and muscle relaxation.<sup>53</sup> The opioids by themselves do not produce muscle relaxation, and even high doses sometimes fail to produce sleep. In the days before muscle relaxants, endotracheal tubes, and controlled ventilation, high doses of morphine were tried alone as total anesthetics and found to be both dangerous and only marginally effective.



**FIGURE 41-14.** Fentanyl 8  $\mu\text{g}/\text{kg}$ , administered intravenously, prevents the increase in mean systemic and wedge pressure following laryngoscopy and intubation. All patients were given thiopental and pancuronium. (Reproduced with permission from Martin DE, Rosenberg H, Aukburg SJ, et al. Low-dose fentanyl blunts circulatory responses to tracheal intubation. *Anesth Analg* 1982;61:680.)

### Balanced Anesthesia

In 1942, Griffiths introduced curare, which made it possible for muscle relaxation to be achieved during relatively light levels of anesthesia.<sup>55</sup> The first attempts at “balanced” anesthesia used curare together with thiopental and nitrous oxide, but these techniques usually failed to block autonomic responses to surgical stimuli. In 1947, Neff et al. introduced a more satisfactory anesthetic that included small doses of meperidine in combination with thiopental, curare, and nitrous oxide.<sup>104</sup> Although the individual components have changed over the years, this technique is the basis for modern balanced anesthesia.

In the 1950s the major tranquilizers (phenothiazines and butyrophenones) were introduced into clinical practice. DeCastro and Mundeleer described a technique called *neuroleptanalgesia* in which a butyrophenone (droperidol) was combined with fentanyl.<sup>27</sup> This combination did not necessarily cause sleep or amnesia, but it produced analgesia, apparent indifference to stimuli, immobility, and autonomic stability. When nitrous oxide was added to produce sleep, the resulting state was called *neuroleptanesthesia*. This anes-

thetic technique is infrequently used today.

In modern practice, nearly all anesthesia is “balanced.” The term is no longer restricted to nitrous oxide-opioid anesthesia, but includes mixtures of opioids with volatile agents or infusions of intravenous hypnotics.

### Intraoperative Analgesia

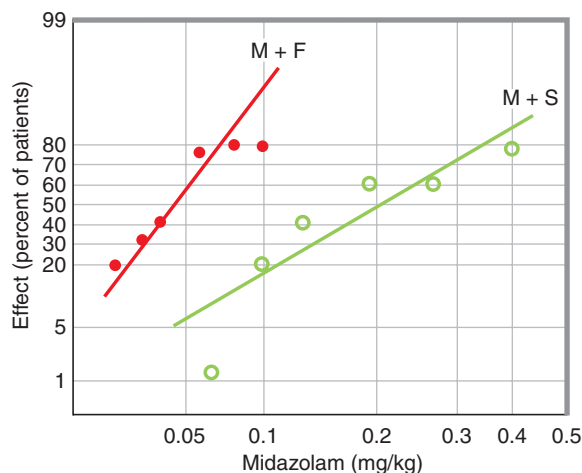
Analgesia is sometimes difficult to assess—or even to define—in a patient who is not awake. In general, we consider intraoperative analgesia to be a reduction in autonomic and somatic responses to noxious surgical stimuli. The cardiovascular responses to incision, laryngoscopy, and other painful events are blunted much more effectively by opioids than by most other intravenous agents<sup>90</sup> (Fig. 41-14).

Analgesia can also be measured by the decreasing requirement for other anesthetic agents. The administration of opioids potentiates the hypnotic effects of barbiturates, benzodiazepines and propofol<sup>13,77</sup> (Fig. 41-15). By reducing the amount of hypnotic administered, an opioid can sometimes produce more rapid emergence. The opioids also produce a dramatic, dose-related decrease in the need for volatile anesthetics, and they are frequently used for this specific purpose. The minimum alveolar concentration (MAC) of isoflurane, for example, is decreased as the blood concentration of remifentanyl is increased<sup>79</sup> (Fig. 41-16). The maximal effect of full opioid agonists seems to be approximately a 70% reduction in

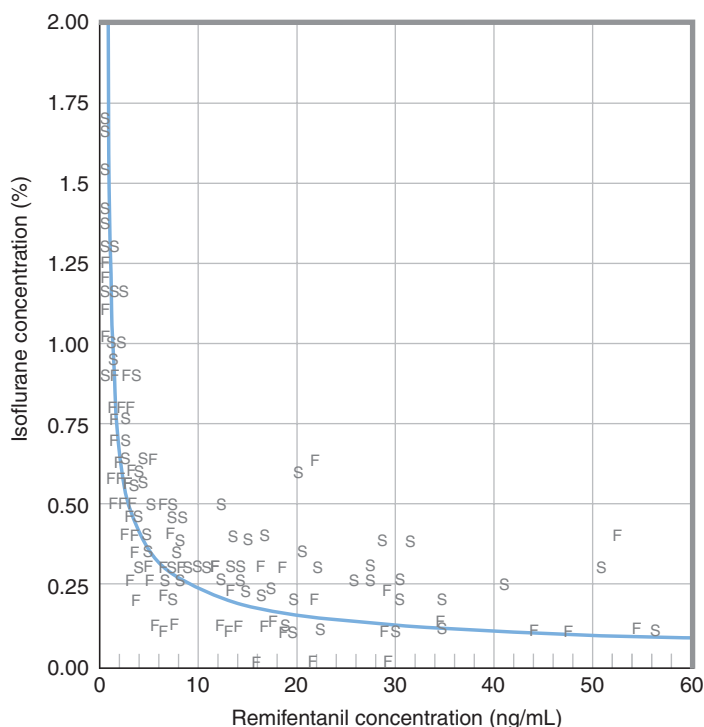
MAC whereas the mixed agonist-antagonists have lower efficacy.<sup>100</sup>

The amount of opioid analgesic required varies tremendously from patient to patient, so anesthetic “recipes” with a predetermined opioid dose are inadvisable. Shafer et al. found that administration of alfentanil at a fixed infusion rate resulted in inadequate anesthesia in some patients and postoperative ventilatory depression in others.<sup>135</sup> This variability is a result of both pharmacokinetic<sup>89</sup> and pharmacodynamic<sup>7</sup> factors. The requirement for opioid also depends on the nature of the surgical stimulus.

Ausems et al. demonstrated the nature of this variability in patients receiving nitrous oxide and a continuous infusion of alfentanil.<sup>7</sup> The infusion was titrated to suppress various clinical responses, and plasma concentrations were measured simultaneously. The Cp50 (plasma concentration necessary to prevent a response in 50% of patients) was calculated for each stimulus. The study showed, for example, that the Cp50 for tracheal intubation was 475 ng/mL of alfentanil, but skin closure required only 150 ng/mL (Fig. 41-17). These investigators also found a 2-fold to 3-fold difference in opioid sensitivity between individuals, but for each patient, the change between adequate and inadequate analgesia occurred over a very small range of plasma concentrations. The challenge for the anesthesiologist is to find the clinical end point that establishes this narrow range for the individual patient.



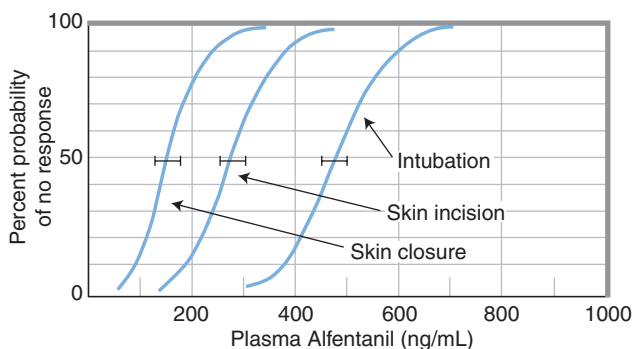
**FIGURE 41-15.** Percentage of patients asleep versus dose of midazolam on a log-probit plot. Curve is shifted to the left in the presence of fentanyl 1.9  $\mu\text{g}/\text{kg}$  ( $M + F$ ) compared to midazolam plus saline ( $M + S$ ). (Ben-Schlomo I, abd-el-Khalim H, Ezry J, et al. Midazolam acts synergistically with fentanyl for induction of anesthesia. *Br J Anaesth* 1990;64:45. By permission of Oxford University Press.)



**FIGURE 41-16.** Decrease in minimum alveolar concentration (MAC) for isoflurane versus blood concentration of remifentanil in humans. *F* represents a patient who moved, and *S* a patient who did not move. (Reproduced with permission from Lang E, Kapila A, Shlugman D, et al. Reduction of isoflurane minimal alveolar concentration by remifentanil. *Anesthesiology* 1996;85:721–728.)

How is an opioid titrated intraoperatively? Decreasing ventilatory rate or depth is usually a reliable sign of increasing opioid effect if the case permits spontaneous ventilation. More commonly, the rise in blood pressure and other autonomic responses to a “painful” stimulus are gauged. This requires good clinical judgment because autonomic responses are non-specific and may be produced by many conditions that do not involve pain. Unlike the volatile anesthetics,

the opioids do not produce graded cardiovascular depression as depth increases. Normal blood pressure does not necessarily mean that the anesthetic level is appropriate, because large overdoses of most opioids are well tolerated as long as ventilation is supported. Thus far, neurophysiologic measurements such as cortical EEG, EMG, cortical-evoked potentials, and evoked spinal reflexes have not been demonstrated to be useful indices of opioid analgesia.



**FIGURE 41-17.** Percentage probability of no response to various stimuli versus plasma concentration of alfentanil. Patients received 66% nitrous oxide and muscle relaxants. During balanced anesthesia, much lower concentrations of alfentanil are required for skin incision and closure than for intubation. (Reproduced with permission from Ausems ME, Hug CC Jr, Stanski DR, et al. Plasma concentrations of alfentanil required to supplement nitrous oxide anesthesia for general surgery. *Anesthesiology* 1986;65:362.)

The dose of opioid may need to be modified according to the patient's age and physical condition. On average, opioid sensitivity is increased in patients who are elderly,<sup>133</sup> hypovolemic, or debilitated. Reduced doses are usually given to patients with significant CNS disease and those who have received other CNS depressants. The clearance of morphine, meperidine, fentanyl, and alfentanil is decreased in the elderly and the neonate; however, pharmacokinetic differences due to age are frequently smaller than those attributable to the variability between individuals. This means that some elderly patients may require higher doses than some young patients. A frail older patient probably requires cautious opioid titration, but arbitrarily reducing the dose can cause unnecessary suffering.<sup>6</sup>

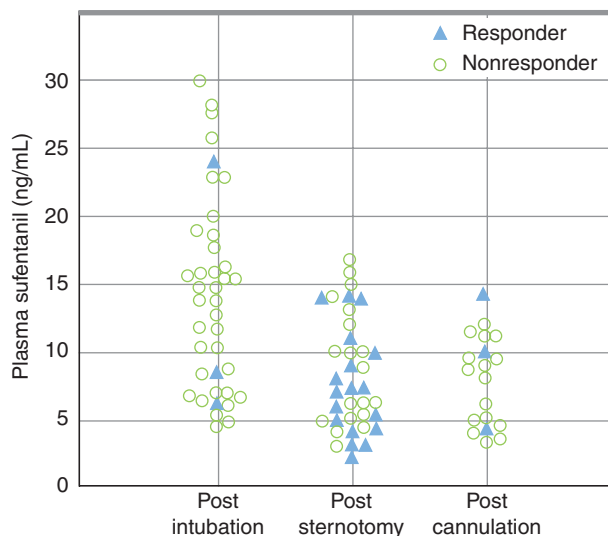
A number of animal studies and a few clinical studies have examined the influence of gender on the response to opioids. Morphine appears to produce a greater analgesic and respiratory depressant effect in males, although the variation among subjects is larger than that attributable to gender.<sup>129</sup> Thus far, the data do not indicate any consistent pattern among the opioid agonists.

Hepatic dysfunction must usually be severe before it produces a substantial change in opioid pharmacokinetics. The clearances of morphine and alfentanil are reduced in cirrhosis, but fentanyl and sufentanil are not greatly affected.<sup>148</sup> Interestingly, renal failure can cause an increase in the effect of morphine, and there have been several cases of ventilatory depression reported in such patients. The mechanism may be delayed renal excretion of morphine's active metabolite.<sup>27</sup> As stated above, remifentanil clearance is unaffected by hepatic or renal dysfunction.

### High-Dose Opioid Anesthesia

Some aspects of high-dose opioid anesthesia are discussed in greater depth in Chap. 51. In 1969, Lowenstein et al. showed that high doses of morphine (>1 mg/kg) with only oxygen, and a muscle relaxant could be used during cardiac surgery to produce profound analgesia and sleep.<sup>87</sup> In patients with left ventricular dysfunction as a consequence of valvular disease, hemodynamics frequently improved because preload and afterload were reduced. This anesthetic technique rapidly became popular for cardiac surgery.





**FIGURE 41-18.** Presence or absence of hemodynamic response versus plasma concentration of sufentanil at three points during cardiac surgery. Patients undergoing coronary revascularization received only sufentanil, 100% oxygen, and muscle relaxant. Response was defined as a blood pressure increase of 15% or more over control value while awake. Given alone, even extremely high concentrations of sufentanil did not block all responses. (Reproduced with permission from Philbin DM, Rosow CE, Schneider RC, et al. Fentanyl and sufentanil anesthesia revisited: how much is enough? *Anesthesiology* 1990;73:5.)

Unfortunately, it had a number of drawbacks, including hypotension, histamine release, occasional intraoperative awareness, and prolonged ventilatory depression. Even these large doses of morphine did not block cardiovascular responses to some stimuli (e.g., sternotomy), but increasing the dose to nearly 10 mg/kg created unacceptable hypotension and fluid shifts.

Stanley evaluated fentanyl-oxygen “anesthesia” in a variety of cardiac surgical populations<sup>144</sup> and found that 50–100 µg/kg of fentanyl produced only modest decreases in systemic pressure and total peripheral resistance. Unlike morphine, high doses of fentanyl did not release histamine.<sup>122</sup> Within a few years, fentanyl had replaced morphine for this indication. Sufentanil was introduced a few years later, and in doses as high as 30 µg/kg, it shared fentanyl’s hemodynamic advantages as an opioid anesthetic.<sup>124</sup>

Why give such huge doses of these opioids? If no other sedative-hypnotic agents are administered, very large doses are *required* to produce sleep.<sup>9,138</sup> Large doses of opioids have some advantages in the cardiac surgical population: induction is usually smooth and well tolerated, even by patients with limited myocardial reserve; most hemodynamic responses to surgery are suppressed, and there are no dangerous interactions with most vasoac-

tive medications. This type of anesthesia can also block the release of many “stress” hormones (catecholamines, insulin, growth hormone, antidiuretic hormone, cortisol, renin, etc.) during major surgery.<sup>17</sup> The long duration of the opioid effect also allows for a smooth transition to mechanical ventilation in the immediate postoperative period.

Fentanyl and sufentanil have fewer limitations than morphine, but they should not be considered complete anesthetics: intraoperative awareness is less common, but still a possibility. Recall has been reported after fentanyl doses as high as 90 µg/kg.<sup>98</sup> Even very high plasma concentrations of fentanyl or sufentanil will not block all hemodynamic and hormonal responses to surgery<sup>112</sup> (Fig. 41-18). Certain reflex cardiovascular responses seem particularly opioid resistant; for example, the reflex hypertension and tachycardia that is elicited by manipulation of the heart and great vessels. The stress hormonal responses that occur during cardiopulmonary bypass are not completely eliminated by opioids.<sup>17</sup>

In clinical practice, “pure” opioid-oxygen anesthesia (without adjuvant anesthetic drugs) is rarely performed. The desire of most clinicians to be flexible and “fast-track” some of their patients makes such a long-lasting anesthetic less desirable. Most patients

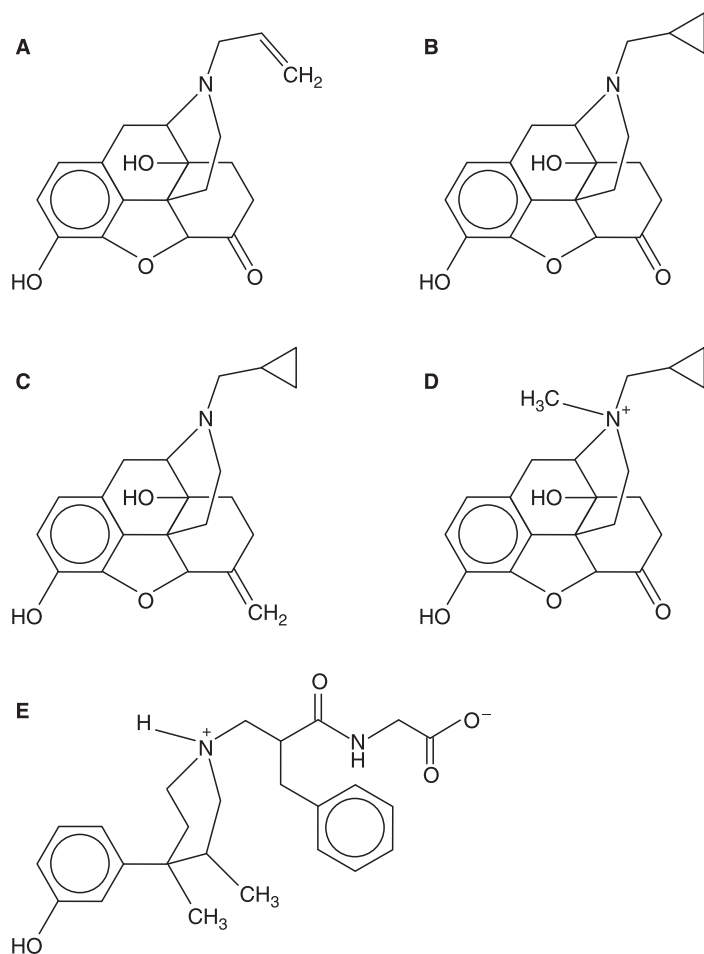
receive premedication and moderate doses of opioids; inhalation or intravenous agents are added to control hemodynamics and to ensure unconsciousness during surgery. The addition of hypnotic agents creates a more complete anesthetic, although cardiovascular depression is more likely. High-dose fentanyl, for example, produces a much larger fall in peripheral resistance when the patient has received intravenous diazepam.<sup>153</sup>

Paradoxically, anesthesiologists rely on opioids during surgery both for suppression and preservation of autonomic function. Opioids suppress autonomic responses to pain, but they are often part of anesthesia for critically ill patients because they preserve myocardial function and many essential hemodynamic reflexes. In an otherwise fit hypertensive patient, the *lack* of cardiovascular depression can sometimes make it difficult to control intraoperative hemodynamics. Opioids are not substitutes for β-blockers, intravenous vasodilators, or the controlled vasodilatation produced by inhalation anesthesia. This was elegantly demonstrated by Wynands et al., who compared high-dose fentanyl anesthesia in patients with good or poor left ventricular function.<sup>167</sup> Plasma concentrations of fentanyl were high in all patients, but hypertensive episodes occurred almost exclusively in those with good left ventricular function. In this study, hypertension was not a sign of insufficient analgesia, it was an indicator of adequate myocardial function! These patients tolerated—and required—supplemental intravenously administered or inhaled anesthetic agents.

## OPIOID ANTAGONISTS

### Naloxone

Naloxone, the *N*-allyl derivative of oxymorphone, was the first pure opioid antagonist to become available for parenteral use (Fig. 41-19A). Naloxone acts as a competitive antagonist at all opioid receptors, but it has greatest affinity for µ receptors. Small doses of naloxone reliably reverse or prevent the effects of pure opioid agonists and most mixed agonist-antagonists. The block is reversible and competitive, so it can be overcome by additional agonist. Naloxone probably has no effect



**FIGURE 41-19.** Structural formulas of naloxone (A), naltrexone (B), nalmeferone (C), methylnaltrexone (D), and alvimopan (E).

on nonopioid anesthetics, although this remains somewhat controversial.<sup>40</sup>

Given alone, naloxone is nearly devoid of clinically demonstrable effects. In humans, extremely large doses (4 mg/kg) cause a mild increase in heart rate and systolic blood pressure, as well as slowing of EEG alpha-wave activity. Animal studies also show that naloxone can reduce food intake, alter sleep patterns, and improve spatial learning. In some disease states, such as septic shock, large doses can have a pressor effect. This may be the result of antagonism of elevated endogenous opioid peptides.<sup>15</sup>

Naloxone is widely distributed and rapidly achieves effective concentrations in the CNS. Plasma and brain levels fall precipitously because of rapid redistribution. The drug is rapidly cleared by hepatic biotransformation, mainly to the 3-glucuronide.<sup>96</sup> The clearance is very high (approximately 30 mL/kg/min), which suggests that extrahepatic elimination

may be occurring. The terminal half-life is 1–2 hours. The onset of antagonist effect is extremely rapid, but the duration of action is quite brief. An IV dose of 0.4 mg will usually antagonize morphine for less than 1 hour; increasing the dose does not increase the duration appreciably. With the exception of remifentanyl, the duration of naloxone is shorter than the opioids it is used to antagonize.

The presence of excessive opioid effects is a common problem in the postoperative setting. Small doses of naloxone (0.04 mg in an adult, repeated every 3 minutes) can be given intravenously, usually with dramatic improvement. In many cases there also is partial reversal of analgesia, but this can be minimized by careful dosing. Patients who receive naloxone need continued observation, and possibly repeated doses. Postoperative ventilatory compromise is frequently caused by a combination of factors, and therapy with naloxone does not eliminate the need

to search for and treat conditions like residual paralysis, bronchospasm, and airway edema.

Naloxone is used to reverse opioids in several other clinical settings:

- In the delivery suite, naloxone can be used in depressed neonates whose mothers received opioids during labor. Clark showed that 0.01 mg/kg via an umbilical vein catheter was usually sufficient.<sup>22</sup> Acidotic infants were slower to reverse and sometimes required a second dose.
- In the emergency department, 0.4–0.8 mg of naloxone is usually administered in cases of suspected heroin overdose. Naloxone is also useful as an aid in the differential diagnosis of coma; if a patient fails to respond to naloxone, nonopioid causes should be considered.
- Patients who receive epidural or intrathecal opioids are frequently troubled by side effects like pruritus and urinary retention (see Chap. 46). An IV infusion of naloxone prevents or reverses these side effects, but may also produce an unacceptable reduction in analgesia.<sup>57</sup>

Opioid reversal can sometimes have important hemodynamic consequences. Increases in systemic pressure, heart rate, and plasma levels of catecholamines can occur. This may be because of the sudden onset of pain, but these effects have been reproduced experimentally in the absence of painful stimuli.<sup>95</sup> There are several case reports of fulminant pulmonary edema, dysrhythmias, and even death in young, previously healthy individuals given naloxone.<sup>4</sup> In one case, the dose of naloxone was only 0.1 mg.<sup>107</sup> The etiology of this rare, catastrophic response is unknown.

### Naltrexone

Naltrexone is the *N*-cyclopropylmethyl derivative of oxycodone (Fig. 41-19B). Like naloxone, it is a relatively pure antagonist. The main clinical use of naltrexone is in the treatment of previously detoxified heroin addicts. When high doses are taken chronically, naltrexone will block the euphoriant effects of injected heroin and thus help to prevent relapse. It also decreases drug craving in former addicts. Interestingly, naltrexone recently has been used to maintain sobriety in alcoholics, although the mechanism in this

indication is less clear.<sup>142</sup> It is available orally and in a depot formulation for intramuscular injection.

Naltrexone is rapidly absorbed and undergoes 95% first-pass metabolism to 6- $\beta$ -naltrexol. This is an active metabolite that probably accounts for most of naltrexone's activity. The metabolite accumulates during chronic treatment; it has a terminal half-life of 12.9 hours, so significant antagonist effects may persist for 2–3 days after naltrexone is stopped.

In the event that a patient on naltrexone requires emergency surgery or treatment for acute pain, the patient should be managed (if possible) with regional anesthesia, nonopioid analgesics, and other nonopioid methods. If opioids are necessary, naltrexone antagonism is competitive and may be overcome with high doses of morphine or fentanyl.

### Nalmefene

Nalmefene is a potent, extremely long-lasting pure antagonist. It is the 6-methylene derivative of naltrexone (Fig. 41-19C). Gal and DiFazio showed that 2 mg of nalmefene can block the effects of repeated fentanyl injections for more than 8 hours.<sup>47</sup> The long duration of nalmefene is probably because of its extensive distribution and long terminal half-life (9 hours).

Reversal with nalmefene can probably cause some of the undesirable autonomic activation seen with naloxone. A single dose of nalmefene should certainly prevent recrudescence of ventilatory depression in most cases, and infusions are unlikely to be necessary. Nalmefene should be titrated carefully, because it can potentially eliminate opioid analgesia for a very long period of time.

### N-Methylnaltrexone

N-methylnaltrexone (MNTX) is a quaternary analogue of naltrexone that does not achieve significant concentrations in the CNS (Fig. 41-19D). It is being investigated in both parenteral and oral forms as a treatment for OBD.<sup>19</sup> In healthy volunteers who were given morphine, intravenous MNTX reversed depression of gastric emptying and intestinal motility, but it did not interfere with analgesia against experimental pain.<sup>168</sup> It rapidly relieves constipation in subjects on methadone maintenance and in hospice patients who are taking opioids chronically. Efficacy of the oral formulation suggests

that this action is likely achieved via an intraluminal effect.<sup>169</sup> MNTX, like naloxone, has minimal effects on opioid-naïve persons.

### Alvimopan

Alvimopan is another permanently charged, peripheral opioid receptor antagonist (Fig. 41-19E).<sup>43</sup> It is poorly absorbed after oral administration, does not cross the blood-brain barrier, and does not reverse opioid analgesia. Alvimopan has been studied exclusively in an oral formulation for the treatment of OBD and also for the more general problem of postoperative ileus. Its efficacy in postoperative ileus may be because surgical insult releases endogenous opioid peptides in the bowel wall, which accounts for some of the decrease in intestinal motility. In both OBD and postoperative ileus, alvimopan significantly improves various indices of motility. The

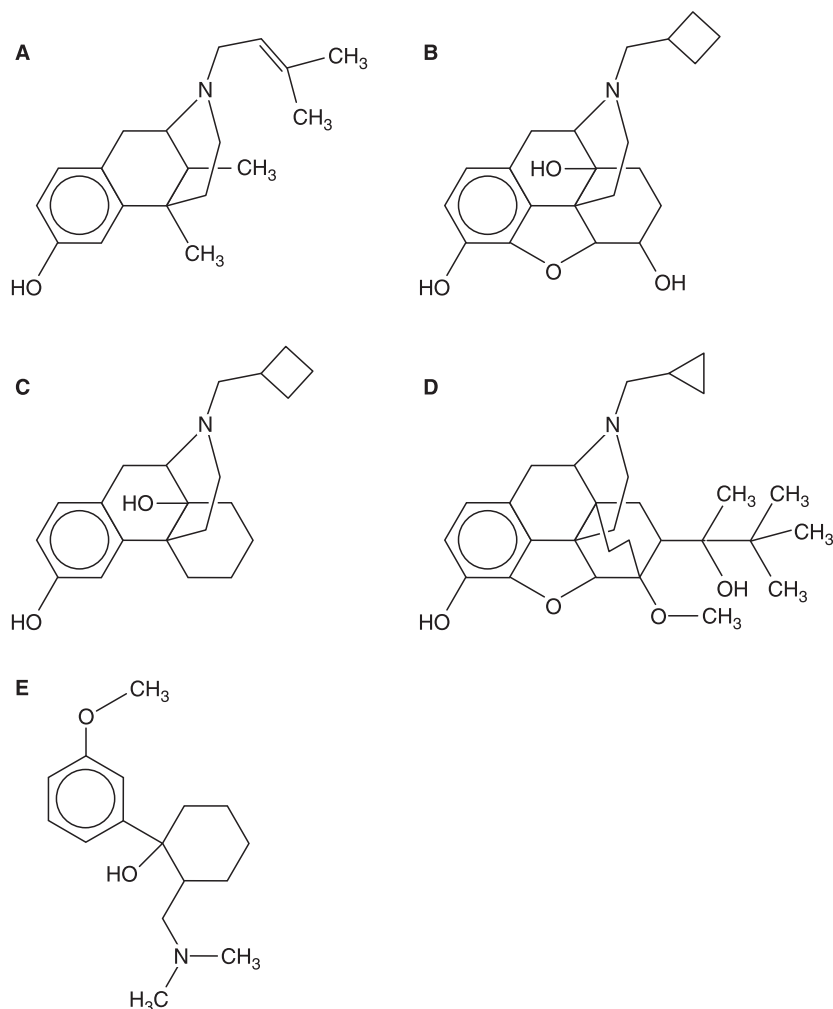
improvement in postoperative ileus decreases the time to hospital discharge.<sup>166</sup> At this writing, FDA approval for the oral use of alvimopan in postoperative ileus is pending.

## OPIOID AGONIST-ANTAGONISTS

### General Properties

The agonist-antagonist opioids are synthetic and semisynthetic analgesics that are structurally related to morphine (Fig. 41-20). They have been used primarily for moderate to severe acute pain, although buprenorphine has now been approved for maintenance therapy in opioid addiction. All these compounds produce some degree of competitive antagonism to morphine and the other pure agonists.

Nalorphine, the original agonist-antagonist, is no longer used clinically,



**FIGURE 41-20.** Structural formulas of pentazocine (A), nalbuphine (B), butorphanol (C), buprenorphine (D), and tramadol (E).

but it has pharmacologic properties that illustrate the most important features of the class:

- A strong analgesic effect, sufficient for moderate to severe postoperative pain.
- A morphine antagonist effect that depends on the ratio of morphine to nalorphine. At very high doses of nalorphine, the agonist effects predominate.
- A very low potential for diversion or abuse. Administration to subjects who are physically dependent on opioids produces a violent “precipitated withdrawal” syndrome. Former heroin addicts given nalorphine do not experience euphoria or perceive the drug as being similar to morphine.
- A combination of typical and atypical opioid side effects. Nalorphine produces limited ventilatory depression and GI effects, but analgesic doses can cause severe psychotomimetic reactions.

The unusual mental effects—distressing hallucinations and dysphoria—made nalorphine clinically unacceptable as an analgesic, although it was used for many years as an opioid antagonist. Nalorphine was an important milestone in opioid pharmacology because it demonstrated, for the first time, that addiction liability and potent analgesia might be separated. All the more modern agonist-antagonist opioids are products of an intense search for strong analgesics that are less likely to be abused.

All of the agonist-antagonists behave as partial agonists; these drugs tend to have shallower dose-response curves and produce lower maximal effects than fentanyl or morphine<sup>119</sup> (Fig. 41-1A). This means there is a “ceiling” to the analgesic effects, but the toxic effects also are limited. Most of the clinically available agonist-antagonists bind to both  $\mu$  and  $\kappa$  receptors, but they have different intrinsic activities at each site:

- $\kappa$  Partial agonists: Pentazocine, butorphanol, and nalbuphine (and nalorphine) produce analgesia and sedation by a partial agonist effect at  $\kappa$  receptors. All of them are competitive antagonists at  $\mu$  receptors, and therefore reverse the effects of morphine.
- $\mu$  Partial agonists: Buprenorphine binds to  $\mu$  receptors with extremely

TABLE 41-4.

Agonist vs. Antagonist Potential of Opioid Mixed Agonist-Antagonists

Drug	Analgesic Potency (Morphine = 1)	Morphine Antagonist Potency (Nalorphine = 1)
Pentazocine	0.2	0.02
Nalbuphine	1	0.25
Butorphanol	5	— <sup>a</sup>
Buprenorphine	25	10

<sup>a</sup>Weak antagonist; see text.

high affinity but has limited efficacy. When given alone, its effects are similar to those of morphine. When given after morphine, it competes with the full agonist and causes a reduction in opioid effect<sup>119</sup> (Fig. 41-1B). Buprenorphine is also an antagonist at  $\kappa$  opioid receptors.

These drugs vary widely in their potencies, both as analgesics and antagonists (Table 41-4). Neither agonist versus antagonist potency nor  $\mu$  versus  $\kappa$  interaction has proved to be a predictor of clinical usefulness or patient acceptance.

### Acute Effects Analgesia

The agonist-antagonists are effective in a variety of acute and chronic pain states. They can be given intramuscularly, orally, sublingually, intranasally, intravenously by bolus or continuous infusion, and in patient-controlled analgesia systems. Table 41-1 lists the agents and their recommended intravenous doses. None of these drugs is currently approved for epidural or intrathecal use, although they have all been reported to be effective by this route.

The agonist-antagonist opioids have been used during balanced anesthesia, but their partial agonist properties are not a particular advantage in this setting. Even extremely large doses of nalbuphine or butorphanol will not produce the intensity of analgesia one expects from fentanyl or its derivatives.<sup>143</sup> Compared with morphine or fentanyl, the agonist-antagonists produce more limited decreases in the requirements for potent volatile anesthetics.<sup>99</sup>

### Sedation and Mood Effects

The subjective effects of buprenorphine are similar to morphine throughout the dose range. The  $\kappa$ -type agonists have been described as producing “apathetic sedation”; this may reflect the localiza-

tion of  $\kappa$  receptors in deeper layers of the cerebral cortex.<sup>50</sup> Patients given pentazocine, nalbuphine, or butorphanol may experience floating and dissociation, but usually do not experience mood elevation like that seen with morphine. After analgesic doses these patients often appear extremely sedated, yet remain capable of surprisingly lucid conversation. With pentazocine, patients are increasingly likely to experience “weird” feelings, dysphoria, or even hallucinations as the dose is raised. As stated previously, these unpleasant effects may also be mediated by  $\kappa$  receptors. They occur less frequently with butorphanol or nalbuphine.

Most physicians are familiar with the pleasant mental detachment produced by morphine and use it as a sign that the drug is working. Because mood elevation and euphoria do not usually occur with the  $\kappa$ -type agonist-antagonists,<sup>71</sup> patient and physician acceptance of these drugs has been somewhat limited. Ironically, lack of a morphine-like mood effect makes these analgesics much less desirable for opioid addicts, and it is thought to be a key factor in their low abuse liability.

The sedative effects of some agonist-antagonists may be used to advantage. Butorphanol was evaluated as a premedicant in elective surgical patients, and it produced useful sedation in doses lower than those routinely used for analgesia.<sup>28</sup> Its effects on body perception, anxiety, and psychomotor testing were similar to those of midazolam. Unlike the benzodiazepine, it produced very little anterograde amnesia. In this patient population, there was no evidence of dysphoria or hallucinations.

### Ventilatory Depression

As stated previously, these opioids are all partial agonists, and their toxic effects are limited in intensity. Ventilatory depression reaches a maximum after about 30 mg of nalbuphine<sup>47</sup> or



2–4 mg of butorphanol,<sup>103</sup> and even larger doses are well tolerated by most patients. Severe depression is still possible in sensitive individuals, those with concomitant CNS or pulmonary disease, and those receiving other depressant drugs. Ventilatory depression may be reversed with naloxone but not with another agonist–antagonist.

A ceiling effect on ventilation has also been demonstrated with the use of buprenorphine. This is important because buprenorphine has very high affinity for  $\mu$  receptors and is not reliably antagonized by naloxone.<sup>46</sup>

### Smooth Muscle Effects

Nalbuphine, butorphanol, and pentazocine do not cause significant elevation of intrabiliary pressure in animals or humans.<sup>5,92,119</sup> These agents may be particularly useful for patients who experience biliary colic after morphine. Buprenorphine is believed to cause biliary effects that are slightly more pronounced.<sup>152</sup> The agonist–antagonists appear to have small effects on smooth muscle in the intestine and bladder, and they cause less constipation than do drugs that are similar to morphine.

### Cardiovascular Effects

The cardiovascular effects of buprenorphine and nalbuphine are similar to those of morphine. Pentazocine produces unusual cardiovascular effects, both in normal individuals and in those with ischemic heart disease.<sup>2</sup> Unlike morphine, pentazocine may increase heart rate, systemic and pulmonary artery pressure, and left ventricle end-diastolic pressure. These effects may be secondary to elevations in plasma catecholamines. Because these changes are likely to elevate myocardial oxygen consumption, pentazocine may be a poor choice for patients with ischemia or infarction.

Butorphanol (2 mg) can also increase pulmonary artery pressure, but heart rate and systemic pressure usually decrease slightly.<sup>113</sup> The rise in pulmonary artery pressure apparently does not increase as the dose is raised: In one study, doses of butorphanol greater than 25 mg were used safely during coronary artery bypass surgery.<sup>3</sup>

### Antagonist Effects

Table 41–4 lists the approximate agonist versus antagonist potencies of these drugs. Nalbuphine and buprenorphine are strong antagonists, and have been used clinically for this

purpose. The available evidence does not suggest that reversal with an agonist–antagonist is safer or more reliable than reversal with naloxone.<sup>70</sup>

Administration of an opioid antagonist to an opioid-dependent patient will precipitate withdrawal; this has occurred after therapeutic doses of pentazocine, nalbuphine, and buprenorphine. Butorphanol is a very weak antagonist, and it produces only mild withdrawal in addicts who are maintained on 30 mg/d of methadone.<sup>116</sup> A low level of physical dependence may occur in patients who receive opioid agonists over long periods, and this subclinical state may be unmasked by administration of an antagonist. During routine perioperative care, it seems prudent to avoid agonist–antagonists in patients who have had significant prior treatment with morphine, meperidine, oxycodone, and other such drugs.

### Chronic Administration

In the United States, pentazocine is the only agonist–antagonist available in a typical oral tablet; butorphanol is available as a nasal spray; and buprenorphine is available as a sublingual tablet. It is possible to give these drugs parenterally for long periods of time, but there are few clinical data on such use.

Long-term studies on ex-heroin addicts showed that tolerance and physical dependence do occur after repeated administration of agonist–antagonist opioids. Withdrawal is usually qualitatively different from that of morphine and not usually accompanied by intense drug-seeking behavior. There has been renewed interest in chronic sublingual administration of buprenorphine since 2002 when the FDA approved it for maintenance therapy of opioid addicts (see Chap. 23). Chronic administration of buprenorphine in relatively high doses prevents withdrawal and reduces drug seeking.<sup>43</sup> Unlike methadone maintenance, buprenorphine treatment of addicts does not have to occur in a specially licensed clinic, although physicians who use it this way must have additional qualifications. The heroin addict is usually switched under supervision to sublingual buprenorphine (the partial agonist properties may sometimes elicit withdrawal symptoms). Chronic dosing is then done by the addict without direct supervision. To reduce the possibility that buprenorphine will be diverted or

abused during chronic maintenance, it is dispensed in a formulation that combines buprenorphine and naloxone (Suboxone). Sublingual administration of the combination produces similar effects to buprenorphine alone, because sublingual naloxone does not achieve high concentrations in blood. If the tablet were inappropriately dissolved and injected intravenously, however, the naloxone would antagonize the euphoriant effect and possibly cause precipitated withdrawal.

In the event that a patient taking buprenorphine/naloxone presents for surgery, treatment of acute pain may present a significant problem. These patients are highly tolerant to opioids, and residual levels of the partial agonist may antagonize other opioids for a long time. Regional anesthesia and nonopioid techniques should be used, whenever possible. If opioid treatment is required, large doses of potent opioid agonists may be needed, and advice should be sought from a specialist in addiction medicine.

### KEY REFERENCES

1. Aulsems ME, Hug CC Jr, Stanski DR, et al. Plasma concentrations of alfentanil required to supplement nitrous oxide anesthesia for general surgery. *Anesthesiology* 1986;65:362.
2. Austin KL, Stapleton JV, Mather LE. Relationship between blood meperidine concentrations and analgesic response: a preliminary report. *Anesthesiology* 1980;53:460.
3. Davies G, Kingswood C, Street M. Pharmacokinetics of opioids in renal dysfunction. *Clin Pharmacokinetics* 1996;31:410–422.
4. Dershwitz M, Randel GI, Rosow CE, et al. Initial clinical experience with remifentanyl, a new opioid metabolized by esterases. *Anesth Analg* 1995;81:619.
5. Forrest WH, Bellville JW. The effect of sleep plus morphine on the respiratory response to carbon dioxide. *Anesthesiology* 1964;25:137.
6. McClain DA, Hug CC Jr. Intravenous fentanyl kinetics. *Clin Pharmacol Ther* 1980;28:106.
7. Philbin DM, Rosow CE, Schneider RC, et al. Fentanyl and sufentanyl

anesthesia revisited: how much is enough? *Anesthesiology* 1990;73:5.

8. Way WL, Costley EC, Way EL. Respiratory sensitivity of the newborn infant to meperidine and morphine. *Clin Pharmacol Ther* 1965;6:454.

## REFERENCES

- Advokat C. The role of descending inhibition in morphine-induced analgesia. *Trends Pharm Sci* 1988;9:330.
- Alderman EL, Barry WH, Graham AF, et al. Hemodynamic effects of morphine and pentazocine differ in cardiac patients. *N Engl J Med* 1972;287:623.
- Aldrete JA, de Campo T, Usubiaga LE, et al. Comparison of butorphanol and morphine as analgesics for coronary bypass surgery: a double-blind randomized study. *Anesth Analg* 1983;62:78.
- Andrée RA. Sudden death following naloxone administration. *Anesth Analg* 1980;59:782.
- Arguelles JE, Franatovic Y, Romo-Salas F, et al. Intrabiliary pressure changes produced by narcotic drugs and inhalation anesthetics in guinea pigs. *Anesth Analg* 1979;58:120.
- Aubrun F, Monsel S, Langeron O, et al. Postoperative titration of intravenous morphine in the elderly patient. *Anesthesiology* 2002;96:17–23.
- Ausems ME, Hug CC Jr, Stanski DR, et al. Plasma concentrations of alfentanil required to supplement nitrous oxide anesthesia for general surgery. *Anesthesiology* 1986;65:362.
- Austin KL, Stapleton JV, Mather LE. Relationship between blood meperidine concentrations and analgesic response: a preliminary report. *Anesthesiology* 1980;53:460.
- Bailey PL, Wilbrink J, Zwanikken P, et al. Anesthetic induction with fentanyl. *Anesth Analg* 1985;64:48.
- Ballantyne JC, Loach AB, Carr DB. Itching after epidural and spinal opiates. *Pain* 1988;33:149.
- Becker LD, Paulson BA, Miller RD, et al. Biphasic respiratory depression after fentanyl-droperidol or fentanyl alone used to supplement nitrous oxide anesthesia. *Anesthesiology* 1976;44:291.
- Ben-Shlomo I, Abd-el-Khalim H, Ezry J, et al. Midazolam acts synergistically with fentanyl for induction of anesthesia. *Br J Anaesth* 1990;64:45.
- Benthuisen JL, Smith NT, Sanford TJ, et al. Physiology of alfentanil-induced rigidity. *Anesthesiology* 1986;64:440.
- Benumof JL. Obstructive sleep apnea in the adult obese patient: implications for airway management. *J Clin Anesth* 2001;13:144–156.
- Bernton EW, Long JB, Holaday JW. Opioids and neuropeptides: mechanisms in circulatory shock. *Fed Proc* 1985;44:290.
- Bjorkman S, Stanski DR, Verotta D, et al. Comparative tissue concentration—profiles of fentanyl and alfentanil in man predicted from tissue-to-blood partition data obtained in rats. *Anesthesiology* 1990;72:865.
- Bovill JG, Sebel PS, Fiolet JW. The influence of sufentanil on endocrine and metabolic responses to cardiac anesthesia. *Anesth Analg* 1983;62:391.
- Bower S, Hull CJ. Comparative pharmacokinetics of fentanyl and alfentanil. *Br J Anaesth* 1982;54:871.
- Boyd TA, Yuan CS. Methylaltraxone: investigations in treating opioid bowel dysfunction. In: Yuan CS, ed. *Handbook of Opioid Bowel Syndrome*. New York: Haworth Medical Press, 2005:197–221.
- Cadet P, Mantione KJ, Stefano GB. Molecular identification and functional expression of mu 3, a novel alternatively spliced variant of the human mu opiate receptor gene. *J Immunol* 2003;170:5118.
- Cicero TJ, Bell RD, Wiest WG, et al. Function of the male sex organs in heroin and methadone users. *N Engl J Med* 1975;292:882.
- Clark RB, Beard AG, Barclay DL. Naloxone in the newborn infant. *Anesth Rev* 1975;(Dec):9.
- Coda B, Tanaka A, Jacobson RC, et al. Hydromorphone analgesia after intravenous bolus administration. *Pain* 1997;71:41–48.
- Costall B, Fortune DH, Naylor RJ. Involvement of mesolimbic and extrapyramidal nuclei in the motor depressant action of narcotic drugs. *J Pharm Pharmacol* 1978;30:566.
- Costello DJ, Borison HL. Naloxone antagonizes narcotic self-blockade of emesis in the cat. *J Pharmacol Exp Ther* 1977;203:222.
- Cullen DJ. Obstructive sleep apnea and postoperative analgesia—a potentially dangerous combination. *J Clin Anesth* 2001;13:83–85.
- Davies G, Kingswood C, Street M. Pharmacokinetics of opioids in renal dysfunction. *Clin Pharmacokinet* 1996;31:410–422.
- De Castro J, Mundeleer R. Anesthésie sans barbituriques: la neuroleptanalgesie. *Anesth Analg (Paris)* 1959;16:1022.
- Dershwitz M, Rosow CE, DiBiase PM, et al. Comparison of the sedative effects of butorphanol and midazolam. *Anesthesiology* 1991;74:717.
- Dershwitz M, Randel GI, Rosow CE, et al. Initial clinical experience with remifentanyl, a new opioid metabolized by esterases. *Anesth Analg* 1995;81:619.
- Dershwitz M, Hoke JF, Rosow CE, et al. Pharmacokinetics and pharmacodynamics of remifentanyl in volunteer subjects with severe liver disease. *Anesthesiology* 1996;84:812.
- Dershwitz M, Walsh JL, Morishige RJ, et al. Pharmacokinetics and pharmacodynamics of inhaled versus intravenous morphine in healthy volunteers. *Anesthesiology* 2000;93:619–628.
- Dershwitz M, Rosow CE. The pharmacokinetics and pharmacodynamics of remifentanyl in volunteers with severe hepatic or renal dysfunction. *J Clin Anesth* 1996;8:88S.
- Dickenson AH, Suzuki R. Opioids in neuropathic pain: clues from animal studies. *Eur J Pain* 2005;9:113–116.
- Donnerer J, Cardinale G, Coffey J, et al. Chemical characterization and regulation of endogenous morphine and codeine in the rat. *J Pharm Exp Ther* 1987;242:583.
- Dray A, Metsch R. Opioids and central inhibition of urinary bladder motility. *Eur J Pharmacol* 1984;98:155.
- Ebert TJ, Kotrlý KJ, Madsen KE, et al. Fentanyl-diazepam anesthesia does not attenuate cardiopulmonary baroreflex-mediated vasoconstrictor responses to controlled hypovolemia in humans. *Anesth Analg* 1988;67:548.
- Eisenberg E, McNicol ED, Carr DB. Efficacy and safety of opioid agonists in the treatment of neuropathic pain of nonmalignant origin: systematic review and meta-analysis of randomized controlled trials. *JAMA* 2005;293:3043–3052.
- Estfan B, LeGrand SB, Walsh D, et al. Opioid rotation in cancer patients: pros and cons. *Oncology (Williston Park)*, 2005;19:511–516.
- Finck AD, Ngai SH, Berkowitz BA. Antagonism of general anesthesia by naloxone in the rat. *Anesthesiology* 1977;46:241.
- Flacke JW, Flacke WE, Bloor BC, et al. Histamine release by four narcotics: a double-blind study in humans. *Anesth Analg* 1987;66:723.
- Forrest WH, Bellville JW. The effect of sleep plus morphine on the respiratory response to carbon dioxide. *Anesthesiology* 1964;25:137.
- Foss JF, Schmidt WK. Management of opioid-induced bowel dysfunction and postoperative ileus: potential role of alvimopan. In: Yuan CS, ed. *Handbook of Opioid Bowel Syndrome*. New York: Haworth Medical Press, 2005:223–249.
- Fudala PJ, Bridge TP, Herbert S, et al. Office-based treatment of opiate addiction with a sublingual-tablet formulation of buprenorphine and naloxone. *N Engl J Med* 2003;349:949–958.
- Fukuda K, Kato S, Morikawa H, et al. Functional coupling of the delta-, mu-, and kappa-opioid receptors to mitogen-activated protein kinase and arachidonate release in Chinese hamster ovary cells. *J Neurochem* 1996;67:1309–1316.
- Gal TJ. Naloxone reversal of buprenorphine induced respiratory depression. *Clin Pharmacol Ther* 1989;45:66–71.

47. Gal TJ, DiFazio CA. Prolonged antagonism of opioid action with intravenous nalmeferene. *Anesthesiology* 1986;64:175.
48. Gal TJ, DiFazio CA, Moscicki J. Analgesic and respiratory depressant activity of nalbuphine: a comparison with morphine. *Anesthesiology* 1982;57:367.
49. Gaveriaux-Ruff C, Matthes HW, Peluso J, et al. Abolition of morphine-induced immunosuppression in mice lacking the  $\mu$ -opioid receptor gene. *Proc Natl Acad Sci U S A* 1998;95:6326–6330.
50. Gillman PK. Monoamine oxidase inhibitors, opioid analgesics and serotonin toxicity. *Br J Anaesth* 2005;95:434–441.
51. Goodman RR, Snyder SH. Autoradiographic localization of kappa opiate receptors to deep layers of the cerebral cortex may explain unique sedative and analgesic effects. *Life Sci* 1982;31:1291.
52. Goodman RR, Snyder SH, Kuhar MJ, et al. Differentiation of  $\delta$  and  $\mu$  opiate receptor localizations by light microscopic autoradiography. *Proc Natl Acad Sci U S A* 1980;77:6239.
53. Gray TC, Rees GJ. The role of apnoea in anaesthesia for major surgery. *Br Med J* 1952;2:891.
54. Green JF, Jackman AP, Krohm KA. Mechanism of morphine-induced shifts in blood volume between extracorporeal reservoir and the systemic circulation of the dog under conditions of constant blood flow and vena caval pressures. *Circ Res* 1978;42:479.
55. Griffith HR, Johnson GE. The use of curare in general anesthesia. *Anesthesiology* 1942;3:418.
56. Grond S, Sablotzki A. Clinical pharmacology of tramadol. *Clin Pharmacokinetics* 2004;43:879–923.
57. Gueneron JP, Ecoffey C, Carli P, et al. Effect of naloxone infusion on analgesia and respiratory depression after epidural fentanyl. *Anesth Analg* 1988;67:35.
58. Gustorff B, Nahlik G, Hoerauf KH, et al. The absence of acute tolerance during remifentanyl infusion in volunteers. *Anesth Analg* 2002;94:1223–1228.
59. Gutstein HB, Rubie EA, Mansour A, et al. Opioid effects on mitogen-activated protein kinase signaling cascades. *Anesthesiology* 1997;87:1118–1126.
60. Henney RP, Vasko JS, Brawley RK, et al. The effects of morphine on the resistance and capacitance vessels of the peripheral circulation. *Am Heart J* 1966;72:242.
61. Henry DJ, Grandy DK, Lester HA, et al. Kappa-opioid receptors couple to inwardly rectifying potassium channels when coexpressed by *Xenopus* oocytes. *Mol Pharmacol* 1995;47:551–557.
62. Hermans JM, Ebertz JM, Hanifin JM, et al. Comparison of histamine release in human skin mast cells induced by morphine, fentanyl, and oxymorphone. *Anesthesiology* 1985;62:124.
63. Horvath G. Endomorphin-1 and endomorphin-2: pharmacology of the selective endogenous  $\mu$ -opioid receptor agonists. *Pharmacol Ther* 2000;88:437–463.
64. Hsu HO, Hickey RF, Forbes AR. Morphine decreases peripheral vascular resistance and increases capacitance in man. *Anesthesiology* 1979;50:98.
65. Hug CC Jr, Murphy MR. Fentanyl disposition in cerebrospinal fluid and plasma and its relationship to ventilatory depression in the dog. *Anesthesiology* 1979;50:342.
66. Hug CC Jr, Murphy MR. Tissue redistribution of fentanyl and termination of effect in rats. *Anesthesiology* 1981;55:369.
67. Hug CC Jr, Murphy MR, Rigel EP, et al. Pharmacokinetics of morphine injected intravenously into the anesthetized dog. *Anesthesiology* 1981;54:38.
68. Inturrisi CE, Colburn WA, Kaiko RF, et al. Pharmacokinetics and pharmacodynamics of methadone in patients with chronic pain. *Clin Pharmacol Ther* 1987;41:392.
69. Inturrisi CE. Pharmacology of methadone and its isomers. *Minerva Anestesiologica* 2005;71:435–437.
70. Jaffe RD, Moldenhauer CC, Hug CC Jr, et al. Nalbuphine antagonism of fentanyl-induced ventilatory depression: a randomized trial. *Anesthesiology* 1988;68:254.
71. Johnson PS, Wang JB, Wang WF, et al. Expressed mu opiate receptor couples to adenylate cyclase and phosphatidylinositol turnover. *Neuroreport* 1994;5:507.
72. Kaiko RF, Wallenstein SL, Rogers AG, et al. Intramuscular meptazinol and morphine in postoperative pain. *Clin Pharmacol Ther* 1985;37:589.
73. Kaufman JJ, Semo NM, Koski WS. Microelectrometric titration measurement of the  $pK_a$ s and partition and drug distribution coefficients of narcotics and narcotic antagonists and their pH and temperature dependence. *J Med Chem* 1975;18:647.
74. Keats AS. The effect of drugs on respiration in man. *Ann Rev Pharmacol Toxicol* 1985;25:41.
75. Kharasch ED, Walker A, Hoffer C, et al. Sensitivity of intravenous and oral alfentanil and pupillary miosis as minimally invasive and noninvasive probes for hepatic and first-pass CYP3A activity. *J Clin Pharmacol* 2005;45:1187–1197.
76. King T, Ossipov MH, Wanderah TW, et al. Is paradoxical pain induced by sustained opioid exposure an underlying mechanism of opioid antinociceptive tolerance? *Neurosignals* 2005;14:194–205.
77. Kissin I, Vinik HR, Castillo R, et al. Alfentanil potentiates midazolam-induced unconsciousness in subanalgesic doses. *Anesth Analg* 1990;71:65.
78. Kurz A, Sessler DI. Opioid-induced bowel dysfunction: pathophysiology and potential new therapies. *Drugs* 2003;63:649–671.
79. Lang E, Kapila A, Shlugman D, et al. Reduction of isoflurane minimal alveolar concentration by remifentanyl. *Anesthesiology* 1996;85:721–728.
80. Lappas DG, Buckley MJ, Laver MB, et al. Left ventricular performance and pulmonary circulation following addition of nitrous oxide to morphine during coronary artery surgery. *Anesthesiology* 1975;43:61.
81. Laubie M, Schmitt H, Vincent M. Vagal bradycardia produced by micro-injections of morphine-like drugs into the nucleus ambiguus in anesthetized dogs. *Eur J Pharmacol* 1979;59:287.
82. Law PY, Loh HH, Wei L-N. Insights into the receptor transcription and signaling: implications in opioid tolerance and dependence. *Neuropharmacology* 2004;47:300.
83. Leaman DM, Levenson L, Zelis R, et al. Effect of morphine on splanchnic blood flow. *Br Heart J* 1978;40:569.
84. Lee HK, Wang SC. Mechanism of morphine-induced miosis in the dog. *J Pharmacol Exp Ther* 1975;192:415.
85. Letrent SP, Pollack GM, Brouwer KR, et al. Effects of a potent and specific P-glycoprotein inhibitor on the blood-brain barrier distribution and antinociceptive effect of morphine in the rat. *Drug Metab Dispos* 1999;27:827–834.
86. Lotsch J, Geisslinger G. Are  $\mu$ -opioid receptor polymorphisms important for clinical opioid therapy? *Trends Mol Sci* 2005;11:82–89.
87. Lowenstein E, Hallowell P, Levine FH, et al. Cardiovascular response to large doses of intravenous morphine in man. *N Engl J Med* 1969;281:1389.
88. Lowenstein E, Whiting RB, Bittar DA, et al. Local and neurally mediated effects of morphine on skeletal muscle vascular resistance. *J Pharmacol Exp Ther* 1972;180:359.
89. Maitre PO, Vozeh S, Heykants J, et al. Population pharmacokinetics of alfentanil: the average dose-plasma concentration relationship and interindividual variability in patients. *Anesthesiology* 1987;66:3.
90. Martin DE, Rosenberg H, Aukburg SJ, et al. Low-dose fentanyl blunts circulatory responses to tracheal intubation. *Anesth Analg* 1982;61:680.
91. Mather LE, Tucker GT, Pfulg AE, et al. Meperidine kinetics in man: intravenous injection in surgical patients and volunteers. *Clin Pharmacol Ther* 1975;17:21.
92. McCammon RL, Stoelting RK, Madura JA. Effects of butorphanol, nalbuphine, and fentanyl on intrabiliary tract dynamics. *Anesth Analg* 1984;63:139.
93. McClain DA, Hug CC Jr. Intravenous fentanyl kinetics. *Clin Pharmacol Ther* 1980;28:106.
95. Milde LN, Milde JH, Gallagher WJ. Cerebral effects of fentanyl in dogs. *Br J Anaesth* 1989;63:710.
95. Mills CA, Flacke JW, Miller JD, et al. Cardiovascular effects of fentanyl reversal by naloxone at varying arterial carbon dioxide tensions in dogs. *Anesth Analg* 1988;67:730.



96. Misra AL. Metabolism of opiates. In: Alder ML, Manara L, Samanin R, eds. *Factors affecting the Action of Narcotics*. New York: Raven Press, 1978, pp. 297–343.
97. Mogil J, Pasternak GW. The molecular and behavioral pharmacology of the orphanin FQ/nociceptin peptide and receptor family. *Pharmacol Rev* 2001;53:381–415.
98. Mummaneni N, Rao TLK, Montoya A. Awareness and recall with high-dose fentanyl-oxygen anesthesia. *Anesth Analg* 1980;59:948.
99. Murkin JM, Moldenhaur CC, Hug CC Jr., et al. Absence of seizures during induction of anesthesia with high-dose fentanyl. *Anesth Analg* 1984;63:489.
100. Murphy MR, Hug CC Jr. The enflurane sparing effect of morphine, butorphanol and nalbuphine. *Anesthesiology* 1982;57:489, 492.
101. Murphy MR, Olson WA, Hug CC Jr. Pharmacokinetics of <sup>3</sup>H-fentanyl in the dog anesthetized with enflurane. *Anesthesiology* 1979;50:13.
102. Murray A, Hagen NA. Hydromorphone. *J Pain Symptom Manage* 2005;29:S57–S66.
103. Nagashima H, Karamanian A, Malovany R, et al. Respiratory and circulatory effects of intravenous butorphanol and morphine. *Clin Pharmacol Ther* 1976;19:738.
104. Neff W, Mayer EC, de la Luz Perales M. Nitrous oxide and oxygen anesthesia with curare relaxation. *Calif Med* 1947;66:67.
105. Joong S. Experimental pentazocine-induced fibrous myopathy. *Ala J Med Sci* 1977;14:64.
106. Okutani R, Philbin DM, Rosow CE, et al. Effect of hypothermic hemodilutional cardiopulmonary bypass on plasma sufentanil and catecholamine concentrations in humans. *Anesth Analg* 1988;67:667.
107. Partridge L, Ward CF. Pulmonary edema following low-dose naloxone administration. *Anesthesiology* 1986;65:709.
108. Pasternak GW. Multiple opiate receptors: déjà vu all over again. *Neuropharmacol* 2004;47:312.
109. Paul D, Levison JA, Howard DH, et al. Naloxone benzoylhydrazone (NalBzoH) analgesia. *J Pharmacol Exp Ther* 1990;255:769.
110. Philbin DM, Moss J, Akins CW, et al. The use of H<sub>1</sub> and H<sub>2</sub> histamine antagonists with morphine anesthesia: a double-blind study. *Anesthesiology* 1981;55:292.
111. Philbin DM, Rosow CE, Schneider RC, et al. Fentanyl and sufentanil anesthesia revisited: how much is enough? *Anesthesiology* 1990;73:5.
112. Piros ET, Prather PL, Loh HH, et al. Ca<sup>2+</sup> channel and adenylyl cyclase modulation by cloned mu-opioid receptors in GH3 cells. *Mol Pharmacol* 1995;47:1041–1049.
113. Popio KA, Jackson DH, Ross AM, et al. Hemodynamic and respiratory effects of morphine and butorphanol. *Clin Pharmacol Ther* 1978;23:281.
114. Porreca F, Heyman JS, Mosberg HI, et al. Role of  $\mu$  and  $\kappa$  receptors in the supraspinal and spinal analgesic effects of [D-Pen<sup>2</sup>,D-Pen<sup>5</sup>]enkephalin in the mouse. *J Pharmacol Exp Ther* 1987;241:393.
115. Porter J, Jick H. Addiction rare in patients treated with narcotics. *N Engl J Med* 1980;302:123.
116. Prather PL, Loh HH, Law PY. Interaction of delta-opioid receptors with multiple G proteins: a non-relationship between agonist potency to inhibit adenylyl cyclase and to activate G proteins. *Mol Pharmacol* 1994;45:997.
117. Preston KL, Bigelow GE, Liebson IA. Butorphanol precipitated withdrawal in opioid dependent human volunteers. *J Pharmacol Exp Ther* 1988;246:441.
118. Price DD, Mayer DJ, Caruso FS. NMDA-receptor antagonists and opioid receptor interactions as related to analgesia and tolerance. *J Pain Symptom Manage* 2000;19:S7–S11.
119. Radnay PA, Duncalf D, Novakovic M, et al. Common bile duct pressure changes after fentanyl, morphine, meperidine, butorphanol and naloxone. *Anesth Analg* 1984;63:441.
120. Rance MJ. Multiple opiate receptors—their occurrence and significance. *Clin Anaesthesiol* 1983;1:183.
121. Romberg R, Olofsen E, Sarton E, et al. Pharmacodynamic effect of morphine-6-glucuronide versus morphine on hypoxic and hypercapnic breathing in healthy volunteers. *Anesthesiology* 2003;99:788–798.
122. Romberg R, Olofsen E, Sarton E, et al. Pharmacokinetic-pharmacodynamic modeling of morphine-6-glucuronide-induced analgesia in healthy volunteers: absence of sex differences. *Anesthesiology* 2004;100:120–133.
123. Rosow CE. Newer synthetic opioid analgesics. In: Smith G, Covino BG, eds. *Acute Pain*. London: Butterworths, 1985, p. 74.
124. Rosow CE, Moss J, Philbin DM, et al. Histamine release during morphine and fentanyl anesthesia. *Anesthesiology* 1982;56:93.
125. Rosow CE, Philbin DM, Keegan CR, et al. Hemodynamics and histamine release during induction with sufentanil or fentanyl. *Anesthesiology* 1984;60:489.
126. Roy SD, Flynn GL. Solubility and related physicochemical properties of narcotic analgesics. *Pharm Res* 1988;5:580–586.
127. Saini V, Carr DB, Hagestad EL, et al. Antifibrillatory action of the narcotic agonist fentanyl. *Am Heart J* 1988;115:598.
128. Sanford TJ Jr, Weinger MB, Smith NT, et al. Pretreatment with sedative-hypnotics, but not with nondepolarizing muscle relaxants, attenuates alfentanil-induced muscle rigidity. *J Clin Anesth* 1994;6:473–480.
129. Sarton E, Olofsen E, Romberg R, et al. Sex differences in morphine analgesia: an experimental study in healthy volunteers. *Anesthesiology* 2000;93:1245–1254.
130. Scamman FL. Fentanyl-O<sub>2</sub>-N<sub>2</sub>O rigidity and pulmonary compliance. *Anesth Analg* 1983;62:332.
131. Schraag S, Checketts MR, Kenny GN. Lack of rapid development of opioid tolerance during alfentanil and remifentanil infusions for postoperative pain. *Anesth Analg* 1999;89:753–757.
132. Scott JC, Ponganis KV, Stanski DR. EEG quantitation of narcotic effect: the comparative pharmacodynamics of fentanyl and alfentanil. *Anesthesiology* 1985;62:234.
133. Scott JC, Stanski DR. Decreased fentanyl and alfentanil dose requirements with age. A simultaneous pharmacokinetic and pharmacodynamic evaluation. *J Pharmacol Exp Ther* 1987;240:159.
134. Sebel PS, Bovill JG, Wauquier A, et al. Effects of high-dose fentanyl anesthesia on the electroencephalogram. *Anesthesiology* 1981;55:203.
135. Shafer A, Sung ML, White PF. Pharmacokinetics and pharmacodynamics of alfentanil infusions during general anesthesia. *Anesth Analg* 1986;65:1021.
136. Shirasaki T, Abe K, Soeda F, et al. Delta-opioid receptor antagonists inhibit GIRK channel currents in acutely dissociated brainstem neurons of rat. *Brain Res* 2004;1006:190–197.
137. Shupak RC, Harp JR. Comparison between high-dose sufentanil-oxygen and high-dose fentanyl-oxygen for neuroanesthesia. *Br J Anaesth* 1985;57:375.
138. Silbert BS, Rosow CE, Keegan CR, et al. The effect of diazepam on induction of anesthesia with alfentanil. *Anesth Analg* 1986;65:71.
139. Skarke C, Darimont J, Schmidt H, et al. Analgesic effects of morphine and morphine-6-glucuronide in a transcutaneous electrical pain model in healthy volunteers. *Clin Pharmacol Ther* 2003;73:107–121.
140. Skarke C, Langer M, Jarrar M, et al. Probenecid interacts with the pharmacokinetics of morphine-6-glucuronide in humans. *Anesthesiology* 2004;101:1394–1399.
141. Smart D, Hirst RA, Hirota K, et al. The effects of recombinant rat mu-opioid receptor activation in CHO cells on phospholipase C, [Ca<sup>2+</sup>] and adenylyl cyclase. *Br J Pharmacol* 1997;120:1165.
142. Spencer RJ, Jin W, Thayer SA, et al. Mobilization of Ca<sup>2+</sup> from intracellular stores in transfected neuron cells by activation of multiple opioid receptor subtypes. *Biochem Pharmacol* 1997;54:809–18.
143. Srisurapanont M, Jarusuraisin N. Opioid antagonists for alcohol dependence. *Cochrane Database Syst Rev* 2005;25:CD001867.
144. Stanley TH, Webster LR. Anesthetic requirements and cardiovascular effects of fentanyl-oxygen and fentanyl-diazepam-oxygen anesthesia in man. *Anesth Analg* 1978;57:411.
145. Stanley TH, Reddy P, Glimore S, et al. The cardiovascular effects of high-dose bu-



- torphanol-nitrous oxide anaesthesia before and during operation. *Can Anaesth Soc J* 1983;30:337.
146. Stein C, Comisel K, Haimerl E, et al. Analgesic effect of intraarticular morphine after arthroscopic knee surgery. *N Engl J Med* 1991;325:1123.
147. Szeto HH, Inturrisi CE, Houde R, et al. Accumulation of normeperidine, an active metabolite of meperidine in patients with renal failure or cancer. *Ann Intern Med* 1977;86:738.
148. Takemori AE, Ho BY, Naeseth JS, et al. Nor-binaltorphimine, a highly selective  $\kappa$ -opioid antagonist in analgesic and receptor binding assays. *J Pharmacol Exp Ther* 1988;246:255.
149. Tallent M, Dichter MA, Bell GI, et al. The cloned kappa opioid receptor couples to an N-type calcium current in undifferentiated PC-12 cells. *Neuroscience* 1994;63:1033-1040.
150. Tegeder I, Lotsch J, Geisslinger G. Pharmacokinetics of opioids in liver disease. *Clin Pharmacokinet* 1999;37:17-40.
151. Tharp MD, Kagey-Sobotka A, Fox CC, et al. Functional heterogeneity of human mast cells from different anatomic sites: In vitro responses to morphine sulfate. *J Allergy Clin Immunol* 1987;79:646-653.
152. Tigerstedt I, Turunen M, Tammisto T, et al. The effect of buprenorphine and oxycodone on the intracholedochal passage pressure. *Acta Anaesth Scand* 1981;25:99.
153. Tomichek RC, Rosow CE, Philbin DM, et al. Diazepam-fentanyl interaction—hemodynamic and hormonal effects in coronary artery surgery. *Anesth Analg* 1983;62:881.
154. Urthaler F, Isobe JH, James T. Direct and vagally mediated chronotropic effects of morphine studied by selective perfusion of the sinus node of awake dogs. *Chest* 1975;68:222.
155. Van Ree JM, Versteeg DH, Spaapen-Kok, et al. Effects of morphine on hypothalamic noradrenaline and on pituitary-adrenal activity in rats. *Neuroendocrinology* 1976;22:305.
156. Verbeeck RK, Branch RA, Wilkinson GR. Meperidine disposition in man: influence of urinary pH and route of administration. *Clin Pharmacol Ther* 1981;30:619.
157. Vinik HR, Kissin I. Rapid development of tolerance to analgesia during remifentanyl infusion in humans. *Anesth Analg* 1998;86:1307-1311.
158. Wang SC, Glaviano VV. Locus of emetic action of morphine and Hydergine in dogs. *J Pharmacol Exp Ther* 1954;111:329.
159. Ward JW, McGrath RL, Weil JV. Effects of morphine on the peripheral vascular response to sympathetic stimulation. *Am J Cardiol* 1972;29:656.
160. Way WL, Costley EC, Way EL. Respiratory sensitivity of the newborn infant to meperidine and morphine. *Clin Pharmacol Ther* 1965;6:454.
161. Wei G, Moss J, Yuan CS. Opioid-induced immunosuppression. In: Yuan CS, ed. *Handbook of Opioid Bowel Syndrome*. New York: Haworth Medical Press, 2005: 45-57.
162. Weil JV, McCullough RE, Kline JS, et al. Diminished ventilatory response to hypoxia and hypercapnia after morphine in normal man. *N Engl J Med* 1975;292:1103.
163. Weinger MB, Smith NT, Blasco TA, et al. Brain sites mediating opiate-induced muscle rigidity in the rat: methylnaloxonium mapping study. *Brain Res* 1991;544:181.
164. Weitz CJ, Faull KF, Goldstein A. Synthesis of the skeleton of the morphine molecule by mammalian liver. *Nature* 1987;330:674.
165. Westmoreland CL, Hoke JF, Sebel PS, et al. Pharmacokinetics of remifentanyl (GI87084B) and its major metabolite (GI90291) in patients undergoing elective inpatient surgery. *Anesthesiology* 1993;79:893.
166. Wolff BG, Michelassi F, Gerkin TM, et al. Alvimopan, a novel, peripherally acting mu opioid antagonist. Results of a multicenter, randomized, double-blind, placebo-controlled, phase III trial of major abdominal surgery and postoperative ileus. *Ann Surg* 2004;240:728-735.
167. Wynands JE, Wong P, Whalley DG, et al. Oxygen-fentanyl anesthesia in patients with poor left ventricular function: hemodynamics and plasma fentanyl concentrations. *Anesth Analg* 1983;62:476.
168. Yuan CS, Foss JF, O'Connor, et al. Methylnaltrexone prevents morphine-induced delay in oral-cecal transit time without affecting analgesia: a double-blind randomized placebo-controlled trial. *Clin Pharmacol Ther* 1996;59:469-475.
169. Yuan CS, Foss JF, Osinski J, et al. The safety and efficacy of oral methylnaltrexone in preventing morphine-induced delay in oral-cecal transit time. *Clin Pharmacol Ther* 1997;61:467-475.
170. Zadina JE, Hackler L, Ge LJ, et al. A potent and selective endogenous agonist for the  $\mu$ -opiate receptor. *Nature* 1997;386:499-501.
171. Zelis R, Mansour EJ, Capone RJ, et al. The cardiovascular effects of morphine. The peripheral capacitance and resistance vessels in human subjects. *J Clin Invest* 1974;54:1247.

# CHAPTER 42

## Total Intravenous Anesthesia

John Sear, MA, PhD, MBBS,  
FFARCS, FANZCA

In 2006, we are still without any one drug that can provide all the requirements of anesthesia (i.e., unconsciousness, analgesia, amnesia, and muscle relaxation). Consequently, administration of several different agents is needed to produce the desired end result. The use of intravenous agents to achieve these goals began with the introduction of the rapidly acting barbiturates in 1934. Despite the disastrous consequences following the use of thiopental at Pearl Harbor in 1941, intravenous anesthesia is now well established as an alternative, and in some circumstances more appropriate, technique than the traditional approaches of volatile anesthetics alone, or balanced anesthesia where volatile and intravenous agents are combined together.

The kinetics of the early barbiturates did not render the drugs ideal for the *maintenance* of anesthesia; the provision of analgesia could not be achieved by the barbiturates alone; and the addition of either meperidine or morphine (both drugs having slow blood–brain equilibration) led to overdosing and hence to poor clinical conditions, especially in the spontaneously breathing patient. The introduction of modern *volatile* agents, starting with halothane in 1956, with their easy titratability, encouraged the anesthetist to turn away from the intravenous agents for the maintenance of anesthesia.

The development of and present interest in total intravenous anesthesia (TIVA) owes much to a number of important studies. From the standpoint of hypnosis, a key contribution was that of Savege et al., in 1975, who used the steroid agent Althesin (alphaxalone and alphadolone acetate) with meperidine to supplement oxygen-enriched air in the spontaneously breathing patient.<sup>97</sup> Subsequent drug developments included the use of in-

fusions of thiopental, methohexital, carboxylated imidazole etomidate, propofol, and ketamine. However, with the exception of ketamine, none of these agents probably provided analgesia (although analgesic effects of alphadolone have been described by Goodchild et al.<sup>36</sup>).

The use of morphine to provide anesthesia as a *sole agent* in patients undergoing cardiac surgery was first described by Lowenstein et al. in 1969, where the hypnotic side effects of large doses of morphine were used to provide sedation.<sup>61</sup> However, this method of anesthesia (more popular in the United States and Europe than in the

United Kingdom) was not reliably effective. It was associated with a high incidence of episodes of awareness during anesthesia, as well as intraoperative episodes of hypotension caused by histamine release, resulting in increased intraoperative and postoperative fluid and blood requirements.

The selective and highly potent  $\mu$ -receptor opiates (fentanyl, alfentanil, sufentanil, and more recently, remifentanyl) have the advantage of less cardiovascular depression, as well as the ability to obtund the hemodynamic responses to laryngoscopy and intubation. However this apparent stability is less evident during major cardiovascu-

### KEY POINTS

1. The appearance of new drugs with short blood–brain equilibration times (especially those with an ester linkage) enables the clinician to use anesthetics and analgesics where titratability will be easy and recovery rapid.
2. Total intravenous anesthesia (TIVA) offers some important advantages over inhalation anesthetics, including rapid recovery with minimal hangover and a low incidence of nausea and vomiting. TIVA may be the technique of choice for some operations.
3. Effective delivery of TIVA requires the clinician to have a good knowledge and understanding of pharmacokinetics, pharmacodynamics, and pharmacokinetic–pharmacodynamic (PK-PD) modeling.
4. Important drug characteristics include induction dose, rate of administration and  $k_{eo}$  (rate constant for the elimination of drug from the effect compartment) (drugs with small  $k_{eo}$  values take longer to equilibrate between the blood and the effect compartment or biophase). Thus for a rapid sequence induction, drugs with a large  $k_{eo}$  are preferable (viz., propofol, thiopental, remifentanyl, and alfentanil compared with midazolam, ketamine, and fentanyl)
5. Drug interactions are important in TIVA. Excepting ketamine, opiates and hypnotics potentiate each other and can result in synergistic cardiovascular and respiratory depression. This means the doses of each can be reduced. There is a ceiling to the potentiating effect of the opiates, beyond which there is an increased incidence of adverse side effects and often delayed onset of spontaneous ventilation at the end of surgery.
6. Ketamine is the only hypnotic drug with analgesic properties; there are few data suggesting that the S (+) isomer has major advantages.
7. If the patient shows signs of response during TIVA, there is need for additional IV supplementation by bolus doses or by increasing the targeted concentration if using target-controlled infusion (TCI).
8. The elimination half-life and systemic clearance are not useful in TIVA for determining the offset of IV drugs. The context-sensitive half-time (CSHT) is more relevant, and modeled data and dynamic measurements correlate well.
9. Context-sensitive decrement times are useful indices of recovery from anesthesia. Recovery is influenced by other factors apart from the CSHT, including patient characteristics such as age, gender, body habitus, and disease states.
10. A knowledge of the context-sensitive decrement times for opiates and hypnotics allows appropriate choice of drugs for the maintenance of anesthesia. CSHT also helps determine which infusions should be terminated at the end of anesthesia, and which some time beforehand.

TABLE 42-1.

## Adverse Properties of Volatile Agents

1. Organ toxicity is associated with the use of most of our present volatile agents, such as dose-related cardiovascular and respiratory depression; dose-related increases in cerebral blood flow and intracranial pressure; hepatic and renal toxicity; coronary blood-flow steal phenomena; and immunodepression.
2. Environmental issues related to trace concentrations of volatile agents and nitrous oxide as well as the effects of these trace concentrations on the health and work performance of anesthesiologists, surgeons, operating room and recovery area personnel.

lar surgery, particularly during the period of sternotomy and aortic root dissection in patients undergoing cardiopulmonary bypass, where there are frequent episodes of significant hypertension and tachycardia that are not always remediable by increased doses of the opiates. Thus it became clear that use of high doses of opiates *alone* was inappropriate to provide anesthesia. Hence attempts to control the hemodynamic effects of surgical stimulation and to reduce the incidence of awareness have used either low inspired concentrations of volatile agents or infusions of a sedative-hypnotic agent as supplements to opiates.

Use of TIVA techniques are not without difficulties in these patients as some combinations of opiates, such as fentanyl and diazepam, can result in significant reductions in both cardiac output and systemic vascular resistance. However, the effectiveness of the benzodiazepines in reducing the circulating levels of catecholamines may be important, and greater hemodynamic stability has been found in cardiac surgical patients where the combination of sufentanil with ketamine or midazolam has been employed. In noncardiac surgery, opiates remain popular as the basis of most neurosurgical anesthetic techniques, as they do not alter the carbon dioxide reactivity of the cerebral blood vessels. The kinetics and dynamics of remifentanyl (and to a less extent alfentanil) allow the anesthesiologist to titrate dose requirements more closely for a given surgical procedure during abdominal

and other major body surface surgical procedures.

Over the past two decades, increased interest in intravenous anesthesia has been prompted both by the availability of newer and more appropriate rapid-onset and short-acting IV sedative-hypnotics (e.g., midazolam, propofol, etomidate), analgesics (alfentanil, sufentanil, remifentanil), and muscle relaxants (atracurium, vecuronium, mivacurium, and rocuronium). All these factors have refocused the anesthetist's attention on the *total* provision of anesthesia by the intravenous route. Furthermore, there are also a number of clinical situations where intravenous anesthesia techniques are advantageous, including:

- To provide sedation to supplement local or regional anesthetic techniques.
- To provide general anesthesia with accompanying minimal cardiovascular depression.
- For office or ambulatory surgery, where the speed and completeness of recovery are important.
- For situations where volatile-based anesthetics may be difficult to administer because of the unavailability of resources, such as nitrous oxide; at sites of military or nonmilitary trauma; and for anesthesia at increased ambient pressure.
- In circumstances where nitrous oxide may either be undesirable (e.g., because of the need for high inspired oxygen concentrations) or contraindicated (e.g., for one-lung anesthesia; for middle ear surgery, some neurosurgical operations, and prolonged abdominal surgery where nitrous oxide can cause closed-space effects as a result of increased volume and pressure; for relief of cardiac tamponade; for airway endoscopies [bronchoscopy and laryngoscopy]; and for bronchotracheal surgery), or where volatile agents may best be avoided (Table 42-1).
- To prevent awareness during cardiopulmonary bypass, and to offer cerebral protection to patients at risk of episodes of brain ischemia.
- In malignant hyperpyrexia-susceptible patients.

However, the general application of TIVA techniques is not without important considerations and questions. These include the possibility and de-

TABLE 42-2.

## Ideal Properties of a Hypnotic Drug for Use during Total Intravenous Anesthesia

1. Soluble in aqueous such that use of a solvent is avoided.
2. Stable in solution and on exposure to light for prolonged periods of time.
3. No absorption onto plastic tubing or giving sets.
4. No venous damage (pain on injection, venous phlebitis, or thrombosis) or tissue damage when administered either extravascularly or intraarterially.
5. Sleep in one arm-brain circulation time.
6. Short duration of action, and inactivation by metabolism in either the liver, blood, or other organs of the vessel-rich group of tissues.
7. Inactive, nontoxic, water-soluble metabolites.
8. Minimal cardiovascular and respiratory side effects.

tection of awareness; the possibility of postoperative respiratory depression because of the persistent effects of concurrently administered analgesic agents; the requirement of a separate dedicated IV access site; appropriate infusion pumps; and the observation that some researchers consider depth of anesthesia as uncontrollable as with the volatile agents.

### What Are the Ideal Drug Properties for and Advantages of TIVA?

Table 42-2 lists the ideal properties of a hypnotic drug for continuous infusion anesthesia. Although *none* of the present hypnotic or analgesic agents fulfills all of these criteria, some are more suitable than others under differing circumstances. Table 42-3 lists the pharmacologic advantages of TIVA over inhalational agents.

### Dosing Strategies for TIVA

The administration of hypnotic, analgesic, and neuromuscular blocking components of TIVA can be provided in a number of different ways:

- Intermittent bolus doses of the drugs;
- Continuous infusions using syringe infusion pumps or similar delivery systems;

TABLE 42-3.

## Advantages of TIVA

1. Smooth induction of anesthesia without coughing or hiccupping.
2. Easy control of depth of anesthesia when using drugs with short blood-brain equilibration times.
3. With most of the agents there is rapid and predictable emergence with minimal hangover.
4. Low incidence of postoperative nausea and vomiting.
5. Ideal operating conditions for neurologic surgery with reduced cerebral brain flow and cerebral metabolic rate for oxygen.
6. Minimal organ toxicity, although infusions of etomidate cause depression of adrenosteroidogenesis and red cell hemolysis. Infusions of propofol can lead to a metabolic syndrome.

- Through the introduction (in most parts of the world, although not presently in the United States) of target-controlled infusion systems (TCI).

When given by intermittent bolus doses, there will be fluctuating drug concentrations that are associated with accompanying changes in the depth of anesthesia. Continuous infusions of IV hypnotics, opiates, and muscle relaxants can reduce these swings in drug concentrations, as well as minimize any relative under- or overdosing during drug administration. This offers a number of advantageous features to the anesthetized patient, including greater hemodynamic stability; fewer episodes of hemodynamic breakthrough and other signs of patient responsiveness; reduced need for supplemental anesthetics or vasoactive drugs; more rapid awakening and decreased incidence of requirements for naloxone or need for postoperative ventilatory support; decreased incidence of side effects; and a 25–30% lower total drug dose compared with bolus dosing.<sup>4,5,92,139,140</sup> Use of continuous drug infusions may also lead to decreased drug costs.

However, because modern IV agents exert profound pharmacologic effects and have short durations of action, frequent adjustments to drug dosage are necessary in order to match anesthetic effect to the varying noxious stimuli being perceived at different

times during surgery, as well as the different noxious intensities of different surgical operations. This requires either frequent additional bolus dosing, or the calculation of new infusion rates to achieve different drug targets.

Early studies using IV infusion anesthesia focused on providing fixed rate infusions that were adequate for 50% or more of a given population.<sup>5,89</sup> With the passage of time, these have been viewed as being less appropriate and flexible in output because they failed to allow easy titration of the achieved drug concentration to clinical effect in accordance with an individual patient's requirements. Indeed there is the probability that many patients received an overdosage because of the desire to design regimens that were “all-embracing” to all people! Nevertheless, the work of Prys-Roberts et al. confirmed the usefulness of this approach to the provision of anesthesia with minimal cardiorespiratory depression, and no reported cases of awareness.<sup>88,109,110</sup>

With the hypnotic drugs currently available for continuous infusion, several manual schema for anesthesia delivery have been developed. For example, there is the regimen for propofol described by Roberts et al. based on an infusion protocol to maintain a plasma propofol concentration of around 3  $\mu\text{g}/\text{mL}$ .<sup>93</sup> This was achieved by an initial 1 mg/kg induction dose, then 10 mg/kg/h for 10 minutes, 8 mg/kg/h for 10 minutes, and maintained at 6 mg/kg/h. As this scheme is designed to achieve a fixed plasma propofol concentration, there is often a need for supplementation with additional propofol boluses and/or opiates during abdominal or other major operations. Manual regimens have similarly been described for midazolam by infusion. Persson et al. used an induction dose of 0.25 mg/kg, followed by a fast infusion of 0.65 mg/kg/h for 15 minutes and maintained with 0.13 mg/kg/h. This provided a hypnotic plasma concentration of between 300 and 400 ng/mL.<sup>84,86</sup> In a separate study, Thiel et al. described an infusion of midazolam (0.1–0.15 mg/kg then 0.02 mg/kg/h) supplemented with an opiate infusion of sufentanil for cardiac surgery.<sup>126</sup>

### Pharmacokinetic Principles of TIVA

Simplistically, the design of infusion schema for TIVA is based on two important equations which define the

loading dose and the maintenance infusion rate.

$$\text{Loading dose} = V_d \times C_p$$

$$\text{Maintenance infusion rate} = C_p \times Cl$$

where  $V_d$  = initial apparent volume of distribution;  $C_p$  = the desired plasma drug concentration; and  $Cl$  the systemic clearance of the drug.

However, these calculations of drug requirements to reach a given target concentration are flawed for several reasons. First, the plasma is not the site of action of IV drugs; the site where the drugs produce their effects is in the brain, and is termed the *biophase*. To reach the biophase, drug redistributes from the blood to the brain. At the same time, drug is also being redistributed to other tissues of the body. Hence the loading dose necessary to produce a desired pharmacologic effect cannot usually be calculated based on the initial volume of drug distribution (which is primarily the blood volume), but should use the apparent volume of distribution into which the drug has distributed once it has equilibrated with the biophase (i.e., this will, of necessity, be a larger volume).

When a drug is given by rapid infusion, there may be a simultaneous pharmacologic effect; however, the measure of drug effect (be it electroencephalogram [EEG] spectral edge frequency, minute ventilation volume, or change in blood pressure or heart rate) does not always parallel the rapid increase and decrease in the plasma drug concentration. This implies “hysteresis” in the relationship between drug concentration and effect. From studies that provide continuous measurement of plasma drug concentration and effect, it is possible to relate the plasma drug concentration to the effect produced in the biophase,<sup>108</sup> and, in turn, to calculate the volume of distribution of this effect compartment. Furthermore, by complex mathematical manipulation, the hysteresis loop can be “collapsed” to derive a linear relationship between concentration and effect. The value that causes the hysteresis loop to collapse represents the rate of equilibration of the drug concentration between the plasma and the biophase. This is termed  $k_{e0}$  or the blood-brain equilibration rate constant. Table 42-4 shows the values of  $k_{e0}$ ,  $t_{1/2}k_{e0}$ , time to peak effect, and the apparent volume of the effect compartment.



TABLE 42-4.

Typical Values for the  $k_{e0}$ ,  $t_{1/2}k_{e0}$ , Time-to-Peak Effect following a Bolus Dose and the Apparent Volume of Distribution Incorporating the Effect Compartment

	$k_{e0}$ (min <sup>-1</sup> )	$t_{1/2}k_{e0}$ (min)	Time-to-Peak Effect (min)	$V_{de}$
PROP	0.291	2.4	2.2	37
THIOP	0.46	1.5	1.4	
ETOM	0.48	1.5	2.0	
KET				
MIDAZ	0.124	5.6	3.0	
REMI	0.46	1.5	1.5	
ALF	0.77	0.9	1.4	5.9
FENT	0.147	4.7	3.6	75
SUF	0.227	3.0	5.6	89

ALF, alfentanil; ETOM, etomidate; FENT, fentanyl; KET, racemic ketamine; MIDAZ, midazolam; PROP, propofol; REMI, remifentanyl; SUF, sufentanil;  $t_{1/2}k_{e0}$ , half-time for blood-brain equilibration; THIOP, thiopental;  $V_{de}$ , volume of distribution incorporating the effect compartment.

Although the  $t_{1/2}k_{e0}$  is the time for blood-brain equilibration, it also relates closely to the “time to peak drug effect.” For optimal dosing strategies,

clinicians need to know the time to peak effect when giving IV drugs during both the induction and maintenance phases of anesthesia (Fig. 42-1).

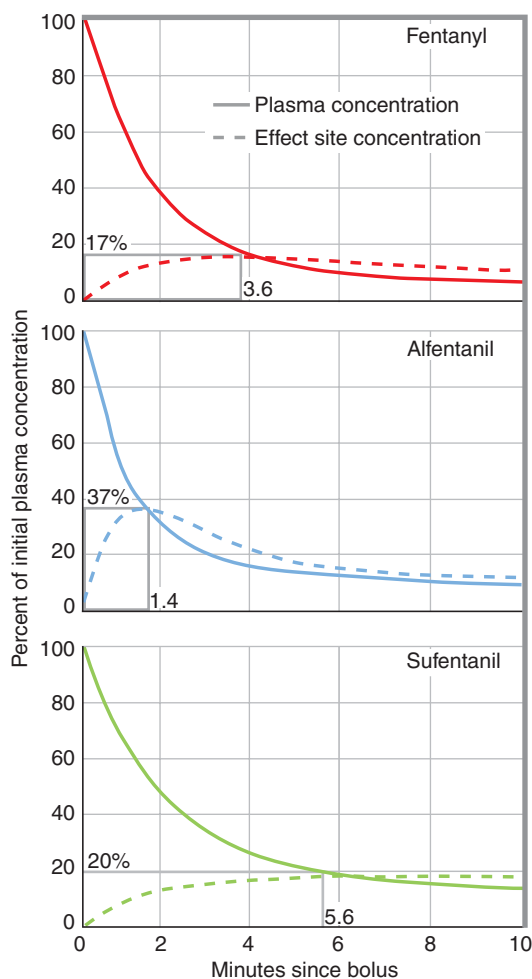


FIGURE 42-1. Computer-simulated plasma and effect-site concentrations for fentanyl, alfentanil, and sufentanil for the first 10 minutes after a bolus injection, as a percent of initial plasma concentration. (Adapted with permission from Shafer SL, Varvel JR. Pharmacokinetics, pharmacodynamics and rational opioid selection. *Anesthesiology* 1990;74:53-63.)

For example, during a rapid sequence induction, the anesthesiologist should use drugs with short times to peak effect. The combination of thiopental or etomidate and alfentanil or remifentanyl is probably more appropriate than a combination of propofol and fentanyl. With the latter combination, the effect of the fentanyl (if given immediately before the hypnotic agent) would not be maximal by the time of intubation, leading to an initial hypertensive response to the noxious stimulus of laryngoscopy. This might then be followed by a hypotensive response when the peak effect of the fentanyl is achieved and airway stimulation is minimal. In addition, when giving drugs by bolus dosing, the interval between doses needs to be of a sufficient duration to allow the peak effect of one bolus to be observed before the next dose of the drug is administered.

For most of the drugs used as the hypnotic and analgesic components of TIVA, plasma (blood) concentration-effect relationships have now been determined. From these, and using appropriate kinetic datasets, the clinician can derive manually controlled dosing schedules (Tables 42-5 and 42-6). However, these schema do not really take account of time delays in the concentration-effect relationship. Hence, many anesthesiologists view TIVA using manually controlled infusion systems and devices as a more complex strategy for maintaining anesthesia than using a vaporizer in the case of volatile agents!

### Computerized Drug Administration: Target-Controlled Infusions

One of the most significant and recent advances in the delivery of infusion anesthesia over the last decade is the introduction of TCI systems that allow the anesthesiologist to set the target concentration of anesthetic. This target can be defined as either the blood or the effect-site (i.e., brain) concentration. In many respects, these systems function in a similar manner to the setting of the inspired concentration of the volatile agents using a vaporizer.

A number of publications describe a theoretical approach to attaining and maintaining steady-state drug concentrations,<sup>55,106,130,131</sup> with different algorithms employed for targeting blood concentrations,<sup>4,22,44,125</sup> and incorporating effect-site concentrations into

TABLE 42-5.

Plasma Drug Concentrations of Hypnotics and Analgesics Needed for Provision of Adequate Anesthesia for Different Noxious Stimuli during Surgery in Patients Receiving TIVA

	Incision	Major Surgery <sup>a</sup>	Minor Surgery <sup>b</sup>
<b>Hypnotics (μg/mL)</b>			
Propofol	5–6	2.5–7.5	2–6
Methohexital	5–10	5–15	5–10
Thiopental	35–45	10–20	10–20
Etomidate	0.4–0.6	0.5–1.0	0.3–0.6
Midazolam	—	0.05–0.20	0.02–0.25
Ketamine (racemic)	—	—	1–2
<b>Opiates (ng/mL)<sup>c</sup></b>			
Alfentanil	200–300	250–450	100–300
Fentanyl	3–6	4–8	2–5
Sufentanil	1–3	2–5	1–3
Remifentanyl	2–6	4–8	2–4

<sup>a</sup>Major surgery includes abdominal and vascular surgery, thoracic surgery, major orthopaedic surgery, and neurosurgery.  
<sup>b</sup>Minor surgery is body surface surgery.  
<sup>c</sup>In the case of the opiates, adequate spontaneous ventilation will occur at concentrations ≤200–250, ≤1–2, ≤0.2, and ≤1–3 ng/mL, respectively.

model-driven automated delivery systems.<sup>48,114</sup> Several different systems for computerized drug delivery have been described. For example, Schwilden et al. formulated a system to maintain anesthesia using the hypnotic agent etomidate.<sup>107</sup> Other systems include the CACI (computer-assisted continuous infusion) system for fentanyl<sup>4</sup>; the TIAC (target-controlled infusion-based anesthesia) system also for fentanyl<sup>5</sup>; and the various systems for propofol.<sup>19</sup>

A TCI system consists of an infusion pump linked to a microprocessor containing the disposition pharmacokinetic

parameters for the drug in question. The equations describing disposition are based on the BET (bolus-elimination-transfer) scheme of Schuttler et al.<sup>105</sup> TCI combines sequential BET schemes for maintaining or increasing the target concentration, and periods of discontinuation of the infusion when the target concentration has to decrease. Infusion halts are mandatory if a new lower drug concentration is to be achieved as fast as possible. The first commercially available TCI system is the Diprifusor,<sup>35</sup> which was introduced in 1996 and uses prefilled glass syringes

TABLE 42-6.

Dosing Strategies (μg/kg or μg/kg/min) of Hypnotics and Analgesics When Given by Manual Infusion Regimens to Achieve the Concentrations (μg/mL) Needed for Major Surgery as Identified in Table 42-5

	Induction or Loading Dose	Maintenance Infusions Rate
<b>Hypnotics</b>		
Propofol	1000–2000	50–150
Methohexital	1500–2500	50–150
Midazolam	50–150	0.25–1.5
Ketamine (racemic)	1500–2500	25–75
<b>Opiates<sup>a</sup></b>		
Alfentanil	50–150	0.5–3.0
Fentanyl	5–15	0.03–0.10
Sufentanil	1–5	0.01–0.05
Remifentanyl	0.5–1.0	0.1–0.4

<sup>a</sup>For the opiates, the induction of loading dose is best given over 2 minutes to avoid marked cardiorespiratory depression.

of propofol tagged with a unique metallic strip. More recently “open TCI systems” that allow use of the various available generic formulations of propofol have been developed. Such systems include the Alaris Asena PK system and the Base Primea system of Fresenius.

At present, no drugs apart from propofol are licensed for use for TCI; in addition, approval for TCI is still awaited in the United States. However, research or developmental computer-driven delivery systems have been described for both sufentanil and remifentanyl.<sup>7,10,42,81,100,116</sup> Sufentanil has been administered by TCI in combination with isoflurane, propofol, and midazolam, with targeted concentrations, in most studies, of sufentanil between 0.2 and 1.5 ng/mL for noncardiac surgery and 3–10 ng/mL for cardiac surgery. Most studies report good quality anesthesia with hemodynamic stability and satisfactory times to return of spontaneous ventilation and extubation. Remifentanyl by TCI has been assessed in combination with both IV hypnotics and volatile agents,<sup>32,41,57,65</sup> the most appropriate kinetic model for drug delivery being that of Minto et al.<sup>68</sup> For analgesia, concentrations between 1 and 1.5 ng/mL are needed. In combination with propofol for noncardiac surgery, remifentanyl concentrations in the range of 4–8 ng/mL are appropriate. However, these data need confirmation in larger clinical trials.

Any TCI drug delivery system has 4 key components:

1. A calculator (computer or microprocessor) and a software program, either separate with cables linking to a syringe pump, or an “all-in-one” system (as is the case with the Diprifusor);
2. Datasets of pharmacokinetic parameters for each drug to be infused;
3. An infusion device; and
4. A user interface.

For TCI delivery, the anesthesiologist needs to enter the patient's age and weight into the device, and then select the desired target drug concentration. On pressing “start,” the TCI system delivers precisely the amount of drug to achieve the target drug concentration and then continues to infuse drug at an appropriate rate to maintain that concentration. Unlike using a manual fixed-infusion system, the anesthesiologist can easily either

increase or decrease the target drug concentration at any time, thereby facilitating the titration of the drug concentration according to the patient's response to differing noxious stimuli.

One fundamental principle underlies the TCI pump—namely, the relationship between the infusion rate and achieved drug concentration:

$$\text{Drug concentration} = \frac{\text{Infusion rate}}{\text{Drug clearance}}$$

If a higher target concentration is selected, the system automatically delivers a further small bolus of drug and then infuses at a faster rate to achieve and maintain the higher drug concentration. When a lower target is chosen, the device discontinues the infusion of drug until the system predicts that the patient's drug concentration has decreased to the new value (by a combination of drug redistribution and clearance). The system then restarts the infusion at the appropriate rate for the new target concentration. With a TCI system, the anesthesiologist does not control the device's infusion rates and the size of bolus doses; rather, the anesthesiologist titrates the depth of anesthesia by selecting target drug concentrations appropriate to the patient's needs. A number of different algorithms are used in the different systems to calculate the required infusion rate.<sup>44,45,55,114</sup>

### Kinetic Model Selection

TCI systems tend to incorporate population-averaged pharmacokinetic parameters to drive the infusion pump. This can lead to considerable variability in the observed drug concentration compared with the targeted concentration. The mean variation between these two concentrations (targeted and observed) is usually of the order of 20–30% with a maximum of 50–60% considered clinically acceptable. It seems likely that greater accuracy is not going to be achievable. The sources of this variability include the differences in the parameter estimates of the polyexponential equation that is used to describe the concentration–time relationship. At the present time, there are several different commercial systems on the market for the delivery of propofol and the opiates sufentanil and remifentanil. Two types of systems can be identified—those incorporating the Diprifusor module, using tagged Dipri-

van prefilled syringes with the finger-grip tag and the original Diprifusor kinetics, and “open” systems that do not require the tagged syringes and use different pharmacokinetic datasets for the delivery of propofol, remifentanil, and sufentanil (Table 42–7).

### Effect-Site Targeting

Initial drug-targeting technology was based on the plasma concentration; but as this is not the site of anesthetic action, it is more logical to target the effect-site or biophase. This has been described by several authors, and reviewed by Jacobs and Williams.<sup>48</sup> Effect-site control should allow for a faster induction time; and during maintenance a more rapid increase in the depth of anesthesia. However, there are some limitations to effect-site compartment targeting, including that of overshoot of the arterial drug concentration with associated adverse consequences. Effect site TCI has been described by a number of different research groups.<sup>48,123,138</sup> Wakeling et al. have compared the efficacy of plasma and effect-site targeting.<sup>137</sup> Twenty ASA (American Society of Anesthesiologists) classification PS-I or PS-II patients were randomized to receive TCI propofol targeted at one or the other site. In this study, the delivery system was modeled according to the kinetic dataset of Gepts and Camu<sup>34</sup> and a  $k_{e0}$  value of 0.63 min<sup>-1</sup>. At a target concentration of 5.4 µg/mL (the predicted effect-site concentration associated with loss of consciousness in 95% of subjects),<sup>117,134</sup> Wakeling found a median time to loss of consciousness of 3.02 minutes in the plasma-targeted group, but only 1.23 minutes in the effect-site targeted group. However, loss of consciousness occurred at the same predicted effect-site concentration in both groups. Other studies of effect-site drug control have found similar results.<sup>82,123,138</sup>

Although an advantage of these systems is that drug delivery is optimized to a given effect-site concentration, the speed of achieving this concentration varies with the  $k_{e0}$  value incorporated into the different delivery systems. At present, several different models with different  $k_{e0}$  values are in use for the delivery of propofol. If the Diprifusor is used with the Marsh model kinetics, the blood–brain equilibrium half-life ( $t_{1/2} k_{e0}$ ) is 2.6 minutes ( $k_{e0}$  0.26 min<sup>-1</sup>).<sup>62</sup> However modifications of the Diprifusor algorithm in the two new “open-TCI” systems (the Base

TABLE 42–7.

TCI Systems Currently Available for the Delivery of Propofol, Remifentanil, and Sufentanil in the United Kingdom and Other Parts of the World<sup>a</sup>

“Diprifusor” TCI systems incorporate use of tagged prefilled syringes:

1. Graseby 3500 system (Graseby Medical, Watford, UK)
2. Vial Medical Master TCI (Fresenius Vial, Brezins, France)
3. Alaris IVAC TIVA TCI (ALARIS Medical Systems, Basingstoke, UK)
4. Terumo TERUFUSION TE-372 TCI TIVA (Terumo Corporation, Tokyo, Japan)

Open TCI systems have the advantages of being able to use “generic” formulations of propofol:

1. **Alaris Asena PK Syringe Pump.** This has the same pharmacokinetic model as in the Diprifusor, with a  $k_{e0}$  of 0.26 min<sup>-1</sup>. It also incorporates modeling for effect-site control.
2. **Base Primea (Fresenius Vial, France).** This includes 2 kinetic sets for propofol delivery. There is the kinetic model included in the Diprifusor but with a modified value for  $k_{e0}$  of 1.21 min<sup>-1</sup>. The second model system is based on the kinetics of Schnider et al.<sup>99</sup> where the kinetics are corrected for patient age and weight. The  $k_{e0}$  is also different (0.456 min<sup>-1</sup>), which leads to a faster rise in brain propofol concentration.
3. **B Braun (FM System—“Space Station”)** incorporating the “ProTiva” pump system. This was introduced in Europe in 2006.

<sup>a</sup>At the time of writing (March 2007), none of these delivery systems are licensed for use in the United States.

Primea and Asena PK systems) with a longer  $k_{e0}$  of 1.2 min<sup>-1</sup> gives a  $t_{1/2} k_{e0}$  of 34 seconds. When the slower  $k_{e0}$  is used, any increase in the target effect-site concentration requires higher blood drug concentrations to generate a bigger gradient to drive drug to the effect-site.

A second effect-site model, based on the kinetics of Schnider et al., incorporates additional details into the algorithms (including patient age, height, weight, and calculated lean body mass). In this system, the  $k_{e0}$  varies with the

age of the patient.<sup>98</sup> Although most studies suggest that effect-site targeting provides faster control, it is only true if there is an accurate value for  $k_{e0}$ ! The recent studies of Kazama et al. show that  $k_{e0}$  values have a wide interindividual variability with regard to age, and end point assessed.<sup>52</sup> This may be a result of a number of factors, including poor delineation of early distribution kinetics and failure to accurately define the EEG hysteresis effect; this will clearly limit the accuracy of any effect-site TCI delivery system in a given individual. Use of effect-site TCI will, of necessity, lead to an overshoot of the plasma drug concentration, which can result in hemodynamic depression. Although this overshoot has little effect in patients younger than age 60,<sup>123</sup> further study is needed in the elderly.

As a further development in effect-site targeting, Van Poucke et al. have described modified delivery algorithms that target the effect-site but limit the peak plasma concentration.<sup>129</sup> This should have the advantage of reducing the acute hemodynamic effect of intravenous anesthetic drugs on the heart and circulation. Simulations suggest that this approach will reduce the plasma overshoot by approximately 60%, with an accompanying 20% delay in the time to peak effect and hence the onset of drug effect. In vivo studies are clearly needed to confirm the efficacy of this method of TCI delivery.

## INDUCTION OF ANESTHESIA WITH TIVA

Several factors affect the speed of induction by TIVA, including the size of the induction dose and important drug interactions.

### Factors Determining the Induction Dose of Hypnotic Agents

The onset of anesthesia requires the brain drug concentration to reach a given level; this can be achieved either slowly or rapidly. Rapid achievement is usually accompanied by significant adverse effects such as hypotension, bradycardia, and respiratory depression. The greater the concentration gradient between the blood and the effect-site, the greater the time needed to induce anesthesia. Conversely, any marked overshoot in the effect-site

concentration leads to a greater incidence and severity of the adverse effects. The transfer of drug from the blood to the effect site is governed by simple diffusion. The time needed to achieve this transfer varies with the concentration gradient and the  $k_{e0}$ .

The rate of infusion of the induction dose is another determinant governing the size of the induction dose; an infusion rate designed to only just achieve a desired effect-site concentration causes a loss of consciousness but at the cost of a slow onset. The loss of consciousness is only transient, and is maintained only for the duration that the targeted effect-site concentration is maintained. A faster rate of infusion provides a more rapid onset of anesthesia and a longer duration of loss of consciousness, but again involves administration of a larger induction dose and hence a greater likelihood of adverse effects.

Variations in induction dose requirements also occur because of interindividual pharmacokinetic differences, and because of pharmacodynamic differences that are the result of age, gender, cardiac output, smoking, concomitant medications, and the presence of coexisting disease states.<sup>46</sup>

### Drug Interactions

Because no single IV drug (with the possible exception of ketamine) can provide hypnosis, amnesia, and analgesia, total intravenous anesthesia will be, by definition, provided by a combination of drugs. However, in contrast to the simply additive effects of the different gaseous and volatile anesthetics, IV anesthetics may interact in either additive or synergistic manners (see Chaps. 40 and 41). In the case of most IV agents, this interaction is synergistic. One example used to good effect is the combination of a hypnotic and benzodiazepine or other sedative drug (such as an  $\alpha_2$ -agonist) for induction of anesthesia (the technique of *coinduction*). One major advantage of this technique is to provide an adequate depth of anesthesia for a noxious stimuli such as laryngoscopy and intubation *without any associated significant cardiovascular depression*.

Also clinically useful is pretreatment with an opiate (fentanyl, sufentanil, alfentanil, or remifentanil), which will reduce the amount of hypnotic agent needed for loss of consciousness and provide analgesia to

reduce the adrenergic stimulus caused by the instrumentation of the airway (whether by laryngoscopy and intubation, or insertion of the laryngeal mask airway). However, the combination of an opiate with an IV hypnotic agent can cause both positive and negative side effects (namely, cardiovascular stability or profound cardiovascular and respiratory depression). Respiratory depression is of little importance in the mechanically ventilated patient, but is a significant and unwanted effect in the spontaneously breathing individual.

Although the combination of benzodiazepines with nitrous oxide produces minimal cardiovascular effects for induction of anesthesia, the combination of benzodiazepines with opiates results in a synergistic depression of most hemodynamic parameters. Because opiates *alone* are not complete anesthetics, they cannot be used reliably to induce anesthesia and amnesia in the absence of supplements. In clinical practice, a second anesthetic drug (such as an IV hypnotic) should always be given to ensure loss of consciousness. Thus the main functions of opiates are to provide analgesia *and potentiate* the effects of IV anesthetic agents, both at induction and during the maintenance phase.

### Termination of IV Anesthetic Action

The duration of drug effect of a bolus dose of IV drugs is terminated predominantly by redistribution of drug from the blood and brain to the lean tissues. This redistribution occurs by a series of different intercompartmental clearances, and to a lesser extent, metabolic clearance, the sum of these being dependent on cardiac output in the case of lipid-soluble hypnotic agents. However, if the dose of the induction agent causes a significant reduction in cardiac output, the offset of the drug effect is delayed.

## DRUGS FOR INDUCTION OF ANESTHESIA

### Thiopental

This thiobarbiturate continues to be the most popular of all IV anesthetic induction agents, even though propofol may be more appropriate in circumstances where rapid recovery from anesthesia is a prerequisite (e.g.,



in ambulatory surgical practice). Thiopental, however, has a number of drawbacks as it is highly alkaline in solution, and therefore extremely irritating if injected extravascularly or intraarterially, and has a low therapeutic index of about 4. When given IV, the barbiturates achieve onset of hypnosis within one arm-brain circulation time. Because of their high lipid solubility and low percentage of ionization at physiologic pH, there is rapid uptake into the brain. The maximum effect of thiopental is seen within about 1 minute of a single induction dose of 3–6 mg/kg. There then follows a similarly rapid decline in the brain concentration as a consequence of redistribution into the “lean” body tissues, making the duration of effect of an induction dose about 5–10 minutes. However, at the time of awakening, only 18% of the injected thiopental dose will have undergone metabolism (compared with approximately 38% of a dose of methohexital and nearly 70% of propofol).

Several different factors influence thiopental elimination. Stanski and Maitre showed that, although age influenced the kinetics of thiopental, it had no effect on brain responsiveness or dynamics when the spectral edge frequency was used as the measure of drug effect.<sup>119</sup> The induction dose requirements for thiopental anesthesia vary with patient age and weight, and, most importantly, cardiac output. Lower doses are indicated in the premedicated patient; in patients with severe anemia or burns; in malnourished patients; in patients with uremia or liver failure; and in the hypovolemic individual regardless of cause. Both circulatory failure and hypothermia slow the circulation time, prolonging the induction period for thiopental. Moreover, the total dose needed in such patients is also reduced.

The blood-brain equilibration rate constant for thiopental is rapid (0.46–0.58 min<sup>-1</sup>). The effect-compartment concentration associated with dropping a loaded syringe is about 17 µg/mL, and the duration of effect of an induction dose of 320 mg is about 4 minutes. Induction with thiopental causes a decrease in cardiac output, and a compensatory 10–15% increase in heart rate. Thiopental also causes venodilation, but has no effect on systemic vascular resistance.<sup>96</sup> Another feature of thiopental induction is the decrease in respiratory responsiveness to hy-

poxia and hypercapnia. Opiates potentiate these effects. When anesthesia is induced with the combination of thiopental and midazolam, the two hypnotics act synergistically; when thiopental is given with an opiate such as alfentanil, there is greater potentiation of the antinociceptive response than hypnosis.<sup>64</sup>

### Thiamylal

Thiamylal (another thiobarbiturate used mainly in the United States and Japan) has pharmacologic characteristics similar to thiopental with regard to potency, incidence of laryngospasm and respiratory depression, cardiac toxicity, and recovery time. It is formulated as a racemic mixture. The potency of the S enantiomer is about twice that of the R+ form, and there are also kinetic differences. The plasma protein binding of the R+ isomer is 82.5%, and of the S- isomer 88.3%. The elimination half-life of the R+ enantiomer is 20.2 hours; the apparent volume of distribution is 3.66 L/kg; and clearance is 0.27 L/kg/h. The corresponding values for the S- compound are 24.1 hours, 2.60 L/kg, and 0.15 L/kg/h, respectively.

### Methohexital

This is an oxybarbiturate with a faster recovery profile than thiopental because of a greater systemic clearance and a shorter elimination half-life. Compared with thiopental, methohexital has a more appropriate kinetic profile for both induction and maintenance of IV anesthesia (elimination half-life of 420–460 minutes, clearance of 700–800 mL/min). Because its main metabolite, 4-OH methohexital, has no pharmacologic activity (unlike thiopental's major metabolite, pentobarbital), methohexital may be usefully given by continuous infusion for maintaining anesthesia or sedation (see Drugs for Maintenance of TIVA).

Induction of anesthesia with methohexital requires doses of 1–2 mg/kg, giving it a potency of 2.7 times that of thiopental. The side-effect profile of methohexital is more significant than that following thiopental, and includes increased incidences of pain on injection, a tendency to venous thrombophlebitis, and exaggerated involuntary movements, especially in the unpremedicated patient. Inadequate induction doses can also cause excitatory phenomena because the inhibitory

areas of the brain are thought to be depressed at lower drug concentrations.

### Etomidate

Etomidate is a carboxylated imidazole compound formulated as the R+ enantiomer. The approximate potency ratio of the enantiomers is R+:S- = 1:10.<sup>127</sup> As an induction agent, etomidate has important advantages over the barbiturates, showing many ideal properties for an IV agent (cardiostability; reduction of cerebral blood flow, cerebral metabolic rate, and intracranial pressure; no release of histamine and low rate of allergic reactions; only transient and minimal respiratory depression and no inhibition of the hypoxic pulmonary vasoconstrictor reflex), and offers hemodynamic advantages during induction of anesthesia in patients with poor cardiac reserve, and hypovolemia. The drug also has a wider margin of safety in animals, with a high therapeutic index of 26.4.

Because it is unstable in water, etomidate is presently solubilized either in 33% propylene glycol or as an emulsion. The drug has a pH of 8.1 and pK<sub>a</sub> of 4.2. It is a base and approximately 99% of the drug is unionized. Plasma protein binding is approximately 75% (mainly to albumen). Metabolism occurs predominantly in the liver and plasma by esterase hydrolysis, and hence etomidate shows the expected high systemic clearance.

Induction doses of 0.2–0.4 mg/kg provide hypnosis for between 5 and 15 minutes, with only minor alterations in cardiovascular parameters in healthy patients and in those with valvular or ischemic heart disease. Little is known about the interaction of etomidate and opiates or other hypnotics for loss of consciousness. Etomidate alone does not obtund the sympathetic responses to laryngoscopy and intubation;<sup>39</sup> and for a smooth hemodynamic profile, etomidate is best combined with an opiate or benzodiazepine.

However, its use as an induction agent is also associated with a number of minor disadvantages, with significant incidences of pain on injection, thrombophlebitis, myoclonia, and a high incidence of postoperative nausea and vomiting. When given either as a single induction dose or by infusion, etomidate suppresses adrenal steroidogenesis,<sup>69</sup> and low plasma cortisol levels are found following use of the agent. Does this matter? In pa-

tients receiving etomidate by infusion for intensive therapy unit sedation, Ledingham et al. found that its use was associated with increased mortality.<sup>58</sup> However these findings were *not* based on a double-blind, randomized, controlled trial. There are no data to support this association when etomidate was administered by continuous infusion to anesthetized surgical patients. As a result of the cortisol suppression, etomidate by infusion is contraindicated in many countries, and any continued use in that way must be considered as off-label.

The role of etomidate is further confused by a recent unreasoned and unsupported editorial in *Anaesthesia* expressing the view that the drug has no place in current anesthetic practice.<sup>70</sup> This view is *not* shared by the present author in the absence of properly conducted clinical outcome trials.

### Alternate Formulations of Etomidate

Attempts at improving the side-effect profile of etomidate have focused primarily on the solvent. Development of an emulsion formulation does not change the drug's dynamic properties, but is associated with lower incidences of pain on injection, myoclonus, and local thrombophlebitis.<sup>56,128</sup> Another advantage of the emulsion formulation is its lower osmolality and higher pH (400 mOsm/kg and pH 7.6 compared with 4965 mOsm/kg and pH 5.1 for the propylene glycol formulation), which means less red cell hemolysis.<sup>29,74</sup> A second reformulation of etomidate has used 2-hydroxypropyl- $\beta$ -cyclodextrin as the solvent.<sup>30</sup> Again, there was a lower incidence of myoclonia (17% vs. 92%) and pain (8% vs. 58%), and thrombophlebitis (0% vs. 42%), and no hemolysis. None of these formulations appears to show alterations in the kinetics or dynamics of etomidate.

Although it is widely believed that use of etomidate is associated with an increased incidence of postoperative nausea and vomiting, this has not been supported by a recent comparison where etomidate-lipuro and propofol were used for induction of anesthesia to supplement isoflurane/fentanyl in air in patients undergoing orthopedic procedures.<sup>122</sup> There were no differences in rates of nausea, vomiting, or the intensity of any nausea during the early postoperative period to 24 hours. However the rates of vomiting after etomidate were higher (27% vs. 10%).

### Midazolam

Midazolam is the only currently available benzodiazepine that is suitable for induction of anesthesia. It has a faster onset and lower incidence of venous complications than either diazepam or lorazepam, but a slower onset than the other IV hypnotic agents (30–60 seconds for loss of consciousness). Induction of anesthesia (as is the case with the barbiturates) coincides with loss of the eyelash reflex. Induction occurs with doses of 0.1–0.2 mg/kg midazolam given over 20–30 seconds; smaller doses are sufficient in premedicated patients, in the elderly, and in patients of ASA groups PS-III to PS-IV. However, emergence from midazolam-induced anesthesia may be prolonged.<sup>79</sup>

Midazolam has some advantages over thiopental, including improved perioperative amnesia and hemodynamic stability. However, the combination of midazolam and an opiate can result in significant cardiovascular depression. Although a single induction dose of midazolam does not suppress the adrenal steroidogenesis,<sup>27</sup> data from Crozier et al. and Desborough et al. suggest that high doses of midazolam given by infusion prevent the increase in plasma cortisol concentrations in response to surgical stress.<sup>24,28</sup> As with etomidate, the significance of this finding during TIVA is uncertain in the absence of appropriate outcome data.

Another advantage of midazolam over other hypnotic agents is the availability of a specific antagonist, flumazenil, which is devoid of any intrinsic effects on the respiratory or cardiovascular systems. However, it has a short duration of action, with peak effect occurring 1–3 minutes following IV injection. Because of its shorter elimination half-life (40–70 minutes) and faster clearance rate than midazolam, flumazenil may produce an initial arousal from sedation or anesthesia, followed by re sedation.<sup>77</sup> Thus, if larger doses of midazolam are used for induction and/or maintenance of anesthesia, flumazenil preferably should be given as the combination of a loading dose and continuous infusion to maintain a plasma drug concentration in excess of 20–40 ng/mL.

### Propofol

This sterically hindered alkyl phenol was originally formulated as an emulsion containing soybean oil and egg phosphatide (Diprivan). A number of

TABLE 42–8.

#### Different Formulations of Propofol (di-Isopropylphenol) Presently in Preclinical Trials, Current Clinical Practice, or Under Development<sup>a</sup>

1. Original preclinical formulation: 2% propofol in 16% Cremophor EL and 8% ethanol
2. 1% Propofol in 16% Cremophor EL (preclinical)
3. 1% Propofol in lipid emulsion (containing 10% soybean) [= Diprivan]; emulsion preservatives include ethylenediaminetetraacetic acid (EDTA) and sulfite
4. Ampofol (Amphaster Pharmaceuticals Inc, Rancho Cucamonga, CA) formulated in 1% propofol in 5% soybean [AQ: Please verify this entry. Product not listed at company's website.]
5. Modified lipid emulsions containing medium-chain triglycerides (MCTs) and 1% propofol: IDD-D propofol (Skye Pharma Inc., New York, NY) and Propofol-lipuro (B Braun, Meslungen, Germany)
6. 6% propofol in MCTs-LCT (long-chain triglycerides) (Lipofundin, B Braun)
7. AM 149 (Amrad Operations Pty Ltd, Richmond, Victoria, Australia): 1% propofol in MCT alone
8. Albumin-containing emulsions (under development)
9. Nonemulsion formulations (under development)
  - $\beta$ -Cyclodextrin
  - Micelle formulations
  - Polysorbate formulation
10. Propofol prodrugs formulated as the hemisuccinate, hemigluratate, hemiadipate, monophosphate, diphosphate

<sup>a</sup>Data so far suggest little difference between formulations with regard to pharmacokinetics and pharmacodynamics.

other formulations are either available or undergoing clinical evaluation (Table 42–8). However, the efficacy of these newer formulations in large outcome studies is awaited, but there appears to be little difference in their kinetic and dynamic properties.

Propofol (as Diprivan) has a neutral pH of 7.4, and  $pK_a$  of 11.0; this means that the drug is 99.7% nonionized and highly lipid soluble at pH 7.0. It is rapidly broken down to inactive me-

tabolites (the glucuronide and the corresponding quinol glucuronide and sulphate) in the liver, and possibly in other organs, such as the lungs.<sup>26,40</sup> Other minor metabolites detected in the urine include 2-( $\omega$ -propranol)-6-isopropylphenol and 2-( $\omega$ -propranol)-6-isopropyl-1,4-quinol. It is not known whether any of these have anesthetic potencies. The hydroxylation of propofol by hepatic cytochrome P450 (CYP) involves the isoform 2B6, which shows wide individual variability.<sup>21</sup> Another isoform that shows high binding for propofol is CYP 2C9.<sup>80</sup>

Despite its rapid and complete offset of effect, propofol has a long elimination half-life (of up to 45 or more hours), an apparent volume of distribution of between 1000 and 3940 L, and a systemic clearance between 1.0 and 1.8 L/min. Because of its high extraction ratio, propofol shows flow-dependent clearance, and its own clearance is reduced secondary to its action on myocardial contractility and cardiac output. Population kinetic analyses by Schuttler and Ihmsen indicate weight to be a significant covariate for the elimination clearance, the 2 intercompartmental clearances of a 3-compartment model, and the apparent volumes of the central and 2 peripheral compartments, whereas in older patients (age >60 years), both elimination clearance and the central volume compartment decrease linearly with age.<sup>102</sup>

Induction of anesthesia with propofol is smooth and associated with a low incidence of excitatory side effects. Doses of 1–2.5 mg/kg (depending on patient age, physical status, and use of premedicant drugs) induce anesthesia in approximately 30 seconds; however, lower induction doses should be used in patients with cardiovascular disease. Loss of consciousness occurs at propofol concentrations between 2.5 and 5.5  $\mu\text{g}/\text{mL}$ , with the concentration for loss of response to verbal command being between 2.5 and 3.5  $\mu\text{g}/\text{mL}$ . The speed of onset and the dose of propofol needed for induction are dependent on the administration rate. Stokes et al. compared induction times when propofol was infused at 50, 100, and 200 mg/min and as a 2 mg/kg bolus. Times to loss of consciousness were 124, 92, 62, and 32 seconds, respectively, with the corresponding total induction doses being 1.4, 1.96, 2.61, and 2.15 mg/kg.<sup>120</sup>

The size of the induction dose depends on many physiologic factors.

Kazama et al. determined 4 factors to be independent variables influencing the size of the induction dose (namely age, lean body mass, central blood volume, and liver blood flow).<sup>53</sup> When the dynamics of propofol are related to age, 3 functions correlate in a linear manner: the blood–brain equilibration rate constant and time to peak effect; the steepness of the concentration–response relationships for EEG activation and depression; and the effect-site concentration associated with 50% of peak EEG activation.<sup>99</sup>

The hemodynamic effects following induction doses of propofol are similar to those of the thiobarbiturates, although propofol additionally decreases systemic vascular resistance. In contrast to the barbiturates, propofol has little effect on heart rate. In contrast to the barbiturates, propofol has little effect on heart rate; the combination of the drug's vagotonic effect and the fall in vascular resistance predisposing to significant falls in blood pressure when used in the hypovolemic patient or in patients receiving other vagotonic drugs (e.g., opiates).<sup>15</sup> The ventilatory effects of propofol are comparable to those of other hypnotic agents. Induction doses cause significant decreases in tidal and minute volumes, coupled with episodes of apnea often greater than 30 seconds, in 25–30% of patients. Comparative studies indicate the duration of apnea following propofol is longer than with thiopental.<sup>118</sup> All induction agents decrease the rib cage and abdominal components of ventilation to a similar amount. The ventilatory depressive effects of propofol are synergistic with those of midazolam and fentanyl, and with the combination alfentanil-midazolam.

One advantage of propofol as an induction agent is the greater depression of pharyngeal and laryngeal reactivity than is seen with thiopental, methohexital, or etomidate. This can be of benefit during upper airway instrumentation and insertion of the laryngeal mask airway.

Pain on injection is commonly observed during induction of anesthesia with propofol, with incidences of up to 50% when administered into the small veins on the dorsum of the hand. The incidence may be reduced by use of large veins, by mixing with lignocaine (10–20 mg), and by pretreatment with drugs such as fentanyl and alfentanil. Other side effects of induction include excitatory myoclonic phenomena and

occasional epileptiform fits reported during recovery. Like etomidate, propofol appears to have in vitro potential for inhibition of adrenal steroidogenesis, but this is not relevant in clinical anesthetic practice.

## Ketamine (2-*O*-Chlorophenyl-2-Methylaminocyclohexanone HCl)

This phencyclidine derivative is formulated as a racemic mixture. It is unique among the induction agents in that it produces both dose-related unconsciousness and analgesia. Following induction with ketamine, patients have little recall of surgery or anesthesia.

The two stereoisomers, R(–) and S(+), show differing anesthetic potencies (1:3–4), but have similar kinetics. The pH of ketamine is 3.5–5.5, and the  $\text{pK}_a$  is 7.5. At physiologic pH, ketamine is highly lipid soluble, with 12–35% being plasma protein bound, and 44% nonionized. Recovery from ketamine anesthesia occurs as a result of both distribution and degradation by demethylation and hydroxylation by hepatic cytochrome P450. The metabolic breakdown of ketamine is complex, but one metabolite (norketamine; metabolite I) is pharmacologically active with a potency of approximately 30% that of the parent drug, and a longer elimination half-life. The main excretory metabolites are ketamine and metabolite I and II glucuronides. The efficacy of ketamine is enhanced in patients with renal impairment with an accompanying delayed recovery. Most of the ketamine is excreted in the urine as the glucuronides; only 2.5% is unchanged.

Ketamine causes rapid induction of anesthesia by the IV route. However, its cardiovascular effects differ from other hypnotic agents; ketamine causes increases in heart rate, blood pressure, and cardiac output. These inotropic and chronotropic effects are seen in both healthy patients and in those with heart disease, and are mediated via central mechanisms. Ketamine blocks the reuptake of noradrenaline by both the uptake 1 (extraneuronal) and uptake 2 (intraneuronal) mechanisms, as well as causes the release of noradrenaline from the sympathetic ganglia. The in vivo effects are obtunded in patients receiving adrenergic antagonists (both  $\alpha$  and  $\beta$ ) and vasodilators, as well as by pretreatment with benzodiazepines.

Ketamine has advantages over propofol and etomidate because it is water



soluble. However, although it lacks the cardiorespiratory depressive properties of other IV agents, its usefulness is limited by high incidences of disturbing emergence reactions (up to 30% of patients). Ketamine also causes increases in intracranial pressure and salivation. The psychomimetic effects of ketamine may be attenuated by benzodiazepine premedication, although these drugs appear to prolong the elimination half-life of ketamine and increase its recovery time.

### Stereoisomers of Ketamine

The potency ratio for anesthesia is approximately 4:2:1 for S(+) ketamine, ketamine racemate, and R(-) ketamine enantiomers. Some data suggest administration of S(+) ketamine is accompanied by a lower median EEG power spectrum, a greater rise in blood pressure and heart rate, decreased locomotor activity, shortened recovery times, and equipotent analgesia compared with the racemate at similar doses.<sup>87,102,104,142</sup>

### Opiates

As already detailed in the section on induction of anesthesia with TIVA, these are not complete IV hypnotics and do not produce anesthesia in the absence of other supplements. However all opiates potentiate the effects of hypnotics when used for induction of anesthesia (this is seen less with thiopental, but is most important with midazolam).

## DRUGS FOR MAINTENANCE OF TIVA

In modern anesthesia, the dosing of both hypnotics and analgesics is by titration to clinical effect, measured either by effects on the cardiovascular system or the EEG (or one of its surrogates). The changes in heart rate and blood pressure tend to be “agent specific” (for most IV agents, increasing depth of anesthesia causes a reduction in heart rate and blood pressure, although with ketamine, the heart rate may increase with increasing plasma drug concentrations). However, of all the markers of inadequate anesthesia, patient movement remains the most reliable.

Despite the availability of pharmacokinetic-based infusion regimens, it is the dynamic responses of the individual patient to any given surgery that governs the rate of drug infusion. No single plasma drug concentration results in satisfactory anesthetic and

surgical conditions for all patients and all operations.

Titration of the infusion rate should reflect the anticipated intensity of the applied stimulus and likely observed patient responses. In general, drug requirements are greatest during endotracheal intubation, and decrease during surgical preparation and draping. The infusion rates will need to be increased prior to skin incision, whereas during anesthesia, drug dosing should be titrated according to signs of patient movement, hemodynamics, and autonomic responses. In the absence of any response over a given period of time, the anesthesiologist may consider reducing the infusion rate by 15–20%.

Table 42–9 shows typical infusion regimens used to achieve the steady drug concentrations required to provide analgesia using IV analgesic drugs given by infusion. If the dose of drug administered is clearly too high in the presence of continuing signs of inadequate anesthesia, then the anesthesiologist should examine for a disconnection of the delivery system, or delivery to a subcutaneous rather than vascular site. Other causes could include incorrect programming of pumps, or mechanical errors of the delivery systems.

During TIVA, use of combinations of drugs poses questions over which one

to increase or decrease and for what reasons. In general, the dosing of opiates should be aimed at achieving analgesic drug concentrations at the effect site, whereas the hypnotic infusion should be titrated to individual patient requirements and to the intensity of the surgical stimulation. At the end of surgery, the anesthesiologist should reduce the infusion rates of the hypnotic and analgesic during skin closure to allow restoration of spontaneous respiration by the end of surgery.

### Thiopental and Thiamylal

Early recovery from thiopental occurs because of a decline in the blood (and brain) concentrations as a result of drug redistribution. Following bolus doses and after short or low-dose infusion regimens, thiopental is eliminated by first-order kinetics and the patient promptly awakens. However, at rates in excess of 300 µg/kg/min, thiopental concentrations increase nonlinearly because of the peripheral tissue stores becoming saturated. Maintaining anesthesia with infusions of thiopental requires rates of 150–300 µg/kg/min in combination with an opiate. This will achieve thiopental concentrations of between 15 and 25 µg/mL.<sup>22</sup> In the absence of an analgesic supplement, thiopental concentrations of the order

TABLE 42–9.

Typical Drug Concentrations and Manual Infusion Regimens to Provide Adequate Analgesia for Major Noncardiac Surgery Under TIVA and Other Target Analgesic Concentrations

	Cp50 (ng/mL) for Surgery	Cp50 (ng/mL) for Adequate Spontaneous Respiration		
Alfentanil	200–300	10–30		
Fentanyl	4–6	0.5–1.0		
Remifentanyl	4–6	0.5–1.0		
Sufentanil	0.3–0.4	0.025–0.05		
<b>Dosing strategies</b>				
	Target Concentration (ng/mL)	Loading Dose (mg/kg)	Maintenance Infusion (mg/kg/min)	
Alfentanil	40	20	0.25	
	160	80	1.0	
	320	160	2.0	
Fentanyl	1	3	0.02	
	4	10	0.07	
Remifentanyl	6	1	0.02	
	12–20	1–2	0.04–1.0	
Sufentanil	0.15	0.15	0.003	
	0.5	0.5	0.01	



of 40–50 µg/mL will abolish the response to squeezing the trapezius muscle (which has been equated with the initial surgical incision). Besides the changes in pharmacokinetics, high doses of thiopental also lead to the formation of significant blood concentrations of its active metabolite, pentobarbital. Other inactive metabolites occur following C<sub>5</sub> side-chain oxidation. Renal excretion of thiopental is very low (approximately 0.3%).

Possible advantages to the use of thiopental infusions include minimal cardiovascular depression and cerebral protection during ischemic episodes, with blood thiopental concentrations on the order of 70 µg/mL resulting in EEG burst suppression.<sup>20</sup>

There are no published reports in the English-language literature of thiamylal being used as part of infusion anesthesia.

### Methohexital

Plasma methohexital concentrations of between 3 and 4 µg/mL result in hypnosis, and concentrations between 10 and 12 µg/mL cause EEG burst suppression. Based on dose–response data from Sear and Prys-Roberts,<sup>90,112,113</sup> infusion rates of 50–65 µg/kg/min supplemented by opiates or of 100 µg/kg/min methohexital alone are required for anesthesia. Methohexital infusions depress both blood pressure and cardiac output; they also decrease baroreceptor reflex sensitivity with a resetting of the response to allow a more rapid heart rate at lower arterial pressures than when awake.<sup>16</sup> Side effects include excitatory movements, pain on injection, and predisposition to convulsions. Epileptiform activity has been recorded by EEG, but clinical fitting is rare. Methohexital also causes pain if accidentally injected into arteries, but unlike thiopental, this does not normally lead to thrombosis.

The combination of methohexital and opiates can cause significant respiratory depression. No untoward effects of methohexital infusions on liver, renal or adrenal function have been described.

### Midazolam

Continuous infusions of midazolam have been used to provide both sedation and maintenance of anesthesia. When used as the hypnotic component to supplement alfentanil in a TIVA technique, and compared with propo-

fol, Vuyk et al. observed similar hemodynamic effects but slower recovery.<sup>135</sup> For the maintenance of anesthesia, infusions on the order of 10 mg/h (resulting in plasma drug concentrations of 200–350 ng/mL) are needed to supplement opiate infusions.<sup>24,79,85,86,92</sup> Several of these studies showed that infusions of midazolam and opiates together may cause myocardial depression; this does not appear to be dose dependent and there is an apparent ceiling effect at midazolam concentrations greater than 100 ng/mL. Clinically relevant rates of infusion of midazolam in combination with alfentanil have no significant effect on the plasma cortisol response during lower abdominal surgery.<sup>78</sup> A major disadvantage of midazolam for TIVA is the slow recovery. Awakening occurs at drug concentrations around 50–80 ng/mL. Nilsson et al. showed that recovery can be improved by reversal with bolus doses of flumazenil; but resedation may subsequently occur as a consequence of the faster elimination of the antagonist and rebinding of the agonist.<sup>77</sup>

### Ketamine

Although widely used throughout the world for the maintenance of anesthesia, there are few concentration-effect data for continuous infusions of ketamine. Most studies suggest hypnotic and analgesic thresholds are about 1.5–2.5 µg/mL and 150–200 ng/mL, respectively. Awakening from anesthesia occurs in the concentration range 600–1100 ng/mL. As sole agent, infusion rates of 60–80 µg/kg/min will provide clinical anesthesia.

The use of TCI ketamine for sedation and maintenance of anesthesia was described by Bowdle et al. and Gray et al.<sup>14,37</sup> For examination of the psychomimetic effects of ketamine, Bowdle et al. designed a BET delivery scheme based on the kinetic parameters of Domino et al.<sup>31</sup> to achieve a stepwise series of plasma target concentrations between 0 and 200 ng/mL. Bowdle et al. showed a good correlation and relationship between the targeted and observed drug concentrations. Increasing ketamine concentrations were associated with greater psychedelic effects for a variety of symptoms. Interestingly, there was no apparent threshold concentration, and no concentration at which these effects plateaued.

In the second study, Gray et al. developed a TCI scheme for ketamine to

provide the analgesic component of a TIVA technique with propofol in spontaneously breathing patients undergoing body-surface surgery, using the kinetic parameters of Wieber et al.<sup>143</sup> The target concentration of ketamine was 300 ng/mL, with propofol delivered according to the manual BET scheme of Roberts et al.<sup>93</sup> Clinically this combination provided good cardiovascular control throughout the surgery, with an average end-tidal carbon dioxide of 5.8 kPa (kilopascals). There were episodes of involuntary movements (although these did not interfere with the surgery being undertaken), and no episodes of recall. However, recovery to giving date of birth was prolonged in some patients. There were no reports of unpleasant dreams or other psychomimetic side effects.

Schuttler et al. described a similar technique in patients undergoing lower abdominal surgery under propofol-ketamine anesthesia.<sup>103</sup> They describe satisfactory anesthesia without any significant psychic disturbances or cardiovascular stimulation. Recovery was not significantly delayed.

A major development in the use of ketamine as part of TIVA has been the separation of the hypnotically active S(+) ketamine enantiomer from the racemic mixture. In a crossover volunteer study, White et al. examined the pharmacologic effects of infusions of racemic, S(+), and R(–) ketamine, with measurement of cardiovascular parameters, the raw EEG, and a battery of psychometric tests.<sup>142</sup> S(+) ketamine was approximately 2 times more potent in terms of anesthesia, and was associated with faster recovery compared to both the racemic mixture and the R(–) isomer. This is in agreement with subsequent kinetic studies showing inhibition of metabolism of S(+) ketamine by its R(–) isomer.<sup>54</sup> Ketamine enantiomer concentrations at time of regaining consciousness and orientation are consistent with an S-to-R potency ratio of 4:1, while for impairment of psychomotor function, the ratio was between 3:1 and 5:1. When administered at equipotent doses, S(+) ketamine produces longer hypnosis than the R(–) isomer, with the racemate being intermediate. Improved recovery was seen after S(+) ketamine by infusion, compared with the racemate. However, cardiovascular stimulation and psychotomimetic effects are seen with both stereoisomers.

When given alone as part of an anesthetic technique to surgical patients, ketamine can cause considerable side effects. Emergence reactions are commoner after infusions of the R(-) enantiomer than after the racemate and S(+) isomer. However the incidences of dreaming with all three treatment groups were comparable.<sup>141</sup> There are no apparent differences between the enantiomers and racemate in their hemodynamic effects, but recovery is faster after the S(+) isomer. The EEG effects of both racemic ketamine and the S(+) isomer are similar; both cause increased fast activity (21–30 Hz) with an accompanying reduction in  $\Delta$  power. The  $IC_{50}$  (concentration that inhibits 50%; in this instance, the plasma ketamine concentration necessary to achieve a 50% depression of the maximal EEG median frequency reduction) was 0.8  $\mu\text{g}/\text{mL}$  for S(+) ketamine, compared with 1.8 and 2.0  $\mu\text{g}/\text{mL}$ , respectively, for the R(-) and the racemic preparations.<sup>104</sup> The concentration-effect relationships show the curve for S(+) ketamine to lie to the left of the racemate, and to be steeper.

## Propofol

Propofol is probably the most used hypnotic for the maintenance of TIVA. Infusion rates of 2–10 mg/kg/h are needed when administered with bolus doses or an opiate infusion, whereas drug concentrations  $>8 \mu\text{g}/\text{mL}$  will be necessary if propofol is used as a sole anesthetic agent. Recovery occurs rapidly after cessation of an infusion at blood concentrations of approximately 1.0  $\mu\text{g}/\text{mL}$ .<sup>15</sup> Because of the wide variability in the therapeutic drug concentration window (related to both age and type of surgery) and intersubject drug kinetics, propofol dosing must be titrated to effect. This is easily achievable as it has a short blood-brain equilibration time ( $t_{1/2} k_{e0}$ ).

When used to maintain anesthesia, infusions of propofol cause dose-related decreases in blood pressure, cardiac output, and systemic vascular resistance.<sup>15</sup> One important difference when compared with methohexital is that infusions of propofol do not show the normal baroreflex increase in heart rate to a decreased blood pressure. Propofol causes a resetting of the baroreceptor reflex such that slower heart rates are seen for a given arterial blood when compared with awake values.<sup>25</sup> As well as these central hemodynamic

effects of propofol by infusion, other cardiac effects, including severe bradycardia, sinus arrest, heart block, and asystole, have been reported, which usually occur when propofol is coadministered with vagotonic drugs.<sup>15</sup> During TIVA, propofol affects ventilatory control, causing a reduction in the ventilatory response to carbon dioxide, and in the acute ventilatory response to isocapnic hypoxia.<sup>73,76</sup>

Although bolus doses of propofol have no effect on renal or portal venous blood flows, dose-related changes in liver blood flow have been reported in dogs during graded infusions to concentrations greater than those needed clinically in people.<sup>111</sup> However, in patients, clinically relevant infusion rates of propofol appear to cause no significant changes of liver blood flow.<sup>72</sup>

As well as being an anesthetic agent, propofol has a number of important and advantageous nonhypnotic effects.

1. *Mood-altering effects:* Subhypnotic doses of propofol administered by a patient-controlled analgesia (PCA) system (10 mg with a 1–5-minute lockout) exerts sedative and anxiolytic effects in anxious patients presenting for ambulatory surgery, and thus can be useful as premedication in ambulatory patients.<sup>94</sup>
2. *Antiemetic effects:* Although several authors have suggested an antiemetic effect of propofol (in both hypnotic and subhypnotic doses), the site of this action of the drug remains uncertain.<sup>11</sup> It is probable that propofol does not act at dopaminergic receptors. Subhypnotic infusions of the hypnotic are also effective in the prevention of nausea and emesis following cisplatin chemotherapy.<sup>11</sup>
3. *Antipruritic effects:* Again subhypnotic doses (10–20 mg IV) of propofol are equally as effective as naloxone in relieving pruritus caused by both epidural and spinally administered opiates.<sup>12,95</sup>
4. *Effects on the central nervous system:* Although in vitro studies demonstrate a vasodilating effect of propofol, in vivo measurement shows that infusions of propofol act to decrease cerebral blood flow and intracranial pressure (ICP), and decrease the cerebral metabolic rate. Infusions of propofol have no effect on cerebrovascular autoregulation to

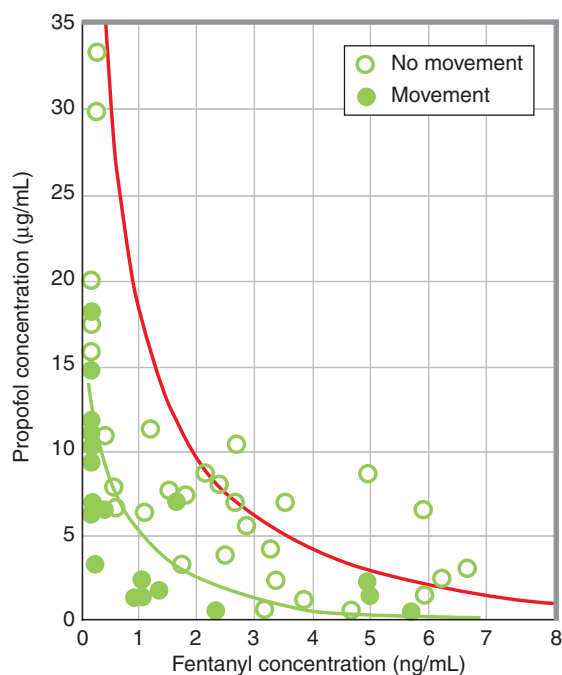
carbon dioxide, although the slope of the curve is decreased. There is some evidence for a cerebral protective effect of propofol, and high doses of propofol have been used to afford protection during cerebral aneurysm surgery in patients requiring cardiopulmonary bypass and deep hypothermic arrest, as well as in patients undergoing nonpulsatile bypass for cardiac surgery.<sup>75,121</sup>

## Propofol-Drug Interactions during TIVA

Because TIVA normally depends on the coadministration of more than one IV drug, there is always the opportunity for drug-drug interactions, which may result in changes to drug distribution, metabolism and elimination, or drug dynamics. In vitro, propofol inhibits drug metabolism at clinical concentrations.<sup>8,18,49</sup> The magnitude of this inhibition varies from 30–71, with the greatest effect on biotransformations mediated by hepatic isocytochrome P450 2B1. Other cytochromes (P450 1A1 and 2A1) are also inhibited, and Chen et al. showed that clinical concentrations of propofol inhibit renal monooxygenase and defluorinase activities.<sup>17</sup>

As infusions of propofol decrease liver blood flow,<sup>111</sup> they also decrease clearance of flow-dependent drugs. Capacity-limited drug clearance is also decreased by action of propofol on the hepatic extraction ratio.<sup>19</sup> These findings are relevant during TIVA, because propofol may decrease the systemic clearance of other coadministered drugs through changes in effective liver blood flow or in the hepatic extraction ratio. However, simulation studies by Schnider et al. suggest that significant changes will not be associated with propofol infusion rates used in clinical practice, as the kinetics of propofol appear linear with regard to infusion rate at those concentrations.<sup>98</sup> Schnider's simulations are in general agreement with the data of Sear and colleagues in an open-chested dog model.<sup>111</sup>

What happens in vivo? There are data indicating significant interactions between propofol and alfentanil that lead to alterations in drug clearance.<sup>67</sup> In male volunteers, the addition of a propofol infusion (at a steady-state concentration ranging between 0.85 and 1.75  $\mu\text{g}/\text{mL}$ ) to alfentanil infused at 25  $\mu\text{g}/\text{kg}/\text{h}$  resulted in a decrease in mean arterial pressure. In turn, this influenced the disposition of the alfentanil,



**FIGURE 42-2.** Increasing concentrations of fentanyl reduces the propofol concentration at which 505 (95%) of patients did not move at skin incision (Cp50i and Cp95i, respectively). *Solid lines*, logistic regression solution. (Adapted with permission from Smith C, McEwan AL, Jhaveri R, et al. The interaction of fentanyl on the Cp50 of propofol for loss of consciousness and skin incision. *Anesthesiology* 1994;81:820–828.)

resulting in a 15% decreased systemic clearance, a 68% reduction in the rapid distribution clearance, and a 51% reduction in slow distribution clearance. A similar interaction is seen with the combination propofol-remifentanyl, where there is a significant reduction in the initial volume of distribution of the opiate and reductions in both systemic clearance and the intercompartmental distributional clearance. Because this effect is not concentration dependent, it does affect the dosing strategy when using this opiate.<sup>13</sup>

Of greater importance, however, are the dynamic interactions between the hypnotics and opiates during the maintenance phase of anesthesia. One of the earliest studies examining the hypnotic-opiate interaction was by Smith et al. (Fig. 42-2).<sup>117</sup> Other clinical studies and computer simulations by Vuyk et al. from Leiden confirm a synergism between these groups of drugs. They also indicate that regardless of an opiate's relative potency, the optimal effect-site concentration should be one that (a) prevents responses to noxious stimulation and (b) allows the rapid recovery of spontaneous ventilation at the end of anesthesia and surgery. Although the original interaction studies focused mainly on the

combination propofol-alfentanil,<sup>67,133–136</sup> more recent studies confirm similar interactions for propofol with remifentanyl and sufentanil.<sup>59,66</sup> A further dynamic interaction is seen between the two groups of drugs, with the frequent need for vasoconstrictor drugs to correct hypotension following the induction of anesthesia.

### Adverse Effects of Propofol during TIVA

Although widely used as the main hypnotic component of TIVA, propofol exhibits a number of significant adverse effects, including pain on injection (especially when given into small veins and to children), hypotension and bradycardia (which are exaggerated in the presence of other vagotonic drugs such as opioids and hypovolemia), apnea in up to 40% of patients after induction, and reports of epileptiform movements and true convulsions.

### $\alpha_2$ -Agonists and Other Sedative Drugs

$\alpha_2$ -Agonist drugs are widely used as part of TIVA techniques in veterinary practice; however, none of these agents are presently licensed for clinical use for sedation or hypnosis in people. Dexmedetomidine (DMD) is

presently undergoing evaluation for both its sedative and hypnotic properties. It can also be seen to have analgesic properties in animals.

In humans, DMD interacts with both opiates and hypnotics to reduce drug requirements needed to maintain sedation or anesthesia. Peden et al. examined the combination DMD and propofol.<sup>83</sup> They found that an infusion of 3 ng/kg/min of DMD reduced the median effective (ED<sub>50</sub>) infusion rate of propofol for loss of consciousness from 5.79 to 3.45 mg/kg/h, and the resulting plasma median effective concentration (EC<sub>50</sub>) from 2.3 to 1.69 µg/mL. However, at these infusion rates, DMD caused significant side effects (with 2 cases of sinus arrest, and 1 of severe postural hypotension persisting for 24 hours postanesthesia). Sinus arrest has also been observed in other studies. Consequently, it is appropriate to pretreat patients (especially those younger than age 40 years) with an anticholinergic agent. At an infusion rate of 3 ng/kg/min, DMD blunted the hemodynamic responses to intubation and surgical incision, with the blood pressure and heart rate remaining stable throughout surgery and into the recovery period.

In a separate study, Dutta et al. determined the EC<sub>50</sub> of propofol for loss of motor response to an electrical stimulus to be 6.63 µg/mL; when DMD was infused to a steady plasma concentration of 0.66 ng/mL, the EC<sub>50</sub> of propofol was reduced by 41% to 3.89 µg/mL.<sup>33</sup>

A number of other clinical studies describe the use of DMD as part of TIVA techniques. Ramsey and Luteran used variable rate DMD infusions to provide hypnosis for surgery in patients with upper airway pathology.<sup>91</sup> When infused at rates up to 10 µg/kg/h, DMD caused no respiratory depression, none of the patients experienced severe hypotension or bradycardia, and recovery was not excessively prolonged (although the patients, who were ages 50–66 years, required 2–3 hours for complete recovery).

Clomethiazole (a derivative of the thiazole part of vitamin B<sub>1</sub>) has been used as a continuous IV anesthetic to supplement both regional and spinal anesthesia. It permits ease of titration of the depth of sedation and anesthesia, with minimal cardiovascular effects. However, widespread use is limited because of the large fluid loads that

occur when administered as a 0.8% infusion in 4% glucose; increased red cell fragility when given as infusions of >5%; a high incidence of peripheral thrombophlebitis, necessitating central venous administration; and minor side effects of nasal irritation and stuffiness. Following prolonged infusions, recovery may be delayed.<sup>63</sup>

## Opiates

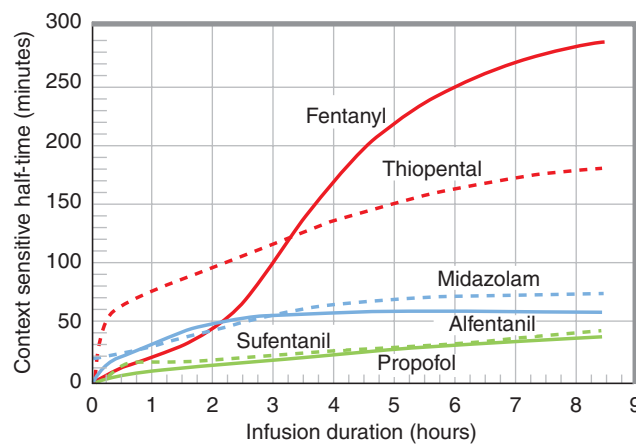
Chapter 41 describes the use of infusions of opiates as part of balanced techniques. When used in TIVA, the opiates act synergistically with most hypnotic agents. Studies by Vuyk et al.,<sup>65,66,133–136</sup> Glass et al.,<sup>117</sup> and Lentschener et al.<sup>59</sup> show that even very small doses of opiates can markedly reduce the requirements of the hypnotic component. These studies also demonstrate a significant “ceiling effect”—such that above a given opiate dose or plasma concentration, little further reduction in hypnotic requirement can be achieved. During TIVA, the ability to prevent autonomic responses appears to be largely dependent on increasing the amount of the opiate drug. Examples of “useful” interactions between the hypnotic and analgesic components of TIVA can be found in the work of Vuyk et al. and Mertens et al.<sup>66,133,134,136</sup> Table 42–9 shows the typical plasma opiate concentrations needed to obtund responses to noxious stimuli during TIVA (and the associated opiate concentrations needed for adequate spontaneous ventilation in the recovery room), together with the regimens needed to achieve other drug concentrations.

## RECOVERY FROM TIVA

The rapidity of recovery after TIVA depends on how well the clinician is able to keep the effect-site drug concentrations near to those concentrations found in the awake or spontaneously breathing subject. If intraoperative concentrations are kept at approximately 20% above those associated with wakefulness, rapid recovery will occur.

### Context-Sensitive Half-Time

In 1992, Hughes et al. offered a different approach to the anesthesiologist's understanding of the recovery profile following infusions of intravenous anesthetic agents. Rather than relating recovery to elimination half-life or systemic clearance, they defined a new



**FIGURE 42–3.** Context-sensitive half-times as a function of infusion duration from computer simulations of pharmacokinetic models. *Solid* and *dashed* lines are used only to permit overlapping lines to be distinguished. (Adapted with permission from Hughes MA, Glass PSA, Jacobs JR. Context-sensitive half-time in multicompartment pharmacokinetic models for intravenous drugs. *Anesthesiology* 1992;76:334–341.)

term: *context-sensitive half-time* (CSHT).<sup>43</sup> Compared to the various half-lives of a kinetic model, the CSHT describes what is happening to the plasma drug concentration.

Termination of drug effect is dependent on two separate kinetic processes: drug distribution and drug elimination. An IV drug with a short elimination half-life is not necessarily a short-acting drug, as drug redistribution can affect the dynamic profile of the agent. The CSHT is dependent on the 3 rate constants— $k_{el}$ ,  $k_{12}$ , and  $k_{21}$ —of a 2-compartment mamillary model in which drug elimination occurs only from the central kinetic compartment. The CSHT is a “half-time” rather than “half-life,” as the time needed for plasma or effect-site drug concentration to decrease by 40% will not be twice that required to decrease by 20%! The term “context” refers to the duration of the drug administration, with the half-time measured from the moment of cessation of the infusion (Fig. 42–3). One limitation of the CSHT is that it describes the time to a 50% decrease in the plasma or central compartment drug concentration. This may not be the required decrement in the drug concentration needed to achieve recovery, although the studies of Prysli-Roberts and Sear suggest that it may certainly be appropriate when predicting the behavior of hypnotic agents given by infusion.<sup>89</sup>

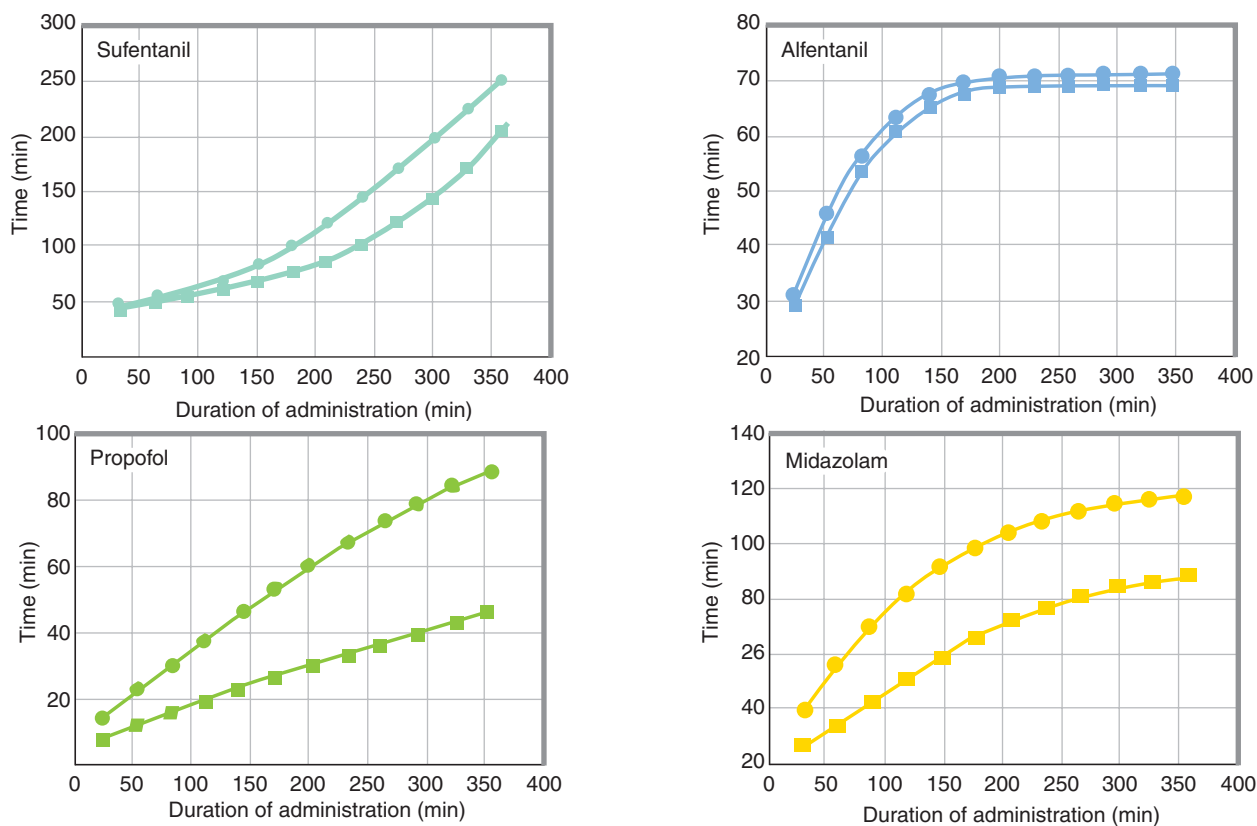
The study of Kapila et al.,<sup>51</sup> comparing the modeled CSHT for both alfentanil and remifentanil with values determined from volunteers where the effect measured was that of depression

of minute ventilation, validated the predictive accuracy of the CSHT. The modeled values of the CSHT following a 3-hour infusion were 2.0 and 51.9 minutes, respectively, for remifentanil and alfentanil, compared with measured values of 3.2 and 47.3 minutes, respectively.

Youngs and Shafer further elaborated on the concept of CSHT.<sup>144</sup> They produced simulations of the time courses not just for a 50% decline in the plasma drug concentration, but also for the 20% and 80% declines after varying-length infusions of 3 opiates (alfentanil, fentanyl, and sufentanil), giving rise to the “20%, 50%, and 80% decrement times.” Examination of the relationship between 6 derived components of a 3-compartment mamillary model (namely  $V_1$ ,  $V_2$ ,  $V_3$ ,  $Cl_{10}$ ,  $Cl_{12}$ , and  $Cl_{13}$ ) on these decrement times show that increases in the initial volume of drug distribution ( $V_1$ ) lead to longer decrement times. The reverse is true after increases in the clearance constant  $Cl_{10}$ . Similarly, increases in the peripheral volumes of distribution ( $V_2$  and  $V_3$ ) and the intercompartmental clearances  $Cl_{12}$  and  $Cl_{13}$  lead to shorter decrement times when the infusion is of limited duration, but longer times after prolonged infusions.

For rapid recovery from TIVA, drugs with a small initial volume of distribution ( $V_1$ ) and high clearance ( $Cl_{10}$ ) are the most suitable. After prolonged anesthesia, the fastest recovery times are seen after infusion of drugs with small apparent peripheral volumes of distribution and small intercompartmental





**FIGURE 42-4.** Comparison of mean effect time (MET) (●) and 50% decrement times (■) as a function of length of administration of sufentanil, alfentanil, propofol, and midazolam when maintained as an infusion maintaining a constant plasma concentration equal to the  $C_{p90}$  for surgery. (Adapted with permission from Bailey JM: Technique for quantifying the duration of intravenous anesthetic effect. *Anesthesiology* 1995;83:1095–1103.)

clearances. As the “biophase” concentration is always related to the plasma drug concentration, the “decrement times” are also a good descriptor of drug effect *except* after bolus doses or very short infusions.

Bailey described another descriptor of recovery following intravenous infusions: the “mean effect time.”<sup>6</sup> The mean effect time is based on whether or not a patient responds to a given parameter or end point. For a given plasma drug concentration, the “probability (p)” of a given drug effect is described by a logistic regression equation of the type:

$$p = C^g / C_{50}^g + C^g$$

where  $C$  = drug concentration;  $C_{50}$  = drug concentration at which there is a 50% probability of a given effect; and  $g$  = a parameter estimate describing the steepness of the concentration–probability relationship. From this equation, Bailey calculates the mean effect time as the integral of  $p$  against time.

Whereas the 50% decrement time of Youngs and Shafer will be, by definition, the median recovery value for a given population of patients after a

given dosing regimen, it will also be the *mean* recovery index based on the probability of that event occurring. A large steepness coefficient  $g$  indicates a steep drug concentration–response relationship. Under such circumstances, the difference between the mean effect time and the 50% decrement times will be insignificant. However, if the concentration–response relationship is flatter, recovery times will tend to be right-skewed, and the mean effect time will be significantly greater than the 50% decrement time.

Although determination of decrement times is straightforward, the calculation of the 50% value for the intraoperative maintenance drug concentration, or determination of the mean effect time requires the anesthetist to have a clear understanding of the nature of the concentration–response relationship (and hence be able to determine  $g$ ). For low values of  $g$ , the anesthetist needs to “overdose” the patient to make sure that *all* patients are adequately asleep or pain free. This necessitates a greater decline in the maintenance drug concentration in order to achieve concentrations where there is a 50% probability of recovery

occurring. Alfentanil is an example of a drug with a high  $g$  value (9.2), whereas sufentanil, propofol, and midazolam have flatter dose–response curves ( $g$  values of 5.99, 3.27, and 3.05, respectively). Thus the mean effect time and the 50% decrement times for alfentanil are similar, whereas those for propofol, midazolam, and sufentanil differ, depending on the duration of drug administration, with the mean effect time being increasingly greater as the dosing time increases<sup>6</sup> (Fig. 42-4).

## How Do All These Simulation Data Compare with In Vivo Observations for Different IV Agents?

### Hypnotics

Propofol has a CSHT of <25 minutes for infusions lasting up to 3 hours duration (Fig. 42-3) and hence recovery will be prompt; in contrast, thiopental has a longer CSHT, and after infusions to achieve plasma concentrations of 10–20  $\mu\text{g}/\text{mL}$ , recovery takes 40–300 minutes.<sup>23</sup>

Methohexital has a CSHT similar to that for propofol, and its recovery profile is similar to that of propofol after

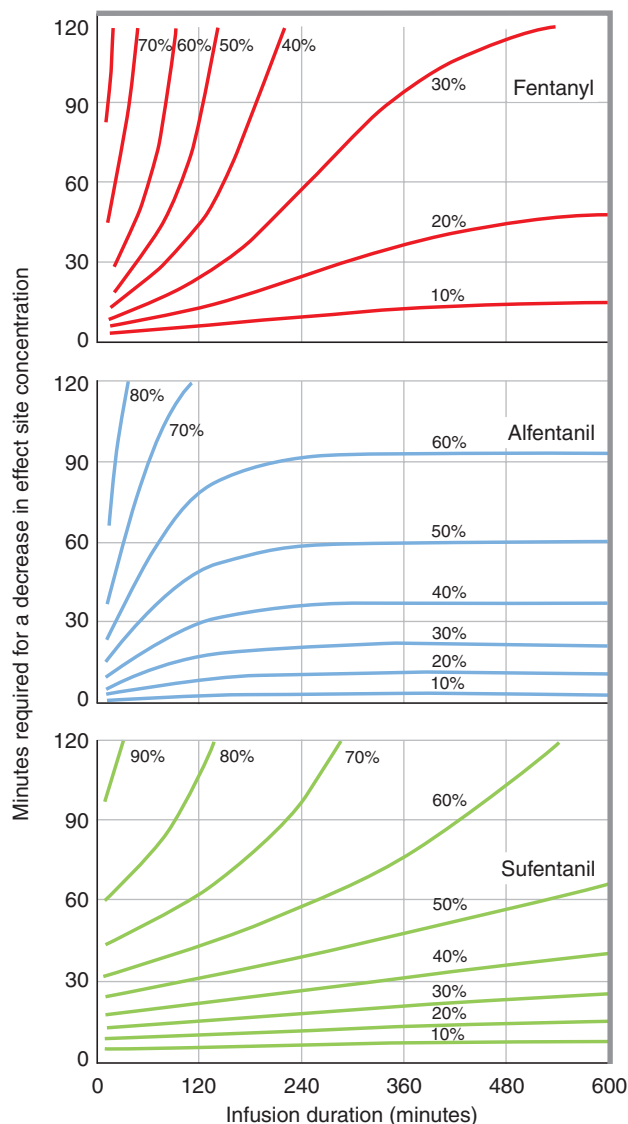
short duration procedures. On the other hand, as the studies of Vuyk et al.<sup>135</sup> demonstrate, midazolam has a CSHT about twice that of propofol. The computed CSHT for ketamine appears to be similar to that for propofol, although its rate of elimination is slower.<sup>47</sup> This is because ketamine equilibrates faster with the peripheral compartments. The modeled CSHT of ketamine after a BET infusion for 8 hours is approximately 50 minutes. However, its recovery profile is influenced by the high incidence of psychological reactions (seen in between 5% and 30% of patients).

Etomidate has a CSHT of approximately 50% that seen with propofol. This should lead to fast recovery after TIVA, but, again, there are associated high incidences of adverse recovery sequelae, including nausea and vomiting (15–20% of patients), twitching and restlessness, and venous sequelae such as thrombophlebitis. The occurrence of these postoperative side effects will slow the completeness of recovery following etomidate.

### Opiates

The rational use of opiates in TIVA has been well discussed by Shafer and Varvel.<sup>115</sup> If a dosing strategy of providing analgesic concentrations is adopted, then a 20–30% decrease in the opiate concentration will allow adequate postoperative ventilation. Fentanyl concentrations show a rapid initial decline followed by a slower decrease, permitting spontaneous ventilation at the end of the procedure while maintaining analgesia for a considerable time thereafter. When a rapid and maximal decline in opiate concentration is desirable (as in ambulatory and day surgery), remifentanyl, alfentanil, and sufentanil are more suitable (Fig. 42–5).

With infusions of less than 8 hours' duration, the decline in the sufentanil concentration is more rapid than that of alfentanil, although alfentanil has the shorter CSHT for infusions lasting 6–8 hours or longer. For infusions of less than 1 hour duration, fentanyl and sufentanil have CSHTs that are both shorter than alfentanil. However, for infusions of variable duration, the CSHT of remifentanyl is virtually independent of its duration, with no adjustment apparently required for weight, age, or gender. Its high systemic clearance is because of its rapid metabolism by plasma esterases. The short



**FIGURE 42–5.** Recovery curves for fentanyl, alfentanil, and sufentanil showing the time required for decreases of a given percentage (labeled for each curve) from the maintained effect-site concentration after termination of the infusion. (Adapted with permission from Shafer SL, Varvel JR. Pharmacokinetics, pharmacodynamics and rational opioid selection. *Anesthesiology* 1990;74:53–63.)

CSHT means that most patients will achieve spontaneous ventilation within 3–5 minutes of stopping the infusion. However, there remains the *major* postoperative problem of how to provide adequate analgesia after the offset of action of the remifentanyl. Although a number of strategies to overcome this have been suggested, several cases of abreaction-type responses to remifentanyl have been described in the literature.<sup>38,50</sup>

Future trends in total intravenous anesthesia will probably be focused in several distinct areas. Firstly, there is need to develop kinetic models for patient populations other than the healthy adult (namely, the young, the elderly and those patients with comor-

bidities). One example is the Paedfusor for propofol administered to children.<sup>1</sup> An alternative will be further development of existing models to allow these covariates to be taken into account (as is presently the case when they are incorporated into TCI systems that use the Schnider kinetic model for propofol delivery).<sup>98</sup> Another major problem is obese patients as weight alone is a poor covariate against which to determine infusion rates or target drug concentrations.

New IV drug developments will include compounds with short context-sensitive half-times, and that are not significantly affected by any of the major comorbidities of renal or hepatic impairment, heart failure, or diabetes

mellitus. Other emphases will be on the development of hypnotic drugs with minimal cardiovascular and respiratory depression, no pain on injection, and, ideally, water soluble. New analgesics should not cause nausea and vomiting, or prolonged or delayed respiratory depression. Drugs fulfilling these desired kinetic and dynamic properties will probably be esterase-metabolized compounds similar to remifentanyl; possible examples under development may include the hypnotic agent THRX-918661 (or TD 4756) and the benzodiazepine-like sedative drugs presently under development by CeNeS.

Patient-controlled TCI systems for sedation and analgesia have the potential to improve patient safety and satisfaction. The use of TCI remifentanyl will probably become more widespread in the next few years.

Another development may be the further development of closed-loop control systems of anesthesia using biomarkers such as auditory-evoked potentials and the bispectral index to provide better control of the depth of sedation and anesthesia.<sup>2,3,60,71,124</sup> Indicators of the depth of analgesia may also be developed.

It is obvious that the development of TIVA has become a major technique in anesthetic practice only because of the availability of drugs with potent hypnotic or analgesic effects, minimal side effects, and kinetic profiles that allow easy and rapid titration to different noxious stimuli. There are still advances to be made, including the best and most accurate method of monitoring depth of anesthesia. Consequently, further developments should include focusing on monitoring for awareness in patients receiving TIVA for sedation or hypnosis.

### KEY REFERENCES

1. Bailey JM. Technique for quantifying the duration of intravenous anesthetic effect. *Anesthesiology* 1995;83:1095–1103.
2. Bryson HM, Fulton BR, Faulds D. Propofol: an update of its use in anaesthesia and conscious sedation. *Drugs* 1995;50:513–559.
3. Glen JB. The development of “Diprifusor”: a TCI system for propofol. *Anaesthesia* 1998;53(Suppl 1):13–21.

4. Hughes MA, Glass PSA, Jacobs JR. Context-sensitive half-time in multicompartment pharmacokinetic models for intravenous drugs. *Anesthesiology* 1992;76:334–341.

5. Jacobs JR, Reves JG. Effect site equilibration time is a determinant of induction dose requirement. *Anesth Analg* 1993;76:1–6.

6. Kapila A, Glass PSA, Jacobs JR, et al. Measured context-sensitive half-times of remifentanyl and alfentanil. *Anesthesiology* 1995;83:968–975.

7. Kazama T, Ikeda K, Morita K, et al. Comparison of the effect-site  $k(e)0$ s of propofol for blood pressure and EEG bispectral index in elderly and younger patients. *Anesthesiology* 1999;90:1517–1527.

8. Mertens MJ, Olofson E, Engbers FHM, et al. Propofol reduces perioperative remifentanyl requirements in a synergistic manner. Response surface modeling of perioperative remifentanyl-propofol interactions. *Anesthesiology* 2003;99:347–359.

9. Mertens MJ, Vuyk J, Olofson E, Bovill JG, Burm AG. Propofol alters the pharmacokinetics of alfentanil in healthy male volunteers. *Anesthesiology* 2001;94:949–957.

10. Schuttler J, Ihmsen H. Population pharmacokinetics of propofol: a multicenter study. *Anesthesiology* 2000;92:727–738.

11. Shafer SL, Varvel JR. Pharmacokinetics, pharmacodynamics and rational opioid selection. *Anesthesiology* 1990;74:53–63.

12. Struys M, MM, De Smet, De-poorter B, et al. Comparison of plasma compartment versus two methods for effect compartment-controlled target-controlled infusion for propofol. *Anesthesiology* 2000;92:399–406.

13. Struys MM, De Smet T, Ver-sichelen L, et al. Comparison of closed-loop controlled administration of propofol using Bispectral Index as the controlled variable versus “standard practice” controlled administration. *Anesthesiology* 2001;95:6–17.

14. Youngs EJ, Shafer SL. Pharmacokinetic parameters relevant to recovery from opioids. *Anesthesiology* 1994;81:833–841.

### REFERENCES

1. Absalom AR, Amutike D, Lal A, White M, Kenny G. Accuracy of the “Paedfusor” in children undergoing cardiac surgery or catheterization. *Br J Anaesth* 2003;91:507–513.
2. Absalom AR, Kenny GN. Closed-loop control of propofol anaesthesia using bispectral index performance assessment in patients receiving computer-controlled and manually-controlled remifentanyl infusions for minor surgery. *Br J Anaesth* 2003;90:737–741.
3. Absalom A, Sutcliffe N, Kenny GN. Closed-loop control of anaesthesia using Bispectral Index performance assessment in patients undergoing major orthopaedic surgery under combined general and regional anaesthesia. *Anesthesiology* 2002;96:67–73.
4. Alvis JM, Reves JG, Govier AV, et al. Computer assisted continuous infusions of fentanyl during cardiac anesthesia: comparison with a manual method. *Anesthesiology* 1985;63:41–49.
5. Ausems ME, Vuyk J, Hug CC, Stanski DR. Comparison of a computer-assisted infusion versus intermittent bolus administration of alfentanil as a supplement to nitrous oxide for lower abdominal surgery. *Anesthesiology* 1988;68:851–861.
6. Bailey JM. Technique for quantifying the duration of intravenous anesthetic effect. *Anesthesiology* 1995;83:1095–1103.
7. Bailey JM, Schwieger IM, Hug CC Jr. Evaluation of sufentanil anesthesia obtained by a computer-controlled infusion for cardiac surgery. *Anesth Analg* 1993;76:247–252.
8. Baker MT, Chadam MV, Ronnenberg WC Jr. Inhibitory effects of propofol on cytochrome P450 activity in rat hepatic microsomes. *Anesth Analg* 1993;76:817–821.
9. Baker MT, Naguib M. Propofol: the challenges of formulation. *Anesthesiology* 2005;103:860–876.
10. Barvais L, Heitz D, Schmartz D, et al. Pharmacokinetic model-driven infusion of sufentanil and midazolam during cardiac surgery: assessment of the prospective predictive accuracy and the quality of anesthesia. *J Cardiothorac Vasc Anesth* 2000;14:402–408.
11. Borgeat A, Wilder-Smith O, Forni M, Suter PM. Adjuvant propofol enables better control of nausea and emesis secondary to chemotherapy for breast cancer. *Can J Anaesth* 1994;41:1117–1119.
12. Borgeat A, Wilder-Smith OHG, Salah M, et al. Subhypnotic doses of propofol relieve pruritus induced by epidural and intrathecal morphine. *Anesthesiology* 1992;76:510–512.
13. Bouillon T, Bruhn J, Radu-Radulescu L, et al. Non-steady state analysis of the pharmacokinetic interaction between propofol and remifentanyl. *Anesthesiology* 2002;97:1350–1362.

14. Bowdle TA, Radant AD, Cowley DS, et al. Psychedelic effects of ketamine in healthy volunteers. relationship to steady-state plasma concentrations. *Anesthesiology* 1998;88:82–88.
15. Bryson HM, Fulton BR, Faulds D. Propofol: an update of its use in anaesthesia and conscious sedation. *Drugs* 1995;50:513–559.
16. Carter JA, Clarke TN, Prys-Roberts C, Spelina KR. Restoration of baroreflex control of heart rate during recovery from anaesthesia. *Br J Anaesth* 1986;58:415–421.
17. Chen TL, Chen TG, Tai YT, et al. Propofol inhibits renal cytochrome P450 activity and enflurane defluorination in vitro in hamsters. *Can J Anaesth* 2000;47:680–686.
18. Chen TL, Ueng TH, Chen SH, et al. Human cytochrome P450 mono-oxygenase system is suppressed by propofol. *Br J Anaesth* 1995;74:558–562.
19. Coetzee JF, Glen JB, Wium CA, Boshoff L. Pharmacokinetic model selection for target controlled infusions of propofol. Assessment of three parameter sets. *Anesthesiology* 1995;82:1328–1345.
20. Cordata DJ, Herkes GK, Mather LE, et al. Prolonged thiopentone infusion for neurosurgical emergencies: usefulness of therapeutic drug monitoring. *Anaesth Intensive Care* 2001;29:339–348.
21. Court MH, Duan SX, Hesse LM, Venkatakrishnan K, Greenblatt DJ. Cytochrome P450 2B6 is responsible for interindividual variability of propofol hydroxylation by human liver microsomes. *Anesthesiology* 2001;94:110–119.
22. Crankshaw DP, Boyd MD, Bjorksten AR. Plasma drug efflux: a new approach to optimization of drug infusion for constant blood concentration of thiopental or methohexital. *Anesthesiology* 1987;67:32–41.
23. Crankshaw DP, Edwards NE, Blackman GL, et al. Evaluation of infusion regimens for thiopentone as a primary anesthetic agent. *Eur J Clin Pharmacol* 1985;28:543–552.
24. Crozier TA, Beck D, Schlaeger M, Wuttke W, Kettler D. Endocrinological changes following etomidate, midazolam or methohexital for minor surgery. *Anesthesiology* 1987;66:628–635.
25. Cullen PM, Turtle M, Prys-Roberts C, Way WL, Dye J. Effect of propofol anaesthesia on baroreflex activity in humans. *Anesth Analg* 1987;66:1115–1120.
26. Dawidowicz Al, Fornal E, Mardarowicz M, Fijalkowska A. The role of human lungs in the biotransformation of propofol. *Anesthesiology* 2000;93:992–997.
27. Dawson D, Sear JW. Influence of induction of anaesthesia with midazolam on the neuro-endocrine response to surgery. *Anaesthesia* 1986;41:268–271.
28. Desborough JP, Hall GM, Hart GR, Burrin JL. Midazolam modifies pancreatic and anterior pituitary hormone secretion during upper abdominal surgery. *Br J Anaesth* 1991;67:390–396.
29. Doenicke AW, Roizen MF, Hoernecke R, Lorenz W, Ostwald P. Solvent for etomidate may cause pain and adverse effects. *Br J Anaesth* 1999;83:464–466.
30. Doenicke A, Roizen MF, Nebauer AE, et al. Comparison of two formulations of etomidate, 2-hydroxypropyl-cyclodextrin (HPCD) and propylene glycol. *Anesth Analg* 1994;79:933–939.
31. Domino EF, Domino SE, Smith RE, et al. Ketamine kinetics in unmedicated and diazepam-premedicated subjects. *Clin Pharmacol Ther* 1984;36:645–653.
32. Drover DR, Lemmens H. Population pharmacodynamics and pharmacokinetics of remifentanyl as a supplement to nitrous oxide anesthesia for elective abdominal surgery. *Anesthesiology* 1998;89:869–877.
33. Dutta S, Karol MD, Cohen T, Jones RM, Mant T. Effect of dexmedetomidine on propofol requirements in healthy subjects. *J Pharm Sci* 2001;90:172–181.
34. Gepts E, Camu F, Cockshott ID, Douglas EJ. Disposition of propofol administered as a constant rate intravenous infusion in humans. *Anesth Analg* 1987;66:1256–1263.
35. Glen JB. The development of “Diprifusor”: a TCI system for propofol. *Anaesthesia* 1998;1982;53(Suppl 1):13–21.
36. Goodchild CS, Robinson A, Nadeson R. Antinociceptive properties of neurosteroids. IV pilot study demonstrating the analgesic effects of alphadolone administered orally to humans. *Br J Anaesth* 2001;86:528–534.
37. Gray C, Swinhoe CF, Myint Y, Mason D. Target controlled infusion of ketamine as analgesia for TIVA with propofol. *Can J Anaesth* 1999;46:957–961.
38. Hansen EG, Duedahl TH, Rousing J, Hilsted KL, Dahl JB. Intra-operative remifentanyl might influence pain levels in the immediate post-operative period after major abdominal surgery. *Acta Anaesthesiol Scand* 2005;49:1464–1470.
39. Harris CE, Murray A, Anderson JM, et al. Effects of thiopentone, etomidate and propofol on the haemodynamic response to tracheal intubation. *Anaesthesia* 1988;43(Suppl):32–36.
40. He YL, Ueyama H, Tashiro C, Mashimo T, Yoshiya I. Pulmonary disposition of propofol in surgical patients. *Anesthesiology* 2000;93:986–991.
41. Hoymork SC, Raeder J, Grimsmo B, Steen PA. Bispectral index, predicted and measured drug levels of target-controlled infusions of remifentanyl and propofol during laparoscopic cholecystectomy and emergence. *Acta Anaesthesiol Scand* 2000;44:1138–1144.
42. Hudson RJ, Henderson BT, Thomson IR, Moon M, Peterson MD. Pharmacokinetics of sufentanyl in patients undergoing coronary artery bypass graft surgery. *J Cardiothorac Vasc Anesth* 2001;15:693–699.
43. Hughes MA, Glass PSA, Jacobs JR. Context-sensitive half-time in multicompartment pharmacokinetic models for intravenous drugs. *Anesthesiology* 1992;76:334–341.
44. Jacobs JR. Algorithm for optimal linear model-based control with application to pharmacokinetic model-driven drug delivery. *IEEE Trans Biomed Eng* 1990;37:107–109.
45. Jacobs JR. Analytical solution to the three compartment pharmacokinetic model. *IEEE Trans Biomed Eng* 1988;35:763–765.
46. Jacobs JR, Reves JG. Effect site equilibration time is a determinant of induction dose requirement. *Anesth Analg* 1993;76:1–6.
47. Jacobs JR, Reves JG, Glass. Rationale and technique for continuous infusion anesthesia. *Int Anesthesiol Clin* 1991;29:23–38.
48. Jacobs JR, Williams EA. Algorithm to control “effect compartment” drug concentrations in pharmacokinetic model-driven drug delivery. *IEEE Trans Biomed Eng* 1993;40:993–999.
49. Janicki PK, James MFM, Erskine WAR. Propofol inhibits enzymatic degradation of alfentanil and sufentanil by isolated liver microsomes in vitro. *Br J Anaesth* 1992;68:311–312.
50. Joly V, Richebe P, Guignaud B, et al. Remifentanyl-induced postoperative hyperalgesia and its prevention with small-dose ketamine. *Anesthesiology* 2005;103:147–155.
51. Kapila A, Glass PSA, Jacobs JR, et al. Measured context-sensitive half-times of remifentanyl and alfentanil. *Anesthesiology* 1995;83:968–975.
52. Kazama T, Ikeda K, Morita K, et al. Comparison of the effect-site  $k(e)0s$  of propofol for blood pressure and EEG bispectral index in elderly and younger patients. *Anesthesiology* 1999;90:1517–1527.
53. Kazama T, Ikeda K, Morita K, et al. Relation between initial blood distribution volume and propofol induction dose requirement. *Anesthesiology* 2001;94:205–210.
54. Kharasch ED, Labroo R. Metabolism of ketamine stereoisomers by human liver microsomes. *Anesthesiology* 1992;7:1201–1207.
55. Kruger-Thiemer E. Continuous intravenous infusion and multicompartment accumulation. *Eur J Pharmacol* 1968;4:317–324.
56. Kulka PJ, Bremer F, Schuttler J. Narkoseeinleitung mit etomidat in lipidemulsion. *Anaesthesist* 1993;42:205–209.
57. Lang E, Kapila A, Shlugman D, et al. Reduction of isoflurane minimal alveolar concentration by remifentanyl. *Anesthesiology* 1996;85:721–728.
58. Ledingham IMcA, Watt I. Influence of sedation on mortality in critically ill multiple trauma patients. *Lancet* 1983;i:1270.
59. Lentschener C, Ghimouz A, Bonnichon P, et al. Remifentanyl-propofol vs. sufenta-



- nil-propofol: optimal combinations in clinical anesthesia. *Acta Anaesthesiol Scand* 2003;47:84–89.
60. Leslie K, Absalom A, Kenny GN. Closed-loop control of sedation for colonoscopy using the bispectral index. *Anaesthesia* 2002;57:693–697.
61. Lowenstein E, Hallowell P, Levine FH, et al. Cardiovascular response to large doses of intravenous morphine in man. *N Engl J Med* 1969;281:1389–1393.
62. Marsh BJ, White M, Morton N, Kenny GN. Pharmacokinetic model driven infusion of propofol in children. *Br J Anaesth* 1991;67:41–48.
63. Mather LE, Cousins MJ. Low dose chloramethiazole infusion as a supplement to central neural blockade: blood concentrations and clinical effects. *Anaesth Intensive Care* 1980;8:421–425.
64. Mehta D, Bradley EL, Kissin I. Effect of alfentanil on hypnotic and antinociceptive components of thiopental sodium anesthesia. *J Clin Anesth* 1991;3:280–284.
65. Mertens MJ, Engbers FH, Burm AG, Vuyk J. Predictive performance of computer-controlled infusion of remifentanil during propofol-remifentanil anaesthesia. *Br J Anaesth* 2003;90:132–141.
66. Mertens MJ, Olofson E, Engbers FHM, et al. Propofol reduces perioperative remifentanil requirements in a synergistic manner. Response surface modeling of perioperative remifentanil-propofol interactions. *Anesthesiology* 2003;99:347–359.
67. Mertens MJ, Vuyk J, Olofson E, Bovill JG, Burm AG. Propofol alters the pharmacokinetics of alfentanil in healthy male volunteers. *Anesthesiology* 2001;94:949–957.
68. Minto CF, Schnider TW, Shafer SL. Pharmacokinetics and pharmacodynamics of remifentanil. II. Model application. *Anesthesiology* 1997;86:24–33.
69. Moore RA, Allen MC, Wood PJ, Rees LH, Sear JW. Perioperative endocrine effects of etomidate. *Anaesthesia* 1985;40:124–130.
70. Morris C, McAlister C. Etomidate for emergency anaesthesia: mad, bad and dangerous to know? *Anaesthesia* 2005;60:737–740.
71. Mortier E, Struys M, De Swet T, Verschelen L, Rolly G. Closed-loop controlled administration of propofol using bispectral analysis. *Anaesthesia* 1998;53:749–754.
72. Murray JM, Trinick TR. Hepatic function and indocyanine green clearance during and after prolonged anaesthesia with propofol. *Br J Anaesth* 1992;69:643–644.
73. Nagyova B, Dorrington KL, Gill EW, et al. Comparison of the effects of sub-hypnotic concentrations of propofol and halothane on the acute ventilatory response to hypoxia. *Br J Anaesth* 1995;75:713–718.
74. Nebauer AE, Doenicke A, Hoerneck R, Angster R, Maker M. Does etomidate cause haemolysis? *Br J Anaesth* 1992;69:58–60.
75. Newman MF, Murkin JM, Roach G, et al. Cerebral physiologic effects of burst suppression doses of propofol during non-pulsatile cardiopulmonary bypass. *Anesth Analg* 1995;81:452–457.
76. Nieuwenhuijs D, Sarton E, Teppema L, et al. Propofol for monitored anesthesia care: implications on hypoxic control of cardiorespiratory responses. *Anesthesiology* 2000;92:46–54.
77. Nilsson A, Persson MP, Hartvig P. Effects of the benzodiazepine antagonist flumazenil on postoperative performance following total intravenous anaesthesia with midazolam and alfentanil. *Acta Anaesthesiol Scand* 1988;32:441–446.
78. Nilsson A, Persson MP, Hartvig P, Wide L. Effects of total intravenous anaesthesia using midazolam/alfentanil on the adrenocortical and hyperglycaemic response to abdominal surgery. *Acta Anaesthesiol Scand* 1988;32:379–384.
79. Nilsson A, Tamsen A, Persson P. Midazolam/fentanyl anaesthesia for major surgery. Plasma levels of midazolam during prolonged total intravenous anaesthesia. *Acta Anaesthesiol Scand* 1986;30:66–69.
80. Oda Y, Hamaoka N, Hiroi T, et al. Involvement of human liver cytochrome P450 2B6 in the metabolism of propofol. *Br J Clin Pharmacol* 2001;51:281–285.
81. Pandin PC, Cantraine F, Ewalenko P, et al. Predictive accuracy of target-controlled propofol and sufentanil coinfusion in long-lasting surgery. *Anesthesiology* 2000;93:653–661.
82. Passot S, Servin F, Allary R, et al. Target-controlled versus manually-controlled infusion of propofol for direct laryngoscopy and bronchoscopy. *Anesth Analg* 2002;94:1212–1216.
83. Peden CJ, Cloote AH, Stafford N, Prys-Roberts C. The effect of intravenous dexmedetomidine premedication on the dose requirement of propofol to induce loss of consciousness in patients receiving alfentanil. *Anaesthesia* 2001;56:408–413.
84. Persson P, Nilsson A, Hartvig P, et al. Pharmacokinetics of midazolam in total I.V. anaesthesia. *Br J Anaesth* 1987;59:548–556.
85. Persson MP, Nilsson A, Hartvig P. Relation of sedation and amnesia to plasma concentrations of midazolam in surgical patients. *Clin Pharmacol Ther* 1988;43:324–331.
86. Persson MP, Nilsson A, Hartvig P, Tamsen A. Pharmacokinetics of midazolam in total intravenous anaesthesia. *Br J Anaesth* 1987;59:548–556.
87. Pfenninger E, Himmelseher S. Neuroprotektion durch ketamin auf zellulärer ebene. *Anaesthesist* 1997;46(Suppl 1):s47–s54.
88. Prys-Roberts C. Cardiovascular effects of continuous intravenous anaesthesia compared with those of inhalational anaesthesia. *Acta Anaesthesiol Scand* 1982;26(Suppl 75):10–17.
89. Prys-Roberts C, Sear JW. Nonbarbiturate intravenous anaesthetics and continuous infusion anaesthesia. In: Prys-Roberts C, Hug CC, eds. *Pharmacokinetics of Anesthetic Drugs*. Oxford, UK: Blackwell Scientific, 1984:128–156.
90. Prys-Roberts C, Sear JW, Low JM, Phillips KC, Dagnino J. Hemodynamic and hepatic effects of methohexital infusion during nitrous oxide anesthesia in humans. *Anesth Analg* 1983;62:317–323.
91. Ramsay MAE, Luteran DL. Dexmedetomidine as a total intravenous anesthetic agent. *Anesthesiology* 2004;101:787–790.
92. Reves J, Glass PSA, Jacobs J. Midazolam and alfentanil: new anesthetic drugs for continuous infusion and an automated method of administration. *Mt Sinai J Med* 1989;56:99–107.
93. Roberts FL, Dixon J, Lewis GTR, et al. Induction and maintenance of anaesthesia. A manual infusion scheme. *Anaesthesia* 1988;43(Suppl):14–17.
94. Rudkin GE, Osborne GA, Curtis NJ. Intra-operative patient-controlled sedation. *Anaesthesia* 1991;46:90–92.
95. Salah M, Borgeat A, Wilder-Smith OH, et al. Epidural morphine-induced pruritus: propofol versus naloxone. *Anesth Analg* 1994;78:1110–1113.
96. Sanders DJ, Jewkes CF, Sear JW, Verhoeff F, Foex P. Thoracic electrical bioimpedance measurement of cardiac output and cardiovascular responses to the induction of anaesthesia and to laryngoscopy and intubation. *Anaesthesia* 1992;47:736–740.
97. Savege TM, Ramsay MAE, Curran JPJ, et al. Intravenous anaesthesia by infusion. A technique using alphaxalone/alphadolone (Althesin). *Anaesthesia* 1975;30:757–764.
98. Schnider TW, Minto CF, Gambus PL, et al. The influence of method of administration and covariates on the pharmacokinetics of propofol in adult volunteers. *Anesthesiology* 1998;88:1170–1182.
99. Schnider TW, Minto CF, Shafer SL, et al. The influence of age on propofol pharmacodynamics. *Anesthesiology* 1999;90:1502–1516.
100. Schraag S, Kenny GN, Mohl U, Georgieff M. Patient-maintained remifentanil target-controlled infusion for the transition to early postoperative analgesia. *Br J Anaesth* 1998;81:365–368.
101. Schuttler J. S-(+) ketamine: the beginning of a new ketamine era. *Anaesthesist* 1992;41:585–587.
102. Schuttler J, Ihmsen H. Population pharmacokinetics of propofol: a multicenter study. *Anesthesiology* 2000;92:727–738.
103. Schuttler J, Schuttler M, Kloos S, Nadstawek J, Schwilden H. Optimal dosage strategies in total intravenous anaesthesia using propofol and ketamine. *Anaesthesist* 1991;40:199–204.
104. Schuttler J, Stanski DR, White PF, et al. Pharmacodynamic modeling of the EEG effects of ketamine and its enantiomers in man. *J Pharmacokinetic Biopharm* 1987;15:241–253.
105. Schuttler J, Schwilden H, Stoekel H. Pharmacokinetics as applied to total intra-

- venous anaesthesia. Practical implications. *Anaesthesia* 1983;38(Suppl):53–56.
106. Schwilden H. A general method for calculating the dosage scheme in linear pharmacokinetics. *Eur J Clin Pharmacol* 1981;20:379–386.
107. Schwilden H, Schuttler J, Stoekel H. Pharmacokinetics as applied to total intravenous anaesthesia. Theoretical considerations. *Anaesthesia* 1983;38(Suppl):51–52.
108. Scott JC, Ponganis KV, Stanski DR. EEG quantitation of narcotic effect: the comparative pharmacodynamics of fentanyl and alfentanil. *Anesthesiology* 1985;62:234–241.
109. Sear JW. Pharmacokinetics and pharmacodynamic aspects of continuous infusion anaesthesia: concept of minimum infusion rate as index of equipotency for IV agents. *Clin Anaesth* 1984;2(1):223–242.
110. Sear JW. Intravenous anaesthesia in the 1990s: a view from Europe. In: Dundee JW, Sear JW, eds. *Intravenous Anaesthesia—What Is New? Clinical Anaesthesiology: International Practice and Research*. London: Balliere Tindall, 1991:399–424.
111. Sear JW, Diedericks J, Foex P. Continuous infusions of propofol administered to dogs: effects on ICG and propofol disposition. *Br J Anaesth* 1994;72:451–455.
112. Sear JW, Phillips KC, Andrews CJH, Prys-Roberts C. Dose-response relationships for infusions of Althesin or methohexitone. *Anaesthesia* 1983;38:931–936.
113. Sear JW, Prys-Roberts C, Phillips KC. Age influences the minimum infusion rate ( $ED_{50}$ ) for continuous infusions of Althesin and methohexitone. *Eur J Anaesthesiol* 1984;1:319–325.
114. Shafer SL, Gregg KM. Algorithm to rapidly achieve and maintain stable drug concentrations at the site of drug effect with computer-controlled infusion pump. *J Pharmacokinetic Biopharm* 1992;20:147–169.
115. Shafer SL, Varvel JR. Pharmacokinetics, pharmacodynamics and rational opioid selection. *Anesthesiology* 1990;74:53–63.
116. Slepchenko G, Simon G, Goubaux B, et al. Performance of target-controlled sufentanil infusion in obese patients. *Anesthesiology* 2003;98:65–73.
117. Smith C, McEwan AL, Jhaveri R, et al. The interaction of fentanyl on the Cp50 of propofol for loss of consciousness and skin incision. *Anesthesiology* 1994;81:820–828.
118. Spens HJ, Drummond GB. Ventilatory effects of etanolone during induction of anaesthesia: comparison with propofol and thiopentone. *Br J Anaesth* 1996;77:194–199.
119. Stanski DR, Maitre PO. Population pharmacokinetics and pharmacodynamics of thiopental: the effect of age revisited. *Anesthesiology* 1990;72:412–422.
120. Stokes DN, Hutton P. Rate-dependent induction phenomena with propofol: implications for the relative potency of intravenous anaesthetics. *Anesth Analg* 1991;72:578–583.
121. Stone JG, Young WL, Marans ZS, et al. Consequences of electroencephalographic suppressive doses of propofol in conjunction with deep hypothermic circulatory arrest. *Anesthesiology* 1996;85:497–501.
122. St Pierre M, Dunkel M, Rutherford A, Hering W. Does etomidate increase postoperative nausea? A double-blind controlled comparison of etomidate in lipid emulsion with propofol for balanced anaesthesia. *Eur J Anaesthesiol* 2000;17:634–641.
123. Struys M, De Smet, Depoorter B, et al. Comparison of plasma compartment versus two methods for effect compartment-controlled target-controlled infusion for propofol. *Anesthesiology* 2000;92:399–406.
124. Struys MM, De Smet T, Versichelen L, et al. Comparison of closed-loop controlled administration of propofol using Bispectral Index as the controlled variable versus “standard practice” controlled administration. *Anesthesiology* 2001;95:6–17.
125. Tavernier A, Coussaert E, D’Hollander A, Cantraine E. Model-based pharmacokinetic regulation in computer-assisted anaesthesia. An interactive model: CARIN. *Acta Anaesthesiol Belg* 1987;38:63–68.
126. Thiel DR, Stanley TE, White W, et al. Midazolam and fentanyl continuous infusion anaesthesia for cardiac surgery; a comparison of computer-assisted versus manual infusion systems. *J Cardiothorac Anesth* 1993;7:300–306.
127. TomLin SL, Jenkins A, Lieb WR, et al. Stereoselective effects of etomidate optical isomers on gamma-aminobutyric acid type A receptors and animals. *Anesthesiology* 1998;88:708–717.
128. Vanacker B, Wiebalck A, Van Aken H, et al. Induktionsqualität und nebennierenrindenfunktion: Ein klinischer vergleich von Etomidat-lipuro und hypnomidate. *Anaesthesist* 1993;42:81–89.
129. Van Poucke GE, Bravo LJ, Shafer SL. Target controlled infusions: targeting the effect site while limiting peak plasma concentration. *IEEE Trans Biomed Eng* 2004;51:1869–1875.
130. Vaughan DP, Tucker GT. General theory for rapidly establishing steady state drug concentrations using consecutive constant rate intravenous infusions. *Eur J Clin Pharmacol* 1975;9:235–238.
131. Vaughan DP, Tucker GT. General derivation of the ideal intravenous drug input required to achieve and maintain a constant plasma drug concentration. Theoretical application to lignocaine therapy. *Eur J Clin Pharmacol* 1976;10:433–440.
132. Vinik HR, Bradley EL, Kissin I. Triple anesthetic combination: propofol-midazolam-alfentanil. *Anesth Analg* 1994;78:354–358.
133. Vuyk J. Pharmacokinetic and pharmacodynamic interactions between opioids and propofol. *J Clin Anesth* 1997;9(Suppl 1):23s–26s.
134. Vuyk J, Engbers F, Lemmens H, et al. Pharmacodynamics of propofol in female patients. *Anesthesiology* 1992;77:3–9.
135. Vuyk J, Hennis PJ, Burm AG, de Voogt JW, Spierdijk J. Comparison of midazolam and propofol in combination with alfentanil for total intravenous anaesthesia. *Anesth Analg* 1990;71:645–660.
136. Vuyk J, Lim T, Engbers F, et al. The pharmacodynamic interaction of propofol and alfentanil during lower abdominal surgery in women. *Anesthesiology* 1995;83:8–22.
137. Wakeling H, Zimmerman J, Howell S, Glass P. Targeting effect compartment or central compartment of propofol. What predicts loss of consciousness? *Anesthesiology* 1999;90:92–97.
138. White M, Schenkels MJ, Engbers F, et al. Effect-site modelling of propofol using auditory evoked potentials. *Br J Anaesth* 1999;82:333–339.
139. White PF. Use of continuous infusion versus intermittent bolus administration of fentanyl or ketamine during outpatient anaesthesia. *Anesthesiology* 1983;59:294–300.
140. White PF, Dworsky WA, Horai Y, Trevor AJ. Comparison of continuous infusion of fentanyl or ketamine versus thiopental—determining the mean effective serum concentration for outpatient surgery. *Anesthesiology* 1983;59:564–569.
141. White PF, Ham J, Way WL, Trevor AJ. Pharmacology of ketamine isomers in surgical patients. *Anesthesiology* 1980;52:231–239.
142. White PF, Schuttler J, Shafer A, et al. Comparative pharmacology of the ketamine isomers. *Br J Anaesth* 1985;57:197–203.
143. Wieber J, Gugler R, Hengstmann JH, Dengler HJ. Pharmacokinetics of ketamine in man. *Anaesthesist* 1975;24:260–263.
144. Youngs EJ, Shafer SL. Pharmacokinetic parameters relevant to recovery from opioids. *Anesthesiology* 1994;81:833–841.

## CHAPTER 43

## Cardiovascular Drugs

Alina Nicoara, MD, Mark Abel, MD, David Bronheim, MD, and Daniel Thys, MD

Cardiovascular disease is common in the general population, affecting the majority of adults past the age of 60 years; persons older than 65 years of age comprise the fastest growing segment of the population. For example, in 1994 there were 33.2 million persons age 65 years or older in the United States, nearly 500,000 (1.5%) of whom suffered a myocardial infarction. By the year 2030, there are expected to be more than 70 million persons in this age group, accounting for more than 1 million infarctions.<sup>1</sup>

No other life-threatening disease is as prevalent or expensive to society, and persons with cardiovascular pathology are likely to die from their disease. As advanced age and concurrent chronic diseases, including cardiovascular diseases, are no longer considered major restrictions to complex surgical procedures, we find ourselves taking care, as anesthesiologists, of sicker and older patients every year. These patients are frequently treated with several chronic medications, making optimal anesthetic management depend on an intimate

## KEY POINTS

1. Patients with preoperative blood pressure elevation have exaggerated perioperative blood pressure fluctuations, which may be associated with electrocardiogram (ECG) evidence of myocardial ischemia. The American College of Cardiology/American Heart Association (ACC/AHA) Guidelines for Perioperative Cardiovascular Evaluation for Noncardiac Surgery recommend that antihypertensive medication be continued during the perioperative period. Particular care should be taken to avoid withdrawal of  $\beta$ -blockers and clonidine because of the potential for catastrophic withdrawal syndromes.
2. Recommendations for patients taking diuretics, call for withholding diuretics on the day of surgery unless evidence suggests volume overload or signs and symptoms of overt congestive heart failure (CHF). In stable patients with chronic mild-to-moderate hypokalemia without signs or symptoms of hypokalemia (e.g., muscle weakness, ileus, and nephropathy) and in the absence of dysrhythmias or digitalis use, anesthesia and surgery can proceed.
3.  $\alpha_2$ -Agonists have many desirable effects such as minimum alveolar concentration (MAC) reduction, analgesia, anxiolysis, sedation, and sympatholysis. Recent studies evaluating the perioperative effect of  $\alpha_2$ -agonists during noncardiac surgery show less perioperative myocardial ischemia. The ACC/AHA guidelines introduced the use of  $\alpha_2$ -agonists as a class IIb recommendation for perioperative control of hypertension or risk reduction in patients with known coronary artery disease (CAD) or major risk factors for CAD.
4. During the perioperative period, patients maintained on angiotensin-converting enzyme (ACE) inhibitors and angiotensin II receptor blockers through the morning of the surgery have an increased number of hypotensive episodes requiring treatment with vasopressors.
5. Perioperatively, IV nitroglycerin may be used for treatment of myocardial ischemia, CHF, acute volume overload, systemic and pulmonary hypertension, and coronary artery spasm. It enhances blood flow to the subendocardium and areas of ischemia by both decreasing preload and left ventricular end-diastolic pressure and volume.
6. The recent focus on perioperative  $\beta$ -blockade has led to mounting evidence that their *prophylactic* use will reduce cardiac mortality and morbidity.  $\beta$ -Blockers reduce ischemia by decreasing myocardial oxygen demand caused by increased stress and catecholamine release in the perioperative period. The ACC/AHA guidelines state that whenever possible  $\beta$ -blockers should be started days or weeks before elective surgery in patients at risk for or with evidence of ischemia. The dose should be titrated to achieve a resting heart rate between 50 and 60 beats/min.
7. The calcium channel blockers represent a diverse group of compounds with dissimilar structures and pharmacologic effects. Unlike  $\beta$ -blockers, which all depend on blockade of receptors for their activity, the sites and mechanisms of action of the individual calcium channel blockers vary, as do their individual actions on different tissues.
8. Over the past decade, the use of most antidysrhythmic drugs has been reassessed and dramatically limited as a result of increased awareness of their proarrhythmic potential and advances in ablation techniques. Moreover, recent clinical trials have demonstrated negative effects on survival in many situations when these drugs may have been administered in the past. Finally, implantable cardio defibrillators have largely replaced antidysrhythmic medications in the management of ventricular dysrhythmias.
9. Amiodarone is considered by some the most efficacious antidysrhythmic agent available; unfortunately, however, it is associated with a high incidence of side effects. In the intraoperative and postoperative settings, IV amiodarone may be used to treat a variety of ventricular and supraventricular arrhythmias. It may be used to convert new onset atrial fibrillation into sinus rhythm. In addition, its use is now advanced cardiac life support (ACLS) recommended for the treatment of pulseless ventricular tachycardia and ventricular fibrillation refractory to defibrillation, stable ventricular tachycardia, wide-complex supraventricular tachycardia, and atrial fibrillation.
10. Several studies have analyzed the effect of statin agents on perioperative cardiovascular mortality and morbidity in patients undergoing noncardiac surgery. Results of these studies, most of them retrospective, showed a reduction in perioperative cardiovascular events or mortality.



knowledge of the pharmacology and interaction of the cardioactive drugs with our anesthetic.

This chapter reviews frequently used cardiovascular medications and the anesthetic considerations associated with their use.

## ANTIHYPERTENSIVES

Analysis of National Health and Nutrition Examination Survey data from 1999–2000 and United States Census bureau information revealed that there are 58–65 million hypertensives in the adult population in the United States.<sup>2</sup> Furthermore, as the population ages and the incidence of obesity increases, this number will continue to grow.

As many antihypertensive agents are currently available for treatment of essential hypertension, selection of one over another depends on the effectiveness of certain drugs within a given population, side effects, and concurrent diseases. For example, patients with hypertension and angina are frequently treated with regimens that include  $\beta$ -adrenergic blocking agents and calcium channel blockers. Hypertensive individuals with chronic obstructive pulmonary disease are managed with drugs that do not increase bronchial tone. Patients with hypertension and heart failure or renal insufficiency will usually be treated with angiotensin-converting enzyme inhibitors or angiotensin II receptor blockers. Certain medications are most useful in combination with a diuretic, whereas diuretics may exacerbate certain diseases (e.g., gout). In addition, patients often tolerate combinations of drugs in low doses better than single medications at higher doses.

Patients with preoperative blood pressure elevation have exaggerated perioperative blood pressure fluctuations, which may be associated with electrocardiogram (ECG) evidence of myocardial ischemia.<sup>3</sup> As perioperative myocardial ischemia has been linked to subsequent increased cardiac morbidity and mortality,<sup>4</sup> anesthesiologists have viewed preoperative control of blood pressure as optimal practice for over a generation. The American College of Cardiology/American Heart Association (ACC/AHA) Guidelines for Perioperative Cardiovascular Evaluation for Noncardiac Surgery guidelines for medical therapy recommend that antihyper-

tensive medication be continued during the perioperative period. In addition, particular care should be taken to avoid withdrawal of  $\beta$ -blockers and clonidine because of the potential for catastrophic withdrawal syndromes.<sup>5</sup>

### Diuretics

Patients with evidence of cardiovascular disease frequently are treated with a regimen that includes a diuretic for control of hypertension, for treatment of congestive heart failure (CHF) and fluid overload states, and for related diseases. Diuretics are among the most commonly used drugs. Table 43–1 lists dosage schedules and side effects for the more commonly prescribed diuretics.

### Thiazides

Thiazide-type diuretics are the most frequently prescribed antihypertensive medications, because they reduce cardiovascular morbidity and mortality to a greater extent than other classes of medications. They are used as initial therapy for most patients with hypertension, either alone or in combination with one of the other classes (angiotensin-converting enzyme [ACE] inhibitors, angiotensin receptor blockers [ARBs],  $\beta$ -blockers, calcium channel blockers).<sup>6</sup> Thiazides act directly on the distal and connecting tubules to decrease sodium, chloride and water reabsorption.<sup>7</sup> This, however, is not the direct mechanism by which thiazides treat hypertension; chronically administered thiazides inhibit a maximal reabsorption of 3–5% of the filtered sodium, have little effect on cardiac output, and decrease plasma volume by only 5%. Blood pressure is directly lowered by arteriolar dilation that accompanies diuretic-induced sodium excretion. These drugs may be used in treatment of CHF, edema secondary to liver disease, diabetes insipidus, and urinary calculi in patients with hypercalciuria. Side effects may include hypokalemia, hypomagnesemia, hyperuricemia, hypocalcemia, hyperglycemia, metabolic alkalosis, hyponatremia, orthostatic hypotension, dysrhythmias, and gout.<sup>8</sup> Recently, studies suggest that lower-than-conventional doses of a thiazide diuretic might be effective, while producing no or only minor metabolic changes.<sup>9</sup>

### Loop Diuretics

Furosemide, bumetanide, ethacrynic acid, and torsemide are unrelated

chemically but act on the kidney at the level of the medullary and cortical aspects of the thick ascending limb of the Henle loop to prevent reabsorption of sodium, chloride, and water. This may not be the loop diuretics' sole effect. When given parenterally, furosemide causes systemic vasodilatation and reduction of left ventricular filling pressure before a diuretic effect is apparent. Loop diuretics are substantially more potent diuretics than thiazides and are indicated in treatment of acute and chronic CHF, as well as in treatment of edema of hepatic or renal origin. Loop diuretics are less effective than thiazides in treatment of hypertension, except when the hypertension is associated with chronic renal insufficiency. In this setting, fluid retention frequently plays a major role in the elevation in blood pressure and thiazides become less effective when the glomerular filtration rate (GFR) falls below 20 mL/min. Side effects include ototoxicity, hypokalemia, hypomagnesemia, hyperuricemia, metabolic alkalosis, dehydration, and hyponatremia. Treatment with loop diuretics may lower serum calcium levels. In combination with hydration, they are used in the acute therapy of hypercalcemia. Finally, loop diuretics have been used to decrease intracranial pressure and to convert acute oliguric renal failure to nonoliguric renal failure.<sup>10</sup>

### Potassium-Sparing Agents

Spirolactone and eplerenone competitively inhibit the mineralocorticoid receptor. By inhibiting the effects of aldosterone on the nephron's distal convoluted tubule and collecting system, they decrease renal sodium absorption and potassium excretion. The potassium-sparing agents have relatively weak natriuretic activity, leading to the maximum excretion of only 1–2% of the filtered sodium.<sup>11</sup> Consequently, they are commonly used in combination with a loop or thiazide diuretic, either to diminish the degree of potassium loss or to increase the net diuresis in patients with refractory edema.<sup>11</sup> Spirolactone is particularly effective in patients with cirrhosis and ascites and improves survival in patients with heart failure when coadministered with conventional therapy.<sup>12</sup>

Triamterene and amiloride are also potassium-sparing diuretics. They are not aldosterone inhibitors but work



TABLE 43-1.

## Diuretics

Agent	Usual Daily Dose (mg)	Precautions and Special Considerations	Side Effects
<b>Thiazides and related sulfonamide diuretics</b>			
Bendroflumethiazide	2.5–5	May be ineffective in renal failure except for indapamide and metolazone; hypokalemia increases digitalis toxicity; may cause an increase in blood levels of lithium; decrease urinary excretion of calcium; may precipitate acute gout	Hypokalemia, hypomagnesemia, hyperuricemia, glucose intolerance, insulin, hypercholesterolemia, increased low-density lipoprotein cholesterol, hypertriglyceridemia, hypercalcemia, sexual dysfunction, weakness, photosensitivity (except for ethacrynic acid), leucopenia, allergic skin rash
Benzthiazide (Exna)	12.5–50		
Chlorothiazide (Diuril)	125–500		
Chlorthalidone (Hygroton)	12.5–50		
Hydrochlorothiazide (HydroDIURIL, Esidrix)	12.5–100		
Hydroflumethiazide (Saluron, Dixardin)	12.5–50		
Indapamide (Lozol)	2.5–5		
Methychlothiazide	2.5–5		
Metolazone (Zaroxolyn)	2.5–5		
Polythiazide (Renese)	1–4		
Quinethazone (Hydromox)	25–100		
Trichlormethiazide	1–4		
<b>Loop diuretics</b>			
Bumetanide (Bumex)	0.5–5	Effective in chronic renal failure; increase urinary calcium excretion	As noted above, except for hypercalcemia
Ethacrynic acid (Edecrin)	25–100		
Furosemide (Lasix)	20–320		
Torsemide (Demadex)	2.5–50		
<b>Potassium-sparing agents</b>			
Amiloride (Midamor)	5–10	Danger of hyperkalemia in patients receiving a potassium supplement, a potassium-containing salt substitute, or an angiotensin-converting enzyme inhibitor, and in patients with renal failure; can cause renal failure in patients treated with a nonsteroidal anti-inflammatory drug (indomethacin and triamterene) may increase blood levels of lithium; spironolactone interferes with digoxin immunoassay; danger of renal calculi (triamterene)	Hyperkalemia for all three agents; for spironolactone only: gynecomastia, mastodynia, gastrointestinal irritation, drowsiness, lethargy, irregular menses or postmenopausal bleeding, hirsutism
Spironolactone (Aldactone)	25–100		
Triamterene (Dyrenium)	50–200		
Eplerenone (Inspra)	50–100		

Modified with permission from Gifford RW. Treatment of patients with systemic arterial hypertension. In: Schlant RG, Alexander RW, eds. *Hurst's The Heart*. New York: McGraw-Hill, 1994:1430.

directly on distal convoluted tubules to prevent sodium-potassium exchange. As with spironolactone, triamterene and amiloride are used in combination with thiazides to treat hypertension and to reverse or prevent hypokalemia.<sup>13</sup> All these drugs may cause hyperkalemia.

### Anesthetic Considerations

The major anesthetic considerations with diuretics pertain to their effects on fluid balance and electrolytes. Recommendations for patients taking diuretics, call for withholding diuretics on the day of surgery unless evidence suggests vol-

ume overload or signs and symptoms of overt CHF. Because intravascular volume may be decreased after diuretic administration, physical examination should include careful evaluation of vital signs, with particular attention to orthostatic blood pressures and other signs or symptoms of dehydration. If hypovolemia goes unrecognized, anesthetic induction may result in significant hypotension and tachycardia.

Diuretics can cause profound electrolyte disturbances, and serum electrolyte levels must be verified preoperatively. Patients receiving chronic therapy with loop diuretics or thia-

zides may have decreased total body potassium and evidence of low serum potassium levels. Chronic use of potassium-wasting diuretics, especially in patients with hypokalemia, is associated with increased incidence of dysrhythmias.<sup>14</sup> Rapid correction of mild-to-moderate hypokalemia before surgery in asymptomatic patients is not indicated for the following reasons:

1. Acute replacement may itself be dangerous and cause life-threatening hyperkalemia.
2. Little can be done to rapidly correct total body potassium. (The differ-

TABLE 43-2.

Centrally Acting  $\alpha_2$ -Adrenoreceptors Agonists

Agent	Dosage (mg)	Duration of Action (hours)	Elimination
Clonidine	0.1–1.0 BID	6–12	Hepatic/renal
Clonidine TTS (patch)	3.5, 7.0, 10.5 cm <sup>2</sup> weekly	7 days	Hepatic/renal
Dexmedetomidine	IV: 1 $\mu$ g/kg loading dose over 10 min; maintenance 0.2–0.7 $\mu$ g/kg/h		Hepatic
Guanabenz	4–64 BID	6–12	Hepatic
Guanfacine	1–3 daily	12–24	Renal
$\alpha$ -Methyldopa	250–1000 BID	6–12	Renal/hepatic

ence between a serum potassium level of 2.5 mEq/L and 3.5 mEq/L may be 200–400 mEq in a 70-kg individual.)

- Some studies suggest that chronic hypokalemia does not increase the incidence of intraoperative dysrhythmias.<sup>15</sup>
- In stable patients with chronic mild to moderate hypokalemia without signs or symptoms of hypokalemia (e.g., muscle weakness, ileus, and nephropathy), and in the absence of dysrhythmias or digitalis use, anesthesia and surgery can proceed.

Diuretics enhance the effects of neuromuscular blocking agents.<sup>16</sup>

### Centrally Acting $\alpha_2$ Agonists

Table 43-2 lists the centrally acting  $\alpha_2$  agonists.

#### Clonidine

Clonidine is an antihypertensive agent with a complex mode of action. Its major effect is to activate central  $\alpha_2$  receptors and reduce norepinephrine (NE) release by peripheral sympathetic nerve terminals. This leads to a 60–80% reduction of sympathetic outflow and catecholamine levels. Part of the antihypertensive effect of clonidine is a result of its action as an agonist of the imidazoline-1 receptors located in the rostral ventrolateral medulla, a vasopressor area of the descending reticular formation.<sup>17</sup> Clonidine decreases heart rate, systemic vascular resistance, plasma renin activity, and epinephrine and norepinephrine levels. Side effects include orthostatic hypotension, sedation, dry mouth, and dizziness. Clonidine is notable in that sudden discontinuation may

result in a severe withdrawal syndrome, which includes rebound hypertension or hypertensive crisis. Restlessness, insomnia, agitation, nausea, and sweating may also occur. These disturbances usually occur 18–36 hours after the last dose. The transdermal clonidine patch allows continued administration in those unable to take oral medication, thereby avoiding withdrawal. Administered orally, clonidine reaches peak plasma concentrations in approximately 90 minutes, whereas when administered topically, it takes approximately 2–3 days to reach therapeutic levels. The clonidine patch is available in 3.5, 7.0, and 10.5 cm sizes, equivalent to oral doses of 0.1, 0.2, and 0.3 mg/d, respectively. Clonidine may also be administered via the intrathecal or epidural route to enhance the efficacy of regional anesthesia.

$\alpha_2$ -Agonists have many desirable effects, such as minimum alveolar concentration (MAC) reduction, analgesia, anxiolysis, sedation, and sympatholysis.<sup>18,19</sup> In this vein, clonidine decreases the intraoperative requirements for isoflurane<sup>20</sup> and narcotics, and improves hemodynamic stability.<sup>21</sup> In addition, clonidine attenuates sympathetic outpouring during drug addiction withdrawal, although there are insufficient data to support their clinical use.<sup>22</sup> Several recent studies evaluating the perioperative effect of clonidine during noncardiac surgery showed less perioperative myocardial ischemia.<sup>23,24</sup> Although evidence supporting the routine use of  $\alpha_2$ -agonists is not as compelling as that for perioperative  $\beta$ -blockade, the ACC/AHA guidelines introduced the use of  $\alpha_2$ -agonists as a class IIb recommendation for perioperative

control of hypertension or risk reduction in patients with known coronary artery disease (CAD) or major risk factors for CAD.<sup>5</sup> Unfortunately, the effects of clonidine are long acting and are not quickly reversed if severe hypotension or bradycardia develops. Recently, there has been resurgence in interest in clonidine because of its analgesic properties, both alone and in combination with other agents.

#### Dexmedetomidine

Dexmedetomidine is a highly selective  $\alpha_2$ -adrenergic receptor agonist (an  $\alpha_2$ -to- $\alpha_1$  selectivity ratio of 1600:1) with pharmacologic properties similar to clonidine. It decreases sympathetic tone with associated decreases in heart rate and blood pressure. Like clonidine, it produces anxiolysis, and sedation with minimal respiratory depression.<sup>25</sup> Dexmedetomidine and other  $\alpha_2$ -agonists are known to interrupt nociceptive processing in the periphery, in the spinal cord, and in supraspinal sites, thereby explaining its analgesic properties.<sup>26</sup>

Dexmedetomidine is administered as a continuous intravenous infusion and its dosage should be individualized and titrated to the desired clinical effect. In adult patients, treatment is generally initiated with a loading infusion of 1  $\mu$ g/kg over 10 minutes, followed by a maintenance infusion of 0.2–0.7  $\mu$ g/kg/h. The rate of the maintenance infusion is adjusted to achieve the desired level of sedation. It is not indicated for infusions lasting longer than 24 hours. When dexmedetomidine is administered chronically and discontinued abruptly, withdrawal symptoms similar to those reported for clonidine (e.g., nervousness, agitation, headache, rapid rise in blood pressure) may result.<sup>27</sup> Transient hypertension has occurred during the administration of the loading dose in association with the initial peripheral vasoconstrictive effects of higher concentrations of dexmedetomidine because of activation of  $\alpha_2$ -adrenoreceptor located on smooth muscle cells in the resistance vessels.<sup>28</sup> Treatment of this hypertension is not usually necessary, although reduction of the loading infusion rate may be beneficial. Dexmedetomidine may result in hypotension and bradycardia consistent with its mechanism. Like clonidine, dexmedetomidine may decrease MAC by up to 50%, thus reducing anesthetic requirements.<sup>29</sup> Because of its sedative-analgesic properties, it has found

TABLE 43-3.

 **$\alpha$ -Adrenergic Blocking Agents**

Agent	Dosage (mg)	Duration of Action
Prazosin	1–10 BID	4–8 h
Terazosin	1–20 daily	12–24 h
Doxazosin	1–16 daily	24 h
Phenoxybenzamine	10–40 BID or TID	3–4 days
Phentolamine	IV: bolus 30–70 $\mu$ g/kg, maintenance 1–20 $\mu$ g/kg/min	10–15 min

application in managing the difficult airway,<sup>30</sup> in providing anesthesia for awake procedures,<sup>31,32</sup> and for sedation and ventilator weaning in ICUs.

**Mivazerol**

Mivazerol, another intravenous  $\alpha_2$ -agonist that is administered by continuous infusion ( $\alpha_2$ -to- $\alpha_1$  receptor selectivity of 119:1), also has been studied for perioperative myocardial protection.<sup>33,34</sup>

 **$\alpha$ -Methyldopa**

$\alpha$ -Methyldopa is an antihypertensive agent that was widely used in the past. Its major pharmacologically active metabolite,  $\alpha$ -methylnorepinephrine, is a potent  $\alpha_2$ -agonist that stimulates brainstem postsynaptic  $\alpha_2$  receptors. This decreases sympathetic tone and systemic vascular resistance.<sup>35</sup> As with clonidine,  $\alpha$ -methyldopa should be used with diuretics to prevent tolerance secondary to volume expansion. Common side effects include orthostatic hypotension, dizziness, sedation, dry mouth, nasal congestion, headache, and impotence. Less common, but more serious, side effects include leukopenia, hepatitis, thrombocytopenia, and a lupus-like syndrome. Rebound syndromes may occur following discontinuation of  $\alpha$ -methyldopa, but much less frequently than with clonidine. Patients unable to take oral medications postoperatively may receive  $\alpha$ -methyldopa intravenously.

**Guanabenz and Guanfacine**

Guanabenz and guanfacine are centrally acting agonists with modes of action and anesthetic considerations similar to those of clonidine, including similar withdrawal syndromes.<sup>36</sup>

**Peripherally Acting Sympatholytic Agents** **$\alpha$ -Adrenergic Blockers**

Table 43-3 lists  $\alpha$ -adrenergic blocking agents.

Prazosin, terazosin, and doxazosin competitively block postsynaptic  $\alpha_1$ -adrenergic receptors in vascular smooth muscle, their main cardiovascular action being arterial and venous dilation. They reduce blood pressure with little effect on cerebral and renal vascular blood flow or heart rate. Virtual absence of tachycardia makes them more useful than the nonselective  $\alpha$ -blockers such as phentolamine. Prazosin, terazosin, and doxazosin have been used for treatment of hypertension and for afterload reduction in patients with CHF. Today, these drugs are most commonly and successfully used for the treatment of benign prostatic hypertrophy.<sup>37</sup> Side effects include orthostatic hypotension, dizziness, and even frank syncope after the initial dose, especially in patients already receiving other antihypertensive medications. Side effects may be significantly reduced by the administration of small initial doses. Subsequent dosages are generally well tolerated.<sup>38</sup> Other, less-common side effects include palpitations, headaches, sedation, dry mouth, gastrointestinal symptoms, tachycardia, and edema. As with clonidine and minoxidil, a diuretic must be added to prevent fluid retention when these drugs are used as antihypertensive agents.

Phenoxybenzamine and phentolamine are noncompetitive, nonselective antagonists. Whereas phenoxybenzamine has a half-life of 24 hours, phentolamine has duration of action of 10–15 minutes, making it suitable for continuous intravenous infusion. Phenoxybenzamine is predominantly used for long-term control of hypertension associated with pheochromocytomas. Phentolamine is used intravenously for perioperative management of hypertension associated with pheochromocytomas<sup>39</sup> and for reversal of deleterious effects secondary to drug extravasation (i.e., norepinephrine, dopamine).<sup>40</sup> Com-

mon side effects of these drugs include hypotension and tachycardia. Tachycardia occurs secondary to baroreceptor reflex activation and blockade of the presynaptic  $\alpha_2$ -receptors interfering with the normal feedback inhibition of norepinephrine release. This tachycardia responds to  $\beta$ -blockers.

**Adrenergic Neuronal Blocking Agents**

Guanethidine and guanadrel are antihypertensive agents more often used in the past. They have limited current use because of availability of drugs with fewer side effects. They are selective inhibitors of postganglionic adrenergic neurons; however, their exact mechanism of action is incompletely understood. Guanethidine must be actively transported into the neuron, where it accumulates in neuronal storage vesicles and causes norepinephrine storage depletion. Although norepinephrine stores are depleted, guanethidine's antihypertensive effect does not actually depend on this depletion. Its major mode of action may be to inhibit nerve pulse transmission at the outer neuronal or vesicular membrane. With chronic administration, peripheral vascular resistance decreases.

Side effects include expansion of intravascular volume, necessitating its use with a diuretic, as well as orthostatic and exercise-induced hypotension, diarrhea, and sexual dysfunction. Tricyclic antidepressants, amphetamines, chlorpromazine, and ephedrine may interfere with its effectiveness by their effects on guanethidine's uptake mechanism. Guanethidine is contraindicated in patients with pheochromocytomas and should not be given to those receiving monoamine oxidase (MAO) inhibitors.

The anesthetic implications of guanethidine involve the decrease in norepinephrine concentration, which may cause the pharmacologic equivalent of denervation hypersensitivity. Therefore, direct-acting sympathomimetics may cause exaggerated hemodynamic responses. Decreased norepinephrine neuronal tissue stores render indirect-acting agents (e.g., ephedrine) less effective.<sup>41</sup>

Reserpine is a *Rauwolfia* alkaloid, which was the first effective antihypertensive agent. It exerts its antihypertensive effect at the postganglionic neuron. It is thought that reserpine's mode of action is related to inhibition of norepi-

TABLE 43-4.

## Direct Acting Vasodilators

Agent	Dosage	Duration of Action
Minoxidil	PO: 10–40 mg daily	8–12 h
Hydralazine (PO)	PO: 40–300 mg daily	6–12 h
Hydralazine (parenteral)	IV: 2.5–10 mg q 20–30 min, max 30–40 mg IM: 10–20 mg q 4–6 h	4–8 h

nephrine and dopamine uptake into terminal vesicles, resulting in increased norepinephrine degradation and decreased conversion of dopamine to norepinephrine. Reserpine crosses the blood–brain barrier and decreases central nervous system (CNS) serotonin and dopamine. Although this effect is thought to be unrelated to its antihypertensive effect, it may be the mechanism by which reserpine causes depression, nightmares, and sedation. Because of vasodilatation, this drug may increase intravascular volume; consequently, diuretic use is mandatory. As with guanethidine, reserpine-induced depletion of norepinephrine stores renders ephedrine and indirect-acting agents less effective, whereas effects of direct-acting agonists may be accentuated.<sup>41</sup>

## Vasodilators

Table 43-4 lists direct-acting vasodilators.

### Hydralazine

Hydralazine is one of the oldest antihypertensives still in use. It is a direct arteriolar vasodilator with little or no effect on the venous circulation. Although ACE inhibitors and angiotensin receptor (ATR) blockers have largely usurped its use, hydralazine is still used in patients who cannot tolerate these other agents, during pregnancy, and intravenously. Several mechanisms of action have been proposed for its direct action on arteriolar smooth muscle, including preventing the accumulation of intracellular free  $Ca^{2+}$ ,<sup>42</sup> promoting influx of potassium,<sup>43</sup> and increasing nitric oxide (NO) production.<sup>44</sup>

In response to arteriolar vasodilatation, a baroreceptor-mediated increase in plasma volume, heart rate, cardiac output, and stroke volume often occurs accompanied sometimes by vasodilatory edema. As a result,  $\beta$ -blockers and/or diuretics are given concurrently to minimize reflex sympathetic stimula-

tion and fluid retention. The addition of an ACE inhibitor or ARB could be more beneficial than a diuretic in controlling the vasodilatory edema if the individual patient<sup>11,45</sup> tolerates these agents. Additional side effects include palpitations, headaches, flushing, and nasal congestion, and in patients with coronary artery disease, worsening angina. Because hydralazine is metabolized by acetylation in the liver, in higher dosages, especially in slow acetylators, it may cause a lupus-like syndrome, which is completely reversible on discontinuation. It may be given by oral, IV, or intramuscular (IM) routes, and may be used in the treatment of hypertension, CHF, and preeclampsia.<sup>46</sup> Perioperatively, hydralazine is titrated intravenously for control of hypertension. Because it may take up to 30 minutes for an intravenous dose of hydralazine to exert its full effect, it should be administered in doses divided by appropriate time intervals.

### Minoxidil

Minoxidil, like hydralazine, is a direct arterial vasodilator that has no effect on the venous circulation. It acts by opening adenosine triphosphate-sensitive potassium channels in vascular smooth muscle cells.<sup>47</sup> It is used to control hypertension resistant to mult-drug regimens.<sup>48</sup> Like hydralazine, minoxidil may increase heart rate and cause fluid retention. To minimize these effects, it is generally administered with a diuretic and a  $\beta$ -blocker. Other side effects include facial hirsutism, hypertrichosis, and, infrequently, pericardial effusion.<sup>49</sup>

### Sodium Nitroprusside

Sodium nitroprusside (SNP) dilates both arterioles and veins, and is one of the most effective parenteral drugs for treatment of hypertensive emergencies and acute congestive heart failure.

In contrast to the organic nitrates, which require the presence of highly specific thiol-containing compounds to generate NO, SNP spontaneously generates this product.<sup>50</sup> In vascular smooth muscle, NO activates the enzyme guanylate cyclase resulting in increased intracellular cyclic guanosine monophosphate (cGMP), which inhibits calcium entry into the smooth muscle cell and may increase calcium uptake by the endoplasmic reticulum producing vasodilatation.<sup>51</sup>

While dissociating to produce NO, SNP interacts with oxyhemoglobin to produce cyanmethemoglobin and cyanide ions.<sup>52</sup> The cyanide ions are converted to thiocyanate via transsulfuration within the liver by the enzyme rhodanese, which uses thiosulfate ions as sulfur donors. In the face of SNP infusion rates exceeding 2  $\mu\text{g}/\text{kg}/\text{min}$ , sulfur donors and methemoglobin are exhausted and cyanide radicals may accumulate, producing clinical cyanide toxicity by binding and inactivating tissue cytochrome oxidase. This prevents oxidative phosphorylation, thus producing tissue hypoxia and cell death despite adequate available oxygen. Because availability of thiosulfate is the rate-limiting step in cyanide metabolism, a concomitant infusion of sodium thiosulfate is advocated to prevent toxicity.<sup>53</sup> Thiocyanate itself can cause toxicity in patients with impaired renal function, but only at concentrations that are seldom reached. Other agents used in the treatment of cyanide toxicity are sodium nitrite, which converts hemoglobin in methemoglobin and hydroxocobalamin. Both methemoglobin and hydroxocobalamin bind cyanide radicals, forming cyanmethemoglobin and cyanocobalamin, respectively.

SNP produces direct venous and arterial vasodilatation with a dose-dependent decrease in blood pressure and a marked decrease in systemic vascular resistance (SVR). It produces pulmonary vasodilatation, decreases pulmonary vascular resistance (PVR), and directly inhibits hypoxic pulmonary vasoconstriction (HPV). The effect on cardiac output is dependent on end diastolic volume. With increased end diastolic volumes, such as one may see in patients with CHF, cardiac output may increase, whereas with normal volumes, cardiac output may be unchanged. SNP can produce “coronary steal” with shunting of blood



away from areas of ischemia.<sup>54</sup> In addition, although SNP appears to impair platelet aggregation via NO<sup>55</sup> in a dose-related manner, the duration of the effect is apparently limited to 5–25 minutes. The clinical importance of this effect has been questioned, as studies have not shown an increase in blood loss or blood transfusions with the use of SNP.<sup>56</sup>

SNP has an immediate onset and a very short duration of action (1–2 minutes), permitting very precise titratability and reliability.

SNP is a popular agent for induced intraoperative hypotension. Concern regarding its toxicity has prompted many anesthesiologists to supplement SNP with  $\beta$ -adrenergic blockers, calcium channel blockers, nitroglycerin, or volatile agents so as to maintain a rate of SNP infusion of less than 2  $\mu\text{g}/\text{kg}/\text{min}$ . SNP has also found use in hypertensive emergencies, management of acute and congestive heart failure, pheochromocytomas, and blood pressure control during cardiac and aortic surgery.<sup>52</sup>

### Other Vasodilators

**Fenoldopam** Fenoldopam, the first selective dopamine type 1 (DA1) receptor agonist, is approved for short-term (up to 48 hours) intravenous management of severe hypertension in hospitalized patients. It is a slightly more potent agonist than dopamine at the DA1 receptors, but does not act as an agonist at dopamine type 2 (DA2) receptors or at  $\alpha$  and  $\beta$  receptors.<sup>57</sup>

Fenoldopam decreases blood pressure without increasing heart rate and cardiac contractility. It dilates a variety of arteries, including coronary arteries, afferent and efferent arterioles of the kidney, and mesenteric arteries.<sup>57</sup> Consequently, it increases renal blood flow,<sup>58</sup> creatinine clearance, urinary flow, and sodium excretion.<sup>59</sup> Fenoldopam can be safely used in hypertensive emergencies, and may be particularly beneficial in patients with renal insufficiency. The infusion is initiated at 0.1  $\mu\text{g}/\text{kg}/\text{min}$  and the dose titrated at 15-minute intervals, depending on the blood pressure response. Although fenoldopam may be considered for control of perioperative blood pressure, agents such as nitroprusside are more titratable and may confer better minute-to-minute blood pressure control during the perioperative period.

Fenoldopam should be given cautiously to patients with glaucoma or

TABLE 43–5.

### Angiotensin-Converting Enzyme Inhibitors

Agent	Dosage	Duration of Action (hours)	Elimination
Captopril	12.5–50 mg BID-TID	4–8	Renal
Enalapril	5–20 mg BID	12–24	Renal
Enalaprilat	1.25 mg IV QID	6	Renal
Lisinopril	10–40 mg daily	24	Renal
Benazepril	10–40 mg daily BID	24	Renal/hepatic
Fosinopril	10–40 mg daily BID	24	Renal/hepatic
Quinapril	5–80 mg daily BID	24	Renal/hepatic
Ramipril	1.25–20 mg daily BID	24	Renal/hepatic
Moexipril	7.5–30 mg daily BID	>24	GI tract/hepatic
Perindopril	4–8 mg daily BID		Renal/hepatic
Trandolapril	2–4 mg daily	72	Renal

high intraocular pressure as it may increase intraocular pressure.<sup>57</sup> Side effects are related to the vasodilator effect, mainly headache, dizziness, tachycardia, or bradycardia.<sup>57</sup>

Because of its renoprotective properties, numerous studies have investigated the usefulness of fenoldopam as prophylaxis for acute renal failure in cardiac surgery with cardiopulmonary bypass or liver transplantation. Results have been controversial: while some studies suggested that renal function was preserved in patients at increased risk for renal dysfunction after cardiac surgery or liver transplantation when low-dose fenoldopam was used in the perioperative period,<sup>60–62</sup> others have shown no difference in the clinical outcome compared with dopamine.<sup>63</sup>

**Eicosanoids** Prostaglandin E<sub>1</sub> (PGE<sub>1</sub>) and prostacyclin (PGI<sub>2</sub>) are direct vasodilators acting on specific prostanoid receptors on vascular smooth muscle. Although they produce reductions in the systemic vascular resistance, their most common clinical use in adults is for their effects on the pulmonary vasculature. PGE<sub>1</sub> is used in neonates and infants to selectively dilate and maintain the patency of the ductus arteriosus. PGI<sub>2</sub> is used for the long-term treatment of primary pulmonary hypertension.<sup>64</sup>

### Angiotensin-Converting Enzyme Inhibitors

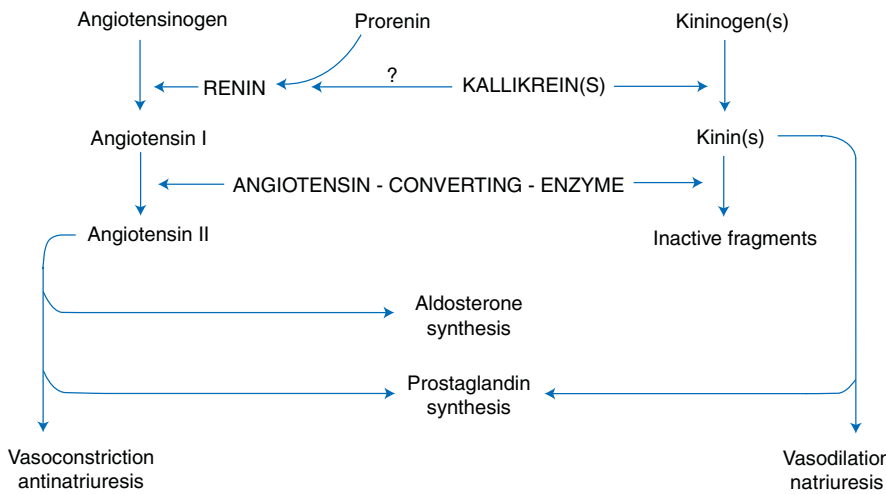
Table 43–5 lists ACE inhibitors.

ACE inhibitors have been successfully used in the management of hypertension, renal insufficiency, and

congestive heart failure. They are generally well tolerated, producing few idiosyncratic side effects. They competitively inhibit the enzyme that converts angiotensin I to the potent vasoconstrictor, angiotensin II (Fig. 43–1). This decrease in plasma angiotensin II causes vasodilatation of both venous capacitance and arteriolar resistance vessels without reflex increases in heart rate.

ACE inhibitors also decrease aldosterone levels, potentiate the vasodilating kallikrein–kinin system and may affect prostaglandin levels. Side effects include hypotension, acute renal failure, and hyperkalemia.<sup>65</sup> Other complications, including cough, bronchospasm, angioneurotic edema, and anaphylactoid reactions, are believed to be related to increased kinin levels because ACE is also kininase. Precipitous reductions in blood pressure may occur following initiation of therapy, particularly in hypovolemic patients.

In those with normal renal function ACE inhibitors generally raise plasma potassium concentrations by less than 0.5 mEq/L. More prominent hyperkalemia may be seen in patients with renal insufficiency, concurrent use of a potassium-sparing diuretic or a nonsteroidal antiinflammatory drug, and in the elderly.<sup>66</sup> Declines in renal function occur in patients with bilateral renal artery stenosis, hypertensive nephrosclerosis, congestive heart failure, polycystic kidney disease, or chronic renal insufficiency. Nevertheless, as a result of the favorable effects on the progression of diabetic<sup>67</sup> and nondiabetic renal disease, an increase in serum creatinine of as much as 35% above baseline is acceptable, unless hyperkalemia develops.<sup>68</sup>



**FIGURE 43–1.** Schematization of the renin–angiotensin–aldosterone system and the kallikrein–kinin system and their interaction with the angiotensin-converting enzyme. (Reproduced with permission from Borek M, Charlap S, Frishman WH. *Enalapril. Pharmacotherapy* 1987;7:135.)

In addition to lowering blood pressure, ACE inhibitors decrease progression of cardiac dysfunction in heart failure, decrease the progression of chronic renal disease,<sup>69</sup> improve survival after myocardial infarction with reduced systolic function, and induce regression of left ventricular hypertrophy.<sup>70</sup> Consequently, they are frequently the antihypertensive of choice.<sup>6</sup> It has also been shown that increased kinin levels may increase insulin sensitivity, which can lower the blood glucose in patients with type 2 diabetes.<sup>71</sup>

During the perioperative period, patients maintained on ACE inhibitors through the morning of the surgery have increased numbers of hypotensive episodes that require treatment with vasopressors.<sup>72</sup>

## Angiotensin II Receptor Blockers

Table 43–6 lists the angiotensin II receptor blockers.

There are two well-described subtypes of angiotensin II receptors, designated AT1 and AT2, both of which have a high affinity for angiotensin II.<sup>73</sup> The AT1 subtype mediates the vasoconstrictor effect of angiotensin II and may mediate angiotensin II-induced growth in the left ventricle and the arterial wall. The AT2 receptor has a less-well-understood role.

ARBs are selective blockers of AT1 receptors on the cell membrane.<sup>74</sup>

The ARBs have been primarily evaluated for the treatment of hypertension, where they appear to have an

effect similar to monotherapy with other antihypertensive drugs, including ACE inhibitors. In fact, ARBs are more effective than  $\beta$ -blockers in reducing the long-term risk of cardiovascular morbidity and mortality.<sup>75</sup> ARBs prolong survival in heart failure<sup>76–78</sup> in patients with systolic heart failure who cannot tolerate ACE inhibitors,<sup>76</sup> and in those treated with both ARBs and ACE inhibitors.<sup>77,78</sup> Two major trials demonstrated a clear benefit in renal protection with ARBs in patients with nephropathy caused by type 2 diabetes, although these trials did not compare ARBs with ACE inhibitors.<sup>79,80</sup>

The angiotensin II receptor blockers are generally well tolerated. They exhibit side effects similar to ACE inhibitors, with the exception of those mediated by kinins, particularly cough, which is the most common reason that patients discontinue ACE inhibitors. Unlike ACE inhibitors, they are effective and safe in the treatment of hypertensives with symptomatic asthma.<sup>81</sup> It should be recognized, however, that

multiple cases of angioedema have been described in patients taking losartan, typically characterized by swelling of the mouth, tongue, pharynx, and eyelids, and occasional laryngeal obstruction.<sup>82</sup> Consequently, physicians should proceed with caution when choosing an antihypertensive for patients who have discontinued ACE inhibitors because of angioedema.

As with ACE inhibitors, patients taking ARBs might be more prone to developing intraoperative hypotension.<sup>83</sup> A study in vascular surgery patients found a statistically significant increase in the number of hypotensive episodes in patients who were treated with ARBs prior to surgery compared with those patients who were treated with  $\beta$ -blockers or calcium channel blockers.<sup>84</sup>

## DIGITALIS

More than 200 years after William Withering published “An account of the foxglove and some of its medical uses,” digoxin remains a mainstay of cardiac therapeutics.

The mechanism of action of the cardiac glycosides is unique. They bind to and directly inhibit the membrane-bound sodium-potassium adenosine triphosphatase (ATPase) pump of the myocardial cell, causing increased intracellular sodium and decreased intracellular potassium. The increase in intracellular sodium changes the sodium concentration gradient and produces decreased exchange of extracellular sodium for intracellular calcium. This leads to net increased inward calcium current and intracellular calcium concentration, resulting in enhanced isolated myocyte contractile performance (increased shortening velocity) and left ventricular (LV) systolic function. Digitalis remains the most prominent

**TABLE 43–6.**

### Angiotensin II Receptor Blockers

Agent	Dosage	Half-Life (hours)
Losartan	50–100 mg daily BID	6–9
Valsartan	80–320 mg daily BID	9
Irbesartan	150–300 mg daily BID	11–15
Telmisartan	40–80 mg daily BID	24
Candesartan	16–32 mg daily BID	3–11
Eprosartan	400–800 mg daily	5–7

inotrope available for chronic oral use and has been shown clinically to decrease symptoms of CHF as well as the number of hospitalizations.<sup>85,86</sup> Unlike all other inotropes, digitalis use is not associated with increased mortality.<sup>87</sup>

Cardiac glycosides have substantial electrophysiologic effects. Digitalis substantially enhances parasympathetic tone while causing some decrease in cardiac sympathetic activity. These effects are why digitalis is efficacious in treatment of supraventricular dysrhythmias.<sup>88</sup> By affecting the sodium-potassium ATPase pump, digitalis may also have effects on conduction that are independent of vagal tone. In normal subjects, digoxin has only a small effect on the sinoatrial (SA) node. It may be safely used in patients with sinus bradycardias without decreasing heart rates. However, patients with evidence of sick sinus syndrome given digitalis may have lengthened SA node conduction and recovery times.<sup>89</sup>

The major effects of digitalis on atrial and atrioventricular (AV) node tissue are also vagally mediated. In humans, therapeutic dosages decrease conduction velocity and either have no effect or increase effective atrial refractory period. Digitalis causes prolongation of both conduction time and the AV node's effective refractory period. In the accessory pathway of patients with Wolff-Parkinson-White (WPW) syndrome, digitalis may shorten the refractory period of the antegrade pathway<sup>90</sup> without affecting the retrograde pathway. Consequently, it should not be used in patients with WPW syndrome. In the ventricle, digitalis shortens the effective refractory period while having little indirect effect.

Digitalis possesses a very low therapeutic index. At toxic levels, in addition to causing anorexia, nausea, fatigue, visual disturbances, and confusion, digitalis may cause severe conduction disturbances. The ECG manifestations may include sinus bradycardia or SA node exit block, AV block, premature atrial contractions, junctional tachycardias, premature ventricular contractions, ventricular tachycardia, and fibrillation.

Certain factors, such as renal insufficiency, electrolyte abnormalities (hypokalemia, hypomagnesemia and hypercalcemia), hypothyroidism, pulmonary disease, and pharmacokinetic interactions with other drugs that can affect digoxin metabolism (quinidine, cyclo-

sporine, verapamil, rifampin), can increase the risk of digitalis intoxication.

Treatment of digitalis toxicity can include several measures, ranging from simply stopping further dosages to aggressively treating hypokalemia and hypomagnesemia, oral therapy with activated charcoal, or placement of a transvenous pacemaker in patients with symptomatic bradycardia or AV dissociation. It has been suggested, however, that transvenous cardiac pacing might precipitate cardiac dysrhythmias and deterioration, and should, if possible, be avoided.<sup>91</sup> Atrial, junctional, and ventricular ectopy are amenable to therapy with phenytoin or procainamide. Ventricular ectopy is usually treated successfully with lidocaine. Anecdotal data suggest that magnesium, bretylium, and amiodarone may suppress severe life-threatening dysrhythmias although amiodarone itself may increase digoxin levels by 100%. In general, drugs that increase serum digitalis levels (e.g., quinidine, propafenone, verapamil) and administration of calcium salts should be avoided.

The availability of digoxin-specific Fab fragments has dramatically changed therapy for severe toxicity. The Fab fragments bind to digoxin intravascularly and in the tissues. The digoxin-Fab fragments complexes are small, so can be rapidly excreted by glomerular filtration in patients with normal renal function. Multiple studies show favorable response to digoxin-specific antibody fragments.<sup>92</sup>

The therapeutic indication for digitalis use is to control heart rate in atrial fibrillation or flutter, and symptomatic management of congestive heart failure.

The usual dose of digoxin is about 0.25 mg/d, with half that dose prescribed for the elderly (age > 65) and patients with renal insufficiency. When acute therapy is necessary, a loading dose of 1–1.5 mg is given over 24 hours. Digoxin-induced arrhythmias and other toxic manifestations occur at progressively increasing frequency as the plasma digoxin concentration rises above 2.0 ng/mL, the upper limit of normal.

Dysrhythmias occur often during the perioperative period. In patients receiving digitalis therapy, the possibility of digitalis toxicity as the dysrhythmia source must always be considered. This could delay introduction of drugs (e.g., verapamil) that substantially in-

crease serum digitalis levels or delay use of cardioversion, which may precipitate ventricular fibrillation in the presence of digitalis toxicity. These considerations become even more significant when one realizes that powerful inotropes and antidysrhythmics with shorter half-lives than digitalis are available for acute administration if necessary.<sup>93</sup>

Some data suggest that halothane, enflurane, ether, methoxyflurane, ketamine, droperidol, and curare may reduce the likelihood of digitalis-induced ventricular dysrhythmias. Thiopental and fentanyl have no effect, whereas succinylcholine, neostigmine, and diazepam may induce dysrhythmias in patients taking digitalis. No reports are available regarding the interaction of digoxin with sevoflurane or desflurane to our knowledge. More important to any discussion of digitalis-associated dysrhythmias and toxicity is prevention of hypokalemia, acid-base imbalance, hypoxia, hypercalcemia, and catecholamine excess states, and avoidance of medications that acutely increase digitalis serum levels.<sup>94</sup>

## ANTIANGINALS

Three groups of drugs—nitrates,  $\beta$ -adrenergic blocking agents, and calcium channel blockers—alone or in combination, are effective and are commonly used to manage angina. Choosing a class of drugs, or a particular drug within each class, depends primarily on patient tolerance of side effects, ventricular function, presence or absence of conduction disease, and relative indications or contraindications caused by additional illnesses.

### Nitrates

Nitrates in many forms have been used in treatment and prevention of angina for more than 100 years. Nitrates are potent dilators of the vascular smooth muscle that affect venous capacitance more than arterial resistance.<sup>95</sup>

Other hemodynamic effects include decreases in left ventricular end-diastolic pressure, pulmonary artery pressure, pulmonary vascular resistance, and right ventricular end-diastolic pressure. Decreases in mean arterial pressure are usually slight and smaller than the other hemodynamic parameters. Low doses have little effect on cardiac output and heart rate in

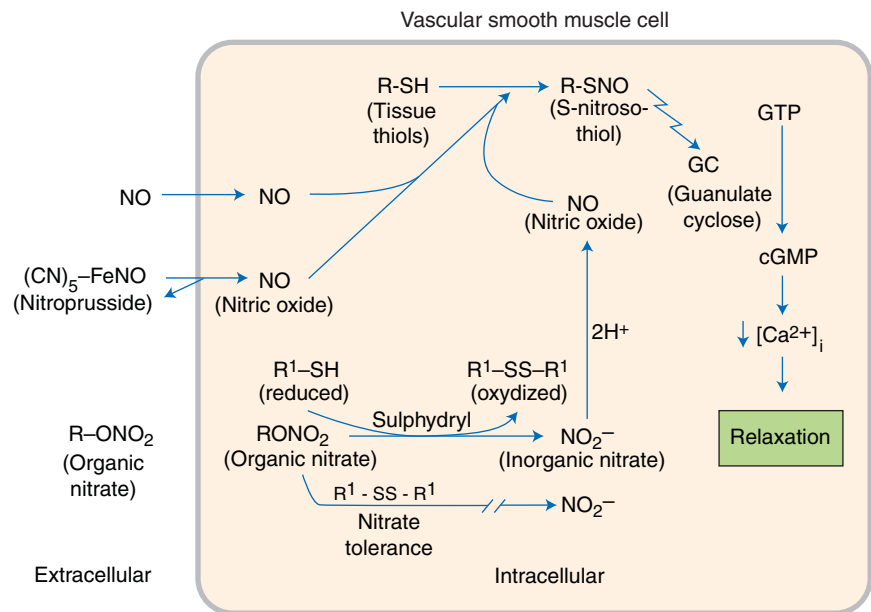
patients with normal or increased intravascular volume. Rapid administration or high doses of nitrates, especially in patients with volume-contracted states, may decrease left ventricular end-diastolic pressure, stroke volume, cardiac output, and mean arterial pressure, and cause reflexive increases in heart rate and sympathetic tone.<sup>95</sup> Nitroglycerin inhibits hypoxic pulmonary vasoconstriction, but to a lesser extent than nitroprusside.

The antianginal use of nitroglycerin stems from its effect on the relationship between myocardial oxygen supply and demand. By increasing venous capacitance, and thus decreasing left ventricular end-diastolic pressure and volume, nitroglycerin decreases systolic ventricular wall tension, which is the major determinant of myocardial energy consumption.

An additional benefit of nitrates is improved flow to areas of ischemia. This effect is related to higher myocardial perfusion pressure, resulting from lower left ventricular diastolic pressure and redistribution of coronary blood flow to subendocardial tissue. This results in an increased endocardial-to-epicardial flow ratio, and probably in a decreased resistance to collateral blood flow.

Nitroglycerin is a direct coronary arterial vasodilator; especially of large epicardial vessels.<sup>96</sup> Dilation of large coronary arteries explains the beneficial effects of nitrates in patients with angina caused by coronary vasospasm. In patients with classic angina caused by coronary insufficiency, net coronary blood flow does not increase following administration of nitroglycerin. It has been postulated that dilation of large epicardial vessels or improvement of cardiac perfusion pressures causes an autoregulated increase in coronary vascular resistance in well-perfused arteriolar resistance vessels distal to large coronary arteries. This increased resistance shunts coronary flow to areas of ischemia where the arterioles are already maximally dilated. Effects of nitrates on coronary blood flow distribution are different (indeed opposite) from those of sodium nitroprusside and dipyridamole. The latter drugs dilate arteriolar resistance vessels and can lead to myocardial steal phenomena.

Nitroglycerin's effects on both systemic and coronary circulations are important. For example, intracoronary



**FIGURE 43-2.** Cellular mechanism of action of nitroglycerin and nitroprusside. (Reproduced with permission from Ignarro LJ, Lipton H, Edwards JC, et al. Mechanism of vascular smooth muscle relaxation by nitrates, nitroprusside and nitric oxide. *J Pharmacol Exp Ther* 1981;218:739.)

injections of nitroglycerin are not as effective as IV nitroglycerin in treatment of pacer-induced ischemia. Beneficial systemic effect is suggested by the observation that intracoronary injection is less effective despite increased coronary blood flow. Conversely, intracoronary nitroglycerin in doses without systemic effect decreases ST segment elevations, improves systolic and diastolic function, and enhances flow to ischemic tissue.<sup>97</sup>

Nitrates produce these effects by entering vascular smooth muscle cells, where they are metabolized to 1,2-glycerol dinitrate and nitrite via mitochondrial aldehyde dehydrogenase, whose sulfhydryl group is required for activity.<sup>98</sup> Nitrite is then oxidized to form nitric oxide. Nitric oxide in combination with tissue thiols forms s-nitroso-thiol, an activator of guanylate cyclase, the enzyme that catalyzes the formation of cGMP (Fig. 43-2).<sup>99</sup> As a second messenger, cGMP mediates many of the biologic effects of nitric oxide, including the control of vascular tone. Dephosphorylation of light-chain myosin occurs through a cGMP-mediated protein kinase, causing smooth muscle relaxation. Higher intracellular levels of cGMP also mediate bronchial, biliary, gastrointestinal, ureteral, and uterine smooth muscle relaxation. Nitrates also have beneficial antiplatelet and antithrombotic properties. The recently recognized

role that platelet-dependent thrombotic processes play in acute coronary syndromes suggests that the inhibition of platelets by nitrates may offer an additional mechanism by which these compounds improve perfusion to ischemic myocardium. This effect is a result of stimulation of platelet guanylate cyclase by nitrates preventing fibrinogen binding to platelet IIb/IIIa receptors, which is essential for platelet aggregation.<sup>100</sup>

Clinically, nitrates can be used transdermally or orally for chronic therapy, on an intermittent basis via the sublingual route, or intravenously for acute therapy (Table 43-7). Clinical indications include classic exertional, Prinzmetal, and unstable angina; acute myocardial infarction (MI), and coronary artery spasm. Nitrates can be also useful in patients with congestive heart failure, particularly at night in those with significant orthopnea or paroxysmal nocturnal dyspnea. Tolerance has been a major problem with the use of nitrates as chronic antianginal therapy. How tolerance occurs is incompletely understood, but it is probably a result of attenuation of the vascular effect of nitrates and not of altered pharmacokinetics.<sup>101</sup> Common adverse effects in patients taking nitrate therapy are headache, flushing, and hypotension. Nitrates must be used cautiously in patients with severe aortic stenosis and volume depletion.



TABLE 43-7.

## Nitrate Preparations

<b>Nitroglycerin</b>	
Sublingual tablets—Nitrostat	0.3–0.6 mg PRN (up to 3 tablets)
Translingual spray—Nitrolingual	0.4 mg/spray (up to 3 sprays)
Transmucosal tablets—Nitrogard (Forest)	1–3 mg q5h TID
Oral extended-release	2.5–6.5 BID to QID
Ointment—2%	1" to 2" q4h for 12–14 h/d
Transdermal patches	1 patch 12–14 h/d
<b>Isosorbide Dinitrate</b>	
Sublingual tablets—immediate release	2.5–10 mg q2–3h
Oral tablets	30 mg BID or 20 mg TID in morning and afternoon
Extended-release tablets and capsules	40–80 mg once daily to TID
<b>Isosorbide-5-Mononitrate</b>	
Immediate release	20 mg in morning and afternoon, 7 hours apart
Extended-release	60–120 mg once daily
<b>Pentaerythroid tetranitrate</b>	
Sublingual	10 mg PRN
<b>Erythritol tetranitrate</b>	
Sublingual	5–10 mg PRN
Oral	10–30 mg TID

Patients taking nitrates who are to have surgery should continue to receive therapy until and possibly throughout surgery. If a substantial perioperative or postoperative lapse is expected, nitrate ointments or IV nitroglycerin may be used.

Perioperatively, IV nitroglycerin may be used for treatment of myocardial ischemia, CHF, acute volume overload, systemic and pulmonary hypertension, and coronary artery spasm. In patients who are undergoing cardiac surgery, nitroglycerin is also used to facilitate infusion of oxygenator reservoir volume by venodilation and transfusion of blood to increase O<sub>2</sub>-carrying capacity. Patients receiving acute nitroglycerin therapy may exhibit exaggerated hemodynamic responses to anesthetics, possibly related to its effects on preload. Prolonged use or excessive doses of nitroglycerin rarely may cause methemoglobinemia,<sup>102</sup> but to a much lesser extent than sodium nitroprusside.

### β-Adrenergic Blocking Agents

β-Adrenergic blocking agents are among the most widely prescribed cardiac medications and have a wide spectrum of therapeutic uses beyond treatment of hypertension, angina, and dysrhythmias.

There are at least three distinct types of β-receptors:

- Activation of β<sub>1</sub> receptors, found primarily in the heart muscle, increases heart rate, contractility, and AV conduction, and decreases AV node refractoriness.
- Activation of β<sub>2</sub> receptors, present in cardiac muscle but more prominently found in bronchial and peripheral vascular smooth muscle, result in bronchodilatation and vasodilatation.
- Activation of β<sub>3</sub> receptors, found in adipose tissue and the heart, may induce thermogenesis<sup>103</sup> and may have cardiodepressant effects.<sup>104</sup>

The major therapeutic effects of β-adrenergic blockers are on the cardiovascular system.

Variations among β-adrenergic blocking agents result from their differing pharmacologic properties in regard to β<sub>1</sub> selectivity, α-adrenergic blocking activity, presence of intrinsic sympathomimetic activity (ISA) or membrane-stabilizing activity (MSA), potency, lipid solubility, first-pass effect, half-life, and mode of metabolism and excretion. All β-adrenergic blocking agents competitively block effects of catecholamines on receptors in the

heart, lung, vasculature, kidney, brain, and eye, and their therapeutic value stems from these effects.

β-Adrenergic blockers lower blood pressure in patients with hypertension, although the mechanism is still debated. β-Blockers decrease myocardial contractility and heart rate, and thus cardiac output, but even at dosages lower than necessary to cause substantial decreases in cardiac output, they can be effective antihypertensives. β-Blockers with ISA such as pindolol, decrease cardiac output less, yet are similarly effective antihypertensives. β-Blockers decrease the release of renin from the juxtaglomerular apparatus. This action contributes to the antihypertensive effect. However, even though hypertensive patients with high plasma renin activity (PRA) respond well to propranolol, which decreases PRA, β-blockers that do not decrease PRA (e.g., pindolol) are also effective.

Evidence suggests that β-blockers cross the blood-brain barrier, and a CNS mechanism involving reduction of receptor-mediated sympathetic outflow has been proposed. On the other hand, lipophilic drugs such as propranolol and metoprolol are no more effective than hydrophilic compounds such as atenolol. Other proposed mechanisms of action include resetting of baroreceptors, attenuation of pressor responses to stress and exercise, and blockade of prejunctional receptors that normally facilitate norepinephrine release.<sup>105,106</sup> Despite unclear mechanisms, β-blockers are among the most useful and commonly prescribed cardiovascular medications.

With the recent introduction of the so-called third-generation β-blockers, other additional antihypertensive mechanisms have been proposed, such as release of nitric oxide, antioxidant action, Ca entry blockade, opening of K channels.<sup>107</sup>

In angina pectoris, β-adrenergic blocking agents decrease heart rate, blood pressure, and contractility, and therefore reduce myocardial O<sub>2</sub> consumption. They may improve perfusion by increasing diastolic coronary filling time. Although β-blockers have little effect on the factors influencing plaque vulnerability, they may decrease the incidence of plaque rupture by reducing mechanical stress.<sup>108</sup> Other mechanisms have been suggested (Box 43-1). Not all the actions of β-blockers are beneficial in all patients.

**BOX 43-1.****Possible Mechanisms by Which  $\beta$ -Blockers Protect the Ischemic Myocardium**

Reduction in myocardial oxygen consumption, heart rate, blood pressure, and myocardial contractility

Augmentation of coronary blood flow  
Increase in diastolic perfusion time by reducing heart rate

Augmentation of collateral blood flow  
Redistribution of blood flow to ischemic areas

Alterations in myocardial substrate utilization

Decrease in microvascular damage  
Stabilization of cell and lysosomal membranes

Shift to oxyhemoglobin dissociation curve to the right

Inhibition of platelet aggregation

Reproduced with permission from Frishman WH. *Clinical Pharmacology of the  $\beta$ -Adrenoceptor Blocking Drug*. 2d ed. Norwalk, CT: Appleton-Century-Crofts, 1984:306.

In patients with very poor ventricular function, worsening failure may negate other gains. Similarly, in Prinzmetal angina,  $\beta$ -blockade is ineffective and may even be harmful because of unopposed  $\alpha$ -tone in the large coronary arteries.<sup>109</sup> Treatment of angina pectoris with  $\beta$ -blockers, in combination with nitrates, aspirin, and/or calcium channel blockers, represents the current standard of care, if no contraindications exist.

Competitive  $\beta$ -receptor inhibition has useful antidysrhythmic effects.  $\beta$ -Blockers decrease the phase IV depolarization slope of the action potential and thus decrease automaticity. They slow the rate of discharge of the sinus and ectopic pacemakers and increase the effective refractory period of the AV node. The membrane-stabilizing effect of  $\beta$ -blockers does not appear to be relevant in the management of arrhythmias as it is manifested at concentrations well above therapeutic levels.  $\beta$ -Blockers are particularly effective in dysrhythmias caused by increased circulating catecholamines such as pheochromocytomas, anxiety, exercise, myocardial ischemia, and heart failure caused by cardiomyopathy; in those caused by increased cardiac sensitivity to catecholamines such as thyrotoxicosis; and in the dysrhythmias of mitral

valve prolapse. They control heart rate in atrial fibrillation, flutter, and paroxysmal atrial tachycardia.<sup>110,111</sup>  $\beta$ -Blockers reduce sudden death, especially in patients with prior myocardial infarction or heart failure.<sup>112</sup> Survivors of myocardial infarctions have decreased morbidity, less sudden death, and fewer recurrent infarctions when treated with  $\beta$ -blockers. Although the reasons for this are not completely clear, a combination of the antiischemic and antidysrhythmic effects seems to play a key role.<sup>113</sup>

Other cardiovascular syndromes in which  $\beta$ -blocker therapy has proved useful include mitral valve prolapse, preexcitation syndromes, hypertrophic cardiomyopathy,<sup>114</sup> tetralogy of Fallot, aortic aneurysm, prolonged QT interval syndromes, and advanced cardiomyopathies. Noncardiac uses have included prevention of bleeding in patients with portal hypertension and treatment of glaucoma, thyrotoxicosis, migraines, essential tremors, delirium tremens, and anxiety.

These important drugs are not without significant side effects.  $\beta$ -Blockers may precipitate congestive heart failure in patients with preexisting ventricular dysfunction. Patients with sinus node dysfunction or AV block may develop symptomatic bradycardias; consequently,  $\beta$ -blockers are relatively contraindicated in patients with sick sinus syndrome. Stimulation of  $\beta_2$  receptors in lungs causes bronchodilation; conversely, treatment with  $\beta$ -blockers may induce bronchospasm. Even  $\beta$ -blockers with relative  $\beta_1$  selectivity (e.g., metoprolol, atenolol, betaxolol, esmolol, acebutolol, bisoprolol) occasionally induce bronchoconstriction in therapeutic doses. Nevertheless, they are preferred in patients with chronic lung disease.<sup>115</sup>  $\beta$ -Blockade may decrease cardiac output and block  $\beta_2$ -mediated coronary or peripheral arterial dilation, allowing unopposed constriction (e.g., spasm). Symptoms of peripheral vascular disease may worsen after  $\beta$ -blocker therapy, although this concern might be overstated in patients with mild to moderate peripheral vascular disease.<sup>116</sup> Additional concerns include impotence, and decreased sympathetic manifestations of hypoglycemia in patients taking insulin or hypoglycemic agents. CNS effects such as depression, psychosis, and obtundation may occur.

Depression, fatigue, and sexual dysfunction are common causes of  $\beta$ -blocker discontinuation.

Multiple interactions between  $\beta$ -adrenergic blocking agents and other drugs have been described, particularly ones that depress myocardial function and automaticity, such as calcium channel blockers and antiarrhythmic drugs.

Abrupt discontinuation of  $\beta$ -blockers can result in a withdrawal syndrome caused by upregulation of  $\beta$ -receptors. This increased sensitivity to endogenous catecholamines can result in hypertension, tachycardia, or exacerbation of anginal syndromes, even MI or death.

The  $\beta$ -adrenergic blocking agents most frequently used in the United States today are described in the following sections (Table 43-8).

**Propranolol**

Propranolol is the prototype against which all other  $\beta$ -adrenergic blocking agents are measured. It is noncardioselective and has no ISA. Although propranolol possesses MSA, this occurs only at doses far beyond therapeutic and is not clinically relevant except following massive overdoses. Propranolol is almost completely absorbed after oral administration, but undergoes extensive first-pass hepatic metabolism. Thus, the usual oral dosage of propranolol is 40–320 mg/d, whereas the IV dosage is only 0.025–0.15 mg/kg. Cimetidine decreases hepatic metabolism and blood flow and may decrease propranolol's therapeutic dose. Propranolol is highly lipophilic and crosses the blood-brain barrier, which may explain its many CNS effects. Its usual oral half-life is approximately 4 hours. Propranolol is available as a long-acting preparation, a marked advantage for treatment of patients with angina pectoris.<sup>117</sup> Propranolol may be slowly administered intravenously to patients under anesthesia in incremental doses of 1 mg with frequent monitoring of blood pressure.

**Metoprolol**

Metoprolol is a  $\beta_1$  selective blocker with no ISA or MSA. It is primarily hepatically metabolized, with a half-life of 3–7 hours. When used in low doses, metoprolol may be preferable to propranolol for smokers and other patients who may have bronchospastic diseases but who require therapy with  $\beta$ -blockers. Although relatively cardi-

TABLE 43–8.

Pharmacologic Properties of  $\beta$  Blockers

Agent	Relative $\beta_1$ Selectivity	ISA	MSA	$\alpha$ Activity	Elimination Half-Life Charts (hours)	Predominant Mode of Elimination	Oral Dosage (mg)	IV Dosage
Acebutolol	+	+	+	–	3–4	Renal/hepatic	200–600 BID	5–10 titrated at 1 mg/min
Atenolol	++	–	–	–	6–7	Renal	50–200 daily	
Betaxolol	++	–	+	–	16–22	Hepatic/renal	10–40 mg daily	0.5–1 mg/kg bolus, then 100–300 $\mu$ g/kg/min
Bisoprolol	++	–	–	–	9–13	Renal/hepatic	10–20 mg daily	
Carteolol	–	+	–	–	5–6	Renal	2.5–10 daily	3.125–25 mg BID
Carvedilol	–	–	+	+	7–10	Hepatic		
Esmolol	++	–	–	–	9 min	Red blood cell esterases	–	0.5–1 mg/kg bolus, then 100–300 $\mu$ g/kg/min
Labetalol	–	–	–	+	6–8	Hepatic	200–1200 BID	5–20 mg initially, then 40 mg q10min up to 300 mg as boluses or 2 mg/min as infusion
Metoprolol	+	–	–	–	3–7	Hepatic	50–200 BID	0.1–0.15 mg/kg titrated slowly to effect
Metoprolol extended release	++	–	–	–	?	Hepatic	50–400 daily	
Nadolol	–	–	–	–	20–24	Renal	40–240 daily	
Oxprenolol	–	+	+	–	4–6	Hepatic	40–80 TID	
Penbutolol	–	+	–	–	5	Renal	20 daily	
Pindolol	–	++	+	–	3–4	Renal/hepatic	5–30 BID	
Propranolol	–	–	++	–	4	Hepatic	40–320 daily, 0.1–0.15 mg/kg BID or QID titrated slowly to effect	
Propranolol extended release	–	–	++	–	10	Hepatic	80–320 daily, BID	
Timolol	–	–	–	–	4–5	Renal	10–30 BID	

oselective, metoprolol still may precipitate bronchospasm. It is less likely than propranolol to mask symptoms of hypoglycemia. Its usual oral dosage is 50–200 mg twice daily, although an extended-release formulation is also available and widely prescribed. Like propranolol, metoprolol is available in IV form, with usual dosage of 0.025–0.15 mg/kg. Metoprolol is used in the treatment of hypertension, stable angina, acute myocardial infarction, and chronic heart failure. The efficacy of metoprolol in heart failure management was studied in several random-

ized clinical trials, which showed an improved survival, reduced need for hospitalizations as a consequence of worsening heart failure, improved New York Heart Association (NYHA) functional class and beneficial effects on patient well-being.<sup>118,119</sup>

### Atenolol

Atenolol is a long-acting, cardioselective  $\beta$ -blocker with no ISA or MSA. It is eliminated by renal excretion, and has a half-life of 6–7 hours. Its usual dosage is 50–200 mg daily. It is available in an IV form, with a recommended

dosage of 5–10 mg given slowly. Besides being cardioselective and requiring only a single daily intake, other possible advantages include relative hydrophilicity and minimal blood–brain barrier crossing. Unfortunately, in clinical trials with atenolol, this has not been reflected by a lower incidence of CNS side effects.<sup>120</sup>

### Bisoprolol

Bisoprolol is a highly selective, long-acting, cardioselective  $\beta$ -blocker, without any ISA or MSA. It is well-absorbed following oral administration and is

eliminated by renal excretion, with 50% unchanged in the urine and the remaining 50% eliminated as inactive metabolites.<sup>121</sup> Its half-life of 9–13 hours makes it suitable for once-a-day administration. Recent randomized clinical trials show that bisoprolol prevents major cardiovascular events in patients with CHF.<sup>122</sup>

### **Betaxolol**

Betaxolol is an oral, long-acting, cardioselective  $\beta$ -blocker with no ISA or MSA. Undergoing mainly hepatic metabolism, its half-life of 16–22 hours makes it suitable for once-a-day administration. As with timolol, betaxolol is available for topical ophthalmic use and may be better tolerated by patients with bronchospastic disease because of its  $\beta_1$  selectivity.

### **Nadolol**

Nadolol is a long-acting, noncardioselective  $\beta$ -blocker with no ISA or MSA. Unlike propranolol, it is renally excreted, with a half-life of 20–24 hours, allowing for once-a-day administration. The usual dosage is 40–240 mg/d; dosage should be reduced in patients with renal failure.

### **Timolol**

Timolol is a noncardioselective  $\beta$ -blocker with no MSA or ISA. Its usual dosage is 10–30 mg twice a day, with a half-life of 4–5 hours. It undergoes both hepatic and renal excretion. Otherwise, it is similar to propranolol. Timolol is frequently used as an eye-drop therapy for open-angle glaucoma. In this form, it is often systemically absorbed and produces effects similar to those after oral ingestion.

### **Acebutolol, Carteolol, Penbutolol, Pindolol**

Acebutolol, carteolol, penbutolol, and pindolol are nonselective  $\beta$ -blockers with ISA and partial agonist effects. With the patient at rest, these drugs may decrease heart rate to a lesser extent than other  $\beta$ -blockers. They are efficacious in blunting exercise-induced hemodynamic response. These drugs are thought to produce fewer lipid abnormalities and peripheral vascular complications, with less myocardial depression and bronchospasm. Specifically, pindolol produces less depression of heart rate and fewer nocturnal pauses in patients with sick sinus syndrome compared with agents

lacking agonist effects.<sup>123,124</sup> Another possible advantage may be the absence of rebound following discontinuation; however, no large-scale trials are available to support these claims. No data are available to support the use of these drugs after MI. Table 43–9 lists the dosages for these drugs.

### **Labetalol**

Labetalol is a nonselective  $\beta$ -blocker unique among  $\beta$ -blockers for its  $\beta$ -adrenergic blocking properties in a ratio of about 7:1 ( $\beta$ : $\alpha$ ). In addition, labetalol has partial agonist activity at  $\beta_2$  receptors.<sup>125</sup> This blocking can be used to decrease arterial pressure with somewhat better maintenance of cardiac output. Labetalol is available in both IV and oral forms and its use is well established in acute therapy of severe hypertension in the emergency room, operating room, and recovery suite, but it is seldom employed as a long-term medication.

### **Esmolol**

Esmolol is a highly cardioselective adrenergic blocker with little ISA and no MSA. It has a distribution half-life of 2 minutes and an elimination half-life of 9 minutes, as a result of rapid hydrolysis by red blood cell (RBC) esterases. Its short duration of action makes it particularly valuable in management of perioperative patients. Esmolol is typically used as a bolus, with or without an infusion. Steady-state plasma levels are obtained within 5 minutes. Usual bolus dosages are 0.5–1 mg/kg. Infusion rates of 50–300  $\mu$ g/kg/min are titrated to clinical effect. On discontinuation of an esmolol infusion, significant recovery occurs within 10–20 minutes, and blood concentrations are undetectable within 30 minutes. Because esmolol is metabolized by red blood cell esterase, plasma cholinesterase inhibitors do not affect metabolism and elimination. Esmolol has been used intraoperatively to attenuate response to intubation, prevent and/or treat tachycardia and ischemia, and produce deliberate hypotension. The time course for attainment of heart rate decreases is faster than for changes in blood pressure.<sup>126</sup> It has been used to attenuate the increased heart rate and mean arterial pressure associated with rapidly increased desflurane concentrations.<sup>127</sup> Postoperatively, it has been used in treatment of hypertension, myocardial ischemia, and supraventricular dysrhythmias.

### **Celiprolol**

Celiprolol is a third-generation cardioselective  $\beta$ -blocker without MSA but with evidence of ISA at the  $\beta_2$  receptor.<sup>107</sup> It is an effective drug in the treatment of hypertension and angina.<sup>128</sup> It is a weak bronchodilator and vasodilator as a result of its  $\beta_2$  receptor effect. It may prove superior to other  $\beta$ -blockers for asthmatic patients.<sup>129</sup>

### **Carvedilol**

Carvedilol is a nonselective  $\beta$ -blocker that also blocks  $\alpha_1$  receptors in a manner similar to labetalol. It has MSA but no ISA. Carvedilol is also a potent antioxidant and antiproliferative, which inhibits vascular smooth muscle proliferation.<sup>130</sup> This property makes it useful in the treatment of chronic congestive heart failure. In numerous clinical trials, carvedilol significantly reduced morbidity and mortality in patients with heart failure.<sup>131</sup> Favorable effects on the remodeling process in heart failure were seen, with a decrease in left ventricular size and improvement in ejection fraction.<sup>132</sup> A recent clinical trial comparing metoprolol and carvedilol in patients with chronic heart failure showed that carvedilol extends survival.<sup>133</sup>

### **Bucindolol**

Bucindolol is a third-generation nonselective  $\beta$ -blocker with  $\alpha_1$  blocking and  $\beta_2$ -agonist capabilities. In contrast to other  $\beta$ -blockers studied, bucindolol failed to show any significant overall survival benefit in patients with advanced cardiac failure.<sup>134</sup>

### **Nebivolol**

Nebivolol is a highly selective  $\beta_1$  receptor blocker, which can be distinguished from other  $\beta$ -blockers by its hemodynamic profile. It combines  $\beta$ -blocking activity with a vasodilating effect, which is mediated at least in part by endothelial NO. The blood-pressure-lowering effect of nebivolol is linked to a reduction in peripheral resistance and an increase in stroke volume with preservation of cardiac output.<sup>135</sup> Recent clinical trials show that it is an effective and well-tolerated treatment for heart failure in the elderly (age > 65).<sup>136</sup>

### **Anesthetic Considerations**

Anesthetic considerations regarding  $\beta$ -blocker therapy are numerous. Initially,  $\beta$ -blockers and antihypertensives were discontinued before anesthesia



TABLE 43-9.

## Pharmacologic Effects of the Calcium Channel Blockers

	HR Acute	SA Node	AV Node	Myocardial Contractility	PVR	CO	CBF	MVO <sub>2</sub>	Oral Dosage	Intravenous Dosage	T <sub>1/2</sub> (hrs)
Diltiazem	↓	↓	↓	↓	↓	V		↓	30-90 mg q6-8h	0.25 mg/kg (bo- lus) then 0.15 ng/kg/hr	2-6
Bepridil	↓	↓	↓	V	-	V		↓	200-400 mg QD	-	24-48
Verapamil	↓	↓	↓	↓↓	↓	↓		↓	80-120 mg q6-2h	0.75-0.15 mg/ kg (bolus) then 0.075- 0.15 ng/kg/hr	3-7
Amlo- dipine		-	-	↓-	↓↓			V	2.5-10 mg QD	-	36-45
Felodipine		-	-	-	↓↓			V	2.5-10 mg QD	-	tri-exponen- tial: 4.8 min; 1.5 h; 9.1 h
Isradipine		-	-	-	↓↓			V	2.5-10 mg QD	-	6-11
Nicardi- pine		-	-	-	↓↓			V	10-20 mg q8h	5-15 mg/h	2
Nifedipine		-	-	↓-	↓↓			V	10-40 mg q8h	-	1.5-5
Nimo- dipine		-	-	-	↓↓			V			
Nisol- dipine		-	-	-	↓↓			V	20-40 mg QD	-	10

↓, decrease; -, no change; AV, atrioventricular; CBF, coronary blood flow; CO, cardiac output; HR, heart rate; MVO<sub>2</sub>, myocardial oxygen consumption; PVR, peripheral vascular resistance; SA, sinoatrial; V, variable.

and surgery because of concerns that their effects would be additive with those of general anesthetic agents. Unfortunately, this sudden withdrawal tended to result in rebound effects with worsening of both angina and hypertension.<sup>137</sup> The 2002 ACC/AHA Guidelines for Perioperative Cardiovascular Evaluation for Noncardiac Surgery recommend that patients previously on  $\beta$ -blockers should continue these agents perioperatively.<sup>5</sup>

The recent focus on perioperative  $\beta$ -blockade has led to mounting evidence that the *prophylactic* use of  $\beta$ -blockers will reduce cardiac mortality and morbidity.  $\beta$ -Blockers reduce ischemia by decreasing myocardial oxygen demand caused by increased stress and catecholamine release in the perioperative period. It has been shown that in high-risk patients who

have to undergo noncardiac surgery, perioperative  $\beta$ -blockade can reduce mortality and cardiovascular complications.<sup>138,139</sup> The ACC/AHA guidelines state that whenever possible  $\beta$ -blocker should be started days or weeks before elective surgery in patients at risk for or with evidence of ischemia. The dose should be titrated to achieve a resting heart rate between 50 and 60 beats/min.<sup>5</sup> Nevertheless, according to recent studies  $\beta$ -blockers are underused in the perioperative period.<sup>140,141</sup> More recent data show that low-risk patients do not benefit, indeed may suffer harm, from perioperative  $\beta$ -blockade. Conversely, high-risk patients may have a greater than 40% reduction in mortality.<sup>142</sup> Furthermore,  $\beta$ -blockers lower the incidence of atrial fibrillation after cardiothoracic surgery.<sup>143</sup>

Because of their pharmacologic effects,  $\beta$ -blockers interact with many anesthetic agents.  $\beta$ -Blockers have additive negative inotropic effects with potent inhalation agents. In dogs at 1.0 MAC of enflurane, propranolol causes mild decreases in myocardial contractility, heart rate, and cardiac output. These changes are more pronounced at deeper anesthetic concentrations. Circulatory depression, although present, is less when halothane or isoflurane are combined with propranolol compared with enflurane. In dogs anesthetized with halothane, isoflurane, or enflurane, propranolol produces additive slowing of heart rate and AV node conduction.<sup>144</sup>

Patients maintained on  $\beta$ -blockers, particularly when combined with calcium channel blockers, are at risk for

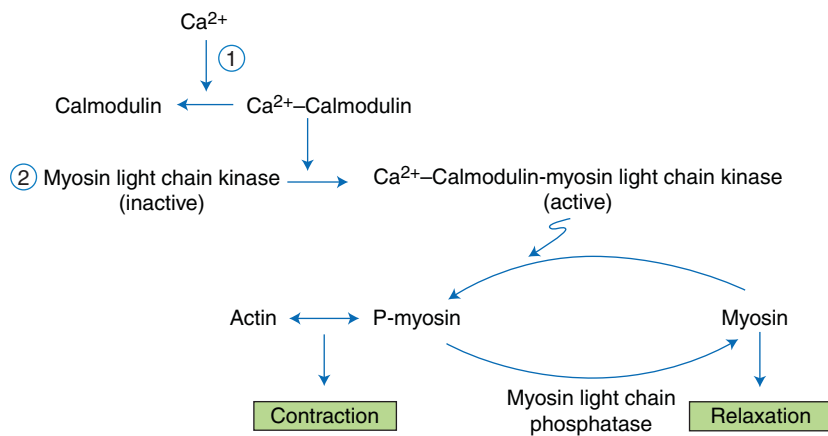
severe bradyarrhythmias when anesthesia is induced with high-dose fentanyl or sufentanil. These bradyarrhythmias especially occur when muscle relaxants lacking vagolytic effects are used. When high-dose narcotics are given to patients who take  $\beta$ -blockers, with or without calcium channel blockers, it is recommended that vagolytic muscle relaxants (e.g., pancuronium) be used.<sup>145</sup>  $\beta$ -Blockers are also associated with bradycardia during neuraxial anesthesia.<sup>146</sup>

The currently available IV  $\beta$  blockers—propranolol, metoprolol, atenolol, labetalol, and esmolol—may be administered perioperatively to attenuate hemodynamic responses to intubation or surgical stress, treat hypertension and ischemia, slow heart rates, or treat dysrhythmias, in addition to the prophylactic uses described above.

## Calcium Channel Blockers

The calcium channel blockers represent a diverse group of compounds with dissimilar structures and pharmacologic effects (Table 43-9). They inhibit voltage-sensitive calcium channel function (L-type or slow channels), which mediate the entry of extracellular calcium into smooth muscle (Fig. 43-3), cardiac myocytes, and SA and AV nodal cells in response to electrical depolarization. They therefore have vasodilatory properties, especially in arterial beds, and have negative chronotropic and inotropic effects to varying degrees.<sup>147,148</sup> Unlike  $\beta$ -blockers, which all depend on blockade of receptors for their activity, the sites and mechanisms of action of the individual calcium channel blockers vary, as do their individual actions on different tissues. They are not nearly as interchangeable as  $\beta$ -blockers.

Used predominantly in antianginal and antihypertensive therapy (Fig. 43-4), calcium channel blockers are also used in treatment of syndromes as diverse as paroxysmal supraventricular tachycardia, hypertrophic obstructive cardiomyopathy, Raynaud phenomenon, preterm labor, and migraine prophylaxis.<sup>114,149,150</sup> The currently available calcium channel blockers can be categorized into 4 groups based on different chemical structures: dihydropyridines (which include nifedipine, nisoldipine, nica-dipine, nimodipine, amlodipine, isradipine, felodipine, nitrendipine), verapamil (a phenylalkylamine), diltiazem



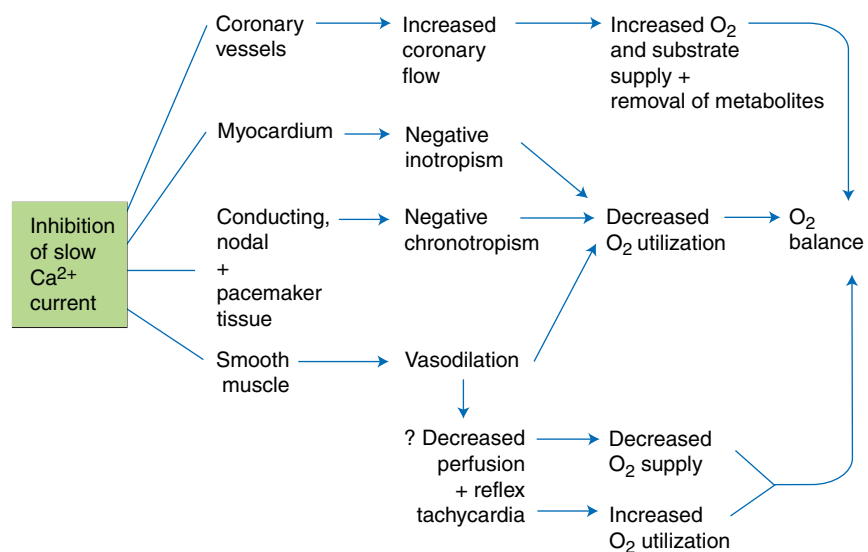
**FIGURE 43-3.** Activation sequence of mechanical contraction in vascular smooth muscle. The calcium ( $Ca^{2+}$ ) calmodulin complex (1) activates myosin light-chain kinase (2), which catalyzes the phosphorylation of myosin (*P-myosin*). Cross-bridge formation between *P-myosin* and actin produces mechanical contraction. (Reproduced with permission from Anderson KE, Hogestatt ED. On the mechanism of action of calcium antagonists. *Acta Med Scand* 1984;681(Suppl):11.)

(a benzothiazepine), and bepridil (a diarylaminopropylamine).

## Verapamil

Verapamil, which is structurally similar to papaverine, has a complex mode of action. It is a racemic mixture with L-verapamil being a more potent calcium channel blocker than D-verapamil.<sup>151</sup> The net effect is depression of both slow channel activation and recovery from inactivation. Via its effects on the calcium channels, verapamil decreases myocardial contractility and dilates coronary and

peripheral vascular beds, increasing coronary blood flow and decreasing systemic vascular resistance. Reflex tachycardia, secondary to decreased systemic vascular resistance, does not occur as a result of its negative chronotropic effect. Like other calcium channel blockers, verapamil has little effect on venous capacitance vessels in clinical doses. By decreasing heart rate, contractility, and peripheral resistance, verapamil decreases myocardial  $O_2$  consumption. By increasing diastolic filling time and coronary blood flow while decreasing coronary



**FIGURE 43-4.** Consequences of calcium channel blockers on myocardial  $O_2$  balance. Because of reflex responses, negative chronotropism and inotropism may not be important. (Reproduced with permission from Nayler WG, Dillon JS, Daly MF. Cellular sites of action of calcium antagonists and  $\beta$ -adrenoceptor blockers. In: Opie LH, ed. *Perspectives in Cardiovascular Research*. Vol 9. Calcium Antagonists and Cardiovascular Disease. New York: Raven Press, 1984:188.)

vascular resistance, it increases myocardial O<sub>2</sub> delivery. *In patients with congestive heart failure, intravenous verapamil can cause a marked decrease in contractility and left ventricular function.* By directly antagonizing coronary vascular spasm, verapamil is useful in treatment of classic and Prinzmetal angina. Verapamil is useful in managing patients after myocardial infarction without congestive heart failure, and its use may decrease long-term mortality.<sup>152</sup>

The electrophysiologic effects of verapamil are substantial. It slows spontaneous rates of firing and increases SA node recovery time, thereby decreasing heart rate. The velocity of AV node conduction decreases as a consequence of both decreased conduction and increased refractoriness. Because of this effect on the AV node conduction, verapamil can terminate paroxysmal supraventricular tachycardia, slow the ventricular response in atrial flutter, fibrillation, and multifocal atrial tachycardia. It can successfully convert paroxysmal supraventricular tachycardias (PSVTs) to sinus rhythm with an effectiveness of greater than 90%. It is also of prophylactic value in preventing recurrences of PSVT and controlling the ventricular response in atrial flutter and fibrillation during long-term oral therapy.<sup>153</sup> It should be noted that in patients with Wolff-Parkinson-White syndrome, verapamil might increase heart rate by preferential AV slowing, which may increase conduction through accessory pathways in patients who develop atrial fibrillation.

The net effect of verapamil in lowering both systolic and diastolic blood pressure with few side effects makes it efficacious for treatment of hypertension, although calcium channel blockers are currently not recommended as first-line therapy for hypertension. Possibly as a result of its improvement in diastolic function, verapamil improves exercise tolerance and decreases the severity of symptoms in patients with hypertrophic obstructive cardiomyopathy (HOCM). It is mainly used in HOCM patients who cannot tolerate  $\beta$ -blockers.<sup>114</sup>

In acute IV therapy, the recommended dose of verapamil is 0.075–0.15 mg/kg titrated to effect. Peak vasodilatory effect occurs at approximately 5 minutes and may persist for 30 minutes, although the antidys-

rhythmic effect may persist substantially longer. IV distribution half-life is 3.5 minutes and elimination half-life 110 minutes. Anesthetics or other drugs that decrease liver blood flow will increase the half-life of verapamil.

The side effects of verapamil are related to its pharmacologic and therapeutic actions. Verapamil may exacerbate SA and AV node dysfunction, especially in patients with underlying disease or those treated with digitalis or  $\beta$ -blockers. Verapamil may worsen symptoms of CHF, especially if used in combination with  $\beta$ -blockers.<sup>147</sup> Digitalis levels increase by an average of 70% after initiation of therapy with verapamil.

### **Diltiazem**

Diltiazem, a benzothiazepine, is a calcium channel blocker with a spectrum of pharmacologic effects between verapamil and the dihydropyridines. Diltiazem, like all calcium channel blockers, is an effective coronary artery dilator, but has less effect on peripheral vessels than the dihydropyridines. It is a mild negative inotrope, but less so than verapamil.<sup>147,154</sup> Reflex tachycardia is also blunted because diltiazem decreases sinus node automaticity and AV nodal conduction, albeit to a lesser extent than verapamil. Although diltiazem can be used in combination with  $\beta$ -blockers, the effects may be additive, causing SA and AV node dysfunction in patients with underlying conduction disease.

Diltiazem is approved for rapid conversion of paroxysmal supraventricular tachycardia to sinus rhythm and for temporary control of rapid ventricular rate in atrial flutter or fibrillation. The usual dose of IV diltiazem is 0.25 mg/kg as a slow loading dose, followed by an infusion of 0.15 mg/kg. An additional bolus of 0.35 mg/kg may be given if needed. Oral diltiazem can be used for the chronic management of these problems.

## **The Dihydropyridines**

### **Nifedipine**

In vitro, nifedipine has significant effects on both smooth muscle and myocardium. In vivo, however, it is an effective coronary and systemic arterial dilator at doses that have little effect on myocardial contractility or conduction tissue. The vasodilatation and increase in coronary artery blood flow result from the blockade of calcium influx, as well as an increase in the

levels of nitric oxide and bradykinin.<sup>155</sup> Because of its afterload reduction, nifedipine may cause reflex sympathetic increases in heart rate and cardiac output.<sup>156</sup> This sympathetic stimulation is more evident with short-acting preparations than it is with sustained-release nifedipine.<sup>157</sup>

Clinically, with the exception of short-acting formulations, which may occasionally worsen angina, nifedipine effectively improves exercise tolerance, prolongs the time to the onset of angina in exercise and decreases the frequency of episodes of angina.<sup>147</sup> Concurrent therapy with nifedipine and a  $\beta$ -blocker is more effective than either agent given alone. Indeed,  $\beta$ -blockers eliminate nifedipine's potentially detrimental reflex increases in heart rate.<sup>158</sup> Although it is an effective antihypertensive, nifedipine, and generally all calcium channel blockers are not currently recommended as first-line therapy, unless there are contraindications to other antihypertensives.<sup>6</sup> Even though nifedipine has fewer negative chronotropic or inotropic effects than verapamil or diltiazem, in long-term studies hemodynamic deterioration occurred in some patients with congestive heart failure who were treated with dihydropyridines.<sup>159</sup>

Because it is light sensitive, IV nifedipine is not commercially available in the United States. Nifedipine's side effects include headaches, pedal edema, hypotension, and exacerbation of angina. Like verapamil, nifedipine increases serum digitalis levels. Because a higher rate of cardiac events was reported among patients who were treated with short-acting nifedipine after myocardial infarction, this preparation is no longer recommended in patients with angina.<sup>160</sup>

### **Nicardipine**

Nicardipine has structural and pharmacologic properties similar to those of nifedipine. Like nifedipine, nicardipine is a potent coronary and systemic vasodilator with little effect on contractility. It is available as an IV agent for treatment of hypertension in acute care settings, including the perioperative period and neurologic emergencies.<sup>161–163</sup> An initial intravenous bolus of 2 mg is followed by an initial infusion rate of 5 mg/h, which may be increased in 2.5-mg increments every 15 minutes, up to a maximum infusion rate of 15 mg/h. Nicardipine administered intraarterially

reverses vasospasm in subarachnoid hemorrhage and interventional coronary procedures.<sup>164,165</sup>

### **Nimodipine**

Nimodipine, a nifedipine analogue, is a calcium channel blocker with high lipid solubility and apparent preference for cerebrovascular smooth muscle. It is useful in inhibiting cerebral vasospasm and improving outcome in patients with neurologic defects associated with cerebral vasospasm after subarachnoid hemorrhage.<sup>166</sup> Its usefulness in patients with acute ischemic stroke has not been proven.<sup>167</sup>

### **Amlodipine, Isradipine, Felodipine, Nisoldipine, and Nitrendipine**

Amlodipine, isradipine, felodipine, nisoldipine, and nitrendipine are structurally and pharmacologically similar to nifedipine, the dihydropyridine prototype. They dilate coronary and peripheral arteries with minimal effect on cardiac conduction and contractility. Like nifedipine, these drugs are used to treat hypertension and angina, and may be safely used in patients with CHF.<sup>168</sup>

The individual agents are distinct from each other in many ways. Because isradipine has an inhibitory effect on the SA node but not on the cardiac myocytes, it produces little or no reflex tachycardia. Felodipine and nisoldipine have a higher degree of vascular specificity than the rest of the dihydropyridines. Several trials have shown that amlodipine increases exercise duration, decreases the number of anginal attacks, and reduces the consumption of nitroglycerin.<sup>169</sup> The Systolic Hypertension in Europe (Syst-Eur) Trial reported that antihypertensive therapy initiated with the nitrendipine reduced the risk of fatal and nonfatal stroke, as well as all cardiovascular events combined, in older patients (age > 65) with isolated systolic hypertension.<sup>170</sup>

### **Mibefradil**

Mibefradil is an antagonist of T-type calcium channels. This arterial dilator has negative chronotropic effects but minimal inotropic effects. Mibefradil is an effective antianginal whose vasodilatory effects are associated with a reduction in heart rate.<sup>171,172</sup> There are case reports of QT interval prolongation and ventricular dysrhythmias during treatment with mibefradil.<sup>173</sup>

### **Monatepil**

Monatepil is a calcium channel blocker similar to nifedipine, which also has  $\alpha_1$ -adrenoreceptor blocking properties. It decreases systolic and diastolic pressure without changes in heart rate. Furthermore, it significantly decreases levels of low-density lipoprotein (LDL) cholesterol, apolipoprotein B, and glycosylated hemoglobin (HgbA<sub>1c</sub>).<sup>174</sup>

### **Bepridil**

Bepridil is structurally unrelated to other calcium channel blockers. It blocks slow calcium channels in both cardiac and vascular smooth muscles as well as fast sodium channels in cardiac muscle. It has negative chronotropic and dromotropic and mild negative inotropic effects.<sup>175</sup> Bepridil reduces blood pressure and heart rate, improves left ventricular performance in patients with angina, and decreases the frequency of exercise-induced angina attacks. Bepridil can prolong QT interval, especially in the setting of hypokalemia or bradycardia, and can precipitate polymorphic ventricular tachycardia.<sup>175</sup> Bepridil is also associated with agranulocytosis and pancytopenia. Because of these serious side effects, it should be used only in cases of angina refractory to other therapies.

### **Anesthetic Considerations**

There are limited data regarding the risks and benefits of calcium channel blockers in the perioperative setting. Although a classic withdrawal syndrome has not been described, there are case reports of severe coronary vasospasm following abrupt discontinuation of the calcium channel blockers.<sup>176</sup> Overall, the continuation of calcium channel blockers in patients already taking them preoperatively is recommended, despite the paucity of information in relation to their interaction with the process of anesthesia and surgery.

There is considerable potential for drug interaction between anesthetic drugs and calcium channel blockers. When used in combination with high-dose narcotics in patients with normal conduction systems and ventricular function, IV verapamil decreases systemic vascular resistance and mean arterial pressure with no change in cardiac output or pulmonary capillary wedge pressure. Although lengthening of the PR interval has been observed,

neither first-degree nor more advanced AV block has occurred.

In combination with inhalation agents, verapamil may produce varying degrees of AV block and must be given carefully in patients anesthetized with enflurane, halothane, and, to a lesser degree, isoflurane in patients with AV nodal block or in patients chronically taking  $\beta$ -blockers.<sup>177</sup>

Verapamil has many perioperative uses. It has been used for intraoperative control of paroxysmal supraventricular tachycardia. During cardiopulmonary bypass, verapamil terminates refractory ventricular fibrillation following aortic cross-clamp removal. Verapamil successfully treats intraoperative myocardial ischemia refractory to IV nitroglycerin.<sup>178</sup>

In vitro, diltiazem may depress left ventricular function in the presence of enflurane or desflurane, while the incidence of bradyarrhythmias is higher with enflurane than with equivalent levels of desflurane.<sup>179</sup> Combined with enflurane, diltiazem is particularly depressant to conduction. Together, they may cause first-degree AV block, Mobitz I AV block, or sinus node dysfunction.<sup>180</sup>

Nifedipine administered in dogs during fentanyl/nitrous oxide anesthesia, decreased systemic vascular resistance accompanied by an increase in cardiac index and heart rate. In vitro, the combined treatment of nifedipine and volatile anesthetics, especially enflurane, additively depresses atrial rate and contractility. However, these effects appear less pronounced than the combination of volatile agents with diltiazem and especially verapamil.<sup>181</sup>

Nicardipine has a longer duration of action in the presence of isoflurane and produces greater initial hypotension with sevoflurane.<sup>182</sup>

Calcium channel blockers may potentiate effects of depolarizing and nondepolarizing neuromuscular blocking agents, although this is controversial. In contrast with  $\beta$ -adrenergic blocking agents, calcium channel blockers have not been shown to be effective in prevention of intraoperative ischemia.<sup>183</sup>

### **Other Antianginals**

Novel therapeutic strategies have been developed for patients with ischemic heart disease and angina pectoris that were unsuccessfully managed with conventional medical or interventional approaches.



### Ivabradine

Ivabradine is the first of a new class of drugs called  $I_f$  inhibitors. It selectively and specifically inhibits  $I_f$ , a sinus node-specific sodium-potassium inward current. It reduces heart rate at rest or exercise without decreasing myocardial contractility, atrioventricular conduction, and ventricular repolarization duration.<sup>184</sup> A double-blind trial comparing the antiischemic and antianginal effects of ivabradine to atenolol showed that ivabradine is as effective as atenolol in preventing exercise-induced angina in patients with chronic stable angina.<sup>185</sup> Ivabradine has been approved in Europe for the symptomatic treatment of chronic stable angina pectoris in patients with normal sinus rhythm who have a contraindication or intolerance to  $\beta$ -blockers. With the exception of reversible, transient visual symptoms described mainly as increases in brightness in limited areas of the visual field, no other adverse effects are attributed to ivabradine therapy.

### Nicorandil

Nicorandil is a nicotinamide ester, which activates the adenosine triphosphate (ATP)-sensitive potassium channel. It dilates peripheral and coronary resistance arterioles, and because of a nitrate-like effect, it dilates systemic veins and epicardial coronary vessels. Consequently, nicorandil increases coronary blood flow, reduces preload and afterload, and has antianginal efficacy similar to oral nitrates,  $\beta$ -blockers, and calcium antagonists.<sup>186</sup> By opening ATP-dependent potassium channels, nicorandil may also mimic a natural process of ischemic preconditioning, protecting the heart from subsequent ischemic attacks. The IONA (Impact of Nicorandil in Angina) trial showed a significant improvement in outcome as a result of reduction in major coronary events by adding nicorandil to standard antianginal therapy in patients with stable angina.<sup>186</sup> Nicorandil is not available in the United States.

### Inhibitors of Fatty Acid Oxidation

Two agents, ranolazine and trimetazidine, are presently available and represent this new class of drug. During episodes of acute myocardial ischemia, fatty acid levels rise, promoting their uptake and use as energy source by the myocardium. Because

fatty acid oxidation is more oxygen inefficient than carbohydrate oxidation, this abrupt increase in circulating free fatty acids imposes a further deleterious effect on an already imbalanced oxygen supply-demand situation. Inhibition of fatty acid oxidation may increase glucose oxidation, which generates more ATP for each molecule of oxygen than fatty acid oxidation, thereby minimizing lactate accumulation.<sup>187</sup> Both drugs are virtually devoid of hemodynamic effects.

The efficacy of ranolazine has been studied in several clinical studies, such as the MARISA (Monotherapy Assessment of Ranolazine in Stable Angina) and CARISA (Combination Assessment of Ranolazine in Stable Angina) trials. Both MARISA and CARISA showed that ranolazine increases exercise capacity and provides antianginal effects on symptomatic patients with chronic angina.<sup>187,188</sup>

Similar benefits were shown in the TRIMPOL (Trimetazidine in Poland) II trial, which studied trimetazidine in patients already receiving metoprolol. The addition of trimetazidine produced significant improvement in exercise stress tests and anginal symptoms relative to metoprolol monotherapy.<sup>189</sup>

Neither ranolazine nor trimetazidine is available in the United States.

## ANTIDYSRHYTHMIC AGENTS

Antidysrhythmic agents are indicated for prevention and treatment of symptomatic dysrhythmias and for therapy of asymptomatic dysrhythmias with malignant potential. Reasons for selecting one drug over another are frequently complex; the choice may depend on type of dysrhythmia, a particular drug's therapeutic index, a medication's effectiveness during electrophysiologic studies, or a patient's tolerance to side effects.

Antidysrhythmic drugs are classified on the basis of their major pharmacologic effects on myocardial electrophysiology, as originally proposed by Vaughan Williams<sup>190</sup> and now modified to include newer agents (Box 43-2). Although now loosely used to group drugs, this classification was originally proposed to rigorously classify patterns of pharmacologic action. This is a subtle but important difference. Many antidysrhythmics, although classified into one group or another, have (a) multiple

actions in a given tissue, (b) different actions in different heart tissues, and (c) active metabolites with different actions than the parent compound.

Since the early nineties, the use of most antidysrhythmic drugs has been reassessed and dramatically limited because of increased awareness of their proarrhythmic potential and advances in ablation techniques. Moreover, recent clinical trials have demonstrated negative effects on survival in many situations where these drugs might have been given in the past. Finally, implantable cardioverter-defibrillators have largely replaced antidysrhythmic medications in the management of ventricular dysrhythmias.<sup>191</sup>

Agents with class I actions include drugs that affect the fast inward sodium current of phase 0, the period of rapid depolarization of the action potential (Fig. 43-5). They have been further divided into three groups: IA, IB, and IC.

Class II actions refer to antidysrhythmic effects associated with  $\beta$ -adrenergic antagonism. Therefore, class II agents include all  $\beta$ -adrenergic blocking agents.

Class III agents block potassium repolarization currents and increase action potential duration (APD) and effective refractory period (ERP) in atrial and ventricular muscle, as well as in Purkinje fibers. The ERP-to-APD ratio is increased.

Class IV agents are represented by blockers of the L-type calcium channel, that is, calcium channel blockers. Among them only verapamil and diltiazem are effective for antidysrhythmic use.

Some newer drugs, such as adenosine and ibutilide, do not fit neatly into any of these categories (although ibutilide is categorized by some as a class III drug).

### Class IA Agents

Antidysrhythmics with class IA action include quinidine, procainamide, and disopyramide (Table 43-10). They all decrease the maximal velocity ( $V_{max}$ ) and amplitude of phase 0 depolarization of the action potential. The ERP, APD, and ERP-to-APD ratio are increased. Automaticity, represented by the decreased slope of phase 4 of the action potential, are decreased with these drugs. These agents produce measurable increases in refractoriness of cardiac tissue and lengthening of the QTc interval on the ECG.

## BOX 43-2.

## Vaughan-Williams Classification of Antiarrhythmic Agents

IA	IB	IC
Quinidine	Lidocaine	Flecainide
Procainamide	Mexiletine	Encainide
Disopyramide	Tocainide	Propafenone
Moricizine	Phenytoin	
Class II $\beta$ blockers		
Propranolol		
Atenolol		
Timolol		
Metoprolol		
Acebutolol		
Esmolol		
Carvedilol		
Class III		
Bretylium		
Amiodarone		
Acecainide ( <i>N</i> -acetylprocainamide)		
Dofetilide		
Ibutilide		
Azimilide		
Sotalol		
Class IV calcium channel blockers		
Verapamil		
Diltiazem		
Bepridil		
Other agents not formally classified		
Digoxin		
Adenosine		

**Quinidine**

Quinidine decreases automaticity in atrial and ventricular tissue and in the His-Purkinje and pacemaker fibers. Quinidine's direct effects on SA node automaticity are balanced by its anticholinergic effects, which speed conduction through the SA and AV nodes, causing little change in heart rate. ECG changes occur with quinidine; most noticeably, it prolongs the QT interval by up to 25% at therapeutic levels.

Quinidine also blocks the rapid component of the K channel, prolonging action potentials in most cardiac cells, especially at slow heart rates.<sup>47</sup> It has been used effectively for conversion of atrial fibrillation, atrial flutter,<sup>192</sup> and PSVT, and for maintenance of sinus rhythm after conversion.<sup>193</sup> In addition, it suppresses ventricular ectopy, tachycardia, and fibrillation.

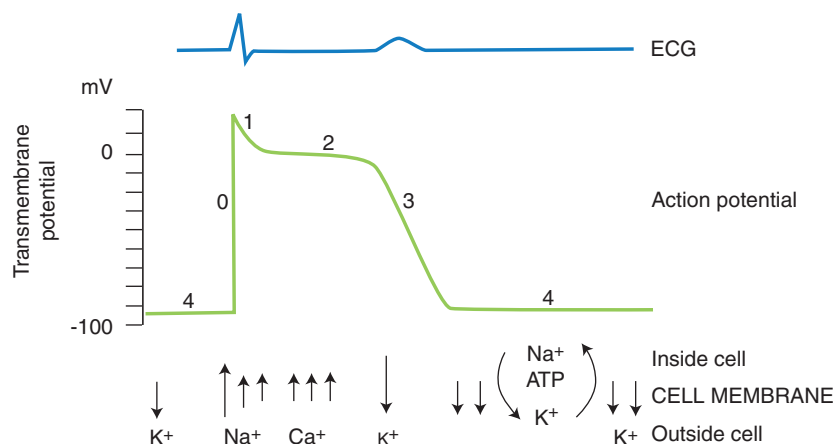
Quinidine is available orally as a sulfate, gluconate, or polygalacturonate salt with 83%, 62%, and 60% quinidine

content, respectively. Quinidine sulfate is typically initiated at 200 mg every 6 hours and increased to 800–2400 mg/d, titrated to drug levels and therapeutic effect. It undergoes hepatic metabolism

(60–80%) and renal excretion (20–40%), with a variable half-life of 4–10 hours. The metabolites of quinidine also possess antidysrhythmic activity. Although it is available in an IV form, this route is usually avoided because of profound hypotensive and negative inotropic effects.

As with all antidysrhythmics, quinidine may be proarrhythmic. Patients with CHF are at greater risk. With congenital prolongation of the QT interval or bradycardia associated with hypokalemia, quinidine, by further lengthening the QT interval, may initiate torsade de pointes, a serious, potentially lethal dysrhythmia.<sup>194</sup> If torsade de pointes occurs, therapy should include increasing heart rate with isoproterenol or pacing, correction of hypokalemia and hypomagnesemia, and discontinuation of quinidine.

Because of its anticholinergic effects on the AV node, quinidine may increase ventricular response in atrial fibrillation and flutter. Consequently, if it is used for conversion of atrial dysrhythmias, digoxin, verapamil, or a  $\beta$ -blocker should be administered concurrently. If quinidine therapy is initiated in a patient receiving digitalis, one must be aware that quinidine may double the digitalis plasma concentration, possibly leading to digitalis toxicity. Digitalis dosages should therefore be decreased by half. Evidence of quinidine-induced cardiac toxicity may be manifested by greater than 50% increase in QT interval, widening of QRS complexes, and SA or AV node disturbances. Noncardiac adverse effects typically occur with quinidine. In 30–40% of patients, therapy must be withdrawn because of gas-



**FIGURE 43-5.** Schematic of the action potential in a ventricular myocardial cell as it correlates with the electrocardiogram (ECG). Arrows indicate times of major ionic movement across the cell membrane.

TABLE 43-10.

## Class IA Antidysrhythmic Agents

Drug	Usual Dosage and Interval	Effect on Electrocardiogram	Adverse Effects	Concentrations	Metabolism	Indications	Half-Life
Quinidine	PO: 200–400 mg q4–6h	Prolongs QRS, QT, and PR (+)	Diarrhea and other GI symptoms; cinchonism; hepatic granulomas and necrosis; thrombocytopenia; rashes; hypotension; heart blocks; tachyarrhythmias; torsade de pointes; fever; lupus-like syndrome	2–7 µg/mL	Hepatic (60–80%); renal (20–40%)	Ventricular and supraventricular arrhythmias, including PAT, AF atrial flutter, WPW, junctional tachycardias	4–10 h; increased in elderly
Procainamide	PO: 50 mg/kg/d in divided doses q3–4h or q6h (long-acting); IV loading no more than 100 mg q5min to 1 g (12 mg/kg); IV maintenance 2–4 mg/min	Prolongs QRS, QT, and PR (+)	Lupus-like syndrome; confusion; disorientation; GI symptoms; rash; blood dyscrasias; fever hypotension; arrhythmias; torsade de pointes	4–10 mg/mL NAPA 10–20 µg/mL	Hepatic, excreted in urine by filtration and active secretion	As above	2–5 h; increased in renal failure
Disopyramide	PO: 100–200 mg q6h	Prolongs QRS, QT, and PR (+)	Anticholinergic effects; hypotension; heart failure; tachyarrhythmias; torsade de pointes; heart block; nausea; vomiting; diarrhea; hepatic toxicity; acute psychosis; agranulocytosis; constipation; hypoglycemia	2–8 µg/mL	Hepatic; 50 excreted unchanged in urine	As above	4–10 h; 8–18 h with renal dysfunction
Moricizine	200–300 mg TID	Prolongs QRS interval	May be prodysrhythmic; Congestive heart failure; intraventricular conduction delays	0.2–1.5 µg/mL	Hepatic; biliary and urinary excretion	Ventricular dysrhythmias	9.2 h

AF, atrial fibrillation; NAPA, N-acetylprocainamide; PAT, paroxysmal atrial tachycardia; WPW, Wolff-Parkinson-White Syndrome.  
Data from Abramowicz M, ed. *Drugs for cardiac arrhythmias*. Med Lett Drugs Ther 1991;33:60.

trointestinal (GI) intolerance. Quinidine may cause CNS toxicity, as manifested by tinnitus and delirium. Other adverse effects include fever,

rash, anaphylaxis, thrombocytopenia, hemolytic anemia, and agranulocytosis.

In surgical patients, quinidine should be continued preoperatively and re-

sumed as soon as possible following surgery. If oral intake is impossible, IV procainamide or lidocaine may be substituted, depending on the original rea-

son for initiating quinidine therapy. Quinidine increases the neuromuscular blockade of succinylcholine and may worsen neuromuscular blockade in myasthenia gravis. Quinidine has fallen into disfavor because it worsens survival in patients with ventricular dysrhythmias.<sup>195</sup> Even in the presence of atrial dysrhythmias, where quinidine may be highly successful in maintaining sinus rhythm, it still has a negative effect on survival.<sup>196</sup>

### Procainamide

Procainamide, an analogue of the local anesthetic procaine, has a pharmacologic effect and a set of clinical indications similar, but not identical, to those of quinidine. Although both are class IA agents, each may be effective in suppression of dysrhythmias that are unresponsive to the other drug. This is not surprising, since procainamide's major metabolite, *N*-acetylprocainamide (NAPA), actually has class III actions.<sup>197</sup> In addition, because procainamide is readily available in stable IV form, it is useful for acute management of atrial fibrillation and flutter, PSVT, and dysrhythmias associated with Wolff-Parkinson-White syndrome. It may also be used for acute suppression of ventricular dysrhythmias following acute MI, and in treatment of ventricular tachycardia. When given intravenously, it may produce vasodilatation by a mild ganglionic blocking action; consequently, loading doses should be given slowly over approximately 20–30 minutes while monitoring the QRS duration. A loading dose up to 1 g may be given, followed by an infusion at 1–4 mg/min. Procainamide undergoes acetylation to NAPA, with half the population being fast acetylators. Subsequently, both substances are renally excreted. Therefore, dosage should be adjusted in patients with renal dysfunction. Procainamide and NAPA levels may prove useful to facilitate dosage adjustment.

Procainamide has fewer anticholinergic properties than quinidine and disopyramide. As with quinidine, procainamide may be proarrhythmic and may cause torsade de pointes.<sup>194</sup> Consequently, it should not be used in patients with prolonged QT interval, hypokalemia, or history of torsade de pointes. Chronic administration is associated with positive antinuclear antibody titers; however, only 15–20% of patients develop a lupus-like syndrome. It usually resolves with discontinuation of the drug. Preoperatively,

procainamide should be continued until surgery. In the perioperative period, procainamide may be given as an IV infusion and used as a substitute for quinidine or disopyramide in treatment of atrial and ventricular dysrhythmias. Like quinidine, procainamide increases long-term mortality and is seldom used on a chronic basis.<sup>195</sup>

### Disopyramide

Disopyramide is used to maintain sinus rhythm in patients with atrial flutter or atrial fibrillation and to prevent recurrence of ventricular tachycardia or ventricular fibrillation. Unlike quinidine and procainamide, it has significant negative inotropic effects. Even more than quinidine, it has substantial anticholinergic effects. If it is tolerated, little additional chronic toxicity occurs.

The usual dosage of disopyramide is 100–400 mg, three to four times daily, up to 800 mg total. Its half-life elimination is 4–10 hours and is usually increased in patients with cardiac or renal disease. Fifty percent is excreted unchanged by the kidney and the remainder as an active metabolite.

As with all class IA agents, disopyramide should not be used in patients with congenital prolongation of the QT interval, hypokalemia, or history of torsade de pointes. It may cause severe bradycardia in patients with sinus node dysfunction or conduction system disease. Because of negative inotropic effects, disopyramide is contraindicated in patients with CHF. Disopyramide is still used in management of dysrhythmias in patients with HOCM, for which its negative inotropic effect is an advantage. In HOCM, it can decrease the subaortic gradient and ameliorate symptoms without increasing mortality.<sup>198</sup> Like other class IA agents, disopyramide has largely been abandoned as a treatment of chronic dysrhythmias. Because of its anticholinergic effects, it is contraindicated in patients with glaucoma and obstructive uropathy. In addition, disopyramide may cause dry mouth, constipation, urinary retention, and esophageal reflux.

### Moricizine

Moricizine, a phenothiazine derivative, has characteristics of class IA, class IB and class IC agents. Moricizine decreases  $V_{max}$  to an extent similar to class IA agents. As with IB agents, it shortens APD and increases the ERP-to-APD ratio. On the ECG, moricizine prolongs the QRS complex with little

effect on the QT interval, a characteristic of class IC agents.

In clinical studies, moricizine has been effectively used for treatment of chronic complex ventricular dysrhythmias and prevention of ventricular tachycardia and fibrillation. However, in the Cardiac Arrhythmia Suppression Trial (CAST) II trial moricizine was shown to increase mortality in patients shortly after a myocardial infarction and did not improve survival during long-term therapy.<sup>199</sup> Moricizine use has therefore been largely abandoned.

Moricizine is well absorbed orally, undergoes hepatic metabolism, biliary and urinary excretion. In healthy volunteers, the half-life 1.5–3.5 was hours; however, cardiac disease may increase this to as long as 13 hours.

Recommended dosages are 600–900 mg three times daily. Adverse reactions include dizziness, nausea, and headaches. Intraventricular conduction delays may occur in up to 9% of patients. Moricizine may be proarrhythmic or worsen CHF in 2–5% of patients.<sup>47</sup> Few data are available about interactions with anesthetic agents.

### Class IB Agents

Drugs with class IB actions, such as lidocaine, mexiletine, tocainide, and phenytoin, have more moderate effects on phase 0 of the action potential (Table 43-11). Unlike class IA agents, they shorten APD and ERP and increase the ERP-to-APD ratio in the Purkinje fibers, but have little effect on the refractory periods in sinus node, atrium, and AV node, thus being ineffective against supraventricular tachycardias. They show little ECG effect. They exhibit rapid association and dissociation from the sodium channels.<sup>47</sup>

### Lidocaine

Although lidocaine, the prototypical class IB agent, was first introduced as a local anesthetic, it is widely used in acute treatment and suppression of all ventricular dysrhythmias, except those associated with prolonged QT intervals and torsade de pointes. As with all class I agents, lidocaine decreases  $V_{max}$  to some extent. In addition to its typical type IB effects, lidocaine decreases the slope of phase 4 of the action potential, reducing automaticity. Like other IB agents, lidocaine has little effect on atrial tissue and thus is ineffective against supraventricular tachycardias.



TABLE 43-11.

## Class IB Antidysrhythmic Agents

Drug	Usual Dosage and Interval	Effect on Electrocardiogram	Adverse Effects	Usually Effective Plasma Concentrations	Indications	Half-Life	Metabolism
Lidocaine (Xylocaine and others)	IV loading: 1 mg/kg given over 2 min, then 2 mg/kg over 20 min or 50 mg given over 1 min and repeated every 5 min $\times$ 3 or 20 mg/min infused over 10 min IV; maintenance for 24–30 h 30 $\mu$ g/kg each min	No significant change	Drowsiness or agitation; slurred speech; tinnitus; disorientation; coma; seizures; paresthesia; cardiac depression, especially with excessive accumulation in heart failure or liver failure or infusions for more than 24 hours	1.5–6 $\mu$ g/mg	Ventricular dysrhythmias	1.5–2.0 h	Hepatic; <10% excreted in urine
Phenytoin (Dilantin and others)	PO loading: 14 mg/kg; PO maintenance: 200–400 mg/d; IV loading: 50 mg q5min to total dose of 1000 mg (up to 12 mg/kg); IV maintenance: 200–400 mg/d	No significant change	Ataxia, nystagmus; drowsiness; coma blood dyscrasias; cardiac toxicity with rapid IV injection; fever; rash; hepatic granulomas and necrosis	5–20 $\mu$ g/mL	Dysrhythmias associated with Digitalis toxicity	22 h	Hydroxylated in liver, excreted in urine
Mexiletine (Mexitil)	PO initial dose: 100–200 mg q8h taken with food; PO maintenance: 100–300 mg q6–12h, maximum 1200 mg/d	No significant change	GI upset; fatigue; nervousness; dizziness; tremor; sleep upset; convulsions; infrequent aggravation of arrhythmias; visual disturbances psychosis; fever; hepatic toxicity; blood dyscrasias	0.5–2 $\mu$ g/mL	Ventricular dysrhythmias	10–12 h	Hepatic
Tocainide (Tonocard)	PO initial dose: 200–400 mg q8h; PO maintenance: 200–600 mg q8h, maximum 2400 mg/d	No significant change	GI upset; paresthesia; dizziness; tremor; confusion; nightmares; psychotic reactions; coma; seizures; rash; fever; arthralgia; infrequent cytosis; aplastic anemia; thrombocytopenia; hepatic granulomas; interstitial pneumonitis	3–10 $\mu$ g/mL	Ventricular dysrhythmias	15 h	Hepatic biotransformation 55%; excreted unchanged in urine 45%

Data from Abramowicz M. ed. Drugs for cardiac arrhythmias. Med Lett Drugs Ther 1991;33:60.

Because lidocaine undergoes rapid first-pass elimination, it is unavailable as an oral agent. IV lidocaine is usually given as a 1 mg/kg bolus, followed by repeat small boluses of an additional 2 mg/kg over 15 minutes and an infusion of 1–4 mg/min. An infusion is necessary because of lidocaine's rapid distribution out of the central compartment with termination of the anti-dysrhythmic activity. Because elimination is significantly longer than central compartment redistribution, a steady-state lidocaine infusion can be discontinued without "tapering." The blood levels will gradually decrease over 8–10 hours.

Modifications of infusion rates are required in the elderly and in patients with liver disease or CHF with decreased liver blood flow. Normal individuals show great variability in plasma levels. Thus, the patient's ECG, blood pressure, and mental status should be carefully monitored so that infusions or boluses may be discontinued if toxicity develops. If dysrhythmias persist at usual doses and no toxic symptoms are present, lidocaine administration may be increased after a drug level has been obtained. If dysrhythmias persist with plasma lidocaine concentrations greater than 9 µg/mL, another agent should be used, even without symptoms of toxicity. Lidocaine provides little anti-dysrhythmic effect at levels less than 1.5 µg/mL, and toxicity often occurs at levels greater than 5 µg/mL.

Lidocaine has been used for the treatment of life-threatening ventricular arrhythmias, especially when associated with myocardial ischemia.

Although shown to be effective in prevention of ventricular fibrillation after acute myocardial infarction, meta-analyses of the effects of lidocaine on in-hospital mortality among patients with acute myocardial infarction suggest that despite a reduction in primary ventricular fibrillation, there is a small *increase* in the risk of death in the hospital among patients treated with lidocaine.<sup>200</sup> In light of this, its prophylactic use following myocardial infarction has fallen into disfavor. Although it remains in the advanced cardiac life support (ACLS) protocol, lidocaine is inferior to amiodarone (see Amiodarone below) in the management of pulseless ventricular tachycardia/fibrillation.<sup>201</sup> Potential adverse reactions to lidocaine include drowsiness, dizziness, confusion, delirium, dysarthria,

dysesthesias (especially periorally), and even coma and seizures. Seizures may occur with nontoxic doses if they are given too quickly. Lidocaine may occasionally cause sinus and AV nodal dysfunction in patients with underlying conduction disease. In patients with atrial fibrillation, lidocaine may increase ventricular response rates. Multiple animal model studies have evaluated cardiac toxicity associated with lidocaine. Lidocaine clearly has cardiac toxicity, but this occurs at levels approximately 4 times higher than those associated with CNS toxicity. Characteristic ECG findings in these studies were sinus arrest, increased PR intervals and AV block, widening QRS complexes, ectopy, and tachydysrhythmias. In dogs, lidocaine, in combination with isoflurane and calcium channel blockers, caused hypotension and AV block, which was reversed with calcium chloride.<sup>202</sup>

### Mexiletine and Tocainide

Mexiletine is an orally active congener of lidocaine with similar indications and modes of action. Mexiletine is indicated in the treatment of life-threatening ventricular arrhythmias in combination with class IA and even class II and class III agents.<sup>203</sup> It may be safer for patients with prolonged QT syndrome than class IA or IC agents. It undergoes predominantly hepatic elimination, with a half-life of 10–12 hours and may be safely administered to patients with renal failure.<sup>204</sup>

Mexiletine has little hemodynamic effect and is well tolerated in patients with CHF. Adverse reactions, such as dizziness, tremor, visual blurring, and nausea, are usually dose related. Rash occurs less often with mexiletine than with tocainide, but thrombocytopenia and positive antinuclear antibody testing occur occasionally. Mexiletine may be prodysrhythmic in 10% of patients. It should be continued perioperatively and restarted as soon as possible postoperatively. If oral intake is not possible, a lidocaine infusion may be substituted. Like other class IA agents, mexiletine increases long-term mortality and is infrequently used.<sup>205</sup>

Tocainide is an orally active, analogue of lidocaine indicated in the chronic treatment of complex ventricular dysrhythmias. Response to lidocaine is often, but not always, predictive of response to tocainide and mexiletine. Like lidocaine, tocainide is ineffective

against supraventricular dysrhythmias. Tocainide and mexiletine are not necessarily interchangeable.

Following oral administration, peak blood concentrations occur at 1–2 hours. Tocainide undergoes both hepatic metabolism and renal elimination, with a 15-hour half-life. Adverse reactions following oral administration occur in approximately 40% of patients. These include nausea, vomiting, tremor, paresthesia and rash. Tocainide worsens symptoms of CHF in approximately 5% of patients and may be prodysrhythmic in 1–8% of patients. *Because tocainide can cause potentially fatal bone marrow aplasia and pulmonary fibrosis, it is no longer available in the United States.*

### Phenytoin

Although mainly used as an anticonvulsant, phenytoin has been used in patients with prolonged QT syndromes, atrial and ventricular dysrhythmias, and chronic ventricular dysrhythmias. Since the advent of Fab fragments, phenytoin is now rarely used to treat digoxin toxicity. In addition to its class IB effects, much of phenytoin's anti-dysrhythmic activity is a result of centrally mediated sympatholysis. It is well tolerated orally in doses of 300 mg/d, titrated to serum blood levels and side effects. A usual loading dose is 1000 mg given at a rate that does not exceed 50 mg/min, while the ECG and blood pressure are monitored to prevent hypotension and cardiovascular collapse.

Phenytoin undergoes hepatic metabolism with excretion in the bile, enterohepatic reabsorption, and subsequent urinary excretion. It has a 22-hour half-life. Common adverse effects include nystagmus, ataxia, slurred speech, confusion, and dizziness. Rarely, reactions that are more serious include severe dermatitis, Stevens-Johnson syndrome, and possibly hematologic malignancies. In patients with liver disease or any altered metabolic state, or when given with a wide range of other medications, phenytoin levels should be reassessed.

### Class IC Agents

Available class IC agents, such as flecainide and propafenone, have the greatest effect on phase 0 of the action potential with minimal effect on repolarization (Table 43–12). As previously mentioned, moricizine shares many

TABLE 43–12.

## Class IC Antidysrhythmic Agents

Drug	Usual Dosage and Interval	Effect on Electrocardiogram	Adverse Effects	Usually Effective Plasma Concentration	Indications	Half-Life	Metabolism
Flecainide (Tambocor)	PO initial dose: 100 mg q12h, increase q4–6d if required, by 50 mg q12h; PO maintenance: up to 400 mg/d	Prolongs PR and QRS	Bradycardia; heart block; new ventricular fibrillation; sustained ventricular tachycardia; heart failure; dizziness; blurred vision; nervousness; headache; GI upset; neutropenia	0.2–1 µg/mL	Ventricular dysrhythmias	12–27 h; unchanged renally	Hepatic; 10–50% excreted
Encainide (Enkaid)	PO initial dose: 25 mg q8h, increase q4–6d if required to 35 mg q8h, and then to 50 mg q8h; maintenance: up to 200 mg/d	Prolongs PR and QRS	Bradycardia; heart block; new ventricular fibrillation; sustained ventricular tachycardia; heart failure; dizziness; headache visual disturbances; diarrhea; GI upset; glucose intolerance	Active metabolites preclude establishment	Ventricular dysrhythmias	12 h	Hepatic metabolism; renal excretion
Propafenone (Rythmol)	PO initial dose: 150 mg q8h, increase q3–4d if required; PO maintenance: 150–300 mg q8h	Prolongs PR and QRS	Bradycardia; heart block; new ventricular fibrillation; sustained ventricular tachycardia; heart failure; dizziness; light-headedness; metallic taste; dysgeusia; GI upset; bronchospasm	Active metabolites preclude establishment	Ventricular dysrhythmias	6–7 h	Hepatic metabolism; renal excretion

Data from Abramowicz M. ed. Drugs for cardiac arrhythmias. Med Lett Drugs Ther 1991;33:60.

of these properties as well. These drugs suppress automaticity of the SA node, slow AV node, His-Purkinje and ventricular conduction. On the ECG, PR and QRS intervals are lengthened, but QTc intervals are largely unchanged. Data from the CASTs that suggest increased mortality with class IC agents after MI have limited their use.<sup>206</sup> Type IC agents all profoundly suppress cardiac conduction, which may explain their proarrhythmic effects.

### Flecainide

Flecainide is indicated in suppression of both ventricular and supraventricular tachycardias, including Wolff-Parkinson-White syndrome. Usual doses

are 200–400 mg daily given in divided doses. Although it undergoes hepatic metabolism, approximately 30% of flecainide is renally excreted, with a usual half-life of 12–27 hours.<sup>207</sup>

As with all antidysrhythmics, flecainide has prodysrhythmic effects. Data from the CASTs have limited its use to pharmacologic cardioversion and maintenance of sinus rhythm in symptomatic atrial fibrillation in patients without heart disease and in patients with hypertension but no left ventricular hypertrophy.<sup>206</sup> Flecainide has a negative inotropic effect, can aggravate CHF in approximately 15% of patients, and can cause sinus arrest, AV block, and intraventricular conduction disturbances.<sup>208</sup> Because flecainide

can increase pacemaker thresholds up to 200%, it should be used with caution in patients with conduction disease. Other adverse effects include dizziness, blurred vision, GI upset, and neutropenia. Flecainide dosages may need to be reduced when given with cimetidine or amiodarone. Conversely, digoxin and propranolol doses must be reduced when flecainide is introduced. Finally,  $\beta$ -adrenergic blocking agents and flecainide may have additive negative effects on myocardial contractility. Few data are available about interaction with anesthetics.

### Encainide

Encainide is no longer readily available in the United States because the CASTs

showed increased incidence of fatal arrhythmias with encainide.<sup>206</sup> It remains available for compassionate use for those who were taking encainide prior to its discontinuation. Encainide's mode of action and indications are similar to those of flecainide. Its pharmacokinetics are complex. Ninety-three percent of the population (normal metabolizers) metabolizes encainide to active metabolites, yielding a 25% bioavailability and half-life between 1 and 12 hours for the various metabolites. In the remaining 7% of the population (slow metabolizers), encainide has a 90% bioavailability and a half-life as long as 20 hours.<sup>209</sup>

### Propafenone

Propafenone, an antidysrhythmic agent approved for management of ventricular dysrhythmias, is a sodium channel blocker with mode of action similar to the other approved class IC agents, flecainide and encainide.<sup>210</sup> Because data from the Cardiac Arrhythmia Suppression Trial Investigators<sup>206</sup> suggested increased mortality in patients taking encainide and flecainide, these drugs were relabeled. Currently, they are only approved in patients with life-threatening dysrhythmias. Because propafenone has a mode of action similar to these two agents, it is also generally used for the same indications.

Propafenone has shown evidence in vitro and in vivo of  $\beta$ -adrenergic blocking properties. Oral propafenone increases human lymphocyte B-cell adrenoceptor density, a phenomenon observed with other  $\beta$ -blockers. In healthy patients and asthmatic persons, propafenone decreases heart rate during exercise, increases airway reactivity to methacholine, and decreases hemodynamic response to isoproterenol.<sup>210</sup> As with other class IC agents, propafenone increases the QRS interval, even at normal heart rates. QT intervals are increased only to the extent that QRS intervals increase. The PR, AH, and HV intervals may also increase. Propafenone depresses sinus node automaticity and increases refractoriness in atrium, AV node, ventricle, and accessory pathways. It has a negative inotropic effect, which may reduce ejection fraction in normal subjects and produce symptoms of CHF in approximately 0.8–2.5% of patients. As with other class IC agents, propafenone may worsen conduction system disease.

After oral administration and absorption, propafenone undergoes a cytochrome P450 metabolism that varies genetically. In 93% of the population, the half-life is 6–7 hours; in the remaining 7% of the population, the elimination half-life is 12–32 hours.<sup>210</sup> Usual starting doses are 150 mg every 8 hours, which may be increased up to 1200 mg/d. Propafenone increases plasma concentrations of digoxin, warfarin, and metoprolol; consequently, dosages of these drugs may need adjustment.

In clinical studies, propafenone has been effective in suppression of frequent ventricular ectopy, nonsustained ventricular tachycardia, and exercise-induced ventricular ectopy. Propafenone has proven useful in prevention of atrial fibrillation and suppression of AV node and accessory pathway supraventricular dysrhythmias. Even when propafenone is not able to suppress these dysrhythmias, it is effective at slowing the heart rate.

Other adverse effects include worsening of asthma and bronchoconstriction, dizziness, and CNS and GI disturbances. Rare cases of cholestatic jaundice have been reported.<sup>210</sup>

### Class III Agents

Class III agents include amiodarone, bretylium, sotalol, ibutilide, dofetilide, and azimilide (Table 43–13). Their predominant effect is to prolong APD and increase ERP via action on potassium channels; ERP to APD ratio is also increased. However, each of these agents has additional effects on other channels and receptors rendering this class of agents a very heterogeneous one.

#### Amiodarone

Some physicians consider amiodarone to be the most efficacious antidysrhythmic agent available; unfortunately, however, it is associated with a high incidence of side effects. It is a structural analogue of thyroid hormone and is highly lipophilic. Many of its side effects are caused by either its thyroxine-like structure or its large volume of distribution and affinity for many tissues.

The electrophysiologic effects of amiodarone are complex. Like all class III agents amiodarone delays repolarization and increases duration of the action potential. Its primary mechanism involves blocking K channels, thereby prolonging repolarization. In

doing so, the ERP is increased and the incidence of reentry rhythms decreased in all cardiac tissues.<sup>211</sup> In addition to blocking K channels, amiodarone is a vasodilator, acting on cardiac and vascular smooth muscle. Consequently, it dilates coronary arteries and causes decreased afterload and oxygen consumption. It also noncompetitively antagonizes  $\alpha$  and  $\beta$  receptors, blocks conversion of thyroxine to triiodothyronine, and blocks inactivated Na and Ca channels. As such, amiodarone's effects on the ECG are complex; it slows the sinus rate, prolongs PR interval and AV node conduction, widens QRS complex, and prolongs QT interval.<sup>212</sup>

Amiodarone is effective in prevention of ventricular tachycardia and fibrillation, in treatment of supraventricular tachycardias with and without preexcitation syndromes, and in conversion and control of paroxysmal atrial fibrillation and flutter or other dysrhythmias associated with hypertrophic cardiomyopathies. It does decrease the incidence of postoperative atrial fibrillation after open-heart surgery.<sup>213</sup> Intravenous amiodarone may improve short-term survival in patients with ventricular fibrillation or hemodynamically unstable ventricular tachycardia that persists despite defibrillation or recurs promptly after successful defibrillation.<sup>201,214</sup> The Antiarrhythmics Versus Implantable Defibrillator (AVID) trial, which included patients with an ejection fraction less than 40% and who had suffered spontaneous hypotensive ventricular tachycardia or cardiac arrest, showed an improved survival in patients in the implantable cardioverter-defibrillator (ICD) group. Nevertheless, despite its toxicity, the use of amiodarone is appropriate for the management of recurrent ventricular fibrillation or unstable ventricular tachycardia in patients with ICDs. In the intraoperative and postoperative settings, IV amiodarone can be used to treat a variety of ventricular and supraventricular arrhythmias. It can be used to convert new onset atrial fibrillation into sinus rhythm. In addition, its use is now ACLS recommended for the treatment of pulseless ventricular tachycardia and ventricular fibrillation refractory to defibrillation, stable ventricular tachycardia, wide complex supraventricular tachycardia, and atrial fibrillation.<sup>215</sup>

Amiodarone is highly lipophilic, with a very large volume of distribu-



TABLE 43-13.

## Class III Antidysrhythmic Agents

Drug	Usual Dosage and Interval	Effect on Electrocardiogram	Adverse Effects	Usually Effective Plasma Concentration	Indication	Half-Life	Metabolism
Amiodarone (Cordarone)	PO loading: 800–1600 mg/d 1–3 weeks then 600–800 mg/d for 4 weeks; PO maintenance: 100–400 mg/d cardia IV 150 mg over 10 min then 1 mg/min × 6 then 0.5 mg/min; may be re-bolused for breakthrough arrhythmias	Prolongs PR, QRS, and QT	Bradycardia; heart block; new ventricular fibrillation; sustained ventricular tachycardia; torsade de pointes; GI upset; alcoholic-like hepatitis; phospholipidosis; ataxia; tremor; dizziness; acute pulmonary toxicity; pulmonary fibrosis; photosensitivity; blue-gray skin; corneal microdeposits; hyper- or hypothyroidism; increased serum cholesterol	Not established	Ventricular and supraventricular dysrhythmias	26–107 days	Hepatic
Bretium (Bretylol and others, Bretiate in Canada)	IV loading: 5 mg/kg with additional doses of 10 mg/kg to maximum of 30 mg/kg (effect must be delayed); IV maintenance: 5–10 mg/kg q6h or continuous infusion 1–2 mg/min	No change; sinus bradycardia	Orthostatic hypotension; nausea and vomiting; increased sensitivity to catecholamines; initial increase in dysrhythmias	Not established	Ventricular dysrhythmias	8 h; increased in renal failure	Renal
Sotalol	PO: 40–80 mg q12h increased to 320 mg q12h as necessary; IV: 0.2 mg/kg initially, increasing to 1.5 mg/kg over 5 min	Prolongs PR and QT interval	Bradycardia; heart block; torsade de pointes; congestive heart failure; bronchospasm; worsening arrhythmias	0.8–2.6 mg/mL	Ventricular dysrhythmias (used for supraventricular arrhythmias in Europe)	12 h	Renal
Ibutilide	IV: 1–2 mg	Prolongs QT interval	Torsade de pointes		Atrial fibrillation and atrial flutter	2–12 h	Hepatic/renal
Dofetilide	PO: 0.125–0.5 mg q12h IV: 4–8 µg/mL	Prolongs QT interval	Torsade de pointes		Conversion of atrial fibrillation and atrial flutter to sinus rhythm and prevention of recurrence	7–13 h	Hepatic/renal

Data from Abramowicz M, ed. Drugs for cardiac arrhythmias. Med Lett Drugs Ther 1991;33:60.

tion; consequently, it needs a long time to reach stable plasma concentrations and has a very long and variable elimination half-life—26–100 days. The North American Society of Pacing and Electrophysiology (NASPE) has published guidelines for the use of amiodarone. With oral therapy, the recommended loading dose for ventricular arrhythmias is 800–1600 mg/d (usually in divided doses) for up to 3 weeks, followed by a maintenance level of 400–600 mg/d during the first year. The maintenance level can be further decreased to 200–300 mg/d. With intravenous therapy, an initial loading dose of 150 mg is given over 10 minutes. The loading dose should be followed by a continuous infusion of 1 mg/min for 6 hours followed by 0.5 mg/min thereafter. Amiodarone should be mixed in a 5% dextrose solution and the amiodarone concentration kept below 2 mg/mL if given through a peripheral vein so as to minimize the development of local phlebitis.<sup>216</sup> In pulseless ventricular tachycardia and fibrillation, 300 mg is given as a bolus.

Amiodarone has little negative inotropic effect, and is frequently used with caution in patients with CHF. It may cause symptomatic heart block, requiring permanent pacemaker insertion in approximately 4% of patients. Its incidence of prodysrhythmic effects is 1–2%; this is less than that associated with other antidysrhythmics.

Noncardiac effects of amiodarone are dose related and occur often. These include photosensitivity dermatitis (which sometimes results in an iridescent blue-gray discoloration), corneal micro deposition, hyper- and hypothyroidism, pulmonary infiltration and fibrosis, tremor, ataxia, neuropathies, myopathies, hepatitis, and gastrointestinal symptoms.<sup>212</sup>

The very long half-life makes preoperative discontinuation impossible. In the past, serious adverse effects have been reported for patients anesthetized while receiving amiodarone. This likely represents the degree of underlying disease in this patient population rather than the drug itself. A poorly understood postoperative acute respiratory distress syndrome (ARDS) has been described in patients taking oral amiodarone who undergo cardiac or noncardiac surgery.<sup>217</sup> Whereas, the hemodynamic consequences of chronic oral amiodarone therapy during noncardiac surgery are usually limited

to hypotension, in the cardiac surgery AV nodal blockade, left ventricular dysfunction and extreme systemic vasodilatation have been reported. As a result, AV pacing, inotropes, and vasoconstrictors should be available and administered as necessary.<sup>217</sup> In an isolated animal heart model, amiodarone in conjunction with potent inhalation agents caused an additive decrease in heart rate and inotropy, along with prolongation of AV conduction time.<sup>218</sup> Despite its hemodynamic and pulmonary side effects, amiodarone remains a valuable therapy for perioperative life-threatening ventricular arrhythmias refractory to conventional therapy.

### Bretylium

Bretylium has been approved for parenteral use in patients with life-threatening ventricular arrhythmias unresponsive to other therapies. Its use has been, by and large, usurped by amiodarone in newer ACLS protocols.

Bretylium has a direct class III action, with increased APD and ERP. In addition, after initially causing norepinephrine release from postganglionic adrenergic nerve terminals, it blocks further release of norepinephrine producing a state resembling chemical sympathectomy.<sup>212</sup> When given intravenously to patients without cardiac arrest, bretylium is administered as a 5-mg/kg loading dose over 10–20 minutes, which may be repeated up to a total dose of 20 mg/kg if no response occurs. Subsequently, a maintenance infusion of 1 to 4 mg/min may be used. Because bretylium is eliminated unchanged in the urine, maintenance infusions must be decreased if creatinine clearance is reduced. In cardiac emergencies, bretylium is given as a rapid bolus in doses of 5–10 mg/kg.

After an initial increase in blood pressure, bretylium can cause significant hypotension, especially in volume-depleted patients. Orthostatic hypotension occurs in almost all patients and may persist for days after drug discontinuation. It has minimal effects on myocardial contractility. Rapid infusion can cause nausea and vomiting in awake patients.

The anesthetic implications for patients receiving bretylium are worth noting. By blocking catecholamine release, bretylium causes the equivalent of a denervated state. Direct-acting catecholamines may cause exaggerated

responses, and indirect agents may be less effective. Bretylium may also be used to treat bupivacaine-induced ventricular arrhythmias.<sup>219</sup>

### Sotalol

Sotalol is another class III antiarrhythmic agent with mixed properties. It is a racemic mixture of *d*- and *l*-sotalol isomers. The *d* isomer has class III antiarrhythmic properties, blocking K channels and prolonging repolarization, whereas the *l* isomer prolongs repolarization and has noncardioselective  $\beta$ -blocking capabilities without any intrinsic sympathomimetic activity or membrane-stabilizing effects.<sup>220</sup> The  $\beta$ -blocking effects of sotalol occur at considerably lower doses than the class III effects.<sup>221</sup>

The electrophysiologic effects of sotalol include an increase in APD and prolongation of ERP. The prolongation of the APD is greater at slower heart rates (reverse use dependence). Automaticity is decreased and, in a manner similar to other  $\beta$ -blockers, sotalol decreases heart rate and slows conduction through the AV node. On ECG, the PR and QT intervals may increase.

The hemodynamic effects of sotalol are secondary to a combination of  $\beta$ -adrenergic antagonist-mediated negative inotropic effects and a propensity to increase contractility secondary to prolonged repolarization, which occurs maximally at slower heart rates.

Sotalol is FDA approved for treatment of life-threatening ventricular arrhythmias. It is also effective for treating supraventricular arrhythmias, as it slows sinus tachycardia, slows the ventricular response rate to atrial fibrillation, and converts atrial flutter and fibrillation to normal sinus rhythm. Sotalol appears to be as effective as  $\beta$ -blockers and amiodarone for the prevention of atrial fibrillation after cardiac surgery.<sup>222</sup>

Table 43-13 summarizes the usual dosage, effective plasma concentration, half-life metabolism, and side effects of sotalol. Notably, many of the adverse effects of sotalol are secondary to its  $\beta$ -blocking activity. These include fatigue, dizziness and dyspnea, aggravation of bronchospasm, hypotension, and bradycardias, much like other  $\beta$ -blockers. However, exacerbations of CHF occurs less frequently with sotalol.<sup>220</sup>

Like all other class III antiarrhythmic drugs, sotalol has an arrhythmogenic

TABLE 43–14.

## Unclassified Antiarrhythmic Agents

Drug	Usual Dosages	Effects on ECG	Adverse Reactions	Usually Effective Plasma Concentration	Indications	Half-Life	Metabolism
Adenosine	6–12 mg IV (may repeat 12 mg × 2)	Increased PR interval; AV block	High-grade block; asystole; hypotension; dizziness; nausea; headaches	0.5–2 µg/mL	Paroxysmal supraventricular tachycardias including Wolff-Parkinson-White syndrome	10 sec	Metabolized to inosine and adenosine monophosphate

Data from Abramowicz M, ed. Drugs for cardiac arrhythmias. *Med Lett Drugs Ther* 1991;33:60.

potential; ventricular tachyarrhythmias occur in approximately 4% of patients and torsade de pointes occur in approximately 2.5% of patients.<sup>212</sup> Predisposing factors include electrolyte disorders (hypokalemia, hypomagnesemia), diuretic therapy, female gender, bradycardia, and concurrent therapy with other drugs that prolong repolarization (e.g., amiodarone, disopyramide, and flecainide).

Studies using an animal heart model show that halothane may sensitize the heart to pharmacologic K channel blockade.<sup>223</sup> Caution should probably be taken when using halothane in patients taking sotalol, although there are no studies to support this. No data exist on the interactions between sotalol and anesthetics.

### Ibutilide

Ibutilide has been approved for acute termination of atrial fibrillation or flutter of recent onset. Like other class III agents, it blocks outward potassium currents; however, unlike other class III drugs, ibutilide also blocks inward sodium currents through slow inward sodium channels. It thereby prolongs repolarization, the action potential duration, and the refractory period. It does not affect AV conduction or QRS duration on the ECG, but it does prolong the QT interval.<sup>224</sup>

The drug undergoes extensive first-pass metabolism and is renally excreted. It is not used orally. Intravenous dosage is usually 1 mg over 10 minutes and may be repeated a second time. Half-life varies between 2 and 12 hours.

In addition to the use for pharmacologic conversion or facilitation of elec-

trical cardioversion of conventional atrial fibrillation, ibutilide may be used to convert atrial fibrillation that occurs after cardiac surgery.<sup>225</sup>

Ibutilide has no significant hemodynamic effects. Its major side effect is QT prolongation and torsade de pointes, which happens in approximately 2% of patients, especially those with left ventricular dysfunction.<sup>212</sup> In light of this, its use is limited to patients with preserved left ventricular function and normal QT intervals.

### Dofetilide

Dofetilide is approved for acute conversion of atrial fibrillation and atrial flutter to sinus rhythm, and for prevention of recurrence of atrial fibrillation.<sup>226</sup>

It is a very potent K channel blocker that prolongs repolarization more prominently in the atria than in the ventricle.<sup>212</sup> Because it is a pure blocker of outward potassium currents, it does not have significant hemodynamic effects, does not depress cardiac function, and lacks extra cardiac effects.

It is partially metabolized in the liver and excreted predominantly in the urine, with an elimination half-life of 7–13 hours. The recommended dose is 0.125–0.5 mg twice daily, initiated under continuous ECG monitoring.<sup>212</sup> Higher-than-usual doses may be required in patients taking drugs that accelerate hepatic metabolism, such as phenytoin.

The most significant adverse effect is QT prolongation and torsade de pointes. Because of its proarrhythmic capabilities the American College of Chest Physicians guidelines do not recommend it for prevention and

management of atrial fibrillation after cardiac surgery.<sup>227</sup>

## Other Nonclassified Agents

### Adenosine

Adenosine is an endogenous nucleotide natural to all cells of the body (Table 43–14). In pharmacologic doses, it slows conduction through the AV node and is proven highly efficacious as acute IV therapy for patients with paroxysmal supraventricular tachycardia in both reentry and accessory pathway (Wolff-Parkinson-White) dysrhythmias. Although adenosine does not convert atrial fibrillation or atrial flutter to sinus rhythm, it may be useful in their diagnosis. It may also terminate adrenergic-sensitive ventricular tachycardias originating from the right ventricular outflow tract.<sup>47</sup>

After IV administration, adenosine undergoes rapid redistribution to erythrocytes and cells of the vascular endothelium, with a half-life estimated at less than 10 seconds. Subsequently, it is metabolized to inosine or adenosine monophosphate. After a bolus of 6 mg, approximately 60% of patients with paroxysmal supraventricular tachycardia will convert to sinus rhythm within 1 minute. If the initial bolus is unsuccessful, 12 mg given intravenously will convert most of the remaining patients, for a cumulative effectiveness of 92%. Transient high-grade blocks, and even asystole, may be seen following adenosine administration. These usually resolve rapidly and without therapy. Dipyridamole blocks reuptake of adenosine, delaying its clearance and potentiating its effects, whereas caffeine and

TABLE 43-15.

## Statins

Drug	Dose	Side Effects
Atorvastatin (Lipitor)	10–80 mg/d	Hepatotoxicity (elevation of aminotransferases); myopathy (factors associated with increased risk include advanced age, hepatic or renal dysfunction, perioperative periods, multisystem disease especially diabetes mellitus, hypothyroidism); proteinuria; headache; nausea
Fluvastatin (Lescol)	20–80 mg/d 80 mg SR/d	
Lovastatin (Mevacor)	20–80 mg/d	
Pravastatin (Pravachol)	10–80 mg/d	
Rosuvastatin (Crestor)	5–40 mg/d	
Simvastatin (Zocor)	5–80 mg/d	

methylxanthines are competitive antagonists, necessitating larger doses of adenosine to achieve clinical effect.<sup>212</sup>

Adenosine is contraindicated in patients with sick sinus syndrome and second- or third-degree AV block. Hypotension may develop, especially when higher dosages are used. Other adverse side effects include facial flushing, headache, chest pain, dyspnea, dizziness, and nausea. Adenosine may precipitate ventricular fibrillation in patients with Wolff-Parkinson-White syndrome when administered during preexcited atrial fibrillation.<sup>228</sup>

Adenosine is also used to induce ischemia in both laboratory models of coronary steal with flow-limiting stenosis and clinically to elicit ischemia in adenosine-thallium scan. Adenosine is not FDA approved for use as a vasodilator or for deliberate intraoperative hypotension. Preclinical studies showed that intrathecal adenosine might be effective in the treatment of acute and chronic pain.<sup>229</sup>

## STATINS

Because patients with dyslipidemias are at an increased risk of developing atherosclerosis and subsequent coronary artery disease, lipid lowering is beneficial for both primary and secondary prevention of coronary heart disease, as shown in several studies involving large populations.<sup>230–232</sup> The statins are the most effective and best-tolerated agents for treating dyslipidemias, and have revolutionized the treatment of lipid abnormalities (Table 43-15).

The mechanism of action is competitive inhibition of 3-hydroxy-3-methylglutaryl coenzyme A reductase, which

catalyzes an early, rate-limiting step in cholesterol biosynthesis, resulting in reduction of low-density lipoprotein cholesterol (LDL-C) levels, the major effect exerted by the statins.

The protective effect related to the use of statins cannot be completely explained by the lowering of LDL-C at baseline. Among the nonlipid-related mechanisms that may be involved are regression of atherosclerotic lesions, plaque stabilization, reduced inflammation, reversal of endothelial dysfunction, and decreased thrombogenicity.<sup>233</sup> Nonlipid properties may be observed earlier than lipid effects.

Several mechanisms may be responsible for the development of coronary ischemia and myocardial infarction in the perioperative setting but there is evidence that coronary plaque rupture, which leads to thrombus formation and coronary artery occlusion, is the most important mechanism.

Recently, several studies analyzed the effect of statin agents on perioperative cardiovascular mortality and morbidity in patients undergoing noncardiac surgery.<sup>234–238</sup> Results of these studies, most of them retrospective, showed a reduction in the perioperative cardiovascular events or mortality.

Statins are effective and generally safe. However, certain side effects are associated with their use, particularly hepatotoxicity and myopathy. Although the incidence of myopathy is low (0.01%), the risk of myopathy, and even of rhabdomyolysis, increases in proportion to plasma statin concentration. There are case reports of perioperative myopathy and rhabdomyolysis in patients treated with statins.<sup>239</sup> Although the benefit and the risk of continuing these agents remain to be demonstrated in large randomized

clinical trials, the data strongly suggest that they should be continued through the perioperative period.

## KEY REFERENCES

1. Eagle KA, et al. ACC/AHA guideline update for perioperative cardiovascular evaluation for noncardiac surgery—executive summary. A report of the American College of Cardiology/American Heart Association Task Force on Practice Guidelines (Committee to Update the 1996 Guidelines on Perioperative Cardiovascular Evaluation for Noncardiac Surgery). *Circulation* 2002; 105(10):1257–1267.
2. Chobanian AV, et al. The Seventh Report of the Joint National Committee on Prevention, Detection, Evaluation, and Treatment of High Blood Pressure: the JNC 7 report. *JAMA* 2003;289(19):2560–2572.
3. Kamibayashi T, Maze M. Clinical uses of alpha<sub>2</sub>-adrenergic agonists. *Anesthesiology* 2000;93(5):1345–1349.
4. Burnier M, Brunner HR. Angiotensin II receptor antagonists. *Lancet* 2000;355(9204):637–645.
5. Bertrand M, et al. Should the angiotensin II antagonists be discontinued before surgery? *Anesth Analg* 2001;92(1):26–30.
6. London MJ, et al. Perioperative β-adrenergic receptor blockade: physiologic foundations and clinical controversies. *Anesthesiology* 2004;100(1):170–175.
7. Lindenauer PK, et al. Perioperative beta-blocker therapy and mortality after major noncardiac surgery. *N Engl J Med* 2005;353(4):349–361.
8. Abernethy DR, Schwartz JB. Calcium-antagonist drugs. *N Engl J Med* 1999;341(19):1447–1457.
9. Dorian P, et al. Amiodarone as compared with lidocaine for shock-resistant ventricular fibrillation. *N Engl J Med* 2002;346(12):884–890.
10. Goldschlager N, et al. Practical guidelines for clinicians who treat patients with amiodarone. Practice Guidelines Subcommittee, North American Society of Pacing and



Electrophysiology. *Arch Intern Med* 2000;160(12):1741–1748.

11. Martinez EA, Epstein AE, Bass EB. Pharmacologic control of ventricular rate: American College of Chest Physicians guidelines for the prevention and management of postoperative atrial fibrillation after cardiac surgery. *Chest* 2005;128(2 Suppl):56S–60S.

12. Poldermans D, et al. Statins are associated with a reduced incidence of perioperative mortality in patients undergoing major noncardiac vascular surgery. *Circulation* 2003;107(14):1848–1851.

## REFERENCES

- Burt VL, et al. Prevalence of hypertension in the US adult population. Results from the Third National Health and Nutrition Examination Survey, 1988–1991. *Hypertension* 1995;25(3):305–313.
- Fields LE, et al. The burden of adult hypertension in the United States 1999 to 2000: a rising tide. *Hypertension* 2004;44(4):398–404.
- Charlson ME, et al. Preoperative characteristics predicting intraoperative hypotension and hypertension among hypertensives and diabetics undergoing noncardiac surgery. *Ann Surg* 1990;212(1):66–81.
- Raby KE, et al. Detection and significance of intraoperative and postoperative myocardial ischemia in peripheral vascular surgery. *JAMA* 1992;268(2):222–227.
- Eagle KA, et al. ACC/AHA guideline update for perioperative cardiovascular evaluation for noncardiac surgery—executive summary. A report of the American College of Cardiology/American Heart Association Task Force on Practice Guidelines (Committee to Update the 1996 Guidelines on Perioperative Cardiovascular Evaluation for Noncardiac Surgery). *Circulation* 2002;105(10):1257–1267.
- Chobanian AV, et al. The Seventh Report of the Joint National Committee on Prevention, Detection, Evaluation, and Treatment of High Blood Pressure: the JNC 7 report. *JAMA* 2003;289(19):2560–2572.
- Shimizu T, et al. Site and mechanism of action of trichlormethiazide in rabbit distal nephron segments perfused in vitro. *J Clin Invest* 1988;82(2):721–730.
- Michael R, Hiremath A, Jain AK. Older and newer diuretics. In: Drayer J, Lowenthal M, Weber A, eds. *Drugs Therapy in Hypertension*, New York: Marcel Dekker, 1987:69–96.
- Carlsen JE, et al. Relation between dose of bendrofluzide, antihypertensive effect, and adverse biochemical effects. *BMJ* 1990;300(6730):975–978.
- Jackson EK. Diuretics. In: Lazo J, Brunton L, Parker K, eds. *Goodman and Gilman's The Pharmacological Basis of Therapeutics*. 11th ed. New York: McGraw-Hill, 2005:749–753.
- Rose BD. Diuretics. *Kidney Int* 1991;39(2):336–352.
- Pitt B, et al. The effect of spironolactone on morbidity and mortality in patients with severe heart failure. Randomized Aldactone Evaluation Study investigators. *N Engl J Med* 1999;341(10):709–717.
- DeCarvalho JG, Emery AC Jr, Frohlich ED. Spironolactone and triamterene in volume-dependent essential hypertension. *Clin Pharmacol Ther* 1980;27(1):53–56.
- Holland OB, Nixon JV, Kuhnert L. Diuretic-induced ventricular ectopic activity. *Am J Med* 1981;70(4):762–768.
- Hirsch IA, et al. The overstated risk of preoperative hypokalemia. *Anesth Analg* 1988;67(2):131–136.
- Miller RD, Sohn YJ, Matteo RS. Enhancement of *d*-tubocurarine neuromuscular blockade by diuretics in man. *Anesthesiology* 1976;45(4):442–445.
- Reis DJ. Neurons and receptors in the rostromedullary medulla mediating the antihypertensive actions of drugs acting at imidazoline receptors. *J Cardiovasc Pharmacol* 1996;27(Suppl 3):S11–S18.
- Kamibayashi, T, Maze M. Clinical uses of alpha<sub>2</sub>-adrenergic agonists. *Anesthesiology* 2000;93(5):1345–1349.
- Khan ZP, Ferguson CN. Jones RM. Alpha-2 and imidazoline receptor agonists. Their pharmacology and therapeutic role. *Anaesthesia* 1999;54(2):146–165.
- Ghignone M, Calvillo O, Quintin L. Anesthesia and hypertension: the effect of clonidine on perioperative hemodynamics and isoflurane requirements. *Anesthesiology* 1987;67(1):3–10.
- Longnecker DE. Alpine anesthesia: can pretreatment with clonidine decrease the peaks and valleys? *Anesthesiology* 1987;67(1):1–2.
- Gowing L, et al. Alpha<sub>2</sub> adrenergic agonists for the management of opioid withdrawal. *Cochrane Database Syst Rev* 2003(2):CD002024.
- Stuhmeier KD, et al. Small, oral dose of clonidine reduces the incidence of intraoperative myocardial ischemia in patients having vascular surgery. *Anesthesiology* 1996;85(4):706–712.
- Nishina K, et al. Efficacy of clonidine for prevention of perioperative myocardial ischemia: a critical appraisal and meta-analysis of the literature. *Anesthesiology* 2002;96(2):323–329.
- Ebert T, Maze M. Dexmedetomidine: another arrow for the clinician's quiver. *Anesthesiology* 2004;101(3):568–570.
- Bonnet F, et al. Clonidine-induced analgesia in postoperative patients: epidural versus intramuscular administration. *Anesthesiology* 1990;72(3):423–427.
- Hussar AD. New drugs of 2000. *J Am Pharm Assoc (Wash)* 2001;41:229–271.
- Bloor BC, et al. Effects of intravenous dexmedetomidine in humans. II. Hemodynamic changes. *Anesthesiology* 1992;77(6):1134–1142.
- Aantaa R, et al. Reduction of the minimum alveolar concentration of isoflurane by dexmedetomidine. *Anesthesiology* 1997;86(5):1055–1060.
- Grant SA, et al. Dexmedetomidine infusion for sedation during fiberoptic intubation: a report of three cases. *J Clin Anesth* 2004;16(2):124–126.
- Bekker AY, et al. The use of dexmedetomidine infusion for awake craniotomy. *Anesth Analg* 2001;92(5):1251–1253.
- Ard J, Doyle W, Bekker A. Awake craniotomy with dexmedetomidine in pediatric patients. *J Neurosurg Anesthesiol* 2003;15(3):263–266.
- Oliver MF, et al. Effect of mivazerol on perioperative cardiac complications during non-cardiac surgery in patients with coronary heart disease: the European Mivazerol Trial (EMIT). *Anesthesiology* 1999;91(4):951–961.
- McSPI-European Research Group. Perioperative sympathectomy. Beneficial effects of the alpha 2-adrenoceptor agonist mivazerol on hemodynamic stability and myocardial ischemia. McSPI—Europe Research Group. *Anesthesiology* 1997;86(2):346–363.
- Langer SZ, Cavero I, Massingham R. Recent developments in noradrenergic neurotransmission and its relevance to the mechanism of action of certain antihypertensive agents. *Hypertension* 1980;2(4):372–382.
- Wendt RL. Guanabenz. In: Scriabine A, ed. *Pharmacology of antihypertensive drugs*. New York: Raven Press, 1980:99–113.
- Caine M. Alpha-adrenergic blockers for the treatment of benign prostatic hyperplasia. *Urol Clin North Am* 1990;17(3):641–649.
- Carruthers SG. Adverse effects of alpha 1-adrenergic blocking drugs. *Drug Saf* 1994;11(1):12–20.
- Prys-Roberts C. Phaeochromocytoma—recent progress in its management. *Br J Anaesth* 2000;85(1):44–57.
- Subhani M, Sridhar S, DeCristofaro JD. Phentolamine use in a neonate for the prevention of dermal necrosis caused by dopamine: a case report. *J Perinatol* 2001;21(5):324–326.
- Wollem GL, Naegli SR, Tarazi RC. Clinical pharmacology of antihypertensive drugs. In: Gross F, Gifford RW, Kirkwood AH, eds. *Antihypertensive therapy, principles and practice*. Proceedings of an international symposium. New York: Springer, 1966.
- Powers DR, Papadokos PJ, Wallin JD. Parenteral hydralazine revisited. *J Emerg Med* 1998;16(2):191–196.
- Zanaboni P, Hill L. Vasodilators. In: Evers AS, Maze M, eds. *Anesthetic Pharma-*

- cology—Physiologic Principles and Clinical Practice. Philadelphia: Churchill Livingstone, 2003:691–699.
44. Taylor AL, et al. Combination of isosorbide dinitrate and hydralazine in blacks with heart failure. *N Engl J Med* 2004; 351(20):2049–2057.
  45. Messerli FH. Vasodilatory edema: a common side effect of antihypertensive therapy. *Curr Cardiol Rep* 2002;4(6):479–482.
  46. Magee LA, et al. Hydralazine for treatment of severe hypertension in pregnancy: meta-analysis. *BMJ* 2003;327(7421):955–960.
  47. Gleva MJ HC. Antiarrhythmic Agents. In: Evers AS, Maze M, eds. *Anesthetic Pharmacology—Physiologic Principles and Clinical Practice*. Philadelphia: Churchill Livingstone, 2003:621–631.
  48. Sica DA. Minoxidil: an underused vasodilator for resistant or severe hypertension. *J Clin Hypertens (Greenwich)* 2004;6(5):283–287.
  49. Sica DA, Gehr TW. Direct vasodilators and their role in hypertension management: minoxidil. *J Clin Hypertens (Greenwich)* 2001;3(2):110–114.
  50. Moncada S, Palmer RM, Higgs EA. Nitric oxide: physiology, pathophysiology, and pharmacology. *Pharmacol Rev* 1991; 43(2):109–142.
  51. Vallance P, Chan N. Endothelial function and nitric oxide: clinical relevance. *Heart* 2001;85(3):342–350.
  52. Friederich JA, Butterworth JFT. Sodium nitroprusside: twenty years and counting. *Anesth Analg* 1995;81(1):152–162.
  53. Kulig K. Cyanide antidotes and fire toxicology. *N Engl J Med* 1991;325(25):1801–1802.
  54. Francis GS. Vasodilators in the intensive care unit. *Am Heart J* 1991;121(6 Pt 1):1875–1878.
  55. Dietrich GV, et al. Platelet function and adrenoceptors during and after induced hypotension using nitroprusside. *Anesthesiology* 1996;85(6):1334–1340.
  56. Lustik SJ, et al. Nicardipine versus nitroprusside for deliberate hypotension during idiopathic scoliosis repair. *J Clin Anesth* 2004;16(1):25–33.
  57. Murphy MB, Murray C, Shorten GD. Fenoldopam: a selective peripheral dopamine-receptor agonist for the treatment of severe hypertension. *N Engl J Med* 2001; 345(21):1548–1557.
  58. Mathur VS, et al. The effects of fenoldopam, a selective dopamine receptor agonist, on systemic and renal hemodynamics in normotensive subjects. *Crit Care Med* 1999;27(9):1832–1837.
  59. Devlin JW, et al. Fenoldopam versus nitroprusside for the treatment of hypertensive emergency. *Ann Pharmacother* 2004;38(5):755–759.
  60. Garwood S, et al. A case series of low-dose fenoldopam in seventy cardiac surgical patients at increased risk of renal dysfunction. *J Cardiothorac Vasc Anesth* 2003;17(1):17–21.
  61. Ranucci M, et al. Fenoldopam prophylaxis of postoperative acute renal failure in high-risk cardiac surgery patients. *Ann Thorac Surg* 2004;78(4):1332–1337; discussion 1337–1338.
  62. Della Rocca G, et al. Fenoldopam mesylate and renal function in patients undergoing liver transplantation: a randomized, controlled pilot trial. *Anesth Analg* 2004; 99(6):1604–1609, table of contents.
  63. Bove T, et al. Renoprotective action of fenoldopam in high-risk patients undergoing cardiac surgery: a prospective, double-blind, randomized clinical trial. *Circulation* 2005;111(24):3230–3235.
  64. Balse J, Butterworth J. Cardiovascular drugs. In: Hensley F, Martin DE, Gravlee GP, eds. *A Practical Approach to Cardiac Anesthesia*. Philadelphia: Lippincott Williams & Wilkins, 2003:79–80.
  65. Kostis JB, et al. Adverse effects of enalapril in the Studies of Left Ventricular Dysfunction (SOLVD). *SOLVD investigators*. *Am Heart J* 1996;131(2):350–355.
  66. Palmer BF. Managing hyperkalemia caused by inhibitors of the renin-angiotensin-aldosterone system. *N Engl J Med* 2004; 351(6):585–592.
  67. Lewis EJ, et al. The effect of angiotensin-converting enzyme inhibition on diabetic nephropathy. The Collaborative Study Group. *N Engl J Med* 1993;329(20):1456–1462.
  68. Bakris GL, Weir MR. Angiotensin-converting enzyme inhibitor-associated elevations in serum creatinine: is this a cause for concern? *Arch Intern Med* 2000;160(5): 685–693.
  69. K/DOQI clinical practice guidelines on hypertension and antihypertensive agents in chronic kidney disease. *Am J Kidney Dis* 2004;43(5 Suppl 1):S1–S290.
  70. Lieve M, et al. Ramipril-induced regression of left ventricular hypertrophy in treated hypertensive individuals. *HYCAR Study Group*. *Hypertension* 1995;25(1):92–97.
  71. Tomiyama H, et al. Kinins contribute to the improvement of insulin sensitivity during treatment with angiotensin-converting enzyme inhibitor. *Hypertension* 1994; 23(4):450–455.
  72. Coriat P, et al. Influence of chronic angiotensin-converting enzyme inhibition on anesthetic induction. *Anesthesiology* 1994;81(2):299–307.
  73. Timmermans PB, et al. Angiotensin II receptors and angiotensin II receptor antagonists. *Pharmacol Rev* 1993;45(2):205–251.
  74. Burnier M, Brunner HR. Angiotensin II receptor antagonists. *Lancet* 2000; 355(9204):637–645.
  75. Lindholm LH, et al. Cardiovascular morbidity and mortality in patients with diabetes in the Losartan Intervention For Endpoint reduction in hypertension study (LIFE): a randomised trial against atenolol. *Lancet* 2002;359(9311):1004–1010.
  76. Granger CB, et al. Effects of candesartan in patients with chronic heart failure and reduced left-ventricular systolic function intolerant to angiotensin-converting enzyme inhibitors: the CHARM-Alternative trial. *Lancet* 2003;362(9386):772–776.
  77. Pfeffer MA, et al. Valsartan, captopril, or both in myocardial infarction complicated by heart failure, left ventricular dysfunction, or both. *N Engl J Med* 2003;349(20): 1893–1906.
  78. McMurray JJ, et al. Effects of candesartan in patients with chronic heart failure and reduced left-ventricular systolic function taking angiotensin-converting-enzyme inhibitors: the CHARM-Added trial. *Lancet* 2003;362(9386):767–771.
  79. Lewis EJ, et al. Renoprotective effect of the angiotensin-receptor antagonist irbesartan in patients with nephropathy due to type 2 diabetes. *N Engl J Med* 2001;345(12): 851–860.
  80. Brenner BM, et al. Effects of losartan on renal and cardiovascular outcomes in patients with type 2 diabetes and nephropathy. *N Engl J Med* 2001;345(12):861–869.
  81. Tanaka H, et al. Effects of candesartan on cough and bronchial hyperresponsiveness in mildly to moderately hypertensive patients with symptomatic asthma. *Circulation* 2001;104(3):281–285.
  82. van Rijnsoever EW, Kwee-Zuiderwijk WJ, Feenstra J. Angioneurotic edema attributed to the use of losartan. *Arch Intern Med* 1998;158(18):2063–2065.
  83. Bertrand M, et al. Should the angiotensin II antagonists be discontinued before surgery? *Anesth Analg* 2001;92(1):26–30.
  84. Brabant SM, et al. The hemodynamic effects of anesthetic induction in vascular surgical patients chronically treated with angiotensin II receptor antagonists. *Anesth Analg* 1999;89(6):1388–1392.
  85. Comparative effects of therapy with captopril and digoxin in patients with mild to moderate heart failure. The Captopril-Digoxin Multicenter Research Group. *JAMA* 1988;259(4):539–544.
  86. Lee DC, et al. Heart failure in outpatients: a randomized trial of digoxin versus placebo. *N Engl J Med* 1982;306(12):699–705.
  87. The effect of digoxin on mortality and morbidity in patients with heart failure. The Digitalis Investigation Group. *N Engl J Med* 1997;336(8):525–533.
  88. Watanabe AM, Digitalis and the autonomic nervous system. *J Am Coll Cardiol* 1985;5(5 Suppl A):35A–42A.
  89. Bolognesi R, et al. Inhibitory effect of acute and chronic administration of digitalis on the sick sinus node. *Eur Heart J* 1986; 7(4):334–340.
  90. Jedeikin R, et al. Effect of ouabain on the anterograde effective refractory period of accessory atrioventricular connections in children. *J Am Coll Cardiol* 1983;1(3): 869–872.

91. Taboulet P, et al. Acute digitalis intoxication—is pacing still appropriate? *J Toxicol Clin Toxicol* 1993;31(2):261–273.
92. Rabetoy GM, et al. Treatment of digoxin intoxication in a renal failure patient with digoxin-specific antibody fragments and plasmapheresis. *Am J Nephrol* 1990;10(6):518–521.
93. Lawson NW, Wallfisch HK. Cardiovascular pharmacology: a new look at the pressors. In: Stoelting RK, ed. *Advances in Anesthesia*. Chicago: Mosby-Year Book, 1986.
94. Atlee JL. Perioperative cardiac dysrhythmias. Chicago: Mosby-Year Book, 1990:314–323.
95. Abrams J. Hemodynamic effects of nitroglycerin and long-acting nitrates. *Am Heart J* 1985;110(1 Pt 2):216–224.
96. Brown BG. Response of normal and diseased epicardial coronary arteries to vasoactive drugs: quantitative arteriographic studies. *Am J Cardiol* 1985;56(9):23E–29E.
97. Liu P, et al. Effect of intracoronary nitroglycerin on myocardial blood flow and distribution in pacing-induced angina pectoris. Quantitative assessment by single-photon emission tomography. *Am J Cardiol* 1985;55(11):1270–1276.
98. Zhang J, et al. Role of mitochondrial aldehyde dehydrogenase in nitroglycerin-induced vasodilatation of coronary and systemic vessels: an intact canine model. *Circulation* 2004;110(6):750–755.
99. Ignarro LJ, et al. Mechanism of vascular smooth muscle relaxation by organic nitrates, nitrites, nitroprusside and nitric oxide: evidence for the involvement of S-nitrosothiols as active intermediates. *J Pharmacol Exp Ther* 1981;218(3):739–749.
100. Loscalzo J. Antiplatelet and antithrombotic effects of organic nitrates. *Am J Cardiol* 1992;70(8):18B–22B.
101. Parker JD, Parker JO. Nitrate therapy for stable angina pectoris. *N Engl J Med* 1998;338(8):520–531.
102. Anderson CM, et al. Methemoglobinemia: an unusual cause of postoperative cyanosis. *J Vasc Surg* 2004;39(3):686–690.
103. Strosberg AD, Pietri-Rouxel F. Function and regulation of the beta<sub>3</sub>-adrenoceptor. *Trends Pharmacol Sci* 1996;17(10):373–381.
104. Skeberdis VA. Structure and function of beta<sub>3</sub>-adrenergic receptors. *Medicina (Kaunas)* 2004;40(5):407–413.
105. Frischman W. *Clinical Pharmacology of Beta-Adrenoceptor Blocking Drugs*. 2 ed. Norwalk: Appleton-Century-Crofts, 1984.
106. Kostis JB, DeFelice EA. Betablockers in the treatment of hypertension. In: Kostis JB, DeFelice EA, eds. *The Pharmacological Treatment of Cardiovascular Disease*. New York: Elsevier Science Publishing Co, 1986:3–28.
107. Toda N. Vasodilating beta-adrenoceptor blockers as cardiovascular therapeutics. *Pharmacol Ther* 2003;100(3):215–234.
108. London MJ, et al. Perioperative beta-adrenergic receptor blockade: physiologic foundations and clinical controversies. *Anesthesiology* 2004;100(1):170–175.
109. Keller, KB, Lemberg L. Prinzmetal's angina. *Am J Crit Care* 2004;13(4):350–354.
110. Singh BN. Beta-adrenergic blockers as antiarrhythmic and antibrillatory compounds: an overview. *J Cardiovasc Pharmacol Ther* 2005;10(Suppl 1):S3–S14.
111. Tamariz LJ, Bass EB. Pharmacological rate control of atrial fibrillation. *Cardiol Clin* 2004;22(1):35–45.
112. Singh SN, Patrick J, Patrick J. Antiarrhythmic drugs. *Curr Treat Options Cardiovasc Med* 2004;6(5):357–364.
113. Frishman WH, Lazar EJ. Reduction of mortality, sudden death and non-fatal reinfarction with beta-adrenergic blockers in survivors of acute myocardial infarction: a new hypothesis regarding the cardioprotective action of beta-adrenergic blockade. *Am J Cardiol* 1990;66(16):66G–70G.
114. Nishimura RA, Holmes DR Jr. Clinical practice. Hypertrophic obstructive cardiomyopathy. *N Engl J Med* 2004;350(13):1320–1327.
115. Sirak TE, Jelic S, Le Jemtel TH. Therapeutic update: non-selective beta- and alpha-adrenergic blockade in patients with coexistent chronic obstructive pulmonary disease and chronic heart failure. *J Am Coll Cardiol* 2004;44(3):497–502.
116. Radack K, Deck C. Beta-adrenergic blocker therapy does not worsen intermittent claudication in subjects with peripheral arterial disease. A meta-analysis of randomized controlled trials. *Arch Intern Med* 1991;151(9):1769–1776.
117. Frishman WH. Beta-adrenergic blockers. *Med Clin North Am* 1988;72(1):37–81.
118. Hjalmarson A, et al. Effects of controlled-release metoprolol on total mortality, hospitalizations, and well-being in patients with heart failure: the Metoprolol CR/XL Randomized Intervention Trial in congestive heart failure (MERIT-HF). MERIT-HF study group. *JAMA* 2000;283(10):1295–1302.
119. Effects of metoprolol CR in patients with ischemic and dilated cardiomyopathy: the randomized evaluation of strategies for left ventricular dysfunction pilot study. *Circulation* 2000;101(4):378–384.
120. Carney RM, et al. Prevalence of major depressive disorder in patients receiving beta-blocker therapy versus other medications. *Am J Med* 1987;83(2):223–226.
121. McGavin JK, Keating GM. Bisoprolol: a review of its use in chronic heart failure. *Drugs* 2002;62(18):2677–2696.
122. Leizorovicz A, et al. Bisoprolol for the treatment of chronic heart failure: a meta-analysis on individual data of two placebo-controlled studies—CIBIS and CIBIS II. *Cardiac Insufficiency Bisoprolol Study*. *Am Heart J* 2002;143(2):301–307.
123. Channer KS, et al. Beta-adrenoceptor blockers in atrial fibrillation: the importance of partial agonist activity. *Br J Clin Pharmacol* 1994;37(1):53–57.
124. Strickberger SA, et al. Comparison of effects of propranolol versus pindolol on sinus rate and pacing frequency in sick sinus syndrome. *Am J Cardiol* 1993;71(1):53–56.
125. Rosendorff C. Beta-blocking agents with vasodilator activity. *J Hypertens Suppl* 1993;11(4):S37–S40.
126. Ornstein E, et al. Are all effects of esmolol equally rapid in onset? *Anesth Analg* 1995;81(2):297–300.
127. Weiskopf RB. Cardiovascular effects of desflurane in experimental animals and volunteers. *Anaesthesia* 1995;50(Suppl):14–17.
128. Witchitz S, et al. Treatment of heart failure with celiprolol, a cardioselective beta blocker with beta-2 agonist vasodilatory properties. The CELICARD Group. *Am J Cardiol* 2000;85(12):1467–1471.
129. Pujet JC, et al. Effects of celiprolol, a cardioselective beta-blocker, on respiratory function in asthmatic patients. *Eur Respir J* 1992;5(2):196–200.
130. Book WM. Carvedilol: a nonselective beta blocking agent with antioxidant properties. *Congest Heart Fail* 2002;8(3):173–177, 190.
131. Packer M, et al. The effect of carvedilol on morbidity and mortality in patients with chronic heart failure. U.S. Carvedilol Heart Failure Study Group. *N Engl J Med* 1996;334(21):1349–1355.
132. Bristow MR, et al. Carvedilol produces dose-related improvements in left ventricular function and survival in subjects with chronic heart failure. MOCHA Investigators. *Circulation* 1996;94(11):2807–2816.
133. Poole-Wilson PA, et al. Comparison of carvedilol and metoprolol on clinical outcomes in patients with chronic heart failure in the Carvedilol Or Metoprolol European Trial (COMET): randomised controlled trial. *Lancet* 2003;362(9377):7–13.
134. Beta-Blocker Evaluation of Survival Trial Investigators. A trial of the beta-blocker bucindolol in patients with advanced chronic heart failure. *N Engl J Med* 2001;344(22):1659–1667.
135. Cockcroft J. Nebivolol: a review. *Expert Opin Pharmacother* 2004;5(4):893–899.
136. Flather MD, et al. Randomized trial to determine the effect of nebivolol on mortality and cardiovascular hospital admission in elderly patients with heart failure (SENIORS). *Eur Heart J* 2005;26(3):215–225.
137. Ponten J, et al. Long-term metoprolol therapy and neuroleptanesthesia in coronary artery surgery: withdrawal versus maintenance of beta 1-adrenoreceptor blockade. *Anesth Analg* 1983;62(4):380–390.
138. Poldermans D, et al. The effect of bisoprolol on perioperative mortality and myocardial infarction in high-risk patients undergoing vascular surgery. Dutch Echocardiographic Cardiac Risk Evaluation Applying Stress Echocardiography Study



- Group. *N Engl J Med* 1999;341(24):1789–1794.
139. Mangano DT, et al. Effect of atenolol on mortality and cardiovascular morbidity after noncardiac surgery. Multicenter Study of Perioperative Ischemia Research Group. *N Engl J Med* 1996;335(23):1713–1720.
140. Schmidt M, et al. Forecasting the impact of a clinical practice guideline for perioperative beta-blockers to reduce cardiovascular morbidity and mortality. *Arch Intern Med* 2002;162(1):63–69.
141. VanDenKerkhof EG, Milne B, Parlow JL. Knowledge and practice regarding prophylactic perioperative beta blockade in patients undergoing noncardiac surgery: a survey of Canadian anesthesiologists. *Anesth Analg* 2003;96(6):1558–1565, table of contents.
142. Lindenauer PK, et al. Perioperative beta-blocker therapy and mortality after major noncardiac surgery. *N Engl J Med* 2005;353(4):349–361.
143. Mathew JP, et al. A multicenter risk index for atrial fibrillation after cardiac surgery. *JAMA* 2004;291(14):1720–1729.
144. Henriksson BA, et al. Cardiovascular effects of enflurane and asphyxia during long-term beta 1-adrenoceptor blockade. *Acta Anaesthesiol Scand* 1985;29(4):363–370.
145. Abel M, Book WJ, Eisenkraft JB. Adverse effects of nondepolarising neuromuscular blocking agents. Incidence, prevention and management. *Drug Saf* 1994;10(6):420–438.
146. Lesser JB, et al. Severe bradycardia during spinal and epidural anesthesia recorded by an anesthesia information management system. *Anesthesiology* 2003;99(4):859–866.
147. Abernethy DR, Schwartz JB. Calcium-antagonist drugs. *N Engl J Med* 1999;341(19):1447–1457.
148. Morel N, et al. The action of calcium channel blockers on recombinant L-type calcium channel alpha1-subunits. *Br J Pharmacol* 1998;125(5):1005–1012.
149. Humbert M, Sitbon O, Simonneau G. Treatment of pulmonary arterial hypertension. *N Engl J Med* 2004;351(14):1425–1436.
150. Wigley FM. Clinical practice. Raynaud's phenomenon. *N Engl J Med* 2002;347(13):1001–1008.
151. Echizen H, et al. The effect of dextro-, levo-, and racemic verapamil on atrioventricular conduction in humans. *Am Heart J* 1985;109(2):210–217.
152. Jespersen CM. The effect of verapamil on major events in patients with impaired cardiac function recovering from acute myocardial infarction. The Danish Study Group on Verapamil in Myocardial Infarction. *Eur Heart J* 1993;14(4):540–545.
153. Singh BN, Nademanee K, Baky SH. Calcium antagonists. Clinical use in the treatment of arrhythmias. *Drugs* 1983;25(2):125–153.
154. Henry PD. Comparative pharmacology of calcium antagonists: nifedipine, verapamil and diltiazem. *Am J Cardiol* 1980;46(6):1047–1058.
155. Kitakaze M, et al. Nifedipine-induced coronary vasodilatation in ischemic hearts is attributable to bradykinin- and NO-dependent mechanisms in dogs. *Circulation* 2000;101(3):311–317.
156. Ellrodt AG, et al. Efficacy and safety of sublingual nifedipine in hypertensive emergencies. *Am J Med* 1985;79(4A):19–25.
157. Schwartz JB, Caputo G, Abbott J. Early experience with dobutamine stress testing and cardiac cine-tomographic imaging in the elderly: antianginal effects of nifedipine-GITS. *J Am Geriatr Soc* 1993;41(9):967–974.
158. Cohn PF. Concomitant use of nitrates, calcium channel blockers, and beta blockers for optimal antianginal therapy. *Clin Cardiol* 1994;17(8):415–421.
159. Elkayam U, et al. A prospective, randomized, double-blind, crossover study to compare the efficacy and safety of chronic nifedipine therapy with that of isosorbide dinitrate and their combination in the treatment of chronic congestive heart failure. *Circulation* 1990;82(6):1954–1961.
160. Ishikawa K, et al. Short-acting nifedipine and diltiazem do not reduce the incidence of cardiac events in patients with healed myocardial infarction. Secondary Prevention Group. *Circulation* 1997;95(10):2368–2373.
161. Rose JC, Mayer SA. Optimizing blood pressure in neurologic emergencies. *Neurocrit Care* 2004;1(3):287–300.
162. Haas CE, LeBlanc JM. Acute postoperative hypertension: a review of therapeutic options. *Am J Health Syst Pharm* 2004;61(16):1661–1673; quiz 1674–1675.
163. Kwak YL, et al. Comparison of the effects of nicardipine and sodium nitroprusside for control of increased blood pressure after coronary artery bypass graft surgery. *J Int Med Res* 2004;32(4):342–350.
164. Rabinstein AA, Wijdicks EF. Cerebral vasospasm in subarachnoid hemorrhage. *Curr Treat Options Neurol* 2005;7(2):99–107.
165. Fischell TA, Maheshwari A. Current applications for nicardipine in invasive and interventional cardiology. *J Invasive Cardiol* 2004;16(8):428–432.
166. Feigin VL, et al. Calcium antagonists for aneurysmal subarachnoid haemorrhage. *Cochrane Database Syst Rev* 2000(2):CD000277.
167. Horn J, Limburg M. Calcium antagonists for acute ischemic stroke. *Cochrane Database Syst Rev* 2000(2):CD001928.
168. de Vries RJ, van Veldhuisen DJ, Dunselman PH. Efficacy and safety of calcium channel blockers in heart failure: focus on recent trials with second-generation dihydropyridines. *Am Heart J* 2000;139(2 Pt 1):185–194.
169. Taylor SH. Usefulness of amlodipine for angina pectoris. *Am J Cardiol* 1994;73(3):28A–33A.
170. Staessen JA, et al. Randomised double-blind comparison of placebo and active treatment for older patients with isolated systolic hypertension. The Systolic Hypertension in Europe (Syst-Eur) Trial Investigators. *Lancet* 1997;350(9080):757–764.
171. Lee DS, et al. Randomized comparison of T-type versus L-type calcium-channel blockade on exercise duration in stable angina: results of the Posicor Reduction of Ischemia During Exercise (PRIDE) trial. *Am Heart J* 2002;144(1):60–67.
172. Frishman WH. Mibefradil: a new selective t-channel calcium antagonist for hypertension and angina pectoris. *J Cardiovasc Pharmacol Ther* 1997;2(4):321–330.
173. Glaser S, et al. Torsades de pointes caused by mibefradil. *Eur J Heart Fail* 2001;3(5):627–630.
174. Sasaki J, et al. Comparative effects of monatepil, a novel calcium antagonist with alpha 1-adrenergic-blocking activity, and nitrendipine on lipoprotein and carbohydrate metabolism in patients with hypertension. *Am J Hypertens* 1994;7(10 Pt 2):161S–166S.
175. Hollingshead LM, Faulds D, Fitton A. Bepridil. A review of its pharmacological properties and therapeutic use in stable angina pectoris. *Drugs* 1992;44(5):835–857.
176. Engelman RM, et al. Rebound vasospasm after coronary revascularization in association with calcium antagonist withdrawal. *Ann Thorac Surg* 1984;37(6):469–472.
177. Marijic J, et al. Effects and interaction of verapamil and volatile anesthetics on the isolated perfused guinea pig heart. *Anesthesiology* 1988;69(6):914–922.
178. Humphrey LS, Blanck TJ. Intraoperative use of verapamil for nitroglycerin-refractory myocardial ischemia. *Anesth Analg* 1985;64(1):68–71.
179. Lee MK, et al. Comparative effects of diltiazem with enflurane or desflurane on myocardial contractility and heart rate in the isolated rat hearts. *Acta Anaesthesiol Sin* 2000;38(4):173–179.
180. Rosenthal T, Ezra D. Calcium antagonists. Drug interactions of clinical significance. *Drug Saf* 1995;13(3):157–187.
181. Gallenberg LA, et al. Effects of nifedipine with isoflurane, halothane, or enflurane on automaticity, conduction, and contractility in isolated guinea pig hearts. *Anesthesiology* 1993;78(6):1112–1119; discussion 23A–24A.
182. Nishiyama T, et al. Interactions between nicardipine and enflurane, isoflurane, and sevoflurane. *Can J Anaesth* 1997;44(10):1071–1076.
183. Chung F, et al. Calcium channel blockade does not offer adequate protection



from perioperative myocardial ischemia. *Anesthesiology* 1988;69(3):343-347.

184. Borer JS, et al. Antianginal and antiischemic effects of ivabradine, an I(f) inhibitor, in stable angina: a randomized, double-blind, multicentered, placebo-controlled trial. *Circulation* 2003;107(6):817-823.

185. Tardif JC, et al. Efficacy of ivabradine, a new selective I(f) inhibitor, compared with atenolol in patients with chronic stable angina. *Eur Heart J* 2005;26(23):2529-2536.

186. IONA Study Group. Effect of nicorandil on coronary events in patients with stable angina: the Impact of Nicorandil in Angina (IONA) randomised trial. *Lancet* 2002;359(9314):1269-1275.

187. Chaitman BR, et al. Effects of ranolazine with atenolol, amlodipine, or diltiazem on exercise tolerance and angina frequency in patients with severe chronic angina: a randomized controlled trial. *JAMA* 2004;291(3):309-316.

188. Chaitman BR, et al. Anti-ischemic effects and long-term survival during ranolazine monotherapy in patients with chronic severe angina. *J Am Coll Cardiol* 2004;43(8):1375-1382.

189. Szwed H, et al. Combination treatment in stable effort angina using trimetazidine and metoprolol: results of a randomized, double-blind, multicentre study (TRIMPOL II). *TRIMetazidine in POLand*. *Eur Heart J* 2001;22(24):2267-2274.

190. Vaughan Williams EM. A classification of antiarrhythmic actions reassessed after a decade of new drugs. *J Clin Pharmacol* 1984;24(4):129-147.

191. The AVID investigators. Antiarrhythmics Versus Implantable Defibrillators (AVID)—rationale, design, and methods. *Am J Cardiol* 1995;75(7):470-475.

192. Gallik D, Altamirano J, Singh BN. Restoring sinus rhythm in patients with atrial flutter and fibrillation: pharmacologic or electrical cardioversion? *J Cardiovasc Pharmacol Ther* 1997;2(2):135-144.

193. Naccarelli GV, et al. Old and new antiarrhythmic drugs for converting and maintaining sinus rhythm in atrial fibrillation: comparative efficacy and results of trials. *Am J Cardiol* 2003;91(6A):15D-26D.

194. Gowda RM, et al. Torsade de pointes: the clinical considerations. *Int J Cardiol* 2004;96(1):1-6.

195. Morganroth J, Goin JE. Quinidine-related mortality in the short-to-medium-term treatment of ventricular arrhythmias. A meta-analysis. *Circulation* 1991;84(5):1977-1983.

196. Coplen SE, et al. Efficacy and safety of quinidine therapy for maintenance of sinus rhythm after cardioversion. A meta-analysis of randomized control trials. *Circulation* 1990;82(4):1106-1116.

197. Roden DM, et al. Antiarrhythmic efficacy, pharmacokinetics and safety of N-acetylprocainamide in human subjects: comparison with procainamide. *Am J Cardiol* 1980;46(3):463-468.

198. Sherrid MV, et al. Multicenter study of the efficacy and safety of disopyramide in obstructive hypertrophic cardiomyopathy. *J Am Coll Cardiol* 2005;45(8):1251-1258.

199. The Cardiac Arrhythmia Suppression Trial II Investigators. Effect of the antiarrhythmic agent moricizine on survival after myocardial infarction. *N Engl J Med* 1992;327(4):227-233.

200. Hine LK, et al. Meta-analytic evidence against prophylactic use of lidocaine in acute myocardial infarction. *Arch Intern Med* 1989;149(12):2694-2698.

201. Dorian P, et al. Amiodarone as compared with lidocaine for shock-resistant ventricular fibrillation. *N Engl J Med* 2002;346(12):884-890.

202. Kapur PA, Grogan DL, Fournier DJ. Cardiovascular interactions of lidocaine with verapamil or diltiazem in the dog. *Anesthesiology* 1988;68(1):79-85.

203. Duff HJ, et al. Mexiletine in the treatment of resistant ventricular arrhythmias: enhancement of efficacy and reduction of dose-related side effects by combination with quinidine. *Circulation* 1983;67(5):1124-1128.

204. Woosley RL, et al. Pharmacology, electrophysiology, and pharmacokinetics of mexiletine. *Am Heart J* 1984;107(5 Pt 2):1058-1065.

205. IMPACT Research Group. International Mexiletine and Placebo Antiarrhythmic Coronary Trial (IMPACT): II. Results from 24-hour electrocardiograms. *Eur Heart J* 1986;7(9):749-759.

206. Echt DS, et al. Mortality and morbidity in patients receiving encainide, flecainide, or placebo. The Cardiac Arrhythmia Suppression Trial. *N Engl J Med* 1991;324(12):781-788.

207. Conard GJ, Ober RE. Metabolism of flecainide. *Am J Cardiol* 1984;53(5):41B-51B.

208. Morganroth J, Anderson JL, Gentzkow GD. Classification by type of ventricular arrhythmia predicts frequency of adverse cardiac events from flecainide. *J Am Coll Cardiol* 1986;8(3):607-615.

209. McAllister CB, et al. Oxidative metabolism of encainide: polymorphism, pharmacokinetics and clinical considerations. *Xenobiotica* 1986;16(5):483-490.

210. Funck-Brentano C, et al. Propafenone. *N Engl J Med* 1990;322(8):518-525.

211. Task Force of the Working Group on Arrhythmias of the European Society of Cardiology. The Sicilian gambit. A new approach to the classification of antiarrhythmic drugs based on their actions on arrhythmogenic mechanisms. *Circulation* 1991;84(4):1831-1851.

212. Miller JM, Zipes DP. Therapy for cardiac arrhythmias. In: Zipes DP, Libby P, Borro RO, Braunwald E, eds. *Braunwald's Heart Disease—A Textbook of Cardiovascular Medicine*. Philadelphia: Elsevier Saunders, 2005:729-731.

213. Daoud EG, et al. Preoperative amiodarone as prophylaxis against atrial fibrilla-

tion after heart surgery. *N Engl J Med* 1997;337(25):1785-1791.

214. Kudenchuk PJ, et al. Amiodarone for resuscitation after out-of-hospital cardiac arrest due to ventricular fibrillation. *N Engl J Med* 1999;341(12):871-878.

215. American Heart Association. 2005 American Heart Association Guidelines for Cardiopulmonary Resuscitation and Emergency Cardiovascular Care. *Circulation* 2005;112(24 Suppl):IV1-IV203.

216. Goldschlager N, et al. Practical guidelines for clinicians who treat patients with amiodarone. Practice Guidelines Subcommittee, North American Society of Pacing and Electrophysiology. *Arch Intern Med* 2000;160(12):1741-1748.

217. Balsler JR. The rational use of intravenous amiodarone in the perioperative period. *Anesthesiology* 1997;86(4):974-987.

218. Rooney RT, et al. Additive cardiac depression by volatile anesthetics in isolated hearts after chronic amiodarone treatment. *Anesth Analg* 1995;80(5):917-924.

219. Feldman HS, et al. Treatment of acute systemic toxicity after the rapid intravenous injection of ropivacaine and bupivacaine in the conscious dog. *Anesth Analg* 1991;73(4):373-384.

220. Anderson JL, Prystowsky EN. Sotalol: an important new antiarrhythmic. *Am Heart J* 1999;137(3):388-409.

221. Nattel S, et al. Concentration dependence of class III and beta-adrenergic blocking effects of sotalol in anesthetized dogs. *J Am Coll Cardiol* 1989;13(5):1190-1194.

222. Crystal E, et al. Interventions on prevention of postoperative atrial fibrillation in patients undergoing heart surgery: a meta-analysis. *Circulation* 2002;106(1):75-80.

223. Sakaguchi Y, et al. Halothane sensitizes the guinea-pig heart to pharmacological i(kr) blockade: comparison with urethane anesthesia. *J Pharmacol Sci* 2005;99(2):185-190.

224. Murray KT. Ibutilide. *Circulation* 1998;97(5):493-497.

225. Vanderlugt JT, et al. Efficacy and safety of ibutilide fumarate for the conversion of atrial arrhythmias after cardiac surgery. *Circulation* 1999;100(4):369-375.

226. Kalus JS, Mauro VF. Dofetilide: a class III-specific antiarrhythmic agent. *Ann Pharmacother* 2000;34(1):44-56.

227. Martinez EA, Epstein AE, Bass EB. Pharmacologic control of ventricular rate: American College of Chest Physicians guidelines for the prevention and management of postoperative atrial fibrillation after cardiac surgery. *Chest* 2005;128(2 Suppl):56S-60S.

228. Gupta AK, et al. Adenosine induced ventricular fibrillation in Wolff-Parkinson-White syndrome. *Pacing Clin Electrophysiol* 2002;25(4 Pt 1):477-480.

229. Eisenach JC, Hood DD, Curry R. Preliminary efficacy assessment of intrathecal

injection of an American formulation of adenosine in humans. *Anesthesiology* 2002;96(1):29–34.

230. Sacks FM, et al. The effect of pravastatin on coronary events after myocardial infarction in patients with average cholesterol levels. Cholesterol and Recurrent Events Trial investigators. *N Engl J Med* 1996;335(14):1001–1009.

231. Scandinavian Simvastatin Survival Study Group. Randomised trial of cholesterol lowering in 4444 patients with coronary heart disease: the Scandinavian Simvastatin Survival Study (4S). *Lancet* 1994;344(8934):1383–1389.

232. The Long-Term Intervention with Pravastatin in Ischaemic Disease (LIPID) Study Group. Prevention of cardiovascular events and death with pravastatin in patients with coronary heart disease and a broad range of

initial cholesterol levels. *N Engl J Med* 1998;339(19):1349–1357.

233. Vaughan CJ, Gotto AM Jr, Basson CT. The evolving role of statins in the management of atherosclerosis. *J Am Coll Cardiol* 2000;35(1):1–10.

234. Durazzo AE, et al. Reduction in cardiovascular events after vascular surgery with atorvastatin: a randomized trial. *J Vasc Surg* 2004;39(5):967–975; discussion 975–976.

235. Poldermans D, et al. Statins are associated with a reduced incidence of perioperative mortality in patients undergoing major noncardiac vascular surgery. *Circulation* 2003;107(14):1848–1851.

236. O'Neil-Callahan K, et al. Statins decrease perioperative cardiac complications in patients undergoing noncardiac vascular

surgery: the Statins for Risk Reduction in Surgery (StaRRS) study. *J Am Coll Cardiol* 2005;45(3):336–342.

237. McGirt MJ, et al. 3-Hydroxy-3-methylglutaryl coenzyme A reductase inhibitors reduce the risk of perioperative stroke and mortality after carotid endarterectomy. *J Vasc Surg* 2005;42(5):829–836; discussion 836–837.

238. Amar D, et al. Statin use is associated with a reduction in atrial fibrillation after noncardiac thoracic surgery independent of C-reactive protein. *Chest* 2005;128(5):3421–3427.

239. Forestier F, et al. Severe rhabdomyolysis after laparoscopic surgery for adenocarcinoma of the rectum in two patients treated with statins. *Anesthesiology* 2002;97(4):1019–1021.

## CHAPTER 44

## Pharmacology of Local Anesthetics\*

James E. Heavner, DVM, PhD

Local anesthetics are widely used to prevent or treat acute pain; to treat inflammatory, cancer, and chronic pain; and for diagnostic and prognostic purposes. Drugs classified as local anesthetics reversibly block action potential propagation in axons by preventing the sodium entry that produces the potentials.<sup>1</sup> However, other actions of these drugs, such as antiinflammation by interaction with G-protein receptors,<sup>2</sup> also are thought to be relevant to their use to prevent or treat pain. Nociceptive pain, as well as neuropathic pain, are targeted with this group of drugs. Any part of the nervous system, from the periphery to the brain, may be where local anesthetics act to produce a desired anesthetic or analgesic effect. A variety of formulations of local anesthetics, routes of administration, and methods of administration are used. The drugs are formulated commercially or by medical personnel according to the intended route of administration and/or to address specific concerns or needs. This chapter provides a concise review of the pharmacology of local anesthetics.

## DISCOVERY AND EVOLUTION OF LOCAL ANESTHETICS

## Cocaine, Procaine, and Lidocaine

Koller is credited with introducing local anesthetics into medical practice when he used cocaine to numb the cornea before operating on the eye.<sup>3</sup> Fundamental to the development of synthetic local anesthetics was isolation of cocaine by Neimann, in 1860, from coca beans, and elucidation of its chemical structure. Procaine was first synthesized in 1904, and lidocaine was

first synthesized in 1943. Synthesis of molecules with local anesthetic activity paved the way for “tinkering” with the molecules by systematically modifying chemical structure and testing for a desired result, for example reducing toxicity, in developing new local anesthetics.

## Roots of Modern Use

Figure 44–1 presents a chronology of the introduction of local anesthetics into clinical practice. Four amino ester-linked local anesthetics (see Three Parts of Local Anesthetic Molecules) appear in the figure: cocaine, procaine, tetracaine, and chlorprocaine. The other local anesthetics are amino amide

linked. What is evident from the figure is the focus since 1955 on the development of amino amide- and not amino ester-linked local anesthetics. Reasons for this include the allergenic potential of amino ester-linked local anesthetics and the instability of amino ester bonds.

## IMPORTANT CHEMICAL FEATURES

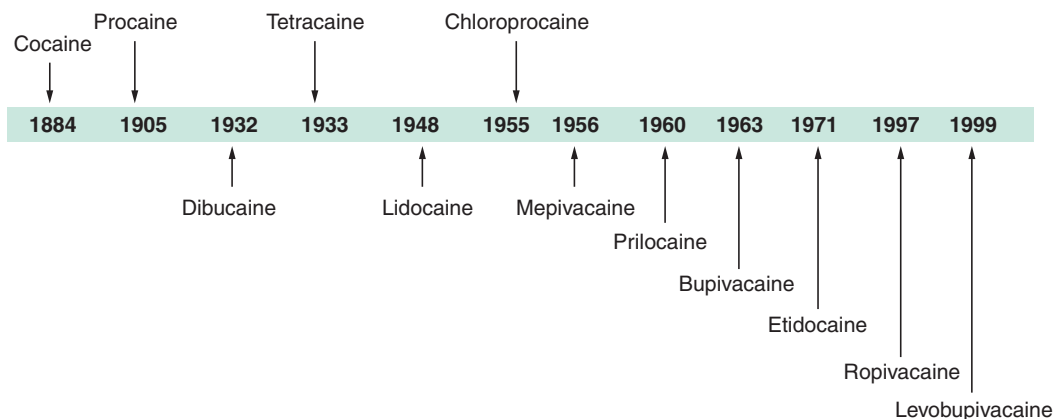
## Three Parts of Local Anesthetic Molecules

All local anesthetic molecules in clinical use have three parts: lipophilic (aromatic) end, hydrophilic (amine) end, and a link between the ends (Fig.

## KEY POINTS

1. Pharmacodynamics—Local anesthetics stop the propagation of action potentials in nerve axons by preventing the influx of sodium through voltage-gated sodium channels in the axon membrane. Other actions of local anesthetics, for example, effects on other voltage-gated ion channels and ligand-gated ion channels, may be important for their analgesic action and/or for undesired side effects.
2. Chemistry—Local anesthetics are weak bases with three structural parts: a hydrophilic end and a lipophilic end linked by an amino ester or an amino amide bond. The bond is the basis for classifying local anesthetics into 2 groups: the amino esters and the amino amides. Optical isomers of local anesthetics with an asymmetric carbon atom usually differ in potency, duration of action, and toxicity.
3. Expression of local anesthetic action—In vitro, there generally is a positive correlation between molecular weight of local anesthetic molecules and lipophilicity, protein binding, duration of action, potency, and toxicity; there is an inverse relation with speed of onset. In vivo expression of local anesthetic action is dependent on other factors as well, such as injection site, dose, intrinsic vasoactivity, and formulation. The manifestation of sensory versus motor block varies and is dependent on many factors, including the agent and type of block technique.
4. Pharmacokinetics—Local anesthetics usually are injected near the target site instead of relying on systemic circulation to carry them there (except, e.g., intravenous regional anesthesia and treatment of certain neuropathic pain states). Barriers to the diffusion of local anesthetics to their target vary and are dependent on injection site (e.g., epidural vs. intrathecal), influence dose, speed of onset, and duration of action. Local anesthetics that reach systemic circulation are widely distributed in the body. Hydrolysis of the amino ester bond by esterases in blood is the primary biotransformation process for amino ester-linked local anesthetics. Hepatic extraction and biotransformation are important elimination and biotransformation pathways for amino amide-linked local anesthetics.
5. Toxicity—Local anesthetic toxicity can be categorized as allergic, tissue, cardiovascular, central nervous system, and methemoglobinemia. Concerns about cardiovascular toxicity related to bupivacaine have driven a search for long-acting local anesthetics with less cardiotoxic action.
6. Formulation—Substances are sometimes added to local anesthetic formulations to preserve the molecules, to prevent microbial growth, to prevent systemic absorption, to enhance and/or prolong local anesthetic action, and to enhance spread of the local anesthetic.

\*This chapter includes substantial material from Covino BG. Pharmacology of local anesthetic agents. In: McRogers, JH Timber, GB Covino, DE Longnecker, eds. Principles and Practice of Anesthesiology. Vol 2. St. Louis: Mosby Year Book, 1993: 1235–1257.



**FIGURE 44-1.** Chronology of the introduction of different anesthetics into clinical practice. Chlorprocaine (1955) is the last amino ester-linked local anesthetic introduced that is still in clinical use. (Courtesy of David A. Scott, Melbourne, Australia, 2000.)

44-2). The link contains either an amino ester or an amino amide bond and local anesthetics are designated as belonging to one of two groups: the amino ester-linked local anesthetics or amino amide-linked local anesthetics. Procaine is the prototypic amino ester-linked local anesthetic, and lidocaine is the prototypic amino amide-linked local anesthetic (Fig. 44-3).

Amino amides are extremely stable agents, whereas amino esters are relatively unstable in solution. Consequently, aqueous solutions of amino ester agents have relatively short shelf lives compared with solutions of amino amides, and are sensitive to exposure to high temperatures. The amino esters are hydrolyzed in plasma by cholinesterase enzymes, whereas the amino amide compounds undergo enzymatic biotransformation in the liver.

There are 2 varieties of amino amide local anesthetics based on the structure of the amino amide link. One variety is the aminoacyl amides, such as lidocaine and bupivacaine, and the other is the aminoalkyl amides such as dibucaine. The different structures influence the duration of action and biotransformation. Further distinction within the aminoacyl amide class is made based on whether the hydrophilic amino end is a straight carbon chain (e.g., lidocaine) or the amino nitrogen is within a

ring structure (pipecoloxylidide, e.g., mepivacaine).

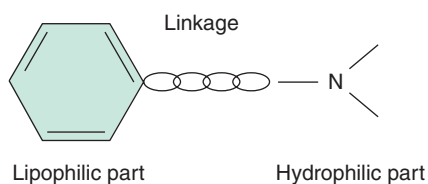
### Chiral Forms

The newest additions to clinically available local anesthetics, ropivacaine (Fig. 44-4) and levobupivacaine, represent (a) the exploitation of technology that permits cost-favorable separation of racemic mixtures of local anesthetics into pure enantiomers and (b) the search for local anesthetics with greater safety margins. Simplistically stated, molecules with an asymmetric carbon atom exist in forms that are mirror images (i.e., exhibit “handness, chirality”), with images (enantiomer, stereoisomers) distinguished by how they rotate light according to the orientation of the structures in three dimensions. Various terms are used to refer to the different enantiomers; this chapter uses S and R to designate two different enantiomers. A racemic mixture contains equal amounts of the R and S isomers. Commercial formulations of

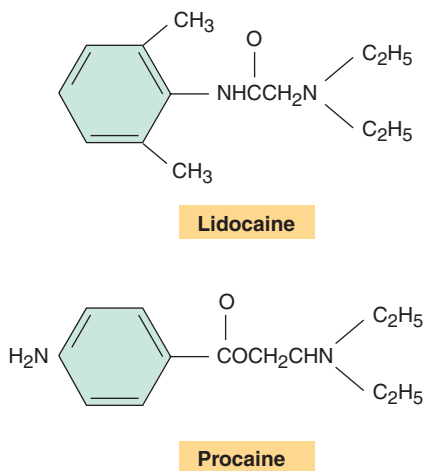
ropivacaine and levobupivacaine contain the S enantiomer. Note that levobupivacaine is the S form of bupivacaine. The motive for marketing pure enantiomers is evidence that the S form is less toxic, more potent, and longer acting than the R form or the racemic mixture (Table 44-1).

### Lipid Solubility and Protein Binding

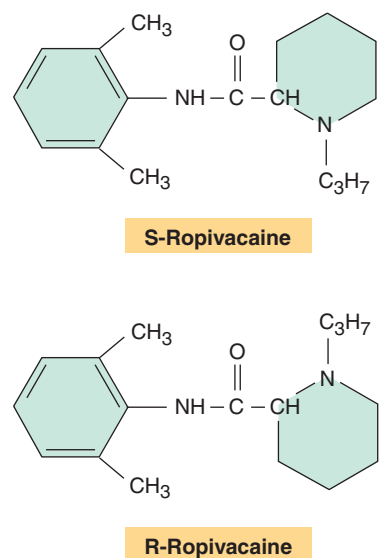
Testing modifications to the basic procaine and lidocaine structure revealed that increasing the molecular weight of the molecules by adding carbon atoms to either end of the structure or to the link generally increases lipid solubility, protein binding, and duration of action and toxicity, and influences biotransformation of the molecule (Figs. 44-5 and 44-6). There



**FIGURE 44-2.** General structure of all local anesthetic molecules showing three parts.



**FIGURE 44-3.** Structure of lidocaine and procaine.



**FIGURE 44-4.** Clinical forms of ropivacaine. The only difference between the S- and R-isomers is their spatial orientation.



TABLE 44-1.

## Anesthetic Duration and Toxicity of Local Anesthetic Isomers

Drug	Duration	Toxicity
Etidocaine	S=R	S=R
Mepivacaine	S>R	S=R
Bupivacaine	S>R	S<R
Ropivacaine	S>R	S<R

is a positive correlation between intrinsic local anesthetic potency and lipid solubility of local anesthetics.

## Cation and Base Forms

Most local anesthetics have a tertiary amine on the hydrophilic end. Exceptions include prilocaine, which has a secondary amine and benzocaine, which has a primary amine. Tertiary amines have a positive charge (*cation*) or are uncharged (*base*). The ratio of cation to base is determined by the  $pK_a$  of the local anesthetic and the pH of the solution (Table 44-2). The unchanged forms of local anesthetics pass readily through cell membranes and hence speed of onset of local anesthetic block, at least theoretically, is increased by increasing the concentration of uncharged local anesthetic molecules injected.

Because local anesthetics are weak bases, increasing the pH ("alkalinization") of solution increases the ratio of base to cation. The Henderson-Hasselbalch equation can be used to quantify the ratio:

$$pK_a(\text{local anesthetic}) - \text{pH}(\text{solution}) = \text{Log} \left( \frac{[\text{cation}]}{[\text{base}]} \right)$$

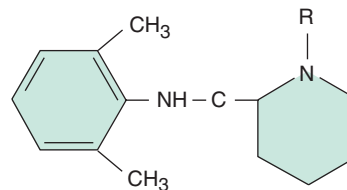
Sodium bicarbonate is used clinically to increase pH of local anesthetic solutions.

Important to note is that commercial aqueous solutions of local anesthetics are acidified, so the hydrophilic (cationic) state, which is water soluble, is favored. Overzealous alkalinization can cause local anesthetic molecules to precipitate from solution.

## PHARMACODYNAMICS OF LOCAL ANESTHETICS

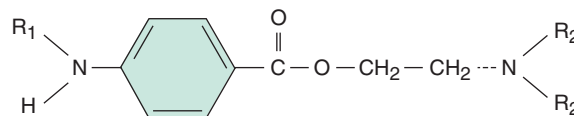
## Neurophysiologic and Neuroanatomical Considerations

Reversible block of voltage-gated sodium channels in axons is generally



	Mepivacaine	Ropivacaine	Bupivacaine
R =	CH <sub>3</sub>	C <sub>3</sub> H <sub>6</sub>	C <sub>4</sub> H <sub>9</sub>
Equieffective	1	0.37	0.25
Lipid/H <sub>2</sub> O	0.8	2.8	27.5
Protein bound (%)	77.5	94	95.6

FIGURE 44-5. Results of structure alterations—amide linked. The amino amide-linked local anesthetics mepivacaine, ropivacaine, and bupivacaine vary only by substitution at R on the basic molecule shown above. As the number of carbon atoms increases at R, potency, lipid solubility, and protein binding increase. (Reprinted from Heavner JE. Pain mechanisms and local anesthetics: scientific foundations for clinical practice. In: Raj PP, ed. Textbook of Regional Anesthesia. New York: Churchill Livingstone, 2002:105-124, with permission from Elsevier.)



	Procaine	Tetracaine
R <sub>1</sub>	H	C <sub>4</sub> H <sub>9</sub>
R <sub>2</sub>	C <sub>2</sub> H <sub>5</sub>	CH <sub>3</sub>
Hydrolysis rate (μM/m1/hr)	1.1	0.25
= potent	2	0.25
Duration (min)	50	175
LD50 (mice)	615	48

FIGURE 44-6. Results of structure alterations—ester linked.

thought to be how local anesthetics block sensory and motor function (Fig. 44-7). Some of the evidence supporting this is the following: (a) action potentials do not develop in axons exposed to local anesthetic; (b) sodium currents responsible for generation of action potentials are blocked by these drugs; and (c) local anesthetics do not affect the transmembrane potential of axons. The "state" of the sodium channel (resting, open, inactivated) changes during the cycle of polarized, depolarized, repolarized. The order of affinity of local anesthetics for different channel states is open > inactivated > resting. Many investigators have shown that the block of propagation of action potentials is a function of frequency of depolarization, which supports the conclusion that the open state of the sodium channel is the primary target of local anesthetic molecules. This is referred to as "state-dependent block."

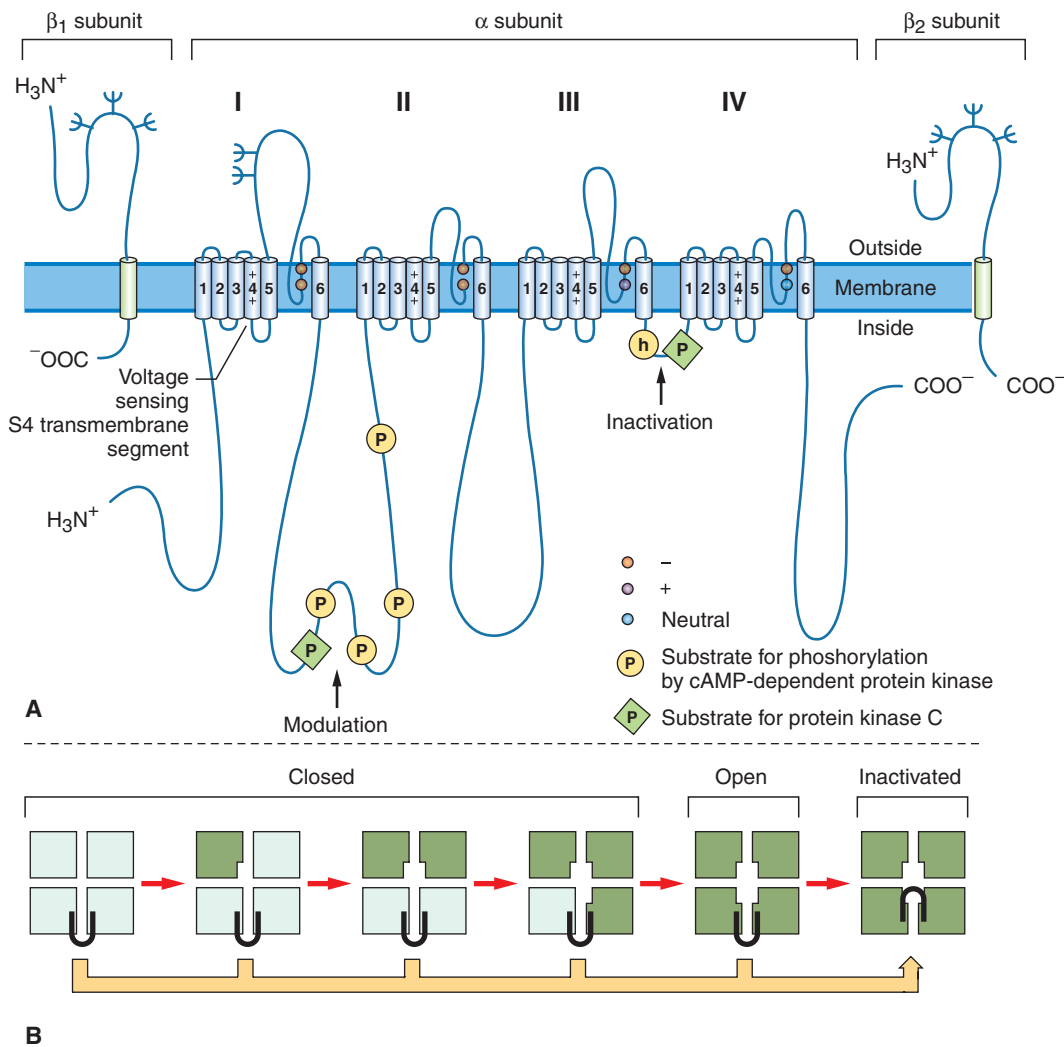
## Voltage-Gated Sodium Channels

Voltage-gated ion channels are ion channels (Na<sup>+</sup>, K<sup>+</sup>, Ca<sup>2+</sup>, etc.) whose permeability is a function of transmembrane potential. There are a number of sodium channel subtypes that generally are divided into those that are tetrodotoxin sensitive (TTXs) and tetrodotoxin resistant (TTXr).<sup>4</sup>

TABLE 44-2.

## Cation-to-Base Ratio

	$pK_a$	pH 7.4
Procaine	8.9	32:1
Lidocaine	7.9	3:1
Mepivacaine	7.6	2:1
Tetracaine	8.5	13:1
Benzocaine	3.5	All base
Bupivacaine	8.1	5:1
Ropivacaine	8.1	5:1



**FIGURE 44-7.** Structure and function of voltage-gated  $\text{Na}^+$  channels. **A.** A two-dimensional representation of the  $\alpha$  (center),  $\beta_1$  (left), and  $\beta_2$  (right) subunits of the voltage-gated  $\text{Na}^+$  channel from mammalian brain. The polypeptide chains are represented by continuous lines with length approximately proportional to the actual length of each segment of the channel protein. Cylinders represent regions of transmembrane  $\alpha$  helices.  $\Psi$  indicates sites of demonstrated *N*-linked glycosylation. Note the repeated structure of the four homologous domains (I through IV) of the  $\alpha$  subunit. Voltage sensing: The S<sub>4</sub> transmembrane segments in each homologous domain of the  $\alpha$  subunit serve as voltage sensors. (+) Represents the positively charged amino acid residues at every third position within these segments. An electrical field (negative inside) exerts a force on these charged amino acid residues, pulling them toward the intracellular side of the membrane. Pore: The S<sub>5</sub> and S<sub>6</sub> transmembrane segments and the short membrane-associated loops between them (segments SS<sub>1</sub> and SS<sub>2</sub>) form the walls of the pore in the center of an approximately symmetrical square array of the four homologous domains (see *B*). The amino acid residues indicated by circles in segment SS<sub>2</sub> are critical for determining the conductance and ion selectivity of the  $\text{Na}^+$  channel and its ability to bind the extracellular pore blocking toxins tetrodotoxin and saxitoxin. Inactivation: The short intracellular loop connecting homologous domains III and IV serves as the inactivation gate of the  $\text{Na}^+$  channel. It is thought to fold into the intracellular mouth of the pore and occlude it within a few milliseconds after the channel opens. Three hydrophobic residues (isoleucine–phenylalanine–methionine [IFM]) at the position marked *H* appear to serve as an inactivation particle, entering the intracellular mouth of the pore and binding to an inactivation gate receptor there. Modulation: The gating of the  $\text{Na}^+$  channel can be modulated by protein phosphorylation. Phosphorylation of the inactivation gate between homologous domains III and IV by protein kinase C slows inactivation. Phosphorylation of sites in the intracellular loop between homologous domains I and II by either protein kinase C (◇) or cyclic adenosine monophosphate (AMP)-dependent protein kinase (⊕) reduces  $\text{Na}^+$  channel activation. **B.** The four homologous domains of the  $\text{Na}^+$  channel  $\alpha$  subunit are illustrated as a square array as viewed looking down on the membrane. The sequence of conformational changes that the  $\text{Na}^+$  channel undergoes during activation and inactivation is diagrammed. Upon depolarization, each of the four homologous domains undergoes a conformational change in sequence to an activated state. After all four domains have activated, the  $\text{Na}^+$  channel can open. Within a few milliseconds after opening, the inactivation gate between domains III and IV closes over the intracellular mouth of the channel and occludes it, preventing further ion conductance. (Reproduced with permission from Catterall W, Mackie K. Local Anesthetics. In Hardman JG, Limbird LE, Gilman AF, eds. *The Pharmacological Basis of Therapeutics*. 10th ed. New York: McGraw-Hill, 2001:370.)

Most sensory neurons generate TTXs currents. However, TTXr currents are present in a high proportion of smaller dorsal root ganglion neurons associated with nociceptive A $\delta$ , and C fibers.

Available evidence indicates that channels from both groups are involved in pain states as a result of changes in channel function and expression caused by disease or injury.

Arguments have been put forth that local anesthetics might exert their pharmacologic action not only on  $\text{Na}^+$  conductance, but also on other ionic conductances (e.g.,  $\text{K}^+$  and  $\text{Ca}^{2+}$ ).<sup>5,6</sup>

TABLE 44-3.

## Disposition Kinetics in Adult Human

Local Anesthetic	V <sub>dss</sub> (L)	Cl (L/min)	T <sub>1/2</sub> γ (h)	Hepatic Extraction	Lipid Solubility	Protein Binding	Blood/Plasma Partitioning
Mepivacaine	84	0.78	1.9	0.40	0.8	78%	0.92
Ropivacaine	59	0.73	1.8	0.40	2.8	94%	0.69
Bupivacaine	73	0.58	2.7	0.51	27.5	96%	0.73
Lidocaine	91	0.95	1.6	0.72	2.9	60%	0.84
Prilocaine	261	2.84	1.5	—	—	55%	—
Etidocaine	133	1.22	2.6	0.74	—	94%	0.58

## Differential Block

Differential block, the block of pain perception without motor block for example, is observed clinically but the mechanism responsible for this is poorly understood. The clinical manifestations of differential block vary depending on the local anesthetic used.<sup>7</sup> For many years, differential block was ascribed to smaller axons being more sensitive than large ones to local anesthetics,<sup>8</sup> but this “size principle” was challenged.<sup>9</sup> Strichartz and Berde<sup>7</sup> cite a number of different factors that might contribute to differential block, including anatomical and relative sensitivity to sodium and potassium channels of different local anesthetics. Oda et al.<sup>10</sup> suggested that preferential block of TTXr sodium channels by ropivacaine in small dorsal root ganglia neurons (associated with nociceptive sensation) underlies differential block observed during epidural anesthesia with this drug.

## Pain Relief by Systemic Administration

Another pharmacodynamic puzzle is the mechanism whereby systemically administered local anesthetic relieves pain. Analgesic effect has been reported following intravenous lidocaine administration in many acute and chronic conditions.<sup>11-18</sup> Subcutaneously injected bupivacaine reportedly produces analgesia via a systemic effect.<sup>19</sup> Normal or altered sodium channels located in various areas of the brain, spinal cord, or dorsal root ganglia, or in peripheral axons, are mentioned most frequently as the action sites. Zhang et al.<sup>20</sup> reported that in rats systemic lidocaine delivered via implanted osmotic pump reduces sympathetic nerve sprouting in dorsal root ganglion that is associated with some neuropathic pain behaviors. Takatori et al.<sup>21</sup> presented evidence that inhibition of nerve growth factor (NGF)

stimulated tyrosine kinase activity of TrkA, a high-affinity receptor of NGF, might be involved in the suppression of neurite outgrowth by local anesthetics.

## Ligand-Gated Ion Channels

Ligand-gated ion channels are channels whose permeability status depends upon the interaction between a ligand and a receptor that influences channel function. Many of these receptors interact with G proteins. Local anesthetics effect a number of biologic processes, including inhibition of G-protein coupled receptor signaling, that are potentially important pharmacodynamic actions of value in treating pain.

## PHARMACOKINETICS OF INJECTED LOCAL ANESTHETICS

### Distribution to the Target Site

The usual pharmacokinetics parameters (Table 44-3) presented for local anesthetics incompletely describe important details regarding distribution of these drugs from application sites to target and nontarget structures. It is well established that systemic absorption of local anesthetics correlates positively with the vascularity of the injection site (intravenous > tracheal > intercostal > paracervical > epidural > brachial plexus > sciatic > subcutaneous). The spinal cord meninges influence distribution of local anesthetics from the epidural and subarachnoid spaces. Intact skin is nearly a complete barrier to local anesthetic penetration. In the latter case, special local anesthetic formulations (e.g., eutectic mixture of local anesthetics [EMLA] cream, an eutectic mixture of lidocaine and prilocaine) or delivery methods (e.g., electrophoresis) are employed to facilitate transcutaneous transfer. The large number of different injection sites used (e.g., epidural, intrathecal,

intrapleural, intraarticular, intramuscular, perineural, topical) and the variety of dosing methods (e.g., single shot, continuous infusion, intermittent infusion) make comprehensive consideration of all pharmacokinetic considerations beyond the scope of this chapter.

## Absorption

In addition to the injection site, the vascular absorption of local anesthetic agents is related to dosage, addition of a vasoconstrictor agent, and specific agent employed. The high blood concentrations following intercostal administration are probably related to the multiple injections required for intercostal nerve blocks. As a consequence of this, local anesthetic solution is exposed to a greater vascular area, which results in a greater rate and degree of absorption. After thoracic paravertebral block, ropivacaine demonstrates a biphasic fast and slow absorption pattern.<sup>22</sup> The fast phase approximates the speed of intravenous injection and accounts for nearly half of ropivacaine absorption. When epinephrine (5 µg/mL) is added, systemic absorption and peak plasma concentration of ropivacaine is significantly reduced.

For most local anesthetic agents, a linear relationship exists between the amount of drug administered and the resultant peak venous plasma concentration. The mean venous plasma concentration of lidocaine increases from approximately 1.5–4 µg/mL as the total dose administered into the lumbar epidural space is increased from 200–600 mg. Depending on the site of administration, a peak blood concentration of 0.5–2.0 µg/mL is achieved for each 100 mg of lidocaine or mepivacaine injected. Simon et al.<sup>23</sup> reported that systemic absorption of ropivacaine following epidural administration was biphasic with higher absorption kinetics in younger than in older

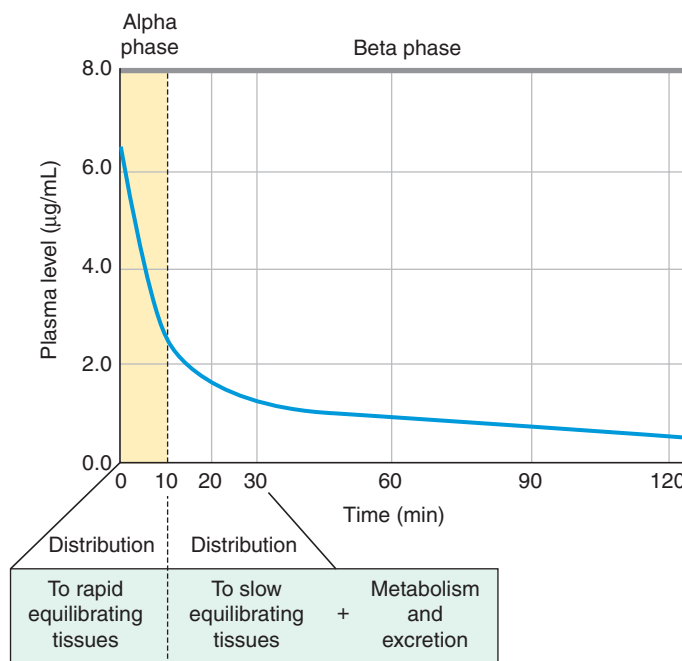
patients. The absorption kinetics were in the same range as for other long-acting local anesthetics.

In general, the addition of epinephrine to local anesthetic solutions decreases the rate of vascular absorption of these agents.<sup>24</sup> Epinephrine 5  $\mu\text{g}/\text{mL}$  (1:200,000) significantly reduces the peak blood concentrations of lidocaine and mepivacaine, regardless of the site of administration. However, peak blood concentrations of bupivacaine and etidocaine are minimally influenced by the addition of epinephrine following injection into the lumbar epidural space. On the other hand, the rate of vascular absorption of these agents is significantly decreased when epinephrine-containing solutions are employed for brachial plexus blockade.<sup>25,26</sup>

The rate of vascular absorption also varies, and is dependent on the specific local anesthetic agent. Lidocaine is absorbed more rapidly following brachial plexus and epidural blockade than is prilocaine, whereas bupivacaine is absorbed more rapidly than etidocaine.<sup>24,26</sup> Prilocaine is a less-potent vasodilator than lidocaine, which partly accounts for lower blood concentrations of prilocaine. The lower peak blood concentrations of etidocaine compared with bupivacaine may be related to the greater lipid solubility of etidocaine, which results in its sequestration by adipose tissue and a decreased rate of absorption. The differences in absorption rates are of practical clinical significance, as they permit the use of larger doses of prilocaine compared with lidocaine and of etidocaine compared with bupivacaine.

### Systemic Distribution

The distribution of local anesthetic agents from systemic circulation can be described by a two- or three-compartment model.<sup>27</sup> The rapid disappearance ( $\alpha$ ) phase is believed to be related to uptake by rapidly equilibrating tissues, that is, tissues with a high vascular perfusion. The slower phase of disappearance from blood ( $\beta$  phase) is mainly a function of distribution to slowly equilibrating tissues and the biotransformation and excretion of the compound (Fig. 44–8). The  $\alpha$  half-life ( $T_{1/2\alpha}$ ) of prilocaine is shorter than that of lidocaine and mepivacaine, which indicates that prilocaine is redistributed at a significantly more rapid rate from blood to tissues than either of the other two drugs (Table 44–3). The  $T_{1/2\alpha}$



**FIGURE 44–8.** Plasma concentration curve of lidocaine following IV administration showing initial rapid rate of disappearance related to distribution to rapidly equilibrating tissues and slower rate of disappearance caused by distribution to slowly equilibrating tissues and biotransformation and excretion. (Reprinted from Covino BG. Pharmacology of local anesthetic agents. In: Rogers MC, Tinker JH, Covino BG, et al., eds. Principles and Practice of Anesthesiology. Vol. 2. St. Louis, MO: Mosby Year Book, 1993:1245, with permission from Elsevier.)

of lidocaine and mepivacaine are similar. The half-life of the  $\beta$  disappearance phase ( $T_{1/2\beta}$ ) of prilocaine is more rapid than that of lidocaine and mepivacaine, suggesting a more rapid rate of biotransformation. A comparison study reveals that etidocaine has a more rapid rate of tissue redistribution and biotransformation than bupivacaine.<sup>28</sup>

Local anesthetic agents are distributed throughout all body tissues, but the relative concentration in different tissues varies as a function of time, vascular perfusion, and tissue mass. Initially, local anesthetic agents are rapidly extracted by lung tissue so that the whole blood concentration of local anesthetics decreases greatly as they pass through the pulmonary vasculature.<sup>29,30</sup> Ultimately, the highest percentage of an injected dose of a local anesthetic agent is found in skeletal muscle, simply because the mass of skeletal muscle makes it the largest reservoir for local anesthetic agents.

### Biotransformation and Elimination

The degradation of local anesthetic agents varies according to their chemical classification. Amino ester local anesthetic drugs are hydrolyzed in plasma by cholinesterase enzymes. Chloro-

procaine shows the most rapid rate of hydrolysis (4.7  $\mu\text{mol}/\text{mL}/\text{h}$ ), compared with a rate of 1.1  $\mu\text{mol}/\text{mL}/\text{h}$  for procaine and 0.3  $\mu\text{mol}/\text{mL}/\text{h}$  for tetracaine.<sup>31</sup> Less than 2% of unchanged procaine is found in urine, whereas approximately 90% of *p*-aminobenzoic acid, which is a primary product of procaine hydrolysis, appears in urine. Only 33% of dimethylaminoethanol, the other hydrolysis product of procaine, is excreted unchanged.

The amino amide agents are biotransformed primarily in the liver.<sup>32</sup> Prilocaine undergoes the most rapid rate of hepatic metabolism, and lidocaine is biotransformed somewhat more rapidly than mepivacaine. In humans, the hepatic clearance of etidocaine is greater than that of bupivacaine, which suggests a more rapid rate of hepatic biotransformation for etidocaine. Evidence also exists that prilocaine may be biotransformed in the kidney, which would explain the rapid clearance of this agent compared with all other amino amides.<sup>33</sup>

The biotransformation of the amino amide-type agents results in the formation of a variety of metabolites. The biotransformation of lidocaine has been studied most extensively. The main pathway of lidocaine biotransfor-



mation in humans involves oxidative deethylation of lidocaine to monoethylglycinexylidide by cytochrome P450 IIIA4, followed by a subsequent hydrolysis of monoethylglycinexylidide to xylidide.

The excretion of the amino amide-type local anesthetic drugs occurs by way of the kidney. Less than 5% of the unchanged drug is excreted via the kidney into the urine. The major portion of the injected agent appears in the urine in the form of various metabolites. The renal clearance of the amino amide local anesthetic agents appears to be inversely related to their protein-binding capacity. Prilocaine, which has a lower protein-binding capacity than lidocaine, has a substantially higher clearance value than lidocaine.<sup>34</sup> Renal clearance also is inversely proportional to the pH of urine, suggesting that urinary excretion of these agents occurs by nonionic diffusion.

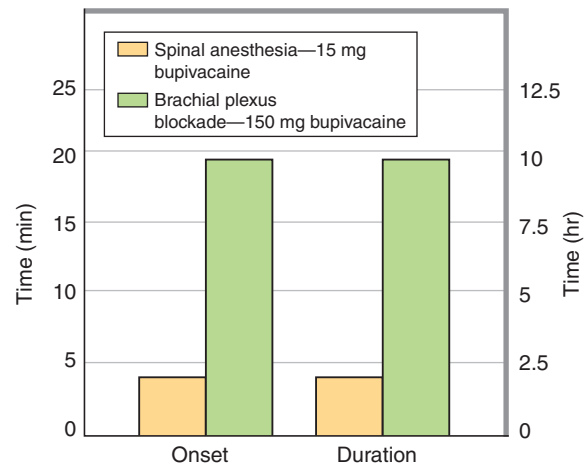
Patient age may influence the physiologic disposition of local anesthetics. The half-life of lidocaine following IV administration increased from an average of 80 minutes in human volunteers 22–26 years of age to 138 minutes in subjects ages 61–71 years.<sup>35</sup> Age-dependent disposition kinetics have been reported for ropivacaine following epidural administration, with elimination half-life significantly longer and clearance significantly decreased in older (>61 years) than in younger patients (18–40 years).<sup>23</sup>

The elimination of local anesthetic agents also is influenced by the individual patient's hepatic and cardiac function. For example, an average lidocaine half-life of 1.5 hours was reported in volunteers with normal hepatic function, whereas patients with liver disease demonstrated an average half-life of 5 hours.<sup>36</sup> In patients with congestive heart failure (CHF) the IV infusion of lidocaine results in significantly higher plasma concentrations of lidocaine than occurs in patients with normal cardiovascular function, indicating a decreased plasma clearance in patients with CHF.<sup>37</sup>

## CLINICAL CONSIDERATIONS

### Routes of Administration

The clinical profile of local anesthetic drugs varies, and is dependent on the type of regional anesthetic technique performed (Fig. 44–9). The shortest duration of action occurs following the



**FIGURE 44–9.** Comparison of onset and duration of spinal anesthesia and brachial plexus blockade with bupivacaine. (Reprinted from Covino BG. Pharmacology of local anesthetic agents. In: Rogers MC, Tinker JH, Covino BG, et al., eds. Principles and Practice of Anesthesiology. Vol. 2. St. Louis, MO: Mosby Year Book, 1993:1242, with permission from Elsevier.)

intrathecal or subcutaneous administration of local anesthetics. The longest latencies and durations are observed following major peripheral nerve blocks, such as brachial plexus blockade. Intrathecal bupivacaine usually produces anesthesia within 5 minutes and persists for 3–4 hours.<sup>38</sup> For brachial plexus blockade, the onset time of bupivacaine is approximately 20–30 minutes, whereas the duration of anesthesia averages approximately 10 hours.<sup>39</sup> These variations in the onset and duration of anesthesia result from differences in the anatomy of the injection sites and the amount of drug employed for various types of regional anesthesia. In the subarachnoid space the lack of a nerve sheath around the spinal cord and the placement of the local anesthetic solution in the immediate vicinity of the spinal cord is responsible for the rapid onset of action. The relatively small amount of drug employed for spinal anesthesia probably accounts for the short duration of conduction block. For example, 50–75 mg of lidocaine and 10–15 mg of bupivacaine are usually employed for most spinal anesthetic procedures.

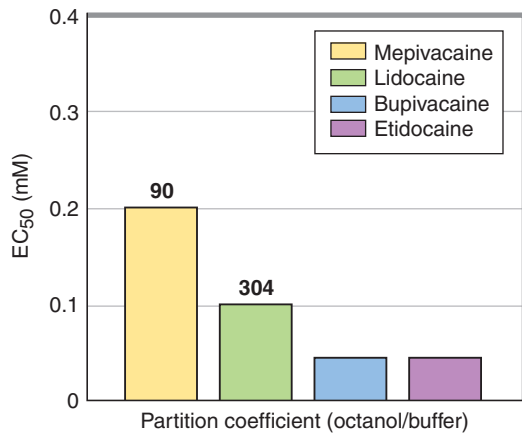
The onset of brachial plexus blockade is slow, as the anesthetic agent is usually injected some distance from the nerve roots and must diffuse through various tissue barriers before reaching the nerve membrane. The prolonged blockade is probably related to the decreased rate of vascular absorption from that site and the larger dose of drug employed for this regional anesthetic technique. For example,

400–600 mg of lidocaine and 100–150 mg of bupivacaine are usually employed for brachial plexus blockade.

### Clinical Manifestations of Potency

In vitro studies show a general positive correlation between lipid solubility of local anesthetics and potency (Fig. 44–10).<sup>40,41</sup> This presumably is because the nerve membrane that represents the site of action of local anesthetics consists primarily of lipids. However, the hydrophobicity and anesthetic potency are not as well correlated in intact animals and humans. The EC<sub>50</sub> (median effective dose) of lidocaine, for example, is significantly less than that of mepivacaine in an isolated nerve, but in humans, little difference in anesthetic potency is apparent between these agents.<sup>24</sup> Etidocaine possesses a lower EC<sub>50</sub> than bupivacaine in an isolated nerve, but etidocaine is approximately half as potent as bupivacaine in vivo<sup>42,43</sup>: 1–1.5% etidocaine is required to achieve a similar degree of epidural blockade as is produced by 0.5–0.75% bupivacaine.

The difference between potency in an isolated nerve and in a clinical situation is probably a function of the vasodilator or tissue redistribution properties of the various local anesthetics. Lidocaine is a more profound vasodilator than mepivacaine in humans. More rapid vascular absorption of lidocaine as a result of vasodilation causing increased blood flow, results in fewer lidocaine molecules being available for neural blockade.



**FIGURE 44-10.** Relationship between concentrations of various local anesthetics required to cause 50% depression in amplitude of isolated nerve action potential (median effective concentration [EC<sub>50</sub>]) and partition coefficient values. (Reprinted from Covino BG. Pharmacology of local anesthetic agents. In: Rogers MC, Tinker JH, Covino BG, et al., eds. Principles and Practice of Anesthesiology. Vol. 2. St. Louis, MO: Mosby Year Book, 1993:1236, with permission from Elsevier.)

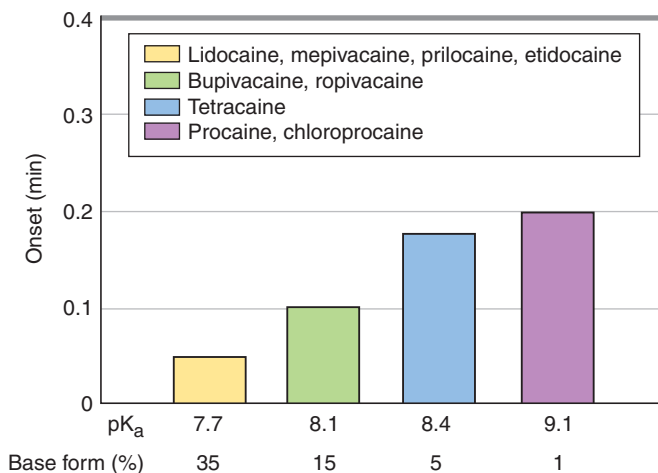
Hence, lidocaine and mepivacaine appear to possess similar anesthetic potencies clinically. The profound conduction-blocking activity of etidocaine *in vitro* is a result of its high lipid solubility. However, sequestration of etidocaine in adipose tissue *in vitro*, such as in the epidural space, results in fewer etidocaine molecules being available for neural blockade compared with bupivacaine.

### Speed of Onset

In isolated nerves,<sup>41,44</sup> onset time of conduction block is correlated with the pK<sub>a</sub> of the various agents (Fig. 44-11) and lipid solubility influences onset of action, too. The pK<sub>a</sub> of local anesthetics and the pH of the anesthetic solution

determine the degree of ionization of specific agents. This is because the degree of ionization influences the rate of diffusion of local anesthetics across the nerve sheath and membrane. The uncharged base form diffuses more easily than the charged cationic form.<sup>45,46</sup>

The pK<sub>a</sub> of all local anesthetics, except benzocaine, varies from 7.6–9.1 and is greater than the physiologic pH (7.4) of tissue (Table 44-4). At a pH of 7.4, approximately 2% of procaine (pK<sub>a</sub> of 9.1) exists in the base form. In contrast, 35% of mepivacaine, lidocaine, etidocaine, and prilocaine, which possess a pK<sub>a</sub> of approximately 7.6, are present in the unionized forms. The pH of most local anesthetic solutions is approximately 5–6 because of the rela-



**FIGURE 44-11.** Relationship between onset of conduction block in isolated nerve and pK<sub>a</sub> and percentage of local anesthetic present in base form. (Reprinted from Covino BG. Pharmacology of local anesthetic agents. In: Rogers MC, Tinker JH, Covino BG, et al., eds. Principles and Practice of Anesthesiology. Vol. 2. St. Louis, MO: Mosby Year Book, 1993:1236, with permission from Elsevier.)

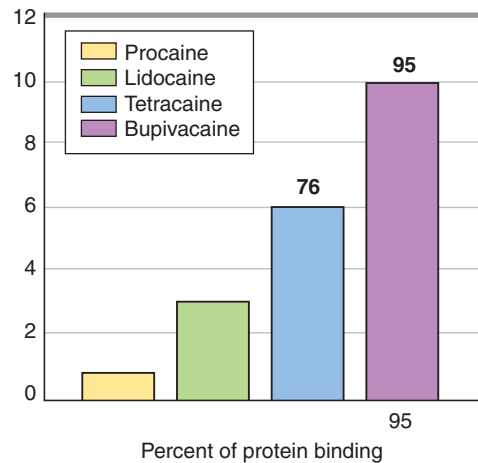
**TABLE 44-4.**

**Dissociation Constants (Rounded)**

Local Anesthetic	pK <sub>a</sub>
Benzocaine	3.5
Mepivacaine	7.7
Lidocaine	7.8
Etidocaine	7.9
Prilocaine	7.9
Ropivacaine	8.1
Bupivacaine	8.1
Tetracaine	8.4
Cocaine	8.6
Dibucaine	8.8
Procaine	8.9
Chlorprocaine	9.1
Hexylcaine	9.3
Procainamide	9.3
Piperocaine	9.8

tively low solubility of local anesthetics in solutions of higher pH. The inclusion of epinephrine in local anesthetic solutions results in a further decrease in pH to approximately 3–4.

Studies *in vitro* clearly demonstrate the relationship among the pK<sub>a</sub> of specific agents, the pH of anesthetic solution, and the onset of conduction block.<sup>44–46</sup> Agents with a relatively low pK<sub>a</sub>, such as lidocaine and mepivacaine, show the most rapid onset of conduction block. Procaine, chlorprocaine, and tetracaine, which possess high pK<sub>a</sub> values, demonstrate a longer latency. The onset of conduction blockade is also reduced by increasing the pH of the bathing solution.<sup>45</sup> Clinically, onset time may be influenced by the dose or concentration of local anesthetic employed.<sup>43</sup> For example, increasing the concentration of bupivacaine from 0.25–0.75% results in a significant acceleration in anesthetic effect. Despite its pK<sub>a</sub> being approximately 9 and its onset of action in isolated nerves being relatively slow, chlorprocaine demonstrates a rapid onset of action in humans. This is because chlorprocaine's low systemic toxicity allows the use of high concentrations such as 3%. Lidocaine has been shown in some studies to produce a more rapid onset of epidural anesthesia than chlorprocaine when employed at the same concentrations. However, use of a 3% chlorprocaine solution results in a more rapid onset of conduction block compared with 2.0% lidocaine.<sup>47</sup>



**FIGURE 44-12.** Relationship between duration of brachial plexus blockade of various local anesthetics and their degree of protein binding. (Reprinted from Covino BG. Pharmacology of local anesthetic agents. In Rogers MC, Tinker JH, Covino BG, et al., eds. Principles and Practice of Anesthesiology. Vol. 2. St. Louis, MO: Mosby Year Book, 1993:1238, with permission from Elsevier.)

### Duration of Action

The various local anesthetics have greatly different durations of action and protein binding apparently is a determinant of duration (Fig. 44-12).<sup>44</sup> Procaine and chlorprocaine have a short duration of action; lidocaine, mepivacaine, and prilocaine have a moderate duration of anesthesia. Tetracaine, bupivacaine, levobupivacaine, etidocaine, and ropivacaine are associated with the longest durations of anesthesia. Procaine produces duration of brachial plexus blockade of 30–60 minutes—approximately 10 hours of anesthesia has been reported following the use of bupivacaine, etidocaine, and ropivacaine for brachial plexus blockade.

Local anesthetics are believed to act by binding to a protein receptor in the sodium channel,<sup>3</sup> and thus the greater protein binding of a specific agent presumably results in a longer period of sodium channel blockade and a longer duration of anesthesia. Plasma proteins have been used to measure protein binding of local anesthetics, assuming that binding to membrane proteins is similar to plasma protein binding.

Duration of action of the various agents is influenced by their peripheral vascular effects. Local anesthetics except cocaine generally tend to have a biphasic effect on vascular smooth muscle.<sup>48–50</sup> These agents cause vasoconstriction at low concentrations and vasodilatation at clinically employed concentrations. The protein kinase C Rho and p44/42 mitogen-activated protein kinase signaling pathways in calci-

um sensitization mechanisms may be involved in the biphasic action.<sup>51</sup>

Differences exist in the vasodilator activity of the various drugs. Lidocaine is a more potent vasodilator than mepivacaine or prilocaine. In vivo, the duration of anesthesia produced by lidocaine is shorter than that of mepivacaine or prilocaine. If epinephrine is added to solutions of these agents, the duration of action for all three drugs is similar. The duration of action of ropivacaine is similar to that of bupivacaine when the agents are administered for peripheral or central neural blocks.<sup>52,53</sup> However, ropivacaine produces a significantly longer duration of infiltration anesthesia than bupivacaine in animals, which appears

related to ropivacaine's cutaneous vasoconstrictor effects (Fig. 44-13).<sup>50,52</sup>

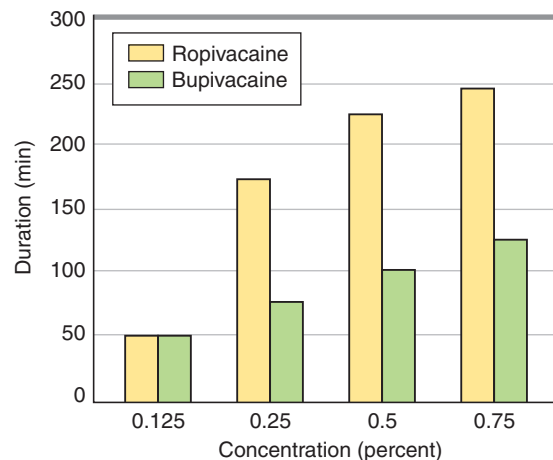
### Differential Sensory/Motor Block

Differential block is observed clinically but is poorly understood. Local anesthetic agents differ with respect to producing motor versus sensory block. The most significant separation between sensory anesthesia and motor blockades is produced by bupivacaine.<sup>43</sup> Depending on the concentration of bupivacaine employed, significant sensory anesthesia may be obtained with little inhibition of motor activity. Ropivacaine appears to provide a similar degree of sensory/motor separation.<sup>54</sup>

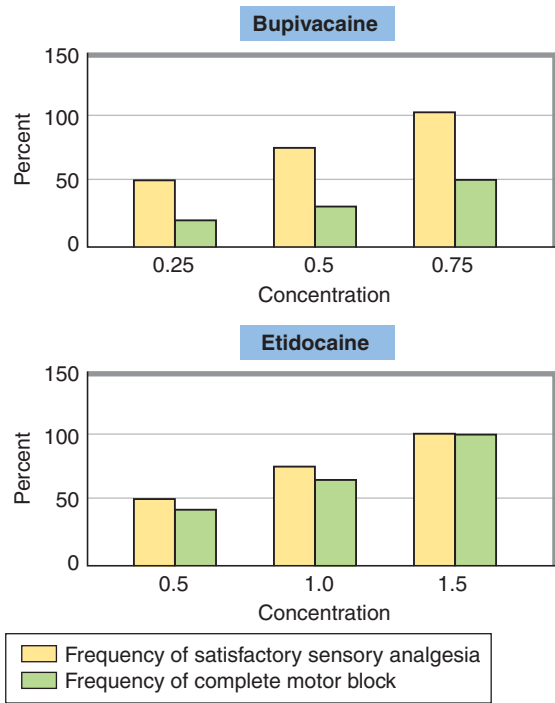
Bupivacaine and etidocaine are notably different in terms of their differential sensory/motor fiber-blocking activity (Fig. 44-14). Bupivacaine is widely used epidurally for obstetric procedures and relief of pain postoperatively because of its ability to provide adequate analgesia with minimal muscle weakness or paralysis, particularly as a 0.125% or 0.25% solution. In contrast, etidocaine shows little separation between blockade of sensory and motor fibers.<sup>43</sup>

### Influence of Dose

An increase in the dose of local anesthetic usually results in a more profound depth of block, a prolongation of satisfactory anesthesia, and a decrease in the onset of block.<sup>43,54</sup> No clinically significant differences in onset, depth, and duration of anesthesia appear to



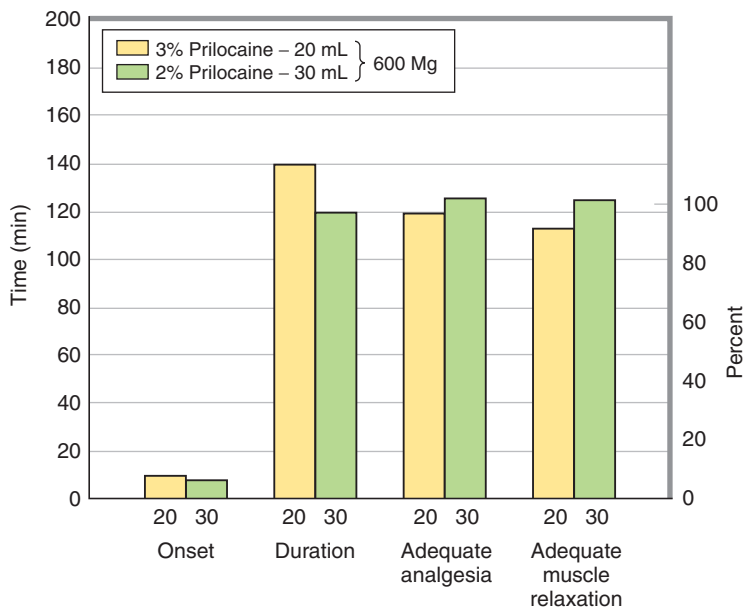
**FIGURE 44-13.** Relationship between duration of infiltration anesthesia and concentration of bupivacaine and ropivacaine. (Reprinted from Covino BG. Pharmacology of local anesthetic agents. In Rogers MC, Tinker JH, Covino BG, et al., eds. Principles and Practice of Anesthesiology. Vol. 2. St. Louis, MO: Mosby Year Book, 1993:1239, with permission from Elsevier.)



**FIGURE 44-14.** Frequency of satisfactory sensory analgesia and frequency of motor block produced by bupivacaine and etidocaine at various concentrations. (Reprinted from Covino BG. Pharmacology of local anesthetic agents. In: Rogers MC, Tinker JH, Covino BG, et al., eds. Principles and Practice of Anesthesiology. Vol. 2. St. Louis, MO: Mosby Year Book, 1993:1239, with permission from Elsevier.)

exist when the same dose of local anesthetic is administered as a large volume of dilute solution or as a small volume of concentrated solution. A

comparison of 15 mL of 2% prilocaine with 10 mL of 3% prilocaine (300 mg) and 30 mL of 2% prilocaine with 20 mL of 3% prilocaine (600 mg) for epidural



**FIGURE 44-15.** Relationship between onset, duration, and frequency of adequate analgesia and frequency of adequate muscle relaxation produced by prilocaine when used as either a 3% solution or a 2% solution for epidural blockade. (Reprinted from Covino BG. Pharmacology of local anesthetic agents. In: Rogers MC, Tinker JH, Covino BG, et al., eds. Principles and Practice of Anesthesiology. Vol. 2. St. Louis, MO: Mosby Year Book, 1993:1240, with permission from Elsevier.)

blockade showed no difference in onset, adequacy, or duration of anesthesia, and onset, depth, and duration of motor blockade if the dose was maintained constant (Fig. 44-15).<sup>55</sup> However, the increase in total dose from 300 to 600 mg of prilocaine did result in a more rapid onset, a greater degree of satisfactory anesthesia, and a prolonged duration of anesthesia.

Similar studies of spinal anesthesia indicate little difference between the use of varying volumes of 0.5% and 0.75% bupivacaine if the total dose was constant (Fig. 44-16).<sup>38</sup> The volume of anesthetic solution may influence the spread of anesthetic in the epidural or subarachnoid space. For example, the level of anesthesia was 4.3 dermatomes higher when 30 mL of 1% lidocaine was injected epidurally compared with 10 mL of 3% lidocaine.<sup>56</sup> In general, increased dosage is usually achieved by the use of more concentrated anesthetic solutions, as the volume of solution that can be administered is usually restricted by the anatomy of the specific injection site.

## FORMULATIONS

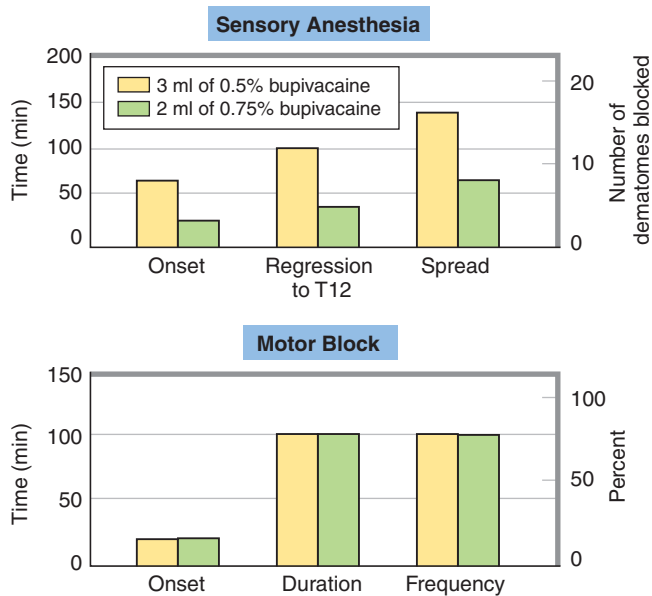
### Purpose of Different Formulations

Local anesthetics are mixed with other substances during the manufacturing process or just prior to administration. Some objectives of this practice are to shorten onset time, limit absorption, increase intensity of action, stabilize local anesthetic molecule, and inhibit microbial growth. A 2004 issue of *Techniques in Regional Anesthesia and Pain Medicine* discussed in detail additives to local anesthetics.<sup>57</sup>

### Mixtures of Local Anesthetics

Mixtures of local anesthetics have been employed by adding an agent, such as chlorprocaine or lidocaine, which have a relatively rapid onset, to a solution of bupivacaine, which has a slow but long duration of action. A mixture of 3% chlorprocaine and 0.5% bupivacaine was reported to produce a rapid onset and prolonged duration of brachial plexus blockade.<sup>58</sup> Subsequent epidural studies indicated that a mixture of chlorprocaine and bupivacaine resulted in a slower onset than chlorprocaine alone and a shorter duration than bupivacaine alone.<sup>59</sup> Isolated nerve studies demonstrate





**FIGURE 44-16.** Relationship between onset, duration, and spread of sensory anesthesia and onset, duration, and frequency of motor block produced by bupivacaine when employed as either a 0.5% or a 0.75% solution for intrathecal use. (Reprinted from Covino BG. Pharmacology of local anesthetic agents. In: Rogers MC, Tinker JH, Covino BG, et al., eds. Principles and Practice of Anesthesiology. Vol. 2. St. Louis, MO: Mosby Year Book, 1993:1240, with permission from Elsevier.)

that the addition of a metabolite of chloroprocaine to bupivacaine significantly decreased the duration of conduction block compared with bupivacaine alone (Fig. 44-17).<sup>60</sup> To date, no similar antagonism has been demonstrated when lidocaine or mepivacaine is mixed with bupivacaine. One should remember that in terms of the potential systemic toxicity of mixtures of local anesthetics, the toxicity of local anesthetics is additive if an unintentional IV injection occurs.

### Use of Vasoconstrictors

Epinephrine (1:200,000; 5 µg/mL) is frequently added to local anesthetic solutions to decrease the rate of vascular absorption.<sup>24</sup> This allows more anesthetic molecules to diffuse to the nerve membrane and thus improves the depth and duration of anesthesia. Epinephrine 1:200,000 has been reported to be the optimal concentration prolonging the duration of anesthesia of lidocaine for epidural or intercostals use. Other vasoconstrictor agents, such as norepinephrine and phenylephrine, have been used but do not appear to be superior to epinephrine. For example, equipotent concentrations of epinephrine and phenylephrine similarly prolong the duration of spinal anesthesia produced by tetracaine (Fig. 44-18).<sup>61</sup>

Epinephrine's ability to prolong the duration of anesthesia depends on the

local anesthetic employed and the injection site. Epinephrine significantly extends the duration of both infiltration anesthesia and peripheral nerve blocks with most agents.<sup>62,63</sup> The duration of surgical epidural anesthesia, however, is not greatly prolonged when epinephrine is combined with prilocaine, bupivacaine, or etidocaine, but does result in a significant increase in the duration of epidural blockade produced by agents such as lidocaine.<sup>64,65</sup> Diluted solutions of bupivacaine employed for epidural analgesia in obstetric patients may be improved with the addition of epinephrine. The depth and duration of epidural analgesia in obstetric patients

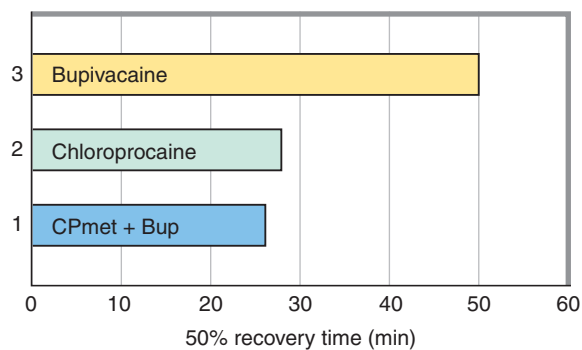
were improved when epinephrine 1:300,000 was added to 0.25% bupivacaine.<sup>66</sup> Although the addition of epinephrine may not significantly prolong the duration of surgical epidural anesthesia produced by 0.5–0.75% bupivacaine, a more profound degree of motor blockade has been observed following the use of bupivacaine with epinephrine.<sup>64</sup>

Epinephrine's ability to prolong spinal anesthesia may be partly related to a direct antinociceptive effect in the spinal cord. Adrenergic receptor agents exert a direct antinociceptive action in the spinal cord. For example, clonidine, an  $\alpha_2$ -adrenergic agonist, produces analgesia following epidural administration.<sup>67</sup>

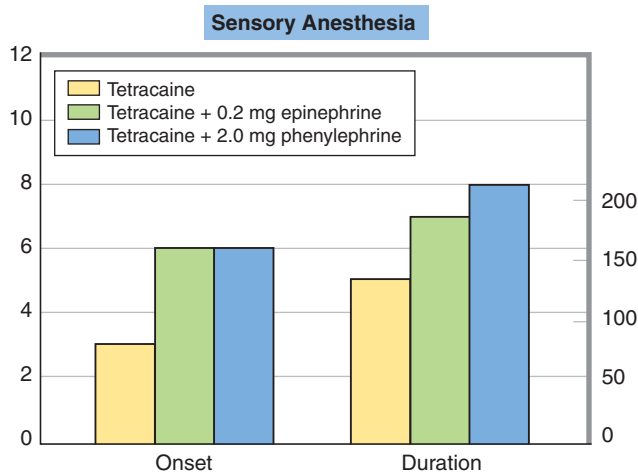
Epinephrine's effect on the onset of regional anesthesia is controversial. Some studies demonstrate a more rapid onset of conduction blockade, presumably because of the decreased vascular absorption of local anesthetics.<sup>62</sup> Others fail to demonstrate any difference in onset time.<sup>68</sup> This is attributed to the low pH of epinephrine-containing local anesthetic solutions, which favor the formation of the local anesthetics cationic form, which does not easily diffuse through nerve sheaths.

### Carbonation and pH Adjustment of Local Anesthetics

Carbonation of local anesthetics results in a more rapid onset and a more profound degree of conduction blockade in an isolated nerve preparation.<sup>45,69,70</sup> The enhanced onset is believed to be related to a more rapid dissociation of the local anesthetic to the base form, a direct depressant ef-



**FIGURE 44-17.** Recovery of conduction blockade in isolated nerve following exposure to bupivacaine alone, chloroprocaine alone, and mixture of a chloroprocaine metabolite and bupivacaine. (Reprinted from Covino BG. Pharmacology of local anesthetic agents. In: Rogers MC, Tinker JH, Covino BG, et al., eds. Principles and Practice of Anesthesiology. Vol. 2. St. Louis, MO: Mosby Year Book, 1993:1243, with permission from Elsevier.)

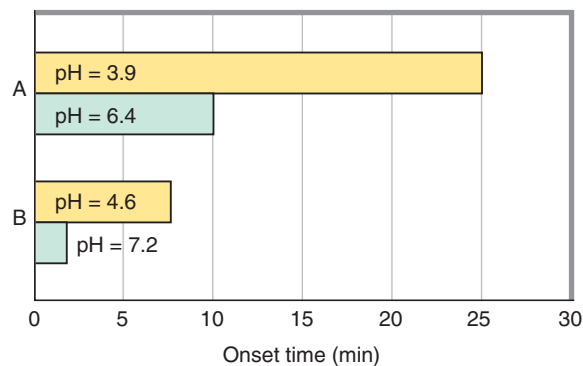


**FIGURE 44-18.** Relationship between onset and duration of spinal anesthesia following use of plain tetracaine, tetracaine with epinephrine, and tetracaine with phenylephrine. (Reprinted from Covino BG. Pharmacology of local anesthetic agents. In: Rogers MC, Tinker JH, Covino BG, et al., eds. Principles and Practice of Anesthesiology. Vol. 2. St. Louis, MO: Mosby Year Book, 1993:1241, with permission from Elsevier.)

fect of carbon dioxide ( $\text{CO}_2$ ) on the nerve membrane, and a decrease in the axoplasmic pH from the diffusion of  $\text{CO}_2$  intraneurally. The lower axoplasmic pH increases the rate of formation of the local anesthetic's active cationic form within the nerve. Although  $\text{CO}_2$  clearly enhances the onset of local anesthetic-induced conduction block in an isolated nerve, discrepancies exist among clinical studies in which hydrochloride and carbonated local anesthetic solutions have been compared. Several investigations have demonstrated a significant decrease in the onset of epidural blockade with lidocaine carbonate compared with lidocaine hydrochloride.<sup>71,72</sup> However, other researchers have failed to observe a significant reduction in onset of epidural anesthesia with lidocaine carbonate.<sup>73</sup> Similarly, differing results concerning onset time have been reported when bupivacaine hydrochloride and bupivacaine carbonate were employed for brachial plexus blocks.<sup>74,75</sup> Although controversy may exist regarding the effect of carbonation on onset of anesthesia, most studies show that carbonated solutions do improve the depth of sensory and motor blockade when administered into the epidural space. Also, these solutions produce a more complete blockade of the various nerve roots when employed for brachial plexus blockade.

Alkalinization of local anesthetic solutions by the addition of solution bicarbonate has also been reported to decrease the onset of conduction block-

ade (Fig. 44-19).<sup>76,77</sup> An increase in the pH of the local anesthetic solution increases the amount of drug in the uncharged base form, which should enhance the rate of diffusion across the nerve sheath and nerve membrane. The use of pH-adjusted solutions of bupivacaine or lidocaine has been reported to significantly decrease the latency of brachial plexus and epidural blockade.<sup>76,77</sup> Again, controversy surrounds the improved onset of pH-adjusted local anesthetic solutions. Some investigators have failed to demonstrate an improved onset of brachial plexus or epidural blockade with the use of pH-adjusted solutions of bupivacaine or lidocaine.<sup>78,79</sup> The differences between these studies might be related to the magnitude of the pH change produced by the addition of bicarbon-



**FIGURE 44-19.** Comparison of onset of brachial plexus blockade with bupivacaine (A) and onset of epidural blockade with lidocaine (B) using solutions of varying pH. (Reprinted from Covino BG. Pharmacology of local anesthetic agents. In: Rogers MC, Tinker JH, Covino BG, et al., eds. Principles and Practice of Anesthesiology. Vol. 2. St. Louis, MO: Mosby Year Book, 1993:1243, with permission from Elsevier.)

ate. In the original study in which onset time for brachial plexus blockade was significantly reduced, the pH of bupivacaine with epinephrine was increased from 3.9 to 6.4.<sup>77</sup> In the subsequent study in which no effect on latency was observed, the pH of plain bupivacaine was increased from 5.5 to 7.0.<sup>78</sup> The amount of bicarbonate added to local anesthetic solutions depends on the particular local anesthetic. One milliliter of sodium bicarbonate is added to 10 mL of lidocaine, whereas 0.1 mL of bicarbonate is added to every 10 mL of bupivacaine. The latter agent is insoluble at a high pH, and the addition of excess bicarbonate will result in a precipitation of bupivacaine.

### Hyaluronidase, Liposomes, Microencapsulation

Hyaluronidase (tissue spreading factor) is sometimes added to local anesthetic solutions to facilitate spread of solution at the injection site, thereby affecting speed of onset and extent of a block. This seems only to be useful when local anesthetic is injected in the orbit preparatory to ophthalmologic surgery. Hyaluronidase may be injected with local anesthetic during epidural neurolysis to treat pain with positive benefit. Various attempts have been made to prolong the duration of action of local anesthetics by loading them into liposomes or microcapsules, but no such formulations have been approved by the FDA for marketing.

### TOXICITY

Table 44-5 shows categorizes the toxic effects of local anesthetics.

TABLE 44-5.

## Categories of Local Anesthetic Toxic Reactions

Localized or Systemic	Systemic	Localized
Allergic reactions	Cardiac/vascular Central nervous system Methemoglobin	Tissue toxicity

### Allergic Reactions

True allergic reactions are associated with amino ester-linked local anesthetics, not amino amide-linked ones. In a study of anaphylactic and anaphylactoid reactions ( $n = 789$ ) occurring during anesthesia, Mertes et al.<sup>80</sup> found no such reactions to local anesthetics. However, Mackley et al.<sup>81</sup> reported that of 183 patients who were patch tested, 4 had positive reactions to lidocaine, 2 of whom had histories of sensitivity to local injections of lidocaine manifested by dermatitis. They concluded that contact-type IV sensitivity to lidocaine might occur more frequently than previously thought. It is common, but inappropriate, to refer to all adverse events as “allergic reactions.”

### Tissue Toxicity

Tissue toxicity, primarily myotoxicity and neurotoxicity can be produced by all local anesthetics if “high” concentrations are used. Signs and symptoms of varying degrees of neuropathy (e.g. transient neurologic symptoms, cauda equina syndrome) have been reported following spinal anesthesia with, for example, 2% and 5% lidocaine. In a recent systematic review, Zaric et al.<sup>82</sup> compared the frequency of transient neurologic symptoms and neurologic complications after spinal anesthesia with lidocaine with that after other local anesthetics. The results showed that the risk for developing transient neurologic symptoms after spinal anesthesia with lidocaine was higher with lidocaine than with bupivacaine, prilocaine, procaine, or mepivacaine.

### Systemic Toxicity

#### Methemoglobinemia

A variety of local anesthetics reportedly may produce methemoglobinemia. Prilocaine is the local anesthetic for which there appears to be greatest risk for this to occur. A dose–response relationship exists between the amount of prilocaine administered epidurally and the degree of methemoglobinemia. In

general, doses of prilocaine of 600 mg are required for the development of clinically significant levels of methemoglobinemia.<sup>83</sup> The formation of methemoglobinemia is believed to be related to prilocaine's chemical structure. This agent lacks a methyl group in the benzene ring. The metabolism of prilocaine in the liver results in the formation of *O*-toluidine, which is responsible for the oxidation of hemoglobin to methemoglobin.<sup>84</sup> The methemoglobinemia associated with prilocaine is spontaneously reversible or may be treated by IV methylene blue.

#### Cardiovascular and Central Nervous System

As concentration of local anesthetic in systemic circulation increases, various cardiovascular system and central nervous system signs and symptoms appear (Fig. 44-20). The relative CNS and cardiovascular toxicity of local anesthetics has been of interest, especially after Albright<sup>85</sup> reported unexpected cardiovascular toxicity of bupivacaine. In animal studies, the ratio of doses of bupivacaine that produced convulsive activity and cardiovascular collapse<sup>86</sup>

was lower than for other local anesthetics such as lidocaine. Human volunteer studies of doses required to produce early features of CNS and cardiovascular system toxicity by ropivacaine and levobupivacaine demonstrated the doses were about equal and higher than for bupivacaine.<sup>87-89</sup>

Brown et al.<sup>90</sup> reviewed records of patients who had seizures while undergoing brachial plexus, epidural, and caudal regional anesthetics. No adverse cardiovascular, pulmonary or nervous system events were associated with any of the seizures, including in 16 patients who received bupivacaine blocks.

In dogs, the relative CNS toxicity of bupivacaine, etidocaine, and lidocaine is 4:2:1,<sup>91</sup> which is similar to the relative potency of these agents for the production of regional anesthesia in humans. IV infusion studies in human volunteers have also demonstrated an inverse relationship between the intrinsic anesthetic potency of various agents and the dosage required to induce CNS toxicity.<sup>92,93</sup>

The rate of IV administration alters the toxicity of local anesthetic agents.<sup>93</sup> In human volunteers, an average dose of 236 mg of etidocaine and a venous blood concentration of 3.0  $\mu\text{g}/\text{mL}$  resulted in CNS symptoms when 10 mg/min was infused. When the infusion rate was increased to 20 mg/min, an average of 161 mg of etidocaine, which produced a venous plasma concentration of approximately 2  $\mu\text{g}/\text{mL}$ , caused symptoms of CNS toxicity.

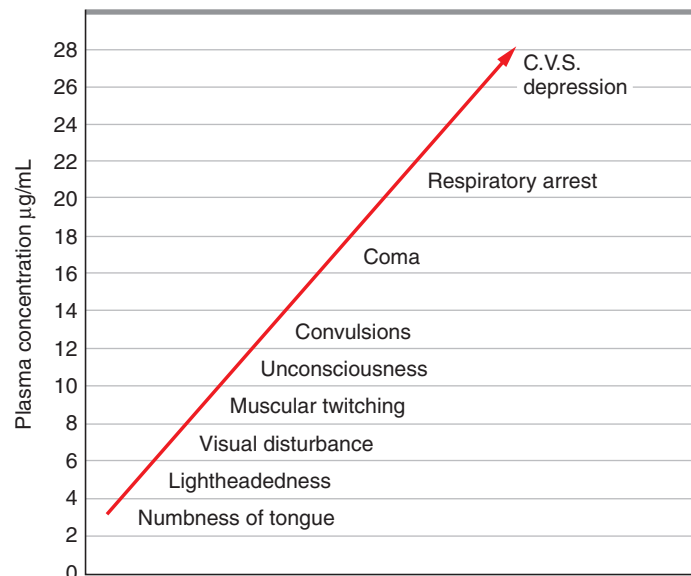
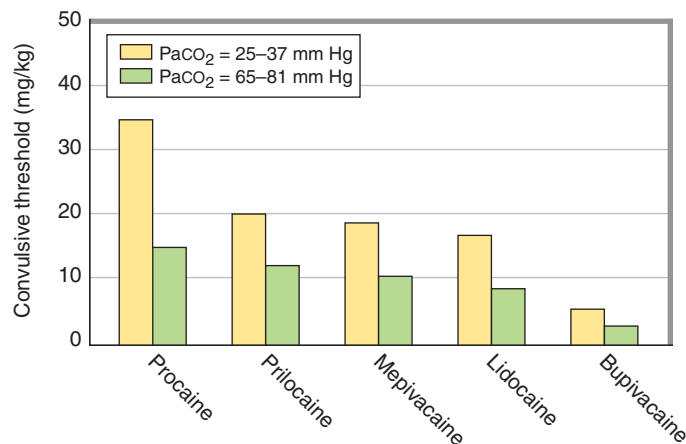


FIGURE 44-20. Plasma concentration of lidocaine versus systemic toxicity.



**FIGURE 44–21.** Relationship between convulsive threshold doses of various local anesthetics and arterial CO<sub>2</sub> tension (PaCO<sub>2</sub>). (Reprinted from Covino BG. Pharmacology of local anesthetic agents. In: Rogers MC, Tinker JH, Covino BG, et al., eds. Principles and Practice of Anesthesiology. Vol. 2. St. Louis, MO: Mosby Year Book, 1993:1247, with permission from Elsevier.)

Acid–base status can alter the CNS activity of local anesthetic agents. In cats, the convulsive threshold of various local anesthetics is inversely related to the arterial CO<sub>2</sub> tension (PaCO<sub>2</sub>)<sup>94</sup> (Fig. 44–21). An increase in PaCO<sub>2</sub> from 25 to 40 mm Hg to a range of 65 to 81 mm Hg decreases the convulsive threshold of procaine, mepivacaine, prilocaine, lidocaine, and bupivacaine by approximately 50%. A decrease in arterial pH also decreases the convulsant threshold of these agents. Respiratory acidosis, with a resultant increase in PaCO<sub>2</sub> and a decrease in arterial pH, consistently decreases the convulsant threshold of local anesthetic agents. However, an elevation in both PaCO<sub>2</sub> and arterial pH, as may occur during metabolic alkalosis, does not increase CNS toxicity to the same degree.

Hypercarbia increases cerebral blood flow, which probably results in a greater uptake of local anesthetic by the brain. In addition, diffusion of CO<sub>2</sub> into neuronal cells decreases intracellular pH and thus increases the intracellular cationic form of the local anesthetic agents. This form does not diffuse well across the nerve membrane, so ion trapping occurs. Hypercarbia and/or acidosis also decrease the plasma protein binding of local anesthetic agents, which will increase the proportion of free drug available for diffusion into the brain.<sup>95,96</sup> On the other hand, acidosis also decreases the percentage of the local anesthetic existing in the base form, which should decrease the rate of diffusion into neuronal cells.

Local anesthetics have a direct effect on both cardiac muscle and vascular

smooth muscle. These agents alter the heart's electrical and mechanical activity. Studies using the intact, isolated mammalian heart in vitro show that highly lipid-soluble, extensively protein-bound, highly potent local anesthetics (e.g., tetracaine, bupivacaine, etidocaine) are much more cardiotoxic than are the less-lipid-soluble, protein-bound, potent local anesthetics (e.g., lidocaine, mepivacaine, prilocaine).<sup>97</sup> Bupivacaine has a potent depressant effect on electrical conduction in the heart primarily via an action on voltage-gated sodium channels that generally govern the initial rapid depolarization (phase 0) of cardiomyocytes. The S forms of bupivacaine are less cardiotoxic than the R form. Bupivacaine actions other than on voltage-gated sodium channels probably also contribute to dose-dependent cardiotoxic effect of this local anesthetic.

Local anesthetics decrease the maximal rate of depolarization in Purkinje's fibers and ventricular muscle because of an inhibition of sodium channels in cardiac membranes.<sup>98–100</sup> Action potential duration and the effective refractory period are also decreased by local anesthetics. However, the ratio of effective refractory period to action potential duration is increased both in Purkinje's fibers and in ventricular muscle.

Qualitative differences exist between the various local anesthetic agents. Bupivacaine depresses the rapid phase of depolarization ( $V_{max}$ ) in Purkinje's fibers and ventricular muscle to a greater extent than does lidocaine.<sup>98–100</sup> In addition, the rate of recovery from a

use-dependent block is slower in bupivacaine-treated than in lidocaine-treated papillary muscles.<sup>101</sup> This slow rate of recovery results in an incomplete restoration of  $V_{max}$  between action potentials, particularly at high heart rates. In contrast, recovery from lidocaine is complete, even at rapid heart rates. These differential effects of lidocaine and bupivacaine may explain the anti-dysrhythmic properties of lidocaine and the dysrhythmogenic potential of bupivacaine.

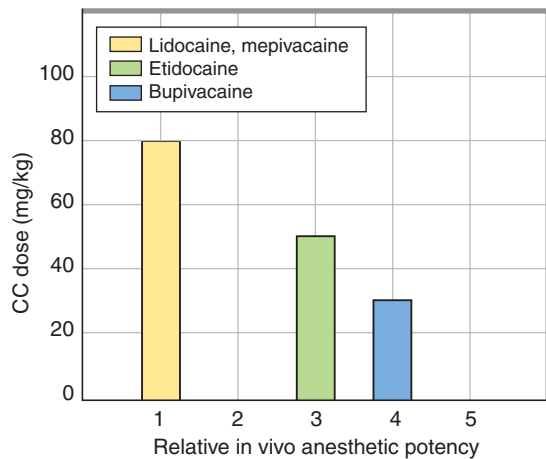
Bupivacaine, and to a lesser degree etidocaine and ropivacaine, can produce severe cardiac dysrhythmias, including ventricular fibrillation, in various animal species.<sup>86,102–106</sup> Ventricular dysrhythmias are rarely seen with lidocaine, mepivacaine, or tetracaine. Although the dysrhythmogenic action of bupivacaine is probably related primarily to an inhibition of the fast sodium channels in the cardiac membrane, evidence also exists that this agent may block the slow calcium channels.<sup>107</sup> These electrophysiologic effects of bupivacaine may result in conduction abnormalities, leading to a reentrant type of dysrhythmia similar to a torsade de pointes dysrhythmia.<sup>103</sup>

The dysrhythmogenic activity of bupivacaine is believed to result primarily from a direct cardiac effect. Isolated guinea pig hearts perfused with bupivacaine revealed evidence of conduction block, bigeminy, and trigeminy.<sup>108</sup> In addition, ventricular fibrillation occurred in intact pigs in which bupivacaine was injected directly into the left anterior descending coronary artery.<sup>105</sup> On the other hand, the injection of bupivacaine directly into certain regions of the brain may result in cardiac dysrhythmias, which may indicate a relationship between the CNS and cardiotoxic effects of bupivacaine.<sup>109,110</sup>

Electrophysiologic studies in intact dogs and in people shown that high blood levels of local anesthetics prolong conduction time through various parts of the heart as indicated by an increase in the PR interval and QRS duration. Extremely high concentrations of local anesthetics depress spontaneous pacemaker activity in the sinus node, resulting in sinus bradycardia and sinus arrest.

Local anesthetic agents also depress myocardial contractility. All local anesthetics exert a dose-dependent negative inotropic action on isolated cardiac





**FIGURE 44-22.** Relationship between dose of various local anesthetics that causes cardiovascular collapse (CC) and in vivo anesthetic potency of these agents. (Reprinted from Covino BG. Pharmacology of local anesthetic agents. In: Rogers MC, Tinker JH, Covino BG, et al., eds. Principles and Practice of Anesthesiology. Vol. 2. St. Louis, MO: Mosby Year Book, 1993:1249, with permission from Elsevier.)

tissue that is proportional to the conduction blocking potency of the various agents in isolated nerves (Fig. 44-22).<sup>111</sup> For example, bupivacaine, tetracaine, and etidocaine produce the greatest degree of myocardial depression. The agents of moderate anesthetic potency (i.e., lidocaine, mepivacaine, prilocaine) are intermediate in terms of their negative inotropic action. Procaine and chlorprocaine, which are the least-potent local anesthetics, require the highest concentration to decrease cardiac contractility.

In dogs, tetracaine is approximately 8–10 times more potent than procaine as a local anesthetic and as a myocardial depressant.<sup>112</sup> Hemodynamic studies in closed-chest anesthetized dogs have shown that tetracaine, etidocaine, and bupivacaine caused a 50% decrease in cardiac output at doses of 10–20 mg/kg, whereas doses of 30–40 mg/kg of lidocaine, mepivacaine, prilocaine, and chlorprocaine were required for a similar decrease in cardiac output. A dose of 100 mg/kg of procaine was needed to reduce cardiac output to 50%.

Most local anesthetic agents exert a biphasic effect on peripheral vascular smooth muscle.<sup>48,49</sup> Low concentrations of lidocaine and bupivacaine produced vasoconstriction in the cremaster muscle of rats, whereas high concentrations increased arteriolar diameter, indicative of vasodilatation. In vivo studies also demonstrate that low doses of local anesthetics decrease peripheral arterial flow without any change in blood pressure, whereas higher doses increase blood flow. Co-

caine causes vasoconstriction because of its ability to inhibit the uptake of norepinephrine by storage granules.<sup>113</sup> Studies indicate that ropivacaine causes cutaneous vasoconstriction, whereas bupivacaine produces vasodilatation.<sup>51</sup>

In a review of the cardiotoxicity of modern local anesthetics, Mather and Chang<sup>114</sup> concluded that as compared with bupivacaine, although ropivacaine and levobupivacaine may be seen as “safer,” they must not be regarded as totally “safe.”

## Factors Influencing Cardiovascular Toxicity

### Specific Agents

Although the CNS is more susceptible to the toxic effects of local anesthetics than the cardiovascular system, differ-

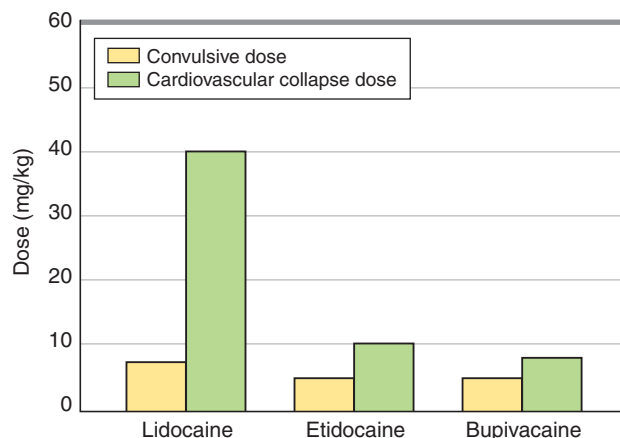
ences exist in the margin between the dose of various agents that causes convulsions and the dose that results in cardiovascular collapse (Fig. 44-23). A cardiovascular collapse (CC)-to-convulsive (CNS) dose ratio of  $7.1 \pm 1.1$  was reported for lidocaine in adult sheep, indicating that 7 times as much drug was required to induce irreversible cardiovascular collapse as to cause convulsions.<sup>115</sup> The CC:CNS ratio for bupivacaine was  $3.7 \pm 0.5$  and for etidocaine,  $4.4 \pm 0.9$ . The CC:CNS blood level ratio of lidocaine was  $3.6 \pm 0.3$ , compared with values of 1.6–1.7 for bupivacaine and etidocaine. At the time of cardiovascular collapse, high concentrations of bupivacaine and etidocaine were present in the myocardium compared with lidocaine, which suggests that the enhanced cardiac toxicity of these more potent agents may result from a greater myocardial uptake.

### Pregnancy

Data regarding the effects of pregnancy on the cardiovascular toxicity of local anesthetic is not conclusive.

### Acidosis and Hypoxia

Hypercarbia, acidosis, and hypoxia potentiate the negative chronotropic and inotropic action of lidocaine and bupivacaine in isolated cardiac tissue.<sup>116</sup> The combination of hypoxia and acidosis greatly potentiates the cardiodepressant effects of bupivacaine. Hypoxia and acidosis also increase the frequency of cardiac dysrhythmias and the mortality rate in sheep following the IV administration of bupivacaine.<sup>116</sup> Hypercarbia, acidosis, and hypoxia



**FIGURE 44-23.** Relationship between dose of lidocaine, bupivacaine, and etidocaine that causes CNS toxicity and dose that produces cardiovascular collapse. (Reprinted from Covino BG. Pharmacology of local anesthetic agents. In: Rogers MC, Tinker JH, Covino BG, et al., eds. Principles and Practice of Anesthesiology. Vol. 2. St. Louis, MO: Mosby Year Book, 1993:1249, with permission from Elsevier.)

occur very rapidly in some patients following seizure activity because of the rapid unintentional intravascular injection of local anesthetic agents.<sup>118</sup> Thus the cardiovascular depression observed in some patients following the accidental IV injection of bupivacaine may be related in part to the severe acid-base changes that occur during toxic reactions to this agent.

Measures to prevent systemic toxic reactions to local anesthetics include following dose recommendations, injecting aliquots over time, avoiding unintentional intravascular injections, and monitoring vital signs during injection. Blanket recommended doses versus block-specific recommended doses were discussed recently.<sup>119,120</sup> Drug administration must be stopped should signs or symptoms of toxicity develop. Seizures induced by local anesthetics are usually self-limiting, and require maintenance of respiratory gas exchange and control of muscle contractions (e.g., intubation, oxygenation, short-acting muscle paralysis). Drugs such as propofol, thiopental, and benzodiazepines are effective against these seizures.

Cardiovascular toxicity is treated according to American Heart Association guidelines, depending on the nature of the toxicity. Recent evidence suggests that in some instances, lipid emulsion infusion may be beneficial.<sup>121</sup>

## SPECIFIC LOCAL ANESTHETICS

### Local Anesthetics in Clinical Use

Table 44-6 lists generic and trade names of local anesthetics. Undoubtedly, lidocaine is most commonly used to prevent procedure-related pain and for diagnostic tests. Intermediate- to long-acting local anesthetics, such as ropivacaine, levobupivacaine, and bupivacaine, are used for therapy.

Table 44-7 lists topical anesthetics and dosage forms. Most of the forms are available without prescription. A 5% lidocaine patch (Lidoderm) is approved by the FDA for controlling postherpetic neuralgia.

### Amino Ester Agents

Local anesthetics in this class have an ester linkage to benzoic acid or its derivatives. The amino ester-linked local anesthetics most commonly used clinically are procaine, chlorprocaine, and

**TABLE 44-6.**

**Generic and Trade Names of Local Anesthetics**

Generic Name	Trade Name(s)
Benoxinate	Dorsacaine; Novesine
Bupivacaine	Marcaine; Sensorcaine
Butacaine	Butyn
Chlorprocaine (2-chloroprocaine)	Nesacaine
Cyclomethycaine	Surfacaine
Dibucaine	Nupercaine; Percaine
Etidocaine	Duranest
Hexylcaine	Cyclaine
Levobupivacaine	Chirocaine
Lidocaine	Xylocaine; Xylotox
Mepivacaine	Carbocaine; Polocaine
Piperocaine	Metycaine
Prilocaine	Citanest
Procaine	Novocain; Planocaine
Proparacaine	Ophthaine; Ocu-Caine
Ropivacaine	Naropin
Tetracaine	Pontocaine; Pantocaine

As these local anesthetics are administered chiefly as the chloride or sulfate salts, it is more accurate to specify procaine hydrochloride than just procaine. Because the latter is the active species, it is the usually used term.  
Modified with permission from deJong RH. Local Anesthetics. St. Louis: Mosby-Year Book, 1994.

tetracaine. All of these agents were introduced into clinical practice by 1955.

### Procaine

Procaine was the first synthetic local anesthetic agent introduced into clinical practice. It is a relatively weak local anesthetic with a slow onset and a short duration of action. Its systemic toxicity

is relatively low because of rapid plasma hydrolysis. Procaine is hydrolyzed to *p*-aminobenzoic acid, which is responsible for the allergic reactions associated with repeated use of procaine. Procaine is used primarily for infiltration anesthesia, diagnostic differential spinal blocks in certain pain states, and obstetric spinal anesthesia.

**TABLE 44-7.**

**Topical: Local Anesthetics and Available Dosage Forms**

Benzocaine	Lidocaine/prilocaine
Cream	Cream
Ointment	Lidocaine/tetracaine
Topical aerosol	Patch
Benzocaine and menthol	Pramoxine
Lotion	Cream
Topical aerosol solution	Lotion
Butamben	Pramoxine and menthol
Ointment	Gel
Dibucaine	Lotion
Cream	Tetracaine
Ointment	Cream
Lidocaine	Tetracaine and menthol
Film-forming gel	Ointment
Ointment	
Patch	
Cream	

From <http://www.nlm.nih.gov/medlineplus/druginfo/uspdi/202042.html> with modification.

### **Chloroprocaine**

Chloroprocaine has rapid onset of action, short duration, and low systemic toxicity. It undergoes hydrolysis by human plasma esterases about 4 times faster than procaine. Chloroprocaine is primarily employed for epidural analgesia and anesthesia in obstetrics because of its rapid onset and low systemic toxicity in the mother and fetus. However, frequent injections are required to provide adequate pain relief during labor. Sometimes, epidural analgesia is established in the pregnant patient with chloroprocaine, followed by a longer-acting agent such as bupivacaine. Chloroprocaine has also proved of value for various regional anesthetic procedures in ambulatory surgical patients for whom surgery is not expected to exceed 30–60 minutes.

Concern about potential myotoxicity and neurotoxicity have haunted chloroprocaine.

### **Tetracaine**

Tetracaine is used primarily for spinal anesthesia. It may be employed as an isobaric, hypobaric, or hyperbaric solution for spinal blockade, although hyperbaric solutions of tetracaine are probably employed most often. Tetracaine provides a relatively rapid onset of spinal anesthesia, excellent qualities of sensory anesthesia, and a profound block of motor function. Plain solutions of tetracaine produce an average duration of spinal anesthesia of 2–3 hours, whereas the addition of epinephrine can extend anesthesia to 4–6 hours.

Tetracaine is rarely used for other forms of regional anesthesia because of its extremely slow onset of action and the potential for systemic toxic reactions when larger doses are employed.

### **Cocaine**

Cocaine was the first agent successfully employed clinically for the production of local anesthesia. It has limited use in modern anesthesia practice because of its relatively high potential for systemic toxicity and addiction liabilities. It is listed as a schedule II drug in the United States. Cocaine is an excellent topical anesthetic agent and it produces vasoconstriction at clinically useful concentrations. As a result, it is still sometimes employed to anesthetize and constrict the nasal mucosa before nasotracheal intubation and otolaryngologists use cocaine during nasal surgery because of its topical anesthetic and vasoconstrictor properties. It is the only local anesthetic

that inhibits the reuptake of catecholamines in the central and peripheral nervous systems.

### **Amino Amide Agents**

Amino amide-linked local anesthetics most commonly used clinically are lidocaine, mepivacaine, ropivacaine, bupivacaine, and levobupivacaine. The first step in the biotransformation of the tertiary amine forms typically is dealkylation of the amino nitrogen by cytochrome P450 in the liver.

#### **Lidocaine**

Lidocaine, the first of the amino amide-type local anesthetics to be introduced into clinical practice, remains the most versatile and most frequently used drug in this class. It is popular because of its inherent potency, rapid onset, moderate duration of action, and topical anesthetic activity. Solutions of lidocaine are available for infiltration, peripheral nerve blocks, and epidural anesthesia. In addition, hyperbaric lidocaine is useful for spinal anesthesia of 30–60 minutes' duration. Lidocaine is also used in ointment, jelly, viscous, and aerosol preparations for a variety of topical anesthetic procedures. Lidocaine currently is still the only agent officially approved in the United States for IV regional anesthesia.

Lidocaine is sometimes given intravenously as an antiepileptic agent, as an analgesic for certain chronic pain states, and as a supplement to general anesthesia. It is administered intravenously for the treatment of ventricular dysrhythmias.

#### **Mepivacaine**

Mepivacaine has a local anesthetic profile similar to that of lidocaine. It can produce a profound depth of anesthesia with a relatively rapid onset and a moderate duration of action. Mepivacaine may be used for infiltration, peripheral nerve blocks, and epidural anesthesia, and in some countries, 4% hyperbaric solutions of mepivacaine are also available for spinal anesthesia.

It is ineffective as a topical anesthetic agent. The metabolism of mepivacaine is greatly prolonged in the fetus and newborn; thus this agent is not usually employed for obstetric anesthesia. Mepivacaine appears to be somewhat less toxic in adults than lidocaine and has less vasodilator activity than lidocaine. Because of the difference in vasoactivity, mepivacaine provides a somewhat longer duration of anesthesia than lidocaine when used without epinephrine.

Mepivacaine seems to be particularly useful for brachial plexus blockade when large volumes of anesthetic solutions without epinephrine are given.

#### **Ropivacaine**

Ropivacaine is prepared as the pure S isomer rather than a racemic mixture. Onset of action, potency and duration of sensory nerve blockade appear similar for ropivacaine and bupivacaine, but ropivacaine is a less potent and short-acting agent in terms of motor fiber blockade. Toxicity studies suggest that ropivacaine is less cardiotoxic than bupivacaine, although ropivacaine still possesses some dysrhythmogenic potentia.

#### **Bupivacaine**

Bupivacaine was the first local anesthetic that combined the properties of an acceptable onset, long duration of action, profound conduction blockade, and significant separation of sensory anesthesia and motor blockade. This agent is used for various regional anesthetic procedures, including infiltration, peripheral nerve blocks, and epidural and spinal anesthesia. The average duration of surgical anesthesia with bupivacaine varies from approximately 3 to 10 hours. Its longest duration of action occurs with major peripheral nerve blocks such as brachial plexus blockade.

The major advantage of bupivacaine appears to involve epidural obstetric analgesia for labor when satisfactory pain relief for 2–3 hours is achieved, which significantly decreases the need for repeated injections in the pregnant patient. Moreover, adequate analgesia is usually achieved without significant motor blockade such that the patient in labor is able to move her legs. This differential blockade of sensory and motor fibers is also the basis for the widespread use of bupivacaine for postoperative epidural analgesia and for certain chronic pain states.

#### **Levobupivacaine**

The clinical profile of levobupivacaine, the S isomer of bupivacaine, is essentially the same as the profile of racemic bupivacaine except with somewhat wider therapeutic index for cardiac toxicity and systemic toxicity.

#### **Prilocaine**

The clinical profile of prilocaine is also similar to that of lidocaine. Prilocaine has a relatively rapid onset of action while providing a moderate duration of anesthesia and a profound depth of conduction blockade. Because this agent

causes significantly less vasodilatation than lidocaine, it can be used without epinephrine.

Prilocaine biotransformation produces aminophenols that oxidize hemoglobin to methemoglobin thus limiting its clinical use. The primary use of prilocaine is in EMLA cream, a eutectic mixture of prilocaine and lidocaine for topical application.

### **Etidocaine**

Etidocaine is characterized by very rapid onset, prolonged duration of action, and profound sensory and motor blockade. It has a significantly more rapid onset of action than bupivacaine. Concentrations of etidocaine required for adequate sensory anesthesia produce profound motor blockade. As a result, etidocaine is primarily useful as an anesthetic for surgical procedures in which muscle relaxation is required. Consequently, this agent is of limited use for obstetric epidural analgesia and postoperative pain relief, as it does not provide a differential blockade of sensory and motor fibers. The drug is used infrequently in North America.

### **Dibucaine**

Dibucaine is only available for topical anesthesia in the United States. It is more potent than tetracaine, although the onset of action of the two agents is similar. The duration of spinal anesthesia is slightly longer with dibucaine. The degree of hypotension and depth of motor blockade appear to be less in patients receiving intrathecal dibucaine than in those receiving tetracaine into the subarachnoid space, although the spread of sensory anesthesia is similar in the two groups.

### **Benzocaine**

This local anesthetic is used exclusively for topical anesthesia. Benzocaine is available in a variety of proprietary and nonproprietary preparations. The most common forms used in an operating room setting are aerosol solutions for endotracheal administration and ointments for lubrication of endotracheal tubes. One should remember that benzocaine also can cause methemoglobinemia.

## KEY REFERENCES

1. Hille B. Ionic Channels of Excitable Membranes. 3rd ed. Stamford,

Connecticut: Sunderland, Sinauer Associates, 2001.

2. de Jong RH. Local Anesthetics. St. Louis: Mosby-Year Book, 1994.

3. Heavner JE, guest ed. Techniques. *Reg Anesth Pain Manage* 2004;8:105–140.

4. Mackley CL, Marks JG, Anderson BE. Delayed-type hypersensitivity to lidocaine. *Arch Dermatol* 2003;139:343–346.

5. Zaric D, Christiansen C, Pace NL, et al. Transient neurologic symptoms after spinal anesthesia with lidocaine versus other local anesthetics: a systematic review of randomized, controlled trials. *Anesth Analg* 2005;100:1811–1816.

6. Albright GA. Cardiac arrest following regional anesthesia with etidocaine or bupivacaine. *Anesthesiology* 1979;51:285–287.

7. Feldman HS, Arthur GR, Covino BG. Comparative systemic toxicity of convulsant and supraconvulsant doses of intravenous ropivacaine, bupivacaine, and lidocaine in the conscious dog. *Anesth Analg* 1989;69:794–801.

8. Stewart J, Kellett N, Castro D. The central nervous system and cardiovascular effects of levobupivacaine and ropivacaine in healthy volunteers. *Anesth Analg* 2003;97:412–416.

9. Heavner JE. Cardiotoxicity of local anesthetics in the intact isolated heart model: a review. *Reg Anesth Pain Med* 2002;27:545–555.

10. Mather LE, Chang H-T. Cardiotoxicity with modern local anesthetics. *Drugs* 2001;61:333–342.

11. Rosenberg PH, Veering BT, Urmey WF. Maximum recommended doses of local anesthetics: a multifactorial concept. *Reg Anesth Pain Med* 2004;29:564–575.

3. de Jong RH. Local Anesthetics. St. Louis: Mosby-Year Book, 1994.

4. Baker MD, Wood JN. Involvement of Na<sup>+</sup> channels in pain pathways. *Trends Pharmacol Sci* 2001;22:27–31.

5. Kindler CH, Yost CS. Two-pore domain potassium channels: new sites of local anesthetic action and toxicity. *Reg Anesth Pain Med* 2005;30:260–274.

6. Xu F, Garavito-Aguilar Z, Pecio-Pinto E, et al. Local anesthetics modulate neuronal calcium signaling through multiple sites of action. *Anesthesiology* 2003;98:1139–1146.

7. Strichartz GR, Berde CB. Local anesthetics. In: Miller RD, ed. *Anesthesia*. 5th ed. Philadelphia: Elsevier, 2005:573–603.

8. Gisson AJ, Covino BG, Gregus J. Differential sensitivities of mammalian nerve fibers to local anesthetic agents. *Anesthesiology* 1980;53:467–474.

9. Fink BR, Cairns A. Lack of size-related differential sensitivity to equilibrium conduction block among mammalian myelinated axons exposed to lidocaine. *Anesth Analg* 1987;66:948–953.

10. Oda A, Ohashi H, Komori S, et al. Characteristics of ropivacaine block of Na<sup>+</sup> channels in rat dorsal root ganglion neurons. *Anesth Analg* 2000;91:1213–1220.

11. Atkinson RL. Intravenous lidocaine for the treatment of intractable pain of adipositas dolorosa. *Int J Obes* 1982;56:351–357.

12. Cassuto J, Wallin G, Hagstrom S, et al. Inhibition of postoperative pain by continuous low-dose intravenous infusion of lidocaine. *Anesth Analg* 1985;64:971–974.

13. Kastrup J, Petersen P, Dejgard A, et al. Intravenous lidocaine infusion: a new treatment of chronic painful diabetic neuropathy? *Pain* 1987;25:69–75.

14. Glazer SAB, Portenoy K. Systemic local anesthetics in pain control. *J Pain Symptom Manage* 1991;6:30–39.

15. Williams DR, Stark RJ. Intravenous lignocaine (lidocaine) infusion for the treatment of chronic daily headache with substantial medication overuse. *Cephalalgia* 2003;23:963–971.

16. Finnerup NB, Biering-Sorensen F, Johannesen IL, et al. Intravenous lidocaine relieves spinal cord injury pain: a randomized controlled trial. *Anesthesiology* 2005;102:1023–1030.

17. Koppert W, Weigand M, Neumann F, et al. Perioperative intravenous lidocaine has preventive effects on postoperative pain and morphine consumption after major abdominal surgery. *Anesth Analg* 2004;98:1050–1055.

18. Attal N, Rouaud J, Brasseur L, et al. Systemic lidocaine in pain due to peripheral nerve injury and predictors of response. *Neurology* 2004;62:218–225.

19. Duarte AM, Pospisilova E, Reilly E, et al. Reduction of postincisional allodynia by subcutaneous bupivacaine. *Anesthesiology* 2005;103:113–125.

20. Zhang JM, Li H, Munir MA. Decreasing sympathetic sprouting in pathologic senso-

## REFERENCES

1. Hille B. Ionic Channels of Excitable Membranes. 3rd ed. Sunderland, Sinauer Associates, 2001.
2. Hollmann MW, Herroeder S, Kurz KS, et al. Time-dependent inhibition of G-protein coupled receptor signaling by local anesthetics. *Anesthesiology* 2004;100:852–860.



ry ganglia: a new mechanism for treating neuropathic pain using lidocaine. *Pain* 2004;109:143–149.

21. Takatori M, Kuroda Y, Hirose M. Local anesthetics suppress nerve growth factor-mediated neurite outgrowth by inhibition of tyrosine kinase activity of TrkA. *Anesth Analg* 2006;102:462–467.

22. Karmaker MK, Ho AM-H, Law BK, et al. Arterial and venous pharmacokinetics of ropivacaine with and without epinephrine after thoracic paravertebral block. *Anesthesiology* 2005;103:704–711.

23. Simon MJG, Veering BT, Vletter AA, et al. The effect of age on the systemic absorption and systemic disposition of ropivacaine after epidural administration. *Anesth Analg* 2006;102:276–282.

24. Braid P, Scott DB. The systemic absorption of local analgesic drugs. *Br J Anaesth* 1965;37:394–404.

25. Tucker GT, Mather LE. Clinical pharmacokinetics of local anesthetics. *Clin Pharmacokinet* 1979;4:241–278.

26. Wildsmith JAW, Tucker GT, Cooper S, et al. Plasma concentrations of local anaesthetics after interscalene brachial plexus block. *Br J Anaesth* 1977;49:461–466.

27. Tucker GT. Pharmacokinetics of local anesthetics. *Br J Anaesth* 1986;58:717–731.

28. Tucker GT, Wiklund L, Berlin-Wahlen AB, et al. Hepatic clearance of local anesthetics in man. *J Pharmacokinet Biopharm* 1977;5:111–122.

29. Lofstrom JB. Tissue distribution of local anesthetics with special reference to the lung. *Int Anesthesiol Clin* 1978;16:53–71.

30. Lofstrom JB, Alm BE, Bertler A, et al. Lung uptake of lidocaine. *Acta Anaesthesiol Scand* 1978;70:80–82.

31. Folds FF, Davidson DM, Dunclaf D, et al. The intravenous toxicity of local anesthetic agents in man. *Clin Pharmacol Ther* 1965;6:328–335.

32. Boyes RN. A review of the metabolism of amide local anesthetic agents. *Br J Anaesth* 1975;47:225–230.

33. Geddes IC. Studies on the metabolism of Citanest C<sup>14</sup>. *Acta Anaesthesiol Scand (Suppl)* 1965;16:37–44.

34. Eriksson E, Granberg PO. Studies on the renal excretion of citanest and Xylocaine. *Acta Anaesthesiol Scand (Suppl)* 1965;16:79–85.

35. Nation RL, Triggs EJ, Selig M. Lignocaine kinetics in cardiac and aged subjects. *Br J Clin Pharmacol* 1977;4:439–448.

36. Stenson RE, Constantino RT, Harrison DC. Interrelationships of hepatic blood flow, cardiac output and blood levels of lidocaine in man. *Circulation* 1971;43:205.

37. Thompson PD, Melmon KL, Richardson JA, et al. Lidocaine pharmacokinetics in advanced heart failure, liver disease and renal failure in humans. *Ann Intern Med* 1973;78:499–508.

38. Sheskey MC, Rocco AG, Bizzarri-Schmid M, et al. A dose-response study of bupiv-

acaine for spinal anesthesia. *Anesth Analg* 1983;62:931.

39. Bromage PR, Gretal M. Improved brachial plexus blockade with bupivacaine hydrochloride and carbonated lidocaine. *Anesthesiology* 1972;36:479–487.

40. Wildsmith JAW, Brown DT, Paul D, et al. Structure–activity relationships in differential nerve block at high and low frequency stimulation. *Br J Anaesth* 1989;63:444–452.

41. Wildsmith JAW, Gissen AJ, Takman B, et al. Differential nerve blockade: esters vs amides and the influence of pK<sub>a</sub>. *Br J Anaesth* 1987;59:379–384.

42. Gissen AJ, Covino BG, Gregus J. Differential sensitivity of fast and slow fibres in mammalian nerve. III. Effect of etidocaine and bupivacaine on fast/slow fibres. *Anesth Analg* 1982;61:570–575.

43. Scott, DB, McClure JH, Giasi RM, et al. Effects of concentration of local anaesthetic drugs in extradural block. *Br J Anaesth* 1980;52:1033–1077.

44. Covino BG. Pharmacology of local anaesthetic agents. *Br J Anaesth* 1986;58:701–716.

45. Gissen AJ, Covino BG, Gregus J. Differential sensitivity of fast and slow fibers in mammalian nerve. VI. Effect of pH on blocking action of local anesthetics. *Reg Anesth* 1986;11:132.

46. Ritchie JM, Ritchie B, Greengard P. The effect of the nerve sheath on the action of local anesthetic. *J Pharmacol Exp Ther* 1965;150:160–164.

47. Galindo A, Benavides O, Ortega de Munos S, et al. Comparison of anesthetic solutions used in lumbar and caudal epidural anesthesia. *Anesth Analg* 1978;57:175–179.

48. Johns RA, DiFazio CA, Longnecker DE. Lidocaine constricts or dilates rat arterioles in a dose-dependent manner. *Anesthesiology* 1985;62:141–144.

49. Johns RA, Seyde WC, DiFazio CA, et al. Dose-dependent effects of bupivacaine on rat muscle arterioles. *Anesthesiology* 1986;65:186–191.

50. Kopacz DJ, Carpenter RL, MacKay DL. Effect of ropivacaine on cutaneous capillary blood flow in pigs. *Anesthesiology* 1989;71:69–74.

51. Yu J, Tokinaga Y, Kuriyama t, et al. Involvement of Ca<sup>2+</sup> sensitization in ropivacaine-induced contraction of rat aortic smooth muscle. *Anesthesiology* 2005;103:548–555.

52. Akerman B, Hellberg I, Trossvik L. Primary evaluation of the local anesthetic properties of the amino agent ropivacaine (LEA-103). *Acta Anaesthesiol Scand* 1988;32:571–578.

53. Feldman HS, Covino BG. Comparative motor-blocking effects of bupivacaine and ropivacaine, a new amino amide local anesthetic in the rat and dog. *Anesth Analg* 1988;67:1047–1052.

54. Concepcion M, Arthur GR, Steele SM, et al. A new local anesthetic, ropivacaine: its epidural effects in humans. *Anesth Analg* 1990;79:80–85.

55. Crawford OB. Comparative evaluation in epidural anesthesia of lidocaine, mepivacaine and L-67, a new local anesthetic agent. *Anesthesiology* 1964;25:321–329.

56. Erdimir HA, Soper LE, Sweet RB. Studies of factors affecting epidural anesthesia. *Anesth Analg* 1965;44:400.

57. Heavner JE, guest ed. *Techniques Reg Anesth Pain Manage* 2004;8:105–140.

58. Cunningham NL, Kaplan JA. A rapid onset long-acting regional anesthetic technique. *Anesthesiology* 1974;41:509–511.

59. Cohen SE, Thurlow A. Comparison of chloroprocaine-bupivacaine mixture with chloroprocaine and bupivacaine used individually for obstetric epidural analgesia. *Anesthesiology* 1979;51:288–292.

60. Corke BG, Carlson CG, Dettbarn WD. The influence of 2-chloroprocaine on the subsequent analgesic potency of bupivacaine. *Anesthesiology* 1984;60:25–27.

61. Conception M, Maddi R, Francis D, et al. Vasoconstrictors in spinal anesthesia with tetracaine: a comparison of epinephrine and phenylephrine. *Anesth Analg* 1984;63:134–138.

62. Albert J, Lofstrom B. Bilateral ulnar nerve blocks for the evaluation of local anesthetic agents. *Acta Anaesthesiol Scand* 1965;9:203–211.

63. Swerdlow M, Jones R. The duration of action of bupivacaine, prilocaine and lignocaine. *Br J Anaesth* 1970;42:335–339.

64. Bromage PR. Spread of analgesic solutions in the epidural space and their site of action. *Br J Anaesth* 1962;34:161–178.

65. Sinclair CJ, Scott DB. Comparison of bupivacaine and etidocaine in extradural blockade. *Br J Anaesth* 1984;56:147–153.

66. Eisenach JC, Grice SC, and Dewan DM. Epinephrine enhances analgesia produced by epidural bupivacaine during labor. *Anesth Analg* 1987;66:447–451.

67. Eisenach JC, Dewan DM, Rose JC, et al. Epidural clonidine produces antinociception, but not hypotension in sheep. *Anesthesiology* 1987;66:496–501.

68. Bromage PR, Burfoot MF, Crowell DE, et al. Quality of epidural blockade. I. Influence of physical factors. *Br J Anaesth* 1964;36:342–352.

69. Bokesch PM, Raymond SA, Strichartz GR. Dependence of lidocaine potency on pH and Pco<sub>2</sub>. *Anesth Analg* 1987;66:9–17.

70. Catchlove RFH. The influence of CO<sub>2</sub> and pH on local anesthetic action. *J Pharmacol Exp Ther* 1972;181:298–307.

71. Bromage PR, Burfoot MF, Crowell DE, et al. Quality of epidural blockade. III. Carbonated local anaesthetic solutions. *Br J Anaesth* 1967;39:197–209.

72. Nickel PM, Bromage RP, Sherrill DL. Comparison of hydrochloride and carbonated salts of lidocaine for epidural analgesia. *Reg Anesth* 1986;11:62–67.

73. Morrison DH. A double-blind comparison of carbonated lidocaine and lidocaine

- hydrochloride in epidural anesthesia. *Can Anaesth Soc J* 1981;28:387–389.
74. Eckstein K, Vincente-Eckstein A, Steiner R, et al. Klinische erprobung von bupivacaine CP2. *Anaesthesist* 1979;27:1.
75. McClure JH, Scott DB. Comparison of bupivacaine hydrochloride and carbonated bupivacaine in brachial plexus block by the inter-scalene technique. *Br J Anaesth* 1981;51:523–526.
76. DiFazio Ca, Carron H, Grosslight KR, et al. Comparison of pH-adjusted lidocaine solutions for epidural anesthesia. *Anesth Analg* 1986;65:760–764.
77. Hilgier M. Alkalinization of bupivacaine for brachial plexus block. *Reg Anesth* 1985;10:59–61.
78. Bedder MD, Kozody R, Craig DB. Comparison of bupivacaine and alkalinized bupivacaine in brachial plexus anesthesia. *Anesth Analg* 1988;67:48–52.
79. Liepert DJ, McMorland GH, Cambling DR, et al. Comparison of lidocaine CO<sub>2</sub>: two percent lidocaine hydrochloride and pH adjusted lidocaine hydrochloride for caesarean section anesthesia *Can J Anaesth* 1990;37:333–336.
80. Mertes PM, Laxenaire MC, Alla F. Anaphylactic and anaphylactoid reactions occurring during anesthesia in France in 1999–2000. *Anesthesiology* 2003;99:536–545.
81. Mackley CL, Marks JG, Anderson BE. Delayed-type hypersensitivity to lidocaine. *Arch Dermatol* 2003;139:343–346.
82. Zaric D, Christiansen C, Pace NL, et al. Transient neurologic symptoms after spinal anesthesia with lidocaine versus other local anesthetics: a systematic review of randomized, controlled trials. *Anesth Analg* 2005;100:1811–1816.
83. Lund PG, Cwik JG. Propitocaine (citanest) and methemoglobinemia. *Anesthesiology* 1965;26:569–571.
84. Hjelm M, Holmdahl MH. Biochemical effects of aromatic amines. *Acta Anaesthesiol Scand* 1965;2:99–120.
85. Albright GA. Cardiac arrest following regional anesthesia with etidocaine or bupivacaine. *Anesthesiology* 1979;51:285–287.
86. Feldman HS, Arthur GR, Covino BG. Comparative systemic toxicity of convulsant and supraconvulsant doses of intravenous ropivacaine, bupivacaine, and lidocaine in the conscious dog. *Anesth Analg* 1989;69:794–801.
87. Stewart J, Kellett N, Castro D. The central nervous system and cardiovascular effects of levobupivacaine and ropivacaine in healthy volunteers. *Anesth Analg* 2003;97:412–416.
88. Knudsen K, Beckman-Suurkula M, Blomberg S, et al. Central nervous and cardiovascular effects of I.V. infusions of ropivacaine, bupivacaine and placebo in volunteers. *Br J Anaesth* 1997;78:507–514.
89. Scott DB, Lee A, Fagan D, et al. Acute toxicity of ropivacaine compared with that of bupivacaine. *Anesth Analg* 1989;69:563–569.
90. Brown DL, Ransom DM, Hall JA, et al. Regional anesthesia and local anesthetic-induced systemic toxicity: seizure frequency and accompanying cardiovascular changes. *Anesth Analg* 1995;81:321–328.
91. Liu PL, Feldman HS, Giasi R, et al. Comparative CNS toxicity of lidocaine, etidocaine, bupivacaine and tetracaine in awake dogs following rapid IV administration. *Anesth Analg* 1983;62:375–377.
92. Arthur GR, Scott DHT, Boyes RN, et al. Pharmacokinetics and clinical pharmacologic studies with mepivacaine and prilocaine. *Br J Anaesth* 1979;1:481–485.
93. Scott DB. Evaluation of clinical tolerance of local anaesthetic agents. *Br J Anaesth* 1975;47:328–331.
94. Englesson S. The influence of acid–base changes on central nervous system toxicity of local anesthetic agents. I. An experimental study in cats. *Acta Anesthesiol Scand* 1974;18:79–87.
95. Apfelbaum JL, Shaw LA, Gross JB, et al. Modification of lidocaine protein binding with CO<sub>2</sub>. *Can Anaesth Soc J* 1985;32:468–471.
96. Burney RG, DiFazio CA, Foster JA. Effects of pH on protein binding of lidocaine. *Anesth Analg* 1978;57:478–480.
97. Heavner JE. Cardiotoxicity of local anesthetics in the intact isolated heart model: a review. *Reg Anesth Pain Med* 2002;27:545–555.
98. Clarkson CS, Hohdeghem LM. Mechanisms for bupivacaine depression of cardiac conduction: fast block of sodium channels during the action potential with slow recovery from block during diastole. *Anesthesiology* 1985;62:396–405.
99. Lynch C. Depression of myocardial contractility in vitro by bupivacaine, etidocaine and lidocaine. *Anesth Analg* 1986;65:551–559.
100. Moller RA, Covino BG. Cardiac electrophysiologic effects of lidocaine and bupivacaine. *Anesth Analg* 1988;67:107–114.
101. Arlock P. Actions of three local anesthetics: lidocaine, bupivacaine and ropivacaine on guinea pig papillary muscle sodium channels ( $V_{max}$ ). *Pharmacol Toxicol* 1988;63:96–104.
102. deJong RH, Ronfeld RA, DeRosa RA. Cardiovascular effects of convulsant and supraconvulsant doses of amide local anesthetics. *Anesth Analg* 1982;61:3–9.
103. Kasten GW. High serum bupivacaine concentrations produce rhythm disturbances similar to torsades de pointes in anesthetized dogs. *Reg Anesth* 1986;11:20–25.
104. Kotelko DM, Shnider SM, Dailey PA, et al. Bupivacaine-induced cardiac arrhythmias in sheep. *Anesthesiology* 1984;60:10–18.
105. Nath S, Haggmark S, Johansson G, Reiz S. Differential depressant and electrophysiologic cardiotoxicity of local anesthetics: an experimental study with special reference to lidocaine and bupivacaine. *Anesth Analg* 1986;65:1263–1270.
106. Sage D, Feldman H, Arthur G, et al. The cardiovascular effects of convulsant doses of lidocaine and bupivacaine in the conscious dog. *Reg Anesth* 1985;10:175–183.
107. Coyle DE, Sperelakis N. Bupivacaine and lidocaine blockade of calcium-mediated slow action potentials in guinea pig ventricular muscle. *J Pharmacol Exp Ther* 1987;242:1001–1005.
108. Tanz RD, Heskett T, Loehning W, et al. Comparative cardiotoxicity of bupivacaine and lidocaine in the isolated perfused mammalian heart. *Anesth Analg* 1984;63:549–556.
109. Heavner JE. Cardiac dysrhythmias induced in infusion of local anesthetics into the lateral cerebral ventricle of cats. *Anesth Analg* 1986;65:133–138.
110. Scott DB. Toxic effects of local anaesthetic agents on the central nervous system. *Br J Anaesth* 1986;48:732–735.
111. Block A, Covino BG. Effect of local anesthetic agents on cardiac conduction and contractility. *Reg Anesth* 1982;6:55–61.
112. Stewart DM, Rogers WP, Mahaffrey JE, et al. Effect of local anesthetics on the cardiovascular system in the dog. *Anesthesiology* 1963;24:620–624.
113. MacMillan WH. A hypothesis concerning the effect of cocaine on the action of sympathomimetic amines. *Br J Pharmacol* 1959;14:385–391.
114. Mather LE, Chang H-T. Cardiotoxicity with modern local anesthetics. *Drugs* 2001;61:333–342.
115. Morishima HO, Pedersen H, Finster M, et al. bupivacaine toxicity in pregnant and nonpregnant ewes. *Anesthesiology* 1985;62:134–139.
116. Sage DJ, Feldman HS, Arthur GR, et al. Influence of lidocaine and bupivacaine on isolated guinea pig atria in the presence of acidosis and hypoxia. *Anesth Analg* 1984;63:1–7.
117. Rosen M, Thigpen J, Shnider S, et al. Bupivacaine-induced cardiotoxicity in hypoxic and acidotic sheep. *Anesth Analg* 1985;64:1089–1096.
118. Moore DC Crawford RD, Scurlock JE. Severe hypoxia and acidosis following local anesthetic-induced convulsions. *Anesthesiology* 1980;53:259–260.
119. Heavner JE. Let's abandon blanket maximum recommended doses of local anesthetics. *Reg Anesth Pain Med* 2004;29:524.
120. Rosenberg PH, Veering BT, Urmey WF. Maximum recommended doses of local anesthetics: a multifactorial concept. *Reg Anesth Pain Med* 2004;29:564–575.
121. Weinberg G, Ripper R, Feinstein DL, et al. Lipid emulsion infusion rescues dogs from bupivacaine-induced cardiac toxicity. *Reg Anesth Pain Med* 2003;28:198–202.

## SECTION D

## REGIONAL ANESTHESIA

## CHAPTER 45

## Incorporating Regional Anesthesia into Anesthetic Practice

Richard W. Rosenquist, MD  
and David L. Brown, MD

Incorporating regional anesthesia into an established anesthesia practice demands that the physicians involved understand and make preparations to address the following:

- Management of regional anesthesia through the perioperative period;
- The clinical indications for the regional anesthetic chosen;
- The resources necessary to perform the blocks efficiently and effectively; and
- Establishment of an institutional strategy to optimize the introduction of new techniques.

Far too often physicians desire to immediately transfer “techniques” they have learned into their own practices. That strategy is often destined to fail as the four areas of understanding clearly need to be managed to predictably and reliably introduce regional anesthesia into established practices. This chapter explores each of these necessary steps for successful introduction of regional anesthesia into a practice and expands on them so that you are able to individualize a plan for your own institution and practice.

### CONCEPT OF THE CONTINUUM OF ANESTHESIA CARE: THE PERIOPERATIVE PERIOD

Physicians who desire to add regional anesthesia techniques to their own

practice are most successful if they fundamentally are truly outstanding physicians and, as a result, excellent anesthesiologists. These physicians must be true perioperative physicians. They *must* be

able to understand patient medical problems, surgeons’ operative requirements, and regional anesthesia techniques, as well as recovery pattern, nursing requirements, rehabilitation,

## KEY POINTS

1. The one overriding benefit of regional anesthesia techniques is that they do not need to end as the patient leaves the operating room at the end of the intraoperative period.
2. The patient education process is most effective if started in the surgeon’s office at the time of the visit at which the decision for operation is completed. Both the surgeon and the nurses need to understand the general concepts and goals of anesthesia and are often strong advocates of better perioperative analgesia for their patients.
3. The perioperative period should be designed so that regional anesthesia does not delay or slow down a surgical day. Surgical delay is one of the most important items to avoid if you desire to successfully add regional anesthetic techniques to your practice.
4. Regional anesthesia techniques should be selected and performed on the basis of clear indications so as to maximize benefit and minimize complications.
5. The preoperative anesthetic note should clearly outline that the patient has been informed of the risks and benefits of the entire anesthetic experience, including the regional anesthetic portion, if that is applicable to the patient.
6. Patients should have regional anesthetics performed in settings where full monitoring, resuscitation equipment, and supplies are available.
7. When a practice has added continuous regional anesthetic techniques (either epidural or continuous peripheral nerve block techniques), it is important that round-the-clock coverage and followup is available to the patient and hospital if the patient remains as an inpatient.
8. One of the most important technical items in the intraoperative period with regional anesthesia is to recognize that if a block is not 100%, the anesthesiologist should be the only individual aware of that fact. This means that if the block is not working as well as desired, general anesthesia or deep sedation should be added efficiently.
9. If a patient is to be discharged with a continuous catheter technique, a clear understanding of catheter and pump management, limb protection, catheter removal, breakthrough pain control, and contact numbers must be assured.
10. Anesthesiologists need to continue their own regional anesthesia education by attending continuing education conferences and workshops that help them to have a more complete understanding of the topic and learn new techniques for introduction into their practice. This enables anesthesiologists to continue the education of physicians, nurses, and others regarding regional anesthesia advances.

and potential complications from the surgical procedure performed. Only if all of these are incorporated into decisions about regional anesthesia will the patient, surgeon, anesthesiologist, and nursing staff be coadvocates of the proposed new technique.

In today's surgical and anesthetic environment, our intraoperative general anesthetic care has advanced to a level where it is unusual to find clear advantages for regional anesthesia when considered during the isolated intraoperative period. There are exceptions, of course. Nevertheless, regional anesthesia may be better termed "regional analgesia," as one seeks to incorporate that concept into a practice. The one overriding benefit of regional anesthesia techniques is that they do not need to end as the patient leaves the operating room at the end of the intraoperative period. Rather, when effectively chosen, these regional techniques can be extended either through appropriate drug selection, or via catheter insertion and continuous infusion of medication. Either of these choices may help transition the patient from the intraoperative to the postoperative period and to nearly full recovery without significant pain. Examples of this include using new, extended-release depot preparations of morphine in the epidural space to extend analgesia, or by inserting *home going* peripheral nerve plexus catheters to provide local anesthetic analgesia into the immediate and more distant postoperative period.<sup>1-4</sup>

A key step in successfully introducing regional anesthesia to an established practice is insuring that preoperative evaluation and education of the patient includes an explanation of regional anesthesia and that realistic patient expectations are established. Far too often patients are under the misunderstanding that because they choose a regional anesthesia technique, they will be "awake" during their surgical procedure. Experts in regional anesthesia are nearly always capable of providing outstanding sedation and anxiolysis for the entire perioperative period for patients undergoing a regional technique. This observation fits with these anesthesiologists being excellent physicians and understanding that it is a rare patient who wants to be, or should be allowed to be, unsedated for a surgical procedure. The patient education process is most effective if

started in the surgeon's office at the time of the visit at which the decision for operation is completed. Both the nurses and the surgeon need to understand the general concepts and goals of anesthesia, including regional anesthesia techniques. Once they understand these concepts, they are often strong coadvocates of better perioperative analgesia for their patients.

When considering patient education, the most important concept is that realistic expectations for both patient and the patient's family are outlined. The patient's expectations should be focused around anesthesia, sedation, postoperative analgesia, and what side effects the patient might experience so that, for example, a "numb" arm does not bother the patient on arrival in the recovery room or discharge to the floor or home. In setting these expectations, it is important that the anesthesiologist and institution design an analgesia transition program that addresses resolution of the regional anesthetic. As an example, outstanding brachial plexus anesthesia and analgesia for an upper-extremity operation can frustrate a patient and the patient's family if the block abruptly wears off while the patient is expecting to sleep through the night and no oral medication regimen has been planned to ease that transition. When setting expectations for surgeons, a key element is that the perioperative period is designed so that regional anesthesia does not delay or slow down a surgical day. This demands that anesthesiologists and institutional leaders be creative about incorporating regional blocks and techniques into their practices. My experience is that surgical delay is one of the most important items to avoid if you desire to successfully add regional anesthesia techniques to your practice.

### CLINICAL INDICATION FOR REGIONAL ANESTHESIA

After considering the continuum of anesthesia care in the entire perioperative period, the next step for successful introduction of regional techniques into a practice is to develop clear indications for the use of these techniques. It must be remembered that the dominant focus for regional anesthesia is regional analgesia and the ability to minimize opioids and other intrave-

nous agents in the immediate perioperative period. Additional advantages of regional anesthesia techniques include the ability to avoid airway manipulations in patients who evidence difficult airway characteristics, or those with full stomach considerations. This does not mean that regional anesthetics should be applied in every full-stomach situation, but a mature clinical risk-to-benefit approach to many emergency patients suggests that the use of effective regional anesthesia does modify risk. Finally, there are selected patients in whom specific regional techniques may provide significant physiologic advantages. As example, in a patient with obstructive cardiomyopathy, the intravascular volume shifts from both general anesthesia vasodilatation and/or neuraxial anesthesia vasodilatation may be avoided, to the patient's advantage, by the use of a brachial plexus nerve block. Another example might be a patient with end-stage pulmonary disease, who requires open reduction internal fixation of a hip fracture. This clinical setting might be effectively handled with a continuous spinal anesthetic and minimal sedation, rather than a general anesthetic with tracheal intubation.

In a patient who is undergoing regional anesthesia, there must be clear documentation of both the technical procedure and the indications for the regional technique in the patient's chart. This is another opportunity for the anesthesiologist to educate both surgeons and nurses about the primary reason why the regional anesthesia technique was chosen. In my opinion, anesthesiologists frequently do not take advantage of the educational opportunities present in writing clear and effective progress notes in a patient's record. The preoperative anesthesia note should clearly outline that the patient has been informed of the risks and benefits of the entire anesthesia experience, including the regional anesthesia portion, if applicable to the patient.

The increasing number of drugs being developed that impact coagulation demands that anesthesiologists interested in adding regional techniques to their practice fully understand the implications of these anticoagulants and platelet-active drugs. For example, consensus statements for the use of neuraxial anesthesia techniques in relation to the use of various anticoagu-



lant and antiplatelet agents were published by the American Society of Regional Anesthesia and Pain Medicine (ASRA) in 2003.<sup>5</sup> Recent data outlining a 10-year Swedish experience with anticoagulants and neuraxial anesthesia underscore the need to understand the potential risks and benefits of this drug and technique combination.<sup>6</sup> The Swedish results reiterated the danger of using more than one agent with anticoagulant or antiplatelet activity in combination. They also identified subgroups of patients at markedly increased risk; for example, elderly females with osteoporosis undergoing total knee arthroplasty under epidural analgesia and receiving once-per-day low-molecular-weight heparin have a 1 in 1800 incidence of epidural hematoma. The data to develop clear consensus statement guidelines regarding the use of anticoagulants and antiplatelet agents in conjunction with peripheral regional anesthetics is extremely limited. It has been suggested that the ASRA consensus guidelines for neuraxial anesthesia be applied to all regional anesthesia techniques. This may be too restrictive. In most cases, techniques performed in areas that are easily compressed in the event of bleeding may be appropriate. Others, such as paravertebral or subclavian blocks, should be avoided unless coagulation parameters are normal.

### RESOURCES REQUIRED FOR EFFICIENT PRACTICE

A common stumbling block for practices desiring to add regional anesthesia expertise to their practice is to have too few anesthesiologists skilled in the techniques. There must be critical masses of personnel, resources for the techniques, as well as interest in the techniques, for these to be added successfully to an anesthesia practice. Many practices often seek to have a single individual provide the regional anesthesia expertise. This is nearly always doomed to failure as that individual cannot be present 24 hours a day, year-round. Rather, it seems important to have enough physicians with the technical skills and interest in these anesthesia approaches to be able to provide consistent delivery of regional anesthesia throughout the day, week, and year. In addition to the physician resources, it is often helpful

to have allied health personnel help to prepare patients and supplies for the regional techniques to optimize timing of the technical performance of the regional anesthetic. This may be with a technician who is well trained in assisting the physicians, a nurse anesthetist who is skilled in this area of practice, or a registered nurse who works for the practice or hospital and has an interest in and a desire to grow this part of the practice.

For the physicians, there must be a complete understanding of anatomy and regional anesthesia technical skills so as to safely and reliably perform the nerve blocks. Patients should have regional anesthetics performed in settings where full monitoring, resuscitation equipment, and supplies are available. These are major anesthesia techniques and need to be treated as such. Monitoring should meet American Society of Anesthesiologists (ASA) standards for performance of an anesthetic.<sup>7</sup> Delays in the surgical day can often be minimized if many of the regional anesthetics are performed outside the operating room itself. This serves two functions. First, it allows the regional anesthesia to be performed while the surgical team is still preparing the operating room. Second, it gives the injected local anesthetic additional time to effectively anesthetize the desired region. This, of course, demands that regional anesthesia block rooms, or at least regional anesthesia block areas, are established outside the operating room. In many practices, this could be accomplished in areas of the preoperative holding or of postoperative anesthesia recovery. The ideal is to have induction rooms near the operating rooms. Within these areas of the hospitals, regional anesthesia carts with supplies easily at hand and with appropriate monitoring and resuscitation gear are critical for effectively caring for these patients.

As the regional anesthetic practice is established, allied health staff assisting physicians with the technical features of these nerve blocks need to be trained and to have regional block protocols developed so that they are most effective. This demands significant planning and communication to effectively implement this practice.

When a practice has added continuous regional anesthesia techniques (either epidural or continuous peripheral nerve block techniques), it is impor-

tant that round-the-clock coverage and followup are available to the patient and hospital if the patient remains as an inpatient. Even the most successful technical regional anesthetic can be viewed as unsuccessful if this part of the practice is not accounted for in the development phase of adding regional anesthesia to a practice. Other ideas to ease the transition of regional anesthetic techniques into a practice are to use regional anesthesia continuous infusion pumps that differ from general intravenous infusion pumps used throughout the hospital with tubing that has no injection ports. This difference helps to minimize the inappropriate administration of other intravenous drugs through regional block catheters. Drug swaps remain one of the dilemmas of modern medicine and the use of different pumps and tubing helps to minimize this type of error and potential neurotoxicity. New devices with the capability to read barcodes and recognize appropriate or inappropriate drugs for the device may provide additional safety in the future. Successful introduction and continued use of regional anesthetic techniques requires that physicians stay abreast of the latest technologies, such as ultrasound guidance or the use of stimulating catheters for catheter placement.<sup>8,9</sup>

### OPTIMIZING INSTITUTIONAL INTRODUCTION OF REGIONAL ANESTHESIA

Once the preceding three major elements are understood and a group decides to move ahead with introduction of regional anesthesia or expansion of regional anesthesia into its practice, strategies need to be developed to optimize this introduction. First, a core group of regional anesthesia physicians who agree, in principle, on the plan must be established. It is most effective if, as a system is rolled out, a small number of surgeons and surgical procedures are used as the initial clinical settings so that "success" can be validated more quickly. One of the easiest ways to cause an introduction of regional anesthesia to a practice to fail is to try to be all things to all patients and all surgeons at the outset. It is important to emphasize that successful introduction of regional anesthesia to a practice demands that all involved perceive that regional anes-

thetia is truly an advantage to the patient, to the surgeon, to the anesthesiologist, and to the institution. Collins et al.<sup>10</sup> provided clear evidence for this as they examined the impact of a regional anesthesia–analgesia program for outpatient foot surgery. They documented a marked increase in regional anesthesia use, no decrease in operating room efficiency, reduced postanesthesia care unit and discharge time, decreased analgesic use, and decreased nursing interventions for analgesia.

An important technical item in the intraoperative period with regional anesthesia is to recognize that if a block is not 100%, the anesthesiologist should be the only individual aware of that fact. This means that if the block is not working as well as desired, general anesthesia or deep sedation should be added efficiently. This demands that anesthesiologists interested in this practice understand enough about regional anesthesia and sedation to blend the two techniques so that patients are effectively sedated and do not have any painful memories of either block insertion or eventual surgical manipulations. The potential for this transition from conscious sedation to deep sedation or general anesthesia should be explained in advance so that patients have realistic expectations regarding the plan of management.

Successful use of regional anesthesia also requires education and training of the nursing staff and development of care protocols. This often begins in the postanesthesia care unit where the limb must be protected. If the patient is to be discharged, the patient and family must be educated about how to protect the limb until recovery from the block has occurred. If the patient is to be discharged with a continuous catheter technique, a clear understanding of catheter and pump management, limb protection, catheter removal, breakthrough pain control, and contact numbers must be assured. In some settings, this may require training home health nurses to facilitate the process. On the inpatient side, education regarding limb protection, neurologic evaluations, breakthrough pain,

and issues with anticoagulation and ambulation must be completed.

Once the techniques are well established within an institution and the anesthesiologists are interested, the anesthesiologists need to continue their own regional anesthesia education by attending continuing education conferences and workshops that help them to an even more complete understanding of the topic and to learn new techniques for introduction into their practice. This enables these anesthesiologists to continue the education of nurses and others interested in regional anesthesia advances. This is a critical component of successful introduction of the practice of regional anesthesia.

Once it is effectively introduced, the registered nurses within an institution often are its most vocal advocates, as they see firsthand the difference between patients having effective regional anesthesia and those having either ineffective regional anesthesia, excessive opioid analgesia, or uncontrolled pain in the perioperative period.

## CONCLUSION

The introduction of regional anesthesia to an established anesthesia practice is no different than the introduction of any new technique to a practice. There must be expertise, planning, and a group of physicians and support staff interested in the entire perioperative period who can coordinate the necessary personnel and resources to provide state-of-the-art medical care.

## KEY REFERENCES

1. Ilfeld BM, Enneking FK. Continuous peripheral nerve blocks at home: a review. *Anesth Analg* 2005; 100:1822–1833.
2. Horlocker TT, Wedel DJ, Benzon H, et al. Regional anesthesia in the anticoagulated patient: defining the risks. *Reg Anesth Pain Med* 2003; 28:172–197.

3. Moen V, Dahlgren N, Irestedt L. Severe neurological complications after central neuraxial blockades in Sweden 1990–1999. *Anesthesiology* 2004;101:950–959.

4. Gray AT. Ultrasound-guided regional anesthesia: current state of the art. *Anesthesiology* 2006;104:368–373.

5. Collins L, Halwani A, Vaghadia H. Impact of a regional anesthesia program for outpatient foot surgery. *Can J Anaesth* 1999;46:840–845.

## REFERENCES

1. Viscusi ER. emerging techniques in the management of acute pain: epidural analgesia. *Anesth Analg* 2004;101(5 Suppl):S23–S29.
2. Viscusi ER, Martin G, Hartrick CT, Singla N, Manvelian G, EREM Study Group. Forty-eight hours of postoperative pain relief after total hip arthroplasty with a novel, extended-release epidural morphine formulation. *Anesthesiology* 2005;102:1014–1022.
3. Ilfeld BM, Enneking FK. Continuous peripheral nerve blocks at home: a review. *Anesth Analg* 2005;100:1822–1833.
4. Ilfeld BM, Wright TW, Enneking FK, Vanderborne K. Total elbow arthroplasty as an outpatient procedure using a continuous infraclavicular nerve block at home: a prospective case report. *Reg Anesth Pain Med* 2006;31:172–176.
5. Horlocker TT, Wedel DJ, Benzon H, et al. Regional anesthesia in the anticoagulated patient: defining the risks. *Reg Anesth Pain Med* 2003;28:172–197.
6. Moen V, Dahlgren N, Irestedt L. Severe neurological complications after central neuraxial blockades in Sweden 1990–1999. *Anesthesiology* 2004;101:950–959.
7. ASA House of Delegates. Standards for basic anesthetic monitoring. 2005. Available at: <http://www.asahq.org/publicationsAndServices/sgstoc.htm>. Last accessed July 8, 2007.
8. Gray AT. Ultrasound-guided regional anesthesia: current state of the art. *Anesthesiology* 2006;104:368–373.
9. Boezaart AP, de Beer JF, Nell ML. Early experience with continuous cervical paravertebral block using a stimulating catheter. *Reg Anesth Pain Med* 2003;28:406–413.
10. Collins L, Halwani A, Vaghadia H. Impact of a regional anesthesia program for outpatient foot surgery. *Can J Anaesth* 1999;46:840–845.

## CHAPTER 46

## Neuraxial Anesthesia

Daniel T. Warren, MD, and  
Spencer S. Liu, MD

With more than 100 years of use, neuraxial anesthesia has enjoyed much success and endured controversy. With the stage set by the developments of the hollow needle and syringe, the discovery of neuraxial anesthesia was born out of mishap in 1885 when Corning was experimenting with effects of cocaine on the spinal nerves of dogs. Bier brought spinal anesthesia into clinical use for surgery in 1898, but only after self-experimentation and a personal experience with a well-described postdural puncture headache. Epidural anesthesia gained widespread attention in the setting of labor analgesia, maintaining the medical community's interest in neuraxial blockade despite rapid advancements in techniques for general anesthesia in the 1940s and 1950s. More recently, the introduction of continuous catheter techniques, combined spinal-epidural anesthesia, and various neuraxial anesthetic adjuvants has allowed further opportunities to provide our patients the benefits of neuraxial blockade.

## ANATOMY

## Neural Structures

A thorough appreciation for the anatomy of the spinal structures is necessary for appropriate technique, patient selection, and management of neuraxial anesthesia. The spinal structures are identified by cervical, thoracic, lumbar, sacral, and caudal regions (Fig. 46-1). The spinal cord begins at the base of the brainstem and continues caudad terminating as the conus medullaris, typically at the level of L1-L2 in the adult. The cord shows cervical and lumbar enlargements to accommodate the increased neuronal supply of the limbs. Rootlets emerge from the dorsal and ventral surface of the spinal cord and converge to form

the respective ventral and dorsal roots of the spinal nerves at each spinal level (Fig. 46-2).

## Cerebrospinal Fluid

As with the brain, the spinal cord and portions of the spinal nerves are bathed in cerebrospinal fluid (CSF), which provides protection for these structures and participates in maintaining homeostasis. The CSF is secreted mainly by the choroid plexuses located on the roofs of the lateral, third, and fourth ventricles, and reabsorbed mainly through the arachnoid villi which project into the parasagittal venous sinuses and to a much lesser extent through the epidural veins of the vertebral column. It typically has a density range of 1.00028–1.00100 g/mL.<sup>1</sup> CSF volume and its clinical consequences are discussed in the Clinical Pharmacology section below.

## Meninges

As with the brain, spinal cord, nerve roots and CSF are enveloped by three membranes: the pia mater, arachnoid mater, and the dura mater (Figs. 46-2 and 46-3). The innermost pia mater is intimately lining the surface of the cord and nerve roots. It is a highly vascular and permeable membrane. The arachnoid mater approximates the

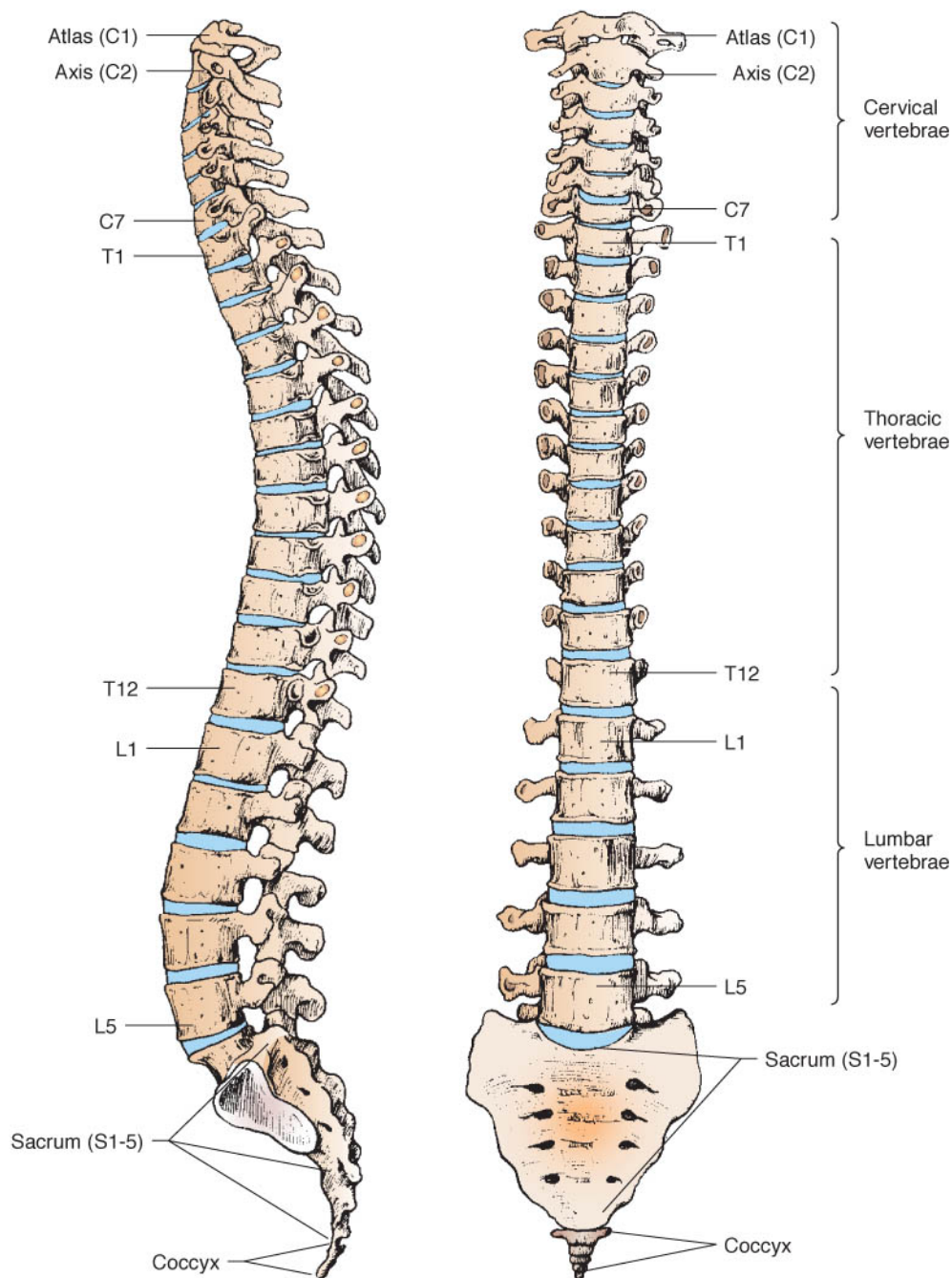
outermost membrane, the dura mater. Within the boundaries of the arachnoid is the subarachnoid space, home to the CSF, trabecular network, and dentate ligaments. The subarachnoid space extends laterally with the dura as nerve root “sleeves,” with the accompanying CSF as far as the dorsal root ganglion. The spinal dura mater extends from the level of the foramen magnum, where it is contiguous with cranial dura, to the level of S2 in most adults. Here the subarachnoid space terminates as the dura fuses with the filum terminale (pial extension), and then with the coccygeal periosteum. Between the dura mater and arachnoid mater resides the subdural space, which contains little more than a small amount of serous fluid. This space is often implicated as a culprit in complications such as a total spinal following an intended epidural administration of local anesthetic and failed spinal anesthetics.

## Vertebrae

The neural structures of the spinal cord are protected by the bony vertebral column comprised of 7 cervical, 12 thoracic, 5 lumbar, 5 sacral, and 4 coccygeal vertebrae (Fig. 46-1). The vertebrae of the sacral and coccygeal regions are fused to form the sacrum

## KEY POINTS

1. A systematic and rational approach based on a thorough three-dimensional understanding of anatomy should be used when accessing the subarachnoid and epidural space.
2. Anesthetic doses, agents, and combinations of agents should be individualized so as to optimize neuraxial blockade for a given clinical setting.
3. Hypotension and bradycardia associated with neuraxial anesthesia should be identified early and treated aggressively in an attempt to prevent cardiovascular collapse and poor outcome.
4. Our understanding of potential neurotoxicity and the nature of transient neurologic symptoms (TNS) are continuing to evolve. However, there is growing consensus that TNS may not represent direct neural toxicity.
5. Evaluating the appropriateness of neuraxial procedures in patients receiving anticoagulant and antiplatelet medications is a challenge. Clinicians should be familiar with the recommendations presented by the American Society of Regional Anesthesia and Pain Management in the consensus statement addressing these issues.
6. When suspicion of spinal hematoma or abscess is credible, definitive diagnosis with appropriate imaging and prompt decompression within 4–6 hours of onset of neurologic symptoms is crucial to improve chances of recovery of function.
7. Developing an understanding of the nature of combined spinal-epidural anesthesia and facility with its techniques can expand a clinician's armamentarium of tools to provide neuraxial anesthesia and optimize patient care.



**FIGURE 46-1.** Regions of the spinal column.

and coccyx, respectively. Cervical and lumbar lordotic curves and thoracic kyphotic curves of the normal spine allow for advantageous distribution of mechanical forces and spinal movements. A typical vertebra consists of a pillar-like vertebral body joined by the pedicles to the posterior elements, namely the laminae, superior and inferior articular processes, transverse processes, and the spinous process. The vertebrae have regional characteristics

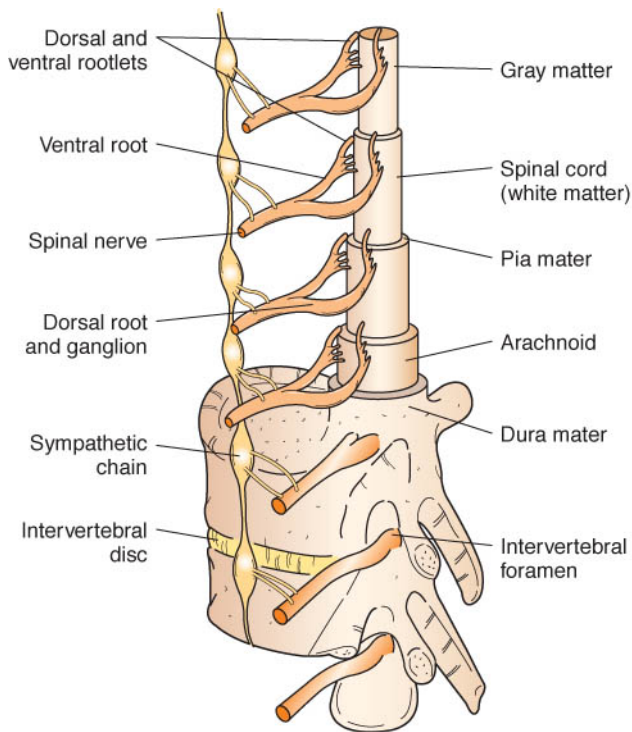
that are relevant to the techniques used to access the neuraxis in clinical situations. The figures depict relevant features of representative thoracic and lumbar vertebrae (Fig. 46-4).

### Intervertebral Disks and Ligaments

The endplates of the vertebral bodies are joined to one another by the intervertebral disks (Fig. 46-2), consisting of the outer annulus fibrosus and the

inner nucleus pulposus. Further structural support comes from the anterior and posterior longitudinal ligaments running along the ventral and dorsal aspects of the vertebral bodies respectively. Along with the supraspinous ligament traversing superficially, the deeper interspinous ligament joins the spinous processes to one another (Fig. 46-3). Adjacent lamina are interconnected by the ligamentum flavum, together forming the posterior wall of the





**FIGURE 46-2.** The spinal cord, along with the emerging root structures, are enveloped by the meninges as depicted in this figure.

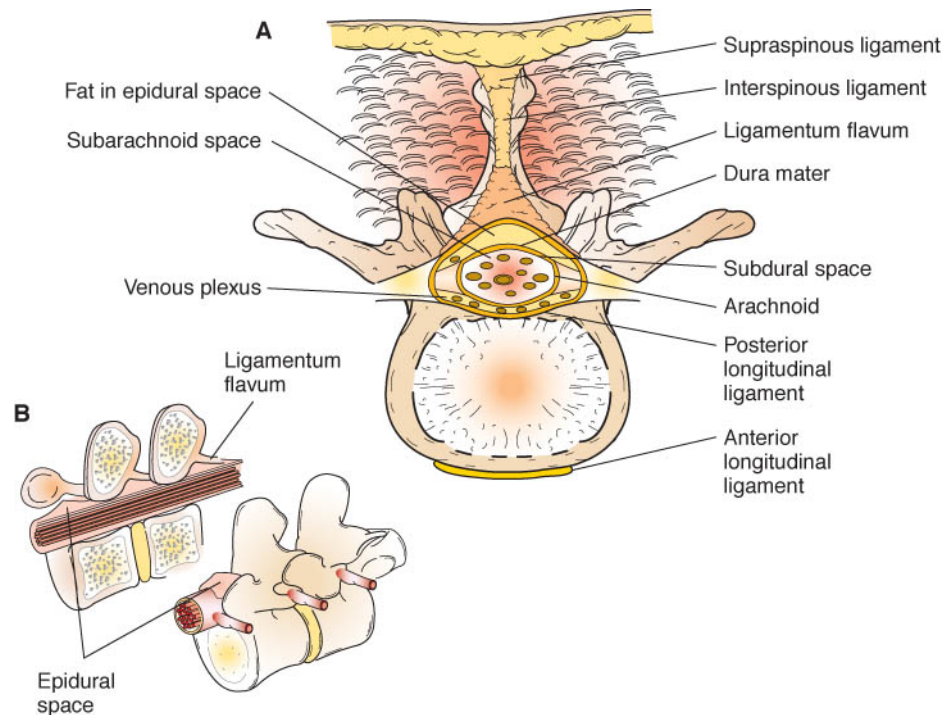
spinal canal. This ligament forms embryologically from two (right and left) separate neural crest structures. These ligamenta meet in the midline at an acute angle, but have an inconsistent

degree of fusion. Incomplete fusion results in sagittal gaps, which are variable not only between individuals, but also among spinal levels within a given patient. Cervical and upper thoracic lev-

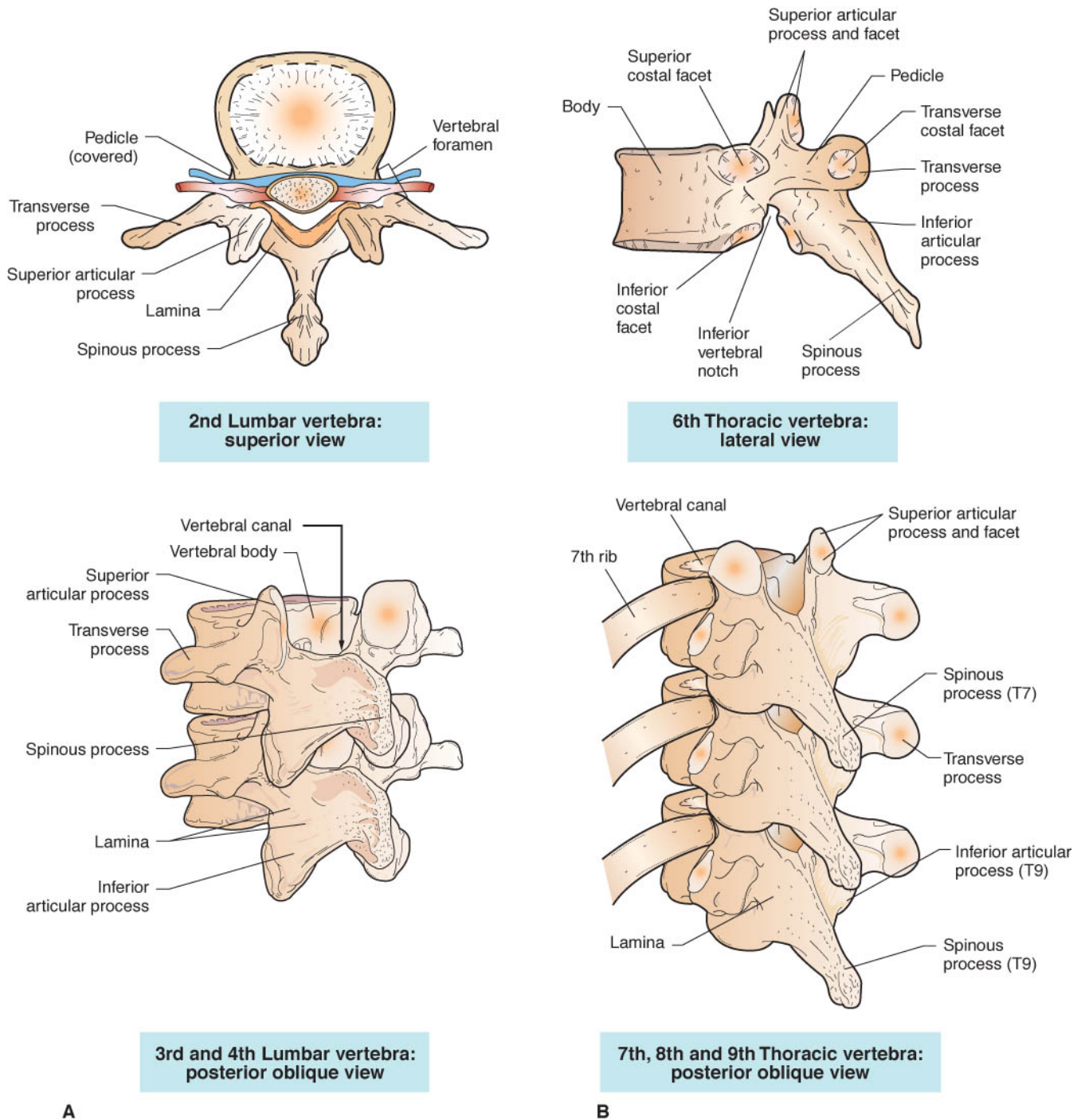
els have a higher rate of failed fusion compared to levels below T3-T4 (as high as 50–70%) and are thus perhaps more difficult for epidural access using the loss or resistance technique.<sup>2</sup>

## Epidural Space

The epidural space (also referred to as extradural and peridural space) lies between the dura and the borders of the spinal canal (Fig. 46-3). Anteriorly, this border is the posterior longitudinal ligament; posteriorly, it is the vertebral lamina and adjoining ligamentum flavum (Fig. 46-3). The spinal epidural space runs from the level of the foramen magnum to the sacral hiatus, which is bound by the sacrococcygeal ligament. The lateral borders of the epidural space are partially delineated by the vertebral pedicles, but this space extends laterally through the intervertebral foramina to communicate with the paravertebral spaces on each side. The epidural space is somewhat compartmentalized by the sections of the dura abutting the ligamentum flavum, vertebral lamina, and other borders of the vertebral canal (Fig. 46-3B). However, these compartments are joined by a “potential space” that is opened by injection of fluid or air, thus connecting the compartments and revealing a more continuous communication.



**FIGURE 46-3.** A. Cross-sectional view of the lumbar region depicting the location of the epidural space and other anatomical structures associated with neuraxial procedures. As demonstrated in (B), the epidural space is somewhat compartmentalized, but continuous via “potential space” pathways that expand with injection of liquid.



**FIGURE 46–4.** Anatomic structures associated with (A) lumbar and (B) thoracic vertebrae.

The contents of the epidural space include epidural fat, venous plexus, and segmental arteries. The epidural fat is largely located in the posterior and lateral aspects of the epidural space. This fat plays a role as a site for depot sequestration of epidurally administered local anesthetics and opioids as a function of the lipid solubility of the drug.<sup>3</sup> The plexus of epidural veins (Batson plexus) is principally within the anterior and lateral portions of the epi-

dural space, with rare presence in the posterior aspect. These veins communicate with the azygous system, and thus can become engorged in the setting of increased intraabdominal pressure.

### EQUIPMENT

#### Spinal Needles

Although many designs have been introduced throughout the history of

spinal anesthesia, the needles commonly used today can be generally classified as either “cutting needles” or “pencil-point needles” (Fig. 46–5). The Quincke-style needle, one of the most frequently used cutting needles, has a medium-length bevel, coming to a sharp point, which cuts through dural and arachnoid structures as it passes to the subarachnoid space. In contrast, pencil-point needles (often called “atraumatic”), such as the Green,

Whitacre, Sprotte, and Gertie-Marx, have a rounded, noncutting tip. The latter three have openings on the side rather than at the tip. Efforts to minimize the incidence of postdural puncture headache have driven the advancement of needle design. More recent designs include tapered needles, and return of stylet-point needles, such as the “Ballpen (Rusch, France) needle.” Needle gauge usually ranges from 27 to 18, with the smaller-gauge needles requiring an introducer needle.

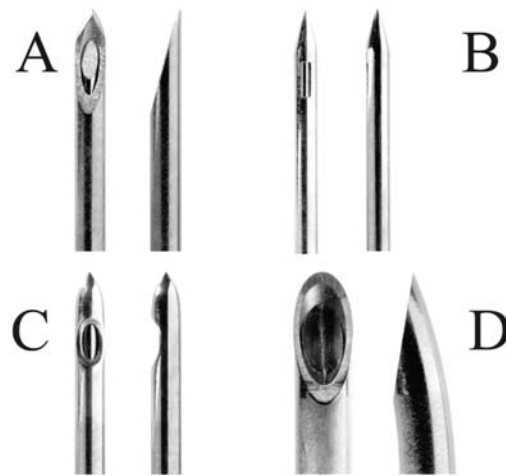
## Epidural Needles and Catheters

Needles for accessing the epidural space need to be able to facilitate catheter insertion and techniques for identification of the epidural space. Currently, the most commonly used needle is the Tuohy needle (Fig. 46-5D). The design of this needle has undergone many modifications, but is characterized by a curved, or Hubber, tip. This curved tip decreases coring of tissue during insertion, but has been employed chiefly to attempt directional control of catheter insertion. Epidural needles are typically 16–20 gauge and accompanied by a tight-fitting stylet. Larger-gauge needles are less likely to be deflected by firm ligaments and osseous structures, and may provide a more reliable “loss-of-resistance” for identification of the epidural space.<sup>4</sup>

Commercially available catheters for cannulation of the epidural space are composed of polyurethane, nylon, or silicone-based material. Catheters with wire-wound reinforcement are designed to prevent kinking of the lumen and to increase durability, thus making them useful for postoperative analgesic infusions. Several variations of catheters have been brought to the market with options for multiorifice tips, metal stylets, and varying stiffness.

## PATIENT SELECTION

The success of neuraxial anesthesia begins with proper patient selection and creation of an environment that is conducive to a variety of regional anesthetic techniques. Principally, the surgical procedure should be able to be performed with a sensory block level that is tolerable and safe for the patient under the appropriate positioning, monitoring, and supplemental medication/sedation for the patient's



**FIGURE 46-5.** Close-up views of the tips of a “cutting-tip” spinal needle. **A.** Quincke, and two “pencil-point” needles; **(B)** Whitacre; **(C)** Gertie-Marx. Also shown is the tip of a common epidural needle, **(D)** the 17-gauge Tuohy.

given condition. Lower-extremity, pelvic, and lower-abdominal procedures can be suited for spinal or epidural anesthesia. Procedures in the perineum usually are more suited to spinal anesthesia because of the potential for sacral nerve sparing with epidural anesthesia. Upper abdominal procedures usually require sensory levels that are not comfortably attainable with regional techniques alone, and would require “supplementation” with light general anesthesia.

It is imperative that the patient be able to cooperate and tolerate the experience, from placement of the block, to block resolution. This can be accomplished through proper preoperative evaluation of the patient's maturity and affect, and appropriate informed consent discussions regarding risks, benefits, alternatives, and patient expectations in light of the requirements of the procedure.

Absolute contraindications to neuraxial anesthesia are few in number, but include patient refusal, significant hypovolemia, infection at the site of needle entrance, increased intracranial pressure, and significant coagulopathy. Relative contraindications require analysis of the risks and benefits for a given patient and situation. Unfortunately, this often needs to be done in light of the current medicolegal environment. Commonly encountered conditions are minor coagulopathy, sepsis/bacteremia, and preexisting neurologic conditions, such as peripheral neuropathy, multiple sclerosis, and other demyelinating processes.

## TECHNIQUE FOR NEURAXIAL ANESTHESIA

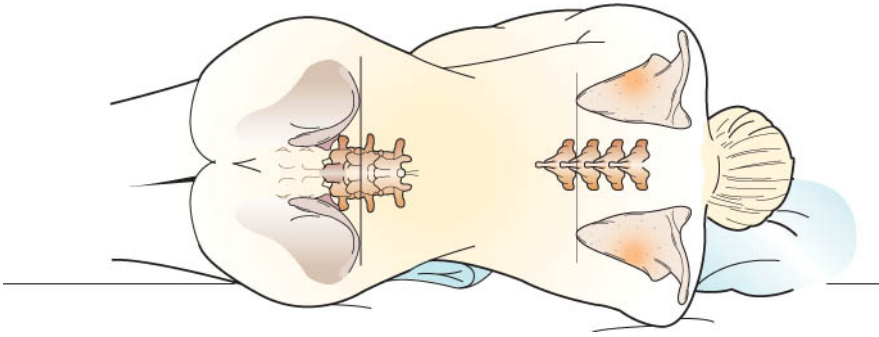
### Patient Positioning and Preparation

In addition to confirming patient consent and understanding, one should also verify the availability of equipment and medications to manage airway compromise and hemodynamic perturbations. The patient should have proper monitoring and supplemental oxygen during neuraxial anesthesia. Most patients prefer to have sedation administered prior to beginning neuraxial anesthesia, but judicious use of agents like midazolam and fentanyl should not significantly impair oxygenation or the patient's ability to reliably report paresthesia or other signs of unintended trauma.

The lateral decubitus position (Fig. 46-6) is most often used for spinal anesthesia. The patient should have hips and knees flexed with head approximating the knees in effort to relax the lumbar lordotic curve and accentuate the interlaminar aperture. This position is useful when employing spinal anesthesia for one-sided procedures, placing the operative side down if using hyperbaric solutions, or operative side up for hypobaric preparations (a technique commonly employed for hip surgery).

Alternatively, neuraxial access can also be obtained with the patient in the sitting position (Fig. 46-7), bending forward to relax the lordotic curve of the lumbar spine. Advantages of this position are that it facilitates the iden-





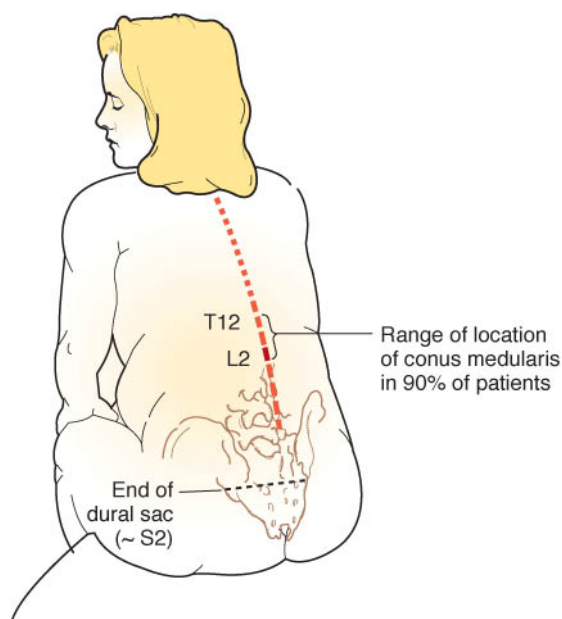
**FIGURE 46-6.** Lateral decubitus position for neuraxial procedures. The patient is positioned with the head tucked down, hips flexed, and back rounded in efforts to maximize the aperture of the interlaminar space. Lines depicting the levels of the iliac crests and scapulae are commonly employed anatomical landmarks to identify the levels of L4 and T7, respectively. However, these landmarks are often unreliable.

tification of the midline in obese or anatomically distorted patients and augments CSF pressure at the needle entrance site, enhancing CSF flow through the needle when performing lumbar puncture. It is also used to accomplish “saddle block” anesthesia for procedures limited to the perineum by administering hyperbaric spinal preparations to the intrathecal space and having the patient remain sitting for at least 5 minutes after injection. If the patient is going to be in the prone position for procedures such as perianal surgery, a hypobaric technique can be employed. This is accomplished by positioning the patient for surgery prone with hips flexed and lumbar

spine relaxed (jackknife) (Fig. 46-8), then accessing the subarachnoid space, using a syringe to aspirate for confirmation of CSF flow. Once a hypobaric solution is administered, it is recommended that the patient remain in a flat or head-down position for at least 30 minutes to prevent unintended rostral “floating” of the anesthetic.

### Accessing the Subarachnoid Space

Several techniques have been described for inserting a needle percutaneously into the subarachnoid space, each having specific advantages in different clinical situations. By developing skill with multiple techniques, the



**FIGURE 46-7.** A patient in the sitting position, with the spine curved to relax the lordotic curve on the lumbar region. The approximate range of cord termination in 90% of patients is from T12 to L2.

practitioner can be prepared to adapt to the clinical challenges presented. Despite the position and technique to be used, a standard approach should begin with identifying the midline, and palpating the iliac crests. The intercrest line (Fig. 46-6) is classically described as crossing the level of the fourth lumbar vertebra, or the L3-L4 or L4-L5 interspace. The most commonly used and easily mastered technique for needle insertion is the midline approach. After identification of the desired interspace for lumbar puncture, skin wheal is raised over the interspace and appropriate infiltration of local anesthetic is fanned along the midline. It is useful to firmly place 2 fingers of the nondominant hand parallel to the axis, straddling the lateral borders of the interspace (Fig. 46-9). When using small-gauge spinal needles, an introducer needle is first inserted in the sagittal plane between the spinous processes, initially parallel to the plane of the surface of the back. The introducer is then stabilized by grasping the hub with the digits of the nondominant hand as the spinal needle is passed through the bore of the introducer and advanced in the sagittal plane. The path of travel for the needle in the midline approach is through skin, subcutaneous tissue, supraspinous ligament, interspinous ligament, ligamentum flavum, and, finally, through the dura and arachnoid matter into the subarachnoid space. As the needle tip passes beyond the ligamentum flavum and through the dura, a change in resistance, and possibly a “pop,” can be appreciated. At this point, the stylet is withdrawn from the spinal needle, and the hub is inspected for free flow of CSF. If bone is contacted prior to entering the thecal sac, the practitioner should reassess the angle of projection and ensure that it is within the sagittal plane. If no correction toward the midline is needed, the most fruitful adjustment is usually an attempt to gradually “walk” the needle tip in a cephalad direction until the subarachnoid space is encountered. If free flow of CSF is in question, rotating the bevel or side hole of the needle through the four quadrants can help ensure proper placement of the needle opening. Once satisfied with needle placement, the dosing syringe (typically a Luer slip style), which was previously prepared with the intended agent, is firm-





**FIGURE 46-8.** Patient positioned in the prone-jackknife position for surgery to be performed under hypobaric spinal anesthesia. Note that the head is below the level of the hips to ensure that the anesthetic “floats” to the caudad portion of the intrathecal space.

ly attached to the hub of the spinal needle. Aspiration of CSF into the syringe is final confirmation of subarachnoid placement; the agent is slowly injected while keeping the needle tip immobile. Once the injection is complete, the patient should be placed in the intended position to effect the spread of the agent, or into the appropriate position for surgery. The advantages of the midline approach include simplicity and the stability provided by the relatively avascular sagittal plane through the interspinous ligament.

The paramedian technique (Fig. 46-10), although routinely used by some, should be mastered to the same level as the midline technique because of its advantages in common clinical situations. When the midline approach is difficult, the paramedian approach may still allow access to the subarach-

noid space when presented with inability to obtain adequate patient positioning (maintained lumbar lordosis), obesity, term pregnancy, heavily calcified interspinous ligament (common in elderly patients), or scoliosis. This advantage is a consequence of the larger interlaminar aperture presented via the path of the paramedian approach, especially when lumbar lordosis is retained. Although variations have been described, in the lumbar region this approach begins with identification of the superior aspect of the caudad spinous process of the interspace to be accessed. The percutaneous entry point is identified 1 cm lateral to this superior tip of the spinous process. After raising a skin wheal and appropriate infiltration with local anesthetic, the introducer and/or spinal needle are advanced through the anesthetized region, directed approximately 10–15°



**FIGURE 46-9.** Fingers of the nondominant hand are used to identify the lateral borders of the interspace of interest. This aids in developing a three-dimensional mental image of the anatomical structures to facilitate neuraxial access.

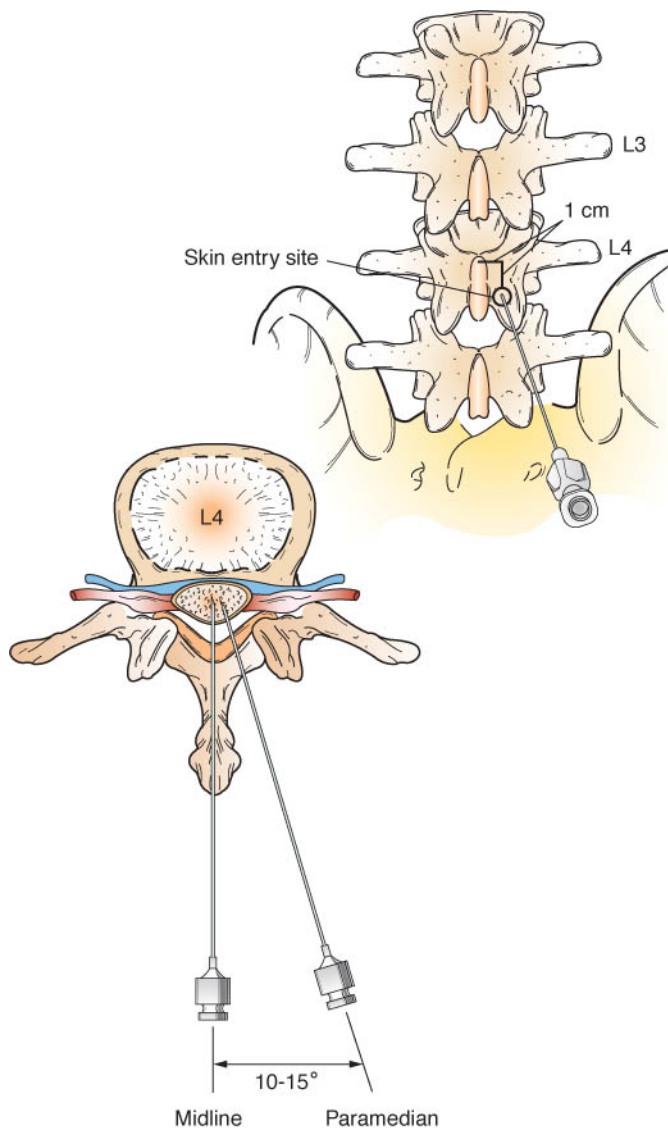
toward midline, and at a slightly cephalad angle. This path will traverse skin, subcutaneous tissue, paraspinous muscle, ligamentum flavum, and dura and arachnoid matter to reach the subarachnoid space. If bone is encountered prior to dural puncture, it is most likely the caudad lamina, in which case the needle should be “walked” cephalad, then medial, until the thecal sac is breached.

The Taylor approach (Fig. 46-11) is a variation of the paramedian technique; it capitalizes on the breadth of the L5-S1 interspace (typically the largest interspace) and the palpable and relatively constant location of the posterior superior iliac spines (PSISs). Once a PSIS is identified, a skin wheal is raised 1 cm medial and caudad to its inferior border. After appropriate infiltration of local anesthetic, the spinal needle (typically at least 22 gauge) is directed approximately 45° medial and cephalad toward the L5-S1 interspace. Again, if bone is contacted, the correction needed is a greater cephalad angle to “walk off” of the superior aspect of the sacrum.

### Accessing the Epidural Space

Although the pathway and approach to the epidural space are the same for the subarachnoid space, the technical skills to correctly and reliably access and identify the epidural space require more experience to develop than those for dural puncture.<sup>5</sup> Again, both midline and paramedian approaches are used for needle placement and the patient can be placed in either the sitting or lateral position. In contrast to spinal anesthesia, the epidural space theoretically can be accessed at any vertebral level. Because of the differences in the projecting angles of the spinous processes in the lumbar and midthoracic regions, an angle of approach closer to the plane of the surface of the back is used when performing thoracic epidural placement.

With the midline approach, the desired interspace is identified by palpation as described above, and a skin wheal is raised with local anesthetic at the site of intended needle entrance, which should be in the sagittal plane at the midpoint between the spinous processes. The needle is inserted through the skin, subcutaneous tissue, and supraspinous ligament, and into the interspinous ligament. With the blunter tip of the larger-gauge needles used for



**FIGURE 46-10.** In the paramedian approach for lumbar neuraxial access, an entrance site is identified 1 cm lateral and caudad to the superior aspect of the inferior spinous process. After appropriate local anesthetic is infiltrated, the needle is typically inserted to touch down on the lamina, then walked, first medially, then cranially, to step off of the lamina.

epidural anesthesia, passage into the interspinous ligament is typically met with a “crunchy” sensation. Patients who are not sedated might either hear or feel this “crunching,” and should be reassured if report of this is elicited. If in the sagittal plane, further advancement of the needle should place the tip in the ligamentum flavum, which provides increased resistance to the needle.

Alternatively, if the paramedian approach is used, as may be preferable in the thoracic region, the interspinous ligament is not encountered. If attempting access in the thoracic region, the appropriate needle entrance site is 1 cm lateral to the inferior aspect of the superior spinous process of the

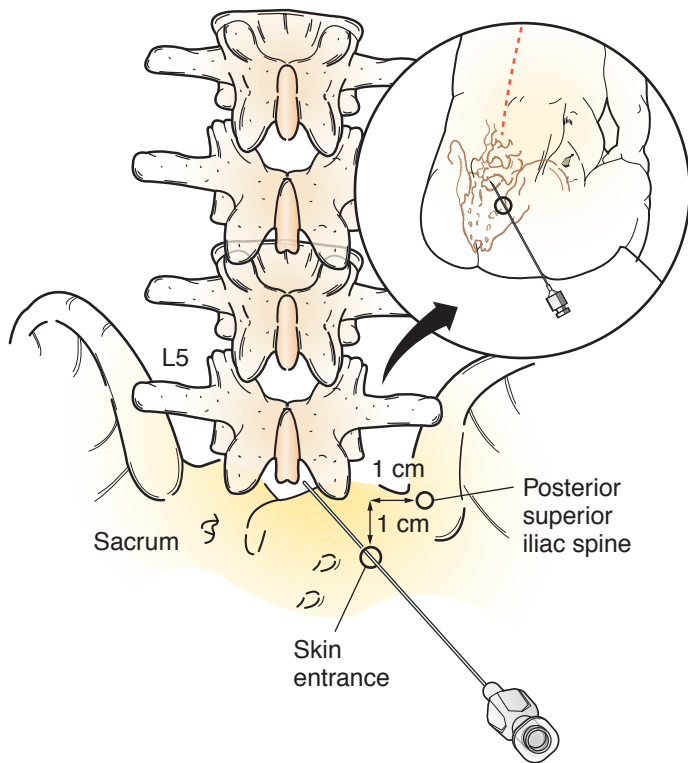
interspace desired. The needle is advanced through an anesthetized skin wheal, subcutaneous tissues, paraspinous muscle, and to the lamina of the inferior vertebra, providing a reference depth. The needle tip is walked medially until the base of the spinous process is encountered, which will be noted to have a shallower depth. The needle tip is then marched superiorly until it “walks off” of the lamina, and should encounter resistance as it meets the ligamentum flavum.

With either approach, correct passage of the needle tip through the ligamentum flavum and into the epidural space without breaching the dura can be accomplished by employing several different methods for iden-

tifying the epidural space. The most commonly used method is the loss of resistance (LOR) technique using saline or air, although saline may be preferred, given the risk of headache if air is unintentionally injected into the subarachnoid space. A low-resistance syringe made of glass or plastic is filled with 1–2 mL of sterile saline, as well as 1 small (0.2-mL) air bubble (Fig. 46-12). This syringe is attached to the epidural needle once the tip has been placed into the ligamentum flavum. The degree of resistance to injection of the saline is assessed by determining if the bubble compresses without allowing injection of fluid. If little resistance is encountered, the needle tip is either not yet reaching the ligamentum flavum, or perhaps has passed through to the epidural space. If uncertain, careful advancement of the needle by a few millimeters could be considered in an attempt to reach the ligament, but one might wish to withdraw and reattempt placement. Once this ligament is identified, the needle is advanced slowly, with constant pressure on the syringe plunger, until the resistance to injection is reduced. A dramatic loss of resistance is reassuring of the passage of the needle tip just beyond the ligamentum flavum and into the epidural space.

An alternative technique is the “hanging drop” of Gutierrez. This relies on a negative pressure in the epidural space to aspirate a visible drop of fluid from the hub of the needle into the lumen of the epidural space itself (Fig. 46-13). This negative pressure is encountered just as the tip of the needle enters the epidural space and is much more reliable in the thoracic and cervical regions. One theory of the nature of this negative pressure is that it is created by the tip of the needle tenting the dura, thus increasing risk of dural puncture. This technique is best used in the thoracic region with a sitting patient. It may be helpful in the setting of combined spinal-epidural anesthesia because of minimal saline entering the epidural space and less chance of a “false return” being interpreted as CSF.<sup>6</sup>

Newer techniques for identifying the epidural space are being described. The use of electrical nerve stimulation via a conducting catheter allows for confirmation of placement of the catheter within the epidural space by confirming appropriate stim-



**FIGURE 46–11.** The Taylor approach begins with identification of the posterior superior iliac spine (PSIS). The skin entrance site is 1 cm medial and 1 cm caudal to the PSIS. The needle is then directed approximately 45° medial and cephalad to enter the L5-S1 interspace.

ulation threshold.<sup>7</sup> Additionally, the myotomal distribution of the stimulation can lend information regarding the spinal level of the catheter tip. Lechner et al.<sup>8</sup> describe an apparatus for use in epidural access that produces both audible and visual indication of the pressure encountered at the tip of

an attached epidural needle. Using this device allows a two-handed advancement of the epidural needle while awaiting the drop in pressure that is characteristic of entering the epidural space. Further testing and study is needed to determine the appropriate usefulness of these new methods.



**FIGURE 46–12.** Photo depicting a glass loss-of-resistance syringe attached to an epidural needle. The syringe is filled with saline and a small (0.2-mL) bubble of air. The bubble provides visual indication of “compression” resultant of resistance to injection that is characteristic of the ligamentum flavum.

## CLINICAL PHARMACOLOGY

### Distribution, Uptake, and Elimination

Prior to reaching the site of action, anesthetic agents injected into the subarachnoid space undergo dilution within the CSF via mass effect. It has long been postulated that CSF circulation played a role in distribution of anesthetic agents; however, this has not been reliably demonstrated. The uptake of anesthetic agents by the spinal cord and nerve roots depends on the concentration of agent at a given region and lipid content of the tissue. Elimination of local anesthetics from the subarachnoid space and spinal cord is determined by regional blood flow and vascular reabsorption, not metabolism of the anesthetic within the intrathecal space. Drugs administered in the epidural space must diffuse into the CSF and neural tissues to exert conduction blockade. The epidural fat acts as a reservoir for injected agents with great affinity for lipophilic agents. The elimination of drug from the epidural space is largely dependent on regional blood flow.

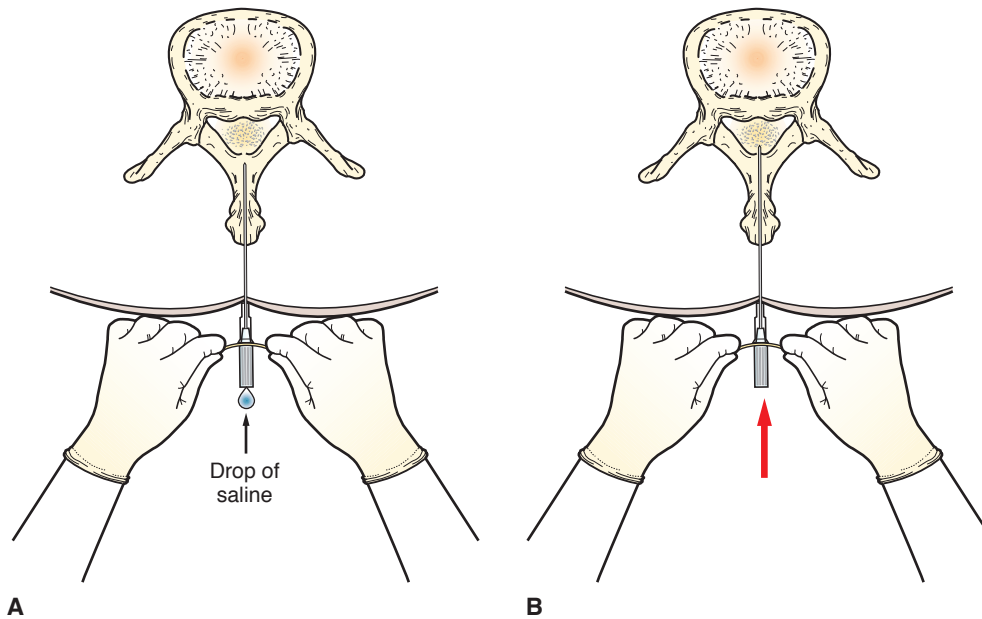
### Factors Affecting Block Height Spinal Anesthesia

The ability to affect and predict block height is important for producing reliable and manageable spinal anesthesia. Many parameters have been studied as potential determinants of block height (Table 46–1). The most significant physiologic parameter related to block height is CSF volume. Unfortunately, easily measurable physical features, such as height, weight, gender, and age, do not correlate well with CSF volume.<sup>9</sup> However, it has been observed that obese individuals have lower CSF volumes than those who are not obese. Although some studies show a slight influence of age and height on peak block levels,<sup>10,11</sup> these are weak correlations with inadequate predictive power to influence clinical practice.

Baricity, drug dose (mass), and patient position relative to baricity of the agent are the most important factors influencing block height. Baricity is defined as the ratio of the specific gravity of the local anesthetic solution to the specific gravity of CSF.

Solutions with a density greater than 1.0015 g/mL (3 standard deviations above mean patient CSF density) can be expected to behave as a hyperbaric





**FIGURE 46-13.** The “hanging drop” technique is performed by first placing a drop of saline at the “mouth” of the needle hub (A). The needle is then advanced while monitoring the drop of fluid. The drop is drawn into the needle when the epidural space is entered (B).

solution (Table 46-2). Hyperbaric solutions are typically prepared by the addition of dextrose to the solution. However, it should be noted that plain 2-chloroprocaine behaves in a hyperbaric fashion. Once injected into the subarachnoid space, hyperbaric solutions migrate “downhill” to the dependent

portions of the spinal column. Thus, for a patient in the sitting position, the agent sinks to the sacral regions to produce a “saddle block.” In the supine patient, hyperbaric agents injected at or above the apex of the lumbar lordotic curvature will migrate to the thoracic kyphosis, hence the tendency for a peak block of T4-6 in most supine patients. Manipulation of patient position after hyperbaric subarachnoid injection can enhance either migration of the agent to the thoracic region (head down position), or to the sacral region (head up or sitting position).

Isobaric solutions have a density that is clinically equivalent to that of CSF. Thus, once injected into the subarachnoid space, the agent neither sinks nor floats. This can be advantageous because patient position does not affect block height. In such a scenario, peak block height is more determined by dose of anesthetic agent (mass effect), but individual CSF density and volume contribute.<sup>16</sup> It should be noted that it may be difficult to achieve block heights above the midthoracic region because of the tendency of isobaric solutions to “stay put” in the lumbar region after injection.

Hypobaric solutions have a distinct advantage in perianal surgery or other procedures that require a head down or jackknife position, or for lateralized procedures when the patient cannot lie on the operative side. These preparations are formed by diluting anes-

thetic agents in distilled water, achieving a density of less than 0.9990 g/mL. With a patient in the prone position with the head down, an intrathecal

**TABLE 46-1.**

**Various Factors Proposed as Determinants of Spinal Block Height**

Patient characteristics	
Height	
Weight	
Age	
Gender	
Intraabdominal pressure	
Technical variations	
Patient positioning	
Site of injections	
Speed of injections	
Direction of bevel	
Barbotage	
Cerebrospinal fluid characteristics	
Volume	
Density	
Velocity/circulation	
Characteristics of the local anesthetic solution	
Baricity	
Volume of injection	
Concentration of solution	
Drug dose (mass)	
Temperature	

**TABLE 46-2.**

**Baricity of Solutions for Spinal Anesthesia**

Agent	Baricity
<b>Hypobaric</b>	
Bupivacaine 0.3% in water	0.9946
Tetracaine 0.2% in water	0.9922
Lidocaine 0.5% in water	0.9985
<b>Isobaric</b>	
Bupivacaine 0.5% in saline	0.9983
Bupivacaine 0.75% in saline	0.9988
Tetracaine 0.5% in saline	0.9997
Lidocaine 2% in saline	0.9986
<b>Hyperbaric</b>	
Bupivacaine 0.75% in 8.25% dextrose	1.0227
Tetracaine 0.5% in 5% dextrose	1.0133
Lidocaine 5% in 7.5% dextrose	1.0265
Procaine 10% in water	1.0104
2-Chloroprocaine 2% in saline	1.0012

Data from Horlocker TT and Wedel DJ<sup>12</sup>; Bodily MN, Carpenter RL, and Owens BD<sup>13</sup>; Greene NM<sup>14</sup>; and Na KB and Kopacz DJ.<sup>15</sup>



injection is performed, and subsequently the agent “floats” to the sacral region, giving excellent anesthesia to the perineal and perianal region. As mentioned previously, the patient must be recovered in the head-down position for a reasonable amount of time to prevent unintentional rise of the block.

**Other Factors** The volume and concentration of isobaric spinal agents have not been shown to affect block height when using a constant dose.<sup>17</sup> In contrast, when using hyperbaric preparations, baricity seems to overcome alterations in dose and volume, showing similar block heights with a range of doses if concentration is held constant. This highlights the propensity for hyperbaric preparations to settle to the dependent portions of the spinal canal.

Injection site can influence the nature of spinal blockade. If using hyperbaric preparations, injection low in the lumbar region can cause failure to achieve expected block height and cephalad block density as a result of sacral pooling and absence of agent above the lordotic curve. However, if injection is made at or above L2-3, then block height and success is more reliable. For isobaric solutions, block height can be reduced by as much as 2 dermatomes per interspace when comparing administrations at L2-3, L3-4, and L4-5.<sup>11</sup> The manner of injection is thought to have influence on block characteristics. Investigations into the effect of barbotage show no impact on peak block height, although it does seem to reduce the time from injection to achievement of peak block height.<sup>18</sup>

### Epidural Anesthesia

In contrast to spinal anesthesia, epidural anesthesia produces a segmental block that is related to the site of injection of local anesthetic. Most procedures that are amenable to spinal anesthesia could also be served by epidural anesthesia that produces a similar block height (Table 46-3). Unless a caudal approach is performed, the potential for sacral nerve sparing with epidural blockade (because of increased epidural fat and nerve root size in the low lumbar and sacral regions) may preclude its use in perineal procedures. When planning an epidural anesthetic, the choice of local anesthetic, dose, and injection site must be appropriate for the given procedure and the clinical scenario.

Injection of local anesthetic into the lumbar epidural space is typically suited for lower-extremity and lower-abdominal procedures, but increasing the dose and volume is necessary to get extension to midthoracic levels. In general, one can think of administering 2 mL of local anesthetic solution for each additional dermatome to be blocked. When administering anesthetic to the thoracic region, the dose is typically reduced by 30-50%, compared to the lumbar region, to accommodate the decreased volume and compliance of the thoracic epidural space and to avoid unwanted cephalad spread. Thoracic epidural injections tend to not extend caudally to the degree that is seen with lumbar injections, thus are reserved for procedures in the thorax and upper abdomen.

When considering the ranges that are typically used for surgical anesthesia, concentration of the anesthetic solution has little effect on extent of the epidural block, but increased block density is observed with higher concentrations. Increasing the volume of solution injected for a given total dose will have a minor effect on cephalad spread (about 4 dermatomes when increasing from 10-30 mL), but will compromise density and quality of the block. Patient position also has no demonstrable effect on lateralization of the block or cephalad spread, but is often used clinically.

The effect of patient age on epidural block height and dose requirement seems to be only clinically relevant in extremes of age, but some studies suggest as much as a 40% reduction in dose requirement when comparing 60-79-year-old patients with 20-39-year-old patients.<sup>19</sup> This is attributed to the increased likelihood of spinal canal stenosis and decreased epidural compliance in the older population. In similar scale, the influence of height and weight on the spread of epidural block is small,<sup>20</sup> and usually not clinically relevant unless considering the extremes of the spectrum.

The effect of pregnancy on the spread of epidural blockade is unclear. Some studies suggest that an observed increased cephalad spread of blockade is a result of an effect of altered abdominal anatomy. However, similar increases seen in early pregnancy suggest that this may be an effect of altered sex steroid levels increasing the sensitivity to anesthetic agents.<sup>21</sup>

TABLE 46-3.

Required Block Height for Common Surgical Procedures

Surgical Procedure	Block Height
Upper abdominal surgery Cesarean section	T4-5
Lower abdominal (appendectomy, inguinal herniorrhaphy)	T6-8
Pelvic procedures Transurethral resection of prostate	T10
Obstetric vaginal delivery Hip and lower extremity (with thigh tourniquet)	
Lower extremity	L2-3
Perineal procedures (limited to exterior)	S1-2

In summary, physical characteristics seem to have little if any clinical effect on epidural block spread for a narrow range of variability. However, clinical judgment may allow for reducing the initial epidural dose for a patient who is very short, very old, and morbidly obese. Conversely, more aggressive dosing can be used for the patient who is very young, tall, and thin. Comorbidities and other challenges may determine the appropriate dose regimen: a failed technique as a result of inadequate block vs. treating the complications resulting from a block that is higher than intended.

## CLINICAL ASPECTS OF NEURAXIAL AGENTS

### Local Anesthetics

Local anesthetic agents are discussed in Chap. 44 in detail, but some clinical points relating to neuraxial anesthesia are addressed here. The choice of neuraxial agents is determined by the nature and estimated time of the surgical procedure, as well as postoperative issues such as disposition. Tables 46-4 and 46-5 list representative durations for doses of spinal and epidural agents. For spinal anesthesia, increasing the dose of agent administered prolongs the block, and unless counteracted by positioning and baricity, it may also increase peak block height. Longer-acting local anesthetics, such as bupivacaine, levobupivacaine, tetracaine, and

TABLE 46-4.

## Typical Dose-Response Effects of Spinal Local Anesthetics

Local Anesthetic	Dose (mg)	Peak Block	Duration of Sensory Block (min)	Duration of Motor Block (min)	Time Until Discharge (min)	Anesthetic Success Rate (%)
Lidocaine	30					0
	40	T <sub>4</sub> (T <sub>2</sub> -10)	130 (26)	93 (24)	173 (34)	90
	60	T <sub>3</sub> (T <sub>2</sub> -10)	162 (32)	128 (31)	216 (33)	90
	80	T <sub>3</sub> (T <sub>1</sub> -7)	170 (24)	142 (32)	236 (46)	97
Bupivacaine <sup>a</sup>	5	T <sub>5</sub> (T <sub>4</sub> -7)	123 (27)	50 (20)	181 (30)	75
	7.5	T <sub>8</sub> (T <sub>4</sub> -11)	144 (25)	75 (24)	202 (28)	100
	10	T <sub>8</sub> (T <sub>6</sub> -10)	194 (26)	100 (24)	260 (30)	100
	15	T <sub>5</sub> (T <sub>4</sub> -7)	343 (28)	150 (24)	471 (35)	100
Mepivacaine	30	T <sub>9</sub> (T <sub>2</sub> -L <sub>5</sub> )	158 (32)	116 (38)	180 (34)	72
	45	T <sub>6</sub> (T <sub>2</sub> -L <sub>2</sub> )	182 (38)	142 (37)	191 (29)	100
	60	T <sub>5</sub> (T <sub>2</sub> -L <sub>1</sub> )	203 (36)	168 (36)	233 (52)	100
Ropivacaine	8	T <sub>9</sub> (T <sub>4</sub> -L <sub>1</sub> )	130 (27)	107 (25)	165 (45)	63
	10	T <sub>8</sub> (T <sub>4</sub> -L <sub>2</sub> )	152 (44)	135 (31)	174 (38)	83
	12	T <sub>8</sub> (T <sub>4</sub> -L <sub>1</sub> )	176 (42)	162 (37)	199 (52)	93
	14	T <sub>9</sub> (T <sub>3</sub> -L <sub>1</sub> )	192 (48)	189 (44)	233 (52)	100
Procaine	100	T <sub>5</sub> (T <sub>1</sub> -10)	120 (23)	100 (30)	244 (43)	83
Prilocaine	50	T <sub>6</sub> (T <sub>1</sub> -10)	128 (38)	165 (37)	253 (55)	100
2-Chloroprocaine <sup>b</sup>	30	T <sub>8</sub> (T <sub>6</sub> -L <sub>1</sub> )	103 (12)	54 (23)	103 (12)	NA
	40	T <sub>7</sub> (T <sub>3</sub> -T <sub>10</sub> )	114 (14)	69 (16)	113 (14)	NA
	60	T <sub>4</sub> (C <sub>6</sub> -T <sub>6</sub> )	132 (23)	100 (13)	141 (21)	NA

NA, Clinical data not available. Increasing doses of spinal local anesthetics increase duration of both anesthesia and recovery. Dose-response data allow selection of appropriate dose for planned anesthetic duration. Isobaric solutions are glucose free. Hyperbaric solutions contain glucose or dextrose

<sup>a</sup>Levobupivacaine is equipotent.

<sup>b</sup>2-chloroprocaine spinal anesthesia is currently an off-label use.

Data from Liu SS and McDonald SB,<sup>22</sup> except data for 2-chloroprocaine is from Kopacz DJ.<sup>38</sup>

ropivacaine are typically chosen for longer procedures (greater than 120 minutes). Lidocaine, mepivacaine, and prilocaine are considered to be of intermediate duration. Short-acting local anesthetics include procaine and 2-chloroprocaine, which are used for appropriately brief procedures.

### Long-Duration Agents

Bupivacaine and levobupivacaine have the benefit of having very low incidence of transient neurologic symptoms

(TNS) when used for low-dose spinal anesthesia.<sup>23</sup> However, the variability in time to complete resolution of the block and achievement of discharge criteria provides a challenge in the ambulatory setting. Bupivacaine and levobupivacaine are employed in epidural anesthesia when a longer block is desired. The use of 0.5% solutions is typical, but the using 0.75% solutions or adding epinephrine may provide increased motor block. Levobupivacaine is approximately equipotent to bupiv-

acaine with the exception of less systemic toxicity.

Ropivacaine was introduced to reduce the risk of cardiotoxicity that is associated with bupivacaine and was released for clinical use in 1996. When used as a spinal agent, ropivacaine has a clinical profile similar to bupivacaine at equipotent doses (ropivacaine is 60% as potent as bupivacaine) with little risk of TNS.<sup>24</sup> Ropivacaine is used in concentrations of 0.5-1% for epidural anesthesia, providing blockade of somewhat shorter duration than bupivacaine. There is some evidence that ropivacaine may have less motor block when compared to bupivacaine when used for labor analgesia.<sup>25</sup>

Although tetracaine is used less commonly at this time, it remains the agent that provides the most reliable hypobaric spinal block (tetracaine 2% in water). It should be noted that the use of vasoconstrictors might increase the risk of TNS with tetracaine.<sup>26</sup>

### Intermediate-Duration Agents

Lidocaine has enjoyed widespread popularity and safety as a neuraxial agent, but it has undergone increasing scruti-

TABLE 46-5.

## Duration of Sensory Block for Commonly Used Local Anesthetics for Epidural Anesthesia

Local Anesthetic	Concentration	Time Until 2 Dermatome Regression (min)	Time Until Complete Regression
2-Chloroprocaine	2-3%	45-60	100-160
Lidocaine	1.5-2%	60-100	160-200
Mepivacaine	1.5-2%	60-100	160-200
Bupivacaine	0.5-0.7%	120-240	300-460
Levobupivacaine	0.5-0.75%	105-290	390-780
Ropivacaine	0.5-1%	90-180	240-420

ny regarding neurotoxicity given the high incidence of TNS seen when used for ambulatory spinal anesthesia (see Neurologic Complications below). To avoid this issue, lower doses of lidocaine have been investigated, usually requiring adjuvant agents to provide suitable reliability of spinal blockade. Lidocaine is used in concentrations of 1.5% and 2% for epidural anesthesia to provide reliable blockade for procedures lasting less than 120 minutes. However, continuous catheter techniques commonly employ lidocaine, with reinjection typically required every 60–90 minutes.

Mepivacaine has a clinical profile similar to that of lidocaine when used as a neuraxial agent, although it has higher potency (1.3:1 compared with spinal lidocaine).<sup>27</sup> It also seems to have similar concerns regarding the high incidence of TNS when used for outpatient spinal anesthesia, depending on concentration of agent.<sup>28</sup> It is used in concentrations of 1–2% for epidural anesthesia, again with similar performance to lidocaine.

Prilocaine is an amide local anesthetic with pharmacologic properties similar to those of lidocaine when used as a spinal anesthetic.<sup>29</sup> However, it shows a much lower incidence of TNS compared to spinal lidocaine, and thus may be a favorable agent for ambulatory spinal anesthesia. Currently, prilocaine is not available in the United States, but it is used commonly in Europe.

### Short-Duration Agents

Having a place in history as the first synthesized local anesthetic, procaine has been used for spinal anesthesia since the early 1900s. Procaine provides brief spinal anesthesia, but has limited clinical usefulness given the rate of block failure (see Table 46–4) and the incidence of side effects. For reasons that are poorly understood, spinal procaine carries a higher risk of nausea than do other local anesthetics (odds ratio [OR] 3:1).<sup>30</sup> Although it has a lower incidence of TNS than spinal lidocaine (Table 46–6), spinal procaine is clearly not enticing when seeking a suitable agent for outpatient spinal anesthesia.

2-Chloroprocaine has received increased attention in regards to the current issues of ambulatory anesthesia and concerns of relative neurotoxicities of neuraxial agents. One year after its

TABLE 46–6.

Typical Incidences of Transient Neurologic Symptoms (TNS) with Outpatient Spinal Anesthesia

Local Anesthetic	Patient Position	TNS (%)
Lidocaine 2–5%	Supine	6
Lidocaine 3%	Prone	0.4
Lidocaine 0.5%	Knee arthroscopy	17
Lidocaine 5%	Knee arthroscopy	16
Lidocaine 5%	Lithotomy	24
Bupivacaine (0.25–0.75%)	Supine	0–1
	Knee arthroscopy	0–1
	Lithotomy	0–1
Mepivacaine 1.5%	Knee arthroscopy/mixed	6–8
Mepivacaine 4%	Mixed	30
Ropivacaine 0.25%	Supine	1
Ropivacaine 0.2–0.35%	Knee arthroscopy	0
Procaine 5%	Knee arthroscopy	6
Prilocaine (2–5%)	Mixed	3–4

Bupivacaine and ropivacaine consistently result in low incidences of TNS, whereas lidocaine typically results in the highest incidences. Other local anesthetics are intermediate in incidence of TNS.  
Data from Liu SS and McDonald SB,<sup>22</sup> and YaDean JT, Liguori GA, and Zayas VM.<sup>28</sup>

introduction into clinical use, in 1952, Foldes and McNall described successful use of a preservative-free preparation of 2-chloroprocaine for spinal anesthesia in 214 patients. Subsequently, 2-chloroprocaine enjoyed increasing popularity as an agent for epidural anesthesia, particularly in the obstetric population. Unfortunately, reports of accidental intrathecal injection of large volumes of Nesacaine-CE intended for the epidural space, resulting in several cases of neurotoxicity with lower-extremity paralysis and sacral nerve dysfunction, came to attention in the 1980s. The combination of the antioxidant sodium bisulfite in the presence of low pH was assumed to be responsible for the neurotoxicity,<sup>31,32</sup> and the formulation of 2-chloroprocaine was changed. Currently, two of the three commercially available formulations of 2-chloroprocaine (Nesacaine-MPF, Astra Pharmaceuticals, Wilmington, DE, and generic chloroprocaine, Bedford Pharmaceuticals, Bedford, OH) are preservative free and antioxidant free. Given the availability of these new preparations and growing concerns about the TNS associated with lidocaine, 2-chloroprocaine has been re-investigated for off-label use as a short-acting spinal anesthetic. Work by Kopacz et al. shows 2-chloroprocaine to provide a reliable spinal anesthesia with consistent time to resolution and achievement of discharge criteria without identifiable occurrence of TNS.<sup>33–38</sup>

It should be noted that 2% 2-chloroprocaine behaves in a hyperbaric fashion,<sup>36</sup> and that the addition of epinephrine to spinal 2-chloroprocaine is not recommended because of consistent and disturbing reports of flu-like symptoms in volunteers receiving this combination.<sup>33</sup> One should also bear in mind that a recent laboratory study observed direct neurotoxicity from high doses of preservative-free 2-chloroprocaine in a rat model that was equivalent to 2% lidocaine.<sup>39</sup> Thus, the complete risk-to-benefit ratio of off-label use of spinal 2-chloroprocaine is not completely known.

The use of 2% and 3% 2-chloroprocaine is an appropriate choice for epidural anesthesia of short duration. Following the release of Nesacaine-MPF containing ethylenediaminetetraacetic acid (EDTA), reports of back pain upon block resolution were associated with high volumes of injected agent (greater than 40 mL).<sup>40</sup> This is thought to be caused by tetanic spasm of the paraspinal muscles resulting from chelation of calcium by the EDTA. Given the above concerns, it may be prudent to use only 2-chloroprocaine preparations that are preservative and antioxidant free for neuraxial blockade.

### Analgesic Adjuncts

Initial interest in adjuvant medications for neuraxial anesthesia centered around increasing the duration and in-

TABLE 46-7.

## Analgesic Adjuvants for Neuraxial Anesthesia

Agent	Dose	Typical Anesthetic Effect	Comments
Clinically Useful Fentanyl	Spinal: 10–25 µg	25% increase in duration of surgical anesthesia 33% increase in anesthetic success with small doses of local anesthetic 60% incidence of easily treated pruritus	No delay of anesthetic recovery
	Epidural: 1–2 µg/kg	2-fold reduction in volatile anesthetic requirements Decreased visceral pain with cesarean section	Bolus administration may act at spinal level, infusions act systemically
Clonidine	Spinal: 15–45 µg	29% increase in duration of motor block 37% increase in anesthetic success with small doses of local anesthetic Mild perioperative sedation and decrease in heart rate and blood pressure	No delay of anesthetic recovery
	Epidural: 150 µg	2–3-fold increase in duration of sensory anesthesia Increased time to first analgesic request	Less oxygen desaturation, pruritus, and urinary retention compared to opioids
Epinephrine	Spinal: 0.1–0.6 mg	Dose-related increase in surgical anesthesia and motor block	Dose-related increase in time until recovery of the same or greater magnitude
	Epidural: 5 µg/mL	Increased duration, intensity of block with lidocaine and 2-chloroprocaine Minimal effect with ropivacaine	Decreased plasma levels with lidocaine and bupivacaine, but not ropivacaine
Investigated Neostigmine	Spinal: 6.25–50 µg	Dose-related increase in surgical anesthesia and motor block	Dose-related increase in time until recovery of the same or greater magnitude
	Epidural: 1–4 µg/kg	Dose dependent analgesic effect Increased time to first analgesic request	Reports of sedation with higher doses

Utility and safety of other agents (ketamine, ketorolac, midazolam) not fully determined.  
Date from references 41, 43–46, 48, 56–57, 60, 62, 65–72, 86, 89, and 94.

tensity of blockade. As the percentage of operations performed in the ambulatory setting increases, interest is shifting to finding adjuncts that will provide faster recovery without compromising anesthetic reliability (Table 46-7).

### Opioids

The potent analgesic effects of neuraxial opioids have been exploited to improve perioperative analgesia and reduce the supraspinal side effects of sedation and respiratory depression seen with systemic opioids. Neuraxial opioids that diffuse into the spinal cord exert spinal analgesia by modulating A-δ and C-fibers to decrease afferent nociceptive input,<sup>41</sup> inhibiting Ca<sup>2+</sup> influx presynaptically, and increasing K<sup>+</sup> conductance and hyperpolarize ascending neurons postsynaptically.<sup>42</sup>

Owing to its hydrophilic nature, neuraxial morphine provides highly selective, prolonged spinal analgesia,

but is not typically used to augment intraoperative anesthesia because of slow onset. The lipophilic opioids, such as fentanyl, are more suited for intraoperative use in the intrathecal space because of rapid onset, modest duration, and lower risk of delayed respiratory depression. The addition of 10–25 µg fentanyl to low-dose lidocaine and bupivacaine spinal anesthetics dramatically improves anesthetic success without delaying achievement of discharge criteria for ambulatory patients.<sup>43,44</sup> However, when used with the ultrashort-acting spinal anesthetic 2-chloroprocaine, fentanyl can slightly delay discharge (95 vs. 104 minutes) and increase pruritus.<sup>35</sup>

The administration of epidural fentanyl can reduce volatile requirements more than intravenous fentanyl (more than 2-fold at 2 µg/kg).<sup>45</sup> The method of delivery of epidural fentanyl may be important for optimal effect. Gino-

saur et al.<sup>46</sup> showed that when epidural fentanyl is given as a bolus, it imparts segmental analgesia consistent with spinal level of action, but if given as an infusion, the analgesia is mediated through systemic uptake and supraspinal effect, as is seen with sufentanil and alfentanil.<sup>47</sup>

### α<sub>2</sub>-Agonists

Interest in α<sub>2</sub>-agonists, such as clonidine, has been rising in the field of regional anesthesia given their ability to enhance neuraxial analgesia without the respiratory depression and pruritus common to opioids. As with analgesia, the sedation, hypotension, and bradycardia seen with neuraxial clonidine are dose dependent.<sup>48</sup> Additionally, less urinary retention is seen with intrathecal clonidine than with intrathecal morphine.<sup>49</sup> Clonidine exerts its analgesic effects by binding to α<sub>2</sub>-adrenoreceptors (on primary afferent, substantia



gelatinosa, and several brainstem nuclei attributed to analgesic mechanisms), attenuating A- $\delta$  and C-fiber nociception, producing conduction blockade via increased potassium conductance,<sup>50,51</sup> as well as increasing acetylcholine and norepinephrine in the CSF, inhibiting the release of substance P.<sup>51</sup> Although clonidine rapidly redistributes systemically to the periphery after epidural or spinal administration as a consequence of lipophilicity, the analgesic effect is spinally mediated as evidenced by the lack of correlation between time of analgesia and peripheral blood levels. Through extensive testing for neurotoxicity and safety in several animal models, neuraxial clonidine shows no histopathologic or behavioral evidence of detriment.

Although previously investigated as a sole anesthetic,<sup>52</sup> the majority of the clinical use of intrathecal clonidine is in combination with a variety of local anesthetics to produce dose-dependent prolongation of both sensory and motor block.<sup>53–56</sup> Showing a promising role in ambulatory anesthesia, De Kock et al.<sup>57</sup> demonstrated that the addition of as little as 15  $\mu\text{g}$  of clonidine to ropivacaine 8 mg for spinal anesthesia in outpatients undergoing knee arthroscopy produced a considerable increase in anesthetic success (from 70–90%) without significant effect on recovery time. However, increasing the dose to 45  $\mu\text{g}$  increased resolution of motor and sensory block and time to void from 170 to 215 minutes. Adding clonidine to local anesthetics intensifies and prolongs epidural blockade and can reduce local anesthetic dose requirement.<sup>58,59</sup> The typical dose of clonidine for addition to local anesthetics for epidural bolus administration is 150  $\mu\text{g}$ , or 2  $\mu\text{g}/\text{kg}$ .<sup>60–62</sup> Klimscha et al. demonstrated that the addition of 150  $\mu\text{g}$  of clonidine to 10 mL of 0.5% bupivacaine for epidural anesthesia increased the mean duration of anesthesia from 1.8 to 5.3 hours, reduced pain scores, and increased time to first postoperative analgesic request.<sup>61</sup> These benefits of clinical doses of neuraxial clonidine typically persist for around 3 hours and can be achieved without increasing hemodynamic instability more than local anesthetic alone or significantly altering responsiveness to resuscitation drugs.<sup>62–65</sup>

### Vasoconstrictors

Vasoconstricting agents, namely epinephrine and phenylephrine, are com-

monly added to local anesthetic solutions and have a long history of clinical use with the intention to prolong the anesthetic effect, provide more reliable block, and intensify anesthesia and analgesia.<sup>66–69</sup> Vasoconstriction, and thus decreased blood flow, can reduce uptake of local anesthetics into the circulation, thus maintaining concentrations at the site of injection and reducing peak plasma concentrations. Additionally, intrinsic analgesic effects of epinephrine are exerted via stimulation of presynaptic  $\alpha_2$  adrenoreceptors found at the terminals of primary afferents. These receptors are also found centrally on neurons in the superficial laminae of the spinal cord and several brainstem nuclei that participate in analgesic mechanisms.

For spinal anesthesia, epinephrine is commonly employed in a typical dose of 0.2 mg (although doses of 0.1–0.6 mg have been described), which when added to a bupivacaine spinal anesthetic, increases time of regression to L2 by 25%.<sup>70,71</sup> The addition of epinephrine to spinal anesthetics prolongs motor block and delays the return of bladder function, which is problematic for ambulatory surgery patients trying to achieve discharge criteria. Chiu et al.,<sup>72</sup> using volunteers, showed that adding 0.2 mg epinephrine to 50 mg hyperbaric lidocaine prolonged surgical anesthesia (as demonstrated by tolerance of transcutaneous electrical stimulation) by 30 minutes, whereas time to void and discharge time were increased by 80 minutes.

As for concerns of safety, intrathecal epinephrine by itself, in clinically relevant doses, shows no neurotoxicity in humans. Spinal cord blood flow is well maintained in the dog and cat model in doses up to 0.5 mg.<sup>73</sup> However, it is suggested that epinephrine may contribute to the neurotoxicity of local anesthetics. Additionally, epinephrine is associated with a case report of cauda equina syndrome after single-shot lidocaine spinal anesthesia.<sup>74</sup> Smith and Kopacz reported consistent flu-like symptoms when epinephrine was added to spinal 2-chloroprocaine in a volunteer study.<sup>33</sup> Phenylephrine may increase the risk of TNS as suggested by Sakura et al. in a study of tetracaine spinal anesthesia.<sup>26</sup>

With epidural anesthesia, the typical use of epinephrine is in concentrations of 1:200,000, or 5  $\mu\text{g}/\text{mL}$ . The clinical effect of epinephrine on duration of

anesthesia depends on the local anesthetic used. Epinephrine is more effective at prolonging the anesthetic duration of shorter-acting agents, such as lidocaine and 2-chloroprocaine. Adding 1:200,000 epinephrine to 2% lidocaine will nearly double the time to resolution of blockade.<sup>75</sup> Agents with longer duration of action show much less prolongation of anesthesia with the addition of epinephrine. Adding epinephrine to ropivacaine will intensify the block, but will not prolong the duration of epidural anesthesia or affect plasma levels.<sup>67</sup> This is likely a result of the inherent vasoconstricting effects of ropivacaine. Other agents do show reduction of plasma levels when epinephrine is added.<sup>66,68</sup> Epinephrine 1:200,000 will decrease plasma lidocaine and chloroprocaine levels by 20–30%, but will decrease plasma bupivacaine levels only by 10–20%. The effect of epinephrine on plasma levels of local anesthetics has long been thought to be caused by constriction of the epidural venous plexus, reducing blood flow and slower uptake of local anesthetics. More recent evidence implies that reduced dural blood flow and increased hepatic clearance may be more important in this phenomenon.<sup>76</sup> Its potential to prolong discharge times and delay bladder function limits the usefulness of adding epinephrine to epidural agents for ambulatory surgery. The premixed solutions of local anesthetics with epinephrine that are commercially available are prepared more acidic in efforts to preserve the potency of the epinephrine. Because this lower pH slows the onset of block and inhibits the vasoconstricting actions of epinephrine, adding “fresh” epinephrine to local anesthetic solutions at the time of use is preferred. When phenylephrine is added to epidural solutions, the systemic absorption results in increased vascular resistance without the benefit of increased contractility or chronotropy seen with epinephrine. Minding this, phenylephrine is typically only used in the subarachnoid space.

### Neostigmine

The acetylcholinesterase inhibitor neostigmine has been investigated as a neuraxial analgesic adjunct because of its ability to provide analgesia without hemodynamic depression. Unfortunately, its tendency to induce nausea and delay recovery from neuraxial

blockade limits clinical use. Intrathecal neostigmine inhibits the breakdown of acetylcholine in the spinal cord via reversible inhibition of acetylcholinesterase. Animal models suggest that acetylcholine plays a role in spinal analgesia through stimulation of cholinergic receptors in the substantia gelatinosa and superficial laminae of the dorsal horn of the spinal cord,<sup>77-79</sup> and perhaps through stimulating nitric oxide production in the spinal cord.<sup>80</sup> Whereas intrathecal injection of cholinergic agonists stimulates all receptors of a particular class, neostigmine increases endogenous acetylcholine in a manner dependent on the tonic production of this neurotransmitter within each particular region of the spinal cord. Hood et al.<sup>81</sup> evaluated safety, analgesic efficacy, and side effects of intrathecal neostigmine in volunteers. All doses produced analgesia without sedation, pruritus, respiratory depression, hypotension, or bradycardia; however, there was dose-related motor weakness, decreases in deep tendon reflexes, urinary incontinence, and nausea and vomiting. Further studies in patients revealed similar responses of nausea and vomiting that proved to be prolonged and difficult to treat.<sup>82-86</sup> Liu et al.<sup>86</sup> showed that when added to low-dose (7.5 mg) bupivacaine spinal anesthetics, 50  $\mu$ g of neostigmine enhanced motor and sensory block, but delayed achievement of discharge criteria. Doses of 6.25 and 12.5  $\mu$ g did not prolong anesthesia but still elicited nausea and delayed discharge. Intrathecal neostigmine does counteract hypotension resulting from bupivacaine spinal anesthesia in rats,<sup>87</sup> but these effects are not reproducible in human subjects.<sup>88</sup> Low and moderate doses of neostigmine are considered to have little or no cardiovascular effects.

Lauretti et al.<sup>89</sup> studied the analgesic effect of epidural neostigmine, in doses from 1 to 4  $\mu$ g/kg added to epidural lidocaine, and showed a dose-independent analgesic effect, increasing time to first analgesic request from 3.5 to 8 hours. Other studies report similar results with doses in the range of 1-10  $\mu$ g/kg, without reporting increased nausea,<sup>90-95</sup> but reporting some suggestion of sedation.<sup>94</sup>

### **Ketamine**

Ketamine is a noncompetitive antagonist of *N*-methyl-D-aspartate (NMDA) receptors, but also has actions at

monoaminergic receptors, opioid receptors, voltage-sensitive calcium channels, muscarinic receptors, and local anesthetic actions through sodium channel blockade.<sup>96</sup> Commercially available as a racemic mixture, the S enantiomer is far more potent at NMDA receptors.<sup>97</sup> Though not approved for neuraxial use, animal models suggest that preservative-free ketamine lacks neurotoxicity.<sup>98</sup> Ketamine was first used intrathecally as a sole anesthetic by Bion in 1984.<sup>99</sup> Hawksworth et al. reported an intolerable rate of anesthetic failure and psychometric side effects at doses of 0.7-0.95 mg/kg.<sup>100</sup> Other investigators found similar problems when combining ketamine with bupivacaine for spinal anesthesia.<sup>101</sup> Epidural administration of ketamine at 0.5-1 mg/kg does reduce intraoperative<sup>102-104</sup> and postoperative<sup>102-105</sup> analgesic requirements without increased side effects. Ozyalcin et al. demonstrated decreased pinprick hyperalgesia and touch allodynia in thoracotomy patients receiving epidural versus intramuscular ketamine.<sup>104</sup> Further work continues to delineate potential applications for chronic neuropathic pain, preemptive analgesia, and modulation of opioid tolerance.

### **Ketorolac**

Ketorolac tromethamine is a nonselective, but cyclooxygenase (COX)-1 preferring, nonsteroidal antiinflammatory drug that has received interest given demonstrated involvement of spinal COX enzymes in postoperative hypersensitivity and pain.<sup>106,107</sup> There is evidence that ketorolac may enhance analgesic effects of intrathecal clonidine<sup>108</sup> and have analgesic synergy with intrathecal morphine<sup>109</sup> in rat models. A phase I safety study of preservative-free ketorolac in healthy volunteers using single bolus doses of 0.5-2 mg showed no immediate or delayed neurologic detriment.<sup>110</sup> This study revealed no significant effect on blood pressure or motor function, but also showed no decrease in pain with heat stimuli. Further human investigations are underway with the hope of identifying the clinical role of intrathecal ketorolac.

### **Alkalinization and Carbonation**

Alkalinizing local anesthetic solutions to raise the pH closer to the  $pK_a$  of the local anesthetic, thereby increasing the proportion of the nonionized form available to cross cell membranes, is

thought to speed the onset of epidural anesthesia. Although this is well demonstrated with peripheral nerves in vitro,<sup>111</sup> studies attempting to demonstrate this clinically in epidural anesthetics are sometimes conflicting.

Most studies show that alkalinization speeds onset of epidural blockade with lidocaine,<sup>112-117</sup> bupivacaine,<sup>112,118,119</sup> mepivacaine<sup>112,120,121</sup> and chloroprocaine<sup>122,123</sup> by up to 10 minutes. Ropivacaine seems to not show faster onset with alkalinization,<sup>124</sup> but as with the other drugs, there is evidence that alkalinization can intensify epidural anesthesia and improve spread to sacral dermatomes.<sup>113,116,117,125</sup> One trend that is noted is that the effects of alkalinization are greatest on solutions containing epinephrine, whether freshly added or prepackaged. This is perhaps a result of pH-dependent vasoconstrictive actions of epinephrine. Alternatively, this may be attributed to the fact that commercially available epinephrine-containing solutions are prepared at lower pH (usually with bisulfite), ranging from 3.2 to 4.2, in efforts to preserve the epinephrine.

Typically recommended volumes of 8.4% sodium bicarbonate to be added to local anesthetic solutions are 1 mL per each 10 mL of lidocaine or mepivacaine, 0.1 mL per 10 mL of bupivacaine, and 0.3 mL per 10 mL of 2-chloroprocaine. Because of the tendency to precipitate, it is not recommended to add sodium bicarbonate to ropivacaine solutions. It should be noted that the degree of alkalinization is limited by precipitation and all preparations should be inspected for precipitation before administration. Alternatively, the carbonate salts of local anesthetics have a more rapid onset of epidural blockade than standard hydrochloride preparations.<sup>126</sup> However, carbonated drugs are of limited availability and may be more prone to induce hypotension with epidural administration.<sup>127</sup>

## **PHYSIOLOGY OF NEURAXIAL ANESTHESIA**

### **Neurophysiology**

Neural blockade by local anesthetics is discussed in Chap. 44, thus this section highlights some of the clinical aspects specific to neuraxial blockade. After intrathecal injection of local anesthetics, drug is found in the spinal cord as

well as in the spinal nerve rootlets within the CSF. After epidural injection, local anesthetic is found in spinal nerves in the epidural space, spinal nerve rootlets within the CSF, and within the spinal cord. Consequently, conduction blockade may take place at multiple sites along the neural pathway for both spinal and epidural anesthesia, and the exact mechanisms are unknown.<sup>128</sup> Previous studies do provide some insight into primary sites of action. After spinal anesthesia, somatosensory evoked potentials from the tibial nerve (peripheral nervous system) are abolished, whereas direct spinal cord stimulation remains unchanged.<sup>129,130</sup> These findings lend support to the theory that the spinal nerve rootlets are the primary site of action of spinal anesthesia and not the spinal cord. Animal studies suggest that the mechanism of action of epidural anesthesia is similar to spinal anesthesia. Measurement of evoked potentials in monkeys again indicates that the primary site of action of epidural anesthesia is the spinal nerve rootlets.<sup>131</sup> Interestingly, epidural anesthesia does not produce complete conduction block, as measurement of somatosensory evoked potentials from the tibial nerve are only modestly changed following induction of epidural anesthesia. Furthermore, magnitude of change in somatosensory evoked potentials does not correlate with intensity of epidural block.<sup>132</sup> This finding is similar to peripheral nerve block, and investigators suggest that anesthesia occurs from loss of information coding inherent in the oscillations of the action potential instead of from complete loss of conduction. Finally, the ability of spinal but not epidural anesthesia to completely suppress somatosensory evoked potentials from the tibial nerve offers objective support for the clinical impression that spinal anesthesia is more intense and complete than epidural anesthesia.

In addition to direct conduction blockade within the CNS, spinal and epidural anesthesia produce sedation that is unrelated to systemic levels of agent, but which correlates with block height.<sup>133</sup> Animal studies using electroencephalogram (EEG) monitoring and direct brain stimulation during spinal anesthesia suggest this is the result of a decrease in reticular activating system activity from decreased tonic afferent input from the anesthetized region.<sup>134</sup>

One may note decreased requirements for supplemental sedation during high spinal blockade from this direct sedative effect. Previous clinical studies examining use of propofol and midazolam suggest that spinal anesthesia per se decreases sedative requirements by approximately 30–50% with clinically relevant spinal block heights.<sup>135,136</sup> This direct sedative effect of epidural anesthesia also becomes clinically relevant when a combined epidural-general anesthesia technique is performed. The use of epidural anesthesia or analgesia reduces volatile anesthetic requirements by 20–30% during surgery when general anesthesia is titrated to either hemodynamics or bispectral index monitoring.<sup>137,138</sup>

### Respiratory Physiology

With spinal or epidural blockade to midthoracic levels, pulmonary function, gas exchange, and control of breathing are generally preserved in patients without preexisting respiratory disease.<sup>139</sup> Many patients will report a subjective sensation of dyspnea as a consequence of reduced sensation of expansion of the chest wall with inspiration. However, resting tidal volumes, respiratory rate, minute ventilation, and lung volumes are maintained in healthy patients.<sup>140,141</sup> Preservation of gross pulmonary function—even with relatively high thoracic level blocks—is explained by the fact that the diaphragm is the primary muscle of ventilation and is innervated by the cervical plexus (C3-5). In contrast, accessory respiratory muscles (abdominal, intercostal) do play a role in active expiratory function and small block-height-dependent decreases in peak expiratory flow can be observed (11% reduction at T8 vs. 17% reduction at T4).<sup>142</sup> Active expiratory function plays a role in ability to cough, thus spinal anesthesia may impair ability to clear secretions.<sup>139</sup> Overall, healthy patients easily tolerate these mild changes, but patients with severe pulmonary disease may not. However, previous studies indicate that patients with chronic lung disease do not suffer from significant reductions in vital capacity or forced expiratory volume at 1 second (FEV<sub>1</sub>) during spinal anesthesia.<sup>139</sup>

Control of breathing during spinal anesthesia is not altered significantly although earlier studies demonstrated a small decrease in resting end-tidal PCO<sub>2</sub>.<sup>143</sup> While hyperventilation as a

consequence of anxiety may cause lowering of the PCO<sub>2</sub>, the hypocapnia is speculated to result from a lack of proprioceptive input from the abdomen and chest wall during spinal anesthesia, resulting in an increased drive to breathe.<sup>143</sup> It has been reported that spinal anesthesia with bupivacaine in unpremedicated patients increased ventilatory responsiveness to CO<sub>2</sub>.<sup>144</sup> The rare respiratory arrest after spinal anesthesia is thought to result from brainstem hypoperfusion secondary to decreased cardiac output rather than the direct effects of local anesthetics on the brainstem, as the concentration of local anesthetic in the ventricular fluid is not high enough to result in medullary depression.

Preoperative discussions usually impart tolerance of the subjective dyspnea, but at times judicious sedation can be used to quell anxieties. It should be noted that sedative medications used to facilitate neuraxial blockade are more likely to impact the patient's respiratory status than the blockade itself.<sup>140</sup> This is likely a result of both reduction in respiratory drive and initiation of paradoxical respiration from upper airway obstruction.

### Cardiovascular Physiology

The perturbations of cardiovascular function during neuraxial anesthesia are perhaps the most critical factors to consider in evaluating the risk to patients and in preventing adverse outcomes. In the nonobstetrical population, the incidences of hypotension and bradycardia after spinal anesthesia are approximately 33% and 13%, respectively.<sup>22,127</sup> Large epidemiology studies from France, Scandinavia, and the United States indicate that the risk of cardiac arrest after spinal anesthesia is approximately 0.1–1:1,000 and 1:10,000 after epidural anesthesia.<sup>145</sup> Although cardiac arrest after spinal anesthesia appears to be distressingly common, a recent study suggests that survival is better for cardiac arrest during neuraxial block than during general anesthesia (65% vs. 31%).<sup>146</sup> This may be a result of enhanced vigilance, as several risk factors for bradycardia and hypotension have been identified for spinal anesthesia (Table 46–8). Risk factors for epidural anesthesia are probably similar but have not been fully identified because of the decreased frequency of occurrences. An appreciation for the mech-

TABLE 46–8.

**Risk Factors for Moderate Bradycardia (Pulse <50 bpm) and Hypotension during Spinal Anesthesia**

Risk Factor	Odds Ratio
<b>Bradycardia</b>	
Baseline heart rate <60 bpm	4.9
ASA physical status P1 (versus ASA physical status P3 or P4)	3.5
Prolonged PR interval	3.2
Use of $\beta$ -blocking drugs	2.9
Sensory level above T <sub>5</sub>	1.7
<b>Hypotension</b>	
Sensory level above T <sub>5</sub>	3.8
Age >40 years	2.5
Baseline SBP <120 mm Hg	2.4
Spinal puncture above L2-3	1.8

Data from Carpenter RL, Caplan RA, Brown DL, et al.,<sup>30</sup> and Salinas FV, Sueda LA, and Liu SS.<sup>139</sup>

anisms involved in these physiologic derangements allows early recognition and prompt treatment of potentially detrimental situations.

Cardiovascular changes seen with spinal anesthesia are caused by blockade of the sympathetic efferent fibers, and thus generally are related to block height.<sup>147</sup> Both arterial and venous relaxation contribute to hypotension, resulting from decreases in systemic vascular resistance (SVR) and cardiac output. SVR decreases to a greater degree in patients aged 69–80 (26% from baseline) than in young healthy subjects (13–18% from baseline).<sup>148</sup> Venodilation causes increased pooling of blood in the capacitance vessels, thus reducing central blood volume. This decreases venous return to the heart, resulting in reduced preload and reduced cardiac output.

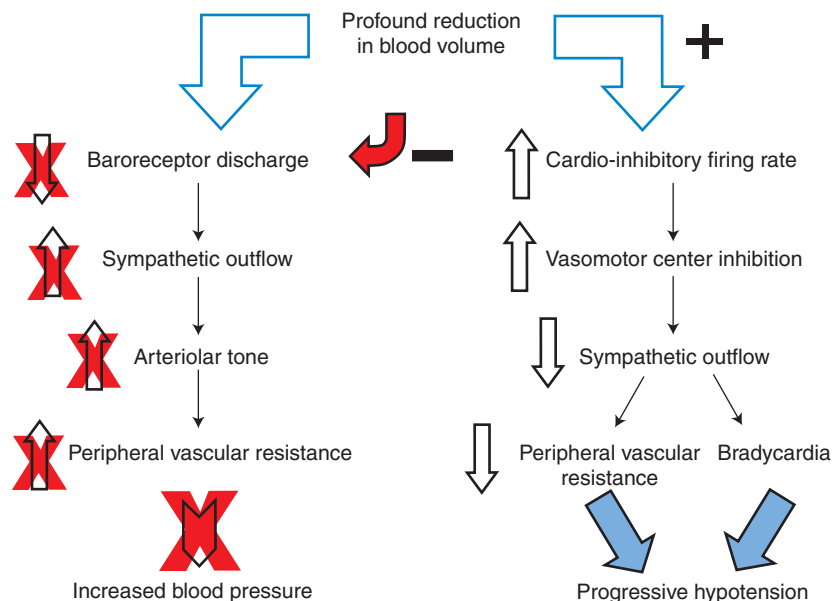
Although heart rate is typically maintained, bradycardia can occur with spinal anesthesia in 10–15% of cases and unexpected circulatory collapse remains a dreaded complication with a potentially grave outcome. In addition to the risk factors of age younger than 50 years, ASA physical status P1, and concomitant use of  $\beta$ -blockers, the incidence of bradycardia increases with increased block height with 75% of occurrences associated with sensory block above T<sub>5</sub><sup>30</sup> (Table 46–8). Cardioaccelerator fibers originate from T1 to

T5 and thus sympathetic blockade above T5 is thought to allow parasympathetic predominance over heart rate, mediated via the vagus nerve. However, some studies of heart rate variability demonstrate that even with high thoracic blockade, the balance between sympathetic and parasympathetic systems can remain in balance.<sup>149,150</sup> Reports of bradycardia/asystole and circulatory collapse in patients with blocks too low to be attributed solely to sympathectomy are further evidence that other factors may play important roles. Bradycardia may be induced by an increase in baroreceptor reflex activity.<sup>151</sup> With redistribution of blood to capacitance vessels and decreased venous return to the heart, resulting decreased filling pressures, intracardiac stretch receptors within the right atrium and left ventricle have been suggested to participate in a bradycardic response (Bezold-Jarisch reflex; Fig. 46–14).<sup>152,153</sup> Maintaining preload and aggressive treatment of bradycardia may help improve the safety of spinal anesthesia.<sup>154</sup>

Efforts have been made to investigate the usefulness of heart rate variability analysis for predicting hypotension after spinal anesthesia for cesarean section to assess the underlying balance of patients' autonomic systems.<sup>155,156</sup> Although small and limited, these studies demonstrate that measurements of heart rate variability are predictive of

hypotension in this patient population. Heart rate variability is extracted from the patient's electrocardiogram (ECG) and analyzed based on the preponderance of low versus high frequencies to determine subsets of patients who are at risk and who would benefit from additional prophylactic interventions (see next paragraph). Computer-aided analysis is being developed, as currently this is not a common analysis of the ECG. More research is needed, but this appears to be a promising clinical tool to direct selective therapy aimed at preventing hypotension with spinal anesthesia.

The prevention and prompt treatment of hypotension and bradycardia during spinal anesthesia is essential in protecting the patient from untoward outcomes. The practice of administering a crystalloid bolus prior to spinal anesthesia has been a standard method for preventing hypotension induced by neuraxial blockade. Behind this is an effort to maintain central blood volume, and, therefore, venous return to the heart, so as to preserve cardiac output. However, studies reveal a more complicated interaction between fluid loading, hemodynamic effects, and efficacy for prevention of hypotension in the nonobstetric population. For example, prophylactic bolusing of 500–1500 mL of crystalloid may be ineffective for prevention of



**FIGURE 46–14.** A proposed mechanism for the participation of the Bezold-Jarisch reflex (BJR)-type cardioinhibitory pathways (right) in the cardiovascular collapse after neuraxial anesthesia. It is suggested that the redistributive hypovolemia produced by neuraxial blockade results in paradoxical bradycardia and inhibition of the baroreceptor reflex pathway (left), which results in progressive hypotension.



hypotension in normovolemic patients if performed prior to induction of spinal anesthesia,<sup>157-159</sup> but may be effective if performed later during the actual performance of spinal anesthesia.<sup>160</sup> This may be a result of the rapid redistribution of crystalloids out of the intravascular compartment, thus providing only a fleeting contribution to venous return.<sup>161</sup> Furthermore, a crystalloid bolus does not adequately address other factors contributing to hypotension, namely heart rate and SVR, and may actually decrease SVR.<sup>162</sup> In contrast, the administration of colloid solutions is more effective in maintaining intravascular volume caused by favorable pharmacokinetics<sup>162,163</sup> and may actually increase SVR.<sup>162</sup> Prophylactic administration of 500–1000 mL of colloid solution prior to induction of spinal blockade more effectively prevents hypotension but can grossly affect fluid balance in the patient. In regards to treatment of hypotension in the setting of established hypovolemia, crystalloid remains a suitable choice because of altered volume kinetics in such a setting.<sup>164</sup> The technique of spinal anesthesia may also be altered to attenuate resultant vasodilatation and hypotension. Sympathetic block is somewhat dose dependent, thus selection of an appropriate dose is helpful. The use of unilateral spinal anesthesia for unilateral lower-extremity procedures allows limited spread of sympathetic block and has been investigated. Typically, a small dose of hyperbaric local anesthetic is injected and the patient is kept in the lateral position (operative side down) for 15 minutes. Casati et al. showed a decreased rate of hypotension in patients with intentionally asymmetric spinal blocks compared to conventional bilateral blockade (5% vs. 22%).<sup>165</sup> Incidence of hypotension is reduced with epidural compared to spinal anesthesia, and placement of a catheter with gradual titration of epidural local anesthetic dose allows time for treatment of the gradual sympathectomy.

Effective treatment of hypotension should be tailored to the clinical situation at hand, with consideration of alterations in SVR and cardiac output. Vasopressors with  $\alpha$ -adrenergic agonist activity, such as phenylephrine and metaraminol, are quite effective for increasing SVR. However, this may be at the expense of a decrease in cardiac output as a response to the increase in

afterload.<sup>166</sup> In light of this, it is thought that the use of mixed  $\alpha$ - and  $\beta$ -adrenergic agonist drugs, like ephedrine, may be more appropriate for the treatment of hypotension induced by neuraxial blockade as a result of the ability to augment heart rate and cardiac output as well as SVR. Ephedrine is most often administered as an intermittent intravenous bolus of 5–10 mg, but may also be given via continuous infusion or intramuscularly as a depot of 25–50 mg. Atropine in doses of 0.4–1 mg intravenously can be used to treat moderate bradycardia if ephedrine is ineffective. In the case of precipitous bradycardia, or in situations unresponsive to the previously mentioned interventions, one should not hesitate to consider administration of epinephrine. Closed claims data analysis suggests that the lack of early administration of epinephrine is a management pattern in spinal anesthesia that leads to cardiac arrest with poor outcome.<sup>167</sup>

Although similar hemodynamic changes are seen with epidural anesthesia, these tend to be better tolerated than changes seen with spinal anesthesia, perhaps because of a more gradual and titratable onset. Nonetheless, sudden bradycardiac cardiac arrest has been described with epidural anesthesia.<sup>168</sup> Risk of sudden cardiovascular collapse from epidural anesthesia may be influenced by the addition of epinephrine to the epidural solution. With the typical dose range used for epidural anesthesia, systemic levels of epinephrine remain low, producing a  $\beta$ -adrenergic effect of vasodilatation, increased heart rate, and myocardial contractility. Ward et al.<sup>169</sup> evaluated the cardiovascular effects of epidural blockade to T5 using lidocaine with and without epinephrine. Mean arterial pressure decreased 20% in the epinephrine group, compared to 10% in the plain lidocaine group. However, the group with epinephrine also showed a 20–30% increase in cardiac output. Bonica suggested that this systemic  $\beta$ -adrenergic effect of epinephrine might prevent the potential cardiovascular collapse from epidural blockade.<sup>170</sup>

### Gastrointestinal, Hepatic, and Genitourinary Physiology

The sympathectomy of spinal anesthesia results in a relaxation of sphincters, constriction of the bowel, and an increase in secretions caused by “parasympathetic dominance.” This imbalance

of the autonomic nervous system is also thought by some to explain the occurrence of nausea seen with spinal anesthesia. Hepatic blood flow is related to mean arterial pressure, and thus maintained if the patient is hemodynamically stable.<sup>171</sup> Likewise, renal blood flow and renal function are preserved during spinal anesthesia when perfusion pressure is adequate.<sup>172</sup> Urinary retention after spinal anesthesia is the most noteworthy and clinically significant concern in regards to the genitourinary system. Postoperative urinary retention occurs in approximately 16% of patients in the recovery unit.<sup>173</sup>

After the induction of spinal anesthesia, the urge to void (normal detrusor function) is abolished within 60 seconds.<sup>174,175</sup> Recovery of the ability to void normally does not return until sensory anesthesia has regressed to the S3 sacral segment.<sup>174</sup> Prolonged inhibition of normal detrusor function with the use of long-acting local anesthetics such as bupivacaine may allow bladder overdistension and urinary retention. In a study of healthy male patients undergoing nonurologic surgery after spinal anesthesia comparing 100 mg lidocaine to 10 mg bupivacaine, the time to return of normal detrusor function was significantly longer in the bupivacaine group ( $233 \pm 31$  vs.  $462 \pm 61$  minutes).<sup>174</sup> The cystometric capacity (the bladder volume at which patients feel an urge to void prior to spinal anesthesia) in this study was between 500 and 600 mL and the patients in the bupivacaine group generated an average of  $875 \pm 385$  mL of urine, far exceeding the cystometric capacity and suggesting that the use of long-acting local anesthetics may lead to bladder overdistension and urinary retention. Other factors such as age (older than 50 years), volume of intraoperative fluid administration, and type of surgical procedure also influence rate of urinary retention.<sup>173</sup>

Concern for postoperative urinary retention is especially important in the ambulatory setting, where the traditional requirement to void after spinal anesthesia often leads to prolonged delays in discharge.<sup>176</sup> However, optimal use of short-acting local anesthetics for ambulatory spinal and epidural anesthesia has not been associated with urinary retention.<sup>177</sup> A recent study of ambulatory surgery patients discharged prior to voiding after short-acting spinal anesthesia demonstrated

significantly shorter discharge times with no reports of urinary retention.<sup>178</sup> Thus, the risk of urinary retention appears to be low after short-acting spinal anesthesia and further prospective study is needed to confirm this practice (discharging patients prior to voiding after short-acting spinal anesthesia) in a large population.

## COMPLICATIONS OF NEURAXIAL ANESTHESIA

### Postdural Puncture Headache

Appreciated since perhaps the first spinal anesthetic, postdural puncture headache (PDPH) remains a common complication of spinal anesthesia and is seen in as much as 50% of cases of unintentional dural puncture during epidural anesthesia. Reported incidence of PDPH following spinal anesthesia varies greatly, depending on the types of needles used and patient population. Although rates as high as 40% are seen with 22-gauge beveled-tip needles,<sup>179</sup> the use of smaller-gauge pencil-point needles has decreased the risk of PDPH after spinal anesthesia to approximately 1%.<sup>180</sup> The traditional mechanism of PDPH is believed to involve the loss of CSF from the thecal sac and a “sagging” of the brain while standing or sitting upright. This is thought to result in traction on the meninges, meningeal vessels, and, at times, traction on the cranial nerves leading to cranial nerve palsy. MRI studies demonstrating reduced CSF volume<sup>181</sup> and meningeal enhancement postgadolinium during PDPH<sup>182</sup> lend support to this theory of CSF loss and meningeal irritation.

There are also data suggesting vasodilatation of cerebral vessels may be important in etiology of PDPH.<sup>183</sup> The headache is typically positional, being most severe while standing and nearly eliminated when supine. Patients usually describe a band-like aching pain in the frontal and occipital regions, posterior neck pain, and at times nausea, tinnitus, photophobia, and diplopia. Differentiation from infectious meningitis is important and usually based on positional nature of symptoms, lack of fever, and if necessary, normal peripheral white cell count and CSF profile.

Although traditionally held to the contrary, patient gender and postoperative recumbency are not related to incidence of PDPH.<sup>184</sup> Although the incidence of PDPH decreases with increasing patient

age,<sup>184</sup> factors that are in the control of the clinician to reduce the occurrence of PDPH include the use of smaller-gauge needles, pencil-point needles, and longitudinal orientation of the bevel if a cutting needle is used.<sup>184,185</sup> The mechanisms in play for the latter two factors are not entirely clear. The classically described scenario is that of more dural fibers being cut by a transversely oriented cutting bevel, and thus a more substantial hole in the dura. However, given that the dural fibers are not actually longitudinally arranged, rather, randomly, the number of these fibers cut should not depend on bevel orientation. It has been suggested that the longitudinal tension placed on the meninges tends to pull open a transversely oriented defect, and thus allow for more CSF leakage. As for pencil-point needles, the supposition that they cause less trauma to the meninges is questionable. Reina et al. suggest that Whitacre needles produce more trauma, as evidenced by electron microscopy images, and that the reduced loss of CSF may be a result of an “edematous plug” resulting from greater inflammatory reaction.<sup>181</sup>

Conservative management of PDPH includes bedrest, oral analgesics, adequate hydration, and caffeine. Patients should be reassured that the symptoms are likely to resolve within 1 week without further invasive treatments. If the patient is not responding adequately to conservative treatments or is having prolonged symptoms, an epidural blood patch can be considered. This is usually performed by accessing the epidural space within 1 interspace of the suspected dural tear and injecting 10–20 mL of autologous blood in an aseptic fashion. This is intended to form a clot, or “patch,” over the dural defect, preventing further leakage of CSF. Additionally, this volume will tamponade the dural sac and restore buoyant support to the brain, explaining the near-immediate relief that many patients report. The reported success of epidural blood patch is reported to be in the range of 70–95%, with those who fail to improve with an initial patch showing the same range of response to a repeat procedure. The effectiveness of prophylactic blood patch administration is controversial with some studies showing no benefit and others reporting greater than 50% success in preventing PDPH.<sup>186</sup> It appears that it may be reasonable and

effective if using larger volumes (15–20 mL) in high-risk patients.<sup>187</sup>

In the search for alternatives to epidural blood patch, administration of saline<sup>188</sup> and dextran<sup>189</sup> have been performed but without prolonged relief of symptoms. Other substances, such as fibrin glue, have been used in the epidural space with some success,<sup>190,191</sup> but further investigation is needed to determine the potential benefits and safety of such procedures.

### Infectious

Infectious complications following neuraxial anesthesia are rare, but can arise in the form of meningitis and epidural abscess. In a large and relatively complete retrospective review, Moen et al. estimated the incidence of meningitis to be less than 1 in 50,000 following spinal anesthesia and about 1 in 90,000 after epidural procedures; and the incidence of epidural abscess to be 1 in 37,000 following epidural blocks.<sup>192</sup> The source of microorganisms can be from contaminated equipment or injected solutions, or from patient source, namely bacteremia. It is speculated that lumbar puncture may disrupt the blood-brain barrier and allow transfer of blood-borne bacteria into the spinal space. Animal studies support this theory, but also show pretreatment with antibiotics to drastically reduce this risk.<sup>193</sup>

Epidural anesthesia for surgical procedures may have a similar risk profile, but the use of indwelling epidural catheters for continuous analgesic infusions provides an additional risk of serving as a wick for surface infections to migrate along the tract to become a deep infection or epidural abscess. However, both surveillance studies and studies examining rates of bacterial contamination of epidural catheter tips indicate that risk is low.<sup>192,194</sup> Patients with postoperative catheters should be under surveillance for signs of infection, having the catheter site inspected daily. If signs of surface infection present, the catheter should be removed and the site monitored for improvement, with or without the initiation of antibiotics as deemed suitable. If the patient presents with severe back pain, and/or new neurologic deficits that are not explained by the analgesic infusion, then the diagnosis of epidural abscess must be considered and MRI or CT performed if appropriate. Du Pen et al. showed successful nonsurgical man-

agement of infections associated with chronic tunneled epidural catheters.<sup>195</sup> However, in the setting of neurologic compromise, prompt diagnosis and surgical evacuation is imperative to permit recovery if an epidural abscess is identified.

### Hemorrhagic Complications

With any invasive procedure, the fear of inducing bleeding in a noncompressible region enters the risk-to-benefit analysis. With neuraxial procedures, hematoma can develop in the epidural, subdural, or intrathecal space, with the potential for devastating neurologic outcome. The estimated incidence of spinal hematoma in the absence of anticoagulant and antiplatelet medications is less than 1 in 150,000 neuraxial blocks.<sup>196</sup> The majority of cases of spinal hematoma are in patients receiving anticoagulants or with impaired hemostatic function from hepatic dysfunction or thrombocytopenia.

The usual presenting symptoms are back pain and motor and/or sensory deficit that is not explained by the administered anesthetic/analgesic agents. In patients with such symptoms, especially in the setting of anticoagulants, definitive diagnosis should be sought without delay. A review by Vandermeulen et al.<sup>197</sup> indicated that early identification by MRI or CT and surgical decompression performed within 4–6 hours of presentation is associated with good neurologic recovery. This review also highlighted the importance of coagulation status at the time of epidural catheter removal with report of 15 patients suffering epidural hematoma associated with this event.

The American Society of Regional Anesthesia and Pain Medicine has released a consensus statement to address the concerning issues surrounding neuraxial procedures in patients receiving anticoagulant and antiplatelet medications.<sup>196</sup> Some of the recommendations from this statement are presented here, but this in no way substitutes for a full review of the information provided by the Consensus Conference. One should also consider that any patient who is receiving combinations of the following medications is likely at further increased risk and appropriate caution taken.

Oral anticoagulants should be stopped 4–5 days prior to planned intervention and international normalized ratio (INR) measured prior to neuraxial pro-

cedures. In patients with indwelling epidural catheters who have had warfarin therapy initiated, a lower-extremity neurologic examination protocol should be followed and the INR should be confirmed to be less than 1.5 prior to epidural catheter removal.

The use of aspirin and nonsteroidal antiinflammatory drugs is not considered to increase the risk of hemorrhagic complications with neuraxial procedures. However, clopidogrel and ticlopidine should be discontinued for at least 7 days and 14 days, respectively, before neuraxial techniques. Given shorter half-lives, the glycoprotein (GP) IIb/IIIa antagonists only need to be held for 24–48 hours to allow return of platelet function.

Patients receiving subcutaneous heparin for thromboprophylaxis are not considered to be at increased risk for spinal hematoma, but considerations should be made with regards to timing of procedures in light of the peak onset of 2 hours after administration of heparin dose. Intraoperative anticoagulation with IV heparin is acceptable if given 1 hour after and discontinued 2–4 hours (and normal partial thromboplastin time [PTT] confirmed) before block placement or catheter removal.

Low-molecular-weight heparins (LMWHs) present added management concerns given the prolonged action (especially in patients with decreased renal clearance) and difficulty in measuring the induced alterations in coagulation status. Current recommendations state that patients receiving thromboprophylactic doses should have neuraxial procedures delayed 10–12 hours after last dose. If receiving “treatment” dosing (1 mg/kg twice a day), a delay of 24 hours is recommended. Following neuraxial procedures, initiation of LMWH therapy should be delayed 6–8 hours for daily dosing or 24 hours for twice-daily dosing.

### Neurologic Complications

Neurologic injury from neuraxial procedures is rare, but it remains a fervently held fear among many patients. The overall incidence of persistent neurologic injury associated with neuraxial blocks is reported to be approximately 0.08–0.16%; however, the vast majority of these reported cases fail to show evidence that the block was directly causative.<sup>198</sup> Potential mechanisms of neurologic injury following neuraxial anesthesia include direct needle or

catheter trauma, neurotoxicity of injected substances (intended agents or unintended chemicals), infectious complications, hemorrhagic complications, or spinal cord ischemia. The majority of perceived injuries are related to persistent paresthesia or motor weakness, but cauda equina syndrome is also scarcely reported.

Although paresthesia is reported in as much as 6% of patients during needle placement for spinal anesthesia, this rarely results in persistent neurologic deficit.<sup>199</sup> Similarly, most paresthesias associated with indwelling epidural catheters are likely to dissipate following removal of the catheter.<sup>200</sup> Despite its rare occurrence, paresthesia during block placement is considered a risk factor for persistent paresthesia. Patients experiencing this should be reassured and queried postoperatively regarding their neurologic status.

Attention has been focused on the issues surrounding neurotoxicity of local anesthetics and common additives because of identification of several cases of cauda equina syndrome associated with continuous spinal anesthesia via microcatheters. Although the injuries in these cases have been attributed to pooling and maldistribution of the local anesthetic within the thecal sac caused by the nature of administration through a catheter,<sup>201</sup> there are reports of similar injuries from single-shot lidocaine spinal anesthetics using relatively high doses (>75 mg) with epinephrine.<sup>74</sup> Despite the long history of relative safety, animal data exist to suggest that all local anesthetics have some potential to cause neural injury; however, lidocaine and tetracaine appear to have a greater potential for neurotoxicity than bupivacaine at clinically relevant concentrations.<sup>202</sup> Drasner has presented recommendations for lidocaine spinal anesthesia, including limiting the dose to 60 mg, avoiding epinephrine, and restricting concentrations to 2.5% or less,<sup>203</sup> although little evidence exists to support these proposals. The concerns of dose, concentration and adjuvants might be applicable to all local anesthetics.

A much more commonly reported complication following neuraxial anesthesia is TNS. These symptoms, initially termed “transient radicular irritation” in 1993,<sup>204</sup> are described as back pain radiating to the buttocks and/or the lower

extremities. Although TNS has been reported following spinal anesthesia with all local anesthetics, it is more common with lidocaine, showing an incidence in prospective studies to be between 4% and 36%.<sup>23</sup> Drastic variation in the observed rates of TNS (Table 46-6) lends support to the theory that multiple factors are involved in its development. Factors demonstrated to contribute to the incidence of TNS include the use of lidocaine (relative risk of 4.35 compared to other local anesthetics),<sup>205</sup> lithotomy position, knee arthroscopy, and early ambulation (as in outpatient surgery) (Table 46-6).<sup>204</sup>

The etiology of TNS remains elusive, but proposed culprits include direct neurotoxicity of local anesthetics, stretching of neural structures via positioning and muscle relaxation, needle trauma, and muscular spasm. The evidence against neurotoxicity being the principal cause of TNS includes lack of motor deficit and electrophysiologic changes during acute symptoms,<sup>206</sup> as well as its response to nonsteroidal antiinflammatory drugs and other modalities treating muscular discomfort.

### Systemic Toxicity and Epidural Test Dose

It is important to verify correct placement of needles and catheters in the epidural space prior to initiating epidural anesthesia. Unintentional subdural or subarachnoid dosing can result in high blocks or “total spinals,” whereas intravascular injection can result in seizures or cardiovascular collapse. Subdural injection is rare and may be difficult to recognize, as CSF will not be aspirated from the needle or catheter. The clinical pattern is one of an unusually high block after administration of local anesthetic.<sup>208</sup> Unintentional subarachnoid injection is a more common occurrence with incidences of “total spinals” ranging from 0.3% to 0.6%. It is important to realize that an epidural catheter may migrate into the subarachnoid space at any time during use. Unintentional intravascular injection is probably more common with incidences of systemic toxic reactions (ranging from mild CNS symptoms to seizures) ranging from 2% to 0.01%.<sup>208</sup> Again, it is important to realize that an epidural catheter may migrate into the intravascular space at any time during use.

Although efficacy is uncertain, it is standard practice to administer a test

**TABLE 46-9.**

#### Use of Epinephrine Test Doses to Detect Intravascular Injection

Patient Type	Hemodynamic Criteria for Intravascular Injection of 15 µg of Epinephrine
Healthy surgical patient	HR increase >20 bpm SBP increase >15 mm Hg T-wave amplitude decreased by ≥25% on ECG
β-Adrenergic blockade	HR unreliable SBP increase >15 mm Hg
Age >60 years	HR increase >9 bpm SBP increase >15 mm Hg
General anesthesia	HR increase >8 bpm SBP increase >13 mm Hg
Spinal anesthesia	HR increase >20 bpm SBP unreliable

HR, heart rate; SBP, systolic blood pressure.  
All responses occur within 2 minutes of injection.

dose prior to initiating full epidural anesthesia.<sup>208</sup> This test dose is meant to detect unintentional placement of the needle or catheter into either the subarachnoid or intravascular space. A 3-mL volume of local anesthetic is the primary component of a test dose. Theoretically, subarachnoid injection of this local anesthetic will produce a much more rapid and profound sensory and motor block than epidural injection. However, changes can be subtle and will require time to develop. Previous reports indicate that 2–4 minutes are required prior to development of sensory or motor block after subarachnoid injection of 3 mL of 1.5% lidocaine.<sup>208,209</sup> Subarachnoid injection of a bupivacaine test dose (3 mL 0.25–0.5%) produces spinal blocks with highly variable onset time and spread and is probably not a reliable indicator.<sup>208</sup> Use of a test dose to detect subarachnoid placement is not without risk, as previous publications have reported high spinal anesthesia requiring tracheal intubation after 3 mL of 1.5% lidocaine or 0.5% bupivacaine.<sup>208</sup> The local anesthetic component can also be used to detect intravascular injection by assessing symptoms of CNS irritability such as tinnitus, perioral tingling, metallic taste, and dizziness. Detection ability is limited as the standard 3-mL test dose (45 mg lidocaine or 15 mg bupivacaine) contains insufficient local anesthetic to reliably produce such symptoms. Previous studies suggest that larger doses, such as 100 mg or 1 mg/kg of lidocaine or

>25 mg of bupivacaine, levobupivacaine, or ropivacaine, are required in the unsedated patient.<sup>208,210</sup> Administration of even modest doses of sedation further reduces the ability of patients to report these symptoms (40% reduction in sensitivity).<sup>211</sup>

Epinephrine is commonly added to the local anesthetic dose to increase sensitivity for detection of intravascular injection. Addition of 15 µg is the standard dose of epinephrine; it will consistently produce increases in heart rate and systolic blood pressure and reduction in T-wave amplitude within 60–120 seconds in healthy patients (Table 46-9).<sup>208,212</sup> Use of β-blockers, advanced age, and addition of general or spinal anesthesia all decrease the hemodynamic response to this dose of epinephrine and reduced criteria should be applied in these circumstances.<sup>208,213,214</sup> Intravascular injection of epinephrine may be of concern in patients with hypertension, patients at risk for myocardial ischemia, and in obstetrical patients, and potential risks should be considered in these patients.

The best method for avoiding systemic toxicity from local anesthetics is through prevention. Toxic systemic levels can occur by unintentional intravenous or intraarterial injection, or by systemic absorption of excessive doses placed in the correct area. Unintentional intravascular and intraarterial injections can be minimized by frequent syringe aspiration for blood, use of a test dose of local anesthetic (see



above), and either slow injection or fractionation of the rest of the dose of local anesthetic.<sup>215</sup> Detailed knowledge of local anesthetic pharmacokinetics will also aid in reducing the administration of excessive doses of local anesthetics. Ideally, heart rate, blood pressure, and the electrocardiogram should be monitored during administration of local anesthetics. Pretreatment with a benzodiazepine might also lower the probability of seizure by raising the seizure threshold.

## CONTINUOUS SPINAL ANESTHESIA

Because of the density and reliability of spinal anesthetic blockade, attempts to extend the duration and graduate the dosing of agents led to techniques for continuous spinal anesthesia (CSA). Almost a century ago, malleable spinal needles were left within the subarachnoid space to allow redosing during prolonged procedures, and, later, Tuohy placed catheters in the intrathecal space. The development of microcatheters (29–32 gauge) in the 1980s led to a revisiting of this technique with hopes of titrating and prolonging spinal blockade with reduced incidence of PDPH as compared to Tuohy's 15-gauge catheters. Unfortunately, beyond the problems of breakage and knotting, these catheters are associated with several reports of cauda equina syndrome, usually with 5% hyperbaric lidocaine used as the agent. The hypothesis is that the small-bore catheters led to a “sacral pooling” of the hyperbaric agents, limiting spread and dilution of the drug in the CSF, unmasking the neurotoxic potential of lidocaine at such a concentration. The FDA subsequently removed these microcatheters from the market, as did the Canadian authorities. Although some practitioners still employ continuous spinal anesthesia using larger-gauge catheters, the risks and benefits must be weighed carefully for the given situation. If CSA is to be undertaken, precautions should be taken to not advance the catheter beyond 3 cm within the intrathecal space, avoid dextrose-containing preparations, give adequate time for spread and distribution of the agent prior to additional dosing, and be prepared to abandon the technique if sacral pooling is suspected.

## COMBINED SPINAL–EPIDURAL ANESTHESIA

Combined spinal–epidural anesthesia (CSEA) is an increasingly popular technique, with an estimated 10-fold increase in use in the past decade.<sup>216</sup> Its advantages include rapid onset, dense neuraxial block, ability to titrate spread and duration of block, and lower total drug dosage when compared to epidural anesthesia. Potential disadvantages include increased time to perform the dual technique, intrathecal migration of epidural drug and/or catheter, effects of increased epidural pressure from injection of solutions on spinal block, and decreased ability and reliability of epidural test dosing. Although a seemingly simple combination of two routine techniques for neuraxial anesthesia, the interactions between the two can be subtle, can impact clinical management, and have not been fully determined.

### Patient Selection and Clinical Applications

#### Obstetrics

CSEA has been most widely accepted in the obstetric population. The concept of the “walking epidural” has become popular among patients, where intrathecal opioid allows rapid onset of analgesia without motor blockade. Lipid-soluble opioids, such as fentanyl (up to 25 µg) and sufentanil (up to 10 µg), are commonly used to provide dose-dependent analgesia for 60–90 minutes.<sup>217</sup> Opioids are also commonly combined with small doses of local anesthetics, such as bupivacaine, to either prolong this initial spinal analgesia or to reduce side effects by decreasing the required dose of opioids. Previous dose response studies indicate that 2.5 mg of bupivacaine combined with either 15 µg of fentanyl or 2.5 µg of sufentanil provides satisfactory analgesia while reducing incidences of nausea and pruritus, when compared to larger doses of opioid.<sup>218,219</sup> Recent comparisons suggest that the newer local anesthetics ropivacaine and levobupivacaine are approximately equipotent for CSEA for labor analgesia and essentially interchangeable with bupivacaine for labor analgesia.<sup>220,221</sup> Preservation of motor function is an important goal after CSEA for labor analgesia, and sophisticated testing of positional sense and motor

function after CSEA indicates little effect from the initial spinal dose (2.5 mg bupivacaine + 5 µg fentanyl).<sup>222</sup> However, subsequent injection of a standard test dose (45 mg lidocaine + 15 µg epinephrine) to confirm epidural catheter placement or the initiation of continuous epidural analgesia appears to degrade motor function and positional sense.<sup>222,223</sup> Addition of other less commonly used adjuncts to standard doses of opioids can also increase duration of analgesia. For example, addition of 200 µg of epinephrine or 50 µg of clonidine to opioid is equivalent to adding 2.5 mg of bupivacaine and can provide an additional 30 minutes of analgesia.<sup>217</sup> Despite the apparent preservation of motor function, large clinical trials have not observed a decrease in incidence of cesarean section when CSEA is compared to conventional epidural analgesia, although the incidence is similar to systemic analgesia.<sup>224–226</sup>

As an anesthetic for cesarean section, CSEA offers a rapid, titratable block, good muscle relaxation, and the ability to use reduced doses of local anesthetic. Several clinical trials have compared CSEA to epidural anesthesia with lidocaine or bupivacaine combined with fentanyl. These studies report more rapid onset, better motor block, decreased anxiety levels, decreased shivering, and greater patient satisfaction with CSEA.<sup>227,228</sup> Incidences of side effects were similar in that the severity of hypotension did not differ, nor did the incidence of postdural puncture headaches, backaches, nausea, or vomiting.<sup>227,228</sup> When compared to conventional single-shot spinal anesthesia, use of CSEA offers the potential advantage of using a smaller initial dose of spinal anesthetic with the epidural catheter available, should the block be insufficient. Such an approach theoretically offers the advantage of greater individual titration with reduction in side effects and faster recovery from conduction block. However, results from studies are inconsistent, with some trials observing faster motor recovery with this approach<sup>229</sup> and others not discerning a reduced dosing need for spinal anesthesia with epidural supplement.<sup>230,231</sup> A potential disadvantage of the CSEA technique versus the single-shot technique is an increased incidence of transient paresthesia during placement of the spinal needle. A previous study randomizing

patients undergoing cesarean section to CSEA versus conventional spinal anesthesia observed incidences of paresthesia of 37% versus 9%. There were no long-term complications, and the authors speculated that the CSEA technique might lead to deeper tissue penetration as a mechanism for increased incidence of transient paresthesia.<sup>232</sup>

### Ambulatory Anesthesia

The dose of local anesthetic determines both anesthetic success and duration of recovery. Availability of the epidural catheter for a rescue anesthetic allows use of minimal doses of spinal local anesthetic with resultant rapid recovery and discharge (Table 46-4) and represents an alternative or complementary strategy to use of analgesic additives. Several clinical trials have determined minimally effective doses for ambulatory knee arthroscopy using this approach. For example, initial doses of spinal lidocaine 40 mg or mepivacaine 45 mg<sup>233,234</sup> have been determined to be optimal doses for CSEA by previous dose-response studies. However, induction of a CSEA technique probably takes more time than conventional spinal anesthesia, and no current data are available to assess relative cost benefit of increased induction time versus decreased recovery time with CSEA. Thus, final conclusions on the role of CSEA in a busy ambulatory surgery center remain to be determined.

### Techniques and Equipment

The most widespread approach used in the literature is the needle-through-needle technique. A number of commercial kits are available. The simplest version is a Tuohy needle (or equivalent) through which a long, small-gauge spinal needle (24–30 gauge) is passed. Epidural needles with a “back hole” are also available, configured to allow placement of the spinal needle through a separate conduit so as to avoid angulation of the spinal needle (Fig. 46-15). Recent studies suggest that use of a back-hole needle may offer advantages over a conventional needle through needle technique. A randomized trial in parturients observed decreased incidence of paresthesia (14% vs. 42%) and failure to obtain CSF on the first attempt (8% vs. 28%) with the back-hole needle.<sup>235</sup> The separate conduit for the spinal needle may also reduce risk of toxicity from metal fragments caused

by needle friction.<sup>236</sup> Metal fragments have been proposed as a cause of aseptic meningitis, following the observation of notches in epidural needle tips.<sup>237</sup> However, recent evaluations using atomic absorption spectrography and photomicrography did not demonstrate metal fragments even after up to 5 spinal needle passes, and suggest the notches were caused by malleability of the metal.<sup>238</sup>

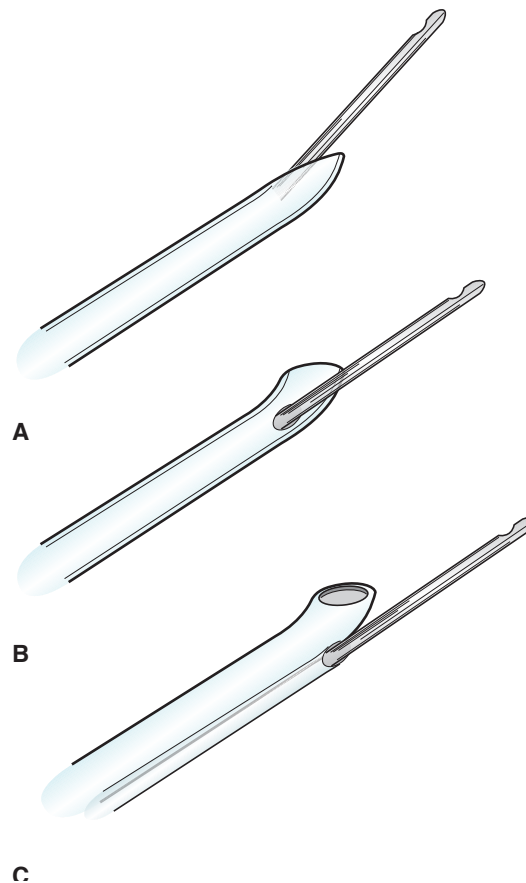
As an alternative to the needle-through-needle technique, the double-segment method also offers the ability to place the epidural catheter and administer a test dose prior to placing the spinal block. Typically, the epidural and spinal portions are performed at different interspaces. By first introducing the catheter, there exists the potential risk of damaging the catheter with the spinal needle. Furthermore, creating two separate cutaneous punctures could lead to increased incidence of adverse events, including backache, headache, infection, and hematoma.<sup>239</sup> A recent study demonstrated greater

acceptance by surgical patients of the needle-through-needle over the double-segment technique (85% vs. 67%).<sup>240</sup> That same study also showed a significantly longer time to perform the double-segment technique without decreasing the failure rate of spinal anesthesia, although other studies suggest a higher failure rate with the needle-through-needle technique.<sup>240</sup>

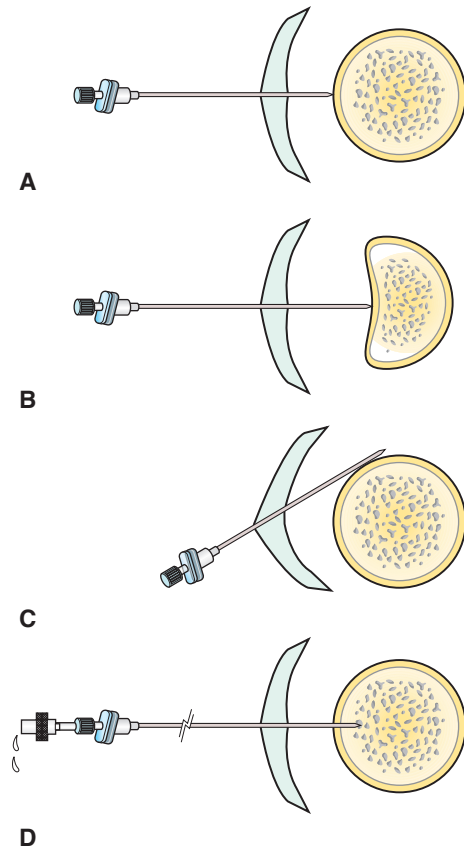
### Potential Complications

#### Failure of Spinal Anesthesia

The combined technique is associated with a higher failure rate of spinal anesthesia than conventional spinal anesthesia. The most recent data suggests about a 5% incidence, improved from older reports of 10–25%.<sup>216</sup> There are a number of reasons for failure to occur. (a) Smaller-gauge spinal needles with long lengths are typically used. These needles lead to slower return of CSF and a greater resistance to injection. (b) Because the epidural needle has penetrated the tissue



**FIGURE 46-15.** Styles of needles for combined spinal-epidural anesthesia. Depicted are (A) “conventional” Tuohy with a long spinal needle exiting the curved tip; (B) “back-eyed” needle with spinal needle exiting through the eye; and (C) “double-barrel” design, with a separate bore for passage of a spinal needle. Notice the difference in the angle of projection of the spinal needle passing out of the “conventional Tuohy” tip, as compared to B and C.



**FIGURE 46-16.** Various reasons for not achieving successful spinal anesthesia when attempting combined spinal–epidural anesthesia. **A.** Inadequate length of spinal needle, or epidural needle not advanced far enough. **B.** Spinal needle rents the dura, but does not achieve puncture. **C.** Angle of advancement deviates too far from midline. **D.** Successful dural puncture with return of CSF.

planes, there is little to anchor the spinal needle in place. Although a Luer lock apparatus is available, it locks at a fixed needle length and can result in not reaching or traversing the dura.<sup>27</sup> (c) Any deviation from midline can lead to missing the dura altogether (Fig. 46-16). (d) If loss-of-resistance technique used saline, a false return of saline in the spinal needle rather than CSF can occur. Kopacz et al. recommend the hanging drop method within the epidural needle to aid identification of dural puncture in this situation.<sup>6</sup> Negative pressure from tenting the dura with the spinal needle will cause an inward movement of the drop of fluid followed by return of CSF. (e) Finally, patient positioning and duration between spinal injection and completion of epidural catheter placement can change the characteristics of the spinal block.

### Failure of Epidural Anesthesia

There are no controlled randomized prospective studies addressing the failure of epidural anesthesia or analgesia with the combined technique.<sup>22</sup> The in-

cidence of failure is unlikely to be higher with the combined technique; however, the difficulty in early testing with a needle-through-needle technique may lead to late recognition of a misplaced catheter. Prior injection of spinal anesthetic precludes testing the epidural catheter for intrathecal placement, and epidural injection of a test dose can lead to increased height of spinal block (see Intrathecal Effects of Epidural Agent below).<sup>243</sup> Reliability of detecting an intravascular test dose using 15  $\mu$ g of epinephrine remains intact in healthy individuals using heart rate and systolic blood pressure criteria, although the developing spinal block will reduce the magnitude of hemodynamic response to epinephrine.<sup>214</sup>

### Intrathecal Effects of Epidural Agent

The intrathecal effects of epidurally administered drugs can occur through migration of the epidural catheter through the dural puncture, leakage of epidural anesthetic through the dural hole, and pressure effects of epidural injection. The likelihood of passing an

epidural catheter through a dural hole is very small, provided a 24-gauge or smaller spinal needle is used. This has been demonstrated using in vitro models and in vivo epiduroscopy.<sup>244</sup> However, intrathecal catheter placement is possible if the epidural needle (17–18 gauge) initially rent the dura. Migration later in the anesthetic course is no more likely than with conventional epidural techniques.

Although significant clinical effects of leakage of epidural local anesthetic or opioid through the small-gauge dural puncture is unlikely, significant leakage of epidural agents can occur through large dural rents such as with a “wet tap.”<sup>245,246</sup>

Pressure effect is the observation that increasing epidural volume can “squeeze” the CSF compartment and thus raise the cephalad spread of spinal drugs. A recent myelographic evaluation demonstrated that the subarachnoid space’s diameter decreased to 25% after 10 mL normal saline was injected through an epidural catheter.<sup>247</sup> The ability to increase dermatomal spread by epidural volume appears to be time dependent. Sensory block extension can be significant (3–4 dermatomes) if epidural saline or air is injected soon after or before bupivacaine spinal anesthesia.<sup>243,248</sup> This block enhancement may be clinically significant, as a recent clinical trial reported that CSEA required 20% less local anesthetic than single-shot spinal anesthesia.<sup>249</sup> However, if delayed until two-segment regression has begun, there is no increase in sensory blockade level<sup>250</sup>; in fact, it can even result in shorter duration of anesthesia.<sup>251</sup>

### KEY REFERENCES

1. Liu SS, McDonald SB. Current issues in spinal anesthesia. *Anesthesiology* 2001;94(5):888–906.
2. Auroy Y, Benhamou D, Bargues L, et al. Major complications of regional anesthesia in France: the SOS Regional Anesthesia Hotline Service. *Anesthesiology* 2002;97(5):1274–1280.
3. Carpenter RL, Caplan RA, Brown DL, Stephenson C, Wu R. Incidence and risk factors for side effects of spinal anesthesia. *Anesthesiology* 1992;76:906–916.

4. Curatolo M, Scaramozzino P, Venuti FS, Orlando A, Zbinden AM. Factors associated with hypotension and bradycardia after epidural blockade. *Anesth Analg* 1996;83(5):1033–1040.
5. Lee LA, Posner KL, Domino KB, Caplan RA, Cheney FW. Injuries associated with regional anesthesia in the 1980s and 1990s: a closed claims analysis. *Anesthesiology* 2004;101(1):143–152.
6. Horlocker TT, Wedel DJ, Benzon HT, et al. Regional anesthesia in the anticoagulated patient: defining the risks (the second ASRA Consensus Conference on Neuraxial Anesthesia and Anticoagulation). *Reg Anesth Pain Med* 2003;28(3):172–197.
7. Pollock JE. Transient neurologic symptoms: etiology, risk factors, and management. *Reg Anesth Pain Med* 2002;27(6):581–586.
8. Cook TM. Combined spinal–epidural techniques. *Anaesthesia* 2000;55:42–64.

## REFERENCES

1. Richardson MG, Wissler RN. Density of lumbar cerebrospinal fluid in pregnant and nonpregnant humans. *Anesthesiology* 1996;85:326–330.
2. Lirk P, Kolbitsch C, Putz C. Cervical and high thoracic ligamentum flavum frequently fails to fuse in the midline. *Anesthesiology* 2003;99:1387–1390.
3. Bernards CM, Shen DD, Sterling ES, et al. Epidural, cerebrospinal fluid, and plasma pharmacokinetics of epidural opioids (part 1): differences among opioids. *Anesthesiology* 2003;99:455–465.
4. Liu SS, Melmed AP, Klos JW, et al. Prospective experience with a 20-gauge Tuohy needle for lumbar epidural steroid injections: is confirmation with fluoroscopy necessary? *Reg Anesth Pain Med* 2001;26:143–146.
5. Kopacz DJ, Neal JM, Pollock JE. The regional anesthesia “learning curve.” What is the minimum number of epidural and spinal blocks to reach consistency? *Reg Anesth* 1996;21:182–190.
6. Kopacz DJ, Bainton BG. Combined spinal epidural anesthesia: a new “hanging drop.” *Anesth Analg* 1996;82:433–434.
7. Goobie SM, Montgomery CJ, Basu R, et al. Confirmation of direct epidural catheter placement using nerve stimulation in pediatric anesthesia. *Anesth Analg* 2003;97:984–988.
8. Lechner TJ, van Wijk MG, Maas AJ, et al. Clinical results with the acoustic puncture assist device, a new acoustic device to identify the epidural space. *Anesth Analg* 2003;96:1183–1187.
9. Hogan QH, Prost R, Kulier A, et al. Magnetic resonance imaging of cerebrospinal fluid volume and the influence of body habitus and abdominal pressure. *Anesthesiology* 1996;84:1341–1349.
10. Pitkanen M, Haapaniemi L, Tuominen M, et al. Influence of age on spinal anaesthesia with isobaric 0.5% bupivacaine. *Br J Anaesth* 1984;56:279–284.
11. Taivainen T, Tuominen M, Rosenberg PH. Influence of obesity on the spread of spinal analgesia after injection of plain 0.5% bupivacaine at the L3-4, or L4-5, interspace. *Br J Anaesth* 1990;64:542–546.
12. Horlocker TT, Wedel DJ. Density, specific gravity, and baricity of spinal anesthetic solutions at body temperature. *Anesth Analg* 1993;76:1015–1018.
13. Bodily MN, Carpenter RL, Owens BD. Lidocaine 0.5% spinal anaesthesia: a hypobaric solution for short-stay perirectal surgery. *Can J Anaesth* 1992;39:770–773.
14. Greene NM. Distribution of local anesthetic solutions within the subarachnoid space. *Anesth Analg* 1985;64:715–730.
15. Na KB, Kopacz DJ. Spinal chloroprocaine solutions: density at 37 degrees C and pH titration. *Anesth Analg* 2004;98:70–74.
16. Higuchi H, Hirata J, Adachi Y, et al. Influence of lumbosacral cerebrospinal fluid density, velocity, and volume on extent and duration of plain bupivacaine spinal anesthesia. *Anesthesiology* 2004;100:106–114.
17. Bengtsson M, Malmqvist LA, Edstrom HH. Spinal analgesia with glucose-free bupivacaine—effects of volume and concentration. *Acta Anaesthesiol Scand* 1984;28:583–586.
18. Janik R, Dick W, Stanton-Hicks MD. Influence of barbotage on block characteristics during spinal anesthesia with hyperbaric tetracaine and bupivacaine. *Reg Anesth* 1989;14:26–30.
19. Hirabayashi Y, Shimizu R. Effect of age on extradural dose requirement in thoracic extradural anaesthesia. *Br J Anaesth* 1993;71:445–446.
20. Duggan J, Bowler GM, McClure JH, et al. Extradural block with bupivacaine: influence of dose, volume, concentration and patient characteristics. *Br J Anaesth* 1988;61:324–331.
21. Fagraeus L, Urban BJ, Bromage PR. Spread of epidural analgesia in early pregnancy. *Anesthesiology* 1983;58:184–187.
22. Liu SS, McDonald SB. Current issues in spinal anesthesia. *Anesthesiology* 2001;94:888–906.
23. Freedman JM, Li DK, Drasner K, et al. Transient neurologic symptoms after spinal anesthesia: an epidemiologic study of 1,863 patients. *Anesthesiology* 1998;89:633–641.
24. McDonald SB, Liu SS, Kopacz DJ, et al. Hyperbaric spinal ropivacaine: a comparison to bupivacaine in volunteers. *Anesthesiology* 1999;90:971–977.
25. Halpern SH, Walsh V. Epidural ropivacaine versus bupivacaine for labor: a meta-analysis. *Anesth Analg* 2003;96:1473–1479.
26. Sakura S, Sumi M, Sakaguchi Y, et al. The addition of phenylephrine contributes to the development of transient neurologic symptoms after spinal anesthesia with 0.5% tetracaine. *Anesthesiology* 1997;87:771–778.
27. Zayas VM, Liguori GA, Chisolm MF. Dose–response relationships for isobaric spinal mepivacaine using the combined spinal epidural technique. *Anesth Analg* 1999;89:1167–1171.
28. YaDeau JT, Liguori GA, Zayas VM. The incidence of transient neurologic symptoms after spinal anesthesia with mepivacaine. *Anesth Analg* 2005;101:661–665.
29. Martinez-Bourio R, Arzuaga M, Quintana JM, et al. Incidence of transient neurologic symptoms after hyperbaric subarachnoid anesthesia with 5% lidocaine and 5% prilocaine. *Anesthesiology* 1998;88:624–628.
30. Carpenter RL, Caplan RA, Brown DL, et al. Incidence and risk factors for side effects of spinal anesthesia. *Anesthesiology* 1992;76:906–916.
31. Gissen AJ, Datta S, Lambert D. The chloroprocaine controversy. II. Is chloroprocaine neurotoxic? *Reg Anesth* 1984;9:135–145.
32. Wang BC, Hillman DE, Spielholz NI. Chronic neurological deficits and Nesacaine-CE: an effect of the anesthetic 2-chloroprocaine, or the antioxidant, sodium bisulfite? *Anesth Analg* 1984;63:445–447.
33. Smith KN, Kopacz DJ, McDonald SB. Spinal 2-chloroprocaine: a dose-ranging study and the effect of added epinephrine. *Anesth Analg* 2004;98:81–88.
34. Yoos JR, Kopacz DJ. Spinal 2-chloroprocaine for surgery: an initial 10-month experience. *Anesth Analg* 2005;100:553–558.
35. Vath JS, Kopacz DJ. Spinal 2-chloroprocaine: the effect of added fentanyl. *Anesth Analg* 2004;98:89–94.
36. Warren DT, Kopacz DJ. Spinal 2-chloroprocaine: the effect of added dextrose. *Anesth Analg* 2004;98:95–101.
37. Kouri ME, Kopacz DJ. Spinal 2-chloroprocaine: a comparison with lidocaine in volunteers. *Anesth Analg* 2004;98:75–80.
38. Kopacz DJ. Spinal 2-chloroprocaine: minimum effective dose. *Reg Anesth Pain Med* 2005;30:36–42.
39. Taniguchi M, Bollen AW, Drasner K. Sodium bisulfite: scapegoat for chloroprocaine neurotoxicity? *Anesthesiology* 2004;100:85–91.
40. Stevens RA, Urmey WF, Urquhart BL, et al. Back pain after epidural anesthesia with chloroprocaine. *Anesthesiology* 1993;78:492–497.



41. Hamber EA, Viscomi CM. Intrathecal lipophilic opioids as adjuncts to surgical spinal anesthesia. *Reg Anesth Pain Med* 1999;24:255-263.
42. Schneider SP, Eckert WA, Light AR. Opioid-activated postsynaptic, inward rectifying potassium currents in whole cell recordings in substantia gelatinosa neurons. *J Neurophysiol* 1998;80:2954-2962.
43. Liu S, Chiu AA, Carpenter RL, et al. Fentanyl prolongs lidocaine spinal anesthesia without prolonging recovery. *Anesth Analg* 1995;80:730-734.
44. Ben-David B, Solomon E, Levin H, et al. Intrathecal fentanyl with small-dose dilute bupivacaine: better anesthesia without prolonging recovery. *Anesth Analg* 1997;85:560-565.
45. Harukuni I, Yamaguchi H, Sato S, et al. The comparison of epidural fentanyl, epidural lidocaine, and intravenous fentanyl in patients undergoing gastrectomy. *Anesth Analg* 1995;81(6):1169-1174.
46. Ginosar Y, Riley ET, Angst MS. The site of action of epidural fentanyl in humans: the difference between infusion and bolus administration. *Anesth Analg* 2003;97(5):1428-1438.
47. Coda BA, Brown MC, Schaffer R, et al. Pharmacology of epidural fentanyl, alfentanil, and sufentanil in volunteers. *Anesthesiology* 1994;81(5):1149-1161.
48. Eisenach JC, De Kock M, Klimscha W. Alpha(2)-adrenergic agonists for regional anesthesia: a clinical review of clonidine (1984-1995). *Anesthesiology* 1996;85:655-674.
49. Gentili M, Bonnet F. Spinal clonidine produces less urinary retention than spinal morphine. *Br J Anaesth* 1996;76(6):872-873.
50. Gaumann DM, Brunet PC, Jirounek P. Hyperpolarizing afterpotentials in C fibers and local anesthetic effects of clonidine and lidocaine. *Pharmacology* 1994;48:21-29.
51. De Kock M, Eisenach J, Tong C, et al. Analgesic doses of intrathecal but not intravenous clonidine increase acetylcholine in cerebrospinal fluid in humans. *Anesth Analg* 1997;84(4):800-803.
52. Malinovsky JM, Bernard JM. Spinal clonidine fails to provide surgical anesthesia for transurethral resection of prostate. A dose-finding pilot study. *Reg Anesth* 1996;21(5):419-423.
53. Bonnet F, Buisson VB, Francois Y, et al. Effects of oral and subarachnoid clonidine on spinal anesthesia with bupivacaine. *Reg Anesth* 1990;15(4):211-214.
54. Ota K, Namiki A, Iwasaki H, et al. Dose-related prolongation of tetracaine spinal anesthesia by oral clonidine in humans. *Anesth Analg* 1994;79(6):1121-1125.
55. Strelbel S, Gurzeler JA, Schneider MC, et al. Small-dose intrathecal clonidine and isobaric bupivacaine for orthopedic surgery: a dose-response study. *Anesth Analg* 2004;99(4):1231-1238.
56. Davis BR, Kopacz DJ. Spinal 2-chloroprocaine: the effect of added clonidine. *Anesth Analg* 2005;100(2):559-565.
57. De Kock M, Gautier P, Fanard L, et al. Intrathecal ropivacaine and clonidine for ambulatory knee arthroscopy: a dose-response study. *Anesthesiology* 2001;94(4):574-578.
58. Aveline C, El Metaoua S, Masmoudi A, et al. The effect of clonidine on the minimum local analgesic concentration of epidural ropivacaine during labor. *Anesth Analg* 2002;95(3):735-740.
59. Landau R, Schiffer E, Morales M, et al. The dose-sparing effect of clonidine added to ropivacaine for labor epidural analgesia. *Anesth Analg* 2002;95(3):728-734.
60. Bouguet D. Caudal clonidine added to local anesthetics enhances post-operative analgesia after anal surgery in adults [abstract]. *Anesthesiology* 1994;81:A942.
61. Klimscha W, Chiari A, Krafft P, et al. Hemodynamic and analgesic effects of clonidine added repetitively to continuous epidural and spinal blocks. *Anesth Analg* 1995;80:322-327.
62. Wu CT, Jao SW, Borel CO, et al. The effect of epidural clonidine on perioperative cytokine response, postoperative pain, and bowel function in patients undergoing colorectal surgery. *Anesth Analg* 2004;99(2):502-509.
63. De Kock M, Versailles H, Colinet B, et al. Epidemiology of the adverse hemodynamic events occurring during "clonidine anesthesia": A prospective open trial of intraoperative. *J Clin Anesth* 1995;7:403-410.
64. Nishikawa T, Kimura T, Taguchi N, et al. Oral clonidine preanesthetic medication augments the pressor responses to intravenous ephedrine in awake or anesthetized patients. *Anesthesiology* 1991;74:705-710.
65. Inomata S, Nishikawa T, Kihara S, et al. Enhancement of pressor response to intravenous phenylephrine following oral clonidine medication in awake and anesthetized patients. *Can J Anaesth* 1995;42:119-125.
66. Burm, AG, van Kleef JW, Gladines MP, et al. Epidural anesthesia with lidocaine and bupivacaine: effects of epinephrine on plasma concentration profiles. *Anesth Analg* 1986;65:1281-1284.
67. Lee BB, Ngan Kee WD, Plummer JL, et al. The effect of the addition of epinephrine on early systemic absorption of epidural ropivacaine in humans. *Anesth Analg* 2002;95(5):1402-1407.
68. Niemi G, Breivik H. Epinephrine markedly improves thoracic epidural analgesia produced by a small-dose infusion of ropivacaine, fentanyl, and epinephrine after major thoracic or abdominal surgery: a randomized, double-blinded crossover study with and without epinephrine. *Anesth Analg* 2002;94:1598-1605.
69. Sakura S, Sumi M, Morimoto N, et al. The addition of epinephrine increases intensity of sensory block during epidural anesthesia with lidocaine. *Reg Anesth Pain Med* 1999;24(6):541-546.
70. Moore JM, Liu SS, Pollock JE, et al. The effect of epinephrine on small-dose hyperbaric bupivacaine spinal anesthesia: clinical implications for ambulatory surgery. *Anesth Analg* 1998;86:973-977.
71. Kito K, Kato H, Shibata M, et al. The effect of varied doses of epinephrine on duration of lidocaine spinal anesthesia in the thoracic and lumbosacral dermatomes. *Anesth Analg* 1998;86:1018-1022.
72. Chiu AA, Liu S, Carpenter RL, et al. The effects of epinephrine on lidocaine spinal anesthesia: a cross-over study. *Anesth Analg* 1995;80:735-739.
73. Kozody R, Palahniuk RJ, Wade JG, et al. The effect of subarachnoid epinephrine and phenylephrine on spinal cord blood flow. *Can Anaesth Soc J* 1984;31:503-508.
74. Gerancher JC. Cauda equine syndrome following single spinal administration of 5% hyperbaric lidocaine through a 25-gauge Whitacre needle. *Anesthesiology* 1997;87:687-689.
75. Liu SS, Hodgson PS. Local anesthetics. In: Barash PG, Cullen BF, Stoelting RF, eds. *Clinical Anesthesia*. Philadelphia: Lippincott-Raven, 2001:449-472.
76. Sharrock N, Go G, Mineo R. Effect of I.V. low-dose adrenaline and phenylephrine infusions on plasma concentrations of bupivacaine after lumbar extradural anaesthesia in elderly patients. *Br J Anaesth* 1991;67:694-698.
77. Seybold VS. Distribution of histaminergic, muscarinic and serotonergic binding sites in cat spinal cord with emphasis on the region surrounding the central canal. *Brain Res* 1985;342:219-296.
78. Yaksh TL, Dirksen R, Harty GJ. Antinociceptive effects of intrathecally injected cholinomimetic drugs in the rat and cat. *Eur J Pharmacol* 1985;117:81-88.
79. Bartolini A, Ghelardini C, Fantetti L, et al. Role of muscarinic receptor subtypes in central antinociception. *Br J Pharmacol* 1992;105:77-82.
80. Chiari A, Eisenach JC. Spinal anesthesia: mechanisms, agents, methods, and safety. *Reg Anesth Pain Med* 1998;23(4):357-362.
81. Hood DD, Eisenach JC, Tuttle R. Phase I safety assessment of intrathecal neostigmine methylsulfate in humans. *Anesthesiology* 1995;82:331-343.
82. Krukowski JA, Hood DD, Eisenach JC, et al. Intrathecal neostigmine for post-caesarean section analgesia: dose response. *Anesth Analg* 1997;84:1269-1275.
83. Lauretti GR, Reis MP, Prado WA, et al. Dose-response study of intrathecal morphine versus intrathecal neostigmine, their combination, or placebo for postoperative analgesia in patients undergoing anterior and posterior vaginoplasty. *Anesth Analg* 1996;82:1182-1187.
84. Lauretti GR, Mattos AL, Reis MP, et al. Intrathecal neostigmine for postoperative analgesia after orthopedic surgery. *J Clin Anesth* 1997;9:473-477.
85. Yegin A, Yilmaz M, Karsli B, et al. Analgesic effects of intrathecal neostig-

- mine in perianal surgery. *Eur J Anaesthesiol* 2003;20(5):404–408.
86. Liu SS, Hodgson PS, Moore JM, et al. Dose–response effects of spinal neostigmine added to bupivacaine spinal anesthesia in volunteers. *Anesthesiology* 1999; 90(3):710–717.
87. Pan HL, Song HK, Eisenach JC. Intrathecal cholinergic agonists lessen bupivacaine spinal-block-induced hypotension in rats. *Anesth Analg* 1994;79(1):112–116.
88. Lauretti GR, Reis MP. Subarachnoid neostigmine does not affect blood pressure or heart rate during bupivacaine spinal anesthesia. *Reg Anesth* 1996;21(6):586–591.
89. Lauretti GR, de Oliveira R, Reis MP, et al. Study of three different doses of epidural neostigmine coadministered with lidocaine for postoperative analgesia. *Anesthesiology* 1999;90(6):1534–1538.
90. Lauretti GR, de Oliveira R, Perez MV, et al. Postoperative analgesia by intraarticular and epidural neostigmine following knee surgery. *J Clin Anesth* 2000;12(6):444–448.
91. Kirdemir P, Ozkocak I, Demir T, et al. Comparison of postoperative analgesic effects of preemptively used epidural ketamine and neostigmine. *J Clin Anesth* 2000;12(7):543–548.
92. Nakayama M, Ichinose H, Nakabayashi K, et al. Analgesic effect of epidural neostigmine after abdominal hysterectomy. *J Clin Anesth* 2001;13(2):86–89.
93. Omais M, Lauretti GR, Paccola CA. Epidural morphine and neostigmine for postoperative analgesia after orthopedic surgery. *Anesth Analg* 2002;95(6):1698–1701.
94. Kaya FN, Sahin S, Owen MD, et al. Epidural neostigmine produces analgesia but also sedation in women after cesarean delivery. *Anesthesiology* 2004;100(2):381–385.
95. Roelants F, Lavand'homme PM. Epidural neostigmine combined with sufentanil provides balanced and selective analgesia in early labor. *Anesthesiology* 2004;101(2): 439–444.
96. Hirota K, Lambert DG. Ketamine: its mechanism(s) of action and unusual clinical uses. *Br J Anaesth* 1996;77(4):441–444.
97. Joó G, Horvath G, Klimscha W, et al. The effects of ketamine and its enantiomers on the morphine- or dexmedetomidine-induced antinociception after intrathecal administration in rats. *Anesthesiology* 2000;93:231–241.
98. Malinovsky JM, Lepage JY, Cozian A, et al. Is ketamine or its preservative responsible for neurotoxicity in the rabbit? *Anesthesiology* 1993;78(1):109–115.
99. Bion J. Intrathecal ketamine for war surgery. A preliminary study under field conditions. *Anaesthesia* 1984;39:1023–1028.
100. Hawksworth C, Serpell M. Intrathecal anaesthesia with ketamine. *Reg Anesth Pain Med* 1998;23:283–288.
101. Togal T, Demirbilek S, Koroglu A, et al. Effects of S(+) ketamine added to bupivacaine for spinal anaesthesia for prostate surgery in elderly patients. *Eur J Anaesthesiol* 2004;21(3):193–197.
102. Xie H, Wang X, Liu G, et al. Analgesic effects and pharmacokinetics of a low dose of ketamine preoperatively administered epidurally or intravenously. *Clin J Pain* 2003;19(5):317–322.
103. Subramaniam K, Subramaniam B, Pawar DK, et al. Evaluation of the safety and efficacy of epidural ketamine combined with morphine for postoperative analgesia after major upper abdominal surgery. *J Clin Anesth* 2001;13(5):339–344.
104. Ozyalcin NS, Yucel A, Camlica H, et al. Effect of pre-emptive ketamine on sensory changes and postoperative pain after thoracotomy: comparison of epidural and intramuscular routes. *Br J Anaesth* 2004;93(3): 356–361.
105. Chia YY, Liu K, Liu YC, et al. Adding ketamine in a multimodal patient-controlled epidural regimen reduces postoperative pain and analgesic consumption. *Anesth Analg* 1998;86:1245–1249.
106. Ma W, Du W, Eisenach JC. Role for both spinal cord COX-1 and COX-2 in maintenance of mechanical hypersensitivity following peripheral nerve injury. *Brain Res* 2002;937(1–2):94–99.
107. Zhu X, Conklin D, Eisenach JC. Cyclooxygenase-1 in the spinal cord plays an important role in postoperative pain. *Pain* 2003;104(1–2):15–23.
108. Conklin DR, Eisenach JC. Intrathecal ketorolac enhances antinociception from clonidine. *Anesth Analg* 2003;96(1):191–194.
109. Martin TJ, Zhang Y, Buechler N, et al. Intrathecal morphine and ketorolac analgesia after surgery: comparison of spontaneous and elicited responses in rats. *Pain* 2005;113(3):376–385.
110. Eisenach JC, Curry R, Hood DD, et al. Phase I safety assessment of intrathecal ketorolac. *Pain* 2002;99(3):599–604.
111. Wong K, Strichartz GR, Raymond SA. On the mechanisms of potentiation of local anesthetics by bicarbonate buffer: drug structure-activity studies on isolated peripheral nerve. *Anesth Analg* 1993;76(1): 131–143.
112. Capogna G, Celleno D, Laudano D, et al. Alkalinization of local anesthetics. Which block, which local anesthetic? *Reg Anesth* 1995;20(5):369–377.
113. Curatolo M, Petersen-Felix S, Arendt-Nielsen L, et al. Adding sodium bicarbonate to lidocaine enhances the depth of epidural blockade. *Anesth Analg* 1998;86(2):341–347.
114. Difazio CA, Carron H, Grosslight KR, et al. Comparison of pH-adjusted lidocaine solutions for epidural anesthesia. *Anesth Analg* 1986;65:760–764.
115. Fernando R, Jones HM. Comparison of plain and alkalinized local anaesthetic mixtures of lignocaine and bupivacaine for elective extradural caesarean section. *Br J Anaesth* 1991;67(6):699–703.
116. Benzon HT, Toleikis JR, Dixit P, et al. Onset, intensity of blockade and somatosensory evoked potential changes of the lumbosacral dermatomes after epidural anesthesia with alkalinized lidocaine. *Anesth Analg* 1993;76(2):328–332.
117. Arakawa M, Aoyama Y, Ohe Y. Block of the sacral segments in lumbar epidural anaesthesia. *Br J Anaesth* 2003;90(2):173–178.
118. McMorland GH, Douglas MJ, Jeffery WK, et al. Effect of pH-adjustment of bupivacaine on onset and duration of epidural analgesia in parturients. *Can Anaesth Soc J* 1986;33(5):537–541.
119. McMorland GH, Douglas MJ, Axelson JE, et al. The effect of pH adjustment of bupivacaine on onset and duration of epidural anaesthesia for caesarean section. *Can J Anaesth* 1998;35(5):457–461.
120. Capogna G, Celleno D, Tagariello V. The effect of pH adjustment of 2% mepivacaine on epidural anesthesia. *Reg Anesth* 1989;14(3):121–123.
121. Capogna G, Celleno D, Varrassi G, et al. Epidural mepivacaine for cesarean section: effects of a pH-adjusted solution. *J Clin Anesth* 1989;3(3):211–214, 1991.
122. Stevens RA, Chester WL, Schubert A, et al. pH adjustment of 2-chloroprocaine quickens the onset of epidural anaesthesia. *Can J Anaesth* 1989;36(5):515–518.
123. Ackerman WE, Denson DD, Juneja MM, et al. Alkalinization of chloroprocaine for epidural anesthesia: effects of pCO<sub>2</sub> at constant pH. *Reg Anesth* 1990;15(2):89–93.
124. Ramos G, Pereira E, Simonetti MP. Does alkalinization of 0.75% ropivacaine promote a lumbar peridural block of higher quality? *Reg Anesth Pain Med* 2001;26(4): 357–362.
125. Gosteli P, Van Gessel E, Gamulin Z. Effects of pH adjustment and carbonation of lidocaine during epidural anesthesia for foot or ankle surgery. *Anesth Analg* 1995; 81(1):104–109.
126. Siler JN, Rosenberg H. Lidocaine hydrochloride versus lidocaine bicarbonate for epidural anesthesia in outpatients undergoing arthroscopic surgery. *J Clin Anesth* 1990;2(5):296–300.
127. Curatolo M, Scaramozzino P, Venuti FS, et al. Factors associated with hypotension and bradycardia after epidural blockade. *Anesth Analg* 1996;83(5):1033–1040.
128. Cohen E. Distribution of local anesthetic agents in the neuraxis of the dog. *Anesthesiology* 1968;29:1002–1005.
129. Boswell MV, Iacono RP, Guthkelch AN. Sites of action of subarachnoid lidocaine and tetracaine: observations with evoked potential monitoring during spinal cord stimulator implantation. *Reg Anesth* 1992;17:37–42.
130. Lang E, Krainick JU, Gerbershagen HU. Spinal cord transmission of impulses during high spinal anesthesia as measured by cortical evoked potentials. *Anesth Analg* 1989;69:15–20.

131. Cusick JF, Myklebust JB, Abram SE. Differential neural effects of epidural anesthetics. *Anesthesiology* 1980;53:299–306.
132. Zaric D, Hallgren S, Leissner L, et al. Evaluation of epidural sensory block by thermal stimulation, laser stimulation, and recording of somatosensory evoked potentials. *Reg Anesth* 1996;21:124–138.
133. Gentili M, Huu PC, Enel D, et al. Sedation depends on the level of sensory block induced by spinal anaesthesia. *Br J Anaesth* 1998;81:970–971.
134. Antognini JF, Jinks SL, Atherley R, et al. Spinal anaesthesia indirectly depresses cortical activity associated with electrical stimulation of the reticular formation. *Br J Anaesth* 2003;91:233–238.
135. Ben-David B, Vaida S, Gaitini L. The influence of high spinal anesthesia on sensitivity to midazolam sedation. *Anesth Analg* 1995;81:525–528.
136. Tverskoy M, Fleyshman G, Bachrak L, et al. Effect of bupivacaine-induced spinal block on the hypnotic requirement of propofol. *Anaesthesia* 1996;51:652–653.
137. Morley AP, Derrick J, Seed PT, et al. Isoflurane dosage for equivalent intraoperative electroencephalographic suppression in patients with and without epidural blockade. *Anesth Analg* 2002;95:1412–1418.
138. Casati L, Fernandez-Galinski S, Barrera E, et al. Isoflurane requirements during combined general/epidural anesthesia for major abdominal surgery. *Anesth Analg* 2002;94:1331–1337.
139. Salinas FV, Sueda LA, Liu SS. Physiology of spinal anaesthesia and practical suggestions for successful spinal anaesthesia. *Best Pract Res Clin Anaesthesiol* 2003;17:289–303.
140. Yamakage M, Kamada Y, Toriyabe M, et al. Changes in respiratory pattern and arterial blood gases during sedation with propofol or midazolam in spinal anesthesia. *J Clin Anesth* 1999;11:375–379.
141. Steinbrook RA, Concepcion M. Respiratory effects of spinal anesthesia: resting ventilation and single-breath CO<sub>2</sub> response. *Anesth Analg* 1991;72:182–186.
142. Egbert LD, Tamersoy K, Deas TC. Pulmonary function during spinal anesthesia: the mechanism of cough depression. *Anesthesiology* 1961;22:822.
143. Hasrrop-Griffiths AW, Ravalia A, Browne DA, et al. Regional anesthesia and cough effectiveness. *Anaesthesia* 1991;46:11–13.
144. Steinbrook RA, Concepcion M, Topulos GP. Ventilatory responses to hypercapnia during bupivacaine spinal anesthesia. *Anesth Analg* 1988;67:247–252.
145. Auroy Y, Benhamou D, Barges L, et al. Major complications of regional anesthesia in France: the SOS Regional Anesthesia Hotline Service. *Anesthesiology* 2002;97:1274–1280.
146. Kopp SL, Horlocker TT, Warner ME, et al. Cardiac arrest during neuraxial anesthesia: frequency and predisposing factors associated with survival. *Anesth Analg* 2005;100:855–865.
147. Defalco RJ. Compared effects of spinal and extradural anesthesia upon the blood pressure. *Anesthesiology* 1962;23:627–630.
148. Rooke GA, Freund PR, Jacobson AF. Hemodynamic response and change in organ blood volume during spinal anesthesia in elderly men with cardiac disease. *Anesth Analg* 1997;85:99–105.
149. Kimura T, Komatsu T, Hirabayashi A, et al. Autonomic imbalance of the heart during total spinal anesthesia evaluated by spectral analysis of heart rate variability. *Anesthesiology* 1994;80:694–698.
150. Introna R, Yodowski E, Pruet J, et al. Sympathovagal effects of spinal anesthesia assessed by heart rate variability analysis. *Anesth Analg* 1995;80:315–321.
151. Gratadour P, Viale JP, Parlow J, et al. Sympathovagal effects of spinal anesthesia assessed by the spontaneous cardiac baroreflex. *Anesthesiology* 1997;87:1359–1367.
152. Campagna JA, Carter C. Clinical relevance of the Bezold-Jarisch reflex. *Anesthesiology* 2003;98:1250–1260.
153. Kinsella SM, Tuckey JP. Perioperative bradycardia and asystole: relationship to vasovagal syncope and the Bezold-Jarisch reflex. *Br J Anaesth* 2001;86:859–868.
154. Pollard JB. Cardiac arrest during spinal anesthesia: common mechanisms and strategies for prevention. *Anesth Analg* 2001;92:252–256.
155. Hanss R, Bein B, Ledowski T, et al. Heart rate variability predicts severe hypotension after spinal anesthesia for elective cesarean delivery. *Anesthesiology* 2005;102:1086–1093.
156. Chamchad D, Arkoosh VA, Horrow JC, et al. Using heart rate variability to stratify risk of obstetric patients undergoing spinal anesthesia. *Anesth Analg* 2004;99:1818–1821.
157. Coe AJ, Revanas B. Is crystalloid preloading useful in spinal anaesthesia in the elderly? *Anaesthesia* 1990;45:241–243.
158. Rout CC, Rocke DA, Levin J, et al. A reevaluation of the role of crystalloid preload in the prevention of hypotension associated with spinal anesthesia for elective cesarean section. *Anesthesiology* 1993;79:262–269.
159. Arndt JO, Bommer W, Krauth J, et al. Incidence and time course of cardiovascular side effects during spinal anesthesia after prophylactic administration of intravenous fluids or vasoconstrictors. *Anesth Analg* 1998;87:347–354.
160. Mojica JL, Melendez HJ, Bautista LE. The timing of intravenous crystalloid administration and incidence of cardiovascular side effects during spinal anesthesia: the results from a randomized controlled trial. *Anesth Analg* 2002;94:432–437.
161. Svensen C, Hahn RG. Volume kinetics of ringer solution, dextran 70, and hypertonic saline in male volunteers. *Anesthesiology* 1997;87:204–212.
162. Marhofer P, Faryniac B, Oismuller C, et al. Cardiovascular effects of 6% hetastarch and lactated Ringer's solution during spinal anesthesia. *Reg Anesth Pain Med* 1999;24:399–404.
163. Sharma SK, Gajraj NM, Sidawi JE. Prevention of hypotension during spinal anesthesia: a comparison of intravascular administration of hetastarch versus lactated Ringer's solution. *Anesth Analg* 1997;84:111–114.
164. Drobin D, Hahn RG. Volume kinetics of Ringer's solution in hypovolemic volunteers. *Anesthesiology* 1999;90:81–91.
165. Casati A, Fanelli G, Aldegheri G, et al. Frequency of hypotension during conventional or asymmetric hyperbaric spinal block. *Reg Anesth Pain Med* 1999;24:214–219.
166. Critchley LA, Conway F. Hypotension during subarachnoid anaesthesia: haemodynamic effects of colloid and metaraminol. *Br J Anaesth* 1996;76:734–736.
167. Lee LA, Posner KL, Domino KB, et al. Injuries associated with regional anesthesia in the 1980s and 1990s: a closed claims analysis. *Anesthesiology* 2004;101:143–152.
168. Liguori GA, Sharrock NE. Asystole and severe bradycardia during epidural anesthesia in orthopedic patients. *Anesthesiology* 1997;86:250–257.
169. Ward RJ, Bonica JJ, Freund FG, et al. Epidural and subarachnoid anesthesia. Cardiovascular and respiratory effects. *JAMA* 1965;25:275.
170. Bonica JJ, Akamatsu TJ, Berges PU, et al. Circulatory effects of epidural block: II. Effects of epinephrine. *Anesthesiology* 1971;34:514.
171. Greene NM, Brull SJ. Hepatic function. In: Greene NM, Brull SJ, eds. *Physiology of Spinal Anesthesia*. 4th ed. Baltimore: Williams & Wilkins 1993:233–262.
172. Greene NM, Brull SJ. Renal function. In: Greene NM, Brull SJ, eds. *Physiology of Spinal Anesthesia*. 4th ed. Baltimore: Williams & Wilkins 1993:263–280.
173. Keita H, Diouf E, Tubach F, et al. Predictive factors of early postoperative urinary retention in the postanesthesia care unit. *Anesth Analg* 2005;101:592–596.
174. Kamphuis ET, Ionescu TI, Kuipers PWG, et al. Recovery of storage and emptying functions of the urinary bladder after spinal anesthesia with lidocaine and with bupivacaine in men. *Anesthesiology* 1998;88:310–316.
175. Axelsson K, Mollefors K, Olsson JO, et al. Bladder function in spinal anaesthesia. *Acta Anaesthesiol Scand* 1985;29:315–321.
176. Pavlin DJ, Rapp SE, Polissar NI, et al. Factors affecting discharge time in adult outpatients. *Anesth Analg* 1998;87:816–826.
177. Mulroy MF, Larkin KL, Hodgson PH, et al. A comparison of spinal, epidural, and general anesthesia for outpatient knee arthroscopy. *Anesth Analg* 2000;91:860–864.



178. Mulroy MF, Salinas FV, Larkin KL, et al. Ambulatory surgery patients may be discharged before voiding after short-acting spinal and epidural anesthesia. *Anesthesiology* 2002;97:315–319.
179. Barker P. Headache after dural puncture. *Anaesthesia* 1989;44:696–697.
180. Lambert DH, Hurley RJ, Hertwig L, et al. Role of needle gauge and tip configuration in the production of lumbar puncture headache. *Reg Anesth* 1997;22:66–72.
181. Reina MA, de Leon-Casasola OA, Lopez A, et al. An in vitro study of dural lesions produced by 25-gauge Quincke and Whitacre needles evaluated by scanning electron microscopy. *Reg Anesth Pain Med* 2000;25:393–403.
182. Hannerz J, Ericson K, Bro Skejo HP. MR imaging with gadolinium in patients with and without post-lumbar puncture headache. *Acta Radiol* 1999;40:135–141.
183. Liu SS. Why are postdural puncture headaches still a problem? *Reg Anesth Pain Med* 2000;25:347–349.
184. Lybecker H, Moller JT, May O, et al. Incidence and prediction of postdural puncture headache. A prospective study of 1021 spinal anesthetics. *Anesth Analg* 1990;70:389–394.
185. Halpern S, Preston R. Postdural puncture headache and spinal needle design: meta-analyses. *Anesthesiology* 1994;81:1376–1383.
186. Cheek TG, Banner R, Sauter J, et al. Prophylactic extradural blood patch is effective: a preliminary communication. *Br J Anaesth* 1988;61:340–342.
187. Colonna-Romano P, Shapiro BE. Unintentional dural puncture and prophylactic epidural blood patch in obstetrics. *Anesth Analg* 1989;69:522–523.
188. Bart AJ, Wheeler AS. Comparison of epidural saline placement and epidural blood placement in the treatment of post-lumbar-puncture headache. *Anesthesiology* 1978;48:221–223.
189. Souron V, Hamza J. Treatment of postdural puncture headaches with colloid solutions: an alternative to epidural blood patch. *Anesth Analg* 1999;89:1333–1334.
190. Crul BJ, Gerritse BM, van Dongen RT, et al. Epidural fibrin glue injection stops persistent postdural puncture headache. *Anesthesiology* 1999;91:576–577.
191. Patel MR, Caruso PA, Yousuf N, Rachlin J. CT-guided percutaneous fibrin glue therapy of cerebrospinal fluid leaks in the spine after surgery. *AJR Am J Roentgenol* 2000;175:443–446.
192. Moen V, Dahlgren N, Irestedt L. Severe neurological complications after central neuraxial blockades in Sweden 1990–1999. *Anesthesiology* 2004;101:950–959.
193. Carp H, Bailey S. The association between meningitis and dural puncture in bacteremic rats. *Anesthesiology* 1992;76:739–742.
194. Steffen P, Seeling W, Essig A, et al. Bacterial contamination of epidural catheters: microbiological examination of 502 epidural catheters used for postoperative analgesia. *J Clin Anesth* 2004;16:92–97.
195. Du Pen SL, Peterson DG, Williams A, et al. Infection during chronic epidural catheterization: diagnosis and treatment. *Anesthesiology* 1990;73:905–909.
196. Horlocker TT, Wedel DJ, Benzon HT, et al. Regional anesthesia in the anticoagulated patient: defining the risks (the Second ASRA Consensus Conference on Neuraxial Anesthesia and Anticoagulation). *Reg Anesth Pain Med* 2003;28:172–197.
197. Vandermeulen EP, Van Aken H, Vermeylen J. Anticoagulants and spinal-epidural anesthesia. *Anesth Analg* 1994;79:1165–1177.
198. Kane RE. Neurologic deficits following epidural or spinal anesthesia. *Anesth Analg* 1981;60:150–161.
199. Horlocker TT, McGregor DG, Matsushige DK, Schroeder DR, Besse JA. A retrospective review of 4767 consecutive spinal anesthetics: central nervous system complications. *Anesth Analg* 1997;84:578–584.
200. Giebler RM, Scherer RU, Peters J. Incidence of neurologic complications related to thoracic epidural catheterization. *Anesthesiology* 1997;86:55–63.
201. Biboulet P, Capdevila X, Aubas P, et al. Causes and prediction of maldistribution during continuous spinal anesthesia with isobaric or hyperbaric bupivacaine. *Anesthesiology* 1998;88:487–494.
202. Hodgson PS, Neal JM, Pollock JE, et al. The neurotoxicity of drugs given intrathecally (spinal). *Anesth Analg* 1999;88:797–809.
203. Drasner, K. Local anesthetic neurotoxicity: clinical injury and strategies that may minimize risk. *Reg Anesth Pain Med* 2002;27:576–580.
204. Schneider M, Ettlin T, Kaufmann M, et al. Transient neurologic toxicity after hyperbaric subarachnoid anesthesia with 5% lidocaine. *Anesth Analg* 1993;76:1154–1157.
205. Zaric D, Christiansen C, Pace NL. Transient neurologic symptoms after spinal anesthesia with lidocaine versus other local anesthetics: a systematic review of randomized, controlled trials. *Anesth Analg* 2005;100:1811–1816.
206. Pollock JE, Burkhead D, Neal JM, et al. Spinal nerve function in five volunteers experiencing neurologic symptoms after lidocaine subarachnoid anesthesia. *Anesth Analg* 2000;90:658–665.
207. Pollock, JE. Transient neurologic symptoms: etiology, risk factors, and management. *Reg Anesth Pain Med* 2002;27:581–586.
208. Mulroy MF, Norris MC, Liu SS. Safety steps for epidural injection of local anesthetics: review of the literature and recommendations. *Anesth Analg* 1997;85:1346–1356.
209. Colonna-Romano P, Padolina R, Lingaraju N, et al. Diagnostic accuracy of an intrathecal test dose in epidural analgesia. *Can J Anaesth* 1994;41:572–574.
210. Owen MD, Gautier P, Hood DD. Can ropivacaine and levobupivacaine be used as test doses during regional anesthesia? *Anesthesiology* 2004;100:922–925.
211. Moore JM, Liu SS, Neal JM. Premedication with fentanyl and midazolam decreases the reliability of intravenous lidocaine test dose. *Anesth Analg* 1998;86:1015–1017.
212. Takahashi S, Tanaka M, Toyooka H. The efficacy of hemodynamic and T-wave criteria for detecting intravascular injection of epinephrine test dose in propofol-anesthetized adults. *Anesth Analg* 2002;94:717–722.
213. Tanaka M, Nishikawa T. Aging reduces the efficacy of the simulated epidural test dose in anesthetized adults. *Anesth Analg* 2000;91:657–661.
214. Liu SS, Stevens RA, Vasquez J, et al. The efficacy of epinephrine test doses during spinal anesthesia in volunteers: implications for combined spinal-epidural anesthesia. *Anesth Analg* 1997;84:780–783.
215. Weinberg GL. Current concepts in resuscitation of patients with local anesthetic cardiac toxicity. *Reg Anesth Pain Med* 2002;27:568.
216. Cook TM. Combined spinal-epidural techniques. *Anaesthesia* 2000;55:42–64.
217. Eisenach JC. Combined spinal-epidural analgesia in obstetrics. *Anesthesiology* 1999;91:299–302.
218. Wong CA, Scavone BM, Slavenas JP, et al. Efficacy and side effect profile of varying doses of intrathecal fentanyl added to bupivacaine for labor analgesia. *Int J Obstet Anesth* 2004;13:19–24.
219. Wong CA, Scavone BM, Loffredi M, Wang WY, Peaceman AM, Ganchiff JN. The dose response of intrathecal sufentanil added to bupivacaine for labor analgesia. *Anesthesiology* 2000;92:1553–1558.
220. Hughes D, Hill D, Fee JP. Intrathecal ropivacaine or bupivacaine with fentanyl for labour. *Br J Anaesth* 2001;87:733–737.
221. Sah N, Vallejo MC, Ramanathan S, Golebiewski K. Bupivacaine versus L-bupivacaine for labor analgesia via combined spinal-epidural: a randomized, double-blinded study. *J Clin Anesth* 2005;17:91–95.
222. Davies J, Fernando R, McLeod A, et al. Postural stability following ambulatory regional analgesia for labor. *Anesthesiology* 2002;97:1576–1581.
223. Calimaran AL, Strauss-Hoder TP, Wang WY, et al. The effect of epidural test dose on motor function after a combined spinal-epidural technique for labor analgesia. *Anesth Analg* 2003;96:1167–1172.
224. Norris MC, Fogel ST, Conway-Long C. Combined spinal-epidural versus epidural analgesia. *Anesthesiology* 2001;95:913–920.
225. Wong CA, Scavone BM, Peaceman AM, et al. The risk of cesarean delivery with



- neuraxial analgesia given early versus late in labor. *N Engl J Med* 2005;352:655–665.
226. Nageotte MP, Larson D, Rumney PJ, et al. Epidural analgesia compared with combined spinal-epidural analgesia during labor in nulliparous women. *N Engl J Med* 1997;337:1715–1719.
227. Davies SJ, Paech MJ, Welch H, Evans S, Pavy TJG. Maternal experience during epidural or combined spinal-epidural anesthesia for caesarean section: a prospective, randomized trial. *Anesth Analg* 1997;85:607–613.
228. Karaman S, Akercan F, Akarsu T, et al. Comparison of the maternal and neonatal effects of epidural block and of combined spinal-epidural block for cesarean section. *Eur J Obstet Gynecol Reprod Biol* 2005;121:18–23.
229. Lew E, Yeo SW, Thomas E. Combined spinal-epidural anesthesia using epidural volume extension leads to faster motor recovery after elective cesarean delivery: a prospective, randomized, double-blind study. *Anesth Analg* 2004;98:810–814.
230. Beale N, Evans B, Plaat F, et al. Effect of epidural volume extension on dose requirement of intrathecal hyperbaric bupivacaine at caesarean section. *Br J Anaesth* 2005;95:500–503.
231. Choi DH, Park NK, Cho HS, et al. Effects of epidural injection on spinal block during combined spinal and epidural anesthesia for cesarean delivery. *Reg Anesth Pain Med* 2000;25:591–595.
232. McAndrew CR, Harms P. Paraesthesiae during needle-through-needle combined spinal-epidural versus single-shot spinal for elective caesarean section. *Anaesth Intensive Care* 2003;31:514–517.
233. Urmey WF, Stanton J, Peterson M, et al. Combined spinal-epidural anesthesia for outpatient surgery. Dose-response characteristics of intrathecal isobaric lidocaine using a 27-gauge Whitacre spinal needle. *Anesthesiology* 1995;83:528–534.
234. Zayas VM, Liguori GA, Chisholm MF, et al. Dose response relationships for isobaric spinal mepivacaine using the combined spinal-epidural technique. *Anesth Analg* 1999;89:1167–1171.
235. Browne IM, Birnbach DJ, Stein DJ, et al. A comparison of Espocan and Tuohy needles for the combined spinal-epidural technique for labor analgesia. *Anesth Analg* 2005;101:535–540.
236. Eldor J. The evolution of combined spinal-epidural anesthesia needles. *Reg Anesth* 1997;22:294–296.
237. Eldor J, Guedj P. Aseptic meningitis due to metallic particles in the needle-through-needle technique. *Reg Anesth* 1995;20:360.
238. Holst D, Molmann M, Schymroszczyk B, et al. No risk of metal toxicity in combined spinal-epidural anesthesia. *Anesth Analg* 1999;88:393–397.
239. Rawal N, Van Zundert A, Holmstrom B, et al. Combined spinal-epidural technique. *Reg Anesth* 1997;22:406–423.
240. Casati A, D'Ambrosio A, De Negri P, et al. A clinical comparison between needle-through-needle and double-segment techniques for combined spinal and epidural anesthesia. *Reg Anesth Pain Med* 1998;23:390–394.
241. Backe SK, Sheikh Z, Wilson R, et al. Combined epidural/spinal anaesthesia: needle-through-needle or separate spaces? *Eur J Anaesthesiol* 2004;21:854–857.
242. Hoffmann VL, Vercauteran MP, Buczkowski, et al. A new combined spinal-epidural apparatus: measurement of the distance to the epidural and subarachnoid spaces. *Anaesthesia* 1997;52:350–355.
243. Stienstra R, Dilrosun-Alhadi BZR, Dahan A, van Kleef JW, Veering BT, Burm AGL. The epidural “top-up” in combined spinal-epidural anesthesia: the effect of volume versus dose. *Anesth Analg* 1999;88:810–814.
244. Angle PJ, Kronberg JE, Thompson DE, et al. Epidural catheter penetration of human dural tissue: in vitro investigation. *Anesthesiology* 2004;100:1491–1496.
245. Swenson JD, Wisniewski M, McJames S, et al. The effect of prior dural puncture on cisternal cerebrospinal fluid morphine concentrations in sheep after administration of lumbar epidural morphine. *Anesth Analg* 1996;83:523–525.
246. Bernards CM, Kopacz DJ, Michel MZ. Effect of needle puncture on morphine and lidocaine flux through the spinal meninges of the monkey in vitro. Implications for combined spinal-epidural anesthesia. *Anesthesiology* 1994;80:853–858.
247. Takiguchi T, Okano T, Egawa H, et al. The effect of epidural saline injection on analgesic level during combined spinal and epidural anesthesia assessed clinically and myelographically. *Anesth Analg* 1997;85:1097–1100.
248. Goy RW, Sia AT. Sensorimotor anesthesia and hypotension after subarachnoid block: combined spinal-epidural versus single-shot spinal technique. *Anesth Analg* 2004;98:491–496.
249. Goy RW, Chee-Seng Y, Sia AT, et al. The median effective dose of intrathecal hyperbaric bupivacaine is larger in the single-shot spinal as compared with the combined spinal-epidural technique. *Anesth Analg* 2005;100:1499–1502.
250. Leeda M, Stienstra R, Arbous MS, et al. The epidural “top-up”: predictors of increase of sensory blockade. *Anesthesiology* 2002;96:1310–1314.
251. Trautman WJ, Liu SS, Kopacz DJ. Comparison of lidocaine and saline for epidural top-up during combined spinal-epidural anesthesia in volunteers. *Anesth Analg* 1997;84:574–577.

# CHAPTER 47

## Paravertebral Anesthesia

Holly Evans, MD, FRCPC, and  
Stephen M. Klein, MD

Paravertebral nerve block (PVB) involves injection of local anesthetic close to the spinal nerve roots within the paravertebral space (PVS). The resulting unilateral or bilateral segmental anesthesia and analgesia of thoracic or lumbar dermatomes has multiple applications. This chapter describes paravertebral anatomy and PVB techniques. The physiologic effects are discussed in relation to the advantages, disadvantages, and contraindications for PVBs. The chapter also summarizes the existing literature outlining the use of PVBs for surgical procedures.

### PARAVERTEBRAL ANATOMY

#### Thoracic Paravertebral Anatomy

The thoracic PVS is a wedge-shaped space that lies on each side of the vertebral column. Detailed descriptions of the anatomic features of the PVS are available.<sup>1-7</sup>

Figure 47-1 illustrates the boundaries of the thoracic PVS. The space is limited posteriorly by the superior costotransverse ligament. At each dermatomal level, this ligament extends from the lower border of the transverse process above to the upper border of the rib below (Fig. 47-2). Anterolaterally, the thoracic PVS is limited by the parietal pleura. The medial base of the thoracic PVS is defined by the posterolateral segment of the vertebral body, the intervertebral disk, the intervertebral foramen and its contents.

The PVS is continuous medially with the epidural space via the intervertebral foramen; in addition, dural sleeves extend into the PVS.<sup>1,5,8</sup> Laterally, the thoracic PVS is continuous with the intercostal space lateral to the transverse processes. Communication with the contralateral PVS may occur by contact through the prevertebral<sup>9,10</sup> or epidural spaces.<sup>2</sup> The PVS is continuous superi-

orly and inferiorly across the heads and necks of adjacent ribs. The precise cranial limit has not been fully elucidated; however, cervical spread of injectate has been observed after thoracic PVB.<sup>2</sup> Caudally the thoracic PVS was previously thought to be limited by the origin of the psoas major muscle;<sup>11</sup> however, continuity with the PVS below the diaphragm has been supported by studies documenting the lumbar spread of dye following thoracic injection.<sup>2,12,13</sup>

The contents of the thoracic PVS include the endothoracic fascia, the spinal nerves, the sympathetic chain, the intercostal vessels, lymphatics, and loose fatty tissue (Fig. 47-3). The endothoracic fascia is the deep, fibroelastic fascia of the thoracic cavity.<sup>14,15</sup> It is continuous medially with the prevertebral fascia that covers the vertebral bodies and intervertebral disks,<sup>15</sup> superiorly with the scalene fascia, and inferiorly with the fascia transversalis of the abdomen.<sup>2,14</sup> Karmakar<sup>2</sup> described the endothoracic fascia as dividing the thoracic PVS into two potential fascial compartments: the anterior “extrapleural paravertebral compartment” and the posterior “subendothoracic paravertebral compartment.” It appears the anterior compartment contains loose areolar connective tissue (subserous fascia)<sup>7</sup> and the sympathetic trunk,<sup>2,16</sup> whereas the posterior compartment contains the intercostal nerves.<sup>2,16</sup>

The spinal nerves emerge from the intervertebral foramina and course through the thoracic PVS as a collection of small nerve rootlets devoid of fascial covering.<sup>2,4,17,18</sup> Early in the course of the spinal nerve, the posterior primary ramus branches to supply the posterior vertebral muscles, ligaments, facet joints and the overlying skin (Fig. 47-3). The sympathetic chain traverses anteriorly

within the thoracic PVS<sup>2</sup> and communicates with the spinal nerves through the preganglionic white rami communicantes and the postganglionic grey rami communicantes (Fig. 47-3). The intercostal arteries (originating from the descending aorta), as well as the hemiazygos and accessory hemiazygos veins,<sup>19</sup> pass through the thoracic PVS. Lymphatic drainage is to local nodes and subsequently to tributaries of the thoracic duct which form a plexiform network around the vertebral bodies.<sup>20</sup>

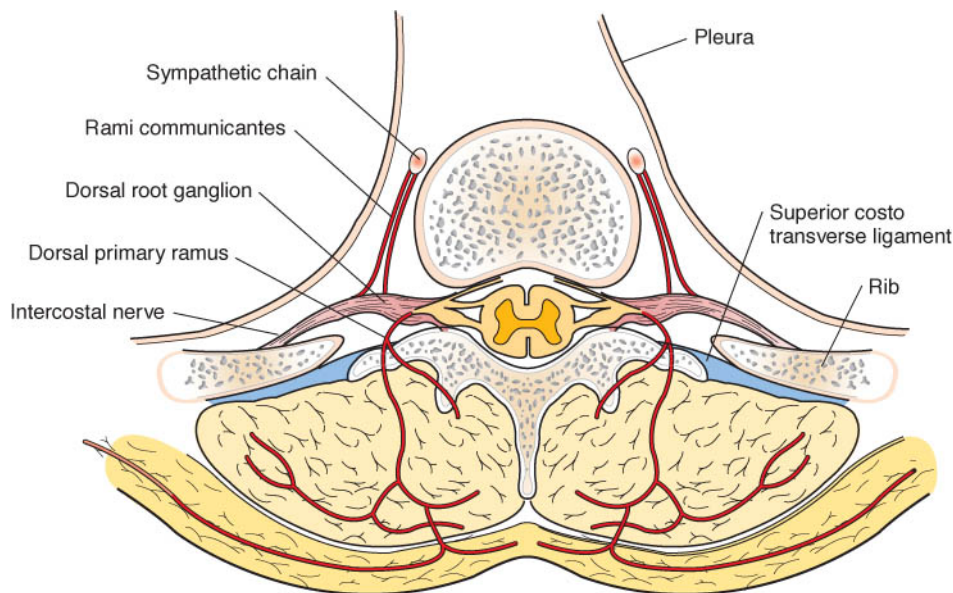
Several features of the thoracic spine are important because they serve as landmarks for performing PVBs. Because the spinous processes in the thoracic spine are steeply angulated, they lie in the same transverse plane as the transverse processes of the vertebra below (i.e., spinous process of T5 is at the same horizontal level as the transverse process of T6) (Fig. 47-2). A spinal nerve exits through its intervertebral foramen to enter the PVS caudal to the transverse process of the same name (i.e., T5 nerve root passes inferior to the T5 transverse process). In adults, the thoracic transverse processes project laterally a mean distance of 3.2 cm from midline (range: 2.1–4.2 cm)<sup>8</sup> and the mean depth from skin to thoracic PVS is 55 mm.<sup>21</sup> Depth is greater in the upper thoracic spine (mean: 77 mm at T1) compared to the mid- and lower thoracic spine (mean: 50 mm at T6);<sup>21</sup> in addition, considerable variation exists as a result of body habitus (mean depth to T1 PVS is 67.5 mm if body mass index [BMI] <25, 78 mm if BMI 25–30, and 84 mm if BMI >30).<sup>21</sup>

#### Lumbar Paravertebral Anatomy

The lumbar paravertebral region possesses generally unique features. While

### KEY POINTS

1. A paravertebral nerve block involves conduction block of the spinal nerve within the paravertebral space.
2. Dense sensory, motor, and sympathetic block results.
3. Unilateral or bilateral, thoracic or lumbar segmental block can be obtained.
4. Common indications include thoracic surgery, breast surgery, and hernia repair.
5. Benefits include diminished stress response to surgery; decreased opioid consumption; reduced opioid-related side effects (nausea, vomiting, sedation); hemodynamic stability as well as preservation of pulmonary mechanics; lower-extremity strength; and bladder function.
6. Potential side effects are rare and include pleural puncture, pneumothorax, intrathecal or epidural injection, and local anesthetic toxicity.



**FIGURE 47-1.** Transverse section of the thoracic spine depicting the boundaries, contents and structures surrounding the paravertebral space. (Reproduced with permission from Eason MJ and Wyatt R.<sup>3</sup>)

1010

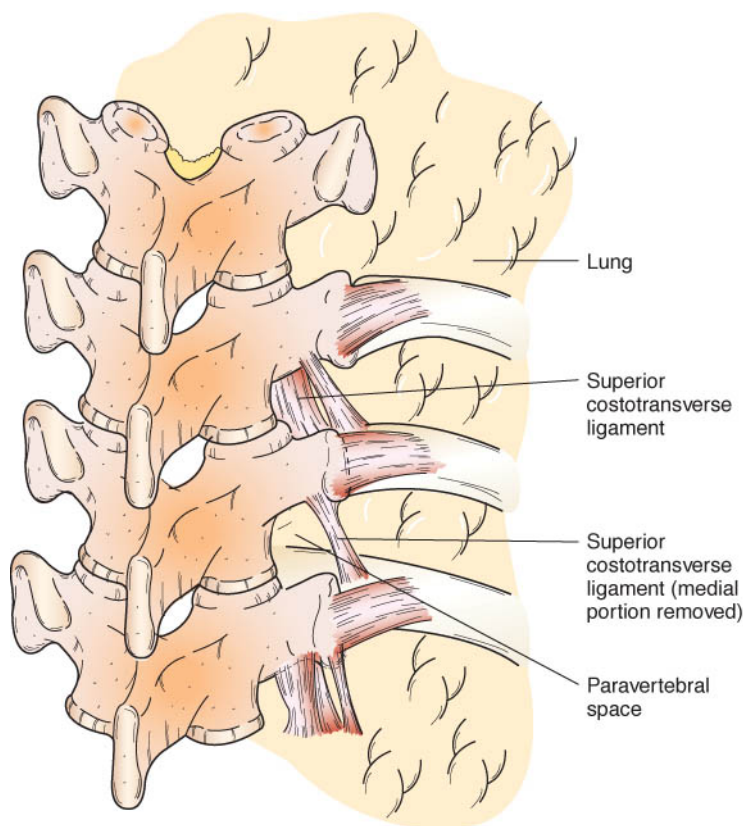
the medial boundary of the lumbar PVS is similar to that described for the thoracic PVS, other differences exist. The posterior boundary of the lumbar PVS is formed by the transverse processes

and paravertebral muscles. The anterior margin of the lumbar PVS is formed by the fascia transversalis, which is the fascial lining of the intraabdominal cavity. The fascia transversalis in the abdo-

men is continuous with the endothoracic fascia in the thoracic PVS (Fig. 47-4).<sup>14</sup> The fascia transversalis blends posteromedially with the anterior layer of the quadratus lumborum fascia and with the psoas fascia (Fig. 47-5).<sup>22</sup> The cephalad part of the psoas and quadratus lumborum fascias are thickened to form the medial and lateral arcuate ligaments, respectively. The medial arcuate ligament is attached medially to the body of L2 and laterally to the transverse process of L1. The lateral arcuate ligament passes from the lateral aspect of the L1 transverse process to the inferior border of the twelfth rib. The transversalis fascia is in direct communication with the endothoracic fascia at the medial and lateral arcuate ligaments as well as at the aortic hiatus. And, it is via these communications that there exists continuity between the thoracic and abdominal PVS.<sup>2,14,23</sup>

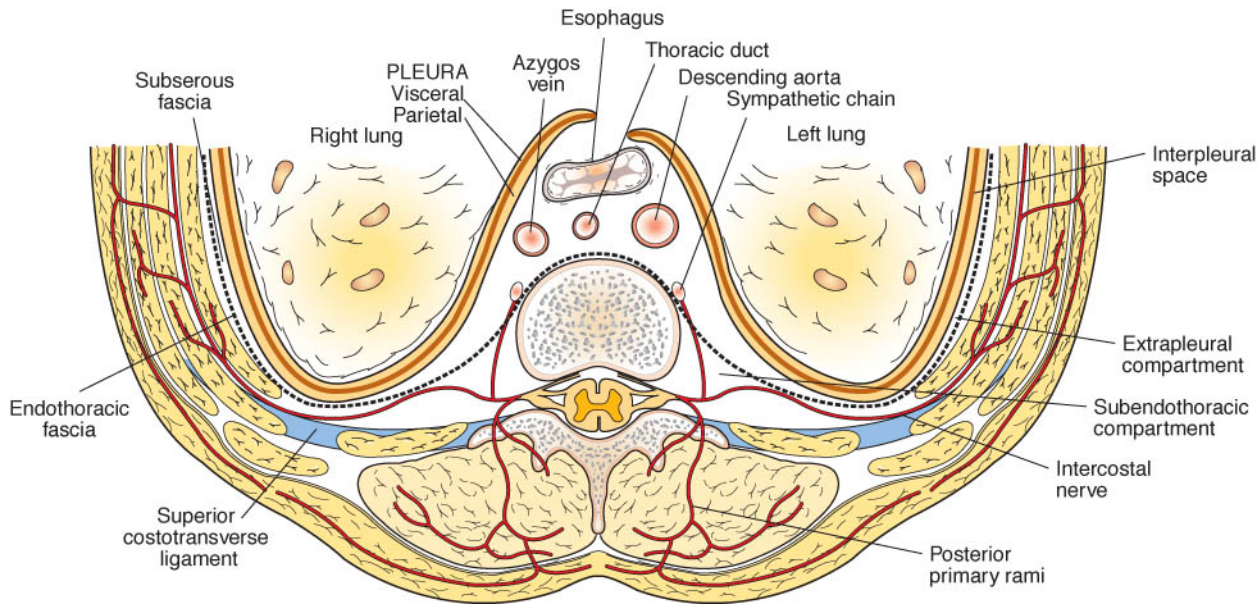
The lumbar nerve roots course through the lumbar PVS and subsequently combine to form the nerves of the lumbar plexus. The subcostal, iliohypogastric, ilioinguinal and lateral femoral cutaneous nerves course anterolaterally over the quadratus lumborum muscle. The genitofemoral and, more distally, the femoral and obturator nerves pass over the anterolateral surface of the psoas muscle. Accordingly, local anesthetic injected into the PVS has the potential to block a segment of the lumbar plexus.

Several features of the lumbar spine's bony anatomy deserve men-



**FIGURE 47-2.** Posterior view of the thoracic spine depicting the relationship between the superior costotransverse ligament and the paravertebral space. Reprinted from Greengrass R, Steele S. Paravertebral blocks for breast surgery. *Tech Reg Anesth Pain Manage* 1998;2:8-12, with permission from Elsevier.





**FIGURE 47-3.** Midthoracic transverse section depicting the contents of the paravertebral space (including the endothoracic fascia) and surrounding structures. (Reproduced with permission from Karmakar MK.<sup>2</sup>)

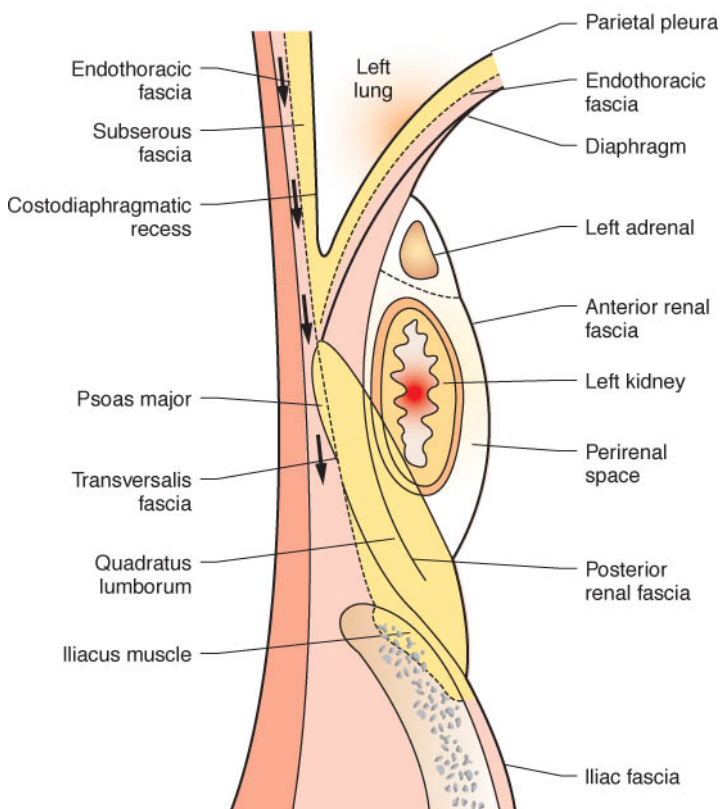
tion. The spinous process of a lumbar vertebra projects posteriorly with less angulation than in the thoracic spine (Fig. 47-6). As a result, a given transverse process lies at the same horizon-

tal level as its corresponding spinous process. In addition, the transverse processes in the lumbar region do not articulate with the ribs and are much smaller and thinner in the anteropos-

terior plane in contrast to the thoracic spine.

## HISTORY

Hugo Selheim, an obstetrician, is credited with the development of paravertebral anesthesia in 1905.<sup>2</sup> Arthur Lawen, a surgical resident, subsequently refined Selheim's technique<sup>2</sup> and performed PVBs on patients presenting with abdominal pain. This provided acute pain relief, which facilitated abdominal muscle relaxation and palpation. Subsequent laparotomy or autopsy allowed identification of the underlying pathology. As a result, detailed information was collected on the segmental innervation of various thoracic and abdominal organs. These pioneers are credited with early development of the familiar segmental dermatome map (Fig. 47-7). Selheim, Lawen, and subsequently Kappis further expanded the use of PVBs for surgical anesthesia in attempt to reduce complications and improve survival in the early years of general and spinal anesthesia.<sup>2</sup> The technique fell into disfavor for several decades until a publication by Eason and Wyatt renewed interest in this modality.<sup>3</sup>

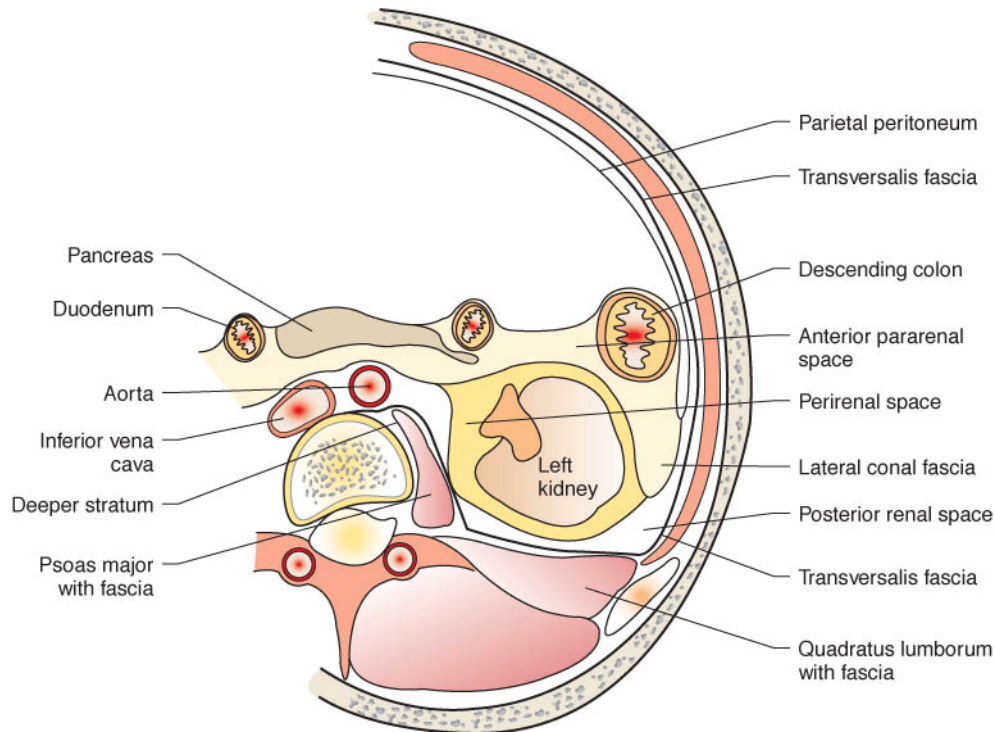


**FIGURE 47-4.** Thoracoabdominal sagittal section showing the relationship between the endothoracic fascia in the chest and the transversalis fascia in the abdomen. Karmakar MK, Gin T, Ho AM. Ipsilateral thoraco-lumbar anaesthesia and paravertebral spread after low thoracic paravertebral injection. *Br J Anaesth* 2001;87:312–316. © The Board of Management and Trustees of the British Journal of Anaesthesia. Reproduced by permission of Oxford University Press/British Journal of Anaesthesia.

## PARAVERTEBRAL BLOCK TECHNIQUE

The patient can be positioned sitting, prone, or lateral decubitus (side to be blocked uppermost). The neck is flexed,





**FIGURE 47-5.** Upper abdominal transverse section depicting the relationship between the fascia transversalis and the fascia of the psoas major and quadratus lumborum muscles. Karmakar MK, Gin T, Ho AM. Ipsilateral thoraco-lumbar anaesthesia and paravertebral spread after low thoracic paravertebral injection. *Br J Anaesth* 2001;87:312–316. © The Board of Management and Trustees of the British Journal of Anaesthesia. Reproduced by permission of Oxford University Press/British Journal of Anaesthesia.

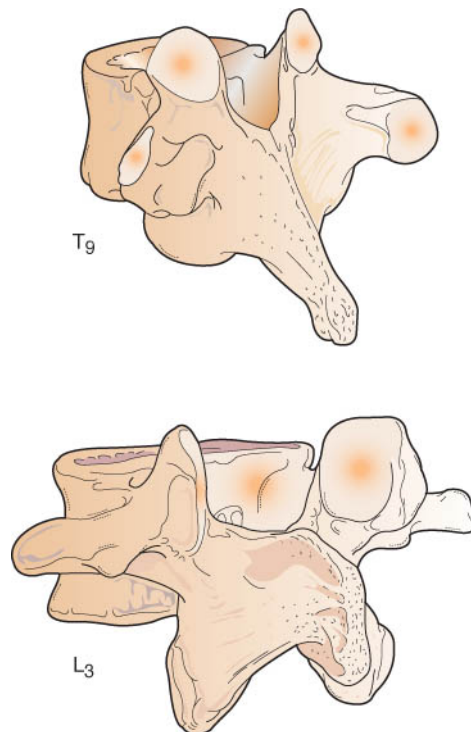
the back is rounded, and the shoulders retracted forward, similar to positioning for a thoracic epidural. Appropriate sedation is useful for anxiolysis and analgesia.

The levels (spinal nerve roots) to be blocked are selected based on the surgical procedure, for example, T1 to T6 for mastectomy and axillary dissection (Ta-

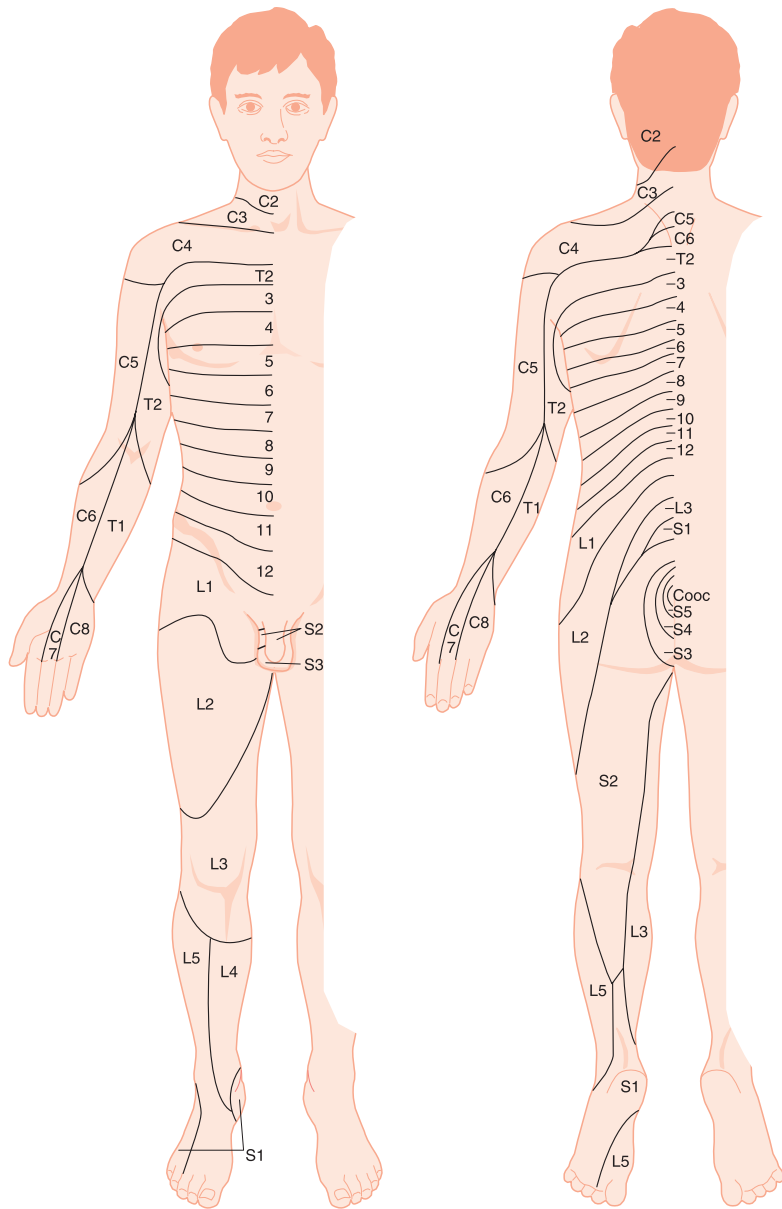
ble 47-1 and Fig. 47-7). The spinal nerve root is located following identification of its corresponding transverse process. In the thoracic spine, a given transverse process is located in the same horizontal plane as the spinous process of the vertebra above (e.g., the T4 transverse process is at the level of the T3 spinous process) (Fig. 47-2). Spinous processes are generally palpable in the midline with the most prominent spinous process in the neck representing C7, the lower border of the scapula corresponding to T7, and the intercrystal line marking L4. The superior aspect of the desired spinous process is identified and, in adults, a mark is drawn 2.5 cm lateral from the midline (Fig. 47-8). The skin is cleaned with disinfectant and subcutaneous infiltration of local anesthetic is given at all needle entry sites. A number of techniques have been described to identify the PVS.

### Anatomic or Loss-of-Resistance Technique

Identification of the thoracic PVS can be made when a tactile “pop” is noted as the needle passes through the superior costotransverse ligament. Alternatively, loss of resistance to injected air or saline may be used; however, this end point is more sub-



**FIGURE 47-6.** Oblique views of a thoracic and a lumbar vertebra. (Reprinted from Covino BG, Scott DB, Lambert DH. In: *Handbook of Spinal Anaesthesia and Analgesia*. Philadelphia, PA: WB Saunders, 1994, with permission from Elsevier.)



**FIGURE 47-7.** Dermatomeal distribution of spinal nerves. (Reprinted from Covino BG, Scott DB, Lambert DH. In: *Handbook of Spinal Anaesthesia and Analgesia*. Philadelphia, PA: WB Saunders, 1994, with permission from Elsevier.)

tle and subjective than with epidural anesthesia.

A 10-cm, 22-gauge Tuohy needle is inserted in a horizontal plane 2.5 cm lateral to the midpoint of the superior border of the appropriate spinous process in adults. The needle is advanced to contact the transverse process, withdrawn to the subcutaneous tissue, and then redirected caudal to the transverse process (Fig. 47-9). The needle is slowly advanced until a change in resistance is perceived. This occurs approximately 1 cm past the depth at which the transverse process is contacted. The depth from skin to thoracic PVS varies by vertebral level and patient habitus.<sup>21</sup>

A cautious approach is warranted if bone is contacted deep to the transverse process as this may represent the rib. Further advancement of the block needle past the rib can result in pleural puncture and pneumothorax. This risk can be minimized when the block needle is redirected caudally after initial bony contact. If the rib is unintentionally contacted first, caudal redirection will bring the block needle in contact with the transverse process at a shallower depth (Fig. 47-10). Subsequently, a more accurate estimation of the depth of the PVS is provided and the risk of pleural puncture is decreased. In contrast, an alternate ap-

proach has been described in which the needle is redirected cephalad to the transverse process. If initial contact is made with the rib, cephalad redirection will not bring the needle into contact with the transverse process. Further advancement of the needle deep to the rib increases the possibility of pleural puncture and resulting pneumothorax.

When the thoracic PVS has been located, 3–5 mL of local anesthetic is typically injected at each level. The syringe containing local anesthetic is aspirated for air, blood, or cerebrospinal fluid prior to injection. Injection should occur without resistance. Local anesthetic doses may need to be adjusted when multiple or bilateral PVBs are performed.

Nerve block adequacy is confirmed by appropriate thoracic dermatomeal sensory block, intercostal muscle motor block, and sympathectomy-related changes such as vasodilatation and increased skin temperature.

Lumbar PVBs involve a modification of the thoracic technique. The needle entry site for each spinal nerve corresponds to the spinous process of the same level, making correction for spinous process angulation unnecessary in the lumbar region. In addition, after contact with the lumbar transverse process, the block needle is advanced no more than 0.5 cm anteriorly. This is because the lumbar transverse processes are thinner in the anteroposterior plane compared to the thoracic spine. Finally, the loss of resistance upon entrance into the lumbar PVS is less-well defined compared to that felt in the thoracic spine. This may be related to the lack of the costotransverse ligament in the lumbar region.

### Nerve Stimulation

The spinal nerve can be located in the PVS using a nerve stimulator and a 10-cm, 21- or 22-gauge short-bevel insulated stimulating needle. The needle is inserted as previously described. Direct paraspinal muscle stimulation is observed initially as the needle passes through these muscles. Further advancement caudal to the transverse process brings the stimulating needle in close proximity to the spinal nerve and leads to intercostal or abdominal muscle contractions depending on the level of stimulation. As for other peripheral nerve blocks, appropriate

TABLE 47-1.

## Clinical Applications for Paravertebral Nerve Blocks

Surgical Procedure	Levels Blocked
Thoracotomy	T4–T9
Thoracoscopy	T4–T9
Rib fractures	Level of fracture with 1 level above and below
Cardiac surgery	T2–T6 bilaterally
Mastectomy, breast surgery	T2–T6
Mastectomy with axillary dissection	T1–T6 with superficial cervical plexus block
Breast biopsy	Level of lesion with 1 level above and below
Inguinal hernia repair	T10–L2
Umbilical hernia repair	T9–T11 bilaterally
Incisional hernia repair	According to level of repair
Ileostomy closure	T8–T12
Nephrectomy	T8–T12
Cholecystectomy	T6–T10
Appendectomy	T10–T12
Adjunct for shoulder surgery (subdeltoid incision)	T1–T2
Adjunct for hip surgery	T11–T12 with lumbar plexus block
Bone marrow aspiration	T11–L2 bilaterally
Iliac crest bone harvesting	T11–L1
Labor analgesia	T10 bilaterally for first stage of labor
Chronic pain	According to condition

Data from Karamaker MK;<sup>2</sup> Richardson J and Lonquist PA;<sup>23</sup> and Greengrass R, and Buckenmaier CC 3d.<sup>102</sup>

1014

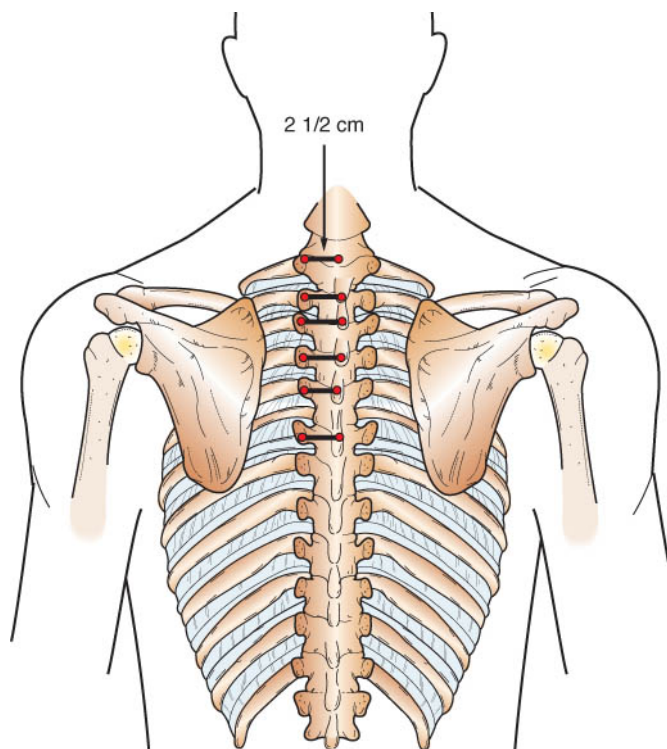


FIGURE 47-8. Skin markings for paravertebral blocks performed for left mastectomy. Reprinted from Greengrass R, Steele S. Paravertebral blocks for breast surgery. *Tech Reg Anesth Pain Manage* 1998;2:8–12, with permission from Elsevier.

needle placement is confirmed when muscle contractions persist with a current of 0.5–0.6 mA. Isolated posterior spinal muscle contraction should not be accepted as this may represent direct muscle activation or stimulation of the posterior ramus of the spinal nerve root after it diverges from the spinal nerve.

Proponents of this technique describe its usefulness in challenging cases (e.g., morbid obesity, ankylosing spondylitis) and as a way to minimize the occurrence of pneumothorax, although this has yet to be proven.<sup>24</sup>

## Other Techniques

### Injection of Radiographic Contrast Dye

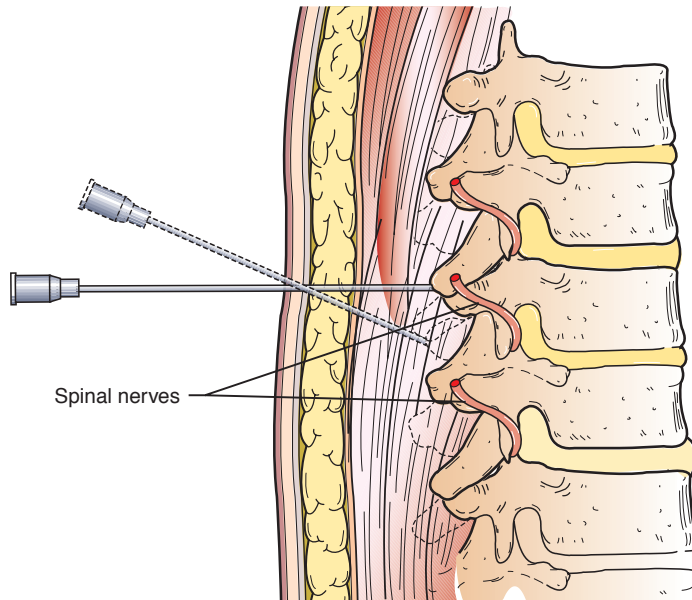
Injection of contrast dye and radiologic examination can be used to confirm proper paravertebral needle location. Dye spread occurs in either a longitudinal distribution or a segmental, cloud-like dispersal (Fig. 47-11).<sup>7</sup> Naja et al.<sup>25</sup> hypothesized that dye dispersion is dependent on the location of the needle with respect to the endothoracic fascia. They conjectured that needle position posterior to the endothoracic fascia would be associated with segmental, cloud-like dye spread and needle position anterior to the endothoracic fascia with more longitudinal dye distribution.<sup>25</sup>

### Pressure Transduction

Pressure measurement has been described to confirm paravertebral needle placement.<sup>26</sup> When the needle tip is in the erector spinae muscle, the measured pressure is higher during inspiration (mean: 29.6 mm Hg) than expiration (mean: 19.4 mm Hg).<sup>26</sup> This is thought to occur as a result of greater muscle activity during inspiration or as a result of muscular compression caused by the expanding chest cage.<sup>23</sup> As the needle is advanced into the PVS, there is a sudden lowering of pressures and expiratory pressure becomes higher (7.6 mm Hg) than inspiratory pressure (3.3 mm Hg).<sup>26</sup> Unintentional puncture is identified when subatmospheric pressures are recorded both during inspiration and expiration.

### Ultrasound-Assisted Technique

Ultrasound imaging can be used to provide an estimate of the location and depth of the transverse process.



**FIGURE 47-9.** Paravertebral nerve block technique. Following identification of the transverse process, the block needle is redirected inferiorly and advanced into the paravertebral space. Reprinted from Greengrass R, Steele S. Paravertebral blocks for breast surgery. *Tech Reg Anesth Pain Manage* 1998;2:8–12, with permission from Elsevier.

Pusch et al.<sup>27</sup> found a close correlation between the needle depth from skin to transverse process and the estimated depth as measured by ultrasound. Moreover, there was also close correlation between the needle depth to the

thoracic PVS and the ultrasound-estimated depth to the parietal pleura.

### Continuous PVBs

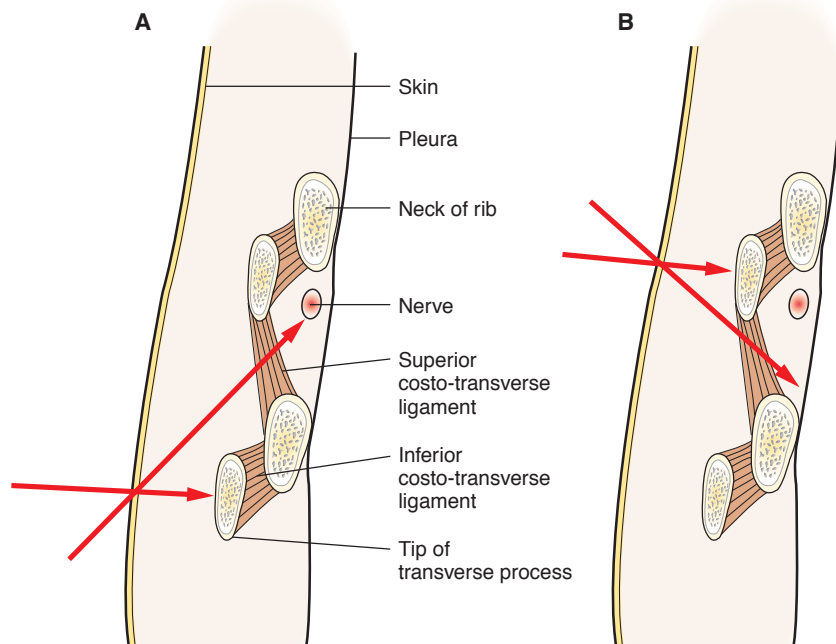
Placing a continuous catheter into the PVS can be used to extend the duration

of postoperative analgesia provided by single-injection PVBs. This is typically reserved for more invasive surgery associated with intense postoperative pain, such as thoracotomy and subcostal incisions. Insertions methods are usually modifications of single injection techniques. A single-injection 22-gauge 10-cm Tuohy needle is initially used to estimate the depth of the transverse process and paravertebral space. A larger-bore (e.g., 18 gauge) Tuohy needle capable of accommodating a 20-gauge epidural catheter is then substituted. Extension tubing or a hemostatic valve is used to create a closed circuit with the needle to mitigate entrainment of air if the pleura is punctured. The catheter is threaded 1–2 cm into the paravertebral space to minimize the risk of migration. Consequently, a catheter with a single distal orifice is used to reduce leakage of local anesthetic solution outside of the paravertebral space. A novel insertion method described for thoracic surgery is to place the catheter under direct vision in the surgical field (Fig. 47–12).<sup>4,23</sup> At the completion of the thoracotomy just prior to chest closure, the surgeon strips away the parietal pleura in the paravertebral gutter at the level of the incision, 2 dermatomes cephalad and 2 dermatomes caudad. A small defect is made in the extrapleural fascia. A Tuohy needle is then introduced percutaneously and a catheter is placed into the PVS through the small defect in the extrapleural fascia. The parietal pleura is repositioned and sutured in place.

### Effect of Technique on Distribution of Injectate

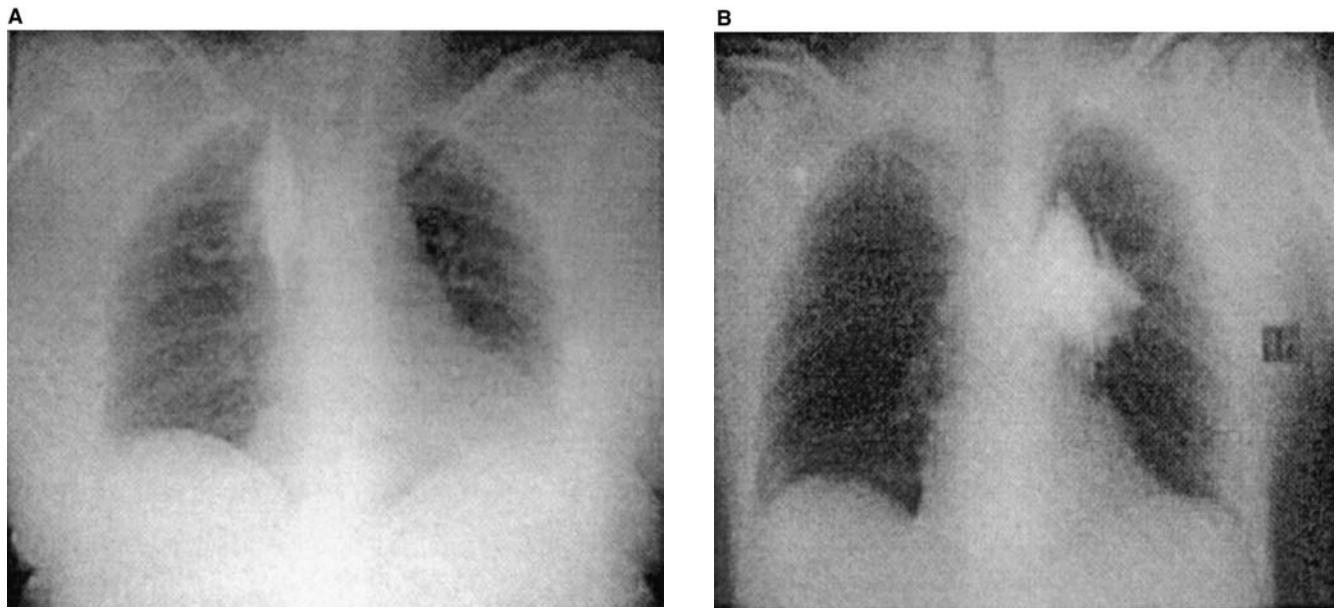
Paravertebral anesthesia can be provided with one injection using a large volume of local anesthetic deposited at one single level. The theoretic advantage of a single-needle insertion is a reduction in the incidence of side effects such as pleural puncture or pneumothorax. Alternatively, PVBs may be performed with multiple injections using a small volume of local anesthetic at each level injected. The theoretic advantage of this method is more extensive and complete anesthesia of the desired dermatomes. Insufficient evidence exists to determine which technique is most effective; current practice is both institution and practitioner dependent.

A single-level paravertebral injection of 10–15 mL of local anesthetic in



**FIGURE 47-10.** Paravertebral nerve block technique. Longitudinal section depicting insertion of the block needle (A) above and (B) below the transverse process or rib. (Reproduced with permission from Eason MJ and Wyatt R.<sup>3</sup>)





**FIGURE 47-11.** Chest radiographs taken following injection of radiocontrast dye into the paravertebral space depicting (A) longitudinal and (B) cloud-like spread. (Reproduced with permission from Naja MZ, Ziade MF, El Rajab M, et al.<sup>25</sup>)

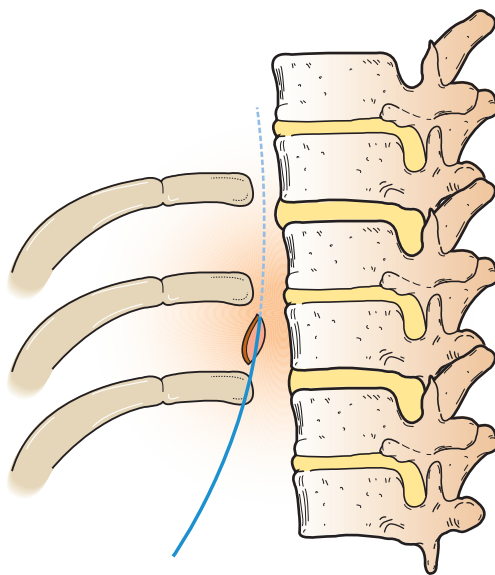
1016

adults,<sup>12,28,29</sup> and 0.5 mL/kg in children,<sup>7</sup> achieves a mean sensory block of 4–5 dermatomes, independent of age, height, weight, or sex. Few studies have been designed to rigorously investigate the potential effect of dose or volume of injectate on spread within the PVS. One study in adults has shown no association between these variables,<sup>28</sup> whereas another study of pediatric patients has found a moderate to strong correlation between in-

jected volume and segmental spread of dye.<sup>7</sup> It has been proposed that there may be an age-related loss of connective tissue leading to greater spread of injectate in adults.<sup>28</sup>

Additional factors do affect the spread of injectate within the PVS. Purcell-Jones et al.<sup>8</sup> studied single-injection PVBs using the loss of resistance technique. They radiographically showed greater craniocaudal distribution of solution (5.5 mL) when

the PVB was associated with epidural spread. They found sensory anesthesia in a mean 1.43 dermatomes when injectate was confined to the PVS; 2.27 dermatomes when injectate was primarily in the PVS but also spread to the epidural space; 4.66 dermatomes when injectate was confined to the epidural space; and 6.6 dermatomes when injectate was primarily in the epidural space but also spread to the PVS. In all instances, the spread of contrast dye was greater than the observed sensory block. Cheema et al.<sup>12</sup> studied patients who received a single-injection PVB using loss of resistance with 15 mL of local anesthetic and dye. They found that the mean extent of vasodilatation (sympathetic block) was 8 dermatomes, which exceeded the mean sensory block of 5 dermatomes. Interestingly, they also discovered that a greater proportion of the solution injected into the PVS spread in a caudad direction. The distribution of craniocaudal spread is also influenced by the direction in which the solute is injected. Saito et al.<sup>29</sup> performed single-injection PVBs with 12 mL of local anesthetic. When all the injectate was given with the needle bevel directed caudally, sensory block developed in a mean of 5.2 dermatomes, whereas when half the injection was made with the needle bevel directed cephalad and half caudad, sensory block developed in a mean 7.7 dermatomes.



**FIGURE 47-12.** Placement of a paravertebral catheter under direct vision. The extrapleural fascia is exposed by raising the parietal pleural from the posterior chest wall. The epidural catheter is lying within the paravertebral space (*broken line*), introduced through the small defect. Reprinted from Berrisford RG, Sabanathan SS. Direct access to the paravertebral space at thoracotomy. *Ann Thorac Surg* 1990;49:854, with permission from the Society of Thoracic Surgeons.

TABLE 47-2.

## Local Anesthetic Regimen for Paravertebral Nerve Blocks

Single-level injection	Children: 0.5 mL/kg up to 20 mL local anesthetic Adults: 10–20 mL local anesthetic (i.e., ropivacaine 0.5% with epinephrine 1:400,000)
Multiple-level injections	Thoracic spine: 3–4 mL local anesthetic per segment Lumbar spine: 5–7 mL local anesthetic per segment (i.e., ropivacaine 0.5% with epinephrine 1:400,000)
Continuous infusion	0.1–0.2 mL/kg/h local anesthetic (i.e., ropivacaine 0.2%)

Cheema et al.<sup>12</sup> theorized that stratification of connective tissue within the thoracic PVS may lead to tracking of injectate such that small differences in needle placement could have important consequences. This was supported by Naja et al.<sup>25</sup> who hypothesized that the endothoracic fascia affects the spread of injectate and may function as a mechanical barrier to diffusion. This was inferred after two distinct patterns of spread of radiographic contrast dye were observed following thoracic PVB with a nerve stimulator. Longitudinal spread occurred more commonly in association with low nerve-stimulating current (0.5 mA), whereas localized, cloud-like spread occurred more commonly with higher nerve-stimulating current (2.5 mA). Although it was not known with certainty where injections were made relative to the endothoracic fascia, the authors conjectured that longitudinal spread was associated with injection anterior to the endothoracic fascia and that cloud-like spread was associated with injection dorsal to the endothoracic fascia. Because of the unpredictable variability in spread of block, more information about the anatomy, permeability, and importance of the endothoracic fascia within the PVS is required.

### Local Anesthetic Regimen

Various local anesthetics can be used for PVBs. Bupivacaine and ropivacaine are the most frequently studied agents and the duration of analgesia is similar to that obtained with brachial plexus anesthesia. Ropivacaine has a sound safety profile and provides analgesia for 12–24 hours. Epinephrine is frequently added to the local anesthetic solution to indicate intravascular injection, to reduce the peak local anesthetic blood level,<sup>30</sup> and to improve analgesia. Epinephrine produces a 25% reduction in the mean peak arterial concentration of ropivacaine and delays the time

to peak arterial and venous concentrations.<sup>30</sup> Some practitioners add opioids or clonidine to the local anesthetic mix;<sup>31,32</sup> however, this has not been extensively studied. Table 47-2 outlines standard dosing regimens. A single-level injection is typically performed with 0.5 mL/kg of dilute local anesthetic solution in children, and 10–20 mL in adults. Multiple-level injections are accomplished in adults with 3–4 mL of local anesthetic per segment in the thoracic region, and 5–7 mL per segment in the lumbar area. Continuous PVBs are managed with 0.1–0.2 mL/kg/h of dilute local anesthetic.

### ADVANTAGES

Table 47-3 summarizes the advantages of PVBs. PVBs provide block of afferent nerve activity leading to dense body wall anesthesia and postoperative analgesia. Richardson et al.<sup>33</sup> performed somatosensory evoked potential testing on patients before and after they received a single-injection block. They discovered complete abolition of the evoked potentials at the level of the paravertebral injection in 100% of patients (Fig. 47-13). They commented

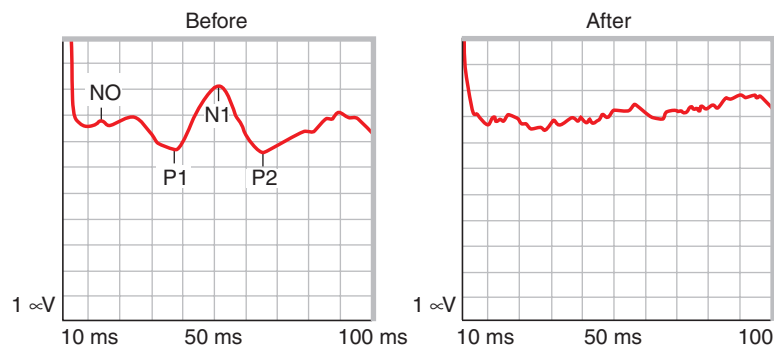
TABLE 47-3.

## Beneficial Effects of Paravertebral Nerve Blocks

Dense sensory, motor, and sympathetic nerve block
Unilateral or bilateral segmental block
Wide application for various surgical procedures
Decreased stress response to surgery <sup>35</sup>
Low postoperative opioid requirements <sup>41,68,88</sup>
Infrequent opioid-related side effects (nausea, vomiting, sedation) <sup>41,68,88</sup>
Postoperative analgesia similar or better than epidural <sup>68,92</sup>
Hemodynamic stability <sup>43,68</sup>
Preservation of pulmonary function <sup>65,68</sup>
Preservation of lower-extremity motor strength
Preservation of bladder function <sup>43,68</sup>
Enhanced perioperative efficiency <sup>31,42</sup>

that such reliable afferent block does not often occur following epidural anesthesia<sup>34</sup> and they postulated that by this mechanism, PVBs may prevent central sensitization and the development of chronic pain conditions.

PVBs also modify the stress response to surgical stimulation. Giesecke et al.<sup>35</sup> studied open cholecystectomy patients under general anesthesia and discovered that those who also received a single injection PVB had lower plasma adrenalin and cortisol concentrations ( $p < 0.05$ ) as well as a smaller rise in plasma glucose concentration ( $p < 0.025$ ) compared to similar patients who did not received PVBs.



**FIGURE 47-13.** A somatosensory evoked potential recording from T<sub>3</sub> before and after deposition of paravertebral bupivacaine at T<sub>2</sub>. Latencies and amplitudes were measured and the evoked potential was abolished after the block. (Reproduced with permission from Lippincott Williams & Wilkins. Richardson J, Jones J, Atkinson R.<sup>33</sup>)

Patients who receive PVBs have lower postoperative opioid consumption and a reduced incidence of opioid-related side effects compared to those who receive intravenous opioid analgesia.<sup>31,36–42</sup> PVBs are associated with more frequent preservation of lower-extremity motor strength, greater hemodynamic stability, and less urinary retention when compared to epidural analgesia.<sup>43</sup> Additionally, this technique has the potential to provide improved analgesia with a reduced risk of pleural puncture and local anesthetic toxicity compared to intercostal and intrapleural analgesia.

## CONTRAINDICATIONS

### Absolute Contraindications

Absolute contraindications to use of PVBs<sup>2,4</sup> are similar to those of other percutaneous techniques. PVBs should be avoided in patients with skin infections at the proposed needle entry site and in those with an empyema or a deep infection within the chest. A paravertebral tumor is considered by some to contraindicate PVB because of the risk of tumor seeding. In addition, this technique is avoided in the setting of local anesthetic allergy, patient refusal, and severe hemodynamic instability.

### Relative Contraindications

Relative contraindications<sup>2,44</sup> to use of PVBs include a severe chest deformity, such as kyphoscoliosis, which increases the risk of pneumothorax or unintentional subarachnoid injection. Similarly, patients who have had a prior thoracotomy are at higher risk of pleural puncture and pneumothorax because of paravertebral scarring and potential obliteration of the thoracic PVS. Nevertheless, operator experience and/or the use of fluoroscopy produces successful blocks in these circumstances with few complications. Coagulopathy represents a relative contraindication to PVB. Based on the increased compliance of the PVS compared with the epidural space, the neurologic impairment from a paravertebral hematoma will be less than from an epidural hematoma.<sup>44</sup>

## ADVERSE EFFECTS

Potential complications for PVBs are summarized in Table 47–4. The inci-

dence rates were obtained from several studies, including two large series.<sup>8,9,41,45–49,51,52,55,61</sup> Naja et al.<sup>45</sup> provide data on multilevel PVBs performed on 662 adult and pediatric patients using nerve stimulation. Lonnqvist et al.<sup>46</sup> reported their results from single-level PVBs performed with the loss-of-resistance technique in 367 adult and pediatric patients.

The most commonly reported adverse event is technique failure. A failure occurs when a PVB does not succeed in providing adequate surgical anesthesia or when general anesthesia is required to complete the procedure. The published incidence of block failure is 6.1–10.7%,<sup>41,45–48</sup> and is relatively similar among different operators and different institutions. Interestingly, the incidence of failure was slightly higher in a series in which a single-level PVB was performed using the loss-of-resistance technique (10.7%)<sup>46</sup> compared to a study in which multilevel PVBs were performed using nerve stimulation (6.1%).<sup>45</sup>

Unintentional vascular puncture occurs in up to 6.8% of PVBs,<sup>45</sup> and when recognized prior to injection of local anesthetic is of little consequence. Blood pressure and heart rate are generally maintained within normal limits after both unilateral and bilateral PVBs.<sup>2</sup> Hypotension has been reported in up to 5.0% of patients<sup>46</sup>;

however, it is usually mild and easily managed. Other common side effects of PVBs include localized hematoma or pain at the site of injection. These are usually self-limiting and do not require treatment.

Unintentional pleural puncture can result from deep insertion of the nerve block needle. A pneumothorax may result and is considered a serious adverse event. An early warning sign includes cough during needle insertion. Aspiration of air occurs if the lung has been punctured or if air has been introduced into the pleural cavity by the needle.<sup>2</sup> Shortness of breath or pleuritic chest pain may follow the PVB. To establish the diagnosis and manage the pneumothorax, a chest radiograph is often required. Many pneumothoraces that result from PVBs are small and can be treated conservatively.<sup>2</sup> Although there are no studies directly comparing the incidence of pleural puncture or pneumothorax using various PVB techniques, the frequency in two large series can be contrasted. The incidence of pleural puncture and pneumothorax in adults were 0.9% and 0.3%, respectively, in the series of patients who received single-level PVBs using loss-of-resistance technique<sup>46</sup>; similarly, these adverse effects occurred in 0.8% and 0.5% in the series of adults who received multilevel PVBs using nerve

TABLE 47–4.

Incidence of Complications following Paravertebral Nerve Blocks<sup>8,9,41,45–49,51,52,55,61</sup>

Complication	Mean Incidence: Adult Patients (%)	Mean Incidence: Pediatric Patients (%)
Block failure <sup>41,46</sup>	6.1–10.7	0–6.2
Inadvertent vascular puncture <sup>45,46</sup>	3.8–6.8	0–4.2
Hypotension <sup>45,46</sup>	4.0–5.0	0
Localized hematoma <sup>45,46</sup>	2.4	0
Localized pain <sup>45</sup>	1.3	0
Pleural puncture <sup>45,46</sup>	0.8–0.9	0–2.0
Pneumothorax <sup>45,46</sup>	0.3–0.5	0
Intrathecal or epidural spread <sup>8,45,46</sup>	1.0–1.1	0
Pulmonary hemorrhage <sup>49</sup>	Case report	
Dural puncture headache <sup>51</sup>	Case report	
Brachial plexus block <sup>9</sup>	Case report	
Horner syndrome <sup>8,9,41,55</sup>	Case report	
Local anesthetic toxicity <sup>52</sup>	Case report	
Nerve injury <sup>61</sup>	Case report	
Infection		

stimulation.<sup>45</sup> Performance of bilateral PVBs doubled the incidence of pneumothorax compared to unilateral PVBs.<sup>45</sup> Pulmonary hemorrhage is a rare respiratory complication that has been reported following PVB.<sup>49</sup> The risk of both pneumothorax and pulmonary hemorrhage is believed to be increased in patients who have an obliterated PVS from scar tissue as a result of previous thoracotomy.<sup>49</sup>

Studies on the spread of injectate within the PVS have shown spread of contrast dye into the epidural space in a variable proportion of patients;<sup>8</sup> however, the magnitude with which epidural block contributes to paravertebral anesthesia is unpredictable.<sup>2,45,46</sup> Subarachnoid injection,<sup>50</sup> total spinal anesthesia, and postdural puncture headache<sup>51</sup> are rare adverse events. They can result either from needle entry into the subarachnoid space or into dural extensions around the spinal nerve roots. The hemodynamic effects of an unintentional thoracic subarachnoid injection can be significant and may require deliberate resuscitation.

Extensive cephalad spread of local anesthetic to the brachial plexus or the stellate ganglion may occur and result in a brachial plexus block<sup>2</sup> or Horner syndrome,<sup>23</sup> respectively. These effects are temporary and patients should be reassured.

Systemic absorption of local anesthetic with resulting toxicity is rare.<sup>52</sup> Local anesthetic plasma levels following paravertebral injections have been extensively studied. Following a bolus dose of 0.75–1.5 mg/kg bupivacaine, mean peak serum levels varied from 0.705 µg/mL<sup>53</sup> to 1.45 µg/mL<sup>54</sup> in adults, and from 1.03 µg/mL<sup>55</sup> to 1.60 µg/mL<sup>56</sup> in children. Karmakar et al. administered a single-level PVB with 2 mg/kg ropivacaine and randomized patients to receive a solution with or without epinephrine. They found that epinephrine decreased mean peak serum concentration of ropivacaine from 2.47 µg/mL to 1.85 µg/mL and increased mean time to peak serum concentration from 7.5 minutes to 11.25 minutes.<sup>30</sup> In other studies, the median time to peak plasma bupivacaine levels ranged from 5 minutes<sup>53</sup> to 25 minutes.<sup>54</sup> Continuous infusion of 0.2–0.5 mg/kg/h of bupivacaine for up to 4 days results in variable mean peak plasma bupivacaine levels. Several studies of adult and pediatric pa-

tients report levels between 1.6 µg/mL and 2.5 µg/mL.<sup>55–57</sup> However, other investigators have found mean peak plasma bupivacaine concentrations as high as 5.43 µg/mL,<sup>54,58</sup> with some individuals as high as 7.48 µg/mL.<sup>54</sup> Despite these high plasma concentrations, no patients in these studies manifested clinical signs of local anesthetic systemic toxicity. Although total bupivacaine increases steadily during paravertebral infusion, free bupivacaine remains unchanged<sup>57</sup> as a result of a perioperative increase in  $\alpha_1$ -acid glycoprotein, a serum protein that binds local anesthetics. This may explain the low incidence of clinical local anesthetic systemic toxicity seen even among patients with plasma bupivacaine concentrations that are considered above the toxic threshold. Chapter 44 fully discusses the diagnosis and management of local anesthetic toxicity.

There are case reports of serious neurologic complications related to PVBs. Cases of incomplete transverse myelitis occurred in association with the use of efocaine,<sup>59</sup> whereas a Brown-Sequard syndrome resulted from paravertebral injection of alcohol.<sup>60</sup> In more recent publications, neurologic injury is rarely reported.<sup>45,46</sup> There is only one case report of chronic segmental pain following PVBs<sup>61</sup>; some authors,<sup>23</sup> however, believe that this complication occurs more frequently but is often attributed to nerve injury from surgical dissection.

## CLINICAL APPLICATIONS

Table 47–1 summarizes the various indications for PVBs, which are described in detail below.

### Thoracic Surgery

The use of PVBs for postoperative analgesia following thoracotomy has been investigated in both adults<sup>36–40</sup> and children.<sup>55,62</sup> A commonly used approach involves preoperative PVBs to provide intraoperative analgesia in addition to a continuous local anesthetic infusion via a paravertebral catheter for postoperative analgesia. Preoperative PVBs are performed to provide sensory block from T4 to T9. This can be achieved with either single or multiple level injections. A paravertebral catheter can either be placed percutaneously by the anesthesiolo-

gist preoperatively or by the thoracic surgeon under direct vision at the time of chest closure.

In a prospective, randomized, placebo-controlled trial, Berrisford et al.<sup>36</sup> documented the beneficial effects of continuous PVBs for thoracotomy patients. They found lower pain scores ( $p < 0.01$ ), reduced opioid consumption (8.6 mg vs. 119 mg over 5 days), fewer postoperative pulmonary complications (8% vs. 52.4%;  $p < 0.05$ ) and better preservation of pulmonary function ( $p < 0.01$ ) in the group who received bupivacaine compared to saline. Comparable results were obtained in a number of studies with similar design.<sup>37–40</sup> An additional advantage of PVBs involves a potential reduction in the incidence of postthoracotomy neuralgia.<sup>63</sup>

Continuous PVBs have a number of theoretical advantages over both continuous interpleural and intercostal blocks. The PVBs more reliably achieve block of the dorsal ramus of the spinal nerve. This is important as much of the pain that results from thoracotomy stems from the paraspinal muscles and other areas innervated by the dorsal ramus. In addition, greater cephalocaudal spread of local anesthetic occurs and results in more extensive block with continuous PVB compared to the other two modalities.<sup>64</sup> Despite these theoretical advantages, prospective studies comparing continuous PVBs versus interpleural<sup>65</sup> and versus intercostal<sup>66</sup> infusions of local anesthetic failed to show a difference between groups in pain scores and opioid consumption. Nevertheless, PVBs were associated with better preservation of lung function as measured by forced vital capacity and forced expiratory volume in 1 second.<sup>65</sup>

Continuous PVBs have also been compared to intermittent boluses of epidural morphine for postthoracotomy analgesia. Dauphin et al.<sup>67</sup> found that these two modalities resulted in similar pain scores and supplemental intravenous morphine consumption.

A number of prospective, randomized trials exist comparing continuous PVBs (local anesthetic alone) versus epidurals (local anesthetic with or without opioid).<sup>43,68–70</sup> In a study by Richardson et al.,<sup>68</sup> the group receiving PVBs had lower postoperative pain scores at rest ( $p = 0.02$ ) and with coughing ( $p =$



0.0001) as well as lower cumulative morphine consumption over 48 hours ( $p \leq 0.008$ ). However, Bimston et al.<sup>70</sup> failed to replicate these findings. A number of investigators have shown a lower incidence of side effects such as nausea,<sup>68</sup> vomiting,<sup>68</sup> hypotension,<sup>43,68</sup> and urinary retention<sup>43,68,70</sup> with PVBs compared to epidurals.

Studies of the effects of PVBs on postoperative lung function are conflicting and further investigation is still necessary. Richardson et al.<sup>68</sup> documented that the postoperative peak expiratory flow rate as a fraction of preoperative value was 0.73 in the PVB group compared to 0.54 in the epidural group ( $p < 0.004$ ), suggesting better preservation of lung function with PVBs. In contrast, Kaiser et al.<sup>69</sup> measured pre- and postoperative forced vital capacity and forced expiratory volume in 1 second and found no significant difference between the two modalities.

In addition to their usefulness for thoracotomies, PVBs also have been used successfully for other indications. In a prospective, randomized, placebo-controlled trial of patients having pleuroctomy, Mozell et al.<sup>71</sup> established that continuous PVB with bupivacaine provided lower pain scores, reduced opioid consumption and better preservation of pulmonary function than placebo. Paravertebral analgesia has also been used to provide analgesia for rib fractures in patients with head<sup>72</sup> and spinal cord<sup>73</sup> injuries. In patients with head injury, paravertebral analgesia reduced the need for potentially sedating analgesics and enhanced neurologic assessment.<sup>72</sup> Unilateral PVBs were administered instead of an epidural block in patients with lumbar spinal cord injury because the PVBs enhanced assessment of lumbosacral spinal cord function.<sup>73</sup> Moreover, paravertebral analgesia provides quality analgesia and has beneficial effects on pulmonary function among patients with traumatic chest injury.<sup>74</sup> Additional applications have been in the treatment of pain following thoracoscopy<sup>75</sup> and in the management of chest pain caused by pleural effusion.<sup>76</sup>

### Breast Surgery

PVBs can be used as the sole intraoperative anesthetic or as an analgesic supplement to general anesthesia for breast surgery. The block may be performed as a single injection or as injections

at multiple levels. The dermatomal levels blocked depend on the surgical procedure (Table 47-1). A block of T2-6 is required for mastectomy. When mastectomy and axillary dissection is scheduled, extending the block to include the T1 dermatome is essential. Supplementing with a superficial cervical plexus block can also enhance analgesia at the superior aspect of the incision. Breast biopsy requires block of the dermatome involved in addition to 1 level cephalad and 1 level caudad. Long-acting local anesthetics such as ropivacaine or bupivacaine can provide postoperative analgesia for up to 23 hours.<sup>77</sup>

A number of prospective, randomized trials exist comparing general anesthesia versus PVBs for breast surgery.<sup>31,41,42,78</sup> Pusch et al.<sup>41</sup> performed a single injection block with bupivacaine using the loss of resistance technique at T4 in patients having breast cancer surgery. They found rapid onset of block with skin incision occurring within 15 minutes of the block. Additionally, they documented a shorter emergence time in the group who had PVBs ( $p < 0.01$ ). The PVB group had lower pain scores during the 13 hours of the study ( $p < 0.05$ ) and received fewer analgesics ( $p < 0.01$ ). There was less-painful restricted motion ( $p < 0.001$ ) and a reduced incidence of postoperative nausea and vomiting ( $p < 0.05$ ) in the PVB group. Paravertebral anesthesia with propofol sedation was inadequate in 6% of patients; however, in these patients, supplemental analgesia with intravenous fentanyl was sufficient to avoid conversion to general anesthesia. Naja et al.<sup>31</sup> used a nerve stimulator and performed injections at multiple levels with a mixture of lidocaine, bupivacaine, epinephrine, fentanyl, and clonidine. They showed an analgesic benefit for the first 5 days postoperatively and also documented a shorter length of hospital stay among patients who received PVBs ( $p < 0.01$ ). Klein et al.<sup>42</sup> studied patients having unilateral or bilateral cosmetic and reconstructive breast surgery and also showed similar benefits including lower verbal pain scores up to 72 hours after surgery. In addition, they were able to reduce intraoperative induction time from 24 minutes with general anesthesia to 4 minutes with PVBs by using a preoperative block area. Terheggen et al.<sup>78</sup> studied patients having minor breast surgery and performed

PVB with bupivacaine via a catheter placed at T3-4. The PVBs reduced intraoperative fentanyl requirements and lowered postoperative pain scores only in the first 90 minutes. Thereafter, pain was minimal.

### Hernia Repair

PVBs can be used for surgical anesthesia or for analgesia as a supplement to general anesthesia for inguinal, umbilical, or incisional hernia repair. When performed for inguinal hernia repair, block of the T10 through L2 dermatomes is typically required. This can be achieved by a single injection in the low thoracic PVS or by injections at multiple levels.

Two prospective series provided evidence for the safety and efficacy of PVBs used as the sole anesthetic for inguinal hernia repair.<sup>79,80</sup> Klein et al.<sup>79</sup> demonstrated that bupivacaine PVBs provide surgical anesthesia within 15-30 minutes and prolonged postoperative analgesia with a mean time to first opioid of 22 hours. In a study by Wetz et al.,<sup>80</sup> the failure rate requiring conversion to general anesthesia was 6.7%; however, these investigators documented low pain scores for 48 hours postoperatively. Two prospective studies have evaluated the efficacy of PVBs compared to other anesthetic techniques for inguinal hernia repair. In a nonrandomized study, Naja et al.<sup>81</sup> compared multilevel PVBs from T12 to L2 versus general anesthesia versus spinal anesthesia. The patients in the PVB group had better postoperative analgesia, a lower incidence of postoperative nausea and vomiting (0 [PVB] vs. 21% [general anesthesia] vs. 19% [spinal anesthesia];  $p < 0.001$ ) and a shorter duration of hospital stay (1.2 days [PVB] vs 2.9 days [general anesthesia] vs. 2.5 days [spinal anesthesia];  $p < 0.0001$ ). Although Naja et al. did not comment on this, another potential advantage of PVBs over spinal anesthesia involves a lower incidence of postoperative urinary retention. In a randomized trial, Wassef et al.<sup>82</sup> compared lidocaine PVBs to field blocks performed with both lidocaine and bupivacaine. The PVBs were associated with less-frequent intraoperative supplementation (20% vs. 41%;  $p < 0.01$ ), a lower rate of conversion to general anesthesia (0 vs. 6.7%) and greater patient satisfaction ( $p < 0.05$ ).

Alternatively, PVBs can supplement another primary anesthetic technique

(e.g., general or spinal anesthesia) to provide postoperative analgesia. In a prospective, randomized study of patients having inguinal hernia repair under general anesthesia, Klein et al.<sup>83</sup> compared postoperative analgesia from ropivacaine PVBs to ilioinguinal-iliohypogastric nerve blocks with wound infiltration. They found reduced opioid consumption intraoperatively ( $p = 0.02$ ) and in the postanesthesia care unit ( $p = 0.002$ ), as well as a lower antiemetic use ( $p < 0.001$ ), in the PVB group; however, there was no subsequent difference in pain scores and opioid use.

When PVBs are used for repair of umbilical hernias of moderate size, a bilateral block from T9 to T11 is required. In a nonrandomized study, Naja et al.<sup>32</sup> compared PVB to general anesthesia. PVBs were performed using a nerve stimulator and a mixture of lidocaine, bupivacaine, epinephrine, fentanyl, and clonidine. Interestingly, 10% of patients in the PVB group required supplemental analgesia as a result of unanticipated extension of the surgical field. Nevertheless, PVBs had a number of benefits, including lower pain scores and reduced opioid requirements, for up to 48 hours ( $p < 0.001$ ). PVBs were also associated with a decreased incidence of postoperative nausea and vomiting (3.3% vs. 26.7%;  $p < 0.05$ ) and shorter length of hospital admission (2.3 days vs. 4.1 days;  $p < 0.05$ ).

Finally, PVBs can be used for incisional hernia repair and are performed according to the dermatomal levels involved. Block from T8 to T12 has also been employed for ileostomy closure.<sup>84</sup>

## Renal Surgery

Unilateral PVBs are well-suited to provide postoperative analgesia following renal surgery. A catheter for continuous local anesthetic infusion can be placed percutaneously by the anesthesiologist preoperatively. Alternatively, a catheter can be placed under direct vision by the surgeon at the time of wound closure.<sup>85</sup> This is accomplished by lifting the psoas fascia from the lateral edge of the incision to the lateral border of the vertebral bodies, continuing this dissection cephalad, inserting an epidural catheter percutaneously and advancing it cranially within the PVS. In a randomized, prospective, placebo-controlled trial, Awwad et al.<sup>85</sup> found reduced pain scores for 3 days ( $p < 0.026$ ) and decreased opioid con-

sumption (13.3 mg vs. 40.13 mg over 3 days;  $p < 0.001$ ) in the group who received continuous PVB with bupivacaine when compared to saline. Lonnqvist et al.<sup>86,87</sup> have used continuous PVBs in children having renal surgery. In a nonrandomized study, they compared the postoperative analgesia obtained from paravertebral versus epidural bupivacaine<sup>87</sup> and found decreased opioid consumption in the PVB group.

## Cholecystectomy

Few studies exist that evaluate the efficacy of PVBs for postoperative analgesia following open cholecystectomy by subcostal incision. Giesecke et al.<sup>35</sup> suggest that PVBs reduce the stress response to surgery; however, Bigler et al.<sup>61</sup> found no benefit from continuous PVB when compared to thoracic epidural. More recently, PVBs have been used to provide postoperative analgesia for laparoscopic cholecystectomy. In a prospective, randomized study Naja et al.<sup>88</sup> randomized patients receiving general anesthesia to have PVBs or opioid analgesia. Although there was no difference between groups in time to first oral intake or length of hospital stay, patients who received PVBs had lower pain scores ( $p < 0.05$ ), reduced opioid consumption over 36 hours ( $p < 0.05$ ), and a decreased incidence of postoperative nausea and vomiting ( $p < 0.05$ ).

## Orthopedic Surgery

PVBs can be used as an adjunct to other peripheral nerve blocks or as the sole regional technique for the treatment of postoperative pain in orthopedic patients. In patients receiving an interscalene brachial plexus block for shoulder surgery, the addition of T1-2 PVBs provides more complete shoulder analgesia. And, in combination with a lumbar plexus block, T11-12 PVBs provide more comprehensive analgesia for patients having hip surgery. Alternatively, PVBs from T12 to L4 and from L2 to S1 have been used to provide postoperative analgesia following total hip and knee arthroplasty, respectively.<sup>89</sup>

## Bone Marrow Aspiration

Bilateral PVBs from T11-L2 can be used to provide intraoperative anesthesia and postoperative analgesia for patients having bone marrow aspiration. This technique provides an alternative option when general and/or spinal anesthesia are contraindicated

(e.g., mediastinal tumor and chemotherapy-related thrombocytopenia).

## Cardiac and Vascular Surgery

PVBs have been used both for analgesia following cardiac surgery and for peripheral vascular procedures.

In a prospective, observational study, Canto et al.<sup>90</sup> performed continuous bilateral ropivacaine PVBs at T3-4 for patients having open-heart surgery with cardiopulmonary bypass. They reported excellent analgesia, a low complication rate, and facilitation of early tracheal extubation. Moderate hypotension and bradycardia were repeatedly observed and presumed because of sympathectomy; however, dopamine support was required in only 6.4% of patients.

Bilateral T4-5 continuous PVBs have also been successfully used for postoperative analgesia following minimally invasive coronary artery bypass.<sup>91</sup> In a prospective, randomized trial, Dhole et al.<sup>92</sup> compared continuous PVB versus epidural analgesia and found no significant differences between the techniques with respect to analgesia.

Paravertebral analgesia following major abdominal vascular surgery was described in an observational study by Richardson et al.<sup>93</sup> They placed bilateral paravertebral catheters at T10 in 8 patients and administered an infusion of bupivacaine. The continuous PVBs provided excellent postoperative analgesia with preserved hemodynamic stability.

## Hepatic Surgery

In a case report, Ho et al.<sup>94</sup> describe the use of a right thoracic paravertebral catheter for hepatectomy and cite their preference for this technique over epidural analgesia in patients who have or may develop a coagulopathy.

In an additional case report, Hall et al.<sup>95</sup> illustrate the use of continuous paravertebral analgesia for the pain associated with a traumatic liver fracture managed conservatively.

## Labor Analgesia for Obstetrics

Bilateral PVBs have been used to provide analgesia for laboring obstetrical patients in whom epidural anesthesia is unattainable or contraindicated. In a case series, Nair et al.<sup>96</sup> described using bilateral T11 and T12 PVBs to obtain labor analgesia for patients with coagulation abnormalities (prolonged bleeding time, syndrome of hemolysis, elevated liver enzymes, and low platelets) and lumbar spinal anomalies

(neuroblastoma, spina bifida occulta). Suelto et al.<sup>97</sup> underline the limitation of this technique in providing analgesia for the second stage of labor as well as for caesarian section.

### Chronic Pain

Several authors have published descriptions of the use of PVBs in the management of chronic pain. Kirvela et al.<sup>98</sup> provided retrospective information on 32 patients having 281 PVBs for chronic chest wall pain. Results were similar for those patients with postthoracotomy chest pain and those with postmastectomy pain. Among the thoracic surgical patients, immediate pain relief occurred in 99% of cases; however, prolonged pain relief was rare: 58% were pain free at 1 month, 30% at 2 months, 8% at 4 months, and only 3% at 5 months. Among the breast cancer patients, 88% were pain free for less than 1 month and only 6% were pain free for more than 5 months. Antila et al.<sup>99</sup> observed similar results in a population of patients who had chronic thoracic pain related to malignant disease with poor prognosis. Limited data exist on the use of PVBs for pain relief from acute herpes zoster<sup>100</sup> and postherpetic neuralgia.<sup>101</sup> Neurolytic PVBs are generally avoided because of the risk of neurologic damage.

### CONCLUSION

The PVB is a technique that offers dense, long-lasting, segmental anesthesia and analgesia. This block takes advantage of the unique anatomical structure and contents of the PVS. Local anesthetic is delivered at discrete locations to achieve site-specific block of both the dorsal and ventral rami, as well as the sympathetic chain. In contrast to neuraxial techniques, PVBs offer the flexibility of either unilateral or bilateral blockade and avoid many of the side effects associated with more centrally administered local anesthetics.<sup>43,68,70</sup> The density of the achieved block is highlighted in the profound analgesia that results and in the mitigation of the surgical stress response.<sup>35</sup> Despite these advantages, the greatest impediments to wider scale adoption of this technique are the low but consistent failure rate of up to 10%<sup>46</sup> and the concern of pneumothorax.

By peripherally targeting individual nerve roots or segmental innervation

the technique has wide-scale applicability for nearly all procedures of the thorax and abdomen, as well as the lower extremities. It has been most extensively studied after thoracotomy, demonstrating profound block, excellent analgesia, opioid sparing and reduction in opioid- and epidural-related side effects.<sup>36–40</sup> In addition, PVBs offer better preservation of pulmonary function and a reduced frequency of postoperative pulmonary complications.<sup>36–40</sup> The magnitude of these outcome differences suggests that PVBs are underused, particularly in procedures such as thoracic surgery where iatrogenic pneumothorax is of limited concern.

The technique of PVB has also been validated as an effective sole intraoperative anesthetic and as an analgesic adjunct for breast surgery<sup>31,41,42,78</sup> and inguinal hernia repair,<sup>79–82</sup> two of the most commonly performed outpatient surgical procedures. When used for ambulatory surgery, PVBs facilitate recovery and have the potential to hasten discharge and reduce costs. Efficacious results have also been produced for procedures as diverse as cardiac surgery,<sup>90,91</sup> cholecystectomy,<sup>35,61,88</sup> and labor.<sup>96</sup> In short, the ability to provide site-specific segmental anesthesia makes PVB one of the most useful and broadly applicable peripheral nerve block techniques.

### KEY REFERENCES

1. Eason MJ, Wyatt R. Paravertebral thoracic block—a reappraisal. *Anaesthesia* 1979;34(7):638–642.
2. Karmakar MK. Thoracic paravertebral block. *Anesthesiology* 2001;95(3):771–780.
3. Cheema S, Richardson J, McGurgan P. Factors affecting the spread of bupivacaine in the adult thoracic paravertebral space. *Anaesthesia* 2003;58(7):684–687.
4. Naja Z, Lonnqvist PA. Somatic paravertebral nerve blockade. Incidence of failed block and complications. *Anaesthesia* 2001;56(12):1184–1188.
5. Karmakar MK, Ho AM, Law BK, Wong ASY, Shafer SL, Gin T. Arterial and venous pharmacokinetics of ropivacaine with and without epinephrine after thoracic paraverte-

bral block. *Anesthesiology* 2005;103(4):704–711.

6. Richardson J, Sabanathan S, Jones J, Shah RD, Cheema S, Mearns AJ. A prospective, randomized comparison of preoperative and continuous balanced epidural or paravertebral bupivacaine on post-thoracotomy pain, pulmonary function and stress responses. *Br J Anaesth* 1999;83(3):387–392.

7. Naja MZ, Ziade MF, Lonnqvist PA. Nerve-stimulator guided paravertebral blockade vs. general anesthesia for breast surgery: a prospective randomized trial. *Eur J Anaesthesiol* 2003;20(11):897–903.

### REFERENCES

1. Macintosh R, Bryce-Smith R. *Local Analgesia—Abdominal Surgery*. 2nd ed. Edinburgh, UK: Livingstone, 1962.
2. Karmakar MK. Thoracic paravertebral block. *Anesthesiology* 2001;95(3):771–780.
3. Eason MJ, Wyatt R. Paravertebral thoracic block—a reappraisal. *Anaesthesia* 1979;34(7):638–642.
4. Richardson J. Fin-de-siècle renaissance of paravertebral analgesia. *Pain Rev* 1997;4:159–171.
5. Conacher I. Resin injection of thoracic paravertebral spaces. *Br J Anaesth* 1988;61:657–661.
6. Karmakar MK. Paravertebral somatic nerve block for outpatient inguinal herniorrhaphy. *Reg Anesth Pain Med* 1999;24(1):96–97.
7. Lonnqvist PA, Hesser U. Radiological and clinical distribution of thoracic paravertebral blockade in infants and children. *Paediatr Anaesth* 1993;3:83–87.
8. Purcell-Jones G, Pither CE, Justins DM. Paravertebral somatic nerve block: a clinical, radiographic, and computed tomographic study in chronic pain patients. *Anesth Analg* 1989;68(1):32–39.
9. Tenicela R, Pollan SB. Paravertebral-peridural block technique: a unilateral thoracic block. *Clin J Pain* 1990;6(3):227–234.
10. Karmakar MK, Kwok WH, Kew J. Thoracic paravertebral block: radiological evidence of contralateral spread anterior to the vertebral bodies. *Br J Anaesth* 2000;84(2):263–265.
11. Lonnqvist PA, Hildingsson U. The caudal boundary of the thoracic paravertebral space. A study in human cadavers. *Anaesthesia* 1992;47(12):1051–1052.
12. Cheema SP, Ilesley D, Richardson J, Sabanathan S. A thermographic study of paravertebral analgesia. *Anaesthesia* 1995;50(2):118–121.



13. Saito T, Den S, Tanuma K, Tanuma Y, Carney E, Carlsson C. Anatomical bases for paravertebral anesthetic block: fluid communication between the thoracic and lumbar paravertebral regions. *Surg Radiol Anat* 1999;21(6):359–363.
14. Dugan DJ, Samson PC. Surgical significance of the endothoracic fascia. The anatomical basis for empyectomy and other extrapleural techniques. *Am J Surg* 1975;130:151–158.
15. Im J, Webb WR, Rosen A, Gamsu G. Costal pleura: appearances at high-resolution CT. *Radiology* 1989;171:125–131.
16. Saito T, Den S, Cheema SP, et al. A single-injection, multi-segmental paravertebral block-extension of somatosensory and sympathetic block in volunteers. *Acta Anaesthesiol Scand* 2001;45(1):30–33.
17. Nunn JF, Slavin G. Posterior intercostal nerve block for pain relief after cholecystectomy. Anatomical basis and efficacy. *Br J Anaesth* 1980;52(3):253–260.
18. Klein SM, Nielsen KC, Ahmed N, Buckenmaier CC, Steele SM. In situ images of the thoracic paravertebral space. *Reg Anesth Pain Med* 2004;29(6):596–599.
19. Kittredge RD. Computed tomographic evaluation of the thoracic prevertebral and paravertebral spaces. *J Comput Tomogr* 1983;7:239–250.
20. Nel L, Conacher ID, Shanahan D. Lymphatic drainage of the thoracic paravertebral space. *Br J Anaesth* 2001;86(3):453–454.
21. Naja MZ, Gustafsson AC, Ziade MF, et al. Distance between the skin and the thoracic paravertebral space. *Anaesthesia* 2005;60(7):680–684.
22. Karmakar MK, Gin T, Ho AM. Ipsilateral thoraco-lumbar anaesthesia and paravertebral spread after low thoracic paravertebral injection. *Br J Anaesth* 2001;87(2):312–316.
23. Richardson J, Lonnqvist PA. Thoracic paravertebral block. *Br J Anaesth* 1998;81(2):230–238.
24. Lang SA. The use of a nerve stimulator for thoracic paravertebral block. *Anesthesiology* 2002;97(2):521.
25. Naja MZ, Ziade MF, El Rajab M, El Tayara K, Lonnqvist PA. Varying anatomical injection points within the thoracic paravertebral space: effect on spread of solution and nerve blockade. *Anaesthesia* 2004;59:459–463.
26. Richardson J, Cheema SP, Hawkins J, Sabanathan S. Thoracic paravertebral space location. A new method using pressure measurement. *Anaesthesia* 1996;51(2):137–139.
27. Pusch F, Wildling E, Klimscha W, Weinstabl C. Sonographic measurement of needle insertion depth in paravertebral blocks in women. *Br J Anaesth* 2000;85(6):841–843.
28. Cheema S, Richardson J, McGurgan P. Factors affecting the spread of bupivacaine in the adult thoracic paravertebral space. *Anaesthesia* 2003;58(7):684–687.
29. Saito T, Gallagher ET, Cutler S, et al. Extended unilateral anesthesia. New technique or paravertebral anesthesia? *Reg Anesth* 1996;21(4):304–307.
30. Karmakar MK, Ho AM, Law BK, Wong ASY, Shafer SL, Gin T. Arterial and venous pharmacokinetics of ropivacaine with and without epinephrine after thoracic paravertebral block. *Anesthesiology* 2005;103(4):704–711.
31. Naja MZ, Ziade MF, Lonnqvist PA. Nerve-stimulator guided paravertebral blockade vs. general anaesthesia for breast surgery: a prospective randomized trial. *Eur J Anaesthesiol* 2003;20(11):897–903.
32. Naja Z, Ziade MF, Lonnqvist PA. Bilateral paravertebral somatic nerve block for ventral hernia repair. *Eur J Anaesthesiol* 2002;19(3):197–202.
33. Richardson J, Jones J, Atkinson R. The effect of thoracic paravertebral blockade on intercostal somatosensory evoked potentials. *Anesth Analg* 1998;87(2):373–376.
34. Dahl JB, Rosenberg J, Lund C, Kehlet H. Effect of thoracic epidural bupivacaine 0.75% on somatosensory evoked potentials after dermatomal stimulation. *Reg Anesth* 1990;15(2):73–75.
35. Giesecke K, Hamberger B, Jarnberg PO, Klingstedt D. Paravertebral block during cholecystectomy: effects on circulatory and hormonal responses. *Br J Anaesth* 1988;61:652–656.
36. Berrisford RG, Sabanathan S, Mearns AJ, Bickford-Smith PJ. Pulmonary complications after lung resection: the effect of continuous extrapleural intercostal nerve block. *Eur J Cardiothorac Surg* 1990;4(8):407–410.
37. Sabanathan S, Bibby SR, Berrisford RG. Efficacy of continuous intercostal nerve blockade on postoperative analgesia and pulmonary mechanics. *Br J Surg* 1989;77:221–225.
38. Sabanathan S, Mearns AJ, Bickford-Smith PJ, et al. Efficacy of continuous extrapleural intercostal nerve block on post-thoracotomy pain and pulmonary mechanics. *Br J Surg* 1990;77(2):221–225.
39. Eng J, Sabanathan S. Continuous extrapleural intercostal nerve block and post-thoracotomy pulmonary complications. *Scand J Thorac Cardiovasc Surg* 1992;26(3):219–223.
40. Barron DJ, Tolan MJ, Lea RE. A randomized controlled trial of continuous extra-pleural analgesia post-thoracotomy: efficacy and choice of local anaesthetic. *Eur J Anaesthesiol* 1999;16:236–245.
41. Pusch F, Freitag H, Weinstabl C, Obwegeser R, Huber E, Wildling E. Single-injection paravertebral block compared to general anaesthesia in breast surgery. *Acta Anaesthesiol Scand* 1999;43(7):770–774.
42. Klein SM, Bergh A, Steele SM, Georgiade GS, Greengrass RA. Thoracic paravertebral block for breast surgery. *Anesth Analg* 2000;90(6):1402–1405.
43. Matthews PJ, Govenden V. Comparison of continuous paravertebral and extradural infusions of bupivacaine for pain relief after thoracotomy. *Br J Anaesth* 1989;62(2):204–205.
44. Richardson J, Sabanathan S. Thoracic paravertebral analgesia. *Acta Anaesthesiol Scand* 1995;39(8):1005–1015.
45. Naja Z, Lonnqvist PA. Somatic paravertebral nerve blockade. Incidence of failed block and complications. *Anaesthesia* 2001;56(12):1184–1188.
46. Lonnqvist PA, MacKenzie J, Soni AK, Conacher ID. Paravertebral blockade. Failure rate and complications. *Anaesthesia* 1995;50(9):813–815.
47. Coveney E, Weltz CR, Greengrass R, et al. Use of paravertebral block anesthesia in the surgical management of breast cancer: experience in 156 cases. *Ann Surg* 1998;227(4):496–501.
48. Greengrass R, O'Brien F, Lysterly K, et al. Paravertebral block for breast cancer surgery. *Can J Anaesth* 1996;43(8):858–861.
49. Thomas PW, Sanders DJ, Berrisford RG. Pulmonary haemorrhage after percutaneous paravertebral block. *Br J Anaesth* 1999;83(4):668–669.
50. Lekhak B, Bartley C, Conacher ID, Nouraei SM. Total spinal anaesthesia in association with insertion of a paravertebral catheter. *Br J Anaesth* 2001;86(2):280–282.
51. Sharrock NE. Postural headache following thoracic somatic paravertebral nerve block. *Anesthesiology* 1980;52(4):360–362.
52. Kairaluoma PM, Bachmann M, Korpinen AK, Rosenberg PH, Pere PJ. Single-injection paravertebral block before general anesthesia enhances analgesia after breast cancer surgery with and without associated lymph node biopsy. *Anesth Analg* 2004;99(6):1837–1843.
53. Snowden CP, Bower S, Conacher I. Plasma bupivacaine levels in paravertebral blockade in adults. *Anaesthesia* 1994;49(6):546.
54. Berrisford RG, Sabanathan S, Mearns AJ, Clarke BJ, Hamdi A. Plasma concentrations of bupivacaine and its enantiomers during continuous extrapleural intercostal nerve block. *Br J Anaesth* 1993;70:201–204.
55. Karmakar MK, Booker PD, Franks R, Pozzi M. Continuous extrapleural paravertebral infusion of bupivacaine for post-thoracotomy analgesia in young infants. *Br J Anaesth* 1996;76:811–815.
56. Cheung SLW, Booker PD, Franks R, Pozzi M. Serum concentrations of bupivacaine during prolonged continuous paravertebral infusion in young infants. *Br J Anaesth* 1997;79:9–13.
57. Dauphin A, Gupta RN, Young JEM, Morton WD. Serum bupivacaine concentrations during continuous extrapleural infusion. *Can J Anaesth* 1997;44(4):367–370.
58. Clark BJ, Hamdi A, Berrisford RG, Sabanathan S, Mearns AJ. Reversed-phase and chiral high-performance liquid chromatographic assay of bupivacaine and its enantiomers in clinical samples after continuous extrapleural infusion. *J Chromatogr* 1991;553:383–390.
59. Brittingham TE, Berlin LN, Wolff HG. Nervous system damage following paraver-



- tebral block with efocaine: report of three cases. *JAMA* 1954;154:329–330.
60. Molitch M, Wilson G. Brown-Sequard paralysis following a paravertebral alcohol injection for angina pectoris. *JAMA* 1931;97:247.
61. Bigler D, Dirkes W, Hansen R, Rosenberg J, Kehlet H. Effects of thoracic paravertebral block with bupivacaine versus combined thoracic epidural block with bupivacaine and morphine on pain and pulmonary function after cholecystectomy. *Acta Anaesthesiol Scand* 1989;33(7):561–564.
62. Shah R, Sabanathan S, Richardson J, Mearns AJ, Bembridge J. Continuous paravertebral block for post thoracotomy analgesia in children. *J Cardiovasc Surg* 1997;38(5):543–546.
63. Richardson J, Sabanathan S, Mearns AJ, Sides C, Goulden C. Post-thoracotomy neuralgia. *Pain Clin* 1994;7(2):87–97.
64. Perttunen K, Nilsson E, Heinonen J, Hirvisalo EL, Salo JA, Kalso E. Extradural, paravertebral and intercostal nerve blocks for post-thoracotomy pain. *Br J Anaesth* 1995;75(5):541–547.
65. Richardson J, Sabanathan S, Mearns AJ, Shah RD, Goulden C. A prospective, randomized comparison of interpleural and paravertebral analgesia in thoracic surgery. *Br J Anaesth* 1995;75:405–408.
66. Richardson J, Sabanathan S, Shah RD, Clarke BJ, Cheema S, Mearns AJ. Pleural bupivacaine placement for optimal postthoracotomy pulmonary function: a prospective, randomized study. *J Cardiothorac Vasc Anesth* 1998;12(2):166–169.
67. Dauphin A, Lubanska-Hubert E, Young EM, Miller JD, Bennett WF, Fuller HD. Comparative study of continuous extrapleural intercostal nerve block and lumbar epidural morphine in post thoracotomy pain. *Can J Surg* 1997;40:431–436.
68. Richardson J, Sabanathan S, Jones J, Shah RD, Cheema S, Mearns AJ. A prospective, randomized comparison of preoperative and continuous balanced epidural or paravertebral bupivacaine on post-thoracotomy pain, pulmonary function and stress responses. *Br J Anaesth* 1999;83(3):387–392.
69. Kaiser AM, Zollinger A, De Lorenzi D, Largiader F, Weder W. Prospective, randomized comparison of extrapleural versus epidural analgesia for postthoracotomy pain. *Ann Thorac Surg* 1998;66:367–372.
70. Bimston DN, McGee JP, Liptay MJ, Fry WA. Continuous paravertebral extrapleural infusion for post thoracotomy pain management. *Surgery* 1999;126:650–656.
71. Mozell EJ, Sabanathan S, Mearns AJ, Bickford-Smith PJ, Majid MR, Zografos G. Continuous extrapleural intercostal nerve block after pleurectomy. *Thorax* 1991;46:21–24.
72. Williamson S, Kumar CM. Paravertebral block in head injured patient with chest trauma. *Anaesthesia* 1997;52:284–285.
73. Karmakar MK, Chui PT, Joynt GM, Ho AM. Thoracic paravertebral block for management of pain associated with multiple fractured ribs in patients with concomitant lumbar spinal trauma. *Reg Anesth Pain Med* 2001;26(2):169–173.
74. Gilbert J, Hultman J. Thoracic paravertebral block: a method of pain control. *Acta Anaesthesiol Scand* 1989;33(2):142–145.
75. Soni AK, Conacher ID, Waller DA, Hilton CJ. Video-assisted thoracoscopic placement of paravertebral catheters: a technique for postoperative analgesia for bilateral thoracoscopic surgery. *Br J Anaesth* 1994;72(4):462–464.
76. Paniagua P, Catala E, Villar Landeira JM. Successful management of pleuritic pain with thoracic paravertebral block. *Reg Anesth Pain Med* 2000;25(6):651–653.
77. Weltz CR, Greengrass RA, Lyerly HK. Ambulatory surgical management of breast carcinoma using paravertebral block. *Ann Surg* 1995;222(1):19–26.
78. Terheggen MA, Wille F, Borel Rinkes IH, Ionescu TI, Knape JT. Paravertebral blockade for minor breast surgery. *Anesth Analg* 2002;94(2):355–359.
79. Klein SM, Greengrass RA, Weltz C, Warner DS. Paravertebral somatic nerve block for outpatient inguinal herniorrhaphy: an expanded case report of 22 patients. *Reg Anesth Pain Med* 1998;23(3):306–310.
80. Weltz CR, Klein SM, Arbo JE, Greengrass RA. Paravertebral block anesthesia for inguinal hernia repair. *World J Surg* 2003;27(4):425–429.
81. Naja MZ, el Hassan MJ, Oweidat M, Zbibo R, Ziade MF, Lonnqvist PA. Paravertebral blockade vs general anesthesia or spinal anesthesia for inguinal hernia repair. *Middle East J Anesthesiol* 2001;16(2):201–210.
82. Wassef MR, Randazzo T, Ward W. The paravertebral nerve root block for inguinal herniorrhaphy—a comparison with the field block approach. *Reg Anesth Pain Med* 1998;23(5):451–456.
83. Klein SM, Pietrobon R, Nielsen KC, et al. Paravertebral somatic nerve block compared with peripheral nerve blocks for outpatient inguinal herniorrhaphy. *Reg Anesth Pain Med* 2002;27(5):476–480.
84. Kalady MF, Fields RC, Klein S, et al. Loop ileostomy closure at an ambulatory surgery facility: a safe and cost-effective alternative to routine hospitalization. *Dis Colon Rectum* 2003;46(4):486–490.
85. Awwad ZM, Atiyat BA. Pain relief using continuous bupivacaine infusion in the paravertebral space after loin incision. *Saudi Med J* 2004;25(10):1369–1373.
86. Lonnqvist PA. Continuous paravertebral block in children. Initial experience. *Anaesthesia* 1992;47(7):607–609.
87. Lonnqvist PA, Olsson GL. Paravertebral vs epidural block in children. Effects on postoperative morphine requirement after renal surgery. *Acta Anaesthesiol Scand* 1994;38(4):346–349.
88. Naja MZ, Ziade MF, Lonnqvist PA. General anesthesia combined with bilateral paravertebral blockade (T5-6) vs. general anesthesia for laparoscopic cholecystectomy: a prospective, randomized controlled trial. *Eur J Anaesthesiol* 2004;21(6):489–495.
89. Bogoch ER, Henke M, Mackenzie T, Olschewski E, Mahomed NN. Lumbar paravertebral nerve block in the management of pain after total hip and knee arthroplasty: a randomized controlled clinical trial. *J Arthroplasty* 2002;17(4):398–401.
90. Canto M, Sanchez MJ, Casas MA, Bataller ML. Bilateral paravertebral blockade for conventional cardiac surgery. *Anaesthesia* 2003;58(4):365–370.
91. Ganapathy S, Murkin JM, Boyd DW, Dobkowski W, Morgan J. Continuous percutaneous paravertebral block for minimally invasive cardiac surgery. *J Cardiothorac Vasc Anesth* 1999;13(5):594–596.
92. Dhole S, Mehta Y, Saxena H, Juneja R, Trehan N. Comparison of continuous thoracic epidural and paravertebral blocks for postoperative analgesia after minimally invasive direct coronary artery bypass surgery. *J Cardiothorac Vasc Anesth* 2001;15(3):288–292.
93. Richardson J, Vowden P, Sabanathan S. Bilateral paravertebral analgesia for major abdominal vascular surgery: a preliminary report. *Anaesthesia* 1995;50(11):995–998.
94. Ho AM, Karmakar MK, Cheung M, Lam GC. Right thoracic paravertebral analgesia for hepatectomy. *Br J Anaesth* 2004;93(3):458–461.
95. Hall H, Leach A. Paravertebral block in the management of liver capsule pain after blunt trauma. *Br J Anaesth* 1999;83(5):819–821.
96. Nair V, Henry R. Bilateral paravertebral block: a satisfactory alternative for labour analgesia. *Can J Anaesth* 2001;48(2):179–184.
97. Suelto MD. Paravertebral lumbar sympathetic block for labor analgesia. *Anesthesiology* 2000;93(2):580.
98. Kirvela O, Antila H. Thoracic paravertebral block in chronic postoperative pain. *Reg Anesth* 1992;17(6):348–350.
99. Antila H, Kirvela O. Neurolytic thoracic paravertebral block in cancer pain. A clinical report. *Acta Anaesthesiol Scand* 1998;42(5):581–585.
100. Johnson LR, Rocco AG, Ferrante FM. Continuous subpleural-paravertebral block in acute thoracic herpes zoster. *Anesth Analg* 1988;67(11):1105–1108.
101. Desai PM. Thoracic paravertebral block. *Br J Anaesth* 1999;82(1):149–150.
102. Greengrass R, Buckenmaier CC 3rd. Paravertebral anaesthesia/analgesia for ambulatory surgery. *Best Pract Res Clin Anaesthesiol* 2002;16(2):271–283.
103. Greengrass R, Steele S. Paravertebral blocks for breast surgery. *Tech Reg Anesth Pain Manage* 1998;2(1):8–12.
104. Berrisford RG, Sabanathan SS. Direct access to the paravertebral space at thoracotomy. *Ann Thorac Surg* 1990;49(5):854.

# CHAPTER 48

## Peripheral Nerve Blocks\*

Denise J. Wedel, MD, and  
Terese T. Horlocker, MD

The techniques of peripheral neural blockade were developed early in the history of anesthesia. American surgeons Halsted and Hall<sup>1,2</sup> described the injection of cocaine into peripheral sites, including the ulnar, musculocutaneous, supratrochlear, and infraorbital nerves, for minor surgical procedures in the 1880s. James Leonard Corning<sup>3</sup> recommended the use of an Esmarch bandage in 1885 to arrest local circulation, thus prolonging the cocaine-induced block and decreasing the uptake of that local anesthetic from the tissues. This concept was furthered by Heinrich F.W. Braun,<sup>4</sup> who substituted epinephrine, a “chemical tourniquet,” in 1903. Braun<sup>5</sup> also introduced the term *conduction anesthesia* in his 1905 textbook on local anesthesia, which described techniques for every region of the body. In 1920, the French surgeon, Gaston Labat, was invited by Charles Mayo to teach innovative methods of regional anesthesia at the Mayo Clinic. During his appointment there, Labat authored *Regional Anesthesia: Its Technic and Application*.<sup>6</sup> Published in 1922, Labat’s text popularized regional anesthesia in the United States by describing techniques already familiar to European surgeons and anesthesiologists. Importantly, Labat described the use of infiltration, peripheral, plexus, and splanchnic blockade (using cocaine and procaine) for surgery to the head and neck, intrathoracic, intraabdominal, and extremities, as general and neuraxial anesthesia were not widely accepted and/or considered more dangerous. Thus, while the techniques of peripheral neural blockade were developed early in the history of anesthesia, the improved safety of neuraxial and general anesthesia supplanted their use and their application diminished.

\*Modified with permission from Wedel DJ, Horlocker TT: Nerve blocks. In: Miller RD, ed. Anesthesia. 6th ed. Philadelphia: Churchill Livingstone, 2005:1685–1717.

The introduction of long-acting local anesthetics and adjuvants, the refinement of imaging modalities to facilitate neural localization, as well as innovations in equipment technology, including stimulating needles and catheters and portable infusion devices, have increased the success rate and popularity of peripheral blockade. Undoubtedly, peripheral nerve blocks represent a new era in regional anesthesia and analgesia. Competence in these techniques is crucial to future practice models.

Peripheral blockade is a well-accepted component of comprehensive anesthetic care, with a role not only within the operating suite, but also within the arena of postoperative and chronic pain management. With appropriate selection and sedation, these techniques can be used in all age groups. Skillful application of peripheral neural blockade broadens the anesthesiologist’s range of options in providing optimal anesthetic care.

### TECHNIQUES FOR LOCALIZING NEURAL STRUCTURES

Several methods of needle localization have been described, including fascial “pops,” elicitation of one or more paresthesias,

perivascular/transarterial injection, electrical stimulation, and field infiltration. More recently, direct imaging using ultrasonography, fluoroscopy, computer tomography (CT), and magnetic resonance imaging (MRI) have been used. Although there is no definitive study that identifies the “best” method for needle placement, generalities are possible. For example, elicitation of a paresthesia appears to be equivalent to electrical stimulation. Success rate and onset time with both paresthesia and nerve stimulation techniques are further improved if multiple injections are performed.<sup>7</sup> A recent Cochrane review evaluating single-, double-, and multiple-injection techniques for axillary block reported that multiple-injection techniques were associated with fewer block failures and improved motor blockade compared to both single and double injections.<sup>8</sup> Conversely, the time to perform single injection is less, but the time required to perform supplementary blocks increased the time to readiness for surgery. Unfortunately, there are insufficient data to compare other outcomes, such as safety.<sup>8</sup> Although used chiefly for axillary blockade, transarterial injection is variably successful; a two-injection transarterial technique

### KEY POINTS

1. In performing peripheral nerve blocks, elicitation of a paresthesia is equivalent to electrical stimulation. Success rate and onset time are improved if multiple stimulations are performed, particularly with axillary blockade.
2. The use of ultrasonography for peripheral blockade improves the quality of blockade and decreases onset time. However, overall success rate is not substantially altered.
3. The role of stimulating versus nonstimulating catheters for continuous peripheral nerve blocks to improve success rate is an active area of research.
4. Diaphragmatic paresis in 100% of patients undergoing interscalene block, even with dilute local anesthetic solutions. Phrenic nerve paresis has also been reported following both supraclavicular and infraclavicular approaches, but with less frequency.
5. Continuous lower-extremity peripheral blockade consistently provides superior analgesia compared to conventional systemic opioid therapy. In addition, continuous femoral nerve block improves outcome and rehabilitation following total knee replacement and is superior to epidural analgesia.
6. Because the sciatic nerve divides into its tibial and peroneal components 7–10 cm above the knee, popliteal fossa block should be performed at this level.
7. Total local anesthetic dosage should be determined and kept within acceptable limits. Accumulation with time may occur with continuous techniques.
8. The frequency of neurologic complications following peripheral blockade is less than that associated with neuraxial techniques. Neurotoxicity and direct-needle trauma are the major etiologies of neurologic complications.

is comparable to either single-injection paresthesia or nerve stimulator approaches. Finally, success rate with a fascial pop or click is variable and may be more reliable in pediatric (compared to adult) patients.<sup>7</sup>

Ultrasound guidance (with and without neural stimulation) is increasing used for peripheral blockade. Initial applications involved upper-extremity techniques, because of capability of the ultrasound to penetrate relatively superficial soft-tissue structures.<sup>9,10</sup> However, visualization of lower-extremity anatomy was recently described.<sup>11</sup> Major advantages of ultrasonography include the ability to identify the neural structure, eliminating the need for “blind” needle placement, and observation of the spread of local anesthetic during injection. For example, investigators have noted that equal distribution of local anesthetic within the neural sheath is associated with successful block.<sup>12</sup> Real-time visualization of local anesthetic spread during injection allows the proceduralist to redirect the needle, as necessary to assure adequate distribution. The overall usefulness of ultrasonography remains to be determined. Existing knowledge suggests that ultrasound-guided blockade may be associated with a decreased performance time and local anesthetic requirement, more rapid onset, and superior quality blockade compared to nerve stimulation alone. However, overall success rate has not been reportedly increased. Importantly, neural structures are not always visualized by ultrasonography and in obese patients or “deep” techniques, such as psoas compartment or proximal sciatic blockade. Thus, ultrasound guidance is not possible in patients in whom the technique would be theoretically most useful.<sup>13,14</sup>

## CHOICE OF LOCAL ANESTHETIC

The choice of local anesthetic for a peripheral nerve block obviously depends to some degree on the duration of the surgical procedure; however, other factors are also important. Local anesthetic and the addition of adjuvants for peripheral nerve block are dependent on the anticipated duration of surgery, the need for prolonged analgesia, and the timing of ambulation/weight-bearing postoperatively. Prolonged blockade for 24 hours (or greater) may occur with long-acting agents such as bupivacaine,

levobupivacaine, or ropivacaine. Although this feature may result in excellent postoperative pain relief for the inpatient, it may be undesirable or cause for concern in the ambulatory patient because of the potential for falls with a partially insensate/weak lower extremity. Likewise, prolonged upper-extremity blockade may impede the ability to perform daily tasks, such as dressing and grooming. Consequently, a medium-acting agent may be more appropriate in the outpatient setting for orthopedic procedures with minimal to moderate postoperative pain. In general, equipotent concentrations of the long-acting amides have a similar onset and quality of block. However, bupivacaine may have a slightly longer duration than levobupivacaine or ropivacaine. Likewise, higher concentrations are more likely to be associated with profound sensory *and* motor block, whereas infusions of 0.1–0.2% bupivacaine or ropivacaine may not result in motor blockade (and allow complete weight bearing with lower-extremity techniques). Recent investigations suggest that increasing the local anesthetic concentration alters the character (i.e., degree of sensory and/or motor block), but not the duration.

The lowest effective dose and concentration should be used to minimize local anesthetic systemic and neural toxicity. It is important to note that the recommendations for maximum doses of local anesthetics were established by the manufacturers (Table 48–1).<sup>15</sup> Maximum doses based on patient weight (with the exception of the pediatric population) also are not evidence based. Recommendations for 24-hour doses of local anesthetics also were established without controlled studies. In essence, the safe dose of a local anesthetic should be individualized based on site of injection, patient age, and the presence of medical conditions that affect local anesthetic pharmacology and toxicity. These considerations are believed to be most critical when large doses of local anesthetics are injected, or in association with repeated blocks/continuous infusions because of the potential for local anesthetic accumulation.

## Adjuvants Epinephrine

Epinephrine decreases local anesthetic uptake and plasma levels, improves the quality of block, and increases the duration of postoperative analgesia during lower-extremity peripheral blockade.

TABLE 48–1.

### Recommended Maximum Doses of Local Anesthetics

Local Anesthetic	Maximum Dose (mg)
2-chloroprocaine	800
With epinephrine	1000
Lidocaine	300
With epinephrine	500
Mepivacaine	400
With epinephrine	550
Bupivacaine	175
	400 mg/24 h
With epinephrine	225
Levobupivacaine	150
	400 mg/24 h
With epinephrine	NA
Ropivacaine	225
	800 mg/24 h
With epinephrine	225

Reprinted from Rosenberg PH, Veering BT, Urmev WF. Maximum recommended doses of local anesthetics: a multifactorial concept. *Reg Anesth Pain Med* 2004;29:564, with permission from American Society of Regional Anesthesia and Pain Medicine.

Epinephrine also allows for the early detection of intravascular injection. Importantly, concentrations of epinephrine ranging from 1.7–5 µg/mL (1:600,000 to 1:200,000 dilution) reduce the uptake and prolong the blockade of medium duration local anesthetics to a similar extent. However, concentrations of 1.7–2.5 µg/mL have little effect on nerve blood flow, which theoretically may reduce the risk of nerve injury for patients with a preexisting angiopathy or neuropathy. In addition, larger doses of epinephrine injected systemically may cause undesirable side effects in patients with known cardiac disease. Concerns regarding neural or cardiac ischemia must be balanced with the need to detect intravascular injection. In general, because of the high doses of local anesthetics administered during peripheral block, the benefits of adding epinephrine outweigh the risks.<sup>16</sup>

Commercially prepared solutions with epinephrine have a lower pH than those in which it is freshly added, resulting in a higher percentage of ionized drug molecules. These ionized molecules do not readily cross the neural membrane, delaying the onset of local anesthetic action after injection. Epinephrine should not be added for ankle block. The addition of epineph-



rine to local anesthetics with intrinsic vasoconstrictive properties, such as ropivacaine, may not increase block duration, but would still facilitate detection of intravascular injection.

### Clonidine

Clonidine consistently prolongs the time to first analgesia when added to intermediate-acting agents during brachial plexus blockade. The effect is most likely peripherally mediated and dose dependent. Side effects such as hypotension, bradycardia, and sedation do not occur with a dose less than 1.5 µg/kg or with a maximum dose of 150 µg. Conversely, the efficacy of clonidine as an adjuvant for lower-extremity single injection and continuous techniques is less defined. Most studies report a modest (20%) prolongation with the addition of clonidine to long-acting local anesthetic solutions.<sup>7,14,17</sup>

### Opioids

Although opioids, including morphine, sufentanil, and fentanyl, are often added to lumbar plexus infusions, there are no convincing data to suggest that block onset, quality, or duration is improved when opioids are added to the local anesthetic solution.<sup>7,14</sup>

### Systemic Local Anesthetic Toxicity

The potential for systemic local anesthetic toxicity would seem to be very high for peripheral nerve blocks because of the relatively large doses of local anesthetic commonly injected and the proximity of needle/catheter insertion to vascular structures and highly vascularized muscle beds. The few cases of systemic toxicity requiring resuscitation occurred shortly after injection, suggesting that it is accidental intravascular injection, rather than systemic absorption, that is the mechanism. Prevention and treatment of local anesthetic toxicity is dependent on the injection of an appropriate volume and concentration of local anesthetic, the use of a vasoconstrictor adjuvant slow injection with frequent aspiration, and increased vigilance for the early detection and treatment of toxic reactions. It is notable that local anesthetic levels peak at approximately 60 minutes following deposition following peripheral block. Thus, patients should be appropriately monitored for signs and symptoms of rising blood levels for this duration. Resuscitation equipment and medications should also be readily available.

## UPPER-EXTREMITY BLOCKS

Successful regional anesthesia of the upper extremity requires knowledge of brachial plexus anatomy from its origin as the nerves emerge from the intervertebral foramina to its termination in the peripheral nerves. Detailed anatomic knowledge enables the anesthesiologist to choose the appropriate technique for the intended surgical procedure and to salvage “inadequate” blocks with local anesthetic supplementation. Without mastery of the anatomy, luck rather than skill will be the primary determinant of successful neural blockade. Also important is an understanding of the side effects and complications of upper-extremity regional techniques, as well as the clinical application of available local anesthetics for these blocks. Finally, one must not underestimate the role of appropriate sedation during placement of the block as well as during the surgical procedure. Many a “perfect” regional anesthetic technique has been undone by inadequate management of sedation.

### Cervical Plexus Blockade

Blockade of the cervical plexus is briefly discussed because of the overlapping innervation of the cervical and brachial plexus. Supplementation of a proximal brachial plexus technique with a deep or superficial cervical plexus block is often required to assure complete blockade of the surgical site.

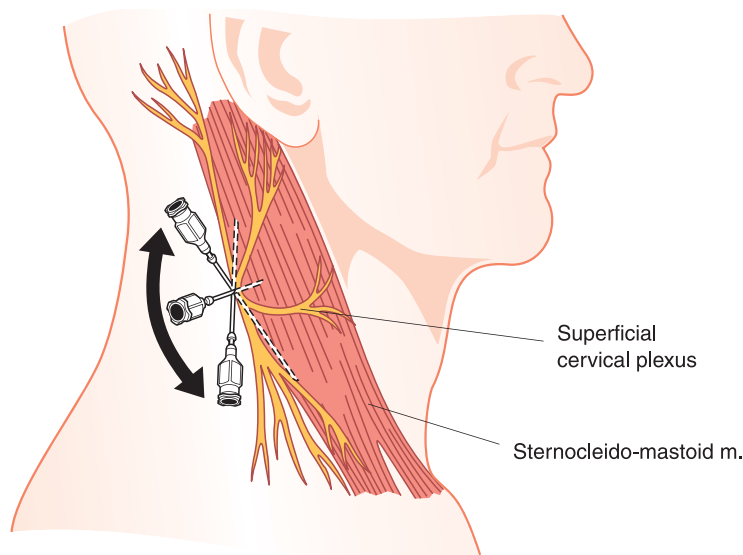
The cervical plexus is derived from the C1, C2, C3, and C4 spinal nerves and supplies branches to the prevertebral muscles, strap muscles of the neck, and phrenic nerve. The deep cervical plexus supplies the musculature of the neck segmentally, as well as the cutaneous sensation of the skin between the trigeminally innervated face and the T2 dermatome of the trunk. Blockade of the superficial cervical plexus results in anesthesia of only the cutaneous nerves.

### Clinical Applications

Blocks of the cervical plexus are easy to perform and provide anesthesia for surgical procedures in the distribution of C2 to C4, including lymph node dissections, plastic repairs, and carotid endarterectomy. The ability to monitor the awake patient's neurologic status continuously is an advantage of this anesthetic technique for the latter procedure and has resulted in an upsurge in the popularity of this technique.<sup>18,19</sup> Bilateral blocks can be used for tracheostomy and thyroidectomy.

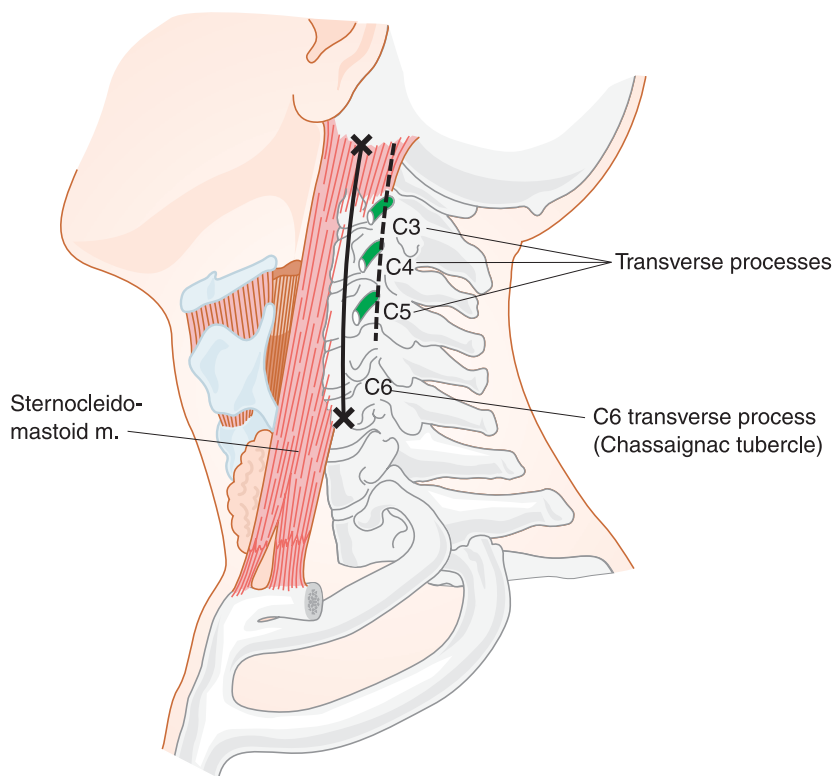
### Techniques

**Superficial Cervical Plexus** The superficial cervical plexus is blocked at the midpoint of the posterior border of the sternocleidomastoid muscle. A skin wheal is made at this point, and a 22-gauge, 4-cm needle is advanced, injecting 5 mL of solution along the posterior border and medial surface of the sternocleidomastoid muscle (Fig. 48-1). It is possible to block the acces-



**FIGURE 48-1.** Anatomic landmarks and method of needle placement for superficial cervical plexus block. (Reprinted from Wedel DJ, Horlocker TT. Nerve blocks. In: Miller RD, ed. Anesthesia. 6th ed. Philadelphia: Churchill Livingstone, 2005:1686–1717, with permission from Elsevier.)





**FIGURE 48-2.** Anatomic landmarks and method of needle placement for deep cervical plexus blocks at C2, C3, and C4. (Reprinted from Wedel DJ, Horlocker TT. Nerve blocks. In: Miller RD, ed. Anesthesia. 6th ed. Philadelphia: Churchill Livingstone, 2005:1686–1717, with permission from Elsevier.)

sory nerve with this injection, resulting in temporary ipsilateral trapezius muscle paralysis.

**Deep Cervical Plexus** The deep cervical plexus block is a paravertebral block of the C2 to C4 spinal nerves as they emerge from their foramina in the cervical vertebrae (Fig. 48-2). The traditional approach uses three separate injections at C2, C3, and C4. The patient lies supine with the neck slightly extended and the head turned away from the side to be blocked. A line is drawn connecting the tip of the mastoid process and the Chassaignac tubercle (transverse process of C6); a second line is drawn 1 cm posterior to this first line. The C2 transverse process lies 1–2 cm caudad to the mastoid process, where it can usually be palpated. The C3 and C4 transverse processes lie at 1.5-cm intervals along the second line. After skin wheals are raised over the transverse processes of C2, C3, and C4, three 22-gauge, 5-cm needles are advanced perpendicular to the skin entry site with a slight caudad

angulation. The transverse process is contacted at a depth of 1.5–3 cm. If a paresthesia is obtained, 3–4 mL of solution is injected after careful aspiration for blood and cerebrospinal fluid. If no paresthesia is elicited initially, the needle is walked along the transverse process in the anteroposterior plane until a paresthesia is obtained.

This block can also be performed with a single injection of 10–12 mL at the C4 transverse process.<sup>20</sup> Cephalad spread of the local anesthetic usually anesthetizes the C2 and C3 nerves. Cervical plexus anesthesia can also be observed after injection at the interscalene level for brachial plexus blockade. Maintenance of distal pressure and a horizontal or slightly head-down position may facilitate the onset of cervical plexus blockade using the interscalene technique.

### Side Effects/Complications

Although these blocks are technically straightforward, needle placement for the deep cervical block allows local anesthetic injection in close proximity

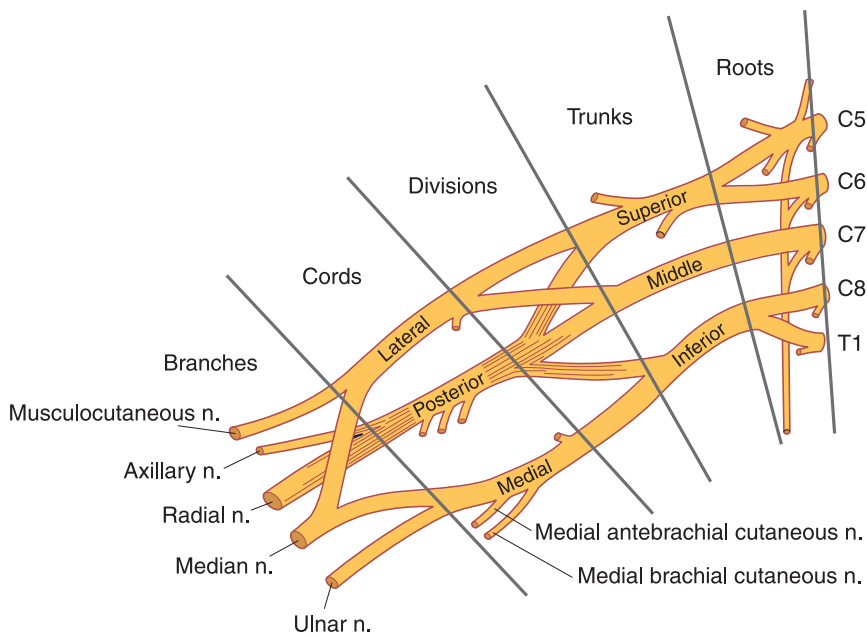
to a variety of neural and vascular structures. Reported complications and side effects include intravascular injection, blockade of the phrenic and superior laryngeal nerve, and spread of local anesthetic solution into the epidural and subarachnoid spaces.

### Brachial Plexus Anatomy

The brachial plexus is derived from the anterior primary rami of the fifth, sixth, seventh, and eighth cervical nerves and the first thoracic nerve, with variable contributions from the fourth cervical and second thoracic nerves. After leaving their intervertebral foramina, these nerves course anterolaterally and inferiorly to lie between the anterior and middle scalene muscles, which arise from the anterior and posterior tubercles of the cervical vertebra, respectively. The anterior scalene muscle passes caudad and laterally to insert into the scalene tubercle of the first rib; the middle scalene muscle inserts on the first rib posterior to the subclavian artery, which passes between these two scalene muscles along the subclavian groove. The prevertebral fascia invests both the anterior and middle scalene muscles, fusing laterally to enclose the brachial plexus in a fascial sheath.

Between the scalene muscles, these nerve roots unite to form three trunks, which emerge from the interscalene space to lie cephaloposterior to the subclavian artery as it courses along the upper surface of the first rib. Therefore, the “superior” (C5 and C6), “middle” (C7), and “inferior” (C8 and T1) trunks are arranged accordingly and are not in a strict horizontal formation, as often depicted. At the lateral edge of the first rib, each trunk forms anterior and posterior divisions that pass posterior to the midportion of the clavicle to enter the axilla. Within the axilla, these divisions form the lateral, posterior, and medial cords, named for their relationship with the second part of the axillary artery. The superior divisions from the superior and middle trunks form the lateral cord, the inferior divisions from all three trunks form the posterior cord, and the anterior division of the inferior trunk continues as the medial cord.

At the lateral border of the pectoralis minor, the three cords divide into the peripheral nerves of the upper extremity. The lateral cord gives rise to the lateral head of the median nerve and



**FIGURE 48-3.** Roots, trunks, divisions, cords, and branches of the brachial plexus. (Reprinted from Wedel DJ, Horlocker TT. Nerve blocks. In: Miller RD, ed. Anesthesia. 6th ed. Philadelphia: Churchill Livingstone, 2005:1686–1717, with permission from Elsevier.)

the musculocutaneous nerve; the medial cord gives rise to the medial head of the median nerve, as well as the ulnar, the medial antebrachial, and the medial brachial cutaneous nerves; and the

posterior cord divides into the axillary and radial nerves (Fig. 48-3).

Aside from the branches from the cords that form the peripheral nerves as described, several branches arise

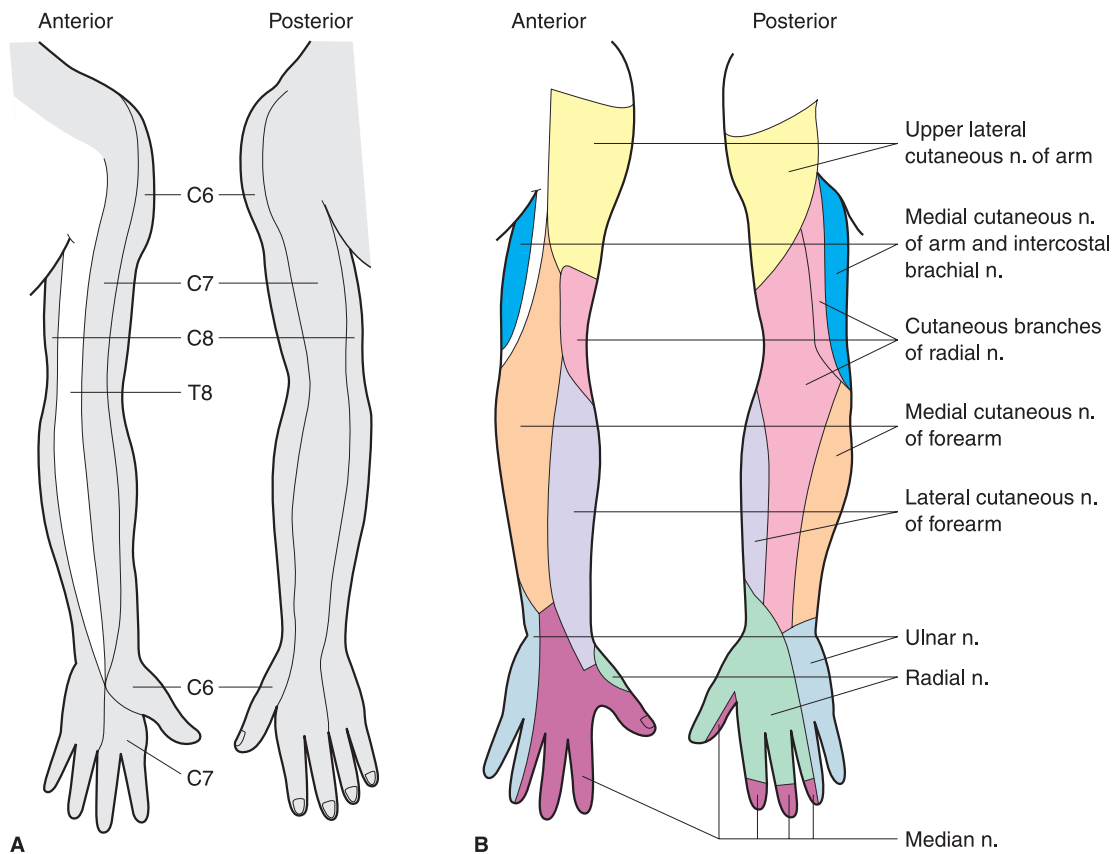
from the roots of the brachial plexus providing motor innervation to the rhomboid muscles (C5), the subclavian muscles (C5 and C6), and the serratus anterior muscle (C5, C6, and C7). The suprascapular nerve arises from C5 and C6 and supplies the muscles of the dorsal aspect of the scapula, as well as making a significant contribution to the sensory supply of the shoulder joint.

Branches arising from the cervical roots are usually blocked only with the interscalene approach to the brachial plexus. Figure 48-4 shows the sensory distributions of the cervical roots and the peripheral nerves.

## Interscalene Block

### Clinical Applications

The principal indication for interscalene block is surgery on the shoulder. Blockade occurs at the level of the upper and middle trunks. Although this approach can be used for forearm and hand surgery, blockade of the inferior trunk (C8 through T1) is often incomplete and requires supplementation at the ulnar nerve for adequate surgical anesthesia in that distribution.<sup>21</sup> In addition, supplementation with a suprascapular nerve



**FIGURE 48-4.** A. Cutaneous distribution of the cervical roots. B. Cutaneous distribution of the peripheral nerves. (Reprinted from Wedel DJ, Horlocker TT. Nerve blocks. In: Miller RD, ed. Anesthesia. 6th ed. Philadelphia: Churchill Livingstone, 2005:1686–1717, with permission from Elsevier.)

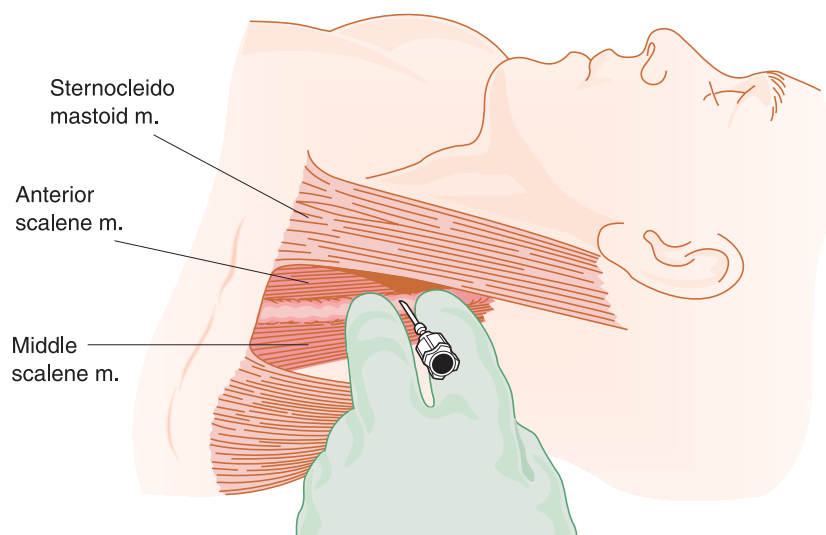
block may further prolong the analgesic effect.<sup>7</sup>

### Technique

The brachial plexus shares a close physical relationship with several structures that serve as important landmarks for the performance of interscalene block. In its course between the anterior and middle scalene muscles, the plexus is superior and posterior to the second and third parts of the subclavian artery. The dome of the pleura lies anteromedial to the inferior trunk.

This technique can be performed with the patient's arm in any position and is technically simple because of easy identification of necessary landmarks.<sup>22</sup> The patient should be in the supine position with the head turned away from the side to be blocked. The posterior border of the sternocleidomastoid muscle is readily palpated by having the patient briefly lift the head. The interscalene groove may be palpated by rolling the fingers posterolaterally from this border over the belly of the anterior scalene muscle into the groove. A line is extended laterally from the cricoid cartilage to intersect the interscalene groove indicating the level of the transverse process of C6. Although the external jugular vein often overlies this point of intersection, it is not a constant or reliable landmark.

The use of a nerve stimulator or elicitation of a paresthesia is recommended with this technique so as to place the local anesthetic solution accurately. After ordinary sterile precautions and injection of a skin wheal, a 22- to 25-gauge, 4-cm needle is inserted medially with a 45° caudad and slightly posterior angle (Fig. 48-5). The needle is then advanced until a paresthesia (usually C5 and C6 dermatomes) or nerve stimulator response is elicited. This usually occurs at a very superficial level. Paresthesia/motor response to the arm or shoulder are equally efficacious.<sup>23</sup> If a blunt needle bevel is used, a "click" may be detected as the needle passes through the prevertebral fascia. Should bone be encountered within 2 cm of the skin, it is likely to be a transverse process, and the needle may be "walked" across this structure to locate the nerve. Likewise, contraction of the diaphragm indicates phrenic nerve stimulation and anterior needle placement; the needle should be redirected posteriorly to locate the brachial plexus.



**FIGURE 48-5.** Interscalene block. The fingers palpate the interscalene groove, and the needle is inserted with a caudad and slightly posterior angle. (Reprinted from Wedel DJ, Horlocker TT. Nerve blocks. In: Miller RD, ed. Anesthesia. 6th ed. Philadelphia: Churchill Livingstone, 2005:1686–1717, with permission from Elsevier.)

Once the appropriate paresthesia or motor response is obtained, the needle is stabilized. The use of flexible extension tubing facilitates the maintenance of the needle position while aspiration and injection occur. After negative aspiration, 10–40 mL of solution is injected incrementally, depending on the desired extent of blockade. Radiographic studies suggest a volume-to-anesthesia relationship with 40 mL of solution associated with complete cervical and brachial plexus block.<sup>22</sup> Clinical studies, however, indicate variable blockade of the lower trunk, which includes the ulnar nerve, even with large volumes of solution.<sup>21</sup> Digital pressure above the injection site and downward massage along with a 45° head-up position may facilitate caudad spread and blockade of the lower trunk.

### Side Effects/Complications

Ipsilateral phrenic nerve block resulting in diaphragmatic paresis occurs in 100% of patients undergoing interscalene blockade,<sup>24</sup> even with dilute solutions of local anesthetics, and is associated with a 25% reduction in pulmonary function.<sup>25,26</sup> This effect is probably a consequence of anterior spread of the solution over the anterior scalene muscle and may cause subjective symptoms of dyspnea. Although rare, respiratory compromise can occur in patients with severe

respiratory disease. A case of lower-lobe collapse (at home) during continuous interscalene infusion has been reported, documenting the need for careful patient selection and ongoing monitoring.<sup>27</sup>

Involvement of the vagus, recurrent laryngeal, and cervical sympathetic nerves is rarely significant, but the patient experiencing symptoms related to these side effects may require reassurance. The risk of pneumothorax is low when the needle is correctly placed at the C5 or C6 level because of the distance from the dome of the pleura.

Severe hypotension and/or bradycardia (Bezold-Jarisch reflex) have been reported in awake, sitting patients undergoing shoulder surgery under interscalene block. The etiology is presumed to be stimulation of intracardiac mechanoreceptors (by decreased venous return), producing an abrupt withdrawal of sympathetic tone, as well as enhanced parasympathetic output. This results in bradycardia, hypotension, and syncope. The frequency is decreased when prophylactic  $\beta$ -blockers are administered.<sup>28</sup>

Nerve damage or neuritis can occur in any peripheral nerve block, but it is uncommon and usually is self-limited. Some surgical approaches to the shoulder are associated with neurologic risk to the brachial plexus, for example, total shoulder arthroplasty.<sup>29</sup> In such cases, interscalene block should be

placed postoperatively for pain relief after the surgical service has ascertained and documented that no neurologic damage has occurred. Epidural and intrathecal injections have been reported with this block, a finding emphasizing the importance of inserting the needle in a caudad direction. The proximity of significant neurovascular structures may increase the risk of serious neurologic complications when interscalene block is performed in heavily sedated or anesthetized patients.<sup>30</sup>

Several vascular structures are in close proximity to a correctly placed needle. Local anesthetic toxicity as a result of intravascular injection should be guarded against by careful aspiration and incremental injection. Seizure activity secondary to this complication is particularly undesirable following rotator cuff surgery, because the repair can be compromised by the associated muscular activity.

## Supraclavicular Block

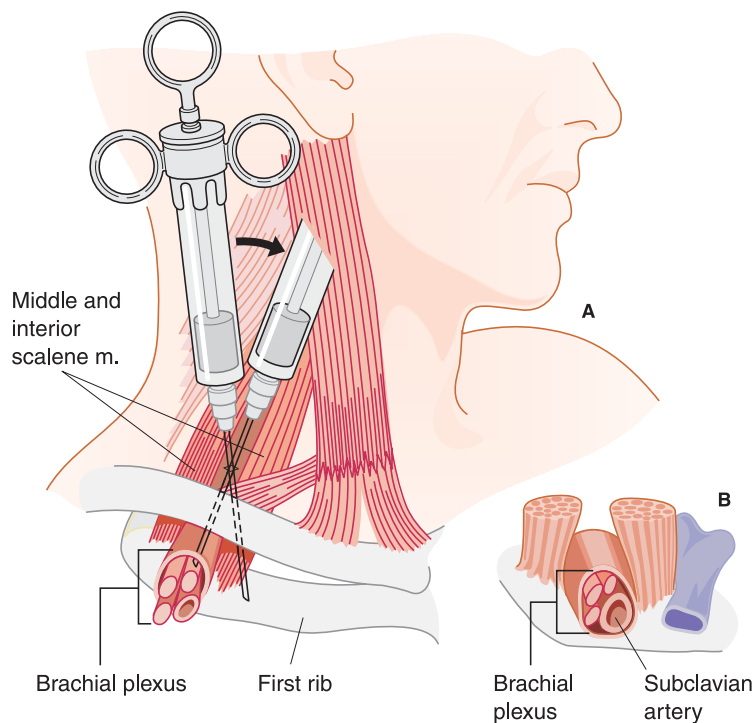
### Clinical Applications

Indications for supraclavicular block are surgery to the elbow, forearm, and hand. Blockade occurs at the distal trunk–proximal division level. At this point, the brachial plexus is compact and a small volume of solution produces rapid onset of reliable blockade of the brachial plexus. An additional advantage is that the block can also be performed with the patient's arm in any position.

Reliable supraclavicular blockade requires elicitation of a paresthesia or motor response. The classic block may be somewhat difficult to describe and to teach. Observation of an experienced anesthesiologist is perhaps the best way to learn the technique. A proposed modification of the technique, the so-called plumb-bob approach, may decrease complications and may simplify the vertical concept of this block.<sup>31</sup>

### Technique

Several anatomic points are important in the performance of the supraclavicular approach. The three trunks are clustered vertically over the first rib cephaloposterior to the subclavian artery, which can often be palpated in a slender, relaxed patient. The neurovascular bundle lies inferior to the clavicle at about its midpoint. The first rib acts as a medial barrier to the needle's reaching the pleural dome and is short, broad, and flat, with an



**FIGURE 48-6.** A. Supraclavicular block. The needle is systematically walked anteriorly and posteriorly along the rib until the plexus is located. B. The three trunks are compactly arranged at the level of the first rib. (Reprinted from Wedel DJ, Horlocker TT. Nerve blocks. In: Miller RD, ed. Anesthesia. 6th ed. Philadelphia: Churchill Livingstone, 2005:1686–1717, with permission from Elsevier.)

anteroposterior orientation at the site of the plexus.

The patient is placed in a supine position, with the head turned away from the side to be blocked. The arm to be anesthetized should be adducted and the hand should be extended along the side toward the ipsilateral knee as far as possible. In the classic technique, the midpoint of the clavicle should be identified and marked. The posterior border of the sternocleidomastoid can be easily palpated when the patient raises the head slightly. The palpating fingers can then roll over the belly of the anterior scalene muscle into the interscalene groove, where a mark should be made approximately 1.5–2.0 cm posterior to the midpoint of the clavicle. Palpation of the subclavian artery at this site confirms the landmark.

After appropriate preparation and injection of a skin wheal, the anesthesiologist stands at the side of the patient facing the patient's head. A 22-gauge, 4-cm needle is directed in a caudad, slightly lateral and posterior direction until either a paresthesia or motor response is elicited or the first rib is encountered. If a syringe is attached,

this orientation causes the needle shaft and syringe to lie almost parallel to a line joining the skin entry and the patient's ear. If the first rib is encountered without elicitation of a paresthesia, the needle can be systematically walked anteriorly and posteriorly along the rib until the plexus or the subclavian artery is located (Fig. 48-6). Location of the artery provides a useful landmark; the needle can be withdrawn and reinserted in a more posterolateral direction that will usually result in a paresthesia or motor response. Upon localization of the brachial plexus, aspiration for blood should be performed prior to incremental injections of a total volume of 20–30 mL of solution.

Usually, the rib is contacted at a needle depth of 3–4 cm; however, in an obese patient or in the presence of tissue distortion resulting from hematoma or injection of solution, the depth may exceed the needle length. Nonetheless, gentle probing in the anterior and posterior directions should be done at the 2–3-cm depth if paresthesias are not obtained before the needle is advanced farther. Multiple injections may improve the quality or may shorten the onset of blockade.



The modified vertical (plumb-bob) approach uses similar patient positioning, although the needle entry site is at the point at which the lateral border of the sternocleidomastoid muscle inserts into the clavicle. After preparation and injection of a skin wheal, a 22-gauge, 4-cm needle is inserted while mimicking a plumb-bob suspended over the needle entry site. Often, a paresthesia or motor response is elicited prior to contacting the first rib or artery. If no paresthesia or motor response is elicited, the needle is reinserted while angling the tip of the needle cephalad, and finally caudad in small steps until the first rib is contacted (Fig. 48–7).

### Side Effects/Complications

The prevalence of pneumothorax following supraclavicular block ranges from 0.5–6% and diminishes with experience. The onset of symptoms is usually delayed and may take up to 24 hours. Consequently, routine chest radiography after the block is not justified. The supraclavicular approach is best avoided when the patient is uncooperative or cannot tolerate any degree of respirato-

ry compromise because of underlying disease. Other complications include frequent phrenic nerve block (40–60%), Horner syndrome, and neuropathy. The presence of phrenic or cervical sympathetic nerve block usually requires only reassurance. Although nerve damage can occur, it is uncommon and usually is self-limited.

### Infraclavicular Block

#### Clinical Applications

Infraclavicular block provides anesthesia to the arm and hand. Blockade occurs at the level of the cords and offers the theoretic advantages of avoiding pneumothorax while affording block of the musculocutaneous and axillary nerves. No special arm positioning is required. A nerve stimulator is required because there are no palpable vascular landmarks to aid in directing the needle. Historically, this approach was considered to be more painful than blockade at the axillary level. However, this has been refuted by recent investigations.<sup>32</sup> In addition, this approach is optimal for indwelling brachial plexus catheters because of the ease of site maintenance.

#### Technique

The needle is inserted 2 cm below the midpoint of the inferior clavicular border and is advanced laterally, using a nerve stimulator to identify the plexus.<sup>33</sup> Marking a line between the C6 tubercle and the axillary artery with the arm abducted is helpful in visualizing the course of the plexus. An incremental injection of 20–30 mL of solution is sufficient once the needle is correctly placed. Stimulation of the posterior cord or a multiple injection technique improves success rate.<sup>34,35</sup>

A coracoid technique, with the needle insertion site 2 cm medial and 2 cm caudal to the coracoid process, has also been described.<sup>36</sup> However, the more lateral insertion site may result in the absence of blockade of the musculocutaneous nerve, removing the major advantage of this approach over the simpler axillary block.

#### Side Effects/Complications

Because of the necessarily blind approach to the plexus, the risk of intravascular injection may be increased. Exaggerated medial needle direction may result in pneumothorax. A 30% reduction in pulmonary function as a consequence of diaphragmatic paresis is noted in the majority of patients;

this could result in respiratory failure. These effects should be considered when evaluating a patient for this technique.<sup>37,38</sup> Other rare complications, such as infection and hematoma, are theoretically possible.

### Axillary Block

#### Clinical Applications

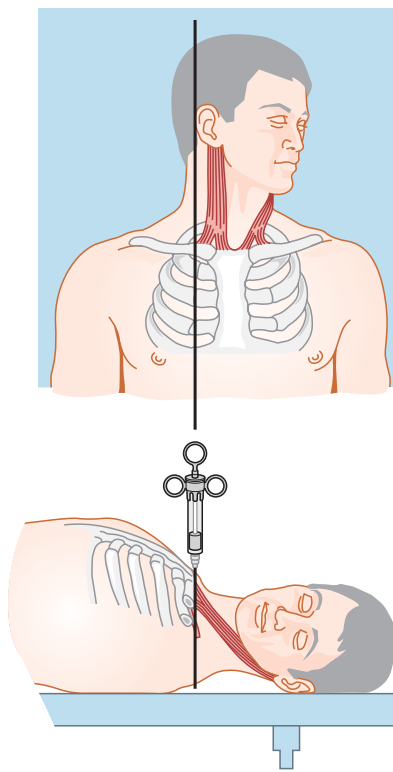
The axillary approach to the brachial plexus is the most popular because of ease of block, reliability, and safety.<sup>39</sup> Blockade occurs at the level of the terminal nerves. Although blockade of the musculocutaneous nerve is not always produced with this approach, it can be supplemented at the level of the axilla or at the elbow. Indications for axillary block include surgery to the forearm and hand. Elbow procedures are also successfully performed using the axillary approach.<sup>40</sup> This block is ideally suited for outpatients and is easily adapted to the pediatric population.<sup>41,42</sup> However, axillary block is unsuitable for surgical procedures on the upper arm or shoulder and the patient must be able to abduct the arm to perform the block.

#### Technique

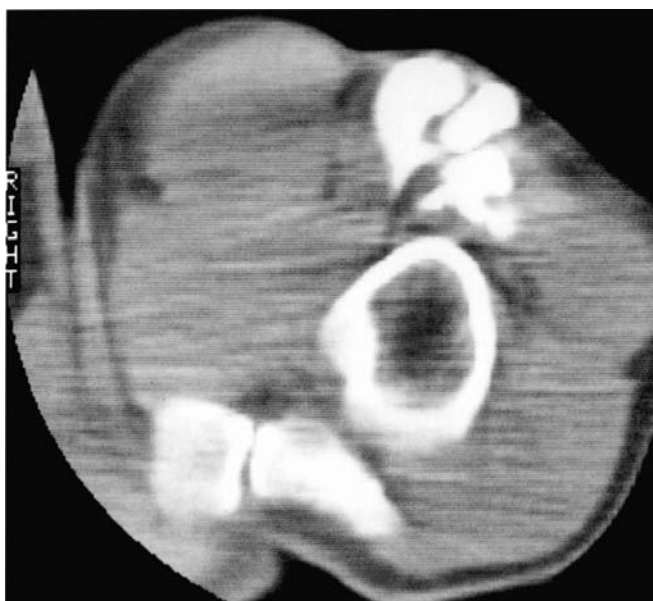
Anatomic concepts that should be considered prior to performing an axillary block include the following:

1. The neurovascular bundle is multi-compartmental (Fig. 48–8).<sup>43</sup>
2. The axillary artery is the most important landmark; the nerves maintain a predictable orientation to the artery.
3. The median nerve is found superior to the artery, the ulnar nerve is inferior, and the radial nerve is posterior and somewhat lateral (Fig. 48–9).
4. At this level, the musculocutaneous nerve has already left the sheath and lies in the substance of the coracobrachialis muscle.
5. The intercostobrachial nerve, a branch of the T2 intercostal nerve, is usually blocked by the skin wheal overlying the artery; however, adequate anesthesia for the tourniquet can be ensured by extending the wheal 1–2 cm caudad and cephalad.

The patient should be in the supine position with the arm to be blocked placed at a right angle to the body, with the elbow flexed to 90°. The dorsum of the hand rests on the bed or



**FIGURE 48–7.** Supraclavicular block. Plumb-bob approach. (Reprinted from Wedel DJ, Horlocker TT. Nerve blocks. In: Miller RD, ed. Anesthesia. 6th ed. Philadelphia: Churchill Livingstone, 2005:1686–1717, with permission from Elsevier.)



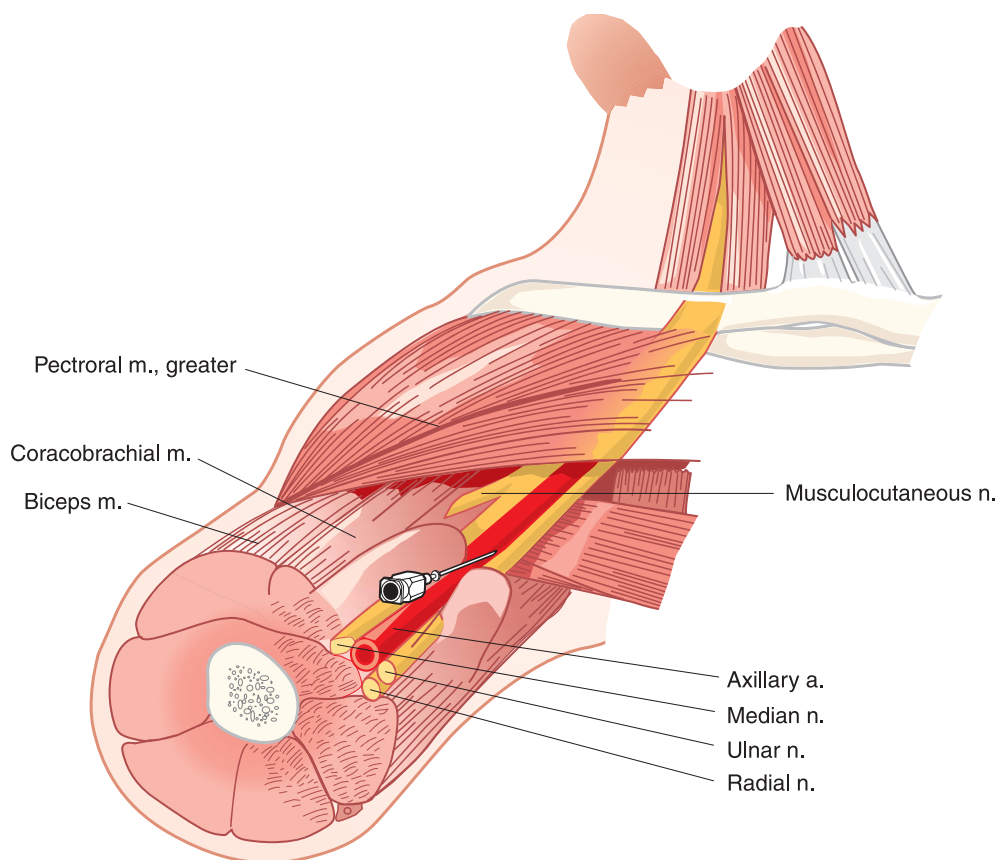
**FIGURE 48-8.** Axillary block. Computed tomogram after axillary block with bupivacaine 0.5% and iodothalamate. Separate injections of 10-mL solution were made after obtaining median and radial nerve paresthesia and transarterially. Contrast medium appears to remain in three separate compartments. (Reprinted from Wedel DJ, Horlocker TT. Nerve blocks. In: Miller RD, ed. Anesthesia. 6th ed. Philadelphia: Churchill Livingstone, 2005:1686–1717, with permission from Elsevier.)

pillow; hyperabduction of the arm with placement of the hand beneath the patient's head is not recommended because this position frequently obliterates the pulse.

The axillary artery is palpated, and a line is drawn tracing its course from the lower axilla as far proximally as possible. The artery is then fixed against the patient's humerus by the index and middle fingers of the left hand, and a skin wheal is raised directly over the artery at a point in the axilla approximating the skin crease. Proximal needle placement and maintenance of distal pressure facilitate proximal spread of the solution.

### **Method of Needle Localization**

Several methods of identifying the axillary sheath have been described, all with reportedly good results. Overall, paresthesia is unnecessary. However, multiple injections may shorten the onset and may improve the reliability of blockade.



**FIGURE 48-9.** Axillary block. The arm is abducted at right angles to the body. Distal digital pressure is maintained during needle placement and injection of local anesthetic. (Reprinted from Wedel DJ, Horlocker TT. Nerve blocks. In: Miller RD, ed. Anesthesia. 6th ed. Philadelphia: Churchill Livingstone, 2005:1686–1717, with permission from Elsevier.)

1. Paresthesias can be sought with a 25-gauge, 2-cm needle, beginning either deep (radial nerve) or with the nerves supplying the surgical site. Needles longer than 2 cm are rarely needed to reach the neurovascular bundle; smaller needles and a short-bevel needle may be associated with a lower risk of nerve damage.<sup>41,44</sup> Ten milliliters of local anesthetic is injected at each paresthesia.
2. A nerve stimulator can also be employed with an insulated needle to locate the nerves. This technique obviates the need for paresthesia. However, this has not been proven to lower the risk of nerve damage.<sup>45,46</sup>
3. A short-bevel needle can be advanced until the “axillary sheath” is entered, as evidenced by a “fascial click,” whereupon 40–50 mL of solution is injected after negative aspiration.<sup>39,47</sup>
4. A transarterial technique can be employed, whereby the needle pierces the artery and 40–50 mL of solution is injected posterior to the artery; or, alternatively, half the solution is injected posterior and half anterior to the artery. Great care must be taken to avoid intravascular injection with this technique, particularly because the pressure of injection within the compartments of the axillary sheath may move anatomic structures in relation to the immobile needle. Some practitioners avoid intentional arterial puncture in the belief that it is unnecessarily traumatic.
5. Field block of the brachial plexus with a fanwise injection of 10–15 mL of local anesthetic solution on each side of the artery is a variation of the sheath technique. Paresthesias, although not sought, are often encountered in this technique and provide evidence of correct placement.

When the injection is completed, the arm should be adducted and returned to the patient's side. This prevents the humeral head from obstructing proximal flow of the solution; distal pressure and massage may also help. Vester-Andersen et al.<sup>48</sup> were unable to consistently block the musculocutaneous nerve with volumes up to 80 mL. Thus, if the musculocutaneous nerve is not blocked by the axillary approach, it can be blocked by injection within the body of the coracobrachialis muscle or at the elbow

superficially at the lateral aspect of the antecubital fossa just above the interepicondylar line.

### **Success Rate with Axillary Block Techniques**

Success rate for axillary block depends on how a successful block is defined (surgical anesthesia vs. blockade of all four terminal nerves of the upper extremity), the technique used to localize the brachial plexus, and the number of injections. Success rates with single-injection techniques are variable.<sup>49,50</sup> Thompson and Rorie<sup>43</sup> concluded that the presence of multiple compartments limits diffusion of the solution (and the success of single-shot techniques). Although Partridge et al.<sup>51</sup> confirmed the presence of these compartments, they concluded that the “septa” dividing them were incomplete on the basis of injections of methylene blue and latex solutions into cadavers.

Eliciting a paresthesia is as efficacious as peripheral nerve stimulation (with a motor response of 0.5–0.8 mA). In addition, most studies suggest that two-injection transarterial techniques are equivalent to single paresthesia or single nerve stimulation approaches. In general, the efficacy of paresthesia and peripheral nerve stimulator techniques increases when multiple injections are employed. Conversely, success rates with perivascular or fascial click approaches are variously reliable.<sup>7</sup> Familiarity with a variety of techniques for axillary block of the brachial plexus allows the anesthesiologist maximal flexibility in tailoring the anesthetic approach to the clinical situation.

### **Side Effects/Complications**

Nerve injury and systemic toxicity are the most significant complications associated with the axillary approach. The assertion that neuropathies are more common with the paresthesia technique may be valid, but it is not supported by the available data. In addition, even when paresthesias are not sought, they often occur unintentionally.<sup>52</sup> Injection of large volumes of local anesthetic, particularly with the transarterial approach, increases the risk of intravascular injection and systemic local anesthetic toxicity. Hematoma and infection are rare complications. Central neural blockade and pneumothorax are not complications, as in other approaches to the brachial plexus.

## **Peripheral Blocks at the Midhumeral Level, Elbow, and Wrist**

### **Clinical Applications**

As techniques for brachial plexus blockade have gained popularity, indications for peripheral nerve blockade at the wrist and elbow have diminished. However, these techniques can be useful when limited anesthesia is required, when contraindications to brachial plexus block (infection, bilateral surgery, coagulation abnormalities, bleeding diathesis, difficult anatomy) exist, and when brachial plexus blockade is incomplete. Only the midhumeral approach provides anesthesia for the use of a tourniquet. Most patients tolerate an inflated tourniquet for only a brief period.

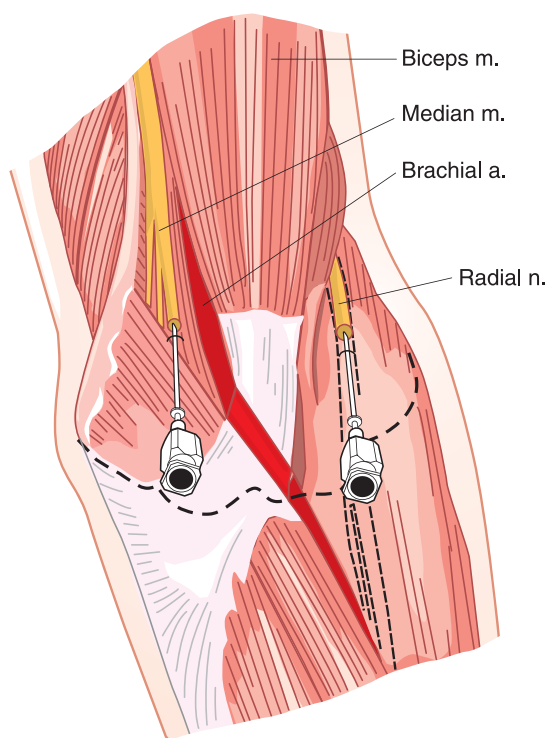
### **Midhumeral Block**

A midhumeral approach to the brachial plexus has been described. This novel approach involves blocking each of the four nerves of the brachial plexus separately in the humeral canal at the level of the proximal one-third and distal two-thirds of the humerus. At this level, the median and ulnar nerves are located on the lateral and medial aspects of the brachial artery, respectively. The musculocutaneous nerve is identified within the body of the biceps muscle, while the radial nerve lies adjacent to the humerus. Eight to 10 mL of local anesthetic is injected after localization of each nerve with a nerve stimulator. Midhumeral block is reported to have a higher success rate than traditional (defined as stimulation of two nerves) axillary brachial plexus block.<sup>53</sup> In this study, time to complete the block did not differ between the two techniques; however, onset of complete sensory block was shorter in the axillary approach, whereas the success rate of blockade of all four major nerves was higher in the midhumeral group. This technique may have applications when anatomic difficulties preclude a traditional approach or when the surgical procedure requires a dense block of all four major nerves.

### **Median Nerve Block**

Block of the median nerve provides anesthesia of the palmar aspects of the thumb and index finger, middle finger, and radial half of the ring finger, and the nail beds of the same digits. Motor block includes the muscles of the thenar eminence, lumbrical muscles of





**FIGURE 48-10.** Anatomic landmarks for median and radial nerve block at the elbow. (Reprinted from Wedel DJ, Horlocker TT. *Nerve blocks*. In: Miller RD, ed. *Anesthesia*. 6th ed. Philadelphia: Churchill Livingstone, 2005:1686–1717, with permission from Elsevier.)

the first and second digits, and, in the case of the block at the elbow, median-innervated wrist flexor muscles of the forearm.

**Technique at the Elbow** With the patient's arm placed in the anatomic position (palm up), a line is drawn connecting the medial and lateral epicondyles of the humerus. The major landmark for this technique is the brachial artery, which is found medial to the biceps tendon at the intercondylar line. The median nerve lies medial to the artery (Fig. 48-10) and can be blocked with 3–5 mL of solution after eliciting a paresthesia. If no paresthesia is obtained, the solution can be injected fanwise medial to the palpated artery.

**Technique at the Wrist** The median nerve is located between the flexor carpi radialis and palmaris longus tendons and can be blocked at a point 2–3 cm proximal to the wrist crease (Fig. 48-11). (The palmaris longus tendon is congenitally or postsurgically absent from some patients.) A loss of resistance is felt as the needle passes through the flexor retinaculum, at which point 2–4 mL of solu-

tion should be injected. A superficial palmar branch supplying the skin of the thenar eminence can be blocked by injecting 0.5–1 mL of solution subcutaneously above the retinaculum. Paresthesia should not be sought because of the confinement of this nerve within the carpal tunnel.

### Radial Nerve Block

Block of the radial nerve provides anesthesia to the lateral aspect of the dorsum of the hand (thumb side) and the proximal portion of the thumb, index, middle, and lateral half of the ring fingers.

**Technique at the Elbow** The radial nerve can be blocked at the elbow as it passes over the anterior aspect of the lateral epicondyle. The intercondylar line and lateral edge of the biceps tendon are marked. A 22-gauge, 3–4-cm needle is inserted at a point 2 cm lateral to the biceps tendon and is advanced until bone is encountered (Fig. 48-12). A fanwise injection is made using 3–5 mL of solution.

**Technique at the Wrist** The radial nerve block at the wrist is a field block of the multiple peripheral branches de-

scending along the dorsum and radial side of the wrist. The extensor pollicis longus tendon can be identified when the patient extends the thumb. The needle insertion is over this tendon at the base of the first metacarpal; the injection is superficial to the tendon. Two milliliters of local anesthetic is injected proximally along the tendon, and an additional 1 mL is injected as the needle passes at a right angle across the “anatomic snuffbox” (Fig. 48-12).

### Ulnar Nerve Block

Blockade of the ulnar nerve provides anesthesia of the ulnar side of the hand, the little finger, and the ring finger and all the small muscles of the hand, except those of the thenar eminence and the first and second lumbrical muscles.

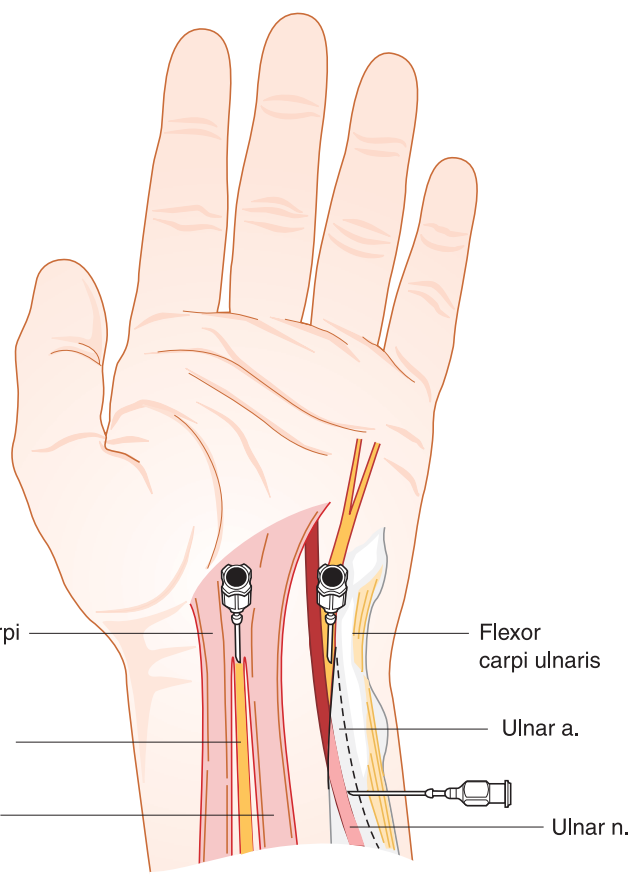
**Technique at the Elbow** Although the ulnar nerve is easily accessible at its subcutaneous position posterior to the medial epicondyle, blockade at this site is associated with a high incidence of neuritis. The nerve is surrounded by fibrous tissue at this point, requiring an intraneural injection for successful blockade. Use of a very fine needle along with a small volume of solution (1 mL) diminishes the risk; however, the nerve can be satisfactorily blocked with 5–10 mL of solution at a site 3–5 cm proximal to the elbow. The local anesthetic should be injected in a fanwise fashion without elicitation of a paresthesia.

**Technique at the Wrist** At the wrist, the ulnar nerve lies beneath the flexor carpi ulnaris tendon between the ulnar artery and the pisiform bone. At this point, it has already given off its palmar cutaneous and dorsal branches. The nerve can be approached by directing the needle medially from the radial side of the tendon or, alternatively, by directing the needle radially from the ulnar side of the tendon (Fig. 48-11). After eliciting a paresthesia, 3–5 mL of solution is injected or spread in a fanwise fashion.

### Musculocutaneous Nerve Block

The musculocutaneous nerve terminates as the lateral cutaneous nerve of the forearm. This nerve provides sensory innervation to the skin on the radial side of the forearm up to the radiocarpal joint. This block is usually performed to supplement the axillary approach to brachial plexus anesthesia.



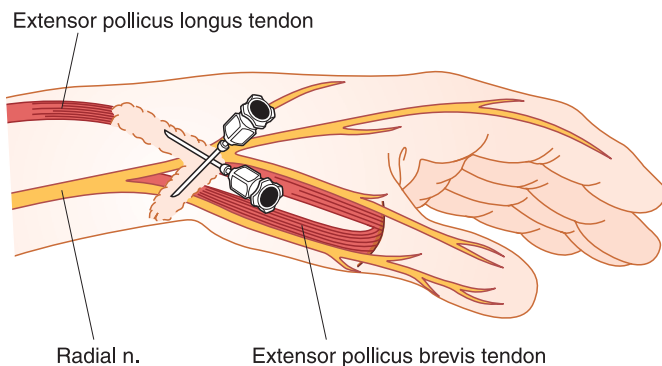


**FIGURE 48–11.** Anatomic landmarks for median and ulnar nerve block at the wrist. An alternative method for ulnar nerve block, from the ulnar side of the wrist, is shown. (Reprinted from Wedel DJ, Horlocker TT. Nerve blocks. In: Miller RD, ed. Anesthesia. 6th ed. Philadelphia: Churchill Livingstone, 2005:1686–1717, with permission from Elsevier.)

**Technique at the Elbow** The lateral cutaneous nerve of the forearm can be blocked 1 cm proximal to the intercondylar line immediately lateral to the biceps tendon. Fanwise infiltration of 3–5 mL of solution subcutaneously at this site provides excellent anesthesia of this nerve.

### Peripheral Blockade at the Elbow versus the Wrist

The forearm cutaneous nerves arise in the upper arm and are not anesthetized by block of the peripheral nerves at the elbow. Hence, there is no advantage of block of the peripheral nerves of the upper extremity when compar-



**FIGURE 48–12.** Anatomic landmarks and method of needle insertion for radial nerve block at the wrist. (Reprinted from Wedel DJ, Horlocker TT. Nerve blocks. In: Miller RD, ed. Anesthesia. 6th ed. Philadelphia: Churchill Livingstone, 2005:1686–1717, with permission from Elsevier.)

ing elbow with wrist techniques; both provide sensory anesthesia of the hand.

### Side Effects/Complications

In general, distal peripheral blocks are associated with a lower risk of complications. However, intravascular injection can occur, and the usual precautions of incremental injection after aspiration are recommended. The risk of nerve injury is theorized to be higher when more distal peripheral blocks are performed. This may be a result of superficial nerve placement between bony and ligamentous structures, thereby offering ready access to the probing needle point.

### Intravenous Regional Blocks

Intravenous regional blocks were first described by August Bier, a German surgeon, in 1908.<sup>54</sup> Early methods involved two tourniquets and the first synthetic local anesthetic, procaine. The technique lost popularity as more reliable methods of blocking the brachial plexus evolved.

### Clinical Applications

The Bier block has multiple advantages, including ease of administration, rapidity of recovery, rapid onset, muscular relaxation, and controllable extent of anesthesia. It is an excellent technique for short ( $\leq 90$  minutes) open surgical procedures and for closed reductions of bony fractures.

### Technique

An intravenous cannula is placed in the upper extremity to be blocked as distally as possible (the patient should also have an intravenous cannula in the nonoperative upper extremity for administration of fluids and other drugs). Traditionally, a double tourniquet is placed on the operative side; both cuffs should have secure closures and reliable pressure gauges. After exsanguination of the arm, the proximal cuff is inflated to approximately 150 mm Hg more than the systolic pressure (absence of a radial pulse confirms adequate tourniquet pressure). Total dose of local anesthetic is based on the patient's weight and is injected slowly (4–6 mg/kg of 0.5% prilocaine or lidocaine—without epinephrine). The onset of anesthesia is usually within 5 minutes. When the patient complains of tourniquet pain, the distal tourniquet, which overlies anesthetized skin, is inflated, and the proximal tourniquet is released. There are

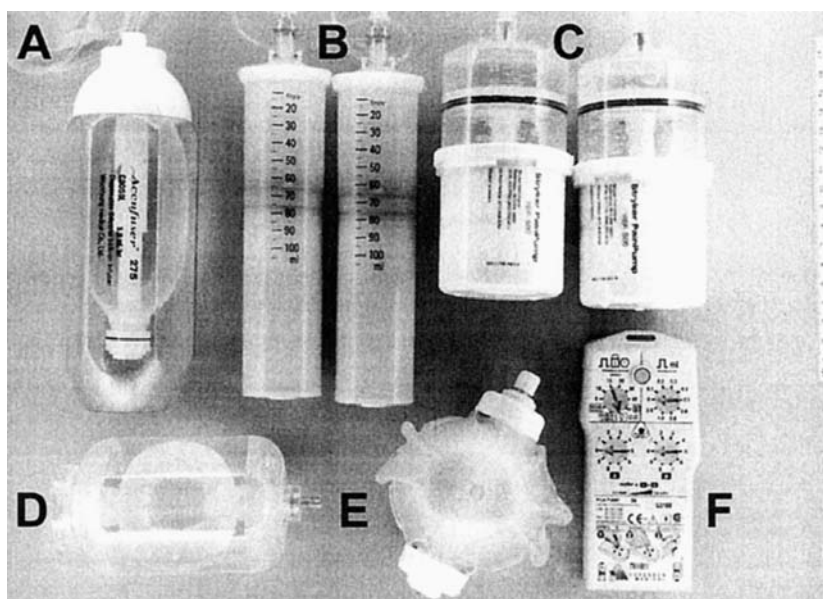
data suggesting that the use of a single wide cuff allows use of lower inflation pressures during intravenous regional anesthesia. The postulated advantage is that the lower pressures will decrease the incidence of neurologic complications related to high inflation pressures with the narrow double cuffs.<sup>55</sup> The tourniquet may be safely released after 25 minutes, but the patient should be closely observed for local anesthetic toxicity for several minutes after the tourniquet release. Slow injection of local anesthetic solutions at a distal site has been shown to lower the risk of toxicity.<sup>56</sup>

### Side Effects/Complications

Technical problems with this block include tourniquet discomfort, rapidity of recovery leading to postoperative pain, difficulty in providing a bloodless field, and the necessity of exsanguination in the case of a painful injury. Accidental or early deflation of the tourniquet or use of excessive doses of local anesthetics can result in toxic reactions. Injection of the drug as distally as possible at a slow rate decreases blood levels of anesthetic and theoretically increases safety.<sup>56</sup> The use of bupivacaine for intravenous regional anesthesia is associated with local anesthetic toxicity and death<sup>57</sup> and is not recommended. Cyclic deflation of the tourniquet at 10-second intervals increases the time to peak arterial lidocaine levels that may decrease potential toxicity.<sup>58</sup> Other rare complications associated with this technique include phlebitis (2-chloroprocaine), development of compartment syndrome, and loss of limb.

### Upper Extremity Continuous Catheter Techniques

The advantages cited for continuous nerve blockade include prolongation of surgical anesthesia, decreased risk of toxicity because of lower incremental doses, and postoperative pain relief and sympathectomy. Catheter placement using both over- and through-needle methods have been described. Advances in equipment technology, including the development of stimulating needles and catheters and portable pumps allowing local anesthetic infusion after hospital dismissal, have increased the success rate and popularity of continuous peripheral blockade (Fig. 48-13).<sup>59,60</sup> Although concern regarding accurate catheter placement



**FIGURE 48-13.** Portable infusion pumps. **A.** Accufuser, McKinley Medical, Wheat Ridge, CO; **(B)** Sgarlato, Sgarlato Labs, Los Gatos, CA; **(C)** Pain Pump, Stryker Instruments, Kalamazoo, MI; **(D)** MedFlo II, MPS Acacia, Brea, CA; **(E)** C-Bloc, I-Flow Corp, Lake Forest, CA; and **(F)** Microject PCA, Sorenson Medical, West Jordan, UT. (Reproduced with permission from Ilfeld BM, Morey TE, and Enneking FK.<sup>59</sup>)

and maintenance still exists, the use of stimulating catheters and radiographic confirmation may further improve the functionality.<sup>61,62</sup> Risks of infection, inadequate anesthesia/analgesia, and accumulation of local anesthetic (systemic toxicity) are the major disadvantages. Catheter migration, catheter kinking or coiling, and nerve damage also rarely may occur.<sup>63</sup>

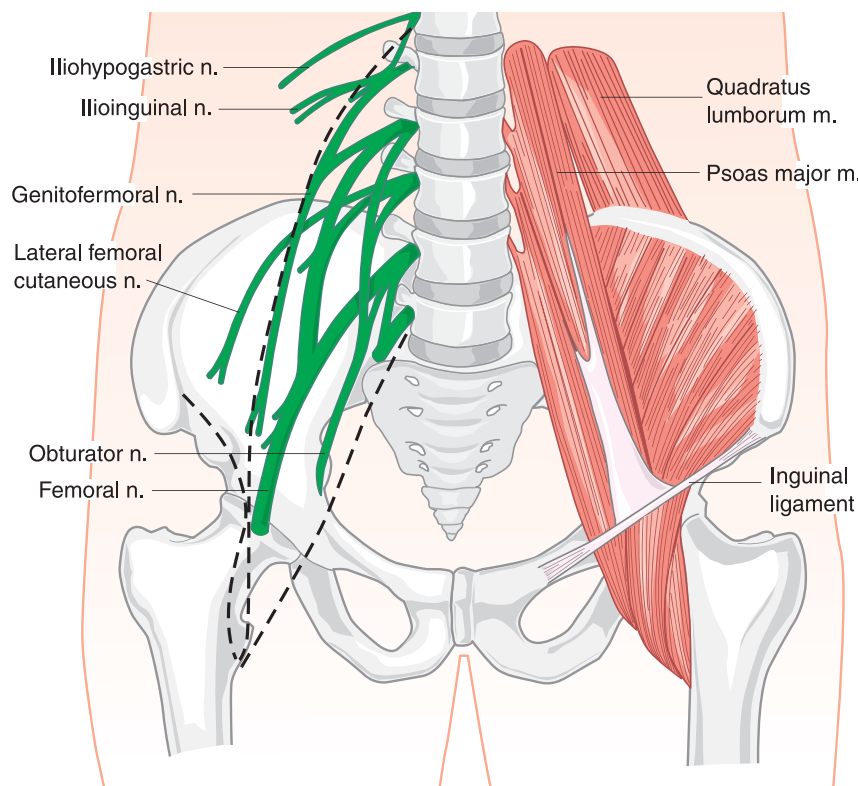
Methods of providing continuous brachial plexus anesthesia have been described since at least the 1940s,<sup>64</sup> and frequently offer ingenious solutions for the placement and securing of the needle or catheter. Longer catheters may be easier to secure and provide superior blockade if the tip lies more proximal in the plexus.<sup>65</sup> This technique is especially applicable to patients with upper extremity or digit replantation, total elbow arthroplasty, or reflex sympathetic dystrophies, for which prolonged pain relief and sympathectomy are advantageous.<sup>66</sup> Despite increased use, few studies have critically analyzed the benefits and outcomes of brachial plexus catheters to single injection or conventional methods of postoperative analgesia. Overall, superior analgesia is consistently reported, with lower opioid use and decreased pain scores. Other benefits include fewer sleep disturbances and increased pa-

tient satisfaction.<sup>7,67</sup> However, substantial improvements in surgical outcomes and economics have not been noted. This may be because of the relatively minor nature of upper-extremity procedures (and the associated decreased analgesic requirements) compared to neuraxial or lower-extremity operations.

### LOWER-EXTREMITY BLOCKS

Knowledge of the anatomy of the lumbosacral plexus and peripheral nerves of the lower extremity enables anesthesiologists to provide more comprehensive anesthetic care. These blocks are safe and have certain advantages, such as postoperative pain relief and lack of complete sympathectomy, which make them ideal for selected patients.

Lower-extremity blocks are less popular than those routinely employed for surgical procedures of the upper extremity. In part, this is a result of the widespread acceptance and safety of spinal and epidural anesthesia. Furthermore, unlike the brachial plexus, the nerves supplying the lower extremity are not anatomically clustered where they can be easily blocked with a relatively superficial injection of local anesthetic. Because of the anatomic



**FIGURE 48–14.** The lumbar plexus lies in the psoas compartment between the psoas major and quadratus lumborum muscles. (Reprinted from Wedel DJ, Horlocker TT. Nerve blocks. In: Miller RD, ed. Anesthesia. 6th ed. Philadelphia: Churchill Livingstone, 2005:1686–1717, with permission from Elsevier.)

considerations, lower-extremity blocks are technically more difficult and require more training and practice before expertise is acquired. Many of these blocks were classically performed using paresthesia, loss of resistance, or field block technique; success was variable. Advances in needles, catheters and nerve stimulator technology have facilitated localization of neural structures and improved success rate. Recent applications have focused on prolonged postoperative analgesia to assist rehabilitation and hospital dismissal.

### Anatomy

The nerve supply to the lower extremity is derived from the lumbar and sacral plexuses. The lumbar plexus is formed by the anterior rami of the first four lumbar nerves, frequently including a branch from T12 and occasionally from L5 (Fig. 48–14). The plexus lies between the psoas major and quadratus lumborum muscles, in the psoas compartment.

The lower components of the plexus, L2, L3, and L4, primarily innervate

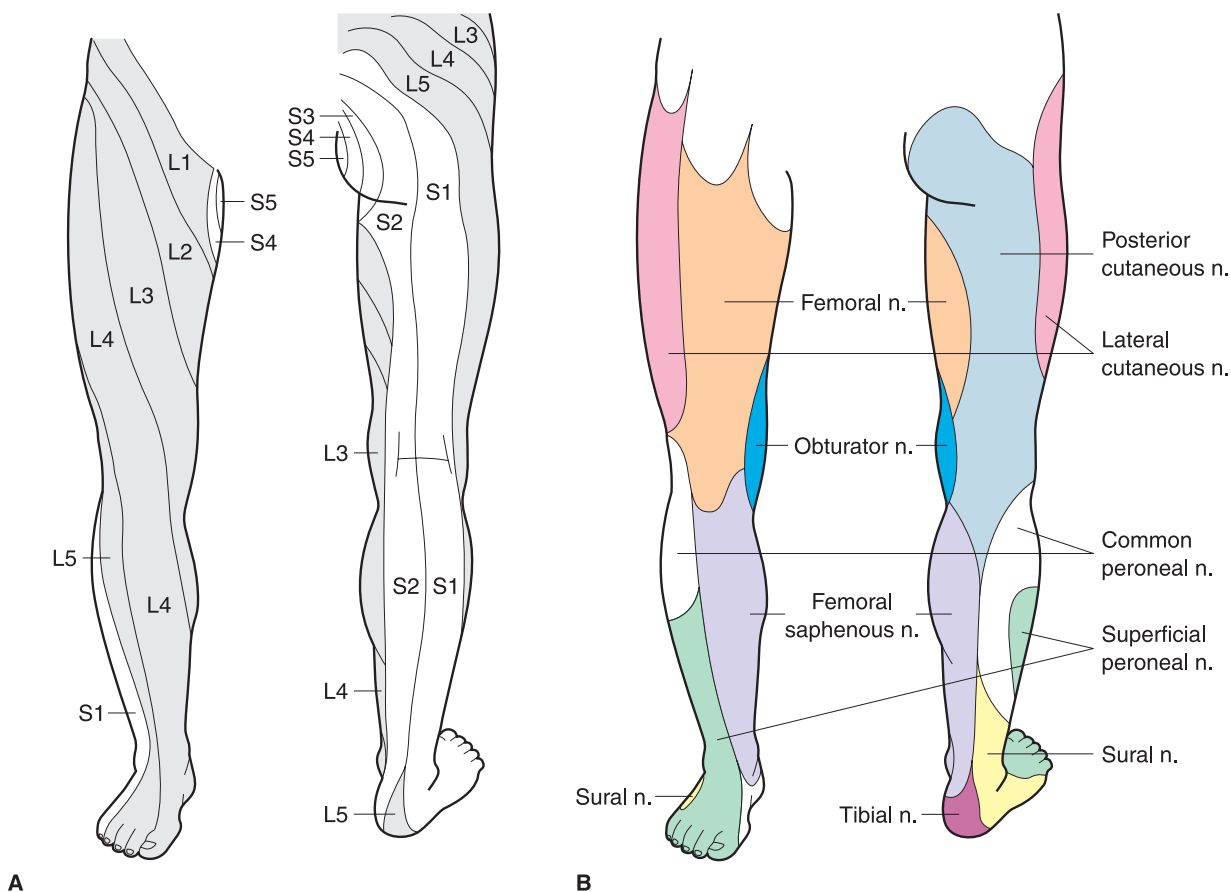
the anterior and medial thigh. The anterior divisions of L2, L3, and L4 form the obturator nerve; the posterior divisions of the same components form the femoral nerve; and the lateral femoral cutaneous nerve is formed from posterior divisions of L2 and L3.

The posterior cutaneous nerve of the thigh and the sciatic nerve are derived from the first, second, and third sacral nerves plus branches from the anterior rami of L4 and L5, respectively. These nerves pass together through the pelvis and the greater sciatic foramen and are blocked by the same technique. The sciatic nerve is actually a combination of two major nerve trunks, the tibial (ventral branches of the anterior rami of L4, L5, S1, S2, and S3) and the common peroneal (dorsal branches of the anterior rami of L4, L5, S1, S2, and S3), which form the sciatic nerve. At or above the popliteal fossa they separate, the tibial nerve passing medially and the common peroneal laterally. Figure 48–15 shows the cutaneous distributions of the lumbosacral and peripheral nerves.

### Lumbar Plexus Block

#### Clinical Applications

The lumbar plexus can be blocked by three distinct approaches. Block of the full lumbar plexus (femoral, lateral femoral cutaneous, obturator) is accomplished with the psoas block.<sup>14,68,69</sup> In comparison, the fascia iliaca and femoral approaches will reliably block the femoral but not the lateral femoral, cutaneous, and obturator nerves.<sup>68–70</sup> Lumbar plexus block is often used to provide postoperative analgesia for patients undergoing major knee and hip surgery. Selection of regional analgesic technique is dependent on the surgical site. For example, the psoas compartment approach to the lumbar plexus is preferable for surgery to the hip because it is the most proximal lumbar plexus technique. Conversely, for surgery to the knee, the more distal femoral and fascia iliaca approaches are sufficient. Importantly, although differences in frequency of complete lumbar plexus blockade exists between techniques, no clinical differences in pain



**FIGURE 48-15.** A. Cutaneous distribution of the lumbosacral nerves. B. Cutaneous distribution of the peripheral nerves of the lower extremity. (Reprinted from Wedel DJ, Horlocker TT. Nerve blocks. In: Miller RD, ed. Anesthesia. 6th ed. Philadelphia: Churchill Livingstone, 2005:1686–1717, with permission from Elsevier.)

scores or supplemental opioid requirements has been noted. For example, femoral and psoas compartment block appear to provide equivalent analgesia following total knee replacement.<sup>14,68</sup> Supplemental sciatic<sup>71–73</sup> or obturator<sup>74</sup> block is required to obtain adequate analgesia following total knee (but not hip) arthroplasty.

### Technique

**Psoas Compartment Approach** The psoas compartment block offers a single injection rather than three separate needle insertions for anesthesia of the lumbar plexus and involves needle placement into the space between the psoas major and quadratus lumborum muscles. A large volume of injected solution anesthetizes the hip and anterolateral thigh.<sup>75</sup>

The patient is placed in the lateral position, hips flexed, and operative extremity uppermost. A line is drawn to connect the iliac crests (intercrystal

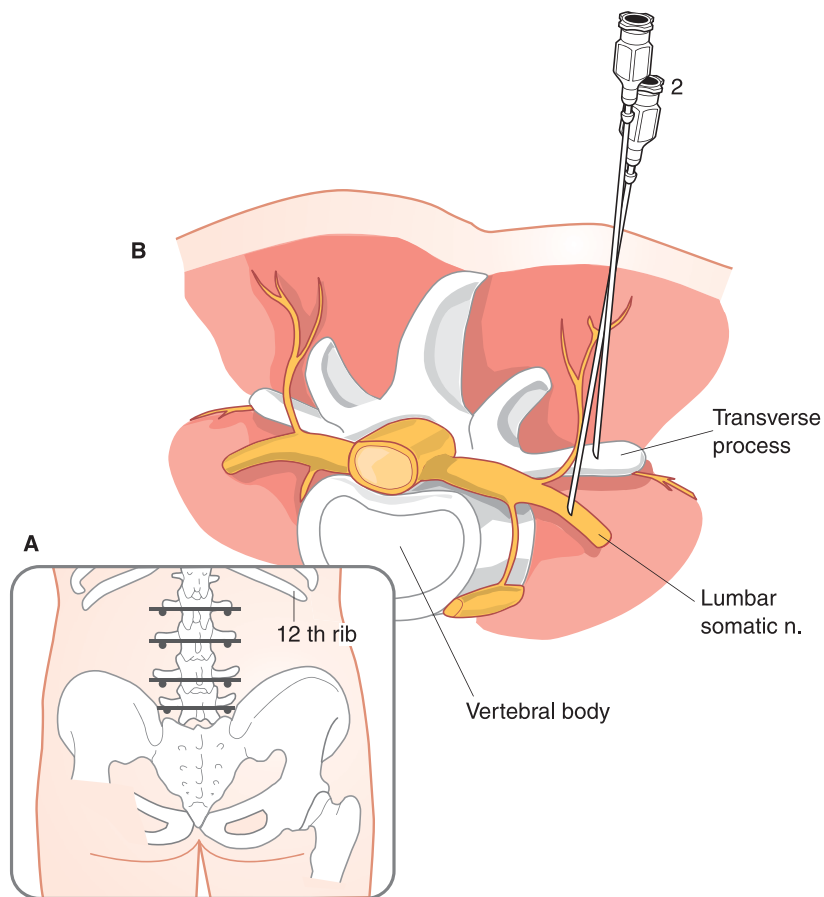
line) identifying the fourth lumbar spine. After skin preparation, a skin wheal is raised 3 cm caudad and 5 cm lateral to the midline on the side to be blocked. A 21-gauge, 10-cm stimulating needle is then advanced perpendicular to the skin entry site until it contacts the fifth lumbar transverse process. The needle is redirected cephalad until it slides off the transverse process. The lumbar plexus is identified by elicitation of a quadriceps motor response. When the needle is in place, 30 mL of solution is injected (Fig. 48-16).

Based on anatomic imaging studies, Capdevila et al.<sup>76</sup> modified the classic psoas technique. Needle insertion site is the junction of the lateral third and medial two thirds of a line between the spinous process of L4 and a line parallel to the spinal column passing through the posterior superior iliac spine. (The spinous process of L4 was estimated to be approximately 1 cm

cephalad to the upper edge of the iliac crests.) The needle is advanced perpendicular to the plane of the back until contact with the transverse process of L4 is obtained and advanced under the transverse process until quadriceps femoris muscle twitches are elicited. Despite a difference between men and women in the depth of the lumbar plexus (median values: 8.5 and 7.0 cm, respectively), the distance from the L4 transverse process to the lumbar plexus was comparable (median value: 2 cm) in both sexes. Thus the authors stressed the importance of achieving contact with the L4 transverse process to establish appropriate needle depth and position.

**Perivascular Approach (“3-in-1 Block”)** The perivascular approach to the psoas compartment is based on the premise that injection of a large volume of local anesthetic within the femoral canal while maintaining distal





**FIGURE 48-16.** A. Lumbar plexus block, psoas compartment approach: patient position and surface landmarks. B. The needle is advanced perpendicularly until it contacts the transverse process. It is redirected to walk off the caudad surface of the transverse process and advanced 1–2 cm. (Reprinted from Wedel DJ, Horlocker TT. Nerve blocks. In: Miller RD, ed. Anesthesia. 6th ed. Philadelphia: Churchill Livingstone, 2005:1686–1717, with permission from Elsevier.)

pressure will result in proximal spread of the solution into the psoas compartment and consequent lumbar plexus block.<sup>77</sup> The key anatomic assumption is that the fascial sheath surrounding the lumbar roots extends into the femoral canal and acts as an enclosed conduit for the spread of local anesthetic solutions. However, despite many efforts to consistently produce a 3-in-1 block, the femoral nerve is the only nerve consistently blocked with this approach.<sup>78</sup> In addition, blockade of the lateral femoral cutaneous and obturator nerves occurs through lateral and medial diffusion of local anesthetic, respectively (and not through proximal spread to the lumbar plexus).

The patient lies in the supine position. The inguinal ligament is marked as a line connecting the pubic tubercle and the anterior superior iliac spine. The femoral artery is marked. A 22-gauge, 5-cm needle is advanced lateral to the artery in a cephalad direction

until a paresthesia or nerve stimulator response is obtained. The needle is held immobile while distal pressure is applied digitally to the femoral sheath. A total of 20–40 mL of solution is injected incrementally after negative aspiration. Reliable anesthesia of the femoral and lateral femoral cutaneous nerves can be predicted with 20 mL. However, obturator nerve block may not occur even with volumes greater than 30 mL (Fig. 48-17A).

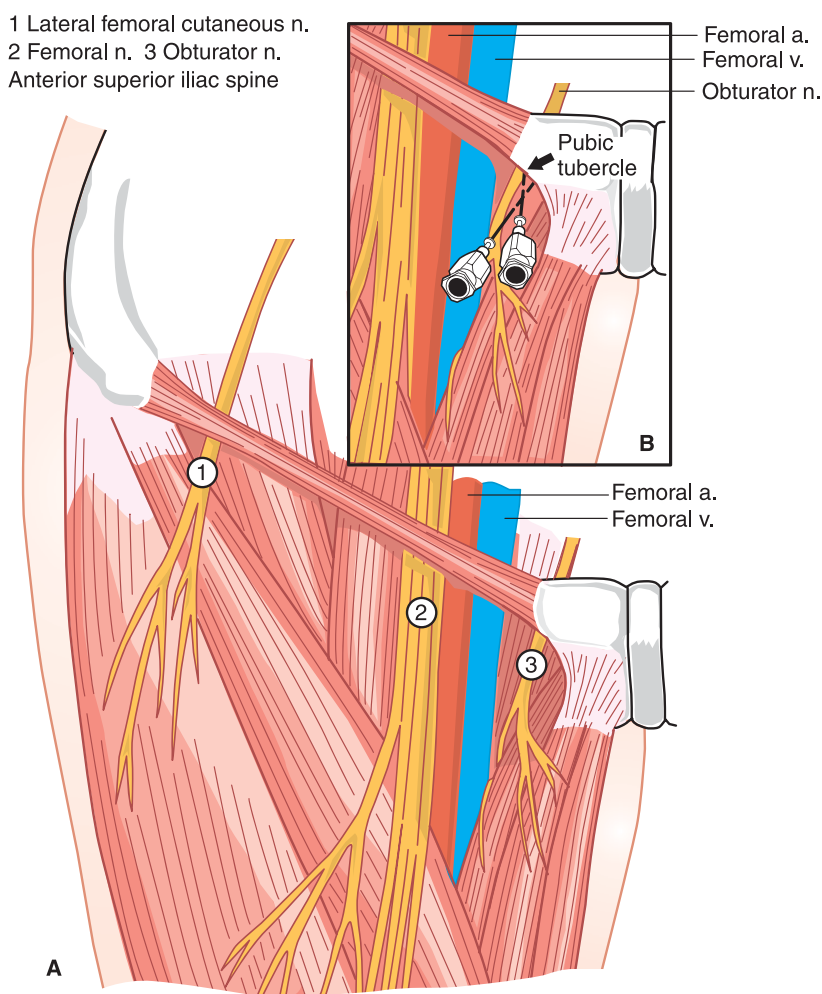
**Fascia Iliaca Approach** The more lateral needle insertion site with this approach to the lumbar plexus increases the likelihood of successful lateral femoral cutaneous block and decreases the frequency of obturator blockade.<sup>14,70</sup> However, proximal catheter advancement is often associated with sciatic spread and improved analgesia.<sup>79</sup> An additional advantage of this approach is the simplicity; because neural structures are not specifically

identified, elicitation of a paresthesia or motor response is not required. Rather, successful needle position is determined by a double “pop.”

The patient is positioned supine and the inguinal ligament is identified and divided into thirds. The junction of the lateral one-third and medial two-thirds is determined. A 17-gauge Tuohy needle is inserted 1 cm below this point. An initial loss of resistance is noted as the needle penetrates the fascia lata. The second loss of resistance is felt as the needle penetrates the fascia iliaca and 30 mL of local anesthetic is incrementally injected (Fig. 48-18).

### Side Effects/Complications

The deep needle placement with the posterior (psoas compartment) approach increases the risk of possible epidural, subarachnoid, or intravascular injection. Peripheral nerve damage is also a potential risk with this technique. Cardiac arrest caused by



**FIGURE 48-17.** A. Anatomic landmarks for lateral femoral cutaneous, femoral, and obturator nerve blocks. B. Obturator nerve block. The needle is walked off the inferior pubic ramus in a medial and cephalad direction until it passes into the obturator canal. (Reprinted from Wedel DJ, Horlocker TT. Nerve blocks. In: Miller RD, ed. Anesthesia. 6th ed. Philadelphia: Churchill Livingstone, 2005:1686–1717, with permission from Elsevier.)

total spinal anesthesia has been reported.<sup>80</sup> Thus, the depth of the neural structures and potential for serious side effects associated with the psoas compartment approach to the lumbar plexus (compared to more superficial fascia iliaca and femoral techniques) warrant consideration. Several authors have advocated use of the psoas compartment block only when more distal approaches are not indicated/efficacious.<sup>68</sup> An additional side effect of the psoas compartment block is the development of a sympathetic block secondary to extravasation of local anesthetic. This unilateral sympathetomy is usually of little consequence. Although one reason

for choosing a lower-extremity block over spinal or epidural blockade is prevention of sympathectomy, the advantage of a psoas compartment block is diminished should this effect occur.

Intravascular injection and hematoma are possible with femoral perivascular and fascia iliaca techniques because of the close proximity of the femoral artery. The presence of femoral vascular grafts is a relative contraindication. Nerve damage is rare with these techniques. The lateral needle insertion site with the fascia iliaca approach overlies the hip joint; a third “pop” may signify advancement into the articular space.

## Femoral Nerve Block

The femoral nerve is formed within the psoas major muscle by posterior divisions of the second, third, and fourth lumbar nerves. It emerges from the lateral border of the psoas muscle to descend in the groove between the psoas and iliacus muscles and enters the thigh by passing beneath the inguinal ligament lateral to the femoral artery. At this point, the nerve divides into multiple terminal branches, which have been classified as anterior and posterior. The anterior branches are primarily cutaneous, the deep branches chiefly motor.

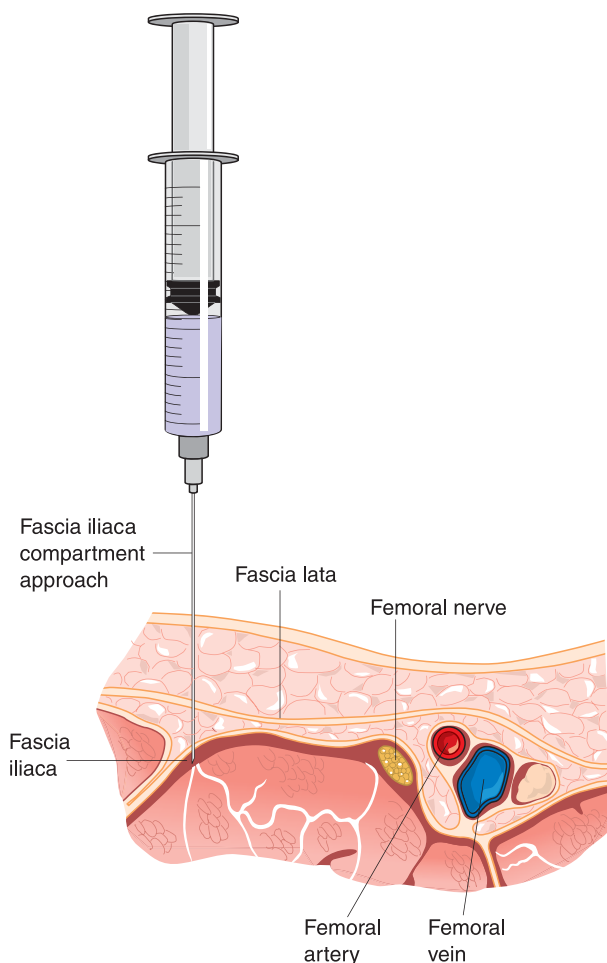
The femoral nerve supplies the anterior compartment muscles of the thigh (quadriceps, sartorius) and the skin of the anterior thigh from the inguinal ligament to the knee. Its terminal branch is the saphenous nerve, which supplies an area of skin along the medial side of the leg from the knee to the big toe.

## Clinical Applications

The femoral block is primarily used in concert with other peripheral blocks. However, it can be used alone for muscle biopsies of the quadriceps muscle or other surgical procedures limited to the anterior thigh, and it is reported effective for anesthetic management of knee arthroscopy and surgical repair of midfemoral shaft fractures.<sup>81,82</sup>

## Technique

The patient is placed in the supine position. A line is drawn between the anterior superior iliac spine and the pubic tubercle, identifying the inguinal ligament. The femoral artery is marked. A 22-gauge, 4-cm needle is advanced lateral to this line (Fig. 48-17A). When the needle reaches the depth of the artery, a pulsation of the hub is visible. Elicitation of a paresthesia or motor response verifies correct needle position. Commonly, the anterior branch of the femoral nerve will be identified first. Stimulation of this branch leads to contraction of the sartorius muscle on the medial aspect of the thigh and should not be accepted. The needle should be redirected slightly laterally and with a deeper direction to encounter the posterior branch of the femoral nerve. Stimulation of this branch is identified by patellar ascension as the quadriceps



**FIGURE 48-18.** Lumbar plexus block: fascia iliaca approach. A discernable “pop” is noted as the needle traverses the fascia lata and then the fascia iliaca. (Reproduced with permission from Lennon RL, Horlocker TT. *Mayo Clinic Analgesic Pathway: Peripheral Nerve Blockade for Major Orthopedic Surgery*. Rochester, MN: Mayo Clinic Scientific Press, 2005:45.)

contract. Local anesthetic, 20 mL, is injected fanwise, lateral to the artery. If a paresthesia/nerve stimulator response is obtained, 7–10 mL of solution should be injected at that site.

### Side Effects/Complications

Intravascular injection and hematoma are possible because of the close proximity of the femoral artery. However, anatomically, the nerve and artery are located in separate sheaths approximately 1 cm apart. In most patients with normal anatomy, the femoral artery can be easily palpated, allowing correct, safe needle positioning lateral to the pulsation. The presence of femoral vascular grafts is a relative contraindication to this block. Nerve damage is rare.

### Lateral Femoral Cutaneous Nerve Block

The lateral femoral cutaneous nerve (L2 and L3) emerges at the lateral border of the psoas muscle immediate-

ly caudad to the ilioinguinal nerve. It descends under the iliac fascia to enter the thigh deep to the inguinal ligament 1–2 cm medial to the anterior superior iliac spine. The nerve emerges from the fascia lata 7–10 cm below the spine and divides into anterior and posterior branches. The skin of the lateral portion of the thigh from the hip to midthigh is supplied by the posterior branch; the anterior branch supplies the anterolateral thigh to the knee.

### Clinical Applications

This block is useful for skin graft harvesting and can be used in concert with other peripheral nerve blocks for complete anesthesia of the lower extremity.

### Technique

A point is marked 2 cm medial and 2 cm caudad to the anterior superior iliac spine. A 22-gauge, 4-cm needle is advanced perpendicular to the skin entry site until a sudden release indicates

passage through the fascia lata. As the needle is moved fanwise laterally and medially, 10–15 mL of solution is injected, depositing local anesthetic above and below the fascia (Fig. 48-17A).

The nerve can also be blocked just medial and posterior to the anterior superior iliac crest with 10 mL of solution. Combining the two techniques increases the success rate, but the total volume of solution used may be limiting.

### Side Effects/Complications

The extent of anesthesia is quite limited with this block, but there is a low risk of associated complications. Neuritis of this nerve secondary to needle trauma or drug toxicity is a potential but unlikely complication. Because there are no large blood vessels in the vicinity of this nerve, the likelihood of rapid uptake or intravascular injection is very small.

### Obturator Nerve Block

The obturator nerve is derived primarily from the third and fourth lumbar nerves with an occasional minor contribution from L2. The nerve lies deep in the obturator canal, having descended from the medial border of the psoas muscle. As the nerve leaves the obturator canal, it divides into anterior and posterior branches. The anterior branch supplies an articular branch to the hip and the anterior adductor muscles and a variable cutaneous branch to the lower medial thigh. The posterior branch innervates the deep adductor muscles and may send an articular branch to the knee.

### Clinical Applications

Usually, the obturator nerve is blocked as part of regional anesthesia for knee surgery. Because it is primarily a motor nerve, it is rarely blocked on its own; however, obturator nerve block can be useful in treating or diagnosing the extent of adductor spasm in patients with cerebral palsy and other muscle or neurologic diseases affecting the lower extremities prior to surgical intervention, such as adductor tenotomy.

### Technique

The patient is placed in the supine position, and a mark is made 1–2 cm lateral and 1–2 cm caudad to the pubic tubercle. A skin wheal is raised, and a 22-gauge, 8–10-cm needle is advanced perpendicular to the skin entry site with a slight medial direction. The

inferior pubic ramus is encountered at a depth of 2–4 cm, and the needle is walked in a lateral and caudad direction, until it passes into the obturator canal. The obturator nerve is located 2–3 cm past the initial point of contact with the pubic ramus (Fig. 48–17B). After negative aspiration, 10–15 mL of local anesthetic is injected. A nerve stimulator is helpful in locating the obturator nerve; correct needle position is evidenced by contraction of the adductor muscles of the medial thigh.

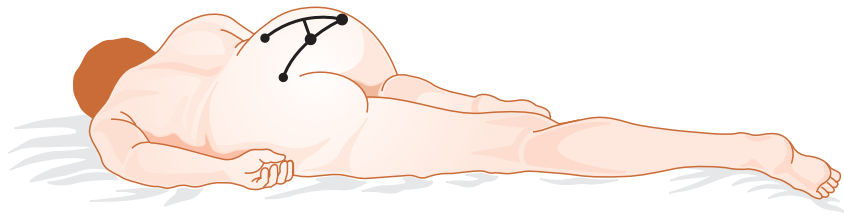
The classic approach to obturator nerve block involves painful periosteal contact and multiple needle redirections. An alternate interadductor approach was described by Wasseff.<sup>83</sup> In this technique, the needle is inserted behind the adductor tendon, near its pubic insertion, and is directed laterally toward a mark on the skin 1–2 cm medial to the femoral artery and immediately below the inguinal ligament representing the obturator canal. The nerve is identified by a motor response to peripheral nerve stimulation in the adductor muscle.

### Side Effects/Complications

Although complications are rare, this block is technically more difficult than other lower-extremity blocks. Because the obturator canal contains vascular and neural structures, there is a theoretical risk of intravascular injection, hematoma, and nerve damage. Absence of anesthesia in the obturator nerve distribution can render an otherwise perfect lower-extremity block inadequate for surgical procedures on the knee.

### Sciatic Nerve Block

The sciatic nerve (L4 and L5, S1 through S3) is the largest of the four peripheral nerves of the lower extremity, with a width of 2 cm as it leaves the pelvis with the posterior cutaneous nerve of the thigh. The sciatic nerve is actually two nerves bound by a common sheath of connective tissue; the tibial component is medial and anterior, whereas the common peroneal component is lateral and slightly posterior. After passing through the sacrosiatic foramen beneath the piriformis muscle, it lies between the greater trochanter of the femur and the ischial tuberosity. The nerve becomes superficial at the lower border of the gluteus maximus muscle, where it begins its descent down the posterior aspect of the thigh to the popliteal



**FIGURE 48–19.** Posterior approach to the sciatic nerve: patient positioning. (Reprinted from Wedel DJ, Horlocker TT. Nerve blocks. In: Miller RD, ed. Anesthesia. 6th ed. Philadelphia: Churchill Livingstone, 2005:1686–1717, with permission from Elsevier.)

fossa. It supplies cutaneous innervation to the posterior thigh and all of the leg and foot below the knee, except for a thin medial strip supplied by the saphenous nerve.

### Clinical Applications

Because of its wide sensory distribution, the sciatic nerve block can be used, together with a saphenous or femoral nerve block, for any surgical procedure below the knee that does not require a thigh tourniquet. It can also be combined with other peripheral nerve blocks to provide anesthesia for surgical procedures involving the thigh and knee. The sciatic nerve may also be blocked at several sites in the hip and thigh. However, the more proximal approaches are necessary to achieve blockade of the posterior femoral cutaneous nerve, which is important in decreasing the posterior knee pain that knee replacement patients often experience in the early postoperative period.<sup>14</sup>

Because this form of anesthesia avoids the sympathectomy associated with neuraxial blocks, it may be advantageous when any shift in hemodynamics could be deleterious, such as in patients with significant aortic stenosis.

### Technique

**Classic Approach of Labat (Posterior)** The patient is positioned laterally, with the leg to be blocked rolled forward onto the flexed knee as the heel rests on the knee of the dependent (nonoperative) leg (Fig. 48–19). A line is drawn to connect the posterior superior iliac spine to the greater trochanter of the femur. A perpendicular line is drawn bisecting this line and extending 5 cm caudad. A second line is drawn from the greater trochanter to the sacral hiatus. The intersection of this line with the perpendicular line indicates the point of needle entry and is located 3–5 cm along the line. A 22-gauge, 10–12-cm needle is advanced until a paresthesia

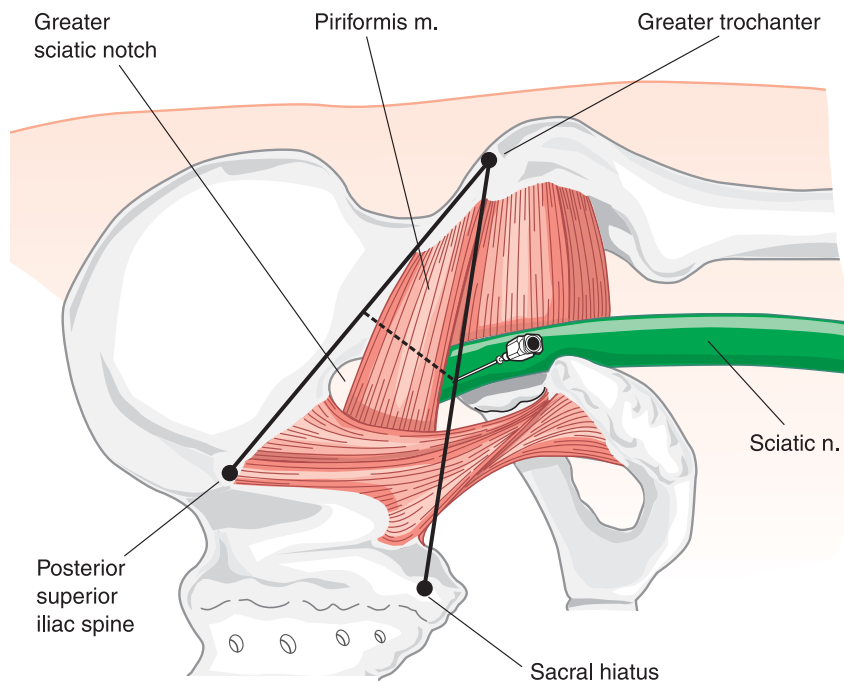
or nerve stimulator response is elicited or bone is contacted (Fig. 48–20). If bone is encountered, the needle is redirected systematically in a lateral or medial direction. Once the needle is properly placed, a total of 20–30 mL of solution is injected.

**Anterior Approach** This technique is useful when the patient cannot be positioned for the classic posterior approach because of pain or lack of cooperation.<sup>84</sup> Blockade of the femoral nerve can be accomplished with the same needle insertion site.

With the patient in the supine position, a line drawn along the inguinal ligament from the anterior superior iliac crest to the pubic tubercle is trisected. A second line parallel to the inguinal ligament is drawn, beginning at the tuberosity of the greater trochanter. A 22-gauge, 10.5–12-cm needle is inserted perpendicularly with a slightly lateral angulation at the point where the line representing the juncture of the middle and medial thirds crosses the second line. This needle is advanced until it contacts bone, the lesser trochanter of the femur (Fig. 48–21). The needle is redirected medially past the femur, and a paresthesia/nerve stimulator response is sought at a depth of about 5 cm past bone. A total of 20–25 mL of solution is injected incrementally after careful aspiration.

**Other Approaches** The sciatic nerve can also be blocked with the patient in the lateral<sup>85</sup> and lithotomy positions,<sup>86</sup> although these are rarely employed clinically. A subgluteal approach, with needle insertion occurring at the midpoint of a line drawn between the greater trochanter of the femur and the ischial tuberosity has been described.<sup>87</sup> However identifying these bony landmarks in very obese patients is sometimes difficult and the patient position requires additional personnel to maintain. Furthermore, when using





**FIGURE 48–20.** Anatomic landmarks for the posterior approach to sciatic nerve block. (Reprinted from Wedel DJ, Horlocker TT. Nerve blocks. In: Miller RD, ed. Anesthesia. 6th ed. Philadelphia: Churchill Livingstone, 2005:1686–1717, with permission from Elsevier.)

more distal approaches to the sciatic nerve, the posterior femoral cutaneous nerve of the thigh will remain unblocked in a significant number of patients and result in pain as a consequence of surgery and/or tourniquet ischemia.

**Techniques to Improve Success Rate** Many methods have been tried to improve success with sciatic nerve blockade. Attempts to place the needle in the middle of the sciatic nerve by identifying a specific motor end point (foot inversion) might increase suc-

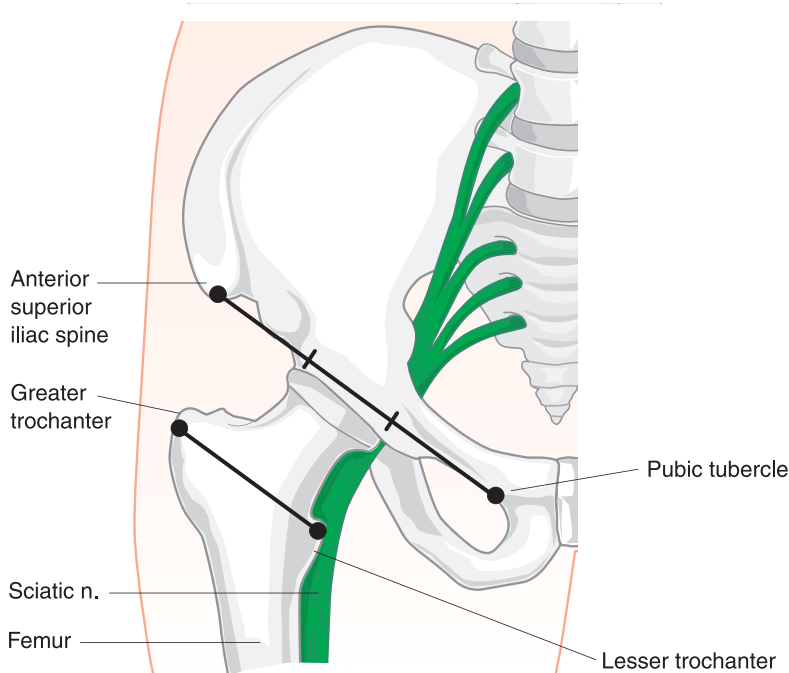
cess rates.<sup>88</sup> Another method is the concept of multiple injections where the two major components of the sciatic nerve are separately identified and blocked.<sup>46</sup> Some experts recommend that sciatic nerve blocks be initiated well before the scheduled time of surgery to allow for long latencies.

### Side Effects/Complications

The block is technically difficult to perform and can be quite painful.<sup>46</sup> Hematoma formation is possible; the risk of nerve damage is also reported, although persistent paresthesias are usually self-limited. A minimal degree of vasodilatation may occur with sciatic nerve block.

### Popliteal Fossa Block

The posterior muscles of the thigh are the biceps femoris, the semimembranosus, semitendinosus, and the posterior portion of the adductor magnus. As these muscles are traced distally from their origin on the ischial tuberosity, they separate into medial (semimembranosus, semitendinosus) and lateral (biceps) musculature, and form the upper border of the popliteal fossa. The lower border of the popliteal fossa is defined by the two heads of the gastrocnemius. In the upper part of the popliteal fossa, the sciatic nerve lies posterolateral to the popliteal vessels. Specifically, the popliteal vein is medial to the nerve, while the



**FIGURE 48–21.** Anatomic landmarks for the anterior approach to the sciatic nerve block. (Reprinted from Wedel DJ, Horlocker TT. Nerve blocks. In: Miller RD, ed. Anesthesia. 6th ed. Philadelphia: Churchill Livingstone, 2005:1686–1717, with permission from Elsevier.)

popliteal artery is most anterior, lying on the popliteal surface of the femur. Near the upper border of the popliteal fossa, the two components of the sciatic nerve separate. The peroneal nerve diverges laterally and the larger tibial branch descends almost straight down through the fossa. The tibial nerve and popliteal vessels then disappear deep to the converging heads of the gastrocnemius muscle.

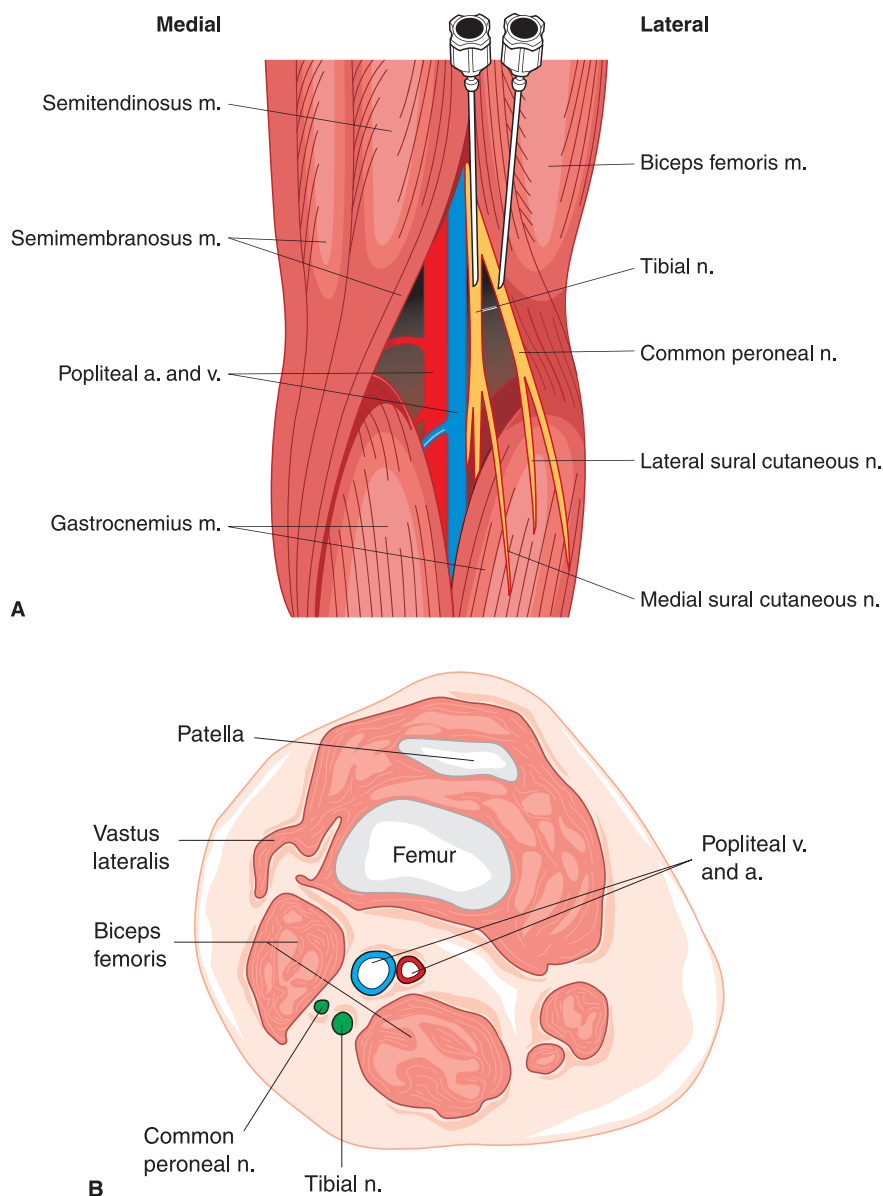
### Clinical Applications

This block is chiefly used for foot and ankle surgery. The block has also been successfully used in the pediatric population. Popliteal fossa block is preferable to ankle block for surgical procedures requiring the use of a calf tourniquet. The components of the sciatic nerve may be blocked at the level of the popliteal fossa through posterior or lateral approaches. Supplemental block of the saphenous nerve is required for surgical procedures to the medial aspect of the leg, or when a calf tourniquet/Esmarch bandage is used.

### Technique

**Posterior Approach** The classic approach to the popliteal fossa is posteriorly, with the patient positioned prone. However, access may also occur with the patient in the lateral (operative side nondependent) or supine (with leg flexed at the hip and knee) positions.

The borders of the popliteal fossa are identified by flexing the knee joint. A triangle is constructed, with the base consisting of the skin crease behind the knee, and the two sides composed of the semimembranosus (medially) and the biceps (laterally). A bisecting line is drawn from the apex to the base of the triangle, and a 5-cm needle is inserted at a site 5–10 cm above the skin fold and 0.5–1 cm lateral to the bisecting line (Fig. 48–22A). Classically, the 5-cm distance was described.<sup>89</sup> However, in an attempt to block the sciatic nerve prior to its division, a 7–10-cm distance has been recommended.<sup>90</sup> The needle is advanced at a 45° angle until either a paresthesia or nerve stimulator response is elicited. With a nerve stimulator technique, inversion is the motor response that best predicts complete neural block of the foot.<sup>91</sup> Injection of approximately 30-mL of local anesthetic solution is sufficient.



**FIGURE 48–22.** A. Anatomic landmarks for posterior approach to the sciatic nerve in the popliteal fossa. B. Anatomic landmarks for lateral approach to the sciatic nerve in the popliteal fossa. (Reprinted from Wedel DJ, Horlocker TT. Nerve blocks. In: Miller RD, ed. Anesthesia. 6th ed. Philadelphia: Churchill Livingstone, 2005:1686–1717, with permission from Elsevier.)

Success rate is typically 90–95%.<sup>89,91</sup> No formal comparison between paresthesia and nerve stimulator techniques has been performed to assess efficacy and complications. It is believed that incomplete block is the result of poor diffusion (because of the size of the sciatic nerve), the separate fascial coverings of the tibial and peroneal nerves, or to blockade of only a single component of the sciatic nerve. Identification of both tibial and peroneal components decreases onset time and improves success rate.<sup>92</sup>

**Lateral Approach** A lateral approach to blockade of the sciatic nerve in the popliteal fossa has been described.<sup>93</sup> Although block time is somewhat longer, onset and quality of block are similar to the posterior approach.<sup>94</sup> The lateral approach allows the patient to be positioned supine and eliminates the need for repositioning. The patient's leg is extended, with the long axis of the foot at a 90° angle to the table. The site of insertion is the intersection of the vertical line drawn from the upper edge of the patella and the

groove between the lateral border of the biceps femoris and vastus lateralis. A 10-cm needle is advanced at a 30° angle posterior to the horizontal plane (Fig. 48–22B). Because the common peroneal nerve is located lateral to the tibial nerve, the stimulating needle encounters the common peroneal nerve first with the lateral approach. As with the classic posterior approach, an elicited inversion response is sought.<sup>91</sup> If a response associated with common peroneal nerve stimulation (such as eversion) is elicited, the needle is redirected more posteriorly.

### Side Effects/Complications

As with other peripheral nerve blocks, neuropathy is the most common complication. Intravascular injection may occur as a result of the presence of vascular structures within the popliteal fossa. Performance of popliteal fossa block in patients with previous total knee arthroplasty or vascular bypass (femoral–popliteal) should be done with care. To date, however, there are no cases of graft disruption or joint infections relating to needle placement in these patients.

### Nerve Blocks at the Ankle

Four of the five individual nerves that can be blocked at the ankle to provide anesthesia of the foot are terminal branches of the sciatic nerve: the posterior tibial, sural, superficial peroneal, and deep peroneal branches. The sciatic nerve divides at or above the apex of the popliteal fossa to form the common peroneal and tibial nerves. The common peroneal nerve descends laterally around the head of the fibula, where it divides into the superficial and deep peroneal nerves.

The tibial nerve divides into the posterior tibial and sural nerves in the lower leg. The posterior tibial nerve becomes superficial at the medial border of the Achilles tendon near the artery of the same name, and the sural nerve emerges lateral to the Achilles tendon.

### Clinical Applications

Ankle blocks are simple to perform and offer adequate anesthesia for surgical procedures of the foot not requiring a tourniquet above the ankle. When a thigh tourniquet is required, a more proximal approach to the sci-

atic nerve (with supplemental saphenous nerve block) or spinal anesthetic is performed.<sup>87</sup>

### Technique

**Posterior Tibial Nerve** The posterior tibial nerve can be blocked with the patient in either the prone or the supine position. The posterior tibial artery is palpated, and a 25-gauge, 3-cm needle is inserted posterolateral to the artery at the level of the medial malleolus (Fig. 48–23A and B). A paresthesia is often elicited; however, it is not necessary for a successful block. If a paresthesia is obtained, 3–5 mL of local anesthetic should be injected. Otherwise, 7–10 mL of solution should be injected as the needle is slowly withdrawn back from the posterior aspect of the tibia. Blockade of the posterior tibial nerve provides anesthesia of the heel, plantar portion of the toes, and the sole of the foot, as well as some motor branches in the same area.

**Sural Nerve** The sural nerve is located superficially between the lateral malleolus and the Achilles tendon. A 25-gauge, 3-cm needle is inserted lateral to the tendon and is directed toward the malleolus as 5–10 mL of solution is injected subcutaneously (Fig. 48–23A and C). This block provides anesthesia of the lateral foot and the lateral aspects of the proximal sole of the foot.

### Deep Peroneal, Superficial Peroneal, and Saphenous Nerves

The deep peroneal, superficial peroneal, and saphenous nerves can be blocked through a single needle entry site (Fig. 48–24). A line is drawn across the dorsum of the foot connecting the malleoli. The extensor hallucis longus tendon is identified by having the patient dorsiflex the big toe. The anterior tibial artery lies between this structure and the tendon of the extensor digitorum longus muscle and is palpable at this level. A skin wheal is raised just lateral to the pulsation between the two tendons on the intermalleolar line. A 25-gauge, 3-cm needle is advanced perpendicular to skin entry site, and 3–5 mL of local anesthetic injected deep to the extensor retinaculum to block the deep peroneal nerve. This technique anesthetizes the skin between the first and second toes and the short extensors of the toes.

The needle is now directed laterally through the same skin wheal while injecting 3–5 mL of solution subcutaneously, thus blocking the superficial peroneal nerve and resulting in anesthesia of the dorsum of the foot, excluding the first interdigital cleft. The same maneuver can now be performed in the medial direction, thereby anesthetizing the saphenous nerve, a terminal branch of the femoral nerve that supplies a strip along the medial aspect of the foot.

### Side Effects/Complications

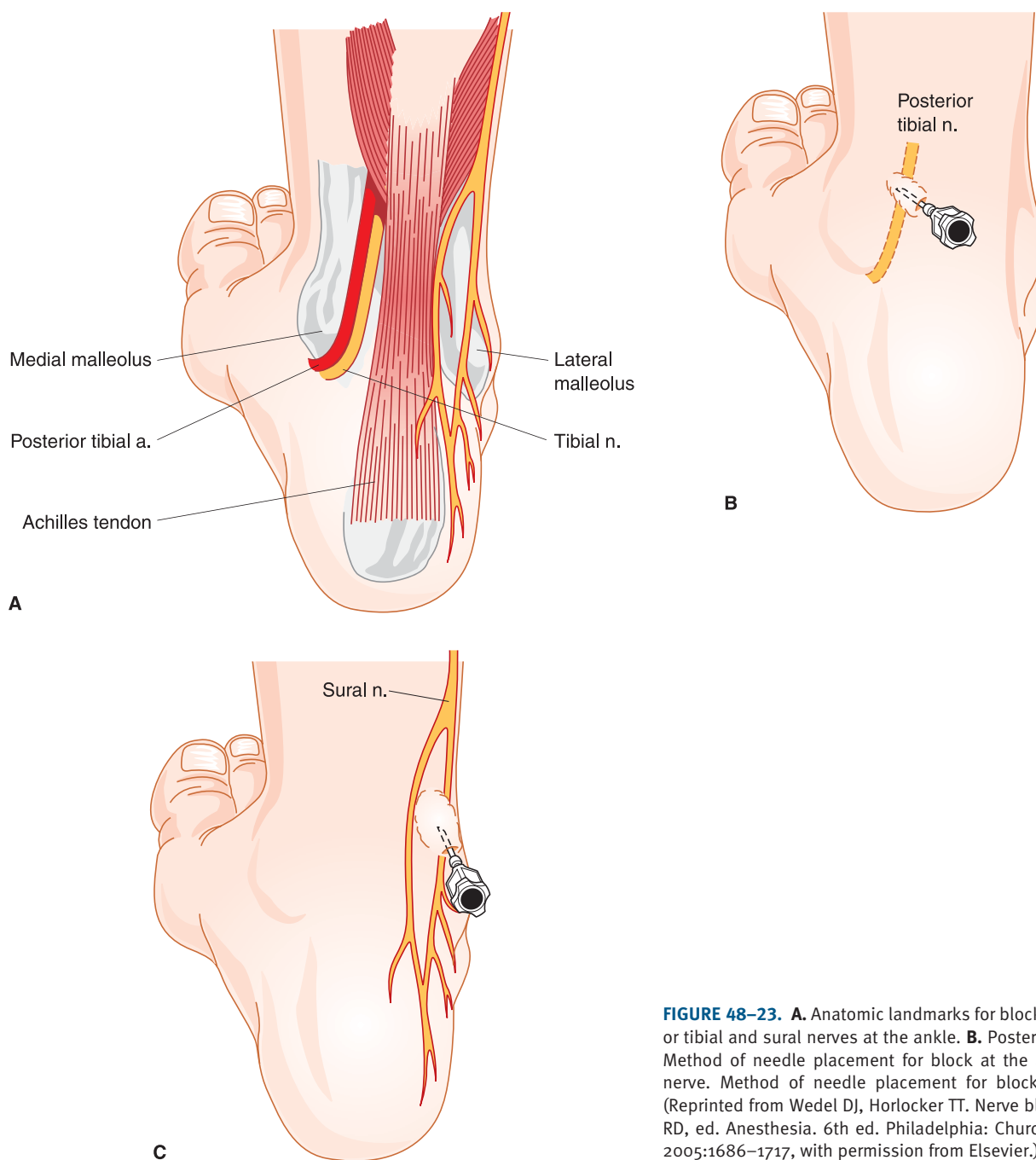
Multiple injections are required for some techniques, resulting in discomfort for the patient. Persisting paresthesia may occur, but it is self-limited. The presence of edema or induration in the area of the ankle block can make palpation of landmarks difficult. Intravascular injection is possible but unlikely if aspiration for blood is negative. The volume of local anesthetic used is small, thereby decreasing the risk of local anesthetic toxicity.

### Continuous Catheter Techniques

Continuous lower-extremity techniques were described decades ago, but remained underused compared to continuous upper-extremity and neuraxial approaches. For example, Brands and Callanan<sup>95</sup> placed psoas compartment catheters to provide analgesia for femoral neck fractures in 1978. Reliable (and improved) success rates and the risk of spinal hematoma following neuraxial techniques lead clinicians to again consider continuous lower-extremity blocks. Contemporary applications for continuous psoas compartment, sciatic, femoral, and popliteal fossa blockade have been reported.<sup>60,76,96</sup> Compared to conventional systemic and neuraxial analgesic methods, continuous lower-extremity blocks provide superior analgesia with fewer side effects, improve perioperative outcomes, and accelerate hospital dismissal following major joint replacement.<sup>76,96,97</sup>

### Perioperative Outcomes with Lower-Extremity Peripheral Regional Techniques

The unilateral nature of lower-extremity peripheral techniques makes them ideal for the patient undergoing total



**FIGURE 48-23.** **A.** Anatomic landmarks for block of the posterior tibial and sural nerves at the ankle. **B.** Posterior tibial nerve. Method of needle placement for block at the ankle. **C.** Sural nerve. Method of needle placement for block at the ankle. (Reprinted from Wedel DJ, Horlocker TT. Nerve blocks. In: Miller RD, ed. Anesthesia. 6th ed. Philadelphia: Churchill Livingstone, 2005:1686–1717, with permission from Elsevier.)

hip or knee arthroplasty, as the contralateral limb is immediately available to assist with early ambulation. Although single-injection techniques have been used, the duration of effect after a single injection is insufficient to result in major improvements in analgesia or outcome.<sup>68,98,99</sup>

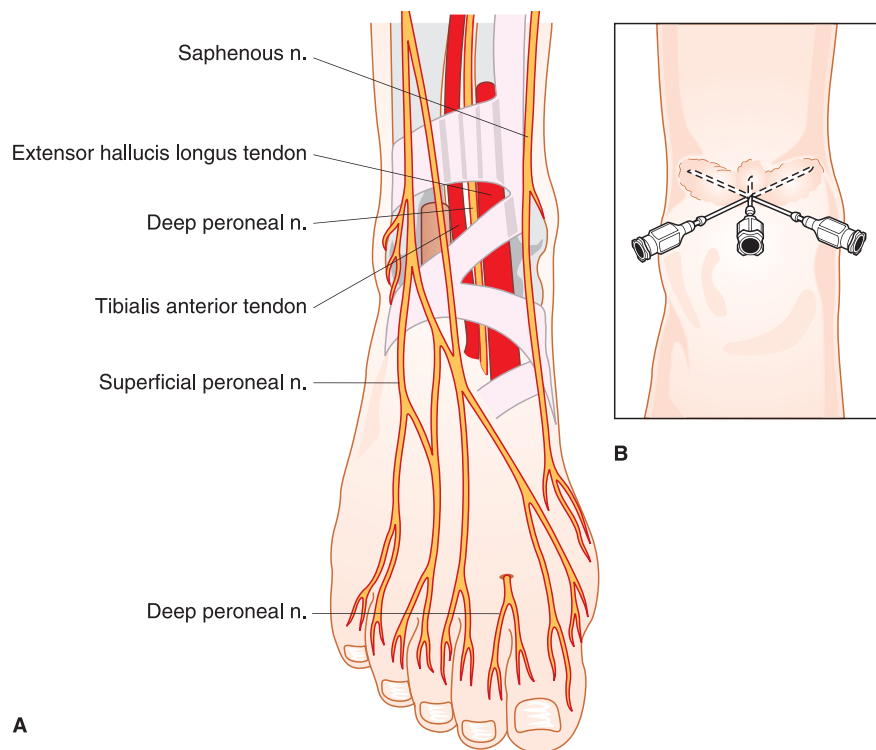
Studies demonstrate that peripheral techniques are equally effective as epidural analgesia (and both are superior to intravenous morphine) in providing analgesia and facilitating rehabilitation

after total joint replacement. For example, after total knee arthroplasty, patients receiving epidural analgesia or continuous femoral block reported lower pain scores, better knee flexion, faster ambulation, and shorter hospital stays than did patients who received intravenous morphine.<sup>96,97,100</sup> However, continuous femoral block was the preferred analgesic technique in each study because there were fewer technical problems and fewer side effects noted compared to epidural and sys-

temic approaches. Similar results were reported for patients undergoing total hip arthroplasty who received a continuous psoas block rather than epidural analgesia or intravenous morphine.<sup>76</sup>

Recent innovations emphasize continuous peripheral nerve blocks combined with multiple scheduled analgesics (OxyContin, acetaminophen) and oral analgesics (e.g., oxycodone); no intravenous opioids are administered. Using strict criteria, 90% of patients undergoing minimally invasive prima-





**FIGURE 48-24.** **A.** Anatomic landmarks for block of the deep peroneal, superficial peroneal, and saphenous nerves at the ankle. **B.** Method of needle placement for block of the deep peroneal, superficial peroneal, and saphenous nerves through a single needle entry site. (Reprinted from Wedel DJ, Horlocker TT. Nerve blocks. In: Miller RD, ed. *Anesthesia*. 6th ed. Philadelphia: Churchill Livingstone, 2005:1686–1717, with permission from Elsevier.)

ry hip or knee replacement achieved readiness for hospital discharge within 48 hours.<sup>101</sup> These studies support the movement toward continuous peripheral technique as the optimal analgesic method following total knee and hip arthroplasty. Additional information is needed to determine the effectiveness of these techniques in conventional primary and revision joint arthroplasty.

## NEUROLOGIC COMPLICATIONS

Nerve injury is a recognized complication of peripheral regional techniques. In a series involving more than 100,000 regional anesthetics, the frequency of neurologic complications following peripheral blockade was less than that associated with neuraxial techniques, and was associated with pain on needle placement or injection of local anesthetic.<sup>102</sup> Risk factors contributing to neurologic deficit after regional anesthesia include neural ischemia, traumatic injury to the nerves during needle or catheter placement, infection, and choice of local anesthetic solution.

However, postoperative neurologic injury as a result of pressure from improper patient positioning, tightly applied casts/surgical dressings, and surgical trauma are often attributed to the regional anesthetic. Patient factors, such as body habitus or a preexisting neurologic dysfunction, can also contribute to postoperative neurologic injury.

Although needle gauge, type (short vs. long bevel), and bevel configuration can influence the degree of nerve injury following peripheral nerve block, the findings are conflicting and there are no confirmatory human studies. Theoretically, localization of neural structures with a nerve stimulator would allow a high success rate without increasing the risk of neurologic complications, but this has not been established. Indeed, serious neurologic injury has been reported following uneventful brachial plexus block using a nerve stimulator technique.<sup>30</sup> Likewise, prolonged exposure, high dose and/or high concentrations of local anesthetic solutions also can result in permanent neurologic deficits. In laboratory models, the ad-

dition of epinephrine increases the neurotoxicity of local anesthetic solutions and decreases nerve blood flow. However, the clinical relevance of these findings in humans remains unclear. Finally, nerve damage caused by traumatic needle placement, local anesthetic neurotoxicity and neural ischemia during the performance of a regional anesthetic may worsen neurologic outcome in the presence of an additional patient factor or surgical injury.<sup>7</sup>

Prevention of neurologic complications begins during the preoperative visit with a careful evaluation of the patient's medical history and appropriate preoperative discussion of the risks and benefits of the available anesthetic techniques. It is imperative that all preoperative neurologic deficits are documented to allow early diagnosis of new or worsening neurologic dysfunction postoperatively. Postoperative sensory or motor deficits must also be distinguished from residual (prolonged) local anesthetic effect. Imaging techniques, such as CT and MRI are useful in identifying infectious processes as well as expanding hematomas. Although most neurologic complications resolve completely within several days or weeks, significant neural injuries necessitate neurologic consultation to document the degree of involvement and coordinate further workup. Neurophysiologic testing, such as nerve conduction studies, evoked potentials, and electromyography are often useful in establishing a diagnosis and prognosis.

## HEMORRHAGIC COMPLICATIONS

Although spinal hematoma is the most significant hemorrhagic complication of regional anesthesia because of the catastrophic nature of bleeding into a fixed and noncompressible space, the associated risk following plexus and peripheral techniques remains undefined. No investigation has examined the frequency and severity of hemorrhagic complications following plexus or peripheral blockade in anticoagulated patients.

Several cases of vascular injury with (or without resultant nerve dysfunction) have been described following plexus or peripheral techniques in patients with normal and abnormal hemostasis. In all patients with neurologic deficits, neurologic recovery was

complete within 6–12 months. Thus, while bleeding into a neurovascular sheath may result in significant decreases in hematocrit, the expandable nature of peripheral site may decrease the chance of irreversible neural ischemia.<sup>103</sup>

Importantly, all cases of major bleeding associated with nonneuraxial techniques occurred after psoas compartment or lumbar sympathetic blockade. Anticoagulants implicated included warfarin, low-molecular-weight and standard heparin, and thienopyridine derivatives (clopidogrel and ticlopidine). These cases suggest that significant blood loss, rather than neural deficits may be the most serious complication of nonneuraxial regional techniques in the anticoagulated patient. Additional information is needed to make definitive recommendations. Conservatively, the Consensus Statements on Neuraxial Anesthesia and Anticoagulation may be applied to plexus and peripheral techniques.<sup>103</sup> However, this may be more restrictive than necessary. Rather, consideration of the degree and duration of anticoagulation as well as the specific site of needle/catheter placement are paramount in optimal management. In general, the authors recommend management of perineuraxial techniques (psoas compartment, lumbar sympathetic) similar to that of neuraxial techniques, whereas more blockade/catheter placement at more superficial and compressible sites (femoral, axillary) may be managed more liberally.

## INFECTIOUS COMPLICATIONS OF PERIPHERAL REGIONAL TECHNIQUES

Although meningitis and epidural abscess are the most significant infectious complications of regional anesthesia, the associate risk following plexus and peripheral techniques remain undefined. Auroy et al.<sup>102</sup> reported no infectious complications in 21,278 single-injection peripheral nerve blocks. The more frequent placement of catheters for peripheral nerve blockade, often for prolonged periods, might be expected to increase the risk of infectious complications; however, few data are available to support this theoretical assumption. Two studies look more specifically at the infectious risk in continuous peripheral nerve blocks. Capdevila et al.<sup>104</sup> prospectively stud-

ied 1416 patients in 10 centers undergoing continuous peripheral nerve blocks for orthopedic procedures. A total of 969 (68%) catheters were cultured when removed, and patients were actively monitored for signs of localized infection or sepsis. A positive bacterial colonization was found in 278 (29%) catheters, most commonly *Staphylococcus epidermidis*. Local inflammation was present in 3% of patients. In these patients, 44% of the catheters were colonized, whereas only 19% of catheters were colonized in patients without inflammatory signs. There was no correlation between colonization and the presence of fever. Risk factors for local infection/inflammation were admission to an intensive care unit, male gender, catheter duration exceeding 48 hours and lack of antibiotic prophylaxis. Cuvillon et al.<sup>105</sup> investigated the incidence of infectious complications in 211 continuous femoral catheters. Colonization of the 208 catheters examined after 48 hours showed a rate of 57%, with the most common organism again being *S. epidermidis* (71%). Echography was performed in each instance of positive catheter colonization. Although no cellulitis or abscess was noted, three transitory bacteremias were attributed to the presence of the femoral catheters. There were no long-term sequelae in these two series as a consequence of infectious causes. Although the necessity of antibiotic prophylaxis during placement of permanent epidural catheters and implantable devices to treat chronic pain is well defined, the importance of antibiotic prophylaxis during placement and maintenance of neuraxial or peripheral catheters is less clear. In a series of 405 axillary catheters, the single infectious complication occurred in a nonsurgical patient who did not receive the “usual” perioperative antibiotic prophylaxis.<sup>63</sup> Until additional information is available, observance of aseptic technique and daily monitoring of catheter site (with appropriate removal if signs of infection are present) are the only evidence-based recommendations possible at this time.

## SUMMARY

Although it is possible to perform all surgical procedures while the patient

is under general anesthesia, the addition of peripheral nerve block techniques to the anesthesiologist's armamentarium adds flexibility and skills that benefit the patient both intraoperatively and postoperatively. Successfully mastering these techniques and applying them to the appropriate clinical situations add valuable options to the anesthetic care. Finally, for the anesthesiologist, knowledge of regional anesthesia is essential for the diagnosis and treatment of acute and chronic pain syndromes.

## KEY REFERENCES

1. Auroy Y, Narchi P, Messiah A, et al. Serious complications related to regional anesthesia. *Anesthesiology* 1997;87:479.
2. Capdevila X, Barthelet Y, Biboulet P, et al. Effects of perioperative analgesic technique on the surgical outcome and duration of rehabilitation after major knee surgery. *Anesthesiology* 1999;91:8.
3. Capdevila X, Coimbra C, Choquet O. Approaches to the lumbar plexus: success, risks, and outcome. *Reg Anesth Pain Med* 2005;30:150.
4. Enneking FK, Chan V, Greger J, et al. Lower-extremity nerve blockade: essentials of our current understanding. *Reg Anesth Pain Med* 2005;30:4.
5. Horlocker TT, Wedel DJ, Benzon H, et al. Regional anesthesia in the anticoagulated patient: defining the risks (the second ASRA consensus conference on neuraxial anesthesia and anticoagulation). *Reg Anesth Pain Med* 2003;28:172.
6. Neal JM, Hebl JR, Gerancher JC, Hogan QH. Brachial plexus anesthesia: essentials of our current understanding. *Reg Anesth Pain Med* 2002;27:402.
7. Singelyn FJ, Deyaert M, Joris D, et al. Effects of intravenous patient-controlled analgesia with morphine, continuous epidural analgesia, and continuous three-in-one block on postoperative pain and knee rehabilitation after unilateral total knee arthroplasty. *Anesth Analg* 1998;87:88.

## REFERENCES

- Hall RJ. Hydrochlorate of cocaine. *N Y Med J* 1884;40:643.
- Halsted WS. Practical comments on the use and abuse of cocaine: suggested by its invariably successful employment in more than a thousand minor surgical operations. *N Y Med J* 1885;42:294.
- Corning JL. On the prolongation of the anaesthetic effect of the hydrochlorate of cocaine, when subcutaneously injected: an experimental study. *N Y Med J* 1885;42:317.
- Braun H. Ueber den Einfluss der Vitalität der Gewebe auf die örtlichen und allgemeinen Giftwirkungen local anesthesirender Mittel und über die Bedeutung des Adrenalins für die local anästhesie. *Arch Klin Chir* 1903;69:541.
- Braun H. Local anesthesia: Its scientific basis and practical use. 3rd ed. Philadelphia: Lea & Febiger, 1914.
- Labat G. Regional anesthesia: Its technic and clinical application. Philadelphia: WB Saunders, 1922.
- Neal JM, Hebl JR, Gerancher JC, Hogan QH. Brachial plexus anesthesia: essentials of our current understanding. *Reg Anesth Pain Med* 2002;27:402.
- Handoll HHG, Koscielniak-Nielsen ZJ. Single, double or multiple injection techniques for axillary brachial plexus block for hand, wrist or forearm surgery. *Cochrane Database Syst Rev* CD003842, 2006.
- Arcand G, Williams SR, Chouinard P, et al. Ultrasound-guided infraclavicular versus supraclavicular block. *Anesth Analg* 2005;101:886.
- Williams SR, Chouinard P, Arcand G, et al. Ultrasound guidance speeds execution and improves the quality of supraclavicular block. *Anesth Analg* 2003;97:1518.
- Chan VW, Nova H, Abbas S, et al. Ultrasound examination of the sciatic nerve: a volunteer study. *Anesthesiology* 2006;104:309.
- Klaastad O, Smedby O, Thompson GE, et al. Distribution of local anesthetic in axillary brachial plexus block: a clinical and magnetic resonance imaging study. *Anesthesiology* 2002;96:1315.
- Franco CD, Gloss FJ, Voronov G, et al. Supraclavicular block in the obese population: an analysis of 2020 blocks. *Anesth Analg* 2006;102:1252.
- Enneking FK, Chan V, Greger J, et al. Lower-extremity nerve blockade: essentials of our current understanding. *Reg Anesth Pain Med* 2005;30:4.
- Rosenberg PH, Veering BT, Urmey WF. Maximum recommended doses of local anesthetics: a multifactorial concept. *Reg Anesth Pain Med* 2004;29:564.
- Neal JM. Effects of epinephrine in local anesthetics on the central and peripheral nervous systems: neurotoxicity and neural blood flow. *Reg Anesth Pain Med* 2003;28:124.
- Iskandar H, Benard A, Ruel-Raymond J, et al. The analgesic effect of interscalene block using clonidine as an analgesic for shoulder arthroscopy. *Anesth Analg* 2003;96:260.
- Tissot S, Frering B, Gagnieu MC, et al. Plasma concentrations of lidocaine and bupivacaine after cervical plexus block for carotid surgery. *Anesth Analg* 1997;84:1377.
- Peitzman AB, Webster WM, Loubeau JM, et al. Carotid endarterectomy under regional (conductive) anesthesia. *Ann Surg* 1982;196:59.
- Winnie AP, Ramamurthy S, Durrani Z, Radonjic, R. Interscalene cervical plexus block: a single injection technic. *Anesth Analg* 1975;54:370.
- Lanz E, Theiss D, Jankovic D. The extent of blockade following various techniques of brachial plexus block. *Anesth Analg* 1983;62:55.
- Winnie AP. Interscalene brachial plexus block. *Anesth Analg* 1970;49:455.
- Roch JJ, Sharrock NE, Neudachin L. Interscalene brachial plexus block for shoulder surgery: a proximal paresthesia is effective. *Anesth Analg* 1992;75:386.
- Urmey WF, Talts KH, Sharrock NE. One hundred percent incidence of hemidiaphragmatic paresis associated with interscalene brachial plexus anesthesia as diagnosed by ultrasonography. *Anesth Analg* 1991;72:498.
- Urmey WF, McDonald M. Hemidiaphragmatic paresis during interscalene brachial plexus block: effects on pulmonary function and chest wall mechanics. *Anesth Analg* 1992;74:352.
- Fujimura N, Namba H, Tsunoda K, et al. Effect of hemidiaphragmatic paresis caused by interscalene brachial plexus block on breathing pattern, chest wall mechanics and arterial blood gases. *Anesth Analg* 1995;81:962.
- Sardesai AM, Chakrabarti AJ, Denny NM. Lower lobe collapse during continuous interscalene brachial plexus local anesthesia at home. *Reg Anesth Pain Med* 2004;29:65.
- Liguori GA, Kahn RL, Gordon J, et al. The use of metoprolol and glycopyrrolate to prevent hypotensive/bradycardic events during shoulder arthroscopy in the sitting position under interscalene block. *Anesth Analg* 1998;87:1320.
- Boardman ND, Cofield RH. Neurologic complications of shoulder surgery [review]. *Clin Orthop Rel Res* 1999;368:44.
- Benumof JL. Permanent loss of cervical spinal cord function associated with interscalene block performed under general anesthesia. *Anesthesiology* 2000;93:1541.
- Brown DL, Cahill DR, Bridenbaugh LD. Supraclavicular nerve block: anatomic analysis of a method to prevent pneumothorax. *Anesth Analg* 1993;76:530.
- Koscielniak-Nielsen ZJ, Rasmussen H, Hesselbjerg L, et al. Infraclavicular block causes less discomfort than axillary block in ambulatory patients. *Acta Anaesthesiol Scand* 2005;49:1030.
- Raj PP, Montgomery SJ, Nettles D, Jenkins MT. Infraclavicular brachial plexus block: a new approach. *Anesth Analg* 1973;52:897.
- Lecamwasam H, Mayfield J, Rosow L, et al. Stimulation of the posterior cord predicts successful infraclavicular block. *Anesth Analg* 2006;102:1564.
- Ilfeld BM, Enneking K. Brachial plexus infraclavicular block success rate and appropriate endpoints. *Anesth Analg* 2002;95:784.
- Wilson JL, Brown DL, Wong GY, et al. Infraclavicular brachial plexus block: parasagittal anatomy important to the coracoid technique. *Anesth Analg* 1998;87:870.
- Rettig HG, Gielen MJ, Mathiew UJM, et al. Vertical infraclavicular block of the brachial plexus: effects on hemidiaphragmatic movement and ventilatory function. *Reg Anesth Pain Med* 2005;30:529.
- Gentili ME, Deleuze A, Estebe JP, et al. Severe respiratory failure after infraclavicular block with 0.75% ropivacaine: a case report. *J Clin Anesth* 2002;14:459.
- De Jong RH. Axillary block of the brachial plexus. *Anesthesiology* 1961;22:215.
- Schroeder LE, Horlocker TT, Schroeder DR. The efficacy of axillary block for surgical procedures about the elbow. *Anesth Analg* 1996;83:747.
- Serlo W, Haapanemi L. Regional anaesthesia in paediatric surgery. *Acta Anaesthesiol Scand* 1985;29:283.
- Eriksson E. Axillary brachial plexus anaesthesia in children with citanest. *Acta Anaesthesiol Scand Suppl* 1965;16:291.
- Thompson GE, Rorie DK. Functional anatomy of the brachial plexus sheaths. *Anesthesiology* 1983;59:117.
- Selander D, Dhuner KG, Lundborg G. Peripheral nerve injury due to injection needles used for regional anesthesia. *Acta Anaesthesiol Scand* 1977;21:182.
- Montgomery SJ, Raj PP, Nettles D, Jenkins MT. The use of the nerve stimulator with standard unshathed needles in nerve blockade. *Anesth Analg* 1973;52:827.
- Fanelli G, Casati A, Garancini P, et al. Nerve stimulator and multiple injection technique for upper and lower limb blockade: failure rate, patient acceptance and neurologic complications. *Anesth Analg* 1999;88:847.
- Winnie AP, Collins VJ. The subclavian perivascular technique to brachial plexus anesthesia. *Anesthesiology* 1964;25:353.
- Vester-Andersen T, Husum B, Lindburg T, et al. Perivascular block. IV. Blockade following 40, 50, or 60 mL of mepivacaine 1% with adrenaline. *Acta Anaesthesiol Scand* 1984;28:99.
- Vester-Andersen T, Christiansen C, Sorensen M, Eriksen E. Perivascular axillary



- block. I. Blockade following 40 mL 1% mepivacaine with adrenaline. *Acta Anaesthesiol Scand* 1982;26:519.
50. Baranowski AP, Pither CE. A comparison of three methods of axillary brachial plexus anaesthesia. *Anaesthesia* 1990;45:362.
51. Partridge BL, Katz J, Benirschke K. Functional anatomy of the brachial plexus sheath: implications for anesthesia. *Anesthesiology* 1987;66:74.
52. Selander D, Edshage S, Wolff T. Paresthesia or no paresthesia. *Acta Anaesthesiol Scand* 1979;23:27.
53. Bouaziz H, Narchi P, Mercier FJ, et al. Comparison between conventional axillary block and a new approach at the midhumeral level. *Anesth Analg* 1997;84:1058.
54. Bier A. Ueber einen neuen Weg Lokalanästhesie an den Gliedmassen zu Erzcugen. *Verh Dtsch Ges Chir* 1908;27:204.
55. Moore MA, Garfin SR, Hargens AR. Wide tourniquets eliminate blood flow at low inflation pressures. *J Hand Surg* 1987;12A:1006.
56. Duggan J, McKeown DW, Scott DB. Venous pressures in intravenous regional anesthesia. *Reg Anesth* 1984;9:70.
57. Davies JAH, Wilkey AD, Hall ID. Bupivacaine leak past inflated tourniquets during intravenous regional analgesia. *Anaesthesia* 1984;39:996.
58. Sukhani R, Garcia CJ, Munhall RJ, et al. Lidocaine disposition following intravenous regional anesthesia with different tourniquet deflation techniques. *Anesth Analg* 1989;68:633.
59. Ilfeld BM, Morey TE, Enneking FK. The delivery rate accuracy of portable infusion pumps used for continuous regional analgesia. *Anesth Analg* 2002;95:1331.
60. Ilfeld BM, Morey TE, Wang RD, Enneking FK. Continuous popliteal sciatic nerve block for postoperative pain control at home: a randomized, double-blinded, placebo-controlled study. *Anesthesiology* 2002;97:959.
61. Copeland SJ, Laxton MA. A new stimulating catheter for continuous peripheral nerve blocks. *Reg Anesth Pain Med* 2001;26:589.
62. Capdevila X, Biboulet P, Morau D, et al. Continuous three-in-one block for postoperative pain after lower limb orthopedic surgery: where do the catheters go? *Anesth Analg* 2002;94:1001.
63. Bergman BD, Hebl JR, Kent J, Horlocker TT. Neurologic complications of 405 consecutive continuous axillary catheters. *Anesth Analg* 2003;96:247.
64. Ansbro PF. A method of continuous brachial plexus block. *Am J Surg* 1946;71:716.
65. Gaumann DM, Lennon RL, Wedel DJ. Continuous axillary block for postoperative pain management. *Reg Anesth* 1988;13:77.
66. O'Driscoll SW, Giori NJ. Continuous passive motion (CPM): theory and principles of clinical application. *J Rehabil Res Dev* 2000;37:179.
67. Liu SS, Salinas FV. Continuous plexus and peripheral nerve block for postoperative analgesia. *Anesth Analg* 2002.
68. Capdevila X, Coimbra C, Choquet O. Approaches to the lumbar plexus: Success, risks, and outcome. *Reg Anesth Pain Med* 2005;30:150.
69. Awad T, Duggan EM. Posterior lumbar plexus block: anatomy, approaches, and techniques. *Reg Anesth Pain Med* 2005;30:143.
70. Morau D, Lopez S, Biboulet P, et al. Comparison of continuous 3-in-1 and fascia iliaca compartment blocks for postoperative analgesia: feasibility, catheter migration, distribution of sensory block, and analgesic efficacy. *Reg Anesth Pain Med* 2003;28:309.
71. Ben-David B, Schmalenberger K, Chelly JE. Analgesia after total knee arthroplasty: is continuous sciatic blockade needed in addition to continuous femoral blockade? *Anesth Analg* 2004;98:747.
72. Pham Dang C, Gautheron E, Guilley J, et al. The value of adding sciatic block to continuous femoral block for analgesia after total knee replacement. *Reg Anesth Pain Med* 2005;30:128.
73. Zaric D, Boysen K, Christiansen C, et al. A comparison of epidural analgesia with combined continuous femoral-sciatic nerve blocks after total knee replacement. *Anesth Analg* 2006;102:1240.
74. Macalou D, Trueck S, Meuret P, et al. Postoperative analgesia after total knee replacement: the effect of an obturator nerve block added to the femoral 3-in-1 nerve block. *Anesth Analg* 2004;99:251.
75. Chayen D, Nathan H, Chayen M. The psoas compartment block. *Anesthesiology* 1976;45:95.
76. Capdevila X, Macaire P, Dadure C, et al. Continuous psoas compartment block for postoperative analgesia after total hip arthroplasty: new landmarks, technical guidelines, and clinical evaluation. *Anesth Analg* 2002;94:1606.
77. Winnie AP, Ramamurthy S, Durrani Z. The inguinal paravascular technique of lumbar plexus anesthesia: The "3-in-1 block." *Anesth Analg* 1973;52:989.
78. Marhofer P, Nasel C, Sitzwohl C, Kapral S. Magnetic resonance imaging of the distribution of local anesthetic during the three-in-one block. *Anesth Analg* 2000;90:119.
79. Ganapathy S, Wasserman RA, Watson JT, et al. Modified continuous 3-in-1 block for postoperative pain after TKA. *Anesth Analg* 1999;99:1197.
80. Auroy Y, Benhamou D, Bargues L, et al. Major complications of regional anesthesia in France: the SOS Regional Anesthesia Hotline Service. *Anesthesiology* 2002;97:1274.
81. Berry FR. Analgesia in patients with fractured shaft of femur. *Anaesthesia* 1977;32:576.
82. Patel NJ, Flashburg MH, Paskin S, Grossman R. A regional anesthetic technique compared to general anesthesia for outpatient knee arthroscopy. *Anesth Analg* 1986;65:185.
83. Wassef MR. Interadductor approach to obturator nerve blockade for spastic conditions of adductor thigh muscles. *Reg Anesth* 1993;18:13.
84. Beck GP. Anterior approach to sciatic nerve. *Anesthesiology* 1963;24:222.
85. Ichihanagi K. Sciatic nerve block: Lateral approach with the patient supine. *Anesthesiology* 1959;20:601.
86. Raj PP, Parks RI, Watson TD, Jenkins MT. New single position supine approach to sciatic-femoral nerve block. *Anesth Analg* 1975;54:489.
87. di Benedetto P, Casati A, Bertini L, Fanelli G. Posterior subgluteal approach to block the sciatic nerve: description of the technique and initial clinical experiences. *Eur J Anaesthesiol* 2002;19:682.
88. Sukhani R, Nader A, Candido KD, et al. Nerve stimulator-assisted evoked motor response predicts the latency and success of a single-injection sciatic block. *Anesth Analg* 2004;99:584.
89. Rorie DK, Byer DE, Nelson DO, et al. Assessment of block of the sciatic nerve in the popliteal fossa. *Anesth Analg* 1980;59:371.
90. Vloka JD, Hadûi A, April E, Thys DM. The division of the sciatic nerve in the popliteal fossa: anatomical implications for popliteal nerve blockade. *Anesth Analg* 2001;92:215.
91. Benzon HT, Kim C, Benzon HP, et al. Correlation between evoked motor response of the sciatic nerve and sensory blockade. *Anesthesiology* 1997;87:547.
92. Paqueron X, Bouaziz H, Macalou D, et al. The lateral approach to the sciatic nerve at the popliteal fossa: one or two injections? *Anesth Analg* 1999;89:1221.
93. Zetlaoui PJ, Bouaziz H. Lateral approach to the sciatic nerve in the popliteal fossa. *Anesth Analg* 1998;87:79.
94. Hadûi A, Vloka JD. A comparison of the posterior versus lateral approaches to the block of the sciatic nerve in the popliteal fossa. *Anesthesiology* 1998;88:1480.
95. Brands E, Callanan VI. Continuous lumbar plexus block—analgesia for femoral neck fractures. *Anaesth Intensive Care* 1978;6:256.
96. Singelyn FJ, Deyaert M, Joris D, et al. Effects of intravenous patient-controlled analgesia with morphine, continuous epidural analgesia, and continuous three-in-one block on postoperative pain and knee rehabilitation after unilateral total knee arthroplasty. *Anesth Analg* 1998;87:88.
97. Capdevila X, Barthelet Y, Biboulet P, et al. Effects of perioperative analgesic technique on the surgical outcome and duration of rehabilitation after major knee surgery. *Anesthesiology* 1999;91:8.
98. Allen HW, Liu SS, Ware PD, et al. Peripheral nerve blocks improve analgesia



after total knee replacement surgery. *Anesth Analg* 1998;87:93.

99. Stevens RD, Van Gessel E, Flory N, et al. Lumbar plexus block reduces pain and blood loss associated with total hip arthroplasty. *Anesthesiology* 2000;93:115.

100. Chelly JE, Greger J, Gebhard R, et al. Continuous femoral blocks improve recovery and outcome of patients undergoing total knee arthroplasty. *J Arthroplasty* 2001;16:436.

101. Hebl JR, Kopp SL, Ali MH, et al. A comprehensive anesthesia protocol that emphasizes peripheral nerve block markedly improves patient care and facilitates early discharge after total hip and knee arthroplasty. *J Bone Joint Surg Am* 2005;87:63.

102. Auroy Y, Narchi P, Messiah A, et al. Serious complications related to regional anesthesia. *Anesthesiology* 1997;87:479.

103. Horlocker TT, Wedel DJ, Benzon H, et al. Regional anesthesia in the anticoagulated patient: defining the risks (the second

ASRA Consensus Conference on Neuraxial Anesthesia and Anticoagulation). *Reg Anesth Pain Med* 2003;28:172.

104. Capdevila X, Pirat P, Bringuier S, et al. Continuous peripheral nerve blocks in hospital wards after orthopedic surgery. *Anesthesiology* 2005;103:1035.

105. Cuvillon P, Ripart J, Lalourcey L, et al. The continuous femoral nerve block catheter for postoperative analgesia: bacterial colonization, infectious rate and adverse effects. *Anesth Analg* 2001;93:1045.

# CHAPTER 49

## Managing Adverse Outcomes during Regional Anesthesia

Ban C.H. Tsui, MSc, MD, FRCPC,  
and Brendan T. Finucane,  
MBBCh, FRCPC

No matter how skillful an anesthesiologist may be, adverse perioperative events are inevitable during regional anesthesia practice. Adverse events have been associated with regional anesthesia since local anesthetics were first introduced by Kolmer in 1884,<sup>1</sup> and will continue no matter how skillful we become. Because it is difficult to thoroughly address all regional anesthesia complications in this chapter, we focus our attention on those areas that have the most relevance to today's practice. This chapter addresses the principles involved in managing complications that are common to all regional anesthesia techniques. Subsequently, we address specific management of complications associated with the most commonly used regional anesthesia techniques.

### GENERAL PRINCIPLES

#### Importance of Prevention

The time-honored statement that “an ounce of prevention is worth a pound of cure” is essential to remember<sup>2</sup> when considering the management of adverse outcomes in regional anesthesia practice. The most effective way to manage regional anesthesia complications is to prevent or minimize the risk of these complications occurring in the first place. Neurologic injury is one of the most dreaded complications associated with all anesthesia techniques, including regional anesthesia, and it is important to realize that once a serious neurologic injury occurs the chances of full recovery are unlikely.

Safe regional anesthesia begins with the first encounter with the patient.

The first task at hand is to perform a thorough preoperative assessment of the patient. Good results are obtained when a *skilled* anesthesiologist uses appropriate equipment and technique. Careful intraoperative sedation and monitoring are vital to the practice of safe regional anesthesia. Resuscitation drugs and equipment must always be immediately available in the event of a problem or if general anesthesia is required. Last but not least, patients must be carefully observed during the postoperative period when most of the serious complications become evident. Early intervention is of the utmost importance in preventing permanent neurologic injury. The anesthesiologist should also be familiar with and aware of the legal implications of adverse events should they occur.

Poor outcomes and serious complications are *not* *prima facie* evidence of negligence. However, the risk of litigation in contemporary anesthesia prac-

tice is closely associated with the severity of patient injury rather than the occurrence of negligence; this is particularly true of regional anesthesia injuries. The Closed Claims study in the United States reported a high incidence of successful suits against anesthesiologists involved in regional anesthesia cases, even though the standard of care was met. The importance of effective communication and truthful disclosure with the patient and the patient's family cannot be overemphasized. Litigation generally results from the combination of an adverse event and a poor physician-patient relationship. A patient who feels that the physician has the patient's best interests at heart is less likely to pursue litigation than is a patient who does not respect or trust the physician; thus, the anesthesiologist should pay particular attention toward developing a good rapport with the patient in the limited time allotted. Table 49-1 summarizes basic recommendations for maintaining a

### KEY POINTS

1. Safe regional anesthesia begins with a thorough knowledge of anatomy. In Labat's words, “anatomy is the foundation upon which the entire concept of regional anesthesia is built.” Studying the anatomy of the major plexuses and peripheral nerves is critical for learning regional anesthesia and avoiding its complications.
2. Prior to performing regional anesthesia, it is imperative to thoroughly discuss the techniques, and their limitations, with the patient. Assessing which patients are most appropriate for performing these techniques on is important, as some are not suitable candidates (e.g., those with major anatomic distortion or serious mental illness).
3. One of the most important principles for safe regional anesthesia is provision of a comfortable patient environment. If a patient suffers as a result of one's intervention, a basic principle of the practice of anesthesia has been violated.
4. Resuscitation equipment must be immediately available when performing regional anesthesia and one must be prepared, at all times, to anesthetize and resuscitate the patient when necessary.
5. Knowing when to stop performing regional anesthesia techniques is crucial. Dogged persistence in the face of failure is inadvisable. Do not hesitate to seek assistance when faced with difficulties and be prepared to change to an alternative route of anesthesia if persistent failure (more than 3 attempts or 20 minutes) occurs.
6. Do not perform regional anesthesia procedures in anesthetized adult patients unless the benefits far outweigh the risks. If this principle is violated, the reasoning must be documented in the patient's file.
7. Always be accompanied by a skilled assistant when performing regional anesthesia.
8. Always ensure adequate patient monitoring during regional anesthesia performance and continuing until the block has completely worn off.
9. If neurologic injury is suspected following regional anesthesia, the cause should be determined quickly so as to prevent permanent injury.
10. One must not assume that all patient injury is from regional anesthesia, as other possibilities exist. Do not hesitate to involve other disciplines in the quest to determine the cause of injury.

TABLE 49–1.

**Maintaining a Standard of Care during Regional Anesthetic Practice**

- Preoperative patient selection
- Appropriate consent
- Using appropriate equipment and technique
- Monitoring regional anesthesia practice
- Accurate and meticulous anesthesia documentation
- Physician–patient communication
- Postoperative followup visit

standard of care in regional anesthesia practice. Maintaining a standard of care at all times does not guarantee against legal action, but it certainly will minimize the risk and is to be encouraged at all times.<sup>3</sup> Legal issues involving anesthesiology practice are discussed in detail in Chap. 95.

The following is a simple guide detailing how to minimize the risk of an adverse legal event by maintaining accepted standards of care during the practice of regional anesthesia.

**Patient Selection**

Proper patient selection is a critical consideration for the safe and successful performance of regional anesthesia,

as not all patients are suitable candidates for regional anesthesia. Some patients are not psychologically suitable for regional anesthesia. A number of patients suffer from needle phobias and faint at the least provocation. Patients with schizophrenia are not suitable candidates for regional anesthesia unless it is combined with general anesthesia. Gross anatomic distortion may preclude the performance of regional anesthesia in some patients. Neuraxial techniques are frequently associated with hemodynamic disturbances such as bradycardia and hypotension; therefore they are contraindicated in hemodynamically unstable patients and in those with fixed cardiac outputs. Regional anesthesia should be used cautiously in patients with preexisting neurologic disease and if these techniques are employed in these patients, neurologic deficits must be clearly documented prior to the performance of regional anesthesia. Some patients are rigidly opposed to regional anesthesia and it is important not to badger them into accepting these techniques if they are reluctant to participate in the first place. If it is clearly evident that a patient will benefit from regional anesthesia, it is reasonable to explain in detail the rationale behind the procedure; however, the decision to undergo regional anesthesia must be finally left

to the discretion of the patient. It is very important to discuss the options of anesthesia with patients even if they are undergoing minor operative procedures. It is imperative to follow national and international guidelines pertaining to regional anesthesia practice (i.e., American Society of Anesthesiologists [ASA] monitoring, American Society of Regional Anesthesia and Pain Medicine [ASRA] guidelines for anticoagulated patients), and if there is any deviation it is important to specify the reasons and to document them. Table 49–2 summarizes the important factors involved in selecting suitable patients for regional anesthesia.

**Consent**

Potentially serious complications associated with regional anesthesia should be disclosed to patients, including convulsions and the risk of cardiac toxicity from systemic injections of local anesthetics, spinal cord/nerve injury leading to paralysis or neurologic deficit, pneumothorax, hematoma, infection, cardiac arrest, and death. Any common unpleasant side effects specific to certain procedures such as the failure to achieve surgical anesthesia, patient awareness during conscious sedation, nausea, pruritus, headache, shivering, backache, dizziness, and urinary retention should also be discussed. Howev-

TABLE 49–2.

**Patient Selection Factors**

Factors Involved in Patient Selection	Relative Contraindications	Absolute Contraindications
Patient cooperation	Anxiety states; needle phobias; poorly controlled psychiatric disease; language barriers; pediatric patients	Patient refusal
Anatomic and physiologic considerations	Anatomical anomalies; technical challenges: obesity, severe arthritis, degenerative joint disease	
Anesthetic considerations		Lack of experience and skills; lack of appropriate equipment for performing the block (e.g., nerve stimulator, ultrasound); lack of appropriate equipment for resuscitation and monitoring (e.g., oxygen, mask, drugs)
Coexisting diseases	Preexisting progressive neurologic disease; comatose states; sepsis; coagulopathy	Infection at the site of injection; allergy to local anesthetics; coagulopathy (although an International Normalized Ratio [INR] of <2 is acceptable for ophthalmic procedures)
Surgical procedures	Lengthy procedures that outlast the duration of action of the local anesthetic (single-injection techniques; uncomfortable positioning for an extended period of time)	

er, anesthesiologists should bear in mind that even with informed consent, proper disclosure, effective communication, and an appropriate ethical approach, there is no guarantee that they will be legally protected.<sup>4</sup>

Informed consent and an explanation of the risks and alternatives to regional anesthesia must be provided to the patient (the anesthesiologist should never coerce a patient to accept or reject any anesthetic plan).

### Use of Appropriate Equipment and Technique

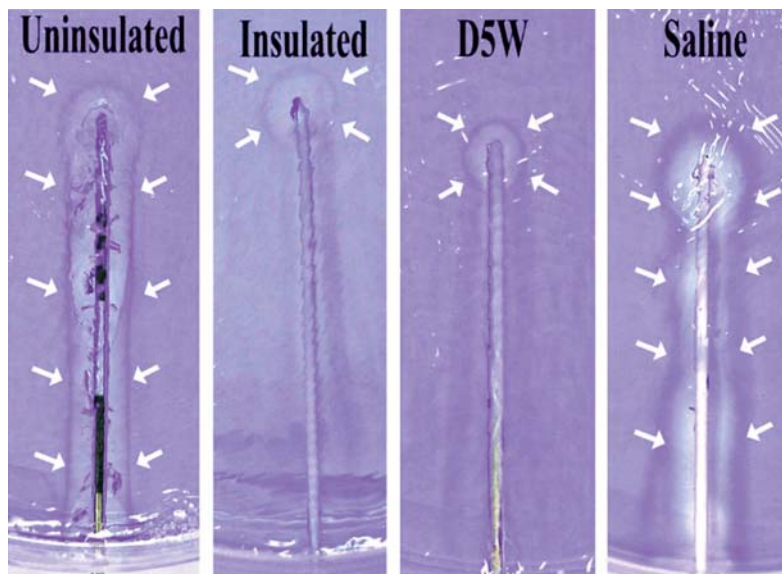
As advances in regional anesthesia continue, techniques used must be continuously revised in light of any new, clinically relevant information and developments. For years, we have been percutaneously inserting needles toward neural targets and have relied solely on our knowledge of anatomy and our somewhat primitive techniques (i.e., paresthesia and the loss-of-resistance [LOR] technique). The introduction of nerve stimulation was an important advance in regional anesthesia because it provided some objective evidence that the needle tip was close to the neural target. Although it did take a long time to convince the artisans of regional anesthesia that the application of nerve stimulation in regional anesthesia was useful, most anesthesiologists currently use nerve stimulation techniques in regional anesthesia. Although nerve stimulation techniques have been used in regional anesthesia for more than 30 years, the science of this technique has not been studied in any great detail.

Nerve stimulation was the first step in the conversion of regional anesthesia from an art to a science. One of the most exciting new advances in regional anesthesia in recent years has been the introduction of ultrasonography as a method to accurately place needles in close proximity to neural targets. Ultrasonography allows real-time visualization of anatomical structures and offers the potential to guide needle and catheter placement in regional anesthesia. This section highlights recent advances in nerve stimulation and ultrasonography that may play an important role in preventing complications during regional anesthesia practice.

**Nerve Stimulation in Regional Anesthesia: Peripheral Nerve Blockade** Despite years of clinical use, the electrophysiologic effect of

injectates on nerve stimulation has never been fully explained. The classical unanswered question concerning electrical stimulation is why is it that one may not be able to consistently stimulate a nerve with a current of less than 0.5 mA, even after eliciting a paresthesia in that nerve? Another phenomenon that is poorly understood is the “Raj test.” The following is a brief description of the Raj test: when nerve stimulation is being used to locate a nerve, a twitch is observed when the needle tip is close to the neural target. Ideally, the twitch is required to persist at a current of 0.5 mA. The clinician then injects a small volume of local anesthetic or normal saline through the needle. If the needle tip is in the correct location, the muscle twitch immediately disappears.<sup>5</sup> Until very recently the disappearance of the twitch was thought to be caused by physical displacement of the nerve by the injectate.<sup>6</sup> We recently learned that this mechanism is best explained in electrical terms and is not entirely a result of the physical displacement of the nerve.<sup>7</sup> In a porcine model, the injection of 0.9% sodium chloride solution (NaCl) abolished the motor response, and a subsequent injection of 5% dextrose reestablished a motor response during peripheral nerve stimulation.<sup>7</sup> An accompanying

in vitro experiment showed that injections of solutions, such as 0.9% NaCl, cause a change in the electrical field at the needle–tissue interface. It was concluded that the injection of electrically conducting solutions (saline or local anesthetic) increases the conductive area surrounding the stimulating needle tip, leading to a decrease in the current density surrounding the target nerve. The current density surrounding the needle tip is then no longer sufficient to stimulate the desired nerve.<sup>7</sup> This observation suggests that effective nerve stimulation is sensitive to changes that occur at the needle–tissue interface, such as the angle of the needle or the injection of the local anesthetic. The net effect of these changes is to alter the current density at the tip of the needle or the path of the electric current, ultimately resulting in a change in the quality of the motor response.<sup>8</sup> This phenomenon has also recently been reported in a clinical setting (Fig. 49–1).<sup>9,10</sup> In a clinical study, the mean current required to stimulate the supraclavicular, axillary, femoral, and sciatic nerves when using an insulated needle was 0.6, 0.5, 0.7, and 0.5 mA, respectively.<sup>11</sup> In contrast, the mean current required to stimulate these same nerves when using a stimulating catheter following the injection of normal saline, was



**FIGURE 49–1.** Gel electrophoresis: changes in the electrical field with uninsulated and insulated needles after 5% dextrose in water (D<sub>5</sub>W) and saline injection. Arrows show the margin of the clear zone/electric field. *Far left:* Diffuse electric field with an uninsulated needle; *center left:* narrow electric field with an insulated needle; *center right:* electric field with an insulated needle after D<sub>5</sub>W injection remains narrow; *far right:* diffuse electric field with an insulated needle after normal saline injection. (Reprinted and adapted from Tsui BC, Wagner A, Finucane B. Electrophysiologic effect of injectates on peripheral nerve stimulation. *Reg Anesth Pain Med* 2004;29(3):189–193. Copyright May 2004, with permission from American Society of Regional Anesthesia and Pain Medicine.)<sup>7</sup>



much higher (1.5, 1.5, 2, and 3 mA, respectively).<sup>11</sup> Those findings had important clinical implications as:

- One may potentially use a nonconducting solution, such as 5% dextrose in water (D<sub>5</sub>W), rather than saline to dilate the perineural space.<sup>7</sup>
- Initial reports of the use of nonconducting injectates (e.g., D<sub>5</sub>W) in peripheral nerve block are promising and appear to provide stability when using electrical stimulation techniques.<sup>9,10</sup>
- Another possible use of D<sub>5</sub>W is to inject a small amount to highlight the needle tip and observe the spread of injectate without inhibiting the ability to use nerve stimulation<sup>12</sup> when using ultrasonography. However, future studies are warranted to determine the merit of this technique.

### Nerve Stimulation in Regional Anesthesia: Neuraxial Blockade

Epidural stimulation has recently been used to confirm and guide catheter placement in the epidural space. The epidural stimulation test confirms catheter placement through stimulation of the spinal nerve roots (not the spinal cord) with a low-amplitude electrical current conducted through normal saline via an electrically conducting catheter.<sup>13</sup> Correct placement of the epidural catheter tip (1–2 cm from the nerve roots) is indicated by a motor response elicited with a current between 1–10 mA.<sup>13,14</sup> Any motor response observed with a significantly lower threshold current (<1 mA) suggests that the catheter is in the subarachnoid or subdural space, or is in close proximity to a nerve root<sup>15,16</sup>; in these rare cases, a motor response is elicited with a significantly lower threshold current because the stimulating catheter may be very close (<1 cm) to the nerve roots or because it may be in direct contact with highly conductive cerebrospinal fluid (CSF) (Table 49–3).

Electrical stimulation has been applied to neural structures for neurophysiologic evaluation and pain control for many years,<sup>17–20</sup> and has proven to be safe. The safety of the epidural stimulation test is not completely known, but it is anticipated that the risk of a brief intermittent electrical stimulation used in this setting would be lower than the risk of chronic epidural stimulation (4–30 mA) used in long-term pain management and during in-

TABLE 49–3.

Comparison of the Standard Test Dose with the Epidural Stimulation (Tsui) Test for Confirming Epidural Catheter Location

Catheter Location	Test Dose	Epidural Stimulation Test
Subarachnoid	Hypotension/total spinal	Positive unilateral/bilateral motor response (< 1 mA)
Subdural	?	Diffuse motor response in many segments (< 1 mA)
Epidural space close to the nerve root	?	Unilateral motor response (<1 mA)
	?	Positive motor response (1–10 mA); threshold current increased after local anesthetic injection
Not intravascular	↑ Heart rate	Remain or return to baseline positive motor response (1–10 mA) even after local anesthetic injection
Intravascular	↑ Blood pressure	Electrocardiogram changes
Subcutaneous	?	Negative response

Reprinted and modified from Tsui BC, Finucane B. Epidural stimulator catheter. *Tech Reg Anesth Pain Manage* 2002;6(4):150–154. Copyright 2002, with permission from Elsevier.<sup>27</sup>

traoperative monitoring for spinal surgery (2–40 mA).<sup>21–24</sup> Although no known complication or patient discomfort has resulted from the epidural stimulation test, it has been recommended to keep the current below 15 mA and the stimulation time as brief (less than a few minutes) as possible.<sup>13,14,25,26</sup> In particular, the current output must be carefully increased from zero and stopped once motor activity is visible to ensure that all motor responses, even those elicited with a low current (<1 mA), are detected. The nerve stimulator must be sensitive enough to allow a gradual increase in current output to at least 10 mA.

Table 49–3 compares features of the epidural “test dose” (lidocaine with 1:200,000 epinephrine) and the epidural stimulation test. Epidural stimulation is a new tool for clinician use that may have a significant impact on three of the most significant complications associated with epidural anesthesia: systemic toxicity, accidental subarachnoid or subdural injections of local anesthetics, and neural damage.

### Ultrasound Usage in Regional Anesthesia

The application of ultrasound in regional anesthesia was first published in 1989 by Ting et al.<sup>28</sup> Since then there has been an increasing number of reports in the world literature on this exciting application in regional anesthesia. It is only a matter

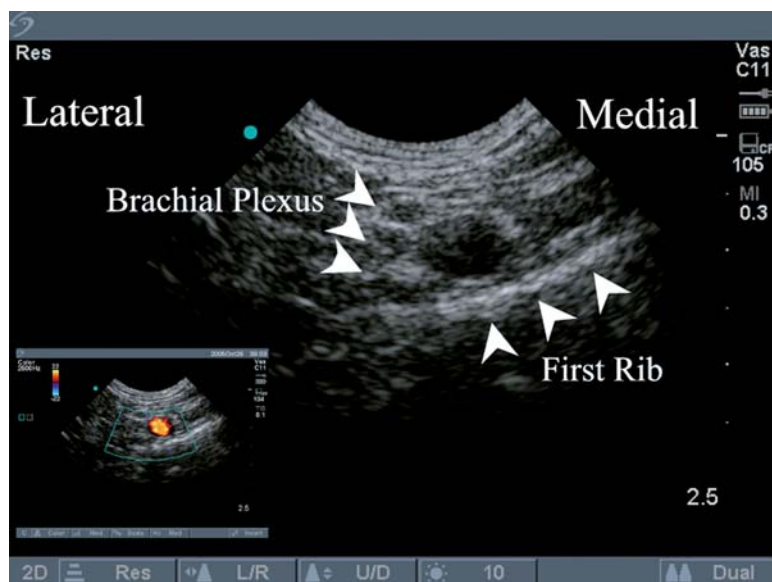
of time before this technology will become a mainstream technique in regional anesthesia practice.

### Ultrasound Usage in Regional Anesthesia: Peripheral Nerve Blocking

Brachial plexus anesthesia is one of the most challenging techniques in regional anesthesia; therefore, ultrasound has a great potential to improve success rates with this technique. The reason that the classic approach to the brachial plexus (the supraclavicular approach) has not withstood the test of time is because of the risk of pneumothorax. The application of ultrasound in regional anesthesia may renew interest in the classic approach to the brachial plexus (Fig. 49–2). With advances in this technology, we will be better able to see nerve trunks, blood vessels, pleura, and the approaching needle.<sup>29,30</sup>

To maximize the safety of regional anesthesia, one may potentially combine ultrasonography and nerve stimulation techniques when performing regional anesthesia.

- Ultrasonography allows the clinician to see the advancing needle approaching what appears to be the target nerve or trunk.
- Nerve stimulation allows one to identify which nerve is being approached and if indeed what is being approached is a neural structure.



**FIGURE 49–2.** Ultrasonogram of supraclavicular region. The trunks of the brachial plexus can be identified as a cluster of circles (i.e., a honeycomb shape) positioned lateral and superior to the subclavian artery. If the identity of the hollow structure was in doubt, the color-flow Doppler provided further verification (*left bottom*).

Ultrasonograph technology is undeniably a great advance in regional anesthesia; however, it does not completely eliminate difficulty in accurately identifying structures and observing the advancing needle in detail in all cases. A number of regional anesthesia experts practicing ultrasonography, have already abandoned neurostimulation, upon discovering the value of ultrasound, yet it is essential to take a deliberate approach when considering the absolute use of ultrasound technology.

- Individually, ultrasonography (anatomic locating tool) and nerve stimulation techniques (physiologic response aid) have their limitations, but when used in combination, these techniques may serve to compensate for each other's weaknesses and may facilitate optimal needle placement for peripheral nerve blocks.
- With the use of ultrasonography, one can observe neural targets, vascular structures, the advancing needle, and the actual spread of the local anesthetic solution, following the injection of the local anesthetic, in real time.
- When one uses D<sub>5</sub>W as a preinjection, in conjunction with nerve stimulation, accurate needle/catheter-tip visibility is enhanced. The motor response resulting from electrical stimulation is augmented following an injection of D<sub>5</sub>W in a very high

percentage of cases (96%). This new observation allows one to increase the accuracy of placement of continuous catheters.<sup>10</sup>

- By using ultrasonography, one can observe the pattern of spread of D<sub>5</sub>W before committing to the injection of local anesthetic

#### Ultrasound Usage in Regional Anesthesia: Neuraxial Blockade

Ultrasonography is useful for guiding peripheral nerve block placement in adult patients;<sup>31,32</sup> however its application for guiding neuraxial blockade in adults and children remains limited, and its use is not as yet widespread.

- Real-time ultrasound imaging of the lumbar spine is a simple procedure. Ultrasound aids the placement of lumbar epidural catheters and enhances the performance of combined spinal–epidural anesthesia.<sup>33,34</sup>
- Ultrasonography use improves the learning curve of obstetric lumbar epidural catheter placement for anesthesia trainees.<sup>35</sup>
- In patients with anticipated difficult epidural localization, this technology is helpful for estimating lumbar epidural depth; it also facilitates ease of placement.<sup>36,37</sup>
- Although ultrasound imaging has been used to guide lumbar epidural needle placement, it may be of limited value in the thoracic region,

particularly in older children and adults, when visualization of the spinal cord and relevant structures is sought.<sup>38,39</sup> Calcification of the posterior vertebral bodies in children older than 6 months of age prevents reliable imaging of the spinal cord.<sup>38</sup>

At the present time, ultrasonography guidance is helpful for viewing the lumbar region of most patients, although its use for thoracic epidural placement is of value only in infants and small children, as their vertebrae are not fully ossified.

#### Monitoring Regional Anesthesia

It is very important to have an assistant observe and aid the patient at all times during the performance of regional anesthesia. As many as 15% of patients have a great fear of needles and vasovagal episodes occur when performing regional anesthesia.<sup>40</sup>

- Standard electrocardiogram and pulse oximetry are essential monitors while performing regional anesthesia.
- Before performing the neural block, a baseline blood pressure reading should be obtained. Once the regional anesthesia procedure is complete, the monitors should remain attached. In conscious patients, end tidal carbon dioxide monitoring is not used; however, there are special nasal prongs available for monitoring awake patients.
- Evidence of regressing sensory and motor blockade and stable vital signs must be present so as to fulfill the criteria for discharge from the recovery area.
- Local anesthetic infusions are now routinely used in many medical centers around the world. Patients receiving local anesthetic infusions should be visited regularly by a qualified physician postoperatively (i.e., Acute Pain Service).

#### Record Keeping/Documentation

Accurate and meticulous recording of anesthesia information is essential for maintaining the quality of care in regional anesthesia, and this will also benefit the clinician if involved in litigation.

- Detailed documentation of patient consent and the clinical procedure is very important.
- Open and honest communication with the patient is essential for providing good quality patient care.

## Physician–Patient Communication

Effective communication with each patient is essential for the prevention and early diagnosis of any potential complications. Discussing the procedures, including their benefits and any significant risks involved, is the medicolegal and professional responsibility of all anesthesiologists. Equally important, maintaining good patient rapport respective of how to recognize and minimize potential risks during the postoperative period will help ensure that the maximum outcome is achieved following regional anesthesia.

- A telephone call to the patient on the first postoperative day is a reasonable and practical alternative to a visit.
- Specific common risks for certain blocks should be discussed with the patient prior to discharge. For instance, patients undergoing supraclavicular blocks should be warned about the risk of pneumothorax and be informed about potential symptoms and what to do if they develop.
- Caution patients about the risk of burns (i.e., from radiators), or the consequences of applying pressure to desensitized areas when sensory anesthesia continues after discharge.
- Warn patients about lying on paralyzed extremities for any length of time.
- Patients should receive written instructions and information about when to seek medical attention prior to discharge from the hospital.

## COMPLICATIONS INVOLVED WITH LOCAL ANESTHETIC ADMINISTRATION IN REGIONAL ANESTHESIA

### Local Anesthetic Allergic Reactions

Although allergies to local anesthetics are rare, a full array of allergic symptoms and signs ranging from mild skin irritation to full-blown anaphylaxis have been described. These signs and symptoms are almost always associated with amino ester preparations or preservatives (e.g., methylparaben). Allergic reactions are more common following exposure to ester compounds than amides.<sup>41</sup>

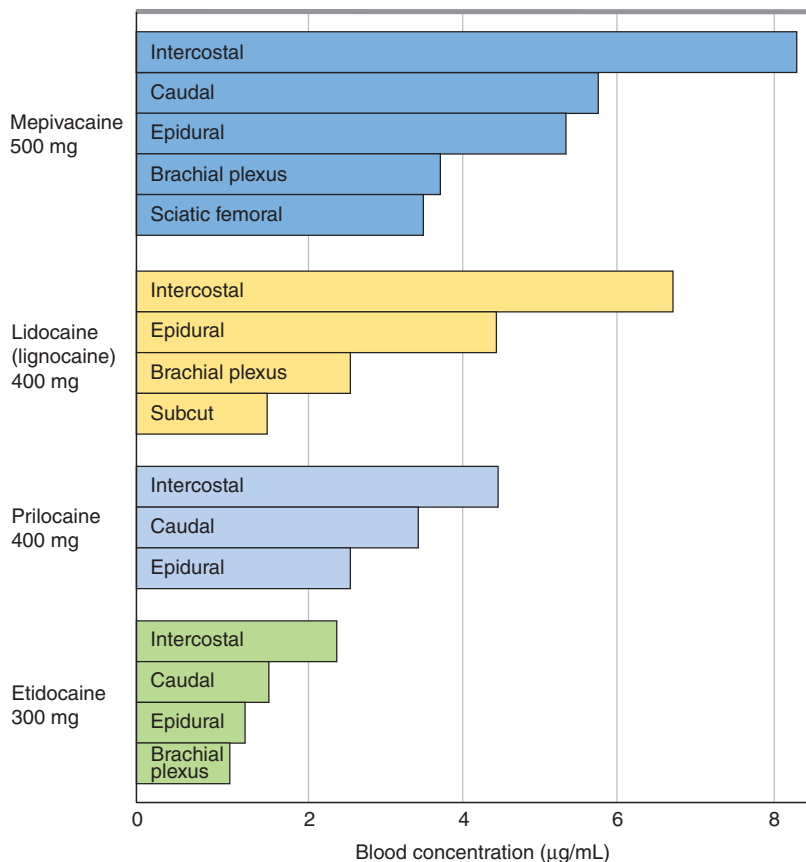
### Systemic Toxic Reactions

Systemic toxic reactions to local anesthetic drugs occur more commonly as a

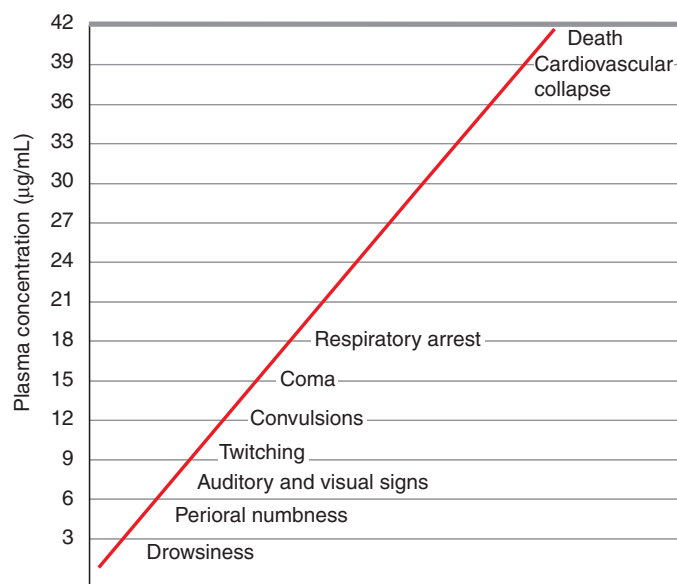
result of unintentional intravascular injection and rarely follow the injection of an excessive quantity of local anesthetic into an appropriate site. The incidence of systemic toxicity has substantially decreased within the past 30 years. In 1969, Massey Dawkins<sup>42</sup> reported the incidence of seizures following local anesthetic injections to be 0.2% following epidural anesthesia. A recent study from France reported an incidence of seizures of 0.01%, which represents a 20-fold decline in a 30-year period.<sup>42,43</sup> A higher occurrence of systemic reactions occurs following peripheral nerve blocks, especially brachial plexus and caudal blocks in adults.<sup>44</sup> The maximum plasma concentration of local anesthetic ( $C_{max}$ ) resulting from an unintentional intravascular injection depends on a number of factors,<sup>45</sup> including the total dose of local anesthetic injected, the speed and site of injection, and whether the injection is administered intravenously or intraarterially. The lungs are an important repository for local anesthetic drugs; plasma concentrations of these drugs will be substantially higher

if the lungs are bypassed (e.g., an accidental intraarterial injection in the head, face, or neck region).<sup>46</sup> Plasma concentrations of local anesthetics are also influenced by the tension of carbon dioxide ( $CO_2$ ) and the pH. An elevated arterial  $CO_2$  tension increases cerebral blood flow, and an acidotic state increases intracellular ion trapping and the amount of free drug available. This combination of factors has a synergistic effect on the seizure threshold.<sup>47</sup>

Systemic toxic reactions occur much less frequently when local anesthetics are administered in peripheral sites. A number of factors influence the degree of absorption taking place from the periphery to the central circulation. The most important factor influencing absorption is the site of injection—absorption is more rapid in highly vascular tissues and less so in poorly perfused tissue. Rapid absorption also occurs from intrapleural injections and very slow absorption occurs from the bladder and skin. Consequently, local anesthetic absorption increases from the highest to the lowest rates in the following



**FIGURE 49–3.** Comparative peak blood concentrations of several local anesthetic agents following administration into various anatomical sites. Subcut, subcutaneous. (Reprinted from Covino BG, Vassallo HG. *Pharmacokinetic Aspects of Local Anesthetic Agents. Local Anesthetics. Mechanisms of Action and Clinical Use.* New York: Grune and Stratton, 1976:95–123. Copyright 1976 Grune and Stratton, with permission from Elsevier.<sup>45</sup>)



**FIGURE 49-4.** Concentration–toxicity profile of lidocaine. (Reprinted with permission from Covino BG. Clinical pharmacology of local anesthetic agents. In: Cousins MJ, Bridenbaugh PO, eds. *Neural Blockade in Clinical Anesthesia and Management of Pain*. 3rd ed. Baltimore: Lippincott Williams & Wilkins, 1998:107.)

anatomic sites: intercostal, epidural, brachial plexus, lower extremity, and subcutaneous tissue (Fig. 49-3).

The rate of absorption is reduced by the addition of epinephrine to local anesthetic drugs, but this also depends on the local anesthetic used. Furthermore, the addition of epinephrine itself may lead to other complications (see Complications of Peripheral Nerve Blocks below). As the plasma concentration of lidocaine increases, there is a typical progression of effects on the CNS and the cardiovascular system. This pattern of symptomatology is not typically seen with the more potent local anesthetics (Fig. 49-4).<sup>48</sup> Central nervous system excitation and cardiovascular manifestations of systemic toxic responses following epidural anesthesia almost always arise as a result of unintentional intravascular injections. Local anesthetics are amphiphilic molecules, having both lipophilic and hydrophilic properties; these drugs enter a variety of cellular compartments, and have the potential to interact with a wide variety of molecules including inotropic signaling pathways (sodium, potassium and calcium ion channels), and also influence adrenergic and lysophosphatide signaling systems, cardiac bioenergetics, and mitochondrial dynamics.<sup>49</sup> Symptoms and signs of an unintentional intravascular injection must be closely monitored. As plasma concentrations of local anesthetic increase, signs of local anesthetic toxicity increase in severity. Con-

current treatment with CNS depressant medications may modify the typical clinical signs of a toxic reaction, and can mask some of the early warning signs (Table 49-4).

The cardiovascular system is more resistant to the toxic effects of local anesthetics than the CNS, especially following toxic doses of lidocaine. Local anesthetics affect both electrical and mechanical cardiac activity. Tachycardia and hypertension are early signs of cardiac toxicity and with increasing doses patients develop bradycardia and hypotension; however, this pattern of symptomatology may not be seen when the patient receives a rapid intravascular injection and this pattern of symptoms and signs is not evident with potent local anesthetics.

### Prevention

Early recognition of an intravascular injection is the key to prevention. Methods investigated for detecting intravascular injection include the following:

- Careful aspiration
- The injection of dye (detected by pulse oximetry)<sup>50</sup>
- The administration of epinephrine and isoproterenol<sup>51</sup>
- Injections of lidocaine

Increased heart rate and systolic blood pressure in addition to T-wave changes are considered sensitive and specific endpoints in response to an intravascular

**TABLE 49-4.**

### Signs of Early Accidental Intravascular Injection

Early Signs	Late Signs
Light-headedness	Muscle twitching
Tinnitus	Drowsiness
Blurred vision	Generalized tonic-clonic convulsions
Perioral numbness	

injection of a test dose containing epinephrine. A single injection of 15 µg of epinephrine produces a heart rate increase of greater than 10 beats/min, a blood pressure increase greater than 15 mm Hg, and a decrease in T-wave amplitude of 25%.<sup>52</sup> In the sedated patient, changes in heart rate may not be as reliable as T-wave and blood pressure changes.<sup>53</sup> Elderly patients (> 60 years old) and those on β-blockers and anesthetized patients are also less sensitive to β-adrenergic stimulation.

In summary, sensible precautions should be undertaken to minimize the impact of accidental intravascular injection. These precautions include the following:

- Incremental administration of the local anesthetic
- Frequent aspiration
- Close observation of heart rate, systolic blood pressure, and T-wave changes
- Close observation of the patient

### Management of Local Anesthetic Toxicity

The initial treatment recommended for the management of patients with systemic toxicity is very similar to that used for any resuscitation. The following mnemonic can be used when dealing with allergic reactions and systemic toxicity to local anesthetics<sup>54</sup>:

- S**top injection
- A**irway
- V**entilation
- E**valuation of the circulation
- D**rugs

Because hypoxia, hypercapnia, and acidosis exacerbate all local anesthetic toxic reactions,<sup>55,56</sup> control of the airway and ventilation is of paramount importance in the treatment of local anesthetic toxicity. Recent studies dem-



onstrate improved hemodynamics and survival in animal models of bupivacaine toxicity with the administration of intravenous lipid emulsion.<sup>57,58</sup> Although the mechanism by which this occurs is unclear, it is suggested that lipid emulsion may remove local anesthetic molecules from binding sites that are responsible for the profound cardiovascular depression that is part of bupivacaine toxicity. Propofol, which is formulated in lipid, may reduce susceptibility to local anesthetic toxicity, however its negative inotropic effects may mitigate against its use as an antidote in the face of cardiovascular collapse.<sup>59</sup> Before either lipid or propofol become recommended elements of the resuscitation paradigm, further evaluation needs to be done. Anticonvulsant medications such as thiopental and the benzodiazepines should be used with caution and in greatly reduced dosage as they themselves may precipitate cardiovascular collapse. The following are the most current (as of this writing) recommendations for the management of significant local anesthetic systemic toxicity:

- Bronchospasm and generalized edema, sometimes associated with allergic reactions may require use of bronchodilators, antihistamines, and corticosteroids.
- Endotracheal intubation and ventilation are required to correct acidosis and hypoxia and hypercarbia.
- Chest compressions, cardioversion may be defibrillation are required to restore organ perfusion and should be instituted as necessary.
- Profound hypotension can occur in both allergic reactions and systemic toxicity, and usually responds well to vasopressors (e.g., epinephrine and vasopressin); hypotension occurring in allergic reactions and systemic toxicity respond well to plasma “expansion.”
- As reduced cardiac contractility is a core element in this condition, it is thought that the maintenance of coronary perfusion with the administration of epinephrine and norepinephrine improves outcome.<sup>60</sup>
- However, malignant dysrhythmias, which particularly occur with bupivacaine systemic toxicity, should be controlled in a timely fashion as epinephrine can exacerbate these dysrhythmias.

- Therapeutic agents that are less arrhythmogenic have been investigated, including the use of vasopressin,<sup>61,62</sup> and phosphodiesterase inhibitors such as milrinone and amrinone.<sup>63</sup>
- Effective resuscitation in this setting is difficult, and atrioventricular pacing and cardiopulmonary bypass are additional options in refractory cases.<sup>64</sup>

## COMPLICATIONS OF PERIPHERAL NERVE BLOCKS

### Direct Needle Trauma to the Nerve

Most of the complications resulting from peripheral nerve blocks (PNBs) are similar to those of neuraxial blocks with the exception of those resulting from ophthalmic, brachial, and intercostal/paravertebral blocks, each of which has its own unique complications. The incidence of minor neural injury following PNBs is in the range of 1–2%; most of these injuries are transient neurapraxias, which represent axonal disruption. Typically neurapraxia injuries are observed postoperatively when patients complain of persistent numbness in the distribution of a peripheral nerve. One cannot simply assume that all neurapraxia injuries are anesthesia related, as patient positioning, surgical trauma, and tourniquet application can all give rise to these symptoms. Numbness gradually regresses over a period of weeks and is rarely observed beyond 3 months, which is the amount of time required for axonal regeneration to occur. Regional anesthesia related injuries are usually the result of needle trauma, injection pressure or the toxic effects of local anesthetics or additives. Auroy et al.<sup>43</sup> reported an incidence of serious nerve injury (permanent sensory and/or motor loss) following PNBs as 1.9 per 10,000 nerve block cases; in this study, all patients with serious injury experienced either pain on injection, or paresthesia, or both during the performance of the block.

### Prevention

Most neural injuries are associated with either paresthesia or pain on injection. Needle damage or pressure generated during injection of local anesthetics account for most of these injuries.<sup>43,65</sup> Needle insertion without injection is a

routine technique used during microneurography and surgical repair procedures, which results in insignificant nerve damage.<sup>66</sup> Considerable nerve damage is more likely to be caused or worsened by both mechanical and chemical injury during intraneural injections of neurotoxic substances (i.e., local anesthetics). High-pressure injections cause mechanical destruction of the neural fascicular architecture, pathophysiologic damage, and neural scarring.<sup>67</sup> Chemically induced damage is also possible from high concentrations of local anesthetics, vasoconstrictors, preservatives, and other additives.

There is an ongoing debate among anesthesiologists about the safety of deliberately seeking paresthesia in regional anesthesia.<sup>68</sup> There is also concern about performing regional anesthesia in comatose/anesthetized patients because of the inability to detect paresthesia.<sup>69,70</sup> However, there is no substantial evidence that performing nerve blocks in awake patients is any safer than performing them in anesthetized patients.

With advances in the technology used for regional anesthesia such as nerve stimulation and ultrasonography, the need to use paraesthesia as a method to identify the location of a given nerve should diminish. Despite the recent advances in technology in regional anesthesia, there is no proof that any one method is safer or better in terms of success achieved. Intuitively, one might expect more success and fewer complications if one could observe a needle advancing toward a neural structure as opposed to the “conventional” blind insertion of needles.

Common sense dictates that small-gauge needles are less likely to damage nerves than larger-gauge ones. More than 30 years ago Selander<sup>71</sup> recommended using blunt needles when performing regional anesthesia, as it was thought that blunt needles were less likely to penetrate neural structures, and resultant intraneural injections would be less likely to occur; this recommendation was based on information derived from animal experiments. Selander's influence on this topic persists to this very day. Even though subsequent studies show that blunt needles, although far less likely to penetrate neural structures, are far more disruptive to neural tissue than sharp needles.<sup>66</sup> Nevertheless, there are no clinical trials supporting any recommendations as to what type of needle is

best for regional anesthesia procedures. Most clinicians prefer small-gauge, short, blunt needles.

Injection pressures may influence the amount of damage inflicted on a nerve. One study suggested that persistent motor deficits were observed in animals injected with pressures  $\geq 20$  psi.<sup>72</sup> Clinicians should avoid rapid and high-pressure injections.

Sterilizing agents, skin cleansing substances, detergents, and certain preservatives (e.g., metabisulfite) all cause neurotoxicity and should be carefully avoided when introduced into perineuronal spaces.

The neurotoxicity of a local anesthetic is related to its potency and its concentration.<sup>73</sup> High concentration local anesthetics such as 2% lidocaine and 0.75% bupivacaine should be avoided in peripheral nerve blocks. The addition of vasoconstrictors (e.g., epinephrine) to local anesthetics may enhance the damage caused by an intraneural injection.<sup>74–76</sup>

Generally, neural damage resulting from peripheral nerve blocks is rare; consequently, it may be difficult to clearly demonstrate the safest equipment and techniques to be used. However, Table 49–5 lists several measures that have been suggested to prevent nerve injuries.

### Management

Because most regional anesthesia procedures involve the percutaneous insertion of needles toward neural, the burden often lies with the anesthesiologist to prove that damage was not caused as a result of improper technique and unsafe practice. Clinicians are obliged to maintain a very open mind when dealing with such challenging cases. When a neurologic injury is suspected postoperatively, a thorough history must be taken, and a complete physical examination must be performed. The anesthesiologist should play a major role in determining the cause of the injury, as anesthesiologists have far more information concerning preoperative and intraoperative events than do most neurologists. Symptoms and signs of compression of the spinal cord must be dealt with urgently (within 6–8 hours); otherwise permanent paraplegia or quadriplegia may result. The anesthesiologist, neurologist, neurosurgeon, and radiologist must work as a team and strive to arrive at a diagnosis before serious permanent injury occurs. Diagnostic tools should be

used judiciously to support the team of clinicians in arriving at a correct diagnosis; this is when we must rely on our neurology and radiology colleagues to guide us. Electrodiagnostic and imaging techniques can often take the guesswork out of many diagnostic dilemmas and allow for quick and precise diagnoses. Table 49–6 summarizes the key steps involved in determining neurologic injury.

**Diagnostic Tools for the Determination of Nerve Injury** Direct injury to the spinal cord, nerve roots, or peripheral nerves is best evaluated using imaging techniques, especially in the early stages of an injury. Electrophysiologic techniques are more useful in the later phases of an injury. The most common imaging modalities used are computerized tomography (CT) and magnetic resonance imaging (MRI). Electrodiagnostic techniques include evoked potentials, nerve conduction studies, and needle electrode examination of muscles (electromyography [EMG]). The use of these tools should complement the clinical examination, rather than replace an examination. Choosing the best tools/technologies for diagnosis should be a joint decision made with the neurologist, surgeon, and radiologist.

- CT is best suited for evaluating bony abnormalities.
- MRI is ideally suited for the examination of soft-tissue abnormalities, especially the spinal cord.
- For peripheral nerve, nerve plexus, and peripheral nerve complications, imaging is less likely to be useful for the demonstration of nerve injury.
- MRI may demonstrate the accumulation of blood and edema fluid, which can lead to compartment syndrome; MRI may also indicate neural compression caused by injury from the needle and local anesthetic injection. Thus, electrodiagnostic techniques can complement imaging, especially for peripheral nerve complications. Nerve conduction studies test the function of large sensory and motor nerve fibers. Evaluating nerve conduction can reveal axonal loss or demyelination of the nerve; however, nerve conduction is less useful in timing lesions when the injury occurs.
- EMG is preferentially used for evaluating smaller motor units. EMG can be useful for the diagnosis of

TABLE 49–5.

### Suggested Methods/Equipment for Preventing Peripheral Nerve Injuries When Performing Regional Anesthesia

- Needle type: small gauge, short beveled
- Patient: awake with appropriate level of sedation
- Nerve stimulation: use accurate nerve stimulators and insulated nerve needles (current at least  $>0.2$  mA)
- Ultrasonography: direct visualization of nerves and surrounding structures by using high-resolution ultrasound equipment if available
- Paresthesia: injection should be stopped and needle repositioned if persistent
- High injection pressure: avoid rapid and high-pressure injections (pressure  $<20$  psi)
- Local anesthetic: avoid high concentrations (i.e., lidocaine 2% or bupivacaine 0.75%)

axonal injury and is also useful for quantitating the severity of the neurologic injury and for identifying the actual site of injury.

The only effective way to manage neurologic complications is to prevent any mishaps from occurring in the first place, as there is limited chance of recovery once the damage has occurred. Currently, there are no reliable standards or guidelines for the management of neurologic injury. Neurologic consultation and testing should be considered if there are any persistent symptoms or signs following a procedure. If symptoms are mild and are not interfering with the patient's daily activities, reassurance can be offered after evaluating the extent and severity of the patient's symptoms. It is of prime importance to continue to follow patients suffering from nerve injury following discharge from the hospital; it is also necessary to instruct patients to seek medical attention if their symptoms worsen or do not improve. Most residual dyesthesias or hypesthesias resolve in 4–6 weeks, and the majority are resolved ( $>99\%$ ) within 1 year.<sup>77,78</sup>

### NEEDLE TRAUMA TO THE SURROUNDING ANATOMY

Surrounding tissues may be unintentionally injured during peripheral nerve

TABLE 49–6.

## Key Steps in Determining Neurologic Injury

- Recognize and identify the neural dysfunction.
- The history of any new or intensifying neural dysfunction in the absence of further anesthetic injection must be considered as a warning sign of possible neural injury.
- When neural damage is suspected, a careful history assessment and a physical examination must be promptly carried out.
- The sequence and onset of the symptoms must be determined.
- The nature of pain, motor weakness, sensory deficit, and sphincter control should be compared to information obtained preoperatively about the patient's baseline neurologic status; such information may provide clues to the cause of injury and appropriate management.
- Symptoms/signs of spinal cord compression must be dealt with urgently (within 6–12 hours), otherwise permanent paraplegia or quadriplegia may occur.
- A thorough postoperative followup should be completed, even if a neurologic injury is not suspected.
- Consider surgical causes
  - Surgical trauma to neural structures from retractors, a scalpel blade, or tension within the surgical site may not have been mentioned to the anesthesiologist.
  - Long-acting local anesthetics may have been injected by the surgeon.
  - Compartment syndrome resulting from edema, or bleeding around the wound caused by dressings or casts, can compromise neural function.
  - Vascular injury during the surgery could result in nerve injury (e.g., spinal cord injury after thoracic aneurysm repair). Because of this, it is probably desirable to let the local anesthetic blockade abate after aortic surgery.
  - Patient positioning must be reviewed to rule out direct pressure (e.g., peroneal nerve at the fibular head) or tension on nerves (e.g., traction on the brachial plexus from hyperextension of the shoulder during thoracotomy); improper patient positioning may produce nerve injury that might otherwise be attributed to a regional anesthetic mishap.
- Consider anesthetic causes
  - The details of anesthesia management should be thoroughly reviewed, especially if portions of the anesthetic care were delivered by other anesthesiologists.
  - Drug choice, dose, and last time of administration should be recorded.
  - Duration of nerve blockade should be noted; a long duration of blockade can result in neural injury.
  - High concentrations of agents probably increase the risk of neural complications.
  - Multiple nerve-blocking attempts can increase the risk of injury.
  - The presence of parasthesia during needle insertion and the subsequent injection of local anesthetic can be a warning sign indicating neural injury.
  - The level of sedation must be appropriated without compromising the ability to observe a parasthesia.

blocks. Vascular injury can also occur during PNB as many peripheral nerves travel in parallel with vascular structures. Other injuries may be caused by direct needle trauma, including pneumothorax and direct spinal cord injury.

### Spinal Cord Injury

Permanent spinal cord injury following brachial plexus block is the most severe complication resulting from PNB. There are a number of reported spinal injuries associated with peripheral nerve blocks: an interscalene block performed with an 8-cm needle resulted in a permanent neural deficit at the C8-

T1 level.<sup>79</sup> In another instance, an anesthetized patient suffered permanent spinal cord injury following an interscalene block.<sup>80</sup> A patient has suffered from Brown-Séquard syndrome following an attempted interscalene block using a spinal needle.<sup>81</sup> Other peripheral blocks may also increase the risk of spinal cord injury. Permanent spinal cord injuries may occur following paravertebral blocks because the needles used for paravertebral blocks are inserted in close proximity to the spinal cord.

### Prevention

It is important to note that most of the serious nerve injury cases reported in-

volve deviations from the recommended anesthetic practice standards. Currently, it is recommended to perform these blocks in awake patients so as to detect paresthesia or pain on injection, which is a clear indicator of the risk of permanent damage. Ultrasonography may help to reduce the risk of spinal injury as needle advancement can be observed in real-time.

The best option for avoiding the risk of nerve injury is to select a blocking insertion site remote from the spinal cord. Axillary blocks appear to be safer than supraclavicular blocks; however, supraclavicular approaches to the brachial plexus are required in shoulder surgery. In most published cases of nerve injury involving the brachial plexus, the recommended standard of care was not followed.

Small-gauge needles and short needles are strongly recommended when performing brachial blocks in the supraclavicular region. Longer-than-usual needles were associated with many of the spinal cord injuries associated with brachial plexus blocks.

### Management

There is no specific treatment for primary needle damage to the spinal cord. Nevertheless, the initial step in the management of spinal cord injury is the recognition and identification of neural dysfunction. Acute, potentially reversible causes of spinal cord injury, such as nerve compression from hematomas, must be identified and dealt with early (within 6–8 hours) otherwise permanent paraplegia or quadriplegia may result. The anesthesiologist, neurologist, and radiologist must work as a team to arrive at a correct diagnosis. Appropriate electrodiagnostic and imaging techniques must be used to make a quick and precise diagnosis.

### Pneumothorax

Any regional technique requiring needle insertion toward the lung involves the risk of pneumothorax. Pneumothorax has been an unwelcome complication of supraclavicular techniques since Kulenkampff first described the classic supraclavicular approach in 1911.<sup>82</sup> The incidence of pneumothorax is difficult to determine and varies depending on the approach. Brand et al. reported an incidence of 6.1% in a large teaching hospital using the classic Kulenkampff technique.<sup>83</sup> DeJong found radiologic evidence of pneumo-



thorax in 25% of patients.<sup>84</sup> Phrenic nerve paresis is very common following supraclavicular blocks, yet patients do not usually become symptomatic.<sup>85</sup> The risk of pneumothorax has deterred many anesthesiologists from using the supraclavicular approach and is the most likely reason that axillary approaches are so popular. The risk of pneumothorax is much lower following the interscalene approach to the brachial plexus compared to the classic supraclavicular approach.<sup>86</sup> Ward et al. reported a 3% incidence of symptomatic pneumothorax following the interscalene technique.<sup>87</sup> The risk of pneumothorax is reduced following the vertical technique mainly because the needle is not directed toward the lung.<sup>88</sup>

### Prevention

Anesthetic techniques requiring the insertion of a needle directed toward the lung in the supraclavicular region all carry the risk of pneumothorax. Extra care should be exercised in tall, thin patients as they appear to be at greater risk of pneumothorax. For all patients, a right-sided pneumothorax occurs more frequently because the cupola of the lung is higher on the right side. Patients should be warned in advance of this risk, and ambulatory patients should be given careful instructions on how to proceed should symptoms develop. Supraclavicular techniques should be used only when indicated.

Supraclavicular approaches should be avoided in patients with moderate or severe impairment of pulmonary function. Blocks should never be performed bilaterally. Intuitively, complications can be avoided or reduced if clinicians are able to visualize the advancing needle approaching the target nerve or trunk. Ultrasonograph technology facilitates this goal in real time. However, this technique requires significant training and much practical experience. Despite adequate training, it can be difficult to accurately identify structures using ultrasonography, and the advancing needle is not easily viewed in all cases. The clinician should pay attention to needle depth in relationship to the classical anatomical landmarks at all times, even when using ultrasonography.

### Management

Because upper-extremity operations are carried out on ambulatory patients who

are discharged within a few hours of surgery, it is imperative that patients be warned about the risk of pneumothorax before leaving the hospital. Patients who develop chest pain, dyspnea, or cyanosis following discharge should be instructed to go to the nearest emergency center. Symptoms and signs may not develop for hours, and patients may not become symptomatic until a 20% pneumothorax is present. A chest tube is usually required when the degree of lung collapse is 25% or greater. Positive pressure ventilation with N<sub>2</sub>O/O<sub>2</sub> in the presence of a small pneumothorax may lead to tension pneumothorax with the rapid deterioration of vital signs. Consequently, a high index of suspicion should always be present when general anesthesia is required following a failed supraclavicular block, and nitrous oxide should be avoided in this situation.

## TOXIC EFFECTS OF LOCAL ANESTHETICS ON THE NERVES AND SURROUNDING ANATOMY

### Incidence of Toxic Effects of Local Anesthetics on the Nerves and Surrounding Anatomy

#### Neural Toxicity

Local anesthetics are considered harmless substances when injected perineurally in appropriate concentrations and quantities. High concentrations of local anesthetics can permanently damage neural tissue in some instances.<sup>89</sup> Preservatives in local anesthetic drugs may also damage nerves and other surrounding tissues. In the United States during the 1970s, it was noted that a change in the constitution of a sodium metabisulfite, a preservative found in chloroprocaine, resulted in several cases of cauda equina syndrome.<sup>90</sup> The addition of ethylenediaminetetraacetic acid (EDTA) to chloroprocaine is associated with severe back pain in some patients following epidural anesthesia.<sup>91,92</sup> Studies show that 5% hyperbaric lidocaine for spinal anesthesia is linked to the syndrome transient neurologic symptoms (TNS).<sup>93</sup>

#### Myotoxicity

Myotoxicity is a recognized complication of intramuscular injections of local anesthetics.<sup>94</sup>

Local anesthetics are proposed to cause a pathologic efflux of Ca<sup>2+</sup> from the sarcoplasmic reticulum, resulting in contracture, cell destruction, and necrosis. Following this occurrence, the regeneration of fibrils occurs within a few weeks. Among the local anesthetics tested, bupivacaine caused the most damage, and procaine caused the least.<sup>95</sup> Injury was noted to be worse with repeated injections and when epinephrine was used.<sup>96–98</sup> All of these mentioned features are highlighted in a case in which a patient who received an interscalene block later developed intense neck pain and tenderness over the sternocleidomastoid muscle, which persisted for 2 months.<sup>99</sup> In clinical practice, myotoxicity is largely unnoticed except in ophthalmic regional anesthesia. Diplopia has been reported following retrobulbar blocks; however, this symptom is short-lived in most cases and permanent damage is rare. Ropivacaine was found to be less myotoxic than bupivacaine in an animal model.<sup>100</sup> The full implications of the effects of local anesthetics on muscle have not yet been evaluated.

### Phrenic Nerve Paralysis

The incidence of hemidiaphragmatic paresis and decreased respiratory function following supraclavicular blocks in 8 healthy volunteers was noted; the overall incidence of paresis was 50% following the administration of 30 mL of lidocaine 1.5% with epinephrine; none of the volunteers reported respiratory symptoms.<sup>101</sup> However, anecdotal reports exist concerning patients who are devoid of respiratory disease, and who later became symptomatic following an interscalene block.<sup>87,102–104</sup>

Temporary phrenic nerve paralysis following interscalene brachial plexus block is expected in up to 100% of cases. Permanent phrenic nerve palsy has been observed following interscalene block,<sup>105</sup> but is extremely rare.<sup>106</sup>

The incidence of ipsilateral phrenic nerve paresis associated with all types of supraclavicular techniques is reported to vary between 36% and 40%, regardless of the technique chosen.<sup>107</sup> In another study, the effects of ipsilateral hemidiaphragmatic paralysis on respiratory function following continuous interscalene blocking showed that all patients had a 27% reduction in forced vital capacity (FVC), a reduced forced expiratory volume (FEV) of 26%, and a decreased peak expirato-



ry flow (PEF) rate.<sup>108</sup> In another small study, the effects of hemidiaphragmatic paralysis lead to a significant decrease in  $\text{PaO}_2$ , despite normal pulmonary function studies.

Thus, the use of supraclavicular techniques in certain groups of patients must be reevaluated. Supraclavicular techniques may need to be avoided in patients with advanced pulmonary disease. Bilateral supraclavicular techniques are *absolutely* contraindicated.

**Prevention** Until we have more data on this topic, it would be prudent to avoid all brachial plexus techniques above the clavicle (especially interscalene blocking) in patients with severe impairment of lung function. The majority of healthy patients do not experience any symptoms. The duration of action of this impairment depends on the dose and the individual properties of the local anesthetic used.<sup>109</sup> It has also been suggested that reducing the volume and quantity of local anesthetic chosen for supraclavicular blocks may influence the incidence of hemidiaphragmatic paresis.

**Management** Ipsilateral phrenic nerve paresis is quite common following all supraclavicular approaches to the brachial plexus. Such approaches to the brachial plexus should be avoided in patients with significant lung disease. Proper consent and information should be provided to the patients. For mild symptoms, reassurance given by the anesthesiologist to the patient and family is generally sufficient for management. For more severe symptoms and patient distress, appropriate monitoring and ventilatory support should be considered and employed until the phrenic nerve paralysis recovers.

### Horner Syndrome

Horner syndrome (ipsilateral, miosis, ptosis, enophthalmos, loss of sweating) is frequently observed following supraclavicular approaches to the brachial plexus,<sup>110</sup> and patients and other caregivers should be informed of this temporary distortion to avoid diagnostic confusion.

### Hoarseness

Hoarseness may occur if the local anesthetic spreads to the recurrent laryngeal nerve.

## Other Complications of Brachial Plexus Blocks

There are a number of other, less common complications following bra-

chial plexus blocks, including bronchospasm, hematoma formation, auditory impairment, total spinal/epidural block, and carotid compression.

### Prevention/Management

The key to preventing complications associated with brachial plexus block is to increase the accuracy of needle placement and to use the minimum volume and concentration of local anesthetic required to successfully complete the block. With a better understanding of neural anatomy and distances between structures gained by using nerve stimulation, the accurate needle placement is a reality. The introduction of ultrasonography has revolutionized regional anesthesia, as ultrasonogram visualization makes it possible to directly visualize, in real time, the needle tip and the local anesthetic spread. With this technology, we believe regional anesthesiologists will have much greater success with regional anesthesia and fewer complications. As with other adverse effects, careful diagnosis of brachial plexus complications and the provision of supportive measures are essential for proper clinical management.

## COMPLICATIONS OF NEURAXIAL BLOCKS (EPIDURAL/SPINAL)

### Direct Needle Trauma

As a needle or catheter is advanced into the epidural space, direct trauma to the spinal cord, conus medullaris, and spinal nerve roots can occur. Sensory loss and, less commonly, motor deficits occur as a result of spinal cord trauma. Some patients recover completely from this unfortunate circumstance; however the injury persists in the majority of patients. The incidence of this complication is very low, and much of the data available comes from retrospective sources. In a prospective multicenter study Auroy<sup>43</sup> found 5 cases of radiculopathy following 30,413 epidurals. In each of these patients, pain or paresthesia was noted during needle insertion and drug administration, and the radiculopathy was observed in the distribution of the associated paresthesia. One of the most disturbing complications of neuraxial blockade is neurologic injury. Three well-known syndromes are associated with damage to the spinal cord, roots,

and coverings: cauda equina syndrome, adhesive arachnoiditis, and anterior spinal artery syndrome. These syndromes are addressed in other chapters under specific complications.

### Prevention

To avoid nerve trauma, a studied technique and accurate anatomic knowledge is advised.<sup>111</sup> Although epidural placement in the anesthetized child is considered safe, similar placement in the adult population remains controversial. Recent case reports highlight the potential for neurologic trauma when performing epidural anesthesia in the anesthetized patient.<sup>69,112,113</sup> The use of the epidural stimulation catheters allow pediatric anesthesiologists to place lumbar or thoracic epidurals from the caudal space, minimizing the risk of needle-mediated nerve injury.<sup>26</sup> When performing an epidural in an awake, cooperative adult, needle advancement should be halted if the patient complains of pain. In most adults, the spinal cord terminates at the lower portion of the body of L1; however, there are considerable variations among individuals. The ability of the clinician to correctly identify lumbar spinous interspaces has been questioned by Broadbent et al. using magnetic resonance imaging.<sup>114</sup> In this study, only 29% of the interspaces were correctly identified, whereas 51% of the time clinicians were at a higher vertebral level than anticipated; furthermore, the spinal cord terminated below L1 in 19% of subjects. Oblique lateral entry into the ligamentum flavum may direct the needle into the dural cuff region, resulting in potential nerve trauma with resultant unisegmental paresthesia; this is a warning sign in a conscious patient indicating that the needle or catheter is encroaching on a neural structure.<sup>115</sup>

Paresthesia associated with spinal cord injury can occur at the time of needle placement, yet it may also occur during the injection of the solution or as a secondary consequence of irritation, edema, or hematoma.<sup>116,117</sup> Pain is more commonly associated with extraaxial lesions affecting the nerve roots or blood vessels that are innervated by pain-mediating sensory neurons.<sup>118</sup> In contrast, because there are no pain receptors within the spinal cord (or the brain), intraaxial trauma may be painless<sup>118</sup>; this allows percutaneous cervical cordotomy to be performed in awake patients.<sup>119,120</sup> During

this procedure, the cervical cord is typically punctured multiple times with a 22-gauge needle electrode, yet the patient generally describes neither pain nor paresthesia.<sup>121</sup> In addition, pain following dural puncture is rare in clinical practice. Thus, anesthesiologists should be reminded that they should not simply assume that paresthesia will always be reported as the needle encroaches on the spinal cord.<sup>122,123</sup> However, one might expect a motor response if a needle encroaches on a motor tract during attempts at epidural anesthesia. Electrical stimulation during epidural needle advancement may provide an additional warning sign.<sup>124,125</sup> Despite all of the controversy on this topic, during thoracic epidural placement risk, minimization should be considered, while placing epidural needles and catheters at a site remote from the spinal cord (i.e., lower lumbar or caudal region) if at all possible.

Ischemic injuries are among the rarest complications reported following regional anesthesia procedures; however, when such injuries occur, several factors play a role, including hypotension, abnormal positioning, vascular disease, diabetes mellitus, and the clamping of major vessels.<sup>65,126</sup> The addition of epinephrine to local anesthetic solutions is controversial, as seen in an animal study where epinephrine and phenylephrine were administered with the result of a significant reduction in dural blood flow and no reduction in spinal cord blood flow.<sup>127</sup> It seems prudent, however, to avoid the use of large amounts of epinephrine in patients at greater risk of ischemia.

### Management

The management of postoperative neurologic sequelae requires the cooperation of the anesthesiologist, surgeon, and neurologist. Advice may also be needed from the radiologist and neurosurgeon. Although it is easy to blame an adverse neurologic outcome on the presence of an epidural, it should be borne in mind that other factors can lead to demonstrable nerve injury, including undiagnosed preexisting neurologic disorders, ligation of nutrient spinal cord vessels during abdominal or thoracic surgery, injury to the femoral nerve during pelvic surgery, injury to the lateral cutaneous nerve of the thigh during retraction close to the inguinal ligament, and pressure on the fibular head leading to neurapraxia of the lat-

eral popliteal nerve. If an adverse outcome occurs, the lesion should be localized by taking the patient's history and by performing a thorough neurologic examination.

- Bilateral symptoms associated with pain should alert one to the possibility of neuraxial pathology.
- Injury at the nerve roots affects both posterior and anterior rami.
- Preservation of sensation over the paraspinous muscles suggests a more distal injury.
- Investigations should include blood cultures and coagulation studies.
- Immediate MRI is the standard for evaluating neuraxial lesions.
- EMG can be used to determine the site of injury and the degree of axonal loss, although it may take up to 3 weeks for changes to appear on the electromyogram. It may be useful to perform this immediately upon recognition of neural dysfunction to establish the possibility of a preexisting lesion.

### Hematoma

Epidural hematoma after neuraxial anesthesia is a rare event. Bleeding from an epidural vein may occur on needle or catheter insertion, but is usually self-limiting. Neurologic symptoms and signs caused by an epidural hematoma are atypical in the presence of normal coagulation; the true incidence is unknown, but is estimated to occur in less than 1 in 150,000 cases of neuraxial anesthesia.<sup>128</sup> Vandermeulen reviewed 61 case reports between 1906 and 1994 and found that two-thirds of the cases had a hemostatic abnormality.<sup>129</sup> Early diagnosis and intervention are essential to preventing any long-term adverse outcomes.

### Prevention

In recent years, new anticoagulant and antiplatelet drugs have been introduced and have given rise to new challenges in the management of the anticoagulated patient undergoing neuraxial blockade. The American Society of Regional Anesthesia has released guidelines in response to this evolving shift in medical practice<sup>128</sup>; it is important to follow these guidelines to minimize the risk of hematoma.

### Management

Similar to the peripheral nerve injury, the evaluation of neurologic injury fol-

lowing regional anesthesia is a vital part of adverse outcome management. Back pain with lower-limb weakness and sensory deficit should alert the clinician to the presence of a central compressing lesion.

- Bowel and bladder incontinence can be an associated finding.
- Painless evolution of this complication has been reported, and early warning signs may be masked by the administration of local anesthetic via an epidural catheter and the presence of a urinary catheter.
- If MRI confirms the diagnosis, then rapid surgical intervention within 6–8 hours is recommended.
- Epidural catheters containing metal elements should be avoided while undergoing MRI as it will not only generate artificial interference and inaccurate diagnoses, but other potential risks are possible albeit presently unknown.<sup>130</sup> Such catheters should be removed if it is safe to do so; if catheter removal is unsafe, a CT scan should be considered instead of an MRI.

### Infection

Epidural abscess formation, although rare, is a serious, potentially devastating complication. Kane's retrospective review of 50,000 epidurals found no case of abscess formation,<sup>131</sup> whereas Moen et al. reported 12 cases of abscess formation from an estimated 250,000 patients following epidural insertion.<sup>132</sup> Of these patients, only 3 were healthy, while the others had infection risk factors. Six of the patients received their epidural for analgesia following trauma, and of these, 5 were thoracic epidurals for chest trauma. The authors speculated that the overrepresentation of thoracic trauma patients might in part be a result of a lesser hygienic standard being observed, where placement likely occurred outside the "cleaner" environment of the operating suite.

Although the immunocompromised patient may carry a greater risk of developing infective complications with epidural use, extensive experience using epidural analgesia and anesthesia with patients who have HIV has countered early fears surrounding regional anesthesia in this population. Regional anesthesia is particularly beneficial for the HIV carrier population, as it eliminates delayed metabo-

lism of systemic opioids caused by protease inhibitors.<sup>133</sup> Patients with AIDS often have neurologic manifestations of their disease, and the prevalence of peripheral neuropathy increases as the disease progresses.<sup>134</sup> Attention should be given to assessing preoperative neurologic status, as this allows the clinician to correctly attribute postblock neurologic sequelae to the true underlying cause.

Epidural abscess presentation can be variable, but the cardinal symptoms and signs involve back pain with localized tenderness and fever. With the presence of an epidurally induced abscess, a leucocytosis can be expected and may occur several days or months following needle and catheter insertion. Following the formation of an epidural abscess, the patient can develop progressive weakness and may develop paraplegia if untreated. Meningitis may develop if the patient has endured a lumbar puncture in this setting. The most common pathogen involved in abscess formation is *Staphylococcus aureus*; it should act as a standard for guiding antibiotic treatment until definitive culture results are available. As with an epidural hematoma, prompt surgical consultation is warranted for abscess development.

In pediatric patients, there is some concern regarding catheter infection with prolonged use of caudally placed catheters because of the proximity of the sacral hiatus to the anal region. Although studies have not found clinical evidence of greater infection rates with the caudal approach to catheter placement, increased bacterial colonization has been reported with this technique. *Staphylococcus epidermidis* was the predominant microorganism colonized on the skin and catheters of lumbar and caudal epidurals, and gram-negative bacteria were also found on tips of caudal catheters.<sup>135</sup> While the overall infection rate associated with caudal epidural catheters appears to be quite low, tunneling caudal catheters or simply fixing the catheter with occlusive dressing in an immediate cephalad direction has been recommended to reduce the risk of contamination by stool and urine.<sup>26,136</sup>

### Prevention

Epidural abscesses can occur spontaneously (a reported incidence of 0.2–2 per 10,000 hospital admissions per year),<sup>137</sup> and lumbar puncture has

been safely performed in potentially bacteremic patients.<sup>138</sup> Following is a list of guidelines for the prevention of epidural abscess formation:

- Factors that contribute to a lower incidence of epidural space infections involve, meticulous aseptic technique, monitoring of the infection site, antibiotic prophylaxis, and bacterial filter use.
- While both lidocaine and bupivacaine are bactericidal in high concentration, this property is much reduced at the concentrations commonly used in clinical practice.<sup>139</sup>
- The performance of neuraxial block should be avoided where local infection exists at the needle entry site.
- Debate continues as to whether systemic or localized infection distal to the entry site carries significant risk. Another concern is whether the catheter may act as a secondary focus for infection. The clinician must weigh the risks and benefits of neuraxial block.

### Management

Following is a list of guidelines for the management of epidural abscess formation:

- Daily catheter site inspection is essential for the early prevention of epidural abscess formation.
- Prompt removal of the catheter is essential when erythema and local discharge are present.
- Carefully assess any symptoms or signs of back pain.
- If any neural dysfunction occurs, a diagnosis must be immediately made in order to evaluate infective causes.
- Once a diagnosis of epidural abscess is made, a combination of medical (antibiotic) and surgical (incision and drainage) treatment may be needed.

### Total Spinal Anesthesia

Total spinal anesthesia occurs when an excessive dose of local anesthetic is injected into the subarachnoid space; this is usually the result of an unintentional injection of a dose of local anesthetic intended for the epidural space. A high spinal may be seen when a small epidural dose or a large spinal dose of local anesthetic enters the subarachnoid space. Obstetric patients are particularly vulnerable because

the engorged epidural venous plexus reduces spinal CSF volume and predisposes this population to cephalad local anesthetic spread. Total spinal anesthesia is rarely seen in nonobstetric cases, as observed by Dawkins, who reported an incidence of 0.2% of total spinal anesthesia in 48,000 patients undergoing epidural anesthesia.<sup>140</sup>

### Prevention

To prevent total spinal anesthetics from occurring, it is essential to use predictable technique when aspirating, and the epidural test dose should be used. The subsequent use of small incremental doses of local anesthetics may reduce the risk of this complication. The use of electrical stimulation is a useful and reliable real-time technique for confirming epidural catheter placement.<sup>13,25,26,141,142</sup> The advantage of the real-time electrical stimulation test is that intrathecal placement can be eliminated prior to the administration of a potentially large test dose. A test dose of lidocaine and epinephrine should still be administered to detect unintentional intravascular placement. However, when combined with the epidural stimulation test as described in the previous section, the test dose can be given with confidence as there is a reduced risk of developing total spinal anesthesia.<sup>12</sup>

### Management

Total spinal anesthesia is a true medical emergency, as patients become profoundly hypotensive, apneic, and unconscious with pupillary dilation. Resuscitation with endotracheal intubation, mechanical ventilation and vasopressor therapy is frequently required, and recovery may take between 30 minutes and 6 hours, depending on the agent used and the type of dose administered. Cerebrospinal fluid lavage via an epidural catheter has been used to successfully treat a total spinal in a 14-year-old child; in this case, the patient recovered within 30 minutes.<sup>143</sup>

With a high spinal, the patient may complain of numbness in the hands or may have difficulty breathing; if this occurs, the situation can usually be managed with reassurance, careful use of sedation and treatment of hypotension. Respiratory function should be closely monitored with pulse oximetry, and measurements of adequate airflow should be made (i.e., determine the patient's ability to vocalize or to blow



out a match [the match test]).<sup>144</sup> The potency of sedative agents is increased in the presence of a high spinal,<sup>145–147</sup> and one should be prepared to intervene in the event of significant respiratory compromise.

## Subdural Injections of Local Anesthetic Drugs

The subdural space is a potential space between the dura and the arachnoid that extends from the level of the second sacral vertebra up to the floor of the third ventricle; the subdural space differs from the epidural space in that it is both extra- and intracranial. This space envelops the cranial and spinal nerves for a short distance, and is widest in the cervical area. The incidence of subdural injections of local anesthetic drugs is reported to range from 0.1% to 0.8%,<sup>148</sup> and this occurs more frequently following epidural injections.<sup>149</sup> However, subdural injection may be an explanation for the occasional failed spinal anesthesia when pencil-point needles with side apertures are used. The design of a pencil-point needle with side apertures makes it possible for the opening to exist partially in both the subarachnoid and the subdural spaces.<sup>150</sup> The diagnosis of a subdural catheter placement is best achieved using an injection of radiopaque dye. A typical radiologic pattern is pathognomic of subdural catheter placement.

### Prevention

Extra care should be exercised in patients who have had previous back surgery or a dural puncture at the same or adjoining interspace, as subdural injections are more likely to occur in these patients. The practice of rotating the Tuohy needle upon entering the epidural space has been implicated as a cause of subdural placement, yet there is no firm data to support this allegation. Clinically, the subdural injection of local anesthetic drugs should be suspected when motor or sensory changes do not follow the expected pattern. Subdural injections result in a very slow onset of motor and sensory anesthesia and extensive and/or patchy sensory blocking.<sup>151</sup> Patients may also complain of respiratory difficulties and may appear obtunded. The degree of cardiovascular depression may vary but hypotension is usually not severe; however, rapid onset of cardiovascular depression with concurrent loss of con-

sciousness can result within 2 minutes, and cardiorespiratory arrest has been reported in the obstetric setting.<sup>152</sup> Based on cases reported, the epidural stimulation test appears to be a potential diagnostic test providing information about the location of the needle or catheter in the subdural space.<sup>16,151</sup>

### Management

The treatment of subdural injections of local anesthetics is predominantly supportive. Patients sometimes require intubation, ventilation, and sedation and usually recover within 6 hours of the injection

## Systemic and Local Toxicity

Unintentional intravascular catheter placement can go unrecognized and may lead to local anesthetic toxicity. There has been a dramatic decline in the incidence of systemic toxic reactions to local anesthetics following epidural anesthesia within the past 30 years. Dawkins reported a 0.2% incidence of toxicity in a retrospective analysis of 48,292 cases of epidural anesthesia in 1969<sup>140</sup>; this series included thoracic, lumbar, and sacral epidurals. More recently, Brown reported a 0.01% incidence of toxicity following lumbar epidural anesthesia in a retrospective study of 16,870 cases,<sup>153</sup> and a 0.69% incidence of toxicity following caudal epidural anesthesia in a series of 1295 cases. This 20-fold reduction in toxic reactions following epidural anesthesia during the past 30 years is in part explained by significant changes in regional anesthesia practice and by the influence of regional anesthesia societies in North America, Europe, Asia, Australia, and New Zealand. In the early 1980s, several deaths were reported in the United States following accidental intravascular injections of bupivacaine whilst performing epidural anesthesia. These deaths occurred as a result of cardiac toxicity which had not been previously reported with bupivacaine.<sup>154</sup> Several deaths were also reported in the United Kingdom when bupivacaine was used for intravenous regional anesthesia.<sup>155</sup> These tragedies led to a practice change in regional anesthesia. Single injection epidural techniques commonly practiced 30 years ago have been replaced by continuous techniques involving injections of small incremental doses of local anesthetics; subsequently, “test dosing” has become a standard when using

local anesthetics in regional anesthesia. Bupivacaine was implicated in 50% of toxic reactions reported by Auroy and in a large percentage of cases in Brown's study.<sup>43,153</sup>

### Prevention/Management

To avoid potential local toxicity, the use of local anesthetic free of preservatives in an appropriate concentration should be considered for use in the neuraxial space.

For epidural catheter anesthesia, using soft-tipped catheters (e.g., metal-reinforced catheter) may reduce the introduction of the catheter into the vessel.<sup>156</sup> The most important aspects of prevention were discussed in Local Anesthetic above but are summarized as follows:

- Aspiration
- Test dose
- Incremental dosing

The epidural stimulation test has the potential to detect intravascular catheter placement, and should not be overlooked.<sup>15</sup> In normal circumstances, repeated injections of local anesthetic into an appropriately placed epidural catheter results in the impairment of nerve conduction and requires a gradual increase in the amplitude of electrical current to produce a positive motor response to the stimulation test.<sup>141</sup> The absence of this trend after repeated doses of local anesthetic suggests that the injected local anesthetic may be rapidly disappearing from the epidural space, as is the case with intravascular placement. However, there have only been a few reported cases of intravascular catheter detection when using this technique. The general principles and treatment involved in managing unintentional intravascular toxicity from local anesthetic have been addressed earlier (see Management of Local Anesthesia Toxicity above).

## Postdural Puncture Headache

Postdural puncture headache (PDPH) is a widely discussed and published topic in regional anesthesia; it is also one of the most common complications of epidural and spinal anesthesia. Advances in needle design and gauge, as well as a better understanding of the physiologic mechanism of PDPH have dramatically reduced the incidence of PDPH associated with spinal anesthesia, even in the obstetric



population.<sup>157</sup> However, the incidence of PDPH following epidural anesthesia in obstetric patients remains unchanged, with headaches ranging from 0 to 2.6% of cases.<sup>157</sup>

### Prevention

Prevention of PDPH relies on the education of clinicians regarding the factors influencing the incidence of PDPH; such information is based on previous clinical case reports and studies. There is a strong link between onset of headache and needle gauge, age, gender, pregnancy, bevel design, and bevel orientation.

The dura consists of a mixture of elastic collagen and elastin fibers contained in a viscous intercellular ground substance<sup>158</sup>; it is primarily a longitudinally oriented structure, and its greatest tensile strength and stiffness exists in the longitudinal orientation. When a needle penetrates the dura, the size of the defect will be dependent on the number of elastin fibers cut, as well as by the tendency of those cut fibers to recoil in opposing directions, creating a crescent-shaped defect. As the gauge of the needle increases, more elastic fibers are cut. Fink examined the dura of elderly cadavers and found less viscoelastic material and more fibrous connective tissue.<sup>159</sup> Young patients are at greatest risk of PDPH as their greater dural elasticity maintains a patent defect compared to the less elastic dura of the elderly.

Norris<sup>160</sup> demonstrated the importance of bevel orientation in relation to the incidence of PDPH following penetration of the dura with an epidural needle. Lybecker<sup>161</sup> suggested that bevel orientation may be even more important than needle gauge and was unable to show any difference in PDPH when using 22- and 25-gauge needles, provided that the bevel was vertically oriented. Ready<sup>162</sup> suggested that the incidence of PDPH is reduced when the needle is placed in an oblique direction. The arachnoid is closely adherent to the dura, and when a needle is advanced perpendicularly, the holes made by the bevel in the dura and arachnoid regions are directly in line with one another. When a needle is directed obliquely, the dural puncture does not line up with that in the arachnoid layer, thus obstructing CSF leakage.

Needle design has been implicated as a factor in the development of PDPH. Blunt-pointed needles (e.g., Sprotte, Whitacre) are linked to a re-

duced incidence of PDPH as opposed to sharp cutting-point needles (e.g., Quincke). Blunt needles rather than sharp needles are the tool of choice, particularly in patients with a high risk of developing PDPH (e.g., adolescent and young adult patients). The most effective way to treat PDPH is to prevent this problem in the first place. The principal factor responsible for the development of PDPH is the size of the dural perforation. Thus, smaller, blunt needles should be used for spinal anesthesia. On the other hand, the most commonly used epidural needle used is the 16- or 17-gauge Tuohy needle for continuous epidural anesthesia.

Because sleep deprivation or continuous night work can be a confounding factor influencing the higher incidence of unintentional dural puncture, clinicians should be well rested when performing these techniques.

### Treatment

Following unintentional dural puncture with a Tuohy needle during epidural catheter placement, some authors suggest that the epidural catheter should be advanced through the puncture hole in an effort to reduce the incidence of PDPH. Intrathecal placement of the epidural catheters following accidental dural puncture in the obstetric setting is common practice in some centers.<sup>163</sup> It is thought that the presence of the epidural catheter generates an inflammatory response, leading to early closure of the dural defect.<sup>164</sup> Because the epidural catheter is in the intrathecal space in this circumstance, extreme caution should be exercised to treat this catheter as a spinal catheter so as to avoid possible neurologic complications and infection.<sup>157</sup> Conservative measures, including bedrest and oral hydration remain popular therapies for PDPH, despite no evidence to support them. Bedrest may postpone the occurrence of the headache, yet it does not prevent the onset.<sup>165</sup> Obstetric patients should be encouraged to mobilize soon after delivery, so that PDPH, if present, can be diagnosed and treated while yet in the hospital.

Mild headaches can be treated with intravenous fluids, caffeine, and theophylline; methylxanthines may block cerebral adenosine receptors, leading to cerebral vasoconstriction. Camann demonstrated the efficacy of caffeine in 40 postpartum patients.<sup>166</sup> A single oral dose of caffeine is safe, less ex-

pensive than intravenous caffeine, and offers temporary relief. Caffeine is a potent CNS stimulant and should be avoided in women who have pregnancy-induced hypertension, as it may lower the seizure threshold.<sup>167</sup> When considering the usage of caffeine as treatment for mild headache, it is worth noting that the cerebral vasoconstrictive properties of caffeine are transient, and the headache may return after 48 hours.

Sumatriptan is a serotonin type 1-d receptor agonist, and has been used for cluster headaches and migraine and also as a treatment of PDPH.<sup>168</sup>

Cosyntropin, the synthetic form of adrenocorticotropic hormone (ACTH), has been used to treat PDPH; this pharmaceutical is thought to work by stimulating CSF production and  $\beta$ -endorphin output.<sup>169</sup>

**Epidural Blood Patch** The epidural blood patch (EBP), was introduced by Gormley in 1960, and is known to be the most effective treatment for PDPH. Gormley observed that patients who bled during myelography had a lower incidence of PDPH,<sup>170</sup> and when he himself subsequently developed PDPH, Gormley requested an injection of autologous blood into his epidural space with the positive result of the alleviation of his headache. In 1970, DiGiovanni and Dunbar's report of the successful use of epidural blood patching in 41 of 45 patients led to its popularization.<sup>171</sup> This form of treatment is indicated when conservative measures have failed and the headache is severe or is likely to extend the hospital stay. The success rate for a first epidural blood patch is 85%, rising to 98% after a second patch.

DiGiovanni suggested that an epidural blood patch acts as a gelatinous tamponade and when injected, the blood generates sufficient pressure to lift the brain;<sup>172</sup> this author has suggested that blood acts as a sealant, plugging the hole created by the needle, thus preventing further CSF leakage. Magnetic resonance images displaying the lumbar region after blood patching shows a mass effect that compresses the thecal sac and conus. The blood spreads 3–5 spinal segments from the injection site, and spreads mostly in the cephalad direction. The mass effect persists beyond 3 hours, and clot resolution occurs in 7 hours.<sup>173</sup> Symptoms are frequently relieved within minutes of the proce-

ture, and this response supports the counterpressure theory.

Szeinfeld studied the dynamics of an epidural injection of blood using tagged red cells.<sup>174</sup> Blood was injected into the lumbar region until patients complained of discomfort in the back, buttocks, or legs. The mean volume of blood required to produce these symptoms was 14.8 mL. This study demonstrated that the blood injectate extended over 9 segments, in which 6 were in the cephalad direction, and 3 in the caudad direction.

When performing an EBP care should be taken to maintain a sterile field, and the epidural space should be identified in the usual manner.

To undergo EBP, an assistant draws 15–20 mL of autologous blood aseptically, which we believe should be further analyzed for cultures. The administration of blood should be done at a rate of 1 mL/3 sec. The end point of injection occurs when the patient complains of back, neck, or buttock pain. Much less blood is required for blood patches in the in the midthoracic region than in the lumbar region, usually in the order of 5–10 mL.

To ensure adequate healing, the patient should remain recumbent for 1–2 hours following a blood patch and may resume ambulation thereafter; the patient should refrain from any strenuous activity for several days.

Complications from EBP are rare, but can be serious. Transient bradycardia, lumbovertebral syndrome, and facial palsy have all been reported.<sup>175–178</sup> One case of cauda equina syndrome has been reported in a patient who was subjected to six blood patches; the patient made a full recovery following evacuation.<sup>179</sup>

EBP has also been successfully performed in children. A caudal blood patch has been performed in a 4-year-old child<sup>180</sup> and a lumbar EBP has been performed in a 7-year-old child.<sup>181</sup> The case reported by Kowbel involved a 4-year-old child who developed a subarachnoid cutaneous fistula following repeated lumbar punctures for chemotherapy.<sup>180</sup> In this situation, the epidural blood patch was performed by passing an epidural catheter via the caudal canal, and by injecting 8 mL of blood. Furthermore, there has been one case reported of cervical dural puncture treated successfully with a lumbar epidural blood patch.<sup>182</sup>

Blood patches have been safely performed in HIV-positive patients. HIV

crosses the blood–brain barrier and infects the CNS early in the clinical course. EBP is unlikely to introduce HIV into the CNS.<sup>165</sup>

### Prophylactic Epidural Blood Patching

Prophylactic blood patches are controversial and have supporters and detractors.<sup>183,184</sup> The effectiveness of using EBP as a prophylactic depends on the proximity of the catheter tip to the dural tear. Although blood patching is a relatively safe procedure, there are some risks associated with its use, and patients do not always get a headache following dural puncture, even with a large-gauge needle. Aldrete describes a case of intrathecal hematoma and arachnoiditis after prophylactic blood patching through a catheter.<sup>185</sup>

### Variations on the Epidural Blood Patch

Epidural saline treatment has been used for PDPH, but is less effective than EBP. Successful use of prolonged saline infusion has been reported in patients with failed EBP.<sup>186,187</sup>

Fibrin glue, a pooled plasma product, has been used to treat CSF leak in cancer patients,<sup>188</sup> and in PDPH cases following spinal anesthesia where two EBPs had failed.<sup>189</sup>

Dextran-40 has also been used to treat PDPH as it undergoes delayed absorption from the epidural space because of its high viscosity and molecular weight.<sup>190</sup>

### Failure of Spinal/Epidural Anesthesia

Failure of neuraxial blockade is more common with epidural rather than spinal anesthesia. Thus, this section will focus on discussing failed epidural anesthesia. Anesthesiologists recognize entry into the *subarachnoid space* by the tactile sensation produced and the visual element of CSF.

On the other hand, anesthesiologists recognize entry into the *epidural space* by the tactile sensation produced when using the LOR technique and the ease of epidural catheter insertion.

Thus, entry into the epidural space is purely tactile, and the end point of entry is subject to more misinterpretation than spinal anesthesia. In epidural anesthesia, false loss of resistance may occur and quite often the only proof that the needle is correctly positioned is that a successful block occurs. False losses of resistance are more frequently encountered in obese

patients where anatomy may be ill-defined. Sharrock suggested that false loss of resistance may also occur in the elderly who have a high incidence of cyst formation within the interspinous ligaments.<sup>191</sup>

### Prevention

An important distinction that should be made during epidural anesthesia is that of complete failure versus a partial blockade/failure. The inability to pass a catheter into the epidural space frequently indicates that the needle is not in the epidural space. Catheters may become occluded with blood, or the catheter may kink, take a unilateral course, break, or become knotted, all of which can contribute to the complete failure of epidural anesthesia.

The presence of a midline epidural band has been suggested<sup>192</sup> and may explain why difficulty may be encountered when threading the catheter through the Tuohy needle.

When epidural local anesthetic dosing for anesthesia approaches the maximum safe limit without noticeable analgesia, a failed epidural must be considered and should prompt the clinician to pursue an alternative course of anesthesia.

Careful matching of the dermatomal level of the catheter tip to that of the surgical site will yield greater success of epidural blockade. The epidural stimulation test has been used to verify accurate epidural tip placement,<sup>26</sup> ensuring that the dermatomes involved in the surgical procedure are selectively blocked.

### Management

Effectively managing partially working and/or failed epidurals is very important in patient satisfaction and safety, particular in obstetric patients. The partially working epidural is commonly encountered when undergoing anesthesia for cesarean sections; reported failure rates are in the order of 2–13.1%.<sup>193</sup> A poorly functioning epidural or partially working spinal should be identified early before the decision to proceed to cesarean section is made. In an emergency situation, the anesthesiologist has a number of options available to rescue the situation; such options include converting to general anesthesia, supplemental epidural or caudal injections and local infiltration anesthesia. Intraoperative discomfort and visceral pain

may occur in up to 50% of cesarean patients.<sup>194</sup> A block to the T4 level is considered optimal in most cesarean patients, however debate exists concerning the best modality with which to test the upper level of the block. Loss of pinprick and cold sensation are popular testing options, but may have poor predictive value.<sup>195,196</sup> The loss of touch is considered by some to best equate with surgical anesthesia.<sup>197</sup>

Surgical factors increasing the likelihood of intraoperative discomfort include exteriorization of the uterus and round ligament stretching, both of which exceed the analgesia provided during an apparently adequately dense nerve block. Subdiaphragmatic blood or amniotic fluid may cause back, chest or shoulder discomfort.

Intervention by the clinician should involve direct communication with the patient. Pharmacologic management may be necessary depending on the level of distress. Intravenous ketamine in 10–20-mg increments and small doses of fentanyl or benzodiazepines are considered safe, although some advise waiting to administer these medications until the umbilical cord is clamped.<sup>193</sup> Nitrous oxide has been used in the treatment of patients with breakthrough pain, but this treatment is controversial in obstetrics anesthetics.<sup>198</sup> If rescue efforts fail, general anesthesia should be considered paying special attention to preoxygenation and potential airway difficulties.

For postoperative epidural analgesia, it is also important to confirm the working condition of epidural analgesia (sensory test, epidural stimulation test, low pain scores). If the epidural analgesia is not sufficient, an alternative mode of analgesia must be considered prior to discharge from the recovery room or as soon as possible.

## Hypotension

Hypotension is a common physiologic change associated with neuraxial blockade. Its presence predicts block success, but as a side effect, if left untreated or poorly managed, hypotension can lead to serious morbidity or death. Hypotension results from preganglionic sympathetic blockade that leads to a reduction in systemic vascular resistance (SVR) and cardiac output if the venous return is not maintained. Systemic vascular resistance decreases as a result of a reduction in sympathetic tone, the extent of which is related to

the number of spinal segments blocked. Cardiac output is altered by changes in heart rate and stroke volume. The reduction in stroke volume is a result of a fall in preload and contractility, which is load dependant. If the block involves the cardiac sympathetic nerve supply, bradycardia and reduced contractility can be expected.

Borghi et al. evaluated the frequency of hypotension and bradycardia during general anesthesia, combined epidural-general anesthesia, and in epidural anesthesia alone, in a population of 210 patients undergoing hip arthroplasty.<sup>199</sup> In this study, hypotension was observed in 18% of patients during the induction of the epidural block. The induction of general anesthesia in the presence of an epidural block was associated with a 4-fold increase in the odds of developing hypotension compared to general anesthesia without an epidural, and a 2-fold increase in these odds when compared to epidural anesthesia alone. One criticism of this study is that the local anesthetic dose administered was the same whether the patient received a general anesthetic or not. Many practitioners would discriminate between epidural analgesia with general anesthesia and epidural anesthesia, and would adjust the dosing regimen accordingly.

High thoracic epidural anesthesia has the potential to block cardiac afferent and efferent fibers originating at the first to fifth thoracic levels. Interest has evolved concerning the potential positive effects of cardiac sympathetic blockade in patients with coronary artery disease: dilation of coronary vessels, reduced heart rate, and decreased myocardial oxygen demand.<sup>200</sup>

## Prevention

The effect of prophylactic administration of intravenous fluid, ephedrine, and methoxamine on cardiovascular responses to both epidural and combined epidural and general isoflurane anesthesia in 45 adult patients undergoing knee arthroplasty has been examined.<sup>201</sup> In Wright's study, systolic blood pressure was significantly greater after ephedrine administration than after fluid preloading or methoxamine administration. An increase in plasma volume triggered by epidural-induced hypotension has been observed as a result of fluid movement from the interstitial to the intravascular space.<sup>202</sup> A larger percentage of fluid adminis-

tered is retained by hypotensive than normotensive patients,<sup>203</sup> resulting in hemodilution. Holte's recent study<sup>204</sup> showed that it was not the epidural that leads to changes in blood volume, but rather the infusion of fluid that effects blood volume. Hydroxyethyl starch and ephedrine have similar hemodynamic effects; ephedrine may be the preferred option for patients when excess fluid administration is undesirable. Fluid administration prior to induction of spinal and epidural analgesia usually can reduce the risk of hypotension. Patient position is crucial in preventing low cardiac output states in patients undergoing epidural anesthesia. If severe hypotension occurs during the course of epidural anesthesia, the most likely cause is inadequate venous return as a result of blood loss, an unfavorable patient position, or surgical obstruction.

## Management

The first step in the management of hypotension is making sure that there is no interference with venous return. Place the patient in 5° of Trendelenburg and in a slightly head-down position. The presence of hypotension prompts the clinician to intervene with fluid or pressor administration to restore the systemic blood pressure to acceptable levels.

Significant changes in blood pressure are uncommon in pediatric patients after the proper administration of epidural analgesia. A high sympathetic single-shot caudal block to T6 caused no significant changes in heart rate, cardiac index, or blood pressure in children.<sup>205,206</sup> Even when thoracic epidural blockade is combined with general anesthesia, cardiovascular stability is usually maintained in otherwise healthy pediatric patients.

Hypotension should prompt anesthesiologists to immediately eliminate a total spinal and/or intravascular injection leading to local anesthetic toxicity and cardiovascular collapse.

## Respiratory Complications

Several studies have examined high thoracic epidurals in both healthy people and in those with chronic obstructive airway disease. Peak expiratory flows, forced vital capacity, forced expiratory volume in 1 second (FEV<sub>1</sub>), and maximum expiratory pressures are reduced<sup>207,208</sup> in those suffering from this disorder. Kochi investigated the

effect of high thoracic epidural anesthesia on the hypercapnic ventilatory response and ventilation pattern;<sup>209</sup> duration of inspiration, rib cage excursion, and its contribution to tidal volume decreased significantly, whereas mean inspiratory flow rate and minute ventilation increased. Furthermore, end-tidal PCO<sub>2</sub> and the tidal excursion of the abdomen remained unchanged, whereas hypercapnic ventilatory response decreased significantly. Lumbar and high-thoracic-region-induced epidurals do not interfere with the ventilatory response to hypoxemia.<sup>210</sup> Gruber demonstrated the safety of thoracic epidural anesthesia with bupivacaine 0.25% in patients with severe chronic obstructive pulmonary disease.<sup>211</sup> The potential for phrenic (C3-C5) palsy is low with an epidural block, except during unintentional blockade following an interscalene brachial plexus block.<sup>212</sup> Cervical epidural anesthesia has been used for upper limb, parathyroid and carotid operations.<sup>213-215</sup>

Bonnet reported respiratory difficulties in 3 of 394 patient undergoing carotid endarterectomy using 15 mL 0.5% bupivacaine or 0.37–0.40% bupivacaine plus fentanyl (50–100 µg).<sup>213</sup> Many case series, although smaller in number than this study published by Bonnet, have not reported respiratory difficulties to be a significant problem.<sup>214,215</sup>

Capdevila reported that both 0.25% and 0.375% cervical epidural bupivacaine impaired diaphragmatic excursion, tidal volume, forced vital capacity, and hand grip strength in patients having postoperative hand rehabilitation, and did not recommend the technique for this purpose.<sup>216</sup>

The incidence of respiratory depression is closely associated with the use of neuraxial opioids. The rate of incidence of respiratory depression requiring intervention after conventional opioid dosing is approximately 1%.<sup>217</sup>

### Prevention

To prevent respiratory complications do the following:

- Avoid the use of high doses of opioids.
- Limit opioid dosages, especially in the intrathecal space.
- Avoid the concomitant use of parenteral opioids or sedatives.
- Avoid or limit doses in the patient with advanced age (> 60 years old), sleep apnea and other coexisting diseases

- Use hydrophilic drugs (e.g., morphine) with caution.

### Management

To manage respiratory complications do the following:

- Treat mild respiratory depression with oxygen.
- If an infusion is used, then reduce the rate.
- Depending on the severity of respiratory complications, consider ventilatory support, the administration of narcotic antagonists, and the discontinuation of the opioid infusion.
- Carefully monitor during the central nerve blocking period—this cannot be overemphasized.

### Nausea and Pruritus

Nausea and pruritus are common side effects seen with the administration of neuraxial opioids. The reported incidence of postoperative nausea and vomiting (PONV) with opioid administration is 30–65%,<sup>218-220</sup> and 80% for pruritus.<sup>221</sup> Pruritus is thought to be multifactorial in nature, and is speculated to operate via an “itch center” in the CNS via medullary dorsal horn activation, and antagonism of inhibitory transmitters.<sup>222</sup> Pruritus is a dose-dependant phenomenon, where its onset involves possible mediators including C fibers in the skin, serotonin (5-HT<sub>3</sub>) receptors, and prostaglandins. The obstetric population seems to be at greater risk for developing pruritus.

PONV is a complex, multifactorial problem:

- Epidural administration of local anesthetics alone carries a low risk of causing the occurrence of PONV.<sup>223</sup>
- Factors such as surgery, age, and gender influence the reported incidence of PONV associated with epidural anesthesia.<sup>224</sup>
- Within 5–15 minutes of epidural administration, peak plasma opioid concentrations can reach levels similar to those seen following an intramuscular injection.<sup>225</sup>
- In patients receiving epidural morphine, there have been no differences in PONV onset or duration when different doses up to 5mg were administered,<sup>226</sup> whereas higher doses have been shown to lead to both an increase and a decrease in reported PONV.<sup>224</sup>

- Epidural fentanyl and meperidine do not appear to influence PONV in the same way that morphine does; as reported, fewer PONV cases have been documented with the use of fentanyl and meperidine after orthopedic surgery when compared with morphine.<sup>227</sup>

### Prevention/Management

To prevent and/or manage PONV do the following:

- Reduce the dose administration and avoid neuraxial opioid administration. Doing so is effective in reducing the incidence of nausea and pruritus.
- Use antihistamines, opioid antagonists (naloxone and nalbuphine), propofol, nonsteroidal antiinflammatory drugs (NSAIDs), and 5-HT<sub>3</sub> receptor antagonists as both preventative and therapeutic measures. Dexamethasone has been shown to be a superior antiemetic for PONV-associated epidural morphine when compared to metoclopramide<sup>228</sup> and 5-HT<sub>3</sub> receptor antagonists.<sup>229</sup>

### Postoperative Urinary Retention

Postoperative urinary retention (POUR) is common following major surgery and occurs in:

- 20–68% of patients after abdominoperineal resection.
- 16–80% of patients after radical hysterectomy.
- 20–25% of patients after anterior resection.
- 10–20% of patients after proctocolectomy.<sup>230</sup>

POUR is a multifactorial problem and involves factors such as age, pain, bladder outlet obstruction, detrusor-inhibiting medication, pelvic autonomic nerve damage, and the inhibition of sympathetic reflexes. A single episode of bladder overdistension can result in significant POUR morbidity. Overfilling of the bladder can stretch and damage the detrusor muscle, leading to atony of the bladder wall, so that recovery of micturition may not occur when the bladder is emptied. On the other hand, the excessive use of an indwelling catheter can lead to urinary tract infection, urethral stricture, prolonged hospital stay, or death.<sup>231,232</sup> Epidural use for postoperative pain management is usually reserved for patients undergoing major surgery,



where urinary catheter placement may be performed for reasons other than anticipated postoperative urinary retention. Stenseth et al. found an incidence of 42% for POUR in 1085 uncatheterized patients having epidural morphine for a variety of major operations.<sup>233</sup> Epidural morphine relaxes the detrusor muscle with a corresponding increase in the maximal bladder capacity; epidurally injecting morphine gives a localized effect, whereas intramuscular and intravenous morphine have no effect on detrusor contraction. This is further supported by the fact that detrusor changes occur 15–30 minutes following epidural morphine administration, and are reversed by intravenous naloxone, suggesting that spinal opioid receptors have an important role.<sup>234</sup>

### Prevention/Management

Other epidural opioids such as fentanyl, meperidine, and methadone may also contribute to POUR, but contribute to a lesser degree than that observed with morphine.<sup>227,235</sup> In addition to bladder catheterization, treatment options for opioid-mediated POUR may include intravenous naloxone administration.<sup>236</sup> Nalbuphine is an opioid-mixed agonist-antagonist and has been used to restore detrusor function without reversing the analgesic effects of epidural morphine.<sup>237</sup> Short-term (24 hours) urinary catheterization for major surgery involving morphine epidural analgesia may help prevent the morbidities associated with both POUR and longer-term epidural catheterization.<sup>238</sup>

### Backache

Backache is a common complaint following epidural anesthesia and its incidence ranges between 2% and 30% of patients.<sup>140,239</sup> The causal relationship between epidural anesthesia and backache has been suggested by some studies,<sup>240,241</sup> and refuted by others.<sup>242,243</sup>

The etiology of backache is multifactorial in nature. Drug use, abnormal posture, muscle relaxation, and in obstetric cases, exaggerated lumbar lordosis and the process of undergoing labor have been implicated as causes.<sup>165</sup>

In a retrospective study Macarthur et al. looked at 11,701 patients.<sup>240</sup> Of the 1634 women who reported backache, 1132 (69%) had experienced it for more than 1 year. In this study, a significant association was found between backache and epidural anesthesia (relative

risk: 1.8); 903 of 4766 women (18.9%) who had had epidural anesthesia reported this symptom, compared with 731 of the 6935 women (10.5%) who had not undergone epidural anesthesia. However, prospective data refutes the findings of Macarthur, as noted by Breen who interviewed 1185 women and found that of the 1042 (88%) for which followup data was available, the incidence of postpartum back pain in those who received epidural anesthesia was equivalent to those who did not (44% vs. 45%).<sup>242</sup> Multiple logistic regressions revealed postpartum back pain was associated with a history of back pain, younger age, and greater weight. Russell and coworkers demonstrated that new-onset postpartum back pain was not associated with regional anesthesia.<sup>196</sup> Among the women in Russell's study who received either 0.125% bupivacaine or 0.0625% bupivacaine, the incidence of new long-term back pain was 7.6% when compared to controls, and there was no difference found between the groups. Women who are seeking analgesia for labor should be reassured that back pain following epidural analgesia is minimal and is usually limited to the early postpartum period.

In 1987, 2-chloroprocaine was marketed by Astra Zeneca in a new formulation (Nesacaine-MPF) involving disodium EDTA as a chelating agent, for epidural and caudal use. Reports linking this new formulation with backache emerged,<sup>92,244</sup> and gave way to a possible explanation that the EDTA could cause hypocalcemic tetany of the paraspinous muscles. The drug now comes preservative-free, and is prepared in dark-glass bottles to prevent light-induced disintegration. Despite the elimination of EDTA from this medication, backache continues to be reported with its use.<sup>245</sup>

### Prevention/Management

Backache following epidural placement should not be ignored, as it can be a cardinal symptom of a space-occupying lesion within the spinal canal. Complications such as an epidural hematoma and abscess, although rare, can have catastrophic outcomes if unrecognized and untreated.

## COMPLICATIONS OF INTRAVENOUS REGIONAL ANESTHESIA

Intravenous regional anesthesia (IVRA) is one of the oldest techniques used in

anesthesia practice today; Bier first described IVRA in 1908.<sup>246</sup> The technique was not widely practiced for the first 50 years of its inception because it was not practical to perform a venous cut down on patients undergoing relatively minor extremity procedures. Holmes made a very simple adjustment to the technique in 1963, and demonstrated that Bier's technique could be performed using a percutaneous intravenous approach.<sup>247</sup> IVRA is now widely used for minor upper- and lower-extremity procedures all over the world<sup>247</sup> because of its ease to perform and association with a very high success rate. There are a number of recognizable risks associated with this procedure, the most serious being compartment syndrome and local anesthetic toxicity. A primary limitation of the technique is the duration of tolerability of the tourniquet, which, without opioid supplementation, is about 45 minutes. The addition of ketamine in very low doses (0.1 mg/kg) greatly extends the time that patients can tolerate the tourniquet. Clonidine and Ketoralac have also been recommended for this purpose. Fortunately systemic toxicity and compartment syndrome are rare complications when IVRA is properly administered.

### Complications of IVRA Compartment Syndrome

Compartment syndrome has been reported following IVRA of the upper and lower extremities.<sup>248,249</sup> In one reported case, hypertonic saline was mistakenly used as a diluent for the local anesthetic. Long bone fractures of the forearm or leg increase the risk of compartment syndrome and IVRA should not be used in this circumstance. Severe ischemia of the upper extremity has been reported in at least one case following IVRA in an otherwise healthy young female, where the etiology was unclear.<sup>250</sup> Table 49-7 lists some of the possible causes of compartment syndrome.

Venous thrombosis is a recognized complication of tourniquet application. There are some anecdotal reports of subclavian steal syndrome following sudden loss of resistance in the upper extremity, leading to transient cortical blindness.<sup>251</sup>

### Local Anesthetic Toxicity

The risk of local anesthetic toxicity is quite low following IVRA. Auroy et al. reported an incidence of 2.7 seizures

TABLE 49-7.

**Causes of Compartment Syndrome**

- Excessive tourniquet pressures
- Allergic reactions
- Undiagnosed Raynaud disease
- Sickle cell disease
- Intraarterial injection
- Drug administration error

per 10,000 cases following IVRA in their study.<sup>43</sup> Deaths have been reported when increased amounts of toxic cardiac drugs (e.g., bupivacaine) have been used for IVRA.<sup>155</sup> The main cause of this complication is faulty tourniquet technique as noted.

Inadequate exsanguination before the inflation of the tourniquet allows the operator to exceed the tourniquet inflation pressure during the injection, thereby allowing local anesthetic solution to escape into the circulation. Interosseous escape of the local anesthetic can occur during injection. Accidental or premature deflation of the tourniquet (within 20 minutes) allows the local anesthetic to enter the circulation in toxic concentrations. When an excessive dose of local anesthetic is injected, toxicity may occur on release of the tourniquet, even when following appropriate recommendations.

**Prevention**

Intravenous regional anesthesia is easy to perform yet one must pay particular attention to the details surrounding the procedure. Preventing complications begins with appropriate patient selection and a positive surgical indication. Good intravenous access is important as is proper exsanguination of the limb. Table 49-8 lists points to consider for proper patient and surgical selection.

Proper techniques for effective and safe IVRA essential to prevent complications are as follows:

- Place the tourniquet above the elbow (tourniquet application is less reliable in the distal portion of the extremity).
- Thorough exsanguinations should take place prior to injection of the local anesthetic. Appropriate doses of preservative-free local anesthetic should be administered.
- Lidocaine free of preservatives is one of the most frequently used local anesthetics for IVRA; the recom-

mended dose is 3 mg/kg. Other drugs, such as prilocaine, have been used because of their favorable pharmacokinetic profile; however, some of these drugs, such as prilocaine, are no longer available in many countries. A preservative-free form of chloroprocaine was recently introduced in Europe and has many potential benefits, especially with regard to toxicity.<sup>252</sup>

- Ropivacaine has also been studied as a potential local anesthetic for IVRA.
- Bupivacaine is contraindicated in IVRA.

**Management**

The management of local anesthetic toxicity is the same as that discussed in the previous section. The clinician must have dedicated intravenous access to inject other medications if required. Proper equipment and personnel must be available for emergency cardiopulmonary support (airway, breathing, circulation).

**COMPLICATIONS OF OPHTHALMIC REGIONAL ANESTHESIA**

Like other types of nerve blocks, there are some serious risks associated with the use of ophthalmic regional anesthesia. Common complications include hemorrhage, brainstem anesthesia, and myotoxicity. However, the clinician should be aware of other less-frequently occurring complications of ophthalmic regional anesthesia that include globe ischemia, perforation of the globe, optic nerve and facial nerve damage, and elicitation of the oculocardiac reflex.

**Hemorrhage**

The reported risk of retrobulbar hemorrhage varies substantially in anesthetic literature.<sup>253</sup> In one of the largest reported series, Hamilton reported an incidence of 0.44% hemorrhages in 12,500 ophthalmic regional anesthesia cases.<sup>254</sup> The severity of retrobulbar hemorrhage varies depending upon the origin of the bleeding. Arterial bleeding is the most dangerous complication of retrobulbar injections because tamponade can occur, which leads to ischemia of the globe. In this situation, lateral canthotomy may be required to relieve the pressure. The

TABLE 49-8.

**Factors for Proper Patient/Surgical Selection**

- The upper-limb surgical procedure should not last longer than 1 hour. Surgical procedures lasting longer than 1 hour are not recommended because patients become very intolerant of the tourniquet.
- Failed IVRA occurs more frequently in lower-extremity procedures.
- The risk of toxicity is much greater in lower-limb surgery where larger quantities of drug are required.
- In addition to the usual contraindications of regional anesthesia, physicians should avoid admitting patients for IVRA who have the following: sickle cell disease, Raynaud disease, sickle cell anemia, or allergies to local anesthetics.
- Patients with gaping venous wounds, those with infected lesions, and those patients with long bone fractures of the extremities should not be recognized as patients suitable for IVRA.
- IVRA is generally not recommended in lengthy procedure.

IVRA, intravenous regional anesthesia.

site of injection is also important to consider in avoiding hemorrhage.

**Prevention of Complications Resultant of Ophthalmic Regional Anesthesia**

To prevent complication as a result of ophthalmic regional anesthesia, do the following:

- Consider only selected patients who are taking anticoagulant medication with the current INR (< 2) levels not exceeding twice the normal value as candidates for ophthalmic regional blocking.<sup>255</sup>
- Carefully weigh the benefits and risks of performing ophthalmic regional anesthesia in patients who have discontinued their anticoagulant medication.
- Consider alternative methods of applying ophthalmic anesthesia if there is risk of thrombotic complications following discontinuation of anticoagulant medication.<sup>256,257</sup>
- Let patients on antiplatelet therapy continue their medications if medically indicated.<sup>258</sup>

- Postpone surgery in severely hypertensive patients.

The use of small-gauge disposable needles (25 gauge), less than 31 mm in length is recommended for use in ophthalmic regional anesthetic procedures.<sup>259,260</sup> The site of anesthetic injection should be carefully considered. Vascular structures are larger in the apex of the orbit, and also the upper nasal area is particularly vascular. Areas with increased vascular architecture should be avoided to prevent complications during the induction of ophthalmic regional anesthesia.

### Management

As with other nerve blocks, once damage has occurred as a result of ophthalmic regional anesthesia it is difficult to reverse. If complications do occur, supportive measures are recommended for patient care.

### Brainstem Anesthesia

When local anesthetic spreads directly into the brain from the orbit, brainstem anesthesia occurs. The incidence of brainstem anesthesia is 1 case for every 350–1500 ophthalmic cases<sup>259</sup> and symptoms may appear within 2 minutes of the injection. Maximum effects usually occur within 20 minutes and recovery occurs in 2–3 hours. Symptoms and signs can vary greatly and include the following (Table 49–9).

### Globe Perforation

Blindly inserting a needle into the orbit is associated with the risk of globe perforation. The site of injection and the axial length of the globe must be carefully considered before needle insertion so as to prevent damaging the globe. In one reported series, there were no globe perforations in 2000 cases of ophthalmic regional anesthesia,<sup>261</sup> whereas another study reported an incidence of 1 case of globe perforation per 12,000 ophthalmic cases.<sup>262</sup>

### Prevention

Globe perforation can be prevented by presurgically assessing the axial length of the patient's eye. Patients susceptible to perforation of the globe include those with elongated globes (>26 mm), which occur in myopic patients, in those with retinal detachment, and in those who require refractive surgery. Myopic patients with staphyloma are particularly vulnerable to globe perforation.<sup>263</sup>

**TABLE 49–9.**

#### Signs and Symptoms of Brainstem Anesthesia, Prevention, and Management

Brainstem anesthesia	<ul style="list-style-type: none"> <li>• Confusion</li> <li>• Shivering</li> <li>• Convulsions</li> <li>• Paralysis</li> <li>• Loss of consciousness</li> <li>• Apnea</li> <li>• Hypotension</li> <li>• Bradycardia</li> <li>• Nausea/vomiting</li> </ul>
Prevention Management	<ul style="list-style-type: none"> <li>• Use short needles (&lt;31 mm) and small doses of local anesthetics.</li> <li>• Surgery should be postponed and the patient should be observed and treated appropriately if symptoms of brainstem anesthesia develop. The treatment varies depending upon the symptoms and is mostly supportive in nature.</li> </ul>

The clinician should attempt to visualize in the “mind’s eye” the equator of the globe and to avoid repositioning the needle until it is located past the equator. All needles should be directed tangentially with the bevel facing the globe. Pain or resistance to needle advancement is a warning sign of perforation of the sclera. Some experts suggest aiming the needle midway between the inferior and lateral rectus muscles to allow a clear point of entry to the intraconal space. The inferior rectus muscle should be carefully avoided to prevent diplopia.

### Management

The key to successful management of globe perforation is early diagnosis and treatment. The patient may report paresthesia at the time of needle insertion. Fundoscopic examination by an ophthalmologist may confirm the diagnosis of globe perforation. Depending on the severity of damage, globe perforation can be managed by laser photocoagulation therapy, cryotherapy, and other prompt surgical procedures. Because the appropriate management of globe perforation is complex, careful consultation should take place with the ophthalmologist.

### Myotoxicity

Myotoxic effects of local anesthetic drugs were discussed in Toxic Effects of Local Anesthetics on the Nerves and Surrounding Anatomy above. Typically, diplopia and ptosis can occur for up to 48 hours when using long-acting local anesthetics. However, direct injection of these drugs into the highly

sensitive eye muscles can permanently damage them. The inferior rectus muscle appears to be particularly vulnerable to injury.<sup>104,264</sup>

### Miscellaneous Complications Resulting from Ophthalmic Regional Anesthesia

Globe ischemia, optic nerve and facial nerve damage and oculocardiac reflex are less-frequent complications of ophthalmic regional anesthesia.

### SUMMARY

This chapter provides a comprehensive review of the management of complications following regional anesthesia.

- Although the overall incidence of complications following brachial plexus anesthesia is low, the proportion of complications following supraclavicular methods is higher than that reported following axillary blocks (i.e., the incidence of seizure activity following interscalene or subclavian perivascular methods is at least 6 times that of the axillary approach).
- Many of the complications of supraclavicular methods have an impact on pulmonary function; consequently, supraclavicular methods should be avoided in patients with significant pulmonary dysfunction. In a sense, there should always be a clear-cut indication for selecting supraclavicular methods because of the risk of pulmonary complications.
- Local anesthetic drugs must be injected slowly and incrementally,



and patients must be observed carefully for signs of local anesthetic toxicity. The addition of epinephrine to local anesthetics is a useful marker for detecting accidental intravascular injections.

- Persistent pain on injection of local anesthetics is a potential sign of intraneural injection.
- Large-gauge and long needles should be avoided, and brachial blocks should be avoided in comatose adult patients.

Finally, brachial plexus anesthesia is not yet an exact science. Ultrasonogram-guided needle insertion is rapidly converting regional anesthesia from an art to a science. There has been renewed interest in regional anesthesia as a result of this advance. Brachial plexus block has been a great challenge to anesthesiologists for more than 100 years. We can expect success rates close to 100% in the near future. However, complications will still occur. Important facts for consideration regarding managing adverse outcomes during regional anesthesia are:

- As professionals, we must select our patients carefully.
- We must provide informed consent.
- The safest approach must be selected.
- The appropriate dose of local anesthetic should be given.
- Patient discomfort must be minimized.

Drug delivery via neuraxial block is an effective method for providing analgesia for lower-extremity, abdominal, and thoracic procedures, as well as for managing labor pain. In the perioperative setting, epidural analgesia has numerous benefits in addition to providing effective pain relief. These benefits include earlier ambulation, rapid weaning from mechanical ventilation, reduced time spent in a catabolic state, and lowered circulating stress hormone levels.<sup>265</sup> While serious complications are uncommon, patients should be informed about common side effects, such as urinary retention and pruritus, and should be counseled concerning the risks of major neurologic complication such as paralysis. Newer technologies such as the use of ultrasonography, and the stimulating epidural catheter may increase the safety and ease of catheter placement. For the individual patient, the risks and benefits of epidu-

ral analgesia should be carefully considered, and prevention of patient injury is the highest priority.

## KEY REFERENCES

1. Auroy Y, Narchi P, Messiah A, Litt L, Rouvier B, Samii K. Serious complications related to regional anesthesia: results of a prospective survey in France. *Anesthesiology* 1997;87(3):479-486.
2. Faccenda KA, Finucane BT. Complications of regional anaesthesia: Incidence and prevention. *Drug Saf* 2001;24(6):413-442.
3. Finucane BT. *Complications of Regional Anesthesia*. New York: Churchill Livingstone, 1999.
4. Horlocker TT, Wedel DJ, Benzon H, et al. Regional anesthesia in the anticoagulated patient: defining the risks (the second ASRA Consensus Conference on Neuraxial Anesthesia and Anticoagulation). *Reg Anesth Pain Med* 2003;28(3):172-197.
5. Moen V, Dahlgren N, Irestedt L. Severe neurological complications after central neuraxial blockades in Sweden 1990-1999. *Anesthesiology* 2004;101(4):950-959.

## REFERENCES

1. Koller C. The use of cocaine for producing anaesthesia of the eye [translated and reprinted]. *Lancet* 1884;II:990-992.
2. Atlee JL, Aronson S, Coursin DB, et al. *Complications in Anesthesia*. Philadelphia: WB Saunders, 1999.
3. Kaye RD, Heard CMB. Alleged malpractice. In: Atlee JL, ed. *Complications of Anesthesia*, 1st ed. Philadelphia: WB Saunders Company, 1999:922.
4. Waisel DB, Truog RD. Informed consent. *Anesthesiology* 1997;87:968-978.
5. Raj PP. Peripheral nerve stimulators for nerve blocks. In: Raj PP, de Andres J, Grossi P, Banister R, Sala-Blanc X, eds. *Textbook of Regional Anesthesia*. New York: Churchill Livingstone, 2002:251-268.
6. Ford DJ, Pither CE, Raj PP. Electrical characteristics of peripheral nerve stimulators: implication for nerve localization. *Reg Anesth* 1984;9:73-77.
7. Tsui BC, Wagner A, Finucane B. Electrophysiologic effect of injectates on peripheral nerve stimulation. *Reg Anesth Pain Med* 2004;29(3):189-193.

8. Hadzic A. Peripheral nerve stimulators: cracking the code-one at a time. *Reg Anesth Pain Med* 2004;29(3):185-188.

9. Pham Dang C. Stimulating catheter and electrophysiologic effect of the flush injectates: exciting. *Reg Anesth Pain Med* 2004;29(5):509-510.

10. Tsui BC, Kropelin B. The electrophysiological effect of dextrose 5% in water on single-shot peripheral nerve stimulation. *Anesth Analg* 2005;100(6):1837-1839.

11. Pham Dang C, Kick O, Collet T, Gouin F, Pinaud M. Continuous peripheral nerve blocks with stimulating catheters. *Reg Anesth Pain Med* 2003;28(2):83-88.

12. Tsui BCH, Finucane B. Practical recommendations for improving needle tip visibility under ultrasound guidance? *Reg Anesth Pain Med*. 2005;30:596-597.

13. Tsui BC, Gupta S, Finucane B. Confirmation of epidural catheter placement using nerve stimulation. *Can J Anaesth* 1998;45(7):640-644.

14. Tsui BC, Guenther C, Emery D, Finucane B. Determining epidural catheter location using nerve stimulation with radiological confirmation. *Reg Anesth Pain Med* 2000;25(3):306-309.

15. Tsui BC, Gupta S, Finucane B. Detection of subarachnoid and intravascular epidural catheter placement. *Can J Anaesth* 1999;46(7):675-678.

16. Tsui BC, Gupta S, Emery D, Finucane B. Detection of subdural placement of epidural catheter using nerve stimulation. *Can J Anaesth* 2000;47(5):471-473.

17. Hoppenstein R. Percutaneous implantation of chronic spinal cord electrodes for control of intractable pain: preliminary report. *Surg Neurol* 1975;4(1):195-198.

18. Krainick JU, Thoden U, Riechert T. Spinal cord stimulation in post-amputation pain. *Surg Neurol* 1975;4(1):167-170.

19. North RB, Kidd DH, Zahurak M, James CS, Long DM. Spinal cord stimulation for chronic, intractable pain: experience over two decades. *Neurosurgery* 1993;32(3):384-394.

20. Richardson RR, Nunez C, Siqueira EB. Histological reaction to percutaneous epidural neurostimulation: initial and long-term results. *Med Prog Technol* 1979;6(4):179-184.

21. Komanetsky RM, Padberg AM, Lenke LG, et al. Neurogenic motor evoked potentials: a prospective comparison of stimulation methods in spinal deformity surgery. *J Spinal Disord* 1998;11(1):21-28.

22. Nagle KJ, Emerson RG, Adams DC, et al. Intraoperative monitoring of motor evoked potentials: a review of 116 cases. *Neurology* 1996;47(4):999-1004.

23. Pereon Y, Bernard JM, Fayet G, Delecrin J, Passuti N, Guiheneuc P. Usefulness of neurogenic motor evoked potentials for spinal cord monitoring: findings in 112 consecutive patients undergoing surgery for spinal deformity. *Electroencephalogr Clin Neurophysiol* 1998;108(1):17-23.



24. Sherwood AM. Biomedical engineering aspects of spinal cord stimulation. *Appl Neurophysiol* 1981;44(1-3):126-132.
25. Tsui BC, Seal R, Koller J, Entwistle L, Haugen R, Kearney R. Thoracic epidural analgesia via the caudal approach in pediatric patients undergoing fundoplication using nerve stimulation guidance. *Anesth Analg* 2001;93(5):1152-1155.
26. Tsui BC, Wagner A, Cave D, Kearney R. Thoracic and lumbar epidural analgesia via the caudal approach using electrical stimulation guidance in pediatric patients: a review of 289 patients. *Anesthesiology* 2004;100(3):683-689.
27. Tsui BC, Finucane B. Epidural stimulator catheter. *Tech Reg Anesth Pain Manage* 2002;6(4):150-154.
28. Ting PL, Sivagnanratnam V. Ultrasonographic study of the spread of local anesthetic during axillary brachial plexus block. *Br J Anaesth* 1989;63:326-329.
29. Koprak S, Krafft P, Eibenberger K, et al. Ultrasound-guided supraclavicular approach for regional anesthesia of the brachial plexus. *Anesth Analg* 1994;78:503-507.
30. Williams SR, Chouinard P, Arcand G, et al. Ultrasound guidance speeds execution and improves the quality of supraclavicular block. *Anesth Analg* 2003;97(5):1518-1523.
31. Chan VW, Perlas A, Rawson R, Odukoya O. Ultrasound-guided supraclavicular brachial plexus block. *Anesth Analg* 2003;97(5):1514-1517.
32. Chan VW. Applying ultrasound imaging to interscalene brachial plexus block. *Reg Anesth Pain Med* 2003;28(4):340-343.
33. Grau T, Leipold RW, Conradi R, Martin E, Motsch J. Efficacy of ultrasound imaging in obstetric epidural anesthesia. *J Clin Anesth* 2002;14(3):169-175.
34. Grau T, Leipold RW, Fatehi S, Martin E, Motsch J. Real-time ultrasonic observation of combined spinal-epidural anaesthesia. *Eur J Anaesthesiol* 2004;21(1):25-31.
35. Grau T, Bartussek E, Conradi R, Martin E, Motsch J. Ultrasound imaging improves learning curves in obstetric epidural anesthesia: a preliminary study. *Can J Anaesth* 2003;50(10):1047-1050.
36. Grau T, Leipold RW, Horter J, Conradi R, Martin EO, Motsch J. Paramedian access to the epidural space: the optimum window for ultrasound imaging. *J Clin Anesth* 2001;13(3):213-217.
37. Grau T, Leipold RW, Conradi R, Martin E. Ultrasound control for presumed difficult epidural puncture. *Acta Anaesthesiol Scand* 2001;45(6):766-771.
38. Chawathe MS, Jones RM, Gildersleve CD, Harrison SK, Morris SJ, Eickmann C. Detection of epidural catheters with ultrasound in children. *Paediatr Anaesth* 2003;13(8):681-684.
39. Chen CP, Tang SF, Hsu TC, et al. Ultrasound guidance in caudal epidural needle placement. *Anesthesiology* 2004;101(1):181-184.
40. Shevde K, Panagopoulos G. A survey of 800 patients' knowledge, attitudes and concerns regarding anesthesia. *Anesth Analg* 1991;73:190-198.
41. Curley RK, MacFarlane AW, King CM. Contact sensitivity to the amide anesthetics lidocaine, prilocaine and mepivacaine: case report and review of literature. *Arch Dermatol* 1986;122:924-926.
42. Massey Dawkins CJ. An analysis of the complications of extradural and caudal block. *Anaesthesia* 1969;24:554-563.
43. Auroy Y, Narchi P, Messiah A, Litt L, Rouvier B, Samii K. Serious complications related to regional anesthesia: results of a prospective survey in France. *Anesthesiology* 1997;87(3):479-486.
44. Brown DT, Beamish D, Wildsmith JAW. Allergic reactions to an amide local anesthetic. *Br J Anaesth* 1981;53:435-437.
45. Covino BG, Vassalo HG. Pharmacokinetic Aspects of Local Anesthetic Agents. *Local Anesthetics. Mechanisms of Action and Clinical Use*. New York: Grune and Stratton, 1976:95-123.
46. Lofstrom JB. Physiologic disposition of local anesthetics. *Reg Anesth* 1982;7:33-38.
47. Englesson S, Grevsten S. The influence of acid-base changes on central nervous system toxicity of local anesthetic agents. II. *Acta Anaesthesiol Scand* 1974;18:88-103.
48. Mather LE, Cousins MJ. *Drugs* 1979;18(3):185-205.
49. Weinberg GL. Current concepts in resuscitation of patients with local anesthetic cardiac toxicity. *Reg Anesth Pain Med* 2002;27(6):568-575.
50. Laurito CE, Chen WX. Biological dyes may improve the safety of local anesthetics. *J Clin Anesth* 1998;10(2):176-177.
51. Tanaka M, Kimura T, Goyagi T, Ogasawara K, Nitta R, Nishikawa T. Evaluating hemodynamic and T wave criteria of simulated intravascular test doses using bupivacaine or isoproterenol in anesthetized children. *Anesth Analg* 2000;91(3):567-572.
52. Tanaka M, Nishikawa T. A comparative study of hemodynamic and T-wave criteria for detecting intravascular injection of the test dose (epinephrine) in sevoflurane-anesthetized adults. *Anesth Analg* 1999;89(1):32-36.
53. Tanaka M, Sato M, Kimura T, Nishikawa T. The efficacy of simulated intravascular test dose in sedated patients. *Anesth Analg* 2001;93(6):1612-1617, table.
54. Faccenda KA, Finucane BT. Complications of regional anaesthesia: Incidence and prevention. *Drug Saf* 2001;24(6):413-442.
55. Heavner JE, Dryden CF Jr, Sanghani V, Huemer G, Bessire A, Badgwell JM. Severe hypoxia enhances central nervous system and cardiovascular toxicity of bupivacaine in lightly anesthetized pigs. *Anesthesiology* 1992;77(1):142-147.
56. Rosen MA, Thigpen JW, Shnider SM, Foutz SE, Levinson G, Koike M. Bupivacaine-induced cardiotoxicity in hypoxic and acidotic sheep. *Anesth Analg* 1985;64(11):1089-1096.
57. Weinberg G, Ripper R, Feinstein DL, Hoffman W. Lipid emulsion infusion rescues dogs from bupivacaine-induced cardiac toxicity. *Reg Anesth Pain Med* 2003;28(3):198-202.
58. Weinberg GL, VadeBoncouer T, Ramaraju GA, Garcia-Amaro MF, Cwik MJ. Pretreatment or resuscitation with a lipid infusion shifts the dose-response to bupivacaine-induced asystole in rats. *Anesthesiology* 1998;88(4):1071-1075.
59. Groban L, Butterworth J. Lipid reversal of bupivacaine toxicity: has the silver bullet been identified? *Reg Anesth Pain Med* 2003;28(3):167-169.
60. Heavner JE, Pitkanen MT, Shi B, Rosenberg PH. Resuscitation from bupivacaine-induced asystole in rats: comparison of different cardioactive drugs. *Anesth Analg* 1995;80(6):1134-1139.
61. Krismer AC, Hogan QH, Wenzel V, et al. The efficacy of epinephrine or vasopressin for resuscitation during epidural anesthesia. *Anesth Analg* 2001;93(3):734-742.
62. Mayr VD, Raedler C, Wenzel V, Lindner KH, Strohmenger HU. A comparison of epinephrine and vasopressin in a porcine model of cardiac arrest after rapid intravenous injection of bupivacaine. *Anesth Analg* 2004;98(5):1426-1431, table.
63. Neustein S, Sampson I, Dimich I, Shiang H, Tatu J. Milrinone is superior to epinephrine as treatment of myocardial depression due to ropivacaine in pigs. *Can J Anaesth* 2000;47(11):1114-1118.
64. Long WB, Rosenblum S, Grady IP. Successful resuscitation of bupivacaine-induced cardiac arrest using cardiopulmonary bypass. *Anesth Analg* 1989;69(3):403-406.
65. Renck H. Neurological complications of central nerve blocks. *Acta Anaesthesiol Scand* 1995;39:859-868.
66. Neal JM, Hebl JR. Complications after peripheral nerve block. In: Benson H et al., ed. *Essentials of Pain Medicine and Regional Anesthesia*. 2 ed. New York: Churchill Livingstone, 2004:694-701.
67. Deschner S, Borgeat A, Hadzic A. Neurologic Complications of Peripheral Nerve Blocks: Mechanisms and Management. In: Hadzic A, ed. *Textbook of Regional Anesthesia and Acute Pain Management*. New York: McGraw-Hill, 2007:969-978.
68. Moore DC, Mulroy MF, Thompson GE. Peripheral nerve damage and regional anesthesia. *Br J Anaesth* 1994;73:435-436.
69. Bromage PR, Benumof JL. Paraplegia following intracord injection during attempted epidural anesthesia under general anesthesia. *Reg Anesth Pain Med* 1998;23(1):104-107.
70. Benumof JL. Permanent loss of cervical spinal cord function associated with interscalene block performed under general anesthesia. *Anesthesiology* 2000;93(6):1541-1544.
71. Selander D, Dhuner KG, Lundborg G. Peripheral nerve injury due to injection

- needles used for regional anesthesia. An experimental study of the acute effects of needle point trauma. *Acta Anaesthesiol Scand* 1977;21(3):182-188.
72. Hadzic A, Dilberovic F, Shah S, et al. Combination of intraneural injection and high injection pressure leads to fascicular injury and neurologic deficits in dogs. *Reg Anesth Pain Med* 2004;29(5):417-423.
73. Weaver MA, Tandatnick CA, Hahn MB. Peripheral nerve blockade. In: Raj PP, ed. *Textbook of Regional Anesthesia*. 9th ed. Philadelphia: Churchill Livingstone, 2002: 857-870.
74. Finucane BT. *Complications of Regional Anesthesia*. New York: Churchill Livingstone, 1999.
75. Mulroy MF. *Regional Anesthesia: An Illustrated Procedural Guide*. Boston: Little, Brown, 1989.
76. Munson ES, Paul WL, Embro WJ. Central nervous system toxicity of local anesthetic mixtures in monkeys. *Anesthesiology* 1977;46(3):179-183.
77. Borgeat A, Ekatodramis G, Kalberer F, Benz C. Acute and nonacute complications associated with interscalene block and shoulder surgery: a prospective study. *Anesthesiology* 2001;95(4):875-880.
78. Urban MK, Urquhart B. Evaluation of brachial plexus anesthesia for upper extremity surgery. *Reg Anesth* 1994;19:175-182.
79. Barutell C, Vidal F, Raich M, et al. A neurological complication following interscalene brachial plexus block. *Anaesthesia* 1980;35:365-367.
80. Passannante AN. Spinal anesthesia and permanent neurologic deficit after interscalene block. *Anesth Analg* 1996;82(4): 873-874.
81. Winnie AP. *Plexus Anesthesia: I. Perivascular Techniques of Brachial Plexus Block*. Philadelphia: WB Saunders, 1983:264-266.
82. Kulenkampff D. Anaesthesia of the brachial plexus [German]. *Zentralbl Chir* 1911;40:849.
83. Brand L, Papper EM. A comparison of supraclavicular and axillary techniques for brachial plexus blocks. *Anesthesiology* 1961;22:226-229.
84. DeJong RH. *Local Anesthetics: Adverse Effects*. Springfield, IL: Charles C Thomas, 1977.
85. Urmey WF, Talts KH, Sharrock NE. One hundred percent incidence of hemidiaphragmatic paresis associated with interscalene brachial plexus anesthesia as diagnosed by ultrasonography. *Anesth Analg* 1991;73:498-503.
86. Winnie AP. Interscalene brachial plexus block. *Anesth Analg* 1970;49(455):466.
87. Ward ME. Interscalene approach to brachial plexus. *Anesthesia* 1974;29:147-157.
88. Brown DL, Bridenbaugh LD. The upper extremity: Somatic block. In: Cousins M, Bridenbaugh PO, eds. *Neural Blockade in Clinical Anesthesia and Management of Pain*. Philadelphia: Lippincott-Raven, 1998: 345-371.
89. Lambert LA, Lambert DH, Strichartz GR. Irreversible conduction block in isolated nerve by high concentrations of local anesthetics. *Anesthesiology* 1994;80:1082-1093.
90. Ravindran RS, Bond VK, Tasch MD, Gupta CD, Luerssen TG. Prolonged neural blockade following regional analgesia with 2-chloroprocaine. *Anesth Analg* 1980;59(6): 447-451.
91. Stevens RA, Urmey WF, Urquhart BL, et al. Back pain after anesthesia with chloroprocaine. *Anesthesiology* 1993;78:492-497.
92. Fibuch EE, Opper SE. Back pain following epidurally administered Nesacaine-MPF. *Anesth Analg* 1989;69(1):113-115.
93. Schneider M, Ettlin T, Kauffman M, et al. Transient neurologic toxicity after hyperbaric subarachnoid anesthesia with 5% lidocaine. *Anesth Analg* 1993;76:1154-1157.
94. Benoit PW, Belt WD. Some effects of local anesthetic agents on skeletal muscle. *Exp Neurol* 1972;34:264-278.
95. Hall-Craggs EC. Rapid degeneration and regeneration of a whole skeletal muscle following treatment with bupivacaine (Marcaïne). *Exp Neurol* 1974;43:349-358.
96. Benoit PW. Microscarring in skeletal muscles after repeated exposures to lidocaine with epinephrine. *J Oral Surg* 1978; 36:530-533.
97. Benoit PW. Reversible skeletal muscle damage after administration of local anesthetics with and without epinephrine. *J Oral Surg* 1978;36:198-201.
98. Kytta J, Heinin G, Rosenberg PH, et al. Effects of repeated bupivacaine administration on sciatic nerve and surrounding tissue in rats. *Acta Anaesthesiol Scand* 1986; 30:625-629.
99. Hogan Q, Dobson R, Erikson S, et al. Local anesthetic myotoxicity: a case and review. *Anesthesiology* 1994;80:942-947.
100. Zink W, Bohl JRE, Hacke N, Sinner B, Martin E, Graf BM. The long-term myotoxic effects of bupivacaine and ropivacaine after continuous peripheral nerve blocks. *Anesth Analg* 2005;101:548-554.
101. Neal JM, Moore JM, Kopacz DJ, et al. Quantitative assessment of respiratory and sensory function after supraclavicular block. *Anesth Analg* 1998;86:1239-1244.
102. Hood J, Knoblanche G. Respiratory failure following brachial plexus block. *Anaesth Intensive Care* 1979;7:285-286.
103. Kayerker UN, Dick MD. Phrenic nerve paralysis following interscalene brachial plexus block. *Anesth Analg* 1983;62:536-537.
104. Rau RH, Chan YL, Chuang HI. Dyspnea resulting from phrenic nerve paralysis after interscalene block in an obese male. *Acta Anaesthesiol Sin* 1997;35:113-118.
105. Bashein G, Robertson HT, Kennedy WF Jr. Persistent phrenic nerve paresis following interscalene brachial plexus block. *Anesthesiology* 1985;63:102-104.
106. Robaux S, Bouaziz H, Boisseau N, Raucoules-Aime M, Laxenaire MC. Persistent phrenic nerve paralysis following interscalene brachial plexus block. *Anesthesiology* 2001;95(6):1519-1521.
107. Farrar MD, Scheybani M, Nolte H. Upper extremity block effectiveness and complications. *Reg Anesth* 1981;6:133-134.
108. Urmey WF, McDonald M. Hemidiaphragmatic paresis during interscalene brachial plexus block: effect on pulmonary function and chest wall mechanics. *Anesth Analg* 1992;74:352-357.
109. Al-Kaisy AA, Chan VWS, Perlas A. Respiratory effects of low-dose bupivacaine interscalene block. *Br J Anaesth* 1999; 82(2):217-220.
110. Al-Khafaji JM, Ellias MA. Incidence of Horner syndrome with interscalene brachial plexus block and its importance in the management of head injury. *Anesthesiology* 1986;64:127.
111. Wong CA. Neurologic deficits and labor analgesia. *Reg Anesth Pain Med* 2004; 29(4):341-351.
112. Kao MC, Tsai SK, Tsou MY, Lee HK, Guo WY, Hu JS. Paraplegia after delayed detection of inadvertent spinal cord injury during thoracic epidural catheterization in an anesthetized elderly patient. *Anesth Analg* 2004;99(2):580-583, table.
113. Rose JB. Spinal cord injury in a child after single-shot epidural anesthesia. *Anesth Analg* 2003;96(1):3-6.
114. Broadbent CR, Maxwell WB, Ferrie R, Wilson DJ, Gawne-Cain M, Russell R. Ability of anaesthetists to identify a marked lumbar interspace. *Anaesthesia* 2000; 55(11):1122-1126.
115. Cousins MJ, Veering BT. Epidural neural blockade. In: Cousins MJ, Bridenbaugh PO, eds. *Neural Blockade in Clinical Anesthesia and Management of Pain*. 3rd ed. Philadelphia: Lippincott-Raven, 1998:310.
116. Hamandi K, Mottershead J, Lewis T, Ormerod IC, Ferguson IT. Irreversible damage to the spinal cord following spinal anesthesia. *Neurology* 2002;59(4):624-626.
117. Simon SL, Abrahams JM, Sean GM, LeRoux PD, Rushton SA. Intramedullary injection of contrast into the cervical spinal cord during cervical myelography: a case report. *Spine* 2002;27(10):E274-E277.
118. Kandel ER, Schwartz JH, Jones RM. The perception of pain. In: Kandel ER, Schwartz JH, Jessel TM, eds. *Principles of Neural Science*. 4th ed. New York: McGraw Hill, 2000:472-491.
119. Jackson MB, Pounder D, Price C, Matthews AW, Neville E. Percutaneous cervical cordotomy for the control of pain in patients with pleural mesothelioma. *Thorax* 1999;54(3):238-241.
120. Lahuerta J, Bowsher D, Lipton S, Buxton PH. Percutaneous cervical cordotomy: a review of 181 operations on 146 patients with a study on the location of "pain fibers" in the C-2 spinal cord segment of 29 cases. *J Neurosurg* 1994;80(6):975-985.
121. Pounder D, Elliott A. An awake patient may not detect spinal cord puncture. *Anaesthesia* 2000;55(2):194.

122. Tripathi M, Nath SS, Gupta RK. Paraplegia after intracord injection during attempted epidural steroid injection in an awake patient. *Anesth Analg* 2005;101(4):1209–1211.
123. Tsui BC, Armstrong K. Can direct spinal cord injury occur without paresthesia? A report of delayed spinal cord injury after epidural placement in an awake patient. *Anesth Analg* 2005;101(4):1212–1214.
124. Tsui BC, Emery D, Uwiera RR, Finucane B. The use of electrical stimulation to monitor epidural needle advancement in a porcine model. *Anesth Analg* 2005;100(6):1611–1613.
125. Tsui BC, Wagner AM, Cunningham K, Perry S, Desai S, Seal R. Threshold current of an insulated needle in the intrathecal space in pediatric patients. *Anesth Analg* 2005;100(3):662–665.
126. Usubiaga JE. Neurological complications following epidural anesthesia. *Int Anesthesiol Clin* 1975;13:1–153.
127. Kozody R, Palahniuk RJ, Wade JG, et al. The effect of subarachnoid epinephrine and phenylephrine on spinal cord blood flow. *Can Anesth Soc J* 1984;31:301–308.
128. Horlocker TT, Wedel DJ, Benzon H, et al. Regional anesthesia in the anticoagulated patient: defining the risks (the second ASRA Consensus Conference on Neuraxial Anesthesia and Anticoagulation). *Reg Anesth Pain Med* 2003;28(3):172–197.
129. Vandermeulen EP, Van AH, Vermeylen J. Anticoagulants and spinal-epidural anesthesia. *Anesth Analg* 1994;79(6):1165–1177.
130. Perkins WJ, Davis DH, Huntoon MA, Horlocker TT. A retained Racz catheter fragment after epidural neurolysis: implications during magnetic resonance imaging. *Anesth Analg* 2003;96(6):1717–1719.
131. Kane RE. Neurologic deficits following epidural or spinal anesthesia. *Anesth Analg* 1981;60(3):150–161.
132. Moen V, Dahlgren N, Irestedt L. Severe neurological complications after central neuraxial blockades in Sweden 1990–1999. *Anesthesiology* 2004;101(4):950–959.
133. Hughes SC. HIV and anesthesia. *Anesthesiol Clin North America* 2004;22(3):379–404, v.
134. Verma A. Epidemiology and clinical features of HIV-1 associated neuropathies. *J Peripher Nerv Syst* 2001;6(1):8–13.
135. Kost-Byerly S, Tobin JR, Greenberg RS, Billett C, Zahurak M, Yaster M. Bacterial colonization and infection rate of continuous epidural catheters in children. *Anesth Analg* 1998;86(4):712–716.
136. Bubeck J, Boos K, Krause H, Thies KC. Subcutaneous tunneling of caudal catheters reduces the rate of bacterial colonization to that of lumbar epidural catheters. *Anesth Analg* 2004;99(3):689–693.
137. Baker AS, Ojemann RG, Swantz MN, et al. Spinal epidural abscess. *N Engl J Med* 1975;293:463–468.
138. Eng RHK, Seligman SJ. Lumbar puncture induced meningitis. *JAMA* 1981;245:1456–1459.
139. Feldman JM, Chapin-Robertson K, Turner J. Do agents used for epidural analgesia have antimicrobial properties? *Reg Anesth* 1994;19(1):43–47.
140. Dawkins CJ. An analysis of the complications of extradural and caudal block. *Anaesthesia* 1969;24(4):554–563.
141. Tsui BC, Gupta S, Finucane B. Determination of epidural catheter placement using nerve stimulation in obstetric patients. *Reg Anesth Pain Med* 1999;24(1):17–23.
142. Tsui BC, Bateman K, Bouliane M, Finucane B. Cervical epidural analgesia via a thoracic approach using nerve stimulation guidance in an adult patient undergoing elbow surgery. *Reg Anesth Pain Med* 2004;29(4):355–360.
143. Tsui BC, Malherbe S, Koller J, Aronyk K. Reversal of an unintentional spinal anesthetic by cerebrospinal lavage. *Anesth Analg* 2004;98(2):434–436, table.
144. Ben-David B, Rawa R. Complications of neuraxial blockade. *Anesthesiol Clin North America* 2002;20(3):669–693.
145. Ben-David B, Vaida S, Gaitini L. The influence of high spinal anesthesia on sensitivity to midazolam sedation. *Anesth Analg* 1995;81(3):525–528.
146. Tverskoy M, Shagal M, Finger J, Kissin I. Spinal anesthesia and midazolam hypnotic requirements. *Anesth Analg* 1996;83(1):198–199.
147. Tverskoy M, Shifrin V, Finger J, Fleyshman G, Kissin I. Effect of epidural bupivacaine block on midazolam hypnotic requirements. *Reg Anesth* 1996;21(3):209–213.
148. Lubenow T, Keh-Wong E, Kristof K, Ivankovich O, Ivankovich AD. Inadvertent subdural injection: a complication of an epidural block. *Anesth Analg* 1988;67(2):175–179.
149. Reynolds F, Speedy HM. The subdural space: the third place to go astray. *Anaesthesia* 1990;45(2):120–123.
150. Mollmann M, Holst D, Enk D, Lubbesmeyer H, Deitmer T, Lawin P. [Subdural intra-arachnoid spread of local anesthetics. A complication of spinal anesthesia]. *Anaesthesist* 1992;41(11):685–688.
151. Lena P, Martin R. Subdural placement of an epidural catheter detected by nerve stimulation: [Positionnement sous-dural d'un catheter epidural detecte par stimulation nerveuse et confirme par tomographie]. *Can J Anaesth* 2005;52(6):618–621.
152. Wills JH. Rapid onset of massive subdural anesthesia. *Reg Anesth Pain Med* 2005;30(3):299–302.
153. Brown DL, Ransom DM, Hall JA, Leicht CH, Schroeder DR, Offord KP. Regional anesthesia and local anesthetic-induced systemic toxicity: seizure frequency and accompanying cardiovascular changes. *Anesth Analg* 1995;81(2):321–328.
154. Albright GA. Cardiac arrest following regional anesthesia with etidocaine or bupivacaine. *Anesthesiology* 1979;51(4):285–287.
155. Reynolds F. Bupivacaine and intravenous regional anaesthesia. *Anaesthesia* 1984;39(2):105–107.
156. Banwell BR, Morley-Forster P, Krause R. Decreased incidence of complications in parturients with the arrow (FlexTip Plus) epidural catheter. *Can J Anaesth* 1998;45(4):370–372.
157. Turnbull DK, Shepherd DB. Post-dural puncture headache: pathogenesis, prevention and treatment. *Br J Anaesth* 2003;91(5):718–729.
158. Patin DJ, Eckstein EC, Harum K, Pallares VS. Anatomic and biomechanical properties of human lumbar dura mater. *Anesth Analg* 1993;76(3):535–540.
159. Fink BR. Postspinal headache. *Anesth Analg* 1990;71(2):208–209.
160. Norris MC, Leighton BL, DeSimone CA. Needle bevel direction and headache after inadvertent dural puncture. *Anesthesiology* 1989;70(5):729–731.
161. Lybecker H, Moller JT, May O, Nielsen HK. Incidence and prediction of postdural puncture headache. A prospective study of 1021 spinal anesthetics. *Anesth Analg* 1990;70(4):389–394.
162. Ready LB, Cuplin S, Haschke RH, Nessly M. Spinal needle determinants of rate of transdural fluid leak. *Anesth Analg* 1989;69(4):457–460.
163. Baraz R, Collis RE. The management of accidental dural puncture during labour epidural analgesia: a survey of UK practice. *Anaesthesia* 2005;60(7):673–679.
164. Kuczkowski KM, Benumof JL. Decrease in the incidence of post-dural puncture headache: maintaining CSF volume. *Acta Anaesthesiol Scand* 2003;47(1):98–100.
165. Munnur U, Suresh MS. Backache, headache, and neurologic deficit after regional anesthesia. *Anesthesiol Clin North America* 2003;21(1):71–86.
166. Camann WR, Murray RS, Mushlin PS, Lambert DH. Effects of oral caffeine on postdural puncture headache. A double-blind, placebo-controlled trial. *Anesth Analg* 1990;70(2):181–184.
167. Bolton VE, Leicht CH, Scanlon TS. Postpartum seizure after epidural blood patch and intravenous caffeine sodium benzoate. *Anesthesiology* 1989;70(1):146–149.
168. Carp H, Singh PJ, Vadhera R, Jayaram A. Effects of the serotonin-receptor agonist sumatriptan on postdural puncture headache: report of six cases. *Anesth Analg* 1994;79(1):180–182.
169. Kshatri AM, Foster PA. Adrenocorticotrophic hormone infusion as a novel treatment for postdural puncture headache. *Reg Anesth* 1997;22(5):432–434.
170. Gormley JB. Treatment of post spinal headache. *Anesthesiology* 1960;21:565.
171. DiGiovanni AJ, Dunbar BS. Epidural injections of autologous blood for postlumbar-puncture headache. *Anesth Analg* 1970;49(2):268–271.



172. DiGiovanni AJ, Galbert MW, Wahle WM. Epidural injection of autologous blood for postlumbar-puncture headache. II. Additional clinical experiences and laboratory investigation. *Anesth Analg* 1972;51(2):226-232.
173. Beards SC, Jackson A, Griffiths AG, Horsman EL. Magnetic resonance imaging of extradural blood patches: appearances from 30 min to 18 h. *Br J Anaesth* 1993;71(2):182-188.
174. Szeinfeld M, Ihmeidan IH, Moser MM, Machado R, Klose KJ, Serafini AN. Epidural blood patch: evaluation of the volume and spread of blood injected into the epidural space. *Anesthesiology* 1986;64(6):820-822.
175. Andrews PJ, Ackerman WE, Juneja M, Cases-Cristobal V, Rigor BM. Transient bradycardia associated with extradural blood patch after inadvertent dural puncture in parturients. *Br J Anaesth* 1992;69(4):401-403.
176. Palmer JH, Wilson DW, Brown CM. Lumbosacral syndrome after repeat extradural blood patch. *Br J Anaesth* 1997;78(3):334-336.
177. Perez M, Olmos M, Garrido FJ. Facial nerve paralysis after epidural blood patch. *Reg Anesth* 1993;18(3):196-198.
178. Seeberger MD, Urwyler A. Lumbosacral syndrome after extradural blood patch. *Br J Anaesth* 1992;69(4):414-416.
179. Tekkok IH, Carter DA, Brinker R. Spinal subdural haematoma as a complication of immediate epidural blood patch. *Can J Anaesth* 1996;43(3):306-309.
180. Kowbel MA, Comfort VK. Caudal epidural blood patch for the treatment of a paediatric subarachnoid-cutaneous fistula. *Can J Anaesth* 1995;42(7):625-627.
181. Roy L, Vischoff D, Lavoie J. Epidural blood patch in a seven-year-old child. *Can J Anaesth* 1995;42(7):621-624.
182. Colonna-Romano P, Linton P. Cervical dural puncture and lumbar extradural blood patch. *Can J Anaesth* 1995;42(12):1143-1144.
183. Cheek TG, Banner R, Sauter J, Gutsche BB. Prophylactic extradural blood patch is effective. A preliminary communication. *Br J Anaesth* 1988;61(3):340-342.
184. Palahniuk RJ, Cumming M. Prophylactic blood patch does not prevent post lumbar puncture headache. *Can Anaesth Soc J* 1979;26(2):132-133.
185. Aldrete JA, Brown TL. Intrathecal hematoma and arachnoiditis after prophylactic blood patch through a catheter. *Anesth Analg* 1997;84(1):233-234.
186. Baysinger CL, Menk EJ, Harte E, Midgaur R. The successful treatment of dural puncture headache after failed epidural blood patch. *Anesth Analg* 1986;65(11):1242-1244.
187. Stevens RA, Jorgensen N. Successful treatment of dural puncture headache with epidural saline infusion after failure of epidural blood patch. Case report. *Acta Anaesthesiol Scand* 1988;32(5):429-431.
188. Gerritse BM, van Dongen RT, Crul BJ. Epidural fibrin glue injection stops persistent cerebrospinal fluid leak during long-term intrathecal catheterization. *Anesth Analg* 1997;84(5):1140-1141.
189. Crul BJ, Gerritse BM, van Dongen RT, Schoonderwaldt HC. Epidural fibrin glue injection stops persistent postdural puncture headache. *Anesthesiology* 1999;91(2):576-577.
190. Reynvoet ME, Cosaert PA, Desmet MF, Plasschaert SM. Epidural dextran 40 patch for postdural puncture headache. *Anaesthesia* 1997;52(9):886-888.
191. Sharrock NE. Recordings of, and an anatomical explanation for, false positive loss of resistance during lumbar extradural analgesia. *Br J Anaesth* 1979;51(3):253-258.
192. Gallart L, Blanco D, Samsó E, Vidal F. Clinical and radiologic evidence of the epidural plica mediana dorsalis. *Anesth Analg* 1990;71(6):698-701.
193. Portnoy D, Vadhera RB. Mechanisms and management of an incomplete epidural block for cesarean section. *Anesthesiol Clin North America* 2003;21(1):39-57.
194. Alahuhta S, Kangas-Saarela T, Hollmen AI, Edstrom HH. Visceral pain during caesarean section under spinal and epidural anaesthesia with bupivacaine. *Acta Anaesthesiol Scand* 1990;34(2):95-98.
195. Bourne TM, deMelo AE, Bastianpillai BA, May AE. A survey of how British obstetric anaesthetists test regional anaesthesia before caesarean section. *Anaesthesia* 1997;52(9):901-903.
196. Russell IF. Levels of anaesthesia and intraoperative pain at caesarean section under regional block. *Int J Obstet Anesth* 1995;4(2):71-77.
197. Russell IF. The futility of using sharp pinprick (or cold) to assess spinal or epidural anaesthesia for caesarean delivery. *Reg Anesth Pain Med* 2001;26(4):385-387.
198. Wong CA, Norris MC. Acute situations: obstetrics. In: Raj, ed. *Textbook of Regional Anesthesia*. Philadelphia: Churchill-Livingstone, 2002:471-504.
199. Borghi B, Casati A, Iuorio S, et al. Frequency of hypotension and bradycardia during general anaesthesia, epidural anaesthesia, or integrated epidural-general anaesthesia for total hip replacement. *J Clin Anesth* 2002;14(2):102-106.
200. Meissner A, Rolf N, Van AH. Thoracic epidural anaesthesia and the patient with heart disease: benefits, risks, and controversies. *Anesth Analg* 1997;85(3):517-528.
201. Wright PM, Fee JP. Cardiovascular support during combined extradural and general anaesthesia. *Br J Anaesth* 1992;68(6):585-589.
202. Hahn RG. Increased haemodilution in hypotension induced by epidural anaesthesia. *Acta Anaesthesiol Scand* 1993;37(4):357-360.
203. Hahn RG. Haemoglobin dilution from epidural-induced hypotension with and without fluid loading. *Acta Anaesthesiol Scand* 1992;36(3):241-244.
204. Holte K, Foss NB, Svensen C, Lund C, Madsen JL, Kehlet H. Epidural anaesthesia, hypotension, and changes in intravascular volume. *Anesthesiology* 2004;100(2):281-286.
205. Dalens B, Hasnaoui A. Caudal anaesthesia in pediatric surgery: success rate and adverse effects in 750 consecutive patients. *Anesth Analg* 1989;68(2):83-89.
206. Tsuji MH, Horigome H, Yamashita M. Left ventricular functions are not impaired after lumbar epidural anaesthesia in young children. *Paediatr Anaesth* 1996;6(5):405-409.
207. McCarthy GS. The effect of thoracic extradural analgesia on pulmonary gas distribution, functional residual capacity and airway closure. *Br J Anaesth* 1976;48(3):243-248.
208. Sundberg A, Wattwil M, Arvill A. Respiratory effects of high thoracic epidural anaesthesia. *Acta Anaesthesiol Scand* 1986;30(3):215-217.
209. Kochi T, Sako S, Nishino T, Mizuguchi T. Effect of high thoracic extradural anaesthesia on ventilatory response to hypercapnia in normal volunteers. *Br J Anaesth* 1989;62(4):362-367.
210. Sakura S, Saito Y, Kosaka Y. Effect of extradural anaesthesia on the ventilatory response to hypoxaemia. *Anaesthesia* 1993;48(3):205-209.
211. Gruber EM, Tschernko EM, Kritzing M, et al. The effects of thoracic epidural analgesia with bupivacaine 0.25% on ventilatory mechanics in patients with severe chronic obstructive pulmonary disease. *Anesth Analg* 2001;92(4):1015-1019.
212. Scammell SJ. Case report: inadvertent epidural anaesthesia as a complication of interscalene brachial plexus block. *Anaesth Intensive Care* 1979;7(1):56-57.
213. Bonnet F, Derosier JP, Pluskwa F, Abhay K, Gaillard A. Cervical epidural anaesthesia for carotid artery surgery. *Can J Anaesth* 1990;37(3):353-358.
214. Michalek P, David I, Adamec M, Janousek L. Cervical epidural anaesthesia for combined neck and upper extremity procedure: a pilot study. *Anesth Analg* 2004;99(6):1833-1836, table.
215. Nystrom UM, Nystrom NA. Continuous cervical epidural anaesthesia in reconstructive hand surgery. *J Hand Surg [Am]* 1997;22(5):906-912.
216. Capdevila X, Biboulet P, Rubenovitch J, et al. The effects of cervical epidural anaesthesia with bupivacaine on pulmonary function in conscious patients. *Anesth Analg* 1998;86(5):1033-1038.
217. Brown MM. Central neuraxial narcotics: side effects. In: Atlee JL, ed. *Complications in Anesthesia*. 1st ed. Philadelphia: WB Saunders, 1999:261-265.
218. Chaney MA. Side effects of intrathecal and epidural opioids. *Can J Anaesth* 1995;42(10):891-903.
219. Tzeng JI, Wang JJ, Ho ST, Tang CS, Liu YC, Lee SC. Dexamethasone for pro-



- phylaxis of nausea and vomiting after epidural morphine for post-caesarean section analgesia: comparison of droperidol and saline. *Br J Anaesth* 2000;85(6):865-868.
220. Wang JJ, Ho ST, Liu YH, Ho CM, Liu K, Chia YY. Dexamethasone decreases epidural morphine-related nausea and vomiting. *Anesth Analg* 1999;89(1):117-120.
221. Jeon Y, Hwang J, Kang J, Han S, Rhee K, Oh Y. Effects of epidural naloxone on pruritus induced by epidural morphine: a randomized controlled trial. *Int J Obstet Anesth* 2005;14(1):22-25.
222. Szarvas S, Harmon D, Murphy D. Neuraxial opioid-induced pruritus: a review. *J Clin Anesth* 2003;15(3):234-239.
223. Emanuelsson BM, Persson J, Alm C, Heller A, Gustafsson LL. Systemic absorption and block after epidural injection of ropivacaine in healthy volunteers. *Anesthesiology* 1997;87(6):1309-1317.
224. Borgeat A, Ekatomramis G, Schenker CA. Postoperative nausea and vomiting in regional anesthesia: a review. *Anesthesiology* 2003;98(2):530-547.
225. Sjoström S, Hartvig P, Persson MP, Tamsen A. Pharmacokinetics of epidural morphine and meperidine in humans. *Anesthesiology* 1987;67(6):877-888.
226. Lanz E, Kehrberger E, Theiss D. Epidural morphine: a clinical double-blind study of dosage. *Anesth Analg* 1985;64(8):786-791.
227. Gedney JA, Liu EH. Side-effects of epidural infusions of opioid bupivacaine mixtures. *Anaesthesia* 1998;53(12):1148-1155.
228. Tzeng JI, Hsing CH, Chu CC, Chen YH, Wang JJ. Low-dose dexamethasone reduces nausea and vomiting after epidural morphine: a comparison of metoclopramide with saline. *J Clin Anesth* 2002;14(1):19-23.
229. Wang JJ, Tzeng JI, Ho ST, Chen JY, Chu CC, So EC. The prophylactic effect of tropisetron on epidural morphine-related nausea and vomiting: a comparison of dexamethasone with saline. *Anesth Analg* 2002;94(3):749-753.
230. Wein AJ. Neuromuscular dysfunction of the lower urinary tract and its management. In: Walsh PC, ed. *Campbell's Urology*. Philadelphia: WB Saunders, 2002:954.
231. Givens CD, Wenzel RP. Catheter-associated urinary tract infections in surgical patients: a controlled study on the excess morbidity and costs. *J Urol* 1980;124(5):646-648.
232. Platt R, Polk BF, Murdock B, Rosner B. Mortality associated with nosocomial urinary tract infection. *N Engl J Med* 1982;9;307(11):637-642.
233. Stenseth R, Sellevold O, Breivik H. Epidural morphine for postoperative pain: experience with 1085 patients. *Acta Anaesthesiol Scand* 1985;29(1):148-156.
234. Rawal N, Mollefors K, Axelsson K, Lingardh G, Widman B. An experimental study of urodynamic effects of epidural morphine and of naloxone reversal. *Anesth Analg* 1983;62(7):641-647.
235. Lytle SA, Goldsmith DM, Neuendorf TL, Lowry ME. Postoperative analgesia with epidural fentanyl. *J Am Osteopath Assoc* 1991;91(6):547-550.
236. Rawal N, Mollefors K, Axelsson K, Lingardh G, Widman B. Naloxone reversal of urinary retention after epidural morphine. *Lancet* 1981;2(8260-61):1411.
237. Malinovsky JM, Lepage JY, Karam G, Pinaud M. Nalbuphine reverses urinary effects of epidural morphine: a case report. *J Clin Anesth* 2002;14(7):535-538.
238. Basse L, Werner M, Kehlet H. Is urinary drainage necessary during continuous epidural analgesia after colonic resection? *Reg Anesth Pain Med* 2000;25(5):498-501.
239. Brown EM, Elman DS. Postoperative backache. *Anesth Analg* 1961;40:683-685.
240. MacArthur C, Lewis M, Knox EG, Crawford JS. Epidural anaesthesia and long term backache after childbirth. *BMJ* 1990;301(6742):9-12.
241. Russell R, Groves P, Taub N, O'Dowd J, Reynolds F. Assessing long term backache after childbirth. *BMJ* 1993;306(6888):1299-1303.
242. Breen TW, Ransil BJ, Groves PA, Oriol NE. Factors associated with back pain after childbirth. *Anesthesiology* 1994;81(1):29-34.
243. Russell R, Dundas R, Reynolds F. Long term backache after childbirth: prospective search for causative factors. *BMJ* 1996;312(7043):1384-1388.
244. Levy L, Randel GI, Pandit SK. Does chloroprocaine (Nesacaine MPF) for epidural anesthesia increase the incidence of backache? *Anesthesiology* 1989;71(3):476.
245. Drolet P, Veillette Y. Back pain following epidural anesthesia with 2-chloroprocaine (EDTA-free) or lidocaine. *Reg Anesth* 1997;22(4):303-307.
246. Bier A. Uben einen neuen weg lokalanästhesie an den gliedmassen zu erzeugen. *Arch Clin Chir* 1908;86:1007-1016.
247. Holmes CM. Intravenous regional analgesia: a useful method of producing analgesia of limbs. *Lancet* 1963;1:245-247.
248. Mabee JR, Bostwick TL, Burke MK. Iatrogenic compartment syndrome from hypertonic saline injection in Bier block. *J Emerg Med* 1994;12:473-476.
249. Quigley JT, Popich GA, Lanz UB. Compartment syndrome of the forearm and hand: a case report. *Clin Orthop* 1981;161:247-251.
250. Luce EA, Mangubat E. Loss of hand and forearm following Bier block: a case report. *J Hand Surg* 1983;8:280-283.
251. Carney AL, Anderson EM. Tourniquet subclavian steal: brainstem ischemia and cortical blindness-clinical significance and testing. *Adv Neurol* 1981;30:283-290.
252. Pitkanen MT, Suzuki N, Rosenberg PH. Intravenous regional anesthesia with 0.5% prilocaine or 0.5% chloroprocaine. A double-blind comparison in volunteers. *Anaesthesia* 1992;47:618-619.
253. Edge KR, Nicoll JMV. Retrobulbar hemorrhage after 12,500 retrobulbar blocks. *Anesth Analg* 1993;76:1019-1022.
254. Hamilton RC. Retrobulbar haemorrhage after retrobulbar blocks. *Anesth Analg* 1994;78:608.
255. Anonymous. Anaesthesia for cataract surgery. *Eur J Implant* 1993;5:1-3.
256. Lichter PR. Avoiding complications from local anesthesia [editorial]. *Ophthalmology* 1988;95:565-566.
257. Smith RJH. Cataract extraction without retrobulbar anaesthetic injection. *Br J Ophthalmol* 1990;74:205-207.
258. Shuler JD, Paschal JF, Holland GN. Antiplatelet therapy and cataract surgery. *J Cataract Refract* 1992;18:567-571.
259. Hamilton RC. Brain stem anesthesia as a complication of regional anesthesia for ophthalmic surgery. *Can J Ophthalmol* 1992;27:323-325.
260. Katsev DA, Drews RC, Rose BT. An anatomic study of retrobulbar needle path length. *Ophthalmology* 1989;217:1221-1224.
261. Davis DB, Mandel MR. Posterior peribulbar anesthesia: an alternative to retrobulbar anesthesia. *J Cataract Refract Surg* 1986;12:182-184.
262. Hamilton RC, Gimbel HV, Struini L. Regional anaesthesia for 12,000 cataract extraction and intraocular lens implantation procedures. *Can J Anaesth* 1988;35:615-623.
263. Berglin L, Stenkula S, Algvere PV. Ocular perforation during retrobulbar and peribulbar injections. *Ophthalmic Surg Lasers* 1995;26:429-434.
264. Hunter DG, Lam GC, Guyton DL. Inferior oblique muscle injury from local anesthesia for cataract surgery. *Ophthalmology* 1995;102:501-509.
265. Peutrell JM, Lonnqvist PA. Neuraxial blocks for anaesthesia and analgesia in children. *Curr Opin Anaesth* 2003;16:461-470.

## SECTION E

## SPECIALTY AREAS OF ANESTHESIA PRACTICE

## CHAPTER 50

## Neuroanesthesia

Michael M. Todd, MD,  
David S. Warner, MD, PhD,  
Mazen A. Maktabi, MD, and  
Kamila Vagnerova, MD

The idea that there is something different about anesthesia for neurosurgery is relatively new, despite occasional observations as early as the mid-1800s about the effect of anesthetics on the condition of the brain; the subspecialty of neuroanesthesia arose in only the late 1960s and early 1970s. It developed because of the newfound ability to measure parameters such as intracranial pressure (ICP), cerebral blood flow (CBF), and cerebral metabolic rate (CMR). The relevance of such measurements was supported by the finding that volatile anesthetics could alter ICP in patients, a change apparently related to an increase in CBF. This was reinforced by the discovery that the barbiturates might be therapeutic in some patients. The result was a rapid growth in research and a simultaneous effort to use this information to guide clinical practice. The discipline has since grown to encompass many areas of neurophysiology as they apply to anesthesia, and to many areas of the basic neurosciences that have no immediate application to clinical care.

Despite scientific expertise, neuroanesthesia is plagued by one difficulty. Most of the physiologic parameters that we regard as important (and which we enjoy measuring under experimental conditions) are extremely difficult to record in patients; that is, it is impossible to *routinely* “monitor” the effects of

drugs on CBF, CMR, or ICP. There is no neuroanesthetic equivalent of the pulmonary artery catheter or the transesophageal echocardiograph that per-

mits a wide range of cerebral physiologic and pharmacologic effects to be followed easily in large number of patients. We can monitor the electroen-

## KEY POINTS

1. Most of the physiologic parameters neuroanesthesiologists want to measure are not easy to record in the clinical setting, such as the effect of drugs on cerebral blood flow, cerebral metabolic rate, or intracranial pressure (ICP).
2. To understand ICP, the anesthesiologist should remember the analogy of the brain as a “closed box,” out of which something must leave if something else goes in.
3. Although blood is the smallest of the four kinds of tissues located in the brain, its importance lies in the fact that the cerebral blood volume—and hence ICP—can be changed very rapidly.
4. The five factors that control cerebral flow, cerebral blood volume, and intracranial pressure are  $P_{aCO_2}$ ,  $P_{aO_2}$  plus arterial content, autoregulation, cerebral flow-metabolism coupling, and autonomic nervous system control.
5. While the mechanism(s) controlling flow-metabolism coupling are unknown, it is important to recognize that anesthetics do not “uncouple” flow and metabolism.
6. Different anesthetics (e.g., barbiturates, propofol, etomidate, the volatile agents, and narcotics) all have somewhat different effects on cerebral blood flow (CBF) and cerebral metabolic rate (CMR). In general, intravenous drugs reduce CBF, whereas volatile agents are vasodilators. Essentially all agents, except perhaps ketamine, reduce CMR.
7. All volatile anesthetics can increase cerebral blood flow and ICP, in some cases dramatically. Nonetheless, these drug-induced ICP increases have never been demonstrated to be detrimental (at least during elective surgery) and are relatively easily counteracted by other ICP control measures, including hyperventilation.
8. Nitrous oxide is not benign in its effects on the brain. It can considerably increase cerebral blood flow.
9. In a patient who is severely hypertensive because of intracranial hypertension, it is probably unwise to aggressively lower blood pressure.
10. The sitting position, although accompanied by hazards of air embolism and other problems, is still in use in neurosurgery. In spite of the problems, it is not clear that alternative positions are better.
11. The concept of cerebrovasospasm, its diagnosis and treatment, should occupy the attention of the neuroanesthesiologist. The most recent work in the field has centered on the calcium antagonists, specifically nimodipine.
12. Continued reduction of brain swelling, even though the cranium is open, is a key to successful neuroanesthesia. “Relaxation” of the brain during the neurosurgical procedure itself may require not only hyperventilation but also osmotic diuretics, such as mannitol.
13. During cerebral aneurysm surgery, there must be a plan for dealing with a sudden rupture and the blood loss that can occur from such a tiny operative site.

cephalogram (EEG), but we have so far been unable to quantitatively link EEG patterns with changes in the other parameters. We can insolate the cerebral vasculature with a transcranial Doppler, but we still don't know what the numbers really mean. We can do wonderful science with magnetic resonance imaging (MRI) or positron emission tomography, but we can't routinely bring these into the operating room. We are thus forced to extrapolate from findings made in the animal or clinical laboratory. This approach is potentially fraught with error. In particular, it is unclear whether the findings made in the laboratory can be easily extrapolated to the clinical setting. Because relatively few neurosurgical patients do poorly after routine surgery, regardless of the management methods used, a huge number of patients would be needed to carry out any valid study relating a drug-mediated change in a hard-to-measure physiologic parameter to outcome. Such studies have never been done and may never be. As a result, we can, for example, show that halothane increases cortical CBF to a greater degree than does isoflurane. However, because the relationships between CBF and ICP are complex, it is not clear whether this means that halothane will produce a greater increase in ICP than will isoflurane. Furthermore, because the relationship between a drug-induced change in ICP and outcome is also unknown, it is even less clear whether the CBF and ICP effects of halothane, isoflurane, N<sub>2</sub>O, barbiturates, narcotics, and other drugs have any real effect on our patients.

These comments are not meant to deprecate the efforts of researchers who have devoted their lives to understanding the cerebrovascular, metabolic, or electrophysiologic effects of anesthetics, nor to criticize those who have attempted to use such data to improve clinical care. We believe that an understanding of cerebrovascular physiology and pharmacology is important to anesthesiologists. As our knowledge grows, the connections between physiology and clinical management will become stronger, although some cherished beliefs will be discarded. We ask only that the reader realize these limitations, refrain from making (or believing) dogmatic statements (including ours), and avoid carelessly translating physiologic and pharmacologic observations into clinical practice.

TABLE 50-1.

## "Normal" Human Values

Parameter	Whole Brain	"Gray"	"White"
CBF (mL/100 g/min)	50	80	20
CBV (mL/100g)	4	4-6	1.5-2.5
CMRO <sub>2</sub>			
mL/100 g/min	2.7-3.6	3.4-4.3	0.7-1.1
μmol/g/min	1.2-1.6	1.5-1.9	0.3-0.5
CMRGlu			
mg/100 g/min	4.9	6.5-8.5	1.2-2.2
μmol/g/min	0.3-0.4	0.36-0.47	0.07-0.12
CMRLact			
mg/100 g/min	-0.32	—	—
μmol/g/min	-0.035	—	—

CBF, cerebral blood flow; CBV, cerebral blood volume; CMRGlu, cerebral metabolic rate of glucose; CMRLact, cerebral metabolic rate of lactate; CMRO<sub>2</sub>, cerebral metabolic rate of oxygen. All values represent the authors' best estimates based on many sources. In PET measurements (which are used to derive regional data), an exact separation of gray and pure white matter is not possible. As a result, most of the gray matter values above might more accurately be described as "cortical," whereas white matter values are typically obtained from areas such as the internal capsule. Note that CMRLact is a negative number, which reflects the fact that lactate is usually produced by the brain rather than consumed (and hence the venous concentration is greater than arterial).

It is impossible to review the entire discipline of "neuroanesthesia." Several books have been written in an attempt to do just this.<sup>151,155,470</sup> We have chosen not to deal with EEGs, evoked potentials, and other forms of clinical monitoring except very briefly. Throughout this chapter we endeavor to exercise the skepticism we have asked of the reader and distinguish between matters of academic/scientific interest and the realities of the neurosurgical operating room.

## BASIC PHYSIOLOGY

## Cerebral Blood Flow, Cerebral Blood Volume, and Cerebral Metabolic Rate

Although we have cautioned about the careless extrapolation of CBF, cerebral blood volume (CBV), and CMR measurements to the clinical setting, we also believe that some understanding of what is and is not known about this subject is important. Specifically, one needs some understanding of the methods used to obtain information, and the specific limitations of these methods.

## Measurement of CBF

Table 50-1 shows normal whole-brain and gray/white CBF values. However,

these values remain somewhat abstract—and can be misinterpreted—unless one knows how they are obtained. This might be untrue if CBF could be measured "mechanically," that is, with a flowmeter around the carotid arteries, or with a technique as simple as thermodilution cardiac outputs. Unfortunately, with few exceptions, such methods do not work. Venous outflow from the dog brain can be diverted through a flowmeter to allow continuous "mechanical" measurements, but this technique is not applicable to humans. Retrograde thermodilution catheters<sup>767</sup> or Doppler ultrasound probes<sup>545</sup> have been placed in the jugular vein of patients and research subjects, but none of these methods has been widely accepted (although they can be extremely useful in selected circumstances). Consequently, we begin with a review of those methods that have been widely used in either the operating room or intensive care unit (ICU), with some later comments on laboratory techniques or more complex clinical methods.

## CBF and CMR Methods for the Operating Room

There are basically 5 methods that have been widely used for CBF studies in the operating room/ICU setting: (a) the Kety-Schmidt method; (b) intracarotid

$^{133}\text{Xe}$  injection; (c) intravenous/inhaled  $^{133}\text{Xe}$ ; (d) intraaortic  $^{133}\text{Xe}$ ; and (e) transcranial Doppler sonography. The resultant CBF values can, with major limitations (Table 50–2), be used to calculate CMR. We also briefly discuss the use of a sixth method, jugular venous  $\text{O}_2$  sampling as a measure of flow–metabolism balance.

**Kety-Schmidt Method** Human CBF was first measured in 1945 by Seymour Kety and Carl Schmidt, using a variation of the Fick principal.<sup>366</sup> Catheters were inserted into a peripheral artery and into the jugular bulb (the internal jugular vein just as it exits the skull). A diffusible tracer (10–15%  $\text{N}_2\text{O}$ ) was given by inhalation, and paired samples of blood entering and leaving the brain were obtained over the next 15–20 minutes. The arterial concentration of  $\text{N}_2\text{O}$  rises quickly, but, because the tracer is being taken up by brain tissue, the cerebral venous concentration rises more slowly (Fig. 50–1). The rate at which tissue saturation is reached (i.e., when arterial and venous concentrations equilibrate) is a reflection of the rate of tracer delivery. If CBF is high, equilibrium will occur quickly; if flow is low, equilibration will be slow.

Even after 50 years, many investigators consider this method to be the gold standard for whole-brain CBF measurements, and it has been widely used in the study of anesthetics. However, it is invasive, it provides only whole-brain CBF information, and it is “blind” to areas of near-zero flow (as areas that do not take up tracer do not contribute to the venous saturation curve). It is also time-consuming, requiring 10–20 minutes to complete a single measurement. For these reasons, a number of other techniques have been developed.

The Kety-Schmidt technique lends itself almost ideally to the calculation of cerebral metabolic rate (CMR), which is the rate at which the brain consumes or produces metabolic substrates or byproducts, e.g., oxygen ( $\text{CMRO}_2$ ), glucose ( $\text{CMRGlu}$ ), or lactate ( $\text{CMRLact}$ ). CMR plays a major role in the control of CBF and is dramatically altered by anesthetics. The standard method for its determination is based on the Fick principle: CBF is multiplied by the arteriovenous concentration difference of the compound of interest. Because the Kety-Schmidt method requires both arterial and jugular venous sampling, obtaining the needed sam-

TABLE 50–2.

## Limitations of Various Flow Measurement Methods

Human and laboratory methods	
Kety-Schmidt	Invasive No regional data Slow (10–20-minute data acquisition) Blind to very-low-flow regions Invasive One hemisphere only Looks primarily at superficial cortex Looks primarily at superficial cortex Extracranial tracer delivery Computationally complex Tracer recirculation Looks primarily at superficial cortex Extracranial tracer delivery Underestimates CBF?
Transcranial Doppler sonography	Measures velocity only Accurately measures CBF changes—but not absolute CBF “Distorted” values if vessel diameter changes
Single-photon emission computed tomography	Typically single measurement
Positron emission topography	Not usable in the operating room or intensive care unit Extremely expensive and technically complex Not usable in the operating room or intensive care unit
Magnetic resonance imaging	Under development Not usable in operating room or intensive care unit
Laboratory methods	
Venous outflow	Tissue injury? Requires craniectomy No regional information Forebrain only Deterioration with time Requires craniectomy
Radioactive microspheres	Limited number of flows (6–8) Requires complex surgery
Autoradiography	One measurement only Complex processing needed

ples for CMR determinations is trivial. For example, if CBF is 50 mL/100 g/min, arterial  $\text{O}_2$  content is 20 mL/100 mL (0.20 mL  $\text{O}_2$ /mL blood), and cerebral venous  $\text{O}_2$  content is 12 mL/100 mL (0.12 mL  $\text{O}_2$ /mL blood), then:

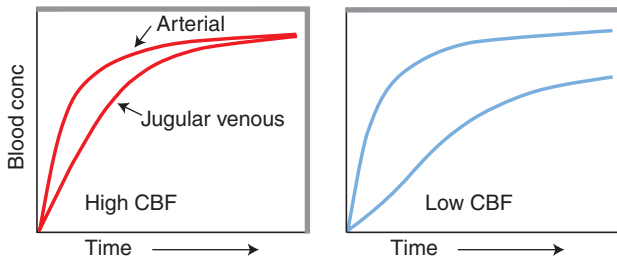
$$\begin{aligned}\text{CMRO}_2 &= \text{CBF} (A - \text{VO}_2) = 50 \\ (0.20 - 0.12) &= 4 \text{ mL } \text{O}_2 / 100 \text{ g/min} \\ &(\text{or } 1.54 \text{ } \mu\text{mol/g/min})\end{aligned}$$

where A is arterial  $\text{O}_2$  content and  $\text{VO}_2$  is venous  $\text{O}_2$  volume. Similar calcula-

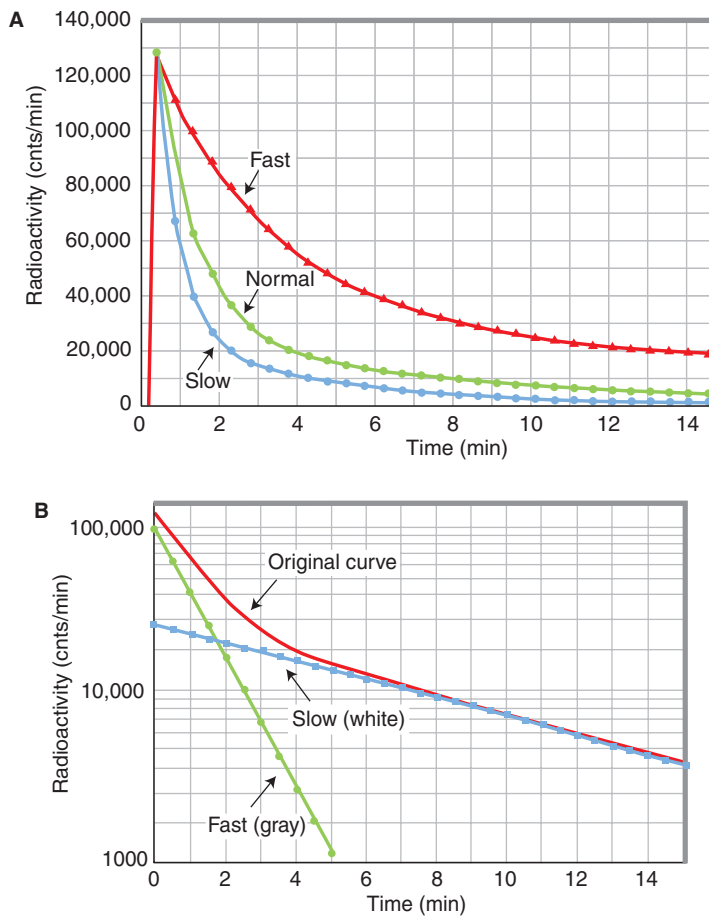
tions yield the other CMR values shown in the first column of Table 50–1. Note that these have also been expressed as  $\mu\text{mol/g/min}$ , which is useful when attempting to examine the stoichiometry of energy metabolism. For example, if you wish to calculate the relative amount of glucose being converted in the brain to  $\text{CO}_2$  and  $\text{H}_2\text{O}$  via oxidative metabolism:

$$\text{CMRO}_2 / \text{CMRGlu} = (1.54 \text{ } \mu\text{mol/g/min}) / (0.27 \text{ } \mu\text{mol/g/min}) = 5.7$$





**FIGURE 50-1.** Cerebral blood flow (CBF) as measured by the Kety-Schmidt method. Catheters are placed into an artery and into the jugular bulb. A diffusible tracer (e.g.,  $N_2O$ ) is then given by inhalation, and pair arterial and jugular venous samples are drawn over time (usually 15–20 minutes). Note that in both of the two sets of curves, the shape of the blood concentration versus time for the arterial curve is essentially the same. However, the time to arteriovenous equilibrium is much longer in the low CBF curve (*right*) than on the *left* (in fact, equilibrium is never achieved on the left). Actual CBF is proportional to the area between the arterial and venous curves.



**FIGURE 50-2.** Single-channel curves showing the washout of radioactivity from the brain after the bolus injection of radioactive  $^{133}\text{Xe}$  into the internal carotid artery. **A.** The curves represent “raw data” plotted on a linear scale (counts vs. time). Injection was made just slightly before time zero. There are three curves, each with different slopes: the top representing a slow flow (low CBF), the middle a normal flow, and the bottom typical of a high flow state. **B.** The middle (normal) curve has been replotted on a log scale and is separated into monoexponential “fast” and “slow” components. Note that although these compartments are labeled as “gray” and “white,” their exact anatomical nature is not defined. The fast compartment has a flow of 80 mL/100g/min, while that for the slow compartment is 20 mL/100g/min. (Reproduced with permission from Hoedt-Rasmussen K. Regional cerebral blood flow. *Acta Neurol Scand* 1967; 43(Suppl 27):13.)

This indicates that for every 5.7 mol of oxygen consumed, 1 mol of glucose is used. Because complete glucose oxidation uses 6 mol of oxygen per mole of glucose, this indicates that all of the glucose being consumed is not being oxidized but is being used in other processes. One can similarly calculate a respiratory quotient, lactate/glucose ratios, and other measures.

**Radioactive Tracer Washout Methods: Intraarterial  $^{133}\text{Xe}$**  To obtain regional data, a diffusible radioactive tracer (e.g.,  $^{133}\text{Xe}$  in saline) can be injected as a bolus into the internal carotid artery. The rate at which radioactivity disappears from the head can then be monitored using extracranial radiation detectors.<sup>541</sup> If CBF is high, the slope of the washout curve will be steep; if slow, the rate of washout will be slow (Fig. 50-2A). If multiple collimated detectors are used, separate washout curves can be recorded from different regions of the hemisphere ipsilateral to the injection. The individual washout curves can be mathematically separated into two components, one representing  $^{133}\text{Xe}$  clearance from a high-flow compartment (gray matter), and one representing a slow-flow compartment (white matter) (Fig. 50-2B). The calculations needed to separate the fast and slow components of the washout curve are identical to those used when distinguishing the early redistribution phase of a drug from its terminal clearance (i.e.,  $t_{1/2\alpha}$  vs.  $t_{1/2\beta}$ ).

Unlike the Kety-Schmidt method, this technique can provide very-high-resolution regional CBF (rCBF) data from the hemisphere ipsilateral to the injection, and several mathematical processes have been developed to make it possible to compute flow indices in as little as 2 minutes after isotope injection (although a second flow cannot be measured until more isotope is cleared). Unfortunately, it requires direct carotid puncture (or transfemoral cannulation of the internal carotid). Nevertheless, its technical simplicity has resulted in its widespread use for flow measurements during carotid surgery, and essentially everything known about the effects of anesthetics during carotid endarterectomies and the cerebral hemodynamic effects of carotid occlusion has been obtained with this method.

**Radioactive Tracer Washout Methods: Inhaled/IV  $^{133}\text{Xe}$  Methods** Intraarterial  $^{133}\text{Xe}$  injection is invasive and provides data from only one

hemisphere. These limitations could be eliminated if an externally detectable tracer could be given IV or by inhalation (which would then be delivered to both hemispheres). Although at first glance this may seem simple, it is much more complex because of two problems.<sup>541</sup> First, an inhaled/IV tracer is delivered to *both* the brain and scalp (unlike tracer injected into the internal carotid artery). Hence the brain washout curve is “contaminated” by another curve representing flow in extracranial tissues. Second, the shape of the arterial wash-in and wash-out curves are much more complex, depending on redistribution of the tracer throughout the body and clearance of the tracer from the lungs. These problems have been solved but require extensive computations (which can now be handled by a desktop PC). Although these calculations require some assumptions, the advantages of relative noninvasiveness and bilateral distribution appear to outweigh them, and hence this method is used by a limited number of centers for anesthesia-related studies.<sup>11,554</sup>

### Radioactive Tracer Washout Methods: Intraaortic <sup>133</sup>Xe Injection

One variation on the intraarterial and intravenous <sup>133</sup>Xe method is used during cardiac surgery.<sup>641</sup> A bolus of <sup>133</sup>Xe in saline is injected into the aortic root or into the aortic cannula. As with the intracarotid method, radioactivity is delivered to the brain as a bolus, and the washout mathematics are relatively simple. However, tracer is also delivered to extracranial tissues, and “contamination” remains a problem. During normothermia, CBF is much higher than scalp flow, making this a minor nuisance. However, during hypothermia, CBF falls and the contaminating influence of extracranial flow may become more of a problem. A study by Cook et al. comparing this method with the traditional Kety-Schmidt technique suggests that serious underestimates of actual CBF may occur.<sup>143</sup>

All three of the <sup>133</sup>Xe-based techniques have been combined with the measurement of arterial and venous blood samples to permit calculation of CMR, with calculations identical to those described above. However, there is one caveat. If CBF and the venous samples represent the same tissue compartment, there are no problems. If not, beware. Blood from the jugular bulb is representative of

blood draining the whole brain (with some hemispheric predominance, particularly in the presence of severe unilateral injury).<sup>709</sup> However, none of the <sup>133</sup>Xe washout methods, strictly speaking, measure whole-brain or hemispheric CBF; typically they yield a CBF value that is dominated by the cortical mantle. Hence the calculation of CMR involves multiplying a whole-brain arteriovenous difference value by an rCBF value. As long as regional and global CBF change in parallel (e.g., during anesthetic administration), calculations of CMR should be reasonable (although the absolute values may differ from those based on Kety-Schmidt flows). If the intervention or disease process being studied results in major flow redistribution or regional heterogeneity, calculated CMR may be misleading.

### Transcranial Doppler Sonography

Doppler-based methods for assessing blood flow in many vessels have been used for decades. These typically involved the use of “continuous wave” Doppler methods, with the probe being placed very close to the vessel of interest. However, in the early 1980s, “pulsed-wave” methods were developed. With this method, packets (brief bursts) of sound are emitted, with an interim period of silence during which the reflected signal is awaited. The time needed for the “round trip” can be used to measure the distance from the probe to the target—and by adjusting the time interval during which the instrument will accept a returning signal (“range gating”), the Doppler signal can effectively be focused on a target a given distance away. This is the basis for transcranial Doppler (TCD) sonography.<sup>52,531</sup> In practice, a hand-held Doppler probe is placed over a thin area of the skull (a “window”). By adjusting the insonation angle and depth it is possible to identify flow signals from multiple cerebral vessels. For example, from the temporal window, it is relatively easy to record signals from the internal carotid, middle cerebral, and anterior cerebral arteries. Other vessels can be found via other windows (e.g., transorbital, occipital). This method has been used extensively to aid in the diagnosis of cerebral occlusive disease.

Physiologic and pharmacologically induced changes in CBF have been assessed by following the changes in

TCD signal from a single vessel during some intervention. This is typically done using the middle cerebral artery (MCA). The probe is placed over the temporal window, and the MCA is identified as it moves toward the probe (which means a high-intensity signal can be recorded as the focal depth is adjusted over a range sometimes as great as 10 mm (e.g., from 45 to 55 mm from the skin). Since red blood cells (RBCs) are moving almost directly toward the probe, the insonation angle is essentially zero, and flow velocity is proportional to absolute flow (although absolute flow can't be known without knowing vessel diameter). If probe position is fixed, changes in flow velocity (denoted as  $V_{mca}$ ) can be measured during various interventions (e.g., drug administration, CO<sub>2</sub> changes). As long as the depth and insonation angle remains constant—and as long as the number of interventions is kept to a minimum—multiple studies have shown that changes in  $V_{mca}$  parallel changes in absolute CBF as measured with more traditional methods.

It can be argued that TCD has now become the preferred method for examining the acute impact of anesthetic agents and adjuncts on CBF.<sup>202,390,450,756</sup> It is also being increasingly used as a monitor during carotid surgery,<sup>435</sup> to aid in the diagnosis of vasospasm in patients with subarachnoid hemorrhage (where a decrease in vessel diameter results in an increase in flow velocity),<sup>491</sup> and to measure flow and detect emboli during cardiac surgery.<sup>114,588,766</sup> We comment more on TCD measurements in our discussion of physiology and anesthetic effects below. However, it is important to understand that this method does not yield absolute flow values—only flow velocities. Its primary advantages are its noninvasiveness, nonradioactive nature, and its ability to monitor at least an index of CBF continuously, something that cannot be done with any other widely used method.

Although it is possible to multiply a  $V_{mca}$  value by an arteriovenous content difference, the resultant number cannot be called “CMR.”  $V_{mca}$  is a velocity measurement (in cm/sec), not absolute flow (in mL/100g/min). In addition, we have little or no information on the tissue compartment being perfused by the insonated vessel. Beware of manuscripts that include such

calculations and attempt to draw conclusions about changes in CMR.

**Jugular Venous Oximetry** It is often impractical to quantify CBF (or CMR) in clinical practice. In an effort to obtain such information, many centers have begun monitoring cerebral venous oxygenation, particularly in the ICU. This is done either via intermittent sampling of jugular venous blood, or by continuously using an “oximetric” catheter. When combined with a measure of arterial saturation, this technique provides a measure of cerebral arteriovenous oxygen content difference (AVDO<sub>2</sub>); if arterial oxygen saturation (SaO<sub>2</sub>) remains near ≈100%, one need not calculate AVDO<sub>2</sub>, but simply follow the jugular venous oxygen saturation (SjvO<sub>2</sub>). This value is a measure of “the balance” between cerebral blood flow and CMRO<sub>2</sub>, even though neither value can be directly calculated from the data. If SjvO<sub>2</sub> decreases, then one can conclude that CBF must be decreasing relative to demand (or, alternatively, CMRO<sub>2</sub> must be increasing disproportionately). This method has been advocated as an adjunct to ICP monitoring; an increase in ICP associated with a rise in SjvO<sub>2</sub> is probably caused by an increase in CBF and CBV, whereas an identical ICP change associated with a fall in SjvO<sub>2</sub> represents a different physiology (e.g., more edema). If venous lactates are also monitored, it may be possible to determine when a CBF reduction is “critical.”<sup>224,613,678</sup>

### Significance of CBF and CMR: Control of Intracranial Pressure

Studies of regional CBF and CMR have provided invaluable information concerning the roles played by different anatomic structures in normal and pathologic brain function. Studies with anesthetics have provided some insights into the anatomic substrate of drug action, and other observations have improved our understanding of changes occurring during cerebral ischemia or after trauma. However, such studies have not yet made much of an impact on clinical neuroanesthetic practice. Why should we be so interested in these variables? This is a difficult question to answer satisfactorily. In simple terms, there seem to be two reasons: (a) CBF bears an important relationship to ICP, and (b) CBF and CMR are clearly important in the

etiology of cerebral ischemia. Because this chapter does not deal directly with ischemia, we direct our attention to the issue of ICP.

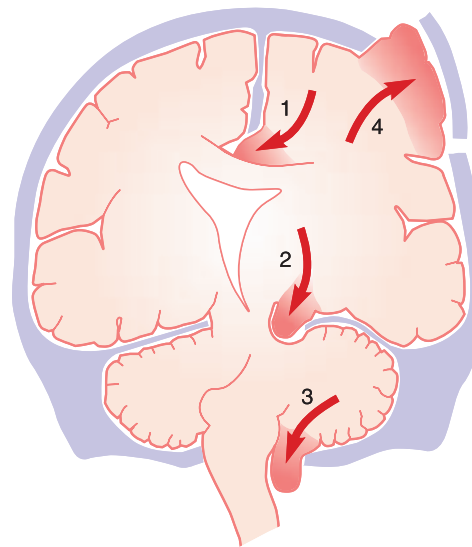
### Physiology of Intracranial Pressure

The bulk of investigative efforts in neuroanesthesia have dealt with ICP. Why such intense interest? First, pressure within the intracranial space is defined by unique conditions. The brain is enclosed in a rigid container. Because neither water nor solids are compressible, any increase in total intracranial volume will result in a rapid increase in pressure. Second, large increases in ICP may have profound effects on the well-being of the brain. Intracranial hypertension can reduce global cerebral perfusion pressure (CPP = mean arterial pressure ICP) or lead to physical shifts in the intracranial contents, with resultant *focal* compression of tissue against the falx, the tentorium, or the foramen magnum (Fig. 50–3); patients dying from intracranial mass lesions or trauma often have very high ICPs, and autopsy studies show clear evidence of compression-related ischemia.<sup>335</sup> If the skull is open, compression problems do not occur as readily, but the brain can swell out of the craniotomy site and impede the surgeon’s ability to carry

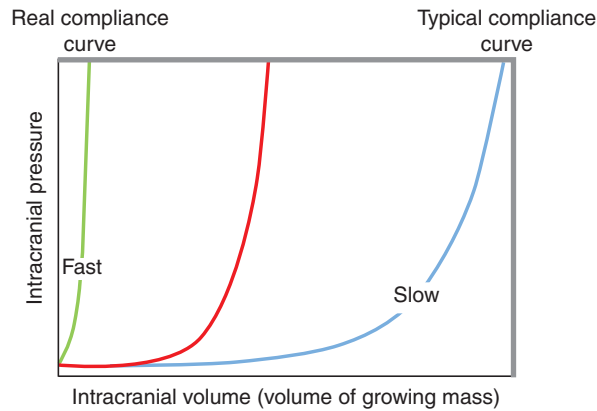
out the required procedures (or make it impossible to close the wound). It may also be necessary to use excessive retraction pressure to obtain the necessary exposure, which can itself lead to tissue injury.<sup>18</sup> In extreme cases, the surgeon may be forced to amputate portions of brain to achieve access (e.g., to an aneurysm) or to allow the dura/skull to be closed.

Any increase in total intracranial volume will increase ICP (or brain bulk). Figure 50–4 shows this phenomenon as the “real” compliance curve, which is what would be expected if we rapidly injected a noncompressible liquid into a rigid container. This real compliance curve differs from the “typical” compliance curve presented in many reviews. The confusion arises because the x-axis on the “typical curve” is often mislabeled as representing “intracranial volume.” In fact, it does not represent total intracranial volume but rather “the volume of the growing mass.” The initial portion of this typical curve is flattened because total volume does not change much during the early period of tumor growth (or, e.g., hematoma expansion). This occurs because of “spatial compensation,” a phenomenon shown schematically in Fig. 50–5.

This diagram, the physiology of ICP, and its control are easier to understand if we conceptually divide the



**FIGURE 50–3.** Brain herniation patterns: (1) herniation of the cingulate gyrus under the falx; (2) transtentorial herniation of the temporal lobe; (3) herniation of the cerebellar tonsils through the foramen magnum; and (4) transcalvarial herniation (via a fracture site of craniectomy). In each case, an increase in brain volume combined with physical shift of the intracranial contents results in intense compression of brain against some rigid structure. (Fishman RA. Brain edema. *N Engl J Med* 1975;293:706. Copyright 1975, Massachusetts Medical Society. All rights reserved.)

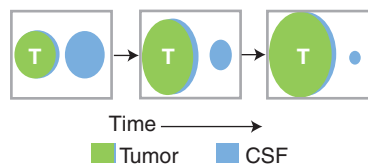


**FIGURE 50-4.** Intracranial pressure “compliance curves.” If intracranial contents are noncompressible and the skull were truly rigid, then the injection of any “extra” volume into the system would produce a very rapid increase in pressure (left curve, labeled *real*). However, this is not the pattern typically seen with a slowly growing mass lesion, which is shown on the right curve (labeled *typical*). Note however, that the x axis is often mislabeled. This should not read “intracranial volume” but rather “volume of growing mass.” As a mass grows, total volume remains almost constant because of compensatory mechanisms (see Fig. 50-5). Only when these are exhausted does pressure rise precipitously. Note also that the faster volume is added, the more quickly are compensatory mechanisms exhausted.

intracranial contents (weights/volumes given are relative to a “normal” brain) into four compartments:

- Tissue water ( $\approx 78\%$  or 1092 g)
- Cerebrospinal fluid (75 mL)
- Blood (50 mL)

An increase in the mass of solid material occurs only during the growth of new cellular material (a tumor). By contrast, edema (an increase in either intracellular or extracellular water) can occur without any alteration in tissue solids. Cerebrospinal fluid (CSF) volume increases when (a) its reabsorption is inhibited (e.g., hydrocephalus) or (b) the mass of solid material/tissue decreases (e.g., cerebral atrophy). Increases in CSF production are rare. In many pathologic states, changes occur in all compartments: a growing tumor may increase interstitial fluid volume (edema) and either in-



**FIGURE 50-5.** Schematic of spatial compensation. As a mass slowly increases in size (solid ellipse, *T*), the volume of some other compartment should get smaller. In most cases, this is cerebrospinal fluid (CSF) volume (dotted ellipse). Compensation can be said to be exhausted when this second compartment can no longer decrease in size, and hence total intracranial volume begins to rise.

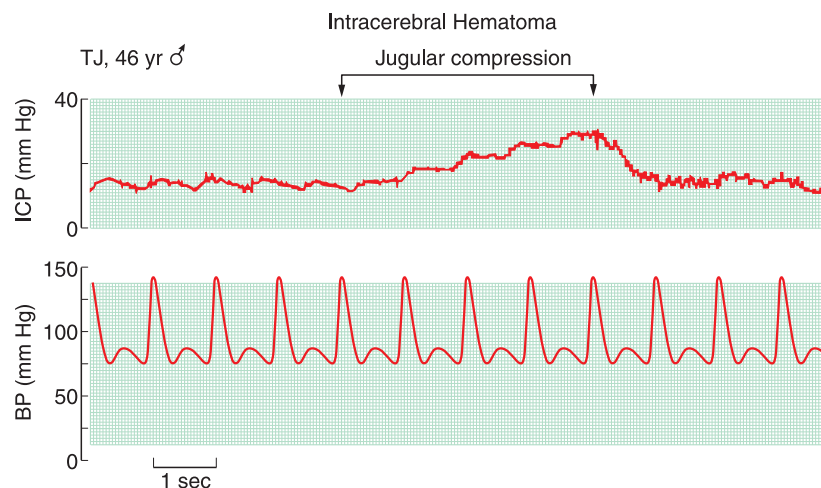
crease or decrease CBV. If the tumor obstructs CSF pathways, hydrocephalus can also occur.

The compartment that plays the greatest role in spatial compensation is CSF. (There is no room to discuss CSF physiology and pharmacology in detail in this chapter, as our emphasis is on blood flow and volume. However, there are two excellent and comprehensive reviews of this subject in the anesthesia literature by Artru.<sup>36,37</sup>) As a mass lesion expands, the size of the CSF space will decrease by an approximately equal volume. This is seen on a CT/MRI scan as a progressive reduction in the size of the cerebral ventri-

cles and/or of the basal cisterns, etc. ICP will increase rapidly only when the CSF space can no longer be “squeezed” (Fig. 50-6) or when intracranial compartmentalization results in some obstruction to CSF flow/absorption. Spatial compensation takes time, and rapidly increasing masses (e.g., hematomas) “exhaust” compensatory mechanisms quickly and can lead to severe increase in ICP much sooner than slowly growing lesions.

The control of intracranial hypertension can also be discussed in terms of these tissue compartments. ICP will increase when the volume of one or more of the compartments increases enough to exhaust compensatory mechanisms. To *decrease* ICP, we need only to decrease the volume of one compartment. We can drain CSF via a ventriculostomy, alter its production rate with acetazolamide or furosemide, decrease peritumoral edema using steroids, or decrease interstitial (or even cell) volume using mannitol or furosemide. Finally, the surgeon can remove the tumor mass. However, except for CSF drainage, most of these interventions are relatively slow, requiring hours or days of effort.

Blood is the smallest of the four compartments. However, its importance to neuroanesthesia is related not to its size but to the fact that CBV can change very rapidly; for example, witness the rapid increase in ICP seen with jugular compression in Fig. 50-6. Other than CSF drainage, the volume of no other compartment can be so rapidly altered by physiologic or phar-



**FIGURE 50-6.** Simultaneous intracranial pressure (ICP) and arterial pressure tracing before and during bilateral jugular vein compression. Note the “arterial” pulsation of both traces, and the “stairstep” rise in ICP when venous outflow is prevented. Each “step” represents the injection of a small increment of blood into the intracranial space.



macologic methods. It can be argued that the neuroanesthesiologist is, in fact, an expert in the controlled manipulation of cerebral blood volume. As a result, in the following discussion of ICP, we focus almost exclusively on the manipulation of CBV. We defer comments concerning tissue water content to a later section, *Hyperosmolar Agents in Neuroanesthesia*, dealing with the clinical management of the swollen brain.

### Measurement of CBV

To determine the *volume* of blood in the intravascular space at any point in time (CBV), one must examine the brain concentration of a tracer that remains within the vasculature (which is not true of most flow tracers). CBV is calculated as the brain concentration of intravascular tracer divided by the arterial concentration. The most common method is to inject radioiodinated serum albumin (RISA) or  $^{99m}\text{Tc}$ -labeled RBCs, measure the concentration in arterial blood, and determine the radioactivity in brain using an external counter.<sup>257</sup> This is complicated by the fact that counts seen by an external detector are emitted from both brain and scalp, and the resultant values are contaminated by extracranial blood (although this can be eliminated by single-photon emission computed tomography [SPECT]). This does not invalidate the technique but does make it more suitable for examining *changes* in CBV rather than absolute volume. This problem can be resolved by using positron emission tomography (PET) or other tomographic techniques to determine only the intracranial (and regional) concentration of an appropriate isotope.<sup>57,582</sup> A simpler semiquantitative approach is to use the subject's own RBCs as a volume tracer, with transcranial near-infrared absorption spectroscopy (NIRAS) used to examine the changing concentrations of hemoglobin. To date, this method has proven useful only in infants in which transcranial illumination is feasible<sup>107</sup>; all developmental efforts are being made to extend it to adults. (NIRAS technology may someday also be useful for the measurement of hemoglobin oxygenation in the brain,<sup>387</sup> and to monitor changes in CBF.<sup>200</sup>)

### CBV Control

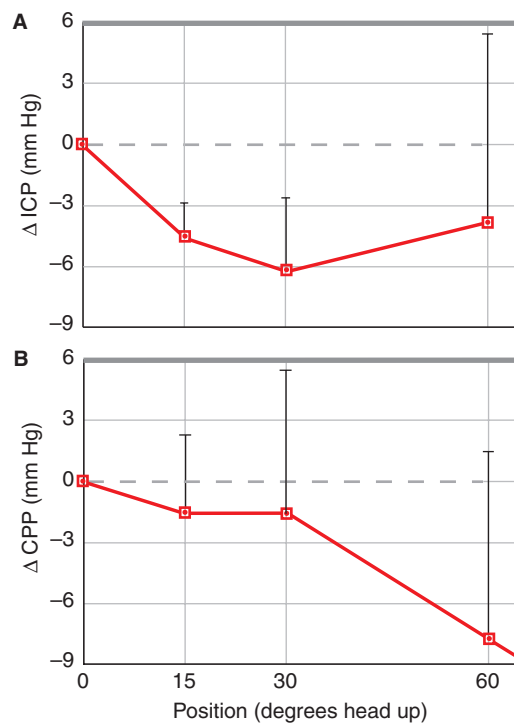
To increase CBV you have to put blood into the head faster than it leaves, at

least until a new steady state is reached. This can be done in two ways: impede the egress of blood, or increase the rate at which it enters.

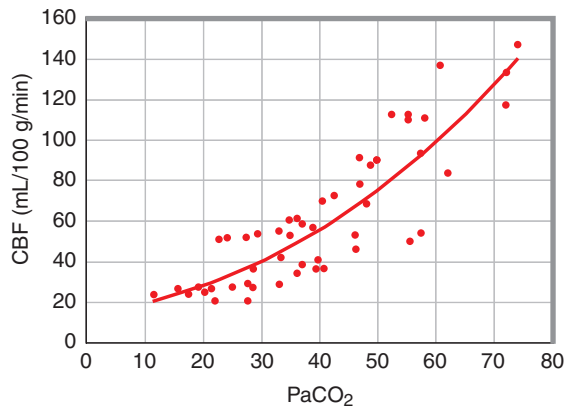
**Impede the Egress of Blood** There are many ways to slow the exit of cerebral venous blood. The most important are occlusion of the jugular veins or an increase in venous pressure. The ways to occlude the jugular veins are legion. The easiest is to rotate the head to one side, or to fully extend the neck (e.g., during a tracheostomy). Direct pressure can be applied with circumferential neck ties (e.g., to secure an endotracheal tube) or a tight cervical collar. It may be possible to obstruct venous drainage by the placement of large catheters into the internal jugular vein (IJV), and some clinicians avoid using the IJV in neurosurgical patients. However, the IJV is very large, and catheters occupy only a small portion of the lumen. At least one study has measured the diameter of the IJV by echo before and after IJV cannulation and showed no changes.<sup>545</sup> The real problems are the positions often used dur-

ing cannulation (head down/rotated). As a result, many experienced neuroanesthesiologists will first attempt to obtain central access via antecubital or subclavian routes, but are still willing to use the IJV as an alternative.

Venous distension can also occur by elevating right heart pressures (major volume overload, right-heart failure), increasing intrathoracic pressure (e.g., positive end-expiratory pressure [PEEP], short expiratory phase, endotracheal tube obstruction), or placing the patient in a head-down posture. Positioning is a crucial factor in the control of CBV, and several studies demonstrate the advantages of a modest head-up posture in minimizing ICP.<sup>193,616,618</sup> However, an angle greater than 30° above horizontal tends to reduce arterial pressure at the head more than it alters ICP and can reduce CPP (Fig. 50-7).<sup>618</sup> We also believe that the problems of PEEP are overrated, and that the use of small amounts of PEEP to improve oxygenation intraoperatively is generally benign.<sup>318</sup> If a patient has lung disease serious enough to warrant high levels of PEEP, only a small fraction of the



**FIGURE 50-7.** Although a head-up posture can reduce intracranial pressure (ICP), it can also reduce perfusion pressure at the head. Changes in both ICP (A) and in calculated cerebral perfusion pressure (CPP) (B) at the head are shown (values are mean  $\pm$  standard deviation [SD]). Note that at 30° head up, ICP has been reduced to the lowest possible level without compromising CPP. (Data from Durward QJ, Amadner AL, Del Maestro RF, et al. Cerebral and vascular responses to changes in head elevation in patients with intracranial hypertension. *J Neurosurg* 1983;59:938.)



**FIGURE 50-8.** The “bottom half” of a normal cerebral blood flow (CBF)– $\text{PaCO}_2$  response curve. Each point represents one measurement. (Data from Grubb RL Jr, Raichle ME, Eichling JO, et al. The effect of changes in  $\text{PaCO}_2$  on cerebral blood volume, blood flow and vascular mean transit time. *Stroke* 1974;5:630, and Wollman H, Smith TC, Stephen GW, et al. Effects of extremes of respiratory and metabolic alkalosis on cerebral blood flow in man. *J Appl Physiol* 1968;24:60.)

intrapulmonary pressure is transmitted to the intrathoracic space<sup>408</sup> and the ICP changes produced by PEEP are often minimal or can be offset by a head-up posture.<sup>144,404</sup> The more common problem is the unintentional or unwarranted application of PEEP in patients with normal lungs. PEEP can also increase respiratory dead-space volume and increase  $\text{PaCO}_2$ .

A third (theoretical) way of increasing CBV is to pharmacologically increase intracranial venous capacitance. Because perhaps 90% of the blood in the brain is postcapillary, this could be important.<sup>649</sup> Venodilation is clearly produced by both volatile anesthetics and by drugs like sodium nitroprusside,<sup>375</sup> but the relevance of this to the ICP effects of these agents remains unknown.

**Increase Inflow** “Increase inflow” is just another way to saying “increase CBF,” which is the focus of the next section of this chapter. However, it is strictly incorrect to say that an increase in CBF will produce an increase in ICP. ICP changes in response to changes in *volume* not flow. When someone says that hypercapnia increases ICP because it increases CBF, what is really meant is that hypercapnia increases CBF, which is, in turn, accompanied by an increase in CBV.

### Normal Control of CBF and CBV

Before we can discuss the influence of drugs on CBF, CBV, and ICP, it is necessary to understand the “normal” factors that control them:  $\text{PaCO}_2$ ,  $\text{PaO}_2$ , arterial  $\text{O}_2$  content, hydrostatic pressure (auto-

regulation), metabolism (flow-metabolism coupling), and the autonomic nervous system.

**$\text{PaCO}_2$**  CBF varies with  $\text{PaCO}_2$  (Fig. 50-8).<sup>416</sup> This response is typically shown as a sigmoid curve, with lower and upper plateaus. The upper portion of the curve is of little interest in anesthesia, as it does not occur until  $\text{PaCO}_2$  is  $\approx 80$ – $100$  mm Hg. In normal primates and humans, the lowest CBF that can be achieved by hyperventilation is  $\approx 18$ – $20$  mL/100 g/min at 10 mm Hg.<sup>259,813</sup> In the midportion of the curve, CBF changes by 1.5–2.0 mL/100 g/min for each mm Hg change in  $\text{PaCO}_2$ . The slope of the CBF– $\text{PaCO}_2$  response curve depends on the baseline normocapnic flow values; as regional CBF increases, the slope of the response curve for that region also increases. As a result,  $\text{CO}_2$  responsiveness in gray matter is greater than in white matter.

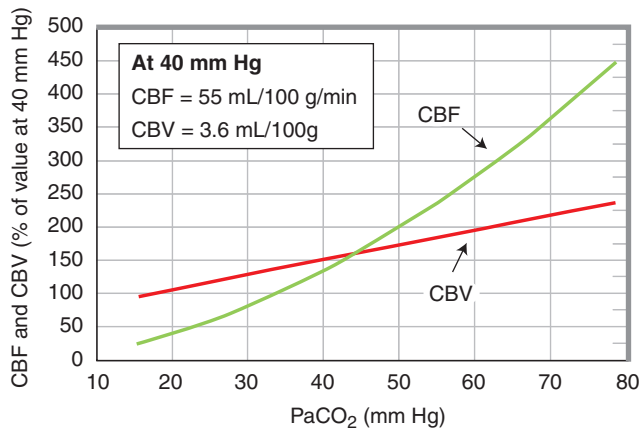
$\text{CO}_2$  responsiveness is driven by changing *extravascular/interstitial*  $\text{H}^+$  concentration. As pH around the extraluminal surface of the vessel decreases, the vessel dilates. By contrast, the intravascular administration of a “fixed” acid or base has little effect. Because  $\text{CO}_2$  readily diffuses across the blood–brain barrier into the interstitial space where it is converted to  $\text{H}^+$  and  $\text{HCO}_3^-$ , an increase in intravascular  $\text{CO}_2$  is accompanied by extravascular acidosis and hence vasodilatation. The CBF response to changing  $\text{PaCO}_2$  is very fast. Severinghaus et al. demonstrated that CBF reached a new steady state within less than 1 minute after a step change in  $\text{PaCO}_2$ .<sup>678</sup> TCD studies suggest that

response may be even faster. This indirectly indicates that the site of action must be very close to the vessels themselves (as  $\text{CO}_2$  can diffuse only a short distance in the time noted).

How does a change in pH change vascular diameter? Several mediators have been studied. Blockade of cyclooxygenase activity (with indomethacin) can blunt  $\text{CO}_2$  response, suggesting some role for prostaglandins.<sup>210</sup>  $\text{CO}_2$  responsiveness can be transiently abolished (for 12–24 hours) by events such as spreading depression that release of glutamate into tissue.<sup>396</sup> Given the well-known link between glutamate, the *N*-methyl-D-aspartate (NMDA) receptor and nitric oxide (NO) release, this suggested that NO may play some role in  $\text{CO}_2$  responsiveness. There is now substantial support for this. Treatment of rats with nitric oxide synthase inhibitors, e.g., L-nitroarginine methyl ester (L-NAME) attenuates response the response to hypercapnia.<sup>214,328</sup> Similar chemicals block the response to extravascular  $\text{H}^+$ . However, this hypothesis is incomplete, and nitrous oxide synthase (NOS) inhibition in primates does not dramatically alter hypercapnic  $\text{CO}_2$  response.<sup>459</sup>

### CBV and Intracranial Pressure

CBV also changes with  $\text{CO}_2$ , but the CBF and CBV response curves are not parallel. Grubb et al. demonstrated a CBF– $\text{PaCO}_2$  response curve in primates with a midrange slope of approximately 1.8 mL/100 g/mm Hg change in  $\text{PaCO}_2$  (Fig. 50-8).<sup>259</sup> However, a simultaneously determined CBV– $\text{PaCO}_2$  curve was much flatter (0.041 mL/100 g/mm Hg) (Fig. 50-9). Hence decreasing  $\text{PaCO}_2$  from 40 to 20 mm Hg will decrease CBF by 36 mL/100 g/min (a 65% decrease), while CBV will decrease to 2.8 mL/100g (a 28% change). This translates into a 10–14 mL fall in whole-brain volume. This seems to be small, but a brief lesson in intracranial compliance demonstrates the contrary. Shapiro et al. showed that the amount of fluid that must be rapidly injected into or withdrawn from the intracranial space to change ICP tenfold (e.g., from 10 to 100 mm Hg) is normally  $\approx 26$  mL.<sup>677</sup> This is called the *pressure-volume index* (PVI). However, PVI values in patients with mass lesions or closed head injuries may be as low as 5 mL.<sup>379</sup> In such situations, a change in CBV of 10–15 mL would be enormous, and it is not surprising that hyperventilation has come to occupy



**FIGURE 50-9.** Cerebral blood flow (CBF) and cerebral blood volume (CBV) responses to  $\text{PaCO}_2$ , with each value expressed as a percentage of that observed at a  $\text{PaCO}_2$  of 40 mm Hg. Note that the slope of the CBV- $\text{PaCO}_2$  response curve is much flatter than that for CBF. (Data from Grubb RL Jr, Raichle ME, Eichling JO, et al. The effect of changes in  $\text{PaCO}_2$  on cerebral blood volume, blood flow, and vascular mean transit time. *Stroke* 1974;5:630.)

such an important position in acute ICP/brain-volume control.

### The Clinical Utility of Hypocapnia

The ability of rapid reductions in  $\text{PaCO}_2$  to acutely reduce ICP is indisputable. Whereas cardiac arrest, stroke, subarachnoid hemorrhage, head trauma, and brain tumors can decrease the slope of the CBF- $\text{PaCO}_2$  curve,  $\text{CO}_2$  responsiveness is almost never completely lost in a viable patient. Consequently, it is unnecessary to worry whether responsiveness is present or absent in a given individual. If there is no  $\text{CO}_2$  response, the patient will probably die, or survive in only a severely debilitated state.

The more important questions are (a) is profound hypocapnia detrimental, and (b) is there any benefit to prolonged hypocapnia. In anesthetized animals, hypercapnia has little influence on  $\text{CMRO}_2$  except at values greater than 200 mm Hg.<sup>83</sup> Moderate hyperventilation also does not alter  $\text{CMRO}_2$ . However, during profound alkalosis ( $\text{PaCO}_2 \approx 10$  mm Hg) glucose consumption ( $\text{CMR}_{\text{Glu}}$ ) increases, as does lactate production. This has been interpreted as indicating excessive cerebral vasoconstriction and tissue ischemia. This may not be true, because alkalosis alone will stimulate glycolysis. Nevertheless, other studies indicate that excess lactate production and some depletion of high-energy phosphates may occur at  $\text{PaCO}_2$  values of 10–15 mm Hg.<sup>717</sup> The EEG slowing seen with extreme hypocapnia can also be reversed by increasing  $\text{PaO}_2$ , suggesting ischemia. This probably *does not* have

any relevance in elective surgery. In a study of the most extreme conditions likely to be encountered clinically, Artru examined cerebral metabolism and tissue high-energy phosphate concentrations during induced hypotension (mean arterial pressure = 40 mm Hg) in dogs with a  $\text{PaCO}_2$  of 20 mm Hg.<sup>35</sup> Although hypotensive/hypocapnic conditions resulted in an increase in tissue lactate,  $\text{CMRO}_2$  and high-energy phosphate values were unchanged compared with normocapnic hypotension. What about hypocapnia in the presence of disease? People have long argued that hypocapnia might constrict normal vessels, and redistribute blood into ischemic areas (“inverse steal”). Unfortunately, although theoretically attractive, such an event does not appear to occur; hypocapnia seems to increase the total amount of tissue “at risk” during focal ischemia, and primate outcome studies show no benefit.<sup>473,622</sup> Hypocapnia is commonly used to control ICP in head trauma. Again, however, available data do not provide much support for anything other than transient value. Robertson et al. used CBF, arteriovenous  $\text{O}_2$ , and lactate measurements (via jugular venous catheters) to define different subgroups of head-injured patients. They showed that a modest increase in  $\text{PaCO}_2$  (from previously severe hypocapnia) in some patients with very low CBF values can reduce lactate production.<sup>613</sup> Others have shown that reductions in  $\text{PaCO}_2$ , although reducing CBF and ICP, may result in evidence of tissue ischemia.<sup>678</sup> A small but important clinical trial compared chronic hypocapnia ( $\text{PaCO}_2$

$\approx 25$  mm Hg) with “normocapnia” ( $\text{PaCO}_2 \approx 35$  mm Hg) and with hypocapnia combined with infusions of Tris(hydroxymethyl)-aminomethane (THAM, an alkalinizing agent that crosses the blood-brain barrier, and hence maintains CSF alkalosis).<sup>515</sup> ICP management was not improved in the hypocapnic patients, and there was a small suggestion of a worsened outcome.

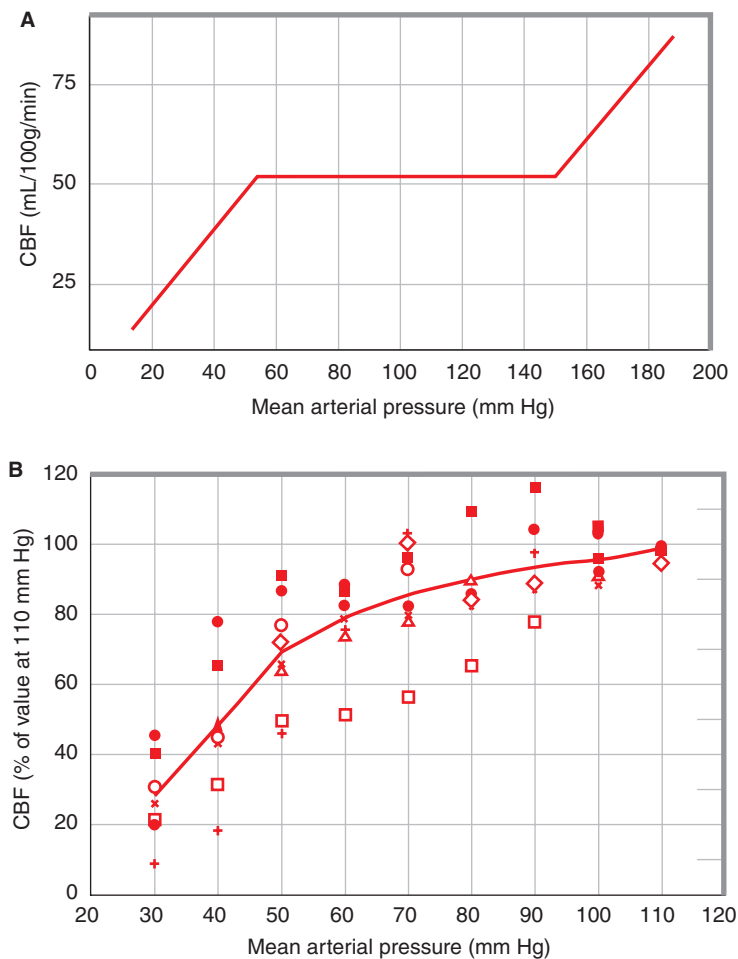
In summary, although reducing  $\text{PaCO}_2$  is of value in the acute control of ICP or brain bulk in an operating room setting (and does not seem to be accompanied by any adverse consequences), essentially no data exist to demonstrate the value of prolonged hypocapnia. Furthermore, in patients with both stroke and head trauma, there is some reason to believe that it may be detrimental.

### $\text{PaO}_2$ , Arterial $\text{O}_2$ Content, and Hemodilution

Cerebral blood flow does not change much until  $\text{PaO}_2$  is less than 50 mm Hg; it then increases progressively. Under normoxic condition, tissue  $\text{PO}_2$  is  $\approx 25$  mm Hg (or lower). Shinozuka et al. showed that regional pH begins to fall (and CBF to rise) when tissue  $\text{PO}_2$  values fall below this level.<sup>681</sup> This does not imply, however, that  $\text{H}^+$  is the direct mediator; it is far more likely that multiple “sensors” are involved, including the endothelium, vascular smooth muscle, and neurons. Vasodilatation may be the direct result of  $\text{O}_2$ -sensitive ion channels in smooth muscle, or be produced by vasoactive substances released from multiple sites. Recent work suggests that adenosine, NO, prostacyclin (and other cyclooxygenase products), and angiotensin are involved, with vasopressin and opioids (met-enkephalin and leu-enkephalin) playing a role in the fetus and newborn.<sup>215,328,562,574,581,769,781</sup> This multiplicity of involved pathways strongly suggests that there is no single chemical or receptor responsible, but instead indicates the likelihood of substantial redundancy.

Although the cerebral vasculature can directly “sense” changes in  $\text{PaO}_2$ , evidence also suggests that arterial  $\text{O}_2$  content is an important determinant.

**Autoregulation: CBF and CBV** Autoregulation refers to the maintenance of a constant CBF in the face of changes in perfusion pressure.<sup>560</sup> This must not be confused with the other factors that control flow. Most texts describe



**FIGURE 50-10.** **A.** Typical autoregulatory curve. Flow is generally shown as being stable between mean arterial pressures (or more strictly, perfusion pressure) of 50 and 150 mm Hg. However, although this expresses the concept of autoregulation well, it does not depict reality. **B.** Data collected from 8 rats during progressive hemorrhagic hypotension, with a fitted average line. Flow was measured continuously with a laser Doppler but summarized in 10 mm Hg steps. Because the laser Doppler does not yield flow in typical units, CBF is expressed as percentage of flow at 110 mm Hg. Note the lack of a sharp “knee” and the wide scatter around the line.

autoregulation with a curve similar to that in Fig. 50-10A; in reality it is much less “distinct” (Fig. 50-10B). Nevertheless, we typically say that CBF is “constant” as long as perfusion pressure is within the range of 50–150 mm Hg. The shape of the curve is similar whether perfusion pressure is altered by changing arterial pressure or changing ICP.<sup>462</sup> Artru et al. also showed that the lower knee of the autoregulatory curve occurs at the same arterial pressure in normocapnic and hypocapnic dogs, even though lower flows are present during normotension in the hypocapnic animals.<sup>40</sup> These studies suggest that *transmural* vessel tension is the controlling factor rather than flow or intraluminal pressure per se (but see McPherson et al.<sup>462</sup>). This is support-

ed by work in isolated vessels, where several workers have shown that increasing transmural pressures result in depolarization of vascular smooth muscle with subsequent constriction.<sup>371,532</sup>

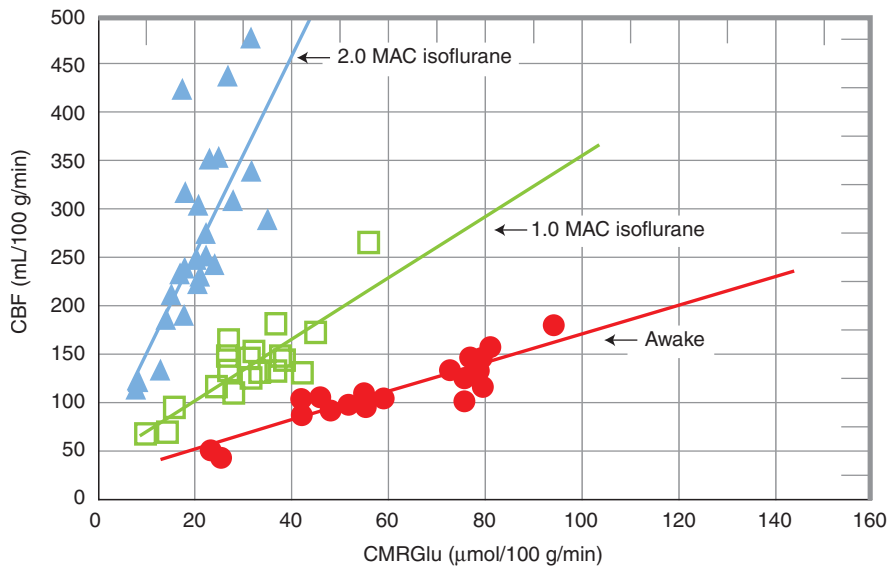
The sympathetic nervous system can modulate autoregulation. Both  $\alpha$ -blockade and cervical sympathectomy can change the lower limit of the autoregulatory curve (shifting it to the left), even though they do not change baseline flow.<sup>196,276,362,624</sup> Conversely, intense sympathetic stimulation and chronic hypertension can shift the curve to the right. Angiotensin also plays a possibly important role.<sup>561,782</sup>

There are a number of misconceptions regarding autoregulation. First, autoregulation is readily abolished. Changes in the shape of curve, shifts in the knees, or complete loss of auto-

regulation (i.e., parallel changes in CBF as blood pressure changes) are commonly present in patients with, for example, tumors, arteriovenous malformations (AVMs), ruptured aneurysms, and strokes. In fact, dysautoregulation is described in neurologically normal individuals and it is thus not clear that alterations in the curve have any serious clinical implications. This, along with the typical scatter seen in Fig. 50-10B, indicates that we cannot rely on the published “normal” limits for autoregulation, at least not in an individual patient. Arguments supporting the safety of some hemodynamic intervention based on the idea, for example, that “the normal lower limit of autoregulation is not exceeded” must always be suspect. This is particularly true if we don’t really know what tissue perfusion pressure is, that is, when there is some proximal carotid stenosis. Second, autoregulation is not instantaneous. Early studies suggested that the autoregulatory responses required 20–60 seconds. Recent studies using TCD indicate that the response is faster at least in normal subjects (i.e., 1–10 seconds).<sup>1</sup> Nevertheless, very abrupt blood pressure changes will lead to transient changes in CBF even when autoregulation is normal. In a patient with disrupted autoregulation, similar changes can lead to large and sustained alterations in CBF and presumably CBV and ICP. This is perhaps most relevant during the abrupt changes in blood pressure produced by, for example, laryngoscopy and tracheal intubation, pin insertion, skin incision, and tracheal suctioning. Because volatile anesthetics appear to slow (and in high enough doses abolish) autoregulation, CBF responses to such stimuli may be exaggerated.<sup>711,738</sup>

The lower end of the curve is of greatest concern during hypotension. CBF is adequately maintained down to perfusion pressures of 30–40 mm Hg during hypotension produced with nitroprusside, halothane, or isoflurane, but signs of cellular dysfunction (e.g. EEG, evoked response changes, acidosis,  $K^+$  escape) appear at notably higher pressures with hemorrhage and with ganglionic blockers, indicating that direct vasodilators shift the knee to the right.<sup>484,508</sup> However, it is not clear that there are any important differences between hypotensive agents at *clinically employed blood pressures*



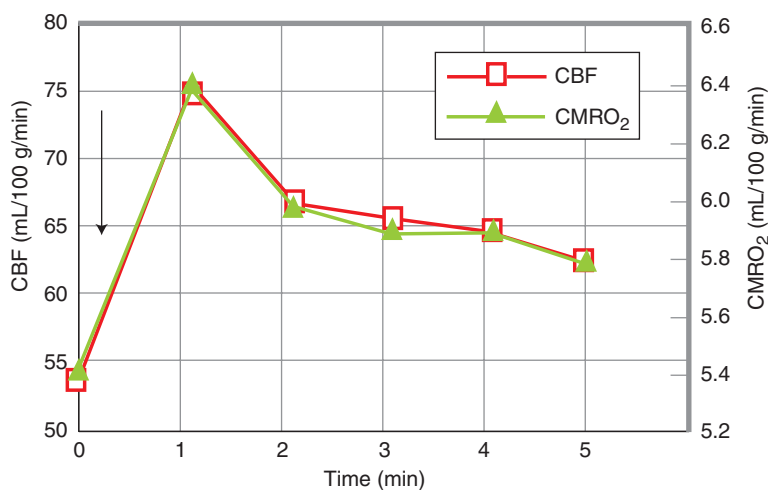


**FIGURE 50-11.** Regression plots of regional cerebral metabolic rate for glucose (CMRGlucose) versus regional cerebral blood flow (rCBF) in the rat. Each point on the curve represents the average CBF and CMRGlucose value for one anatomic region (e.g., auditory cortex, caudate), determined by  $^{14}\text{C}$ -iodoantipyrine and  $^{14}\text{C}$ -deoxyglucose autoradiography, respectively. Animals were studied awake and at stable isoflurane doses of 1 and 2 MAC (minimum alveolar concentration). For each situation, a significant straight-line relationship between CMRGlucose and CBF is seen, indicating the persistence of a coupled relationship between these variables. As the concentration of isoflurane is increased, however, the slope of the regression line increases (i.e., higher CBF for a given CMRGlucose value). This indicates that isoflurane is a cerebrovasodilator in the rat brain but it does not uncouple flow and metabolism, even at 2 MAC. (Data from Maekawa T, Tommasino C, Shapiro HM, et al. Local cerebral blood flow and glucose utilization during isoflurane anaesthesia in the rat. *Anesthesiology* 1986;65:144.)

(e.g., mean arterial pressure [MAP] = 50–60 mm Hg), and no pharmacologic hypotensive technique has been shown to be preferable to any other. Furthermore, when autoregulation is clearly altered (e.g., in a patient with vasospasm), hypotension induced

with even “good” drugs can exacerbate tissue injury.

**Flow-Metabolism Coupling** Obviously there must be a method for matching  $\text{O}_2$ /glucose delivery to metabolic demand. This is commonly re-



**FIGURE 50-12.** Flow-metabolism coupling as a dynamic event. Dogs were prepared for the near-continuous measurement of both cerebral blood flow (CBF) and cerebral metabolic rate for oxygen ( $\text{CMRO}_2$ ) using a venous outflow method. At the arrow, the femoral nerve was electrically stimulated. This is immediately followed by a matched increase in both  $\text{CMRO}_2$  and CBF, demonstrating the presence of coupling. (Data from Kuramoto T, Oshita S, Takeshita H, et al. Modification of the relationship between cerebral metabolism, blood flow, and the EEG by stimulation during anesthesia in the dog. *Anesthesiology* 1979;51:211.)

ferred to as “flow-metabolism coupling” and is reflected by parallel changes in CBF as CMR changes; tissue regions with high metabolic rates (e.g., gray matter) will have higher flows than regions with low CMR (Fig. 50-11).<sup>388,406</sup> This is reflected by a constant ratio between CBF and CMR (and by the straight line in Fig. 50-12). Under dynamic conditions, any change in CMR is rapidly matched by an appropriate change in CBF. A relationship between *functional* cerebral activity, CMR, and CBF is clearly present in humans.<sup>397</sup> For example, a light flashed into one visual field results in increases in both CBF and  $\text{CMR}_{\text{Glucose}}$  in the contralateral occipital visual cortex, and repeated clenching of one hand is accompanied by changes in the contralateral sensorimotor cortex. In fact, multiple studies indicate that coupling is probably the major mechanism by which the delivery of  $\text{O}_2$  and nutrients is regionally modulated.

Many situations encountered in anesthesia and neurosurgery change CMR and have the potential to change CBF, CBV, and ICP. The most dramatic example is a seizure (which increases CBF, CBV, and ICP-8),<sup>192</sup> but examples also include fever, shivering, and pain. However, the most common cause of changing CMR is the anesthetic itself. This is discussed in greater detail in the following section. These CMR changes play a major role in defining the CBF changes produced by many anesthetics.

Finally, one other misconception needs to be corrected. Drugs that increase CBF without increasing CMR (or that decrease CMR) are often said to “uncouple” flow and metabolism. This divergence of CBF and CMR is seen with volatile anesthetics. However, these drugs do not *uncouple* CBF and CMR because the previously mentioned linear relationships (Fig. 50-11) persist during anesthesia with these drugs, except at very high concentrations.<sup>281,421</sup> True uncoupling can be demonstrated only by showing that an increase in either neuronal activity or CMR occurs without any accompanying increase in CBF.

**Autonomic Control** Many early reviews of anesthesia and cerebrovascular physiology ignored the effect of the autonomic nervous system. This stemmed largely from the observation that clinically relevant doses of most adrenergic and cholinergic agents have

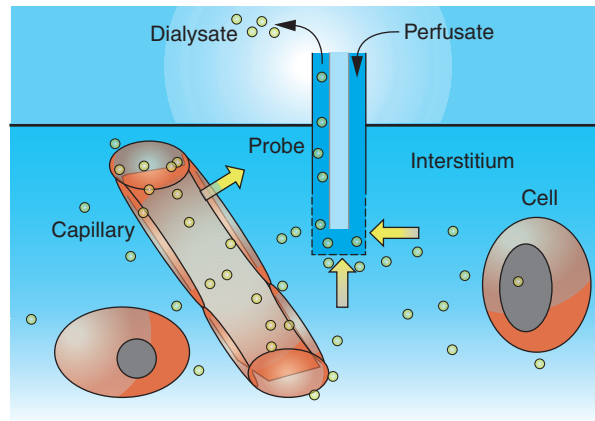
little effect on resting CBF. However, brain vessels are well innervated by postganglionic sympathetic nerves that originate from the superior cervical sympathetic ganglia, and by fibers that appear to modulate parasympathetic activity.<sup>84,524,718,781</sup> Under physiologic conditions (normotension, normoxia, and normocapnia), sympathetic nerves exert very little effect on cerebral blood flow. In contrast, high levels of sympathetic activity (such as encountered during hemorrhagic shock) shift the autoregulatory curve to right, and blunt both hypoxic and hypercapnic vasodilatation.<sup>115,162,563</sup> Conversely, adrenergic antagonists (e.g. phentolamine) or sympathetic ganglionectomy shift the curve to the left.<sup>276,362,624</sup> During acute hypertension, sympathetic nerves are activated and vasoconstrict cerebral vessels thus providing some protection against cerebral hyperemia and disruption of the blood–brain barrier. This phenomenon appears to be more effective in the brain stem than in the supratentorial part of the brain. Stimulation of parasympathetic pathways may play some role in cerebral vasodilatation—particularly during anesthesia.<sup>712</sup> Atropine has relatively little influence of CBF except in huge doses.

$\alpha_1$ -Receptor agonists such as phenylephrine and norepinephrine exert little effect on cerebral vessels except in very high doses, and then often only by shifting autoregulatory limits. This may be altered somewhat depending on the preexisting state of the cerebral vasculature (e.g., in the presence of vasodilators),<sup>559</sup> but we believe that there is little reason for the oft-expressed concern that the clinical use of these drugs will somehow result in cerebral ischemia. In contrast  $\alpha_2$ -agonists such as clonidine and dexmedetomidine produce peripheral vasodilatation and cerebral vasoconstriction.

$\beta$ -Agonists (isoproterenol) exert important influences on CBF only if the blood–brain barrier is disrupted.  $\beta$ -Receptors are present on neurons. When the barrier is open—or in very high doses— $\beta$ -agonists may increase CMR with a resultant coupled increase in CBF. Whether this is of clinical relevance remains unclear.

## MICRODIALYSIS

The technique of cerebral microdialysis allows the clinician to estimate the



**FIGURE 50–13.** Diagram of a microdialysis probe. The semipermeable membrane at the probe tip allows exchange of soluble molecules between the probe and the surrounding tissue. When the probe is implanted into tissue interstitium, molecules continuously diffuse out of the interstitial space fluid into the perfusion medium. Samples are continuously collected and analyzed by standard chemical analytical techniques. (Reproduced with permission from Muller M.<sup>547</sup>)

regional chemical composition of the brain's interstitial tissue fluid<sup>513</sup> and indirectly obtain an assessment of changes in brain-tissue chemistry.<sup>263</sup> Although this technique has been used extensively in animal models of brain injury, the first microdialysis studies in human were not published until the early 1990s.<sup>301,466</sup> Microdialysis requires inserting a fine catheter (diameter 0.62 mm) into the brain tissue, in a fashion similar to brain-tissue oxygen monitoring (Fig 50–13).<sup>513</sup> The catheter, with its polyamide dialysis membrane lining, is perfused with a physiologic solution (e.g., lactated Ringer solution) at ultralow flow rates (0.1–2.0  $\mu\text{L}/\text{min}$ ) using a precision pump.<sup>263</sup> The probe is perfused continuously so that low-molecular-weight constituents of the extracellular space can diffuse across the membrane and into the perfusion medium of the probe.

In theory, any soluble molecules that are in the interstitium and that are small enough to diffuse through the dialysis membrane can be detected in the perfusate.<sup>341</sup> The perfusate exiting the dialysis catheter is collected in aliquots for subsequent analysis, allowing for temporal resolution of changes in the composition of the interstitium. The concentration of any molecule in the perfusate will be dependent on the diffusing capacity (area of membrane [length and diameter of diffusion membrane], molecular weight of the molecule, pore size of the membrane, rate of perfusion, diffusion gradient, temperature, pH, shape and charge of the molecules influencing the diffusion coefficient, and the binding of the proteins to the membrane and the

tubing, and possible degradation of the proteins.<sup>198,364,365</sup> Conventional microdialysis uses CMA70 catheters with 20-kDa molecular weight cut-off membranes enabling the measurement of small molecules such as glucose, lactate, pyruvate, and glutamate. The CMA71 100-kDa molecular weight cut-off microdialysis catheter was introduced to allow detection of larger molecules such as cytokines.<sup>327</sup> Microdialysis is just a sampling tool and needs to be linked to an analytical device. In 1995, CMA Microdialysis (Stockholm, Sweden) introduced microdialysis instruments for clinical use (including catheters for peripheral and brain tissue, a microdialysis pump, and a bedside chemical analyzer). Good correlation has been shown between the CMA analyzer and the gold standard of high-performance liquid chromatography (HPLC).<sup>326</sup>

The key substances measured by microdialysis can be divided into four groups: energy metabolites (e.g., glucose, lactate, pyruvate, adenosine, xanthine); neurotransmitters (e.g., glutamate, aspartate,  $\gamma$ -aminobutyric acid [GABA]); markers of tissue damage and inflammation (e.g., glycerol, potassium, cytokines); and exogenous substances (e.g., drugs).<sup>263</sup> Microdialysis has also been used to estimate the brain concentration of drugs that have been administered either systemically or centrally.<sup>516</sup> Microdialysis can also be used to directly administer drugs into targeted brain areas while simultaneously measuring their effects on brain concentrations of other compounds (e.g., neurotransmitters) of interest.<sup>517</sup>

In vivo cerebral microdialysis is a powerful research technique for purposes of analyzing neurochemical dynamics of brain injury.<sup>89</sup> Over the last few years, extension of laboratory-based studies have been reported,<sup>80,81,652</sup> in patients with large hemispheric infarctions, traumatic brain injury,<sup>820</sup> global cerebral ischemia,<sup>525</sup> and subarachnoid hemorrhage.<sup>534,706</sup> Neuroprotective strategies,<sup>377</sup> including hypothermia,<sup>322,403,507</sup> and their effects on neurotransmitter release have been well-described using this technique.<sup>89</sup>

However, this technique has significant limitations in the clinical setting.<sup>89</sup> Because microdialysis only allows for a very small sampling volume of brain tissue (at best, a radial distance of a few millimeters around the probe), it may not represent pathology that exist at distant brain locations.<sup>105</sup> Although some sense of time of change may be gained from analyzing dialysate samples collected over individual epochs,<sup>377</sup> time resolution is poor because of the slow perfusion rates required to accumulate enough solute to measure.<sup>105,534,706</sup> In addition, there is evidence that chronic indwelling probes may cause the development of reactive gliosis around the probe.<sup>89</sup> The reactive gliosis influences the recovery of substances through the microdialysis membrane, but this gliosis plays a minor role in the first hours after implantation.<sup>76,77,105,685,804</sup>

Use of microdialysis is associated with wide intersubject variability in basal neurochemical values and following tissue perturbations<sup>89</sup> and the lack of reference values taken, for example, from the contralateral hemisphere as described by other authors is a fundamental problem of microdialysis studies in humans. But ethical aspects make investigations of basal or reference values delicate or impossible.<sup>105</sup>

## CEREBROVASCULAR PHARMACOLOGY OF ANESTHETICS AND ADJUVANTS

As stated earlier, neuroanesthesia is the practice of applied cerebrovascular physiology and pharmacology, particularly the manipulation of CBV. Anesthetics affect all of the parameters discussed in the previous sections, as does natural sleep.<sup>229,367</sup> The oft-noted attempt in the experimental laboratory to design a combination of anesthetic agents that have

no such effects can only be viewed with humorous disdain. However, differing drug-induced changes do have some bearing on clinical practice, and it is important to understand them.

## Intravenous Anesthetics

### Barbiturates

Barbiturates were the first anesthetics whose cerebrovascular effects were examined. Thiopental is the prototype, and all other clinically used barbiturates are similar (although their pharmacokinetics differ). Increasing doses of thiopental progressively decrease CMR and CBF (assuming that  $Paco_2$  does not change).<sup>375,468</sup> The changes in CBF appear to occur as the result of metabolic suppression and a coupled decrease in flow. If coupling is disrupted, if CMR is already maximally depressed *vasodilatation* in response to barbiturates can be demonstrated.<sup>465</sup> This can also be seen in isolated vessels.<sup>289,402,431,543</sup> The relationship between dose and CBF/CMR is not linear, with large decreases seen with small doses, and progressively less effect as blood concentrations increase further. The maximal decrease in both CBF and  $CMRO_2$  occurs coincident with the appearance of isoelectricity on the EEG, and is equal to  $\approx 50\%$  of awake normal (although the metabolic/CBF difference between burst suppression and isoelectricity is small).<sup>353,468</sup> Thiopental even in very high doses, does not appear to abolish autoregulation,  $CO_2$  response, or flow-metabolism coupling. Barbiturates have also been shown to result in lower CBV values than volatile agents.<sup>746</sup>

### Propofol

Like thiopental, propofol produces dose-related EEG suppression (including isoelectricity) and progressive reductions in both CBF and CMR, with minimum CMR values of 40–60% of control values.<sup>43,576,593,770</sup> The relationship between these CBF changes and reductions in ICP was initially clouded by the decreases in blood pressure sometimes seen with the recommended induction doses, but subsequent data indicate that propofol does reduce CBF independent of any systemic hemodynamic changes.<sup>593</sup> The only available CBV data again suggests similarities with the barbiturates.<sup>746</sup> The drug has been used successfully in many neurosurgical procedures and in neurosurgical intensive care units in both Europe and the United States.<sup>109,295,694</sup>

In recent years, a number of case reports have appeared suggesting that propofol can induce seizures. However, this event is uncommon and the drug has been given uneventfully to epileptic patients.<sup>195,698</sup>

### Etomidate

Etomidate is remarkably barbiturate-like, producing similar CBF and CMR changes. In dogs, etomidate reduces CBF more rapidly than  $CMRO_2$ , suggesting that it may have some direct cerebral vasoconstricting properties.<sup>489,608</sup> No CBV data are available, but the drug does reduce ICP.<sup>161,171,489</sup> It is possible to produce an isoelectric EEG, but this may be preceded by intermittent spiking, which may be associated with myoclonus.<sup>603</sup> True seizure activity (as distinguished from myoclonus) is not typically seen in normal patients. However, in patients with convulsive disorders, small doses (8–12 mg) of etomidate can elicit seizures, and the drug can be used to unmask seizure foci during operative EEG mapping.<sup>194,603</sup>

Recently, toxicity related to the propylene glycol solvent has been reported in patients given etomidate infusions for long periods of time.<sup>398</sup>

### Ketamine

Ketamine is capable of producing increases in CBF,<sup>320,724</sup> and in ICP, particularly in spontaneously breathing patients.<sup>153,675</sup> It has also been reported to increase ICP when used for anesthetic induction.<sup>74</sup> Thus, for many years, ketamine was one of the few agents whose use was deemed absolutely contraindicated in neuroanesthesia. The subsequent literature on this drug is extremely contradictory. In 1982, Schwedler et al. reported no important CBF changes in chronically instrumented goats (as long as ventilation was supported),<sup>667</sup> although others have reported significant increases in both rabbits and dogs.<sup>40,604</sup> In 1990, Werner et al., using TCD to assess CBF, demonstrated a clear dose-related CBF increase, whereas Mayberg et al. saw no changes in either  $V_{mca}$  or ICP when the drug was given to anesthetized and ventilated individuals.<sup>452,803</sup> Friesen et al. found that ketamine could block the ICP response to intubation and infants, and had no direct ICP effects when ventilation was supported.<sup>229,230</sup> It is difficult to draw firm conclusions from such data, other than to concur with suggestions that ketamine is probably



inappropriate as a sole agent for neurodiagnostic procedures.

### Eltanalone

Eltanalone is a new steroid hypnotic with a rapid onset of action and short duration of action.<sup>120</sup> Only one study of its cerebrovascular effects has appeared, and this demonstrates an action very similar to other intravenous agents.<sup>811</sup>

### Opioids

It was once believed that narcotics had no effect on CMR or CBF because even 1–3 mg/kg doses of morphine have little effect on CBF and CMR in ventilated patients who were also receiving N<sub>2</sub>O.<sup>340</sup> However, drugs like fentanyl have changed this picture. Low doses of fentanyl (e.g., 5–15 µg/kg) probably have little effect, but much larger doses of fentanyl (e.g., ≈50–100 µg/kg), sufentanil, alfentanil, and remifentanil progressively decrease CMR and CBF in many species, including humans.<sup>121,312,367,502,518,829</sup> The maximum reduction is ≈40–50%, with CMRO<sub>2</sub> values of ≈2 mL/100 g/min and CBF values of 20–25 mL/100 g/min being observed in patients given “cardiac” doses of fentanyl (typically combined with small doses of diazepam).<sup>518,519</sup> The CMR/CBF changes occur in parallel with progressive EEG slowing<sup>668,797</sup> although isoelectricity is not achievable. High doses of most opioids can produce rare seizures in humans<sup>595,625</sup> and seizure-associated histopathologic injury in some animals,<sup>378</sup> however, efforts to consistently demonstrate seizures in normal humans have been generally unsuccessful.<sup>520</sup> Low-voltage spikes similar to discharges seen during sleep have been reported in cardiac surgical patients<sup>363</sup> and seizures have been reported following high-dose fentanyl in patients with complex partial epilepsy.<sup>728</sup> Finally, meperidine is a well-known convulsant as a consequence of the activity of its metabolite, normeperidine.

Although opioids produce dose-related reductions in CBF and CMR, they have never found a major role in the control of ICP. One reason may relate to a unique property of these drugs. In 1990, Milde et al. reported that bolus administration of 2–200 µg/kg doses of sufentanil produced transient but often pronounced increases in ICP in lightly anesthetized dogs.<sup>487</sup> This report was the subject of great debate,

but several subsequent human studies have shown that the synthetic opioids can increase ICP under some (poorly defined) conditions.<sup>9,442,700</sup> Fentanyl and sufentanil can also increase CBF (as measured by TCD) in normocarbic human volunteers.<sup>756</sup> The mechanism for such changes remains unclear—perhaps activation of mu (µ) receptors on cerebral vessels plays some role. However, the only available clinical trials suggest that opioid–N<sub>2</sub>O anesthesia is acceptable for elective neurosurgery,<sup>745</sup> and show no clear advantages of any particular opioid.<sup>233</sup> This latter conclusion may change as experience is gained with the ultrashort-acting opioid remifentanil.<sup>248,312</sup>

The CNS effects of naloxone also have been the subject of numerous studies. Naloxone alone probably has no important CBF/ICP effects.<sup>44</sup> When carefully titrated, it normalizes CBF and CMRO<sub>2</sub> in narcotized subjects.<sup>446</sup> However, abrupt reversal with excessive doses of naloxone has resulted in hypertension, pulmonary edema, dysrhythmias, and intracranial hemorrhage.<sup>212,585</sup>

### Sedative Agents

#### Benzodiazepines and Antagonists

Diazepam, midazolam, and lorazepam typically produce small falls in CBF or CMRO<sub>2</sub>, in both sedative and anesthetic doses.<sup>221,223,372,612,771</sup> A distinct ceiling effect is present, and an isoelectric EEG is never produced.<sup>221</sup> No data on CBV are available. The ICP effects of these drugs are strikingly small.<sup>244,726</sup>

Flumazenil was introduced as a receptor-specific benzodiazepine antagonist. Like naloxone, it has little or no CNS effect when given alone.<sup>222</sup> It also appears to have no unique properties when used to reverse a benzodiazepine.<sup>372,611</sup> However, Fleischer et al. noted a dramatic rebound increase in canine CBF (and ICP) to values higher than baseline when a high-dose midazolam anesthetic is reversed by the bolus administration of a large dose of flumazenil.<sup>221</sup> Similar changes have been recorded by Chiolerio et al. in humans.<sup>127</sup> This phenomenon is akin to the withdrawal phenomena seen when naloxone is given in large doses after narcotic anesthesia. Flumazenil is also known to precipitate seizures.

#### Butyrophenones (Droperidol)

Most data on droperidol were been obtained when it was used in combina-

tion with opioids. Large doses (0.35 mg/kg) in dogs can reduce CBF by 40% but not change CMRO<sub>2</sub>.<sup>480</sup> This change occurred very gradually, and the pattern of decreasing CBF without changing CMRO<sub>2</sub> or blood pressure is unique among anesthetics. In humans, the combination of droperidol (5 mg) and fentanyl (100 µg) uniformly reduced CBF and ICP, but droperidol alone (in relatively large doses) seems to produce a small increase.<sup>137,492,497</sup> In view of these data, it is unlikely that small antiemetic (0.0625–1.25 mg) or sedative (2.5–5 mg) doses of droperidol have any important CBF/ICP effects.

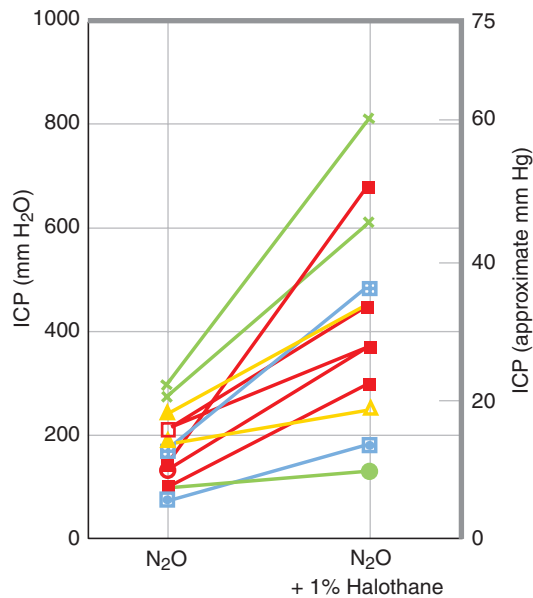
### Dexmedetomidine

Since the early 1990s, there has been intense interest in the sedative/anesthetic properties of drugs that act as agonists at central α<sub>2</sub>-adrenergic receptors.<sup>99,453,454</sup> The best characterized (and most potent) of these agents is dexmedetomidine.<sup>182</sup> Although there is little clinical experience with this drug in neurosurgery, experimental studies clearly demonstrate its ability to markedly reduce CBF in both animals and humans,<sup>350,843</sup> and to reduce ICP in animals.<sup>846</sup> What remains uncertain is whether this vasoconstriction (which is at least partially independent of changes in CMR) is beneficial or not. The drug also may reduce seizures thresholds (and hence may be a “proconvulsant”).<sup>496</sup>

### Volatile Agents

When halothane was introduced in the 1950s, it was hailed as the neuroanesthetic of choice. It was nonflammable, induction and emergence were rapid and smooth (compared with ether), anesthetic depth and arterial pressure could be easily and quickly controlled, >95% O<sub>2</sub> could be given, and ventilation was usually adequate to prevent severe brain swelling. If not, ventilation was easily controlled. However, in the late 1960s it was discovered that halothane could increase ICP. Despite its decade-long record of success, the use of halothane in neurosurgery declined. This was accelerated by the enthusiasm for barbiturates that appeared in the early 1970s and by the development of short-acting opioids. A resurgence in the use of volatile anesthetics for neurosurgery was prompted by the introduction of insoluble ethers, first enflurane and then isoflu-





**FIGURE 50-14.** Intracranial pressure (ICP) responses to the addition of 1% halothane in a series of patients with space-occupying intracranial lesions. ICP was measured with a ventriculostomy. (Modified and reprinted from Jennett WB, Barker J, Fitch W, et al. Effects of anesthesia on intracranial pressure in patients with space-occupying lesions. *Lancet* 1969;1:61, with permission from Elsevier.)

rane. Both of these drugs were initially reported to have advantages over halothane in terms of CNS effects. Unfortunately, despite widespread beliefs, these “advantages” remain generally unproved.

### Halothane, Enflurane, and Isoflurane

The effects of halothane on CBF were first examined in humans in 1964.<sup>812</sup> During normocapnic administration of ≈1.2% halothane (inspired), global CBF was 51 mL/100 g/min, as compared with awake normal values of 44 mL/100 g/min in the same group of subjects. The authors concluded that “halothane in the concentration studied was “...a mild cerebral vasodilator.” (Note: Compare the magnitude of these CBF changes with that produced by a 5 mm Hg change in  $P_{aCO_2}$ ; see Fig. 50-9.) The first “clinical” correlate was reported by Jennett et al. in 1969, who demonstrated ICP increases in neurosurgical patients (Fig. 50-14).<sup>336</sup> This was confirmed by Adams et al. in 1972.<sup>4</sup> Neither group found any evidence of clinical deterioration in the patients given halothane, although Adams et al. demonstrated that ICP changes were not seen in the presence of hypocapnia.

In 1974, enflurane was introduced into clinical practice, followed in 1981 by isoflurane. Numerous human and animal studies have compared the CBF/CMR effects of these agents with those

of halothane.<sup>101,197,280,417-419,476,644,741,829</sup> Since some of the earlier studies (particularly that of Eintrei et al.<sup>197</sup>) showed that halothane (at least in doses >1 MAC [minimum alveolar concentration]) resulted in the largest CBF changes, many clinicians concluded that isoflurane and enflurane were “better” than halothane. Because the capacity of enflurane to induce electroencephalographic seizures, particularly during hypocapnia, is viewed as “bad,” the result was growth in the popularity of isoflurane as a neurosurgical anesthetic.

Unfortunately, this scenario may be wrong. The reported CBF differences among these drugs may be an “artifact” of the specific measurement methods used. Recent work disputes the idea that volatile agents “uncouple” flow and metabolism and also supports the idea that changing CMR plays a major role in defining the CBF changes produced by the drugs. Finally, data exist concerning the relationships between the CBF, CBV, and ICP effects of these drugs, and lastly it may be incorrect to conclude that differences in CBF can be translated into differences in clinical usefulness and safety.

### CBF: Flow Distribution and Method-Related “Artifacts”

In an earlier section, Significance of CBF and CMP, we cautioned against interpreting CBF measurements without understanding the limitations inherent in the

specific measurement method used. This caveat applies to volatile anesthetics. In 1988, Hansen et al. demonstrated that 1 MAC halothane and isoflurane produced identical hemispheric CBF values in rats.<sup>280</sup> However, <sup>14</sup>C-iodoantipyrine autoradiography revealed that the two drugs produced remarkably different flow patterns. Subsequent SPECT studies by Reinstrup et al. confirmed different flow distribution pictures.<sup>606</sup> Halothane selectively increased flow to the cortex while reducing subcortical flow. By contrast, isoflurane resulted in more uniform flow patterns. This implied that if one were to compare the CBF effects of these volatile agents using a technique that selectively looked at the cortical mantle (e.g., most <sup>133</sup>Xe washout methods), halothane would appear to have the greater effect. By contrast, if whole-brain flow were examined (e.g., using a Kety-Schmidt technique), flows would be very similar.

There is animal and human evidence to support this hypothesis (Table 50-3). At least 13 studies compare halothane and isoflurane in some manner. These were all carried out at roughly 1 MAC doses with variable background anesthetics (e.g., N<sub>2</sub>O, morphine, subarachnoid tetracaine). However, *within* each study the CBF effects of the volatile agents were determined under similar conditions, and hence the differing background conditions do not confuse the comparison. When the method used to measure CBF provides cortically weighted data, flow values average 1.6 times greater with halothane than with isoflurane. However, when *global* measurements are compared, there are no differences between these agents.

We recognize that this is circumstantial evidence but believe that it is compelling. All volatile agents are mild cerebral vasodilators. However, there appear to be no major differences in their effects on global CBF. If the CBF-CBV relationships are similar for these different drugs, we would predict that isoflurane and halothane would have similar CBV effects. Taking the argument one step further, we would also predict that these agents should have identical effects on ICP. This is explored in the following sections.

It is tempting to dismiss the regional differences in the CBF effects of these drugs as an academic curiosity. However, such observations have impor-

TABLE 50–3.

## The Relative Cerebral Blood Flow Effects of Volatile Agents and the Influence of Measurement Method

Authors	Reference	Year	Species	Method	Cortical/ Global	Halothane	Isoflurane	Halothane/ Isoflurane Ratio
Todd et al.	416	1984	Cat	IC <sup>133</sup> Xe	Cortical	61 ± 15	48 ± 24	1.3
Eintrei et al.	111	1985	Human	Topical <sup>133</sup> Xe	Cortical	177 ± 39	67 ± 27	1.8
Scheller et al.	372	1986	Rabbit	H <sub>2</sub> clearance	Cortical	138 ± 94	62 ± 27	2.2
Michenfelder et al.	268	1987	Human	IC <sup>133</sup> Xe	Cortical	62 ± 24	37 ± 14	1.7
Hansen et al.	158	1988	Rat	Autoradiography	Cortical	185 ± 18	154 ± 19	1.2
Young et al.	458	1989	Human	IH/IV <sup>133</sup> Xe	Cortical	34	24	1.4
Madsen et al.	226–228	1986–87	Human	Kety-Schmidt	Global	36 ± 8	33 ± 11	1.1
Hansen et al.	158	1988	Rat	Autoradiography	Global	150 ± 16	147 ± 19	1.0

Where available, all values are presented as mean ± standard deviation (SD) (with SD calculated when standard error of mean [SEM] is reported in the original article). The designation of cortical vs. global refers to the primary area studied using the cerebral blood flow (CBF) method listed in the fourth column. For example, cortical measurements obtained with microspheres indicates that cortical tissue was specifically separated from underlying regions, whereas cortical measurements using H<sub>2</sub> clearance indicates electrode placement in the cortex. “Global” indicates that flow values reflect both cortical and deep structures combined (e.g., H<sub>2</sub> electrode placed in the confluence of venous sinuses). In all cases, CBF values within a row are reported either in the same manuscript, or represent work from the same laboratory using the same methodology. Background anesthetics do differ from study to study, but are consistent within a row, except for the values listed in parenthesis. All measurements were made at approximately 1 minimum alveolar concentration (MAC) of volatile agent, except for Boarini et al. (1.3 MAC). The data from Michenfelder et al. represents values obtained prior to carotid cross-clamping in grade 1 patients undergoing carotid endarterectomies.

tant implications relative to the *mechanism* by which volatile agents influence CBF. If these drugs acted by directly relaxing vascular smooth muscle, we would expect to see either more uniform flow distribution patterns or at least *similar* distribution patterns with different agents. How does one explain markedly different regional effects? We believe that some factor must be acting as an intermediary. Additional support for this hypothesis comes from experiments in our laboratory, in which a focal cryogenic injury dramatically attenuated the CBF increase seen with isoflurane.<sup>592</sup> Most important, this altered flow response was seen in brain regions far removed from the site of injury, regions in which the response to CO<sub>2</sub> was unaltered. The nature of this hypothetical mediator is unknown at present but could be biochemical, metabolic, or neurogenic. There are now a growing body of data suggesting that either NO, a prostaglandin, or acetylcholine may play some intermediary role in the effects of volatile agents, although the data are still incomplete.<sup>375,376,460,503,712,749</sup>

**CBV and ICP** Based on the apparent similarity of the CBF effects of halothane and isoflurane, we predicted that the two drugs should produce similar changes in CBV and ICP. In 1982, Artru<sup>32,33</sup> measured the acute changes in CBV produced by 1 MAC concentra-

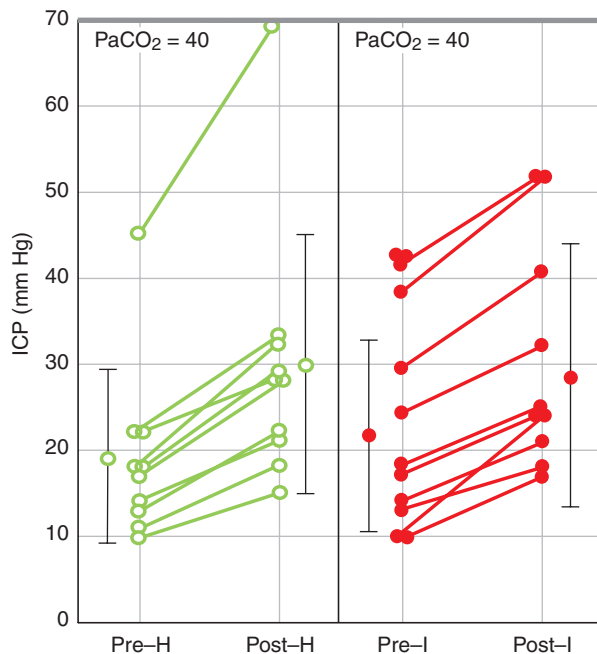
tions of halothane, enflurane, and isoflurane in dogs ventilated with 70% N<sub>2</sub>O. All three drugs produced 8–11% increases in volume, with no statistical differences. Subsequently, Weeks et al. quantified cerebral plasma volume in rats anesthetized with 1 MAC halothane and isoflurane. There were no differences between these agents during normocapnia.<sup>800</sup>

There is less information available regarding ICP. All three volatile agents are capable of increasing ICP.<sup>3,4,258,336,510</sup> However, the only human comparative data came from the two studies by Adams et al. with halothane and isoflurane.<sup>3,4</sup> The two agents were not studied concurrently nor in equipotent doses, but both studies indicated that (a) the two drugs could increase ICP when given during normocapnia, (b) neither drug had any ICP effect when given to hypocapnic patients, and (c) none of the ICP increases seen with either agent were associated with any adverse clinical outcome. Finally, animal work by Scheller et al. showed that in rabbits with severe brain injuries and preexisting intracranial hypertension, the ICP effects of the drugs were essentially identical (Fig. 50–15).<sup>645</sup>

There are two possible exceptions to this “halothane = enflurane = isoflurane” hypothesis. Artru showed that volatile agents have quite different effects on CSF production and reabsorption.<sup>31,33,42</sup> Enflurane produc-

es an increase in CSF production, and prolonged exposure can lead to slightly higher ICPs. By contrast, halothane decreases CSF production, a change that Maktabi et al. suggest is mediated by vasopressin.<sup>425</sup> Drummond et al. and Scheller et al. have provided evidence that there may be some unique interaction between CO<sub>2</sub> and isoflurane. Drummond et al. showed that the slope of the CBF–Paco<sub>2</sub> response curve between 20 and 40 mm Hg was steeper for isoflurane than halothane,<sup>189</sup> whereas Scheller et al. noted that when isoflurane was given to hypocapnic rabbits, CBF actually decreased (but rose with halothane).<sup>644</sup> Weeks et al. found that although CBV was identical during normocapnic anesthesia with halothane and isoflurane, CBV fell more readily during hypocapnic isoflurane anesthesia than with halothane.<sup>800</sup> Thus it is possible that there may be agent-specific ICP differences during hypocapnia although this was not observed by Scheller et al. in injured animals.<sup>645</sup>

**CMR** Volatile agents increase CBF at the same time CMR is decreasing. This was interpreted by many as indicating that these drugs “uncoupled” flow and metabolism. We now know that this is not true. As noted, Kuramoto et al. showed parallel increases in CBF and CMR during stimulation of the femoral nerve in dogs anesthetized with halothane.<sup>385</sup> Furthermore, Maekawa et



**FIGURE 50-15.** Maximum intracranial pressure (ICP) responses to the addition of 1 MAC (minimum alveolar concentration) halothane (on the *left*) or isoflurane (on the *right*) to normocarbic rabbits after a focal cortical brain injury. The background anesthetic was morphine- $N_2O$ . Baseline ICP in both groups was elevated by the injury (to 18–20 mm Hg), but the increases produced by the volatile agents were statistically identical. (Scheller MS, Todd MM, Drummond JC, et al. The intracranial pressure effects of isoflurane and halothane administered following cryogenic brain injury in rabbits. *Anesthesiology* 1987;67:507–512.)

al. and Hansen et al. both showed that linear relationships between CBF and CMR<sub>glu</sub> are maintained during halothane and isoflurane anesthesia, at least with concentrations of  $\approx 1$  MAC (and possibly higher) (see Fig. 50-11).<sup>281,421</sup> These experiments demonstrate that coupling is present during these relatively modest doses of volatile agent, although Kuramoto et al. did provide some evidence for true uncoupling at higher concentrations of halothane (>2 MAC).

The persistence of coupling has two implications. First, because the different volatile agents have different effects on CMR, observed variations in cortical flow may be the result of differing effects on metabolism, rather than different direct effects on the cerebral vasculature. With intact coupling, the direct vasodilating effects of a drug may be offset by the indirect, metabolically linked vasoconstriction. Two agents with identical direct vasodilating properties, but with differing metabolic effects, may have very different effects on CBF. Second, they suggest that the CBF effects of a volatile agent may depend on the metabolic condition of the brain at the time of agent administration. This latter possi-

bility is best demonstrated by Drummond et al., who exposed rabbits to equi-MAC concentrations of halothane and isoflurane and noted that halothane appeared to produce a greater increase in cortical CBF (as expected).<sup>190</sup> However, when baseline CMRO<sub>2</sub> was reduced by the administration of barbiturates, the flow effects of the two drugs were identical. An essentially identical experiment was carried out in humans by Matta et al. using TCD—with essentially identical results.<sup>450</sup> Such experiments suggest that the influence of a volatile agent may depend highly on the other drugs that have been given to the patient during that anesthetic.

**Precautions** The previous comments indicate that the simple concepts concerning the different effects of volatile agents on the brain are not correct. Although it would be incorrect to state that there are no differences between volatile agents, these three agents are certainly more similar than heretofore believed. All three can increase CBF, CBV, and ICP. Nevertheless, these drug-induced ICP increases have never been demonstrated to be detrimental and are easily counteract-

ed by other ICP control measures, such as hyperventilation. To conclude that such agents are contraindicated in all but a tiny fraction of neurosurgical patients is a serious misinterpretation of the available data. More importantly, to conclude that “halothane is bad but isoflurane is good (or better)” is simply wrong, at least with respect to cerebrovascular physiology.

### **Desflurane and Sevoflurane**

These newer agents may have some advantages over the current drugs because of their low blood-gas solubility characteristics (0.6 for sevoflurane; 0.4 for desflurane), which should allow more rapid titration of anesthetic depth and faster emergence. Several studies of the cerebrovascular effects of sevoflurane have appeared.<sup>141,370,429,642,643</sup> Of interest is that essentially all of these showed a modest decrease in flow, even under conditions where isoflurane resulted in small increases. Although it is tempting to conclude that this suggests some “advantage” to sevoflurane, it is also important to realize that the reported differences were small. One potential problem with sevoflurane is that it is metabolized actively, releasing inorganic fluoride.<sup>682</sup> Prolonged use can lead to elevated fluoride concentrations,<sup>373</sup> and this process can be accelerated in animals given enzyme-inducing drugs, such as phenobarbital and phenytoin.<sup>307</sup> Because many neurosurgical patients are taking such drugs, the potential for renal toxicity, particularly with long operations, needs to be addressed in future research studies.

In the early 1990s, the group at the Mayo Clinic reported dose-related increases in CBF with desflurane (as long as MAP was supported), and reductions in CMRO<sub>2</sub>.<sup>410</sup> When blood pressure fell, CBF declined.<sup>486</sup> The most direct comparison of desflurane with isoflurane was performed in humans by Ornstein et al.<sup>554</sup> These measurements were performed in hypocapnic patients undergoing craniotomy, and showed essentially identical reductions in CBF with both drugs after induction, with no subsequent increases as dose was raised. The one unique finding with desflurane is that it appears to produce a small but steady increase in ICP.<sup>523</sup> Artru has demonstrated a decrease in intracranial compliance with desflurane, which may be the result of altered CSF dynamics.<sup>38</sup>

None of these physiology studies have addressed the crucial issue of the clinical acceptability/advantages of these agents. However, given the relatively minor differences seen between the cerebrovascular behavior of these drugs and isoflurane, it is unlikely that their use poses any significant problems—although it is equally uncertain that they offer any practical advantages.

### Nitrous Oxide

For some inexplicable reason, most clinicians think of N<sub>2</sub>O as having few cerebrovascular effects. This is not true. N<sub>2</sub>O can increase CBF in animals and humans by more than 60–100%,<sup>66,173,566</sup> and can produce large ICP increases in patients with mass lesions.<sup>293,511</sup> Similar increases in CBF and ICP can be seen when N<sub>2</sub>O is added to a volatile agent or opioid background,<sup>11,188,281,346,390,629</sup> and Archer et al. showed that N<sub>2</sub>O can increase CBV.<sup>24</sup> The CBF changes are not altered by hypocapnia<sup>740</sup> although the ICP response can be blunted if compliance is improved. A similar alteration of the ICP response to N<sub>2</sub>O can be achieved by the administration of any agent that will decrease CBV (e.g., thiopental).<sup>575</sup>

Several investigators have attempted to compare the CBF effects of N<sub>2</sub>O with those produced by volatile agents. Their results suggest that N<sub>2</sub>O may be a *more potent* vasodilator than either halothane or isoflurane. For example, Hansen et al. compared the CBF effects of a 1 MAC anesthetic provided either with a volatile agent alone, or by a combination of 0.5 MAC volatile agent and 0.5 MAC N<sub>2</sub>O.<sup>281</sup> In all cases, CBF was higher in the presence of N<sub>2</sub>O. Similar results have now been obtained in two human studies.<sup>11,390</sup> Adding N<sub>2</sub>O to a volatile agent background did not have any CMR effects, suggesting that one reason for the dramatic CBF effects of N<sub>2</sub>O is that vasodilatation is unopposed by indirect, CMR-mediated vasoconstriction.<sup>600</sup>

One unique property of N<sub>2</sub>O is its low solubility in air, and its propensity to diffuse rapidly into closed, air-filled spaces, such as a pneumocephalus.<sup>627</sup> Because pneumocephalus is an almost uniform consequence of intracranial surgery<sup>556,602</sup> some have argued against the use of the drug. However, as long as N<sub>2</sub>O is used throughout the procedure and can equilibrate with any air bubble before the dura is closed, its use poses no problems, and discontinua-

tion can actually reduce ICP at the end of surgery.<sup>178,691</sup>

## Adjuvant Drugs

### Nondepolarizing Muscle Relaxants

**Intracranial Pressure Effects** Although many studies have been done, one is struck by the extraordinarily benign nature of these agents in terms of CBF and ICP. The only suggestion of a detrimental effect follows the bolus administration of large doses of *d*-tubocurarine, where histamine release can increase both CBV and ICP.<sup>725</sup>

### Interactions with Phenytoin and Other Anticonvulsants

There is one practical concern regarding nondepolarizing relaxants and neurosurgery. Case reports and clinical studies have demonstrated that treatment of patients with phenytoin (and possibly carbamazepine) increases the dose requirements for all nondepolarizers except perhaps atracurium, and markedly reduces the duration of action.<sup>552,553</sup> The mechanism involves changes in both protein binding and in the number of acetylcholine receptors.<sup>368,441</sup>

One other factor occasionally complicates the use of nondepolarizing relaxants in neurosurgery. This is the presence of local neurologic deficits, particularly hemiplegia. It has long been known that paretic/plegic extremities are relatively resistant to the action of nondepolarizing relaxants.<sup>504</sup> Titration of relaxants in response to twitch monitoring of this extremity can lead to relative overdosage and difficulties with reversal. This can pose certain unique problems during intracranial surgery because in many institutions, the operating table is positioned such that the paretic extremity is the most readily available (i.e., contralateral to the surgical hemisphere).

### Succinylcholine

There is little question that succinylcholine can increase ICP in humans.<sup>437,494,512</sup> In early work, these ICP changes could not be separated from those caused by laryngoscopy or changes in ventilation, but more recent studies indicate the drug has ICP effects that are clearly independent of other events.<sup>494,708</sup> Animal studies indicate that these changes are associated with increased CBF and may be related to increases in muscle spindle afferent activity.<sup>391,392</sup> These ICP effects can be completely blocked by prior

paralysis or “precurarization” with pancuronium or metocurine,<sup>284,391,494</sup> indicating that the peripheral neuromuscular junctions play some role.

Does this mean that succinylcholine is contraindicated in neurosurgery? Probably not. The changes in ICP are modest and transient. There seems little reason to avoid the drug in situations where very rapid paralysis is needed. This does not apply to most elective situations, but under emergency conditions, the consequences of an unsecured airway and hypoxia/hypercapnia are far worse than any changes that might occur with succinylcholine. Furthermore, when succinylcholine is given to severely head-injured patients in ICU situations (or to animals with intracranial hypertension), it appears to have no such detrimental effects.<sup>213,272,380</sup>

## Antihypertensives

### Smooth Muscle Relaxants: Nitroprusside, Nitroglycerin, and Hydralazine

All antihypertensive drugs with direct smooth muscle relaxant properties are capable of increasing ICP in humans, and this is clearly true for these particular agents.<sup>148,149,242,438,760</sup> However, the idea that these drugs (at least nitroprusside and nitroglycerin) increase CBF as well has little consistent support.<sup>474</sup> Essentially all studies (human and animal) have reported either no change or a fall in CBF.<sup>45,139,294,395,577</sup> These indicate that these drugs are capable of increasing CBV independently of their effects on flow. This possibility has been directly investigated in two studies. Michenfelder and Milde gave dogs nitroprusside under conditions where blood pressure was maintained constant and observed an increase in ICP without a rise in CBF.<sup>474</sup> Dahl et al. measured flow velocity in the basilar cerebral vessels using transcranial Doppler methods and also measured CBF using SPECT during nitroglycerin infusion.<sup>163</sup> They found that MCA flow velocity decreased while CBF was unchanged. These changes can be explained only by an increase in the diameter of the MCA, which did not translate into a flow change. In both cases, the results are compatible with drug effects on CBV independent of CBF. This may be a manifestation of completely normal physiology. If autoregulation is intact, a reduction in arterial pressure must be accompanied by cerebral vasodilatation, which acts to maintain CBF constant.



This vasodilatation is manifested by an increase in CBV. In other words, some of the ICP increases seen with antihypertensives (or hypotensive agents) may be a reflection of a normal process rather than a pathologic one.

One can argue that an increase in ICP combined with a fall in CBF may be detrimental, and these changes have lead some to conclude that these drugs are contraindicated in patients with mass lesions. Is this concern reasonable? In this case the answer is both yes and no. Nitroprusside can produce ICP-related neurologic deterioration in animals with mass lesions,<sup>509</sup> and there is one report of a decrease in the level of consciousness in a human given modest doses of the drug.<sup>438</sup> No similar observations have been made with nitroglycerin, but since most work suggests its ICP effects are identical, it is reasonable to accept the possibility. The difficulty with this caveat is that it limits the anesthesiologist to a group of clearly less useful/reliable drugs, e.g., trimethaphan (assuming that similar ICP changes don't occur). Furthermore, nitrates (and hydralazine) have been successfully used for many years in patients with a wide variety of neurologic disorders. Part of this success probably relates to the techniques with which the drugs are used. Marsh et al. documented that the magnitude of the ICP change is related to the speed of onset of drug effect.<sup>436</sup> When the dose of nitroprusside was gradually increased over many minutes, no ICP changes were seen. Presumably this allowed time for spatial compensation. This is also probably the reason that hydralazine, which has a very slow onset, has been used so widely with such safety in neurosurgical practice. In addition, these drugs are most often used in combination with other drugs (e.g.,  $\beta$ -blockers, captopril) that act to reduce the total dose of vasodilator given and hence their ICP effects.

**Antiadrenergic Agents:  $\alpha$ - and  $\beta$ -Blockers and Trimethaphan** As stated, nonanesthetic adrenergic agonists and antagonists appear to have little effect on resting CBF. These drugs also have little effect on ICP. Labetalol has been studied extensively in both animals and humans. Orłowski et al. administered labetalol to 15 postoperative neurosurgical patients who previously had required nitroprusside for the control of hypertension.<sup>551</sup> Mean ICP decreased from 11.3 mm Hg

with nitroprusside to 8.6 mm Hg after conversion to labetalol. Esmolol has also been used for blood pressure control in neurosurgical patients.<sup>522</sup> Its ICP effects have not been well evaluated but are expected to be minor.

There is relatively little information available concerning the CBF/ICP effects of pure  $\alpha$ -blocking drugs (phenoxymethamine, prazosin) in the context of neurosurgery, and much of this is quite old. Most authors suggest that these agents have little direct CBF/ICP effects, but shift the autoregulatory curve to the left, at least when hypotension is produced by hemorrhage.<sup>276,362</sup> Presumably, this results from blocking the effects of high circulating catecholamine concentrations.

For many years, the ganglionic blocker trimethaphan has been touted as an antihypertensive with little or no cerebral vascular effects. This is probably untrue—or at least the drug is not remarkably “better” than nitroprusside.<sup>474</sup> However, because this agent is now effectively obsolete, we do not discuss it further.

**Calcium Channel Antagonists** Most work with calcium channel blockers has focused on their potential as cerebral protectants. However, in many hospitals, these drugs are used for the acute control of hypertension. All of the available agents (verapamil, diltiazem, nifedipine, nimodipine, and nicardipine) can increase ICP in both animal models and humans.<sup>63,71,237,238,535</sup> Consequently, they have no apparent cerebrovascular advantages over smooth muscle relaxants, except perhaps in certain patients with ischemic heart disease. They are relatively long acting, and nifedipine can be given sublingually. Nicardipine has now supplanted verapamil and diltiazem as an intravenous antihypertensive.

**Adenosine** Adenosine is used for the treatment of supraventricular dysrhythmias.<sup>117</sup> It (or its analogue, adenosine triphosphate [ATP]) can be given intravenously, and its effects are rapid in onset and of generally short duration. Unlike nitroprusside, the drug appears to have few toxic side effects, and tachyphylaxis is rare.<sup>697</sup> However, modest degrees of blood pressure reduction have been associated with increases in ICP.<sup>765</sup> It has not been well evaluated as an antihypertensive (as opposed to being used for induced hypotension).

## HYPEROSMOLAR AGENTS IN NEUROANESTHESIA

The intraoperative fluid management of neurosurgical patients presents special challenges for anesthesiologists. Osmotic agents are among the most important tools to control ICP, however prospective data to establish clear guidelines for the use of these agents are lacking.<sup>542</sup> When the planned strategy only involves fluid restriction, patients are at risk for systemic hypotension, and a decrease in cerebral perfusion pressure resulting in brain ischemia. During surgery, administration of volatile anesthetics and potent vasodilators may further decrease cardiac filling pressures without actual changes in intravascular volume.<sup>844</sup>

One of the key physical features of any solution is its osmolality (the others are vapor pressure, freezing point and boiling point). Osmolality is a function of the number of particles in solution, commonly expressed as milliosmoles (mOsm) per kilogram of solvent.<sup>842</sup> Table 50–4 lists the osmolality and oncotic pressure of some commonly used intravenous fluids.<sup>844</sup> Oncotic pressure is the osmotic pressure generated by the solutes larger than some arbitrary limit (usually 30,000 molecular weight).<sup>844</sup> All plasma proteins (e.g., albumin, globulins, fibrinogen) contribute to the oncotic pressure, which represents less than 0.5% of the total osmotic pressure. For most physiologic solutions, the terms “osmolality” and “osmolality” can be used interchangeably.

Osmolarity is an important determinant of fluid movement between various physiologic compartments, as water from the solution of lower osmolality, will move across a semipermeable membrane, and into the solution of higher osmolality until the osmolalities of the two solutions are equal or the hydrostatic pressure is great enough to prevent additional flow of water across the membrane.<sup>844</sup>

In normal brain tissue, the blood-brain barrier limits the diffusion of molecules between the intra- and extravascular spaces. Small pore sizes of the blood-brain barrier prevent the movement of plasma proteins and even of ions (e.g., sodium, chloride, potassium) between the intravascular compartment and the interstitium of the brain.<sup>218</sup> The blood-brain barrier acts very much like a semipermeable membrane and the movement of water across it is deter-

TABLE 50–4.

## Osmolarity of Commonly Used Intravenous Fluids

Fluid	Osmolarity (mOsm/L)	Oncotic Pressure (mm Hg)
Lactated Ringer solution	273	0
D5 lactated Ringer solution	525	0
0.9% saline	308	0
D5 0.45% saline	406	0
0.45% saline	154	0
20% mannitol	1098	0
Hetastarch (6%)	310	31
Dextran 40 (10%)	approx. 300	169
Dextran 70 (6%)	approx. 300	19
Albumin (5%)	290	19
Plasma	295	21

Reprinted from Zornow MH, Scheller MS. Intraoperative fluid management during craniotomy. In: Cottrell JE, Smith DS eds. *Anesthesia and Neurosurgery*. 4th ed. St. Louis: Mosby, 2001: 237–243, with permission from Elsevier.

mined by the relative differences in the concentrations of impermeable constituents on either side of the membrane.<sup>844</sup> The situation is different in peripheral tissue, where the pore sizes between the capillary endothelial cells can be of much greater magnitude and movement of water is primarily determined by the plasma concentration of large macromolecules; primarily plasma proteins.<sup>496,842</sup> The differences between the mechanism for fluid movement in brain and peripheral tissue explain why administration of the large volumes of isoosmolar crystalloid results in peripheral edema (dilutional reduction in plasma protein concentration) but does not increase brain water content or ICP. Likewise, it follows that fluid restriction typically has no direct effect on brain water content.<sup>844</sup> Only the infusion of hyperosmolar or hypoosmolar solutions cause a net flux of water (by creating an osmotic gradient) across the intact blood–brain barrier.

Administration of large volumes of hypotonic (e.g., hypoosmolar) solutions increases brain water content and edema,<sup>842</sup> which can be deleterious in cases of intracranial hypertension.<sup>88,287,615</sup> Conversely, administration of hypertonic solutions “dehydrates” normal brain tissue and decreases ICP.<sup>844</sup> The acute effect of hyperosmolar solutions on lowering the ICP has been demonstrated.<sup>154,260,261,673,744,845</sup>

If the blood–brain barrier is intact, plasma osmolarity is the key determinant of water movement into brain. Therefore, compromise of blood–brain barrier integrity greatly decreases the effectiveness of any hyperosmolar agent. If the blood–brain barrier is

profoundly disrupted, plasma proteins will extravasate into the interstitial space and in addition to being unable to generate an osmolar gradient, it will be impossible to generate even an oncotic gradient. In such situations, changes in plasma oncotic pressure will not have any effect on water movement because no oncotic gradient between the plasma and the brain interstitial space can be produced (i.e., the proteins leak out of the capillaries into the brain tissue).<sup>844</sup> Therefore, the beneficial effects of the hypertonic solutions in cases of the localized brain injury, with disruption of the blood–brain barrier, are most likely derived from the ability of hyperosmolar solutions to cause a fluid flux out of brain tissue where the blood–brain barrier remains intact.<sup>844,845</sup>

Historically, a variety of osmotic agents (urea, mannitol, glycerol, and sorbitol) have been used for the treatment of cerebral edema. The ideal osmotic agent creates a desirable osmotic gradient by remaining largely in the intravascular compartment, is inert, nontoxic, and has minimal systemic side effects.<sup>88,287,555,640,841</sup>

### Mannitol

Mannitol, a simple alcohol derivative of the sugar mannose, came into clinical use in the 1960s. In current practice, mannitol is the mainstay of hyperosmolar therapy. Its popularity comes from the stability of solution, lack of toxicity and less vein irritation as compared to urea or hypertonic saline (HS). The effects of a single injection of mannitol on intracranial pressure are rapid, ranging from 30 to 60 minutes and a return to

baseline values in 2–10 hours.<sup>646</sup> Mannitol lowers ICP as a result of its osmotic properties and potent diuretic effect, and it decreases brain water content and cerebrospinal fluid volume.<sup>78,179,810</sup> Mannitol is considered to act first rheologically, improving cerebral perfusion by decreasing viscosity<sup>18</sup> and enhancing oxygen delivery, and then osmotically. But the rheologic effect of mannitol is not well documented and still remains debatable. Mannitol is commonly administered as 0.25–1 g/kg doses via a rapid intravenous infusion.<sup>844</sup> Neurotrauma guidelines recommend 20% mannitol (2 mL/kg) infused over 20 minutes for patients with elevated ICP and for patients with clinical signs of herniation and/or progressive neurologic deterioration before placement of an ICP monitor.<sup>87</sup>

The effects of 1 and 2 g/kg doses of mannitol on serum electrolytes and plasma osmolality have been examined.<sup>427</sup> In addition to an increase in plasma osmolality, there was a decrease in bicarbonate concentration. Mannitol doses of 1 g/kg result in an initial mild hyponatremia and hypokalemia from dilutional/osmotic effects. Hyponatremia can occur after diuresis. Neurotrauma guidelines identify 320 mOsm/L as a safe level to avoid nephrotoxicity from mannitol.

### Glycerol

Glycerol is naturally present in mammalian tissues. Intravenous glycerol has less hemodynamic impact than mannitol and can produce hemolysis when administered rapidly.<sup>555</sup> Oral glycerol can reduce ICP without significant gastrointestinal side effects. The use of glycerol for control of intracranial hypertension in the United States has become obsolete.

### Hypertonic Saline

Since the first description by Weed and McKibben in 1919, the beneficial effects of intravenous HS solutions on brain tissue have attracted interest for clinical use.<sup>799</sup> In the early 1980s, hypertonic solutions were shown to be beneficial in hemorrhagic shock.<sup>381,572,703</sup> Subsequently, the cerebral effects of these solutions were explored in animal models, supporting use in human brain injury. The goal of osmotherapy for cerebral edema is to maintain a euvolemic (or a mildly hypervolemic) but also hyperosmolar state.<sup>88,287</sup> A serum osmolality of 300–320 mOsm/L (corresponding serum

$\text{Na}^+$ , 145–155mEq/L) has been recommended for patients with poor intracranial compliance/elasticity.<sup>615,716</sup>

Experimentally the symptoms of hypernatremia ( $\text{Na}^+ > 145$  mEq/L) have been correlated with the speed of increase in serum sodium concentrations and appear at an osmolality  $> 350$  mOsm/L.<sup>29,451,773</sup> A sudden increase in natremia of more than 30 mEq/L will likely lead to lesions.<sup>773</sup> Clinical data on the complications of hypertonic states are found mostly in anecdotal reports of hypernatremia linked to dehydration.<sup>29,773</sup>

HS is an effective agent for hyperosmolar therapy that also has hemodynamic, vasoregulatory, and immunomodulatory effects.<sup>20,22,181,283,549</sup> Mechanisms explaining the vasoregulatory properties of HS include plasma volume expansion leading to increased vessel diameter, decreased endothelial cell edema, and decreased vascular resistance secondary to accentuated release of nitric oxide.<sup>69,145,762</sup> HS administered in bolus form demonstrates a biphasic response, suggesting first rheologic, then osmotic effect. Although a reduction in cerebral water content has been demonstrated in many animal models of cerebral edema,<sup>53,750,751</sup> the cerebral rheologic effects have only been established in animal models of hemorrhagic shock.<sup>672</sup> Under conditions of disrupted blood-brain barrier, the benefit of HS is tempered by extravasation of osmotically active substances into injured tissue (reverse osmotic gradient).<sup>555,640,841</sup>

### Traumatic Brain Injury

Osmotic agents reduce traumatic brain injury (TBI)-induced intracranial hypertension.<sup>241,319,589,713</sup> Shackford et al. demonstrated that treatment with either HS or hypertonic lactated Ringer solution ameliorated elevated ICP in TBI patients.<sup>671</sup> Vialet et al. described more effective treatment with isovolemic bolus (2 mL/kg) of 7.5% HS solution than with 20% mannitol in patients with refractory elevated ICP after severe TBI.<sup>773</sup> However, no difference in clinical outcome was demonstrated between the two groups.

### Ischemic Stroke

Ischemic stroke results in biphasic cerebral edema. Early anoxic injury results in cell death and intracellular swelling or cytotoxic edema. Blood-brain barrier disruption after hypoxia-

ischemia involves a cascade of events in which cytokines, vascular endothelial growth factor (VEGF), and nitric oxide are important mediators.<sup>55</sup> Disruption of blood-brain barrier and consequent vasogenic edema are known to intensify 3–72 hours after cellular injury.<sup>314,583,648,784</sup> Randomized clinical trials have not shown the routine use of mannitol in cases of ischemic stroke to be beneficial.<sup>78,79</sup> Mannitol boluses effectively reduce ICP but have no effect on clinical outcome.<sup>2</sup> Current guidelines recommend the use of mannitol in patients with large ischemic strokes only to control episodes of intracranial hypertension.

The efficacy of HS solutions in ischemic stroke is still not well defined. In patients experiencing intracranial hypertension resulting from large hemispheric stroke, HS seems to exert an effective transient improvement that is at least as reliable as, and may be greater than, mannitol.<sup>666</sup>

### Subarachnoid Hemorrhage

HS boluses have been reported to be effective in patients with subarachnoid hemorrhage (SAH) and elevated ICP refractory to mannitol.<sup>319</sup> Suarez et al. demonstrated that HS solutions could be used in patients with vasospasm and mild hyponatremia after aneurysmal SAH.<sup>714</sup> HS solution increases central venous pressure (CVP) and CPP; both are desirable effects of hypervolemic therapy for cerebral vasospasm. Likewise, intravenous infusion of HS enhanced CBF in patients with high-grade SAH.<sup>759</sup> However, the increase in global perfusion observed after HS appears to only be of transient duration.

### Tumor Edema

The space-occupying lesion and peritumor edema both play an important role in ICP elevation. The mechanisms leading to tumor-induced cerebral edema are not well understood but are related to histologic grade, the degree of brain invasion, and, in the case of meningioma, the amount of cortical blood supply.<sup>542</sup> Brain edema secondary to tumor responds well to corticosteroids. Hyperosmolar therapy is used for ICP crises, usually as a step before surgical decompression. There is only one study where investigators have examined the effect of HS on cerebral edema secondary to tumor effects.<sup>753</sup> They found HS to be more

effective than either furosemide or mannitol in reducing both ipsilateral and contralateral water content as measured by wet-to-dry-weight ratios.

Caution is required in the clinical use of HS as there are risks associated with the HS therapy. Table 50–5 summarizes the potential complications of using the HS.<sup>89</sup>

Although some suggest that HS solution administration may be particularly efficacious for lowering ICP in patients with head trauma, SAH, and postoperative cerebral edema, there are few, if any, direct comparisons of equiosmolar loads of hypertonic saline versus mannitol. Furthermore, no study of HS has reported a survival benefit of using HS as a treatment or prophylaxis for ICP episodes in intracerebral hemorrhage patients, this may be because of the generally poor prognoses of patients with intracerebral hemorrhage.<sup>89,542</sup>

## ANESTHETIC NEUROPROTECTION

The potential neuroprotective effect of anesthetic agents was originally described in the 1960s<sup>252,802</sup> when patients under general anesthesia appeared to demonstrate greater tolerance to ischemia than those who were not anesthetized. It was hypothesized that the mechanism for this increased tolerance was that the anesthetic-induced suppression of electrocortical activity enabled the brain to better tolerate a disruption in metabolic substrate delivery.<sup>483</sup>

The putative neuroprotective effect of anesthetics may be especially important for patients undergoing procedures known to have increased risk for cerebral ischemia (e.g., carotid endarterectomy, cardiopulmonary bypass, cerebral aneurysm clipping). However, until the therapeutic efficacy of individual anesthetics is established in humans, specific clinical recommendations are unwarranted. Although there are many preclinical studies that demonstrate the potential for anesthesia-induced neuroprotection, results of those animal studies have often been conflicting. Human trials are few, underpowered, and rarely assessed long-term efficacy.

The apparently conflicting results of laboratory outcome studies may be at least partially explained by consideration of methodologic details. During

TABLE 50–5.

## Potential Complications with HS Therapy

Potential Complication	Comments
Myelinolysis	Occurs commonly with rapid overcorrection of preexisting hyponatremia. Not reported with a change in serum sodium from a normonatremic to hypernatremic state in humans. In naïve, uninjured rats, induced hypernatremia (145–155 mEq/K) with HS solution does not cause myelin injury ( $\Delta$ 17 mEq/L) and a rapid increase of 35–40 mEq/L is required to induce myelinolysis.
Encephalopathy	Confusion, lethargy, seizures, and occasionally coma.
Subdural hematomas	Shearing of bridging veins owing to hyperosmolar contracture of the brain or effusions away from the dura
Transient hypotension	Occurs with rapid intravenous bolus injections, usually transient.
Pulmonary edema, heart failure, ventilatory failure	Rapid volume expansion is especially important in patients with poor cardiovascular reserve and a history of heart failure, neurogenic cardiac stun or pulmonary edema.
Hypokalemia	Rapid expansion of plasma volume without concomitant potassium replacement could lead to hypokalemia and cardiac arrhythmias.
Hyperchloremic acidemia	HS solution as a mixture of chloride-to-acetate (50:50) is recommended to avoid metabolic acidemia.
Coagulopathy	Caused by elevations in prolonged activated prothrombin and partial thromboplastin times impaired platelet aggregation.
Intravascular hemolysis	Slow infusion of HS solution is recommended because rapid changes in osmotic gradients in the serum may lead to hemolysis.
Phlebitis	Central route of administration is recommended. May occur if concentrated HS solution ( $>$ 2%) is given via the peripheral route.
Rebound cerebral edema	Usually occurs because of rapid withdrawal leading to elevated intracranial pressure or herniation syndromes. Slow withdrawal of therapy with HS solution is recommended.

Reproduced with permission from Bhardwaj A and Ulatowski JA.<sup>89</sup>

the first 30 years of research, there was little or no effort to control brain temperature, plasma glucose, or perfusion pressure in animals exposed to anesthetics for the purpose of studying neuroprotection. All of these factors are now known to be major determinants of ischemic outcome.<sup>788</sup> Also long-term outcome studies have been infrequently conducted. Finally, in the majority of studies, the presumed neuroprotective anesthetic was compared with another anesthetic that was assumed to be inert. Later studies, capitalizing on development of minimally invasive stroke models, have shown that these “control” anesthetics, in fact, may also have neuroprotective effects.

Anesthetics provide protection in animal models of both cerebral is-

chemic and traumatic insults when used during the insult but anesthetics have failed to provide benefit when administered after the insult.<sup>635,705</sup> This likely eliminates their use for postischemic neuroresuscitation.

Another important limitation of anesthesia-induced neuroprotection is the timing of the outcome assessment in animal models. When the outcome is assessed within a few days (less than 1 week) after an ischemic insult, protection is often robust, but 2 weeks after the ischemic insult, no protection is present. Kawaguchi et al. subjected rats to prolonged focal ischemia while awake or anesthetized with isoflurane. Isoflurane markedly reduced cerebral infarct size when assessed 2 days postischemia.<sup>360</sup> However, when

assessed at 14 days, the infarct sizes of the isoflurane group had expanded to a size similar to the awake group. Subsequent work provides evidence that the infarct expansion was attributable to apoptosis, which isoflurane failed to inhibit.<sup>331</sup> These results suggest that isoflurane delays but does not, by itself, prevent cerebral infarction caused by focal ischemia. However, these studies examined durations of vessel occlusion that markedly exceed those typically observed in clinical practice. It remains possible that sustained protection by volatile anesthetics can occur when more clinically relevant durations of ischemia are studied.

There are no data on long-term benefit from barbiturates given either prior to or during ischemia. Nehls et al. showed improved histologic outcome in baboons anesthetized with thiopental relative to those anesthetized with isoflurane following 6 hours of middle cerebral artery occlusion.<sup>527</sup> However, they did not evaluate long-term outcome intervals of weeks to months, now recognized to be essential in defining neuroprotective efficacy.<sup>98,135,331,359,763</sup> No effort has been made in vivo to determine whether barbiturates suppress apoptotic responses to ischemia. Thus, it remains unknown if barbiturate administration provides meaningful long-term neuroprotection following an ischemic event.<sup>98,135,331,359,763</sup> Based on the observation that brain continues to deteriorate for days to weeks after an ischemic insult, the concept of “neuroprotection” has been reconsidered. Classically, neuroprotection has been defined as prevention of cell death by treatment administered prior to the ischemic insult. In contrast, neuroresuscitation has been defined as treatment initiated after the ischemic insult, intended as a rescue for dying cells. Thus, the concept of neuroprotection can be extended to include protection of cells from delayed demise, attributable to apoptosis, inflammation, and oxidative stress that persists long after blood flow has been restored. The mechanisms of anesthetic neuroprotection remain under investigation. Barbiturates decrease CMRO<sub>2</sub>,<sup>798</sup> inhibit protein kinase C (PKC), decrease production of free fatty acids,<sup>683</sup> scavenge reactive oxygen species,<sup>693</sup> inhibit white blood cell function,<sup>529</sup> and inhibit excitatory neurotransmitter receptors.<sup>727</sup>



Volatile anesthetics share many of these properties. It has been postulated that a principal mechanism of anesthetic protection is potentiation of GABAergic afferentation consistent with an important known mechanism of anesthetic action. This would serve to balance markedly increased excitation occurring during the acute phase of energy failure. Others suggest that volatile anesthetics also serve to regulate intracellular calcium concentrations, which are critical to cell survival.<sup>256</sup>

Halothane,<sup>472,527,628,791,792</sup> isoflurane,<sup>65,66,240,476,488,530,789</sup> and sevoflurane<sup>792</sup> have been extensively studied in animal models of ischemia, most with short-term outcome analysis. In most cases, substantive protection was observed. However, there have been no attempts to define efficacy in human outcome trials. Thus, while volatile anesthetics have both theoretical and experimental bases to expect protection in humans, their efficacy in clinical scenarios remains speculative.

Nitrous oxide has been the subject of numerous studies. It carries the theoretical advantage of inhibiting glutamatergic hyperexcitation during ischemia because it is an N-methyl-D-aspartate antagonist. However, nitrous oxide can cause an increase in cerebral metabolic rate, especially if administered alone. Available evidence indicates that nitrous oxide is inert in the context of ischemic brain injury and its use during high risk procedures is better defined on the basis of criteria other than neuroprotection.<sup>786</sup>

Propofol (2,6-diisopropylphenol) attenuates neuronal injury in a number of experimental conditions, but studies in models of cerebral ischemia have yielded conflicting results. Moreover, its neuroprotective mechanism is poorly defined. Propofol reduces postischemic damage in models of transient ischemia<sup>239,374,579,609</sup> but not permanent focal ischemia.<sup>757</sup>

Etomidate showed similar efficacy as thiopental in a model of severe forebrain ischemia<sup>634</sup> but was less effective than thiopental in transient focal ischemia.<sup>184</sup> Etomidate was less effective than desflurane in maintaining tissue PO<sub>2</sub> during cerebral aneurysm surgery in humans.<sup>310</sup> Etomidate may even increase brain injury from focal ischemia in rat in part by a nitric oxide mechanism.<sup>186</sup> For these reasons, etomidate is rarely advocated as an intraoperative neuroprotective agent.

$\alpha_2$ -Adrenergic agonists (e.g., dexmedetomidine) showed neuroprotection in some models of cerebral ischemia<sup>383</sup> but  $\alpha_2$ -agonists may also prevent hyperemia and appropriate oxygen supply during hypoxia<sup>461</sup> because of a direct cerebral vasoconstriction.<sup>329</sup>

In addition to the anesthetics listed, many other nonanesthetic drugs are reported to have credible experimental neuroprotective properties. These drugs have been exploited to target specific mechanisms of ischemic injury by serving as reactive oxygen and nitrogen-species scavengers, excitatory amino acid antagonists, caspase inhibitors, inducible and neuronal nitric oxide synthase inhibitors, stimulators of endothelial nitric oxide synthase, protease inhibitors, and antiinflammatory/neutrophil adhesion agents. However, none have yet been found to provide clinically evident benefit and that implicates an exceedingly complex response of brain to ischemia.

Despite the many reports defining the neuroprotective effects of general anesthetics in animal models, there also are reports that under some conditions isoflurane, nitrous oxide, and ketamine have direct toxic effects in the brain, which are manifested by apoptotic neurodegeneration.<sup>337,755</sup> The developing brain (i.e., newborn animals) appears to be particularly sensitive to the toxic effects of these anesthetics. Anesthetic-induced brain injury is at least partially related to an excitatory amino acid toxicity and can be prevented by treatment with GABA agonists.<sup>330,332</sup> The clinical importance of this experimental finding has yet to be determined.

## ANESTHETIC PRECONDITIONING

Activation of injury cascades by a sublethal stimulus induces tolerance toward a subsequent lethal insult.<sup>128</sup> Preconditioning in the brain relies on the fact that prior exposure of the brain to minor "insults" will result in increased tolerance to future, more severe events. Acquired tolerance may be transiently and rapidly induced, or delayed and sustained.

Preconditioning can be classified as early or delayed. Early preconditioning produces tolerance within minutes to hours after the inducing stimulus, whereas delayed preconditioning re-

quires hours to days to develop a tolerant state.<sup>102</sup> In the brain, more attention has been paid to delayed preconditioning,<sup>369</sup> although from an anesthesiologist's perspective, acute preconditioning might offer more clinical relevance. Preconditioning can be induced by different stimuli such as mild ischemia, oxidative stress, hyperbaric oxygenation, inflammation, seizures, spreading depression, heat stress, and pharmacologic agents, including anesthetics.<sup>128,177,369</sup>

The underlying mechanism of preconditioning-induced neuroprotection remains controversial, but many studies described increased mitochondrial resistance as a consequence of preconditioning.<sup>26,166,835,837</sup> In clinical medicine, it has been suggested that preconditioning may be achieved with preoperative short-duration anesthetic administration, hyperoxia, electroconvulsive shock, the potassium channel opener diazoxide, and erythromycin.<sup>279</sup> However, none of these strategies has been tested in humans and thus none is (yet) clinically employed.

## Hypothermia

The neuroprotective quality of systemic hypothermia in neurosurgery was first reported in 1955.<sup>407</sup> Many laboratory studies have since demonstrated that mild hypothermia (a clinically relevant temperature of approximately 91.4–95 °F [33–35 °C], which does not require cardiopulmonary bypass) improves outcome from experimental ischemic and traumatic brain injury.<sup>132,176,493</sup> Translation of these observations to humans has been more difficult. A large-scale trial of mild hypothermia applied after traumatic brain injury failed to show benefit in humans.<sup>133</sup> Similarly, a study employing moderate hypothermia in patients undergoing cerebral aneurysm surgery found no benefit in 3-month outcome.<sup>743</sup> Both studies evaluated a large number of patients and were expected to find benefit. It remains plausible that study designs are in part accountable for the absence of benefit. For example, in the trauma study, cooling was not started for many hours after the injury occurred. Plausibly, an earlier onset of induced hypothermia might provide a different result and this is being investigated. Regarding aneurysm surgery, the goal was to achieve hypothermia at the time the aneurysm was clipped, after which rapid rewarm-

ing was begun. Perhaps earlier onset of hypothermia and/or a prolonged interval of postoperative cooling might have provided a different result. However, until such studies are conducted, we are left with no evidence that hypothermia provides benefit to patients with these disorders.

A large number of drugs have been studied in humans and to date none have been proven to be effective neuroprotectants. This raises the question whether it will ever be possible to achieve improved outcome when treatment is begun after the primary injury has occurred. We now know this is possible. Recent studies in patients with out-of-hospital cardiac arrest,<sup>82</sup> and with perinatal birth hypoxic/ischemic encephalopathy,<sup>250,674</sup> have been positive when cooling was begun shortly after the primary insult. In cases of cardiac arrest, the effects observed were sufficient for both the American Heart Association and the International Liaison Committee on Resuscitation<sup>537</sup> to recommend sustained cooling of patients remaining comatose after out-of-hospital ventricular fibrillation-induced cardiac arrest. The pediatric community has been less welcoming to the positive-outcome studies in infants and recommends that induced hypothermia be considered as an evolving therapy.<sup>299</sup>

The case of cardiac arrest may be the most relevant to management of anesthetic complications. The suggestion that patients suffering unanticipated perioperative cardiac arrest sufficient to sustain brain injury should be cooled to improve outcome is not novel.<sup>75</sup> Because of the low incidence of cardiac arrest in the operating room, it is unlikely that we will ever achieve a randomized prospective trial that definitively states whether or not induced hypothermia is efficacious in improving neurologic outcome. Similar issues pertain to cases of drowning which are sporadic. The American Heart Association has recognized the dilemma in defining efficacy in populations other than out-of-hospital cardiac arrest. They have stated that similar therapy may be beneficial for patients with nonventricular fibrillation cardiac arrest.

Thus hypothermia has been proven to offer postischemic efficacy in two discrete human conditions. The question arising from these studies is how widely can this data be extrapolated to circumstances that have not been spe-

cifically studied. We know from the traumatic brain injury and intraoperative aneurysm surgery trials that hypothermia, at least as it was employed in those trials, offers no benefit. Thus it cannot be expected to be universally protective. Conversely, both the trauma and aneurysm studies found negligible complications from the use of hypothermia. Consequently, current practice decisions, outside the bounds of out-of-hospital cardiac arrest, rest on the clinician's interpretation of the clinical circumstances resulting in an ischemic or hypoxic insult (e.g., loss of airway, drug-induced respiratory arrest, drowning, accidental asphyxia), and feasibility of rapid induction of moderate hypothermia. When loss of consciousness persists beyond restitution of ventilation and circulation, such patients are typically placed in an intensive care environment and are subjected to mechanical ventilation. Induction of hypothermia and its sustained maintenance for 12–24 hours is readily achieved by surface cooling (or gastric lavage or intravenous infusion with chilled saline). This approach to management should be considered.

## PRACTICAL CLINICAL MANAGEMENT

The challenge is now to translate physiology and pharmacology into a rational approach to clinical management. This is not an easy task because few clinical management schemes have been subjected to an objective trial. As a result, most published material, including this chapter, is contaminated by personal opinion and by experiences that may be unique to a particular practice setting. Because there is insufficient space to discuss every possible neurosurgical procedure, we have chosen to concentrate on three major areas: craniotomy for a supratentorial tumor, craniectomy for an infratentorial tumor, and craniotomy for an intracranial vascular lesion. Our discussion concludes with a few brief remarks about the care of patients with cervical spine disease and those undergoing transphenoidal operations.

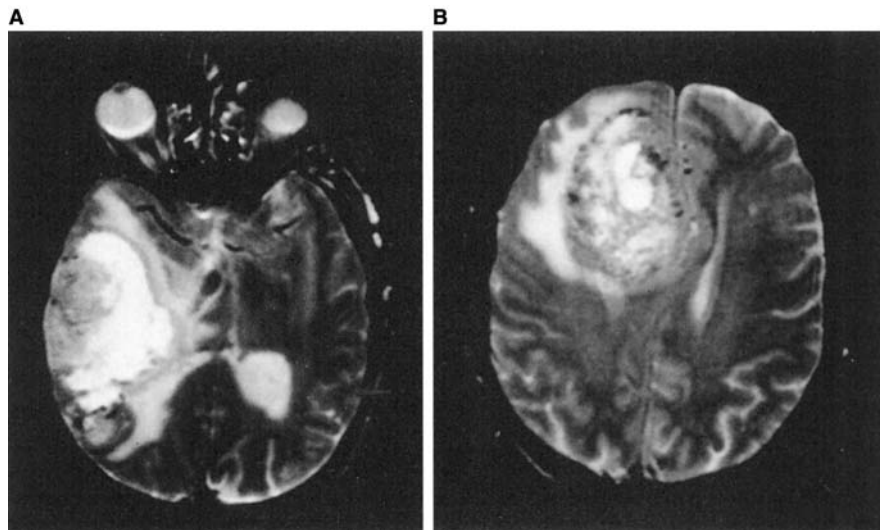
### Anesthesia for Supratentorial Craniotomy Preoperative Assessment

Neurosurgical patients require a comprehensive preoperative evaluation as

does any other individual scheduled for major surgery. However, other than routine information, three specific questions need to be asked: (a) Where is the mass lesion? (b) Is ICP already elevated? and (c) What is the patient's current neurologic status? The answer to the first question defines the surgical position and hence the placement of monitoring devices. It also tells something about the likely deficits that can arise. If retraction on the lateral sensorimotor cortex is needed to obtain exposure, the patient's contralateral upper extremity may be weak in the early postoperative period. If cranial nerve (CN) III must be manipulated by the surgeon, one pupil may be widely dilated in the postoperative period. With respect to ICP, not all patients with mass lesions have intracranial hypertension (most do not). Conversely, clinically normal patients do not necessarily have normal ICPs. Determining the likelihood of intracranial hypertension requires examination of the patient and a preoperative CT or MRI scan. The clinical diagnosis of intracranial hypertension is obvious in some patients (e.g., diminished level of consciousness, nausea, vomiting, anisocoria, papilledema). However, most patients do not have any of the "classic" signs and symptoms of intracranial hypertension and present to the hospital with headaches, seizures, or a focal neurologic deficit. The changes associated with intracranial hypertension include extensive edema surrounding the tumor and evidence for activation of compensatory mechanisms, including ventricular effacement, shifted midline structures, and compression of the basal cisterns. Alternatively, certain lesions, particularly those in the midline, may obstruct the normal flow of CSF and produce hydrocephalus. Finally, a brief neurologic examination provides the anesthesiologist with some basis for later comparison; the anesthesiologist may be the last person to see the patient before the induction of anesthesia and the first to see the patient awaken. This examination need not be complex. A simple, quick "move your arms, move your legs, open your eyes, where are you, what's your name..." is sufficient.

### Premedication and Transportation

After evaluation is complete, it is possible to make an intelligent decision regarding premedication. All sedatives



**FIGURE 50-16.** MRI scans from two patients with very large intracranial lesions. In both cases there was significant edema, ventricular effacement, and some degree of midline shift (most noticeable in **B**). In spite of similar apparent mass effects, however, intraoperative ICP measured under identical anesthetic conditions ( $\text{Paco}_2 = 30$  mm Hg, isoflurane/ $\text{N}_2\text{O}$  anesthesia,  $10^\circ$  head up, no mannitol until after measurements) was 12 mm Hg in **A**, and 55 mm Hg in **B**. The only difference between patients was that the family of **B** has noted the patient to be a bit more sleepy than usual.

1106

(including benzodiazepines) carry the potential for producing hypercapnia. Fortunately, a few mm Hg increase in  $\text{Paco}_2$  is probably not important in the great majority of patients, and most experienced neuroanesthesiologists are comfortable with premedicant doses of midazolam. In contrast, opioids are almost universally avoided. A 5-mg dose of midazolam may be appropriate for a neurologically intact patient with a small mass lesion, no midline shift, normal ventricular size, and so forth, but it might be fatally inappropriate in an individual such as the one shown in Fig. 50-16. Most patients are not closely observed after premedicant drugs are given. If they deteriorate, they may do so alone. An alternative is to administer sedatives intravenously when patients arrive in the operating room area where they can be more closely observed.

Given the value of a head-up posture for controlling ICP, we recommend that patients with mass lesions be transported with the head of the bed elevated  $15\text{--}30^\circ$ .

### Monitoring

Monitoring decisions have become simpler in recent years because of the availability of capnography, pulse oximetry, and automated oscillometric blood pressure cuffs, as well as the routine acceptance of arterial catheters. Arterial catheters serve two roles.

First, they assist in the management of arterial blood gases and blood chemistry. Second, they provide a beat-by-beat view of blood pressure, which may be useful in situations where autoregulation is disturbed. If a patient is cooperative, it is reasonable to place the catheter before the induction of anesthesia, but it is rarely mandatory. It may be entirely acceptable to induce anesthesia guided by expired  $\text{CO}_2$ ,  $\text{SpO}_2$  (oxygen saturation as measured using pulse oximetry), and a rapidly cycled automated cuff; the arterial catheter can be placed later. In fact, some cases can be handled without an arterial catheter, particularly in healthy individuals with small and easily accessible tumors.

CVP catheters are used far less commonly. They provide information about intravascular volume when major blood loss is anticipated (e.g., during the resection of a large and highly vascular meningioma or hemangioblastoma). They also can monitor intrathoracic pressure. Finally, they can be invaluable in the fluid management of patients who are at risk for the development of diabetes insipidus, such as those undergoing resections of large suprasellar tumors such as craniopharyngiomas. There are very few “neurosurgical indications” for pulmonary artery catheterization. These include patients with significant cardiac disease or elderly patients for whom

massive blood loss or a very long anesthetic is anticipated, or in whom profound induced hypotension is planned. (The use of pulmonary artery catheters as a monitor for venous air embolism is discussed later in Venous Air Embolism.)

A recurrent question concerns the “indications” for the preanesthetic placement of ICP monitors. Fifteen years ago some would have said that any patient with a large mass lesion, particularly with an altered level of consciousness, should have a preoperative ICP monitor placed.<sup>73</sup> This is no longer reasonable. Our current understanding of ICP physiology and the effects of our agents have made it unnecessary to directly measure ICP for purely anesthetic reasons. The intraoperative measurement of ICP before opening the dura (e.g., with an epidural device) may prove useful in determining the need for mannitol, and there is some limited interest in postoperative monitoring, particularly in patients having posterior fossa procedures.<sup>558,617</sup> It is not, however, possible to make any firm recommendations for such use at present.

### Anesthetic Induction and Maintenance

There is simply no evidence that any one approach to anesthetizing these patients is better than any other. The fact that one drug increases CBF more than another or has a 10% small effect on ICP is insufficient to conclude that it is a “bad” neuroanesthetic. Agents such as halothane and  $\text{N}_2\text{O}$  have been used successfully in tens of thousands of patients. However, most commonly “accepted” methods have three goals in common: (a) a smooth induction without sudden hypertension or hypotension; (b) the rapid achievement of hypocapnia before the administration of volatile agents and/or  $\text{N}_2\text{O}$ ; and (c) that the technique is compatible with a rapid postoperative emergence. There are obviously many ways to accomplish such goals, and the following points represent only the most general guidelines.

Despite many years of effort and many alternative drugs (e.g., methohexital, Althesin, etomidate, diazepam, midazolam, ketamine, alfentanil, propofol, etlanolone), no induction agent is clearly superior to thiopental. Hypotension during induction can usually be avoided by preinduction volume loading (e.g., 10 mL/kg of lactated Ringer



solution) and by adjusting the dose according to patient age and physical status. The patient should be in a modest head-up posture at the time of induction (i.e.,  $10^\circ$ ). When consciousness is lost, manual hyperventilation is begun with oxygen. When a patent airway is assured (using oral or nasal airways if needed), a paralyzing dose of a nondepolarizing relaxant is given, and administration of the primary agent is started gradually. The most common alternatives involve incremental loading with one of the synthetic opioids (fentanyl, sufentanil, alfentanil—or perhaps remifentanyl) combined with  $N_2O$ , or the administration of a volatile agent in progressively increasing concentrations (with or without  $N_2O$ ). A propofol infusion can also be used. However, data now available indicate that none of these approaches offers any major advantages.<sup>745</sup> With respect to the three opioids, fentanyl is equivalent to sufentanil and alfentanil and much cheaper.<sup>232</sup> Remifentanyl has been compared with fentanyl, and again, offers no striking advantages other than slightly more rapid emergence (Warner D, Hindman B, and Young W, personal communications). The trachea is intubated when paralysis is complete. The hemodynamic response to intubation can be blunted in many ways. These include additional opioids (e.g., fentanyl to a total loading dose of 10–12  $\mu\text{g}/\text{kg}$ ), supplementary thiopental, intravenous lidocaine (1–1.5  $\text{mg}/\text{kg}$ ) or short-acting antihypertensives (e.g., labetalol, esmolol). Topical anesthesia of the trachea is also widely used, although this does not alter the response to laryngoscopy per se.<sup>277</sup> Mechanical ventilation is begun, the endotracheal tube is secured, additional monitors are inserted (e.g., esophageal stethoscope, temperature probes), the eyes are securely closed, and surgical positioning is begun. The patient is covered with blankets (or forced air warmer) to maintain body temperature.

Like induction and maintenance, there are a dozen different ways of waking someone up. We believe that blood pressure should be restored to normal before the dura is closed. This is a simple way of verifying the adequacy of hemostasis. Normocapnia should be present before dural closure is complete; if the brain is so badly swollen that the dura cannot be closed, the patient should be taken to the ICU on controlled ventilation. Because uncontrolled hypertension

is associated with an increased incidence of postoperative intracranial hemorrhage,<sup>347</sup> aggressive treatment is necessary. As with other aspects of management, the choice of antihypertensive drug is a matter of personal preference (see previous discussion in Antihypertensives). Some added blood pressure control can be obtained by reducing the dose of atropine or glycopyrrolate given at the time neuromuscular blockade is reversed, thereby avoiding any tachycardia. A very brief period of coughing/gagging at the time of extubation is probably acceptable if blood pressure is controlled, although this can be blunted with lidocaine if desired. We also believe that such patients should be transported to the postanesthesia care unit or surgical intensive care unit with at least some form of blood pressure monitoring, particularly if the resection was very bloody.

### Management of Severe Intraoperative Brain Swelling

The preceding protocols will serve the majority of cases. The most serious deviation from routine involves the management of the severely swollen brain. Because this is so often mismanaged by the inexperienced anesthesiologist, some specific recommendations are appropriate. The course taken is defined by the answers to some simple questions:

- Is this a major ventilatory disaster?
- Is the brain swollen because of a disconnect, severe hypoxia, hypercapnia, etc.?
- Is the chest moving appropriately?
- Does the patient have a reasonable expired  $\text{CO}_2$  waveform, and what is the end-tidal carbon dioxide ( $\text{ETCO}_2$ ) concentration?
- What is the  $\text{SpO}_2$ ? An arterial blood gas sample should be drawn immediately.
- Is the swelling related to impaired cerebral venous drainage?

As noted earlier, the problems of venous drainage are often overlooked. We believe that the overwhelming majority of swelling problems encountered in the neurosurgical operating room are related to poor venous drainage. The most common are (a) excessive rotation of the neck, (b) inadequate head-up posture, and (c) some form of expiratory obstruction in the patient circuit. There is little reason for employing pharmacologic ICP con-

trol methods unless these have been corrected. Simply increasing the degree of head-up tilt is often sufficient.

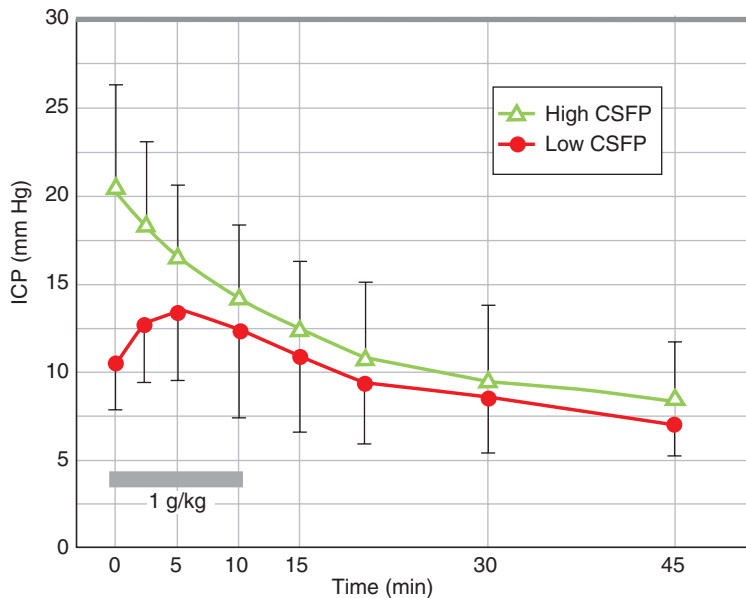
- Is the swelling hemodynamic?
- Is the patient hypertensive and/or tachycardic?
- Is the anesthesia too light? In some cases, light anesthesia combined with inadequate paralysis can be manifested by chest tightness and increasing intrathoracic pressures, without other movement.

After these three (a), (b), (c) iatrogenic causes have been ruled out, it is best to first assume that the swelling is related to patient disease, not some iatrogenic factor. The next therapeutic step is to reduce  $\text{Paco}_2$  to between 20 and 25 mm Hg, and verify that  $\text{Pao}_2$  is  $>100$  mm Hg. Ideally, this should be achieved without an increase in mean intrathoracic pressure, something accomplished by keeping an inspiratory-to-expiratory (I:E) ratio  $>1:2$ . The limitations of greater degrees of hypocapnia have been described in The Clinical Utility of Hypocapnia.

Next, diuretic therapy is begun, typically with osmotic agents. Such compounds (mannitol, urea, sorbitol and hypertonic saline) all act in the same fashion: they produce an osmotic gradient across the intact blood-brain barrier which acts to “draw” water down its concentration gradient from brain to blood.<sup>217</sup> Again mannitol is the best characterized compound and remains the agent of choice when the patient's baseline osmolality is  $<290$   $\text{mOsm}/\text{kg}$ . A reasonable starting dose is 0.25  $\text{g}/\text{kg}$ , a value derived from experience with ICP control after head trauma. However, there is a major difference between controlling ICP (where small volume changes can have huge ICP effects when compliance is poor) and controlling brain bulk (where much larger reductions in volume may be needed to facilitate surgical exposure). For this reason, there should be little hesitation to increase the dose to  $>1$   $\text{g}/\text{kg}$  if swelling does not resolve. The upper dosage limit is defined only by osmolality, which should remain  $<310$ – $320$   $\text{mOsm}/\text{kg}$  (Fig. 50–17).<sup>604</sup>

Another alternative (or supplementary) choice is furosemide in doses of 0.3 to 1.0  $\text{mg}/\text{kg}$ .<sup>633,807</sup> It is not as reliable as mannitol, but may be preferable in patients unable to tolerate the transient intravascular volume expansion





**FIGURE 50-17.** Changes in ICP (actually lumbar cerebrospinal fluid [CSF] pressure) after the administration of 1 g/kg of mannitol. Patients in the “high CSF pressure” group had a mean premannitol ICP of 20.8 mm Hg, whereas those in the “low CSF pressure” group had a pressure of 10.5 mm Hg. In the low CSF pressure group, mannitol resulted in a significant but transient increase in ICP. Nonetheless, no such transient increase was seen in patients with prior intracranial hypertension. All values are mean  $\pm$  standard deviation (SD). (Data recalculated from Ravussin P, Abou-Madi M, Archer D, et al. Changes in CSF pressure after mannitol in patients with and without elevated CSF pressure. *J Neurosurg* 1988;69:869.)

that occurs with mannitol. Its effects are much slower in onset.<sup>807</sup> In situations where brain swelling is severe, a combination of mannitol and furosemide has been used successfully. Under these conditions, the value of furosemide may be related to its unique ability to inhibit the mechanisms that act to maintain normal cell volume in the face of hypertonicity.<sup>458</sup> When normal cells (including neurons and glia) are exposed to a hypertonic environment, they transiently shrink, but rapidly regain their normal volume, largely a result of the active importation of chloride. This influx of Cl can be blocked by loop diuretics, with the result being a persistent reduction in cell volume. The major problem with a combination of mannitol and furosemide is the often extraordinary diuresis that ensues—a diuresis that can be difficult to distinguish from severe diabetes insipidus.

If this sequence fails to control swelling, the surgeon should be asked to cannulate one of the ventricles to remove CSF and to decompress any cystic lesions or hematomas. At the same time, anesthetic management should be reevaluated. If fluid removal cannot be accomplished, it may be appropriate to discontinue agents with the potential for increasing CBV. We

believe that the first drug to discontinue is N<sub>2</sub>O. It can be replaced with a volatile agent, an opioid, or a combination of an opioid and a sedative-hypnotic. If swelling does not resolve, the volatile agent should be discontinued. Only when these interventions fail should high-dose barbiturates be used as a *therapy of last resort*. Before starting, every effort should be made to ensure the patient is normovolemic, using whatever isotonic intravenous fluid is desired. Several groups have shown that barbiturates are both venous and arterial vasodilators, as well as myocardial depressants,<sup>742,754</sup> and Traeger et al. showed that hypotension is most commonly related to inadequate cardiac filling pressures.<sup>754</sup> We begin with incremental doses of 150–250 mg, repeated as often as hemodynamically tolerated. This is continued until swelling is under control or cardiovascular toxicity becomes a problem. In rare situations, inotropic support may be needed.

### Anesthesia for Infratentorial Craniectomy: The Sitting Position

Operations in the posterior fossa are unique for several reasons. First, the lesion itself and/or surgical trauma can

damage brain areas that control the airway (pharynx, tongue, larynx), respiration, autonomic function, and consciousness. Second, these operations are performed in unusual positions—that is, prone, lateral, or sitting—each of which has particular problems. It is the sitting position that has received the bulk of our attention and that poses the greatest management problems. Consequently, we first discuss the management of the upright craniectomy and then briefly mention the differences introduced by the alternatives.

### Problems

In spite of the concerns about venous air embolization, the sitting position is still in widespread use and offers many advantages over alternative positions. These include excellent surgical exposure, particularly of midline structures and those located in or on the high dorsal brainstem or midbrain (e.g., the pineal). There is less pooling of blood and CSF in the surgical field, and blood loss may be less than with nonsitting positions because of the lower venous pressures.<sup>96</sup> It is comfortable for the surgeon. It is often easier to move a large patient into the sitting position. In addition, peak airway pressures may be lower and ventilation-perfusion matching better than those seen in the prone position. The face and airway are accessible, making it easier to monitor facial nerve function. These must be balanced against the disadvantages: (a) venous air embolism, (b) paradoxical air embolism, (c) quadriplegia, (d) hemodynamic deterioration, and (e) pneumocephalus. Other concerns are peripheral nerve injuries and head/neck/tongue edema. In addition, a serious concern in any posterior fossa procedure is the possibility of injury to the lower cranial nerves and respiratory centers.

**Venous Air Embolization** Venous air embolization (VAE) can occur whenever the pressure within an open blood vessel is subatmospheric. Because normal right atrial pressures range from 2 to 10 mm Hg, this can theoretically occur any time the surgical site is located more than  $\approx$ 5 cm above the heart. However, experience indicates that clinically significant VAE is rare unless the surgical site is elevated by more than 20–40 cm. (VAE can occur in other surgical settings. However, an enormous number

of patients undergo procedures where the surgical site is higher than the heart, including supratentorial craniotomies, shoulder repairs, hysterectomies, and lumbar laminectomies. VAE has been anecdotally described in all of these, as well as during the injection of air during placement of epidural catheters. However, clinical experience tells us that the incidence of hemodynamically important emboli in such situations is vanishingly low.) In addition, the risk of VAE increases when open veins cannot collapse. This is encountered with injury to, for example, the venous sinuses, cerebellar bridging veins, epidural veins, emissary veins, and marrow spaces in the skull or cervical vertebra. This latter possibility explains occasional embolization of air from pin-fixation sites. Another unusual source of air entry is a *ventriculoatrial* (VA) shunt (not a *ventriculoperitoneal* [VP] shunt). If a bubble enters the ventricles, the shunt acts as a direct route to the heart.

It was once believed that VAE was a rare but fatal complication. When more sophisticated monitors were used, a much higher incidence of generally benign events was seen. Standifer et al. evaluated 322 cases (288 with a Doppler ultrasound) and noted VAE in only 22 patients (7%).<sup>702</sup> However, Matjasko et al. reviewed their experience in 554 seated cases and noted air entry in 41% of patients undergoing suboccipital craniectomies and in 11.4% of those having cervical laminectomies.<sup>445</sup> Young et al. reported a similar incidence (43%) among 146 patients undergoing suboccipital craniectomies, with an overall incidence of 30% (all procedures combined, 255 patients).<sup>827</sup> Black et al. also noted an incidence of 43%.<sup>93</sup> Hence it is reasonable to conclude that among patients undergoing posterior fossa procedures, the incidence of VAE is approximately 40%, compared with 10–15% for cervical spine surgery.

These four studies include ≈1500 reasonably monitored patients, among which VAE was detected in 372. This is probably an underestimate because some earlier patients were not Doppler ultrasound monitored, and there are no data regarding Doppler placement in any study. However, a possible relationship between intraoperative VAE and postoperative morbidity or death could be defined in only 6 cases (≈0.4%). This compares with a “surgical” mortality of ≈2%. Although this,

again, may be an underestimate, these data still do not support the idea that the sitting position should be abandoned purely because of the risk of VAE. The obvious caveat is that these results were obtained in centers with a great deal of experience and may not be reproducible in hospitals that do only an occasional sitting procedure.

### **Paradoxical (Arterial) Air Embolization**

There is a potential for the passage of air from the right to the left of the heart, with subsequent entry into the coronary or cerebral circulation. This can occur via either the pulmonary vascular bed, or more commonly, a patent foramen ovale (PFO). The incidence of clinically significant paradoxical air embolism (PAE) is unknown. However, a large number of patients are theoretically at risk. Autopsy studies indicate that 25–35% of patients have at least a probe-patent foramen ovale. Given a 40% incidence of VAE, one can calculate that ≈12% of patients are “at risk” for a PAE (30% of 40%). This value is far greater than the number of patients who suffer a deficit/complication of a VAE. Why? First, not everyone with a probe-PFO has a *functional* right-to-left shunt. The number of patients is theoretically reduced even further by the fact that the normal pressure gradient (right atrial pressure less than left atrial pressure) reverses during anesthesia in the sitting position in only approximately 50% of patients. (The importance of this observation has been questioned by Black et al. who demonstrated that changes in the gradient may not be as important as believed, largely because transient reversal of the gradient during a single cardiac cycle occurred commonly in pigs with a surgically created atrial septal defect.<sup>94</sup>) Echocardiographic studies demonstrate that right-to-left shunting of contrast material can be shown in up to 18% of normal volunteers,<sup>412</sup> but was detected in only 6–10% of patients scheduled for surgery.<sup>95</sup> In many cases, shunting was seen only during a Valsalva maneuver that is performed to increase right atrial pressure. Even in anesthetized, sitting patients, echocardiographic studies revealed right-to-left air passage (either during testing or during a clinical VAE) in 3 of 20 patients (15%). The absence of right-to-left shunting, with or without the Valsalva maneuver during the preoperative evaluation, does not preclude the

occurrence of paradoxical air embolism intraoperatively.

If 15% of patients suffering a VAE also have PAE, why is the incidence of PAE-related complications so low? The principal reason is that most paradoxical emboli are benign. A review of the anesthetic literature shows a total of 7 patients with echocardiographically documented PAE during sitting surgery.<sup>95,156–158,236</sup> No sequelae were noted in any of these patients. Animal studies in our own laboratory (Dan Reasoner and Brad Hindman, personal communication) suggest that doses of air on the order of 100–150  $\mu\text{L}/\text{kg}$  must be directly injected into the internal carotid artery to reliably produce a deficit—which indicates that tiny bubbles are unlikely to be detrimental (although continuous streams of bubbles, even small ones, may lead to injury).

These arguments are not intended to suggest that PAE is trivial or that the potential for PAE should be ignored. Quite the contrary—it is a devastating complication. However, every bubble entering the arterial circulation does not mean that a stroke will occur, and *the best prevention of PAE is still the early detection and prevention of VAE*. It has been suggested that all patients considered for a sitting position undergo preoperative echocardiography. Although an attractive idea, it is unlikely to find wide acceptance in an era of cost consciousness, particularly in view of the documented safety of doing the surgery without such studies. A more reasonable approach would be to carry out echocardiographic studies in patients with clinical signs or history suggestive of a PFO, such as unevaluated murmurs now or in the past. This study should be done with contrast medium injected before, during, and immediately after a Valsalva maneuver. If shunting is demonstrated, the procedure should probably be carried out in an alternative position—although surgical considerations must be weighed as well.

**Quadriplegia** Episodic cases of unexpected quadriplegia/paresis have been reported for many years after cases in the sitting position.<sup>806</sup> Neither the incidence nor the etiology is known with certainty, but two cases were reported among the ≈1500 patients reported in the four studies noted previously. The most likely cause is a combination of cervical cord

compression from extreme neck flexion and a reduced arterial perfusion pressure produced by elevating the neck above the heart. In support of this, McPherson et al. have reported major evoked potential changes with neck flexion/rotation even in a horizontal position.<sup>463</sup> The risk may be greater in persons with cervical cord compression, that is, the same people who undergo cervical procedures in the sitting position.<sup>172</sup> The only suggested preventive measures are the avoidance of extreme flexion and the monitoring of blood pressure at the level of the surgical site, rather than the heart. Somatosensory evoked potential monitoring is a potential but insufficiently evaluated monitor of such conditions.

### Hemodynamic Deterioration

Moving an anesthetized patient from the supine to the sitting position does result in a number of hemodynamic changes, although few data are available. The most complete study is by Marshall et al., who studied patients receiving one of four anesthetics (enflurane-N<sub>2</sub>O, halothane-N<sub>2</sub>O, Innovar-N<sub>2</sub>O, or morphine-N<sub>2</sub>O).<sup>440</sup> In all groups, assumption of the sitting position was accompanied by a decrease in wedge pressure and cardiac output, with an increase in systemic resistance. The smallest changes were observed in patients receiving a combination of morphine-N<sub>2</sub>O, but hemodynamic parameters recorded during surgery were remarkably similar with the groups. This study failed to include a “time-control” group of patients receiving the same anesthetic but left in the supine position, and some of the changes may simply be related to the duration of anesthesia, not position. More important, little information is available concerning the hemodynamic consequences of the alternative surgical positions (prone, lateral), but it is noteworthy that Black et al. found essentially identical 20% incidences of hypotension requiring vasopressors in 330 sitting patients and in 229 patients who remained in a horizontal position.<sup>96</sup>

**Pneumocephalus** Some degree of pneumocephalus occurs in all craniectomies performed in the sitting position,<sup>752</sup> in fact, it is seen in all postoperative craniotomy/craniectomy patients regardless of position.<sup>602</sup> Hence it is not surprising that tension pneumocephalus

is a well-described event after such procedures.<sup>702</sup> CSF drains easily in the sitting position, and air will move upward and collect over the cerebral convexity (the “upside-down bottle” effect). If the wound is then closed and the patient returned to the supine position, cerebral venous pressure rises, CBV increases, and the brain reexpands, potentially compressing the gas. This alone may be capable of producing a tension pneumocephalus. Artru has argued that the intraoperative use of N<sub>2</sub>O may worsen this situation,<sup>30</sup> although experimental studies disagree<sup>178,691</sup>; the key seems to be whether N<sub>2</sub>O administration is delayed until after pathways for air escape have been closed (i.e., whether there is a trapped bubble). Delayed problems can also occur if CSF reaccumulates at a rate faster than the air is absorbed. Tension pneumocephalus may be difficult to diagnose, but should at least be suspected when a patient fails to awaken after an uneventful procedure, deteriorates after awakening, or suffers some unexplained cardiovascular catastrophe. If clinical changes are mild, simple administration of high concentrations of O<sub>2</sub> will speed the resolution of the bubble.<sup>95</sup> If the changes are major, surgical evacuation is indicated.

**Other Problems** The two final difficulties deserving mention are peripheral nerve injuries<sup>96,456</sup> and severe swelling of the face and tongue.<sup>199,455</sup> Direct pressure injuries can also occur, more commonly in nonsitting positions. Sciatic stretch injuries can also occur if excessive flexion at the hip is allowed. Facial/glossal swelling (sometimes so severe as to preclude extubation) is probably related to excessive neck flexion. Similar swelling can also be seen in the prone position.

### Preoperative Evaluation and Premedication

Although intracranial hypertension is a common concern in the patient with a supratentorial tumor, this is less common in those presenting for posterior fossa procedures. The most common cause of elevated ICP in such patients is hydrocephalus, resulting from obstruction of the aqueduct or the fourth ventricle. This is easily recognized on the CT/MRI scan, and in many situations is corrected preoperatively or intraoperatively with a ventricular cannula. Nevertheless, the

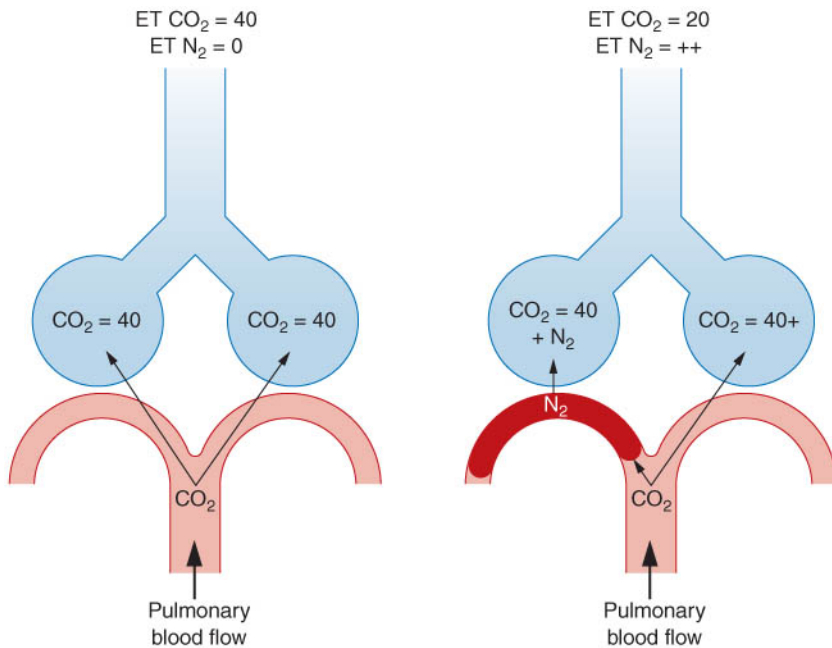
presence of symptomatic hydrocephalus or elevated pressures in the posterior fossa represent a contraindication to premedication. Asymptomatic persons with small cerebellopontine angle masses or tumors of the cerebellar hemispheres can usually be premedicated without difficulty.

### Monitoring and the Physiology of VAE

The principal monitoring challenge of the sitting position is to rapidly detect VAE. Fortunately, extensive clinical and experimental work has removed much of the guesswork from this area.

The slow entrainment of small bubbles is of little significance; either gas dissolves in the blood or the bubbles pass into the pulmonary capillaries and are absorbed. If the embolus is larger and/or enters faster than it can be cleared, one sees progressive occlusion of the pulmonary vascular bed. This results in an increase in pulmonary vascular resistance, a rise in pulmonary artery mean pressure, and an increase in right-heart “afterload” with eventual increase in right atrial pressure. If obstruction is severe, cardiac output will fall, caused by (a) an “air-lock” in the right ventricle (RV), (b) RV failure, or (c) impaired left ventricle (LV) filling caused by displacement of the intraventricular septum by a distended RV. In addition, respiratory abnormalities appear. Vascular obstruction results in an increase in the ventilation/perfusion mismatch (“dead space”; Fig. 50-18). The result is an increased gradient between arterial and ET<sub>CO</sub><sub>2</sub> concentrations, manifested by a falling ET<sub>CO</sub><sub>2</sub> and a rising P<sub>a</sub>CO<sub>2</sub>.<sup>249</sup> These same ventilation-perfusion ( $\dot{V}/\dot{Q}$ ) abnormalities will lead to hypoxemia, partly as a result of mechanical occlusion and partly because of the release of vasoactive compounds from either blood or from the vessel walls. In fact, changes in P<sub>a</sub>O<sub>2</sub> often precede alterations in positive airway pressure or ET<sub>CO</sub><sub>2</sub>, supporting the idea that vasoactive compounds may be involved. Finally, the bubbles of air entering the capillary bed will result in the appearance of N<sub>2</sub>O in expired gas, although this is usually detectable only when a patient is breathing 100% O<sub>2</sub>.

In the face of a sudden, massive embolus, these changes occur almost simultaneously. Under such circumstances, “monitoring” is irrelevant. However,



**FIGURE 50–18.** Changes in expired CO<sub>2</sub> and N<sub>2</sub> in alveoli (*left* diagram). A VAE does two things (*right* diagram). First, it occludes a portion of the pulmonary circulation, preventing the delivery of CO<sub>2</sub> to the alveoli. As a result, end-tidal CO<sub>2</sub> (which should represent an alveolar gas sample) will decrease (even though PaCO<sub>2</sub> may rise). In addition, N<sub>2</sub> present in the gas bubble will diffuse into the alveoli and appear in exhaled gas.

most emboli are not this catastrophic. What typically occurs is a continuous infusion or repeated small boluses of air.

We believe that changes in hemodynamic and respiratory parameters are very insensitive monitors of air entrainment. We believe that the only clinically acceptable “early warning” device is the precordial Doppler ultrasound.<sup>245,475</sup> This device reflects sound waves from moving red blood cells. Bubbles entering the circulation change the reflectance characteristics of the blood and alter the Doppler frequency. Multiple studies and human experience have demonstrated the extraordinary sensitivity of this device. In our operating room, Doppler placement is routinely tested by the injection of 0.25–1.0 mL of air (i.e., 0.004–0.01 mL/kg) or 3–5 mL of agitated saline. Gilgenberg et al. showed that a Doppler can reliably detect air being infused at a rate of 0.021 mL/kg/min in dogs.<sup>245</sup> This is at least 10 times more sensitive than any hemodynamic/respiratory monitor studied under the best of laboratory conditions. It also has the advantage of being audible, allowing the anesthesiologist to attend to other duties. The transesophageal echocardiograph is equally sensitive but requires continuous visual attention (and is far more expensive).<sup>157</sup>

There are admittedly two difficulties with the Doppler: it must be accurately placed and it may be too sensitive. Doppler placement is not a trivial undertaking. It is unacceptable to place the transceiver in the fourth intercostal space to the right of the sternum, hear heart sounds, and proceed (this will identify only 90% of air emboli). One should place the Doppler wherever the right atrium is! Furthermore, this should be done after the patient has been placed in the sitting position and not before, because the heart moves with gravity as the sitting position is assumed. Testing is mandatory and should be repeated at intervals throughout surgery so that all operating room personnel become familiar with the sound of air entrainment and to confirm that the Doppler is still in the right place. The “gold standard” is air or CO<sub>2</sub> injected through a right atrial catheter. If a catheter cannot be placed, air or agitated saline can be injected through a peripheral IV. However, if a convincing change in Doppler sounds is not heard, one cannot depend on the instrument as an early warning device. Under no conditions should a neurosurgical procedure in the sitting position proceed without a properly placed Doppler even in the presence of a capnograph or respiratory gas monitoring.

The question of excessive sensitivity deserves comment. The Doppler commonly presents its audience with a chorus of chirps and blips, none of which appear to be of consequence. Obviously, one cannot disrupt surgery for each. The difficulty lies in deciding which sounds deserve attention. Distinguishing the sounds of air from other sounds is largely a matter of experience, but recognition can be improved by repeated testing of the instrument, by the injection of tiny amounts of air or agitated saline. Determining the amount of air being entrained is a different question, because the Doppler is not quantitative. In some cases, the changed Doppler signal is obvious. In others, one remains uncertain. In the latter, hemodynamic and respiratory monitors become invaluable. In our practice all sitting procedures are monitored with a Doppler, a right atrial catheter, expired CO<sub>2</sub>, and expired N<sub>2</sub>. If a change in the Doppler signal is noted, attention is shifted to the other monitors. If a change in any of these is noted, the surgeon is notified. A brief Doppler change occurring in isolation rarely brings action. One must be aware of the possibility that the Doppler may miss an embolus. This should not occur with proper positioning, but this may be more easily said than done. Any sudden decrease in ET CO<sub>2</sub> or the appearance of expired N<sub>2</sub> should quickly prompt one to aspirate from the right atrial catheter. Any sudden decrease in blood pressure should also be considered as a VAE until proven otherwise.

With these comments, what specific monitors are needed for a posterior fossa craniectomy performed in the sitting position? Almost all patients require arterial catheterization. This is both for blood pressure control and for diagnosis. One needs to remember that blood pressure at the level of the head is lower than that at the heart. For every 30 cm vertical distance between the levels of the heart and that of the brain there are 20 mm Hg difference in mean blood pressure. If the zeroing and calibration of the blood pressure transducer are done at the level of the third or fourth intercostal space, cerebral perfusion pressure can be estimated by moving the pressure transducer up to the level of the head (the external auditory meatus is a good reference point). Alternatively, one can zero and calibrate the transducer at the level of the



head. Probably the most common and serious complications of such operations involve unintentional injury to cranial nerves or their nuclei, or to other crucial areas on the floor of the fourth ventricle or within the brain stem. Sudden changes in any hemodynamic parameter (blood pressure, heart rate or rhythm) are the most reliable early warning signs of surgical impingement on these crucial structures (although some still believe that respiratory changes in unparalyzed patients are helpful; see the following section, Anesthesia). Beat-to-beat monitoring of arterial pressure provides the necessary early warning. We prefer a right atrial catheter and believe an effort should be made to place one, although failure need not result in cancellation of a case.<sup>469</sup> The greatest value of the right atrial catheter, in our opinion, is to assist in the accurate placement of the Doppler and to help make the diagnosis of VAE when Doppler changes are unclear. A correctly placed Doppler will readily detect a tiny bubble of air injected into the superior vena cava. If it does not, and the catheter location is known to be correct, then the Doppler position needs to be adjusted. Most centers use multiorifice catheters, which allow much more efficient air aspiration.<sup>112,138</sup> The catheter tip should probably be placed just above the right atrium.<sup>112,469</sup> This position can be determined in a number of ways although the most rapid method is still by electrocardiography (ECG). Our practice is to attach the right arm lead of a standard operating room ECG system to the catheter, either via a fluid column (sodium bicarbonate) or via the J-wire used to place the catheter. The catheter is then advanced until a biphasic P wave is seen, then withdrawn 1–3 cm (Fig. 50–19). Some argument exists regarding the site of origin of an ECG signal recorded from a multiorifice catheter.<sup>39</sup> However, because no one has ever shown the clinical need for precise catheter positioning, we think this is generally unimportant. Finally, both expired CO<sub>2</sub> and N<sub>2</sub> are monitored.

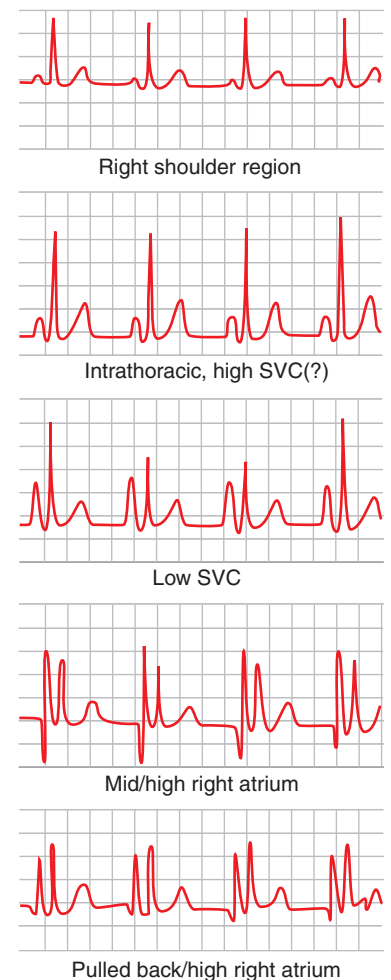
Transesophageal echocardiography is a sensitive detector of air and is the only device capable of detecting PAE. However, it requires constant visual attention. It is also not clear whether the use of such a device is cost-effective, given the low incidence of PAE-related neurologic injury. Furthermore, the detection of PAE is quite

different from prevention. This is best accomplished by the early detection of VAE, something that the Doppler does exceptionally well. The early detection of large or repeated PAE might be an indication for discontinuation of the sitting position, and the TEE may be useful in those few patients in whom Doppler placement is impossible. On balance, however, we think that it is not justified at present to recommend the routine use of this device, particularly in the absence of any concrete information showing that it can reduce the already low incidence of air-related morbidity. One hopes a more definitive answer to this issue will be available in the future, when current studies with this device are completed.

### Anesthesia

As in most neuroanesthetic situations, there are no well-defined indications or contraindications for any particular anesthetic drug combinations. Opioid/N<sub>2</sub>O combinations seem to be associated with fewer hemodynamic changes during assumption of the sitting position, although there are few truly important differences between blood pressure in the anesthetized-supine and anesthetized-sitting groups regardless of anesthetic.<sup>440</sup> Some have argued that N<sub>2</sub>O should be avoided in all sitting cases because it will diffuse into and expand the size of any entrained bubble. However, it has been shown that the use of 50% nitrous oxide did not increase the risk of venous air embolism in patients operated upon in the sitting position.<sup>405</sup> Alternative anesthetic regimens include volatile agent/O<sub>2</sub>, high-dose opioid, or purely intravenous techniques. We believe that nitrous oxide has a major place among the agents used for the anesthetic care sitting position patients. If air embolization takes place, we feel comfortable (as others did in the past) with discontinuing N<sub>2</sub>O when air is detected. In this case, the N<sub>2</sub>O-free alternative must be determined before the case starts.

Because some degree of neck flexion is required, we routinely place wire-reinforced endotracheal tubes. An alternative is nasotracheal intubation. Wire reinforced tubes are not risk-free in the postoperative period. These tubes are indented permanently if the patient bites on them. Needless to say, this is a life-threatening situation that one needs to deal with promptly. If



**FIGURE 50–19.** Typical catheter tip electrocardiograph (ECG) signals obtained during placement of a right atrial catheter for a sitting position procedure. The right-arm lead (+) was attached to the catheter, and a lead 2 configuration was used. In the *top panel*, a typical lead 2 pattern is seen with the catheter tip in an extrathoracic position near the shoulder. As the catheter enters the thorax, the amplitude of all ECG components increases. As the tip nears the right atrium, there is a selective increase in P-wave amplitude, with a relatively sudden change to a biphasic tracing in the high/mid atrium. The bottom tracing was obtained after the catheter was withdrawn 1–3 cm from atrial location and was left to reside in the high atrium or low superior vena cava. (Reprinted from Todd MM. *Monitoring in neuroanesthesia*. In: Saidman L, Smith NT, eds. *Monitoring in Anesthesia*. 3rd ed. Boston: Butterworth, 1992: 183, with permission from Elsevier.)

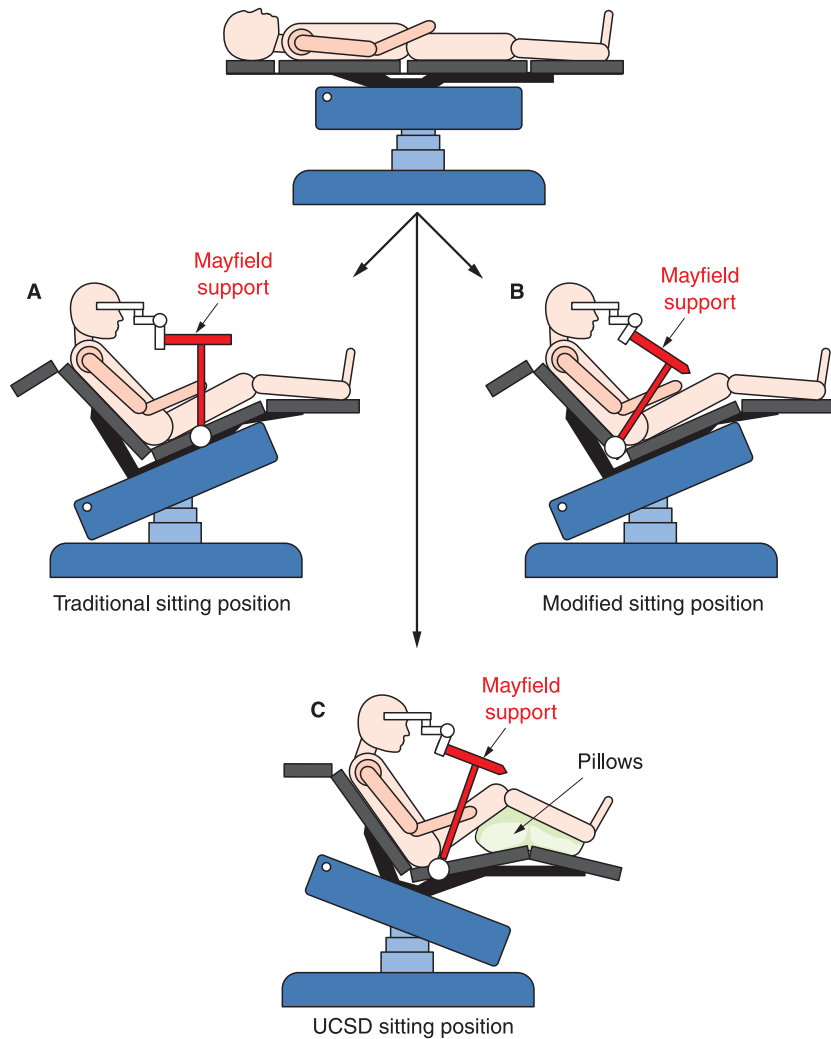
prolonged postoperative intubation is needed, we recommend changing the wire-reinforced tube to a regular endotracheal tube at the conclusion of surgery. If this is not possible because of airway and tongue swelling, we do not attempt to change the wire-reinforced tube (even over a tube changer). Use of

bite-blocking devices, good communication with the patient, and vigilance by intensive care personnel is important in preventing this complication.

Some comments on ventilatory management are appropriate. In the early days of posterior fossa surgery, spontaneous ventilation was used as a monitor of brainstem function. This has been supplanted by the use of better hemodynamic monitors combined with controlled ventilation. Most anesthesiologists choose to modestly hyperventilate their patients. However, Zettner et al. argue that the risk of VAE may be reduced by modest hypoventilation,<sup>833</sup> and Gelb et al. have data indicating that respiratory changes can be observed in unparalyzed patients before (or in the absence of) hemodynamic changes.<sup>426</sup> We are still uncomfortable with allowing patients in the sitting position to breath spontaneously because VAE can trigger a strong inspiratory effort (which can increase the amount of air entrained). However, a reasonable argument can be made for spontaneous ventilation in horizontal patients, at least after the skull is open and any brainstem compression or hydrocephalus has been relieved.

### Positioning and the Response to VAE

We have discussed some of the potential complications of positioning. However, another aspect of positioning may be more important. When a major VAE is encountered, the initial response is to ask the surgeon to flood the wound or pack it with wet gauze, discontinue  $N_2O$ , and aspirate from the right atrial catheter. Two additional maneuvers can be performed to slow air entry. These are the addition of PEEP and/or bilateral jugular compression.<sup>404,568,573</sup> In both cases, the goal is to increase venous pressure in the head. There are problems with both. Jugular compression is effective and may help to identify venous bleeders in the surgical field that might have been the source of air entrainment. However, this occupies both hands of the anesthesiologist, and the anesthesiologist cannot do anything else. High levels of PEEP (10–15 cm  $H_2O$ ) are required to elevate venous pressure at the head to values greater than zero,<sup>219</sup> but some feel this will facilitate the right-to-left passage of air through the heart.<sup>568</sup> This is disputed,<sup>94,564</sup> and many are uncomfortable



**FIGURE 50–20.** Three variations of the sitting position. **A.** In the “traditional sitting position,” the table is placed in steep Trendelenburg, the back elevated, and the Mayfield support attached to the midsection of the table. It is possible to return the patient to a horizontal position after a severe VAE without removing the head from pin fixation. To facilitate a return to a horizontal position, two alternatives are suggested. **B.** In the first (modified sitting position), the same table position is used, but the Mayfield support is attached to the back section of the table. The horizontal position can now be achieved simply by lowering the back. **C.** In the “UCSD (University of California at San Diego) position” the table base is placed in reverse Trendelenburg, the back elevated, and the legs supported on pillows. In the event of a serious VAE, the horizontal position can be achieved simply by placing the table in the Trendelenburg position.

with applying PEEP in the face of hemodynamic instability.

If air entrainment continues, or hemodynamic deterioration occurs, the patient must be moved into a horizontal position. With the traditional sitting position (Fig. 50–20A), this can be accomplished only by removing the patient from pin fixation. Because this is time-consuming and difficult to do without contaminating the wound, we believe that the only acceptable sitting position is one that allows the patient to be easily moved. There are two major ways to accomplish this. In the first, described by Dr. Shapiro at University of California at San Diego, the primary

axis of the operating room table is placed in reverse Trendelenburg, and the legs are supported on pillows (Fig. 50–20B). A horizontal posture then can be achieved simply by moving the table into a head-down position. An alternative is to place the main axis into steep Trendelenburg, raise the back, and attach the over-bed support arch and pin-fixation device to the back portion of the table, rather than to the bottom (Fig. 50–20C). A supine position is achieved simply by lowering the back.

### Emergence

In a routine, uncomplicated procedure, the patient can be awakened and

extubated at the end of the case. However, two situations alter this.

**Air Embolism and Pulmonary Edema** On occasion, a large air embolism will precipitate pulmonary edema. The etiology is unknown, but the condition is usually self-limited. However, if a patient has suffered a major embolus and has a persistent, large shunt, we prefer to continue mechanical ventilation until a more complete evaluation can be carried out.

**Cranial Nerve Dysfunction** As noted previously, a major complication of posterior fossa surgery (regardless of position) is damage to those cranial nerves that control airway function (i.e., CN IX, X, and XI). There is no reliable intraoperative method for assessing the function of these nerves (although CN VII and VIII can be monitored using facial nerve stimulation and brainstem auditory evoked responses, respectively). In all cases, patients must be carefully monitored after emergence to verify that function has been maintained. In our practice, patients who have suffered more than two or three transient, sudden hemodynamic or respiratory events during surgical dissection (e.g., hypertension-tachycardia, hypertension-bradycardia, inspiratory effort) are left intubated after awakening. The concern is that these hemodynamic events reflect brainstem injury. These individuals are sedated with fentanyl/droperidol and are generally extubated 24–36 hours postoperatively.

There is a small incidence of neurogenic pulmonary edema after posterior fossa surgery, particularly when surgery is performed on the floor of the fourth ventricle. Unlike edema encountered after head trauma, respiratory failure can occur suddenly in fully awake patients. We believe that such an event is most likely to occur in those patients in whom we have seen hemodynamic evidence for brainstem injury, and this provides another reason to be extremely cautious about extubation.

### Anesthesia for Infratentorial Craniectomy: The Horizontal Position

The use of horizontal positions (prone or lateral) generally avoids the problems of massive VAE (although Black et al. showed that Doppler ultrasound-detected VAE occurs in up to 12% of

these cases, although apparently without important consequences.<sup>96</sup> The remaining problems are similar, except for positioning. There is reason to believe that the prone, lateral, and park bench positions are associated with a higher incidence of positioning related injuries such as the following:<sup>96,456</sup>

- *Brachial plexus injuries* are a particular problem in the lateral/park bench positions when the “up” arm is pulled caudally to improve access to the retromastoid area, or when the head/neck is excessively rotated. A similar problem can occur in the prone position if the arms are pulled down with excessive force.
- *Ulnar nerve injury.*
- *Pressure blisters/skin necrosis* of the face caused by inadequate weight distribution on a horseshoe headrest.
- *Blindness* caused by pressure on the eyes in the prone position.
- *Quadriplegia* associated with extreme flexion of the neck (quadriplegia has been described in the prone position as well sitting).

These problems are all avoidable but only by careful attention to position, nerve stretch, padding, and so forth. It has been argued that because these problems are unlikely to be fatal, these alternative positions are “better” than the sitting position. However, because VAE/PAE-related fatalities are so rare in the hands of experienced teams, we believe that morbidity is the more important factor. These positioning problems make it likely that the overall morbidity of horizontal approaches is no better than with the sitting position.

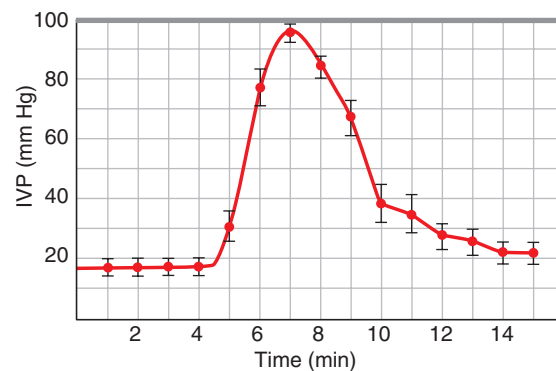
### Anesthesia for Intracranial Vascular Procedures: Aneurysms

Aneurysmal SAH strikes ≈30,000 people a year in North America.<sup>91,351</sup> Only 17,000–20,000 patients are admitted to the hospital, and only 70% of these will come to the operating room. Of patients entered into the International Cooperative Aneurysm Study, only 58% of individuals admitted to the hospital within 3 days after hemorrhage had a “good” outcome; if analysis is restricted to patients who actually undergo surgery, a “good outcome” is seen in approximately 68%, with death occurring in ≈14%.<sup>356,357</sup>

The most common presenting symptom is severe headache, with or without a loss of consciousness. The cause of both the headache and the initial neurologic deterioration is a sudden, severe increase in ICP (Fig. 50–21).<sup>776</sup> If ICP does not rapidly normalize, the patient will die. Severe ischemia that results from shorter or less-severe increases in ICP is a major cause of neurologic deficit among survivors. After a patient reaches a medical facility, the patient faces three major problems: (a) “vasospasm,” (b) recurrent hemorrhage, and (c) hydrocephalus (we do not discuss this problem).

### Vasospasm

Strictly speaking, vasospasm is an angiographic diagnosis. Arteries constrict in response to extravascular blood, but this is transient. By contrast, clinical “vasospasm” typically occurs several days after the initial hemorrhage.<sup>180,356,357,801</sup> Acute vasoconstriction is easily reversed by vasodilators (e.g., nitroprusside, nitro-



**FIGURE 50–21.** ICPs recorded during and after recurrent subarachnoid hemorrhage. Data represent the average from seven patients. Note the abrupt increase to near systemic levels (go to 100 mm Hg) and the rapid decline. (Reproduced with permission from Voldby B, Enevoldson EM. Intracranial pressure changes follow aneurysm rupture: recurrent hemorrhage. *J Neurosurg* 1982; 56:784.)

TABLE 50–6.

## Neurologic Grading System for Patients with Subarachnoid Hemorrhage

Grade	Criteria
Hunt and Hess	
Grade I	Asymptomatic or minimal headache and slight nuchal rigidity
Grade II	Moderate-to-severe headache, nuchal rigidity, no neurologic deficit other than cranial nerve palsy
Grade III	Drowsiness, confusion, or mild focal deficit
Grade IV	Stupor, moderate-to-severe hemiparesis
Grade V	Deep coma, decerebrate rigidity, moribund appearance
World Federation of Neurologic Surgeons	
Grade I	GCS (Glasgow Coma Scale) 15, no motor deficit
Grade II	GCS 14–13, no motor deficit
Grade III	GCS 14–13, any motor deficit
Grade IV	GCS 12–7, with or without motor deficit
Grade V	GCS 6–3, with or without motor deficit

glycerin), but delayed vasospasm is not. This had led to the hypothesis that vasospasm is actually a form of vessel injury or vasculopathy. Other work indicates that either endothelial relaxing factor or endothelin (a constricting factor) play an important role in this disorder.<sup>142,146,620</sup> In view of uncertainties concerning the etiology of this disorder, many clinicians prefer the term “delayed cerebral ischemia” to define the development or worsening of focal neurologic deficits in patients with SAH. Such an event occurs in roughly 30–40% of patients admitted with SAH.<sup>356,357</sup>

### Recurrent Hemorrhage

Without therapy, 20–30% of patients hospitalized after SAH will rebleed within 2 weeks (≈7% of patients rebleed within 48 hours).<sup>355–357</sup> It can be prevented only by clipping the aneurysm. To reduce the presurgical risk, patients are treated with bedrest, sedation, antihypertensives, and antifibrinolytic drugs. These are “two-edged swords” that increase the risk of respiratory complications and deep vein thrombosis. Antifibrinolytics can also increase the incidence of vasospasm. Given these problems, surgeons have long been interested in early, definitive surgery. Data obtained in the early 1980s indicated little difference in morbidity or mortality between patients operated on early or late,<sup>356,357</sup> with patients undergoing early surgery succumbing to more frequent vasospasm. However, the subsequent introduction of more effective treatments for vasospasm (nimodipine and hypertensive/

hypervolemic therapy) has convinced most surgical teams to operate early, at least in good-grade patients.

### Preoperative Evaluation

Special areas of concern in these patients include the assessment of (a) neurologic status, (b) cardiac dysrhythmias and other ECG abnormalities, (c) intravascular volume status, and (d) the use of calcium entry blockers for the prevention of vasospasm.

**Neurologic Status** All patients suffering aneurysmal SAH are assigned a clinical “grade” that provides prognostic information and allows better communication between clinicians. The most widely used system was proposed by Hunt and Hess,<sup>323</sup> although the World Federation of Neurologic Surgeons (WFNS) scale may be more objective (Table 50–6).<sup>183</sup> Other grading systems have been proposed, but all follow the same general pattern: The greater the numerical score, the more severely ill the patient.

There are three reasons for the anesthesiologist to be aware of the patient’s neurologic status. These patients may deteriorate rapidly, and the anesthesiologist may be the first to identify such a change. Second, the failure of a patient to return to his/her baseline status upon emergence from anesthesia requires that a distinction be made between residual anesthetic effects and surgical concerns. Finally, clinical grade correlates well with alterations in intracranial physiology.<sup>777,778</sup> As grade deteriorates, autoregulation and CO<sub>2</sub> responsiveness

become progressively disordered, and the incidence of intracranial hypertension increases. Grades I and II patients typically have near-normal ICP values and normal vascular responsiveness. Such patients can be approached differently by the anesthesiologist in terms of premedicants, the use of volatile agents and N<sub>2</sub>O, the limits of hypotension, and so forth, than can grades III through V individuals.

### Cardiac Dysrhythmias and Other ECG Abnormalities

SAH is associated with an increased incidence of dysrhythmias and ECG morphologic abnormalities.<sup>168,434</sup> Holter monitoring reveals rhythm disturbances in as many as 91% of patients, although retrospective analysis of multiple studies suggest an incidence of ≈40% is more accurate.<sup>168,175,393</sup> The most frequent abnormalities are prolongation of the Q-T interval, flattened or inverted T waves, S-T segment depression, and prominent U waves. These may occur in combination or sequentially (Fig. 50–22). The mechanism of these changes remains controversial. Elevated catecholamines, hypercortisolism, and hypokalemia have all been implicated, and evidence also exists that incriminates a hypothalamic neurogenic mechanism. Studies of myocardium-specific enzymes are inconsistent, but postmortem studies show evidence of subendocardial injury. However, noninvasive studies of myocardial perfusion (thallium scans) and LV function (echocardiography) show a high incidence of abnormalities, at least in patients with ECG abnormalities.<sup>167,720</sup>

The patient with serious dysrhythmia requires prompt treatment, and patients with SAH should have continuous ECG monitoring throughout the perioperative period. The most difficult dilemma is the patient with ECG changes suggestive of myocardial injury, particularly when the clinical grade is good and early surgery is contemplated. If there is no evidence of congestive heart failure or angina, and serial enzymes are negative, surgery should proceed. The greater problem is the individual with enzymatic evidence of myocardial damage. Which represents the greater risk: anesthesia and surgery in the face of a recent myocardial infarction, or rebleeding because the aneurysm is not clipped? This problem has not been studied systematically. Furthermore,





**FIGURE 50–22.** Serial electrocardiogram tracing obtained in a young woman with a subarachnoid hemorrhage. The first tracing was obtained at about 30 minutes after the onset of headache. Note the sequential appearance of ST-segment elevation, QT prolongation, T-wave inversion, and QRS axis changes. There were no changes in serum creatine kinase isoenzymes at any time.

the prognostic implications of a myocardial infarction precipitated by an SAH are unknown, and cardiovascular diseases are a relatively minor cause of death among patients with SAH.<sup>356,357</sup> In the cooperative study, overall hospital mortality from recurrent hemorrhage was 236 of 3521 (6.7%), and the risk of hemorrhage was generally judged to be 1–2% per day. In addition, 15–20% of patients suffer some degree of serious morbidity caused by vasospasm, which might be alleviated by early surgery combined with aggressive therapy. We believe that there is little justification for delaying surgery for anything other than an obvious myocardial infarction with serious LV dysfunction.

**Intravascular Volume Status** The preoperative volume status of untreated patients with SAH is often abnormal. In earlier days, patients were relatively hypovolemic because of bed-rest, negative nitrogen balance, decreased erythropoiesis, iatrogenic blood

loss, and dysregulation of the autonomic nervous system; this has become less common because of the frequent use of hypervolemia to treat/prevent vasospasm. Hyponatremia is also occasionally observed, caused by either a central salt-wasting syndrome or true syndrome of inappropriate antidiuretic hormone.<sup>690</sup>

**Calcium Antagonists** Although multiple methods have been used for the treatment of vasospasm, most recent work has centered on the calcium antagonists, with nimodipine being the first drug released for the specific prophylaxis of vasospasm.<sup>316,614</sup> Like every new drug, nimodipine initially raised concern about whether its preoperative use would make anesthesia more dangerous or difficult. Fortunately, these fears are unfounded. While patients taking nimodipine have lower blood pressures (as well as lower systemic vascular resistances and higher cardiac outputs), there are no clinical management difficulties as long as anesthetic agents are carefully

titrated. An alternative calcium blocker, nicardipine, was initially evaluated as an antivasospastic agent, but trials were halted with the introduction of nimodipine.<sup>273</sup> The drug is now approved only for blood pressure control.

Another drug under evaluation for the treatment/prevention of vasospasm (or its ischemic consequences) is the 21-aminosteroid tirilazad.<sup>274,275</sup> This compound is chemically related to methylprednisolone, but has glucocorticoid activity. Its primary mode of action appears to be as a free-radical scavenger. Clinical trials in Europe suggest some benefit in men only; US trials are ongoing.<sup>352</sup> The drug appears to pose no anesthetic problems.

### Premedication

The choice of premedication must balance two factors: (a) the risk of anxiety-related hypertension and aneurysmal rerupture, and (b) the chance of respiratory depression that may exacerbate intracranial hypertension. Fortunately, it is possible to generate some guidelines. Voldby et al. demonstrated a good relationship between clinical grade and ICP, with patients in grades I and II almost uniformly having near-normal ICP values (Table 50–7).<sup>778</sup> As clinical grade deteriorates, the incidence of intracranial hypertension increases. Consequently, there is little reason to avoid modest sedation (e.g., with benzodiazepines) in grades I and II individuals, particularly several days after the initial hemorrhage. By contrast, patients who are somnolent or who have focal deficits (grades III through V) are transported to the operating room without premedication. If premedication is needed, it should be given intravenously with the anesthesiologist in attendance.

### Routine Monitoring

Given the potential risks associated with rapid swings in blood pressure (e.g., aneurysmal rupture, profound hypoperfusion) and the need for very accurate beat-to-beat control during profound hypotension, direct arterial cannulation is mandatory (although this can be deferred until after induction if it results in patient agitation). Urinary bladder catheterization yields information on fluid balance, but the routine use of mannitol or furosemide limits the value of urine output as an index of intravascular volume. To improve our assessment of volume status,

TABLE 50-7.

## ICP and Vascular Responsiveness after Subarachnoid Hemorrhage

Grade	ICP (mm Hg)	CO <sub>2</sub> response	Autoregulation
		$\Delta$ CBF/ $\Delta$ PCO <sub>2</sub>	$\Delta$ CBF/ $\Delta$ % MABP
II	10 $\pm$ 3	1.61 $\pm$ 0.67	-0.042 $\pm$ 0.194
III	18 $\pm$ 6	1.02 $\pm$ 0.5	-0.230 $\pm$ 0.514
IV-V	29 $\pm$ 6	0.61 $\pm$ 0.42	-0.334 $\pm$ 0.219

CBF, cerebral blood flow; ICP, intracranial pressure; MABP, mean arterial blood pressure. Data are all mean [+/-] standard deviation (SD). Units for CO<sub>2</sub> response are all mL/100g/min change in CBF/mm Hg change in CO<sub>2</sub>. Autoregulation is expressed as mL/100g/min change in CBF/% change in MABP (a value of 0.000 would be perfect autoregulation, and a more negative number indicates progressive autoregulatory impairment). Note that the clinical grading was not consistent between the two reports, and hence the first column was constructed to the best of our ability. Data from Voldby B, Envoldsen EM, Jensen FT. Cerebrovascular reactivity in patients with ruptured intracranial aneurysm. *J Neurosurg* 1985;62:59, and Voldby B, Envoldsen EM. Intracranial pressure changes following aneurysm rupture. Part I: clinical and angiographic correlations. *J Neurosurg* 1982;56:186.

we lean toward the placement of central venous or pulmonary artery catheters, in those with preoperative ECG changes that cannot be readily distinguished from myocardial ischemia and in patients with large or relatively inaccessible aneurysm (i.e., where “excess” blood loss is anticipated). Note that this is perhaps the only surgical procedure where pharmacologic hypotension must be maintained in the face of active arterial hemorrhage (from a ruptured aneurysm). Other than central vascular cannulation, there are no reliable methods for rapidly distinguishing normovolemic hypotension from shock in such situations. We recognize that there are risks associated with central catheter placement, and we also realize that many experienced centers do not employ central catheters, particularly those that have abandoned induced hypotension. Pulmonary artery catheterization is reserved for patients with known preexisting cardiac disease, or perhaps for cases where surgery is anticipated to be difficult or prolonged.

### Specialized Monitoring: EEG and Evoked Potentials

Because the most feared immediate complication of surgery is a misplaced clip or tissue injury caused by excessive retraction and/or hypotension, many groups have attempted to improve their ability to detect ischemic changes before they become irreversible. Nevertheless, the value of electrophysiologic monitoring remains unclear. EEGs recorded from the perimeter of the craniotomy have yielded contradictory re-

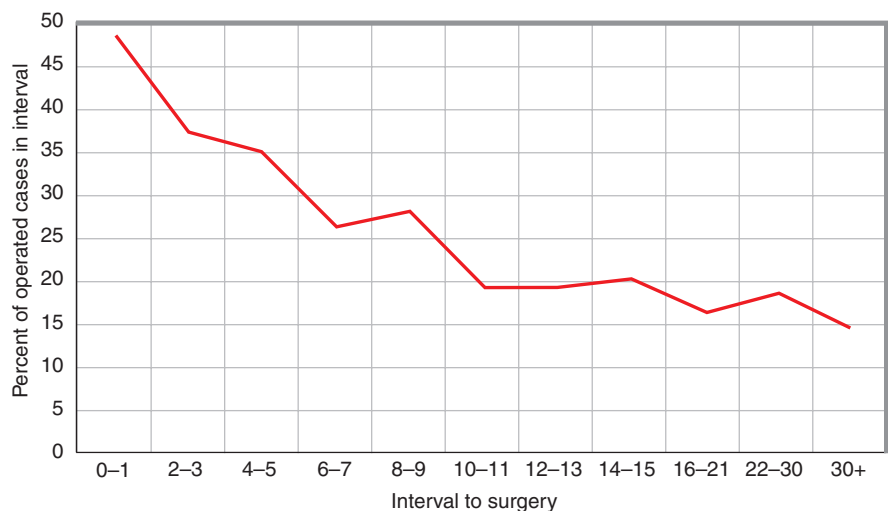
sults.<sup>340,729</sup> Because of the uncertainty, most centers probably only use EEG monitoring to facilitate drug administration (e.g., barbiturates). Greater attention has been directed at somatosensory evoked potentials (SEPs), because the conduction pathways pass through areas at greatest risk. Symon et al. have presented extensive data relating changes in central conduction time with outcome.<sup>228,719</sup> A correlation with outcome need not necessarily mean that monitoring can prevent a deficit, but several groups have now used SEP monitoring to define the limits of temporary vessel occlusion during surgery.<sup>428,499</sup> Hence, although SEP moni-

toring has not yet been established as a routine, it may offer some benefits.

### Induction and Maintenance

We believe that the principal risk is rebleeding. Four papers have shown that the incidence of hemorrhage on induction ranges from 1% to 2%.<sup>243,357,715,758</sup> In one of these studies, hemorrhage was associated with airway difficulties encountered during induction that presumably led to hypertension and coughing. Given these considerations, induction is designed to avoid sudden hypertensive events, particularly during laryngoscopy and intubation. We tend to carry patients “deeper” at the time of intubation, using volatile agents, larger doses of opioids (e.g., fentanyl 12–15  $\mu$ g/kg), or additional thiopental or lidocaine. Arterial pressure is continuously monitored; if blood pressure or heart rate starts to rise with laryngoscopy alone, the laryngoscope is removed and additional anesthetic given. In general, we are far more tolerant of hypotension during induction than we are of hypertension.

Subsequent management is directed at ensuring adequate surgical conditions. Because aneurysms are located around the base of the brain, exposure may be a challenge, particularly in the face of cerebral swelling. This is clearly much worse during “early” surgery (Fig. 50-23).<sup>357</sup> If exposure cannot be facilitated, then the risk of tissue injury from excessive retractor pressures<sup>18,587</sup>



**FIGURE 50-23.** The incidence of subjectively “tight” brain at craniotomy, relative to the time of surgery after subarachnoid hemorrhage. There is clearly a far greater likelihood of difficult operating conditions with acute aneurysm surgery. (Reproduced with permission from Kassel NF, Toner JC, Jane JA, et al. The international cooperative study on the timing of aneurysm surgery surgical results. *J Neurosurg* 1990;73:37.)

or uncontrolled aneurysmal hemorrhage is high. For these reasons, patients may have spinal drains placed, receive mannitol, and be aggressively hyperventilated ( $Paco_2 \approx 25$  mm Hg).

### **Induced Hypotension versus Temporary Occlusion**

To minimize the risk of aneurysmal rupture during dissection, one of two interventions is employed: induced hypotension or temporary vessel occlusion (trapping). In both cases, the goal is to reduce intraluminal pressure. In the case of hypotension, a secondary goal is to slow the rate of hemorrhage in the event that rupture occurs.

**Hypotension** Induced hypotension has long been a standard component of surgery. Most surgeons believe it to be of value, although this is impossible to “prove,” particularly because most surgery performed before the introduction of hypotensive techniques was also done before the use of the operating microscope. The argument against hypotension is that SAH and vasospasm may disrupt cerebral autoregulation, particularly in lower-grade patients.<sup>216,777</sup> As a result, the lowest safe MAP that can be employed is unknown, particularly in the face of retraction pressure. Hypotension also poses a risk of myocardial ischemia especially in patients with coronary artery disease. Nevertheless, most centers are willing to reduce MAP to values of 70 mm Hg during initial dissection, and to pressures as low as 50 mm Hg during direct manipulation of the aneurysm.

Considerable effort has been directed toward determining the ideal agent to produce the hypotension. These efforts have not succeeded. The three agents in most common use are sodium nitroprusside, nitroglycerin, and isoflurane. Isoflurane has gained some popularity because it is well tolerated, and some believe it to have some protective effects. Unfortunately, there have been no prospective studies demonstrating an improved (or worsened) neurologic outcome or altered complication rate with any agent. The picture is even more complex because polypharmacy is the rule, and these drugs are combined with long-acting nitrates (e.g., hydralazine),  $\beta$ -blockers, calcium antagonists, preoperative clonidine, and so forth.

Regardless of the agent used, several points from the earlier discussion of

basic physiology/pharmacology should be remembered. Autoregulation is not instantaneous and abrupt decreases or increases in pressure may lead to transient hypoperfusion during the induction of hypotension and hyperperfusion upon its discontinuation. Hypotension increases several humoral factors, including norepinephrine, epinephrine, and renin-angiotensin. Recovery from hypotension then may be followed by rebound hypertension that can persist for several hours unless treated. Finally, because hemostasis must be verified before dural closure, blood pressure should be allowed to gradually rise to values on the “high end” of normal (e.g., 140–160 mm Hg systolic) during the completion of the intracranial portion of the procedure.

**Temporary Occlusion** Hypotension has become far less common in recent years, being replaced by the placement of temporary clips on the parent artery (which effectively produces “regional hypotension”). This avoids many of the systemic problems associated with hypotension and also prevents rupture. However, if temporary occlusion is prolonged (i.e., >10–20 minutes), it may increase the risk of focal ischemic deficits.<sup>499,632</sup> Despite this risk, the approach is gaining in popularity. In most centers, blood pressure is modestly reduced during initial dissection, and then normalized after temporary clip placement. In some cases, barbiturates are administered to protect the brain, although we reserve this for procedures where the duration of occlusion is prolonged.

### **Emergence and Early Postoperative Care**

A rapid return to consciousness permits early clinical assessment and the detection of unexpected neurologic deficits (e.g., caused by a clot or misplaced clip). This can lead to either a diagnostic procedure (e.g., angiography and/or reoperation) or the institution of hypertensive-hypervolemic therapy. This emphasis on rapid emergence makes the maintenance of hemodynamic stability a bit more difficult. Kalfas and Little demonstrated a 2.3% incidence of postoperative intracranial hemorrhage among patients undergoing aneurysm clippings.<sup>347</sup> Their data implicate uncontrolled hypertension as a causative factor. We believe the arterial pressure should be monitored without interrup-

tion in these patients, including during transportation from the operating room to the recovery room, and from the recovery room to the surgical intensive care unit. Obviously, if such monitoring is to be useful, the patients must be accompanied at all times in the early postoperative period by an individual able to administer the pharmacologic agents needed to control hypertensive events.

### **Treatment of Delayed Ischemic Deficits/Symptomatic Vasospasm**

In spite of the use of calcium antagonists, vasospasm remains a major cause of morbidity and death even after an otherwise successful clipping. Although there is growing interest in the use of endovascular therapy (e.g., balloon angioplasty) or fibrinolytics (e.g., tissue plasminogen activator),<sup>180,533</sup> the only widely accepted acute therapy is hypervolemia-hypertension.<sup>50,180,354,698</sup> The patient with a new focal deficit or decrease in level of consciousness is first scanned to rule out an infarct, clot, or hydrocephalus. An angiogram may be carried out to verify clip placement. Patients then are moved to an ICU where arterial and central venous/pulmonary artery pressure monitors are placed, if not already in place. Albumin and/or crystalloids are infused to increase CVP to values of 10–12 mm Hg, or pulmonary capillary wedge pressure (PCWP) to 15–18 mm Hg. (*Note:* Initial volume loading can obviously be started before monitoring catheters are in place. However, continued therapy is dangerous without such monitors [see following discussion].) Hetastarch is avoided because large doses (>1–1.5 L) are associated with coagulation deficits and intracranial hemorrhage.<sup>160,165</sup> If these measures fail to reverse the neurologic deficit, blood pressure is elevated pharmacologically. There are no good guidelines concerning the target blood pressure, but most groups will increase systolic pressure to values as high as 160–200 mm Hg if tolerated. The most common drug used is dopamine, but other agents or combinations of agents seem equally efficacious. Many groups think that hematocrit can be modestly decreased (i.e., 33–36%), but there is little current enthusiasm for more profound hemodilution.

The major complications are cardiovascular, with a reported incidence of pulmonary edema ranging from 7% to

17%.<sup>50,354,822</sup> Cerebral edema has also been reported.<sup>680</sup> One must beware of the urge to “keep pushing” when initial volume expansion fails to resolve the deficit. Severe pulmonary edema with resultant acute respiratory distress syndrome has been seen. Also, increasing and maintaining an elevated PCWP and blood pressure is strikingly difficult in some patients, particularly the young. They will mount a brisk diuresis in response to volume loading and may be refractory to vasopressors. Vasopressin or DDAVP (1-deamino-8-D-arginine-vasopressin) can be used in such cases, along with more potent  $\alpha$ - and  $\beta$ -adrenergic agents, but these, in turn, further increase the risk of fluid overload, tachyarrhythmias, or myocardial ischemia.

### Special Problems

**Intraoperative Hemorrhage** Intraoperative aneurysmal rupture is a potentially catastrophic event occurring in 15–20% of patients.<sup>61</sup> However, hemorrhagic shock and death are not the most important consequences. Instead, one sees cerebral ischemic damage. When brisk bleeding occurs deep within the cranium, the operator is blinded. Ischemia results from efforts to slow this bleeding. This may stem from excessive hypotension (elective or otherwise), more vigorous retraction, or from clips placed on major cerebral vessels (either intentionally or unintentionally).

This is not a rare event and some kind of plan should exist. First, do not panic! The rate of blood loss is usually slow enough to be handled. Our first response is to increase the rate of IV fluid administration. If bleeding is not stopped within a few minutes, blood pressure is progressively (and smoothly) reduced to mean values as low as 40–50 mm Hg (measured at the head). This can be accomplished by any method desired as long as normovolemia is maintained. Manual compression of the carotid arteries in the neck is also effective but it leaves the anesthesiologist unable to perform other tasks. The goal is to slow the rate of hemorrhage so that the source can be found or a feeding vessel identified. If the aneurysm can be directly clipped, there are few problems. More commonly a clip is temporarily applied to a feeding vessel. (*Note:* There is some evidence that prolonged hypotension in the face of ruptures may be more dangerous than temporary

clipping.<sup>243</sup> Consequently, it is probably reasonable to keep the duration of hypotension as short as possible.)

**Intraoperative Protection** Barbiturates are the only drugs shown to be useful in situations of temporary intracranial vessel occlusion (albeit in repeated animal studies).<sup>527,701,795</sup> Contrary to popular belief, they need not be given before occlusion but can be administered up to 30–60 minutes after occlusion and still be beneficial. Hence there is no need to subject a hypovolemic patient to the hemodynamic risks of “emergency” barbiturate loading. Our practice is to ensure adequate vascular volume and hypotension and then to begin barbiturate administration with small (100–200-mg) boluses of thiopental. Other anesthetics are progressively reduced as the dose increases. Our goal is to administer a dose of  $\approx 15$ –30 mg/kg of drug over a 30-minute period. If vessel occlusion persists, a dose of 5–6 mg/kg/h of thiopental will maintain a reasonable degree of EEG and metabolic suppression. Note, however, that while the traditional goal is EEG burst suppression or isoelectricity, there are data suggesting that even lower doses are equally effective.<sup>68,793</sup>

Etomidate is also advocated as a protective agent, based on its ability to reduce CMR.<sup>62</sup> However, because two animal studies failed to demonstrate protective efficacy,<sup>184,634</sup> we do not believe this is reasonable, other than in the context of a clinical trial.

Renewed interest in the use of hypothermia has been generated by the recent demonstration of the protective value of relatively mild hypothermia 89.6–93.2 °F (32–34 °C). Some have argued that patients should simply be allowed to spontaneously cool (as they always do) rather than be actively warmed. This may prove to be reasonable, but in view of the problems associated with awakening a hypothermic patient, as well as the risk of myocardial ischemia,<sup>226</sup> we believe that some concrete demonstration of efficacy is needed before this is done routinely.

### Anesthesia for Intracranial Vascular Procedures: Arteriovenous Malformations

Although the care of these patients has many things in common with the care of those undergoing aneurysm clippings, certain differences exist. First, the risk of recurrent hemorrhage is

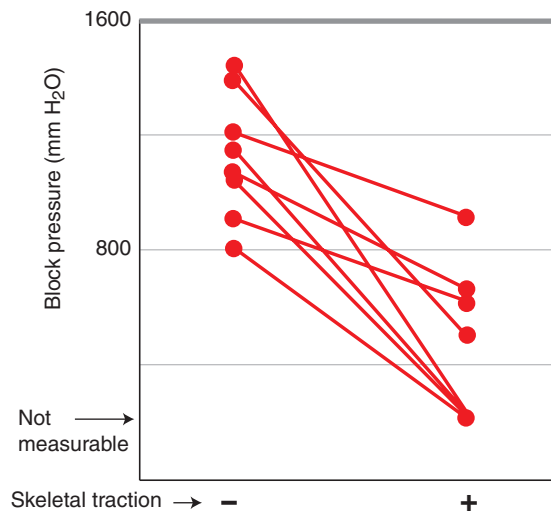
much lower than with an aneurysm (and hence surgery for definitive excision is rarely emergent). Second, hypertension-induced hemorrhage appears to be almost nonexistent,<sup>721</sup> and hence blood pressure control during induction is probably not as crucial. Because vasospasm is rare, there is little need for calcium antagonists or hypervolemic-hypertensive therapy. The major risks are intraoperative hemorrhage—which can be torrential—and a disorder called reperfusion breakthrough.<sup>8,51,506</sup> Hemorrhage is handled by transfusion and induced hypotension; reperfusion breakthrough, however, is a much more difficult problem.

An AVM represents a low resistance pathway shunting blood directly from arteries to veins. The result is that perfusion pressure to adjacent normal tissues may be very low, and these tissues may therefore be maximally dilated. If the AVM is suddenly obliterated, the perfusion pressure to these tissues may rise dramatically. For example, AVM flow rates in excess of 1 L/min have been estimated, and 50–75 mm Hg increases in collateral perfusion pressures have been seen with AVM occlusion.<sup>538</sup> This can lead to either the rapid formation of cerebral edema or the physical disruption of vessels with intraparenchymal hemorrhage. The result is a phenomenon often called malignant brain swelling or “reperfusion breakthrough,” where the brain begins to rapidly herniate out of the craniotomy site.

To date, the only successful therapy for this disorder is a combination of induced hypotension (to reduce perfusion pressure) and very high doses of barbiturates.<sup>170,439</sup> The doses used are governed by the patient's response, not by some theoretical “EEG-suppressant” dose of barbiturate. Thiopental (or pentobarbital) loading is continued until the swelling is controlled or cardiovascular toxicity occurs. Barbiturate-induced hypotension may actually be beneficial. Of equal importance is the realization that this therapy, particularly the control of blood pressure, may need to be continued for several days postoperatively. This necessitates pulmonary artery catheterization, mechanical ventilation, heavy sedation, ICP monitoring, and a very skilled ICU team.

There is a theoretical risk that hyperventilation will increase flow throughout the AVM because only normal vessels are responsive. However, although





**FIGURE 50-24.** Changes in cervical “block pressure” (y-axis) during laryngoscopy before and after the application of neck traction. Data were obtained from 8 patients with cervical stenosis. Note that “block pressure” is measured by placing a catheter in the lumbar subarachnoid space and then measuring CSF pressure during a controlled infusion of fluid. With cervical cord compression, lumbar CSF pressure rises rapidly until it exceeds that needed to force fluid around the area of compression, at which point a plateau appears in the pressure trace. Less compression results in lower block pressures. (Reproduced with permission from Magnaes B. Clinical recording of pressure on the spinal cord and cauda equina. Part 3. Pressure on the cervical spinal cord during endotracheal intubation in patients with cervical spondylosis. *J Neurosurg* 1982;57:64.)

there is some experimental support for this idea,<sup>505,833</sup> there is little clinical reason for concern at present.

### Anesthesia for the Patient with Cervical Spine Disease

The care of patients with cervical spine disease does not involve much “neuroanesthetic” physiology or pharmacology and is well reviewed elsewhere.<sup>152,285</sup> However, a few comments are in order.

Our greatest fear in patients with cervical spine disease is that we may permanently injure the spinal cord in the process of induction, intubation, and positioning. This is not a trivial concern. Neck extension can compress the cervical cord, at least in patients with cervical stenosis.<sup>422</sup> More importantly, quadriplegia/paresis following anesthetic induction has been reported in at least 3 patients, and for obvious medicolegal reasons, this is almost certainly only the tip of the proverbial iceberg. There is no doubt that these patients can be managed safely,<sup>152</sup> but only if we understand the diseases involved and the consequences of our various interventions.

This fear has led some to conclude that all patients with any form of cervical spine disease require awake fiberoptic intubation and awake positioning. This is clearly an excessively

dogmatic—and unthinking—approach. It is far preferable to make some assessment of spinal column stability and/or spinal cord compression. Usually this determination will have already been made in the course of diagnostic workup. In many cases, however, the information is not present in the chart, and there are no obvious clues, such as Gardner-Wells tongs or a halo-fixation device. In these cases the anesthesiologist must make an evaluation. The first step is a history, and next is examination of the patient’s *active* range of motion. (The patient is allowed to do the moving, do not move the neck for the patient!) If the patient has a full range of motion, an otherwise normal airway, and no displacement on flexion–extension films, general anesthesia can probably be induced in a routine manner, followed by direct laryngoscopy. Axial traction (perhaps applied manually) is probably a reasonable supplement in the patient with a normal airway and a stable cervical spine whose only complaint is mild pain on rotation or extension, particularly if the disorder is some form of spondylolisthesis or spinal stenosis. The role of traction in decompressing the cervical cord in such situations has been demonstrated by Magnaes (Fig. 50-24).<sup>422</sup> However, if a difficult intubation is anticipated, if

there is any radiologic evidence of instability (even if the patient can move), if there is a serious preexisting neurologic deficit (even if partially resolved), or if neck movement is accompanied by severe pain, we believe that some alternative approach is indicated. Our preference remains an awake fiberoptic intubation, followed by awake positioning. Alternatively, one of the alternate airway management devices (e.g., Bullard laryngoscope, light wand, Augustine intubating airway) can be used. In some cases, it may be reasonable to perform the intubation after the induction of general anesthesia, at least if the patient can be easily ventilated by mask. Any of the above noted devices can then be used to facilitate intubation. A suggested compromise is the use of the laryngeal mask airway, a device that can serve as both a means of ventilation and a guide for the fiberoptic scope. The exact method chosen is often a matter of personal choice; regardless of technique, the obvious goal is to avoid marked extension (or flexion) of the cervical spine.

What is the approach for the patient with a truly unstable neck who will not cooperate with an awake intubation? Some might insist on an awake approach, but we disagree; does it matter whether the cervical cord is injured by the intubation or by a thrashing patient? Another factor that plays a role in decision making is the location of the injury. The bulk of cervical spine movement during direct laryngoscopy occurs between the occiput and C2.<sup>286,638</sup> If the airway is determined to be normal, it may be more acceptable to perform direct laryngoscopy with manual stabilization (perhaps after placement of Gardner-Wells tongs) in a patient with a subaxial injury than someone with a C1-C2 fracture/instability. Note that the goal is not to apply traction (which, if applied with excessive vigor, may produce vertebral separation<sup>92</sup>) but to simply prevent extension of the neck. To further avoid extension, we rarely attempt to obtain full exposure of the glottis, preferring instead to carry out a “directed but semiblind” intubation. On the other hand, if the airway is judged to be “difficult” (where more movement may occur at lower segments), this may be dangerous—although there maybe little choice. An alternative may be a fiberoptic intubation after the induction

of anesthesia, a “blind” nasal intubation, or the use of the alternate intubating devices mentioned above.<sup>286</sup> If an awake intubation is deemed impossible, if the airway is truly difficult (e.g., massive facial trauma) and if general anesthesia before intubation is felt to be dangerous (e.g., a truly full stomach), there may be little choice but to proceed with tracheostomy (although doing this in an awake, combative patient may not be “ideal”). Note that if neurologic assessment after intubation is critical, it is possible to induce anesthesia using thiopental or propofol and a short-acting relaxant, maintain anesthesia with N<sub>2</sub>O or propofol, and then reawaken the patient to assess motor function.

One issue we have not discussed concerns the quadriplegic patient with spinal shock. The physiology of this disorder is well described and is very similar to the hypotension seen during high spinal anesthesia. Usually such patients are already intubated and should have arterial and central venous/pulmonary artery catheters in place. The keys to successful care are the maintenance of normal intravascular volume without overload and the judicious use of vasopressors (ephedrine, dopamine, phenylephrine).

## Transsphenoidal Hypophysectomy

This operation revolutionized the surgical approach to the sella turcica and to the immediate suprasellar region, turning a difficult subfrontal craniotomy into a relatively simple operation. Nevertheless, there are a few major problems.

First, the airway is shared with the surgeon, and the endotracheal tube must be secured to the lower jaw. There is also the danger that blood, tissue, and bone fragments can fall into the posterior pharynx. A throat pack minimizes the chance of their being swallowed, but we believe that laryngoscopy should be performed before extubation, simply to ensure that the pharynx is clear.

Second, typical neuroanesthetic maneuvers designed to reduce ICP can be counterproductive in these cases because they make the pituitary retreat upward out of the sella. In contrast, many surgeons request that the patient be hypercapnic or that a Valsalva maneuver be performed to “deliver” the gland down into the surgical field.

Third, the carotid arteries lie just lateral to the surgical site, particularly in the suprasellar area. If they are damaged, blood loss can be torrential (and, because the bleeding site is often intracranial, usually fatal).

Fourth, these patients are at risk for developing diabetes insipidus, particularly when the resection involves the suprasellar regions. The diagnosis is usually straightforward (i.e., sudden onset of diuresis). The best course is to initially decrease the IV rate to a minimum and wait. If the diuresis persists in the face of such restriction, the diagnosis becomes easier; it becomes certain if hypovolemia develops in the face of continuing urine output. If in doubt, paired urine and serum osmolalities will help although again these may be erroneously “normal” if the patient has received a large volume of IV fluids. In the event that diabetes insipidus does develop, the temptation to reach for an antidiuretic hormone replacement should probably be resisted, at least initially. Most cases are transient and require no therapy other than fluid replacement. We treat only when the volume of urine output begins to exceed 1 L/h or if it persists for more than a few hours. The drug choice is largely personal, although pitressin in oil is probably obsolete. Intravenous DDAVP is available and is both safer than aqueous pitressin (which can produce intense coronary vasoconstriction) and longer acting.

## KEY REFERENCES

1. Artru AA. Cerebrospinal fluid. In: Cottrell JE, Smith DS, eds. *Anesthesia and Neurosurgery*. St. Louis: Mosby, 1994:93–116.
2. Matta BF, Mayberg TS, Lam AM. Direct cerebrovasodilatory effects of halothane, isoflurane, and desflurane during propofol-induced isoelectric electroencephalogram in humans. *Anesthesiology* 1995; 83:980–985.
3. Samson D, Batjer HH, Bowman G, et al. A clinical study of the parameters and effects of temporary arterial occlusion in the management of intracranial aneurysms. *Neurosurgery* 1994;34:22–27.
4. Strebel S, Lam AM, Matta B, et al. Dynamic and static cerebral

autoregulation during isoflurane, desflurane, and propofol anesthesia. *Anesthesiology* 1995;83:66–76.

5. Zornow MH, Scheller MS. Intraoperative fluid management during craniotomy in: *Anesthesia and Neurosurgery*. In: Cottrell JE, Smith DS, eds. *Anesthesia and Neurosurgery*. 4th ed. St. Louis: Mosby, 2001:237–243.

6. Bhardwaj A, Ulatowski JA. Hypertonic saline solutions in brain injury. *Curr Opin Crit Care* 2004;10: 126–131.

7. Todd MM, Hindman BJ, Clarke WR, et al. Mild intraoperative hypothermia during surgery for intracranial aneurysm. *N Engl J Med* 2005; 352:135–145.

8. Hans P, Bonhomme V. The rationale for perioperative brain protection. *Eur J Anaesthesiol* 2004;21:1–5.

9. Warner DS. Pharmacologic protection from ischemic neuronal injury. *J Neurosurg Anesthesiol* 2004; 16:95–97.

## REFERENCES

1. Aaslid R, Newell DW, Stooss R, et al. Assessment of cerebral autoregulation dynamics from simultaneous arterial and venous transcranial Doppler recordings in humans. *Stroke* 1991;22:1148–1154.
2. Adams HP Jr, Adams RJ, Brott T, et al. Guidelines for the early management of patients with ischemic stroke: a scientific statement from the Stroke Council of the American Stroke Association. *Stroke* 2003; 34:1056–1083.
3. Adams RW, Cucchiara RF, Gronert GA, et al. Isoflurane and cerebrospinal fluid pressure in neurosurgical patients. *Anesthesiology* 1981;54:97–99.
4. Adams RW, Gronert GA, Sundt TM, et al. Halothane, hypocapnia, and cerebrospinal fluid pressure in neurosurgery. *Anesthesiology* 1972;37:510–517.
5. Adembri C, Venturi L, Tani A, et al. Neuroprotective effects of propofol in models of cerebral ischemia: inhibition of mitochondrial swelling as a possible mechanism. *Anesthesiology* 2006;104:80–89.
6. Adler L, Firestone L, Mintun M, et al. Central mechanisms of pain and opioid analgesia elucidated by positron emission tomography. *Anesthesiology* 1994;81: A917.

7. Akira T, Henry D, Baldwin RA, et al. Nitric oxide participates in excitotoxic mechanisms induced by chemical hypoxia. *Brain Res* 1994;645:285-290.
8. Al-Rodhan NRF, Sundt TM, Piepgras DG, et al. Occlusive hyperemia—a theory for the hemodynamic complications following resection of intracerebral arteriovenous malformations. *J Neurosurg* 1993;78:167-175.
9. Albanese J, Durbec O, Viviani X, et al. Sufentanil increases intracranial pressure in patients with head trauma. *Anesthesiology* 1993;79:493-497.
10. Alberti KG, Cuthbert C. The hydrogen ion in normal metabolism: a review. *Ciba Found Symp* 1982;87:1-19.
11. Algotsen L, Messeter K, Rosen I, et al. Effects of nitrous oxide on cerebral haemodynamics and metabolism during isoflurane anaesthesia in man. *Acta Anaesthesiol Scand* 1992;36:46-52.
12. Alkire MT, Haier RJ, Barker SJ, et al. Cerebral metabolism during propofol anesthesia in humans studied with positron emission tomography. *Anesthesiology* 1995;82:393-403.
13. Aloyo VJ, Dave KD, Rahman T, et al. Selective and divergent regulation of cortical 5-HT(2A) receptors in rabbit. *J Pharmacol Exp Ther* 2001;299:1066-1072.
14. Altenburg BM, Michenfelder JD, Theye RA. Acute tolerance to thiopental in canine cerebral oxygen consumption studies. *Anesthesiology* 1969;31:443-457.
15. Amar D, Zhang H, Leung DH, et al. Older age is the strongest predictor of postoperative atrial fibrillation. *Anesthesiology* 2002;96:352-356.
16. Amess PN, Penrice J, Cady EB, et al. Mild hypothermia after severe transient hypoxia-ischemia reduces the delayed rise in cerebral lactate in the newborn piglet. *Pediatr Res* 1997;41:803-808.
17. Andersen AR. <sup>99m</sup>Tc-D,L-hexamethyl-ene-propyleneamine oxime (<sup>99m</sup>Tc-HMPAO): basic kinetic studies of a tracer of cerebral blood flow. *Cerebrovasc Brain Metab Rev* 1989;1:288-318.
18. Andrews RJ, Bringas JR. A review of brain retraction and recommendations for minimizing intraoperative brain injury. *Neurosurgery* 1993;33:1052-1064.
19. Andrews RJ, Bringas JR, Muto RP. Effects of mannitol on cerebral blood flow, blood pressure, blood viscosity, hematocrit, sodium, and potassium. *Surg Neurol* 1993;39:218-222.
20. Angle N, Cabello-Passini R, Hoyt DB, et al. Hypertonic saline infusion: can it regulate human neutrophil function? *Shock* 2000;14:503-508.
21. Aoki M, Nomura F, Stromski ME, et al. Effects of pH on brain energetics after hypothermic circulatory arrest. *Ann Thorac Surg* 1993;55:1093-1103.
22. Arbabi S, Garcia I, Bauer G, et al. Hypertonic saline induces prostacyclin production via extracellular signal-regulated kinase (ERK) activation. *J Surg Res* 1999;83:141-146.
23. Archer DP, Labrecque P, Tyler JL, et al. Measurement of cerebral blood flow and volume with positron emission tomography during isoflurane administration in the hypocapnic baboon. *Anesthesiology* 1990;72:1031-1037.
24. Archer DP, Labrecque P, Tyler JL, et al. Cerebral blood volume is increased in dogs during administration of nitrous oxide or isoflurane. *Anesthesiology* 1987;67:642-648.
25. Argaud L, Gateau-Roesch O, Chalabreysse L, et al. Preconditioning delays Ca<sup>2+</sup>-induced mitochondrial permeability transition. *Cardiovasc Res* 2004;61:115-122.
26. Argaud L, Ovize M. [How to use the paradigm of ischemic preconditioning to protect the heart?]. *Med Sci (Paris)* 2004;20:521-525.
27. Argaud L, Prigent AF, Chalabreysse L, et al. Ceramide in the antiapoptotic effect of ischemic preconditioning. *Am J Physiol Heart Circ Physiol* 286:H246-251, 2004.
28. Argaud L, Rioufol G, Lievre M, et al. Preconditioning during coronary angioplasty: no influence of collateral perfusion or the size of the area at risk. *Eur Heart J* 2004;25:2019-2025.
29. Arieff AI, Guisado R. Effects on the central nervous system of hypernatremic and hyponatremic states. *Kidney Int* 1976;10:104-116.
30. Artru AA. Nitrous oxide plays a direct role in the development of tension pneumocephalus intraoperatively. *Anesthesiology* 1982;57:59-61.
31. Artru AA. Effects of halothane and fentanyl on the rate of CSF production in dogs. *Anesth Analg* 1983;62:581-585.
32. Artru AA. Relationship between cerebral blood volume and CSF pressure during anesthesia with halothane or enflurane in dogs. *Anesthesiology* 1983;58:533-539.
33. Artru AA. Isoflurane does not increase the rate of CSF production in the dog. *Anesthesiology* 1984;60:193-197.
34. Artru AA. Relationship between cerebral blood volume and CSF pressure during anesthesia with isoflurane or fentanyl in dogs. *Anesthesiology* 1984;60:575-579.
35. Artru AA. Cerebral metabolism and the electroencephalogram during hypocapnia plus hypotension induced by sodium nitroprusside or trimethaphan in dogs. *Neurosurgery* 1986;18:36-44.
36. Artru AA. Cerebrospinal fluid dynamics. In: Cucchiara RM, Michenfelder JD, eds. *Clinical Neuroanesthesia*. New York: Churchill-Livingstone, 1990:41-76.
37. Artru AA. Cerebrospinal fluid. In: Cottrell JE, Smith DS, eds. *Anesthesia and Neurosurgery*. St. Louis: Mosby, 1994:93-116.
38. Artru AA. Intracranial volume/pressure relationship during desflurane anesthesia in dogs: comparison with isoflurane and thiopental/halothane. *Anesth Analg* 1994;79:751-760.
39. Artru AA, Colley PS. The site of origin of the intravascular electrocardiogram recorded from multiorificated intravascular catheters. *Anesthesiology* 1988;69:44-48.
40. Artru AA, Katz RA. Cerebral blood volume and CSF pressure following administration of ketamine in dogs; modification by pre- or posttreatment with hypocapnia or diazepam. *J Neurosurg Anesthesiol* 1989;1:8-15.
41. Artru AA, Katz RA, Colley PS. Autoregulation of cerebral blood flow during normocapnia and hypocapnia in dogs. *Anesthesiology* 1989;70:288-292.
42. Artru AA, Nugent M, Michenfelder JD. Enflurane causes a prolonged and reversible increase in the rate of CSF production in the dog. *Anesthesiology* 1982;57:255-260.
43. Artru AA, Shapira Y, Bowdle TA. Electroencephalogram, cerebral metabolic, and vascular responses to propofol anesthesia in dogs. *J Neurosurg Anesthesiol* 1992;4:99-109.
44. Artru AA, Steen PA, Michenfelder JD. Cerebral metabolic effects of naloxone administered with anesthetic and subanesthetic concentrations of halothane with the dog. *Anesthesiology* 1980;52:217-220.
45. Artru AA, Wright K, Colley PS. Cerebral effects of hypocapnia plus nitroglycerin-induced hypotension in dogs. *J Neurosurg* 1986;64:924-31.
46. Asai A, Tanahashi N, Qiu JH, et al. Selective proteasomal dysfunction in the hippocampal CA1 region after transient forebrain ischemia. *J Cereb Blood Flow Metab* 2002;22:705-710.
47. Asano S, Kawahara N, Kirino T. Intradural spinal seeding of a clival chordoma. *Acta Neurochir (Wien)* 2003;145:599-603; discussion 603.
48. Atlas D, Teichberg VI, Changeux JP. Direct evidence for beta-adrenoreceptors on the Purkinje cells of mouse cerebellum. *Brain Res* 1977;128:532-536.
49. Aube C, Racineux PX, Lebigot J, et al. [Diagnosis and quantification of hepatic fibrosis with diffusion weighted MR imaging: preliminary results]. *J Radiol* 2004;85:301-306.
50. Awad IA, Carter LP, Spetzler RF, et al. Clinical vasospasm after subarachnoid hemorrhage: response to hypervolemic hemodilution and arterial hypertension. *Stroke* 1987;18:365-372.
51. Awad IA, Magdinec M, Schubert A. Intracranial hypertension after resection of cerebral arteriovenous malformations—predisposing factors and management strategy. *Stroke* 1994;25:611-620.
52. Babikian VL, Wechsler LR. *Transcranial Doppler Ultrasonography*. St. Louis: Mosby, 1993.
53. Bacher A, Wei J, Grafe MR, et al. Serial determinations of cerebral water content by magnetic resonance imaging after an infusion of hypertonic saline. *Crit Care Med* 1998;26:108-114.
54. Bachli H, Langemann H, Mendelowitsch A, et al. Microdialytic monitoring dur-



- ing cerebrovascular surgery. *Neurol Res* 1996;18:370–376.
55. Ballabh P, Braun A, Nedergaard M. The blood–brain barrier: an overview: structure, regulation, and clinical implications. *Neurobiol Dis* 2004;16:1–13.
  56. Barber PA, Hoyte L, Colbourne F, et al. Temperature-regulated model of focal ischemia in the mouse: a study with histopathological and behavioral outcomes. *Stroke* 2004;35:1720–1725.
  57. Baron JC, Frackowiak RSJ, Herholz K, et al. Use of PET methods for measurement of cerebral energy metabolism and hemodynamics in cerebrovascular disease. *J Cereb Blood Flow Metab* 1989;9:723–742.
  58. Barone FC, Feuerstein GZ, White RF. Brain cooling during transient focal ischemia provides complete neuroprotection. *Neurosci Biobehav Rev* 1997;21:31–44.
  59. Barth J, Petermann W, Entzian P, et al. Modulation of oxygen-free radicals from human leukocytes during halothane- and enflurane-induced general anesthesia. *Acta Anaesthesiol Scand* 1987;31:740–743.
  60. Baskin DS, Widmayer MA, Browning JL, et al. Evaluation of delayed treatment of focal cerebral ischemia with three selective kappa-opioid agonists in cats. *Stroke* 1994;25:2047–2053; discussion 2054.
  61. Batjer H, Samson D. Intraoperative aneurysm rupture: incidence, outcome and suggestions for surgical management. *Neurosurgery* 1986;18:701–707.
  62. Batjer HH. Cerebral protective effects of etomidate—experimental and clinical aspects. *Cerebrovasc Brain Metab Rev* 1993;5:17–32.
  63. Bauer JH, Reams GP. The role of calcium entry blockers in hypertensive emergencies. *Circulation* 1987;75:V174–V180.
  64. Baughman VL, Becker GL, Ryan CM, et al. Effectiveness of triazolam, diazepam, and placebo as preanesthetic medications. *Anesthesiology* 1989;71:196–200.
  65. Baughman VL, Hoffman WE, Miletich DJ, et al. Neurologic outcome in rats following incomplete cerebral ischemia during halothane, isoflurane, or N<sub>2</sub>O. *Anesthesiology* 1988;69:192–198.
  66. Baughman VL, Hoffman WE, Miletich DJ, et al. Cerebrovascular and cerebral metabolic effects of N<sub>2</sub>O in unrestrained rats. *Anesthesiology* 1990;73:269–272.
  67. Baughman VL, Hoffman WE, Thomas C, et al. The interaction of nitrous oxide and isoflurane with incomplete cerebral ischemia in the rat. *Anesthesiology* 1989;70:767–774.
  68. Baughman VL, Hoffman WE, Thomas C, et al. Comparison of methohexital and isoflurane on neurologic outcome and histopathology following incomplete ischemia in rats. *Anesthesiology* 1990;72:85–94.
  69. Bayir H, Clark RS, Kochanek PM. Promising strategies to minimize secondary brain injury after head trauma. *Crit Care Med* 2003;31:S112–S117.
  70. Bayona NA, Gelb AW, Jiang Z, et al. Propofol neuroprotection in cerebral ischemia and its effects on low-molecular-weight antioxidants and skilled motor tasks. *Anesthesiology* 2004;100:1151–1159.
  71. Bedford RF, Dacey R, Winn HR, et al. Adverse impact of a calcium entry-blocker (verapamil) on intracranial pressure in patients with brain tumors. *J Neurosurg* 1983;59:800–802.
  72. Bedford RF, Marshall WK, Butler A, et al. Cardiac catheters for diagnosis and treatment of venous air embolism. *J Neurosurg* 1981;55:610–614.
  73. Bedford RF, Morris L, Jane JA. Intracranial hypertension during surgery for supratentorial tumor: correlation with preoperative computed tomography scans. *Anesth Analg* 1982;61:430–433.
  74. Belopavlovic M, Buchthal A. Modification of ketamine-induced intracranial hypertension in neurosurgical patients by pretreatment with midazolam. *Acta Anaesthesiol Scand* 1982;26:458–462.
  75. Benson DW, Williams GR Jr, Spencer FC, et al. The use of hypothermia after cardiac arrest. *Anesth Analg* 1959;38:423–428.
  76. Benveniste H, Diemer NH. Cellular reactions to implantation of a microdialysis tube in the rat hippocampus. *Acta Neuropathol (Berl)* 1987;74:234–238.
  77. Benveniste H, Drejer J, Schousboe A, et al. Regional cerebral glucose phosphorylation and blood flow after insertion of a microdialysis fiber through the dorsal hippocampus in the rat. *J Neurochem* 1987;49:729–734.
  78. Berezcki D, Liu M, Prado GF, et al. Cochrane report: a systematic review of mannitol therapy for acute ischemic stroke and cerebral parenchymal hemorrhage. *Stroke* 2000;31:2719–2722.
  79. Berezcki D, Mihalka L, Szatmari S, et al. Mannitol use in acute stroke: case fatality at 30 days and 1 year. *Stroke* 2003;34:1730–1735.
  80. Berger C, Annecke A, Aschoff A, et al. Neurochemical monitoring of fatal middle cerebral artery infarction. *Stroke* 1999;30:460–463.
  81. Berger C, Schabitz WR, Georgiadis D, et al. Effects of hypothermia on excitatory amino acids and metabolism in stroke patients: a microdialysis study. *Stroke* 2002;33:519–524.
  82. Bernard SA, Gray TW, Buist MD, et al. Treatment of comatose survivors of out-of-hospital cardiac arrest with induced hypothermia. *N Engl J Med* 2002;346:557–563.
  83. Berntman L, Dahlgren N, Siesjö BK. Cerebral blood flow and oxygen consumption in the rat brain during extreme hypercarbia. *Anesthesiology* 1979;50:299–305.
  84. Bevan JA. The human adrenergic neurovascular mechanism. *Fed Proc* 1985;44:317–320.
  85. Bhardwaj A. In vivo regional neurochemistry in stroke: clinical applications, limitations, and future directions. *Stroke* 2004;35:e74–e75.
  86. Bhardwaj A, Castro IA, Alkayed NJ, et al. Anesthetic choice of halothane versus propofol: impact on experimental perioperative stroke. *Stroke* 2001;32:1920–1925.
  87. Bhardwaj A, Harukuni I, Murphy SJ, et al. Hypertonic saline worsens infarct volume after transient focal ischemia in rats. *Stroke* 2000;31:1694–1701.
  88. Bhardwaj A, Ulatowski JA. Cerebral edema: hypertonic saline solutions. *Curr Treat Options Neurol* 1999;1:179–188.
  89. Bhardwaj A, Ulatowski JA. Hypertonic saline solutions in brain injury. *Curr Opin Crit Care* 2004;10:126–131.
  90. Bickler PE, Buck LT, Feiner JR. Volatile and intravenous anesthetics decrease glutamate release from cortical brain slices during anoxia. *Anesthesiology* 1995;83:1233–1240.
  91. Biller J, Godersky JC, Adams HP. Management of aneurysmal subarachnoid hemorrhage. *Stroke* 1988;19:1301–1318.
  92. Bivins HG, Ford S, Bezmalinovic Z, et al. The effect of axial traction during orotracheal intubation of the trauma victim with an unstable cervical spine. *Ann Emerg Med* 1988;17:25–29.
  93. Black PM, Tzouras A, Foley L. Cerebrospinal fluid dynamics and hydrocephalus after experimental subarachnoid hemorrhage. *Neurosurgery* 1985;17:57–62.
  94. Black S, Cucchiara RF, Nishimura RA, et al. Parameters affecting the occurrence of paradoxical air embolism. *Anesthesiology* 1989;71:235–241.
  95. Black S, Muzzi DA, Nishimura RA, et al. Preoperative and intraoperative echocardiography to detect right-to-left shunt in patients undergoing neurosurgical procedures in the sitting position. *Anesthesiology* 1990;72:436–438.
  96. Black S, Ockert DB, Oliver WC, et al. Outcome following posterior fossa craniectomy in patients in the sitting or horizontal positions. *Anesthesiology* 1988;69:49–56.
  97. Bleyaert AL, Nemoto EM, Safar P, et al. Thiopental amelioration of brain damage after global ischemia in monkeys. *Anesthesiology* 1978;49:390–398.
  98. Block F, Bozdog I, Nolden-Koch M. Inflammation contributes to the postponed ischemic neuronal damage following treatment with a glutamate antagonist in rats. *Neurosci Lett* 2001;298:103–106.
  99. Bloor BC. General pharmacology of  $\alpha_2$ -adrenoceptors. *Anaesth Pharmacol Rev* 1993;1:221–232.
  100. Blumberg S, Teichberg VI, Charli JL, et al. Cleavage of substance P to an N-terminal tetrapeptide and a C-terminal heptapeptide by a post-proline cleaving enzyme from bovine brain. *Brain Res* 1980;192:477–486.
  101. Boarini DJ, Kassell NF, Coester HC, et al. Comparison of systemic and cerebrovascular effects of isoflurane and halothane. *Neurosurgery* 1984;15:400–409.
  102. Bolli R. Cardioprotective function of inducible nitric oxide synthase and role of nitric oxide in myocardial ischemia and



- preconditioning: an overview of a decade of research. *J Mol Cell Cardiol* 2001;33:1897–1918.
103. Bolli R, Dawn B, Xuan YT. Emerging role of the JAK-STAT pathway as a mechanism of protection against ischemia/reperfusion injury. *J Mol Cell Cardiol* 2001;33:1893–1896.
104. Bolognese P, Miller JI, Heger IM, et al. Laser-Doppler flowmetry in neurosurgery. *J Neurosurg Anesthesiol* 1993;5:151–8.
105. Bosche B, Dohmen C, Graf R. Cerebral microdialysis in stroke patients: potentials and limitations of a method with longitudinal information: response. *Stroke* 2004;35:e75–e76.
106. Bradford HF, Crowder JM, White EJ. Inhibitory actions of opioid compounds on calcium fluxes and neurotransmitter release from mammalian cerebral cortical slices. *Br J Pharmacol* 1986;88:87–93.
107. Brazy JE. Effects of crying on cerebral blood volume and cytochrome aa3. *J Pediatr* 1988;112:457–61.
108. Breivik H, Safar P, Sands P, et al. Clinical feasibility trials of barbiturate therapy after cardiac arrest. *Crit Care Med* 1978;6:228–244.
109. Bryson HM, Fulton BR, Faulds D. Propofol. *Drugs* 1995;50:513–559.
110. Buchanan TA, Cane P, Eng CC, et al. Hypothermia is critical for survival during prolonged insulin-induced hypoglycemia in rats. *Metabolism* 1991;40:330–334.
111. Bullock R, Zauner A, Woodward J, et al. Massive persistent release of excitatory amino acids following human occlusive stroke. *Stroke* 1995;26:2187–2189.
112. Bunegin L, Albin MS, Helsel PE, et al. Positioning the right atrial catheter. *Anesthesiology* 1981;55:343–348.
113. Burke AM, Quest DO, Chien S, et al. The effects of mannitol on blood viscosity. *J Neurosurg* 1981;55:550–553.
114. Burrows FA, Bissonnette B. Cerebral blood flow velocity patterns during cardiac surgery utilizing profound hypothermia with low-flow cardiopulmonary bypass or circulatory arrest in neonates and infants [see comments]. *Can J Anaesth* 1993;40:298–307.
115. Busija DW. Sympathetic nerves reduce cerebral blood flow during hypoxia in awake rabbits. *Am J Physiol* 1984;247:H446–H451.
116. Busto R, Dietrich WD, Globus MY, et al. Small differences in intras ischemic brain temperature critically determine the extent of ischemic neuronal injury. *J Cereb Blood Flow Metab* 1987;7:729–738.
117. Camm AJ, Garratt CJ. Adenosine and supraventricular tachycardia. *N Engl J Med* 1991;325:1621.
118. Cao G, Minami M, Pei W, et al. Intracellular Bax translocation after transient cerebral ischemia: implications for a role of the mitochondrial apoptotic signaling pathway in ischemic neuronal death. *J Cereb Blood Flow Metab* 2001;21:321–333.
119. Cao Y, Dave KB, Doan TP, et al. Fatty acid CoA ligase 4 is up-regulated in colon adenocarcinoma. *Cancer Res* 2001;61:8429–8434.
120. Carl P, Hogskilde S, Lang-Jensen T, et al. Pharmacokinetics and pharmacodynamics of eltanolone (pregnenolone), a new steroid intravenous anaesthetic. In: humans. *Acta Anaesthesiol Scand* 1994;38:734–41.
121. Carlsson C, Smith DS, Keykha MM, et al. The effects of high dose fentanyl on cerebral circulation and metabolism in rats. *Anesthesiology* 1982;57:375–380.
122. Chan R, Leniger-Follert E. Effect of isovolemic hemodilution on oxygen supply and electrocorticogram in cat brain during focal ischemia and in normal tissue. *Int J Microcirc Clin Exp* 1983;2:297–313.
123. Chen CH, Toung TJ, Hurn PD, et al. Ischemic neuroprotection with selective kappa-opioid receptor agonist is gender specific. *Stroke* 2005;36:1557–1561.
124. Chen CH, Toung TJ, Sapirstein A, et al. Effect of duration of osmotherapy on blood-brain barrier disruption and regional cerebral edema after experimental stroke. *J Cereb Blood Flow Metab* 2006;26:951–958.
125. Chen TY, Goyagi T, Toung TJ, et al. Prolonged opportunity for ischemic neuroprotection with selective kappa-opioid receptor agonist in rats. *Stroke* 2004;35:1180–1185.
126. Cheng MA, Theard MA, Tempelhoff R. Intravenous agents and intraoperative neuroprotection. Beyond barbiturates. *Crit Care Clin* 1997;13:185–199.
127. Chioloro RL, Ravussin P, Anderes JP, et al. The effects of midazolam reversal by RO 15-1788 on cerebral perfusion pressure in patients with severe head injury. *Intensive Care Med* 1988;14:196–200.
128. Cho S, Park EM, Zhou P, et al. Obligatory role of inducible nitric oxide synthase in ischemic preconditioning. *J Cereb Blood Flow Metab* 2005;25:493–501.
129. Chopp M, Knight R, Tidwell CD, et al. The metabolic effects of mild hypothermia on global cerebral ischemia and recirculation in the cat: comparison to normothermia and hyperthermia. *J Cereb Blood Flow Metab* 1989;9:141–148.
130. Ciesla DJ, Moore EE, Zallen G, et al. Hypertonic saline attenuation of polymorphonuclear neutrophil cytotoxicity: timing is everything. *J Trauma* 2000;48:388–395.
131. Clifton GL, Christensen ML. Use of moderate hypothermia during elective craniotomy. *Tex Med* 1992;88:66–69.
132. Clifton GL, Jiang JY, Lyeth BG, et al. Marked protection by moderate hypothermia after experimental traumatic brain injury. *J Cereb Blood Flow Metab* 1991;11:114–121.
133. Clifton GL, Miller ER, Choi SC, et al. Lack of effect of induction of hypothermia after acute brain injury. *N Engl J Med* 2001;344:556–563.
134. Cloyd JC, Snyder BD, Cleeremans B, et al. Mannitol pharmacokinetics and serum osmolality in dogs and humans. *J Pharmacol Exp Ther* 1986;236:301–306.
135. Colbourne F, Li H, Buchan AM, et al. Continuing postischemic neuronal death in CA1: influence of ischemia duration and cytoprotective doses of NBQX and SNX-111 in rats. *Stroke* 1999;30:662–668.
136. Colbourne F, Sutherland G, Corbett D. Postischemic hypothermia. A critical appraisal with implications for clinical treatment. *Mol Neurobiol* 1997;14:171–201.
137. Cold GE, Christensen KJ, Nordentoft J, et al. Cerebral blood flow, cerebral metabolic rate of oxygen and relative CO<sub>2</sub> reactivity during neurolept anaesthesia in patients subjected to craniotomy for supratentorial cerebral tumours. *Acta Anaesth Scand* 1988;32:310–315.
138. Colley PS, Artru A, Bunegin-Albin catheter improves air retrieval and resuscitation from lethal venous air embolism in dogs. *Anesth Analg* 1987;66:991–994.
139. Colley PS, Sivarajan M. Regional blood flow in dogs during halothane anesthesia and controlled hypotension produced by nitroprusside or nitroglycerin. *Anesth Analg* 1984;63:503–510.
140. Conroy BP, Lin CY, Jenkins LW, et al. Hypothermic modulation of cerebral ischemic injury during cardiopulmonary bypass in pigs. *Anesthesiology* 1998;88:390–402.
141. Conzen PF, Vollmar B, Kabazettl H, et al. Systemic and regional hemodynamics of isoflurane and sevoflurane in rats. *Anesth Analg* 1992;74:79–88.
142. Cook DA. Mechanisms of cerebral vasospasm in subarachnoid haemorrhage. *Pharmacol Ther* 1995;66:259–84.
143. Cook DJ, Anderson RE, Michenfelder JD, et al. Cerebral blood flow during cardiac operations: comparison of Kety-Schmidt and xenon-133 clearance methods [see comments]. *Ann Thorac Surg* 1995;59:614–20.
144. Cooper KR, Boswell PA, Choi SC. Safe use of PEEP in patients with severe head injury. *J Neurosurg* 1985;63:552–555.
145. Corso CO, Okamoto S, Leiderer R, et al. Resuscitation with hypertonic saline dextran reduces endothelial cell swelling and improves hepatic microvascular perfusion and function after hemorrhagic shock. *J Surg Res* 1998;80:210–220.
146. Cosentino F, Katusic ZS. Does endothelin-1 play a role in the pathogenesis of cerebral vasospasm? *Stroke* 1994;25:904–8.
147. Cote CJ, Greenhow DE, Marshall BE. The hypotensive response to rapid intravenous administration of hypertonic solutions in man and in the rabbit. *Anesthesiology* 1979;50:30–35.
148. Cottrell JE, Gupta B, Rappoport H, et al. Intracranial pressure during nitroglycerin-induced hypotension. *J Neurosurg* 1980;53:309–311.
149. Cottrell JE, Patel K, Turndorf H, et al. Intracranial pressure changes induced by sodium nitroprusside in patients with intra-

- cranial mass lesions. *J Neurosurg* 1978;48:329–331.
150. Cottrell JE, Robustelli A, Post K, et al. Furosemide-and mannitol-induced changes in intracranial pressure and serum osmolality and electrolytes. *Anesthesiology* 1977;47:28–30.
151. Cottrell JE, Smith DS. *Anesthesia and Neurosurgery*. 3rd ed. St. Louis: Mosby, 1994.
152. Crosby ET, Lui A. The adult cervical spine: implications for airway management. *Can J Anaesth* 1990;37:77–93.
153. Crumrine RS, Nulsen FE, Weiss MH. Alterations in ventricular fluid pressure during ketamine anesthesia in hydrocephalic children. *Anesthesiology* 1975;42:758–61.
154. Cruz J, Minoja G, Okuchi K. Improving clinical outcomes from acute subdural hematomas with the emergency preoperative administration of high doses of mannitol: a randomized trial. *Neurosurgery* 2001;49:864–871.
155. Cucchiara RF, Michenfelder JD. *Clinical Neuroanesthesia*. New York: Churchill Livingstone, 1990.
156. Cucchiara RF, Nishimura RA, Black S. Failure of preoperative echo testing to prevent paradoxical air embolism: report of two cases. *Anesthesiology* 1989;71:604–607.
157. Cucchiara RF, Nugent M, Seward JB, et al. Air embolism in upright neurosurgical patients: detection and localization by two-dimensional transesophageal echocardiography. *Anesthesiology* 1984;60:353–355.
158. Cucchiara RF, Seward JB, Nishimura RA, et al. Identification of patient foramen ovale during sitting position craniotomy by transesophageal echocardiography with positive airway pressure. *Anesthesiology* 1985;63:107–109.
159. Cucchiara RF, Theye RA, Michenfelder JD. The effects of isoflurane on canine cerebral metabolism and blood flow. *Anesthesiology* 1974;40:571–574.
160. Cully MD, Larson CP, Silverberg GD. Hetastarch coagulopathy in a neurosurgical patient. *Anesthesiology* 1987;66:706–707.
161. Cunitz G, Danhauser I, Wickbold J. Comparative investigations on the influence of etomidate, thiopentone and methohexitone on the intracranial pressure of the patient. *Anaesthesia* 1978;27:64–70.
162. D'Alecy LG, Rose CJ, Sellers SA. Sympathetic modulation of hypercapnic cerebral vasodilation in dogs. *Circ Res* 1979;45:771–785.
163. Dahl A, Russell D, Nyberg-Hansen R, et al. Effect of nitroglycerin on cerebral circulation measured by transcranial Doppler and SPECT. *Stroke* 1989;20:1733–1736.
164. Dam M, Ori C, Pizzolato G, et al. The effects of propofol anesthesia on local cerebral glucose utilization in the rat. *Anesthesiology* 1990;73:499–505.
165. Damon L, Adams M, Stricker RB, et al. Intracranial bleeding during treatment with hydroxyethyl starch [letter]. *N Engl J Med* 1987;317:964–965.
166. Dave KR, Saul I, Busto R, et al. Ischemic preconditioning preserves mitochondrial function after global cerebral ischemia in rat hippocampus. *J Cereb Blood Flow Metab* 2001;21:1401–1410.
167. Davies KR, Gelb A, Manninen PH, et al. A comparison of electrocardiographic and echocardiographic abnormalities in subarachnoid hemorrhage. *Can J Anaesth* 1990;37:S25.
168. Davis TP, Alexander J, Lesch M. Electrocardiographic changes associated with acute cerebrovascular disease: a clinical review. *Prog Cardiovasc Dis* 1993;36:245–260.
169. Dawn B, Xuan YT, Marian M, et al. Cardiac-specific abrogation of NF-kappa B activation in mice by transdominant expression of a mutant I kappa B alpha. *J Mol Cell Cardiol* 2001;33:161–173.
170. Day AL, Friedman WA, Sypert GW, et al. Successful treatment of the normal perfusion pressure breakthrough syndrome. *Neurosurgery* 1982;11:625–630.
171. Dearden NM, McDowall DG. Comparison of etomidate and Althesin in the reduction of increased intracranial pressure after head injury. *Br J Anaesth* 1985;57:361–368.
172. Deem S, Shapiro HM, Marshall LF. Quadriplegia in a patient with cervical spondylosis after thoracolumbar surgery in the prone position. *Anesthesiology* 1991;75:527–528.
173. Deutsch G, Samra SK. Effects of nitrous oxide on global and regional cortical blood flow. *Stroke* 1990;21:1293–1298.
174. Dexter F, Hindman BJ. Theoretical analysis of cerebral venous blood hemoglobin oxygen saturation as an index of cerebral oxygenation during hypothermic cardiopulmonary bypass. A counterproposal to the “luxury perfusion” hypothesis. *Anesthesiology* 1995;83:406–412.
175. DiPasquale G, Pinelli G, Andreoli A, et al. Holter detection of cardiac arrhythmias in intracranial subarachnoid hemorrhage. *Am J Cardiol* 1987;59:596–600.
176. Dietrich WD, Busto R, Halley M, et al. The importance of brain temperature in alterations of the blood-brain barrier following cerebral ischemia. *J Neuropathol Exp Neurol* 1990;49:486–497.
177. Dirnagl U, Simon RP, Hallenbeck JM. Ischemic tolerance and endogenous neuroprotection. *Trends Neurosci* 2003;26:248–254.
178. Domino KB, Hemstad JR, Lam AM, et al. Effect of nitrous oxide in intracranial pressure after cranial-dural closure in patients undergoing craniotomy. *Anesthesiology* 1992;77:421–425.
179. Donato T, Shapira Y, Artru A, et al. Effect of mannitol on cerebrospinal fluid dynamics and brain tissue edema. *Anesth Analg* 1994;78:58–66.
180. Dorsch NW. Cerebral arterial spasm—a clinical review. *Br J Neurosurg* 1995;9:403–12.
181. Doyle JA, Davis DP, Hoyt DB. The use of hypertonic saline in the treatment of traumatic brain injury. *J Trauma* 2001;50:367–383.
182. Doze VA, Chen BX, Maze M. Dexmedetomidine produces a hypnotic-anesthetic action in rats via activation of central alpha-2 adrenoceptors. *Anesthesiology* 1989;71:75–79.
183. Drake CG. Report of World Federation of Neurological Surgeons Committee on a universal subarachnoid hemorrhage grading scale. *J Neurosurg* 1988;68:985–986.
184. Drummond JC, Cole DJ, Patel PM, et al. Focal cerebral ischemia during anesthesia with etomidate, isoflurane, or thiopental: a comparison of the extent of cerebral injury. *Neurosurgery* 1995;37:742–748.
185. Drummond JC, McKay LD, Cole DJ, et al. The role of nitric oxide synthase inhibition in the adverse effects of etomidate in the setting of focal cerebral ischemia in rats. *Anesth Analg* 2005;100:841–846.
185. Drummond JC, Patel PM. Editorial Board reproached for publication of BIS-mortality correlation. *Anesth Analg* 2005;101:1238–1239; author reply 1240–1231.
186. Drummond JC, Petrovitch CT. Intraoperative blood salvage: fluid replacement calculations. *Anesth Analg* 2005;100:645–649, table of contents.
187. Drummond JC, Prutow RJ, Scheller MS. A comparison of the sensitivity of pulmonary artery pressure, end-tidal carbon dioxide, and end-tidal nitrogen in the detection of venous air embolism in the dog. *Anesth Analg* 1985;64:688–692.
188. Drummond JC, Scheller MS, Todd MM. The effect of nitrous oxide on cortical CBF during anesthesia with halothane and isoflurane, with and without morphine, in the New Zealand White rabbit. *Anesth Analg* 1987;66:1083–1089.
189. Drummond JC, Todd MM. The response of the feline cerebral circulation to PaCO<sub>2</sub> during anesthesia with isoflurane and halothane and during sedation with nitrous oxide. *Anesthesiology* 1985;62:268–273.
190. Drummond JC, Todd MM, Scheller MS, et al. A comparison of the direct cerebral vasodilating potencies of halothane and isoflurane in the New Zealand White rabbit. *Anesthesiology* 1986;65:462–467.
191. Ducey JP, Mozingo DW, Lamiell JM, et al. A comparison of the cerebral and cardiovascular effects of complete resuscitation with isotonic and hypertonic saline, hetastarch, and whole blood following hemorrhage. *J Trauma* 1989;29:1510–1518.
192. Duncan R. Epilepsy, cerebral blood flow, and cerebral metabolic rate. *Cerebrovasc Brain Metab Rev* 1992;4:105–121.
193. Durward QJ, Amacher L, Maestro RF, et al. Cerebral and cardiovascular responses to changes in head elevation in patients with intracranial hypertension. *J Neurosurg* 1983;59:938–944.
194. Ebrahim ZY, DeBoer GE, Luders H, et al. Effect of etomidate on the electroen-

- cephalogram of patients with epilepsy. *Anesth Analg* 1986;65:1004–1006.
195. Ebrahim ZY, Schubert A, Vanness P, et al. The effect of propofol on the electroencephalogram of patients with epilepsy. *Anesth Analg* 1994;78:275–279.
196. Edvinsson L. Sympathetic control of cerebral circulation. *TINS* 1982;5:425–429.
197. Eintrei C, Leszniewski W, Carlsson C. Local application of (133)Xenon for measurement of regional cerebral blood flow (rCBF) during halothane, enflurane and isoflurane anesthesia in humans. *Anesthesiology* 1985;63:391–394.
198. Eliasson A. Microdialysis—principles of recovery. *CMA/Microdialysis*, Stockholm, 1991.
199. Ellis SC, Bryan-Brown CW, Hyderally H. Massive swelling of the head and neck. *Anesthesiology* 1975;42:102–103.
200. Elwell CE, Cope M, Edwards AD, et al. Quantification of adult cerebral hemodynamics by near-infrared spectroscopy. *J Appl Physiol* 1994;77:2753–2760.
201. Enblad P, Valtysson J, Andersson J, et al. Simultaneous intracerebral microdialysis and positron emission tomography in the detection of ischemia in patients with subarachnoid hemorrhage. *J Cereb Blood Flow Metab* 1996;16:637–644.
202. Eng C, Lam AM, Mayberg TS, et al. The influence of propofol with and without nitrous oxide on cerebral blood flow velocity and CO<sub>2</sub> reactivity in humans. *Anesthesiology* 1992;77:872–879.
203. Engel J Jr. Mesial temporal lobe epilepsy: what have we learned? *Neuroscientist* 2001;7:340–352.
204. Engelhard K, Werner C, Eberspacher E, et al. The effect of the alpha 2-agonist dexmedetomidine and the N-methyl-D-aspartate antagonist S(+)-ketamine on the expression of apoptosis-regulating proteins after incomplete cerebral ischemia and reperfusion in rats. *Anesth Analg* 2003;96:524–531, table of contents.
205. English JB, Westenskow D, Hodges MR, et al. Comparison of venous air embolism monitoring methods in supine dogs. *Anesthesiology* 1978;48:425–429.
206. Erecinska M, Silver IA. ATP and brain function. *J Cereb Blood Flow Metab* 1989;9:2–19.
207. Erecinska M, Silver IA. Ions and energy in mammalian brain. *Prog Neurobiol* 1994;43:37–71.
208. Erecinska M, Silver IA. Tissue oxygen tension and brain sensitivity to hypoxia. *Respir Physiol* 2001;128:263–276.
209. Erecinska M, Thoresen M, Silver IA. Effects of hypothermia on energy metabolism in mammalian central nervous system. *J Cereb Blood Flow Metab* 2003;23:513–530.
210. Eriksson S, Hagenfeldt L, Law D, et al. Effect of prostaglandin synthesis inhibitors on basal and carbon dioxide stimulated cerebral blood flow in man. *Acta Physiol Scand* 1983;117:203–211.
211. Eshhar N, Lederkremer G, Beaujean M, et al. Kainyl-bovine serum albumin: a novel ligand of the kainate sub-type of glutamate receptor with a very high binding affinity. *Brain Res* 1989;476:57–70.
212. Estilo AE, Cottrell JE. Naloxone, hypertension, and ruptured cerebral aneurysm. *Anesthesiology* 1981;54:352.
213. Fanconi S, Duc G. Intratracheal suctioning in sick preterm infants: prevention of intracranial hypertension and cerebral hypoperfusion by muscle paralysis. *Pediatrics* 1987;79:538–543.
214. Faraci FM, Brian JE. Nitric oxide and the cerebral circulation. *Stroke* 1994;25:692–703.
215. Faraci FM, Heistad DD. Regulation of cerebral blood vessels by humoral and endothelium-dependent mechanisms. Update on humoral regulation of vascular tone. *Hypertension* 1991;17:917–922.
216. Farrar JK, Gamache FW, Ferguson G, et al. Effects of profound hypotension on cerebral blood flow during surgery for intracranial aneurysms. *J Neurosurg* 1981;55:857–64.
217. Fenstermacher JD. Volume regulation of the central nervous system. In: Staub NC, Taylor AE, eds. *Edema*. New York: Raven Press, 1984:383–404.
218. Fenstermacher JD, Johnson JA. Filtration and reflection coefficients of the rabbit blood–brain barrier. *Am J Physiol* 1966;211:341–346.
219. Ferry JA, Srigley JR, Young RH. Granulocytic sarcoma of the testis: a report of two cases of a neoplasm prone to misinterpretation. *Mod Pathol* 1997;10:320–325.
220. Fisher B, Thomas D, Peterson B. Hypertonic saline lowers raised intracranial pressure in children after head trauma. *J Neurosurg Anesth* 1992;4:4–10.
221. Fleischer JE, Milde JH, Moyer TP, et al. Cerebral effects of high-dose midazolam and subsequent reversal with Ro 15-1788 in dogs. *Anesthesiology* 1988;68:234–242.
222. Forster A, Juge O, Louis M, et al. Effects of a specific benzodiazepine antagonist (RO 15-1788) on cerebral blood flow. *Anesth Analg* 1987;66:309–313.
223. Forster A, Juge O, Morel DK. Effects of midazolam on cerebral blood flow in human volunteers. *Anesthesiology* 1982;56:453–455.
224. Fortune JB, Feustel PJ, Weigle CGM, et al. Continuous measurement of jugular venous oxygen saturation in response to transient elevations of blood pressure in head-injured patients. *J Neurosurg* 1994;80:461–468.
225. Fox PT, Raichle ME, Mintun MA, et al. Nonoxidative glucose consumption during focal physiologic neural activity. *Science* 1988;241:462–464.
226. Frank SM, Beattie C, Christopherson R, et al. Unintentional hypothermia is associated with postoperative myocardial ischemia. *Anesthesiology* 1993;78:468–476.
227. Frenk H, Liban A, Urca G, et al. Absence of side-effects in the anticonvulsant action of cortically applied antagonists of N-methyl-D-aspartate. *Brain Res* 1986;373:222–226.
228. Friedman WA, Chadwick GM, Verhoeven FJS, et al. Monitoring of somatosensory evoked potentials during surgery for middle cerebral artery aneurysms. *Neurosurgery* 1991;29:83–88.
229. Friesen RH, Honda AT, Thieme RE. Changes in anterior fontanel pressure in preterm neonates during tracheal intubation. *Anesth Analg* 1987;66:874–878.
230. Friesen RH, Thieme RE, Honda AT, et al. Changes in anterior fontanel pressure in preterm neonates receiving isoflurane halothane fentanyl or ketamine. *Anesth Analg* 1987;66:431–434.
231. Frohlich D, Rothe G, Schwall B, et al. Effects of volatile anaesthetics on human neutrophil oxidative response to the bacterial peptide FMLP. *Br J Anaesth* 1997;78:718–723.
232. From RP, Warner DS, Todd MM, et al. Anesthesia for craniotomy: a double-blind comparison of alfentanil, fentanyl, and sufentanil. *Anesthesiology* 1990;73:896–904.
233. Frost JJ. Receptor imaging by positron emission tomography and single-photon emission computed tomography. *Invest Radiol* 1992;27:S54–S58.
234. Fujisawa H, Koizumi H, Ito H, et al. Effects of mild hypothermia on the cortical release of excitatory amino acids and nitric oxide synthesis following hypoxia. *J Neurotrauma* 1999;16:1083–1093.
235. Fukuda O, Endo S, Kuwayama N, et al. The characteristics of laser-Doppler flowmetry for the measurement of regional cerebral blood flow. *Neurosurgery* 1995;36:358–364.
236. Furuya H, Suzuki T, Okumura F, et al. Detection of air embolism by transesophageal echocardiography. *Anesthesiology* 1983;58:124–129.
237. Gaab MR, Czech T, Korn A. Intracranial effects of nicardipine. *Br J Clin Pharmacol* 1985;20(Suppl 1):67S–74S.
238. Gaab MR, Haubitz I, Brawanski A, et al. Acute effects of nimodipine on the cerebral blood flow and intracranial pressure. *Neurochirurgia (Stuttg)* 1985;281:93–99.
239. Gelb AW, Bayona NA, Wilson JX, et al. Propofol anesthesia compared to awake reduces infarct size in rats. *Anesthesiology* 2002;96:1183–1190.
240. Gelb AW, Boisvert DP, Tang C, et al. Primate brain tolerance to temporary focal cerebral ischemia during isoflurane- or sodium nitroprusside-induced hypotension. *Anesthesiology* 1989;70:678–683.
241. Gemma M, Cozzi S, Tommasino C, et al. 7.5% hypertonic saline versus 20% mannitol during elective neurosurgical supratentorial procedures. *J Neurosurg Anesthesiol* 1997;9:329–334.
242. Ghani GA, Sung YF, Winstein MS, et al. Effects of intravenous nitroglycerin on the intracranial pressure and volume pressure response. *J Neurosurg* 1983;58:562–565.



243. Giannotta SL, Oppenheimer JH, Levy ML, et al. Management of intraoperative rupture of aneurysm without hypotension. *Neurosurgery* 1991;28:531–536.
244. Giffin JP, Cottrell JE, Shwiry B, et al. Intracranial pressure, mean arterial pressure, and heart rate following midazolam or thiopental in humans with brain tumors. *Anesthesiology* 1984;60:491–494.
245. Gildenberg PL, O'Brien RP, Britt WJ, et al. The efficacy of precordial Doppler monitoring for the detection of venous air embolism. *J Neurosurg* 1981;54:75–78.
246. Ginsberg MD, Sternau LL, Globus MY, et al. Therapeutic modulation of brain temperature: relevance to ischemic brain injury. *Cerebrovasc Brain Metab Rev* 1992;4:189–225.
247. Gisvold SE, Safar P, Hendrickx HH, et al. Thiopental treatment after global brain ischemia in pigtailed monkeys. *Anesthesiology* 1984;60:88–96.
248. Glass PSA, Hardman D, Kamiyama Y, et al. Preliminary pharmacokinetics and pharmacodynamics of an ultra-short-acting opioid—remifentanyl (G187084B). *Anesth Analg* 1993;77:1031–1040.
249. Glenski JA, Cucchiara RF, Michenfelder JD. Transesophageal echocardiography and transcutaneous O<sub>2</sub> and CO<sub>2</sub> monitoring of neurosurgical patients: Detection of air embolism. *Anesthesiology* 1986;64:546–550.
250. Gluckman PD, Wyatt JS, Azzopardi D, et al. Selective head cooling with mild systemic hypothermia after neonatal encephalopathy: multicentre randomised trial. *Lancet* 2005;365:663–670.
251. Godin DV, Mitchell MJ, Saunders BA. Studies on the interaction of barbiturates with reactive oxygen radicals: implications regarding barbiturate protection against cerebral ischaemia. *Can Anaesth Soc J* 1982;29:203–211.
252. Goldstein AJ, Wells BA, Keats AS. Increased tolerance to anoxia by pentobarbital. *Arch Int Pharmacodyn Ther* 1966;161:138–143.
253. Goluboff B, Shenkin HA, Haft H. The effects of mannitol and urea on cerebral hemodynamics and cerebrospinal fluid pressure. *Neurology* 1964;14:891–898.
254. Gonzalez AM, Carman LS, Ong M, et al. Storage, metabolism, and processing of <sup>125</sup>I-fibroblast growth factor-2 after intracerebral injection. *Brain Res* 1994;665:285–292.
255. Graham SH, Chen J. Programmed cell death in cerebral ischemia. *J Cereb Blood Flow Metab* 2001;21:99–109.
256. Gray JJ, Bickler PE, Fahlman CS, et al. Isoflurane neuroprotection in hypoxic hippocampal slice cultures involves increases in intracellular Ca<sup>2+</sup> and mitogen-activated protein kinases. *Anesthesiology* 2005;102:606–615.
257. Greenberg JH, Alavi A, Reivich M, et al. Local cerebral blood volume response to carbon dioxide in man. *Circ Res* 1978;43:324–331.
258. Grosslight K, Foster R, Colohan AR, et al. Isoflurane for neuroanesthesia: risk factors for increases in intracranial pressure. *Anesthesiology* 1985;63:533–536.
259. Grubb RL, Raichle ME, Eichling JO, et al. The effects of changes in PaCO<sub>2</sub> on cerebral blood volume, blood flow, and vascular mean transit time. *Stroke* 1974;5:630–639.
260. Gunnar W, Jonasson O, Merlotti G, et al. Head injury and hemorrhagic shock: studies of the blood brain barrier and intracranial pressure after resuscitation with normal saline solution, 3% saline solution, and dextran-40. *Surgery* 1988;103:398–407.
261. Gunnar WP, Merlotti GJ, Barrett J, et al. Resuscitation from hemorrhagic shock. Alterations of the intracranial pressure after normal saline, 3% saline and dextran-40. *Ann Surg* 1986;204:686–692.
262. Guo Y, Bolli R, Bao W, et al. Targeted deletion of the A3 adenosine receptor confers resistance to myocardial ischemic injury and does not prevent early preconditioning. *J Mol Cell Cardiol* 2001;33:825–830.
263. Gupta AK. Monitoring the injured brain in the intensive care unit. *J Postgrad Med* 2002;48:218–225.
264. Gur D, Yonas H, Good WF. Local cerebral blood flow by xenon-enhanced CT: current status, potential improvements, and future directions. *Cerebrovasc Brain Metab Rev* 1989;1:68–86.
265. Guyenet PG, Stornetta RL, Riley T, et al. Alpha 2A-adrenergic receptors are present in lower brainstem catecholaminergic and serotonergic neurons innervating spinal cord. *Brain Res* 1994;638:285–294.
266. Gyulai F, Firestone L, Mintun M, et al. Loci of N<sub>2</sub>O analgesia in the human brain. A PET study. *Anesthesiology* 1995;83:A163.
267. Haaland K, Loberg EM, Steen PA, et al. Posthypoxic hypothermia in newborn piglets. *Pediatr Res* 1997;41:505–512.
268. Haberl RL, Heizer ML, Marmarou A, et al. Laser-Doppler assessment of brain microcirculation: effect of systemic alterations. *Am J Physiol* 1989;256:H1247–H1254.
269. Haberl RL, Villringer A, Dirnagl U. Applicability of laser-Doppler flowmetry for cerebral blood flow monitoring in neurological intensive care. *Acta Neurochir Suppl* 1993;59:64–68.
270. Haelewyn B, Yvon A, Hanouz JL, et al. Desflurane affords greater protection than halothane against focal cerebral ischaemia in the rat. *Br J Anaesth* 2003;91:390–396.
271. Hagihira S, Okitsu K, Kawaguchi M. Unusually low bispectral index values during emergence from anesthesia. *Anesth Analg* 2004;98:1036–1038, table of contents.
272. Haigh JD, Nemoto EM, DeWolf AM, et al. Comparison of the effects of succinylcholine and atracurium on intracranial pressure in monkeys with intracranial hypertension. *Can Anaesth Soc J* 1986;33:421–426.
273. Haley EC, Kassell NF, Torner JC, et al. A randomized trial of two doses of nicardipine in aneurysmal subarachnoid hemorrhage—a report of the Cooperative Aneurysm Study. *J Neurosurg* 1994;80:788–796.
274. Hall ED. Neuroprotective actions of glucocorticoid and nonglucocorticoid steroids in acute neuronal injury. *Cell Mol Neurobiol* 1993;13:415–32.
275. Hall ED, Yonkers PA, Andrus PK, et al. Biochemistry and pharmacology of lipid antioxidants in acute brain and spinal cord injury. *J Neurotrauma* 1992;9:S425–S442.
276. Hamar J, Arisztid GB, Kovach AGB, et al. Effect of phenoxybenzamine on cerebral blood flow and metabolism in the baboon during hemorrhagic shock. *Stroke* 1979;10:401–407.
277. Hamill JF, Bedford RF, Weaver DC, et al. Lidocaine before endotracheal intubation: intravenous or laryngotracheal? *Anesthesiology* 1981;55:578–581.
278. Hammer MD, Krieger DW. Hypothermia for acute ischemic stroke: not just another neuroprotectant. *Neurologist* 2003;9:280–289.
279. Hans P, Bonhomme V. The rationale for perioperative brain protection. *Eur J Anaesthesiol* 2004;21:1–5.
280. Hansen TD, Warner DS, Todd MM, et al. Distribution of cerebral blood flow during halothane versus isoflurane anesthesia in rats. *Anesthesiology* 1988;69:332–337.
281. Hansen TD, Warner DS, Todd MM, et al. The role of cerebral metabolism in determining the local cerebral blood flow effects of volatile anesthetics: Evidence for persistent flow-metabolism coupling. *J Cereb Blood Flow and Metab* 1989;9:323–328.
282. Hansen TD, Warner DS, Todd MM, et al. Relative cerebral blood flow effects of nitrous oxide and volatile anesthetics. *Br J Anaesth* 1989;63:290–295.
283. Hartl R, Medary MB, Ruge M, et al. Hypertonic/hyperoncotic saline attenuates microcirculatory disturbances after traumatic brain injury. *J Trauma* 1997;42:S41–S47.
284. Hartman GS, Fiamengo SA, Riker WF. Succinylcholine: mechanism of fasciculations and their prevention by *d*-tubocurarine or diphenylhydantoin. *Anesthesiology* 1986;65:405–413.
285. Hastings RH, Marks JD. Airway management for trauma patients with potential cervical spine injuries. *Anesth Analg* 1991;73:471–482.
286. Hartvig P, Valtysson J, Antoni G, et al. Brain kinetics of (R)- and (S)-[N-methyl-<sup>11</sup>C]ketamine in the rhesus monkey studied by positron emission tomography (PET). *Nucl Med Biol* 1994;21:927–934.
287. Harukuni I, Kirsch JR, Bhardwaj A. Cerebral resuscitation: role of osmotherapy. *J Anesth* 2002;16:229–237.
288. Hastings RH, Vigil AC, Hanna R, et al. Cervical spine movement during laryngoscopy with the Bullard, Macintosh, and Miller laryngoscopes. *Anesthesiology* 1995;82:859–869.
289. Hatano Y, Nakamura K, Moriyama S, et al. The contractile responses of isolated



dog cerebral and extracerebral arteries to oxybarbiturates and thiobarbiturates. *Anesthesiology* 1989;71:80-86.

290. Heinemeyer G. Clinical pharmacokinetic considerations in the treatment of increased intracranial pressure. *Clin Pharmacokinet* 1987;13:1-25.

291. Hellstrom HO, Wanhainen A, Valtysson J, et al. Effect of tirilazad mesylate given after permanent middle cerebral artery occlusion in rat. *Acta Neurochir (Wien)* 1994;129:188-192.

292. Hemstreet MK, Matsumoto RR, Bowen WD, et al. Sigma binding parameters in developing rats predict behavioral efficacy of a sigma ligand. *Brain Res* 1993;627:291-298.

293. Henriksen HT, Jorgensen PB. The effect of nitrous oxide on intracranial pressure in patients with intracranial disorders. *Br J Anaesth* 1973;45:486-492.

294. Henriksen L, Paulson OB, Lauritzen M. The effects of sodium nitroprusside on cerebral blood flow and cerebral venous blood gases. I. Observations in awake man during and following moderate blood pressure reduction. *Eur J Clin Invest* 1982;12:383-387.

295. Herregods L, Mergaert C, Rolly G, et al. Comparison of the effects of the 24-hour propofol or fentanyl infusions on intracranial pressure. *J Drug Dev* 1989;2:99-100.

296. Herrmann O, Tarabin V, Suzuki S, et al. Regulation of body temperature and neuroprotection by endogenous interleukin-6 in cerebral ischemia. *J Cereb Blood Flow Metab* 2003;23:406-415.

297. Heymann MA, Payne BD, Hoffman JIE, et al. Blood flow measurements with radionuclide-labeled particles. *Prog Cardiovasc Dis* 1977;20:55-79.

298. Hickey RW, Ferimer H, Alexander HL, et al. Delayed, spontaneous hypothermia reduces neuronal damage after asphyxial cardiac arrest in rats. *Crit Care Med* 2000;28:3511-3516.

299. Higgins RD, Raju TN, Perlman J, et al. Hypothermia and perinatal asphyxia: executive summary of the National Institute of Child Health and Human Development workshop. *J Pediatr* 2006;148:170-175.

300. Hillered L, Persson L, Carlsson H, et al. Studies on excitatory amino acid receptor-linked brain disorders in rat and man using in vivo microdialysis. *Clin Neuropharmacol* 1992;15(Suppl 1 Pt A):695A-696A.

301. Hillered L, Persson L, Ponten U, et al. Neurometabolic monitoring of the ischaemic human brain using microdialysis. *Acta Neurochir (Wien)* 1990;102:91-97.

302. Hillered L, Vespa PM, Hovda DA. Translational neurochemical research in acute human brain injury: the current status and potential future for cerebral microdialysis. *J Neurotrauma* 2005;22:3-41.

303. Himmelseher S, Pfenninger E, Morin P, et al. Hypertonic-Hyperoncotic saline differentially affects healthy and glutamate-injured primary rat hippocampal neurons and cerebral astrocytes. *J Neurosurg Anesthesiol* 2002;13:120-130.

304. Hirota K, Hara T, Hosoi S, et al. Two cases of hyperkalemia after administration of hypertonic mannitol during craniotomy. *J Anesth* 2005;19:75-77.

305. Hlatky R, Valadka AB, Goodman JC, et al. Patterns of energy substrates during ischemia measured in the brain by microdialysis. *J Neurotrauma* 2004;21:894-906.

306. Hochachka PW, Mommsen TP. Protons and anaerobiosis. *Science* 1983;219:1391-1397.

307. Hoffman J, Konopka K, Buckhorn C, et al. Ethanol-inducible cytochrome P450 in rabbits metabolizes enflurane. *Br J Anaesth* 1989;63:103-108.

308. Hoffman JM, Hanson MW, Coleman RE. Clinical positron emission tomography imaging. *Radiol Clin North Am* 1993;31:935-959.

309. Hoffman WE, Charbel FT, Edelman G. Desflurane increases brain tissue oxygenation and pH. *Acta Anaesthesiol Scand* 1997;41:1162-1166.

310. Hoffman WE, Charbel FT, Edelman G, et al. Thiopental and desflurane treatment for brain protection. *Neurosurgery* 1998;43:1050-1053.

311. Hoffman WE, Charbel FT, Edelman G, et al. Comparison of the effect of etomidate and desflurane on brain tissue gases and pH during prolonged middle cerebral artery occlusion. *Anesthesiology* 1998;88:1188-1194.

312. Hoffman WE, Cunningham F, James MK, et al. Effects of remifentanyl, a new short-acting opioid, on cerebral blood flow, brain electrical activity, and intracranial pressure in dogs anesthetized with isoflurane and nitrous oxide. *Anesthesiology* 1993;79:107-113.

313. Hoffman WE, Pelligrino D, Werner C, et al. Ketamine decreases plasma catecholamines and improves outcome from incomplete cerebral ischemia in rats. *Anesthesiology* 1992;76:755-762.

314. Hofmeijer J, Veldhuis WB, Schepers J, et al. The time course of ischemic damage and cerebral perfusion in a rat model of space-occupying cerebral infarction. *Brain Res* 2004;1013:74-82.

315. Homi HM, Yokoo N, Ma D, et al. The neuroprotective effect of xenon administration during transient middle cerebral artery occlusion in mice. *Anesthesiology* 2003;99:876-881.

316. Hongo K, Kobayashi S. Calcium antagonists for the treatment of vasospasm following subarachnoid haemorrhage. *Neuro Res* 1993;15:218-224.

317. Horiuchi T, Kawaguchi M, Sakamoto T, et al. The effects of the delta-opioid agonist SNC80 on hind-limb motor function and neuronal injury after spinal cord ischemia in rats. *Anesth Analg* 2004;99:235-240.

318. Hormann C, Mohsenipour I, Gottardis M, et al. Response of cerebrospinal fluid pressure to continuous positive airway pressure in volunteers. *Anesth Analg* 1994;78:54-57.

319. Horn P, Munch E, Vajkoczy P, et al. Hypertonic saline solution for control of

elevated intracranial pressure in patients with exhausted response to mannitol and barbiturates. *Neurol Res* 1999;21:758-764.

320. Hougaard K, Hansen A, Brodersen P. The effect of ketamine on regional cerebral blood flow in man. *Anesthesiology* 1974;41:562-567.

321. Hoya K, Asai A, Sasaki T, et al. Expression of myosin heavy chain isoforms by smooth muscle cells in cerebral arteriovenous malformations. *Acta Neuropathol (Berl)* 2003;105:455-461.

322. Huang FP, Zhou LF, Yang GY. Effects of mild hypothermia on the release of regional glutamate and glycine during extended transient focal cerebral ischemia in rats. *Neurochem Res* 1998;23:991-996.

323. Hunt WE, Hess RM. Surgical risk as related to time of intervention in the repair of intracranial aneurysms. *J Neurosurg* 1968;28:14-20.

324. Hutchinson PJ, Al-Rawi PG, O'Connell MT, et al. Biochemical changes related to hypoxia during cerebral aneurysm surgery: combined microdialysis and tissue oxygen monitoring: case report. *Neurosurgery* 2000;46:201-205; discussion 205-206.

325. Hutchinson PJ, Gupta AK, Fryer TF, et al. Correlation between cerebral blood flow, substrate delivery, and metabolism in head injury: a combined microdialysis and triple oxygen positron emission tomography study. *J Cereb Blood Flow Metab* 2002;22:735-745.

326. Hutchinson PJ, O'Connell MT, Al-Rawi PG, et al. Clinical cerebral microdialysis: a methodological study. *J Neurosurg* 2000;93:37-43.

327. Hutchinson PJ, O'Connell MT, Nortje J, et al. Cerebral microdialysis methodology—evaluation of 20 kDa and 100 kDa catheters. *Physiol Meas* 2005;26:423-428.

328. Iadecola C, Pelligrino DA, Moskowitz MA, et al. Nitric oxide synthase inhibition and cerebrovascular regulation. *J Cereb Blood Flow Metab* 1994;14:175-192.

329. Iida H, Ohata H, Iida M, et al. Direct effects of alpha<sub>1</sub>- and alpha<sub>2</sub>-adrenergic agonists on spinal and cerebral pial vessels in dogs. *Anesthesiology* 1999;91:479-485.

330. Ikonomidou C, Bosch F, Miksa M, et al. Blockade of NMDA receptors and apoptotic neurodegeneration in the developing brain. *Science* 1999;283:70-74.

331. Inoue S, Drummond JC, Davis DP, et al. Combination of isoflurane and caspase inhibition reduces cerebral injury in rats subjected to focal cerebral ischemia. *Anesthesiology* 2004;101:75-81.

332. Ishimaru MJ, Ikonomidou C, Tenkova TI, et al. Distinguishing excitotoxic from apoptotic neurodegeneration in the developing rat brain. *J Comp Neurol* 1999;408:461-476.

333. Jenkins LW, DeWitt DS, Johnston WE, et al. Intrischemic mild hypothermia increases hippocampal CA1 blood flow during fore-brain ischemia. *Brain Res* 2001;890:1-10.

334. Jennett B, Bond M. Assessment of outcome after severe brain damage. *Lancet* 1975;1:480-484.

335. Jennett B, Teasdale G. Management of Head Injuries. Philadelphia: FA Davis, 1981:19.
336. Jennett WB, Barker J, Fitch W, et al. Effect of anesthesia on intracranial pressure in patients with space-occupying lesions. *Lancet* 1969;1:61-64.
337. Jevtovic-Todorovic V, Hartman RE, Izumi Y, et al. Early exposure to common anesthetic agents causes widespread neurodegeneration in the developing rat brain and persistent learning deficits. *J Neurosci* 2003;23:876-882.
338. Jin K, Graham SH, Mao X, et al. Fas (CD95) may mediate delayed cell death in hippocampal CA1 sector after global cerebral ischemia. *J Cereb Blood Flow Metab* 2001;21:1411-1421.
339. Jin K, Graham SH, Nagayama T, et al. Altered expression of the neuropeptide-processing enzyme carboxypeptidase E in the rat brain after global ischemia. *J Cereb Blood Flow Metab* 2001;21:1422-1429.
340. Jobs DR, Kennell EM, Bush GL, et al. Cerebral blood flow and metabolism during morphine-nitrous oxide anesthesia in man. *Anesthesiology* 1977;47:16-18.
341. Johnston AJ, Gupta AK. Advanced monitoring in the neurology intensive care unit: microdialysis. *Curr Opin Crit Care* 2002;8:121-127.
342. Johnston AJ, Steiner LA, Coles JP, et al. Effect of cerebral perfusion pressure augmentation on regional oxygenation and metabolism after head injury. *Crit Care Med* 2005;33:189-195.
343. Jones TH, Chiappa KH, Young RR, et al. EEG monitoring for induced hypotension for surgery of intracranial aneurysms. *Stroke* 1979;10:292-294.
344. Jorgensen MB, Diemer NH. Selective neuron loss after cerebral ischemia in the rat: possible role of transmitter glutamate. *Acta Neurol Scand* 1982;66:536-546.
345. Jost SC, Diringer MN, Zazulia AR, et al. Effect of normal saline bolus on cerebral blood flow in regions with low baseline flow in patients with vasospasm following subarachnoid hemorrhage. *J Neurosurg* 2005;103:25-30.
346. Kaieda R, Todd MM, Warner DS. The effects of anesthetics and PaCO<sub>2</sub> on the cerebrovascular, metabolic, and electroencephalographic responses to nitrous oxide in the rabbit. *Anesth Analg* 1989;68:135-143.
347. Kalfas IH, Little JR. Postoperative hemorrhage: a survey of 4992 intracranial procedures. *Neurosurgery* 1988;23:343-347.
348. Kalra PS, Dube MG, Kalra SP. Facilitatory effects of testosterone on hypothalamic tachykinin levels and release. *Brain Res* 1994;653:285-288.
349. Kapinya KJ, Lowl D, Futterer C, et al. Tolerance against ischemic neuronal injury can be induced by volatile anesthetics and is inducible NO synthase dependent. *Stroke* 2002;33:1889-1898.
350. Karlsson BR, Forsman M, Roald OK, et al. Effect of dexmedetomidine, a selective and potent  $\alpha_2$ -agonist, on cerebral blood flow and oxygen consumption during halothane anesthesia in dogs. *Anesth Analg* 1990;71:125-129.
351. Kassell NF, Drake CG. Timing of aneurysm surgery. *Neurosurgery* 1982;10:514-519.
352. Kassell NF, Haley EC, Apperson-Hansen C, et al. Randomized, double-blind, vehicle controlled trial of tirilazad mesylate in patients with aneurysmal subarachnoid hemorrhage: a cooperative study in Europe, Australia and New Zealand. *J Neurosurg* 1996;84:221-228.
353. Kassell NF, Hitchon PW, Gerk MK, et al. Alterations in cerebral blood flow, oxygen metabolism, and electrical activity produced by high dose sodium thiopental. *Neurosurgery* 1979;7:598-603.
354. Kassell NF, Peerless SJ, Durward QJ, et al. Treatment of ischemic deficits from vasospasm with intravascular volume expansion and induced arterial hypertension. *Neurosurgery* 1982;11:337-343.
355. Kassell NF, Torner JC. Aneurysmal rebleeding: a preliminary report from the Cooperative Aneurysm Study. *Neurosurgery* 1983;13:479-481.
356. Kassell NF, Torner JC, Haley EC, et al. The International Cooperative Study on the timing of aneurysm surgery. Part 1: overall management results. *J Neurosurg* 1990;73:18-36.
357. Kassell NF, Torner JC, Jane JA, et al. The International Cooperative Study on the timing of aneurysm surgery. Part 2: surgical results. *J Neurosurg* 1990;73:37-47.
358. Kaufmann AM, Cardoso ER. Aggravation of vasogenic cerebral edema by multiple-dose mannitol. *J Neurosurg* 1992;77:584-589.
359. Kawaguchi M, Drummond JC, Cole DJ, et al. Effect of isoflurane on neuronal apoptosis in rats subjected to focal cerebral ischemia. *Anesth Analg* 2004;98:798-805, table of contents.
360. Kawaguchi M, Kimbro JR, Drummond JC, et al. Isoflurane delays but does not prevent cerebral infarction in rats subjected to focal ischemia. *Anesthesiology* 2000;92:1335-1342.
361. Kawai N, Okauchi M, Morisaki K, et al. Effects of delayed intraischemic and postischemic hypothermia on a focal model of transient cerebral ischemia in rats. *Stroke* 2000;31:1982-1989; discussion 1989.
362. Kawamura Y, Meyer JS, Hiramoto H, et al. Neurogenic control of cerebral blood flow in the baboon. Effects of alpha adrenergic blockade with phenoxybenzamine on cerebral autoregulation and vasomotor reactivity to changes in PaCO<sub>2</sub>. *Stroke* 1974;5:747-758.
363. Kears LA, Koski G, Husain MV, et al. Epileptiform activity during opioid anesthesia. *Electroencephalogr Clin Neuro* 1993;87:374-379.
364. Kehr J. In vitro recovery measures of peptides. *CMA Application Note* 9, 1991.
365. Kehr J. In vivo microdialysis of peptides vasopressin and oxytocin. *CMA Application Note* 10, 1991.
366. Kety S, Schmidt CF. The determination of cerebral blood flow in man by the use of nitrous oxide in low concentrations. *Am J Physiol* 1945;143:53-65.
367. Keykhah MM, Smith DS, Carlsson C, et al. Influence of sufentanil on cerebral metabolism and circulation in the rat. *Anesthesiology* 1985;63:274-277.
368. Kim CS, Arnold FJ, Itani MS, et al. Decreased sensitivity to metocurine during long-term phenytoin therapy may be attributable to protein binding and acetylcholine receptor changes. *Anesthesiology* 1992;77:500-506.
369. Kirino T. Ischemic tolerance. *J Cereb Blood Flow Metab* 2002;22:1283-1296.
370. Kitaguchi K, Ohsumi H, Kuro M, et al. Effects of sevoflurane on cerebral circulation and metabolism in patients with ischemic cerebrovascular disease. *Anesthesiology* 1993;79:704-709.
371. Knot HJ, Nelson MT. Regulation of membrane potential and diameter by voltage dependent K<sup>+</sup> channels in rabbit myogenic cerebral arteries. *Am J Physiol* 1995;269:H348-H355.
372. Knudsen L, Cold GE, Holdgard HO, et al. Effects of flumazenil on cerebral blood flow and oxygen consumption after midazolam anaesthesia for craniotomy. *Br J Anaesth* 1991;67:277-80.
373. Kobayashi Y, Ochiai R, Takeda J, et al. Serum and urinary inorganic fluoride concentrations after prolonged inhalation of sevoflurane in humans. *Anesth Analg* 1992;74:753-757.
374. Kochs E, Hoffman WE, Werner C, et al. The effects of propofol on brain electrical activity, neurologic outcome, and neuronal damage following incomplete ischemia in rats. *Anesthesiology* 1992;76:245-252.
375. Koenig HM, Pelligrino DA, Albrecht RF. Halothane vasodilation and nitric oxide in rat pial vessels. *J Neurosurg Anesthesiol* 1993;5:264-71.
376. Koenig HM, Pelligrino DA, Wang Q, et al. Role of nitric oxide and endothelium in rat pial vessel dilation response to isoflurane. *Anesth Analg* 1994;79:886-891.
377. Koinig H, Vornik V, Rueda C, et al. Lubeluzole inhibits accumulation of extracellular glutamate in the hippocampus during transient global cerebral ischemia. *Brain Res* 2001;898:297-302.
378. Kofke WA, Garman RH, Tom WC, et al. Alfentanil-induced hypermetabolism, seizure, and histopathology in rat brain. *Anesth Analg* 1992;75:953-964.
379. Kosteljanetz M. Acute head injury: Pressure-volume relations and cerebrospinal fluid dynamics. *Neurosurgery* 1986;18:17-24.
380. Kovarik WD, Mayberg TS, Lam AM, et al. Succinylcholine does not change intracranial pressure, cerebral blood flow velocity, or the electroencephalogram in patients with neurologic injury. *Anesth Analg* 1994;78:469-473.

381. Kreimeier U, Brueckner UB, Schmidt J, et al. Instantaneous restoration of regional organ blood flow after severe hemorrhage: effect of small-volume resuscitation with hypertonic-hyperoncotic solutions. *J Surg Res* 1990;49:493-503.
382. Krieger DW, De Georgia MA, Abou-Chebl A, et al. Cooling for acute ischemic brain damage (cool aid): an open pilot study of induced hypothermia in acute ischemic stroke. *Stroke* 2001;32:1847-1854.
383. Kuhmonen J, Pokorny J, Miettinen R, et al. Neuroprotective effects of dexmedetomidine in the gerbil hippocampus after transient global ischemia. *Anesthesiology* 1997;87:371-377.
384. Kuo JR, Lin CL, Chio CC, et al. Effects of hypertonic (3%) saline in rats with circulatory shock and cerebral ischemia after heatstroke. *Intensive Care Med* 2003;29:1567-1573.
385. Kuramoto T, Oshita S, Takeshita H, et al. Modification of the relationship between cerebral metabolism, blood flow and the EEG by stimulation during anesthesia in the dog. *Anesthesiology* 1979;51:211-217.
386. Kurth CD, O'Rourke MM, O'Hara IB. Comparison of pH-stat and alpha-stat cardiopulmonary bypass on cerebral oxygenation and blood flow in relation to hypothermic circulatory arrest in piglets. *Anesthesiology* 1998;89:110-118.
387. Kurth CD, Steven JM, Nicolson SC. Cerebral oxygenation during pediatric cardiac surgery using deep hypothermic circulatory arrest. *Anesthesiology* 1995;82:74-82.
388. Kuschinsky W. Coupling between functional activity, metabolism and blood flow in the brain: State of the art. *Microcirculation* 1982;2:357-378.
389. Lagerkranser M, Stange K, Sollevi A. Effects of propofol on cerebral blood flow, metabolism, and cerebral autoregulation in the anesthetized pig. *J Neurosurg Anesthesiol* 1997;9:188-193.
390. Lam AM, Mayberg TS, Eng CC, et al. Nitrous oxide-isoflurane anesthesia causes more cerebral vasodilation than an equipotent dose of isoflurane in humans. *Anesth Analg* 1994;78:462-468.
391. Lanier W, Iaizzo P, Milde J. Cerebral function and muscle afferent activity following intravenous succinylcholine in dogs anesthetized with halothane: the effects of pretreatment with a defasciculating dose of pancuronium. *Anesthesiology* 1989;71:87-95.
392. Lanier WL, Milde JH, Michenfelder JD. Cerebral stimulation following succinylcholine in dogs. *Anesthesiology* 1986;64:551-559.
393. Lanzino G, Kongable GL, Kassell NF. Electrocardiographic abnormalities after nontraumatic subarachnoid hemorrhage. *J Neurosurg Anesthesiol* 1994;6:156-162.
394. Larsen M, Hegstad E, Berg-Johnsen J, et al. Isoflurane increases the uptake of glutamate in synaptosomes from rat cerebral cortex. *Br J Anaesth* 1997;78:55-59.
395. Larsen R, Teichmann J, Hilfiker O, et al. Nitroprusside-hypotension: cerebral blood flow and cerebral oxygen consumption in neurosurgical patients. *Acta Anaesth Scand* 1982;26:327-330.
396. Lauritzen M. Long-lasting reduction of cortical blood flow of the rat brain after spreading depression with preserved autoregulation and impaired CO<sub>2</sub> response. *J Cereb Blood Flow Metab* 1984;4:546-554.
397. Lebrun-Gandie P, Baron J, Soussaline F, et al. Coupling between regional blood flow and oxygen utilization in the normal human brain. *Arch Neurol* 1983;40:230-236.
398. Levy ML, Aranda M, Zelman V, et al. Propylene glycol toxicity following continuous etomidate infusion for the control of refractory cerebral edema. *Neurosurgery* 1995;37:363-371.
399. Lewelt W, Jenkins LW, Miller JD. Effects of experimental fluid-percussion injury of the brain on cerebrovascular reactivity to hypoxia and to hypercapnia. *J Neurosurg* 1982;56:332-338.
400. Li F, Omae T, Fisher M. Spontaneous hyperthermia and its mechanism in the intraluminal suture middle cerebral artery occlusion model of rats. *Stroke* 1999;30:2464-2470; discussion 2470-2471.
401. Li JJ, Voisin D, Quiquerez AL, et al. Differential expression of advanced glycosylation end-products in neurons of different species. *Brain Res* 1994;641:285-288.
402. Lischke V, Busse R, Hecker M. Selective inhibition by barbiturates of the synthesis of endothelium-derived hyperpolarizing factor in the rabbit carotid artery. *Br J Pharmacol* 1995;115:969-974.
403. Lo EH, Steinberg GK, Panahian N, et al. Profiles of extracellular amino acid changes in focal cerebral ischaemia: effects of mild hypothermia. *Neurol Res* 1993;15:281-287.
404. Lodrini S, Montolivo M, Pluchino F, et al. Positive end-expiratory pressure in supine and sitting positions: Its effects on intrathoracic and intracranial pressures. *Neurosurgery* 1989;24:873-877.
405. Losasso TJ, Muzzi DA, Dietz NM, et al. Fifty percent nitrous oxide does not increase the risk of venous air embolism in neurosurgical patients operated upon in the sitting position. *Anesthesiology* 1992;77:21-30.
406. Lou HC, Edvinsson L, MacKenzie ET. The concept of coupling blood flow to brain function: Revision required? *Ann Neurol* 1987;22:289-297.
407. Loughheed WM, Sweet WH, White JC, et al. The use of hypothermia in surgical treatment of cerebral vascular lesions; a preliminary report. *J Neurosurg* 1955;12:240-255.
408. Luce JM, Huseby JS, Kirk W, et al. Mechanism by which positive end-expiratory pressure increases cerebrospinal fluid pressure in dogs. *J Appl Physiol* 1982;52:231-235.
409. Luini A, Tal N, Goldberg O, et al. An evaluation of selected brain constituents as putative excitatory neurotransmitters. *Brain Res* 1984;324:271-277.
410. Lutz LJ, Milde JH, Milde LN. The cerebral functional, metabolic, and hemodynamic effects of desflurane in dogs. *Anesthesiology* 1990;73:125-131.
411. Luvisotto TL, Auer RN, Sutherland GR. The effect of mannitol on experimental cerebral ischemia, revisited. *Neurosurgery* 1996;38:131-138; discussion 139.
412. Lynch JJ, Schuchard GH, Gross CM, et al. Prevalence of right-to-left atrial shunting in a healthy population: Detection by Valsalva maneuver contrast echocardiography. *Am J Cardiol* 1984;53:1478-1480.
413. Ma D, Hossain M, Chow A, et al. Xenon and hypothermia combine to provide neuroprotection from neonatal asphyxia. *Ann Neurol* 2005;58:182-193.
414. MacIver MB, Amagasa SM, Mikulec AA, et al. Riluzole anesthesia: use-dependent block of presynaptic glutamate fibers. *Anesthesiology* 1996;85:626-634.
415. MacMillan V, Siesjo BK. The influence of hypocapnia upon intracellular pH and upon some carbohydrate substrates, amino acids and organic phosphates in the brain. *J Neurochem* 1973;21:1283-1299.
416. Madden JA. The effect of carbon dioxide on cerebral arteries. *Pharmacol Ther* 1993;59:229-250.
417. Madsen JB, Cold GE, Eriksen HO, et al. CBF and CMRO<sub>2</sub> during craniotomy for small supratentorial cerebral tumours in enflurane anaesthesia A dose response study. *Acta Anaesthesiol Scand* 1986;30:633-636.
418. Madsen JB, Cold GE, Hansen ES, et al. The effect of isoflurane on cerebral blood flow and metabolism in humans during craniotomy for small supratentorial cerebral tumors. *Anesthesiology* 1987;66:332-336.
419. Madsen JB, Cold GE, Hansen ES, et al. Cerebral blood flow and metabolism during isoflurane induced hypotension in patients subjected to surgery for cerebral aneurysms. *Br J Anaesth* 1987;59:1204-1207.
420. Madsen PL, Vorstrup S. Cerebral blood flow and metabolism during sleep. *Cerebrovasc Brain Metab Rev* 1991;3:281-296.
421. Maekawa T, Tommasino C, Shapiro HM, et al. Local cerebral blood flow and glucose utilization during isoflurane anesthesia in the rat. *Anesthesiology* 1986;65:144-151.
422. Magnaes B. Clinical recording of pressure on the spinal cord and cauda equina. Part 3: pressure on the cervical spinal cord during endotracheal intubation in patients with cervical spondylosis. *J Neurosurg* 1982;57:64-66.
423. Maher J, Hachinski V. Hypothermia as a potential treatment for cerebral ischemia. *Cerebrovasc Brain Metab Rev* 1993;5:277-300.
424. Maheshwari GK, Baboo HA, Ashwathkumar R, et al. Scalp metastasis from squamous cell carcinoma of the cervix. *Int J Gynecol Cancer* 2001;11:244-246.



425. Maktabi MA, Elbokl FF, Faraci FM, et al. Halothane decreases the rate of production of cerebrospinal fluid—possible role of vasopressin V1 receptors. *Anesthesiology* 1993;78:72–82.
426. Manninen PH, Cuillerier DJ, Nantau WE, et al. Monitoring of brainstem function during vertebral basilar aneurysm surgery—the use of spontaneous ventilation. *Anesthesiology* 1992;77:681–685.
427. Manninen PH, Lam AM, Gelb AW, et al. The effect of high-dose mannitol on serum and urine electrolytes and osmolality in neurosurgical patients. *Can J Anaesth* 1987;34:442–446.
428. Manninen PH, Lam AM, Nantau WE. Monitoring of somatosensory evoked potentials during temporary arterial occlusion in cerebral aneurysm surgery. *J Neurosurg Anesth* 1990;2:97–104.
429. Manohar M. Regional brain blood flow and cerebral cortical O<sub>2</sub> consumption during sevoflurane anesthesia in healthy isocapnic swine. *J Cardiovasc Pharmacol* 1986;8:1268–1275.
430. Marcus ML, Busija DW, Bischof CJ, et al. Methods for measurement of cerebral blood flow. *Fed Proc* 1981;40:2306–2310.
431. Marin J, Lobato RD, Rico ML, et al. Effect of pentobarbital on the reactivity of isolated human cerebral arteries. *J Neurosurg* 1981;54:521–524.
432. Marion DW, Leonov Y, Ginsberg M, et al. Resuscitative hypothermia. *Crit Care Med* 1996;24:S81–S89.
433. Marion DW, Penrod LE, Kelsey SF, et al. Treatment of traumatic brain injury with moderate hypothermia. *N Engl J Med* 1997;336:540–546.
434. Marion DW, Segal R, Thompson ME. Subarachnoid hemorrhage and the heart. *Neurosurgery* 1986;18:101–106.
435. Markus H. Transcranial Doppler detection of circulating cerebral emboli—a review. *Stroke* 1993;24:1246–1250.
436. Marsh ML, Aidinis SJ, Naughton KVH, et al. The technique of nitroprusside administration modifies the intracranial pressure response. *Anesthesiology* 1979;51:538–541.
437. Marsh ML, Dunlop BJ, Shapiro HM, et al. Succinylcholine-intracranial pressure effects in neurosurgical patients. *Anesth Analg* 1980;59:550–551.
438. Marsh ML, Shapiro HM, Smith RW, et al. Changes in neurologic status and intracranial pressure associated with sodium nitroprusside administration. *Anesthesiology* 1979;51:336–338.
439. Marshall LF, U HS. Treatment of massive intraoperative brain swelling. *Neurosurgery* 1983;13:412–414.
440. Marshall WK, Bedford RF, Miller ED. Cardiovascular responses in the seated position—impact of four anesthetic techniques. *Anesth Analg* 1983;62:648–653.
441. Martyn JA, White DA, Gronert GA, et al. Up- and down-regulation of skeletal muscle acetylcholine receptors. Effects on neuromuscular blockers. *Anesthesiology* 1992;76:822–843.
442. Marx W, Shah N, Long C, et al. Sufentanil, alfentanil and fentanyl: Impact on cerebrospinal fluid pressure in patients with brain tumors. *J Neurosurg Anesth* 1989;1:3–7.
443. Masuo Y, Matsumoto Y, Tokito F, et al. Effects of vasoactive intestinal polypeptide (VIP) and pituitary adenylate cyclase activating polypeptide (PACAP) on the spontaneous release of acetylcholine from the rat hippocampus by brain microdialysis. *Brain Res* 1993;611:207–215.
444. Masuo Y, Suzuki N, Matsumoto H, et al. Regional distribution of pituitary adenylate cyclase activating polypeptide (PACAP) in the rat central nervous system as determined by sandwich-enzyme immunoassay. *Brain Res* 1993;602:57–63.
445. Matjasko J, Petrozza P, Cohen M, et al. Anesthesia and surgery in the seated position: analysis of 554 cases. *Neurosurgery* 1985;17:695–702.
446. Matsumiya N, Dohi S. Effects of intravenous or subarachnoid morphine on cerebral and spinal cord hemodynamics and antagonism with naloxone in dogs. *Anesthesiology* 1983;59:175–181.
447. Matsumoto K, Graf R, Rosner G, et al. Elevation of neuroactive substances in the cortex of cats during prolonged focal ischemia. *J Cereb Blood Flow Metab* 1993;13:586–594.
448. Matsumoto M, Zornow MH, Rabin BC, et al. The alpha 2 adrenergic agonist, dexmedetomidine, selectively attenuates ischemia-induced increases in striatal norepinephrine concentrations. *Brain Res* 1993;627:325–329.
449. Matta BF, Lam AM, Mayberg TS, et al. A critique of the intraoperative use of jugular venous bulb catheters during neurosurgical procedures. *Anesth Analg* 1994;79:745–750.
450. Matta BF, Mayberg TS, Lam AM. Direct cerebrovasodilatory effects of halothane, isoflurane, and desflurane during propofol-induced isoelectric electroencephalogram in humans. *Anesthesiology* 1995;83:980–985.
451. Mattar JA. Hypertonic and hyperoncotic solutions in patients. *Crit Care Med* 1989;17:297–298.
452. Mayberg TS, Lam AM, Matta BF, et al. Ketamine does not increase cerebral blood flow velocity or intracranial pressure during isoflurane/nitrous oxide anesthesia in patients undergoing craniotomy. *Anesth Analg* 1995;81:84–89.
453. Maze M, Scheinin M. Molecular pharmacology of  $\alpha_2$ -adrenergic receptors. *Anaesth Pharmacol Rev* 1993;1:233–237.
454. Maze M, Tranquilli W. Alpha-2 adrenoceptor agonists: defining the role in clinical anesthesia. *Anesthesiology* 1991;74:581–605.
455. McAllister RG. Macroglossia—a positional complication. *Anesthesiology* 1974;40:199–200.
456. McAlpine FS, Seckel BR. Complications of positioning. The peripheral nervous system. In: Martin JT, ed. *Positioning in Anesthesia and Surgery*. Philadelphia: WB Saunders, 1987.
457. McCormick PW, McCormick J, Zabramski JM, et al. Hemodynamics of subarachnoid hemorrhage arrest. *J Neurosurg* 1994;80:710–715.
458. McManus ML, Churchwell KB, Strange K. Regulation of cell volume in health and disease. *N Engl J Med* 1995;333:1260–1266.
459. McPherson RW, Kirsch JR, Ghaly RF, et al. Effect of nitric oxide synthase inhibition on the cerebral vascular response to hypercapnia in primates. *Stroke* 1995;26:682–687.
460. McPherson RW, Kirsch JR, Moore LE, et al. Nitro-L-arginine methyl ester prevents cerebral hyperemia by inhaled anesthetics in dogs. *Anesth Analg* 1993;77:891–897.
461. McPherson RW, Koehler RC, Kirsch JR, et al. Intraventricular dexmedetomidine decreases cerebral blood flow during normoxia and hypoxia in dogs. *Anesth Analg* 1997;84:139–147.
462. McPherson RW, Koehler RC, Traystman RJ. Effect of jugular venous pressure on cerebral autoregulation in dogs. *Am J Physiol* 1988;255:H1516–H1524.
463. McPherson RW, Szymanski J, Rogers MC. Somatosensory evoked potential changes in positioning-related brain stem ischemia. *Anesthesiology* 1984;61:88–90.
464. Mendelow AD, Teasdale GM, Russell T, et al. Effect of mannitol on cerebral blood flow and cerebral perfusion pressure in human head injury. *J Neurosurg* 1985;63:43–48.
465. Messeter K, Nordstrom CH, Sundberg G, et al. Cerebral hemodynamics in patients with acute severe head trauma. *J Neurosurg* 1986;64:231–237.
466. Meyerson BA, Linderth B, Karlsson H, et al. Microdialysis in the human brain: extracellular measurements in the thalamus of parkinsonian patients. *Life Sci* 1990;46:301–308.
467. Miao N, Nagao K, Lynch C, 3rd. Thiopental and methohexital depress Ca<sup>2+</sup> entry into and glutamate release from cultured neurons. *Anesthesiology* 1998;88:1643–1653.
468. Michenfelder JD. The interdependency of cerebral functional and metabolic effects following massive doses of thiopental in the dog. *Anesthesiology* 1974;41:231–236.
469. Michenfelder JD. Central venous catheters in the management of air embolism: whether as well as where. *Anesthesiology* 1981;55:339–341.
470. Michenfelder JD. *Anesthesia and the Brain: Clinical, Functional, Metabolic, and Vascular Correlates*. New York: Churchill Livingstone, 1988.
471. Michenfelder JD, Maccarty CS, Theye RA. Physiologic studies following closed-chest technique of profound hypothermia in neurosurgery. *Anesthesiology* 1964;25:131–136.



472. Michenfelder JD, Milde JH. Influence of anesthetics on metabolic, functional and pathological responses to regional cerebral ischemia. *Stroke* 1975;6:405-410.
473. Michenfelder JD, Milde JH. Failure of prolonged hypocapnia, hypothermia, or hypertension to favorably alter acute stroke in primates. *Stroke* 1977;8:87-91.
474. Michenfelder JD, Milde JH. The interaction of sodium nitroprusside, hypotension and isoflurane in determining cerebral vascular effects. *Anesthesiology* 1988;69:870-875.
475. Michenfelder JD, Miller RH, Gronert GA. Evaluation of an ultrasonic device (pre-cordial Doppler) for the diagnosis of venous air embolism. *Anesthesiology* 1972;36:164-167.
476. Michenfelder JD, Sundt TM, Fode N, et al. Isoflurane when compared with enflurane and halothane decreases the frequency of cerebral ischemia during carotid endarterectomy. *Anesthesiology* 1987;67:336-340.
477. Michenfelder JD, Theye RA. Hypothermia: effect on canine brain and whole-body metabolism. *Anesthesiology* 1968;29:1107-1112.
478. Michenfelder JD, Theye RA. The effects of profound hypocapnia and dilutional anemia on canine cerebral metabolism and blood flow. *Anesthesiology* 1969;31:449-457.
479. Michenfelder JD, Theye RA. The effects of anesthesia and hypothermia on canine cerebral ATP and lactate during anoxia produced by decapitation. *Anesthesiology* 1970;33:430-439.
480. Michenfelder JD, Theye RA. Effects of fentanyl, droperidol, and Innovar on canine cerebral metabolism and blood flow. *Br J Anaesth* 1971;43:630-635.
481. Michenfelder JD, Theye RA. Effects of cyclopropane on canine cerebral blood flow and metabolism: modification by catecholamine suppression. *Anesthesiology* 1972;37:32-39.
482. Michenfelder JD, Theye RA. Cerebral protection by thiopental during hypoxia. *Anesthesiology* 1973;39:510-517.
483. Michenfelder JD, Theye RA. Effects of methoxyflurane on canine cerebral metabolism and blood flow. *Anesthesiology* 1973;38:123-127.
484. Michenfelder JD, Theye RA. Canine systemic and cerebral effects of hypotension induced by hemorrhage, trimethaphan, halothane, or nitroprusside. *Anesthesiology* 1977;46:188-195.
485. Michenfelder JD, Van Dyke RA, Theye RA. The effects of anesthetic agents and techniques on canine cerebral ATP and lactate levels. *Anesthesiology* 1970;33:315-321.
486. Milde LN, Milde JH. The cerebral and systemic hemodynamic and metabolic effects of desflurane-induced hypotension in dogs. *Anesthesiology* 1991;74:513-518.
487. Milde LN, Milde JH, Gallagher WJ. Effects of sufentanil on cerebral circulation and metabolism in dogs. *Anesth Analg* 1990;70:138-146.
488. Milde LN, Milde JH, Lanier WL, et al. Comparison of the effects of isoflurane and thiopental on neurologic outcome and neuropathology after temporary focal cerebral ischemia in primates. *Anesthesiology* 1988;69:905-913.
489. Milde LN, Milde JH, Michenfelder JD. Cerebral functional, metabolic, and hemodynamic effects of etomidate in dogs. *Anesthesiology* 1985;63:371-377.
490. Miller JD, Piper IR, Dearden NM. Management of intracranial hypertension in head injury: matching treatment with cause. *Acta Neurochir Suppl (Wien)* 1993;57:152-159.
491. Miller JD, Smith RR. Transcranial Doppler sonography in aneurysmal subarachnoid hemorrhage. *Cerebrovasc Brain Metab Rev* 1994;6:31-46.
492. Miller R, Tausk HC, Stark DC. Effect of Innovar, fentanyl and droperidol on the cerebrospinal fluid pressure in neurosurgical patients. *Can Anaesth Soc J* 1975;22:502-508.
493. Minamisawa H, Nordstrom CH, Smith ML, et al. The influence of mild body and brain hypothermia on ischemic brain damage. *J Cereb Blood Flow Metab* 1990;10:365-374.
494. Minton MD, Grosslight K, Stirt JA, et al. Increases in intracranial pressure from succinylcholine: prevention by prior non-depolarizing blockade. *Anesthesiology* 1986;65:165-169.
495. Mirski MA, Dechnev DI, Schnitzer MS, et al. Comparison between hypertonic saline and mannitol in the reduction of elevated intracranial pressure in a rodent model of acute cerebral injury. *J Neurosurg Anesthesiol* 2000;12:334-344.
496. Mirski MAZ, Rossell LA, McPherson RW, et al. Dexmedetomidine decreases seizure threshold in a rat model of experimental generalized epilepsy. *Anesthesiology* 1994;81:1422-1428.
497. Misfeldt BB, Jorgensen PB, Spotoft H, et al. The effects of droperidol and fentanyl on intracranial pressure and cerebral perfusion pressure in neurosurgical patients. *Br J Anaesth* 1976;48:963-968.
498. Miyazaki H, Nakamura Y, Arai T, et al. Increase of glutamate uptake in astrocytes: a possible mechanism of action of volatile anesthetics. *Anesthesiology* 1997;86:1359-1366; discussion 1358A.
499. Mizoi K, Yoshimoto T. Permissible temporary occlusion time in aneurysm surgery as evaluated by evoked potential monitoring. *Neurosurgery* 1993;33:434-440.
500. Moghaddam B, Bunney BS. Ionic composition of microdialysis perfusing solution alters the pharmacological responsiveness and basal outflow of striatal dopamine. *J Neurochem* 1989;53:652-654.
501. Mohammadi I, Piens MA, Audigier-Vallette C, et al. Fatal *Microascus trigonosporus* (anamorph *Scopulariopsis*) pneumonia in a bone marrow transplant recipient. *Eur J Clin Microbiol Infect Dis* 2004;23:215-217.
502. Monitto CL, Kurth CD. The effect of fentanyl, sufentanil, and alfentanil on cerebral arterioles in piglets. *Anesth Analg* 1993;76:985-989.
503. Moore L, Kirsch J, Helfaer M, et al. Isoflurane induced cerebral hyperemia: role of prostanoids and nitric oxide in pigs [abstract]. *J Neurosurg Anesth* 1992;4:304.
504. Moorthy SS, Hilgenberg JC. Resistance to non-depolarizing muscle relaxants in parietic upper extremities of patients with residual hemiplegia. *Anesth Analg* 1980;59:624-627.
505. Morgan MK, Anderson RE, Sundt TM. The effects of hyperventilation on cerebral blood flow in the rat with an open and closed carotid-jugular fistula. *Neurosurgery* 1989;25:606-612.
506. Morgan MK, Johnston IH, Hallinan JM, et al. Complications of surgery for arteriovenous malformations of the brain. *J Neurosurg* 1993;78:176-182.
507. Mori K, Maeda M, Miyazaki M, et al. Effects of mild (33 degrees C) and moderate (29 degrees C) hypothermia on cerebral blood flow and metabolism, lactate, and extracellular glutamate in experimental head injury. *Neurol Res* 1998;20:719-726.
508. Morris PJ, Heuser D, McDowall DG, et al. Cerebral cortical extracellular fluid H<sup>+</sup> and K<sup>+</sup> activities during hypotension in cats. *Anesthesiology* 1983;59:10-18.
509. Morris PJ, Todd MM, Philbin D. Changes in canine intracranial pressure in response to infusion of sodium nitroprusside and nitroglycerin. *Br J Anaesth* 1982;54:991-996.
510. Moss E, Dearden NM, McDowall DG. Effects of 2% enflurane on intracranial pressure and cerebral perfusion pressure. *Br J Anaesth* 1983;55:1083-1087.
511. Moss E, McDowall DG. ICP increases with 50% nitrous oxide in oxygen in severe head injuries during controlled ventilation. *Br J Anaesth* 1979;51:757-760.
512. Moszynski K. Dynamic changes in cerebrospinal fluid pressure during neurosurgical operations. *Acta Neurochir* 1976;34:285-286.
513. Muller M. Science, medicine, and the future; microdialysis. *BMJ* 2002;324:588-591.
514. Muizelaar JP, Lutz HA, 3rd, Becker DP. Effect of mannitol on ICP and CBF and correlation with pressure autoregulation in severely head-injured patients. *J Neurosurg* 1984;61:700-706.
515. Muizelaar JP, Marmarou A, Ward JD, et al. Adverse effects of prolonged hyperventilation in patients with severe head injury: a randomized clinical trial. *J Neurosurg* 1991;75:731-739.
516. Muller M. Microdialysis in clinical drug delivery studies. *Adv Drug Deliv Rev* 2000;45:255-269.
517. Muller M. Science, medicine, and the future: microdialysis. *BMJ* 2002;324:588-591.

518. Murkin JM, Farrar JK, Tweed WA. Sufentanil anaesthesia reduces cerebral blood flow and cerebral oxygen consumption. *Can J Anaesth* 1988;35:S131.
519. Murkin JM, Farrar JK, Tweed WA, et al. Cerebral autoregulation and flow/metabolism coupling during cardiopulmonary bypass: the influence of PaCO<sub>2</sub>. *Anesth Analg* 1987;66:825–832.
520. Murkin JM, Moldenhauer CC, Hug CC, et al. Absence of seizures during induction of anesthesia with high-dose fentanyl. *Anesth Analg* 1984;63:489–494.
521. Murphy PG, Davies MJ, Columb MO, et al. Effect of propofol and thiopentone on free radical mediated oxidative stress of the erythrocyte. *Br J Anaesth* 1996;76:536–543.
522. Muzzi DA, Black S, Losasso TJ, et al. Labetalol and esmolol in the control of hypertension after intracranial surgery. *Anesth Analg* 1990;70:68–71.
523. Muzzi DA, Losasso TJ, Dietz NM, et al. The effect of desflurane and isoflurane on cerebrospinal fluid pressure in humans with supratentorial mass lesions. *Anesthesiology* 1992;76:720–724.
524. Nakai M, Tamaki K, Maeda M. Sympathetic and metabolic mechanisms of the cerebrovasomotor function of the caudal ventrolateral medulla in rats. *Neuroscience* 1992;50:655–662.
525. Nakashima K, Todd MM. Effects of hypothermia on the rate of excitatory amino acid release after ischemic depolarization. *Stroke* 1996;27:913–918.
526. Nedelcu J, Klein MA, Aguzzi A, et al. Resuscitative hypothermia protects the neonatal rat brain from hypoxic-ischemic injury. *Brain Pathol* 2000;10:61–71.
527. Nehls DG, Todd MM, Spetzler RF, et al. A comparison of the cerebral protective effects of isoflurane and thiopental during temporary focal ischemia in primates. *Anesthesiology* 1987;66:453–464.
528. Nemoto EM, Klementavicius R, Melick JA, et al. Suppression of cerebral metabolic rate for oxygen (CMRO<sub>2</sub>) by mild hypothermia compared with thiopental. *J Neurosurg Anesthesiol* 1996;8:52–59.
529. Neuwelt EA, Kikuchi K, Hill SA, et al. Barbiturate inhibition of lymphocyte function. Differing effects of various barbiturates used to induce coma. *J Neurosurg* 1982;56:254–259.
530. Newberg LA, Michenfelder JD. Cerebral protection by isoflurane during hypoxemia or ischemia. *Anesthesiology* 1983;59:29–35.
531. Newell DW, Aaslid R. Transcranial Doppler: Clinical and experimental uses. *Cerebrovasc Brain Metab Rev* 1992;4:122–143.
532. Ngai AC, Winn HR. Modulation of cerebral arteriolar diameter by intraluminal flow and pressure. *Circ Research* 1995;77:823–840.
533. Nichols DA, Meyer FB, Piepgras DG, et al. Endovascular treatment of intracranial aneurysms. *Mayo Clin Proc* 1994;69:272–85.
534. Nilsson OG, Brandt L, Ungerstedt U, et al. Bedside detection of brain ischemia using intracerebral microdialysis: subarachnoid hemorrhage and delayed ischemic deterioration. *Neurosurgery* 1999;45:1176–1184; discussion 1184–1185.
535. Nishikawa T, Omote K, Namiki A, et al. The effects of nicardipine on cerebrospinal fluid pressure in humans. *Anesth Analg* 1986;65:507–510.
536. Nishina K, Akamatsu H, Mikawa K, et al. The inhibitory effects of thiopental, midazolam, and ketamine on human neutrophil functions. *Anesth Analg* 1998;86:159–165.
537. Nolan JP, Morley PT, Vanden Hoek TL, et al. Therapeutic hypothermia after cardiac arrest: an advisory statement by the advanced life support task force of the International Liaison Committee on Resuscitation. *Circulation* 2003;108:118–121.
538. Nornes H, Grip A. Hemodynamic aspects of cerebral arteriovenous malformations. *J Neurosurg* 1980;53:456–464.
539. Nussmeier NA, Arlund C, Slogoff S. Neuropsychiatric complications after cardiopulmonary bypass: cerebral protection by a barbiturate. *Anesthesiology* 1986;64:165–170.
540. Oberg PA. Laser-Doppler flowmetry. *Crit Rev Biomed Eng* 1990;18:125–163.
541. Obrist WD, Wilkinson WE. Regional cerebral blood flow measurement in humans by xenon-133 clearance. *Cerebrovasc Brain Metab Rev* 1990;2:283–327.
542. Ogden AT, Mayer SA, Connolly ES Jr. Hyperosmolar agents in neurosurgical practice: the evolving role of hypertonic saline. *Neurosurgery* 2005;57:207–215.
543. Ogura K, Takayasu M, Dacey RG. Differential effects of pentobarbital on intracerebral arterioles and venules of rats in vitro. *Neurosurgery* 1991;28:537–541.
544. Ohata K, Saito K, Sekhar LN, et al. ["How I do it" no. 6, a case with a giant petroclival meningioma presented with progressive ataxia: how should this case be managed?]. *No Shinkei Geka* 2003;31:1125; discussion 1126–1137.
545. Ohsumi H, Kitaguchi K, Nakajima T, et al. Internal jugular bulb blood velocity as a continuous indicator of cerebral blood flow during open heart surgery. *Anesthesiology* 1994;81:325–332.
546. Ohta H, Matsumoto K, Watanabe H. The interaction between central cholinergic and peripheral beta-adrenergic systems on radial maze performance in rats. *Brain Res* 1993;622:353–356.
547. Ohtsuki T, Matsumoto M, Kitagawa K, et al. Induced resistance and susceptibility to cerebral ischemia in gerbil hippocampal neurons by prolonged but mild hypoperfusion. *Brain Res* 1993;614:279–284.
548. Ohtsuki T, Matsumoto M, Suzuki K, et al. Effect of transient forebrain ischemia on superoxide dismutases in gerbil hippocampus. *Brain Res* 1993;620:305–309.
549. Oreopoulos GD, Hamilton J, Rizoli SB, et al. In vivo and in vitro modulation of intercellular adhesion molecule (ICAM)-1 expression by hypertonicity. *Shock* 2000;14:409–414.
550. Ori C, Cavallini L, Freo U, et al. The effects of propofol on cerebral high energy metabolites, lactate, and glucose in normoxic and severely hypoxic rats. *Life Sci* 1997;60:1349–1357.
551. Orłowski JP, Shiesley D, Vidt DG, et al. Labetalol to control blood pressure after cerebrovascular surgery. *Crit Care Med* 1988;16:765–768.
552. Ornstein E, Matteo RS, Schwartz AE, et al. The effect of phenytoin on the magnitude and duration of neuromuscular block following atracurium or vecuronium. *Anesthesiology* 1987;67:191–196.
553. Ornstein E, Matteo RS, Young WL, et al. Resistance to metocurine-induced neuromuscular blockade in patients receiving phenytoin. *Anesthesiology* 1985;63:294–298.
554. Ornstein E, Young WL, Fleischer LH, et al. Desflurane and isoflurane have similar effects on cerebral blood flow in patients with intracranial mass lesions. *Anesthesiology* 1993;79:498–502.
555. Paczynski RP. Osmotherapy. Basic concepts and controversies. *Crit Care Clin* 1997;13:105–129.
556. Pandit UA, Mudge BJ, Keller TS, et al. Pneumocephalus after posterior fossa exploration in the sitting position. *Anaesthesia* 1982;37:996–1001.
557. Pandya JD, Dave KR, Katyare SS. Effect of long-term aluminum feeding on lipid/phospholipid profiles of rat brain synaptic plasma membranes and microsomes. *J Alzheimers Dis* 2001;3:531–539.
558. Pappada G, Formaggio G, Regalia F, et al. Course of intracranial pressure after extirpation of posterior fossa tumours. *Acta Neurochir (Wien)* 1984;70:11–19.
559. Patel PM, Mutch WAC. The cerebral pressure-flow relationship during 1.0 MAC isoflurane anesthesia in the rabbit: The effect of different vasopressors. *Anesthesiology* 1990;72:118–124.
560. Paulson OB, Strandgaard S, Edvinsson L. Cerebral autoregulation. *Cerebrovasc Brain Metab Rev* 1990;2:161–192.
561. Paulson OB, Waldemar G. Role of the local renin-angiotensin system in the autoregulation of the cerebral circulation. *Blood Vessels* 1991;28:231–235.
562. Pearce WJ. Mechanisms of hypoxic cerebral vasodilatation. *Pharmacol Ther* 1995;65:75–91.
563. Pearce WJ, D'Alecy LG. Hemorrhage induced cerebral vasoconstriction in dogs. *Stroke* 1980;11:190–197.
564. Pearl RG, Larson, CP. Hemodynamic effects of positive end-expiratory pressure during continuous venous air embolism in the dog. *Anesthesiology* 1986;64:724–729.
565. Peerdeman SM, Girbes AR, Vandertop WP. Cerebral microdialysis as a new tool for neurometabolic monitoring. *Intensive Care Med* 2000;26:662–669.

566. Pelligrino DA, Miletich DJ, Hoffman WE, et al. Nitrous oxide markedly increases cerebral cortical metabolic rate and blood flow in the goat. *Anesthesiology* 1984;60:405–412.
567. Pemberton PL, Dinsmore J. The use of hypothermia as a method of neuroprotection during neurosurgical procedures and after traumatic brain injury: a survey of clinical practice in Great Britain and Ireland. *Anaesthesia* 2003;58:370–373.
568. Perkins-Pearson NAK, Bedford RF. Hemodynamic consequences of PEEP in seated neurological patients—implications for paradoxical air embolism. *Anesth Analg* 1984;63:429–432.
569. Persson L, Hillered L. Chemical monitoring of neurosurgical intensive care patients using intracerebral microdialysis. *J Neurosurg* 1992;76:72–80.
570. Persson L, Valtysson J, Enblad P, et al. Neurochemical monitoring using intracerebral microdialysis in patients with subarachnoid hemorrhage. *J Neurosurg* 1996;84:606–616.
571. Peters CE, Korcok J, Gelb AW, et al. Anesthetic concentrations of propofol protect against oxidative stress in primary astrocyte cultures: comparison with hypothermia. *Anesthesiology* 2001;94:313–321.
572. Peters RM, Shackford SR, Hogan JS, et al. Comparison of isotonic and hypertonic fluids in resuscitation from hypovolemic shock. *Surg Gynecol Obstet* 1986;163:219–224.
573. Pfitzner J, McLean AG. Controlled neck compression in neurosurgery: studies on venous air embolism in upright sheep. *Anaesthesia* 1985;40:624–629.
574. Phillis JW. Adenosine in the control of the cerebral circulation. *Cerebrovasc Brain Metab Rev* 1989;1:26–54.
575. Phirman JR, Shapiro HM. Modification of nitrous oxide induced intracranial hypertension by prior induction of anesthesia. *Anesthesiology* 1977;46:150–152.
576. Pinaud M, Lelausque JN, Chetanneau A, et al. Effects of propofol on cerebral hemodynamics and metabolism in patients with brain trauma. *Anesthesiology* 1990;73:404–409.
577. Pinaud M, Souron R, Lelausque JN, et al. Cerebral blood flow and cerebral oxygen consumption during nitroprusside-induced hypotension to less than 50 mm Hg. *Anesthesiology* 1989;70:255–260.
578. Piriou V, Chiari P, Gateau-Roesch O, et al. Desflurane-induced preconditioning alters calcium-induced mitochondrial permeability transition. *Anesthesiology* 2004;100:581–588.
579. Pittman JE, Sheng H, Pearlstein R, et al. Comparison of the effects of propofol and pentobarbital on neurologic outcome and cerebral infarct size after temporary focal ischemia in the rat. *Anesthesiology* 1997;87:1139–1144.
580. Plahta WC, Clark DL, Colbourne F. 17Beta-estradiol pretreatment reduces CA1 sector cell death and the spontaneous hyperthermia that follows forebrain ischemia in the gerbil. *Neuroscience* 2004;129:187–193.
581. Pohl U. Endothelial cells as part of a vascular oxygen-sensing system: hypoxia-induced release of autocooids. *Experientia* 1990;46:1175–9.
582. Powers WJ, Raichle ME. Positron emission tomography and its application to the study of cerebrovascular disease in man. *Stroke* 1985;16:361–376.
583. Preston E, Webster J. A two-hour window for hypothermic modulation of early events that impact delayed opening of the rat blood-brain barrier after ischemia. *Acta Neuropathol (Berl)* 2004;108:406–412.
584. Prichard JW, Rosen BR. State-of-the-art review—functional study of the brain by NMR. *J Cereb Blood Flow Metab* 1994;14:365–372.
585. Prough DS, Roy R, Bumgarner J, et al. Acute pulmonary edema in healthy teenagers following conservative doses of intravenous naloxone. *Anesthesiology* 1984;60:485–486.
586. Prough DS, Whitley JM, Taylor CL, et al. Regional cerebral blood flow following resuscitation from hemorrhagic shock with hypertonic saline. Influence of a subdural mass. *Anesthesiology* 1991;75:319–327.
587. Proust F, Hannequin D, Langlois O, et al. Causes of morbidity and mortality after ruptured aneurysm surgery in a series of 230 patients. The importance of control angiography. *Stroke* 1995;26:1553–1557.
588. Pugsley W, Klinger L, Paschalis C, et al. The impact of microemboli during cardiopulmonary bypass on neuropsychological functioning. *Stroke* 1994;25:1393–1399.
589. Qureshi AI, Suarez JI, Bhardwaj A, et al. Use of hypertonic (3%) saline/acetate infusion in the treatment of cerebral edema: effect on intracranial pressure and lateral displacement of the brain. *Crit Care Med* 1998;26:440–446.
590. Qureshi AI, Suri MF, Ringer AJ, et al. Regional intraparenchymal pressure differences in experimental intracerebral hemorrhage: effect of hypertonic saline. *Crit Care Med* 2002;30:435–441.
591. Qureshi AI, Wilson DA, Traystman RJ. Treatment of elevated intracranial pressure in experimental intracerebral hemorrhage: comparison between mannitol and hypertonic saline. *Neurosurgery* 1999;44:1055–1063.
592. Ramani R, Todd MM, Warner DS. The influence of a cryogenic brain injury on the cerebrovascular response to isoflurane in the rabbit. *J Cereb Blood Flow Metab* 1991;11:388–397.
593. Ramani R, Todd MM, Warner DS. A dose-response study of the influence of propofol on cerebral blood flow, metabolism and the electroencephalogram in the rabbit. *J Neurosurg Anesthesiol* 1992;4:110–119.
594. Rao TLK, Jacobs KH, El-Etr AA. Reinfarction following anesthesia in patients with myocardial infarction. *Anesthesiology* 1983;59:499–505.
595. Rao TLK, Mummaneni N, El-Etr AA. Convulsions: An unusual response to intravenous fentanyl administrations. *Anesth Analg* 1982;61:1020–1021.
596. Rapoport SI. Advances in osmotic opening of the blood-brain barrier to enhance CNS chemotherapy. *Expert Opin Investig Drugs* 2001;10:1809–1818.
597. Ratnakumari L, Hemmings HC Jr. Effects of propofol on sodium channel-dependent sodium influx and glutamate release in rat cerebrocortical synaptosomes. *Anesthesiology* 1997;86:428–439.
598. Ravussin P, Abou-Madi M, Archer D, et al. Changes in CSF pressure after mannitol in patients with and without elevated CSF pressure. *J Neurosurg* 1988;69:869–876.
599. Ravussin P, Archer DP, Tyler JL, et al. Effects of rapid mannitol infusion on cerebral blood volume. A positron emission tomographic study in dogs and man. *J Neurosurg* 1986;64:104–113.
600. Reasoner D, Warner DS, Todd MM, et al. Effects of nitrous oxide on cerebral metabolic rate in rats anaesthetized with isoflurane. *Br J Anaesth* 1990;65:210–215.
601. Reasoner DK, Ryu KH, Hindman BJ, et al. Marked hemodilution increases neurologic injury after focal cerebral ischemia in rabbits. *Anesth Analg* 1996;82:61–67.
602. Reasoner DK, Todd MM, Scamman FL, et al. The incidence of pneumocephalus after supratentorial craniotomy—observations on the disappearance of intracranial air. *Anesthesiology* 1994;80:1008–1012.
603. Reddy RV, Moorthy SS, Dierdorf SF, et al. Excitatory effects and electroencephalographic correlation of etomidate, thiopental, methohexital, and propofol. *Anesth Analg* 1993;77:1008–1011.
604. Reicher D, Bhalla P, Rubinstein EH. Cholinergic cerebral vasodilator effect of ketamine in rabbits. *Stroke* 1987;18:445–449.
605. Reinstrup P, Ryding E, Algotsson L, et al. Effects of nitrous oxide on human regional cerebral blood flow and isolated pial arteries. *Anesthesiology* 1994;81:396–402.
606. Reinstrup P, Ryding E, Algotsson L, et al. Distribution of cerebral blood flow during anesthesia with isoflurane or halothane in humans. *Anesthesiology* 1995;82:359–366.
607. Reinstrup P, Stahl N, Mellergard P, et al. Intracerebral microdialysis in clinical practice: baseline values for chemical markers during wakefulness, anesthesia, and neurosurgery. *Neurosurgery* 2000;47:701–709; discussion 709–710.
608. Renou AM, Vernhiet J, Macrez P, et al. Cerebral blood flow and metabolism during etomidate anaesthesia in man. *Br J Anaesth* 1978;50:1047–1051.
609. Ridenour TR, Warner DS, Todd MM, et al. Comparative effects of propofol and halothane on outcome from temporary middle cerebral artery occlusion in the rat. *Anesthesiology* 1992;76:807–812.
610. Roach GW, Newman MF, Murkin JM, et al. Ineffectiveness of burst suppression therapy in mitigating perioperative cerebrovascular dysfunction. Multicenter Study



- of Perioperative Ischemia (McSPI) Research Group. *Anesthesiology* 1999;90:1255-1264.
611. Roald OK, Steen PA, Milde JH, et al. Reversal of the cerebral effects of diazepam in the dog by the benzodiazepine antagonist Ro15-1788. *Acta Anaesth Scand* 1986;30:341-345.
612. Roald OK, Steen PA, Stangland K, et al. The effects of triazolam on cerebral blood flow and metabolism in the dog. *Acta Anaesthesiol Scand* 1986;30:223-226.
613. Robertson CS, Narayan RK, Gokaslan ZL, et al. Cerebral arteriovenous oxygen difference as an estimate of cerebral blood flow in comatose patients. *J Neurosurg* 1989;70:222-230.
614. Robinson MJ, Teasdale GM. Calcium antagonists in the management of subarachnoid haemorrhage. *Cerebrovasc Brain Metabol Rev* 1990;2:205-226.
615. Ropper AH RM. Physiological and clinical aspects of raised intracranial pressure. In: Ropper AH, ed. *Neurological and Neurosurgical Intensive Care*, 3rd ed. New York: Raven Press, 1993:11-27.
616. Ropper AH, O'Rourke D, Kennedy SK. Head position, intracranial pressure, and compliance. *Neurology* 1982;32:1288-91.
617. Rosenwasser RH, Kleiner LI, Krzeminski JP, et al. Intracranial pressure monitoring in the posterior fossa: a preliminary report. *J Neurosurg* 1989;71:503-505.
618. Rosner MJ, Coley IB. Cerebral perfusion pressure, intracranial pressure, and head elevation. *J Neurosurg* 1986;65:636-641.
619. Rothman SM. Synaptic activity mediates death of hypoxic neurons. *Science* 1983;220:536-537.
620. Roux S, Loeffler BM, Gray GA, et al. The role of endothelin in experimental cerebral vasospasm. *Neurosurgery* 1995;37:78-86.
621. Rudehill A, Lagerkranser M, Lindquist C, et al. Effects of mannitol on blood volume and central hemodynamics in patients undergoing cerebral aneurysm surgery. *Anesth Analg* 1983;62:875-880.
622. Ruta TS, Drummond JC, Cole DJ. The effect of acute hypocapnia on local cerebral blood flow during middle cerebral artery occlusion in isoflurane anesthetized rats. *Anesthesiology* 1993;78:134-140.
623. Sabatini U, Celsis P, Viillard G, et al. Quantitative assessment of cerebral blood volume by single-photon emission computed tomography. *Stroke* 1991;22:324-330.
624. Sadoshima S, Fujii K, Kusuda K, et al. Importance of bilateral sympathetic innervation on cerebral blood flow autoregulation in the thalamus. *Brain Res* 1987;413:297-301.
625. Safwat AM, Daniel D. Grand mal seizure after fentanyl administration. *Anesthesiology* 1983;59:78.
626. Saha GB, MacIntyre WJ, Go RT. Cyclotrons and positron emission tomography radiopharmaceuticals for clinical imaging. *Semin Nucl Med* 1992;22:150-161.
627. Saidman LJ, Eger EI. Changes in cerebral spinal fluid pressure during pneumoencephalography under nitrous oxide anesthesia. *Anesthesiology* 1965;26:67-72.
628. Saito R, Graf R, Hubel K, et al. Reduction of infarct volume by halothane: effect on cerebral blood flow or perifocal spreading depression-like depolarizations. *J Cereb Blood Flow Metab* 1997;17:857-864.
629. Sakabe T, Kuramoto T, Kumagai S, et al. Cerebral responses to the addition of nitrous oxide to halothane in man. *Br J Anaesth* 1976;48:957-961.
630. Sakurada O, Kennedy C, Jehle J, et al. Measurement of local cerebral blood flow with iodo[14C]antipyrine. *Am J Physiol* 1978;3:H59-H66.
631. Samra SK, Sneyd JR, Ross DA, et al. Effects of propofol sedation on seizures and intracranially recorded epileptiform activity in patients with partial epilepsy. *Anesthesiology* 1995;82:843-851.
632. Samson D, Batjer HH, Bowman G, et al. A clinical study of the parameters and effects of temporary arterial occlusion in the management of intracranial aneurysms. *Neurosurgery* 1994;34:22-27.
633. Samson D, Beyer CW. Furosemide in the intraoperative reduction of intracranial pressure in the patient with subarachnoid hemorrhage. *Neurosurgery* 1982;10:167-169.
634. Sano T, Patel PM, Drummond JC, et al. A comparison of the cerebral protective effects of etomidate, thiopental, and isoflurane in a model of forebrain ischemia in the rat. *Anesth Analg* 1993;76:990-997.
635. Sarraf-Yazdi S, Sheng H, Brinkhous AD, et al. Effects of postischemic halothane administration on outcome from transient focal cerebral ischemia in the rat. *J Neurosurg Anesthesiol* 1999;11:31-36.
636. Sarraf-Yazdi S, Sheng H, Miura Y, et al. Relative neuroprotective effects of dizocilpine and isoflurane during focal cerebral ischemia in the rat. *Anesth Analg* 1998;87:72-78.
637. Sawaya R, Ingvar DH. Cerebral blood flow and metabolism in sleep. *Acta Neurol Scand* 1989;80:481-491.
638. Sawin P, Todd MM, Traynelis V, et al. Cervical spine motion with direct laryngoscopy and orotracheal intubation: an in vivo cinefluoroscopic study. *Anesthesiology* 1996;85:26-36.
639. Schabitz WR, Berger C, Schellinger PD, et al. Neurometabolic changes during treatment with moderate hypothermia in a patient suffering from severe middle cerebral artery infarction. *Cerebrovasc Dis* 2001;12:298-302.
640. Schell RM, Applegate RL 2nd, Cole DJ. Salt, starch, and water on the brain. *J Neurosurg Anesthesiol* 1996;8:178-182.
641. Schell RM, Kern FH, Greeley WJ, et al. Cerebral blood flow and metabolism during cardiopulmonary bypass. *Anesth Analg* 1993;76:849-865.
642. Scheller MS, Nakakimura K, Fleischer JE, et al. Cerebral effects of sevoflurane in the dog: comparison with isoflurane and enflurane. *Br J Anaesth* 1990;65:388-392.
643. Scheller MS, Tateishi A, Drummond JC, et al. The effects of sevoflurane on cerebral blood flow, cerebral metabolic rate for oxygen, intracranial pressure and the electroencephalogram are similar to those of isoflurane in the rabbit. *Anesthesiology* 1988;68:548-551.
644. Scheller MS, Todd MM, Drummond JC. Isoflurane, halothane and regional cerebral blood flow at various levels of PaCO<sub>2</sub> in rabbits. *Anesthesiology* 1986;64:598-604.
645. Scheller MS, Todd MM, Drummond JC, et al. The intracranial pressure effects of isoflurane and halothane administered following cryogenic brain injury in rabbits. *Anesthesiology* 1987;67:507-512.
646. Scheller MS, Zornow MH, Seok Y. A comparison of the cerebral and hemodynamic effects of mannitol and hypertonic saline in a rabbit model of acute cryogenic brain injury. *J Neurosurg Anesthesiol* 1991;3:291-296.
647. Schettini A, Stahurski B, Young HF, et al. Plasma electrolytes and electrolyte excretion during osmotic and combined osmotic loop diuresis in neurosurgery. *Anesth Analg* 1982;61:213-214.
648. Schlaug G, Siewert B, Benfield A, et al. Time course of the apparent diffusion coefficient (ADC) abnormality in human stroke. *Neurology* 1997;49:113-119.
649. Schmidek HH, Auer LM, Kapp JP. The cerebral venous system. *Neurosurgery* 1985;17:663-678.
650. Schmidt M, Marx T, Gloggl E, et al. Xenon attenuates cerebral damage after ischemia in pigs. *Anesthesiology* 2005;102:929-936.
651. Schmoker JD, Zhuang J, Shackford SR. Hypertonic fluid resuscitation improves cerebral oxygen delivery and reduces intracranial pressure after hemorrhagic shock. *J Trauma* 1991;31:1607-1613.
652. Schneweis S, Grond M, Staub F, et al. Predictive value of neurochemical monitoring in large middle cerebral artery infarction. *Stroke* 2001;32:1863-1867.
653. Schwab S, Steiner T, Aschoff A, et al. Early hemicraniectomy in patients with complete middle cerebral artery infarction. *Stroke* 1998;29:1888-1893.
654. Schwartz ML, Tator CH, Rowed DW, et al. The University of Toronto head injury treatment study: a prospective, randomized comparison of pentobarbital and mannitol. *Can J Neurol Sci* 1984;11:434-440.
655. Schwarz S, Georgiadis D, Aschoff A, et al. Effects of hypertonic (10%) saline in patients with raised intracranial pressure after stroke. *Stroke* 2002;33:136-140.
656. Schwarz S, Schwab S, Bertram M, et al. Effects of hypertonic saline hydroxyethyl starch solution and mannitol in patients with increased intracranial pressure after stroke. *Stroke* 1998;29:1550-1555.
657. Schwedler M, Miletich DJ, Albrecht RF. Cerebral blood flow and metabolism following ketamine administration. *Can Anaesth Soc J* 1982;29:222-226.
658. Scott JC, Cooke JE, Stanski DR. Electroencephalographic quantitation of opioid



- effect: comparative pharmacodynamics of fentanyl and sufentanil. *Anesthesiology* 1991;74:34–42.
669. Seve S, Mohammedi I, Martin O, et al. [*Brevundimonas vesicularis* bacteremia in a patient in aplasia]. *Presse Med* 2004;33:172.
670. Severinghaus JW, Lassen N. Step hypocapnia to separate arterial from tissue  $\text{PCO}_2$  in the regulation of cerebral blood flow. *Circ Res* 1967;20:272–278.
671. Shackford SR, Bourguignon PR, Wald SL, et al. Hypertonic saline resuscitation of patients with head injury: a prospective, randomized clinical trial. *J Trauma* 1998;44:50–58.
672. Shackford SR, Norton CH, Todd MM. Renal, cerebral, and pulmonary effects of hypertonic resuscitation in a porcine model of hemorrhagic shock. *Surgery* 1988;104:553–560.
673. Shackford SR, Zhuang J, Schmoker J. Intravenous fluid tonicity: effect on intracranial pressure, cerebral blood flow, and cerebral oxygen delivery in focal brain injury. *J Neurosurg* 1992;76:91–98.
674. Shankaran S, Laptok AR, Ehrenkranz RA, et al. Whole-body hypothermia for neonates with hypoxic-ischemic encephalopathy. *N Engl J Med* 2005;353:1574–1584.
675. Shapiro HM, Wyte SR, Harris AB. Ketamine anaesthesia in patients with intracranial pathology. *Br J Anaesth* 1972;44:1200–1204.
676. Shapiro K, Fried A, Takei F, et al. Effect of the skull and dura on neural axis pressure–volume relationships and CSF hydrodynamics. *J Neurosurg* 1985;63:76–81.
677. Shapiro K, Marmarou A, Shulman K. Characterization of clinical CSF dynamics and neural axis compliance using the pressure–volume index: I. The normal pressure–volume index. *Ann Neurol* 1980;7:508–514.
678. Sheinberg M, Kanter MJ, Robertson CS, et al. Continuous monitoring of jugular venous oxygen saturation in head-injured patients. *J Neurosurg* 1992;76:212–217.
679. Shimizu S, Nagayama T, Jin KL, et al. bcl-2 Antisense treatment prevents induction of tolerance to focal ischemia in the rat brain. *J Cereb Blood Flow Metab* 2001;21:233–243.
680. Shimoda M, Oda S, Tsugane R, et al. Intracranial complications of hypervolemic therapy in patients with a delayed ischemic deficit attributed to vasospasm. *J Neurosurg* 1993;78:423–429.
681. Shinozuka T, Nemoto EM, Winter PM. Mechanisms of cerebrovascular  $\text{O}_2$  sensitivity from hyperoxia to moderate hypoxia in the rat. *J Cereb Blood Flow Metab* 1989;9:187–195.
682. Shiraiishi Y, Ikeda K. Uptake and biotransformation of sevoflurane in humans: a comparative study of sevoflurane with halothane, enflurane, and isoflurane [see comments]. *J Clin Anesth* 1990;2:381–386.
683. Shiu GK, Nemoto EM. Barbiturate attenuation of brain free fatty acid liberation during global ischemia. *J Neurochem* 1981;37:1448–1456.
684. Shockley RP, LaManna JC. Determination of rat cerebral cortical blood volume changes by capillary mean transit time analysis during hypoxia, hypercapnia and hyperventilation. *Brain Res* 1988;454:170–178.
685. Shuaib A, Xu K, Crain B, et al. Assessment of damage from implantation of microdialysis probes in the rat hippocampus with silver degeneration staining. *Neurosci Lett* 1990;112:149–154.
686. Shulman RG, Blamire AM, Rothman DL, et al. Nuclear magnetic resonance imaging and spectroscopy of human brain function. *Proc Natl Acad Sci U S A* 1993;90:3127–3133.
687. Siesjo BK. *Brain Energy Metabolism*. New York: John Wiley, 1978.
688. Simma B, Burger R, Falk M, et al. A prospective, randomized, and controlled study of fluid management in children with severe head injury: lactated Ringer's solution versus hypertonic saline. *Crit Care Med* 1998;26:1265–1270.
689. Simon RP, Swan JH, Griffiths T, et al. Blockade of *N*-methyl-D-aspartate receptors may protect against ischemic damage in the brain. *Science* 1984;226:850–852.
690. Sivakumar V, Rajshekhar V, Chandy MJ. Management of neurosurgical patients with hyponatremia and natriuresis. *Neurosurgery* 1994;34:269–274.
691. Skahen S, Shapiro HM, Drummond JC, et al. Nitrous oxide withdrawal reduces intracranial pressure in the presence of pneumocephalus. *Anesthesiology* 1986;65:192–195.
692. Smith AL, Hoff JT, Nielsen SL, et al. Barbiturate protection in acute focal cerebral ischemia. *Stroke* 1974;5:1–7.
693. Smith DS, Rehncrona S, Siesjo BK. Inhibitory effects of different barbiturates on lipid peroxidation in brain tissue in vitro: comparison with the effects of promethazine and chlorpromazine. *Anesthesiology* 1980;53:186–194.
694. Smith I, White PF, Nathanson M, et al. Propofol. An update on its clinical use. *Anesthesiology* 1994;81:1005–1043.
695. Snyder BD, Ramirez-Lassepas M, Sukhum P, et al. Failure of thiopental to modify global anoxic injury. *Stroke* 1979;10:135–141.
696. Sokoloff L. Localization of functional activity in the central nervous system by measurement of glucose utilization with radioactive deoxyglucose. *J Cereb Blood Flow Metab* 1981;1:7–36.
697. Sollevi A, Lagerkranser M, Irestedt L, et al. Controlled hypotension with adenosine in cerebral aneurysm surgery. *Anesthesiology* 1984;61:400–405.
698. Solomon RA, Fink ME, Lennihan L. Prophylactic volume expansion therapy for the prevention of delayed cerebral ischemia after early aneurysm surgery: results of preliminary trial. *Arch Neurol* 1988;45:325–332.
699. Soupart A, Penninckx R, Namias B, et al. Brain myelinolysis following hypernatremia in rats. *J Neuropathol Exp Neurol* 1996;55:106–113.
700. Sperry RJ, Bailey PL, Reichman MV, et al. Fentanyl and sufentanil increase intracranial pressure in head trauma patients. *Anesthesiology* 1992;77:416–420.
701. Spetzler RF, Hadley MN. Protection against cerebral ischemia: the role of barbiturates. *Cerebrovasc Brain Metab Rev* 1989;1:212–229.
702. Standifer M, Bay JW, Trusso R. The sitting position in neurosurgery: a retrospective analysis of 488 cases. *Neurosurgery* 1984;14:649–658.
703. Stanford GG, Patterson CR, Payne L, et al. Hypertonic saline resuscitation in a porcine model of severe hemorrhagic shock. *Arch Surg* 1989;124:733–736.
704. Star RA. Hyperosmolar states. *Am J Med Sci* 1990;300:402–412.
705. Statler KD, Alexander H, Vagni V, et al. Comparison of seven anesthetic agents on outcome after experimental traumatic brain injury in adult, male rats. *J Neurotrauma* 2006;23:97–108.
706. Staub F, Graf R, Gabel P, et al. Multiple interstitial substances measured by microdialysis in patients with subarachnoid hemorrhage. *Neurosurgery* 2000;47:1106–1115.
707. Steen PA, Milde JH, Michenfelder JD. No barbiturate protection in a dog model of complete cerebral ischemia. *Ann Neurol* 1979;5:343–349.
708. Stirt JA, Grosslight KR, Bedford RF, et al. “Defasciculation” with metocurine prevents succinylcholine-induced increases in intracranial pressure. *Anesthesiology* 1987;67:50–53.
709. Stocchetti N, Paparella A, Bridelli F, et al. Cerebral venous oxygen saturation studied with bilateral samples in the internal jugular veins. *Neurosurgery* 1994;34:38–44.
710. Stratford N, Murphy P. Effect of lipid and propofol on oxidation of haemoglobin by reactive oxygen species. *Br J Anaesth* 1997;78:320–322.
711. Strebel S, Lam AM, Matta B, et al. Dynamic and static cerebral autoregulation during isoflurane, desflurane, and propofol anesthesia. *Anesthesiology* 1995;83:66–76.
712. Sturaitis MK, Moore LE, Kirsch JR, et al. A cholinergic agonist induces cerebral hyperemia in isoflurane- but not pentobarbital-anesthetized dogs. *Anesth Analg* 1994;78:876–883.
713. Suarez JI, Qureshi AI, Bhardwaj A, et al. Treatment of refractory intracranial hypertension with 23.4% saline. *Crit Care Med* 1998;26:1118–1122.
714. Suarez JI, Qureshi AI, Parekh PD, et al. Administration of hypertonic (3%) sodium chloride/acetate in hyponatremic patients with symptomatic vasospasm following subarachnoid hemorrhage. *J Neurosurg Anesthesiol* 1999;11:178–184.

715. Sundt TM, Whisnant JP. Subarachnoid hemorrhage from intracranial aneurysms. Surgical management and natural history of disease. *N Engl J Med* 1978;299:116-122.
716. Surgeons AAoN: Brain Trauma Foundation, American Association of Neurological Surgeons, Joint Section of Neurotrauma and Critical Care: use of mannitol. *J Neurotrauma* 2000;17:521.
717. Sutton LN, McLaughlin AC, Dante S, et al. Cerebral venous oxygen content as a measure of brain energy metabolism with increased intracranial pressure and hyperventilation. *J Neurosurg* 1990;73:927-932.
718. Suzuki N, Hardebo JE. The cerebrovascular parasympathetic innervation. *Cerebrovasc Brain Metab Rev* 1993;5:33-46.
719. Symon L, Wang AD, Costa e Silva IE, et al. Perioperative use of somatosensory evoked responses in aneurysm surgery. *J Neurosurg* 1984;60:269-275.
720. Szabo MD, Crosby G, Hurford WE, et al. Myocardial perfusion following acute subarachnoid hemorrhage in patients with an abnormal electrocardiogram. *Anesth Analg* 1993;76:253-258.
721. Szabo MD, Crosby G, Sundaram P, et al. Hypertension does not cause spontaneous hemorrhage of intracranial arteriovenous malformations. *Anesthesiology* 1989;70:761-763.
722. Takayasu M, Dacey RG. Effects of mannitol on intracerebral arteriolar diameter in vitro: Extraluminal and intraluminal application. *Neurosurgery* 1989;25:747-752.
723. Takeshita H, Michenfelder JD, Theye RA. The effects of morphine and N-allylnormorphine on canine cerebral metabolism and circulation. *Anesthesiology* 1972;37:605-612.
724. Takeshita H, Okuda Y, Sari A. The effects of ketamine on cerebral circulation and metabolism in man. *Anesthesiology* 1972;36:69-75.
725. Tarkkanen L, Laitinen L, Johansson G. Effects of D-tubocurarine on intracranial pressure and thalamic electrical impedance. *Anesthesiology* 1974;40:247-251.
726. Tateishi A, Maekawa T, Takeshita H, et al. Diazepam and intracranial pressure. *Anesthesiology* 1981;54:335-337.
727. Teichberg VI, Tal N, Goldberg O, et al. Barbiturates, alcohols and the CNS excitatory neurotransmission: specific effects on the kainate and quisqualate receptors. *Brain Res* 1984;291:285-292.
728. Tempelhoff R, Modica PA, Bernardo KL, et al. Fentanyl-induced electrocorticographic seizures in patients with complex partial epilepsy. *J Neurosurg* 1992;77:201-208.
729. Tempelhoff R, Modica PA, Rich KM, et al. Use of computerized electroencephalographic monitoring during aneurysm surgery. *J Neurosurg* 1989;71:24-31.
730. Theye RA, Michenfelder JD. The effect of halothane on canine cerebral metabolism. *Anesthesiology* 1968;29:1113-1118.
731. Theye RA, Michenfelder JD. The effect of nitrous oxide on canine cerebral metabolism. *Anesthesiology* 1968;29:1119-1124.
732. Theye RA, Michenfelder JD. Individual organ contributions to the decrease in whole-body  $\text{Vo}_2$  with isoflurane. *Anesthesiology* 1975;42:35-40.
733. Theye RA, Milde JH, Michenfelder JD. Effect of hypocapnia on cardiac output during anesthesia. *Anesthesiology* 1966;27:778-782.
734. Thomas PM, Phillips JP, O'Connor WT. Microdialysis of the lateral and medial temporal lobe during temporal lobe epilepsy surgery. *Surg Neurol* 2005;63:70-79; discussion 79.
735. Thoresen M, Penrice J, Lorek A, et al. Mild hypothermia after severe transient hypoxia-ischemia ameliorates delayed cerebral energy failure in the newborn piglet. *Pediatr Res* 1995;37:667-670.
736. Thoresen M, Satas S, Loberg EM, et al. Twenty-four hours of mild hypothermia in unsedated newborn pigs starting after a severe global hypoxic-ischemic insult is not neuroprotective. *Pediatr Res* 2001;50:405-411.
737. Thoresen M, Satas S, Puka-Sundvall M, et al. Post-hypoxic hypothermia reduces cerebrocortical release of NO and excitotoxins. *Neuroreport* 1997;8:3359-3362.
738. Tiecks FP, Lam AM, Aaslid R, et al. Comparison of static and dynamic cerebral autoregulation measurements. *Stroke* 1995;26:1014-1019.
739. Tiwari RR, Rajmohan HR, Dave SK, et al. Care of burns: a knowledge, attitude and practice study among match industry workers. *Indian J Med Sci* 2001;55:600-603.
740. Todd MM. The effects of  $\text{PaCO}_2$  on the cerebrovascular response to nitrous oxide in the halothane anesthetized rabbit. *Anesth Analg* 1987;66:1090-1095.
741. Todd MM, Drummond JC. A comparison of the cerebrovascular and metabolic effects of halothane and isoflurane in the cat. *Anesthesiology* 1984;60:276-282.
742. Todd MM, Drummond JC, U HS. The hemodynamic consequences of high dose thiopental anesthesia in humans. *Anesth Analg* 1985;64:681-687.
743. Todd MM, Hindman BJ, Clarke WR, et al. Mild intraoperative hypothermia during surgery for intracranial aneurysm. *N Engl J Med* 2005;352:135-145.
744. Todd MM, Tommasino C, Moore S. Cerebral effects of isovolemic hemodilution with a hypertonic saline solution. *J Neurosurg* 1985;63:944-948.
745. Todd MM, Warner DS, Sokoll MD, et al. A prospective, comparative trial of three anesthetics for elective supratentorial craniotomy. *Anesthesiology* 1993;78:1005-1020.
746. Todd MM, Weeks JB. Comparative effects of propofol, pentobarbital and isoflurane on cerebral blood flow and blood volume. *J Neurosurg Anesth* 1996;8:296-303.
747. Todd MM, Weeks JB, Warner DS. Cerebral blood flow, blood volume, and brain tissue hematocrit during isovolemic hemodilution with hetastarch in the rat. *Am J Physiol* 1992;263:H75-H82.
748. Todd MM, Weeks JB, Warner DS. Microwave fixation for the determination of cerebral blood volume in rats. *J Cereb Blood Flow Metab* 1993;13:328-336.
749. Todd MM, Wu B, Warner DS, et al. The dose-related effects of nitric oxide synthase inhibition on cerebral blood flow during isoflurane and pentobarbital anesthesia. *Anesthesiology* 1994;80:1128-1136.
750. Toung TJ, Chang Y, Lin J, et al. Increases in lung and brain water following experimental stroke: effect of mannitol and hypertonic saline. *Crit Care Med* 2005;33:203-208; discussion 259-260.
751. Toung TJ, Hurn PD, Traystman RJ, et al. Global brain water increases after experimental focal cerebral ischemia: effect of hypertonic saline. *Crit Care Med* 2002;30:644-649.
752. Toung TJK, McPherson RW, Ahn H, et al. Pneumocephalus: effects of patient position on the incidence and location of aerocele after posterior fossa and upper cervical cord surgery. *Anesth Analg* 1985;65:65-70.
753. Toung TJ, Tyler B, Brem H, et al. Hypertonic saline ameliorates cerebral edema associated with experimental brain tumor. *J Neurosurg Anesthesiol* 2002;14:187-193.
754. Traeger SM, Henning RJ, Dobkin W, et al. Hemodynamic effects of pentobarbital therapy for intracranial hypertension. *Crit Care Med* 1983;11:697-701.
755. Traystman RJ. Anesthetic mediated neuroprotection: established fact or passing fancy? *J Neurosurg Anesthesiol* 2004;16:308-312.
756. Trindle MR, Dodson BA, Rampil JJ. Effects of fentanyl versus sufentanil in equianesthetic doses on middle cerebral artery blood flow velocity. *Anesthesiology* 1993;78:454-460.
757. Tsai YC, Huang SJ, Lai YY, et al. Propofol does not reduce infarct volume in rats undergoing permanent middle cerebral artery occlusion. *Acta Anaesthesiol Sin* 1994;32:99-104.
758. Tsementzis SA, Hitchcock ER. Outcome from rescue clipping of ruptured intracranial aneurysm during induction anesthesia and endotracheal intubation. *J Neurol Neurosurg Psych* 1985;48:160-163.
759. Tseng MY, Al-Rawi PG, Pickard JD, et al. Effect of hypertonic saline on cerebral blood flow in poor-grade patients with subarachnoid hemorrhage. *Stroke* 2003;34:1389-1396.
760. Turner JM, Powell D, Gibson RM, et al. Intracranial pressure changes in neurosurgical patients during hypotension induced with sodium nitroprusside or trimethaphan. *Br J Anaesth* 1977;49:419-424.
761. Ueda S, Matsumoto Y, Azmitia EC, et al. Intraocular co-grafts of fetal dorsal raphe nucleus and suprachiasmatic nucleus. *Brain Res* 1993;605:181-186.
762. Vacca G, Papillo B, Battaglia A, et al. The effects of hypertonic saline solution on

- coronary blood flow in anaesthetized pigs. *J Physiol* 1996;491(Pt 3):843–851.
763. Valtysson J, Hillered L, Andine P, et al. Neuropathological endpoints in experimental stroke pharmacotherapy: the importance of both early and late evaluation. *Acta Neurochir (Wien)* 1994;129:58–63.
764. Valtysson J, Persson L, Hillered L. Extracellular ischaemia markers in repeated global ischaemia and secondary hypoxaemia monitored by microdialysis in rat brain. *Acta Neurochir (Wien)* 1998;140:387–395.
765. Van Aken H, Puchstein C, Anger C, et al. Changes in intracranial pressure and compliance during adenosine triphosphate-induced hypotension in dogs. *Anesth Analg* 1984;63:381–385.
766. van der Linden J, von-Ahn H, Ekroth R, et al. Middle cerebral artery flow velocity during coronary surgery; influence of clinical variables. *J Clin Anesth* 1990;2:7–15.
767. van der Linden J, Wesslen O, Ekroth R, et al. Transcranial Doppler-estimated versus thermodilution-estimated cerebral blood flow during cardiac operations. Influence of temperature and arterial carbon dioxide tension. *J Thorac Cardiovasc Surg* 1991;102:95–102.
768. Van Wylen DG, Park TS, Rubio R, et al. Increases in cerebral interstitial fluid adenosine concentration during hypoxia, local potassium infusion, and ischemia. *J Cereb Blood Flow Metab* 1986;6:522–528.
769. Van Wylen DGL, Sciotti VM, Winn HR. Adenosine and the regulation of cerebral blood flow. In: Phillis JW, ed. *Adenosine and Adenine Nucleotides as Regulators of Cellular Function*. Boca Raton, FL: CRC Press, 1991:191–202.
770. Vandesteene A, Trempont V, Engelman E, et al. Effect of propofol on cerebral blood flow and metabolism in man. *Anaesthesia* 1988;43(Suppl):42–43.
771. Veselis R, Reinsel R, Feshchenko V, et al. Cerebral blood flow (CBF) changes during midazolam sedation using O-15 positron emission tomography. *Anesthesiology* 1995;83:A154.
772. Vespa P, Bergsneider M, Hattori N, et al. Metabolic crisis without brain ischemia is common after traumatic brain injury: a combined microdialysis and positron emission tomography study. *J Cereb Blood Flow Metab* 2005;25:763–774.
773. Violet R, Albanese J, Thomachot L, et al. Isovolume hypertonic solutes (sodium chloride or mannitol) in the treatment of refractory posttraumatic intracranial hypertension: 2 mL/kg 7.5% saline is more effective than 2 mL/kg 20% mannitol. *Crit Care Med* 2003;31:1683–1687.
774. Videen TO, Zazulia AR, Manno EM, et al. Mannitol bolus preferentially shrinks non-infarcted brain in patients with ischemic stroke. *Neurology* 2001;57:2120–2122.
775. Vogel G. Expanding the habitable zone. *Science* 1999;286:70–71.
776. Voldby B, Enevoldsen EM. Intracranial pressure changes follow aneurysm rupture. Part 3: recurrent hemorrhage. *J Neurosurg* 1982;56:784–789.
777. Voldby B, Enevoldsen EM and Jensen FT. Cerebrovascular reactivity in patients with ruptured intracranial aneurysm. *J Neurosurg* 1985;62:59–67.
778. Voldby B, Enevoldsen EM. Intracranial pressure changes following aneurysm rupture. Part 1: clinical and angiographic correlations. *J Neurosurg* 1982;56:186–196.
779. Wade CE, Grady JJ, Kramer GC, et al. Individual patient cohort analysis of the efficacy of hypertonic saline/dextran in patients with traumatic brain injury and hypotension. *J Trauma* 1997;42:S61–S65.
780. Wagner CL, Eicher DJ, Katikaneni LD, et al. The use of hypothermia: a role in the treatment of neonatal asphyxia? *Pediatr Neurol* 1999;21:429–443.
781. Wahl M, Schilling L. Regulation of cerebral blood flow—a brief review. *Acta Neurochir Suppl* 1993;59:3–10.
782. Waldemar G, Paulson OB. Angiotensin converting enzyme inhibition and cerebral circulation—a review. *Br J Clin Pharmacol* 1989;28:177S–182S.
783. Walle F, Mohammedi I, Argaud L, et al. [Diuretics use in the intensive care unit: results of a prevalence study]. *Ann Fr Anesth Reanim* 2004;23:161–162.
784. Warach S, Gaa J, Siewert B, et al. Acute human stroke studied by whole brain echo planar diffusion-weighted magnetic resonance imaging. *Ann Neurol* 1995;37:231–241.
785. Ware ML, Nemani VM, Meeker M, et al. Effects of 23.4% sodium chloride solution in reducing intracranial pressure in patients with traumatic brain injury: a preliminary study. *Neurosurgery* 2005;57:727–736.
786. Warner DO, Vettermann J, Brichant JF, et al. Direct and neurally mediated effects of halothane on pulmonary resistance in vivo. *Anesthesiology* 1990;72:1057–1063.
787. Warner DS. Anesthetics provide limited but real protection against acute brain injury. *J Neurosurg Anesthesiol* 2004;16:303–307.
788. Warner DS. Pharmacologic protection from ischemic neuronal injury. *J Neurosurg Anesthesiol* 2004;16:95–97.
789. Warner DS, Deshpande JK, Wieloch T. The effect of isoflurane on neuronal necrosis following near-complete forebrain ischemia in the rat. *Anesthesiology* 1986;64:19–23.
790. Warner DS, Hansen TD, Vust L, et al. Distribution of cerebral blood flow during deep isoflurane vs pentobarbital anesthesia in rats with middle cerebral artery occlusion. *J Neurosurg Anesthesiol* 1989;1:219–226.
791. Warner DS, Ludwig PS, Pearlstein R, et al. Halothane reduces focal ischemic injury in the rat when brain temperature is controlled. *Anesthesiology* 1995;82:1237–1245; discussion 1227A.
792. Warner DS, McFarlane C, Todd MM, et al. Sevoflurane and halothane reduce focal ischemic brain damage in the rat. Possible influence on thermoregulation. *Anesthesiology* 1993;79:985–992.
793. Warner DS, Takaoka S, Ludwig P, et al. Low-dose pentobarbital reduces focal ischemic infarct volume in a magnitude similar to burst suppression. *J Neurosurg Anesthesiol* 1995;7:303.
794. Warner DS, Zhou JG, Ramani R, et al. Nitrous oxide does not alter infarct volume in rats undergoing reversible middle cerebral artery occlusion. *Anesthesiology* 1990;73:686–693.
795. Warner DS, Zhou J, Ramani R, et al. Reversible focal ischemia in the rat: effects of halothane, isoflurane, and methohexital anesthesia. *J Cereb Blood Flow and Metab* 1991;11:794–802.
796. Watanabe K, Saito N, Taniguchi M, et al. Analysis of taste disturbance before and after surgery in patients with vestibular schwannoma. *J Neurosurg* 2003;99:999–1003.
797. Wauquier A, Bovill JG, Sebel PS. Electroencephalographic effects of fentanyl, sufentanil and alfentanil anesthesia in man. *Neuropsychobiology* 1984;11:203–206.
798. Wechsler RL, Dripps RD, Kety SS. Blood flow and oxygen consumption of the human brain during anesthesia produced by thiopental. *Anesthesiology* 1951;12:308–314.
799. Weed LH MKP. Experimental alteration of brain bulk. *Am J Physiol* 1919;48:531–555.
800. Weeks JB, Todd MM, Warner DS, et al. The influence of halothane, isoflurane, and pentobarbital on cerebral plasma volume in hypocapnic and normocapnic rats. *Anesthesiology* 1990;73:461–466.
801. Weir B, MacDonald L. Cerebral vasospasm. *Clin Neurosurg* 1993;40:40–55.
802. Wells BA, Keats AC, Cooley DA. Increased tolerance to cerebral ischemia produced by general anesthesia during temporary carotid occlusion. *Surgery* 1963;54:216–223.
803. Werner C, Kochs E, Rau M, et al. Dose-dependent blood flow velocity changes in the basal cerebral arteries following low-dose ketamine. *J Neurosurg Anesth* 1990;2:86–91.
804. Whittle IR, Glasby M, Lammie A, et al. Neuropathological findings after intracerebral implantation of microdialysis catheters. *Neuroreport* 1998;9:2821–2825.
805. Wieloch T, Lindvall O, Blomqvist P, et al. Evidence for amelioration of ischaemic neuronal damage in the hippocampal formation by lesions of the perforant path. *Neurol Res* 1985;7:24–26.
806. Wilder BL. Hypothesis: the etiology of midcervical quadriplegia after operation with the patient in the sitting position. *Neurosurgery* 1982;11:530–531.
807. Wilkinson HA, Rosenfeld S. Furosemide and mannitol in the treatment of acute experimental intracranial hypertension. *Neurosurgery* 1983;12:405–410.



808. Williams SR, Crockard HA, Gadian DG. Cerebral ischaemia studied by nuclear magnetic resonance spectroscopy. *Cerebrovasc Brain Metab Rev* 1989;1:91-114.
809. Wilson JX, Gelb AW. Free radicals, antioxidants, and neurologic injury: possible relationship to cerebral protection by anesthetics. *J Neurosurg Anesthesiol* 2002;14:66-79.
810. Winkler SR, Munoz-Ruiz L. Mechanism of action of mannitol. *Surg Neurol* 1995;43:59.
811. Wolff J, Carl P, Hansen PB, et al. Effects of etanolone on cerebral blood flow and metabolism in healthy volunteers. *Anesthesiology* 1994;81:623-627.
812. Wollman H, Alexander SC, Cohen PJ, et al. Cerebral circulation of man during halothane anesthesia. Effects of hypocarbia and of *d*-tubocurarine. *Anesthesiology* 1964;25:180-184.
813. Wollman H, Smith TC, Stephan GW, et al. Effects of extremes of respiratory and metabolic alkalosis on cerebral blood flow in man. *J Appl Physiol* 1968;24:60-65.
814. Wong EH, Leeb-Lundberg LM, Teichberg VI, et al. Gamma-aminobutyric acid activation of 36Cl<sup>-</sup> flux in rat hippocampal slices and its potentiation by barbiturates. *Brain Res* 1984;303:267-275.
815. Wood JH, Kee DB. Hemorheology of the cerebral circulation in stroke. *Stroke* 1985;16:765-772.
816. Worthley LIG, Cooper DJ, Jones N. Treatment of resistant intracranial hypertension with hypertonic saline: report of two cases. *J Neurosurg* 1988;68:478-481.
817. Wyper DJ. Functional neuroimaging with single-photon emission computed tomography (SPECT). *Cerebrovasc Brain Metab Rev* 1993;5:199-217.
818. Xiong L, Zheng Y, Wu M, et al. Preconditioning with isoflurane produces dose-dependent neuroprotection via activation of adenosine triphosphate-regulated potassium channels after focal cerebral ischemia in rats. *Anesth Analg* 2003;96:233-237, table of contents.
819. Xu GP, Dave KR, Moraes CT, et al. Dysfunctional mitochondrial respiration in the wobbler mouse brain. *Neurosci Lett* 2001;300:141-144.
820. Yamaguchi S, Nakahara K, Miyagi T, et al. Neurochemical monitoring in the management of severe head-injured patients with hypothermia. *Neural Res* 2000;22(7):657-664.
821. Yokoo N, Sheng H, Mixco J, et al. Intraischemic nitrous oxide alters neither neurologic nor histologic outcome: a comparison with dizocilpine. *Anesth Analg* 2004;99:896-903, table of contents.
822. Yoshimoto Y, Kwak S. Age-related multifactorial causes of neurological deterioration after early surgery for aneurysmal subarachnoid hemorrhage. *J Neurosurg* 1995;83:984-988.
823. Yoshioka M, Matsumoto M, Togashi H, et al. Opioid receptor regulation of 5-hydroxytryptamine release from the rat hippocampus measured by in vivo microdialysis. *Brain Res* 1993;613:74-79.
824. Yoshitani K, Kawaguchi M, Tatsumi K, et al. Intravenous administration of flurbiprofen does not affect cerebral blood flow velocity and cerebral oxygenation under isoflurane and propofol anesthesia. *Anesth Analg* 2004;98:471-476, table of contents.
825. Youn KS, Tokeshi J. Therapy with hypertonic saline in combination with anti-convulsants for hyponatremia-induced seizure: a case report and review of the literature. *Hawaii Med J* 2002;61:280-281.
826. Young GB, McLachlan RS, Kreeft JH, et al. An electroencephalographic classification for coma. *Can J Neurol Sci* 1997;24:320-325.
827. Young ML, Smith DS, Murtagh F, et al. Comparison of surgical and anesthetic complications in neurosurgical patients experiencing venous air embolism in the sitting position. *Neurosurgery* 1986;18:157-161.
828. Young W. H<sub>2</sub> clearance measurement of blood flow: a review of technique and polarographic principles. *Stroke* 1980;11:552-564.
829. Young WL, Prohovnik I, Correll JW, et al. Cerebral blood flow and metabolism in patients undergoing anesthesia for carotid endarterectomy: a comparison of isoflurane, halothane, and fentanyl. *Anesth Analg* 1989;68:712-717.
830. Young WL, Solomon RA, Prohovnik I, et al. <sup>133</sup>Xe blood flow monitoring during arteriovenous malformation resection: a case of intraoperative hyperperfusion with subsequent brain swelling. *Neurosurgery* 1988;22:765-769.
831. Young Y, Menon DK, Tisavipat N, et al. Propofol neuroprotection in a rat model of ischaemia reperfusion injury. *Eur J Anaesthesiol* 1997;14:320-326.
832. Yvon A, Hanouz JL, Haelewyn B, et al. Mechanisms of sevoflurane-induced myocardial preconditioning in isolated human right atria in vitro. *Anesthesiology* 2003;99:27-33.
833. Zentner J, Albrecht T, Hassler W. Prevention of an air embolism by moderate hypoventilation during surgery in the sitting position. *Neurosurgery* 1991;28:705-708.
834. Zetterstrom T, Vernet L, Ungerstedt U, et al. Purine levels in the intact rat brain. Studies with an implanted perfused hollow fibre. *Neurosci Lett* 1982;29:111-115.
835. Zhan RZ, Fujihara H, Baba H, et al. Ischemic preconditioning is capable of inducing mitochondrial tolerance in the rat brain. *Anesthesiology* 2002;97:896-901.
836. Zhang H, Downey GP, Suter PM, et al. Conventional mechanical ventilation is associated with bronchoalveolar lavage-induced activation of polymorphonuclear leukocytes: a possible mechanism to explain the systemic consequences of ventilator-induced lung injury in patients with ARDS. *Anesthesiology* 2002;97:1426-1433.
837. Zhang HX, Du GH, Zhang JT. Ischemic pre-conditioning preserves brain mitochondrial functions during the middle cerebral artery occlusion in rat. *Neurol Res* 2003;25:471-476.
838. Zhang Z, Chen TY, Kirsch JR, et al. Kappa-opioid receptor selectivity for ischemic neuroprotection with BRL 52537 in rats. *Anesth Analg* 2003;97:1776-1783.
839. Zhao Q, Memezawa H, Smith ML, et al. Hyperthermia complicates middle cerebral artery occlusion induced by an intraluminal filament. *Brain Res* 1994;649:253-259.
840. Ziai WC, Mirski MA, Bhardwaj A. Use of hypertonic saline in ischemic stroke. *Stroke* 2002;33:1166-1167.
841. Zornow MH. Hypertonic saline as a safe and efficacious treatment of intracranial hypertension. *J Neurosurg Anesthesiol* 1996;8:175-177.
842. Zornow MH. Perioperative Fluid Management of Patients with Intracranial Hypertension. Philadelphia: Lippincott Williams & Wilkins, 2000.
843. Zornow MH, Maze M, Dyck JB, et al. Dexmedetomidine decreases cerebral blood flow velocity in humans. *J Cerebr Blood Flow Metab* 1993;13:350-353.
844. Zornow MH, Scheller MS. Intraoperative fluid management during craniotomy. In: Cottrell JE, Smith DS, eds. *Anesthesia and Neurosurgery*. 4th ed. St. Louis: Mosby, 2001:237-243.
845. Zornow MH, Scheller MS, Shackford SR. Effect of a hypertonic lactated Ringer's solution on intracranial pressure and cerebral water content in a model of traumatic brain injury. *J Trauma* 1989;29:484-488.
846. Zornow MH, Scheller MS, Sheehan PB, et al. Intracranial pressure effects of dexmedetomidine in rabbits. *Anesth Analg* 1992;75:232-237.



# CHAPTER 51

## Cardiac Anesthesia

Mark A. Chaney, MD,  
Albert T. Cheung, MD,  
Christopher A. Troianos, MD,  
Jessica L. Willert, MD,  
David A. Zvara, MD, and  
Stanton K. Sherman, MD

Cardiac anesthesia remains one of the more dynamic subspecialties within the clinical practice of anesthesia. Continuing innovation in pharmacologic development, technology and surgical interventions have had a significant impact on the core body of knowledge and experience required by perioperative intensivists who practice cardiac anesthesia. Furthermore, over the past several years, the risk profile of cardiac surgical patients has shifted towards higher risk populations predisposed to increased perioperative morbidity and mortality, thus further contributing to the increasing complexity and specialization of the techniques required for monitoring, anesthetizing, and managing these patients. This chapter will review the basic fundamental principles which remain the core body of knowledge required for the perioperative anesthetic management of patients undergoing cardiac surgery.

### CARDIOPULMONARY BYPASS: PATHOPHYSIOLOGY AND PATIENT MANAGEMENT CONSIDERATIONS

Despite the introduction and perseverance of off-pump coronary artery bypass graft surgery (OPCABG), cardiopulmonary bypass (CPB) remains an essential technique for the vast majority of cardiac surgical patients.<sup>1</sup> A comprehensive understanding of the CPB circuit, pathophysiology, and important patient management issues is essential for anesthesiologists responsible for the perioperative care of these patients.

#### Fundamental Components of a CPB Circuit

Traditionally, the CPB circuit removes blood from the body via the venous circulation and returns blood to the

### KEY POINTS

1. Initiation of cardiopulmonary bypass initiates an extremely complex and multifactorial response involving activation of complement, platelets, neutrophils, monocytes, and macrophages, thus initiating the coagulation, fibrinolytic, and kallikrein cascades. The systemic inflammatory response to cardiopulmonary bypass is further amplified by subsequent stimulated release of various endotoxins and cytokines, including interleukins and tumor necrosis factor, which further promote endothelial cell permeability.
2. Preparation for separation from cardiopulmonary bypass must be based on a clear understanding of the patient's preoperative condition and events of the operative course. Weaning from cardiopulmonary bypass is initiated after review and adjustment of numerous physiologic and technical variables, including temperature, laboratory data, heart rate and rhythm, myocardial contractility, and mechanical ventilation.
3. The anesthetic management of patients undergoing coronary artery bypass graft surgery requires an understanding of myocardial oxygen supply and demand, patient monitoring, and the anesthetic techniques that provide myocardial protection and favor oxygen supply over demand.
4. Patients with coronary artery disease presenting for coronary artery bypass graft surgery require special considerations in their anesthetic management. First and foremost are techniques that minimize myocardial oxygen demand while maximizing myocardial oxygen delivery. These considerations include preoperative preparation, intraoperative monitoring, and the use of anesthetic agents with hemodynamic effects that favor oxygen supply over demand and allow for myocardial protection. Postoperative management that provides particular attention to pain management, temperature control, and hemodynamic monitoring to avoid tachycardia, hypotension, and hypertension also must be considered.
5. Modern practices that focus on early extubation and "fast-tracking" cardiac surgical patients through the postoperative period use smaller narcotic doses, with supplementation by short-acting hypnotic agents.
6. Patients at risk for increased mortality after coronary artery bypass graft surgery are identified by preoperative factors. The most significant risk factors that increase mortality are age >80 years, emergent surgery, prior cardiac surgery, and renal failure.
7. The unifying concept in all valve surgery includes the principles of preserving myocardial function and the influence of preload, afterload, inotropy, rate, rhythm, and diastolic function on myocardial performance and mechanics.
8. Intraoperative transesophageal echocardiography is an essential diagnostic tool and monitor of cardiac performance for patients undergoing heart valve procedures.
9. Cardiac anesthesia for heart valve surgery is associated with a number of special considerations not found in other aspects of cardiothoracic anesthesiology. Among these considerations is familiarity with the type of repair technique or prosthetic valve used.
10. The process of repairing or replacing a portion of the thoracic aorta typically requires the temporary or permanent interruption of blood flow through the aorta or its major branch vessels, creating the potential for ischemia or infarction of almost any major organ system. Techniques to protect organs during temporary interruption of blood flow in the thoracic aorta include deep hypothermic circulatory arrest, selective antegrade cerebral perfusion, retrograde cerebral perfusion, and partial left heart bypass for distal aortic perfusion. Intraoperative neurophysiologic monitoring and lumbar cerebrospinal fluid drainage are recognized techniques commonly used for repairs involving the descending thoracic or thoracoabdominal aorta to decrease the risk of spinal cord ischemia and infarction.

*Continued*

**Key Points—continued**

11. Preoperatively, the anesthesiologist must identify any neurologic deficits and ascertain the extent of major organ dysfunction, including renal or hepatic insufficiency, which are common in patients undergoing placement of a ventricular assist device. Any further deterioration in the perioperative period may prevent a full recovery and eliminate the possibility of a patient qualifying for a subsequent heart transplantation at a later date.
12. Right heart failure is one of the most important causes of perioperative

death in patients undergoing placement of a left ventricular assist device. Right ventricular dysfunction and failure may develop in up to 20–30% of patients implanted with an isolated left ventricular assist device.  $\beta$ -Adrenergic agonists, phosphodiesterase inhibitors, as well as nitric oxide should be initiated to improve right ventricular contractility and decrease right ventricular afterload in an attempt to improve transpulmonary blood flow. A supplemental temporary right ventricular assist device may be necessary if right ventricular dysfunction persists.

body via the arterial circulation.<sup>2</sup> Thus, CPB must function “physiologically” as the patient’s heart and lungs. Most commonly, blood is drained by gravity via cannulas in the superior and/or inferior vena cavae and then similarly returned by a cannula in the ascending aorta. Although the CPB circuit consists of many important components, the two most important components are the pump, which functions as the patient’s heart, and the oxygenator, which functions as the patient’s lungs.

The two most common types of pumps used are roller pumps and centrifugal pumps. Roller pumps induce blood flow by compressing the tubing via rollers, thereby pushing the blood ahead through the tubing. Flow rate depends upon the size of the tubing, length of the roller track, and rotation rate of the rollers (i.e., revolutions per minute). Alternatively, centrifugal pumps induce blood flow by either a vaned impeller or a group of cones that reside inside a plastic housing. The impellers or cones are magnetically coupled with an electric motor and, when rotated rapidly, generate a pressure differential that may cause movement of blood through the tubing. Thus, unlike roller pumps, centrifugal pumps are afterload dependent, such that increases in resistance decreases forward flow delivered to the patient.

The two most common types of oxygenators used are membrane oxygenators and bubble oxygenators. Membrane oxygenators attempt to achieve separation between blood and gas in a manner analogous to the natural lung. Bubble oxygenators physically mix blood and gas, allowing sufficient time for adequate gas ex-

change to occur prior to defoaming and delivery to the patient. A heat exchanger usually is an integral part of the oxygenator. The type of oxygenator used influences the configuration of the CPB circuit. Membrane oxygenators typically are positioned after the pump because the resistance in most membrane oxygenators requires blood to be pumped through them. Thus, a venous reservoir collects venous return from the patient before delivery to the pump, followed by the membrane oxygenator, then back to the patient. Alternatively, bubble oxygenators typically are positioned before the pump because they do not require blood to be pumped through them, and they contain a reservoir of oxygenated blood that supplies the pump before it directly delivers blood back to the patient.

Over the past four decades, CPB technology has undergone a dramatic metamorphosis and can no longer be simply viewed as “the pump.”<sup>3</sup> Additional vital components of the CPB circuitry include the arterial line filter, bubble detector, cardioplegia lines, suction lines, temperature monitor, arterial line pressure monitor, anesthetic vaporizer, and oxygen monitor, among others. Needless to say, the perfusionist plays an important role in intraoperative patient management during cardiac surgery.

### Pathophysiology of CPB

Substantial controversy surrounds questions regarding “optimal” flow and pressure during CPB. Each patient must be individualized, with specific goals determined by numerous factors, including age, comorbidity, temperature, and body mass. However, most

clinicians aim for flows in the range from 2.4–2.8 L/min/m<sup>2</sup> and pressures in the range from 50–80 mm Hg. It has been known for many years that CPB induces a systemic inflammatory response syndrome (SIRS) in patients following cardiac surgery that can lead to major organ injury and postoperative morbidity.<sup>4–7</sup> Initiation of CPB initiates an extremely complex and multifactorial response involving activation of complement, platelets, neutrophils, monocytes, and macrophages, thus initiating the coagulation, fibrinolytic, and kallikrein cascades. The SIRS response to CPB is further amplified by subsequent stimulated release of various endotoxins and cytokines, including interleukins (ILs) and tumor necrosis factor (TNF), which further promote endothelial cell permeability. Transvascular migration of activated leukocytes into tissues associated with SIRS results in the release of various proteases and neutrophil elastases, which cause additional vascular and parenchymal damage that can exacerbate ischemia–reperfusion injury associated with CPB and cardiac surgery.<sup>8</sup>

The basic physiologic insults caused by CPB have been associated with major postoperative morbidity, including neurologic dysfunction, pulmonary dysfunction, renal dysfunction, and/or hematologic abnormalities. Additional clinical manifestations associated with SIRS include increased metabolism and fever, fluid retention, myocardial edema, and detrimental hemodynamic alterations. Recent controversies surrounding clinical management of patients exposed to CPB have focused on the potential detrimental physiologic effects of hemodilution<sup>9,10</sup> and hyperglycemia<sup>11</sup> on postoperative morbidity. Over the years, a wide variety of antiinflammatory treatment options have been used in patients subjected to CPB in hopes of attenuating the SIRS, including leukocyte depletion techniques, neutrophil adhesion molecule blockade, heparin coating of CPB circuitry, and use of monoclonal antibodies directed specifically against various inflammatory mediators. Although results from animal work appear promising, the demonstration of a definite clinical benefit in humans has not been consistent.<sup>12–16</sup>

### Management of Anticoagulation Heparin Dosing

Anticoagulation is used during cardiac surgery to prevent thrombosis of the

CPB circuit and to minimize excessive CPB-related activation of the hemostatic system. Heparin is used routinely because it is effective, immediately reversible, generally well tolerated, and inexpensive.<sup>17,18</sup> Heparin induces anticoagulation primarily by potentiating the activity of antithrombin III. Most heparin preparations are “unfractionated,” meaning that the heparin compound isolated from animal tissues, including porcine intestine and bovine lung, contains heparin molecules of various lengths. Because the relationship between mass (milligrams) and potency (units) varies among heparin preparations, most clinicians record heparin doses in units rather than milligrams. The anticoagulant effect of an intravenous dose of heparin occurs within minutes, and the intravenous heparin bolus dose administered prior to initiation of CPB may decrease arterial pressure and/or systemic vascular resistance.

Much controversy surrounds appropriate heparin dosing and monitoring of anticoagulation in patients exposed to CPB. Somewhat surprisingly, the literature does not consistently support the importance of anticoagulation monitoring techniques during CPB.<sup>19</sup> However, bleeding and transfusion outcomes likely can be improved by refining heparin monitoring techniques, either by sustaining better anticoagulation during CPB or by optimizing reversal of anticoagulation with protamine. Most clinicians administer an initial dose of 200–400 units/kg and maintenance doses determined by the particular laboratory test used for assessment of anticoagulation. The activated clotting time (ACT) is perhaps the most widely used method, and most clinicians administer additional heparin periodically in order to maintain the ACT >400–480 seconds. However, numerous other clinical conditions can affect the ACT, including hypothermia, hemodilution, thrombocytopenia, and aprotinin administration. Heparin concentration measurement techniques also are commonly used. Whatever laboratory test is used, most clinicians assess anticoagulation every 30 minutes during CPB.

### Protamine

Protamine neutralizes heparin-induced anticoagulation. Salmon milt provides the pharmaceutical source of protamine, which neutralizes the antithrombin III effect of heparin by forming

large complexes with heparin's sulfate groups. Protamine may exhibit antihemostatic properties by affecting platelets and by releasing tissue plasminogen activator from endothelial cells.

Much controversy surrounds the recommended dose of protamine to adequately neutralize heparin. Questions regarding the optimal ratio of milligrams of protamine to units of heparin, and how much heparin is actually left in the patient, are central to this controversy. Most clinicians use protocols that call for administration of protamine in slight excess doses of the usual ratio of 1 mg of protamine to 1 mg of heparin in order to assure return of normal coagulation. Subsequent postoperative administration of protamine may be required to prevent “heparin rebound.”<sup>20</sup>

A spectrum of adverse reactions may be associated with protamine use; the most important is hypotension and/or anaphylactoid/anaphylactic reaction.<sup>21</sup> Hypotension following administration of protamine is fairly common and may be related to rate of injection, subsequent decreased systemic vascular resistance, and perhaps myocardial depression. True anaphylactoid/anaphylactic reactions to protamine are rare. Patients receiving protamine-containing insulins and/or previously exposed to protamine may be at slightly increased risk of developing anaphylactic reactions. Pulmonary vasoconstriction causing pulmonary hypertension may be associated with protamine use. Heparin–protamine complexes and complement activation may be the primary mediators of these adverse reactions. Slow administration of protamine may limit adverse reactions. If sudden hypotension and/or pulmonary hypertension occur, protamine administration should immediately cease. Heparin may be considered in order to reduce heparin–protamine complex load. Hemodynamic support with vasopressors and inotropes may be required in addition to reinitiation of CPB. Milder cases may resolve without intervention.

### Heparin-Induced Thrombocytopenia

Unfractionated heparin given during CPB is remarkably immunogenic. In fact, as many as 25–50% of cardiac surgical patients develop heparin-dependent antibodies postoperatively over the first 5–10 days after expo-

sure. This immunogenic response can strongly activate platelets and coagulation, causing the prothrombotic disorders known as heparin-induced thrombocytopenia (HIT).

HIT is defined as thrombocytopenia with a potential for associated thrombosis (HITT). A definitive diagnosis usually requires one or more positive tests for HIT antibodies.<sup>22</sup> An otherwise unexplained perioperative platelet count fall  $\geq 50\%$  from baseline or any thrombosis that occurs 5–14 days after cardiac surgery is suggestive of HIT, even when heparin is not still being given (i.e., delayed-onset HIT). Regarding laboratory testing, commercially available enzyme immunoassays and washed platelet activation assays (i.e., platelet serotonin release or heparin-induced platelet activation) are highly sensitive for detecting HIT antibodies such that a negative test result essentially rules out HIT. Antibody seroconversion of no clinical consequence is common following cardiac surgery. Thus, the presence of HIT antibodies in the absence of thrombocytopenia or thrombosis does not indicate HIT. However, patients with acute HIT usually have strong positive HIT antibody results. In general, the greater the magnitude of a positive HIT antibody test result, the greater the likelihood the patient has HIT. In patients following cardiac surgery, the frequency of HIT is approximately 2%. Although HIT antibodies are transient, at least half of patients with HIT develop thrombotic complications. Porcine intestine heparin has been associated with a lower risk of HIT than with bovine lung heparin.

If high suspicion of HIT exists, all heparin should be discontinued. In general, HITT should be treated with one of the following alternative anticoagulants: lepirudin, argatroban, danaparoid, or bivalirudin.<sup>22</sup> Warfarin and other oral anticoagulants are generally contraindicated during acute HIT and should be delayed pending substantial recovery of the platelet count. The alternative anticoagulant should be stopped only when platelet count recovery is complete and therapeutic oral anticoagulation is achieved. For patients strongly suspected of having HIT but without clinical evidence of thrombosis, an alternative anticoagulant in therapeutic doses is recommended because of the high risk of developing thrombosis.



Standard anticoagulation with heparin is recommended for cardiac surgical patients with previous HIT in whom HIT antibodies are no longer detectable (or only weakly detectable) by enzyme immunoassay. In patients with acute or subacute HIT who require cardiac surgery and yet in whom the platelet count has recovered yet HIT antibodies remain detectable, two general approaches are available. One approach is administration of an alternative anticoagulant (i.e., lepirudin, argatroban, danaparoid, bivalirudin) and avoidance of heparin exposure. The other is administration of standard heparin anticoagulation along with a platelet antagonist, including epoprostenol or tirofiban. Given the absence of prospective comparative studies, no single option can be generally recommended in these patients.

### Antifibrinolytics

Antifibrinolytic agents, including the lysine analogues *e*-aminocaproic acid and tranexamic acid, and the serine protease inhibitor aprotinin have become mainstay prophylactic therapies for reducing bleeding and blood product transfusions for cardiac surgical patients.<sup>23</sup> Although many studies have demonstrated beneficial effects of these agents in reducing perioperative bleeding and morbidity,<sup>24</sup> others have reported adverse side effects associated with multiorgan dysfunction and prothrombotic outcomes,<sup>25</sup> especially among patients with a genetic predisposition to a hypercoagulable state.<sup>26</sup> Thus, similar to all pharmacologic agents, the decision to administer any antifibrinolytic should include a thorough risk-to-benefit consideration that is individualized to each patient.

### Management of Patients during Weaning and Separation from CPB

Weaning from CPB should represent a smooth transition from the mechanical pump back to the patient's heart and lungs as the source of blood flow and gas exchange. The process should always be conducted in a coordinated fashion with all members of the team, including the surgeon, anesthesiologist, and perfusionist.<sup>27</sup> Preparation for separation from CPB must be based on a clear understanding of the patient's preoperative condition and events of the operative course. Weaning is initiated after review and adjustment of

numerous physiologic and technical variables, including temperature, laboratory data, heart rate and rhythm, myocardial contractility, and mechanical ventilation, among others. The patient should be normothermic ( $>97^{\circ}\text{F}$   $36^{\circ}\text{C}$ ) and demonstrate normal laboratory values for hemoglobin, potassium, calcium, and acid-base balance. Myocardial function, including heart rate, cardiac rhythm, myocardial contractility, and preload, should be optimized, which may require administration of intravenous medications, depending on the desired goal (Table 51-1). Many patients usually require medications that increase myocardial contractility during separation from CPB. In extreme cases, mechanical devices may be required (intraaortic balloon pump [IABP], ventricular assist device [VAD]). It now is clear that information obtained from transesophageal echocardiography (TEE) is far superior in quality and quantity to that obtained from a pulmonary artery catheter (PAC) and may be very helpful in guiding therapy toward optimizing hemodynamics and guiding de-airing procedures during weaning from CPB. Furthermore, TEE has proved invaluable in assessing the quality of surgical procedure following separation from CPB, especially among patients with significant ventricular dysfunction and those undergoing valve procedures, congenital heart surgery, and aortic surgery.<sup>27-30</sup>

### ANESTHETIC MANAGEMENT DURING CORONARY ARTERY BYPASS GRAFTING

The anesthetic management of patients undergoing coronary artery bypass graft surgery (CABG) requires an understanding of myocardial oxygen supply and demand, patient monitoring, and the anesthetic techniques that provide myocardial protection and favor oxygen supply over demand. Myocardial ischemia results as an imbalance between the oxygen supply of the coronary circulation and the metabolic demand of myocardial tissue. Ischemia initially causes contractile dysfunction. However, if ischemia is severe or prolonged, it can lead to cell death, tissue necrosis, and permanent loss of contractile function of the affected myocardial region. This section reviews the basic pathophysiology of myocardial

TABLE 51-1.

#### Common Cardiac Drugs Used during Weaning from Cardiopulmonary Bypass

<b>Inotropic Agents</b>
Dopamine
Dobutamine
Epinephrine
Milrinone
<b>Vasopressor Agents</b>
Norepinephrine
Phenylephrine
Vasopressin
<b>Vasodilator Agents</b>
Nitroglycerin
Nitroprusside

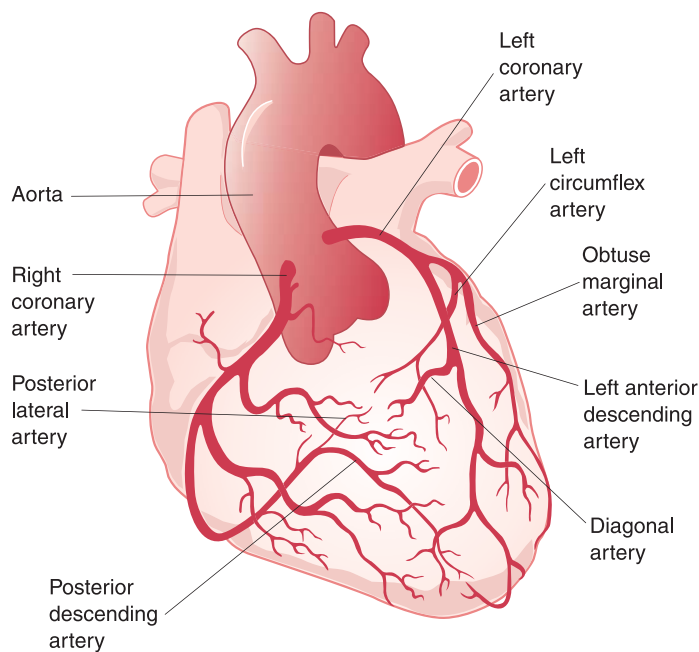
ischemia, the anesthetic management of patients at risk for developing myocardial ischemia, and anesthetic considerations during CABG surgery.

### Coronary Artery Anatomy

Coronary artery anatomy is particularly relevant to the anesthesiologist caring for patients with coronary artery disease. The severity of the blockages correlates with the margin of reserve for tolerating tachycardia and hypotension. Patients with coronary lesions obstructing 99% of the lumen (subtotal occlusion) may not tolerate even mild degrees of tachycardia and hypotension, whereas patients with lesions in the 70–75% range may tolerate some degree of hemodynamic compromise without causing ischemia. Knowledge of specific coronary lesions also allows for focused monitoring of targeted myocardial regions at increased risk for developing myocardial ischemia.

The two major coronary arteries are the first arterial branches of the aorta, which arise from two of the three sinuses of Valsalva in the aortic root (Fig. 51-1). The right coronary sinus is anteriorly located, although the left coronary sinus is located laterally and slightly posterior. The left coronary artery (LCA) divides into the left anterior descending coronary artery (LAD) and left circumflex artery (LCx). The LAD gives rise to the diagonal branches and supplies the anterior wall of the right ventricle (RV), the anterior two thirds of the interventricular septum, the anterior wall of the left ventricle (LV), and the ventricular apex. The LCx gives rise to the obtuse marginal branches and supplies the left atrium (LA), and the posterior and lateral





**FIGURE 51–1.** Coronary anatomy. (From [www.bph.co.th/heartcenter/heartCardiacCatheterization.html](http://www.bph.co.th/heartcenter/heartCardiacCatheterization.html) with permission.)

walls of the LV. Patients described as having “a left main” have a significant lesion in the LCA and are at particular risk for developing ischemia that affects a large portion of the LV, which would cause rapid hemodynamic compromise and cardiac arrest. Patients described as having a “left main equivalent” have high-grade obstructions in both the LAD and LCx arteries. These patients potentially have the same risk of coronary ischemia and rapid hemodynamic compromise as do patients with left main disease.

The right coronary artery (RCA) supplies blood to the lateral and posterior walls of the RV, the inferior wall of the LV, and the posterior third of the interventricular septum. The RCA terminates as the posterior descending artery (PDA) in 85–90% of the population. The blood supply of the PDA determines the pattern of coronary dominance: RCA for right dominant and LCx for left dominant. Most patients have an RCA dominant or balanced pattern of blood supply to the PDA. A balanced pattern is used to describe coronary anatomy with no particular dominance in terms of the blood supply to the PDA. The presence of a right dominant or balanced system during OPCABG frequently leads to bradycardia and hypotension during RCA occlusion because it supplies blood to the sinoatrial node in 55% of patients, whereas the PDA

supplies the atrioventricular node in right dominant patients.

Myocardial blood collects in the coronary veins, which drain into the coronary sinus, and subsequently the right atrium (RA). The coronary sinus is often used as a conduit for the delivery of cardioplegia to the myocardium in a retrograde fashion. This is possible because the coronary veins lack valves, allowing blood to flow in either direction. Retrograde cardioplegia is used in patients with aortic insufficiency (AI), during aortic valve (AV) surgery, in the presence of high-grade coronary obstructions, and in patients with previous CABG who have a patent internal mammary artery graft. All of these situations limit the antegrade delivery of cardioplegia to the myocardium from the aortic root. Retrograde delivery of cardioplegia via the coronary sinus also has limitations. A coronary sinus catheter inserted beyond the small cardiac vein will prevent delivery of cardioplegia to the RV. Subsequently, the right heart may be poorly protected from myocardial ischemia during aortic cross-clamping.<sup>31</sup> Coronary sinus catheters that are directed into the small or middle cardiac vein may cause coronary sinus rupture.

The LAD is positioned on the anterior aspect of the heart. The obtuse marginal branches of the LCx and diagonal branches of the LAD are located on the lateral or posterior aspect of the

heart (Fig. 51–1). The surgeon must rotate or lift the heart to gain access to these vessels, causing hemodynamic compromise if the cardiac chambers are compressed. The pulmonary outflow tract also may be compressed with cardiac rotation, again resulting in severe hypotension by dramatically reducing preload. Additionally, the electrocardiographic (ECG) axis changes during cardiac manipulation and may change the ECG–coronary artery anatomic relationship, limiting the ability to use ECG for ischemia monitoring. Use of TEE for ischemia and ventricular function monitoring may be compromised when the heart is lifted or manipulated within the surgical field. The PAC may be malpositioned during these maneuvers, providing erroneous data regarding cardiac output and filling pressures.

## Coronary Blood Flow Physiology

The physiology of coronary blood flow is based upon the assumption that coronary arteries are nondistensible tubes, and that blood is a homogeneous fluid. Blood flows from a region of higher pressure (aorta) to one of lower pressure (capillaries). The rate of flow is dependent on the pressure gradient that moves red blood cells through the coronary arteries in a laminar flow pattern. Flow is most dependent on the radius of the blood vessel, which is why coronary arterioles maximally dilate in response to coronary arterial stenosis.<sup>32</sup> Coronary stenosis causes the vessel to maximally dilate distal to the stenosis, creating a vessel with a fixed radius. Manipulation of the coronary perfusion pressure then becomes the most important factor that determines coronary blood flow and the most important physiologic parameter manipulated by the anesthesia provider in the setting of coronary ischemia. Exercise-induced ischemia causes a compensatory increase in heart rate,  $\alpha_1$ -adrenergic-induced vasoconstriction, and increased LV filling pressure, all of which reduce coronary blood flow.<sup>33</sup> Adequate coronary perfusion pressure is the most important factor in the prevention and treatment of myocardial ischemia, both in the operating room and during exercise.

A second important factor is blood viscosity determined rheologically as the concentration or suspension of erythrocytes within the blood. Patients

with coronary artery disease (CAD) have disturbed blood flow patterns that create an increased tendency for coronary arterial thrombosis.<sup>34</sup> These abnormal flow patterns underscore the importance of aspirin therapy in the medical management of patients with CAD by reducing platelet adhesion and aggregation at the site of coronary stenoses.

Coronary blood flow has a characteristic phasic perfusion pattern, 70–80% of which occurs during the diastolic phase of the cardiac cycle. Cardiac contraction during systole impedes myocardial perfusion by increasing intraventricular cavitory pressure and coronary artery resistance, thus producing a nonlinear relationship between heart rate and diastolic time.<sup>35</sup>  $\beta$ -blockade is a very effective medical therapy for patients with CAD by preventing even small increases in heart rate during the perioperative period, reducing mortality with heart rate reduction, and improving outcome.<sup>36</sup>

Heart rate reduction improves subendocardial coronary artery blood flow,<sup>37,38</sup> allowing for better matching of myocardial oxygen supply and demand (myocardial perfusion–contraction coupling), thus preserving regional myocardial contractility.<sup>39</sup> Recovery of stunned or hibernating myocardium in patients with ischemic heart disease occurs with restoration of myocardial perfusion–contraction coupling.

### Myocardial Oxygen Delivery

Myocardial oxygen delivery depends on the oxygen content in the blood and is composed of hemoglobin-bound oxygen and dissolved oxygen. Hemoglobin-bound oxygen composes most of the blood's carrying capacity. However, delivery of oxygen to myocardial cells is dependent on release of oxygen from hemoglobin and is represented by the oxygen–hemoglobin dissociation curve. A leftward shift of this curve from normal indicates a greater affinity of oxygen by hemoglobin, which has the effect of drawing more oxygen into the blood as it passes through the lungs but reducing oxygen release at the cellular level. A leftward shift is caused by alkalosis (both metabolic and respiratory), hypothermia, carboxyhemoglobinemia, methemoglobinemia, and decreased red blood cell 2,3-diphosphoglycerate (DPG), which may be observed after transfusion of a large volume of old blood stored in

acid-citrate-dextrose. A rightward shift indicates less affinity of the red cells for oxygen, which has the effect of greater oxygen release to the tissues but at the expense of drawing less oxygen into the blood as it passes through the lungs. A rightward shift is caused by acidosis (both metabolic and respiratory), hyperthermia, and increased 2,3-DPG in the red blood cells.

Although anemia clearly reduces the oxygen carrying capacity of blood, clinical studies have not determined the lowest acceptable level of anemia that does not produce myocardial ischemia. The degree of anemia that produces myocardial ischemia is dependent on factors that are specific for each patient and the loading conditions of the ventricle. Factors include the severity of CAD, myocardial wall thickness and tension, heart rate, and perfusion pressure. Isovolemic reduction of hemoglobin to 4.6–5.3 mg/dL in healthy volunteers produced ST-segment changes on Holter monitoring in two of 11 subjects, whereas hemoglobin levels of 5.0 mg/dL led to myocardial ischemia infrequently.<sup>40</sup> In another investigation, ECG ST-segment changes suggestive of ischemia occurred in only three of 55 subjects during acute reduction of hemoglobin concentrations to 5 g/dL. These authors attributed the imbalance of myocardial oxygen supply and demand to tachycardia.<sup>41</sup> No adverse outcomes were found in healthy children undergoing scoliosis surgery who experienced acute intraoperative, normocarbic, normovolemic, hemodilution to 3.0 g/dL.<sup>42</sup>

Patients with ischemic heart disease require a higher hemoglobin concentration to minimize perioperative complications. A higher incidence of postoperative mortality was found in cardiac surgical patients older than 75 years whose preoperative systemic oxygen delivery was <320 mL/min/m<sup>2</sup> and who had anemia on the second postoperative day.<sup>43</sup> Bracey et al.<sup>44</sup> found no increase in morbidity, mortality, or patient self-assessment of fatigue when the hemoglobin threshold for red cell transfusion was lowered to 8.0 g/dL after CABG. Therefore, the lower limit of hemoglobin concentration depends on multiple factors, such as the patient's age, heart rate, perfusion pressure, clinical evidence of myocardial ischemia, and success of coronary revascularization.

### Myocardial Oxygen Demand

Myocardial oxygen demand is primarily determined by heart rate, ventricular wall tension, and myocardial contractility. Acting on the myocardial  $\beta$ -receptors,  $\beta$ -blockers decrease heart rate and reduce contractility and thus are primary treatment for patients with CAD at risk for myocardial ischemia. Although treatment with atenolol in the perioperative period does not significantly alter the neuroendocrine stress response,<sup>45</sup> perioperative  $\beta$ -blockade reduces mortality and myocardial infarction (MI) among patients undergoing noncardiac surgery.<sup>46–48</sup> Patients treated with metoprolol and for whom ventricular filling pressures were unchanged had an up to 40% reduction in myocardial oxygen consumption.<sup>36</sup> Metoprolol also improves survival, patient well-being, and New York Heart Association (NYHA) functional class in patients with congestive heart failure (CHF).<sup>49,50</sup>  $\beta$ -Blockade and subsequent heart rate reduction clearly decrease myocardial oxygen consumption and increase oxygen supply in patients with CHF. Although most anesthesiologists recognize the benefits of perioperative  $\beta$ -blockade, few institutions have formalized protocols for administering  $\beta$ -blockers to surgical patients.<sup>51</sup>

### Preload

Preload is the ventricular volume at end-diastole that determines myocardial fiber length, which in part determines the force of ventricular contraction. Manipulation of preload is an important therapeutic option in the care of patients with myocardial ischemia. Nitroglycerin is commonly used for treatment of myocardial ischemia, primarily exhibiting its anti-anginal effect by preload reduction through venodilation and coronary vasodilatation. Morphine also is useful for treating myocardial ischemia by causing vasodilatation (preload reduction) and providing pain relief, thereby leading to reduced heart rate. Furosemide reduces preload through both its diuretic action and venodilation.<sup>52</sup>

Determination of end-diastolic volume is problematic in the clinical arena. Pulmonary artery occlusion pressure (PAOP) is commonly used for approximating LV end-diastolic volume (LVEDV), but multiple assumptions must be made in order to use PAOP to estimate preload. Use of a pressure

measurement to estimate volume must take into account LV compliance, which is the change in unit pressure for each change of unit volume. Both LVEDV and the compliance of the myocardium determine the LV end-diastolic pressure (LVEDP). Myocardial ischemia decreases ventricular compliance, thereby increasing LVEDP for the same LVEDV. This change may be reflected in PAOP measurements, allowing use of PAOP as an ischemia monitor.

Other factors that affect the relationship between PAOP and LVEDP are mitral stenosis (MS), LA compliance, and intrathoracic pressure. Although the severity of MS does not change over the course of an anesthetic or surgical procedure, the pressure gradient between the LA and LV is dynamic, dependent on the cardiac output, heart rate, and flow through the mitral valve (MV) during the diastolic phase of the cardiac cycle. Tachycardia decreases diastolic time, thereby increasing flow through the MV during diastole and hence increasing the pressure gradient between the LA and LV. An increase in PAOP in this circumstance is due to an increase in the pressure gradient across the MV rather than an increase in preload. Actual LV preload may be reduced because tachycardia impedes LV filling in patients with MS. When PAOP is used for ischemia monitoring, trends in pressure changes must be taken in the context of these other hemodynamic variables in patients with MS.

Fig. 51–2 shows a normal central venous pressure waveform and the relationship of the waveform with the ECG. PAOP appears similar but reflects LA pressure rather than RA pressure. The presence of large prominent V waves is indicative of mitral regurgi-

tation (MR), which can occur with ischemic papillary muscle dysfunction. This acute increase in LA volume decreases the compliance of the LA and pulmonary veins.

Large changes in intrathoracic pressure also affect PAOP.<sup>53</sup> During spontaneous inspiration, mean PAOP declines because of the decrease in intrathoracic pressure. Positive-pressure ventilation causes increased intrathoracic pressure, which is reflected in the pulmonary venous pressure. Measurement of PAOP is made at the end of expiration to minimize the effects of inspiration on intrathoracic pressure and the pulmonary vasculature.

### Afterload

Afterload is impedance to ventricular ejection and is best described with pressure–volume loops. The ratio of end-systolic pressure to stroke volume defines the elastance of the arterial tree. In the absence of aortic stenosis (AS), this is primarily determined by arterial vasculature tone. Afterload conditions that allow more fiber shortening allow greater metabolic efficiency and reduced oxygen consumption.<sup>54</sup> The clinician can manipulate afterload by changing the size or radius of the LV through preload manipulation or more commonly by affecting systemic vascular resistance or blood viscosity. Although systemic vascular resistance is only one component of afterload, it is the only factor that is easily measured and readily changed clinically.

### Contractility

Inotropy describes the contractile state of the ventricle and is measured using either the ejection or isovolumic phase of ventricular contraction. Pressure–volume loops consisting of ejection, re-

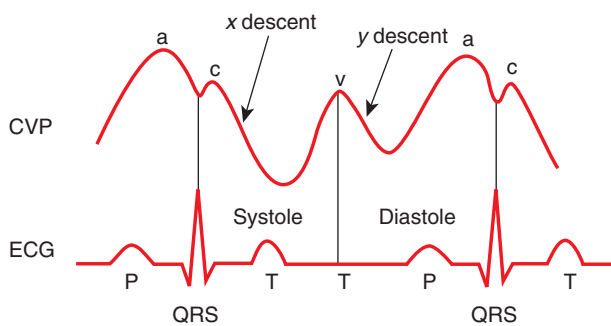
laxation, and isovolemic pressure are drawn under different loading conditions. The slope of the serial end-systolic pressure–volume relationship describes the myofibril contractile state independently from preload or afterload (Fig. 51–3). Simple clinical tools for measuring contractility independent of preload and afterload do not exist; however, some investigators have used simultaneous pressure and echocardiography area relationships to provide measurements of contractility.<sup>55</sup>

## Anesthetic Considerations for Patients Undergoing CABG Surgery

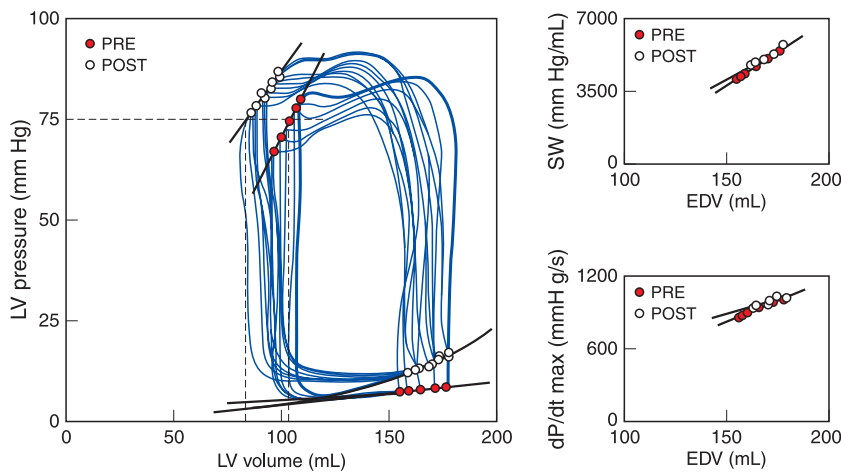
Patients with CAD presenting for CABG require special considerations in their anesthetic management. First and foremost are techniques that minimize myocardial oxygen demand while maximizing myocardial oxygen delivery, as described in previous sections. These considerations include preoperative preparation, intraoperative monitoring, and the use of anesthetic agents with hemodynamic effects that favor oxygen supply over demand and allow for myocardial protection. Postoperative management that provides particular attention to pain management, temperature control, and hemodynamic monitoring to prevent tachycardia, hypotension, and hypertension also must be considered. Many of these considerations apply to patients undergoing CABG surgery, with or without CPB. However, certain considerations apply to patients who undergo CABG with CPB, although others apply if coronary revascularization is performed without CPB (i.e., OPCABG).

### Preoperative Evaluation

Most patients presenting for CABG surgery undergo extensive preoperative testing of their cardiac disease and other medical problems. Medical conditions that predispose patients to the development of CAD also affect other organ systems. They include smoking, hypertension, hypercholesterolemia, diabetes, obesity, and advanced age. It is particularly important to identify comorbidities that may prolong or complicate the patient's postoperative course. One comorbidity that deserves particular attention is respiratory insufficiency. Patients with CAD often complain of dyspnea due to ventricular dysfunction caused by myocardial



**FIGURE 51–2.** A normal central venous pressure (CVP) waveform consists of three systolic components (c wave, x descent, and v wave) and two diastolic components (y descent, a wave). ECG, Electrocardiogram. (Reprinted and modified from Mark JB. Central venous pressure monitoring: clinical insights beyond the numbers. *J Cardiothorac Vasc Anesth* 1991;5:163–73. Copyright 1991 Elsevier.)



**FIGURE 51-3.** Example of end systolic pressure–volume relations (ESPVRs) derived by caval vein occlusion before and after cardiopulmonary bypass (CPB). The ESPVRs (left) show the increased contractile performance after CPB in this patient. Although the slope of the ESPVR ( $E_{es}$ ) is slightly decreased, the position of all end-systolic pressure–volume points to the left and above the pre-CPB ESPVR suggests higher contractility. Dotted lines indicate the position of the ESPVR at 75 mm Hg. The same holds for the preload recruited stroke work (PRSW) relation (upper right) and the  $dP/dt_{max}$ –end-diastolic volume (EDV) relation (lower right), although the differences are much less pronounced. The EDPVRs (left panel) provide clear evidence for a substantial increase in chamber stiffness after CPB, as observed in all patients. (From Tulner SA, Klautz RJ, van Rijk-Zwikker GL, et al. Perioperative assessment of left ventricular function by pressure–volume loops using the conductance catheter method. *Anesth Analg* 2003; 97:950–957, with permission.)

ischemia. Dyspnea related to myocardial ischemia should resolve with adequate revascularization. However, patients with a long-standing smoking history who develop underlying pulmonary disease may not derive the same benefit after CABG surgery, but instead experience exacerbation of their pulmonary disease and require prolonged postoperative mechanical ventilation and suffer pulmonary complications after surgery.

Diabetes is a progressive metabolic disorder that leads to the development of CAD, cerebral vascular disease, neuropathy, nephropathy, and retinopathy. An important aspect of diabetes in the patient with CAD is that myocardial ischemia may occur in the absence of classic symptoms. Patients may suffer from ischemic episodes without therapy, leading to potentially irreversible cardiac damage. They may have prolonged recovery from CABG surgery because of the increased need for inotropic support. Tight control of glycemic blood levels during the perioperative period is important for reducing the incidence of wound infection following cardiac surgery.

Hypertension is another medical condition common in patients with CAD. It also is a risk factor for cerebral vascular disease, renal failure, and CHF. This condition may be asymp-

tomatic, yet it carries the risk of end-organ damage if untreated for prolonged periods. Patients with uncontrolled hypertension often are more difficult to manage because of wide swings in blood pressure associated with events such as sternotomy and pericardotomy. Their vasculature is more responsive to catecholamines causing an exaggerated response, while the relatively volume contracted state leads to exaggerated hypotension in response to vasodilator therapy.

Renal disease is associated with cardiac surgical patients, especially in those with hypertension and diabetes. Development of renal failure after cardiac surgery is a concern, which occurs in 0.9% of CABG patients and 2.0% of patients undergoing valve procedures. More importantly, operative mortality has been reported to be 63.7% in patients who develop acute renal failure versus 4.3% for patients who did not develop renal failure.<sup>56</sup> The risk of postoperative MI, reoperation for bleeding, and mediastinitis is higher in patients who develop postoperative renal failure.<sup>57</sup>

### Monitoring

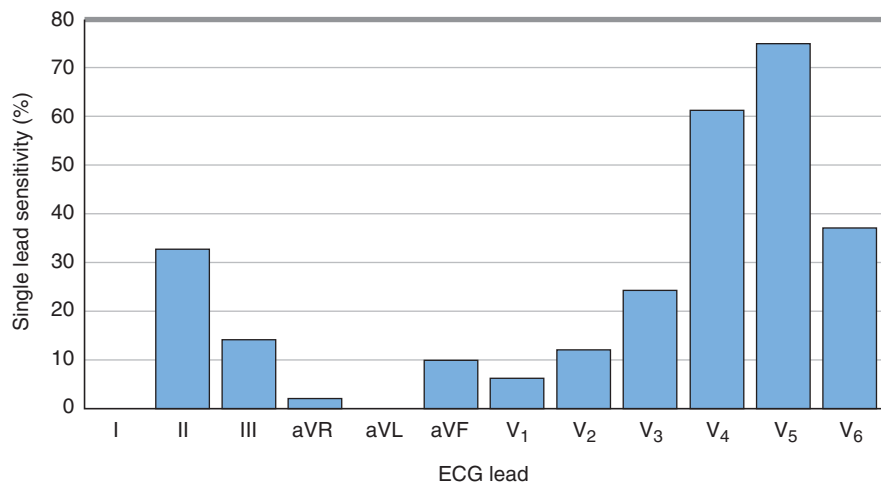
Continuous ECG monitoring, along with blood pressure measurement, pulse oximetry, and end-tidal carbon dioxide ( $CO_2$ ) analysis are standard

monitors for all anesthetized patients. For the cardiac surgical patient, a display monitor that allows viewing of two ECG leads simultaneously, with automated ST-segment analysis, is preferred. Limb leads II and  $V_5$  of the ECG allow for monitoring of myocardial regions supplied by the RCA and LAD coronary arteries, respectively. Automated ST-segment trending has only moderate sensitivity and specificity (75% for both) in detecting changes found by off-line Holter monitoring<sup>58</sup> but is a marked improvement over the observation of the clinician, whose attention must also be directed at providing anesthetic care. Monitoring two ECG leads simultaneously increases the sensitivity of detecting ischemia to 80% if leads II and  $V_5$  are monitored, 82% if leads II and  $V_4$  are monitored, and 90% if leads  $V_4$  and  $V_5$  are monitored (Fig. 51-4).<sup>59</sup> Factors such as LV hypertrophy, cardiac conduction changes, electrolytes, and drugs such as digitalis all can affect the interpretation of ST segments,<sup>60</sup> but the primary concern is acute ST-segment changes that occur during the perioperative period (Fig. 51-5).

All cardiac surgical patients require invasive arterial blood pressure monitoring. Although the radial artery is used at many institutions, consideration must be given to the possibility of harvesting the radial artery as a conduit for CABG. When used, the radial artery is harvested from the patient's non-dominant hand, so radial artery cannulation should be performed in the dominant hand. Femoral artery cannulation can be used and is preferred by some clinicians and institutions. The benefits of using femoral artery cannulation include a better correlation with mean arterial pressure in the immediate post-CPB period and access to the femoral artery if an IABP must be inserted. The intraarterial catheter can be placed prior to or immediately after induction, but preinduction placement allows the clinician to respond more rapidly to the changing hemodynamic conditions often present during induction of anesthesia. If a potential difficult airway is anticipated or if the patient has a greater risk of rapidly changing hemodynamics (left main disease or severe ventricular dysfunction), then preinduction placement of the arterial catheter is preferred.

All cardiac surgical patients should have central venous access for the





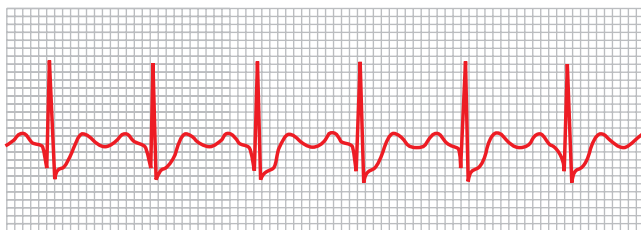
**FIGURE 51-4.** Distribution of ischemic ST-segment changes in each of the 12 ECG leads of 105 patients with known or suspected coronary artery disease undergoing noncardiac surgery with general anesthesia. Sensitivity was calculated from the number of changes in a single lead as a percentage of the total number of episodes obtained with continuous intraoperative recording. (From London et al.<sup>59</sup> with permission.)

purpose of administering important vasoactive medications into the central circulation and for assessing volume status. The issue of whether to place a central venous pressure (CVP) catheter versus a PAC is controversial. A PAC measures pulmonary artery (PA) pressure and provides a means for sampling mixed venous oxygen saturation (SvO<sub>2</sub>). PA pressure is not easily obtained with TEE, and SvO<sub>2</sub> cannot be obtained with a CVP catheter or by TEE. Some studies suggest that use of a PAC does not improve outcome in cardiac surgery.<sup>61</sup> However, prolonged pre-CPB pulmonary hypertension and post-CPB elevation of PA diastolic pressure are predictors for the development of perioperative MI.<sup>62</sup> Early treatment of pulmonary hypertension is presumed to improve outcome.

The American Society of Anesthesiologists (ASA) Task Force on Pulmonary Artery Catheterization has provided practice guidelines for PAC insertion (Table 51-2).<sup>63</sup> PA pressure monitoring is indicated based on the medical condition of the patient or the

nature of the surgery (Table 51-3) but is not recommended when the patient, procedure, and practice setting each poses a low risk for hemodynamic complications.<sup>63</sup> Cardiac surgical patients with unstable angina, recent MI, active CHF, severe CAD or valvular heart disease, and severe pulmonary or renal disease should have PA pressure monitoring. However, routine PA catheterization is not necessary in all patients undergoing CABG. Outcome after CABG is not influenced by routine use of a PAC, suggesting its use can be delayed until a clinical need develops.<sup>61</sup>

Right bundle-branch block occurs in approximately 3% of patients undergoing PA catheterization.<sup>64</sup> For this reason, placement of a PAC in patients with a previous left bundle-branch block is not recommended unless precautions are taken for managing the patient should complete heart block occur. A decision-making algorithm for inserting a PAC in patients with a preexisting left bundle branch block is shown in Fig. 51-6.



**FIGURE 51-5.** Electrocardiogram with ST-segment depression indicating myocardial ischemia. (From [www.cardionetics.com/docs/healthcr/ecg/isch\\_bd.htm](http://www.cardionetics.com/docs/healthcr/ecg/isch_bd.htm) with permission.)

**TABLE 51-2.**

**American Society of Anesthesiologists Task Force on Pulmonary Artery Catheterization Practice Guidelines<sup>63</sup>**

**Indications Related to the Patient**

- Clinical evidence of significant cardiovascular disease
- Pulmonary dysfunction
- Hypoxia
- Renal insufficiency
- Other conditions associated with hemodynamic instability (e.g. advanced age, endocrine disorders, sepsis, trauma, burns)

**Indications Related to Surgery**

- Surgical procedures associated with an increased risk of hemodynamic changes, including damage to the heart, kidneys, lungs, or brain

**Indications Related to Practice Setting**

- Physician skills
- Duration of procedure
- Technical support
- Training and experience of nursing staff
- Ability to manage potential complications

Data from American Society of Anesthesiologists Task Force on Pulmonary Artery Catheterization. Practice guidelines for pulmonary artery catheterization: an updated report by the American Society of Anesthesiologists Task Force on Pulmonary Artery Catheterization. *Anesthesiology* 2003;99:988–1014.

**TABLE 51-3.**

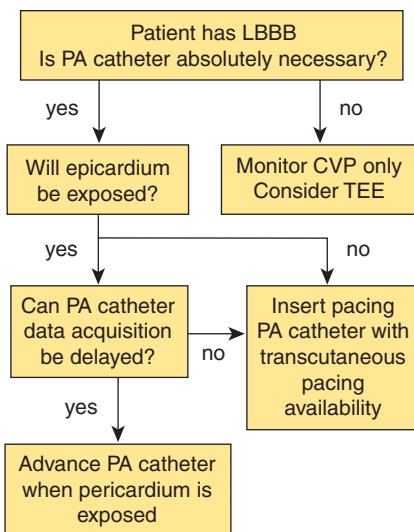
**Indications for Pulmonary Arterial Pressure Monitoring**

**Indications Related to the Patient**

- Right heart failure
- Pulmonary hypertension
- Pulmonary embolism
- Unstable angina
- Recent myocardial infarction
- Acute congestive heart failure
- Severe coronary artery disease
- Shock (cardiogenic, septic, or hemorrhagic)
- Massive trauma
- Severe lung disease
- Severe renal disease

**Indications Related to Surgery**

- Major organ transplantation
- Aortic cross-clamping procedures
- Large fluid shifts
- Massive blood loss
- Implantation/explantation of ventricular assist devices



**FIGURE 51–6.** Algorithm for pulmonary artery (PA) catheter insertion in patients with left bundle-branch block (LBBB). TEE, Transesophageal echocardiography. (Reprinted from Troianos CA. Intraoperative monitoring. In: *Anesthesia for the Cardiac Patient*. St. Louis: Mosby, 2002: 106, with permission from Elsevier.)

TEE can be used to assess global and regional myocardial contractility, volume status, and valvular function during cardiac surgery. Although TEE has revolutionized the intraoperative assessment and management of patients undergoing cardiac surgery, few data suggest that routine use of TEE for all patients with normal ventricular function undergoing elective CABG improves outcome. Regional wall-motion assessment by qualitative inspection of radial shortening and wall thickening is subjective. Accurate diagnosis is dependent on observer experience and having the ischemic myocardial segment in the imaging plane during the ischemic episode. More sophisticated techniques such as computerized digitations, color kinesis, and tissue Doppler imaging may allow for better assessment, but these techniques are not readily available or familiar to all users. Nonetheless, information obtained from TEE is far superior in quality and quantity to that obtained from a PAC and may be very helpful in guiding therapy toward optimizing hemodynamics in the perioperative period. Furthermore, TEE has proven invaluable for assessing the quality of the surgical procedure following separation from CPB, especially among patients undergoing CABG surgery who have significant ventricular dysfunction and those undergoing concurrent

valve procedures, congenital heart surgery, and/or aortic surgery.<sup>27–30</sup>

Near-infrared reflectance spectroscopy has been used to demonstrate a correlation between low bifrontal regional cortical oxygen saturation and cognitive dysfunction, prolonged hospital stay, and perioperative stroke. Thus, some clinicians have advocated monitoring of cerebral oximetry in CABG patients as a technique for preventing profound cerebral desaturation and associated morbidity.<sup>65</sup>

### Anesthetic Induction

Induction of general anesthesia for CABG surgery patients can be accomplished using a variety of medications, provided the goals of preventing tachycardia, hypotension, and hypertension are achieved. The worst combination is tachycardia and hypotension. Although hypertension increases ventricular wall tension and therefore myocardial oxygen demand, it also increases coronary perfusion pressure. Myocardial depression and the vasodilating effects of the anesthetic agents are most important considerations in patients with severely impaired ventricular function or valvular heart disease. Laryngoscopy and intubation are the first intraoperative events after induction of anesthesia that test the effects of the anesthetic technique used. Coincident with these events is the institution of positive-pressure ventilation, which may result in hypotension among hypovolemic patients or in patients with air trapping due to pulmonary disease.

Patients with CAD benefit from a narcotic-based technique because of the lack of myocardial depression, a tendency for decreased heart rate, and an attenuated response to laryngoscopy and intubation. Fentanyl probably is the most frequently used opioid in cardiac surgery, although sufentanil is a reasonable choice. Use of remifentanyl and sufentanil during induction has been associated with a high incidence of bradycardic/asystolic complications in patients who have been treated with  $\beta$ -blockers and calcium channel blockers.<sup>66,67</sup> Many patients with CAD are likely to be taking one or both types of drugs. A nondepolarizing muscle relaxant devoid of cardiovascular side effects is used to facilitate intubation. Pancuronium can be used with a large dose of narcotic because the tachycardic side effects of pancu-

ronium are balanced by the bradycardic side effects of the large-dose narcotic. Use of vecuronium or rocuronium is prudent when the initial narcotic dose is smaller because the bradycardic effects of the narcotic are not as pronounced. Pancuronium use with only a small narcotic bolus may result in undesirable tachycardia.

Modern practices that focus on early extubation and “fast-tracking” the patients through the postoperative period use smaller narcotic doses, with supplementation by short-acting hypnotic agents, such as midazolam. Use of an intraoperative awareness protocol is prudent in these patients to minimize the incidence of intraoperative recall, which is more of a concern with a primarily narcotic-based anesthetic technique. The anesthetic technique usually will use a low concentration of a potent inhalational agent or intravenous propofol for hypnosis and amnesia. Reduced doses of opioids often are administered with small doses of hypnotic drugs such as benzodiazepines, thiopental, propofol, or etomidate to promote early postoperative extubation. Care must be taken when hypnotics are administered concomitantly with opioids. Mean arterial pressure can drop precipitously in hypovolemic patients. Midazolam significantly decreases blood pressure and increases heart rate when used as an induction agent.<sup>68</sup> Propofol causes venodilation and can profoundly decrease blood pressure.<sup>69</sup> A vasoactive drug such as ephedrine or phenylephrine should be readily available to treat hypotensive episodes during the induction of anesthesia. Although regional anesthesia for cardiac surgery may provide superior postoperative analgesia, shorter postoperative ventilation, reduced incidence of supraventricular dysrhythmias, and lower rates of perioperative MI,<sup>70</sup> most clinicians use general anesthesia during CABG procedures.

The same hemodynamic goals must be achieved for the patient with a difficult airway who requires an awake/sedated fiberoptic intubation prior to general anesthesia. The patient's airway should be well anesthetized with local anesthetics and the patient sedated with short-acting intravenous agents that blunt the response to laryngoscopy and intubation. An inhalational induction also might be considered in some patients. Alternatively, an intubating laryngeal mask

airway can be used to secure the difficult airway under general anesthesia. The particular technique or approach is individualized to the patient's anatomy and medical condition and the experience of the clinician in using one or more of these techniques.

### Pre-CPB Management

Once the airway is secured and general anesthesia induced, anesthesia care is directed toward maintaining a stable blood pressure and heart rate. If access to the central circulation was not obtained before induction of anesthesia, cannulation of the internal jugular or subclavian vein is performed, and a PAC is inserted if indicated. The right internal jugular vein is often used because of its predictable location, accessibility, and direct route into the RA. The patient is placed in the Trendelenburg position during central venous cannulation, which increases preload and helps maintain blood pressure at an acceptable range following the induction of anesthesia, in the absence of surgical stimulation. Use of surface ultrasound for guiding the insertion and placement of central venous cannula has become more popular.<sup>71</sup> As the operating room table is leveled following cannulation, the blood pressure frequently declines. A fluid bolus or small doses of vasoactive drugs may be required.

Additional tasks for the anesthesia provider before surgical incision include placement of a TEE probe, antibiotic administration, determination of a baseline ACT, and infusion of antifibrinolytic drugs. Although many studies have demonstrated the beneficial effects of antifibrinolytic agents in reducing perioperative bleeding and morbidity<sup>24</sup> others have reported adverse side effects associated with multiorgan dysfunction and prothrombotic outcomes,<sup>25</sup> especially among patients with a genetic predisposition to a hypercoagulable state.<sup>26</sup> Thus, similar to all pharmacologic agent, the decision to administer any antifibrinolytic should include a thorough risk-to-benefit consideration that is individualized to each patient.

Patients must be anesthetized to a depth that avoids a tachycardic and hypertensive response to surgical incision. Small doses of short-acting agents such as esmolol (50–100 mg) or nitroglycerin (50–100 µg) can be administered, or the anesthetic depth can be

deepened with additional narcotic or potent inhalational agent. The patient's response to skin incision is a gauge to his or her subsequent response to the more stimulating event of median sternotomy. If the anesthetic depth was not adequate for skin incision, then additional narcotic or a bolus of esmolol should be administered before sternotomy. The lungs typically are deflated during sternotomy to prevent the sternal saw from cutting the lung parenchyma. Another complication that can occur during sternotomy is accidental tearing of the innominate vein or the RV. Sternotomy is especially hazardous during repeat CABG surgery, where adhesions from previous surgery placed the heart immediately posterior to the sternum. Banked packed red blood cells must be immediately available at the time of sternotomy, particularly for patients at increased risk for this complication.

Maintenance of anesthesia during the pre-CPB period can be accomplished with a variety of techniques. Isoflurane–fentanyl anesthesia and propofol–fentanyl anesthesia both are acceptable techniques for maintaining anesthesia during CABG surgery.<sup>72</sup> Use of sevoflurane and desflurane has been shown to result in shorter intensive care unit (ICU) and hospital length of stay.<sup>73</sup> This finding seemed to be related to better preservation of early postoperative myocardial function. Considerable research has recently focused on the myocardial protective effects of potent inhalational anesthetics. Isoflurane protects the myocardium during ischemic episodes in an experimental model.<sup>74,75</sup> Isoflurane and other volatile anesthetics may mimic the protective effects of a process called *ischemic preconditioning*.<sup>76</sup> Brief periods of ischemia activate the protein kinase C–mediated pathway that confers cardioprotection during subsequently longer periods of ischemia.<sup>77</sup> Sevoflurane decreases the inflammatory response after CPB, as measured by the release of IL-6, neutrophil β-integrins (CD11b/CD18), and TNF-α. Myocardial function after CPB, as assessed by regional wall motion and LV stroke work index, also is improved with sevoflurane.<sup>78</sup> Both halothane and isoflurane have been shown to provide significant preservation of adenosine triphosphate (ATP) levels during ischemia, but this preservation did not improve hemodynamic

recovery.<sup>79</sup> In a comparative study in which patients received either propofol or inhalational anesthesia during CABG surgery, patients who received inhalational anesthesia (sevoflurane or desflurane) but not propofol had preserved LV function after CPB, with less evidence of postoperative myocardial injury.<sup>80</sup> The cardioprotective effects are clinically most apparent when the inhalational agent is administered throughout the operation.<sup>81</sup>

Important activities that occur during the pre-CPB period include surgical dissection of the left internal mammary artery, opening of the pericardium, and placement of the aortic and venous cannulas in preparation for CPB. Sternal retraction that exposes the internal mammary artery may affect the function of intravenous and arterial catheters placed in the ipsilateral arm. This most commonly affects the left arm with harvesting of the left internal mammary artery. Papaverine is commonly injected into the ligated internal mammary artery to prevent vasospasm but may cause hypotension. This decrease in blood pressure usually is brief but may require treatment with a small dose of phenylephrine. Hypertension may develop during surgical manipulation of the pericardium and aorta as a result of sympathetic activation. A small bolus of narcotic or esmolol can blunt this hypertensive response.

Heparin is administered prior to ligation of the internal mammary artery (if used) and cannulation of the aorta to prevent thrombus formation. Heparin is a polyanionic mucopolysaccharide that increases the rate of anticoagulant effect of antithrombin III on factors II, X, XI, XII, and XIII. It usually is given in a dose range of 300–400 units/kg to achieve ACT >400 seconds. The adequacy of anticoagulation must be determined prior to initiating CPB. For patients undergoing OPCABG, some surgeons administer a smaller dose of heparin, with the goals of achieving ACT >300 seconds.

### CABG without CPB

CABG without CPB (OPCABG) was first reported during the 1960s and 1970s.<sup>82,83</sup> Advancements in the safety of CPB with better equipment and techniques allowed surgical access to more distal coronary target sites and a quiet surgical field, thereby eliminating the need for CABG without CPB.<sup>1</sup>

Developments in mechanical stabilization devices during the 1990s renewed the interest among surgeons to return to this technique in order to avoid the deleterious effects of CPB, particularly in elderly patients with calcified aortas. OPCABG also allowed faster recovery and fewer ICU days, providing an economic incentive to using this technique.

The anesthetic management of patients undergoing OPCABG encompasses the same hemodynamic goals as the pre-CPB management of patients undergoing CABG with CPB, but the goals are more difficult to achieve, particularly when distal coronary anastomoses are being performed. Myocardial protection with the use of inhalational agents remains an important consideration. Compared to patients who receive propofol, patients receiving sevoflurane have less myocardial injury in the first 24 postoperative hours.<sup>84</sup> OPCABG requires more attention, vigilance, and intervention on the part of the anesthesia provider while the surgeon is performing the distal coronary anastomoses. Maintenance of perfusion pressure, cardiac output, and normothermia, while avoiding profound myocardial ischemia, is challenging during surgical manipulation that produces ventricular compression and temporary coronary occlusion. Ischemia monitoring is compromised by cardiac displacement that alters ECG polarization and affects the anatomic relation with a TEE probe. Vasoactive medications and the Trendelenburg position are used to maintain blood pressure and cardiac output. Despite the best efforts, however, decreases in cardiac output with elevations in central venous and PAOP are commonly observed during surgical manipulation. Cardiac dysrhythmias are not uncommon and are treated by increasing the perfusion pressure and with use of medications such as lidocaine, amiodarone, and magnesium. Malignant dysrhythmias that are not corrected by medications or electrical cardioversion may prompt the need for CPB. Temporary cardiac pacing may be required in patients with right coronary dominant anatomy because of bradycardia or cardiac arrest during right coronary occlusion. Upon successful completion of all distal coronary anastomoses, the blood pressure is lowered before application of the partial aortic clamp for the prox-

imal anastomoses. Release of this clamp after all of the proximal grafts are completed may produce reperfusion dysrhythmias or send air through the coronary grafts, if they were not adequately de-aired by the surgeon.

Anticoagulation is reversed with protamine after the surgeon is satisfied with the grafts and the absence of surgical bleeding. The surgical wound is closed, and the patient is transported to the ICU. Some patients may be candidates for extubation immediately after surgery, but this should be individualized according to the patient's temperature, need for inotropic and mechanical support of the circulation, coexisting medical problems, and degree of mediastinal bleeding.<sup>85</sup> Extubation within 2–4 hours after surgery is a reasonable goal for most patients undergoing OPCABG.

### CABG with CPB

For patients undergoing CABG with CPB, a two-stage cannula is placed in the RA to direct blood away from the patient to the CPB circuit and a cannula is placed in the aorta to return oxygenated blood to the patient's circulatory system. The patient must be fully heparinized before cannulation to avoid thrombus formation. The arterial blood pressure is lowered to 85–90 mm Hg systolic pressure prior to aortic cannulation to reduce aortic wall tension and minimize the risk of aortic dissection as the aortic wall is punctured. The surgeon may request hand-bag ventilation to provide better visualization of the RA for insertion of the venous cannula. Atrial fibrillation may develop during placement of the venous or coronary sinus catheters. Cardioversion with internal paddles may be required if the patient becomes hypotensive prior to CPB.

Some institutions “retrograde prime” the CPB circuit by allowing the patient's blood to displace the clear fluid priming volume from the aortic and venous lines to the CPB machine. This process nearly always causes hypotension due to volume depletion and requires vigilance and treatment by the anesthesia provider to avoid profound hypotension. Small boluses of phenylephrine are effective for raising blood pressure during this process. Once the retrograde priming is complete, pump volume is infused through the aortic cannula and the venous cannula is unclamped, thereby initiating CPB.

### Cardiopulmonary Bypass

Mechanical ventilation is discontinued when a calculated circulation flow is reached. The surgical field is observed for evidence of venous obstruction, aortic dissection, and cardiac distension. Anesthesia is maintained by volatile anesthetics administered through a vaporizer on the CPB machine or by continuous infusion of hypnotic drugs such as propofol, titrated according to mean arterial blood pressure and readings on the awareness monitor. Some clinicians routinely administer hypnotics with initiation of CPB and during rewarming to reduce the incidence of intraoperative awareness. Additional muscle relaxation helps reduce oxygen consumption by minimizing shivering as the patient is cooled. ECG, systemic and pulmonary pressures, urine output, and temperature are monitored. PA pressure may increase with cardiac distension or because the PAC has migrated to more peripheral regions in the lung during cardiac manipulation. In the absence of cardiac distension, the PAC should be withdrawn until the pressure measured in the distal port decreases.

The clinician should use the CPB time to prepare for post-CPB events. Most patients with good ventricular function do not require inotropic support following successful coronary revascularization. However, patients with poor preoperative ventricular function and those who undergo complicated surgical procedures and prolonged bypass ischemia often require inotropic or IABP support in the postbypass period. Prior to termination of CPB, the surgeon places epicardial atrial and ventricular pacing leads, to be used as needed to establish an adequate cardiac rhythm and rate.

### Post-CPB Management

The patient is rewarmed to normothermia with CPB as the surgeon completes the coronary anastomoses. The rewarming process may take longer in patients with a higher body mass index and after more profound hypothermia. Mechanical ventilation is resumed upon the surgeon's request, after inspection of the anastomotic sites reveals the absence of a surgical cause for bleeding. If inhaled anesthetics are being used in the CPB circuit, their delivery should be continued via the anesthesia machine. The dose of the potent inhalational agent used should



be minimal to avoid myocardial depression. Vasoactive infusions should be started or maintained. Communication should take place between the surgeon and the anesthesiologist to confirm that both are ready to begin the process to separate the patient from CPB. Venous drainage to the pump is reduced, and the patient's heart begins to receive more blood from the circulation. Preload is adjusted by observing mean arterial pressure, cardiac distension, and PA or central venous pressure. The physician performing TEE provides information to the surgeon regarding volume status and contractility, which also aids the separation from CPB. A cardiac index is determined if a PAC is used. The venous cannula is removed from the RA with satisfactory separation from CPB. The surgeon, perfusionist, and anesthesiologist all must be aware when protamine is administered to reverse the anticoagulant effects of heparin. With adequate neutralization of the heparin, the surgeon inspects the surgical field for bleeding and closes the surgical wound with adequate hemostasis. The patient is transported to the ICU for postoperative care.

### Postoperative Complications

Postoperative myocardial ischemia occurs in up to 48% of cardiac surgical patients and is associated with adverse cardiac outcomes.<sup>86</sup> Thirty-eight percent of ischemic episodes occur during the first 2 postoperative days and peak within the first 2 hours of revascularization. These findings have important implications for monitoring, diagnosis, and treatment. Treatment of myocardial ischemia is directed toward adjusting the factors that determine myocardial oxygen supply and demand. Ischemia that develops immediately upon termination of CPB usually is related to air or particulate emboli in the bypass grafts. Elevation of mean arterial pressure and incremental increases in boluses of nitroglycerin are effective for treating ischemia caused by air in the venous grafts. The surgeon should confirm graft patency with Doppler flow probes or palpation. Persistent myocardial ischemia is treated with placement of an IABP. "Stunned myocardium" may be the result of reperfusion injury or intraoperative MI. These patients will require support of cardiac function until myocardial function improves.

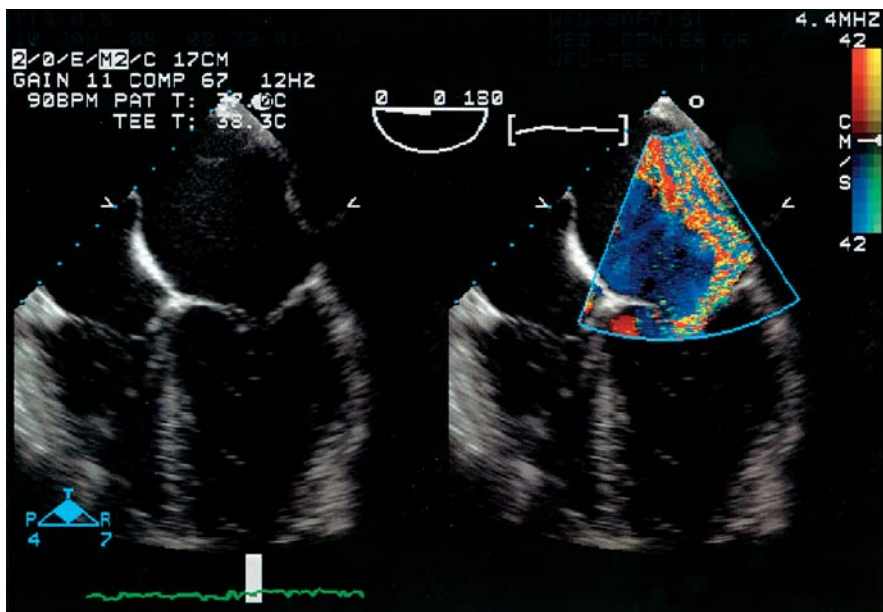
Patients at risk for increased mortality after CABG are identified by preoperative factors. The most significant risk factors that increase mortality are age >80 years, emergent surgery, prior cardiac surgery, and renal failure.<sup>57,87</sup> Cerebral vascular events are more common among elderly patients. Mediastinitis is more common among patients with chronic obstructive lung disease, severe obesity, diabetes, renal failure, emergent surgery, and preoperative ejection fraction <40%.<sup>57,87</sup> Renal failure is associated with advanced age, history of CHF, and preexisting renal disease.<sup>57,87</sup>

### CARDIAC ANESTHESIA FOR VALVE SURGERY

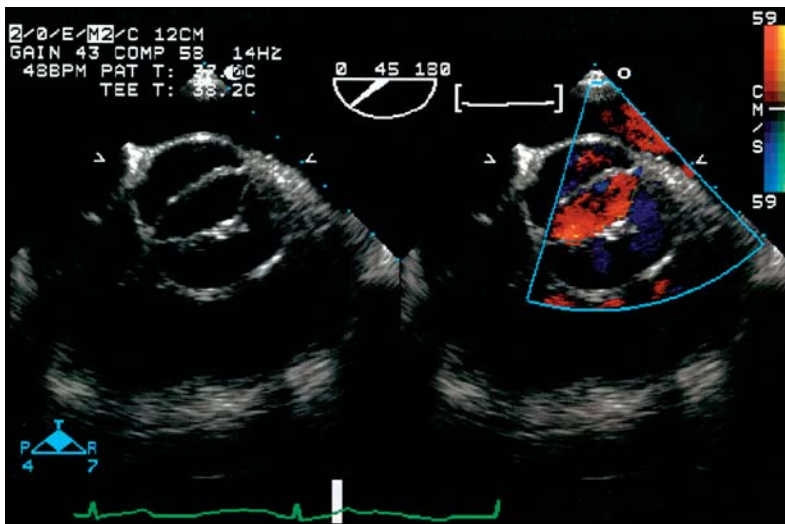
Whereas the number of CABG procedures in the United States has decreased over the past several years, operations for heart valve disease are increasing. More than five million people have moderate-to-severe valvular regurgitation in the United States alone.<sup>88</sup> Our aging population, expanding indications for surgery, improvements in valve repair techniques and replacement construction, and reduced patient morbidity and mortality after surgical intervention all suggest that valve surgery likely will increase in coming years.

The two most common valves requiring surgical intervention are the MV and AV. Most patients in the United States undergo MV procedures for MR because of annular dilation, leaflet prolapse, or leaflet tethering (Fig. 51-7). Myxomatous MV disease is the most common cause of isolated MR.<sup>89</sup> The defect usually is associated with advancing age and degenerative changes. The pathophysiology includes elongated and/or ruptured chordae with generous leaflet tissue, dilated annulus, and severe regurgitation. The defect is associated with increased mortality, even in asymptomatic patients.<sup>90</sup> A majority of these patients are amenable to valve repair rather than valve replacement. AV disease is a common indication for surgery. Calcific AS is seen in elderly patients, whereas a bicuspid AV is common in younger patients. Bicuspid AVs are found in approximately 0.5% of the population.<sup>91</sup> The bicuspid AV is a heritable condition, associated with a defect in fibrillin and matrix metalloproteinase-2, which leads to weakening and aneurysm formation (Figs. 51-8 and 51-9).<sup>92,93</sup> These patients often present for AV replacement with an ascending aortic root replacement requiring deep hypothermic circulatory arrest (DHCA).

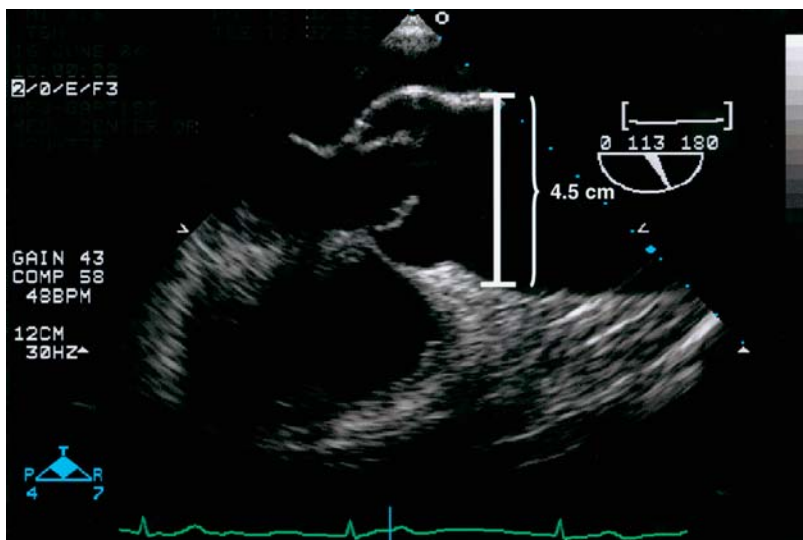
The spectrum of valve surgery extends well beyond this limited review. There are both regurgitant and stenotic



**FIGURE 51-7.** Midesophageal transesophageal echocardiographic two-dimensional (left) and color flow Doppler (right) views showing mitral regurgitation associated with posterior leaflet tethering secondary to left ventricular dilation after a myocardial infarction. A coronary artery bypass grafting procedure was performed, and the valve was repaired with a ring annuloplasty.



**FIGURE 51-8.** Transesophageal midesophageal aortic valve short-axis two-dimensional (left) and color flow Doppler (right) views showing a bicuspid aortic valve.



**FIGURE 51-9.** Transesophageal midesophageal ascending aortic long-axis view demonstrating a bicuspid aortic valve and a dilated aorta measuring 4.5 cm just beyond the sinotubular junction. Aortic dilation is commonly associated with a bicuspid aortic valve defect.

lesions of all heart valves. The etiology varies widely from congenital birth defects, senile calcific stenosis, infective endocarditis, rheumatic disease, trauma, and other causes. The unifying concept in all valve surgery, however, remains the principles of preserving myocardial function and the influence of preload, afterload, inotropy, rate, rhythm, and diastolic function on myocardial performance and mechanics (Table 51-4). In pathologic conditions that acutely affect valve function, such as endocarditis or chordal rupture, the compensatory reserve of the heart and vascular system are limited. Alternatively, in more chronic conditions including myxomatous MR or senile or calcific AS, compensatory reserve can be significant. Perioperative anesthetic management of these patients requires a comprehensive appreciation of myocardial performance, the acuity of the defect, the extent and mechanism of compensation, and the interplay of anesthetic drugs and surgery on the patient's condition.

Valve surgery will remain a mainstay in the practice of contemporary cardiothoracic anesthesiology. This section reviews the preoperative evaluation of patients presenting for heart valve surgery, perioperative management techniques, and special considerations relating to the anesthesiologist's management of these complex patients.

### Preoperative Evaluation

In valvular heart disease, a number of questions that will directly influence anesthetic management must be answered. Many procedures are sched-

**TABLE 51-4.**

#### Valve Abnormalities and Hemodynamic Goals

	Preload	Afterload	Contractility	Heart Rate	Diastolic Function <sup>a</sup>
Aortic stenosis	↑	↑	↔	↓	Impaired relaxation
Aortic regurgitation	↑	↓	↔	↑	Restrictive
Mitral stenosis	↑	↔	↔	↓	Normal
Mitral regurgitation	↓, ↔ <sup>b</sup>	↓	↔	↑	Restrictive
HOCM	↑	↑	↓	↓	Impaired relaxation
Tricuspid stenosis	↑	↑, ↔	↔	↓, ↔	Normal
Tricuspid regurgitation	↑	↔	↔	↑, ↔	Normal
Pulmonic stenosis	↑	↔	↔	↑, ↔	Normal
Pulmonic regurgitation	↑	↔	↔	↑, ↔	Normal

↑; Increase; ↓; decrease; ↔; maintain.

HOCM; Hypertrophic obstructive cardiomyopathy with systolic anterior motion of the mitral valve.

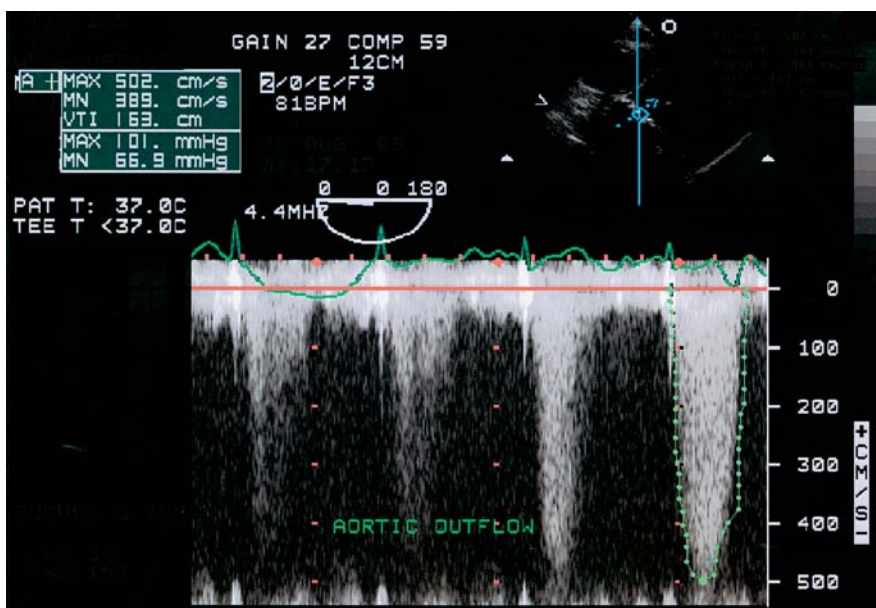
<sup>a</sup>Typical transmitral Doppler flow velocity profile pattern.

<sup>b</sup>Augmentation of preload usually is required to maintain forward stroke volume. However, excessive preload can induce further left ventricular dilation and exacerbate mitral regurgitation and left atrial hypertension.

uled only as “aortic valve replacement” or “mitral valve replacement,” with little information pertaining to the etiology or mechanism of valve dysfunction, associated collateral cardiac dysfunction, or patient comorbidity. Understanding the specific valve pathology preoperatively is essential in preparing to achieve the hemodynamic goals for the induction, maintenance, and postoperative care of these patients.

Additional information unrelated to the valve pathology is important to obtain. For example, will other procedures or interventions be performed during this repair (e.g., carotid endarterectomy, CABG, septal myomectomy, maze procedure for atrial fibrillation procedure)? What is the clinical condition of the patient? Is the patient in a compensated or uncompensated state? In the patient with AS, the timing of surgery will have a great impact on outcome depending on the patient's condition. For example, a patient in the early to middle stages of AS will have a hyperdynamic, hypertrophied heart that likely will perform well after CPB. In contrast, a patient with chronic AS may have CHF, with reduced ejection fraction, and likely will require extensive inotropic support after CPB.

A number of essential imaging and laboratory studies should be reviewed preoperatively. Preoperative echocardiography will establish the type of lesion (stenosis versus regurgitant), extent of valve disease, and cardiac function. The valve area is of critical importance in assessing stenotic lesions. In patients with normal LV function, gradients associated with severely stenotic lesions may be very high (Figs. 51–10 and 51–11). Patients with poor ventricular performance may have anatomically critical lesions (AV area < 0.7 cm<sup>2</sup>) and a relatively low gradient. These patients are especially prone to intraoperative instability with induction of general anesthesia and may require significant inotropic support post-CPB. Other important imaging modalities include coronary angiography to rule out concurrent CAD, a chest x-ray film, and perhaps thoracic CT or MRI to evaluate thoracic anatomy. A chest x-ray film is essential for “redo” operations involving the heart and mediastinum. The heart may be adherent to the posterior margin of the sternum, rendering sternotomy quite hazardous. All precautions, including

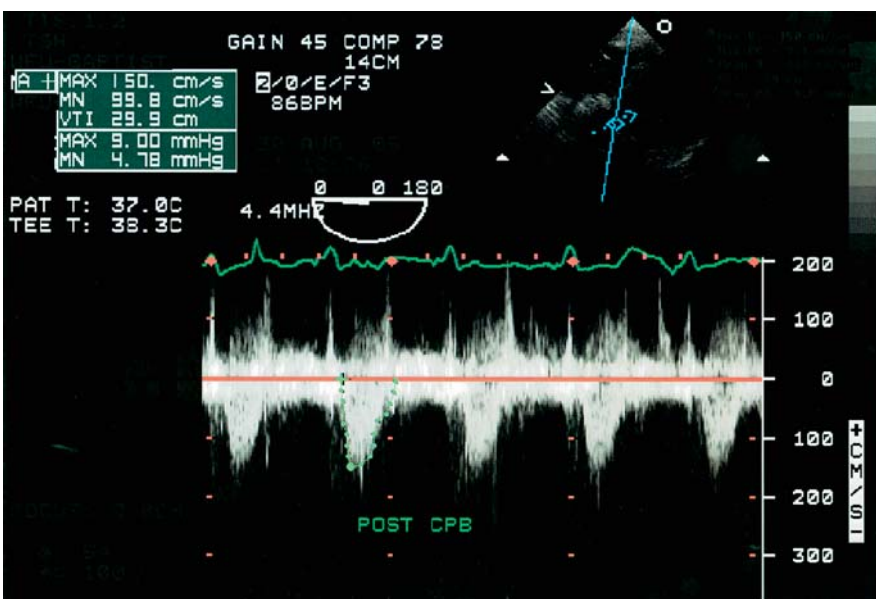


**FIGURE 51–10.** Intraoperative transesophageal deep transgastric long-axis view using continuous-wave Doppler obtained prior to cardiopulmonary bypass in a patient with aortic stenosis scheduled for an aortic valve replacement. Peak (101 mm Hg) and mean (66.9 mm Hg) transaortic valve (AV) pressure gradients ( $\Delta P$ ) are shown.  $\Delta P$  is obtained from the peak velocity ( $V = 502$  cm/s) using the simplified Bernoulli equation:  $\Delta P = 4V^2$ .

adequate venous access, immediate availability of blood products, and intraoperative vigilance by the entire operating room team, are required in these situations (Fig. 51–12).

Atrial natriuretic peptides are useful markers for evaluating CHF due to valvular pathology. In 130 patients

with severe AS followed for  $377 \pm 150$  days, the natriuretic peptides increased with increasing NYHA functional classes and decreasing LV ejection fraction.<sup>94</sup> Asymptomatic patients who later became symptomatic had higher levels of B-type natriuretic peptide (BNP) and N-terminal BNP (NtB-



**FIGURE 51–11.** Intraoperative transesophageal deep transgastric long-axis view using continuous-wave Doppler obtained prior to cardiopulmonary bypass in the same patient shown in Fig. 51–10 after aortic valve replacement for aortic stenosis. Peak (9 mm Hg) and mean (4.78 mm Hg) transaortic valve (AV) pressure gradients are significantly reduced and consistent with a normal prosthetic valve area.





**FIGURE 51–12.** Preoperative MRI showing the close proximity of the aorta (Ao) to the sternum in a patient scheduled for a fourth reoperation for mitral regurgitation. Sternotomy in this patient poses extreme risk for aortic trauma and hemorrhage. Consequently the surgical approach was via a right thoracotomy to avoid this complication.

NP) at baseline. Following AV surgery, BNP levels decreased.

## Monitoring

Consideration for monitoring during heart valve surgery varies little from monitoring required during CABG and other cardiac procedures. In addition to the standard monitors recommended by the ASA, an arterial line and a central venous line are essential. Many institutions routinely use PACs to monitor cardiac output, mixed venous oxygenation, PA pressures, and PAOP. Although this is standard practice by many clinicians, outcome data supporting PA catheterization are lacking.

Intraoperative TEE is an essential diagnostic tool and monitor of cardiac performance for patients undergoing heart valve procedures.<sup>29,30,95,96</sup> Extensive preoperative evaluation by TEE often reveals previously unknown structural or functional defects. In addition, TEE can provide instant assessment of the status of a valve repair or replacement, including the presence of perivalvular leaks or persistent valve dysfunction. TEE may assist in identifying the presence of left-sided intracardiac air and guide de-airing procedures. TEE is helpful in guiding post-CPB hemodynamic intervention and treatment. In recognition of this tool's utility in cardiac surgical proce-

dures, the ASA, Society of Cardiovascular Anesthesiologists (SCA), American Society of Echocardiography (ASE), American College of Cardiology (ACC), and American Heart Association (AHA) all strongly recommend use of intraoperative TEE for heart valve surgical procedures.<sup>97,98</sup>

Assessment of diastolic dysfunction by TEE is important in all patients presenting for cardiac surgical procedures. Dourvas et al.<sup>99</sup> reported 40 consecutive cases of RV diastolic dysfunction in patients with significant AI, LV ejection fraction  $>55\%$ , LV end-diastolic pressure  $<15$  mm Hg, RV systolic pressure  $<30$  mm Hg, and normal coronary arteries. The pathophysiology of this defect may be related to rapid LV dilation in early diastole, a bulging septum, and interference with RV filling. On examination, these patients show a small RV and a large RA.<sup>100</sup> An awareness of diastolic dysfunction may guide intraoperative and postoperative hemodynamic therapy.<sup>101,102</sup>

Other special monitoring devices in heart valve surgery include processed electroencephalographic (EEG) monitoring either for patient awareness or to monitor activity during procedures in which stoppage of all electrical activity is desired (i.e., circulatory arrest). Cerebral oximetry and transcranial Doppler ultrasound also have also

been advocated by some as potential efficacious monitors.<sup>103</sup>

## Induction of Anesthesia

Extraordinary care and vigilance are required by the cardiac anesthesiologist during the induction of general anesthesia of patients with heart valve disease. The clinician should have a clear understanding of how preload, afterload, inotropy, heart rate and rhythm, and diastolic function interact during this critical time of induction.

Table 51–4 outlines several basic considerations regarding these parameters. On occasion, a patient will present with a constellation of disease processes. For example, the patient may have concurrent severe AS with moderate-to-severe AI and CAD. How should the information in Table 51–4 be applied to such a patient? There are two approaches. One approach identifies the lesion that poses the greatest proximate risk. For example, a patient with AS and tricuspid regurgitation (TR) most likely will be symptomatic from the effects of the AS rather than the low-pressure, high-volume TR lesion. When caring for this type of patient, it is sometimes best to apply the hemodynamic recommendations according to the AS algorithm. Another approach is to maintain the hemodynamic parameters for a patient's most compensated condition. For example, for a patient who presents with compensated AI, it may be most optimal to maintain preload, afterload, inotropy, rate, and rhythm unchanged from the patient's conscious condition.

No induction agents are specifically indicated in any of the heart valve conditions. More important than a specific agent is the adherence to identifying and maintaining clear hemodynamic goals. In certain disease states, an abrupt alteration of a particular hemodynamic parameter can lead to catastrophic results. For example, in patients with severe LV hypertrophy, AS, and CAD, a drop in arterial blood pressure may lead to significant myocardial ischemia and cardiovascular collapse. These patients with a relatively fixed outflow obstruction are unable to alter ejection; therefore, any drop in preload and afterload may reduce both stroke volume and coronary perfusion. Furthermore, the hypertrophied heart is especially subject to increased myocardial oxygen demands; therefore, the consequences of



ischemia will be magnified in severity and hastened in onset.

### Maintenance of Anesthesia

No agents or techniques are indicated for maintenance of anesthesia in any specific valve disease condition. Again, adherence to the hemodynamic goals outlined in Table 51-4 will provide appropriate guidance when maintaining anesthetic depth. The sound principles of anesthesia apply, including loss of consciousness, muscle relaxation, and hemodynamic stability (i.e., blunting of the autonomic nervous system).

Patient awareness during cardiac surgical procedures requires special attention. Awareness, especially auditory recollection, may occur in up to 6% of patients requiring CPB.<sup>104</sup> Sebel et al.<sup>105</sup> reported a 0.13% incidence of operative awareness in a broad population of 19,575 surgical patients. Multivariate logistic regression identified increasing ASA status and type of procedure as risk factors for recall. For cardiac surgical procedures, the odds ratio for recall was 3.58 with a 95% confidence interval of 0.72–17.9. As with any procedure, attention to hemodynamic signs, depth of anesthesia, use of benzodiazepines, and inhalational agents likely will reduce the risk of operative recall.

Good data support the concept of “fast-track” or early extubation protocols in the care of patients presenting for CABG.<sup>106</sup> Benefits include reduced hospital stay, ICU stay, and reduced cost of care. Data on early extubation protocols in valve surgery are less common, although one might expect similar benefit as observed in CABG surgery.<sup>107</sup> One should be aware, however, that many valvular procedures are complex in nature, requiring extended CPB time, potential DHCA, and increased requirements for blood and blood product transfusion. All of these factors may limit the opportunity for early extubation protocols.

Reports of regional anesthesia for heart valve surgery are limited. Canto et al.<sup>108</sup> reported a series of 305 patients undergoing heart valve surgery managed with general anesthesia and thoracic epidural anesthesia. Sixty-five percent of these patients were extubated in the operating room. An epidural catheter was placed at T1–3 on the day of surgery, a rigid anticoagulation protocol was followed both before and after surgery, and no neurologic com-

plications from epidural hematomas occurred. Hemmerling et al.<sup>109</sup> found similar benefit with rapid extubation, lower postoperative pain scores, and no epidural hematomas with high thoracic epidural anesthesia after AV surgery in 45 patients. There are case reports of AV replacement in conscious patients under regional anesthesia without intubation.<sup>110,111</sup> Nonetheless, it is unlikely that regional anesthesia techniques will replace more traditional general anesthetics for heart valve surgery.

### Weaning from Bypass and the Postbypass Period

Once a dysfunctional valve has been adequately repaired or replaced, the hemodynamic goals of the patient may be fundamentally different from the pre-CPB period. A more normal hemodynamic profile usually is immediately observed while in the operating room. The anticipation is that the heart will now perform normally, but this frequently is not the case. The heart suffers an acute insult from the surgical intervention, aortic cross-clamping, and the myocardial depressant effects of the various anesthetic agents. As with any cardiac surgical procedure, evidence of new regional wall-motion abnormalities, global cardiac dysfunction, and peripheral vascular dysfunction may be seen. Thus, in patients with valvular heart disease, the heart will require some time to remodel before significant improvement is observed.

In some patients, hemodynamics may be greatly improved after CPB. In simple, compensated AS, the patient may be hyperdynamic and hypertensive after weaning from bypass. However, it also may be possible that, because of LV hypertrophy, cardioplegia was incomplete for total myocardial protection, and the patient emerged from CPB with transient myocardial dysfunction. In complex repairs or multiple valve surgery, an extended CPB period may be required, thereby increasing the risk of immediate postoperative cardiac dysfunction and the requirement for inotropic or even IABP support. Ejection fraction and LV function may decline after surgery for MR, commonly thought to be caused by the new loading conditions of the heart after removal of the “pop-off” MR flow. This likely is not true, as emerging data on MV repair procedures with sparing of the valve apparatus show

little alteration in ejection fraction.<sup>112</sup> This preservation of mitral annular integrity stabilizes LV shape and contractility, thereby preserving function. The diminished performance likely is secondary to other factors, including extended cross-clamp time, inadequate myocardial protection, and myocardial stunning. Combined CABG and valvular heart surgery is associated with inotrope use during separation from CPB.<sup>113</sup> In a retrospective study of 1009 consecutive patients undergoing either CABG or CABG with valve surgery and CPB, multivariate risk analysis revealed extended cross-clamp time, worsening wall-motion score index, reoperation, combined procedures, severe MR, and low ejection fraction as predictors of inotrope use during separation from CPB.

TEE is especially useful in the immediate post-CPB period.<sup>29,30</sup> TEE facilitates the assessment of myocardial function and filling parameters, providing important information that will affect decisions about inotropes and volume management. TEE also can assess the condition of the valve repair or replacement. On every case in which TEE is used and images can be obtained, complete evaluation of the valve is required, including assessment of its structure and function, degree of residual regurgitation or stenosis, and any collateral injury. Following a valve repair or replacement, documentation of any perivalvular or central regurgitation and a gradient across the valve should be obtained. In addition, after MV repair, assessment for systolic anterior motion should be obtained. Finally, it is important that the anesthesiologist have a comprehensive understanding of the echocardiographic “signatures” of the most commonly used prosthetic valves, including their expected normal washing jets, closing jets, and transvalvular gradients.

The post-CPB period may be a time of hemodynamic instability. The heart is adjusting to new preload, afterload, and inotropic conditions, often in the presence of ongoing bleeding. Constant vigilance regarding hemodynamics, blood volume, blood gas chemistry, and metabolic state (i.e., ionized calcium, glucose concentrations, and urine output) are required. In addition, there may be new rhythm disturbances. Patients with preoperative atrial fibrillation now may be converted to sinus rhythm after MV repair

and a surgical maze procedure. Other patients may suffer from third-degree heart block, bradycardia, tachycardia, or other rate and rhythm abnormalities, making management difficult.

### Special Considerations and Long-Term Prognosis

Cardiac anesthesia for heart valve surgery is associated with a number of special considerations not found in other aspects of cardiothoracic anesthesiology. Among these considerations is familiarity with the type of repair technique or prosthetic valve used. There are a number of valve types, including mechanical and bioprosthetic valves. The choice of valve is up to the surgeon; however, the anesthesiologist may be asked to provide a comprehensive TEE assessment that may guide the surgeon in valve selection. For example, measurement of AV annulus size is important when determining the size of a prosthetic valve. In the assessment of a patient for a possible Ross procedure, pulmonary annulus size and degree of pulmonary insufficiency are important factors before committing to the procedure. After valve replacement, the anesthesiologist should have a comprehensive understanding of the echocardiographic “signatures” of the most commonly used prosthetic valves, including their expected normal washing jets, closing jets and transvalvular gradients. Bioprosthetic and mechanical valves all come with a complete hemodynamic profile in their package insert, and this information should be consulted when rendering a decision on the function of a new valve. Sometimes the expected gradients are higher, and the calculated valve area may be less than expected. The impact of valve prosthesis–patient mismatch (VP-PM) on mortality is as high as 25% in patients with a severe VP-PM mismatch.<sup>114</sup> In a followup study of 1563 patients undergoing AV replacement, the adjusted hazard ratio (95% confidence interval) at 5 years for heart failure with a VP-PM mismatch was 1.64 (1.01–2.56;  $P = .047$ ) and for heart failure deaths was 2.09 (1.03–4.27;  $P = .043$ ).<sup>115</sup> Referring to the package insert will help guide the clinician in deciding whether intraoperative gradients and calculated valve areas are acceptable.

Valve repair for patients with endocarditis presents all of the hemodynamic considerations in addition to the frequently septic condition of the

patient (Fig. 51–13). Patients with endocarditis usually have acute regurgitant lesions and present in CHF. The in-hospital mortality for acute endocarditis is 20%, and 82% of patients have endocarditis of a native heart valve.<sup>116</sup> The early predictors of in-hospital mortality include embolic events, diabetes mellitus, *Staphylococcus aureus* bacteremia, and Acute Physiology and Chronic Health Evaluation (APACHE) II score. Use of intraoperative TEE is especially helpful in the diagnosis of endocarditis and quantification of the valve defect. Valve surgery reduces 6-month mortality. In a study by Lung et al.,<sup>117</sup> 513 patients with complicated left-sided infective endocarditis were treated with antibiotics, 45% underwent valve surgery, and 55% received medical therapy alone. The 6-month mortality was 16% in the surgery group compared to 33% in the medical group ( $P < .01$ ). Patients with the most severe CHF demonstrated the greatest reduction in mortality with surgery (14% vs. 51%,  $P = .001$ ).

Significant data support valve repair and replacement in patients with heart valve disease over medical management.<sup>118,119</sup> After surgery for AS, there is initial remodeling of the heart with subsequent LV mass reduction.<sup>120</sup> Between 1986 and 2001, 1410 patients underwent surgery for severe AI, of whom 160 (11%) had valve repair.<sup>121</sup>

One operative death (0.6%) occurred, and two patients required early re-repair. Seven years after repair, the survival rate was 89%, and the reoperation rate on the AV was 15%. Patients with MR receive symptomatic relief and improvement in LV ejection fraction following valve surgery.<sup>122</sup> Although early mortality is associated with heart valve surgery, the long-term benefit remains superior to medical management even among asymptomatic patients.<sup>123</sup> As the population extends longevity, more patients will present for valve procedures. Although advancing age is associated with poor outcome, there is no upper limit of age at which time valve surgery is contraindicated. In summary, these and other data show that surgery offers an opportunity for improved mortality, symptomatic relief, and hemodynamic improvement in nearly all patients with valve dysfunction.

The impact of percutaneous valves and other unconventional surgical valve repair procedures on the volume of heart valve surgery is unknown.<sup>124</sup> However, patients undergoing percutaneous valve procedures likely will require anesthesiologists to provide sedation and/or general anesthesia. In addition, comprehensive TEE imaging inevitably will be essential for the appropriate positioning of these devices and perioperative hemodynamic monitoring of these patients.



**FIGURE 51–13.** Intraoperative transesophageal midesophageal aortic valve (AV) long-axis view showing an AV vegetation and abscess formation (arrow) in a patient who presented with sepsis.

## ANESTHETIC CONSIDERATIONS FOR AORTIC SURGERY

Thoracic aortic diseases are generally surgical problems (Table 51-5).<sup>125</sup> The most common operations performed on the thoracic aorta are repair of aortic dissection, aortic aneurysm, traumatic aortic injury, and aortic coarctation. Operative repair involving the aortic root, ascending aorta, or transverse aortic arch typically is approached through a median sternotomy. Operative repairs involving the distal aortic arch or descending thoracic and thoracoabdominal aorta typically are approached through a left thoracotomy or thoracoabdominal incision. Endovascular stent graft techniques for repair of descending thoracic aortic aneurysm (TAA) and dissection have been developed that are accomplished by access through the femoral or iliac arteries.<sup>126</sup>

The anesthetic management of patients undergoing thoracic aortic operations has contributed to the overall success of these operations and requires specialized knowledge of several unique techniques that are practiced routinely in few other areas of medicine. Clinical application of TEE and ultrasound imaging performed by the anesthesiologist provides a means to emergently diagnose acute aortic syndromes, identify associated life-threatening complications, and detect cerebral malperfusion, permitting early surgical intervention and treatment.<sup>127</sup> The process of repairing or replacing a portion of the thoracic aorta typically requires the temporary or permanent interruption of blood flow through the aorta or its major branch vessels, creating the potential for ischemia or infarction of almost any major organ system. Techniques to protect organs during temporary interruption of blood flow in the thoracic aorta include DHCA, selective antegrade cerebral perfusion, retrograde cerebral perfusion, and partial left heart bypass for distal aortic perfusion. Intraoperative neurophysiologic monitoring and lumbar cerebrospinal fluid (CSF) drainage are recognized techniques commonly used for repairs involving the descending thoracic or thoracoabdominal aorta to decrease the risk of spinal cord ischemia and infarction.

### Thoracic Aortic Aneurysm

Aortic aneurysm is a dilation of the aorta containing all three layers of the

vessel wall that has a diameter of at least 1.5 times that of the normal diameter of the corresponding aortic segment. TAAs are common. They are detected in 10% of autopsies, have an incidence of 5.9 per 100,000 person-years, and are the most common reason for thoracic aortic operation.<sup>128</sup> TAAs can be characterized by etiology, location, diameter, and extent of aortic involvement. Aortic pseudoaneurysms are caused by a contained rupture of the aorta or arise from intimal disruptions, penetrating atherosclerotic ulcers, or partial dehiscence of the suture line at the site of a previous aortic vascular graft. Aortic aneurysms can be associated with dissection of the vessel wall.

Surgical repair of TAAs is performed for acute rupture, AI, or refractory pain, or to prevent eventual rupture. Rupture of the aortic root or proximal ascending aorta will cause cardiac tamponade because the first several centimeters of the ascending aorta lies within the pericardial sac. Dilation of the proximal ascending aorta may cause AI by distortion of the aortic root and outward tethering of the AV cusps.<sup>128,129</sup> Because the risk of aortic rupture is associated with aneurysm size, aortic diameter is commonly used as a clinical indication for elective repair (Table 51-6). For the ascending aorta, aneurysm diameter  $\geq 4.5$  cm in patients with Marfan syndrome, collagen vascular disease, bicuspid AV, or a family history of aneurysm,  $\geq 5.0$  cm in patients requiring AV replacement, or  $\geq 5.5$  cm in any patient is generally considered an indication for operative repair.<sup>130-132</sup> Because the operative risks associated with open repair of the descending thoracic aorta is greater, repair usually is not performed until an aneurysm size 6.5 cm is reached.<sup>131,132</sup> Very large aneurysms of

TABLE 51-5.

### Diseases of the Thoracic Aorta That Are Amenable to Surgical Treatment

<b>Aneurysm</b>
Congenital or developmental
Marfan syndrome, Ehlers-Danlos syndrome
Degenerative
Cystic medial degeneration
Annuloaortic ectasia
Atherosclerotic
Traumatic
Blunt and penetrating trauma
Inflammatory
Takayasu arteritis, Behçet syndrome, Kawasaki disease
Microvascular diseases (polyarteritis)
Infectious (mycotic)
Bacterial, fungal, spirochetal, viral
Mechanical
Poststenotic, associated with arteriovenous fistula
Anastomotic (postarteriotomy)
Pseudoaneurysm
Aortic dissection
Stanford type A
Stanford type B
Intramural hematoma
Penetrating atherosclerotic ulcer
Atherosclerotic disease
Traumatic aortic injury
Aortic coarctation

Adapted from Kouchoukos NT, Dougenis D. Surgery of the thoracic aorta. *N Engl J Med* 1997;336:1876-1888. Copyright, 1997 Massachusetts Medical Society. Adapted with permission.

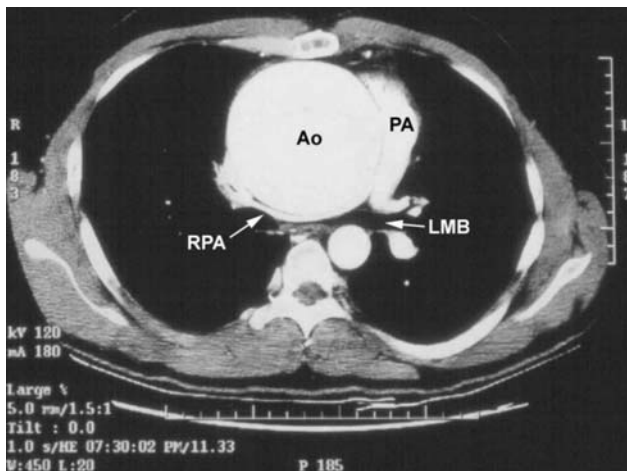
the ascending aorta, aortic arch, or descending thoracic aorta may produce a mediastinal mass effect, causing extrinsic compression of the trachea, left

TABLE 51-6.

### Indications for Surgical Repair of Thoracic Aortic Aneurysm

Ascending Aortic Diameter (cm)	Condition
$\geq 4.5$	Marfan syndrome, collagen vascular disease, familial aortic dissection, bicuspid aortic valve
$\geq 5.0$	Requiring aortic valve replacement or repair
$\geq 5.5$	Any patient
Descending Aortic Diameter (cm)	Condition
$\geq 6.0$	Marfan syndrome, familial aortic dissection or aneurysm
$\geq 6.5$	Any patient





**FIGURE 51-14.** CT angiogram of the chest showing a large ascending aortic aneurysm (Ao) causing compression of the right pulmonary artery (RPA), distal trachea, and left mainstem bronchus (LMB). PA, Main pulmonary artery.

mainstem bronchus, right PA, RV outflow tract, or esophagus (Fig. 51-14). In contrast to patients with collagen vascular or familial aortic aneurysms, patients with atherosclerotic aneurysms generally are elderly and have more comorbid conditions and peripheral vascular disease.

### Ascending Aorta and Aortic Arch Aneurysm

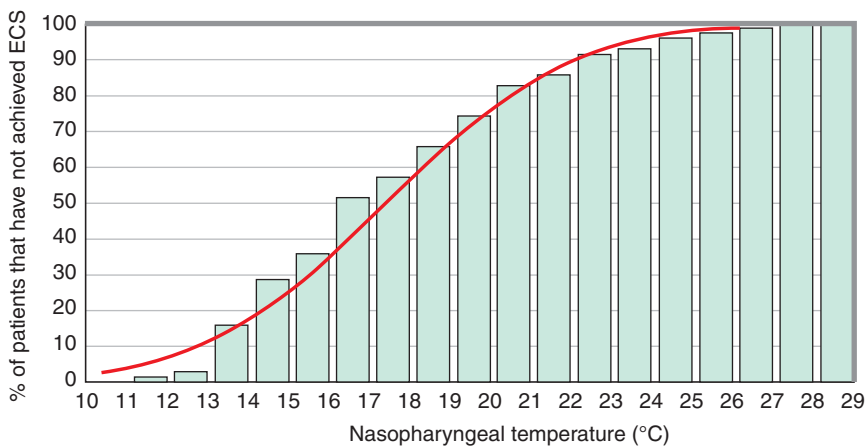
Aortic aneurysms limited to the aortic root and proximal ascending aorta can be repaired using standard CPB with cannulation of the aneurysm, ascending aorta, or femoral artery and cross-clamping of the distal ascending aorta. Based on assessment of the AV, the AV may be replaced, resuspended, or re-

implanted within the prosthetic vascular graft. Replacement of the aortic root requires reimplantation of the right and left coronary arteries. Intraoperative TEE is useful for evaluating the native AV prior to repair and for determining if the presence of residual AI after valve-sparing operations.

Operative repair of aortic aneurysms that extend into or involve the aortic arch require temporary interruption of cerebral perfusion. The primary technique used to protect the brain from ischemic injury in the absence of cerebral blood flow is DHCA. In the conduct of DHCA, achieving a satisfactory level of hypothermia is considered the most important intervention for brain protection, but the optimal tempera-

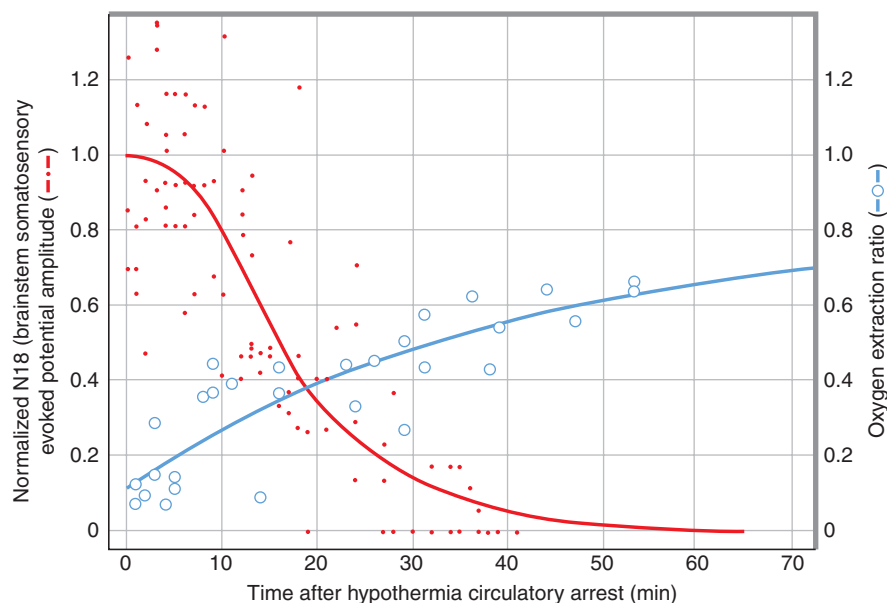
ture for DHCA, best site for temperature measurement, and safe duration of DHCA have not been established. EEG during the conduct of DHCA has demonstrated that the average nasopharyngeal temperature required to produce electrocortical silence was approximately 18°C, but a nasopharyngeal temperature of 12.1°C or cooling on CPB for at least 50 minutes was necessary to achieve electrocortical silence in 95% of patients (Fig. 51-15).<sup>133</sup> Clinical studies indicate that the cerebral metabolic rate decreases by a factor of approximately 2.6 for each 10°C decrease in temperature ( $Q_{10}$  ratio for adults).<sup>134</sup> Assuming the brain can tolerate an ischemic period of approximately 3–5 minutes at 37°C, the reduction in cerebral metabolism at a temperature of 17°C would predict that the brain should tolerate approximately 20–34 minutes of ischemia. Clinical studies support this prediction and have detected the onset of neuronal ischemia at approximately 18 minutes after DHCA (Fig. 51-16).<sup>135</sup> Other studies have indicated that postoperative neurocognitive dysfunction was more frequent when DHCA duration exceeded 25 minutes.<sup>136</sup>

Strategies for improving the safety of DHCA to facilitate operations requiring temporary interruption of blood flow in the aortic arch include techniques to provide retrograde cerebral perfusion or selective antegrade cerebral perfusion. Retrograde cerebral perfusion (RCP) can be provided immediately after initiation of DHCA by infusing cold oxygenated blood into the superior vena cava at flow rates averaging 150–250 mL/min.<sup>137</sup> During RCP, the pressure within the superior vena cava is generally maintained  $\leq$  25 mm Hg to decrease the risk of cerebral edema, the aortic arch is opened to atmospheric pressure to prevent pressurization of the arterial system, and the patient is positioned in 8–10° Trendelenburg to prevent air entry into the aortic arch branch vessels. Experimental and clinical studies have demonstrated that RCP via the superior vena cava provides perfusion to the brain, but existing evidence indicated that the flow achieved with RCP was insufficient to prevent cerebral ischemia.<sup>137</sup> Nevertheless, advocates of RCP argue that even some substrate delivery increases the margin of safety of DHCA, that cerebral hypothermia is maintained with RCP, and that RCP deas-



**FIGURE 51-15.** Relationship between electroencephalographic (EEG) activity and nasopharyngeal temperature prior to deep hypothermic circulatory arrest in 109 patients undergoing thoracic aortic operations requiring circulatory arrest. Electrocortical silence (ECS) was achieved by EEG in all patients after 50 minutes of cooling or at a nasopharyngeal temperature of 12.5°C. At a nasopharyngeal temperature of 18°C, only 50% of patients had electrocortical silence by EEG. This article was published in and adapted from Stecker MM, Cheung AT, Pochettino A, et al. Deep hypothermic circulatory arrest: I. Effects of cooling on electroencephalogram and evoked potentials. *Ann Thorac Surg* 2001;71:14–21. Copyright Elsevier 2001.





**FIGURE 51-16.** Changes in brainstem (N18) somatosensory evoked potential amplitudes after initiation of deep hypothermic circulatory arrest with retrograde cerebral perfusion superimposed on the change in brain oxygen extraction ratio (OER) in patients during retrograde cerebral perfusion (O; n = 19). The N18 somatosensory evoked potential decayed to half its original amplitude at 16 minutes after interruption of antegrade cerebral perfusion. OER decreased to half its maximal value of 0.66, also at 16 minutes after interruption of antegrade cerebral perfusion. (Adapted from Cheung et al.<sup>135</sup> with permission.)

es the risk of cerebral embolization by flushing out particulate matter in the cerebral arteries prior to resumption of antegrade cerebral perfusion.

Selective antegrade cerebral perfusion can be accomplished by arterial cannulation and perfusion of the axillary artery, innominate artery, subclavian artery, or even the internal carotid arteries.<sup>138</sup> Antegrade perfusion into a single arch branch vessel provides flow to the contralateral cerebral hemisphere through a functional circle of Willis. Selective antegrade cerebral perfusion is generally performed in combination with deep hypothermia for operations where the duration of DHCA is anticipated to exceed 30 minutes. Flow rates for antegrade cerebral perfusion typically range from 400–1000 mL/min at radial artery pressures of 50–80 mm Hg. Clinical studies supporting the efficacy of antegrade cerebral perfusion demonstrated acceptable morbidity despite antegrade cerebral perfusion duration times as long as 75–235 minutes.<sup>138</sup>

Attempts to further improve the safety of DHCA by manipulating pH, blood viscosity, or hemoglobin concentration or by administration of pharmacologic agents often are practiced, but no clinical evidence has supported the efficacy of these other interventions. Barbiturates or other central nervous system depressants are sometimes adminis-

tered in an effort to decrease cerebral oxygen demands. Glucocorticoids, magnesium sulfate, lidocaine, and mannitol are sometimes administered in an effort to protect against cerebral and end-organ injury. In general, the existing evidence suggests that pharmacologic neuroprotection is unproven and should not be considered a substitute for hypothermia to protect against cerebral ischemia in the setting of hypoperfusion.

### Descending Thoracic and Thoracoabdominal Aortic Aneurysm

Classification of TAAs and thoracoabdominal aortic aneurysms (TAAAs) according to anatomic extent provides

a useful guide to surgical approaches, anesthetic management, and estimate of perioperative mortality and postoperative paraplegia associated with operative repair (Table 51-7).<sup>139</sup> In the Crawford classification, extent I TAAA involves the entire descending thoracic aorta from the origin of the left subclavian artery to the level of the diaphragm, extent II TAAA involves the entire descending thoracic aorta with extension across the diaphragm through the abdominal aorta to the aortic bifurcation, extent III TAAA involves the distal half of the descending thoracic aorta and most of the abdominal aorta, and extent IV TAAAs are confined to the upper abdominal aorta (Fig. 51-17). Isolated TAAs are those confined to the descending thoracic aorta between the origin of the left subclavian artery and the diaphragm. TAAAs can be further distinguished into those with dissection and those without dissection. Operative repair of TAAA with an interposition tube graft is approached through a left thoracoabdominal incision and requires single-lung ventilation. Repairs originally were accomplished by cross-clamping the thoracic aorta proximal to the aneurysm. Modifications of this technique included passive arterial shunting (Gott shunt) or partial left heart bypass using extracorporeal circulation to provide distal aortic perfusion while the proximal descending thoracic aorta was cross-clamped.<sup>140</sup> CPB with DHCA may be necessary for aneurysms that extend into the distal aortic arch.<sup>141</sup> Endovascular stent graft repair has become an option for repair of isolated TAAs.<sup>126</sup> One of the major complications of operative repair is spinal cord ischemia or infarction resulting in postoperative paraplegia.

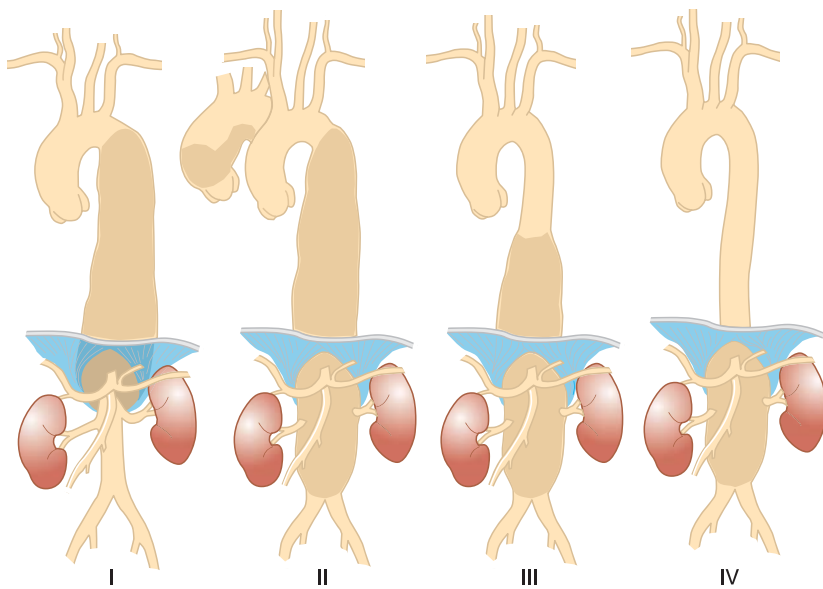
**TABLE 51-7.**

**Mortality and Paraplegia after Thoracoabdominal Aortic Aneurysm Repair in 1,220 Consecutive Patients**

TAAA Extent	Number of Patients	30-Day Mortality	Hospital Mortality	Paraplegia/Paraparesis
I	400 (35.1%)	20 (5.0%)	30 (7.5%)	16 (4.1%)
II	343 (30.1%)	18 (5.2%)	29 (8.5%)	28 (8.2%)
III	184 (16.1%)	9 (4.9%)	9 (4.9%)	7 (3.8%)
IV	213 (18.7%)	7 (3.3%)	12 (5.6%)	3 (1.4%)

TAAA; Thoracoabdominal aortic aneurysm.

This article was published in Coselli JS, LeMaire SA, Miller CC 3rd, et al. Mortality and paraplegia after thoracoabdominal aortic aneurysm repair: a risk factor analysis *Ann Thorac Surg* 2000;69:409–414. Copyright Elsevier 2000.



**FIGURE 51-17.** Crawford classification of thoracoabdominal aortic aneurysm extent. (From Coselli JS. Descending thoracoabdominal aortic aneurysms. In Edmunds LH, ed. *Cardiac Surgery in the Adult*. New York: McGraw-Hill, 1997:1232, with permission.)

The risk of spinal cord ischemia is a consequence of interruption of distal aortic perfusion or the sacrifice of intercostal, lumbar, and sacral artery branches that provide collateral flow supplying the spinal cord. Strategies to prevent, detect, and treat spinal cord ischemia are important aspects in the anesthetic management of patients undergoing TAA and TAAA repair. Spinal cord protection strategies include deliberate hypothermia, surgical techniques to minimize ischemia time, arterial pressure augmentation, avoiding hypotension, lumbar CSF drainage, and perioperative neurophysiologic monitoring of spinal cord function. Deliberate hypothermia is an established technique to protect against neuronal ischemia and can be accomplished by passive cooling to 3°C, active cooling using extracorporeal circulation, or selective cooling by infusion of cold saline into the epidural space (Table 51-8).<sup>142,143</sup> Passive arterial shunting using an ascending aorta to distal aortic shunt or partial left heart bypass using extracorporeal circulation to direct blood from the LA to the femoral artery can be used to provide distal aortic perfusion during construction of the proximal aortic anastomosis and decreases the duration of lower body ischemia. While the descending aorta is cross-clamped, spinal cord perfusion via the vertebral arteries can be augmented by maintaining the proximal aortic pressure  $\geq 90$  mm Hg. Intraoperative neuro-

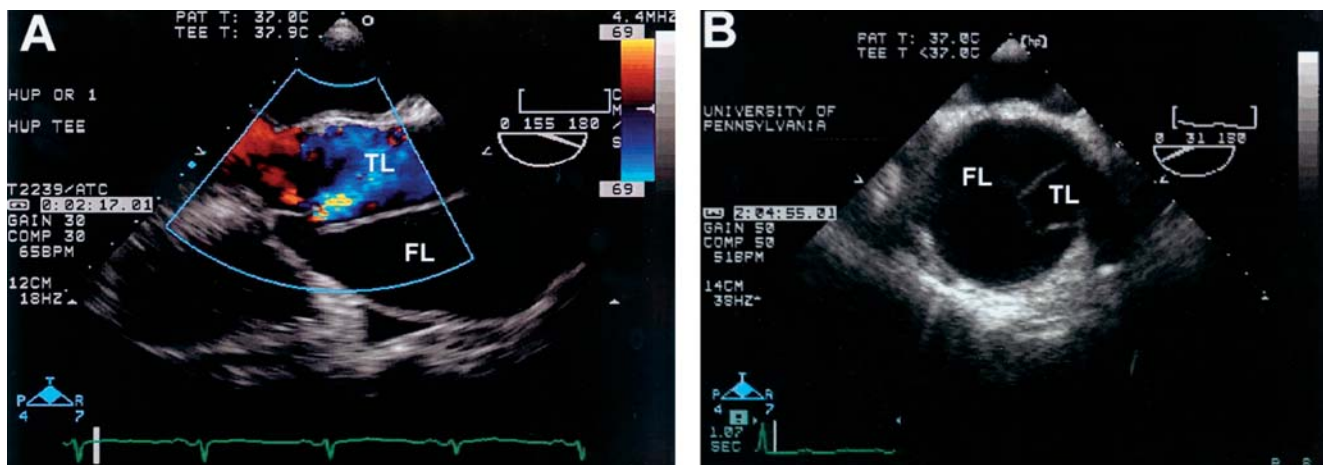
physiologic monitoring of somatosensory evoked or motor evoked potentials from the posterior tibial nerves has been advocated for detection of spinal cord ischemia during operation in the anesthetized patient to permit early intervention or to prompt the reattachment of intercostal artery branches.<sup>144</sup> Pharmacologic agents such as glucocorticoids or even naloxone have been administered for spinal cord protection, but their efficacy remains unproven. Patients with delayed-onset paraplegia or paraparesis after TAA, TAAA, or endovascular stent graft repair often respond to strategies to improve spinal cord perfusion by increasing the arterial pressure and drainage of CSF.<sup>142,143</sup> One rationale for the routine use of lumbar CSF drainage is that the lumbar CSF pressure may increase during repair as a consequence of aortic cross-clamping or spinal cord edema during reperfusion. Hypotension associated with spinal cord ischemia may be a consequence of general anesthesia, regional anesthesia, blood loss, vasodilatation, or even neurogenic shock from spinal cord ischemia and requires prompt treatment. The effectiveness of lumbar CSF drainage for treatment of spinal cord ischemia may be improved when combined with arterial pressure augmentation. Interventions to increase spinal cord perfusion pressure appear to be most effective when applied immediately upon detection of spinal cord ischemia. Although the

**TABLE 51-8.**

**Strategies to Decrease the Risk of Paraplegia from Spinal Cord Ischemia after Thoracic or Thoracoabdominal Aortic Procedures**

Distal Aortic Perfusion
Passive shunt (Gott)
Partial left heart bypass
Partial cardiopulmonary bypass
Minimize aortic cross clamp time
Deliberate Hypothermia
Mild-to-moderate systemic hypothermia (32°–35°C)
Deep hypothermic circulatory arrest (14°–18°C)
Selective spinal cord hypothermia (epidural cooling, 25°C)
Increase Spinal Cord Perfusion Pressure
Re-implantation of critical intercostal and segmental arterial branches
Lumbar cerebrospinal fluid (CSF) drainage (CSF pressure $\leq 10$ mm Hg)
Arterial pressure augmentation (mean arterial pressure $\geq 85$ mm Hg)
Avoid hypotension
Intraoperative Monitoring of Lower Extremity Neurophysiologic Function
Somatosensory evoked potentials
Motor evoked potentials
Postoperative Neurologic Assessment for Early Detection of Delayed-Onset Paraplegia
Serial neurologic examination
Pharmacologic Neuroprotection
Glucocorticoid
Barbiturate or central nervous system depressants
Magnesium sulfate
Mannitol
Naloxone
Lidocaine
Intrathecal papaverine

routine use of lumbar CSF drainage remains controversial, its effectiveness has been demonstrated in randomized controlled trials and case series.<sup>145</sup> Complications of lumbar CSF drainage are uncommon and include intracranial hypotension, subdural hematoma, catheter fracture, meningitis, and hemorrhagic complications.<sup>146,147</sup> Precise monitoring of CSF pressure, controlled drainage of CSF to maintain a lumbar CSF pressure of at least 10 mm Hg, and supervised insertion and removal of catheters may decrease the risk of complications. Considering the



**FIGURE 51-18.** Transesophageal midesophageal long-axis view of the aortic valve (A) and short-axis views of the ascending aorta (B) in a patient with a type A aortic dissection. An intimal flap separating the true lumen (TL) of the aorta from the false lumen (FL) was shown in the aortic root and ascending aorta. Extension of the dissection into the aortic root may cause aortic regurgitation or coronary insufficiency.

morbidity associated with paraplegia, the application of lumbar CSF drainage, arterial pressure augmentation, and neurophysiologic monitoring can be justified in patients at risk for postoperative spinal cord ischemia.

### Aortic Dissection

Aortic dissection evolves from a tear in the intima that allows blood to enter the medial layer of the vessel, causing the intima to separate or dissect circumferentially and longitudinally within the aorta. Aortic dissection is diagnosed by demonstrating a true and a false lumen separated by an intimal flap within the vessel (Fig. 51-18).<sup>148,149</sup> Aortic intramu-

ral hematoma is a variant of aortic dissection characterized by hemorrhage into the medial layer producing circumferential thickening of the vessel wall.<sup>150</sup> Aortic dissection affects a wide demographic population and age range. The most common associated diseases are hypertension, atherosclerosis, and cystic medial degeneration. Other associated conditions include collagen vascular disease, familial aortic dissection, bicuspid AV, aortic coarctation, pregnancy, cocaine abuse, arteritis, and aortic trauma. Early complications of aortic dissection include dissection into aortic branch vessels causing malperfusion, resulting in myocardial, cerebral, mesenteric, or

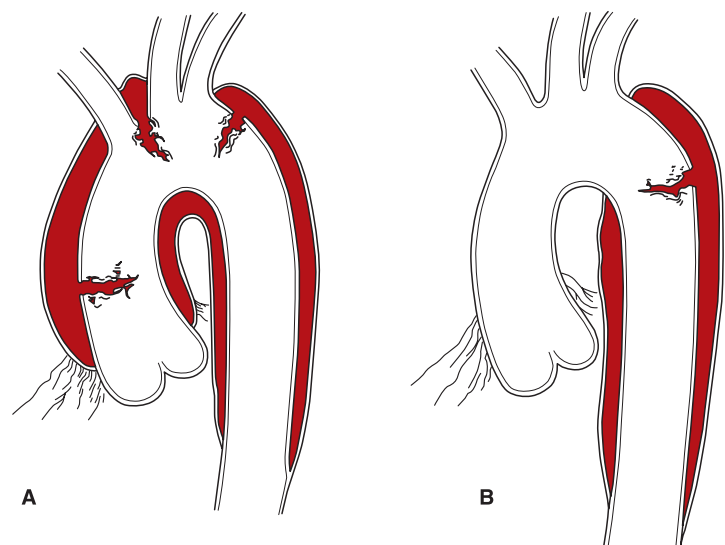
limb ischemia (Table 51-9). Dissection into the aortic root may cause acute aortic regurgitation. Rupture of the proximal ascending aorta causes cardiac tamponade. Dilatation and expansion in the diameter of the aorta over time as a consequence of a weakened vessel wall is a long-term complication of aortic dissection. Aortic dissection is classified according to location. Dissections involving the ascending aorta and aortic arch are classified as Stanford type A or DeBakey type I or II. Dissections confined to the descending aorta are classified as Stanford type B or DeBakey type III (Fig. 51-19). Aortic dissections involving the ascending aorta (Stanford type A or De-

**TABLE 51-9.**

#### Complications of Acute Stanford Type A Aortic Dissection (N = 513)

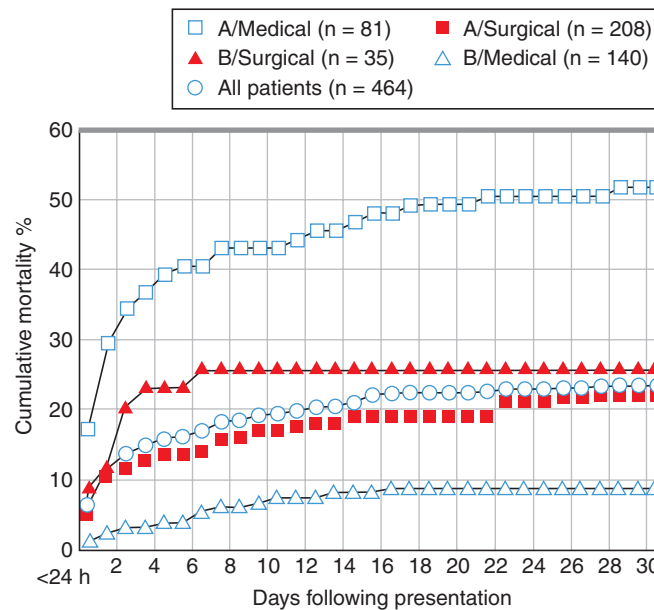
Complications	Percent
All neurologic defects	18.0%
Coma/altered consciousness	14.0%
Myocardial ischemia/infarction	10.0%
Limb ischemia	10.0%
Mesenteric ischemia/infarction	4.0%
Acute renal failure	6.2%
Hypotension	26.0%
Cardiac tamponade	17.0%
Mortality	30.0%

This article was published in and adapted from Bossone E, et al. Usefulness of pulse deficit to predict in-hospital complications and mortality in patients with acute type A aortic dissection. *Am J Cardiol* 2002;89:851-855. Copyright Elsevier 2002.



**FIGURE 51-19.** Stanford classification of aortic dissection. In type A aortic dissection, the ascending aorta is dissected regardless of the location or number of intimal tears (A). In type B aortic dissection, the dissection is limited to the descending aorta (B) distal to the origin of the left subclavian artery. (Reprinted with permission from Daily PO, Trueblood HW, Stinson EB, et al. Management of acute aortic dissections. *Ann Thorac Surg* 1970;10:237-247.)

Bakey type I or II) are considered surgical emergencies. According to an international registry for acute aortic dissection, mortality rates for patients with Stanford type A aortic dissection managed without surgery was approximately 1–2% per hour following the initial symptom onset for the first 48 hours, 60% by day 6, 74% by 2 weeks, and 91% by 6 months.<sup>151</sup> When managed with surgery, the mortality rate for type A aortic dissection was 26% (Fig. 51–20).<sup>151</sup> Aortic dissections confined to the descending thoracic aorta (Stanford type B) are considered surgical emergencies only if there is evidence of a life-threatening complication such as malperfusion or aortic rupture. Mortality in patients with acute type B aortic dissection managed surgically was 31.4% at 30 days compared to a mortality rate of 10.7% at 30 days in medically managed patients (Fig. 51–20).<sup>151</sup> Acute management of patients with suspected aortic dissections requires establishing the diagnosis, distinguishing Stanford type A from Stanford type B aortic dissection, and detecting malperfusion or rupture. In an international registry of aortic dissection, the initial diagnosis was established by computed tomography in 61% of patients.<sup>149</sup> Echocardiography was used as the initial diagnostic technique in 33% of cases but was used as a secondary diagnostic technique in 56% of cases.<sup>149</sup> TEE is useful for intraoperative diagnosis and classification of dissection in unstable patients. Intraoperative TEE also is useful for detecting AI, cardiac tamponade, and myocardial ischemia. Surgery for type A aortic dissection involves replacement of the ascending aorta or aortic arch together with AV repair or replacement. Patients with type B aortic dissection are preferentially managed medically unless they have evidence of aortic rupture or malperfusion. Endovascular stent graft repair has become an alternative to open repair in patients with type B aortic dissection complicated by malperfusion or rupture. The anesthetic management of operations for the repair of type A aortic dissection is similar to the management of patients undergoing repair of ascending aortic and arch aneurysms and typically requires temporary interruption of cerebral perfusion and DHCA. A rare but lethal complication of CPB in patients with aortic dissection is acute cerebral malperfusion caused by inadvertent cannulation of the false lumen of the



**FIGURE 51–20.** Thirty-day mortality in 464 patients from the International Registry of Aortic Dissection (IRAD) stratified by medical and surgical treatment in both type A and type B aortic dissection. (From Nienaber and Eagle<sup>148</sup> with permission.)

aorta or compression of the true lumen by expansion of the false lumen.<sup>152</sup> This complication can be detected by intraoperative TEE evaluation of blood flow in the aorta and ultrasound confirmation of carotid artery flow during initiation of CPB. Treatment consists of immediate discontinuation of CPB, cannulation of the contralateral femoral artery for CPB, or open fenestration of the intimal flap within the aorta. The anesthetic management of operations for type B aortic dissections require the same strategies and techniques used for patients undergoing TAA and TAAA repair.

## ANESTHETIC MANAGEMENT FOR VADS

The first left ventricular assist device (LVAD) was implanted by DeBakey in 1966 as a “bridge to recovery” in a patient suffering from postcardiotomy cardiogenic shock (PCCS).<sup>153</sup> The decompressed and rested native LV recovered after 6 days of support, and the device was explanted. Barnard performed the first orthotopic cardiac transplantation 1 year later. During the 1970s, the development of heart transplantation as a viable therapy for end-stage CHF was hindered by the use of nonspecific immunosuppressive agents that resulted in patient deaths from opportunistic infections.

By the early 1980s, with the introduction of cyclosporine, a specific T-cell inhibitor, heart transplantation became a viable therapy for end-stage CHF, with risk-adjusted survival rates of 50% at 10 years.<sup>154</sup> VADs subsequently took on a new role as a “bridge to transplant.”<sup>155</sup> End-stage CHF patients on transplant waiting lists who are supported by a VAD prior to transplantation could wait longer, recover secondary organ function, be discharged to home, and enjoy improved survival after transplantation.

More than 500,000 Americans are diagnosed each year with CHF, but only 2000 donor hearts become available each year worldwide for transplantation. In the late 1990s, the REMATCH (Randomized Evaluation of Mechanical Assistance for the Treatment of Congestive Heart Failure) trial showed that the HeartMate (Thoratec Corporation, Pleasantville, CA, USA) LVAD could be used as an alternative to transplantation as “destination therapy” in end-stage CHF patients who were not candidates for transplantation.<sup>156</sup> Use of the device conferred a survival benefit compared to optimal medical therapy. Data suggest that long term VAD patients are at risk for three major complications: infections, thromboembolic events, and device malfunction.<sup>157</sup> These are the current challenges for today’s physicians caring long term for assist device patients.



Heart transplantation remains a viable option for a relatively small percent of the population of patients with CHF who remain symptomatic despite medical therapy. However, considering the wider availability and recent success of VADs for this population, cardiac anesthesiologists are more likely to encounter patients with CHF who require VAD placement. Therefore, a review of the perioperative anesthetic considerations for this procedure probably is more relevant.

### Fundamental Components of a VAD

VADs are pumps that collect blood returning to the heart and eject it downstream of the failing ventricle. VADs differ from CPB and extracorporeal membrane oxygenation devices in that they do not provide any respiratory function. The goal of VAD implantation is to decompress the acutely ischemic and failing, or chronically failing, ventricle by diminishing the radius, wall tension, and oxygen consumption. The ventricle may rest and recover while perfusion to the body is maintained by the VAD. For LV support, the inflow cannula is placed in either the LA or LV and drains into the device. Optimal drainage and decompression occur when the cannula is placed in the ventricular apex; however, sutures may not be well supported by infarcted ventricular tissue.<sup>158</sup> The outflow cannula is generally placed in the ascending aorta. A notable exception is the Jarvik 2000 (Jarvik Heart, Inc., New York, NY, USA), in which the outflow cannula is sutured to the descending aorta.<sup>159</sup> For RV support, blood is drained from the RA or RV to the pump and returned to the main PA.

### Determinants for Ventricular Device Selection

The duration of support, patient body habitus, ventricle(s) to be supported, and surgical preference are the main determinants in choosing a particular VAD. Some devices, such as the Tandem Heart Percutaneous VAD (pVAD; Cardiac Assist, Pittsburgh, PA, USA) and the Impella Recover LP 5.0 LV system (ABIOMED, Inc., Danvers, MA, USA), are designed for short-term LV support (days) and can be implanted percutaneously in the cardiac catheterization laboratory or operating room. The Tandem Heart pVAD is a low-speed centrifugal, continuous flow

pump inserted percutaneously through the femoral vessels. The Impella Recover LP 5.0 LV system is a miniaturized impeller, microaxial pump located within a catheter that is placed percutaneously through the femoral artery and positioned in the LV. These devices provide time to transfer the patient to a tertiary center and can be considered a “bridge to a bridge” or a temporary means of support until another longer-term VAD can be implanted. The ABIOMED BVS 5000 provides an intermediate duration of support, from 10–14 days. It can support the RV, LV, or both ventricles. It is most often implanted in the stunned ventricle, after an MI or for PCCS, in which recovery is expected. It also can be used to assist the failing RV after heart transplantation or LVAD implantation. Because only a small incision is made in the ventricle or atrium and a pursestring suture is used to secure the inflow cannula, insertion of ABIOMED cannulas is less traumatic to the tissue and explantation is much easier compared to the Thoratec Ventricular Device System and HeartMate LVAD in which the LV apex must be cored out in order to accommodate the inflow cannula and therefore requires a patch repair of the apex upon explantation. The Thoratec Ventricular Device System is the only FDA-approved device that can provide long-term (months to years) biventricular support to serve as a bridge to transplant. It can be used to support the RV, LV, or both ventricles. The Thoratec HeartMate provides only LV support and provides long-term support as either a bridge to transplant or as destination therapy. Because the Thoratec HeartMate is implanted intracorporeally in the left upper quadrant of the abdomen in the preperitoneal or intra-abdominal compartment, it is suitable only for patients with a body surface area  $>1.8 \text{ m}^2$ .

### Modes of VAD Operation

Most VADs operate in a “volume mode” in which the VAD ejects as soon as the chamber is filled. VADs function best with slightly increased intravascular volume and slightly decreased intravascular resistance. Hypovolemia slows the rate of filling, thereby decreasing the number of pump cycles per minute and overall VAD output. Increased vascular resistance may impede VAD ejection, resulting in prolonged ejection or decreased chamber emptying and de-

creased pump output. Incomplete chamber emptying may result in blood stasis in the pump chamber, with resultant risk of thromboembolism. In the case of the LVAD, systemic vascular resistance is the main component of afterload, whereas for an RVAD pulmonary vascular resistance is the major determinant of afterload.

The ABIOMED BVS 5000 pump fills by continuous gravity drainage. The pump automatically ejects when full. It is preprogrammed to deliver approximately 5 L/min of flow. There are no dials to adjust. Anticoagulation with heparin is mandatory to prevent thrombus formation on the mechanical valves in the pump. The goal ACT is between 180–200 seconds. Filling of the ABIOMED BVS 5000 is independent of the underlying cardiac rhythm. Patients with malignant arrhythmias with biventricular support will remain hemodynamically stable.

The Thoratec VAD pump is filled by vacuum-assisted drainage. The pump can operate in one of three operating modes. In “volume mode,” the pump ejects as soon as it is full, similar to the ABIOMED. In “asynchronous mode,” the device operates in a fixed manner according to defined variables. The “external synchronization mode” is used to provide counterpulsation during device weaning. The Thoratec HeartMate LVAD has an extremely sophisticated control algorithm that adjusts device output to the patient's needs. As long as intravascular volume and the RV are functioning properly, there is no need to adjust the control settings. Anticoagulation initially is achieved with heparin, with a goal ACT between 180 and 200 seconds, but once the patient can tolerate oral medications, anticoagulation can be maintained with warfarin (Coumadin) with a goal international normalized ratio of 2.5–3.5.<sup>160</sup>

### Preoperative Anesthetic Considerations

Most patients presenting for VAD implantation are critically ill and often arrive from an ICU or the cardiac catheterization laboratory, or they have developed PCCS in the operating room. When indicated, VAD insertion should be performed early in the setting of PCCS. If a patient is weaned from CPB on significant doses of two inotropes, hospital mortality is 42% and increases to 80% if three inotropes are used to

separate from CPB.<sup>161</sup> If these patients undergo VAD insertion within 3 hours of the first attempt to wean from CPB, a VAD wean rate of 60% and a hospital discharge rate of 43% can be achieved. If VAD insertion is delayed, a wean rate of 27% and hospital discharge rate of 7% are expected, along with an increased risk of end-organ damage and decreased survival.<sup>162</sup>

Preoperatively, the anesthesiologist must identify any neurologic deficits and ascertain the extent of major organ dysfunction, including renal or hepatic insufficiency, which are very common in this patient population. Any further deterioration in the perioperative period may prevent a full recovery and eliminate the possibility of the patient qualifying for a subsequent heart transplantation at a later date.<sup>160</sup>

Strict sterile technique for all invasive procedures and appropriate antibiotic prophylaxis is mandatory in this high-risk population. Antibiotic therapy is ineffective in treating assist device infection once it occurs. CVP monitoring may be of questionable accuracy in patients with an RVAD. However, central access still may be useful for drug and volume infusions. PACs may provide little useful information in the patient with an LVAD that displays real-time cardiac output. However, PACs may be useful in patients with pulmonary hypertension at risk for developing RV failure after LVAD implantation but should not be placed in patients with a functioning RVAD.

CAD is common in LVAD candidates. Adequate preoperative evaluation of CAD is important to ensure the best outcome after VAD implantation. RCA bypass grafts may be particularly necessary to support RV function after LVAD implantation. If RCA bypass grafts are to be performed, placement of the proximal anastomosis site should take into account the LVAD outflow cannula anastomosis site. The lesser curvature of the aorta has been suggested as a good location for the proximal anastomosis site if the VAD outflow cannula is to be sutured to the anterolateral aspect of the ascending aorta.<sup>163</sup>

### Pre-CPB Intraoperative TEE Examination

Intraoperative TEE is the monitor of choice for patients undergoing VAD placement. It may be particularly useful in identifying anatomic and physiologic abnormalities in an attempt to

preempt possible complications or VAD malfunction.<sup>164</sup>

### Valve Pathology

Over 20% of patients scheduled for LVAD insertion have some degree of AI.<sup>164</sup> Persistent AI following LVAD implantation results in high pump flow rates secondary to increased LVAD preload from the regurgitant volume and decreased systemic blood flow. Hypotension, organ hypoperfusion, and metabolic acidosis may occur despite high VAD output. Some centers recommend oversewing, repairing, or replacing the AV if AI  $\geq 2+$ . Oversewing also may be considered if the LVAD is being implanted as a bridge to transplant. However, the outcome of LVAD failure in the setting of an oversewn AV is ominous. If the valve cannot be repaired and must be replaced, bioprosthetic valves are preferred to mechanical valves because of their lower thrombotic potential. After LVAD implantation, AI severity may worsen when the aortic to LV pressure gradient is increased as the device ejects blood into the aorta at arterial pressures while diastolic pressures in the LV remain subphysiologic. In addition, unloading of the LV by a properly functioning LVAD may distort the AV and induce AI.

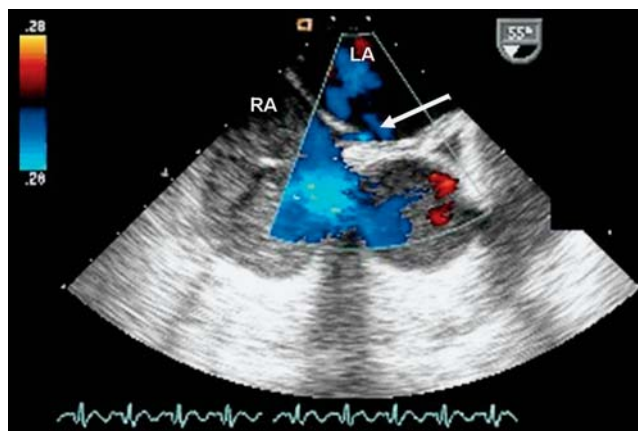
TR is commonly found in patients scheduled for VAD placement. However, unless ascites is present, no benefit has been found in repairing this lesion.<sup>163</sup> As LV failure improves with device support, so too will RV failure and associated TR tend to improve. MS can compromise device inflow and should be corrected at the time of

implant. MR generally has little effect on pump flow rates and often improves with LVAD activation and prolonged support.<sup>164,165</sup>

### Patent Foramen Ovale and Atrial Septal Aneurysm

A patent foramen ovale (PFO) may be found by pre-CPB intraoperative TEE in >9% of patients undergoing VAD placement.<sup>164</sup> Under normal physiologic conditions, LA pressure is greater than RA pressure, and flow through the defect is left to right. Arterial saturation remains normal. However, with initiation of LVAD inflow, LA and LV pressures fall dramatically and frequently become lower than right-sided pressures, thus promoting right-to-left-shunting through the PFO. Undiagnosed or unrepaired PFOs may result in significant arterial hypoxemia during separation from CPB and LVAD device activation (Fig. 51–21)<sup>166</sup> and pose an increased risk for paradoxical embolism.

Atrial septal aneurysm is defined echocardiographically as a protrusion of the aneurysm at least 10 mm beyond the plane of the atrial septum. According to one study, as many as 85% of patients with atrial septal aneurysms have a coexisting PFO.<sup>167</sup> Atrial septal aneurysms may be a cardiogenic source of thromboembolus.<sup>168</sup> In addition, obstruction of an RVAD inflow cannula by an atrial septal aneurysm has been reported.<sup>169</sup> A “bubble test” in which 10 mL of agitated saline is injected into the RA immediately after the release of positive pressure during a Valsalva maneuver is considered the gold standard for PFO identi-



**FIGURE 51–21.** Transesophageal echocardiographic view showing an undiagnosed patent foramen ovale (arrow), which can result in arterial hypoxemia and paradoxical embolus following left ventricular assist device activation. LA, left atrium; RA, right atrium.

fication. However, even this test occasionally fails to identify a PFO, and only after VAD insertion may the PFO become identifiable.<sup>164</sup> Correction of a PFO or atrial septal aneurysm requires dual cannulation and necessitates prompt identification and communication with the surgical team. A PFO identified post-CPB necessitates a return to CPB for repair.

### Right Heart Failure

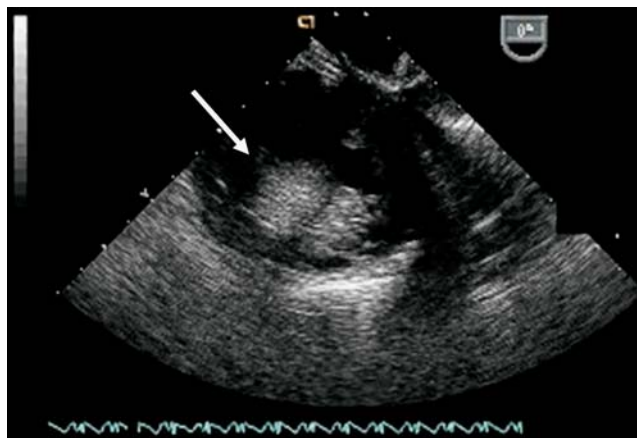
RV dysfunction and failure may develop in up to 20–30% of patients implanted with an isolated LVAD.<sup>170</sup> Decompression of the left side of the heart after LVAD activation can lead to altered RV geometry. A leftward shift of the interventricular septum after LV decompression may result in increased RV compliance and decreased RV contractility.<sup>170</sup> Additionally, although an LVAD should decrease RV afterload and thereby improve RV function in patients with normal pulmonary vascular resistance, patients with fixed pulmonary vascular resistance may actually experience an increase in RV afterload as increased left-sided output from the VAD increases venous return and flow through the pulmonary vasculature.

Right heart failure is one of the most important causes of perioperative death in LVAD patients.<sup>163,171</sup> Blood flow into the LVAD is dependent on adequate pressure gradients to drive blood flow between the LV and the device reservoir and pump. Right heart failure leads to diminished transpulmonary flow and decreased left-sided heart pressures, thus reducing the driving force for LVAD filling.

Acoustic quantification can be used to measure the RV fractional area of change. A preoperative RV fractional area of change  $<20\%$  is associated with RV failure upon LVAD device activation.<sup>164</sup> Low preoperative mean PA pressures and RV stroke work index also can be used to identify patients at risk for developing RV failure after LVAD implantation.<sup>172</sup>

### Thrombus

In addition to sepsis and device malfunction, neurologic dysfunction including stroke and transient ischemic attacks remains one of the most common adverse events following VAD implantation.<sup>157</sup> Intracavitary thrombus has been identified as a thromboembolic risk factor in patients with VADs (Fig. 51–22).<sup>173</sup> LV or LA throm-



**FIGURE 51–22.** Large left ventricular thrombus (arrow) identified during precardiopulmonary bypass intraoperative transesophageal echocardiographic examination in a patient about to receive a left ventricular assist device.

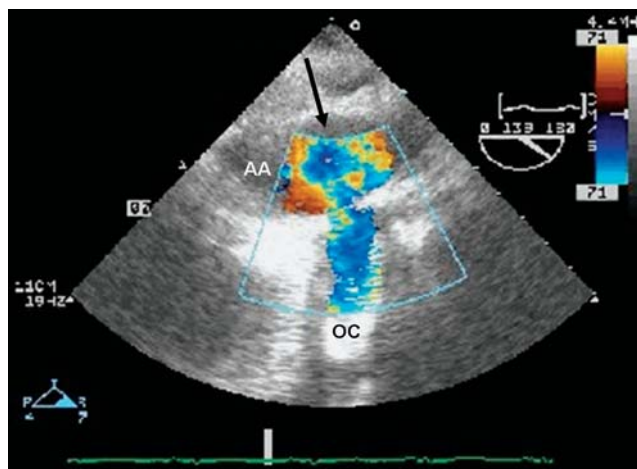
bus has been diagnosed by intraoperative TEE in 9.4% and 3%, respectively, of patients prior to LVAD insertion.<sup>164</sup> Intracavitary thrombus can lead to VAD inflow cannula obstruction and mechanical pump failure.<sup>174</sup>

Thrombus formation in the LV occurs under conditions of blood stasis or low-velocity flow. Apical akinesis, ventricular aneurysm, or diffuse ventricular dysfunction (ejection fraction  $<20\%$ ) may promote thrombus formation. The sensitivity of echocardiography for detecting LV thrombi is operator dependent. Even when an LV thrombus is not identified on echocardiographic exam, the likelihood of thrombus formation remains high in the aforementioned patient population. Evidence of apical flow stasis or continuous swirling of flow around the apex identifies patients at risk for

thrombus. Certain clues should help the operator identify apical thrombus and distinguish it from apical trabeculations. A thrombus is somewhat more echogenic than myocardium, has a distinct contour from the endocardial border, and is located in a region of wall-motion abnormality.<sup>175</sup>

### Weaning from CPB and Initiating LVAD Operation De-Airing

Before the LVAD is activated, the outflow graft is slowly unclamped and the pump is hand cranked. A modified TEE midesophageal AV long-axis view at  $130^\circ$  can be used to monitor air efflux from the outflow graft into the ascending aorta (Fig. 51–23). If large quantities of air are observed, the hand cranking is stopped, the outflow graft is reclamped, and the aorta is



**FIGURE 51–23.** Transesophageal midesophageal ascending aortic long-axis view showing a normal color flow Doppler jet (arrow) at the anastomotic site between a left ventricular assist device (LVAD) outflow cannula (OC) and the ascending aorta (AA). This same view can be used to monitor air efflux from the outflow graft into the ascending aorta prior to full activation of the LVAD.



vented. This process is repeated until minimal air is observed. The pump then is activated at a low rate, approximately 4 L/min.

### Assessing RV Function

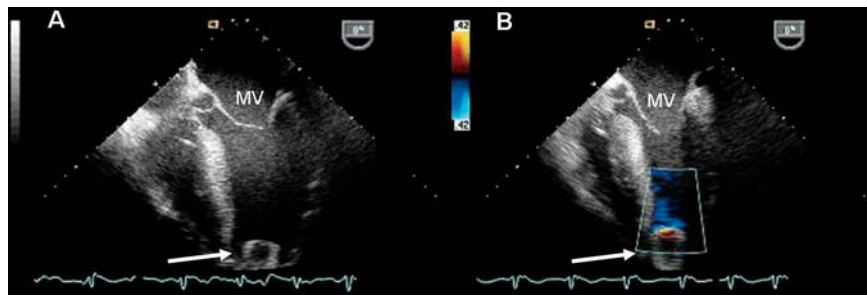
In the early minutes after LVAD pump activation, determination of RV function is critical. Acute RV failure usually is associated with dilation, global dysfunction, and TR. If transpulmonary blood flow does not improve and the device continues to function, the left-sided chambers will collapse and potentially lead to obstruction of the inflow cannula. If the device pump continues to operate, air may be entrained from the sewing ring or the inlet cannula connections and ejected systemically in large quantities into the aorta.<sup>164</sup> If these conditions exist, the device should be turned off and the patient returned to CPB.  $\beta$ -Adrenergic agonists, phosphodiesterase inhibitors, and nitric oxide should be initiated to improve RV contractility and decrease RV afterload in an attempt to improve transpulmonary blood flow. After a period of several minutes, the LVAD can be restarted. If the same hemodynamic conditions persist, a supplemental temporary RV assist device should be implanted.

### LVAD Inflow Cannula Position

Inflow cannula patency is essential for adequate stroke volume and device output. Ideally the LVAD inflow cannula orifice should be directed toward the MV opening and located in the center of the apex (Fig. 51-24).<sup>159</sup> In practice, the inflow cannula often is misdirected anteroseptally (Fig. 51-25). Apical trabeculations, thrombi, papillary muscles, and surgical misplacement can lead to cannula obstruction and LVAD stroke volume reduction. Inflow cannula obstruction can be assessed using color flow Doppler, looking for turbulent flow. In addition, continuous-wave Doppler in the TEE midesophageal four-chamber view can be used to identify inflow cannula obstruction by demonstrating peak velocities  $>2.5$  m/s. Significant obstruction requires repositioning of the inflow cannula.<sup>164</sup>

### Hypotension and Low LVAD Pump Flow Rates

Hypovolemia, RV failure, inflow cannula obstruction, pulmonary embolus, and cardiac tamponade are the most frequent causes of hypotension associated with low LVAD pump flow rates.



**FIGURE 51-24.** Transesophageal midesophageal four-chamber two-dimensional (A) and color flow Doppler (B) images showing correct positioning of the inflow cannula (arrows), with the orifice directed at the mitral valve (MV) orifice.

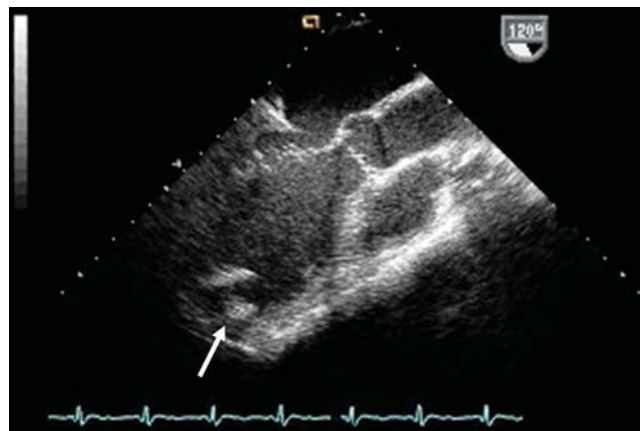
TEE clues to pericardial tamponade include pericardial effusion, systolic collapse of the RA, and diastolic collapse of the RV. Correlation with a low QRS voltage on the ECG and equalization of chamber pressures by catheterization may be helpful in making the diagnosis.<sup>176</sup> Pulmonary embolus may be difficult to distinguish from acute RV failure because both result in RV dilation and severe TR. However, in patients with a pulmonary embolus, an echogenic density may be identified in the main or proximal branch right PA. Hypovolemia is best assessed by TEE. End-diastolic area is a more accurate measure of LV preload than is PAOP; however, the range of normal values for the end-diastolic area is wide.<sup>177</sup>

Device malfunction is the third most common cause of death in long-term Thoratec HeartMate VAD assisted patients.<sup>178</sup> Device malfunctions leading to hypotension with decreased pump flow rates include inflow cannula obstruction and outflow cannula kinking. Clues to inflow conduit obstruction can be acquired by assessing color flow Doppler

of the normal laminar diastolic filling pattern into the apical cannula. In cases of cannula obstruction, the flow pattern is intermittently interrupted. Pulse-wave Doppler of the inflow cannula also may indicate periods of obstruction to flow. The most common cause of inflow cannula obstruction is deviation of the inflow cannula toward the interventricular septum (Fig. 51-25). Outflow graft obstruction may occur and is best diagnosed using contrast angiography, which will demonstrate an acute angle bend or “kinking” if obstruction is present.

### Hypotension and High LVAD Pump Flow Rates

Hypotension and high LVAD pump flow rates may present either in the immediate post-CPB period or after patients have been discharged from the hospital and the natural course of assist device decline and malfunction occurs. In LVAD patients who are hypotensive and demonstrate high flow rates, it is important to determine whether the right- and left-sided cardiac outputs are



**FIGURE 51-25.** Transesophageal midesophageal long-axis view showing anteroseptal malalignment of a left ventricular assist device (LVAD) inflow cannula (arrow), which can cause obstruction and hypotension associated with low LVAD output.

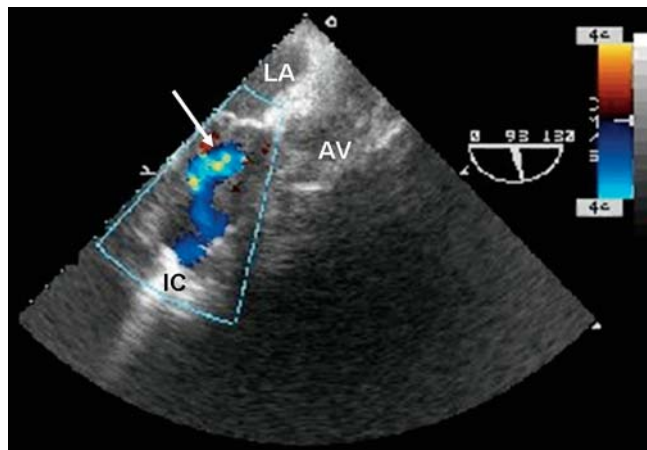


equal. This may require placement of a PAC to determine the right-sided cardiac output or performance of a TEE or transthoracic echocardiographic examination with calculation of right-sided cardiac output. High biventricular flow rates suggest sepsis. However, if left-sided significantly exceeds right-sided cardiac output, one of the following three etiologies must be ruled out: AI (Fig. 51-26), inflow valve regurgitation, or outflow valve regurgitation. In one prospective study, 26% of Thoratec HeartMate LVAD patients discharged from the hospital developed inflow valve regurgitation, 32% developed new AI, and 0% were identified as having outflow valve incompetence.<sup>179</sup>

AI develops in LVAD patients secondary to native valve distortion after LV decompression and diminished ejection through the native valve. LVAD inflow valve incompetence may be caused by endocarditis, a torn cusp, or commissural dehiscence of the LVAD prosthetic. Although the inflow valve cannot be directly viewed by TEE, clues to incompetency may be acquired by placing the color flow Doppler sector over the orifice of the inflow cannula during device systole. Backflow into the ventricle during device systole suggests inflow valve incompetence<sup>180</sup> (Fig. 51-27). AV opening may be a clue that inflow valve regurgitation exists, as up to 65% of LVAD patients with inflow valve regurgitation have been shown to demonstrate frequent AV opening versus only 19% of patients without inflow valve regurgitation.<sup>179</sup> In addition, echocardiographically acquired outflow graft velocity, velocity-time integral, and stroke volume all are significantly diminished in patients with inflow valve regurgitation.

### Anesthetic Management of VAD Patients for Noncardiac Surgery

As the population of patients with VADs increases, we can anticipate a greater number of these patients presenting for noncardiac surgical procedures that require perioperative anesthetic management. Because infection and thromboembolic events are the two most common causes of morbidity in long-term VAD-assisted patients, every effort should be made to correctly manage antibiotic prophylaxis, ensure the strictest sterile technique for invasive procedures, and manage anticoagulation therapy appropriately.



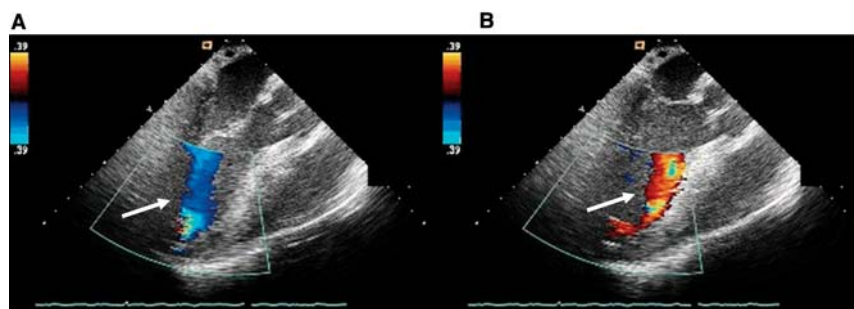
**FIGURE 51-26.** Transesophageal midesophageal aortic valve (AV) long-axis view showing a color flow Doppler jet of aortic regurgitation (AR; arrow) directed apically toward the inflow cannula (IC) of a left ventricular assist device (LVAD). AR in LVAD patients may lead to hypotension and increased output. LA, Left atrium.

Patients with long-term intracorporeal devices, such as the Thoratec HeartMate, suffer from delayed gastric emptying and early satiety because of the proximity of the device to the stomach. Cricoid pressure and a rapid sequence induction should be performed for these individuals if general anesthesia is desired. With the exception of patients with the Thoratec HeartMate, which has a titanium-covered pump chamber and requires only aspirin for anticoagulation, patients with most other VADs will require maintenance of some level of anticoagulation to prevent thromboembolic complications. Increased intraoperative bleeding should be anticipated. The surgeon and the anesthesiologist should discuss coagulation management prior to surgery. Giving small amounts of fresh-frozen plasma to achieve the lower limits of anticoagulation recommended by the device manufacturer may help control excessive blood loss. Regional

techniques usually are contraindicated secondary to the need for anticoagulation maintenance.

Fundamental anesthetic principles regarding decisions to intubate and extubate patients also apply in VAD-assisted patients. Although positive-pressure ventilation may affect venous return to the left heart and diminish LVAD filling, in most circumstances this is only a minor consideration, and mechanical ventilation should be implemented if needed. In addition, the VAD should be set on a “volume mode” prior to general anesthesia induction. Slight increases in preload and small decreases in afterload will optimize VAD filling and output.

Invasive monitoring is generally not necessary because the VAD control console continuously displays the device output. An arterial line can be inserted under strict sterile precautions if frequent blood gasses will be needed or if large alterations in blood pressure are anticipated. Otherwise, a



**FIGURE 51-27.** Transesophageal midesophageal long-axis views demonstrating normal laminar diastolic left ventricular assist device inflow (A; arrow), and a high-velocity jet of inflow valve regurgitation seen during device systole (B; arrow). Inflow valve regurgitation is the most common form of malfunction in HeartMate VE and XVE devices.

noninvasive blood pressure cuff usually is adequate. Finally, because the VAD-assisted patient likely was transported to the operating room on battery-assisted power, it is important to remember to reconnect the VAD to the power supply in the operating room to prevent battery failure.

## KEY REFERENCES

- Laffey J, Boylan J, Cheng D. The systemic inflammatory response to cardiac surgery. *Anesthesiology* 2002;97:215–252.
- Rady MY, Ryan T, Starr NJ. Perioperative determinants of morbidity and mortality in elderly patients undergoing cardiac surgery. *Crit Care Med* 1998;26:225–235.
- De Hert SG, Van der Linden PJ, Cromheecke S, et al. Choice of primary anesthetic regimen can influence intensive care unit length of stay after coronary surgery with cardiopulmonary bypass. *Anesthesiology* 2004;101:9–20.
- Smith RC, Leung JM, Mangano DT. Postoperative myocardial ischemia in patients undergoing coronary artery bypass graft surgery. S.P.I. Research Group. *Anesthesiology* 1991;74:464–473.
- Borer JS, Bonow RO. Contemporary approach to aortic and mitral regurgitation. *Circulation* 2003;108:2432–2438.
- Click RL, Abel MD, Schaff HV. Intraoperative transesophageal echocardiography: 5-year prospective review of impact on surgical management. *Mayo Clin Proc* 2000;75:241–247.
- Mckinlay KH, Schinderle DB, Swaminathan M, et al. Predictors of inotrope use during separation from cardiopulmonary bypass. *J Cardiothorac Vasc Anesth* 2004;18:404–408.
- Kouchoukos NT, Dougenis D. Surgery of the thoracic aorta. *N Engl J Med* 1997;336:1876–1888.
- Ling E, Arellano R. Systematic overview of the evidence supporting the use of cerebrospinal fluid drainage in thoracoabdominal aneurysm surgery for prevention of

paraplegia. *Anesthesiology* 2000;93:1115.

10. Rose EA, Moskowitz AJ, Packer M, et al. The REMATCH trial: rationale, design, and end-points. Randomized Evaluation of Mechanical Assistance for the Treatment of Congestive Heart Failure. *Ann Thorac Surg* 1999;67:723–730.

11. Stone ME, Soong W, Krol M, Reich DL. The anesthetic considerations in patients with ventricular assist devices presenting for non-cardiac surgery: a review of eight cases. *Anesth Analg* 2002;95:42–49.

12. Fukamachi K, McCarthy PM, Smedira NG, et al. Preoperative risk factors for right ventricular failure after implantable left ventricular assist device insertion. *Ann Thorac Surg* 1999;68:2181–2184.

## REFERENCES

- Sellke FW, DiMaio JM, Caplan LR, et al. Comparing on-pump and off-pump coronary artery bypass grafting: numerous studies but few conclusions: a scientific statement from the American heart Association council on cardiovascular surgery and anesthesia in collaboration with the interdisciplinary working group on quality of care and outcomes research. *Circulation* 2005;111:2858–2864.
- DeBaKey ME. John Gibbon and the heart-lung machine: a personal encounter and his import for cardiovascular surgery. *Ann Thorac Surg* 2003;76:S2188–S2194.
- Edmunds LH. Advances in the heart-lung machine after John and Mary Gibbon. *Ann Thorac Surg* 2003;76:S2220–S2223.
- Levy JH, Tanaka KA. Inflammatory response to cardiopulmonary bypass. *Ann Thorac Surg* 2003;75:S715–S720.
- Ascione R, Lloyd C, Underwood M, et al. Inflammatory response after coronary revascularization with or without cardiopulmonary bypass. *Ann Thorac Surg* 2000;69:1198–1204.
- Asimakopoulos G, Smith PLC, Ratnatunga CP, et al. Lung injury and acute respiratory distress syndrome after cardiopulmonary bypass. *Ann Thorac Surg* 1999;68:1107–1115.
- Boyle EM, Pohlman TH, Johnson MC, et al. The systemic inflammatory response. *Ann Thorac Surg* 1997;64:S31–S37.
- Shernan S. Perioperative myocardial ischemia-reperfusion injury. *Anesthesiology* Clin N Am 2003;2:465–485.
- Murkin JM. Transfusion trigger HCT 25%: above or below, which is better? Pro: HCT < 25% is better. *J Cardiothorac Vasc Anesth* 2004;18:234–237.
- Wall MH. Con: HCT > 25% is better. *J Cardiothorac Vasc Anesth* 2004;18:238–241.
- Kersten JR, Warltier DC, Pagel PS. Aggressive control of intraoperative blood glucose concentration: a shifting paradigm? [Editorial]. *Anesthesiology* 2005;103:677–678.
- Royston D, Kovesi T, Marczin N. The unwanted response to cardiac surgery: time for a reappraisal? [Editorial]. *J Thorac Cardiovasc Surg* 2003;125:32–35.
- Laffey J, Boylan J, Cheng D. The systemic inflammatory response to cardiac surgery. *Anesthesiology* 2002;97:215–252.
- Chaney MA. Corticosteroids and cardiopulmonary bypass: a review of clinical investigations. *Chest* 2002;121:921–931.
- Mojcik CF, Levy JH. Aprotinin and the systemic inflammatory response after cardiopulmonary bypass. *Ann Thorac Surg* 2001;71:745–754.
- Verrier E, Shernan S, Taylor K, et al., for the PRIMO-CABG. Terminal complement blockade with pexelizumab during coronary artery graft surgery requiring cardiopulmonary bypass: PRIMO-CABG randomized trial. *JAMA* 2004;291:2319–2327.
- Hirsh J, Anand SS, Halperin JL, et al. Guide to anticoagulant therapy: heparin. A statement for healthcare professionals from the American Heart Association. *Circulation* 2001;103:2994–3018.
- Frederiksen JW. Cardiopulmonary bypass in humans: bypassing unfractionated heparin. *Ann Thorac Surg* 2000;70:1434–1443.
- Despotis GJ, Gravelee G, Filos K, et al. Anticoagulation monitoring during cardiac surgery: a review of current and emerging techniques. *Anesthesiology* 1999;91:1122–1151.
- Teoh KHT, Young E, Blackall MH, et al. Can extra protamine eliminate heparin rebound following cardiopulmonary bypass surgery? *J Thorac Cardiovasc Surg* 2004;128:211–219.
- Welsby IJ, Newman MF, Phillips-Bute B, et al. Hemodynamic changes after protamine administration: association with mortality after coronary artery bypass surgery. *Anesthesiology* 2005;102:308–314.
- Warkentin TE, Greinacher A. Heparin-induced thrombocytopenia and cardiac surgery. *Ann Thorac Surg* 2003;76:2121–2131.
- Serna DL, Thourani VH, Puskas JD. Antifibrinolytic agents in cardiac surgery: current controversies. *Semin Thorac Cardiovasc Surg* 2005;17:52–58.
- Sedrakyan A, Treasure T, Elefteriades JA. Effect of aprotinin on clinical outcomes in coronary artery bypass graft surgery: a systematic review and meta-analysis of randomized clinical trials. *J Thorac Cardiovasc Surg* 2004;128:442–448.
- Mangano DT, Tudor IC, Dietzel C. The risk associated with aprotinin in cardiac surgery. *N Engl J Med* 2006;354:353–365.
- Fanashawe MP, Shore-Lesserson L, Reich DL. Two cases of fatal thrombosis

after aminocaproic acid therapy and deep hypothermic circulatory arrest. *Anesthesiology* 2001;95:1525–1527.

27. Savage R, Aronson S, Navia J, et al. Intraoperative echocardiography is indicated in high-risk coronary artery bypass grafting. *Ann Thorac Surg* 1997;64:368–373.

28. Mishra M, Chauhan R, Sharma KK, et al. Real-time intraoperative TEE—how useful? Experience of 5,016 cases. *J Cardiothorac Vasc Anesth* 1998;12:625–632.

29. Fox J, Friedrich A, Formanek V, et al. Intraoperative echocardiography. In Cohn L, Edmunds LH, eds. *Cardiac Surgery in the Adult*. 2nd ed. New York: McGraw-Hill, 2003:283–314.

30. Fox J, Glas K, Swaminathan M, et al. The impact of intraoperative echocardiography on clinical outcomes following adult cardiac surgery. *Semin Cardiothorac Vasc Anesth* 2005;9:25–40.

31. Kaukoranta PK, Lepojarvi MV, Kiviluoma KT, et al. Myocardial protection during antegrade versus retrograde cardioplegia. *Ann Thorac Surg* 1998;66:755–761.

32. Klocke FJ, Mates RE, Cauty JM Jr, et al. Coronary pressure-flow relationships. Controversial issues and probable implications. *Circ Res* 1985;56:310–323.

33. Duncker DJ, Van Zon NS, Crampton M, et al. Coronary pressure-flow relationship and exercise: contributions of heart rate, contractility, and alpha 1-adrenergic tone. *Am J Physiol* 1994;266(2 Pt 2):H795–H810.

34. Rainer C, Kawanishi DT, Chandraratna PA, et al. Changes in blood rheology in patients with stable angina pectoris as a result of coronary artery disease. *Circulation* 1987;76:15–20.

35. Boudoulas H, Rittgers SE, Lewis RP, et al. Changes in diastolic time with various pharmacologic agents: implication for myocardial perfusion. *Circulation* 1979;60:164–169.

36. Andersson B, Lomsky M, Waagstein F. The link between acute haemodynamic adrenergic beta-blockade and long-term effects in patients with heart failure. A study on diastolic function, heart rate and myocardial metabolism following intravenous metoprolol. *Eur Heart J* 1993;14:1375–1385.

37. Hongo M, Nakatsuka T, Watanabe N, et al. Effects of heart rate on phasic coronary blood flow pattern and flow reserve in patients with normal coronary arteries: a study with an intravascular Doppler catheter and spectral analysis. *Am Heart J* 1994;127:545–551.

38. McGinn AL, White CW, Wilson RF. Interstudy variability of coronary flow reserve. Influence of heart rate, arterial pressure, and ventricular preload. *Circulation* 1990;81:1319–1330.

39. Goto Y, Futaki S, Kawaguchi O, et al. Coupling between regional myocardial oxygen consumption and contraction under altered preload and afterload. *J Am Coll Cardiol* 1993;21:1522–1531.

40. Weiskopf RB, Viele MK, Feiner J, et al. Human cardiovascular and metabolic re-

sponse to acute, severe isovolemic anemia. *JAMA* 1998;279:217–221.

41. Leung JM, Weiskopf RB, Feiner J, et al. Electrocardiographic ST-segment changes during acute, severe isovolemic hemodilution in humans. *Anesthesiology* 2000;93:1004–1010.

42. Fontana JL, Welborn L, Mongan PD, et al. Oxygen consumption and cardiovascular function in children during profound intraoperative normovolemic hemodilution. *Anesth Analg* 1995;80:219–225.

43. Rady MY, Ryan T, Starr NJ. Perioperative determinants of morbidity and mortality in elderly patients undergoing cardiac surgery. *Crit Care Med* 1998;26:225–235.

44. Bracey AW, Radovancevic R, Riggs SA, et al. Lowering the hemoglobin threshold for transfusion in coronary artery bypass procedures: effect on patient outcome. *Transfusion* 1999;39:1070–1077.

45. Zaugg M, Tagliente T, Lucchinetti E, et al. Beneficial effects from beta-adrenergic blockade in elderly patients undergoing noncardiac surgery. *Anesthesiology* 1999;91:1674–1686.

46. Poldermans D, Boersma E, Bax JJ, et al. The effect of bisoprolol on perioperative mortality and myocardial infarction in high-risk patients undergoing vascular surgery. Dutch Echocardiographic Cardiac Risk Evaluation Applying Stress Echocardiography Study Group. *N Engl J Med* 1999;341:1789–1794.

47. Yeager RA, Moneta GL, Edwards JM, et al. Reducing perioperative myocardial infarction following vascular surgery. The potential role of beta-blockade. *Arch Surg* 1995;130:869–872.

48. Auerbach AD, Goldman L. beta-Blockers and reduction of cardiac events in noncardiac surgery: scientific review. *JAMA* 2002;287:1435–1444.

49. Hjalmarson A, Goldstein S, Fagerberg B, et al. Effects of controlled-release metoprolol on total mortality, hospitalizations, and well-being in patients with heart failure: the Metoprolol CR/XL Randomized Intervention Trial in congestive heart failure (MERIT-HF). MERIT-HF Study Group. *JAMA* 2000;283:1295–1302.

50. Reiken S, Wehrens XH, Vest JA, et al. Beta-blockers restore calcium release channel function and improve cardiac muscle performance in human heart failure. *Circulation* 2003;107:2459–2466.

51. VanDenKerkhof EG, Milne B, Parlow JL. Knowledge and practice regarding prophylactic perioperative beta blockade in patients undergoing noncardiac surgery: a survey of Canadian anesthesiologists. *Anesth Analg* 2003;96:1558–1565.

52. Biddle TL, Yu PN. Effect of furosemide on hemodynamics and lung water in acute pulmonary edema secondary to myocardial infarction. *Am J Cardiol* 1979;43:86–90.

53. Hoyt JD, Leatherman JW. Interpretation of the pulmonary artery occlusion pressure in mechanically ventilated pa-

tients with large respiratory excursions in intrathoracic pressure. *Intensive Care Med* 1997;23:1125–1131.

54. Burkhoff D, de Tombe PP, Hunter WC, et al. Contractile strength and mechanical efficiency of left ventricle are enhanced by physiological afterload. *Am J Physiol* 1991;260(2 Pt 2):H569–H578.

55. Mandarino WA, Pinsky MR, Gorcsan J 3rd. Assessment of left ventricular contractile state by preload-adjusted maximal power using echocardiographic automated border detection. *J Am Coll Cardiol* 1998;31:861–868.

56. Chertow GM, Lazarus JM, Christiansen CL, et al. Preoperative renal risk stratification. *Circulation* 1997;95:878–884.

57. Suen WS, Mok CK, Chiu SW, et al. Risk factors for development of acute renal failure requiring dialysis in patients undergoing cardiac surgery. *Angiology* 1998;49:789–800.

58. Leung JM, Voskarian A, Bellows WH, et al. Automated electrocardiograph ST segment trending monitors: accuracy in detecting myocardial ischemia. *Anesth Analg* 1998;87:4–10.

59. London MJ, Hollenberg M, Wong MG, et al. Intraoperative myocardial ischemia: localization by continuous 12-lead electrocardiography. *Anesthesiology* 1988;69:232–241.

60. Jain U. Electrocardiographic determination of perioperative myocardial ischemia and stunning. *J Card Surg* 1994;9(3 Suppl):413–416.

61. Tuman KJ, McCarthy RJ, Spiess BD, et al. Effect of pulmonary artery catheterization on outcome in patients undergoing coronary artery surgery. *Anesthesiology* 1989;70:199–206.

62. Reich DL, Bodian CA, Krol M, et al. Intraoperative hemodynamic predictors of mortality, stroke, and myocardial infarction after coronary artery bypass surgery. *Anesth Analg* 1999;89:814–822.

63. American Society of Anesthesiologists Task Force on Pulmonary Artery Catheterization. Practice guidelines for pulmonary artery catheterization: an updated report by the American Society of Anesthesiologists Task Force on Pulmonary Artery Catheterization. *Anesthesiology* 2003;99:988–1014.

64. Sprung CL, Elser B, Schein RM, et al. Risk of right bundle-branch block and complete heart block during pulmonary artery catheterization. *Crit Care Med* 1989;17:1–3.

65. Murkin JM, Adams S, Novick RJ, et al. Monitoring brain oxygen saturation during coronary bypass surgery: a randomized, prospective study. *Anesth Analg* 2007;104:51–58.

66. Wang JY, Winship SM, Thomas SD, et al. Induction of anaesthesia in patients with coronary artery disease: a comparison between sevoflurane-remifentanyl and fentanyl-etomidate. *Anaesth Intensive Care* 1999;27:363–368.



67. Starr NJ, Sethna DH, Estafanous FG. Bradycardia and asystole following the rapid administration of sufentanil with vecuronium. *Anesthesiology* 1986;64:521-533.
68. Samuelson PN, Reves JG, Kouchoukos NT, et al. Hemodynamic responses to anesthetic induction with midazolam or diazepam in patients with ischemic heart disease. *Anesth Analg* 1981;60:802-809.
69. Muzi M, Berens RA, Kampine JP, et al. Venodilation contributes to propofol-mediated hypotension in humans. *Anesth Analg* 1992;74:877-883.
70. Djaiani G, Fedorko L, Beattie WS. Regional anesthesia in cardiac surgery: a friend or a foe? *Semin Cardiothorac Vasc Anesth* 2005;9:87-104.
71. Bartal J, Graber R, Markowitz AH, et al. Case 6-2006 percutaneous superior vena cava cannulation for repeat sternotomy in cardiac operations. *J Cardiothorac Vasc Anesth* 2006;20:881-887.
72. Phillips AS, McMurray TJ, Mirakhor RK, et al. Propofol-fentanyl anesthesia: a comparison with isoflurane-fentanyl anesthesia in coronary artery bypass grafting and valve replacement surgery. *J Cardiothorac Vasc Anesth* 1994;8:289-296.
73. De Hert SG, Van der Linden PJ, Cromheecke S, et al. Choice of primary anesthetic regimen can influence intensive care unit length of stay after coronary surgery with cardiopulmonary bypass. *Anesthesiology* 2004;101:9-20.
74. Kersten JR, Schmeling TJ, Pagel PS, et al. Isoflurane mimics ischemic preconditioning via activation of K(ATP) channels: reduction of myocardial infarct size with an acute memory phase. *Anesthesiology* 1997;87:361-370.
75. Ismaeil MS, Tkachenko I, Gamperl AK, et al. Mechanisms of isoflurane-induced myocardial preconditioning in rabbits. *Anesthesiology* 1999;90:812-821.
76. Toller WG, Kersten JR, Gross ER, et al. Isoflurane preconditions myocardium against infarction via activation of inhibitory guanine nucleotide binding proteins. *Anesthesiology* 2000;92:1400-1407.
77. Belhomme D, Peynet J, Florens E, et al. Is adenosine preconditioning truly cardioprotective in coronary artery bypass surgery? *Ann Thorac Surg* 2000;70:590-594.
78. Nader ND, Li CM, Khadra WZ, et al. Anesthetic myocardial protection with sevoflurane. *J Cardiothorac Vasc Anesth* 2004;18:269-274.
79. Boutros A, Wang J, Capuano C. Isoflurane and halothane increase adenosine triphosphate preservation, but do not provide additive recovery of function after ischemia, in preconditioned rat hearts. *Anesthesiology* 1997;86:109-117.
80. De Hert SG, Cromheecke S, ten Broecke PW, et al. Effects of propofol, desflurane, and sevoflurane on recovery of myocardial function after coronary surgery in elderly high-risk patients. *Anesthesiology* 2003;99:314-323.
81. De Hert SG, Van der Linden PJ, Cromheecke S, et al. Cardioprotective properties of sevoflurane in patients undergoing coronary surgery with cardiopulmonary bypass are related to the modalities of its administration. *Anesthesiology* 2004;101:299-310.
82. Kolessov VI. Mammary artery-coronary artery anastomosis as method of treatment for angina pectoris. *J Thorac Cardiovasc Surg* 1967;54:535-544.
83. Ankeney JL. Off-pump bypass surgery: the early experience 1969-1985. *Tex Heart Inst J* 2004;31:210-213.
84. Conzen PF, Fischer S, Detter C, et al. Sevoflurane provides greater protection of the myocardium than propofol in patients undergoing off-pump coronary artery bypass surgery. *Anesthesiology* 2003;99:826-833.
85. Myles PS, Daly DJ, Djaiani G, et al. A systematic review of the safety and effectiveness of fast-track cardiac anesthesia. *Anesthesiology* 2003;99:982-987.
86. Smith RC, Leung JM, Mangano DT. Postoperative myocardial ischemia in patients undergoing coronary artery bypass graft surgery. S.P.I. Research Group. *Anesthesiology* 1991;74:464-473.
87. Batchelor WB, Anstrom KJ, Muhlbaier LH, et al. Contemporary outcome trends in the elderly undergoing percutaneous coronary interventions: results in 7,472 octogenarians. National Cardiovascular Network Collaboration. *J Am Coll Cardiol* 2000;36:723-730.
88. Borer JS, Bonow RO. Contemporary approach to aortic and mitral regurgitation. *Circulation*;2003;108:2432-2438.
89. Yacoub MH, Cohn LH. Novel approaches to cardiac valve repair. From structure to function, part two. *Circulation* 2004;109:1064-1072.
90. Ling H, Enriquez-Sarano M, Seward J, et al. Clinical outcome of mitral regurgitation due to flail leaflets. *N Engl J Med* 1996;335:1417-1423.
91. Bassco C, Boschello M, Perrone C, et al. An echocardiographic survey of primary school children for bicuspid aortic valve. *Am J Cardiol* 2004;93:661-663.
92. Fedax PWM, de Sa MPL, Verma S, et al. Vascular matrix remodeling in patients with bicuspid aortic valve malformations: implications for aortic aneurysms. *J Cardiovasc Surg* 2003;126:797-806.
93. Boyum J, Fellner EK, Schmoker JD, et al. Matrix metalloproteinase activity in thoracic aortic aneurysms associated with bicuspid and tricuspid valves. *J Thorac Cardiovasc Surg* 2004;127:686-691.
94. Bergler-Klein J, Klaar U, Heger M, et al. Natriuretic peptides predict symptom free survival and post-operative outcome in severe aortic stenosis. *Circulation* 2004;109:2302-2308.
95. Nowrangi SK, Connolly HM, Freeman WK, et al. Impact of intraoperative transesophageal echocardiography among patients undergoing aortic valve replacement for aortic stenosis. *J Am Soc Echocardiogr* 2001;14:863-86.
96. Click RL, Abel MD, Schaff HV. Intraoperative transesophageal echocardiography: 5-year prospective review of impact on surgical management. *Mayo Clin Proc* 2000;75:241-247.
97. Cheitlin MD, Armstrong MW, Aurigemma GpP et al. ACC/AHA/ASE 2003. Guidelines for the clinical application of echocardiography: summary article. A report of the American College of Cardiology/American Heart Association Task Force on Practice Guidelines. *J Am Soc Echocardiogr* 2003;10:1091-1110.
98. Thys D. Practice guidelines for perioperative transesophageal echocardiography. A report by the American Society of Anesthesiologists and the Society of Cardiovascular Anesthesiologists Task Force on Transesophageal Echocardiography. *Anesthesiology* 1996;84:986-1006.
99. Dourvas IN, Parharidas GE, Efthimiadas GK, et al. Right ventricular diastolic function in patients with chronic aortic regurgitation. *Am J Cardiol* 2004;93:115-117.
100. Wood P. Hypertensive heart disease. In: *Diseases of the Heart and Circulation*. 2nd rev ed. London: Eyre and Spottiswoode, 1956:761-805.
101. Lappas DG, Skubas NJ, Lappas GD, et al. Prevalence of left ventricular diastolic filling abnormalities in adult cardiac surgical patients: an intraoperative echocardiographic study. *Semin Thorac Cardiovasc Surg* 1999;11:125-133.
102. Djaiani GN, Shernan SK. Intraoperative assessment of diastolic function: utility of echocardiography. *Curr Opin Anaesthesiol* 2003;16:11-19.
103. Edmonds HL Jr. Protective effect of neuromonitoring during cardiac surgery. *Ann N Y Acad Sci* 2005;1053:12-19.
104. Wang Y, Yue Y, Sun YH, et al. Investigation and analysis of incidence of awareness in patients undergoing cardiac surgery. *Chin Med J (Engl)* 2005;118:1190-1194.
105. Sebel PS, Bowdle TA, Ghoneim MM, et al. The incidence of awareness during anesthesia: a multicenter United States study. *Anesth Analg* 2004;3:833-839.
106. Myles PS, McLroy D. Fast-track cardiac anesthesia: choice of anesthetic agents and techniques. *Semin Cardiothorac Vasc Anesth* 2005;9:5-16.
107. Myles PS, McLroy D. Fast track cardiac anesthesia: choice of anesthetic agents and techniques. *Semin Cardiothorac Vasc Anesth* 2005;9:5-16.
108. Canto M, Casas A, Sanchez MJ, et al. Thoracic epidurals in heart valve surgery: neurologic risk evaluation. *J Thorac Vasc Anesth* 2002;16:723-726.
109. Hemmerling TM, Le N, Oliver JF, et al. Immediate extubation after aortic valve surgery using high thoracic epidural analgesia or opioid-based analgesia. *J Cardiothorac Vasc Anesth* 2005;19:176-181.



110. Schachner T, Bonatti J, Balogh D, et al. Aortic valve replacement in the conscious patient under regional anesthesia without endotracheal intubation. *J Thorac Cardiovasc Surg* 2003;125:1526-1527.
111. Klokocovnik T, Hollan J, Sostaric M, et al. Minimally invasive aortic valve replacement under thoracic epidural anesthesia in a conscious patient. *Heart Surg Forum* 2004;7:E196-E197.
112. Rozich JD, Carabello BA, Usher BW, et al. Mitral valve replacement with and without chordal preservation in patients with chronic mitral regurgitation: mechanisms for differences in post-operative ejection fractions. *Circulation* 1992;86:1718-1726.
113. Mckinlay KH, Schinderle DB, Swaminathan M, et al. Predictors of inotrope use during separation from cardiopulmonary bypass. *J Cardiothorac Vasc Anesth*;2004;18:404-408.
114. Blais C, Dumesnil JG, Baillot R, et al. Impact of valve prosthesis-patient mismatch on short-term mortality after aortic valve replacement. *Circulation* 2003;108:983-988.
115. Ruel M, Rubens FD, Masters RG, et al. Late incidence and predictors of persistent or recurrent heart failure in patients with aortic prosthetic valves. *J Thorac Cardiovasc Surg* 2004;127:149-159.
116. Chu VH, Caball CH, Benjamin DK, et al. Early predictors of in-hospital death in infective endocarditis. *Circulation* 2004;109:1745-1749.
117. Iung B, Rousseau-Piziaud J, Coruier B, et al. Contemporary results of mitral valve repair for infective endocarditis. *J Am Coll Cardiol* 2004;43:386-392.
118. Monin JL, Quere JP, Monchi M, et al. Low-gradient aortic stenosis: operative risk stratification and predictors for long-term outcome. A multicenter study using dobutamine stress hemodynamics. *Circulation* 2003;108:319-324.
119. Taniguchi K, Nakano S, Kawashima Y, et al. Left ventricular ejection performance, wall stress, and contractile state in aortic regurgitation before and after aortic valve replacement. *Circulation* 1990;82:798-807.
120. Tasca G, Brunelli F, Cirillo M, et al. Mass regression in aortic stenosis after valve replacement with small size pericardial bioprosthesis. *Ann Thorac Surg* 2003;76:1107-1113.
121. Minakata K, Schaff HV, Zehr KJ, et al. Is repair of aortic valve regurgitation a safe alternative to replacement? *J Thorac Cardiovasc Surg* 2004;127:645-653.
122. Starling MR. Effects of valve surgery on left ventricular contractile function in patients with long-term mitral regurgitation. *Circulation* 1995;92:811-818.
123. Enriquez-Sarano M, Avierinos JF, Messika-Zeitoun D, et al. Quantitative determinants of the outcome of asymptomatic mitral regurgitation. *N Engl J Med* 2005;352:875-883.
124. Babaliaros V, Block P. State of the art percutaneous intervention for the treatment of valvular heart disease: a review of the current technologies and ongoing research in the field of percutaneous valve replacement and repair. *Cardiology* 2006;107:87-96.
125. Kouchoukos NT, Dougenis D. Surgery of the thoracic aorta. *N Engl J Med* 1997;336:1876-1888.
126. Katzen BT, Dake MD, MacLean AA, et al. Endovascular repair of abdominal and thoracic aortic aneurysms. *Circulation* 2005;112:1663-1675.
127. Pantin EJ, Cheung AT. Transesophageal echocardiographic evaluation of the aorta and pulmonary artery. In Konstadt SN, Shernan S, Oka Y, eds. *Clinical Transesophageal Echocardiography. A Problem Oriented Approach*. 2nd ed. Philadelphia; Lippincott Williams & Wilkins, 2003:215-244.
128. Pressler V, McNamara JJ. Aneurysm of the thoracic aorta. Review of 260 cases. *J Thorac Cardiovasc Surg* 1985;89:50.
129. Movsowitz HD, Levine RA, Hilgenberg AD, et al. Transesophageal echocardiographic description of the mechanisms of aortic regurgitation in acute type A aortic dissection: implications for aortic valve repair. *J Am Coll Cardiol* 2000;36:884-890.
130. Borger MA, Preston M, Ivanov J, et al. Should the ascending aorta be replaced more frequently in patients with bicuspid aortic valve disease? *J Thorac Cardiovasc Surg* 2004;128:677-683.
131. Isselbacher EM. Thoracic and abdominal aortic aneurysms. *Circulation* 2005;111:816-828.
132. Elefteriades JA. Natural history of thoracic aortic aneurysms: indications for surgery, and surgical versus nonsurgical risks. *Thorac Surg* 2002;74:S1877-S1880.
133. Stecker MM, Cheung AT, Pochettino A, et al. Deep hypothermic circulatory arrest: I. Effects of cooling on electroencephalogram and evoked potentials. *Ann Thorac Surg* 2001;71:14.
134. Croughwell N, Smith LR, Quill T, et al. The effect of temperature on cerebral metabolism and blood flow in adults during cardiopulmonary bypass. *J Thorac Cardiovasc Surg* 1992;103:549-554.
135. Cheung AT, Bavaria JE, Pochettino A, et al. Oxygen delivery during retrograde cerebral perfusion in humans. *Anesth Analg* 1999;88:8-15.
136. Reich D, Uysal S, Sliwinski M, et al. Neuropsychologic outcome after deep hypothermic circulatory arrest in adults. *J Thorac Cardiovasc Surg* 1999;117:156.
137. Pochettino A, Cheung AT. Pro: Retrograde cerebral perfusion is useful for deep hypothermic circulatory arrest. *J Cardiothorac Vasc Anesth* 2003;17:764-767.
138. Reich DL, Uysal S. Con: Retrograde cerebral perfusion is not an optimal method of neuroprotection in thoracic aortic surgery. *J Cardiothorac Vasc Anesth* 2003;17:768-769.
139. Coselli JS, LeMaire SA, Miller CC 3rd, et al. Mortality and paraplegia after thoracoabdominal aortic aneurysm repair: a risk factor analysis. *Ann Thorac Surg* 2000;69:409-414.
140. Safi HJ, Hess KR, Randel M, et al. Cerebrospinal fluid drainage and distal aortic perfusion: reducing neurologic complications in repair of thoracoabdominal aortic aneurysm types I and II. *J Vasc Surg* 1996;23:223.
141. Kouchoukos NT, Masetti P, Rokkas CK, et al. Hypothermic cardiopulmonary bypass and circulatory arrest for operations on the descending thoracic and thoracoabdominal aorta. *Ann Thorac Surg* 2002;74:S1885-S1887.
142. Cheung AT, Weiss SJ, McGarvey ML, et al. Interventions for reversing delayed-onset postoperative paraplegia after thoracic aortic reconstruction. *Ann Thorac Surg* 2002;74:413-419.
143. Cheung AT, Pochettino A, McGarvey M, et al. Strategies to manage paraplegia risk after endovascular stent repair of descending thoracic aortic aneurysms. *Ann Thoracic Surg* 2005;80:1280-1289.
144. Guerit JM, Witdoeck C, Verhelst R, et al. Sensitivity, specificity, and surgical impact of somatosensory evoked potentials in descending aorta surgery. *Ann Thorac Surg* 1999;67:1943-1946.
145. Coselli JS, Lemaire SA, Koksoy C, et al. Cerebrospinal fluid drainage reduces paraplegia after thoracoabdominal aortic aneurysm repair: results of a randomized clinical trial. *J Vasc Surg* 2002;35:631-639.
146. Ling E, Arellano R. Systematic overview of the evidence supporting the use of cerebrospinal fluid drainage in thoracoabdominal aneurysm surgery for prevention of paraplegia. *Anesthesiology* 2000;93:1115.
147. Cheung AT, Pochettino A, Guvakov DV, et al. Safety of lumbar drains in thoracic aortic operations performed with extracorporeal circulation. *Ann Thorac Surg* 2003;76:1190-1196.
148. Nienaber CA, Eagle KA. Aortic dissection: new frontiers in diagnosis and management: part I. from etiology to diagnostic strategies. *Circulation* 2003;108:628-635.
149. Nienaber CA, Eagle KA. Aortic dissection: new frontiers in diagnosis and management: part II. Therapeutic management and follow-up. *Circulation* 2003;108:772-778.
150. von Kodolitsch Y, Csosz SK, Koschyk DH, et al. Intramural hematoma of the aorta: predictors of progression to dissection and rupture. *Circulation* 2003;107:1158-1163.
151. Hagan PG, Nienaber CA, Isselbacher EM, et al. The international registry of acute aortic dissection (IRAD): new insights into an old disease. *JAMA* 2000;283:897.
152. Estrera AL, Garami Z, Miller C 3rd, et al. Cerebral monitoring with transcranial Doppler ultrasonography improves neuro-

- logic outcome during repairs of acute type A aortic dissection. *J Thor Cardiovascul Surg* 2005;129:277-285.
153. DeBaakey ME. Left ventricular bypass for cardiac assistance. *Am J Cardiol* 1971; 27:3-11.
154. Westaby S. Ventricular assist devices as destination therapy. *Surg Clin N Am* 2004;84:91-123.
155. Kherani AR, Oz MC. Ventricular assistance to bridge to transplantation. *Surg Clin N Am* 2004;84:75-89.
156. Rose EA, Moskowitz AJ, Packer M, et al. The REMATCH trial: rationale, design, and end-points. Randomized Evaluation of Mechanical Assistance for the Treatment of Congestive Heart Failure. *Ann Thorac Surg* 1999;67:723-730.
157. Park SJ, Tector AT, Piccioni W, et al. Left ventricular assist devices as destination therapy: a new look at survival. *J Thorac Cardiovasc Surg* 2005;129:9-17.
158. Entwistle JWC. Short-and long-term mechanical ventricular assistance towards myocardial recovery. *Surg Clin N Am* 2004; 84:201-221.
159. Nussmeier NA, Probert CB, Hirsch D, et al. Anesthetic management for implantation of the Jarvik 2000 left ventricular assist system. *Anesth Analg* 2003;97:964-971.
160. Stone ME, Soong W, Krol M, et al. The anesthetic considerations in patients with ventricular assist devices presenting for noncardiac surgery: a review of eight cases. *Anesth Analg* 2002;95:42-49.
161. Samuels LE, Holmes EC, Thomas MP, et al. Management of acute cardiac failure with mechanical assist: experience with the ABIOMED BVS 5000. *Ann Thorac Surg* 2001;71(Suppl 3): S67-S72.
162. Samuels LE, Kaufman MS, Thomas MP, et al. Pharmacologic criteria for ventricular assist device insertion: experience with the ABIOMED BVS 5000. *J Card Surg* 1999;14:288-293.
163. DiGiorgi PL, Naka Y, Oz MC. Left ventricular assist devices. *Contemp Cardiol Surg Manage Congest Heart Failure* 2001;7: 155-189.
164. Scalia GM, McCarthy PM, Savage RM, et al. Clinical utility of echocardiography in the management of implantable ventricular assist devices. *J Am Soc Echocardiogr* 2000;13:754-763.
165. Holman WL, Bourge RC, Fan P, et al. Influence of longer term left ventricular assist device support on valvular regurgitation. *ASAIO J* 1994;40:M454-M459.
166. Baldwin RT, Duncan JM, Frazier OH, et al. Patent foramen ovale: a cause of hypoxemia in patients on left ventricular support. *Ann Thorac Surg* 1991;52:865-867.
167. Zabalgoitia-Reyes M, Herrera C, Ganghi DK, et al. A possible mechanism for neurologic ischemic events in patients with atrial septal aneurysm. *Am J Cardiol* 1990; 66:761-764.
168. Mugge A, Daniel WG, Angermann C, et al. Atrial septal aneurysm in adult patients. A multicenter study using transthoracic and transesophageal echocardiography. *Circulation* 1995;91:2785-2792.
169. Augoustides J, Mancini DJ, Horak J, et al. Case-1-2003. The use of intraoperative echocardiography during insertion of ventricular assist devices. *J Cardiothorac Vasc Anesth* 2003;17: 113-120.
170. Santamore WP, Gray LA. Left ventricular contributions to right ventricular systolic function during LVAD support. *Ann Thorac Surg* 1996;61:350-356.
171. Ochai Y, McCarthy PM, Smedira NG, et al. Predictors of severe right heart failure after implantable left ventricular assist device insertion: analysis of 245 patients. *Circulation* 2002;106(12 Suppl 1):I198-I202.
172. Fukamachi K, McCarthy PM, Smedira NG, et al. Preoperative risk factors for right ventricular failure after implantable left ventricular assist device insertion. *Ann Thorac Surg* 1999;68:2181-2184.
173. Beppu S, Tanaka N, Noda H, et al. High incidence of left ventricular thrombosis and systemic embolism in patients with left ventricular assist system. *J Cardiol* 1992;22:713-720.
174. Wilhelm, MJ, Hammel D, Schmid C, et al. Clinical experience with nine patients supported by the continuous flow Debaakey VAD. *J Heart Lung Transplant* 2001;20:201.
175. Otto, C. Echocardiographic evaluation of cardiac masses and potential cardiac "source of embolus." In Otto C, ed. *Textbook of Clinical Echocardiography*. 2nd ed. Philadelphia: WB Saunders, 2000;14:360-362.
176. Bruch C, Schemermund A, Dagres N, et al. Changes in QRS voltage in cardiac tamponade and pericardial effusion: reversibility after pericardiocentesis and after anti-inflammatory drug treatment. *J Am Coll Cardiol* 2001;38:219-226.
177. Lobato E, Urdaneta F. Transesophageal echocardiography in the intensive care unit. In Perrino AC, Reeves ST, eds. *A Practical Approach to Transesophageal Echocardiography*. Philadelphia: Lippincott William & Wilkins, 2003;17:272-285.
178. Poirier V, Burke E, Fryc R, et al. Diagnosing left ventricular assist system-related malfunctions. *Advanced practice guidelines for HeartMate destination therapy*. 2004;2:30-37.
179. Horton SC, Khoaverdian R, Chatelain P, et al. Left ventricular assist device malfunction. *JACC* 2005;45:1435-1440.
180. Collard CD, Body SC. Endocarditis of a left ventricular assist device resulting in regurgitant flow. *Anesth Analg* 2003;97: 1542-1551.

## CHAPTER 52

## Anesthesia for Surgical Treatment of Congenital Heart Disease: A Problem-Oriented Approach

James S. Harrington, MD,  
Avinash C. Shukla, MBBS,  
and Paul R. Hickey, MD

The goal of anesthetic management in the treatment of patients with congenital heart disease (CHD) is maintenance of circulatory homeostasis despite the destabilizing events accompanying therapeutic procedures. Anesthesia for management of CHD is complicated by the diversity of lesions and the variety of therapeutic approaches. Congenital cardiac defects vary widely in severity, anatomic combinations, and pathophysiologic conditions. Complex cardiovascular pathophysiologic conditions change dynamically with time and with organ development and therapeutic interventions. In these circumstances, simple formulas for anesthetic management are not valid. The pathophysiology of each lesion and its alteration by previous medical and surgical treatment and by the proposed procedure should be individually considered in planning anesthetic management. Major interventional procedures in the catheterization laboratory are increasingly replacing or supplementing surgical procedures. Their anesthetic management also should be considered. Such transcatheter procedures can cause profound changes in homeostasis and often require anesthesia, particularly in children. Thus, anesthetic considerations for these transcatheter interventional procedures have been included. Anesthetic management of CHD is first approached by focusing on common pathophysiologic problems related to specific cardiac defects and previous therapeutic interventions. Understanding these problems is critical for determining anesthetic management priorities. Knowledge of the effects of anesthetics, manipulations, and ad-

## KEY POINTS

1. Congenital heart diseases that decrease cardiopulmonary reserve include intracardiac shunting, hypoxemia from inadequate pulmonary blood flow or intracardiac shunting, congestive failure from volume or pressure overload, vascular obstructive disease from excessive pulmonary blood flow, various kinds of stenoses, and occasional coronary ischemia.
2. Many of the determinants of shunting (its magnitude and direction) may change considerably during anesthesia and operative manipulations.
3. There are simple shunts, bidirectional shunts, and occasionally complex shunts. The key for anesthesia providers is understanding the effects of vasodilators, cardiac depressants, and surgical manipulation on these various shunts.
4. “Bubble discipline” is an important concept in dealing with anesthesia administration for patients with congenital heart disease.
5. Chronic hypoxia leads to polycythemia, which, in turn, leads to dramatic increases in blood viscosity.
6. The anesthesia provider should understand the hemodynamic consequences of pulmonary vascular hypertrophy, the end stage of which is the Eisenmenger syndrome.
7. Even though a child with congenital heart disease may not have frank failure, cardiac reserves may be dramatically decreased, especially if episodes of prolonged congestive failure have been a part of the patient’s history and have resulted in cardiomegaly or ventricular hypertrophy.
8. “Transitional circulation” keeps neonates with severe life-threatening congenital heart disease alive. In this context, therapy with prostaglandin  $E_1$  infusion should be understood, especially the possibility of side effects such as apnea and major vasodilatation.
9. The functional capacities of the immature heart should be of particular interest to anesthesia providers. The immature noncompliant ventricle is extraordinarily sensitive to increases in volume and is considerably restricted in its ability to respond to same by increasing stroke volume. The Starling curve plateau in neonates is reached at left ventricular end-diastolic pressures of 4 mm Hg. Therefore, cardiac compliance values in neonates do not correspond to values for adult patients.
10. Adult arterial pressures, especially during bypass, do not apply to neonates and infants.
11. The procedures for weaning from bypass and using deep hypothermic circulatory arrest or low-flow hypothermic bypass are important and should be reviewed in detail.
12. The anesthesia provider should fully understand the hemodynamic consequences and purpose of various pulmonary artery banding procedures and various kinds of transcatheter management of congenital lesions. Transcatheter procedures require anesthetic care in the interventional cardiac catheterization laboratory.
13. Halothane has been a successful induction anesthetic in children with various kinds of transcatheter treatment of congenital lesions.
14. Transcatheter procedures require anesthetic care in the interventional cardiac catheterization laboratory.
15. Intravenous anesthetics, including high-dose opioids and ketamine, may provide increased margins of safety in some infants with congenital heart disease. Intravenous agents, however, have the possibility of very high transients after intravenous bolus doses because of inadequate mixing or shunting.
16. Intramuscular ketamine 3–5 mg/kg is reasonably well tolerated, even in sick children with cyanotic congenital heart disease.
17. Manipulation of pulmonary and systemic vascular resistance described in this chapter is worth reviewing for anesthesia providers engaged in the practice of anesthesia for congenital heart disease.
18. Inhaled nitric oxide is now a clinically useful and efficacious selective pulmonary vasodilator for many, but not all, patients with congenital heart disease.

junctional agents on the pathophysiologic and therapeutic procedure is essential for anticipating the responses of any patient.

## SPECIFIC PROBLEMS RESULTING FROM CHD

Although many different lesions in varying combinations occur in patients with CHD, problems that decrease cardiopulmonary reserve include (1) intracardiac shunting with increases and decreases in pulmonary blood flow, (2) hypoxemia from inadequate pulmonary blood flow or intracardiac shunting, (3) congestive heart failure from volume or cardiac pressure overload, (4) pulmonary vascular obstructive disease (PVOD) from excessive pulmonary blood flow and pressure, (5) obstruction to left or right heart outflow from stenosis at various sites, and (6) coronary ischemia from congenital defects and iatrogenic intrusions. Of the eight of 1000 live births with CHD, one third have critical diseases requiring catheterization or surgery in the first year, so anesthetic management for CHD frequently involves immature neonatal circulatory and pulmonary physiology.<sup>1,2</sup> Physiologic limitations of the immature heart, circulation, and lungs are superimposed on CHD problems. Table 52-1 shows problems encountered with CHD patients usually seen in the operating room or catheterization laboratory and frequencies of occurrence. In long-standing or particularly severe lesions, problems may occur more frequently than indicated in Table 52-1.

### Intracardiac Shunting

Shunting within the heart and between the great vessels gives rise to many of the problems seen in patients with CHD. These include hypoxemia, excessive pulmonary blood flow, high volume loads, and CHD. Thus, control of intracardiac shunting is a central issue in CHD and its anesthetic management. The hemodynamics of intracardiac shunts are complex and depend on numerous factors determining shunt magnitude and direction (Fig. 52-1). Complete description of the dynamics of a particular shunt requires more data than are ordinarily clinically available.<sup>3</sup> The determinants of shunting, such as ventricular compliance, may change

considerably during anesthesia and operative manipulations, but the changes may not be readily measurable. A simplified view of shunt hemodynamics is useful in clinically assessing the hemodynamic importance of shunts and their probable alterations during therapeutic procedures.

Shunt orifice and outflow resistance are important determinants of shunting. By considering outflow resistance and the size of the shunt orifice, intraoperative changes in shunt magnitude and direction can be predicted for simple and complex shunts. Manipulation of pulmonary or systemic outflow resistances can alter shunt directions and magnitudes, depending on the type of shunt. Influences of cytokines, activated complement, and other endogenously released humoral agents such as nitric oxide also are important in determining pulmonary vascular resistance (PVR) and systemic vascular resistance (SVR). Local and circulating levels of such agents can be profoundly altered by surgical procedures and cardiopulmonary bypass (CPB).<sup>4</sup> Effects of such agents on vascular resistances may overwhelm clinical efforts to manipulate vascular resistances.

### Simple Shunts

In simple shunts (without associated obstructive lesions), outflow resistance is equivalent to PVR on the right and SVR on the left. The effects of shunt orifice and vascular resistances on simple shunts are schematically shown in Fig. 52-2. Shunts with small orifices are relatively fixed in magnitude and are restrictive by definition. As the communication becomes larger and nonrestrictive (equal to or exceeding the aortic valve area), shunt direction and magnitude depend more on the ratio of outflow resistances, that is, the relative resistances of the pulmonary versus systemic vascular beds (PVR/SVR).<sup>5</sup>

In many forms of CHD, hypoxemia requires additional pulmonary blood flow from surgically constructed aortopulmonary anastomoses. Aorta-to-pulmonary artery flow through a small diameter (restrictive) Blalock-Taussig shunt increases moderately with elevations in systemic arterial pressure when PVR remains constant or alternatively by decreasing PVR with a constant systemic arterial pressure. These changes increase pulmonary blood flow and arterial oxygen saturation (SaO<sub>2</sub>) and probably are beneficial in increasing tissue oxygen delivery

when oxygen saturations are very low (>70%). In contrast, when SaO<sub>2</sub> values are greater (e.g., 85–90%, approaching the plateau of the oxyhemoglobin dissociation curve), further increases in SaO<sub>2</sub> require high levels of pulmonary blood flow and may not improve tissue oxygen delivery because of concomitant decreases in systemic flow (Fig. 52-3). High pulmonary flow through large, unrestrictive shunts is required for greater levels of SaO<sub>2</sub>, and it increases cardiac volume loading. This volume loading often may exacerbate congestive heart failure, producing a net decrease in systemic cardiac output and net oxygen delivery despite the small increases in SaO<sub>2</sub> produced by increased pulmonary flow. Thus, the same relative changes in SVR and PVR could be detrimental with a large, nonrestrictive aortopulmonary shunt. Also, with large, nonrestrictive ventricular septal defects (VSDs), the same relative changes in PVR/SVR can increase left-to-right shunting, subjecting the heart to further increased volume loads, worsening congestive heart failure.

In contrast, with tetralogy of Fallot, because pathophysiology consists of right-to-left complex shunt flow through a VSD, the same changes, namely, increasing SVR and decreasing or holding PVR constant, decrease right-to-left shunting and improve the clinical picture. SaO<sub>2</sub> increases by decreasing systemic venous blood shunted into the left atrium and mixing with pulmonary venous blood, improving the patient's clinical condition. Relative levels of PVR and SVR needed to optimize the patient's clinical status with an intracardiac shunt become clearer when the pathophysiologic condition of the defect is detailed. Characteristics and examples of simple shunts of various sizes are listed in Table 52-2.

### Mixing

If the intracardiac communication is sufficiently large, the two cardiac chambers or great vessels effectively become a common chamber. More or less complete mixing (bidirectional shunting) occurs. This usually causes some degree of hypoxemia, despite normal or increased pulmonary blood flow. Mixing implies equal shunting in both directions for any period greater than a few cardiac cycles. If shunting is bidirectional but quantitatively unequal for any long period, there is a net transfer of blood into the pulmo-

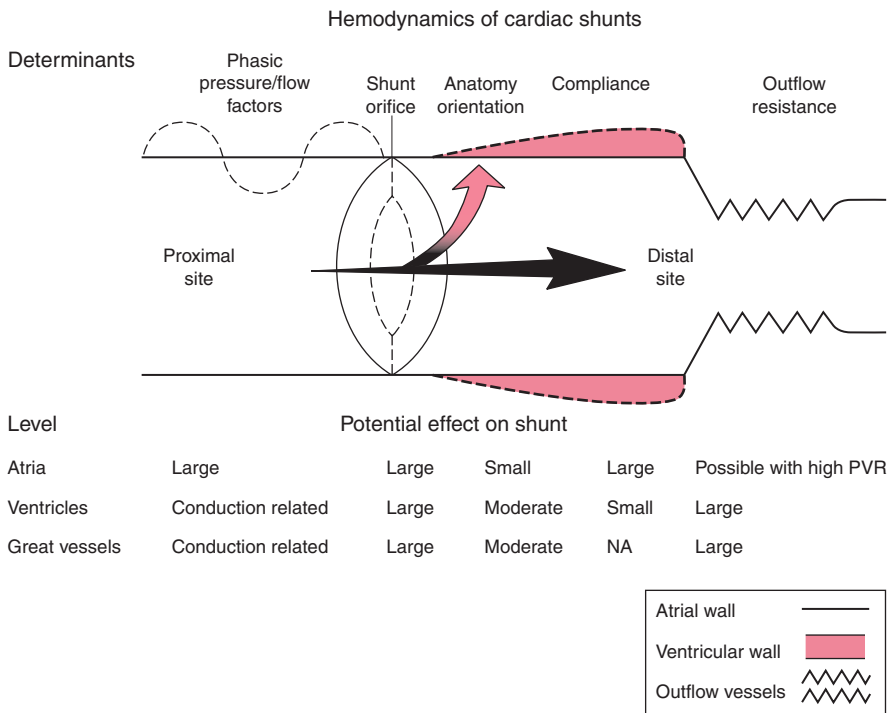


TABLE 52-1.

## Frequency of Hemodynamic Problems in Various Forms of Congenital Heart Disease

Lesion	Hypoxemia	Intracardiac Shunting	Excessive Pulmonary Blood Flow	Congestive Heart Failure	Left-Sided Obstruction	Coronary Ischemia	Immature Circulation	Obstruction to Pulmonary Flow
Atrial septal defect	Rarely	Always (L → R)	Usually	Rarely	Not seen	Not seen	Not seen	Rarely
Patent ductus arteriosus	Rarely	Always (L → R)	Usually	Sometimes	Not seen	Not seen	Sometimes	Rarely
Ventricular septal defect	Rarely	Always (L → R)	Usually	Often	Not seen	Not seen	Often	Late (PVOD)
Tetralogy of Fallot	Often	Always (L → R)	Rarely	Sometimes	Not seen	Rare	Occasionally	Usually
Atrioventricular canal (partial or complete)	Rarely	Always (L → R)	Usually	Often	Not seen	Rare	Often	Late (PVOD)
Transposition of the great arteries	Always	Always (mixing)	Sometimes	Sometimes	Rare	Sometimes	Often	Rarely
Coarctation of aorta	Not seen	Occasionally (through PDA)	Not seen	Rarely	Always	Occasionally	Sometimes	Not seen
Interrupted aortic arch	Always (in lower half of body)	Always (through PDA)	Not seen	Rarely	Always	Rarely	Usually	Not seen
Pulmonary atresia	Always	Always (L → R)	Sometimes	Sometimes	Rare	Occasionally	Usually	Always
Truncus arteriosus	Usually	Always (mixing)	Usually	Often	Rare	Sometimes	Usually	Late (PVOD)
Anomalous of original coronary artery	Not seen	Not seen	Not seen	Often	Not seen	Always	Occasionally	Not seen
Single Ventricle	Usually	Always (mixing)	Often	Often	Occasionally	Sometimes	Usually	Occasionally
Aortic stenosis	Not seen	Not seen	Not seen	Occasionally	Always	Not seen	Occasionally	Sometimes
Critical aortic stenosis	—	Usually (PDA)	Not seen	Usually	Always	Not seen	Frequently	Always
Pulmonic stenosis	Occasionally	Not seen	Not seen	Occasionally	Not seen	Always	Not seen	Sometimes
Critical pulmonary stenosis	Always	Usually (PDA)	Not seen	Usually	Not seen	Always	Not seen	Always
Tricuspid atresia	Always	Always	Frequently	Occasionally	Not seen	Always	Rarely	Frequently
Total anomalous pulmonary venous return	Occasionally	Always	Sometimes	Frequently	Not seen	Frequently	Rarely	Always

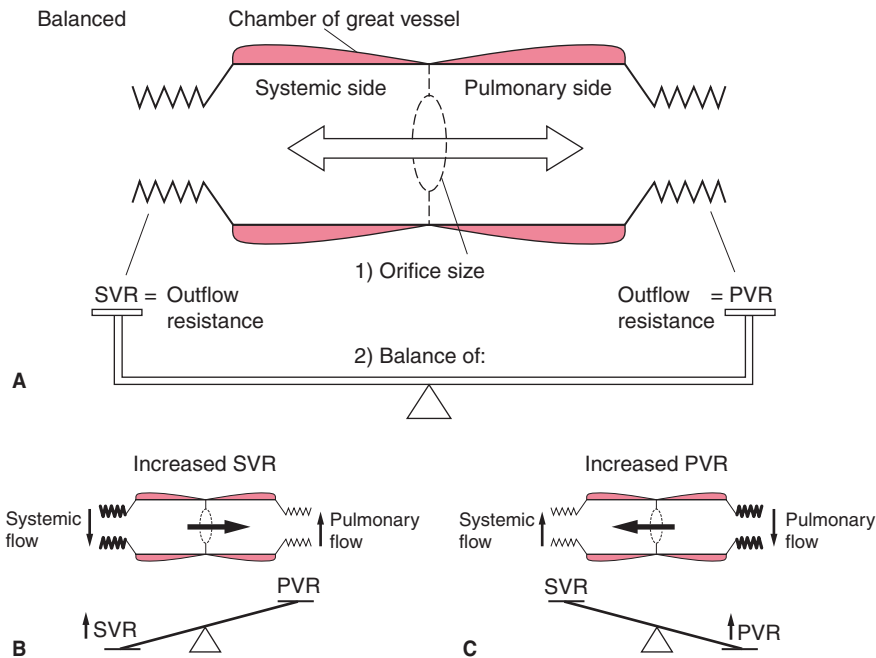
L, left; PDA, patent ductus arteriosus; PVOD, pulmonary vascular obstructive disease; R, right.



**FIGURE 52-1.** Effects of the many determinants on central cardiac shunting at various levels. PVR, Pulmonary vascular resistance. (From Berman<sup>3</sup> with permission.)

nary or systemic circulation. Continued for more than a few minutes (several hundred cardiac cycles in the infant), this theoretically puts the pa-

tient's entire blood volume on one side of the circulation. However, this does not occur because changes in compliance resulting from large shifts of



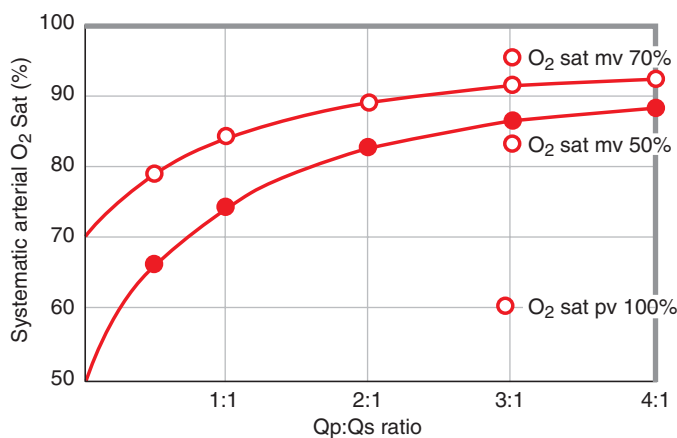
**FIGURE 52-2.** Determinants of magnitude and direction of simple central shunts. (1) Orifice size is important in determining magnitude of shunting and pressure gradient across the shunt and is generally fixed. (2) Balance of pulmonary vascular resistance (PVR) and systemic vascular resistance (SVR) is dynamic and determines the direction of shunt and variations in magnitude around limits fixed by orifice size. **A.** Balanced PVR/SVR. **B.** Increased pulmonary flow with increased SVR. **C.** Increased systemic flow with increased PVR. (Reprinted from Hickey PR, Wessel DL. Anesthesia for treatment of congenital heart disease. In Kaplan JA, ed. Cardiac Anesthesia. 2d ed. New York: Grune & Stratton, 1987, with permission from Elsevier.)

blood tend to counteract shunt inequality. Thus, for periods longer than a few cardiac cycles, shunting is equal in both directions.

With complete mixing in a common chamber and with no outflow obstruction, the amount of pulmonary and systemic blood flow depends on PVR/SVR. Because normal PVR often is much less than SVR (as little a 1/20 of SVR in older children and adults), pulmonary blood flow can become large with a nonrestrictive simple shunt, even in neonates. In these situations, it can become important to limit pulmonary blood flow because pulmonary volume overload can lead to congestive heart failure, inadequate systemic flow, and progressive acidosis. With mixing, SaO<sub>2</sub> is determined by the relative amount of pulmonary blood flow and systemic blood flow (Qp:Qs). Because of the shape of the oxyhemoglobin dissociation curve, increasingly large amounts of pulmonary blood flow are required to further increase SaO<sub>2</sub> as it increases. This is shown in Fig. 52-3 and explains why high SaO<sub>2</sub> ≥ 90% when CHD is present with mixing physiology can occur only with very high pulmonary blood flows. This high flow frequently leads to congestive heart failure from volume overload, which in turn results in net decreased systemic cardiac output.

**Complex Shunt Lesions**

In complex shunts (Fig. 52-4), fixed central outflow obstruction is present at some level on one or the other side of the circulation. Fixed resistance additively increases downstream vascular outflow resistance, which increases shunting to the opposite side. When the fixed resistance is high, it largely dictates total shunting; only part of shunt flow in complex shunts is related to relative resistances in the distal pulmonary and systemic beds. As outflow obstruction increases and becomes a greater component of total resistance to flow, changes in ipsilateral vascular resistance (PVR or SVR) become progressively less important in determining flow because they become smaller components of total resistance. This is particularly true on the right side, where normal PVR is only a fraction of the resistance offered by most right-sided obstructive lesions seen in CHD. In contrast, changes in vascular resistance (PVR or SVR) contralateral to the fixed obstruction become relatively more impor-



**FIGURE 52-3.** Changes in systemic arterial O<sub>2</sub> saturation with mixing lesions as the ratio of pulmonary flow to systemic flow (Qp:Qs) changes, assuming different levels of mixed venous (mv) O<sub>2</sub> saturation. This assumes a pulmonary venous (pv) O<sub>2</sub> saturation of 100%.<sup>5</sup>

tant in determining shunting in complex shunts. For example, in tetralogy of Fallot with severe pulmonic stenosis, a large component of the right-to-left VSD shunting is caused by fixed pulmonary valve stenosis. An additional variable aspect of shunting may be caused by variations in PVR or dynamic right outflow infundibular obstruction. Dynamic changes in variable portions of the total right ventricular outflow obstruction may increase or decrease total right-to-left shunting, thereby increasing or decreasing hypoxemia. At baseline, when dynamic obstructive components are minimal, right-to-left shunting is determined largely by this large, fixed pulmonic obstruction. This presumes constant SVR and cardiac output; large changes in SVR markedly change shunting by altering the balance contralateral to the final obstruction (Fig. 52-4). Characteristics and examples of complex shunts are listed in Table 52-3.

### Complete Obstruction

When obstruction to central outflow becomes complete, as in patients with tricuspid atresia, pulmonary atresia, or aortic atresia, shunting across communications proximal to the obstruction becomes total and obligatory and can be considered an extreme type of simple shunt, as listed in Table 52-3. This should be associated with another downstream shunt that provides flow to the obstructed side of the circulation. The associated shunt can be a patent ductus arteriosus (PDA), which provides pulmonary blood flow in pulmonary valvular atresia or provides systemic blood flow in aortic valvular atresia. Downstream shunting variably

depends on PVR/SVR, depending on the restrictive nature of the “compensatory” shunt, that is, a small patent ductus constitutes most of the resistance when the ductus is the site of the compensatory shunt in pulmonic atresia. In this situation, the small ductus limits pulmonary blood flow.

### Intracardiac Shunting and Air Emboli

Systemic air embolus is a constant danger in patients with CHD regardless of nominal left-to-right shunting patterns because anesthetic and surgical manipulations can dynamically alter shunts. Air traps are advisable for all intravenous (IV) lines but are not substitutes for meticulous attention and constant vigilance in the purging of air bubbles.

Systemic air emboli are a relative contraindication to use of nitrous oxide in patients with CHD. Right-to-left shunts may occur during some portions of the cardiac cycle or during straining or coughing in patients with open communications and nominal left-to-right shunts because normal transatrial pressure gradients are transiently reversed.<sup>6-8</sup> Right-to-left shunting may occur even across functionally “closed” communications. A “probe patent” foramen ovale is common in children (and adults) with and without CHD. Transient right-to-left shunting across such a foramen ovale has even been documented in a healthy child during emergence from anesthesia.<sup>9</sup> In many patients with CHD, direct shunting of microbubbles and macrobubbles of air into the systemic intracerebral arterial circulation from multiple IV lines and injections can be readily documented with transcranial Doppler (TCD). “Bubble-free” room temperature solutions may “rain out” bubbles at 37°C. The cerebral effects of such arterial air emboli have not been ascertained except in patients with massive cerebral arterial air emboli.

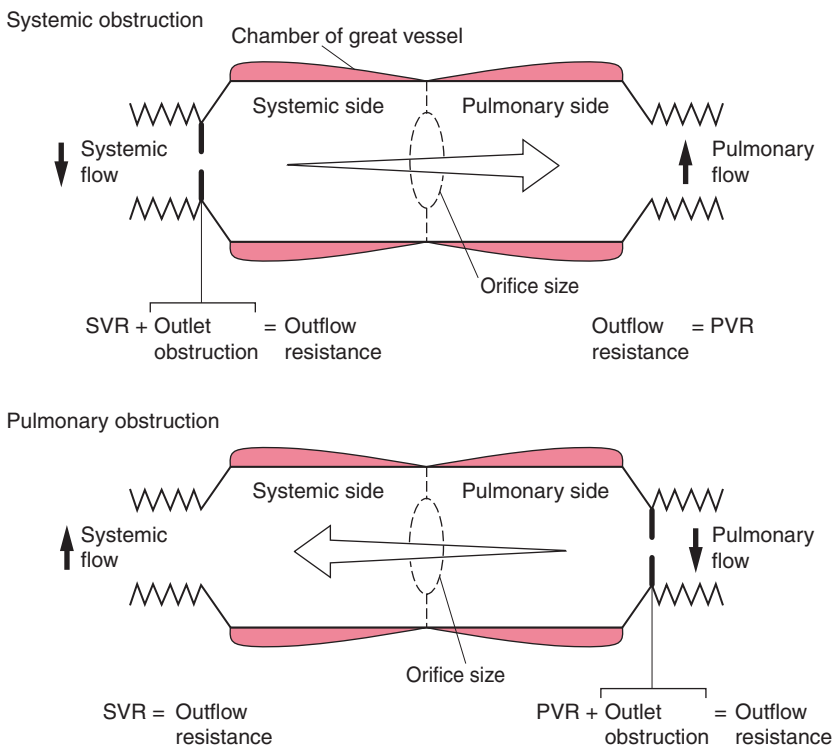
### Severe Hypoxemia

Severe hypoxemia in patients with CHD results from inadequate pulmonary blood flow or defects that allow mixing as defined previously. Chronic hypoxemia requires adaptations to provide adequate tissue oxygen transport. Although moderate hypoxemia is well tolerated in neonates, hypox-

**TABLE 52-2.**

#### Simple Shunts (No Obstructive Lesions)

Restrictive Shunts (Small Communication)	Nonrestrictive Shunts (Large Communication)	Common Chambers (Complete Mixing)
<b>Characteristics</b>		
Large pressure gradient	Small pressure gradient	No pressure gradient
Direction and magnitude more independent	Direction and magnitude more dependent on PVR/SVR	Bidirectional shunting
Less subject to control	More subject to control	Net Qp/Qs totally dependent on PVR/SVR
<b>Examples</b>		
Small VSD, small PDA, Blalock shunts, small ASD	Large VSD, large PDA, large Waterston shunts	Single ventricle, truncus arteriosus, single atrium
ASD, Atrial septal defect; PDA, patent ductus arteriosus; PVR, pulmonary vascular resistance; Qp, pulmonary blood flow; Qs, systemic blood flow; SVR, systemic vascular resistance; VSD, ventricular septal defect.		



**FIGURE 52-4.** Determinants of complex shunting with systemic or pulmonary outflow obstruction. Orifice size again limits magnitude, but balance of outflow resistances include outlet obstruction on either side of the circulation in addition to systemic vascular resistance (SVR) or pulmonary vascular resistance (PVR). Addition of outlet obstruction increases flow on the opposite side and decreases flow on the same side. (Reprinted from Hickey PR, Wessel DL. Anesthesia for treatment of congenital heart disease. In Kaplan JA, ed. Cardiac Anesthesia. 2d ed. New York: Grune & Stratton, 1987, with permission from Elsevier.)

emia after infancy produces special problems, including polycythemia; increased blood volume; and vasodilation, neovascularization, and alveolar hyperventilation with chronic respiratory alkalosis. Chronic hypoxemia and its accompanying adaptive mechanisms may limit cardiac reserve and oxygen delivery during the stress of anesthetic induction and surgery. Ad-

ditionally, in such patients, the margin for error and tolerance for loss of airway is decreased.<sup>10</sup>

Polycythemia increases blood hematocrit and blood viscosity to dangerously high levels that cause vascular stasis and worsen tissue hypoxia.<sup>11</sup> Although an increased hematocrit improves blood oxygen carrying capacity, resultant increased blood viscosity decreases

es cardiac output when the hematocrit is >60%. Patients with polycythemia and cyanosis have increased risk for renal or cerebral thrombosis because of increased viscosity, particularly if they become dehydrated.<sup>12</sup> Hematocrits >70% generally are associated with increased risk of cerebrovascular accidents and coagulopathies. These patients may have a history of cerebrovascular accidents and sometimes already have residual neurologic deficits. They require IV hydration starting on the evening before anesthesia and also postoperatively until oral intake is adequate. Some patients may benefit from erythropheresis before surgery if hematocrits are >60–70%. Polycythemic CHD patients also have coagulopathies in part because of decreased levels of platelets and fibrinogen.<sup>13</sup> These coagulopathies increase the risk of excess intraoperative bleeding, and appropriate arrangements should be made for intraoperative transfusion of clotting factors when necessary.

Patients with severe hypoxemia caused by intracardiac shunting generally undergo anesthesia for procedures designed to improve their pulmonary blood flow and SaO<sub>2</sub>. Induction of anesthesia itself using a variety of techniques markedly increases arterial saturation.<sup>14,15</sup> This induction-related increase in arterial saturation probably results from greater systemic venous oxygen saturation caused by greater inspired oxygen concentrations plus decreased oxygen consumption with induction of anesthesia and muscle paralysis.<sup>16,17</sup> Systemic venous blood with a greater oxygen saturation is shunted into the systemic circulation, decreasing the degree of hypoxemia seen. Thus, induction of anesthesia itself may be therapeutic for patients with CHD with severe hypoxemia and sometimes can be used to temporize until correction or palliation can be accomplished surgically.

### Excessive Pulmonary Blood Flow

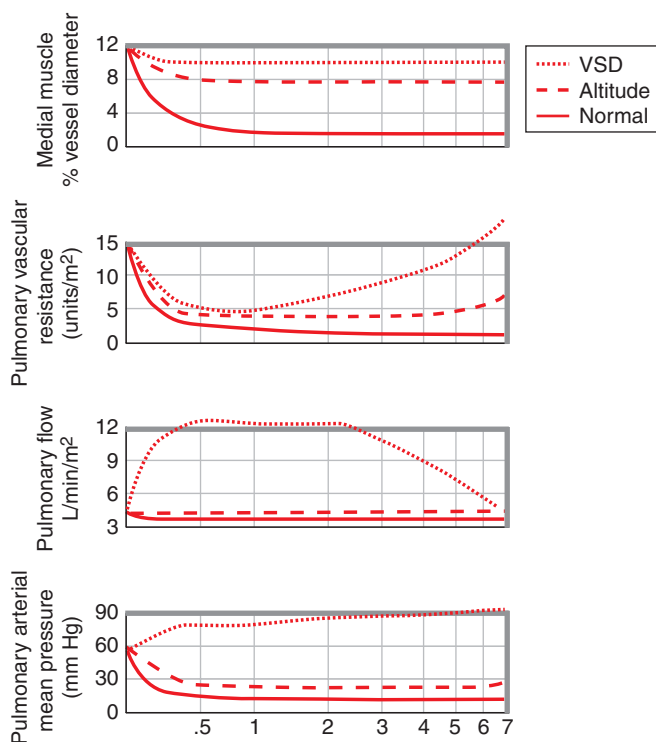
Excessive pulmonary blood flow is common in patients with CHD and produces cardiac and pulmonary complications. Volume overload always compromises cardiac reserve regardless of the presence of frank congestive heart failure. Increased pulmonary artery (PA) pressure and blood flow can limit gas exchange by several mechanisms. Compression of large

**TABLE 52-3.**

#### Complex Shunts (Shunt and Obstructive Lesions)

Partial Outflow Obstruction	Total Outflow Obstruction
<b>Characteristics</b>	
Shunt magnitude and direction largely fixed by obstruction	Shunt magnitude and direction totally fixed
Shunt depends less on PVR/SVR	All flow goes through shunt
Orifice and obstruction determine pressure gradient	Pressure gradient depends on orifice
<b>Examples</b>	
Tetralogy of Fallot, VSD and pulmonic stenosis, VSD with coarctation	Tricuspid atresia, mitral atresia, pulmonary atresia, aortic atresia
PVR, Pulmonary vascular resistance; SVR, systemic vascular resistance; VSD, ventricular septal defect.	





**FIGURE 52-5.** Normal and abnormal developmental changes in pulmonary arterial tree during the first years of life. Pulmonary vascular resistance, percent of arterial smooth muscle, and pressure normally decrease in the first year of life. A large, nonrestrictive ventricular septal defect with a large left-to-right shunt results in an immediate increase in flow and a later increase in vascular resistance.<sup>5</sup>

bronchi by distended pulmonary vessels may obstruct large and small airways and increase the work of breathing. The increased pulmonary venous return distends the left atrium and may obstruct the left main stem bronchus. Most important, increased pulmonary blood flow and pressure combine with elevated left atrial pressure to produce pulmonary venous congestion and increased interstitial and alveolar lung water. Resultant lung compliance deterioration and increased airway resistance can produce tachypnea and sometimes wheezing. Regions of the lung with atelectasis and intrapulmonary shunt then contribute to systemic arterial desaturation, even in a child with “cyanotic” heart disease and left-to-right shunting.

PVOD is produced by prolonged high pulmonary flows and pressures. The anatomic lesion is hypertrophy of the medial layer of pulmonary arteries and intimal thickening, with resultant increased PVR and reactivity.<sup>18,19</sup> Fig. 52-5 shows normal progression of pulmonary flows, pressures, and vascular resistance during early childhood and alterations in the normal progression with a large VSD. Fig. 52-6 indicates

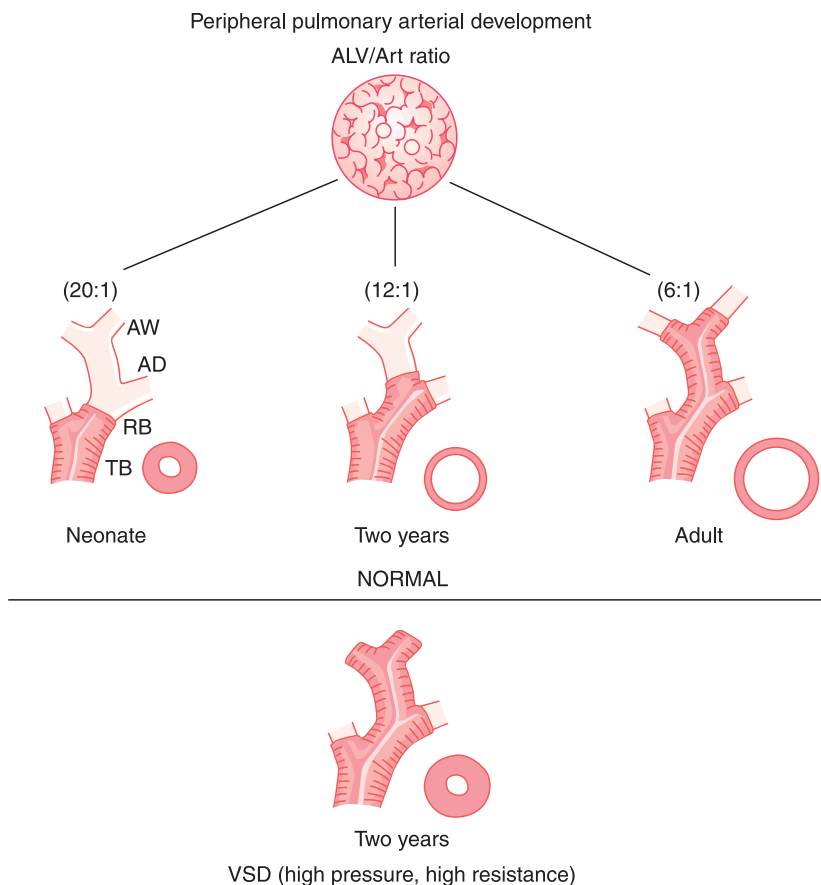
normal evolution of pulmonary arteries during infancy and alteration caused by high pulmonary flows and pressures resulting from left-to-right shunting through a VSD. Smaller pulmonary arteries are anatomic substrates of increased pulmonary vascular reactivity and high PVR seen in patients with PVOD. When PVR eventually equals or exceeds SVR, a left-to-right shunt then becomes a right-to-left shunt (Eisenmenger syndrome). PVOD can occur during the first year of life in patients with some lesions, such as an atrioventricular canal, but may require decades to develop in patients with atrial septal defects (ASDs).<sup>20,21</sup> Depending on the severity and duration of these changes, correction of the underlying lesion may result in varying degrees of reversal of pulmonary vascular changes and decreases in pulmonary hypertension.

In neonates with a widely PDA and a single source of blood supply to the systemic and pulmonary circulations, pulmonary blood flow may become particularly excessive intraoperatively. This is signaled by high systemic arterial saturations (>90%) in these mixing types of pathophysiologic conditions. It

occurs in patients with lesions, such as truncus arteriosus or hypoplastic left heart syndrome (HLHS), and results in acute congestive heart failure with ventricular enlargement, low systemic output, high SaO<sub>2</sub>, and hypotension. This can produce myocardial ischemia in neonates.<sup>22</sup> The myocardial ischemia seen in this situation can be remedied only by acutely increasing PVR by placing a tourniquet on one of the branch pulmonary arteries or by applying a partially occluding PA clamp. These maneuvers mechanically increase PVR, decrease the excessive pulmonary blood flow and arterial saturation, increase systemic (coronary) perfusion pressure, and decrease cardiac volume load and reduce ventricular diameter. In patients with CHD with tendencies toward excessive pulmonary blood flow and only mild hypoxemia, anesthetic management is planned to avoid major decreases in PVR because such decreases exacerbate the increased pulmonary flow and lead to cardiovascular decompensation.

## Congestive Heart Failure

The child with CHD develops congestive heart failure because of increased pressure, volume, or combined pressure and volume loads. Increased volume loads can result from intracardiac shunting or valvular insufficiency. Increased pressure loads can result from valvular obstruction, stenosis of major systemic or pulmonary arteries, or diffuse PVOD. Patients compensate by well-known mechanisms. Increased catecholamine production redistributes cardiac output to favored organs, increases heart rate, decreases skin temperature, and frequently induces a catabolic nutritional state.<sup>23</sup> Pulmonary congestion increases the work of breathing and caloric demand, whereas tachypnea limits intake of calories. Derangements vary with severity of congestive heart failure. In the severe cases, growth is retarded, and body weight is well below the third percentile for age. These patients often are tachypneic, tachycardic, and dusky in room air and may have chest wall retractions, expiratory wheezes, and diffuse rhonchi. Capillary refill may be prolonged and extremities cool to the touch, with palpable hepatomegaly. Preoperative chest radiographs demonstrate cardiac enlargement and increased pulmonary vascular markings with areas of atelectasis despite hyperexpansion of



**FIGURE 52–6.** Developmental changes in peripheral pulmonary arterial tree in normal patients and in the presence of a ventricular septal defect (VSD) with a large left-to-right shunt. Alveolar-to-arteriolar (ALV/Art) ratio decreases with age because of extensive arborization of arterial tree as arteriolar lumen increases and muscle layer thins and spreads distally. Pulmonary hypertension with high flow from left-to-right shunt in a VSD causes pulmonary vascular obstructive disease marked by decreased numbers of pulmonary arterioles (ALV/Art = 25:1), decrease in vessel lumen, increase in muscle thickness, and more distal spread of muscle. Letters indicate arteriole from level of the terminal bronchiolus (TB) to the alveolar wall (AW).<sup>5,19</sup>

the lungs. In severe cases, medical management consisting of administration of digoxin and diuretics is indicated before surgery, which may induce a profound metabolic hypochloremic alkalosis with potassium depletion.

Other children with lesser degrees of congestive heart failure caused by CHD may be only mildly symptomatic but still have substantially decreased cardiovascular reserves. The additional stress of anesthesia and surgery may result in cardiac decompensation, particularly when compensation depends on maximal sympathetic tone. Reversibility of ventricular dysfunction accompanying congestive heart failure in those with CHD varies depending on the severity of the defect, degree of correction, and duration of ventricular dysfunction.

Prolonged congestive heart failure and attendant ventricular dysfunction result in cardiomegaly and ventricular

hypertrophy. The amount and location of cardiomegaly or hypertrophy occurring depends on the combination of cardiac pressure and volume loads and intracardiac anatomy. Long-standing cardiomegaly and hypertrophy jeopardize the myocardium in children, particularly in those with chronic hypoxemia. In the young, growing heart, pressure-overload hypertrophy appears to occur in association with myocardial angiogenesis rather than with diminished myocardial capillary density as occurs in adults.<sup>24</sup> Despite the former compensatory mechanism, microscopic areas of myocardial infarction eventually appear in young hearts subjected to chronic overload, particularly in those with chronic hypoxemia.<sup>25</sup> This results in progressive ventricular dysfunction in the affected ventricle, as working muscle mass is depleted and is replaced by fibrous tissue. Some ventricular dysfunction

may be reversible, depending on timing of correction of the underlying defect. For example, VSDs and tetralogy of Fallot defects repaired during early infancy before myocardial damage occurs subsequently have better ventricular function than those repaired later in childhood.<sup>26–30</sup>

In patients with any degree of congestive heart failure, anesthetic treatment is planned to avoid large doses of myocardial depressants and alterations of PVR or SVR that exacerbate cardiac failure. The detrimental alterations depend on individual pathophysiology findings. In patients with severe congestive heart failure or in those with detrimental alterations in pathophysiologic conditions that cannot be avoided, appropriate pressor and inotropic support are included in the anesthetic plan.

### Obstructions to Systemic Blood Flow

Congenital lesions producing obstruction to left heart outflow include interruption of the aortic arch, coarctation of the aorta, aortic stenosis (subvalvar, valvar, or supravalvar), mitral stenosis and atresia, and HLHS. These patients may have left ventricular hypertrophy, coronary ischemia, and limited systemic ventricular reserve. Systemic perfusion in neonates with these problems often depends on a PDA that may be rapidly narrowing. Such infants usually present with shock and metabolic acidosis, requiring resuscitation with prostaglandin  $E_1$  ( $PGE_1$ ) preoperatively. Ventricular fibrillation is a distinct risk. Older children with less severe forms of stenosis often are asymptomatic, with only mild hypertension in coarctation of the aorta or mild aortic stenosis. They may have dysrhythmias, syncope, fatigue, or chest pain in various forms of aortic stenosis.

### Obstructions to Pulmonary Blood Flow

Pulmonary flow obstructions occur at many levels in the right side of the circulation. Right ventricular hypertension, pulmonary hypertension, and hypoxemia may result, depending on the location of obstructions and the presence of intracardiac shunting. Combinations of these problems are seen in pulmonary valve and subvalvular stenosis, PA stenosis, PVOD, tetralogy of Fallot, and pulmonary atresia. High levels of right ventricular after-

load result in a hypertensive, hypertrophied right ventricle that is prone to myocardial ischemia. As right ventricular intracavitary pressures approach and then exceed systemic arterial pressures, coronary perfusion pressures become inadequate, and right ventricular failure results from myocardial ischemia. Acute therapy is aimed at increasing systemic arterial pressure with  $\alpha$ -adrenergic agents, such as phenylephrine, to improve coronary perfusion of the right ventricle.<sup>31</sup> Lowering of PVR also is beneficial if it can be accomplished without decreasing systemic (coronary) perfusion pressure.

Patients with right ventricular hypertension resulting from outflow obstruction or obstruction of the larger pulmonary vessels can be effectively treated with balloon dilation in the cardiac catheterization laboratory or with a surgical procedure. Unilateral or segmental pulmonary edema requiring management may be seen after such procedures. When PVR at the small vessel level is markedly elevated and irreversible, as in patients with end-stage PVOD, therapy frequently is ineffective. Patients with a markedly hypertensive pulmonary circulation of any duration have cor pulmonale or dysrhythmias and are prone to sudden, poorly understood increases in PVR. Such pulmonary hypertensive crises may occur without warning, resulting in refractory acute right ventricular failure and sometimes in death. When systemic levels of pulmonary arterial pressure are encountered in the operating room, despite corrective procedures, every effort should be made to correct this problem because of the associated high risks of sudden decompensation and death.

### Coronary Ischemia

Although acquired coronary artery disease is rare in children with CHD, except in those with transplanted hearts, coronary ischemia may occur with left heart outflow obstruction, surgical retraction, "pulmonary steal" in neonates with a single source of pulmonary and systemic flows, or anomalous coronary arteries arising from the PA. In neonates with truncus arteriosus, intraoperative decreases in PVR can lead to decreased systemic flow and diastolic pressure, which produces ST-segment changes indicative of acute myocardial ischemia.

Maneuvers to decrease pulmonary flow, such as temporarily ligating the

left or right PA, can increase diastolic pressure and reverse the ischemia and ST-segment changes seen on electrocardiography (ECG).<sup>22</sup> In anomalous coronary arteries, retrograde flow into the PA occurs via anastomotic connection with normal coronary arteries (i.e., those with aortic origin) when flow is "stolen" from the high-pressure origin and diverted to the low-pressure pulmonary circulation. Myocardial infarcts and ventricular dysfunction can result. These problems may be preventable or reversible if the anomalous coronary arteries are detected and corrected early in life.

Rarely, patients have aberrant sinusoidal coronary arteries originating directly from the right ventricular cavity. These arteries provide nutrient, antegrade (albeit hypoxemic) flow into the coronary bed as long as high (systemic) pressures are maintained in the right ventricle. Any intervention that substantially decreases right ventricular intracavitary pressure results in intractable and even fatal coronary ischemia. When perfusion pressure decreases, flow from these vessels becomes retrograde into the right ventricular cavity as flow is "stolen" from adjacent, communicating systemic coronary arterial beds.

### Immaturity of Circulation Transitional Circulation

Transitional circulation consists of a PDA, patent foramen ovale, and high PVR, as shown schematically in Fig. 52-7. In neonates with severe, life-threatening CHD, the transitional circulation plays a major role in maintaining viability because its persistence is required to sustain functional circulation until therapeutic interventions can be undertaken. Particularly important in maintaining an intact circulation is patency of the ductus arteriosus. Before anatomic (as opposed to physiologic) closure occurs at several weeks of age in the normal sequence, the ductus may remain open in response to hypoxemia or PGE<sub>1</sub> infusion.<sup>32,33</sup> Reopening of the ductus has been documented in infants older than 7 days in whom the ductus has been kept open with PGE<sub>1</sub> infusions for many weeks when necessary.<sup>34,35</sup>

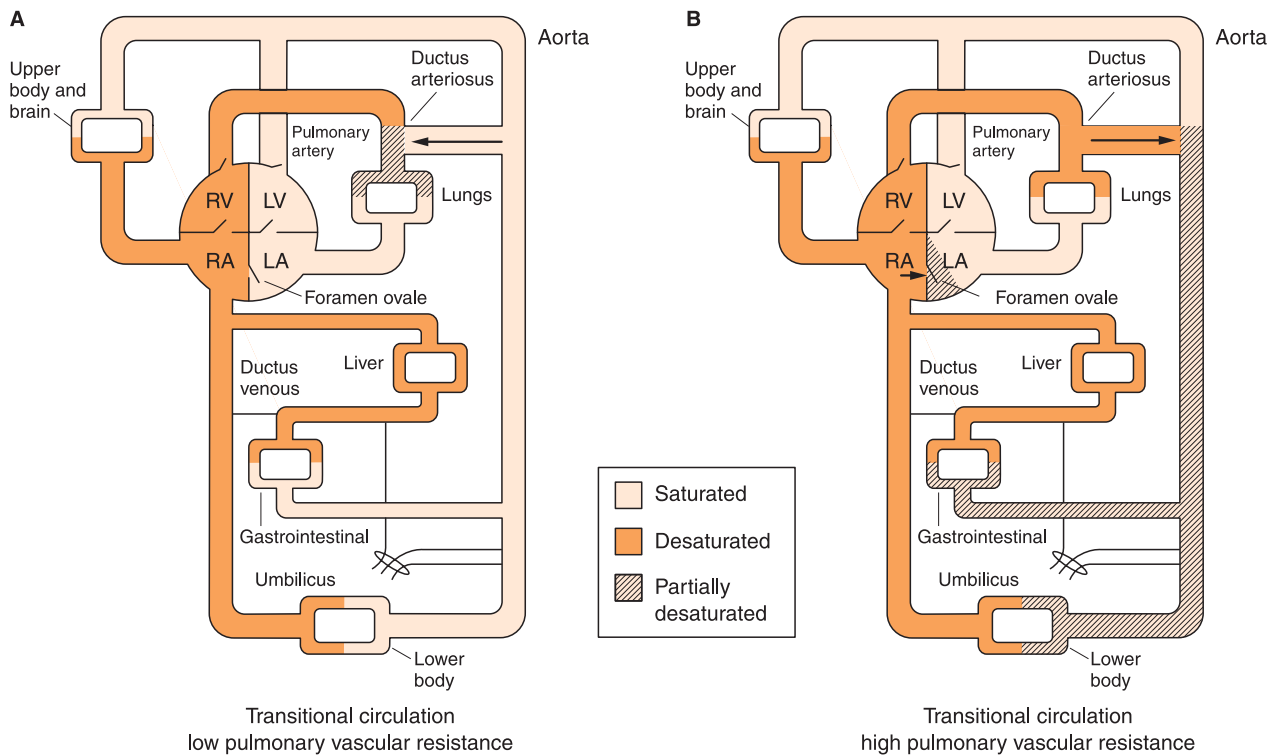
The PDA plays a critical role in maintaining life by providing either systemic or pulmonary blood flow in neonates with severe congenital heart lesions (Box 52-1). Acute decompen-

sation occurs in these infants when the ductus closes. When systemic and coronary perfusion depend on a PDA, closure results in reduction of systemic flow, coronary insufficiency, rapidly progressive metabolic acidosis, and death.<sup>36</sup> When pulmonary flow depends on a patent ductus, closure results in acute reduction of pulmonary flow, progressive hypoxemia, and death.<sup>37</sup> In neonates with ductus-dependent lesions who decompensate after closure, therapy with PGE<sub>1</sub> infusion for 24–48 hours provides effective resuscitation and correction of metabolic deficits.<sup>38</sup> Side effects of PGE<sub>1</sub> infusion include apnea and vasodilatation; many neonates receiving PGE<sub>1</sub> infusions need intubation and ventilatory support and supplementation of intravascular volume.<sup>39</sup>

High PVR in the transitional circulation is particularly important when the congenital defect has only a single, nonrestrictive source of pulmonary and systemic blood flow, as in truncus arteriosus, HLHS, or pulmonary atresia. When the ductus arteriosus is kept widely patent with PGE<sub>1</sub> or when no ductus is involved (truncus arteriosus), decreases in high PVR from the immediate postnatal levels produce "pulmonary steal" of systemic blood flow and low diastolic blood pressure. This leads to systemic hypoperfusion, coronary ischemia, and progressive metabolic acidosis despite good SaO<sub>2</sub>.<sup>40,41</sup>

### The Immature Heart

At birth, the immature heart is markedly different from the mature heart. Right and left ventricles have approximately equal size and wall thickness; the right ventricle is slightly heavier.<sup>42</sup> The increased afterload on the left and decreased afterload on the right, occurring with birth, lead to progressive thickening of the left ventricular wall. By 4 weeks of age, the left ventricle weighs more than the right ventricle.<sup>43</sup> By 3 or 4 years of age, the left ventricle is approximately twice as heavy as the right, the normal adult relationship. These changes are accompanied by myocyte ultrastructural development. Small immature myocytes with chaotically arranged myofibrils accounting for 30% of gross muscle mass evolve into larger mature myocytes with organized, longitudinally oriented myofibrils that make up 60% of muscle mass.<sup>44,45</sup> The larger mass of noncontractile elements in immature myo-



**FIGURE 52-7.** Schematic diagram of central shunting and blood saturations that occur normally in the transitional circulation in the first few hours and days after birth. **A.** In the first few hours, the foramen ovale is widely patent and pulmonary vascular resistance is high, leading to right-to-left shunting. **B.** Later stage of transitional circulation when pulmonary vascular resistance decreases and the ductus remains patent, resulting in left-to-right shunting. Foramen ovale is functionally closed. (Reprinted from Hickey PR, Crone RK. Cardiovascular physiology and pharmacology in children. In Ryan JR, Todres PS, Coté C, et al., eds. *A Practice of Anesthesia for Infants and Children*. New York: Grune & Stratton, 1986, with permission from Elsevier.)

cytes results in noncompliant cells with diminished contractile capacity. Myocardial contractility and compliance increase with development; immature myocardium develops less force during contraction than does adult myocardium, and velocity and magnitude of shortening also are less in immature myocytes.<sup>45,46</sup>

Other changes include development of the transverse tubular system, es-

entially absent in the neonatal heart, and development of sarcoplasmic reticulum, increasing its capacity to store and release calcium.<sup>47,48</sup> Contractile proteins, namely, myosin, troponin, and troponin T, required for myocardial contraction also change their isoforms during this period.<sup>49</sup> These changes, taken together, may explain increased sensitivity to inhalational anesthetics seen in the immature heart.<sup>50-53</sup> Ultrastructural changes occurring in maturing myocytes result in improved myocardial function, but until myocytes fully mature, cardiac reserve is limited. This should be appreciated in anesthetic treatment of infants with CHD, who have additional sources of decreased cardiac reserve in addition to immaturity. Despite these factors, immaturity confers some “advantage” for cardiac function during hemodynamic stress because during acidosis contractile function is less affected<sup>54,55</sup> and intracellular myocardial pH is better maintained.<sup>46</sup>

Functional capacities of the immature heart are well defined. The immature, noncompliant ventricle is highly sensitive to increases in filling volume and is relatively restricted in its ability

to respond with increased stroke volume. Although stroke volume improves with increased filling pressure, the range over which this occurs is narrow. The Starling curve is reached at filling pressures of 4 mm Hg, and stroke volume actually decreases at filling pressures near 7 mm Hg.<sup>56</sup> This Starling plateau may be a result of increased afterload effects as mean arterial pressure increases with increased preload.<sup>57</sup> The immature ventricle is highly sensitive to increased afterload. With constant afterload, stroke volume improves with progressive increases in left atrial pressure from 5–10 mm Hg. Because the immature heart is noncompliant, small increases in intravascular volume rapidly increase filling pressures to the plateau of the Starling curve where stroke volume is fixed. At the level of filling pressure where stroke volume is fixed, cardiac output becomes rate dependent. Additional increases in volume push filling pressures to the descending portion of the curve, and the ventricle begins to fail. Although the Starling curve of the neonate is clearly shifted to the left compared with the curve of older children and adults, it still does apply.<sup>58,59</sup> Be-

### BOX 52-1.

#### Ductus-Dependent Neonatal Congenital Heart Defects

##### PDA Provides Systemic Flow

- Critical coarctation of the aorta
- Interrupted aortic arch
- Hypoplastic left heart syndrome
- Critical aortic stenosis

##### PDA Provides Pulmonary Flow

- Pulmonary atresia
- Critical pulmonic stenosis
- Severe subpulmonic stenosis with ventricular septal defect
- Tricuspid atresia with pulmonic stenosis

PDA, Patent ductus arteriosus.



cause of this, cardiac output is not entirely rate dependent at lesser filling pressures and rates within neonatal physiologic range. Increases or decreases in heart rate within physiologic ranges result in changes in stroke volume without major changes in cardiac output in the term human fetus and in the lamb.<sup>60,61</sup> It is only when the plateau of the Starling curve is reached that the immature heart becomes truly rate dependent.

Reduced compliance and similarity in size and wall thickness of the ventricles during the first month lead to an intimate interrelationship between right and left ventricular function.<sup>58</sup> Failure of one immature ventricle quickly causes septal shift, and, in contrast to adults, congestive heart failure quickly becomes biventricular. This has important implications for ventilatory management, namely, the fact that inadequate ventilation in infants rapidly leads to increased right ventricular afterload and biventricular failure because of the muscular, hyperreactive pulmonary circulation. This also applies to small infants with CHD. As a result of the poor tolerance of the immature heart for increased afterload, right ventricular failure of some degree may result, which, in turn, rapidly compromises function of the left ventricle. Thus, adequacy of ventilation in the infant frequently determines cardiac function even if severe hypoxemia has not yet occurred.

In summary, functional capacity of the immature infant heart and cardiac reserve improve with age. Increasing preload or afterload results in ventricular failure sooner in neonates and infants than in adults, and failure quickly becomes biventricular. By 3 or 4 years of age, adult levels of systemic arterial pressure and PVR are achieved, and the previously mentioned functional limitations probably no longer apply. Additional stresses and loads placed on the immature heart by various forms of CHD further reduce cardiac reserves in infants, thus reducing their already compromised ability to deal with the stresses of anesthesia and surgery.

### Combined Problems

Combinations of the previously mentioned problems are found in many patients with CHD. Excessive flows caused by intracardiac shunting and flow obstruction often lead to congestive heart failure. In older children with

long-standing complex lesions that cannot be readily corrected, ventricular function may gradually deteriorate because of long-standing ventricular pressure or volume overload. Chronic volume loading is seen in those with aortic or mitral valve regurgitation or in patients with long-standing pulmonary-to-systemic arterial shunts. The latter patients may have only mild-to-moderate hypoxemia despite complete mixing when there is a large shunt and excessive pulmonary blood flow.

The price paid for near-normal levels of  $\text{SaO}_2$  is chronic ventricular dilation and potential development of PVOD. These patients may have combined problems of hypoxemia and mild cyanosis, some degree of PVOD, and left ventricular dilation with progressively decreasing ejection fractions.

In infants and especially neonates, problems of transitional circulation and limited functional capacity of the immature heart are invariably added to physiologic problems created by the CHD itself. Because the most severe forms of CHD generally are present in neonates, such congenital heart problems are complicated by physiologic limitations of the immature heart and lungs.

In patients with complex congenital disease in whom a number of previously discussed problems are present, assessment should be directed at myocardial performance and reserve, quantification of pulmonary blood flow, degree of cyanosis, and evaluation of PVR. For example, a patient with a long-standing Waterston shunt who is only mildly cyanotic but easily fatigued and who has a heaving precordium with bounding pulses may be expected to have a high normal hematocrit with oxygen saturation in the upper 80s. Pulmonary blood flow is torrential, and PVR is elevated. This patient may not be a candidate for reparative cardiac procedures because of high (and irreversible) PVR resulting from progressive PVOD.

## INTRAOPERATIVE PROBLEMS FROM SPECIFIC PROCEDURES OR TECHNIQUES

Complex intracardiac anatomy, incomplete or misdiagnosis of specific lesions, limitations of currently available procedures, and technical errors combine to result in hemodynamic

problems in an appreciable fraction of patients who require surgical or transcatheter treatment of CHD. These problems often present as hemodynamic instability, low cardiac output, or hypoxemia in the operating room or in the catheterization laboratory immediately after the cardiac repair or later in the intensive care unit. Causes may not be readily apparent and may require intraoperative pressure measurements, intraoperative or postoperative echocardiography, and sometimes early postoperative cardiac catheterization before the cause is clearly established and before therapy can be properly directed.

### Specific Surgical Procedures

The anesthesia care team should deal with *intraoperative problems* until their causes are discovered and corrected. Primary pump failure is only infrequently the cause of difficulties seen in this setting. In the majority of patients, a specific mechanical problem in the circulation system is responsible. Table 52-4 lists the incidence of different problems commonly seen with specific surgical procedures.

### Excessive Pulmonary Flow

In addition to its occurrence in lesions described previously, excessive pulmonary flow may be a result of operative procedures. A surgically created aortopulmonary shunt, such as a Blalock-Taussig shunt, can be too large, with excessive pulmonary blood flow and low systemic cardiac output. Residual intracardiac left-to-right shunt can produce excessive pulmonary blood flow as a result of incomplete repair or undiagnosed and unsuspected defect. Increased volume load may result in low cardiac output in a heart that has been injured by a period of hypothermic ischemia with cross-clamping during CPB. Measures designed to increase PVR and to provide inotropic support improve the hemodynamic condition temporarily until a specific diagnosis can be made and residual problems corrected (Box 52-2).

Excessive pulmonary flow can result from failure to ligate an aortopulmonary shunt (e.g., PDA or Blalock-Taussig shunt). In some patients, an extensive series of large and small native aortopulmonary collateral vessels from the descending aorta, bronchial arteries, and vertebral arterial system can produce excessive pulmonary flow postoperatively. In the ab-

TABLE 52-4.

## Hemodynamic Problems Resulting from Various Cardiac Surgical Procedures

Procedure	Excessive Pulmonary Flow	Inadequate Pulmonary Flow	Intracardiac Shunting	Obstruction to Left Heart Inflow/Outflow	Obstruction to Right Heart Inflow/Outflow	Coronary Ischemias	Dysrhythmias	Low Cardiac Output
PDA ligation	Rarely (partial ligation)	Rarely (mistaken PA ligation)	Not seen	Rarely (mistaken aortic ligation)	Rarely (ligation of PA)	Not seen	Not seen	Rarely
ASD closure	Rarely (residual ASD)	Not seen	Rarely (residual ASD)	Not seen	Not seen	Not seen	Rarely	Rarely
VSD closure	Occasionally (residual VSD)	Not seen	Occasionally (residual VSD)	Occasionally	Rarely	Not seen	Rarely	Occasionally (residual VSD)
Tetralogy of Fallot repair	Occasionally	Rarely	Occasionally (residual VSD)	Not seen	Occasionally (residual PS)	Not seen	Rarely	Occasionally (RV dysfunction and PI)
Complete atrioventricular canal repair	Occasionally (residual VSD)	Not seen	Occasionally (residual VSD)	Not seen	Not seen	Not seen	Rarely	Occasionally (mitral insufficiency)
Transposition: Mustard or Senning repair	Not seen	Not seen	Rarely	Occasionally (obstruction of pulmonary veins—inflow)	Occasionally (SVC or IVC inflow obstruction)	Rarely	Frequently (atrial)	Occasionally
Transposition: arterial switch repair	Not seen	Not seen	Rarely	Rarely (supraaortic stenosis)	Rarely (suprapulmonary stenosis)	Occasionally (iatrogenic coronary obstruction)	Rarely	Occasionally (2 degrees to coronary ischemia)
Coarctation repair	Not seen	Not seen	Not seen	Occasionally (residual aortic gradient)	Not seen	Not seen	Not seen	Not seen
Fontan repair	Not seen	Occasionally	Occasionally (baffle leak)	Not seen	Occasionally	Not seen	Occasionally (often second degree to high PVR)	Often (second degree to high PVR)
PA banding	Occasionally	Often	Always	Not seen	Always	Not seen	Rarely	Occasionally (loose PA band)
Blalock-Taussig shunt (classic or modified)	Occasionally	Occasionally	Always	Not seen	Not seen	Not seen	Rarely	Occasionally

(continued)

TABLE 52-4.

Hemodynamic Problems Resulting from Various Cardiac Surgical Procedures (Continued)

Procedure	Excessive Pulmonary Flow	Inadequate Pulmonary Flow	Intracardiac Shunting	Obstruction to Left Heart Inflow/Outflow	Obstruction to Right Heart Inflow/Outflow	Coronary Ischemias	Dysrhythmias	Low Cardiac Output
Glenn shunt	Not seen	Occasionally	Always	Not seen	Often (transient SVC obstruction)	Not seen	Rarely	Occasionally
Total anomalous pulmonary venous return	Not seen	Occasionally	Rarely	Occasionally (PV obstruction)	Often (transient increased PVR)	Not seen	Rarely	Often

ASD, atrial septal defect; PA, pulmonary artery; PDA, patent ductus arteriosus; PS, pulmonic stenosis; PV, pulmonary vein; PVR, pulmonary vascular resistance; RV, right ventricle; SVC, superior vena cava; VSD, ventricular septal defect.

sence of a few large collaterals that can be easily approached and ligated surgically, this problem is best approached preoperatively or postoperatively in the catheterization laboratory where multiple small vessels can be embolized. Until interruption of collateral supply is accomplished, inotropic support often is needed. Presence of such collaterals can jeopardize cerebral blood flow during CPB, particularly when the pulmonary collaterals originate from vessels also supplying the head. This problem is more likely when  $\alpha$ -stat acid-base management is used for hypothermic bypass and low  $Paco_2$  levels dilate the pulmonary circulation while constricting the cerebral circulation.

**BOX 52-2.****Anesthetic Management of Excessive Pulmonary Blood Flow****Signs**

- High arterial saturations in mixing physiology
- Oxygen saturation step-up from right atrium to pulmonary artery
- Elevated pulmonary artery pressures

**Therapeutic Maneuvers**

- Low fraction of inspired oxygen
- Normocapnia or mild hypercapnia
- Positive end-expiratory pressure
- Mechanical restriction of pulmonary flow (clamp or band)
- Inotropic and pressor support
- Ligation or coil embolization of aortopulmonary shunts and collaterals

**Inadequate Pulmonary Flow**

Inadequate pulmonary flow occurs in association with surgically created aortopulmonary shunts, such as the Blalock shunt, that are too small, are clotted, or have partially obstructed anastomoses. These patients may become hypoxemic ( $SaO_2 < 70\%$ ) immediately after opening the newly constructed shunt after an existing source of pulmonary blood, such as PDA, is ligated. The degree of hypoxemia may not be appreciated until reversal of muscle paralysis and emergence from anesthesia. Increases in oxygen consumption and resultant decreases in mixed venous oxygen saturation accompanying these events can result in substantial decreases in  $SaO_2$  when pulmonary flow through the shunt is marginal. Anesthesia, hypothermia, and paralysis using muscle relaxants improve the situation temporarily until increased shunt flow can be established. PA banding procedures can produce similar results. Inadequate flow and increased right ventricular afterload resulting from excessive tightening usually is immediately apparent as progressive hypoxemia, right ventricular dilation, hypotension, and bradycardia. This is acute right ventricular failure and is managed by immediate loosening of the band.

Inadequate pulmonary flow may occur after a Fontan procedure. This procedure is used when there is no pulmonary ventricle to pump blood through the lungs; pulmonary blood flow depends on a gradient between central venous pressure (CVP) and left atrial pressure. Moderate elevations in

PVR resulting from CPB and associated events or mechanical obstruction to blood flow in the Fontan pathway can severely restrict pulmonary flow, resulting in inadequate left heart filling. Low cardiac output is seen with high CVP ( $> 17\text{--}20$  mm Hg). These patients generally are not hypoxemic. Inotropic support, "pulmonary" vasodilators, and other manipulations to decrease PVR (Box 52-3) are only temporizing measures. Urgent reparations are needed to avoid progressive low cardiac output,

**BOX 52-3.****Anesthetic Management of Inadequate Pulmonary Blood Flow****Signs**

- Arterial oxygen saturation  $< 75\%$
- Right atrial pressure  $> 15\text{--}17$  mm Hg (Fontan)

**Therapeutic Maneuvers**

- 100%  $O_2$
- Increased systemic perfusion pressure with pressors
- Hypocapnia to  $Paco_2 < 25$  mm Hg with hyperventilation and alkalization
- Maintenance of normal functional residual capacity (avoiding hyperexpansion or atelectasis of lungs)
- Trial of positive end-expiratory pressure (low levels 3–7 cm  $H_2O$ )
- Reduce oxygen consumption (anesthesia, paralysis, hypothermia)
- Drainage of pleural and peritoneal cavities
- Trial of pulmonary vasodilators, including nitric oxide

**BOX 52-4.****Anesthetic Management of Left Heart Outflow Obstruction****Signs**

- Large inotropic requirement
- Low cardiac output
- High left atrial pressure

**Therapeutic Maneuvers**

- High left atrial filling pressures
- Maintenance of high coronary perfusion pressures
- Minimization of right ventricular afterload
- Inotropic and pressor support

multiorgan dysfunction, and death. When fenestrated Fontan procedures are done, shunting through the fenestration maintains cardiac output even when PVR is high; cardiac output is maintained, but hypoxemia results from low pulmonary blood flow. With the fenestrated Fontan, the cardiac output is better maintained, and tolerance for transient increases as PVR improves.

**Intracardiac Shunting**

Intracardiac shunting occurs intentionally in surgical procedures, such as creation of aortopulmonary shunts and PA bands, because in these palliative procedures no attempt is made to completely correct the anatomy. Residual intracardiac shunting also occurs unintentionally. Residual defects may remain because of inadequacies in the surgical repair or because of undiagnosed additional defects. Whenever an intracardiac patch or baffle is placed, there is potential for residual intracardiac shunting. Such residual shunting usually produces either excessive or insufficient pulmonary blood flow, depending on individual pathophysiology. It is handled by manipulating SVR/PVR to minimize detrimental effects.

**Obstruction to Left Heart Outflow or Inflow**

When complex reconstructions of the ventricular septum are performed inside the heart near the left ventricular outflow tract, subaortic obstructions to flow may be created, which result in low cardiac output and persistent, large inotropic requirement. This problem should be suspected because of the combination of hemodynamic instability and a complex VSD repair in the subaortic region. Diagnosis can be made using pullback pressure measurements from the left ventricle to the

aortic root and by intraoperative echocardiography. Supportive measures, including inotropic support (Box 52-4), in these patients are no substitute for correction of outflow obstruction.

In other ventricular septal repairs, large degrees of obstruction to right heart outflow producing suprasystemic right ventricular pressures may cause bowing and shift of the intraventricular septum into the left ventricular outflow tract and even obstruction. The obstruction to right ventricular outflow should be corrected and usually greatly improves left heart function. Again, inotropic support is only a temporizing measure.

Obstruction to left heart inflow (i.e., pulmonary venous return) may occur with atrial baffle repairs of transposition of the great arteries (Mustard or Senning repair) or occasionally with repair of total anomalous pulmonary venous return. This condition presents as low cardiac output; pulmonary hypertension, and severe, poorly tolerated pulmonary edema. Immediate relief of the pulmonary venous obstruction is indicated.

**Obstruction to Right Heart Outflow or Inflow**

This occurs most frequently in tetralogy of Fallot repair or other repairs of pulmonic stenosis and PA hypoplasia. Inadequate relief of pulmonary stenosis leads to right ventricular hypertension and often some degree of right heart failure, which may not be tolerated. In the immature heart, right ventricular failure is always accompanied by some degree of left ventricular dysfunction. Moderate outflow obstruction usually does not cause severe problems but often requires inotropic support intraoperatively and postoperatively. Measures used in these situations are outlined in Box 52-5.

Obstruction to right heart inflow occasionally occurs with complex intraatrial baffle repairs of transposition of the great arteries (Mustard or Senning repair). Most common is superior vena cava obstruction, intraoperatively seen as low cardiac output and immediately apparent when surgical drapes are removed and severe head and upper body edema and venous stasis are apparent. Similar problems with inferior vena cava obstruction occur less frequently during Mustard and Senning repairs. These repairs are now infrequently performed because of the superiority of great vessel switch procedures for transposition repairs.

**BOX 52-5.****Anesthetic Management of Right Heart Outflow Obstruction****Signs**

- Inotropic requirement
- Low cardiac output
- High right atrial and right ventricular pressures

**Therapeutic Maneuvers**

- Maintenance of high right atrial filling pressures
- Maintenance of high coronary perfusion pressures
- Minimization of pulmonary vascular resistance
- Inotropic support

**Coronary Ischemia**

Coronary ischemia associated with congenital heart procedures usually has iatrogenic origins. The “switch” operation for transposition of the great arteries entails relocation of the coronary arteries in small infants from the right ventricular outflow tract to the left ventricular outflow tract. Technical errors in transplantation of these small coronary arteries may result in stenosis from excessive tension, anastomotic obstruction, or torsion of transplanted coronary arteries. Coronary ischemia may develop intraoperatively or later. It most often is apparent as ventricular failure and low cardiac output.

In other types of repairs in which dissection and retraction around the aortic root are performed, compression, inadvertent suture ligation, and inadvertent transection of coronary arteries can occur. These events may first be signaled by ST-T wave ECG changes. It is important to continuously monitor two ECG leads in congenital heart surgery, preferably leads II and V<sub>5</sub> or V<sub>6</sub>. When ischemia is seen, the measures outlined in Box 52-6 are useful until the cause is found and corrected.

The most frequent type of coronary ischemia seen is simply that associated with inadequate coronary perfusion pressures when weaning from bypass. Even in children with normal coronary arteries, stress of high afterload, dilated ventricles, and tachycardia can result in coronary ischemia, particularly during hypotension. Such ischemia usually is easily managed by increasing systemic arterial pressure using a vasopressor or by increasing CPB flow pump output, slowing heart rate, and



## BOX 52-6.

**Anesthetic Management of Coronary Ischemia in Congestive Heart Disease****Signs**

ST-T segment changes in electrocardiographic lead II or V<sub>5</sub>  
Cyanotic demarcation of epicardial coronary distribution  
Dyskinetic regional myocardial wall motion

Low cardiac output

**Therapeutic Maneuvers**

Checking of surgical retraction  
High coronary perfusion pressures  
Minimization of ventricular distension and heart rate  
Nitroglycerin rarely useful  
Inotropic and pressure support

correcting overdilation of the ventricle. Nitroglycerine is rarely useful because of the etiology of most coronary ischemia in patients with CHD.

**Dysrhythmias**

Most dysrhythmias seen in patients with CHD are iatrogenic and are related to mechanical or ischemic injury to conduction pathways. Anesthetics can alter or exacerbate existing dysrhythmias but are rarely solely responsible for dysrhythmias seen during cardiac procedures.<sup>62</sup> These dysrhythmias limit cardiovascular reserve and increase operative risk. Some patients with CHD may be receiving antiarrhythmic drugs or have implanted pacemakers. Particular attention should be paid to the patient's intrinsic rate and rhythm plus characteristics of pacemaker function. In patients with surgically induced complete heart block, immediate temporary pacing generally is required. If atrioventricular conduction has not returned in 10 days, permanent pacing is needed because atrioventricular conduction rarely returns after this time.<sup>63</sup>

In patients with CHD and permanent pacemakers undergoing cardiac surgical procedures, asystole often results if pacemaker failure occurs. Although setting the pacemaker to asynchronous mode protects against interference from inappropriate sensing caused by electrocautery, cautery use occasionally has caused complete pacemaker failure in patients with CHD through actual "burnout" of the pacemaker generator from current induced in the pacer lead by high-frequency electrocautery currents. External pacing ca-

pabilities or pacing via a temporary wire may be needed. Alternatively, a bipolar cautery can be used until the pacemaker generator is removed. Bipolar cautery does not interfere with normal pacemaker function or damage pacemaker generator circuits, unlike the radiofrequency currents used by electrocautery.

In patients whose conduction systems have been injured intraoperatively and whose cardiac output is marginal after surgery, synchronous atrioventricular pacing may be useful to increase cardiac output. Ventricular extrasystoles are unusual in children with CHD and usually indicate myocardial damage. They are managed conventionally with normalization of electrolytes and acid-base balance, overdrive pacing, and antidysrhythmic agents.

**Low Cardiac Output**

Low cardiac output is the final common pathway and expression of multiple problems associated with surgical treatment of patients with CHD. Supportive management with inotropic and pressor agents, replacement of intravascular volume, pacing, and other measures should be considered as only temporary therapy for support until the cause can be accurately diagnosed and corrected (Box 52-7). Primary myocardial injury and pump failure should be a diagnosis of last resort. All other possible residual or undiagnosed and correctable lesions should be sought before this diagnosis is accepted. When all other possibilities have been excluded and when a reversible lesion such as myocardial "stunning" or reversible pulmonary hypertension is diagnosed, maximal medical and ventilatory support is instituted. In extreme cases, extracorporeal membrane oxygenation (ECMO) and ventricular assist devices (VADs) have been successfully used for temporary circulatory and ventilatory support.<sup>64</sup>

**Management of Problems Associated with CPB**

Management of CPB in children with CHD differs considerably from treatment of adults with acquired heart disease. Aortopulmonary communications, abnormal intracardiac anatomy, small body size, and immature cardiovascular systems alter CPB management. Historically, the morbidity of CPB in neonates and small infants has been a major limiting factor to surgical treatment.<sup>65</sup> Substantial evidence indi-

## BOX 52-7.

**Anesthetic Management of Low Cardiac Output****Signs**

High filling pressures  
Poor ventricular function  
Progressive metabolic acidosis  
Low urine output

**Therapeutic Maneuvers**

Cause should be determined  
Discontinuation of inhalational anesthetics  
Optimizing of ventilatory pattern  
Synchronous arteriovenous pacing  
Elevation of filling pressures  
Period of partial circulatory support on bypass  
Maximization of pressor and inotropic support  
Ventricular assist devices if indicated  
Extracorporeal membrane oxygenation support if indicated

cates that nonepithelial surface-induced damage to formed blood elements and blood proteins is proportionally greater in small children and infants, who have large surface area-to-body mass ratios. In recent years, technologic refinements have lowered the contribution of CPB-related problems to pediatric mortality, but CPB remains a substantial issue, particularly in small infants. Growing knowledge about the roles of cytokines, activated leukocytes, platelets, and endothelial cells in the inflammatory response to CPB holds promise for reducing the morbidity rate.<sup>66</sup>

**Potential Perfusion Problems**

Because of the factors of scale related to surface area and blood volume, substantial hemodilution and multiple exchanges of the entire circulating blood volume are required when conventional pediatric CPB circuits are used in small infants. The minimum pump prime required even by current infant-sized pump oxygenator circuits (250–500 mL) is very large compared with the neonate native circulating blood volume (~300 mL). CPB results in an exchange of one or more blood volumes in neonates and small infants, plus hemodilution to hematocrits of 20%. This extensive dilutional exchange may make postbypass hemostasis difficult without fresh blood products and also imposes large crystalloid and metabolic loads. CPB priming solution has substantial metabolic consequences be-

cause of its large volume. Depending on the constituents of the pump prime solution, large glucose, lactate, and osmotic loads are imposed.<sup>67</sup> These loads can be substantially reduced with modern washing and ultrafiltration techniques.<sup>68</sup> Ultrafiltration techniques likely reduce bypass morbidity in infants by decreasing levels of cytokines and other inflammatory mediators.<sup>4,69</sup>

Pump perfusion in children is regulated primarily by flow rate in most institutions. Because of the greater relative cardiac output of infants and their greater surface area-to-body mass ratio, pump flow rates as high as 150–200 mL/kg/min are used in neonates weighing 2–3 kg to provide normal cardiac output. Despite these high flows, mean arterial pressures during bypass often are approximately 30 mm Hg in infants, particularly during deep hypothermia when hemodilution markedly decreases blood viscosity. In older children, lesser flows are used, and perfusion pressures increase until the standard adult flows (50–70 mL/kg/min) and pressures are achieved in patients weighing >50 kg. Because of the low mean arterial pressures frequently used during bypass surgery in infants, unobstructed venous return to the pump oxygenator reservoir is critically important during bypass surgery, particularly in the superior vena cava. Presence of high venous pressures in the cerebral circulation can markedly hamper cerebral perfusion in children when mean arterial pressures are low during bypass surgery. This is particularly true during deep hypothermia in children when pressure-flow autoregulation of cerebral perfusion may not be present.<sup>70,71</sup> When caval occlusion tapes are tightened around venous cannulae, it is especially important to check for signs of superior or inferior vena caval obstruction or alternatively to monitor pressures in central venous lines positioned superior to the caval tape.

In the absence of inferior or superior vena caval obstructions, with normal venous pressures, low arterial perfusion pressures cause no problem in hemodiluted children receiving adequate flow. However, the margin of error is small for proper positioning of inferior and superior vena cava cannulae in the small infant heart. Obstruction of hepatic or jugular veins can easily occur, so signs of caval obstruction should not be ignored, particularly when venous pump return is inadequate.

The frequent presence of aortopulmonary collaterals in patients with CHD makes the definition of adequate bypass flow rates uncertain. In assessing perfusion during CPB in patients with CHD, the potential effect of aortopulmonary shunts or collaterals on systemic perfusion should be considered. A high perfusion rate may be indicated by pump head revolutions, but unless all sources of aortopulmonary shunting are controlled, much of the aortic perfusion from the pump passes into the lungs through shunts and collaterals and returns to the pump from the pulmonary veins through intracardiac defect to the right atrial venous cannula. Blood traveling this route does not perfuse the systemic circulation and especially does not perfuse brain. This may constitute a large proportion of apparent pump flow. Although well-defined shunts, such as PDA, Blalock-Taussig shunt, or Waterston shunt, may be ligated before bypass, many children with cyanotic disease have extensive aortopulmonary collaterals that are not easily controlled. During these conditions, pump flow rates may bear little relation to actual systemic perfusion.

Abnormally low perfusion pressure during bypass surgery despite high pump flows should suggest open systemic-to-pulmonary shunts. Sources of such shunts should be sought and controlled. Other indices of flow adequacy should be followed to ensure adequate perfusion of vital organs. Evidence indicates, for example, that systemic arterial collaterals to the lungs originating from the vertebral arteries may “steal” flow from the basilar artery and the brain during CPB, causing cerebral ischemia and choreoathetosis.<sup>72</sup>

During bypass cooling and warming, the rate of change recorded from temperature probes placed in various parts of the body provides an index of regional perfusion. Core temperature, measured by distal esophageal temperature, generally changes most quickly, followed by a lag of several degrees for nasopharyngeal or tympanic temperatures, the latter two better indicating brain perfusion. Rectal or extremity skin temperatures lag further because these areas reflect more peripheral perfusion. Temperature gradients between these regional beds decrease as steady state is approached and generally are seen in reverse order during warming. Deviations from normal tem-

perature gradients seen on cooling and warming may indicate perfusion problems. However, such variations from normal temperature gradients do not predict the adequacy of cooling when jugular venous bulb oxygen saturations are measured during bypass cooling in small children.<sup>73</sup> In the absence of bypass warming or cooling, urine output and systemic acid–base balance are reasonable indicators of perfusion. Oxygen saturation of the venous outflow to the pump also is an important indicator of tissue perfusion. This value should be approximately 70% or greater, particularly during hypothermic bypass surgery.

Management of ventilation of the lungs during bypass surgery has been controversial. During partial bypass surgery, some ventilation probably is indicated if the pulmonic ventricle is demonstrably ejecting blood. This serves to oxygenate the small amount of blood being ejected so that the coronary arteries, which receive the bulk of this blood, are perfused with saturated blood. Low flow of 100% oxygen into the lungs should continue, even if no mechanical ventilation takes place, so that apneic oxygenation occurs as long as pulmonary blood flow continues. Frequent visual checks of arterial and venous lines at the pump provide estimates of the arteriovenous oxygen saturation difference and oxygen consumption. These estimates are periodically confirmed by measurement of venous and arterial blood gases, along with electrolytes, glucose, hematocrit, ionized calcium, and activated thromboplastin time (activated clotting time) during bypass surgery. Addition of blood, sodium bicarbonate, calcium, heparin, potassium, and crystalloid solutions to the pump reservoir, along with gas flow through the oxygenator, are guided by these measurements. Instruments that provide continuous  $P_{aO_2}$ ,  $P_{VO_2}$ , pH, and  $PCO_2$  are available for use during bypass but may not be as accurate as *in vitro* blood gas analysis.

### **Brain Damage**

The mortality after pediatric cardiac surgery has decreased significantly over the past few decades. As a result, attention has turned to the issue of morbidity, particularly neurologic morbidity. A survey of six major North American hospitals was conducted from 1988–1989. The conclusion drawn from this study was that

the incidence of brain injury in children who had undergone pediatric cardiac surgery ranged from 2–25%.<sup>74</sup> Although significant improvements have been made in the perioperative management of children, the incidence remains significant. The most common problem seen is choreoathetosis, which has been reported with deep and moderate hypothermia, with long and short circulatory arrest, and with low and normal bypass flows.<sup>75,76</sup> Thus, the exact cause of this problem is unclear, but it is almost certainly the result of disturbances of brain perfusion in the basal ganglia. Although it is known that brain blood flow is altered by temperature,<sup>77</sup> PaCO<sub>2</sub> levels,<sup>78</sup> and use of prolonged circulatory arrest periods,<sup>77</sup> among other factors, how these factors may interact to produce brain damage, such as choreoathetosis, in the isolated cases in which it occurs is not known. Studies have identified cerebral steal from systemic arterial collaterals to the pulmonary arteries originating from the vertebral–basilar artery system and short cooling times as a possible cause, but this remains to be confirmed.<sup>22</sup> In brain damage other than choreoathetosis, a relationship between high cooling rates and short cooling times before circulatory arrest and subsequent decreases in neurodevelopmental test scores in infants has been shown.<sup>79</sup> Even in the absence of overt neurologic injury, studies have shown that periods of hypothermic circulatory arrest >30–40 minutes during bypass repairs of CHD in infants are associated with a greater incidence of postoperative seizures and lesser neurodevelopmental scores at 1 year of age.<sup>79,80</sup> In addition, the etiology of cerebral injury in adults usually is secondary to embolic phenomenon but in children is less clear. Preoperative, intraoperative, and postoperative factors all contribute to the final neurologic insult in children.

### Preoperative Factors

Children with CHD may have some preexisting neurologic impairment or neurodevelopmental delay. Such abnormality has been known for some time with regard to the well-known syndromes, such as Down syndrome, Williams syndrome, and trisomy 13, but is being found with increasing frequency in patients with CHD as our ability to detect it improves. Limperopoulos et al.<sup>81</sup> studied 131 new-

borns and infants before surgery for CHD. This group reported neurobehavioral abnormalities in more than half of the newborns, with >38% of the infants also showing neurodevelopmental abnormalities.

In addition to congenital abnormalities, acquired causes seem to make a significant contribution. The immature brain is extremely susceptible to the cardiorespiratory imbalance that often occurs in the preoperative patient before surgery.<sup>79</sup> Poor cardiac output, elevated CVP, chronic hypoxia, and possible embolic phenomena all put the immature brain at risk. Limperopoulos et al.<sup>81</sup> also noted that infants who had a saturation <85% preoperatively had a significantly greater incidence of neurologic abnormalities than those whose saturation was >85%. In a more recent study of babies with HLHS, 22 full-term neonates were examined by magnetic resonance imaging before surgery. Ischemic lesions were demonstrated in 23% of the patients.<sup>82</sup> Finally, the diagnosis itself has a significant prognostic effect. Patients with single ventricle physiology and arch obstruction have the highest risk of perioperative cerebral injury compared with all other forms of CHD.<sup>83</sup>

### Intraoperative Factors

Intraoperative cerebral injury usually is the result of ischemia and associated reperfusion injury. Some degree of inflammatory effect also may play a part. Current evidence suggests that management of the CPB aspect of the operation can substantially influence the outcome.

### Deep Hypothermic Circulatory Arrest and Low-Flow Bypass

In an effort to lower the high morbidity rate historically associated with CPB in young children undergoing intracardiac repairs for CHD, deep hypothermia with circulatory arrest or low-flow continuous bypass has been used. Deep hypothermic circulatory arrest (DHCA) with core and cerebral temperatures <20 °C in children weighing <10 kg and in selected older patients provides ideal operating conditions for the surgeon, reduces bypass time and blood trauma, and maximizes myocardial protection.<sup>84</sup> These advantages are offset by risk of CNS damage from prolonged ischemic times. Current studies, both animal and human, suggest that arrest times >40 minutes

increase the likelihood of severe injury.<sup>77,81,85–87</sup> Some centers have abandoned DHCA in favor of hypothermic low-flow CPB techniques because of concerns about subclinical neurologic damage and impairment of intellectual development, whereas others advocate using shorter periods of arrest interrupted by periods of perfusion to replace cerebral energy stores; however, this technique has not been conclusively proved in human studies.<sup>88</sup>

The potential disadvantages of DHCA are prolonged periods of ischemia to vital organs. As a practical matter in the large clinical experience with DHCA during the past 20 years, the only organ at appreciable risk is the brain. The majority of studies of neurologic outcome with DHCA in children and adults show no overt cerebral damage resulting from DHCA.<sup>89–95</sup> A minority of these studies have shown some evidence of effects on subsequent intellectual development, but usually only at circulatory arrest periods >45 minutes. Neurologic outcome studies of DHCA patients have been criticized as being poorly controlled and nonrigorous in their assessment of neurologic injuries and of combining heterogeneous groups of patients. The most recent study that avoids these problems shows evidence of intellectual impairment at 1-year followup evaluations in infants subjected to DHCA periods ≥ 30 minutes.<sup>79,80</sup> Because mechanisms of ischemic protection of the hypothermic brain are incompletely understood, there are no accepted optimal techniques for cerebral protection and no well-defined “safe” period of circulatory arrest; however, circulatory arrest is being used less frequently in favor of low-flow bypass techniques. DHCA periods >30 minutes are avoided whenever possible.

The alternative to DHCA, low-flow hypothermic CPB, in theory should allow for a reasonable surgical field while still providing adequate tissue perfusion to prevent cerebral injury. This has been demonstrated to be true metabolically, but recent studies in children have shown some significant deleterious effects of low-flow CPB.<sup>96,97</sup> In addition, there is no “standard” for “low-flow” bypass. Experimental studies have established that with decreasing total bypass flow during moderately hypothermic CPB surgery, the brain takes an increasingly larger fraction for itself to preserve normal cerebral oxy-



gen consumption levels. When flow becomes sufficiently low, oxygen consumption decreases because of ischemia.<sup>98,99</sup> Several studies have demonstrated that low-flow bypass resulted in loss of somatosensory evoked-potentials and intracellular adenosine triphosphate (ATP) and was associated with decreased intracellular pH when flow levels were sufficiently lessened.<sup>100-102</sup> In experimental studies measuring brain levels of high-energy phosphates in vivo, very low flows (down to 10 mL/kg/h) maintained normal brain creatinine phosphate and ATP levels in sheep during hypothermic low-flow bypass surgery.<sup>85</sup> In contrast, no middle cerebral artery (MCA) flow has been detected using TCD in clinical studies of infants and using greater levels of flow during hypothermic low-flow bypass surgery in one institution. A clinical study showed inconsistent perfusion of the MCA during hypothermic low-flow bypass surgery in infants in whom flows <30 mL/kg/min were used.<sup>103</sup>

Rossi et al.<sup>104</sup> showed that creatine kinase levels were equally elevated after DHCA and after low-flow hypothermic bypass in infants, suggesting no difference between the two techniques using this measure of brain injury. Thus, without any established “safe” level of low-flow bypass surgery, some degree of cerebral ischemia and damage may occur even when low-flow bypass surgery is used in preference to DHCA. Thus, continuous low-flow bypass surgery may well provide a false sense of security about brain protection. Together with less favorable operating conditions obtained with low-flow bypass surgery, this false security can markedly prolong low-flow bypass time, bypass damage, and potentially cerebral ischemic time that may occur during low-flow bypass surgery. Because the mechanisms of cerebral injury and the physiology of low-flow bypass surgery during hypothermia in infants and children are not well understood, the cerebral protective effects of low-flow bypass surgery may not always be better than DHCA.

Cerebral blood flow studies in children undergoing DHCA and low-flow bypass surgery by Greeley et al.<sup>77</sup> have shown that cerebral pressure-flow autoregulation is lost in children during deep hypothermia but that metabolism-flow regulation is retained. After prolonged circulatory arrest, cerebral

blood flow and metabolism subsequently remain depressed during and after bypass compared with more normal recovery of metabolic rate and cerebral blood flow with continuous low-flow bypass.<sup>70,71,76</sup> These findings are consistent with delayed recovery of electroencephalographic (EEG) and somatosensory-evoked potentials after prolonged DHCA.<sup>105,106</sup> Despite delayed recovery of these functional measures and low cerebral blood flow and metabolism immediately after DHCA, gross neurologic deficits are seen infrequently.

DHCA provides optimal conditions for precise surgical repairs of complex intracardiac problems in tiny hearts, minimizes the formidable morbidity of CPB in small infants, improves myocardial protection, and lessens the incidence of cannulation-related problems and obstruction in the inferior and superior venae cavae. Low-flow bypass should provide less cerebral risk, with most of the surgical benefit associated with visualization of anatomy. In the Boston Circulatory Arrest Study, which compared these two support strategies in patients diagnosed with D-transposition of the great arteries, results were less conclusive. The patients in the DHCA group had worse outcome with respect to seizure activity postoperatively, motor skills at 1 year of age, and behavior, speech, and language at 4 years of age. However, at 8-year follow-up, the low-flow CPB group demonstrated more impulsive behavior, and although the DHCA group still fared worse with regard to manual dexterity and speech, IQ was similar across both groups but below the average for the normal population.<sup>80,107,108</sup>

### Glucose Management

Evidence suggests that management of glucose levels is important in cerebral protection. Recovery from cerebral ischemia occurring during hyperglycemia is impaired, suggesting that hyperglycemia in the mature brain should be avoided in DHCA.<sup>109</sup> In addition, children often have hyperglycemic responses to the stress of hypothermic CPB surgery, and deep levels of anesthesia can markedly attenuate both the hyperglycemic stress responses and other hormonal and metabolic stress responses seen with CPB in children.<sup>110,111</sup> In a study<sup>112</sup> that attempted to evaluate the effect of glucose levels on children undergoing the arterial

switch procedure, patients were randomized to low-flow versus DHCA and a retrospective analysis of glucose versus outcome was performed. This study suggested that lower blood glucose in the early postbypass period tended to predict EEG seizures but was not associated with an increase in clinical seizures. The report concluded that because glucose levels in the perioperative period were not associated with neurodevelopmental outcome at 1, 4, and 8 years of age, perhaps avoidance of hypoglycemia should be more of a priority in the perioperative period than should avoidance of hyperglycemia. Anesthetic management should emphasize use of muscle relaxants, barbiturates, and reduction of stress responses to minimize oxygen consumption and hyperglycemia during the ischemic period, but avoidance of hypoglycemia should remain a priority.<sup>112</sup> Pharmacologic protective agents, such as high-dose steroids and barbiturates, have not been shown to be protective against DHCA-related brain damage despite theoretical support for their use.

### Acid–Base Management

Although cogent theoretical reasons exist for why acid–base management, through its influences on cerebral blood flow and cerebral intracellular pH in the brain, may affect such damage, clinical studies of its effects during DHCA have not yet been performed.<sup>101</sup> Acid–base management thus far has not been shown to have an important effect on the incidence of cerebral complications in hypothermic open heart surgery, at least in adults in whom circulatory arrest has not been used.<sup>113</sup> A large prospective trial comparing pH-stat and  $\alpha$ -stat strategies for patients undergoing surgery requiring DHCA demonstrated a lower incidence of seizures, shorter time to first EEG activity, lower postoperative morbidity and mortality, and better cardiac output perioperatively in the pH-stat group. Thus, pH-stat is the recommended technique at present.<sup>114</sup>

### Temperature Management

Temperature management has the most significant effect on cerebral homeostasis. Decreasing temperature provides for luxury perfusion of the brain. An increase in temperature above normal provides for an equally deleterious medium. Any excess in temperature



increases the release of excitatory amino acids resulting in increased reperfusion injury and apoptosis.

### Postoperative Factors

Temperature management, inhibition of inflammatory mediators, and maintaining adequacy of cerebral oxygen delivery remain the mainstay by which cerebral injury is prevented in the postoperative period. As a result of this, the concept of multimodality neurophysiologic monitoring in the perioperative period has emerged.<sup>115</sup> Although none of these modalities has been shown to predict cerebral injury individually, use of a combination may serve as a surrogate marker predictive of injury. The combination required is not yet decided.

### Near-Infrared Spectroscopy

Near-infrared spectroscopy (NIRS) is a technique that enables continuous monitoring of regional cerebral oxygenation. Similar to pulse oximetry, cerebral oximetry uses the fact that oxygenated and deoxygenated hemoglobin absorb near-infrared light to differing degrees. With more than one wavelength, the oxyhemoglobin fraction can be determined. Currently two types of monitors are available for NIRS: a concentration monitor that measures the concentration of oxyhemoglobin and reduced hemoglobin and the relative redox state of cytochrome aa3, and the saturation monitor that measures the ratio of oxyhemoglobin and deoxyhemoglobin.

The skull is translucent to infrared light, so intracranial measurement is possible. The device uses a light-emitting diode (near-infrared light 700–1000 nm) and two light sensors placed 3 and 4 cm away from the light source. The diode emits near-infrared light, which passes through a tissue volume to the detectors. The proximal detector detects light absorbed by extracranial tissues and is subtracted from the total signal, thus allowing determination of intracranial absorption.

Although two instruments, the INVOS 4100 (and 5100 for pediatrics; Somanetics, Troy, MI) and the NIRO 300 (Hamamatsu, Hamamatsu City, Japan) are commercially available, only the INVOS has FDA approval. The INVOS is a continuous-wave, spatially resolved spectrometer that measures change in regional oxygen saturation (rSO<sub>2</sub>). Although the device appears to

provide continuous monitoring of cerebral oxygenation, the technology has some drawbacks. Because the range of values has not been established, only a trend can be followed, and absolute values are not available. Thus, rSO<sub>2</sub> is reported as a percentage on a scale from 15–95%. This in itself may expose the patient to the risk of hyperperfusion at high cerebral rSO<sub>2</sub> values.<sup>116</sup> In addition, the proprietary algorithm used to calculate the rSO<sub>2</sub> value is based on the assumption that 25% of the intracranial blood is arterial and 75% is venous. In attempting to validate this assumption in children, Watzman et al.<sup>117</sup> found a ratio closer to 15:85, with much interindividual variation. Finally, obtaining an estimate of cerebral blood volume is possible but not yet validated, so its accuracy and usefulness remain uncertain. Despite this, the INVOS instrument is increasingly used in the pediatric operating room, with a deviation of 20% from baseline suggestive of an abnormal event.<sup>118,119</sup>

### TCD Ultrasound

TCD ultrasound allows noninvasive continuous monitoring of cerebral blood flow velocity and emboli in the proximal segment of the MCA. This artery provides 70% of the blood flow to the ipsilateral cerebral hemisphere.<sup>120</sup> When using this device, the assumption is made that the diameter of the MCA remains constant, and that there is an association between blood velocity and actual blood flow that is independent of variables such as cerebral vascular resistance and temperature.

Comparing TCD with the xenon technique for measuring cerebral blood flow, Bishop et al.<sup>121</sup> found a poor correlation between absolute values of cerebral blood flow velocity and cerebral blood flow. However, a good correlation was found during hypocapnia, leading the authors to conclude that changes in cerebral blood flow velocity expressed as a reactivity index, not an absolute number, should be used as an indicator of cerebral blood flow.<sup>121</sup> A study using TCD to examine the effect of temperature on cerebral blood flow during CPB found that autoregulation was maintained at normothermia, partially lost with moderate hypothermia, and totally lost with profound hypothermia under  $\alpha$ -stat conditions.<sup>122</sup> TCD has also been used to detect emboli reaching the cerebral circula-

tion. True emboli are designated high-intensity transient signals and have characteristic audio and visual signals that differentiate them from false-positives. However, distinguishing between true emboli and false-positives is difficult in practice, and the problem remains that detection occurs after the insult and thus does not in itself prevent the incident. Cannula malposition, however, causes a sudden reduction in blood flow velocity and thus is detected very quickly by TCD. Overall, although TCD can provide a gauge by which changes in cerebral blood flow can be monitored, its use as a preventative tool is yet to be determined.

### Jugular Bulb Oximetry

The cerebral venous sinuses drain into a venous dilation known as the *jugular bulb*. SjvO<sub>2</sub> is thus a monitor of global cerebral oxygenation. Currently, reflectance oximetry has made possible the continuous noninvasive monitoring of SjvO<sub>2</sub>. Normal SjvO<sub>2</sub> values range from 55–75%, with arterial–jugular venous oxygen content difference of 4–7 mL/dL. In general, upon initiation of CPB, SjvO<sub>2</sub> increases despite the relative hypotension; however, the saturation may fall upon rewarming, reflecting a global increase in cerebral oxygen consumption.<sup>123</sup> However, studies have shown an association of both an increase and a decrease in SjvO<sub>2</sub> during CPB with short-term cognitive impairment.<sup>124,125</sup> This may be explained by the fact that although SjvO<sub>2</sub> is a good monitor of global oxygenation, it may not reflect regional ischemia. Thus, its use as a predictor of adverse neurologic outcome currently is limited. In the field of pediatric cardiac surgery, the best monitor of potential cerebral injury is still undecided, and most likely a multimodality plan is required. The exact combination and how significant each monitor is in the overall scheme is yet to be decided. Further studies are required.

### Weaning from Bypass

During rewarming, air is vented from the heart before ejection of blood into the systemic circulation is allowed. Arterial blood gases, electrolytes, glucose, and coagulation parameters are checked periodically during bypass surgery, but especially during rewarming. Electrolytes, especially ionized calcium, are adjusted to normal ranges

before separation from bypass. Adequacy of rewarming is judged by temperature recording from multiple sites and is particularly important when deep hypothermia has been used.

The need for vasopressor and inotropic support to accomplish weaning from bypass is first estimated by close observation of the heart's behavior during rewarming. Dysrhythmias, coronary perfusion problems, and state of myocardial contractility can be estimated from the appearance of the heart. Separation from bypass should be accomplished in close concert with the surgical team using all available sources of information about hemodynamic status. Monitoring appropriate intracardiac and intraarterial pressures and waveforms and transesophageal echocardiogram may provide good information about the adequacy of the operative repair, myocardial preservation, ventricular function, and the state of the pulmonary circulation.<sup>126</sup> Slavish adherence to numbers produced by intracardiac catheters and pressure monitoring systems without visual confirmation of cardiac performance can lead to numerous errors. Small size and presence of unsuspected congenital defects make interpretation of pressures from monitors difficult.<sup>127-129</sup> When rewarming is complete and cardiac function is judged adequate, weaning from extracorporeal circulation is accomplished by slowly allowing the heart to fill and eject while reestablishing ventilation. Optimal ventricular filling pressures are estimated using filling pressures from preoperative catheterization data, appearance of the heart, and infusion of small volume increments while watching filling and systemic arterial pressures. Using this latter technique, a mental Frank-Starling curve can be constructed.

If systemic arterial pressure or gas exchange is inadequate, CPB is reinstated while problems are analyzed. Problems with oxygenation after bypass surgery are caused as frequently by deficiencies in pulmonary blood flow as by deficiencies in ventilation. With low  $Pao_2$ , adequacy of pulmonary blood flow and ventilation should be critically assessed. Analysis of problems with weaning should start with reassessment of surgical repair, adequacy of ventilation, and verification that inotropic support is reaching the heart. Measurement of PA and atrial and intraventricular pressures often is

helpful, along with pullback pressure gradient measurement across aortic and pulmonic valves if indicated.

In patients who are doing poorly after the bypass period, missed or residual lesions are likely. This possibility should be carefully considered before committing the child to prolonged inotropic support postoperatively. Residual defects are by far the most frequent cause of immediate hemodynamic problems and instability after repair, even in institutions with superb diagnostic and surgical expertise in CHD.

Questions of inadequate repair should be resolved using intraoperative echocardiography, including Doppler assessment of intracardiac shunts, with either epicardial or transesophageal approaches.<sup>130-132</sup> In complex CHD, a physician specially trained and expert in the echocardiographic assessment of CHD should interpret such studies. When the problem is identified, appropriate corrective measures are taken, and weaning is again attempted. If no anatomic problems are readily apparent and if the difficulty with weaning appears to be a result of reversible myocardial dysfunction or reversible pulmonary hypertension that cannot be adequately managed, use of a left or right VAD or ECMO should be considered.

### Anesthetic Problems during Closed Cardiac Procedures

Anesthesia for closed cardiac procedures may be more demanding than for those involving CPB because bypass support can temporarily solve many hemodynamic problems that otherwise cause intraoperative deterioration. Monitoring requirements are just as stringent, and venous and arterial access are even more important. Pulse oximetry is invaluable to help evaluate the infant's condition. PDA and coarctation of the aorta are the only lesions corrected with closed surgical procedures; ductus ligation and other closed procedures now can be performed using video-assisted thoracoscopic surgery. Closed palliative procedures are used in patients with hypoxemia to increase pulmonary blood flow by constructing surgical shunts, to decrease excessive pulmonary blood flow using a PA band, and to improve atrial mixing of pulmonary and systemic venous return (Blalock-Hanlon atrial septectomy) in transposition of the great arteries. Palliative

surgical procedures now are performed less frequently because early correction of many severe cases of CHD has become possible with accompanying low mortality rate and because of the efficacy and safety of interventional cardiac catheterization. Such palliative procedures, when used in preference to reparative procedures, have appreciable mortality and morbidity rates of their own.<sup>133</sup> Reparative operations that correct the intracardiac pathophysiologic conditions are increasingly feasible and preferable even in newborns.<sup>134-137</sup>

Acid-base and electrolyte balance are meticulously maintained throughout closed procedures. When these procedures are performed via thoracotomy, the operative field is rarely visible to the anesthesia care team. Marked deterioration in cardiopulmonary status may result from surgical manipulation and retraction. Any deterioration of the infant's condition should be immediately communicated to the surgical team, which has a better view of the surgical field. Serious deterioration should prompt solicitation of surgical help. Release of retraction usually results in return to hemodynamic stability. Some compromise of ventilation and pulmonary blood flow inevitably occurs in these procedures, sometimes with severe decreases in  $SaO_2$ . Inadvertent compression of coronary arteries during these procedures may cause severe cardiac ischemia and dysfunction, which is readily correctable by adjustment of retraction. Anesthetic management using deep levels of anesthesia that minimize oxygen consumption and support cardiovascular stability usually minimizes intraoperative problems but may prolong postoperative ventilation. In extreme cases, periods of inotropic and pressor support may be required intraoperatively.

### Ductus Arteriosus and Vascular Ring Interruption

PDA ligation and other procedures, such as interruption of vascular rings, now can be performed thoracoscopically, with either one-lung anesthesia or two-lung anesthesia with lung retraction.<sup>138</sup> In either case, transient decreases in  $SaO_2$  that may occur can be managed with brief reexpansion of the collapsed lung. Visualization of the operative field is superior when thoracoscopy is used. Conversion to open

thoracotomy occasionally is required if exposure is not adequate or if bleeding occurs. Transesophageal echocardiographic confirmation of interruption of flow is useful to ensure complete closure of the vessel.<sup>139</sup>

### **Surgical Shunts**

Severe hypoxemia occurring in the operating room during or after creation of the shunt implies inadequate pulmonary blood flow. Intrapulmonary shunting should be considered in lungs that are retracted, but mechanical obstruction of flow into the PA because of retraction or actual shunt obstruction (kinking or thrombosis) is the usual cause. Re-inflation of the retracted lung segment eliminates intrapulmonary shunting. If hypoxemia persists, hyperventilation can minimize PVR and optimize gas exchange until pulmonary blood flow can be improved. Systemic-to-PA shunts are inherently inefficient, recirculating oxygenated blood into the lungs and placing a volume load on the heart.

Pulmonary blood flow should be several times greater than systemic flow to substantially reduce hypoxemia (Fig. 52-3). When the surgically created shunt is too large, pulmonary flows are excessive. This is manifested by pulmonary edema (sometimes unilateral) on chest radiography obtained postoperatively. Intraoperatively, large pulse pressures, excessively low diastolic arterial pressures, and sometimes inadequate systemic output result in children whose SaO<sub>2</sub> is relatively high despite complete mixing of systemic and pulmonary venous return. Maneuvers to increase PVR can compensate for excessive pulmonary flow to a limited degree, but early or late shunt revision often is necessary. Other reported acute complications of systemic-to-PA shunts include Horner syndrome, chylothorax, and acute ischemia of the ipsilateral arm when the subclavian artery is sacrificed.

The Glenn shunt (superior vena cava to right PA with no pump in between) is limited to patients with low PVR because venous pressure is used to provide pulmonary blood flow. Consequently, its use in newborns and infants is excluded. Other problems with Glenn shunts include thrombosis, occlusion, and elevation of PVR leading to superior vena cava syndrome. The Glenn shunt is more efficient than an arterial shunt and is useful in

patients who have congestive heart failure stemming from volume overload. In general, for other patients, the Blalock-Taussig shunt has proven the most reliable of the surgical shunts, with good long-term patency rates regardless of age. Early mortality and the incidence of late postoperative complications are lesser than for alternative shunt procedures.<sup>140</sup>

### **PA Banding**

When pulmonary blood flow is excessive and high pressure is communicated to the pulmonary vasculature, surgical intervention may be necessary to prevent progressive PVOD or to lessen symptoms of high-output congestive heart failure and inadequate systemic output. When early complete repair is not possible, pulmonary blood flow is restricted by banding the PA. This adds pulmonary outflow resistance, which converts simple, nonrestrictive shunting situations into complex shunts with limited pulmonary flow. During induction of anesthesia before the band is applied, PVR occasionally may decrease enough to result in massive pulmonary flow and systemic hypotension ("pulmonary steal"). In this case, a partial occlusion of the PA with a clamp aids in maintaining hemodynamic stability until the band can be applied.

However, the banding procedure is unsatisfyingly crude, and results are hemodynamically unpredictable.<sup>133</sup> Adequacy of the band in the operating room is assessed by observing an increased systemic blood pressure and an acceptable decrease in systemic oxygen saturation. Direct measurement of PA pressure beyond the band is made, and the pressure is adjusted to approximately half the systemic arterial pressure. Continuous monitoring of SaO<sub>2</sub> is helpful in rapidly assessing critically low levels of pulmonary blood flow that may occur during band tightening.

### **Transcatheter Management in the Cardiac Catheterization Laboratory**

Congenital heart problems are frequently managed today by transcatheter interventions in the catheterization laboratory.<sup>141,142</sup> Physiologic derangement and complications during such interventions may approach that seen in the cardiac operating room.<sup>143</sup> Anesthesia is often advisable for patient comfort and safety and for monitoring and management of complications.<sup>144</sup>

Table 52-5 lists the lesions currently managed using interventional cardiac catheterization, the procedures used, and their effects and complications.

Evolving techniques of nonsurgical management of CHDs have markedly altered pediatric cardiac anesthesia. ASDs, VSDs, PDA, and coarctation of the aorta commonly form the bulk of pediatric cardiac surgery performed in many programs. These lesions now can be managed in the interventional catheterization laboratory using nonsurgical transcatheter techniques.<sup>145-148</sup> A number of these procedures, including closure of ASDs and PDAs, can even be performed on an outpatient basis.<sup>143,148</sup> In centers that perform large numbers of interventional catheterization procedures, these common congenital heart lesions are seen less frequently in the operating room. Transcatheter closures of ASDs have been successfully done in hundreds of patients. Smaller number of VSDs, including multiple VSDs, have been closed with these techniques.<sup>144</sup>

Newer techniques continue to move this field forward. Patients with tetralogy of Fallot (and its subtypes) require relief of right ventricular outflow tract obstruction or restoration of continuity between the right ventricle and the pulmonary arteries. Whether the repair is conducted as a primary neonatal procedure or after a palliative arteriopulmonary connection is largely related to institutional bias. However, the end result appears very similar. In particular, this subgroup progresses very well toward adulthood, but the life span of prosthetic conduits is finite. Conduit stenosis and valve regurgitation appear to be the most problematic, requiring intervention before end-stage right ventricular dysfunction. Because this is difficult to predict, the timing for any intervention is also difficult. Too early results in further reoperation to enlarge the conduit; too late and the right ventricle is unable to remodel. Although many formulations of conduits have been used over time, probably the fresh, autologous pericardial valved conduits are the most promising. A long-term follow-up study showed that inserted conduits  $\geq 16$  mm had a 100% freedom from operation at 10 years.<sup>149</sup> In this case, provided ventricular function has not deteriorated before the patient has reached a body size that allows insertion of this size of conduit, this might

TABLE 52-5.

## Interventional Procedures Performed in the Cardiac Catheterization Laboratory Affecting Pathophysiology of Congenital Heart Disease

Procedure	Structure/Lesion	Effects	Complications
Coil embolization	Aortopulmonary collateral Blalock-Taussig shunts Anomalous coronary arteries	Reduce pulmonary flow Reduce pulmonary flow Increase coronary flow, reduce pulmonary flow	Hypoxemia, systemic embolization
Transcatheter device closures	Patent ductus arteriosus	Eliminate shunt, reduce pulmonary flow	Air embolization, device embolization, interference with mitral and tricuspid valve function
	Atrial septic defect	Eliminate shunt, reduce pulmonary flow, prevent paradoxical embolization	
	Ventricular septal defect	Eliminate shunt, reduce pulmonary flow	
Balloon and stent dilations	Pulmonary stenosis	Increase pulmonary flow	Embolization of stent, pulmonary artery disruption, unilateral pulmonary edema, pulmonary insufficiency, aortic insufficiency, mitral insufficiency, tricuspid insufficiency, aortic dissection
	Blalock-Taussig shunt	Increase pulmonary flow	
	Pulmonary valve stenosis	Increase pulmonary flow	
	Tricuspid valve stenosis	Increase pulmonary flow	
	Aortic valve stenosis	Increase pulmonary flow	
	Mitral valve stenosis Aorta (coarctations and others)	Increase systemic flow Increase systemic flow	
Atrial septostomies (balloon and blade)	Interatrial septum	Increase pulmonary blood flow	Perforation of heart, tamponade
Radiofrequency transcatheter mapping and ablation	Anomalous conduction pathways	Eliminate dysrhythmias, especially supraventricular tachycardia	Complete heart block; supraventricular tachycardia

be an appropriate point at which to consider the final replacement.

Percutaneous stenting is already used as a technique to delay surgical replacement. Further development in this area has included the development of percutaneous pulmonary valve insertion. A biologic valve is harvested from a bovine jugular vein. A section of this vein containing the trileaflet valve is then mounted in a stent for percutaneous insertion. Current studies have successfully demonstrated this technique, with low morbidity and mortality. The long-term durability of this stent and the ability to perform sequential percutaneous pulmonary valve implantation will determine its eventual place in the armamentarium, but at present it certainly should help to delay surgery to such a time that a 16-mm valve can be inserted rather than performing earlier and repetitive surgery with the obvious associated risks.<sup>150,151</sup> Interventional catheteriza-

tion techniques listed in Table 52-5 also are used increasingly in conjunction with surgical procedures to improve the results of surgical management of CHD and to extend therapy to previously unmanageable lesions.

### Anesthetic Care

Catheterization procedures have become more invasive, use larger and multiple catheters, involve greater blood loss, and produce more pain in smaller and sicker patients. The cardiac catheterization laboratory has effectively turned into an operating room in which major problems and complications can result from increasingly invasive procedures.<sup>143</sup> Although many patients seen in the pediatric catheterization laboratory can be adequately sedated by cardiologists, complex procedures in sick children require anesthetic care.<sup>143</sup> Anesthesia, monitoring, and hemodynamic management are needed for many of these

invasive procedures performed in children and contribute substantially to a successful procedure.<sup>141,152</sup> Many patients can be treated with monitored IV sedation techniques, but others require general endotracheal anesthesia. Indications for using either technique are not yet well defined but depend on patient condition, procedure, and anticipated complications.

Anesthetic management is handicapped by the catheterization laboratory environment. Problems include poor patient access, poor lighting, radiation hazards, and lack of communication with cardiologists. Independent monitoring, independent IV and sometimes intraarterial access, independent light sources, and adequate access to the patient's airway should be sought. Prevention or prompt management of complications is a major anesthetic task in this setting. Without a thorough understanding of transcatheter procedures, their complications, and their management,



the anesthesia provider is handicapped in coping with accelerating development of these new techniques.

### Problems and Hemodynamic Complications

Complications of various interventional procedures are related partly to the type of interventional procedure, but all share risks associated with percutaneous access to major veins and arteries. Specific problems that may occur during various interventional transcatheter procedures are listed in Table 52-5. Many problems are sudden, occur without warning, and are potentially life threatening. As in the operating room, successful management of complications depends heavily on prompt action by anesthesiologists cooperating closely with interventional cardiologists and radiologists.

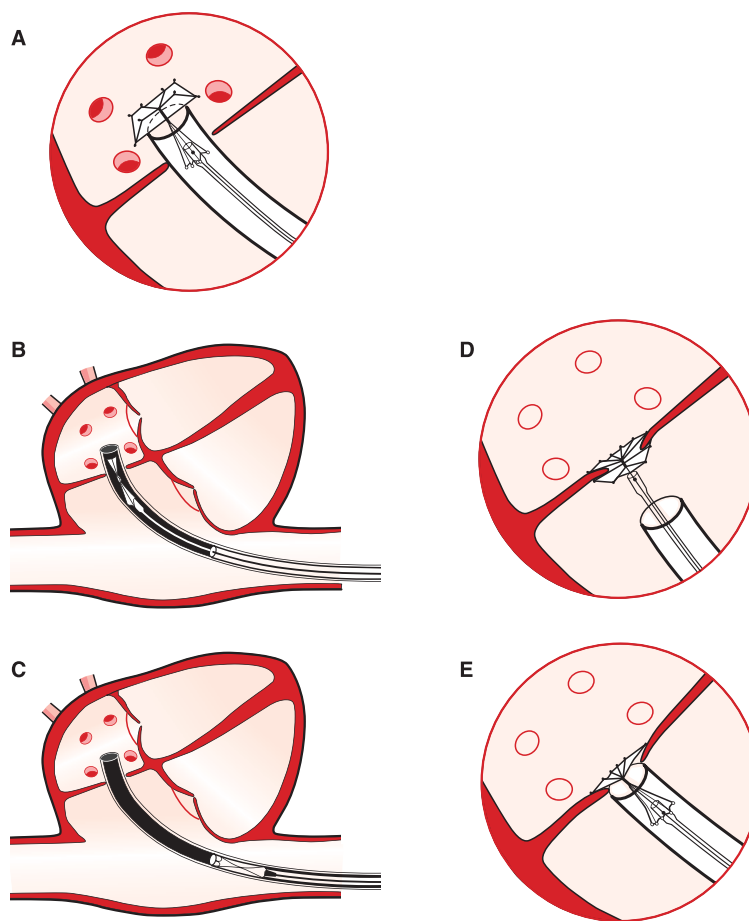
Loss of control of embolic and closure devices results in systemic and pulmonary arterial embolization. Embolized devices usually can be retrieved using a variety of retrieval catheters, but in a minority of patients, surgical removal is required. If the device is lodged in the heart or a great vessel, CPB may be required for removal. Such device embolizations usually do not cause extreme hemodynamic instability or cardiovascular decompensation requiring emergency surgical removal, but urgent surgical procedures may be necessary. Even after successful transcatheter retrieval, femoral artery and vein reconstructions occasionally are necessary when embolized devices or large dilation balloons are removed through these vessels.<sup>153</sup> When deliberate embolization of aortopulmonary collaterals excessively decreases pulmonary flow and produces severe hypoxemia, general anesthesia and muscle paralysis can increase  $\text{SaO}_2$  to acceptable levels by decreasing oxygen consumption, at least until surgical intervention.

Disruption and avulsion of major blood vessels occur, particularly PA disruption during balloon dilation procedures.<sup>154</sup> PA disruption is signaled by hemoptysis or appearance of contrast media in the pleural space or major lung fissures. Substantial hemoptysis calls for immediate endotracheal intubation for airway control and ventilation. Positive end-expiratory pressure (PEEP) may be useful. Intrapulmonary hemorrhage often is self-limited, but hemothorax can be severe and can result in death.<sup>154</sup> Transient unilateral

pulmonary edema can occur during PA dilation because of sudden increases in flow after dilation to a previously underperfused lung.<sup>154,155</sup> Unilateral pulmonary edema and disruption of PA integrity can occur abruptly. Both can cause the appearance of frank blood or blood-tinged edema or fluid in substantial quantities in the airway. Management starts with endotracheal intubation and positive-pressure ventilation unless symptoms are only minimal.

Intracardiac air embolization may be a particular problem when clamshell devices are used for PDA, ASD, and VSD closures because the large delivery sheath in the heart is transiently open to atmosphere. Transcatheter closure of an ASD using a clamshell device is shown schematically in Fig. 52-8. In patients with intracardiac shunts, air embolization

may be life threatening. The large delivery sheath is a potential space for air accumulation and subsequent delivery into the heart. In addition, when the entry port of the large delivery sheath is open during removal and reinsertion of various catheters and devices, extreme inspiratory efforts may entrain intracardiac air. Air delivered into the right atrium may be shunted across the ASD even in the presence of nominal left-to-right shunting. Left atrial air embolization during these procedures can be seen with fluoroscopy. Resultant ST-segment changes, hypotension, arterial desaturation, and bradycardia generally respond to air aspiration followed by sealing the entry port, along with administration of atropine and inotropic support to maintain coronary perfusion. Meticulous purging of air from



**FIGURE 52-8.** Technique of transcatheter atrial septal defect closure. **A.** Collapsed clamshell device is through the sheath. **B.** Device and sheath as a unit are positioned on the left atrial side of the defect using previously determined fluoroscopic landmarks. **C.** Sheath is pulled partially back, allowing one set of flexible, spring-loaded arms (covered with Dacron mesh) to spring open in the left atrium. **D.** Sheath, delivery system, and half-opened clamshell device are pulled back as a unit until the open arms engage the left atrial septal surface. **E.** Sheath is pulled farther back to expose the proximal half of the device, allowing it to spring open and engage the right atrial septal surface. Subsequently, the clamshell device is released and the delivery system withdrawn.

the catheter system, with sealing of open ports, should minimize air embolism. Controlled positive-pressure endotracheal ventilation in anesthetized, paralyzed patients may decrease the potential for air entrainment.

Tricuspid or mitral regurgitation with hemodynamic compromise may occur acutely when large catheters impinge on atrioventricular valves. These large catheters can cause dynamic stenosis as they pass across small valves. These problems usually respond to inotropic support and repositioning of the delivery catheter and device. Acute myocardial perforation with tamponade occurs occasionally during the course of interventional cardiac catheterization procedures. Prompt support of the circulation with volume infusions and pressor support, along with immediate catheter drainage of the pericardial space, are essential.

## EFFECTS OF ANESTHESIA AND RELATED MANIPULATIONS ON PATHOPHYSIOLOGY

### Anesthetics

Individual pathophysiology and the proposed therapeutic procedure largely dictate anesthetic management. Often the skill with which the technique is used determines the success of the anesthesia team in maintaining cardiovascular stability. Several anesthetic techniques provide good cardiovascular stability in children with severe CHD, but cardiovascular stability may not be the only criterion for a successful anesthetic.<sup>156</sup> Stress responses to pain and other noxious stimulation are profound even in the youngest neonates.<sup>157–159</sup> Extreme hormonal and metabolic stress responses during cardiac surgery and CPB can be pathologic in magnitude and are associated with poorer outcome in neonates undergoing cardiac surgery, despite hemodynamic stability.<sup>160,161</sup> Anesthetic techniques clearly have an effect on stress responses—metabolic and hormonal. It is important that children of all ages be given adequate anesthesia for suppression of hormonal and metabolic responses to noxious stimulation and for humane considerations.

### Inhalational Anesthetics

Inhalational anesthetics should be used cautiously in children with CHD because of their myocardial and circu-

latory depression. This is particularly true for induction of anesthesia before adequate access to the circulation and complete hemodynamic monitoring are established. Safe use of conventional inhalation induction with potent anesthetics depends on evaluation of the child's cardiac lesion and understanding the effects in young children with CHD. In children of any age with marginal cardiovascular reserve, myocardial depression caused by potent inhalational agents may produce systemic hypotension, but these agents are still unquestionably useful in small, titrated concentrations to control hypertensive responses after induction when the airway is secure after monitoring and hemodynamic stability is established.

Even in cyanotic children, if they have reasonable functional cardiac reserve, anesthesia can be induced with halothane and oxygen, even with 70% nitrous oxide (the latter relatively contraindicated because of air bubble expansion), without clinically significant decreases in  $\text{SaO}_2$ .<sup>162,163</sup> Dramatic decreases in arterial pressures occur with these techniques, sometimes to severe degrees. In infants, such induction techniques are of special concern because of the immature circulatory system. Use of these agents may considerably narrow the margin of safety in infants and younger children with severe CHD. At least in those given halothane, the levels tolerated by sick infants provide little suppression of the stress responses to cardiac surgery and CPB.<sup>160</sup>

Numerous studies have shown that even the normal immature cardiovascular system of infants without CHD does not tolerate halothane or isoflurane well; approximately 50% of infants with normal cardiovascular systems develop substantial hypotension and bradycardia during induction with these agents unless cardiovascular function is supported.<sup>32,50,164,165</sup> Ventricular function declines during halothane and isoflurane induction in normal infants; stroke volume and ejection fraction decrease by as much as 38%, although the depression with isoflurane may be somewhat less than with halothane.<sup>166–167</sup>

Sevoflurane is a fluorinated derivative of methyl isopropyl ether and is rapidly becoming the inhalational agent of choice for children. This is largely because it is the only ethereal anesthetic that does not trigger a reflex response

or cause airway irritation during inhaled induction. This, combined with its rapid recovery and minimal metabolism, makes sevoflurane an ideal agent in general pediatrics. However, it does cause myocardial depression in children, although stroke volume and ejection fraction are somewhat less depressed with sevoflurane than with other potent inhalational agents.<sup>168–170</sup> In adults, isoflurane appears to decrease SVR more than sevoflurane does. Although this decrease occurs, cardiac index appears to be preserved with both agents, and patients undergoing cardiac or thoracic procedures appear to tolerate either anesthetic safely.<sup>171–175</sup> In one of the few studies comparing isoflurane and sevoflurane in children with CHD, similar results were found. Fifty-four children undergoing cardiac surgery received sevoflurane, isoflurane, halothane, or fentanyl-midazolam. Only sevoflurane and isoflurane maintained cardiac index, with sevoflurane producing less reduction in SVR than any other agent in the study.<sup>176</sup>

Few published studies of desflurane in children with CHD are available, but studies in healthy children suggest that the effects of desflurane on ejection fraction and stroke volume are little different from those of halothane.<sup>177</sup> Isoflurane may be an unwise choice for inhalation induction in cyanotic children because increased airway problems and laryngospasm during induction (because of the agent's pungency) may lead to increases in PVR. Somewhat less myocardial depression occurs in older children.<sup>178</sup> These clinical findings are supported by experimental findings in immature animals, both in vitro with isolated atrial and ventricular muscle and in vivo with some species of young animals.<sup>51–53,179,180</sup>

Halothane can cause loss of normal sinus rhythm because of selective sinoatrial node depression. Because ventricular function depends on normal sinus rhythm in compromised hearts, loss of this mechanism may be especially critical in CHD. This applies to right and left ventricular function in patients in whom right ventricular dysfunction may be expected to be a problem, such as in patients with tetralogy of Fallot.<sup>181</sup> Although greater reductive metabolism of halothane has been demonstrated in cyanotic cardiac patients, no increase in postoperative hepatic and renal derangements has been

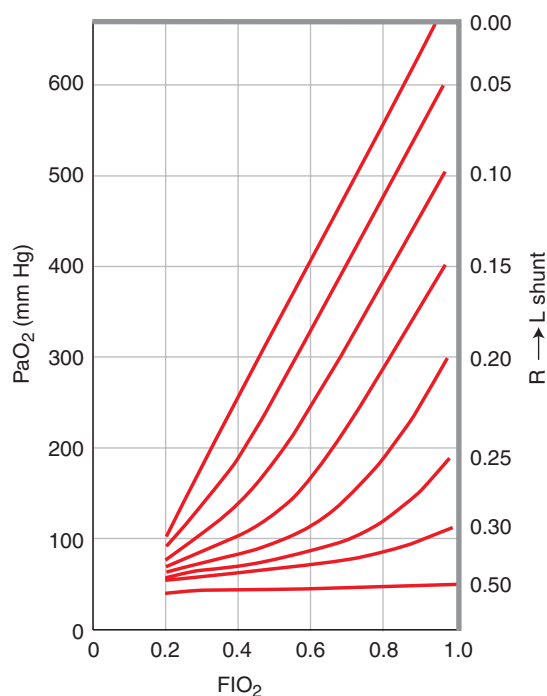
documented, and historically “halothane hepatitis” has not been a problem in cyanotic (or other) children.<sup>53</sup>

### Sevoflurane

Use of nitrous oxide in children with CHD and shunts is controversial because of its potential for enlarging systemic air emboli. Use of nitrous oxide may cause expansion of intravascular air emboli, exaggerating their circulatory effects, even without additional systemic embolization.<sup>182</sup> In patients with systemic embolization of air to the coronary circulation, nitrous oxide has been shown experimentally to be deleterious.<sup>183</sup> In children with intracardiac shunts, the potential exists for systemic shunting of microbubbles and macrobubbles of air from IV lines and from exposure of the left heart to the atmosphere during open cardiac surgical procedures. Although clinical problems from enlargement of air emboli by nitrous oxide have not been reported in this setting, avoidance of its use is prudent in patients in whom systemic air embolization is a strong possibility.

Nitrous oxide in adults decreases cardiac output, systemic arterial pressure, and heart rate and increases PVR, especially in patients with elevated PVR.<sup>184–186</sup> In children with right-to-left shunts who have decreased pulmonary flow or pulmonary hypertension, increases in PVR with nitrous oxide are detrimental. However, at least in one study, no increase in PA pressure or PVR was observed in infants given 50% nitrous oxide, regardless of preexisting PVR.<sup>187</sup> Mild but notable decreases in cardiac output, systemic arterial pressure, and heart rate were seen in these infants. Inhalation induction with 70% nitrous oxide and halothane in cyanotic children does not decrease  $SaO_2$ , suggesting that pulmonary blood flow is not decreased and that PVR is not substantially increased by nitrous oxide.<sup>14,15</sup> Although use of nitrous oxide prevents use of 100%  $O_2$ , this may not actually decrease arterial saturation in cyanotic children without lung disease because increases in the fraction of inspired oxygen ( $FiO_2$ ) have little effect on arterial desaturation caused by large central intracardiac cardiac shunts.<sup>188</sup> The effects of  $FiO_2$  on arterial saturation for different levels of right-to-left shunting are shown in Fig. 52–9.

Use of inhalational agents in children with intracardiac shunting is theoretical-



**FIGURE 52–9.** Iso-shunt graph depicting relationship between fraction of inspired oxygen ( $FiO_2$ ) and arterial  $PaO_2$  with different amounts of right-to-left shunting. Assumes normal values of pH,  $Paco_2$ , pulmonary venous saturation, and mixed venous saturation. (Modified from Lawler PG, Nunn JF. A reassessment of the validity of the iso-shunt graph *Br J Anaesth* 1984;56:1325–1335. © The Board of Management and Trustees of the British Journal of Anaesthesia. Reproduced by permission of Oxford University Press/British Journal of Anaesthesia.<sup>188</sup>)

ly complicated by differences in uptake and distribution. A complex computer model suggests inhalation induction is slowed in the presence of central right-to-left shunts, is slowed less in mixed shunts, and is little changed in pure left-to-right shunts, all in proportion to the size of the shunt.<sup>189</sup> These models assume constant cardiac output and are most marked for insoluble gases such as nitrous oxide. In children with left-to-right shunts, speed of inhalation induction actually is altered little clinically.<sup>190</sup> Experimental data in animals with right-to-left shunts confirm slowing of induction, but data in children with right-to-left shunts are not available.<sup>191</sup> Inhalation induction often seems somewhat slow in children with pure right-to-left shunts, but this effect is not marked, probably because of the effects of multiple other variables affecting uptake. Relatively slow induction of anesthesia in children with pure right-to-left shunts is a consideration in deciding how rapidly to increase the inhaled concentrations of potent anesthetics during induction without producing severe myocardial depression.

### Intramuscular and IV Anesthetics

Some IV anesthetics, such as ketamine and high-dose opiates, can provide improved safety margins for induction of

anesthesia in the immature and compromised cardiovascular system of neonates and infants with severe cardiac disease and in older children with minimal cardiovascular reserve. Very high transient arterial, cardiac, and brain concentrations of IV agents can result from normal IV doses given as a bolus in children with known right-to-left shunts because mixing, uptake, and pulmonary metabolism are bypassed. For example, IV lidocaine in a 1-mg/kg antiarrhythmic bolus dose administered in dogs with right-to-left shunts resulted in arterial concentrations higher than those reported to cause irreversible myocardial toxicity.<sup>192</sup> The potential for transiently high arterial levels of IV anesthetics in patients with intracardiac mixing and right-to-left shunts should be considered in planning.

**Ketamine** When IV access is a problem, intramuscular ketamine 3–5 mg/kg is well tolerated in sick children with cyanosis or congestive heart failure.<sup>193,194</sup> In contrast to older literature, experimental studies of isolated ventricular muscle show that ketamine has a positive inotropic effect.<sup>192,195,196</sup> Concomitant intramuscular succinylcholine can be used to facilitate airway control. Atropine or glycopyrrolate given with



ketamine may be helpful to offset secretions produced by ketamine. A small dose of midazolam (0.1 mg/kg) can be used to attenuate ketamine's dysphoric effects. Although increases in PVR have been reported in adults after ketamine administration, in well-premedicated children, ketamine causes no change in PVR when the airway is maintained and ventilation is supported.<sup>163,197,198</sup> In children with CHD, the ejection fraction has been shown to be well preserved during ketamine anesthesia. Our clinical experience with intramuscular ketamine has been excellent with most forms of heart disease, including patients with limited pulmonary blood flow and cyanosis in whom arterial saturation usually improves with ketamine.<sup>14,15</sup> Ketamine has long been used for cardiac catheterization procedures. Ketamine combined with midazolam has been used for interventional cardiac catheterization procedures such as PDA and ASD closures.<sup>141,199</sup>

When IV access is available in patients with marginal cardiac reserve, ketamine (1 or 2 mg/kg IV) is an excellent induction agent in patients with most forms of CHD. Relative contraindications are coronary insufficiency caused by an anomalous coronary artery, severe critical aortic stenosis, and HLHS with aortic atresia and hypoplasia of the ascending aorta. These patients are at risk for ventricular fibrillation because of relative coronary insufficiency; tachycardia and catecholamine release with ketamine may predispose these patients to ventricular fibrillation.

**Etomidate** This imidazole derivative is being used with increasing frequency in patients with CHD. Studies in children are rare, but one study has examined the use of etomidate as an induction agent in children with limited hemodynamic reserve. The study concluded that etomidate was safe for use in children with limited hemodynamic reserve but suggested the need for studies in neonates and children with substantial ventricular dysfunction.<sup>200</sup> In another study comparing etomidate with ketamine and  $\gamma$ -hydroxybutyrate as the sole anesthetic for cardiac catheterization in children, no difference could be demonstrated among the three groups with regard to hemodynamic or respiratory effects. However, etomidate produced recovery that was more rapid and of a better quality than in either of the other groups.<sup>201</sup> In

addition, induction with etomidate is generally as rapid as with thiopental, and with a distribution half-life of 2–3 minutes, recovery is very rapid for procedures such as cardioversions, which are common in this subgroup.

One presumed disadvantage of etomidate is the temporary suppression of adrenocortical function associated with its use, particularly when patients receive a continuous infusion. This is subject to interpretation. One study compared etomidate and ketamine induction with regard to cortisol production in the postoperative period. These investigators demonstrated reduced cortisol levels in the etomidate group but believed that this finding may be beneficial and certainly not detrimental in the context of pediatric cardiac surgery.<sup>202</sup>

**Opiates** As in adults with severe cardiac disease, high-dose IV opiates, given together with pancuronium and 100% oxygen, or air and oxygen, are excellent as induction agents in very sick children with all forms of CHD. High-dose opiates in infants and neonates provide excellent hemodynamic stability with suppression of hormonal and metabolic stress responses.<sup>159,160</sup> Anesthetic techniques based primarily on high doses of opiates have become standard care for infants and small children with severe forms of CHD, especially if they are critically ill. Hyperglycemic responses to cardiac surgery in children are suppressed by greater doses of fentanyl, so blood glucose measurements are necessary.<sup>203</sup> High-dose fentanyl technique has been reported to be effective in premature neonates undergoing patent ductus ligation and has been shown to effectively attenuate stress responses for this procedure.<sup>159,204</sup> Fentanyl doses as low as 10  $\mu\text{g}/\text{kg}$  may be sufficient for effective baseline anesthesia in neonates, but larger doses are necessary for prolonged anesthesia.<sup>205</sup> In high-risk, full-term neonates and older infants with severe CHD, use of high-dose fentanyl in doses up to 75  $\mu\text{g}/\text{kg}$ , given with pancuronium, results in minimal hemodynamic changes on induction and intubation; only mild hemodynamic responses to surgical incision generally occur.<sup>206</sup> Additional doses or infusions of potent opiates may be necessary for procedures involving CPB because narcotic levels decrease markedly in children on CPB.<sup>207</sup>

Evidence indicates that suppression of stress responses and amnesia is bet-

ter if another anesthetic, such as a benzodiazepine (midazolam), is used during high-dose opiate anesthesia. With the use of high-dose opiate anesthetic techniques, oxygen saturation levels are well maintained and may actually improve during induction, intubation, and surgical stimulation even in cyanotic children.<sup>15</sup> Changes in cardiac index, SVR, and PVR in infants given 25  $\mu\text{g}/\text{kg}$  of fentanyl have been shown to be minimal.<sup>208</sup>

Use of pancuronium with the high-dose fentanyl technique is recommended; the vagolytic effects of pancuronium offset the vagotonic effects of fentanyl. When other muscle relaxants are used with high-dose opiates, hemodynamic stability may not be obtained.<sup>209</sup> When fentanyl or other opiates are used with nitrous oxide, the negative inotropic effects of nitrous oxide may appear, especially in sicker patients.<sup>210</sup> Sufentanil (5–20  $\mu\text{g}/\text{kg}$ ) is an alternative to fentanyl and provides roughly equivalent hemodynamic stability, suppression of stress responses, and postoperative analgesia.<sup>211,212</sup> The use of a high-dose fentanyl or sufentanil technique usually necessitates continuous postoperative ventilatory support. Alfentanil, a shorter-acting potent opiate used as a continuous infusion, can be useful for providing hemodynamic stability and stress suppression in children in whom postoperative ventilatory support is not needed. A loading dose of 20  $\mu\text{g}/\text{kg}$  and an infusion of 1  $\mu\text{g}/\text{kg}/\text{min}$  as a supplement to nitrous oxide–halothane has been reported in children undergoing surgery for CHD.<sup>213</sup>

Remifentanyl, an ultrashort-acting opiate, has been shown to be a useful agent in patients with CHD undergoing surgical correction, with no clinical differences in hemodynamic and respiratory parameters both intraoperatively and 24 hours postoperatively compared with fentanyl.<sup>214</sup> This opiate has clearly been shown to have no negative inotropic effect on the failing myocardium and has allowed for full response to  $\beta$ -adrenergic stimulation at all concentrations.<sup>215</sup> Remifentanyl has been shown to be very predictable in the post-CPB period, with little change in the coefficient of variation despite 20% increased postbypass clearance values.<sup>216</sup>

**Propofol** Its short duration of action makes propofol attractive for brief procedures in patients with CHD. In the



isolated heart, propofol has myocardial depressant properties somewhat greater than those of thiopental and substantially more than those of ketamine.<sup>217</sup> Its use in patients with CHD should be restricted to those with adequate cardiovascular reserve. For patients with marginal cardiovascular reserve, use of propofol can precipitate cardiovascular decompensation and even collapse.

Successful use of propofol for pediatric patients with CHD undergoing cardiac catheterization and transesophageal echocardiography has been reported,<sup>218</sup> but in one study, a substantial percentage of patients given propofol had decreases in blood pressure >20% from baseline.<sup>219</sup> These mild deleterious effects on blood pressure are confirmed in other studies.<sup>220</sup> Increased incidences of bradycardia and junctional rhythm have been reported in children receiving propofol compared with those receiving barbiturates.<sup>221</sup> In one specific study of propofol's effects on cardiac conduction in pediatric patients, no substantial effects were seen.<sup>58</sup> These data, taken together with clinical experience, suggest that use of propofol in patients with CHD should be restricted to those with good levels of cardiovascular reserve because of the drug's cardiac depressant properties.

**Dexmedetomidine** Dexmedetomidine is a new  $\alpha_2$ -agonist approved by the FDA in 1999 for short-term (<24 hours) sedation and analgesia in critically ill patients. It has been shown to be highly effective for sedating children after cardiac and thoracic surgery who were either ventilated or spontaneously breathing.<sup>222</sup> The infusion rate of 0.3  $\mu\text{g}/\text{kg}/\text{h}$  (range 0.1–0.5  $\mu\text{g}/\text{kg}/\text{h}$ ) provided mild-to-moderate sedation in 93% of the children for a range of 3–26 hours. Higher mean dosing was required in children younger than 1 year, and these children required more rescue medications compared with older children.<sup>222</sup> For painful interventions, adjunct pain medication frequently is required because the sedative properties of this medication are clearly higher than the analgesic effect. However, it is useful for very sick pediatric patients undergoing nonpainful procedures and allows completion of the procedure without subjecting these children to intubation and mechanical ventilation. Finally, increasing evidence indicates that dexmedetomidine may be useful in facilitating acute discontinuation of opi-

oids and/or benzodiazepines in children in the ICU setting.<sup>223</sup>

### Thiopental and Other IV Agents

IV induction with thiopental generally is not used in patients with severe cardiac defects. However, a reduced dose of thiopental 1 or 2 mg/kg may be safe for induction in patients with moderate defects and may actually result in improved  $\text{SaO}_2$  in cyanosis. In pediatric patients with minimal or mild cardiac defects, IV induction with larger doses of thiopental (3–5 mg/kg) usually are well tolerated, provided the patient is not hypovolemic. Rectally administered barbiturates, notably methohexital, may be an acceptable induction technique in an otherwise uncooperative child with less severe CHD and good cardiac reserve, but absorption is variable, and myocardial depression is possible.<sup>224</sup> The experience with etomidate use in CHD has not been sufficiently extensive to determine the drug's effects with certainty, and no studies of the hemodynamic effects in small children are available.

### Muscle Relaxants

Pancuronium dosage requirements are unchanged in children with CHD and intracardiac shunts; it produces no heart rate or blood pressure changes when given slowly in these patients.<sup>225</sup> Through its vagolytic effect, a bolus dose of pancuronium can produce tachycardia and hypertension in children, which may be desirable to support cardiac output in infants with relatively fixed stroke volumes.<sup>226</sup> If tachycardia is undesirable, metocurine (Metubine) causes no increase in heart rate, blood pressure, or cardiac rhythm changes in small children, even at doses of 0.5 mg/kg.<sup>227</sup> For patients in whom a short-acting nondepolarizing muscle relaxant is desirable, atracurium, vecuronium, and cisatracurium at the lower end of their dose ranges have few cardiovascular side effects in children.<sup>228,229</sup> Use of the latter two muscle relaxants rather than pancuronium during induction combined with a high-dose opiate anesthetic may produce clinically significant bradycardia, as reported in adults. Bradycardia and even sinus arrest can be problems with use of succinylcholine in children with CHD, particularly those given large doses of opiates. To avoid these problems in vagotonic young children, atropine should be used with succinylcholine.

If potent opiates are used at the same time as succinylcholine, severe bradycardia may be avoided by concomitant use of atropine.

### Novel Inotropic Drugs

The increased sympathetic drive in these patients inevitably leads to an elevation in catecholamine levels. The continued stimulation of  $\alpha$ - and  $\beta$ -receptors by both endogenous and exogenous catecholamines leads to a decreased effect via downregulation and ultimately causes irreversible destruction of receptors. Once this level of desensitization has occurred, recovery requires RNA-directed new receptor synthesis. The options available to support the circulation become limited. Either mechanical support must be initiated or nonadrenergic receptor-mediated inotropic support is instituted. Current therapy is discussed.

### Phosphodiesterase Inhibitors

Phosphodiesterase inhibitors are the most commonly used noncatecholamine-mediated inotropic agent. The mechanism of action of these agents is also the most straightforward. Phosphodiesterases degrade cyclic adenosine monophosphate (cAMP) to 5-adenosine monophosphate (5-AMP). Phosphodiesterase inhibitors prevent this degradation, thus allowing the concentration of cAMP to increase. The increased levels of this secondary messenger lead to increased calcium availability and thus increased contractility. Because the response is related to an increase in cAMP and not purely to inhibition of phosphodiesterase, the greatest effect is seen if initial levels of cAMP are higher than normal. Thus, synergy is seen with  $\beta$ -agonists. In addition, phosphodiesterase inhibitors reduce afterload and improve coronary perfusion without any change in myocardial oxygen consumption.

### Triiodothyronine

The hormone triiodothyronine ( $\text{T}_3$ ) is essential for maturation of sarcolemmal calcium channels, myosin, actin, and troponin. Hypothyroid rats demonstrate reduced numbers of  $\beta$ -receptors, as well as a reduction in stimulatory secondary messenger protein density with an increase in inhibitory secondary messenger protein density.  $\text{T}_3$  is mostly produced by monodeiodination of thyroxine. This process is inhibited by surgery, hypothermia,

catecholamines, propranolol, and amiodarone. Thus, postoperative  $T_3$  levels are reduced.

$T_3$  replacement acts via two pathways, intranuclear and extranuclear. Intranuclear effects include increased mitochondrial density and respiration, increased contractile protein synthesis, and upregulation in  $\beta$ -adrenoceptors. Extranuclear effects include improved glucose transport, increased stimulation of L-type calcium channels with subsequent calcium mobility, and increased efficiency in calcium reuptake with subsequent improvement in diastolic relaxation.

A randomized, double-blind, placebo-controlled study by Bettendorf et al.<sup>230</sup> examined 40 children undergoing both simple and complex cardiac surgery. Results demonstrated that the group allocated to receive  $T_3$  had better myocardial function with a decreased duration of ICU stay.  $T_3$  provides improved contractility without any associated increase in oxygen consumption. In addition, the Bettendorf group demonstrated no delay in recovery of thyroid function secondary to exogenous administration.

### Levosimendan

Levosimendan is a novel drug with a unique mechanism of action. The levosimendan molecule binds to the N-terminal domain of troponin C in cardiac muscle. This process allows for stabilization of the troponin C molecule and maintains tropomyosin in an elevated position. This allows for prolongation of the contractile effect of a set dose of calcium. In addition, levosimendan acts via ATP-sensitive potassium channels, thus causing peripheral vasodilatation, coronary vasodilatation, and myocyte myocardial activation.

Follath et al.<sup>231</sup> reported a multicenter, randomized, double-blind trial comparing levosimendan with dobutamine. Two hundred three patients with severe low-output heart failure were randomly allocated to receive levosimendan or dobutamine. The levosimendan patients reported a significant improvement in cardiac output and subsequent reduction in pulmonary capillary occlusion pressure with an associated reduction in mortality at 180 days. Two other large-scale studies found similar benefits in acute and chronic heart failure patients.<sup>231-233</sup> Levosimendan in adults improves systolic and diastolic function and reduces

preload and afterload without any demonstrated increase in myocardial oxygen consumption. Studies in children are required.

### Brain Natriuretic Factor and Nesiritide

Brain natriuretic peptide (BNP) is a member of the natriuretic peptide family, which includes atrial natriuretic peptide, BNP, and C-type NP. These peptides together play a large role in maintaining hemodynamic and neurohumoral equilibrium. BNP is secreted from cardiac ventricles in response to increased stimulation of cardiac stretch receptors and increased intraventricular tension and acts mostly via natriuretic peptide receptors (NPRs) present in large vessels and kidneys. Once stimulated, NPRs promote diuresis, natriuresis, and vasodilatation and inhibit the renin-angiotensin-aldosterone system. BNP is used as a marker for heart failure in adults and as a method for monitoring therapeutic progress. Its usefulness in children is less obvious as there is no consensus regarding the normal range. Two studies attempting to determine the predictive value of BNP in acute heart failure in children came to directly opposing conclusions.<sup>234,235</sup>

Nesiritide is the recombinant form of BNP; thus, it acts via the same receptors and has the same end results. Studies suggest that patients with decompensated heart failure may benefit from nesiritide administration, with demonstrated improvement in cardiac output, reduction in pulmonary capillary occlusion pressure, arterial and venous dilation, and minimal associated increase in heart rate or myocardial oxygen consumption. Pediatric studies are awaited.

### Nonpharmacologic Support

The failing pediatric heart may require more support than is possible with medical management alone. The need for alternative assist devices is increasing dramatically for two reasons. The chief reason is that increasing numbers of pediatric patients with severe, complicated congenital cardiac anomalies are no longer considered inoperable. As a result, patients now frequently survive long enough to present for surgery and are smaller and much sicker than previously seen. Significant morbidity and mortality in these patients result from postcardiotomy car-

diogenic shock, which may necessitate mechanical support of the sick ventricle(s) even if it did not require support preoperatively. Second, heart transplantation in the pediatric population has become much more successful in the past few years as the result of improved pretransplant diagnosis, better rejection prevention, and more sophisticated monitoring of rejection, leading to a vast increase in the potential recipient pool.<sup>236</sup> The donor pool has not increased with the demand, however, and is even more disparate in the pediatric population than in the adult population; therefore, patients are waiting longer for transplants and tend to be much sicker before they receive a new heart.<sup>237,238</sup> The number of pediatric patients that potentially could benefit from VADS as a bridge to transplant has been estimated to be 7,000–30,000 patients per year in the United States alone.<sup>239</sup>

### ECMO

ECMO is the most widely used ventricular support modality in the United States. It has been shown to be quite successful and technically easier to initiate and discontinue, and it has the ability to provide oxygenation support in associated pulmonary failure/inadequacy. One study reported that approximately 40% of pediatric patients requiring ECMO for myocardial failure recovered sufficient function to allow them to be discharged from the hospital intact.<sup>240,241</sup> This includes patients with palliative anatomy, such as bidirectional Glenn, and those post Fontan<sup>242</sup>; however, single-ventricle physiology patients have decreased survival to hospital discharge.<sup>243</sup> ECMO use within 24 hours of cardiac arrest suffered in the ICU has been shown to be associated with reduced mortality (odds ratio, 0.8%; confidence interval, 0.04–0.76).<sup>244</sup> ECMO is highly successful and technically feasible for use as a rescue device in patients undergoing interventional cardiac procedures, and successful outcomes have been demonstrated even with extended pre-ECMO cardiopulmonary resuscitation times.<sup>245-247</sup> One center described routine postoperative support of patients after the Norwood stage I procedure with good results,<sup>248</sup> and ECMO has been used and shown to be safe in neonates as small as 1.6 kg.<sup>249</sup> Favorable outcomes as high as 48% for ECMO have been reported when used as a bridge to

transplant.<sup>250,251</sup> Preprimed ECMO circuits may remain clear primed and stagnant for up to 30 days and still be able to far exceed the required minimum of 6 mL O<sub>2</sub>/kg /min required by neonates for the first 6 hours of support.<sup>252</sup>

ECMO is associated with multiple, serious potential liabilities that can lead to increased frequency and acuity of complications. The nonpulsatile flow delivered by ECMO is nonphysiologic and associated with slower, more hemodynamically unstable, and longer recovery times. The list of liabilities includes requirement for anticoagulation and associated increased bleeding, embolization (air and/or thromboembolism), need for deep sedation and immobilization, and need for constant sophisticated physiologic and laboratory monitoring. Finally, ECMO cannulation of the carotid vessels is controversial and may lead to increased incidence of neurologic deficits via cerebral infarcts and/or hemorrhage. Venovenous ECMO cannulation is useful when cardiac output support is not required, as pulsatile blood flow is preserved and there is no arterial compromise and no direct route for embolization to the arterial system (barring intracardiac atrial or ventricular right-to-left shunting), all of which may contribute to a lower incidence of neurologic complications.<sup>253</sup> There is also increased oxygen delivery to the myocardium and pulmonary vascular bed with venovenous ECMO, and it may be delivered through a single cannula in tiny neonates.<sup>253</sup> Venovenous ECMO does present the disadvantage of requiring ongoing, possibly intense respiratory/mechanical ventilation support.

The invasive nature of ECMO cannulation increases the risk of potentially fatal infections. The risk of these complications is magnified as the patient's time on ECMO increases, making ECMO generally unsuitable for long-term support (more than a few weeks at most).<sup>254,255</sup> These complex associated difficulties have helped fuel the search for alternative support modalities.

## VADs

VADs for pediatric patients have become much more sophisticated and more available in the past few years as their size has decreased, but they still are trailing adult devices in the development process. This is primarily secondary to the smaller number of patients requiring the devices and the

historically superior results in pediatric patients, compared with adult patients, treated with ECMO in the United States. Smaller devices operated at low flow rates historically have shown increased propensity for thrombosis and embolus formation<sup>256</sup>; this is improving with better anticoagulation protocols, more postoperative care experience, and improved device materials that are less thrombogenic.<sup>257</sup>

Use of VADs is much more common in Europe than in the United States, and the results have been very encouraging. Multiple new devices are now in common use as the result of these recent successes.<sup>258</sup> The Thoratec VAD (Thoratec Corporation, Pleasanton, CA) is still the most common, having been used in more than 1000 patients worldwide since its launch. Thoratec VADs are paracorporeal devices attached to a large driving console and are less suited to long-term support.<sup>259</sup> They have been used in patients with a body surface area as small as 0.7 m<sup>2</sup>. In a large series, survival rates in small patients were higher (~72%) for patients with cardiomyopathy or myocarditis than for patients with congenital cardiac anomalies (~14%).<sup>260</sup> A previous multicenter study showed that 60% of patients survived to transplant, but only 10% survived after recovery of their native heart.<sup>261</sup> The most common complication associated with the Thoratec VAD is infection, and the most common cause of death is multiorgan failure; embolization is always possible.<sup>299</sup> The Berlin Heart VAD and the Medos VAD (MEDOS Medizintechnik AG, Stolberg, Germany) have been used with good results in Europe as a bridge to ventricular recovery and transplantation and are now arriving for use in the United States. They are favorable for use in the pediatric population because they are available in multiple ventricle and cannula sizes.

The Medos DeltaStream DPI VAD (MEDOS Medizintechnik AG) is an extracorporeal rotary pump with a diagonal flow impeller capable of both continuous and pulsatile blood flow. It has a very small priming volume (~30 mL) and a high pumping capability (≤ 8 L/min).<sup>262</sup> Clinical trials now underway have initially shown faster lactate recovery, reduced need for inotropic support, reduced assistance duration needed in bridge-to-recovery cases, and smoother, more physiologic he-

modynamics in patients receiving pulsatile flow delivery.<sup>262</sup>

The Berlin Heart VAD is pneumatically driven, delivers pulsatile flow, and has been implemented in patients as small as 4 kg.<sup>263,264</sup> By 1999, the Berlin Heart VAD had been implanted in more than 350 European patients, and it has been used in patients for as long as 114 days. Overall survival rates have been reported as high as 69% for the Thoratec VAD, 49% for the Berlin Heart VAD, and 36% for the Medos VAD.<sup>265</sup> These numbers are not statistically different from ECMO.<sup>258</sup> When used as a bridge to transplant, the 1-month survival rate for VADs is 72% and, as with ECMO, was higher in patients with cardiomyopathies compared with congenital cardiac defects. Complications associated with VAD use include minor infection at cannula exit sites, generalized sepsis, hemorrhagic events, and thromboembolic events.<sup>258</sup> These complications have been shown to be less common with VADs than with ECMO.<sup>266</sup> Patients with the Berlin Heart VAD consume fewer red blood cell units, platelets, and fresh-frozen plasma compared with ECMO, which decreases exposure to potential blood-borne pathogens.<sup>267</sup> Potential advantages of VADs compared with ECMO are increased patient mobility (possibly even return to home and/or school), increased level of physical activity, and longer complication-free use time. However, use of these devices is just as expensive as ECMO and dramatically increases the cost of hospitalization and the overall costs of cardiac transplantation.

## Intraaortic Balloon Pumps

Use of intraaortic balloon pumps (IABPs) in the pediatric patient population has been reported, but in general their effectiveness is limited in this setting. Infants and small children have small vessels for access and exhibit increased aortic elasticity, rapid heart rates (which makes synchronization difficult), and small stroke volumes.<sup>268</sup> They also frequently suffer from right heart dysfunction, which is not supported by IABP.

## Conduct of the Anesthetic Anesthetic Plan and Goals

Virtually all children with CHD tolerate well-managed anesthetics, but their tolerance for events, such as loss of airway patency, hypoventilation, in-



**BOX 52-8.****Indices of Critical Impairment in Congenital Heart Disease**

Arterial saturation  $<75\%$   
 Qp:Qs  $>2:1$   
 Left ventricular outflow tract gradient  
 $>50$  mm Hg  
 Right ventricular outflow tract gradient  
 $>50$  mm Hg  
 Pulmonary vascular resistance  $>6$   
 Woods units  
 Polycythemia with hematocrit  $>60\%$   
 Qp, Pulmonary flow; Qs, systemic flow.

appropriate amounts and choices of anesthetics, and major intraoperative surgical insults, often is limited. The anesthetic plan should be aimed at maintaining or improving existing circulatory homeostasis throughout the procedure, but particularly during induction of anesthesia. Because resuscitation may be very difficult in patients with CHD once cardiovascular collapse occurs, prevention of circulatory decompensation is the priority. This makes anticipation of potential problems a particularly important part of the anesthetic plan.

**Preoperative Assessment**

An important aim of preoperative assessment is identifying those patients with CHD who are likely to develop problems. Cardiac catheterization and echocardiographic data are most useful. Box 52-8 lists the critical indices of severe circulatory impairment in CHD. Patients who have any one of these indices are at risk for perioperative hemodynamic problems. If a patient has two or more of the listed criteria of critical impairment, particular care should be taken with planning the anesthetic. In such patients, depending on the experience of the anesthesia team, consultation with the patient's cardiologist to clarify critical aspects of the patient's pathophysiology may be advisable. In patients who have CHD that does not include any of the criteria listed in Box 52-8, the chances of hemodynamic problems with anesthesia are relatively low. Additional risk factors for patients with CHD undergoing anesthesia are listed in Box 52-9.

**Preoperative Preparation and Medication**

Before surgery, patients should be in the optimum condition allowed by

their underlying disease. Emergency operations in critically ill, severely hypoxicemic, and acidotic neonates are rarely necessary because of the advent of PGE<sub>1</sub> treatment of ductus-dependent circulation in those with CHD. A period of 24–48 hours of medical therapy markedly improves the condition of most critically ill children with CHD and lessens perioperative morbidity. Such therapy should be considered part of the preoperative preparation of sick children with CHD.

Patients with more chronic problems, such as congestive heart failure and chronic pulmonary infections resulting from excessive pulmonary blood flow and congestion, should be at their pulmonary baselines if possible. Children taking cardiac medications should continue doing so up to and including the morning of surgery, except for diuretics. Preoperative medication can take many forms. A good preoperative visit may establish sufficient rapport with parents and child to eliminate the need for preoperative medication, whereas relatively large doses of IV sedation may be needed for the extremely anxious child. The goal should be a lightly sedated patient without respiratory depression. In patients with severe hypoxemia and cyanosis or with pulmonary hypertension, premedication should be relatively light to prevent depression of ventilation that may exacerbate their decreased hypoxic ventilatory drive or further increase their PVR. When the anxiety level is high and severe hypoxemia, severe congestive heart failure, or pulmonary hypertension precludes heavy premedication before the patient arrives in the preoperative holding area, intramuscular ketamine and midazolam are given just before the child is taken to the operating room. Such premedication is well tolerated by all but critically ill children and can ease the difficulties experienced by children and parents. Properly monitored transport should be available, with an anesthesia caregiver in constant attendance. This combination of drugs is quickly effective so that a deeply sedated child can be separated from anxious parents. Use of portable pulse oximetry and a precordial stethoscope often are advisable for the trip to the operating room. If there is any question of cardiac stability during this period, an IV line is started immediately after sedation is

**BOX 52-9.****General Associated Risk Factors in Congenital Heart Disease**

Severe form of isolated lesion  
 Complex lesions  
 Concurrent infectious disease  
 Metabolic derangements  
 Congestive heart failure  
 Previous palliative or corrective procedures  
 Acute hemodynamic deterioration

given or, in extreme cases, even before sedation. With the availability of eutectic mixture of local anesthetics (EMLA) cream, preoperative IV insertion for premedication has become much easier.

Alternatively, oral midazolam at a dose of 0.75–1.0 mg/kg can be given to small children in the presence of the anesthesia provider. This often results in excellent premedication and may be supplemented by intramuscular ketamine, if needed, mixed with atropine or glycopyrrolate.

**Induction of Anesthesia**

Because of the potential for rapid and dramatic hemodynamic changes in young patients with CHD, especially infants, complete preparation of anesthetic and monitoring equipment and required drugs is essential. Adequate assistance should be immediately available during induction, particularly if the patient meets a number of the criteria of severe disease listed in Table 52-1. Flexibility is needed in the choice of induction techniques because response to premedication and emotional needs of parents and children facing a cardiac procedure can place constraints on choices.

Choice of induction technique is influenced by response to premedication and the parent-child-anesthesia provider relationship and to the anesthetic management plan. In older patients who are not hypoxicemic and have minimal compromise of cardiac reserve, choice of induction techniques is large. Rectal, intramuscular, IV, or inhalation induction techniques using various agents can be used with reasonable safety if individual pathophysiologic limitations are respected. Choices decrease for younger, sicker, and less cooperative patients. In older children with only mildly compromised cardiac function, rectal admin-



istration of anesthetics, such as barbiturates, can be a useful technique, but lack of control and potential for circulatory depression make this technique unacceptable for sick infants.

In children with good IV access, quick insertion of a small-bore IV needle for induction can be virtually painless if sufficiently long applications of EMLA cream are used. Cooperative small children who have adequate cardiac reserve but difficult IV access or a morbid fear of needles can be induced cautiously with inhalational anesthetics, even if they are cyanotic. An IV catheter is then inserted expeditiously to facilitate intubation with adjunctive IV agents, avoiding the risk of deep levels of inhalational anesthesia in circulatory systems with little reserve, particularly in the immature circulation of the infant. Such use of an inhalational anesthetic for induction of patients with severe CHD without the presence of a working IV heavily depends on the judgment of the anesthesia provider for safety.

### Maintenance of Anesthesia

Maintenance of anesthesia in the pediatric heart patient depends on preoperative status and response to induction and on the surgical procedure and intraoperative events. Whether inhalational agents, additional narcotics, or other IV agents are used for maintenance depends on patient tolerance and postoperative plans for ventilatory management. In children with CHD, intraoperative changes in cardiac shunting are unique problems during maintenance of anesthesia. Whether clinical deterioration is caused by changes in shunting or by primary myocardial depression or dysfunction is not always clear, the intraoperative events and progress of the anesthetic usually suggest a cause. Hypotension and hypoxemia, particularly during induction of anesthesia, should be managed aggressively and immediately. Decreases in arterial oxygenation or systemic blood flow may be caused by alterations in intracardiac shunting in these children and usually can be managed by manipulations of PVR/SVR; however, inotropes are needed in some patients, assuming their circulating blood volume is adequate.

### Manipulation of PVR and SVR

Manipulation of PVR/SVR allows some control over shunting, depending on

specific pathophysiology. PVR is particularly important because of the frequency of disturbances of pulmonary blood flow and right-sided defects in patients with CHD. Usually the goal is to decrease PVR in order to improve pulmonary flow, right heart function, and oxygenation, but in some lesions, pulmonary flow is excessively high at the expense of systemic output, requiring increases in PVR.<sup>40</sup> Many intraoperative manipulations tend to alter PVR. Manipulations that increase PVR are frequent problems because of the increased reactivity of the abnormal pulmonary vasculature often found in patients with CHD. These manipulations include sympathetic stimulation, encroachments on lung volumes that produce atelectasis (surgical retraction, pleural and peritoneal collections, and abdominal packing), CPB, alveolar hypoxia, and hypoventilation. Manipulations that increase and decrease PVR are listed in Box 52-10. Ventilation is important because it is subject to control by the anesthesia provider and is crucial in attempts to control PVR via airway pressure, lung volumes, alveolar  $P_{aCO_2}$  and  $P_{aO_2}$ , and other, less well-understood variables.

The effects of various anesthetics on PVR are poorly understood. Ketamine and nitrous oxide increase PVR in adults, but studies of ketamine and nitrous oxide in infants with normal or elevated PVR have shown no increase in PVR when ventilation and  $FiO_2$  are constant.<sup>163,187,188</sup> Stress responses in the pulmonary circulation of patients with CHD are a primary concern in some patients. Large doses of potent narcotics, such as fentanyl, attenuate pulmonary vascular responses to noxious stimuli, such as endotracheal suctioning in infants, but they do not change baseline PVR.<sup>269,270</sup> Reactive pulmonary hypertensive responses are partially mediated by the sympathoadrenal axis and thus are attenuated by an adequate depth of anesthesia. CPB increases PVR through activation of the inflammatory response, cytokine release, and ischemia of the endothelium in the pulmonary circulation. After bypass surgery, elevated PVR can be a substantial problem.

PVR can be controlled independently of SVR by manipulating various aspects of ventilation (Box 52-10). Nitric oxide delivered through alveoli has been shown to be a pulmonary vasodilator

#### BOX 52-10.

##### Manipulation Altering Pulmonary Vascular Resistance

###### Increased PVR

- Hypoxia
- Hypercapnia
- Acidosis
- Hyperinflation
- Atelectasis
- Sympathetic stimulation
- High hematocrit
- Mechanical pulmonary artery constriction

###### Decreased PVR

- Oxygen
- Hypocapnia
- Alkalosis
- Normal functional residual capacity
- Blockage of sympathetic stimulation
- Low hematocrit
- Inhaled nitric oxide

and to be effective in patients with CHD.<sup>270</sup> In contrast to inhaled nitric oxide, even selective infusions of rapidly metabolized vasodilators (e.g., nitroprusside) into the pulmonary circulation can result in systemic drug concentrations and systemic hemodynamic effects without desired effects on PVR.<sup>270</sup> Nitric oxide has been shown to be effective in selectively reducing PVR in a variety of different CHD lesions accompanied by high PVR; this can be accomplished without altering SVR.<sup>271</sup> Not all patients with CHD and high PVR respond to inhaled nitric oxide, particularly after the neonatal period, but nitric oxide therapy should be tried whenever high PVR is a substantial problem in patients of any age with CHD.<sup>272</sup> High levels of inspired oxygen, especially 100%  $O_2$ , also decrease elevated PVR in infants without changing SVR, whereas inspired oxygen levels  $\leq 21\%$  increase PVR.<sup>273,274,278,279</sup> Hypoventilation, with associated acidosis and hypercapnia, increases PVR. Hyperventilation to alkalotic pH  $>7.50$  and low  $P_{aCO_2}$  reliably decreases PVR in infants and improves right ventricular function.<sup>275-278</sup> This maneuver increases pulmonary blood flow and decreases right-to-left shunting in neonates, increasing  $P_{aO_2}$ .<sup>279,280</sup> Although prolonged hyperventilation to decrease PVR theoretically may cause problems from decreased cerebral blood flow, clinical and

experimental studies in hyperventilated infants show no evidence of cerebral damage.<sup>278,281,282</sup> The pattern of ventilation and PEEP can alter PVR. PVR is lowest at normal functional residual capacity. At low lung volumes with atelectasis and at high lung volumes with hyperinflation of alveoli, PVR increases.<sup>283</sup> High levels of PEEP increase PVR primarily by hyperinflation of alveoli, but if atelectasis and pulmonary edema are corrected by PEEP, PVR may decrease. Different patterns of ventilation may further reduce PVR by releasing prostacyclin in the pulmonary vasculature.<sup>284,285</sup>

Manipulation of SVR with vasopressors is useful when there is a need for increased coronary perfusion pressure or a need to decrease right-to-left shunting that causes severe systemic hypoxemia. Phenylephrine has been shown effective in reducing right-to-left shunting in patients with tetralogy of Fallot and increasing SaO<sub>2</sub>.<sup>286</sup> A mechanical method for increasing SVR to decrease right-to-left shunting in tetralogy of Fallot is compression of the abdominal aorta. This can be done immediately and can be used to gain time while other pharmacologic therapy is started or while the child is prepared for CPB.

## KEY REFERENCES

1. Anand KJ, Hickey PR. Halothane-morphine compared with high-dose sufentanil for anesthesia and postoperative analgesia in neonatal cardiac surgery. *N Engl J Med* 1992;326:1-9.
2. Bellinger DC, Wypij D, duDuplelessis AJ, et al. Neurodevelopmental status at eight years in children with dextro-transposition of the great arteries: the Boston Circulatory Arrest Trial. *J Thorac Cardiovasc Surg* 2003;126:1385-1396.
3. Berman WJ. The hemodynamics of shunts in congenital heart disease. In Johansen K, Burggren WW, eds. *Cardiovascular Shunts: Phylogenetic, Ontogenetic, and Clinical Aspects*. New York, Raven Press, 1985:399-410.
4. Chang AC, Zucker HA, Hickey PR, et al. Pulmonary vascular resistance in infants after cardiac surgery: role of carbon dioxide and

hydrogen ion. *Crit Care Med* 1995; 23:568-574.

5. Greeley WJ, Ungerleider RM, Smith LR, et al. The effects of deep hypothermic cardiopulmonary bypass and total circulatory arrest on cerebral blood flow in infants and children. *J Thorac Cardiovasc Surg* 1989;97:737-745.

6. Hickey PR, Hansen DD. Fentanyl- and sufentanil-oxygen-pancuronium anesthesia for cardiac surgery in infants. *Anesth Analg* 1984; 63:117-124.

7. Ibrahim AE, Duncan BW, Blume ED, et al. Long-term follow-up of pediatric cardiac patients requiring mechanical circulatory support. *Ann Thorac Surg* 2000;69:186-192.

8. Newburger JW, Jonas RA, Wernovsky G, et al. A comparison of the perioperative neurologic effects of hypothermic circulatory arrest versus low-flow cardiopulmonary bypass in infant heart surgery. *N Engl J Med* 1993;329:1057-1064.

9. Rivenes SM, Lewin MB, Stayer SA, et al. Cardiovascular effects of sevoflurane, isoflurane, halothane, and fentanyl-midazolam in children with congenital heart disease: an echocardiographic study of myocardial contractility and hemodynamics. *Anesthesiology* 2001;94:223-229.

10. Sarkar M, Laussen PC, Zurakowski D, et al. Hemodynamic responses to etomidate on induction of anesthesia in pediatric patients. *Anesth Analg* 2005;101: 645-650.

## REFERENCES

1. Fyler DC. Report of the New England regional infant cardiac program. *Pediatrics* 1980;3;65(Suppl 2):375.
2. Hoffman JI, Christianson R. Congenital heart disease in a cohort of 19,502 births with long-term follow-up. *Am J Cardiol* 1978;42:641-647.
3. Berman WJ. The hemodynamics of shunts in congenital heart disease. In Johansen K, Burggren WW, eds. *Cardiovascular Shunts: Phylogenetic, Ontogenetic, and Clinical Aspects*. New York: Raven Press, 1985:399-410.
4. Journois D, Israel-Biet D, Pouard P, et al. High-volume, zero-balanced hemofiltration to reduce delayed inflammatory response to cardiopulmonary bypass in children. *Anesthesiology* 1996;85:965-976.

5. Rudolph AM. *Congenital Diseases of the Heart*. Chicago: Year Book Medical Publishing, 1974:79-87.

6. Banas JS Jr, Meister SG, Gazzaniga AB, et al. A simple technique for detecting small defects of the atrial septum. *Am J Cardiol* 1971;28:467-471.

7. Gross CM, Wann S, Johnson GL, et al. Valsalva maneuver echocardiography: a new technique for improved detection of right-to-left shunting in patients with systemic embolism [Abstract]. *Am J Cardiol* 1982;49:955.

8. Kronik G, Mossbacher H. Positive contrast echocardiography in patients with patent foramen ovale and normal right heart hemodynamics. *Am J Cardiol* 1982; 49:1806-1809.

9. Moorthy SS, Dierdorf SF, Krishna G, et al. Transient hypoxemia from a transient right-to-left shunt in a child during emergence from anesthesia. *Anesthesiology* 1987;66:234-235.

10. Theodore J, Robin ED, Burke CM, et al. Impact of profound reductions of PaO<sub>2</sub> on O<sub>2</sub> transport and utilization in congenital heart disease. *Chest* 1985;87:293-302.

11. Nadas AS, Fyler DC. *Pediatric Cardiology*. Philadelphia: WB Saunders, 1972.

12. Phornphutkul C, Rosenthal A, Nadas AS, et al. Cerebrovascular accidents in infants and children with cyanotic congenital heart disease. *Am J Cardiol* 1973;32:329-334.

13. Kontras SB, Sirak HD, Newton WA Jr. Hematologic abnormalities in children with congenital heart disease. *JAMA* 1966; 195:611-615.

14. Greeley WJ, Bushman GA, Davis DP, et al. Comparative effects of halothane and ketamine on systemic arterial oxygen saturation in children with cyanotic heart disease. *Anesthesiology* 1986;65:666-668.

15. Laishley RS, Burrows FA, Lerman J, et al. Effect of anesthetic induction regimens on oxygen saturation in cyanotic congenital heart disease. *Anesthesiology* 1986;65: 673-677.

16. Irish CL, Murkin JM, Cleland A, et al. Neuromuscular blockade significantly decreases systemic oxygen consumption during hypothermic cardiopulmonary bypass. *J Cardiothorac Vasc Anesth* 1991;5:132-134.

17. Lindahl SG. Oxygen consumption and carbon dioxide elimination in infants and children during anaesthesia and surgery. *Br J Anaesth* 1989;62:70-76.

18. Haworth SG. Normal pulmonary vascular development and its disturbance in congenital heart disease. In Godman MJ, ed. *Paediatric Cardiology*. New York: Churchill-Livingstone, 1983:46-55.

19. Rabinovitch M, Haworth SG, Castaneda AR, et al. Lung biopsy in congenital heart disease: a morphometric approach to pulmonary vascular disease. *Circulation* 1978; 58:1107-1122.

20. Haworth SG. Pulmonary vascular disease in secundum atrial septal defect in childhood. *Am J Cardiol* 1983;51:265-272.

21. Thiene G, Mazzucco A, Grisolia EF, et al. Postoperative pathology of complete atrioventricular defects. *J Thorac Cardiovasc Surg* 1982;83:891-900.
22. Wong RS, Baum VC, Sangwan S. Truncus arteriosus: recognition and therapy of intraoperative cardiac ischemia. *Anesthesiology* 1991;74:378-380.
23. Talner NS. Heart failure. In Adams FH, Emmanouilides GC, eds. *Moss' Heart Diseases in Infants, Children and Adolescents*. Baltimore: Williams & Wilkins, 1983:708-725.
24. Flanagan MF, Fujii AM, Colan SD, et al. Myocardial angiogenesis and coronary perfusion in left ventricular pressure-overload hypertrophy in the young lamb. Evidence for inhibition with chronic protamine administration. *Circ Res* 1991;68:1458-1470.
25. Franciosi RA, Blanc WA. Myocardial infarcts in infants and children. I. A necropsy study in congenital heart disease. *J Pediatr* 1968;73:309-319.
26. Borow KM, Keane JF, Castaneda AR, et al. Systemic ventricular function in patients with tetralogy of Fallot, ventricular septal defect and transposition of the great arteries repaired during infancy. *Circulation* 1981;64:878-885.
27. Graham TP Jr, Cordell D, Atwood GF, et al. Right ventricular volume characteristics before and after palliative and reparative operation in tetralogy of Fallot. *Circulation* 1976;54:417-423.
28. Jarmakani JM, Graham TP Jr, Canent RV Jr, et al. The effect of corrective surgery on left heart volume and mass in children with ventricular septal defect. *Am J Cardiol* 1971;27:254-258.
29. Katz NM, Blackstone EH, Kirklin JW, et al. Late survival and symptoms after repair of tetralogy of Fallot. *Circulation* 1982;65:403-410.
30. Reduto LA, Berger HJ, Johnstone DE, et al. Radionuclide assessment of right and left ventricular exercise reserve after total correction of tetralogy of Fallot. *Am J Cardiol* 1980;45:1013-1018.
31. Vlahakes GJ, Turley K, Hoffman JI. The pathophysiology of failure in acute right ventricular hypertension: hemodynamic and biochemical correlations. *Circulation* 1981;63:87-95.
32. Friesen RH, Lichtor JL. Cardiovascular effects of inhalation induction with isoflurane in infants. *Anesth Analg* 1983;62:411-414.
33. Moss AJ, Emmanouilides GC, Adams FH, et al. Response of ductus arteriosus and pulmonary and systemic arterial pressure to changes in oxygen environment in newborn infants. *Pediatrics* 1964;33:937-944.
34. Clyman RI, Mauray F, Roman C, et al. Factors determining the loss of ductus arteriosus responsiveness to prostaglandin E. *Circulation* 1983;68:433-436.
35. Yokota M, Muraoka R, Aoshima M, et al. Modified Blalock-Taussig shunt following long-term administration of prostaglandin E1 for ductus-dependent neonates with cyanotic congenital heart disease. *J Thorac Cardiovasc Surg* 1985;90:399-403.
36. Jonas RA, Lang P, Mayer JE, et al. The importance of prostaglandin E1 in resuscitation of the neonate with critical aortic stenosis. *J Thorac Cardiovasc Surg* 1985;89:314-315.
37. Buckley LP, Dooley KJ, Flyer DC, et al. Pulmonary atresia and intact ventricular septum in New England. *Am J Cardiol* 1976;37:124-129.
38. Yamaguchi M. Congenital heart disease: diagnostic approaches, surgical indications and operative results. *Prog Cardiovasc Dis* 1989;32:48.
39. Lewis AB, Freed MD, Heymann MA, et al. Side effects of therapy with prostaglandin E1 in infants with critical congenital heart disease. *Circulation* 1981;64:893-898.
40. Hansen DD, Hickey PR. Anesthesia for hypoplastic left heart syndrome: use of high-dose fentanyl in 30 neonates. *Anesth Analg* 1986;65:127-132.
41. Jonas RA, Lang P, Hansen D, et al. First-stage palliation of hypoplastic left heart syndrome. The importance of coarctation and shunt size. *J Thorac Cardiovasc Surg* 1986;92:6-13.
42. Romero T, Covell J, Friedman WF. A comparison of pressure-volume relations of the fetal, newborn, and adult heart. *Am J Physiol* 1972;222:1285-1290.
43. Emery JL, Mithal A. Weights of cardiac ventricles at and after birth. *Br Heart J* 1961;23:313-316.
44. Anversa P, Olivetti G, Loud AV. Morphometric study of early postnatal development in the left and right ventricular myocardium of the rat. I. Hypertrophy, hyperplasia, and binucleation of myocytes. *Circ Res* 1980;46:495-502.
45. Nassar R, Reedy MC, Anderson PA. Developmental changes in the ultrastructure and sarcomere shortening of the isolated rabbit ventricular myocyte. *Circ Res* 1987;61:465-483.
46. Nakanishi T, Seguchi M, Tsuchiya T, et al. Effect of acidosis on intracellular pH and calcium concentration in the newborn and adult rabbit myocardium. *Circ Res* 1990;67:111-123.
47. Nayler WG, Fassold E. Calcium accumulating and ATPase activity of cardiac sarcoplasmic reticulum before and after birth. *Cardiovasc Res* 1977;11:231-237.
48. Vetter R, Will H, Kuttner I, et al. Developmental changes of Ca<sup>++</sup> transport systems in chick heart. *Biomed Biochim Acta* 1986;45:S219-S222.
49. Humphreys JE, Cummins P. Regulatory proteins of the myocardium. Atrial and ventricular tropomyosin and troponin-I in the developing and adult bovine and human heart. *J Mol Cell Cardiol* 1984;16:643-657.
50. Friesen RH, Henry DB. Cardiovascular changes in preterm neonates receiving isoflurane, halothane, fentanyl, and ketamine. *Anesthesiology* 1986;64:238-242.
51. Krane EJ, Su JY. Comparison of the effects of halothane on skinned myocardial fibers from newborn and adult rabbit. I. Effects on contractile proteins. *Anesthesiology* 1989;70:76-81.
52. Krane EJ, Su JY. Comparison of the effects of halothane on skinned myocardial fibers from newborn and adult rabbit: II. Effects on sarcoplasmic reticulum. *Anesthesiology* 1989;71:103-109.
53. Rao CC, Boyer MS, Krishna G, et al. Increased sensitivity of the isometric contraction of the neonatal isolated rat atria to halothane, isoflurane, and enflurane. *Anesthesiology* 1986;64:13-18.
54. Nakanishi T, Okuda H, Kamata K, et al. Influence of acidosis on inotropic effect of catecholamines in newborn rabbit hearts. *Am J Physiol* 1987;253:H1441-H1448.
55. Nakanishi T, Okuda H, Nakazawa M, et al. Effect of acidosis on contractile function in the newborn rabbit heart. *Pediatr Res* 1985;19:482-488.
56. Thornburg KL, Morton MJ. Filling and arterial pressures as determinants of RV stroke volume in the sheep fetus. *Am J Physiol* 1983;244:H656-H663.
57. Van Hare GF, Hawkins JA, Schmidt KG, et al. The effects of increasing mean arterial pressure on left ventricular output in newborn lambs. *Circ Res* 1990;67:78-83.
58. Downing SE, Talner NS, Gardner TH. Ventricular function in the newborn lamb. *Am J Physiol* 1965;208:931-937.
59. Kirkpatrick SE, Pitlick PT, Naliboff J, et al. Frank-Starling relationship as an important determinant of fetal cardiac output. *Am J Physiol* 1976;231:495-500.
60. Brinkman CR 3rd, Johnson GH, Assali NS. Hemodynamic effects of bradycardia in the fetal lamb. *Am J Physiol* 1972;223:1465-1469.
61. Kenny J, Plappert T, Doubilet P, et al. Effects of heart rate on ventricular size, stroke volume, and output in the normal human fetus: a prospective Doppler echocardiographic study. *Circulation* 1987;76:52-58.
62. Lavoie J, Walsh EP, Burrows FA, et al. Effects of propofol or isoflurane anesthesia on cardiac conduction in children undergoing radiofrequency catheter ablation for tachyarrhythmias. *Anesthesiology* 1995;82:884-887.
63. Driscoll DJ, Gillette PC, Hallman GL, et al. Management of surgical complete atrioventricular block in children. *Am J Cardiol* 1979;43:1175-1180.
64. Anderson HL 3rd, Attorri RJ, Custer JR, et al. Extracorporeal membrane oxygenation for pediatric cardiopulmonary failure. *J Thorac Cardiovasc Surg* 1990;99:1011-1019.
65. Kirklin JK, Westaby S, Blackstone EH, et al. Complement and the damaging effects of cardiopulmonary bypass. *J Thorac Cardiovasc Surg* 1983;86:845-857.



66. Hickey PR, McGowan FX. Adhesion molecules and inflammation: the next targets for perioperative organ protection? *Anesth Analg* 1995;81:1123-1124.
67. McKnight CK, Elliott MJ, Pearson DT, et al. The effects of four different crystalloid bypass pump-priming fluids upon the metabolic response to cardiac operation. *J Thorac Cardiovasc Surg* 1985;90:97-111.
68. Ridley PD, Ratcliffe JM, Alberti KG, et al. The metabolic consequences of a "washed" cardiopulmonary bypass pump-priming fluid in children undergoing cardiac operations. *J Thorac Cardiovasc Surg* 1990;100:528-537.
69. Journois D, Pouard P, Greeley WJ, et al. Hemofiltration during cardiopulmonary bypass in pediatric cardiac surgery. Effects on hemostasis, cytokines, and complement components. *Anesthesiology* 1994;81:1181-1189.
70. Greeley WJ, Ungerleider RM, Kern FH, et al. Effects of cardiopulmonary bypass on cerebral blood flow in neonates, infants, and children. *Circulation* 1989;80:I209-I215.
71. Greeley WJ, Ungerleider RM, Smith LR, et al. The effects of deep hypothermic cardiopulmonary bypass and total circulatory arrest on cerebral blood flow in infants and children. *J Thorac Cardiovasc Surg* 1989;97:737-745.
72. Wong PC, Barlow CF, Hickey PR, et al. Factors associated with choreoathetosis after cardiopulmonary bypass in children with congenital heart disease. *Circulation* 1992;86(Suppl 5):118-126.
73. Kern FH, Jonas RA, Mayer JE Jr. Temperature monitoring during CPB in infants: does it predict efficient brain cooling? *Ann Thorac Surg* 1992;54:749-754.
74. Ferry PC. Neurologic sequelae of open-heart surgery in children. An "irritating question." *Am J Dis Child* 1990;144:369-373.
75. Barratt-Boyes BG. Choreoathetosis as a complication of cardiopulmonary bypass. *Ann Thorac Surg* 1990;50:693-694.
76. DeLeon S, Ilbawi M, Arcilla R, et al. Choreoathetosis after deep hypothermia without circulatory arrest. *Ann Thorac Surg* 1990;50:714-719.
77. Greeley WJ, Kern FH, Ungerleider RM, et al. The effect of hypothermic cardiopulmonary bypass and total circulatory arrest on cerebral metabolism in neonates, infants, and children. *J Thorac Cardiovasc Surg* 1991;101:783-794.
78. Murkin JM, Farrar JK, Tweed WA, et al. Cerebral autoregulation and flow/metabolism coupling during cardiopulmonary bypass: the influence of  $Paco_2$ . *Anesth Analg* 1987;66:825-832.
79. Bellinger DC, Jonas RA, Rappaport LA, et al. Developmental and neurologic status of children after heart surgery with hypothermic circulatory arrest or low-flow cardiopulmonary bypass. *N Engl J Med* 1995;332:549-555.
80. Newburger JW, Jonas RA, Wernovsky G, et al. A comparison of the perioperative neurologic effects of hypothermic circulatory arrest versus low-flow cardiopulmonary bypass in infant heart surgery. *N Engl J Med* 1993;329:1057-1064.
81. Limperopoulos C, Majnemer A, Shevell MI, et al. Neurodevelopmental status of newborns and infants with congenital heart defects before and after open heart surgery. *J Pediatr* 2000;137:638-645.
82. Dent CL, Spaeth JP, Jones BV, et al. Brain magnetic resonance imaging abnormalities after the Norwood procedure using regional cerebral perfusion. *J Thorac Cardiovasc Surg* 2006;131:190-197.
83. Clancy RR, McGaurn SA, Wernovsky G, et al. Preoperative risk-of-death prediction model in heart surgery with deep hypothermic circulatory arrest in the neonate. *J Thorac Cardiovasc Surg* 2000;119:347-357.
84. Hickey PR, Andersen NP. Deep hypothermic circulatory arrest: a review of pathophysiology and clinical experience as a basis for anesthetic management. *J Cardiothorac Anesth* 1987;1:137-155.
85. Swain JA, McDonald TJ Jr, Griffith PK, et al. Low-flow hypothermic cardiopulmonary bypass protects the brain. *J Thorac Cardiovasc Surg* 1991;102:76-83.
86. Forbess JM, Visconti KJ, Hancock-Friessen C, et al. Neurodevelopmental outcome after congenital heart surgery: results from an institutional registry. *Circulation* 2001;106(Suppl 1):I95-102.
87. Wypij D, Newburger JW, Rappaport LA, et al. The effect of duration of deep hypothermic circulatory arrest in infant heart surgery on late neurodevelopment: the Boston Circulatory Arrest Trial. *J Thorac Cardiovasc Surg* 2003;126:1397-1403.
88. Scallan MJ. Brain injury in children with congenital heart disease. *Paediatr Anaesth* 2003;13:284-293.
89. Blackwood MJ, Haka-Ikse K, Steward DJ. Developmental outcome in children undergoing surgery with profound hypothermia. *Anesthesiology* 1986;65:437-440.
90. Clarkson PM, MacArthur BA, Barratt-Boyes BG, et al. Developmental progress after cardiac surgery in infancy using hypothermia and circulatory arrest. *Circulation* 1980;62:855-861.
91. Coselli JS, Crawford ES, Beall AC Jr, et al. Determination of brain temperatures for safe circulatory arrest during cardiovascular operation. *Ann Thorac Surg* 1988;45:638-642.
92. Dickinson DF, Sambrooks JE. Intellectual performance in children after circulatory arrest with profound hypothermia in infancy. *Arch Dis Child* 1979;54:1-6.
93. Settergren G, Ohqvist G, Lundberg S, et al. Cerebral blood flow and cerebral metabolism in children following cardiac surgery with deep hypothermia and circulatory arrest. Clinical course and follow-up of psychomotor development. *Scand J Thorac Cardiovasc Surg* 1982;16:209-215.
94. Wells FC, Coghill S, Caplan HL, et al. Duration of circulatory arrest does influence the psychological development of children after cardiac operation in early life. *J Thorac Cardiovasc Surg* 1983;86:823-831.
95. Wright JS, Hicks RG, Newman DC. Deep hypothermic arrest: observations on later development in children. *J Thorac Cardiovasc Surg* 1979;77:466-468.
96. Astudillo R, van der Linden J, Ekroth R, et al. Absent diastolic cerebral blood flow velocity after circulatory arrest but not after low flow in infants. *Ann Thorac Surg* 1993;56:515-519.
97. van der Linden J, Astudillo R, Ekroth R, et al. Cerebral lactate release after circulatory arrest but not after low flow in pediatric heart operations. *Ann Thorac Surg* 1993;56:1485-1489.
98. Fox LS, Blackstone EH, Kirklin JW, et al. Relationship of brain blood flow and oxygen consumption to perfusion flow rate during profoundly hypothermic cardiopulmonary bypass. An experimental study. *J Thorac Cardiovasc Surg* 1984;87:658-664.
99. Miyamoto K, Kawashima Y, Matsuda H, et al. Optimal perfusion flow rate for the brain during deep hypothermic cardiopulmonary bypass at 20 degrees C. An experimental study. *J Thorac Cardiovasc Surg* 1986;92:1065-1070.
100. Rebeyka IM, Coles JG, Wilson GJ, et al. The effect of low-flow cardiopulmonary bypass on cerebral function: an experimental and clinical study. *Ann Thorac Surg* 1987;43:391-396.
101. Watanabe T, Orita H, Kobayashi M, et al. Brain tissue pH, oxygen tension, and carbon dioxide tension in profoundly hypothermic cardiopulmonary bypass. Comparative study of circulatory arrest, nonpulsatile low-flow perfusion, and pulsatile low-flow perfusion. *J Thorac Cardiovasc Surg* 1989;97:396-401.
102. Wilson GJ, Rebeyka IM, Coles JG, et al. Loss of the somatosensory evoked response as an indicator of reversible cerebral ischemia during hypothermic, low-flow cardiopulmonary bypass. *Ann Thorac Surg* 1988;45:206-209.
103. Zimmerman AA, Burrows FA, Jonas RA, et al. The limits of detectable cerebral perfusion by transcranial Doppler sonography in neonates undergoing deep hypothermic low-flow cardiopulmonary bypass. *J Thorac Cardiovasc Surg* 1997;114:594-600.
104. Rossi R, van der Linden J, Ekroth R, et al. No flow or low flow? A study of the ischemic marker creatine kinase BB after deep hypothermic procedures. *J Thorac Cardiovasc Surg* 1989;98:193-199.
105. Coles JG, Taylor MJ, Pearce JM, et al. Cerebral monitoring of somatosensory evoked potentials during profoundly hypothermic circulatory arrest. *Circulation* 1984;70:I96-I102.
106. Weiss M, Weiss J, Cotton J, et al. A study of the electroencephalogram during



- surgery with deep hypothermia and circulatory arrest in infants. *J Thorac Cardiovasc Surg* 1975;70:316-329.
107. Bellinger DC, Wypij D, Kuban KC, et al. Developmental and neurological status of children at 4 years of age after heart surgery with hypothermic circulatory arrest or low-flow cardiopulmonary bypass. *Circulation* 1999;100:526-532.
108. Bellinger DC, Wypij D, duDuplessis AJ, et al. Neurodevelopmental status at eight years in children with dextro-transposition of the great arteries: the Boston Circulatory Arrest Trial. *J Thorac Cardiovasc Surg* 2003;126:1385-1396.
109. Lanier WL, Stangland KJ, Scheithauer BW, et al. The effects of dextrose infusion and head position on neurologic outcome after complete cerebral ischemia in primates: examination of a model. *Anesthesiology* 1987;66:39-48.
110. Benzing G 3rd, Francis PD, Kaplan S, et al. Glucose and insulin changes in infants and children undergoing hypothermic open-heart surgery. *Am J Cardiol* 1983;52:133-136.
111. Seifen AB, Schedewie HK, Williams DG, et al. Endocrine functions during deep hypothermia in pediatric cardiac surgery [Abstract]. *Anesthesiology* 1982;57:A419.
112. de Ferranti S, Gauvreau K, Hickey PR, et al. Intraoperative hyperglycemia during infant cardiac surgery is not associated with adverse neurodevelopmental outcomes at 1, 4, and 8 years. *Anesthesiology* 2004;100:1345-1352.
113. Bashein G, Townes BD, Nessly ML, et al. A randomized study of carbon dioxide management during hypothermic cardiopulmonary bypass. *Anesthesiology* 1990;72:7-15.
114. Bellinger DC, Wypij D, du Plessis AJ, et al. Developmental and neurologic effects of alpha-stat versus pH-stat strategies for deep hypothermic cardiopulmonary bypass in infants. *J Thorac Cardiovasc Surg* 2001;121:374-383.
115. Austin EH 3rd, Edmonds HL Jr, Auden SM, et al. Benefit of neurophysiologic monitoring for pediatric cardiac surgery. *J Thorac Cardiovasc Surg* 1997;114:707-715, 717.
116. Andropoulos DB, Stayer SA, McKenzie ED, et al. Novel cerebral physiologic monitoring to guide low-flow cerebral perfusion during neonatal aortic arch reconstruction. *J Thorac Cardiovasc Surg* 2003;125:491-499.
117. Watzman HM, Kurth CD, Montenegro LM, et al. Arterial and venous contributions to near-infrared cerebral oximetry. *Anesthesiology* 2000;93:947-953.
118. Cho H, Nemoto EM, Yonas H, et al. Cerebral monitoring by means of oximetry and somatosensory evoked potentials during carotid endarterectomy. *J Neurosurg* 1998;89:533-538.
119. Samra SK, Dy EA, Welch K, et al. Evaluation of a cerebral oximeter as a monitor of cerebral ischemia during carotid endarterectomy. *Anesthesiology* 2000;93:964-970.
120. Russo G, Profeta G, Acampora S, et al. Transcranial Doppler ultrasound. Examination technique and normal reference values. *J Neurosurg Sci* 1986;30:97-102.
121. Bishop CC, Powell S, Rutt D, et al. Transcranial Doppler measurement of middle cerebral artery blood flow velocity: a validation study. *Stroke* 1986;17:913-915.
122. Taylor RH, Burrows FA, Bissonnette B. Cerebral pressure-flow velocity relationship during hypothermic cardiopulmonary bypass in neonates and infants. *Anesth Analg* 1992;74:636-642.
123. Nakajima T, Kuro M, Hayashi Y, et al. Clinical evaluation of cerebral oxygen balance during cardiopulmonary bypass: on-line continuous monitoring of jugular venous oxyhemoglobin saturation. *Anesth Analg* 1992;74:630-635.
124. Croughwell ND, Newman MF, Blumenthal JA, et al. Jugular bulb saturation and cognitive dysfunction after cardiopulmonary bypass. *Ann Thorac Surg* 1994;58:1702-1708.
125. Yoshitani K, Kawaguchi M, Sugiyama N, et al. The association of high jugular bulb venous oxygen saturation with cognitive decline after hypothermic cardiopulmonary bypass. *Anesth Analg* 2001;92:1370-1376.
126. Gold JP, Jonas RA, Lang P, et al. Trans-thoracic intracardiac monitoring lines in pediatric surgical patients: a ten-year experience. *Ann Thorac Surg* 1986;42:185-191.
127. Coblenz MG, Criscito MA, Cohn JD. Persistent left superior vena cava complicating hemodynamic monitoring catheterization. *Crit Care Med* 1978;6:32-35.
128. Moore RA, McNicholas K, Gallagher JD, et al. Migration of pediatric pulmonary artery catheters. *Anesthesiology* 1983;58:102-104.
129. Sprague DH, Sherwood HL. Retrograde cannulation of a persistent superior vena cava. *Anesthesiology* 1980;53:268.
130. Cyran SE, Kimball TR, Meyer RA, et al. Efficacy of intraoperative transesophageal echocardiography in children with congenital heart disease. *Am J Cardiol* 1989;63:594-598.
131. Greeley WJ, Kern FH, Ungerleider RM, et al. Intramyocardial air causes right ventricular dysfunction after repair of a congenital heart defect. *Anesthesiology* 1990;73:1042-1046.
132. Ungerleider RM, Greeley WJ, Sheikh KH, et al. Routine use of intraoperative epicardial echocardiography and Doppler color flow imaging to guide and evaluate repair of congenital heart lesions. A prospective study. *J Thorac Cardiovasc Surg* 1990;100:297-309.
133. Macartney FJ, Taylor JF, Graham GR, et al. The fate of survivors of cardiac surgery in infancy. *Circulation* 1980;62:80-91.
134. Castaneda AR, Freed MD, Williams RG, et al. Repair of tetralogy of Fallot in infancy. Early and late results. *J Thorac Cardiovasc Surg* 1977;74:372-381.
135. Castaneda AR, Mayer JE Jr, Jonas RA, et al. The neonate with critical congenital heart disease: repair—a surgical challenge. *J Thorac Cardiovasc Surg* 1989;98:869-875.
136. Kirklin JK, Blackstone EH, Kirklin JW, et al. Intracardiac surgery in infants under age 3 months: incremental risk factors for hospital mortality. *Am J Cardiol* 1981;48:500-506.
137. Norwood WI, Dobell AR, Freed MD, et al. Intermediate results of the arterial switch repair. A 20-institution study. *J Thorac Cardiovasc Surg* 1988;96:854-863.
138. Lavoie J, Burrows FA, Hansen DD. Video-assisted thoracoscopic surgery for the treatment of congenital cardiac defects in the pediatric population. *Anesth Analg* 1996;82:563-567.
139. Lavoie J, Javorski JJ, Donahue K, et al. Detection of residual flow by transesophageal echocardiography during video-assisted thoracoscopic patent ductus arteriosus interruption. *Anesth Analg* 1995;80:1071-1075.
140. Arciniegas E, Farooki ZQ, Hakimi M, et al. Classic shunting operations for congenital cyanotic heart defects. *J Thorac Cardiovasc Surg* 1982;84:88-96.
141. Beekman RH, Rocchini AP. Transcatheter treatment of congenital heart disease. *Prog Cardiovasc Dis* 1989;32:1-30.
142. Perry SB, Keane JF, Lock JE. Interventional catheterization in pediatric congenital and acquired heart disease. *Am J Cardiol* 1988;61:109G-117G.
143. Hickey PR, Wessel DL, Streitz SL, et al. Transcatheter closure of atrial septal defects: hemodynamic complications and anesthetic management. *Anesth Analg* 1992;74:44-50.
144. Laussen PC, Hansen DD, Perry SB, et al. Transcatheter closure of ventricular septal defects: hemodynamic instability and anesthetic management. *Anesth Analg* 1995;80:1076-1082.
145. Bridges ND, Perry SB, Keane JF, et al. Preoperative transcatheter closure of congenital muscular ventricular septal defects. *N Engl J Med* 1991;324:1312-1317.
146. Lock JE, Rome JJ, Davis R, et al. Transcatheter closure of atrial septal defects. Experimental studies. *Circulation* 1989;79:1091-1099.
147. Rome JJ, Keane JF, Perry SB, et al. Double-umbrella closure of atrial defects. Initial clinical applications. *Circulation* 1990;82:751-758.
148. Wessel DL, Keane JF, Parness I, et al. Outpatient closure of the patent ductus arteriosus. *Circulation* 1988;77:1068-1071.
149. Schlichter AJ, Kreutzer C, Mayorquim RC, et al. Five- to fifteen-year follow-up of fresh autologous pericardial valved conduits. *J Thorac Cardiovasc Surg* 2000;119:869-879.
150. Bonhoeffer P, Boudjemline Y, Qureshi SA, et al. Percutaneous insertion of the

- pulmonary valve. *J Am Coll Cardiol* 2002;39:1664–1669.
151. Coats L, Tsang V, Khambadkone S, et al. The potential impact of percutaneous pulmonary valve stent implantation on right ventricular outflow tract re-intervention. *Eur J Cardiothorac Surg* 2005;27:536–543.
152. Malviya S, Burrows FA, Johnston AE, et al. Anaesthetic experience with paediatric interventional cardiology. *Can J Anaesth* 1989;36:320–324.
153. Burrows PE, Benson LN, Williams WG, et al. Iliofemoral arterial complications of balloon angioplasty for systemic obstructions in infants and children. *Circulation* 1990;82:1697–1704.
154. Rothman A, Perry SB, Keane JF, et al. Early results and follow-up of balloon angioplasty for branch pulmonary artery stenoses. *J Am Coll Cardiol* 1990;15:1109–1117.
155. Arnold LW, Keane JF, Kan JS, et al. Transient unilateral pulmonary edema after successful balloon dilation of peripheral pulmonary artery stenosis. *Am J Cardiol* 1988;62:327–330.
156. Glenski JA, Friesen RH, Hassanein RS, et al. Comparison of the hemodynamic and echocardiographic effects of sufentanil, fentanyl, isoflurane, and halothane for pediatric cardiac surgery. *J Cardiovasc Anesth* 1988;2:147–155.
157. Anand KJS, Aynsley-Green A. Metabolic and endocrine effects of surgical ligation of patent ductus arteriosus in the human preterm neonate: are there implications for further improvement of postoperative outcome? *Mod Probl Paediatr* 1985;23:143–157.
158. Anand KJ, Brown MJ, Bloom SR, et al. Studies on the hormonal regulation of fuel metabolism in the human newborn infant undergoing anaesthesia and surgery. *Horm Res* 1985;22:115–128.
159. Anand KJ, Sippell WG, Aynsley-Green A. Randomised trial of fentanyl anaesthesia in preterm babies undergoing surgery: effects on the stress response. *Lancet* 1987;1:62–66.
160. Anand KJ, Hansen DD, Hickey PR. Hormonal-metabolic stress responses in neonates undergoing cardiac surgery. *Anesthesiology* 1990;73:661–670.
161. Anand KJ, Hickey PR. Halothane-morphine compared with high-dose sufentanil for anesthesia and postoperative analgesia in neonatal cardiac surgery. *N Engl J Med* 1992;326:1–9.
162. Hensley FA, Larach DR, Stauffer RA, et al. The effect of halothane/nitrous oxide/oxygen mask induction on arterial hemoglobin [Abstract]. *Anesthesiology* 1985;63:A3.
163. Morray JP, Lynn AM, Stamm SJ, et al. Hemodynamic effects of ketamine in children with congenital heart disease. *Anesth Analg* 1984;63:895–899.
164. Diaz JH, Lockhart CH. Is halothane really safe in infancy? [Abstract]. *Anesthesiology* 1979;51:S313.
165. Friesen RH, Lichtor JL. Cardiovascular depression during halothane anesthesia in infants: study of three induction techniques. *Anesth Analg* 1982;61:42–45.
166. McNeill AM, Lerman J, Gregory GA, et al. Echocardiographic assessment of ventricular function in children during isoflurane anesthesia [Abstract]. *Anesthesiology* 1984;61:A426.
167. Murray D, Forbes R, Murphy K, et al. Nitrous oxide: cardiovascular effects in infants and small children during halothane and isoflurane anesthesia. *Anesth Analg* 1988;67:1059–1064.
168. Holzman RS, van der Velde ME, Kaus SJ, et al. Sevoflurane depresses myocardial contractility less than halothane during induction of anesthesia in children. *Anesthesiology* 1996;85:1260–1267.
169. Lerman J, Oyston JP, Gallagher TM, et al. The minimum alveolar concentration (MAC) and hemodynamic effects of halothane, isoflurane, and sevoflurane in newborn swine. *Anesthesiology* 1990;73:717–721.
170. Piat V, Dubois MC, Johanet S, et al. Induction and recovery characteristics and hemodynamic responses to sevoflurane and halothane in children. *Anesth Analg* 1994;79:840–844.
171. Ebert TJ, Kharasch ED, Rooke GA, et al. Myocardial ischemia and adverse cardiac outcomes in cardiac patients undergoing noncardiac surgery with sevoflurane and isoflurane. Sevoflurane Ischemia Study Group. *Anesth Analg* 1997;85:993–999.
172. Bennett SR, Griffin SC. Sevoflurane versus isoflurane in patients undergoing coronary artery bypass grafting: a hemodynamic and recovery study. *J Cardiothorac Vasc Anesth* 1999;13:666–672.
173. Tomiyasu S, Hara T, Hasuo H, et al. Comparative analysis of systemic and coronary hemodynamics during sevoflurane- and isoflurane-induced hypotension in dogs. *J Cardiovasc Pharmacol* 1999;33:741–747.
174. Saito M, Cho S, Morooka H, et al. Effects of sevoflurane compared with those of isoflurane on arterial oxygenation and hemodynamics during one-lung ventilation. *J Anesth* 2000;14:1–5.
175. Nishiyama T. Hemodynamic and catecholamine response to a rapid increase in isoflurane or sevoflurane concentration during a maintenance phase of anesthesia in humans. *J Anesth* 2005;19:213–217.
176. Rivenes SM, Lewin MB, Stayer SA, et al. Cardiovascular effects of sevoflurane, isoflurane, halothane, and fentanyl-midazolam in children with congenital heart disease: an echocardiographic study of myocardial contractility and hemodynamics. *Anesthesiology* 2001;94:223–229.
177. Zwass MS, Fisher DM, Welborn LG, et al. Induction and maintenance characteristics of anesthesia with desflurane and nitrous oxide in infants and children. *Anesthesiology* 1992;76:373–378.
178. Barash PG, Glanz S, Katz JD, et al. Ventricular function in children during halothane anesthesia: an echocardiographic evaluation. *Anesthesiology* 1978;49:79–85.
179. Boudreaux JP, Schieber RA, Cook DR. Hemodynamic effects of halothane in the newborn piglet. *Anesth Analg* 1984;63:731–737.
180. Cook DR, Brandom BW, Shiu G, et al. The inspired median effective dose, brain concentration at anesthesia, and cardiovascular index for halothane in young rats. *Anesth Analg* 1981;60:182–185.
181. Guyton RA, Andrews MJ, Hickey PR, et al. The contribution of atrial contraction to right heart function before and after right ventriculotomy. Experimental and clinical observations. *J Thorac Cardiovasc Surg* 1976;71:1–10.
182. Mehta M, Sokoll MD, Gergis SD. Effects of venous air embolism on the cardiovascular system and acid base balance in the presence and absence of nitrous oxide. *Acta Anaesthesiol Scand* 1984;28:226–231.
183. Tuman KJ, McCarthy RJ, Spiess BD, et al. Effects of nitrous oxide on coronary perfusion after coronary air embolism. *Anesthesiology* 1987;67:952–959.
184. Hilgenberg JC, McCammon RL, Stoelting RK. Pulmonary and systemic vascular responses to nitrous oxide in patients with mitral stenosis and pulmonary hypertension. *Anesth Analg* 1980;59:323–326.
185. Lappas DG, Buckley MJ, Laver MB, et al. Left ventricular performance and pulmonary circulation following addition of nitrous oxide to morphine during coronary-artery surgery. *Anesthesiology* 1975;43:61–69.
186. Schulte-Sasse U, Hess W, Tarnow J. Pulmonary vascular responses to nitrous oxide in patients with normal and high pulmonary vascular resistance. *Anesthesiology* 1982;57:9–13.
187. Hickey PR, Hansen DD, Strafford M, et al. Pulmonary and systemic hemodynamic effects of nitrous oxide in infants with normal and elevated pulmonary vascular resistance. *Anesthesiology* 1986;65:374–378.
188. Lawler PG, Nunn JF. A reassessment of the validity of the iso-shunt graph. *Br J Anaesth* 1984;56:1325–1335.
189. Tanner GE, Angers DG, Barash PG, et al. Effect of left-to-right, mixed left-to-right, and right-to-left shunts on inhalational anesthetic induction in children: a computer model. *Anesth Analg* 1985;64:101–107.
190. Tanner G, Angers D, Barash PG, et al. Does a left to right shunt speed the induction of inhalational anesthesia in congenital heart disease? [Abstract]. *Anesthesiology* 1982;57:A427.
191. Stoelting RK, Longnecker DE. The effect of right-to-left shunt on the rate of increase of arterial anesthetic concentration. *Anesthesiology* 1972;36:352–356.
192. Cook DJ, Carton EG, Housmans PR. Mechanism of the positive inotropic effect

of ketamine in isolated ferret ventricular papillary muscle. *Anesthesiology* 1991;74:880–888.

193. Levin RM, Seleny FL, Streczyn MV. Ketamine-pancuronium-narcotic technic for cardiovascular surgery in infants—a comparative study. *Anesth Analg* 1975;54:800–805.

194. Vaughan RW, Stephen CR. Ketamine for corrective cardiac surgery in children. *South Med J* 1973;66:1226–1230.

195. Riou B, Lecarpentier Y, Viars P. Inotropic effect of ketamine on rat cardiac papillary muscle. *Anesthesiology* 1989;71:116–125.

196. Riou B, Viars P, Lecarpentier Y. Effects of ketamine on the cardiac papillary muscle of normal hamsters and those with cardiomyopathy. *Anesthesiology* 1990;73:910–918.

197. Gassner S, Cohen M, Aygen M, et al. The effect of ketamine on pulmonary artery pressure. An experimental and clinical study. *Anaesthesia* 1974;29:141–146.

198. Hickey PR, Hansen DD, Cramolini GM, et al. Pulmonary and systemic hemodynamic responses to ketamine in infants with normal and elevated pulmonary vascular resistance. *Anesthesiology* 1985;62:287–293.

199. Coppel DL, Dundee JW. Ketamine anaesthesia for cardiac catheterisation. *Anaesthesia* 1972;27:25–31.

200. Sarkar M, Laussen PC, Zurakowski D, et al. Hemodynamic responses to etomidate on induction of anesthesia in pediatric patients. *Anesth Analg* 2005;101:645–650.

201. Nguyen NK, Magnier S, Georget G, et al. [Anesthesia for heart catheterization in children. Comparison of 3 techniques]. *Ann Fr Anesth Reanim* 1991;10:522–528.

202. Donmez A, Kaya H, Haberal A, et al. The effect of etomidate induction on plasma cortisol levels in children undergoing cardiac surgery. *J Cardiothorac Vasc Anesth* 1998;12:182–185.

203. Ellis DJ, Steward DJ. Fentanyl dosage is associated with reduced blood glucose in pediatric patients after hypothermic cardiopulmonary bypass. *Anesthesiology* 1990;72:812–815.

204. Robinson S, Gregory GA. Fentanyl-air-oxygen anesthesia for ligation of patent ductus arteriosus in preterm infants. *Anesth Analg* 1981;60:331–334.

205. Yaster M. The dose response to fentanyl in neonatal surgery. *Anesthesiology* 1985;63:A471.

206. Hickey PR, Hansen DD. Fentanyl- and sufentanil-oxygen-pancuronium anesthesia for cardiac surgery in infants. *Anesth Analg* 1984;63:117–124.

207. Koren G, Goresky G, Crean P, et al. Pediatric fentanyl dosing based on pharmacokinetics during cardiac surgery. *Anesth Analg* 1984;63:577–582.

208. Hickey PR, Hansen DD, Wessel DL, et al. Pulmonary and systemic hemodynamic

responses to fentanyl in infants. *Anesth Analg* 1985;64:483–486.

209. Salmenpera M, Peltola K, Takkunen O, et al. Cardiovascular effects of pancuronium and vecuronium during high-dose fentanyl anesthesia. *Anesth Analg* 1983;62:1059–1064.

210. Motomura S, Kissin I, Aultman DF, et al. Effects of fentanyl and nitrous oxide on contractility of blood-perfused papillary muscle of the dog. *Anesth Analg* 1984;63:47–50.

211. Davis PJ, Cook DR, Stiller RL, et al. Pharmacodynamics and pharmacokinetics of high-dose sufentanil in infants and children undergoing cardiac surgery. *Anesth Analg* 1987;66:203–208.

212. Moore RA, Yang SS, McNicholas KW, et al. Hemodynamic and anesthetic effects of sufentanil as the sole anesthetic for pediatric cardiovascular surgery. *Anesthesiology* 1985;62:725–731.

213. den Hollander JM, Hennis PJ, Burm AG, et al. Alfentanil in infants and children with congenital heart defects. *J Cardiothorac Anesth* 1988;2:12–17.

214. Akpek EA, Erkaya C, Donmez A, et al. Remifentanil use in children undergoing congenital heart surgery for left-to-right shunt lesions. *J Cardiothorac Vasc Anesth* 2005;19:60–66.

215. Ogletree ML, Sprung J, Moravec CS. Effects of remifentanil on the contractility of failing human heart muscle. *J Cardiothorac Vasc Anesth* 2005;19:763–767.

216. Davis PJ, Wilson AS, Siewers RD, et al. The effects of cardiopulmonary bypass on remifentanil kinetics in children undergoing atrial septal defect repair. *Anesth Analg* 1999;89:904–908.

217. Stowe DF, Bosnjak ZJ, Kampine JP. Comparison of etomidate, ketamine, midazolam, propofol, and thiopental on function and metabolism of isolated hearts. *Anesth Analg* 1992;74:547–558.

218. Marcus B, Steward DJ, Khan NR, et al. Outpatient transesophageal echocardiography with intravenous propofol anesthesia in children and adolescents. *J Am Soc Echocardiogr* 1993;6:205–209.

219. Lebovic S, Reich DL, Steinberg LG, et al. Comparison of propofol versus ketamine for anesthesia in pediatric patients undergoing cardiac catheterization. *Anesth Analg* 1992;74:490–494.

220. Jones RD, Visram AR, Chan MM, et al. A comparison of three induction agents in paediatric anaesthesia—cardiovascular effects and recovery. *Anaesth Intensive Care* 1994;22:545–555.

221. Saarnivaara L, Hiller A, Oikkonen M. QT interval, heart rate and arterial pressures using propofol, thiopentone or methohexitone for induction of anaesthesia in children. *Acta Anaesthesiol Scand* 1993;37:419–423.

222. Chrysostomou C, Di Filippo S, Manrique AM, et al. Use of dexmedetomidine in

children after cardiac and thoracic surgery. *Pediatr Crit Care Med* 2006;7:126–131.

223. Finkel JC, Johnson YJ, Quezado ZM. The use of dexmedetomidine to facilitate acute discontinuation of opioids after cardiac transplantation in children. *Crit Care Med* 2005;33:2110–2112.

224. Forbes RB, Murray DJ, Dull DL, et al. Haemodynamic effects of rectal methohexitone for induction of anaesthesia in children. *Can J Anaesth* 1989;36:526–529.

225. Maunukela EL, Gattiker RI. Use of pancuronium in children with congenital heart disease. *Anesth Analg* 1981;60:798–801.

226. Cabal LA, Siassi B, Artal R, et al. Cardiovascular and catecholamine changes after administration of pancuronium in distressed neonates. *Pediatrics* 1985;75:284–287.

227. Goudsouzian NG, Liu LM, Savarese JJ. Metocurine in infants and children: neuromuscular and clinical effects. *Anesthesiology* 1978;49:266–269.

228. Goudsouzian NG, Liu LM, Cote CJ, et al. Safety and efficacy of atracurium in adolescents and children anesthetized with halothane. *Anesthesiology* 1983;59:459–462.

229. Goudsouzian NG, Martyn JJ, Liu LM, et al. Safety and efficacy of vecuronium in adolescents and children. *Anesth Analg* 1983;62:1083–1088.

230. Bettendorf M, Schmidt KG, Grulich-Henn J, et al. Tri-iodothyronine treatment in children after cardiac surgery: a double-blind, randomised, placebo-controlled study. *Lancet* 2000;356:529–534.

231. Follath F, Cleland JG, Just H, et al. Efficacy and safety of intravenous levosimendan compared with dobutamine in severe low-output heart failure (the LIDO study): a randomized double-blind trial. *Lancet* 2002;360:196–202.

232. Slawsky MT, Colucci WS, Gottlieb SS, et al. Acute hemodynamic and clinical effects of levosimendan in patients with severe heart failure. Study Investigators. *Circulation* 2000;102:2222–2227.

233. Moiseyev VS, Poder P, Andrejevs N, et al. Safety and efficacy of a novel calcium sensitizer, levosimendan in patients with left ventricular failure due to an acute myocardial infarction. A randomized, placebo-controlled, double-blind study (RUSSLAN). *Eur Heart J* 2002;23:1422–1432.

234. Claudius I, Lan YT, Chang RK, et al. Usefulness of B-type natriuretic peptide as a noninvasive screening tool for cardiac allograft pathology in pediatric heart transplant recipients. *Am J Cardiol* 2003;92:1368–1370.

235. Suda K, Matsumura M, Matsumoto M. Clinical implication of plasma natriuretic peptides in children with ventricular septal defect. *Pediatr Int* 2003;45:249–254.

236. Webber SA. The current state of, and future prospects for, cardiac transplanta-



- tion in children. *Cardiol Young* 2003;13:64–83.
237. Boucek MM, Edwards LB, Keck BM, et al. The Registry of the International Society for Heart and Lung Transplantation: Fifth Official Pediatric Report-2001 to 2002. *J Heart Lung Transplant* 2002;21:827–840.
238. Mital S, Addonizio LJ, Lamour JM, et al. Outcome of children with end-stage congenital heart disease waiting for cardiac transplantation. *J Heart Lung Transplant* 2003;22:147–153.
239. Spray T. Demographics of heart failure in the pediatric population. 47th Annual ASAIO Conference, New York, 2001.
240. Ibrahim AE, Duncan BW, Blume ED, et al. Long-term follow-up of pediatric cardiac patients requiring mechanical circulatory support. *Ann Thorac Surg* 2000;69:186–192.
241. Duncan BW. Mechanical circulatory support in children: extracorporeal membrane oxygenation and ventricular assist devices. *Expert Rev Med Devices* 2005;2:239–241.
242. Booth KL, Roth SJ, Thiagarajan RR, et al. Extracorporeal membrane oxygenation support of the Fontan and bidirectional Glenn circulations. *Ann Thorac Surg* 2004;77:1341–1348.
243. Kolovos NS, Bratton SL, Moler FW, et al. Outcome of pediatric patients treated with extracorporeal life support after cardiac surgery. *Ann Thorac Surg* 2003;76:1435–1441.
244. de Mos N, van Litsenburg RR, McCrindle B, et al. Pediatric in-intensive-care-unit cardiac arrest: Incidence, survival, and predictive factors. *Crit Care Med* 2006;34:1209–1215.
245. Dalton HJ, Rycus PT, Conrad SA. Update on extracorporeal life support 2004. *Semin Perinatol* 2005;29:24–33.
246. Kelly RB, Porter PA, Meier AH, et al. Duration of cardiopulmonary resuscitation before extracorporeal rescue: how long is not long enough? *ASAIO J* 2005;51:665–667.
247. Allan CK, Thiagarajan RR, Armsby LR, et al. Emergent use of extracorporeal membrane oxygenation during pediatric cardiac catheterization. *Pediatr Crit Care Med* 2006;7:212–219.
248. Shen I, Ungerleider RM. Routine use of mechanical ventricular assist following the Norwood procedure. *Semin Thorac Cardiovasc Surg Pediatr Card Surg Annu* 2004;7:16–21.
249. Rozmiarek AJ, Qureshi FG, Cassidy L, et al. How low can you go? Effectiveness and safety of extracorporeal membrane oxygenation in low-birth-weight neonates. *J Pediatr Surg* 2004;39:845–847.
250. Karl T. Options for mechanical support in pediatric patients. In Oz MC, Goldstein DJ, eds. *Cardiac Assist Devices*. Armonk, NY: Futura Publishing Co., 2000:37–62.
251. Kirshbom PM, Bridges ND, Myung RJ, et al. Use of extracorporeal membrane oxygenation in pediatric thoracic organ transplantation. *J Thorac Cardiovasc Surg* 2002;123:130–136.
252. Walczak R, Lawson DS, Kaemmer D, et al. Evaluation of a preprimed microporous hollow-fiber membrane for rapid response neonatal extracorporeal membrane oxygenation. *Perfusion* 2005;20:269–275.
253. Imamura M, Schmitz ML, Watkins B, et al. Venovenous extracorporeal membrane oxygenation for cyanotic congenital heart disease. *Ann Thorac Surg* 2004;78:1723–1727.
254. Fiser WP, Yetman AT, Gunselman RJ, et al. Pediatric arteriovenous extracorporeal membrane oxygenation (ECMO) as a bridge to cardiac transplantation. *J Heart Lung Transplant* 2003;22:770–777.
255. Minami K, Knyphausen E, Suzuki R, et al. Mechanical ventricular circulatory support in children; Bad Oeynhausen experience. *Ann Thorac Cardiovasc Surg* 2005;11:307–312.
256. Daily BB, Pettitt TW, Sutera SP, et al. Pierce-Donachy pediatric VAD. Progress in development. *Ann Thorac Surg* 1996;61:437–443.
257. Schmid C, Tjan TD, Etz C, et al. First clinical experience with the Incor left ventricular assist device. *J Heart Lung Transplant* 2005;24:1188–1194.
258. Arabia FA, Tsau PH, Smith RG, et al. Pediatric bridge to heart transplantation: application of the Berlin Heart, Medos and Thoratec ventricular assist devices. *J Heart Lung Transplant* 2006;25:16–21.
259. Farrar DJ, Hill JD, Pennington DG, et al. Preoperative and postoperative comparison of patients with univentricular and biventricular support with the Thoratec ventricular assist device as a bridge to cardiac transplantation. *J Thorac Cardiovasc Surg* 1997;113:202–209.
260. Reinhartz O, Copeland JG, Farrar DJ. Thoratec ventricular assist devices in children with less than 1.3 m<sup>2</sup> of body surface area. *ASAIO J* 2003;49:727–730.
261. Reinhartz O, Keith FM, El-Banayosy A, et al. Multicenter experience with the Thoratec ventricular assist device in children and adolescents. *J Heart Lung Transplant* 2001;20:439–448.
262. Agati S, Mignosa C, Ciccarello G, et al. Pulsatile ECMO in neonates and infants: first European clinical experience with a new device. *ASAIO J* 2005;51:508–512.
263. Loebe M. Extracorporeal support: the Berlin heart. In Oz MC, Goldstein DJ, eds. *Cardiac Assist Devices*. Armonk, NY: Futura Publishing Co., 2000:275–287.
264. Merkle F, Boettcher W, Stiller B, et al. Pulsatile mechanical cardiac assistance in pediatric patients with the Berlin heart ventricular assist device. *J Extra Corpor Technol* 2003;35:115–120.
265. Reinhartz O, Stiller B, Eilers R, et al. Current clinical status of pulsatile pediatric circulatory support. *ASAIO J* 2002;48:455–459.
266. Busch U, Waldenberger FR, Redlin M, et al. Successful treatment of postoperative right ventricular heart failure with the HIA-Medos-assist system in a 2-year-old girl. *Pediatr Cardiol* 1999;20:161–163.
267. Stiller B, Lemmer J, Merkle F, et al. Consumption of blood products during mechanical circulatory support in children: comparison between ECMO and a pulsatile ventricular assist device. *Intensive Care Med* 2004;30:1814–1820.
268. Minich LL, Tani LY, Hawkins JA, et al. Intra-aortic balloon pumping in children with dilated cardiomyopathy as a bridge to transplantation. *J Heart Lung Transplant* 2001;20:750–754.
269. Hickey PR, Hansen DD, Wessel DL, et al. Blunting of stress responses in the pulmonary circulation of infants by fentanyl. *Anesth Analg* 1985;64:1137–1142.
270. Vacanti JP, Crone RK, Murphy JD, et al. The pulmonary hemodynamic response to perioperative anesthesia in the treatment of high-risk infants with congenital diaphragmatic hernia. *J Pediatr Surg* 1984;19:672–679.
271. Wessel DL, Adatia I. Clinical applications of inhaled nitric oxide in children with pulmonary hypertension. *Adv Pharmacol* 1995;34:475–504.
272. Wessel DL, Adatia I, Thompson JE, et al. Delivery and monitoring of inhaled nitric oxide in patients with pulmonary hypertension. *Crit Care Med* 1994;22:930–938.
273. Abman SH, Wolfe RR, Accurso FJ, et al. Pulmonary vascular response to oxygen in infants with severe bronchopulmonary dysplasia. *Pediatrics* 1985;75:80–84.
274. Bush A, Busst C, Booth K, et al. Does prostacyclin enhance the selective pulmonary vasodilator effect of oxygen in children with congenital heart disease? *Circulation* 1986;74:135–144.
275. Chang AC, Zucker HA, Hickey PR, et al. Pulmonary vascular resistance in infants after cardiac surgery: role of carbon dioxide and hydrogen ion. *Crit Care Med* 1995;23:568–574.
276. Morray JP, Lynn AM, Mansfield PB. Effect of pH and P<sub>CO<sub>2</sub></sub> on pulmonary and systemic hemodynamics after surgery in children with congenital heart disease and pulmonary hypertension. *J Pediatr* 1988;113:474–479.
277. Viitanen A, Salmenpera M, Heinonen J, et al. Pulmonary vascular resistance before and after cardiopulmonary bypass.



The effect of  $\text{Paco}_2$ . *Chest* 1989;95:773–778.

278. Viitanen A, Salmenpera M, Heinonen J. Right ventricular response to hypercarbia after cardiac surgery. *Anesthesiology* 1990;73:393–400.

279. Drummond WH, Gregory GA, Heymann MA, et al. The independent effects of hyperventilation, tolazoline, and dopamine on infants with persistent pulmonary hypertension. *J Pediatr* 1981;98:603–611.

280. Peckham GJ, Fox WW. Physiologic factors affecting pulmonary artery pressure in infants with persistent pulmonary

hypertension. *J Pediatr* 1978;93:1005–1010.

281. Bernbaum JC, Russell P, Sheridan PH, et al. Long-term follow-up of newborns with persistent pulmonary hypertension. *Crit Care Med* 1984;12:579–583.

282. Ferrara B, Johnson DE, Chang PN, et al. Efficacy and neurologic outcome of profound hypocapneic alkalosis for the treatment of persistent pulmonary hypertension in infancy. *J Pediatr* 1984;105:457–461.

283. West JB, Dollery CT, Naimark A. Distribution of blood flow in isolated lung;

relation to vascular and alveolar pressures. *J Appl Physiol* 1964;19:713–724.

284. Leffler CW, Hessler JR, Green RS. The onset of breathing at birth stimulates pulmonary vascular prostacyclin synthesis. *Pediatr Res* 1984;18:938–942.

285. Said SI. Pulmonary metabolism of prostaglandins and vasoactive peptides. *Annu Rev Physiol* 1982;44:257–268.

286. Nudel DB, Berman MA, Talner NS. Effects of acutely increasing systemic vascular resistance on oxygen tension in tetralogy of Fallot. *Pediatrics* 1976;58:248–251.

# CHAPTER 53

## Thoracic Anesthesia

Stuart J. Weiss, MD, PhD, and  
E. Andrew Ochroch, MD, MSCE

Advances in the management of thoracic disease parallel the advances in thoracic anesthesia and surgery. In the early 20th century, thoracic surgery was limited to rib resection, decortication, and drainage of empyema as management for tuberculosis. During the first part of the 20th century, pulmonary resections were accomplished by tightening a snare or tourniquet around the lesion and subsequently removing the necrotic tissue several days later. These procedures depended on the iatrogenic development of a passive pneumothorax in spontaneously ventilating patients. As expected, the unilateral pneumothorax was poorly tolerated and was associated with mediastinal shift, dyspnea, and rapid ineffective spontaneous respiratory movements. A high incidence of perioperative morbidity resulted from infection, hemorrhage, and air leak.

The period from 1930–1950 saw major advancements in surgery and anesthesia. In the 1930s, Drs. Gale and Waters in the United States and Magill in the United Kingdom developed the techniques of endobronchial intubation and placement of bronchial blockers, respectively, to selectively ventilate one lung. In addition, the introduction of muscle relaxants and controlled ventilation improved patient safety and surgical operating conditions. The development of single-lung isolation techniques accelerated from 1950–1960 with the development of double-lumen endotracheal tubes. In addition, patient safety and anesthetic management were markedly improved by the introduction of halogenated inhalational anesthetics and the dramatically increased use of perioperative physiologic monitoring. More recently, use of the fiberoptic bronchoscope greatly increased the success of single-lung ventilation by facilitating the placement and confirmation of position of double-lumen endotracheal tubes and bronchial blockers.

### KEY POINTS

1. Thoracic surgery is being performed on patients with more severe pulmonary disease than performed in earlier years. Previous exclusion criteria for undergoing general anesthesia now are considered overly conservative.
2. Because the mortality rate of untreated lung cancer approaches 100%, assigning definitive exclusion criteria for lung resection is difficult. Parameters used to predict patients at increased risk for postoperative complications include forced vital capacity, forced expiratory volume in 1 second, split lung functions, and exercise tolerance.
3. Patients undergoing thoracic surgical procedures often have preexisting pulmonary and cardiac disease.
4. Preoperative symptoms of dyspnea, shortness of breath, and hoarseness of voice may be related to thoracic tumor pathology. Possible etiologies include superior vena cava obstruction, mediastinal mass, tracheal compression, tracheomalacia, and malignancy.
5. One goal of preoperative preparation is to improve pulmonary function by use of bronchodilators for reactive airway disease, antibiotics for infection, and education to promote the cessation of smoking. Smoking should stop at least 4–8 weeks preoperatively.
6. Routine diagnostic procedures that are performed to confirm and evaluate the extent of pulmonary and thoracic disease include bronchoscopy, mediastinoscopy, and video-assisted thoracoscopic surgery.
7. The anesthetic plan should be coordinated with the surgeon and support staff to limit perioperative risk. In high-risk patients, anesthesia can proceed with a slow, controlled, staged induction that can be stopped if respiratory difficulties ensue.
8. Lateral decubitus position impacts negatively on the physiology of ventilation and circulation and is associated with position-related injuries.
9. Fiberoptic bronchoscopy is the most reliable method for ascertaining correct positioning of the double-lumen endotracheal tube and assuring pulmonary toilet.
10. When using single-lung ventilation, the anesthesiologist should be especially alert to problems with ventilation or oxygenation. The majority of problems are related to malposition of the double-lumen tube. Once proper position of the tube is confirmed, management strategies include (1) increased oxygenation to dependent lung (positive end-expiratory pressure, increased tidal volume, increased fraction of inspired oxygen), (2) increased oxygenation of blood flowing to the nondependent lung (continuous positive airway pressure, intermittent ventilation), (3) decreased blood perfusion to nondependent lung (discontinue drugs that inhibit hypoxic pulmonary vasoconstriction, ligature to pulmonary artery), increased oxygen content of blood (transfusion, improve mixed venous oxygen saturation), and (4) increased perfusion of the dependent lung (increased cardiac output and administration of a pulmonary vasodilator).
11. Hypoxic pulmonary vasoconstriction is a homeostatic mechanism that limits perfusion of unventilated non-oxygenated atelectatic alveoli, thereby decreasing the shunt admixture. Hypoxic pulmonary vasoconstriction is activated by decreased alveolar oxygen tension but is inhibited by certain anesthetic agents and vasodilators.
12. Volume reduction surgery and other sophisticated intrathoracic operations require careful and complex planning and constant vigilance to maintain adequate ventilation, oxygenation, and hemodynamic stability.
13. Postoperative management after thoracotomy or thoracoscopy is directed to the balance between pain relief and respiratory depression associated with opioids. Epidural analgesia represents best practice in these patients.

Thoracic surgery and anesthesia continue to evolve. The development of endoscopic surgery has revolutionized thoracic surgery by providing for relatively noninvasive access to thoracic cavity contents. Although endoscopic surgery has not replaced open thoracotomy for major pulmonary surgical resections, its use has further expanded to nonpulmonary surgery, such as thymectomy, pericardectomy, and sympathectomy. Surgical management of end-stage disease by lung reduction and transplantation are additional current challenges for thoracic anesthesiologists.

This chapter focuses on important perioperative considerations for the patient undergoing thoracic surgery. The initial portion of the chapter presents the relevant anatomy and pathophysiology. The next sections focus on specific anesthetic concerns and perioperative management issues of operative procedures. Our approach to the anesthetic management of these patients should be flexible to allow for either the short diagnostic procedure or the prolonged anatomic tumor resection. Current strategies for staging and management of lung tumors call for sequential bronchoscopy, mediastinoscopy, and pulmonary resection. In addition, nonpulmonary thoracic operations, such as thymectomy, pericardectomy, and sympathectomy, use many of the same techniques and management strategies.

## ANATOMY/PHYSIOLOGY

### Thoracic Cavity

The thoracic cavity is formed by the ribs laterally, sternum anteriorly, vertebral column posteriorly, and diaphragm and thoracic inlet inferiorly and superiorly. The thoracic cavity encompasses the lungs, which provide oxygenation of venous blood, excretion of carbon dioxide, and metabolism of endogenous compounds.

### Airway

The trachea is the initial conduit for air flow. Its cross-section is outlined by the horseshoe shape of the cartilage anteriorly and the membranous portion posteriorly. The membranous portion consists of a fibrous envelope containing smooth muscle and epithelium. The location of the membranous trachea

and the vertical orientation of the exposed muscle fibers guide fiberoptic-assisted placement of double-lumen endotracheal tubes into the appropriate side. The innominate artery lies just anterior to the trachea. Tracheal-innominate fistulae are rare but lethal complications of tracheal resection, tracheostomy, and prolonged intubation.

The trachea initially bifurcates into the right and left mainstem bronchi and then into the lobar and segmental bronchi. The right bronchus is shorter, wider, and more in line with the trachea compared with the left bronchus. Because of the more oblique orientation of the left bronchus, inhaled foreign bodies and aspirated fluid are more likely to go into the right bronchus. The right bronchus provides access to three lobes (upper, middle, lower) that are separated by major fissures. On the left, a major fissure separates the lower and upper lobes. The lobes of the lung are subdivided into bronchial pulmonary segments, each of which has its own bronchus, artery, and vein. The movement of air progresses through a series of branching tubes, which become narrower and more numerous as they penetrate deeper into the lung. The conducting airways contain no alveoli and therefore contribute a portion, approximately 50 mL, of the anatomic dead space.

### Mediastinum

The mediastinum is the region between the two pleural sacs. It contains the heart, great vessels, and thymus gland. For purposes of description, the mediastinum is divided into four subdivisions (middle, posterior, anterior, superior). The middle mediastinum contains the pericardium with the adjacent phrenic nerves, the heart, and the great vessels emanating to and from it. The superior mediastinum lies between the thoracic inlet and the horizontal plane connecting the sternal angle with the lower border of the fourth thoracic vertebrae. The main contents of the superior mediastinum are the thymus, great vessels, and several nerves. The posterior mediastinum, which is bounded anteriorly by the pericardium and posteriorly by the vertebral column, contains the thoracic aorta, thoracic duct, azygos and hemiazygos veins, esophagus, and bifurcation of the trachea with the two bronchi. The anterior mediastinum, which lies between the sternum and

the pericardium, contains lymphatic vessels, lymph nodes, and branches of the internal thoracic artery.

### Pulmonary Vasculature

The lungs are blood vessel-rich structures with extensive capillary networks that allow gas exchange. The main pulmonary artery (PA) branches and follows the bronchial tree, decreasing in size with each bronchial generation. The arteries branch to supply the respiratory bronchioles and alveolar sacs, which provide for gas exchange. The vascular endothelial surfaces form boundaries of the capillaries and occupy approximately 50% of the surface of the alveolar wall.

The pulmonary capillary network provides an enormous surface area not only for gas exchange but also for active metabolism, synthesis, and release of stored vasoactive substances. The lung maintains an active role as a biochemical filter, inactivating exogenous and endogenous substances by metabolic elimination or cellular uptake. The release of vasoactive substances can be stimulated either by manipulation during surgery or by hypoinflation or hyperinflation. One example is hypoxic pulmonary vasoconstriction (HPV), which functions in a homeostatic capacity to normalize the perfusion to ventilation inhomogeneity caused by alveolar hypoxia.

The metabolic functions of the pulmonary circulation can trigger pathologic consequences. Anaphylactoid response to protamine is of particular importance to the cardiac anesthesiologist. The biologically active substances [histamine, slow-reacting substance of anaphylaxis, prostaglandin E<sub>1</sub> (PGE<sub>1</sub>), prostaglandin E<sub>2</sub> (PGE<sub>2</sub>), prostaglandin F<sub>2</sub> (PGF<sub>2</sub>), bradykinin] are released in response to specific biochemical and mechanical triggers.

### Bronchial Vessels

The bronchial vasculature normally accounts for approximately 1% of the cardiac output, but it may increase its flow in response to acute lung disease or injury. The origin of the bronchial arteries is variable, coming from the aorta or the intercostal, subclavian, or innominate arteries. The bronchial arteries enter the hilus of the lung and form a communicating arc around the main bronchus. The vessels follow the bronchi distally, supplying the vasa vasorum of the PAs and bronchi. The

dominant deep bronchial venous system drains into the pulmonary veins, and the lesser superficial system of bronchial veins drains into the azygos, hemiazygos, and mediastinal veins. The clinical importance of the bronchial vasculature system is appreciated under conditions of acute lung stress or injury. Neovascularization and increased blood flow occur in response to acute and chronic lung disease. This response may help preserve normal pulmonary ventilation-to-perfusion ratio ( $\dot{V}/\dot{Q}$ ) and protect the lung from ischemia. The absence of an intact bronchial arterial circulation in patients receiving a lung transplant place the new lung at increased risk for ischemic injury immediately after surgery.

### Lymphatic System

The lymphatic circulation has a major role in maintaining the balance of fluids across the endothelial membrane. Transcapillary flow ( $F$ ) is proportional to the difference between pulmonary capillary hydrostatic pressure (inside pressure – outside pressure) and the difference between the capillary oncotic pressure ( $F_a$ ) [ $P$  (inside – outside) –  $P$  (capillary – interstitial)]. Transcapillary flow also depends on the capillary filtration coefficient ( $K$ ), which is a function of the effective capillary surface area and membrane permeability. Any clinical situation that impedes lymphatic flow increases the risk of pulmonary edema and pleural effusion. Abnormal clinical states that increase capillary permeability increase the flow of fluid into the interstitial space and increase the chance of developing pulmonary edema. In addition, pulmonary interstitial edema may result from marked increases in negative pleural pressure. Markedly increased negative pressures can result from upper airway obstruction (tumors, laryngospasm, epiglottitis), rapid reexpansion of the lung, and aggressive suctioning.

The lymphatic drainage pattern is from the periphery toward more proximal lymph nodes, which are located at the carina and points of bifurcation of the bronchi and alongside the trachea and great cardiac vessels. The location of the lymph nodes is classified for prognostic assessment of primary pulmonary cancers. The lowest number is assigned to the most central nodes and progresses to greater numbers at the

periphery. The pattern of lymphatic drainage impacts on the sensitivity and specificity of mediastinoscopy to diagnose and detect the spread of disease. Malignant disease of the right lung spreads ipsilaterally up the chain from the pulmonary nodes in the periphery to the paratracheal, scalene, or tracheal nodes more proximally. In contrast, disease from the left lung can either spread ipsilaterally or contralaterally up the chain or proceed subdiaphragmatically to the paraaortic lymph nodes. Biopsy of a lymph node unilateral to the lesion may provide false-negative results if spread occurs contralaterally or subdiaphragmatically.

### Work of Breathing

During normal spontaneous inspiration, the major contribution to respiratory mechanics is by the contraction and downward excursion of the diaphragm, which increases the vertical dimension of the thorax. The dimensions of the thorax also are increased by the outward and upward swinging movement of the ribs during inspiration. The importance of diaphragmatic excursion and chest wall movement is most easily appreciated in patients with compromised respiratory function related to positioning. The patient in a flexed lateral decubitus or Trendelenburg position experiences increased abdominal pressure, which limits diaphragmatic excursion and chest wall movement. In addition, patients undergoing thoracic operations are at increased risk for phrenic nerve injury or diaphragmatic dysfunction, which may result in postoperative ventilatory compromise.

The mechanics of respiration are divided into the inspiratory and expiratory phases. The work of normal breathing is associated with the inspiratory phase, whereas expiration normally is a passive process related to elastic recoil of the lung and chest cage structures. The work of inspiration depends on overcoming airway resistance and the elastic forces created by the lung and chest wall mechanics. During normal quiet breathing, the work of respiration constitutes only 2–3% of total energy expenditure. During heavy exercise, pulmonary ventilation and total body energy expenditure may increase 15- to 20-fold, but the energy expended for ventilation increases only slightly to 3–4%. Pulmonary disease or dysfunction that alters compliance, airway resistance, or lung

or chest wall mechanics can dramatically increase the work of breathing to one third or more of the total body energy expenditure. For example, the patient with preexisting respiratory disease having minimal reserve is at increased risk for postoperative ventilatory failure and may require reintubation because of diaphragmatic dysfunction and atelectasis.

### Cough Reflex

A normal cough reflex is critical for maintenance of pulmonary toilet. Afferent impulses from the respiratory passages are conducted centrally by the vagus nerve. Efferent impulses trigger closure of the epiglottis, apposition of the vocal cords, and contraction of abdominal, chest, and diaphragmatic muscles to produce an explosive exhalation of air. Patients having postoperative dysfunction related to recurrent laryngeal or phrenic nerve injury, trauma to the diaphragm, or pain and who cannot cough effectively are at risk for respiratory failure related to aspiration and poor pulmonary toilet resulting in pneumonia. Such patients may benefit from conservative measures, such as breathing humidified gases to prevent inspissated secretions, chest physiotherapy, and nasal tracheal suctioning to clear secretions.

## PREOPERATIVE EVALUATION OF THE PATIENT UNDERGOING THORACIC SURGERY

### History

Most patients with lung cancer have a history of smoking and therefore have some degree of chronic bronchitis and emphysema. This history is important because the management of infections and reactive airway disease preoperatively will have a positive impact by decreasing the incidence of postoperative complications. Exercise tolerance also should be assessed because it will estimate the patient's cardiovascular and pulmonary reserve.<sup>1-5</sup>

### Physical Examination

Along with a routine assessment of the airway and cardiovascular systems, the anesthesiologist should pay particular attention to the respiratory system during the physical examination. Observation of the respiratory rate and pattern may give insight into the



pulmonary reserve of the patient. The auscultation of wheezes, rales, or rhonchi indicates abnormalities that can be managed preoperatively. Clubbing of the fingernails may indicate chronic hypoxia or lung cancer. Deviation of the trachea may indicate a mediastinal mass, hemothorax, pneumothorax, or fibrothorax. The anesthesiologist should assess the patient's ability to tolerate the supine position, because an intolerance to this position may indicate congestive heart failure or major airway obstruction from a mediastinal mass.

### Diagnostic Studies

Laboratory tests should be ordered based on positive findings elicited from history and physical examination. The complete blood count may reveal polycythemia, reflecting prolonged smoking and hypoxia, or leukocytosis, indicating an active infection. Liver function studies may be altered, indicating hepatic metastases or drug or alcohol effects.

The electrocardiogram (ECG) should be assessed for the presence of cardiac or pulmonary disease. Signs and symptoms of ischemia may indicate the need for further cardiac workup. Manifestations of cor pulmonale may indicate the presence of pulmonary hypertension, which may alter intraoperative management or portend intolerance to major pulmonary resection.<sup>6</sup> However, the futility of subsequent therapeutic intervention is controversial. Recent research on patients undergoing aortic or peripheral arterial bypass graft surgery indicates that, in some instances, coronary revascularization does not decrease the rate of perioperative myocardial infarction or long-term mortality.<sup>7</sup>

Abnormal chest radiographs frequently antedate the first sign or symptom of lung cancer by many months. The radiograph may reveal tumor, secondary changes in lung parenchyma distal to an obstructed airway, or other abnormalities caused by intrathoracic and extrapulmonary tumor spread. Radiographic findings that may have implications to perioperative anesthetic management are listed in Table 53-1. The tumor may impinge on the trachea or the mainstem bronchi and thus influence the induction of anesthesia or choice and placement of an endotracheal tube (Fig. 53-1). For example, tumor involvement of the trachea would sug-

TABLE 53-1.

Radiographic Findings with Important Anesthetic Complications

Abnormality	Anesthetic Implication
Tracheal deviation	Difficulty with intubation Identify cause: mediastinal mass, nodal metastasis, thyroid gland, aortic aneurysm, other
Mediastinal mass	Difficulty with intubation Difficulty with ventilation even after successful intubation (see section entitled Anesthesia for Patients with Mediastinal Masses) Possibility of superior vena cava syndrome and obstruction Cardiac and vascular compressions
Pleural effusion	Cor pulmonale congestive heart failure Need for additional monitoring Careful assessment of response to myocardial depression from anesthetic drugs
Bullae	Risk of rupture with positive pressure and creation of pneumothorax Wasted ventilation, increased dead space Compression of healthy adjacent lung
Abscess	Need for separation of two lungs to prevent spillage and contamination of healthy lung
Consolidation and atelectasis	Need to manage infections aggressively with antibiotics Ventilation/perfusion mismatch admixture and hypoxia
Normal chest radiograph	Patient still may have chronic, diffuse infiltrative lung disease with normal chest radiograph Computed tomography is superior to chest radiography in diagnosing diffuse infiltrative lung disease and should be done before lung biopsy

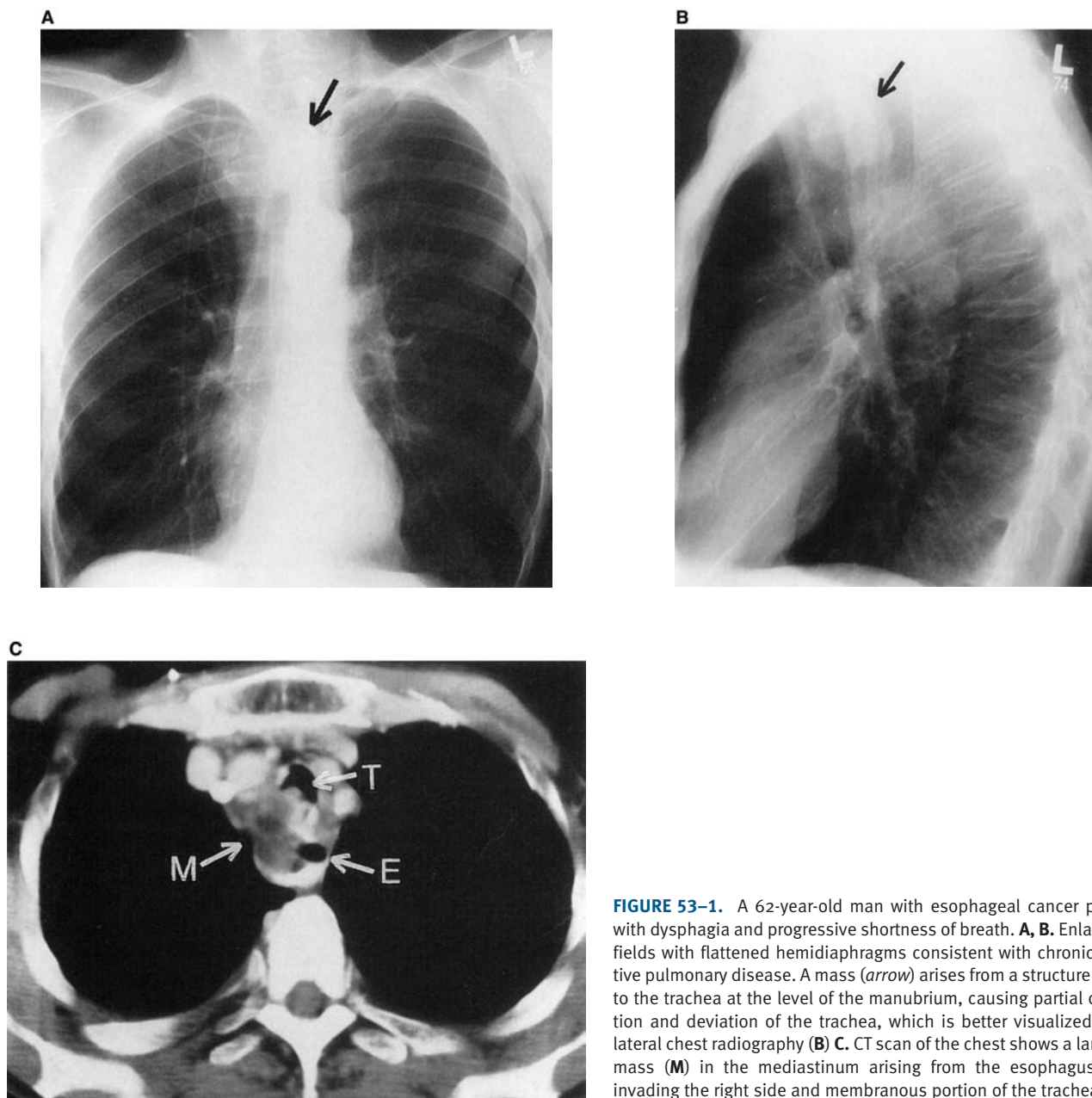
gest use of awake sedated fiberoptic intubation, whereas isolated impingement of the left bronchus would suggest use of a right-sided, double-lumen endotracheal tube.

In addition, patients will undergo computed tomographic (CT) scan of the chest, which is helpful in delineating the presence or absence of high-level nodal and extrapulmonary spread of the disease. Further diagnostic workup is guided by these studies. If mediastinal nodes are suspected, mediastinoscopy or parasternal mediastinotomy may be performed to confirm the diagnosis and determine the extent of tumor spread. If clinical manifestations of distant organ involvement are present, appropriate investigations, such as bone scan and scan of the brain, liver, and upper abdomen, also should be performed.

### Assessment of Respiratory Function

Preoperative evaluation of pulmonary functional reserve is used to estimate the patient's ability to tolerate thoracotomy and lung resection.<sup>1,6,9-28</sup> Pa-

tients undergoing thoracotomy for lung resection usually have a long-standing history of smoking and varying degrees of underlying lung disease. Therefore, they have decreased pulmonary reserve and are at increased risk for operative and postoperative morbidity and mortality. Smokers have a significantly increased risk for postoperative pulmonary complications: 8% for nonsmokers and 23% for smokers.<sup>8</sup> Carcinoma of the lung is associated with an average survival period of 18 months and a mortality rate of 100% after 5 years if not surgically treated. Therefore, every effort should be made to give the patient the benefit of surgical resection. It is difficult to answer the question, "What is an appropriate risk for rendering the patient a respiratory cripple postoperatively when managing a disease with a mortality rate of almost 100%?" Although most patients do not undergo a complete pneumonectomy, they should be evaluated as potential candidates. Not uncommonly, a more extensive resection is needed than initially anticipated. The next section discusses the tests



**FIGURE 53-1.** A 62-year-old man with esophageal cancer presented with dysphagia and progressive shortness of breath. **A, B.** Enlarged lung fields with flattened hemidiaphragms consistent with chronic obstructive pulmonary disease. A mass (*arrow*) arises from a structure posterior to the trachea at the level of the manubrium, causing partial opacification and deviation of the trachea, which is better visualized with the lateral chest radiography (**B**). **C.** CT scan of the chest shows a large tumor mass (**M**) in the mediastinum arising from the esophagus (**E**) and invading the right side and membranous portion of the trachea (**T**).

available for assessing respiratory function and the criteria for eligibility to undergo thoracotomy and pulmonary resection (Fig. 53-2).

### Arterial Blood Gas Analysis

Arterial carbon dioxide tension  $>40$  mm Hg suggests increased risk for postoperative complications. Because hypercapnia may be reversible, attempts should be made to correct all potential reversible conditions, such as bronchospasm and infection. In contrast, hypoxemia is not a consistent criterion for increased risk. The change in arterial partial pressure of oxygen ( $P_{aO_2}$ ) after thoracotomy and lung resection varies. Lung resection

beyond the tumor may not be associated with any further decrement in oxygenation, but it may increase oxygenation by improving  $\dot{V}/\dot{Q}$  matching. Tumors that have occluded the bronchus and the blood supply have already caused a functional resection.

### Spirometry

Spirometry has proved to be an effective, inexpensive, noninvasive way of measuring pulmonary reserve and predicting postoperative pulmonary function. Abnormal spirometry results that suggest an increased risk for postoperative pulmonary complications include forced vital capacity (FVC)  $<50\%$  of predicted, forced expiratory

volume in 1 second ( $FEV_1$ )  $<2$  L, and  $FEV_1/FVC <50\%$ . Other tests of predictive value are the maximum voluntary ventilation (MVV) and the diffusing capacity of lung for carbon monoxide (DLCO). MVV is effort dependent, requiring the patient to breath as quickly and as deeply as possible for 6–12 seconds. This test is similar to an exercise test because it reflects the entire cardiorespiratory system and the patient's cooperation and motivation. DLCO is reemerging as an important predictor of risk in patients undergoing pulmonary resection. Several studies have shown that DLCO is a good predictor of postoperative complications, including death

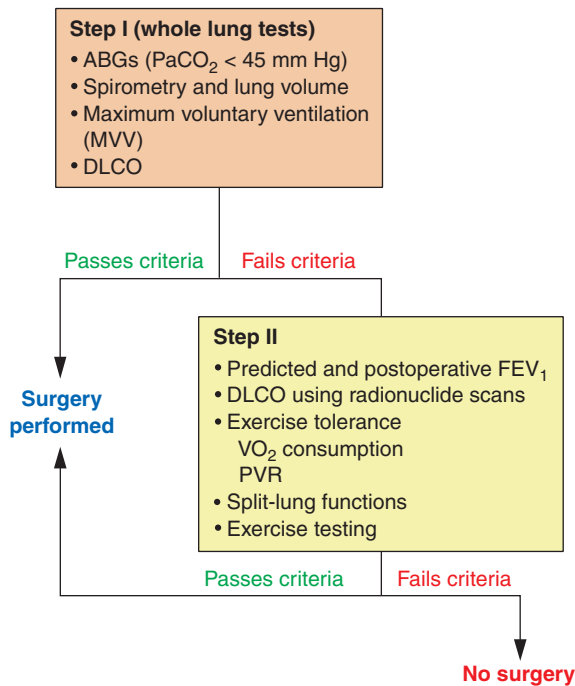


FIGURE 53–2. Sequence of tests for lung resection.

and respiratory failure (Fig. 53–3). DLCO < 50–60% of the predicted value is an indication for further testing with split lung function studies before undertaking major pulmonary resection.

### Split Lung Function and Ventilation: Perfusion Studies

Patients who are deemed to be at increased risk after the initial phase of the pulmonary function evaluation should undergo additional testing to assess the effect of lung resection. The goal is to predict the impact of resection on postoperative lung function.

The involved lung tissue may contribute little to existing lung function, and therefore its removal may not cause further deterioration of pulmonary function. Thus, some patients who would be denied operations based on the initial results may be considered surgical candidates after more specific evaluation.

The effect of anticipated lung resection can be predicted using radioisotope ventilation scans, perfusion scans, or a combination of both. More recently, dynamic perfusion magnetic resonance imaging (MRI)<sup>29</sup> and quantita-

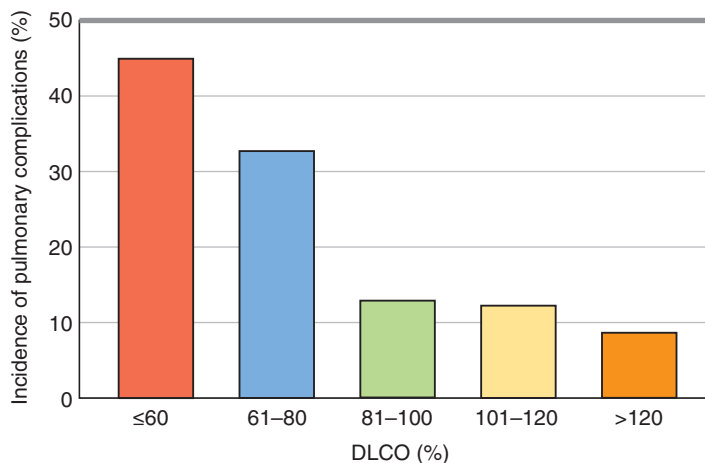


FIGURE 53–3. Prevalence of pulmonary complications after major pulmonary resection versus diffusing capacity of lung for carbon monoxide (%) in 165 patients.

### BOX 53–1.

#### Factors That Predict Increased Perioperative Morbidity and Mortality

$\text{PaCO}_2 > 45$  mm Hg  
 $\text{PaO}_2 < 50$  mm Hg on room air  
 Inability to walk 2000 feet in 6 minutes  
 Inability to ascend two flights of stairs  
 Inability to attain 7.5 mL/kg/min  $\text{O}_2$  consumption  
 Predicted postoperative  $\text{FEV}_1 < 30\%$  of expected normal value for patient  
 Combined predicted postoperative  $\text{FEV}_1 < 35\%$  and predicted postoperative DLCO < 35% of expected normal value for patient  
 Measures of right-heart catheterization after balloon occlusion of PA of a mean PA pressure > 35 mm Hg,  $\text{PaO}_2 < 45$  mm Hg,  $\text{PaCO}_2 > 60$  mm Hg  
 DLCO, Diffusing capacity of lung for carbon monoxide;  $\text{FEV}_1$ , forced expiratory volume in 1 second; PA, pulmonary artery;  $\text{PaO}_2$ , arterial partial pressure of oxygen;  $\text{PaCO}_2$ , arterial partial pressure of carbon dioxide.

tive CT have been shown to be as accurate as perfusion scintigraphy at predicting postoperative  $\text{FEV}_1$ .<sup>30</sup> Most authorities consider the minimal predicted postoperative  $\text{FEV}_1$  that will be tolerated by a patient is 800 mL (Box 53–1). This is based on the observation that patients with chronic obstructive pulmonary disease (COPD) having  $\text{FEV}_1 < 800$  mL had dramatic reduction in their level of daily function.<sup>25</sup> Additionally, patients with COPD start retaining  $\text{CO}_2$  and developing hypercapnia when their  $\text{FEV}_1$  value is < 800 mL.<sup>31</sup> These previous studies may have been overly conservative.<sup>31,32</sup> Because an absolute value for  $\text{FEV}_1$  does not account for persons of different gender, height, and age, some physicians base their decision on  $\text{FEV}_1 > 30\text{--}40\%$  of the predicted value.<sup>22</sup>

The radioactive technetium-99scan yields data about regional perfusion, and the xenon-133 ventilation scan provides data about regional ventilation and lung volumes. The results allow estimation of the fraction of lung function that is contributed by the lung segments to be removed. The equation for calculating the predicted postpneumonectomy lung function is: Postoperative  $\text{FEV}_1 = \text{Preoperative } \text{FEV}_1 \times \text{Perfusion } (\%)$  to the remaining lung. A modification of this equation has been proposed to predict the decrement in lung function after lobectomy: Loss of

**BOX 53–2.****Clinical Signs and Symptoms of Pulmonary Hypertension, Right Ventricular Hypertrophy, and Cor Pulmonale**

Patient has prominent neck veins, prominent A waves, and perhaps prominent V waves seen on electrocardiogram.

Prominent left parasternal heave and rocking motion synchronous with heartbeat may be present.

Dullness to percussion over left second intercostal space near sternum may be present, indicating dilatation of main pulmonary artery. However, if too much emphysema is present, entire precordium may be resonant because of hyperinflation of lungs.

On auscultation, pulmonary component of second heart sound increases, with narrowing or loss of normal splitting in second heart sound.

High-pitched, early systolic ejection click is heard.

Systolic ejection murmur is present.

Right-sided atrial  $S_4$  gallop usually indicates increased right ventricular end-diastolic pressure and may coincide with prominent A waves in jugular venous pulse.  $S_4$  gallop usually is not ominous.

Middiastolic right-sided  $S_3$  gallop usually is evidence of impaired right ventricular function and usually is ominous. Right-sided gallops can be differentiated from left-sided gallops because they increase in intensity with inspiration.

Early-diastolic, pulmonary regurgitant murmur may indicate functional pulmonary insufficiency caused by dilation of root of pulmonary artery and pulmonic valve.

Right-sided heart failure with chronic, dependent edema; large, tender liver; ascites; positive, hepatojugular reflex; and dilated, distended, pulsating neck veins are signs.

function = Preoperative  $FEV_1 \times$  Functional segments in the lobe to be resected/Total number of segments in both lungs.

**Exercise Studies**

In contrast with some previous studies, preoperative maximal and submaximal

exercise testing has been shown to be a good predictor of postoperative pulmonary complications in patients undergoing pulmonary resection.<sup>12,19,28,33</sup> Exercise testing may better predict adverse outcomes by uncovering deficits in  $O_2$  transport or cardiac function. Maximal oxygen consumption  $<1$  L/min is associated with a 75% mortality rate, whereas death is rare if maximal oxygen consumption is  $>1$  L/min. Other exercise-related criteria indicating increased risk for pulmonary resection are (1) pulmonary vascular resistance (PVR)  $>190$  dynes/sec/cm<sup>5</sup> (with exercise), (2) arterial oxygen desaturation  $>2\%$  with exercise, and (3) maximal oxygen consumption  $<15$  mL/kg/min. Disadvantages of exercise testing are its dependence on patient effort and cooperation and its requirement for special equipment and trained personnel to administer the tests.

**Right-Heart Function**

Patients who are to undergo thoracotomy and lung resection frequently have a long-standing history of smoking and underlying COPD, which can lead to pulmonary arterial hypertension and its sequelae. Pulmonary arterial hypertension results from an increase in PVR caused by a reduction of cross-sectional area of the pulmonary vascular bed associated with destruction of alveolar septa and hypoxemia-induced pulmonary vasoconstriction. Over time, pulmonary hypertension can lead to right ventricular hypertrophy, cor pulmonale, and right ventricular failure. The normal pulmonary vascular bed can tolerate an increase in cardiac output of 250% without an increase in PA pressure. In contrast, even a small increase of cardiac output causes a large increase in PA pressure in patients with a restricted pulmonary vascular bed. Pre-existing impairment of pulmonary vascular compliance associated with congestive heart failure and cor pulmonale may be exacerbated after extensive lung resection, leading to serious pulmonary hypertension and right-sided heart failure. Preoperative evaluation of these patients should assess for signs and symptoms of pulmonary hypertension, right ventricular and right atrial hypertrophy, cor pulmonale, and congestive heart failure (Boxes 53–2 and 53–3). A fixed elevated PVR has been associated with an increased risk for complications.<sup>6</sup> In an attempt to simulate the cardiovascular effects of pneu-

**BOX 53–3.****Radiographic Signs of Pulmonary Hypertension**

Dilation of main pulmonary vessels  
Attenuation of peripheral pulmonary vasculature, leading to oligemic peripheral lung zones

Radiographic findings characteristic of chronic obstructive pulmonary disease, such as hyperinflated lungs and low, flat diaphragms

Manifestations of right ventricular hypertrophy, clockwise cardiac rotation, and loss of air space behind sternum on lateral chest radiograph

monectomy, patients can undergo a right-heart catheterization with occlusion of the affected PA. The criteria for inoperability include (1) increase in mean PA pressure to  $>35$ – $40$  mm Hg, (2) increase in  $Paco_2$  to  $>60$  mm Hg, and (3) decrease in  $PaO_2$  to  $<45$  mm Hg (Box 53–1).<sup>6,34</sup>

**PREOPERATIVE PREPARATION OF THE PATIENT UNDERGOING THORACIC SURGERY**

Preoperative preparation of the patient for thoracic surgery should focus on treatable conditions.<sup>2–5,35,36</sup> Stein et al.<sup>36</sup> found that postoperative complications developed in four of 17 well-prepared patients compared with 13 of 17 unprepared patients. Prophylactic measures, such as bronchodilator therapy, hydration, and chest physical therapy, decrease the incidence of postoperative complications and should be started preoperatively and continued postoperatively. In addition, preoperative patient education about the importance of cessation of smoking, incentive spirometry, and bronchodilator therapy are beneficial.

Cessation of smoking for at least 4–8 weeks before surgery is associated with a decreased incidence of postoperative respiratory complications.<sup>8,37</sup> Although cessation of smoking for 12–24 hours preoperatively does not decrease the incidence of postoperative respiratory complications, it still may have a salutary effect by decreasing the concentration of carboxyhemoglobin. Other beneficial effects of stopping smoking several weeks before surgery are decreasing sputum production and improving ciliary activity.<sup>37,38</sup>



Elective operations should be postponed in patients with acute exacerbation until proper management has been instituted. Sympathomimetic drugs can be administered to activate  $\beta_2$ -adrenergic receptors, increasing intracellular cyclic adenosine monophosphate and leading to bronchodilation. Bronchodilation also can be produced by parasympatholytics, such as ipratropium bromide, which inhibit parasympathetic vagal tone of the tracheobronchial tree. Other management for wheezing includes administration of steroids to suppress inflammation and decrease mucosal edema. However, because steroids are slow acting, their benefit in patients with acute bronchospasm is limited.

Mobilization of secretions and improved pulmonary toilet improve perioperative pulmonary function. Mobilization of secretions is achieved by a combination of deep breathing, vigorous coughing, postural drainage, hydration, and chest percussion.<sup>39,40</sup> However, chest physical therapy is relatively contraindicated in patients with lung abscesses, pulmonary metastases, or a history of hemoptysis.

Acute and chronic infection should be managed with antibiotics before operation. A change in the color and quantity of sputum produced by a patient with COPD may indicate infection. One prospective study reported a decreased incidence of postoperative pulmonary complications and mortality rate in patients treated with prophylactic antibiotics before pulmonary operations.<sup>41</sup>

Preoperative pulmonary rehabilitation should be considered for all patients. It typically includes all of the steps reviewed in the preceding three paragraphs along with structured exercise. Compared with education alone, comprehensive pulmonary rehabilitation has produced a significant increase in 6-minute walk test,<sup>42</sup> maximal exercise tolerance,<sup>43</sup> maximal oxygen uptake,<sup>43</sup> and quality of life measures.<sup>42-44</sup> These interventions decrease postoperative pulmonary complications<sup>45</sup>; however, the programs must be initiated 24 weeks before surgery to achieve maximal effectiveness,<sup>42</sup> which typically is not possible in patients with lung cancer.

## LUNG CANCER

### Classification

Lung cancer is currently the most common cause of cancer mortality in the

United States and throughout the world. The World Health Organization (WHO) classification of lung tumors, revised most recently in 2004, remains the foundation for lung carcinoma nomenclature.<sup>46</sup> The characterization of lung carcinomas by histopathologic subtype is the basis of formal classification and has implications to management and prognosis. Lung cancer is divided into several broad categories based on histology: adenocarcinoma (25%), squamous cell carcinoma ( $\approx$ 35%), large cell carcinoma, adenosquamous carcinoma, carcinoid tumors, and carcinomas with pleomorphic elements.

The therapeutic approach to lung cancer depends on the histologic type of tumor and its extent (stage). The most commonly staging classification, the TNM system, is based on cell type (T), extent of lymph node involvement (N), and metastatic spread (M; Box 53-4). The TNM system is used to group patients into subsets or stages that have implications on treatment options, surgical resectability, and prognosis.

The approaches to therapy for small cell lung carcinoma (SCLC) and for non-small cell lung carcinoma (NSCLC) differ. SCLCs account for approximately 25% of all bronchogenic carcinomas and have a strong correlation with cigarette smoking. In general, SCLC has metastasized by the time of diagnosis and are managed primarily by chemotherapy without radiotherapy. NSCLCs often are more localized and thus are better candidates for curative resection. Surgical resection is a standard component of the attempt to cure lung cancer in patients with stage I and II NSCLC. In addition to surgery, adjuvant chemotherapy may be administered for selected patients with stage IB and stage II disease. Although the value of resection has never been established through randomized trials, the favorable results in surgical series and the relative infrequency of long-term survival in patients treated without surgery have established surgery as the treatment of choice.<sup>47</sup>

Lobectomy, the surgical removal of an anatomic lung segment, is generally accepted as the optimal procedure for early-stage NSCLC because of its ability to preserve pulmonary function.<sup>48</sup> Limited (sublobar) resection is increasingly used to treat patients who cannot tolerate a full lobectomy because of severely compromised pulmonary function, advanced age, or other extensive comor-

bidity. In addition, advances in video-assisted thoracoscopic surgery (VATS) have facilitated the use of limited resections in selected patients.

### Intrathoracic Metastatic Manifestations

Clinical manifestations of lung cancer are varied. Common symptoms include shortness of breath, hemoptysis, chest pain, and increasing dyspnea (Table 53-2). Pleural effusions are a common but nonspecific finding observed on chest radiographs. The effusions result from obstruction of lymphatic drainage or malignant extension of the tumor to the lung surface. Chest pain associated with lung cancer usually is dull or mild and nonspecific, occurring ipsilateral to the tumor. Metastasis to the chest wall and ribs can result in local tenderness and pleuritic chest pain. Shoulder pain may result from tumor growth at the lung apex and invasion or encroachment of the brachial plexus (such as in Pancoast tumor). Tumor extension into the pericardium can result in pericarditis, cardiac dysrhythmias, and pericardial effusions that cause tamponade. In addition, superior vena cava obstruction by local growth or lymphatic metastases will impede venous return from the head and upper extremities. Its implications to clinical management are discussed in the section entitled Anesthesia for Patients with Mediastinal Masses.

Other manifestations of lung cancer include neurologic symptoms caused by mechanical encroachment or invasion of the nerve plexus. Involvement of the brachial plexus may result not only in shoulder pain but also in upper arm weakness. Involvement of the phrenic nerve can lead to unilateral diaphragmatic dysfunction, and involvement of the recurrent laryngeal nerve can result in hoarseness of voice.

### Extrathoracic Metastatic Manifestations

Common extrathoracic sites of metastases include lymph nodes, brain, bone, liver, skin, and suprarenal glands. The neurologic manifestations of metastatic brain tumors include hemiplegia, personality changes, cerebellar disturbances, seizures, headache, and confusion. Metastases to bone occur primarily in ribs, vertebra, humerus, and femur. Although metastases to the spinal cord and vertebral column are less common, they have implications for positioning and postoperative management of pain.

## BOX 53-4.

## Definitions for Staging Bronchogenic Carcinoma

To: No evidence of primary tumor

TX: Tumor proved by presence of malignant cells in bronchopulmonary secretions but not visualized radiographically or bronchoscopically, or any tumor that cannot be assessed

TIS: Carcinoma in situ

T1: Tumor 3.0 cm or less in greatest diameter, surrounded by lung or visceral pleura, and without evidence of invasion proximal to lobar bronchus at bronchoscopy

T2: Tumor more than 3.0 cm in greatest diameter or tumor of any size that either invades visceral pleura or has associated atelectasis or obstructive pneumonitis extending to hilar region; at bronchoscopy proximal extent of demonstrable tumor should be within lobar bronchus at least 2.0 cm distal to carina; any associated atelectasis or obstructive pneumonitis should involve less than an entire lung, and no pleural effusion should be present

T3: Tumor of any size with direct extension into an adjacent structure, such as parietal pleura, chest wall, diaphragm, or mediastinum and its contents; or tumor shown bronchoscopically to involve a main bronchus less than 2.0 cm distal to carina; or any tumor associated with atelectasis or obstructive pneumonitis of an entire lung or pleural effusion

No: No demonstrable metastasis to regional lymph nodes

N1: Metastasis to lymph nodes in peribronchial or ipsilateral hilar region, or both, including direct extension

Mo: No distant metastasis

M1: Distant metastasis, such as scalene, cervical, or contralateral hilar lymph nodes; brain; bones, liver; or contralateral lung

## Occult carcinoma

TX No Mo

## Stage 1

TIS No Mo

T1 No Mo

T1 N1 Mo

T2 No Mo

## Stage 2

TS N1 Mo

## Stage 3

T3 any N or M

N2 any T or M

M1 any T or N

M1 any T or N

From Spiro SG. The diagnosis and staging of lung cancer. In Smyth JR, ed. The Management of Lung Cancer. London: Edward Arnold, 1984, pg. 117, with permission.

## Extrathoracic Nonmetastatic Manifestations

The extrapulmonary manifestations of lung cancer affect the metabolic, neuromuscular, skeletal, dermatologic, vascular, and hematologic systems. Although uncommon, the systemic manifestations of such paraneoplastic syndromes can impact on the perioperative treatment. The metabolic and neuromuscular manifestations are more likely to affect perioperative management (Box 53-5). In general, the symptoms resolve, and results of laboratory studies return to normal after a successful tumor resection.

Metabolic manifestations usually result from endocrine secretions by the tumor.

- Cushing syndrome most often is associated with SCLC; it is characterized by increased adrenocorticotropic hormone levels.
- The syndrome of excessive antidiuretic hormone, which is associated with SCLC, may manifest as nausea, vomiting, anorexia, hyponatremia, seizures, or other neurologic disturbances.
- Carcinoid syndrome is associated with production of serotonin; it is

diagnosed by elevated 5-hydroxyindoleacetic acid (5-HIAA) levels.

- Hypercalcemia, which is associated with hypophosphatemia, results from a parathyroid hormone-like polypeptide secreted most often by bronchogenic carcinoma.
- Hypoglycemia and ectopic gonadotropin production are rare manifestations.
- Neuromuscular manifestations are the most frequent extrathoracic nonmetastatic effects of lung cancer, most often SCLC.<sup>52</sup> The paraneoplastic myopathy Eaton-Lambert syndrome may appear as a myasthenic-like syndrome characterized by proximal muscle weakness, particularly of the pelvic and thigh muscles. The defect in neuromuscular transmission is a result of an antibody-mediated impairment of presynaptic neurocalcium channel activity, which reduces the release of acetylcholine.<sup>53,54</sup> Patients with this syndrome do not respond as well to anticholinesterase drugs as do patients with myasthenia gravis. In contrast, these patients exhibit increased sensitivity to succinylcholine and nondepolarizing muscle relaxants.

- Other neuromuscular manifestations include subacute cerebral degeneration, encephalomyelopathy, and polymyositis. The cause and pathogenesis of these neuropathies are not completely understood. Immunologic factors are believed to be important because antibody and T-cell responses are directed against shared antigens that are ectopically expressed by the tumor but otherwise exclusively expressed by the nervous system.<sup>55,56</sup>

## MONITORING DURING THORACIC ANESTHESIA

The treatment of patients undergoing thoracic surgery is a challenging aspect of anesthesiology. These patients usually have underlying respiratory and cardiac disease that are altered further by surgical manipulations, operative position, and periods of lung collapse and one-lung ventilation, which worsen  $\dot{V}/\dot{Q}$  mismatches. Thus, it is important to constantly monitor oxygenation and ventilation. There is disagreement about the need for invasive monitoring in patients undergoing thoracotomy. Monitoring should be individualized, depending on the extent of operation and the

TABLE 53-2.

## Incidence of Various Clinical Manifestations on Initial Examination of Patients with Bronchogenic Carcinoma

Clinical Manifestation	Incidence (%)
Asymptomatic	5
Bronchopulmonary	75
Cough	
Hemoptysis	57
Chest pain	40
Dyspnea	30
Wheezing	10
Extrapulmonary intra-thoracic	
Hoarseness	5
Superior vena cava syndrome	4
Chest wall pain	5
Pain radiating into upper extremity	5
Horner syndrome	5
Dysphagia	1
Pleural effusion	10
Extrathoracic metastatic	3-6
Liver skeleton	
Adrenals	
Gastrointestinal tract	
Kidneys	
Pancreas	
Extrathoracic nonmetastatic (paraneoplastic)	2
Endocrine/metabolic	
Neuromuscular	
Skeletal	
Dermatologic	
Hematologic	
Nonspecific	10-22
Weight loss	
Weakness	
Anorexia	
Lethargy	
Malaise	
Fever	

Based on data from references 49-51.

patient's underlying cardiovascular and respiratory condition (Table 53-3).

Monitoring of patients undergoing thoracic surgery includes ECG, pulse oximetry, blood pressure, and capnography. Other noninvasive monitors provide crucial information. Auscultation for wheezing, rales, or rhonchi assist in the diagnosis of endotracheal tube malposition, congestive heart failure, airway disconnect, and bronchospasm. Airway pressures give valuable information

about changes in lung compliance, occurrence of bronchospasm, and malposition of the double-lumen endotracheal tube. Perioperatively, pulse oximetry is the most valuable monitor for early diagnosis of problems with oxygenation. Capnography gives a continuous display of the CO<sub>2</sub> waveform and alerts the anesthesiologist to apnea, airway disconnects, and hypoventilation. End-tidal CO<sub>2</sub> usually is 5 mm Hg less than arterial pCO<sub>2</sub>; the difference between them will increase as  $\dot{V}/\dot{Q}$  mismatching develops, as in the case of one-lung ventilation or pulmonary disease.

The anesthesiologist may require additional monitoring, such as systemic arterial or PA catheters, when caring for patients with a history of pneumonia, cardiac disease, or major anatomic pulmonary resection. Intraarterial catheters are routinely used to monitor arterial blood gases and hemodynamics during major pulmonary resections. However, any monitoring device has risks, and a risk-benefit analysis should always be undertaken.<sup>57</sup>

The PA catheter is used to monitor cardiac output, left ventricular function, PA pressures, and mixed venous oxygenation. It can be used to assess the effect of pulmonary resection on right ventricular function because patients with preoperative cardiac dysfunction are at risk for acute right ventricular failure after a pulmonary resection. A dramatic increase in PA pressures during temporary clamping of vessels might contraindicate such resection. More than 90% of PA catheters end in the right lung.<sup>58</sup> During a right thoracotomy with the patient in the left lateral decubitus position, the PA catheter is in the nondependent lung. Although one study found that the PA catheter in the nondependent lung underestimated measured cardiac output values, other clinical and animal studies found no difference whether the thermistor was located in the main trunk or branches of the PA or in the dependent or nondependent lung.<sup>59-61</sup> Thus, accuracy and clinical interpretation of PA pressures and PA occlusion pressures must account for the location of the PA catheter in relation to patient positioning, mode of ventilation, blood flow, and HPV.

## LATERAL DECUBITUS POSITION

The lateral decubitus position (or some variation of it) is nearly universal dur-

BOX 53-5.

### Classification of Extrapulmonary Manifestations of Lung Carcinoma

#### Metabolic

##### Cushing syndrome

Syndrome of inappropriate diuretic hormone secretion

Carcinoid syndrome

Hypercalcemia

Ectopic gonadotropin

Insulin-like activity

#### Neuromuscular

Carcinomatous myopathy

Peripheral neuropathies

Subacute cerebellar degeneration

Encephalomyelopathy

#### Skeletal

Clubbing

Pulmonary hypertrophic osteoarthropathy

#### Dermatologic

Acanthosis nigricans

Scleroderma

Other dermatoses

#### Vascular

Migratory thrombophlebitis

Nonbacterial verrucal endocarditis

Arterial thrombosis

#### Hematologic

Anemia

Fibrinolytic purpura

Nonspecific leukocytosis

Polycythemia

From Shields<sup>51</sup> with permission.

ing thoracic surgery (Table 53-4). It allows for complete access to the hemithorax and permits extending the incision anteriorly and posteriorly. It offers access to the pleural cavity, hilar vessels, lateral pericardium, and descending thoracic aorta. The lateral decubitus position is used for patients undergoing pulmonary surgery, operations on the esophagus, thoracic aorta, thoracic spine, and certain cardiac procedures. This position may affect pulmonary, cardiovascular, and neurologic physiology. Orientation of one lung in a more dependent position alters pulmonary mechanics and increases the risk of contaminating the dependent lung with blood and purulent materials. The dependent lung has decreased functional residual capacity (FRC) and increased airway closure and atelectasis. Increased pulmonary blood flow and reduced ventilation to the dependent lung results in ventila-

TABLE 53–3.

## Use of Monitoring to Detect and Diagnose Intraoperative Events

<b>Respiration</b>	
Pattern, respiratory rate	Apnea, respiratory difficulty, rales
Auscultation	Wheezing, rhonchi, apnea, compliance
Airway pressure	Obstruction, pneumothorax, bronchospasm, secretions
<b>Oxygenation</b>	
FiO <sub>2</sub> analyzer	Inadvertent hypoxia
Pulse oximetry	Hypoxia, integrity of pulse
Arterial blood gas	Acidosis (metabolic, respiratory)
<b>Ventilation</b>	
Capnography	Bronchospasm Hypoventilation and apnea Confirm endotracheal intubation Return of spontaneous ventilation during controlled ventilation
<b>Cardiovascular function</b>	
Electrocardiography	Arrhythmia, ischemia
Intraarterial catheter	Hypotension or hypertension Arterial compression
Pulmonary artery catheter	Pulmonary hypertension, filling pressures, assess cardiac performance
SvO <sub>2</sub>	Adequacy of cardiac output
Transesophageal echocardiography	Ischemia, volume status, right ventricular dysfunction

tion and perfusion abnormalities when both lungs are ventilated, although the increased blood flow to the dependent lung is advantageous during single-lung ventilation.

The lateral decubitus position is associated with hazards (see Chap. 26). To avoid complications, special atten-

tion should be given to the orientation of the cervical spine, positioning of the extremities, and placement of straps to anchor the body. A chest roll should be placed under the dependent axilla to prevent compression of neurovascular structures by the head of the humerus. Use of a soft contour bag

(“bean bag”) is advocated because it not only functions as a chest roll but also supports the patient and decreases the risk of pressure necrosis by molding to the patient’s body. Patients often are flexed to open the intercostal spaces and to facilitate the introduction of cameras and surgical instruments. Additionally, slight flexion of the dependent hip and knee help stabilize the patient and decrease stretch of the sciatic nerve. The non-dependent leg is positioned on a pillow to avoid pressure on the dependent leg. Positioning of the upper extremities and the head requires special attention to avoid compression and stretch injury to the brachial plexus and peripheral nerves. The cervical spine is placed in a neutral position, and the dependent arm is outstretched (Fig. 53–4). The nondependent arm is elevated superiorly on an arm board to bring the vertebral border of the scapula forward. The decubitus position is further stabilized by placing straps or tape across the table at the level of the hip and across the leg, paying attention to avoid compression of tissue.

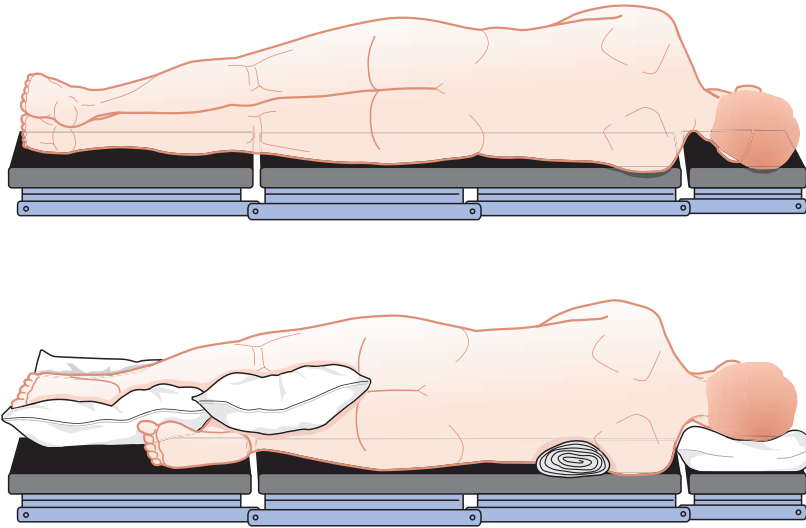
The standard lateral decubitus position may be modified to facilitate surgical exposure. Slight rotation of the upper chest from 90° permits better access for more anterior or posterior incisions. Positioning of the nondependent arm in a more cephalad and abducted orientation permit a surgical

TABLE 53–4.

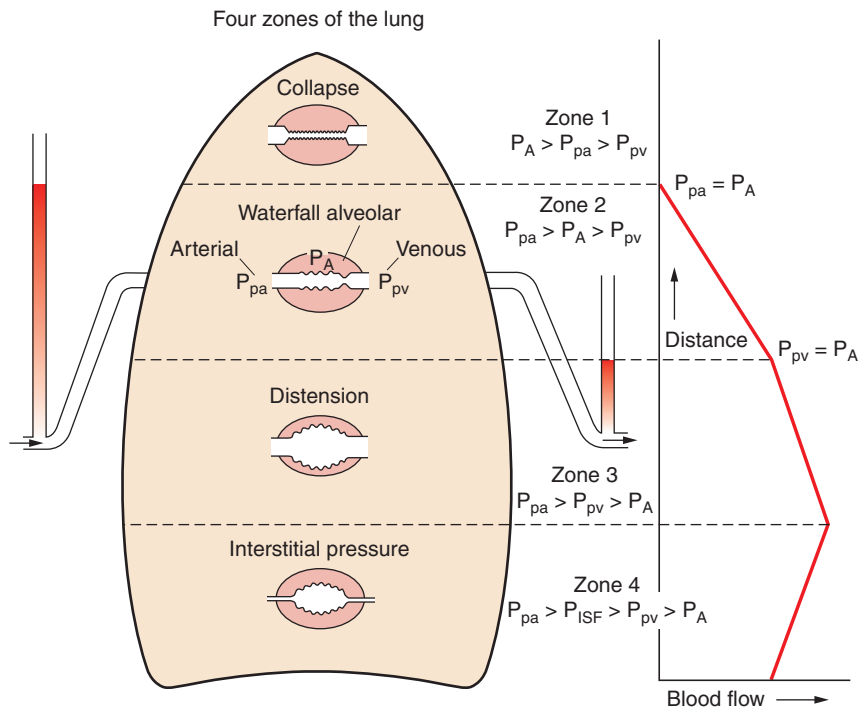
## Various Patient Positions Used during Thoracic Surgery

Position	Possible Surgical Incisions	Clinical Application
Supine	Median sternotomy	Cardiac surgery, mediastinal, major liver, vascular trauma
	Bilateral intercostal transverse sternotomy	Repair pectus excavatum, bilateral lung transplant
	Anterior or anterolateral incisions: side to be incised can be slightly elevated	Pericardial tamponade, lung biopsy
Upright	For minor thoracic procedures during local anesthesia	Used in high-risk patients (e.g., open drainage of empyema) and for biopsy of lung or pleura
Lateral decubitus (90° angle to table)	Anterolateral and posterolateral thoracotomy incisions	Standard thoracotomy position
To provide optimal access for cardiac, thoracic, vascular, or gastrointestinal pathology, the obliqueness of the patient’s back to the table can vary between 45° and 135°	Anterolateral and posterolateral thoracotomy Anterior thoracotomy Thoracoabdominal incisions	To improve exposure in certain cardiothoracic, vascular, or gastroesophageal procedures Tracheal or esophageal surgery, thyroid or vascular trauma, penetrating neck injuries Thoracoabdominal aortic surgery





**FIGURE 53-4.** Standard right lateral decubitus position. Top. Improper head position and inadequate padding. Bottom. Proper padding over bony prominences, chest roll to protect axilla, proper alignment of cervical spine. Flexed lower leg stabilizes torso.



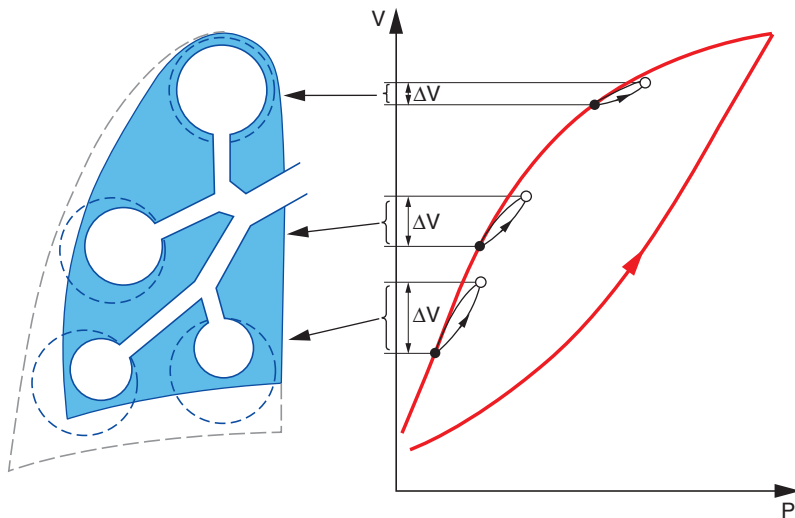
**FIGURE 53-5.** Schematic diagram showing the distribution of blood flow in the upright lung. In zone 1, alveolar pressure ( $P_A$ ) exceeds pulmonary artery pressure ( $P_{pa}$ ), and no flow occurs because the intraalveolar vessels are collapsed by the compressing alveolar pressure. In zone 2, arterial pressure exceeds alveolar pressure, but alveolar pressure exceeds pulmonary venous pressure ( $P_{pv}$ ). Flow in zone 2 is determined by the arterial–alveolar pressure difference ( $P_{pa} - P_A$ ) and has been likened to an upstream river waterfall over a dam. Because  $P_{pa}$  increases down zone 2 and  $P_A$  remains constant, the perfusion pressure increases, and flow steadily increases down the zone. In zone 3, pulmonary venous pressure exceeds alveolar pressure, and flow is determined by the arterial–venous pressure difference ( $P_{pa} - P_{pv}$ ), which is constant down this portion of the lung. The transmural pressure across the wall of the vessel increases down this zone so that the caliber of the vessels increases (resistance decreases) and therefore flow increases. Finally, in zone 4, pulmonary interstitial pressure becomes positive and exceeds pulmonary venous pressure and alveolar pressure. Consequently, flow in zone 4 is determined by the arterial–interstitial pressure difference ( $P_{pa} - P_{ISF}$ ). (Redrawn from West JB. Ventilation Blood Flow and Gas Exchange. 4th ed. Oxford: Blackwell Scientific, 1985, pg. 221, and Wagner PD, Saltzman HA, West JB. Measurement of continuous distribution of ventilation-perfusion ratios: theory. *J Appl Physiol* 1974;36:588 with permission.)

approach that preserves the integrity of the latissimus and pectoralis muscles—a “muscle-sparing approach.”

Proper positioning of the endobronchial tube should be reconfirmed after the patient is repositioned because slight flexion or extension of the neck can displace the endotracheal tube. Flexion of the neck moves the endotracheal tube distally, whereas extension of the neck moves the tube proximally. Confirmation of tube position with fiberoptic endoscopy decreases the incidence of inadequate lung isolation.

### Physiology: Principles of Ventilation and Perfusion

Disparity between the greater gravitational pressures at the base and the greater negative intrapleural pressure at the apex are major factors in understanding normal ventilation and perfusion. Gravitational hydrostatic pressure cause distension of vessels and increased perfusion in the more dependent portions of the lung (Fig. 53-5). The apices of the lung may have little or no perfusion. In addition, the effects of gravity tend to collapse the apex of the lung inward and create a negative intrapleural pressure, whereas the lower dependent regions tend to push outward toward the chest wall and create a relatively positive pressure. Because the density of the lungs is 25% that of water and because the height of the upright lung is approximately 30 cm, the difference between the intrapleural pressure at the base of the lung versus the apex is approximately 7.5 cm  $H_2O$ .<sup>62</sup> Because the intraalveolar pressure is the same throughout the lung, the transpulmonary distending pressure is greatest at the top of the lung and decreases toward the bottom. Therefore, the alveoli in the apices are largest, and those in the base are the smallest. An approximately 4-fold alveolar volume difference exists between the base and the apex of the lung (Fig. 53-6). The small alveoli in the base of the lung are on the steep portion of their compliance curve, whereas the nondependent alveoli are on the relatively flat, noncompliant portion of the curve. Therefore, in the upright position, the tidal volume is preferentially distributed to the basilar alveoli because they expand more per unit pressure change than do the apical alveoli. These physiologic effects result in greater increases in blood flow ( $\dot{Q}$ ) than the increase in ventilation ( $\dot{V}$ ), and  $\dot{V}/\dot{Q}$



**FIGURE 53-6.** During quiet breathing, the lower parts of the lung show greater volume changes (ventilation) than do the upper parts. (From Weibel ER, ed. *The Pathway for Oxygen: Structure and Function in the Mammalian Respiratory System*. Cambridge: Harvard University Press, 1984, with permission.)

decreases from lung apex to base (Figs. 53-7 and 53-8).

### Physiology: Lateral Decubitus Position

#### **Patient Awake, Spontaneously Breathing**

Gravity causes a vertical gradient in the distribution of pulmonary blood flow in the lateral decubitus position for the same reason it does in the upright position (Fig. 53-9). The verti-

cal hydrostatic gradient is less than it is in the upright position because the distance from the most dependent to the most nondependent part of the lung is less. Nevertheless, blood flow to the dependent lung still is much greater than blood flow to the nondependent lung. Normally, in the upright position, the right lung because of its larger size receives 55% of the total blood flow, whereas the left lung receives 45% of total blood flow.<sup>63,64</sup> When the right lung is nondependent,

it receives approximately 45% of total blood flow, whereas the dependent left lung receives 55% of the total blood flow. When the left lung is nondependent, it receives approximately 35% of the total blood flow, whereas the dependent right lung receives 65%. As in the upright position, ventilation is relatively increased in the dependent lung zones (Fig. 53-10).

In addition, in the lateral decubitus position, the dome of the lower diaphragm is pushed higher into the chest than is the dome of the upper diaphragm and therefore is more stretched and sharply curved than is the upper diaphragm. This gives the dependent diaphragm more efficiency during spontaneous ventilation. Thus, in the lateral decubitus position with an awake, spontaneously breathing patient, the dependent lung is better ventilated than the nondependent lung, and  $\dot{V}/\dot{Q}$  still is well matched.<sup>65</sup>

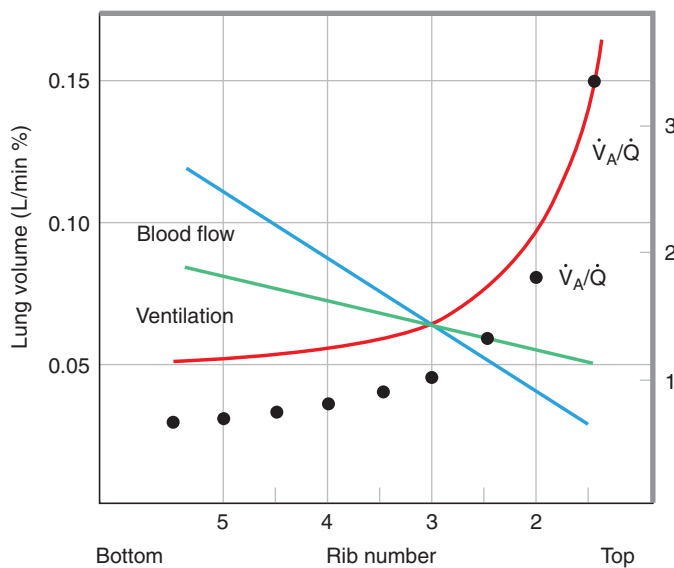
#### **Patient Anesthetized, Chest Closed**

In the anesthetized, spontaneously breathing patient in the lateral decubitus position, the dependent lung continues to receive relatively more perfusion than the nondependent lung.

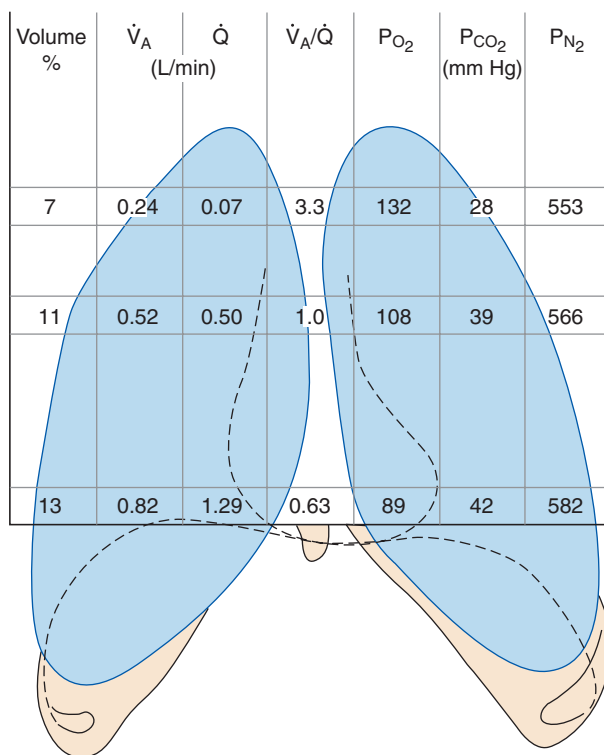
The distribution of ventilation changes after induction of anesthesia (Fig. 53-11).<sup>63,66</sup> With the induction of general anesthesia, FRC decreases. Both lungs share in the loss of lung volume and move to a lower location on the pressure-volume curve. The dependent lung now occupies the low flat portion of the curve (i.e., is less compliant). The nondependent lung, initially in the noncompliant part, now moves to the steep compliant part of the curve. Compression by the weight of the mediastinum and the abdominal contents contribute to the decrease in FRC of the dependent lung. Therefore, with induction of anesthesia, little change occurs in perfusion distribution, whereas dramatic change occurs in ventilation distribution. Now the nondependent lung receives most of the ventilation but still is less perfused, whereas the dependent lung receives less ventilation but continues to be more perfused, which leads to an increase in shunt (dependent lung has low  $\dot{V}/\dot{Q}$ ) and dead space ventilation (nondependent lung has  $\dot{V}/\dot{Q} > 1$ ).

#### **Patient Anesthetized, Paralyzed, Mechanically Ventilated**

Mechanical ventilation causes further deterioration in the  $\dot{V}/\dot{Q}$  relationship.



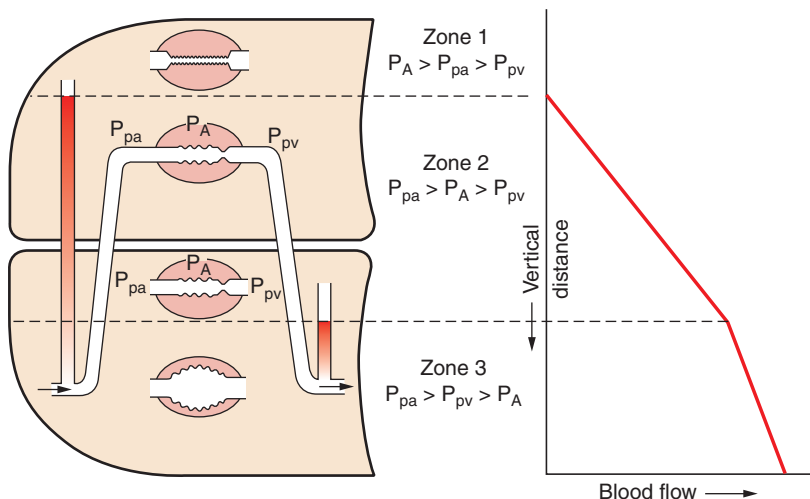
**FIGURE 53-7.** Distribution of ventilation and blood flow (left vertical axis) and ventilation/perfusion ratio (right vertical axis) in normal upright lung. Blood flow and ventilation are expressed in liters per minute percent alveolar volume and are drawn as smoothed out linear functions of vertical height. Closed circles mark ventilation-to-perfusion ratios of horizontal lung slices (three of which are shown in Fig. 53-8). Cardiac output of 6 L/min and total minute ventilation of 5.1 L/min were assumed. (From West JB. *Ventilation: Blood Flow and Gas Exchange*. 4th ed. Oxford: Blackwell Scientific, 1985, with permission.)



**FIGURE 53-8.** Ventilation-to-perfusion ratio ( $\dot{V}/\dot{Q}$ ) and regional composition of alveolar gas. Values for regional flow ( $\dot{Q}$ ), ventilation ( $\dot{V}_A$ ),  $P_{O_2}$ , and  $P_{CO_2}$  are derived from Fig. 53-7.  $P_{N_2}$  is obtained from what remains of the total gas pressure (which, including water vapor, equals 760 mm Hg). The volumes (vol [%]) of the three lung slices also are shown. Compared with the top of the lung, the bottom of the lung has a low  $\dot{V}/\dot{Q}$  and is relatively hypoxic and hypercapnic. (From West JB. Regional differences in gas exchange in the lung of erect man. *J Appl Physiol* 1962;17:893, with permission.)

Perfusion continues to be greater to the dependent lung because of gravitational effects, but now even more distribution of ventilation goes to the nonde-

pendent lung. With the institution of mechanical ventilation, the highly curved diaphragm in the dependent hemithorax no longer confers any ad-



**FIGURE 53-9.** Schematic representation of the effects of gravity on the distribution of pulmonary blood flow in the lateral decubitus position. Vertical gradients in the lateral decubitus position are similar to those in the upright position and cause the creation of zones 1, 2, and 3. Consequently, pulmonary blood flow increases with lung dependency and is largest in the dependent lung and least in the nondependent lung. (Modified from Kaplan JA. Hemodynamic monitoring.)

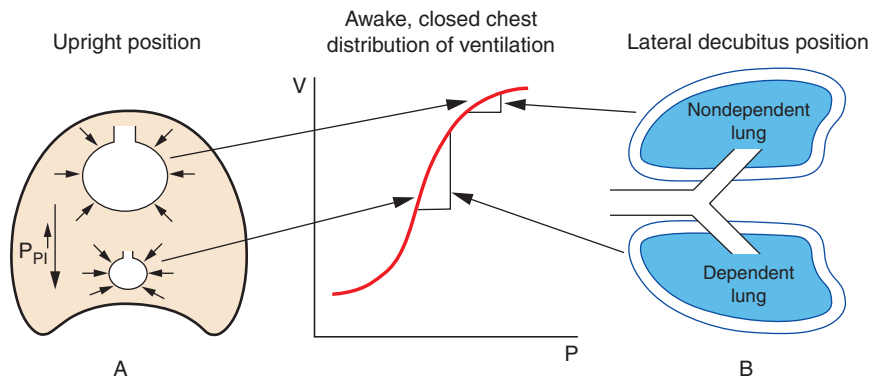
vantage in ventilation because it is no longer actively contracting.<sup>67</sup> In addition, the weight of the abdominal viscera physically restricts expansion of the dependent lung, leading to further preferential distribution of ventilation to the nondependent, less-perfused lung. The anesthetized patient in the lateral decubitus position has an unfavorable  $\dot{V}/\dot{Q}$  that is worsened by muscle relaxation and controlled ventilation. The application of positive end-expiratory pressure (PEEP) to both lungs restores their FRC and most ventilation to the dependent lung.<sup>63</sup> The lower lung returns to a steeper, more favorable part on the pressure-volume curve, and the upper lung resumes its original position on the flat, unfavorable portion of the curve.

### Patient Anesthetized, Chest Open

In the spontaneously ventilating patient with an open chest, the inspiratory tidal volume in the dependent lung is decreased by the downward displacement of the mediastinum, which leads to impaired ventilation to the dependent lung and paradoxical respiration. Paradoxical respiration refers to the movement of air between the dependent lung and the nondependent lung during respiration and the ambient atmosphere in and out of the open chest cavity. These physiologic changes can affect circulatory performance by decreasing venous return and triggering associated sympathetic reflexes, resulting in a clinical picture similar to that of shock. The reflex symptoms of hypotension, pallor, cold and clammy extremities, and pupillary dilatation can be lessened by local anesthetic infiltration of the pulmonary plexus at the hilum. Most commonly, the ventilatory and circulatory changes associated with mediastinal shift are abolished by positive-pressure ventilation.

### Patient Anesthetized, Mechanically Ventilated, Chest Open

Opening the chest results in a marked increase in the compliance of the upper lung, with a slight but still important increase in the compliance of the dependent lung. Airway pressure decreases in the dependent and the nondependent lungs. As a result, ventilation of the nondependent lung increases further compared with the closed-chest state.<sup>68</sup> The cardiac index increases with opening of the chest



**FIGURE 53-10.** Pleural pressure in the awake patient (closed chest) is most positive in the dependent portion of the lung; therefore, alveoli in this region are most compressed and have the least volume. Pleural pressure is least positive (most negative) at the apex of the lung; therefore, alveoli in this region are least compressed and have the largest volume. When these regional differences in alveolar volume are translated to a regional transpulmonary pressure–alveolar volume curve, the small dependent alveoli are on a steep (large-slope) portion of the curve, and the large nondependent alveoli are on a flat (small-slope) portion of the curve. In this diagram, regional slope equals regional compliance. Thus, for a given and equal change in transpulmonary pressure, the dependent part of the lung receives a much larger share of the tidal volume than does the nondependent part of the lung. In the lateral decubitus position (*right side of diagram*), gravity also causes pleural pressure gradients and therefore similarly affects the distribution of ventilation. The dependent lung lies on a relatively steep portion, and the upper lung lies on a relatively flat portion of the pressure–volume curve. Thus, in the lateral decubitus position, the dependent lung receives the majority of the tidal ventilation.

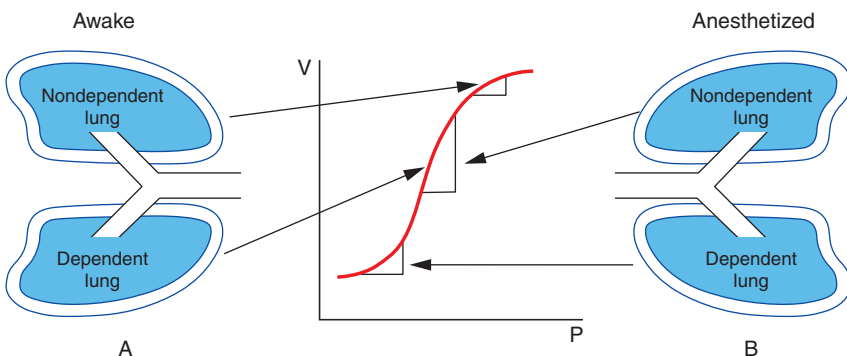
and pleura, but mean arterial pressure does not change significantly.<sup>69</sup>

The upper lung eliminates more  $\text{CO}_2$  shortly after the pleura has been opened.<sup>69</sup> The increased elimination of  $\text{CO}_2$  from the upper lung is proportionately greater than the increase in ventilation. Also, the end-tidal  $\text{PCO}_2$  measured from the upper lung increases more than that of the lower lung, which reflects a marked increase in

the blood flow to the upper lung. The decrease in airway pressure on opening the pleura, along with the increase in cardiac index, results in increased blood flow to the nondependent lung.

### Effect of PEEP

Selective PEEP application to the dependent lung can improve oxygenation by decreasing the shunt fraction. The explanation is that PEEP to the



**FIGURE 53-11.** Schematic diagram showing the distribution of ventilation in the awake patient (closed chest) in the lateral decubitus position (*left*) and the distribution of ventilation in the anesthetized patient (closed chest) in the lateral decubitus position (*right*). Induction of anesthesia has caused a loss in lung volume in both lungs, with the nondependent (*up*) lung moving from a flat noncompliant portion to a steep compliant portion of the pressure–volume curve and the dependent (*down*) lung moving from a steep compliant part to a flat, noncompliant part of the pressure–volume curve. Thus, in the anesthetized patient in a lateral decubitus position, the majority of the tidal ventilation occurs in the nondependent lung (where there is the least perfusion) and the minority of the tidal ventilation in the dependent lung (where there is the most perfusion).

dependent lung increases the FRC of that lung, moving it to a steeper, more favorable portion on its pressure–volume curve and leading to improved ventilation of the dependent lung. Even if the increase in PVR caused by the application of PEEP shifts blood flow from the dependent to the nondependent lung, that portion of the cardiac output diverted to the nondependent lung still participates in gas exchange as long as it is ventilated or exposed to continuous positive airway pressure (CPAP).

### Effects of Surgical Manipulation

With the onset of surgical manipulations, compliance and distribution of ventilation to the upper lung decrease dramatically. End-tidal  $\text{PCO}_2$  and  $\text{CO}_2$  elimination from the upper lung decrease, but changes in  $\text{Paco}_2$  are minimal.<sup>69</sup>

### Summary

The anesthetized, paralyzed patient in the lateral decubitus position with an open chest may have considerable  $\dot{V}/\dot{Q}$  mismatch. The nondependent lung receives greater ventilation and less perfusion and has  $\dot{V}/\dot{Q} > 1$ . The dependent lung has more perfusion and less ventilation (i.e., low  $\dot{V}/\dot{Q}$ ) and therefore acts as a physiologic shunt. The blood flow distribution is mainly determined by the effects of gravity. Causes of poor ventilation of the dependent lung are (1) loss of FRC because of induction of general anesthesia, (2) compression of the dependent lung by the mediastinum, (3) upward shift of the abdominal contents and paralysis of the diaphragm, (4) suboptimal positioning effects, (5) impaired ciliary clearance of mucus, and (6) absorption atelectasis from the use of high fraction of inspired oxygen ( $\text{FiO}_2$ ). Consequently, two-lung ventilation in these patients may result in an increased alveolar-to-arterial  $\text{PO}_2$  difference and less than optimal oxygenation.

### ONE-LUNG ISOLATION

#### Indications

The techniques of lung isolation are used to selectively ventilate the lung within one hemithorax while the nearly motionless lung is operated on in the contralateral hemithorax. Collapse of the nondependent lung produces less



trauma than surgical retraction and offers better exposure of structures within the hemithorax.<sup>15,16</sup> The airways of the operated lung can be incised while positive-pressure ventilation continues in the other lung. During thoracoscopic surgery, collapse of the operated lung is essential to provide adequate visualization of structures within the pleural cavity. Although many surgical procedures are facilitated by use of isolation techniques, most procedures are feasible without isolation.

Single-lung isolation is indicated under certain clinical conditions. When one lung contains either blood or infectious secretions, isolation of the lungs is imperative to prevent spillage of contents into the unaffected lung. Isolated lung ventilation is essential when a bronchopleural or bronchocutaneous fistula renders positive-pressure ventilation difficult or impossible. Furthermore, directing ventilation toward the healthier lung may result in better oxygenation and ventilation.<sup>70</sup> Some procedures require isolated ventilation, including open procedures on the trachea and mainstem bronchi, such as sleeve and carinal resections, and bronchopulmonary lavage for pulmonary alveolar proteinosis.

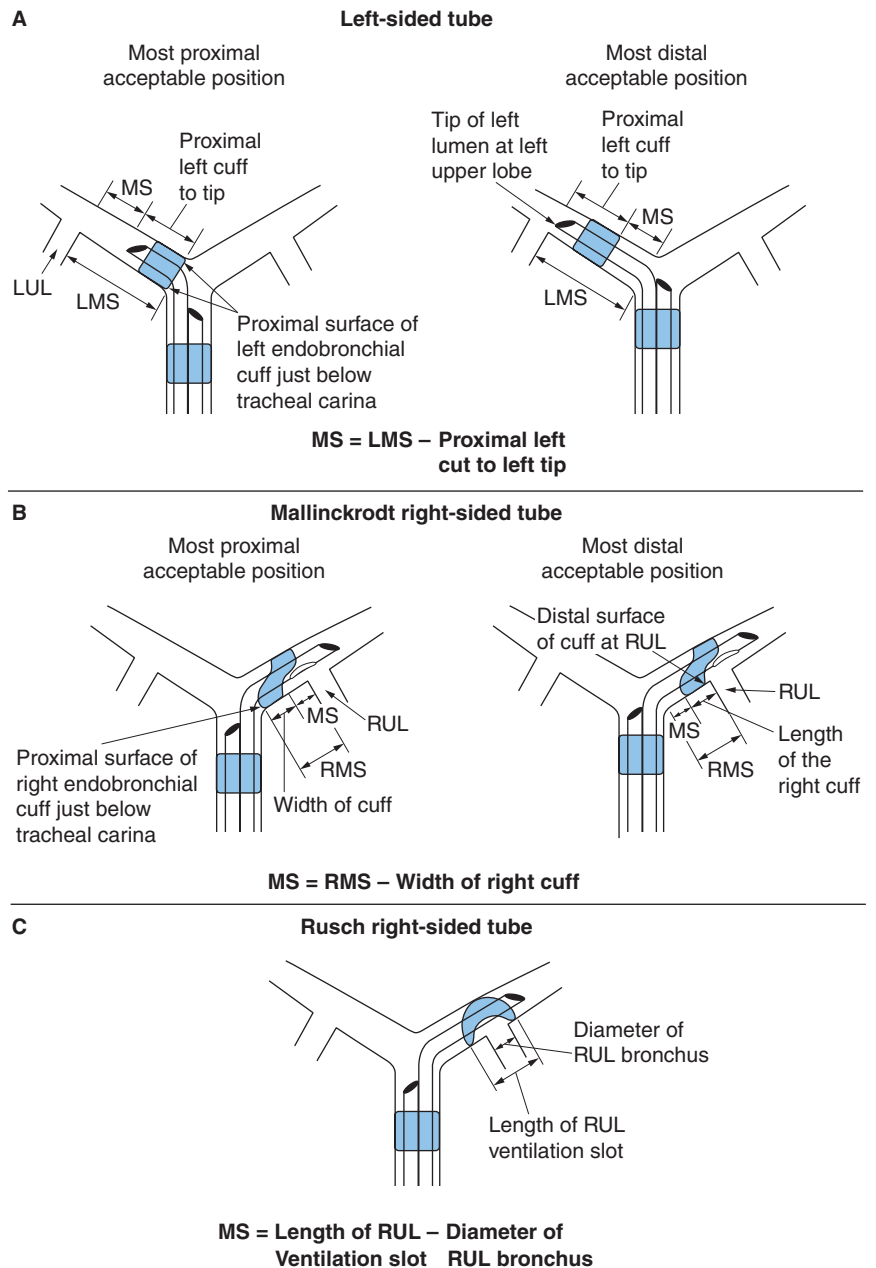
### Design of Double-Lumen Tubes

Isolated lung ventilation usually is accomplished through a double-lumen endotracheal tube. The central shaft of a double-lumen endotracheal tube is cylindrical and contains a septum that divides it into two symmetric D-shaped lumens. At the proximal end of each lumen is a short length of tubing that creates a Y-shape that permits independent attachment for ventilatory apparatus, clamping, or opening to atmospheric pressure. At the distal end, the shaft is surrounded by an inflatable tracheal cuff. The tracheal lumen terminates just below the tracheal cuff. The other lumen has a cylindrical extension, curved to fit into one of the mainstem bronchi, and carries an inflatable circumferential bronchial cuff. After the double-lumen endotracheal tube has been properly placed within the patient's airway, the bronchial cuff permits use of the bronchial lumen for positive-pressure ventilation or exclusion of the hemithorax in which it resides. The tracheal cuff provides a seal that directs pressurized gas from

the tracheal lumen into the other bronchus. Hence, a properly placed double-lumen endotracheal tube permits selective ventilation or collapse of either lung.

Double-lumen endotracheal tubes are manufactured with selective bronchial extensions intended for placement into either the left or right mainstem bronchus. The left mainstem

bronchus arises at a more acute angle with reference to the tracheal axis, but it is adequately long to easily accommodate the endobronchial extension with its inflatable cuff. In contrast, the right mainstem bronchus is nearly a direct extension of the trachea, but it contains a branch to the right upper lobe bronchus that arises close to the tracheal bifurcation (Fig. 53-12). A



**FIGURE 53-12.** Schematic showing the definitions of the most proximal and most distal acceptable positions of left- and right-sided double-lumen tubes and the margin of safety in positioning double-lumen tubes. **A.** All left-sided double-lumen tubes. **B.** Mallinckrodt right-sided double-lumen tube. **C.** Rusch right-sided double-lumen tube. LMS, Length of left mainstem bronchus; LUL, left upper lobe; MS, margin of safety in positioning double-lumen tube; RMS, length of right mainstem bronchus; RUL, right upper lobe.

TABLE 53-5.

## Choice of Double-Lumen Endotracheal Tube

Patient Height	Tube Size (Fr)	Depth of Insertion (cm)
136–164 cm 4'5.5"–5'4.5"	37	27
165–179 cm 5'5"–5'10.5"	39	29
180–194 cm 5'11"–6'4.5"	41	31

From Brodsky JB, Benumof JF, Ehenworth J, et al. Depth of placements of left double-lumen endobronchial tubes. *Anesth Analg* 1991; 73:570–572, with permission.

right-sided double-lumen endotracheal tube has a fenestration within the bronchial extension and an elaborately shaped cuff to permit a seal without airflow obstruction. Because of these considerations, right-sided tubes are more difficult to insert and require more maintenance to ensure continuous ventilation of all lobes of the right lung. In the absence of a specific indication for a right-sided double-lumen endotracheal tube, a left-sided tube is strongly preferred.

### Placement of Double-Lumen Tubes

The type of tube is chosen based on the surgical procedure, and its size is based on the patient's body habitus (Table 53-5). Direct laryngoscopy with a curved (MacIntosh) laryngoscope blade is preferred because the glottic opening is better exposed compared with a straight blade. The double-lumen endotracheal tube is held with its bronchial curve oriented anteriorly and its tracheal-pharyngeal curve oriented to the right. The tube is advanced through the glottic opening until the bronchial cuff just passes the vocal cords. If a stylet was used, it is removed.

Two methods are used for cannulation of the desired bronchus: empiric or "blind placement," and direct vision using fiberoptic assistance. In the first method, the tracheopharyngeal curve is rotated anteriorly until the proximal end of the double-lumen endotracheal tube just passes the midsagittal axis. The bronchial curve should now be oriented to the side dictated by the tube selected. It then is advanced until moderate resistance to further insertion is encountered.

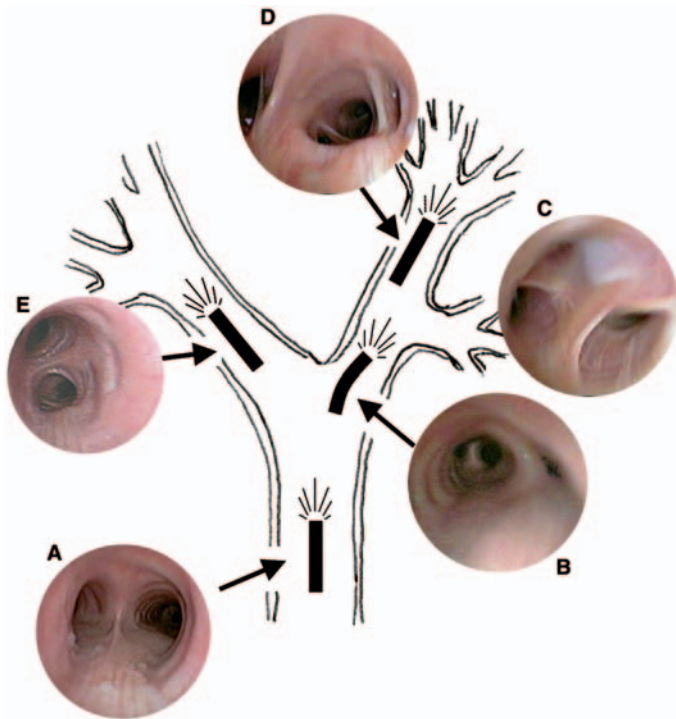
A bifurcated connector is attached to the two lumens, and the tracheal cuff is inflated. Intubation of the trachea is confirmed by capnography, auscultation, and observation of chest excursion. Once both lungs are determined to be adequately ventilated, it is safe to proceed with confirmation that the tube is positioned to allow isolation of the two lungs. Correct placement can be determined by a series auscultation maneuvers whereby the tracheal and bronchial lumens are ventilated independently. However, this technique is time consuming and may often prove inaccurate. The alternative method uses a bronchoscope to confirm placement. Each lumen of the bifurcated double-lumen endotracheal tube connector is fitted with a fenestrated membrane covered by a removable cap. While the lungs are ventilated with positive pressure, the fenestrated membrane on the tracheal lumen is uncovered, and the bronchoscope is passed through it into the double-lumen endotracheal tube to confirm placement.

The alternative method of tube placement, which uses direct observation via a fiberoptic bronchoscope, is the most efficient method for confirming appropriate anatomic placement. The bronchoscope is steadily advanced through the tracheal lumen until its tip just exits from the distal opening. If the tube is properly positioned, the carina should be seen just beyond the opening, and the medial wall of the endobronchial extension should be seen entering the contralateral bronchus. The bronchial cuff should be entirely contained within the contralateral bronchus, while an unobstructed view of the opening into the ipsilateral bronchus is enjoyed. Disposable double-lumen tubes usually feature a prominent band around the endobronchial extension several millimeters above the endobronchial cuff to facilitate positioning. When ideally positioned, the band should lie at the level of the carina. It may be necessary to slightly advance or withdraw the tube to achieve ideal position. Once anatomically correct tube position has been confirmed, it is secured in place, and the endobronchial cuff is gently inflated under direct bronchoscopic visualization to ensure that the cuff does not herniate into the trachea. Each time the patient is repositioned, the position of the double-lumen endotracheal tube should be verified.

An alternative method of tube placement eliminates the possibility of placing the endobronchial extension in the wrong bronchus. The tube is passed through the cords and rotated as for the first method. It is advanced only until the tip of the bronchial extension is 20–22 cm beyond the central incisors as determined by markings on the shaft. The bronchial cuff is inflated to seal against the wall of the trachea. An anesthetic circuit is attached to the connector for the bronchial lumen, and intubation of the trachea is confirmed. The bronchoscope is passed into the bronchial lumen. After the tip of the bronchoscope has entered the trachea, it is advanced under direct visualization past the carina into the desired mainstem bronchus (Figs. 53-13 and 53-14). After the bronchoscope is advanced as far as possible, the bronchial cuff is deflated. Using the bronchoscope as a directing stylet, the double-lumen endotracheal tube is advanced until gentle resistance is met. The bronchoscope is withdrawn and placed in the tracheal lumen to confirm unimpeded access to the ipsilateral bronchus as in the first method. Once placement is confirmed, the tube is secured.

Occasionally, double-lumen endotracheal tube is malpositioned. Three possible reasons are (1) the tube is inserted so deeply that the tracheal opening is beyond the carina; (2) the tube is not inserted far enough so that the bronchial cuff is above the carina, and (3) the endobronchial extension has entered the incorrect bronchus so that the tracheal lumen opening is trapped against the lateral wall of the trachea on the ipsilateral side (Fig. 53-15). Gently withdrawing or advancing the tube under direct bronchoscopic visualization should reveal and correct either of the first two causes. If the endobronchial extension is not in the correct bronchus, the tube is repositioned by inserting the fiberoptic bronchoscope in the endobronchial lumen and withdrawing the tube and scope until the carina is encountered. The tube and scope then are advanced down the appropriate mainstem bronchus.

Right-sided tubes require more vigilance and confirmation that the fenestration supplying the right upper lobe bronchus is positioned correctly. This is accomplished by passing the bronchoscope into the endobronchial lumen and observing the upper lobe



**FIGURE 53-13.** Bronchoscopic guide for placement of single lung-ventilation devices. **A.** The bronchoscope is situated in the distal trachea. In this view, the carina is clearly visualized along with the anterior cartilaginous rings and the posterior striated membranous portion of the trachea. The takeoff of the right mainstem bronchus is more aligned with the trachea, predisposing to endobronchial intubation of the right mainstem bronchus when an endotracheal tube is advanced too far. The easiest way of absolutely identifying the carina is to locate the right upper lobe. Confirmation of the “true” left and right mainstem bronchi is the best way to ensure proper placement of the selective lung ventilation device. **B.** The bronchoscope is in the right mainstem bronchus, just proximal to the bronchus intermedius, which begins below the origin of the right upper lobe. Origin of the right upper lobe is variable but usually arises 1–1.5 cm past the carina between 2 and 4 o’clock. **C.** The bronchoscope is in the right upper lobe bronchus. The right upper lobe branches into three segments: apical, posterior, and anterior. These three orifices typically are arranged in “V” pattern, but they also can be oriented in a line. **D.** The bronchoscope is in the distal bronchus intermedius. The right middle lobe, which is to the right, immediately splits into the lateral and medial segments. It is possible to advance a double-lumen endotracheal tube distal enough down the right side so that the endobronchial lumen will be in the right inferior lobe and the tracheal lumen will expose the right middle lobe. The right middle lobe’s lateral segment orifice could be confused for the right upper lobe orifice, but the right middle lobe’s lateral segment does not subdivide like the right upper lobe. **E.** The bronchoscope is in the distal left mainstem bronchus. This view reveals the left upper and lower lobe bronchi. It is important to ensure that left-sided double lumen tubes have not been advanced too far, leading to selective intubation of the left upper or lower lobe.

bronchial orifice through the fenestration in the lateral wall of the endobronchial extension (Fig. 53-16).

Although confirmation of position through direct visualization with a fiberoptic bronchoscope usually is rapid and definitive, it is not always feasible. Furthermore, although it assures anatomically correct position, it does not ensure functional isolation of the left and right lungs. Functional isolation is tested by selectively ventilating one lung while the other is vented to the atmosphere, and unilateral ventilation of the intended lung is confirmed by auscultation and visual or tactile observation. The opposite lung then is venti-

lated, and the test is repeated. A test for functional isolation should always be used when the double-lumen endotracheal tube is placed to prevent spillage of liquid from one lung to the other.

### Complications

Complications associated with double-lumen endotracheal tubes can be divided into two types: those resulting from malposition of the tube, and those caused by trauma to the tracheobronchial tree.

### Malposition

Malposition may lead to failure either to ventilate segments of the depen-

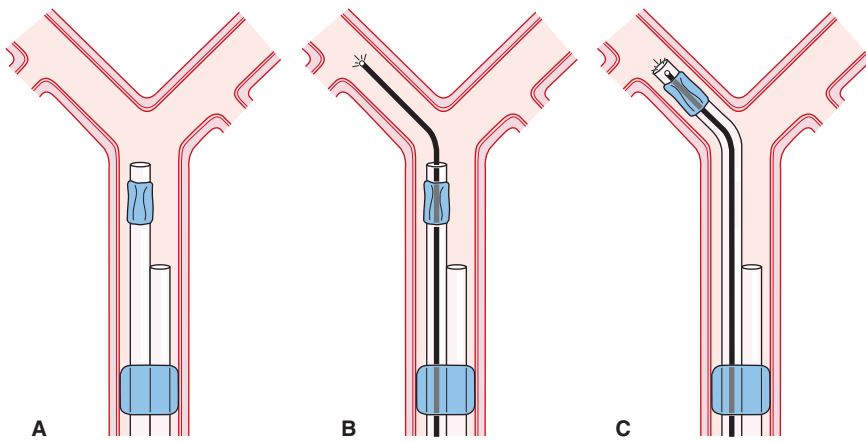
dent lung or to collapse the operative lung. Failure to ventilate segments of the ventilated lung can occur if the bronchial lumen obstructs the origin of the upper lobe bronchus, which frequently manifests as hypoxemia and increased peak airway pressures. A common cause of upper lobe obstruction is distal migration of the endobronchial lumen associated with flexion of the neck. Upper lobe obstruction is more common when a right-sided double-lumen endotracheal tube is inserted. Failure to collapse the nonventilated lung may interfere with the operation.

Cephalad migration of the double-lumen endotracheal tube can be caused by surgical manipulation, neck extension, or traction on an inadequately secured tube. As the tube withdraws, the bronchial cuff herniates over the carina into the trachea. When partially herniated, increased cuff pressure may force the cuff further into the trachea. The herniated cuff may partially or fully obstruct the contralateral mainstem bronchus, making that lung difficult or impossible to collapse (or ventilate).

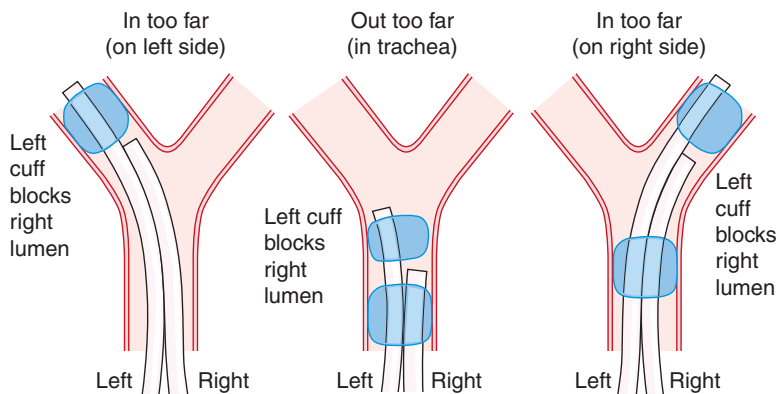
Malposition of the tube should be suspected when peak airway pressure suddenly increases, hypoxemia occurs, or inflation of the nonventilated lung is detected. Vigilance should be heightened immediately after the patient is repositioned and during surgical manipulation near the hilum of the lung. At the first suspicion of a malpositioned double-lumen endotracheal tube, tube position should be confirmed immediately by fiberoptic bronchoscopy. If discerning the anatomy during an open thoracotomy is difficult, the surgeon may be able to manually guide the endobronchial lumen of the double-lumen endotracheal tube into the desired mainstem bronchus.

### Traumatic Damage

Trauma to the tracheobronchial tree by double-lumen endotracheal tubes include minor insults, such as ecchymosis of the mucous membranes, and more severe insults, such as arytenoid dislocation and vocal cord rupture. Catastrophic tracheobronchial rupture has been reported.<sup>71-76</sup> The multiple-lumen design and relatively large size of double-lumen endotracheal tubes make them stiffer than conventional endotracheal tubes, thus increasing the risk of damage from forceful ad-



**FIGURE 53-14.** Schematic diagram portraying use of the fiberoptic bronchoscope to insert a left-sided double-lumen tube. **A.** The double-lumen tube can be put into the trachea in a conventional manner, and both lungs can be ventilated by both lumens. The fiberoptic bronchoscope can be inserted into the left lumen of the double-lumen tube through a self-sealing diaphragm in the elbow connector to the left lumen. This allows continued positive-pressure ventilation of both lungs through the right lumen without creating a leak. After the fiberoptic bronchoscope has been passed into the left mainstem bronchus (**B**), it is used as a stylet for the after-coming left lumen (**C**). The fiberoptic bronchoscope is then withdrawn. Final precise positioning of the double-lumen tube is performed with the fiberoptic bronchoscope in the right lumen.



Procedure	Breath sounds heard		
	Left	Left and right	Right
Clamp right lumen (both cuffs inflated)	Left	Left and right	Right
Clamp left lumen (both cuffs inflated)	None or very ↓↓	None or very ↓↓	None or very ↓↓
Clamp left lumen (deflate left cuff)	Left	Left and right	Right

**FIGURE 53-15.** The three major (involving a whole lung) malpositions of a left-sided double-lumen endotracheal tube. The tube can be in too far on the left (both lumens are in the left mainstem bronchus), out too far (both lumens are in the trachea), or down the right mainstem bronchus (at least the left lumen is in the right mainstem bronchus). In each of these three malpositions, the left cuff, when fully inflated, can completely block the right lumen. Inflation and deflation of the left cuff while the left lumen is clamped creates a breath sound—differential diagnosis of tube malposition (see text for explanation). L, left; R, right; ↓, decreased.

vancement against resistance. The stiffness is further increased by use of a rigid stylet during tube placement. Therefore, when use of a stylet is required for intubation of the trachea, it should be withdrawn before the bronchial lumen of the double-lumen endotracheal tube is advanced into the mainstem bronchus.

Injuries may result from excessive pressure in either the tracheal or bronchial cuffs, leading to tissue necrosis or rupture. The small size and high pressure of the bronchial cuff increase the risk of tissue injury from overinflation. Cuff pressure should be regularly monitored by palpation of the pilot balloon or by use of a calibrated device.

Failure to obtain a complete seal is especially hazardous when the double-lumen endotracheal tube is used to protect one lung from liquid contents within the other. The leak may allow spillage of liquid into the unaffected lung. Liquids include saline during bronchopulmonary lavage, pus from unilateral empyema, and blood from airway hemorrhage.

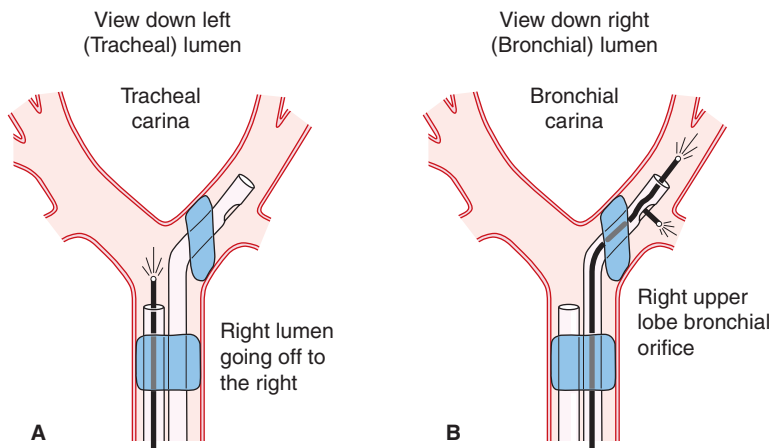
### Contraindications

The principal contraindication to use of a double-lumen endotracheal tube is the presence of a luminal airway mass that may be dislodged or may prevent passage of the tube. Relative contraindications include critical dependence on bilateral mechanical ventilation in patients unable to tolerate its interruption, patients requiring rapid placement of an endotracheal tube to avoid aspiration of gastric contents, and patients in whom conventional tracheal intubation is judged to be difficult.

### Alternative Methods of Lung Isolation

When collapse of the left lung and ventilation of the right are required or use of a double-lumen endotracheal tube is not feasible, a bronchial blocker can be placed in the left mainstem bronchus. This strategy eliminates the risk of losing the airway while changing the endotracheal tube at the end of the case for patients requiring postoperative ventilation. Specific bronchial blockers having a patent central lumen to permit deflation of the distal airway have been developed. The Arndt catheter has a nylon loop that is used to ensnare the distal portion of the fiberoptic scope as it is advanced in the selected mainstem bronchus. The loop





**FIGURE 53-16.** Schematic diagram portraying use of a fiberoptic bronchoscope to determine precise right-sided double-lumen tube position. **A.** When the fiberoptic bronchoscope is passed down the left (tracheal) lumen, the endoscopist should see a clear straight-ahead view of the tracheal carina and the right lumen going off into the right mainstem bronchus. **B.** When the fiberoptic bronchoscope is passed down the right (bronchial) lumen, the endoscopist should see the bronchial carina off in the distance. When the fiberoptic bronchoscope is flexed cephalad and passed through the right upper lobe ventilation slot, the right upper lobe bronchial orifice should be visualized.

1232

is loosened and advanced distal to the fiberoptic scope. Another variation, the Cohen endobronchial blocker, incorporates a small wheel that is used to deflect the tip of the catheter into the selected bronchus. Under direct vision, the catheter is slowly withdrawn until the inflated balloon is just distal to the level of the carina. In an emergency, an angled Fogarty catheter is inserted through the endotracheal tube under radiographic or fiberoptic guidance into the desired bronchus.<sup>77</sup> Absence of a patent lumen extending below the balloon of Fogarty catheters prevents suctioning or oxygen delivery to the occluded lung segment.

Endobronchial intubation with a single-lumen tube offers an alternative to the double-lumen endotracheal tube, which can be especially useful in emergencies. Disadvantages of using a single-lumen tube include loss of ability to selectively ventilate or suction the contralateral lung and increased difficulty in placing or ascertaining correct placement of the tube. Endobronchial intubation is especially useful for patients who require emergent tracheal intubation for massive hemoptysis. For adults, endobronchial intubation requires a tube of adequate length, often >31 cm, to ensure that the entire cuff is placed below the carina. Occasionally it is necessary to extend the tube using a length of tubing and a connector. Although endo-

bronchial intubation of the right side is easier, preserving ventilation to the right upper lobe is inherently difficult. Mainstem intubation is facilitated using a fiberoptic bronchoscope as a directing stylet. Blind left mainstem placement can be achieved with a 92% success rate by turning the head to the right after the tube has passed through the vocal cords and then rotating the tube 180° so that the convex curve faces posteriorly before advancing it.<sup>78</sup>

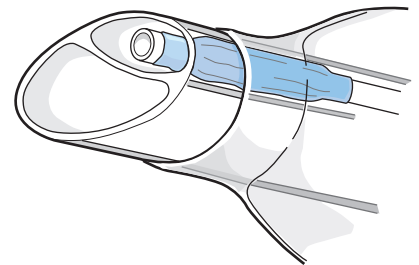
The Univent tube is a single-lumen endotracheal tube that contains a bronchial blocker that passes through a small channel within the wall of an endotracheal tube. The bronchial blocker carries a low-pressure, high-volume cuff and has an internal lumen that can be used for suctioning the collapsed lung or for providing CPAP or high-frequency jet ventilation (Fig. 53-17).<sup>79</sup> Initial tube placement in the trachea is accomplished as for any single-lumen tube; then it is rotated 90° toward the lung into which the blocker will be passed and advanced (Fig. 53-18). The blocker is advanced into the targeted mainstem bronchus, after which the tracheal cuff is inflated and the tube secured. The depth of the blocker is adjusted and confirmed using a flexible bronchoscope passed through the main lumen of the tube. Additional techniques to assist in placing the blocker include rotation of the head and placing the fiberoptic scope

in the opposite lung to divert the blocker into the contralateral side. The tube offers the advantage of allowing easy conversion from one- to two-lung ventilation (and vice versa), and it is suitable for long-term use in an intensive care unit (ICU) setting. The mobility of the blocker and the large volume of its cuff increase the likelihood of proximal migration, with herniation of the cuff into the trachea.

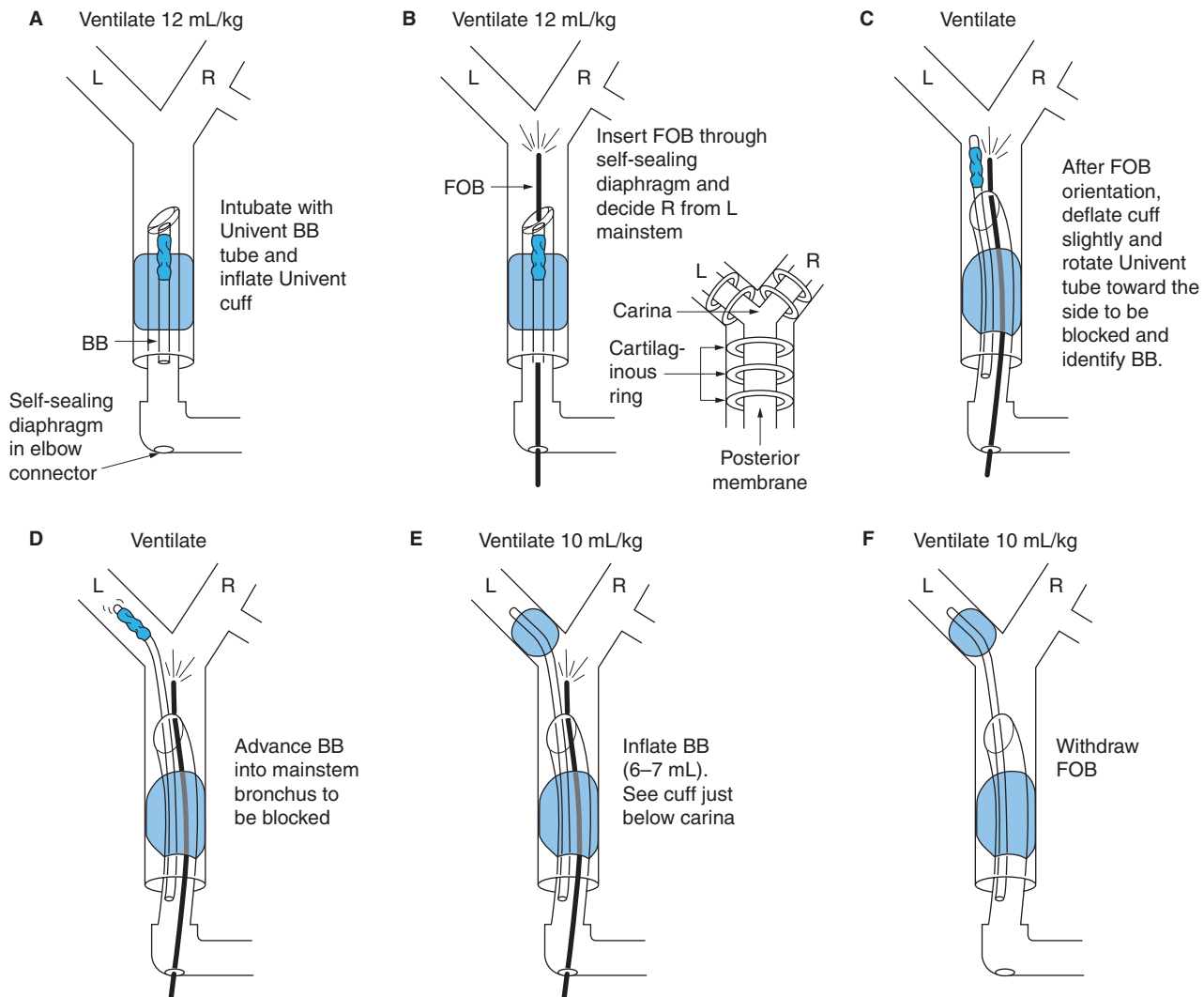
## HYPoxic PULMONARY VASOCONSTRICTION

Humans encounter hypoxia throughout their lives. Hypoxia occurs in utero, through disease, and by desire, in our quest for higher altitude. HPV is a widely conserved, homeostatic, vasomotor response of precapillary smooth muscle in the PAs to alveolar hypoxia.<sup>80-82</sup> HPV mediates  $\dot{V}/\dot{Q}$  matching and, by reducing shunt fraction, optimizes systemic  $pO_2$ .

Although total pulmonary blood flow is directly proportional to right ventricular cardiac output, its distribution within the pulmonary vasculature can be altered dynamically. Hypoxia, caused by either atelectasis or ventilation with a hypoxic gas mixture, diverts blood flow to better ventilated, nonhypoxic lung segments. This phenomenon of HPV, first noted by Von Euler and Liljestrand in 1946, is of importance to the anesthesiologist, particularly during thoracic anesthesia. In the absence of inhibiting factors, HPV can divert blood flow away from nonventilated regions.<sup>80</sup> When a patient is in the lateral decubitus position, the dependent lung receives 60% of the cardiac output, whereas the nondependent lung receives 40%. If



**FIGURE 53-17.** Close-up of the Univent tube shows two lumens. The small tube is retracted into the small lumen before intubation. (Modified from Kamaya H, Krishna PR. New endotracheal tube [Univent tube] for selective blockade of one lung, *Anesthesiology* 1985;63:342, with permission.)



**FIGURE 53–18.** Sequential steps of the fiberoptic-aided method for inserting and positioning the Univent bronchial blocker in the left mainstem bronchus. One- and two-lung ventilation are achieved by simply inflating and deflating, respectively, the bronchial blocker balloon. FOB, fiberoptic bronchoscope.

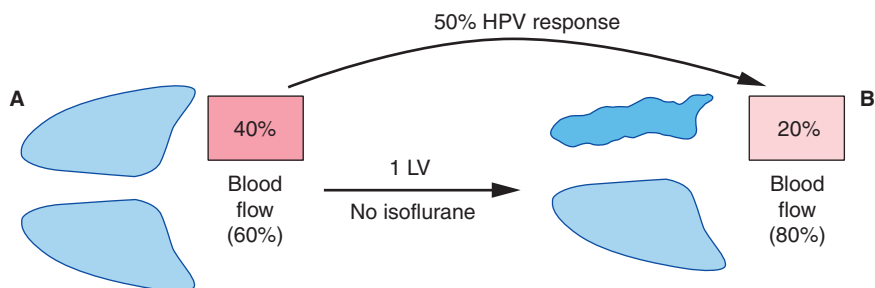
the nondependent lung is not ventilated and is atelectatic, a maximal HPV response can reduce its blood supply by 50%. As a result, the dependent lung receives 80% of the cardiac output, and the atelectatic nondependent lung receives only 20% of the cardiac output (Fig. 53–19). Therefore, the arterial oxygen tension ( $P_{aO_2}$ ) observed during regional lung hypoxia is much greater than would be expected if the HPV response were not present (Fig. 53–20).

### Mechanisms

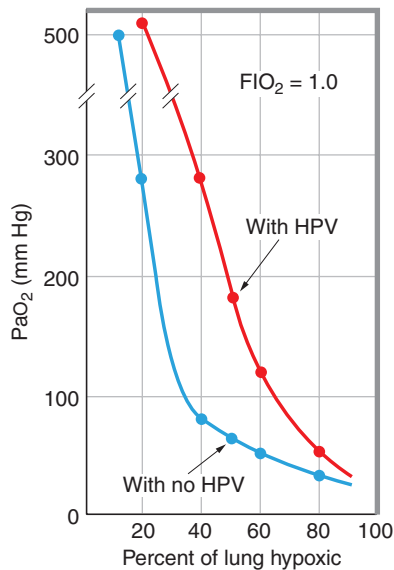
HPV is mediated by the smooth muscle cells throughout the lung. Although modulated by the endothelium, the core mechanism is in the smooth muscle cell. The Redox Theory for the mechanism of HPV proposes the coordinated action of a redox sensor (proxi-

mal mitochondrial electron transport chain) that generates a diffusible mediator (reactive  $O_2$  species) that regulates an effector protein [voltage-gated potas-

sium (Kv) and calcium channels]. The subsequent inhibition of  $O_2$ -sensitive Kv channels, particularly Kv1.5 and Kv2.1, depolarizes PA smooth muscle,



**FIGURE 53–19.** **A.** Schematic diagram showing that the two-lung ventilation nondependent-to-dependent lung blood flow ratio is 40%/60%. **B.** When two-lung ventilation is converted to one-lung ventilation (as indicated by atelectasis of the nondependent lung), the hypoxic pulmonary vasoconstriction response decreases the blood flow to the nondependent lung by 50% so that the nondependent-to-dependent lung blood flow ratio is now 20%/80%.



**FIGURE 53–20.** Effect of hypoxic pulmonary vasoconstriction (HPV) on arterial  $\text{PO}_2$  ( $\text{PaO}_2$ ). As the percent of lung that is hypoxic increases (X-axis),  $\text{PaO}_2$  decreases (Y-axis). When the amount of lung that is 30% to 70% hypoxic, which is in the one-lung ventilation/anesthesia range, the decrease in  $\text{PaO}_2$  is much greater if there is no HPV compared with the normal expected amount of HPV. (From Benumof JL. One-lung ventilation and hypoxic pulmonary vasoconstriction: implications for anesthetic management. *Anesth Analg* 1985;64:821, with permission.)

activating voltage-gated  $\text{Ca}^{2+}$  channels and causing  $\text{Ca}^{2+}$  influx and vasoconstriction.<sup>81</sup> A similar mechanism for regulating  $\text{O}_2$  uptake/distribution exists in simpler organisms and in other specialized mammalian  $\text{O}_2$ -sensitive tissues, including the carotid body and ductus arteriosus.<sup>82</sup>

Hemodynamic variables can influence the magnitude of HPV. The pulmonary vasoconstrictor response to hypoxia is decreased with increases in PA pressure, cardiac output, left atrial pressure, and central blood volume.<sup>83</sup> Increases in pulmonary vascular pressures can mechanically open and recruit closed vessels in hypoxic lung regions, overcoming part of the active pulmonary vasoconstriction.<sup>84</sup> An increase in cardiac output can mask the HPV response by recruiting pulmonary vessels or increasing  $\text{PvO}_2$ . Alternatively, HPV may increase PVR and PA pressures as flow is diverted from a proportionately large section of hypoxic lung to a smaller section of normoxic lung.<sup>84</sup> When flow is diverted from small hypoxic segments, the high compliance of the pulmonary circulation prevents clinically significant changes in PVR or PA pressure.

Drugs and anesthetics may modulate HPV and interfere with  $\dot{V}/\dot{Q}$  matching. Calcium channel blockers and vasodilators, such as sodium nitroprusside, attenuate the HPV response (Table 53–6). These drugs increase the A–a gradient, often leading to hypoxemia perioperatively. Other perioperative conditions, such as hypocapnia and hypothermia, also decrease the normal HPV response.<sup>83,85</sup>

### Effects of Anesthetics

Extensive studies have been performed to examine the effect of inhalation and intravenous (IV) anesthetics on HPV. The results and implications of these studies differ according to the type of experimental preparation used. In human studies and in more physiologic in vivo investigations with an intact systemic circulation, inhalation anesthetics produced either no effect or only a mild decrease in HPV.<sup>97,98</sup> In part, the discrepancy between the more complex in vivo studies and simpler in vitro models occur because the additional factors that can modulate the HPV response, such as pulmonary vascular pressure, cardiac output,  $\text{PCO}_2$ , and temperature, are absent. In the more biologically complex in vivo models, these factors seem to diminish the inhibitory effect of inhaled anesthetics on HPV.<sup>99,100</sup>

IV agents such as ketamine and propofol do not significantly affect HPV.<sup>99,101</sup> HPV is not directly affected by thoracic epidural analgesia. Any changes that have been observed during epidural may be attributable to alterations in cardiac function and loading conditions.<sup>102</sup>

### Nitric Oxide

Nitric oxide (NO) is a unique endogenous compound that is found in endothelium and smooth muscle cells. NO induces vasodilatation by activating

protein kinases and guanylate cyclase and reducing or resequencing intracellular  $\text{Ca}^{2+}$ . A class of IV vasodilators, including nitroglycerine and nitroprusside, produces muscle relaxation in a similar manner.

The most common clinical uses of NO are for management of pulmonary hypertension and  $\dot{V}/\dot{Q}$  mismatching. IV therapy nonselectively produces pulmonary and systemic vasodilatation. In contrast, NO administered as an inspired gas selectively dilates the vascular supply to those areas, thereby improving  $\dot{V}/\dot{Q}$  matching. NO has been used clinically in cases of primary pulmonary hypertension, lung transplantation, cardiac transplantation, cardiac disease, adult respiratory distress syndrome (ARDS), acute pulmonary hypertension, congenital heart disease, and idiopathic pulmonary hypertension. Its clinical potential has been hampered by the complexity and cost of the gas and its delivery system.

Delivery systems require an adequate scavenging system to reduce the risk of occupational exposure and continuous gas concentration monitoring. The potential toxicity of NO focuses on its conversion from the free radical form to  $\text{NO}_2$ , which is associated with lung toxicity, and the formation of nitrosylhemoglobin, which is rapidly converted to methemoglobin.<sup>103–106</sup> Clinical reports of NO-associated toxicity include methemoglobin toxicity, paradoxical deterioration in oxygenation related to edema or worsening of right-to-left shunting,<sup>79,103,105,107–109</sup> and rebound pulmonary hypertension.<sup>103,110,111</sup> Because of these latter responses, the dose of NO should be gradually decreased to avoid prevent in oxygenation or rebound pulmonary hypertension.

### Prostacyclin

Prostacyclin ( $\text{PGI}_2$ , Epoprostenol, Flolan) is a member of the prostaglandin fam-

**TABLE 53–6.**

#### Effect of Vasodilators on Hypoxic Pulmonary Vasoconstriction

Drug	Effect	References
Hydralazine	No change	86
Nifedipine	Inhibited	86–89
Verapamil	Inhibited	90, 91
Nitroglycerin	Inhibited	93
Sodium nitroprusside	Inhibited	94
Nicardipine	No change	95
Labetalol	No change	96

ily of lipid mediators derived from arachidonic acid. It is synthesized predominantly by endothelial cells, including the pulmonary vascular endothelium.<sup>112</sup> PGI<sub>2</sub> produces vasodilation in low-resistance vascular beds such as the pulmonary circulation.<sup>113</sup> Not only has PGI<sub>2</sub> been shown to stimulate endothelial release of NO,<sup>114</sup> but NO has been shown in turn to enhance the production of PGI<sub>2</sub> in human PA smooth muscle cells. It has a good safety profile; PGI<sub>2</sub> is spontaneously hydrolyzed in plasma to its inactive metabolite, 6-keto-prostaglandin F. The in vitro half-life of prostacyclin in human blood at 37°C and pH 7.4 is approximately 6 minutes.<sup>115</sup> Animal studies demonstrate that IV PGI<sub>2</sub> has a high clearance (93 mL/min/kg), small volume of distribution (357 mL/kg), and short half-life (2.7 minutes).<sup>115</sup>

Prostacyclin that can be delivered as an aerosol has replaced NO as the preferred inhaled selective pulmonary vasodilators because of its lower cost and absence of toxic metabolites.<sup>112</sup> It has minimal effects of systemic arterial pressure but results in dramatic improvements in arterial oxygenation and lowering of pulmonary arterial pressures. Its use during one-lung anesthesia can improve  $\dot{V}/\dot{Q}$  matching, but it is not as effective as CPAP in the nonventilated (nondependent, operative) lung (see Strategies for Improving Oxygenation during One-Lung Ventilation).

## STRATEGIES FOR IMPROVING OXYGENATION DURING ONE-LUNG VENTILATION

Arterial hypoxemia during one-lung ventilation is difficult to predict clinically. Previous studies have attempted to identify predictive preoperative and intraoperative factors of Pao<sub>2</sub> during single-lung ventilation. Some variables (relative perfusion to the operative lung, intraoperative Pao<sub>2</sub> during two-lung ventilation) were strongly identified as predictors of low Pao<sub>2</sub> during one-lung ventilation, whereas other factors (side of operation, preoperative pulmonary function tests) have been controversial.<sup>117,118</sup> Interestingly, patients with a hematocrit value >45% are reported to have lower Pao<sub>2</sub> values during one-lung ventilation.<sup>119</sup> The occurrence of hypoxia mainly depends on factors such as residual shunt to the nonventilated lung, cardiac output,

and degree of pulmonary vasoconstriction. However, strategies for managing hypoxemia during one-lung ventilation are available.

The basic principles for management of one-lung ventilation include (1) delaying initiation until after the patient is turned to the lateral decubitus position while still allowing sufficient time for the nondependent lung collapse, (2) confirming correct positioning of the double-lumen tube by fiberoptic bronchoscopy, (3) using high-inspired O<sub>2</sub> concentrations to decrease the risk of systemic hypoxemia, (4) using a large tidal volume of approximately 10 mL/kg and adjusting respiratory rate to keep Paco<sub>2</sub> at approximately 40 mm Hg, (5) continuously monitoring oxygenation using pulse oximetry, and (6) continuously monitoring ventilation by noting changes in end-tidal CO<sub>2</sub> concentrations and peak inspiratory pressures.

Measures for improving oxygenation during one-lung ventilation include one or more of the following strategies: (1) improving  $\dot{V}/\dot{Q}$  distribution in the dependent lung (i.e., lung recruitment maneuver, PEEP), (2) increasing alveolar partial pressure of oxygen (Pao<sub>2</sub>) in the nondependent lung (i.e., CPAP), (3) decreasing blood flow to the nondependent lung (i.e., placement of a ligature on the PA), and (4) increasing blood flow and perfusion to the dependent lung (i.e., prostacyclin or NO).

## Prevention of Absorption Atelectasis

Absorption atelectasis, caused by increased FiO<sub>2</sub>, can be decreased or prevented by ventilation using large tidal volumes, application of PEEP to the dependent lung, and ventilation with FiO<sub>2</sub> <100%.<sup>81</sup> Use of 10–20% nitrogen with 80–90% O<sub>2</sub> has been suggested to decrease the possibility of absorption atelectasis because nitrogen keeps open the alveoli in areas of low  $\dot{V}/\dot{Q}$ . The small reduction in FiO<sub>2</sub> causes only a small decrease in Pao<sub>2</sub>.

## Verification of Lung Isolation

The most important factor in assuring adequate oxygenation and ventilation is proper positioning of the double-lumen endotracheal tube or bronchial blocker. Tube position should be reconfirmed after the patient is turned. Secretions that interfere with ventilation and increase inflation pressure should be suctioned from the airway.

## Recruitment Maneuver

Progressive atelectasis associated with decreasing Pao<sub>2</sub> is a common problem in patients undergoing single-lung ventilation during thoracic surgery. These patients are at increased risk for atelectasis as a result of single-lung ventilation, lateral decubitus positioning, inhibition of HPV, and periodic disconnection from the ventilator. Recruitment maneuvers are used to reinflate collapsed alveoli, resulting in improved oxygenation and ventilation. A sustained pressure of approximately 35 cm H<sub>2</sub>O, which is above the tidal ventilation range, is applied for a period of 30–60 seconds in order to inflate lung units. After this maneuver, increasing the tidal volume or PEEP is not necessary because the subsequent lung volumes should be maintained. A successful procedure will result in improved oxygenation, reduced end-tidal CO<sub>2</sub>, and improved compliance.

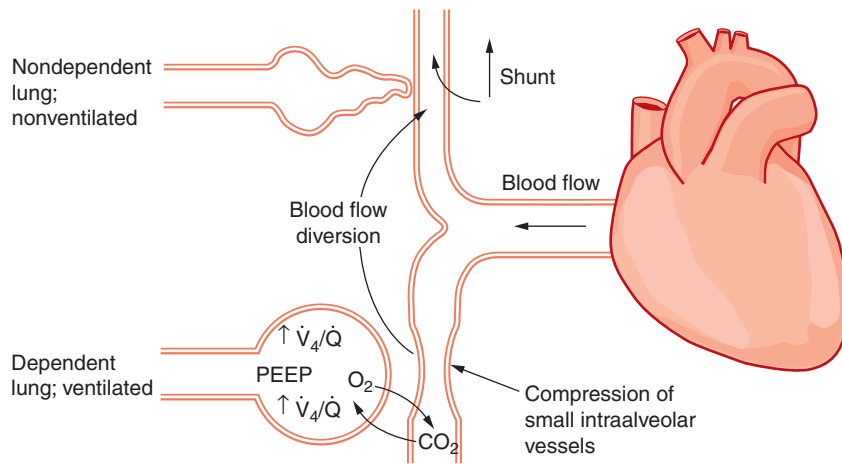
## Ventilation Using Large Tidal Volumes

Small tidal volume ventilation to the dependent lung decreases FRC and promotes airway closure and atelectasis. The development of hypoxic areas in the dependent lung interferes with the overall effectiveness of HPV in the nondependent lung, optimizing oxygenation of the dependent lung. The tidal volume at initiation of one-lung ventilation should be approximately 10 mL/kg, which is relatively large compared with the usual tidal volume during two-lung ventilation of 12 mL/kg. The tidal volume is adjusted upward or downward according to the airway pressures and arterial blood gas values. Delivering an excessively large tidal volume to the dependent lung paradoxically can worsen oxygenation and ventilation of the dependent lung. Increased airway pressures with the associated risks of pneumothorax or barotrauma and increased PVR can divert blood, that is, perfusion, to the nonventilated nondependent lung.<sup>120–123</sup>

## Maintenance of Normocapnia

Respiratory rates should be adjusted to maintain normocapnia. Because tidal volume decreases with initiation of one-lung ventilation, the respiratory rate should be increased to maintain the same minute ventilation and Paco<sub>2</sub>. The change from two-lung ventilation to one-lung ventilation usually causes no problem with CO<sub>2</sub> elimina-





**FIGURE 53–21.** Selective positive end-expiratory pressure (PEEP) to the ventilated-dependent lung can increase dependent lung ventilation-to-perfusion ratios ( $\uparrow \dot{V}_A/\dot{Q}$ ). Dependent lung PEEP also can cause compression of the small intraalveolar vessels in the dependent lung, causing blood flow diversion to the nonventilated nondependent lung, thereby increasing the shunt through the nonventilated nondependent lung. Therefore, the overall arterial oxygenation effect of dependent lung PEEP will be a tradeoff between the good effect of an increase in dependent lung  $\dot{V}_A/\dot{Q}$  and the bad effect of increased nonventilated lung blood flow.

tion because of the high diffusibility of  $\text{CO}_2$  across the alveolar membrane.<sup>123–125</sup> Theoretically, hypocapnia should be avoided because it can directly dilate the pulmonary vessels, interfering with HPV in the nondependent lung. Alternatively, hypercapnia will increase PVR and can increase right-heart strain.

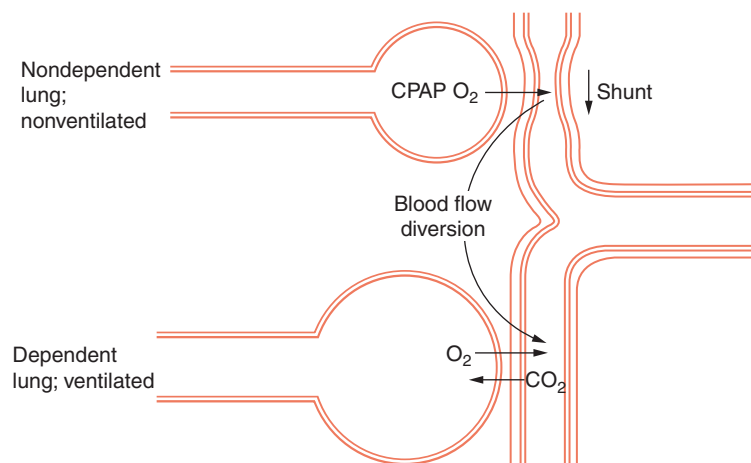
### Dependent-Lung PEEP

Because the dependent lung often has decreased volume during one-lung ventilation, attempts have been made to improve oxygenation by managing the ventilated lung with PEEP. The application of PEEP to the dependent lung maintains recently recruited atelectatic alveoli to increase FRC and lung compliance. The disadvantage of applying PEEP to the dependent lung is that the associated increased mean airway pressure and PVR may divert some blood flow to the nondependent, atelectatic, nonventilated lung. Therefore, the effect of using PEEP is a balance between its potential beneficial effects and the possible deleterious effects of decreasing HPV, causing the redistribution of blood flow to the nondependent nonventilated lung. In a patient with a diseased dependent lung, the positive effect of selective dependent lung PEEP may outweigh its negative effects. In contrast, patients who have a relatively normal dependent lung may have decreased

oxygenation if PEEP is selectively applied to that lung (Fig. 53–21).

### Selective Nondependent-Lung CPAP

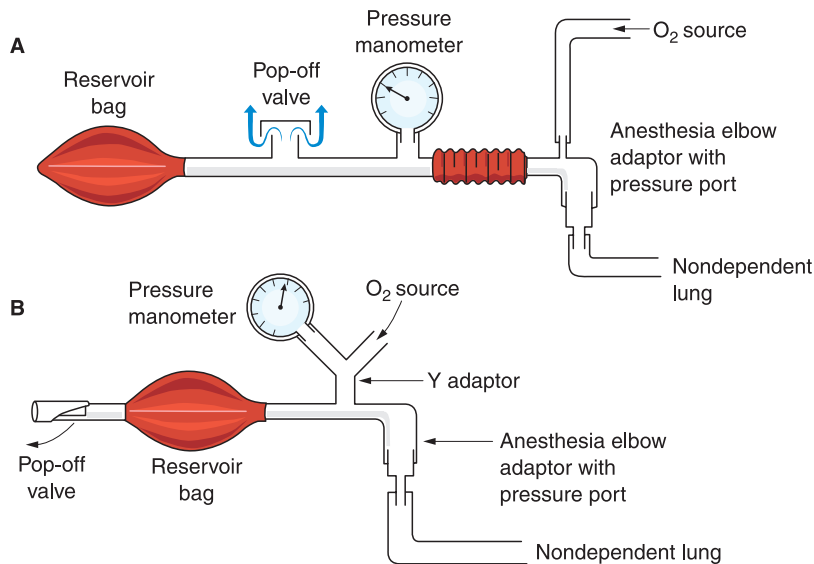
Application of CPAP to the nonventilated nondependent lung improves oxygenation during one-lung ventilation (Fig. 53–22). Even with a maximal HPV response, 20% of the cardiac output still flows through the nondepen-



**FIGURE 53–22.** Selective continuous positive airway pressure (CPAP) to the nonventilated nondependent lung (static distension without tidal movement) allows this lung to participate in oxygen uptake and markedly decreases the shunt through the nonventilated nondependent lung. Even if the nonventilated nondependent lung CPAP causes blood flow diversion to the ventilated dependent lung, the diverted flow can still participate in oxygen uptake and  $\text{CO}_2$  elimination in the ventilated dependent lung. Usually 5–10 cm  $\text{H}_2\text{O}$  of nondependent lung CPAP is all that is clinically needed, and this amount of CPAP does not cause any serious surgical interference. (From Benumof JL, ed. *Anesthesia for Thoracic Surgery*. Philadelphia: WB Saunders, 1995, pg. 416, with permission.)

dent lung. Use of an inhalational agent, such as isoflurane, may increase the nondependent lung blood flow. Application of CPAP during one-lung ventilation leads to oxygenation of blood that perfuses the nondependent lung, thereby increasing  $\text{Pao}_2$ . CPAP is initiated during the deflation phase of a large tidal volume breath to maintain uniform expansion and prevent the need to overcome critical opening pressures of collapsed alveoli. Application of 5–10 cm  $\text{H}_2\text{O}$  CPAP may not interfere with surgical exposure during open thoracotomies but will significantly impede visualization during thoracoscopy. In addition, CPAP < 10 cm  $\text{H}_2\text{O}$  does not compress small intraalveolar vessels or produce significant hemodynamic effects, but 15 cm  $\text{H}_2\text{O}$  CPAP decreases blood flow through the nondependent lung, diverting flow to the dependent lung.<sup>126</sup>

During one-lung ventilation, the nondependent lung does not remain totally unventilated. Each time the dependent lung is inflated, the mediastinum is displaced upward into the nondependent thorax. During the exhalation phase, the mediastinum falls away from the nondependent side. The effect of mediastinal movement created by ventilation is asynchronous, “pendelluft” ventilation of the nondependent lung. This phenomenon can be observed as a small puff of air emanating from the lumen of nondependent endotracheal



**FIGURE 53-23. A, B.** Schematic diagram showing two nondependent lung continuous positive airway pressure (CPAP) systems without reservoir bags. Both contain an oxygen source and a pressure relief valve, but A has a pressure manometer to measure CPAP, whereas B does not.

tube, which may be misinterpreted as a failed seal of the bronchial cuff. Because the nondependent lung is ordinarily open to the atmosphere, the pendelluft ventilation introduces room air into the tracheobronchial tree. Thus, even in the absence of CPAP, delivering 100% oxygen via a T-piece may improve oxygenation of blood flowing through the nondependent lung.

The conventional method for instituting CPAP during one-lung ventilation uses an O<sub>2</sub> source and a manometer or PEEP valve (Fig. 53-23).<sup>127</sup> Alternatively, delivery of oxygen at high flows via a catheter placed in the mainstem bronchus of the nondependent lung produces CPAP without need for a PEEP valve. In most situations, an O<sub>2</sub> flow rate of 5–10 L/min creates CPAP of 5–10 cm H<sub>2</sub>O, which is sufficient for improving oxygenation. One advantage of this system is that elimination of CO<sub>2</sub> is proportional to the flow rate of the gas in the CPAP system. A very high O<sub>2</sub> flow rate delivered at or below the carina may improve gas exchange without any tidal exchange, which is known as “continuous high-flow apneic ventilation.”

### Strategies for Improving Oxygenation during Single-Lung Ventilation

The strategies for maintaining oxygenation are individualized to account for patient factors and surgical considerations. Although application of CPAP

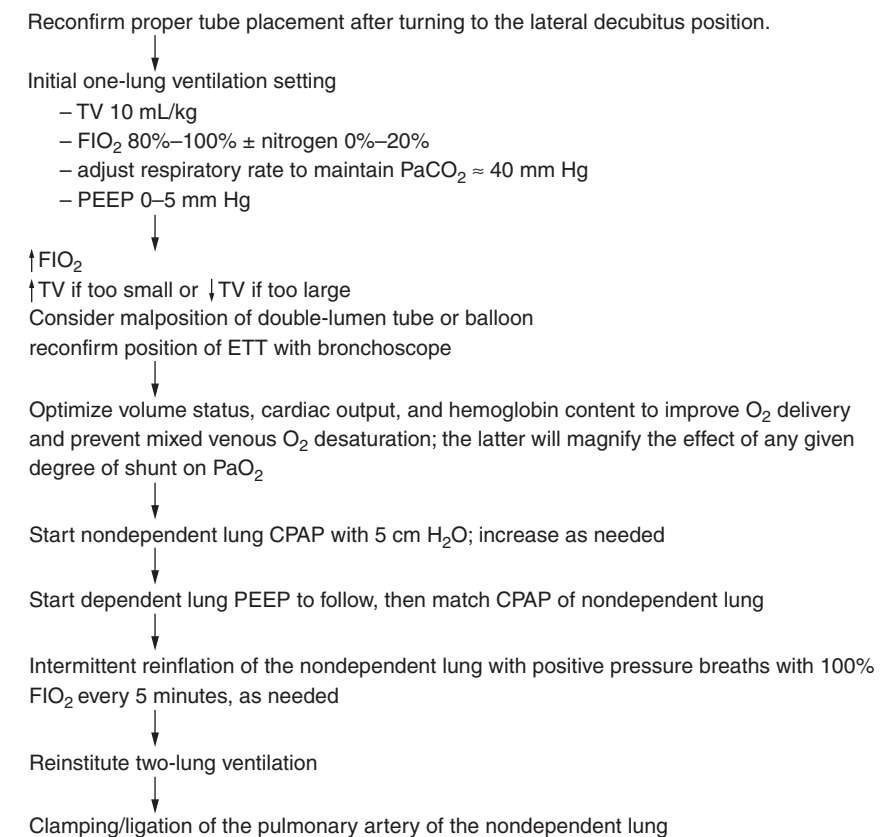
during video thoracoscopy is contraindicated, its use for open thoracotomy would be better tolerated. The first step to improve arterial oxygenation is confirming proper tube placement. If oxygenation is still inadequate, the

strategies of applying CPAP to the dependent lung and PEEP to the dependent lung can be sequentially and additively applied. If arterial oxygenation remains poor, the patient's hemodynamic status should be assessed. A decrease in cardiac output, leading to a decrease in mixed venous oxygen saturation (SvO<sub>2</sub>), can magnify the effect of shunt on arterial oxygenation.

If hypoxemia still persists after differential CPAP/PEEP, the nondependent lung may be intermittently ventilated with positive pressure and 100% O<sub>2</sub>. Intermittent reinflation of the collapsed lung with O<sub>2</sub> is beneficial, but its beneficial value was found to decline with repeated inflations.<sup>128</sup> Finally, most of the  $\dot{V}/\dot{Q}$  mismatch and arterial hypoxemia can be eliminated by decreasing blood flow to the nondependent lung by temporarily ligating its PA (Fig. 53-24).

### Selective Nondependent Lung High-Frequency Ventilation

Any method that results in splinting the alveoli and air spaces of the nondependent lung will lead to an improvement in arterial oxygenation and a decrease in the transpulmonary shunt.



**FIGURE 53-24.** Algorithm for managing one-lung ventilation and improving oxygenation.

High-frequency ventilation of the non-dependent lung has been studied in combination with conventional positive-pressure ventilation of the dependent lung. Using this combination,  $P_{aO_2}$  was much better than with intermittent positive-pressure ventilation of the dependent lung with total collapse of the nondependent lung.<sup>129</sup> In most patients, the same increase in arterial oxygenation can be achieved using selective nondependent lung CPAP, which requires much simpler equipment compared with high-frequency ventilation apparatus. In some situations, high-frequency ventilation may be more advantageous.

If the nondependent lung has a major bronchopleural fistula, high-frequency ventilation to the nondependent lung using low airway pressures helps to decrease the air leak and improve oxygenation and ventilation.<sup>130</sup>

During operation on the major conducting airways, high-frequency ventilation permits the use of small ventilation catheters that pass through the operating field.<sup>130-133</sup>

Unilateral high-frequency jet ventilation with contralateral intermittent positive-pressure ventilation has been used in the anesthetic treatment of patients with severely compromised respiratory reserve. The technique provided satisfactory anesthesia, good operating conditions, and adequate gas exchange.<sup>134</sup>

## ANESTHETIC TECHNIQUES

Although thoracic surgery can be performed solely using a regional block, most thoracotomies are performed using general anesthesia with controlled ventilation. Epidural or other regional anesthetic techniques often are used to decrease the intraoperative anesthetic requirement, to facilitate emergence and extubation, and to control postoperative pain.<sup>135,136</sup>

### General Anesthesia

The choice of induction agent and dosage is influenced by the patient's medical condition. In patients in whom extensive airway instrumentation or manipulation precedes thoracotomy, the antisialagogue glycopyrrolate can reduce secretions. Opioids supplement the inhalational anesthetic, although the dosage of systemic narcotic should be reduced in patients

who will receive epidural opioids. The incidence of postoperative respiratory depression is related to the total dosage of opioids administered systematically and epidurally.

After induction of anesthesia, the trachea is intubated with a single-lumen or double-lumen tube as indicated by the surgical procedure. Position of the endotracheal tube is confirmed by careful auscultation, capnography, and, if indicated, fiberoptic bronchoscopy.

Volatile, halogenated anesthetic drugs have several desirable properties for use during thoracic procedures. They decrease airway irritability and obtund airway reflexes in patients who usually have reactive airways, and they maintain adequate anesthesia while allowing increased inspired oxygen concentrations. They can be eliminated rapidly, allowing tracheal extubation in the operating room with less concern for postoperative respiratory depression. Although volatile anesthetics allow high inspired  $O_2$  concentrations, they may reduce  $P_{aO_2}$  by increasing the shunt related to partial inhibition of HPV.<sup>97,98,137</sup> Inhibition of HPV by inhaled anesthetics may exhibit substantial variability.

Patients with mediastinal and airway tumors may be at risk for airway obstruction during induction of anesthesia. In such patients, the anesthetic plan and emergency treatment strategies should be discussed with the surgeon preoperatively. If emergent tracheostomy, rigid bronchoscopy, or extracorporeal oxygenation is anticipated, the entire operating team should be prepared to act smoothly and efficiently. Patients at increased risk for airway obstruction may require awake fiberoptic intubation or spontaneous ventilation to avoid airway obstruction.

### Regional Anesthesia

Epidural anesthesia, paravertebral block, intercostal nerve blocks, or field blocks have been used occasionally as the sole anesthetic for various thoracic procedures, including thoracotomy. Thoracic epidural blockade in awake sedated patients has been used successfully for open thoracotomies and thoracoscopies.<sup>138,139</sup> Crawford et al.<sup>140</sup> described 677 patients with tuberculosis in whom epidural anesthesia was used for thoracotomy. The most surprising results were the absence of paradoxical respiration and dyspnea.

The breathing pattern and speech appeared normal even when an upper lobe bronchus was transected and held open. Several factors may have contributed to the success of this unorthodox technique: (1) the patients were extremely cooperative and had a good rapport with the anesthesiologist; (2) analgesia was complete, and patients were comfortable; (3) use of premedication and sedation avoided the pitfalls of over sedation and excitability; (4) supplemental  $O_2$  was administered by positive-pressure mask if the patient reported any shortness of breath; and (5) operation was remarkably gentle and swift. It is doubtful that all of these conditions could be fulfilled during an anatomic resection in the routine patient by the average surgeon.

### Combined Epidural Blockade and General Anesthesia

The techniques of general and epidural anesthesia often are combined to achieve the benefits of each. Epidural block may be used either for postoperative analgesia or as the major anesthetic, with light general anesthesia used for amnesia and sedation. Epidural anesthesia has the advantages of reduction in afterload,<sup>141</sup> improved pulmonary function, decreased incidence of venous thromboembolism,<sup>142,143</sup> and suppression of the stress response.<sup>97,144-145</sup> Potential disadvantages include the time required to establish the block, increased fluid requirements and relative decrease in blood pressure associated with sympathectomy, and potential for technical complications such as epidural hematoma.

Vital capacity and lung compliance decrease after general anesthesia and neuromuscular blockade in patients undergoing thoracotomy. Epidural analgesia with light general anesthesia results in less decrease in static compliance and fewer alterations in postoperative pulmonary function.<sup>146</sup> Perioperative use of epidural anesthesia is associated with fewer major postoperative infections. This may result from (1) decreased duration of endotracheal intubation and mechanical ventilation, which diminishes many of the defense mechanisms against infection<sup>147,148</sup>; (2) decreased duration of ICU stay postoperatively and reduced risks of nosocomial infection; and (3) suppression of the endocrine stress response to operation, which has an inhibitory effect on the im-

immune system.<sup>149</sup> Immune competence is less disturbed postoperatively when epidural anesthesia is used compared with other anesthetic and analgesic techniques.<sup>150–154</sup>

An epidural catheter can be inserted in the midthoracic (T4–T9) or low thoracic–lumbar (T9–L2) regions. To date, no studies have demonstrated superiority of one approach. In the experience of the authors, the midthoracic level, approximately T7, provides excellent conditions for thoracic and thoracoabdominal procedures. The higher thoracic approach generally is avoided because of the risk of blocking the phrenic nerve (C3, C4, C5) through cephalad extension of epidural local anesthetics. The low thoracic region is suitable for thoracoabdominal procedures, such as gastrectomy. Use of a lumbar epidural blockade in patients undergoing thoracic surgery requires a larger dosage of local anesthetics or narcotics to provide analgesia in the thoracic regions and is not routinely recommended. Because of the multiple advantages conferred by thoracic epidural analgesia, the anesthetic plan for open thoracotomy should always include placement of a thoracic epidural catheter unless an absolute contraindication is present.

## THORACOSCOPY VERSUS THORACOTOMY

Evolution of surgical technique and technical advances in electronics and instrumentation have led to renewed interest in thoracoscopy. In a health-care environment that values cost and patient outcome, VATS has advantages beyond open thoracotomy, including decreased postoperative pain, pulmonary impairment, and hospital stay. Thoracoscopy permits visualization of the pulmonary cavity through several small portals. These portals provide access for the video camera and allow manipulation of thoracic structures and use of surgical instruments such as staplers, dissectors, coagulators, and lasers. Although initially used for only minor surgical procedures, the application of VATS has expanded considerably for both diagnostic and therapeutic procedures (Box 53–6). If access is inadequate or if bleeding complications occur, VATS is easily converted to a limited open thoracotomy.

Anesthetic treatment for patients undergoing thoracoscopy is similar to that for open thoracotomy (Table 53–7). Although limited thoracoscopy has been performed in spontaneously breathing, sedated patients, this procedure usually is performed during general anesthesia with placement of a double-lumen endotracheal tube for lung separation. Because the ability to visualize the contents of the thoracic cavity is predicated on adequate lung isolation and deflation of the operative lung, use of bronchial blockers is generally deemed inadequate, especially for right-sided procedures. Many patients have obstructive lung disease that impedes passive deflation of the nonventilated lung. To foster deflation, the nondependent lung should be carefully suctioned of secretions that may cause air trapping, then denitrogenated by ventilating with 100% oxygen, with single-lung ventilation initiated before skin incision. The tidal volume delivered to the ventilated dependent lung should be decreased to prevent upward shift of the mediastinum during single-lung ventilation. If deflation is inadequate, CO<sub>2</sub> can be insufflated into the nondependent thoracic cavity. Hypercarbia and hypotension may develop if excessive gas inflation causes mediastinal shift and reduction in venous return to the heart. Use of VATS over open thoracotomy has several advantages. Analgesic requirements and length of hospital stay are less than those for open thoracotomy.<sup>155–159</sup> Adequate postoperative analgesia can be obtained with a combination of parenteral opioids, nonsteroidal antiinflammatory drugs (NSAIDs), or intercostal nerve blocks. It is not our practice to place an epidural catheter for VATS except in patients with severe pulmonary or cardiac disease.

## ANESTHESIA FOR PATIENTS UNDERGOING BRONCHOSCOPY

### Background

Although introduced in the 1890s, it remained for Chevalier Jackson to perfect the therapeutic application of rigid bronchoscopy for retrieval of foreign bodies and diagnostic use in patients with neoplastic and inflammatory disease. The rigid bronchoscope is a hollow, metal tube with a blunted and beveled distal tip that allows insertion into the airway with minimal trauma.

### BOX 53–6.

#### Applications of Video-Assisted Thoracoscopy

<b>Pulmonary</b>
Lung biopsy
Resection mass
Bleb resection
Volume reduction pneumoplasty
<b>Pleura</b>
Diagnostic evaluation
Pleurodesis
Decortication
<b>Pericardium</b>
Pericardial drainage
Pericardectomy
<b>Cardiac</b>
Automatic implantable cardioverter-defibrillator placement
Cryoablation, radiofrequency ablation for treatment of atrial fibrillation
Cardiac pacemaker placement
<b>Mediastinum</b>
Lymph node biopsy
Biopsy and resection of mediastinal mass
Vagotomy
<b>Esophageal surgery</b>
Thoracic duct ligation
<b>Miscellaneous</b>
Sympathectomy
Microdiscectomy

The proximal end is adapted for observation of the airway, maintenance of gas exchange, and introduction of surgical instruments. The proximal side arm is adapted for administration of oxygen or other gases and enables mechanical ventilation during bronchoscopy. Within the wall of the bronchoscope are a series of channels for illumination of the distal field and for suctioning of secretions and blood. The large size of the rigid bronchoscope permits insertion of sponges, snares, knives, scissors, electrodes, and other special devices. The most common uses of a rigid bronchoscope are retrieval of large foreign bodies, evaluation and debulking of bronchial tumors, access to bleeding sites, and overall evaluation of the airways.

The introduction of the fiberoptic bronchoscope has had a dramatic impact by supplanting the use of the rigid instrument in many patients. Several hollow ports or channels are incorporated for suctioning, instillation of medications or lavage fluid, and introduction of accessory instruments. Flexion



TABLE 53–7.

## Anesthetic Guidelines for Video-Assisted Thoracoscopic Surgery and Thoracotomy

	<b>Video-Assisted Thoracoscopic Surgery</b>	<b>Thoracotomy</b>
Indication	Diagnostic, therapeutic (see Box 53–6)	Same <sup>a</sup>
Monitors	Standard monitors Optional (arterial, pulmonary artery catheter, Foley catheter)	Same <sup>a</sup>
Anesthesia	General anesthesia Optional (combined regional/general anesthesia)	Same <sup>a</sup>
Additional equipment	Fiberoptic bronchoscope Arm board Pillows Bean bag or chest roll	Same <sup>a</sup>
Ventilation	Double-lumen endotracheal tube Bronchial blockers	
Position	Later decubitus position (check and pad pressure points)	Same <sup>a</sup>
Incision	Several portals for the introduction of equipment	Lateral thoracotomy  Anterior thoracotomy Posterior thoracotomy Muscle-sparing incision
Unique considerations	Single-lung ventilation	Same <sup>a</sup>
Intraoperative complications	Hypoxia Hypercapnia Bleeding	Same <sup>a</sup>
Estimated blood loss	<300 mL	Variable
Postoperative analgesia	Parenteral opiates  Nonsteroidal anti-inflammatory drugs Intrapleural catheter, intercostal nerve block	Epidural > parenteral opiates  NSAIDs
Postoperative morbidity	Hypoxia (atelectasis, pneumothorax, pleural effusion) Bleeding	Same <sup>a</sup>
Postoperative case	Adequate analgesia Supplemental O <sub>2</sub> Chest radiography May require close followup evaluation overnight	Same <sup>a</sup>

<sup>a</sup>Same as video-assisted thoracoscopic surgery.

of the distal tip by cables allows the instrument to be directed to all segments of the tracheobronchial tree. Indications for fiberoptic bronchoscopy are listed in Box 53–7. Bronchoscopy often is only the first of several diagnostic or therapeutic procedures. After bronchoscopy, mediastinoscopy or thoracoscopy may be performed to further

evaluate the presence of disease or for its management.

### Flexible Fiberoptic Bronchoscopy

#### Anesthetic Management

Flexible fiberoptic bronchoscopy can be performed during local anesthesia in sedated spontaneously breathing

BOX 53–7.

### Indications for Fiberoptic Bronchoscopy

#### Diagnostic Indications

Staging and characterization of pulmonary disease

Evaluation of the site and etiology of pulmonary symptoms

#### Therapeutic Indications

Tracheal intubation

Positioning of double-lumen endotracheal tube

Removal of secretions and bronchial toilet

Laser of tumors

patients or during general anesthesia with or without placement of an endotracheal tube (Table 53–8).

Awake fiberoptic bronchoscopy is performed after administration of sedation, an antisialagogue, and adequate local anesthesia. If the correct balance of these components is not achieved, trauma can result from coughing and movement of the uncomfortable patient.

#### Ventilation Management

When performed during general anesthesia, fiberoptic bronchoscopy usually is accomplished through an endotracheal tube. The resulting marked reduction in the effective functional internal diameter of the endotracheal tube available for ventilation is associated with increased airway resistance and can result in distal air trapping. To reduce complications, the anesthesiologist should avoid spontaneous ventilation, eliminate PEEP from the circuit, ventilate with a prolonged expiratory phase (inspiratory:expiratory [I/E] ratio of 1:3), and use the largest endotracheal tube possible.

### Rigid Bronchoscopy

#### Anesthetic Management

Maintenance of anesthesia can be achieved with mixtures of IV sedatives and narcotics or in combination with potent inhalational anesthetics. Use of inhaled anesthetics has the obvious disadvantage of exposing personnel to the escaping anesthetic vapors. In our experience, an infusion of remifentanyl and propofol provides very acceptable anesthetic conditions characterized by quick emergence and negligible residual sedation. Topical anesthesia with lidocaine can be used to suppress

TABLE 53–8.

## Anesthetic Guidelines for Fiberoptic Bronchoscopy and Rigid Bronchoscopy

	Fiberoptic Bronchoscopy	Rigid Bronchoscopy
Indications	Diagnostic, biopsy, lavage, confirm placement of endotracheal tube	Therapeutic. Laser, retrieval or foreign body, pulmonary toilet
Monitors	Standard monitors	Same <sup>a</sup>
Anesthesia	General anesthesia, sedation with block	General anesthesia
Additional equipment		Shoulder roll
Airway	Awake spontaneous ventilation, single-lumen endotracheal tube ( $\geq 8$ mm)	Apneic ventilation Intermittent positive pressure ventilation Jet ventilation
Position	Semirecumbent (awake patients)	Cervical extension
Unique considerations	Local and nerve block, antisialagogue	Lidocaine intravenously or intratracheal, muscle relaxation, antisialagogue
Intraoperative complications	Bronchospasm Bleeding Pneumomediastinum Pneumothorax Subcutaneous emphysema Barotrauma Hypoxia Hypercapnia	Same <sup>a</sup> Dental trauma
Analgesia	Minimal pain (parental opiates)	
Postoperative morbidity	Atelectasis Bleeding and hemoptysis Bronchospasm Fever	Same <sup>a</sup>
Postoperative care	Chest radiography Humidified O <sub>2</sub> No eating or drinking until protective airway reflexes have returned	Same <sup>a</sup>

<sup>a</sup>Same as fiberoptic bronchoscopy.

cough reflexes and prevent bronchospasm. Patients undergoing rigid bronchoscopy can be paralyzed to prevent sudden movement or cough, which can result in major morbidity.

### Ventilation Management

Intermittent positive-pressure ventilation can be delivered during rigid bronchoscopy by connecting the standard anesthesia circuit to the ventilating side port of the rigid bronchoscope (Fig. 53–25). This ventilating technique requires no special equipment, allows for accurate measurement of FiO<sub>2</sub> and inhaled anesthetic concentration, and provides adequate oxygenation in most patients. The ventilating gases may leak through the space between the bronchoscope and the tracheal wall. To compensate for the leak, gas flows should be increased, and the posterior pharynx and larynx can be packed with gauze.

### Jet Ventilation

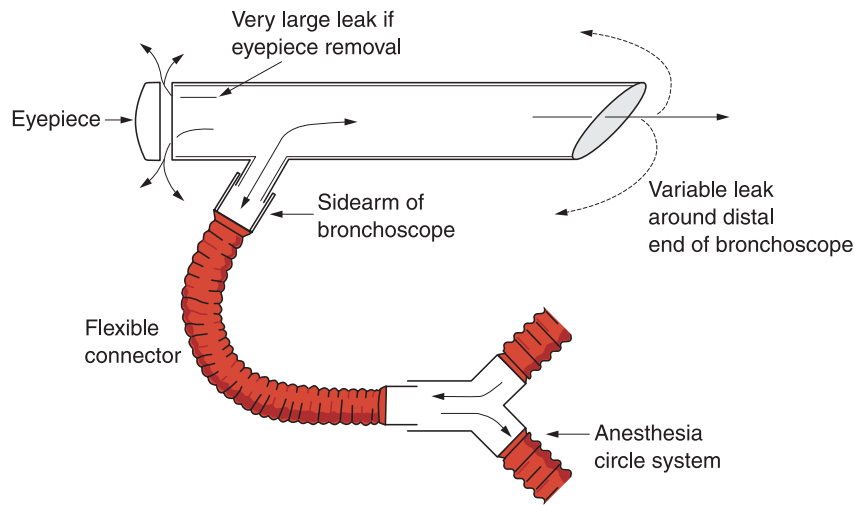
Use of jet ventilation has been advocated for prolonged rigid bronchoscopy. The Venturi jet ventilation technique allows the surgeon an unhurried, undisturbed period of viewing without the need for an eyepiece. A potential disadvantage is that jet ventilation can result in spillage of blood and other debris into the tracheobronchial tree.

An intermittent high-velocity jet of oxygen entrains air into the bronchoscope, resulting in expansion of the lungs. If the lungs are noncompliant or if the bronchoscope is small in relation to the trachea, large amounts of tidal volume will escape between the bronchoscope and tracheal wall, resulting in poor alveolar ventilation. Careful observation of the patient's chest movement is necessary to ensure adequate tidal volumes. The adequacy of ventilation, a function of total thoracic compliance, can be moni-

tored by obtaining an arterial blood sample, by transcutaneous CO<sub>2</sub> monitoring, or by intermittent capnography. Determining the inspired concentration of oxygen can be difficult because of the variable entrainment of room air, but the adequacy of oxygenation can be monitored by pulse oximetry or arterial blood gas sampling.

Intraluminal pressure is a function of the driving pressure from the inline reducing valve, size and length of the needle jet, and design of the bronchoscope. In addition, a decrease in the effective intraluminal diameter by the introduction of suction catheters or biopsy forceps can prevent escape of gas introduced by the jet and results in a dramatic increase in intratracheal pressure. If the instruments are tight fitting, the driving pressure should be decreased to minimize barotrauma.

The apparatus described by Sanders uses a high-pressure oxygen source of



**FIGURE 53-25.** Schematic diagram showing a rigid ventilating bronchoscope system, which consists of the anesthesia circle system attached to a flexible connector that is attached to the sidearm of the bronchoscope. With the proximal eyepiece in place, most of the inspired gas goes into the patient. Because the bronchoscope cannot fully fill the area of the trachea, there is a variable leak around the distal end of the bronchoscope. Exhaled gases are exhaled either through the leak around the bronchoscope or through the anesthesia circle system. When the eyepiece is removed, there is a very large leak out the proximal end of the bronchoscope.

50 psi, which is delivered through a 16- or 18-gauge needle located within the rigid bronchoscope (Fig. 53-26). The original jet ventilation system has been improved by connecting the side arm to the anesthesia circuit, thereby entraining an oxygen anesthetic gas mixture. Increasing the size of the jet port (the Carden side arm) results in increased inflation pressure and increased  $\text{FiO}_2$  at the distal tip of the bronchoscope.<sup>160</sup> Jet ventilation at low frequencies can provide for adequate oxygenation and ventilation. Commercial high-frequency jet ventilators (HFJVs) have been used with the rigid bronchoscope. Rates of 150–300 breaths/min result in ventilation and oxygenation comparable with intermittent low-frequency jet ventilation,<sup>161</sup> but rates >300 breaths/min result in a decrease in oxygenation and an increase in  $\text{Paco}_2$ . The major advantage of HFJV over low-frequency jet ventilation is less movement of the tracheobronchial tree, providing better surgical conditions for procedures such as laser therapy.

### Apneic Oxygenation

In the absence of ventilation, adequate oxygenation can be maintained for a prolonged period at the expense of increasing  $\text{Paco}_2$ . Initially, the patient is hyperventilated ventilated with 100% inspired oxygen until relative hypocap-

nia and denitrogenation is achieved. A period of hyperventilation, to  $\text{Paco}_2$  of approximately 30 mm Hg, will increase the period of apnea that can be tolerated before respiratory acidosis ensues. A small catheter is placed above the carina and insufflated with  $\text{O}_2$  at 10–15 L/min. The adequacy of oxygen reserve and generation of  $\text{CO}_2$  are functions of pulmonary mechanics and body size.

### Complications

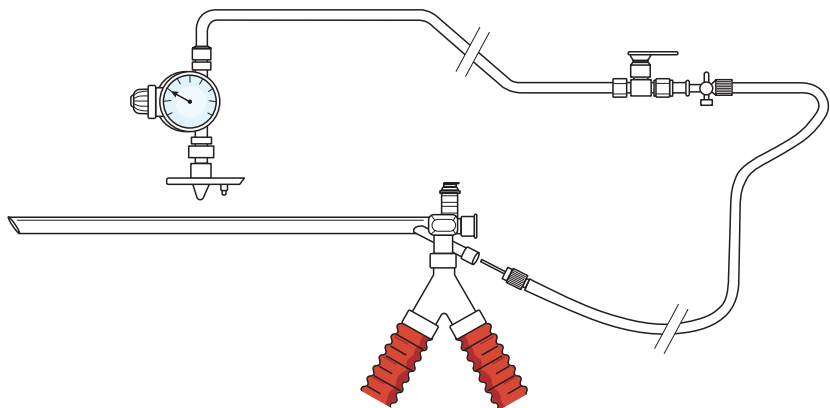
Aside from the inherit risks of local and general anesthetics, bronchoscopy of

the airway may exhibit decreases in  $\text{FEV}_1$ , FVC, peak expiratory flow rate, and peak inspiratory flow rate. Additional factors that may contribute to decreased lung function or bronchospasm are airway mucosal edema and mechanical activation of irritated airway reflexes.<sup>162</sup> These responses may be mediated in part by the vagus nerve because preoperative administration of an anticholinergic agent, such as glycopyrrolate or atropine, has been shown to prevent or attenuate these response.

Rigid bronchoscopy is associated with more trauma than is flexible fiberoptic bronchoscopy. Positioning of the patient and placement of the rigid bronchoscope can result in dental trauma or laceration of the mucosa of the larynx, trachea, or bronchi. The trauma has been associated with pneumomediastinum, pneumothorax, and perforation of the esophagus. The cervical hyperextension required for placement of the rigid bronchoscope can cause injury to the cervical spine, vasovagal reaction, and cerebral ischemia by occlusion of vertebral arteries.

Hypoxemia and hypercarbia are common complications during rigid bronchoscopy.<sup>121,163–165</sup> At the end of a procedure during general anesthesia, a single-lumen endotracheal tube should be placed, and the lung should be suctioned and ventilated with large tidal volumes to restore atelectatic alveoli.

Transient cardiac dysrhythmias are common in patients undergoing bronchoscopy.<sup>166–169</sup> They are caused by hypoxia, intense stimulation, hypoventilation with hypercapnia, inadequate depth of anesthesia, vasovagal reaction,  $\beta_2$ -adrenergic agonists, and bronchodilators.



**FIGURE 53-26.** Components needed for jet ventilation through the bronchoscope (Sanders injector). Wall connector for oxygen supply, reducing valve and pressure gauge, high-pressure tubing, toggle switch, and needle injector jet. (From Eisenkraft JB, Neustein SM. *Problems in Anesthesia*, vol 4. Philadelphia: JB Lippincott, 1990, pg. 223, with permission.)

## ANESTHESIA FOR PATIENTS UNDERGOING BRONCHOALVEOLAR LAVAGE

Bronchopulmonary lavage is indicated for management of alveolar proteinosis.<sup>170–176</sup> The long-term improvements in arterial oxygenation, exercise tolerance, and level of activity vary among patients. Some patients require annual or semiannual lavage, whereas others remain in remission for years.<sup>177</sup> The pathophysiology of the disease is characterized by abnormal bilateral accumulation of alveolar surfactant.<sup>177,178</sup> Its accumulation is attributed to a failure of clearance mechanisms rather than increased formation. Most patients are diagnosed between the ages of 20 and 50 years and have symptoms of cough, fever, and chest pain. Pulmonary function tests and chest radiographs are abnormal, but definitive diagnosis requires lung biopsy.

### Intraoperative Management

Unilateral lung lavage is performed by irrigation of the tracheobronchial tree during general anesthesia (Table 53–9).

Preoperative assessment should include  $\dot{V}/\dot{Q}$  scans to characterize the distribution of impairment. Unilateral lung lavage requires placement of a double-lumen endotracheal tube to prevent spillage to the contralateral lung. After induction of general anesthesia, the trachea is intubated with the largest left-sided double-lumen endotracheal tube that can be positioned properly. Correct tube position is essential and should be confirmed with a fiberoptic bronchoscope. To prevent leakage of lavage fluid into the contralateral lung, it has been suggested that the bronchial cuff be inflated to 50 cm H<sub>2</sub>O. The patient should be ventilated with 100% oxygen to minimize the risk of hypoxemia and eliminate nitrogen from the lung. Failure to adequately denitrogenate before lavage may leave residual pockets of intraalveolar nitrogen, thus limiting the effectiveness of the procedure.

The positioning of the patient is controversial. Lavage of the nondependent lung in the lateral decubitus position has the advantage of improving oxygenation by decreasing blood flow to the nonventilated lung. How-

ever, this arrangement increases the risk of displacement of the bronchial cuff and spillage from the nondependent to the dependent lung. Lavage of the dependent lung decreases the possibility of spillage, but it may be associated with hypoxia resulting from shunt flow. The supine position balances the risk of aspiration against the risk of hypoxia.

The choice of which lung to lavage first is based on the ventilation and perfusion studies; the lung with the least perfusion is chosen to be lavaged first. The procedure is performed by instilling warm isotonic saline by gravity from a height of 30 cm. The lung will accept 700–1000 mL of lavage fluid in the adult. Vigorous manual chest percussion is applied to the hemithorax throughout the lavage. Then, the lavage fluid is drained passively into a collecting system. The lavage procedure is repeated until the drainage decreases in turbidity to near clarity so that fine print can be read through a 0.25-inch diameter column of fluid. Typically, 12–30 L of saline is required. Accurate records of fluid administration and drainage are kept. After the effluent lavage fluid clears, the procedure is terminated, the lavaged lung thoroughly suctioned, and ventilation reestablished. Because the lavaged lung has decreased compliance, it is ventilated with a large tidal volume (15–20 mL/kg) to reexpand the alveoli. To improve compliance during the immediate postprocedure period, the patient should be positioned to enhance drainage, and secretions should be suctioned from the airway.

During the lavage procedure, most patients remain hemodynamically stable, although this procedure may increase right-heart strain and decrease left ventricular filling and systemic blood pressure.<sup>179</sup> Arterial oxygen saturation increases during lung filling and decreases with drainage. The increase in intraalveolar pressure, resulting from fluid administration, causes an increase in PVR, thereby diverting blood flow to the ventilated side and decreasing the venous admixture. When the lavage fluid is drained, PVR decreases, and the venous admixture increases.

Spillage of lavage fluid into the untreated lung is a serious complication. Leakage is detected by the appearance of bubbles in the lavage fluid, rales or rhonchi in the ventilated lung, discrepancy between the drained lavage fluid

TABLE 53–9.

Anesthetic Guidelines for Bronchial Alveolar Lavage

Indication	Diagnostic Therapeutic (alveolar proteinosis, cystic fibrosis)
Monitors	Standard monitoring, optional (arterial catheter)
Anesthesia	General anesthesia (allows for sequential lavages on both sides) Awake, sedated (lavage by bronchoscopy limited to lobe)
Ventilation	Left double-lumen endotracheal tube
Position	Lateral decubitus Supine
Unique considerations	Single-lung ventilation To prevent spillage to the opposite lung, endobronchial balloon should be inflated to functionally separate lungs (~50 cm H <sub>2</sub> O) (1) Drain 700–1000 mL warm saline into lung (2) Manual chest percussion (3) Drainage of fluid in Trendelenburg position (4) Repeat until turbidity clears (5) Repeat for contralateral lung (6) Maintain accurate account of infusion and drainage volumes (7) After lavage is completed, suction both lungs thoroughly ventilate and positive end-expiratory pressure
Intraoperative complications	Spillage of lavage fluid to contralateral lung Hypoxia Decrease pulmonary compliance Pneumothorax, hydropneumothorax Pulmonary edema
Analgesia	None required
Postoperative care	Supplemental O <sub>2</sub> Chest radiography



volumes, and arterial desaturation. If spillage is suspected, lavage should be stopped, the lung drained, and position of the double-lumen endotracheal tube confirmed. Massive spillage produces acute decreases in lung compliance and severe arterial desaturation. An unusual but serious complication of lung lavage is hydropneumothorax, which is characterized by increased peak airway pressures, decreased oxygen saturation 20 minutes after an uneventful lung lavage, and a chest radiograph revealing mediastinal shift and a left pneumothorax. It was hypothesized that lung lavage decreased lung compliance by washing out surfactants, making it more susceptible to barotrauma. A chest radiograph should be obtained routinely within the first hour after lavage and compared with prelavage examination.<sup>180</sup>

## ANESTHESIA FOR PATIENTS WITH BRONCHOPLEURAL FISTULA

### Etiology

The possibility of a bronchopleural fistula should be considered after pneumonectomy, lobectomy, bullectomy, or volume reduction surgery. The symptoms and findings of a clinically significant bronchopleural fistula include dyspnea, subcutaneous emphysema, contralateral deviation of the trachea, expectoration of purulent material, persistent air leak, and purulent drainage from the chest tube. Diagnosis is confirmed by bronchoscopy. Factors that predispose patients to developing air leaks after lung resection include cancer, malnourishment, debilitation, trauma, barotrauma, lung abscesses, immunosuppression, steroid therapy, diabetes, preoperative or postoperative radiation therapy, and pulmonary resection for tuberculosis. A continued air leak can lead to infection in the pleural space and dehiscence of the bronchial stump.<sup>181</sup>

### Therapeutic Management

When bronchopleural fistula occurs early after resection, prompt resuturing of the bronchial stump may correct it. If the fistula develops later after operation, adequate drainage and reduction of the pleural space constitute initial therapy. Many small fistulas close spontaneously using conservative therapy of nutritional support, antibiotics for infection, and spontaneous ventilation. If the lung expands to fill

the thoracic cavity, the leak usually can be controlled with passive chest tube drainage. A persistent space indicates a leak from a larger bronchus, usually requiring surgical treatment.<sup>181</sup> Sepsis should be controlled with antibiotics and adequate chest drainage.

Surgical options include (1) decortication if the lung is entrapped by a thick purulent layer; (2) revision of a long bronchial stump; (3) closure of the bronchopleural fistula with a pedicled muscle flap, usually in the form of an intercostal flap<sup>182,183</sup>; (4) thoracoplasty to obliterate the pleural space, usually combined with a pedicled muscle flap to cover the bronchial stump; (5) bronchoscopic application of fibrin glue to seal the communication; and (6) temporary deployment of a Silastic stent.

### Ventilation

Goals include maintenance of adequate ventilation and oxygenation and protection of the contralateral lung from spillage of purulent material. Application of positive pressure by a mask or a mechanical ventilator may lead to apparently inadequate ventilation because the tidal volume is lost through the fistula. Several methods have been developed to improve the ventilation of patients with bronchopleural fistula and decrease the risk of pneumothorax. Chest tubes with unidirectional valves have been used to prevent air leak during spontaneous inspiration. During positive-pressure ventilation, low inflation pressures should be used, and spontaneous ventilation with pressure support should be encouraged to decrease the air leak and to promote closure of the bronchopleural fistula. High-frequency ventilation has been used to manage bronchopleural fistula but with varying results.<sup>184-186</sup>

The proposed advantage of high-frequency ventilation is that lower inspiratory pressures and smaller tidal volumes may result in less gas leak through the fistula. It appears to be less effective when patients have bilaterally diseased, noncompliant lungs. Improvement in the air leak depends on a decrease in peak and mean airway pressures; it is recommended that tracheal pressures and air flow through the leak be measured during HFJV and compared with values obtained during conventional mechanical ventilation.

### Anesthetic Management

Intraoperative treatment of patients with bronchopleural fistula presents

unique challenges. Management strategies for induction and intubation depend on the severity of the bronchopleural fistula and the presence of infection. If a chest tube is not in place or is malfunctioning, accumulation of escaping air into the enclosed pleural space will result in a tension pneumothorax. Because positive-pressure ventilation increases the air leak and risks contaminating the noninfected lung, patients often are induced using rapid sequence induction to minimize the time before tracheal intubation and lung isolation. An alternative approach is to intubate a spontaneously ventilating patient with a double-lumen tube. Awake sedated intubation can be considered for patients at increased risk for aspiration of gastric contents caused by full stomach or bronchopleuroenteric fistula.<sup>187</sup> Once the tube has been positioned, the healthy lung should be isolated immediately and the head raised slightly to decrease the likelihood of contamination of the healthy lung.

In patients with a small chronic bronchopleural fistula with minimal air leak and no associated infection or empyema, a standard endotracheal tube is often used safely. If intermittent positive-pressure ventilation is then found to be inadequate, the tube can be advanced into the bronchus of the normal lung or replaced with a double-lumen tube. An empyema, if present, should be drained before induction of anesthesia. Decreasing the amount of pus in the pleural cavity reduces the chance of contaminating the contralateral lung and developing a tension pneumothorax. If intermittent positive-pressure ventilation using a double-lumen tube provides inadequate oxygenation or ventilation, HFJV to the affected lung through the double-lumen tube is another option.<sup>130</sup> When a double-lumen tube cannot be used, as in small pediatric patients or in those with difficult airway anatomy, lung separation can be achieved by endobronchial placement of a single-lumen endotracheal tube.

## ANESTHETIC IMPLICATIONS OF SPONTANEOUS PNEUMOTHORAX

Patients who develop spontaneous pneumothorax usually are young, healthy, and sometimes athletic, with

no preexisting lung disease and no previous lung resections. Surgical treatment of spontaneous pneumothorax includes pleurectomy and chemical pleurodesis.<sup>188</sup>

Surgical treatment is indicated in the following situations: (1) failure of the pneumothorax to resolve with chest tube drainage and suction, which indicates that bronchopleural fistula has formed; (2) when a second ipsilateral or first contralateral spontaneous pneumothorax occurs; and (3) if the patient's lifestyle is such that a recurrence may be life threatening or highly inconvenient (recurrence rate for spontaneous pneumothorax is 10–25%).

When patients with pneumothorax come to the operating room, they typically have a chest tube in place, so tension pneumothorax usually is not a major concern. Patients usually are treated with a double-lumen endotracheal tube to facilitate surgical exposure for either thoracoscopy or thoracotomy. If a single-lumen tube is placed and the air leak is too large, a single-lumen tube can be advanced into the bronchus of the unaffected side with the guidance of a fiberoptic bronchoscope, or it can be replaced with a double-lumen tube.

## ANESTHESIA FOR PATIENTS UNDERGOING BULLECTOMY AND VOLUME REDUCTION PNEUMOPLASTY

There has been resurgence in the surgical management of bullous disease and emphysema. Studies have documented the efficacy of this procedure for patients with isolated large bullae, although the benefits of resection of diseased peripheral lung tissue in the presence of bullous emphysema is less certain. Large multicenter trials assessing the efficacy of this therapeutic modality are under way.

Bullae are air-filled spaces within the lung parenchyma. As bullae expand, the volume of the remaining lung is reduced (Fig. 53–27). The rationale for surgical resection of the diseased lung is removal of areas of nonfunctional lung to permit reexpansion of compressed functional alveoli and to improve diaphragmatic function.<sup>33,189</sup> Patients most likely to benefit from the plication of large bullae are those in whom the bullae occupies >30% of the hemithorax,<sup>190–192</sup> those with progressively en-

larging nonfunctional pulmonary units and recurrent pneumothoraces, and those with moderate-to-severe dyspnea that is refractory to conventional medical therapy.<sup>191</sup> A prospective trial with 20 patients reported an increase in FEV<sub>1</sub> (from 0.77 to 1.4 l), FVC (from 2.2 to 2.8 L), and arterial oxygenation on inspired room air (from 64 to 70 mm Hg). Patients experienced less dyspnea and improved quality of life during the next 6 months. The beneficial effects were attributed to expansion of the remaining lung and improved diaphragmatic function, resulting in improved respiratory mechanics and decreased  $\dot{V}/\dot{Q}$  mismatching. Another study reported more modest improvements in symptoms and pulmonary function analysis (FEV<sub>1</sub>, from 1.74 to 1.85 l; FVC, from 1.82 to 2.21 l) and was associated with a mortality rate of 5.5%.<sup>192</sup> Whether the difference between these two studies reflects patient selection or a difference in surgical technique is not known.

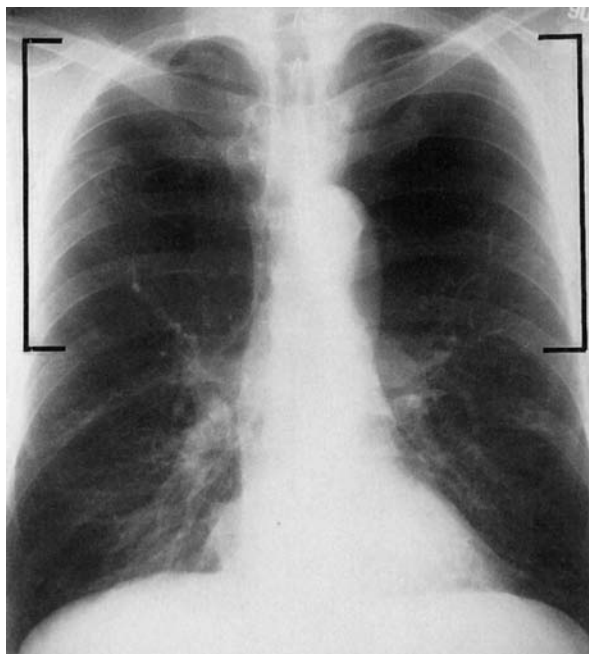
### Lung Volume Reduction Surgery

In 1995, Cooper et al.<sup>193</sup> initiated a renewed interest in lung volume reduction surgery, the technique of removing hyperinflated emphysematous lung to allow normal lung more

space to function properly.<sup>193–196</sup> From this case series, many institutions started offering this invasive procedure to this high-risk patient population. Although many centers reported good results, increased rates of morbidity and mortality raised the need for a comprehensive multicenter trial.

### Surgery

These procedures can be performed as single unilateral, sequential unilateral, or bilateral operations. Single unilateral bullectomy and volume reduction procedures are performed using the lateral decubitus position and video thoracoscopy or open thoracotomy. Sequential unilateral procedures can be performed by repositioning the patient to the contralateral decubitus position after the first side is completed. Bilateral procedures can be performed through a median sternotomy. Median sternotomy does not require repositioning and provides access to the contralateral pleural space in patients with pneumothorax. Plication of bullae and resection of peripheral lung tissue are accomplished with the use of a stapler. A major complicating factor in postoperative recovery is persistent air leaks at the suture line. This problem is decreased by using a stapler with a pericardial buttress.<sup>190</sup>



**FIGURE 53–27.** Characteristic radiographic findings of patients with bullous disease. Typical findings in patients with chronic obstructive pulmonary disease include an increased size of lung fields and flattened hemidiaphragms. The appearance of hyperaeration of both apical lung fields (bracketed area), decreased vascular marking in upper lung fields, and compressive atelectasis of the lower lung fields are consistent with severe bullous lung disease.

TABLE 53–10.

## Anesthetic Guidelines for Bullectomy and Volume Reduction Pneumoplasty

	<b>Bullectomy/Volume Reduction Pneumoplasty</b>	<b>Volume Reduction Pneumoplasty</b>
Indication	Bullectomy—large bullae >30% of hemithorax Volume reduction—severe bullous emphysema	Severe bullous emphysema
Preoperative concerns	Review preoperative pulmonary function tests and check arterial blood gases Pulmonary symptoms may mask presence of coronary artery disease	Same <sup>a</sup>
Monitors	Standard monitors and A-line	Same <sup>a</sup>
Anesthesia	General anesthesia Combined regional/general anesthesia	Same <sup>a</sup>
Additional equipment	Optional (jet ventilator)	Same <sup>a</sup>
Ventilation	Double-lumen endotracheal tube	Same <sup>a</sup>
Position	Bullectomy (lateral decubitus) Volume reduction pneumoplasty (lateral, supine)	Lateral decubitus Supine (median sternotomy)
Incision	Bullectomy (thoracotomy, VATS) Volume reduction pneumoplasty (thoracotomy, VATS, median sternotomy)	Thoracotomy VATS Median sternotomy
Unique considerations	Single-lung ventilation Avoid positive end-expiratory pressure Minimize use of long-lasting respiratory depressants Restrict administration of intravenous fluids	Same <sup>a</sup> Same <sup>a</sup>
Intraoperative complications	Tension pneumothorax Pneumothorax Hypoxia Hypercarbia	Same <sup>a</sup>
Blood loss	Minimal <500 mL	Same <sup>a</sup>
Postoperative analgesia	Epidural Parenteral opiates/NSAIDs	Same <sup>a</sup>
Postoperative morbidity	Persistent air leak Respiratory dysfunction Hypoxia Hypercarbia Pneumothorax Difficulty weaning from ventilator	
Postoperative care	Monitor respiratory status overnight for signs of decompensation Supplemental O <sub>2</sub> Chest radiography Adequate analgesia Minimize air leak by placing chest tubes to water seal or minimizing suction	

<sup>a</sup>Same as bullectomy/volume reduction pneumoplasty.  
VATS, Video-assisted thoracoscopic surgery.

### Anesthetic Considerations

Patients presenting for bullectomy or lung volume reduction surgery have poor respiratory reserve and challenge the anesthesiologist during induction, single-lung ventilation, and extuba-

tion.<sup>197,198</sup> Many patients may have been considered for lung transplantation but were excluded because of their age or the presence of coexisting diseases. Their cardiopulmonary status requires judicious use of any benzodiazepines or narcotics. In addition

to the standard monitors, an arterial catheter should be placed to assess adequacy of oxygen and ventilation perioperatively.

Either thoracotomy or thoracoscopy requires general anesthesia and single-lung ventilation (Table 53–10). The combination of general anesthesia and epidural analgesia decreases the anesthetic requirement intraoperatively, thereby minimizing postoperative residual sedation. Patients with end-stage emphysema tend to have increased endogenous catecholamines caused by hypoxemia and hypercapnia, often are hypovolemic, and are at risk for hypotension after induction of general anesthesia. General anesthesia can be maintained with either inhalational or IV agents or with a combination of techniques. Nitrous oxide should be avoided because of the risk for increasing the size of bullae, further compressing the adjacent lung or causing rupture. Communications between bullae and the airway may function as one-way valves, resulting in air trapping with rapid enlargement and compression of the surrounding lung. Initiation of controlled ventilation may be associated with hypoxemia and hypercapnia. Acute rupture of bullae with resulting pneumothorax is a constant threat. An acute decrease in blood pressure associated with increased inspiratory pressures and loss of breath sounds should be considered a pneumothorax unless proven otherwise. Prompt placement of a chest tube is indicated. Low inflation pressures, that is, inspiratory pressures < 25 cm H<sub>2</sub>O, will decrease the risk of pneumothorax.

One-lung ventilation with a double-lumen tube facilitates bilateral volume reduction yet retaining the capacity for intermittent ventilation of the operative lung to manage hypoxia or hypercapnia or to assist the surgeon in identifying the location of bullae. Initiation of single-lung ventilation is associated with an increase in airway pressure and the concomitant risk of pneumothorax. Jet ventilation has been used to decrease airway pressures. The nonoperated, ventilated lung should be prepped and draped to allow access in case of a pneumothorax. Increased concentrations of halogenated anesthetics may worsen the venous admixture by inhibition of HPV.

### Postoperative Ventilation

Extubation of the trachea at the end of operation can be accomplished in most

patients. The need for continued mechanical ventilation is greater after volume reduction pneumoplasty compared with plication of bullae. The beneficial effects of operation are not realized immediately after operation. Patients undergoing volume reduction may decompensate in response to the usual decrement in postoperative pulmonary function associated with thoracic surgery and pain. They also seem to be more sensitive to residual sedation, respiratory depression from analgesics, residual muscle relaxants, and hypercapnia. The presence of a major air leak can interfere with respiratory function. Criteria for extubation include the presence of a regular respiratory pattern, adequate patient strength, alertness, ability to respond to command, and measurement of arterial blood gas. If mechanical ventilation is required postoperatively, positive airway pressure should be minimized to decrease the chance of producing pneumothorax from rupture of residual bullae or suture lines. If air leak remains an important factor, airway peak pressure can be minimized by changing the mode of ventilation to pressure control. In addition, the chest tube suction should be put to water seal, or at least the suction pressure should be minimal.

## ANESTHESIA FOR PATIENTS UNDERGOING DECORTICATION AND PLEURODESIS PROCEDURES

### Clinical Features

Pleural inflammation, either infectious or noninfectious, increases permeability and results in the collection of high-protein pleural fluid. Lymphatic obstruction, altered central venous pressures, and low oncotic pressure contribute to pleural fluid accumulation. Large effusions may dramatically decrease pulmonary function. The collection of blood or empyema precipitates deposition of a fibrin layer on the pleura. As the fibrin layer (or peel) matures, the underlying lung is entrapped, and lung expansion is decreased, necessitating surgical intervention to release and expand collapsed lung and to manage infection.

Patients with a simple nonloculated empyema may be treated conservatively with antibiotic therapy and chest tube drainage. Once the empyema becomes loculated or develops into a fibrous peel, surgical intervention by

thoracotomy or thoracoscopy is performed during general anesthesia. The access provided by VATS may be limited, and open thoracotomy may be required for more definitive procedure. Failure to adequately manage a chronic draining empyema may require the placement of an open window thoracostomy for long-term care. This procedure consists of suturing a flap of skin to the pleura, creating an epithelial-lined sinus into the empyema cavity.

Occasionally, additional intervention, pleurodesis, is required because reaccumulation of the effusion either causes respiratory compromise or is refractory to medical therapy, as in the case of malignancies. A number of agents have been used intrapleurally to produce a chemical pleurodesis that leads to formation of adhesions and obliteration of the pleural space. Common sclerosing agents include tetracycline, talc, and bleomycin. Fever and chest pain are the most common complications of pleurodesis.

### Anesthesia Management

Surgical decortication requires the differential ventilation of healthy from diseased lung in order to facilitate surgical exposure and permit complete reexpansion after surgical intervention.<sup>199</sup> After induction and tracheal intubation, patients usually are placed in a lateral decubitus position with the affected lung in the nondependent position. In patients with a lung abscess, placement of an infected lung in the nondependent position increases the risk of contamination to the dependent lung. Most common management issues involve hypovolemia related to bleeding or sepsis and pain associated with decortication and pleurodesis. Inability to remove the fibrous peel may result in failure to reexpand the entrapped lung. After the decortication procedure is completed, positive pressure can be applied to the diseased lung to help break residual fibrous deposition, thus enabling lung reexpansion. Options for postoperative analgesia include patient-controlled analgesia or placement of an epidural catheter.

## ANESTHESIA FOR PATIENTS UNDERGOING ESOPHAGEAL SURGERY

Dysphagia is the most common symptom of esophageal disease. When

### BOX 53–8.

#### Common Lesions of the Esophagus

##### Tumors

- Squamous cell
- Adenocarcinoma
- Hiatal hernia

##### Benign strictures

- Reflux esophagitis in the lower third of the esophagus
- Caustic fluid ingestion in the upper third of the esophagus

##### Motility disorders

- Achalasia
- Schatzki ring

##### Collagen diseases (e.g., scleroderma)

##### Diverticula

- Tracheoesophageal fistula (congenital or malignant)

##### Traumatic perforation or rupture

##### Foreign bodies

present for any major length of time, dysphagia can result in dramatic weight loss, dehydration, hypoalbuminemia, anemia, and depressed immune status. Postprandial heartburn, another common symptom of esophageal disease, is related to reflux of gastric contents into the esophagus. Symptoms may manifest with change in position, exercise, or belching. Patients who experience such symptoms usually are evaluated by barium swallow under fluoroscopy, followed by esophagoscopy and tissue biopsy. Common esophageal lesions are summarized in Box 53–8.

### Esophagoscopy

Esophagoscopy is used for tissue biopsy or clarification of esophageal lesions detected after barium contrast studies. In addition, esophagoscopy is used for removal of foreign bodies, dilation of esophageal strictures, sclerotherapy of esophageal varices, diagnosis and management of bleeding lesions, and placement of prosthetic stents across malignant strictures.

Esophagoscopy can be performed using either a rigid or a flexible fiberoptic esophagoscope. Flexible esophagoscopy allows for greater comfort while examining the upper gastrointestinal tract and usually is performed on awake, slightly sedated patients. Although rigid esophagoscopy can be performed on awake, sedated patients, it is more readily accomplished during general endotracheal anesthesia. Rigid



TABLE 53–11.

## Anesthetic Guidelines for Esophagoscopy

Indication	Diagnostic (biopsy mass, evaluate esophagus) Therapeutic (removal foreign body, arrest bleeding, sclerosis)
Monitors	Standard monitors
Anesthesia	Awake sedated (flexible fiberoptic) General anesthesia (flexible fiberoptic and rigid)
Additional equipment	None
Ventilation	Awake spontaneous respiration Single-lumen endotracheal tube (may require small size or cuff deflation to pass scope)
Position	Supine
Incision	None
Unique considerations	Antisialagogue Aspiration precautions
Intraoperative complications	Dysrhythmia Aspiration Hematemesis Pneumomediastinum Pneumoperitoneum Pneumothorax Dental trauma Respiratory compromise Perforation esophagus
Postoperative analgesia	Minimal pain (parenteral opiates, nonsteroidal anti-inflammatory drugs)
Postoperative morbidity	Hematemesis Respiratory distress (vocal cord paralysis)
Postoperative care	Chest radiography No eating or drinking until protective airway reflexes have returned

esophagoscopy is particularly valuable for removal of foreign bodies and for the examination and management of massive esophageal bleeding.

### Anesthetic Management

Fiberoptic esophagoscopy can easily be performed during topical anesthesia of the mouth and pharynx combined with mild sedation and an antisialagogue (Table 53–11). Patients should not be allowed to eat or drink until several hours after the procedure when the effect of topical anesthesia has dissipated and protective airway reflexes have returned.

Rigid esophagoscopy usually is performed on patients during general anesthesia with endotracheal intubation and muscle relaxation. An anticholinergic agent is administered to decrease airway secretions and vagal responses to airway manipulation and gastric distension. Cricoid pressure should be used during induction because many patients are at risk for regurgitation

from esophageal diverticula, stenosis, or obstruction. Awake, sedated endotracheal intubation is an option. To avoid injury to the esophagus during passage of the esophagoscope, a smaller than typical endotracheal tube is used, and the patient is paralyzed before introduction of the esophagoscope. Temporary deflation of the endotracheal tube cuff to facilitate passage of the esophagoscope may be necessary. Complications during esophagoscopy include hemorrhage, cardiac dysrhythmias, aspiration pneumonia, and perforation of the esophagus. Perforation can result in pneumothorax, pneumomediastinum, pneumoperitoneum, or subcutaneous emphysema. At the conclusion of the procedure, the trachea should remain intubated until protective reflexes have returned.

### Esophageal Cancer

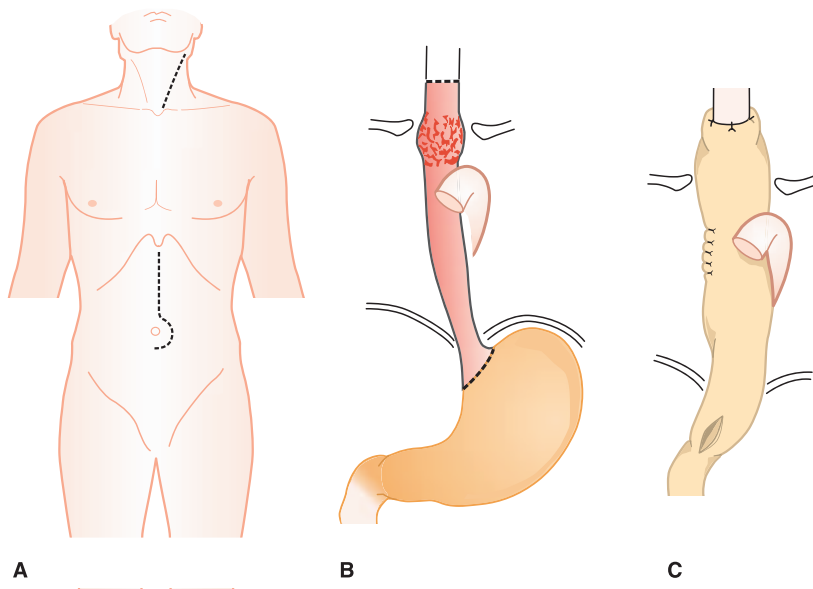
Patients with esophageal malignancy often are malnourished and have poor nutritional status predictive of poor

outcome. Preoperative improvement in nutritional status has been shown to decrease the incidence of wound sepsis and perioperative morbidity and mortality.<sup>169,200</sup> Indications for total parenteral nutrition include inability to swallow food, at least 10% decrease in body weight, serum albumin <3 g/dL, cachexia and anergy, leukopenia, and low transferrin value.

Patients with esophageal cancer often are treated with chemotherapeutic agents before surgery. Perioperative implications of previous use of anti-neoplastic agents for management of esophageal cancer include anemia, leukopenia, and thrombocytopenia. Drugs such as doxorubicin (Adriamycin), bleomycin, and mitomycin C have additional side effects that are important considerations for the anesthesiologist.

Doxorubicin can result in acute and chronic toxic cardiac effects. Acute cardiac toxicity from doxorubicin is characterized by supraventricular and ventricular dysrhythmias, abnormal conduction patterns, and ST-T wave changes. These acute changes usually resolve 1–2 months after cessation of therapy,<sup>201</sup> although doxorubicin administration also may result in irreversible cardiomyopathy and congestive heart failure. To avoid this complication, the total cumulative dose of doxorubicin usually is limited to a maximum of 300 mg/m<sup>2</sup>. Doxorubicin-induced cardiomyopathy is diagnosed by obtaining an endomyocardial biopsy and determining the ejection fraction using a multigated acquisition (MUGA) nuclear scan. If the usual maximal dose is exceeded or if patients demonstrate evidence of cardiomyopathy, then dexrazoxane (Zinecard) is given before future doxorubicin therapy.

Bleomycin and mitomycin C395 can result in pulmonary toxicity. Early symptoms include cough, dyspnea, and rales. The toxic signs may progress to severe hypoxemia at rest and a radiologic picture similar to that of ARDS, followed by pulmonary fibrosis. Predisposing factors include age older than 20 years, dosage >400 U, underlying pulmonary disease, and previous radiation therapy. O<sub>2</sub> in high concentration can predispose the patient to pulmonary toxicity from bleomycin. Because the duration of O<sub>2</sub> sensitivity after the conclusion of bleomycin therapy is unknown, the lowest FiO<sub>2</sub> necessary to maintain adequate arterial saturation should be used perioperatively.



**FIGURE 53-28.** For esophagectomy without thoracotomy, the patient is in the supine position. **A.** Upper midline and left cervical incision (*broken lines*) are made. **B.** Extent of resection (*shaded area*). **C.** Completed anastomosis.

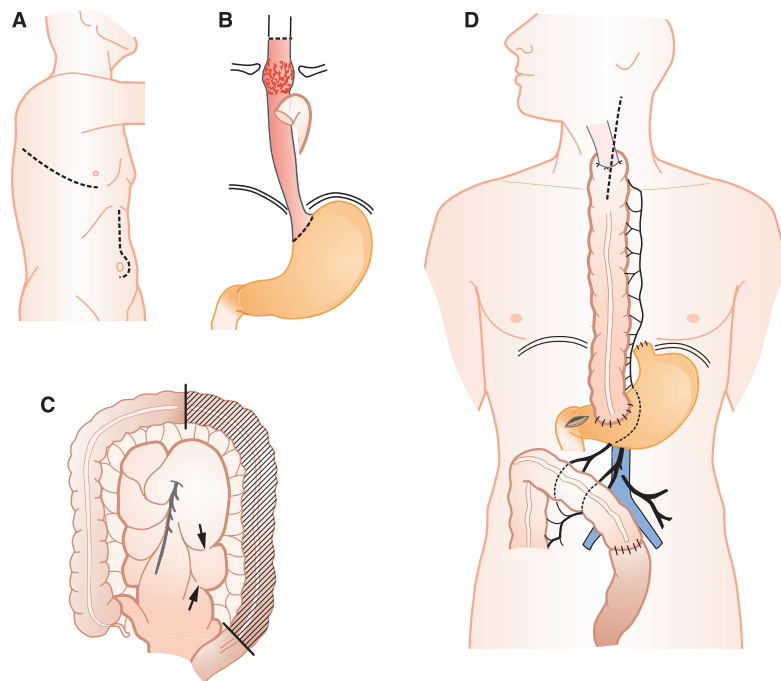
## Esophageal Surgery: Esophageal Cancer

### Management Strategies

Tumors of the lower third of the esophagus are managed by esophagogastrectomy through a left-sided thoracotomy or transhiatal esophagogastrectomy and gastric pull-through technique (Fig. 53-28).<sup>202</sup> Lesions of the middle third of the esophagus are managed by a combined laparotomy and right-sided thoracotomy.<sup>203</sup> Lesions of the upper third of the esophagus can be managed by combined laparotomy and cervical incision (Fig. 53-29).<sup>202</sup> Esophagogastrectomy with colon interposition is a two-stage procedure used for lesions in the upper third of the esophagus when insufficient stomach length or gastric disease prevents performing an esophagogastrectomy. During the first stage, the esophagogastrectomy is performed through a midline laparotomy and right thoracotomy. The patient is then turned supine, and a cervical esophagostomy is performed. During the second stage, an antiperistaltic segment of the colon is passed into the retrosternal space and anastomosed to the cervical esophagus above and to the stomach remnant below (Fig. 53-29).

The approach to surgical management of esophageal cancer is controversial. Major issues involve whether the goal is cure or merely is palliation. The transthoracic approach, which in-

volves complete resection of lymph nodes, is potentially curative, whereas the transhiatal approach is considered palliative. Other controversies include



**FIGURE 53-29.** Esophagectomy with interposition of antiperistaltic segment of left colon. **A.** Incisions used in performance of esophagectomy, cervical esophagostomy, pyloromyotomy, and gastrectomy. **B.** Extent of esophageal resection (*shaded area*). **C.** Preparation of segment of left colon (*shaded area*) for interposition based on middle colic artery (note sites of vascular interruption, which maintain the integrity of the vascular arcade). **D.** Completed operation.

whether the patient should undergo immediate reconstruction with colon or stomach to restore continuity or delayed repair. Long-term survival appears to be a function of the stage and aggressiveness of the tumor at the time of operation rather than the type of operation. Surgical resection is associated with a local recurrence rate of 30–60% and 5-year survival rate of 20–25%. The addition of induction therapy of any kind does not significantly alter these survival rates.<sup>204</sup>

### Anesthetic Management

Preoperative evaluation should concentrate on the hematologic, nutritional, and cardiopulmonary systems. Preoperative improvement of nutritional status improves outcome. Hypoalbuminemia, an indicator of poor nutritional status, is associated with increased tissue edema, and anemia may increase the risk of ischemia. Because the operation may be associated with episodes of hemodynamic instability and cardiac arrhythmias, the patient should undergo a thorough cardiac evaluation preoperatively. Accompanying respiratory disease should be

TABLE 53–12.

## Anesthetic Guidelines for Esophagogastrectomy and Esophagectomy

Indication	Therapeutic (palliative and curative procedures for esophageal cancer)
Preoperative considerations	Assessment of nutritional status Presence of coexisting cardiopulmonary disease Implications of preoperative chemotherapy
Monitors	Standard monitors, optional (arterial catheter, central venous, or pulmonary artery catheters)
Anesthesia	General anesthesia, optional (combined regional and general anesthesia)
Additional equipment	Shoulder roll
Ventilation	Double-lumen ETT or bronchial blocker Single-lumen ETT
Position	Supine Lateral decubitus
Incision	Left thoracotomy—mobilize distal esophagus and stomach without changing positions Right thoracotomy—good exposure of upper and midesophagus, easy access to the azygous vein Abdominal transhiatal, abdominal and neck incisions, esophagus mobilized by blunt dissection
Unique considerations	Single-lung ventilation Anticholinergic drug to block carotid sinus reflex (vagal-mediated response) Avoid N <sub>2</sub> O with abdominal surgery Increased risk for aspiration
Intraoperative complications	Aspiration Hypotension Bradycardia Dysrhythmia Hemorrhage Tracheal tears Recurrent laryngeal nerve injury Hypoxia and hypercapnia during one-lung ventilation
Blood loss	1000 mL, but potential for large acute blood loss
Postoperative analgesia	Epidural > parenteral opiates
Postoperative morbidity	Aspiration Pneumothorax Respiratory compromise Hemoptysis Infection Anastomotic leaks
Postoperative care	Chest radiography Elevate head to bed to decrease edema and improve respiratory function Increased fluid requirements during early postoperative procedures

ETT, Endotracheal tube.

managed if possible, and strong consideration should be given to placement of an epidural catheter for postoperative analgesia.

Preoperative medication is given to allay anxiety in accordance with the patient's general condition. Use of an

anticholinergic drug may be helpful if awake intubation is planned. Guidelines for anesthetic management are given in Table 53–12. Use of central venous catheterization is encouraged for monitoring of central venous pressure, administration of antiarrhythmics

or vasopressors, and fluid resuscitation. A PA catheter should be placed if indicated, based on the patient's cardiopulmonary status; it may prove beneficial postoperatively for optimizing fluid therapy. Arterial lines are strongly recommended, particularly for transhiatal esophagogastrectomy where surgeons are bluntly dissecting behind the heart and induce profound hypotension.

Before induction of anesthesia, a large-bore nasogastric tube should be passed, and the proximal esophageal pouch should be emptied. The patient should be considered to have a full stomach because the esophagus cannot be completely emptied through a nasogastric tube. Awake intubation during topical anesthesia or induction with cricoid pressure is indicated. If airway compression by large mediastinal lymph nodes is noted, the patient should be treated as described in the section entitled Anesthesia for Patients with Mediastinal Masses (Fig. 53–1). Anesthesia is maintained using inhalation anesthetics in O<sub>2</sub>, supplemented with intermittent or continuous infusion of narcotics and nondepolarizing muscle relaxants. The combination of epidural and general anesthesia can dramatically decrease inhalation anesthetic and muscle relaxant requirements.

If thoracotomy is planned for esophageal surgery, a double-lumen endobronchial tube or bronchial blocker to permit single-lung ventilation facilitates surgical exposure. Whether a right-sided or left-sided thoracotomy is performed, a left-sided double-lumen endobronchial tube is recommended because it is easier to position and offers less risk of obstruction of the upper lobe bronchial orifice. In patients undergoing nonpulmonary surgery, the nondependent lung usually is not severely diseased and thus contributes greatly to normal respiratory function. Paradoxically, this increases the incidence of hypoxemia during single-lung ventilation compared with that during pulmonary surgery, and the hypoxemia persists as long as the lung is collapsed.<sup>125</sup>

Fluctuating cardiovascular responses are observed frequently during transhiatal esophagectomy. Bradycardia and hypotension may result from stimulation of carotid sinus reflexes during neck dissection and mobilization of the esophagus. They are easily managed with an anticholinergic drug such as atropine. Blunt manual dissection of

the esophagus through the diaphragmatic hiatus is associated with hemodynamic lability. Arterial hypertension often occurs during manual dissection of the esophagus and when the stomach is brought up through the posterior mediastinum, whereas hypotension may result from impaired venous return and cardiac function during manual dissection. Patients with advanced cardiac dysfunction may not tolerate these manipulations and therefore are not good candidates for transhiatal esophagectomy. Sudden severe intraoperative hemorrhage can occur, so large-bore venous access is essential. Other complications include tracheal damage and recurrent laryngeal nerve palsy. Tracheal damage has been reported during transhiatal esophagectomy without thoracotomy and during dissection of the middle third of the esophagus during thoracotomy.

### Postoperative Concerns

Because esophagogastrectomy is associated with extensive visceral manipulations, difficulty in clearing secretions, advanced patient age with concomitant debilitation, and cardiorespiratory impairment, patients may remain intubated overnight in the ICU. They often have increased fluid requirements during the initial postoperative period, and central venous monitoring is useful in guiding fluid management. Postoperative complications include pleural effusions, wound infection, pneumonia, and leak from the anastomotic site, resulting in mediastinitis, sepsis, hydrothorax, or pyrothorax.<sup>205</sup> Impaired pulmonary function, airway closure, atelectasis, and hypoxemia typically occur postoperatively because of lung manipulation, residual anesthesia, and postoperative incisional pain. Effective postoperative pain control is essential to facilitate deep breathing, cough, mobilization of secretions, participation in chest physiotherapy, and early ambulation. Postoperative analgesia is most effectively achieved using a thoracic epidural catheter for infusion of narcotics, with or without local anesthetics.

## ANESTHESIA FOR PATIENTS UNDERGOING LASER SURGERY OF THE AIRWAY

Laser technology has been applied extensively for procedures on the upper

and lower airways. It has been used successfully in the management of laryngeal tumors, subglottic stenosis, recurrent laryngeal papillomatosis in children, and for removal and debulking of obstructing airway tumors.<sup>206–213</sup>

### Laser Surgery of the Airway

Malignant tumors of the tracheobronchial tree lead to progressive obstruction of major airways that manifest as progressive stridor. Laser resection has been used in the treatment of partially or totally occluding airway lesions with partial or complete relief of symptoms.<sup>214–216</sup> In patients with a totally obstructing airway lesion, lasers can be used to bore through the tumor to reestablish an airway. A serious risk of bronchial perforation and hemorrhage exists. On the other hand, a partially obstructing tumor can be approached tangentially and gradually resected, resulting in widening of the available airway lumen. For partially obstructing lesions, laser resection often provides immediate and dramatic relief of symptoms with a low incidence of bleeding complications. The neodymium:yttrium aluminum-garnet (Nd:YAG) laser is the most frequently used laser to resect obstructing tracheobronchial tree tumors.<sup>214–216</sup> If a CO<sub>2</sub> laser is to be used for a subglottic lesion, a rigid bronchoscope or laryngoscope is required because the CO<sub>2</sub> laser beam cannot be transmitted along fiberoptic bundles. For supraglottic lesions being managed with a CO<sub>2</sub> laser, a small endotracheal tube can be used for patient ventilation, but the tube should be protected from the laser beam to prevent ignition.

### Intraoperative Considerations Safety Issues

Use of a laser in the operating rooms poses safety hazards for patients and operating room personnel. Warning signs on the operating room door should be clearly visible. The most common major complication of CO<sub>2</sub> laser surgery is the risk of explosion or fire.<sup>217,218</sup> The anesthesiologist should limit the O<sub>2</sub> concentration to the minimum needed to maintain adequate oxygenation, even if the endotracheal tube is adequately wrapped and protected.

#### Use of Helium

Use of helium and O<sub>2</sub> mixtures (60%/40%) during CO<sub>2</sub> laser application has been reported to prevent ignition and fires with unwrapped polyvinyl chlo-

ride (PVC) tubes.<sup>209,219</sup> Helium has greater thermal conductivity, thermal capacity, and thermal diffusivity than does nitrogen. These properties of helium inhibit the increase in temperature around the site of laser exposure and thus prevent spontaneous ignition. Besides protecting against airway fire, helium may improve ventilation across an obstructing airway lesion because of its lower density compared with nitrogen, thereby decreasing turbulent gas flow across the stenotic area. The problem of delivering a hypoxic gas mixture of helium in certain anesthesia machines can be circumvented by using heliox, a commercially available O<sub>2</sub>-helium mixture.

### Anesthetic Management

Because of the risk of life-threatening airway obstruction during induction of anesthesia or manipulation of the airway, the anesthesiologist should carefully examine the radiologic and other studies to define precisely the site and extent of airway compromise. Good communication with the surgeon or pulmonologist is necessary to plan anesthetic (e.g., choice of endotracheal tube will depend on the size of bronchoscope and type of laser) and management strategies in case of emergencies.

Patients at risk for developing airway obstruction or those with severe pulmonary disease should be premedicated with an antisialagogue and minimal sedation only. If the patient is not at risk for airway obstruction, sedative premedications can be administered more liberally. Some ventilation techniques described in the section entitled Use of Rigid Bronchoscopy during Resection of Airway Tumors do not allow the use of capnography. In these patients, monitoring of ventilation is done by careful auscultation of breath sounds, observation of chest movements, or monitoring of arterial blood gases.

Patients with minimal or no airway obstruction can receive a routine induction of anesthesia, followed by muscle relaxation and endotracheal intubation or placement of a laryngeal mask airway. The choice of anesthetic induction technique depends on the extent of airway compromise. Patients who have major airway obstruction should maintain spontaneous ventilation during induction. Therefore, induction can be achieved with inhalational agents or by administer-



ing incremental doses of IV hypnotics and narcotics followed by the gradual introduction of inhalational anesthetics by mask. Alternatively, fiberoptic bronchoscopy can be performed in an awake sedated patient whose airway has been topically anesthetized (Table 53–13).

Local anesthesia can be used for laser resection of an airway tumor via flexible fiberoptic bronchoscopy. Adequate anesthesia can be achieved by topicalization of the mouth and oropharynx, spraying of the larynx and vocal cords with local anesthetics, superior laryngeal nerve block, or transtracheal injection of a local anesthetic. To avoid serious potential complications, adequate sedation is imperative when awake sedated anesthesia is used. This technique is not recommended for patients undergoing laser airway surgery performed with a rigid bronchoscope. The degree of discomfort is greater than that with fiberoptic bronchoscopy, and patient movement resulting in trauma and misdirection of the laser beam is more likely to occur.

### **Use of Fiberoptic Bronchoscopy during Laser Therapy**

Fiberoptic bronchoscopy for laser resection of airway tumors can be performed during local anesthesia and sedation or during general anesthesia with the fiberoptic bronchoscope introduced through the lumen of the endotracheal tube or laryngeal mask airway. The device with largest luminal diameter should be used to allow for sufficient ventilation after the fiberoptic bronchoscope is introduced. Because resistance to airflow occurs with introduction of the bronchoscope into an endotracheal tube, patients should receive either total mechanical or pressure support ventilation to overcome the resistance created by the bronchoscope. The administration of muscle relaxants is relatively contraindicated in patients with partial airway obstruction.

Hypercapnia is a common complication of transfiberoptic laser tumor resection, with  $Paco_2$  ranging from 45–60 mm Hg.<sup>212</sup> Long-acting opioids and benzodiazepines should be avoided because of prolonged postoperative somnolence and respiratory depression. Short-action inhalation anesthetics and sedatives allow for rapid emergence without postoperative respiratory depression or sedation.

**TABLE 53–13.**

**Anesthetic Guidelines for Laser Ablation**

Indication	Therapeutic (palliative of airway obstruction related to tumor)
Monitors	Standard monitors Optional (arterial)
Anesthesia	General anesthesia
Additional equipment	Anesthetic ventilator capable of blending an O <sub>2</sub> and air mixture
Ventilation	Rigid bronchoscope Single-lumen ETT (special laser tube, but may be less important when using laser way distal to the ETT)
Position	Supine
Unique considerations	Maintain $FiO_2 < 40\%$ Avoid nitrous oxide (N <sub>2</sub> O; also supports combustion)
Intraoperative complications	Hemoptysis Hemorrhage Airway fire Airway obstruction Bronchospasm Hypoxia Perforation of the tracheobronchial tree
Analgesia	Opiates
Postoperative morbidity	Hemoptysis Bronchospasm Airway edema
Postoperative care	Humidified O <sub>2</sub>
ETT, Endotracheal tube.	

### **Use of Rigid Bronchoscopy during Resection of Airway Tumors**

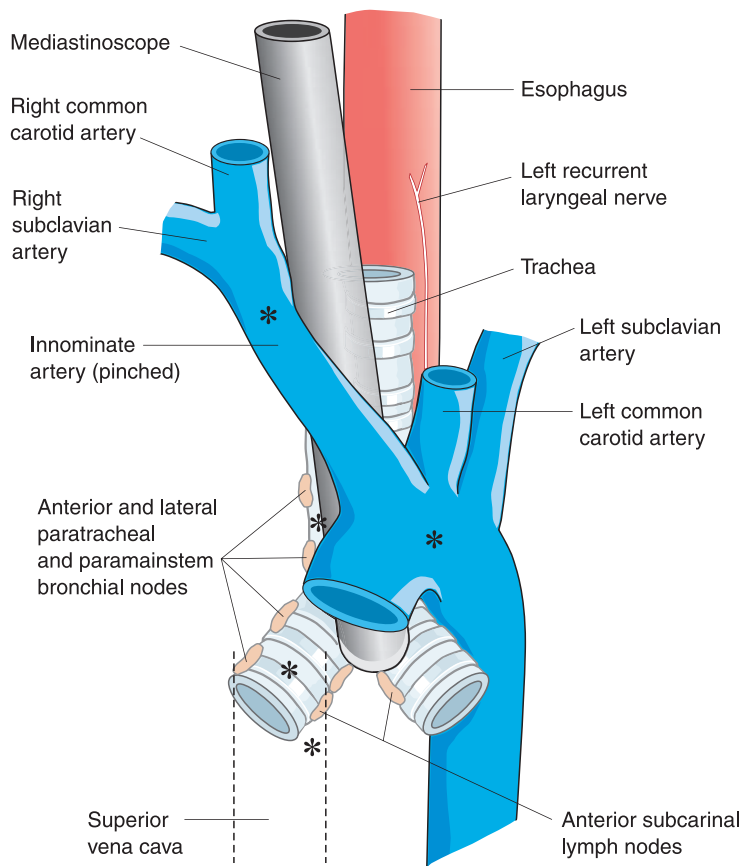
Many laser resections are performed using a rigid, open-tube bronchoscope.<sup>216</sup> It allows easy manipulation of the laser beam and provides a greater field of vision and greater access for suction catheters, removal of tumor fragments, and restoration of homeostasis. The rigid bronchoscope can be used to establish an airway. If airway obstruction occurs, the bronchoscope is advanced distally to the site of obstruction, thereby reestablishing airway patency. The absence of a combustible endotracheal tube decreases the chance of an airway fire. Although the metal bronchoscope will not burn, carbonized tissue may flare.<sup>220</sup> It is important to use the lowest O<sub>2</sub> concentration needed to maintain adequate arterial saturation. The rigid bronchoscope facilitates homeostasis because the bronchoscope can be gradually withdrawn while the endoscopist coagulates bleeding sites as they appear.

Maintenance of ventilation can be achieved using one of several techniques. Conventional intermittent positive-pressure ventilation can be main-

tained by connecting the anesthesia circuit to the ventilating side arm of the rigid bronchoscope, which allows the administration of O<sub>2</sub> and inhalation anesthetics from the anesthesia machine. If a major leak occurs around the rigid bronchoscope interfering with the adequacy of ventilation, packing the nose, mouth, and pharynx with gauze is helpful. Alternatively, anesthesia can be provided by use of IV agents to avoid exposing the surgical staff to any inhalational agents. Often, the patients are paralyzed to eliminate the risk of sudden unexpected movement. Ventilation and oxygenation may be further compromised if the rigid bronchoscope is advanced into the mainstem bronchus. Inadequate ventilation to the contralateral lung will result unless the bronchoscope has side holes that allow ventilation of the opposite lung.

### **ANESTHESIA FOR PATIENTS UNDERGOING MEDIASTINOSCOPY**

Mediastinoscopy and mediastinotomy are performed to diagnose and stage



**FIGURE 53–30.** Mediastinoscope within the mediastinum. Note the pinched innominate artery.

lung cancer to determine resectability. These procedures provide access to paratracheal, subaortic, and bronchial lymph nodes to detect metastatic spread of lung carcinomas. Lymphatics of the lung initially drain into the subaortic and paratracheal areas and then to the sides of the trachea, supraclavicular areas, and thoracic ducts. The surgical site is chosen based on likely path for regional spread of metastatic disease. Cervical mediastinal exploration (mediastinoscopy) yields a greater percentage of positive results for tumors affecting the right upper and middle lobes and, to a lesser extent, left lower lobes. Anterior mediastinotomy is recommended for patients suspected of having tumor in the left upper lobe.

Mediastinoscopy is performed in patients in the supine position with the neck extended. Access is gained through an incision in the suprasternal notch, and a tunnel is created by blunt dissection anterior and slightly lateral to the trachea into the mediastinum. The rigid mediastinoscope passes posterior to the innominate and aortic arteries down to the subcarinal

area. The mediastinoscope can injure adjacent structures (Fig. 53–30). Increased risk of complications during mediastinoscopy has been noted in patients with major collateral vascular flow and in those with abnormal or altered anatomy (Table 53–14).<sup>221</sup>

### Anesthetic Management

Preoperative assessment should include inspection for the presence of occult airway obstruction or distortion, superior vena cava outlet obstruction, evidence of paraneoplastic syndromes, and cerebral vascular disease. The standard anesthetic plan is designed to permit rapid emergence and extubation after surgical pathology confirms adequacy of the specimen. General anesthesia with mechanical ventilation is the most commonly used technique (Table 53–15). However, mediastinoscopy can be performed using local anesthesia with sedation in rare cases, that is, mediastinal masses with airway compromise. Muscle relaxants are advantageous for facilitating intubation, controlling ventilation, and preventing sudden movement or coughing that would increase the risk of surgical com-

**TABLE 53–14.**

**Complications of Mediastinoscopy from Review of 14 Mediastinoscopy Series (1968–1970)**

Complications	No. of Patients
Bleeding	
Moderate	15
Necessitating thoracotomy	4
From superior vena cava	1
From brachiocephalic artery	1
Wound hematoma	1
Vocal cord paralysis	
Left vocal cord	7
Side not given	4
Bilateral	4
Hoarseness, possible vocal cord paralysis	1
Pneumothorax	11
Pleural tear	3
Tumor seeding in incision line	1
Perforation of esophagus	1
Myocardial infarction (postoperative)	1
Bradycardia	4
Cardiac arrest (anesthetic error)	1
Wound infection	2
Left hemiparesis (transient)	1
<b>Total</b>	<b>60</b>

Foster ED, Munro DD, Dobell AR. Mediastinoscopy. A review of anatomical relationships and complications. *Ann Thorac Surg* 1972;13:273–286. This article was published in *The Annals of Thoracic Surgery*.

plications.<sup>222</sup> The negative intrathoracic pressure associated with spontaneous ventilation may increase the risk of air embolism through open venous structures. Manipulation of the mediastinoscope can compress the innominate artery, thereby decreasing arterial blood flow to the right upper extremity and the right common carotid arteries and obliterating the pulse and pressure in the right arm.<sup>223</sup> It is recommended that a noninvasive blood pressure cuff be placed on the patient's left arm and either pulse oximetry probe or an arterial catheter (if indicated) be placed in the right upper extremity. Waveform analysis of the arterial pressure or pulse oximeter plethysmograph trace can detect compression of the innominate artery.<sup>224</sup>

## Complications

The overall complication rate for mediastinoscopies ranges from 1.5–3%.<sup>221,225–227</sup> Appreciation for the surgical risks associated with mediastinoscopy comes from an understanding of the anatomy relevant to the procedure. The most common and potentially serious complications are bleeding, cardiac tamponade, and air embolism. Compromise of other structures, such as the trachea, bronchi, esophagus, laryngeal nerve, and innominate artery, can lead to temporary or permanent complications. Hemorrhage can result from laceration of a PA or a thoracic aortic artery.<sup>227</sup> Therefore, a large-bore IV access catheter should be placed before induction of anesthesia. Clinical situations that increase collateral vascular flow, such as superior vena cava syndrome or aortic coarctation, predispose to bleeding and are relative contraindications to the procedure. Hemorrhage may be temporarily controlled by packing the surgical wound. Immediate thoracotomy may be required to control bleeding. In patients with superior vena cava obstruction, IV access should be secured in the lower extremity to avoid distending the thoracic venous vasculature and increasing the risk of bleeding.

Laceration of venous structures in the mediastinum increases the risk of air embolism.<sup>228</sup> Air embolism is associated with a sudden decrease in end-tidal CO<sub>2</sub>, relative hypotension, tachycardia, and a change in heart sounds heard through an esophageal stethoscope or by precordial Doppler monitor.

Compression of the vertebral arteries from hyperextension of the cervical spine or compression of the innominate artery that feeds the right common carotid artery can cause central nervous system (CNS) complications.<sup>224,229,230</sup> One study documented transient decreases in blood flow for periods ranging from 15–35 seconds in four of seven patients.<sup>229</sup> However, the clinical significance of such transient effects is unknown.

Tracheal laceration can lead to mediastinal emphysema and loss of effective ventilation. If tracheal laceration is suspected, fiberoptic bronchoscopy should be used to define the site and to guide advancement of the endotracheal tube beyond the laceration. Tracheomalacia resulting from longstanding compression of the trachea by mediastinal tumor can predispose to acute tracheal injury or collapse.

TABLE 53–15.

Anesthetic Guidelines for Mediastinoscopy and Mediastinotomy

Indication	Diagnostic (biopsy mass, lymph nodes)
Monitors	Standard monitors, optional (arterial catheter)
Anesthesia	General anesthesia
Additional equipment	Shoulder roll
Ventilation	Single-lumen endotracheal tube
Position	Supine with cervical extension
Incision	Mediastinoscopy (suprasternal) Mediastinotomy
Unique considerations	To avoid artifact induced by innominate artery compression, place noninvasive blood pressure cuff on left To detect innominate artery compression, place pulse oximeter on right hand
Intraoperative complications	Dysrhythmia Asthma Hemorrhage Pneumothorax Recurrent laryngeal nerve injury Respiratory compromise Air embolism Perforation esophagus or bronchus Neurologic event (compression innominate artery or hyperextension of the neck)
Blood loss	Usually minimal
Postoperative analgesia	Parenteral opiates
Postoperative morbidity	Pneumothorax Hemoptysis Respiratory distress (vocal cord paralysis)
Postoperative care	Chest radiography Elevate head of bed to decrease edema and improve respiratory function

Pneumothorax is the second most common complication of mediastinoscopy. It may be unilateral or bilateral. Use of positive-pressure ventilation can rapidly increase pneumothorax size, causing hemodynamic compromise. It should be suspected if the patient exhibits an increase in peak airway pressures, hypotension, dysrhythmias, deviation of the trachea, or unilateral absence of breath sounds. If time permits, a chest radiograph can be obtained to confirm the diagnosis. If the patient exhibits hemodynamic instability, rapid placement of a chest tube is indicated.

## Postoperative Concerns

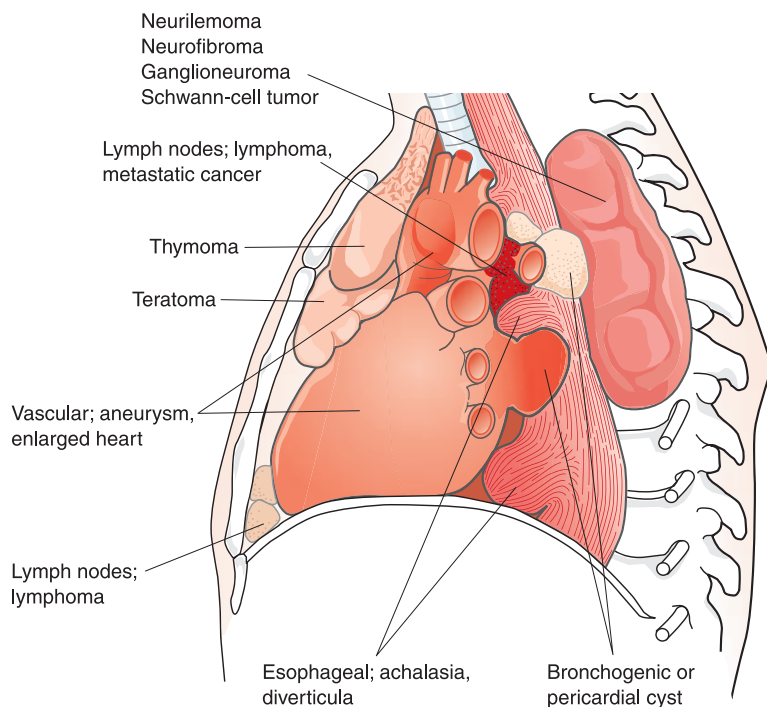
Dyspnea and respiratory difficulty may occur in the initial postoperative period. Intraoperative bleeding or edema can cause compression of the airway, especially in patients with tracheomalacia.<sup>226</sup> Raising the head of the bed improves ventilatory mechanics, facilitates venous return, and decreases edema. Damage to the recurrent

laryngeal nerve during mediastinoscopy does not become evident until after extubation. If injury to the recurrent laryngeal is suspected, the vocal cords should be visualized during extubation with the patient breathing spontaneously. Unilateral nerve damage without airway obstruction is managed conservatively.<sup>228,231</sup> Bilateral nerve injury requires reintubation to prevent airway obstruction. Laryngeal nerve injury during these conditions is permanent in 50% of patients.<sup>232</sup>

## ANESTHESIA FOR PATIENTS WITH MEDIASTINAL MASSES

Patients with mediastinal masses may experience significant complications during general anesthesia.

The mediastinum is divided into the superior, anterior, middle, and posterior mediastina. The most common tumors in the anterior mediastinum are thymomas, mesenchymal tumors, dermoid cysts, thyroid and parathyroid



**FIGURE 53–31.** Anatomic location of commonly encountered mediastinal masses. (Modified from Netter FH. The CIBA Collection of Medical Illustrations, vol 7. Summit, NJ: CIBA, 1979, pg. 23, with permission.)

tumors, and lymphomas (Fig. 53–31 and Table 53–16). In the middle and posterior mediastinum, tumor pathologies include pericardial cysts, bronchogenic cysts, lymphomas, neurogenic tumors, and aortic aneurysms.

### Signs and Symptoms

The mechanisms postulated for the clinical symptoms of respiratory and cardiovascular compromise in awake patients (Table 53–17) include (1) pro-

gressive airway obstruction caused by compression of the distal trachea or bronchi, (2) loss of lung volume, (3) compression of the PA or the heart, (4) superior vena caval obstruction, (5) involvement of the important nervous system elements in the mediastinum (e.g., recurrent laryngeal nerves, sympathetic chain), and (6) spinal cord compression from intraspinal extension of neurogenic tumors of the posterior mediastinum.

The incidence of perioperative complications generally is related to the size of the mediastinal mass and to the extent of disease within the thoracic cavity.<sup>233</sup> In one large series, clinical manifestations included (1) cough and pain, 40% each; (2) weight loss and fever, 24% each; (3) dyspnea and dysphagia, 20% each; (4) superior vena caval obstructions, 16%; (5) tracheal deviation, 12%; (6) Horner syndrome, 7%; (7) spinal cord compression, 5%; and (8) cyanosis, mediastinal widening, and hoarseness, 3% each. Twenty percent of patients were asymptomatic. Not all patients with mediastinal masses who have acute life-threatening airway complications during anesthesia are symptomatic preoperatively. Some are asymptomatic and show no airway compression on chest radiographs. Therefore, the severity of the patient's preoperative respiratory symptoms may be unrelated to the extent of respiratory or cardiovascular compromise encountered during anesthesia.<sup>233–235</sup>

### Diagnostic Evaluation

Careful preoperative diagnostic evaluation should be performed, even in the asymptomatic patient, to determine the extent of mediastinal pathology. A flow chart showing the preoperative evaluation of patients with mediastinal masses is shown in Fig. 53–32. Most patients with mediastinal masses require scans to delineate tumor size and location. The anesthesiologist should evaluate the extent of compression of the airway, heart, and vascular

**TABLE 53–16.**

#### Mediastinal Mass Location

Superior	Anterior	Middle	Posterior
<b>Children</b>			
Lymphoma	Lymphoma	Lymphoma	Neurogenic tumors
Thymoma	Teratoma	Tuberculous nodes	Esophageal duplication cysts
Retrosternal thyroid	Cystic hygroma		Diaphragmatic hernia (Bochdalek)
Parathyroid tumor	Thymoma		
	Pericardial cysts		
	Diaphragmatic hernia (Morgagni)		
<b>Adults</b>			
Lymphoma	Lymphoma	Lymphoma	Neurogenic tumors
Thymoma	Metastatic carcinoma	Metastatic carcinoma	Lymphoma
Retrosternal thyroid	Teratoma	Teratoma	Hernia (Bochdalek)
Metastatic carcinoma	Bronchogenic cyst	Bronchogenic cyst	Aortic aneurysm
Parathyroid tumors	Aortic aneurysm	Aortic aneurysm	
Zenker diverticulum	Pericardial cyst	Pericardial cyst	
Aortic aneurysm			



TABLE 53-17.

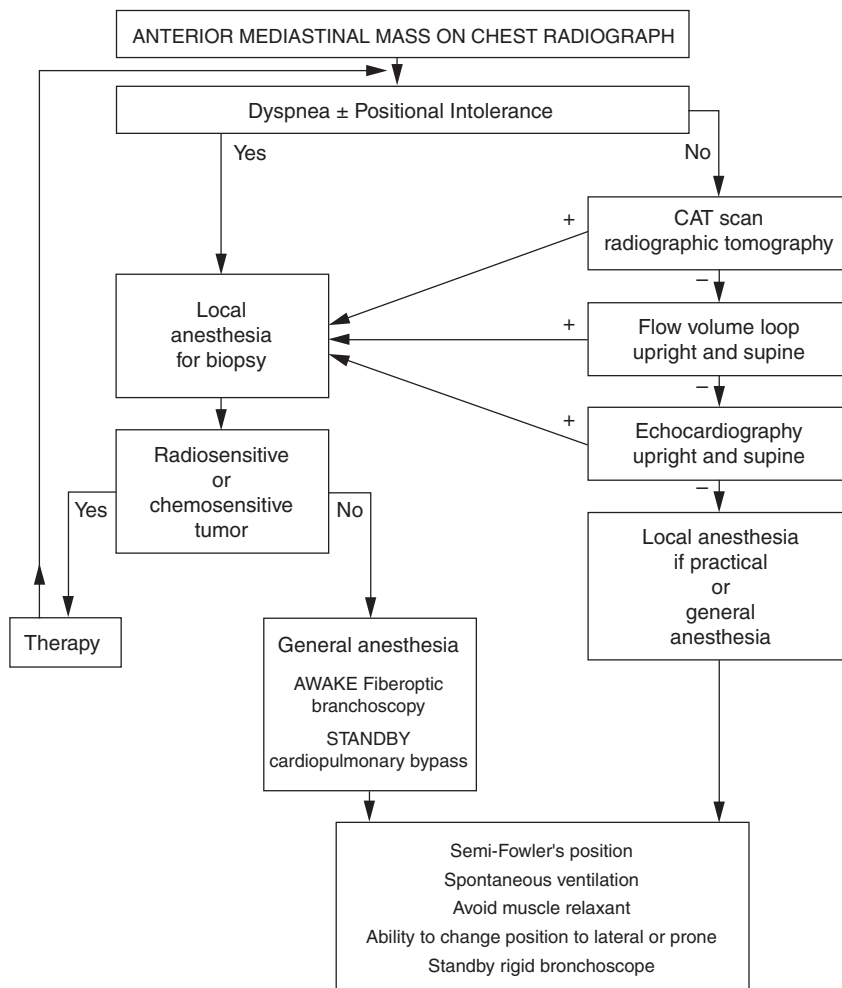
## Clinical Findings in Patients with Mediastinal Masses

History	Physical Examination	Laboratory
<b>Airway</b>		
Cough	Decreased breath sounds	Chest radiograph (posteroanterior and lateral to look for tracheal deviation or compression)
Cyanosis	Wheezing	Flow-volume loops, supine and sitting
Dyspnea	Stridor	
Orthopnea	Cyanosis	
<b>Cardiovascular</b>		
Fatigue	Neck or facial edema	Chest radiographic changes in cardiac silhouette
Faintness	Jugular distension	Echocardiogram, supine and sitting
Headache	Papilledema	
Shortness of breath, orthopnea	Blood pressure changes or pallor with postural changes	
Cough	Pulsus paradoxus	

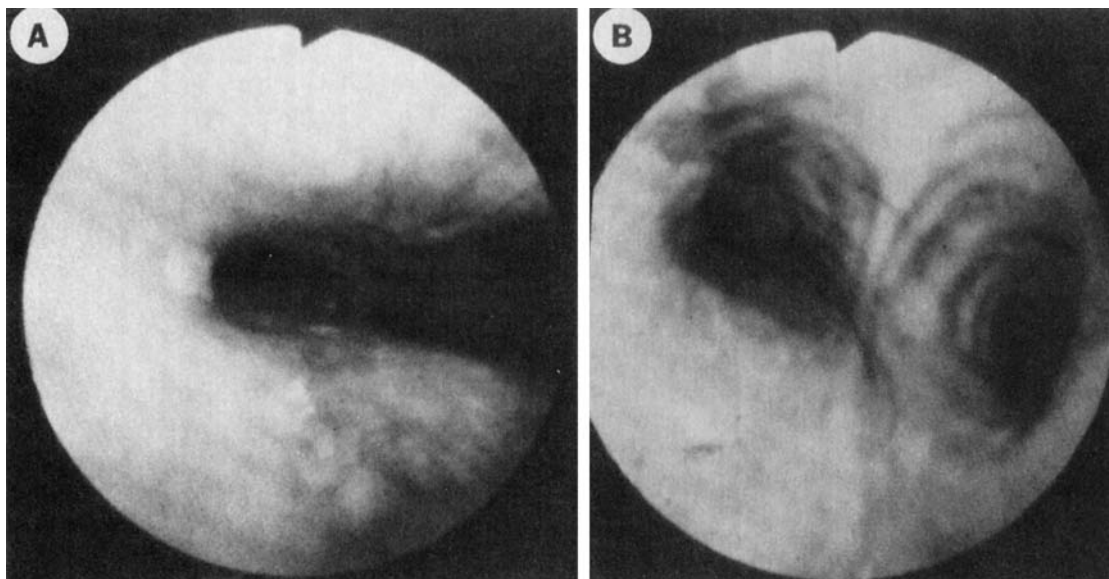
structures preoperatively.<sup>236,237</sup> The extent of tracheal compression is a reliable predictor of whether difficulty with the airway may be expected. In one series, all patients who developed total or near-total airway obstruction during induction or emergence from anesthesia had a >50% decrease in tracheal cross-sectional area as measured by CT scan.<sup>238</sup>

In addition to the chest radiograph and CT scan, a series of noninvasive studies can be performed to evaluate the risk of occult airway or cardiac involvement. Upright and supine flow-volume loops are simple, noninvasive, sensitive studies for the diagnosis of occult airway obstruction. The dynamic nature of this study makes it an extremely sensitive tool for evaluating obstructive lesions of major airways. The inspiratory limb of the flow-volume loop is useful in diagnosing extrathoracic airway obstruction, whereas the expiratory limb is sensitive to intrathoracic airway obstruction. Maximal inspiratory and expiratory flow-volume loops obtained with the patient in the upright and supine positions enable quantitation of the extent of functional impairment and help distinguish fixed from variable intrathoracic airway obstruction.<sup>239</sup> A disproportionate reduction in maximal expiratory flow should alert the physician to the presence of tracheomalacia and the inherent risk of airway collapse after extubation of the trachea. In addition, echocardiography in the upright and supine positions can reveal encroachment of tumor on the heart and intrathoracic vessels. Flexible fiberoptic bronchoscopy is another method for evaluating dynamic airway obstruction (Fig. 53-33). It allows assessment of the functional anatomy of the entire airway and the response of the airway to variations in intrathoracic pressure and position.

Pretreatment with radiotherapy or chemotherapy to reduce the tumor size decreases the risk of perioperative complications. Several investigators have suggested that patients receive empiric treatment of mediastinal pathology for the presumed diagnosis.<sup>240</sup> Dramatic decrease in postoperative respiratory complications and improvement in risk category were achieved by preoperative radiation therapy for patients with severe clinical or radiologic findings.<sup>241</sup> Such views are controversial, and most clinicians advocate obtaining a biopsy



**FIGURE 53-32.** Flowchart showing the preoperative evaluation of the patient with an anterior mediastinal mass. +, Positive finding; -, negative workup. (From Neuman GG, Weingarten AE, Abramowitz RM, et al. The anesthetic management of the patient with an anterior mediastinal mass. *Anesthesiology* 1984;60:144, with permission.)



**FIGURE 53–33.** Fiberoptic bronchoscopic appearance of lower trachea with patient in supine position (**A**), exhibiting almost total obstruction of trachea in anteroposterior plane. With patient in sitting position (**B**), the lumen appears normal. (From Prakash UBS, Abel MD, Hubmayr RD. Mediastinal mass and tracheal obstruction during general anesthesia. *Mayo Clin Proc* 1988;63:1004, with permission.)

before initiating therapy, even if this procedure requires administration of general anesthesia with its inherent risks. An accurate pathologic diagnosis may be compromised if patients are empirically pretreated. In addition, the option of administering radiotherapy or chemotherapy to reduce the size of the mediastinal mass is not applicable to all patients. Some patients have large, benign mediastinal masses, such as large dermoid cysts that cannot be managed except by surgical excision. Transcarinal aspiration of a large cystic subcarinal mass can be performed through a fiberoptic bronchoscope. This technique can be used preoperatively in patients who have cystic subcarinal masses to decrease the size of the mass before anesthetic induction. This technique has been reported to facilitate anesthetic management intraoperatively when a patient developed airway obstruction after induction of anesthesia.<sup>242</sup>

### Anesthetic Implications and Management

Symptomatic and asymptomatic patients are at risk for developing severe, life-threatening complications after induction of general anesthesia (Table 53–18). Infants and small children may have obstructive symptoms earlier than adults do because their small airway size increases the magnitude of airway resistance produced by decreases in airway dimensions. To avoid the risk of complications inherent with

**TABLE 53–18.**

#### Anesthetic Guidelines for Mediastinal Mass

Indication	Biopsy or resection of mediastinal mass
Monitors	Standard monitors, arterial catheter
Anesthesia	Preferably awake, sedated using local anesthesia If general anesthesia is necessary, spontaneous ventilations should be maintained <sup>a</sup>
Additional equipment	Fiberoptic and rigid bronchoscope Multiple-sized endotracheal tube Standby of cardiopulmonary bypass or extracorporeal membrane oxygenation
Ventilation	Spontaneous ventilation preferred Intubation does not guarantee a secure patent airway Use of flexible bronchoscope to evaluate and intubate airway
Position	As tolerated by patient (sitting, semirecumbent, or supine)
Incision	Depends on location and size of tumor Surgical options include biopsy during local anesthesia, mediastinoscopy, mediastinotomy, median sternotomy
Unique considerations	Inability to ventilate Risk of cardiovascular collapse Superior vena cava syndrome (increased risk of airway edema, bleeding, placement of IV access in lower extremity) Avoid use of muscle relaxants Maintenance of spontaneous ventilation
Intraoperative complications	Hypoxia Bleeding Hypotension Obstruction of airway
Postoperative morbidity	Airway edema, inability to extubate
Postoperative care	Monitor in intensive care environment
<sup>a</sup> Until one can demonstrate that controlled ventilation does not cause airway obstruction or cardiovascular instability.	

general anesthesia, alternate diagnostic techniques can be used. Alternative methods that can be performed in awake, sedated patients include percutaneous needle aspiration of the hilum and mediastinum, mediastinotomy, and thoracoscopy.<sup>243</sup>

When the surgical procedure requires general anesthesia, the anesthesiologist and surgeon should discuss the plan and confirm availability of equipment for emergency airway management (e.g., fiberoptic and rigid bronchoscopes). Difficulties may occur during induction when the patient position is changed, when positive pressure is applied, after administration of muscle relaxants, after intubation, during emergence, or after extubation. The patient should undergo a slow controlled inhalational induction, with a staged approach that confirms an adequate airway before progressing. Induction may begin in a semirecumbent or seated position and progress to the supine position. After a deep anesthetic plane has been achieved, the anesthesiologist should attempt to gradually control ventilation. If wheezing or stridor ensues, the patient should be returned to spontaneous ventilation. If muscle relaxation is required to facilitate tracheal intubation, an ultrashort-acting relaxant such as succinylcholine should be used. The anesthetic technique should include the use of short-acting agents and avoidance of bolus administration of large doses of drugs. Intubation does not eliminate the risk of complications. Obstruction may even occur distal to a properly placed endotracheal tube and interfere with the normal protective glottic mechanism of physiologic PEEP that increases the tracheal distending pressure and reduces the possibility of dynamic collapse. Dynamic collapse of a tracheal segment also may occur with rapid respirations or cough during awakening from anesthesia.

### **Compression of the Tracheobronchial Tree**

Neither the presence nor the severity of the patient's preoperative respiratory symptoms reliably predicts the extent of respiratory compromise that could be encountered during anesthesia, although most patients with severe respiratory symptoms have significant decreases in tracheal cross-sectional area.<sup>238</sup> The supine position, anesthesia, and muscle paralysis are associated with decreased dimensions of the rib cage, cephalad displacement of the

dome of the diaphragm, and a reduction in thoracic volume limiting the space available for the trachea.<sup>244-247</sup> At low lung volumes, the decreased tracheal distending pressure can lead to tracheal collapse, particularly with tracheomalacia. Spontaneous ventilation is preferred to positive-pressure ventilation because the negative intrapleural pressure of spontaneous ventilation exerts a distending force that opposes bronchial and tracheal collapse. The supine position increases the central blood volume, which can further increase tumor volume and size. Edema, bleeding, and hematoma formation in the tumor as a result of surgical biopsy can contribute to airway compromise.

### **Compression of PA and Heart**

Compression of the main PA is relatively rare, partly because of the protective effect of the aorta. Compression of the pulmonary trunk or one of the main pulmonary arteries can result in sudden hypoxemia, hypotension, and cardiac arrest. Syncope during forced Valsalva maneuvers, such as occurs with a bowel movement, should alert the physician to the possibility of cardiovascular compression. Important factors contributing to a reduction in right ventricular output, hypotension, and severe hypoxemia include patient position, induction of anesthesia, and gravitational effects of the tumor on the heart and PA.

### **Superior Vena Cava Syndrome Pathophysiology**

Superior vena cava syndrome occurs in approximately 6-7% of patients with lung carcinoma. Other causes are bronchial carcinoma, malignant lymphoma, and benign conditions, including multinodular goiter, mediastinal granulomas, idiopathic mediastinal fibrosis, and catheter-induced thrombosis of the superior vena cava.<sup>24</sup> Obstruction of the superior vena cava impedes venous flow from the head and upper extremities. Clinical features are listed in Box 53-9. The symptoms of dyspnea, dysphasia, and stridor may be associated with ruddy complexion and dilated veins across the upper chest and neck (Fig. 53-34). The severity of clinical manifestations depends on the rate at which the superior vena cava is occluded. Slow gradual obstruction is associated with mild signs and symptoms, whereas more severe symptoms occur with rapid onset of obstruction. The severity also

#### **BOX 53-9.**

#### **Clinical Features of Superior Vena Cava Syndrome**

##### **Neurologic**

Headache, dizziness, decreased mentation, visual changes, restlessness, agitation, Horner syndrome, stupor, convulsions

##### **Pathophysiology**

Low cardiac output, decreased cerebral perfusion, increased cerebral venous pressure, cerebral edema

##### **Respiratory**

Shortness of breath, cough, hoarseness, hypoxemia, tachypnea, stridor

##### **Pathophysiology**

Upper airway edema, tracheal obstruction, vocal cord paralysis

##### **Cardiac**

Tachycardia; thoracic and cervical venous distension; plethoric face; edema of the face, neck, upper extremities, and trunk; cyanosis; distended veins over chest wall

##### **Pathophysiology**

Decreased venous return, development of collateral venous circulation, increased peripheral venous circulation, increased peripheral venous pressure, as high as 40 mm Hg

##### **Gastrointestinal**

Nausea, vomiting, dysphagia

##### **Pathophysiology**

Fluid imbalance, upper airway edema

##### **Renal**

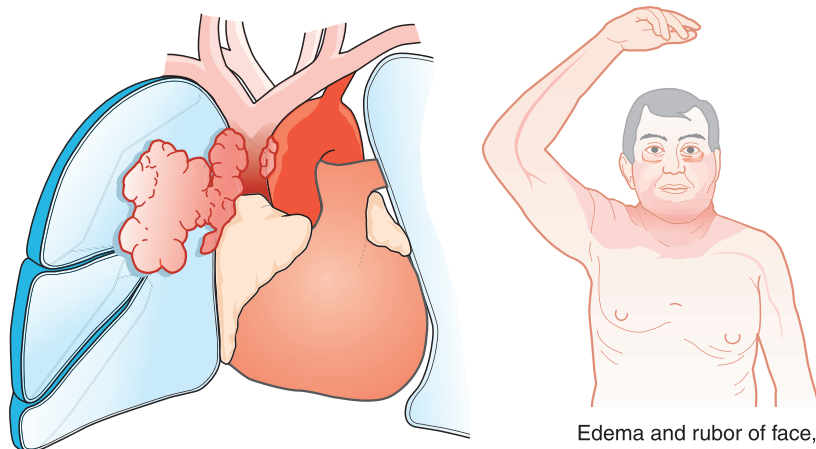
Decreased urine output

##### **Pathophysiology**

Low cardiac output

depends on the extent of obstruction, site of obstruction (above or below the azygos vein), and integrity of the azygos venous system. Occlusion of the azygos venous system often is symptomatic and may require surgery to bypass the spinal vein and to resect the obstructing lesion.

Choice of therapy depends on etiology. Therapeutic options include radiation, chemotherapy, and thrombectomy. Once obstruction has produced complete thrombosis, thrombectomy is of little benefit. Patients having total or near-total obstruction are at risk for cerebral vascular and airway compromise, both predictors of poor outcome. A tissue diagnosis should be obtained before institution of therapy, if possi-



Edema and rubor of face, neck, and upper chest; arm veins fail to empty on elevation

**FIGURE 53-34.** Bronchogenic carcinoma producing superior vena cava obstruction. Superior vena cava syndrome is characterized by edema and rubor of the face, neck, and upper chest. Arm veins fail to empty on elevation. (Modified from Netter FH. The CIBA Collection of Medical Illustrations, vol 7. Summit, NJ: CIBA, 1979, pg. 28, with permission.)

ble. In most patients this can be achieved noninvasively by bronchoscopy or lymph node biopsy. Occasionally, an open procedure requiring general anesthesia is necessary. MRI and contrast venography are used to define the type and location of obstruction. If biopsy of the mediastinal mass is required, an open mediastinotomy should be performed instead of mediastinoscopy because the increased venous pressure increases the risk of bleeding during cervical exploration.

### Anesthetic Management

Patients with superior vena cava syndrome are at increased risk for airway compromise resulting from acute laryngospasm, bronchospasm, and airway edema caused by tumor edema or surgical manipulation.<sup>248</sup> Venous distension and symptoms are exacerbated by changes in positioning (supine or Trendelenburg) and by administration of IV fluids, especially through a catheter placed in the upper extremity. All venous access should be placed in the lower extremity, and an arterial catheter should be placed to monitor blood gases and blood pressure. Venous congestion increases the risk of airway compromise, bleeding, and hypotensive episodes. Preoperative evaluation should include careful assessment of the airway. Edema of the oral pharynx, larynx, and trachea may be more severe than the external edema and swelling of the face and neck. Venous engorgement and tumor may involve the recurrent laryngeal nerve and cause external compression of the air-

way. These patients should be regarded in a manner similar to those with mediastinal masses. Premedication should be limited to administration of an antisialagogue, and patients should be transported in a semiseated position to decrease airway edema and facilitate venous drainage. If major airway edema is present, general anesthesia should be induced in a sitting position, and fiberoptic bronchoscopy may be required for airway access. Intraoperative management may be complicated by an abnormal response to muscle relaxants related to a paraneoplastic myasthenic syndrome.<sup>249</sup> Many of these patients remain intubated postoperatively until edema of the airways and laryngeal structures decreases.

### ANESTHESIA FOR PATIENTS WITH THORACIC OUTLET SYNDROME

Thoracic outlet syndrome refers to neurologic and vascular symptoms affecting the upper extremity resulting from compression of the neurovascular bundle at the thoracic outlet between the first rib and the clavicle or between the anterior scalene muscle and the medial scalene muscle.<sup>78,250-253</sup> The etiology is classified as either noncancerous or cancerous.

The majority of noncancerous causes are related to either trauma or the presence of a cervical rib. A less frequent etiology is hypertrophy of the scalene and subclavian muscles. Clini-

cal manifestations usually are vague and obscure and may be misinterpreted as angina. Pain may be localized to the shoulder or extend along the medial aspect of the arm and forearm, along the proximal shoulder girdle, or to the neck and face. Symptoms may include weakness, numbness, and paresthesias. Conservative management includes rehabilitation exercises, antiinflammatory drugs, and analgesics. In those with vascular insufficiency or with symptoms refractory to medical therapy, operation may be indicated. Surgical approaches include resection of the first rib, partial resection of the scalene muscles, and removal of anomalous fibromuscular bands.

The presentation of lung cancer with symptoms of thoracic outlet syndrome is known as *Pancoast syndrome*. The most common etiology is a bronchogenic carcinoma originating in or near the superior pulmonary sulcus. These tumors invade the lymphatic system and spread by direct extension to entwine the brachial plexus intercostal arteries, stellate ganglia, and sympathetic chain, thereby producing Horner syndrome. If the tumor is considered resectable, the pulmonary tumor and extension into the chest wall and brachial plexus should be excised.

Anesthetic management includes the use of routine monitoring and may require one-lung isolation (Table 53-19). The patient is placed in the lateral decubitus position, and an incision is made in the lower margin of the anterior axilla. Intraoperative complications include hemorrhage, pneumothorax, brachial nerve injury with resulting nerve dysfunction, temporary phrenic nerve palsy, injury to the subclavian artery, and cervical sympathectomy on the ipsilateral side. Because of the position of the nondependent arm and the site of surgery, stretch and surgical trauma to the brachial plexus are major risks.

### ANESTHESIA FOR PATIENTS UNDERGOING THYMECTOMY: MYASTHENIA GRAVIS

#### Clinical Features

The thymus is a central lymphoid gland that functions in the development and maintenance of immunologic competence. Surgical resection of the thymus most often is performed for myasthenia gravis and less often



TABLE 53–19.

## Anesthetic Guidelines for Thoracic Outlet Syndrome

Indication	Therapeutic (syndrome characterized by lateral upper extremity weakness, numbness, paresthesias, pain)
Monitors	Standard monitors Noninvasive cuff on opposite side Ipsilateral pulse oximetry
Anesthesia	General anesthesia
Ventilation	Single-lumen or double-lumen endotracheal tube
Position	Supine or lateral decubitus position, determined by surgical approach
Incision	Cervical region (partial resection of first rib) Scalene muscles
Unique considerations	Intravenous access on opposite side
Intraoperative complications	Pneumothorax Pleural effusion Vascular injury Neural injury Cervical sympathectomy
Blood loss	Minimal <500 mL
Postoperative analgesia	Parenteral opiates
Postoperative morbidity	Temporary phrenic nerve palsy Pneumothorax Brachial plexus neuralgia or palsy Injury to long thoracic nerve and T1 roots
Postoperative care	Chest radiography

for primary neoplasm, carcinoid tumor, and multiple endocrine neoplasm syndrome. Seventy-five percent of the patients with myasthenia gravis have associated thymic hyperplasia or thymomas (Table 53–20).

Therapy for myasthenia gravis includes anticholinesterase drugs, corticosteroids, other immunosuppressants, plasmapheresis, and thymectomy. These therapies can be used individually or in combination. Anticholinesterase drugs, such as neostigmine or pyridostigmine, most often are selected because they provide immediate symp-

tomatic relief. These drugs inhibit the enzyme responsible for hydrolysis of acetylcholine and thereby increase the concentration of neurotransmitter at the neuromuscular junction. Surgical resection of the thymus gland may result in complete remission or dramatic improvement in symptoms.<sup>254</sup>

### Anesthetic Considerations

Management of anesthesia for patients with myasthenia gravis should consider the severity of symptoms, presence of other associated disorders (Box 53–10), and preoperative drug therapy. Consid-

BOX 53–10.

## Disorders Associated with Myasthenia Gravis

Thyroid disease
Hyperthyroidism
Hypothyroidism
Thyroiditis
Thymoma
Pernicious anemia
Multiple sclerosis
Ulcerative colitis
Leukemia
Lymphoma
Autoimmune disorders
Systemic lupus erythematosus
Idiopathic thrombocytopenic purpura
Rheumatoid arthritis
Scleroderma
Polymyositis
Sjögren syndrome

erations for the perioperative period are given in Table 53–21. An assessment of preoperative pulmonary function should be obtained as a baseline for comparison. The patient's preoperative medications should be reviewed for drugs that could interfere with neuromuscular function (Box 53–11). Drugs that have the potential to exacerbate muscle weakness in these patients include calcium channel blockers, aminoglycosides, and antiarrhythmic agents.<sup>255–257</sup> Most authors recommend that patients continue their usual dose of anticholinesterase therapy the night before surgery. On the day of operation, patients who are severely symptomatic should receive a full morning dose. Patients who are only mildly affected should receive half a dose or none at all. The rationale for withholding the morning dose is to prevent antagonism of muscle relaxants that may be used to facilitate tracheal intubation. Patients receiving systemic steroids should continue steroid supplementation on the day of surgery.

Special attention should be given to the psychological preparation of these patients. They should be told about the increased risk for prolonged muscle weakness and respiratory depression that uncommonly require temporary postoperative ventilation.

We believe all patients undergoing thymectomy require general anesthesia regardless of the surgical approach. In patients undergoing a transmediastinal approach, use of an epidural block

TABLE 53–20.

## Clinical Classification of Myasthenia Gravis

Stage	Term	Description
I	Ocular myasthenia	Involvement of ocular muscles only; mild symptoms of ptosis and diplopia
II	Mild-to-moderate generalized myasthenia	Slow onset; usually ocular, spreading to skeletal and bulbar muscles; no respiratory involvement; good response to drug
III	Acute fulminating myasthenia	Rapid onset of severe bulbar and skeletal weakness with involvement of respiratory muscles; poor response to therapy
IV	Late severe myasthenia	Severe disease developing 2 years after onset of stage I or II symptoms; poor response to therapy and poor prognosis

TABLE 53–21.

## Anesthetic Guidelines for Thymectomy: Myasthenia Gravis

Indication	Therapeutic (myasthenia gravis, thymoma, multiple endocrine neoplasm syndrome)
Monitors	Standard monitors
Anesthesia	General anesthesia
Preoperative considerations	Review use of anticholinesterase medications Evaluate strength Assess respiratory function
Ventilation	Usually single-lumen ETT Double-lumen ETT if by video-assisted thoracoscopic surgery
Position	Supine with shoulder roll Occasionally by left lateral decubitus (thoracoscopy)
Incision	Sternotomy, transcervical Portals for video-assisted thoracoscopic surgery
Unique considerations	Myasthenia gravis (increased sensitivity to muscle relaxants, risk of remaining intubated postoperatively, avoid neuromuscular blocking effects of antiarrhythmics, diuretics, and aminoglycosides)
Intraoperative complications	Myasthenia gravis (residual weakness or sedation leading to inability to extubate)
Blood loss	Minimal
Postoperative analgesia	Parenteral opiates, epidural
Postoperative morbidity	Respiratory insufficiency (inadequate reversal of muscle relaxants, excessive sedation, not received daily dose of anticholinesterase)
Postoperative care	Chest radiography Optimize respiratory function (analgesics, raise head of bed) Observe in monitored environment

ETT, Endotracheal tube.

as an adjunct to general anesthesia has been found to decrease the intraoperative minimum alveolar concentration (MAC), lessen postoperative analgesic requirements, improve respiratory mechanics, and dramatically decrease the frequency of prolonged intubation.<sup>258</sup> Use of a muscle relaxant is not required but may facilitate tracheal intubation. Patients with myasthenia gravis have a marked sensitivity to nondepolarizing muscle relaxants, increasing their sensitivity and duration of action. If muscle relaxation is required, a small dose of a short-acting nondepolarizing drug, such as cisatracurium, should be used. Although muscle relaxation usually is less sensitive to succinylcholine in patients receiving anticholinergic therapy, the duration of action of the drug may be extended. If succinylcholine is to be used, the dose should be reduced to avoid prolongation of the response and associated phase II block.<sup>258–261</sup> Halogenated inhaled anesthetics have muscle-relaxing properties. One study found that patients with myasthenia

gravis were more sensitive to the neuromuscular depressant effects of isoflurane.<sup>262</sup> Recovery of the electromyographic response still was incomplete 1 hour after terminating isoflurane, despite satisfactory clinical recovery.

The most common surgical approaches are the transcervical and transsternal approaches; a minority of cases are performed by thoracotomy or VATS. The transcervical approach has the advantage of avoiding the immediate postoperative alterations in pulmonary mechanics.<sup>263–265</sup> Mediastinotomy may be necessary when resecting a hypertrophied thymus that extends substernally. If mediastinotomy or the cervical approach is to be used, a single-lumen tube is appropriate. Alternatively, a double-lumen endotracheal tube or bronchial blocker is indicated if lateral thoracotomy is planned.

### Postoperative Concerns

Improvement in myasthenic symptoms after thymectomy may take weeks to months. Therefore, the pa-

BOX 53–11.

#### Drugs That Can Exacerbate Myasthenia Gravis

Acetylcholinesterase in high doses  
Aminoglycosides  
Other antibiotics (e.g., clindamycin, colistin, polymyxin B, tetracycline, trimethaphan)  
Antidysrhythmics (e.g., procainamide, quinidine, propranolol, lidocaine)  
Thyroid hormones  
Quinine (tonic water)  
Lithium  
Phenytoin (Dilantin)  
Oxytocin  
Chlorpromazine  
Chloroquine

tient should receive any missed dose of anticholinesterase from the morning of operation. At the end of the operation, neuromuscular transmission is assessed using a nerve stimulator; nondepolarizing muscle relaxants are reversed. Residual weakness from an inhaled anesthetic can cause fade in the response to tetanic stimulation. Suitability for extubation is judged by measuring the patient's pulmonary function and comparing the results with preoperative values. Negative inspiratory force, tidal volume, and vital capacity should be measured immediately before induction and used as the basis for comparison. To improve respiratory mechanics, the patient is placed in a semirecumbent position with the head of the bed raised approximately 30°, is suctioned for secretions, and receives adequate analgesia without inducing respiratory depression. The patient should be monitored closely for 18–24 hours after operation. A chest radiograph is obtained immediately postoperatively to rule out the presence of a pneumothorax.

### ANESTHESIA FOR PATIENTS UNDERGOING TRACHEAL RESECTION AND TRACHEOBRONCHIAL RECONSTRUCTION

Indications for tracheal resection include the following:

- Tracheal tumors, most of which are malignant
- Carinal tumors or carinal involvement with a bronchogenic carcinoma

- Tracheal involvement with a thyroid carcinoma
- Traumatic disruption of the trachea and bronchi, which may occur as a result of blunt trauma, penetrating injuries, iatrogenic manipulations, and aspirated sharp foreign bodies
- Tracheal stenosis after prolonged intubation or trauma

Patients undergoing surgical resection of the trachea, main bronchi, or both impose special anesthetic management problems. The surgical procedure often is prolonged, and episodes of ventilatory insufficiency may be unavoidable. Communication between the anesthesia and surgical teams, with emphasis on the ventilatory treatment of the patient during each phase of the procedure, is imperative. The most challenging aspect of these procedures is designing an effective method for ventilating the lungs during the resection and reconstruction of the airway that does not interfere with surgical exposure and that provides adequate ventilation and oxygenation. Patients with large intratracheal or carinal masses may develop total airway obstruction upon induction of anesthesia. Fortunately, many of these patients undergo laser debulking procedures before surgical resection. Because an inflated cuff and positive-pressure ventilation adjacent to the suture line may interfere with healing or cause disruption of the anastomosis, after the procedure the patient should breathe spontaneously and be extubated in the operating room or shortly thereafter.

Surgical techniques include resection and primary anastomosis, resection, and reconstruction with prosthetic material or with insertion of a T-tube stent.

Therapeutic adjuncts include radiotherapy (preoperatively or postoperatively), radioactive seed implantation, and preoperative laser debulking.

### Surgical Considerations

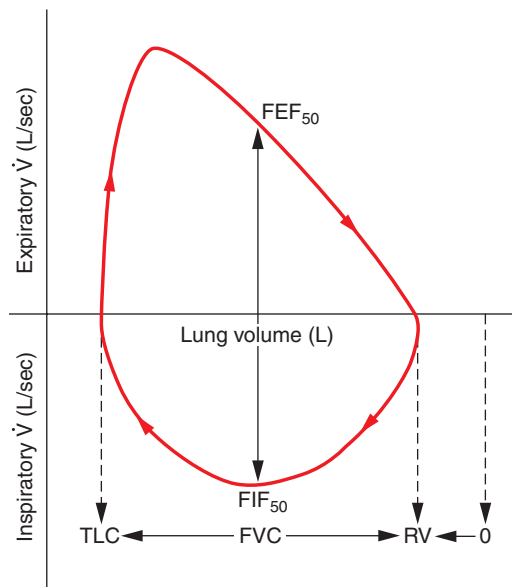
Surgery on the trachea and bronchi usually is performed through a right thoracotomy to avoid the aortic arch, although if the left bronchus is involved or a left pulmonary resection may be done, a left thoracotomy may be performed. The surgical procedure requires extensive hilar dissection, mobilization of the lungs, and possibly opening of the pericardium. Use of the omentum, serratus muscle, or intercos-

tal muscle to wrap the anastomosis or to cover defects in the tracheobronchial tree may be necessary. Mobilization of the omentum requires an additional abdominal incision. Thoracoabdominal exposure substantially increases fluid requirements. On occasion, pericardium can be used to patch sections of the PA involved with tumor. Every effort should be made to maintain normothermia and minimize heat loss. After the procedure, maintaining the patient's neck in a flexed position by suturing the skin and soft tissues of the chin to the anterior chest wall may be necessary to decrease tension on the anastomosis. Even in this situation, it is advantageous to extubate the trachea as soon as possible after surgery to minimize airway pressures. Therefore, the anesthetic should be planned with the goal of rapid emergence and recovery from muscle relaxants. Thorough suctioning of the tracheobronchial tree, via a fiberoptic bronchoscope if indicated, should be performed immediately before emergence from anesthesia.

### Perioperative Management Issues

#### Preoperative Assessment and Preparation

Patients should be evaluated for airway patency and cardiopulmonary re-

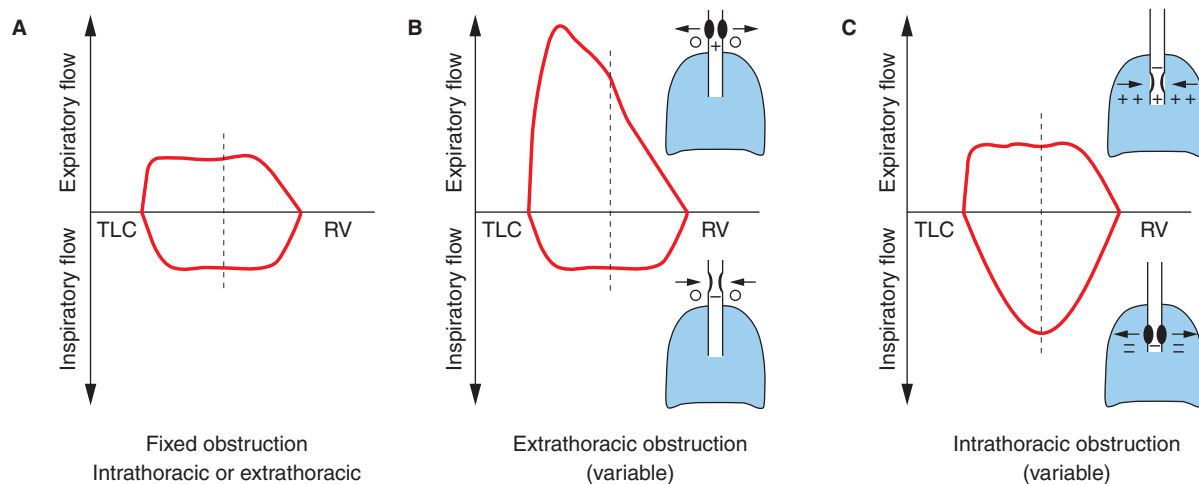


**FIGURE 53-35.** Idealized flow–volume (V–V) loop. During forced expiration, the rate of airflow increases rapidly at volume close to total lung capacity. As lung volume decreases, flow progressively falls in a near-linear fashion caused by increasing airway resistance. With maximum inspiratory effort, flow normally peaks at a lung volume near the midpoint of the forced vital capacity. At midpoint lung volume, the forced inspiratory flow (FIF<sub>50</sub>) and forced expiratory flow (FEF<sub>50</sub>) should normally be equal. FIF<sub>50</sub>/FEF<sub>50</sub> < unity suggests an extrathoracic obstruction, compromising inspiratory flow. FIF<sub>50</sub>/FEF<sub>50</sub> > 1 supports a diagnosis of intrathoracic airway obstruction.

serve. Unless airway obstruction is imminent, requiring emergency surgery, pulmonary function studies should be obtained (Figs. 53-35 and 53-36). Flow–volume loops are helpful in detecting fixed or variable intrathoracic or extrathoracic obstructions. Most of these patients have serious underlying pulmonary disease that may further compromise gas exchange intraoperatively and postoperatively. Reversible conditions that alter pulmonary function should be managed with antibiotics and bronchodilators preoperatively. All considerations that apply to patients with airway obstruction resulting from extrinsic compression by mediastinal masses also apply to patients with intrinsic obstruction of the airways. Preoperative arterial blood gas values should be obtained. Mucosal edema frequently contributes to airway obstruction in these patients, and preoperative steroids and diuretics may be beneficial.

### Monitoring

An intraarterial catheter is indicated for continuous monitoring of blood pressure and for frequent sampling of arterial blood gases. Noninvasive monitoring should include pulse oximetry and capnography. Placement of the pulse oximetry probe on the hand opposite



**FIGURE 53-36.** Maximal inspiratory and expiratory flow–volume curves in fixed obstruction (intrathoracic or extrathoracic), in which airway diameter does not change with either inspiration or expiration, extrathoracic variable obstruction, or intrathoracic variable obstruction. The dotted line indicates 50% of the vital capacity (VC). The ratio of expired-to-inspired flow at this point is the mid-VC ratio and is normally 0.9–1.0. **A.** With a fixed obstruction, expiratory and inspiratory flows are equally altered, and the mid-VC ratio remains normal. **B.** With a variable extrathoracic obstruction, forced expiration results in a slightly positive (+) intratracheal pressure that is greater than the pressure around the airway (atmospheric or 0), resulting in a decrease of the obstruction (airway dilates). During forced inspiration, when pressure around the airway (o) exceeds the intratracheal pressure (–), the obstruction is increased (airway narrows). Because the expiratory curve is normal and the inspiratory curve is altered, the mid-VC ratio is much greater than normal. **C.** With a variable intrathoracic obstruction, forced expiration results in a very positive (++) pleural pressure that is greater than the slightly positive (+) intratracheal pressure, resulting in an increase of the obstruction (airway narrows). During forced inspiration, the intratracheal pressure (–) is greater than the pleural pressure (––), thus decreasing the obstruction (airway dilates). Because the inspiratory curve is normal and the expiratory curve is attenuated, the mid-VC ratio is much less than normal. A normal flow–volume curve is a composite of the inspiratory curve in B and the expiratory curve in C. RV, Residual volume; TLC, total lung capacity.

the intraarterial catheter facilitates continuous verification of adequate blood delivery to both upper extremities and can signal the need for adjustment of patient position or surgical retraction.

### Induction of Anesthesia

Induction of anesthesia follows the same guidelines as discussed in the Section on Anesthesia for Patients with Mediastinal Masses.

### Modes of Ventilation

The major challenge during operation for tracheobronchial resection and reconstruction is maintenance of ventilation. The options include (1) a single-lumen endotracheal tube, (2) a single endobronchial tube or two endobronchial tubes, one into each mainstem bronchus distal to the area of resection, (3) low-frequency jet ventilation, (4) high-frequency ventilation to one or both lungs, above the site of the lesion, and (5) cardiopulmonary bypass through the femoral approach during resection of the carina.<sup>266,267</sup> Because of the risk of intrapulmonary hemorrhage with heparinization, cardiopulmonary bypass should be used only in selected patients when absolutely necessary.

### Use of Conventional Ventilation for Tracheobronchial Reconstruction

When planning to use conventional ventilation during tracheobronchial reconstructive surgery, the anesthesiologist should have several different sizes of armored endotracheal tubes available, some of them still sterile. A long sterile anesthesia circuit is required because often the surgeon must intubate the trachea or bronchus within the sterile field. Airway management depends on the location of the lesion and its distance from the carina.

#### Resection of a High Tracheal Lesion

A single-lumen, uncut endotracheal tube is placed above the tracheal lesion after induction of general anesthesia. If the obstruction is mild or if the area of obstruction can be bypassed, mechanical positive-pressure ventilation is safe. The surgeon may help guide the endotracheal tube past the area of stenosis when the trachea is open. Alternatively, a sterile tube can be passed through the field into the distal trachea after the trachea has been transected below the lesion. That tube is then connected, via sterile an-

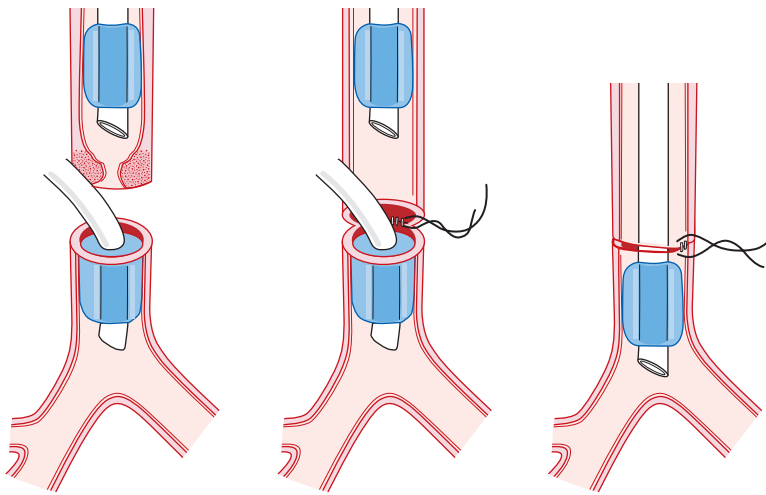
esthesia hoses and Y-piece, to the anesthesia machine. Armored endotracheal tubes should be used to decrease the possibility of kinking and obstruction. If the distal segment of the trachea is short, the tip of the endotracheal tube can be cut distal to the cuff so that the tube can remain above the carina (Fig. 53-37).

Repair of a high tracheal lesion usually is done through a cervical incision, possibly combined with a median sternotomy. After excision of the tracheal lesion and placement of the posterior tracheal suture line, the distal endotracheal or endobronchial tube is removed from the trachea. The proximal endotracheal tube is advanced past the anastomotic lines, reconnected to the anesthesia circuit, and the anastomosis completed.

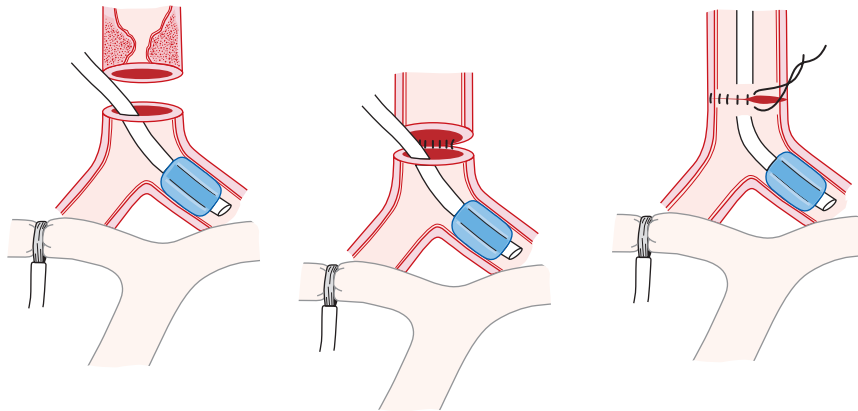
#### Resection of a Low Tracheal Lesion

This usually is performed through a right thoracotomy incision. A single-lumen endotracheal tube is placed with its tip above the lesion. If sufficient length of trachea distal to the area of resection is available, a Foley catheter with its tip removed just distal to the balloon can be used as a single-

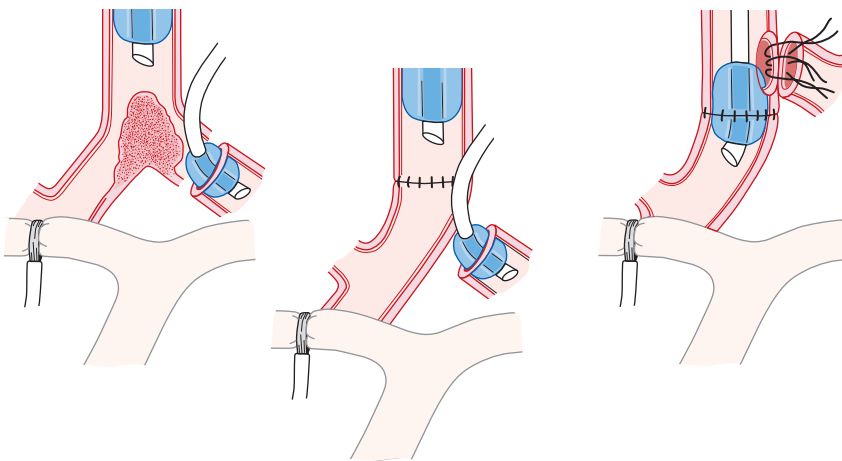




**FIGURE 53-37.** Procedure for resection of high tracheal lesion. (Modified from Geffin B, Bland J, Grillo HC, et al. Anesthetic management of tracheal resection and reconstruction. *Anesth Analg* 1969;48:884, with permission.)



**FIGURE 53-38.** Procedure for resection of lower tracheal lesions. (Modified from Geffin B, Bland J, Grillo HC, et al. Anesthetic management of tracheal resection and reconstruction. *Anesth Analg* 1969; 48:884, with permission.)



**FIGURE 53-39.** Procedure for resection of carinal lesions. (Modified from Geffin B, Bland J, Grillo HC, et al. Anesthetic management of tracheal resection and reconstruction. *Anesth Analg* 1969;48: 884, with permission.)

lumen endotracheal tube. It is inserted by the surgeon and maintained in place above the carina, thereby avoiding endobronchial intubation and the need for one-lung ventilation. If the distal tracheal stump is very short, the tube should be advanced into the bronchus of the dependent (usually the left) lung. If oxygenation is inadequate, the shunt can be decreased by temporarily clamping the PA of the nondependent side (Fig. 53-38).<sup>268,269</sup> When the posterior tracheal suture line has been completed, the distal endobronchial tube or Foley catheter is removed, and the original orotracheal tube is advanced across the suture line into the bronchus of the dependent lung. The anterior suture line then is completed. The endotracheal tube is pulled proximally so that its tip lies above the suture line.

For carinal resection, a single-lumen endotracheal tube is inserted through the larynx (Fig. 53-39). After the carina is resected, the surgeon places a second endotracheal tube into the bronchus of the dependent lung, usually the left. The tube is connected by a set of sterile anesthesia hoses and Y-piece to the anesthesia machine. The left lung is ventilated through the endobronchial tube, whereas the right lung is collapsed as the right bronchus is attached to the trachea. After the right mainstem bronchus has been reattached to the trachea, the original translaryngeal endotracheal tube is advanced past the suture line into the right mainstem bronchus. Cutting the tip of this endotracheal tube helps prevent obstruction of the right upper lobe bronchus. The left endobronchial tube is removed, and the left mainstem bronchus is attached to the trachea by an end-to-side anastomosis. The endotracheal tube is pulled proximally so that its tip is above both anastomotic lines.

Alternatively, after the carina is resected, the anesthesiologist can independently ventilate each lung through the distal bronchial stumps. The surgeon places a single-lumen endotracheal tube into each bronchial stump. A plastic Y-connector is used to deliver the tidal volume to both endotracheal tubes. A good air seal can be achieved by using stay sutures to pull the bronchial stump against the distal end of the inflated cuff. As the posterior layer of the anastomosis is performed, ventilation is maintained through the accessible distal bronchi. To attach the lateral

wall of a bronchus to the trachea, the corresponding endobronchial tube is removed, and one-lung ventilation is used for a limited period. As the anastomosis of the anterior wall nears completion, ventilation from above is restored. The remaining air leak will progressively diminish as the incision is closed. If the air leak is too large, the proximal translaryngeal endotracheal tube can be passed across the anastomotic line into the distal bronchus for short periods. When the anastomosis of one side is complete, that side then is ventilated, and the other endobronchial tube is removed to allow surgical access. Once the second anastomosis is complete, ventilation through the trachea is reestablished. Airway stents can be left in the trachea postoperatively to maintain airway patency.

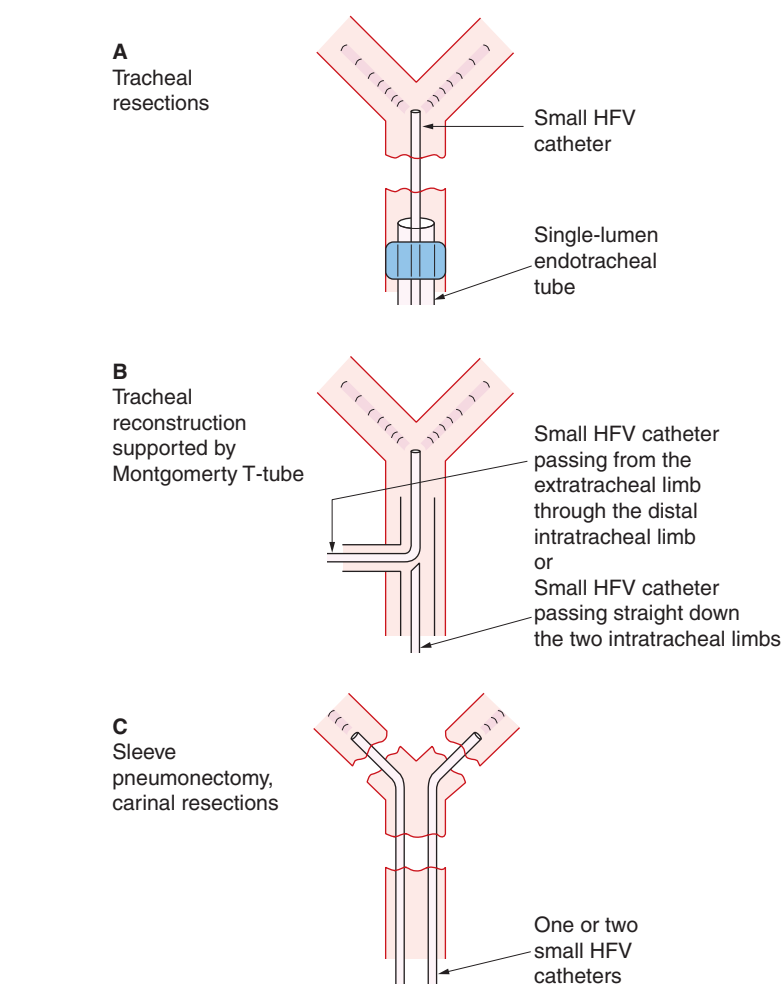
### Low Frequency Jet Ventilation/ Low-Frequency Interrupted High-Flow Ventilation

Low-frequency jet ventilation has been used to maintain ventilation during tracheal resection.<sup>270,271</sup> Intermittent O<sub>2</sub> jets at a rate of 10–20 breaths/min and a pressure of 40–60 psi are delivered to the lungs via a small-bore catheter inserted through the endotracheal tube.<sup>270</sup> The pressure is regulated to produce adequate chest expansion and oxygenation. After the tracheal anastomosis is complete, the catheter is removed, and the endotracheal tube above the suture line is used conventionally.

### High-Frequency Ventilation

High-frequency positive-pressure ventilation (HFPPV) usually uses a respiratory rate of 60–100 breaths/min administered with a volume-cycled ventilator. It does not depend on gas entrainment. Inspiration is active, and expiration is passive. HFJV uses jet pulsations at a rate of 100–400 breaths/min. It depends on gas entrainment. Again, inspiration is active, and expiration is passive. Several reports have described the successful use of HFPPV or HFJV in the treatment of patients undergoing tracheobronchial reconstructions.<sup>272–275</sup>

HFJV depends on gas entrainment for adequate ventilation and can result in distal aspiration of blood and tumor debris. With HFPPV, a continuous flow of gas occurs to the outside, which protects against distal aspiration of blood and debris. HFPPV provides adequate oxygenation and venti-

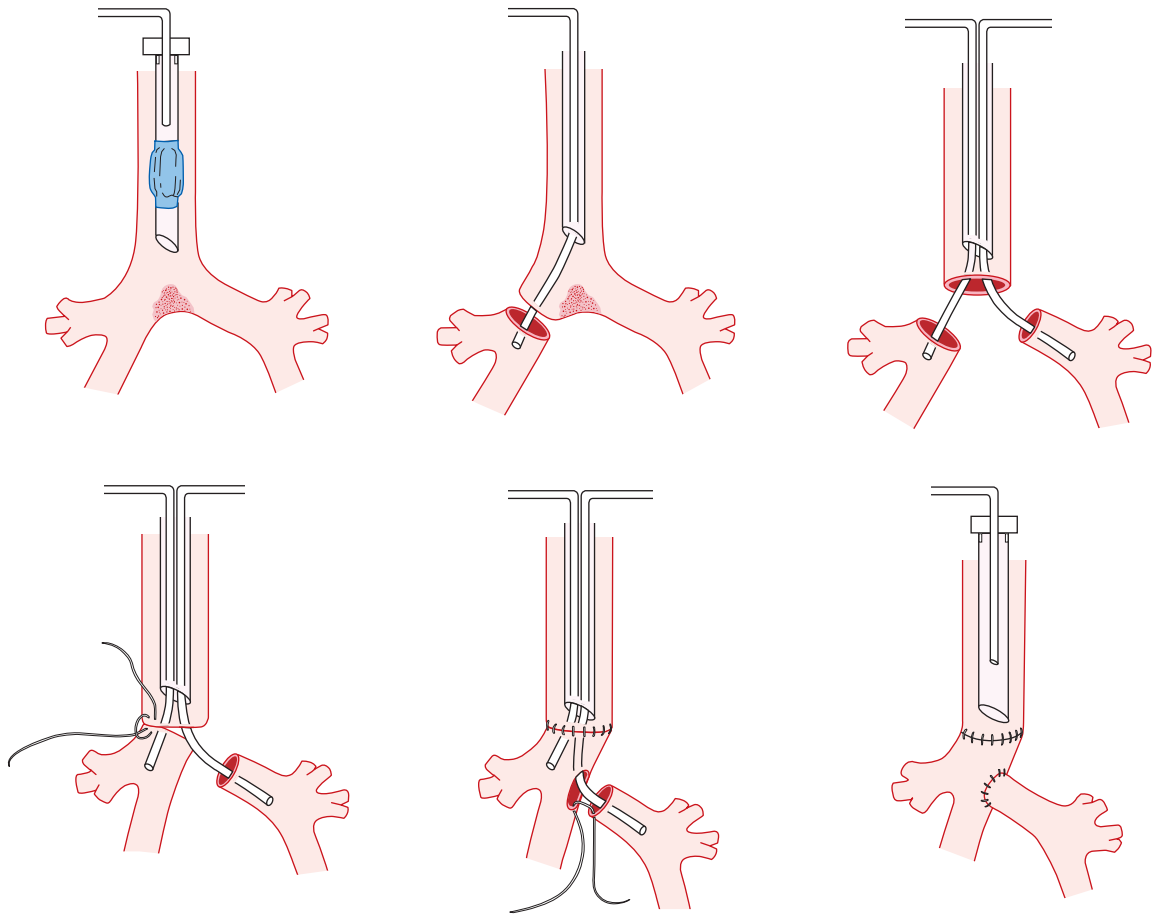


**FIGURE 53-40.** Three types of airway surgery aided by small high-frequency ventilation (HFV) are tracheal resections, tracheal reconstructions that require support by a Montgomery T-tube, and carinal procedures (sleeve pneumonectomy, carinal resections). **A.** With tracheal resections, a simple HFV catheter can be passed beyond the point of airway interruption, but above the tracheal carina, and used to ventilate both lungs with HFV. **B.** With tracheal reconstructions supported by a Montgomery T-tube, the small HFV catheter can be passed from either the extraluminal limb or the proximal intraluminal trachea limb to the distal intraluminal tracheal limb and can be used to ventilate both lungs with HFV. **C.** With carinal procedures, one or two HFV catheters can be passed into one or both of the mainstem bronchi and can be used to ventilate one or both of the lungs with HFV.

lation by the generation of eddy flows in the airway. It may lead to improved distribution of gas flow compared with conventional mechanical ventilation. Airway pressure during HFPPV is continuously positive. Intrapleural pressure is continuously subatmospheric, with minimal effect on pulmonary and systemic hemodynamics. The principal advantage of HFPPV in tracheobronchial resection is the ability to deliver ventilation through small catheters either located free in the airway or passed through standard endotracheal tubes. These catheters provide less interference with the surgical technique than do standard single-lumen or double-lumen endotracheal

tubes. In addition, as soon as the lesion is resected, jet ventilation catheters can be passed into one or both bronchi, providing independent ventilation to both lungs.

HFPPV is likely to be beneficial in patients undergoing (1) carinal resections, (2) sleeve pneumonectomies or sleeve upper lobe resections, (3) tracheal reconstruction supported by Montgomery T-tubes, and (4) tracheal resections (Fig. 53-40). For left-sided sleeve pneumonectomy, endobronchial intubation, with a small catheter passed through an endotracheal tube, provides the surgeon with an unobstructed field of vision. The catheter is passed through the operative field and



**FIGURE 53-41.** Arrangement of high-frequency jet ventilation (HFJV) catheters during the different phases of the operation. At the end of the right tracheobronchial anastomosis, the left catheter passes between two membranous sutures. It is then withdrawn and introduced into the left main bronchus via the bronchotomy of the right middle bronchus. (Modified from Crinquette et al.<sup>272</sup> with permission.)

guided by the surgeon into the left mainstem bronchus. The continuous outflow of gas through the open bronchus during HFPPV minimizes soiling with blood. Ventilation of the right lung with HFPPV via a thin catheter inside the right main bronchus eliminates the problem of right upper lobe collapse associated with the use of right-sided endobronchial tubes.

Carinal resection has been performed using two HFJVs and two catheters, one into each bronchus, to provide independent ventilation to both lungs (Fig. 53-41).<sup>272</sup> This is particularly advantageous when a large carinal tumor obstructs one or both bronchi, preventing delivery of adequate tidal volume to either lung. In this situation, a catheter is passed into one or both bronchi under fiberoptic bronchoscope guidance. The presence of even two HFJV catheters through the surgical field does not interfere with surgical exposure.

Patients with major tracheal stenosis may not accommodate an endotra-

cheal tube large enough to permit adequate ventilation. Several solutions exist for this problem. First, a special long endotracheal tube that has a small internal diameter can be used; for example, a long 5-mm oral endotracheal tube may pass through the tracheal lesion. Ventilation through such a small endotracheal tube requires high proximal airway pressures and may not be effective. Second, HFPPV with a small catheter passed through the stenotic area can be used. The anesthesiologist should ensure enough space between the stenotic lesion and the catheter to allow for the adequate outflow of gas; otherwise, barotrauma will occur. Third, the surgeon first can perform laser resection of the stenotic lesion to increase airway diameter.

HFPPV facilitates tracheal reconstruction supported by a Montgomery tracheal T-tube.<sup>276</sup> The Montgomery tracheal T-tube is used as a stent to maintain the patency of the upper airway in patients with subglottic and

upper tracheal stenosis. The intraluminal limb also maintains the circumference of the airway and supports the tissue graft applied during reconstruction of the larynx and cervical trachea. Because of the design and shape of the Montgomery endotracheal tube, establishing an adequate airway for administration of conventional mechanical ventilation is difficult. Use of the extraluminal limb as an airway for delivery of large tidal volumes is associated with a large gas leak through the open, upper intraluminal limb and around the uncuffed tracheal limb. This can be circumvented by two methods. Occlusion of the superior part of the intraluminal limb can decrease the air leak. The occlusion can be accomplished with a Fogarty embolectomy catheter or with a tight pharyngeal pack. Alternatively, the anesthesiologist can perform translaryngeal intubation of the upper intraluminal limb with a small cuffed endotracheal tube. Occlusion of the extraluminal limb then allows use of positive-pressure ventilation.<sup>277</sup>

HFPPV through a catheter with a 2-mm internal diameter can provide adequate alveolar ventilation and oxygenation during tracheal reconstruction with a tracheal T-tube. The T-tube and open trachea around it function as expiratory ports for the continuous outflow of gas. If the patient already has a tracheal T-tube in place before operation, translaryngeal intubation of the intraluminal limb and trachea can be easily accomplished with the small HFPPV catheter. Alternatively, the catheter can be introduced through the extraluminal limb and gently flexed to direct the catheter to lie above the carina.<sup>274</sup>

Differential lung ventilation with HFJV has been used in patients undergoing tracheobronchial reconstructive surgery, such as pneumonectomy, sleeve lobectomies, and tracheal reconstruction, who have compromised pulmonary reserve. For example, a patient undergoing a right upper sleeve lobectomy is ventilated through an endotracheal tube until resection of the right bronchus and the right upper lobe begins. The endotracheal tube then is advanced into the left mainstem bronchus, and unilateral intermittent positive-pressure ventilation is continued to the left lung. At the same time, HFJV is delivered to the right intermediate bronchus to ventilate the residual right, middle, and lower lobes and thereby maintain better oxygenation.

## ANESTHESIA FOR PATIENTS UNDERGOING URGENT SURGERY

### Anesthesia for Patients with Massive Hemoptysis

#### Therapeutic Approaches

Massive hemoptysis is an uncommon but life-threatening event that requires rapid management. Massive hemoptysis refers to bleeding that ranges from >200 mL during one episode to 1000 mL within 24 hours.<sup>278–280</sup> The most common associated diseases are tuberculosis, bronchiectasis, lung abscesses, and lung cancer (Box 53–12). The cause of hemoptysis is either direct invasion by infection or tumor into blood vessels or trauma (e.g., bleeding after use of a PA catheter). Patients at increased risk for perforation of the PA by a PA catheter include those with pulmonary hypertension, hypothermia, or coagulopathy.<sup>281</sup>

Death from hemoptysis usually results from asphyxia and rarely from exsanguination. The most effective way to stop bleeding from pulmonary sources is definitive pulmonary resection. The site of bleeding can be identified with either a rigid or a flexible bronchoscope. Rigid bronchoscopy is preferred because it provides more access for suctioning of blood and removal of clots. The endoscopist can perform therapeutic interventions by the administration of topical saline or vasoconstrictors, laser therapy, or placement of a balloon-tipped Fogarty catheter. Alternative management includes transcatheter embolization of the bronchial and intercostal arteries, but this risks embolization of the spinal cord via collateral circulation. Placement of a PA catheter under fluoroscopic guidance can be used in conjunction with other therapies to decrease bleeding by occluding the branch of the PA feeding the bleeding site.

#### Anesthetic Management

Management strategies are listed in Table 53–22. Patients with massive hemoptysis often are hemodynamically unstable as a result of hypovolemia and hypoxemia. They require resuscitation with a large-bore IV catheter for rapid infusion of fluids to restore cardiac preload, blood products to correct any coagulopathies, and vasoactive drugs. Time permitting, an arterial catheter should be placed for monitoring of blood pressure and arterial blood gases. One of the major goals is isolating the source of bleeding to prevent contamination of the healthy lung and prevent further hypoxia.

Patients with massive hemoptysis are at significant risk for aspiration. These patients should undergo either awake intubation or rapid sequence induction followed by tracheal intubation during cricoid pressure. Use of ketamine or etomidate for induction of anesthesia may be indicated because the patients are hypovolemic. Intubation may be complicated by blood in the airway, obscuring laryngeal structures. Suctioning may not provide adequate visualization. Air bubbles exiting the trachea may serve as the only guide to the site of the glottic orifice. Choice of endotracheal tube depends on the proposed management. Lung separation is best accomplished by placement of a left double-lumen endo-

### BOX 53–12.

#### Causes of Massive Hemoptysis

- Infection
- Tuberculosis
- Bronchiectasis
- Bronchitis
- Lung abscess
- Necrotizing pneumonia
- Neoplasm
- Bronchogenic carcinoma
- Metastatic carcinoma
- Mediastinal tumor
- Endobronchial polyp
- Cardiovascular disease
- Mitral stenosis
- Pulmonary arteriovenous malformation
- Pulmonary embolus
- Pulmonary vasculitis
- Miscellaneous causes
- Pulmonary artery catheterization
- Exploratory needling
- Cystic fibrosis
- Pulmonary contusion, laceration
- Reperfusion of pulmonary vasculature after pulmonary embolectomy and after cardiopulmonary bypass

From Benumof L. *Anesthesia for Thoracic Surgery*. Philadelphia: WB Saunders, 1987, pg. 613, with permission.

tracheal tube but may be technically difficult to accomplish in emergency situations. If bleeding originates from the left side, a single-lumen tube can be blindly advanced into the right mainstem bronchus. If bleeding originates from the right side, intubation of the left mainstem bronchus can be guided with the assistance of a fiberoptic bronchoscope.

If definitive surgical intervention is required, the patient is placed in a lateral decubitus position for resection of the bleeding lung segment. Placement of the bleeding lung in a nondependent position mandates complete separation of the lungs to prevent soiling of the dependent nonbleeding lung. Suctioning of the tracheobronchial tree improves ventilation and oxygenation of the dependent nonbleeding lung. At the end of operation, the double-lumen endotracheal tube should be left in place, and the patient should be mechanically ventilated. Patients should be observed for recurrent bleeding and impaired oxygen exchange during the early postoperative period.



TABLE 53–22.

## Anesthetic Guidelines for Patients with Massive Hemoptysis

Indication	Hemoptysis
Monitors	Standard monitors, arterial catheter
Anesthesia	General anesthesia
Additional equipment	Shoulder roll or bean bag
Ventilation	Double-lumen endotracheal tube (if possible)
Position	Lateral decubitus, supine
Incision	Thoracotomy, median sternotomy
Unique considerations	Frequently hypoxic; “full stomach” precautions, hypotensive, tachycardic Infectious precautions Type and cross for blood products Check coagulation status
Intraoperative complications	Hypoxia Hypotension Hemorrhage Dysrhythmia Syndrome of inappropriate antidiuretic hormone secretion Possibility of extensive lung resection
Blood loss	Variable >500 mL
Analgesia	Epidural thoractomy
Postoperative morbidity	Respiratory insufficiency Aspiration pneumonia Hemoptysis Acute respiratory distress syndrome
Postoperative care	Hypoxia Chest radiography Monitor in intensive care environment

### Anesthesia for Patients Undergoing Removal of Foreign Body from the Airways

Aspiration of foreign bodies is a common problem, particularly in children, and is associated with considerable morbidity and mortality.<sup>166</sup> In adults, acute alcoholism, dementia, bulbar muscle dysfunction, and history of aspiration are common predisposing factors.<sup>166,282,283</sup> The location of the aspirated object depends on the patient's posture at the time of aspiration. The right lung most often is involved because the axis of the right mainstem bronchus is more in line with the trachea. If the patient is upright at the time of aspiration, the right lower lobe most frequently is affected. The right upper lobe most often is involved in patients in the supine position.

More than 80% of aspirated foreign bodies are organic material. Organic material, particularly peanuts and other nuts, produce severe mucosal irritation and swelling around the foreign body. The clinical sequelae of foreign body aspiration include acute airway obstruction, atelectasis, inflammation, pneumo-

nia, and abscess formation (Fig. 53–42). The foreign body may act as a one-way valve, resulting in air trapping and regional hyperinflation.

#### Clinical Features and Diagnosis

Acute signs and symptoms of aspiration include cough, wheezing, dyspnea, stridor, fever, cyanosis, and hemoptysis. Alternatively, the patient may have a history of recurrent or intractable pneumonia, unexplained atelectasis, or emphysema.<sup>166,283</sup> Physical examination may reveal unilateral decreased air entry, unilateral localized wheezing, or aphonia.<sup>166,283,284</sup> Most foreign bodies are radiolucent but are associated with an abnormal chest radiograph. Findings may include atelectasis, localized hyperinflation, pneumonia, and mediastinal shift.<sup>282</sup>

#### Therapeutic Approach

The urgency of proceeding to bronchoscopy is dictated by the severity of the patient's respiratory distress. Objects located in the larynx or proximal trachea cause considerably more distress and are associated with greater

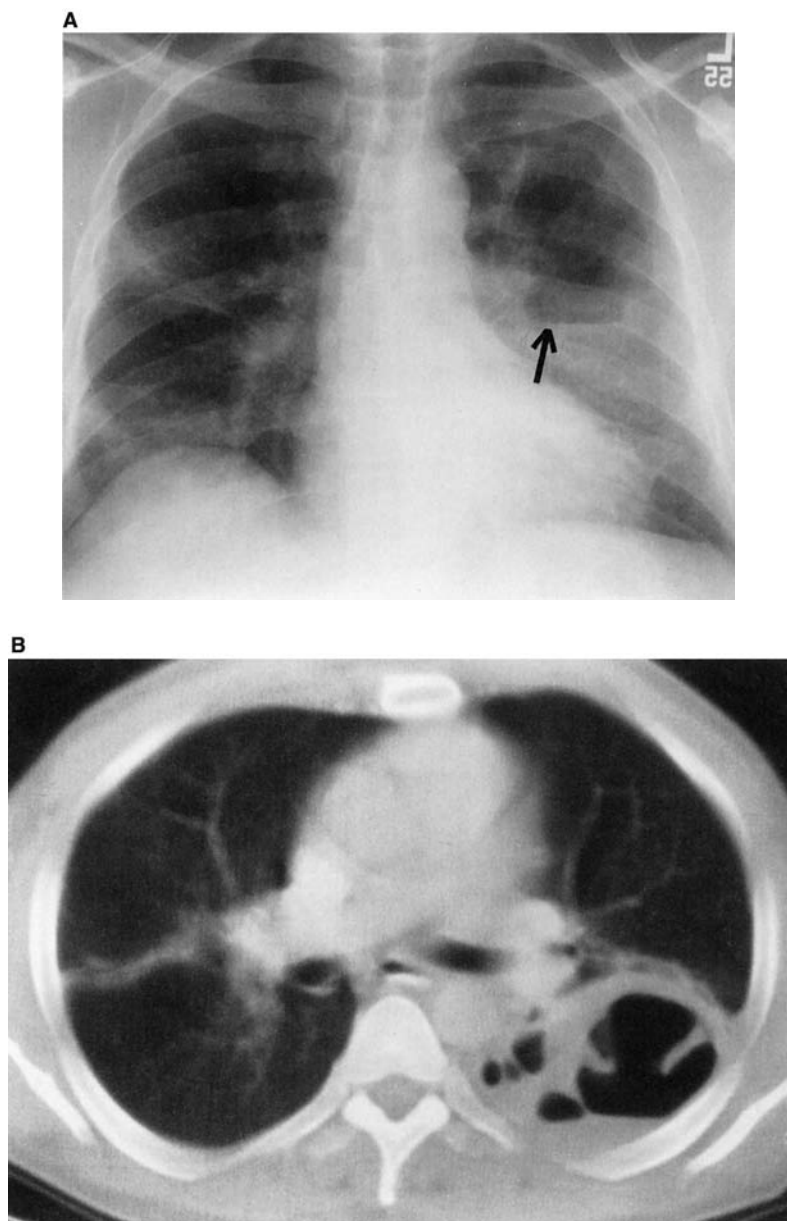
mortality than objects lodged more peripherally.<sup>285</sup> Foreign bodies typically are removed within the first 24 hours to avoid dislodging them into a more critical position and to decrease the incidence of secondary pneumonia. If possible, removal should be delayed long enough to allow for gastric emptying and patient preparation. Use of bronchodilators, postural drainage, and chest physiotherapy to dislodge and expel the foreign body is contraindicated. These procedures occasionally result in total airway obstruction and cardiac arrest and are no longer recommended.<sup>286,287</sup>

Bronchoscopy for removal of the foreign body is successful in approximately 95% of cases but may need to be repeated because the foreign body either was not found initially or was incompletely removed.<sup>286,287</sup> Fluoroscopic guidance during bronchoscopy can aid in the removal of small radiopaque objects.<sup>288</sup> Rarely, thoracotomy is necessary for retrieval of the foreign body.

#### Anesthetic Management

Anesthetic management depends on the patient's age, presence of a full stomach, severity of respiratory distress, and location of the foreign body. All patients should be premedicated with an anticholinergic to decrease airway secretions, H<sub>2</sub>-receptor antagonists to decrease gastric acid secretion, and metoclopramide to promote gastric emptying (Table 53–23). The endoscopist should be prepared for immediate rigid bronchoscopy in case of total airway obstruction.

Adults receive preoxygenation, IV induction, and direct laryngoscopy. A technique of IV anesthesia would address the concerns of providing adequate doses of inhaled agents. A foreign body located in the larynx often can be removed during direct laryngoscopy, and the patient is allowed to emerge from anesthesia. A foreign body in the trachea or the bronchus requires rigid or fiberoptic bronchoscopy for removal. When a rigid bronchoscope is introduced into the airway, its ventilating side arm is attached to the anesthesia circuit to provide O<sub>2</sub> and inhaled anesthesia. Use of a helium–O<sub>2</sub> mixture can be helpful in patients with partial airway obstruction because the decreased density of the inhaled mixture decreases turbulence and improves flow



**FIGURE 53-42.** Aspiration pneumonia in 58-year-old man with a history of alcohol abuse progressed to a suppurative cavitory lesion. The patient presented with progressive shortness of breath, fevers, and foul-smelling sputum. **A.** Chest radiograph shows cavitory lesion with an air-fluid level in the left lung and several pneumonic infiltrates in the right lung. **B.** Chest CT shows a large cavitation in the left lower lobe, consistent with the diagnosis of abscess or tumor. The patient subsequently underwent pulmonary resection that required placement of a double-lumen endotracheal tube to prevent soilage of the contralateral lung.

across the stenotic airway. The maximal effect is obtained with a helium-O<sub>2</sub> mixture of 80% helium and 20% O<sub>2</sub>, but helium also is therapeutic when used in lesser concentrations. After the trachea is intubated, a large-bore nasal or oral gastric tube is inserted into the stomach, and the gastric contents are thoroughly suctioned.

Children are more difficult to manage because of their small airway, which makes them more susceptible to major airway obstruction. In chil-

dren with severe respiratory distress, the risks of total airway obstruction that can occur during rapid sequence induction should be weighed against the risk of aspiration during a slow inhalation induction with spontaneous ventilation. Attempting to place an IV catheter before induction can trigger violent struggling, straining, and crying and can precipitate total airway obstruction. A gentle inhalation induction, using cricoid pressure, can be used even in children with a full stom-

ach. In the absence of IV access, intramuscular ketamine can be used for induction. As soon as the child becomes sleepy, cricoid pressure is applied, and inhalation of anesthetic agents is started while continuing spontaneous ventilation.

If the patient is minimally symptomatic with no serious respiratory distress and if the foreign body is thought to be peripherally located, the anesthesiologist can wait 6–8 hours before bronchoscopy, although some surgeons or endoscopists do not agree with this approach and prefer to proceed immediately to prevent a local inflammatory reaction to the foreign body. In the absence of a full stomach and if symptoms are minimal, the child can be heavily premedicated to facilitate a smooth inhalation induction. Spontaneous ventilation can facilitate detection of airway obstruction and prevents distal migration of the foreign body caused by positive-pressure ventilation. When using a rigid bronchoscope, many anesthesiologists administer muscle relaxants to prevent airway trauma induced by patient movement.

Some objects, such as beads, are hard to grip and may slip during removal, resulting in occlusion more proximally. The object should then be pushed back to its original location to allow adequate ventilation. Multiple instrumentations of the airway may produce mucosal edema and respiratory distress postoperatively. Therapy includes administration of steroids (dexamethasone 0.5–1.5 mg/kg), humidification of inspired gases, nebulized racemic epinephrine, and initiation of broad-spectrum antibiotic therapy.

### Anesthesia for Patients Undergoing Endoscopy for Ingested Foreign Bodies

The incidence of ingested foreign bodies in the hypopharynx or esophagus in young children is as common as for aspirations in the airway. Coins and fish bones are the most frequent foreign bodies in the esophagus. Most foreign bodies initially cause laryngeal irritation, coughing, or choking. Subsequent signs and symptoms include refusal to eat, increased salivation, pain or discomfort during swallowing, and vomiting.

The anesthesiologist should determine the nature and location of the foreign body. Lateral neck radiographs should be obtained to determine the

TABLE 53–23.

## Anesthetic Guidelines for Retrieval of Foreign Body

Indication	Aspiration of foreign body
Monitors	Standard monitors
Anesthesia	Pediatric (general anesthesia) Adult (awake sedated, general anesthesia)
Additional equipment	Fiberoptic bronchoscope Rigid bronchoscope
Ventilation	Usually try to maintain spontaneous ventilation Controlled ventilation may be appropriate if mass is distal in tracheobronchial tree
Position	Seated or semirecumbent (positioned to optimize respiratory status)
Unique considerations	Respiratory status Sedation as tolerated Antisialagogue Precautions for “full stomach” H <sub>2</sub> -blocker, metoclopramide, cricoid pressure Anesthetize airway for awake, sedated approach Availability of additional support personnel Place gastric tube to empty stomach after airway is secured
Complications	Loss of airway Hypoxia Cardiac arrest Aspiration Hemoptysis Soilage from contents distal to obstruction
Postoperative morbidity	Hemoptysis Postoperative edema (steroids, raise head of bed) Bronchospasm (racemic epinephrine, bronchodilators) Pneumonia Atelectasis
Postoperative care	Observe in monitored environment Aggressive pulmonary toilet, physical therapy Supplemental O <sub>2</sub> Chest radiography

extent of impingement on the airway. In the absence of respiratory distress or airway compression, the anesthesiologist should consider waiting 4–8 hours for gastric emptying.<sup>289</sup> The child then is sedated, and anesthesia is induced with either inhalational or IV anesthetic agents. Emergency endoscopy should be performed in patients with respiratory distress and airway compression. In spontaneously ventilated patients, preoperative sedation is omitted, and general anesthesia is induced. For patients with foreign bodies located in the hypopharynx or upper esophagus, cricoid pressure is contraindicated. The endotracheal tube size chosen should be slightly smaller than usual to facilitate endoscopy and decrease subsequent subglottic swelling.<sup>289</sup> In addition, a prophylactic dose of dexametha-

sone (0.5–1.0 mg/kg) can be given to decrease laryngeal edema.

A foreign body that is located high in the esophagus may dislodge into the larynx and produce an airway obstruction. Therefore, children with high esophageal foreign bodies should be heavily sedated, IV access obtained, and anesthesia induced. In the absence of major airway compression, an IV induction with muscle relaxants can be used.

## ANESTHESIA FOR PATIENTS WITH ZENKER DIVERTICULUM

### Clinical Features

Zenker diverticulum is an outpouching of the pharyngeal mucosa between the inferior constrictor muscles of the pharynx, the thyropharyngeus, and

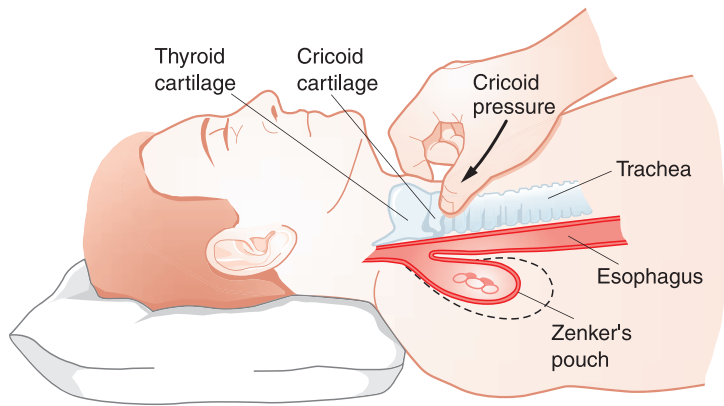
the cricopharyngeus muscles. The etiology is believed to be dysfunction or spasm of the cricopharyngeus muscle. Patients complain of food sticking in the throat, difficulty swallowing, noisy swallowing, regurgitation of food, and bouts of coughing when lying supine. Neck radiographs may reveal a collection of air anterior to C5 and C6, but diagnosis is confirmed with a barium swallow. Physical examination may reveal a compressible swelling as the sac enlarges. Patients usually are elderly, malnourished,<sup>290</sup> debilitated with coexisting cardiac and respiratory diseases, and susceptible to recurrent pneumonias and lung abscesses from aspiration. Symptomatic lesions are managed by surgical resection.

### Intraoperative Management

Oral premedications are not suitable because tablets may lodge in the pouch or be aspirated into the lungs.<sup>291</sup> The risk of regurgitation and aspiration of diverticular contents into the lungs during the immediate preoperative and intraoperative periods is a major concern for the anesthesiologist. The contents of the pouch usually have an alkaline pH and therefore are unlikely to benefit from H<sub>2</sub>-receptor antagonists, antacids, or metoclopramide. Regurgitation and aspiration may occur even after successful tracheal intubation because of seepage of fluid around the endotracheal tube cuff during surgical manipulation. Measures to decrease the risk of aspiration during anesthesia include fasting overnight, preoperative emptying of the pouch by manual external pressure, and tilting the head of the bed upward 10–30°.

Awake intubation is an option, but coughing and straining may result in regurgitation and aspiration. The risk of aspiration may be increased by topical anesthesia and sedation, which blunt airway reflexes. Therefore, some authors advise against awake intubation.<sup>292</sup> Use of topical anesthesia should be limited to either the supraglottic or infraglottic part of the airway, leaving part of the airway responsive as a protection against aspiration.

Use of cricoid pressure may precipitate aspiration. Careful preoperative examination of the barium swallow image may help determine whether cricoid pressure will be beneficial or harmful by defining the size and location of the pouch. If the sac is large, extending



**FIGURE 53-43.** Zenker pouch in the hypopharynx, with the opening at the level of cricoid cartilage. (From Thiagarajah S, Lear E, Keh M. Anesthetic implications of Zenker's diverticulum. *Anesth Analg* 1990;70:709, with permission.)

down into the mediastinum with its orifice at the level of the cricoid cartilage, cricoid pressure should obliterate the opening and protect against regurgitation. If the sac is small and the opening is cephalad to the cricoid cartilage, application of cricoid pressure may actually squeeze the sac, resulting in regurgitation of its contents into the hypopharynx (Fig. 53-43).

The preferred approach is a smooth induction with a 30° upward head tilt and avoidance of coughing, bucking, and straining. The combination of IV hypnotics (i.e., thiopental or etomidate) supplemented with opioids and lidocaine and slow, gentle manual mask ventilation should result in a smooth uneventful induction. A non-depolarizing muscle relaxant is administered, and endotracheal intubation is performed after complete relaxation has been achieved. The pharynx around the endotracheal tube can be packed with gauze to prevent seepage of the contents of the diverticulum into the hypopharynx with collection above the endotracheal tube cuff. Surgical access usually is through a cervical incision. A large diverticulum may extend into the mediastinum. Great care and gentleness should be exercised when inserting a nasogastric tube because of the potential for perforation of the diverticulum. Likewise in patients with a difficult airway, blind attempts at intubation of the trachea risk perforating the pouch. Perforation of the diverticulum results in mediastinitis and sepsis. Other complications include air embolism if major vessels are opened during the dissection or bradycardia and hypotension resulting from stimulation of baroreceptors during retraction near the carotid bifurcation.

An alternative is to perform the procedure during regional anesthesia using deep and superficial cervical plexus blocks. Adams<sup>293</sup> describes the use of this approach in 58 patients undergoing repair of a Zenker diverticulum. The risk of aspiration is minimized by preserving protective airway reflexes. Provided the block is limited to one side, the awake, sedated patient is able to cooperate with the surgeon and can swallow on command, allowing the surgeon to view the pathology and assess the adequacy of repair.

## COMPLICATIONS OF THORACIC SURGERY AND THEIR MANAGEMENT STRATEGIES

The postoperative complications of thoracic surgery can be characterized as pulmonary, hemodynamic, neurologic, or miscellaneous (Box 53-13). Some of these complications are medical and surgical emergencies that require prompt diagnosis and management. Conditions requiring emergent intervention include pneumothorax, pulmonary edema, torsion of a residual lobe, herniation of the heart, malignant arrhythmias, and major hemorrhage. Early diagnosis and efficient management depend on the cooperative efforts of the anesthesia, surgical, and nursing staff. In the following section, the order of presentation is based on the system involved and the severity of symptoms.

### Hemodynamic

#### **Herniation of the Heart**

Cardiac herniation is a rare and rapidly fatal injury if not immediately diag-

### BOX 53-13.

#### Complications of Thoracic Surgery

##### Hemodynamic

- Arrhythmias
- Cardiac herniation
- Right-sided failure
- Tension pneumothorax
- Bleeding

##### Pulmonary

- Pneumothorax
- Atelectasis
- Shunting
- Pulmonary edema
- Torsion of lobe
- Damage phrenic nerve
- Damage recurrent laryngeal nerve
- Pain

##### Neurologic

- Positioning injuries
- Brachial plexus, ulnar nerve, peroneal nerve
- Phrenic nerve
- Recurrent laryngeal nerve
- Paradoxical embolization
- Spinal cord

##### Miscellaneous

- Alopecia
- Necrosis ear, nose
- Infection

nosed and managed. This complication occurs more often after right pneumonectomy in which the pericardium was opened to gain better access to the pulmonary vessels. It may occur after the creation of a pericardial window for management of a pericardial effusion. This complication has been associated with changing of patient position (from lateral decubitus to supine position or placement of the operative lung in the dependent position) or a differential change in intrapleural pressures caused by suctioning of the chest tube after pneumonectomy or vigorous coughing.<sup>294,295</sup>

The clinical features of cardiac herniation include acute cardiovascular collapse, evidence of superior vena cava obstruction (distension of neck veins, facial flushing, edema), altered axis of ECG, bulging of cardiac silhouette, and unusual positioning of PA catheter on chest radiograph. Differential diagnosis includes tension pneumothorax, cardiac tamponade, dysrhythmia, pulmonary emboli, and massive hemorrhage. These patients require immediate operation, but they may be stabilized by placing them in a



lateral position with the operated lung in the nondependent position.<sup>296,297</sup> Even if the heart does not fall back into its normal position, repositioning may relieve aortocaval kinking and increase cardiac output. The tidal volume should be decreased and use of PEEP discontinued to decrease any mediastinal shift. Suctioning of the chest tubes should be discontinued, and injection of air to counter cardiac herniation should be considered.

Definitive management requires that the thorax be reexplored and pericardial defect repaired by primary closure, autograft, or prosthetic material.<sup>298</sup> Anesthesia should be induced with either ketamine or etomidate and a muscle relaxant. To decrease mediastinal shift, the lungs should be ventilated with small tidal volumes.

### Cardiac Dysrhythmias

Supraventricular dysrhythmias, primarily sinus tachycardia and atrial fibrillation or flutter, which occur after thoracic surgery are associated with increased postoperative morbidity. Significant risk factors include male sex, advanced age, history of congestive heart failure or arrhythmias, and type of surgery (pneumonectomy > bilobectomy > lobectomy > esophagectomy > resection of mediastinal tumor or thymectomy).<sup>299,300</sup> Manipulation of the pulmonary veins, a major nidus for atrial fibrillation, is thought to be a significant factor.<sup>301</sup> Other potential causes are retraction and trauma of the heart (intrapericardial dissection), increased sympathetic tone related to inadequate postoperative analgesia, and postoperative respiratory or metabolic imbalance (hypoxia, hypercapnia, respiratory acidosis, electrolyte imbalances). Whereas use of digitalis for thoracic surgery is not supported by clinical trials, calcium channel blockers and  $\beta$ -blockers are effective in reducing postoperative atrial tachyarrhythmias.<sup>302</sup> However, the use of such medications should be individualized to account for the possible adverse consequences of  $\beta$ -blocker use in this patient population. Interestingly, the preoperative use of statins has also been associated with a protective effect against postoperative atrial fibrillation, but its mechanism has not been elucidated.<sup>303</sup>

### Right Ventricular Failure

The postoperative course after anatomic pulmonary resection may be

complicated by right ventricular failure and acute cor pulmonale. Decreases in the vascular cross-sectional area caused by pulmonary resection increase PVR and right ventricular afterload. Preoperative right-heart catheterization or echocardiography may predict patients at risk for this postoperative complication. Operative risk is increased if PVR is >190 dynes/sec/cm<sup>5</sup> or if PA pressure increases by >40 mm Hg in response to balloon occlusion. In addition, hypercapnia, acidosis, and increases in airway pressure may increase the risk for developing right-heart failure. Patients with right-heart failure have distended neck veins, peripheral edema, and new onset of atrial dysrhythmias. Echocardiography can be used to differentiate right-heart failure from cardiac tamponade. Increased right-heart volume and ventricular dysfunction can lead to a shift of the intraventricular septum and impede left ventricular filling and function. A decrease in left ventricular preload caused by increased PVR and abnormal septal wall motion will result in decreased cardiac output and peripheral perfusion pressure. Patients who have chronic right-sided heart failure with right ventricular hypertrophy may be at increased risk for developing myocardial ischemia and dysfunction related to decreased coronary perfusion. Increased oxygen demand related to wall stress and decreased coronary perfusion resulting from decreased cardiac output and hypotension may exacerbate preexisting right ventricular dysfunction.

The treatment strategies for patients having right ventricular failure differ from those used for patients with primary left ventricular dysfunction. Volume expansion in patients with increased PVR will increase wall stress and further exacerbate right ventricular dysfunction. The management goals are to improve right ventricular function by decreasing PVR, increasing myocardial contractility, and maintaining coronary perfusion. Vasodilating agents, such as milrinone, prostacyclin, NO, and nitroglycerin, have been used to decrease PVR. Often agents such as dobutamine or milrinone are chosen for their combined inotropic and vasodilator properties. In patients with decreased systemic blood pressure and inadequate coronary perfusion, vasopressors such as epinephrine, dopamine, phenyleph-

rine, or norepinephrine can be added to enhance coronary perfusion.

### Intracardiac Shunting

The incidence of a probe patent foramen ovale is approximately 25% in adults. During normal conditions, right-to-left shunt across the atrial septal defect is negligible because the left atrial pressure exceeds that of the right. If the gradient between the right atrium and left atrium is reversed, oxygenated blood can flow from right to left, resulting in paradoxical embolization and hypoxia. The reversal of atrial pressures can occur during conditions of increased peripheral vascular resistance related to use of PEEP or during the occurrence of pulmonary emboli, pulmonary hypertension, valvular stenosis, ARDS, or even coughing. Reversal of pressures may occur after pneumonectomy or lobectomy.<sup>304-306</sup> The occurrence of intracardiac shunt should be suspected in patients with unexplained postoperative dyspnea and systemic oxygen desaturation. Transesophageal echocardiography can confirm the diagnosis and visualize the atrial septal defect.

Management goals are to decrease shunt flow by decreasing right-sided pressures and PVR. Initial management should involve correction of hypoxia, hypercapnia, acidosis, and increased sympathetic tone related to inadequate postoperative analgesia. Administration of pulmonary vasodilators and preload reduction can be used to decrease right-heart pressures. Use of PEEP should be avoided if possible in patients who are mechanically ventilated. When conservative measures fail, open surgical or percutaneous closure of the atrial septal defect may be necessary. Because the presence of an intracardiac shunt predisposes to paradoxical embolization, all IV solutions should be rigorously free of air bubbles, and blood products should be administered through filters to exclude particulate matter.

### Major Hemorrhage

Postoperative bleeding that requires surgical intervention is uncommon. The postoperative findings are those of hypovolemia (tachycardia, hypotension, respiratory variation, absence of jugular venous distension). Most major hemorrhage results from slippage of ligatures around major pulmonary vessels. Bleeding from raw pleural surfac-

es is likely when vascular adhesions between the visceral and parietal pleura have been divided. Other sites of potential bleeding include the bronchial and intercostal arteries. Although chest tube drainage is an indicator of the extent of bleeding, the absence of chest tube drainage does not rule out major hemorrhage. Chest tubes may be malpositioned or occluded by clot, thus hiding the resulting hemothorax. If suspected, repositioning the patient and obtaining a chest radiography will confirm the presence of serious pleural effusion with blood.

## Pulmonary

### **Pneumothorax**

Pneumothoraces are common complications occurring intraoperatively and postoperatively. The presence of a large pneumothorax is a medical emergency. Clinical signs and symptoms include respiratory distress, decreased breath sounds unilaterally, increased airway pressure with decreased chest compliance, and decreased arterial oxygen saturation. Pneumothorax can expand to the point of tension pneumothorax, which is characterized by hypotension, tracheal shift, and cardiovascular collapse. If sufficient time is available, a chest radiograph is obtained to confirm diagnosis.

Management entails placement of a chest tube for evacuation of intrapleural air. In a spontaneously ventilating patient, the indications for chest tube placement are pneumothorax occupying at least 15% of the hemithorax or the presence of symptoms. Because mechanically ventilated patients are at risk for increasing size of the pneumothorax, they usually require placement of a chest tube. In emergency situations, decompression of the hemothorax can be accomplished by placement of a 14-gauge IV catheter into the second intercostal space in the anterior axillary line.

### **Torsion of Residual Lobe**

Pulmonary torsion refers to lung rotation on its bronchovascular pedicle. If uncorrected, it will result in pulmonary infarction. Patients undergoing lung resection are at increased risk for torsion of the remaining lobe. The right middle lobe and lingula are at greatest risk for torsion after right upper or left upper lobectomy.<sup>307</sup> Chest radiograph reveals an area of atelectasis or an expanding intrathoracic mass. If suspected, bron-

choscopy should be performed, followed by immediate surgical reexploration. A double-lumen endotracheal tube should be placed to allow for complete pneumonectomy or untwisting of the rotated bronchial vascular pedicle.

### **Postoperative Respiratory Failure**

The risks of postoperative respiratory dysfunction increase as the incidence of coexisting disease increases and the economic pressure to extubate and streamline the postoperative period continues to grow. Patients with chronic lung disease have an increased incidence of pulmonary complications. The increase in risk is related to the decrement in preoperative pulmonary function. The postoperative respiratory complications associated with smoking may be reduced with cessation of smoking at least 8 weeks before operation.<sup>308,309</sup>

The importance of factors such as age, obesity, and malnutrition are less clear. Advanced age alone does not appear to be a risk factor, but it may be a confounding variable. Respiratory mechanics and pulmonary functions are altered in obese patients.<sup>310,311</sup> The accumulation of fat in respiratory structures reduces compliance and increases the work of breathing. Although obesity may influence the risk of postoperative pulmonary complications, its importance is minor except in morbidly obese patients. Malnutrition is not a major risk factor for postoperative pulmonary complications, although it impairs immunity, decreases diaphragmatic muscle function, and diminishes the ventilation response to hypoxia.<sup>312</sup> Even though aggressive nutritional support improves biochemical parameters, it has not been shown to improve pulmonary function.<sup>313,314</sup>

### **Pulmonary Edema**

Pulmonary edema occurs because of altered balance of the Starling forces, resulting in a net movement of fluid into the interstitial space. Risk factors for pulmonary edema include cardiac, pulmonary, and anatomic reasons.

Pneumonectomy or reexpansion of atelectatic lung is associated with postoperative pulmonary edema. The etiology of these complications most likely is multifactorial and involves changes in hydrostatic pressure, oncotic pressure, cardiac output, and vascular permeability. Reexpansion pulmonary edema is unilateral and follows the reinflation of

atelectatic lungs caused by removal of effusions, evacuation of a pneumothorax, or reinflation after use of a double-lumen endotracheal tube.<sup>315,316</sup> This type of edema has been related to increased vascular permeability caused by an inflammatory reaction to the endothelium and mechanical changes to the blood vessels.<sup>317,318</sup> To avoid mechanical damage caused by excess stretching and increased pressure gradients, the lung should be expanded slowly and gradually.<sup>319</sup> The factors associated with postoperative pulmonary edema are more complicated. Postpneumonectomy pulmonary edema has been commonly attributed to increased cardiac output and fluid overload. Pneumonectomy dramatically decreases the cross-sectional area of the vascular bed, increasing hydrostatic pressure. During normal conditions, the vascular bed can accommodate the increased flow without dramatic increase in pulmonary arterial pressure, although the presence of pre-existing cardiac disease combined with aggressive fluid replacement and reduction of lymphatic drainage may predispose to the transudation of edema fluid. More recently, it has been recognized that a change in permeability is a major contributing factor to edema after pneumonectomy.<sup>319</sup> Occurrence of acute re-expansion pulmonary edema can be severe and result in mortality.<sup>316</sup> Patients become tachypneic, tachycardic, and hypoxic. These patients often remain intubated and require postoperative ventilatory support. Therapy is generally supportive. Mechanical ventilation with PEEP, diuresis, and hemodynamic support may be appropriate.<sup>320</sup> Patient positioning may be therapeutic when pulmonary edema is unilateral. Lateral decubitus positioning with the affected side up will reduce intrapulmonary shunting and improve oxygenation.<sup>321</sup>

## Neurologic Injuries

### **Phrenic Nerve Injury**

The phrenic nerve originates from C3, C4, and C5, passing into the chest anterior to the hilum of the lung within the pericardium. It is susceptible to damage during median sternotomy or thoracotomy. Phrenic nerve injury manifests as respiratory failure or failure to wean from mechanical ventilation. Diagnostic tests include chest radiography and fluoroscopic examination of diaphragmatic movement. Chest radiography shows a clear lung with an elevated hemidiaphragm, whereas fluo-

roscopy documents paradoxical movement of the diaphragm during inspiration. Most patients with normal lung function can tolerate unilateral phrenic nerve injury, although patients with preexisting lung disease or those who have undergone extensive pulmonary resection may be debilitated. If lung function does not return within 2–9 months, alternative therapies, including diaphragmatic pacing and diaphragmatic plication, can be considered.

### **Recurrent Laryngeal Nerve Injury**

The left recurrent laryngeal nerve is susceptible to injury during hilar dissection and mediastinoscopy. Unilateral laryngeal nerve injury usually is asymptomatic or manifests as hoarseness of voice, although bilateral nerve injury can result in apposition of the vocal cords and inspiratory obstruction requiring emergent reintubation of the trachea. If vocal cord function does not return after several months, the involved vocal cord can be injected with Teflon to improve its function.

### **Spinal Cord Injury**

Spinal cord injury is a rare complication after thoracic surgery.<sup>322</sup> The mechanisms of injury include nerve compression and vascular ischemia. Epidural hematomas and nerve compression can result from placement of epidural catheters or from surgical bleeding into the epidural space. Disruption of the major intercostal artery supplying the anterior spinal artery can result in anterior spinal artery syndrome, leading to paralysis.

### **Brachial Plexus Injury**

The brachial plexus is susceptible to injury caused by surgical trauma and indirectly caused by positioning.<sup>323</sup> Stretch injury of the plexus can occur with extreme abduction, external rotation, and dorsal extension of the arm (for further discussion, see Chap. 26).

## **POSTOPERATIVE PAIN MANAGEMENT**

The pain that accompanies thoracic surgery is notable for its intensity and duration. Acutely, moderate to severe levels of pain may not decrease substantially over the course of hospitalization and the first postoperative month.<sup>324</sup> Noxious input associated with thoracic surgery is conveyed to the CNS along the intercostal, vagus,

and phrenic nerves. Afferent phrenic activity is believed to be the source of the shoulder pain that frequently accompanies thoracic procedures because this is curtailed by phrenic<sup>325</sup> but not suprascapular or epidural blockade.<sup>326</sup> Intercostal nerve dysfunction resulting from incision, retraction, trocar placement, or suture is common<sup>327</sup> and likely plays a significant role in the pain accompanying thoracic surgery. Although used with increasing frequency, thoracoscopic approaches have not had the favorable impact on pain that many had anticipated.<sup>328,329</sup>

Postoperative pain control is one of the most important management goals for preventing postoperative respiratory complications. Inadequate pain control leads to shallow respirations, tachypnea, inability to cough effectively, retention of secretions, and atelectasis. These symptoms contribute to postoperative hypoxia, hypercapnia, and respiratory failure in postthoracotomy patients. Effective postoperative pain management decreases these deleterious effects. We are strong advocates of epidural analgesia using local anesthetic and opioid that is initiated intraoperatively and continued postoperatively. This therapy can be supplemented with NSAIDs, acetaminophen,  $\alpha_2$ -adrenergic agonists, and ketamine. Other options are patient-controlled analgesia, intercostal nerve blocks, cryoanalgesia, intrapleural catheters, and paravertebral block.

### **Intercostal Nerve Block**

Intercostal nerve block is an effective technique to provide postoperative analgesia without central respiratory depression and to attenuate the decrease in pulmonary function after thoracic surgery.<sup>330</sup> Postthoracotomy pain is not completely managed with intercostal analgesia; it requires supplemental use of parenteral opioids or NSAIDs. Complications of this technique are few but include pneumothorax, local anesthetic toxicity, and neuroaxonal spread of local anesthetics that can result in unintentional hypotension.<sup>83,331</sup>

Intercostal nerve block can be performed intraoperatively by intrathoracic injection or percutaneously by the anesthesiologist. Nerve blocks are performed at the levels above and below the site of chest tube insertion and incision (Fig. 53–44). Nerve blocks are performed by injection of 2–3 mL

of bupivacaine 0.5% with epinephrine (1:200,000 concentration). Because the average duration of these nerve blocks is 4–8 hours, placement of indwelling catheters in the intercostal space is used to provide analgesia up to 6 days.

A variation in providing postoperative intercostal analgesia is cryogenic analgesia. The efficacy of this technique is debatable compared with epidural or IV anesthesia.<sup>138,332</sup> Problems associated with cryoanalgesia of the intercostal nerves include long-term neuralgias, prolonged paresthesia, dysesthesias, and loss of intercostal muscle tone. Another possible option is paravertebral analgesia, which is a variation of intercostal nerve block.

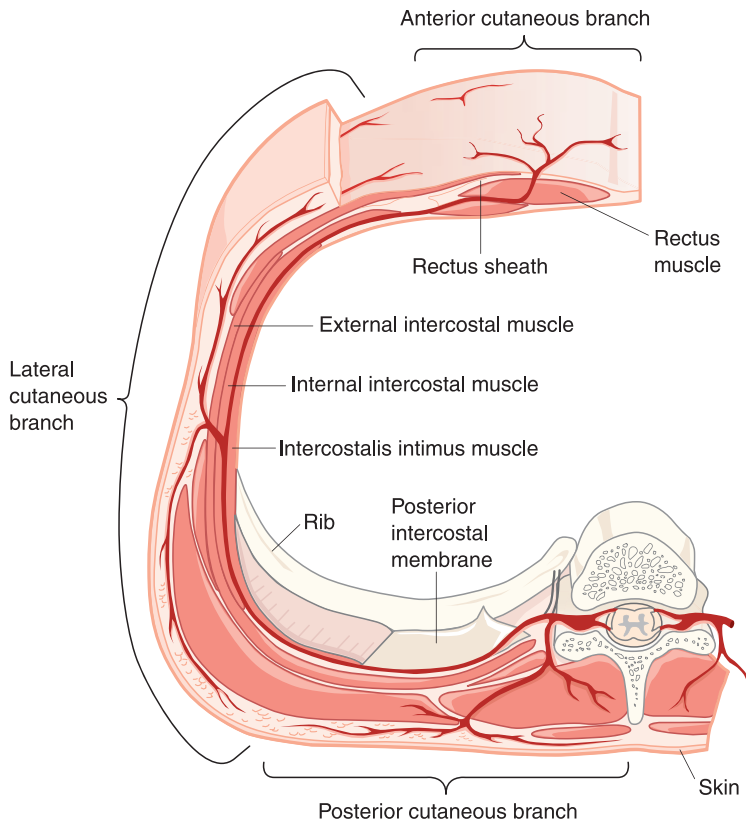
### **Thoracic Paravertebral Block**

An alternate method for achieving multiple intercostal nerve blockade is placement of a thoracic paravertebral block, either by single injection or continuous catheter.<sup>333,334</sup> Unilateral analgesia is achieved by depositing local anesthetic in the paravertebral space, which is the locus of the primary ramus of the intercostal nerve. Although this technique avoids some of the disadvantages of intrapleural analgesia, such as loss through chest tube and risk of rapid absorption, it has not gained widespread popularity. No studies to date have documented an improvement in respiratory function equal to or exceeding that reported with use of epidural analgesia.

### **Epidural Anesthesia**

Epidural anesthesia is commonly used for management of postthoracotomy pain and has potential benefits for the pulmonary and cardiovascular systems.<sup>335–337</sup> Surprisingly, VATS is associated with postoperative pain and a prevalence of chronic pain comparable to that of open procedures, with rates of pain ranging from 22–63%,<sup>328,329</sup> which probably due to intercostal nerve and muscle damage from trocar insertion. Consequently, epidural analgesia is strongly recommended for patients undergoing VATS who are deemed high risk during preoperative evaluation.

Epidural analgesia lessens the postoperative reduction in pulmonary function (FVC, FEV<sub>1</sub>, peak exploratory flow rate) and improves arterial oxygenation compared with use of parenteral opioids. In addition, administration of epidural opioids attenuates postoperative sympathetic stimulation and conse-



**FIGURE 53–44.** Intercostal nerve and its branches, and approximate area of skin supplied by the branches. There is evidence that local anesthetic injected near the lateral cutaneous branch diffuses posteriorly to reach the posterior cutaneous branch. Note also the spinal nerves and dorsal root ganglia in the region of intervertebral foramen, with risk of perineural spread into spinal fluid after intraneural injection in this region. Direct injection into an intervertebral foramen may reach spinal fluid by means of a dural cuff. Local anesthetic may gain access to epidural space by diffusing into an intervertebral foramen. Close to the midline, the intercostal nerve lies directly on the posterior intercostal membrane and pleura. (From Cousins MJ, Bindenbough PO, eds. *Neural Blockade*. 2nd ed. Philadelphia: JB Lippincott, 1988, pg. 247, with permission.)

quent hypertension and tachycardia.<sup>338</sup> Use of local anesthetics may be cardioprotective by producing sympathetic blockade, resulting in vasodilatation of epicardial vessels, improving left ventricular function during ischemia, and decreasing adrenergic outflow.<sup>141</sup> Animal studies that evaluated the effects of thoracic epidural analgesia have shown a lessening of myocardial ischemia and a reduction in the area of infarction.<sup>339</sup>

Effective postoperative analgesia can be obtained by placing the epidural catheter in either the thoracic or lumbar regions.<sup>340–345</sup> The efficacy of the site of epidural opioid administration may depend in part on the hydrophobicity of the opioid. Some investigators have proposed that epidural administration of lipophilic opioids produces analgesia predominantly by systemic absorption and not at the level of the spinal cord.<sup>335,345</sup>

It is the clinical practice in many institutions to combine the use of epi-

dural opioids with local anesthetics. Theoretically, the combination of the two agents act synergistically to provide better analgesia while minimizing the side effects of either agent. The combination of epidural bupivacaine plus morphine or fentanyl provides better analgesia than does local anesthetic alone.<sup>346</sup>

Side effects associated with neuraxial administration of local anesthetics include hypotension and bradycardia, caused by sympathectomy and peripheral vasodilatation, and blockade of the cardiac accelerator nerve fibers at T1–T4. Administration of opioids is associated with side effects such as nausea, vomiting, pruritus, urinary retention, central narcosis, and respiratory depression. The incidence of respiratory depression from neuraxial administration of opioids varies from 0.1–3%.<sup>335</sup> Depending on the agent used, respiratory depression from opioids may peak from 4–10 hours after bolus injection

#### BOX 53–14.

##### Factors Predisposing to Development of Respiratory Depression after Epidural Opioids

###### Drug factor

- Hydrophilic drug (e.g., morphine)
- Large doses
- Repeated doses
- Concomitant administration of parenteral opioids or other CNS depressants

###### Patient factors

- Elderly or debilitated
- Coexisting respiratory disease
- Thoracic epidural
- High sensitivity to opioids (i.e., no previous exposure to opioids)
- Intrathecal administration
- Increased intrathoracic pressure (e.g., controlled ventilation, coughing, vomiting)

From Etches et al.<sup>335</sup> with permission.

but may persist up to 24 hours. Patients at increased risk for developing respiratory depression include older, sicker patients undergoing lengthy surgical procedures and those receiving major parenteral opioids perioperatively or > 6 mg of epidural morphine or 0.5 mg of intrathecal morphine (Box 53–14).<sup>335</sup> To decrease complications associated with respiratory depression, the patient should be monitored and cared for by knowledgeable staff with clear instructions for management of respiratory depression.

The acute and chronic pain that accompanies thoracic surgery is significant but often underappreciated, with a well-established level of significant physiologic and functional impact and unknown social and economic costs. An appropriate perioperative analgesic regimen, apart from its more immediate benefits with respect to comfort and pulmonary function, likely will lead to reductions in longer-term pain. Therefore, we strongly recommend thoracic epidural analgesia in all patients scheduled for open thoracotomy and serious consideration of epidural analgesia in patients undergoing VATS. Epidural analgesia can be combined with NSAIDs and/or acetaminophen to reduce pain as much as possible to reduce risk and promote well-being. Patients whose pain is not well controlled (visual analogue pain score  $\geq 3$  out of 10) must be assessed for epidural func-



tion and the need for additional alternate analgesics, including IV opioids, ketamine, and  $\alpha_2$ -agonists. These regimens should be directed by physicians trained in pain management who will be immediately available to best care for these high-risk patients.

## KEY REFERENCES

1. Benumof JL, Partridge BL, Salvatierra C, et al. Margin of safety in positioning modern double-lumen endotracheal tubes. *Anesthesiology* 1987;67:729.
2. Martinez FJ, Chang A. Surgical therapy for chronic obstructive pulmonary disease. *Semin Respir Crit Care Med* 2005;26:67.
3. Gottschalk A, Cohen SP, Yang S, et al. Preventing and treating pain after thoracic surgery. *Anesthesiology* 2006;104:594.
4. Pate P, Tenholder MF, Griffin JP, et al. Preoperative assessment of the high-risk patient for lung resection. *Ann Thorac Surg* 1996;61:1494.
5. Schmiesing CA, Brodsky JB. The preoperative anesthesia evaluation. *Thorac Surg Clin* 2005;15:305.
6. Kaza AK, Mitchell JD. Preoperative pulmonary evaluation of the thoracic surgical patient. *Thorac Surg Clin* 2005;15:297.
7. Weir EK, Archer SL. The mechanism of acute hypoxic pulmonary vasoconstriction: the tale of two channels. *FASEB J* 1995;9:183.
8. Takaoka ST, Weinacker AB. The value of preoperative pulmonary rehabilitation. *Thorac Surg Clin* 2005;2:203.

## REFERENCES

1. Anderson WG. Respiratory aspects of the preoperative examination. *Br J Anaesth* 1974;46:549-554.
2. Bartlett RH, Krop P, Hanson EL, Moore FD. Physiology of yawning and its application to postoperative care. *Surg Forum* 1970;21:222-224.
3. Bartlett RH, Gazzaniga AB, Geraghty T. The yawn maneuver: prevention and treatment of postoperative pulmonary complications. *Surg Forum* 1971;22:196-198.
4. Egbert LD, Battit GE, Welch CE, et al. Reduction of postoperative pain by encour-

agement and instruction of patients. A study of doctor-patient rapport. *N Engl J Med* 1964;270:825-827.

5. Palmer KNV, Sellick BA. The prevention of postoperative pulmonary atelectasis. *Lancet* 1953;1:164.
6. Fee HJ, Holmes EC, Gewirtz HS, et al. Role of pulmonary vascular resistance measurements in preoperative evaluation of candidates for pulmonary resection. *J Thorac Cardiovasc Surg* 1978;75:519-524.
7. McFalls EO, Ward HB, Moritz TE, et al. Coronary-artery revascularization before elective major vascular surgery. *N Engl J Med* 2004;351:2795-2804.
8. Barrera R, Shi W, Amar D, et al. Smoking and timing of cessation: impact on pulmonary complications after thoracotomy. *Chest* 2005;127:1977-1983.
9. Ali MK, Mountain CF, Ewer MS, et al. Predicting loss of pulmonary function after pulmonary resection for bronchogenic carcinoma. *Chest* 1980;77:337-342.
10. Bagg LR. The 12-min walking distance; its use in the pre-operative assessment of patients with bronchial carcinoma before lung resection. *Respiration* 1984;46:342-345.
11. Baldi S, Scappaticci E, Rapellino M, et al. Effect of lung resection on pulmonary function. A comparative study in different surgical procedures. *Panminerva Med* 1989;31:19-21.
12. Bechard D, Wetstein L. Assessment of exercise oxygen consumption as preoperative criterion for lung resection. *Ann Thorac Surg* 1987;44:344-349.
13. Boysen PG, Harris JO, Block AJ, et al. Prospective evaluation for pneumonectomy using perfusion scanning: follow-up beyond one year. *Chest* 1981;80:163-166.
14. Boysen PG, Block AJ, Olsen GN, et al. Prospective evaluation for pneumonectomy using the 99mtechnetium quantitative perfusion lung scan. *Chest* 1977;72:422-425.
15. Boysen PG, Block AJ, Moulder PV. Relationship between preoperative pulmonary function tests and complications after thoracotomy. *Surg Gynecol Obstet* 1981;152:813-815.
16. Boysen PG. Pulmonary resection and postoperative pulmonary function. *Chest* 1980;77:718-719.
17. DeMeester TR, Van Heertum RL, Karas JR, et al. Preoperative evaluation with differential pulmonary function. *Ann Thorac Surg* 1974;18:61-71.
18. Ferguson MK, Little L, Rizzo L, et al. Diffusing capacity predicts morbidity and mortality after pulmonary resection. *J Thorac Cardiovasc Surg* 1988;96:894-900.
19. Gass GD, Olsen GN. Preoperative pulmonary function testing to predict postoperative morbidity and mortality. *Chest* 1986;89:127-135.
20. Jarvinen A, Mattila T, Appelqvist P, et al. Cardiac disturbances after pneumonectomy—the value of prophylactic digitalization. *Ann Chir Gynaecol* 1978;67:77-81.

21. Marion JM, Alderson PO, Lefrak SS, et al. Unilateral lung function. Comparison of the lateral position test with radionuclide ventilation-perfusion studies. *Chest* 1976;69:5-9.

22. Markos J, Mullan BP, Hillman DR, et al. Preoperative assessment as a predictor of mortality and morbidity after lung resection. *Am Rev Respir Dis* 1989;139:902-910.
23. Miller JL, Grossman GD, Hatcher CR. Pulmonary function test criteria for operability and pulmonary resection. *Surg Gynecol Obstet* 1981;153:893-895.
24. Nogueira C, Mincer F, Botstein C. Long survival in patients with bronchogenic carcinoma complicated by superior vena caval obstruction. *Chest* 1979;75:325-329.
25. Olsen GN, Block AJ, Swenson EW, et al. Pulmonary function evaluation of the lung resection candidate: a prospective study. *Am Rev Respir Dis* 1975;111:379-387.
26. Olsen GN, Weiman DS, Bolton JW, et al. Submaximal invasive exercise testing and quantitative lung scanning in the evaluation for tolerance of lung resection. *Chest* 1989;95:267-273.
27. Olsen GN, Block AJ, Tobias JA. Prediction of postpneumonectomy pulmonary function using quantitative macroaggregate lung scanning. *Chest* 1974;66:13-16.
28. Olsen GN. The evolving role of exercise testing prior to lung resection. *Chest* 1989;95:218-225.
29. Ohno Y, Hatabu H, Higashino T, et al. Dynamic perfusion MRI versus perfusion scintigraphy: prediction of postoperative lung function in patients with lung cancer. *AJR Am J Roentgenol* 2004;182:73-78.
30. Wu MT, Pan HB, Chiang AA, et al. Prediction of postoperative lung function in patients with lung cancer: comparison of quantitative CT with perfusion scintigraphy. *AJR Am J Roentgenol* 2002;178:667-672.
31. Bolliger CT, Soler M, Stulz P, et al. Evaluation of high-risk lung resection candidates: pulmonary haemodynamics versus exercise testing. A series of five patients. *Respiration* 1994;61:181-186.
32. Pate P, Tenholder MF, Griffin JP, et al. Preoperative assessment of the high-risk patient for lung resection. *Ann Thorac Surg* 1996;61:1494-1500.
33. Ohta M, Nakahara K, Yasumitsu T, et al. Prediction of postoperative performance status in patients with giant bulla. *Chest* 1992;101:668-673.
34. Laros CD, Swierenga J. Temporary unilateral pulmonary artery occlusion in the preoperative evaluation of patients with bronchial carcinoma. Comparison of pulmonary artery pressure measurements, pulmonary function tests and early postoperative mortality. *Med Thorac* 1967;24:269-283.
35. Anderson WH, Dossett BE Jr, Hamilton GL. Prevention of postoperative pulmonary complications: use of isoproterenol and intermittent positive pressure breathing on inspiration. *JAMA* 1963;186:763.

36. Stein M, Koota GM, Simon M, et al. Pulmonary evaluation of surgical patients. *JAMA* 1962;181:765-770.
37. Pearce AC, Jones RM. Smoking and anesthesia: preoperative abstinence and perioperative morbidity. *Anesthesiology* 1984;61:576-584.
38. Jones RM. Smoking before surgery: the case for stopping. *Br Med J (Clin Res Ed)* 1985;290:1763-1764.
39. May DB, Munt PW. Physiologic effects of chest percussion and postural drainage in patients with stable chronic bronchitis. *Chest* 1979;75:29-32.
40. Oldenburg FA Jr, Dolovich MB, Montgomery JM, et al. Effects of postural drainage, exercise, and cough on mucus clearance in chronic bronchitis. *Am Rev Respir Dis* 1979;120:739-745.
41. Cooper DK. The incidence of postoperative infection and the role of antibiotic prophylaxis in pulmonary surgery. A review of 221 consecutive patients undergoing thoracotomy. *Br J Dis Chest* 1981;75:154-160.
42. Verrill D, Barton C, Beasley W, et al. The effects of short-term and long-term pulmonary rehabilitation on functional capacity, perceived dyspnea, and quality of life. *Chest* 2005;128:673-683.
43. Ries AL, Kaplan RM, Limberg TM, et al. Effects of pulmonary rehabilitation on physiologic and psychosocial outcomes in patients with chronic obstructive pulmonary disease. *Ann Intern Med* 1995;122:823-832.
44. California Pulmonary Rehabilitation Collaborative Group. Effects of pulmonary rehabilitation on dyspnea, quality of life, and healthcare costs in California. *J Cardiopulm Rehabil* 2004;24:52-62.
45. Bozzone A, Romanelli A, Magrone G, et al. Pulmonary rehabilitation: pre-and post-operative treatment. *Rays* 2004;29:431-433.
46. Beasley MB, Brambilla E, Travis WD. The 2004 World Health Organization classification of lung tumors. *Semin Roentgenol* 2005;40:90-97.
47. Manser R, Wright G, Hart D, et al. Surgery for early stage non-small cell lung cancer. *Cochrane Database Syst Rev* 2005; CD004699.
48. Ginsberg RJ, Rubinstein LV. Randomized trial of lobectomy versus limited resection for T1 N0 non-small cell lung cancer. Lung Cancer Study Group. *Ann Thorac Surg* 1995;60:615-622.
49. Jones DP. Diagnostic work-up of chest disease. *Surg Clin North Am* 1980;60:743-755.
50. Spiro SG. The diagnosis and staging of lung cancer. In Smyth JF, ed. *The management of Lung Cancer*. London: Edward Arnold, 1984.
51. Shields TW. Carcinoma of the lung. In Shields TW, ed. *General Thoracic Surgery*. Philadelphia: Lea & Febiger, 1983.
52. Goodman GE, Livingston RB. Small cell lung cancer. *Curr Probl Cancer* 1989;13:1-54.
53. Irita K, Satoh M, Akata T, et al. Lambert-Eaton myasthenic syndrome. *Can J Anaesth* 1990;37:944.
54. Pancrazio JJ, Viglione MP, Tabbara IA, et al. Voltage-dependent ion channels in small-cell lung cancer cells. *Cancer Res* 1989;49:5901-5906.
55. Dalmau J, Gultekin HS, Posner JB. Paraneoplastic neurologic syndromes: pathogenesis and physiopathology. *Brain Pathol* 1999;9:275-284.
56. Dalmau J, Furneaux HM, Cordon-Cardo C, et al. The expression of the Hu (paraneoplastic encephalomyelitis/sensory neuronopathy) antigen in human normal and tumor tissues. *Am J Pathol* 1992;141:881-886.
57. Cooper JB, Newbower RS, Kitz RJ. An analysis of major errors and equipment failures in anesthesia management: considerations for prevention and detection. *Anesthesiology* 1984;60:34-42.
58. Benumof JL, Saidman LJ, Arkin DB, et al. Where pulmonary arterial catheters go: intrathoracic distribution. *Anesthesiology* 1977;46:336-338.
59. Fry DI, Hyatt RE. Pulmonary mechanics: a unified analysis of the relationship between pressure, volume and gas flow in the lungs of normal and diseased human subjects. *Am J Med* 1960;29:672.
60. Hasan FM, Malanga A, Corrao WM, et al. Effect of catheter position on thermodilution cardiac output during continuous positive-pressure ventilation. *Crit Care Med* 1984;12:387-390.
61. Landais A, Morin JP, Roche A, et al. Measurement of cardiac output by the thermodilution method during left thoracotomy in the lateral position in the dog. *Acta Anaesthesiol Scand* 1990;34:158-161.
62. Hoppin FG Jr, Green ID, Mead J. Distribution of pleural surface pressure in dogs. *J Appl Physiol* 1969;27:863-873.
63. Rehder K, Wenthe FM, Sessler AD. Function of each lung during mechanical ventilation with ZEEP and with PEEP in man anesthetized with thiopental-meperidine. *Anesthesiology* 1973;39:597-606.
64. Wulff KE, Aulin I. The regional lung function in the lateral decubitus position during anesthesia and operation. *Acta Anaesthesiol Scand* 1972;16:195-205.
65. Svanberg L. Influence of posture on lung volumes, ventilation and circulation in normals. *Scand J Clin Lab Invest* 1957; 9(Suppl 25):1.
66. Potgieter SV. Atelectasis: its evolution during upper urinary tract surgery. *Br J Anaesth* 1959;31:472.
67. Rehder K, Hatch DJ, Sessler AD, et al. The function of each lung of anesthetized and paralyzed man during mechanical ventilation. *Anesthesiology* 1972;37:16-26.
68. Nunn JF. The distribution of inspired gas during thoracic surgery. *Ann R Coll Surg Engl* 1961;28:223.
69. Werner O, Malmkvist G, Beckman A, et al. Gas exchange and haemodynamics during thoracotomy. *Br J Anaesth* 1984;56:1343-1349.
70. Glass DD, Tonnesen AS, Gabel JC, et al. Therapy of unilateral pulmonary insufficiency with a double lumen endotracheal tube. *Crit Care Med* 1976;4:323-326.
71. Brodsky JB, Adkins MO, Gaba DM. Bronchial cuff pressures of double-lumen tubes. *Anesth Analg* 1989;69:608-610.
72. Burton NA, Fall SM, Lyons T, et al. Rupture of the left main-stem bronchus with a polyvinylchloride double-lumen tube. *Chest* 1983;83:928-929.
73. Dryden GE. Circulatory collapse after pneumonectomy (an unusual complication from the use of a Carlens catheter): case report. *Anesth Analg* 1977;56:451-452.
74. Foster JM, Lau OJ, Alimo EB. Ruptured bronchus following endobronchial intubation. A case report. *Br J Anaesth* 1983;55:687-688.
75. Guernelli N, Bragaglia RB, Briccoli A, et al. Tracheobronchial ruptures due to cuffed Carlens tubes. *Ann Thorac Surg* 1979;28:66-67.
76. Heiser M, Steinberg JJ, MacVaugh H III, et al. Bronchial rupture, a complication of use of the Robertshaw double-lumen tube. *Anesthesiology* 1979;51:88.
77. Olivet RT, Nauss LA, Payne WS. A technique for continuous intercostal nerve block analgesia following thoracotomy. *J Thorac Cardiovasc Surg* 1980;80:308-311.
78. Pang D, Wessel HB. Thoracic outlet syndrome. *Neurosurgery* 1988;22(1 Pt 1):105-121.
79. Wessel DL, Adatia I, Thompson JE, et al. Delivery and monitoring of inhaled nitric oxide in patients with pulmonary hypertension. *Crit Care Med* 1994;22:930-938.
80. Marshall BE, Marshall C. Continuity of response to hypoxic pulmonary vasoconstriction. *J Appl Physiol* 1980;49:189-196.
81. Moudgil R, Michelakis ED, Archer SL. Hypoxic pulmonary vasoconstriction. *J Appl Physiol* 2005;98:390-403.
82. Archer SL, Wu XC, Thebaud B, et al. O<sub>2</sub> sensing in the human ductus arteriosus: redox-sensitive K<sup>+</sup> channels are regulated by mitochondria-derived hydrogen peroxide. *Biol Chem* 2004;385:205-216.
83. Benumof JL, Wahrenbrock EA. Blunted hypoxic pulmonary vasoconstriction by increased lung vascular pressures. *J Appl Physiol* 1975;38:846-850.
84. Miller FL, Chen L, Malmkvist G, et al. Mechanical factors do not influence blood flow distribution in atelectasis. *Anesthesiology* 1989;70:481-488.
85. Benumof JL, Wahrenbrock EA. Dependency of hypoxic pulmonary vasoconstriction on temperature. *J Appl Physiol* 1977; 42:56-58.
86. Bishop MJ, Kennard S, Artman LD, et al. Hydralazine does not inhibit canine hypoxic pulmonary vasoconstriction. *Am Rev Respir Dis* 1983;128:998-1001.
87. Redding GJ, Tuck R, Escourrou P. Nifedipine attenuates acute hypoxic pulmo-

- nary vasoconstriction in awake piglets. *Am Rev Respir Dis* 1984;129:785-789.
88. Simonneau G, Escourrou P, Duroux P, et al. Inhibition of hypoxic pulmonary vasoconstriction by nifedipine. *N Engl J Med* 1981;304:1582-1585.
89. Bishop MJ, Cheney FW. Comparison of the effects of minoxidil and nifedipine on hypoxic pulmonary vasoconstriction in dogs. *J Cardiovasc Pharmacol* 1983;5:184-189.
90. Brown SE, Linden GS, King RR, et al. Effects of verapamil on pulmonary haemodynamics during hypoxaemia, at rest, and during exercise in patients with chronic obstructive pulmonary disease. *Thorax* 1983;38:840-844.
91. Tucker A, McMurtry IF, Grover RF, et al. Attenuation of hypoxic pulmonary vasoconstriction by verapamil in intact dogs. *Proc Soc Exp Biol Med* 1976;151:611-614.
92. Chick TW, Kochukoshy KN, Matsumoto S, et al. The effect of nitroglycerin on gas exchange, hemodynamics, and oxygen transport in patients with chronic obstructive pulmonary disease. *Am J Med Sci* 1978;276:105-111.
93. Colley PS, Cheney FW Jr, Hlastala MP. Pulmonary gas exchange effects of nitroglycerin in canine edematous lungs. *Anesthesiology* 1981;55:114-119.
94. Parsons GH, Leventhal JP, Hansen MM, et al. Effect of sodium nitroprusside on hypoxic pulmonary vasoconstriction in the dog. *J Appl Physiol* 1981;51:288-292.
95. Nakazawa K, Amaha K. Effect of nicardipine hydrochloride on regional hypoxic pulmonary vasoconstriction. *Br J Anaesth* 1988;60:547-554.
96. Dunn PF. Physiology of the lateral decubitus position and one-lung ventilation. *Int Anesthesiol Clin* 2000;38:25-53.
97. Benumof JL, Augustine SD, Gibbons JA. Halothane and isoflurane only slightly impair arterial oxygenation during one-lung ventilation in patients undergoing thoracotomy. *Anesthesiology* 1987;67:910-915.
98. Rees DI, Gaines GY III. One-lung anesthesia—a comparison of pulmonary gas exchange during anesthesia with ketamine or enflurane. *Anesth Analg* 1984;63:521-525.
99. Benumof JL. One-lung ventilation and hypoxic pulmonary vasoconstriction: implications for anesthetic management. *Anesth Analg* 1985;64:821-833.
100. Lennon PF, Murray PA. Attenuated hypoxic pulmonary vasoconstriction during isoflurane anesthesia is abolished by cyclooxygenase inhibition in chronically instrumented dogs. *Anesthesiology* 1996;84:404-414.
101. Van Keer L, Van Aken H, Vandermeersch E, et al. Propofol does not inhibit hypoxic pulmonary vasoconstriction in humans. *J Clin Anesth* 1989;1:284-288.
102. Ishibe Y, Shiokawa Y, Umeda T, et al. The effect of thoracic epidural anesthesia on hypoxic pulmonary vasoconstriction in dogs: an analysis of the pressure-flow curve. *Anesth Analg* 1996;82:1049-1055.
103. Adatia I, Lillehei C, Arnold JH, et al. Inhaled nitric oxide in the treatment of postoperative graft dysfunction after lung transplantation. *Ann Thorac Surg* 1994;57:1311-1318.
104. Gibson WH, Roughton FJ. The kinetics and equilibria of the reactions of nitric oxide with sheep haemoglobin. *J Physiol* 1957;136:507-524.
105. Tibballs J. Clinical applications of gaseous nitric oxide. *Anaesth Intensive Care* 1993;21:866-871.
106. Wightman JA. A prospective survey of the incidence of postoperative pulmonary complications. *Br J Surg* 1968;55:85-91.
107. Bocchi EA, Bacal F, Auler JO Jr, et al. Inhaled nitric oxide leading to pulmonary edema in stable severe heart failure. *Am J Cardiol* 1994;74:70-72.
108. Okamoto K, Sato T, Kurose M, et al. Successful use of inhaled nitric oxide for treatment of severe hypoxemia in an infant with total anomalous pulmonary venous return. *Anesthesiology* 1994;81:256-259.
109. Oriot D, Bousseart T, Berthier M, et al. Paradoxical effect of inhaled nitric oxide in a newborn with pulmonary hypertension. *Lancet* 1993;342:364-365.
110. Bigatello LM, Hurford WE, Kacmarek RM, et al. Prolonged inhalation of low concentrations of nitric oxide in patients with severe adult respiratory distress syndrome. Effects on pulmonary hemodynamics and oxygenation. *Anesthesiology* 1994;80:761-770.
111. Gerlach H, Pappert D, Lewandowski K, et al. Long-term inhalation with evaluated low doses of nitric oxide for selective improvement of oxygenation in patients with adult respiratory distress syndrome. *Intensive Care Med* 1993;19:443-449.
112. Dandel M, Hetzer R. Clinical value of prostacyclin and its analogs in the management of pulmonary arterial hypertension. *Curr Vasc Pharmacol* 2003;1:171-181.
113. Lowson SM, Doctor A, Walsh BK, et al. Inhaled prostacyclin for the treatment of pulmonary hypertension after cardiac surgery. *Crit Care Med* 2002;30:2762-2764.
114. Baker SE, Hockman RH. Inhaled iloprost in pulmonary arterial hypertension. *Ann Pharmacother* 2005;39:1265-1274.
115. Vane JR, Botting RM. Pharmacodynamic profile of prostacyclin. *Am J Cardiol* 1995;75:3A-10A.
116. Augoustides JG, Ochroch EA. Pro: inhaled prostaglandin as a pulmonary vasodilator instead of nitric oxide. *J Cardiothorac Vasc Anesth* 2005;19:400-402.
117. Slinger P, Suissa S, Triolet W. Predicting arterial oxygenation during one-lung anaesthesia. *Can J Anaesth* 1992;39:1030-1035.
118. Hurford WE, Kolker AC, Strauss HW. The use of ventilation/perfusion lung scans to predict oxygenation during one-lung anesthesia. *Anesthesiology* 1987;67:841-844.
119. Guenoun T, Journois D, Sillerean-Chasany J, et al. Prediction of arterial oxygenation during one-lung ventilation: analysis of preoperative and intraoperative variables. *J Cardiothorac Vasc Anesth* 2002;16:199-203.
120. Benumof JL, Rogers SN, Moyce PR, et al. Hypoxic pulmonary vasoconstriction and regional and whole-lung PEEP in the dog. *Anesthesiology* 1979;51:503-507.
121. Finley TN, Hill TR, Bonica JJ. Effect of intrapleural pressure on pulmonary shunt to atelectatic dog lung. *Am J Physiol* 1963;205:1187.
122. Katz JA, Laverne RG, Fairley HB, et al. Pulmonary oxygen exchange during endobronchial anesthesia: effect of tidal volume and PEEP. *Anesthesiology* 1982;56:164-171.
123. Kerr JH. Physiological aspects of one-lung (endobronchial) anesthesia. *Int Anesthesiol Clin* 1972;10:61-78.
124. Bachand R, Audet J, Meloche R, et al. Physiological changes associated with unilateral pulmonary ventilation during operations on the lung. *Can Anaesth Soc J* 1975;22:659-664.
125. Hatch D. Ventilation and arterial oxygenation during thoracic surgery. *Thorax* 1966;21:310-314.
126. Alfery DD, Benumof JL, Trousdale FR. Improving oxygenation during one-lung ventilation in dogs: the effects of positive end-expiratory pressure and blood flow restriction to the nonventilated lung. *Anesthesiology* 1981;55:381-385.
127. Baraka A, Sibai AN, Muallem M, et al. CPAP oxygenation during one-lung ventilation using an underwater seal assembly. *Anesthesiology* 1986;65:102-103.
128. Malmkvist G. Maintenance of oxygenation during one-lung ventilation. Effect of intermittent reinflation of the collapsed lung with oxygen. *Anesth Analg* 1989;68:763-766.
129. Wilks D, Schumann T, Rey R. Selective high-frequency jet ventilation of the operative lung improves oxygenation during thoracic surgery. *Anesthesiology* 1985;63:A568.
130. Benjaminsson E, Klain M. Intraoperative dual-mode independent lung ventilation of a patient with bronchopleural fistula. *Anesth Analg* 1981;60:118-119.
131. Parish JM, Gracey DR, Southorn PA, et al. Differential mechanical ventilation in respiratory failure due to severe unilateral lung disease. *Mayo Clin Proc* 1984;59:822-828.
132. Rivara D, Bourgain JL, Rieuf P, et al. Differential ventilation in unilateral lung disease: effects on respiratory mechanics and gas exchange. *Intensive Care Med* 1979;5:189-191.
133. Stow PJ, Grant I. Asynchronous independent lung ventilation. Its use in the treatment of acute unilateral lung disease. *Anaesthesia* 1985;40:163-166.
134. Morgan BA, Perks D, Conacher ID, et al. Combined unilateral high frequency jet ventilation and contralateral intermittent



- positive pressure ventilation. *Anaesthesia* 1987;42:975-979.
135. Neustein SM, Kreitzer JM, Krellenstein D, et al. Preemptive epidural analgesia for thoracic surgery. *Mt Sinai J Med* 2002;69:101-104.
136. Cerfolio RJ, Bryant AS, Bass CS, et al. A prospective, double-blinded, randomized trial evaluating the use of preemptive analgesia of the skin before thoracotomy. *Ann Thorac Surg* 2003;76:1055-1058.
137. Bjertnaes LJ. Hypoxia-induced vasoconstriction in isolated perfused lungs exposed to injectable or inhalation anesthetics. *Acta Anaesthesiol Scand* 1977;21:133-147.
138. Maiwand MO, Makey AR, Rees A. Cryoanalgesia after thoracotomy. Improvement of technique and review of 600 cases. *J Thorac Cardiovasc Surg* 1986;92:291-295.
139. Hasenbos MA, Gielen MJ. Anaesthesia for bullectomy. A technique with spontaneous ventilation and extradural blockade. *Anaesthesia* 1985;40:977-980.
140. Crawford OB, Buckingham WW, Ottosen P, et al. Peridural anesthesia in thoracic surgery, a review of 677 cases. *Anesthesiology* 1951;12:73.
141. Vik-Mo H, Ottesen S, Renck H. Cardiac effects of thoracic epidural analgesia before and during acute coronary artery occlusion in open-chest dogs. *Scand J Clin Lab Invest* 1978;38:737-746.
142. Modig J, Borg T, Karlstrom G, et al. Thromboembolism after total hip replacement: role of epidural and general anesthesia. *Anesth Analg* 1983;62:174-180.
143. Moir DD. Blood loss during major vaginal surgery. A statistical study of the influence of general anaesthesia and epidural analgesia. *Br J Anaesth* 1968;40:233-240.
144. Engquist A, Brandt MR, Fernandes A, et al. The blocking effect of epidural analgesia on the adrenocortical and hyperglycemic responses to surgery. *Acta Anaesthesiol Scand* 1977;21:330-335.
145. Yeager MP, Glass DD, Neff RK, et al. Epidural anesthesia and analgesia in high-risk surgical patients. *Anesthesiology* 1987;66:729-736.
146. Bromage PR. Spirometry in assessment of analgesia after abdominal surgery; a method of comparing analgesic drugs. *Br Med J* 1955;4939:589-593.
147. Sackner MA, Hirsch J, Epstein S. Effect of cuffed endotracheal tubes on tracheal mucous velocity. *Chest* 1975;68:774-777.
148. Spray SB, Zuidema GD, Cameron JL. Aspiration pneumonia; incidence of aspiration with endotracheal tubes. *Am J Surg* 1976;131:701-703.
149. Howard RJ, Simmons RL. Acquired immunologic deficiencies after trauma and surgical procedures. *Surg Gynecol Obstet* 1974;139:771-782.
150. Hole A, Unsgaard G. The effect of epidural and general anaesthesia on lymphocyte functions during and after major orthopaedic surgery. *Acta Anaesthesiol Scand* 1983;27:135-141.
151. Rem J, Brandt MR, Kehlet H. Prevention of postoperative lymphopenia and granulocytosis by epidural analgesia. *Lancet* 1980;1:283-284.
152. Klassen GA, Bramwell RS, Bromage PR, et al. Effect of acute sympathectomy by epidural anesthesia on the canine coronary circulation. *Anesthesiology* 1980;52:8-15.
153. Pflug AE, Halter JB. Effect of spinal anesthesia on adrenergic tone and the neuroendocrine responses to surgical stress in humans. *Anesthesiology* 1981;55:120-126.
154. Licker M, Spiliopoulos A, Tschopp JM. Influence of thoracic epidural analgesia on cardiovascular autonomic control after thoracic surgery. *Br J Anaesth* 2003;91:525-531.
155. Landreneau RJ, Hazelrigg SR, Mack MJ, et al. Postoperative pain-related morbidity: video-assisted thoracic surgery versus thoracotomy. *Ann Thorac Surg* 1993;56:1285-1289.
156. Mack MJ, Regan JJ, McAfee PC, et al. Video-assisted thoracic surgery for the anterior approach to the thoracic spine. *Ann Thorac Surg* 1995;59:1100-1106.
157. Molin LJ, Steinberg JB, Lanza LA. VATS increases costs in patients undergoing lung biopsy for interstitial lung disease. *Ann Thorac Surg* 1994;58:1595-1598.
158. Rubin JW, Finney NR, Borders BM, et al. Intrathoracic biopsies, pulmonary wedge excision, and management of pleural disease: is video-assisted closed chest surgery the approach of choice? *Am Surg* 1994;60:860-863.
159. Waller DA, Forty J, Morritt GN. Video-assisted thoracoscopic surgery versus thoracotomy for spontaneous pneumothorax. *Ann Thorac Surg* 1994;58:372-376.
160. Carden E, Raj PP. Special new low resistance to flow tube and endotracheal tube adapter for use during fiberoptic bronchoscopy. *Ann Otol Rhinol Laryngol* 1975;84(5 Pt 1):631-634.
161. Vourc'h G, Fischler M, Michon F, et al. High frequency jet ventilation v. manual jet ventilation during bronchoscopy in patients with tracheo-bronchial stenosis. *Br J Anaesth* 1983;55:969-972.
162. Lukomsky GI, Ovchinnikov AA, Bilal A. Complications of bronchoscopy: comparison of rigid bronchoscopy under general anesthesia and flexible fiberoptic bronchoscopy under topical anesthesia. *Chest* 1981;79:316-321.
163. Albertini RE, Harrell JH, Moser KM. Management of arterial hypoxemia induced by fiberoptic bronchoscopy. *Chest* 1975;67:134-136.
164. Albertini RE, Harrell JH, Kurihara N, et al. Arterial hypoxemia induced by fiberoptic bronchoscopy. *JAMA* 1974;230:1666-1667.
165. Dubrawsky C, Awe RJ, Jenkins DE. The effect of bronchofiberscopic examination on oxygenation status. *Chest* 1975;67:137-140.
166. Blazer S, Naveh Y, Friedman A. Foreign body in the airway. A review of 200 cases. *Am J Dis Child* 1980;134:68-71.
167. Elguindi AS, Harrison GN, Abdulla AM, et al. Cardiac rhythm disturbances during fiberoptic bronchoscopy: a prospective study. *J Thorac Cardiovasc Surg* 1979;77:557-561.
168. Neuhaus A, Markowitz D, Rotman HH, et al. The effects of fiberoptic bronchoscopy with and without atropine premedication on pulmonary function in humans. *Ann Thorac Surg* 1978;25:393-398.
169. Salisbury BG, Metzger LF, Altose MD, et al. Effect of fiberoptic bronchoscopy on respiratory performance in patients with chronic airways obstruction. *Thorax* 1975;30:441-446.
170. Cohen E, Eisenkraft JB. Bronchopulmonary lavage: effects on oxygenation and hemodynamics. *J Cardiothorac Anesth* 1990;4:609-615.
171. de Blic J, Blanche S, Danel C, et al. Bronchoalveolar lavage in HIV infected patients with interstitial pneumonitis. *Arch Dis Child* 1989;64:1246-1250.
172. Felicetti SA, Silbaugh SA, Muggenburg BA. Effect of flow rate of lavage fluid on the removal of radioactive particles from the lung by bronchopulmonary lavage. *Health Phys* 1975;28:399-403.
173. Hiratzka LF, Swan DM, Rose EF, et al. Bilateral simultaneous lung lavage utilizing membrane oxygenator for pulmonary alveolar proteinosis in an 8-month-old infant. *Ann Thorac Surg* 1983;35:313-317.
174. Lippmann M, Mok MS, Wasserman K. Anaesthetic management for children with alveolar proteinosis using extracorporeal circulation. Report of two cases. *Br J Anaesth* 1977;49:173-177.
175. Mann JM, Altus CS, Webber CA, et al. Nonbronchoscopic lung lavage for diagnosis of opportunistic infection in AIDS. *Chest* 1987;91:319-322.
176. Pedersen B, Dahl R. [Fiber bronchoscopy and bronchoalveolar lavage in patients with asthma. A description of the method]. *Ugeskr Laeger* 1989;151:3229-3232.
177. Rogers RM, Levin DC, Gray BA, et al. Physiologic effects of bronchopulmonary lavage in alveolar proteinosis. *Am Rev Respir Dis* 1978;118:255-264.
178. Kariman K, Kylstra JA, Spock A. Pulmonary alveolar proteinosis: prospective clinical experience in 23 patients for 15 years. *Lung* 1984;162:223-231.
179. Swenson JD, Astle KL, Bailey PL. Reduction in left ventricular filling during bronchopulmonary lavage demonstrated by transesophageal echocardiography. *Anesth Analg* 1995;81:634-637.
180. Gale ME, Karlinsky JB, Robins AG. Bronchopulmonary lavage in pulmonary alveolar proteinosis: chest radiograph observations. *AJR Am J Roentgenol* 1986;146:981-985.
181. Steiger Z, Wilson RF. Management of bronchopleural fistulas. *Surg Gynecol Obstet* 1984;158:267-271.
182. Barker WL, Faber LP, Ostermiller WE Jr, et al. Management of persistent bron-



- chopleural fistulas. *J Thorac Cardiovasc Surg* 1971;62:393-401.
183. Demos NJ, Timmes JJ. Myoplasty for closure of tracheobronchial fistula. *Ann Thorac Surg* 1973;15:88-93.
184. Albelda SM, Hansen-Flaschen JH, Taylor E, et al. Evaluation of high-frequency jet ventilation in patients with bronchopleural fistulas by quantitation of the airleak. *Anesthesiology* 1985;63:551-554.
185. Bishop MJ, Benson MS, Sato P, et al. Comparison of high-frequency jet ventilation with conventional mechanical ventilation for bronchopleural fistula. *Anesth Analg* 1987;66:833-838.
186. Orlando R III, Gluck EH, Cohen M, et al. Ultra-high-frequency jet ventilation in a bronchopleural fistula model. *Arch Surg* 1988;123:591-593.
187. Clarke HJ, Kwan A, Wright ES, et al. Enterobronchial fistula. *Can J Surg* 1984;27:185-186.
188. Riordan JF. Management of spontaneous pneumothorax. *Br Med J (Clin Res Ed)* 1984;289:71.
189. Naunheim KS, Ferguson MK. The current status of lung volume reduction operations for emphysema. *Ann Thorac Surg* 1996;62:601-612.
190. Hannenberg AA, Satwicz PR, Dienes RS Jr, et al. A device for applying CPAP to the nonventilated upper lung during one-lung ventilation. II. *Anesthesiology* 1984;60:254-255.
191. Little AG, Swain JA, Nino JJ, et al. Reduction pneumoplasty for emphysema. Early results. *Ann Surg* 1995;222:365-371.
192. Wesley JR, Macleod WM, Mullard KS. Evaluation and surgery of bullous emphysema. *J Thorac Cardiovasc Surg* 1972;63:945-955.
193. Cooper JD, Trulock EP, Triantafillou AN, et al. Bilateral pneumectomy (volume reduction) for chronic obstructive pulmonary disease. *J Thorac Cardiovasc Surg* 1995;109:106-116.
194. Rationale and design of The National Emphysema Treatment Trial: a prospective randomized trial of lung volume reduction surgery. The National Emphysema Treatment Trial Research Group. *Chest* 1999;116:1750-1761.
195. National Emphysema Treatment Trial Research Group. Patients at high risk of death after lung-volume-reduction surgery. *N Engl J Med* 2001;345:1075-1083.
196. Fishman A, Martinez F, Naunheim K, et al. A randomized trial comparing lung-volume-reduction surgery with medical therapy for severe emphysema. *N Engl J Med* 2003;348:2059-2073.
197. Laurenzi GA, Turino GM, Fishman AP. Bullous disease of the lung. *Am J Med* 1962;32:361-378.
198. Ting EY, Kopstock R, Lyons HA. Mechanical properties of pulmonary cysts and bullae. *Am Rev Respir Dis* 1963;87:538.
199. Kaiser D. [Indications for thoracoscopy in pleural empyema]. *Pneumologie* 1989;43:76-79.
200. Moghissi K, Hornshaw J, Teasdale PR, et al. Parenteral nutrition in carcinoma of the oesophagus treated by surgery: nitrogen balance and clinical studies. *Br J Surg* 1977;64:125-128.
201. Lefrak EA, Pitha J, Rosenheim S, et al. A clinicopathologic analysis of Adriamycin cardiotoxicity. *Cancer* 1973;32:302-314.
202. Lin J, Iannettoni MD. Transhiatal esophagectomy. *Surg Clin North Am* 2005;85:593-610.
203. Nichols FC III, Allen MS, Deschamps C, et al. Ivor Lewis esophagogastrrectomy. *Surg Clin North Am* 2005;85:583-592.
204. Altorki N. En-bloc esophagectomy—the three-field dissection. *Surg Clin North Am* 2005;85:611-619, xi.
205. Condon HA. Anaesthesia for pharyngo-laryngo-oesophagectomy with pharyngo-gastrostomy. *Br J Anaesth* 1971;43:1061-1065.
206. Dumon JF, Shapshay S, Bourcereau J, et al. Principles for safety in application of neodymium-YAG laser in bronchology. *Chest* 1984;86:163-168.
207. Froese AB, Bryan AC. High frequency ventilation. *Am Rev Respir Dis* 1987;135:1363-1374.
208. Hermens JM, Bennett MJ, Hirshman CA. Anesthesia for laser surgery. *Anesth Analg* 1983;62:218-229.
209. Pashayan AG, Gravenstein JS, Cassisi NJ, et al. The helium protocol for laryngotracheal operations with CO<sub>2</sub> laser: a retrospective review of 523 cases. *Anesthesiology* 1988;68:801-804.
210. Sosis M. Anesthesia for laser surgery. *Int Anesthesiol Clin* 1990;28:119-131.
211. Van Der Spek AF, Spargo PM, Norton ML. The physics of lasers and implications for their use during airway surgery. *Br J Anaesth* 1988;60:709-729.
212. Warner ME, Warner MA, Leonard PF. Anesthesia for neodymium-YAG (Nd-YAG) laser resection of major airway obstructing tumors. *Anesthesiology* 1984;60:230-232.
213. Wolf GL, Simpson JI. Flammability of endotracheal tubes in oxygen and nitrous oxide enriched atmosphere. *Anesthesiology* 1987;67:236-239.
214. Dedhia HV, Lapp NL, Jain PR, et al. Endoscopic laser therapy for respiratory distress due to obstructive airway tumors. *Crit Care Med* 1985;13:464-467.
215. Gelb AF, Epstein JD. Laser in treatment of lung cancer. *Chest* 1984;86:662-666.
216. Parr GV, Unger M, Trout RG, et al. One hundred neodymium-YAG laser ablations of obstructing tracheal neoplasms. *Ann Thorac Surg* 1984;38:374-381.
217. Healy GB, Strong MS, Shapshay S, et al. Complications of CO<sub>2</sub> laser surgery of the aerodigestive tract: experience of 4416 cases. *Otolaryngol Head Neck Surg* 1984;92:13-18.
218. Fried MP. A survey of the complications of laser laryngoscopy. *Arch Otolaryngol* 1984;110:31-34.
219. Pashayan AG, Gravenstein JS. Helium retards endotracheal tube fires from carbon dioxide lasers. *Anesthesiology* 1985;62:274-277.
220. Paes ML. General anaesthesia for carbon dioxide laser surgery within the airway. A review. *Br J Anaesth* 1987;59:1610-1620.
221. Foster ED, Munro DD, Dobell AR. Mediastinoscopy. A review of anatomical relationships and complications. *Ann Thorac Surg* 1972;13:273-286.
222. Vueghs PJ, Schurink GA, Vaes L, et al. Anesthesia in repeat mediastinoscopy: a retrospective study of 101 patients. *J Cardiothorac Vasc Anesth* 1992;6:193-195.
223. Lee JH, Salvatore A. Innominate artery compression simulating cardiac arrest during mediastinoscopy: a case report. *Anesth Analg* 1976;55:748-749.
224. Garry BP, Bivens HE. Blood pressure monitoring during mediastinoscopy. *Can J Anaesth* 1989;36(3 Pt 1):365.
225. Ashbaugh DG. Mediastinoscopy. *Arch Surg* 1970;100:568-573.
226. Barash PG, Tsai B, Kitahata LM. Acute tracheal collapse following mediastinoscopy. *Anesthesiology* 1976;44:67-68.
227. Weissberg D, Herczeg E. Perforation of thoracic aortic aneurysm. A complication of mediastinoscopy. *Chest* 1980;78:119-120.
228. Robert JT, Gissen AG. Management of complications encountered during anesthesia for mediastinoscopy. *Anesth Rev* 1979;6:31.
229. Petty C. Right radial artery pressure during mediastinoscopy. *Anesth Analg* 1979;58:428-430.
230. Urschel JD, Vretenar DF, Dickout WJ, et al. Cerebrovascular accident complicating extended cervical mediastinoscopy. *Ann Thorac Surg* 1994;57:740-741.
231. Jahangiri M, Taggart DP, Goldstraw P. Role of mediastinoscopy in superior vena cava obstruction. *Cancer* 1993;71:3006-3008.
232. Gunstensen J, Wade JD. Mediastinoscopy. An analysis of 320 consecutive cases. *Br J Surg* 1972;59:209-213.
233. Bray RJ, Fernandes FJ. Mediastinal tumour causing airway obstruction in anaesthetised children. *Anaesthesia* 1982;37:571-575.
234. deSoto H. Direct laryngoscopy as an aid to relieve airway obstruction in a patient with a mediastinal mass. *Anesthesiology* 1987;67:116-117.
235. John RE, Narang VP. A boy with an anterior mediastinal mass. *Anaesthesia* 1988;43:864-866.
236. Graeber GM, Shriver CD, Albus RA, et al. The use of computed tomography in the evaluation of mediastinal masses. *J Thorac Cardiovasc Surg* 1986;91:662-666.

237. Parish JM, Rosenow EC III, Muhm JR. Mediastinal masses. Clues to interpretation of radiologic studies. *Postgrad Med* 1984;76:173-176.
238. Azizkhan RG, Dudgeon DL, Buck JR, et al. Life-threatening airway obstruction as a complication to the management of mediastinal masses in children. *J Pediatr Surg* 1985;20:816-822.
239. Miller RD, Hyatt RE. Obstructing lesions of the larynx and trachea: clinical and physiologic characteristics. *Mayo Clin Proc* 1969;44:145-161.
240. Loeffler JS, Leopold KA, Recht A, et al. Emergency prebiopsy radiation for mediastinal masses: impact on subsequent pathologic diagnosis and outcome. *J Clin Oncol* 1986;4:716-721.
241. Turoff RD, Gomez GA, Berjian R, et al. Postoperative respiratory complications in patients with Hodgkin's disease: relationship to the size of the mediastinal tumor. *Eur J Cancer Clin Oncol* 1985;21:1043-1046.
242. McDougall JC, Fromme GA. Transcarinal aspiration of a mediastinal cyst to facilitate anesthetic management. *Chest* 1990;97:1490-1492.
243. Adler OB, Rosenberger A, Peleg H. Fine-needle aspiration biopsy of mediastinal masses: evaluation of 136 experiences. *AJR Am J Roentgenol* 1983;140:893-896.
244. Bergman NA. Reduction in resting end-expiratory position of the respiratory system with induction of anesthesia and neuromuscular paralysis. *Anesthesiology* 1982;57:14-17.
245. DeGraff AC Jr, Bouhuys A. Mechanics of air flow in airway obstruction. *Annu Rev Med* 1973;24:111-134.
246. Levin H, Bursztein S, Heifetz M. Cardiac arrest in a child with an anterior mediastinal mass. *Anesth Analg* 1985;64:1129-1130.
247. Hall KD, Friedman M. Extracorporeal oxygenation for induction of anesthesia in a patient with an intrathoracic tumor. *Anesthesiology* 1975;42:493-495.
248. Davenport D, Ferree C, Blake D, et al. Radiation therapy in the treatment of superior vena caval obstruction. *Cancer* 1978;42:2600-2603.
249. Croft PB. Abnormal responses to muscle relaxants in carcinomatous neuropathy. *Br Med J* 1958;29:181-187.
250. Karas SE. Thoracic outlet syndrome. *Clin Sports Med* 1990;9:297-310.
251. Cuetter AC, Bartoszek DM. The thoracic outlet syndrome: controversies, overdiagnosis overtreatment and recommendations for management. *Muscle Nerve* 1990;13:362.
252. Bergmans J, Fannes-Breselow CF, Griboimont B. A reassessment of the neurophysiological evidence for a presynaptic defect in myasthenia gravis. *Electromyogr Clin Neurophysiol* 1976;16:337-351.
253. Cull-Candy SG, Miledi R, Trautmann A, et al. On the release of transmitter at normal, myasthenia gravis and myasthenic syndrome affected human end-plates. *J Physiol* 1980;299:621-638.
254. Hankins JR, Mayer RF, Satterfield JR, et al. Thymectomy for myasthenia gravis: 14-year experience. *Ann Surg* 1985;201:618-625.
255. Bennett EJ, Schmidt GB, Patel KP, et al. Muscle relaxants, myasthenia, and munitards? *Anesthesiology* 1977;46:220-221.
256. Drachman DA, Skom JH. Procainamide—a hazard in myasthenia gravis. *Arch Neurol* 1965;13:316-320.
257. Kornfeld P, Horowitz SH, Genkins G, et al. Myasthenia gravis unmasked by antiarrhythmic agents. *Mt Sinai J Med* 1976;43:10-14.
258. Baraka A, Afifi A, Muallem M, et al. Neuromuscular effects of halothane, suxamethonium and tubocurarine in a myasthenic undergoing thymectomy. *Br J Anaesth* 1971;43:91-95.
259. Eisenkraft JB, Book WJ, Mann SM, et al. Resistance to succinylcholine in myasthenia gravis: a dose-response study. *Anesthesiology* 1988;69:760-763.
260. Eisenkraft JB, Book WJ, Papatestas AE. Sensitivity to vecuronium in myasthenia gravis: a dose-response study. *Can J Anaesth* 1990;37:301-306.
261. Stanski DR, Lee RG, MacCannell KL, et al. Atypical cholinesterase in a patient with myasthenia gravis. *Anesthesiology* 1977;46:298-301.
262. Rowbottom SJ. Isoflurane for thymectomy in myasthenia gravis. *Anaesth Intensive Care* 1989;17:444-447.
263. Eisenkraft JB, Papatestas AE. Anesthesia for trans-sternal thymectomy in myasthenia gravis. *Ann R Coll Surg Engl* 1988;70:257-258.
264. Girnar DS, Weinreich AI. Anesthesia for transcervical thymectomy in myasthenia gravis. *Anesth Analg* 1976;55:13-17.
265. Shrager JB, Deeb ME, Mick R, et al. Transcervical thymectomy for myasthenia gravis achieves results comparable to thymectomy by sternotomy. *Ann Thorac Surg* 2002;74:320-326.
266. Jensen V, Milne B, Salerno T. Femoral-femoral cardiopulmonary bypass prior to induction of anaesthesia in the management of upper airway obstruction. *Can Anaesth Soc J* 1983;30(3 Pt 1):270-272.
267. Woods F, Palatchi A, Neptune W. Resection of the carina and mainstem bronchi with extracorporeal circulation. *N Engl J Med* 1961;264:492.
268. Bland S, Lazerou L, Dyck G, et al. The influence of the "chest wall" on respiratory rate and depth. *Respir Physiol* 1967;3:47-54.
269. Grillo HC, Bendixen HH, Gephart T. Resection of the carina and lower trachea. *Ann Surg* 1963;158:889-893.
270. Macnaughton FI. Catheter inflation ventilation in tracheal stenosis. *Br J Anaesth* 1975;47:1225-1227.
271. Scamman FL, Choi WW. Low frequency jet ventilation for tracheal resection. *Laryngoscope* 1986;96:678-679.
272. Crinquette V, Wurtz A, Leroy S, et al. [Resection and reconstruction of the carina with separate two-lung high-frequency jet ventilation]. *Ann Chir* 1989;43:673-676.
273. El Baz N, Holinger L, El Ganzouri A, et al. High-frequency positive-pressure ventilation for tracheal reconstruction supported by tracheal T-tube. *Anesth Analg* 1982;61:796-800.
274. El Baz N, El Ganzouri A, Gottschalk W, et al. One-lung high-frequency pressure ventilation for sleeve pneumonectomy: an alternative technique. *Anesth Analg* 1981;60:683-686.
275. Glenski JA, Crawford M, Rehder K. High-frequency, small-volume ventilation during thoracic surgery. *Anesthesiology* 1986;64:211-214.
276. Kamvyssi-Dea S, Kritikou P, Exarhos N, et al. Anaesthetic management of reconstruction of the lower portion of the trachea. Case report. *Br J Anaesth* 1975;47:82-84.
277. Lee P, English IC. Management of anaesthesia during tracheal resection. *Anaesthesia* 1974;29:305-306.
278. Corey R, Hla KM. Major and massive hemoptysis: reassessment of conservative management. *Am J Med Sci* 1987;294:301-309.
279. Muthuswamy PP, Akbik F, Franklin C, et al. Management of major or massive hemoptysis in active pulmonary tuberculosis by bronchial arterial embolization. *Chest* 1987;92:77-82.
280. Yeoh CB, Hubaytar RT, Ford JM, et al. Treatment of massive hemorrhage in pulmonary tuberculosis. *J Thorac Cardiovasc Surg* 1967;54:503-510.
281. Cervenko FW, Shelley SE, Spence DG, et al. Massive endobronchial hemorrhage during cardiopulmonary bypass: treatable complication of balloon-tipped catheter damage to the pulmonary artery. *Ann Thorac Surg* 1983;35:326-328.
282. Black RE, Choi KJ, Syme WC, et al. Bronchoscopic removal of aspirated foreign bodies in children. *Am J Surg* 1984;148:778-781.
283. Kim IG, Brummitt WM, Humphry A, et al. Foreign body in the airway: a review of 202 cases. *Laryngoscope* 1973;83:347-354.
284. Baraka A. Bronchoscopic removal of inhaled foreign bodies in children. *Br J Anaesth* 1974;46:124-126.
285. Healy GB. Foreign bodies of the air and food passages in children. *Am J Dis Child* 1987;141:249.
286. Campbell DN, Cotton EK, Lilly JR. A dual approach to tracheobronchial foreign bodies in children. *Surgery* 1982;91:178-182.
287. Law D, Kosloske AM. Management of tracheobronchial foreign bodies in chil-

- dren: a reevaluation of postural drainage and bronchoscopy. *Pediatrics* 1976;58:362–367.
288. Mills LJ, Lolley DM, Estrera AS, et al. Use of fluoroscopy in the removal of aspirated foreign bodies. *JAMA* 1977;237:1077.
289. Motoyama EK, Davis PJ. *Anesthesia for Infant*. 5th ed. St. Louis: Mosby-Year Book, 1990.
290. Payne WS, King RM. Pharyngoesophageal (Zenker's) diverticulum. *Surg Clin North Am* 1983;63:815–824.
291. Baron SH. Zenker's diverticulum as a cause for loss of drug availability: a "new" complication. *Am J Gastroenterol* 1982;77:152–153.
292. Cope R, Spargo P. Anesthesia for Zenker's diverticulum. *Anesth Analg* 1990;71:312.
293. Adams CF. Regional anesthesia for repair of Zenker's diverticulum. *Anesth Analg* 1990;70:676.
294. Gravel JA. Herniation of the heart—a hazard of thoracic surgery: report of two fatal cases. *Can J Surg* 1966;9:72–73.
295. McKlveen JR, Urgena RB, Rossi NP. Herniation of the heart following radical pneumonectomy: a case report. *Anesth Analg* 1972;51:680–683.
296. Cassorla L, Katz JA. Management of cardiac herniation after intrapericardial pneumonectomy. *Anesthesiology* 1984;60:362–364.
297. Levin PD, Faber LP, Carleton RA. Cardiac herniation after pneumonectomy. *J Thorac Cardiovasc Surg* 1971;61:104–106.
298. Bergsland J, Battaglia R, Takita H. Modification of the technique of radical intrapericardial pneumonectomy. *Scand J Thorac Cardiovasc Surg* 1985;19:89–92.
299. Krowka MJ, Pairolero PC, Trastek VF, et al. Cardiac dysrhythmia following pneumonectomy. Clinical correlates and prognostic significance. *Chest* 1987;91:490–495.
300. Vaporciyan AA, Correa AM, Rice DC, et al. Risk factors associated with atrial fibrillation after noncardiac thoracic surgery: analysis of 2588 patients. *J Thorac Cardiovasc Surg* 2004;127:779–786.
301. Haissaguerre M, Jais P, Shah DC, et al. Spontaneous initiation of atrial fibrillation by ectopic beats originating in the pulmonary veins. *N Engl J Med* 1998;339:659–666.
302. Sedrakyan A, Treasure T, Browne J, et al. Pharmacologic prophylaxis for postoperative atrial tachyarrhythmia in general thoracic surgery: evidence from randomized clinical trials. *J Thorac Cardiovasc Surg* 2005;129:997–1005.
303. Amar D, Zhang H, Heerdt PM, et al. Statin use is associated with a reduction in atrial fibrillation after noncardiac thoracic surgery independent of C-reactive protein. *Chest* 2005;128:3421–3427.
304. Sprung CL, Loewenherz JW, Baier H, et al. Evidence for increased permeability in reexpansion pulmonary edema. *Am J Med* 1981;71:497–500.
305. Holtzman H, Lippmann M, Nakhjavan F, et al. Postpneumonectomy interatrial right-to-left shunt. *Thorax* 1980;35:307–309.
306. Dlabal PW, Stutts BS, Jenkins DW, et al. Cyanosis following right pneumonectomy: importance of patent foramen ovale. *Chest* 1982;81:370–372.
307. Patterson GA, Cooper JD. Complications of thoracotomy. In Marshall BD, Longnecker DE, Fairley HB, eds. *Anesthesia for Thoracic Procedures*. Boston: Blackwell Scientific, 1998.
308. Mitchell C, Garrahy P, Peake P. Postoperative respiratory morbidity: identification and risk factors. *Aust N Z J Surg* 1982;52:203–209.
309. Warner MA, Divertie MB, Tinker JH. Preoperative cessation of smoking and pulmonary complications in coronary artery bypass patients. *Anesthesiology* 1984;60:380–383.
310. Pasulka PS, Bistrrian BR, Benotti PN, et al. The risks of surgery in obese patients. *Ann Intern Med* 1986;104:540–546.
311. Luce JM. Respiratory complications of obesity. *Chest* 1980;78:626–631.
312. Pingleton SK. Nutritional support in the mechanically ventilated patient. *Clin Chest Med* 1988;9:101–112.
313. Ellis LM, Copeland EM III, Souba WW. Perioperative nutritional support. *Surg Clin North Am* 1991;71:493–507.
314. Buzby GP, Williford WO, Peterson OL, et al. A randomized clinical trial of total parenteral nutrition in malnourished surgical patients: the rationale and impact of previous clinical trials and pilot study on protocol design. *Am J Clin Nutr* 1988;47(2 Suppl):357–365.
315. McCoskey EH, McKinney LM, Byrd RP Jr, et al. Re-expansion pulmonary edema following puncture of a giant bulla. *J Am Osteopath Assoc* 2000;100:788–791.
316. Marujo WC, Takaoka F, Moura RM, et al. Early perioperative death associated with reexpansion pulmonary edema during liver transplantation. *Liver Transpl* 2005;11:1439–1443.
317. Sakao Y, Kajikawa O, Martin TR, et al. Association of IL-8 and MCP-1 with the development of reexpansion pulmonary edema in rabbits. *Ann Thorac Surg* 2001;71:1825–1832.
318. Nakamura M, Fujishima S, Sawafuji M, et al. Importance of interleukin-8 in the development of reexpansion lung injury in rabbits. *Am J Respir Crit Care Med* 2000;161(3 Pt 1):1030–1036.
319. Suzuki S, Niikawa H, Shibuya J, et al. Analysis of edema fluids and histologic features of the lung in reexpansion pulmonary edema during video-assisted thoracoscopic surgery. *J Thorac Cardiovasc Surg* 2002;123:387–389.
320. Iqbal M, Multz AS, Rossoff LJ, et al. Reexpansion pulmonary edema after VATS successfully treated with continuous positive airway pressure. *Ann Thorac Surg* 2000;70:669–671.
321. Trachiotis GD, Vricella LA, Aaron BL, et al. As originally published in 1988: Reexpansion pulmonary edema. Updated in 1997. *Ann Thorac Surg* 1997;63:1206–1207.
322. Mathew NT, John S. Iatrogenic ischaemic paraplegia. *Med J Aust* 1970;2:29–30.
323. Ewing MR. Postoperative paralysis in the upper extremity; report of five cases. *Lancet* 1950;1:99–103.
324. Ochroch EA, Gottschalk A, Augustides J, et al. Long-term pain and activity during recovery from major thoracotomy using thoracic epidural analgesia. *Anesthesiology* 2002;97:1234–1244.
325. Scawn ND, Pennefather SH, Soorae A, et al. Ipsilateral shoulder pain after thoracotomy with epidural analgesia: the influence of phrenic nerve infiltration with lidocaine. *Anesth Analg* 2001;93:260–264.
326. Tan N, Agnew NM, Scawn ND, et al. Suprascapular nerve block for ipsilateral shoulder pain after thoracotomy with thoracic epidural analgesia: a double-blind comparison of 0.5% bupivacaine and 0.9% saline. *Anesth Analg* 2002;94:199–202.
327. Benedetti F, Vighetti S, Ricco C, et al. Neurophysiologic assessment of nerve impairment in posterolateral and muscle-sparing thoracotomy. *J Thorac Cardiovasc Surg* 1998;115:841–847.
328. Landreneau RJ, Mack MJ, Hazelrigg SR, et al. Prevalence of chronic pain after pulmonary resection by thoracotomy or video-assisted thoracic surgery. *J Thorac Cardiovasc Surg* 1994;107:1079–1085.
329. Bertrand PC, Regnard JF, Spaggiari L, et al. Immediate and long-term results after surgical treatment of primary spontaneous pneumothorax by VATS. *Ann Thorac Surg* 1996;61:1641–1645.
330. Sabanathan S, Mearns AJ, Bickford Smith PJ, et al. Efficacy of continuous extrapleural intercostal nerve block on post-thoracotomy pain and pulmonary mechanics. *Br J Surg* 1990;77:221–225.
331. Moore DC. Intercostal nerve block for postoperative somatic pain following surgery of thorax and upper abdomen. *Br J Anaesth* 1975;47(Suppl):284–286.
332. Katz J, Nelson W, Forest R, et al. Cryoanalgesia for post-thoracotomy pain. *Lancet* 1980;1:512–513.
333. Eason MJ, Wyatt R. Paravertebral thoracic block—a reappraisal. *Anaesthesia* 1979;34:638–642.
334. Gilbert J, Hultman J. Thoracic paravertebral block: a method of pain control. *Acta Anaesthesiol Scand* 1989;33:142–145.
335. Etches RC, Sandler AN, Daley MD. Respiratory depression and spinal opioids. *Can J Anaesth* 1989;36:165–185.
336. Kavanagh BP, Katz J, Sandler AN. Pain control after thoracic surgery. A review of current techniques. *Anesthesiology* 1994;81:737–759.
337. Shulman M, Sandler AN, Bradley JW, et al. Postthoracotomy pain and pulmonary

- function following epidural and systemic morphine. *Anesthesiology* 1984;61:569–575.
338. Kennedy WF Jr, Sawyer TK, Gerbershagen HY, et al. Systemic cardiovascular and renal hemodynamic alterations during peridural anesthesia in normal man. *Anesthesiology* 1969;31:414–421.
339. Ottesen S, Renck H, Jynge P. Cardiovascular effects of epidural analgesia. II. Haemodynamic alterations secondary to lumbar epidural analgesia and their modification by plasma expansion and adrenaline administration. An experimental study in the sheep. *Acta Anaesthesiol Scand Suppl* 1978;69:17–31.
340. George KA, Wright PM, Chisakuta A. Continuous thoracic epidural fentanyl for post-thoracotomy pain relief: with or without bupivacaine? *Anaesthesia* 1991;46:732–736.
341. El Baz NM, Faber LP, Jensek RJ. Continuous epidural infusion of morphine for treatment of pain after thoracic surgery: a new technique. *Anesth Analg* 1984;63:757–764.
342. Benzoni HT. Post-thoracotomy epidural analgesia: lumbar or thoracic placement? *J Cardiothorac Vasc Anesth* 1993;7:515–516.
343. Guinard JP, Mavrocordatos P, Chiolerio R, et al. A randomized comparison of intravenous versus lumbar and thoracic epidural fentanyl for analgesia after thoracotomy. *Anesthesiology* 1992;77:1108–1115.
344. Hurford WE, Dutton RP, Alfille PH, et al. Comparison of thoracic and lumbar epidural infusions of bupivacaine and fentanyl for post-thoracotomy analgesia. *J Cardiothorac Vasc Anesth* 1993;7:521–525.
345. Sandler AN, Stringer D, Panos L, et al. A randomized, double-blind comparison of lumbar epidural and intravenous fentanyl infusions for postthoracotomy pain relief. Analgesic, pharmacokinetic, and respiratory effects. *Anesthesiology* 1992;77:626–634.
346. Badner NH, Komar WE. Bupivacaine 0.1% does not improve post-operative epidural fentanyl analgesia after abdominal or thoracic surgery. *Can J Anaesth* 1992;39:330–336.



## CHAPTER 54

## Anesthesia for Major Vascular Surgery

Alina Nicoara, MD, and Madhav Swaminathan, MD

The management of anesthesia for surgery of the aorta and its major branches, including carotid endarterectomy (CEA), aortic aneurysm and occlusive repair, and lower-extremity vascular bypass grafting is both challenging and dynamic. The pathologic processes that give rise to aneurysmal and occlusive disease are largely systemic, and thus patients presenting for major vascular surgery usually have either overt or occult involvement of several organ systems. Coexisting coronary artery disease (CAD) is of particular concern because myocardial ischemia, myocardial infarction (MI), and myocardial failure constitute most of the perioperative morbidity. The stress response of surgery must also be aggressively controlled in both the intraoperative and the postoperative periods to minimize complications.

Vascular surgery necessitates the temporary interruption of arterial blood flow by isolation of the diseased vessel segment with occluding clamps, resulting in dramatic physiologic changes superimposed on complex disease states.

Minimally invasive techniques were developed to reduce morbidity and mortality and to provide an alternative to patients who are at high risk of postoperative complications with standard surgical therapy. The success of intraluminal and hybrid (both intra- and extraluminal) techniques has increased over the last decade and these treatment options are becoming more widely used, changing the role of the anesthesiologist.

This chapter details the fundamental considerations surrounding the perioperative evaluation, preparation, and management of major vascular surgery.

Portions of this chapter were previously published in Beattie C, Frank SM, Walker GV, Siex NW. Anesthesia for major vascular surgery. In: Longnecker DE, Tinker JH, Morgan E, Jr, eds. *Principles and Practice of Anesthesiology*. 2nd ed. St. Louis: Mosby, 1998:1841–1880, and are used here with permission.

## KEY POINTS

1. Atherosclerosis is a multifactorial disease. Besides traditional risk factors (age, sex, elevated blood pressure, smoking, high levels of low-density lipoprotein [LDL] cholesterol, and low levels of high-density lipoprotein [HDL] cholesterol), newer risk factors have been described, such as fasting glucose, triglycerides and triglyceride-rich lipoprotein remnants, lipoprotein (a), homocysteine, and high-sensitivity C-reactive protein.
2. The precise mechanism of final injury caused by atherosclerosis is one or more of the following: (a) plaque enlargement reducing blood flow; (b) arterial embolism of plaque-associated platelet thrombi or atheromatous debris; and (c) complete occlusion of arteries at sites of advanced plaques.
3. Patients presenting for major vascular surgery usually have either overt or occult involvement of several organ systems. The vascular patient population has a high incidence of significant coronary artery disease (CAD); for example, left ventricular systolic dysfunction (left ventricular ejection fraction less than 40 percent) is five times more common in patients with cerebrovascular disease or peripheral arterial disease compared with matched controls.
4. The current standards for preoperative cardiac evaluation of these patients are the guidelines published by the American College of Cardiology (ACC) and the American Heart Association (AHA), initially in 1996 and updated in 2002, which provide an 8-step algorithm stratifying patients' risks based on the integration of major, intermediate, and minor predictors of cardiac risk, including functional capacity, the surgery-specific risk, and, when indicated, the results of stress testing.
5. Perioperative myocardial ischemia can result from increases in myocardial oxygen demand secondary to increases in blood pressure and heart rate, anemia, elevated preload, or increased contractility, or from decreases in oxygen supply as a consequence of hypotension, tachycardia, increased filling pressure, anemia, hypoxemia, and obstructed coronary blood flow because of acute thrombosis or spasm.
6. The ACC/AHA guidelines for perioperative cardiovascular evaluation for noncardiac surgery in 2002 recommend that patients previously on  $\beta$ -blockers should continue these agents perioperatively and whenever possible  $\beta$ -blocker should be started days or weeks before elective surgery in high-risk patients in whom there are findings of ischemia on preoperative testing, and the dose should be titrated to achieve a resting heart rate between 50 and 60 beats/min.
7. Invasive monitoring should be chosen and implemented based on patient's condition, ancillary diseases, and anticipated hemodynamic changes associated with the surgical procedure.
8. Monitoring of the awake patient during carotid endarterectomy (CEA) is the gold standard for neurologic assessment and may allow for prompt identification of patients who would benefit from shunt placement. This method of monitoring requires the absolute cooperation of surgeon, anesthesiologist, and patient.
9. One goal of anesthesia for CEA is to avoid hemodynamic extremes during induction, incision, surgical manipulation, emergence, and extubation. The blood pressure during carotid occlusion should be maintained at or up to 20% higher than the patient's highest recorded resting blood pressure when awake so as to maintain adequate collateral blood flow. The patient should be sufficiently responsive immediately after surgery to obey commands and thereby facilitate neurologic evaluation.
10. The estimated annual rupture risk according to abdominal aortic aneurysm (AAA) diameter is 0.5–5% for those 4.0–4.9 cm, 10–20% for those 6.0–6.9 cm, 20–40% for those 7.0–7.9 cm, and 30–50% for those greater than 8.0 cm in diameter.
11. The physiology of aortic cross-clamping includes changes in blood pressure, cardiac output, myocardial perfusion, pH, and tissue perfusion of the spinal cord, kidneys, and viscera.

*Continued*

*Key Points—continued*

12. The degree of hypertension caused by application of an aortic cross-clamp depends on the location of the clamp, the degree of collateralization, and the preocclusion aortic flow.
13. The main hemodynamic pathophysiologic factors involved in the response to the aortic cross-clamping are an increase in afterload caused by an increase in the impedance to aortic flow and an increase in preload caused by blood volume redistribution from the veins distal to the aortic occlusion to the proximal vasculature.
14. Multiple interventions have been proposed to counteract the effect of increased afterload and preload secondary to aortic cross-clamping such as arteriolar dilation, venodilation, and passive and active shunts.
15. As the incidence of acute renal failure during aortic aneurysm repair varies from 3–13%, preservation of renal function is a primary concern during aortic aneurysm surgery.
16. Modalities of spinal cord protection during aortic surgery include identification of ischemia by monitoring evoked potentials (somatosensory evoked potential and motor evoked potential), reimplantation of segmental vessels, sequential aortic clamping, maintaining aortic distal aortic perfusion through shunt or bypass, cerebrospinal fluid drainage, epidural cooling or hypothermic cardiopulmonary bypass, and circulatory arrest.
17. Unclamping leads to an acute fall in blood pressure as a result of a decrease in systemic vascular resistance. Gradual release of the aortic clamp and its reapplication has been recommended to allow time for volume replacement and washout of the vasoactive and cardiodepressant mediators from the ischemic tissues.
18. Endovascular repair of the aorta has steadily gained popularity as a reliable alternative to conventional surgical repair of aortic aneurysms. The concept of endovascular repair of abdominal aneurysms developed from the desire to reduce morbidity and mortality and to provide an alternative to patients who cannot undergo standard surgical therapy.
19. Various types of anesthesia can be used for stent repair, specifically general anesthesia, regional anesthesia, and monitored anesthesia care with local anesthetic infiltration at the incision site. Goals of an anesthetic plan should be to provide hemodynamic stability and adequate oxygenation and ventilation, to preserve organ function, and to maintain normothermia.

## PATHOPHYSIOLOGY OF VASCULAR DISEASE

### Pathogenesis of Atherosclerosis

The arterial wall response to hypertension, diabetes, and the stimuli of elevated blood lipids and cigarette smoke occurs predominantly in men and demonstrates a genetic susceptibility. The cellular response includes macrophage migration from blood to intima, intimal macrophage lipid accumulations, smooth muscle cell migration from media to intima, intimal smooth muscle cell proliferation, lipid-laden macrophage necrosis, and organic calcium precipitation. In addition to these considerations, complexities of the blood-surface arterial interface implicate the factors of velocity, shear stress, pulsatility, elasticity, and microbiobiochemical environment at the endothelial surface.<sup>1</sup>

Multiple factors contribute to the pathogenesis of atherosclerosis including endothelial dysfunction, dyslipidemia, inflammatory and immunologic factors, plaque rupture, and smoking. Dyslipidemia, especially high levels of low-density lipoprotein (LDL) and low levels of high-density lipoprotein (HDL), play a crucial role in the development of atherosclerosis.

Endothelial dysfunction induced by dyslipidemia is an initial step in atherosclerosis, is induced by oxidized LDL, can be worsened by cigarette smoking, and can be reversed with correction of hyperlipidemia by diet and/or therapy. Accelerated accumulation of oxidized LDL in cholesterol-enriched macrophages leads to mitochondrial dysfunction, apoptosis, and necrosis, with resultant release of cellular proteases, inflammatory cytokines, and prothrombotic molecules.<sup>2</sup> The presence of inflammation plays

an important role in the development of atherosclerosis. Among the inflammatory markers for atherosclerosis risk that have received attention are interleukins and C-reactive protein. Interleukin-6, a circulating cytokine has been identified as a marker of inflammation in coronary atherosclerotic plaques. Interleukin-6 stimulates platelet aggregation and the expression of tissue factor, macrophage LDL receptors, C-reactive protein, and fibrinogen. Interleukin-6 also regulates the expression of other inflammatory cytokines, such as interleukin-1 and tumor necrosis factor- $\alpha$ . C-reactive protein, one of many human acute-phase reactants, is produced in the liver in response to interleukin-6, interleukin-1 $\beta$ , and tumor necrosis factor- $\alpha$ . It activates the classic complement cascade, mediates phagocytosis, regulates inflammation, and is a non-specific but sensitive marker of infection and tissue inflammation.<sup>3</sup> Plaque hemorrhage and plaque rupture may also contribute to the progression of the atherosclerotic lesion.

### Pathophysiology of Atherosclerosis

Atherosclerosis is the primary process leading to MI, stroke, chronic mesenteric ischemia, renovascular hypertension, extremity ischemia, and aneurysmal disease. These pathologic states occur years after the slow onset of plaque formation in the vascular wall. The precise mechanism of final injury is one or more of the following: (a) plaque enlargement reducing blood flow; (b) arterial embolism of plaque-associated platelet thrombi or atheromatous debris; and (c) complete occlusion of arteries at sites of advanced plaques.

Atherosclerosis is a multifactorial disease. The impact of traditional risk factors such as age, sex, elevated blood pressure, smoking, high levels of LDL cholesterol, and low levels of HDL cholesterol on coronary heart disease risk has been demonstrated beyond any doubt. Newer risk factors, such as impaired fasting glucose, triglycerides and triglyceride-rich lipoprotein remnants, lipoprotein(a), homocysteine, and high-sensitivity C-reactive protein also contribute to an increased risk of coronary and cardiovascular diseases (Table 54-1).<sup>4</sup> Correction or modification of some of these may arrest or lessen the progression of the disease.

TABLE 54-1.

## Old, Old/New, and New Risk Factors for Atherosclerosis

Old	Old/New	New
Sex (men > women) Age Family history of premature cardiovascular disease Total cholesterol; LDL cholesterol; HDL cholesterol (negative risk factor) Hypertension Smoking Overweight/obesity	High-normal blood pressure Metabolic syndrome Diabetes mellitus, impaired glucose tolerance, impaired fasting glucose	Apolipoprotein B; apolipoprotein A-1 Triglycerides, triglyceride-rich lipoprotein remnants Small dense LDL, oxidized LDL, antibodies against oxidized LDL Lipoprotein(a) Homocysteine High-sensitivity C-reactive protein
HDL, high-density lipoprotein; LDL, low-density lipoprotein. Fruchart JC, Neirman MC, Stroes ES, Kastelein JJ, Dureiz P. New risk factors for atherosclerosis and patient risk assessment. <i>Circulation</i> 2004; 109(23 Suppl 1):III15-III19.		

The Committee on Vascular Lesions of the American Heart Association identifies 6 histologic types of atherosclerotic lesions. The initial (type I) lesion contains enough atherogenic lipoprotein to elicit an increase in macrophages and formation of scattered macrophage foam cells. Type II (fatty streak) lesions consist primarily of layers of macrophage foam cells and lipid-laden smooth muscle cells and include lesions grossly designated as fatty streaks. In addition to the lipid-laden cells of type II, type III (intermediate) lesions contain scattered collections of extracellular lipid droplets and particles that disrupt the coherence of some intimal smooth muscle cells. This extracellular lipid is the immediate precursor of the larger, confluent and more disruptive core of extracellular lipid that characterizes type IV (atheroma) lesions. Beginning around the fourth decade of life, lesions that usually have a lipid core may also contain thick layers of fibrous connective tissue (type V lesion-fibroatheroma) and/or fissure, hematoma, and thrombus (type VI-complicated lesion; Fig. 54-1).<sup>5</sup>

Fatty streaks are commonly observed in young adults and have been identified in the coronary artery intima of children. Isolated lipid-laden monocytes and macrophages, called *foam cells*, have been identified in the intima of infants as young as 1 month of age.<sup>6</sup>

Atherosclerosis is generally asymptomatic until the plaque stenosis exceeds 70 or 80%, which can produce a critical reduction in flow as with coronary blood flow to the myocardium. These large lesions can produce typi-

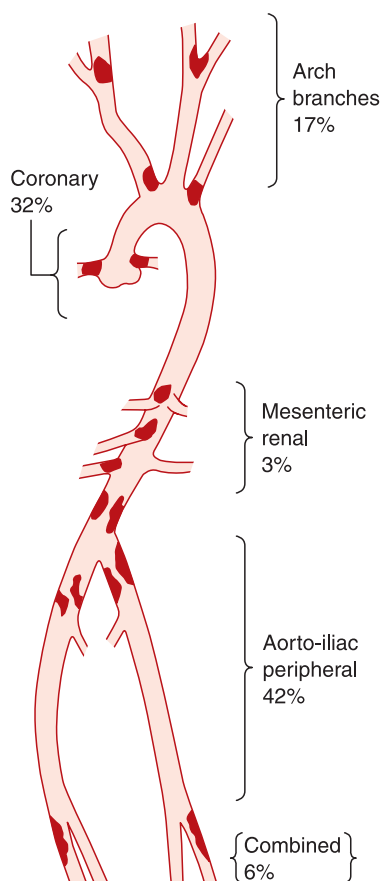
cal symptoms of angina pectoris. However, acute coronary and cerebrovascular syndromes (unstable angina, MI, sudden death, and stroke) are typically caused by rupture of plaques with less than 50% stenosis.<sup>7</sup>

Atherosclerotic plaques tend to occur in several specific anatomic locations, and plaque development at other sites is uncommon. The coronary arteries, the carotid bifurcation, the infrarenal abdominal aorta, the

Nomenclature and main histology	Sequences in progression	Main growth mechanism	Earliest onset	Clinical correlation
Type I (initial) lesion isolated macrophage foam cells	<pre> graph TD     I((I)) --&gt; II((II))     II --&gt; III((III))     III --&gt; IV((IV))     IV --&gt; V((V))     IV --&gt; VI((VI))     V --&gt; VI     V --&gt; IV </pre>	growth mainly by lipid accumulation	from first decade	clinically silent
Type II (fatty streak) lesion mainly intracellular lipid accumulation				
Type III (intermediate) lesion Type II changes & small extracellular lipid pools				
Type IV (atheroma) lesion Type II changes and core of extracellular lipid				
Type V (fibroatheroma) lesion lipid core and fibrotic layer, or multiple lipid cores and fibrotic layers, or mainly calcific, or mainly fibrotic	accelerated smooth muscle and collagen increase	from fourth decade	clinically silent or overt	
Type VI (complicated) lesion surface defect, hematoma-hemorrhage, thrombus				thrombosis, hematoma

**FIGURE 54-1.** Flow diagram in center column indicates pathways in evolution and progression of human atherosclerotic lesions. Roman numerals indicate histologically characteristic types of lesions enumerated in the text and defined at left of flow diagram. The direction of arrows indicates sequence in which characteristic morphologies may change. From type I to type IV, changes in lesion morphology occur primarily because of increasing accumulation of lipid. The loop between types V and VI illustrates how lesions increase in thickness when thrombotic deposits form on their surfaces. Thrombotic deposits may form repeatedly over varied time spans in the same location and may be the principal mechanism for gradual occlusion of medium-sized arteries. Source: Stary HC, Chandler AB, Dinsmore RE, et al.<sup>5</sup>





**FIGURE 54-2.** Distribution of atherosclerotic lesions. Source: Zwolak RM CJ.<sup>1</sup>

iliac arteries, and the superficial femoral artery are the most usual sites of development (Fig. 54-2).

Arterial emboli vary in significance, depending on the size of the embolus, the development of collateral circulation, and the metabolic rate of the ischemic tissue. Common sources of the embolic material are cardiac thrombosis (90%) from the left atrium or ventricle and atherosclerotic debris (10%) from an arterial plaque.<sup>1</sup> Emboli tend to lodge at bifurcations or at sites of vessel narrowing.

Additional comments on pathophysiology are presented at the beginning of the separate sections on carotid, lower-extremity, and aortic surgery.

## PREOPERATIVE EVALUATION OF THE VASCULAR SURGERY PATIENT

Although occasionally the atherosclerotic process manifests itself in a discrete vascular segment, the more common presentation is diffuse involvement of several organ systems. The vascular pa-

tient population has a high incidence of significant CAD; for example, left ventricular systolic dysfunction (left ventricular ejection fraction less than 40 percent) is 5 times more common in patients with cerebrovascular disease or peripheral arterial disease than in matched controls.<sup>8</sup>

In addition, vascular patients often report a heavy smoking history, and some degree of pulmonary compromise is expected. Diabetes mellitus is frequently associated with vascular disease, necessitating appropriate evaluation and treatment in the preoperative period. Hypertension is both a predisposing factor for vascular disease and a consequence of its development.

Risk assessment will have value only if it leads to risk modification or otherwise influences the decisions regarding surgical or anesthetic procedures. A great deal of investigational activity has been conducted to evaluate preoperative testing procedures with the highest degree of sensitivity and specificity that identify patients at risk for perioperative cardiac morbidity and mortality.<sup>9-11</sup>

These risk-assessment models are based on findings from the history, physical, and electrocardiogram (ECG), and/or additional information from diagnostic studies. As cardiac complications pose one of the most significant risks to patients undergoing major vascular surgery, the continuing debate concerns the appropriate management sequence to be followed once the risk is predicted. That is, should other tests, such as dipyridamole-thallium imaging (DTI) or dobutamine stress echocardiography (DSE), be performed to select a subset of patients to be revascularized with percutaneous transluminal angioplasty<sup>12</sup> or coronary artery bypass graft (CABG) prior to vascular surgery, or should the patient proceed directly to vascular surgery with aggressive perioperative medical management in an attempt to reduce risk.

The current standards for preoperative cardiac evaluation of these patients are the guidelines published by the American College of Cardiology (ACC) and the American Heart Association (AHA) initially in 1996 and updated in 2002.<sup>10</sup> The guidelines provide an 8-step algorithm stratifying patients' risks based on the integration of major, intermediate, and minor predictors of cardiac risk (Box 54-1),<sup>10</sup> including functional capacity (i.e., metabolic equivalent<sup>13</sup>

### BOX 54-1.

#### Clinical Predictors of Increased Perioperative Cardiovascular Risk (Myocardial Infarction, Heart Failure, Death)

##### Major

Unstable coronary syndromes

- Acute or recent myocardial infarction<sup>a</sup> with evidence of important ischemic risk by clinical symptoms or noninvasive study
- Unstable or severe angina (Canadian class III or IV)

Decompensated heart failure

Significant arrhythmias

- High-grade atrioventricular block
- Symptomatic ventricular arrhythmias in the presence of underlying heart disease
- Supraventricular arrhythmias with uncontrolled ventricular rate

Severe valvular disease

##### Intermediate

Mild angina pectoris (Canadian class I or II)

Previous myocardial infarction by history or pathologic Q waves

Compensated or prior heart failure

Diabetes mellitus (particularly insulin-dependent)

Renal insufficiency

##### Minor<sup>b</sup>

Advanced age

Abnormal ECG (left ventricular hypertrophy, left bundle-branch block, ST-T abnormalities)

Rhythm other than sinus (e.g., atrial fibrillation)

Low functional capacity (e.g. inability to climb one flight of stairs with a bag of groceries)

History of stroke

Uncontrolled systemic hypertension

ECG, electrocardiogram.

<sup>a</sup>The American College of Cardiology National Database Library defines recent myocardial infarction as greater than 7 days but less than or equal to 1 month (30 days); acute MI is within 7 days.

<sup>b</sup>May include "stable" angina in patients who are usually sedentary. Campeau L. Grading of angina pectoris. *Circulation* 1976;54:522-523. Eagle KA, Berger PB, Calkins H. ACC/AHA Guideline Update for Perioperative Cardiovascular Evaluation for Noncardiac Surgery-Executive Summary A Report of the American College of Cardiology/American Heart Association Task Force on Practice Guidelines (Committee to Update the 1996 Guidelines on Perioperative Cardiovascular Evaluation for Noncardiac Surgery). *Circulation* 2002;105:1257.



## BOX 54-2.

## Estimated Energy Requirements for Various Activities

1 MET	Can you take care of yourself? Eat, dress, or use the toilet? Walk indoors around the house? Walk a block or two on level ground at 2–3 mph or 3.2–4.8 km/h	4 METs	Walk on level ground at 4 mph or 6.4 km/h? Run a short distance? Do heavy work around the house like scrubbing floors or lifting or moving heavy furniture? Participate in moderate recreational activities like golf, bowling, dancing, doubles tennis, or throwing a baseball or football?
4 METs	Do light work around the house like dusting or washing dishes? Climb a flight of stairs or walk up a hill?	Greater than 10 METs	Participate in strenuous sports like swimming, singles tennis, football, basketball, or skiing?

MET, metabolic equivalent.

Eagle KA, Berger PB, Calkins H. ACC/AHA Guideline Update for Perioperative Cardiovascular Evaluation for Noncardiac Surgery-Executive Summary A Report of the American College of Cardiology/American Heart Association Task Force on Practice Guidelines (Committee to Update the 1996 Guidelines on Perioperative Cardiovascular Evaluation for Noncardiac Surgery). *Circulation* 2002;105:1257.

or exercise duration; Box 54-2),<sup>10</sup> the surgery-specific risk (Box 54-3),<sup>10</sup> and when indicated, the results of stress testing (Fig. 54-3). Several studies have assessed the utility of the ACC/AHA guidelines for risk stratification. Licker et al. compared data from two consecutive 4-year periods (1993–1996 control period versus 1997–2000 intervention period). Introduction of ACC/AHA protocols was associated with increased preoperative myocardial scanning (44.3% vs. 20.6%) and coronary revascularization (7.7% vs. 0.8%), as well as a significant decrease in the incidence of cardiac complications (from 11.3% to 4.5%) and an increase in event-free survival at 1 year after surgery (from 91.3% to 98.2%).<sup>14,15</sup>

Application of these guidelines results in approximately 50% of all major vascular surgery patients undergoing noninvasive testing.<sup>16</sup> The results of such testing then lead to either the original vascular procedure when negative, or to angiography when positive with some patients requiring coronary revascularization prior to vascular surgery.

Many tests have been both supported and refuted over time as valuable predictors of perioperative cardiac morbidity. However, the cost of these tests is a limiting factor. For example, it has been estimated that annual medical costs would rise \$100 million

should DTI be used in half of the vascular surgery patients.<sup>17</sup>

### Clinical Predictors of Perioperative Risk

Peripheral vascular surgery is associated with greater cardiac morbidity and overall mortality than other forms of noncardiac surgery.<sup>18,19</sup> Perioperative MI is reported to occur in 4–15% of patients undergoing peripheral vascular surgery and accounts for more than 50% of perioperative mortality.<sup>19</sup>

Hertzer showed that only 8% of 1000 vascular surgery patients in whom coronary angiography was performed had normal coronary arteries.<sup>20</sup> Severe and surgically correctable CAD was documented in 14% of patients who had no clinical criteria to suggest this degree of disease. Depending on the screening test employed, the incidence of significant CAD in patients with abdominal aneurysms, claudication, or carotid artery disease varies from 25% to 90%.<sup>20,21</sup>

Physiologic factors associated with surgery predispose to myocardial ischemia, which is more pronounced in patients with underlying coronary disease. Myocardial ischemia can result from increases in myocardial oxygen demand secondary to increases in blood pressure and heart rate, anemia, elevated preload increased contractility, or from decreases in oxygen supply as a result of hypotension, tachycardia, in-

## BOX 54-3.

Cardiac Risk<sup>a</sup> Stratification for Noncardiac Surgical Procedures

High (reported cardiac risk often greater than 5%)

- Emergent major operations, particularly in the elderly
- Aortic and other major vascular surgery
- Peripheral vascular surgery
- Anticipated prolonged surgical procedures associated with large fluid shifts and/or blood loss

Intermediate (reported cardiac risk generally less than 5%)

- Carotid endarterectomy
- Head and neck surgery
- Intraperitoneal and intrathoracic surgery
- Orthopedic surgery
- Prostate surgery

Low (reported cardiac risk generally less than 1%)

- Endoscopic procedures
- Superficial procedures
- Cataract surgery
- Breast surgery

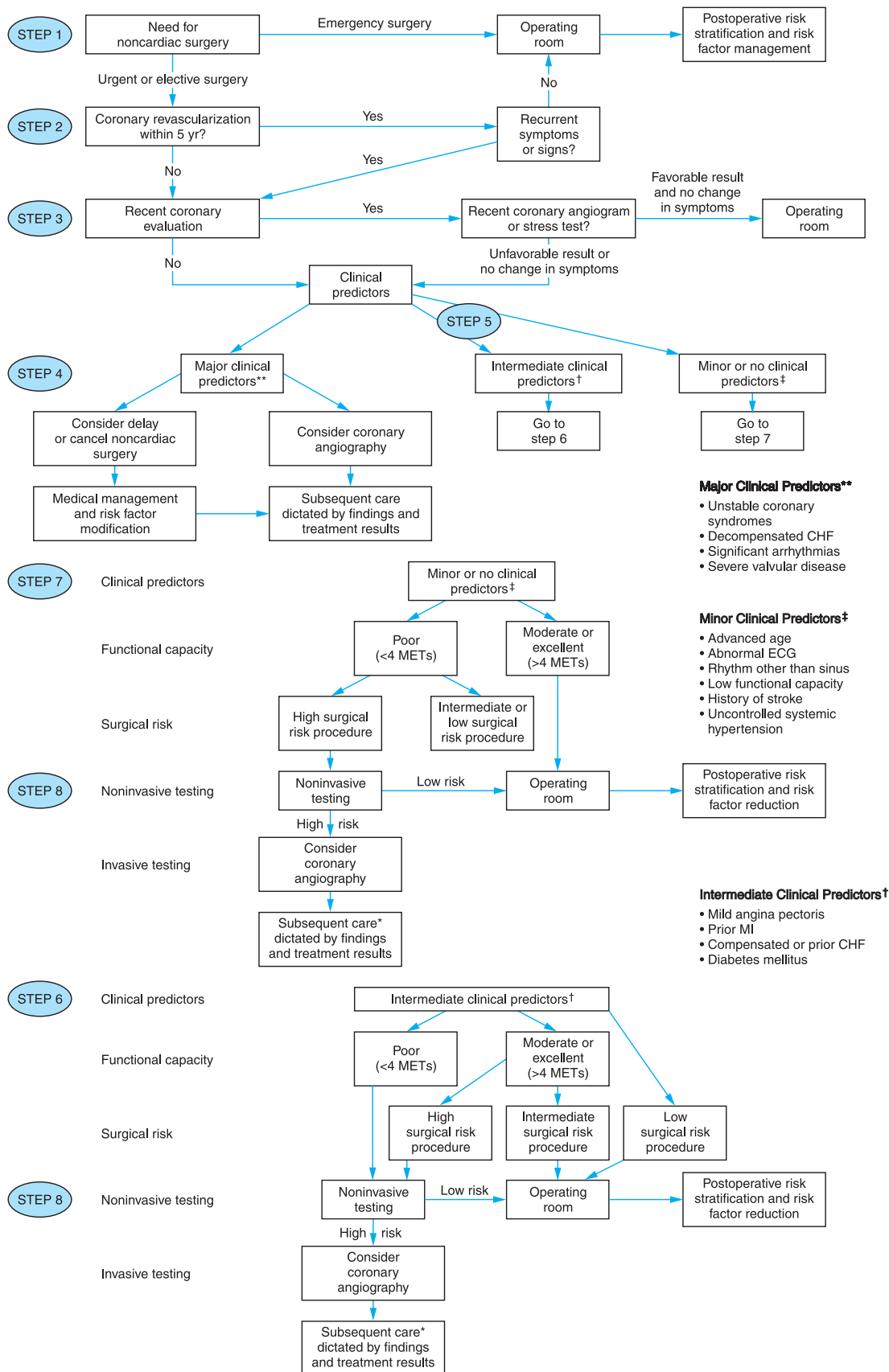
<sup>a</sup>Combined incidence of cardiac death and nonfatal myocardial infarction.

<sup>b</sup>Do not generally require further preoperative cardiac testing.

Eagle KA, Berger PB, Calkins H. ACC/AHA Guideline Update for Perioperative Cardiovascular Evaluation for Noncardiac Surgery-Executive Summary A Report of the American College of Cardiology/American Heart Association Task Force on Practice Guidelines (Committee to Update the 1996 Guidelines on Perioperative Cardiovascular Evaluation for Noncardiac Surgery). *Circulation* 2002;105:1257.

creased filling pressure, anemia, hypoxemia, and obstructed coronary blood flow as a consequence of acute thrombosis or spasm. Acute coronary and cerebrovascular syndromes (unstable angina, MI, sudden death, and stroke) are typically caused by rupture of plaques with less than 50% stenosis<sup>7</sup> and perioperative cardiovascular testing may not clearly identify these patients.

Several studies have looked at adverse cardiac events related to type of surgery. L'Italien et al. investigated 547 patients who were undergoing vascular surgery from two medical centers. These patients underwent clinical evaluation, DTI, and either aortic, infrainguinal, or carotid vascular surgery. Perioperative MI occurred in 6% of patients who underwent aortic and carotid artery surgery



**FIGURE 54–3.** Stepwise approach to preoperative cardiac assessment. Steps are discussed in text. \*Subsequent care may include cancellation or delay of surgery, coronary revascularization followed by noncardiac surgery, or intensified care. Eagle KA, Berger PB, Calkins H. ACC/AHA Guideline Update for Perioperative Cardiovascular Evaluation for Noncardiac Surgery-Executive Summary A Report of the American College of Cardiology/American Heart Association Task Force on Practice Guidelines (Committee to Update the 1996 Guidelines on Perioperative Cardiovascular Evaluation for Noncardiac Surgery). *Circulation* 2002;105:1257.

and in 13% of patients who underwent infrainguinal procedures ( $p = 0.019$ ). Significant ( $p < 0.05$ ) predictors of MI were history of angina, fixed and reversible dipyridamole-thallium defects, and ischemic ST depression during testing. Although patients who underwent infrainguinal procedures exhibited more than twice the risk for perioperative MI of patients who underwent aortic surgery (relative risk: 2.4 [1.2–4.5,  $p = 0.008$ ]), this value was reduced to insignificant levels (relative risk: 1.6 [0.8–3.2,  $p = 0.189$ ]) after adjustment for comorbid factors.<sup>16</sup>

Thirty-day mortality after elective aneurysm repair was 5.8% and 2.7% in the United Kingdom Small Aneurysm trial and the Aneurysm Detection and Management (ADAM) trial, respectively.<sup>22,23</sup> Perioperative mortality is much higher with emergency surgery, occurring in 37% of 81 patients in a large screening trial.<sup>24</sup>

Using multivariable analysis, the revised Goldman cardiac risk index identified 6 clinical factors that predicted major cardiac complications in a cohort of 2893 patients who underwent elective noncardiac surgery. These factors were high-risk surgery, history of CAD, no history of revascularization, history of congestive heart failure, preoperative use of insulin, and preoperative serum creatinine greater than 2 mg/dL. These predictors were then validated in a cohort of 1422 patients. The predictive value was significant in all types of elective major noncardiac surgery except for abdominal aortic aneurysm surgery. Cardiac event rates for zero, 1, 2, and  $\geq 3$  of the 6 factors were 0.4%, 0.9%, 7%, and 11%, respectively.<sup>25</sup>

### **Recent Myocardial Infarction and Angina**

Patients with prior MI are at greater risk for perioperative reinfarction. Traditionally, risk assessment for noncardiac surgery was based on the time interval between the MI and the surgery. Older studies found as much as a 36% risk of reinfarction or cardiac death when patients underwent surgery within 3 months of a previous MI. The risk fell to 15–25 percent at 3–6 months, and to 5% when surgery was performed after more than 6 months after a previous MI.<sup>26</sup> However, the risk was lower in later studies because of preoperative optimization and intensive perioperative monitoring.<sup>12</sup>

The American College of Cardiology National Database Library defines recent MI as greater than 7 days but less than 1 month since the occurrence. The ACC/AHA guidelines for perioperative evaluation of the cardiac patient undergoing noncardiac surgery categorizes those who have had a MI within the past 6 weeks as being in the group of highest risk; after that 6-week period risk stratification is based on the presentation of the disease.<sup>10</sup> Risk stratification of patients with acute coronary syndromes such as unstable angina predict those who are at high risk for further ischemic events or adverse outcomes. Such patients should not undergo noncardiac surgery except in the most emergent of circumstances.

### **Valvular Diseases**

Although severe valvular disease is considered by the ACC/AHA guidelines as a major clinical predictor of increased perioperative cardiovascular risk, studies show that when the clinician is aware of the pathophysiologic implications of the disease and manages the patient accordingly, patients with severe aortic stenosis even if symptomatic, can undergo surgery with a risk that is not so high, and may not be different from controls.<sup>27,28</sup>

### **Diabetes**

Diabetes has been strongly suggested as a predictor for perioperative cardiac morbidity after vascular surgery.<sup>29</sup> Altered autonomic function in diabetes may predispose to greater intraoperative risk of blood pressure lability, variation of heart rate, gastroparesis, and decreased esophageal sphincter tone. Diabetic autonomic neuropathies can obscure symptoms of myocardial ischemia, thus adding to the already high incidence of “silent” ischemia seen in the perioperative period. The presence of diabetes in vascular surgery patients may identify a population in whom DTI is useful.<sup>30</sup>

### **Assessment of Pulmonary Status**

Many vascular patients are chronic smokers, and cigarette smoking increases the risk for postoperative pulmonary complications. The risk of pneumonia is twice as high in smokers as in nonsmokers, and the development of hypoxemia in the postoperative period occurs more frequently and more severely in smokers as compared with nonsmokers. Pulmonary function tests are indicated only

when clinical assessment suggests severe compromise of pulmonary function, and may be useful in identifying patients who would benefit from perioperative care and those who are likely to require mechanical ventilation postoperatively. Arterial blood gases may be used to evaluate the degree of pulmonary disease and provide a baseline for subsequent clinical decisions. A persistently elevated PaCO<sub>2</sub> greater than 45 mm Hg reliably predicts a high risk for pulmonary complications.<sup>31</sup>

### **Assessment of Renal Function**

A comprehensive preoperative evaluation of a vascular surgical patient should include an assessment of renal function as this patient population is at increased risk for renal failure.

Causes of baseline renal insufficiency include atherosclerosis of the renal arteries, hypertension, diabetic nephropathy, and depressed myocardial function. Contrast-enhanced imaging studies performed before surgery also alter renal function by both a direct toxic effect and by a hyperosmolar-induced diuresis that reduces the intravascular volume. Intravascular volume expansion before, during, and after the angiographic study minimizes renal effects.

In the vascular patient who is undergoing abdominal aortic surgery, there are several causes of renal impairment superimposing on an already precarious renal function, such as wide fluctuations in the intravascular volume and cardiac output, altered neuroendocrine milieu with increased epinephrine, norepinephrine, and renin secretion, emboli shower dislodged by the aortic clamp, and dysfunctional effects on renal hemodynamics from aortic cross-clamping.

Evolving technology and progress in surgical and anesthetic management has decreased the incidence of renal failure.

### **Diagnostic Testing**

#### **Electrocardiogram**

Preoperative ECG abnormalities are observed in 40–70% of patients with CAD who are undergoing noncardiac surgery. ST-segment and T-wave abnormalities are noted (65–90%) and Q waves occur in 0.5–8% of patients. The presence of Q waves or significant ST-segment elevation or depression is associated with an increased incidence of cardiac complications.<sup>30</sup>

### Exercise Electrocardiography

Noninvasive diagnostic tests have been proposed to evaluate the extent of CAD before noncardiac surgery and to permit further stratification in patients who are deemed to be at intermediate risk after clinical evaluation. One caveat of interpreting stress testing in the overall preoperative evaluation of the patient is that for the purpose of predicting perioperative cardiac events, stress testing has a high negative predictive value (90–100%) but low positive predictive value (6–67%); consequently, it is more useful in reducing estimated risk if negative (or normal) than for identifying patients who are at very high risk if positive.<sup>32</sup>

Exercise ECG without myocardial imaging has been the traditional method for evaluating CAD, and is the standard method for determining functional capacity and detecting myocardial ischemia with a sensitivity of 68–81% and a specificity of 66–77%. Exercise tolerance appears to be more important than the ECG response to exercise. Inability to perform moderate exercise or to achieve greater than 85% of predicted maximal heart rate during treadmill exercise testing is associated with a high risk of a postoperative cardiac event, even in the absence of diagnostic ischemic ECG changes.<sup>33</sup> In patients who cannot exercise and who have abnormalities on the baseline ECG that interfere with interpretation, pharmacologic stress testing is warranted. The two most common used tests are DTI and DSE.

### Dipyridamole-Thallium Myocardial Perfusion Imaging

The two vasodilators used for pharmacologic myocardial perfusion imaging are adenosine and dipyridamole. Adenosine and dipyridamole are equally effective, but adenosine has the advantages of very short half-life, rapid reversal of side effects after the test is completed, and possibly more predictable vasodilatation. Thallium-201 is taken up by cells similarly to potassium and is readily assimilated by healthy myocardial cells; consequently, infarcted, ischemic, and hypoperfused areas appear as defects. After injection of thallium or 99-technetium, normal myocardium will show up on initial imaging whereas areas of infarction or hypoperfusion distal to a stenosis will appear as a defect. After dissipation of the dilatory effect and after a

second injection of technetium, defects caused by ischemia will resolve whereas those caused by scarred infarcted tissue will persist.

In a 1995 review of the 5 largest series of 1410 selected patients referred for dipyridamole-thallium myocardial perfusion imaging prior to vascular surgery, the sensitivity and specificity for a major cardiac event was 85% and 60%, respectively. The negative predictive value of dipyridamole-thallium imaging was 98%, but the positive predictive value was only 18%.<sup>34</sup> The ability to identify patients who are at risk may be improved when taking into account the extent of ischemia rather than only its presence. A recent meta-analysis showed that the probability of MI or cardiac death without reperfusion ranged from 3–4% in patients with no or only fixed defects, to 9% with reversible defects involving less than 20% of the left ventricle, to 18% with reversible defects involving 30–49% of the left ventricle, and to 45% with reversible defects involving more than 50 percent of the left ventricle.<sup>35</sup> There are, however, differences in predicted values reported between consecutive and selective series of patients.<sup>36</sup> Eagle et al. studied 200 patients who were undergoing vascular surgery, and found that DTI was most helpful in stratifying patients who had already been identified as high risk by clinical markers alone (e.g., angina, age >70 years, ventricular ectopy, diabetes, Q waves on ECG). These experts suggest using DTI to further delineate risk in patients with 1 or 2 of these clinical markers. In this subset of patients, a positive DTI was associated with a 10-fold higher incidence of cardiac morbidity. The study recommends proceeding with coronary angiography in these patients, as well as in any patient with 3 or more markers, in which case the DTI is unnecessary.<sup>30</sup> Conversely, Baron et al. studied a large consecutive population of patients who were undergoing abdominal aortic surgery, and were unable to demonstrate an association between thallium redistribution and perioperative cardiac morbidity.<sup>9</sup>

### Dobutamine Stress Echocardiography

Dobutamine stress echocardiography is preferred in patients with bronchospastic lung disease and in those with severe carotid stenosis because dipyridamole can induce bron-

chospasm and a decrease in blood pressure. It also provides information about left ventricular function or valvular heart disease. As opposed to DTI, which is limited in its methodology by not increasing myocardial oxygen consumption, the administration of dobutamine mimics intraoperative conditions by increasing heart rate. The predictive value appears to vary with patient risk. This was illustrated in a recent analysis of 1097 patients who were assigned 1 point for each of the following clinical risk factors: age older than 70 years, current angina, MI, congestive heart failure, prior cerebrovascular event, diabetes mellitus, and renal failure (Eagle criteria). The study showed that the additional predictive value of DSE is limited in clinically low-risk patients who are receiving  $\beta$ -blockers such that DSE may be avoided in a large number of patients who can proceed safely for surgery without delay. In clinically intermediate- and high-risk patients who are receiving  $\beta$ -blockers, DSE may help identify those who can undergo surgery and those in whom cardiac revascularization should be considered.<sup>37</sup> Some studies suggest that DSE is superior in its ability to predict morbidity in vascular surgery but, unfortunately, the test is also the most expensive noninvasive technique.<sup>11,38</sup>

### Transthoracic Echocardiography

Transthoracic echocardiography may add predictive information regarding left ventricular function and valvular lesions in certain patients who are undergoing noncardiac surgery. Although it has been shown that depressed ventricular function assessed by left ventricular ejection fraction may be predictive of postoperative heart failure,<sup>9</sup> data do not support the use of transthoracic echocardiography for the noninvasive assessment of left ventricular function to predict preoperative cardiac risk before noncardiac surgery, as stated in a position paper of the American College of Physicians.<sup>39</sup>

### Ambulatory ECG Monitoring

Preoperative ambulatory ECG monitoring provides a means of monitoring continuously for significant ST-segment changes. Some studies correlated the duration and severity of preoperative ST-segment changes with perioperative cardiac morbidity in patients who were undergoing vascular surgery.



Raby et al. showed that 12 of 32 (37%) patients with preoperative ischemia detected by ambulatory ECG suffered a MI, unstable angina, or pulmonary edema during or after major vascular surgery, whereas only 1 postoperative myocardial event occurred among 144 patients who did not exhibit preoperative ischemia.<sup>40</sup> Baseline ECG changes are found in a significant number of vascular patients and limit the use of this test. In addition, the test provides binary outcomes and cannot further stratify high-risk patients.<sup>41</sup>

**Coronary Angiography** In the perioperative setting many infarctions are the result of acute thrombosis of a noncritical stenosis, which limits the value of routine angiography prior to major noncardiac surgery. The ACC/AHA guidelines' class I recommendations state that coronary angiography should be considered in patients with suspected or known CAD with at least 1 of the following findings: (a) evidence for high risk of adverse outcome based on noninvasive test results, (b) angina unresponsive to adequate medical therapy, (c) unstable angina, particularly when facing intermediate-risk or high-risk noncardiac surgery, and (d) equivocal noninvasive test results in patients at high clinical risk who are undergoing high-risk surgery.<sup>10</sup>

## PREOPERATIVE THERAPY

### Preoperative Coronary Artery Bypass Grafting

Some patients who present for major surgery have unstable coronary syndromes that are sufficiently high risk to mandate coronary revascularization. For most patients, however, the issue is considerably less clear.

The results of the Coronary Artery Revascularization Prophylaxis (CARP) trial were recently published. This study prospectively randomized 510 patients with stable coronary disease to either coronary revascularization by CABG surgery, percutaneous coronary intervention (PCI), or medical therapy before undergoing major vascular surgery. Two-thirds of the enrolled patients had either one- or two-vessel disease. Excluded from the study were patients who had unstable coronary disease, left main coronary artery stenosis, severe left ventricular dysfunction, or severe aortic stenosis. Potentially

beneficial medications, including  $\beta$ -blockers, antiplatelet agents, angiotensin-converting enzyme inhibitors, and statins were widely used in both groups.  $\beta$ -Blockers were given to 84% of the patients in the revascularization group and to 86% of the patients in the medical therapy group. The study found no significant difference in long-term outcome. After 2.7 years, mortality was 22% in the revascularization group and 23% in the nonrevascularized group. These data support the current ACC/AHA perioperative cardiovascular recommendations that the decision to perform coronary revascularization should be based on the same well-proven indications used in the nonoperative setting. However, the study was also not large enough to provide a conclusive analysis of the potential benefit of revascularization in high-risk subgroups, such as those with a large stress-induced defect on myocardial perfusion imaging (MPI) or those with three vessel disease plus left ventricular dysfunction.<sup>42</sup>

In contrast to these findings, other reports suggest that surgical revascularization may provide a net reduction in perioperative and, in particular, long-term morbidity and mortality in selected patients with coronary disease who undergo major noncardiac surgery. A retrospective cohort analysis evaluated 1834 patients with both coronary and peripheral arterial disease. A significant long-term survival benefit was seen in patients who underwent CABG compared with medical therapy, regardless of the need for vascular surgery. Subgroup analysis suggested that the survival benefits with CABG were limited to patients with three-vessel disease, and were inversely related to the left ventricular ejection fraction.<sup>43</sup>

### Preoperative Percutaneous Coronary Intervention

PCI can be performed either through stenting or angioplasty (percutaneous transluminal coronary angioplasty [PTCA]). Drug-eluting stents are now implanted in the great majority of PCI procedures because of a much lower expected rate of restenosis and target-vessel revascularization than seen with angioplasty alone or bare-metal stents. However, recent studies have questioned whether long-term outcomes, including stent restenosis, MI, and cardiac death are lower with drug-eluting stents than with bare-metal stents.<sup>44-46</sup>

The role of PCI in the preoperative management of patients who are undergoing noncardiac surgery is less-well established. One study looking at an administrative database of patients who were undergoing surgery in Washington State found that, compared with patients who did not undergo PTCA preoperatively, the procedure led to a lower incidence of perioperative cardiac complications. The benefit of revascularization was most apparent in the group that underwent PTCA at least 90 days before undergoing noncardiac surgery. In contrast, when revascularization was performed less than 90 days before noncardiac surgery, PTCA was not associated with an improved outcome. This finding suggests that PTCA should not be used solely as a means of reducing perioperative risk.<sup>47</sup>

Coronary stenting poses unique challenges related either to perioperative bleeding because of postprocedural antiplatelet therapy or to stent thrombosis that may be associated with withholding or reducing antiplatelet therapy so as to minimize bleeding. The authors of the ACC/AHA guidelines recommend a delay of at least 2 weeks, ideally 4-6 weeks, before noncardiac surgery to allow 4 full weeks of dual antiplatelet therapy and complete reendothelialization of the stent.

### Perioperative Medical Therapy

Nitrates,  $\beta$ -blockers, and calcium channel blockers are common chronic medications in vascular surgery patients. Because perioperative discontinuation of these therapies may lead to perioperative ischemia, dysrhythmias, MI, and cardiac death, it is recommended to continue all significant cardiovascular medications up to and including the morning of surgery.

The focus on perioperative  $\beta$ -blockade has led to mounting evidence that their prophylactic use reduces cardiac mortality and morbidity.  $\beta$ -Blockers reduce ischemia by decreasing myocardial oxygen demand as a result of increased stress and catecholamine release in the perioperative period, and may decrease the incidence of plaque rupture by reducing mechanical stress via hemodynamic effects.<sup>48</sup>  $\beta$ -Blockers are the most studied and advocated perioperative medical therapy. Clinical studies show that perioperative  $\beta$ -blockade can reduce mortality and

cardiovascular complications in high-risk patients who must undergo noncardiac surgery.<sup>49,50</sup> The 2002 ACC/AHA guidelines for perioperative cardiovascular evaluation for noncardiac surgery recommend that patients previously on  $\beta$ -blockers should continue these agents perioperatively. The guidelines also suggest that, whenever possible,  $\beta$ -blocker should be started days or weeks before elective surgery in high-risk patients in whom there are findings of ischemia on preoperative testing, and that the dose should be titrated to achieve a resting heart rate between 50 and 60 beats/min. The use of  $\beta$ -blockers is also recommended in patients with known risk factors for coronary disease who are undergoing noncardiac surgery (a class II indication).<sup>10</sup>

Although evidence supporting the routine use of  $\alpha_2$ -agonists such as clonidine is not as compelling as that for perioperative  $\beta$ -blockade, the ACC/AHA guidelines introduced the use of  $\alpha_2$ -agonists as a class IIb recommendation for perioperative control of hypertension or risk reduction in patients with known CAD or major risk factors for CAD.<sup>10</sup>

## GENERAL CONSIDERATIONS

Modern developments in risk assessment, surgical risk modification, physiologic monitoring, antiischemic therapies, techniques of anesthesia and analgesia, and postoperative intensive care and rehabilitation can all produce clinical pathways that truly optimize patient care. Full realization of this potential requires an integrated approach and collaboration between vascular surgery, cardiac surgery, cardiology, anesthesiology, and critical care medicine to a degree not easily achievable in most institutions.

Vascular surgery patients require intensive perioperative monitoring for two primary reasons: (a) these patients often have systemic manifestations of atherosclerotic vascular disease and are at risk for cardiac, cerebral, renal and spinal cord ischemia, all of which can be diagnosed and treated using appropriate monitors; and (b) vascular procedures involve major physiologic changes, including significant third-space losses, blood loss, and the complications of transfusion (coagulopathies, hypocal-

cemia, hypothermia, and acidosis). There can also be significant changes in the hemodynamic profile associated with the application and release of vascular clamps.

To reduce cardiac morbidity, appropriate ECG monitoring is mandatory. One study showed that monitoring the standard leads II and V<sub>5</sub> detects 80% of ST-segment changes caused by ischemia, although V<sub>4</sub> is preferable to V<sub>5</sub>, and the concomitant monitoring of 3 leads increases the sensitivity to 95% or higher.<sup>51</sup> The following discussions assume that the American Society of Anesthesiology (ASA) standards of basic monitoring are met, including employing pulse oximetry, capnography, ECG and body temperature measurement.

## CAROTID ENDARTERECTOMY

### Pathophysiology of Carotid Disease

Occlusive disease of the carotid system is commonly caused by atherosclerosis and involves the origins of both the internal and external carotid arteries as well as the bifurcation of the common carotid artery. Carotid atherosclerosis is usually most severe within 2 cm of the bifurcation of the common carotid artery, and predominantly involves the posterior wall of the vessel. The plaque encroaches on the lumen of the internal carotid artery and often extends caudally into the common carotid artery. Various theories have been proposed to explain atheromatous plaque formation at the carotid bifurcation. Impedance mismatch, with altered hemodynamic conditions that accompany division of a vessel into conduits of substantially different sizes, may be implicated in the vessel injury.<sup>52</sup> Plaque formation may produce symptoms either through low flow as a result of the stenosis with inadequate collateral compensation or by exhibiting degenerative changes that lead to atheromatous emboli and thromboemboli.

### Indications

Although successful CEA may reduce the risk of stroke in selected patients, it is always important to balance the risk of operation with the risk of stroke from the unoperated lesion.

Three major trials have investigated the efficacy of CEA in selected patients with symptomatic carotid ath-

erosclerosis: the North American Symptomatic Carotid Endarterectomy Trial (NASCET), the European Carotid Surgery Trial (ECST), and the Veterans Affairs Cooperative Trial 309. These major clinical trials defined symptomatic carotid disease as focal ischemic symptoms that are referable to the appropriate carotid artery distribution, including one or more transient ischemic attacks characterized by focal neurologic dysfunction or transient monocular blindness or one or more minor (nondisabling) ischemic strokes.<sup>53</sup> A recent pooled analysis of these three trials using the same measurements and definitions yielded highly consistent results. CEA is of some benefit for patients with 50–69% symptomatic stenosis, and highly beneficial for those with 70% symptomatic stenosis or greater but without near-occlusion. Benefit in patients with carotid near-occlusion is marginal in the short-term and uncertain in the long-term. CEA was not beneficial for symptomatic carotid stenosis of 30–49%, and was harmful for symptomatic patients with less than 30% stenosis.<sup>54</sup>

Three high-quality major trials—the Veterans Affairs Cooperative Study Group, the Asymptomatic Carotid Atherosclerosis Study (ACAS), and the Asymptomatic Carotid Surgery Trial (ACST) have evaluated the efficacy of CEA in patients with asymptomatic high-grade carotid stenosis (60% or greater). A meta-analysis of these three trials showed that despite approximately a 3% perioperative stroke or death rate, CEA for asymptomatic carotid stenosis reduces the risk of any stroke by approximately 30% over 3 years. However, the absolute risk reduction is small for the first few years of followup. The ACST showed that significant benefit for the population is not evident until 2 years after surgery. Early after CEA, perioperative morbidity outweighs the modest, although significant, reduction in stroke risk that accompanies this procedure.

Data from several studies identified clinical predictors for adverse outcome. Although not validated in other studies, one or more of the following characteristics are associated with an increased risk of poor outcome (stroke, MI, or death) at 30 days after CEA: age older than 80 years, congestive heart failure, chronic obstructive pulmonary disease, renal failure (serum creatinine concentration >2.0 mg/dL), contralateral ca-

rotid artery occlusion, and recurrent ipsilateral carotid artery stenosis.<sup>55</sup>

### Intraoperative Monitoring Monitoring for Cerebral Ischemia

The beneficial effects of CEA over medical therapy are partially dependent on low perioperative morbidity. It is recommended that perioperative stroke and death rate be less than 6% for symptomatic patients and less than 3% for asymptomatic patients so as to maintain this benefit.<sup>56</sup>

The carotid artery must be temporarily completely occluded by a cross-clamp in order to perform the CEA. Although 80–85% of patients tolerate clamping of the carotid artery without symptoms, assessment of collateral circulation occurring contralaterally via the circle of Willis is needed in all patients. The most common technique to restore flow across the carotid artery is a temporary Javid shunt, which is inserted through the arteriotomy distally in the internal carotid artery and proximally in the common carotid artery. Although beneficial in restoring blood flow, shunt insertion may cause an embolism-associated stroke, can be associated with intimal dissection leading to acute occlusion, and may affect the adequacy of the endarterectomy by limiting exposure of the plaque. Several authorities argue that any monitoring modality that could reliably indicate inadequate cerebral blood flow would allow a more conservative use of the shunting procedure.

**Electroencephalography** Electroencephalography is the gold standard for monitoring patients under general anesthesia. Cerebral ischemia produces neuronal dysfunction, leading to slowing of frequencies or reduced amplitude in the electroencephalogram (EEG) tracing. These changes may be generalized (global ischemia) or regional (focal ischemia). The depth of ischemia is associated with the severity of EEG changes. Electroencephalography cannot assess the whole cerebral cortex and is less reliable at assessing subcortical structures. In the setting of CEA, the focal EEG changes after cross-clamping the carotid artery may be defined as none, mild (<25% increase in theta waves or >50% decrease in amplitude), moderate (>25% increase of theta waves or <25% increase of delta waves), or severe (>25% increase of delta waves and severe flattening of

amplitude or isoelectric curve).<sup>57</sup> A recent study evaluated the efficacy of continuous intraoperative EEG monitoring in a group of 1661 CEA operations in which the EEG was the sole criterion for shunt insertion.<sup>58</sup> Intraoperative stroke rate in the study group was 0.3% (5 strokes). A statistically significant increase in intraoperative stroke rate was associated with the development of an abnormal EEG, a contralateral internal carotid artery occlusion, and the combination of both an abnormal EEG and a contralateral internal carotid occlusion.<sup>58</sup> One explanation for the high sensitivity of the EEG monitoring in this study may be the technique used (16-channel EEG interpreted by experts). In less-experienced hands, the sensitivity for detection of ischemia decreases.<sup>59</sup> Patients who have preexisting neurologic deficits should be monitored with caution. One study showed that 4 (3%) of 124 patients who had strokes or reversible neurologic deficits before CEA awoke with new deficits despite an unchanged EEG during the procedure.<sup>60</sup>

Electroencephalography is affected by anesthetic agents and changes in temperature and blood pressure. Additionally, the value of EEG monitoring is limited by the fact that the majority of neurologic deficits after CEA is caused by thromboembolism rather than occlusion of blood flow during carotid clamping.

Processed electroencephalography, such as compressed spectral array, density spectral array, and spectral edge frequency, is easier to monitor and interpret. Although there is still insufficient data, studies so far show that these techniques have a lower sensitivity than raw electroencephalography.

### Somatosensory Evoked Potentials

The most commonly used electrophysiologic technique to monitor functional continuity of nerve, spinal cord and brain is somatosensory evoked potentials (SSEPs). The use of SSEP monitoring during CEA is still inconclusive. While some studies found similar sensitivity in their ability to detect postoperative neurologic defects when compared with electroencephalography<sup>61</sup> others found SSEP to be less sensitive than electroencephalography in predicting the need for shunting.<sup>62</sup> Under general anesthesia the cortical SSEP is depressed, amplitude is decreased, and there is increased latency in a dose-

dependent manner by inhalational agents. It can be obtained, however, in most patients with 0.5 minimum alveolar concentration of a volatile anesthetic supplemented by intravenous medications, usually narcotics or intravenous hypnotics. Furthermore, the technique is dependent on availability of specialized equipment and trained staff.

**Transcranial Doppler** Transcranial Doppler (TCD) provides noninvasive assessment of the middle cerebral artery (MCA) by insonating the MCA through the temporal bone using a specially designed Doppler probe. As long as fluctuations in arterial blood pressure and arterial CO<sub>2</sub> content are small, changes in flow velocity reflect changes in cerebral blood flow. Hemodynamic compromise is indicated by a reduction in mean flow velocities or when there is slow flow acceleration. In addition, TCD has the unique capability to detect cerebral microembolic signals, reflecting the presence of gaseous or particulate matter in the insonated cerebral artery, which occur most commonly during the dissection phase, during shunting and unclamping, during wound closure, and in the first few hours postoperatively.<sup>63</sup>

Data regarding the reliability of TCD in monitoring for cerebral ischemia is controversial. Emboli during dissection and wound closure, as well as greater than 90% decrease of MCA peak systolic velocity at cross-clamping or greater than 100% increase of the pulsatility index of the Doppler signal at clamp release, were independently associated with stroke.<sup>64</sup> Belardi et al. concluded that neither TCD nor the stump pressures are reliable in predicting the need for carotid shunting.<sup>65</sup> TCD may be used as a complementary monitoring technique to electroencephalography. Although there is high overlap between low-flow velocities and ipsilateral EEG slowing, neither technique alone may identify all candidates for shunting or prevent all strokes.<sup>57</sup> Technical difficulties or inappropriate visualization window make TCD difficult to interpret in 15–20% of cases.

**Near-Infrared Spectroscopy** Near-infrared spectroscopy (NIRS) is a noninvasive technique that allows continuous monitoring of regional cerebral oxygenation saturation (rSO<sub>2</sub>) through the scalp and skull.

Although easy to use and interpret, noninvasive NIRS has several limitations related to the fact that NIRS primarily measures venous oxygen saturation at the level of the frontal lobes, and there is a wide range of values that are not associated with a clinically detectable neurologic dysfunction. Samra et al. noted that although there was a significant change in ipsilateral  $rSO_2$  during carotid cross-clamping as compared with preclamping and postclamping values, there was a highly variable patient-to-patient change in  $rSO_2$  after carotid cross-clamping, with no relation to neurologic dysfunction.<sup>66</sup>

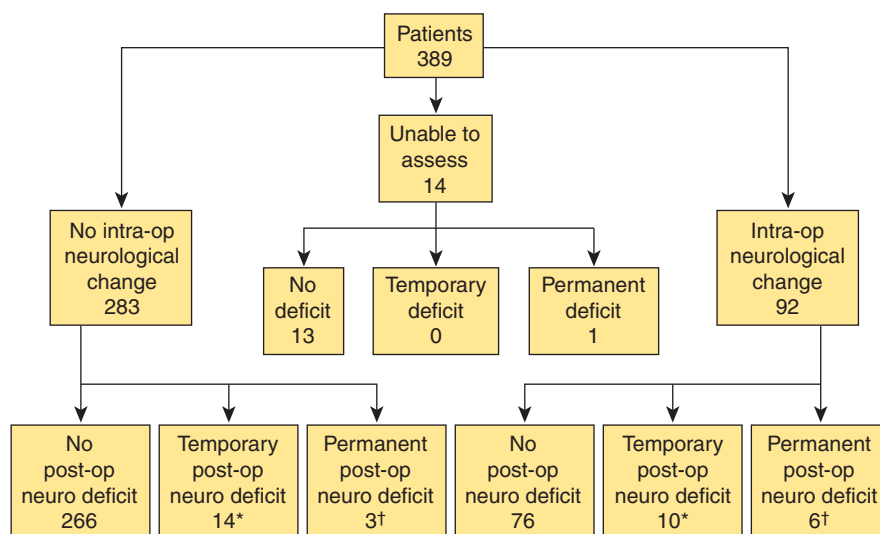
NIRS is a simple and noninvasive method to indirectly assess cerebral perfusion in patients undergoing CEA. Although it correlates with the development of clinical and EEG signs of cerebral ischemia, it should not be used alone to predict the need for shunt placement because of its low sensitivity and specificity.<sup>67</sup>

**The Awake Patient** Monitoring of the awake patient is the gold standard for neurologic assessment and may allow for prompt identification of patients who would benefit from shunt placement. Change in contralateral strength or consciousness in the setting of adequate mean arterial pressure is an indication for shunt placement. Intraoperative neurologic changes in the awake patient may predict a sixfold increase in the incidence of postoperative stroke (Fig. 54-4).<sup>68</sup> A study reporting the synchronous use of EEG monitoring with mental status evaluation in patients undergoing CEA under regional anesthesia showed that EEG monitoring yielded a significant number of false-positive (6.7%) and false-negative (4.5%) results in the detection of neurologic deficits when compared with mental status evaluation alone in the awake patients.<sup>69</sup> This method of monitoring requires the absolute cooperation of surgeon, anesthesiologist, and patient.

## GENERAL CONSIDERATIONS

Standard cardiovascular monitoring should include continuous ECG with two leads displayed (usually II and  $V_5$ ) and invasive continuous measurement of arterial blood pressure.

The 2003 ASA revised practice guidelines for the use of pulmonary artery catheters (PACs) do not support



**FIGURE 54-4.** Correlation of intraoperative neurologic change and postoperative neurologic outcome. Number of patients is shown in each box. \* $p < 0.05$  for temporary neurologic complication. † $p < 0.01$  for permanent neurologic complication. Source: Stoughton J, Nath RL, and Abbott WM.<sup>69</sup>

the use of PACs in peripheral vascular surgery unless indicated by comorbidities.<sup>70</sup> As changes in pulmonary capillary occlusion pressure are relatively insensitive to myocardial ischemia some advocate continuous use of transesophageal echocardiography (TEE) in patients with severe CAD.

Intravenous access may be limited to large-bore peripheral intravenous catheters. The use of central venous catheters should be parsimonious, weighing in risks and benefits. It may be more appropriately reserved for patients with documented or suspected severe CAD or valvular heart disease. The contralateral internal jugular vein should be preferably and cautiously cannulated under ultrasound guidance to avoid carotid puncture.

## Anesthetic Techniques

The goals of anesthesia, with balanced concerns for both brain and heart, may be summarized as follows:

- Hemodynamic extremes should be avoided during induction, incision, surgical manipulation, emergence and extubation.
- The patient should be sufficiently responsive immediately after surgery to facilitate neurologic evaluation.

Clearly, these two objectives narrow the range of acceptable anesthetic options and require clinical expertise.

Because the impact of the anesthetic technique on outcome remains controversial, both regional and general anes-

thesia techniques have proponents. Some investigators have found that regional anesthesia by cervical plexus block obviates the use of a shunt in more than 80% of patients, and facilitates safe, simple, and effective intraoperative cerebral function monitoring.<sup>71-73</sup> Regional anesthesia may be associated with shorter hospital stays, decreased intensive care costs, and less cardiovascular morbidity.<sup>74-76</sup>

A meta-analysis of the available randomized clinical trials comparing CEA under local anesthesia versus general anesthesia<sup>77</sup> showed that although local anesthesia was associated with a significant reduction in local postoperative hemorrhage, there were no significant differences in morbidity and mortality outcomes. These results should be interpreted with caution because of small sample sizes and insufficient power. Results from a large, ongoing, randomized trial (general anesthetic versus local anesthetic for carotid surgery [GALA]) are awaited before recommendations can be made regarding favoring one type of anesthesia over another.

Regional anesthesia is performed by blocking the superficial and deep cervical plexus formed from C2 to C4 anterior rami of the ipsilateral spinal roots. Proponents of this technique believe that an awake patient is the best monitor of neurologic function during carotid surgery. To achieve this goal the patient must be minimally sedated; the procedure requires a high degree of patient cooperation, a profound block-



ade, and an expeditious surgeon. Intraoperatively, the internal, external, and common carotid arteries are clamped sequentially followed by neurologic assessment. If neurologic deficit is noted by monitoring speech and upper-extremity motor function, surgery may proceed either with elevation of systemic blood pressure, reocclusion and reassessment of the patient, or with placement of a Javid shunt that bypasses the operative area.

Complications associated with regional anesthesia include infection, hematoma, local anesthetic toxicity, nerve injury, inadvertent spinal anesthesia, and phrenic nerve blockade, which can result in loss of function of the ipsilateral hemidiaphragm and consequent respiratory insufficiency, especially in patients with chronic respiratory disease.<sup>78</sup>

Disadvantages of regional anesthesia include patient discomfort and loss of cooperation, confusion, panic, and seizures. Management of intraoperative problems may be more difficult and, theoretically, associated with increased morbidity.

General anesthesia allows reliable airway control, better control of ventilation, nearly eliminating the possibility of hypoxemia and hypo- or hypercapnia, and optimal operating conditions for the surgical team. A potential benefit of using general anesthesia is the ability to monitor with TEE to detect wall-motion abnormalities and to guide therapy in patients with severe CAD.

Induction of general anesthesia should proceed slowly with medications titrated to the desired effect. Sodium thiopental, propofol, and etomidate are the induction agents employed most frequently because of their neuroprotective effects. Addition of a short- or intermediate-acting narcotic, depending on the proposed duration of surgery, is recommended. Moderate doses of narcotic allow for better hemodynamic control during intubation and incision, and permit a lower dose of inhalational agent to be used for anesthetic maintenance. The choice of neuromuscular blocking agents is unimportant as long as the duration of action of the agent does not delay emergence and it is not associated with hemodynamic disturbances related to the vagolytic or histamine release effects. Vecuronium seems to be the ideal muscle relaxant for procedures lasting ninety minutes or less.

The use of a laryngeal mask airway may lessen perioperative hemodynamic responses associated with airway management during intubation and extubation, but this decision must be based individually on the pros and cons related to the use of either an endotracheal tube or laryngeal mask airway.

Maintenance of general anesthesia can be achieved with various agents depending on hemodynamic stability provided, rapidity of emergence, and interference with the methods of monitoring employed. The rapid elimination of desflurane and sevoflurane may allow earlier postoperative neurologic assessment compared with isoflurane. However, desflurane may be associated with tachycardia and hypertension and therefore may increase cardiovascular risk. A study investigating hemodynamic and recovery characteristics in patients scheduled for CEA anesthetized with isoflurane, sevoflurane, or desflurane found no significant perioperative differences were noted in cardiac index or ST-segment analysis. The times to extubation, movement on command, and consciousness were shorter after desflurane and sevoflurane than after isoflurane.<sup>79</sup> As mentioned in the paragraphs above, moderate amounts of opioids can be used to enhance hemodynamic stability during maintenance of anesthesia, with care not to compromise rapid emergence at the end of the procedure. Researchers have found that although fentanyl, sufentanil, and remifentanyl offered similar intra- and postoperative hemodynamic stability, remifentanyl allowed faster recovery and earlier neurologic examination and was superior in blunting the sympathetic response to intubation.<sup>80,81</sup>

Blood pressure and heart rate changes during and after CEA surgery are quite variable and can even be extreme.<sup>82</sup> Surgical manipulation of the carotid sinus can cause an increase in afferent impulses to the brainstem and trigger an abrupt bradycardic response and hypotension. This may be prevented by infiltration of the sinus with local anesthetic by the surgeon. If infiltration has not been performed, then clamp application may cause hypertension and tachycardia because the sinus now senses a low pressure. The reverse may or may not be observed with unclamping. The variability between individuals in this reflex behavior may be a result of differences

in sinus insensitivity secondary to the atherosclerotic process.

Control of the arterial partial pressure of carbon dioxide in the arterial blood is controversial. Hypocapnia produces nondiscriminatory bilateral cerebral vasoconstriction whereas hypercapnia may induce a "steal" phenomenon. Consequently, most authors recommend the maintenance of normocarbia during CEA.<sup>82</sup>

A number of animal studies of traumatic brain injury, focal cerebral ischemia, and global cerebral ischemia demonstrate that glycemic control is a critical factor in terms of outcome.<sup>83</sup> Glycemic control with insulin improves neurologic outcome in patients who are critically ill and in those who are undergoing cardiac surgery.<sup>84</sup> Although there is relative lack of evidence to support the tight control of glucose in diabetic patients who are undergoing CEA, the adverse impact of hyperglycemia on cerebral ischemic injury suggests that the perioperative management of glucose is vital in these patients.

It is universally accepted that blood pressure during carotid occlusion should be maintained at or up to 20% higher than the patient's highest recorded resting blood pressure when awake so as to maintain adequate collateral blood flow. This may be achieved by titration of vasoconstrictors or inotropes, or by infusion of intravenous fluids. Although many recommend using dilute continuous infusions of an  $\alpha$ -agonist to achieve this goal, Smith et al. showed a higher incidence of myocardial ischemia when phenylephrine was used to achieve blood pressure goals in patients who were under moderately deep levels of inhalational anesthesia. Interestingly, despite the high incidence of intraoperative myocardial ischemia, no patient in this study suffered perioperative MI. It is noteworthy that this investigation used an anesthetic procedure that did not include short-acting narcotics as a supplement to the inhalational agent.<sup>85</sup> No evidence is available to help choose one intervention over another.<sup>82</sup>

Nowhere are emergence issues more important and complex than in CEA. Although it is desirable to have the patient alert and responsive immediately after the procedure to permit neurologic assessment, hypertension, which can stress and rupture the surgical anastomosis, is an ever-present

threat. Patients are frequently smokers with hyperreactive airways and copious airway secretions. Unless thorough precautions are taken, stimulation from the endotracheal tube at the time of emergence from general anesthesia will cause coughing and straining and can result in severe hypertension. Residual effects from previously administered narcotics are particularly helpful at this time. Early extubation could be considered in selected patients. Careful evacuation of oropharyngeal secretions, instillation of 60–80 mg of 2% lidocaine in the endotracheal tube during the surgical closure, and careful adjustment to minimal pressure in the endotracheal tube cuff, are partially effective techniques to blunt hypertension caused by the presence of the endotracheal tube. Aggressive pharmacologic intervention may be necessary with short-acting agents.

### Postoperative Considerations

There are several potential complications that may occur postoperatively, notably stroke, MI, and respiratory dysfunction. Hypertension is common, can have a multifactorial etiology, and is associated with increased incidence of cardiac and neurologic complications. An avoidable consequence of poorly controlled hypertension is wound hematoma necessitating prompt evaluation and possible wound exploration.

Patients with severe hypertension are at risk of developing hyperperfusion syndrome, which is an abrupt increase in blood flow with loss of autoregulation in the surgically reperfused brain. Reports describe a spectrum of findings, including severe headache, transient ischemia, seizures, and intracerebral hemorrhage, which presents as headache, seizures, or cerebral edema, and often occurs several days after surgery.<sup>86</sup>

Hypotension and bradycardia may occur secondary to carotid sinus hypersensitivity after plaque removal. Carotid body injury may persist for up to 10 months postoperatively. Recurrent laryngeal, hypoglossal, and marginal mandibular nerve injury may result in hoarseness, tongue deviation on protrusion, and drooping of the corner of the mouth. Superior laryngeal nerve injury may present as impaired phonation. Spinal accessory nerve injury may result in ipsilateral shoulder weakness.<sup>87</sup>

## LOWER-EXTREMITY VASCULAR SURGERY

### An Overview of Peripheral Arterial Disease

Peripheral arterial disease (PAD) is a growing clinical problem in the United States and its prevalence is only likely to increase as the population ages. Between 1999 and 2000 the National Health and Nutrition Examination Survey examined the population older than age 40 years and found that PAD affected more than 5 million adults in the United States. PAD prevalence increases dramatically with age from 0.9% between the ages of 40 and 49 years to 14.5% in those age 70 years and older. African American ethnicity, current smoking, diabetes, hypertension, hypercholesterolemia, and low kidney function were significantly associated with prevalence of PAD.<sup>88</sup>

Atherosclerosis is the most common etiology of PAD. Other, less-common causes are acute arterial disease (embolism, thrombosis, dissection, trauma), adventitial cystic disease, arterial fibrodysplasia, occluded limb aneurysms, and tumors. Of the cases of embolism to the lower extremities, 90% are caused by emboli that originated in the heart in patients with cardiac dysrhythmias, recent MIs or ventricular aneurysms with intracardiac thrombus, or diseased or prosthetic cardiac valves.

Patients are candidates for elective surgery to correct peripheral occlusive disease if they exhibit (a) intermittent, activity-limiting claudication; (b) ischemic rest pain; (c) ischemic ulceration; or (d) gangrene. According to the ACC/AHA and TransAtlantic Inter-Society Consensus (TASC) guidelines, certain issues have to be considered before revascularization: morphology of the lesions, projected natural history and prognosis of the patient, projected improvement in quality of life from alleviation of claudication, and inadequate response to exercise rehabilitation and medical therapy.<sup>89,90</sup>

Patients with intermittent claudication have normal flow to skeletal muscle at rest but markedly impaired flow to meet metabolic demands during exercise. The location of pain varies with the anatomic site of obstruction: buttock and hip pain is usually caused by aortoiliac disease, thigh pain is caused by common femoral artery dis-

ease, calf pain is caused by either superficial femoral artery or popliteal artery disease, and foot pain is caused by tibial or peroneal artery disease. Over time PAD affects skeletal muscle neurologic and metabolic functions, leading to further impairments in muscle performance and patient functional status.<sup>89</sup>

Modifiable atherosclerotic risk factors for PAD include smoking, diabetes, obesity, hyperlipidemia, hypertension, and homocysteine elevation.<sup>89</sup> Although more than 70% of the patients with PAD have no progression of symptoms with conservative management such as smoking cessation, exercise rehabilitation, and antiplatelet therapy,<sup>90</sup> the remainder have progression of their symptoms that mandate revascularization. When revascularization is required, the options are percutaneous interventional procedures and surgery.

Percutaneous transluminal angioplasty results in a “controlled” dissection of the arterial media. Percutaneous transluminal angioplasty traditionally has been limited to the treatment of focal, short segmental stenoses or occlusions. With advancements in technology, percutaneous transluminal angioplasty is now routinely applied to more extensively diseased segments to attempt limb salvage before a distal surgical bypass. Percutaneous transluminal angioplasty can also be used in patients who are poor surgical candidates. The TASC group recommends endovascular treatment for single lesions less than 3 cm in the common or external iliac artery (type A lesions) and surgical treatment for complete common femoral artery, superficial femoral artery or popliteal artery occlusions and proximal trifurcation occlusions (type D lesions). For lesions of intermediate severity there is insufficient evidence to make recommendations and these may be treated on an individual basis.<sup>89</sup>

Individuals who are undergoing lower-extremity vascular surgery present a dilemma to the anesthesia provider. The procedure itself is associated with far less (intraoperative and postoperative) nociceptive stimulation than aortic surgery, less hemodynamic fluctuation than carotid or aortic surgery and can be performed with a pure regional anesthetic. On the other hand, patients may have severe CAD and other systemic disorders, the

former undiscovered because of mobility limitations, placing these patients at high risk for perioperative complications. In a large study, patients undergoing infrainguinal bypass had a 30-day mortality rate of 5.8% and a 1-year mortality of 16.3%.<sup>91</sup> Thus the perioperative management of this group, including the anesthetic technique, must proceed with considerable caution.

## Anesthetic Considerations

### Monitoring

Standard monitoring should include continuous ECG with two leads displayed (usually II and V<sub>5</sub>), pulse oximetry, noninvasive blood pressure capnography, and temperature. In patients with cardiac risk factors who are undergoing noncardiac surgery, the perioperative maintenance of normothermia is associated with a reduced incidence of morbid cardiac events and ventricular tachycardia.<sup>92</sup>

Arterial cannulation and continuous pressure monitoring are considered standard. If a radial line is not technically feasible, the axillary approach is recommended. Central venous pressure (CVP) monitoring is frequently helpful. Volume status can be difficult to judge, especially in long, complicated cases that can evolve unpredictably. Improved response time to the administration of vasoactive agents is often sufficiently important to justify central venous cannulation.

Pulmonary artery catheterization is not routinely employed. Although monitoring with PACs provides more hemodynamic data, its benefit has not been demonstrated in several outcome studies, so is not routinely employed.<sup>93,94</sup> The 2003 ASA revised practice guidelines for the use of PACs do not support their use in peripheral vascular surgery unless indicated by comorbidities.<sup>70</sup> As changes in pulmonary capillary occlusion pressure are relatively insensitive to myocardial ischemia, some advocate continuous use of TEE in patients with severe CAD.

### Anesthetic Techniques

Because of their especially high-risk status, and because the nature of the surgery permits a pure regional technique, lower-extremity vascular surgery patients have been the subject of several studies comparing regional and general anesthesia.

Spinal and epidural anesthesia using local anesthetic agents have long been believed to provide overall better operative conditions for a variety of reasons, including avoidance of exposure to airway and pulmonary morbidity, lower blood loss, and ablation of the surgical stress response. The latter effect presumably produces more stable hemodynamics, reduced hypercoagulability, better wound healing, and less immune suppression. Furthermore, vasodilatation secondary to sympathetic blockade should be particularly helpful in sustaining graft patency.

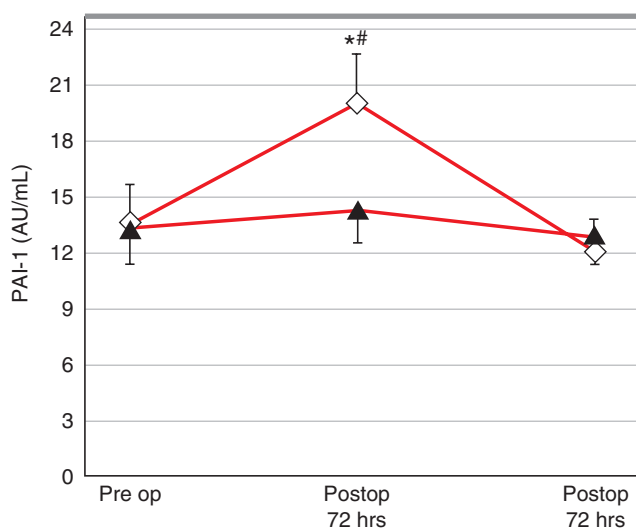
A recent meta-analysis of 141 randomized trials compared neuraxial anesthesia with general anesthesia for all types of patients and demonstrated that neuraxial blockade reduced the odds of deep vein thrombosis by 44%, pulmonary embolism by 55%, transfusion requirements by 50%, pneumonia by 39%, and respiratory depression by 59% (all  $P < 0.001$ ). There were also reductions in MI and renal failure.<sup>95</sup>

Serious difficulties have plagued many published investigations, including both prospective, randomized clinical trials and retrospective studies. The failure to adequately address these issues has produced findings that vary widely and therefore must be carefully interpreted.

The landmark study by Yeager et al. showed much less morbidity and mortality in a group of patients who underwent diverse major surgical procedures and who were given regional anesthesia and analgesia postoperatively, compared with those who received general anesthesia followed by on-demand parenteral narcotics. Only a few vascular surgery subjects were included in this study and the morbidity and mortality in the general anesthesia group was much higher than reported in other studies. No management techniques were specified and the general anesthesia group actually received a wide variety of techniques.<sup>96</sup> Tuman et al. randomized patients undergoing lower-extremity vascular surgery or aortic abdominal aneurysm surgery to receive either epidural-supplemented general anesthesia followed by postoperative epidural analgesia or general anesthesia followed by on-demand parenteral narcotics.<sup>97</sup> The investigators found somewhat higher cardiac morbidity in the general anesthesia group, but the difference was much less dramatic

than in the study by Yeager et al. The most remarkable outcome was a larger number of reoperations for inadequate lower-extremity flow in the general anesthesia group (20%). Tuman has speculated that the mechanism for this morbidity was attributable to perioperative hypercoagulability in the general anesthesia group that was not seen in the regional anesthesia group. It has been long believed, with some hard data, that regional blockade with local agents blunts certain components of the surgical stress response, including procoagulant activity. Although establishing the ability of regional anesthesia to attenuate this phenomenon would be significant, caution is warranted in the attribution of prevention of hypercoagulability to the reduced revascularization rates because other possibilities include sympathetic blockade as well as other aspects of management. Two other studies that compared regional and general anesthesia,<sup>98,99</sup> in which neuraxial analgesia was not continued in the postoperative period, found no benefit in terms of vascular graft patency.

Christopherson et al. conducted a randomized trial, called the Perioperative Ischemia Randomized Anesthesia Trial (PIRAT), of 100 patients who were undergoing lower-extremity grafts under epidural or general anesthesia. Postoperative analgesia included epidural fentanyl in the regional group and IV patient-controlled analgesia in the general group. Cardiac morbidity and mortality in each group was low, and the revascularization rate was high in the general anesthesia group.<sup>100</sup> Rosenfeld et al. using patients from the PIRAT study, reported an increase in plasminogen activator inhibitor in the general patients, but not in the regional patients, on the morning after surgery (Fig. 54–5).<sup>101</sup> This finding confirms the hypercoagulable state found by Tuman et al. postoperatively in the general anesthesia group, as well as the ability of regional anesthesia and analgesia to prevent the phenomenon. Also reporting from the PIRAT study, Breslow showed that norepinephrine levels rise at the end of surgery in the general, but not the regional, anesthesia group, and remain elevated throughout the postoperative period. Clearly, in this study, regional anesthesia/analgesia was effective in blocking the stress response after surgery.<sup>102</sup>



**FIGURE 54-5.** Plasminogen activator inhibitor-1 levels in activity units per milliliter for general and regional anesthesia groups over time. Values are mean  $\pm$  SEM (standard error of mean). #*p*, 0.001 compared to preoperative and 72 hours postoperative. \**p* = 0.05 general anesthesia (GA) compared to regional anesthesia (RA). Source: Rosenfeld BA, Beattie C, Christopherson R, et al.<sup>101</sup>

Bode et al. conducted a trial larger than the previous studies. In their trial, 423 patients who were undergoing lower-extremity grafts were randomized to either regional (spinal or epidural) or general anesthesia. They found low cardiac morbidity and mortality and low revascularization rates in both groups. In this study, however, all patients were monitored with pulmonary artery catheters intraoperatively and for the first 48 hours postoperatively. This permitted aggressive optimization of hemodynamic status and probably contributed to the excellent results in both groups.<sup>103</sup>

Anticoagulant therapy is an important adjunct in the perioperative period in the maintenance of vascular graft patency. As this has implications in the choice of anesthetic technique, the American Society of Regional Anesthesia and Pain Medicine has issued guidelines regarding neuraxial anesthesia and anticoagulants.<sup>104</sup> A few of these recommendations are as follows:

1. Unfractionated heparin should not be given for at least 1 hour after needle placement. Epidural catheters should be removed at least 1 hour before a heparin dose and at least 2–4 hours after a heparin dose after evaluation of patient's coagulation status. There should be careful monitoring of the patient's neurologic status in the postoperative period and minimal concentration of local anesthetic should be used.

2. There are no current contraindications to using neuraxial techniques in patients who are on subcutaneous heparin prophylaxis.
3. For patients who are on low-molecular-weight heparin, needle placement should occur at least 12 hours after the last thromboprophylactic dose of low-molecular-weight heparin and at least 24 hours after the last therapeutic dose.
4. Warfarin therapy should be discontinued 4–5 days before block placement, and coagulation status should be checked.
5. There are no contraindications to giving a neuraxial anesthetic to patients who are on nonsteroidal anti-inflammatory drugs.
6. Clopidogrel should be discontinued for 7 days, and ticlopidine for 14 days, prior to neuraxial anesthesia.

Although regional anesthesia has desirable effects, there is insufficient data to recommend one technique over another. With the advent of new anesthetic agents, general anesthesia can be safely employed with attention to detail throughout the perioperative period and aggressive management of hemodynamic changes.

## ANEURYSMS

### Pathophysiology and Management

Aneurysms are arterial expansions that occur as the vascular wall be-

comes weakened from atherosclerosis or other degenerative processes. The abdominal aorta is the most common site of arterial aneurysm. Abdominal aortic aneurysms (AAAs) most often occur in the segment of aorta between the renal and inferior mesenteric arteries. Approximately 5% involve the renal or visceral arteries. Thoracoabdominal aneurysms involve the thoracic and abdominal aorta together.

Recently, the role of atherosclerosis in the pathogenesis of aneurysms has become less clear and the underlying cause of aneurysmal aortic dilation is uncertain in most patients. A genome scan of 36 families with abdominal aortic aneurysm identified a possible gene locus for this disease on chromosomes 19q13 and 4q31.<sup>13</sup> Other investigators suggested that destruction of elastin in the aortic wall is a key event that shifts the load produced by blood pressure on collagen. This is exacerbated in the presence of hypertension. Smoking and age are other important factors. The location of the aneurysm is also important, as elastic lamellae are relatively less common in the abdominal aorta. Once the shielding effect of elastin is lost, further dilation and rupture of the aorta depend on the physical properties of the collagen present.<sup>105</sup>

Although the infrarenal portion may exhibit atherosclerosis, the suprarenal aorta often shows degenerative changes of the media called *mucoïd degeneration*, *myxomatous degeneration*, or *cytic medial necrosis*.<sup>106</sup>

The natural progression of untreated aneurysm is expansion and eventual rupture. This is because with equal distending pressure within a vessel, the wall tension is higher when the vessel radius is larger, as described by the Laplace law. This physical principle states that the tension (T) sustained by a vessel wall because of blood pressure (P) is directly proportional to the vessel radius (R) as given by the following relationship:  $T \sim P \times R$ .

Perioperative mortality after elective aneurysm repair is low (5.8 and 2.7% in the United Kingdom Small Aneurysm and the ADAM trials, respectively).<sup>22,23</sup> In contrast, perioperative mortality is much higher with emergency surgery, occurring in 37% of 81 patients in a large screening trial.<sup>24</sup> Consequently, it is important to identify individuals who are at greatest risk for rupture and appropriately time the surgical repair.



The likelihood that an aneurysm will rupture is influenced by a number of factors, including aneurysm diameter, rate of expansion, and gender. According to a statement from the Joint Council of the American Association for Vascular Surgery and Society for Vascular Surgery, the estimated annual risk of rupture, according to AAA diameter, is 0.5–5% for AAAs that are 4.0–4.9 cm in diameter; 10–20% for AAAs that are 6.0–6.9 cm in diameter; 20–40% for AAAs that are 7.0–7.9 cm in diameter; and 30–50% for those AAAs that are greater than 8.0 cm in diameter.<sup>107</sup> Other factors include continued smoking, uncontrolled hypertension, increased wall stress, and rate of expansion (a rate of growth of more than 0.5 cm in 6 months).<sup>90</sup>

Two randomized trials, the United Kingdom Small Aneurysm and the ADAM trials, investigated the management of medium-size aneurysms (4.0–5.5 cm), comparing early surgery with ultrasound surveillance. Both trials showed no long-term difference in mean survival between the early surgery and surveillance groups, although in the United Kingdom Small Aneurysm trial, after 8 years there was a lower total mortality in the early surgery group, probably attributable to changes in lifestyle adopted by patients in this group.

In 2005 the ACC/AHA, published guidelines on the diagnosis and management of peripheral arterial disease in collaboration with major vascular medicine, vascular surgery, and interventional radiology societies. Some of the recommendations are as follows:

1. Aneurysms 4.0–5.4 cm in diameter should be monitored by ultrasound or tomographic scanning every 6–12 months.
2. Aneurysms 3.0–4.0 cm in diameter should be monitored by ultrasound every 2–3 years.
3. Aneurysms with diameter larger than 5.5 cm should be repaired.
4. Earlier repair may be beneficial in patients with aneurysms that increase in diameter more than 0.5 cm in 6 months.
5. Patients with symptomatic aneurysms should undergo repair, regardless of aneurysm diameter.

## Anesthetic Considerations

### Monitoring

All patients undergoing aortic surgery should have continuous intravascular

monitoring of arterial pressure. As with other types of surgery, the first site considered is the radial artery of the arm with the highest pressure, determined by sphygmomanometry. Reasons for choosing other sites include inadequate collateral flow to the hand (the Allen test), poor radial pulsations caused by previous trauma or proximal vascular disease, and site of cross-clamping above the left subclavian. The axillary artery offers an excellent alternative. Cannulation of the axillary artery is usually performed with the Seldinger technique. Caution is warranted in flushing an axillary artery catheter because the tip is rather more proximate to the carotid and vertebral system, and air or particulate matter could enter these vessels.

In addition to radial or axillary pressure monitoring, a femoral arterial cannula should be strongly considered in thoracic or thoracoabdominal aneurysm surgery where shunt or bypass procedures are employed. Knowledge of arterial pressure distal to the cross-clamp permits a considerably more rational approach to hemodynamic manipulations during surgery. Although embolization and arterial occlusion can occur, studies show that complication rates are similar for ulnar, brachial, axillary, femoral, and dorsalis pedis cannulation and are very low.<sup>108</sup>

The use of PACs in the perioperative setting and their impact on morbidity and mortality is still under intense scrutiny and debate. Although some clinicians advocate the use of PACs in all patients who are undergoing an aortic cross-clamp procedure, others moderate their use based on the cross-clamp level and extent of comorbid disease. Several clinical trials have compared outcomes in vascular surgical patients monitored with CVP only versus PACs. Sandison et al. compared the outcome of patients undergoing nonelective AAA repair at two hospitals under the care of a single vascular surgeon and found that the hospital that used fewer PACs and less intervention (in the form of colloid and inotropes) had lower mortality. One other prospective trial randomized abdominal aortic reconstructive surgery patients to monitoring with a central venous catheter or with a PAC, and showed that the choice of central venous catheter or pulmonary artery catheter monitoring made little differ-

ence in outcome.<sup>109</sup> Sandham et al. and the Canadian Critical Care Trials Group published a landmark study that looked at the routine use of PACs and found no benefit to therapy directed by PAC over standard care in elderly, high-risk surgical patients who required intensive care. They also found a higher rate of pulmonary emboli among the catheter group.<sup>110</sup> A rational approach is to use a PAC in those cases requiring a suprarenal (or above) cross-clamp and reserve its use in infrarenal aneurysms and occlusive disease to those individuals with significant cardiac, renal, or pulmonary pathology. This endorsement presumes that the venous cannulation and balloon flotation are initiated safely; the pressure transducers are properly leveled, zeroed, and calibrated; thermodilution cardiac outputs are technically sound; calculated and measured parameters are interpreted correctly; and therapeutic interventions reflect appropriate understanding of physiology and pharmacology. If any one of these requisites is missing, PACs are best omitted.<sup>111</sup>

TEE is a valuable tool, increasingly available in the noncardiac operating rooms. According to the 2003 guidelines issued by the American College of Cardiology and the American Society of Echocardiography, class I and class II indications for intraoperative TEE use in vascular surgery are intraoperative evaluation of severe hemodynamic instability unresponsive to treatment; perioperative monitoring of patients who are at increased risk of myocardial ischemia or with severe ventricular dysfunction; perioperative assessment of thoracic aortic aneurysms and stent placement; intraoperative evaluation of aortic atheroma; and monitoring of the placement and function of intracardiac and intravascular devices.<sup>112</sup> TEE is a sensitive monitor for detecting myocardial ischemia, considered by many to be more sensitive than ECG, PACs, or other means of hemodynamic monitoring.<sup>113</sup> Smith et al. determined that intraoperative TEE could successfully demonstrate myocardial ischemia by revealing acute segmental wall-motion abnormalities. He also found that when new segmental wall-motion abnormalities continued until the end of the operation, MI was likely to have occurred.<sup>85</sup> There are certain risks involved with a TEE examination, such as anatomic damage from insertion

and manipulation of the probe, incomplete examination, and incorrect interpretation of the images, which can lead to decisions detrimental to the patient. TEE may prove particularly useful in patients who are undergoing supraceliac cross-clamping procedures.<sup>114</sup>

Despite tremendous development in surgical and anesthetic techniques, resection of the thoracic and thoraco-abdominal segments of the aorta remains associated with the risk of paralysis. Procedures that require aortic cross-clamping above the celiac axis or more cephalad incur a progressively higher risk of major neurologic sequelae. The number of reported incidents of paraplegia following aortic surgery varies from approximately 1 in 1000 for elective repair of uncomplicated abdominal aortic aneurysm to 30% when the entire thoracic aorta is replaced emergently.<sup>115</sup> Monitoring of functional continuity of the spinal cord would allow for implementation of hemodynamic or cytoprotective interventions to minimize spinal cord injury. The perioperative use of SSEPs to monitor spinal function is well established. Cunningham et al. reported that ischemic periods associated with less than 30 minutes of SSEPs loss did not result in paraplegia, whereas longer periods of ischemia resulted in a 71% incidence of paraplegia.<sup>116</sup> However false-positive and false-negative results have been reported with the use of SSEPs. SSEPs monitor only the posterior column of the spinal cord, are very sensitive to anesthetic agents (especially volatile agents), can be influenced by temperature, hypoxia, hypotension, ischemia of the peripheral nerves, or peripheral neuropathies.<sup>115</sup> To complement SSEPs in monitoring spinal cord functional integrity, motor evoked potentials (MEPs) were introduced. MEPs are produced by stimulation of the motor cortex. The response typically is recorded near the muscle as a compound muscle action potential. Transcranial MEPs are exquisitely sensitive to anesthesia. Total intravenous technique with propofol/ketamine and opioid continuous infusions is favored when MEP monitoring is employed.

Blood loss during aneurysm surgery is highly variable. Central venous access and large-bore peripheral venous access for the administration of large blood volumes is necessary. A rapid infusion system that can administer

up to 1500 mL/min of warmed fluids, should be available. Blood-salvaging techniques for autotransfusion have proven useful in aortic aneurysm repair. Systems that use cell separation and return only red blood cells result in fewer coagulation abnormalities than systems that return whole blood. Given the high cost of current technology, it becomes cost-effective (when compared to the cost of providing allogeneic blood) when 2 or more units of blood can be salvaged and reinfused. Major vascular surgery offers the best opportunity for appropriate employment of blood-salvaging units. Although no randomized, prospective studies of efficacy have been reported, it is obvious that the use of these devices would decrease the exposure of multiple donors. One study showed a 25–57% reduction in the number of different donors for patients having vascular procedures.<sup>117</sup>

Some degree of hypothermia is commonly observed in patients who are undergoing aneurysm surgery. This is caused by the exposure of abdominal contents, the administration of large amounts of fluid, and disturbances in thermoregulatory mechanism caused by both inhaled and intravenous anesthetics. Whereas hyperthermia is associated with increased metabolic rates with deleterious cerebral and spinal cord effects, hypothermia is associated with adverse myocardial events, coagulopathy, wound infection, and delayed wound healing. In a review of patients who underwent elective AAA repair, Bush et al.<sup>118</sup> noted significantly more organ dysfunction (53% vs. 29%) and higher mortality rate (12% vs. 1.5%) in hypothermic patients (temperature less than 94.1°F [34.5°C]) than in normothermic patients. Active measures should be taken to maintain normothermia. However, during aortic cross-clamping, the lower body should not be actively warmed.

### Physiology of Cross-Clamping

The hemodynamic and metabolic alterations caused by acute interruption of aortic blood flow have been the subject of both animal and human investigations for many years.<sup>119–121</sup> Features of particular relevance to anesthetic management include changes in arterial blood pressure, cardiac function, myocardial perfusion, and acid-base status, as well as tissue integrity of the kidneys, viscera, and

spinal cord. Conflicting findings have been obtained and likely reflect species variation, patient characteristics, degree of collateralization, location of the cross-clamp, baseline cardiac function, type of anesthesia, the use and type of vasodilators, and the presence or absence of CAD. This section reviews the classic and conflicting findings from the literature and presents plausibility arguments for making rational clinical decisions.

**Blood Pressure** The degree of hypertension caused by application of an aortic cross-clamp depends on the location of the clamp, the degree of collateralization, and the preocclusion aortic flow. Thus an infrarenal clamp in a patient with aortic occlusive disease may cause virtually no elevation in the blood pressure because distal preclamp flow was minimal. Also, aortic clamping above a thoracic coarctation may result in no pressure change proximal (or distal) to the clamp because of adequate collateral flow. In the case of AAA repair, runoff is usually good and collateralization minimal. Therefore, an increase in blood pressure should be expected, the magnitude of which is proportional to how proximal the location of cross-clamp is in relation to the heart. Clamping below the renal arteries is common and usually produces only a small increase in blood pressure,<sup>121</sup> but supraceliac occlusion can result in significant hypertension.<sup>119</sup> Other factors may contribute to the observed hypertension. During proximal aortic occlusion, increased concentrations of catecholamines, angiotensin, and renin have been observed. These agents, as well as other mediators released from ischemic tissues below the clamp, may influence the vascular tone above the clamp.<sup>122</sup>

### Venous Return and Cardiac Output

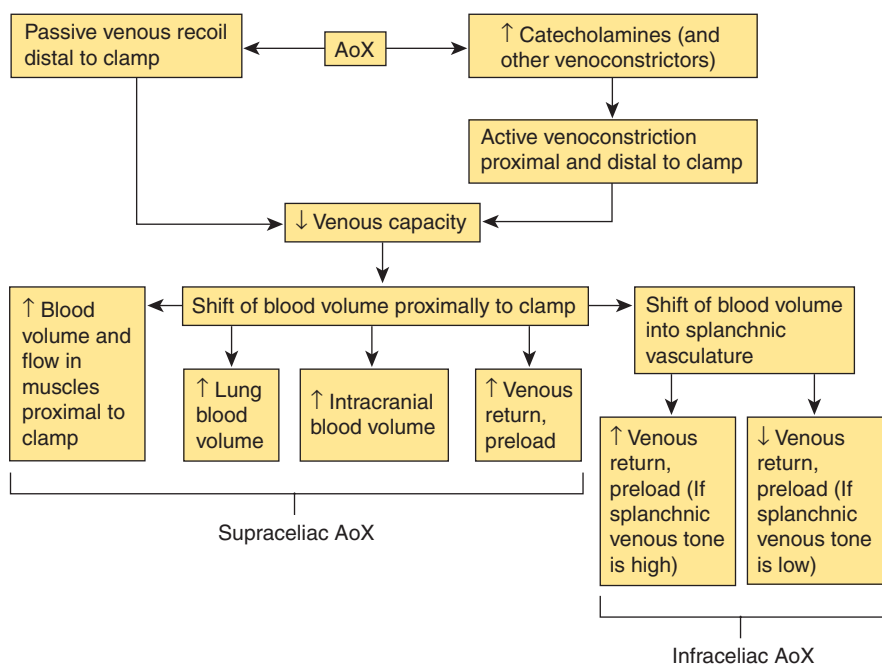
Although it may seem intuitive that cardiac output should decrease with acute occlusion of a major arterial conduit caused by an increase in afterload, reflex mechanisms, venous return, and left-heart function may modify this response. For example, location of the cross-clamp is important. If the clamp is placed in the supraceliac region, evidence suggests that venous return and cardiac output actually increase. This is probably a result of splanchnic venous collapse distal to the cross-clamp and blood volume redistribution above the level

of the clamp with increased filling pressures (central venous pressure, pulmonary capillary wedge pressure, or left ventricular end-diastolic pressure). However, an infrarenal cross-clamp may redistribute blood volume back to the compliant splanchnic bed, decrease preload, and cause a decrease in cardiac output.<sup>120</sup>

Other mechanisms have been suggested to explain an increase in cardiac output with thoracic aortic clamping, including an aortic–cardiac reflex,<sup>123</sup> which increases contractility and elimination of slow time-constant vascular beds (splanchnic) from the circulation.<sup>124,125</sup> Conversely, an increase in aortic pressure should stimulate baroreceptors to depress heart rate, contractility, and vascular tone. Previous studies showed a decrease in cardiac output with aortic occlusion, and this finding has come to represent the common understanding.<sup>114,126</sup> How is it possible to obtain such opposing results? Paradoxically, infrarenal and suprarenal cross-clamps eliminate fast time-constant vascular beds (lower extremities, kidneys) and thus could reduce cardiac output, whereas higher thoracic clamps remove the slow time-constant visceral circulation, thereby increasing cardiac output. Figure 54–6 summarizes the issues surrounding blood volume distribution during application of supra- and infraceliac cross-clamps.

**Myocardial Effects** The effects of aortic cross-clamping on cardiac function and myocardial perfusion have been the subject of several investigations. In the absence of any underlying disorder of contractility or coronary flow, the heart can generate and withstand very high arterial pressures. However, serious deterioration of pump function could be produced if a high afterload is superimposed on a myocardium depressed by cardiomyopathic processes. Moreover, myocardial ischemia itself could be precipitated during clamping, leading to regional wall motion abnormalities or infarction if afterload elevation occurs in the presence of coronary artery stenosis.<sup>114</sup> The presumed mechanism for this ischemia is subendocardial hypoperfusion caused by the high intercavitary pressures during diastole and systole, in conjunction with impaired inflow caused by stenotic coronary lesions.

One investigation used TEE monitoring and determined that occlusion of



**FIGURE 54–6.** Blood volume redistribution during aortic cross-clamping. This scheme depicts the reason for the decrease in venous capacity, which results in blood volume redistribution from the vasculature distal to aortic occlusion to the vasculature proximal to aortic occlusion. If the aorta is occluded above the splanchnic system, the blood volume travels to the heart, increasing preload and blood volume in all organs and tissues proximal to the clamp. However, if the aorta is occluded below the splanchnic system, blood volume may shift into the splanchnic system or into the vasculature of other tissues proximal to the clamp. The distribution of this blood volume between the splanchnic and nonsplanchnic vasculature determines changes in preload. ↑, increase; ↓, decrease; AoX, aortic cross-clamping. Source: Gelman S.<sup>120</sup>

the aorta at the supraceliac level caused major increases in left ventricular end-systolic and end-diastolic dimensions, decreases in ejection fraction, and frequent wall-motion abnormalities. These changes were not detected by conventional monitoring devices. Occlusion at the suprarenal–infraceliac level caused similar but smaller changes, and occlusion at the infrarenal level caused only minimal cardiovascular effects. The hemodynamic effects of clamping the aorta were managed by administration of vasodilating drugs, anesthetics and fluids to keep systemic and pulmonary arterial pressures normal. The same study reported the onset or worsening of regional wall abnormalities during aortic occlusion, which did not resolve with modification of the loading conditions using vasodilators and inhalational agents.<sup>114</sup>

It is quite possible that aortic occlusion could have effects on ventricular function even if mean arterial pressure and systemic vascular resistance were normalized to baseline. The blood pressure wave form, as observed in the ascending aorta, is created by characteristics of ventricular ejection

and vascular resistance and compliance, as well as by pressure waves returning retrograde from major reflecting sites in the periphery. If sufficiently delayed, reflected waves may appear in diastole, thus augmenting myocardial perfusion. Return during systole, however, would add to wall stress during ejection and increase myocardial oxygen demand.<sup>127</sup> By moving the major reflecting site closer to the heart, aortic cross-clamping could thus cause myocardial dysfunction in the face of a mean aortic pressure normalized by therapy.

Aortic cross-clamping is associated with increases in preload and afterload, leading to an increase in myocardial oxygen demand. The intact coronary vasculature responds to this increase in demand by an increase in flow. In one set of experiments, cross-clamping of the aorta was associated with a greater than 65% increase in the coronary blood flow, which probably represents coronary blood flow autoregulation and increases in myocardial oxygen demand and consumption.<sup>119</sup>

Responses to cross-clamping differ in patients with and without CAD. In

conditions of increased systolic left ventricular pressure and left ventricular dilation, the normal ventricle responds with a positive inotropic effect (the “Anrep effect”).<sup>120</sup> In contrast, in the presence of CAD, left ventricular decompensation ensues because of the inability to increase subendocardial blood flow in response to an increase in intraventricular pressure.

**Metabolic Changes** Two fundamental interconnected metabolic effects characterize aortic cross-clamping: (a) lowered total-body oxidative metabolism ( $\text{VO}_2$ ) and (b) conversion to anaerobic metabolism of the hypoperfused body mass distal to the clamp. Gelman et al.<sup>120</sup> showed that application of an infrarenal cross-clamp caused a 16% decrease in  $\text{VO}_2$ . Presumably, a suprarenal occlusion would cause a reduction similar to the infrarenal occlusion because the kidneys do not consume oxygen in proportion to their flow.

The effects of aortic cross-clamping on mixed venous oxygen saturation and partial pressure depend on the therapeutic modalities used to control blood pressure. If arteriolar dilation is the dominant therapy, then aerobically functioning tissue will be overperfused, its extraction will decrease, and the saturation and partial pressure of oxygen of mixed venous blood will increase substantially. Conversely, preload reduction techniques maintain both oxygen extraction ratio and mixed venous saturation at approximately their preclamp values.

Anaerobic metabolism by tissue below the aortic cross-clamp produces lactic acid that reaches the proximal circulation by collaterals, leading to progressive rise in blood lactate. For infrarenal cross-clamps, the buildup in systemic lactate during occlusion, as well as its release with unclamping, is noticeable but rarely clinically significant.<sup>121</sup> Exceptions to this occur with grossly prolonged ischemic times.

Cross-clamps above the celiac axis not only produce a larger anaerobically functioning tissue mass but also, by excluding the liver and kidneys, greatly attenuate the elimination of lactate.

### Therapeutic Strategies

Most clinicians view the physiologic problem of aortic cross-clamping as a consequence of increased left ventricular afterload, and propose interventions

that reverse this effect. Vasodilators, notably sodium nitroprusside, are routinely used to control hypertension.<sup>129</sup>

Arteriolar dilation in vessels supplying organs proximal to the clamp can, in most circumstances, cause them to accommodate a sufficient increase in blood flow to maintain blood pressure within an acceptable range. Obviously, this produces a relative over-perfusion of the affected organs. Problems with this method include (a) partial failure (e.g., inability to adequately control pressure); (b) the need for high doses of sodium nitroprusside; and (c) exceedingly low pressures in the circulation distal to the lowest clamp.

Alternate strategies involve manipulating the venous return. During the period of cross-clamp, that portion of the body supplied by the occluded arterial flow is unavailable for oxidative metabolism. Thus, the heart does not need to maintain its preclamp output, and interventions that would reduce output seem appropriate.<sup>120</sup> Simultaneous interventions to decrease the venous return and minimize blood redistribution may solve the problem.

Venodilation with nitroglycerine, sufficient to lower filling pressure and reduce cardiac output, appears to be the most attractive alternative. In experimental aortic cross-clamping in animals, despite the severe myocardial depression observed, nitroglycerin maintained transmural distribution of flow favoring the endocardium. The benefit probably reflected decreased ventricular wall tension resulting from an increase in venous capacitance and subsequent preload reduction.<sup>130</sup>

Although nitroglycerin is an attractive alternative given its coronary vasodilatory and preload reduction effects, it is a weak arteriodilator and may not be sufficient in controlling blood pressure in situations of high aortic occlusion.<sup>122</sup> The use of a combination of low-dose nitroprusside along with nitroglycerine as a titratable technique to control pressure will benefit from both afterload and preload reduction with rapid termination of the pharmacologic effects before aortic unclamping.

Isoflurane, which mildly depresses contractility and causes vasodilatation of both resistance and capacitance vessels, has been safely used for anesthesia and blood pressure control in pa-

tients with good myocardial function who are undergoing thoracic aneurysm repair.<sup>131</sup>

Bypass and shunting techniques that divert flow from the left atrium, left ventricle, or proximal aorta to the aorta distal to the lowest clamp have been used to blunt the effects of cross-clamping. Because these methods are not devoid of complications, they are usually reserved for surgery that necessitates thoracic aortic clamping.

Femoral vein–femoral artery bypass uses femoral venous inflow by gravity to a reservoir/oxygenator, and roller-pump-generated outflow to a femoral artery, thus perfusing retrograde vasculature below the most distal clamp (femoral–femoral bypass). Hypertension caused by clamp application is quickly resolved by increasing volume in the venous reservoir, which reduces venous return to the heart and lowers cardiac output.<sup>132</sup> The requirement for full systemic anticoagulation can be a disadvantage in terms of postoperative bleeding. Technical problems with cannula size and placement that limit the venous return will decrease the bypass pump flows and will limit the distal perfusion and the effectiveness of the circuit in controlling proximal blood pressure.<sup>122</sup>

A Gott shunt is a heparin-coated conduit that passively shunts blood from the proximal to the distal aorta without the need of systemic coagulation. One end of the conduit is placed in the ascending aorta or in the aortic arch and the distal end is placed in the distal descending aorta.<sup>133</sup> Although it is a simple and inexpensive technique, distal flow is limited by the size of the shunt, and dislodgement of atheromatous plaque, vessel injury, bleeding, kinking, and malpositioning of the conduit can occur.

Partial left-heart bypass uses extracorporeal circulation to shunt flow from the left atrium to the distal circulation. The left atrium is commonly cannulated via a left pulmonary vein and oxygenated blood is diverted either through a centrifugal pump or through an oxygenator/reservoir and a roller pump to the femoral artery. Whereas using a reservoir requires full systemic anticoagulation, using a centrifugal pump requires minimal or no heparin. Bypass flow rates ranging from 25–40 mL/kg/min seem sufficient to normalize proximal aortic pressures and maintain adequate distal perfusion.<sup>122,134</sup>



**Renal Protection** As the incidence of acute renal failure during aortic aneurysm repair varies from 3–13%,<sup>122</sup> preservation of renal function is a primary concern during aortic aneurysm surgery. Clearly, procedures that require cross-clamping of the aorta above the renal arteries will result in a temporary period of renal ischemia, with the potential for inducing some degree of renal injury.

In animal experiments, preischemia administration of mannitol exerts a protective effect on renal function.<sup>135</sup> Because the mechanisms that produce acute tubular necrosis are complex, it is not surprising that controversy exists regarding the exact manner in which mannitol and other agents might prevent acute tubular necrosis. It is possible that mannitol, a potent osmotic diuretic, exerts its protective effect by the scavenging of free radicals produced upon reperfusion of the kidney with cross-clamp release and by shifting blood flow to the renal cortex by its vasodilatory properties. As there is some evidence to support a beneficial effect of intravenous mannitol given before aortic clamping,<sup>136</sup> it is common clinical practice to administer 12.5 g/70 kg 10–15 minutes before aortic cross-clamping.

The use of furosemide is more controversial. Although a protective effect of furosemide has not been established per se, it is generally believed that this agent may result in a conversion of low-output-to-high-output renal failure, the latter being much easier to manage in the postoperative period. When diuretics are used, increased fluid requirements and hypokalemia should be anticipated throughout the perioperative period.

For the more common infrarenal aneurysms, where cross-clamp application would not seem to impede renal perfusion, renal vascular resistance increases and renal blood flow decreases.<sup>120,135,137</sup> The distribution of renal blood flow is altered during infrarenal aortic cross-clamping, and this phenomenon can result in impairment of function.<sup>137</sup> Renal blood flow is reduced not only during cross-clamping, but after cross-clamping blood flow does not immediately return to normal.<sup>120</sup> All of these factors combine to increase the risk of postoperative renal dysfunction. Patients with preoperative renal insufficiency are at greatest risk of developing renal failure.<sup>136</sup>

Maintenance of adequate intravascular volume<sup>138</sup> and a short cross-clamp time, usually less than 30 minutes,<sup>122</sup> are the most important factors for avoiding renal dysfunction postoperatively. Many clinicians advocate the use of low-dose dopamine (3 µg/kg/min) to increase renal blood flow during aneurysm surgery, although there is no evidence to support this approach.<sup>139</sup> Fenoldopam mesylate, a highly selective dopamine type-1 agonist that preferentially dilates the renal and splanchnic vasculature, has renoprotective effects and is associated with a relatively rapid return of renal function to baseline values in this setting.<sup>140</sup>

Other methods of renal protection include partial left heart bypass or renal cooling with selective cold crystalloid perfusion.<sup>141,142</sup>

**Spinal Cord Ischemia and Protection** The spinal cord receives blood via radicular arteries that supply the anterior spinal artery and the posterolateral spinal arteries. The upper part of the spinal cord receives most of its blood supply via the vertebral arteries and in a small proportion via the ascending and deep cervical arteries and through the costovertebral arteries. The lower half of the spinal cord is supplied entirely by branches of the intercostals, lumbar, ilio-lumbar, and lateral sacral arteries. The paired posterior arteries supply the posterior one-third of the spinal cord while the anterior spinal artery supplies the anterior two-thirds of the spinal cord.

The single anterior artery commences from the spinal branches of the vertebral arteries and receives variable blood supply through radicular arteries derived from ascending cervical, intercostal, lumbar, and ilio-lumbar arteries. The largest and most developed radicular artery is the *arteria radicularis magna*, or the artery of Adamkiewicz, which can originate from T9 to L3 levels, but most commonly arises from T9 to T12.<sup>115</sup>

Based on anatomic distribution of segmental vessels supplying the spinal cord, the tenuous collateral flow to the anterior spinal artery in the midthoracic region makes the spinal cord vulnerable to ischemia during aortic occlusion or hypotension.

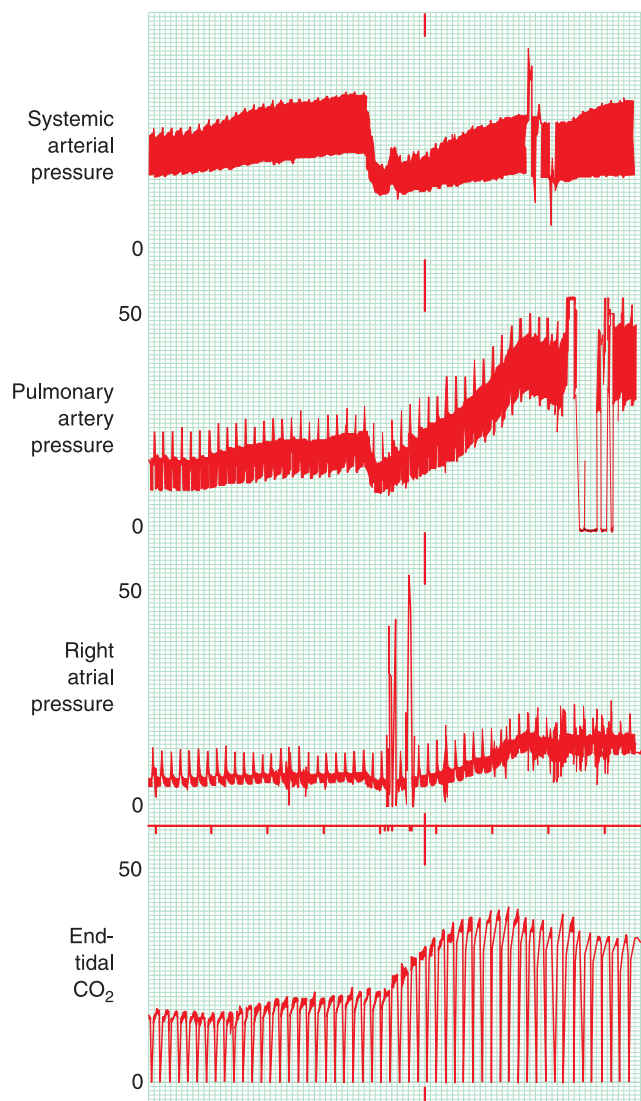
Aortic cross-clamping, which either incorporates the artery of Adamkiewicz between clamps or exposes it

to hypoperfusion, may lead to paraplegia or paraparesis.<sup>143</sup> Because the incidence of these complications increases from 1% in the low abdominal aortic aneurysms to 7–40% for thoracic and thoracoabdominal aneurysm repair,<sup>144</sup> several modalities to provide spinal cord protection have been developed, including identification of ischemia by monitoring evoked potentials (SSEP and MEP), reimplantation of segmental vessels, sequential aortic clamping, maintaining aortic distal aortic perfusion through shunt or bypass, cerebrospinal fluid drainage, epidural cooling, or hypothermic cardiopulmonary bypass and circulatory arrest.<sup>145</sup>

### Unclamping

Release of the aortic cross-clamp results in metabolic and hemodynamic changes that vary in magnitude according to (a) the extent and nature of the tissue reperfused; (b) the total occlusion time; (c) administration of fluids and therapeutic agents during the cross-clamp period and at the moment of unclamping; and (d) the use of shunts or bypass. The most consistent cardiovascular response to clamp release in the absence of shunts or bypass is an acute fall in systemic blood pressure. The dominant influence is a decrease in systemic vascular resistance caused by opening of the previously minimally perfused vascular beds, which may be maximally dilated due to reactive hyperemia.

Release of an infrarenal clamp usually causes a small drop in blood pressure that is transient and well-tolerated, although treatment with fluid infusion or small increments of a vasopressor may be occasionally necessary. Removal of a supraceliac cross-clamp can result in profound hypotension, which should be anticipated by vigorous prerelease intravascular volume administration, and frequently requires transient vasopressor support (Fig. 54–7). However, indiscriminate use of vasopressors may result in excessive vasoconstriction above the aortic clamp compared with below the clamp because the former, which is nonischemic, would respond better to vasopressors than the latter, which is acidotic. This would promote redistribution of blood volume from the upper to the lower part of the body, further reducing the flow above the aortic clamp.<sup>120</sup> Figure 54–8 summarizes the hemodynamic responses to aortic unclamping.



**FIGURE 54-7.** Continuous chart recording of arterial, pulmonary artery (PA), and right arterial pressures and end-tidal CO<sub>2</sub> around the time of release of a supraceliac cross-clamp. Note the prerelease rise in pressures as vasodilatation is reduced. Fall of pressures with release is followed by rapid return resulting from administration of vasopressors and volume. Elevation of CO<sub>2</sub> may contribute to rise in PA pressures.

Several different mediators have been suggested as being responsible for the hemodynamic effects seen after the release of the aortic cross-clamp including acidosis, lactate production, renin-angiotensin system, oxygen free radicals, prostaglandins, complement activation, and myocardial depressant factors.<sup>120</sup> Unless the myocardium becomes ischemic or fails, stability usually returns within several minutes with conservative therapy. Disseminated intravascular coagulation is an unusual but devastating complication.<sup>146</sup> The etiology of the condition is largely unknown, but is likely related to cross-clamp duration and intestinal ischemia.

Total body oxygen consumption increases with unclamping as below-clamp tissues return to aerobic metabolism. Mixed venous blood shows an abrupt desaturation within minutes after release of a supraceliac clamp, and rapidly returns to preclamp values. The transient rise in oxygen extraction implied by this finding may only reflect “reloading” of oxygen-depleted hemoglobin, myoglobin, and cytochromes, rather than actual energy production. Investigators have addressed the issue of “oxygen debt,” wherein reperfusion of a previously ischemic tissue mass may result in an overshoot of oxygen consumption to “repay” a deficit incurred during the anaerobic period.<sup>147</sup>

Carbon dioxide is elevated in arterial and venous blood within moments of unclamping, and this is reflected in the end-tidal partial pressure (see Fig. 54-7). Two principal sources contribute to the appearance of CO<sub>2</sub>: (a) as the end product of aerobic metabolism and (b) from the buffering (through carbonic acid) of organic acids that are washed out during reperfusion. It was formerly common clinical practice to administer a bolus of sodium bicarbonate just before unclamping in an attempt to buffer the expected fall in pH. Unfortunately, additional CO<sub>2</sub> produced by the exogenous sodium bicarbonate buffering adds to the CO<sub>2</sub> produced by aerobic metabolism and dramatically increases PaCO<sub>2</sub> levels. Carbon dioxide readily diffuses across cell membranes and could worsen intracellular acidosis, resulting in organ dysfunction (e.g., cardiac conduction and contractility disturbances).<sup>148</sup> Bicarbonate should be administered, if desired, before unclamping when volume resuscitation, perfusion and ventilation are adequate.

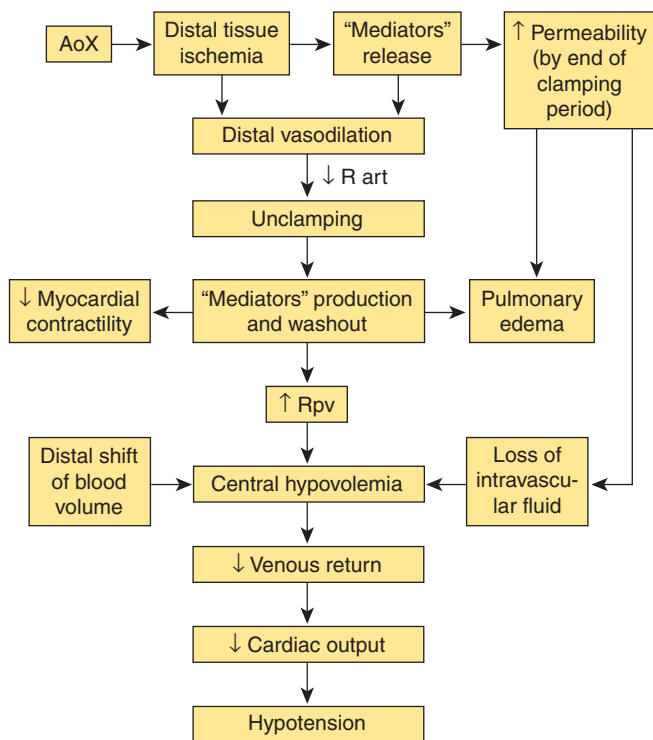
Blood lactate levels often increase after release of the aortic clamp. Higher concentrations occur with prolonged ischemia and higher levels of clamping. Lactate levels rapidly return to normal after complete restoration of hepatic and liver flow and elimination of continued excess production. It is uncommon for significant lactate elevation to persist into the postoperative period.

Gradual release of the aortic clamp and its reapplication has been recommended to allow time for volume replacement and washout of the vasoactive and cardiodepressant mediators from the ischemic tissues.<sup>120</sup>

### Anesthetic Techniques

The anesthetic plan should take into consideration the comorbidities of the patient and knowledge of intraoperative physiologic changes, as well as specific plans for postoperative care.

**General Anesthesia** After institution of appropriate monitoring, induction of general anesthesia can be induced with sodium thiopental, etomidate, or propofol while avoiding hemodynamic extremes. Intravenous opioids, such as fentanyl and sufentanil, can be titrated to blunt the hemodynamic effects of endotracheal intubation. Neuromuscular blockade may



**FIGURE 54–8.** Systemic hemodynamic response to aortic unclamping. ↑, increase; ↓, decrease; AoX, aortic cross-clamping; Cven, venous capacitance; R art, arterial resistance; Rpv, pulmonary vascular resistance. Source: Gelman S.<sup>120</sup>

be introduced at any time during this process after the loss of consciousness. Tachycardia and/or hypertension that may be triggered by laryngoscopy and intubation can be controlled with short-acting  $\beta$ -blockers such as esmolol. Brisk fluid administration may be necessary during induction to prevent hypotension. Preoperative antihypertensive medications, recent use of intravenous contrast agents, and fasting can result in intravascular volume depletion. The generalized withdrawal of sympathetic tone that accompanies anesthetic induction can then lead to hypotension. Anesthesia may be maintained with volatile agents in combination with opioids and neuromuscular blocking agents. The choice of volatile agent may be based on their secondary effects. Isoflurane causes mild vasodilation and minimal myocardial depression and seems to be the agent of choice. More importantly, both isoflurane and sevoflurane protect the myocardium from ischemia by means of preconditioning.<sup>149</sup>

Total intravenous anesthesia can be used with titrated, continuous infusion of propofol and short-acting opioids such as remifentanyl and alfentanil. Total intravenous anesthesia should be considered when intraoperative neuro-

logic monitoring with SSEP and MEP is employed. This technique is also appealing in patients who have renal insufficiency or in cases involving suprarenal aortic clamping because of the lack of dependency of these agents on renal clearance for recovery. Additionally, it allows rapid emergence and extubation. Although there may be concerns with total intravenous anesthesia because of its tendency to cause hypotension, this can be prevented by ensuring euvolemic status before induction.<sup>150</sup>

**Combined Techniques** The introduction of intrathecal and epidural narcotics for both intraoperative and postoperative analgesia has proved to be a major advance in perioperative anesthetic management. When patient-controlled analgesia is combined with classic methods of regional anesthesia, a variety of intraoperative and postoperative strategies using local anesthetics and opioids are possible. A comprehensive discussion of postoperative analgesic techniques is beyond the scope of this chapter, but certain pertinent issues relating to major vascular surgery are outlined. First, intraoperative and postoperative management issues clearly should be separated. Improved

clinical outcome for regional or combined regional/general techniques compared with general anesthesia may be attributable to differences in postoperative pain management rather than intraoperative technique. Studies disagree on the influence of anesthetic technique on perioperative morbidity in this patient population.<sup>151</sup> Second, although the value of neuraxial narcotics in moderating postoperative stress is increasingly clear, intraoperative use of this modality influences anesthetic management. Any significant dose of parenteral opiates given to blunt the stimuli of intubation and incision may act synergistically with the neuraxial narcotic to produce prolonged or delayed respiratory depression at the end of the procedure, thereby delaying emergence. Epidural anesthesia using local anesthetic agents is an attractive adjunct to general anesthesia and has been advocated for vascular surgery.<sup>96</sup> With noxious stimuli blocked at the level of somatic afferents, only those systemic agents necessary to produce unconsciousness, amnesia, and reflex suppression are required. Experience shows, however, that extreme hypotension can result in patients who are undergoing aortic surgery when combined regional and general anesthetics are used. The drop in blood pressure that accompanies removal of an aortic cross-clamp is exacerbated by any degree of sympathetic blockade. Adequate fluid resuscitation before cross-clamp or the use of vasopressors with declamping may be required. Although excessive fluid administration may predispose to hypervolemia in the postoperative period, the use of vasopressors may cloud clinical judgment when organ or limb perfusion is in doubt. Hypotension can be minimized by optimizing intravascular volume and by administering much smaller volumes of local anesthetics in the epidural space than normally required for a “pure” regional anesthetic.

It is increasingly evident that the postoperative period is associated with a high risk of morbidity in patients with cardiac disease undergoing non-cardiac surgery.<sup>19,34</sup> Several possible sequelae of major vascular surgery, including “third-space” fluid accumulation, postoperative pulmonary dysfunction, coagulopathy, hypothermia and renal failure, may make emergence and extubation problematic. The ideal is to have an extubated, comfort-

able, well-oxygenated, ventilating patient who is normothermic and normovolemic, with good renal function and stable vital signs.

### Postoperative Care

Even with the wide variation in clinical practice, emergence technique, need for mechanical ventilation, and postoperative analgesia are critical determinants of postoperative morbidity. Relevant issues to consider are the anesthetic technique, extent of aneurysm repair, and patient stability with regard to certain physiologic parameters, including body temperature, pulmonary function, urine output, blood loss, and intravascular volume.

Many patients will be ready for extubation at the termination of surgery. Several factors, however, may complicate what would otherwise appear to be a simple decision. Patients with a significant smoking history may have respiratory compromise. Postoperative deterioration of pulmonary function superimposed on preexisting dysfunction can result in poor oxygenation immediately after surgery. Furthermore, varying degrees of fluid shift commonly occur during aortic aneurysm repair and continue postoperatively. Even if intravascular volume has been carefully maintained, extravascular fluid must be mobilized and eliminated over time. It is not always possible to monitor and control this process with a sufficient degree of precision. Thus patients who seem to be doing well may develop problems several hours after the procedure and require reintubation after an apparently “normal” recovery.

Several authors have recommended the use of epidural narcotics and local anesthetics for postoperative pain control.<sup>96,152</sup> The benefits of epidural analgesia include efficient pain management, a decrease in adrenocortical stress response, and a reduction in protein catabolism, immunosuppression, and pulmonary and cardiac morbidity.<sup>97,122,153,154</sup> However, other investigations have found no difference in morbidity or mortality rates when pure general anesthesia was compared with a combined regional/general technique.<sup>155,156</sup>

Myocardial ischemia is common in the postoperative period, although much of it may be “silent” and require careful surveillance to detect. There is also a strong association between postoperative ischemia and adverse outcome.<sup>34</sup>

Postoperative care of vascular surgery patients can be challenging. Coagulopathy in the perioperative period can become a major problem requiring reexploration. Hypothermia may persist and require treatment with heating blankets. Electrolytes and blood gases should be followed closely and hemodynamic profiles optimized. Patients who have experienced a ruptured aneurysm and/or prolonged suprarenal cross-clamping are at high risk of acute renal failure. Adequate attention to these details is essential for ensuring a successful outcome.

### Anesthetic Considerations for Endovascular Aneurysm Repair

Endovascular aortic repair (EVAR) has steadily gained popularity as a reliable alternative to conventional surgical repair of aortic aneurysms. Endovascular repair of abdominal aneurysms was developed to reduce morbidity and mortality and to provide an alternative for patients who cannot undergo standard surgical therapy.

To define the role of EVAR in the management of aortic abdominal aneurysms, two randomized trials investigated both short- and long-term outcome of patients who were considered suitable candidates for either elective open surgery or endovascular repair. The EVAR 1 (endovascular aortic repair) trial included 1082 patients with aneurysms at least 5.5 cm in diameter who were at least 60 years of age and found that the 30-day mortality was significantly lower with endovascular than with open repair (1.6% vs. 4.6%). However, overall survival was comparable in both groups 4 years after randomization.<sup>157</sup> The Dutch Randomized Endovascular Aneurysm Management (DREAM) trial evaluated 345 patients with aneurysms of at least 5 cm in diameter, and found a significant trend toward lower operative mortality with EVAR than with conventional surgery (1.2% vs. 4.6%). There was no difference in cumulative survival at 2 years of follow-up (89.7% vs. 89.6% with surgical repair), an effect that was present at 1 year.<sup>158</sup> The short-term survival advantage of EVAR appears to be much greater when it is limited to patients who are at highest risk from open surgery.<sup>159</sup> EVAR avoids the hemodynamic lability associated with major abdominal incision and aortic cross-clamping and unclamping, and

also presents other subtle benefits, such as significantly smaller changes in plasma catecholamine levels, improved acid–base homeostasis,<sup>160</sup> and a decreased metabolic stress response.<sup>161</sup>

In 2005, the ACC/AHA published practice guidelines for the management of patients with peripheral arterial disease (lower extremity, renal, mesenteric, and abdominal aortic).<sup>90</sup> The following 3 recommendations were made with regard to the type of intervention:

1. Open surgical repair for patients at low or average risk of operative complications.
2. EVAR in patients who are at high risk of complications from open operations.
3. EVAR for patients who are not at high surgical risk; however, evidence of benefit is less-well established in this setting.

For the deployment of the graft, a femoral or iliac arteriotomy is performed, and a sheath is passed into the aorta over a guidewire. The endovascular stent is threaded over the guidewire and is positioned under fluoroscopic guidance. An inflatable balloon catheter is positioned inside the proximal attachment system. The balloon is inflated for a period of 30–60 seconds during which time aortic blood flow is occluded. This expands the stent and imbeds the hooks into the normal arterial wall. Newer, approved devices are self-expanding once released from the sheath and use a trilobed balloon for stent fixation. This combination results in less hemodynamic stress as the aorta is never totally occluded during balloon expansion.

Endovascular repair is suitable for patients who meet certain anatomic criteria: at least 1.5 cm of aneurysmal neck below the renal arteries; at least 1 cm of aneurysmal neck above the aortic bifurcation; femoral artery free from limiting occlusion and at least 8 mm in diameter; and, if the distal attachment is the iliac artery, a minimal length and maximum diameter of healthy artery as specified by the manufacturer.

Surgical complications can include damage to iliofemoral vessels (dissection, ischemia), distal embolization of atheromatous debris, adverse reactions to radiographic contrast, rupture of aneurysm, and displacement of the proximal stent to occlude the renal or mesenteric arteries or other arteries in repair of the thoracic aorta.



*Endoleak* is defined as the persistence of blood flow outside the lumen of the endograft but within an aneurysm sac. Endoleak may occur as a consequence of misplacement or poor sizing of an endograft (technical error), fatigue, displacement or distortion of the endograft material (device failure), or by reactions to the endograft within the aneurysmal sac environment. Endoleaks are classified based on location/mechanism and timing of occurrence. Type I endoleak is a persistent flow around the attachment sites (proximal or distal) of the endograft as a result of inadequate or ineffective seal at the graft ends. Type II endoleak is a result of retrograde flow into the aneurysmal sac from a patent collateral branch vessel. Type III endoleak is defined as flow into the aneurysmal sac because of a tear or defect in the endograft fabric or because of leakage between modular segments of an endograft. Type IV endoleak is flow detected in the aneurysmal sac as a consequence of the highly porous graft material.<sup>162</sup>

### Anesthetic Techniques

General anesthesia, regional anesthesia and monitored anesthesia care with local anesthetic infiltration at the incision site have all been used successfully for EVAR. Goals of an anesthetic plan should be to maintain hemodynamic stability, provide adequate oxygenation and ventilation, preserve organ function, and maintain normothermia.<sup>163</sup>

Certain concerns related to the procedure should be addressed. Careful positioning of the device over guidewires for accurate deployment and the use of fluoroscopy require the patient to be perfectly still, sometimes for longer periods of time than anticipated. Care must be taken to ensure that tachycardia and hypertension are avoided. During the transient balloon occlusion of the aorta, the surgeon may request that the mean blood pressure be maintained at about 60 mm Hg so that the force pushing the stent distally is minimized. Also at this time the patient may experience significant hemodynamic stress, especially if baseline cardiac function was poor. Vasopressors and inotropes must be available at hand to manage hemodynamic emergencies. Preparation must be made for sudden massive blood loss, following major disruption of the aorta, and immediate laparotomy with aortic cross-clamping.

Blood loss can be difficult to quantify, as it is often lost around the sheaths

and catheters, and can be retroperitoneal in the case of injury to femoral or iliac vessels. Hemoglobin should be checked during the procedure, especially if the patient becomes unstable. Endovascular procedures involve the liberal use of radiographic contrast to assist in appropriate deployment of the graft, ensure exclusion of the aneurysmal sac and determine branch vessel patency. It is important to ensure that patients are adequately hydrated during the procedure and in the postoperative period to minimize contrast induced nephropathy.

At the time of instrumentation of the aorta the patient must be anticoagulated with intravenous heparin. This, however, should not restrict the use of regional anesthesia as long as the recommendations made by the American Society of Regional Anesthesia and Pain Medicine regarding neuraxial anesthesia and anticoagulation are followed.

Various studies have compared anesthetic techniques. A recent retrospective analysis based on the European registry of patients who underwent EVAR (the European collaborators on stent/graft techniques for aortic aneurysm repair [EUROSTAR] registry) showed that a benefit in systemic complications, hospital stay, and admission to the intensive care unit could be documented for both local and regional anesthesia compared with general anesthesia.<sup>164</sup> DeVirgilio et al. compared cardiopulmonary morbidity and mortality rates in a retrospective study of 200 patients who underwent infrarenal EVAR and found no overall difference.<sup>165</sup> This study, as well as other studies, noted lower fluid requirements and less need for vasopressor support associated with local anesthesia.<sup>166</sup> Also, by avoiding mechanical ventilation, patients with pulmonary comorbidities may benefit from a regional or local anesthesia technique.

From the preceding discussion, it is apparent that a variety of anesthetic techniques may be used, as long as specific goals of EVAR are met. Future randomized trials are needed, however, to further assess the impact of anesthetic technique on outcomes.

### CONCLUSION

The patient who is undergoing major vascular surgery can be both challenging and rewarding for the anesthesiologist. The pathophysiology of vascular

disease is complex and involves several organ systems. Predictive factors for vascular disease such as smoking, hypertension, and diabetes must also be considered when planning perioperative anesthesia management. Temporary flow interruption of major diseased vessels may induce dramatic physiologic changes that can be a challenge during the intraoperative phase. Adequate knowledge of the pathology of vascular disease, operative technique, and the available monitoring modalities is essential in ensuring favorable outcomes in this high-risk patient population.

### KEY REFERENCES

1. Eagle KA, Berger PB, Calkins H, et al. ACC/AHA guideline update for perioperative cardiovascular evaluation for noncardiac surgery—executive summary: a report of the American College of Cardiology/American Heart Association Task Force on Practice Guidelines (Committee to Update the 1996 Guidelines on Perioperative Cardiovascular Evaluation for Noncardiac Surgery). *J Am Coll Cardiol* 2002; 39(3):542–553.
2. Fleisher LA. Preoperative cardiac evaluation. *Anesthesiol Clin North America* 2004;22(1):59–75.
3. L'Italien GJ, Cambria RP, Cutler BS, et al. Comparative early and late cardiac morbidity among patients requiring different vascular surgery procedures. *J Vasc Surg* 1995;21(6):935–944.
4. Mangano DT. Perioperative cardiac morbidity. *Anesthesiology* 1990;72(1):153–184.
5. Lederle FA, Wilson SE, Johnson GR, et al. Immediate repair compared with surveillance of small abdominal aortic aneurysms. *N Engl J Med* 2002;346(19):1437–1444.
6. Practice guidelines for pulmonary artery catheterization: an updated report by the American Society of Anesthesiologists Task Force on Pulmonary Artery Catheterization. *Anesthesiology* 2003;99(4): 988–1014.
7. Yastrebov K. Intraoperative management: carotid endarterectomies.

Anesthesiol Clin North America 2004;22(2):265–287;vi-vii.

8. Hirsch AT, Haskal ZJ, Hertzner NR, et al. ACC/AHA guidelines for the management of patients with peripheral arterial disease (lower extremity, renal, mesenteric, and abdominal aortic): a collaborative report from the American Association for Vascular Surgery/Society for Vascular Surgery, Society for Cardiovascular Angiography and Interventions, Society for Vascular Medicine and Biology, Society of Interventional Radiology, and the ACC/AHA Task Force on Practice Guidelines (Writing Committee to Develop Guidelines for the Management of Patients with Peripheral Arterial Disease)—summary of recommendations. *J Vasc Interv Radiol* 2006;17(9):1383–1397; quiz 1398.

9. Dormandy JA, Rutherford RB. Management of peripheral arterial disease (PAD). TASC Working Group. TransAtlantic Inter-Society Consensus (TASC). *J Vasc Surg* 2000;31(1 Pt 2):S1–S296.

10. Fleisher LA, Eagle KA, Shaffer T, Anderson GF. Perioperative- and long-term mortality rates after major vascular surgery: the relationship to preoperative testing in the medicare population. *Anesth Analg* 1999;89(4):849–855.

11. Tuman KJ, McCarthy RJ, March RJ, DeLaria GA, Patel RV, Ivankovich AD. Effects of epidural anesthesia and analgesia on coagulation and outcome after major vascular surgery. *Anesth Analg* 1991;73(6):696–704.

12. Gelman S. The pathophysiology of aortic cross-clamping and unclamping. *Anesthesiology* 1995;82(4):1026–1060.

13. O'Connor CJ, Rothenberg DM. Anesthetic considerations for descending thoracic aortic surgery: part II. *J Cardiothorac Vasc Anesth* 1995;9(6):734–747.

14. Baron JF, Bertrand M, Barre E, et al. Combined epidural and general anesthesia versus general anesthesia for abdominal aortic surgery. *Anesthesiology* 1991;75(4):611–618.

## REFERENCES

1. Zwolak RM CJ. Pathophysiology of vascular disease. Norwalk, CT: Appleton & Lange, 1990.

2. Tabas I. Consequences of cellular cholesterol accumulation: basic concepts and physiological implications. *J Clin Invest* 2002;110(7):905–911.

3. Paoletti R, Gotto AM Jr, Hajjar DP. Inflammation in atherosclerosis and implications for therapy. *Circulation* 2004;109(23 Suppl 1):III20–III26.

4. Fruchart JC, Nierman MC, Stroes ES, Kastelein JJ, Duriez P. New risk factors for atherosclerosis and patient risk assessment. *Circulation* 2004;109(23 Suppl 1):III15–III19.

5. Sary HC, Chandler AB, Dinsmore RE, et al. A definition of advanced types of atherosclerotic lesions and a histological classification of atherosclerosis. A report from the Committee on Vascular Lesions of the Council on Arteriosclerosis, American Heart Association. *Circulation* 1995;92(5):1355–1374.

6. Strong JP, Malcom GT, McMahan CA, et al. Prevalence and extent of atherosclerosis in adolescents and young adults: implications for prevention from the Pathobiological Determinants of Atherosclerosis in Youth Study. *JAMA* 1999;281(8):727–735.

7. Falk E, Shah PK, Fuster V. Coronary plaque disruption. *Circulation* 1995;92(3):657–671.

8. Kelly R, Staines A, MacWalter R, Stonebridge P, Tunstall-Pedoe H, Struthers AD. The prevalence of treatable left ventricular systolic dysfunction in patients who present with noncardiac vascular episodes: a case-control study. *J Am Coll Cardiol* 2002;39(2):219–224.

9. Baron JF, Mundler O, Bertrand M, et al. Dipyridamole-thallium scintigraphy and gated radionuclide angiography to assess cardiac risk before abdominal aortic surgery. *N Engl J Med* 1994;330(10):663–669.

10. Eagle KA, Berger PB, Calkins H, et al. ACC/AHA guideline update for perioperative cardiovascular evaluation for noncardiac surgery—executive summary: a report of the American College of Cardiology/American Heart Association Task Force on Practice Guidelines (Committee to Update the 1996 Guidelines on Perioperative Cardiovascular Evaluation for Noncardiac Surgery). *J Am Coll Cardiol* 2002;39(3):542–553.

11. Mantha S, Roizen MF, Barnard J, Thisted RA, Ellis JE, Foss J. Relative effectiveness of four preoperative tests for predicting adverse cardiac outcomes after vascular surgery: a meta-analysis. *Anesth Analg* 1994;79(3):422–433.

12. Rivers SP, Scher LA, Gupta SK, Veith FJ. Safety of peripheral vascular surgery after recent acute myocardial infarction. *J Vasc Surg* 1990;11(1):70–75; discussion 76.

13. Shibamura H, Olson JM, van Vlijmen-Van Keulen C, et al. Genome scan for familial abdominal aortic aneurysm using

sex and family history as covariates suggests genetic heterogeneity and identifies linkage to chromosome 19q13. *Circulation* 2004;109(17):2103–2108.

14. Fleisher LA. Preoperative cardiac evaluation. *Anesthesiol Clin North America* 2004;22(1):59–75.

15. Licker M, Khatchaturian G, Schweizer A, Bednarkiewicz M, Tassaux D, Chevalley C. The impact of a cardioprotective protocol on the incidence of cardiac complications after aortic abdominal surgery. *Anesth Analg* 2002;95(6):1525–1533, table of contents.

16. L'Italien GJ, Cambria RP, Cutler BS, et al. Comparative early and late cardiac morbidity among patients requiring different vascular surgery procedures. *J Vasc Surg* 1995;21(6):935–944.

17. Mangano DT. Preoperative risk assessment: many studies, few solutions. Is a cardiac risk assessment paradigm possible? *Anesthesiology* 1995;83(5):897–901.

18. Criqui MH, Langer RD, Fronek A, et al. Mortality over a period of 10 years in patients with peripheral arterial disease. *N Engl J Med* 1992;326(6):381–386.

19. Mangano DT. Perioperative cardiac morbidity. *Anesthesiology* 1990;72(1):153–184.

20. Hertzner NR, Beven EG, Young JR, et al. Coronary artery disease in peripheral vascular patients. A classification of 1000 coronary angiograms and results of surgical management. *Ann Surg* 1984;199(2):223–233.

21. Leppo J, Plaja J, Gionet M, Tumolo J, Paraskos JA, Cutler BS. Noninvasive evaluation of cardiac risk before elective vascular surgery. *J Am Coll Cardiol* 1987;9(2):269–276.

22. Long-term outcomes of immediate repair compared with surveillance of small abdominal aortic aneurysms. *N Engl J Med* 2002;346(19):1445–1452.

23. Lederle FA, Wilson SE, Johnson GR, et al. Immediate repair compared with surveillance of small abdominal aortic aneurysms. *N Engl J Med* 2002;346(19):1437–1444.

24. Ashton HA, Buxton MJ, Day NE, et al. The Multicentre Aneurysm Screening Study (MASS) into the effect of abdominal aortic aneurysm screening on mortality in men: a randomised controlled trial. *Lancet* 2002;360(9345):1531–1539.

25. Lee TH, Marcantonio ER, Mangione CM, et al. Derivation and prospective validation of a simple index for prediction of cardiac risk of major noncardiac surgery. *Circulation* 1999;100(10):1043–1049.

26. Rao TL, Jacobs KH, El-Etr AA. Reinfarction following anesthesia in patients with myocardial infarction. *Anesthesiology* 1983;59(6):499–505.

27. O'Keefe JH, Jr., Shub C, Rettke SR. Risk of noncardiac surgical procedures in patients with aortic stenosis. *Mayo Clin Proc* 1989;64(4):400–405.

28. Raymer K, Yang H. Patients with aortic stenosis: cardiac complications in non-car-

- diac surgery. *Can J Anaesth* 1998;45(9):855-859.
29. Axelrod DA, Upchurch GR, Jr., DeMonner S, et al. Perioperative cardiovascular risk stratification of patients with diabetes who undergo elective major vascular surgery. *J Vasc Surg* 2002;35(5):894-901.
  30. Eagle KA, Coley CM, Newell JB, et al. Combining clinical and thallium data optimizes preoperative assessment of cardiac risk before major vascular surgery. *Ann Intern Med* 1989;110(11):859-866.
  31. Mohr DN, Lavender RC. Preoperative pulmonary evaluation. Identifying patients at increased risk for complications. *Postgrad Med* 1996;100(5):241-244, 247-248, 251-242 passim.
  32. Auerbach A, Goldman L. Assessing and reducing the cardiac risk of noncardiac surgery. *Circulation* 2006;113(10):1361-1376.
  33. McPhail N, Calvin JE, Shariatmadar A, Barber GG, Scobie TK. The use of preoperative exercise testing to predict cardiac complications after arterial reconstruction. *J Vasc Surg* 1988;7(1):60-68.
  34. Mangano DT, Goldman L. Preoperative assessment of patients with known or suspected coronary disease. *N Engl J Med* 1995;333(26):1750-1756.
  35. Etchells E, Meade M, Tomlinson G, Cook D. Semiquantitative dipyridamole myocardial stress perfusion imaging for cardiac risk assessment before noncardiac vascular surgery: a meta-analysis. *J Vasc Surg* 2002;36(3):534-540.
  36. Fleisher LA. Preoperative Cardiac Evaluation before Major Vascular Surgery. In: Kaplan JA, Lake CL, Murray MJ. *Vascular Anesthesia*. 2nd ed. Philadelphia: Churchill Livingstone, 2004.
  37. Boersma E, Poldermans D, Bax JJ, et al. Predictors of cardiac events after major vascular surgery: Role of clinical characteristics, dobutamine echocardiography, and beta-blocker therapy. *JAMA* 2001;285(14):1865-1873.
  38. Shaw LJ, Eagle KA, Gersh BJ, Miller DD. Meta-analysis of intravenous dipyridamole-thallium-201 imaging (1985 to 1994) and dobutamine echocardiography (1991 to 1994) for risk stratification before vascular surgery. *J Am Coll Cardiol* 1996;27(4):787-798.
  39. Guidelines for assessing and managing the perioperative risk from coronary artery disease associated with major noncardiac surgery. American College of Physicians. *Ann Intern Med* 1997;127(4):309-312.
  40. Raby KE, Goldman L, Creager MA, et al. Correlation between preoperative ischemia and major cardiac events after peripheral vascular surgery. *N Engl J Med* 1989;321(19):1296-1300.
  41. Fleisher LA, Rosenbaum SH, Nelson AH, Jain D, Wackers FJ, Zaret BL. Preoperative dipyridamole thallium imaging and ambulatory electrocardiographic monitoring as a predictor of perioperative cardiac events and long-term outcome. *Anesthesiology* 1995;83(5):906-917.
  42. McFalls EO, Ward HB, Moritz TE, et al. Coronary-artery revascularization before elective major vascular surgery. *N Engl J Med* 2004;351(27):2795-2804.
  43. Rihal CS, Eagle KA, Mickel MC, Foster ED, Sopko G, Gersh BJ. Surgical therapy for coronary artery disease among patients with combined coronary artery and peripheral vascular disease. *Circulation* 1995;91(1):46-53.
  44. Spaulding C, Daemen J, Boersma E, Cutlip DE, Serruys PW. A pooled analysis of data comparing sirolimus-eluting stents with bare-metal stents. *N Engl J Med* 2007;356(10):989-997.
  45. Stone GW, Moses JW, Ellis SG, et al. Safety and efficacy of sirolimus- and paclitaxel-eluting coronary stents. *N Engl J Med* 2007;356(10):998-1008.
  46. Lagerqvist B, James SK, Stenestrand U, Lindback J, Nilsson T, Wallentin L. Long-term outcomes with drug-eluting stents versus bare-metal stents in Sweden. *N Engl J Med* 2007;356(10):1009-1019.
  47. Posner KL, Van Norman GA, Chan V. Adverse cardiac outcomes after noncardiac surgery in patients with prior percutaneous transluminal coronary angioplasty. *Anesth Analg* 1999;89(3):553-560.
  48. London MJ, Zaugg M, Schaub MC, Spahn DR. Perioperative beta-adrenergic receptor blockade: physiologic foundations and clinical controversies. *Anesthesiology* 2004;100(1):170-175.
  49. Mangano DT, Layug EL, Wallace A, Tateo I. Effect of atenolol on mortality and cardiovascular morbidity after noncardiac surgery. Multicenter Study of Perioperative Ischemia Research Group. *N Engl J Med* 1996;335(23):1713-1720.
  50. Poldermans D, Boersma E, Bax JJ, et al. The effect of bisoprolol on perioperative mortality and myocardial infarction in high-risk patients undergoing vascular surgery. Dutch Echocardiographic Cardiac Risk Evaluation Applying Stress Echocardiography Study Group. *N Engl J Med* 1999;341(24):1789-1794.
  51. Landesberg G, Mosseri M, Wolf Y, Veselov Y, Weissman C. Perioperative myocardial ischemia and infarction: identification by continuous 12-lead electrocardiogram with online ST-segment monitoring. *Anesthesiology* 2002;96(2):264-270.
  52. Ross R. The pathogenesis of atherosclerosis—an update. *N Engl J Med* 1986;314(8):488-500.
  53. North American Symptomatic Carotid Endarterectomy Trial Collaborators. Beneficial effect of carotid endarterectomy in symptomatic patients with high-grade carotid stenosis. *N Engl J Med* 1991;325(7):445-453.
  54. Rothwell PM, Eliasziw M, Gutnikov SA, et al. Analysis of pooled data from the randomised controlled trials of endarterectomy for symptomatic carotid stenosis. *Lancet* 2003;361(9352):107-116.
  55. Reed AB, Gaccione P, Belkin M, et al. Preoperative risk factors for carotid endarterectomy: defining the patient at high risk. *J Vasc Surg* 2003;37(6):1191-1199.
  56. Chaturvedi S, Bruno A, Feasby T, et al. Carotid endarterectomy—an evidence-based review: report of the Therapeutics and Technology Assessment Subcommittee of the American Academy of Neurology. *Neurology* 2005;65(6):794-801.
  57. Arnold M, Sturzenegger M, Schaffler L, Seiler RW. Continuous intraoperative monitoring of middle cerebral artery blood flow velocities and electroencephalography during carotid endarterectomy. A comparison of the two methods to detect cerebral ischemia. *Stroke* 1997;28(7):1345-1350.
  58. Pinkerton JA Jr. EEG as a criterion for shunt need in carotid endarterectomy. *Ann Vasc Surg* 2002;16(6):756-761.
  59. Kresowik TF, Worsley MJ, Khoury MD, et al. Limitations of electroencephalographic monitoring in the detection of cerebral ischemia accompanying carotid endarterectomy. *J Vasc Surg* 1991;13(3):439-443.
  60. Rosenthal D, Stanton PE Jr, Lamis PA. Carotid endarterectomy. The unreliability of intraoperative monitoring in patients having had stroke or reversible ischemic neurologic deficit. *Arch Surg* 1981;116(12):1569-1575.
  61. Lam AM, Manninen PH, Ferguson GG, Nantau W. Monitoring electrophysiologic function during carotid endarterectomy: a comparison of somatosensory evoked potentials and conventional electroencephalogram. *Anesthesiology* 1991;75(1):15-21.
  62. Kearse LA Jr, Brown EN, McPeck K. Somatosensory evoked potentials sensitivity relative to electroencephalography for cerebral ischemia during carotid endarterectomy. *Stroke* 1992;23(4):498-505.
  63. Sloan MA. Prevention of ischemic neurologic injury with intraoperative monitoring of selected cardiovascular and cerebrovascular procedures: roles of electroencephalography, somatosensory evoked potentials, transcranial Doppler, and near-infrared spectroscopy. *Neurol Clin* 2006;24(4):631-645.
  64. Ackerstaff RG, Moons KG, van de Vlasakker CJ, et al. Association of intraoperative transcranial Doppler monitoring variables with stroke from carotid endarterectomy. *Stroke* 2000;31(8):1817-1823.
  65. Belardi P, Lucertini G, Ermirio D. Stump pressure and transcranial Doppler for predicting shunting in carotid endarterectomy. *Eur J Vasc Endovasc Surg* 2003;25(2):164-167.
  66. Samra SK, Dorje P, Zelenock GB, Stanley JC. Cerebral oximetry in patients undergoing carotid endarterectomy under regional anesthesia. *Stroke* 1996;27(1):49-55.
  67. Rigamonti A, Scandroglio M, Minicucci F, Magrin S, Carozzo A, Casati A. A clinical evaluation of near-infrared cerebral oxime-



- try in the awake patient to monitor cerebral perfusion during carotid endarterectomy. *J Clin Anesth* 2005;17(6):426–430.
68. Davies MJ, Mooney PH, Scott DA, Silbert BS, Cook RJ. Neurologic changes during carotid endarterectomy under cervical block predict a high risk of postoperative stroke. *Anesthesiology* 1993;78(5):829–833.
69. Stoughton J, Nath RL, Abbott WM. Comparison of simultaneous electroencephalographic and mental status monitoring during carotid endarterectomy with regional anesthesia. *J Vasc Surg* 1998;28(6):1014–1021; discussion 1021–1013.
70. Practice guidelines for pulmonary artery catheterization: an updated report by the American Society of Anesthesiologists Task Force on Pulmonary Artery Catheterization. *Anesthesiology* 2003;99(4):988–1014.
71. Donato AT, Hill SL. Carotid arterial surgery using local anesthesia: a private practice retrospective study. *Am Surg* 1992;58(8):446–450.
72. Lee KS, Davis CH, Jr., McWhorter JM. Low morbidity and mortality of carotid endarterectomy performed with regional anesthesia. *J Neurosurg* 1988;69(4):483–487.
73. Shah DM, Darling RC, 3rd, Chang BB, Bock DE, Paty PS, Leather RP. Carotid endarterectomy in awake patients: its safety, acceptability, and outcome. *J Vasc Surg* 1994;19(6):1015–1019; discussion 1020.
74. Allen BT, Anderson CB, Rubin BG, et al. The influence of anesthetic technique on perioperative complications after carotid endarterectomy. *J Vasc Surg* 1994;19(5):834–842; discussion 842–833.
75. Lipsett PA, Tierney S, Gordon TA, Perler BA. Carotid endarterectomy—is intensive care unit care necessary? *J Vasc Surg* 1994;20(3):403–409; discussion 409–410.
76. Muskett A, McGreevy J, Miller M. Detailed comparison of regional and general anesthesia for carotid endarterectomy. *Am J Surg* 1986;152(6):691–694.
77. Rerkasem K, Bond R, Rothwell PM. Local versus general anaesthesia for carotid endarterectomy. *Cochrane Database Syst Rev* 2004(2):CD000126.
78. Hadzic A, Vloka, J.D. *Cervical Plexus Block*. New York: McGraw-Hill, 2004.
79. Umbrain V, Keeris J, D'Haese J, et al. Isoflurane, desflurane and sevoflurane for carotid endarterectomy. *Anaesthesia* 2000;55(11):1052–1057.
80. Mouren S, De Winter G, Guerrero SP, Baillaud C, Bertrand M, Coriat P. The continuous recording of blood pressure in patients undergoing carotid surgery under remifentanyl versus sufentanil analgesia. *Anesth Analg* 2001;93(6):1402–1409, table of contents.
81. Wilhelm W, Schlaich N, Harrer J, Kleinschmidt S, Muller M, Larsen R. Recovery and neurological examination after remifentanyl-desflurane or fentanyl-desflurane anaesthesia for carotid artery surgery. *Br J Anaesth* 2001;86(1):44–49.
82. Yastrebov K. Intraoperative management: carotid endarterectomies. *Anesthesiol Clin North America* 2004;22(2):265–287; vi–vii.
83. Harukuni I, Bhardwaj A. Mechanisms of brain injury after global cerebral ischemia. *Neurol Clin* 2006;24(1):1–21.
84. Gandhi GY, Nuttall GA, Abel MD, et al. Intraoperative hyperglycemia and perioperative outcomes in cardiac surgery patients. *Mayo Clin Proc* 2005;80(7):862–866.
85. Smith JS, Cahalan MK, Benefiel DJ, et al. Intraoperative detection of myocardial ischemia in high-risk patients: electrocardiography versus two-dimensional transesophageal echocardiography. *Circulation* 1985;72(5):1015–1021.
86. Breen JC, Caplan LR, DeWitt LD, Belkin M, Mackey WC, O'Donnell TP. Brain edema after carotid surgery. *Neurology* 1996;46(1):175–181.
87. Sweeney PJ, Wilbourn AJ. Spinal accessory (11th) nerve palsy following carotid endarterectomy. *Neurology* 1992;42(3 Pt 1):674–675.
88. Selvin E, Erlinger TP. Prevalence of and risk factors for peripheral arterial disease in the United States: results from the National Health and Nutrition Examination Survey, 1999–2000. *Circulation* 2004;110(6):738–743.
89. Dormandy JA, Rutherford RB. Management of peripheral arterial disease (PAD). TASC Working Group. TransAtlantic Inter-Society Consensus (TASC). *J Vasc Surg* 2000;31(1 Pt 2):S1–S296.
90. Hirsch AT, Haskal ZJ, Hertzner NR, et al. ACC/AHA guidelines for the management of patients with peripheral arterial disease (lower extremity, renal, mesenteric, and abdominal aortic): a collaborative report from the American Associations for Vascular Surgery/Society for Vascular Surgery, Society for Cardiovascular Angiography and Interventions, Society for Vascular Medicine and Biology, Society of Interventional Radiology, and the ACC/AHA Task Force on Practice Guidelines (Writing Committee to Develop Guidelines for the Management of Patients with Peripheral Arterial Disease)—summary of recommendations. *J Vasc Interv Radiol* 2006;17(9):1383–1397; quiz 1398.
91. Fleisher LA, Eagle KA, Shaffer T, Anderson GF. Perioperative- and long-term mortality rates after major vascular surgery: the relationship to preoperative testing in the medicare population. *Anesth Analg* 1999;89(4):849–855.
92. Frank SM, Fleisher LA, Breslow MJ, et al. Perioperative maintenance of normothermia reduces the incidence of morbid cardiac events. A randomized clinical trial. *JAMA* 1997;277(14):1127–1134.
93. Polanczyk CA, Rohde LE, Goldman L, et al. Right heart catheterization and cardiac complications in patients undergoing non-cardiac surgery: an observational study. *JAMA* 2001;286(3):309–314.
94. Valentine RJ, Duke ML, Inman MH, et al. Effectiveness of pulmonary artery catheters in aortic surgery: a randomized trial. *J Vasc Surg* 1998;27(2):203–211; discussion 211–202.
95. Rodgers A, Walker N, Schug S, et al. Reduction of postoperative mortality and morbidity with epidural or spinal anaesthesia: results from overview of randomised trials. *BMJ* 2000;321(7275):1493.
96. Yeager MP, Glass DD, Neff RK, Brinck-Johnsen T. Epidural anesthesia and analgesia in high-risk surgical patients. *Anesthesiology* 1987;66(6):729–736.
97. Tuman KJ, McCarthy RJ, March RJ, DeLaria GA, Patel RV, Ivankovich AD. Effects of epidural anesthesia and analgesia on coagulation and outcome after major vascular surgery. *Anesth Analg* 1991;73(6):696–704.
98. Cook PT, Davies MJ, Cronin KD, Moran P. A prospective randomised trial comparing spinal anaesthesia using hyperbaric bupivacaine with general anaesthesia for lower limb vascular surgery. *Anaesth Intensive Care* 1986;14(4):373–380.
99. Pierce ET, Pomposelli FB Jr, Stanley GD, et al. Anesthesia type does not influence early graft patency or limb salvage rates of lower extremity arterial bypass. *J Vasc Surg* 1997;25(2):226–232; discussion 232–223.
100. Christopherson R, Beattie C, Frank SM, et al. Perioperative morbidity in patients randomized to epidural or general anesthesia for lower extremity vascular surgery. Perioperative Ischemia Randomized Anesthesia Trial Study Group. *Anesthesiology* 1993;79(3):422–434.
101. Rosenfeld BA, Beattie C, Christopherson R, et al. The effects of different anesthetic regimens on fibrinolysis and the development of postoperative arterial thrombosis. Perioperative Ischemia Randomized Anesthesia Trial Study Group. *Anesthesiology* 1993;79(3):435–443.
102. Breslow MJ, Parker SD, Frank SM, et al. Determinants of catecholamine and cortisol responses to lower extremity revascularization. The PIRAT Study Group. *Anesthesiology* 1993;79(6):1202–1209.
103. Bode RH Jr, Lewis KP, Zarich SW, et al. Cardiac outcome after peripheral vascular surgery. Comparison of general and regional anesthesia. *Anesthesiology* 1996;84(1):3–13.
104. Horlocker TT, Wedel DJ, Benzon H, et al. Regional anesthesia in the anticoagulated patient: defining the risks (the second ASRA Consensus Conference on Neuraxial Anesthesia and Anticoagulation). *Reg Anesth Pain Med* 2003;28(3):172–197.
105. MacSweeney ST, Powell JT, Greenhalgh RM. Pathogenesis of abdominal aortic aneurysm. *Br J Surg* 1994;81(7):935–941.
106. Crawford ES, DeNatale RW. Thoracoabdominal aortic aneurysm: observations



- regarding the natural course of the disease. *J Vasc Surg* 1986;3(4):578-582.
107. Brewster DC, Cronenwett JL, Hallett JW Jr, Johnston KW, Krupski WC, Matsumura JS. Guidelines for the treatment of abdominal aortic aneurysms. Report of a subcommittee of the Joint Council of the American Association for Vascular Surgery and Society for Vascular Surgery. *J Vasc Surg* 2003;37(5):1106-1117.
108. Frezza EE, Mezghebe H. Indications and complications of arterial catheter use in surgical or medical intensive care units: analysis of 4932 patients. *Am Surg* 1998;64(2):127-131.
109. Isaacson IJ, Lowdon JD, Berry AJ, et al. The value of pulmonary artery and central venous monitoring in patients undergoing abdominal aortic reconstructive surgery: a comparative study of two selected, randomized groups. *J Vasc Surg* 1990;12(6):754-760.
110. Sandham JD, Hull RD, Brant RF, et al. A randomized, controlled trial of the use of pulmonary-artery catheters in high-risk surgical patients. *N Engl J Med* 2003;348(1):5-14.
111. Iberti TJ, Fischer EP, Leibowitz AB, Panacek EA, Silverstein JH, Albertson TE. A multicenter study of physicians' knowledge of the pulmonary artery catheter. Pulmonary Artery Catheter Study Group. *JAMA* 1990;264(22):2928-2932.
112. Cheitlin MD, Armstrong WF, Aurigemma GP, et al. ACC/AHA/ASE 2003 guideline update for the clinical application of echocardiography: summary article. A report of the American College of Cardiology/American Heart Association Task Force on Practice Guidelines (ACC/AHA/ASE Committee to Update the 1997 Guidelines for the Clinical Application of Echocardiography). *J Am Soc Echocardiogr* 2003;16(10):1091-1110.
113. Comunale ME, Body SC, Ley C, et al. The concordance of intraoperative left ventricular wall-motion abnormalities and electrocardiographic S-T segment changes: association with outcome after coronary revascularization. Multicenter Study of Perioperative Ischemia (McSPI) Research Group. *Anesthesiology* 1998;88(4):945-954.
114. Roizen MF, Beaupre PN, Alpert RA, et al. Monitoring with two-dimensional transesophageal echocardiography. Comparison of myocardial function in patients undergoing supraceliac, suprarenal-infrarenal, or infrarenal aortic occlusion. *J Vasc Surg* 1984;1(2):300-305.
115. Shenaq SA, Svensson LG. Paraplegia following aortic surgery. *J Cardiothorac Vasc Anesth* 1993;7(1):81-94.
116. Cunningham JN Jr, Laschinger JC, Spencer FC. Monitoring of somatosensory evoked potentials during surgical procedures on the thoracoabdominal aorta. IV. Clinical observations and results. *J Thorac Cardiovasc Surg* 1987;94(2):275-285.
117. Hallett JW, Jr., Popovsky M, Ilstrup D. Minimizing blood transfusions during abdominal aortic surgery: recent advances in rapid autotransfusion. *J Vasc Surg* 1987;5(4):601-606.
118. Bush HL Jr, Hydo LJ, Fischer E, Fantini GA, Silane MF, Barie PS. Hypothermia during elective abdominal aortic aneurysm repair: the high price of avoidable morbidity. *J Vasc Surg* 1995;21(3):392-400; discussion 400-392.
119. Brusoni B, Colombo A, Merlo L, Marchetti G, Longo T. Hemodynamic and metabolic changes induced by temporary clamping of the thoracic aorta. *Eur Surg Res* 1978;10(3):206-216.
120. Gelman S. The pathophysiology of aortic cross-clamping and unclamping. *Anesthesiology* 1995;82(4):1026-1060.
121. Silverstein PR, Caldera DL, Cullen DJ, Davison JK, Darling RC, Emerson CW. Avoiding the hemodynamic consequences of aortic cross-clamping and unclamping. *Anesthesiology* 1979;50(5):462-466.
122. O'Connor CJ, Rothenberg DM. Anesthetic considerations for descending thoracic aortic surgery: part II. *J Cardiothorac Vasc Anesth* 1995;9(6):734-747.
123. Pagani M, Pizzinelli P, Bergamaschi M, Malliani A. A positive feedback sympathetic pressor reflex during stretch of the thoracic aorta in conscious dogs. *Circ Res* 1982;50(1):125-132.
124. Stene JK, Burns B, Permutt S, Caldini P, Shanoff M. Increased cardiac output following occlusion of the descending thoracic aorta in dogs. *Am J Physiol* 1982;243(1):R152-R158.
125. Stokland O, Miller MM, Ilebakk A, Kiil F. Mechanism of hemodynamic responses to occlusion of the descending thoracic aorta. *Am J Physiol* 1980;238(4):H423-H429.
126. Slogoff S, Keats AS, Ott E. Preoperative propranolol therapy and aortocoronary bypass operation. *JAMA* 1978;240(14):1487-1490.
127. Latson TW YF, Hunter WC. The Effects of Finite Wave Velocity and Discrete Reflections on Ventricular Loading. New York: Springer-Verlag, 1987.
129. Shenaq SA, Chelly JE, Karlberg H, Cohen E, Crawford ES. Use of nitroprusside during surgery for thoracoabdominal aortic aneurysm. *Circulation* 1984;70(3 Pt 2):17-10.
130. Hummel BW, Raess DH, Gewertz BL, Wheeler HT, Fry WJ. Effect of nitroglycerin and aortic occlusion on myocardial blood flow. *Surgery* 1982;92(2):159-166.
131. Godet G, Bertrand M, Coriat P, Kieffer E, Mouren S, Viars P. Comparison of isoflurane with sodium nitroprusside for controlling hypertension during thoracic aortic cross-clamping. *J Cardiothorac Anesth* 1990;4(2):177-184.
132. Kazui T, Komatsu S, Yokoyama H. Surgical treatment of aneurysms of the thoracic aorta with the aid of partial cardiopulmonary bypass: an analysis of 95 patients. *Ann Thorac Surg* 1987;43(6):622-627.
133. Verdant A, Cossette R, Page A, Baillet R, Dontigny L, Page P. Aneurysms of the descending thoracic aorta: three hundred sixty-six consecutive cases resected without paraplegia. *J Vasc Surg* 1995;21(3):385-390; discussion 390-381.
134. Livesay JJ, Cooley DA, Ventemiglia RA, et al. Surgical experience in descending thoracic aneurysmectomy with and without adjuncts to avoid ischemia. *Ann Thorac Surg* 1985;39(1):37-46.
135. Abbott WM, Austen WG. The reversal of renal cortical ischemia during aortic occlusion by mannitol. *J Surg Res* 1974;16(5):482-489.
136. Miller DC, Myers BD. Pathophysiology and prevention of acute renal failure associated with thoracoabdominal or abdominal aortic surgery. *J Vasc Surg* 1987;5(3):518-523.
137. Gamulin Z, Forster A, Morel D, Simonet F, Aymon E, Favre H. Effects of infrarenal aortic cross-clamping on renal hemodynamics in humans. *Anesthesiology* 1984;61(4):394-399.
138. Williams GM. Complications of vascular surgery. *Surg Clin North Am* 1993;73(2):323-335.
139. Kellum JA, J MD. Use of dopamine in acute renal failure: a meta-analysis. *Crit Care Med* 2001;29(8):1526-1531.
140. Gilbert TB, Hasnain JU, Flinn WR, Lilly MP, Benjamin ME. Fenoldopam infusion associated with preserving renal function after aortic cross-clamping for aneurysm repair. *J Cardiovasc Pharmacol Ther* 2001;6(1):31-36.
141. Koksoy C, LeMaire SA, Curling PE, et al. Renal perfusion during thoracoabdominal aortic operations: cold crystalloid is superior to normothermic blood. *Ann Thorac Surg* 2002;73(3):730-738.
142. Svensson LG, Crawford ES, Hess KR, Coselli JS, Safi HJ. Variables predictive of outcome in 832 patients undergoing repairs of the descending thoracic aorta. *Chest* 1993;104(4):1248-1253.
143. Hollier LH, Money SR, Naslund TC, et al. Risk of spinal cord dysfunction in patients undergoing thoracoabdominal aortic replacement. *Am J Surg* 1992;164(3):210-213; discussion 213-214.
144. Crawford ES, Crawford JL, Safi HJ, et al. Thoracoabdominal aortic aneurysms: preoperative and intraoperative factors determining immediate and long-term results of operations in 605 patients. *J Vasc Surg* 1986;3(3):389-404.
145. Barkhordarian S, Dardik A. Preoperative assessment and management to prevent complications during high-risk vascular surgery. *Crit Care Med* 2004;32(4 Suppl):S174-S185.
146. Mulcare RJ, Royster TS, Weiss HJ, Phillips LL. Disseminated intravascular coagulation as a complication of abdominal aortic aneurysm repair. *Ann Surg* 1974;180(3):343-349.
147. Adams RP, Cain SM. Total and hind-limb oxygen deficit and "repayment" in

- hypoxic anesthetized dogs. *J Appl Physiol* 1983;55(3):913–922.
148. Bishop RL, Weisfeldt ML. Sodium bicarbonate administration during cardiac arrest. Effect on arterial pH PCO<sub>2</sub> and osmolality. *JAMA* 1976;235(5):506–509.
149. Kato R, Foex P. Myocardial protection by anesthetic agents against ischemia-reperfusion injury: an update for anesthesiologists. *Can J Anaesth* 2002;49(8):777–791.
150. van der Starre PJ, Guta C. Choice of anesthetics. *Anesthesiol Clin North America* 2004;22(2):251–264; vi.
151. Baron JF, Bertrand M, Barre E, et al. Combined epidural and general anesthesia versus general anesthesia for abdominal aortic surgery. *Anesthesiology* 1991;75(4):611–618.
152. Breslow MJ, Jordan DA, Christopherson R, et al. Epidural morphine decreases postoperative hypertension by attenuating sympathetic nervous system hyperactivity. *JAMA* 1989;261(24):3577–3581.
153. Flores JA, Nishibe T, Koyama M, et al. Combined spinal and epidural anesthesia for abdominal aortic aneurysm surgery in patients with severe chronic pulmonary obstructive disease. *Int Angiol* 2002;21(3):218–221.
154. Michaloudis D, Petrou A, Fraidakis O, Kafkalaki K, Katsamouris A. Continuous spinal anaesthesia/analgesia for abdominal aortic aneurysm repair and post-operative pain management. *Eur J Anaesthesiol* 1999;16(11):810–815.
155. Haku E, Hayashi M, Kato H. Anesthetic management of abdominal aortic surgery: a retrospective review of perioperative complications. *J Cardiothorac Anesth* 1989;3(5):587–591.
156. Seeling W, Bruckmooser KP, Hufner C, Kneiting E, Rigg C, Rockemann M. [No reduction in postoperative complications by the use of catheterized epidural analgesia following major abdominal surgery.] *Anaesthesist* 1990;39(1):33–40.
157. Greenhalgh RM, Brown LC, Kwong GP, Powell JT, Thompson SG. Comparison of endovascular aneurysm repair with open repair in patients with abdominal aortic aneurysm (EVAR trial 1), 30-day operative mortality results: randomised controlled trial. *Lancet* 2004;364(9437):843–848.
158. Prinssen M, Verhoeven EL, Buth J, et al. A randomized trial comparing conventional and endovascular repair of abdominal aortic aneurysms. *N Engl J Med* 2004;351(16):1607–1618.
159. Teufelsbauer H, Prusa AM, Wolff K, et al. Endovascular stent grafting versus open surgical operation in patients with infrarenal aortic aneurysms: a propensity score-adjusted analysis. *Circulation* 2002;106(7):782–787.
160. Thompson JP, Boyle JR, Thompson MM, Strupish J, Bell PR, Smith G. Cardiovascular and catecholamine responses during endovascular and conventional abdominal aortic aneurysm repair. *Eur J Vasc Endovasc Surg* 1999;17(4):326–333.
161. Baxendale BR, Baker DM, Hutchinson A, Chuter TA, Wenham PW, Hopkinson BR. Haemodynamic and metabolic response to endovascular repair of infra-renal aortic aneurysms. *Br J Anaesth* 1996;77(5):581–585.
162. White GH, Yu W, May J, Chaufour X, Stephen MS. Endoleak as a complication of endoluminal grafting of abdominal aortic aneurysms: classification, incidence, diagnosis, and management. *J Endovasc Surg* 1997;4(2):152–168.
163. Mordecai MM, Crawford CC. Intraoperative management: endovascular stents. *Anesthesiol Clin North America* 2004;22(2):319–332; vii.
164. Ruppert V, Leurs LJ, Steckmeier B, Buth J, Umscheid T. Influence of anesthesia type on outcome after endovascular aortic aneurysm repair: an analysis based on EUROSTAR data. *J Vasc Surg* 2006;44(1):16–21; discussion 21.
165. De Virgilio C, Romero L, Donayre C, et al. Endovascular abdominal aortic aneurysm repair with general versus local anesthesia: a comparison of cardiopulmonary morbidity and mortality rates. *J Vasc Surg* 2002;36(5):988–991.
166. Bettex DA, Lachat M, Pfammatter T, Schmidlin D, Turina MI, Schmid ER. To compare general, epidural and local anaesthesia for endovascular aneurysm repair (EVAR). *Eur J Vasc Endovasc Surg* 2001;21(2):179–184.

# CHAPTER 55

## Anesthesia for Gastrointestinal Surgery

Martin Slodzinski, MD, PhD,  
and  
William T. Merritt, MD, MBA

In recent years, technical advances and increased experience with these techniques have led to remarkable changes in gastrointestinal (GI) surgical practice. These include the routine use of laparoscopy and the increasing use of robot-assisted surgery.

The GI tract is a fascinating organ system with a complex neurochemical organization.<sup>1</sup> GI surgery occupies a major percentage of the operative time in any general hospital setting. Anesthesia for such procedures likewise represents a major portion of the anesthesiologist's responsibilities. Many of these procedures are done so frequently that they may become routine. Others are sufficiently sophisticated that they may only be performed in tertiary care and teaching institutions. This chapter includes illustrations of some typical procedures and discusses preoperative, intraoperative, and postoperative considerations. It begins with a discussion of issues pertinent to the effects of anesthesia administration on GI function. Subsequent sections deal with surgical and anesthetic considerations of specific areas regarded as GI in nature.

### OROPHARYNX

Digestive physiology begins with mastication. Pulmonary aspiration of oropharyngeal, esophageal, or gastric contents is a high concern for anesthesiologists caring for patients with gastrointestinal disorders/symptoms. Local and general anesthesia depress sensation of the upper digestive system, beginning with trigeminal innervation of the nasopharynx. The posterior third of the tongue and oral pharynx are innervated by the glossopharyngeal nerve,

which accompanies the carotid sheath emerging from the jugular foramen. The superior laryngeal nerve innervates the tongue base and inferior epiglottis to the vocal cords. The recurrent laryngeal nerve innervates from the vocal cords distally. The remaining larynx and trachea are innervated by penetrating branches of the vagus. Any specific or general (i.e., stroke) pathology affecting the innervation of these areas increases risks of perioperative mishandling of oropharyngeal secretions and fluids, and an increased potential for aspiration.

### ESOPHAGUS AND STOMACH

Proper function of the esophagus and the lower esophageal sphincter (LES) is a concern during anesthesia care. If the esophagus is dilated because of obstruction by tumor, destruction of neural mechanisms (e.g., achalasia), or existence of a diverticulum, particulate matter will remain for hours (if not days) after ingestion, and secretions will not pass normally to the stomach. *If the LES is not functioning properly, or if a hiatal hernia exists, stomach contents may reflux into the esophagus and even*

### KEY POINTS

1. Diseases of the gastrointestinal system frequently result in abnormal gastric function, with potentially increased anesthetic risk caused by increased intragastric pressure, delayed gastric emptying, gastric dilation, and increased gastric secretion.
2. The volume, pH, and amount of particulate matter in the aspirate appear to be the three most important factors determining the severity of the pulmonary insult.
3. Extensive bowel, pancreatic, or esophageal resections entail considerable morbidity, with potential serious postoperative complications such as hemorrhage, coagulopathy, and hepatic, renal, pulmonary, or cardiovascular failure.
4. Laparoscopy entails the installation of gas (usually CO<sub>2</sub>) into the peritoneal cavity with physiologic changes resulting from this gas under pressure and subsequent surgical positioning. Hemodynamic compromise can occur, which, although rare, can be catastrophic.
5. The systemic inflammatory response syndrome/multiorgan dysfunction syndrome continuum is often accompanied by GI mucosal ischemia and the release of mediators that further compromise both splanchnic and systemic perfusion. Anesthetic care of these patients is especially challenging.
6. If the lower esophageal sphincter is not functioning properly, or if a hiatal hernia exists, stomach contents may reflux into the esophagus and pharynx during anesthesia and surgery, increasing the potential for serious aspiration pneumonia.
7. Narcotics have intestinal side effects that are well recognized. Lower esophageal sphincter tone is decreased. Gastric emptying is impaired because of decreased propulsive motility and increased tone in the antrum of the stomach.
8. During laparoscopy, the development of pneumothorax and/or pneumomediastinum is a serious and/or potentially life-threatening complication. When either is suspected, from hemodynamic deterioration or from the presence of subcutaneous emphysema, especially of the neck and face, aggressive investigation (auscultation, chest radiograph) and management (e.g., chest tube for tension pneumothorax) should be undertaken. Procedures on the lower esophagus may be more likely to result in these complications.
9. Approximately 40% of patients with gastroesophageal reflux have delayed gastric emptying, and in approximately one-third of these, the delay is clinically significant.
10. Maneuvers necessary for blunt esophagectomy are capable of causing serious hemodynamic and ventilatory compromise and require appropriate monitoring of blood pressure and respiration.
11. Bariatric surgery patients may have significant medical problems and their perioperative care can be quite challenging. Newer procedures continue to lessen morbidity and mortality.

the pharynx during anesthesia and surgery, increasing the potential for serious aspiration pneumonia. Placement of a cuffed endotracheal tube during surgical procedures largely protects the airway from such materials. When obstructions are present, endotracheal intubation should occur with the patient awake (e.g., direct oral, blind nasal, or fiberoptic bronchoscopy) or via a rapid sequence method with the patient anesthetized. With the awake method, sedation should be limited or avoided altogether, especially in patients with a “full” stomach, proximal obstruction, esophageal diverticulum, or altered consciousness. Emptying the gastric or esophageal contents (e.g., nasogastric tube, Sengstaken-Blakemore tube) should decrease the volume and nature of any fluid available for reflux.<sup>2,3</sup> In any patient with known hiatal hernia or LES dysfunction, or when the stomach or esophagus is suspected to contain fluid or particulate matter, an attempt should also be made to aspirate the material before emergence from anesthesia. In addition, extubation should occur only after swallowing, adequate strength, and the ability to follow commands are apparent.

Many surgical approaches to the esophagus require a thoracotomy and a laparotomy, the lateral position, and a method of collapsing one lung. In addition, a temporary esophageal dilator may be requested intraoperatively by the surgeon; a nasogastric or naso-“intestinal” tube will need to be positioned at some point during the procedure to maintain continuity above and below the anastomosis. Such procedures can be demanding and require considerable preoperative planning.

## MANAGEMENT OF ACID REFLUX

Abdominal surgery has been associated with as much as 75% of the perioperative mortality related to aspiration pneumonitis.<sup>4</sup> In addition, fasting gastric volume can be large in patients with GI disorders, especially duodenal ulcer disease.<sup>5</sup> Many other conditions, some directly related to the GI tract, are associated with some risk of regurgitation of esophageal or stomach contents and ultimate pulmonary aspiration (Box 55–1). In these conditions, an inadequate initial clearance or the return of a substance to the pharynx may

be followed by ineffective removal with subsequent passage through the glottic opening into the lungs.<sup>6</sup> Mortality associated with aspiration ranges from 3–70%,<sup>7–10</sup> and the true incidence and morbidity are not well quantified. A large European study suggests the actual incidence is considerably lower, approximately 0.05%.<sup>11</sup> Unrecognized or “silent” regurgitation typically occurs, as does subsequent aspiration.<sup>12–15</sup>

*The volume, pH, and amount of particulate matter in the aspirate appear to be the three most important factors determining the severity of the pulmonary insult.* Particulate matter obstructs airways and quickly leads to ventilation and perfusion mismatching, hypoxia, hemorrhagic edema, and sometimes acute pulmonary hypertension.<sup>16</sup> Traditionally, gastric volumes greater than 25 mL and pH less than 2.5 have been associated with the most severe pneumonitis,<sup>17,18</sup> although more recent data suggest that greater volumes of nonparticulate aspirated fluid would be tolerated when the pH is greater than 2.5.<sup>16,19,20</sup>

In addressing the problem of aspiration during the delivery of anesthesia, anesthesiologists have focused on four areas: (a) reduction of the acid content and volume of the stomach contents, (b) improvement of intestinal motility, (c) prevention of reflux into the pharynx, and (d) a better understanding of gastric emptying.

Although antacids increase gastric pH, particulate (i.e., opaque) antacids produce severe aspiration damage similar to that of gastric acid.<sup>19</sup> The use of clear antacids is just as effective in increasing pH but is associated with only mild pulmonary changes if aspirated.<sup>21–23</sup>

Histamine-2 (H<sub>2</sub>)-blocking agents are effective in reducing the acidity and, to a lesser extent, the volume of gastric fluid. Three agents are currently used: cimetidine and ranitidine are backed by extensive clinical experience; famotidine is a more recent introduction.<sup>24,25</sup> None of these agents has much effect on the acidity of material already present in the stomach (e.g., that found in the trauma patient or patients requiring other emergency surgery) but may decrease intraoperative acid production if given before surgery. Oral therapy seems to be as effective (and considerably less expensive) as intravenous (IV) or intramuscular forms when premedication by the oral route is suitable. Administra-

### BOX 55–1.

#### Conditions Associated with Aspiration Pneumonia

- Altered state of consciousness
- Inadequate pharyngeal reflexes
- Anesthesia induction, intubation
- “Full” stomach
- Abnormal esophageal function
- Abnormal LES
- Intestinal obstruction, dysmotility
- Abdominal distension
- Pregnancy
- Obesity
- Inadequate muscle relaxant reversal
- Poor cough
- Abdominal infection
- Abdominal trauma
- Pain
- Recent extubation (dysfunctional vocal cords/hypopharynx/sedation)

tion the night before and the morning of surgery consistently increases gastric pH to above 2.5. Rapid administration of cimetidine is associated with hypotension,<sup>26–28</sup> bradycardia,<sup>29</sup> and cardiac arrest.<sup>30</sup> Ranitidine appears to have a lesser incidence of similar side effects.<sup>31,32</sup> Mechanisms may include blockage of the inotropic and chronotropic responses of stimulation of myocardial H<sub>2</sub> receptors.<sup>33,34</sup> These agents alter metabolism or kinetics of various drugs, including the cytochrome P450 system,<sup>35,36</sup> lidocaine,<sup>37</sup> nifedipine,<sup>38</sup> theophylline,<sup>39,40</sup> warfarin,<sup>41</sup> and phenytoin.<sup>42</sup> Although atropine and glycopyrrolate decrease gastric acid production somewhat, they generally are not used for this specific purpose because they also decrease LES tone.

Rapid-acting intravenous proton pump inhibitors are effective in reducing gastric volume and increasing gastric pH. In a prospective, randomized, controlled trial, proton pump inhibitors were compared with H<sub>2</sub> antagonists. After intravenous administration 1 hour prior to surgery, pantoprazole 40 mg (Protonix) and ranitidine 50 mg (Zantac) were compared. Gastric aspirate pHs were 5.3 and 4.8 and residual volumes 8 mL and 15 mL, respectively, measured just after induction of anesthesia. This was compared with an IV saline control. Patients receiving pantoprazole and ranitidine had statistically greater gastric pH and less gastric volume than control patients (5 mL IV saline with gastric aspirate pH 3.7 and 29 mL volume), but



there was no statistical difference between the pantoprazole and ranitidine groups.<sup>43</sup> Although both proton pump and H<sub>2</sub> inhibition may be used to reduce perioperative gastric acid, neither seems to be superior.

Gastric and intestinal motility are stimulated by metoclopramide, which acts centrally by inhibiting dopamine and in the gut by releasing acetylcholine. LES tone also increases, but the pylorus and duodenum relax.<sup>44,45</sup> Metoclopramide usually is administered concurrently with an H<sub>2</sub> blocker.

Preventing refluxed material from reaching the pharynx is the goal of cricoid pressure (the Sellick maneuver) and rapid sequence intubation. When properly performed, cricoid pressure should provide a barrier for at least 100 cm H<sub>2</sub>O of esophageal pressure.<sup>46</sup> Pressure should not be released until the cuff is inflated and until correct placement has been verified by appropriate observations, including auscultation and capnometry. However, a meta-analysis of 241 peer-reviewed articles found little evidence that rapid sequence intubation provided protection against aspiration. Furthermore, in a controlled, blinded, randomized, crossover study comparing the Sellick and BURP (backward, upward, and right-sided pressure on the thyroid cartilage) maneuvers, the BURP maneuver and cricoid pressure worsened the laryngoscopic view in 30% of cases, cricoid pressure alone worsened the view in 12.5% of cases, and there was no difference in 65% of cases.<sup>47,48</sup>

As more is learned about the physiology of gastric emptying, the tradition of overnight fasting for elective surgery has come into question.<sup>49–53</sup> Residual gastric volumes may be acceptable after 2–4 hours of fasting, and the addition of H<sub>2</sub> blockers lowers pH as well. One should not extrapolate from such information directly to the emergency patient or the patient with a full stomach. *The aspiration of particulate matter produces such a devastating insult in the lung that, except for the most urgent situations, 6–8 hours of fasting after solid foods is recommended.* Even after this waiting period, the stomach often still contains food and large amounts of fluid.

## BOWEL DISTENSION

Nitrous oxide (N<sub>2</sub>O) administration is associated with an increase in intralu-

menal gas volume. Experimentally, in dogs, bowel gas volume increases approximately 75–100% after 2 hours of 70–80% N<sub>2</sub>O, and by 100–200% after 4 hours.<sup>54</sup> Normally, luminal contents include approximately 100 mL of gas, mostly swallowed air; aerophagia or bowel obstruction greatly increases this volume. Clinically, N<sub>2</sub>O use results in a slow increase in bowel distension and intraluminal pressure. The principal surgical consequence is difficulty with abdominal closure at the completion of a procedure. During extreme conditions (e.g., obstruction with distended bowel), increased intraluminal pressure may lead to bowel ischemia. N<sub>2</sub>O use during abdominal surgery, if needed, should be limited to the initial 10–15 minutes at induction and intubation and during the period of abdominal wall closure at the completion of the surgical procedure. (See Endoscopic Procedures below for issues regarding N<sub>2</sub>O during laparoscopy.)

## BOWEL MOTILITY

Neostigmine is representative of anticholinesterase drugs necessary for the reversal of residual nondepolarizing muscular blockade. These drugs have a history of relative safety, although their parasympathetic stimulation leads to undesirable side effects. Bradycardia occurs so often that it is anticipated and managed before its occurrence by the administration of a parasympatholytic drug (e.g., atropine or glycopyrrolate) at reversal of neuromuscular blockade. This parasympathetic stimulation also affects intestinal motility, increasing the frequency and pressure of peristaltic waves, especially in the colon. For unknown reasons, diseased colon (e.g., from ulcerative colitis, diverticulitis<sup>55</sup>) appears to be more susceptible to this effect. This has led to considerable debate over the potential for cholinesterase inhibitors to cause breakdown of colonic anastomoses.<sup>56–59</sup> Fortunately, residual anesthetic agents and pretreatment with parasympatholytic agents (atropine, glycopyrrolate) attenuate this response. Inadequate perfusion of the anastomotic site, infection, and underlying tissue abnormality are now thought to be more significant issues.

Thiopental increases electrical and mechanical activity of the duodenum and jejunum in experimental studies, and atropine premedication decreases

the response.<sup>60</sup> Ketamine has little effect on GI motility, and oral diazepam reduces gastric emptying and increases small bowel transit time.<sup>61</sup>

*Narcotics have significant intestinal side effects. LES tone is decreased.<sup>62</sup> Gastric emptying is impaired<sup>63</sup> because of decreased propulsive motility and increased tone in the antrum of the stomach.* The duodenum and the small intestine undergo a decrease in propulsive contractions, whereas the amplitude of rhythmic segmental nonpropulsive contractions often is enhanced, which results in an increase in resting tone and can cause peristaltic spasms. The proximal small bowel is more affected than the distal part, and the tone of the ileocecal valve is increased. Parasympatholytic agents can partially abolish these effects. In the large intestine, the effects can be more pronounced; peristaltic waves are decreased or absent. The amplitude of rhythmic nonpropulsive contractions is increased, often to the point of spasm. Anal tone also is increased. Again, diseased bowel appears more susceptible to such effects.<sup>64</sup>

High spinal or epidural anesthesia promotes hyperperistaltic activity because of blockade of sympathetic innervation. The unopposed parasympathetic activity may cause nausea and vomiting in approximately 20% of patients, for whom atropine may be effective.<sup>65</sup> Because of the increased peristaltic activity, controversy has arisen over the effects of spinal or epidural anesthesia on anastomotic breakdown, especially in colon surgery. Some data suggest that this problem is not significantly increased with regional anesthesia<sup>66</sup> and that colonic blood flow is improved by spinal or epidural anesthesia.<sup>67</sup> Others disagree with these findings.<sup>68,69</sup>

Postoperative ileus is probably associated with the manual trauma during laparotomy or from increased splanchnic nerve discharge in other procedures. Gastric peristalsis returns within 24–48 hours, and colonic activity returns after 48 hours, beginning at the cecum and progressing caudally. Small bowel motility returns more rapidly, and sometimes enteral tube feedings can be initiated within 24 hours. This ileus can lead to mild abdominal distension and absent bowel sounds for as long as 48–72 hours. Passage of flatus, cramping, and return of appetite suggest the return of normal peristaltic activity.<sup>70,71</sup>

Although neuraxial narcotics generally are recommended for pain relief in

most patients, the side effects of pruritus, urinary retention, and especially respiratory depression are problematic in some. Effects are presumably through local spinal cord receptors and via more central mechanisms after rostral spread in the cerebrospinal fluid or systemic absorption. Although used extensively and successfully in patients undergoing all forms of surgery, including many varieties of abdominal surgery,<sup>33,72</sup> there are animal data that document alterations in intestinal motility associated with neuraxial narcotics,<sup>73</sup> and at least one note of caution in humans.<sup>74</sup> Most studies conclude that postoperative epidural anesthesia and analgesia directed by an anesthesiologist, compared with intravenous anesthesia administered by a surgeon, provides superior analgesia, but does not reduce mortality or major morbidity, especially after major abdominal and cardiac surgical procedures.<sup>75</sup>

## BILIARY EFFECTS

Therapeutic doses of the opioids can cause a marked increase in biliary tract pressure in susceptible patients. For example, 10 mg of subcutaneous morphine can produce a 10-fold increase in common bile duct pressure within 15 minutes that can last 2 or more hours.<sup>76</sup> This effect results from opiate receptor-mediated mechanisms that cause spasm of the sphincter of Oddi. Fentanyl and alfentanil also increase common bile duct pressure.<sup>77,78</sup> The general importance of this effect on intraoperative cholangiograms is uncertain, but fentanyl-supplemented anesthesia is associated with a 3% surgical failure rate.<sup>79</sup> Meperidine increases biliary tract pressure via mechanisms that are not receptor-mediated.<sup>80</sup> Opiate antagonists (e.g., naloxone) can reverse this opiate-related increase in biliary tract pressure (except for that caused by meperidine)<sup>81</sup> but also may reverse general analgesic effects. Sublingual nitroglycerin (0.6 mg) decreases the elevated intrabiliary pressure, but atropine only partially attenuates the response. Glucagon (1–3 mg), titrated to effect, also reverses opiate-related biliary spasm.<sup>82</sup>

## RESPIRATORY FUNCTION

Because abdominal surgery is performed with the patient in the supine

position, the anesthesiologist should remember several points. Functional residual capacity (FRC) is decreased by 0.5–1.0 L in the supine position, and the relationship of FRC to closing volume contributes to the alveolar–arterial oxygen difference and shunt.<sup>83–85</sup> This augments the 15–20% decrease in FRC associated with general anesthesia,<sup>86</sup> which continues postoperatively.<sup>87</sup> The Trendelenburg position aggravates this problem even further<sup>88</sup> because more of the lung assumes zone III conditions. Patients with elevated pulmonary arterial pressure (e.g., mitral stenosis) generally do not tolerate the Trendelenburg position. Diaphragmatic impairment and abdominal pain contribute to the potential for major respiratory embarrassment after abdominal surgery and, at least initially, are intensified by any negative effects from residual inhalation agents, IV anesthetics, and neuromuscular blockade. After upper abdominal surgery, vital capacity remains abnormal for more than 1 week.<sup>89,90</sup> Experimental data demonstrate that excessive fluid administration contributes to hypoxemia if fluid accumulates in the lungs and leads to increasing arteriovenous shunting.<sup>91</sup> However, no rigorous evidence exists favoring either the amount or type (colloid vs. crystalloid) of intravenous fluid, in spite of decades of controversy.<sup>92,93</sup>

## ANESTHESIA FOR ENDOSCOPIC PROCEDURES

Endoscopic abdominal procedures leave inconspicuous scars, result in less postoperative pain with shorter hospitalizations, decreased hospital costs,<sup>94,95</sup> and even immunologic advantages.<sup>96</sup> As “minimally invasive” surgical techniques, reduced risk is implied, but endoscopic surgery involves the instillation of gas under pressure into a “closed” cavity, a process that may initiate unique physiologic responses and potential complications.

Diagnostic examination, cholecystectomy, vagotomy, appendectomy, adrenalectomy, nephrectomy, bariatric procedures, liver resection, pancreatic surgery, colectomy and hiatal, diaphragmatic, and inguinal hernia repair are among the abdominal procedures being performed with laparoscopic equipment. Each procedure has its own indications and conversion rates to an open method (e.g., 1.0–6.9% con-

version to laparotomy with laparoscopic cholecystectomy).<sup>97</sup>

The physiologic changes associated with laparoscopy include those associated with tilting the patient to facilitate instrumentation and surgical exposure, the pressure effects of instilled gas, and the systemic effects of the gas—almost universally CO<sub>2</sub>—that is instilled (and absorbed or embolized).

The head-down position (i.e., Trendelenburg) reduces vital capacity because of the increased weight of the abdominal contents on the diaphragm.<sup>98</sup> This effect is more pronounced in elderly, obese, and debilitated patients. In those undergoing *open* procedures, it is made worse by the placement of retractors and surgical packing under the diaphragm. In addition to this encroachment on lung expansion, right mainstem bronchial intubation can occur. Either of these can be associated with hypoxemia.<sup>99</sup> In contrast, the head-up position redistributes central blood volume peripherally and further aggravates any impairment of venous return created by the pneumoperitoneum.

The instillation of CO<sub>2</sub> to create an intentional pneumoperitoneum carries with it a number of physiologic side effects and complications (Box 55–2). Mechanical injury at the time of trocar insertion can lead to bleeding or bowel perforation. Bleeding also can occur from injury to vessels encountered during surgical instrumentation and dissection. With current laparoscopic

### BOX 55–2.

#### Reported Complications with Laparoscopy

- Hemorrhage
- Hypotension, decreased cardiac output
- Acidosis
- Pneumothorax
- Pneumomediastinum
- Mainstem intubation
- Subcutaneous emphysema
- Airway obstruction
- Retroperitoneal CO<sub>2</sub>
- Venous stasis
- Bradycardia, increased vagal tone
- Cardiac arrest
- Increased sympathetic activity secondary to increased CO<sub>2</sub>
- Venous CO<sub>2</sub> embolism, fatal
- Regurgitation and aspiration

equipment, intraabdominal pressure is maintained between 12 and 15 mm Hg (17–22 cm H<sub>2</sub>O). Because of leaks around the various cannulae, enormous gas volumes ( $\geq 50$  L)<sup>100</sup> may be required during the course of the procedure to generate this relatively low pressure. Such pressures and the resulting abdominal distension may disturb the protective function of the gastroesophageal junction. The hemodynamic changes associated with this pneumoperitoneum depend on a number of factors, including the resulting intraabdominal pressure, the amount of CO<sub>2</sub> absorbed, the patient's level of hydration, the type of ventilation, and the nature of the surgery. Cardiac function during insufflation of peritoneal CO<sub>2</sub> has been studied primarily in healthy (e.g., no known cardiac disease) patients using a variety of cardiac function measurements (dye dilution, impedance cardiography, transesophageal echocardiography, and pulmonary artery catheters). Unfortunately, none of the studies have controlled well for the level of anesthesia at the various stages of the procedures and have managed hypercapnia differently. Most studies,<sup>101–105</sup> but not all,<sup>106–109</sup> report a decrease in left ventricular function and cardiac output (cardiac output decreased 7–24%). Similarly, most studies found an increase in central venous pressure (redistribution of abdominal blood volume?), with an increase in systemic vascular resistance and mean arterial pressure. In addition, with assumption of the reverse Trendelenburg position, cardiac index may decrease by 50% of preanesthesia and preinsufflation values.<sup>103,110</sup> Left ventricular end-diastolic, right atrial, and pulmonary capillary wedge pressures dramatically decrease after assumption of reverse Trendelenburg position.<sup>111</sup> Venous stasis of the lower extremities also occurs, with attendant concerns for embolic phenomenon.<sup>112,113</sup> Patients with cardiovascular disease will have responses to laparoscopy that are affected by the extent of cardiac reserve, baseline medications, level of hydration, and their response to the anesthesia medications used.<sup>110,114</sup> The potential deleterious effects of hypercapnia on cardiac function (e.g., increased sympathetic activity, myocardial depression) may further complicate laparoscopy in those with cardiovascular disease.<sup>115</sup>

During retroperitoneoscopic adrenalectomy (prone–jackknife position or lateral), a small (<10 cm) cavity in the lumbodorsal fascia is created with a distension balloon trocar. CO<sub>2</sub> is insufflated to a pressure of 15–20 mm Hg. Unlike laparoscopy, stroke volume and cardiac output appear to increase with insufflation, as do mean arterial pressure, central venous pressure, and pulmonary artery pressure. No change was noted in pulmonary capillary wedge pressure, heart rate, and systemic vascular resistance.<sup>116</sup>

Relatively small CO<sub>2</sub> emboli have been detected by transesophageal echocardiography in 69% of patients, classified by the American Society of Anesthesiologists as physical status P1 to P3, who undergo laparoscopic cholecystectomy.<sup>117</sup> Fatal massive CO<sub>2</sub> embolism has been reported,<sup>118</sup> including a report of death from delayed CO<sub>2</sub> embolism associated with gas trapping in the portal circulation.<sup>119</sup> With time, subcutaneous or mediastinal emphysema and pneumothorax may develop, with associated hypoxemia, hypotension, and cardiovascular collapse. The incidence of extraperitoneal insufflation of CO<sub>2</sub> has been reported to range from as little as 0.4–2%<sup>120</sup> to 20–64%,<sup>121</sup> and is more likely during lengthy procedures such as fundoplication.<sup>122</sup> *The development of pneumothorax and/or pneumomediastinum during endoscopic surgery is a serious and potentially life-threatening complication. When either is suspected, from hemodynamic deterioration or from the presence of subcutaneous emphysema, especially of the neck and face, aggressive investigation (auscultation, chest radiograph) and management (e.g., chest tube for tension pneumothorax; conversion to an open procedure) should be undertaken. Procedures on the lower esophagus are more likely to result in these complications.*<sup>121</sup>

Ventilation and pulmonary function are important concerns during laparoscopy. With conventional open laparotomy, it is well accepted that upper abdominal surgery is associated with postoperative pulmonary dysfunction in approximately 50% of patients.<sup>123</sup> This dysfunction is related to impaired diaphragmatic function, pain, type of incision, and decreased FRC.<sup>124–126</sup> *Pulmonary function is also impaired after laparoscopic cholecystectomy, with sustained decreases in forced vital capacity, peak expiratory flow, and forced*

*expiratory volume in 1 second (FEV<sub>1</sub>) noted 24 hours after surgery; fortunately, these changes are only approximately 50% of those seen in conventional open cholecystectomy.*<sup>127</sup>

The exogenous CO<sub>2</sub> insufflated during laparoscopy is soluble in blood and after transperitoneal absorption is presented to the lungs for excretion. End-tidal CO<sub>2</sub> (ETCO<sub>2</sub>) increases from 0–30%<sup>128–130</sup> when minute ventilation is held constant. Increasing ventilation by as much as 30% may be necessary to keep the ETCO<sub>2</sub> in the mid-30s (mm Hg) range.<sup>131</sup>

During laparoscopy, an overriding anesthetic concern is the preservation of ventilation, which tends to be impaired by surgical positioning and abdominal distension. This almost always means general anesthesia with endotracheal intubation.<sup>132,133</sup> Not only does this provide protection for the airway,<sup>134</sup> but it permits adequate measurement of ETCO<sub>2</sub> and manipulation of ventilation as needed. Routine intraoperative monitoring (ETCO<sub>2</sub>, pulse oximetry, blood pressure, airway pressure) should be adequate for the expected physiologic changes encountered in most patients. The anesthesiologist should be aware of the insufflating pressure being used and should be alerted if an unusual amount of CO<sub>2</sub> is required.

It is theoretically sound to avoid N<sub>2</sub>O for at least two reasons. First, it diffuses into the abdominal cavity in concentrations sufficient to support combustion of intestinal gas<sup>135,136</sup>; second, it will diffuse into CO<sub>2</sub> bubbles and emboli, increasing their size and the potential for an obstructive event.

Adequate muscle relaxation is required during laparoscopy so that spontaneous respiratory effort does not impair the surgical procedure or risk increasing the gradient for embolic gas to enter the central circulation.

Despite the limited surgical incision(s), postoperative muscle pain remains a problem, even in children.<sup>137</sup> This has not been eliminated by avoiding succinylcholine or by manipulation of other anesthetic regimens.<sup>138</sup> Nausea and vomiting is common after laparoscopy, especially in women, and it appears that women are at increased risk for this during their menses.<sup>139</sup> Droperidol, a dopamine receptor antagonist, has been found to decrease nausea and vomiting in nonmenstruating women, but not during menses. Because serotonin has been implicated



in several premenstrual syndromes, serotonin antagonist therapy (e.g., ondansetron) can be beneficial.

In the rare event of catastrophic hemodynamic collapse during laparoscopy, several possible causes should be considered. *During laparoscopy, hemorrhage can be obvious or occult (e.g., retroperitoneal). Pneumothorax, massive CO<sub>2</sub> embolus, and pneumomediastinum may occur. Initial therapy includes releasing the pressurized pneumoperitoneum (i.e., conversion to open procedure). For pneumothorax, a thoracentesis should be performed. If massive embolization occurs, N<sub>2</sub>O, if employed, should be discontinued immediately and cardiopulmonary resuscitation should be performed.* The patient should be placed in the left lateral position. Attempts at embolus retrieval should be made through central venous access, if available. If these measures do not provide sustained benefit, even cardiopulmonary bypass may be necessary.

## GASTROINTESTINAL ENDOCRINOLOGY

Understanding of GI endocrine tumors has expanded dramatically since original descriptions of the *carcinoid syndrome* several decades ago. That clinical syndrome (including flushing, diarrhea, telangiectasias, bronchoconstriction, fibrous endocardial plaques) has traditionally been said to originate from metastatic carcinoid tumors in the GI system, pancreas, biliary vessels, bronchi, ovaries, and testes via release of vasoactive hormones into systemic circulation. Cardiac involvement (primarily right-sided valvular) is actually noted in more than 50% of patients by echocardiography and may require valvular surgery.

It is now recognized that there are at least 14 different endocrine cell types in the gastrointestinal tract that produce numerous peptide hormones such as gastrin, glucagon, somatostatin, secretin, and vasoactive intestinal peptide (VIP). They may have hormonal and/or neurotransmitter functions. Their interactive biology is complex and tumor presentation uncommon; excellent references detail their complexity, management, and uncommon clinical syndromes.<sup>140-142</sup> Most produce small amounts of neuroendocrine substances and do not result in clinical symptoms until late stages of disease. These tu-

mors tend to have an indolent course, and aggressive malignancy is relatively infrequent. An increasing number of such lesions are being discovered before biochemical clinical symptoms. In addition to these endocrine/neuroendocrine tumors (terms considered synonymous), there are also pancreatic islet cell tumors. Duodenal gastrinomas can be associated with multiple endocrine neoplasia type-1 and may or may not result in the Zollinger-Ellison syndrome. Somatostatinomas may be associated with neurofibromatosis.

These gastroenteropancreatic neuroendocrine tumors have a yearly incidence of 1.0–2.6 per 100,000 population from gastrointestinal origin, with an additional 0.2–0.4 per 100,000 population from the pancreas. Since only approximately 10% of the 100,000 population produce bioactive hormones, diagnosis often occurs late after metastasis has occurred. There is emerging evidence of distinct molecular genetic differences between GI and pancreatic neuroendocrine tumors.<sup>143</sup>

Therapy of functional tumors involves controlling symptoms, which includes somatostatin analogues for carcinoid syndrome, watery diarrhea syndrome (“VIPomas”), and hyperglucagonemia. For those with gastrinoma (Zollinger-Ellison syndrome), proton pump inhibitors have improved therapy of high acid production. In addition to true insulinomas, some other neuroendocrine tumors may secrete a chemical that behaves like insulin.

Surgical treatment includes attempts to discover/remove the primary tumor, regional lymph nodes, and appropriate distant metastases, for example, liver tumors. This includes liver resection and both cryoablation and radiofrequency ablation. Impressive improvements in symptomatology can occur, and depending on cell type, meaningful 5-year survival may result.<sup>144</sup>

Anesthesia management of this broad group of patients requires an understanding of the biochemical abnormalities noted, the clinical/potential clinical manifestations, medical therapy being used, the surgical/diagnostic procedure(s) contemplated, and the ability to monitor hemodynamics and lab values (e.g., glucose) closely in the operating room/perioperative environment.

For the carcinoid syndrome, a nonhistamine releasing anxiolytic can be employed to reduce the catecholamine levels. The somatostatin analogue,

octreotide,<sup>145</sup> odansetron (5-HT<sub>3</sub> antagonist),<sup>146</sup> and remifentanyl<sup>147</sup> have been found useful in perioperative suppression of carcinoid signs and symptoms.

## MEDICAL AND SURGICAL CONCERNS IN GI ILLNESS

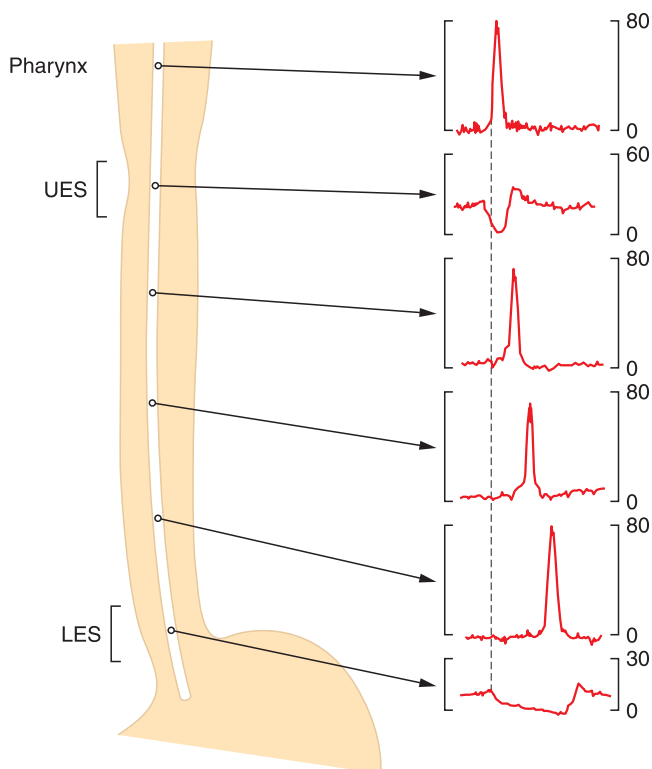
### The Esophagus

The esophagus extends from the pharynx at the level of C6 to the gastroesophageal junction. The hypopharynx courses from the level of the epiglottis to the upper border of the esophagus and funnels food into the esophagus. Swallowing begins as a voluntary process as food and liquid pass through the mouth, which initiates a complex and normally coordinated sequence of involuntary discharges through cranial nerves V, VII, X, and XII to the oropharynx and the esophagus. The upper third of the esophagus contains striated musculature, the lower third has smooth muscle, and the middle third has a mixed muscular supply. Motor innervation is supplied by the vagus nerves. Striated muscle is innervated by preganglionic fibers and smooth muscle by postganglionic fibers from the Auerbach plexus.

In adults, the upper esophageal sphincter (UES) is approximately 3 cm in length and consists of the cricopharyngeal muscle (striated), a portion of the inferior constrictor muscle superiorly, and circular esophageal muscles inferiorly.<sup>148,149</sup> The primary function of the UES is controlled by the swallowing mechanism in general, but its resting tone is increased in response to esophageal distension or acid from gastroesophageal reflux<sup>150</sup> and decreases during sleep.<sup>151</sup>

The lower end of the esophagus (3–5 cm in length) acts as a functional LES. Thickness of the smooth muscle layers increases in this area, and circular fibers develop considerable tension. Control of the LES tone is complex and chiefly results from vagal cholinergic and myogenic mechanisms, although prostaglandins,<sup>152</sup> neuropeptides (e.g., vasoactive intestinal peptide),<sup>153</sup> GI hormones (e.g., gastrin, motilin),<sup>154</sup> the progesterones and estrogens of pregnancy, and thyroid-stimulating hormone<sup>155</sup> are among substances known or suspected of affecting LES tone. Material enters the esophagus after voluntary propulsion by the tongue into the hypopharynx. With relaxation of the UES (resting tone, ap-





**FIGURE 55-1.** Esophageal manometry. Simplified representation of normal physiologic pressures in pharynx, upper esophageal sphincter (UES), esophagus, and lower esophageal sphincter (LES). On right, high-pressure zones are noted as the pressure catheter is withdrawn from stomach. On left, normal peristalsis occurs after a swallow, with relaxation followed by contraction and return to resting tone for UES and LES.

proximately 20–60 mm Hg), food enters the esophagus and is moved along by primary peristaltic waves (25–80 mm Hg). LES relaxation (resting tone, 10–20 mm Hg) occurs, and the bolus enters the stomach. This whole process takes only 4–8 seconds. Secondary peristaltic waves serve to move residual matter through and into the stomach. Figure 55-1 depicts normal esophageal motility.

### Acid Reflux and Hiatal Herniation

Reflux of material from the stomach into the esophagus is a complex topic and is covered in depth in other texts.<sup>156</sup> Criteria for diagnosis include

#### BOX 55-3.

##### Symptoms of Acid Reflux

- Water brash
- Heartburn
- Anginal type of chest pain
- Dysphagia
- Regurgitation with bending or in supine position
- Coughing or wheezing from aspiration
- Vagally induced bronchoconstriction

those of reflux symptoms (Box 55-3) and the results of various tests, including radiographic studies, endoscopy, biopsy, manometry, and prolonged esophageal pH monitoring. The pH test demonstrates that virtually all healthy subjects have episodes during daily activity when their esophagus is exposed to pH less than 4. This exposure is increased during awake upright activity, especially after eating, and

occurs during supine sleep activity,<sup>157</sup> when swallowing frequency is diminished and less effective (Table 55-1). Reflux is associated with pressure gradients between the abdomen (positive pressure) and the thorax (intermittently negative pressure) and with poorly understood episodes of “transient lower esophageal relaxation.”<sup>158-163</sup> pH testing also detects those patients with reflux of alkaline duodenal material into the stomach and esophagus.<sup>164</sup>

The etiology for increased exposure of the esophagus to acid material and ultimately to the risks of acid and particulate matter aspiration can involve one of several mechanisms (Box 55-4). The mechanical competence of the LES depends on intrinsic tone (normally greater than 5 mm Hg<sup>165</sup>), the overall length of the LES muscular segment (normally 3 cm or longer), the portion of that segment that is intra-abdominal (at least 1 cm), and interaction with the cardia of the stomach, which should transmit intraabdominal pressure to the distal LES.<sup>164,166-168</sup> The most common abnormality is decreased LES tone, but even normal LES tone can be affected by the other mechanisms.<sup>169</sup>

Esophageal clearance of reflux material depends on swallowing, gravity, intrinsic motor activity, salivation, and whether a hiatal hernia is present. Although the frequency of acid reflux may be greater during the day, the duration of episodes is longer when the patient is in the supine position because of loss of gravitational effects. Additionally, any disease that affects the motor activity of the esophagus may lead to impaired clearance of acid material (Box 55-5), with resultant ef-

**TABLE 55-1.**

Exposure of Esophagus to pH <4 (n = 50)<sup>a</sup>

Segment of 24 hour pH test	Mean	SD	95%
Total time (%)	1.51	1.36	4.45
Upright time (%)	2.34	2.34	8.42
Supine time (%)	0.63	1.0	3.45
Number of episodes/24 hours	19.00	12.76	46.90
Number of episodes >5	0.84	1.18	3.45
Longest episode (usually in supine position)	6.74	7.85	19.80

95%, asymptomatic volunteers; SD, standard deviation.

<sup>a</sup>This represents a “normal” level of reflux in healthy subjects. Those with gastroesophageal reflux disease have more “frequent” and longer episodes (>5 min) representing a greater % of time.

Modified from DeMeester TR, Stein HJ. Gastroesophageal reflux disease. In: Moody FG, ed. Surgical Treatment of Digestive Disease. Chicago: Year Book Medical Publishers, 1990:68.

**BOX 55-4.****Etiology of Acid Reflux**

Mechanically incompetent lower esophageal sphincter  
 Transient lower esophageal relaxation  
 Ineffective esophageal clearance of refluxed material  
 Abnormal gastric function

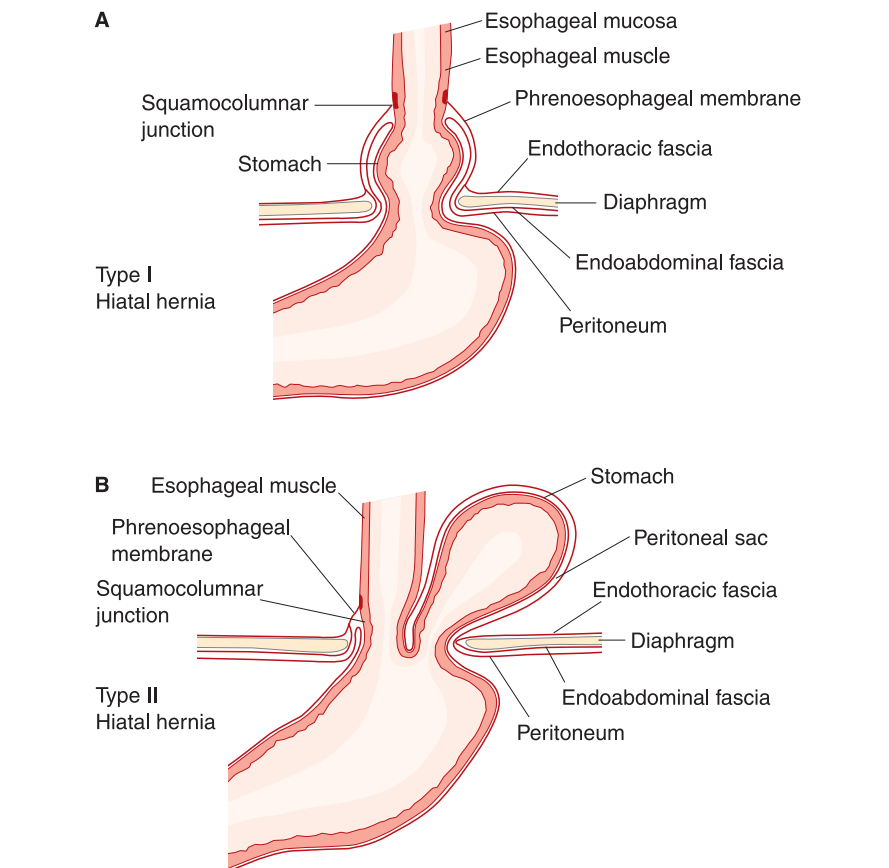
**BOX 55-5.****Diseases Affecting Esophageal Motility**

Achalasia  
 Alcoholic neuropathy  
 Brainstem lesions  
 Chagas disease  
 Diabetes mellitus  
 Familial dysautonomia  
 Myotonia dystrophica  
 Polymyositis and dermatomyositis  
 Scleroderma

fects on the esophageal mucosa and potential for aspiration.<sup>170</sup> Saliva is important in neutralizing the small amounts of acid refluxed with peristalsis even in healthy persons, and clearance of this acid is prolonged when saliva is removed by suctioning.<sup>171</sup> The salivation stimulated by heartburn (termed *water brash*) can lead to repetitive swallowing, aerophagia, and gastric distension with further reflux.<sup>172</sup> Perioperatively, the presence of a nasogastric/orogastric tube may contribute to reflux of gastric contents and the risk of aspiration, and has been challenged as a routine practice.<sup>173,174</sup>

The presence of a hiatal hernia is associated with additional abnormalities (Fig. 55-2). The hernia produces a defect in esophageal propulsion that results in inadequate acid clearance and longer transit time.<sup>175</sup> The retreat of all or part of the distal LES into the chest impairs the ability of the lower third of the LES, in concert with the cardia of the stomach, to impart extrinsic abdominal pressure and enhance sphincter function. If intrinsic LES tone also is decreased, a setup exists for major reflux of acid material and, ultimately, for the development of aspiration pneumonia. Despite this, most patients with hiatal hernias are asymptomatic.<sup>176</sup>

Certain abnormalities of gastric function also can result in acid reflux



**FIGURE 55-2.** Types of hiatal hernia. **A.** Type I sliding, or axial, hiatal hernia. **B.** Rarer type II rolling, or paraesophageal, hernia.

through a normal gastroesophageal junction or by exacerbating preexisting LES abnormalities (Box 55-6). Normally, the body and fundus of the stomach are able to adapt to a large volume of material with minimal increases in pressure, although a previous vagotomy interferes with the active relaxation necessary for this to occur, and greater intragastric pressures occur with lesser volumes.<sup>177</sup> Outlet obstruction of the stomach more obviously leads to increases in pressure, which occurs normally with vomiting, but also with pyloric stenosis in newborns and obstructing ulcers or tumors in patients of any age.

Delayed gastric emptying leads to persistence of gastric acid and food-

stuffs. The causes are varied<sup>156</sup> (Box 55-7) but yield a similar effect. As larger volumes accumulate and persist for a longer period, the potential for reflux through either a normal or abnormal LES increases. Approximately 40% of patients with gastroesophageal reflux have delayed gastric emptying,<sup>178,179</sup> and in approximately one third of these, the delay is clinically significant. Those rare patients with postviral gastroparesis also may have serious autonomic neuropathy.<sup>180</sup> Patients with various neurologic illnesses may manifest a variety of GI motility abnormalities.<sup>181</sup>

**BOX 55-6.****Abnormal Gastric Function and Acid Reflux**

Increased intragastric pressure  
 Delayed gastric emptying  
 Gastric dilation  
 Increased acid secretion

**BOX 55-7.****Delayed Gastric Emptying**

Myogenic abnormalities  
 Diabetic gastric atony  
 Diffuse neuromuscular disorders  
 Postviral gastroparesis  
 Postvagusotomy  
 Pyloric dysfunction  
 Altered duodenal motility

As the stomach dilates from any cause, the relationship between the cardia and abdominal portion of the LES changes, which results in decreased maintenance of proper LES tone and increased risk of reflux. In addition to the conditions already mentioned, aerophagia from several causes also may lead to gastric distension. Normally, each pharyngeal swallow results in several cubic centimeters of swallowed air. Patients with reflux may habitually swallow (some even chew gum to stimulate saliva) to clear acid and can develop air-induced gastric distension, which can exacerbate their reflux. Other patients with decreased saliva formation (e.g., with Sjögren syndrome) or after head and neck irradiation may swallow excessively with resultant aerophagia. Loss of secondary peristalsis, which can occur with diabetes mellitus and collagen vascular diseases, also leads to inordinate swallowing in an effort to propel food along, again with resultant aerophagia.

Gastric acid hypersecretion plays a role in some patients with gastroesophageal reflux who have a mechanically normal LES, and is a complicating factor in other patients with abnormal LES function.<sup>182–184</sup>

*The most serious acute consequence of acid reflux is the risk of aspiration of stomach contents. Chronic complications include esophagitis, stricture formation, Barrett esophagus (with risk of esophageal cancer), and chronic pulmonary disease from repeated episodes of aspiration. Aspects of surgical management are discussed next.*

### Surgical Procedures of the Esophagus

Several surgical procedures for patients with esophageal disease are worthy of specific mention, but an extensive discussion of all approaches is beyond the scope of this text.<sup>185,186</sup> Patient positioning, site of incision, and whether the esophagus will be transected are important to the anesthesiologist in all esophageal procedures.

Several approaches exist for the management of reflux disease.<sup>187</sup> The Nissen-type (360° gastric fundoplication) procedure may be approached abdominally (open or more commonly via laparoscopy) or through a left posterolateral thoracotomy. During the abdominal approach, severe liver retraction typically occurs, and the reverse Trendelenburg position is useful

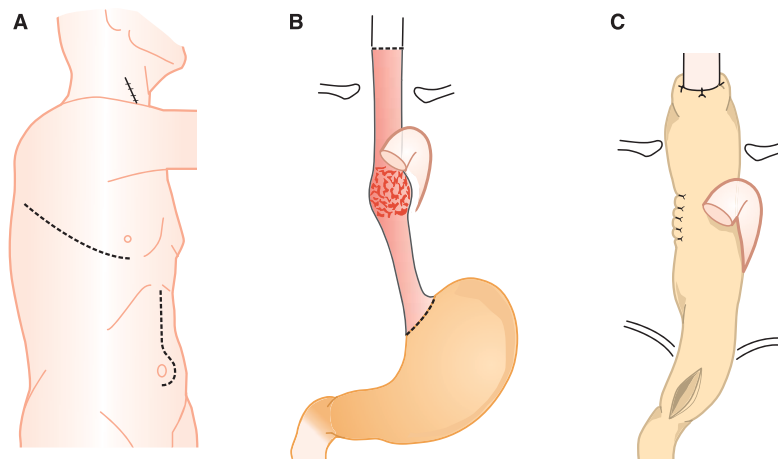
to the surgeon. The transthoracic approach may be used for repeat procedures, in obese patients, and when esophageal shortening is suspected. The Belsey-type (240° fundoplication) procedure also is approached from a left lateral chest incision. For any of these procedures, the anesthesiologist may be asked to pass a bougie through the pharynx into the distal esophagus to the area of surgical manipulation so that the repair can be sized. Should the restoration tend to slide back into the chest because the esophagus is too short, a lengthening procedure (e.g., colon interposition) may be required. Except for this latter maneuver, the esophagus is not transected for these procedures. Laparoscopic and robotically assisted laparoscopic surgeries have increased in quantity and complexity.<sup>188</sup> Because of restrictions in patient positioning and the shear mass of the robotic devices, access to the patient during these procedures may be suboptimal. Heightened awareness of the operative field is required by the anesthesiologist since the surgeon may be viewing only the video projection at a platform physically removed from the patient.

Several techniques are used for patients with esophageal cancer. For lesions of the distal esophagus, the Ivor-Lewis/McKeown-type repair (Fig. 55–3) includes an anterior abdominal incision followed by a right thoracotomy. The McKeown-type is similar but adds a right neck incision to facilitate the anastomosis of the stomach to the cervical esophageal remnant. Either procedure may include extensive node dissection

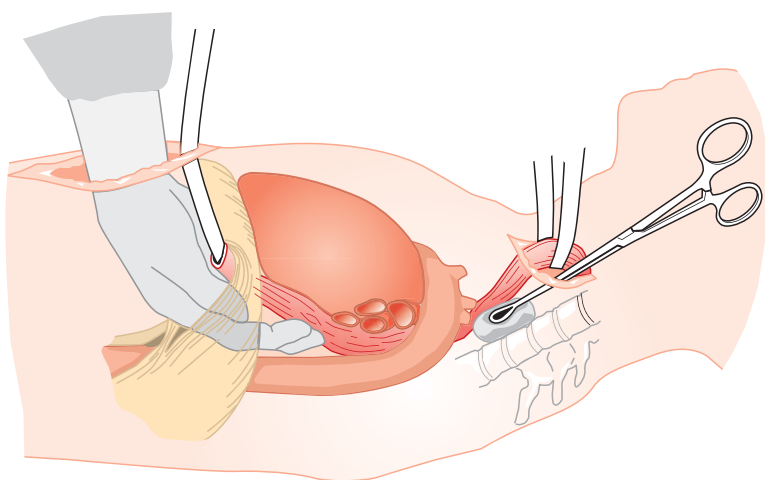
in the chest, entry into the pericardium or the opposite chest, and thoracic duct ligation. Single-lung ventilation may facilitate operative exposure. Blunt esophagectomy (Fig. 55–4) is used for cervical esophageal disease, for lower-third esophageal carcinoma, and in early noninvasive disease. Abdominal and left cervical incisions are made, and extensive, “blind” bimanual dissection through the chest is performed. Bleeding or tracheal injury may necessitate an emergent thoracotomy. Postoperative recurrent nerve injury is described in 10% of patients.<sup>189</sup>

### Peptic Ulcer Disease and Duodenal and Gastric Carcinoma

Millions of Americans have symptoms of acid and peptic ulcer disease,<sup>190</sup> and annual direct and indirect costs exceed \$3.4 billion.<sup>191</sup> Duodenal ulcer disease (DUD) occurs 2–3 times more often in men than in women, and mortality rates may be somewhat greater in nonwhites ages to about 65 years. Genetic (e.g., family history, blood group O, human leukocyte antigen [HLA] types B<sub>5</sub> and B<sub>12</sub>) and environmental (e.g., smoking, aspirin, nonsteroidal antiinflammatory drugs [NSAIDs]) factors are involved in DUD. Chronic pulmonary disease, cirrhosis, renal transplantation, and possibly high psychological stress also may increase the incidence of ulcer disease. Resting and stimulated secretion of acid are increased<sup>192,193</sup> in common DUD, and in patients with gastrinoma (Zollinger-Ellison syndrome—see Gastrointestinal Endocrinology). The



**FIGURE 55–3.** Ivor-Lewis/McKeown-type esophagectomy. After abdominal mobilization of stomach, the chest and neck are explored concurrently to allow total esophagectomy and cervical esophagogastrostomy.



**FIGURE 55-4.** Blunt esophagectomy. Maneuvers necessary for this procedure are capable of causing serious hemodynamic and ventilatory compromise and require appropriate monitoring of blood pressure and respiration.

number of parietal cells secreting acid may be increased. The rapid emptying of stomach contents in some patients with DUD may overwhelm duodenal buffering and clearance mechanisms. Because these patients appear to have reduced duodenal bicarbonate secretion,<sup>194</sup> they are predisposed to ulceration.<sup>195</sup>

Gastric ulcers occur only one third to one fifth as often as duodenal ulcers, and causal factors in gastric ulcer disease (GUD) are largely unrelated to those for DUD. Genetic, psychological, and hypersecretion of acid are not factors for most patients. The largest group of patients with GUD have normal-to-low secretion of acid and evidence of decreased gastric mucosal defenses against acid and pepsin-related endothelial injury. GUD tends to occur in older patients, and possibly as a result, this mortality rate is higher. GUD is associated with gastritis and with gastric carcinoma. Aspirin is clearly a risk factor,<sup>196</sup> as may be NSAIDs; both are thought to work via inhibition of prostaglandin synthesis. Pyloric function may be defective in patients with GUD, permitting reflux of duodenal, biliary, and pancreatic secretions into the stomach, initiating gastritis, and, ultimately, ulcerations.<sup>197</sup> Smoking reduces pyloric sphincter tone and increases the risk of bleeding from ulcers.<sup>198</sup> DUD and GUD are associated with *Helicobacter pylori* infection<sup>199</sup> and elimination of *H. pylori* is a focus of treatment.

### Medical Treatment

The medical treatment of patients with ulcer disease involves dietary

and environmental restrictions (e.g., avoiding aspirin, NSAIDs, smoking, alcohol; limiting caffeine, anxiety) and medication. Antacids, H<sub>2</sub>-receptor antagonists, and coating agents (e.g., sucralfate) are useful in patients with DUD or GUD. Protein pump (H, K-ATPase) inhibition (e.g., omeprazole) has become important as an extremely potent inhibitor of gastric acid secretion in the patient with DUD. Exogenous prostaglandins ultimately may have a role. Bleeding patients undergo endoscopic procedures with the potential for cauterization. At arteriography, selective administration of vasopressor (e.g., vasopressin into the left gastric artery) or embolization may be warranted. Multiple trials support the suppression of acid production in the critically ill patient, especially those receiving anticoagulation or on mechanical ventilation. However, there is insufficient data to support proton pump inhibitors over H<sub>2</sub> antagonists, but in the acutely bleeding patient, proton pump inhibitors are quite effective as prophylaxis and superior to H<sub>2</sub> antagonists.<sup>200</sup>

### Surgical Treatment

Several procedures and variations are performed for the management of DUD (Box 55-8). Duration of symptoms, gastric outlet obstruction, perforation,<sup>201</sup> and hemorrhage impose specific considerations, as do various known complications of these procedures (Box 55-9). For example, after a truncal or selective vagotomy, approximately 20% of patients will have clinically impaired gastric emptying if a drainage procedure also is not performed.<sup>202</sup>

#### BOX 55-8.

##### Surgical Management of Duodenal Ulcer Disease

Vagotomy with drainage via pyloroplasty or gastrojejunostomy  
 Vagotomy with antrectomy (hemigastrectomy) and gastroduodenostomy (Billroth I) or gastrojejunostomy (Billroth II)  
 Subtotal gastrectomy and Billroth I or II

Erosive gastritis is a common problem. Therapy involves appropriate blood and volume resuscitation, gastric irrigation with saline, and instillation of antacids. When bleeding does not stop or recurs, endoscopic evaluation and cauterization may suffice. If not, angiography may allow visualization of the damaged vessel for embolization or continuous infusion of intraarterial vasopressin.<sup>203</sup> Surgical procedures for hemorrhagic gastritis are required in 10–20% of patients. No single technique is considered the procedure of choice, and decisions regarding the nature of the procedure selected may require open visualization of the focal versus diffuse nature of the bleeding. Total gastrectomy, partial gastrectomy with vagotomy, vagotomy and pyloroplasty, devascularization, and simple oversew procedures all have advocates.<sup>204–206</sup>

Surgical therapy for patients with gastric ulcer generally involves ulcer removal and antrectomy (i.e., distal gastrectomy) with direct anastomosis to the duodenum (Billroth I procedure). Unless features of hypersecretion of acid exist, a vagotomy generally is not performed. Perforation can be managed with excision and simple closure in debilitated elderly patients or more definitively in younger stable patients. If malignancy is encountered, an appropriate procedure should be performed.

#### BOX 55-9.

##### Complications of Procedures for Duodenal Ulcer Disease

Abdominal fullness and pain  
 Nausea  
 Heartburn  
 Reflux and regurgitation  
 Bile and food emesis  
 Dumping syndrome  
 Diarrhea



Gastric carcinoma generally is divided into two broad categories. Early carcinoma is confined to the gastric mucosa or submucosa, regardless of size or of lymph node seeding. Many of these patients are curable surgically. A subtotal gastrectomy is warranted for localized disease, and a total gastrectomy is needed for more extensive involvement. Surgical therapy for advanced gastric carcinoma is generally less successful because less than 10% of patients survive 5 years.<sup>207</sup> Procedures vary as to the extent of gastric resection and to the aggressiveness of lymph node and adjacent organ resection.<sup>208–211</sup> Some studies suggest improved survival for patients undergoing palliative resections even when a cure is not possible.

### Cholecystitis, Gallstone Disease, Cholecystectomy, and Biliary Disease

Approximately 20 million Americans have cholelithiasis, and another 800,000 are diagnosed with it each year.<sup>212</sup> Many predisposing factors exist (Box 55–10). The three basic types of gallstones are cholesterol, pigment, and mixed. The last category represents approximately 75% of all affected patients. Catalysts for stone formation include decreased gallbladder motility with stasis, increased gallbladder mucous secretion, altered epithelial ion transport, and possibly increased gallbladder synthesis of prostaglandins<sup>213</sup> and increased biliary calcium.<sup>214,215</sup>

#### Diagnosis

Clinical cholecystitis is classically associated with obstruction of the cystic duct (e.g., from stone, edema, sludge, fibrosis) and subsequent epithelial injury, enzyme release, and inflammatory response.<sup>216</sup> In approximately 75% of patients, cholecystitis is self-limiting and resolves over approximately 1 week, but 5–10% of patients develop serious complications, including empyema, cholangitis, gangrene, or perforation. Positive cultures are found in approximately 20–30% of patients younger than 50 years of age, in greater than 50% of patients older than 70 years of age,<sup>217</sup> in 20–40% of those with chronic disease, and in 60–70% of those with acute cholecystitis.<sup>218,219</sup> Gram-negative organisms predominate. An overriding focus in evaluating patients is detecting cystic duct obstruction. Abdominal ultrasonography is extremely

#### BOX 55–10.

##### Factors Associated with Increased Incidence of Gallbladder Disease

- Increased age
- Female sex
- Pregnancy
- Obesity
- Hemolysis
- After truncal vagotomy
- Long-term parenteral nutrition
- Pima Indian

useful in detecting cholelithiasis and technetium scans in detecting cystic duct obstruction (even in patients with elevated bilirubin levels). Plain abdominal films, oral cholecystography, and IV cholangiography are more limited as diagnostic tools.

#### Treatment

Oral therapy using deoxycholic acid analogues results in cholelitholysis because of their ability to decrease the rate-limiting enzyme in cholesterol synthesis, coenzyme A reductase.<sup>83</sup> This is effective in some patients. Although it is recognized that asymptomatic gallstones frequently exist, management options are debated. Some studies document that about one third of these patients will develop complications requiring urgent surgery.<sup>220,221</sup> Others note that morbidity and mortality are lower after elective procedures in younger patients,<sup>181,222</sup> although most suggest that routine prophylactic cholecystectomy for asymptomatic disease is not required.<sup>223</sup>

Cholecystectomy generally is performed within several days of onset of symptoms. Approximately 25% of patients develop recurrent cholecystitis if surgery is delayed, and 1 in 8 will require emergency cholecystectomy.<sup>224–226</sup> Despite the risks associated with older patients, conservative management (e.g., delayed surgery) in the elderly population may be inadvisable; gallbladder empyema, perforation, sepsis, and cardiovascular complications occur more often in this group.<sup>227–229</sup>

Lithotripsy with high-frequency shock waves disintegrates some gallstones. General anesthesia usually is not needed, but sedation and analgesia with appropriate monitoring are required.<sup>230</sup> Although laparoscopic cholecystectomy<sup>25</sup> has become the staple of gallbladder removal, management considerations are

#### BOX 55–11.

##### Effects and Complications Associated with Laparoscopy

- Altered ventilatory dynamics caused by large volume of intraabdominal carbon dioxide (CO<sub>2</sub>)
- Hypercapnia from CO<sub>2</sub> absorption
- Decreased venous return from increased intraabdominal pressure/patient position
- Venous CO<sub>2</sub> embolism, intraoperatively and in early postoperative period
- Abnormal gastroesophageal junction competence from high intraabdominal pressure
- Effects of patient positioning

similar to those of any laparoscopic procedure (Box 55–11).

Open laparotomy is generally reserved for more complicated considerations (e.g., abscess, perforation, need for intraoperative cholangiogram or bile duct exploration, suspected anatomic abnormalities, obesity). In addition, laparotomy remains the back-up procedure for other procedures that fail or for patients with complications. Surgical manipulation of the abdominal viscera has been associated with various circulatory changes, including bradycardia and hypotension.

#### Biliary Tract Cancer

As many as 2000 new cases of gallbladder carcinoma may be seen in the United States annually. Patients are likely to be elderly women who have associated gallstones. Because of early metastasis, most patients are unresectable at presentation, and their 5-year survival rate is extremely low. Patients with microscopic disease have a much better prognosis. Palliative procedures are difficult for those with advanced disease; biliary decompression stents are placed for bile drainage.

Extrahepatic bile duct cancer survival rate depends on the location of the tumor. Survival improves from proximal to distal common duct sites and is best with a papillary morphology. Patients may undergo one or more laparotomies before arrival at a tertiary/definitive treatment center. Surgical management generally involves some form of biliary-enteric anastomosis (e.g., Roux-en-Y hepaticojejunostomy, Roux-en-Y choledochojejunostomy, Whipple procedure, palliative Silastic tube drainage) depending on the tumor's location.

### Strictures of the Biliary Tract and Sclerosing Cholangitis

Benign strictures of the biliary tract result from various causes, including surgical trauma, inflammation from calculi, biliary tract infection (e.g., bacterial cholangitis), blunt or penetrating abdominal trauma, toxic injury during hepatic arterial infusion therapy, and sclerosing cholangitis. Eighty percent of patients have symptoms within 1 year of the associated surgery or trauma.<sup>231</sup> Symptoms and signs include abnormal biliary drainage or bile leakage immediately postoperatively and variable evidence of biliary obstruction and abnormal liver function in all patients. Painless jaundice and cholangitis are seen less often. Cholangiography should define biliary tree anatomy, and the placement of a ring catheter permits drainage and management of infection preoperatively.

When patients have an acute stricture after surgery, operative treatment may consist of the resection of a short segment of bile duct or a segmental duct ligation. More involved injuries usually demand creation of a Roux-en-Y jejunal limb and T-tube of transhepatic drainage catheters. Later in the postinjury period, extensive adhesions often are present, necessitating tedious dissection. Again, surgical management requires creation of a Roux-en-Y loop and decompression via T-tube, ring catheter, or a transhepatic Silastic stent.

## BARIATRIC PROCEDURES

Ten percent of all health costs in the United States are related to treating obesity and obesity-related complications.<sup>232</sup> Perioperative care of the extremely obese (body mass index [BMI] > 40 kg/m<sup>2</sup>) presents multiple challenges. A myriad of comorbidities including obstructive sleep apnea, diabetes, dyslipidemia, hypertension, atherosclerosis, cardiomyopathy, colicystitis, nonalcoholic steatohepatitis, and certain cancers<sup>233</sup> make this a formidable group of patients.

Bariatric surgery refers to procedures of the stomach or intestines designed to result in weight loss. Initial attempts at such surgery (e.g., jejunoileal bypass) induced malabsorption and rapid weight loss, but the resulting blind loop syndrome limited its long-term acceptability. Some advo-

cate adjustable gastric banding, whereas others advocate a procedure involving the so-called duodenal switch. Variations on the theme of a Roux-en-Y gastric bypass may be the most frequently employed method in the United States. With the advent and increasing use of laparoscopic approaches, the early postoperative course and recovery have been greatly improved. Ultimately, the goal has been to balance restriction of food intake and malabsorption for enhanced patient acceptance and success of therapy.<sup>234</sup> Even endoluminal and transgastric procedures are now being performed.<sup>235</sup>

Peripheral venous access is often difficult or impossible and central venous access is required. Central access can be very challenging because of an inability to properly appreciate anatomical landmarks; however, such access has been greatly facilitated by use of ultrasound guidance.<sup>236,237</sup> Measurement of an accurate blood pressure usually requires invasive access. Unsurprisingly, the physical mass of the extremely obese patient requires appropriate bed selection and positioning because of the risk of compression neurologic injuries.<sup>238</sup>

One misconception associated with anesthesia for the extremely obese involves airway management; with increasing bariatric surgical experience, extreme obesity no longer is an independent risk factor for difficult intubations. In more than 750 patients without airway pathology, no correlation between BMI and difficult intubation was noted.<sup>239</sup> In fact, of 100 direct laryngoscopies of patients with BMI > 40 kg/m<sup>2</sup>, only 1 intubation failed and only 12 intubations were deemed challenging (not significantly different from the general population).<sup>240</sup> Morbidities associated with obstructive sleep apnea include hypoxemia, pulmonary hypertension, and cor pulmonale.

Extreme obesity is associated with significant cardiovascular perioperative risks. More than 50% of these patients are hypertensive.<sup>241</sup> (See Chap. 22 for a detailed discussion of the preoperative assessment of the obese patient.) The Framingham study indicated that for every increased increment in body mass index (weight in kg/height in m<sup>2</sup>), a 5–7% increase risk of congestive heart failure exists.<sup>242</sup> An “X” syndrome of massive obesity that includes glucose intolerance, hypertension, hyperlipidemia, and microalbuminemia has

been described; it is strongly associated with coronary artery disease.<sup>24</sup> Such findings suggest the potential positive benefits of bariatric surgery: for example, for every kilogram of weight loss, systolic pressure decreases 0.5%, serum glucose decreases 0.2 mM, low-density lipoprotein cholesterol decreases 0.7%, and high-density lipoprotein cholesterol increases 0.25.<sup>244</sup> In spite of these potential long-term benefits, bariatric surgery still contains significant perioperative risk: mortality 1.5%, pulmonary embolism 1.14%, and small bowel obstruction and anastomotic leaks 3% each.<sup>245</sup> In addition, there are both short- and long-term metabolic and nutritional issues that vary with the procedure type and can be of concern.<sup>246,247</sup>

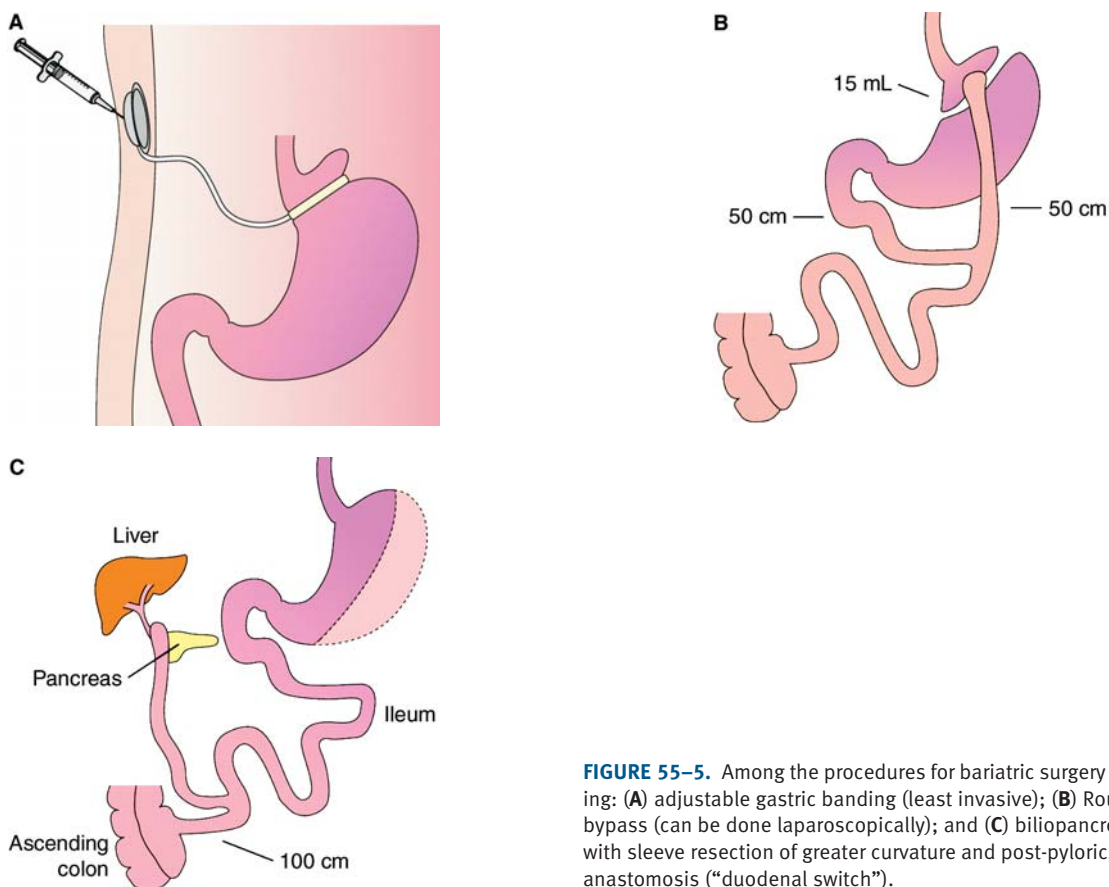
Mean weight loss for patients undergoing all forms of bariatric surgery has been reported to be approximately 61% of excess body weight, and maintenance of weight loss far exceeds that from medical treatments alone. Significant improvements in diabetes, hyperlipidemia, hypertension, and obstructive sleep apnea are usually expected. Improvements in other comorbidities, such as fatty infiltration of the liver, respiratory and asthmatic symptoms, and cardiomyopathy are more modest. Emerging studies suggest a reduction in mortality associated with bariatric surgery and a clear improvement in quality of life.<sup>234,248</sup> and many consider such surgery the only cure for morbid obesity (Fig. 55–5).

## The Pancreas and Surgery

### Pancreatitis

Although the treatment of acute pancreatitis is primarily medical, surgery may be required for such conditions as draining an abscess. Emerging evidence suggests that early surgery may not be as high a risk as previously thought.<sup>249</sup> Patients with pancreatitis are extremely ill with severe abdominal pain and may have fever, nausea and vomiting, jaundice, hypotension, ileus, and external distortion of the stomach on radiographs. Management includes nasogastric suction, maintenance of intravascular volume, anticipation of respiratory insufficiency,<sup>250–252</sup> analgesia, and nutritional support.

The patient with chronic pancreatitis may have incapacitating upper abdominal pain radiating to the back, which can be continuous or intermittent, especially after eating. Forty percent of pa-



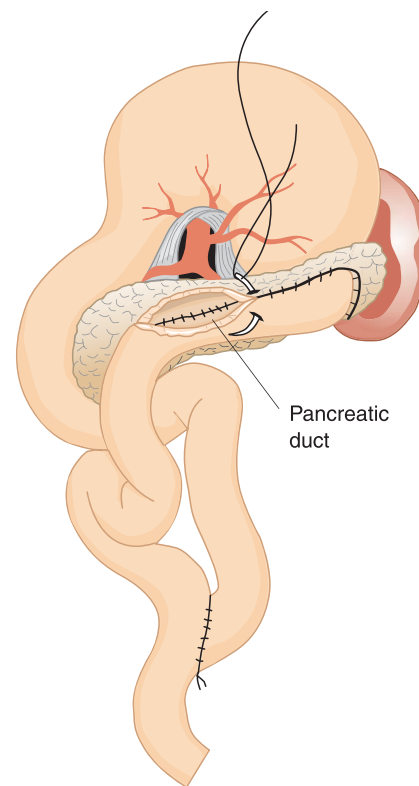
**FIGURE 55-5.** Among the procedures for bariatric surgery are the following: **(A)** adjustable gastric banding (least invasive); **(B)** Roux-en-Y gastric bypass (can be done laparoscopically); and **(C)** biliopancreatic diversion with sleeve resection of greater curvature and post-pyloric, duodenoileal anastomosis (“duodenal switch”).

tients have diabetes from loss of pancreatic tissue.<sup>253</sup> Exocrine function may be sufficiently abnormal to require pancreatic enzyme replacement. Obstructions, strictures, and dilations of the pancreatic ductal system are thought to produce the pain through sympathetic pathways. Several surgical procedures have evolved to decompress the ducts and remove damaged pancreas. A caudal pancreatojejunostomy<sup>254</sup> uses a Roux-en-Y loop to decompress the tail of the pancreas. With the Puestow-type<sup>255</sup> procedure (Fig. 55-6), the Roux-en-Y limb envelops the pancreas distally, allowing pancreatic ducts to be opened longitudinally for drainage into the loop. For both of these procedures, a splenectomy and excision of the tail of the pancreas are necessary for technical reasons. A modification of the Puestow procedure<sup>256</sup> (Partington procedure) allows the tail of the pancreas and the spleen to be spared. Postoperatively, some patients require insulin and pancreatic enzyme replacement. Other patients with severe chronic pancreatitis require a near-total pancreatectomy or a pancreatoduodenectomy to remove sufficient tissue to relieve pain. Patients with pseudocyst of the pancreas require

drainage of the cyst through a Roux-en-Y loop or directly into the stomach. Alternatively, a distal cyst may be removed by a partial pancreatectomy.

### Other Conditions

Cancer of the pancreas and periampullary area is a frequently diagnosed problem with, unfortunately, an increasing incidence. Approximately 25,000 patients are diagnosed each year in the United States. Diagnosis usually is suggested by ultrasonography or computed tomography. Magnetic resonance imaging, endoscopic retrograde cholangiopancreatography, or percutaneous transhepatic cholangiography may yield information concerning the site and etiology of bile duct obstruction. Percutaneous fine-needle aspiration biopsy may be performed with the aid of ultrasound examination or computed tomography. Despite this array of tests, determination of the extent of disease and often the tissue diagnosis should await a thorough intraoperative examination. Only then can the necessary procedure be decided. The cure rate is 5% or less, largely because of relatively vague and general symptoms before



**FIGURE 55-6.** Puestow procedure: lateral or longitudinal pancreatojejunostomy. Roux-en-Y limb of jejunum is sutured to open pancreatic duct along its length.

the onset of jaundice, which greatly narrows the diagnostic possibilities. By the time the diagnosis is suspected, the lesion may be unresectable. Because only small lesions of the head of the pancreas or ampullary area are resectable and because many of the remaining patients still require a palliative procedure to relieve obstructive jaundice, a considerable number of these patients undergo laparotomy.

Most procedures aimed at a cure are termed a *pancreatoduodenectomy* (Fig. 55-7; i.e., Whipple procedure). Variations include total pancreatectomy, regional pancreatectomy, and similar procedures that preserve the pylorus of the stomach. *These are long, extensive bowel resections that cause considerable morbidity. Serious postoperative complications include hemorrhage, coagulopa-*

*thy, and hepatic, renal, pulmonary, and cardiovascular failure.*

Endocrine disease of the pancreas also is managed surgically. An insulinoma is the most common of these diseases. Because this tumor secretes insulin autonomously, spontaneous hypoglycemia is seen, with symptoms caused by decreased blood sugar levels and the resultant burst of catecholamine release. The differential diagnosis for hypoglycemia is extensive, but once insulinoma is diagnosed, management is surgical. Benign tumors are either enucleated or resected with a margin of pancreas. When no tumor is found at laparotomy, a distal or near-total pancreatectomy is performed, depending on the histology. Malignant disease may be surgically debulked with subsequent chemotherapy.

The Zollinger-Ellison syndrome results from a pancreatic or duodenal tumor (gastrinoma) that secretes excessive gastrin. Symptoms usually are abdominal pain and possibly diarrhea. Associated endocrinopathies include multiple endocrine neoplasia syndrome type 1 (MEN 1: parathyroid, pituitary, adrenal) and MEN 2 (medullary carcinoma of the thyroid, parathyroid adenoma, pheochromocytoma). Medical management involves  $H_2$ -receptor antagonists or proton pump blocker therapy. Surgical management involves vagotomy and pyloroplasty when no tumor is discovered at laparotomy or major resection procedures when a localized tumor is found. The presence of metastatic disease and MEN syndromes dictates medical therapy.

Other endocrine tumors of the pancreas include VIP (VIPoma), glucagonoma, and somatostatinoma. Surgical considerations are similar to those for insulinoma and gastrinoma (see Gastrointestinal Endocrinology).

### Pancreas Transplantation

Pancreas transplantation (PTX)<sup>257</sup> has become a surgical treatment for type 1 diabetes mellitus.<sup>258</sup> Most patients receive their PTX with or shortly after a renal transplantation, although some have received a pancreas before becoming uremic (such treatment is controversial).<sup>259</sup>

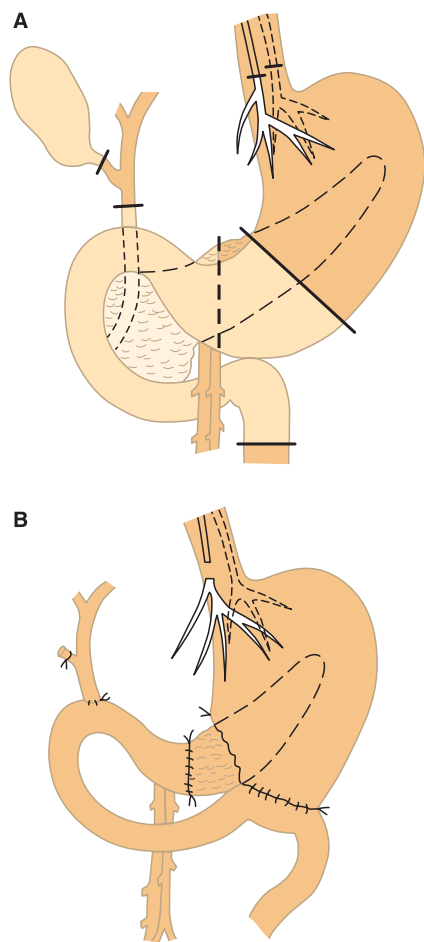
Evaluation of patients before PTX includes extensive assessment of the cardiovascular system because the incidence of coronary artery disease in young diabetic patients with end-stage

renal disease is high.<sup>260</sup> Active infection (e.g., dental abscess, peritonitis, osteomyelitis, decubitus ulcers) should be sought and managed before transplantation. Secondary diabetic complications (e.g., retinopathy) should be documented and quantified in an effort to gauge the effects of the transplant process on their progression. Recipient contraindications include malignancy and active infection, with concern for those with blindness, advanced cardiovascular disease, and major amputation.

Donor organs typically come from patients younger than 55 years of age without major atherosclerosis of the celiac axis, abdominal contamination, pancreatic injury or pancreatitis, or diabetes. Neither donor serum glucose nor amylase appear to have predictive value for ultimate function in the recipient.<sup>261</sup> Earlier competition between harvesting teams for the liver or pancreas has been largely resolved by techniques permitting simultaneous retrieval of the liver and the pancreas.<sup>262,263</sup>

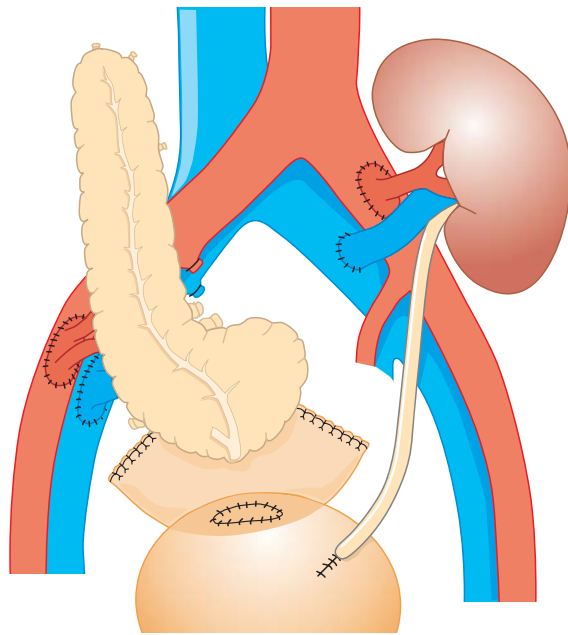
There are several approaches to implanting the pancreas. Some drain the pancreas enterically via a Roux-en-Y loop.<sup>264,265</sup> Reexploration is frequent with this procedure because of a high incidence of complications. Assessment of organ function and rejection is difficult.<sup>266</sup> Other centers perform PTX via a bladder drainage procedure (Fig. 55-8). Some use direct draining of the pancreatic duct into the ureter or bladder, whereas others use a small "button" of duodenum or a closed duodenal segment for union with the bladder. Vascular anastomoses are with the iliac vessels, similar to a renal transplantation. Hypertension, abnormal renal function, and all the sequelae of diabetes mellitus and its management make this a challenging group of patients.

Perioperatively, patients undergoing PTX need to have appropriate cardiovascular monitoring and a regimented approach to managing serum glucose levels. This may entail insulin infusion protocols and frequent intraoperative glucose determinations in an attempt to prevent hypoglycemia and hyperglycemia. Glucose-containing solutions are avoided unless the glucose level is lowered to less than 60 mg/dL. With reperfusion of the new pancreas, a dramatic increase occurs in blood sugar levels for reasons not entirely understood, so it is also prudent to monitor glucose levels frequently for



**FIGURE 55-7.** Pancreatoduodenectomy (Whipple procedure). **A.** Presurgical anatomic relationships. **B.** Reconstruction demonstrating biliary, pancreatic, and gastric anastomoses. If distal stomach and pylorus are preserved, truncal vagotomy is unnecessary. Gallbladder is removed if diseased.





**FIGURE 55–8.** Pancreas transplantation. Pancreas transplanted with bladder drainage via a pancreatic duodenocystostomy. Concurrent renal transplantation also is depicted.

1328

the first hour or so after reperfusion. Postoperatively, the patient is treated in an intensive care setting.<sup>267–269</sup> (See Chap. 58 for an in-depth discussion of pancreas transplantation.)

### SMALL BOWEL TRANSPLANTATION

Because of extremely poor outcomes in patients with extensive bowel resection for acute and chronic disease and because of success in other solid-organ transplantation, small bowel transplantation has been pursued by a few selective academic centers. Candidate patients have intestinal failure and have significant complications from total parenteral nutrition. Furthermore, these patients have one of the highest mortality rates of any patients waiting for solid organs.<sup>270</sup> Candidate organs are difficult to acquire because the intestine is sensitive to pressor-induced ischemia that may occur during aggressive intensive care both before and after brain-death declaration. (See Chap. 58 for a detailed discussion of small bowel transplantation.)

Small bowel transplantation may be coupled with liver or en bloc visceral organ transplantation. Anesthesia for small bowel transplantation with liver or en bloc visceral transplantation is

similar to orthotopic liver transplantation. (See Chap. 56 for a detailed discussion of liver transplantation.) For isolated small bowel transplantation, significant lysis of adhesions and vascular anastomoses require adequate perfusion pressure and fluid resuscitation.<sup>271</sup>

Surgical technique of en bloc visceral transplantation and the exclusion of the colon aided the improvement of small bowel transplantation.<sup>271</sup> But the greatest advances, as with other solid-organ transplantation, have occurred because of improvements in immunosuppression, which have led to longer organ and patient survival. Tacrolimus, mycophenolate, rapamycin, dclizumab, alemtuzumab, interleukin-2 antagonists, and steroids represent novel increments in immunosuppression developed in the last 20 years. Others have used donor bone marrow infusion with ex vivo graft irradiation as adjuvant therapies to improve small bowel survival.<sup>271,272</sup>

Preoperative screening and aggressive therapy for cytomegalovirus and Epstein-Barr virus are also important considerations for extending organ and patient survival.<sup>273,274</sup>

### Gastrointestinal Bleeding

GI bleeding often represents a major diagnostic and therapeutic challenge.

Initial signs may be hematemesis, melena, hematochezia, or occult blood in the stool. As little as 60 mL loss per day can result in a black stool, and less than 10 mL can result in a positive Hemoccult test. Many patients with GI bleeding are elderly or debilitated, and symptomatic hemorrhage causes major stress to other organ systems (e.g., cardiac, renal, central nervous).

### Upper Tract Bleeding

The list of potential etiologies for upper GI hemorrhage is lengthy, but the four most common causes appear to be peptic ulcer disease, erosive gastritis, esophageal varices, and Mallory-Weiss tears of the esophagus.<sup>275</sup> Other causes include malignancy, blood dyscrasias, hemostatic disorders, aortoenteric fistulas, Dieulafoy syndrome, and collagen vascular diseases. In one series, 12% of patients with upper GI bleeding had chronic renal failure and bled from angiodysplastic lesions of the stomach and duodenum.<sup>276</sup> *It usually is stated that if the patient's systolic pressure is less than 100 mm Hg, with a pulse greater than 100 beats/min (i.e., a loss of 2 or 3 units or more of blood) and red or maroon stools, then the mortality rate is greater than 20% and surgical intervention is necessary in more than 50% of patients.*<sup>277</sup> Chronic lung, renal, cardiac, and liver disease and age older than 60 years add to this burden.

Diagnosis is aided by esophagogastroduodenoscopy in the first 24 hours. Management includes volume replacement and attention to illness in other systems. Some patients may receive parenteral vasopressin, such as an arterial infusion after angiography locates a bleeding ulcer or Mallory-Weiss tear, or an IV infusion for variceal bleeding. Varices often can be controlled with a Sengstaken-Blakemore tube, usually in preparation for more definitive management, such as sclerotherapy. Vasopressin often is still infusing when patients arrive for surgery to control bleeding. Vasopressin increases splanchnic and hepatic arteriolar resistance while decreasing portal venous pressure and hepatic blood flow. After a bolus dose, effects may last for approximately 1 hour.<sup>278</sup> Worrisome side effects of vasopressin include coronary artery vasoconstriction with myocardial infarction, a potential complication of its use in patients with myocardial ischemia.<sup>279</sup> Intestinal and extremity ischemia also can occur.<sup>280,281</sup>

### Lower-Tract Bleeding

The more frequent causes of lower GI bleeding are anorectal polyps, colonic polyps, colorectal cancer, inflammatory bowel disease, submucosal angiodysplasia, and diverticular disease. In children, juvenile polyps, Meckel diverticulum, and arteriovenous malformations are additional causes. Because the bleeding often is intermittent, diagnostic evaluation may be frustratingly negative. Endoscopy, radiographic examinations, and selective angiography are among the diagnostic and therapeutic (e.g., electrocoagulation, embolization) modalities. Technetium-99m-labeled erythrocyte scans appear to be useful for slow, recurrent, lower GI bleeding.<sup>282</sup> Surgical procedures are directed toward the suspected diagnosis. Infrequently, when troublesome and symptomatic bleeding persists without a diagnosis, laparotomy may be undertaken for intraoperative endoscopy.

### Obstructive Disease

Impaired GI transit results from various conditions causing pseudoobstruction (i.e., decreased motility) and paralytic ileus and those producing varying degrees of mechanical obstruction (Box 55-12). Considerable variation exists within each of these broad categories, and associated illness can be extensive.

Pseudoobstruction and paralytic ileus generally represent intestinal motility disorders, and the list of causes is long (Box 55-13).<sup>283</sup> Patients with pseudoobstruction usually have an insidious clinical course that evolves over months and years for the primary disease and for any coexisting GI manifestations. In general, remissions and exacerbations often occur.

Paralytic ileus tends to be acute in onset and to develop in patients with no suspected predisposing disease process. Although probably caused by neurohumoral mechanisms, paralytic ileus is not well understood. *The most common ileus is that seen after intraabdominal operations.*<sup>56</sup> Length of hospitalization following abdominal surgery depends on several factors including pain control, presence of mechanical devices (drains, catheters, and intervenous tubes) and postoperative ileus. In 2000, the Health Care Financing Administration demonstrated that 161,000 Medicare patients underwent major intraabdominal operative procedures costing more than \$1 billion. Postoperative

#### BOX 55-12.

##### Causes of Impaired Intestinal Transit

Impaired motility  
Pseudoobstruction  
Paralytic ileus  
Mechanical obstruction

ileus has the potential to play a significant role in length of hospitalization, morbidity, mortality and cost.

Normal gastrointestinal motility is an integration of smooth muscle contraction, neural input, hormonal signals, and an enteric nervous system. The digestive system has as many neurons (Auerbach and Meissner plexus) as the spinal cord. After an intraabdominal operation, the electrical disorganization and ineffective coordination of propulsion characterizing an ileus usually resolves after 4–5 days.<sup>284</sup> *The small intestine usually recovers motility within a few hours.*<sup>285</sup> *The stomach resumes its ability to empty after about 24 hours, but the colon may not regain effective motility for 48 hours or longer.*<sup>286–289</sup>

Physical manipulation of the abdominal viscera, opioids, catecholamines, and inhalational anesthesia decrease bowel motility.<sup>290</sup> To date, there is no specific treatment for postoperative ileus. Nasogastric tubes historically have been inserted to reduce pulmonary complication, hasten bowel function return, increase patient comfort, and shorten hospital stay. In fact, a Cochrane analysis (4194 patients, 2108 routine nasogastric tube, 2087 no or selective tubes) demonstrated that *not* having a nasogastric tube after a procedure hastened return of bowel function ( $P < 0.001$ ) and marginally decreased pulmonary complication ( $P = 0.07$ ).<sup>291</sup> Early ambulation is an inexpensive therapy that decreases risk of thromboembolism and may be psychologically helpful for patients, but does not appear to benefit patients in resolution of postoperative ileus.<sup>292</sup> In 1928, Steinbrok et al. reported treatment of ileus by splanchnic epidural anesthesia. Although there have been suggestions that sympathectomy from epidural anesthesia will cause an increase in anastomotic leaks, an analysis of 12 trials with 562 patients failed to find an association between epidural anesthesia and anastomotic breakdown.<sup>293</sup> Furthermore, when compared with patients who were receiving patient-controlled parenteral opioids, epidural

#### BOX 55-13.

##### Pseudoobstruction Syndromes

- I. Primary idiopathic pseudoobstruction
  - A. Familial syndromes
    1. Visceral myopathies
    2. Visceral neuropathies
  - B. Sporadic syndromes
    1. Visceral myopathies
    2. Visceral neuropathies
- II. Secondary pseudoobstruction
  - A. Diseases of GI muscle
    1. Collagen disease
      - a. Scleroderma
      - b. Dermatomyositis and polymyositis
      - c. Systemic lupus erythematosus
    2. Amyloidosis
    3. Generalized muscle disease
      - a. Myotonic dystrophy
      - b. Progressive muscular dystrophy
  - B. Diseases of GI nerves
    1. Parkinson disease
    2. Hirschsprung disease
    3. Chagas disease
    4. Primary autonomic dysfunction
  - C. Endocrine diseases involving GI tract
    1. Myxedema ileus
    2. Diabetes mellitus
    3. Hypoparathyroidism
    4.  $\geq$  Pheochromocytoma
  - D. Drug-induced syndromes
    1. Opiates
    2. Psychotropic drugs
    3. Antiparkinsonian drugs
    4. Cathartics
  - E. Miscellaneous
    1. Jejunioileal bypass
    2. Jejunal diverticulosis
    3. Inflammatory bowel disease
    4. Paraneoplastic neuropathy
- III. Paralytic ileus
  - A. Intraabdominal disease
  - B. Extraabdominal disease

Modified from Christensen J. Intestinal pseudo-obstruction and paralytic ileus. In: Moody FG, ed. *Surgical Treatment of Digestive Disease*. 2nd ed. Chicago: Mosby-Year Book, 1990.

analgesia provided better postoperative pain control.<sup>293</sup>

Although neostigmine, metoclopramide, cisapride, erythromycin, ceruletide, somatostatin, laxatives, and nonsteroidal antiinflammatory agents have theoretical advantages for enhancing GI

motility, investigations have not demonstrated useful effects in humans.<sup>284</sup> It is well established that opioids acutely and chronically slow gastrointestinal motility. Administration of peripheral opioid antagonists appears to lead to a faster return of bowel function, faster hospital discharge, without an increase in readmissions, and with *no difference* in pain scores.<sup>294,295</sup>

Other abdominal causes of paralytic ileus include blunt trauma, bowel perforation, bile peritonitis, and intraabdominal sepsis. Nonabdominal causes include lobar pneumonia, myocardial infarction, massive trauma, generalized sepsis, and electrolyte abnormalities such as hypophosphatemia and hypokalemia.

*Mechanical obstruction* is a vexing diagnostic problem that generally requires surgical intervention. Simple obstruction implies adequate blood flow to the obstructed area, whereas strangulation connotes insufficient circulation to the area. Obturated obstruction is caused by an intraluminal foreign body. Mechanical obstruction tends to be acute, with fairly rapid progression to complete obstruction.

Approximately 60–80% of obstruction occurs in the small intestine.<sup>296</sup> Pain, distension, emesis, and obstipation typically are present. Volume loss, tachycardia, and electrolyte disturbances can occur from severe vomiting and the massive volumes that are sequestered in strangulated bowel.

Approximately 7–9 L of fluid are presented to the gut daily<sup>297</sup> from varied sources (Table 55–2). With obstruction, not only is reabsorption hindered, but intestinal fluid secretion may be increased.<sup>298</sup> In addition, rapid infusion of IV fluids, which may be necessary for hemodynamic support, has been reported to increase secretion.<sup>299</sup> Once intraluminal pressure exceeds approximately 20 cm H<sub>2</sub>O, reabsorption fails.<sup>300</sup>

Because intestinal fluid has a tonicity and electrolyte composition similar to extracellular fluids, acid-base and electrolyte disturbances generally are not severe. Duodenal obstruction can lead to hypokalemic alkalosis resulting from severe emesis. In addition, once strangulation occurs (and no definitive criteria exist for this diagnosis), necrosis of bowel and bacterial proliferation contribute to rapid sequestration of fluid and colloid in the affected bowel and peritoneal cavity. Together with

TABLE 55–2.

## Fluids Entering Bowel Daily

Source	Volume (mL)
Diet	2000
Saliva	1000
Gastric juice	2000
Bile	1000
Pancreatic juice	2000
<i>Succus entericus</i>	1000

vomiting, this can produce marked depletion of intravascular volume and the potential for renal and cardiovascular instability.

Other conditions can mimic small bowel obstruction (Box 55–14), making the diagnosis difficult. This especially applies to elderly patients, who often have only minimal evidence of peritoneal irritation.

Acute, large bowel obstruction is associated with pain, distension, vomiting, and obstipation, although large bowel obstruction can be more insidious than small bowel obstruction and may present without pain but with “overflow” diarrhea. Fifty percent or more of large bowel obstructions result from colorectal cancer, with much of the rest caused by diverticulitis, volvulus, and fecal impaction.<sup>301</sup> Small bowel obstruction may occur concurrently. An incompetent ileocecal valve may permit the eventual development of feculent vomiting.

Management includes decompression of the stomach, appropriate IV fluids, and attention to conditions in other systems (e.g., infection, renal and cardiovascular problems). Depending on the patient's age and the severity of illness or suspected intervention, invasive hemodynamic monitoring may be warranted.

*Patients with GI motility disorders and those with obvious obstruction are at risk for regurgitation and aspiration during the induction and maintenance of anesthesia and postoperatively.* The anesthesiologist should be aware of the potential for such difficulty with this group of patients and treat appropriately. At the least, this would include the omission of oral premedication and the use of postoperative (and preoperative when indicated) nasogastric suctioning. Anesthesia should be induced using awake intubation or rapid sequence considerations.

BOX 55–14.

## Conditions Mimicking Small Bowel Obstruction

Diabetic ketoacidosis  
Sickle crisis  
Porphyria  
Pancreatitis  
Ureteral and biliary colic  
Food poisoning  
Pseudoobstruction

## The Systemic Inflammatory Response Syndrome—Multiple Organ Failure Continuum

Many severely ill patients require emergency surgical intervention for life-threatening conditions such as abdominal trauma, resection of nonviable bowel, relief of obstruction or strangulation, drainage of an abscess, or removal of a severely inflamed gallbladder. In addition to their abdominal disorder, they may be intubated in an intensive care unit, may have evidence of organ system failure (e.g., pulmonary, renal, central nervous system and major metabolic changes), or may be older with serious cardiac and vascular disease. Many behave as if they have a severe infection whether or not one is eventually discovered. In the past, varying etiologies have been suggested, including gram-negative sepsis, endotoxemia, sepsis syndrome, and multiple system organ failure. Because of the many similarities among such patients, even for those whose clinical course falls outside these diagnoses (e.g., patients with gram-positive sepsis, viral or fungal infection, or no infection at all), other explanations have been sought.

Common to many of these patients is evidence of major inflammatory mediator production and release by polymorphonuclear leukocytes, macrophages, monocytes, platelets, and the endothelium. The cyclooxygenase pathway has important effects. More than 30 such mediators have been identified, with cytokines such as tumor necrosis factor, interleukins 1, 6, and 8, substance P, granulocyte-macrophage colony-stimulating factor, interferon, and platelet-activating factor among the most studied.<sup>302,303</sup>

It has been suggested that the *systemic inflammatory response syndrome* represents the earliest, fairly nonspe-

## BOX 55-15.

**Diagnostic Findings in Systemic Inflammatory Response Syndrome\***

Temperature  $>100.4^{\circ}\text{F}$  ( $38^{\circ}\text{C}$ ),  $<96.8^{\circ}\text{F}$  ( $36^{\circ}\text{C}$ )

Heart rate  $>90$  beats/min

Respiration rate  $>20$  breaths/min or  $\text{PaCO}_2 <32$  mm Hg

Leukocyte  $>12.0 \times 10^9/\text{L}$  or  $<4 \times 10^9/\text{L}$  or  $>0.10$  immature cells

\*Two or more should be present for a diagnosis to be made.

cific, phase of a process that may lead to organ dysfunction and ultimately, organ failure. Currently, the diagnosis of SIRS requires that two of the findings in Box 55-15 be present.<sup>304</sup> *Systemic inflammatory response syndrome and multiple organ failure appear to be the ends of a hierarchical continuum with an increasing inflammatory response to infectious and noninfectious stimuli,*<sup>305</sup> while initially organ dysfunction is more functional than permanent, organ failure and mortality increase with increasing inflammatory response.<sup>306,307</sup>

The GI tract is a vulnerable organ system. Any insult to adequate core tissue perfusion (e.g., hemorrhage, cardiac arrest, cardiopulmonary bypass) may result in severe or relative hypotension, with ensuing GI mucosal ischemia. Endogenous vasoconstrictors may be released<sup>308</sup> (Box 55-16), which may affect the splanchnic bed more consistently than others.<sup>309-313</sup> Reperfusion after shock may be associated with oxygen and free radical mucosal damage. In addition, so-called myocardial depressant factors can be released from the pancreas and possibly the small intestine, which further contribute to tissue hypoperfusion and low cardiac output syndrome. As much as 15-65% of the circulating volume can redistribute to damaged bowel during this process. While inadequate perfusion limits delivery of oxygen for cellular processes, other mechanisms that directly affect mitochondria may have similar effects even with relatively adequate (or increased) perfusion. A host of factors affect the mitochondria, including reactive oxygen species, local  $\text{PO}_2$ , levels of adenosine triphosphate, and hormonal influences such as thyroid, catecholamines, corticosteroids, and leptins. Nitric oxide is a strong inhibitor of mitochondrial electron trans-

## BOX 55-16.

**Vasoactive Substances Affecting Splanchnic Bed****Vasoconstrictors***Endogenous*

Angiotensin II

Vasopressin

Catecholamines

Certain prostaglandins

$\text{PGF}_{2\alpha}$

$\text{PGB}_2$

$\text{PGD}_2$

Certain leukotrienes

$\text{C}_4$

$\text{D}_4$

$\text{E}_4$

Certain thromboxanes

$\text{TxA}_2$

? Serotonin

*Exogenous*

Digoxin

Atropine

Physostigmine

**Vasodilators***Endogenous*

Vasoactive intestinal peptide

Histamine

Glucagon

Cholecystokinin

Other eicosanoids

$\text{PGI}_2$  (prostacyclin)

$\text{PGE}_2$

Serotonin

Nitric oxide

port. If insufficient energy is available to fuel metabolism, critical thresholds of adenosine triphosphate result and cellular dysfunction and death ensue.

Although the systemic cardiovascular response demanded by these conditions usually is hyperdynamic, it often is inadequate, either because metabolic requirements are too high (or because of end-organ inability to use oxygen) or because of limitations imposed by evolving or underlying myocardial dysfunction. Management of these patients is beyond the scope of this chapter. When the anesthesiologist encounters these patients, they frequently are already receiving vasopressor and inotropic support. Intraoperative care includes intensive evaluation of oxygen delivery, optimization of volume and cardiovascular function, and avoidance of drugs and agents that will further compromise their already tenuous status.<sup>314,315</sup>

## SUMMARY

The complex physiologic and metabolic interactions of the GI tract and other organ system functions can present fascinating challenges for the anesthesiologist. Because GI surgery often can seem so benign, it is perhaps more difficult to remain "tuned in" to such concerns. The rewards of good patient care should be sufficient incentive to reexamine important issues in GI surgery and anesthesia from time to time.

## KEY REFERENCES

- Goyal RK, Hirano I. The enteric nervous system. *N Engl J Med* 1996;334:1106-1115.
- Marston A, Bulkley G, Fiddian-Green R, et al., eds. *Splanchnic Ischemia and Multiple Organ Failure*. London: Edward Arnold, 1989.
- Rangel-Frausto MS, Pittet D, Costigan M, et al. The natural history of the systemic inflammatory response syndrome (SIRS). A prospective study. *JAMA* 1995;273:117-123.
- Sollinger HW. Pancreas transplantation in humans. In: Moody FG, ed. *Surgical Treatment of Digestive Disease*. 2nd ed. Chicago: Mosby-Year Book, 1990.
- Block BM, Liu SS, Rowlingson AJ, Cowan AR, Cowan JA Jr, Wu CL. Efficacy of postoperative epidural analgesia: a meta-analysis. *JAMA* 2003;290:2455-2463.
- Ng A, Smith G. Gastroesophageal reflux and aspiration of gastric contents in anesthetic practice. *Anesth Analg* 2001;93:494-513.
- Cash BD. Evidence-based medicine as it applies to acid suppression in the hospitalized patient. *Crit Care Med* 2002;30:S373-S378.
- Mokdad AH, Bowman BA, Ford ES, Vinicor F, Marks JS, Koplan JP. The continuing epidemics of obesity and diabetes in the United States. *JAMA* 2001;286:1195-1200.
- Shah M, Simha V, Garg A. Long-term impact of bariatric surgery on body weight, comorbidities, and nutritional status [review]. *J Clin Endocrinol Metab* 2006;91:4223-4231.



10. Singer M, De Santis V, Vitale D, Jeffcoate W. Multiorgan failure is an adaptive, endocrine-mediated, metabolic response to overwhelming systemic inflammation. *Lancet* 2004;363:545–548.

## REFERENCES

- Goyal RK, Hirano I. The enteric nervous system. *N Engl J Med* 1996;334:1106.
- Brock-Utne J, Rout C, Moodley J, et al. Does pre-operative gastric emptying decrease the risk of acid aspiration in obstetrical anesthesia? A study of gastric acidity and volume at emergency cesarean section. *Anesth Analg* 1989;68:S39.
- Holdsworth J, Furness R, Roulston G. A comparison of apomorphine and stomach tubes for emptying the stomach before general anaesthesia in obstetrics. *Br J Anaesth* 1974;46:526.
- Edwards G, Morton H, Pask E, et al. Deaths resulting from anaesthesia: a report on 1,000 cases. *Anaesthesia* 1995;50(5):440–453.
- Brock-Utne J, Moshal M, Downing J, et al. Fasting volume and acidity of stomach contents associated with gastrointestinal symptoms. *Anaesthesia* 1977;32:749.
- Burgess G, Cooper J, Marino R, et al. Laryngeal competence after tracheal extubation. *Anesthesiology* 1979;51:73.
- Arms R, Dines D, Tinstman T. Aspiration pneumonia. *Chest* 1974;65:136.
- Awe WC, Fletcher WS, Jacob SW. The pathophysiology of aspiration pneumonitis. *Surgery* 1966;60:232.
- Cameron J, Mitchell W, Zuidema G. Aspiration pneumonia: clinical outcome following documented aspiration. *Arch Surg* 1973;106:49.
- Mendelson C. The aspiration of stomach contents into the lungs during obstetric anesthesia. *Am J Obstet Gynecol* 1946;52:191.
- Olsson GL, Hallen B, Hambræus-Jonzon K. Aspiration during anaesthesia: a computer-aided study of 185,358 anaesthetics. *Acta Anaesthesiol Scand* 1986;30:84.
- Berson W, Adriani J. "Silent" regurgitation and aspiration during anesthesia. *Anesthesiology* 1954;15:644.
- Blitt CD, Gutman HL, Cohen DD, et al. "Silent" regurgitation and aspiration during general anesthesia. *Anesth Analg* 1970;40:707.
- Carlsson C, Islander G. Silent gastropharyngeal regurgitation during anesthesia. *Anesth Analg* 1981;60:655.
- Weiss WA. Regurgitation and aspiration of gastric contents during inhalation anesthesia. *Anesthesiology* 1950;11:102.
- Schwartz D, Wynne J, Gibbs C, et al. The pulmonary consequences of aspiration of gastric contents at pH values greater than 2.5. *Am Rev Respir Dis* 1980;121:119.
- Roberts R, Shirley M. Reducing the risk of acid aspiration during cesarean section. *Anesth Analg* 1974;53:859.
- Teabeaut JR. Aspiration of gastric contents: an experimental study. *Am J Pathol* 1952;28:51.
- Gibbs C, Schwartz D, Wynne J, et al. Antacid pulmonary aspiration in the dog. *Anesthesiology* 1979;51:380.
- James C, Modell J, Gibbs C, et al. Pulmonary aspiration: effects of volume and pH in the rat. *Anesth Analg* 1984;63:665.
- Chen C, Toung T, Haupt H, et al. Evaluation of the efficacy of Alka-Seltzer effervescent in gastric acid neutralization. *Anesth Analg* 1984;63:325.
- Eyler S, Cullen B, Murphy M, et al. Antacid aspiration in rabbits: a comparison of Mylanta and Bicitra. *Anesth Analg* 1982;61:288.
- Viegas O, Ravindran R, Stoops C. Duration of efficacy of sodium citrate as an antacid [abstract]. *Anesth Analg* 1982;61:220.
- Abe K, Shibata M, Demizu A, et al. Effect of oral and intramuscular famotidine on pH and volume of gastric contents. *Anesth Analg* 1989;68:541.
- Dubois F, Icard P, Berthelot G, et al. Coelioscopic cholecystectomy: preliminary report of 36 cases. *Ann Surg* 1990;211:60.
- Cohen J, Weetman A, Dargie J, et al. Life-threatening arrhythmias and intravenous cimetidine. *Br Med J* 1979;2:768.
- Coursin D, Farin-Rusk C, Springman S, et al. The hemodynamic effects of intravenous cimetidine versus ranitidine in intensive care unit patients: a double-blind, prospective, cross-over study. *Anesthesiology* 1988;69:975.
- Freston J. Cimetidine. II. Adverse reactions and patterns of use. *Ann Intern Med* 1982;97:728.
- Reding P, Devroede C, Barbier P. Bradycardia after cimetidine. *Lancet* 1977;2:1227–1228.
- Shaw R, Mashford M, Desmond P. Cardiac arrest after intravenous injection of cimetidine. *Med J Aust* 1980;2:629.
- Balestrazzi P, Gregori G, Bernasconi S, et al. Bradycardia and neurologic disorders associated with ranitidine in a child. *Am J Dis Child* 1985;139:442.
- Camarri E, Chirone E, Fanteria G, et al. Ranitidine induced bradycardia. *Lancet* 1982;2:160.
- Cousins M, Mather L. Intrathecal and epidural administration of opioids. *Anesthesiology* 1984;61:276.
- Ginsburg R, Bristow M, Stinson E, et al. Histamine receptors in the human heart. *Life Sci* 1980;26:2245.
- Bell J, Gower A, Martin L, et al. Interaction of H<sub>2</sub>-receptor antagonists with drug metabolizing enzymes. *Biochem Soc Trans* 1981;9:113.
- Mitchard M, Harris A, Mullinger B. Ranitidine drug interactions—a literature review. *Pharmacol Ther* 1987;32:293.
- Bauer L, Edwards A, Randolph F, et al. Cimetidine-induced decrease in lidocaine metabolism. *Am Heart J* 1984;198:413.
- Smith S, Kendall M, Lobo J, et al. Ranitidine and cimetidine: drug interactions with single dose and steady-state nifedipine administration. *Br J Clin Pharmacol* 1987;23:311.
- Gardner M, Sikorski G. Ranitidine and theophylline. *Ann Intern Med* 1985;102:559.
- Weinberger M, Smith G, Milavetz G, et al. Decreased theophylline clearance due to cimetidine. *N Engl J Med* 1981;304:72.
- Silver B, Bell W. Cimetidine potentiation of the hypoprothrombinemic effects of warfarin. *Ann Intern Med* 1979;90:348.
- Bartle W, Walker S, Shapero T. Dose-dependent effect of cimetidine on phenytoin kinetics. *Clin Pharmacol Ther* 1983;33:649.
- Memis D, Turan A, Karamanlioglu B, Saral P, Ture M, Pamukcu Z. The effect of intravenous pantoprazole and ranitidine for improving preoperative gastric fluid properties in adults undergoing elective surgery. *Anesth Analg* 2003;97:1360–1363.
- Brock-Utne J, Dow T, Dimopoulos G, et al. The effect of metoclopramide on the lower oesophageal sphincter in late pregnancy. *Anaesth Intensive Care* 1978;6:26.
- Schulze-Delrieu K. Metoclopramide. *Gastroenterology* 1979;77:768.
- Sellick BA. Cricoid pressure to control regurgitation of stomach contents during induction of anesthesia. *Lancet* 1961;2:404.
- Butler J, Sen A. Best evidence topic report. Cricoid pressure in emergency rapid sequence induction. *Emerg Med J* 2005;22:815–816.
- Snider DD, Clarke D, Finucane BT. The "BURP" maneuver worsens the glottic view when applied in combination with cricoid pressure. *Can J Anaesth* 2005;52:100–104.
- Crawford M, Lerman J, Christensen S, et al. Effects of duration of fasting on gastric fluid pH and volume in healthy children. *Anesth Analg* 1990;71:400.
- Hutchinson A, Maltby J, Reid C. Gastric fluid volume pH in elective inpatients. I. Coffee or orange juice versus overnight fast. *Can J Anaesth* 1988;35:12.
- Maltby J, Reid C, Hutchinson A. Gastric fluid volume and pH in elective inpatients. II. Coffee or orange juice with ranitidine. *Can J Anaesth* 1988;35:16.
- McGrady E, MacDonald A. Effect of the preoperative administration of water on gastric volume and pH. *Br J Anaesth* 1988;60:803.
- Sutherland A, Maltby J, Sale JP, et al. The effect of preoperative oral fluid and ranitidine on gastric fluid volume and pH. *Can J Anaesth* 1987;34:117.
- Eger EI, Saidman LJ. Hazards of nitrous oxide anesthesia in bowel obstruction and pneumothorax. *Anesthesiology* 1965;26:61.
- Painter NS, Truelove SC. The intraluminal pressure patterns in diverticulosis of

- the colon. Part III. The effect of prostigmine. *Gut* 1964;5:365.
56. Aitkenhead AR. Anaesthesia and bowel surgery. *Br J Anaesth* 1984;56:95.
57. Bell CM, Lewis CB. Effect of neostigmine on integrity of ileorectal anastomoses. *Br Med J* 1968;3:587.
58. Child CS. Prevention of neostigmine-induced colonic activity: a comparison of atropine and glycopyrronium. *Anaesthesia* 1984;39:1083.
59. Wilkins JL, Hardcastle JD, Mann CV, et al. Effects of neostigmine and atropine on motor activity of ileum, colon, and rectum of anaesthetized subjects. *Br Med J* 1970;1:793.
60. Healy T, Foster GE, Evans DF, et al. Effect of some IV anaesthetic agents on canine gastrointestinal motility. *Br J Anaesth* 1981;52:229.
61. Birnbaum D, Ben-Menachem J, Schwartz A. The influence of oral diazepam on gastrointestinal motility. *Am J Proctol* 1970;21:263.
62. Dowlathshahi K, Evander A, Walther B, et al. Influence of morphine on the distal oesophagus and the lower oesophageal sphincter—a manometric study. *Gut* 1985;26:802.
63. Lamki L, Sullivan S. A study of gastrointestinal opiate receptors: the role of the mu receptor on gastric emptying: concise communication. *J Nucl Med* 1983;24:689.
64. Painter NS, Truelove SC. The intraluminal pressure patterns in diverticulosis of the colon. Part II. The effect of morphine. *Gut* 1964;5:201.
65. Ward R, Kennedy W, Bonica J, et al. Experimental evaluation of atropine and vasopressors for the treatment of hypotension of high subarachnoid anesthesia. *Anesth Analg* 1966;45:621.
66. Aitkenhead AR, Wishart HY, Peebles-Brown DA. High spinal nerve block for large bowel anastomosis. *Br J Anaesth* 1978;50:177.
67. Aitkenhead A, Gilmour D, Hothersall A, et al. Effects of subarachnoid nerve block and arterial PCO<sub>2</sub> on colon blood flow in the dog. *Br J Anaesth* 1980;52:1071.
68. Bigler D, Hjortso N-C, Kehlet H. Disruption of colonic anastomosis during continuous epidural analgesia: an early postoperative complication. *Anaesthesia* 1985;40:278.
69. Threissman DA. Disruption of colonic anastomosis associated with epidural anesthesia. *Reg Anaesth* 1980;5:22.
70. Moossa AR, Mayer AD, Lavelle-Jones M. Surgical complications. In: Sabiston DC, ed. *Textbook of Surgery: The Biological Basis of Modern Surgical Practice*. 14th ed. Philadelphia: WB Saunders, 1991.
71. Yamada T, Alpers DH, Owyang C, et al. eds. *Textbook of Gastroenterology*. Philadelphia: JB Lippincott, 1991.
72. Rawal N, Coombs DW, eds. *Spinal Narcotics*. Boston: Kluwer Academic, 1990.
73. Bardon T, Ruckebusch Y. Comparative effects of opiate agonists on proximal and distal colonic motility in dogs. *Eur J Pharmacol* 1985;110:329.
74. Ryan P, Schweitzer S, Collopy B, et al. Combined epidural and general anesthesia versus general anesthesia in patients having colon and rectal anastomoses. *Acta Chir Scand Suppl* 1988;550:146.
75. Kozian A, Schilling T, Hachenberg T. Non-analgetic effects of thoracic epidural anaesthesia. *Curr Opin Anaesthesiol* 2005;18:29–34.
76. Thompson DR. Narcotic analgesic effects on the sphincter of Oddi: a review of the data and therapeutic implications in treating pancreatitis. *Am J Gastroenterol*. 2001;96:1266–72.
77. Hynynen MJ, Turanen M, Kortilla KT. Effects of alfentanil and fentanyl on common bile duct pressure. *Anesth Analg* 1986;65:370.
78. Radnay PA, Duncalf D, Novakoric M, et al. Common bile duct pressure changes after fentanyl, morphine, meperidine, butorphanol and naloxone. *Anesth Analg* 1984;63:441.
79. Jones R, Detmer M, Hill A, et al. Incidence of choledochoduodenal sphincter spasm during fentanyl-supplemented anesthesia. *Anesth Analg* 1981;60:638.
80. Goldberg M, Vatahsky E, Haskel Y, et al. The effect of meperidine on the guinea pig extrahepatic biliary tract. *Anesth Analg* 1987;66:1282.
81. McCammon R, Stoelting R, Madura J. Effects of butorphanol, nalbuphine and fentanyl on intrabiliary tract dynamics. *Anesth Analg* 1984;63:139.
82. Bailey PL, Egan TD, Stanley TH. Intravenous opioid anesthetics. Chapter 10. In: Miller RD. *Anesthesia*, 5th ed. Philadelphia: Churchill Livingstone, 2000;273–379.
83. Coyne M, Bonorris G, Goldstein L, et al. Effect of chenodeoxycholic acid and phenobarbital on the rate-limiting enzymes of hepatic cholesterol and bile acid synthesis in patients with gallstones. *J Lab Clin Med* 1976;87:281.
84. Mead J. The Respiratory System Volume III, Parts 1 & 2: Mechanics of Breathing. In: *Handbook of Physiology*. Bethesda, MD: American Physiological Society, 1988.
85. Nunn J. Pulmonary ventilation: mechanisms and work of breathing. In: Nunn JF, *Applied Respiratory Physiology*, 4th ed. Oxford: Butterworth, 1993;117–134.
86. Don H. The mechanical properties of the respiratory system during anesthesia. In: Kafer E, ed. *Anesthesia and Respiratory Function*. Boston: Little Brown, 1977.
87. Alexander J, Spence A, Parikh R, et al. The role of airway closure in postoperative hypoxemia. *Br J Anaesth* 1973;45:34.
88. Slocum H, Hoeflich E, Allen CR. Circulatory and respiratory distress from extreme positions on the operating table. *Surg Gynecol Obstet* 1947;84:1065.
89. Ali J, Weisel R, Layug A, et al. Consequences of postoperative alterations in respiratory mechanics. *Am J Surg* 1974;128:376.
90. Ford G, Whitelaw W, Rosenal T, et al. Diaphragm function after upper abdominal surgery in humans. *Am Rev Respir Dis* 1983;127:431.
91. Ray J, Yost L, Moallem S, et al. Immobility, hypoxemia, and pulmonary arteriovenous shunting. *Arch Surg* 1974;109:537.
92. Moller AM, Pedersen T, Svendsen PE, Engquist A. Perioperative risk factors in elective pneumonectomy: the impact of excess fluid balance. *Eur J Anaesthesiol* 2002;19:57–62.
93. Joshi GP. Intraoperative fluid restriction improves outcome after major elective gastrointestinal surgery. *Anesth Analg* 2005;101:601–605.
94. Southern Surgeons Club. A prospective analysis of 1518 laparoscopic cholecystectomies. *N Engl J Med* 1991;324:1073.
95. McDougall EM, Clayman RV, Fadden PT. Retroperitoneoscopy: the Washington University Medical School experience. *Urology* 1994;43:446.
96. Novitsky YW, Litwin DE, Callery MP. The net immunologic advantage of laparoscopic surgery. *Surg Endosc* 2004;18:1411–1419.
97. Cunningham AJ. Laparoscopic surgery—anaesthetic implications. *Surg Endosc* 1994;8:1271.
98. Wilcox S, Vandam LD. Alas, poor Trendelenburg and his position! A critique of its uses and effectiveness. *Anesth Analg* 1988;67:574.
99. Burton A, Steinbrook RA. Precipitous decrease in oxygen saturation during laparoscopic surgery. *Anesth Analg* 1993;76:1177.
100. Cunningham AJ. Laparoscopic surgery—anaesthetic implications. *Surg Endosc* 1994;8:1272.
101. Critchley LAH, Critchley AJH, Gin T. Haemodynamic changes in patients undergoing laparoscopic cholecystectomy: measurement by transthoracic electrical bioimpedance. *Br J Anaesth* 1993;70:681.
102. Johannsen G, Anderson M, Juhl B. The effect of general anesthesia on the haemodynamic events during laparoscopy with CO<sub>2</sub>-insufflation. *Acta Anaesthesiol Scand* 1989;33:132.
103. Joris JL, Noirot DP, Legrand MJ, et al. Hemodynamic changes during laparoscopic cholecystectomy. *Anesth Analg* 1993;76:1067.
104. McLaughlin JG, Bonnell BW, Scheeres DE, et al. The adverse hemodynamic effects related to laparoscopic cholecystectomy. *Anesthesiology* 1992;77:A70.
105. Safran D, Sgambati S, Orlando R. Laparoscopy in high-risk cardiac patients. *Surg Gynecol Obstet* 1993;176:548.
106. Ekman LG, Abrahamsson J, Biber B, et al. Hemodynamic changes during laparoscopy with positive end-expiratory pressure ventilation. *Acta Anaesthesiol Scand* 1988;32:447.
107. Kelman G, Swapp G, Smith I, et al. Cardiac output and arterial blood-gas tension during laparoscopy. *Br J Anaesth* 1972;44:1155–1162.
108. Marshall RL, Jebson PJR, Davie IT, et al. Circulatory effects of carbon dioxide insufflation of the peritoneal cavity for laparoscopy. *Br J Anaesth* 1972;44:680.

109. Odeberg S, Ljungqvist O, Svenberg T, et al. Haemodynamic effects of pneumoperitoneum and the influence of posture during anaesthesia for laparoscopic surgery. *Acta Anaesthesiol Scand* 1994;38:276.
110. Harris SN, Luther MA, Ballantyne GH, et al. Alterations of cardiovascular performance during laparoscopic colectomy. *Anesthesiology* 83:A75, 1995.
111. Cunningham AJ, Turner J, Rosenbaum S, et al. Transesophageal echocardiographic assessment of haemodynamic function during laparoscopic cholecystectomy. *Br J Anaesth* 1993;70:621.
112. Celli BR, Rodriques KS, Snider GL. A controlled trial of intermittent positive pressure breathing, incentive spirometry, and deep breathing exercises in preventing pulmonary complications after abdominal surgery. *Am Rev Respir Dis* 1984;130:12.
113. Millard JA, Hill BB, Cook PS, et al. Intermittent sequential pneumatic compression in prevention of venous stasis associated with pneumoperitoneum during laparoscopic cholecystectomy. *Arch Surg* 1993;128:914.
114. Wittgen CM, Andrus CH, Fitzgerald SD, et al. Analysis of the hemodynamic and ventilatory effects of laparoscopic cholecystectomy. *Arch Surg* 1991;12:997.
115. Rasmussen JP, Dauchot PJ, DePalma RG, et al. Cardiac function and hypercarbia. *Arch Surg* 1978;113:1196.
116. Giebler RM, Walz MK, Peitgen K, et al. Hemodynamic changes after retroperitoneal CO<sub>2</sub> insufflation for posterior retroperitoneoscopic adrenalectomy. *Anesth Analg* 1996;82:827.
117. Derouin M, Couture P, Boudreault D, et al. Detection of gas embolism by transesophageal echocardiography during laparoscopic cholecystectomy. *Anesth Analg* 1996;82:119.
118. Lantz PE, Smith JD. Fatal carbon dioxide embolism complicating attempted laparoscopic cholecystectomy: case report and literature review. *J Forensic Sci* 1994;39:1468.
119. Root B, Levy M, Pollack S, et al. Gas embolism death after laparoscopy delayed by "trapping" in portal circulation. *Anesth Analg* 1978;57:232.
120. Kalhan SB, Reaney JA, Collins RL. Pneumomediastinum and subcutaneous emphysema during laparoscopy. *Cleve Clin J Med* 1990;57:639.
121. Wahba RWM, Tessler MJ, Kleiman SJ. Acute ventilatory complications during laparoscopic upper abdominal surgery. *Can J Anaesth* 1996;43:77.
122. Chice JD, Joris J, Lamy M. Respiratory changes induced by subcutaneous emphysema during laparoscopic fundoplication. *Br J Anaesth* 1994;72:A37.
123. Hedenstierna G. Mechanisms of post-operative pulmonary dysfunction. *Acta Chir Scand (Suppl)* 1989;550:152.
124. Becquemin JP, Piquet J, Becquemin MH, et al. Pulmonary function after transverse or midline incision in patients with obstructive pulmonary disease. *Intensive Care Med* 1985;11:247.
125. Johnson WC. Postoperative ventilatory performance: dependence upon surgical incision. *Am Surg* 1975;41:15.
126. Rademaker BM, Ringers J, Odoom JA, et al. Pulmonary function and stress response after laparoscopic cholecystectomy: comparison with subcostal incision and influence of thoracic epidural analgesia. *Anesth Analg* 1992;75:381.
127. Putensen-Himmer G, Putensen C, Lammer H, et al. Functional residual capacity, post-operative lung function, and gas exchange following open laparotomy or laparoscopy for cholecystectomy. *Anesthesiology* 1992;77:A1253.
128. Desmond J, Gordon RA. Ventilation in patients anaesthetized for laparoscopy. *Can Anaesth Soc J* 1970;17:378.
129. Hsing CH, Hseu SS, Tsai SK, et al. The physiologic effect of CO<sub>2</sub> pneumoperitoneum in pediatric laparoscopy. *Acta Anaesthesiol Sin* 1995;33:1.
130. Pelosi P, Foti G, Cereda M et al. Effects of carbon dioxide insufflation for laparoscopic cholecystectomy on the respiratory system. *Anaesthesia*. 1996;51:744-9.
131. Hirvonen EA, Nuutinen LS, Kauko M. Ventilatory effects, blood gas changes, and oxygen consumption during laparoscopic hysterectomy. *Anesth Analg* 1995;80:961.
132. Edelman DS. Laparoscopic cholecystectomy under continuous epidural anesthesia in patients with cystic fibrosis. *Am J Dis Child* 1991;145:723.
133. Williamson R. Clinical freedom, clinical behaviour, and anesthesia for laparoscopy. *Anesthesia* 1988;44:999.
134. Filipi CJ, Fitzgibbons RJ, Salerno GM, et al. Laparoscopic herniorrhaphy. *Surg Clin North Am* 1992;75:1109.
135. Diemunsch PA, Torp KD, Van Dorsseleer T et al. Nitrous oxide fraction in the carbon dioxide pneumoperitoneum during laparoscopy under general inhaled anesthesia in pigs. *Anesth Analg*. 2000;90:951-3.
136. Neukman GG. Laparoscopy explosion hazards with nitrous oxide. *Anesthesiology* 1993;78:875.
137. Lejus C, Delile L, Plattner V, et al. Randomized, single-blinded trial of laparoscopic versus open appendectomy in children: effects on postoperative analgesia. *Anesthesiology* 1996;84:801.
138. Smith I, Ding Y, White PF. Muscle pain after outpatient laparoscopy: influence of propofol versus thiopental and enflurane. *Anesth Analg* 1993;76:1181.
139. Beattie WS, Lindblad T, Buckley DN, et al. Menstruation increases the risk of nausea and vomiting after laparoscopy. *Anesthesiology* 1993;78:272.
140. Rorstat O. Prognostic indicators for carcinoid neuroendocrine tumors of the gastrointestinal tract. *J Surg Oncol* 2005;89:151-160.
141. Doherty GM. Rare endocrine tumours of the GI tract. *Best Pract Res Clin Gastroenterol* 2005;19:807-817.
142. Hoffman KM, Furukawa M, Jensen RT. Duodenal neuroendocrine tumors: classification, functional syndromes, diagnosis and medical treatment. *Best Pract Res Clin Gastroenterol* 2005;19:675-697.
143. Zikusoka MN, Kidd M, Eick G, Latich I, Modlin IM. The molecular genetics of gastroenteropancreatic neuroendocrine tumors. *Cancer* 2005;104:2292-2309.
144. Niederhuber JE, Fojo T. Treatment of metastatic disease in patients with neuroendocrine tumors. *Surg Oncol Clin N Am* 2006;15:511-533.
145. Kinney MA, Warner ME, Nagorney DM, et al. Perianaesthetic risks and outcomes of abdominal surgery for metastatic carcinoid tumours. *Br J Anaesth* 2001;87:447-452.
146. Wilde MI, Markham A. Ondansetron. A review of its pharmacology and preliminary clinical findings in novel applications. *Drugs* 1996;52:773-794.
147. Farling PA, Durairaju AK. Remifentanyl and anaesthesia for carcinoid syndrome. *Br J Anaesth* 2004;92:893-895.
148. Hurwitz A, Duranceau A. Upper-esophageal sphincter dysfunction: pathogenesis and treatment. *Am J Dig Dis* 1978;23:275.
149. Palmer E. Disorders of the cricopharyngeus muscle: a review. *Gastroenterology* 1976;71:510.
150. Winship D. Upper esophageal sphincter: does it care about reflux? *Gastroenterology* 1983;85:470.
151. Kahrilas P, Dodds W, Dent J, et al. Effect of sleep, spontaneous gastroesophageal reflux, and a meal on upper esophageal sphincter pressure in normal human volunteers. *Gastroenterology* 1987;92:466.
152. Behar J. Gastroesophageal reflux disease and its complications with a critical analysis of treatment. In: Cohen S, Soloway R, eds. *Diseases of the Esophagus*. Edinburgh: Churchill-Livingstone, 1982;195-213.
153. Biancani P, Walsh J, Behar J. Vasoactive intestinal peptide: a neurotransmitter for lower esophageal sphincter relaxation. *J Clin Invest* 1984;73:963.
154. Grossman M. Chemical messengers: a view from the gut. *Fed Proc* 1979;38:2341.
155. Aggestrup S. Effect of thyrotropin-releasing hormone on the human lower esophageal sphincter pressure. *Scand J Gastroenterol* 1984;19:631.
156. DeMeester TR, Stein HJ. Gastroesophageal reflux disease. In: Moody FG, ed. *Surgical Treatment of Digestive Disease*. 2nd ed. Chicago: Mosby-Year Book, 1990;63-108.
157. Dent J, Dodds W, Friedman R, et al. Mechanism of gastroesophageal reflux in recumbent asymptomatic human subjects. *J Clin Invest* 1980;65:256.
158. Babka J, Hagar G, Castell D. The effect of body position on lower esophageal sphincter pressure. *Am J Dig Dis* 1973;18:441.



159. Banchero N, Schwartz PE, Wood E. Intraesophageal pressure gradient in man. *J Appl Physiol* 1967;22:1066.
160. Johnson L, Lin T, Hong S. Gastroesophageal dynamics during immersion in water to the neck. *J Appl Physiol* 1975;38:449.
161. Orr W, Robinson M, Johnson L. Acid clearing during sleep in patients with esophagitis and controls. *Dig Dis Sci* 1981;26:423.
162. Zaninotto G, DeMeester T, Schwizer W, et al. The lower esophageal sphincter in health and disease. *Am J Surg* 1988;155:104.
163. Crookes PF. Physiology of reflux disease: role of the lower esophageal sphincter. *Surg Endosc* 2006;S462-S466.
164. Streets CG, DeMeester TR. Ambulatory 24-hour esophageal pH monitoring: why, when, and what to do. *J Clin Gastroenterol* 2003;37:14-22.
165. DeMeester T, Lafontaine E, Joelsson B, et al. The relationship of a hiatal hernia to the function of the body of the esophagus and the gastroesophageal junction. *J Thorac Cardiovasc Surg* 1981;82:547.
166. Bonavina L, Evander A, DeMeester T, et al. Length of the distal esophageal sphincter and competency of the cardia. *Am J Surg* 1986;151:25.
167. O'Sullivan G, DeMeester T, Joelsson B, et al. The interaction of the lower esophageal sphincter pressure and length of sphincter in the abdomen as determinants of gastroesophageal competence. *Am J Surg* 1982;143:40.
168. Pellegrini C, DeMeester T, Skinner D. Response of the distal esophageal sphincter to respiratory and positional maneuvers in humans. *Surg Forum* 1976;27:380.
169. Ng A, Smith G. Gastroesophageal reflux and aspiration of gastric contents in anesthetic practice. *Anesth Analg* 2001;93:494-513.
170. Holloway R. The oesophagus. In: Shearman D, Finlayson N, eds. *Diseases of the Gastrointestinal Tract and Liver*. 2nd ed. Edinburgh: Churchill-Livingstone, 1989; 151-200.
171. Helm J, Dodds W, Pelc L, et al. Effect of esophageal emptying and saliva on clearance of acid from the esophagus. *N Engl J Med* 1984;310:284.
172. Helm J, Dodds W, Hogan W. Salivary responses to esophageal acid in normal subjects and patients with reflux esophagitis. *Gastroenterology* 1982;93:1393.
173. Cheatham M, Chapman W, Key S, Sawyers J. A meta-analysis of selective versus routine nasogastric decompression after elective laparotomy. *Ann Surg* 1995;221:469-478.
174. Manning BJ, Winter DC, McGreal G, Kirwan WO, Redmond HP. Nasogastric intubation causes gastroesophageal reflux in patients undergoing elective laparotomy. *Surgery* 2001;130:788-791.
175. Mittal R, Lange R, McCallum R. Identification and mechanism of delayed esophageal acid clearance in subjects with hiatus hernia. *Gastroenterology* 1987;92:130.
176. Crozier R, Jonasson H. Symptomatic esophageal hiatus hernias: study of 105 patients. *Arch Intern Med* 1964;113:737.
177. Davenport HW. *Physiology of the Digestive Tract*. 5th ed. Chicago: Mosby-Year Book, 1982.
178. McCallum R, Berkowitz D, Lerner E. Gastric emptying in patients with gastroesophageal reflux. *Gastroenterology* 1981;80:285.
179. Schwizer W, Hinder R, DeMeester T. Does delayed gastric emptying contribute to gastroesophageal reflux disease? *Am J Surg* 1989;157(1):74-81.
180. Oh JJ, Kim CH. Gastroparesis after a presumed viral illness: clinical and laboratory features and natural history. *Mayo Clin Proc* 1990;65:636.
181. Ganey J, Johnson P, Prillaman P, et al. Cholecystectomy: clinical experience with a large series. *Am J Surg* 1986;151:352.
182. Barlow AP, DeMeester T, Ball C, et al. The significance of the gastric secretory state in gastroesophageal reflux disease. *Arch Surg* 1989;124(8):937-940.
183. Casten DF. Esophageal hiatal hernia and gastric acid secretion. *Arch Surg* 1964;88:255.
184. Johansson K, Ask P, Boeryd B, et al. Oesophagitis, signs of reflux and gastric acid secretion in patients with gastro-oesophageal reflux disease. *Scand J Gastroenterol* 1986;21:837.
185. Moody FG, ed. *Surgical Treatment of Digestive Disease*. 2nd ed. Chicago: Mosby-Year Book, 1990.
186. Schwartz SI, Ellis H, eds. *Maingot's Abdominal Operations*. 9th ed. Norwalk, CT: Appleton & Lange, 1989.
187. DeMeester TR, Wernly J, Bryant G, et al. Clinical and in vitro analysis of determinants of gastroesophageal competence: a study of the principles of antireflux surgery. *Am J Surg* 1979;137:39.
188. Lunca S, Bouras G, Stanescu AC. Gastrointestinal robot-assisted surgery. A current perspective. *Rom J Gastroenterol* 2005;14:385-391.
189. Tryzelaar JF, Neptune WB, Ellis FA, et al. Esophagectomy without thoracotomy for carcinoma of the esophagus. *Am J Surg* 1982;143:486.
190. Josun Hui A, Wing Loong Leong R, Ka Leung Chan F. Gastric Ulcer. In: *Encyclopedia of Gastroenterology*. Philadelphia: Elsevier, 2004;157-162.
191. Yuan Y, Padol IT, Hunt RH. Peptic ulcer disease today. *Nat Clin Pract Gastroenterol Hepatol* 2006;3:80-89.
192. Baron JH. Current views on pathogenesis of peptic ulcer. *Scand J Gastroenterol* 1982;17(Suppl 80):1.
193. Feldman M, Richardson CT. Total 24-hour gastric acid secretion in patients with duodenal ulcer: comparison with normal subjects and effects of cimetidine and parietal vagotomy. *Gastroenterology* 1986;90:540.
194. Isenberg JI, Selling JA, Hogan D, et al. Impaired proximal duodenal mucosal bicarbonate secretion in patients with duodenal ulcer. *N Engl J Med* 1987;316:374.
195. Lam SK, Isenberg JI, Grossman MI, et al. Rapid gastric emptying in duodenal ulcer patients. *Dig Dis Sci* 1982;27:598.
196. Richardson C. Gastric ulcer. In: Sleisenger MH, Fordtran J, eds. *Gastrointestinal Disease: Pathophysiology, Diagnosis, Management*. Philadelphia: WB Saunders, 1983;672-693.
197. Fisher R, Cohen S. Pyloric sphincter dysfunction in patients with gastric ulcer. *N Engl J Med* 1976;288:273.
198. Cheung LY, Ashley SW. The pathogenesis of acid-peptic disease. In: Moody FG, ed. *Surgical Treatment of Digestive Disease*. 2nd ed. Chicago: Mosby-Year Book, 1990;151-172.
199. Ormand J, Talley N. *Helicobacter pylori*: controversies and an approach to management. *Mayo Clin Proc* 1990;65:414.
200. Cash BD. Evidence-based medicine as it applies to acid suppression in the hospitalized patient. *Crit Care Med* 2002;30:S373-S378.
201. Boey J, Choi S, Alagaratnam T. Risk stratification in perforated duodenal ulcers. *Ann Surg* 1987;205:22.
202. Fromm D. Duodenal ulcer. In: Moody FG, ed. *Surgical Treatment of Digestive Disease*. 2nd ed. Chicago: Mosby-Year Book, 1990;197-211.
203. Athanasoulis C. Medical progress: therapeutic application of angiography. *N Engl J Med* 1980;302:1117.
204. Cody H, Wichern W. Choice of operation for acute gastric mucosal hemorrhage: report of 36 cases and review of the literature. *Am J Surg* 1977;134:322.
205. Hubert J, Kiernan P, Welch J, et al. The surgical management of bleeding stress ulcers. *Ann Surg* 1980;191:672.
206. Wilson W, Gadacz T, Olcott C, et al. Superficial gastric erosions: response to surgical treatment. *Am J Surg* 1973;126:133.
207. Dupont J, Cohn I. Gastric carcinoma. *Curr Probl Cancer* 1980;4:1.
208. Dent D, Madden M, Price S. Randomized comparison of R1 and R2 gastrectomy for gastric cancer. *Br J Surg* 1988;75:110.
209. Kodama Y, Sugimachi K, Soejia K, et al. Evaluation of extensive lymph node dissection for carcinoma of the stomach. *World J Surg* 1981;5:241.
210. Korenaga D, Okamura T, Baba H, et al. Results of resection of gastric cancer extending to adjacent organs. *Br J Surg* 1988;75:12.
211. Shiu M, Moore E, Sanders M, et al. Influence of the extent of resection on survival after curative treatment of gastric carcinoma. *Arch Surg* 1987;122:1347-1351.
212. Roslyn J, DenBesten L. Gallstones and cholecystitis. In: Moody F, ed. *Surgical*



Treatment of Digestive Disease. 2nd ed. Chicago: Mosby-Year Book, 1990.

213. LaMorte W, Booker M, Scott T, et al. Increases in gallbladder prostaglandin synthesis before the formation of cholesterol gallstones. *Surgery* 1985;98:445.

214. Been J, Bills P, Lewis D. Microstructure of gallstones. *Gastroenterology* 1979;76:548.

215. Shiffman J, Moore E. Acidification of gallbladder bile is defective in patients with all types of gallstones: a selective defect. *Gastroenterology* 1988;94:591.

216. Sjodahl R, Tagesson C, Wetterfors J. Lysolecithin-mediated inflammatory reaction in rabbit gallbladder. *Acta Chir Scand* 1975;141:403.

217. Reiss R, Eliashiv A, Deutsch A. Septic complications and bile cultures in 800 consecutive cholecystectomies. *World J Surg* 1982;6:192.

218. Chetlin S, Elliott D. Biliary bacteremia. *Arch Surg* 1971;102:303.

219. Fukunaga F. Gallbladder bacteriology, histology and gallstones: study of unselected cholecystectomy specimens in Honolulu. *Arch Surg* 1973;106:169.

220. Clagett OT. Diseases of the gallbladder: diagnosis and management. *Surg Clin North Am* 1945;25:929.

221. Wenckert A, Robertson B. The natural course of gallstone disease: eleven-year review of 781 nonoperated cases. *Gastroenterology* 1966;50:376.

222. Glenn F. Silent gallstones. *Ann Surg* 1981;193:251.

223. Gracie W, Ransohoff D. The natural history of silent gallstones: the innocent gallstone is not a myth. *N Engl J Med* 1982;307:798.

224. Jarvinen H, Hastabacka J. Early cholecystectomy for acute cholecystitis, a prospective randomized study. *Ann Surg* 1980;191:501.

225. Lahtinen, Alhava E, Aukee S. Acute cholecystitis treated by early and delayed surgery: a controlled clinical trial. *Scand J Gastroenterol* 1978;13:673.

226. van der Lindenden W, Sunzel H. Early versus delayed operation for acute cholecystitis: a controlled clinical trial. *Am J Surg* 1970;120:7.

227. Glenn F. Surgical management of acute cholecystitis in patients 65 years of age and older. *Ann Surg* 1981;193:56.

228. Morrow D, Thompson J, Wilson S. Acute cholecystitis in the elderly: a surgical emergency. *Arch Surg* 1978;113:1149.

229. Roslyn J, Busuttill R. Perforation of the gallbladder: a frequently mismanaged condition. *Am J Surg* 1979;137:307.

230. Sackmann M, Delius M, Sauerbruch T, et al. Shockwave lithotripsy of gallbladder stones: the first 175 patients. *N Engl J Med* 1988;318:393.

231. Pitt HA, Miyamoto T, Parapatis SK, et al. Factors influencing outcome in patients with postoperative biliary strictures. *Am J Surg* 1982;144:14.

232. Mokdad AH, Bowman BA, Ford ES, Vinicor F, Marks JS, Koplan JP. The continuing epidemics of obesity and diabetes in the United States. *JAMA* 2001;286:1195-1200.

233. Pi-Sunyer FX. The medical risks of obesity. *Obes Surg* 2002;1977;12(Suppl 1):6S-11S.

234. Crookes PF. Surgical Treatment of Morbid Obesity. *Annu Rev Med* 2006;57:243-264.

235. Schauer P, Chand B, Brethauer S. New applications for endoscopy: the emerging field of endoluminal and transgastric bariatric surgery. *Surg Endosc* 2007;21(3):347-356.

236. Gilbert TB, Seneff MG, Becker RB. Facilitation of internal jugular venous cannulation using an audio-guided Doppler ultrasound vascular access device: results from a prospective, dual-center, randomized, crossover clinical study. *Crit Care Med* 1995;23:60-65.

237. Juvin P, Blarel A, Bruno F, Desmots JM. Is peripheral line placement more difficult in obese than in lean patients? *Anesth Analg* 2003;96:1218, table of contents.

238. Schulz-Stubner S. Bilateral occipital neuropathy as a rare complication of positioning for thyroid surgery in a morbidly obese patient. *Acta Anaesthesiol Scand* 2004;48:126-127.

239. Ezri T, Weisenberg M, Khazin V, et al. Difficult laryngoscopy: incidence and predictors in patients undergoing coronary artery bypass surgery versus general surgery patients. *J Cardiothorac Vasc Anesth* 2003;17:321-324.

240. Ezri T, Gewurtz G, Sessler DI, et al. Prediction of difficult laryngoscopy in obese patients by ultrasound quantification of anterior neck soft tissue. *Anaesthesia* 2003;58:1111-1114.

241. Nowbar S, Burkart KM, Gonzales R, et al. Obesity-associated hypoventilation in hospitalized patients: prevalence, effects, and outcome. *Am J Med* 2004;116:1-7.

242. Kenchaiah S, Evans JC, Levy D, et al. Obesity and the risk of heart failure. *N Engl J Med* 2002;347:305-313.

243. Mitka M. Metabolic syndrome recasts old cardiac, diabetes risk factors as a "new" entity. *JAMA* 2004;291:2062-2063.

244. Anderson JW, Konz EC. Obesity and disease management: effects of weight loss on comorbid conditions. *Obes Res* 2001;9 Suppl 4:326S-334S.

245. Fernandez AZ Jr, DeMaria EJ, Tichansky DS, et al. Experience with over 3,000 open and laparoscopic bariatric procedures: multivariate analysis of factors related to leak and resultant mortality. *Surg Endosc* 2004;18:193-197.

246. Lynch RL, Eisenberg D, Bell RL. Metabolic consequences of bariatric surgery. *J Clin Gastroenterol* 2006;40:659-668.

247. Shah M, Simha V, Garg A. Long-term impact of bariatric surgery on body weight, comorbidities, and nutritional status [review]. *J Clin Endocrinol Metab* 2006;91:4223-4231.

248. Mango VL, Frishman WH. Physiologic, psychologic, and metabolic consequences of bariatric surgery. *Cardiol Rev* 2006;14:232-237.

249. De Waele JJ, Hoste E, Blot SI, et al. Perioperative factors determine outcome after surgery for severe acute pancreatitis. *Crit Care* 2004;8:R504-R511.

250. Imrie CW, Ferguson JC, Murphy D, et al. Arterial hypoxia in acute pancreatitis. *Br J Surg* 1997;64:185.

251. Lankisch P, Rahlf G, Koop H. Pulmonary complications in fatal acute hemorrhagic pancreatitis. *Dig Dis Sci* 1983;28:111.

252. Ranson JH, Turner J, Roses D, et al. Respiratory complications in acute pancreatitis. *Ann Surg* 1974;179:557.

253. Prinz RA, Greenlee HB. Pancreatic duct drainage in 100 patients with chronic pancreatitis. *Ann Surg* 1981;194:313.

254. DuVal MK. Caudal pancreatico-jejunostomy for chronic relapsing pancreatitis. *Ann Surg* 1954;140:775.

255. Puestow CB, Gillesby WJ. Retrograde surgical drainage of the pancreas for chronic relapsing pancreatitis. *Arch Surg* 1958;76:898.

256. Partington P, Rochelle R. Modified Puestow procedure for retrograde drainage of the pancreatic duct. *Ann Surg* 1960;152:1037.

257. Larson-Wadd K, Belani KG. Pancreas and islet cell transplantation. *Anesthesiol Clin North America*. 2004;22:663-674.

258. Kelly W, Lillehei R, Merkel F, et al. Allotransplantation of the pancreas and duodenum along with the kidney in diabetic nephropathy. *Surgery* 1967;61:827.

259. Sollinger HW. Pancreas transplantation in humans. In: Moody FG, ed. *Surgical Treatment of Digestive Disease*. 2nd ed. Chicago: Mosby-Year Book, 1990;577-598.

260. Orie J, Jabi H, Besozzi M, et al. Thallium-201 myocardial perfusion imaging and coronary arteriography in asymptomatic patients with end stage renal disease secondary to juvenile onset diabetes mellitus. *Transplant Proc* 1986;18:1709.

261. Hesse U, Sutherland D. Influence of serum amylase and plasma glucose levels in pancreas cadaver donors on graft function in recipients. *Diabetes* 1989;38(Suppl 1):1.

262. Marsh C, Perkins J, Sutherland D, et al. Combined hepatic and pancreatoduodenal procurement for transplantation. *Surg Gynecol Obstet* 1989;168:254.

263. Thistlethwaite J, Lloyd D, Broelsch C, et al. Whole-pancreas and liver procurement from single-cadaver organ donors: where should vascular structures be divided? *Diabetes* 1989;38(Suppl 1):232.

264. Groth C, Lundgren G, Ostman J, et al. Experience with nine segmental pancreatic transplantations in pre-uremic diabetic patients in Stockholm. *Transplant Proc* 1980;12:68.

265. Tyden G, Groth CG. Vascularized pancreatic transplantation. In: Morris PT, Tilney N, eds. *Progress in Transplantation*. London: Churchill-Livingstone, 1986.

266. Tyden G, Reinholt F, Brattstrom C, et al. Diagnosis of rejection in recipients of pancreatic grafts with enteric exocrine diversion by monitoring pancreatic juice cytology and amylase secretion. *Transplant Proc* 1987;19:3892.
267. Fromme G, Janosy T. Glucose changes during pancreas transplantation. *Anesth Analg* 1989;68:S92.
268. Perkins J, Fromme G, Narr B, et al. Pancreas transplantation at Mayo. II. Operative and perioperative management. *Mayo Clin Proc* 1990;65:483.
269. Squifflet J, Carlier M, Pirson Y, et al. Six human pancreas transplants: results and perioperative management. *Acta Anaesthesiol Belg* 1986;37:107.
270. Fryer J, Pellar S, Ormond D, Koffron A, Abecassis M. Mortality in candidates waiting for combined liver-intestine transplants exceeds that for other candidates waiting for liver transplants. *Liver Transpl* 2003;9:748-753.
271. Abu-Elmagd K, Reyes J, Bond G, et al. Clinical intestinal transplantation: a decade of experience at a single center. *Ann Surg* 2001;234:404-416; discussion 416-417.
272. Nishida S, Levi D, Kato T, et al. Ninety-five cases of intestinal transplantation at the University of Miami. *J Gastrointest Surg* 2002;6:233-239.
273. Farmer DG, McDiarmid SV, Edelstein S, et al. Induction therapy with interleukin-2 receptor antagonist after intestinal transplantation is associated with reduced acute cellular rejection and improved renal function. *Transplant Proc* 2004;36:331-332.
274. Farmer DG, McDiarmid SV, Edelstein S, et al. Improved outcome after intestinal transplantation at a single institution over 12 years. *Transplant Proc* 2004;36:303-304.
275. Greenberger NJ. *Gastrointestinal Disorders: A Pathophysiologic Approach*. 4th ed. Chicago: Mosby-Year Book, 1990.
276. Zuckerman GR, Cornette GL, Clouse RE, et al. Upper gastrointestinal bleeding in patients with chronic renal failure. *Ann Intern Med* 1985;102:588.
277. Greenberger NJ. Gastrointestinal bleeding. In: Moody FG, ed. *Surgical Treatment of Digestive Disease*. 2nd ed. Chicago: Mosby-Year Book, 1990;19-29.
278. Shaldon S, Dolle W, Guevara L, et al. Effect of pitressin on the splanchnic circulation in man. *Circulation* 1961;24:797.
279. Beller B, Trevino A, Urban E. Pitressin induced myocardial injury and depression in a young woman. *Am J Med* 1971;51:675.
280. Anderson J, Johnston G. Development of cutaneous gangrene during continuous peripheral infusion of vasopressin. *Br Med J* 1983;287:1657.
281. Lambert M, de Peyer R, Muller A. Reversible ischemic colitis after intravenous vasopressin therapy. *JAMA* 1982;247:666.
282. Kalloo A, Ciarleglio C, Stanczak V, et al. Technetium-99m labeled red blood cell scans: are they really useful in the diagnosis of lower gastrointestinal bleeding? *Gastroenterology* 1988;95:A213.
283. Christensen J. Intestinal pseudo-obstruction and paralytic ileus. In: Moody FG, ed. *Surgical Treatment of Digestive Disease*. 2nd ed. Chicago: Mosby-Year Book, 1990;605-623.
284. Person B, Wexner SD. The management of postoperative ileus. *Curr Probl Surg* 2006;43:6-65.
285. Rennie JA, Christofides ND, Mitchener P, et al. Neural and humoral factors in postoperative ileus. *Br J Surg* 1980;67:694.
286. Carmichael MJ, Weisbrodt NW, Cope land EM. Effect of abdominal surgery on intestinal myoelectrical activity in the dog. *Am J Surg* 1977;133:34.
287. Neely J, Catchpole B. Ileus: the restoration of alimentary-tract motility by pharmacological means. *Br J Surg* 1971;58:21.
288. Wangenstein OH. *Intestinal Obstruction*. 3rd ed. Springfield, IL: Charles C Thomas, 1955.
289. Huger A, Kreis ME, Zittel TT, Becker HD, Starlinger MJ, Jehle EC. Postoperative colonic motility and tone in patients after colorectal surgery. *Dis Colon Rectum* 2000;43:932-939.
290. Ogilvy AJ, Smith G. The gastrointestinal tract after anaesthesia. *Eur J Anaesthesiol Suppl* 1995;10:35-42.
291. Nelson R, Tse B, Edwards S. Systematic review of prophylactic nasogastric decompression after abdominal operations. *Br J Surg* 2005;92:673-680.
292. van Nieuwenhoven MA, Brouns F, Brummer RJ. The effect of physical exercise on parameters of gastrointestinal function. *Neurogastroenterol Motil* 1999;11:431-439.
293. Block BM, Liu SS, Rowlingson AJ, Cowan AR, Cowan JA Jr, Wu CL. Efficacy of postoperative epidural analgesia: a meta-analysis. *JAMA* 2003;290:2455-2463.
294. Wolff BG, Michelassi F, Gerkin TM, et al. Alvimopan, a novel, peripherally acting mu opioid antagonist: results of a multicenter, randomized, double-blind, placebo-controlled, phase III trial of major abdominal surgery and postoperative ileus. *Ann Surg* 2004;240:728-734; discussion 734-735.
295. Yuan CS. Clinical status of methylnaltrexone, a new agent to prevent and manage opioid-induced side effects. *J Support Oncol* 2004;2:111-117; discussion 119-122.
296. Welch J. *Bowel Obstruction: Differential Diagnosis and Clinical Management*. Philadelphia: WB Saunders, 1989.
297. Phillips SF. Diarrhea: a current view of the pathophysiology. *Gastroenterology* 1972;63:495.
298. Herrin R, Meek W. Distention as a factor in intestinal obstruction. *Arch Intern Med* 1933;51:152.
299. Sung D, Williams L. Intestinal secretion after intravenous infusion in small bowel obstruction. *Am J Surg* 1971;121:91.
300. Wright H, O'Brien J, Tilson M. Water absorption in experimental closed segment obstruction of the ileum in man. *Am J Surg* 1971;121:96.
301. Welch J. Mechanical obstruction of the small and large intestines. In: Moody FG, ed. *Surgical Treatment of Digestive Disease*. 2nd ed. Chicago: Mosby-Year Book, 1990.
302. Beal AL, Cerra FB. Multiple organ system failure syndrome in the 1990s. Systemic inflammatory response and organ dysfunction. *JAMA* 1994;271:226.
303. Moore EE, Moore FA, Harken AH, Johnson JL, Ciesia D, Ganerjee A. The two-event construct of postinjury multiple organ failure. *Shock* 2006;24:71-74.
304. Bone RC. Sepsis, sepsis syndrome, and the systemic inflammatory response syndrome (SIRS). Gulliver in Laputa. *JAMA* 1995;273:155.
305. Rangel-Frausto MS, Pittet D, Costigan M, et al. The natural history of the systemic inflammatory response syndrome (SIRS): a prospective study. *JAMA* 1995;273:117.
306. Casey LC, Balk RA, Bone RC. Plasma cytokine and endotoxin levels correlate with survival in patients with the sepsis syndrome. *Ann Intern Med* 1993;119:771.
307. Singer M, De Santis V, Vitale D, Jeffcoate W. Multiorgan failure is an adaptive, endocrine-mediated, metabolic response to overwhelming systemic inflammation. *Lancet* 2004;363:545-548.
308. Porter J, Sussman M, Bulkley G. Splanchnic vasospasm in circulatory shock. In: Marston A, Bulkley G, Fiddian-Green RG, et al., eds. *Splanchnic Ischemia and Multiple Organ Failure*. London: Edward Arnold, 1989;73-88.
309. Bailey R, Bulkley G, Hamilton S, et al. Pathogenesis of nonocclusive ischemic colitis. *Ann Surg* 1986;203:590.
310. Bounous G. Acute necrosis of the intestinal mucosa. *Gastroenterology* 1982;82:1457.
311. Bulkley GB. Mediators of splanchnic organ injury: overview and perspective. In: Marston A, Bulkley G, Fiddian-Green RG, et al., eds. *Splanchnic Ischemia and Multiple Organ Failure*. London: Edward Arnold, 1989;183-194.
312. Bynum T, Gallavan R, Jacobson E. The pathophysiology of nonocclusive ischemia. In: Shepherd A, Granger D, eds. *Physiology of the Intestinal Circulation*. New York: Raven Press, 1984;369-376.
313. Cheung L. Gastric mucosal blood flow: its measurement and importance in mucosal defense mechanisms. *J Surg Res* 1984;36:282.
314. Singer M. Metabolic failure. *Crit Care Med* 2005;33:S539-S542.
315. Barie PS, Hydo LJ. Epidemiology of multiple organ dysfunction syndrome in critical surgical illness. *Surg Infect* 2000;1:173-186.

## CHAPTER 56

## Anesthesia for Liver Surgery and Transplantation

Warren S. Sandberg, MD, PhD,  
and Douglas E. Raines, MD

## INTRODUCTION

Anesthesiology is an ever evolving field, and anesthesia for surgery of the hepatobiliary system is no exception. Over the past 3 decades, hepatic surgery has developed as a separate subspecialty, and this development has paralleled the evolution of hepatic surgery from a risky and heroic enterprise to a more routine undertaking. Better understanding of hepatic anatomy, better diagnostic imaging capabilities, better patient selection and risk stratification, better surgical techniques, and better anesthetic techniques have at once improved the morbidity and mortality profiles of liver surgery while extending the limits of what can safely be accomplished.

This chapter describes the anesthetic management of patients undergoing hepatic surgery, ranging from minimally invasive procedures, such as transjugular intrahepatic portosystemic shunting, to orthotopic liver transplantation. Patients presenting for hepatic surgery can generally be divided into two groups, each of which provides unique challenges for the anesthesiologist:

1. Patients presenting for hepatic surgery who do not have significant liver disease—for example, the patient with isolated hepatocellular carcinoma. These patients can generally be evaluated and managed as patients presenting for other types of major intraabdominal surgery.
2. Patients with significant liver disease presenting for hepatic surgery for either amelioration of the liver disease itself or, more rarely, treatment of a distinct hepatobiliary problem. Hepatobiliary operations performed on patients with liver disease include portosystemic shunts, hepatic resection, and orthotopic liver transplantation.

Patients with liver disease who require nonhepatic surgery are a broader group unified by a common derangement. In these individuals, the liver disease must be taken into account and will shape preoperative preparation, anesthetic technique, and postoperative care (for more details on the evaluation and general anesthetic

management of the patient with liver disease presenting for nonhepatic surgery, see Chap. 14).

The general principles evinced in Chap. 14 apply as well to patients with liver disease presenting for hepatobiliary surgery. In this chapter, we first review the relevant anatomy, physiology, and hepatobiliary pathophysiology.

## KEY POINTS

1. Patients with chronic liver dysfunction and cirrhosis have a hyperdynamic circulation with low peripheral vascular resistance and an increased cardiac index.
2. Coagulopathies, edema and ascites, renal dysfunction, portopulmonary hypertension, hepatopulmonary syndrome, and autonomic neuropathies are common in patients with liver disease.
3. The cause of hepatic encephalopathy is believed to be multifactorial. Hepatic encephalopathy resembles, and must be differentiated from, many other nonfocal neurologic conditions, such as hypoglycemia, hyponatremia, intracranial hemorrhage or mass lesions, and meningitis.
4. Patients scheduled for hepatic resection should be evaluated as any patient scheduled for major noncardiac surgery. Plans for monitoring, vascular access, induction and maintenance of anesthesia, postoperative pain control, and postoperative care should take into account a large subcostal incision and the potential for sudden massive hemorrhage and severe physiologic derangements during and after surgery.
5. The most common indication for liver transplantation is chronic hepatocellular disease because of alcohol and/or hepatitis. Hepatitis C is increasingly important, representing a unique and growing health risk for anesthesiologists.
6. Cardiac assessment of the patient being considered for liver transplantation focuses on functional and invasive tests of cardiac performance that assess ischemic potential and the search for cardiac structural anomalies that might compromise outcome from orthotopic liver transplantation.
7. Liver transplantation comprises three phases. During the *preanhepatic* phase, a complete hepatectomy is performed. During the *anhepatic* phase, vascular anastomoses between the donor liver and the recipient's vessels are constructed. During the *neohepatic* phase, the hepatic arterial and biliary anastomoses are constructed, and the wound is closed.
8. The two common techniques for liver transplantation are the en bloc technique with interruption of vena caval flow and the piggyback technique with preservation of vena caval flow.
9. The goals of hemodynamic management are to provide sufficient circulating volume, vascular tone, and cardiac output to perfuse the vital organs. This is not guided by any single parameter but rather by a synthesis of all available data.
10. Most livers made available for transplantation come from heart beating cadaveric donors. When caring for organ donors, the focus of care has shifted from preserving the patient to preserving the function of graft organs. Because of the shortage of cadaveric donors, the use of living donors is growing. In these cases, donor safety is a primary concern because the donor derives no physical benefit from the surgery.
11. The effects of portal hypertension and ascites are alleviated by nonshunting and shunting procedures. Nonshunting procedures are aimed at controlling hemorrhage from portosystemic varices. Shunting procedures redirect the portal venous flow into the systemic venous circulation via a nonvariceal conduit, thus relieving portal hypertension, decompressing varices, and at the same time relieving ascites.



gy that affect the anesthetic management of patients presenting for hepatic surgery. Next, we describe at a high level the surgical considerations informing the various groups of hepatic operations, followed by detailed consideration of the consequent anesthetic management goals.

## ANATOMY AND PHYSIOLOGY

### Anatomy of the Liver

The liver contains two lobes (right and left) that are separated on the anterior side by the falciform ligament and supplied by right and left branches of the portal vein and the hepatic artery. Two smaller additional lobes can be visualized on the posterior aspect of the liver, the caudate and quadrate lobes. The liver is subdivided into eight segments that are defined by secondary and tertiary branching of the blood supply. The caudate lobe contains segment 1, the left lobe contains segments 2 and 3, the quadrate contains segment 4, and the right lobe contains segments 5 through 8.

Blood flow to the liver is 1 L/min/kg of hepatic tissue, or approximately 25% of the cardiac output. Most of this blood supply is via the portal vein (75%), which delivers approximately 45–50% of the hepatic oxygen supply, with the balance coming via the hepatic artery. Portal venous blood flow is controlled primarily by the arterioles within upstream splanchnic organs and, to a more limited extent, by resistance within the liver. Hepatic artery blood flow is controlled directly via arterial smooth muscle under autonomic regulation. In addition, metabolic factors such as blood pH and/or oxygen content can modulate hepatic arterial resistance and, hence, blood flow. After coursing through the liver, blood drains via the hepatic veins and into the inferior vena cava.

### Overview of Liver Functions

The liver is among the most complex organs in the body and is responsible for a wide range of important synthetic and metabolic processes. A detailed review is beyond the scope of this chapter, but a brief overview is provided here.

#### Albumin Synthesis

The liver synthesizes more albumin than any other protein, in the range of

10–20 g/day. As the most abundant plasma protein, it serves an important role in maintaining the normal oncotic pressure of plasma. A decrease in albumin synthesis can allow transudation of fluids into extravascular spaces, producing edema and ascites. Albumin has a half-life of approximately 20 days; therefore, it is not a good indicator of liver function in patients with acute hepatic disease. Because many drugs, including barbiturates and benzodiazepines, are bound by albumin in the blood, the hypoalbuminemia frequently observed in patients with significant hepatic dysfunction can lead to an increase in the free or active concentrations of the drugs. This may account, in part, for the increased sensitivity of patients with severe hepatic disease to sedatives and anesthetics.

#### Coagulation Factor Synthesis

The liver is the major site of synthesis of most procoagulant and inhibitory clotting factors, including fibrinogen, factors II, V, VII, IX, XII, and XIII, plasminogen, antithrombin, and proteins C and S. Consequently, loss of hepatic parenchymal cells can lead to clotting factor deficiencies with resultant coagulopathy. Systemic fibrinolysis, which is found in 30% of patients with end-stage liver disease, may contribute to clotting factor deficiencies.<sup>1</sup> Although the pathogenesis of this fibrinolysis is not clearly defined, studies suggest that it involves altered tissue plasminogen activator activity, impaired synthesis of the inhibitors of plasminogen and plasmin,  $\alpha_2$ -antiplasmin, and histidine-rich glycoprotein.<sup>2–5</sup> Additionally, patients with advanced liver disease exhibit an exaggerated fibrinolytic response to major surgery, such as liver transplantation, predisposing them to significant perioperative hemorrhage.<sup>6</sup>

#### Carbohydrate Metabolism

Regulation of blood glucose concentrations is controlled largely by the liver and is under hormonal control. In response to lowered concentrations of glucose in the portal vein, glycogen stored in the liver is broken down to glucose for use by other tissues (glycogenolysis). During periods of fasting when glycogen stores have been depleted, the liver can also generate glucose from noncarbohydrate sources, such as lactate, amino acids, and glycerol (gluconeogenesis). Ingestion of carbohydrates replenishes glycogen

stores and allows fatty acids to be synthesized by the liver.

#### Bile Acid Synthesis

Bile acids are important compounds required for elimination of cholesterol and absorption of vitamins and fats. The liver converts approximately 500 mg/day of cholesterol into bile acids in processes that involve 17 different enzymes and are regulated by many factors, including nutrients and hormones.<sup>7</sup> Bile acids are stored in the gallbladder and released into the small intestine to emulsify lipids, cholesterol, and the fat-soluble vitamins A, D, E, and K. Most (90–95%) of the secreted bile acids are reabsorbed by the liver and recycled.

#### Drug Metabolism

A number of enzymatic pathways are involved in the metabolism of drugs by the liver, each can be placed into one of two reaction categories. Phase 1 reactions use the chemical processes of oxidation, reduction, and hydrolysis; occur in the hepatocyte smooth endoplasmic reticulum; and are mediated primarily by the cytochrome P450 family of enzymes. Phase 2 reactions increase the water solubility of drugs by coupling (conjugating) drugs with polar moieties, thereby facilitating biliary excretion. Often, phase 2 reactions follow phase 1 reactions because the products of phase 1 reactions may not be sufficiently water soluble to be readily excreted.

## PATHOPHYSIOLOGY RELEVANT TO ANESTHESIA FOR LIVER SURGERY

In this section, we briefly review the disease entities leading to liver failure (for a more complete description and a discussion of the Child-Turcotte-Pugh classification scheme for evaluating the surgical risk associated with progressive worsening of liver disease, see Chap. 14). Later in this section, we describe the pathogenesis and medical management of organ system derangements that are associated with acute and chronic liver disease.

### Chronic Liver Disease

Chronic liver disease may result from a variety of conditions, including infection, biliary obstruction, toxicity, and inborn errors of metabolism (Box 56–1). These conditions can progress to



## BOX 56-1.

**Major Causes of Chronic Liver Disease**

Intraparenchymal disease  
 Viral infections  
 Chronic active hepatitis B  
 Chronic active hepatitis C  
 Hepatitis D  
 Toxins  
 Ethanol  
 Miscellaneous  
 Cystic fibrosis  
 Hemochromatosis  
 Wilson disease  
 $\alpha_1$ -Antitrypsin deficiency  
 Metabolic errors of carbohydrate, lipid, protein  
 Cholestatic disease  
 Primary biliary cirrhosis  
 Primary sclerosing cholangitis

cirrhosis, which is characterized by hepatic cell death, fibrosis, and formation of regenerative nodules. This process is essentially irreversible and leads to important physiologic disturbances. Elevation of the blood pressure within the portal venous system (i.e., portal hypertension) is common in patients with significant chronic liver disease and results from increased portal blood flow and/or intrahepatic resistance. It is associated with the formation of ascites, esophageal varices, hepatic encephalopathy, and splenomegaly. Ascites is a hallmark of decompensated liver cirrhosis, and its cause is multifactorial. These factors include alterations in portal blood flow dynamics, activation of the renin-angiotensin-aldosterone system, and reduction in plasma oncotic pressure. The primary treatments of ascites are sodium and water restriction, administration of diuretics, and abdominal paracentesis, which can lead to intravascular fluid depletion.

Esophageal variceal bleeding is a potentially lethal complication of cirrhosis. Treatment options depend on the severity of the bleeding and include the administration of  $\beta$ -blockers, variceal banding, sclerotherapy, and portosystemic shunting. However, an important potential complication of portosystemic shunting is that it may cause or worsen existing hepatic encephalopathy.<sup>8</sup>

**Fulminant Hepatic Failure**

Fulminant hepatic failure is generally defined as severe hepatic dysfunction

## BOX 56-2.

**Major Causes of Fulminant Hepatic Failure**

Toxins  
 Acetaminophen  
 Ethanol  
*Amanita phalloides*  
 Halothane  
 Phosphorus  
 Viral infections  
 Hepatitis A  
 Hepatitis B  
 Hepatitis C  
 Hepatitis D  
 Miscellaneous  
 Budd-Chiari syndrome  
 Acute fatty liver of pregnancy  
 Wilson disease

that occurs either in the absence of preexisting liver disease or in the presence of well-compensated liver disease. Drug toxicity, most frequently by acetaminophen, is the most common cause of fulminant hepatic failure (Box 56-2), followed by viral hepatitis. However, not uncommonly (17%), no causative agent is identified.<sup>9</sup> Acute hepatic encephalopathy is a prominent clinical feature of fulminant hepatic failure and is associated with progressive brain swelling and an increase in intracranial pressure (ICP) that can result in brain herniation and death. Brain herniation is also the most commonly identifiable cause of death found at autopsy.<sup>10</sup> In patients who are awake and responsive, regular neurologic examinations can be used to exclude dangerous brain swelling. However, neurologic examinations cannot detect dangerous increases in ICP when patients are comatose because of encephalopathy or in patients during general anesthesia. Therefore, some centers regularly institute ICP monitoring during major surgery. However, such monitoring is controversial because patients with fulminant hepatic failure commonly are coagulopathic, and placement of ICP monitors is associated with a significant (10–20%) risk of intracranial bleeding.<sup>11,12</sup>

Treatment of fulminant hepatic failure is supportive, and many patients recover. However, some patients do not recover and thus require liver transplantation. Regardless of the final path to resolution, supportive care aims to reduce the impact of severe encephalopathy and brain swelling.

## BOX 56-3.

**Hemodynamic Derangements in Cirrhotic Liver Disease**

Decreased systemic vascular resistance due to:  
 Peripheral vasodilatation  
 Arteriovenous shunting  
 Redirection of blood flow:  
 Increased pulmonary, splanchnic, muscle, skin blood flow  
 Decreased portal vein flow to liver  
 Normal or increased hepatic arterial flow  
 Normal to decreased renal blood flow  
 Increased blood volume  
 Decreased serum albumin  
 Decreased plasma oncotic pressure  
 Increased cardiac output  
 Apparent cardiomyopathy despite increased output  
 Decreased arteriovenous O<sub>2</sub> content difference  
 Increased venous O<sub>2</sub> content  
 Decreased responsiveness to catecholamines

Mild hypothermia appears to be protective in patients with encephalopathy during acute liver failure awaiting liver transplantation, but this has not been unequivocally demonstrated by randomized studies.<sup>13</sup> Similarly, barbiturates can be used to lower brain oxygen consumption as an additional temporizing measure.

Bacterial infection develops in up to 80% of patients with fulminant hepatic failure.<sup>14,15</sup> These infections most commonly involve the respiratory and urinary systems.<sup>15</sup> Acute infection may prevent transplantation.

**Hemodynamic Changes in Liver Disease**

Patients with chronic liver dysfunction and cirrhosis commonly have a hyperdynamic circulation (Box 56-3) with a low peripheral vascular resistance and an increased cardiac index.<sup>16</sup> It has been suggested that a low systemic vascular resistance results from an increase in circulating endogenous vasodilators, including nitric oxide, calcitonin gene-related peptide, and substance P, the metabolism of which is reduced by the presence of intrahepatic and extrahepatic arteriovenous shunts.<sup>17-19</sup> Cardiac output is frequently elevated in cirrhotic patients, attributable to increased sympathetic

nervous system activity, increased blood volume and preload, and reduced systemic vascular resistance.<sup>20,21</sup> However, even in the setting of increased cardiac output, patients with cirrhosis may have significant cardiac dysfunction. Typical features of “cirrhotic cardiomyopathy” include impaired cardiac contractility, conduction abnormalities, impaired excitation–contraction coupling, and decreased  $\beta$ -adrenergic receptor function.<sup>22</sup> Some patients with a hyperdynamic circulation develop significant left ventricular failure after liver transplantation. The condition has been suggested to result from increased peripheral vascular resistance after relief of vasodilatation by transplantation. With inotropes, mechanical ventilation, and close monitoring, results from small series suggest that these patients will survive.<sup>23</sup>

### Renal Function in Patients with Liver Disease

Renal dysfunction is common in patients with liver disease and has at least three major causes.<sup>24</sup> First, prerenal azotemia resulting from overaggressive use of diuretics used to control ascites can result in rising blood urea nitrogen (BUN) and creatinine concentrations indicating worsening renal function. These elevations usually respond to reduction of the diuretic dose and gentle hydration. The second common cause of renal dysfunction in patients with liver disease is acute tubular necrosis in the setting of another acute, precipitating factor. In patients with liver disease, a common scenario is the development of a low-tone, sepsis syndrome in the setting of an infection, such as spontaneous bacterial peritonitis, followed by renal failure. Renal failure commonly develops in the setting of infection in patients with liver disease. For example, it has been reported that 27% of patients with cirrhosis and sepsis progressed to renal failure.<sup>25</sup> Of these patients, renal failure was reversible in 76%,<sup>25</sup> demonstrating that renal function tends to recover with removal of the inciting insult. However, the mortality rate for patients with high Model of End-Stage Liver Disease (MELD) scores (i.e., severe liver disease) was high.<sup>25</sup> The third common cause of renal failure in the cirrhotic patient is hepatorenal syndrome.<sup>26</sup> The diagnostic criteria for hepatorenal syndrome are given in Box 56–4.

Hepatorenal syndrome is marked by worsening of renal function as the liver

disease progresses. Renal function will not recover unless liver function improves.<sup>24</sup> Temporizing measures to treat hepatorenal syndrome are based on theories of its pathophysiology. One such theory is that the inciting factor is the peripheral vasodilatation that characterizes late cirrhosis.<sup>27</sup> Decreased peripheral vascular resistance activates vasoconstrictor systems (e.g., renin–angiotensin–aldosterone, antidiuretic hormone, and sympathetics), leading to renal vasoconstriction. This in turn leads to sodium and water retention and the formation of ascites. Another theory is that portal hypertension reduces blood flow to hepatocytes,<sup>28</sup> which sense the reduced flow as a manifestation of inadequate blood volume and activate a hepatorenal reflex causing vasoconstriction and sodium and water retention. Thus, the temporizing therapies for hepatorenal syndrome include both renal vasodilators and splanchnic vasoconstrictors. Splanchnic vasoconstrictors, such as vasopressin and its longer-lived relatives, are sometimes coadministered with a plasma expander such as albumin.<sup>24</sup> This is the preferred treatment for patients with liver transplantation as an option, and renal function typically recovers after transplantation.<sup>24</sup> However, transplantation is complicated by the presence of renal failure, and renal replacement therapy for control of pH, serum potassium, and intravascular volume is frequently required for these patients.

### Pulmonary System in Liver Disease

Some patients with chronic liver disease and portal hypertension develop alterations in pulmonary physiology leading to two clinically distinct syndromes: portopulmonary hypertension and hepatopulmonary syndrome. Management depends on appreciating the difference between portopulmonary hypertension and hepatopulmonary syndrome and the therapeutic approaches to each.<sup>29</sup>

#### Portopulmonary Hypertension

Portopulmonary hypertension occurs most frequently in patients with advanced liver disease. In one study of patients with cirrhosis and refractory ascites, the prevalence of portopulmonary hypertension was 16%.<sup>30</sup> Portopulmonary hypertension is characterized by mean pulmonary arterial pressure >25 mm Hg with normal pulmonary capillary wedge pressure (<15

#### BOX 56–4.

##### Diagnostic Criteria for Hepatorenal Syndrome<sup>a</sup>

###### Major Criteria

- Low glomerular filtration rate, as indicated by serum creatinine >1.5 mg/dL
- Exclusion of shock, ongoing bacterial infection, volume depletion, or use of nephrotoxic drugs
- No improvement in renal function after stopping diuretics and volume repletion with 1.5 L of normal saline
- No proteinuria or evidence of obstructive uropathy or parenchymal renal disease

###### Minor Criteria

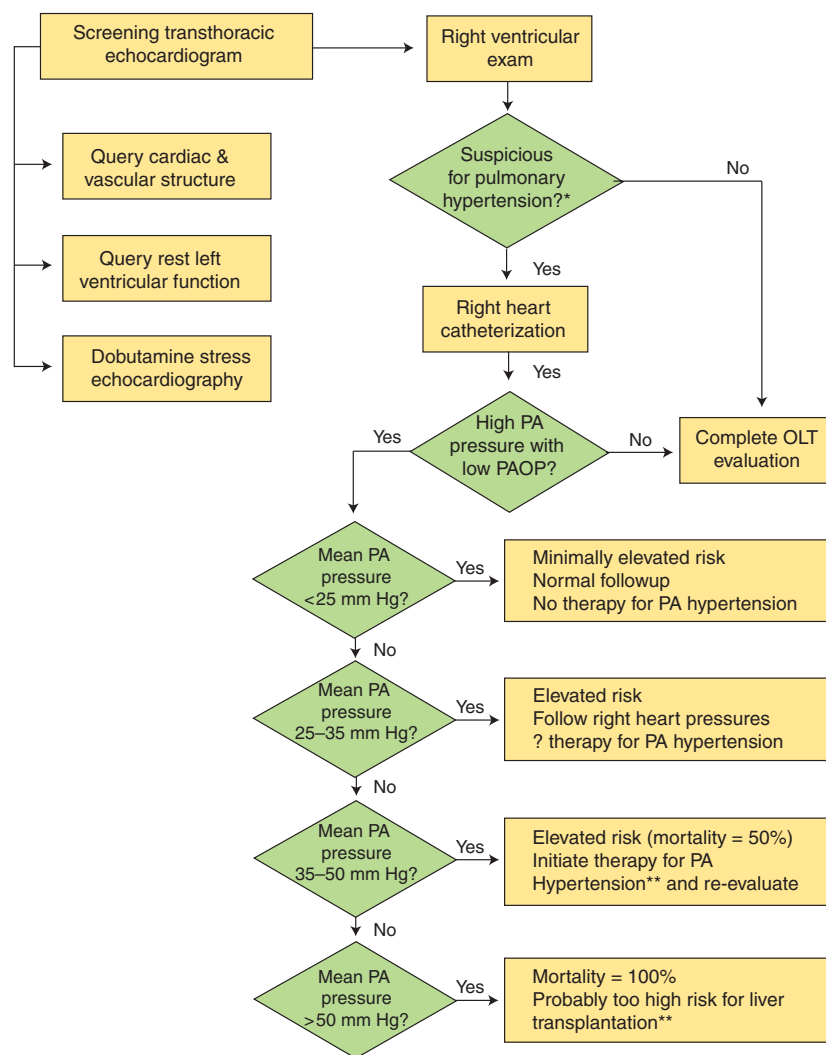
- Urine volume <500 mL/d
- Urine sodium <10 mEq/L
- Urine osmolality > plasma osmolality
- Urine red blood cells <50 per high-power field
- Serum sodium <130 mEq/L

From Cardenas<sup>26</sup> with permission.

<sup>a</sup>Only major criteria are needed to establish the diagnosis.

mm Hg) and elevated pulmonary vascular resistance (>120 dyne/sec/cm<sup>5</sup>) in the setting of portal hypertension.<sup>29</sup> Multiple factors have been implicated in the etiology of portopulmonary hypertension, including (1) increased pulmonary arterial blood flow secondary to the increase in cardiac index frequently observed in cirrhosis, (2) increased circulating blood volume, and (3) vasoconstriction and progressive pulmonary vascular remodeling due to proliferation of endothelial and smooth muscle cells with or without thrombotic change.<sup>29,31</sup> The most common symptom of portopulmonary hypertension is dyspnea on exertion, with fatigue, palpitations, chest pain, and syncope being less frequent.<sup>32,33</sup>

Evidence of portopulmonary hypertension can be obtained noninvasively using transthoracic Doppler echocardiography. Fig. 56–1 outlines the diagnostic approach to pulmonary hypertension. Although transthoracic echocardiography is a useful screening tool for portopulmonary hypertension, it frequently overestimates right ventricular pressure,<sup>34</sup> producing a large number of false-positive results as determined by direct pressure measurements at subsequent



\* Right ventricular systolic pressure estimate > 40 mm Hg, right ventricular hypertrophy or right ventricular dilation.

\*\*Provocative testing during right heart catheterization, e.g., inhaled nitric oxide by face mask or intravenous epoprostenol, may predict treatment efficacy.

**FIGURE 56–1.** Suggested diagnostic paradigm for excluding or monitoring pulmonary hypertension. Although many variations exist, it is important to complete the process with a detailed knowledge of the patient's pulmonary hemodynamics. Normal follow-up: repeat transthoracic echocardiogram or right-heart catheterization 1 year after previous test. Elevated risk implies high risk of perioperative mortality (see text for details). OLT, Orthotopic liver transplantation; PA, pulmonary artery.

cardiac catheterization.<sup>34,35</sup> For example, a right ventricular systolic pressure estimate  $\geq 40$  mm Hg obtained from transthoracic echocardiography is associated with significant pulmonary hypertension (i.e., mean pulmonary arterial pressure >25 mm Hg) at right-heart catheterization in only approximately 65% of cases.<sup>35</sup> Conversely, the sensitivity of Doppler echocardiography for detecting portopulmonary hypertension is sufficiently high that a normal study rules out portopulmonary hypertension.<sup>35</sup> Because of the severe consequences of failing to diagnose and manage portopulmonary hypertension during

later liver surgery or transplantation, the best current approach is to screen with transthoracic echocardiography and perform pulmonary artery catheterization to confirm or exclude portopulmonary hypertension in patients with high right ventricular systolic pressure estimates at transthoracic echocardiography.

Effective management of portopulmonary hypertension is important because reducing pulmonary arterial pressures, unloading the right heart, and allowing time for pulmonary vascular remodeling may allow patients who are not liver transplant candidates to become potential recipients.<sup>36</sup> Pul-

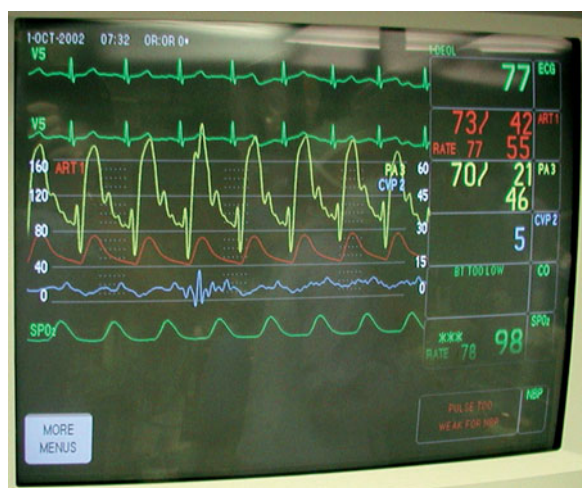
monary vasodilator treatment also may allow a marginal patient to receive a transplant with reduced mortality.<sup>36</sup> Vasodilators, such as epoprostenol, sildenafil, and nitric oxide, can reduce pulmonary vascular resistance<sup>37,38</sup> and are used for this purpose by programs that consider liver transplantation in patients whose pulmonary pressures can be satisfactorily lowered. Whether these interventions improve survival at liver transplantation is unclear given the current level of evidence. How long pulmonary arterial pressures must be lowered to confer the benefit (if any) of the intervention at subsequent transplantation also is unclear. Case reports of patients with good response to pulmonary vasodilators who subsequently had poor outcomes of transplantation temper enthusiasm for the prospects of such patients.<sup>39</sup>

Experience with pulmonary vasodilators is greatest with IV epoprostenol. Epoprostenol appears to be effective in reducing pulmonary arterial pressures, although it can lead to splenomegaly.<sup>40</sup> Epoprostenol use was more common in patients with pulmonary hypertension who survived liver transplantation than in nonsurvivors with the same degree of pulmonary hypertension, although the difference was not significant.<sup>41</sup> Unfortunately, IV epoprostenol requires continuous IV access for infusion, with all of the attendant complications of permanent venous access and pump failures.

The difficult logistics of continuous epoprostenol use have prompted a search for more convenient routes of administration and/or longer-lived prostaglandin analogues. For example, early reports indicate that continuous subcutaneous administration of treprostanil<sup>42</sup> reduces the symptoms of pulmonary hypertension and lowers pulmonary arterial pressures. Oral beraprost<sup>43</sup> also reduces symptoms of pulmonary hypertension, but the reductions in pulmonary arterial pressures were modest and did not achieve statistical significance despite a relatively large sample size. Inhaled iloprost quickly reduces right-heart pressures and is easy to deploy (and should be pulmonary selective).<sup>44–46</sup>

Of note, none of these alternatives to IV epoprostenol produces more than a few millimeters of mercury reduction in mean pulmonary arterial pressure. Consequently, these drugs may have limited effectiveness in the preparation of patients with pulmo-





**FIGURE 56–2.** Pulmonary and systemic pressures immediately after pulmonary artery catheter placement during liver transplantation in a patient with apparent pulmonary hypertension.

nary hypertension for liver transplantation. Conversely, results from individual patients indicate that IV epoprostenol can lower mean pulmonary arterial pressure from approximately 50 to 25 mm Hg.<sup>37,47</sup>

The discovery that nitric oxide can induce pulmonary vasodilatation has provided another approach to lowering pulmonary arterial pressures. Inhaled nitric oxide is a selective pulmonary vasodilator that lowers pulmonary arterial pressures in patients with portopulmonary hypertension.<sup>38</sup> Nitric oxide administered by face mask can be used as a diagnostic tool to assess pulmonary arterial pressure response to vasodilators during right-heart catheterization.<sup>48</sup>

When pulmonary hypertension is discovered unexpectedly in the operating room at the beginning of a transplant, reversible causes of pulmonary hypertension, such as hypoventilation-induced hypercarbia, should be ruled out or reversed. Fig. 56–2 illustrates apparently severe pulmonary hypertension, with pulmonary pressures equal to systemic pressure. Reversing hypercarbia attributable to hypoventilation and lightening the anesthetic lowered the pulmonary pressures and raised the systemic pressures, after which the patient had an uneventful liver transplant.

When newly discovered apparent pulmonary hypertension does not respond to such simple maneuvers, inhaled nitric oxide may be very effective in lowering the pulmonary arterial pressures acutely, without the systemic effects of a nonselective vasodilator such as epoprostenol. Pulmonary arterial pressures (and consequently cen-

tral venous pressure) should be lowered as effectively as possible, both to minimize hemorrhage and to avoid acute graft congestion that could cause early graft compromise in the operating room.<sup>29</sup> Also of importance is extending treatment of pulmonary hypertension well into the postoperative period because graft failure due to poor blood flow remains a concern. Thus, as the patient moves toward extubation, it is necessary to transition from inhaled nitric oxide to an IV agent (e.g., epoprostenol) or oral agent (e.g., sildenafil) as part of weaning from the ventilator, with the lowest achievable pulmonary arterial pressure being the goal.

Sildenafil is an inhibitor of phosphodiesterase-5 that blocks degradation of cyclic guanosine monophosphate, the second messenger of nitric oxide. Sildenafil also produces selective pulmonary vasodilatation.<sup>49</sup> There are early anecdotal reports of its use as a pulmonary vasodilator in patients prior to liver transplant.<sup>50,51</sup> Oral sildenafil is a useful adjunct to inhaled iloprost, a prostacyclin analogue.<sup>52</sup> To date, far less evidence supports the efficacy of sildenafil, particularly as monotherapy, than IV epoprostenol as therapy for portopulmonary hypertension, but early reports are encouraging.

### **Hepatopulmonary Syndrome**

Hepatopulmonary syndrome is defined by the presence of hepatic dysfunction or portal hypertension, an elevated alveolar–arterial oxygen gradient, and intrapulmonary vasodilatation.<sup>29,53</sup> Thus, although portopulmonary hypertension is associated with pulmonary vascular

vasoconstriction, hepatopulmonary syndrome results from vasodilatation and pulmonary vascular remodeling. Patients may present with digital clubbing, spider angiomas, arterial hypoxemia, and dyspnea that worsens upon moving from a recumbent to an upright position (orthodeoxia and platypnea).<sup>53</sup> Early diagnostic criteria required ruling out the presence of other cardiopulmonary abnormalities. However, it now is apparent that hepatopulmonary syndrome may contribute to hypoxemia even when other cardiopulmonary abnormalities are present.<sup>54,55</sup> Intrapulmonary vasodilatation may reflect true anatomic shunt, physiologic shunt, and precapillary or capillary dilation leading to alterations in oxygen diffusion.<sup>56</sup> Nitric oxide level is elevated in the exhaled breath of patients with hepatopulmonary syndrome, suggesting a causative role.<sup>57,58</sup> Interestingly, a case of normalization of exhaled nitric oxide accompanied by return to normoxia after liver transplantation has been reported.<sup>58</sup>

The diagnosis of hepatopulmonary syndrome depends on documenting the presence of arterial desaturation and pulmonary vasodilatation in patients with liver disease. Other causes of hypoxia in patients with liver disease must be excluded (Box 56–5). Pulse oximetry is a sensitive, noninvasive screening tool for detecting low arterial oxygen saturation, the results of which can be confirmed using arterial blood gas analysis.<sup>59</sup> Pulmonary

#### **BOX 56–5.**

##### **Major Causes of Hypoxia in Patients with Liver Disease**

- Ventilation–perfusion mismatching
- Premature airway closure
- Pulmonary vasodilatation
- Impaired hypoxic pulmonary vasoconstriction
- Diffusion–perfusion deficit
- Pulmonary emboli
- Compression of lung tissue
- Impaired diaphragmatic function due to ascites
- Pleural effusion
- Pulmonary edema
- Pulmonary manifestations of specific liver disease (e.g.,  $\alpha_1$ -antitrypsin deficiency)
- Acute exacerbations of intercurrent chronic lung disease



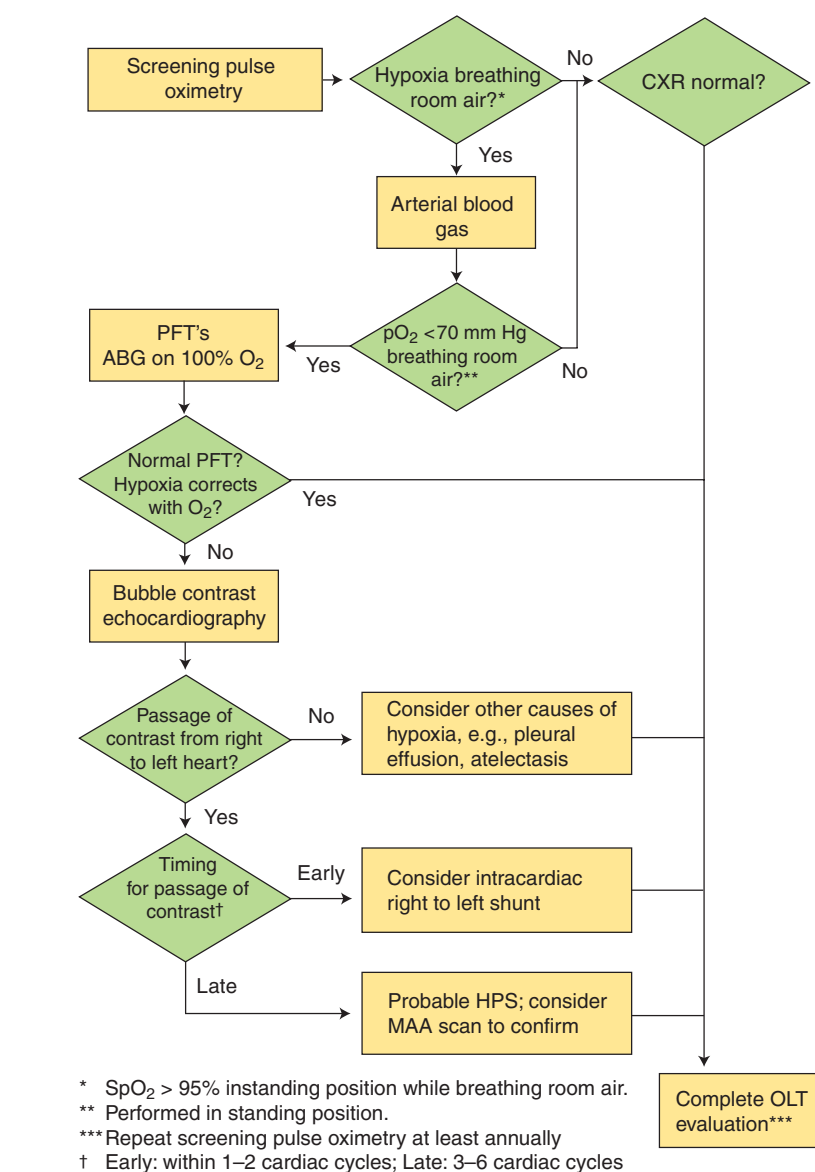
vasodilatation can be documented using a variety of modalities, including contrast echocardiography, lung perfusion scanning, or pulmonary artery catheterization.<sup>29,53</sup> During contrast echocardiography, late appearance (i.e., 3–6 cardiac cycles) of contrast in the left heart suggests intrapulmonary shunting, whereas early appearance (immediate to one cardiac cycle) indicates intracardiac shunting.<sup>29</sup> Pulmonary angiography is rarely indicated but may be useful to exclude or embolize arteriovenous malformations causing large right-to-left shunts.<sup>29</sup> A flowchart outlining the assessment for hepatopulmonary syndrome is shown in Fig. 56–3.

No effective medical therapies for hepatopulmonary syndrome are available, although selective inhibition of nitric oxide production shows theoretical promise.<sup>29,53</sup> For patients with end-stage liver disease, liver transplantation frequently leads to reduced intrapulmonary shunting and improved oxygenation.<sup>60</sup> Transplantation in patients with hepatopulmonary syndrome is no riskier than is transplantation in patients without hepatopulmonary syndrome; the outcomes of transplantation are the same whether or not the recipients have the condition.<sup>61,62</sup> Among patients with hepatopulmonary syndrome, orthotopic liver transplantation leads to longer survival than does medical management without transplantation.<sup>63</sup> Furthermore, cirrhotic patients with hepatopulmonary syndrome are more likely to die while receiving medical therapy alone (as opposed to transplantation) than are matched cirrhotic control patients without hepatopulmonary syndrome.<sup>63,64</sup> Transplantation must be performed early in patients with hepatopulmonary syndrome; delaying transplant until patients are profoundly hypoxemic is associated with mortality as high as 30%.<sup>65,66</sup>

## Nervous System in Liver Disease

### Hepatic Encephalopathy

The cause of hepatic encephalopathy is generally believed to be multifactorial. Elevated ammonia levels are frequently, but not always, found in patients with hepatic encephalopathy, and ammonemia is traditionally believed to play a role in its development. Activation of  $\gamma$ -aminobutyric acid (GABA) receptors in the brain



**FIGURE 56–3.** Diagnostic algorithm for hepatopulmonary syndrome. Some centers extend this algorithm by the routine performance of <sup>99</sup>Tc macroaggregated albumin scanning, which is very sensitive to intrapulmonary shunts when other possible right-to-left shunts have been excluded. Screening pulse oximetry should be carried out at every clinic visit and at least annually because development of hepatopulmonary syndrome shortens life expectancy and is accorded additional Model of End-Stage Liver Disease (MELD) points when discovered. ABG, Arterial blood gas; HPS, hepatopulmonary syndrome; MAA, technetium-99 (<sup>99</sup>Tc) macroaggregated albumin; PFTs, pulmonary function tests.

also may contribute to hepatic encephalopathy, as evidenced by the ability of the GABA<sub>A</sub> receptor antagonist flumazenil to produce a short-term improvement in hepatic encephalopathy.<sup>67,68</sup> Interestingly, ammonia has been shown to enhance GABA-ergic currents, perhaps explaining its role in hepatic encephalopathy.<sup>69</sup> Hepatic encephalopathy resembles many other nonfocal neurologic conditions (Box 56–6) from which it must be differentiated. Many of these are comorbid conditions in patients with liver failure. The severi-

ty of encephalopathy contributes to the Child-Turcotte-Pugh system for stratifying severity of hepatic disease (see Chap. 14).

### Autonomic Neuropathy

Autonomic neuropathies are found in up to 50% of patients with chronic liver disease.<sup>70,71</sup> They most commonly manifest as impaired cardiovascular function<sup>71</sup> and gastric motility.<sup>72</sup> Patients with autonomic neuropathies experience a higher incidence of hypotension during general anesthesia.<sup>73</sup>

**BOX 56-6.****Conditions Resembling Hepatic Encephalopathy**

Metabolic disorders  
 Hypoglycemia  
 Hyponatremia  
 Hypernatremia  
 Intracranial processes  
 Subdural hematoma  
 Intracranial hemorrhage  
 Intracranial mass lesion  
 Infectious diseases  
 Meningitis

More importantly, autonomic neuropathy predicts increased mortality in cirrhotic patients relative to cirrhotic controls without autonomic neuropathy.<sup>74</sup> The development of autonomic neuropathies is not dependent on the etiology of the liver disease, and studies have not consistently found a correlation between the severity of liver disease and the incidence of autonomic neuropathies. Importantly, autonomic neuropathies resolve with the return of normal liver function after transplantation.<sup>71,75</sup>

**HEPATIC RESECTION****Indications and Patient Characteristics**

Hepatic resection is performed to remove lesions in the liver by resecting either an entire hepatic lobe, one or more anatomic segments of the liver, or nonanatomic wedges of liver tissue. Such operations were first reported in the 1950s and for the next 30 years were considered to be high risk. For example, the rate of mortality from hepatic resection reported in 1977 was 13–20%, depending on the extent of the resection.<sup>76</sup> Many of these deaths were due to hemorrhage. However, during the 1990s, improved surgical and anesthesia techniques, along with a growing operative experience and an increased ability to plan resections, have reduced perioperative mortality. The current perioperative mortality for hepatic resections performed in high-volume centers is estimated to be 1–7%.<sup>77-81</sup> In addition, multiple trends in morbidity and mortality are developing. In one center, the number of hepatic segments resected declined during the 1990s, and a concomitant decline in mortality was demonstrated.<sup>77</sup> At the same time, high-volume

centers performing hepatic resections are liberalizing their acceptance criteria for patients, operating on older patients with more comorbid illnesses, including liver dysfunction, all while sustaining reductions in morbidity and mortality.<sup>81</sup> Advanced age (>70 years) is no longer a contraindication to hepatic resection for primary hepatocellular carcinoma or for metastases from other cancers.<sup>82-84</sup> Even patients with significant cirrhosis and liver dysfunction tolerate hepatic resections, in part because operative approaches now allow shorter hepatic ischemic time and removal of less liver tissue, all while achieving satisfactory surgical margins.<sup>85</sup> Even in patients with cirrhosis, morbidity from hepatic resections ranges from 20–50% (comparable with the rate reported in noncirrhotic cohorts), and mortality ranges from 0–10%.<sup>85</sup>

Long-term outcomes after hepatic resection are reasonable. After resection of hepatocellular carcinoma, the 3-year survival rate ranges from 40–70%, whereas the 5-year survival rate ranges from 40–50%.<sup>85</sup> Even hepatic resections for metastatic cancer (e.g., colon) have 1-, 3-, and 5-year survival rates of 90%, 54%, and 34%, respectively.<sup>86</sup>

Most patients present for hepatic resection because of malignancy (Box 56-7). In the United States, approximately 90% of patients in one large series had a malignancy; 69% of these lesions were metastatic, and 80% were colorectal in origin, making metastatic colon cancer the leading cause for hepatic resection.<sup>77</sup> In Asia, the ratio of malignant to benign indications for hepatic resection is similar, but three fourths of the malignancies are hepatocellular carcinoma,<sup>81</sup> reflecting the regional heterogeneity of the distribution of this cancer. Together, these two studies report on more than 3000 patients undergoing hepatic resection between approximately 1990 and 2000.<sup>77,81</sup> With such large numbers, the authors were able to conduct multivariate analyses to detect factors associated with increased risk of morbidity and mortality in the perioperative period after hepatic resection. Multivariate analysis yielded the following factors associated with elevated morbidity: blood loss, number of hepatic segments resected, added major biliary procedure, low preoperative albumin, presence of one or more comorbid conditions, male gender, elevated serum creatinine level, added major vascular procedure, and throm-

**BOX 56-7.****Potentially Resectable Hepatic Lesions**

Benign lesions  
 Hemangioma  
 Focal nodular hyperplasia  
 Liver cell adenoma  
 Cysts  
 Hydatid disease  
 Malignant lesions  
 Primary hepatobiliary cancers  
 Hepatocellular  
 Cholangiocarcinoma  
 Hepatoblastoma  
 Angiosarcoma  
 Lymphoma  
 Cancers with local invasion of liver  
 Gallbladder and extrahepatic bile ducts  
 Colon  
 Stomach  
 Duodenum  
 Adrenal  
 Metastatic cancers  
 From possibly “isolated hepatic” spread  
 Colorectal  
 Rectum  
 Pancreatic islet cell  
 Carcinoid  
 Sarcoma  
 From possibly widespread metastases  
 Lung  
 Breast  
 Esophagus  
 Stomach  
 Pancreas  
 Other GI tract  
 Melanoma

bocytopenia.<sup>77,81</sup> Risk factors for elevated mortality include blood loss, number of segments resected, preoperative bilirubin, complex hepatic resection, preoperative platelet count, low preoperative albumin, and patient age.<sup>77,81</sup>

Currently, the majority of hepatic resections are performed for cancer. However, the major modes of therapy are in flux. State-of-the-art therapy for hepatocellular carcinoma includes radiofrequency ablation, hepatic resection, and orthotopic liver transplantation, depending on the number, size, and location of the lesions. Thus, minimally invasive destructive therapies may significantly reduce the need for major hepatectomy in the future.<sup>85</sup>

## Operative Considerations for Hepatic Resection

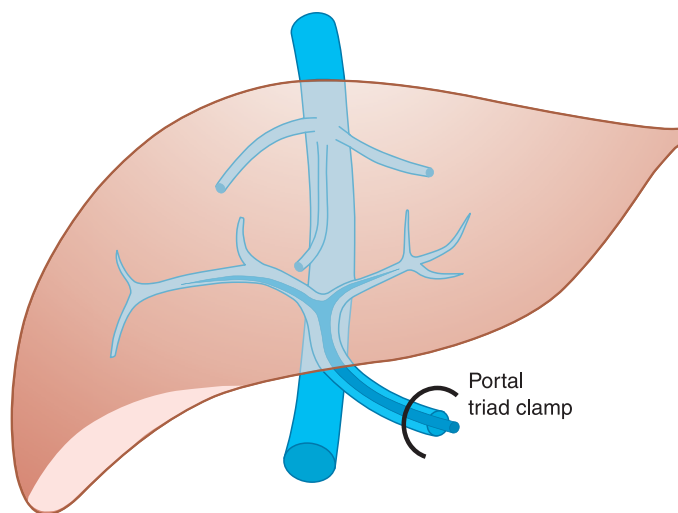
After the incision for hepatic resection is made, the abdomen is explored for metastases. If previously unsuspected widely metastatic disease is found, the operation ends quickly. Therefore, large doses of long-acting opioids and paralyzing agents should be avoided in the initial stage of surgery. If a large volume of ascites is drained immediately after the incision, hemodynamic instability may ensue because of sudden shifts of fluid out of the intravascular system.

After the initial exploration, a self-retaining retractor (Bookwalter or equivalent) is placed to assure good exposure. The placement of the retractor itself can depress splanchnic venous return and compromise respiratory mechanics by compressing the lung and overlying ribs.

The liver is dissected free of its attachments as needed to gain exposure, first to establish control of the vasculature and then to complete the hepatic resection. This involves moving the liver to gain exposure to the vascular structures underneath, which may twist the liver on its vascular pedicle or compress the vena cava, both leading to sudden changes in venous return with consequent hemodynamic effects. After gaining vascular control, the surgeon usually attempts to create anatomic planes (i.e., those that will bleed relatively little) between liver segments, or a dissection for a formal hepatic lobectomy is performed.

An understanding of the techniques for hepatic vascular occlusion during hepatic resection is important because uncontrolled and massive blood loss is a major risk of the operation. Multiple hepatic vascular occlusion techniques are available, each with its own implications for the anesthesiologist (Figs. 56-4 through 56-6).<sup>87</sup> In one common vascular exclusion maneuver, a clamp is placed on the portal triad. In this case, “portal triad” encompasses the hepatic artery, portal vein, and common bile duct (Fig. 56-4).

Total vascular exclusion techniques allow for “bloodless” surgery. In addition to clamping the portal triad, clamps are placed on the inferior vena cava above and below the liver (Fig. 56-5). This combination of clamps prevents both inflow of blood and backflow from the vena cava. In one report using total vascular exclusion, the average red cell transfusion was 2.2 units.<sup>88</sup> Selective



**FIGURE 56-4.** Location of vascular clamp for the classic “Pringle” maneuver, in which portal vein (purple) and hepatic artery (red) inflows to the liver are temporarily occluded to reduce blood loss during hepatic resections. The liver still is exposed to the vascular system by the hepatic veins (blue) draining into the inferior vena cava. Thus, bleeding is strongly influenced by central venous pressure.

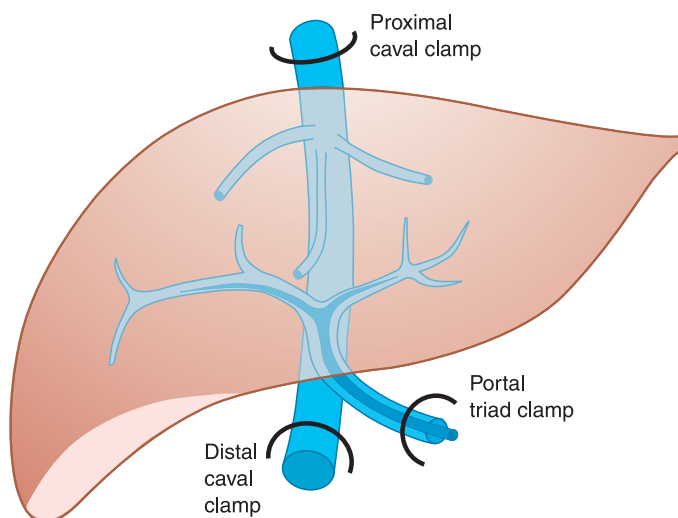
techniques have been described for total vascular exclusion in which the hepatic veins, rather than the inferior vena cava, are clamped.<sup>89</sup> Portal triad clamping is accompanied by venous outflow clamping of either all of the hepatic veins or only those draining the resected territory (Fig. 56-6). In the report of the technique, most patients received no transfusion.<sup>89</sup> Vascular exclusion techniques were first described by Pringle and are collectively described as the “Pringle maneuver.” During vascular exclusion, the liver is warm and ischemic, so great attention is paid to keeping track of and minimizing “Pringle time.”

At the conclusion of the resection, hemostasis is obtained, and the inci-

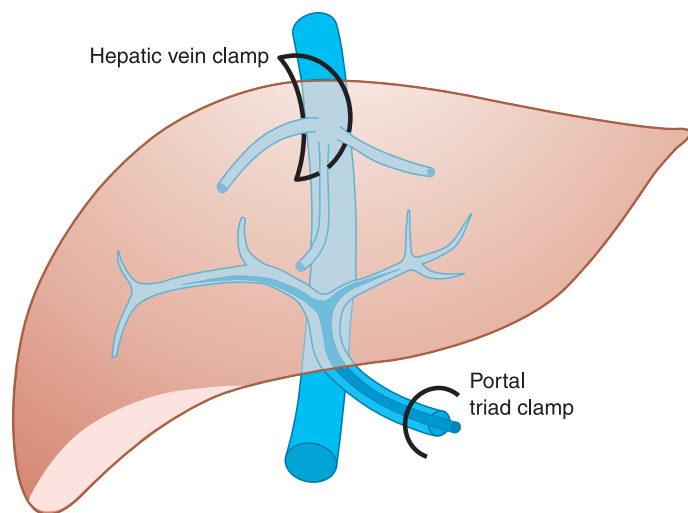
sion is closed. These portions of the procedure can be lengthy and deserve attention, because control of hemorrhage is the key to a successful early postoperative period. During the latter phases of the operation, the anesthesia team should make plans for postoperative disposition, either to the recovery room or to an intensive care unit (ICU) if the insult from surgery has been severe.

## Anesthesia for Hepatic Resection

Anesthesia for hepatic resection has been reviewed,<sup>90,91</sup> and the anesthetic approaches are appropriately changing over time to correspond to the



**FIGURE 56-5.** Total vascular exclusion of the liver. Portal vein (purple) and hepatic artery (red) inflows to the liver are temporarily occluded. Additionally, the inferior vena cava (blue) is cross-clamped above and below the hepatic veins to exclude the liver from central venous circulation.



**FIGURE 56–6.** Total vascular exclusion of the liver with preservation of vena cava flow. Portal vein (purple) and hepatic artery (red) inflows to the liver are temporarily occluded. Additionally, the hepatic veins (blue) are clamped to exclude the liver from central venous circulation. Hepatic venous clamping can involve the entire liver or only the territory to be resected.

improvements in surgical technique and changes in patient selection. In general, patients scheduled for hepatic resection should be evaluated as any patient scheduled for major noncardiac surgery. Plans for monitoring, vascular access, induction and maintenance of anesthesia, postoperative pain control, and postoperative care should take into account a large subcostal incision and the potential for sudden massive hemorrhage and severe physiologic derangements during and after surgery.

The history and physical examination include a typical preanesthetic history, including questions directed to assess hepatic synthetic function, as well as global and focal neurologic status. For example, evidence of hepatic encephalopathy should be sought, both from the patient and from any persons accompanying the patient. Significant encephalopathy predicts worsened postoperative neurologic status if hepatic resection or portal diversion is planned. Focal neurologic deficits (i.e., sensory, motor, or pain abnormalities localized to a body part) should be sought and documented because the procedures require prolonged immobility, and positioning injuries may occur.

The assessment of cardiac ischemia risk cannot be overemphasized. Hepatic resections are frequently characterized by significant hemorrhage, leading to hypotension and tachycardia that may persist for some time as the anesthesia team restores intravascular

volume. In addition to derangements in myocardial oxygen supply and demand during the case, the surgical stress induces a proinflammatory state. Major liver resection also leads to a hyperdynamic state with increased cardiac output and decreased systemic vascular resistance in the postoperative period.<sup>92,93</sup> Thus, the patient should be questioned in detail about risk factors pertaining to coronary artery disease as well as his or her level of physical activity and exercise tolerance. Symptoms of angina or anginal equivalents should be carefully sought.

The laboratory examination prior to hepatic resection includes an assessment of hepatic synthetic function [albumin, clotting factors as assessed by prothrombin time (PT), partial thromboplastin time (PTT), and fibrinogen measurement], metabolic function [aspartate aminotransferase (AST), alanine aminotransferase (ALT)], and excretory function (bilirubin). Assessment of coagulation function (PT, PTT, platelet count), oxygen-carrying capacity (hematocrit), and serum electrolytes completes the general picture of the patient. A chest x-ray film is useful for assessing lung volumes and the status of the lung parenchyma and in searching for preoperative pleural effusions (common in patients with significant liver disease but rare in others).

Preoperatively, a transthoracic echocardiogram may be useful for assessing resting atrial and ventricular function and valve performance and excluding (within the power of this relatively non-

invasive test) septal defects that might allow paradoxical embolization. As mentioned, cardiac risk stratification begins with careful history taking but should include functional testing as indicated by the history and the guidelines of the American Heart Association.<sup>94</sup>

### Preanesthetic Planning

Hepatic resections are almost always performed with the patient in the supine position through a right-sided subcostal incision. There may be extensions into the left subcostal region, superiorly in the midline, or both. The area of surgical preparation usually includes the entire abdomen and the lower chest up to the nipples. Monitor placement, warming strategies, and pain management planning should account for this area.

Typical monitoring consists of standard monitors and selected invasive monitors directed toward managing problems likely to arise during the case. An arterial catheter is useful for early recognition of hypotension and for obtaining blood samples. Central venous pressure measurement is useful to guide intravascular volume replacement and to assess right-heart pressures when a large hepatic resection is planned or when the dissection is expected to be bloody. Central venous access has the added benefit of providing a conduit for potent vasopressor administration. A pulmonary artery catheter is useful for measuring pulmonary arterial pressures, assessing left heart filling pressures, and guiding pharmacologic therapy. Transesophageal echocardiography can provide information regarding both intravascular volume status and cardiac performance and may replace invasive pressure measurements if the potential need for central venous access as a conduit for vasopressors is judged to be low.

Peripheral vascular access with sufficiently large catheters (14 gauge or larger) usually is sufficient for a hepatic resection. One helpful device is the rapid infusion catheter (RIC, Arrow International, Reading, PA, USA). The RIC is a 6.4 cm × 8.5 F peripherally inserted catheter useful for rapid infusion of large volumes. It can be placed in any large peripheral vein. Antecubital or cephalic veins are commonly chosen, but even distal veins on the forearm and hand can be used if they are large enough. The RIC alleviates the need for multiple central lines that



might be required to pass a pulmonary artery catheter, run multiple infusions, and accommodate high-flow administration of large volumes.

### **Induction and Maintenance of Anesthesia**

Induction of anesthesia is readily accomplished using standard methods. Major considerations for induction are directed toward comorbidities (gastroesophageal reflux disease, coronary artery disease) rather than any unique feature of the liver disease. Patients with ascites should be considered to have a full stomach and receive a rapid sequence induction with cricoid pressure, if not otherwise contraindicated.

Maintenance of anesthesia is accomplished by standard methods, with attention to homeostatic control. Patient warming is important to maintain good clotting performance and minimize the risk of surgical site infection.<sup>95,96</sup> A single forced-air warming unit applied to the upper chest, arms, and head usually is sufficient. IV fluids should be either warm or actively warmed during infusion.

Because large hepatic resections may produce transient hepatic dysfunction, choosing drugs whose elimination is not completely dependent on hepatic metabolism may be preferable. In general, all the usual techniques for maintenance of general anesthesia are acceptable, although there are some minor differences between drugs commonly chosen for maintenance. Compared with isoflurane, sevoflurane was associated with smaller elevations in liver enzymes after hepatic segmentectomy.<sup>97</sup> These elevations were of uncertain clinical relevance, because no clinical liver damage was detected in either group. Cisatracurium, atracurium, and remifentanyl might be more reliably eliminated than drugs that depend on hepatic hydrolysis and/or conjugation for termination of their effect. In practice, the dose-to-effect mode of administration almost always is sufficient to minimize the interaction between choice of anesthetic and the effect of liver resection.

If an epidural catheter has been inserted, it can be used intraoperatively with the understanding that the associated sympathetic blockade may cause hypotension. The severity of hypotension correlates with the concentration and volume of local anesthetic administered. Conversely, relatively dilute

local anesthetic (e.g., 0.25% bupivacaine, 7–10 mL/h after a bolus) or dilute mixtures of local anesthetic combined with an opioid likely will provide significant analgesia during general anesthesia, with little hemodynamic effect. Hypotension resulting from local anesthetic-induced sympathetic blockade can be effectively treated with infusion of a vasopressor such as phenylephrine or norepinephrine.

### **Goals for Oxygenation and Ventilation**

Changes in the fraction of inspired oxygen (FiO<sub>2</sub>) and ventilation predictably result in changes in liver oxygenation and carbon dioxide (CO<sub>2</sub>) elimination.<sup>98</sup> Vascular exclusion techniques to reduce bleeding create periods of hepatic ischemia. Thus, it seems prudent to provide normal systemic conditions by ventilating to keep the pH normal and the oxygen saturation high so that the liver is best prepared to tolerate these insults.

### **Hemodynamics**

Clamping the portal triad reduces venous return, and cardiac output and blood pressure would be expected to fall. Cardiac output does indeed fall, but blood pressure increases because of an increase in systemic vascular resistance evoked by portal triad clamping. The increase in blood pressure appears to be a neurally mediated reflex, as the increase in systemic vascular resistance can be ablated by infiltrating the portal triad with lidocaine prior to clamping.<sup>99</sup> In contrast to portal triad clamping, total vascular exclusion of the liver via a vena cava cross-clamp does reduce blood pressure concomitant with a fall in cardiac output because the loss of venous return is so much larger.

### **Bleeding and Coagulation**

Blood loss is affected by central venous pressure during surgery. When central venous pressure is maintained at <5 mm Hg, blood loss is predictably lower than when central venous pressure is ≥ 6 mm Hg. In the original publication describing low central venous pressure approaches to hepatic resection, median blood loss was only 200 mL, with most patients in the low central venous pressure study group not requiring transfusion.<sup>100</sup> In contrast, when central venous pressure was ≥ 6 mm Hg, median blood loss was 1 L, and half of

the patients required transfusion.<sup>100</sup> Other centers practicing low central venous pressure techniques for hepatic resection report average estimated blood losses of approximately 1 L.<sup>80</sup>

Low central venous pressure approaches affect outcomes beyond transfusion and blood loss, as reflected in longer hospital stays for patients whose central venous pressure was >6 mm HG during hepatic resection.<sup>101</sup> Blood loss (and the subsequent requirement for transfusion) is associated with longer hospitalization, greater perioperative morbidity, and doubling of perioperative mortality (from 1.2% to 2.5%).<sup>86</sup> Reports in the surgical literature caution that extreme care must be taken during dissection of the liver so as not to make holes in the hepatic veins, which can lead to catastrophic hemorrhage or air embolism.<sup>102</sup> Obviously the risk of severe air embolism is elevated under low central venous pressure conditions, and the anesthesia team must be highly vigilant for such an event.

Low central venous pressure anesthesia apparently is safe with respect to renal function. Only 3% of patients experience any degree of permanent renal dysfunction after hepatic resection using a low central venous pressure technique.<sup>80</sup> This was lower than the historical incidence of renal failure complicating hepatic resection without the use of low central venous pressure.<sup>80</sup> However, these favorable outcomes are predicated on maintaining good renal perfusion pressure (typically believed to be ≥ 60 mm Hg) and renal blood flow throughout surgery.<sup>91</sup>

### **Control of Clotting**

Multiple drugs that modify clotting are available to minimize blood loss during hepatic resection. Pharmacologic aids for minimizing blood loss are attractive given the concerns regarding transfusion in cancer surgery, but they are no substitute for good surgical technique. A complete discussion of the use of procoagulants during liver surgery appears in the Liver Transplantation section (see below). Briefly, three classes of agents are available: those that modify platelet and von Willebrand factor function (desmopressin and its analogues), the antifibrinolytics (aprotinin, ε-aminocaproic acid, and tranexamic acid), and replacements of specific clotting factors (e.g., recombinant factor VII).

Desmopressin increases factor levels and improves laboratory measures of clotting during hepatectomy but has no effect on blood loss.<sup>103</sup> The antifibrinolytic drug aprotinin reduces blood loss during elective liver resection,<sup>104</sup> as demonstrated in a small prospective trial. However, a large multicenter outcome study comparing aprotinin with the other antifibrinolytics and placebo in cardiac surgery demonstrated that the drug is not superior to  $\epsilon$ -aminocaproic acid or tranexamic acid for reducing blood loss.<sup>105</sup> However, aprotinin is associated with excess renal failure and mortality compared with the other alternatives in cardiac surgery.<sup>105</sup> Therefore, routine use of aprotinin during hepatic resection must be questioned until studies demonstrating its safety in large numbers of hepatectomy patients are reported. Recombinant factor VII does not reduce blood loss or transfusion requirements in patients undergoing major hepatic resections,<sup>106</sup> but off-label use of this drug has been associated with unwanted thrombotic complications.<sup>107</sup>

### Postoperative Planning

Postoperative planning after hepatectomy addresses three major concerns: immediate postsurgical airway management, postoperative disposition, and pain management.

Assessment of the airway after surgery and planning for extubation are guided by the same considerations as applied to any major case with the potential for large volume shifts and with a high abdominal incision. First, the magnitude of the operation and the patient's preoperative functional status are inventoried, followed by the magnitude of hemorrhage and the adequacy of its replacement, manifested by hemodynamic stability and acid-base status. Factors within the anesthesiologist's control (e.g., patient temperature, sedation, residual general anesthetics, and muscle strength) are considered. A physical examination of the face and upper airway assesses the degree of edema and swelling that might compromise the extubated airway. If all of these considerations are judged to be in satisfactory order, then it is reasonable to extubate the trachea at the end of a hepatic resection; otherwise the prudent course is a period of postoperative airway protection and support with mechanical ventilation.

Postoperative disposition is dictated by the patient's clinical condition. The same considerations that bore upon the decision to extubate the trachea apply to planning for disposition. A patient who has undergone an uncomplicated operation and uneventful extubation can be managed in the recovery room and discharged to the hospital floor. Intubated patients and those with important postoperative concerns should be managed in an ICU.

Analgesic requirements for patients after hepatic resection deserve careful consideration. Subcostal incisions typically are quite painful, and ineffective pain therapy will degrade the patient's ability to comply with postoperative pulmonary recruitment maneuvers and early ambulation. Regional anesthesia (e.g., epidural catheter) added to general anesthesia provides superior early postoperative pain control.<sup>108</sup> This must be balanced against the potential for postoperative hepatic synthetic failure and coagulopathy complicating subsequent removal of the epidural catheter. However, many practitioners opt to place the epidural catheter and monitor patients carefully for signs and symptoms of epidural hematoma.

### Complications during Hepatic Resection

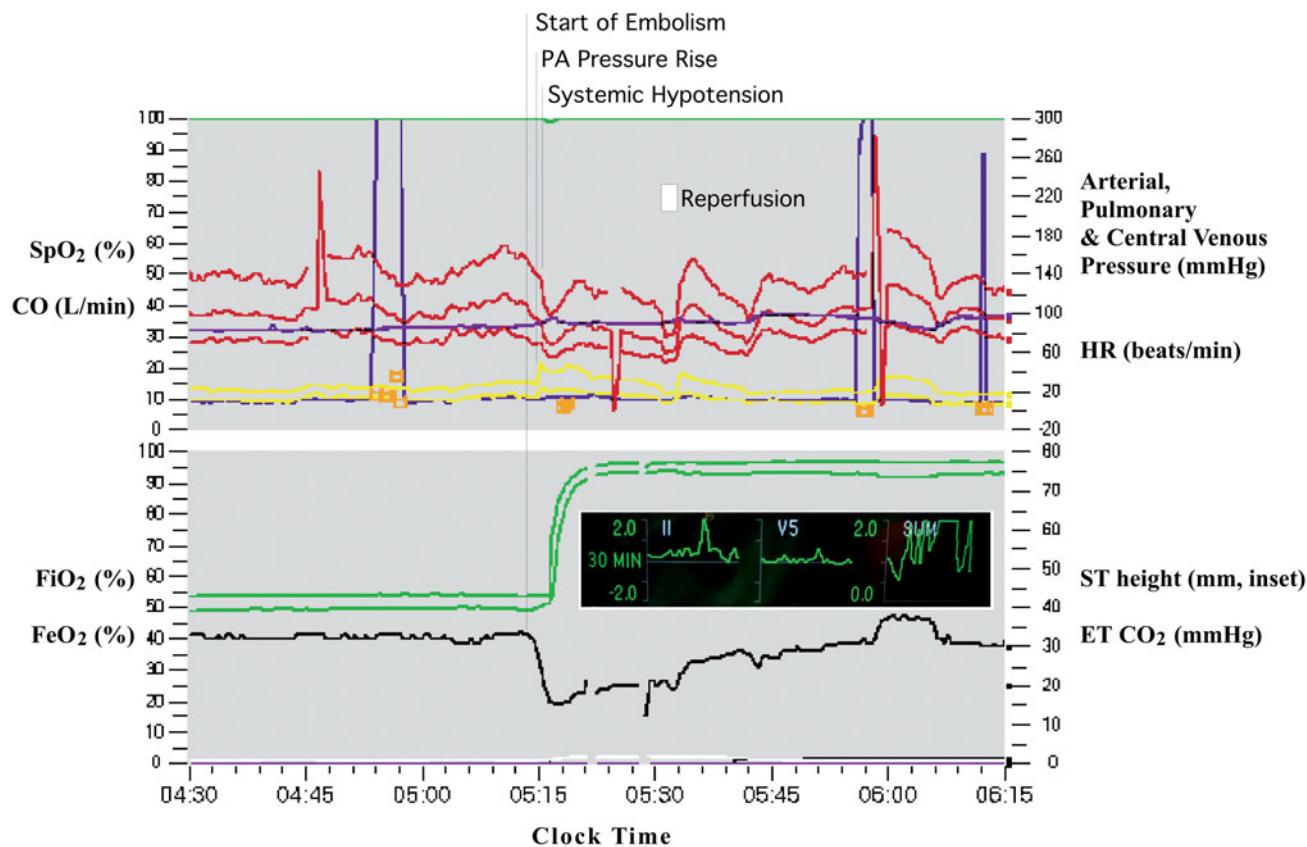
Intraoperative complications of hepatic resection almost always can be ultimately traced to excessive blood loss. Bleeding can result from either poor hemostatic control or coagulopathy. Coagulopathy rarely ensues during hepatic resection unless the patient had tenuous liver function at the start, the hemorrhage is severe, or patient warming was inadequate. Reversible causes of coagulopathy should be sought and corrected and the circulating blood volume supported by infusions of crystalloids, colloids, and transfusion as appropriate.

Air embolism is another common complication. Air embolism during hepatic resection (as well as transplantation) is problematic because it alters pulmonary vascular resistance, right-heart performance, and left-heart filling. The pathophysiology of venous air embolism has been studied in dogs.<sup>109</sup> Slow entrainment of air (rate 0.01–2.0 mL/kg/min), as might occur during surgery with small sites of venous opening, causes a progressive rise in central venous pressure, an early abrupt rise in pulmonary arterial pres-

sure to a hypertensive plateau, and an unexplained decline in systemic vascular resistance. Air irritates the vascular endothelium, with resulting pulmonary edema, hypoxia, and reduced pulmonary compliance. Bolus infusion of air (1–13 mL/kg in a sudden bolus), as might occur with a major tear in the vena cava, causes increased central venous pressure. Because air fills the right ventricle, pulmonary and systemic pressures plummet, and cardiovascular collapse ensues.<sup>109</sup>

Air embolism apparently is a complication of many hepatic resections, although it is not always symptomatic. Some procedural approaches that may be advantageous from a surgical perspective may not be ideal from the anesthetist's viewpoint. For example, when comparing techniques for parenchymal dissection of the liver, the Cavatron ultrasonic aspirator (CUSA) is associated with less blood loss<sup>110</sup> than is a clamp-and-crush method. However, all CUSA patients had air emboli during hepatectomy, and in 44% of these patients the air filled more than half of the right ventricle. Air emboli occurred in 68% of patients undergoing clamp-and-crush hepatic resection as well, but to a much smaller extent. None of these emboli had pulmonary or hemodynamic effects on the patients, but this study suggests that air embolism is so common as to be considered ubiquitous during hepatic resection. Gas embolism from other commonly used devices (e.g., argon beam coagulators) has been described, in this instance with a fatal outcome.<sup>111</sup>

Air embolism is problematic during liver surgery and transplantation because of the risk of catastrophic paradoxical embolism.<sup>112</sup> Paradoxical embolism need not occur through an intracardiac right-to-left defect. Many patients presenting for hepatic resection (and certainly most liver transplant patients) have cirrhosis, and many cirrhotic patients have abnormal arteriovenous connections in the pulmonary circulation. Thus, venous air embolism should be minimized to lower the risk of paradoxical embolism. Massive venous embolism and/or paradoxical embolism must be high on the differential diagnosis of unexplained cardiopulmonary performance problems during hepatic resection. Fig. 56–7 shows the hemodynamic consequences of a large venous air embolism during a liver transplant. The



**FIGURE 56-7.** Screen shot of automated anesthesia information management system trend display marked by accidental venous air embolism. Inset (black) shows a trend display of the electrocardiographic ST segments, demonstrating inferior and lateral ST elevations.

first indication is an abrupt fall in end-tidal  $\text{CO}_2$  (black trace), followed a few moments later by rising pulmonary arterial pressure (yellow trace). Systemic hypotension ensued (red trace). Inferior and lateral (see inset) ST-segment elevations accompanied systemic hypotension, caused by either coronary hypoperfusion or air in the coronary circulation. The circuit gas composition (green trace) was changed to 100% oxygen to minimize the size of gas bubbles. Cardiac output (orange rectangles) fell by 50% after the embolus.

Some practitioners recommend conducting hepatic surgery with the operating room table in a  $15^\circ$  head-down tilt to prevent embolized air from migrating cephalad,<sup>113</sup> but this may interfere with surgical exposure and may contribute to head and neck edema. If air embolism occurs, ventilation with 100% oxygen should be instituted. In severe embolism, placing the patient in the left lateral decubitus position with the head down may shift the gas bubble away from the right ventricular outflow tract and restore cardiac output. A central line placed into the right atrium can be used to aspirate gas from the heart. These measures must

be undertaken while other supportive measures, including cardiopulmonary resuscitation and fluid/pressor administration, are continued. Cardiopulmonary bypass has been used successfully for resuscitation from gas embolism and should be considered if initial measures are unsuccessful.<sup>114</sup>

## LIVER TRANSPLANTATION

### Indications, Contraindications, and Patient Characteristics

The indications for liver transplantation are myriad in detail (Box 56-8), but all come down to liver failure sufficiently severe to preclude further survival without transplantation.

The most common indication for liver transplantation is chronic hepatocellular disease because of alcohol and/or hepatitis. Hepatitis C is an increasingly important indication for liver transplantation, representing a unique and growing health risk for anesthesiologists who provide care for these patients. Currently no vaccine against hepatitis C is available, and

medical therapy is suboptimal. Thus, the most effective protection from the disease is avoiding exposure.

Hepatitis B and C both predispose patients to hepatocellular carcinoma. As the prevalence of hepatitis C in the population increases, so does the incidence of hepatocellular carcinoma. Thus, this tumor is becoming increasingly common as an indication for liver transplantation.

As surgical techniques, risk stratification of potential recipients, and management of intercurrent diseases (e.g., HIV infection) all improve, the contraindications to liver transplantation are becoming more nuanced. For example, advanced age is not necessarily considered a contraindication to transplantation. Instead, elderly patients are assessed using sophisticated testing of cardiopulmonary performance and rigorous assessment of nutritional status, body mass index (BMI), and exercise tolerance. Box 56-9 provides a general list of contraindications to liver transplantation, but each patient must be evaluated as an individual, with consideration of many extenuating and complicating factors.

**BOX 56–8.****Indications for Liver Transplantation (Not Exhaustive)**

End-stage liver disease (chronic)

- Hepatocellular disease
  - Chronic viral hepatitis (mostly hepatitis C)
  - Alcoholic liver disease
  - “Cryptogenic” cirrhosis
  - Chronic drug-induced liver disease
- Cholestatic disease
  - Primary sclerosing cholangitis
  - Primary biliary cirrhosis
  - Biliary atresia (mostly children)
  - Other familial cholestatic syndromes
- Vascular disease
  - Budd-Chiari syndrome
  - Venoocclusive disease
  - Polycystic liver disease
- Hepatic malignancies not amenable to other therapy
  - Hepatocellular carcinoma (often in setting of hepatitis C)
  - Cholangiocarcinoma
  - Carcinoid tumor
  - Other cancers (e.g., insulinoma)
- Fulminant hepatic failure
  - Drug induced
    - Acute viral hepatitis (A, B, C, D)
  - Metabolic diseases
    - Wilson disease, organic aciduria, other
- Metabolic diseases affecting the liver
  - $\alpha_1$ -Antitrypsin deficiency
  - Wilson disease
  - Hemochromatosis
  - Other rare diseases (e.g., Alagille syndrome, glycogen storage diseases, urea cycle deficiencies)

Patients with fulminant hepatic failure require particular attention because their status with respect to contraindications to transplantation may change on a daily or even hourly basis. As mentioned, acute infection is common in patients with fulminant hepatic failure but should be actively sought (or at least a high index of suspicion of considered) in any candidate who is high on the recipient list because acute infection is a clear contraindication to transplantation. Brain herniation (portending brain death) is another clear contraindication to transplantation. In critically ill, comatose transplant candidates, herniation is always a possibility,

yet transplantation may avert this disastrous outcome. Incipient brain herniation is commonly assessed by serial head CT or, ideally, by ICP monitoring so that donor organs are not mistakenly allocated to patients who can no longer benefit from them. However, many neurosurgeons are reluctant to place ICP monitors because of the risk for hemorrhage (see above).

**Patient Selection for Liver Transplantation**

Liver transplantation is an arduous process before, during, and after the operation. Part of the evaluation aims to identify individuals who can comply with lifestyle requirements needed to maintain the health of the grafted organ. Recipients must be able to sustain lifelong abstinence from alcohol, illicit drugs, and diverted prescription narcotics. Lifelong immunosuppression is another requirement, and patients must have the means to obtain these necessary drugs and the personal organization and/or social supports to follow the complex medication regimen.

Evaluation seeks to identify individuals with sufficient psychological resilience, insight, and social supports who will be able to benefit over the long term from a resource as scarce as a donor liver. Thus, liver transplant listing committees are composed not only of surgeons and hepatologists, and, ideally, anesthesiologists, but also psychiatrists, addictions specialists, social services specialists, family therapists, and financial assistance experts.

Potential liver transplant recipients must be willing to accept massive blood transfusion during and after surgery. This requirement, formerly absolute, is being relaxed as some centers gain sufficient expertise to reliably perform liver transplantation with little or no requirement for transfused blood. For example, Jehovah's Witnesses formerly were excluded from orthotopic liver transplantation candidacy unless they were willing to accept blood product transfusion. However, case reports of successful transplants<sup>115</sup> have appeared, and some centers are willing to offer transplantation to Jehovah's Witnesses who refuse transfusion. Of note, Jehovah's Witnesses are allowed some latitude regarding their choice to receive or refuse transfusion, although the ultimate choices are personal ones made by the patient.

Potential recipients must be in the best possible physical condition within

**BOX 56–9.****Contraindications to Liver Transplantation****Absolute Contraindications**

- Brain herniation/brain death
- Sepsis outside the hepatobiliary tree (peritonitis)
- Metastatic hepatobiliary tumors
- Current extrahepatic malignancy
- Advanced cardiopulmonary disease
  - Unrevascularized ischemic coronary disease
- Recent drug-eluting stent placement
- Critical aortic stenosis
- Severe pulmonary hypertension (mean pulmonary arterial pressure  $>45$  mm Hg)
- AIDS (but not HIV infection)

**Relative Contraindications**

- Obesity (body mass index  $>30$ )
- Moderate pulmonary hypertension (mean pulmonary arterial pressure  $>35$  mm Hg)
- Mild or moderate aortic stenosis
- Revascularized coronary artery disease with depressed cardiac function
- Advanced chronic renal failure
- Severe hyponatremia
- Portal vein thrombosis
- Hepatitis (hepatitis B surface antigen or hepatitis Be surface antigen positive)
- Prior open vascular portosystemic shunt
- Prior complex hepatobiliary surgery
- Hypoxemia with intrapulmonary shunts
- Hepatic coma with intracranial hypertension
- Active alcohol abuse
- Active drug abuse
- Cholangiocarcinoma or other aggressive tumor
- Advanced age (no consensus on definition of “advanced age”)
- Poor social supports to assist with posttransplant medical compliance
- Advanced malnutrition

the context of hepatic failure and end-stage liver disease. For example, many programs require obese potential candidates to lose weight because obesity (BMI  $> 30$ ) is associated with excess mortality in the perioperative period.<sup>116</sup> BMI  $> 30$  is considered a relative contraindication to transplantation.



TABLE 56-1.

## Model for End-Stage Liver Disease (MELD) Scoring System

Prognostic Factor <sup>a</sup>	Regression Coefficient
Serum creatinine <sup>b</sup> (log <sub>e</sub> value)	0.957
Serum bilirubin (log <sub>e</sub> value)	0.378
INR (log <sub>e</sub> value)	1.120

<sup>a</sup>Laboratory values < 1.0 are set to 1.0 for MELD score calculation.

<sup>b</sup>Maximum serum creatinine considered in the MELD score equation is 4.0 mg/dL (i.e., for patients with serum creatinine > 4.0 mg/dL, the serum creatinine level is set to 4.0 mg/dL). Patients on dialysis have their serum creatinine level automatically set to 4.0 mg/dL. INR, International normalized ratio.

## MELD Scoring System

The United Network for Organ Sharing (UNOS; [www.unos.org](http://www.unos.org)) administers the allocation of donated organs in the United States. Liver transplant recipient candidates are priority ranked by application of the Model of End-Stage Liver Disease (MELD) scoring system. The MELD system ranks patients by expected mortality based on the severity of their liver disease. An analogous system for pediatric patients, the Pediatric End-Stage Liver Disease (PELD) scoring system, is applied for patients younger than 12 years. Thus, the MELD and PELD scores provide a method for ranking patients in descending order of disease severity (as reported by the likelihood of death from untreated disease), with higher scores indicating more severe disease burden.

The MELD scoring system uses a multivariate regression model to calculate risk of death from the patient's liver disease based on prognostic factors (laboratory values reflecting hepatic synthetic and excretory function) and regression coefficients (Table 56-1). Patients are assigned a MELD score based on the following calculation:

$$\text{MELD Score} = (0.957 \times \log_e[\text{creatinine mg/dL}] + 0.378 \times \log_e[\text{bilirubin mg/dL}] + 1.120 \times \log_e[\text{INR}] + 0.643) * 10, \quad (1)$$

where INR = international normalized ratio.

Scores are rounded to the nearest whole number. Thus, the risk score of a hypothetical patient with cirrhosis who has serum creatinine concentration = 1.9 mg/dL, serum bilirubin concentration = 4.2 mg/dL, and INR = 1.2 would be calculated as follows:

$$\text{MELD Score} = ([0.957 \times \log_e 1.9] + [0.378 \times \log_e 4.2] + [1.120 \times \log_e 1.2] + 0.643) * 10 \approx 20 \quad (2)$$

Recognizing that the MELD score does not fully encompass the unique characteristics of patients requiring liver transplantation, UNOS defines several exceptions and modifications to the MELD system. For example, patients with hepatocellular carcinoma are given additional MELD points, improving their likelihood of receiving a transplant. Similar adjustments are made for adult patients with hepatic metabolic syndromes. Finally, patients with acute liver failure can receive a special listing status—Status 1A—that puts them at the top of the waiting list. A candidate can be listed as Status 1A if he or she has fulminant liver failure with a life expectancy without a liver transplant of < 7 days, as defined by the following four categories:

1. Fulminant hepatic failure defined as the onset of hepatic encephalopathy within 8 weeks of the first symptoms of liver disease. The absence of preexisting liver disease is critical to the diagnosis. One of the following three criteria must be met in order to list an adult patient, who must be in the ICU, with fulminant liver failure: (1) ventilator dependence, (2) requiring dialysis or continuous venovenous hemofiltration or continuous venovenous hemodialysis, or (3) INR > 2.0, or
2. Primary nonfunction of a transplanted liver within 7 days of implantation, as defined by (a) or (b):
  - (a) AST ≥ 5000 and one or both of the following:
    - INR ≥ 2.5
    - Acidosis, defined as pH ≤ 7.3 and/or lactate ≥ 2× normal
  - (b) Anhepatic patient, or
3. Hepatic artery thrombosis in a transplanted liver within 7 days of implantation, with evidence of graft failure as defined in (2a) and (2b), or
4. Acute decompensated Wilson disease

Status 1 patients accrue additional points for time spent waiting for an organ while in that status. Each major blood group has a separate waiting list. To ensure the fair allocation of livers, adherence to the system is mandatory throughout the United States. Similar systems are in place throughout the developed world.

When a donor organ becomes available, it is offered to transplant programs in the following order of priority:

1. The organ is offered to Status 1 patients (in descending point order) in the same local area as the procuring center.
2. The organ is offered to transplant programs with Status 1 patients (in descending point order) in the same organ-sharing region as the procuring center.
3. The organ is offered to candidates with MELD/PELD scores ≥ 15 in descending order of MELD/PELD scores, first locally and then regionally.
4. The organ is offered to patients with MELD/PELD scores < 15, locally and then regionally.

If no transplant program has accepted the organ by the end of this list, then the organ is offered at the national level, first to Status 1 patients in rank order and then down the MELD/PELD waiting list.

## Preanesthetic Evaluation of the Liver Transplant Candidate

Because of the prescreening process for listing a patient for liver transplantation, most patients are “well studied,” that is, they have undergone extensive prior diagnostic and risk stratification assessment. Thus, on the day of surgery, the immediate preoperative evaluation of the patient for liver transplantation focuses on the history and physical examination relevant to the case immediately at hand. Furthermore, although technically elective surgery, liver transplantation is an unscheduled, urgent case with many surgical teams, recipient patients, and hospitals throughout the region preparing for synchronous receipt of donor organs. Thus, efficient and effective immediate preoperative care of the potential liver recipient is beneficial, both to the patients and to the medical system in general.

A typical preanesthetic history is taken, with attention to a few key points. Specific questioning pertinent to liver transplantation covers a variety of topics, as follows:

- Because liver transplants are unscheduled, patients are rarely fasting. However, the quality and quantity of recent oral intake help define the risk and potential consequences of regurgitation and aspiration of gastric contents.
- Liver transplantation requires ample vascular access for resuscitation and monitoring. A history of central venous and/or arterial catheter placement will alert the anesthesia team to possible difficulty with access because of occluded vessels, although in practice, ultrasonography used in catheter placement also shows vessel patency.
- Questions should also be directed to assess hepatic synthetic function, which may have deteriorated further since the patient's last reevaluation. A history of increasing abdominal girth or peripheral edema indicates failure to synthesize sufficient albumin and other plasma proteins to maintain plasma oncotic pressure. A history of easy bruising, bleeding during oral hygiene, or prolonged bleeding from minor injuries indicates insufficient hepatic function to maintain clotting factor levels at even a fraction of normal levels.
- The history should address neurologic status, searching for evidence of worsening encephalopathy, manifesting as loss of mental acuity, forgetfulness, fatigue, and somnolence. Also important is characterizing and documenting any preoperative focal neurologic deficits to establish the patient's status prior to the case. Positioning injuries with consequent neurologic deficits are not uncommon. If a patient complains of a deficit in the postoperative period, it is useful to know whether that deficit was present prior to surgery.
- The anesthesia team should reassess cardiac risk during the history, because many orthotopic liver transplant candidates wait months or years between rescreening tests of cardiac function and ischemic risk. Determining whether decreasing exercise tolerance is attributable to cardiac dysfunction or worsening

liver disease can be difficult, so symptoms or signs of angina should be sought.

The physical examination should be as complete as that conducted for any patient undergoing major intraabdominal surgery. Special attention should be paid to the assessment of ascites. Ascites potentiates the possibility of regurgitation and aspiration. It also compromises pulmonary performance and may prevent the patient from being able to breathe while supine for central venous catheter placement. Finally, ascites pushes the diaphragm upward, causing atelectasis and diminishing functional residual capacity. Thus, ascites predisposes liver transplant patients to rapid and severe desaturation during induction of anesthesia, even after asiduous denitrogenation.

Attention should be paid to sites for vascular access. Large-bore (14 gauge or 8.5 F) venous cannulas are essential for volume resuscitation during the case, and they must be located above the diaphragm because the inferior vena cava will be cross-clamped at times. A femoral arterial catheter for pressure monitoring may be useful (see below). Landmarks for internal and external jugular cannulation, as well as subclavian access, should be examined, as well as peripheral venous and arterial sites on both arms.

### Diagnostic Studies in the Liver Transplant Candidate

Laboratory tests obtained in the immediate preoperative period should include measures of hepatic synthetic and excretory function. Specifically, serum albumin and bilirubin should be measured. Routine coagulation studies (prothrombin time, partial thromboplastin time, fibrinogen, and platelet count) provide a measure of how hepatic synthetic failure has affected clotting factor levels. The platelet count can be low in the case of portal hypertension, as platelets are sequestered in the enlarged spleen.

Preoperative measurement of serum electrolytes is essential to provide baseline data about possible hyponatremia, hypokalemia or hyperkalemia, hypocalcemia, and hypomagnesemia. BUN and creatinine concentrations should be measured to assess the patient's renal function, which may, in turn, presage poor platelet function if uremia is present. This assessment of

renal function (and acid-base status; see below) guides the possible use of intraoperative renal replacement therapy. Although rarely required, intraoperative renal replacement therapy may be needed if significant renal failure, electrolyte abnormality, or acid-base problems are found in the immediate preoperative laboratory investigation.

Hemoglobin should be measured to establish the preoperative baseline oxygen-carrying capacity. The patient's blood type should be redetermined, and a sample sent to the blood bank for antibody screening in anticipation of allogeneic transfusion. An electrocardiogram should be obtained in the immediate preoperative period to search for new changes suggestive of coronary artery disease. Finally, a preoperative chest x-ray film is obtained as a baseline for comparison of postoperative films.

Patients presenting for liver transplantation almost always have an extensive body of laboratory and diagnostic test results available to aid in perioperative risk assessment and anesthetic planning. Patients with acute liver failure may be exceptions to this generalization, being listed for transplantation and subsequently receiving grafts within a few days of their initial presentation.<sup>9</sup> However, in almost all cases, the following assessments either are repeated upon admission for transplantation or have been performed within the prior year.

Laboratory assessment of pulmonary function includes arterial blood gas measurement and pulmonary function testing. Blood gas measurement identifies patients with hypoxia, suggesting hepatopulmonary syndrome. Pulmonary function testing often reveals small lung volumes reflecting the effect of ascites. A superimposed obstructive pattern on spirometry may be seen in patients with a long history of smoking. These results are important, because the liver transplant patient is mechanically ventilated for a prolonged intraoperative period and perhaps for some time in the postoperative period.

Cardiac assessment of the patient being considered for liver transplantation focuses on functional and invasive tests of cardiac performance that assess ischemic potential and the search for cardiac structural anomalies that might compromise outcome from orthotopic liver transplantation.<sup>117</sup>

The incidence and severity of coronary artery disease increases with age

and with well-known risk factors, many of which are commonly found in patients with liver failure, such as diabetes, smoking, and obesity. Furthermore, better surgical and anesthetic techniques are allowing older patients, that is, patients with greater age-related risk of significant coronary disease, to be considered for liver transplantation. Flow-limiting coronary artery disease is of grave concern because liver transplantation is still a highly stressful operation. The potential for sudden, massive, ongoing blood loss complicated by extreme electrolyte derangements is still present, so all potential liver transplant recipients must be evaluated as if they are required to tolerate minutes to hours of a hypothetical state with heart rate >110 beats/min, mean arterial pressure <50 mm Hg, hemoglobin 7 g/dL, and pH <7.2. Only patients with ideal cardiac status are likely to survive this scenario unscathed.

To ensure that new and previously listed transplant candidates meet these criteria, the anesthesia liver transplant team periodically reviews the preoperative evaluation of individuals high on the liver transplant list. This task involves reviewing the echocardiogram, the results of functional stress testing, and, if performed, cardiac catheterization. This is not an academic exercise, because a significant fraction of patients being evaluated for liver transplantation has coronary artery disease, and with the coronary disease in many of these patients unsuspected prior to pretransplantation evaluation. For example, in a study applying coronary angiography to all potential liver transplant recipients older than 50 years, there was a 27% incidence of moderate-to-severe coronary artery disease, with 13.3% of the cohort having clinically unsuspected moderate or severe coronary disease.<sup>118</sup> Another study showed a 5.6% incidence of coronary artery disease in patients older than 40 years,<sup>119</sup> and the consensus seems to be that approximately 2.5–10% of patients have moderate to significant coronary artery disease.<sup>120</sup> Untreated significant coronary disease is potentially lethal in the setting of liver transplantation.<sup>117</sup> In one study, half of the patients with coronary artery disease who underwent liver transplantation died in the perioperative period, and the morbidity rate was 81%.<sup>121</sup>

Dobutamine stress echocardiography or possibly exercise stress thallium

imaging appears to be the best screening test in patients with end-stage liver disease.<sup>120,122–124</sup> A recent meta-analysis indicates that dobutamine stress echocardiography has a superior negative predictive value in patients having elective noncardiac surgery.<sup>125</sup> Dobutamine stress is commonly used in pretransplant evaluation because it is considered to most closely mimic the state commonly found during liver transplantation and end-stage liver disease.<sup>122</sup> A negative dobutamine stress echocardiogram with adequate stress appears to predict a favorable perioperative cardiac outcome.<sup>123,126</sup> However, it is important to achieve at least 85% of the predicted maximal heart rate so that the dobutamine stress echocardiogram is diagnostic. Otherwise, the diagnostic value of the test is compromised.<sup>127</sup> In the aforementioned study, many patients were taking  $\beta$ -blockers, and more than half of the tests were nondiagnostic.<sup>127</sup> To achieve a diagnostic test, temporary withholding of  $\beta$ -blockade and use of supplemental atropine during testing may be necessary.

In the hyperdynamic state produced by the dobutamine stress echocardiography protocol, a significant number of patients develop a dynamic left ventricular outflow tract obstruction. However, despite the fact that more patients with dynamic left ventricular outflow tract obstruction developed intraoperative hypotension at transplantation, the overall outcomes (mortality) were the same between patients with obstruction and those without.<sup>128</sup>

Most transplant programs use a cardiac risk stratification schema similar to that devised by Plevak.<sup>122</sup> The version used by our program is shown in Fig. 56–8.

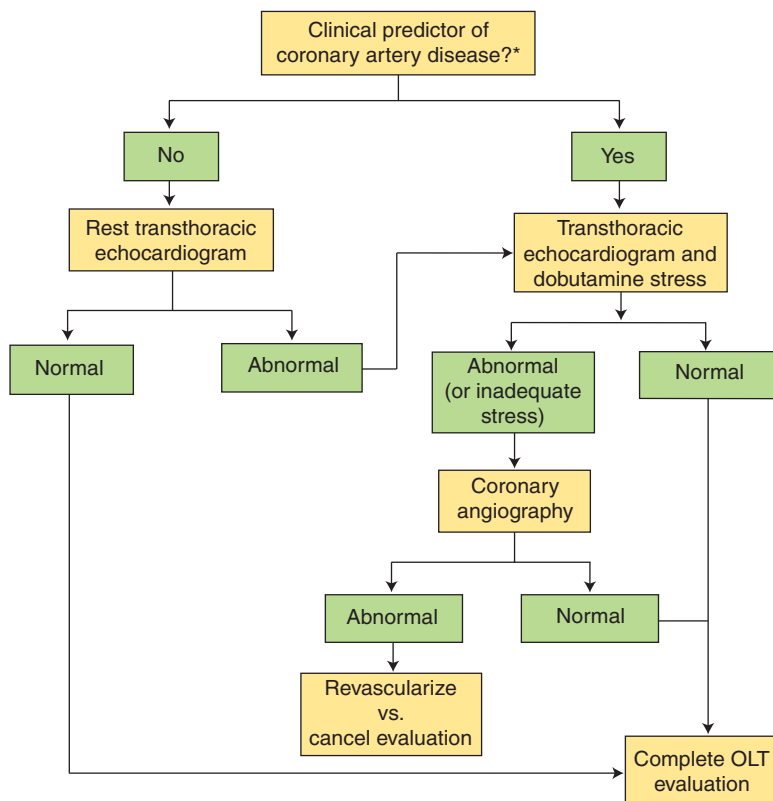
The ideal management of potential liver transplant recipients with significant coronary disease is a difficult problem with little evidence to guide decision making. Patients with end-stage liver disease who undergo coronary artery bypass grafting have significant morbidity. In one study, patients with cirrhosis who underwent coronary artery bypass grafting had a 58% incidence of morbidity and significant complications.<sup>129</sup> Even patients with relatively mild liver disease (Child Class A and B liver disease) who underwent coronary artery bypass grafting had extremely high mortality and morbidity.<sup>130</sup> The benefit of an interven-

tion, such as coronary angioplasty, stenting, or atherectomy, has not been formally studied on a large scale to show outcome compared with coronary artery bypass grafting.<sup>120</sup> Small series have reported good results with combined orthotopic liver transplantation and coronary artery bypass grafting,<sup>119,131,132</sup> but at present such a combined procedure is considered heroic in most transplant centers.

Independent of ischemic coronary artery disease, many patients with end-stage liver disease have a poorly understood disorder known as *cirrhotic cardiomyopathy* (a different entity from alcoholic cardiomyopathy) despite supranormal cardiac outputs.<sup>22</sup> This condition is multifactorial, and its mechanisms may include impairment of the  $\beta$ -adrenergic system, nitric oxide (overproduced in liver failure), cytokines, and prolonged hyperdynamic circulation.<sup>133</sup> Many patients with apparently normal ventricular function prior to surgery develop left ventricular failure in the postoperative period.<sup>23,126</sup> These patients, representing 1–6% of liver-transplanted individuals, may have had occult cirrhotic cardiomyopathy. Unfortunately, prospective diagnostic criteria for cirrhotic cardiomyopathy are lacking, and the diagnosis is commonly made only after a patient has suffered heart failure in the absence of any myocardial insult in the peritransplant period.

All patients being considered for liver transplantation should undergo a screening transthoracic echocardiogram. This is a good screening test to search for cardiac structural abnormalities as well as anomalies of the surrounding vasculature. Testing to exclude portopulmonary hypertension also is important.

Cardiac structural anomalies can affect outcome by impairing cardiac performance intraoperatively (e.g., functional or fixed valve stenoses) or by allowing passage of emboli from the right to the left side of the heart. Patent foramen ovale and other septal defects are a significant risk to orthotopic liver transplant patients and patients undergoing hepatic resection when fixed or transient right-to-left shunting occurs. Right-to-left shunt increases the possibility of paradoxical embolus of clot, air, or debris. Hepatic surgery can lead to large openings in the inferior vena cava, so the embolization problem can be severe. In fact, in two series, thrombus



\*Clinical predictors that would trigger dobutamine stress:

- History of coronary disease or congestive heart failure
- Signs or symptoms of coronary disease or congestive heart failure
- Abnormal ECG
- Diabetes
- Current or prior smoking
- Hypertension
- Hyperlipidemia
- Obesity
- Age > 50 for males, > 55 for females even in absence of any of the above

**FIGURE 56-8.** Suggested algorithm for assessment of inducible myocardial ischemia. OLT, Orthotopic liver transplantation.

was detected in the right heart in between 1% and 6% of all patients undergoing orthotopic liver transplantation.<sup>134,135</sup> Because approximately 25% of all hearts in unselected autopsy subjects have patent foramen ovals,<sup>136</sup> the risk of injury due to paradoxical embolism may be greater than currently appreciated. Thus, in preparation for elective hepatic surgery and certainly in the evaluation for orthotopic liver transplantation, cardiac septal defects should be sought by echocardiography or MRI.

Transthoracic echocardiography can be used to interrogate the intraatrial septum using color flow Doppler mode. Additionally, bubble contrast echocardiography is a highly sensitive test for septal defects. Early passage (within 1–2 beats) of air from the right to the left heart indicates a septal defect, whereas later arrival of air on the left side indicates intrapulmonary shunting. This

latter finding cannot be remedied, but when atrial defects are detected, consideration should be given to closing them.

Closure of patent foramen ovale prior to orthotopic liver transplantation is controversial, although it can now be accomplished percutaneously.<sup>137</sup> No controlled studies evaluating the usefulness of this intervention have appeared. Several factors favor closure: (1) embolism is common, particularly during the reperfusion period; (2) right-heart dysfunction with right-heart pressures greater than left-heart pressures is common during reperfusion; and (3) paradoxical embolism occurs in this setting.<sup>138</sup> On the other hand, the relationship between the presence or size of patent foramen ovale and the likelihood of paradoxical embolus is not clearly established. Although case series of paradoxical embolism have been documented by transesophageal echo-

cardiography during liver transplantation,<sup>138</sup> whether these necessarily occur through a patent foramen ovale is not clear. Furthermore, closing a patent foramen ovale commits the coagulopathic patient with liver disease to months of therapy with antiplatelet agents.

MRI has recently been applied to the assessment of the intraatrial septum. Small studies comparing this technique with color flow Doppler echocardiography and bubble contrast studies indicate that MRI has similar sensitivity and specificity to these echocardiographic techniques.<sup>139</sup>

The final cardiopulmonary problem to be investigated in the prelisting evaluation is portopulmonary hypertension, the management of which was described above. Fig. 56-1 outlines the diagnostic and therapeutic decision approach to portopulmonary hypertension. Portopulmonary hypertension occurs in 2–4% of patients with end-stage liver disease and 5–10% of patients being evaluated for orthotopic liver transplantation.<sup>36</sup> The clinical predictors of pulmonary hypertension in liver transplantation include systemic hypertension, right ventricular dilation by echocardiography, estimated pulmonary artery systolic pressure  $\geq 40$  mm Hg by transthoracic echocardiography, right ventricular hypertrophy by echocardiography, or right ventricular heave.<sup>140</sup> The mortality associated with pulmonary hypertension during liver transplantation is significant. Half of patients with mean pulmonary pressures between 35 and 50 mm Hg died in the peritransplant period, and mortality was 100% in those with mean pulmonary arterial pressure > 50 mm Hg.<sup>141</sup> These results are similar in a multicenter retrospective review,<sup>41</sup> leading many centers to deny orthotopic liver transplantation to patients with more than mild portopulmonary hypertension. However, in some centers, mild portopulmonary hypertension (mean pulmonary arterial pressure < 35 mm Hg with good ventricular function) is not associated with poor early or late outcomes.<sup>142</sup>

Transesophageal echocardiography is rarely indicated in the preoperative assessment of orthotopic liver transplantation candidates. The procedure may require sedation, which can be complicated in the patient with end-stage liver disease. Furthermore, there is the risk of disrupting esophageal varices during the examination.



## Operative Approaches for Liver Transplantation

Liver transplantation is conveniently divided into three phases: preanhepatic, anhepatic, and neohepatic. During the *preanhepatic* phase, a complete hepatectomy is performed. During the *anhepatic* phase, vascular anastomoses between the donor liver and the recipient's vessels are constructed. During the *neohepatic* phase, the hepatic arterial and biliary anastomoses are constructed, and the wound is closed.

A liver transplant begins like a hepatic resection, using the same incision and exposure and imposing the same hemodynamic consequences. The surgeon exposes and gains control of the hepatic vasculature. The hepatic artery, portal vein, and common bile duct are clamped and divided. Two different techniques are commonly used for controlling hepatic venous outflow and constructing the hepatic venous anastomosis: (1) an en bloc technique in which part of the recipient's vena cava is resected and replaced with a section of the donor vena cava, or 2) a "piggyback" technique in which the recipient vena cava is clamped with a side-biting clamp and a side-to-side anastomosis is constructed to the donor liver venous outflow. The choice of technique has important implications for anesthetic management and the expected course of the case (as described in the following paragraphs).

In the en bloc resection technique, the inferior vena cava must be clamped above and below the liver, with consequent severe reduction in venous return to the heart. Because both the portal vein and the inferior vena cava are clamped, the entire body below the caval cross-clamp, as well as the abdominal viscera, suffers venous congestion and ischemia unless an alternate route of venous return can be established. This massive loss of venous return, coupled with the insult of recirculating blood from such a large ischemic territory at the time of reperfusion, leads to profound hemodynamic instability requiring pharmacologic intervention, sudden hypothermia at reperfusion, and elevated potential for malignant cardiac arrhythmias. These difficulties have motivated the development and routine use of venovenous bypass techniques. This is commonly achieved via venovenous bypass from the lower half of the body to a great vein draining into the superior vena cava.

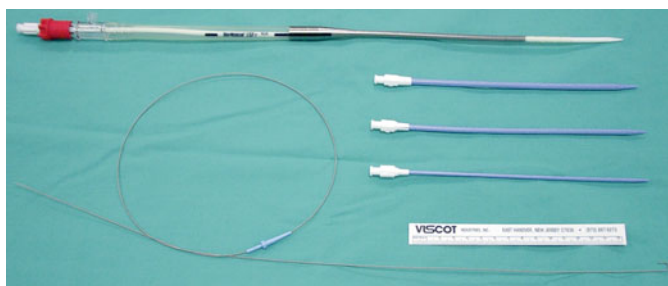


FIGURE 56-9. Large-bore venovenous bypass cannula with guidewire and dilators.

Venovenous bypass can be used to decompress the lower systemic venous circulation, the portal circulation, or both. The advantages and disadvantages of venovenous bypass have been reviewed.<sup>143</sup> Without the preserved venous return afforded by venovenous bypass, cardiac output and blood pressure may fall dramatically; often cardiac output falls by > 50%. Such falls in cardiac output are suggested to increase morbidity and mortality,<sup>143</sup> although primary research has failed to detect this association.<sup>144,145</sup>

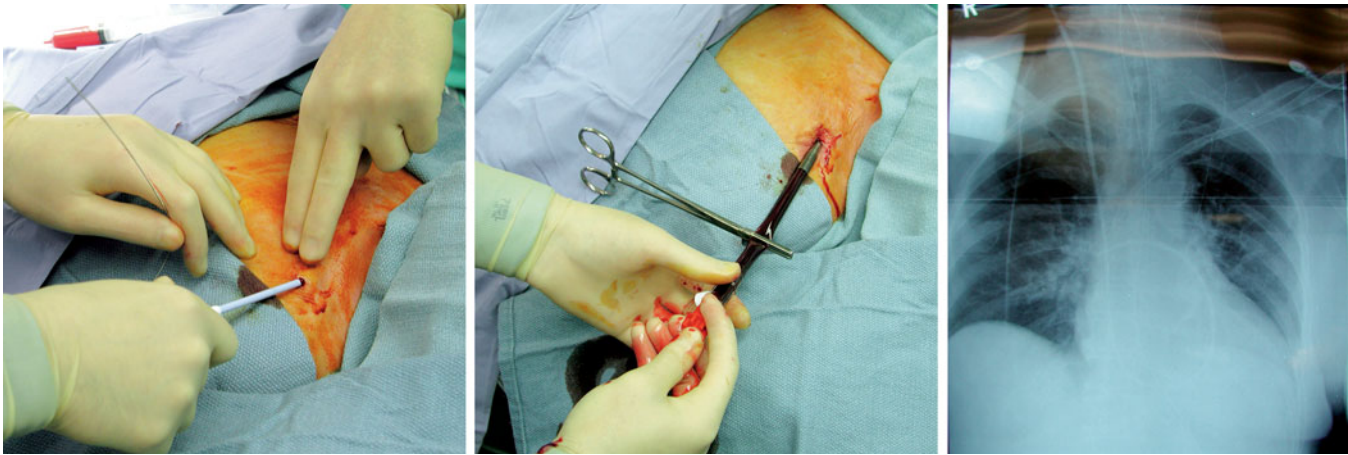
Failure to decompress the lower systemic and portal venous systems leads to severe venous congestion below the caval cross-clamp. Above the clamp, reduced venous return reduces left ventricular preload and cardiac output, with a net result of reduced perfusion pressure for organs below the caval cross-clamp. Thus, without venovenous bypass, renal venous pressure is elevated, systemic arterial pressure is depressed, and renal perfusion pressure is degraded. Thus, venovenous bypass might be expected to afford some protection from renal failure in the perioperative period, but the net effect on renal function is equivocal. For example, venovenous bypass is not associated with improved postoperative renal function relative to matched patients whose liver transplant was performed without bypass.<sup>146</sup>

First described in 1984,<sup>147</sup> venovenous bypass is a technique wherein blood is actively pumped using a centrifugal pump from large-bore drainage cannulas to a similarly large return line (Fig. 56-9). The cannulas can be inserted percutaneously or via a cutdown procedure. A common drainage site for the lower systemic venous circulation is the left femoral vein. The portal vein, if drained, is accessed from the surgical field. Common return sites are the right internal jugular and left subclavian veins via percutaneous access or the left axillary vein via a cutdown technique.

Percutaneous insertion of the bypass cannulas can be performed by the surgical team or by the anesthesia team at the beginning of the case. An alternative approach is to prepare the left groin and axilla for possible cutdown access and then defer access until the need for venovenous bypass becomes clear. Percutaneous access appears to be quicker and to provide better flows,<sup>148,149</sup> but the cutdown technique persists. The bypass cannulas are very large and, when placed percutaneously, require multiple passes with successively larger sharp stiff dilators passed over a stiff guidewire to create a large enough skin entrance (Fig. 56-10).

Assiduous care should be taken to pass the dilators only deep enough to enlarge the skin punctures. Under no circumstance should the tip of any dilator be allowed to pass beyond the end of the guidewire. Exsanguinating hemorrhage into the chest and cardiac tamponade from cardiac puncture have occurred as mishaps of venovenous bypass cannula placement.<sup>150</sup> Every care should be taken to facilitate reliable cannulation of the target vein, including possible use of ultrasonography to guide initial venous access and manometry to confirm venous placement using a small, temporary catheter prior to beginning dilation. A postinsertion chest x-ray film to confirm vascular placement and correct insertion depth is mandatory prior to initiating venovenous bypass.

The bypass circuit should be carefully cleared of air as connections are made and all connections secured prior to initiating bypass. Systemic heparinization is not performed because the bypass circuit is heparin bonded.<sup>151</sup> Bypass flow rates of 1.5-5 L/min are typical. The initiation of bypass is a critical period, as malplacement of the return line becomes apparent with disastrous consequences almost immediately. For example, accidental placement of the tip of the return line through a cardiac



**FIGURE 56-10.** Subclavian placement of a percutaneous venovenous bypass cannula. **Left.** Use of a large-bore dilator after placement of the guidewire into the central circulation. **Center.** Cannula in place and clamped prior to connecting to the venovenous bypass pump tubing. **Right.** Portable chest x-ray film confirming intravascular placement.

chamber wall and into the pericardial sac will lead to nearly instantaneous, severe cardiac tamponade with initiation of flow. Fatal air embolism has occurred because of connection failure during venovenous bypass, so the pump and its circuit require constant attention by dedicated, specialized personnel.

Despite the improved conditions afforded during surgery, whether venovenous bypass improves long-term outcomes is not clear. Because of the potential for complications, coupled with improvements in surgical techniques (see next paragraph), some have questioned the usefulness of routine venovenous bypass.<sup>143</sup>

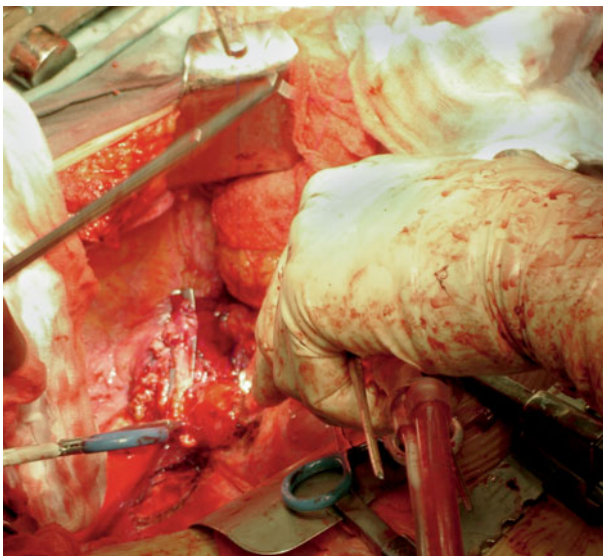
The alternative approach to liver transplantation, the vena cava preservation (or “piggyback”) technique,<sup>152</sup> is

designed to preserve vena cava flow for all but a few minutes of the transplant procedure. Portal venous and hepatic arterial control are obtained as in the en bloc technique. Instead of a cross-clamp, a “side-biter” clamp placed on the inferior vena cava isolates the liver from the systemic venous system. Figs. 56-6 and 56-11 illustrate this clamping method. In Fig. 56-11, a button of vena cava with the hepatic vein attachments has been removed, and the hole is held closed by the side-biter clamp at the bottom of the wound. The vena cava deep to this clamp is largely open to flow. This allows venous return from the lower systemic, but not the portal, venous system. Frequently, a brief period of total venous occlusion with a vena cava cross-clamp is need-

ed to position the side-biter clamp. Vena cava distension due to overzealous volume replacement during the hepatectomy can make the piggyback technique more difficult for surgeons. Because the exposure made for hepatectomy is more difficult and the anastomosis is more complicated, the piggyback technique may take longer to perform. However, many programs now use this technique almost exclusively.<sup>153</sup> Piggyback transplantation is associated with a lower incidence of renal failure<sup>154</sup> and better gas exchange, acid-base status at reperfusion,<sup>155</sup> and intraoperative hemodynamic stability.

Failure to decompress the portal system may lead to splanchnic congestion unless the recipient has large portosystemic shunts. Nevertheless, the piggyback technique reduces transfusion requirement as well as the need for vasoactive drugs during completion of the hepatectomy and construction of the venous anastomoses.<sup>156</sup> Temporary portocaval shunts have been described in association with piggyback technique. The temporary shunt appears to improve intraoperative hemodynamics and reduce transfusion requirements<sup>157</sup> but is not widely used. In general, use of the piggyback technique dramatically reduces the severity of problems during the anhepatic and reperfusion stages of the operation.

As the hepatectomy is being completed, a separate surgical team working at a different table prepares the donor liver for implantation. The graft vessels are trimmed to fit their counterparts in the recipient. Next, the graft is brought to the recipient surgi-



**FIGURE 56-11.** Photograph of a side-biting cross-clamp (lower left) on the inferior vena cava after removal of the liver. The patient’s head is to the upper left.

TABLE 56–2.

## Major Foci of Intraoperative Management during Anesthesia for Orthotopic Liver Transplantation

Major Focus (Problem or Organ System)	Subtopics	Perturbing Factors
Cardiac	Ischemic potential Dysrhythmias Right ventricular performance	Hemorrhage (demand and carrying capacity) Acid–base and electrolyte disturbances Emboli, hepatic washout
Portal-to-central venous gradient	Graft perfusion is tenuous	Need to keep central venous pressure adequate to provide cardiac preload during vena cava cross-clamping Need to prevent venous air embolism Sudden hemorrhage
Renal performance	Urine output	Hypovolemia and hypotension Preexisting renal disease Need for intraoperative renal replacement therapy
Anesthesia	Hypnosis Analgesia Muscle relaxation	
Brain protection Immunosuppression Prophylaxis	Temperature management Deep venous thrombosis prophylaxis Preemptive antibiotics	Large incision, large prepared area
Glucose management	Coexisting diabetes	Dilution due to massive hemorrhage Steroid administration Absent gluconeogenesis during anhepatic phase
Coagulation	Hypocoagulable state due to liver failure	Massive hemorrhage Acute fibrinolysis at graft reperfusion
Electrolytes	Platelet sequestration Platelet dysfunction due to uremia	
	Potassium Sodium	Elevated by potassium load in blood products Hyponatremic patient at risk for central pontine myelinolysis (CPML) with massive infusions of sodium-rich fluids
Pulmonary performance	Calcium	Citrate in blood products chelates Ca <sup>2+</sup>
	Ventilation Oxygenation Pulmonary vascular resistance	May be impaired by pleural effusions May be impaired by intrapulmonary shunts Acutely elevated in the face of acid load at graft reperfusion
Hemodynamics	Vasodilated hyperdynamic circulation Massive hemorrhage Vena cava compression Possible venovenous bypass	

cal field, and the vascular anastomoses are constructed. The surgical goal during this phase of the operation is to construct patent, nonleaking anastomoses as efficiently as possible to minimize the warm ischemic time of the liver. Thrombosis of the recipient portal vein is a relatively common finding, either during the dissection or at the time of initial graft reperfusion. When discovered, portal venous thrombosis typically prompts an attempted thrombectomy using Fogarty catheters, a potentially bloody process. Typically, the donor hepatic to recipient vena cava and the donor portal to recipient portal venous anastomoses

are constructed, flushed, and perfused as quickly as possible to establish a circulation in the graft. Then the hepatic arterial anastomosis is constructed, flushed, and opened, completing the graft blood supply.

Finally, a biliary drainage is constructed. This can be accomplished either by direct anastomosis of the graft bile duct to the recipient common bile duct or by a Roux-en-Y anastomosis using the jejunum.

### Anesthesia for Liver Transplantation

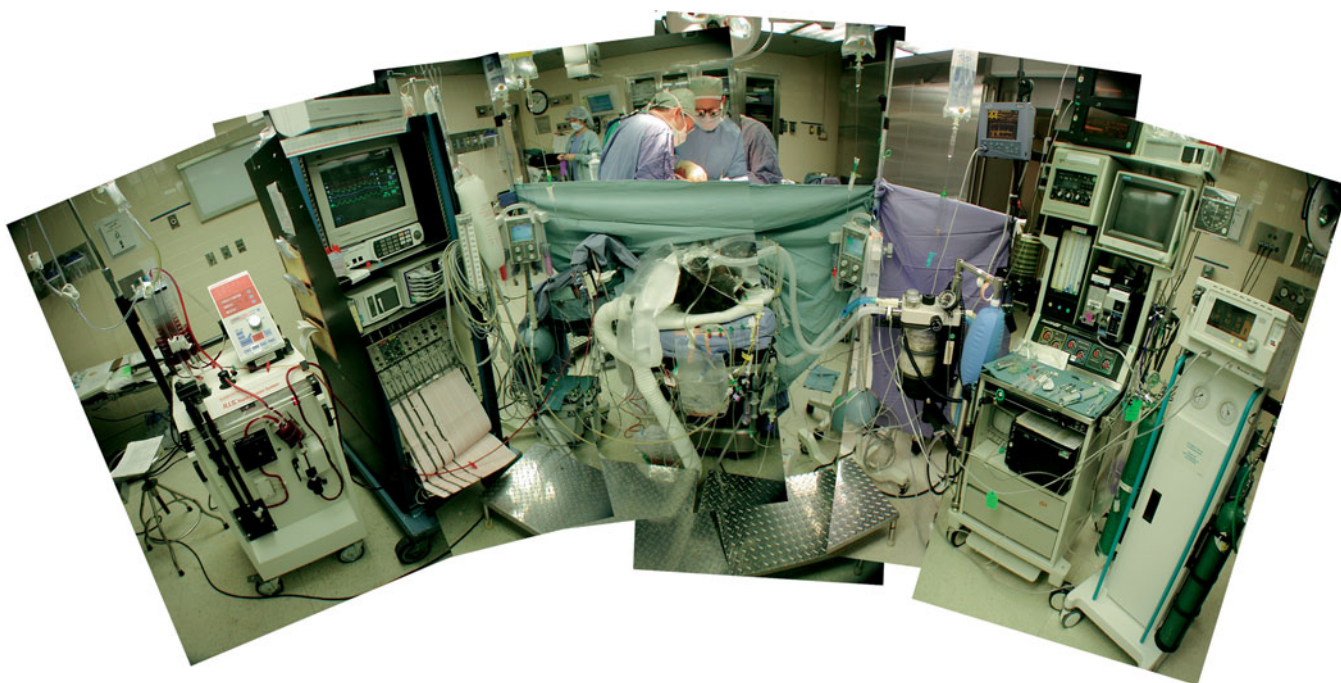
Concerns and activities during anesthesia for liver transplantation mirror

the major phases of the surgery. The anesthetic can be approximately divided into the following phases:

- Preinduction
- Induction, preparation for surgery, and maintenance
- Preanhepatic phase
- Anhepatic phase
- Venous reperfusion of the graft
- Neohepatic phase
- Emergence/transport to ICU

The anesthesia team attends to multiple homeostatic goals throughout the case (Table 56–2). Administration of





**FIGURE 56–12.** Panorama of anesthesia equipment used for liver transplantation. The equipment (from left to right) includes rapid infusion system, six-pressure physiologic monitor with eight-channel chart recorder, syringe microinfusion pumps for vasoactive drugs, forced-air warmer, syringe microinfusion pumps for anesthetics, muscle relaxants, and miscellaneous drugs, level-of-consciousness monitor, anesthesia machine, and delivery system for inhaled nitric oxide. Blood recovery system is out of view to the right.

liver transplant anesthetics is among some of the most complex currently performed because of the surgical and medical criticality of the patients and the complexity of the equipment required to perform the case.

Fig. 56–12 is a panorama from the anesthesiologist's perspective during a liver transplant. Multiple user interfaces, cables, monitoring lines, and infusions must be well organized and set up systematically to make the cognitive load from the equipment acceptable and predictable so that the anesthesiologist can attend properly to the patient and the operation. Liver transplantation consumes tremendous resources. Most programs responding to a survey reported assigning at least two anesthesiology personnel and at least two additional professional personnel (i.e., perfusionist, monitoring nurse, auto-transfusion nurse) to each case.<sup>158</sup> Thus, in addition to the complexity of the equipment, team leadership, communication, and delegation of responsibility must be considered and managed during the case.

During the preinduction phase, the final evaluation of the patient is performed. Although any doubt about the identity of the patient and the operation to be performed are unlikely, the anesthesia team must independently confirm the patient's identity, the operation

to be performed, and the recipient's blood type. Last-minute laboratory results should be reviewed. It is always prudent for a member of the anesthesia team to personally consult with the blood bank about the upcoming liver transplant so that they may prepare for a possible heavy demand for blood products. This is particularly true if the patient has developed antibodies to allogeneic red blood cells from previous transfusions, which presents an added challenge to the blood bank.

Close communication with the graft harvest team is essential to best sequence the activities with the donor to minimize graft ischemic time while minimizing the recipient's exposure to risks of anesthesia and invasive monitoring. Thus, one might obtain initial peripheral IV access and then wait to place any additional monitors or vascular access until the suitability of the graft is confirmed. In most situations, graft suitability is known at least 1 hour before the need to start the recipient's surgery, leaving ample time for induction of anesthesia, placement of central venous or pulmonary artery catheters, positioning of the patient, application of warming devices, and initial surgical preparation and draping.

Most patients with end-stage liver disease have at least some encephalopathy. Thus, it is prudent to dose seda-

tive premedications, such as benzodiazepines and opioids, judiciously, giving small doses and monitoring closely for desired and undesired effects.

Monitoring for liver transplantation relies on standard monitors plus invasive monitors directed toward the likely areas of additional concern during the case. Central venous pressure monitoring likely will be needed to assess intravascular volume status. Additionally, central venous catheterization provides large-bore transfusion access, allows passage of a pulmonary artery catheter, if needed, and provides a conduit for central vasopressor administration. Thus, placement of a central venous catheter for liver transplantation seems almost obligatory. However, central venous pressure monitoring gives much of the same information as provided by intraoperative transesophageal echocardiography, which could replace the intravascular monitor if another suitable route for the drugs can be found.

Pulmonary artery catheterization is performed if left-heart or right-heart performance is in doubt, if problems with pulmonary hypertension are anticipated, and to distinguish hypotension due to hypovolemia or heart failure from that due to lack of peripheral vascular tone. One type of pulmonary artery catheter also allows for atrioven-



tricular pacing. The pulmonary artery catheter allows the team to follow cardiac output and stroke volume throughout the case. The initial cardiac output measurements typically confirm a hyperdynamic circulation, with cardiac outputs of 10–1 L/min frequently seen at rest in adult male patients with end-stage liver disease.

An arterial catheter usually is inserted to closely monitor blood pressure. It also provides convenient access for frequent laboratory sampling. Compared with femoral arterial catheters, radial artery catheters may not reflect the true systolic pressure during the reperfusion phase of transplantation or during vasopressor administration.<sup>159</sup> However, mean pressures measured in the radial and femoral arteries correlate well regardless of the phase of the case or vasopressor administration.<sup>159</sup> Thus, a radial arterial catheter is sufficient to guide management of mean pressure.

Transesophageal echocardiography should be considered for assessment of cardiac performance during transplantation and for monitoring embolism of air or thrombus. Air embolism is common, and transesophageal echocardiography frequently reveals such events. Transesophageal echocardiography is most useful for early detection of large embolic events, with the hope of minimizing their effect by early detection and removal of the source. It is also a useful tool for assessing the effect of both embolic events and therapeutic interventions on cardiac performance.

It is also useful to consider level-of-consciousness monitoring (bispectral index or similar). Liver transplant patients may be highly sensitive to anesthetics, requiring smaller doses than typical patients. Thus, level-of-consciousness monitoring can be used to minimize exposure to anesthetic agents and their potential deleterious effects on the circulatory system while providing some assurance that the patient will not recall the surgery.

Vascular access for rapid volume replacement can be either peripheral or in the central circulation. The patient likely requires central venous access for vasopressor administration, so it is tempting to use this route for volume as well. However, it is important to isolate vasopressors from the main volume cannula, because fluid for resuscitation may be delivered under pressure, effectively stopping

the vasopressors. Multilumen large-bore central venous catheters or multiple catheters at separate central venous sites provide the necessary isolation. Alternatively, peripheral vascular access (e.g., multiple 14-gauge IV catheters or a rapid infusion catheter as described above) can be established. It is important that at least one cannula be dedicated to carrying the maximum flow rate of the available rapid infusion device.

### **Anesthetic Induction, Preparation for Surgery, and Maintenance**

Because most patients with end-stage liver disease have ascites and/or have undergone sclerotherapy of lower esophageal varices, rapid sequence induction is the norm, with cricoid pressure applied and the patient in optimal position for laryngoscopy. Careful denitrogenation is important, because most end-stage liver disease patients have reduced functional residual capacity. Vasodilatation and encephalopathy make patients with end-stage liver disease sensitive to induction agents. Thus, the induction dose of hypnotic drugs, such as propofol or pentothal, should be reduced (e.g., 1 mg per kilogram of ideal body weight for propofol in a cachectic patient with encephalopathy). Some clinicians elect to sidestep this issue entirely by using an induction agent such as etomidate. Skeletal muscle paralysis typically is obtained with succinylcholine followed by a nondepolarizing agent, or with rocuronium at a dose sufficient for rapid sequence induction.

Antibiotics targeted against skin flora (e.g., cefazolin) should precede skin incision by no more than 60 minutes.<sup>160</sup> Antibiotics should be re-dosed throughout the case to account for elimination and loss due to hemorrhage.

During maintenance of anesthesia, hepatic encephalopathy reduces opioid and anesthetic requirements. Thus, inadvertent administration of relative overdoses of anesthetics by overestimating the patient's needs is possible. Similarly, opioids may have enhanced potency and prolonged duration of action because of the patient's hepatic failure. On the other hand, massive hemorrhage and resuscitation can diminish the circulating opioid concentration. Thus, it is appropriate to titrate intermediate-acting opioids, such as morphine, hydromorphone, or fen-

tanyl, to the patient's needs throughout the case. The choice of paralyzing agent also should be guided by the clinical situation. For example, agents requiring hepatic degradation probably are not optimal if early extubation is contemplated.

Positioning the patient requires special attention. Liver transplants are long cases with the potential for hypotension and consequent extremity hypoperfusion. Surgeons may lean heavily on the patient to perform parts of the operation. Thus, positioning injuries are possible, and great care should be taken to protect the patient by generously supporting and padding all of the body, either with compressible foam or viscoelastic gel.

The case is performed with the patient in the supine position. Usually the right arm is tucked alongside the patient's body to allow access for several surgeons. Thus, the right arm is out of reach of the anesthesiologist, and no critical monitors or access devices should be placed there unless no alternative sites are available. In addition to problems with accessibility, devices placed in the tucked right arm may cause patient injury from compression. Accordingly, we typically limit devices in the right arm to a single large-bore peripheral IV. The left arm is abducted to facilitate access for venovenous bypass. Therefore, the left arm is also an ideal site for arterial monitoring and peripheral venous access. Venous access in the left arm may be occluded if venovenous bypass is instituted via cut-down to the axillary vein, but the bypass circuit has a separate high-flow inlet into which this infusion can be attached. Other sites of access include both femoral regions. Venous access below a potential vena cava cross-clamp is of little use, either for monitoring or volume administration. Furthermore, the left femoral vein typically is reserved for possible venovenous bypass access. However, cannulation of the right femoral artery may be useful if a complicated case is anticipated. Both internal jugular veins are available with the patient in supine position.

The entire abdomen and chest are prepared for surgery. Additionally, the left groin and axilla are included in one large, contiguous preparation if venovenous bypass via open access is contemplated.

Patient warming becomes a major issue because of the extensive use of

TABLE 56-3.

## Characteristics of Common Rapid Infusion Devices

Device	Reservoir	Pump	Air Detector	Postpump Filter	Measured Flow Rate	Maximum Flow Rate
Level 1	No	No	Yes	No	No	Catheter limited
Haemonetics RIS	Yes	Yes	Yes	Yes	Yes (from pump)	1500 mL/min
Belmont FMS	Yes	Yes	Yes	No	Yes (from pump)	750 mL/min

FMS, Fluid Management System; RIS, Rapid Infusion System.

alcohol-based skin preparation solutions over a large surface, the size of the incision, the duration of the case, and reperfusion of a cold graft. Hypothermia should be prevented because it negatively affects coagulation,<sup>96</sup> resistance to infection,<sup>95</sup> and the potential for early extubation. Warming strategies commonly focus on IV fluids and forced-air warming devices.

Forced-air warming is effective, although the extensive area exposed and prepared during liver transplantation makes finding sufficient surface area on which to apply warmers a challenge. A procedure involving the entire abdomen, as well as the left groin and axilla for establishment of venovenous bypass, leaves the head, left arm, and lower legs for warming. Recently, forced-air warming blankets for underbody use, which presumably function by forming a warmed-air plenum under the drapes, have become available. These blankets appear to be effective because they are not compressed and deflated by the weight of drapes and by surgeons pressing against them. In this instance, we place forced-air warming blankets on all available sites, including under the patient. In our experience, patient temperature drops to approximately 36°C during induction, preparation, and draping; increases to 37°C during the preanhepatic phase; and then falls by approximately 1°C at hepatic reperfusion. Subsequently, the temperature increases to 37°C during the neohepatic phase, prompting gradual discontinuation of forced-air warming to maintain normothermia.

Warming IV infusions is mandatory, given the volume of refrigerated banked-blood products that likely will be transfused. Fluid warming for liver transplantation usually is achieved with commercially available high-flow warming devices. The ideal transfusion device has a reservoir that allows the user to establish a reserve of blood for sustained rapid infusion in the face

of uncontrolled hemorrhage. The device should report the infusion flow rate. The device must contain an air detector that stops the infusion when air is detected in the patient limb of the circuit. Ideally the device contains a debris filter between the reservoir and the patient.

Three devices are in common use, each with unique advantages and weaknesses. The characteristics of the three major rapid infusion systems are listed in Table 56-3. The first device, manufactured by Level 1 (Rockland, MA, USA), uses a countercurrent heat exchanger to warm fluid administered under pressure from bags. The second device, the RIS, formerly manufactured by Haemonetics (Braintree, MA, USA), is no longer commercially available but is still in common use. The third device, the Belmont Fluid Management System (FMS), is manufactured by Belmont Instrument Corp. (Billerica, MA, USA). The pumped devices are pressure limited at 300 mm Hg, that is, their maximum flow rates in actual clinical use are limited by the resistance characteristics of the infusion catheter or by the maximum rate of the pump if the back-pressure is <300 mm Hg when maximum pump flow is attained.

Of the three devices listed in Table 56-3, the RIS most closely approaches the characteristics of the ideal transfusion device. It has a debris filter/air removal system downstream of the warmer and pump but proximal to the final air detector, thus providing maximal embolism exclusion. The RIS also has the highest flow rate, delivering 1500 mL/min, or roughly one third of the normal adult cardiac output, exceeding the flow capacities of all but the largest catheters. However, the RIS disposable insert is bifurcated, which allows the pumped flow to be sent to two infusion catheters in parallel.

Of the two available devices, the FMS is preferable because it satisfies

more of the requirements listed. Its maximum flow rate does not exceed the capacity of an RIC or percutaneous introducer sheath, but it does exceed the capacity of a 14-gauge peripheral IV or the auxiliary lumen of a centrally inserted device, such as the Multi-Access Catheter (Arrow International, Reading, PA, USA) or the Advanced Vascular Access device (Edwards Lifesciences, Irvine, CA, USA).

### The Preanhepatic Phase

As in a hepatic resection, clamping the portal triad reduces venous return. However, as mentioned above, cardiac output and blood pressure do not necessarily fall. Liver transplantation almost always requires a vena cava cross-clamp, creating total vascular exclusion physiology for at least a brief duration. In contrast to portal triad clamping, total vascular exclusion of the liver via a vena cava cross-clamp reduces systemic blood pressure and cardiac output because the loss of venous return is quite large. The vena cava cross-clamp can be applied briefly to facilitate completion of the hepatectomy or for a longer time to allow construction of the hepatic venous anastomoses. Severe cardiovascular compromise during the vena cava cross-clamp may necessitate institution of venovenous bypass. However, more moderate decreases in cardiac output and blood pressure can be treated by vasopressor administration coupled with judicious intravascular volume expansion. Modest doses of a vasopressor during caval cross-clamp to construct caval anastomoses apparently are well tolerated, with graft and patient survival rates comparable with those obtained when venovenous bypass is used.<sup>161</sup>

Low central venous pressure does not seem advantageous during liver transplantation, in contrast to hepatic resection. For patients undergoing orthotopic liver transplantation, keep-

ing central venous pressure < 5 mm Hg is associated with higher incidences of postoperative renal failure and 30-day mortality relative to patients whose central venous pressure was allowed to run between 7 and 10 mm Hg.<sup>162</sup>

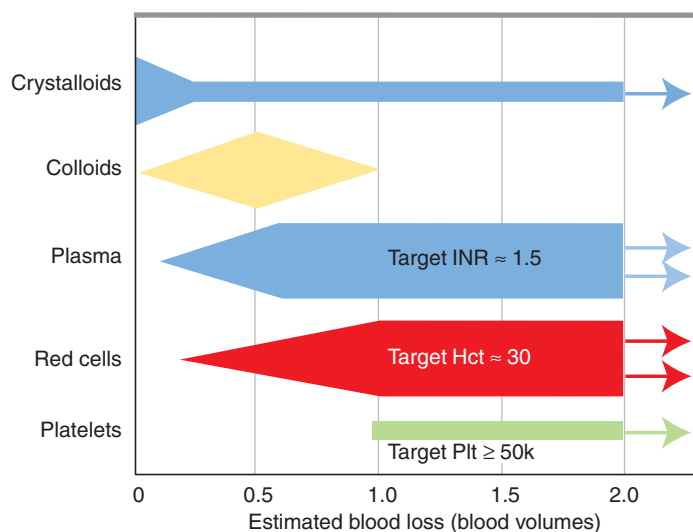
As in partial hepatectomy, two major contributors to hemodynamic changes during liver transplantation are changes in cardiac performance due to episodic alterations in venous return and hemorrhage. However, these factors are only two of the many sources of cardiovascular instability during liver transplantation. Sepsis, acidemia, hypocalcemia due to citrate toxicity, embolism, and acute right ventricular failure all are major contributors to hemodynamic problems. The period of graft reperfusion (described below) is particularly unstable in many instances.

The goals of hemodynamic management are to provide sufficient circulating volume, vascular resistance, and cardiac output to perfuse the vital organs. This process is not guided by any single parameter but rather by a synthesis of all available data, including urine output, central venous pressure (in relation to preoperative central venous pressure and with a full appreciation of the factors that may artificially alter it), and the presence of only a minimal vasopressor requirement except during periods of inadequate venous return.

### Choice of Vasopressor

With adequate volume management, vasopressors are rarely required intraoperatively except during periods of inadequate venous return (i.e., during inferior vena cava cross-clamping) and transiently at liver reperfusion. Administration of vasopressors is a choice between the global detrimental effects of untreated significant hypotension and the potential negative effect of vasoconstrictors on perfusion of the new graft. In animal models, both epinephrine and norepinephrine reduced graft macroperfusion and microperfusion,<sup>163</sup> but the functional consequences of these effects on human allograft performance or survival are unclear.

Vasopressin is a tempting choice because it is effective regardless of pH, it reduces norepinephrine requirements, and it is effective for managing hepatorenal syndrome before transplantation. Currently, use of vasopressin for control of blood pressure during liver transplantation has not



**FIGURE 56-13.** High-level overview of volume and blood component replacement strategy for liver transplantation requiring massive transfusion. All fluids are warmed (see text for discussion). The thickness of the bars represents the approximate relative proportions of each fluid in the replacement infusions.

been reported. Most studies of vasopressin to date are in patients with septic or postcardiotomy shock. Vasopressin is effective in these circumstances, reducing the requirement for catecholamine vasopressor support. Limited observational studies indicate that although vasopressin raises the blood pressure, it does not compromise the microvascular circulation.<sup>164</sup> However, there is no clear evidence that vasopressin would be beneficial or harmful during liver transplantation. In fact, in one study that retrospectively reviewed the use of vasopressin in septic shock, vasopressin was associated with increased levels of liver enzymes, bilirubin, or both.<sup>165</sup>

Adjuvant drugs, such as aprotinin, reduce the requirement for vasopressors, presumably by improving clotting performance and minimizing blood loss.<sup>166</sup> However, these advantages must be balanced against the other potential risks of aprotinin infusion (see below).

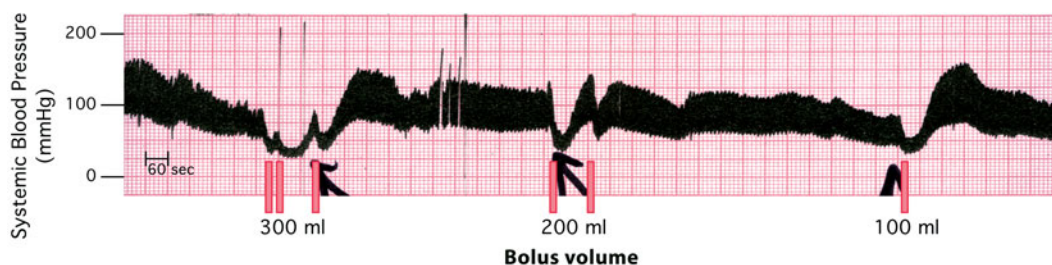
### Transfusion and Other Therapies to Maintain Intravascular Volume

The goal of volume management and transfusion in liver transplantation is maintaining sufficient intravascular volume to support a well-functioning circulation. Additionally, in many instances, the hemorrhage is sufficiently large that the anesthesiologist must intervene directly to control the composition of the circulating intravascular volume. Thus, in addition to red

cell mass and intravascular volume, the anesthesiologist attends to plasma oncotic pressure, electrolyte composition, serum glucose and clotting factor levels, and platelets. In many cases, maintaining intravascular volume and management of coagulopathy are intertwined, so these topics are treated together in this section. Fig. 56-13 gives a high-level overview of a strategy for volume and transfusion management as a function of blood loss during transplantation.

Plasma oncotic pressure is a function of the osmotically active species in the plasma (proteins and, to a very small degree, cells). Albumin and other plasma proteins, mostly synthesized by the liver, provide plasma oncotic pressure. During liver transplantation, colloids should be used to replace intravascular volume lost through hemorrhage, with the addition of formed blood components as needed to meet specific needs (e.g., red blood cells for oxygen-carrying capacity).

One attractive approach to managing plasma oncotic pressure is use of fresh-frozen plasma as a volume expander. This is particularly appropriate when the patient is coagulopathic due to hepatic synthetic failure, because fresh-frozen plasma contains most of the proteins found in normal plasma. However, fresh-frozen plasma also contains most of the citrate added to blood at the time of collection to prevent clotting. Thus, rapid infusions (> 1 mL/kg min) of fresh-frozen plas-



**FIGURE 56–14.** Acute systemic hypotension due to rapid transfusion of a citrate-containing 50:50 mix of fresh-frozen plasma and packed red blood cells. Boluses of 100 mL (vertical bars) were infused at 500 mL/min using a Rapid Infusion System (Haemonetics, Braintree, MA, USA). The hypotensive response is superimposed on acute hypotension due to sudden hemorrhage that was to be treated by the fluid challenge. The infusion-exacerbated hypotension was treated by infusion of norepinephrine.

ma can chelate  $\text{Ca}^{2+}$ , which is proposed to cause acute hypocalcemia with consequent vasodilatation and hypotension at inopportune times.<sup>167</sup> Fig. 56–14 illustrates the consequences of rapid infusion of citrated blood products during liver transplantation.

Fresh-frozen plasma is a poor choice for volume expansion when the patient is not coagulopathic, because each unit of fresh-frozen plasma carries the potential to trigger transfusion-related lung injury. Also, liver transplantation entails the construction of multiple low-pressure, low-flow anastomoses. Some practitioners believe that maintaining a slightly hypocoagulable state lessens the possibility of unwanted hepatic or portal venous thromboses. Thus, in the absence of significant coagulopathy, 5% albumin solution probably is a better choice for volume expansion. Synthetic colloids composed of long-chain polysaccharides are available but are not popular because they can interfere with clot formation.

### **Transfusion and Other Therapies to Maintain Coagulation Capacity**

Coagulation is monitored using standard laboratory tests, augmented in some cases by point-of-care functional tests and ultimately by clinical correlation of the laboratory test results with direct observation of the surgical field. The basic tests for monitoring coagulation status are prothrombin time, activated partial thromboplastin time, and platelet count. D-Dimer and fibrinogen levels provide information about the presence of clot lysis. However, these tests provide a far-from-complete picture of a patient's coagulation performance. Many centers use thromboelastography to obtain near-patient diagnostics of clot initiation, formation, and lysis.<sup>168,169</sup> Thromboelastography is a mechanical test described in detail in Chapter 14. The test is sensitive to

extraneous influences (including environmental disruption) and is not well standardized. However, thromboelastography is useful in liver transplantation because, unlike other tests, it gives information about clot lysis.<sup>169</sup>

Coagulation performance during liver transplantation in patients with end-stage liver disease tends to follow a predictable course.<sup>170</sup> Patients with hepatic synthetic failure start out hypocoagulable, and, with appropriate transfusion of fresh-frozen plasma as part of the volume replacement strategy, coagulation status tends not to worsen significantly during the preanhepatic and anhepatic phases of the operation. After reperfusion of the graft, a clot lysis syndrome develops, and some patients become hypercoagulable at the same time (i.e., disseminated intravascular coagulation develops).<sup>170</sup> Even patients who present with normal hepatic synthetic function and no coagulopathy can develop a dilutional coagulopathy as well as the reperfusion clot lysis syndrome.

Volume replacement therapy should aim to preserve or move clotting potential toward a normal state as part of the effort to reduce blood loss. However, transfusion therapy and coagulation management are not substitutes for good surgical technique. Successful transplantation requires attention to both. Typically, fresh-frozen plasma is used to replace clotting factors. Liver transplant patients frequently are in a state of low-grade disseminated intravascular coagulation and thus consume fibrinogen and clotting factors even in the absence of massive hemorrhage. Fresh-frozen plasma usually supplies sufficient fibrinogen, but cryoprecipitate may be helpful if fibrinogen levels become unacceptably low.

Platelets are rarely needed prior to graft reperfusion, even in patients with low platelet counts (e.g., 50,000).

Furthermore, many patients manifest splenic sequestration of platelets and have no response to transfusion.

Antifibrinolytic drugs and other procoagulants can be used prophylactically in the preanhepatic phase to minimize bleeding. These drugs are discussed in detail in the section on the Neohepatic Phase of Liver Transplantation.

### **Anhepatic Phase**

The anhepatic phase of liver transplantation is frequently described as the time from explantation of the diseased liver to reperfusion of the new liver. However, the anhepatic phase of the operation actually begins once the native liver is sufficiently compromised to have no further function. During liver transplantation, this usually occurs after the hepatic artery is clamped, which can precede portal and hepatic vein clamping by many minutes. During this time, especially in the setting of portal hypertension, the diseased liver receives no oxygenated inflow and begins to die, with consequent effect on the patient's acid-base status. However, the problem ends once the liver is completely excluded from the circulation. After this, the anhepatic phase is often a relatively quiet period in the case. Bleeding should be under control, and the surgeons are engaged in the delicate task of constructing the venous anastomoses. During the construction of the venous anastomoses, the liver is kept on ice (Fig. 56–15, left).

Any drugs dependent on hepatic metabolism begin to accumulate once the portal vein and hepatic artery are clamped. Thus, infusions of drugs should be titrated to effect. Of course, drugs not dependent on hepatic metabolism (e.g., inhaled agents, remifentanyl) are unaffected by this transition.

The anesthesia team should attend to immunosuppression during the early





**FIGURE 56-15.** Liver transplantation surgery. **Left.** Construction of the initial anastomosis, with the liver kept on ice to minimize warm ischemic time. **Right.** Liver being placed into the body cavity. At this point, immunosuppressants should be given. The anastomoses are partially tied, after which the liver is flushed and the anastomoses completed and perfused.

anhepatic phase. The patient will have received an induction dose of an immunosuppressant, such as mycophenolate mofetil, prior to coming to the operating room. Obviously, this should be confirmed prior to starting the case. Typically, a modest dose of steroid (e.g., 100 mg methylprednisolone) is given in the operating room as the new liver is initially placed into the recipient (before opening of the anastomoses; Fig. 56-15, right). For patients with hepatitis C, alternative regimens can be used, such as an infusion of rabbit antithymocyte globulin begun at the completion of the hepatectomy and 10 mg methylprednisolone when the liver is placed into the recipient. In practice, the immunosuppression regimen is chosen by the surgeon, and the anesthesia team should ascertain the drugs, doses, routes, and timing prior to starting surgery.

Hemodynamics frequently stabilize during the anhepatic phase, particularly if a piggyback technique is used. This period of stability may derive from the fact that the rapid alterations in venous return during gross manipulations of the liver are superseded by more delicate tasks. If an en bloc resection has been used with a complete vena cava cross-clamp, the circulation still may be stable if venovenous bypass also is used. However, if the vena cava is clamped without a venous return conduit, support of the circulation with a potent vasoconstrictor, preferably an agent with some inotropic activity, such as norepinephrine, often is necessary.

Hypotension with diminished central venous pressure may occur even with significant preservation of venous return during the anhepatic phase. Lower extremity and splanchnic congestion lowers the effective circulating volume and central venous pressure above the diaphragm, with attendant hypotension. However, overtreatment of this condition with aggressive volume replacement can lead to hypervolemia at the time of graft reperfusion. Instead, support of the circulation with a low dose of a vasopressor is preferable, with anticipation of mobilization of blood from below the diaphragm once the liver is reperfused.

Finally, some poorly understood physiologic feature of the anhepatic phase may directly affect left ventricular performance, contributing to hypotension. Echocardiographic studies of ventricular function demonstrate that left ventricular shortening fraction diminishes during the anhepatic phase, relative to preanhepatic phase, then returns to normal after reperfusion.<sup>171</sup> These results await confirmation, because this was a small study and the degree to which patients became compromised during the anhepatic phase is unclear.

### **Electrolyte Management**

Serum electrolyte levels and acid-base balance are subject to wide and rapid swings during liver transplantation, especially if the case is bloody and extensive transfusion is required. The fluctuations are most severe during the

anhepatic phase, when even the small residual function of the native liver has been removed. However, even during the preanhepatic phase, the patient's acid-base, electrolyte, red cell mass, and coagulation statuses are likely change rapidly as a result of brisk hemorrhage, various cross-clamping maneuvers, and compression of abdominal vasculature, as well as potentially massive transfusion. Thus, frequent monitoring (i.e., at least every 30 minutes) of arterial blood gases, serum electrolytes, red cell mass, and laboratory measures of clotting is mandatory from the beginning of surgery.<sup>172</sup> During the active portion of the case, we interpret and respond to laboratory results as they are returned, allow for equilibration, and then recheck the laboratory values.

Metabolic acidosis may develop in the anhepatic phase because of portal cross-clamping, as well as partial or complete inferior vena cava cross-clamping, creating imperfect lower extremity and splanchnic venous return. In addition, any residual ability to clear organic acids is lost. At the time of reperfusion, the donor liver and underperfused tissues from the patient release acid loads. Ongoing transfusion of low-pH, citrated blood products also contributes to acidemia.

Various maneuvers can mitigate acidemia during liver transplantation. Hyperventilation can be used to establish an acute respiratory compensation for metabolic acidosis. Sodium bicarbonate can be administered to correct acidemia, although the need to minimize sodium loads, particularly in patients who are hyponatremic, may limit the usefulness of bicarbonate. Sodium bicarbonate must not be coadministered in the same infusion as  $\text{Ca}^{2+}$  solutions because the combination will precipitate. Tromethamine (THAM) can also be used to control acidemia.

Acidemia at the time of reperfusion should be corrected by hyperventilation and administration of bicarbonate. This minimizes the hemodynamic and cardiac effect of the acid load and metabolic waste products released by reperfusion of the allograft. However, overzealous correction of metabolic acidemia is undesirable, particularly in the setting of massive transfusion. The new liver clears citrate and organic acids, resulting in a rebound metabolic alkalosis; this may be seen developing even during the late neohepatic

phase. Thus, a reasonable strategy is to use modest hyperventilation to keep the pH near normal, with the use of bicarbonate of tromethamine only as needed to keep the pH above approximately 7.35 after respiratory maneuvers have been fully implemented.

Patients presenting for liver transplantation may be either hyperkalemic or hypokalemic, depending on whether potassium-sparing or potassium-wasting diuretics have been used to control ascites. Potassium balance is also influenced by the underlying renal function or compromise. Serum potassium is subject to strong influences favoring hyperkalemia during the anhepatic phase. This may lead to large swings in serum potassium levels, especially if renal function is compromised or if large volumes of blood products are required. Additionally, splanchnic ischemia during the case tends to elevate serum potassium. Metabolic acidosis tends to worsen hyperkalemia. Finally, the preservative solution in the donor liver is rich in potassium.

Dangerous levels of serum potassium should be treated to avoid myocardial irritability and cardiac dysrhythmias. In patients with preserved renal function, this is accomplished initially by controlling the pH, using potassium-wasting diuretics if the volume status permits, and avoiding potassium-containing solutions. Bicarbonate to increase pH tends to drive potassium intracellularly, whereas  $\text{Ca}^{2+}$  administration to replete deficits stabilizes irritable myocardium. Rapid or persistent increases in serum potassium are treated with glucose and insulin to drive potassium intracellularly by glucose cotransport. The combination of insulin and glucose predictably reduces serum potassium even during the anhepatic phase.<sup>173</sup>

If renal function is severely compromised, renal replacement therapy, either by continuous venovenous hemofiltration or by conventional dialysis, may be warranted to control serum potassium, sodium, and pH. Intraoperative renal replacement therapy can strain the resources of hospital dialysis services, so early consultation with a dialysis nephrologist is important once the need for such therapy becomes apparent.

Calcium is required for smooth muscle and myocardial contractility. Thus, hypocalcemia during liver transplanta-

tion depresses inotropy (manifested as depressed cardiac index, reduced cardiac stroke index, and left ventricular work index<sup>174</sup>) and reduces vascular tone. In this setting, vasopressor activity also is compromised. Hypocalcemia may interfere with clotting, as calcium is a required cofactor for many clotting factors. Thus, monitoring and correcting abnormal serum calcium levels are important. During liver transplantation, serum ionized calcium tends to decrease as a result of vigorous administration of citrated blood products. As a rule of thumb, administration of  $\geq 6$  units of acid-citrate-dextrose preserved packed red blood cells requires supplementation of calcium.

Calcium can be repleted with calcium gluconate or calcium chloride. The positive inotropic effects of calcium administration are quick in onset but are short lived. Overaggressive correction of ionized calcium intraoperatively precipitates a rebound hypercalcemia during the postoperative period as the liver metabolizes the citrate chelator. Thus, the goal of intraoperative calcium management is achieving the lowest ionized calcium concentration consistent with good cardiac performance and coagulation, typically 0.9–1.0 mmol/L. Postoperative hypercalcemia is treated with hydration and furosemide diuresis.

Serum sodium frequently is low in liver transplant patients because of formation of ascites, the effects of renal failure, the use of diuretics, or combinations of the three. Accidental aggressive overcorrection of hyponatremia should be avoided because too-rapid correction of hyponatremia can cause central pontine myelinolysis, an irreversible neurologic injury. Unfortunately, many useful replacement fluids contain sodium. For example, fresh-frozen plasma, packed red blood cells, and 5% albumin all contain sodium at normal physiologic concentrations. To maintain intravascular volume while avoiding too-rapid correction of hyponatremia, a strategy of administering colloids along with 5% dextrose while inducing a diuresis of sodium and water with furosemide can be used. In patients with renal failure, dialysis or continuous venovenous hemofiltration against a low-sodium bath can be used to remove the volume without increasing sodium too abruptly.

Glucose management during liver transplantation usually is fairly straight-

forward despite the liver's central role in glucose handling. The liver is the major site for gluconeogenesis, and this function is preserved to some degree in even the most severe cases of end-stage liver disease. Thus, complete hepatectomy creates the possibility of intraoperative hypoglycemia during liver transplantation. This is particularly true if the anhepatic phase of the operation is prolonged.

Serum glucose during liver transplantation is influenced by exogenous sources, including carrier infusions and release of glucose from graft preservation solution. Thus, intraoperative hypoglycemia is rarely a problem in practice, especially if some IV fluids (e.g., drug-carrier infusions) contain 5% dextrose. The liver is at once the major site of gluconeogenesis and insulin-mediated glucose uptake. Therefore, the anhepatic phase may be marked by hyperglycemia or hypoglycemia, both of which should be avoided and treated. Hypoglycemia tends to be the rule, especially during the anhepatic period. As in the case of other major operations, tight glycemic control probably is beneficial, and blood glucose concentration should be measured frequently, with a target blood glucose level of 150–200 mg/dL.

### **Renal Protection during Transplantation**

Renal failure requiring renal replacement therapy (e.g., dialysis or continuous venovenous hemofiltration) is common after liver transplantation, with rates of approximately 5–10%.<sup>175,176</sup> Peritransplantation acute renal failure requiring renal replacement therapy is associated with higher mortality compared with liver transplant patients not requiring dialysis.<sup>177</sup> Whether a cause-and-effect relationship exists between acute renal failure and death after liver transplantation is not clear, but renal failure is an unwelcome outcome.

Protection of renal function probably depends, among other things, on maintaining renal perfusion during the liver transplant procedure. Renal perfusion is subject to many insults during transplantation, including hypovolemia and increased resistance to venous outflow due to vena cava compression or cross-clamping. Maintaining an adequate circulating volume facilitates preserving renal function. However, this can be difficult, and a selective medical thera-

py to protect the kidney in the peri-transplant period would be useful.

Attention has focused on selective splanchnic vasodilators, such as low-dose dopamine, or, more recently, fenoldopam, as protective agents during major surgery. Fenoldopam has been studied in liver transplant patients randomized to one of three groups (fenoldopam, low-dose dopamine, or placebo) prior to surgery. Neither fenoldopam nor dopamine was superior to placebo for preservation of any measure of renal function (urine output, serum creatinine, creatinine clearance, use of diuretics, or use of pressors) immediately after surgery. On the third and fourth days after transplantation, creatinine clearance was reduced in patients receiving placebo or low-dose dopamine but was preserved in patients receiving fenoldopam.<sup>178</sup> The authors concluded that fenoldopam may counteract the renal arterial constrictive effects of cyclosporine.<sup>178</sup>

In this small, unblinded study, neither low-dose dopamine nor fenoldopam demonstrated obvious renal protective effects in the early perioperative period.<sup>178</sup> Similarly, another small study by the same researchers demonstrated that fenoldopam resulted in better creatinine and BUN values at day 3 after liver transplant, but the functional effect of this result on the incidence of acute renal failure was not demonstrated.<sup>179</sup>

More conventional approaches to renal protection include maintaining adequate circulating volume and perfusion pressure. Urine output is commonly used to judge renal function in the operating room, and “target” urine flows of 1 ml/kg/hr are frequently sought. When the urine output falls below this target and the circulating volume and perfusion pressure are judged to be adequate, furosemide or mannitol is sometimes used to increase urine output.

### Reperfusion of the Graft

Preparation for reperfusion involves optimizing volume status and hemodynamic performance and preparing the operating room for a potentially chaotic reperfusion period. Potential distractions related to the anesthetic (e.g., need to re-dose drugs, syringe changes, carrier infusions) should be addressed in advance. Laboratory studies should have been sent in time for the results to arrive 5 minutes prior to reperfusion.

Abnormalities in pH, serum potassium, or calcium should be corrected prior to reperfusion. Sodium bicarbonate, glucose and insulin, and calcium chloride should be prepared and ready for use. Some practitioners use combinations of these agents prophylactically prior to reperfusion.<sup>138</sup>

Vasopressors may be required at the time of reperfusion and should be available for immediate infusion. Because there is no compelling or logical best choice among the commonly used vasopressors, institutional preferences prevail. Epinephrine, dopamine, and norepinephrine all are acceptable choices. Vasopressors are also commonly used prophylactically at reperfusion, frequently as a small bolus such as epinephrine, 10 µg.

Just prior to reperfusion, the new liver is flushed antegrade from the portal vein to the hepatic vein to wash out the preservative solution (which contains large doses of potassium and heparin). Flushing is accomplished with crystalloid, colloid (such as 5% albumin), or blood. A blood flush is performed by constructing the portal and hepatic venous anastomoses, after which the portal anastomosis is completed but the hepatic venous anastomosis is left incomplete. The portal vein cross-clamp is removed, and blood is allowed to flush the liver and run out into the field, where it is recovered by suction. Concomitant with this controlled hemorrhage, fluid should be rapidly transfused to maintain euvolemia.

Graft reperfusion has its most obvious effect on cardiac performance, and the anesthesia team should be prepared for pulmonary hypertension and acute right-heart dysfunction. Liver transplantation in and of itself does not appear to cause right-heart dysfunction.<sup>180</sup> However, release of preservative solution, air, clot, and debris (as well as acidemic blood from the reperfused splanchnic circulation) into the pulmonary vasculature can cause sudden and severe pulmonary hypertension, elevated right-heart pressures, and right ventricular failure. Systemic pressure (and coronary perfusion pressure) decreases because of inadequate left ventricular preload. Elevated right-heart pressures may open an occult patent foramen ovale, with risk of paradoxical embolism.<sup>181</sup> Central venous pressure frequently increases because of right-heart and pulmonary congestion. Ordinarily this is desirable to a point to assure right

ventricular preload. However, in the immediate reperfusion period, elevated central venous pressure compromises graft perfusion and may contribute to early graft failure. Thus, preserving or reestablishing efficient right ventricular pumping and a low-resistance pulmonary circulation is important.

Pulmonary hypertension, right ventricular overload, and the resulting central venous congestion reduce the hepatic perfusion pressure, which is simply the difference between the portal and central venous pressure when only the venous anastomoses have been constructed. The portal venous pressure is not typically measured, so the hepatic perfusion pressure is not directly accessible. However, inadequate perfusion pressure can be deduced if the liver becomes engorged. This alarming appearance somewhat mimics that of hyperacute rejection. To avoid confusion, hepatic perfusion pressure ideally is controlled by keeping the central venous pressure low at the time of reperfusion. This is not possible in the event of acute pulmonary hypertension unless inotropes and selective pulmonary vasodilators are used. Typically, the heart is supported with an inotrope, and the lungs are hyperventilated to raise the pH and induce pulmonary vasodilatation. Inhaled nitric oxide may be useful at this point.

Good communication between the surgical and anesthesia teams is important to minimize the effect of reperfusion. Reperfusion should not occur until the anesthesia team has optimized the patient's physiology, and this should be accomplished in time to allow prompt reperfusion. If severe problems occur at reperfusion, the surgeon can partially reclamp the portal vein to lessen the effect of the effluent from the new liver.

The combined effect of multiple insults on cardiac and pulmonary performance at reperfusion may lead to cardiovascular collapse. Advanced cardiac life support protocols directed at the presumptive major problem should be promptly initiated while the underlying insults are identified and corrected. In the event of cardiopulmonary arrest not responsive to pharmacologic support (or due to reversible causes such as pulmonary embolus), mechanical circulation and oxygenation can be provided by percutaneous femoral venoarterial cardiopulmonary bypass, with acceptable survival.<sup>182</sup>



In the early postreperfusion period, severe volume overload from overaggressive fluid replacement during the period of poor venous return may compromise hepatic perfusion, even with adequate cardiac performance. If the problem is slight, it may be possible to administer furosemide to induce diuresis or to wait for the blood volume to fall as a result of bleeding. In the case of severe volume overload and poor graft perfusion, phlebotomy from a large port on a central venous catheter is a logical option.

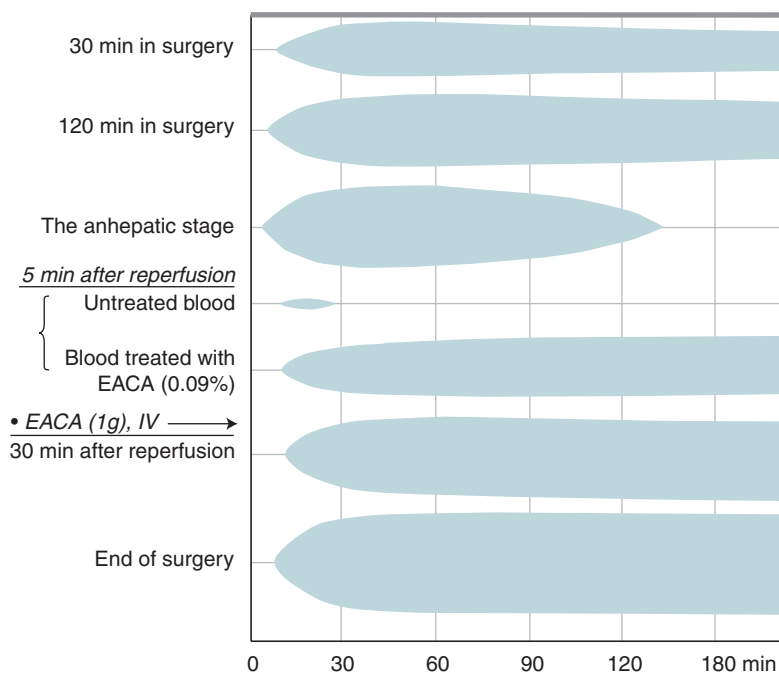
### Neohepatic Phase

The neohepatic phase begins with the initial reperfusion of the liver. Frequently, the next step is constructing the hepatic arterial anastomosis. The liver ultimately needs a high-pressure, oxygenated perfusion source, and the surgical team will turn attention to this as soon as the immediate effects of venous reperfusion have passed. Opening of the hepatic arterial anastomosis usually has little or no hemodynamic effect.

An acute clot lysis syndrome frequently develops in the early neohepatic phase. This manifests clinically as diffuse bleeding from previously coagulated sites in the surgical field, new oozing from previously quiescent vascular catheter insertion sites, and ongoing transfusion requirements. Laboratory analysis shows a further elevation of the prothrombin time relative to baseline and a sometimes profound elevation of the partial thromboplastin time (e.g., to >150 seconds), as if the patient had received a large dose of heparin. Thromboelastography demonstrates poor clot initiation and rapid dissolution of clot. Fig. 56-16 shows sequential thromboelastograms obtained from a single patient during the course of transplantation.<sup>183</sup>

Because the cause of clot lysis syndrome is not completely understood, the ability to tailor treatment to specific causes is limited. Multiple mechanisms have been proposed and may operate simultaneously, including release of heparin (from preservative solution) during reperfusion or release of endogenous activators of tissue plasminogen activator and/or endogenous heparinoids from the graft.<sup>170</sup>

A central goal in this phase of the transplant is stopping clot lysis. A key first step toward achieving this goal is providing adequate levels of platelets and factors to support clotting in the



**FIGURE 56-16.** Sequential thromboelastograms from a single patient undergoing liver transplantation. Marked fibrinolysis developed during the anhepatic phase. Note development of severe coagulopathy in the “5 min after reperfusion” sample consisting of poor clotting and early fibrinolysis more severe than during the anhepatic phase.  $\epsilon$ -Aminocaproic acid (EACA) was given and arrested the clot lysis. (From Kang et al.<sup>183</sup> with permission.)

face of ongoing consumption, with the expectation that a functioning graft will begin to provide appropriate clot lysis inhibitors and clotting factors on its own. Administration of a small (20–50 mg) dose of protamine<sup>170</sup> can be considered if clot formation is suspected to be deficient, especially if the liver flush prior to reperfusion was not optimal and the patient might have received heparin from the graft.

Fibrinolytic activity is frequently increased during liver transplantation, reflecting reduced hepatic clearance of tissue plasminogen activating factor during the anhepatic phase and release of tissue plasminogen activator from the epithelial cells of the reperfused graft.<sup>184–186</sup> In addition, plasminogen activator inhibitor-1 activity is reduced<sup>185</sup> during transplantation. Fibrinolysis probably contributes to the unwanted clot lysis syndrome after reperfusion.

Strategies for reducing fibrinolysis and transfusion requirements include use of antifibrinolytic agents such as aprotinin,<sup>187</sup> tranexamic acid, and  $\epsilon$ -aminocaproic acid.<sup>188</sup> However, use of antifibrinolytics in liver transplantation is somewhat controversial because of concerns about unwanted thrombosis.

$\epsilon$ -Aminocaproic acid and tranexamic acid both are synthetic analogues of the

amino acid lysine.  $\epsilon$ -Aminocaproic acid and tranexamic acid competitively inhibit the binding of plasminogen (a lysine protease) to lysine residues on fibrin, thus inhibiting fibrinolysis. Both drugs also prevent the conversion of plasminogen to plasmin, again by acting as competitive antagonists of a lysine protease.  $\epsilon$ -Aminocaproic acid is used during liver transplantation as a loading dose (typically a 1- to 2-g bolus over 1–10 minutes), followed by infusions of 1–2 g/h. It reliably arrests fibrinolysis as assessed by thromboelastography (Fig. 56-16).<sup>183</sup> The drug is eliminated by the kidney, with 65% of a dose appearing unchanged in the urine. The elimination half-life of  $\epsilon$ -aminocaproic acid is approximately 2 hours.

Tranexamic acid is 6–10 times more potent than  $\epsilon$ -aminocaproic acid and has a longer elimination half-life. It also is renally eliminated, with 95% of the drug appearing unchanged in the urine. It is the least well studied of the three major antifibrinolytics.<sup>188</sup> Dose rates between 2 and 40 mg/kg/h have been reported in small studies with either  $\epsilon$ -aminocaproic acid or aprotinin as comparisons.

Aprotinin is a protease inhibitor isolated from the lungs of swine and cows. It inhibits a variety of human proteases, including plasmin, trypsin,



kallikrein, chymotrypsin, activated protein C, and thrombin. These proteases are important in fibrinolysis and coagulation, as well as complement activation and inflammation. Each uses a serine residue for catalysis at the active site, and aprotinin acts by forming a specific aprotinin-active site serine complex with each protease. Aprotinin has an approximately 1-hour redistribution half-life after a bolus and a 7- to 10-hour elimination half-life. It is given as a bolus, followed by an infusion. A typical bolus is 2 million kallikrein inactivator units (KIU), followed by an infusion of 500,000 to 1 million KIU per hour.<sup>188</sup>

Use of antifibrinolytic drugs may have deleterious effects. Anecdotal evidence indicates that antifibrinolytic therapy may increase the incidence of thrombotic events during liver transplantation, including fatal pulmonary thromboembolism.<sup>189</sup> Additionally, aprotinin is no more effective than are the lysine analogues, but it is associated with higher morbidity and mortality relative to these other drugs when used in cardiac surgery.<sup>105</sup> This finding suggests that, during liver transplantation, antifibrinolytic agents should be reserved for patients who have a relatively high risk of severe hemorrhage,<sup>190</sup> and that aprotinin might best be avoided altogether. However, the clotting cascade in liver transplant patients is quite deranged, and cardiopulmonary thromboembolism, even in the absence of exogenous procoagulants, may be more common than is usually appreciated.<sup>134</sup>

Thus, antifibrinolytics might be considered for rescue if bleeding becomes a problem in the postanhepatic phase,<sup>188</sup> as judged by the disappearance of clot from the surgical field, or as a prophylactic measure in patients expected to have severe bleeding problems (e.g., multiorgan transplant in a patient with renal failure). Balanced against this cautious approach are some practices that advocate use of antifibrinolytics prophylactically, in advance of any pathologic bleeding.<sup>188</sup> However, in addition to enhanced fibrinolysis, many other factors contribute to blood loss late in orthotopic liver transplantation, including coagulopathy due to synthetic failure, thrombocytopenia, platelet dysfunction, dysfibrinogenemia, dilutional coagulopathy, hypothermia, and bleeding from surgical technical prob-

lems. Because postreperfusion fibrinolysis is largely a diagnosis of exclusion, all of these other factors must be ruled out before administration of potent procoagulants.

Procoagulant agents, such as purified specific clotting factors, can be used, either prophylactically or as attempted therapy for excessive bleeding. For example, in one study, recombinant factor-7 corrected coagulopathy when given as single bolus prior to transplant but had no effect on transfusion requirements.<sup>191</sup> In a different study, recombinant factor-7 was used in a small number of patients but had no clear evidence of clinical harm or benefit.<sup>192</sup> Recombinant factor-7 has the theoretical advantage of being selective only for areas that are bleeding, that is, areas that have sustained tissue damage. This is because recombinant factor-7 requires tissue factor for full activity, and tissue factor is available only in areas where the subendothelial layers are exposed. Of course, the vascular anastomoses in the new graft would have exposed tissue factor, at least theoretically increasing the risk of thromboses of the anastomoses. Furthermore, recombinant factor-7 apparently is not as selective as initially hoped. A recent report documents many episodes of arterial and venous thromboses distant from the hoped-for site of action (e.g., cerebrovascular accident, myocardial infarction, pulmonary embolism, and deep venous thrombosis) when recombinant factor-7 was used in various "off-label" applications.<sup>107</sup>

If the fibrinolysis reaction cannot be controlled, the patient will have an ongoing transfusion requirement. The anesthesia team should quantify the hourly transfusion needs in the neohepatic phase and make preparations to meet this need during the end of the case, the move from operating room table to ICU bed, transport to the ICU, and in the ICU itself.

During the neohepatic phase, the anesthesia team prepares for the postoperative disposition of the patient. Most liver transplant recipients are discharged from the operating room to an ICU bed. The anesthesia team seeks to manage this transition as smoothly as possible. The patient should be transported on an ICU bed, with all necessary infusions running and the patient fully monitored. Comprehensive communication between the operating room and the ICU team

is essential to facilitate the smooth transition of care.

The anesthesia team also prepares for the early postoperative care of the patient. Very early extubation (i.e., in the operating room) is possible and desirable.<sup>193</sup> Suitability for extubation is influenced by many factors. Among these are the intraoperative transfusion requirement (as a warning of possible airway edema); the presence or development of pulmonary, cardiac, and renal compromise; and the presence and severity of encephalopathy.<sup>194</sup> Fluid administration and possible volume overload are some of many factors that can interfere with the patient's readiness for extubation at end of case. In one study, controlled fluid administration supported by adjuvant vasopressors led to reduced rates of reintubation.<sup>195</sup> Intraabdominal hypertension is common after orthotopic liver transplantation and limits the potential for extubation. Intraabdominal hypertension (pressure > 25 mm Hg in the bladder) developed in 32% of patients<sup>196</sup> in one series. It is expected that these patients are less likely to meet criteria for early extubation and will be harder to wean from the ventilator.

If in doubt, it is always acceptable and prudent to leave the patient intubated for pulmonary support in the early postoperative period. Postoperative mechanical ventilation allows the team to focus on ongoing transfusion requirements, to exclude the possibility of intraabdominal hypertension, and to gradually prepare the patient for extubation. Despite the concern about elevated intraabdominal pressures on graft viability, postoperative application of positive end-expiratory pressure (PEEP) does not have a major effect on graft function, although in half of the patients the cardiac output declined with PEEP.<sup>197</sup> This finding is encouraging because PEEP may be needed to counteract the pulmonary consequences of intraabdominal hypertension.

Pain management after liver transplantation is relatively straightforward. Many patients remain intubated and receive potent opioids as sedatives. Epidural analgesia is traditionally avoided because of profound coagulopathy manifested by end-stage liver disease patients, both preoperatively and in the postoperative period. Furthermore, orthotopic liver transplant patients have less postoperative pain than do hepatectomy patients.<sup>198</sup> The reason

for this difference in pain threshold is unclear, although some have implicated the steroids used for immunosuppression. Steroids have analgesic properties in other patient populations.<sup>199</sup>

## Perioperative Complications of Liver Transplantation

Complications of liver transplantation are frequent. Here we focus on the early complications of liver transplantation, that is, those that occur in the operating room or the ICU within hours or days of the procedure.

Complications and risks of massive transfusion consist of pulmonary edema, transfusion-related acute lung injury,<sup>200,201</sup> and viral infection. Much attention has focused on transmission of cytomegalovirus. The incidence of cytomegalovirus transmission is much higher with a cytomegalovirus-infected donor organ than with blood that has not been screened or reduced for cytomegalovirus.<sup>202</sup> Many centers now use routine pharmacoprophylaxis against cytomegalovirus infection because leukoreduction of blood or use of cytomegalovirus-negative donors has been deemed impractical by many blood banks.

Massive transfusion contributes to the development of intraabdominal hypertension. Patients with intraabdominal hypertension had a higher incidence of renal failure, more postoperative complications, and higher ICU mortality than did patients without this complication.<sup>196</sup>

Anastomotic leaks involving the vascular or bile duct connections can prompt reexploration and anastomotic revisions. Anastomotic bleeding tends to be most severe during the latter stages of the surgery and on the first postoperative day. An ongoing brisk transfusion requirement, an expanding abdomen, or falling hematocrit can prompt reexploration even before leaving the operating room. The threshold to reexplore for bleeding should be low because an abdomen full of blood or clot is a nidus for infection. In addition, the compressive effect of a large hematoma potentially compromises graft, pulmonary, and cardiac function. Reexploration in the early postoperative period should be handled with the same degree of preparation as the original transplant procedure. In particular, a disruption of one of the anastomoses without surgical control of the vessel will lead to massive hemorrhage.

Other vascular complications necessitating prompt reexploration include stenosis and thrombosis of the anastomoses of the liver vessels. These complications may occur intraoperatively or postoperatively. In the postoperative period, vascular patency is monitored by serial ultrasound examinations.<sup>203</sup> Hepatic artery thrombosis is the most common vascular complication in the postoperative period.<sup>203</sup> If the condition is not diagnosed and treated promptly, severe graft dysfunction or total graft loss will occur. Treatment of hepatic artery thrombosis usually requires urgent reoperation to remove the obstruction. If flow cannot be restored, the patient probably will need to be relisted for liver transplantation as a Status 1 candidate. However, there is a small but growing experience of temporizing with hyperbaric oxygen therapy.<sup>204</sup>

Neurologic complications are relatively common after liver transplantation. Their causes are multifactorial, related both to intraoperative and early postoperative events, as well as the ongoing effects of toxic immunosuppressants. Of particular concern to anesthesiologists is central pontine myelinolysis,<sup>205</sup> which has been associated with rapid correction of hyponatremia in the peritransplant period. The syndrome is characterized by a general neurologic decline hours or days after a sudden correction of hyponatremia. Much attention focuses on central pontine myelinolysis because patients presenting for liver transplantation frequently are hyponatremic and because of the association between the syndrome and an inciting event (e.g., rapid correction of hyponatremia). However, central pontine myelinolysis is a relatively rare neurologic complication of liver transplantation. For example, in a study of 463 patients receiving transplants at multiple centers,<sup>206</sup> 93 (20.1%) patients had peritransplant neurologic complications. Of these patients, six (1.2% of the starting cohort) were confirmed to have central pontine myelinolysis. Two of these patients had rapid increases in serum sodium concentration for a period of hours during transplant; the rest did not.<sup>206</sup> In another multicenter prospective cohort study involving 1730 liver transplant patients, 60 patients had radiologically confirmed central nervous system lesions. Of these patients, five (0.3% of

### BOX 56–10.

#### Procedures for Alleviating Portal Hypertension and/or Ascites

##### Nonshunting Procedures

Endoscopic therapy for esophageal varices

Percutaneous embolization of varices

Surgical ligation of varices, including hemorrhoids

Portal–azygous disconnection

##### Surgical Vascular Shunting Procedures

###### Nonselective shunts

Portocaval shunt

Mesocaval shunt

Proximal splenorenal shunt

“Selective” vascular shunt

Distal splenorenal shunt

##### Percutaneous Vascular Shunting Procedure

Transjugular intrahepatic portosystemic stent shunt

##### Peritoneovenous Shunts (Nonvascular)

Denver

LeVein

the original cohort) had central pontine myelinolysis.<sup>207</sup>

## SPECIAL OPERATIONS ON THE LIVER

### Procedures for Portal Hypertension and Ascites

A variety of surgical and minimally invasive interventional procedures have been developed to ameliorate the problems associated with liver disease. Portal hypertension underlies most of these problems, leading to ascites or to varices that are the source of life-threatening hemorrhage. Procedures for alleviating portal hypertension and ascites are listed in Box 56–10. They are divided into *nonshunting* procedures (i.e., those that do not seek to redirect portal venous flow) and *shunting* procedures. Nonshunting procedures aim to control hemorrhage from portosystemic varices. Varices at the gastroesophageal junction are the most troublesome of the portosystemic varices, but they are amenable to endoscopic therapy. Shunting procedures redirect the portal venous flow into the systemic venous circulation

via a nonvariceal conduit, thus relieving portal hypertension, decompressing varices, and relieving ascites. Because these shunts bypass the liver, they may create new problems as a result of encephalopathy. Shunting procedures have undergone a transformation from open surgical procedures performed on high-risk patients (high Child-Turcotte-Pugh scores predicting elevated perioperative morbidity and mortality) to a more minimally invasive approach.

### Nonshunting Procedures for Portal Hypertension

These procedures (e.g., ablation of esophageal varices or hemorrhoids) aim to reduce variceal hemorrhage. The procedures ligate decompressive alternate conduits for portal blood flow around the cirrhotic liver, so they are expected to worsen portal hypertension and ascites. Minimally invasive procedures have largely replaced surgical approaches for managing varices. Minimally invasive approaches include endoscopic ligation or embolization (e.g., endoscopic sclerotherapy of esophageal varices) and percutaneous embolization procedures. Many of the minimally invasive procedures for obliterating varices are performed outside of the operating room (i.e., in remote procedure areas in the hospital), frequently with local or topical anesthesia and conscious sedation provided under the direction of the proceduralist. Thus, anesthesiologists now encounter relatively few patients presenting for variceal ligation, and frequently these are only the most complex procedures, the sickest patients, or both. Anesthesia for these patients should follow the model for patients with severe decompensated liver disease outlined in Chapter 14.

### Portosystemic Shunts

Portosystemic shunts aim to reduce the hydrostatic pressure in the portal venous system by providing an alternate, nonvariceal conduit that bypasses the cirrhotic liver. A variety of approaches have been developed to shunt portal venous blood away from the liver and into the central venous circulation, first by open surgical procedures and now increasingly via percutaneous approaches. Again, there is a group of patients whose medical conditions or procedural needs preclude a minimally invasive approach, so a limited popula-

tion of patients present for surgical portosystemic shunts.

#### Open Portosystemic Shunts

Surgical or “open” portosystemic shunts are listed in Box 56–10. Each is designed to reduce portal hypertension, differing mostly in the topology of the vascular connection that is constructed. In every case the surgery is an open abdominal procedure in which venous vascular anastomoses are constructed. Anesthesia for open portosystemic shunts should follow the model described for patients with decompensated end-stage liver disease described in Chapter 14.

#### Transjugular Intrahepatic Portosystemic Stent Shunts

Transjugular intrahepatic portosystemic stent shunts (TIPSS) are indicated for patients with refractory ascites because of portal hypertension. Refractory ascites carries substantial morbidity (i.e., spontaneous bacterial peritonitis, renal failure) and has a 1-year survival rate <50%. Thus, removal of ascites may benefit these patients, and TIPSS is successful in decompressing the portal system in approximately 90% of cases. A meta-analysis of studies comparing TIPSS with conventional therapy (periodic large volume paracentesis) indicates that TIPSS is superior for removing ascites but at the expense a higher incidence of hepatic encephalopathy.<sup>208</sup> This comes as no surprise, as the shunt routes blood past the liver.

TIPSS has important implications for subsequent orthotopic liver transplantation. For example, TIPSS causes transient (lasting approximately 6 months) increases in cardiac volume load. Importantly, pulmonary systolic pressures (as estimated during transthoracic echocardiography) in one cohort increased from approximately 30 mm Hg prior to TIPSS to 44 mm Hg in the period immediately after TIPSS,<sup>209</sup> potentially jeopardizing candidacy for transplantation. During transplantation, the shunt must be removed along with the diseased liver. Because the shunt by design drains into the hepatic venous circulation, a piggyback technique may be precluded if the shunt protrudes into the proximal hepatic veins. The presence of a TIPSS frequently leads to a complicated and bloody dissection during the hepatectomy phase of liver transplantation. In

extreme cases, the shunt can be dislodged and migrate into the right-heart or pulmonary circulation.<sup>210</sup>

TIPSS is frequently performed “off site” (i.e., in a radiology procedure area rather than an operating room), so all of the special concerns for out-of-operating room anesthesia apply. Patients presenting for TIPSS usually are severely debilitated and may be acutely ill, and this level of acuity coupled with the out-of-operating room location magnifies the effort required to safely care for these patients.

Monitoring for TIPSS should be tailored to meet the needs of the patient and the anesthetic plan. Standard monitoring usually is sufficient for patients having TIPSS under sedation, monitored anesthesia care, or general anesthesia. TIPSS usually is performed under monitored anesthesia care or general anesthesia because the procedure can require long periods of immobility, and it may be difficult or impossible for an awake patient with massive ascites to remain motionless and supine for the procedure.

The TIPSS procedure typically does not involve large fluid shifts or the potential for massive hemorrhage, so a reliable peripheral IV catheter usually is sufficient vascular access. The invasive radiologist establishes separate central venous access for the procedure, usually via the right internal jugular vein. The radiologist then tunnels a catheter from the inferior vena cava (actually a hepatic vein) through the liver parenchyma and into the portal circulation. The shunt is then placed via the catheter and dilated within the liver parenchyma.

Complications of TIPSS are relatively common but must be balanced against the complications of no therapy, frequent large-volume paracentesis, and surgical portosystemic shunts, none of which are benign. Complications of TIPSS include those of central venous cannulation in patients with coagulopathy. Complications related to central venous cannulation can be avoided or minimized by using an internal jugular site (which is compressible in the event of inadvertent arterial puncture) and ultrasound guidance to visualize the target vessel during the vascular access procedure. The procedure requires passing guidewires, catheters, and dilators from the superior vena cava, through the right atrium, and into the inferior vena cava. Cardi-

ac perforation and tamponade<sup>211</sup> have occurred as rare complications. Acute volume overload<sup>209</sup> from sudden outflow of portal blood into systemic circulation is a much more frequent complication. Hepatic encephalopathy occurs frequently after TIPSS.<sup>212</sup> Encephalopathy is refractory to treatment or prophylaxis,<sup>212</sup> and acute onset of encephalopathy may make extubation impossible.

## Hepatic Donation

### Heart Beating Cadaveric Donor

Most livers made available for transplantation come from heart beating cadaveric donors and are obtained in the course of harvesting other organs. Anesthesia care often is complicated by the numerous complex physiologic derangements manifested by these organ donors.<sup>213</sup> Such physiologic changes are responsible for the loss of up to 25% of potential organ donors.<sup>214</sup> Hemodynamic instability commonly develops and may occur in two phases. An initial phase may occur soon after brain death, characterized by excessive sympathetic activation leading to tachycardia, vasoconstriction, hypertension, and increased cardiac workload. This may be followed by a hypotensive phase in which sympathetic activity is reduced, leading to loss of vascular tone, decreased cardiac output, and hypotension.<sup>215</sup> Hemodynamic stability may be further compromised by volume depletion resulting from prior use of diuretics to manage elevated ICP, blood loss from injuries, insensible losses, and/or diabetes insipidus associated with damage to the neurohypophyseal-hypothalamic axis.

Sympathetic stimulation can be treated with short-acting  $\beta$ -blockers and vasodilators that may be easily titrated, such as nitroprusside and esmolol. As the brain-dead patient progresses into the hypotensive phase, it must be remembered that hypotension can have multiple causes. It is important to identify and appropriately treat the underlying etiology. Hypovolemic patients should receive volume resuscitation to achieve a hematocrit of 30%. Beyond that, crystalloid solutions are appropriate to replace free water as guided by central venous pressure measurements and to maintain or correct electrolyte and glucose concentrations. To reduce volume loss and electrolyte derangements associated with diabetes insipidus, desmopressin acetate (DDAVP)

can be administered. Vasopressors and inotropic drugs are appropriate for donors with impaired vascular tone or myocardial function, respectively, to maintain adequate perfusion to organs. In such cases, therapy is most effectively guided by measurements of cardiac function and central filling pressures using a pulmonary artery catheter and/or echocardiography.

Organ donors can present with significant pulmonary dysfunction.<sup>216</sup> Neurogenic pulmonary edema is most commonly observed in patients with increased ICP, and although the etiology is not entirely clear, it likely is related to excessive sympathetic stimulation. Excess pulmonary interstitial and alveolar fluid can be treated with fluid restriction and diuresis, but it should be recognized that a negative fluid balance may compromise the viability of other organs. Other common causes of pulmonary dysfunction in organ donors are pneumonia, pulmonary emboli, mucus plugging, and pulmonary contusions.

An important principle to recognize when caring for organ donors is that the focus of care has shifted from preserving the patient to preserving the function of graft organs. This can best be achieved by being well prepared; organ harvesting is a major surgical procedure that requires full homeostatic support for the donor organs. In addition to routine intraoperative monitors, intraarterial and central venous or pulmonary artery catheters are required. Because procurement may be accompanied by significant blood loss, it is important to be adequately prepared with large-gauge IV catheters and packed red blood cells for transfusion. Inotropic agents and vasopressors should be readily available to treat hypotension caused by myocardial dysfunction and reduced vascular tone. Nondepolarizing neuromuscular blockers should be used to facilitate surgical exposure and ablate reflex movements mediated by the spinal cord. General anesthesia is not necessary, but general anesthetic drugs may be useful for blunting the hemodynamic response to surgical stimulation associated with the dissection.

### Living Donor

The shortage of cadaveric livers has led to the use of living donors to meet the growing need for liver grafts. Donor safety is a primary concern, as the donor

derives no physical benefit from the surgery. Donor deaths have been reported during the perioperative period, and serious complications can occur. Like orthotopic liver transplantation itself, living donor hepatectomy has a steep and long learning curve with many opportunities for morbidity. For example, in one program, major complications were frequent in the first 50 living donor patients but declined significantly in the subsequent 50 patients.<sup>217</sup> In experienced centers, living donor hepatectomy can be performed with an average blood loss of 1 L and minimal requirements for transfusion.<sup>218</sup>

The majority of liver transplantations using living donors involve donor-recipient pairs who are ABO compatible. ABO-incompatible transplantations can be performed in some cases, but recipient survival outcomes are markedly worse.<sup>219</sup> Potential donors should undergo thorough screening to assess their suitability. Such screening includes a detailed history along with physical and psychological examinations, evaluation of routine laboratory values with particular attention to measurements of liver function, testing for transmissible viral illnesses, and, in some cases, percutaneous liver biopsy. Radiologic imaging studies are a routine part of the donor evaluation. Doppler ultrasound can be used to detect gross pathologic conditions such as tumors and portal vein thrombosis. CT and MRI are useful for defining a potential donor's vascular anatomy and hepatic volume and for providing a roadmap for surgical planning.<sup>220</sup>

Typically a right hepatic lobectomy from an average-sized adult living donor provides sufficient liver mass for an adult recipient. A left hepatic lobectomy from an adult donor provides enough liver mass for a pediatric recipient. This is advantageous for the donor, as the larger right hepatic lobectomy regularly leads to transient measurable compromise in liver synthetic function, with resultant coagulopathy.

General anesthesia for a living donor hepatectomy can be induced and maintained using a variety of techniques. Anesthetic concerns for living donor hepatectomy are similar to those of any major intraabdominal surgical procedure and include the potential for significant hemorrhage and hemodynamic changes. In particular, systemic vascular resistance commonly decreases after donor hepatic resec-



tion, whereas cardiac output and heart rate increases.<sup>92</sup> The cause(s) of these changes is not known, but a role for splanchnic mediators, such as endotoxins, has been suggested.<sup>221</sup> Maintaining low central filling pressures has been recommended for reducing intraoperative blood loss and improving surgical exposure.<sup>222</sup> However, these benefits must be balanced against the potential increased risk of air embolism.

Because transient coagulopathies are commonly observed in the early postoperative period, the placement of epidural catheters for postoperative analgesia is the subject of controversy.<sup>223–225</sup> However, pain control requires careful consideration, and some programs use epidural catheters. In one study, donor hepatectomy patients had more pain than did patients having equivalent-sized right hepatectomy for tumor resection, despite identical pain management regimens, including thoracic epidural use.<sup>226</sup> The authors suggested that this finding might be due to longer operative times required for donor hepatectomy.<sup>226</sup> Postoperatively, liver donors have significant coagulopathy, which can complicate the timing of discontinuation of epidural analgesia.<sup>224,227</sup> On the other hand, thromboelastography studies indicate that liver donors become hypercoagulable during the first postoperative week, despite conventional laboratory studies that indicate elevations of conventional coagulation parameters, such as partial thromboplastin time or activated prothrombin time and thrombocytopenia.<sup>228</sup> This may give a protective effect against epidural hematoma, but this theory has not been tested.

### Donation after Cardiac Death

The number of livers from brain dead donors has been relatively stagnant, and living donation is not a common option. The shortage of organs has resulted in renewed interest in a procedure for recovering organs known as *donation after cardiac death*. This term refers to a donation protocol for patients who have sustained a traumatic brain injury but do not meet the definition of brain death and thus cannot be declared brain dead. Nevertheless, families may realize that there is no hope for recovery and decide to withdraw invasive life support. Once such a decision has been made, the family may decide to donate the patient's organs after cardiac death has occurred.

Donations after cardiac death occur only after patients are declared dead after cardiac and respiratory arrest following the removal of life support. Donation after cardiac death is considered only after the family has decided to withdraw life support. The patient is taken to the operating room, usually with the family in attendance. There, the patient is extubated, vasoactive infusions may be discontinued, and the patient is allowed to die peacefully. The family leaves the room, and surgical removal of organs for transplantation ensues.

Donation after cardiac death exposes the donor liver to a period of warm ischemia that does not occur in beating heart donors. Liver viability declines as a function of the elapsed time after cardiac arrest in animals.<sup>229</sup> In humans, the immediate outcomes appear to be worse in recipients of donation after cardiac death livers compared with recipients of beating heart donor organs, but the overall outcomes appear promising relative to no organ at all.<sup>230</sup>

Despite the fact that donation after cardiac death involves patients who are dead by every definition and hence have no use for homeostatic support, there is much that the anesthesia team can contribute to these cases. Planned death in the operating room, with grieving family members present in large numbers and in civilian dress, is an extraordinary event and flies in the face of many of the assumptions and mores of operating room personnel. Anesthesiologists can manage operating room access to allow donation to occur promptly and with respect to the deceased and his or her family, even to the point of mediating the cancellation of elective surgery to facilitate these singularly lifesaving events.

The anesthesia teams should sequence the preparation of recipient(s) to minimize donor organ ischemic time if possible. Anesthesiologists currently do not have any direct interaction with the donor, except possibly to perform the extubation. Extubation should be skillfully handled, both to protect family members from unnecessary psychological trauma and to minimize the risk of aspiration that spoils the lungs for donation. Anesthesiologists may become more involved in donation after cardiac death cases, as they may be asked to reintubate the trachea for lung protection (allowing lung donation) after asystole occurs.

## KEY REFERENCES

1. Abdalla EK, Noun R, Belghiti J. Hepatic vascular occlusion: which technique? *Surg Clin North Am* 2004;84:563–585.
2. Emond JC, Samstein B, Renz JF. A critical evaluation of hepatic resection in cirrhosis: optimizing patient selection and outcomes. *World J Surg* 2005;29:124–130.
3. Hoepfer MM, Krowka MJ, Strassburg CP. Portopulmonary hypertension and hepatopulmonary syndrome. *Lancet* 2004;363:1461–1468.
4. Jarnagin WR, Gonen M, Fong Y, et al. Improvement in perioperative outcome after hepatic resection: Analysis of 1,803 consecutive cases over the past decade. *Ann Surg* 2002;236:397–406.
5. Keeffe BG, Valantine H, Keeffe EB. Detection and treatment of coronary artery disease in liver transplant candidates. *Liver Transpl* 2001;7:755–761.
6. Pham PT, Pham PC, Rastogi A, Wilkinson AH. Review article: current management of renal dysfunction in the cirrhotic patient. *Aliment Pharmacol Ther* 2005;21:949–961.
7. Razek T, Olthoff K, Reilly PM. Issues in potential organ donor management. *Surg Clin North Am* 2000;80:1021–1032.
8. Reddy K, Mallett S, Peachey T. Venovenous bypass in orthotopic liver transplantation: time for a rethink? *Liver Transpl* 2005;11:741–749.
9. Xia VW, Steadman RH. Antifibrinolytics in orthotopic liver transplantation: current status and controversies. *Liver Transpl* 2005;11:10–18.

## REFERENCES

1. Hu KQ, Yu AS, Tiyyagura L, et al. Hyperfibrinolytic activity in hospitalized cirrhotic patients in a referral liver unit. *Am J Gastroenterol* 2001;96:1581–1586.
2. Hersch SL, Kunelis T, Francis RB Jr. The pathogenesis of accelerated fibrinolysis in liver cirrhosis: A critical role for tissue

- plasminogen activator inhibitor. *Blood* 1987;69:1315–1319.
3. Knot EA, Drijfhout HR, ten Cate JW, et al. Alpha 2-plasmin inhibitor metabolism in patients with liver cirrhosis. *J Lab Clin Med* 1985;105:353–358.
  4. Leebeek FW, Klufft C, Knot EA, et al. Histidine-rich glycoprotein is elevated in mild liver cirrhosis and decreased in moderate and severe liver cirrhosis. *J Lab Clin Med* 1989;113:493–497.
  5. Leebeek FW, Klufft C, Knot EA, et al. A shift in balance between profibrinolytic and antifibrinolytic factors causes enhanced fibrinolysis in cirrhosis. *Gastroenterology* 1991;101:1382–1390.
  6. Steib A, Gengenwin N, Freys G, et al. Predictive factors of hyperfibrinolytic activity during liver transplantation in cirrhotic patients. *Br J Anaesth* 1994;73:645–648.
  7. Russell DW. The enzymes, regulation, and genetics of bile acid synthesis. *Annu Rev Biochem* 2003;72:137–174.
  8. Somberg KA, Riegler JL, LaBerge JM, et al. Hepatic encephalopathy after transjugular intrahepatic portosystemic shunts: incidence and risk factors. *Am J Gastroenterol* 1995;90:549–555.
  9. Ostapowicz G, Fontana RJ, Schiødt FV, et al. Results of a prospective study of acute liver failure at 17 tertiary care centers in the united states. *Ann Intern Med* 2002;137:947–954.
  10. Gazzard BG, Portmann B, Murray-Lyon IM, et al. Causes of death in fulminant hepatic failure and relationship to quantitative histological assessment of parenchymal damage. *Q J Med* 1975;44:615–626.
  11. Blei AT, Olafsson S, Webster S, et al. Complications of intracranial pressure monitoring in fulminant hepatic failure. *Lancet* 1993;341:157–158.
  12. Vaquero J, Fontana RJ, Larson AM, et al. Complications and use of intracranial pressure monitoring in patients with acute liver failure and severe encephalopathy. *Liver Transpl* 2005;11:1581–1589.
  13. Vaquero J, Rose C, Butterworth RF. Keeping cool in acute liver failure: rationale for the use of mild hypothermia. *J Hepatol* 2005;43:1067–1077.
  14. Rolando N, Philpott-Howard J, Williams R. Bacterial and fungal infection in acute liver failure. *Semin Liver Dis* 1996;16:389–402.
  15. Wade JJ, Rolando N, Hayllar K, et al. Bacterial and fungal infections after liver transplantation: an analysis of 284 patients. *Hepatology* 1995;21:1328–1336.
  16. Trevisani F, Sica G, Mainqua P, et al. Autonomic dysfunction and hyperdynamic circulation in cirrhosis with ascites. *Hepatology* 1999;30:1387–1392.
  17. Henriksen JH, Møller S, Schifter S, et al. Increased arterial compliance in decompensated cirrhosis. *J Hepatol* 1999;31:712–718.
  18. Møller S, Bendtsen F, Schifter S, et al. Relation of calcitonin gene-related peptide to systemic vasodilatation and central hypovolaemia in cirrhosis. *Scand J Gastroenterol* 1996;31:928–933.
  19. Lee FY, Lin HC, Tsai YT, et al. Plasma substance p levels in patients with liver cirrhosis: Relationship to systemic and portal hemodynamics. *Am J Gastroenterol* 1997;92:2080–2084.
  20. Henriksen JH, Møller S, Ring-Larsen H, et al. The sympathetic nervous system in liver disease. *J Hepatol* 1998;29:328–341.
  21. Fernandez-Rodriguez CM, Prieto J, Zozaya JM, et al. Arteriovenous shunting, hemodynamic changes, and renal sodium retention in liver cirrhosis. *Gastroenterology* 1993;104:1139–1145.
  22. Møller S, Henriksen JH. Cirrhotic cardiomyopathy: a pathophysiological review of circulatory dysfunction in liver disease. *Heart* 2002;87:9–15.
  23. Sampathkumar P, Lerman A, Kim BY, et al. Post-liver transplantation myocardial dysfunction. *Liver Transpl Surg* 1998;4:399–403.
  24. Pham PT, Pham PC, Rastogi A, et al. Review article: current management of renal dysfunction in the cirrhotic patient. *Aliment Pharmacol Ther* 2005;21:949–961.
  25. Terra C, Guevara M, Torre A, et al. Renal failure in patients with cirrhosis and sepsis unrelated to spontaneous bacterial peritonitis: value of meld score. *Gastroenterology* 2005;129:1944–1953.
  26. Cardenas A. Hepatorenal syndrome: a dreaded complication of end-stage liver disease. *Am J Gastroenterol* 2005;100:460–467.
  27. Schrier RW, Arroyo V, Bernardi M, et al. Peripheral arterial vasodilation hypothesis: a proposal for the initiation of renal sodium and water retention in cirrhosis. *Hepatology* 1988;8:1151–1157.
  28. Lieberman FL. Functional renal failure in cirrhosis. *Gastroenterology* 1970;58:108–110.
  29. Hoepfer MM, Krowka MJ, Strassburg CP. Portopulmonary hypertension and hepatopulmonary syndrome. *Lancet* 2004;363:1461–1468.
  30. Benjaminov FS, Prentice M, Sniderman KW, et al. Portopulmonary hypertension in decompensated cirrhosis with refractory ascites. *Gut* 2003;52:1355–1362.
  31. Pietra GG, Edwards WD, Kay JM, et al. Histopathology of primary pulmonary hypertension. A qualitative and quantitative study of pulmonary blood vessels from 58 patients in the National Heart, Lung, and Blood Institute, Primary Pulmonary Hypertension Registry. *Circulation* 1989;80:1198–1206.
  32. Robalino BD, Moodie DS. Association between primary pulmonary hypertension and portal hypertension: analysis of its pathophysiology and clinical, laboratory and hemodynamic manifestations. *J Am Coll Cardiol* 1991;17:492–498.
  33. Robalino BD, Moodie DS. Primary pulmonary hypertension, then and now: 28 years of experience. *Cleve Clin J Med* 1992;59:411–417.
  34. Torregrosa M, Genesca J, Gonzalez A, et al. Role of Doppler echocardiography in the assessment of portopulmonary hypertension in liver transplantation candidates. *Transplantation* 2001;71:572–574.
  35. Colle IO, Moreau R, Godinho E, et al. Diagnosis of portopulmonary hypertension in candidates for liver transplantation: a prospective study. *Hepatology* 2003;37:401–409.
  36. Kuo PC, Plotkin JS, Gaine S, et al. Portopulmonary hypertension and the liver transplant candidate. *Transplantation* 1999;67:1087–1093.
  37. Krowka MJ, Frantz RP, McGoon MD, et al. Improvement in pulmonary hemodynamics during intravenous epoprostenol (prostacyclin): a study of 15 patients with moderate to severe portopulmonary hypertension. *Hepatology* 1999;30:641–648.
  38. Findlay JY, Harrison BA, Plevak DJ, et al. Inhaled nitric oxide reduces pulmonary artery pressures in portopulmonary hypertension. *Liver Transpl Surg* 1999;5:381–387.
  39. Mair P, Kaehler CH, Pomaroli A, et al. Orthotopic liver transplantation in a patient with severe portopulmonary hypertension. *Acta Anaesthesiol Scand* 2001;45:513–518.
  40. Findlay JY, Plevak DJ, Krowka MJ, et al. Progressive splenomegaly after epoprostenol therapy in portopulmonary hypertension. *Liver Transpl Surg* 1999;5:362–365.
  41. Krowka MJ, Mandell MS, Ramsay MA, et al. Hepatopulmonary syndrome and portopulmonary hypertension: a report of the multicenter liver transplant database. *Liver Transpl* 2004;10:174–182.
  42. Simonneau G, Barst RJ, Galie N, et al. Continuous subcutaneous infusion of treprostinil, a prostacyclin analogue in patients with pulmonary arterial hypertension: a double-blind, randomized, placebo-controlled trial. *Am J Respir Crit Care Med* 2002;165:800–804.
  43. Galie N, Humbert M, Vachiery JL, et al. Effects of beraprost sodium, an oral prostacyclin analogue in patients with pulmonary arterial hypertension: a randomized, double-blind, placebo-controlled trial. *J Am Coll Cardiol* 2002;39:1496–1502.
  44. Hoepfer MM, Schwarze M, Ehlerding S, et al. Long-term treatment of primary pulmonary hypertension with aerosolized iloprost, a prostacyclin analogue. *N Engl J Med* 2000;342:1866–1870.
  45. Olschewski H, Simonneau G, Galie N, et al. Inhaled iloprost for severe pulmonary hypertension. *N Engl J Med* 2002;347:322–329.
  46. Schroeder RA, Wood GL, Plotkin JS, et al. Intraoperative use of inhaled PGI(2) for acute pulmonary hypertension and right ventricular failure. *Anesth Analg* 2000;91:291–295.
  47. Krowka MJ. Hepatopulmonary syndrome and portopulmonary hypertension: implications for liver transplantation. *Clin Chest Med* 2005;26:587–597, vi.
  48. Pepke-Zaba J, Higenbottam TW, Dinh-Xuan AT, et al. Inhaled nitric oxide as a cause of selective pulmonary vasodilata-

- tion in pulmonary hypertension. *Lancet* 1991;338:1173-1174.
49. Michelakis E, Tymchak W, Lien D, et al. Oral sildenafil is an effective and specific pulmonary vasodilator in patients with pulmonary arterial hypertension: comparison with inhaled nitric oxide. *Circulation* 2002;105:2398-2403.
  50. Chua R, Keogh A, Miyashita M. Novel use of sildenafil in the treatment of portopulmonary hypertension. *J Heart Lung Transplant* 2005;24:498-500.
  51. Makisalo H, Koivusalo A, Vakkuri A, et al. Sildenafil for portopulmonary hypertension in a patient undergoing liver transplantation. *Liver Transpl* 2004;10:945-950.
  52. Ghofrani HA, Rose F, Schermuly RT, et al. Oral sildenafil as long-term adjunct therapy to inhaled iloprost in severe pulmonary arterial hypertension. *J Am Coll Cardiol* 2003;42:158-164.
  53. Fallon MB, Abrams GA. Pulmonary dysfunction in chronic liver disease. *Hepatology* 2000;32:859-865.
  54. Abrams GA, Nanda NC, Dubovsky EV, et al. Use of macroaggregated albumin lung perfusion scan to diagnose hepatopulmonary syndrome: a new approach. *Gastroenterology* 1998;114:305-310.
  55. Martinez G, Barbera JA, Navasa M, et al. Hepatopulmonary syndrome associated with cardiorespiratory disease. *J Hepatol* 1999;30:882-889.
  56. Stoller JK. As the liver goes, so goes the lung. *Chest* 1990;97:1028-1030.
  57. Rolla G, Brussino L, Colagrande P, et al. Exhaled nitric oxide and oxygenation abnormalities in hepatic cirrhosis. *Hepatology* 1997;26:842-847.
  58. Cremona G, Higenbottam TW, Mayoral V, et al. Elevated exhaled nitric oxide in patients with hepatopulmonary syndrome. *Eur Respir J* 1995;8:1883-1885.
  59. Abrams GA, Sanders MK, Fallon MB. Utility of pulse oximetry in the detection of arterial hypoxemia in liver transplant candidates. *Liver Transpl* 2002;8:391-396.
  60. Battaglia SE, Pretto JJ, Irving LB, et al. Resolution of gas exchange abnormalities and intrapulmonary shunting following liver transplantation. *Hepatology* 1997;25:1228-1232.
  61. Collisson EA, Nourmand H, Fraiman MH, et al. Retrospective analysis of the results of liver transplantation for adults with severe hepatopulmonary syndrome. *Liver Transpl* 2002;8:925-931.
  62. Kim HY, Choi MS, Lee SC, et al. Outcomes in patients with hepatopulmonary syndrome undergoing liver transplantation. *Transplant Proc* 2004;36:2762-2763.
  63. Swanson KL, Wiesner RH, Krowka MJ. Natural history of hepatopulmonary syndrome: impact of liver transplantation. *Hepatology* 2005;41:1122-1129.
  64. Schenk P, Schoniger-Hecke M, Fuhrmann V, et al. Prognostic significance of the hepatopulmonary syndrome in patients with cirrhosis. *Gastroenterology* 2003;125:1042-1052.
  65. Aboussouan LS, Stoller JK. The hepatopulmonary syndrome. *Baillieres Best Pract Res Clin Gastroenterol* 2000;14:1033-1048.
  66. Arguedas MR, Abrams GA, Krowka MJ, et al. Prospective evaluation of outcomes and predictors of mortality in patients with hepatopulmonary syndrome undergoing liver transplantation. *Hepatology* 2003;37:192-197.
  67. Barbaro G, Di Lorenzo G, Soldini M, et al. Flumazenil for hepatic encephalopathy grade III and IVa in patients with cirrhosis: an Italian multicenter double-blind, placebo-controlled, cross-over study. *Hepatology* 1998;28:374-378.
  68. Als-Nielsen B, Gluud LL, Gluud C. Benzodiazepine receptor antagonists for hepatic encephalopathy. *Cochrane Database Syst Rev* 2004;CD002798.
  69. Takahashi K, Kameda H, Kataoka M, et al. Ammonia potentiates GABAA response in dissociated rat cortical neurons. *Neurosci Lett* 1993;151:51-54.
  70. Chaudhry V, Corse AM, O'Brian R, et al. Autonomic and peripheral (sensorimotor) neuropathy in chronic liver disease: a clinical and electrophysiologic study. *Hepatology* 1999;29:1698-1703.
  71. McDougall AJ, Davies L, McCaughan GW. Autonomic and peripheral neuropathy in endstage liver disease and following liver transplantation. *Muscle Nerve* 2003;28:595-600.
  72. Verne GN, Soldevia-Pico C, Robinson ME, et al. Autonomic dysfunction and gastroparesis in cirrhosis. *J Clin Gastroenterol* 2004;38:72-76.
  73. Latson TW, Ashmore TH, Reinhart DJ, et al. Autonomic reflex dysfunction in patients presenting for elective surgery is associated with hypotension after anesthesia induction. *Anesthesiology* 1994;80:326-337.
  74. Fleckenstein JF, Frank S, Thuluvath PJ. Presence of autonomic neuropathy is a poor prognostic indicator in patients with advanced liver disease. *Hepatology* 1996;23:471-475.
  75. Perez-Pena J, Rincon D, Banares R, et al. Autonomic neuropathy in end-stage cirrhotic patients and evolution after liver transplantation. *Transplant Proc* 2003;35:1834-1835.
  76. Foster JH, Berman MM. Solid liver tumors. *Major Probl Clin Surg* 1977;22:1-342.
  77. Jarnagin WR, Gonen M, Fong Y, et al. Improvement in perioperative outcome after hepatic resection: analysis of 1,803 consecutive cases over the past decade. *Ann Surg* 2003;236:397-406.
  78. Allen PJ, Jarnagin WR. Current status of hepatic resection. *Adv Surg* 2003;37:29-49.
  79. Pol B, Campan P, Hardwigen J, et al. Morbidity of major hepatic resections: a 100-case prospective study. *Eur J Surg* 1999;165:446-453.
  80. Melendez JA, Arslan V, Fischer ME, et al. Perioperative outcomes of major hepatic resections under low central venous pressure anesthesia: blood loss, blood transfusion, and the risk of postoperative renal dysfunction. *J Am Coll Surg* 1998;187:620-625.
  81. Poon RT. Recent advances in techniques of liver resection. *Surg Technol Int* 2004;13:71-77.
  82. Brand MI, Saclarides TJ, Dobson HD, et al. Liver resection for colorectal cancer: Liver metastases in the aged. *Am Surg* 2000;66:412-415.
  83. Fong Y, Brennan MF, Cohen AM, et al. Liver resection in the elderly. *Br J Surg* 1997;84:1386-1390.
  84. Cescon M, Grazi GL, Del Gaudio M, et al. Outcome of right hepatectomies in patients older than 70 years. *Arch Surg* 2003;138:547-552.
  85. Emond JC, Samstein B, Renz JF. A critical evaluation of hepatic resection in cirrhosis: Optimizing patient selection and outcomes. *World J Surg* 2005;29:124-130.
  86. Kooby DA, Stockman J, Ben-Porat L, et al. Influence of transfusions on perioperative and long-term outcome in patients following hepatic resection for colorectal metastases. *Ann Surg* 2003;237:860-869.
  87. Abdalla EK, Noun R, Belghiti J. Hepatic vascular occlusion: which technique? *Surg Clin North Am* 2004;84:563-585.
  88. Emond JC, Kelley SD, Heffron TG, et al. Surgical and anesthetic management of patients undergoing major hepatectomy using total vascular exclusion. *Liver Transpl Surg* 1996;2:91-98.
  89. Cherqui D, Malassagne B, Colau PI, et al. Hepatic vascular exclusion with preservation of the caval flow for liver resections. *Ann Surg* 1999;230:24-30.
  90. Lentschener C, Ozier Y. Anaesthesia for elective liver resection: some points should be revisited. *Eur J Anaesthesiol* 2002;19:780-788.
  91. Redai I, Emond J, Brentjens T. Anesthetic considerations during liver surgery. *Surg Clin North Am* 2004;84:401-411.
  92. Niemann CU, Roberts JP, Ascher NL, et al. Intraoperative hemodynamics and liver function in adult-to-adult living liver donors. *Liver Transpl* 2002;8:1126-1132.
  93. Thasler WE, Bein T, Jauch KW. Perioperative effects of hepatic resection surgery on hemodynamics, pulmonary fluid balance, and indocyanine green clearance. *Langenbecks Arch Surg* 2002;387:271-275.
  94. Eagle KA, Berger PB, Calkins H, et al. ACC/AHA guideline update for perioperative cardiovascular evaluation for noncardiac surgery—executive summary. a report of the American College of Cardiology/American Heart Association Task Force on Practice Guidelines (Committee to Update the 1996 Guidelines on Perioperative Cardiovascular Evaluation for Noncardiac Surgery). *Anesth Analg* 2002;94:1052-1064.
  95. Kurz A, Sessler DI, Lenhardt R. Perioperative normothermia to reduce the incidence of surgical-wound infection and shorten hospitalization. *Study of Wound*



- Infection and Temperature Group. *N Engl J Med* 1996;334:1209–1215.
96. Spahn DR, Rossaint R. Coagulopathy and blood component transfusion in trauma. *Br J Anaesth* 2005;95:130–139.
97. Nishiyama T, Fujimoto T, Hanaoka K. A comparison of liver function after hepatectomy in cirrhotic patients between sevoflurane and isoflurane in anesthesia with nitrous oxide and epidural block. *Anesth Analg* 2004;98:990–993.
98. Brooks AJ, Eastwood J, Beckingham IJ, et al. Liver tissue partial pressure of oxygen and carbon dioxide during partial hepatectomy. *Br J Anaesth* 2004;92:735–737.
99. Lentschener C, Franco D, Bouaziz H, et al. Haemodynamic changes associated with portal triad clamping are suppressed by prior hepatic pedicle infiltration with lidocaine in humans. *Br J Anaesth* 1999;82:691–697.
100. Jones RM, Moulton CE, Hardy KJ. Central venous pressure and its effect on blood loss during liver resection. *Br J Surg* 1998;85:1058–1060.
101. Smyrniotis V, Kostopanagiotou G, Theodoraki K, et al. The role of central venous pressure and type of vascular control in blood loss during major liver resections. *Am J Surg* 2004;187:398–402.
102. Dixon E, Vollmer CM Jr, Bathe OF, et al. Vascular occlusion to decrease blood loss during hepatic resection. *Am J Surg* 2005;190:75–86.
103. Wong AY, Irwin MG, Hui TW, et al. Desmopressin does not decrease blood loss and transfusion requirements in patients undergoing hepatectomy. *Can J Anaesth* 2003;50:14–20.
104. Lentschener C, Benhamou D, Mercier FJ, et al. Aprotinin reduces blood loss in patients undergoing elective liver resection. *Anesth Analg* 1997;84:875–881.
105. Mangano DT, Tudor IC, Dietzel C. The risk associated with aprotinin in cardiac surgery. *N Engl J Med* 2006;354:353–365.
106. Lodge JP, Jonas S, Oussoultzoglou E, et al. Recombinant coagulation factor VIIa in major liver resection: a randomized, placebo-controlled, double-blind clinical trial. *Anesthesiology* 2005;102:269–275.
107. O'Connell KA, Wood JJ, Wise RP, et al. Thromboembolic adverse events after use of recombinant human coagulation factor VIIa. *JAMA* 2006;295:293–298.
108. Siniscalchi A, Begliomini B, Matteo G, et al. Intraoperative effects of combined versus general anesthesia during major liver surgery. *Minerva Anestesiologica* 2003;69:885–895.
109. Adornato DC, Gildenberg PL, Ferrario CM, et al. Pathophysiology of intravenous air embolism in dogs. *Anesthesiology* 1978;49:120–127.
110. Koo BN, Kil HK, Choi JS, et al. Hepatic resection by the Cavitron ultrasonic surgical aspirator increases the incidence and severity of venous air embolism. *Anesth Analg* 2005;101:966–970.
111. Ousmane ML, Fleyfel M, Vallet B. Venous gas embolism during liver surgery with argon-enhanced coagulation. *Eur J Anaesthesiol* 2002;19:225.
112. Lee SY, Choi BI, Kim JS, et al. Paradoxical air embolism during hepatic resection. *Br J Anaesth* 2002;88:136–138.
113. Baer HU, Blumgart LH. Venous air embolism with a water jet dissector. *Br J Anaesth* 1993;71:921.
114. Diakun TA. Carbon dioxide embolism: successful resuscitation with cardiopulmonary bypass. *Anesthesiology* 1991;74:1151–1153.
115. Figueiro J, Vaidya A, Ciancio G, et al. Simultaneous pancreas-kidney transplantation in Jehovah's Witness patients. *Clin Transplant* 2003;17:140–143.
116. Hillingso JG, Wettergren A, Hyoudo M, et al. Obesity increases mortality in liver transplantation—the Danish experience. *Transpl Int* 2005;18:1231–5.
117. Therapondos G, Flapan AD, Plevris JN, et al. Cardiac morbidity and mortality related to orthotopic liver transplantation. *Liver Transpl* 2004;10:1441–1453.
118. Carey WD, Dumot JA, Pimentel RR, et al. The prevalence of coronary artery disease in liver transplant candidates over age 50. *Transplantation* 1995;59:859–864.
119. Morris JJ, Hellman CL, Gawey BJ, et al. Case 3–1995. Three patients requiring both coronary artery bypass surgery and orthotopic liver transplantation. *J Cardiothorac Vasc Anesth* 1995;9:322–332.
120. Keeffe BG, Valentine H, Keeffe EB. Detection and treatment of coronary artery disease in liver transplant candidates. *Liver Transpl* 2001;7:755–761.
121. Plotkin JS, Scott VL, Pinna A, et al. Morbidity and mortality in patients with coronary artery disease undergoing orthotopic liver transplantation. *Liver Transpl Surg* 1996;2:426–430.
122. Plevak DJ. Stress echocardiography identifies coronary artery disease in liver transplant candidates. *Liver Transpl Surg* 1998;4:337–339.
123. Plotkin JS, Benitez RM, Kuo PC, et al. Dobutamine stress echocardiography for preoperative cardiac risk stratification in patients undergoing orthotopic liver transplantation. *Liver Transpl Surg* 1998;4:253–257.
124. Plotkin JS, Johnson LB, Rustgi V, et al. Coronary artery disease and liver transplantation: The state of the art. *Liver Transpl* 2000;6(4 Suppl 1):S53–S56.
125. Beattie WS, Abdelnaem E, Wijeyesundera DN, et al. A meta-analytic comparison of preoperative stress echocardiography and nuclear scintigraphy imaging. *Anesth Analg* 2006;102:8–16.
126. Donovan CL, Marcovitz PA, Punch JD, et al. Two-dimensional and dobutamine stress echocardiography in the preoperative assessment of patients with end-stage liver disease prior to orthotopic liver transplantation. *Transplantation* 1996;61:1180–1188.
127. Williams K, Lewis JF, Davis G, et al. Dobutamine stress echocardiography in patients undergoing liver transplantation evaluation. *Transplantation* 2000;69:2354–2356.
128. Maraj S, Jacobs LE, Maraj R, et al. Inducible left ventricular outflow tract gradient during dobutamine stress echocardiography: An association with intraoperative hypotension but not a contraindication to liver transplantation. *Echocardiography* 2004;21:681–685.
129. Bizouarn P, Ausseur A, Desseigne P, et al. Early and late outcome after elective cardiac surgery in patients with cirrhosis. *Ann Thorac Surg* 1999;67:1334–1338.
130. Klemperer JD, Ko W, Krieger KH, et al. Cardiac operations in patients with cirrhosis. *Ann Thorac Surg* 1998;65:85–87.
131. Axelrod D, Koffron A, Dewolf A, et al. Safety and efficacy of combined orthotopic liver transplantation and coronary artery bypass grafting. *Liver Transpl* 2004;10:1386–1390.
132. Eckhoff DE, Frenette L, Sellers MT, et al. Combined cardiac surgery and liver transplantation. *Liver Transpl* 2001;7:60–61.
133. Myers RP, Lee SS. Cirrhotic cardiomyopathy and liver transplantation. *Liver Transpl* 2000;6(4 Suppl 1):S44–S45.
134. Lerner AB, Sundar E, Mahmood F, et al. Four cases of cardiopulmonary thromboembolism during liver transplantation without the use of antifibrinolytic drugs. *Anesth Analg* 2005;101:1608–1612.
135. Gologorsky E, De Wolf AM, Scott V, et al. Intracardiac thrombus formation and pulmonary thromboembolism immediately after graft reperfusion in 7 patients undergoing liver transplantation. *Liver Transpl* 2001;7:783–789.
136. Hagen PT, Scholz DG, Edwards WD. Incidence and size of patent foramen ovale during the first 10 decades of life: An autopsy study of 965 normal hearts. *Mayo Clin Proc* 1984;59:17–20.
137. Bijl JM, Ruygrok PN, Hornung TS, et al. Percutaneous closure of patent foramen ovale. *Intern Med J* 2005;35:706–710.
138. Ellis JE, Lichter JL, Feinstein SB, et al. Right heart dysfunction, pulmonary embolism, and paradoxical embolization during liver transplantation. A transesophageal two-dimensional echocardiographic study. *Anesth Analg* 1989;68:777–782.
139. Mohrs OK, Petersen SE, Erkapic D, et al. Diagnosis of patent foramen ovale using contrast-enhanced dynamic MRI. A pilot study. *AJR Am J Roentgenol* 2005;184:234–240.
140. Pilatis ND, Jacobs LE, Rerkpattanapit P, et al. Clinical predictors of pulmonary hypertension in patients undergoing liver transplant evaluation. *Liver Transpl* 2000;6:85–91.
141. Krowka MJ, Plevak DJ, Findlay JY, et al. Pulmonary hemodynamics and perioperative cardiopulmonary-related mortality in patients with portopulmonary hypertension undergoing liver transplantation. *Liver Transpl* 2000;6:443–450.



142. Starkel P, Vera A, Gunson B, et al. Outcome of liver transplantation for patients with pulmonary hypertension. *Liver Transpl* 2002;8:382–388.
143. Reddy K, Mallett S, Peachey T. Venovenous bypass in orthotopic liver transplantation: time for a rethink? *Liver Transpl* 2005;11:741–749.
144. Schwarz B, Pomaroli A, Hoermann C, et al. Liver transplantation without venovenous bypass: morbidity and mortality in patients with greater than 50% reduction in cardiac output after vena cava clamping. *J Cardiothorac Vasc Anesth* 2001;15:460–462.
145. Wall WJ, Grant DR, Duff JH, et al. Liver transplantation without venous bypass. *Transplantation* 1987;43:56–61.
146. Grande L, Rimola A, Cugat E, et al. Effect of venovenous bypass on perioperative renal function in liver transplantation: results of a randomized, controlled trial. *Hepatology* 1996;23:1418–1428.
147. Shaw BW Jr, Martin DJ, Marquez JM, et al. Venous bypass in clinical liver transplantation. *Ann Surg* 1984;200:524–534.
148. Tisone G, Mercadante E, Dauri M, et al. Surgical versus percutaneous technique for veno-venous bypass during orthotopic liver transplantation: a prospective randomized study. *Transplant Proc* 1999;31:3162–3163.
149. Washburn WK, Lewis WD, Jenkins RL. Percutaneous venovenous bypass in orthotopic liver transplantation. *Liver Transpl Surg* 1995;1:377–382.
150. Budd JM, Isaac JL, Bennett J, et al. Morbidity and mortality associated with large-bore percutaneous venovenous bypass cannulation for 312 orthotopic liver transplantations. *Liver Transpl* 2001;7:359–362.
151. Griffith BP, Shaw BW Jr, Hardesty RL, et al. Veno-venous bypass without systemic anticoagulation for transplantation of the human liver. *Surg Gynecol Obstet* 1985;160:270–272.
152. Calne RY, Williams R. Liver transplantation in man. I. Observations on technique and organization in five cases. *Br Med J* 1968;4:535–540.
153. Lerut J, Ciccarelli O, Roggen F, et al. Cavocaval adult liver transplantation and retransplantation without venovenous bypass and without portocaval shunting: a prospective feasibility study in adult liver transplantation. *Transplantation* 2003;75:1740–1745.
154. Cabezuelo JB, Ramirez P, Acosta F, et al. Does the standard vs piggyback surgical technique affect the development of early acute renal failure after orthotopic liver transplantation? *Transplant Proc* 2003;35:1913–1914.
155. Walsh TS, Hopton P, Garden OJ, et al. Effect of graft reperfusion on haemodynamics and gas exchange during liver transplantation. *Br J Anaesth* 1998;81:311–36.
156. Moreno-Gonzalez E, Meneu-Diaz JG, Fundora Y, et al. Advantages of the piggy back technique on intraoperative transfusion, fluid consumption, and vasoactive drugs requirements in liver transplantation: a comparative study. *Transplant Proc* 2003;35:1918–1919.
157. Figueras J, Llado L, Ramos E, et al. Temporary portocaval shunt during liver transplantation with vena cava preservation. Results of a prospective randomized study. *Liver Transpl* 2001;7:904–911.
158. Schumann R. Intraoperative resource utilization in anesthesia for liver transplantation in the united states: a survey. *Anesth Analg* 2003;97:21–28.
159. Arnal D, Garutti I, Perez-Pena J, et al. Radial to femoral arterial blood pressure differences during liver transplantation. *Anaesthesia* 2005;60:766–771.
160. Bratzler DW, Houck PM. Antimicrobial prophylaxis for surgery: an advisory statement from the National Surgical Infection Prevention Project. *Clin Infect Dis* 2004;38:1706–1715.
161. Wu Y, Oyos TL, Chenhsu RY, et al. Vasopressor agents without volume expansion as a safe alternative to venovenous bypass during cavaplasty liver transplantation. *Transplantation* 2003;76:1724–8.
162. Schroeder RA, Collins BH, Tuttle-Ne-whall E, et al. Intraoperative fluid management during orthotopic liver transplantation. *J Cardiothorac Vasc Anesth* 2004;18:438–441.
163. Mehrabi A, Golling M, Kashfi A, et al. Negative impact of systemic catecholamine administration on hepatic blood perfusion after porcine liver transplantation. *Liver Transpl* 2005;11:174–187.
164. Dubois MJ, De Backer D, Creteur J, et al. Effect of vasopressin on sublingual microcirculation in a patient with distributive shock. *Intensive Care Med* 2003;29:1020–1023.
165. Luckner G, Dunser MW, Jochberger S, et al. Arginine vasopressin in 316 patients with advanced vasodilatory shock. *Crit Care Med* 2005;33:2659–2666.
166. Findlay JY, Kufner RP. Aprotinin reduces vasoactive medication use during adult liver transplantation. *J Clin Anesth* 2003;15:19–23.
167. Hammer GB, Krane EJ. Anaesthesia for liver transplantation in children. *Paediatr Anaesth* 2001;11:3–18.
168. Kang YG, Martin DJ, Marquez J, et al. Intraoperative changes in blood coagulation and thrombelastographic monitoring in liver transplantation. *Anesth Analg* 1985;64:888–896.
169. Salooja N, Perry DJ. Thrombelastography. *Blood Coagul Fibrinolysis* 2001;12:327–337.
170. Kang Y. Coagulation and liver transplantation: Current concepts. *Liver Transpl Surg* 1997;3:465–467.
171. Krenn CG, Hoda R, Nikolic A, et al. Assessment of ventricular contractile function during orthotopic liver transplantation. *Transpl Int* 2004;17:101–104.
172. Drummond JC, Petrovitch CT. The massively bleeding patient. *Anesthesiol Clin North Am* 2001;19:633–649.
173. Li Q, Zhou MT, Wang Y, et al. Effect of insulin on hyperkalemia during anhepatic stage of liver transplantation. *World J Gastroenterol* 2004;10:2427–2429.
174. Marquez J, Martin D, Virji MA, et al. Cardiovascular depression secondary to ionic hypocalcemia during hepatic transplantation in humans. *Anesthesiology* 1986;65:457–461.
175. Gainza FJ, Valdivieso A, Quintanilla N, et al. Evaluation of acute renal failure in the liver transplantation perioperative period: incidence and impact. *Transplant Proc* 2002;34:250–251.
176. Lima EQ, Zanetta DM, Castro I, et al. Risk factors for development of acute renal failure after liver transplantation. *Ren Fail* 2003;25:553–560.
177. Lafayette RA, Pare G, Schmid CH, et al. Pretransplant renal dysfunction predicts poorer outcome in liver transplantation. *Clin Nephrol* 1997;48:159–164.
178. Biancofiore G, Della Rocca G, Bindi L, et al. Use of fenoldopam to control renal dysfunction early after liver transplantation. *Liver Transpl* 2004;10:986–992.
179. Della Rocca G, Pompei L, Costa MG, et al. Fenoldopam mesylate and renal function in patients undergoing liver transplantation: a randomized, controlled pilot trial. *Anesth Analg* 2004;99:1604–1609.
180. De Wolf AM, Begliomini B, Gasior TA, et al. Right ventricular function during orthotopic liver transplantation. *Anesth Analg* 1993;76:562–568.
181. Saada M, Liu N, Cherqui D, et al. [Opening of a foramen ovale during liver transplantation. The value of transesophageal echocardiography]. *Ann Fr Anesth Reanim* 1990;9:412–414.
182. Schwarz B, Mair P, Margreiter J, et al. Experience with percutaneous venoarterial cardiopulmonary bypass for emergency circulatory support. *Crit Care Med* 2003;31:758–764.
183. Kang Y, Lewis JH, Navalgund A, et al. Epsilon-aminocaproic acid for treatment of fibrinolysis during liver transplantation. *Anesthesiology* 1987;66:766–773.
184. Cheema SP, Webster NR, Dunn F, et al. Mediators of fibrinolysis in orthotopic liver transplantation. *Clin Transplant* 1996;10:24–27.
185. Porte RJ, Bontempo FA, Knot EA, et al. Systemic effects of tissue plasminogen activator-associated fibrinolysis and its relation to thrombin generation in orthotopic liver transplantation. *Transplantation* 1989;47:978–984.
186. Segal H, Cottam S, Potter D, et al. Coagulation and fibrinolysis in primary biliary cirrhosis compared with other liver disease and during orthotopic liver transplantation. *Hepatology* 1997;25:683–688.
187. Porte RJ, Molenaar IQ, Begliomini B, et al. Aprotinin and transfusion requirements in orthotopic liver transplantation: a multicentre randomised double-blind study. EMSALT Study Group. *Lancet* 2000;355:1303–1309.

188. Xia VW, Steadman RH. Antifibrinolytics in orthotopic liver transplantation: current status and controversies. *Liver Transpl* 2005;11:10-18.
189. Fitzsimons MG, Peterfreund RA, Raines DE. Aprotinin administration and pulmonary thromboembolism during orthotopic liver transplantation: report of two cases. *Anesth Analg* 2001;92:1418-1421.
190. Lentschener C, Roche K, Ozier Y. A review of aprotinin in orthotopic liver transplantation: can its harmful effects offset its beneficial effects? *Anesth Analg* 2005;100:1248-1255.
191. Kalicinski P, Markiewicz M, Kaminski A, et al. Single pretransplant bolus of recombinant activated factor VII ameliorates influence of risk factors for blood loss during orthotopic liver transplantation. *Pediatr Transplant* 2005;9:299-304.
192. Meijer K, Hendriks HG, De Wolf JT, et al. Recombinant factor VIIa in orthotopic liver transplantation: influence on parameters of coagulation and fibrinolysis. *Blood Coagul Fibrinolysis* 2003;14:169-174.
193. Biancofiore G, Bindi ML, Romanelli AM, et al. Fast track in liver transplantation: 5 years' experience. *Eur J Anaesthesiol* 2005;22:584-590.
194. Biancofiore G, Romanelli AM, Bindi ML, et al. Very early tracheal extubation without predetermined criteria in a liver transplant recipient population. *Liver Transpl* 2001;7:777-782.
195. Ponnudurai RN, Koneru B, Akhtar SA, et al. Vasopressor administration during liver transplant surgery and its effect on endotracheal reintubation rate in the postoperative period: a prospective, randomized, double-blind, placebo-controlled trial. *Clin Ther* 2005;27:192-198.
196. Biancofiore G, Bindi ML, Romanelli AM, et al. Postoperative intra-abdominal pressure and renal function after liver transplantation. *Arch Surg* 2003;138:703-706.
197. Krenn CG, Krafft P, Schaefer B, et al. Effects of positive end-expiratory pressure on hemodynamics and indocyanine green kinetics in patients after orthotopic liver transplantation. *Crit Care Med* 2000;28:1760-1765.
198. Moretti EW, Robertson KM, Tuttle-Ne-whall JE, et al. Orthotopic liver transplant patients require less postoperative morphine than do patients undergoing hepatic resection. *J Clin Anesth* 2002;14:416-420.
199. Romundstad L, Breivik H, Roald H, et al. Methylprednisolone reduces pain, emesis, and fatigue after breast augmentation surgery: a single-dose, randomized, parallel-group study with methylprednisolone 125 mg, parecoxib 40 mg, and placebo. *Anesth Analg* 2006;102:418-425.
200. Toy P, Gajic O. Transfusion-related acute lung injury. *Anesth Analg* 2004;99:1623-1624.
201. Toy P, Popovsky MA, Abraham E, et al. Transfusion-related acute lung injury: definition and review. *Crit Care Med* 2005;33:721-726.
202. Ljungman P. Risk of cytomegalovirus transmission by blood products to immunocompromised patients and means for reduction. *Br J Haematol* 2004;125:107-116.
203. Crossin JD, Muradali D, Wilson SR. US of liver transplants: normal and abnormal. *Radiographics* 2003;23:1093-1114.
204. Dubost T, Goubaux B, Duhalde M, et al. Use of hyperbaric oxygen for hepatic artery thrombosis following adult orthotopic liver transplantation. *Eur J Anaesthesiol* 2002;19:223-224.
205. Laurenro R, Karp BI. Myelinolysis after correction of hyponatremia. *Ann Intern Med* 1997;126:57-62.
206. Bronster DJ, Emre S, Boccagni P, et al. Central nervous system complications in liver transplant recipients—incidence, timing, and long-term follow-up. *Clin Transplant* 2000;14:1-7.
207. Bonham CA, Dominguez EA, Fukui MB, et al. Central nervous system lesions in liver transplant recipients: prospective assessment of indications for biopsy and implications for management. *Transplantation* 1998;66:1596-1604.
208. Saab S, Nieto JM, Ly D, et al. Tips versus paracentesis for cirrhotic patients with refractory ascites. *Cochrane Database Syst Rev* 2004;CD004889.
209. Merli M, Valeriano V, Funaro S, et al. Modifications of cardiac function in cirrhotic patients treated with transjugular intrahepatic portosystemic shunt (TIPS). *Am J Gastroenterol* 2002;97:142-148.
210. Rumi MN, Schumann R, Freeman RB, et al. Acute transjugular intrahepatic portosystemic shunt migration into pulmonary artery during liver transplantation. *Transplantation* 1999;67:1492-1494.
211. McCowan TC, Hummel MM, Schmucker T, et al. Cardiac perforation and tamponade during transjugular intrahepatic portosystemic shunt placement. *Cardiovasc Interv Radiol* 2000;23:298-300.
212. Riggio O, Masini A, Efrati C, et al. Pharmacological prophylaxis of hepatic encephalopathy after transjugular intrahepatic portosystemic shunt: a randomized controlled study. *J Hepatol* 2005;42:674-679.
213. Nygaard CE, Townsend RN, Diamond DL. Organ donor management and organ outcome: a 6-year review from a Level I trauma center. *J Trauma* 1990;30:728-732.
214. Razek T, Olthoff K, Reilly PM. Issues in potential organ donor management. *Surg Clin North Am* 2000;80:1021-1032.
215. Szabo G. Physiologic changes after brain death. *J Heart Lung Transplant* 2004;23(9 Suppl):S223-S226.
216. Avlonitis VS, Fisher AJ, Kirby JA, et al. Pulmonary transplantation: the role of brain death in donor lung injury. *Transplantation* 2003;75:1928-1933.
217. Grewal HP, Thistlewaite JR Jr, Loss GE, et al. Complications in 100 living-liver donors. *Ann Surg* 1998;228:214-219.
218. Lutz JT, Valentin-Gamazo C, Gorlinger K, et al. Blood-transfusion requirements and blood salvage in donors undergoing right hepatectomy for living related liver transplantation. *Anesth Analg* 2003;96:351-355.
219. Todo S, Furukawa H, Jin MB, et al. Living donor liver transplantation in adults: outcome in japan. *Liver Transpl* 2000;6(6 Suppl 2):S66-S67.
220. Sahani D, Mehta A, Blake M, et al. Preoperative hepatic vascular evaluation with CT and MR angiography: implications for surgery. *Radiographics* 2004;24:1367-1380.
221. Boermeester MA, Straatsburg IH, Houdijk AP, et al. Endotoxin and interleukin-1 related hepatic inflammatory response promotes liver failure after partial hepatectomy. *Hepatology* 1995;22:1499-1506.
222. Ayanoglu HO, Ulukaya S, Yuzer Y, Tokat Y. Anesthetic management and complications in living donor hepatectomy. *Transplant Proc* 2003;35:2970-2973.
223. Beebe DS, Carr R, Komanduri V, et al. Living liver donor surgery: Report of initial anesthesia experience. *J Clin Anesth* 2000;12:157-161.
224. Matot I, Scheinin O, Eid A, et al. Epidural anesthesia and analgesia in liver resection. *Anesth Analg* 2002;95:1179-1181.
225. Siniscalchi A, Begliomini B, De Pietri L, et al. Increased prothrombin time and platelet counts in living donor right hepatectomy: implications for epidural anesthesia. *Liver Transpl* 2004;10:1144-1149.
226. Cywinski JB, Parker BM, Xu M, et al. A comparison of postoperative pain control in patients after right lobe donor hepatectomy and major hepatic resection for tumor. *Anesth Analg* 2004;99:1747-1752.
227. Schumann R, Zabala L, Angelis M, et al. Altered hematologic profiles following donor right hepatectomy and implications for perioperative analgesic management. *Liver Transpl* 2004;10:363-368.
228. Cerutti E, Stratta C, Romagnoli R, et al. Thromboelastogram monitoring in the perioperative period of hepatectomy for adult living liver donation. *Liver Transpl* 2004;10:289-294.
229. Garcia-Valdecasas JC, Tabet J, Valero R, et al. Evaluation of ischemic injury during liver procurement from non-heart-beating donors. *Eur Surg Res* 1999;31:447-456.
230. Foley DP, Fernandez LA, Levenson G, et al. Donation after cardiac death: the University of Wisconsin experience with liver transplantation. *Ann Surg* 2005;242:724-731.

# CHAPTER 57

## Anesthesia for Heart or Lung Transplantation

Benjamin A. Kohl, MD, and  
Joseph S. Savino, MD

### INTRODUCTION

Heart and/or lung transplantation is an emergency operation for extremely ill patients who have very little organ reserve. Understanding the anesthetic implications and underlying pathophysiology is necessary for a successful outcome. This chapter reviews heart and lung transplantation, with an emphasis on intraoperative anesthetic management and postoperative care. The first section reviews the history of lung and heart transplantation. The second section discusses surgical alternatives. The third section reviews the immunobiology of transplantation, which perhaps is the area in which most research has been devoted. The fourth section reviews methods of organ procurement and the concept of reperfusion and “washout” and discusses various methods used in protecting the allograft. The remainder of the chapter is devoted to specific anesthetic concerns, management, recovery, and postoperative complications. The perioperative care of patients undergoing lung and heart transplantation challenges even the most experienced anesthesiologists, surgeons, and intensivists, and dedicated teams are devoted to this high-risk procedure despite its relative low volume.

### HISTORICAL ASPECTS

The history of heart and lung transplantation parallels the development of immunosuppression (Table 57-1). From an historical standpoint, many of the pioneers in transplantation received little notoriety because their experiments were performed on animals. In 1946, Vladimir P. Demikhov was the first to perform intrathoracic transplantation of the heart alone, lung alone,

and the heart and lungs in a warm-blooded animal.<sup>1,2</sup> Incidentally, these operations were performed without use of hypothermia or extracorporeal oxygenation. Similarly, heart transplants were first performed in dogs by Alexis Carrel and Charles Guthrie in 1905,<sup>3</sup> but attempts at human orthotopic heart transplantation were not made until the 1950s. Finally, although Reitz and Shumway are credited with the first heart-lung transplant in humans in 1981, Denton Cooley, in 1968, first replaced the heart and lungs of a 2-month-old infant, who had an atrioventricular canal defect, with those of an

anencephalic donor. Although the recipient survived only 14 hours, precedent was certainly established for future endeavors.<sup>4-6</sup> These are the heroes of modern-day transplantation. First-person accounts of their trials and tribulations abound in the literature and convey the frustrations many went through to advance the field to its current level.<sup>7-9</sup>

### Epidemiology Lung Transplant

The most common indications for lung transplantation in the United States are chronic obstructive lung disease (par-

### KEY POINTS

1. All heart and/or lung transplantations are considered emergency operations. As a result, the anesthetic preparation and management should reflect a consideration of the risks inherent in such a patient population.
2. The most common indications for adult cardiac transplantation are ischemic and idiopathic dilated cardiomyopathies. The most common indications for adult lung transplantation are chronic obstructive pulmonary disease (particularly emphysema and  $\alpha_1$ -antitrypsin disease) followed by cystic fibrosis.
3. Acute rejection after lung transplantation occurs with greater frequency compared with transplantation of other solid organs, particularly during the first 6 months after surgery. Thus, timely administration of immunosuppressants is believed to be of key importance in lung transplantation.
4. Although immunosuppressant agents have dramatically reduced the incidence of acute rejection after cardiac transplantation, these drugs have been implicated in cardiac allograft vasculopathy, which remains a leading cause of morbidity and mortality among heart transplant recipients.
5. Patients with primary pulmonary hypertension may have an exacerbation and incremental increase in pulmonary vascular resistance caused by anxiety and agitation. Sedation with minimal respiratory depression is the goal in the lung transplantation population.
6. Typically, aortic cross-clamping of the donor coincides with induction of general anesthesia in the recipient. This coordinated event across centers is intended to achieve arrival of the donor organ at the recipient's operating room at the time when the recipient has been prepared for receiving the new organ. Delay in implantation of the transplanted organ leads to increased organ ischemia and may increase the risk for early postoperative graft failure.
7. The anesthetic management of end-stage lung disease patients is aimed at minimizing further increases in pulmonary vascular resistance, as the patient is transitioned from the awake spontaneously breathing condition to the anesthetized, paralyzed, mechanically ventilated condition.
8. Familiarity and appreciation of pulmonary allograft physiology is imperative for ventilation of the new lung. Native lung explantation and subsequent allograft implantation produce denervated lungs and airways, loss of a functional pulmonary system, and loss of bronchial artery blood flow.
9. The most common disorders that lead to heart transplantation are ischemic cardiomyopathy, idiopathic cardiomyopathy, congenital heart disease, and viral myocarditis.
10. Right-heart failure can be precipitated by increased pulmonary vascular resistance in the cardiac recipient. Treatment includes inotropes and pulmonary vasodilators, as well as hyperventilation, increasing oxygen tension, decreasing positive end-expiratory pressure, and decreasing lung water.



TABLE 57-1.

## Key Time Points in the History of Heart and Lung Transplantation

Date	Event
1962	Introduction of antirejection drug azathioprine (Imuran).
1963	First single-lung transplant performed by Dr. James D. Hardy (University of Mississippi, Oxford, Mississippi). The patient died on postoperative day 8. Immunosuppressive regimen included azathioprine and mediastinal irradiation.
1967	First successful heart transplant performed by Dr. Christian Barnard (Groote Schur Hospital, Cape Town, South Africa). The patient died on postoperative day 18. Immunosuppressive regimen included azathioprine, prednisolone, and mediastinal irradiation.
1969	First artificial heart implantation (Liotta Total Artificial Heart) performed by Dr. Denton A. Cooley (Texas Heart Institute, Houston, Texas). The patient survived for 64 hours, at which point she received a donor heart.
1978	Introduction of the immunosuppressant cyclosporine.
1981	First successful heart–lung transplant performed by Dr. Bruce Reitz and Dr. Norman Shumway (Stanford University, Stanford, California). Immunosuppressive regimen included cyclosporine.
1982	First permanent artificial heart (Jarvik 7) implanted by Dr. William C. DeVries (University of Utah, Salt Lake City, Utah). The 61-year-old patient survived for 112 days.
1983	First successful long-term single-lung transplant performed by Dr. Joel Cooper (Toronto General Hospital, Toronto, Ontario, Canada) in patient with pulmonary fibrosis. The patient survived 6 years (died of progressive renal failure).
1986	First successful double-lung transplant performed by Dr. Joel Cooper (Toronto General Hospital, Toronto, Ontario, Canada) in patient with emphysema. The patient survived 15 years (died of brain aneurysm).
1990	Introduction of the immunosuppressant FK506 (tacrolimus).

ticularly emphysema and  $\alpha_1$ -antitrypsin deficiency) followed by cystic fibrosis.<sup>10</sup> Other indications include pulmonary fibrosis, sarcoidosis, and primary pulmonary hypertension. Less commonly, lung transplantation has been offered as a viable option for patients with bronchoalveolar carcinoma.<sup>11</sup> The U.S. Organ Procurement and Transplantation Network (OPTN) and the Scientific Registry of Transplant Recipients (SRTR) jointly published an annual report (dating back to 1993) of organ-specific statistics.<sup>12</sup> Recipients are getting older and, as a result, have an increasing incidence of comorbidities. In 1993, patients older than 50 years composed only 43% of registrants, whereas in 2005 this age group composed almost 60% of registrants. Similar to heart transplantation, the major limiting factor in the number of lung transplantations is the availability of donor organs. In 2004, the Transplant/Immunology Network of the American College of Chest Physicians (ACCP) published a survey of practice patterns among North American transplant centers.<sup>13</sup> The number of lung transplantations performed ranged

from 0–87 in the United States, whereas the average number of lung transplants performed annually, in responding centers, was 22. Although patient selection criteria showed a remarkable degree of consistency, there was profound variability in posttransplant management.<sup>13,14</sup> Clearly this represents a “snapshot” in time. However, this survey is the most comprehensive assessment available regarding clinical practice patterns in North America.

The suitability of lung donation is based on a number of criteria (Table 57-2).<sup>15</sup> However, as the waiting list continues to expand (reaching a new high of 3836 registrants as of December 31, 2003), guidelines for donation criteria likely will be revisited. A total of 1080 lung transplants were reported in 2003, representing a 3.7% increase from the previous year. Although patient survival after lung transplantation continues to improve, both 1- and 5-year survival rates remain the lowest (80% and 46%, respectively) compared with all other organ transplants (excluding combined heart–lung). Early mortality rates approach 15%, and pre-

TABLE 57-2.

## Ideal Donor Criteria for Lung Transplantation

Age <55 years
ABO compatibility
No radiographic anomalies
No history of tobacco use
No evidence of pulmonary contusion or other chest trauma
No evidence of aspiration
No evidence of sepsis
Pristine bronchoscopic appearance/ no purulent secretions
<10 <sup>5</sup> organisms on quantitative sputum sample
PaO <sub>2</sub> >300 mm Hg on FiO <sub>2</sub> = 1.0, PEEP 5 cm H <sub>2</sub> O
No prior thoracic surgery
Reprinted and adapted from Orens JB, Boehler A, de Perrot M, et al. A review of lung transplant donor acceptability criteria. <i>J Heart Lung Transplant</i> 2003;22:1183–1200. Copyright Elsevier 2003.
FiO <sub>2</sub> , Fraction of inspired oxygen; PEEP, positive end-expiratory pressure.

dictors of 90-day mortality have been, and continue to be, identified.<sup>16,17</sup>

**Heart Transplant**

An increasing number of patients with heart failure has accompanied improvements in pharmacotherapy and advances in both surgical- and catheter-based management of acute coronary syndromes combined with an ageing population. Among industrialized countries, the incidence and prevalence of heart failure is 0.15% and 1%, respectively.<sup>18</sup> Concomitant with progress in medical management, heart transplantation and circulatory assist devices have become viable alternatives, particularly for patients with advanced heart failure.<sup>19–21</sup>

The number of heart transplants being performed annually in the United States ranges from 2000–2500 (<4500 worldwide). The volume appears to have reached a plateau and is limited primarily by the availability of donors. Of patients who were placed on the wait list in 2004, <25% were alive after waiting 1 year (if not transplanted).<sup>22</sup> The median time to transplant after being placed on the waiting list was between 200 and 300 days. The percentage of patients awaiting transplantation for more than 2 years increased from 23% in 1994 to 49% by 2003.<sup>12</sup> In general, older patients compose a larger number of those listed for



TABLE 57-3.

## Disease-Specific Guidelines for Lung Transplant Eligibility

The following patient populations are considered to be in the transplant window if they meet the listed criteria:

Nonbronchiectatic chronic obstructive lung disease

FEV<sub>1</sub> <25% predicted (without reversibility) and/or

Paco<sub>2</sub> ≥55 mm Hg and/or increasing PAPs with progressive deterioration

Cystic fibrosis and other bronchiectatic diseases

FEV<sub>1</sub> ≤30% predicted or rapid deterioration with FEV<sub>1</sub> >30% predicted

Paco<sub>2</sub> >50 mm Hg; Pao<sub>2</sub> <55 mm Hg on room air

Young female cystic fibrosis patient whose condition deteriorates rapidly

Idiopathic pulmonary fibrosis/systemic disease with pulmonary fibrosis

Symptomatic, progressive disease not improved with steroids or other immunosuppressants

Abnormal pulmonary function

VC <60–70% predicted

DLCO <50–60% predicted

Pulmonary hypertension without congenital heart disease

Symptomatic and progressive despite optimal medical/surgical treatment

CI <2 L/min/m<sup>2</sup>

RAP >15 mm Hg

mPAP >55 mm Hg

Pulmonary hypertension secondary to congenital heart disease

Progressive symptoms with NYHA class III or IV function despite optimal medical management

Data from International guidelines for the selection of lung transplant candidates. The American Society for Transplant Physicians (ASTP)/American Thoracic Society (ATS)/European Respiratory Society (ERS)/International Society for Heart and Lung Transplantation (ISHLT). *Am J Respir Crit Care Med* 1998;158:335–339.

CI, Cardiac index; DLCO, diffusing capacity of carbon monoxide in lung; FEV<sub>1</sub>, forced expiratory volume in 1 second; mPAP, mean pulmonary arterial pressure; NYHA, New York Heart Association; Paco<sub>2</sub>, partial pressure of carbon dioxide in arterial blood; Pao<sub>2</sub>, partial pressure of oxygen in arterial blood; PAP, pulmonary arterial pressure; RAP, right atrial pressure; VC, vital capacity.

heart transplantation. By 2003, 13% of registrants were older than 65 years. The two most common reasons for transplantation are ischemic cardiomyopathy and idiopathic dilated cardiomyopathy, which together compose approximately 90% of cases.<sup>18</sup> The premise of any therapeutic intervention is that survival and quality of life are better than is the natural history of disease. The 1-year mortality of patients with symptomatic congestive heart failure is estimated to be 45%,<sup>23</sup> and the 5-year survival is <30%.<sup>24</sup> In comparison, the 1-year survival after heart transplantation is approximately 85%, the 10-year survival is between 40% and 50%,<sup>25–27</sup> and the 15-year survival has *recently* been reported as 30–40%.<sup>12,28</sup> The survival benefit from heart transplantation is greatest in patients who are at highest risk for dying of heart failure without transplantation.<sup>25,26,29</sup>

## Indications

### Lung Transplantation

In 1998, a consensus statement was released that proposed indications and

contraindications for lung transplant.<sup>30</sup> Disease-specific guidelines could be used by practitioners to classify patients with regard to eligibility (Table 57-3). The diseases included chronic obstructive lung disease, cystic fibrosis, idiopathic pulmonary fibrosis, pulmonary hypertension with and without congenital heart disease, and combined pulmonary/other organ failure (e.g., advanced liver disease with pulmonary hypertension). Since that time, significant changes have been made in our understanding and management of end-stage pulmonary disease, with increasing evidence of improving post-transplant survival rates.<sup>31</sup> In 2005, the United Network for Organ Sharing/Organ Procurement and Transplantation Network Thoracic Organ Transplantation Committee established a revised allocation system for donor lungs. The revised system, which became effective in the summer of 2005, assigns a lung allocation score (0–100) to each potential recipient based on the patient's projected benefit received

TABLE 57-4.

## General Indications for Lung Transplantation

Single-lung transplant

Chronic obstructive pulmonary disease with FEV<sub>1</sub> ≤25% predicted

Pulmonary hypertension (mPAP ≥55 mm Hg)

Connective tissue disorder (sarcoidosis, lymphangiomyomatosis, eosinophilic granulomas)

Pulmonary fibrosis

Interstitial lung disease

Bronchoalveolar carcinoma

Double-lung transplant

Emphysema

Pulmonary hypertension

Cystic fibrosis

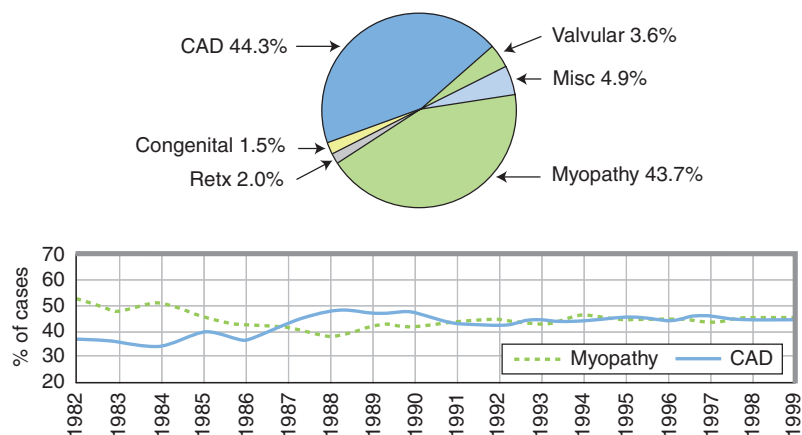
Bronchiectasis

Reprinted and adapted from Rosenberg AL, Rao M, Benedict PE. Anesthetic implications for lung transplantation. *Anesthesiol Clin North Am* 2004;22:767–788. Copyright Elsevier 2004. FEV<sub>1</sub>, Forced expiratory volume in 1 second; mPAP, mean pulmonary arterial pressure.

from transplant, the patient's waiting list urgency, and the predicted 1-year posttransplant survival score (UNOS calculation). Indications for lung transplantation can be divided into those for single-lung transplantation and for double-lung transplantation (Table 57-4).<sup>10</sup> Single-lung transplantation is contraindicated, and bilateral lung transplantation is necessary, in patients in whom the donor lung would be cross-contaminated by the contralateral native lung (e.g., cystic fibrosis, bronchiectasis). Single-lung transplantation has most commonly been used in the treatment of end-stage chronic obstructive pulmonary disease (COPD). Use of single-lung transplantation in patients with primary pulmonary hypertension and Eisenmenger syndrome remains controversial.

### Heart Transplantation

The most common indications for adult cardiac transplantation are ischemic and idiopathic dilated cardiomyopathies (Figure 57-1).<sup>32</sup> The benefit of transplant must outweigh the enhanced quality of life offered by maximal medical therapy without surgery. Patients in whom medical management may achieve similar survival outcomes as with heart transplantation warrant reconsideration for the



**FIGURE 57-1.** Indications for adult heart transplantation. CAD, Coronary artery disease; Misc, miscellaneous; Retx, retransplantation. Reprinted from Hosenpud JD, Bennett LE, Keck BM, et al. The Registry of the International Society for Heart and Lung Transplantation: seventeenth official report—2000. *J Heart Lung Transplant* 2000;19:909-931. Copyright Elsevier 2000.

planned operation.<sup>33,34</sup> Thus, potential candidates must be significantly disabled despite optimal medical therapy.

The most widely used criteria for identifying potential heart transplant candidates are based on peak oxygen consumption ( $\text{VO}_2$ ) and the heart failure survival score (HFSS).<sup>35,36</sup> Peak  $\text{VO}_2 < 14$  cc/min/kg or medium- to high-risk HFSS is believed to be predictive of patients who will sustain a survival benefit with transplantation.<sup>25,37,38</sup> Other important factors that are considered before a patient is listed for cardiac transplantation are pulmonary vascular resistance (PVR), age, and comorbidities. Patients with severe heart failure frequently have elevated PVR as a consequence of chronically elevated left ventricular end-diastolic pressure. The concern with transplanting a heart in such patients is the increased right ventricular afterload, which the donor heart is unaccustomed to generating. There is a linear correlation between PVR and 1- and 5-year mortality.<sup>39</sup> Most centers consider PVR  $> 3$ – $4$  Wood units (on maximal medical therapy) to be a contraindication to cardiac transplantation. Although the recipient's age historically was a common limiting factor, survival rates of selected recipients older than 69 years were found to be similar to the rates of younger patients.<sup>40</sup> Finally, in addition to comorbidities of the recipient that may affect survival, the decision to list a patient for heart transplantation must be based on psychological and social factors. In the end, the decision is individualized and must be made by a designated transplantation team (including, but not limited to, physicians, nurses,

and social workers) along with the patient and his or her family.

## SURGICAL ALTERNATIVES TO TRANSPLANTATION

Transplantation of any organ frequently represents the penultimate rescue therapy. These patients typically, although not always, have undergone numerous attempts at alternate strategies to improve organ function. Both heart and lung transplantation represent a decisive therapy that often follows one or more surgical alternative therapies. This section is not meant to be a comprehensive review of alternate therapies but rather introduces several strategies with which the anesthesiologist should be familiar, as a transplant recipient may have been exposed to one or more of these operations previously.

### Lung

Surgical options, other than transplantation, for treating advanced lung disease are few, and their efficacy is equivocal. The most common option for treating advanced emphysema is lung volume reduction surgery (LVRS). The procedure is often performed as a “bridge” to lung transplantation as a means for patients to survive the estimated 18- to 24-month transplant waiting period.<sup>41</sup> Volume reduction surgery involves excision of as much as one third of the emphysematous lung, thus increasing elastic recoil in the remaining lung. Although no randomized study has compared LVRS with lung transplantation, the latter carries higher perioperative mortality and predisposes the patient to

infection as a result of immunosuppression. LVRS can be performed via median sternotomy or video-assisted thoracoscopic surgery. Patients presenting for lung transplantation status post LVRS should be considered at high risk during thoracic entry, and standard “redo” precautions should be taken. Although continuous intravenous prostacyclin is another alternative to transplantation, many use this therapy as a “bridge” to transplantation. Prostacyclin is a metabolite of arachidonic acid and is a potent vasodilator. Because it usually is administered by long-term continuous intravenous infusion, permanent central venous access is necessary. Significant risks associated with this therapy are central line infection and thrombosis.

### Heart

A number of surgical procedures are available for heart failure patients short of heart transplantation, including reduction ventriculoplasty, transmyocardial laser revascularization, dynamic cardiomyoplasty, and insertion of partial or total heart assist devices. Often one or more of these procedures has been performed on the patient presenting for heart transplantation. Reduction ventriculoplasty (also called the *Batista procedure*) has been used as an alternative to transplantation for patients with dilated cardiomyopathy. By decreasing ventricular volume and excising dyskinetic myocardium, the ejection efficiency in patients with dilated cardiomyopathy is improved and cardiac output is maintained. Transmyocardial laser revascularization is an option in patients with small, diffusely diseased coronary arteries that are not amenable to other interventional therapies. The procedure applies a laser to permeate the myocardium and incite an inflammatory reaction that, over time, promotes angiogenesis and neovascularization in the ischemic region. Heart function tends to deteriorate in the immediate postoperative period secondary to acute myocardial edema. Benefit is more evident months later. Transmyocardial laser revascularization typically is performed via a minithoracotomy. Dynamic cardiomyoplasty involves encasing the heart with muscle, usually the latissimus dorsi, which subsequently is stimulated to contract in synchrony with cardiac systole. Stimuli are generated through an implantable cardiomyostimulator. All of these procedures place

the recipient for heart transplantation at greater risk as a result of adhesions, particularly during redo sternotomy. Type- and cross-matched blood in the operating room before incision is necessary. During any redo sternotomy, the lungs should continue to be ventilated because they “protect” the heart during thoracic entry. That is, if the sternal saw inadvertently slips too far beneath the sternum, mortality is less *likely* if the saw enters the lung rather than the heart.

The basic mechanism underlying all ventricular assist devices (VADs) is similar. Blood is removed proximal to the diseased ventricle. This involves the superior vena cava (SVC) or right atrium for a right VAD and the left atrium or left ventricle for a left VAD. The blood is returned distal to the affected ventricle: the pulmonary artery in a right VAD and the ascending or descending aorta in a left VAD. The design of VADs has improved, allowing patients who are not transplantation candidates to remain indefinitely on the device (so-called “destination therapy”). However, most devices continue to be used as a “bridge” to transplantation, sustaining the function of all other organs until heart transplantation. Heart transplant recipients commonly arrive in the operating room with a VAD that may have been in place for months.

## IMMUNOBIOLOGY OF TRANSPLANTATION

Transplant immunology was borne from an observation by Karl Landsteiner in 1901 that the clumping of donor red blood cells was responsible for manifestations of the transfusion reaction. He went on to formally classify human blood into the A, B, AB, and O groups.<sup>42</sup> Blood group compatibility is a requirement not only for blood transfusion but also for organ transplantation. In the early 1950s, Peter Medawar further advanced the field of transplant immunology by observing the viability of skin grafts on burns.<sup>43</sup> The observation that first-time grafts from donors lasted approximately 10 days, whereas subsequent grafts were rejected immediately suggested the subsequent response was somehow affected by prior exposure. If, however, mouse embryos were inoculated with cells from another strain and then grafted after birth with skin

from that strain, the grafts were not rejected. In 1958, Dausset described the first leukocyte antigen that allowed for tissue matching.<sup>44,45</sup> Human leukocyte antigens (HLAs) are encoded by a group of genes on chromosome 6 known as the human *major histocompatibility complex* (MHC). Because these genes are highly polymorphic (HLA-B has >50 alleles), two unrelated individuals likely will not have the same HLA type. Because HLA mismatch necessarily causes rejection (by antibodies, lymphocytes, or both), immunosuppressive drugs are required to ensure recipient tolerance of the allograft.

Three main types of rejection can occur in clinical transplantation: hyperacute, acute, and chronic. Hyperacute rejection typically occurs within minutes to days and is caused by preformed recipient IgG antibodies reacting against the allograft class I HLA. A profound and immediate decrement in organ function caused by complement activation and antibody deposition leads to vascular destruction. As cross-matching techniques have improved, hyperacute rejection is less commonly seen. The most common form of rejection is acute rejection, usually occurring within 6 months of transplantation. Acute rejection is caused by infiltration of allograft tissue with host T cells and subsequent clonal expansion. As these alloreactive lymphocytes enter the circulation, they react with allograft vascular endothelium (the primary target of the initial stages of acute rejection), leading to eventual tissue destruction. Immunosuppressive drugs are most effective in subjugating this phase of rejection. Chronic rejection is not well understood. It may occur as early as 6–12 months after transplantation but usually occurs much later. It is typified by a slow deterioration in allograft function and is identified histologically by intimal hypertrophy and fibrosis. In heart transplant patients, chronic rejection is manifest by progressive atherosclerosis and coronary artery disease, whereas lung transplant recipients develop bronchiolitis obliterans. Currently there is no standard treatment of chronic rejection. Most heart transplant recipients average one to two episodes of rejection per year. The bulk of these episodes are minor, resolving with corticosteroids or small changes in the immunosuppressive regimen.

## Immunosuppression Regimens

### Safety

The anesthesiologist is frequently asked to prepare and/or administer an immunosuppressive agent intraoperatively. Although proper handling of all medications is always recommended, particular attention should be focused on these drugs. The Occupational Safety and Health Administration (OSHA) through the United States Department of Labor has published a technical manual that includes a section entitled “Controlling Occupational Exposure to Hazardous Drugs.”<sup>46</sup> The realization that many of these drugs are cytotoxic and genotoxic and are potential carcinogens has prompted OSHA to continually revise these recommendations. Some specific recommendations to limit exposure include the following:

1. Clearing air from syringe before injection to avoid aerosolization
2. Careful attention to avoid leakage in syringe, tubing, or stopcock sites
3. Immediate disposal of contaminated materials (syringes, needles, bottles, etc.)
4. Careful handling of excreta of patients, because many drugs are excreted unchanged or are converted to mutagenic metabolites.

Additionally, because many drugs must be reconstituted, particular recommendations to avoid aerosolization include attention when withdrawing a needle from a vial, attention when breaking open an ampule, and limiting the expulsion of air from a drug-filled syringe.

### Drugs

As stated above the preceding list, and as seen in the following Lung and Heart sections, a plethora of immunosuppressive regimens are available. The decision to administer a particular drug frequently is dictated by patient comorbidity, pharmacodynamics, and kinetics of the drug as well as institutional preference. The purpose of this section is not to give a comprehensive review on the pharmacology of immunosuppressant agents but rather to introduce several drugs commonly given by the anesthesiologist.

Before the discovery of cyclosporine in 1976, the most common pharmacologic regimen for immunosuppression



was a combination of azathioprine and corticosteroids. Azathioprine is a derivative of 6-mercaptopurine. Its mechanism of action includes suppression of cell-mediated hypersensitivity and antibody production. Metabolism occurs in the liver and erythrocytes with very little renal accumulation. Because azathioprine inhibits cell proliferation in a nonselective manner, the major toxicity associated with this drug includes neutropenia and thrombocytopenia as a result of profound bone marrow suppression. With the discovery of cyclosporine, immunosuppression without significant bone marrow suppression became possible. Since 1983, when the drug was FDA approved to prevent graft rejection in transplantation, cyclosporine has been limited by its nephrotoxicity and the inability to completely control chronic rejection. The incidence of nephrotoxicity with cyclosporine is 40–70%.<sup>47</sup> Newer classes of drugs have since been developed for use in heart and lung transplantation.

Tacrolimus (FK506) is a macrolide antibiotic that inhibits calcineurin and T-lymphocyte function with greater potency than does cyclosporine.<sup>48</sup> Although the incidence of nephrotoxicity is similar to that of cyclosporine, less arterial hypertension and hyperlipidemia is seen with FK506. Deciding which calcineurin inhibitor to use usually is patient dependent and often institutionally biased.

Mycophenolate mofetil (MMF; CellCept, Roche Pharmaceutical, Nutley, NJ, USA) is a morpholinoethyl ester of mycophenolic acid. It acts as a reversible uncompetitive inhibitor of inosine monophosphate dehydrogenase and inhibits guanine nucleotide synthesis in lymphocytes. A comprehensive review of its proposed mechanism of action is available elsewhere.<sup>49</sup> Almost all studies in heart and lung transplantation have substituted MMF with azathioprine as a triple-drug regimen and have shown better graft survival and fewer episodes of rejection.<sup>50</sup>

Almost every transplant recipient receives a corticosteroid. Although methylprednisolone typically is started perioperatively, the patient can be maintained on oral prednisone. Specific immunosuppressive regimens for heart and lung transplantation are given in Table 57–5.

### Lung

Acute rejection after lung transplantation occurs with greater frequency

compared with transplantation of other solid organs, particularly during the first 6 months after surgery. Additionally, there is a greater risk for chronic transplant dysfunction progressing to allograft loss. Although bronchiolitis obliterans syndrome is the major cause of morbidity and mortality among long-term survivors after lung transplantation, acute allograft rejection is a major risk factor for the development of bronchiolitis obliterans syndrome. Thus, timely administration of immunosuppressants is believed to be of key importance in lung transplantation. Immunosuppressive agents frequently are given to lung transplant recipients immediately before or during surgery. The most common agents administered are steroids, cyclosporine A, azathioprine, and tacrolimus. A typical regimen may include cyclosporine (2.5–5 mg/kg PO), azathioprine (2 mg/kg IV), or MMF (1000 mg IV) administered preoperatively. Methylprednisolone usually is administered just before lung reperfusion (500 mg to 1 gm IV; Table 57–5). Future directions in lung transplant immunosuppression include inhaled delivery of cyclosporine.<sup>51</sup> A case-controlled trial comparing inhaled and oral cyclosporine in lung transplant recipients with bronchiolitis obliterans showed improved survival in the inhalational group.<sup>52</sup> Although a subsequent randomized, double-blinded, placebo-controlled trial confirmed survival advantage with inhaled cyclosporine, rates of acute rejection were similar between the two groups.<sup>53</sup> Further studies are ongoing.

### Heart

Most immunosuppressive regimens for heart transplantation currently include a calcineurin inhibitor, a corticosteroid, and some adjunct (Table 57–5). Usually a postoperative triple-drug regimen of cyclosporine or tacrolimus (FK506), azathioprine or MMF, and prednisone is typical. With a combination of these three agents, acute rejection has been dramatically reduced.<sup>54</sup> Evidence suggests that the combination of tacrolimus and MMF yields superior outcomes in heart transplant recipients.<sup>55</sup> Newer agents used in some institutions include sirolimus (rapamycin) and monoclonal antibody interleukin-2 receptor antagonists such as dacliximab (daclizumab) and basiliximab. Cardiac allograft vasculopathy remains a leading cause of morbidity and mortality among heart transplant

**TABLE 57–5.**

### Example of Typical Immunosuppressive Regimens for Heart and Lung Transplantation

<b>Heart</b>
<b>Early</b>
Mycophenolate mofetil 3000 mg/d PO
Prednisone 1 mg/kg/d PO tapered to 0.4 mg/kg/d
<b>Late</b>
Mycophenolate mofetil 3000 mg/d PO
Prednisone 0.1–0.2 mg/kg/d PO
<b>Lung</b>
<b>Early</b>
Cyclosporine 5–10 mg/kg/d PO (or 0.01–0.1 mg/kg/h IV)
Methylprednisolone 500 mg IV after reperfusion followed by 125 mg IV every 8 hours for 3 doses
Prednisone 0.6 mg/kg/d PO starting on day 15
Azathioprine 2 mg/kg/d PO
Rabbit antithymocyte globulin (RATG) 2.5 mg/kg/d IV on days 1, 2, 3, 5, and 7
<b>Late</b>
Cyclosporine 3–6 mg/kg/d PO
Prednisone 0.1–0.2 mg/kg/d PO
Azathioprine 1–2 mg/kg/d PO

Adapted from references 32 and 120.

recipients.<sup>56,57</sup> Although this vasculopathy is multifactorial and has been shown to arise from both immune- and nonimmune-related mechanisms, immunosuppressants have been implicated as a contributing factor.<sup>56,58,59</sup> For example, calcineurin inhibitors, such as cyclosporine and tacrolimus, in addition to having profound nephrotoxic effects, can alter vascular remodeling, contributing to graft vasculopathy. However, several prospective studies have confirmed that both drugs have similar efficacy in preventing acute rejection in heart transplant recipients.<sup>60–63</sup> Thus, a future challenge in heart transplant immunosuppressive regimens remains the prevention of cardiac allograft vasculopathy.

## DONOR SELECTION AND ORGAN PROCUREMENT

### Lung

Most potential multiorgan donors are not suitable candidates for donating



lungs because the vital organs are common targets of end-of-life events. Chest trauma, pulmonary edema, aspiration, pulmonary infection, and pulmonary embolism often preclude the use of lungs for donation. A smoking history does not preclude the use of donor lungs for transplantation. Oxygen challenge tests are performed on the donor with administration of 100% oxygen with 5 cm H<sub>2</sub>O positive end-expiratory pressure (PEEP). An acceptable oxygen response is an arterial partial pressure of oxygen >300 mm Hg. Cytomegalovirus (CMV) serology of the donor affects the selection of the recipient. A CMV-negative recipient should receive CMV-negative donor lungs. However, a CMV-positive recipient can receive lungs from a CMV-negative or CMV-positive donor.

Once a donor has been identified, all possible recipients for organ transplantation are evaluated for ABO compatibility and size matching. In recipients with COPD, disparity in size between donor and recipient lungs is less important. Patients with COPD tend to have large barrel chests that can accommodate lungs that ordinarily come from larger donors. Donor lungs increase in size when implanted and partially fill an enlarged pleural space in patients with COPD. Recipients with restrictive lung disease tend to have a normal or decreased thoracic size, and lung sizing is paramount. Too large a lung may preclude its implantation in a recipient. During procurement, the donor lungs are flushed in situ, and the harvest is completed. Bilateral lungs are excised in their entirety and separated from the native airway at the trachea. Single-lung harvests require separation with the main bronchus, pulmonary artery, and cuff of the left atrium. Total ischemic time is defined from excision to reimplantation and reperfusion and should be kept at a minimum (ideally <6 hours).<sup>64,65</sup>

Before 1984, lung procurement in close proximity to the recipient was deemed necessary because of unrefined preservation techniques.<sup>66</sup> Since that time, however, improved understanding of ischemia-reperfusion injury has led to the development of novel solutions that have reduced the incidence of primary graft dysfunction after lung transplantation. Additionally, newer preservation protocols now allow procurement at centers as far away as 6–8 hours from the recipient.

Procurement of any solid organ involves confirmation of donor eligibility,

dissection, and isolation of the specific organ, followed by preservation and transport. The sole principle of preservation is to minimize both ischemia and reperfusion injury to the allograft.<sup>67</sup> Confirmation of donor eligibility includes review of pertinent consents, history, radiographs, laboratory values (including arterial blood gas), blood type, and bronchoscopy. Methods for minimizing injury include donor pretreatment, organ preservation, and recipient treatments. Although preservation techniques and solutions differ among transplantation centers, one commonality is the use of deliberate hypothermia, which is used universally during explantation, storage, and reimplantation. Hypothermia can reduce the tissue's metabolic demand by 99%. Before explantation, lungs are flushed with solution at 32–50° F (0–10° C) and stored at a similar temperature. The lung is flushed most commonly with a low-potassium dextran (e.g., Perfadex, Vitrolife AB, Gothenburg, Germany) or University of Wisconsin solution<sup>13</sup> at the time of harvest and kept cold during transport to the recipient site and implantation and until reperfusion. During implantation, the lungs are covered with gauze soaked in ice saline slush in an attempt to maintain a cold environment.

Potential lung transplant recipients require careful cardiovascular evaluation. Right-heart function is assessed to determine the ability of the recipient's right ventricle to tolerate acute increases in PVR associated with pulmonary artery clamping and pneumonectomy. Standard assessment modalities include echocardiography and right-heart catheterization. Left-heart catheterization and coronary artery arteriography are often used in older patients to detect coronary artery disease and left ventricular dysfunction. Intracardiac shunts, such as a patent foramen ovale, are detected preoperatively because they predispose to paradoxical embolization in patients with increased right-sided pressures.

Unlike many other transplanted organs, lungs and hearts must be functional immediately on reperfusion. Improvement in both donor management and procurement strategies has increased the likelihood of viability.

## Heart

Similar to lung transplantation, the recipient waiting list for heart transplantation continues to grow, and donor organ shortage persists. As a result, the criteria

TABLE 57–6.

### Donor Criteria for Heart Transplantation

- Age ≤60 years
- No evidence of prolonged shock causing
  - SBP <90 mm Hg or MAP <60 mm Hg
  - Profound inotropic support (>10 µg/kg/min dopamine)
- No evidence of prolonged hypoxemia
- Normal electrocardiogram and/or echocardiogram
- Preserved right ventricular/left ventricular function
- No intrinsic myocardial disease
- No history of severe chest trauma
- No evidence of extracerebral malignancy

Adapted from Harringer W, Haverich A. Heart and heart-lung transplantation: standards and improvements. *World J Surg* 2002;26:218–225. With kind permission of Springer Science and Business Media. MAP, Mean arterial pressure; SBP, systolic blood pressure.

for heart donation are broad and continue to be liberalized (Table 57–6).<sup>68,69</sup> Absolute contraindications continue to include most malignancies and positive serologies for human immunodeficiency virus (HIV) and hepatitis B and C. Although low-dose vasopressor requirements are commonplace in the donor population, high doses of catecholamines may downregulate β receptors on cardiac myocytes and can cause intramyocardial hemorrhage and necrosis. Echocardiography may provide valuable information but frequently is unavailable at all times in many hospitals. Thus, transplant surgeons frequently rely on direct inspection and palpation to assess for significant coronary artery disease, contractility, and/or myocardial hematoma suggestive of blunt thoracic injury. Height and weight of the donor preferably should match those of the recipient; however, differences of up to 20% are acceptable.

Procurement of intrathoracic organs begins with median sternotomy and pericardial incision. The procurement team (of which there may be more than one in the case of multiple donations) inspects and manually palpates the heart and coronary arteries to rule out blunt injury or significant cardiac disease. After administration of 30,000 U of heparin intravenously, the superior and inferior vena cavae and azygos

vein are clamped and divided. The aortic cross-clamp is placed proximal to the takeoff of the innominate artery, and the heart is arrested with an infusion of 500 mL cold cardioplegic solution injected proximal to the cross clamp. The heart is cooled with topical ice slush, and the remaining vessels (pulmonary veins and artery, ascending aorta) are transected. The allograft is placed in a sterile container and transported expeditiously to the recipient hospital. Allowable cardiac ischemic time is 4–6 hours. Most transplants proceed with transport of the heart after a single flush of cardioplegic solution followed by hypothermic storage. Commonly used solutions include University of Wisconsin, Euro-Collins, St. Thomas, and HTK.<sup>70,71</sup> The optimal transport temperature likely is between 39° F (4° C) and 50° F (10° C).<sup>72</sup>

## PERIOPERATIVE CARE

### Lung Transplantation

#### Preoperative Assessment

Candidates for allograft lung transplantation includes patients with severe pulmonary vascular or parenchymal disease resulting in debilitating respiratory failure. Allocation of scarce resources (e.g., donor lungs) to high-risk patients with serious comorbidities often precludes the eligibility of this patient population because of the high risk for death. However, lung transplantation in the less sick does not appear to significantly increase life span. In the end-stage emphysematous population, lung transplantation does not improve survival compared with aggressive pulmonary rehabilitation.<sup>73</sup> More recently, organ procurement organizations have liberalized the selection criteria for lung transplants to include patients with severe comorbidities and systemic disorders such as renal failure. These patients would have a very high mortality rate if they did not receive the benefit of a new lung. The outcome of this new allocation strategy remains to be determined, but these high-risk patients are at increased risk of perioperative mortality.

An efficient but comprehensive evaluation often is performed immediately before surgery. Many of these patients are on a waiting list for months, and their medical conditions may change rapidly during this time. Lung transplants are emergencies, and

recipients should be considered at increased risk for aspiration. Full stomach precautions are warranted.

#### Operating Room Preparation

The operating room is set up in typical fashion for cardiothoracic surgery. This includes fiberoptic bronchoscope equipment, cardiopulmonary bypass machine, different-sized double lumen tracheal tubes, and medications. A full complement of PEEP valves and the ability to provide continuous positive airway pressure may prove useful. On occasion, extremely ill patients require a “Surgical Intensive Care Unit (SICU) ventilator” to maintain adequate ventilation and oxygenation after induction of anesthesia. Prepared medications include heparin, diuretics, antiarrhythmics, inotropic and vasoactive agents, induction agents, muscle relaxants, and sedative-hypnotics. Immunosuppressive medications should be discussed with the transplant coordinator. Antibiotic administration usually is based upon institutional protocol, although often it must be tailored to culture results from the donor and the recipient. This is especially true in the setting of chronic infections, such as patients with cystic fibrosis and bronchiectasis.

All lung transplant operations are emergency procedures and, for some yet-undetermined reason, typically occur during off hours. The cardiothoracic anesthesiologist usually is notified of the impending lung transplant procedure by the transplant coordinator and/or attending surgeon. This initial communication establishes the identification of the donor and the donor blood type and includes a brief synopsis of the primary and secondary diagnoses. In addition, this communication identifies the location and condition of the donor, including associated medical disorders, and anticipated cross-clamp time and arrival time of the donor organ to the transplanting center. From this information, the operating room team establishes the time the recipient is brought to the operating room. Often, the patient's arrival to the operating room is the first (and only) encounter with the anesthesiologist. In certain centers, a preoperative evaluation clinic provides a mechanism for the assessment and evaluation of lung transplant recipient candidates as part of the pretransplant evaluation. However, patients may wait for a lung transplant for many months, and conditions may change rapidly as patients are waiting for a transplant organ to become

available. The lung transplant recipient is brought to the operating room in sufficient time to perform a comprehensive preoperative assessment, with acquisition of informed consent, placement of thoracic epidural, and invasive hemodynamic monitoring. These activities should be completed in advance of the anticipated time for induction of anesthesia and beginning of surgery. Anesthesia equipment and supplies are similar to those required for thoracic and cardiac surgery. Mechanisms for maintaining normothermia in patients undergoing lung transplantation without cardiopulmonary bypass are important adjuncts to intraoperative care. Options include fluid warmers, heated operating room table mattresses, warmed and humidified gases, increased room temperature, and body surface heating devices.

The operating room medications that should be readily available include antiarrhythmics, inotropic agents, vasodilators, and vasoconstrictors. Inhaled pulmonary vasodilators, such as nitric oxide and prostacyclin, typically are available via operating room pharmacy systems.

#### Patient Arrival

The patient is greeted by the attending anesthesiologist immediately on arrival. A high level of anxiety and anticipation is to be expected from patients undergoing lung transplantation. These patients are afflicted with a life-threatening disorder and typically have a good understanding of the severity of their illness and the magnitude of the operative procedure for which they are being prepared to undergo. The anesthesiologist informs the patient of the conduct of the planned anesthetic and associated risks and obtains consent for anesthesia and related procedures. The exchange of information between the anesthesiologist and the patient is designed to inform the patient of the upcoming events and risks without producing harmful levels of anxiety and fear. The patient's preoperative laboratory workup is reviewed before his or her arrival, typically through electronic computerized databases. The patient is questioned regarding changes in physical condition since his or her last evaluation.

#### Preinduction Activity

The patient is brought into the operating room, and routine monitors are applied once the patient is on the operating

room table. Large-bore venous access is achieved, and, if indicated, an epidural catheter is inserted. Placement of an intravenous catheter in the antecubital fossa is discouraged because many patients are positioned in a manner that may compromise patency of the catheter if the elbow is flexed.

Postoperative analgesia is planned before induction of anesthesia. Thoracic epidural catheters are routinely inserted for single or bilateral sequential single-lung transplants that do not require cardiopulmonary bypass. Placement of an epidural catheter for administration of local anesthetics and/or narcotics provides effective postoperative analgesia and can be used intraoperatively to decrease the anesthetic requirement.<sup>74</sup> A common analgesic regimen includes low-concentration local anesthetics and narcotics administered intraoperatively and continued into the postoperative course. Thoracic epidural catheters typically are inserted for single or bilateral sequential single-lung transplantations that do not require cardiopulmonary bypass. In patients with significant pulmonary hypertension or other indications for use of cardiopulmonary bypass, the benefit of placing an epidural catheter in a patient who is anticoagulated is balanced against a risk of epidural hematoma.<sup>75–79</sup> The data supporting this contraindication are sparse, and this clinical judgment is based more on intuition and clinical impression rather than on evidence.<sup>80</sup> In many centers, if placement of an epidural needle produces a “bloody tap,” surgery is postponed if anticoagulation is anticipated. Although this practice is acceptable for most operations, lung transplantation cancellation may result in loss of the donor organ. In addition, the recipient may not have another opportunity to receive a transplant.

Strict aseptic techniques are used throughout the surgical and anesthetic care of the patient because the patient receives large doses of immunosuppressants and is at very high risk for postoperative infections. Before insertion of intravascular catheters, the skin is prepared with either a chlorhexidine- or an iodine-based solution that provides lasting antimicrobial effects.

The administration of anxiolytics is done judiciously and with caution. Low doses of sedative-hypnotics or narcotics could render a patient with end-stage lung disease unstable because

these medications may significantly blunt the patient's respiratory drive. Antisialagogue administration is helpful in patients with increased secretions. Care must be taken to avoid tachycardia with the administration of vagolytic agents. Patients with primary pulmonary hypertension may have an exacerbation and incremental increase in PVR caused by anxiety and agitation. Sedation with minimal respiratory depression is the goal in this cohort of patients. All sedated patients receive supplemental oxygen in addition to standard monitoring. All lung transplant patients receive a central venous catheter, although a pulmonary artery catheter is not absolutely indicated. A radial artery catheter is inserted for continuous measurement of blood pressure and access to arterial sampling of blood for laboratory testing.

A central venous catheter usually is inserted before induction of general anesthesia. The pertinent information deemed from the pulmonary artery catheter includes assessment of pulmonary hypertension and an estimate of the risk of cross-clamping the right or left pulmonary artery. Induction of anesthesia can proceed safely without the information provided by a central venous or pulmonary artery catheter. However, the urgency of moving forward with the surgical procedure once the donor organ has been deemed suitable often precludes placement of the catheter after this notification. Typically, aortic cross-clamping of the donor coincides with induction of general anesthesia in the recipient. This coordinated event across centers is intended to achieve arrival of the donor organ at the recipient's operating room at the time when the recipient has been prepared for receiving the new organ. Delay in the implantation of the transplanted organ leads to increased organ ischemia and may increase the risk for early postoperative graft failure.<sup>81,82</sup>

Confirmation of the laterality of the operation is critical in the early moments of the interaction between anesthesiologist and patient. The laterality is confirmed through repeated, redundant mechanisms set in place at each transplantation center. Typically, the right, left, or midline chest of the recipient undergoing a single-lung transplant is marked soon after arrival of the recipient to the operating room. Confirmation of the proposed surgery

and laterality by the patient, operating room nurse, anesthesiologist, transplant coordinator, and surgeon is vital. Patients for planned double-lung transplant (e.g., no laterality) also have the site of their incision marked. The patient's blood type is confirmed with data from the blood bank and posted in the operating room.

Antibiotics are administered according to institutional protocol and known organismal sensitivities soon after intravenous access is attained. Administration of vancomycin should be done over 30–60 minutes and administered within 120 minutes before incision to attain effective soft-tissue drug concentration levels.<sup>83</sup> Administration of immunosuppressants typically is delayed until the time when full commitment to proceed with the lung transplant has been made.

In the early management of lung transplant anesthesia and surgery, a “hurry-up-and-wait” approach is not uncommon. Typically, patients arrive to the operating room 90 minutes before the anticipated cross-clamp time in the donor and hence anticipated incision time in the recipient. However, delays at both donor and recipient sites are common. Delays at the donor site often are related to coordinating various transplant teams arriving from different institutions. The harvest of various organs for multiple institutions often leads to unanticipated delays resulting in the recipient waiting with anticipation in an otherwise quiet operating room. During this time of waiting and anticipation, low doses of sedatives, as well as warm blankets and comfort measures, are appropriate. Information regarding the source of the donor organs should not be shared with the recipient.

### **Anesthesia Induction and Maintenance**

The commitment to proceed with surgery is intimately linked with the functional status of the donor organ. Deterioration in pulmonary function occurring at the donor site that precludes use of the lungs for transplantation is not uncommon. The harvest team reviews the laboratory data, including arterial blood gas measurements, chest radiographs, and visual inspection of the lungs through bronchoscopy and direct inspection. Oxygen challenge testing typically is undertaken in the donor to calculate

alveolar–arterial oxygen gradients. Progressive increases in alveolar–arterial oxygen differences are a common reason for abandoning the donor lungs as a transplant organ. Other causes include pneumonia, infiltrate on radiograph, contusion, edema, and injury during harvest.<sup>84</sup> Lack of recipient is an uncommon cause for not using a donor organ.<sup>85</sup> If the donor organ is considered unsuitable, the recipient operating room is immediately notified, and the planned lung transplantation is canceled. Unfortunately, the cancellation of lung transplants occurs all too often, and potential recipients may become disappointed, discouraged, or die of their disease before being offered another opportunity for a transplant. The case provided by the anesthesiologist does not end when the procedure is canceled. The invasive monitoring is removed from the patient, taking care that sites of insertion are clean and without hematoma. The cancellation of a lung transplant procedure challenges many institutions as to appropriate accommodations for the patient. Typically, these patients have traveled long distances to the operating hospital. They have end-stage lung disease, have received sedatives and antibiotics, and have had intravenous, intraarterial, and central venous catheters inserted. Many patients have received a thoracic epidural for postoperative analgesia. *Canceled lung transplant procedures should not result in the immediate discharge of patients to home even if they were admitted from home.* Instead, these patients are admitted to a postanesthesia care unit, where they are subject to the same discharge criteria as patients who have undergone surgery. The lung failure medical team is notified of the patient's condition and coordinates the patient's admission to the hospital, if necessary, or discharge to home.

If the donor lungs are deemed acceptable by the harvest team, the message usually arrives directly in the operating room: "The donor lungs are acceptable. We anticipate cross-clamp in [X] minutes and arrival time at recipient hospital in [Y] minutes." The mode of transportation and anticipated arrival time of the harvest team are critical to the timing of induction of general anesthesia. Ideally, the donor lungs arrive at the operating room with the chest open and native lungs excised or in the process of being excised. Minimizing ischemic time of

the donor lungs is crucial because postoperative graft dysfunction appears to be related to the duration of organ ischemia.<sup>86</sup> Delays in induction and operation contribute to ischemic time and may lead to poor outcome.

A common trigger for induction of anesthesia in the recipient is cross-clamp in the donor. Induction of general anesthesia must always assume the patient is at increased risk for aspiration because he is likely to have eaten in the previous hours. Mode of induction is dictated by the underlying disease process. Patients with severe COPD poorly tolerate positive-pressure ventilation. Air trapping and auto-PEEP are common, often producing circulatory instability. A severely decreased inspiratory:expiratory ratio with permissive hypercapnia is commonly necessary to maintain hemodynamic stability.

Patients are preoxygenated and denitrogenated with 100% oxygen applied by face mask, followed by intravenous induction of general anesthesia with application of cricoid pressure. Intravenous induction agents may include sodium thiopental, propofol, etomidate, and/or benzodiazepines. Narcotics are added for analgesic supplementation even if an epidural is inserted. Nondepolarizing muscle relaxants are administered to facilitate laryngoscopy and tracheal intubation. The administration of anesthetics, analgesics, and muscle relaxants should account for planned immediate postoperative extubation. Isolated lung ventilation during lung transplantation is vital to performing the operation without cardiopulmonary bypass. Techniques include the use of double-lumen endotracheal tubes or bronchial blockers. Procedures anticipated to be done using cardiopulmonary bypass may still require single-lung isolation for pneumonectomy and postcardiopulmonary bypass repair. On occasion, only one of the two donor lungs is implanted using cardiopulmonary bypass.

The trachea is intubated using an appropriately sized left-sided double-lumen endotracheal tube. Standard procedure dictates the insertion of a left-sided double-lumen tube in all patients having lung transplantation because of the variability of the position of the right upper lobe orifice and alignment of the Murphy eye of a right-sided double-lumen tube. Bronchial blockers can be used for single-

lung isolation during lung transplantation, but they have the disadvantage of being more prone to dislodgement and are not as reliable for preventing contamination of the trachea and contralateral lung. Bronchial blockers do not permit selective suctioning. Bronchial blockers of the right lung do not reliably isolate the right upper lobe. Positioning of the double-lumen tube is confirmed using bronchoscopy and reconfirmed once the patient has been moved from the supine to the operating position.

Initiation of single-lung ventilation is associated with increased peak airway pressure and may produce rupture of bulla and cause pneumothorax or air trapping resulting in "pulmonary tamponade." To mitigate against the sudden increase in airway pressures, the initial set tidal volume is decreased when instituting single-lung ventilation with a compensatory increase in respiratory rate in an attempt to maintain adequate minute ventilation. However, the relationships among tidal volumes, peak and mean airway pressures, and volume of air trapping and auto-PEEP are not linear. In many patients, only a nominal reduction in tidal volume is necessary. Persistent pulmonary blood flow through the nonventilated lung increases shunt fraction and may produce hypoxemia. Standard measures for treating hypoxia during single-lung ventilation include use of 100% oxygen, application of PEEP to the dependent lung, and use of conventional critical care ventilators that permit multiple ventilator modes (e.g., pressure control ventilation, alternate ramp settings, wide variety of inspiratory:expiratory ratios). On occasion, circulatory deterioration during one-lung ventilation may require partial cardiopulmonary bypass.

Anesthetic maintenance is achieved through the administration of oxygen and/or air mixed with a volatile anesthetic (e.g., isoflurane, sevoflurane, desflurane). Inhalation anesthetics may be contraindicated when alternate modalities of ventilation such as a jet ventilator, are used. Decreasing inspired oxygen concentrations to decrease the risk of oxygen toxicity and reperfusion injury in the newly transplanted lung is controversial.<sup>87</sup> Epidural analgesia is often used to supplement intraoperative anesthesia, although epidural administration of dilute local anesthetics



may produce significant sympatholysis and hypotension.

Patients undergoing lung transplantation have parenchymal, airway, or vascular disease. Patients with pulmonary vascular disease (primary pulmonary hypertension) may have pulmonary arterial pressures equal to or exceeding systemic arterial pressures. The anesthetic management of these patients is aimed at minimizing further increases in PVR as the patient is transitioned from the awake spontaneously breathing condition to the anesthetized, paralyzed, mechanically ventilated condition. Inhaled pulmonary vasodilators may decrease PVR to some degree. Typically, these patients do not tolerate right or left pulmonary artery clamping for pneumonectomy without the use of cardiopulmonary bypass. Inhaled prostacyclin or nitric oxide, intravenous prostaglandin E<sub>1</sub>, hyperventilation, 100% oxygen, and mild hypovolemia may contribute to decreasing pulmonary arterial pressures in anticipation of pulmonary artery clamping. Poor tolerance of right or left pulmonary artery clamping in the setting of severe pulmonary hypertension is manifest by severe systemic hypotension, increasing pulmonary hypertension, increased central venous pressure, and heart failure. If this condition persists, the pneumonectomy is delayed, the cross-clamp is removed, and the patient is anticoagulated and prepared for cardiopulmonary bypass. A cardiopulmonary bypass machine and perfusionist should be on standby for most lung transplant cases.

Patients with nonvascular lung disease have either parenchymal disease (pulmonary fibrosis, sarcoidosis) or airway disease (COPD,  $\alpha_1$ -antitrypsin deficiency). COPD typically is characterized by normal or mildly elevated pulmonary arterial pressures. COPD patients usually tolerate clamping of one of the pulmonary arteries and pneumonectomy without the use of cardiopulmonary bypass.<sup>88</sup>

Intraoperative hemodynamic instability is not uncommon during lung transplant surgery. The loss of autonomic tone with induction of general anesthesia may be exaggerated in patients with end-stage lung disease in the setting of relative hypovolemia. Strategies for managing hypotension rely on information gained from central venous catheters (central venous pressure, pulmonary arterial pressure,

and cardiac output). These strategies may include judicious expansion of intravascular volume and the administration of  $\alpha$ -adrenergic or  $\beta$ -adrenergic agonists.

Pneumonectomy is performed on confirmation of arrival of the donor lung. Appropriate sizing of the donor organ with the recipient is crucial, especially in patients with restrictive pulmonary disorders who often have a small thoracic cavity relative to total body mass. Patients with COPD typically have large, hyperinflated chest cavities that can accommodate donor lungs without difficulty.

During the pneumonectomy, the donor lung is prepared by a second surgeon at a separate operating table. Aggressive attempts are made to keep the donor organ cold before reperfusion. Completion of the pneumonectomy by clamping the pulmonary artery eliminates the source of venous admixture and improves oxygenation and ventilation. However, clamping of the pulmonary artery also produces a sudden increase in right ventricular afterload and increases the risk for right ventricular failure. The acute increase in pulmonary arterial pressure may cause acute right ventricular dilation and tricuspid regurgitation. Alterations in right ventricular geometry affect the contractility of the right ventricle and the ventricular septum, thus affecting left ventricular contractility. Inotropic agents may increase right (and left) ventricular contractility. Pulmonary vasodilators are administered in an attempt to decrease right ventricular afterload. Intravenous nitroglycerin, nitroprusside, and prostaglandin E<sub>1</sub> may produce systemic hypotension. Differential infusion of vasoconstrictive agents into the left side of the heart and vasodilating agents into the right side of the heart has been suggested.<sup>89,90</sup> Inhaled nitric oxide or inhaled prostacyclin may have a similar role in decreasing PVR and allowing the right ventricle to tolerate pulmonary artery clamping with minimal systemic effects.<sup>91</sup> Monitoring with transthoracic echocardiography provides continuous qualitative assessment of right ventricular function, although this modality is not standard in lung transplant surgery.

The donor lung is placed into the void created by the pneumonectomy, and the first anastomosis usually is donor bronchus to native bronchus. The com-

petency of this anastomosis is assessed with the application of continuous positive airway pressure with the anastomosis submerged in saline. The surgeon inspects for air leaks and performs repairs to the anastomosis if necessary. Once the bronchial anastomosis has been completed, the surgeon performs the anastomosis between donor and recipient pulmonary arteries and pulmonary veins. The latter usually are included in a cuff of left atrium. As the pulmonary transplant is nearing completion, the clamps are gradually released to produce back-bleeding in an attempt to remove any residual air or debris from the left atrium and pulmonary vascular bed. Restoring circulation to the transplanted nonventilated lung results in shunting and potentially significant hypoxia. In addition, the acute blood loss associated with back-bleeding and the flushing out of the preservative solution and its metabolites into the systemic circulation may produce hypotension. Gradual unclamping and administration of intravenous fluids blunt the hypotensive effect. If anastomosis of the bronchus precedes revascularization and the lung is ventilated before reperfusion, the risk of hypoxemia is reduced. Ventilation of the reperfused allograft should be performed with oxygen concentrations sufficient to adequately oxygenate. Evidence is accruing that high oxygen levels in the early reperfusion period may be detrimental to the allograft<sup>92,93</sup>; thus, many transplant centers attempt to oxygenate with  $\text{FiO}_2 \leq 50\%$ .

Corticosteroids typically are administered before the new lung is reperfused. Bleeding during lung transplantation surgery can be decreased in patients who have undergone prior operations by selecting an alternate site of surgery (e.g., sternotomy instead of thoracotomy).<sup>94-96</sup>

Patients for single-lung transplantation for end-stage lung disease typically have either chronic idiopathic pulmonary fibrosis or emphysema. Patients with end-stage emphysema pose a significant added challenge if they undergo single-lung transplantation. Posttransplant, hyperinflation and hyperventilation of the native emphysematous lung often produce severe ventilation-perfusion mismatch and compression of the newly transplanted lung. Avoidance of positive-pressure ventilation after single-lung transplantation in patients with

preexisting emphysema appears to decrease this risk. The actual differences in outcome comparing single-lung with double-lung transplantation in patients with end-stage emphysema that are due to differences in ventilation-perfusion matching remain equivocal.<sup>95,97,98</sup>

The benefit of single-lung transplantation in patients with pulmonary hypertension and Eisenmenger syndrome remains controversial.<sup>31</sup> These procedures typically require the use of cardiopulmonary bypass to prevent acute right ventricular failure at the time of pulmonary artery clamping. Single-lung transplantation in this patient population may produce a functional pneumectomy for the remaining native lung. Although both lungs are well ventilated posttransplant, blood flow is severely diverted to the transplanted lung from the native (high PVR) lung, with increasing risk of pulmonary infarction in the native lung. Thus, it has been suggested that combined heart-lung transplantation might be best in this population.<sup>99</sup>

Bilateral and bilateral sequential single-lung transplantations are performed in patients with infection in one or both lungs or in patients with severe pulmonary hypertension. Historically, bilateral lung transplantation was performed using an en bloc procedure with a tracheal anastomosis and cardiopulmonary bypass. Disadvantages include the need for systemic anticoagulation, increased use of blood products, use of cardiac arrest, and increased risk of ischemia at the site of tracheal anastomosis. The advent of bilateral lung transplantation performed as sequential single-lung transplantation using bronchial anastomoses averted most of these disadvantages.<sup>100,101</sup> Bilateral sequential single-lung transplantation has a number of advantages compared with en bloc double-lung transplantation. Single-lung transplantation is technically easier, and cardiopulmonary bypass is not necessary in most patients; thus, ischemic arrest of the heart is not required. The en bloc transplantation of both lungs is performed through a median sternotomy and requires an abdominal laparotomy for access to the omental flap. In addition, double bronchial anastomoses appear to result in fewer ischemic complications compared with the single anastomosis of the trachea that is required in the en bloc technique.

The surgical approach for sequential bilateral lung transplantation is either through sequential right and left thoracotomies or through a median sternotomy. The large transverse thoracosternotomy that extends from axillary line to axillary line producing the classic “clamshell” or “chevron” incision has fallen out of favor because of its effects on postoperative respiratory function. Bilateral sequential single-lung transplantations can be performed through a muscle-sparing thoracotomy. The native lung with the more severe disease (poorer function) is transplanted first. After the first new lung is implanted, ventilation is switched to the newly transplanted lung, and the second lung is excised and transplanted. In patients with severe obstructive disease, the contralateral chest cavity is not open during the first single-lung transplant because the lung becomes severely hyperinflated when not confined to the pleural cavity. The resulting air trapping can create significant ventilatory and hemodynamic derangements.

In patients with primary pulmonary hypertension, lung disease may have been the primary disease process, with the patient having relatively normal underlying heart function. However, chronic pulmonary hypertension leads to progressive right ventricular hypertrophy and heart failure. Often, lung transplantation results in remodeling of the right ventricle, obviating the need for heart transplantation.<sup>102</sup>

### Postoperative Management

After completion of surgery while the patient is still in the operating room, either the patient is awakened from general anesthesia and extubated, or the double-lumen endotracheal tube is exchanged with a single-lumen endotracheal tube. In patients having lung transplantation with a single-lumen tracheal tube and bronchial blocker, only removal of the bronchial blocker is necessary because the existing tracheal tube suffices as the conduit supporting mechanical ventilation in the postoperative setting. Caution should be taken to ensure that the tracheal tube has an internal diameter of at least 8 mm to facilitate suctioning and bronchoscopy. The concentration of oxygen is decreased after surgery to avoid oxygen toxicity with the goal of maintaining arterial oxygen tension of approximately 100 mm Hg.<sup>103</sup> Problems of postoperative ventilation-perfusion mismatch,

shunting, and increased dead space are more pronounced in patients undergoing single-lung transplantation compared with bilateral lung transplantation. In patients who are not eligible for extubation at the completion of surgery or soon after arrival to the intensive care unit, a ventilator weaning protocol is instituted in the ICU.

The contribution of a “denervated” lung to pulmonary mechanics and physiology in the postoperative period is poorly understood. Familiarity and appreciation of allograft physiology are imperative for ventilation of the new lung. Native lung explantation and subsequent allograft implantation produce denervated lungs and airways, loss of a functional pulmonary system, and loss of bronchial artery blood flow. Normally, afferent input from the pulmonary stretch receptors via the vagus nerve is relayed to the medulla.<sup>104</sup> In lung transplant recipients, respiratory rate and tidal volumes cannot be dependent on the medulla via the vagus system. Instead, ventilatory information depends more on chest wall afferent signals.<sup>105,106</sup> Denervation of the vagus nerve input to the lungs includes blunting of the cough reflex and possible increased risk of aspiration in the early postoperative period, although patients appear to tolerate this denervation fairly well, with fewer than expected long-term sequelae. Patients undergoing left lung transplantation are at risk for injury to the recurrent laryngeal nerve. Disruption of the lymphatic system in the donor lung increases the risk of fluid accumulation and interstitial pulmonary edema. Judicious fluid administration and use of diuretics to keep patients “relatively dry” are attempts to minimize this effect. Hypoxic pulmonary vasoconstriction remains intact in the denervated allograft.<sup>107</sup> The newly transplanted lung is susceptible to fluid overload as a result of disruption of pulmonary lymphatics. The incidence of early postoperative pulmonary edema with normal pulmonary artery occlusion pressure may be as high as 60%.<sup>108</sup> In this low-pressure pulmonary edema, the ratio of protein concentration of the edema fluid compared with that of the serum is  $>0.5$ , suggesting increased permeability (so-called exudate) that could have resulted from endothelial damage.<sup>109</sup> An association exists between the occurrence of pulmonary edema and graft ischemic time.<sup>108</sup> In an attempt to minimize vol-

ume administration to minimize pulmonary edema, low-dose vasoconstrictors are often used to support blood pressure, especially in the setting of sympatholytic treatments such as epidurally administered local anesthetics.

Some degree of acute pulmonary rejection may occur in as many as 50–87% of patients after lung transplantation.<sup>110</sup> Clinical manifestations include cough, breathlessness, low-grade fever, and wheezing. Decreases in the forced expiratory volume in 1 second (FEV<sub>1</sub>) and forced vital capacity with characteristic abnormalities on the chest radiograph are common.<sup>111,112</sup> Differential diagnosis includes postoperative edema, infection, and bronchiolitis obliterans. A bronchial lavage is often sent for culture.

Bronchiolitis obliterans is a devastating complication of lung transplantation and is a leading cause of morbidity and mortality beyond the first year after transplantation. It is characterized by decreased FEV<sub>1</sub> and obstruction and destruction of pulmonary airways, which lead to hypoxia.<sup>113</sup> Diagnosis is established by transbronchial biopsy. Therapeutic options are limited because the condition is relatively refractory to increasing immunosuppressant therapy.<sup>113,114</sup> Retransplantation often is the only option, and these patients may present again to the operating room anesthesiologist.

Infectious complications after lung transplantation cause significant morbidity and mortality. Predisposing factors to bacterial infection include immunosuppressant therapy, ischemic injury to the lung, persistent pleural effusions, interruption of lymphatic drainage, and diminished cough reflex secondary to denervation. Donor transmitted infections are associated with high mortality rates. Hence, the airways of the donor lungs are routinely cultured, and antibiotics in the recipient are adjusted accordingly. Infection with CMV is associated with significant mortality in lung transplant recipients and is the most common viral infection in the recipient population.<sup>11</sup> Symptoms are nonspecific and include malaise and fever. Laboratory findings include leukopenia, thrombocytopenia, atypical lymphocytosis, and hepatitis.<sup>115–117</sup> The recipient may acquire primary infection from a CMV antibody-positive donor or from blood products. Hence, blood transfused to a transplant recipient

should be CMV negative. Even recipients who are CMV-antibody positive before transplantation can experience reactivation of previous infection or be infected with a different strain from the donor.<sup>118,119</sup> Fortunately, ganciclovir is an effective antiviral agent in the treatment of most CMV infections and pneumonitis and often is administered prophylactically in the posttransplant period. Fungal infections are more common in the lung transplant recipient than in other solid organ transplant recipients.<sup>10</sup> The two most common species isolated are *Candida* and *Aspergillus*. Although treatment of invasive infection usually includes amphotericin, many transplant programs prophylactically administer an azole agent such as itraconazole.

### Heart Transplantation

Heart transplants are always emergency operations. The most common disorders leading to heart transplantation include ischemic cardiomyopathy, idiopathic cardiomyopathy, congenital heart disease, and viral myocarditis. Patients are evaluated as candidates for heart transplantation through a heart failure clinic, which typically includes cardiac surgeons and cardiologists. A battery of preoperative tests aims to define the cause of heart failure and comorbidities. The workup usually is performed on an outpatient basis, and input from the department of anesthesiology can be gained if the institution has a preoperative clinic. However, in many sites in the United States, the first interaction between anesthesiologist and patient undergoing heart transplantation occurs a few moments before the heart transplant. The preoperative workup of patients for heart transplantation includes assessment of PVR. PVR is the difference between mean pulmonary arterial pressure and left atrial pressure divided by cardiac output. PVR is expressed in Wood units (normal = 1–2). Increased PVR that is irreversible and >6 Wood units may preclude eligibility for heart transplantation. Donor hearts typically are harvested from patients who have normal or near-normal cardiopulmonary physiology. The donor right ventricle is accustomed to pumping blood through a low PVR bed. Once explanted, the donor heart undergoes a period of ischemia until reimplanted and reperfused. The donor right ventricle, in the setting of acute

ischemia and reperfusion, is then exposed to an acute increase in PVR (afterload) from the chronically ill recipient who may have a PVR significantly greater than that of the donor. The clinical manifestations of acute increased PVR after a period of cross-clamp ischemia may include right ventricular failure and dilation. Right ventricles often require pharmacologic support during this critical time.

### DONOR

Organ harvests are conducted in large and small community hospitals. The quality of the donor organ often depends on the ability to maintain hemodynamic stability at the time of harvest. Criteria for heart donation are multifactorial and include age, preexisting cardiovascular disease, heart size, and echocardiographic, electrocardiographic, and cardiac catheterization data. The Organ Procurement Organization (OPO) is notified of potential organ donors. The list of eligible candidates is reviewed. The recipient is selected based on ABO blood typing compatibility, heart size, and acuity of illness. The recipient is notified and instructed to go to the hospital.

The timing of the recipient's transportation to the operating room and the donor harvest is multifactorial and, as in lung transplants, depends on what other organs are being harvested, the distance between the two sites, and the mode of transportation. In many organ harvests, procurement teams arrive from multiple institutions and from various locations across the country. Organ procurement is conducted under the auspices of the OPO, the harvest teams, and the on-site anesthesiologist and physician group. The vast majority of donors are patients with preexisting brain death for whom the family has consented for organ donation. A small fraction of organ harvests originate from “non-beating heart donors.” The latter group is not currently used for the donation of hearts. Nonbeating heart donors are patients with terminal illness who do not meet the criteria for brain death but in whom prognosis is grim and discontinuation of life support has been selected by the patient and/or family. If the patient or family is willing to donate, these patients are transported to the operating room, comfort

measures are emphasized, and discontinuation of support and end of life are followed by organ harvest.

The avoidance of significant hypotension, myocardial ischemia, and high pressor dependency is believed to be important in organ function after implantation. The heart is excised in its entirety, including significant portions of the superior and inferior vena cavae, pulmonary artery, and aorta. Before its excision, the heart is inspected by the harvest team as a final check for viability for transplantation. In many centers, induction of anesthesia in the recipient is linked to the final viability check of the donor heart.

## RECIPIENT

Typically the recipient is notified by pager or cell phone that a heart transplant is available. The recipient arrives at the hospital, goes through the admission process, and is transported to the perioperative area. Clinical data pertinent to the preoperative workup typically are available through the heart failure clinic and ideally in a condensed packet format. These data are most readily accessible via an electronic database format.

The operating room is set up in a conventional format for cardiac surgery. Medications that are available but not necessarily open include isoproterenol, milrinone, epinephrine, systemic vasodilators, and inhaled pulmonary vasodilators (nitric oxide or prostacyclin).

## Preoperative Management

The heart transplant recipient is often brought to the operating room directly from home. Admission processes, updated laboratory testing, and a blood sample to the blood bank for type and cross match require time and should be considered when the sequence to heart transplantation is planned. Informed consent is obtained in the usual fashion, including placement of invasive monitors, postoperative ventilatory support, and transesophageal echocardiography. Intravenous access is followed by insertion of an intraarterial and central venous catheter. Large-bore intravenous access (e.g., two large-bore catheters) is vital for redo sternotomy cases because bleeding can be abrupt and severe. Blood products should be immediately available in the

operating room. A pulmonary artery catheter is not absolutely required but often is useful in the titration of pulmonary vasodilators in patients with increased PVR. Defibrillation pads are placed on all patients who have undergone prior heart surgery or sternotomy. Antibiotics should be administered 30–60 minutes before incision and should cover broadly both gram-positive and gram-negative organisms. Sedation is administered judiciously. No epidural is inserted. Postoperative pain is controlled with parenteral narcotics. Toradol and other nonsteroidal anti-inflammatory drugs are avoided because of their risk for renal toxicity, particularly in patients who receive high doses of cyclosporine or tacrolimus.

## Intraoperative Management

Induction of general anesthesia often coincides with conformation of a suitable donor organ. Induction is accomplished with intravenous sedative-hypnotics and narcotics accompanied by a muscle relaxant. Aspiration precautions are prudent because these emergency operations often occur in the setting of a full stomach. Preoperative inotropes (intravenous milrinone) are titrated based on hemodynamics and often are continued until cardiopulmonary bypass. Immunosuppressive therapy begins after induction of anesthesia based on institution-specific protocols. The prebypass period is characterized by sternotomy, exposure of the heart, heparinization, and cannulation. Patients with a VAD bridge device require VAD explantation before heart transplantation. These patients often are anticoagulated preoperatively and are at very high risk for bleeding.

Use of antifibrinolytic therapy is common during heart transplantation. In addition to avoiding the risk of transmission of infection, the avoidance of blood transfusion may decrease the risk of postoperative infection. The available antifibrinolytics are tranexamic acid,  $\epsilon$ -aminocaproic acid (Amicar), and aprotinin. Red blood cell replacement therapy is leukocyte depleted and CMV matched. Treatment of coagulopathy includes plasma, cryoprecipitate, platelets, and recombinant factor VIIa. Protamine is administered to reverse heparin after bypass.

Cannulation before bypass includes bicaval cannulas and standard aortic cannulas. The SVC cannula increases the risk of SVC hypertension if effec-

tive drainage is not achieved. Monitoring the venous pressure proximal to the tourniquet tie of the SVC is prudent. Initiation of cardiopulmonary bypass occurs when the donor heart has arrived. Systemic cooling is common, but cardioplegia of the native heart is not necessary. The explanted heart is excised in its entirety except for residual portions of left and right atria. The newly arrived donor heart is prepared cold on a separate table by a separate surgeon. The aorta, pulmonary artery, and left and right atria are anastomosed. A variation in the technique is to perform bicaval anastomosis. If a pulmonary catheter is inserted, it must be withdrawn out of the heart that will be excised. Some surgeons prefer to pull the pulmonary catheter out of the native heart but keep it clamped to the side on the surgical field and manually insert it into the donor heart before right atrial anastomosis.

Rewarming typically triggers a series of checks and balances in all cardiac operations, including heart transplants. Typically, a large dose of corticosteroids is administered before unclamping and reperfusion of the new heart. The prepreparation from bypass checklist includes achieving normothermia; balanced acid-base and electrolyte status, especially potassium, calcium, and magnesium; pacing capability; adequate sedative hypnotic and analgesic drug concentrations; minimizing negative inotropes (inhalation anesthetics); and availability of inotropes, vasodilators, and pressors. Adequate oxygen-carrying capacity is assured. There is no predefined hemoglobin concentration below which red cell transfusion is indicated. These decisions are based on the individual patient and conditions. Use of selective pulmonary vasodilators is more common in heart transplants than in conventional CABG surgery. Inhaled prostacyclin is initiated when ventilation is resumed. Unclamping of the aorta results in reperfusion of the donor heart. Return of heart rhythm soon follows, and assistance with external pacing may be necessary. The duration of reperfusion before separation from bypass is controversial. It is desirable to minimize bypass time and its deleterious effects on blood and vital organs (inflammation, red cell destruction, dilution, emboli). However, the ischemic heart (from cross-clamp in the donor to unclamping in the recipient) is depleted of energy stores,



such as glycogen, adenosine triphosphate, and other high-energy molecules. In addition, intracellular and extracellular acidosis is severe in the heart after a period of prolonged ischemia, even if the heart is kept cold with cardioplegia. The needed recovery time is somewhat arbitrary and institution dependent.

Separation from bypass often is performed slowly, with gradual loading of the right ventricle. Pharmacologic support is common and often includes isoproterenol. This pure  $\beta$ -agonist is a potent inotrope and pulmonary vasodilator. The increased heart rate often is well tolerated and many times desirable, as cardiac output from hearts from young donors is often heart rate dependent with a relatively fixed or limited stroke volume. Left-heart failure is less common in heart transplantation compared with other forms of heart surgery because presumably a normal or near-normal heart is retrieved. Difficulty with preservation of myocardium, prolonged ischemic time, occult coronary artery disease, and air emboli to the coronary circulation can contribute to left ventricular dysfunction. Right-heart failure can be precipitated by increased PVR in the recipient. Treatment of the latter includes inotropes and pulmonary vasodilators, as well as hyperventilation, increasing oxygen tension, decreasing PEEP, and decreasing lung water.

Once separation from bypass has been achieved, circulatory stability is confirmed and heparin is reversed with protamine. The postbypass period is characterized by correction of coagulopathy (if present), maintaining circulatory stability and body homeostasis (temperature, electrolytes, acid-base balance), and closure of the incision. Point-of-care coagulation testing offers the opportunity to quickly diagnose a bleeding diathesis and its cause, thereby permitting a targeted blood product replacement strategy. On completion of surgery, the patient is transported to the intensive care unit with full monitoring.

## SUMMARY

The last several decades have witnessed considerable advances in both lung and heart transplantation. Much of this improvement results from a better understanding of the immune

mechanisms involved in allograft rejection, which has spurred ongoing development of novel immunosuppressive regimens. For example, studies have demonstrated that tacrolimus is at least as effective as cyclosporine in preventing acute rejection episodes of cardiac allografts. Novel regimens that combine tacrolimus with MMF or sirolimus may hold promise as rescue therapy after refractory rejection. However, randomized studies are needed to confirm this result. Importantly, the anesthesiologist plays a pivotal role in the management of the transplant recipient's physiology and, as a result, both the short- and long-term morbidity/mortality of these patients. Attention to detail, an understanding of the operation, and an appreciation of allograft physiology all contribute to patient outcome. In coming years, greater insight into mechanisms of ischemia-reperfusion injury and acute rejection will have a positive effect on the outcome of this high-risk population. Additionally, as anesthesiologists continue to increase their presence in intensive care units, postoperative management of this high-risk population, including, but not limited to, volume administration (colloid vs. crystalloid), ventilatory strategies (low stretch vs. open lung), and glycemic control, will be relegated to the domain of anesthesiology. It is incumbent on anesthesiologists to be leaders in this advancement and to act as vital members of the entire transplantation team.

## KEY REFERENCES

1. Miniati DN, Robbins RC. Heart transplantation: a thirty-year perspective. *Annu Rev Med* 2002;53:189–205.
2. Rosenberg AL, Rao M, Benedict PE. Anesthetic implications for lung transplantation. *Anesthesiol Clin North Am* 2004;22:767–788.
3. Hosenpud JD, Bennett LE, Keck BM, et al. The Registry of the International Society for Heart and Lung Transplantation: seventeenth official report—2000. *J Heart Lung Transplant* 2000;19:909–931.
4. Mehra MR, Kobashigawa JA. Advances in heart and lung transplantation 2004: Report from the 24th

International Society for Heart and Lung Transplantation Annual Meeting, San Francisco, April 21–24, 2004. *J Heart Lung Transplant* 2004;23:925–930.

5. Balsam LB, Yuh DD, Robbins RC, et al. Heart-lung and lung transplantation. In Cohn LH, Edmunds LH Jr, eds. *Cardiac Surgery in the Adult*. 2d ed. New York: McGraw-Hill, 2003:1461–1490.

## REFERENCES

1. Demikhov V. Experimental transplantation of an additional heart in the dog. *Bull Exp Biol Med (Russia)* 1950;1:241.
2. Konstantinov I. A mystery of Vladimir P. Demikhov: the 50th anniversary of the first intrathoracic transplantation. *Ann Thorac Surg* 1998;65:1171–1177.
3. Carrel A, Guthrie CC. The transplantation of vein and organs. *Am Med* 1905;10:101.
4. Cooley DA, Bloodwell RD, Hallman GL. Cardiac transplantation for advanced acquired heart disease. *J Cardiovasc Surg (Torino)* 1968;9:403–413.
5. Cooley DA, Bloodwell RD, Hallman GL, et al. Transplantation of the human heart. Report of four cases. *JAMA* 1968;205:479–486.
6. Cooley DA, Hallman GL, Bloodwell RD, et al. Human heart transplantation. Experience with twelve cases. *Am J Cardiol* 1968;22:804–810.
7. Bahnson HT. Transplantation of the heart: reminiscences of the past and inklings of the future. *Ann Thorac Surg* 1997;64:1561–1563.
8. Dalton ML. The first lung transplantation. *Ann Thorac Surg* 1995;60:1437–1438.
9. Hoffman R, Christiaan Barnard: his first transplants and their impact on concepts of death. *BMJ* 2001;323:1478–1480.
10. Rosenberg AL, Rao M, Benedict PE. Anesthetic implications for lung transplantation. *Anesthesiol Clin North Am* 2004;22:767–788.
11. Etienne B, Bertocchi M, Gamondes JP, et al. Successful double-lung transplantation for bronchioalveolar carcinoma. *Chest* 1997;112:1423–1424.
12. 2004 Annual Report of the U.S. Organ Procurement and Transplantation Network and the Scientific Registry of Transplant Recipients: transplant data 1994–2003. Rockville, MD: Department of Health and Human Services, Health Resources and Services Administration, Healthcare Systems Bureau, Division of Transplantation, 2004.
13. Levine SM. A survey of clinical practice of lung transplantation in North America. *Chest* 2004;125:1224–1238.

14. Zwischenberger JB, Hyde BR, Escalon JC. What's new in general thoracic surgery. *J Am Coll Surg* 2005;201:90-99.
15. Orens JB, Boehler A, de Perrot M, et al. A review of lung transplant donor acceptability criteria. *J Heart Lung Transplant* 2003;22:1183-1200.
16. Christie JD, Bavaria JE, Palevsky HI, et al. Primary graft failure following lung transplantation. *Chest* 1998;114:51-60.
17. Whitson BA, Nath DS, Johnson AC, et al. Risk factors for primary graft dysfunction after lung transplantation. *J Thorac Cardiovasc Surg* 2006;131:73-80.
18. Hosenpud JD, Bennett LE, Keck BM, et al. The Registry of the International Society for Heart and Lung Transplantation: eighteenth official report—2001. *J Heart Lung Transplant* 2001;20:805-815.
19. Deng MC, De Meester JM, Smits JM, et al. Effect of receiving a heart transplant: analysis of a national cohort entered on to a waiting list, stratified by heart failure severity. Comparative Outcome and Clinical Profiles in Transplantation (COCPIIT) Study Group. *BMJ* 2000;321:540-545.
20. Packer M, Coats AJ, Fowler MB, et al. Effect of carvedilol on survival in severe chronic heart failure. *N Engl J Med* 2001;344:1651-1558.
21. Rose EA, Gelijns AC, Moskowitz AJ, et al. Long-term mechanical left ventricular assistance for end-stage heart failure. *N Engl J Med* 2001;345:1435-1443.
22. Scientific Registry of Transplant Recipients, 2005. <http://www.ustransplant.org/>. Accessed November 22, 2006.
23. Jessup M, Brozena S. Heart failure. *N Engl J Med* 2003;348:2007-2018.
24. Levy D, Larson MG, Vasan RS, et al. The progression from hypertension to congestive heart failure. *JAMA* 1996;275:1557-1562.
25. Deng MC. Cardiac transplantation. *Heart* 2002;87:177-184.
26. Deng MC, Smits JM, Packer M. Selecting patients for heart transplantation: which patients are too well for transplant? *Curr Opin Cardiol* 2002;17:137-144.
27. Shiba N, Chan MC, Valantine HA, et al. Longer-term risks associated with 10-year survival after heart transplantation in the cyclosporine era. *J Heart Lung Transplant* 2003;22:1098-1106.
28. Ozduran V, Yamani MH, Chuang HH, et al. Survival beyond 10 years following heart transplantation: The Cleveland Clinic Foundation experience. *Transplant Proc* 2005;37:4509-4512.
29. United Network for Organ Sharing. Calculation of lung allocation score (LAS). [http://www.unos.org/resources/frm\\_LAS\\_Calculator.asp](http://www.unos.org/resources/frm_LAS_Calculator.asp). Accessed November 22, 2006.
30. International guidelines for the selection of lung transplant candidates. The American Society for Transplant Physicians (ASTP)/American Thoracic Society (ATS)/European Respiratory Society(ERS)/International Society for Heart and Lung Transplantation (ISHLT). *Am J Respir Crit Care Med* 1998;158:335-339.
31. Nathan SD. Lung transplantation: disease-specific considerations for referral. *Chest* 2005;127:1006-1016.
32. Miniati DN, Robbins RC. Heart transplantation: a thirty-year perspective. *Annu Rev Med* 2002;53:189-205.
33. Levine TB, Levine AB, Goldberg AD, et al. Clinical status of patients removed from a transplant waiting list rivals that of transplant recipients at significant cost savings. *Am Heart J* 1996;132:1189-1194.
34. Rickenbacher PR, Trindade PT, Haywood GA, et al. Transplant candidates with severe left ventricular dysfunction managed with medical treatment: characteristics and survival. *J Am Coll Cardiol* 1996;27:1192-1197.
35. Aaronson KD, Schwartz JS, Chen TM, et al. Development and prospective validation of a clinical index to predict survival in ambulatory patients referred for cardiac transplant evaluation. *Circulation* 1997;95:2660-2667.
36. Mancini DM, Eisen H, Kusmaul W, et al. Value of peak exercise oxygen consumption for optimal timing of cardiac transplantation in ambulatory patients with heart failure. *Circulation* 1991;83:778-786.
37. Hunt SA, Baker DW, Chin MH, et al. ACC/AHA guidelines for the evaluation and management of chronic heart failure in the adult: executive summary. A report of the American College of Cardiology/American Heart Association Task Force on Practice Guidelines (Committee to Revise the 1995 Guidelines for the Evaluation and Management of Heart Failure): Developed in collaboration with the International Society for Heart and Lung Transplantation; endorsed by the Heart Failure Society of America. *Circulation* 2001;104:2996-3007.
38. Stevenson LW. Selection and management of candidates for heart transplantation. *Curr Opin Cardiol* 1996;11:166-173.
39. Hosenpud JD, Bennett LE, Keck BM, et al. The Registry of the International Society for Heart and Lung Transplantation: seventeenth official report—2000. *J Heart Lung Transplant* 2000;19:909-931.
40. Blanche C, Blanche DA, Kearney B, et al. Heart transplantation in patients seventy years of age and older: a comparative analysis of outcome. *J Thorac Cardiovasc Surg* 2001;121:532-541.
41. Lipson DA, Edelman JD, Palevsky HI. Alternatives to lung transplantation: lung volume reduction surgery and continuous intravenous prostacyclin. *Transplant Proc* 2002;34:1283-1286.
42. Landsteiner K. On agglutination of normal human blood. *Transfusion* 1961;1:5-8.
43. Billingham RE, Brent L, Medawar PB. Quantitative studies on tissue transplantation immunity. III. Actively acquired tolerance. *Philos Trans R Soc Lond (Biol)* 1956;239:357.
44. Dausset J. The birth of MAC. *Vox Sang* 1984;46:235-237.
45. Dausset J, Colin M. [Research technic for immunologic thrombo-agglutinins; influence of previous heating of platelet suspensions.]. *Rev Fr Etud Clin Biol* 1958;3:60-61.
46. Controlling occupational exposure to hazardous drugs. OSHA Technical Manual. Washington, DC: U.S. Department of Labor, 2006.
47. Kobashigawa JA. Controversies in heart and lung transplantation immunosuppression: tacrolimus versus cyclosporine. *Transplant Proc* 1998;30:1095-1097.
48. Goto T, Kino T, Hatanaka H, et al. FK 506: historical perspectives. *Transplant Proc* 1991;23:2713-2717.
49. Ransom JT. Mechanism of action of mycophenolate mofetil. *Ther Drug Monit* 1995;17:681-684.
50. Kobashigawa JA, Patel JK. Immunosuppression for heart transplantation: where are we now? *Nat Clin Pract Cardiovasc Med* 2006;3:203-212.
51. Burkart GJ, Smaldone GC, Eldon MA, et al. Lung deposition and pharmacokinetics of cyclosporine after aerosolization in lung transplant patients. *Pharm Res* 2003;20:252-256.
52. Iacono AT, Corcoran TE, Griffith BP, et al. Aerosol cyclosporin therapy in lung transplant recipients with bronchiolitis obliterans. *Eur Respir J* 2004;23:384-390.
53. Iacono AT, Johnson BA, Grgurich WF, et al. A randomized trial of inhaled cyclosporine in lung-transplant recipients. *N Engl J Med* 2006;354:141-150.
54. Eisen H, Ross H. Optimizing the immunosuppressive regimen in heart transplantation. *J Heart Lung Transplant* 2004;23:S207-S213.
55. Mehra MR, Kobashigawa JA. Advances in heart and lung transplantation 2004: Report from the 24th International Society for Heart and Lung Transplantation Annual Meeting, San Francisco, April 21-24, 2004. *J Heart Lung Transplant* 2004;23:925-930.
56. Weis M. Cardiac allograft vasculopathy: prevention and treatment options. *Transplant Proc* 2002;34:1847-1849.
57. Young JB. Allograft vasculopathy: diagnosing the nemesis of heart transplantation. *Circulation* 1999;100:458-460.
58. Davidson J, Wilkinson A, Dantal J, et al. New-onset diabetes after transplantation: 2003 International consensus guidelines. Proceedings of an International Expert Panel Meeting. Barcelona, Spain, 19 February 2003. *Transplantation* 2003;75:SS3-SS24.
59. Kobashigawa JA, Miller L, Yeung A, et al. Does acute rejection correlate with the development of transplant coronary artery disease? A multicenter study using intravascular ultrasound. *Sandoz/CVIS Investigators. J Heart Lung Transplant* 1995;14:S221-S226.
60. Meiser BM, Uberfuhr P, Fuchs A, et al. Single-center randomized trial comparing tacrolimus (FK506) and cyclosporine in the prevention of acute myocardial rejection. *J Heart Lung Transplant* 1998;17:782-788.

61. Pham SM, Kormos RL, Hattler BG, et al. A prospective trial of tacrolimus (FK 506) in clinical heart transplantation: intermediate-term results. *J Thorac Cardiovasc Surg* 1996;111:764-772.
62. Reichart B, Meiser B, Vigano M, et al. European Multicenter Tacrolimus (FK506) Heart Pilot Study: one-year results—European Tacrolimus Multicenter Heart Study Group. *J Heart Lung Transplant* 1998;17:775-781.
63. Taylor DO, Barr ML, Radovancevic B, et al. A randomized, multicenter comparison of tacrolimus and cyclosporine immunosuppressive regimens in cardiac transplantation: decreased hyperlipidemia and hypertension with tacrolimus. *J Heart Lung Transplant* 1999;18:336-345.
64. Christie JD. Lung allograft ischemic time: crossing the threshold. *Am J Respir Crit Care Med* 2005;171:673-674.
65. Thabut G, Mal H, Cerrina J, et al. Graft ischemic time and outcome of lung transplantation: a multicenter analysis. *Am J Respir Crit Care Med* 2005;171:786-791.
66. Hardesty RL, Griffith BP. Procurement for combined heart-lung transplantation. Bilateral thoracotomy with sternal transection, cardiopulmonary bypass, and profound hypothermia. *J Thorac Cardiovasc Surg* 1985;89:795-799.
67. Conte JV, Baumgartner WA. Overview and future practice patterns in cardiac and pulmonary preservation. *J Card Surg* 2000;15:91-107.
68. el Oakley RM, Yonan NA, Simpson BM, et al. Extended criteria for cardiac allograft donors: a consensus study. *J Heart Lung Transplant* 1996;15:255-259.
69. Harringer W, Haverich A. Heart and heart-lung transplantation: standards and improvements. *World J Surg* 2002;26:218-225.
70. Briganti EM, Bergin PJ, Rosenfeldt FL, et al. Successful long-term outcome with prolonged ischemic time cardiac allografts. *J Heart Lung Transplant* 1995;14:840-845.
71. Demertzis S, Wippermann J, Schaper J, et al. University of Wisconsin versus St. Thomas' Hospital solution for human donor heart preservation. *Ann Thorac Surg* 1993;55:1131-1137.
72. Keon WJ, Hendry PJ, Taichman GC, et al. Cardiac transplantation: the ideal myocardial temperature for graft transport. *Ann Thorac Surg* 1988;46:337-341.
73. Stavem K, Bjortuft O, Borgan O, et al. Lung transplantation in patients with chronic obstructive pulmonary disease in a national cohort is without obvious survival benefit. *J Heart Lung Transplant* 2006;25:75-84.
74. Lubenow TR, Faber LP, McCarthy RJ, et al. Postthoracotomy pain management using continuous epidural analgesia in 1,324 patients. *Ann Thorac Surg* 1994;58:924-929.
75. Harik SI, Raichle ME, Reis DJ. Spontaneously remitting spinal epidural hematoma in a patient on anticoagulants. *N Engl J Med* 1971;284:1355-1357.
76. Horlocker TT, Wedel DJ, Offord KP. Does preoperative antiplatelet therapy increase the risk of hemorrhagic complications associated with regional anesthesia? *Anesth Analg* 1990;70:631-634.
77. Odoom JA, Sih IL. Epidural analgesia and anticoagulant therapy. Experience with one thousand cases of continuous epidurals. *Anaesthesia* 1983;38:254-259.
78. Rao TL, El-Etr AA. Anticoagulation following placement of epidural and subarachnoid catheters: an evaluation of neurologic sequelae. *Anesthesiology* 1981;55:618-620.
79. Stow PJ, Burrows FA. Anticoagulants in anaesthesia. *Can J Anaesth* 1987;34:632-649.
80. Pastor MC, Sanchez MJ, Casas MA, et al. Thoracic epidural analgesia in coronary artery bypass graft surgery: seven years' experience. *J Cardiothorac Vasc Anesth* 2003;17:154-159.
81. Guillen RV, Briones FR, Marin PM, et al. Lung graft dysfunction in the early postoperative period after lung and heart lung transplantation. *Transplant Proc* 2005;37:3994-3995.
82. Pierre AF, Keshavjee S. Lung transplantation: donor and recipient critical care aspects. *Curr Opin Crit Care* 2005;11:339-344.
83. Bratzler DW, Houck PM. Antimicrobial prophylaxis for surgery: an advisory statement from the National Surgical Infection Prevention Project. *Am J Surg* 2005;189:395-404.
84. Granton J. Update of early respiratory failure in the lung transplant recipient. *Curr Opin Crit Care* 2006;12:19-24.
85. Ojo AO, Heinrichs D, Emond JC, et al. Organ donation and utilization in the USA. *Am J Transplant* 2004;9(Suppl 4):27-33.
86. de Perrot M, Keshavjee S. Lung preservation. *Semin Thorac Cardiovasc Surg* 2004;16:300-308.
87. Conacher ID, McNally B, Choudhry AK, et al. Anaesthesia for isolated lung transplantation. *Br J Anaesth* 1988;60:588-591.
88. Benditt JO. Surgical options for patients with COPD. Sorting out the choices. *Respir Care* 2006;51:173-182.
89. Hochberg MS, Gielchinsky I, Parsonnet V, et al. Pulmonary inactivation of vasoconstrictors following cardiac operations. *Ann Thorac Surg* 1986;41:200-203.
90. Stobierska-Dzierzek B, Awad H, Michler RE. The evolving management of acute right-sided heart failure in cardiac transplant recipients. *J Am Coll Cardiol* 2001;38:923-931.
91. Adatia I, Wessel DL. Therapeutic use of inhaled nitric oxide. *Curr Opin Pediatr* 1994;6:583-590.
92. de Perrot M, Liu M, Waddell TK, et al. Ischemia-reperfusion-induced lung injury. *Am J Respir Crit Care Med* 2003;167:490-511.
93. Ellman PI, Alvis JS, Tache-Leon C, et al. Hyperoxic ventilation exacerbates lung reperfusion injury. *J Thorac Cardiovasc Surg* 2005;130:1440.
94. Experience with single-lung transplantation for pulmonary fibrosis. The Toronto Lung Transplant Group. *JAMA* 1988;259:2258-2262.
95. Mal H, Andreassian B, Pamela F, et al. Unilateral lung transplantation in end-stage pulmonary emphysema. *Am Rev Respir Dis* 1989;140:797-802.
96. Yacoub MH, Banner NR. Recent developments in lung and heart-lung transplantation. In Morris P, ed. *Transplantation Reviews*, vol. 3. London: Bailliere Tindall, 1989:1-29.
97. Trulock EP, Egan TM, Kouchoukos NT, et al. Single lung transplantation for severe chronic obstructive pulmonary disease. Washington University Lung Transplant Group. *Chest* 1989;96:738-742.
98. Veith FJ, Koerner SK, Siegelman SS, et al. Single lung transplantation in experimental and human emphysema. *Ann Surg* 1973;178:463-476.
99. Waddell TK, Bennett L, Kennedy R, et al. Heart-lung or lung transplantation for Eisenmenger syndrome. *J Heart Lung Transplant* 2002;21:731-737.
100. Metras D, Noirclerc M, Vaillant A, et al. Double-lung transplant: the role of bilateral bronchial suture. *Transplant Proc* 1990;22:1477-1478.
101. Patterson GA, Todd TR, Cooper JD, et al. Airway complications after double lung transplantation. Toronto Lung Transplant Group. *J Thorac Cardiovasc Surg* 1990;99:14-20.
102. Kasimir MT, Seebacher G, Jaksch P, et al. Reverse cardiac remodeling in patients with primary pulmonary hypertension after isolated lung transplantation. *Eur J Cardiothorac Surg* 2004;26:776-781.
103. Triantafyllou AN, Heerdt PM. Lung transplantation. *Int Anesthesiol Clin* 1991;29:87-109.
104. von Euler C. On the central pattern generator for the basic breathing rhythmicity. *J Appl Physiol* 1983;55:1647-1659.
105. Bland S, Lazerou L, Dyck G, et al. The influence of the "chest wall" on respiratory rate and depth. *Respir Physiol* 1967;3:47-54.
106. Trippenbach T. Chest wall reflexes in newborns. *Bull Eur Physiopathol Respir* 1985;21:115-122.
107. Robin ED, Theodore J, Burke CM, et al. Hypoxic pulmonary vasoconstriction persists in the human transplanted lung. *Clin Sci (Lond)* 1987;72:283-287.
108. Sleiman C, Mal H, Fournier M, et al. Pulmonary reimplantation response in single-lung transplantation. *Eur Respir J* 1995;8:5-9.
109. Ware LB, Golden JA, Finkbeiner WE, et al. Alveolar epithelial fluid transport capacity in reperfusion lung injury after

- lung transplantation. *Am J Respir Crit Care Med* 1999;159:980–988.
110. Trulock EP. Management of lung transplant rejection. *Chest* 1993;103:1566–1576.
111. Heritier F, Madden B, Hodson ME, et al. Lung allograft transplantation: indications, preoperative assessment and postoperative management. *Eur Respir J* 1992;5:1262–1278.
112. Millet B, Higenbottam TW, Flower CD, et al. The radiographic appearances of infection and acute rejection of the lung after heart-lung transplantation. *Am Rev Respir Dis* 1989;140:62–67.
113. Burke CM, Theodore J, Dawkins KD, et al. Post-transplant obliterative bronchiolitis and other late lung sequelae in human heart-lung transplantation. *Chest* 1984;86:824–829.
114. Scott JP, Higenbottam TW, Clelland C, et al. The natural history of obliterative bronchiolitis and occlusive vascular disease of patients following heart-lung transplantation. *Transplant Proc* 1989;21:2592–2593.
115. Dauber JH, Paradis IL, Dummer JS. Infectious complications in pulmonary allograft recipients. *Clin Chest Med* 1990;11:291–308.
116. Dummer JS, White LT, Ho M, et al. Morbidity of cytomegalovirus infection in recipients of heart or heart-lung transplants who received cyclosporine. *J Infect Dis* 1985;152:1182–1191.
117. Sissons JG, Borysiewicz LK. Human cytomegalovirus infection. *Thorax* 1989;44:241–246.
118. Chou SW. Acquisition of donor strains of cytomegalovirus by renal-transplant recipients. *N Engl J Med* 1986;314:1418–1423.
119. Wreghitt T. Cytomegalovirus infections in heart and heart-lung transplant recipients. *J Antimicrob Chemother* 1989;23(Suppl E):49–56.
120. Balsam LB, Yuh DD, Robbins RC, et al. Heart-lung and lung transplantation. In Cohn LH, Edmunds LH Jr, eds. *Cardiac Surgery in the Adult*. 2d ed. New York: McGraw-Hill, 2003:1461–1490.



# CHAPTER 58

## Anesthesia for Kidney, Pancreas, or Other Organ Transplantation

David S. Beebe, MD, and  
Kumar G. Belani, MBBS, MS

### KIDNEY TRANSPLANTATION

#### History and Introduction

The technique for the vascular anastomosis basic to kidney transplantation was described by Carrel in 1902. However, because of the lack of safe, effective immunosuppressive agents, the first successful kidney transplant was not performed until the mid-1950s. This transplant was between identical twins.<sup>1</sup> Transplantation between identical twins resulted in excellent long-term graft and patient survival. However, the growth of kidney transplantation began in earnest with the development of improved immunosuppressive agents, particularly cyclosporine. Kidney transplantation is now the preferred treatment of end-stage renal disease (ESRD) of almost any origin. Recipients of kidney transplants have improved survival and quality of life compared to patients who remain on dialysis. In the United States, approximately 15,999 kidney transplants were performed in 2004.<sup>2</sup>

#### Organ Matching, Availability, and Allocation

The high success of kidney transplantation for treatment of renal failure and the significantly improved quality of life experienced by patients has created a major demand for this operation. Currently, the need for renal transplants exceeds the supply of available cadaveric organs. The number of patients on the waiting list now exceeds 55,000.<sup>3</sup> Unfortunately, not every organ is suitable for transplantation, and many patients have conditions that make successful transplantation difficult. For example, in most patients, the blood type of the kidney must be compatible with that of the recipient. Anti-

A antibodies from a blood type O recipient can react with the donor endothelial cells with blood type A and result in acute rejection. Obtaining a kidney with as close a human leukocyte antigen (HLA) antigen match as possible also is important to lessen the incidence of rejection.<sup>4</sup> On the other hand, patients may benefit from earlier transplantation even if the graft is not optimal because the high mortality of long-term dialysis favors the risk-to-benefit ratio toward transplantation.<sup>5</sup>

The United Network for Organ Sharing (UNOS), which uses the principle of medical utility and justice, has been responsible for developing algorithms for determining which patients should receive a cadaveric kidney since 1987. The United States is divided into 11 geographic regions, within which cadaveric organs are allocated based upon the allocation algorithm.<sup>2</sup> The allocation algorithm takes into account the duration patients are on dialysis, the quality of antigen matching, and

### KEY POINTS

1. Half of all deaths after renal transplantation are cardiac related, and cardiac disease is the leading cause of death in the first year posttransplant. Therefore, detection of severe coronary artery disease in patients prior to transplantation is vital.
2. Diabetics with autonomic neuropathy are at risk for severe hypotension and bradycardia during induction of general anesthesia and for sudden death in the postoperative period.
3. Blood glucose levels should be determined every hour in renal transplant recipients who have insulin-dependent diabetes mellitus. Evidence suggests that the incidence of wound infections in diabetic patients can be reduced if blood sugar levels are tightly controlled.
4. Patients undergoing renal transplantation usually benefit from central venous pressure measurement, which helps determine if the patient's volume status is adequate at the time of reperfusion of the allograft.
5. To ensure adequate volume expansion in adult kidney recipients, central venous pressure should be raised to 14 or 15 mm Hg with intravenous normal saline or 5% albumin prior to perfusion of the allograft. If the patient is relatively anemic (hemoglobin <10 g/dL), packed red blood cells can be used for this purpose as well.
6. Hypotension can result in decreased graft perfusion and delayed graft function in adult kidney recipients. Therefore, it is helpful to intentionally raise the systolic blood pressure to 130 or 140 mm Hg by reducing the concentration of inhaled anesthetic agents administered prior to reperfusion of the allograft. A vasopressor such as ephedrine (5–10 mg) or phenylephrine (100–200 µg), or infusion of dopamine (3–5 µg/kg/min) occasionally is required to treat hypotension during and after perfusion.
7. Animal studies have shown that hyperglycemia causes islet cell dysfunction. Therefore, blood glucose levels must be checked at least hourly or more frequently during pancreas or islet cell transplantation with the goal of keeping serum glucose levels between 100–150 mg/dL.
8. Patients undergoing hematopoietic stem cell transplantation may have metabolic disorders that can make intubation difficult. Mucositis also can make intubation difficult. When endotracheal intubation is required, airway care must be provided in an environment equipped to handle a patient with a difficult airway.
9. Because of the high incidence of venous thrombosis in patients receiving intravenous hyperalimentation, it is recommended that all patients referred for intestinal transplantation undergo preliminary mapping of their venous access by Doppler ultrasound. Patients with multiple thrombosed vessels should be considered for additional angiographic evaluation.
10. Significant bleeding may occur during the dissection process for small bowel transplantation. A rapid infusion device often is beneficial and should be available, and blood-salvaging devices should be used.

the age of the patient. The algorithms for allocation have been changed periodically. For example, prior to 2002, more weight was given to having closer matching of HLA antigens than is required currently, as enhancements in immunosuppression therapy have improved the outcomes of recipients with lesser degrees of HLA matching.<sup>6</sup>

Several means to increase the number of kidneys available for transplantation are being used and/or investigated. One method has been the promotion of voluntary living renal donation because people can live perfectly healthy lives with only one kidney. Living related transplantation as a means of providing a replacement for a diseased organ was therefore first applied to the kidney. Approximately 6500 patients received a transplant from a living donor in 2003. Recipients of living related kidney transplants generally suffer fewer episodes of acute and chronic rejection than those receiving cadaveric organs. Recipients also benefit because living related and unrelated transplantation is performed on an elective, nonemergent basis.<sup>3</sup>

Improved immunosuppressive regimens have led to the advent of living unrelated renal transplantation. Living unrelated renal transplantation appears to have a superior outcome over cadaveric transplantation, probably because of the shorter cold ischemia time. As a result, the incidence of delayed graft function and subsequent graft loss is lower than in cadaveric transplantation. Some studies show that living unrelated transplantation has a similar incidence of rejection as living related transplantation in spite of inferior HLA matching.<sup>7</sup>

Cadaveric kidney transplants now are being performed with an increasing number of organs from donors who would have been deemed unsuitable in earlier times, such as donor age >55 years, non-heart-beating donors, cold ischemia time >36 hours, and donor hypertension or diabetes mellitus of >10 years' duration (Expanded Donor Criteria).<sup>8</sup> Although overall survival in recipients of a marginal cadaveric donor kidney was less than that of recipients who received better matched organs, these patients had improved survival when compared to transplant candidates who remained on dialysis.<sup>5</sup> Approximately 20% of all cadaveric kidney transplants performed in 2003 were from expanded donor criteria organs.<sup>3</sup>

New techniques such as plasmapheresis, high-dose intravenous immunoglobulin, and potent immunosuppressive agents have made transplantation with ABO-incompatible kidneys and kidneys from recipients with a positive cross-match to the donor possible. Although the success rate in patients receiving incompatible organs is lower than in those with compatible organs, the overall morbidity and mortality may be lower in many patients than in patients undergoing continued dialysis while waiting for a high-compatibility organ.<sup>4</sup>

### **Indications and Contraindications**

The most common causes of end-stage renal failure in adults are diabetes, systemic hypertension, glomerulonephritis, and polycystic kidney disease. In children and adolescents, the most common causes of ESRD are congenital malformations of the kidneys and urinary tract and focal segmental glomerulosclerosis.<sup>9</sup>

Organ systems are adversely affected by a prolonged time on dialysis, and these changes can increase the morbidity and mortality of a kidney transplant. Ideally patients with progressive renal failure should receive a kidney transplant before they begin dialysis.<sup>9</sup> Diabetic patients with marginal renal function who receive a pancreas transplant should receive a simultaneous kidney transplant because the immunosuppressive agents required for the pancreas transplant may cause further deterioration of renal function to the point of requiring dialysis.<sup>10</sup>

Living related and unrelated transplants are one method by which kidneys can be transplanted before dialysis becomes necessary because they can be scheduled electively before dialysis is required.<sup>9</sup>

Unfortunately, because of the long waiting times to receive a renal allograft, most patients receiving renal transplants have ESRD that has already progressed to the point where dialysis is required. The 5-year survival rate of patients on chronic hemodialysis or peritoneal dialysis is only 30%. In contrast, the 5-year survival rate following transplantation for ESRD is 70%. Therefore, except in rare instances, transplantation should be performed in all patients with renal failure in whom it is technically feasible.<sup>9</sup>

The number of absolute and relative contraindications to renal transplantation is decreasing. In the past, the presence of diabetes as a cause of renal failure was a contraindication to renal transplantation. Currently, renal failure from diabetes is the primary indication for transplantation in adults. Diabetics who receive a kidney transplant survive longer, with a better quality of life, than do those who require long-term dialysis.<sup>11</sup>

Other conditions that previously were thought to be contraindications to transplantation now are considered acceptable. HIV infection once was considered an absolute contraindication, but transplantation now has been successfully performed, with 5-year outcomes similar to the rates in other patient populations.<sup>12</sup> Similarly, patients infected by hepatitis C virus can receive a kidney transplant with success rates comparable to the rates in patients without hepatitis C and may benefit by being eligible to receive a kidney from a donor who also has hepatitis C.<sup>13</sup> Patients older than 65 years now receive kidney transplants with outcomes similar to younger recipients.<sup>14</sup> Patients with advanced congestive heart failure as well as renal failure do better with renal transplantation compared to those treated medically with dialysis.<sup>15</sup> Highly sensitized patients, T-cell-positive cross-match, and ABO blood group-incompatible patients now are considered potential renal transplant candidates, albeit with increased morbidity and mortality.<sup>4</sup>

Although the indications for kidney transplantation have been expanded significantly, some individuals with ESRD are not good candidates for the procedure. Active infection, active drug abuse, complete thrombosis of the vena cava and iliac veins, and disseminated malignancies are among the contraindications to transplantation. Sensitization by previous failed transplants, blood transfusions, or pregnancy will require individual assessment because in some patients the graft survival would be too poor to transplant.<sup>16</sup> Patients who have a history of noncompliance or mental retardation who are unlikely to take their medications constitute relative contraindication to transplantation. However, patients with mental retardation can be transplanted successfully if they have a caregiver responsible for administering the medications.<sup>17</sup>

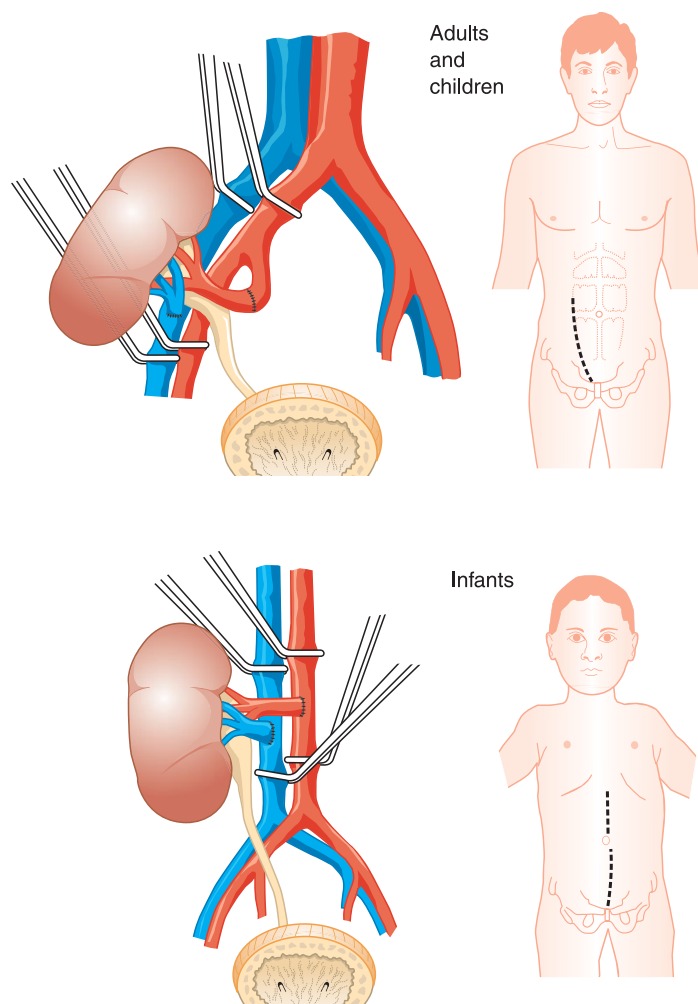
## Surgical Procedure

The surgical procedure of kidney transplantation is straightforward. In adults and older children (>20 kg), the transplanted kidney usually is placed in the extraperitoneal iliac fossa via a curvilinear incision along the lateral margin of the rectus muscle approximately 8–10 inches from just above the pubic bone to just above the umbilicus (Fig. 58–1). The common and external iliac arteries and veins are exposed retroperitoneally. The renal vein is anastomosed before the renal artery, and an end-to-side or end-to-end anastomosis can be performed, depending upon the anatomy of the vessels and depth of the renal pelvis. The renal artery is then anastomosed to the internal or external iliac artery. Occasionally, donors have multiple renal arteries, and several arterial anastomoses are required. Renal revascularization involves clamping of the iliac artery and vein. This process can result in ischemia to the lower extremity for as long as 60 minutes. After the vascular anastomoses are completed, the clamps are released in a staged fashion, resulting in perfusion of the kidney graft and lower extremities. The final stage of the operation involves reconstruction of the urinary drainage by anastomosing the donor ureter to the patient's bladder.

In infants and small children (<20 kg), a transperitoneal approach is used. An incision from the xiphoid process to the pubis is made (Fig. 58–1). The bowel is mobilized, and the aorta and vena cava are exposed. The donor artery and vein are anastomosed to the aorta and vena cava end to side. Once the vascular anastomoses are complete, the clamps are released, resulting in reperfusion of both lower extremities and the donor kidney. The urinary drainage is then reconstructed.<sup>18</sup>

## Pretransplant Evaluation

Patients undergoing kidney transplantation require a complete medical review and evaluation of their medical condition prior to surgery. This is best done by the transplant surgery team prior to placing the patient on the transplant list. If the evaluation is not performed prior to listing, the patient, surgeon, anesthesia provider and internist, and/or pediatrician are faced with the task of performing a last-minute workup in suboptimal conditions when an organ suddenly becomes available.



**FIGURE 58–1.** Surgical procedure for kidney transplantation in adults, children, and infants. See text for details.

Both the underlying cause of renal failure and the renal failure itself contribute to the pathology often seen in patients with renal insufficiency. Often renal insufficiency and the underlying medical condition act synergistically to harm the patient. For example, autonomic neuropathy can be caused by both renal failure and diabetes and has been associated with sudden death following anesthesia and surgery.<sup>19</sup>

## Comorbid Conditions

Table 58–1 lists the problems related to ESRD. Dialysis corrects many of the abnormalities associated with chronic renal failure, but many conditions persist. Therefore, each organ system must be evaluated prior to the patient undergoing renal transplantation.

## Cardiac Evaluation

Half of all deaths after renal transplantation are cardiac related, and cardiac disease is the leading cause of death in

the first year posttransplant.<sup>20</sup> Therefore, detection of severe coronary artery disease in patients prior to transplantation is vital.

Patients with diabetes, peripheral vascular disease, angina, or a longer duration of ESRD have a greater risk of mortality.<sup>20</sup> However, what constitutes the optimal pretransplant cardiac evaluation, particularly in diabetic patients, is still debated. Currently, exercise tolerance testing is recommended for patients with diabetes and those older than 50 years.<sup>21</sup> Patients with evidence of reversible cardiac ischemia should be referred for cardiac catheterization. Unfortunately, many patients with renal failure do not have the exercise capacity to adequately undergo exercise stress testing. Thus, dobutamine stress echocardiography has been proposed as a better predictor of coronary artery disease than exercise stress testing alone in renal transplant candidates.<sup>22</sup>

TABLE 58-1.

## Medical Problems in Patients with End-Stage Renal Failure

System	Complications Associated with Renal Failure
Cardiovascular	Hypertension, atherosclerosis, coronary artery disease, congestive heart failure, pulmonary edema, pulmonary hypertension, pericarditis, cardiomyopathy, arrhythmias
Hematologic	Anemia, platelet dysfunction, coagulopathies, increased capillary fragility
Immune	Impaired immunity
Neurologic	Peripheral neuropathy, autonomic neuropathy
Musculoskeletal	Myopathy
Gastrointestinal	Impaired gastric emptying, gastroparesis, nausea, vomiting, anorexia, peptic ulcer disease
Electrolyte and acid–base regulation	Potassium, sodium, calcium, magnesium, phosphate, bicarbonate imbalances, metabolic acid accumulation
Endocrine	Hyperparathyroidism, osteodystrophy, impaired growth and development (especially in children), glucose intolerance
Pulmonary	Pneumonia, pulmonary edema, pleuritis, atelectasis
Hepatic	Hypoalbuminemia, cytochrome P450 abnormality, hepatitis

Data from Koehntop DE, Beebe DS, Belani KG. Kidney transplantation. In Klinck JL, Lindop MJ eds. *Anesthesia and Intensive Care for Organ Transplantation*. London: Chapman and Hall 1998:254-280.

### High Incidence of Cardiovascular Disease, Especially in Diabetics

Patients with diabetes and renal failure are at particular risk for coronary artery disease.<sup>20</sup> Evaluation of these patients often is difficult because they have a high incidence of silent ischemia. In addition, some noninvasive tests, such as thallium stress test, have not been as reliable for evaluating cardiac pathology in diabetic patients with renal failure as in nondiabetic patients.<sup>23</sup> This has led some centers to recommend coronary angiography in patients with ESRD associated with diabetes if they are older than 45 years, have a history of smoking, have had diabetes for >25 years, or have electrocardiographic signs of ischemia.<sup>24</sup> Diabetic patients who have significant coronary disease with treatable lesions should undergo coronary artery surgery or angioplasty prior to receiving a kidney transplant.<sup>24</sup> Some diabetics have significant but diffuse coronary disease (identified by angiography) that cannot be treated surgically or by angioplasty. These patients may still benefit from kidney transplantation instead of chronic dialysis, but they are at higher risk for perioperative cardiac events.<sup>18</sup>

### Dialysis

Patients presenting for renal transplantation may be receiving either hemodialysis or peritoneal dialysis. Each method has its associated morbidity

and complications that influence the care of patients who undergo kidney transplantation. Both methods often fail to correct completely the metabolic acidosis associated with renal failure. Other metabolic problems, including hyperkalemia, also may not be corrected completely with either method.<sup>18</sup>

Peritoneal dialysis may result in intravascular volume overload or depletion, depending upon the volume and osmolality of the dialysate. Atelectasis may occur as a result of diaphragmatic splinting resulting from the dialysate, and pleural effusion may occur if the fluid leaks into the pleural space. However, the most common complication of peritoneal dialysis is peritonitis. This usually resolves with antibiotic treatment but may cause cancellation of the transplant if peritonitis is present when a donor organ becomes available.<sup>18</sup>

Hemodialysis by its nature results in rapid shifts in the patient's intravascular volume status. For example, 8 hours of dialysis in an adult reduces body water by an average of 1.5 L and the plasma volume by 0.7 L. This rapid volume shift may result in hypotension during dialysis in some patients. Significant hypotension upon induction of general anesthesia in a patient who has recently hemodialyzed is common.<sup>18</sup>

### Preoperative Assessment

Several items in the pretransplant evaluation are of concern to the anesthesia

provider. A major concern is the cause of the patient's renal failure. Diabetes currently is the most common cause of ESRD in adults. In addition, diabetic patients suffer from a host of other comorbidities that affect anesthetic care, including gastroparesis, autonomic neuropathy, peripheral neuropathy, cardiovascular disease, and peripheral vascular disease. Diabetics with autonomic neuropathy are at risk for severe hypotension and bradycardia during induction of general anesthesia and for sudden death in the postoperative period.<sup>25</sup> Hypertension is another common cause of renal failure that affects multiple organ systems. Thus, the results of other tests of organ function, such as coronary angiograms that were obtained as part of the general pretransplant evaluation, must be reviewed and the results incorporated in the plan for anesthesia care.

The frequency and type of dialysis, if used, are important as well. The interval since the last dialysis will be helpful in determining the volume status of the patient. The time of insulin administration in diabetic patients is important to note because it can influence the plan for perioperative glucose management. A history of hypotension with dialysis in a diabetic patient suggests the patient may suffer from autonomic neuropathy. These patients are at risk for hypotension upon induction of general anesthesia. Diabetic patients should be asked about symptoms of gastroparesis, such as heartburn, bloating, and explosive diarrhea, because they may be at risk for aspiration of gastric contents upon induction of general anesthesia. These patients will benefit from a nonparticulate antacid, such as sodium citrate or related compounds, prior to induction of general anesthesia. In addition, the type and last dose of antihypertensive medications that the patient receives should be recorded. In general, patients should receive their usual blood pressure medications prior to surgery.<sup>26</sup> However, angiotensin system inhibitors administered immediately before operation have been associated with a greater incidence of hypotension upon induction of general anesthesia in hypertensive patients.<sup>27</sup> As a result, these drugs should be withheld in patients undergoing kidney transplantation, particularly if they have other risk factors for hypotension upon induction of general



anesthesia, such as autonomic neuropathy and dialysis related hypovolemia.

### Physical Examination

Several components of the physical examination deserve special consideration in the preanesthetic evaluation of the renal transplant patient. The evaluation of the airway is particularly important for patients in whom diabetes is the cause of renal failure. Patients with long-standing diabetes often develop stiff joints due to glycosylation of the connective tissue that results from elevated blood sugar levels. The inability to oppose the palms of the hands is one sign that stiff connective tissue may be present in a diabetic patient. Patients with stiff joints may be difficult to intubate and may require an awake, fiberoptic intubation.<sup>28</sup> The patient should also be examined for signs of congestive heart failure, such as rales and peripheral edema.

The arms of patients on chronic hemodialysis should be examined for the presence of both functioning and non-functioning dialysis shunts and fistulas. Upper extremity fistulas may clot during transplantation surgery from reduced blood flow during surgery or perioperative elevation of clotting factors. Care must be taken when padding the upper extremity with a forearm fistula so that blood flow in the fistula is not restricted. Blood flow through the fistula during surgery can be monitored by palpation or a Doppler device. The arm with a functioning fistula should not be used for blood pressure monitoring, venipuncture, or placement of intravascular catheters because each such maneuver may cause the fistula to thrombose.<sup>26</sup> In the event of delayed graft function or even nonfunction following kidney transplantation, a functioning dialysis shunt is invaluable in the postoperative period.

### Assessment of Fluid Balance

Fluid balance often is difficult to assess in patients on chronic dialysis. Depending on the type of dialysis and the interval since last dialysis, the patient may arrive in the operating room either hypervolemic or hypovolemic. Therefore, the type of dialysis, time of last dialysis, and frequency of dialysis are important information to obtain.<sup>26</sup>

**Comparison of Current Weight with Dry Weight** One method to help evaluate the volume status of a

patient on chronic dialysis is to review the patient's body weight before and after dialysis. The weight of the patient at the completion of dialysis, the "dry" weight, can be determined and compared to the weight when the patient presents for surgery.<sup>18</sup> If the patient has not been dialyzed for several days prior to surgery and has a preoperative weight that is the same or greater than the predialysis weight, the patient likely is euvolemic or even hypervolemic. However if the patient's weight is close to the dry weight, the patient may be hypovolemic. Finally, patients who are dialyzed the day of surgery and lose more than 2 kg of weight have a high incidence of hypotension upon induction of general anesthesia because of hypovolemia.<sup>27</sup> Anesthesia care providers must be prepared to rapidly replace the intravascular volume in these patients. Depending upon the extent of hypovolemia, either intravenous normal saline or 5% albumin can be used to provide a more rapid and sustainable cardiovascular response.

### Laboratory Tests

Several laboratory tests should be performed in all patients. Because electrolyte and blood glucose levels can change markedly over several days, particularly in patients on dialysis, most of these tests should be performed at or close to the time of operation. An electrocardiogram should be obtained in all patients at risk for cardiac disease and the results compared to previous studies. The serum potassium level may increase during surgery from the effects of drugs administered, blood transfusions, or infusion of hyperkalemic preservative solution from the new kidney. Therefore, delay of surgery may be necessary and dialysis or other intervention performed if the patient is hyperkalemic ( $>6$  mmol/L) preoperatively. Coagulation studies (international normalized ratio, partial thromboplastin time, fibrinogen, platelet count) should be obtained if the patient has a history of bleeding or other evidence of a possible coagulopathy. Finally, a hemoglobin level should be drawn and several units of blood made available preoperatively because patients with renal failure often are markedly anemic preoperatively.<sup>26</sup> Fluid loading to increase central venous pressure in preparation for reperfusion and surgical blood loss may

further decrease blood hemoglobin values and thus warrant intraoperative packed red cell transfusion.

## Anesthetic Management

### Induction and Maintenance of General Anesthesia

The choice of induction agent depends on the overall health of the patient, the volume status of the patient, the presence of autonomic neuropathy, and the presence of cardiovascular or other disease. Relatively healthy renal transplant recipients tolerate induction of general anesthesia with propofol (2.0–3.0 mg/kg) or thiopental (2.5–3.0 mg/kg) without difficulty. However, hemodynamically compromised patients tolerate etomidate (0.2 mg/kg) better because it causes minimal myocardial depression and preserves autonomic tone. These features are particularly important in diabetic patients with autonomic neuropathy. Fentanyl (50–100  $\mu$ g/kg IV) can be administered during induction to blunt the hypertensive response to tracheal intubation. In patients who do not have a history of gastroparesis or acid reflux disease, intermediate-duration nondepolarizing muscle relaxants that do not depend on renal excretion for elimination, such as rocuronium (0.5 mg/kg), cisatracurium (0.2 mg/kg), or vecuronium (0.1 mg/kg), can be administered to facilitate tracheal intubation.<sup>26</sup>

In patients with gastroparesis or acid reflux disease, a rapid sequence induction, including the Sellick maneuver to prevent regurgitation of gastric contents, should be performed. The depolarizing agent succinylcholine (1.5 mg/kg IV) has classically been used in patients without renal failure to provide rapid skeletal muscle relaxation for immediate tracheal intubation. However, the serum potassium level can increase 0.6 mmol/L with its administration, so it should be used with caution, if at all, in patients with renal failure who have a preoperative elevated potassium level ( $>5.5$  mmol/L). Because of the increased serum potassium level in renal transplant recipients, many anesthesia providers prefer to use nondepolarizing agents even if a rapid sequence induction is required. Rocuronium is useful for this purpose because at high doses (1.2 mg/kg) it has an onset of action of 60–90 seconds and does not require renal function for elimination.<sup>26</sup>  $\beta$ -Blockers such as metoprolol should be administered to patients at risk for cor-

onary disease if they have not received the drugs preoperatively. Although not studied specifically in renal transplant recipients,  $\beta$ -blockers have been shown to decrease the likelihood of perioperative myocardial infarction in patients with coronary disease undergoing major vascular surgery similar to kidney transplantation.<sup>29</sup> In a multicenter study conducted in patients undergoing elective abdominal aortic or infrainguinal arterial reconstruction, Polderman et al.<sup>29</sup> reported that  $\beta$ -blockers were able to reduce the combined incidence of perioperative cardiac events from 34% to 3.4%.

The inhaled agents desflurane and isoflurane both are extremely useful for the maintenance of general anesthesia for kidney transplantation. Neither agent has nephrotoxic properties, and no deterioration of renal function has been noted with either agent in patients with or without renal disease.<sup>9</sup> Nitrous oxide can be used with the potent inhaled agent. It has minimal side effects, no renal toxicity, and rapid elimination. However, nitrous oxide is associated with increased nausea and vomiting in the postoperative period.<sup>30</sup> As a result, it may be used less frequently for these procedures in the future. Sevoflurane is rarely used for renal transplantation. This agent is metabolized by the liver to produce inorganic fluoride, a substance that has been shown to produce renal toxicity in patients receiving methoxyflurane. Although fluoride toxicity has not been reported with sevoflurane, the possibility still exists, particularly in a donor organ that likely has sustained some degree of ischemic damage. Sevoflurane also reacts with soda lime to form a substance that is nephrotoxic in animal and some human studies.<sup>31</sup> Therefore, the safety of sevoflurane in renal transplantation is unclear. Given that other alternatives are available, there seems to be little reason to select sevoflurane for inhalation anesthesia in these patients.

During anesthesia care, narcotics such as fentanyl (50–100  $\mu\text{g}/\text{h}$ ) often are administered throughout the transplant procedure to reduce the amount of inhaled agent required and to decrease the likelihood of the patient awakening in severe pain. The pharmacokinetics and pharmacodynamics of fentanyl, sufentanil, alfentanil, and remifentanyl are not significantly altered by kidney disease, and all have

been successfully used during renal transplantation.<sup>32</sup>

Ongoing skeletal muscle relaxation can be provided with nondepolarizing muscle relaxants that do not depend on the kidney for elimination, such as *cis*-atracurium, rocuronium, and vecuronium. All three agents have been used successfully in patients with marginal or no renal function, and they have minimal effects on heart rate and blood pressure. *Cis*-atracurium is broken down in the plasma by Hoffman elimination, which does not depend on renal or hepatic function. Its duration of action is not prolonged in renal failure. Although the liver metabolizes rocuronium and vecuronium primarily, the duration of blockade with these two agents may be prolonged if large doses are used.<sup>9,33</sup> Pancuronium should not be used in kidney transplant recipients because the drug depends primarily on the kidney for elimination. If the new kidney does not function adequately initially, a prolonged neuromuscular block may result.<sup>9</sup>

Blood glucose determinations should be made every hour in renal transplant recipients who have insulin-dependent diabetes mellitus. Evidence suggests that the incidence of wound infections can be reduced in diabetic patients if blood sugar levels are tightly controlled. One method to maintain tight control of the blood sugar level in adults is to begin an intravenous insulin infusion at 1 unit/h if the blood glucose level is  $>90$  g/dL and adjust the rate to maintain a blood sugar level between 90 and 110 g/dL. In addition, a low-dose dextrose solution (D51/2 normal saline at 25 mL/h) should be administered concurrently throughout the procedure to provide for intraoperative nutrition and prevent hypoglycemia.<sup>34</sup>

Following surgery, most patients can be extubated in the operating room or recovery room when they are alert, strong, and able to maintain adequate ventilation. Postoperative ventilation is rarely required. Epidural analgesia has been used successfully for postoperative analgesia in renal transplant recipients.<sup>35</sup> Use of combined spinal–epidural anesthesia for both surgical anesthesia as well as postoperative pain relief has been reported.<sup>35,36</sup> There is a small but rare risk of epidural hematoma when epidural analgesia is used in anticoagulated patients.

Because most graft recipients receive heparin intraoperatively and

some in the postoperative period, intravenous narcotics such as fentanyl, morphine, and hydromorphone usually are used for postoperative analgesia. These agents also can be used for patient-controlled analgesia following discharge from the recovery room.<sup>9</sup>

All narcotics must be used cautiously in renal transplant recipients, particularly if the graft is not functioning properly. For example, a metabolite of morphine, morphine-6-B-glucuronide, has opioid agonist activity and is excreted by the kidneys. It can accumulate in renal failure and cause respiratory depression with long-term use. The metabolism of hydromorphone produces a neuroexcitatory compound that can accumulate in renal failure. However, hydromorphone has been used extensively in renal failure patients with no adverse effects. In contrast, a metabolite of meperidine (Demerol), normeperidine, can accumulate in significant amounts in patients with renal failure and can cause seizures. Therefore, meperidine should not be used for postoperative analgesia in renal transplant recipients.<sup>33</sup>

### Monitoring

Patients undergoing renal transplantation usually benefit from central venous pressure measurement, which helps determine if the volume status of the recipient is adequate at the time of reperfusion of the allograft. It also provides convenient vascular access to obtain blood samples and for administration of immunosuppressive drugs that must be administered centrally. Pulmonary artery catheters rarely are necessary except in patients with severe cardiac disease. Direct arterial catheters also are rarely necessary except in compromised patients in whom frequent blood gases must be determined.<sup>26</sup>

### Immunosuppression

Reactions to immunosuppressive drugs occur occasionally.<sup>37</sup> For example, cyclosporine administration can result in hypomagnesemia, rhabdomyolysis, and other electrolyte disorders.<sup>38</sup> Reactions to antibody OKT3 can be severe and result in hypotension and pulmonary edema. Treatment with diphenhydramine, vasopressors, steroids, diuresis, and postoperative ventilation may be required.<sup>26</sup>

**Immunosuppressive Regimens May Dictate Need for Central Access** Some immunosuppressive agents require administration via a cen-

tral rather than a peripheral vein. For example, the polyclonal antibody anti-thymocyte globulin is so irritating to peripheral veins that it must be administered centrally (Thymoglobulin [anti-thymocyte globulin (rabbit)] prescribing information, Sangstat Medical Corporation, Menlo Park, CA).

### Allograft Perfusion

Intraoperative volume expansion has been shown to increase renal blood flow and improve immediate graft function. Immediate graft function is associated with increased allograft and patient survival.<sup>9</sup> One method to ensure adequate volume expansion in most patients is to raise the central venous pressure to 14 or 15 mm Hg with intravenous normal saline or 5% albumin prior to perfusion of the allograft. If the patient is relatively anemic (hemoglobin <10 g/dL), packed red blood cells can be used for this purpose as well.

Hypotension can result in decreased graft perfusion and delayed graft function. Often adequate volume expansion prevents the hypotension seen with reperfusion. However, hypotension still can result from products of ischemia from the graft or lower extremity when the vascular clamps are released. The microvasculature of the graft and lower extremity are also vasodilated maximally with reperfusion after a period of ischemia and can result in low peripheral resistance. Therefore, it is helpful to intentionally raise the systolic blood pressure to 130 or 140 mm Hg by reducing the concentration of inhaled anesthetic agents administered prior to reperfusion of the allograft. A vasopressor such as ephedrine (5–10 mg) or phenylephrine (100–200 µg) or infusion of dopamine (3–5 µg/kg/min) occasionally is required to treat hypotension during and after perfusion. One advantage of dopamine over the other vasopressors is that it can increase diuresis in the allograft. However, graft survival has not been shown to increase in spite of this increased diuresis.<sup>9</sup>

Mannitol administration (0.25–1 g/kg) prior to perfusion of the allograft, when combined with volume expansion, has been shown to decrease the incidence of acute tubular necrosis in the transplanted kidney. The mechanism by which this is accomplished may be related to decreasing tubular swelling by its osmotic effect, its action as a free-radical scavenger, or by flushing away of sloughed renal tubule

cells before they can cause injury by secondary obstruction.<sup>39</sup> Other diuretics such as furosemide can be administered to enhance diuresis but have not been shown to reduce the incidence of acute tubular necrosis or delayed graft function in the transplanted kidney.<sup>9</sup>

### Monitoring Urine Output

After reperfusion of the allograft, the urine output, intravascular volume, and overall circulatory status should be followed carefully. Hypovolemia, hypotension, acute tubular necrosis, or acute rejection can result in diminished urine output. Evaluation of decreased urine output posttransplant usually begins with an assessment of the patient's volume status. A biopsy of the transplanted kidney may be necessary to determine if the patient is suffering from acute tubular necrosis or graft rejection.<sup>26</sup>

### Decreasing Urine Output May Indicate a Reversible Surgical Problem

Anuria may be due to a mechanical factor. Vascular complications, such as arterial thrombosis, arterial stenosis, and venous occlusion, may result in oliguria. Distal obstruction of the ureter by a clot, kinking, or pressure on the kidney by a lymphocele or hematoma may compromise the function of the new kidney. Fortunately, many of the mechanical causes of oliguria are correctible if the diagnosis can be made in a timely fashion.<sup>26</sup>

### Postoperative Considerations and Complications

Most patients do not require admission to the intensive care unit in the postoperative period, provided the nursing unit is experienced in the care of transplant recipients. The standard postoperative care must be provided for the patient who has undergone major abdominal surgery, and the function of the new kidney in the transplant recipient must be followed carefully. Rejection, viral infection, vascular thrombosis, and urinary obstruction are complications that may occur in the perioperative period.<sup>26</sup>

The most common causes of death after transplantation are cardiovascular-related events. Up to 6% of patients with coronary artery disease experience a cardiac complication within 30 days of transplantation.<sup>40</sup> Administering perioperative  $\beta$ -blockade, providing normothermia, maintaining hematocrit >30%, and ensuring patients have optimum

analgesia in the perioperative period are measures that may help reduce the risk in patients with cardiac disease undergoing renal transplantation.<sup>9</sup>

### Anesthetic Considerations for Patients with Prior Renal Transplantation

Even with a functioning graft, the renal excretion of drugs in transplant recipients usually is decreased compared to those with normal functioning native kidneys. Furthermore, recipients may still suffer from their other systemic disease, such as diabetes or hypertension, that initially resulted in renal insufficiency. Therefore, the anesthetic management of patients with a prior renal transplant is similar to the management of the transplant itself. Muscle relaxants that depend on renal excretion for elimination, such as pancuronium, should be used only with the recognition that excretion may be delayed. Sevoflurane should not be used for the reasons described previously in the section on Induction and Maintenance of General Anesthesia. Adequate hydration should be ensured in the perioperative period, and hypotension avoided to ensure adequate perfusion to the allograft.<sup>41</sup>

Long-term immunosuppression can result in significant morbidity in kidney transplant recipients. The effect of immunosuppressive drugs should be considered when evaluating a kidney transplant recipient for nontransplant surgery. For example, cyclosporine use may cause hypertension and worsen atherosclerosis in kidney transplant recipients. Most patients have some degree of adrenal suppression because of long-term steroid use. Therefore, a stress dose of steroids may be necessary in renal transplant recipients who have received steroids for immunosuppression.<sup>41</sup>

### Special Considerations in Pediatric Patients

The anesthetic care of older children and adolescents is similar to the care of adults. Infants and small children younger than 2 years are more challenging. Infants and small children usually receive an adult kidney rather than one from a donor similar in age because there is a high incidence of vascular thrombosis with allografts from infants and small children. However, an adult kidney is so large compared to an infant kidney that it must be anastomosed to the infant's aorta



and vena cava rather than the iliac vessels (Fig. 58-1), as in older children or adults.<sup>42</sup> Therefore, the aorta and vena cava both must be cross-clamped during performance of the vascular anastomoses. The adult kidney can sequester up to 300 mL of blood upon reperfusion. Reperfusion can also result in acidosis from the ischemic organ and lower extremities. Hyperkalemia may result from absorption of the standard hyperkalemic (University of Wisconsin) preservative solution. Hypothermia may result with reperfusion of the allograft. Ischemic vasodilatation upon reperfusion of the allograft can result in low peripheral vascular resistance and hypotension. In addition, the adult kidney initially can produce urine at a rate equal to the patient's blood volume every hour.<sup>43</sup> All this dictates that caregivers pay close attention to circulatory hemodynamics in young infants receiving an adult kidney allograft.

### Allograft Perfusion

The goals of the anesthetic management of kidney transplantation in infants and small children are the same as in older children and adults. Adequate volume expansion must occur to prevent severe hypotension upon perfusion of the allograft. Often a permanent, large-bore (2-mm internal diameter) dialysis catheter is valuable for central vascular access and provides a means for hemodialysis if the kidney does not function immediately. Direct arterial pressure monitoring is useful in infants and very small children because blood pressure changes can be rapid and profound. In contrast to older children and adults, the central venous pressure in infants must be increased to 16–20 mm Hg before reperfusion of the allograft. Colloids such as 5% albumin as well as blood products are generally used for this purpose. The amount of colloids and/or blood products administered can be profound. In one review of infants and small children receiving an adult kidney transplant, the amount of colloids and/or blood products administered averaged  $90 \pm 41$  mL/kg.<sup>43</sup>

### Postoperative Admission to the Intensive Care Unit

Postoperatively, pediatric patients are at an increased risk for pulmonary edema. Most pediatric patients tolerate the volume administration without morbidity. In a review of 24 infants who received an adult kidney trans-

plant, 17 (71%) were extubated in the recovery room, and most of the other infants were extubated in the intensive care unit the following day. Only 2 (8.3%) patients required mechanical ventilation beyond 24 hours to aid in fluid management. However, 7 (29%) of the 24 patients had radiographic evidence of pulmonary edema on the postoperative chest x-ray film. Therefore, the pulmonary status of pediatric patients should be monitored in an intensive care unit setting following surgery, and some of these patients may require postoperative ventilatory support.<sup>43</sup>

### Outcome

Approximately 25,000 patients per year now receive a kidney transplant, either from a living or a cadaver donor. The 1-year graft survival rate is 89% from cadaveric donors and 95% from living related donors. At 5 years, the graft survival is 79% from living related donors and 66% from cadaveric. The 5-year patient survival rate is 81% for recipients of cadaveric organs and 90% for recipients of living donors. In addition, comparison with earlier data shows improved survival of both the patients and the allografts over time. Renal transplantation has become one of the great success stories in medicine.

### Summary

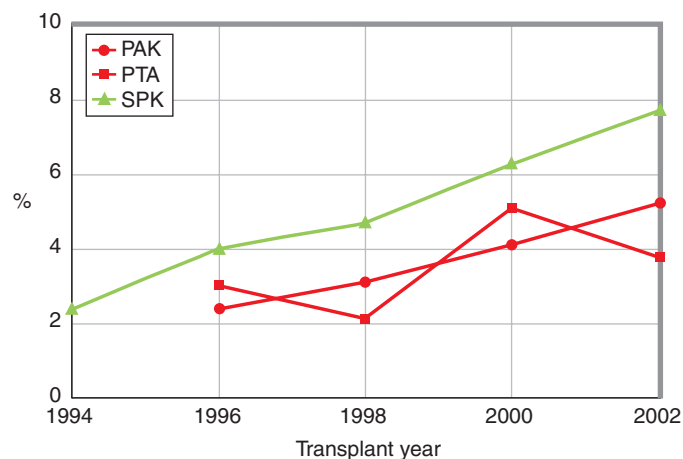
Kidney transplantation offers both better survival and a better lifestyle to patients in renal failure. Patients with

renal failure are challenging for the anesthesia provider. With careful anesthetic care, knowledge of the pathophysiology of renal failure and associated disease, and understanding of the physiology of perfusion of the renal allograft, satisfying outcomes can be obtained.

## PANCREAS AND ISLET CELL TRANSPLANTATION

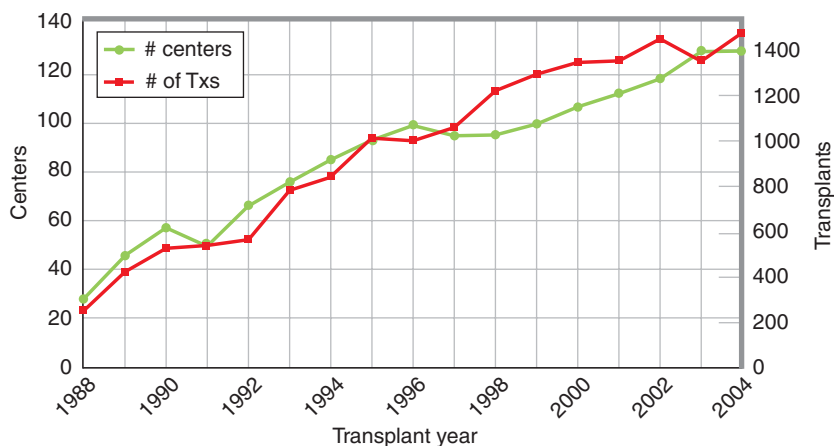
### History and Introduction

In 1967, Kelly et al.<sup>44</sup> reported the first combined transplantation of the pancreas and duodenum along with a kidney in a human with diabetic nephropathy. Today, this procedure is commonplace for the surgical treatment of type 1 diabetes mellitus in patients with ESRD. Because renal failure often accompanies diabetes mellitus and although pancreas transplantation alone can be done, pancreas transplantation is most commonly performed (as mentioned in the discussion on kidney transplantation) simultaneously with a kidney transplant procedure or following kidney transplantation.<sup>45,46</sup> Thus, transplantation of the pancreas or islet cells<sup>47</sup> constitutes surgical treatment for patients with type 1 diabetes mellitus and now increasingly for those with type 2 diabetes mellitus (Fig. 58-2).<sup>45,48</sup> Cadaveric donors provide whole pancreas grafts and islet cells, whereas living donors provide distal segments for transplantation. Autologous islet cell transplantation is the



**FIGURE 58-2.** Patients undergoing pancreas transplantation who were diagnosed pretransplant as having type 2 diabetes mellitus. The number of patients in the PAK and SPK groups has increased steadily. PAK, Pancreas after kidney transplantation; PTA, pancreas transplantation alone; SPK, simultaneous pancreas and kidney transplantation. (From Gruessner and Sutherland<sup>45</sup> with permission from Blackwell Publishing.)





**FIGURE 58-3.** Number of pancreas transplants performed annually in the United States between 1988 and 2004. Note that the number of centers performing pancreas transplants has increased. (Data from Gruessner and Sutherland<sup>45</sup> with permission from Blackwell Publishing.)

treatment of choice for endocrine deficiency following total pancreatectomy.<sup>49</sup> The most recent published data (2005) indicate that more than 23,000 pancreas transplants from approximately 140 centers in the United States were reported to the International Pancreas Transplant Registry.<sup>45</sup> The majority (>17,000) were performed in the United States (Fig. 58-3). The majority of transplants are simultaneous pancreas and kidney transplants (78%), then pancreas after kidney transplants (16%), followed by pancreas transplants alone (7%).<sup>45</sup> More than 700 islet allograft transplants were reported globally until June 2003.<sup>47</sup> Between 2003 and 2004, the number of simultaneously performed kidney and pancreas transplants increased by 1.3%, pancreas after kidney transplants increased by 21.9%, and pancreas transplants alone increased by 12.8%.<sup>50</sup>

### Pathophysiology of Diabetes Mellitus

Diabetes mellitus is a multisystem disease characterized by hyperglycemia resulting from deficiency in insulin secretion or action. It is one of the leading causes of death and disability in the United States. According to the estimates from the National Institutes of Health, more than 18 million people in the United States have diabetes mellitus; approximately six million remain undiagnosed.<sup>48</sup> Each year more than one million people older than 20 years are diagnosed with diabetes; thus, by 2025, diabetes is predicted to affect nearly 9% of the population. Pediatric endocrinologists also are recognizing the increased importance of this prob-

lem.<sup>51</sup> Because diabetes mellitus is associated with long-term complications that affect almost every system in the body, in 2002, approximately \$132 billion was spent in the United States for medical care and lost productivity because of diabetes mellitus in patients.<sup>48</sup>

Diabetes mellitus is classified based on the pathogenic process leading to hyperglycemia.<sup>52</sup> Type 1 diabetes occurs as a result of absolute insulin deficiency; it is immune mediated or idiopathic in origin. The condition usually results from the synergistic effects of genetic, environmental, and immunologic factors leading to pancreatic beta-cell destruction. Approximately 5–10% of diagnosed cases of diabetes are type 1, which usually affects individuals during childhood and adolescence.<sup>51,52</sup> The nonsurgical treatment of type 1 diabetes consists of lifelong administration of exogenous insulin. The Diabetes Control and Complications study demonstrated that tight glucose control delays the onset and slows the progression of diabetic retinopathy, nephropathy, and neuropathy.<sup>53–56</sup> These studies have concluded that the risk of the 3-fold increase in severe hypoglycemia outweighs the benefits of delay in progression of diabetic end-organ damage. Despite this finding, pancreas or islet cell transplantation offers patients with insulin-dependent diabetes mellitus an endogenous source of insulin. Even though increasingly sicker recipients are being transplanted, long-term insulin independence is achieved in 77–85% of pancreas transplant recipients.<sup>45,57</sup>

Insulin resistance with a relative insulin deficiency is classified as type

2 diabetes.<sup>52</sup> It is the more common type of diabetes that is managed by diet, oral hypoglycemic agents, and/or exogenous insulin administration.<sup>48</sup> It usually is seen in adults older than 40 years, but the incidence of onset in adolescence is increasing rapidly, as is the metabolic syndrome that consists of several coexisting problems, namely, obesity, hypertension, and diabetes mellitus.<sup>58</sup> In patients with metabolic syndrome, high amounts of visceral fat are more influential in the development of diabetes-related complications, such as cardiovascular disease.

Patients with type 1 diabetes mellitus develop progressive changes in almost every organ system because of microangiopathy. Chronically increased blood glucose concentrations lead to glycosylation of proteins. Acute complications of diabetes include diabetic ketoacidosis, hyperglycemic hyperosmolar nonketotic coma, lactic acidosis, and hypoglycemia.<sup>59</sup> Chronic complications of type 1 diabetes mellitus include coronary artery disease, peripheral vascular disease, cerebrovascular disease, nephropathy, autonomic and peripheral neuropathy, and retinopathy.<sup>48,53–56,60–62</sup> Table 58-2 summarizes the cumulative prevalence and relative risk of these complications in patients with insulin-dependent diabetes mellitus.<sup>63</sup>

### Rationale for Pancreas Transplantation

The goal of pancreas and islet cell transplantation is restoration of normoglycemia and the glucagon response to hypoglycemia, allowing patients to be insulin free and eat a regular diet.<sup>48,64</sup> Carbohydrate metabolism after pancreas transplant may stabilize and even improve macrovascular and microvascular disease.<sup>65,66</sup> A secondary benefit is the improved quality of life reported by patients.<sup>67–69</sup> Although most patients do not require exogenous insulin, some may still develop retinopathy and show progression of macrovascular disease despite successful kidney and pancreas transplantation.<sup>70</sup>

The current recommendations for pancreas transplantation are summarized in Fig. 58-4. The American Diabetes Association's position statement on pancreas and islet transplant recommends pancreas transplant as an acceptable therapeutic alternative to insulin therapy in diabetic patients with imminent or established ESRD who already have or plan to have a

TABLE 58-2.

## Cumulative Prevalence and Relative Risk of Diabetes Complications

Complication	Cumulative Prevalence	Relative Risk <sup>a</sup>
Blindness	16%	20
Renal failure	22%	25
Amputation	12%	40
Myocardial infarction	21%	2-5
Stroke	10%	2-3

<sup>a</sup>Compared to relative risk for people without diabetes.  
Data from Nathan DM. Long-term complications of diabetes mellitus. *N Engl J Med* 1993;328:1676-1685.

renal transplant.<sup>71</sup> Survival is better if a pancreas transplant is also performed in patients requiring a kidney transplant.<sup>72</sup> Diabetic patients with a history of frequent, acute, severe metabolic complications, incapacitating clinical and emotional problems with exogenous insulin therapy, and consistent failure of insulin-based management to prevent complications should be considered for pancreas transplant in the absence of indications for kidney transplant. Islet cell transplant is still in its infancy and thus should be performed only in a controlled setting where facilities for performing this procedure are available.

### Surgical Options

Several surgical techniques have been described, but all require vascularization of the pancreas and a method for draining the pancreatic duct.<sup>47</sup> Exocrine secretions can be managed by either enteric or bladder drainage (Fig.

58-5). From 1987-1995, >90% of pancreas transplants were performed using bladder drainage (Fig. 58-5B), which allows serial measurements of urinary amylase to monitor for rejection.<sup>45,66,73,74</sup> Chronic loss of pancreatic secretions into the bladder can result in dehydration, electrolyte abnormalities, local bladder irritation, hematuria, urethritis, and allograft pancreatitis.<sup>74-76</sup> With improvement in surgical technique, enteric drainage (Fig. 58-5A) has become the surgical procedure of choice.<sup>66,74,76</sup> Initially, it was associated with a high morbidity rate as a result of leakage and the need for frequent reoperations. However, enteric drainage avoids the complications associated with bladder drainage.<sup>66,74,76</sup>

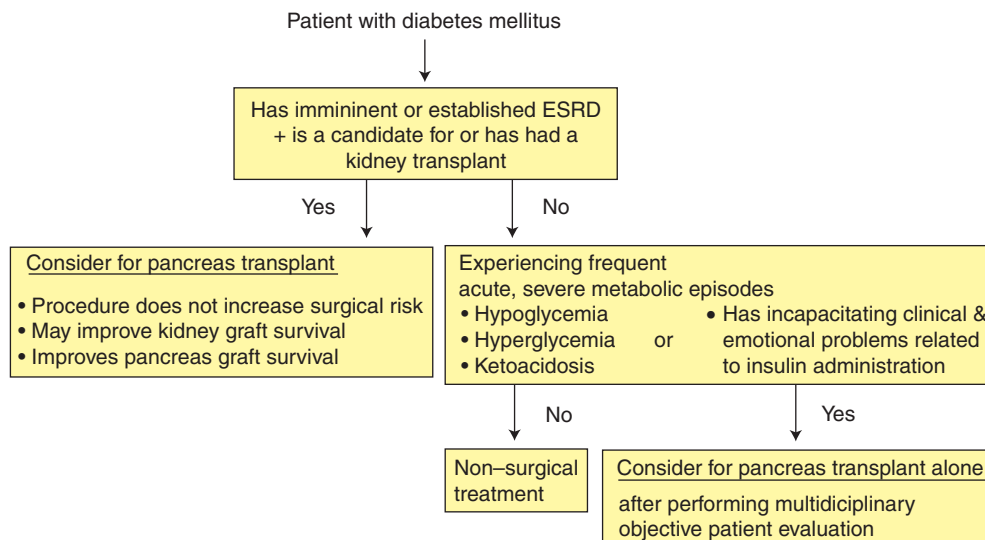
Vascular management includes arterial anastomosis and venous drainage either systemically or into the portal venous system. Portal venous drainage has remained constant for patients undergoing simultaneous pancreas

and kidney transplantation but since 2002 has been decreasing for the other transplant categories.<sup>45</sup> Both portal and systemic drainage are associated with excellent glycemic control, but fasting serum insulin levels are significantly lower in portal drainage without an effect on graft survival rates at 1 year for simultaneous pancreas and kidney or pancreas after kidney transplantation.<sup>74</sup> Currently, vascular management strategies have little impact on graft survival rate.<sup>45</sup>

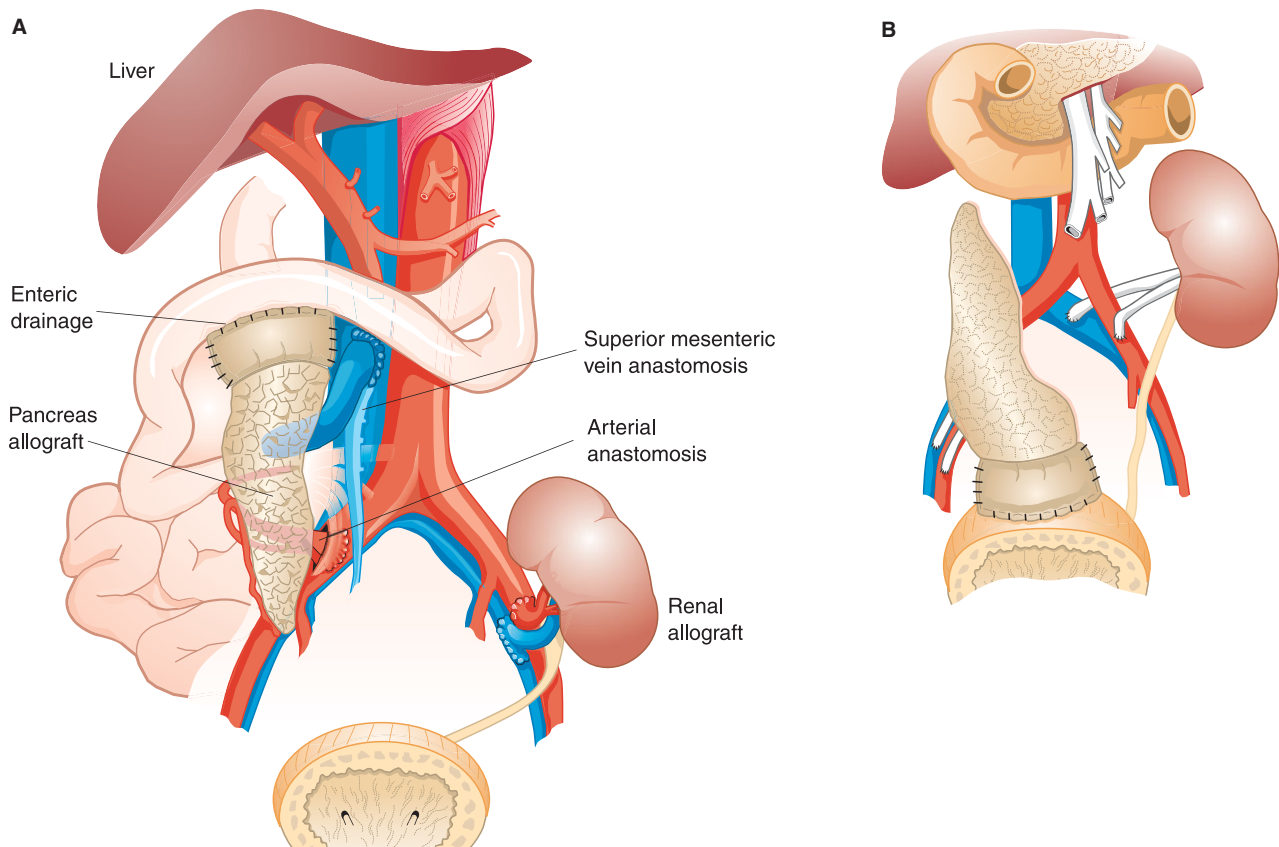
Because of technical problems, pancreas grafts are associated with the highest surgical complication rate of all routinely transplanted solid organs. Causes for technical failure of cadaveric primary pancreas transplants include pancreatitis, anastomotic leak, bleeding, and rejection.<sup>77-82</sup> Significant risk factors for graft loss include older donor age, donor obesity, retransplantation, and relaparotomy for infection, leak, or bleeding, and the immunosuppression protocol.<sup>79,82-85</sup> The quality of a cadaveric donor graft can directly affect graft performance.<sup>84,85</sup> Table 58-3 lists the inclusion criteria for a cadaveric pancreas donor.<sup>48</sup> The incidence of relaparotomy has decreased with increasing experience with pancreas transplants.<sup>79</sup> Risk factors for recipient death include older recipient, retransplantation, relaparotomy for thrombosis, infection, leak, or bleeding.<sup>45,48</sup>

### Preoperative Evaluation

Cadaveric pancreas procurement usually is part of a multiple organ harvest.



**FIGURE 58-4.** Flow diagram summarizing the indications for pancreas transplantation in patients with diabetes mellitus. Islet cell transplantation, which requires immunosuppression, will be the procedure of choice in the future but is still in the developmental stages. Data from Robertson RP, et al. Pancreas transplantation for patients with type 1 diabetes. *Diabetes Care* 2003;26(Suppl 1):S120.



**FIGURE 58-5.** Surgical vascularization of the pancreas graft showing enteric drainage (A) and bladder drainage (B). (Diagrams in A courtesy of DE Sutherland and modified from Bretzel et al.<sup>47</sup> with permission from Edizioni Minerva Medica.)

For successful graft function, preservation time preferably is <24 hours. This limit requires that the anesthesia provider be able to perform a thorough evaluation of the recipient in an efficient manner. As emphasized in the discussion on kidney transplantation, patient care efficiency requires that

**TABLE 58-3.**

**Inclusion Criteria for Cadaveric Pancreas Donors**

- 10–50 years old
- Ideally death from trauma rather than intracerebral hemorrhage
- Hemodynamic stability
- No diabetes
- No alcohol abuse
- No hypertension
- Normal renal function
- No sepsis, hepatitis B surface antigen negativity, hepatitis C negativity, human immunodeficiency, virus negativity
- No malignancy
- Donor surgeon macroscopic assessment for normalcy

pancreas transplant centers exercise a stringent policy with regard to workup and selection.<sup>66</sup> An advance evaluation should include coronary artery disease,<sup>86</sup> renal status, autonomic nervous system, systemic neuropathy, metabolic status, presence of gastroparesis, and the possibility of difficult intubation.<sup>48</sup> Table 58-4 outlines areas that should be included during the preoperative assessment.

Coronary artery disease is responsible for the majority of perioperative mortality in pancreas recipients.<sup>87,88</sup> Noninvasive screening tests or preoperative coronary angiography helps plan intraoperative and postoperative care to decrease complications.<sup>87-90</sup> Pretransplantation coronary revascularization reduces the risk of subsequent cardiac events.<sup>89</sup> Because simultaneous pancreas and kidney transplants account for 78% of pancreas transplants and pancreas after kidney transplants for 16% of transplants,<sup>45</sup> evaluation of renal function, including determination of acid-base status, glucose levels, electrolyte concentrations, and time of last hemodialysis, is important. ESRD is often associated with anemia, which

can have a significant impact on morbidity and graft success.<sup>48</sup>

Autonomic nervous system dysfunction predisposes patients to severe hypotension during anesthesia. Sudden death in patients not continu-

**TABLE 58-4.**

**Preoperative Assessment of Pancreas Transplantation Recipients**

Routine	Specific
Medications	End-stage renal disease
Allergies	Cardiomyopathy
History of smoking	Ischemic heart disease
Other	Hypertension
	Stroke/transient ischemic attack
	Autonomic nervous system dysfunction
	Neuropathy
	Gastroparesis
	Orthostatic hypotension
	Airway

ously monitored during the immediate postoperative period, possibly as a result of an altered response to hypoxia, has been reported.<sup>91-97</sup>

When gastroparesis is present, aspiration prophylaxis with nonparticulate antacids, H<sub>2</sub> antagonists, and metoclopramide are suitable options. Rapid sequence induction with cricoid pressure should be considered in patients with gastroparesis.

Careful evaluation of the airway is necessary in pancreas transplant recipients. As discussed earlier, patients with long-standing type 1 diabetes have an increased incidence of intubation difficulty. The inability to oppose palmar flexion because of stiffness of the interphalangeal joints is predictive of difficult tracheal intubation.<sup>28,98-106</sup>

### Intraoperative Care

General anesthesia is induced with agents appropriate for the patient's baseline medical condition followed by orotracheal intubation. A combination of anesthetic drugs is used to maintain general anesthesia. In patients with renal dysfunction, isoflurane and desflurane appear to be virtually devoid of nephrotoxicity. As described in the discussion on kidney transplantation, among the opioids, fentanyl, sufentanil, alfentanil, and remifentanyl can be selected if renal disease is present. Morphine and meperidine are best avoided for the reasons enumerated earlier. At our institution, fentanyl is the narcotic of choice; it is also associated with minimal hemodynamic alterations. The choice of muscle relaxant should take into account the degree of renal impairment. Thus, patients who are on dialysis should not receive pancuronium (see discussion on kidney transplantation). Vecuronium and rocuronium are eliminated by both the hepatic and the renal routes and can be used in patients with chronic renal disease if neuromuscular junction monitoring (e.g., train-of-four response) is used to guide repeat dosing after an initial bolus dose has been administered. At our institution, cisatracurium is used most commonly because it is cleared by Hoffmann elimination rather than hepatic or renal function. In addition to standard anesthetic monitors, patients receiving a pancreas transplant require central venous access, which is useful in the assessment of intravascular volume

**TABLE 58-5.**

#### Insulin and Dextrose Infusion Guidelines for Pancreas Recipients

Blood Glucose Concentration (mg/dL)	Insulin Infusion (U/h)	Dextrose (mL/h) <sup>a</sup>
>350	3-5 (after bolus of 4 U)	0
250-350	2 (after bolus of 3 U)	0
150-250	2 (after bolus of 2 U)	0
100-150	2	20
70-100	1-2	20-100
<70	0	100

<sup>a</sup>As 5% dextrose in water with half normal saline.

status, to provide access for possible pressor support and immunosuppressive drugs, and as a means for frequent intraoperative blood sampling. In patients with significant cardiovascular disease, direct arterial pressure monitoring and right-heart monitoring with a pulmonary artery catheter and/or transesophageal echocardiography are monitoring options to assist during surgery.<sup>107</sup>

Blood glucose levels must be checked at least hourly or more frequently during general anesthesia, with the goal of keeping serum glucose levels between 100 and 150mg/dL.<sup>107,108</sup> Animal studies have shown that hyperglycemia causes islet cell dysfunction.<sup>109,110</sup> Maintaining serum glucose levels in an acceptable range is accomplished by continuous infusion of regular insulin at a rate of 1-5 U/h with concurrent dextrose infusion when blood glucose levels are <150 mg/dL (Table 58-5). The addition of dextrose ensures uninterrupted intracellular nutrition to avoid intraoperative ketosis.

Pancreatic beta cells can start releasing insulin as early as 5 minutes after reperfusion.<sup>31</sup> Delayed graft function can be treated postoperatively with an insulin infusion titrated to keep blood glucose levels <150 mg/dL.<sup>111</sup> Somatostatin can be administered to decrease pancreatic enzyme secretion.<sup>76,112,113</sup>

To ensure adequate perfusion and prevent hypotension upon allograft reperfusion, the patient's hemodynamic status must be optimal prior to release of the vascular clamps. Administration of intravenous fluids, either crystalloid or colloid, to achieve a central venous pressure in the range from 12-14 mm Hg and systolic blood pressure at least 140 mm Hg is recommended in patients without significant heart disease.<sup>48</sup> Alternatively, in patients with a pulmo-

nary artery catheter, careful titration of volume versus filling pressures and cardiac output can be used to optimize intravascular fluid status prior to vascular unclamping. In preparation for unclamping, a reduced concentration of potent inhalational agents may be needed. Hypotension at unclamping may require administration of fluids, pressors, and blood products as appropriate. Maintenance of perfusion pressure and blood flow to the new allograft is important. Hetastarch is often preferred as a colloid in patients with functioning kidneys because it improves not only preload but also graft vessel flow. This prevents graft vessel thrombosis, the most common cause of technical pancreatic graft failure.<sup>45</sup> The goals of successful intraoperative care are listed in Table 58-6.

Most patients can be extubated in the operating room after surgery, provided they meet extubation criteria, that is, they are alert, are normothermic, have recovered from neuromuscular blockade, and are hemodynamically stable. When the patient arrives in the postanesthesia care unit, blood glucose, hemoglobin, electrolytes, and troponin levels should be checked. Dehydration, electrolyte, acid-base disorders, and hy-

**TABLE 58-6.**

#### Goals of Intraoperative Care of Pancreas Transplant Recipients

- Cardiovascular stability
- Optimize graft perfusion pressure
- Metabolic control
- Normothermia
- Electrolyte homeostasis

Data from Dean M. Opioids in renal failure and dialysis patients. *J Pain Symptom Manage* 2004;28:497-504.



poglycemia or hyperglycemia can develop quickly in the postoperative period. Patients with a bladder anastomosis may become dehydrated and develop frequent infections and often require supplemental sodium bicarbonate to treat the metabolic acidosis caused by loss of pancreatic secretions into the bladder.<sup>66,75–77,111</sup> In our institution, all diabetic patients undergoing solid organ transplant are assessed for myocardial infarction with serial troponin levels and electrocardiogram because of the incidence of silent myocardial infarction in this patient population. Postoperatively, patients receive 5% dextrose in 0.45N saline as maintenance fluid. Nasogastric and urine output losses are replaced in equivalent amounts with 0.45N saline.

### Immunosuppression

Pancreas transplant recipients have a higher incidence of acute rejection and immunologic graft loss than any other solid organ. The four main protocols of initial maintenance immunosuppression used from 1996–2002 for US cadaveric primary pancreas transplants are azathioprine, cyclosporine, mycophenolate mofetil, and tacrolimus. Sirolimus is another agent.<sup>45,114</sup> In the United States the most common induction protocol uses an antibody induction in combination with tacrolimus, mycophenolate mofetil, and steroids.

Pancreas transplant recipients are at risk for developing infection for numerous reasons, including immunosuppression, contamination from the duodenal segment of the graft, and blood glucose irregularity due to diabetes.<sup>111</sup> Infection prophylaxis with broad-spectrum antibiotics targeting staphylococcus, gram-negative bacteria, anaerobes, and cytomegalovirus is routine in many centers.<sup>66,76,79</sup> Prophylaxis against vascular thrombosis consists of either low-dose intravenous heparin (300–500 U/h) or subcutaneous heparin followed by aspirin.<sup>66,79</sup>

### Islet Cell Transplantation

Transplantation of pancreatic islet cells for treatment of diabetes mellitus is being conducted clinically but is not yet considered a definitive procedure because long-term success is not as high as with pancreas graft vascularization. Resolution of logistic problems, including setting up an infrastructure to perform islet isolation on a large scale, is required to make islet cell transplantation a more commonly performed procedure.<sup>115–118</sup>

Advances in immunosuppression and isolation techniques have been shown to improve outcomes with islet cell transplantation.<sup>119–121</sup> Similarly, recipients with a low body mass index (BMI) have a higher success rate with islet cell transplantation when the islets are obtained from a donor with a high BMI because of a higher yield of islets.<sup>122</sup> Islet isolation requires special processing of pancreas tissue to yield a maximum number of islets available for transplantation.<sup>123</sup> Pancreatic islet cell preparations (Table 58–7) with >5000 islet equivalents and volume <5–10 mL are generally acceptable for transplant after proper dilution in Connaugh Medical Research Laboratories (CMRL) media supplemented with albumin or Hetastarch and heparin.<sup>67,124</sup> These harvested islet cells can be transplanted in diabetic recipients using local anesthesia and sedation.<sup>117</sup>

A cannula is placed percutaneously into the portal vein through the liver. Both ultrasound and fluoroscopic guidance are used to facilitate catheter positioning.<sup>40,43</sup> After final catheter position is confirmed, the portal vein pressure is measured and the islets are infused by gravity over 20–60 minutes.<sup>43</sup> Portal pressures are measured every 15 minutes to monitor for acute portal hypertension, which commonly occurs if the islets are transfused rapidly. After the islets are transplanted and before the infusion catheter is removed, heparin is administered directly into the portal vein.<sup>117,124</sup> As the infusion catheter is removed, thrombin-soaked Gelfoam is embolized into the peripheral hepatic parenchymal catheter tract.<sup>117,125</sup>

Complications of islet cell transplant include posttransplant hemorrhage (requiring transfusion), intraparenchymal

hemorrhage, subcapsular hemorrhage, portal vein thrombosis, hemothorax, pneumothorax, hemobilia, and inadvertent puncture of the neighboring structures.<sup>117</sup> Some patients require more than one islet transplant to achieve insulin independence.<sup>125</sup> With increasing experience, the progress has been encouraging. With these promising results, pancreatic islet transplantation eventually could become the beta-cell replacement of choice over whole-organ pancreas transplant.

### Outcome following Transplantation

Analysis of the results reported in the International Pancreas Transplant Registry (IPTR) indicate that long-term insulin independence following transplantation has improved over time.<sup>45</sup> Patient survival rates for all three categories (simultaneous pancreas and kidney transplant, pancreas after kidney transplant, pancreas transplant only) are >90% at 3 years posttransplant.<sup>45</sup> Most deaths occur as a result of cardiovascular disease. Pancreas graft survival rates are better with simultaneous pancreas and kidney transplantation (84% vs. 76% for pancreas after kidney transplantation and 77% for pancreas transplant only). Chronic rejection continues to be a major challenge.<sup>126</sup>

### Conclusions

Pancreas transplantation is now an established procedure for the surgical treatment of diabetes mellitus. It is most commonly performed simultaneously with kidney transplantation because patients will already be receiving immunosuppression, and individual graft survival is improved when both organs are transplanted. No doubt islet cell transplantation will be the procedure of choice once it becomes a more routine procedure because of the minimal surgery involved. The perioperative care of patients who have undergone pancreas transplantation requires an understanding of the goals of the procedure and the pathophysiology of diabetes mellitus and renal failure.

## HEMATOPOIETIC AND STEM CELL TRANSPLANTATION

### History and Introduction

Anesthesia providers may encounter patients who have an illness requiring hematopoietic stem cell transplanta-

**TABLE 58–7.**

#### Requirements for Islet Cell Numbers, Purity, and Viability before Transplantation

- Viability at least 70%
- Purity at least 30%
- Number at least 4.00 international equivalents/kg of recipient
- Packed tissue volume <10 mL
- Endotoxin level <5 endotoxin units/kg recipient/h of infusion
- Gram-stain negative for microorganism

Adapted from Hakim<sup>67</sup> and Ricordi<sup>124</sup> with permission.

tion (HSCT), who are being prepared for HSCT, or have already undergone HSCT and are being seen because of a complication. The success of HSCT was recognized as early as 1968<sup>127</sup> when a 2-year-old boy with severe Wiskott-Aldrich syndrome was successfully treated with bone marrow cells provided from his histocompatible healthy sister; this patient has been followed up for 15 years.<sup>128</sup> The HSCT procedure has since become popular for use in patients with severe combined immunodeficiency<sup>129</sup> and many other malignancies and genetic disorders.<sup>130-134</sup> Autologous HSCT as rescue therapy for the bone marrow usually is done following chemotherapy to treat malignancy.<sup>130</sup> Hematopoietic stem cells (HSCs) can be used for autologous, syngeneic, and allogeneic transplantation. HSCs are special cells that can self-renew and differentiate into all mature blood lineages. When a patient's own HSCs are used as the source of stem cells, the process is termed an *autologous stem cell transplant*. When HSCs are obtained from another human, the process is referred to as *allogeneic transplantation*. Transplantation between genetically identical members of the same species (e.g., identical twins) is referred to as *syngeneic transplantation*. HSCs can be obtained in different ways. The most common source is bone marrow harvest from the posterior iliac crest. Another source is the peripheral blood compartment. Because the number of HSCs is low in this compartment, a peripheral blood stem cell mobilization protocol is needed to increase their number in this pool. This protocol usually entails the administration of myelosuppressive chemotherapy, hematopoietic growth factors (e.g., granulocyte colony-stimulating factor, granulocyte-macrophage colony-stimulating factor), or both. Umbilical cord blood is another source of HSCs. The risk of viral exposure is minimal with cord blood, and the donor is not placed at risk. In addition, the incidence of graft-versus-host disease (GVHD) is markedly lower than in standard bone marrow or peripheral stem cell transplants.<sup>131</sup> Although the death rate from graft failure, infection, and GVHD is high (approximately 40%), the success rate has improved over time with advances in immunosuppression, chemotherapy, antibiotics, and supportive care.<sup>132</sup> The number of children receiving

HSCTs for various disorders is increasing approximately 10–15% per year.<sup>133</sup>

### Indications for HSCT

HSCT can be performed to treat a variety of hematologic, metabolic, genetic, and oncologic disorders in adult and pediatric patients.<sup>134-136</sup> Table 58–8 summarizes the annual report by the Center for International Blood and Marrow Transplant Research (CIBMTR; <http://www.ibmtr.org/>) that lists the diseases for which HSCT was performed. The majority of HSCTs are performed for either acute or chronic myeloid leukemia, followed by acute lymphoblastic leukemia, myelodysplastic leukemia, and non-Hodgkin lymphoma. HSCT is also performed for a variety of metabolic disorders and inborn errors of metabolism.

### Preconditioning, Associated Risks, and Complications

Adults and children who receive HSCT are at risk for complications.<sup>137</sup> Thus, they may develop respiratory failure or acute GVHD.<sup>137,138</sup> Acute GVHD is the most important complication that significantly influences clinical outcome.

Almost all patients who receive HSCT undergo total body irradiation and/or myeloablative preconditioning to eradicate malignant disease, if present, suppress the recipient's immune system to decrease the chance for graft rejection, and to create space in the bone marrow microenvironment to allow donor stem cell engraftment.<sup>139</sup> This predisposes them to hemorrhagic and infection risks as noted by Bacigalupo<sup>138</sup> and others (Fig. 58–6).<sup>137,139,144</sup> Infection risks occur from secondary immunodeficiency and neutropenia. Because neutropenia ensues as a result of the preparatory regimen prior to HSCT and lasts until full engraftment of transplanted stem cells occurs, patients are at risk for infection. This is another cause of morbidity and mortality for several weeks. T- and B-cell function may be depressed for several months following bone marrow transplantation and cause recipients to be susceptible to viral and fungal infections.<sup>132,140</sup>

Total body irradiation may cause pneumonitis, restrictive cardiomyopathy, pulmonary fibrosis, and oral mucositis. Chemotherapeutic agents such as doxorubicin (Adriamycin) can result in cardiomyopathy or other toxicities. In addition, venoocclusive dis-

TABLE 58–8.

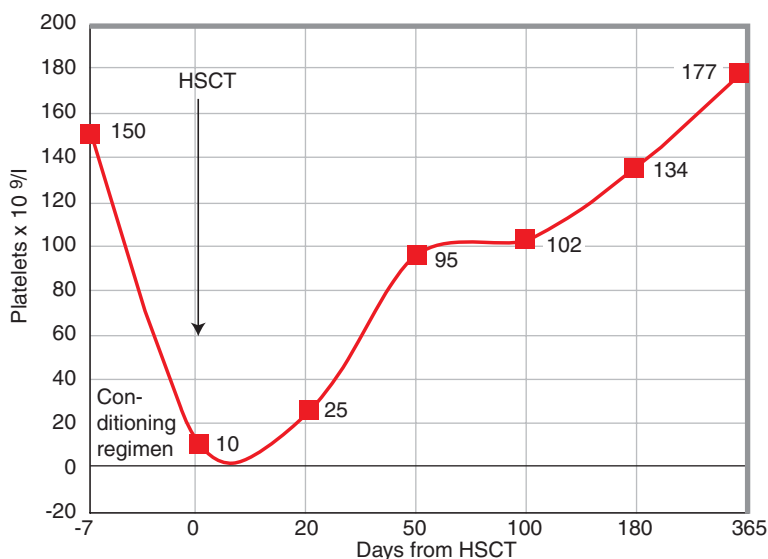
Distribution of Diseases for which Hematopoietic Stem Cell Transplantation Was Performed

Disease	Total
• Acute myelogenous leukemia	3655
• Chronic myelogenous leukemia	3408
• Acute lymphoblastic leukemia	2642
• Myelodysplastic disorders	1409
• Non-Hodgkin lymphoma	981
• Severe aplastic anemia	640
• Other leukemia	514
• Plasma cell disorders	257
• Inherited disorders of metabolism	256
• Severe combined immunodeficiency disease and other immunodeficiencies	229
• Hodgkin lymphoma	226
• Histiocytic disorders	113
• Other malignancies	46
• Inherited erythrocyte abnormalities	20
• Inherited platelet disorders	15
• Other	14
<b>Total</b>	<b>14,425</b>

As reported in the National Marrow Donor Program database, 1987–2004 (<http://www.ibmtr.org/>).

ease of the liver may develop following intensive chemotherapy and irradiation therapy. This complication, which most often is fatal, occurs approximately 2 weeks posttransplant when the small hepatic venules become fibrotic and develop pericentral hepatocyte necrosis and congestion.<sup>141</sup>

GVHD can significantly influence the outcome of HSCT recipients. GVHD starts as an acute disorder but sometimes manifests as chronic GVHD. Acute GVHD may be mild or life threatening (Table 58–9).<sup>142</sup> In GVHD, immunologically competent donor T cells transplanted in the recipient react against host tissue cells, which are recognized as host-foreign antigens. This results in the secretion of cytokines, including interleukin-1, interleukin-2, and tumor necrosis factor, which are responsible for the signs and symptoms of acute GVHD.<sup>142</sup>



**FIGURE 58-6.** Prior to hematopoietic stem cell transplantation (HSCT), patients undergo preparation with myeloablative therapy. The process results in significant thrombocytopenia that predisposes patients to hemorrhagic diathesis. Because of this condition, HSCT recipients often require blood and blood products perioperatively. At day 100 after HSCT, the platelet count stabilizes to clinically acceptable values. Reprinted from Bacigalupo A. Haemopoietic stem cell transplants: the impact of haemorrhagic complications. *Blood Rev* 2003;17(Suppl 1):S6–S10, with permission from Elsevier.

Chronic GVHD develops >100 days after HSCT and is characterized as multiorgan involvement.<sup>142</sup> Patients present with features resembling naturally occurring autoimmune disease due to chronic cytokine effects and is associated with thymic atrophy and lymphocyte depletion. Thus, patients may present with scleroderma, oral mucositis, interstitial pneumonitis, and polymyositis.<sup>132,143–145</sup>

During preanesthesia assessment for HSCT, recipients must be investigated for multiorgan involvement.<sup>146</sup> Noninfectious pulmonary and other complications typically occur before the first 100 days following HSCT (Fig. 58-7).<sup>147</sup> Thus, HSCT recipients are at risk for airway complications during the first 2 months of transplantation.

### Anesthesia Considerations

Before receiving a bone marrow transplant, pediatric and some adult patients often require anesthesia for permanent central venous catheterization, biopsies, and total body irradiation. Following transplantation, these individuals often require anesthesia for (1) biopsies to evaluate the status of the bone marrow transplant and determine if GVHD has developed and (2) for treatment of the surgical complications that may follow the procedure. Most patients undergoing HSCT tolerate anesthesia for these procedures without difficulty. However, complications can

occur, particularly in recipients younger than 2 years. In these individuals, anesthesia providers must keep in mind the unique medical problems associated with children undergoing bone marrow transplantation.<sup>132,140</sup> Several children with inborn errors of metabolism also may require anesthesia for several procedures related to HSCT and may be anesthetic challenges because of their primary disease.<sup>148</sup> Thus, some patients with metabolic disease may be difficult to intubate. In addition, mucositis and upper airway edema (Fig. 58-7) can complicate anesthesia care. When endotracheal intubation is required either for complications related to HSCT or for anesthesia needs, airway care must be provided in an environment equipped to handle a

patient with a difficult airway. Clinical judgment must be used to determine whether an otolaryngologist skilled in pediatric and adult upper airway care must be present during anesthesia induction and/or sedation and intubation and for extubation in some instances.

Radiation and/or chemotherapy in patients with GVHD can result in nausea and vomiting. Tracheal intubation and airway protection may be required in some patients.

### Anesthetic Management

A variety of anesthetic techniques can be used safely to anesthetize children and adults receiving care for HSCT. No drug, agent, or technique is absolutely contraindicated.<sup>132,145</sup> Nitrous oxide suppresses methionine synthetase and other anesthetics are myelosuppressive, but use of these agents during anesthesia care is not contraindicated.<sup>149–151</sup>

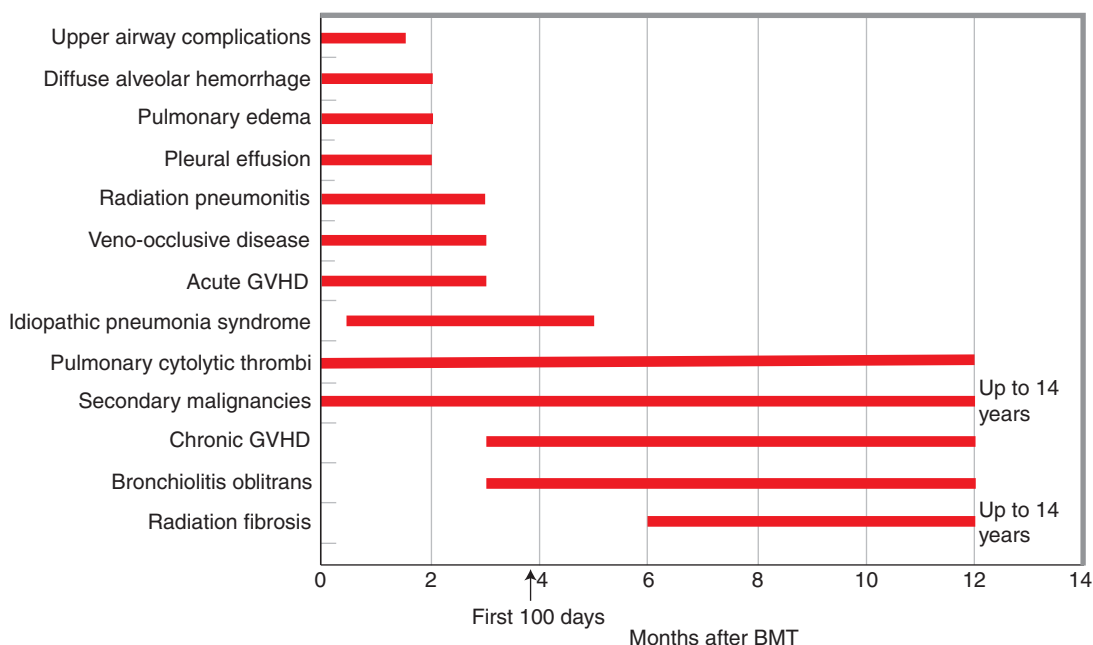
The concern unique to bone marrow recipients is the high incidence and potential morbidity from mucositis that occurs when patients are neutropenic. Pediatric anesthesia care providers must minimize airway manipulation if possible. Intravenous propofol has proved useful for sedation for total body irradiation using spontaneous ventilation without airway instrumentation. It is the preferred drug because of its rapid recovery and antiemetic profile, which allows earlier feeding and better nutrition in infants undergoing radiation therapy than other intravenous agents such as ketamine or thiopental.<sup>132</sup> Even in children with Hurler syndrome, proper neck and head positioning can allow safe propofol sedation, but in some instances the laryngeal mask airway has been used. Because of potential injury, propofol must be used with caution in patients

**TABLE 58-9.**

**Clinical Grading of Acute Graft-Versus-Host Disease**

Overall Grade	Skin	Liver	Gut	Functional Impairment
0 (None)	0	0	0	0
1 (Mild)	+ to ++	0	0	0
2 (Moderate)	+ to +++	+	+	+
3 (Severe)	+ to +++	+ to +++	+ to +++	++
4 (Life-threatening)	+ to ++++	+ to ++++	+ to ++++	+++

This article was published in Flowers ME, Kansu E, Sullivan KM, Pathophysiology and treatment of graft-versus-host disease. *Hematol Oncol Clin North Am* 1999;13:1091–112. Copyright Elsevier 1999.



**FIGURE 58–7.** Upper airway and other nonpulmonary complications following hematopoietic stem cell transplantation. Note that most acute problems occur in the first 100 days following transplantation. (From Khurshid and Anderson<sup>147</sup> with permission from BMJ Publishing Group, Ltd.)

with mucositis.<sup>152</sup> When tracheal intubation is required for airway care, the preoperative airway examination may be difficult because of severe pain.<sup>153</sup> For the same reason, awake intubation may be impossible as well. Movement and struggling during the procedure may cause bleeding and edema and obscure the laryngeal inlet. Therefore, use of a rapid sequence induction technique may be necessary to minimize the time when the airway is unprotected while providing conditions as optimal as possible for rapid endotracheal intubation. However, when stridor or other signs of airway obstruction are evident, an inhaled induction of general anesthesia with sevoflurane and oxygen similar to that used in a child with epiglottitis may be required. For such patients, anesthesia providers must have adequate suction and several tracheal tube sizes readily available because the laryngeal inlet may be narrowed due to edema and inflammation.<sup>132</sup>

Care must be taken with extubation as well. Most patients with mucositis can be extubated when fully awake. Often these patients develop croup in the postoperative period and may require treatment with dexamethasone (0.5–1 mg/kg) and one or more courses of racemic epinephrine. However, patients with mucositis and severe edema of the laryngeal inlet may require prolonged intubation until the edema resolves.<sup>132</sup>

## Conclusions

For successful care of patients requiring HSCT, the anesthesia practitioner must be aware of the unique problems that accompany patient preparation and the problems related to myeloablative therapy. Most acute problems occur in the first 100 days following transplantation. Children may require HSCT for metabolic diseases, including some inborn errors of metabolism. The primary disease can be challenging for anesthesia providers. The outcome of HSCT depends upon the indication and the severity of disease prior to HSCT.

## SMALL BOWEL TRANSPLANTATION

### History and Introduction

Lillehei et al.<sup>154</sup> performed the first transplant of a small bowel in humans at the University of Minnesota when they performed a graft of the stomach, small bowel, and pancreas in a patient with a mesenteric venous thrombosis. Other attempts were made over the years, but all were unsuccessful, with very high mortality from uncontrolled graft rejection and patient sepsis. Grant et al.<sup>155</sup> reported the first long-term survivor from a combined small bowel and liver graft using cyclosporine-based immunosuppression in

1990. It was not until the introduction of tacrolimus for immunosuppression in 1991 that outcomes improved.<sup>156</sup>

In contrast to patients undergoing kidney transplantation, the number of patients undergoing intestinal transplantation is modest. For example, in 2003 only 112 patients underwent intestinal transplantation, including those receiving an intestinal transplant combined with a liver or other organ. Approximately 50% of intestinal transplant recipients receive another organ. Unadjusted graft survival rates in 2003 were 84% at 3 months, 69% at 1 year, 47% at 3 years, and 30% at 5 years.<sup>157</sup> These outcomes are markedly improved from earlier reports. Living related bowel transplantation is being developed,<sup>158</sup> so bowel transplantation likely will be performed more frequently in the future.

### Indications

Indications for transplantation include chronic, irreversible intestinal failure with loss of vascular access preventing nutrition and fluid maintenance, frequent episodes of severe sepsis, frequent severe dehydration, and impending or overt liver failure (Table 58–10).

The short-gut syndrome, either surgical or congenital, is the most common primary indication for transplantation. Sixty-four percent of patients receiving bowel transplants have short-



TABLE 58-10.

## Leading Causes of Intestinal Failure in Children and Adults

Children		Adults	
• Miscellaneous diagnoses	26%	• Ischemia	23%
• Gastroschisis	21%	• Miscellaneous diagnoses	20%
• Volvulus	17%	• Crohn's disease	14%
• Necrotizing enterocolitis	12%	• Traumatic injury	10%
• Pseudo-obstruction	9%	• Desmoid tumors	9%
• Intestinal atresia	8%	• Other short gut diagnoses	7%
• Hirschsprung's disease	7%	• Volvulus	7%
		• Retransplant	6%
		• Other tumors	4%

From The Intestinal Transplant Registry. Current Results, Slides 9 and 10 (report of data between April 1985 and May 31, 2003). Available at: <http://www.ihsc.on.ca.itr/>.

gut syndrome.<sup>159</sup> Short-gut syndrome can develop from a variety of causes, including intestinal atresia, midgut volvulus, gastroschisis, abdominal trauma, Crohn disease, mesenteric thrombosis, and surgical adhesions. Other causes of intestinal failure that may benefit from bowel transplantation are intestinal motility disorders such as total intestinal aganglionosis, severe intestinal malabsorption disorders, and gastrointestinal neoplasm.<sup>160</sup>

Isolated intestinal transplantation is recommended for patients on home parenteral nutrition who have ex-

hausted their venous access because of thrombosis of major central veins, have life-threatening complications from frequent line infections and sepsis or frequent episodes of severe dehydration, or exhibit signs of impending liver failure.

Patients with intestinal failure can develop severe hepatic dysfunction, usually from total parental nutrition-induced cholestasis. For patients with irreversible intestinal failure and end-stage liver disease, a combined small bowel and liver transplant is the recommended treatment.<sup>160</sup>

## Surgical Procedure

## Isolated Intestinal Transplant

Fig. 58-8 shows the isolated bowel transplant. Vascular continuity is established between the superior mesenteric artery bowel graft and the aorta, and the superior mesenteric vein of the graft and the recipient vena cava.

In a combined liver and bowel transplant, the liver and bowel can be transplanted separately. This method is used if a living related combined liver and bowel transplant is performed. In certain circumstances, en bloc combined liver and bowel transplant can be performed (Fig. 58-9). The small bowel may also be transplanted as part of a combined multivisceral transplantation that includes the stomach, pancreas, and liver (Fig. 58-10).

## Preoperative Considerations

Patients being considered for small bowel transplantation must undergo thorough evaluation of each organ system. Bowel transplantation is a stressful operation, and the patient's cardiovascular status should be determined prior to surgery. If the patient is older than 40 years or has a history of cardiac disease, tests such as an echocardiogram, dobutamine stress test, or assess-

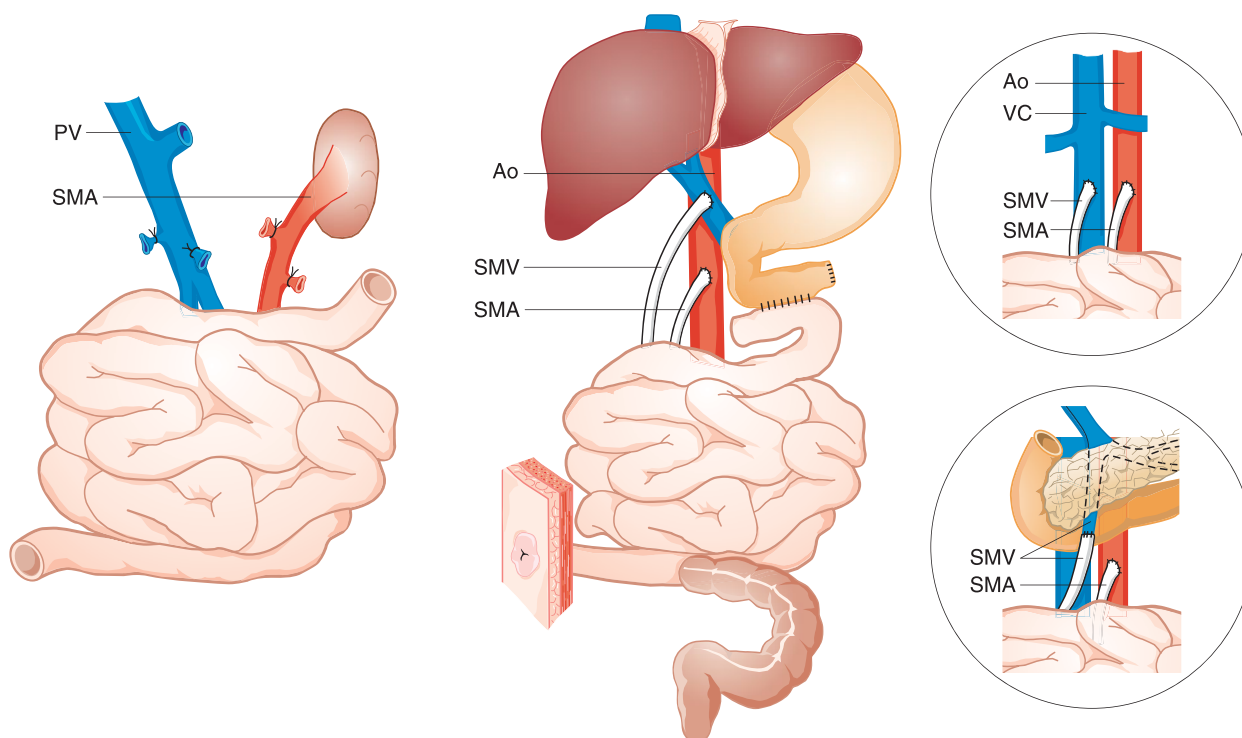
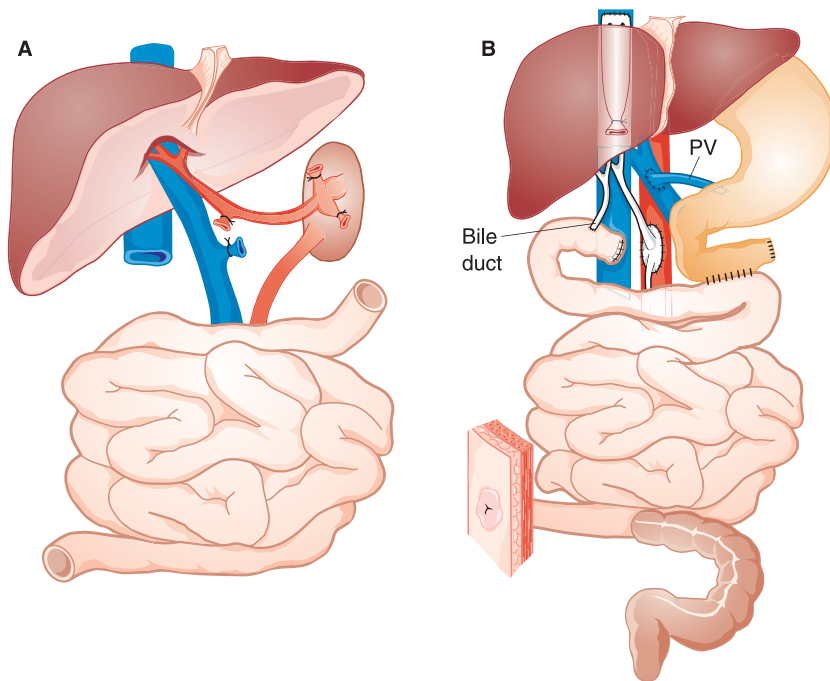


FIGURE 58-8. Isolated intestinal transplantation. This is the simplest form of intestinal transplantation.



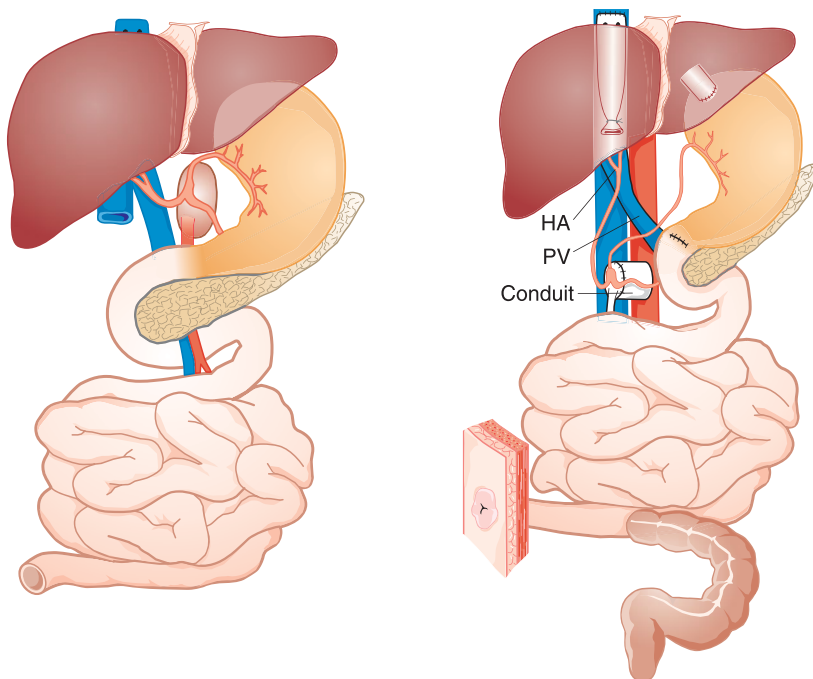
**FIGURE 58-9.** En bloc combined liver and intestine transplant. **A.** Graft. **B.** Graft after implantation.

ment of the coronaries by angiography may be required. The patient's liver function must be evaluated because most have been on chronic intravenous hyperalimentation, which is hepatotoxic. Some patients with short-gut syndrome have lost their intestines from vascular thrombosis. Therefore, a thor-

ough investigation of the coagulation status of patients undergoing small bowel transplantation is required.<sup>161</sup>

#### **Evaluation of Patency of Central Vessels**

Patients presenting for small bowel transplantation are often a vascular ac-



**FIGURE 58-10.** Multivisceral transplantation involves en bloc transplantation of the stomach, pancreas, liver, and intestine.

cess nightmare for the anesthesia provider. Long-term hyperalimentation and central venous catheterization destroy many of the vessels that normally would be used during major abdominal surgery. Thrombosis of at least one vessel is present in approximately 50% of patients, and 25% have multiple thromboses. Because of the high incidence of venous thrombosis, it is recommended that all patients referred for intestinal transplantation should undergo preliminary mapping of their venous access by Doppler ultrasound, and patients with multiple thrombosed vessels should be considered for additional angiographic evaluation.<sup>162</sup>

The radiologist can perform recanalization of extensive chronic vein occlusions. This procedure is high risk, but it can be lifesaving for patients who require total parenteral nutrition and can restore candidacy for intestinal and multivisceral transplantation.<sup>163</sup>

### **Anesthetic Care**

#### **Induction and Maintenance of Anesthesia**

Often patients presenting for bowel transplantation have delayed gastric emptying, so rapid sequence induction of general anesthesia is indicated. In many instances this may require intravenous induction of general anesthesia with etomidate. Using this approach is beneficial because it maintains hemodynamic stability if the patient is dehydrated or suffers some other compromise of the cardiovascular system. Maintenance of general anesthesia is similar to that for liver or renal transplantation. Balanced anesthesia using desflurane or isoflurane for the potent inhaled agent along with narcotics (fentanyl, sufentanil) and muscle relaxants (vecuronium, cis-atracurium, rocuronium) is commonly used.<sup>161</sup> Because many of these patients have impaired renal function, muscle relaxants such as pancuronium that are dependent on renal elimination are not used. Similarly, sevoflurane is generally not used because its safety in patients with impaired renal function has not been established.<sup>26</sup>

Small bowel transplantation is long and arduous. Significant bleeding may occur during the dissection process, so adequate vascular access must be established. A rapid infusion device often is beneficial and should be available, and blood-salvaging devices should be used. Frequent (hourly) determinations of laboratory values, such as arterial blood

gases, electrolytes, hemoglobin and platelet levels, and clotting studies, often are necessary.<sup>161</sup> These patients can be hypothermic as a result of the long, extensive dissection in the abdomen and exposure of the bowel to ambient temperature. Forced air surface warming is extremely valuable and prevents significant hypothermia in patients undergoing extensive abdominal operations such as bowel transplantation.<sup>164</sup>

When bowel transplant surgery is completed, only rarely can the patient be extubated in the recovery room. Often patients require positive-pressure ventilation for a period equivalent to the duration of surgery or longer because the edematous graft placed in the small abdominal cavity limits descent of the diaphragm. Positive-pressure ventilation may be needed until the edema resolves and the abdominal cavity stretches to accommodate the new bowel.<sup>165</sup>

### Monitoring

In all patients, a large-bore central venous catheter must be placed for rapid volume administration and measurement of central venous pressure prior to beginning transplantation. Measurement of central venous pressure is essential to ensure adequate blood and volume replacement throughout the operation as well as to prevent overhydration following reperfusion of the bowel. Since the venous drainage of the small-bowel allograft is into the vena cava, an elevated central venous pressure can reduce the perfusion of the allograft and increase small bowel edema. Measurement of pulmonary arterial pressures and cardiac output may be beneficial in patients in whom it is technically feasible.<sup>161</sup> Monitoring of cardiac output may help in handling the hypotension often seen with reperfusion of the small bowel allograft.<sup>161</sup> Direct arterial pressures also should be monitored, preferably from a catheter in an upper extremity artery, because the aorta is partially or completely cross-clamped for part of the procedure.<sup>165</sup> Transesophageal echocardiography may be helpful, particularly in patients with chronic occlusions of the central venous system that preclude access for pulmonary artery catheterization.<sup>161</sup>

### Allograft Perfusion and Fluid Management

In most cases of isolated small bowel transplantation, both the aorta and vena

cava must be cross-clamped while the venous and arterial anastomoses are made. In some cases, the vascular anastomoses can be made with side-biting or partially occluding vascular clamps for either the aortic or venous anastomoses. With partial occlusion, the hemodynamic effects of cross-clamp release usually are diminished. If technically feasible, venous drainage of the intestinal allograft is made into the portal system of the recipient in some cases. The portal vein rather than the vena cava is completely or partially occluded.<sup>161</sup> This may result in less hemodynamic compromise because venous drainage from the lower extremities is maintained. In combined small bowel and liver transplants or multivisceral transplants, separate anastomoses for the small bowel may not be made. Rather, the small bowel is reperfused as the liver and other organs are reperfused. The hemodynamic changes with reperfusion are likely to be profound in these operations.<sup>166,167</sup> With the aid of a rapid infusion device, rapid fluid replacement during reperfusion can be ensured. This diminishes the likelihood of hypovolemia-related hypotension and hypoperfusion of the newly anastomosed allografts.

Regardless of the type of anastomoses or operation, the small bowel prior to reperfusion is cold and filled with University of Wisconsin solution for preservation. University of Wisconsin solution is very high in potassium. Particularly if the venous drainage of the bowel is to the inferior vena cava, flushing of the cold preservative solution into the venous system with release of the aortic cross-clamp can result in hypotension and myocardial depression. With portal drainage, buffering by the liver occurs and the direct effect of the preservative solution on the heart is less profound.<sup>165</sup>

Prior to reperfusion of the allograft, the anesthesia provider should be sure that the patient has been adequately hydrated with blood products and/or colloid solution as guided by the central venous pressure and hemogram assessments. Excessive crystalloid solution beyond the maintenance rate should not be administered to minimize peripheral edema. If the urine output falls to  $<1$  mL/kg/min despite a central venous pressure of 10 mm Hg, mannitol, furosemide, or dopamine (2–3  $\mu$ g/kg/min) should be administered.<sup>165</sup>

From 10–15 minutes before release of the vascular clamps, the volatile agent can be reduced to raise the systemic pressure, countering the fall commonly seen with reperfusion. The anesthesia provider must be prepared to administer calcium chloride (10 mg/kg) to counteract the hyperkalemia occasionally seen with washout of the preservative solution, well as to administer a vasopressor such as phenylephrine (50–100  $\mu$ g). Inotropes such as dopamine and/or epinephrine also may be required if the hypotension persists.

Reperfusion changes can occur several minutes after cross-clamp release. A review of 30 adults undergoing small bowel transplantation showed that reperfusion was associated with an increase in cardiac filling pressures, an increase in cardiac output, a decrease in mean arterial pressure to  $<60$  mm Hg in 47% of patients, and a decrease in systemic vascular resistance that persisted 5 minutes after release of the vascular clamps. Approximately half of the patients required inotropic support; however, the changes resolved by the end of surgery.<sup>166</sup>

Some patients require a continuous infusion of prostaglandin E<sub>1</sub> (alprostadil 0.1–0.6  $\mu$ g/kg/h). This drug is thought to increase blood flow to the bowel and may help protect the bowel from ischemic injury. Systemic hypotension may result from prostaglandin E<sub>1</sub> administration, requiring a continuous infusion of dopamine or epinephrine.<sup>161</sup>

### Immunosuppression

Immunosuppressive regimens change rapidly, particularly in a developing field such as small bowel transplantation. In general, most immunosuppressive agents can be administered to patients, with few hemodynamic effects; however, some reactions to immunosuppressive agents have occurred. For example, patients have developed severe hypotension and pulmonary edema with administration of the murine monoclonal antibody OKT3. Treatment with diphenhydramine (Benadryl), vasopressors, steroids, diuresis, and postoperative ventilation may be required if a reaction to this or another immunosuppressive agent occurs.<sup>26</sup>

### Postoperative Considerations and Complications

All patients undergoing small bowel transplantation require care in the intensive care unit in the immediate

postoperative period. Many patients require postoperative positive-pressure ventilation. Intravenous infusions of vasopressors or alprostadil may still be required. Close observation is needed for early complications such as arterial or venous thrombosis, which requires immediate action to correct.<sup>165</sup>

Most patients require a prolonged period of hospitalization after the immediate postoperative period. Small bowel function is impaired in the immediate postoperative period as a result of denervation and interruption of the lymphatics. High ileostomy output is common in the perioperative period and may result in dehydration.<sup>165</sup>

Other complications are serious and may result in mortality and graft loss. Prior to the development of tacrolimus, rejection resulted in loss of virtually all intestinal grafts.<sup>159</sup> Rejection still is a common cause of graft loss and mortality, although less so than in the past. GVHD, in which the lymphoid cells transplanted from the intestinal graft react against the host, can occur after intestinal transplants but is rare.<sup>165</sup> Infection still results in graft loss and/or mortality. The barrier to bacterial translocation is altered following ischemic injury to the bowel. Immunosuppression can further alter the bowel flora as well as the patient's ability to fight infection if bacterial translocation occurs.<sup>168</sup> Post-transplant lymphoproliferative disease may develop in bowel transplant recipients. Occurrence of the disease was very high prior to the use of tacrolimus but is less often now with use of tacrolimus as the immunosuppressive agent.<sup>165</sup>

### Anesthetic Considerations for Patients with Prior Intestinal Transplants

A high level of multidisciplinary support is required for prior recipients of intestinal and multivisceral transplants. These patients should be referred back to the transplant center whenever possible.<sup>41</sup>

The nutritional status of the bowel transplant patient must be assessed prior to the patient having surgery. If the transplant is functioning poorly, the patient may be malnourished. Dehydration from diarrhea may be a problem.<sup>41</sup>

Patients with prior intestinal or multivisceral transplants are prone

to infection for multiple reasons, including the chronic need for immunosuppressive medications to prevent rejection, altered intestinal permeability and absorption, and intestinal denervation and lymphatic dysfunction. Strict aseptic technique is mandatory. Stress dose steroids may be necessary in the perioperative period if the patient is taking prednisone as part of the immunosuppression regimen.<sup>41</sup>

If the patient requires abdominal surgery, difficult dissection with potential for massive bleeding and the need for large-volume fluid resuscitation should be anticipated because these patients usually have undergone multiple laparotomies and can have extensive adhesions. Early in the course of their underlying disease, patients may still have a long-term venous access device such as a Hickman catheter, which can be used. Patients who present years later may no longer have a venous access device. Venous access may be extremely challenging, so previous studies should be reviewed and ultrasound guidance or assistance requested by the interventional radiology department.<sup>41</sup>

### Results and Outcome from Intestinal Transplantation

As noted earlier, the initial results for small-bowel transplantation were disappointing and resulted in few organ transplants. The results have improved since the late 1990s. In 2003, a graft survival rate of 81% was reported using immunosuppression with antithymocyte globulin induction and tacrolimus maintenance. Eighty percent of the survivors had stopped total parenteral nutrition and resumed normal daily activities. Fifty percent of grafts transplanted since 1998 have been functioning 5 years or more. The longest survivor was on an oral diet 14 years after an intestinal transplant for volvulus.<sup>159</sup>

### Summary

Intestine transplantation is still in its infancy. As immunosuppression improves, it likely will be used more often to prevent the complications of long-term hyperalimentation. The medical care of these patients can be challenging for the anesthesia provider. However, it also can be rewarding because many patients who earlier could not be treated now can benefit from this procedure.

## KEY REFERENCES

1. Lemmens HJ, Kidney transplantation: recent developments and recommendations for anesthetic management. *Anesthesiol Clin North America* 2004;22:651–662.
2. Sprung J, et al. Anesthesia for kidney transplant surgery. *Anesthesiol Clin North America* 2000;18:919–951.
3. Beebe DS, et al. Anesthetic management of infants receiving an adult kidney transplant. *Anesth Analg* 199;73:725–730.
4. Larson-Wadd K, Belani KG. Pancreas and islet cell transplantation. *Anesthesiol Clin North America* 2004;22:663–674.
5. Planinsic RM. Anesthetic management for small bowel transplantation. *Anesthesiol Clin North America* 2004;22:675–685.
6. Beebe DS, Urban M, Belani KG. Anaesthetic management of bone marrow transplant recipients less than two years of age. *Paediatr Anaesth* 1995;5:107–114.
7. Kutt JA, Asfar S, Ghent C, et al. Small bowel transplantation. In Sharpe MD, Gelb AW, eds. *Anesthesia and Transplantation*. Boston: Butterworth-Heinemann, 1999: 201–215.
8. Jacque JJ. Anesthetic considerations for multivisceral transplantation. *Anesthesiol Clin North America* 2004;22:741–751.

## REFERENCES

1. Harrison JH Merrill JP, Murray JE. Renal homotransplantation in identical twins. *Surg Forum* 1956;6:432–436.
2. Norman DJ. The kidney transplant waitlist: allocation of patients to a limited supply of organs. *Semin Dial* 2005;18:456–459.
3. Port FK, et al. Trends and results for organ donation and transplantation in the United States 2004. *Am J Transplant* 2005; 5(4 Pt 2):843–849.
4. Dean PG Gloor JM, Stegall MD. Conquering absolute contraindications to transplantation: positive-crossmatch and ABO-incompatible kidney transplantation. *Surgery* 2005;137:269–273.
5. Kacar S, et al. Marginal donors in kidney transplantation. *Ann Transplant* 2004;9:5–7.



6. Danovitch GM, Cecka JM. Allocation of deceased donor kidneys: past, present, and future. *Am J Kidney Dis* 2003;42:882–890.
7. Humar A, et al. Living unrelated donors in kidney transplants: better long-term results than with non-HLA-identical living related donors? *Transplantation* 2000;69:1942–1945.
8. Ojo AO, et al. Trends in cadaveric organ donation in the United States: 1990–1999. *Clin Transpl* 2002;105–109.
9. Lemmens HJ. Kidney transplantation: recent developments and recommendations for anesthetic management. *Anesthesiol Clin North America* 2004;22:651–662.
10. Gruessner R, Gruessner AC. Long-term pancreas graft function. In Gruessner RS, ed. *Transplantation of the Pancreas*. New York: Springer-Verlag, 2004:521–530.
11. Brunkhorst R, et al. Improved survival in patients with type 1 diabetes mellitus after renal transplantation compared with hemodialysis: a case-control study. *Transplantation* 2003;76:115–119.
12. Stock PG, et al. Kidney and liver transplantation in human immunodeficiency virus-infected patients: a pilot safety and efficacy study. *Transplantation* 2003;76:370–375.
13. Mandal AK, et al. Shorter waiting times for hepatitis C virus seropositive recipients of cadaveric renal allografts from hepatitis C virus seropositive donors. *Clin Transplant* 2000;14(4 Pt 2):391–396.
14. Segoloni GP, et al. Renal transplantation in patients over 65 years of age: no more a contraindication but a growing indication. *Transplant Proc* 2005;37:721–725.
15. Wali RK, et al. Effect of kidney transplantation on left ventricular systolic dysfunction and congestive heart failure in patients with end-stage renal disease. *J Am Coll Cardiol* 2005;45:1051–1060.
16. Dilioglou S, Cruse JM, Lewis RE. High panel reactive antibody against cross-reactive group antigens as a contraindication to renal allotransplantation. *Exp Mol Pathol* 2001;71:73–78.
17. Benedetti E, et al. Kidney transplantation in recipients with mental retardation: clinical results in a single-center experience. *Am J Kidney Dis* 1998;31:509–512.
18. Koehntop DE, Beebe DS, Belani KG. Kidney transplantation. In Klinck JL, Lindop MJ eds. *Anaesthesia and Intensive Care for Organ Transplantation*. London: Chapman and Hall 1998:254–280.
19. Ciccarelli LL, Ford CM, Tsueda K. Autonomic neuropathy in a diabetic patient with renal failure. *Anesthesiology* 1986;64:283–287.
20. Gill JS, Pereira BJ. Death in the first year after kidney transplantation: implications for patients on the transplant waiting list. *Transplantation* 2003;75:113–117.
21. Steinman TI, et al. Guidelines for the referral and management of patients eligible for solid organ transplantation. *Transplantation* 2001;71:1189–1204.
22. Sharma R, et al. Dobutamine stress echocardiography and the resting but not exercise electrocardiograph predict severe coronary artery disease in renal transplant candidates. *Nephrol Dial Transplant* 2005;20:2207–2214.
23. Holley JL, Fenton RA, Arthur RS. Thallium stress testing does not predict cardiovascular risk in diabetic patients with end-stage renal disease undergoing cadaveric renal transplantation. *Am J Med* 199;90:563–570.
24. Manske CL, et al. Screening diabetic transplant candidates for coronary artery disease: identification of a low risk subgroup. *Kidney Int* 1993;44:617–621.
25. Usher S, Shaw A. Peri-operative asystole in a patient with diabetic autonomic neuropathy. *Anaesthesia* 1999;54:1125.
26. Sprung J, et al. Anesthesia for kidney transplant surgery. *Anesthesiol Clin North America* 2000;18:919–951.
27. Comfere T, et al. Angiotensin system inhibitors in a general surgical population. *Anesth Analg* 2005;100:636–644.
28. Nadal JL, et al. The palm print as a sensitive predictor of difficult laryngoscopy in diabetics. *Acta Anaesthesiol Scand* 1998;42:199–203.
29. Poldermans D, et al. The effect of bisoprolol on perioperative mortality and myocardial infarction in high-risk patients undergoing vascular surgery. Dutch Echocardiographic Cardiac Risk Evaluation Applying Stress Echocardiography Study Group. *N Engl J Med* 1999;341:1789–1794.
30. Apfel CC, et al. A factorial trial of six interventions for the prevention of postoperative nausea and vomiting. *N Engl J Med* 2004;350:2441–2451.
31. Eger EI 2nd, et al. Nephrotoxicity of sevoflurane versus desflurane anesthesia in volunteers. *Anesth Analg* 1997;84:160–168.
32. Dean M. Opioids in renal failure and dialysis patients. *J Pain Symptom Manage* 2004;28:497–504.
33. Sakamoto H, et al. Increased sensitivity to vecuronium and prolonged duration of its action in patients with end-stage renal failure. *J Clin Anesth* 2001;13:193–197.
34. Robertshaw HJ, McAnulty GR, Hall GH. Strategies for managing the diabetic patient. *Best Pract Res Clin Anaesthesiol* 2004;18:631–643.
35. Akpek E, et al. Epidural anesthesia for renal transplantation: a preliminary report. *Transplant Proc* 1999;31:3149–3150.
36. Hadimioglu N, et al. A randomized study comparing combined spinal epidural or general anesthesia for renal transplant surgery. *Transplant Proc* 2005;37:2020–2022.
37. Loushin MK, Hasinoff IK, Belani KG. A delayed cardiopulmonary reaction to an intravenous immunosuppressant thymoglobulin after pancreas transplant. *Anesth Analg* 2001;93:1260–1261.
38. Cavdar C, et al. Hypomagnesemia and mild rhabdomyolysis in living related donor renal transplant recipient treated with cyclosporine A. *Scand J Urol Nephrol* 1998;32:415–417.
39. Tiggeler RG, et al. Prevention of acute tubular necrosis in cadaveric kidney transplantation by the combined use of mannitol and moderate hydration. *Ann Surg* 1985;201:246–251.
40. Humar A, et al. Peri-operative cardiac morbidity in kidney transplant recipients: incidence and risk factors. *Clin Transplant* 2001;15:154–158.
41. Keegan MT, Plevak DJ. The transplant recipient for nontransplant surgery. *Anesthesiol Clin North America* 2004;22:827–861.
42. Neipp M, et al. Kidney transplant in children weighing less than 15 kg: donor selection and technical considerations. *Transplantation* 2002;73:409–416.
43. Beebe DS, et al. Anesthetic management of infants receiving an adult kidney transplant. *Anesth Analg* 199;73:725–730.
44. Kelly WD, et al. Allotransplantation of the pancreas and duodenum along with the kidney in diabetic nephropathy. *Surgery* 1967;61:827–837.
45. Gruessner AC, Sutherland DE. Pancreas transplant outcomes for United States (US) and non-US cases as reported to the United Network for Organ Sharing (UNOS) and the International Pancreas Transplant Registry (IPTR) as of June 2004. *Clin Transplant* 2005;19:433–455.
46. Becker BN, et al. Simultaneous pancreas-kidney and pancreas transplantation. *Minerva Urol Nefrol* 2002;54:213–226.
47. Bretzel RG, Eckhard M, Brendel MD. Pancreatic islet and stem cell transplantation: new strategies in cell therapy of diabetes mellitus. *Panminerva Med* 2004;46:25–42.
48. Larson-Wadd K, Belani KG. Pancreas and islet cell transplantation. *Anesthesiol Clin North America* 2004;22:663–674.
49. Gruessner RW, et al. Transplant options for patients undergoing total pancreatectomy for chronic pancreatitis. *J Am Coll Surg* 2004;198:559–567.
50. US Department of Health and Human Services. 2005 Annual Report of the U.S. Organ Procurement and Transplantation Network and the Scientific Registry of Transplant Recipients: Transplant Data 1995–2004. Rockville, MD: Health Resources and Services Administration, Healthcare Systems Bureau, Division of Transplantation.
51. Haller MJ, Atkinson MA, Schatz D. Type 1 diabetes mellitus: etiology, presentation, and management. *Pediatr Clin North Am* 2005;52:1553–1578.
52. Report of the expert committee on the diagnosis and classification of diabetes mellitus. *Diabetes Care* 2003;26(Suppl 1):S5–S20.
53. The effect of intensive treatment of diabetes on the development and progression of long-term complications in insulin-dependent diabetes mellitus. *The Diabetes*

- Control and Complications Trial Research Group. *N Engl J Med* 1993;329:977-986.
54. Effect of intensive diabetes treatment on the development and progression of long-term complications in adolescents with insulin-dependent diabetes mellitus: Diabetes Control and Complications Trial. *Diabetes Control and Complications Trial Research Group. J Pediatr* 1994;125:177-188.
55. Sustained effect of intensive treatment of type 1 diabetes mellitus on development and progression of diabetic nephropathy: the Epidemiology of Diabetes Interventions and Complications (EDIC) study. *JAMA* 2003;290:2159-2167.
56. Bretzel RG. Intensive insulin regimens: evidence for benefit. *Int J Obes Relat Metab Disord* 2004;28(Suppl 2):S8-S13.
57. Nath DS, et al. Outcomes of pancreas transplants for patients with type 2 diabetes mellitus. *Clin Transplant* 2005;19:792-797.
58. Procopiou M, Philippe J. The metabolic syndrome and type 2 diabetes: epidemiological figures and country specificities. *Cerebrovasc Dis* 2005;20(Suppl 1):2-8.
59. Umpierrez GE, Kitabchi AE. Diabetic ketoacidosis: risk factors and management strategies. *Treat Endocrinol* 2003;2:95-108.
60. Toto RD. Heart disease in diabetic patients. *Semin Nephrol* 2005;25:372-378.
61. Molina JE, et al. Coronary bypass before simultaneous pancreas-kidney transplants for type 1 diabetics in renal failure. *World J Surg* 2004;28:1036-1039.
62. Libby P, et al. Report of the National Heart, Lung, Blood Institute-National Institute of Diabetes and Digestive and Kidney Diseases Working Group on Cardiovascular Complications of Type 1 Diabetes Mellitus. *Circulation* 2005;111:3489-3493.
63. Nathan DM. Long-term complications of diabetes mellitus. *N Engl J Med* 1993;328:1676-1685.
64. Rickels MR, et al. Islet cell hormonal responses to hypoglycemia after human islet transplantation for type 1 diabetes. *Diabetes* 2005;54:3205-3211.
65. Tamajon LP, et al. Improved cardiovascular risk profile of patients with type 1 diabetes mellitus and renal failure after simultaneous pancreas-kidney transplantation. *Transplant Proc* 2005;37:3979-3980.
66. Coosemans W, Pirenne J. Pancreatic transplantation. *Acta Chir Belg* 2003;103:73-80.
67. Hakim NS. Recent developments and future prospects in pancreatic transplantation. *Exp Clin Transplant* 2003;1:26-34.
68. Kiberd BA, Larson T. Estimating the benefits of solitary pancreas transplantation in nonuremic patients with type 1 diabetes mellitus: a theoretical analysis. *Transplantation* 2000;70:1121-1127.
69. Kwiatkowski A, et al. Quality of life after simultaneous pancreas-kidney transplantation. *Transplant Proc* 2005;37:3558-3559.
70. Nankivell BJ, et al. Progression of macrovascular disease after transplantation. *Transplantation* 2000;69:574-581.
71. Robertson RP, et al. Pancreas transplantation for patients with type 1 diabetes. *Diabetes Care* 2003;26(Suppl 1):S120.
72. Mohan P, et al. Improved patient survival in recipients of simultaneous pancreas-kidney transplant compared with kidney transplant alone in patients with type 1 diabetes mellitus and end-stage renal disease. *Br J Surg* 2003;90:1137-1141.
73. Bloom RD, et al. An overview of solid organ transplantation. *Clin Chest Med* 2005;26:529-543, v.
74. Cattral MS, et al. Portal venous and enteric exocrine drainage versus systemic venous and bladder exocrine drainage of pancreas grafts: clinical outcome of 40 consecutive transplant recipients. *Ann Surg* 2000;232:688-695.
75. Kahl A, Bechstein WO, Frei U. Trends and perspectives in pancreas and simultaneous pancreas and kidney transplantation. *Curr Opin Urol* 2001;11:165-174.
76. Bloom RD, et al. Long-term pancreas allograft outcome in simultaneous pancreas-kidney transplantation: a comparison of enteric and bladder drainage. *Transplantation* 1997;64:1689-1695.
77. Michalak G, et al. Surgical complications of simultaneous pancreas-kidney transplantation: a 16-year-experience at one center. *Transplant Proc* 2005;37:3555-3557.
78. Humar A, et al. Surgical risks and outcome of pancreas retransplants. *Surgery* 2000;127:634-640.
79. Humar A, et al. Decreased surgical risks of pancreas transplantation in the modern era. *Ann Surg* 2000;231:269-275.
80. Sutherland DE, et al. Lessons learned from more than 1,000 pancreas transplants at a single institution. *Ann Surg* 2001;233:463-501.
81. Laftavi MR, et al. Diagnosis of pancreas rejection: cystoscopic transduodenal versus percutaneous computed tomography scan-guided biopsy. *Transplantation* 1998;65:528-532.
82. Troppmann C, et al. Surgical complications requiring early relaparotomy after pancreas transplantation: a multivariate risk factor and economic impact analysis of the cyclosporine era. *Ann Surg* 1998;227:255-268.
83. Humar A, et al. The impact of donor obesity on outcomes after cadaver pancreas transplants. *Am J Transplant* 2004;4:605-610.
84. Malaise J, et al. Simultaneous pancreas-kidney transplantation in a large multicenter study: surgical complications. *Transplant Proc* 2005;37:2859-2860.
85. Humar A, et al. Technical failures after pancreas transplants: why grafts fail and the risk factors—a multivariate analysis. *Transplantation* 2004;78:1188-1192.
86. Lin K, et al. Pre-transplant cardiac testing for kidney-pancreas transplant candidates and association with cardiac outcomes. *Clin Transplant* 2001;15:269-275.
87. Ramanathan V, et al. Screening asymptomatic diabetic patients for coronary artery disease prior to renal transplantation. *Transplantation* 2005;79:1453-1458.
88. Eschertzhuber S, et al. Incidence of coronary heart disease and cardiac events in patients undergoing kidney and pancreatic transplantation. *Transplant Proc* 2005;37:1297-1300.
89. Rabbat CG, et al. Prognostic value of myocardial perfusion studies in patients with end-stage renal disease assessed for kidney or kidney-pancreas transplantation: a meta-analysis. *J Am Soc Nephrol* 2003;14:431-439.
90. Bostom AD, et al. Prevention of post-transplant cardiovascular disease—report and recommendations of an ad hoc group. *Am J Transplant* 2002;2:491-500.
91. Reissell E, et al. Sudden cardiorespiratory arrest after renal transplantation in a patient with diabetic autonomic neuropathy and prolonged QT interval. *Acta Anaesthesiol Scand* 1994;38:406-408.
92. Kageyama S, et al. Cardiorespiratory arrest in a patient with advanced diabetic autonomic neuropathy. *Diabetes Res Clin Pract* 1985;1:243-6.
93. Nouchi T, et al. [Cardiorespiratory arrest in a juvenile diabetic woman with autonomic neuropathy (author's translation)]. *Nippon Naika Gakkai Zasshi* 1981;70:1267-1272.
94. Garcia-Bunel L. Cardiorespiratory arrest in diabetic autonomic neuropathy. *JAMA* 1979;241:2006-2007.
95. Vaisrub S. Cardiorespiratory arrest in diabetic autonomic neuropathy. *JAMA* 1978;240:1754.
96. Garcia-Bunuel L. Cardiorespiratory arrest in diabetic autonomic neuropathy. *Lancet* 1978;1:935-936.
97. Page MM, Watkins PJ. Cardiorespiratory arrest and diabetic autonomic neuropathy. *Lancet* 1978;1:14-16.
98. Warner ME, Warner MA, Narr BJ. Difficult laryngoscopy and diabetes mellitus. *Anesth Analg* 1989;69:550-551.
99. Warner ME, et al. Diabetes mellitus and difficult laryngoscopy in renal and pancreatic transplant patients. *Anesth Analg* 1998;86:516-519.
100. Vani V, Kamath SK, Naik LD. The palm print as a sensitive predictor of difficult laryngoscopy in diabetics: a comparison with other airway evaluation indices. *J Postgrad Med* 2000;46:75-79.
101. Salzarulo HH, Taylor LA. Diabetic "stiff joint syndrome" as a cause of difficult endotracheal intubation. *Anesthesiology* 1986;64:366-368.
102. Reissell E, et al. Predictability of difficult laryngoscopy in patients with long-term diabetes mellitus. *Anaesthesia* 1990;45:1024-1027.

103. Meyer RM. Difficult intubation in severe diabetics. *Anesth Analg* 1989;69:419.
104. Eleborg L, Norberg A. Are diabetic patients difficult to intubate? *Acta Anaesthesiol Scand* 1988;32:508.
105. Brussel T. [Anesthesia and diabetes mellitus]. *Anaesthesist* 1994;43:333-346.
106. Hogan K, Rusy D, Springman SR. Difficult laryngoscopy and diabetes mellitus. *Anesth Analg* 1988;67:1162-1165.
107. Halpern H, et al. Anesthesia for pancreas transplantation alone or simultaneous with kidney. *Transplant Proc* 2004;36:3105-3106.
108. Powner DJ. Donor care before pancreatic tissue transplantation. *Prog Transplant* 2005;15:129-136.
109. Clark A, et al. Islet changes induced by hyperglycemia in rats. Effect of insulin or chlorpropamide therapy. *Diabetes* 1982;31(4 Pt 1):319-325.
110. Ar'Rajab A, Ahren B. Prevention of hyperglycemia improves the long-term result of islet transplantation in streptozotocin-diabetic rats. *Pancreas* 1992;7:435-442.
111. Troppmann C, et al. Delayed endocrine pancreas graft function after simultaneous pancreas-kidney transplantation. Incidence, risk factors, and impact on long-term outcome. *Transplantation* 1996;61:1323-1330.
112. Drexel H, et al. Long-term follow-up of glycaemic control and parameters of lipid transport after pancreas transplantation. *Diabetologia* 199;34(Suppl 1):S47-S50.
113. Emoto T, et al. Simultaneous observation of endocrine and exocrine functions of the pancreas responding to somatostatin in man. *Regul Pept* 1997;68:1-8.
114. Garcia VD, et al. Immunosuppression in pancreas transplantation: mycophenolate mofetil versus sirolimus. *Transplant Proc* 2004;36:975-977.
115. Froud T, et al. Islet transplantation in type 1 diabetes mellitus using cultured islets and steroid-free immunosuppression: Miami experience. *Am J Transplant* 2005;5:2037-2046.
116. Sutherland DE, Gruessner A, Hering BJ. Beta-cell replacement therapy (pancreas and islet transplantation) for treatment of diabetes mellitus: an integrated approach. *Endocrinol Metab Clin North Am* 2004;33:135-148, x.
117. Goss JA, et al. Pancreatic islet transplantation: the radiographic approach. *Transplantation* 2003;76:199-203.
118. Matsumoto S, et al. Pancreatic islet transplantation for treating diabetes. *Expert Opin Biol Ther* 2006;6:23-37.
119. Ricordi C, Strom TB. Clinical islet transplantation: advances and immunological challenges. *Nat Rev Immunol* 2004;4:259-268.
120. Bretzel RG, et al. Islet transplantation: present clinical situation and future aspects. *Exp Clin Endocrinol Diabetes* 2001;109(Suppl 2):S384-S399.
121. Hakim N, Papalouis V. Pancreas and islet transplantation. *Ann Ital Chir* 2004;75:1-7.
122. Toso C, et al. Factors affecting human islet of Langerhans isolation yields. *Transplant Proc* 2002;34:826-827.
123. Ichii H, et al. Rescue purification maximizes the use of human islet preparations for transplantation. *Am J Transplant* 2005;5:21-30.
124. Ricordi C. Islet transplantation: a brave new world. *Diabetes* 2003;52:1595-1603.
125. Close NC, Hering BJ, Eggerman TL. Results from the inaugural year of the Collaborative Islet Transplant Registry. *Transplant Proc* 2005;37:1305-1308.
126. Humar A, et al. Chronic rejection: the next major challenge for pancreas transplant recipients. *Transplantation* 2003;76:918-923.
127. Bach FH, et al. Bone-marrow transplantation in a patient with the Wiskott-Aldrich syndrome. *Lancet* 1968;2:1364-1366.
128. Meuwissen HJ, et al. Long-term survival after bone marrow transplantation: a 15-year follow-up report of a patient with Wiskott-Aldrich syndrome. *J Pediatr* 1984;105:365-369.
129. Good RA. Bone marrow transplantation for immunodeficiency diseases. *Am J Med Sci* 1987;294:68-74.
130. Saarinen UM, Pihko H, Makierna A. High-dose thiotepa with autologous bone marrow rescue in recurrent malignant oligodendroglioma: a case report. *J Neurooncol* 1990;9:57-61.
131. Cohena Y, Nagler A. Hematopoietic stem-cell transplantation using umbilical-cord blood. *Leuk Lymphoma* 2003;44:1287-1299.
132. Beebe DS, Urban M, Belani KG. Anaesthetic management of bone marrow transplant recipients less than two years of age. *Paediatr Anaesth* 1995;5:107-114.
133. Goldman JM, Horowitz MM. The international bone marrow transplant registry. *Int J Hematol* 2002;76(Suppl 1):393-397.
134. Appelbaum FR. Allogeneic stem cell transplantation for the treatment of hematologic malignancies: current indications and challenges. *J Rheumatol Suppl* 1997;48:41-45.
135. Steward CG, Jarisch A. Haemopoietic stem cell transplantation for genetic disorders. *Arch Dis Child* 2005;90:1259-1263.
136. Abdelkefi A, et al. Prevalence of inherited prothrombotic abnormalities and central venous catheter-related thrombosis in haematopoietic stem cell transplants recipients. *Bone Marrow Transplant* 2005;36:885-889.
137. Diaz MA, et al. Predicting factors for admission to an intensive care unit and clinical outcome in pediatric patients receiving hematopoietic stem cell transplantation. *Haematologica* 2002;87:292-298.
138. Bacigalupo A. Haemopoietic stem cell transplants: the impact of haemorrhagic complications. *Blood Rev* 2003;17(Suppl 1):S6-S10.
139. Tabbara IA, et al. Allogeneic hematopoietic stem cell transplantation: complications and results. *Arch Intern Med* 2002;162:1558-1566.
140. Stein RA Jr, Messino MJ, EA Hessel 2nd. Anaesthetic implications for bone marrow transplant recipients. *Can J Anaesth* 1990;37:571-578.
141. Gentet JC, et al. Veno-occlusive disease in children after intensive chemo- and radiotherapy and repeated halothane anesthetics. A report of 2 cases. *Acta Oncol* 1988;27:579-581.
142. Flowers ME, Kansu E, Sullivan KM. Pathophysiology and treatment of graft-versus-host disease. *Hematol Oncol Clin North Am* 1999;13:1091-1112, viii-ix.
143. Schure AY, Holzman RS. Anesthesia in a child with severe restrictive pulmonary dysfunction caused by chronic graft-versus-host disease. *J Clin Anesth* 2000;12:482-486.
144. Boeckh M, et al. Late cytomegalovirus disease and mortality in recipients of allogeneic hematopoietic stem cell transplants: importance of viral load and T-cell immunity. *Blood* 2003;101:407-414.
145. Fallows G, Rubinger M, Bernstein CN. Does gastroenterology consultation change management of patients receiving hematopoietic stem cell transplantation? *Bone Marrow Transplant* 2001;28:289-294.
146. Haire WD. The multiple organ dysfunction syndrome in cancer patients undergoing hematopoietic stem cell transplantation. *Semin Thromb Hemost* 1999;25:223-237.
147. Khurshid I, Anderson LC. Non-infectious pulmonary complications after bone marrow transplantation. *Postgrad Med J* 2002;78:257-262.
148. Belani KG, et al. Children with mucopolysaccharidosis: perioperative care, morbidity, mortality, and new findings. *J Pediatr Surg* 1993;28:403-408.
149. Lederhaas G, et al. Is nitrous oxide safe for bone marrow harvest? *Anesth Analg* 1995;80:770-772.
150. Carmel R, Rabinowitz AP, Mazumder A. Metabolic evidence of cobalamin deficiency in bone marrow cells harvested for transplantation from donors given nitrous oxide. *Eur J Haematol* 1993;50:228-233.
151. Domenegati E, et al. [Intravenous versus inhalation anesthetics in anesthesia for bone marrow harvest for transplantation]. *Minerva Anesthesiol* 1993;59:157-161.
152. Marjot R. Trauma to the posterior pharyngeal wall caused by a laryngeal mask airway. *Anaesthesia* 1991;46:589-590.
153. Demarosi F, et al. Transdermal fentanyl in HSCT patients, an open trial using transdermal fentanyl for the treatment of oral mucositis pain. *Bone Marrow Transplant* 2004;33:1247-1251.

154. Lillehei RC, et al. Transplantation of stomach, intestine, and pancreas: experimental and clinical observations. *Surgery* 1967;62:721–741.
155. Grant D, et al. Successful small-bowel/liver transplantation. *Lancet* 1990;335:181–184.
156. Grant D. Current results of intestinal transplantation. The International Intestinal Transplant Registry. *Lancet* 1996;347:1801–1803.
157. Hanto DW, et al. Liver and intestine transplantation: summary analysis 1994–2003. *Am J Transplant* 2005;5(4 Pt 2):916–933.
158. Gruessner RW, Sharp HL. Living-related intestinal transplantation: first report of a standardized surgical technique. *Transplantation* 1997;64:1605–1607.
159. Grant D, et al. 2003 report of the intestine transplant registry: a new era has dawned. *Ann Surg* 2005;241:607–613.
160. Abu-Elmagd K, Bond G. Gut failure and abdominal visceral transplantation. *Proc Nutr Soc* 2003;62:727–737.
161. Planinsic RM. Anesthetic management for small bowel transplantation. *Anesthesiol Clin North America* 2004;22:675–685.
162. Selvaggi G, et al. Analysis of vascular access in intestinal transplant recipients using the Miami classification from the VIIIth International Small Bowel Transplant Symposium. *Transplantation* 2005;79:1639–1643.
163. Lang EV, et al. Central venous recanalization in patients with short gut syndrome: restoration of candidacy for intestinal and multivisceral transplantation. *J Vasc Interv Radiol* 2005;16:1203–1213.
164. Kurz A, et al. Forced-air warming maintains intraoperative normothermia better than circulating-water mattresses. *Anesth Analg* 1993;77:89–95.
165. Kutt JA, Asfar S, Ghent C, et al. Small bowel transplantation. In Sharpe MD, Gelb AW, eds. *Anesthesia and Transplantation*. Boston: Butterworth-Heinemann, 1999:201–215.
166. Planinsic R, Nicoau-Raducu R, Aggarwal S, et al. Post reperfusion changes during small bowel transplantation. *Transplantation* 2004;78(Suppl 1):410–411.
167. Jacque JJ. Anesthetic considerations for multivisceral transplantation. *Anesthesiol Clin North America* 2004;22:741–751.
168. Cicalese L, et al. Bacterial translocation in clinical intestinal transplantation. *Transplantation* 2001;71:1414–1417.
169. Kato T, et al. Intestinal and multivisceral transplantation. *World J Surg* 2002;26:226–237.
170. Kato T, Tzakis A, Selvaggi G, et al. Surgical techniques used in intestinal transplantation. *Curr Opin Organ Transpl* 2004;9:207–213.



## CHAPTER 59

## Endocrine Surgery and Intraoperative Management of Endocrine Conditions

Robert A. Peterfreund, MD, PhD, and Stephanie L. Lee, MD, PhD

Endocrine diseases are common comorbid conditions in patients undergoing surgery for a variety of reasons. The consequences of a coexisting endocrine disorder may impact upon the anesthetic and immediate perioperative management of these patients. Diabetes mellitus (DM) is the most common comorbid endocrine condition, affecting as many as 20% of patients scheduled for surgery and requiring anesthesia. The prevalence of thyroid disease is approximately 20% in the general population, so large numbers of patients who present for nonendocrine surgery have concomitant diagnoses of a thyroid disorder.

The surgical condition may result in part or entirely from the endocrine disorder, for example, vasoocclusive disease in the patient with DM requiring peripheral vascular surgery. Alternatively, the surgery may directly target endocrine tissue, either for biopsy or for excision. The pathophysiologic implications of the endocrine lesion and of surgical manipulation of the diseased tissue must be understood in the context of anesthetic and perioperative management. The most common endocrine surgery involves the thyroid gland.

This chapter reviews the immediate perioperative implications of major endocrine disorders and addresses the specific issues encountered in surgery for common endocrine pathologies.

## DIABETES MELLITUS

DM is a condition with an absolute (type 1) or a relative (type 2) deficiency of insulin. Chapter 12 reviews the

complex physiology of DM. A fundamental concept in perioperative management is that the *type 1 diabetic patient has an absolute requirement for continuous exogenous insulin*, which can be supplied in several different preparations.<sup>1</sup> In the absence of insulin, despite a normal or low blood sugar concentration, the patient with type 1 DM will develop *ketoacidosis*, a metabolic derangement that interferes with basic cellular metabolism and drug responses. The pharmacokinetic profiles of the various insulin preparations warrant careful consideration (Table 59-1).<sup>2</sup> Without a source of glucose in the perioperative period, a patient may develop hypoglycemia from the residual effects of a long-acting insulin preparation.

In the immediate perioperative period, it is generally recommended that patients receive regular insulin by intravenous (IV) bolus or IV infusion. The uptake of intramuscular or subcutaneous insulin may be unpredictable in the perioperative period because of changes in tissue perfusion.

Patients with type 2 DM can be managed with diet alone, with oral agents alone, with insulin, or with a combination of oral agents, one of the newer injectable drugs (incretin mimetics), and insulin. The pharmacokinetic and pharmacodynamic profiles of oral hypoglycemic agents differ markedly (Table 59-2). Some oral agents (e.g., sulfonylureas) remain active for 24 hours, predisposing the

patient to hypoglycemia during fasting. Other oral agents act as insulin sensitizers, improving the postreceptor action of insulin. Insulin sensitizers and incretin mimetics do not cause hypoglycemia when used in single-agent therapy. Some of these agents are newly introduced into clinical practice, so experience with their use in surgical patients during the perioperative period is minimal.

## Clinical Features of DM

Although both major types of DM can share a number of clinical features, such as the presence of neuropathy, vascular and renal disease, and a predisposition to infection (see Chapter 12), an appreciation of the essential and distinctive features of each type is important.

## Type 1 DM

The patient with type 1 DM usually is first diagnosed at a young age, but the disease may occur at any stage of life. The patient is generally thin or of normal body habitus. The patient with type 1 DM has an absolute requirement for chronic insulin therapy to prevent diabetic ketoacidosis (DKA). As a general rule, patients with type 1 DM are extremely sensitive to the effects of insulin compared to patients with type 2 DM and therefore receive relatively small doses of insulin to both control blood sugar levels and prevent DKA. Acute medical or surgical conditions can precipitate DKA

## KEY POINTS

1. Endocrine diseases are common comorbid conditions in surgical patients.
2. The patient's type of diabetes mellitus must be known and the differing therapies of types 1 and 2 appreciated.
3. Frequent monitoring of glucose levels is a mainstay in the management of the diabetic patient undergoing anesthesia and surgery.
4. Hypothyroid patients may exhibit sensitivity to sedative and hypnotic drugs used perioperatively. Hemodynamic instability should be anticipated.
5. Hyperthyroid patients may exhibit hemodynamic instability and are at particular risk for tachydysrhythmias and metabolic decompensation.
6. The airway is a key consideration in patients undergoing thyroid surgery.
7. Pheochromocytoma patients require careful preoperative preparation, and plans must be made to manage hemodynamic extremes during surgery.
8. Glucocorticoid deficiency in patients at risk for adrenal suppression should be anticipated.
9. The implications of growth hormone excess (acromegaly) and adrenal steroid excess (Cushing disease) should be considered when preparing patients for pituitary surgery.

TABLE 59-1.

## Insulin Preparations for Management of Diabetes Mellitus Therapy

Agent	Time to Onset (h)	Peak (h)	Duration of Action (h)
<b>Insulin (subcutaneous administration)</b>			
Lispro (Humalog)	0.1–0.25	1–2	4–6
Aspart (NovoLog)	0.1–0.25	1–2	4–6
Glulisine (Apidra)	0.1–0.25	1–2	4–6
Regular	0.5–1	2–4	6–10
Semilente	0.5–3	2–10	12–16
NPH	2–4	6–12	12–18
Lente	1–3	6–15	22–28
Protamine zinc	1–6	14–24	≥36
Ultralente	2–8	10–30	≥36
Glargine (Lantus)	2–4	“Peakless”	20–24
Detemir (Levemir)	2–4	“Peakless”	20–24
<b>Insulin (inhaled)</b>			
Exubra	0.1–0.25	1	4–6

Regular insulin can be administered intravenously. The biologic effect of receptor-bound insulin lasts approximately 1 hour. The circulating half-life of unbound insulin is a few minutes. Renal insufficiency prolongs the half-life of circulating insulin.

(diagnostic criteria are listed in Table 59-3). Consequently, these patients may arrive urgently in the operating

room requiring surgical intervention (i.e., due to trauma, acute abdomen, abscess, ischemic limb) but may have

a concurrent metabolic derangement. Therefore, intraoperative anesthetic management of the patient with type 1 DM may include treatment of DKA.

**Diabetic Ketoacidosis**

Features of DKA (Table 59-3) include circulatory depression, as acidosis and metabolic derangements can reduce cardiac contractility and peripheral vascular tone. Hyperglycemia with attendant hyperosmolality produces osmotic diuresis resulting in hypovolemia. Abnormalities often include hyperglycemia (although glucose usually is <500 mg/dL), intracellular dehydration, hyperkalemia, and hyponatremia. Dehydration frequently is severe because of poor oral intake due to the primary illness, exacerbated by hyperglycemia-induced osmotic diuresis. Plasma potassium ( $K^+$ ) levels can be elevated because metabolic acidosis drives  $K^+$  out of cells. Insulin concentrations are insufficient to maintain intracellular  $K^+$  levels, so total body  $K^+$  actually is depressed (reduced by 3–10 mEq per kilogram body weight). Measured sodium ( $Na^+$ ) concentrations are

1421

TABLE 59-2.

## Other Agents Used for Treatment of Type 2 Diabetes

Agent	Route of Administration	Mechanism of Action	Major Side Effects	Time to Onset (h)	Duration of Action (h)
Chlorpropamide	Oral	Increases insulin secretion	Hypoglycemia	1	60
Glimepiride				1	24
Tolbutamide				≤0.25	6–12
Tolazamide				1	10–24
Glyburide				1	6–12
Glipizide XL				1	3–4
Nateglinide				1	24
Repaglinide				1	3–4
Byetta (exenatide)	Subcutaneous	GLP1 mimetic, increases insulin secretion only with hyperglycemia	No risk for hypoglycemia as single agent, delays gastric emptying, nausea, anorexia	≤0.25	6–12
Symlin (pramlintide)	Subcutaneous	Suppresses postprandial glucagon secretion	Hypoglycemia when given with insulin, delays gastric emptying, nausea	≤0.25	2–4
Januvia (sitagliptin)	Oral	DPP4 inhibitor increases GLP1		1	24
Rosiglitazone	Oral	Insulin sensitizer	Peripheral edema, abdominal obesity congestive heart failure, anemia, hepatotoxicity	1	24
Pioglitazone				1	24
Metformin	Oral	Decreases hepatic glucose output, insulin sensitizer	Lactic acidosis, diarrhea	1	8–12
Acarbose	Oral	Decreases gastrointestinal glucose absorption	Malabsorption, flatulence, diarrhea	Immediate	<0.3
Miglitol				Immediate	<0.3

Incretin-mimetics and insulin sensitizers in single-agent therapy do not predispose to hypoglycemia even in the fasting state.

TABLE 59-3.

## Criteria for Diagnosis of DKA and HONK

Laboratory Parameter	DKA	HONK	Mixed
Serum glucose (mg/dL)	>300	>600	>600
Serum bicarbonate (mEq/L)	<15	≥15	<15
Serum osmolarity (mOsm/L)	≤320	>320	>320
pH	<7.3	≥7.3	
Urinary ketones	>3+	<sup>a</sup>	<sup>b</sup>
Serum ketones	+	<sup>a</sup>	<sup>b</sup>

<sup>a</sup>Trace to small amounts of ketones may be present.  
<sup>b</sup>Ketones may be present.  
DKA, diabetic ketoacidosis; HONK, hyperglycemic hyperosmolar nonketotic coma.

artificially lowered ~1.6 mEq/L for every 100 mg/dL that the glucose level is elevated above 100 mg/dL. Thus, the serum Na<sup>+</sup> level of a severely hyperglycemic patient may not reliably reflect the degree of dehydration. Plasma hypophosphatemia and hypomagnesemia commonly result from excessive urinary losses in DKA.

Management of DKA includes repletion of intravascular volume with salt and water to resolve fluid deficits and help restore blood pressure, tissue perfusion, and glomerular filtration. Initial volume resuscitation usually is accomplished with normal saline. Vigorous hydration also decreases glucose levels by 20–40%. Insulin therapy (regular insulin by IV bolus and subsequent infusion) is crucial in treating DKA. Insulin inhibits gluconeogenesis and ketone production in the liver and decreases lipolysis in adipose tissues. Insulin administration must be continued if acidosis or ketosis persists, even though glucose levels have normalized. During administration of insulin, an infusion containing 5% dextrose (e.g., D<sub>5</sub>NS, 100 mL/h) will prevent hypoglycemia when plasma glucose concentrations decrease to <250 mg/dL. Blood glucose levels should be monitored every hour, with frequent electrolyte determinations.

Potassium and phosphate replenishment are essential for insulin's action. These electrolytes should be replaced carefully, after first verifying that the patient has normal renal function and adequate urine output. Potassium can be replaced with an equal mixture of potassium chloride and potassium phosphate.

Serum K<sup>+</sup> < 3 mEq/L, give K<sup>+</sup>, 40 mEq/h

Serum K<sup>+</sup> < 4 mEq/L give K<sup>+</sup>, 30 mEq/h

Serum K<sup>+</sup> < 5 mEq/L, give K<sup>+</sup>, 20 mEq/h

Serum K<sup>+</sup> ≥ 5 mEq/L, no replacement

Consideration should be given to bicarbonate therapy only for severe acidosis (e.g., when arterial pH falls to <7.0) or hemodynamic instability, or for patients with cardiac rhythm disturbances. Following administration of bicarbonate, arterial pH levels should be monitored.

An emerging form of diabetes associated with obesity and presenting with ketoacidosis is called *Flatbush type 2 DM*. Most or almost all of these patients can be treated with oral agents after initial management with intensive insulin therapy. Initial treatment of ketoacidosis in the patient with Flatbush type 2 DM is the same as for the typical type 1 DM patient.

### Type 2 DM

Patients with type 2 DM generally are older, obese, and subject to metabolic syndrome, a complex pathophysiologic state characterized by hypercholesterolemia, hypertriglyceridemia, hyperglycemia, hypertension, and DM.<sup>3,4</sup> In patients with metabolic syndrome, the cardiovascular risk of anesthesia and surgery may elevate markedly. Hypercoagulability is one feature of metabolic syndrome potentially relevant to these patients, who may be prone to thrombosis as a result of their surgical conditions or the consequences of surgery and anesthesia.<sup>5</sup> Of burgeoning clinical importance is the growing population of young, typically obese, patients with type 2 DM. The practitioner encounters a juvenile or adolescent patient with the combined anesthetic management challenges of youth, obesity, and diabetes. Type 2

DM may occur in young, nonobese, adolescents (maturity-onset diabetes of the young [MODY]) because of autosomal dominant inheritance of a mutation in the glucokinase gene that results in impaired hepatic glucose uptake and reduced insulin secretion.

A fundamental concept of type 2 DM is that patients with the condition usually produce sufficient insulin to avoid DKA, the severe metabolic consequence of absolute insulin deficiency seen in patients with type 1 DM. However, patients with type 2 DM have reduced cellular response to insulin binding to its receptor. Patients are described as being resistant to the hypoglycemic actions of insulin and may require large insulin doses to achieve normal glucose levels.

Initial medical therapy for type 2 DM includes administration of agents to increase endogenous insulin release, reduce intestinal uptake of carbohydrates, or increase peripheral sensitivity to insulin. When these measures are insufficient, insulin therapy can be initiated, but patients may require very high insulin doses. A new class of therapeutic agents, currently represented by pramlintide, has been approved by the US FDA for reducing postprandial glucagon secretion and suppressing hepatic glucose release.

### Hyperglycemic Hyperosmolar Nonketotic Coma

Hyperglycemic hyperosmolar nonketotic coma (HONK), also known as *hyperglycemic hyperosmolar syndrome*, is a clinical syndrome encountered in some type 2 diabetic patients with decompensated DM. As the name implies, features include hyperglycemia, hyperosmolarity, and dehydration (typical water deficit 10–12 L). Severe ketosis is rare, but mild acidemia can be caused by inadequate circulation and lactic acidosis (Table 59-3). The precipitating factors for HONK are similar to those of DKA (Table 59-4). Patients presenting for surgery, especially urgent procedures, may have HONK as a comorbid condition requiring management during administration of their anesthetics. The classic presentation of patients with HONK includes fatigue, blurred vision, polydipsia, polyuria, leg cramps, and weight loss. The laboratory findings of HONK are related to dehydration and hypovolemia. Derangements in serum electrolyte levels occur, and

TABLE 59-4.

## Precipitating Factors for Hyperglycemic Hyperosmolar Nonketotic Coma

Precipitating Events	Pharmacologic Agents	
Infection (pneumonia, urinary tract infection, sepsis)	Amphetamines	Niacin
Noncompliance with insulin regimen	β-Blockers	Pentamidine
First presentation of diabetes mellitus	β-Agonists	Protease inhibitors
Dehydration	Diuretics	Salicylates
Impaired renal function	Glucocorticoids	Sympathomimetics

hemoconcentration causes increases in blood levels of hemoglobin, protein, calcium, amylase, lactate dehydrogenase, and transaminases. Some patients present a mixed picture, with features of both DKA and HONK (Table 59-3).

Fluid administration in the setting of HONK is crucial. The rate of fluid administration depends on the patient's volume status, total body water deficit, serum osmolality, and renal and cardiac function. Normal saline (2-3 L) is an appropriate fluid bolus in a patient with adequate cardiac and renal function and serum osmolality <320 mOsm/L. Even larger fluid boluses may be required if serum osmolality is >320 mOsm/L. In hypotensive patients who do not respond to aggressive crystalloid administration, colloidal or vasopressor infusions are additional treatments. Central venous pressure or pulmonary arterial monitoring may help guide therapy, especially in patients with HONK who are elderly and at significant risk for concomitant cardiovascular disease.

Medical therapy for HONK includes a low-dose, continuous, IV infusion of insulin. If no decrease of glucose levels occurs over the first 2-4 hours, doubling the insulin infusion rate every hour until a response occurs is recommended. Potassium chloride usually is administered as part of the fluid regimen. The total body potassium deficits encountered in HONK are modest compared to DKA because of the absence of acidosis (see guidelines for potassium replacement in DKA). Potassium acetate and/or potassium phosphate can be used in order to avoid excessive chloride levels. Bicarbonate need not be given unless lactic acidosis causes arterial pH to decrease to <7.0. Thrombotic/embolic events are common complications of HONK. Prophylaxis against thrombosis war-

rants consideration. Should thrombosis occur, an anticoagulating dose of IV heparin or low-molecular-weight heparin anticoagulation is indicated.

### Perioperative Insulin/Glucose Management

As a rule, long-acting oral hypoglycemic agents (sulfonylurea drugs) should not be given before surgery to reduce the risk of hypoglycemia, signs and symptoms of which may be masked by general anesthesia. However, it is unlikely that insulin sensitizers or incretin mimetics will produce hypoglycemia. Theoretically, inhibitors of glucagon secretion may lead to hypoglycemia in the fasting state. Patients with type 2 DM treated with insulin are at risk for hyperglycemia if their insulin is withheld completely. Typically, these patients receive about half of their usual morning insulin dose in the form of long-acting insulin preparations, such as NPH insulin. Short-acting insulins are omitted. *Patients with type 1 DM must receive some insulin.* In this population, half of the usual morning dose of long-acting insulin may be appropriate before surgery. One key to management is frequent monitoring of glucose levels in all patients with DM. As a general rule, diabetic patients should undergo their anesthetic and surgical procedures as early in the day as possible. This limits the perturbations caused by prolonged fasting and disruption of customary diabetes medical regimens.

Recently, patients have been chronically managed with a portion of their insulin requirements supplied by continuous infusion delivered with a pump. Recommendations for the perioperative period for patients with pumps include (1) maintaining the basal infusion rate of insulin, (2) omitting any preprandial insulin boluses in the fasting patient, (3) monitoring of

glucose levels at frequent intervals, and (4) resuming the usual diet and insulin therapy regimen as soon as possible.<sup>6</sup> However, the anesthesiologist must recognize that these pumps deliver the insulin dose subcutaneously. Uptake of the drug from this depot may be affected by alterations (usually reductions) in tissue perfusion that are commonly encountered during surgery or the perioperative period. Consequently, depending on the surgical circumstances, it may be advantageous to interrupt the continuous subcutaneous administration of insulin by pump and to substitute carefully titrated IV infusions of insulin. To decide on the initial IV insulin infusion rate, first determine the total 24-hour basal insulin dose typically administered by the subcutaneous infusion. Divide this basal dose by 24. Start the IV infusion with this number of units of regular insulin per hour, again with close monitoring of blood glucose and serum potassium levels.

### Intraoperative Insulin Therapy

A variety of regimens exist for IV infusion of regular insulin in the operating room. For the routine surgical population, the "Vellore Regimen" has been evaluated.<sup>7</sup> Other schemes also are acceptable,<sup>8</sup> as long as glucose and potassium levels are closely monitored and treated when necessary. Table 59-5 outlines one practical method of insulin administration in the operating room that is used at our institutions. Cardiac surgical patients<sup>9</sup> and pediatric surgical patients<sup>10</sup> may benefit from regimens tailored to the special needs of these particular populations.

A growing consensus holds that in some surgical situations (e.g., neurovascular procedures or carotid endarterectomy) associated with significant risk for cerebral ischemia, blood glucose levels should be more tightly controlled to avoid hyperglycemia. Unlike the situation with critically ill patients for whom outcome studies provide data supporting tight glucose control (blood glucose target typically <110-120 mg/dL), clinical outcome studies establishing optimum intraoperative blood glucose levels for more routine surgical patients do not yet exist. Coursin and Prielipp<sup>11</sup> conclude that the optimum insulin regimen for a given surgical situation and the ideal range of blood glucose levels for routine anesthetics remain undetermined.



TABLE 59–5.

## Perioperative Intravenous Regular Insulin Regimens

**A. Initial regular insulin IV bolus: 0.05–0.1 U/kg**

Dose additional boluses based on glucose levels

**B. Regular insulin infusions (1 U regular insulin/mL normal saline)**

Initial Regular Insulin Infusion Rate (U/h)

Type 1 DM (female)	0.5
Type 1 DM (male)	1.0
Type 2 DM (male or female)	1.0

**Notes on IV Regular Insulin Action**

1. Onset is immediate
2. Duration is ~ 1 h.
3. Duration of action prolonged in renal insufficiency.

**Adjustment of IV Regular Insulin Infusion Rate (U/h)**

Glucose (mg/dL)	Rate Change	Other Rx
<70	Hold 30 min	Give D <sub>50</sub> , 15–20 mL. Recheck blood glucose level after 30 min. Give more dextrose until blood glucose level >70 mg/dL.
70–120	↓ 0.3 U/h	
121–180	No change	
181–240	↑ 0.3 U/h	
241–300	↑ 0.6 U/h	
>300	↑ 1.0 U/h	

**Notes on IV Regular Insulin Dosing**

1. Insulin guidelines assume patient is fasting and is not in diabetic ketoacidosis.
2. DOSING MUST BE INDIVIDUALLY TITRATED BASED ON FREQUENT BLOOD GLUCOSE MONITORING.

DM, diabetes mellitus.

**Metformin**

Metformin is an oral hypoglycemic agent of the biguanide class with an important role in type 2 diabetes therapy, particularly because of its favorable effects on cardiovascular mortality.<sup>12</sup> This drug, which has multiple pharmacologic effects, has also been associated with the serious side effect of lactic acidosis, which may become life threatening. Whether metformin causes lactic acidosis or exacerbates lactic acidosis resulting from other conditions remains undetermined.<sup>13</sup> When administered according to guidelines and avoiding contraindications including renal and hepatic insufficiency and a history of alcohol abuse, the incidence of lactic acidosis is very low.<sup>12</sup> In conditions where tissue hypoxia already exists (including circulatory failure) or circulatory insufficiency is anticipated (e.g., major surgery), it is prudent to withhold metformin. In anticipation of IV radiologic contrast exposure, metformin

should be stopped and not restarted until the creatinine level has been checked to confirm baseline renal function. Recognizing that conclusive data do not exist to support their suggested guidelines, Jones et al.<sup>14</sup> and Vreven and De Kock<sup>15</sup> proposed that metformin be withdrawn 2 days before general anesthesia and reinstated when renal function is demonstrated to be stable. Metformin should not produce hypoglycemia in the fasting preoperative patient.

**Steroid (Glucocorticoid) Therapy: Implications for DM**

Administration of pharmacologic doses of glucocorticoids increases resistance to insulin action by inhibiting glucose uptake into muscle and fat.<sup>16</sup> In many patients, the effect is primarily postprandial hyperglycemia. Thus, morning fasting glucose levels are only mildly elevated, but glucoses levels rise substantially after meals in the afternoon and evening.

Glucose levels will increase in patients with known diabetes. Glucocorticoid therapy reveals previously undiagnosed insulin resistance in 25% of all patients receiving such treatment.<sup>17</sup> The hyperglycemia resulting from glucocorticoid therapy can be managed with insulin, oral hypoglycemic agents, or combination therapy. When glucocorticoid therapy is tapered, insulin resistance decreases with a lag of 1–3 days. Hyperglycemia therapies (e.g., insulin infusions) must then be reduced to avoid hypoglycemia. The complexities of the patient's regimen for controlling hyperglycemia must be considered when managing medications and glucose in the perioperative period.

Postoperative stress usually leads to excess endogenous glucocorticoid production and consequent insulin resistance. This may result in hyperglycemia lasting 1–3 days after the procedure or for as long as significant infection or pain-related stress is present. Treatment of this manifestation of hyperglycemia is accomplished by administering a long-acting insulin plus a short-acting insulin at mealtime in the patient who is able to eat. Other patients may require regular insulin administered by IV infusion.

**Counterregulatory Hormones  
Glucagon**

Glucagon is a 29-amino-acid polypeptide secreted by the alpha cells of the pancreatic islet. Glucose is the most important regulator of glucagon secretion. Hyperglycemia decreases glucagon secretion. Hypoglycemia stimulates glucagon secretion via direct effects on islets and via central nervous system pathways activated by hypoglycemia.  $\beta$ -Adrenergic receptor activation stimulates glucagon secretion.<sup>18</sup> Glucagon acts primarily on the liver to increase both glycogenolysis and gluconeogenesis. Increased glucose output balances glucose utilization during the fasting state to maintain euglycemia.<sup>19</sup> Patients with hepatic or pancreatic insufficiency are theoretically at risk for hypoglycemia as a result of lack of glucagon effects. In addition,  $\beta$ -blocker therapy potentially reduces glucagon secretion. The implication for anesthetic management is the need to monitor glucose levels frequently in patients at risk and to intervene as needed.

**Epinephrine**

Epinephrine and glucagon are the most important hormones maintaining eu-

glycemia during the fasting state.<sup>20</sup> The central nervous system reacts to hypoglycemia by stimulating secretion of epinephrine. Activation of pancreatic  $\alpha$ -adrenergic receptors by epinephrine inhibits insulin secretion.  $\beta$ -Adrenergic receptor activation stimulates secretion of glucagon. Epinephrine, via  $\beta_2$ -adrenergic receptors, also acts directly on the liver to increase glycogenolysis and gluconeogenesis. Therefore, patients at risk for blunted sympathetic responses, either following neuraxial anesthesia or from receiving  $\beta$ -blocker therapy, may fail to react normally to hypoglycemia. The implication for anesthetic management is, again, a need to anticipate potential hypoglycemia, with close monitoring of glucose levels in patients at risk, and to treat as needed.

### Glucocorticoids and Growth Hormone

Growth hormone (GH) and cortisol play minor roles in the restoration of euglycemia after hypoglycemia. Prevention of cortisol secretion and GH deficiency does not inhibit restoration of euglycemia after hypoglycemia.<sup>21</sup> The hyperglycemic response to the combination of glucagon, epinephrine, and cortisol is larger than to each of these hormones given individually, suggesting that synergism contributes to normal physiologic responses to hypoglycemia.<sup>22</sup>

### Hypoglycemic Unawareness

Some patients with long-standing DM and frequent bouts of hypoglycemia lose their normal sympathetic response to low blood sugar levels. The failure to consciously recognize low blood sugar levels is known as “hypoglycemic unawareness.” Fasting in the perioperative period, particularly in the setting of continued insulin therapy administered by infusion pump, may predispose these patients to potentially dangerous hypoglycemia. The anesthesiologist cannot rely on such patients to symptomatically monitor their own blood glucose levels and to respond appropriately, even when managed with regional anesthesia and minimal sedation. Assessment of glucose levels by glucometer or laboratory methods, and appropriate therapy, is essential for these patients.

### DM: Implications for Anesthesia

Although general anesthesia may be mandatory for some surgical procedures, other options (including regional

anesthesia or neuraxial anesthesia) exist for some situations.<sup>23</sup> Neuraxial anesthesia may provide an advantage by blocking “stress responses” to surgery involving counterregulatory hormones such as epinephrine and glucocorticoids. Regional or neuraxial block anesthetic techniques may allow some diabetic patients to return to their customary diets earlier than they would if given general anesthesia, facilitating resumption of chronic diabetes regimens. Metabolic control in the diabetic patient may be improved by regional anesthetic techniques, at least in some patient populations.<sup>24</sup> Regional anesthesia or neuraxial techniques may also be useful for patients with diabetic gastroparesis, who are at elevated risk for aspiration under general anesthesia, or who may be difficult to intubate because of stiff joints (including the temporomandibular joints and the cervical spine) associated with their disease. However, the effects of neuraxial techniques are complicated by their effects on gut motility and absorption. In addition, preexisting autonomic neuropathy may compound the effects of sympathectomy produced by neuraxial block. There is some concern that patients at risk for diabetic neuropathy may be more likely to develop peripheral nerve injury in association with regional or neuraxial techniques. No published studies in readily identifiable sources support or refute this possibility.<sup>25</sup> McAnulty and Hall<sup>26</sup> conclude that no body of evidence indicates that regional anesthesia alters overall surgical morbidity and mortality in the diabetic patient population. Consequently, a well-conducted anesthetic, regardless of specific technique, probably is the most important factor in the care of the diabetic patient. Of note, general anesthesia often masks the autonomic response to hypoglycemia, and changes in vital signs can easily be misinterpreted as a response to increased surgical stimulation rather than hypoglycemia. Consequently, close monitoring of glucose levels in patients at risk for hypoglycemia and appropriate therapy are essential.

### Specific Surgical Procedures and Glucose Homeostasis

Total pancreatectomy eliminates insulin-producing islet cells as well as cells secreting the counterregulatory hormone glucagon. This surgery renders the patient as having type 1 DM with

an absolute requirement for insulin therapy. The biologic effect of insulin molecules bound to cellular receptors lasts for approximately 1 hour, but the chemical half-life of insulin in the circulation is just a few minutes. Consequently, following a total pancreatectomy, the need for insulin therapy to prevent DKA begins within 60 minutes of devascularizing the pancreatic islets.

Surgery for insulinoma or glucagonoma poses no particular management challenges as long as glucose levels are monitored closely and the means for treating hypoglycemia are readily available.

## THYROID DISEASE

Thyroid diseases compose the second most common endocrine conditions appearing as comorbidities in patients presenting for surgery of any kind. Hypothyroidism and hyperthyroidism have significantly different implications for anesthetic management. Where possible, assessment of the current status of the patient's thyroid condition provides information useful for predicting sensitivity to drugs commonly administered in the perioperative period, hemodynamic responses during surgery and anesthesia, and physiologic perturbations potentially requiring investigation and treatment, such as electrolyte disorders and adrenal insufficiency.<sup>27</sup> It is important to recognize that medical treatment of altered thyroid function (hypothyroidism or hyperthyroidism) may require several weeks to achieve a new steady state. In general, mildly hypothyroid patients can proceed to elective surgery without delay. Postponement of elective surgery may be indicated to allow evaluation and treatment of hyperthyroidism and to allow medical management of hypothyroid patients with more than mild to moderate thyroid insufficiency.

### Implications of Hyperthyroidism

The clinical features of hyperthyroidism result from excess thyroid hormone and enhanced  $\beta$ -adrenergic activity.<sup>27,28</sup> Etiology, manifestations, and medical management of thyroid disorders are discussed in detail in Chapter 12. Endocrinologists distinguish *thyrotoxicosis*, which is a general term for excessively elevated thyroid hormone of any cause (including excessive exogenous thyroid

TABLE 59–6.

## Clinical Features of Thyroid Disease

**Hyperthyroidism/Thyrotoxicosis**

Volume depletion	Eyelid retraction
Tachycardia or atrial fibrillation	Lid lag, stare
Systolic hypertension	Elevated liver function tests
Congestive heart failure	Decreased cholesterol
Hyperthermia and increased perspiration	Exophthalmos (Graves disease only)
Adrenocortical insufficiency	Warm, moist skin
Proximal muscle weakness	Hypercalcemia
Motor hyperkinesia	Tremor

**Hypothyroidism**

Decreased spontaneous respiration	Hypothermia
Reduced plasma volume	Enlarged tongue
Hypoglycemia	Slow movement
Hyponatremia	Slow speech
Impaired hepatic drug metabolism	Hoarseness
Hypometabolic state	Elevated creatine phosphokinase
Adrenocortical insufficiency	Dry, sallow skin
Obesity	Periorbital edema
Enlarged cardiac silhouette on radiography	Nonpitting edema (myxedema)
Congestive heart failure	Delayed relaxation of deep tendon reflexes
Bradycardia	Low-voltage electrocardiogram
Hypertension (especially diastolic)	Elevated cholesterol
Depressed mental state	Ileus

hormone), from *hyperthyroidism*, in which thyroid gland hypersecretion is the reason for excessive thyroid hormone activity. The clinical features of hyperthyroidism or thyrotoxicosis that are particularly relevant to anesthetic management of thyroid surgery, or of nonthyroid surgery that cannot be postponed until the patient is rendered euthyroid, are summarized in Table 59–6. Atrial dysrhythmias, including atrial fibrillation, and premature atrial contractions, tachycardia, systolic hypertension, ischemic cardiac disease, and congestive heart failure, should be specifically considered when planning an anesthetic for the hyperthyroid patient.<sup>29</sup> Muscle weakness may impair perioperative respiratory reserve.  $\beta$ -Adrenergic blockade is the mainstay of anesthetic management. High doses of  $\beta$ -blockers may be required to control cardiac manifestations of hyperthyroidism in the immediate perioperative period.

### Implications of Hypothyroidism

The clinical features of hypothyroidism result from a deficiency of thyroid hormone action.<sup>27,30</sup> Etiology, manifestations, and medical management are discussed in detail in Chapter 12. The

clinical features that are particularly relevant to the anesthetic management of thyroid or nonthyroid surgery that cannot be postponed until the patient is rendered euthyroid are summarized in Table 59–6. Bradycardia, diastolic hypertension, congestive heart failure (systolic and diastolic dysfunction), pericardial or pleural effusions, seizures, depressed mentation or frank coma, hypothermia, coagulopathy, and ileus should be specifically considered when evaluating for suspected hypothyroidism. The patient may have a blunted hypercapnic or hypoxic ventilatory drive. Adrenal cortical insufficiency may impair normal stress responses. Laboratory findings include hyponatremia and hypoglycemia.

### Pharmacologic Implications

#### Minimum Alveolar Concentration

Conventional anesthetic wisdom holds that thyroid status does not alter the minimum alveolar concentration. Data from studies of experimental animals using agents such as halothane and cyclopropane support this assertion.<sup>31,32</sup> Data from studies of humans or of any species on the interaction of thyroid status with minimum alveolar concentration for newer potent inhalational

agents such as desflurane and sevoflurane have not been reported. As demonstrated in rats, thyroid status may alter the metabolism of the older potent inhalational anesthetics halothane, enflurane, and methoxyflurane,<sup>33</sup> but the clinical relevance of this finding for commonly used, newer agents is not reported.

#### Altered Drug Metabolism/Sensitivity

Conventional wisdom holds that hypothyroidism increases the sensitivity to sedative, analgesic, and anesthetic medications.<sup>30</sup> Evidence supporting this concept is limited to older drugs without recent studies.<sup>34</sup> One case report cites the accumulation of midazolam in prolonged sedation of a critically ill patient with hypothyroidism as a comorbid condition.<sup>35</sup> Whether this observation can be generalized to all hypothyroid patients or to use of other commonly administered sedative, hypnotic, and analgesic agents remains unproven.

#### Amiodarone

Amiodarone is widely used for the management of atrial and ventricular dysrhythmias. The amiodarone molecule contains approximately 37% iodine by weight, resulting in the delivery of large amounts of iodine to patients receiving standard doses of the drug. The effects of amiodarone therapy on thyroid function are complex, and patients may become either hypothyroid or hyperthyroid when their cardiac electrophysiologic disturbances are treated with amiodarone.<sup>28,36,37</sup> Consequently, patients presenting for surgery who are receiving chronic amiodarone therapy may warrant consideration of their risk for thyroid dysfunction in the perioperative period.

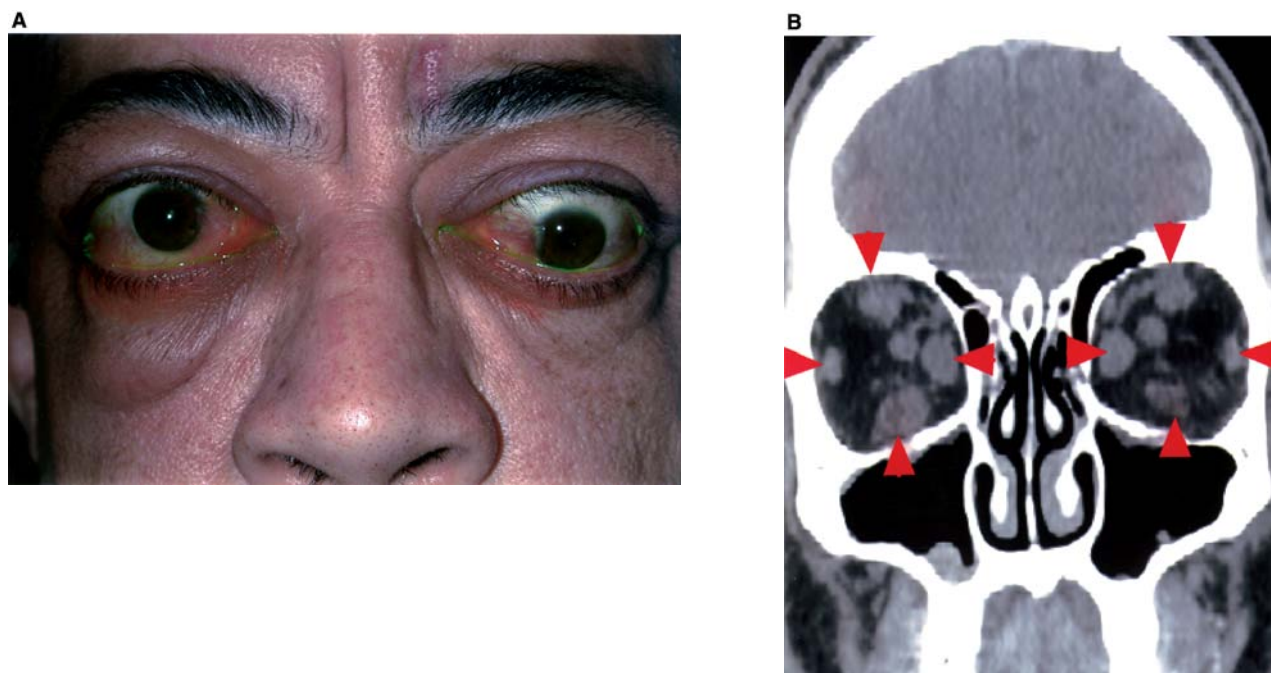
### Exophthalmos: Anesthetic Implications

Exophthalmos, a clinical feature of Graves disease, results from the accumulation of retroorbital fat and swollen ocular muscles resulting in proptosis (Fig. 59–1). The eyelid may not cover the globe, and the exposed cornea and prominent globe are subject to mechanical trauma, including pressure injury.

### Management of Severe Hyperthyroidism or Thyroid Storm in Urgent Surgery

Severe hyperthyroidism is a relative contraindication to anesthesia and sur-





**FIGURE 59-1.** Graves ophthalmopathy with exophthalmos. **A.** Photograph of the face. Note the protuberant orbits and disconjugate gaze caused by accumulation of tissue in the retroorbital area, and edema and fibrosis of the extraocular muscles. **B.** CT scan through the orbits of a different patient showing extraocular muscle edema (*arrows*).

gery. When extreme hyperthyroidism progresses to physiologic decompensation with circulatory collapse, altered mental status, and hyperthermia, the diagnosis is thyroid storm, a life-threatening condition that ideally should be medically controlled before a patient is brought to surgery (Table 59-7). If the primary surgical condition itself is life-threatening and an operation cannot be delayed, the patient must be rapidly prepared in order to limit the effects of the endocrine disorder on the clinical course. Mainstays of therapy include medications to control the thyroid gland,  $\beta$ -adrenergic blockers to blunt sympathetic effects of the excess thyroid condition, glucocorticoids, and circulatory support.<sup>38,39</sup> Iopanoic acid is a valuable treatment option now available only in Europe. The drug may be particularly useful in the setting of amiodarone-induced thyrotoxicosis.<sup>38,40</sup> In the United States, saturated solution of potassium iodide (SSKI) may be used in combination with  $\beta$ -adrenergic blockers.<sup>41,42</sup>

### Thyroid Surgery Anesthetic Options

General anesthesia is commonly administered for thyroid surgery. General anesthesia has the advantages of patient comfort, amnesia, and immobility, along with control of the airway.

Airway control often is achieved by intubation with a cuffed endotracheal tube. However, use of the laryngeal mask airway (LMA) has been considered an option for airway control because intraoperative inspection of vocal cord function and glottic structures can be accomplished with a fiberoptic scope.<sup>43-48</sup> Direct visualization may be particularly valuable if the surgical procedure places a recurrent laryngeal nerve (RLN) at significant risk. An advantage of the technique is that the RLN can be continuously monitored throughout the surgical procedure if the fiberoptic scope is left in place, allowing real-time identification of compromised RLN function. Because some patients may require endotracheal intubation but also benefit from continuous direct observation of glottic structures, Hillermann et al.<sup>48</sup> proposed the use of a small-diameter (5.0-mm inner diameter) endotracheal tube together with an LMA through which a fiberoptic scope was positioned. This setup allows control of the airway with a cuffed endotracheal tube while permitting visual monitoring of RLN function.

Muscle relaxants facilitate endotracheal intubation and may constitute one component of anesthesia maintenance. Muscle relaxants may interfere with motor monitoring of the RLN or

other nerves placed at risk by the surgical procedure. Partial pharmacologic paralysis may permit motor nerve monitoring in some situations<sup>49</sup> if the level of muscle relaxation is closely monitored.

An alternative to general anesthesia is regional anesthesia with supplemental local anesthetic infiltration as needed.<sup>50-52</sup> A consideration in planning a regional anesthetic is that systemic absorption of epinephrine, a common additive to local anesthetic solutions, may exacerbate tachycardia or other tachydysrhythmias encountered in hyperthyroid patients. Thus, epinephrine should be given cautiously or avoided entirely.

Unilateral and bilateral deep cervical plexus block or superficial cervical plexus block with local supplementation has been described for thyroid surgery. Advantages of regional anesthesia include the ability to assess spontaneous respiration and the voice as indicators of RLN integrity during the procedure. In addition, regional anesthesia provides the possibility of early postoperative pain control with little or no need for systemic analgesics. Deep cervical plexus block carries the associated risk of anesthetizing the phrenic nerve with resulting diaphragm dysfunction. Unilateral or bilateral diaphragmatic dysfunction may



TABLE 59-7.

### Treatment of Severe Hyperthyroidism or Decompensated Hyperthyroidism (Thyroid Storm)

#### Therapy to Control the Thyroid

- Thionamides (PTU, methimazole)
- Iodinated medications (iopanoic acid, stable potassium iodide, Lugol solution), Graves disease only
- Lithium carbonate

#### Therapy to Block Conversion of $T_4$ to $T_3$

- PTU
- Iopanoic acid
- Propranolol
- Corticosteroids

#### Therapy to Enhance Clearance of Thyroid Hormones

- Gastrointestinal clearance  
Cholestyramine
- Blood clearance  
Hemoperfusion  
Plasmapheresis

#### Therapy to Block the Effects of Thyroid Hormones

- $\beta$ -Blockers to control heart rate
- Corticosteroids

#### Supportive Measures

- Antipyretics (acetaminophen)
- Cooling
- Meperidine (blocks shivering induced by cooling)
- Correction of dehydration
- Nutrition
- Oxygen
- Treatment of congestive heart failure

#### Therapy for the Precipitating Illness

PTU, Propylthiouracil;  $T_3$ , triiodothyronine;  $T_4$ , L-Thyroxine.

precipitate respiratory distress, especially if the surgical procedure disturbs RLN function with airway compromise. However, little or no change of the forced vital capacity (FVC) measured by incentive spirometry was detected in 21 patients undergoing thyroid surgery with bilateral deep cervical plexus block, and no patient experienced subjective respiratory distress.<sup>51</sup> A study that focused on the analgesic efficacy of cervical plexus block administered in conjunction with general anesthesia for thyroid surgery reported no subjective respiratory complaints among the 39 subjects.<sup>53</sup> However, the study did not include any quantitative objective assessments of respiratory function. Taken together,

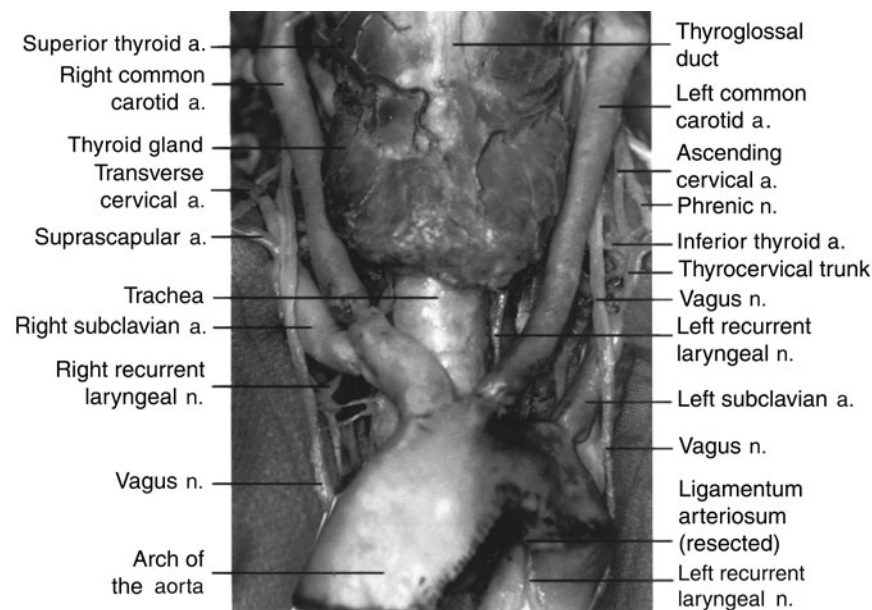


FIGURE 59-2. Anatomic relationships of the normal anterior neck. (From Monfared et al.<sup>61</sup> with permission.)

er, the findings of these small clinical studies suggest that bilateral cervical plexus block may be suitable for appropriately selected patients, but more definitive investigation, particularly of the incidence of perioperative respiratory complications, is needed.

Cervical epidural anesthesia has been used successfully for parathyroid surgery in patients maintained awake to evaluate their vocal cord function.<sup>54</sup> Significant decreases in FVC were encountered, but other measured respiratory variables remained stable, with minimal subjective respiratory compromise. Because the airway and respiratory considerations for thyroid and parathyroid surgery are comparable, the findings suggest that cervical epidural anesthesia may provide an anesthetic option for thyroid surgery where general anesthesia is not desirable.

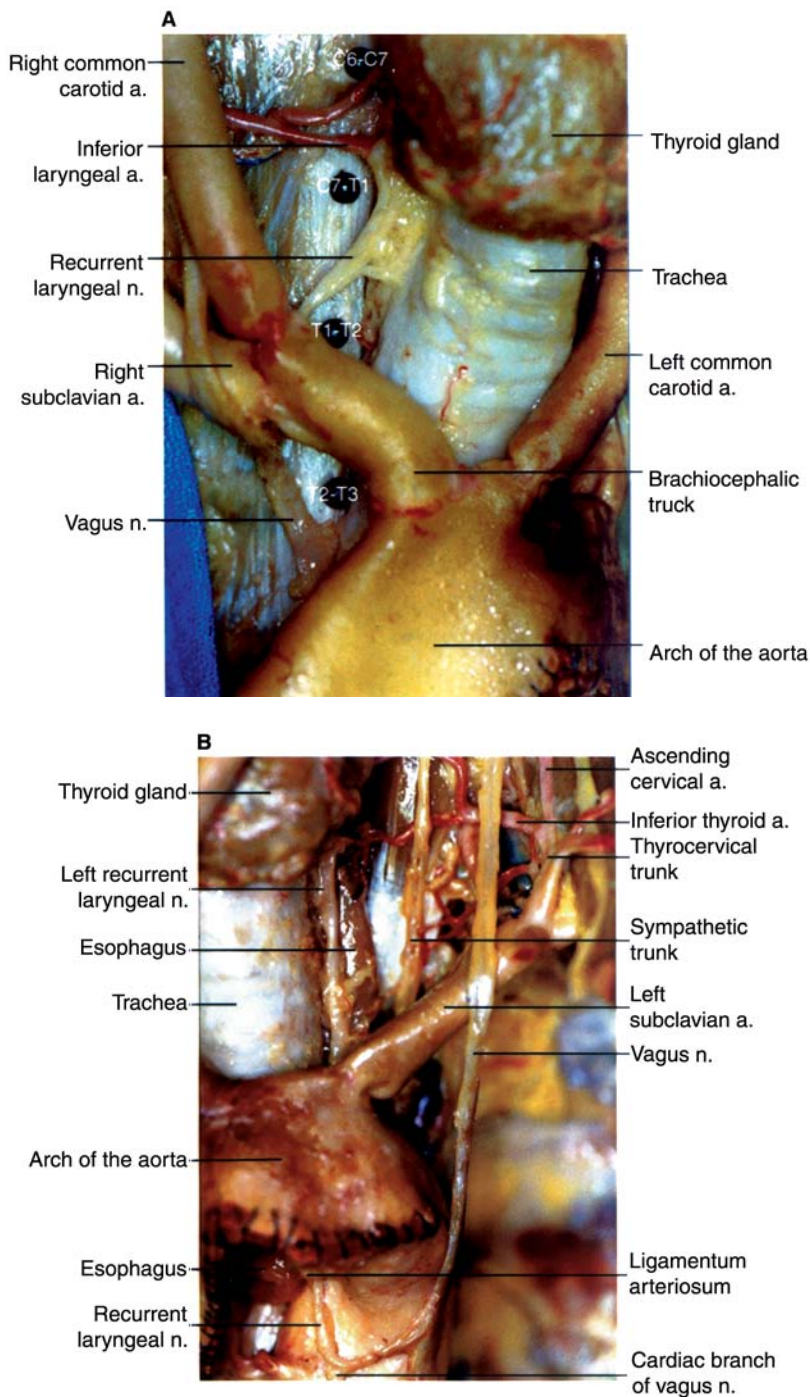
Deep cervical plexus block may impair RLN function when the anesthetic spreads to block the vagus nerve. Although this would not affect direct stimulation of an RLN (as for electromyographic [EMG] monitoring) during surgery, the ability to assess spontaneous vocal cord function would be compromised by anesthetizing an RLN during the course of a deep cervical plexus block. Superficial cervical plexus block avoids the potential airway or respiratory problems of a deep cervical plexus block but may not provide sufficient analgesia for the deeper structures of the neck that may be involved in the surgery. Lack of airway control,

in a situation where the location of the surgical site complicates establishing emergency airway control, is a disadvantage of this regional anesthesia technique. An analgesia option for thyroid surgery is placement of regional blocks intended to provide postoperative pain control in conjunction with administering general anesthesia for the operative period.<sup>53,55</sup>

### Anatomic Concerns

Situated at the base of the anterior neck, the thyroid gland lies in close proximity to major vascular structures, including the internal jugular veins and the carotid arteries (Figs. 59-2 and 59-3).<sup>56</sup> Distortion of normal anatomic relationships, as in the case of a large goiter or a thyroid cancer, can complicate the insertion of an internal jugular catheter (Fig. 59-4). The thyroid gland wraps around the trachea in a nearly circumferential fashion. Direct extension of thyroid cancers into the trachea may obstruct the lumen. Large thyroid masses sometimes compress the tracheal lumen (Fig. 59-5) or distort the glottic or supraglottic airway (Figs. 59-6 and 59-7). Some thyroid masses penetrate or compress the esophagus with implications for the patient's nutritional status. Insertion of nasogastric or orogastric tubes also may be complicated.

Emergency airway algorithms contain a provision for establishing a surgical airway, either by cricothyrotomy or by tracheostomy. Extension of



**FIGURE 59-3.** Anatomic relationships of the thyroid gland. The recurrent laryngeal nerve branches from the vagus and ascends in a groove between the trachea and the esophagus. **A.** Right exposure. **B.** Left exposure. (From Monfared et al.<sup>61</sup> with permission.)

thyroid tissue rostrally over the cricothyroid membrane, or caudally toward the sternal notch, positions this highly vascular tissue directly in front of the airway. Thyroid isthmus tissue may be encountered even in routine tracheostomy placement.<sup>57</sup> A cadaver study reported a high incidence of percutaneous tracheostomy catheters malpositioned so as to puncture the

thyroid isthmus.<sup>58</sup> Complications of surgical airway insertion related to thyroid tissue or vessels have been reported.<sup>59</sup> Hemorrhage can easily complicate attempts to establish a surgical airway.

Other structures in close proximity to the thyroid gland include the parathyroid glands, which are placed at risk during thyroid surgery, and



**FIGURE 59-4.** Large recurrent goiter overlying the anterior and right neck in a patient with a previous partial thyroidectomy.

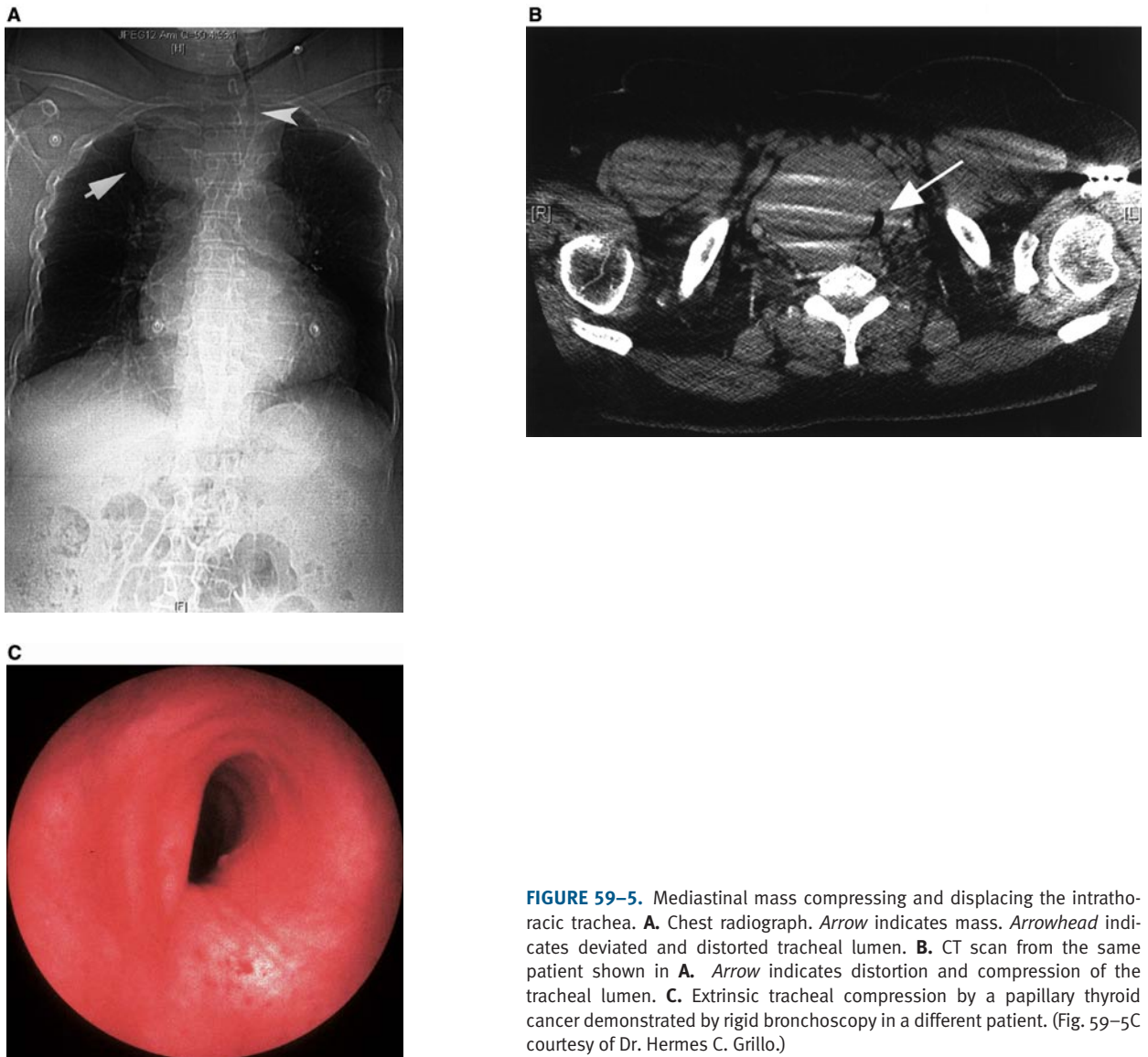
the recurrent and superior laryngeal nerves, which supply the larynx.<sup>60,61</sup>

### Airway Concerns

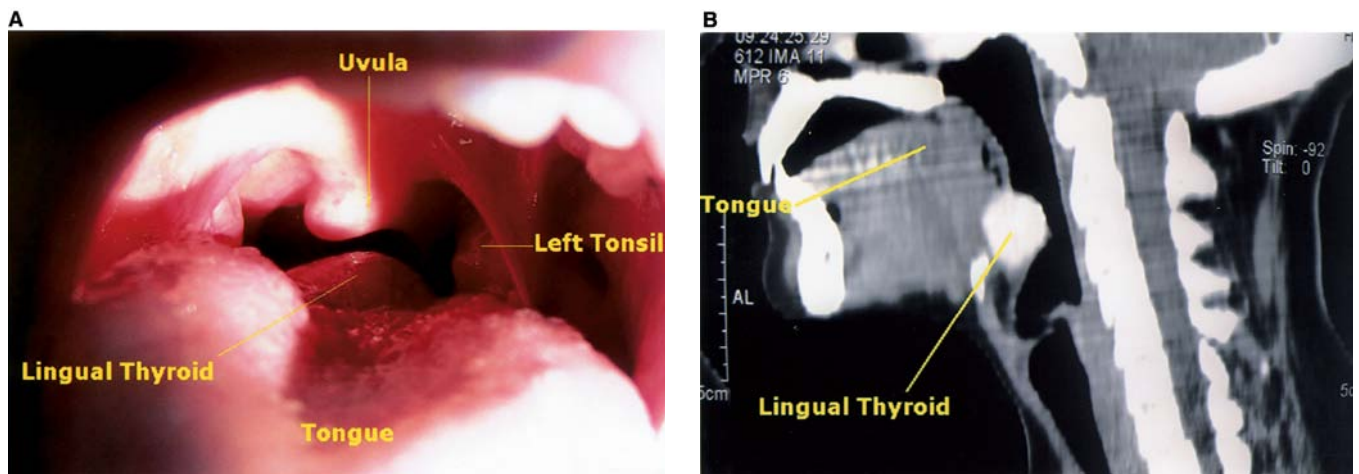
Airway management is a principal anesthetic concern in thyroid surgery. Thyroid masses can affect the airway in the supraglottic region. Lingual thyroid tissue arising from the base of the tongue may obstruct the oropharynx, compromising spontaneous respiration,<sup>62</sup> mask ventilation, and direct laryngoscopy. Thyroid masses invading or compressing the glottis potentially compromise visualization of the glottic opening or passage of an endotracheal tube through the vocal cords. Bouaggad et al.<sup>63</sup> studied 320 patients scheduled for thyroidectomy in an analysis of potential factors helpful for predicting difficult endotracheal intubation. Endotracheal intubation was found to be easy in 36.9% of patients, and the investigators encountered only minor difficulties in 57.8% of the study group. The study concluded that the presence of a large goiter is not of itself predictive of a difficult endotracheal intubation. However, multivariate analysis identified the presence of Cormack grade III or IV view and the presence of a cancerous mass as independent predictors of a difficult oral intubation. Potential risk factors for difficult airway management include the body mass index, Mallampati class, thyromental distance, neck mobility, and airway compression.

Thyroid masses within the thorax compromise the airway in the subglottic region by external compression of

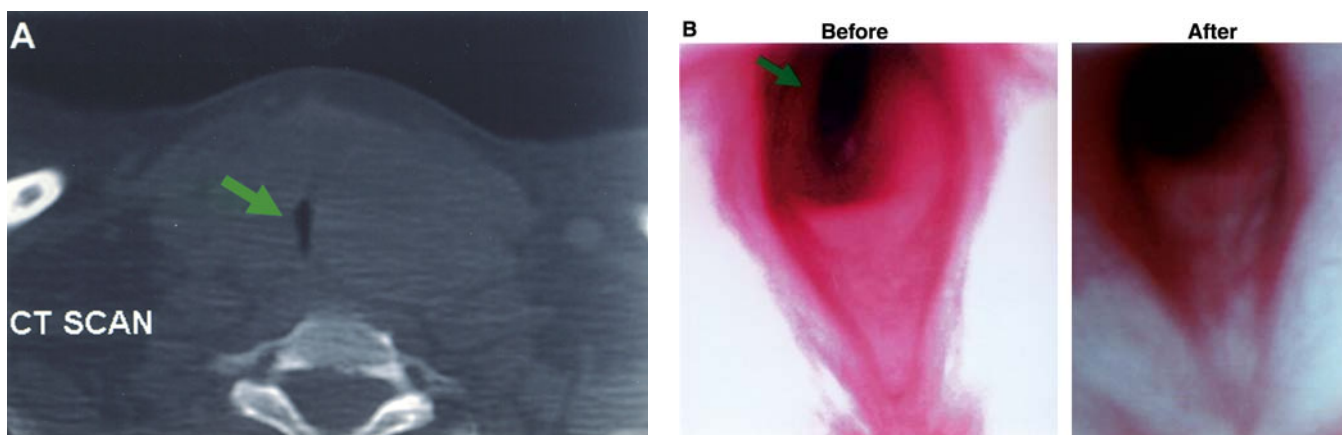




**FIGURE 59-5.** Mediastinal mass compressing and displacing the intrathoracic trachea. **A.** Chest radiograph. *Arrow* indicates mass. *Arrowhead* indicates deviated and distorted tracheal lumen. **B.** CT scan from the same patient shown in **A.** *Arrow* indicates distortion and compression of the tracheal lumen. **C.** Extrinsic tracheal compression by a papillary thyroid cancer demonstrated by rigid bronchoscopy in a different patient. (Fig. 59-5C courtesy of Dr. Hermes C. Grillo.)



**FIGURE 59-6.** Lingual thyroid tissue obstructing the airway. **A.** Intraoral photograph showing a mass arising at the base of the tongue. The ectopic thyroid tissue may be friable and prone to bleed with manipulation or trauma. **B.** CT scan, midline sagittal image of the same patient shown in **A.** (Images courtesy of Dr. B.Y. Ghorayeb, <http://www.ghorayeb.com>.)



**FIGURE 59–7.** Airway obstruction by a thyroid mass. **A.** CT scan showing tracheal compression. Arrow indicates compressed tracheal lumen at the level of the clavicles. **B.** Endoscopic view of the same patient showing extrinsic narrowing and distortion of the glottis (arrow) before surgical resection (left) and relief of the obstruction resulting from surgical decompression (right).

the trachea or direct extension into the airway. Preoperative imaging studies<sup>64</sup> and flow–volume loops may provide information useful for planning the approach to the airway.

### Laryngeal Nerve Monitoring: Anesthetic Implications

Several methods have been described to monitor the function of the RLN, which controls the function of the vocal cords and other nerves at risk, such as the external branch of the superior laryngeal nerve, which supplies the cricothyroid muscle and therefore regulates voice pitch.<sup>65,66</sup> Most attention has been devoted to monitoring the RLN. Monitoring techniques generally require some form of direct RLN stimulation. Function following stimulation usually is detected by (1) direct visualization of the cords via a fiberoptic scope (see above), (2) palpation of the larynx during RLN stimulation,<sup>67</sup> (3) EMG monitoring using recording electrodes inserted directly into the laryngeal muscles,<sup>68</sup> or (4) EMG monitoring via endotracheal tubes fitted with external sensing electrodes.<sup>69</sup> Nerve monitoring often impacts anesthetic management by the need for a special method of airway control (e.g., LMA vs. cuffed endotracheal tube) or the need to avoid muscle relaxants as part of the anesthetic technique.

### Perioperative Complications of Thyroid Surgery

#### Laryngeal Nerve Injury

A major complication of thyroid surgery that usually appears early (immediately or within hours) in the postop-

erative period is airway obstruction attributable to RLN injury with resultant narrowing of the glottic opening. A unilateral RLN palsy would not produce significant respiratory compromise if the contralateral nerve and vocal apparatus function normally. However, bilateral nerve palsy, as from a new unilateral RLN injury in the setting of a preexisting deficit on the other side, can produce complete closure of the glottis and respiratory obstruction. Prompt endotracheal intubation may be lifesaving.

Estimates of the overall incidence of unilateral temporary RLN palsy after major thyroid surgery range from 1.2–1.4% to 5.1–8.7%.<sup>70–74</sup> Estimates of the incidence of permanent lesions range from 0.4–0.6% to 0.9–1.4%.<sup>70–74</sup> Factors associated with an increased likelihood of RLN injury include surgery for thyroid cancer or Graves disease, reoperation, and extensive neck and lymph node dissections. Positive identification of the RLN and documentation of its integrity during the course of surgery are associated with a reduced likelihood of palsies in the postoperative period. Overall, despite extensive investigation, intraoperative RLN monitoring has not been shown to confer protection against RLN injury after surgery.<sup>73,75–77</sup> RLN monitoring correlates with a reduced incidence of RLN injury only for initial procedures for benign goiter.<sup>78</sup> Monitoring may facilitate visual identification of the RLN, as in cases of reoperation or anatomic variants of nerve position. Of note, endotracheal intubation alone may account for 7–11% of all RLN paralyses.<sup>79</sup>

### Hypocalcemia

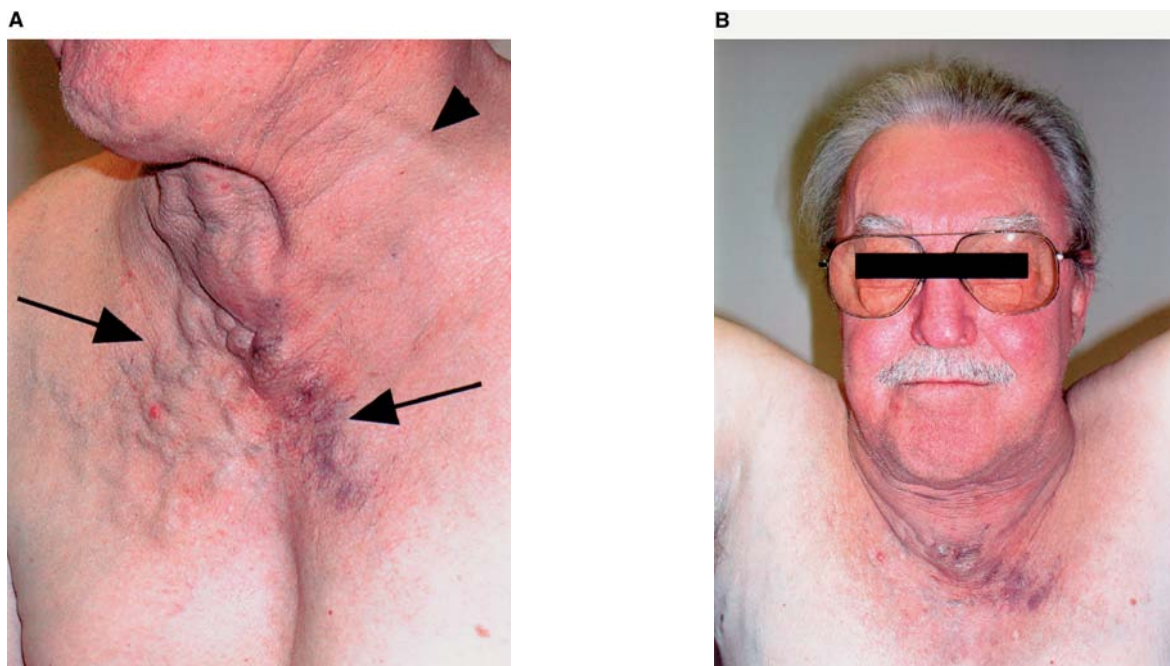
Damage to parathyroid glands during thyroid surgery can cause reduced secretion of parathyroid hormone (PTH), resulting in hypocalcemia. Positive identification of the parathyroid glands at the time of surgical dissection can prevent postoperative hypocalcemia. Estimates of the prevalence of temporary hypocalcemia range from 8.3–27.5%, and estimates of permanent hypocalcemia range from 1.7–5.1%.<sup>70,71</sup> Patients with acute hypocalcemia can present with paresthesias, muscle cramps, stridor, dysrhythmias, or seizures. Some studies suggest that the circulating PTH level obtained during surgery or in the immediate postoperative period is predictive of laboratory or symptomatic evidence of hypocalcemia.<sup>80,81</sup>

### Hemorrhage

The thyroid bed is extremely vascular. Inadequate hemostasis may result in formation of hematomas. Rapid onset of life-threatening airway obstruction is a known complication of thyroid (and parathyroid) surgery. Consideration should be given to prompt intubation to preserve airway patency, even before a return to the operating room for neck exploration. Decompression of the neck at the bedside by opening the wound is a potentially lifesaving option.<sup>65</sup> Use of surgical drains is advocated, at least in selected circumstances, to prevent accumulation of blood or serous fluid in the closed potential space of the neck.<sup>75</sup>

Obstruction of venous drainage from the head by large intrathoracic thyroid masses sometimes results in superior vena cava syndrome (Fig. 59–8). Resec-



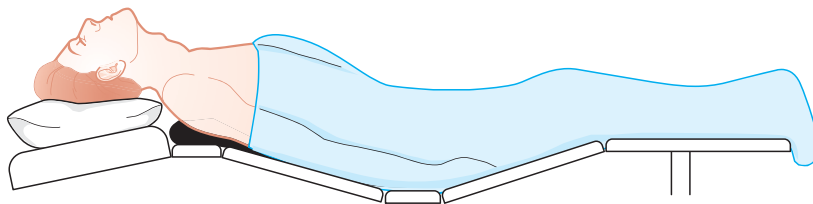


**FIGURE 59-8.** Large cervical and intrathoracic goiter obstructing venous drainage from the head. Note venous engorgement and cutaneous venous varicosities returning blood from the head to the chest (A) and facial erythema (B). This patient lost >5 L of blood during surgery to resect the thyroid mass.

tion of such lesions may be compromised by substantial blood loss.

### Positioning Injuries

Thyroid surgery typically is accomplished with the patient in the supine position with the neck extended and the arms wrapped and supported at the patient's side (Fig. 59-9). Cervical spine conditions may limit the ability to extend the patient's neck safely or comfortably. A pressure injury to the occipital nerves has been described in a patient with the potential risk factors of obesity and DM undergoing thyroid surgery.<sup>82</sup> Risk of ulnar neuropathy related to positioning of the arms at the sides with the potential for pressure on the elbow should be considered. In addition, patients with proptosis from Graves ophthalmopathy may be at particular risk for corneal abrasions or pressure injuries to the globe.



**FIGURE 59-9.** Patient positioning for thyroid and parathyroid surgery. The patient lies supine with the neck extended, usually by an inflatable pouch positioned under the scapulae (“thyroid bag”). The arms are tucked at the sides or rest on the abdomen. The anesthesiologist has little access to the patient once surgical drapes are placed.

## PARATHYROID DISEASE AND DISORDERS OF CALCIUM METABOLISM

Patients may present for surgery to treat parathyroid disease (parathyroidectomy) or require surgery in the setting of disorders of calcium homeostasis. Anesthetic considerations for parathyroidectomy substantially overlap with many of the issues encountered in thyroid surgery. These concerns include monitoring of RLN function, risks of postoperative hypocalcemia and postoperative neck hematoma, and positioning.<sup>75,83</sup> Manifestations of renal insufficiency are particularly important for patients presenting for parathyroidectomy to treat secondary or tertiary hyperparathyroidism.

Advanced preoperative imaging techniques facilitate identification of abnormal parathyroid tissue, sometimes per-

mitting less invasive surgery with achievement of therapeutic goals.<sup>52,75,84</sup> However, failed explorations persist as a surgical problem. Rapid intraoperative immunoassay for PTH can assist the surgeon in determining whether pathologic parathyroid tissue has been identified and removed.<sup>85</sup> Propofol does not interfere with the intraoperative PTH assay.<sup>86</sup>

Anesthesia options for parathyroid surgery include general anesthesia with or without endotracheal intubation, and regional anesthesia techniques.<sup>51,54,75,87</sup> One advantage of regional anesthesia is the avoidance of nausea and vomiting, which is common following parathyroid surgery.<sup>88</sup>

### Implications of Hypocalcemia

Hypocalcemia is a feature of many medical conditions (Table 59-8). Of particular relevance to the anesthesiologist planning to take a hypocalcemic patient to the operating room are critical illness conditions, including pancreatitis or fat embolism syndrome, hepatic or renal failure, and rhabdomyolysis. Detection of hypocalcemia should provide an impetus to comprehensively evaluate the overall condition of a patient to ascertain whether other significant disorders are present.

Features of hypocalcemia (Table 59-9) of particular relevance to perioperative management include a pre-

TABLE 59–8.

## Causes of Hypocalcemia

<p><b>Hypoparathyroidism</b></p> <ul style="list-style-type: none"> <li>• Primary</li> <li>• Surgical</li> <li>• Idiopathic</li> <li>• Autoimmune</li> <li>• Hypomagnesemia</li> <li>• Peripheral resistance (pseudohypoparathyroidism)</li> <li>• Hemosiderosis</li> <li>• Amyloidosis</li> </ul> <p><b>Hyperphosphatemia</b></p> <ul style="list-style-type: none"> <li>• Rhabdomyolysis</li> <li>• Phosphate therapy</li> <li>• Renal failure</li> <li>• Chemotherapy/tumor lysis</li> </ul> <p><b>Vitamin D deficiency</b></p> <ul style="list-style-type: none"> <li>• Hepatic failure</li> <li>• Renal failure</li> <li>• Lack of sun exposure</li> <li>• Dietary deficiency</li> </ul>	<p><b>Critical illness</b></p> <ul style="list-style-type: none"> <li>• Alkalosis</li> <li>• Burns</li> <li>• Toxic shock</li> <li>• Pancreatitis</li> <li>• Fat embolism</li> </ul> <p><b>Anticonvulsant therapy</b></p> <p><b>Hypoalbuminemia</b></p> <p><b>Osteoblastic metastases</b></p> <p><b>Loop diuretics</b></p> <p><b>Contrast media containing EDTA</b></p> <p><b>Intestinal malabsorption</b></p> <p><b>Massive transfusion (citrate intoxication with chelation of calcium)</b></p>
---	---

disposition to laryngospasm, cardiac dysrhythmias, muscle weakness, hypotension, congestive heart failure, altered mental status, and coagulopathy. Massive transfusion with attendant citrate intoxication, especially in the setting of hepatic insufficiency, is a commonly encountered clinical situation with a significant risk for hypocalcemia that may exacerbate the hemodynamic and metabolic disturbances of complicated surgery. Hy-

pocalcemia should be considered in the differential diagnosis of altered mental status following emergence from a craniotomy.

Treatment of hypocalcemia in the perioperative setting is best accomplished with IV calcium chloride, although calcium gluconate is another option. Clinicians should recognize that 1 g of calcium chloride solution provides three times the amount of elemental calcium

present in 1 g of calcium gluconate. Serial blood ionized calcium measurements should guide therapy.

**Implications of Hypercalcemia**

Hypercalcemia is a feature of many medical conditions (Table 59–10). Detection of hypercalcemia warrants evaluation for the possible presence of other major physiologic disturbances, including pheochromocytoma, adrenal insufficiency, and acromegaly. Hypercalcemia should be considered in the differential diagnosis of altered mental status in the perioperative period.

Features of hypercalcemia of particular relevance to perioperative management include a predisposition to cardiovascular disturbances, such as dysrhythmias and hypertension (Table 59–11). Muscular weakness caused by hypercalcemia can exacerbate respiratory insufficiency. Positioning should take into account the risk of fracturing osteopenic bone. Urgent treatment of hypercalcemia may be required in the operating room or in the immediate perioperative period. First-line therapy includes IV hydration and diuresis. Treatment modalities are summarized in Table 59–12.

**PHEOCHROMOCYTOMA AND PARAGANGLIOMA**

Pheochromocytomas are neuroendocrine tumors arising from chromaffin

TABLE 59–9.

## Signs and Symptoms of Hypocalcemia

<p><b>Paresthesias</b> (acral, perioral)</p> <p><b>Muscle spasms</b></p> <ul style="list-style-type: none"> <li>• Stridor</li> <li>• Laryngospasm</li> <li>• Carpal/pedal spasm</li> <li>• Chvostek sign</li> <li>• Trousseau sign</li> <li>• Tetany</li> </ul> <p><b>Dysrhythmias</b></p>	<p><b>Weakness</b></p> <p><b>Hypotension</b></p> <p><b>Congestive heart failure</b></p> <p><b>Altered mental status</b></p> <p><b>Apnea</b></p> <p><b>Seizures</b></p> <p><b>Catechol resistance</b></p> <p><b>Coagulopathy</b></p>
--	---

Particularly when symptomatic, hypocalcemia should be treated if total calcium is <7.5 g/dL. Of note, alkalosis decreases ionized calcium 0.1 mg/dL (0.25 mEq/L) for every increase of 0.1 pH unit. Total calcium is not affected by pH changes.

TABLE 59–10.

## Causes of Hypercalcemia

<p><b>Endocrine</b></p> <ul style="list-style-type: none"> <li>• Hyperparathyroidism (primary, tertiary)</li> <li>• Hyperthyroidism</li> <li>• MEN syndromes</li> <li>• Acromegaly</li> <li>• Pheochromocytoma</li> <li>• Adrenal insufficiency</li> </ul> <p><b>Malignancy</b></p> <ul style="list-style-type: none"> <li>• Squamous cell cancers (i.e., lung)</li> <li>• Pancreatic cancer</li> <li>• Hypernephroma</li> <li>• Myeloma</li> <li>• Breast cancer</li> <li>• Lymphoma/leukemia (rare)</li> </ul> <p><b>AIDS</b></p> <p><b>Renal disease (various)</b></p> <p><b>Familial/genetic causes (various)</b></p>	<p><b>Immobilization</b></p> <p><b>Granulomatous disease</b></p> <ul style="list-style-type: none"> <li>• Sarcoidosis</li> <li>• Histoplasmosis</li> <li>• Coccidiomycosis</li> <li>• Tuberculosis</li> <li>• Berylliosis</li> </ul> <p><b>Drugs</b></p> <ul style="list-style-type: none"> <li>• Iatrogenic administration</li> <li>• Theophylline</li> <li>• Lithium</li> <li>• Thiazides</li> <li>• Vitamin D</li> <li>• Antacids (containing calcium)</li> <li>• Vitamin A</li> </ul>
---	---

AIDS, Acquired immune deficiency syndrome; MEN, multiple endocrine neoplasia.

TABLE 59–11.

## Signs and Symptoms of Hypercalcemia

<b>Gastrointestinal</b>	<b>Osteopenia/osteoporosis</b>
<ul style="list-style-type: none"> <li>• Nausea/vomiting</li> <li>• Anorexia</li> <li>• Constipation</li> <li>• Pancreatitis</li> <li>• Peptic ulcers</li> </ul>	<b>Weakness/atrophy/fatiguability</b>
<b>Hemodynamic</b>	<b>Central nervous system</b>
<ul style="list-style-type: none"> <li>• Dehydration</li> <li>• Hypertension</li> <li>• Electrocardiographic/conduction changes</li> <li>• Digitalis sensitivity</li> <li>• Dysrhythmias</li> <li>• Catecholamine resistance</li> </ul>	<ul style="list-style-type: none"> <li>• Seizures</li> <li>• Disorientation/psychosis</li> <li>• Memory loss</li> <li>• Sedation/lethargy/coma</li> </ul>
	<b>Renal</b>
	<ul style="list-style-type: none"> <li>• Polyuria</li> <li>• Nephrolithiasis</li> <li>• Oliguric failure (late)</li> </ul>

cells in the adrenal medulla.<sup>89</sup> These tumors may be benign or malignant. Secretion of vasoactive substances, including the catecholamines (dopamine, norepinephrine, and epinephrine), leads to clinical manifestations of the tumors. Neuroendocrine chromaffin tumors that arise outside of the adrenal medulla are referred to as *paragangliomas*.<sup>90,91</sup> Because the clinical presentation and management issues are similar, the anesthetic implications of pheochromocytoma and paraganglioma are discussed together. Several excellent reviews of the pathophysiology, presentation,

and perioperative management of pheochromocytoma appear in the literature.<sup>89–92</sup>

### Clinical Manifestations of Pheochromocytoma

As reviewed in Chapter 12, the clinical manifestations of a pheochromocytoma in a patient depend on the profile of catecholamine secretion. Tumors secreting primarily norepinephrine are associated with hypertension. If epinephrine is the major secreted catecholamine, tachycardia, tachydysrhythmias, and hypotension often result. Dopamine is the major catecholamine

secreted by some tumors, and hypotension is the significant clinical feature. However, the overall manifestations of pheochromocytoma are variable, often paroxysmal or episodic, and sometimes similar to other conditions such as severe hyperthyroidism<sup>90,91</sup> or preeclampsia.<sup>89</sup> If a patient is diagnosed with pheochromocytoma, rapid, extreme, perturbations in hemodynamics or other signs and symptoms can be anticipated and should be promptly and appropriately managed in the operating room, postanesthesia care unit (PACU), or ICU. The undiagnosed patient poses a significant management challenge in the perioperative period because the differential diagnosis of extreme physiologic perturbations is so extensive and treatments differ markedly.

For the anesthesiologist, particularly salient clinical features of pheochromocytoma are hypertension, tachycardia and dysrhythmias, cardiac ischemia or myocardial dysfunction, hyperglycemia, intravascular volume depletion, and lactic acidosis. Patients may present in shock, caused by either the secreted products of the tumor or some complication of the disease, such as myocardial infarction, cardiac failure, or dissected/ruptured aorta. Acute manifestations of an unsuspected pheochromocytoma must be considered in the differential diagnosis

TABLE 59–12.

## Medical Management of Symptomatic and/or Severe Hypercalcemia

Mode of Action	Measure/Substance	Indication	Side Effects/Complications
Intravenous hydration	Isotonic saline administration at 200–300 mL/h (4–6 L/d)	Universal	Volume expansion, hypokalemia, hypomagnesemia
Loop diuretic	Furosemide 20–40 mg, q6–12h, up to 500 mg/d or continuous infusion 100 mg/h	Universal in cases of fluid retention	Hypokalemia, hypomagnesemia
Bisphosphonates	Pamidronate 60–90 mg IV over 4 h Zoledronate 4 mg IV over 15 min Repeat every 2–3 wk <sup>a</sup>	Universal (preferred in HHM)	Fast administration → renal insufficiency Fever, myalgia
Calcitonin	200–500 IU/d subcutaneously	Universal (adjuvant)	Nausea, vomiting, tachyphylaxis
Steroids	Prednisone 40–100 mg/d for 3–5 days	Vitamin D intoxication, sarcoidosis (rarely HHM)	Iatrogenic Cushing syndrome
Hemodialysis (if renal failure)	Ca <sup>2+</sup> -free dialysate	Hypercalcemic crisis and renal insufficiency	Dialysis related
Diet low in Ca <sup>2+</sup> / Vitamin D	<100 mg Ca <sup>2+</sup> per day	Universal	None

HHM, Humeral hypercalcemia of malignancy.  
<sup>a</sup>Reduce bisphosphonate doses in renal insufficiency.

sis of many intraoperative clinical scenarios.

## Preoperative Preparation

A patient with a known pheochromocytoma scheduled for tumor resection undergoes extensive preparation for the procedure. Preoperative medical management has been reviewed.<sup>89,90,93</sup> The major concerns are as follows:

1. Control of elevated blood pressure
2. Repletion of intravascular volume
3. Assessment of end-organ consequences of the disease (e.g., cardiomyopathy)
4. Recognition of the potential impact of conditions associated with a pheochromocytoma (e.g., multiple endocrine neoplasia type II, von Hippel-Lindau syndrome)
5. Normalization of glucose and electrolyte levels

A number of regimens have been reported to reduce blood pressure in the preoperative period in preparation for surgery to resect the pheochromocytoma.  $\alpha$ -Adrenergic blockade has been widely used. Phenoxybenzamine, a nonselective, noncompetitive,  $\alpha$ -adrenergic blocker that covalently binds to  $\alpha$ -adrenergic receptors, has been a mainstay of therapy.<sup>89,94</sup> Competitive blockers selective for the  $\alpha_1$  subtype of  $\alpha$ -adrenergic receptors (e.g., doxazosin) have been used to successfully prepare patients for surgery.<sup>95</sup>

A potential advantage of competitive, selective  $\alpha_1$ -blockade is that once the tumor has been resected and excess catecholamine release eliminated,  $\alpha$ -adrenergic receptors can return quickly to normal function, for example, in regulating vascular tone and blood pressure. A disadvantage of competitive  $\alpha$ -adrenergic blockade is the possibility that massive concentrations of catechols released by the tumor can overwhelm the competitive receptor antagonist, resulting in clinical manifestations including hypertension. Covalent, noncompetitive deactivation of  $\alpha$ -adrenergic receptors, as with phenoxybenzamine, can withstand a surge in circulating catechol levels. However, following resection of the tumor and removal of excess circulating catecholamines, permanent deactivation of  $\alpha$ -adrenergic receptors by phenoxybenzamine may result in hypotension refractory to  $\alpha$ -adrenergic agonists for days until new receptors are synthesized.<sup>90,91,96</sup>

Tachycardia is one consequence of elevated catecholamine levels.  $\beta$ -Adrenergic blockade is commonly used to control tachycardia. However,  $\beta$ -blockade must not be instituted before initiation of  $\alpha$ -blockade so that  $\alpha$ -adrenergic activation would be unopposed in the vasculature.<sup>97</sup>  $\alpha$ -Adrenergic blockade is physiologically complex because activation of  $\alpha_2$ -adrenergic receptors, which are presynaptic, reduces catecholamine secretion, whereas activation of  $\alpha_1$ -adrenergic receptors, which are postsynaptic, causes vasoconstriction. A theoretical advantage of drugs such as doxazosin lies in their selectivity for  $\alpha_1$ -adrenergic receptors so that the normal regulatory activities of presynaptic  $\alpha_2$ -receptors are not impaired, as in the case with the nonselective agent phenoxybenzamine. Urapidil, another selective  $\alpha_1$ -antagonist deliverable by IV infusion, provides similar advantages.<sup>98</sup>

Other approaches to preoperative control of blood pressure use calcium channel blockers such as nifedipine,<sup>99</sup> the mixed  $\alpha$ - and  $\beta$ -receptor antagonist labetalol,<sup>100</sup> infusions of magnesium,<sup>92,101–103</sup> and treatment with metyrosine,<sup>104</sup> which inhibits catecholamine biosynthesis. The aims of preoperative preparation are to prevent an acute hypertensive crisis before entering the operating room and then to minimize catecholamine-induced hemodynamic changes during anesthesia and surgery. With adequate preoperative preparation, which has been defined as a systemic blood pressure stabilized below 160/90 mm Hg with only modest orthostatic hypotension, rare ventricular extrasystoles, and no electrocardiographic evidence of ischemia, perioperative mortality from pheochromocytoma has dropped to <3%.<sup>91,94</sup> However, intraoperative hemodynamic lability (both hypertension and hypotension) requiring treatment remains a persistent challenge.<sup>94</sup>

## Anesthesia for Pheochromocytoma Resection

Laparoscopy is currently the favored surgical approach for abdominal pheochromocytoma resection.<sup>89,91,105–107</sup> However, open surgery may be required depending upon the exact location of the lesion (e.g., neck paraganglioma) or the anatomic features of an abdominal tumor. Epidural anesthesia provides one option for hemodynamic control.<sup>102</sup> Infusions of

nitroprusside, nitroglycerin, magnesium sulfate, esmolol, fenoldopam, phentolamine, urapidil, dexmedetomidine, and nicardipine are reported to successfully control hemodynamics in a readily titratable fashion (Table 59–13).<sup>96,98,99,103,108</sup> Case reports suggest that remifentanyl infusions fail to blunt episodes of hemodynamic lability.<sup>109,110</sup> Careful reading of various publications advocating the advantages of particular agents for controlling hemodynamics during pheochromocytoma surgery reveals that, in fact, multiple drugs of different classes often are administered in combination. Appropriate sedation contributes to hemodynamic control in the perioperative period.<sup>89</sup>

During administration of the anesthetic, the usual triggers for hemodynamic activation, such as laryngoscopy, may result in exaggerated hemodynamic responses in a patient with pheochromocytoma. Insufflation of the abdomen with CO<sub>2</sub> for laparoscopy may stimulate release of catecholamines from tumors,<sup>90</sup> and direct manipulation of the tumor may precipitate rapid secretion of vasoactive substances.<sup>89,111</sup> Once the major draining vein of the tumor is ligated, plasma catecholamine levels generally decline precipitously. Hypotension often ensues. Volume repletion, infusions of  $\alpha$ -adrenergic agonists such as phenylephrine, and cessation of vasodilators can be used to support hemodynamics. However, as discussed in the section on Preoperative Preparation, phenoxybenzamine produces sustained deactivation of  $\alpha$ -adrenergic receptors, which limits the response to phenylephrine. Vasopressin may circumvent this problem.<sup>112</sup> Hypoglycemia should be specifically anticipated and treated as needed.<sup>89,91</sup>

No particular anesthetic technique is specifically indicated, or contraindicated, for pheochromocytoma surgery. Agents known to cause the release of catecholamines, such as ketamine, ephedrine, meperidine, and desflurane, should be used with care or avoided entirely. Whereas neuraxial anesthesia produces sympathectomy (thereby blunting physiologic autonomic responses to surgical stimulation) and may be a useful adjunct to general anesthesia, especially for postoperative analgesia, the release of catecholamines from tumor cells is not prevented by spinal or epidural anesthetics.



TABLE 59–13.

## Medications Used in Perioperative Management of Pheochromocytoma

Drug	Dose	Indication
Phentolamine	2.5–5 mg IV at 1 mg/min, repeated every 5 minutes until blood pressure is controlled. Constant infusion, 100 mg/500 mL D <sub>5</sub> W, infusion rate adjusted to targeted blood pressure	Treatment of acute hypertensive crisis
Nitroprusside	0.5–10 mcg/kg/min IV, infusion rate adjusted to targeted blood pressure	Treatment of acute hypertensive episodes
Nitroglycerin	0.5–10 mcg/kg/min IV, infusion rate adjusted to targeted blood pressure	Treatment of acute hypertensive episodes
Doxazosin β-Blockers	2–16 mg/d, orally Atenolol, metoprolol, propranolol, esmolol, labetalol, dose titrated to effect	Preoperative preparation Used preoperatively only after complete α-adrenergic blockade is achieved. Used intraoperatively for treatment of acute hypertensive episodes or tachycardia
Phenoxybenzamine	20–30 mg/d initially, then can be increased to 60–250 mg/d (1 mg/kg/d in 3 divided doses) until blood pressure is controlled	Preoperative preparation may be achieved in 10–14 days Used for prevention of hypertensive crisis
Nicardipine	20–60 mg/d, 3 divided doses, orally  0.5–10.0 mcg/kg/min IV infusion rate adjusted to targeted blood pressure, or IV bolus 1–2 mg	Preoperative preparation and intraoperative hemodynamic control
MgSO <sub>4</sub>	Bolus 2–4 g IV Infusion 1–2 g/h IV	Preoperative control of hypertensive crisis Control of intraoperative hemodynamics
Fenoldopam Urapidil	0.02–0.1 mcg/kg/min IV infusion 10–15 mg/h IV infusion	Control of intraoperative hemodynamics Preoperative preparation and intraoperative hemodynamic control
α-Methyl-para-tyrosine	Start at 250 mg orally, 4 times per day Increase to maximum of 4 g/d	Preoperative depletion of catecholamine stores by inhibiting catecholamine synthesis at rate-limiting enzyme. Maximal effect in 2–3 days, start 7–14 days preoperatively

The choice of monitors and vascular access should take into account the need to assess volume status and cardiac performance and the utility of a central route for delivering vasoactive or inotropic drugs. An arterial line likely will be useful.<sup>94</sup> Central venous access and pulmonary arterial catheter insertion remain important considerations. Prys-Roberts<sup>90</sup> reported few pulmonary arterial catheter insertions in a large series of pheochromocytoma resections. Volume loss due to surgical bleeding during pheochromocytoma resection typically is on the order of a few hundred milliliters, although plans for volume access should take into account potential overall volume depletion, especially in the patient who has not been well prepared for surgery. General preparations should include planning for postoperative care in a setting capable of monitoring

and treating volume, hemodynamic, and metabolic concerns.

### ADRENAL CORTEX AND PERIOPERATIVE MANAGEMENT OF GLUCOCORTICOIDS

Surgeons approach lesions of the adrenal cortex by both laparoscopic and open methods. Anesthetic considerations resemble those for other procedures in the abdomen or retroperitoneum (see Chapters 55, 60). The physiology of adrenal cortical hormones and pathophysiologic conditions of the adrenal cortex are covered in Chapter 12. In general, an excess or deficiency of the mineralocorticoid aldosterone and of adrenal sex steroids have little impact on perioperative anesthetic management, as long as their

existence is recognized and medical management is appropriate, including control of blood pressure and treatment of any electrolyte imbalances.

### Adrenalectomy for Primary Adrenal Hypercortisolism

For the patient undergoing surgery on one adrenal cortex for primary hyperadrenal cortisolism, anesthesia considerations include the consequences of prolonged production of excess cortisol. Relevant features of this condition are summarized in Table 59–14. Hypertension may be particularly difficult to treat during surgery. Plasma glucose levels are likely to be high, requiring therapy. Prolonged excess cortisol levels affect body habitus and can potentially complicate airway management, positioning, and vascular access. Osteopenia renders the patient at risk for fractures, even with minimal mechanical stress.

TABLE 59–14.

## Clinical Features of Glucocorticoid Excess or Deficiency

Glucocorticoid Excess	
Proximal myopathy	Osteoporosis
Muscle wasting	Truncal obesity
Glucose intolerance, diabetes mellitus	Inhibited wound healing
Hypertension	Immunosuppression
Coronary artery disease, peripheral vascular disease	Bowel perforation
Hypervolemia	Gastric ulcers
Hypernatremia	Pancreatitis
Hypokalemia	Behavioral disturbances
Hypercalciuria	Depression
Hypercoagulability	Easy bruising
Glucocorticoid Deficiency	
Postural hypotension	Anorexia
Weakness/fatigue	Nausea/vomiting
Depressed catechol responses	Abdominal pain
Fever	Diarrhea, constipation
Weight loss	Hyperpigmentation

In general, mineralocorticoid function is preserved in primary adrenal hypercortisolism. Following unilateral adrenalectomy, mineralocorticoid replacement probably is unnecessary. Because the function of the opposite normal adrenal cortex may be suppressed, glucocorticoid replacement will be required in the early postoperative period until the hypothalamic–pituitary–adrenal (HPA) axis recovers. This may take several weeks. Because the half-life of cortisol is several hours, an Addisonian crisis likely will not develop in the operating room. However, glucocorticoid replacement therapy must be started early in the postoperative period.

If the patient undergoes bilateral adrenal resection, replacement of both

a glucocorticoid and a mineralocorticoid ultimately will be necessary.<sup>113</sup>

### Adrenal Insufficiency

As reviewed in Chapter 12, native adrenal cortex function may be absent or suppressed by a variety of conditions. Administration of exogenous glucocorticoid is the most common reason for native adrenal suppression. Key features of adrenal insufficiency are summarized in Table 59–14. Of particular relevance in the perioperative period, adrenal insufficiency warrants consideration in the differential diagnosis of refractory hypotension.

In the 1950s, case reports described perioperative deaths of patients who were chronically treated with gluco-

corticoids and found to have adrenal atrophy.<sup>114</sup> The concept emerged that patients at risk for adrenal insufficiency should receive glucocorticoid supplementation in the perioperative period. Risk factors for adrenal suppression and perioperative adrenal insufficiency include prolonged glucocorticoid therapy and doses of steroids exceeding prednisone 5–7.5 mg/d or equivalent for 3 weeks or longer.<sup>115</sup> Table 59–15 lists the relative potencies of a variety of common glucocorticoids and their mineralocorticoid activities. Recovery from adrenal cortical suppression is variable but may take up to 1 year. Thus, patients treated with glucocorticoids within 12 months of surgery are considered to be at risk for adrenal suppression. Provocative testing with cosyntropin may help identify patients at risk for adrenal suppression, but such evaluation is expensive and cumbersome, and the biochemical results may not correspond to clinical events.<sup>116</sup>

An accepted regimen for perioperative patients that was developed without formal clinical trials calls for the administration of hydrocortisone in “stress” doses. Typically, at least three doses of hydrocortisone, 100 mg IV, are administered every 8 hours, followed by tapering of the dose over several days to the patient’s baseline steroid regimen. However, this commonly accepted stress dose steroid regimen has been questioned, based on an increased understanding of physiologic stress responses and glucocorticoid secretion.<sup>116</sup> Baseline normal cortisol production may be as low as 10–15 mg/d,<sup>117–119</sup> rather than 30 mg or more as once believed.<sup>120</sup> Thus, even if extreme surgical stresses result in a 10-fold increase of cortisol production,<sup>121</sup> 100–150 mg of exogenous cortisol or glucocorticoid equivalent should suffice to sustain hemodynamics and metabolism in the absence of any endogenous HPA axis activity. Of note, Leopold et al.<sup>122</sup> did identify larger increases in glucocorticoid production in a group of joint replacement patients; however, these elevations were transient.

The requirement for exogenous glucocorticoid support has been tested in controlled clinical studies of patients chronically treated with steroids.<sup>123–125</sup> The chief end points in these studies were blood pressure or heart rate. With-

TABLE 59–15.

## Relative Potencies of Glucocorticoid and Mineralocorticoid Hormones

Steroid	Glucocorticoid	Mineralocorticoid	Equivalent dose (mg)	Duration (h)
<b>Short-acting</b>				
Cortisol	1.0	1.0	20	8–12
Cortisone	0.8	0.8	25	8–12
Aldosterone	0.3	3000	—	8–12
<b>Intermediate-acting</b>				
Prednisone	4.0	0.8	5	12–36
Prednisolone	4.0	0.8	5	12–36
Methylprednisolone	5.0	0.5	4	12–36
Fludrocortisone	10.0	125	—	12–36
<b>Long-acting</b>				
Dexamethasone	25–40	0	0.75	>24

TABLE 59–16.

## Suggested Perioperative Steroid Supplementation with Hydrocortisone in Patients with Chronic Adrenal Insufficiency

Anticipated Surgical Stress	Preoperative	Intraoperative	Postoperative
Minor <sup>a</sup>	25 mg or usual dose	None, unless complications	Resume usual replacement POD 1
Moderate <sup>b</sup>	50–75 mg or usual steroid dose, whichever is higher	50 mg IV	20 mg IV q8h on POD 1, then resume preoperative replacement dose on POD 2
Major <sup>c</sup>	100–150 mg or usual steroid dose, whichever is higher, within 2 h of start of procedure	50 mg IV q8h after initial dose	50 mg IV q8h, or 150 mg continuously over 24 h for 2–3 days, then reduce dose by 50% per day until preoperative regimen is reached.

<sup>a</sup>Inguinal herniorrhaphy, minor urologic or gynecologic procedures, oral surgery, plastic surgery  
<sup>b</sup>Total joint replacement, open cholecystectomy, lower extremity revascularization  
<sup>c</sup>Thoracotomy, cardiac surgery, major abdominal surgery  
 POD, Postoperative day  
 Note that these guidelines may not meet the requirements of all patients, and perioperative or stress steroid replacement should be individually tailored.

holding steroid supplementation resulted in minimal evidence of hemodynamic instability. Based on these results and the limited number of similar studies in animals and humans, a graded approach to steroid supplementation has been recommended for patients believed to be at risk for adrenal insufficiency in the perioperative period. Recommendations take into account the anticipated magnitude of surgical stress. Table 59–16 combines the recommendations from several sources.<sup>97,116,126</sup> Of note, prolonged tapering of exogenous glucocorticoid therapy does not appear to be essential, as long as baseline therapy is resumed within a few days of surgery.<sup>127</sup> These recommendations should not necessarily be taken to apply to critically ill patients who come to the operating room from an ICU setting. Some evidence suggests that adrenal insufficiency occurs in at least some critically ill patients,<sup>115</sup> particularly those with sepsis. Such patients may require large doses of supplemental steroids for prolonged periods.

### Etomidate

The favorable hemodynamic properties of the IV induction agent etomidate give this drug an important place in the anesthesiologist's armamentarium. However, unique among all anesthetic agents, etomidate inhibits the mitochondrial enzyme 11 $\beta$ -hydroxylase, an essential enzyme in the biosynthetic pathway for steroids. An induction dose of etomidate reduces cortisol and aldosterone production

for approximately 8 hours. Repeated doses or infusions of etomidate have more prolonged suppressant effects on steroid production, which may become clinically relevant. Consequently, the use of etomidate should be evaluated in the context of the patient's adrenal reserve.

## PITUITARY DISEASES AND PITUITARY SURGERY

### Anatomy of the Pituitary Gland

The pituitary gland lies within a recess of the sphenoid bone, the sella turcica. The gland is composed of two major subdivisions, the anterior pituitary and the posterior pituitary. Magnetic resonance imaging (MRI) readily visualizes these structures because the posterior pituitary appears as a bright spot on T1-weighted images, as shown in the sagittal view in Fig. 59–10A. Structures next to the pituitary are shown in the coronal view in Fig. 59–10B.

The posterior pituitary contains axon terminals of specialized neurons arising within the supraoptic and paraventricular nuclei of the hypothalamus. These nerves secrete oxytocin and vasopressin (antidiuretic hormone [ADH]). Thus, the posterior pituitary is a direct extension of the brain. In contrast, the anterior pituitary derives embryologically from the Rathke pouch; it is composed primarily of epithelial cells. It does not have direct neuronal connections to the brain. The anterior pituitary is dependent

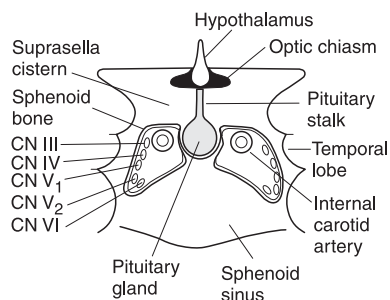
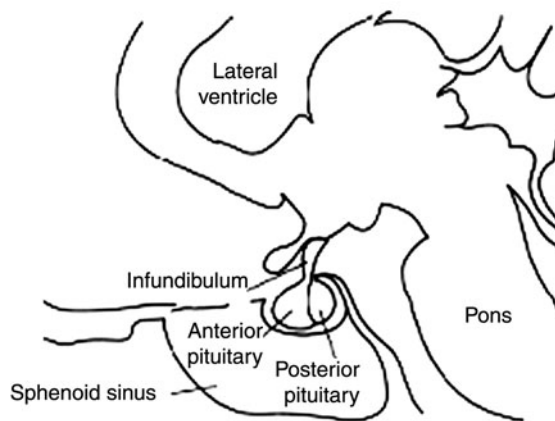
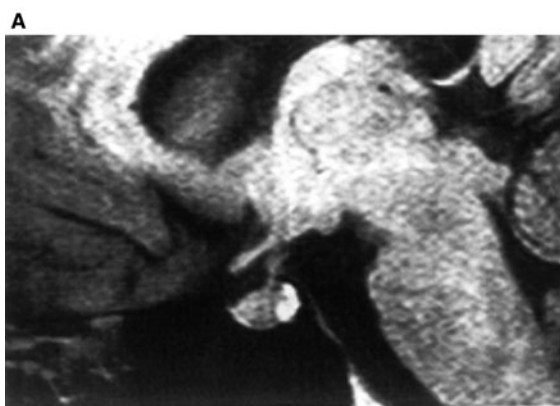
upon a vascular conduit, the pituitary portal plexus, which directly links the hypothalamus to the anterior pituitary gland. The portal plexus is a venous plexus and is the major source of blood flow to the anterior pituitary, which has little or no arterial blood supply. The major cell types and secretory products of the anterior pituitary gland are listed in Table 59–17.

### Pituitary Lesions

Pituitary lesions can be placed in broad categories according to their functional effects. Lesions can cause mass effects, anterior pituitary hyperfunction, or anterior pituitary hypofunction.

Pituitary adenomas arise from anterior pituitary cells; therefore, they almost always are located in the sella turcica. They compose approximately 10–15% of all intracranial neoplasms. Adenomas <1 cm in diameter typically are referred to as *microadenomas*, whereas adenomas with diameters  $\geq$ 1 cm are commonly referred to as *macroadenomas*.<sup>128,129</sup> Macroadenomas and some microadenomas can be visualized by MRI following IV infusion of gadolinium. Autopsy studies reveal that 25% of individuals have asymptomatic pituitary adenomas. Only adenomas with endocrine syndromes as a result of hyposecretion or hypersecretion, or which cause symptomatic mass effects on adjacent brain structures, come to medical attention. The prevalence of diagnosed pituitary adenomas is 8.9:100,000.<sup>129</sup>

In addition to pituitary tumors, many other masses appear in the sella



**FIGURE 59–10.** Anatomic relationships of the normal pituitary gland. **A.** Sagittal view. **B.** Coronal view.

or parasellar region.<sup>128,130</sup> Meningiomas, craniopharyngiomas, chordomas, and metastatic carcinomas occasionally appear as pituitary masses. Benign sellar cysts derive primarily from the Rathke cleft; they frequently are asymptomatic and are found incidentally. Infiltrative diseases mimicking masses in the pituitary include sarcoidosis, lymphocytic hypophysitis, histiocytosis X, and tuberculosis.

### **Classification of Pituitary Adenomas**

Pituitary adenomas are classified by either their hypersecretory product or their lack of hormonal secretion (non-secretory pituitary adenomas).<sup>128,130</sup> Some tumors secrete more than one pituitary hormone (plurihormonal adenomas). The most common combination seen in these tumors is GH and prolactin.<sup>131</sup> Other pituitary adenomas do not secrete bioactive hormone but may secrete the  $\alpha$ - or  $\beta$ -subunits of the glycoprotein hormones luteinizing hormone (LH), follicle stimulating hormone (FSH), or thyroid stimulating hormone (TSH). Table 59–18 lists the most common types of pituitary adenomas, their most abundant secretory products, and their relative frequency.

### **Clinical Symptoms of Pituitary Masses**

Because the pituitary gland lies adjacent to the cavernous sinus, temporal lobes, and sphenoid sinus (Fig. 59–11), the presentation of pituitary lesions occasionally includes other clinical symptoms (Table 59–19). Palsies of extraocular muscles, sensory disturbances in the first and second branches of the fifth cranial nerve, temporal lobe seizures, and cerebrospinal fluid (CSF) rhinorrhea may bring a patient to medical attention.<sup>128</sup> Disorders of both the hypothalamus and pituitary can compress or infiltrate the optic chiasm, resulting in a variety of visual field abnormalities affecting peripheral vision (superolateral visual field defect).

## **Pituitary Hypofunction: Causes, Presentation, and Treatment of Hypopituitarism**

### **Causes of Deficient Pituitary Hormone Secretion**

Many disorders cause hypopituitarism by affecting either the hypothalamus or the pituitary gland. Pituitary adenomas are the most common cause of



TABLE 59–17.

## Major Cell Types and Secretory Products of the Anterior Pituitary Gland

Cell Type	Secretory Products	Cell Population (%)
Somatotroph	Growth hormone	50
Lactotroph	Prolactin	15
Corticotroph	Adrenocorticotrophic hormone	15
Thyrotroph	Thyroid stimulating hormone	10
Gonadotroph	Luteinizing hormone/follicle stimulating hormone	10

TABLE 59–18.

## Classification of Pituitary Adenomas

Tumor Type	Secretory Product(s)	Relative Frequency (%)
Lactotroph adenoma, prolactinoma	Prolactin	50
Somatotroph adenoma	Growth hormone	10
Corticotroph adenoma	ACTH	5
Thyrotroph adenoma	TSH	1
Nonsecreting adenoma	$\alpha$ -Subunit	34
FSH/LH adenoma	FSH, LH	<1

ACTH, Adrenocorticotrophic hormone; FSH, follicle stimulating hormone; LH, luteinizing hormone; TSH, thyroid stimulating hormone.

hypopituitarism.<sup>128,132</sup> Other less common causes are listed in Table 59–20.

### Symptoms of Deficient Pituitary Hormone Secretion

Specific symptoms associated with the loss of individual pituitary hormones are listed in Table 59–21. Although a diagnosis of some pituitary deficiencies can be inferred based on history and clinical findings, demonstrating hormone deficiencies by biochemical testing is essential to establishing the diagnosis of hypopituitarism. A more detailed description of hypothyroidism and cortisol insufficiency can be found in the thyroid and adrenal sections of Chapter 12. A variety of tests can be performed to evaluate the reserve of each of the pituitary hormones. It is extremely important to make the diagnosis of adrenocorticotrophic hormone (ACTH) and/or TSH deficiency, because these anterior pituitary hormones are essential to surviving perioperative stress.<sup>128,132</sup> Destruction of the posterior pituitary, stalk compression, or stalk section results in a complete or relative lack of ADH. ADH causes the renal tubules to reabsorb water. Lack of ADH results in failure to concentrate urine, produc-

ing dilute urine (low specific gravity and low osmolality) despite dehydration with an elevated blood osmolality. Urine output can exceed 1–2 L/h, resulting in severe dehydration, hyponatremia, and vascular collapse.<sup>132</sup>

### Treatment of Deficient Pituitary Hormone Secretion

The aim of treatment is to replace the hormonal deficiencies needed for nor-

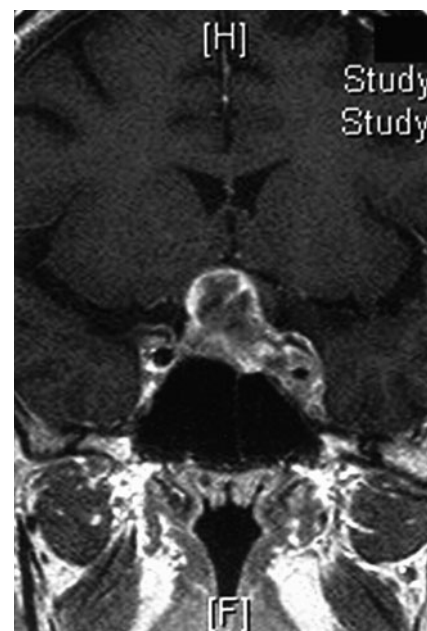


FIGURE 59–11. Pituitary mass encroaching on nearby structures. Coronal magnetic resonance imaging shows a large pituitary mass extending laterally, encasing and narrowing the left carotid artery within the cavernous sinus and abutting the left temporal lobe.

mal function and to treat the underlying disease process.<sup>128,133</sup> In most instances, replacement of hormone deficiencies can be accomplished by oral, IV, cutaneous (skin patch), subcutaneous, or nasal administration of deficient hormones. The dose usually is the same from day to day, with the exception of glucocorticoid replacement, which must be increased during times of stress (see Adrenal Cortex

TABLE 59–19.

## Clinical Signs and Symptoms of Pituitary Lesions

Direction of Tumor Expansion	Neighboring Structures	Symptoms of Compression
Upward	Optic pathways	Visual field cuts, blindness
	Hypothalamus	Disturbed temperature auto-regulation
Lateral	Olfactory nerve	Anosmia
	Cavernous sinus	Proptosis, eyelid edema
	Internal carotid	Hemiplegia, altered level of consciousness
	Oculomotor nerve	Ophthalmoplegia, ptosis, pupil defects
Downward	Abducens, trochlear nerves	Ophthalmoplegia
	Ophthalmic nerve	Facial pain, corneal anesthesia
	Sphenoid sinus	Epistaxis, cerebrospinal fluid rhinorrhea

TABLE 59–20.

## Disorders That Can Cause Hypopituitarism

<b>Benign Neoplasms</b> Pituitary adenoma Craniopharyngioma Meningioma Optic nerve glioma	<b>Malignant Neoplasms</b> Germ cell tumors (germinoma) Lymphoma Plasmacytoma Metastatic disease (breast, lung)	<b>Cysts</b> Arachnoid Dermoid Epidermoid Rathke cleft
<b>Granulomatous Disease</b> Eosinophilic granuloma Histiocytosis Sarcoidosis	<b>Vascular Disorders</b> Aneurysm Cavernous angioma Infarction (postpartum, diabetes mellitus)	<b>Infections</b> Abscess Cysticercosis Tuberculosis
<b>Autoimmune</b> Lymphocytic hypophysitis Vasculitis	<b>Traumatic</b> Pituitary stalk transection	<b>Other</b> Cerebral edema Pituitary apoplexy

TABLE 59–21.

## Symptoms Associated with Hypopituitarism

<b>Growth Hormone</b> Weight gain (abdominal adiposity) Decreased muscle strength Decreased exercise capacity Impaired psychological well-being Growth retardation in children	<b>Gonadotrophins (Luteinizing Hormone/ Follicle Stimulating Hormone)</b> Amenorrhea/oligomenorrhea Infertility Dyspareunia Loss of secondary sexual hair Decreased libido Impotence Small, soft testes
<b>Thyroid Stimulating Hormone</b> Sensitivity to cold Dry skin Constipation Decreased energy	<b>Adrenocorticotropic Hormone</b> Weight Loss Fatigue Pallor Hypoglycemia
<b>Prolactin</b> Poor or absent lactation	<b>Vasopressin (Antidiuretic Hormone)</b> Urinary frequency, thirst

TABLE 59–22.

## Hormone Replacement Therapy in Hypopituitarism

Deficient Hormone	Replacement
ACTH	Glucocorticoids (hydrocortisone, prednisone, dexamethasone)
TSH	L-Thyroxine (T <sub>4</sub> )
Prolactin	Not replaced
LH/FSH	Estradiol + medroxyprogesterone (women) Testosterone (men) <i>or</i> Pulsatile synthetic GnRH (if anterior pituitary intact) <i>or</i> HCG/ human recombinant FSH to induced ovulation/spermatogenesis if fertility desired
GH	Recombinant human growth hormone (rhGH)
Vasopressin (ADH)	Desmopressin (DDAVP)

ACTH, Adrenocorticotropic hormone; ADH, antidiuretic hormone; FSH, follicle stimulating hormone; GH, growth hormone; GnRH, gonadotropin releasing hormone; hCG, human chorionic gonadotropin; LH, luteinizing hormone; TSH, thyroid stimulating hormone.

and Perioperative Management of Glucocorticoids for a detailed discussion of baseline and stress doses of glucocorticoids). Table 59–22 lists the common drugs used for hormone replacement therapy in hypopituitarism. As a general rule, glucocorticoid replacement therapy should be given first. Thyroid hormone replacement therapy should never be given before glucocorticoids have been replaced in order to avoid precipitating an Addisonian crisis.<sup>128,133</sup>

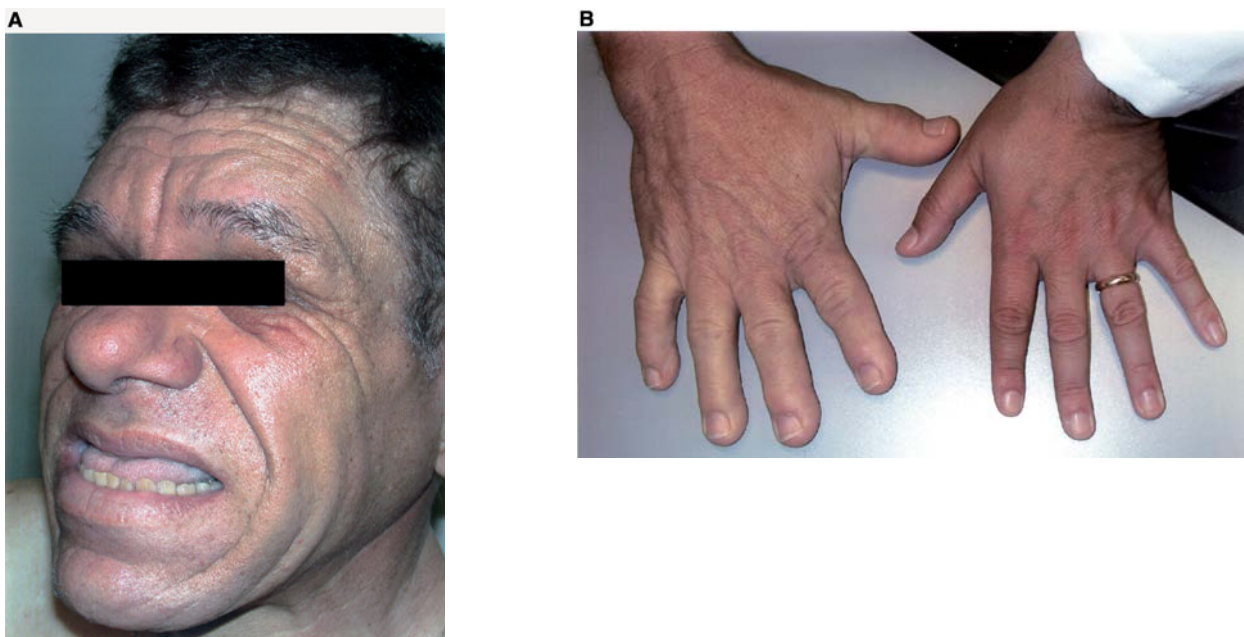
### Pituitary Hypersecretion and Neoplasia

Pituitary hypersecretion may occur physiologically, for example, when LH and FSH rise during menopause with the loss of feedback inhibition by gonadal steroids, or when ACTH secretion increases during stress. Pathophysiologic causes of pituitary hormone hypersecretion include hyperplasia of one or more cell types in the anterior pituitary, driven by excessive production of hypothalamic releasing factors. Tumors in the hypothalamus (hamartomas, gangliocytomas) or in the periphery (carcinoids, islet cell tumors) may secrete these factors. However, the most common cause for pathologic hypersecretion of anterior pituitary hormones is pituitary adenoma.<sup>128,130</sup> The most common pituitary adenoma is a prolactinoma.<sup>134</sup> The lesions with greatest significance for anesthetic management are corticotroph and somatotroph adenomas.

#### Prolactinomas

The prolactinoma is the most common pituitary adenoma.<sup>134</sup> In women, the majority of tumors present as microadenomas, whereas in men, macroadenomas predominate. Symptoms due to compression of local structures thus are generally found in men.<sup>128</sup> Signs and symptoms associated with hyperprolactinemia mainly relate to reproductive tissues and function, including amenorrhea and impotence.

Treatment of patients with a prolactinoma depends upon the size of the adenoma and the degree of symptoms. If the adenoma is small and endocrine consequences are minor, management is conservative because most lesions will not enlarge. Adenomas requiring therapy generally respond to medical management with the dopamine agonists bromocriptine or cabergoline.<sup>128,134</sup>



**FIGURE 59-12.** Patient with acromegaly: bony tissue changes. **A.** Face view. Note coarsening of the features with jaw prominence and distortion of the tooth occlusion. Also note large nose and tongue. **B.** Hand view of acromegalic patient (*left*) and normal adult (*right*).

1442

By stimulating D<sub>2</sub> receptors on the adenoma, these drugs cause a reduction in tumor size and inhibit prolactin synthesis and secretion. Most adenomas will regrow, however, if therapy is stopped. If tumors resist medical therapy, transsphenoidal (TSP) surgery is performed. Surgical success rates are high for microadenomas (>70%), but postoperative recurrence may reach 50% over 5 years.<sup>134</sup> Macroadenomas are difficult to cure by surgery, with success rates of ~30%. Radiotherapy is not very effective and is used as a last resort.<sup>128,134</sup>

### Somatotroph Adenomas

GH is primarily under the regulation of two opposing hypothalamic peptides, growth hormone-releasing hormone (GHRH) and somatostatin. GH stimulates insulin-like growth factor-1 (IGF-1), which exerts feedback effects on the hypothalamus and pituitary to inhibit both GHRH and GH secretion, respectively. GH secretion is stimulated by hypoglycemia, amino acids, exercise, and stress. Glucose inhibits GH secretion.

Random GH determinations are generally not helpful in diagnosing acromegaly. Nighttime GH levels at the peak of a GH spike can be within the range of an individual with acromegaly. Conversely, normal GH levels may be found in individuals with acromegaly, but these individuals lose the normal pulsatile rhythm of GH.<sup>128,130</sup>

GH hypersecretion is almost always due to a pituitary adenoma. Rarely, excess GH secretion results from hyperplasia of anterior pituitary somatotrophs as a result of ectopic secretion of GHRH. GH hypersecretion causes gigantism in children and adolescents (before closure of the epiphyses) and acromegaly in adults.

Acromegaly, largely a disorder of middle age, has a peak incidence between ages 40 and 50 years. If untreated, it is associated with a 2- to 3-fold increased mortality due to cardiovascular disease (hypertension, cardiomyopathy, arrhythmias, stroke), cancer (especially adenocarcinoma of the colon), and respiratory impairment.<sup>130</sup>

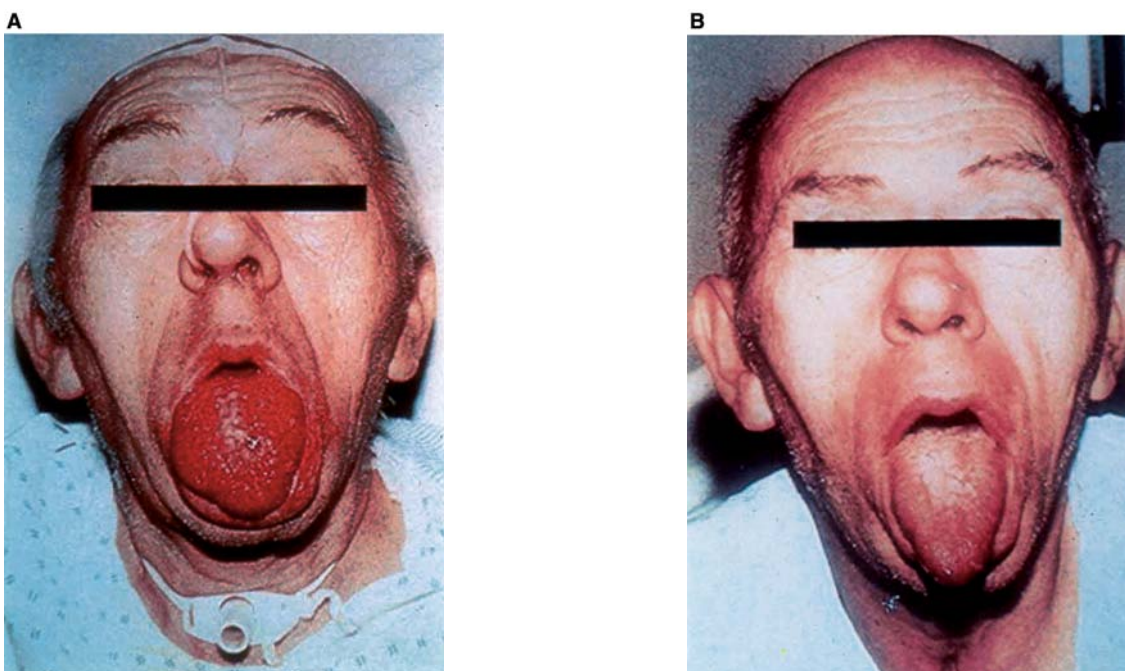
Acromegaly leads to profound physical deformity due to skeletal overgrowth (bone and cartilage) and fibroblast proliferation under the influence of IGF-1. This is particularly manifest in the facial bones, where enlargement of the mandible results in protrusion of the jaw (prognathism), dental malocclusion, and often an increased space between the teeth (Fig. 59-12). Facial features are thickened, coarsened, or swollen, making skin creases very pronounced, partly due to sodium and water retention and increased glycosaminoglycan accumulation in the skin. The lips, tongue, and tissue in the posterior pharynx become very large (Fig. 59-13). Increased cartilaginous growth contributes to the very promi-

nent nose. Enlargement of the hands and feet result in the common complaint that ring, glove, and shoe sizes increase. Arthralgias are particularly common (75%) due to cartilaginous overgrowth in the joints resulting in misalignment and destabilization of the joints and ultimately joint destruction. Other manifestations of acromegaly are listed in the Table 59-23. It is important to make the diagnosis of acromegaly early to prevent irreversible, devastating complications.<sup>128</sup>

Because of the insidious nature of the disease and delays in diagnosis, almost all individuals with acromegaly have macroadenomas when they come to medical attention. Approximately 30% have microadenomas. TSP surgery successfully removes approximately 80% of microadenomas. Only approximately 30% of individuals with macroadenomas have a surgical cure.<sup>128</sup> Radiation therapy is only partly successful in reducing GH hypersecretion to normal, although preliminary data using radiosurgery therapy suggest a 60% cure rate over 4 years. Several medical treatments have become available to control GH hypersecretion and, in some cases, tumor growth. These medications, which include somatostatin analogues and blockers of dopamine receptors, can be given singly or in combination.

Successful treatment of acromegaly results in reduction of left ventricular





**FIGURE 59-13.** Soft-tissue changes in a patient with acromegaly: tongue enlargement. **A.** Before treatment. The large tongue obstructs the airway. The patient received a tracheostomy. **B.** After treatment. Soft-tissue changes have substantially reversed, allowing decannulation of the tracheostomy.

hypertrophy and some improvement of diastolic function (increase in transmitral peak flow velocity and decreased isovolumic relaxation time).<sup>135,136</sup> However, skeletal and soft-tissue changes persist and may pose challenges when patients require surgery and anesthesia for conditions other than their pituitary disease.

### Corticotropin Adenoma

Pituitary secretion of ACTH normally is under negative feedback inhibition by circulating cortisol. ACTH-secreting pituitary adenomas are partially autonomous; feedback inhibition by cortisol remains but at a higher set point. Hence, ACTH and cortisol can be suppressed in individuals with ACTH-secreting pituitary adenomas when they receive sufficiently large doses of exogenous glucocorticoids. Dexamethasone, a semisynthetic steroid, is often used for this purpose because it does not interfere with cortisol radioimmunoassays. By administering graded doses of dexamethasone (Liddle test) to individuals suspected of having Cushing syndrome and measuring ACTH and cortisol levels, it is possible to distinguish individuals having ACTH-secreting adenomas, adrenal adenomas, and ectopic ACTH secretion (e.g., oat cell carcinoma, medullary thyroid carcinoma, islet cell tumors, pheochromocytoma) from individuals who simply are obese.

Alternatively, measurement of a late night plasma or salivary cortisol level can be used to distinguish individuals with Cushing disease from normal individuals. This discrimination is based on the normal physiologic diurnal variation of cortisol levels, which peak at around 8 AM and have their nadir at around midnight. Thus, a normally suppressed midnight cortisol level excludes the diagnosis of Cushing disease. In some patients, midnight cortisol levels are elevated, but MRI fails to demonstrate a pituitary adenoma (60% of cases due to the small size of ACTH-secreting pituitary

adenomas; macroadenomas are rare). In this situation, a corticotropin-releasing hormone (CRH) stimulation test can be performed with sampling of venous blood draining the pituitary gland. However, a skilled invasive radiologist is needed to catheterize each inferior petrosal sinus vein.

Some individuals have clinical and biochemical findings consistent with Cushing disease but instead are diagnosed with a condition called pseudo-Cushing syndrome. Pseudo-Cushing syndrome may result from alterations in the set point for feedback inhibition of CRH or ACTH by cortisol. The con-

**TABLE 59-23.**

#### Manifestations of Acromegaly

<b>General</b> Soft tissue swelling Acral enlargement	<b>Cardiovascular</b> Hypertension Cardiac enlargement Congestive heart failure Ischemic heart disease	<b>Gastrointestinal</b> Colonic polyps Enlarged colon Colon cancer
<b>Musculoskeletal</b> Arthralgia Arthritis Prognathism	<b>Respiratory</b> Tongue enlargement Sleep apnea Somnolence	<b>Neurologic</b> Paresthesias Carpel tunnel syndrome
<b>Cutaneous</b> Increased sweating Acne Skin tags	<b>Psychological</b> Depression Decreased vigor	<b>Metabolic</b> Diabetes mellitus Hyperlipidemia Hypercalcemia

Adapted from Harris AG. *Acromegaly and Its Management*. New York: Lippincott-Raven, 1996.



dition is associated with excessive alcohol intake, depression, severe obesity, and severe illness. Preservation of the normal cortisol circadian rhythm distinguishes pseudo-Cushing syndrome from true Cushing disease. In pseudo-Cushing syndrome, the abnormal endocrine findings revert to normal with correction of the precipitating cause. Table 59–14 summarizes clinical characteristics relevant to perioperative management

Treatment of Cushing disease is primarily surgical, with removal of the pituitary adenoma by TSP surgery. For individuals not cured by surgery, treatment options include conventional radiation or radiosurgery therapy, with or without medical therapy. Medications used in the management of Cushing disease and their mechanisms of action are summarized in Table 59–24.

### Thyrotroph Adenomas

Thyrotroph adenomas are rare pituitary adenomas.<sup>128,130</sup> The vast majority of these tumors are macroadenomas; therefore, they may be associated with mass effects. Their principal clinical presentation is thyrotoxicosis due to excessive TSH secretion. A goiter occurs in >90% of cases. Graves disease is often misdiagnosed in these patients. Inappropriately elevated TSH levels (for the levels of thyroid hormones) and the absence of ophthalmopathy allow differentiation between the two disorders. Resistance to thyroid hormone because of mutations of the thyroid hormone receptors also can result in inappropriately elevated TSH levels despite the high circulating levels of thyroid hormones. This unusual condition can be differentiated from thyrotroph adenoma because the adenoma secretes an excess of  $\alpha$ -subunit compared to intact TSH.

Surgery is the primary therapy for a thyrotroph adenoma, but complete removal often is difficult because of the large size of these tumors. Radiation therapy and/or medical therapy with octreotide are used for treating persistent disease. Octreotide is very effective in reducing TSH secretion to normal and reversing thyrotoxicosis but is not very effective in shrinking tumors.

### Nonsecreting Adenomas

The majority (90%) of nonsecreting pituitary adenomas are actually glycoprotein hormone-producing adenomas, manufacturing various subunits of gly-

coprotein hormones including  $\alpha$ -subunit,  $\beta$ -LH, and  $\beta$ -FSH.<sup>131</sup> Because these subunits are biologically inactive, clinical syndromes usually are not observed. As a result, most of these tumors come to medical attention because of mass effects and/or hypopituitarism.

Treatment depends upon the size of the adenoma. Small adenomas do not necessarily require treatment if they do not compress local structures or cause hypopituitarism. Periodic MRI can assess their rate of growth. Large tumors are treated by TSP surgery. Complete resection of the tumor is not necessary. Relief of compressive symptoms is adequate. If hypopituitarism persists following surgery or is caused by surgery, replacement therapy is given. Occasionally, anterior pituitary function recovers after decompression of the residual normal anterior pituitary cells.<sup>128</sup>

### Anesthetic Considerations for Pituitary Surgery

Most sellar lesions are accessible by a TSP approach.<sup>137–139</sup> The nares is the preferred route for entering the sella (Fig. 59–14A). However, this approach may not be anatomically feasible, so the surgeon may achieve adequate exposure by dissecting over the palate with an incision above the maxillary teeth (sublabial approach; Fig. 59–14B). Consequently, the surgeon and anesthesiologist share the head during TSP surgery. General endotracheal anesthesia is indicated. To prevent accumulation of secretions, blood, or CSF in the airway or stomach, a throat pack typically is inserted.

Preoperative assessment requires an understanding of the implications of the patient's endocrine condition. Nonsecreting adenomas, prolactinomas, and the rare adenomas secreting glycoprotein hormones generally have little impact on anesthetic management. Patients with Cushing disease may have all the features of sustained cortisol excess. Potential anesthetic concerns with these patients include airway management, positioning, glucose and electrolyte disturbances, and control of blood pressure. Some patients with Cushing disease have refractory hypertension that poses a significant treatment challenge.

Patients with acromegaly have a propensity for ischemic cardiac disease as well as myocardial dysfunction. Cardiac status should be specifi-

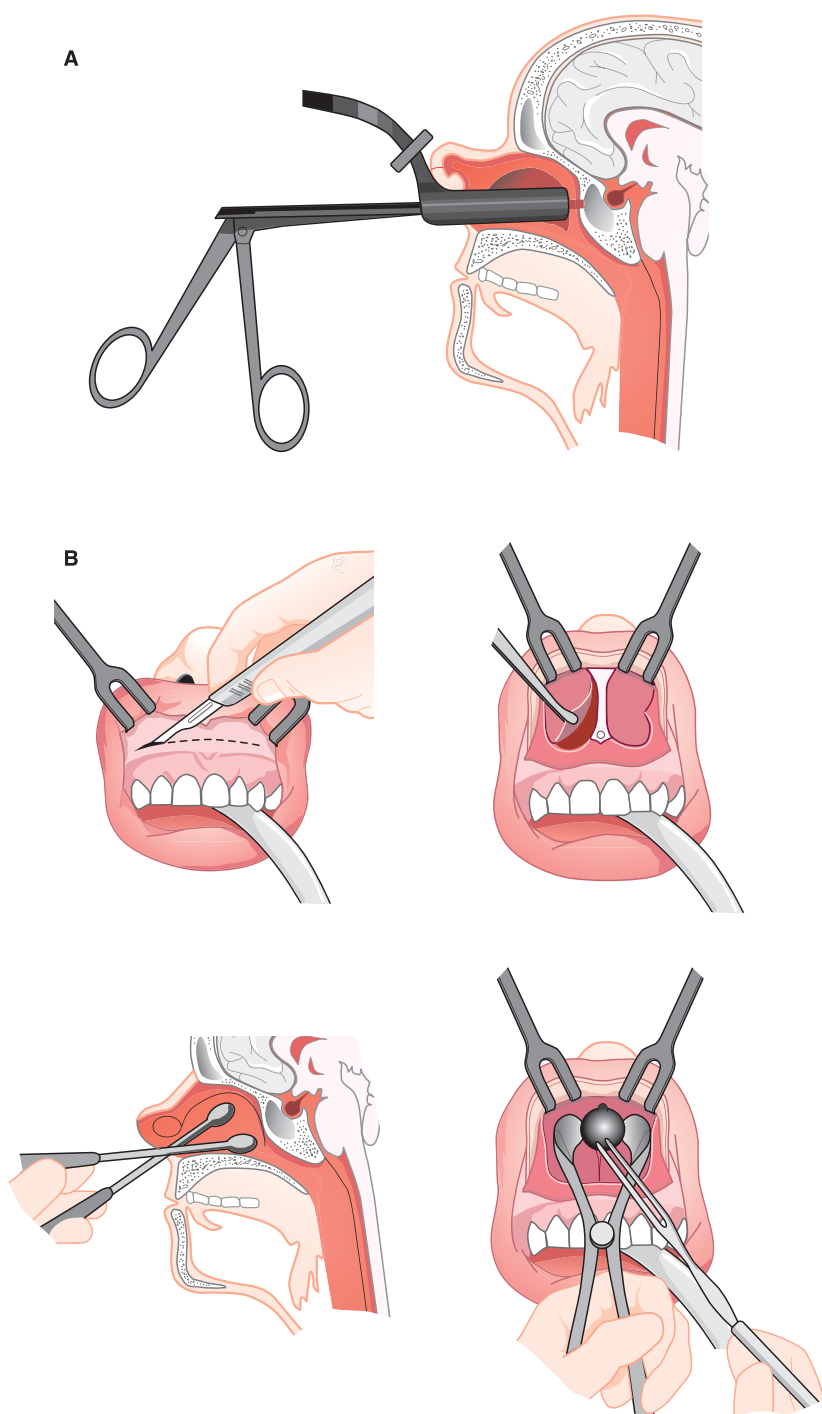
TABLE 59–24.

### Medical Therapy for Cushing Disease

Drug	Mechanism of Action
Ketoconazole	Antifungal agent. Blocks cholesterol side-chain cleavage to reduce cortisol.
Metyrapone	Inhibits 11 $\beta$ -hydroxylase to reduce cortisol. May cause hypertension and hypokalemia due to increase in 11-deoxycorticosterone and hirsutism due to increased androgens.
Aminoglutethimide	Often used with metyrapone to reduce side effects. Inhibits cholesterol side-chain cleavage and 11-/18-hydroxylation.
Mitotane	Destructive to adrenal cortex. Frequent adverse reactions.
Mifepristone (RU-486)	Glucocorticoid antagonist (not available in the United States).

cally assessed before surgery. Because of the skeletal and soft-tissue effects of sustained exposure to GH, patients with acromegaly may present substantial challenges in airway management. Mask ventilation and conventional direct laryngoscopy may be difficult or impossible (Fig. 59–15). Advanced airway management devices may be required. Consideration should be given to awake fiberoptic intubation in selected patients.

For most patients undergoing TSP surgery, standard monitoring and routine IV access suffice. Addition of an arterial line may be indicated for patients with comorbidities, or Cushing disease or acromegalic patients with refractory hypertension or cardiac issues. Volume loss likely will be minimal, so large-bore IV access usually is unnecessary. However, the sella is situated near major vascular structures, and the need to augment IV access may develop during surgery.



**FIGURE 59–14.** Transsphenoidal approach to the sella turcica for pituitary surgery. **A.** Following induction of general anesthesia, the surgeon inserts a speculum into the nares. Instruments are manipulated through the speculum. The sphenoid bone is breached to expose the sella and the pituitary gland within. **B.** If a nasal approach is not anatomically feasible, the sella can be accessed over the roof of the mouth (sublabial approach) following an incision above the maxillary teeth. (From Molitch<sup>141</sup> with permission.)

The transnasal TSP surgical procedure is only moderately stimulating, and postoperative pain control requirements are modest.<sup>132</sup> Early hypertension during the surgical procedure may be a result of the application of vasoconstrictors to the nasal mu-

cosa by the surgeon, with subsequent systemic effects. Surgical procedures generally terminate abruptly, so the anesthesiologist must titrate drugs carefully to permit a prompt and smooth emergence. It is highly desirable for the patient to be able to main-

tain his/her own airway without support or the need for bag-mask positive-pressure ventilation following extubation. The dura has been opened at the surgical site, which now communicates with the nasal passages. Positive-pressure ventilation can, in theory, cause the introduction of air or infectious material through the dural opening into the CSF space.

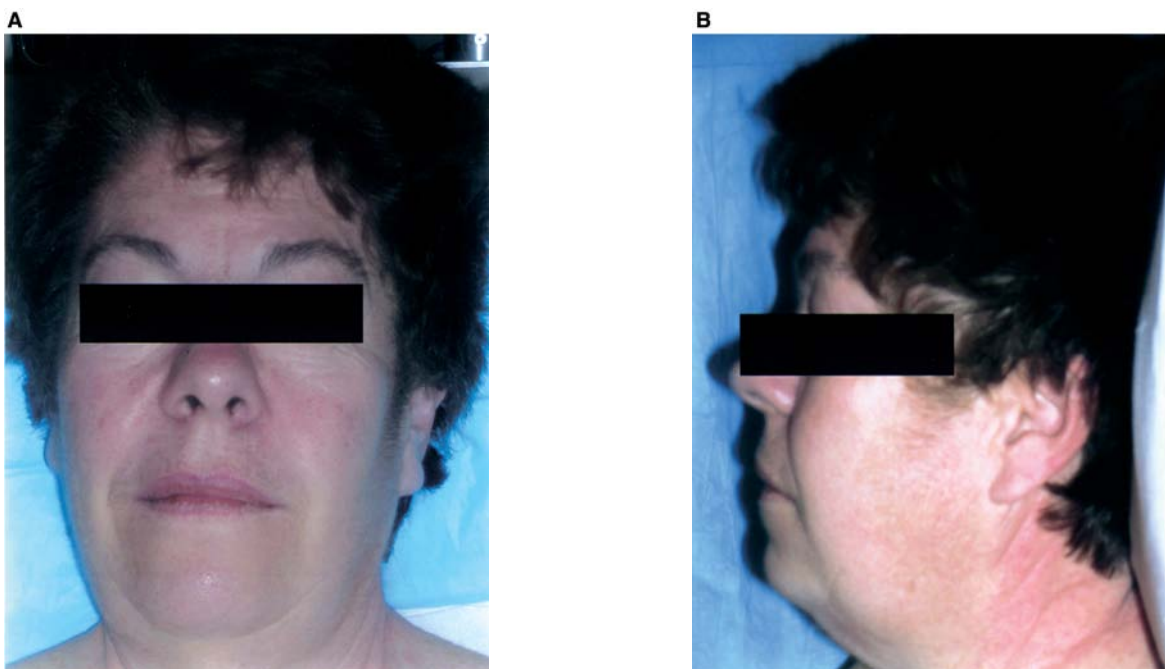
Some centers use intraoperative MRI techniques to assist the surgeon in gauging the extent of dissection or resection. This poses some additional concerns for easy access to the patient's airway. In addition, preparations include ensuring the availability of MRI-compatible equipment (e.g., monitoring devices and the anesthesia machine itself).

### Postoperative Care after Pituitary Surgery

Patients are at risk for diabetes insipidus immediately after surgery.<sup>140</sup> Monitoring includes frequent determinations of serum sodium levels and meticulous recording of daily weight and fluid balance, with hourly measurement of urine output and assessment of urine specific gravity every 4 hours. A triphasic course is often seen. Early ADH deficiency is attributed to immediate perioperative neuronal damage, followed a few days later by excess ADH release and associated hyponatremia from retrograde neuronal death and release of ADH stores. Finally, permanent deficiency of ADH develops with return of diabetes insipidus.

The vasopressin analog desmopressin should be administered postoperatively when urine output exceeds fluid intake and the serum sodium level rises. Careful monitoring of body weight, fluid balance, urine specific gravity, and plasma sodium level should continue daily to avoid electrolyte abnormalities. Desmopressin therapy starts with a single dose at bedtime in a patient diagnosed with partial central diabetes insipidus to avoid hyponatremia. Patients with acromegaly can have salt and water diuresis after successful tumor removal. Such patients should not be immediately treated with vasopressin.

With the exception of patients with Cushing disease, all patients undergoing pituitary surgery should be placed on steroids appropriate for surgical stress. The rate of decrease in steroid dose should be guided by clinical and hemodynamic status after



**FIGURE 59-15.** Patient with acromegaly who could not be intubated by conventional means. This woman lacked symptoms of airway obstruction. There was little external evidence of excessive airway soft tissue. With induction of general anesthesia, a mask airway was established with only moderate difficulty. Attempts at direct laryngoscopy by experienced anesthesiologists with different blades failed to produce any view of recognizable glottic structures. Excess soft tissue prevented insertion of a fiberoptic scope into the trachea. The patient emerged from anesthesia without airway compromise; the planned surgery was cancelled. **A.** Frontal face photograph. **B.** Profile photograph.

surgery. In an uncomplicated postoperative course, taper steroids to physiologic replacement doses over 2–3 days. Patients with Cushing disease should not be placed on hydrocortisone immediately after surgery, but cortisol levels should be checked every 6 hours and replacement therapy initiated as needed.

### KEY REFERENCES

1. Brown CJ, Buie WD. Perioperative stress dose steroids: do they make a difference? *J Am Coll Surg* 2001;193:678–686.
2. Connery LE, Coursin DB. Assessment and therapy of selected endocrine disorders. *Anesthesiol Clin North Am* 2004;22:93–123.
3. Cooper DS. Hyperthyroidism. *Lancet* 2003;362:459–468.
4. Coursin DB, Connery LE, et al. Perioperative diabetic and hyperglycemic management issues. *Crit Care Med* 2004;32(4 Suppl): S116–S125.
5. Eckel RH, Grundy SM, et al. The metabolic syndrome. *Lancet* 2005;365:1415–1428.

6. Hirsch IB. Insulin analogues. *N Engl J Med* 2005;352:174–183.
7. Jabbour SA. Steroids and the surgical patient. *Med Clin North Am* 2001;85:1311–1317.
8. Kinney MA, Narr BJ, et al. Perioperative management of pheochromocytoma. *J Cardiothorac Vasc Anesth* 2002;16:359–369.
9. Langley RW, Burch HB. Perioperative management of the thyrotoxic patient. *Endocrinol Metab Clin North Am* 2003;32:519–534.
10. Lenders JW, Eisenhofer G, et al. Pheochromocytoma. *Lancet* 2005;366:665–675.
11. Nemergut EC, Dumont AS, et al. Perioperative management of patients undergoing transsphenoidal pituitary surgery. *Anesth Analg* 2005;101:1170–1181.
12. Roberts CG, Ladenson PW. Hypothyroidism. *Lancet* 2004;363:793–803.

### REFERENCES

1. Sonksen P, Sonksen J. Insulin: understanding its action in health and disease. *Br J Anaesth* 2000;85:69–79.

2. Hirsch IB. Insulin analogues. *N Engl J Med* 2005;352:174–183.
3. Eckel RH, Grundy SM, et al. The metabolic syndrome. *Lancet* 2005;365:1415–1428.
4. Moller DE, Kaufman KD. Metabolic syndrome: a clinical and molecular perspective. *Annu Rev Med* 2005;56:45–62.
5. Nieuwdorp M, Stoes ES, et al. Hypercoagulability in the metabolic syndrome. *Curr Opin Pharmacol* 2005;5:155–159.
6. Ahmed Z, Lockhart CH, et al. Advances in diabetic management: implications for anesthesia. *Anesth Analg* 2005;100:666–669.
7. Miriam A, Korula G. A simple glucose insulin regimen for perioperative blood glucose control: the Vellore regimen. *Anesth Analg* 2004;99:598–602.
8. Coursin DB, Connery LE, et al. Perioperative diabetic and hyperglycemic management issues. *Crit Care Med* 2004;32(4 Suppl): S116–S125.
9. Carvalho G, Moore A, et al. Maintenance of normoglycemia during cardiac surgery. *Anesth Analg* 2004;99:319–324.
10. Rhodes ET, Ferrari LR, et al. Perioperative management of pediatric surgical patients with diabetes mellitus. *Anesth Analg* 2005;101:986–999.
11. Coursin DB, Prielipp RC. The new anesthesia diet plan: keeping perioperative carbs in check. *Anesth Analg* 2004;99:316–318.
12. Setter SM, Iltz JL, et al. Metformin hydrochloride in the treatment of type 2 diabetes mellitus: a clinical review with a



- focus on dual therapy. *Clin Ther* 2003;25:2991–3026.
13. Stades AM, Heikens JT, et al. Metformin and lactic acidosis: cause or coincidence? A review of case reports. *J Intern Med* 2004;255:179–187.
  14. Jones GC, Macklin JP, et al. Contraindications to the use of metformin. *BMJ* 2003;326:4–5.
  15. Vreven R, De Kock M. Metformin lactic acidosis and anaesthesia: myth or reality? *Acta Anaesthesiol Belg* 2005;56:297–302.
  16. Arner P, Gunnarsson R, et al. Some characteristics of steroid diabetes: a study in renal-transplant recipients receiving high-dose corticosteroid therapy. *Diabetes Care* 1983;6:23–25.
  17. McMahon M, Gerich J, et al. Effects of glucocorticoids on carbohydrate metabolism. *Diabetes Metab Rev* 1988;4:17–30.
  18. Gerich JE, Charles MA, et al. Regulation of pancreatic insulin and glucagon secretion. *Annu Rev Physiol* 1976;38:353–388.
  19. Lecavalier L, Bolli G, et al. Contributions of gluconeogenesis and glycogenolysis during glucose counterregulation in normal humans. *Am J Physiol* 1989;256(6 Pt 1): E844–E851.
  20. Cryer PE. Hierarchy of physiological responses to hypoglycemia: relevance to clinical hypoglycemia in type I (insulin dependent) diabetes mellitus. *Horm Metab Res* 1997;29:92–96.
  21. Feldman JM, Plonk JW, et al. The role of cortisol and growth hormone in the counterregulation of insulin-induced hypoglycemia. *Horm Metab Res* 1975;7:378–81.
  22. Shamon H, Hendler R, et al. Synergistic interactions among antiinsulin hormones in the pathogenesis of stress hyperglycemia in humans. *J Clin Endocrinol Metab* 1981;52:1235–1241.
  23. Robertshaw HJ, McAnulty GR, et al. Strategies for managing the diabetic patient. *Best Pract Res Clin Anaesthesiol* 2004;18:631–643.
  24. Barker JP, Robinson PN, et al. Metabolic control of non-insulin-dependent diabetic patients undergoing cataract surgery: comparison of local and general anaesthesia. *Br J Anaesth* 1995;74:500–505.
  25. Hebl JR. Neurological complications of regional anesthesia and pain medicine: the patient with pre-existing disease. *American Society of Regional Anesthesia and Pain Medicine, 30th Annual Spring Meeting and Workshops, Toronto, Ontario, Canada, 2005.*
  26. McAnulty GR, Hall GM. Anaesthesia for the diabetic patient. *Br J Anaesth* 2003;90:428–429.
  27. Farling PA. Thyroid disease. *Br J Anaesth* 2000;85:15–28.
  28. Cooper DS. Hyperthyroidism. *Lancet* 2003;362:459–468.
  29. Klein I, Ojamaa K. Thyroid hormone and the cardiovascular system. *N Engl J Med* 2001;344:501–509.
  30. Roberts CG, Ladenson PW. Hypothyroidism. *Lancet* 2004;363:793–803.
  31. Babad AA, Eger EI 2nd. The effects of hyperthyroidism and hypothyroidism on halothane and oxygen requirements in dogs. *Anesthesiology* 1968;29:1087–1093.
  32. Munson ES, Hoffman JC, et al. The effects of acute hypothyroidism and hyperthyroidism on cyclopropane requirement (MAC) in rats. *Anesthesiology* 1968;29:1094–1098.
  33. Siegers CP, Mackenroth T, et al. Effects of thyroid dysfunction on the metabolism of halothane, enflurane and methoxyflurane in rats. *Pharmacology* 1981;22:41–46.
  34. Murkin JM. Anesthesia and hypothyroidism: a review of thyroxine physiology, pharmacology, and anesthetic implications. *Anesth Analg* 1982;61:371–383.
  35. Bolon M, Bastien O, et al. Prolonged sedation due to an accumulation of midazolam in an intensive care patient with hypothyroidism. *Eur J Clin Pharmacol* 2000;56:771–772.
  36. Loh KC. Amiodarone-induced thyroid disorders: a clinical review. *Postgrad Med J* 2000;76:133–140.
  37. Martino E, Bartalena L, et al. The effects of amiodarone on the thyroid. *Endocr Rev* 2001;22:240–254.
  38. Bogazzi F, Miccoli P, et al. Preparation with iopanoic acid rapidly controls thyrotoxicosis in patients with amiodarone-induced thyrotoxicosis before thyroidectomy. *Surgery* 2002;132:1114–1117.
  39. Panzer C, Beazley R, et al. Rapid preoperative preparation for severe hyperthyroid Graves' disease. *J Clin Endocrinol Metab* 2004;89:2142–2144.
  40. Bogazzi F, Aghini-Lombardi F, et al. Iopanoic acid rapidly controls type I amiodarone-induced thyrotoxicosis prior to thyroidectomy. *J Endocrinol Invest* 2002;25:176–180.
  41. Franklyn J. Thyrotoxicosis. *Clin Med* 2003;3:11–15.
  42. Langley RW, Burch HB. Perioperative management of the thyrotoxic patient. *Endocrinol Metab Clin North Am* 2003;32:519–534.
  43. Shah EF, Allen JG, et al. Use of the laryngeal mask airway in thyroid and parathyroid surgery as an aid to the identification and preservation of the recurrent laryngeal nerves. *Ann R Coll Surg Engl* 2001;83:315–318.
  44. Eltzschig HK, Posner M, et al. The use of readily available equipment in a simple method for intraoperative monitoring of recurrent laryngeal nerve function during thyroid surgery: initial experience with more than 300 cases. *Arch Surg* 2002;137:452–456.
  45. Scheuller MC, Ellison D. Laryngeal mask anesthesia with intraoperative laryngoscopy for identification of the recurrent laryngeal nerve during thyroidectomy. *Laryngoscope* 2002;112:1594–1597.
  46. Hobbiger HE, Allen JG, et al. The laryngeal mask airway for thyroid and parathyroid surgery. *Anaesthesia* 1996;51:972–974.
  47. Tanigawa K, Inoue Y, et al. Protection of recurrent laryngeal nerve during neck surgery: a new combination of neotracer, laryngeal mask airway, and fiberoptic bronchoscope. *Anesthesiology* 1991;74:966–967.
  48. Hillermann CL, Tarpey J, et al. Laryngeal nerve identification during thyroid surgery—feasibility of a novel approach. *Can J Anaesth* 2003;50:189–192.
  49. Stefanov CS, Dimov RS, et al. Method of anaesthesia in thyroid surgery with intraoperative monitoring of the recurrent laryngeal nerves. *Folia Med (Plovdiv)* 2001;43:14–18.
  50. Tobias JD. Cervical plexus block in adolescents. *J Clin Anesth* 1999;11:606–608.
  51. Kulkarni R, Braverman L, et al. Bilateral cervical plexus block for thyroidectomy and parathyroidectomy in healthy and high risk patients. *J Endocrinol Invest* 1996;19:714–718.
  52. Miccoli P, Berti P, et al. Results of video-assisted parathyroidectomy: single institution's six-year experience. *World J Surg* 2004;28:1216–1218.
  53. Aunac S, Carlier M, et al. The analgesic efficacy of bilateral combined superficial and deep cervical plexus block administered before thyroid surgery under general anaesthesia. *Anesth Analg* 2002;95:746–750.
  54. Michalek P, David I, et al. Cervical epidural anesthesia for combined neck and upper extremity procedure: a pilot study. *Anesth Analg* 2004;99:1833–1836.
  55. Dieudonne N, Gomola A, et al. Prevention of postoperative pain after thyroid surgery: a double-blind randomized study of bilateral superficial cervical plexus blocks. *Anesth Analg* 2001;92:1538–1542.
  56. Miller FR. Surgical anatomy of the thyroid and parathyroid glands. *Otolaryngol Clin North Am* 2003;36:1–7.
  57. Calhoun KH, Weiss RL, et al. Management of the thyroid isthmus in tracheostomy: a prospective and retrospective study. *Otolaryngol Head Neck Surg* 1994;111:450–452.
  58. Dexter TJ. A cadaver study appraising accuracy of blind placement of percutaneous tracheostomy. *Anaesthesia* 1995;50:863–864.
  59. Tschang TP, Cramer S. Massive hemorrhage from perforated thyroid complicating tracheostomy. Report of two cases. *Arch Otolaryngol* 1977;103:557–559.
  60. Monfared A, Kim D, et al. Microsurgical anatomy of the superior and recurrent laryngeal nerves. *Neurosurgery* 2001;49:925–932.
  61. Monfared A, Gorti G, et al. Microsurgical anatomy of the laryngeal nerves as related to thyroid surgery. *Laryngoscope* 2002;112:386–392.
  62. Barnes TW, Olsen KD, et al. Obstructive lingual thyroid causing sleep apnea: a case



report and review of the literature. *Sleep Med* 2004;5:605–607.

63. Bouaggad A, Nejmi SE, et al. Prediction of difficult tracheal intubation in thyroid surgery. *Anesth Analg* 2004;99:603–606.

64. Toyota K, Uchida H, et al. Preoperative airway evaluation using multi-slice three-dimensional computed tomography for a patient with severe tracheal stenosis. *Br J Anaesth* 2004;93:865–867.

65. Fewins J, Simpson CB, et al. Complications of thyroid and parathyroid surgery. *Otolaryngol Clin North Am* 2003;36:189–206.

66. Sulica L. The superior laryngeal nerve: function and dysfunction. *Otolaryngol Clin North Am* 2004;37:183–201.

67. Randolph GW, Kobler JB, et al. Recurrent laryngeal nerve identification and assessment during thyroid surgery: laryngeal palpation. *World J Surg* 2004;28:755–760.

68. Hermann M, Hellebart C, et al. Neuromonitoring in thyroid surgery: prospective evaluation of intraoperative electrophysiological responses for the prediction of recurrent laryngeal nerve injury. *Ann Surg* 2004;240:9–17.

69. Hemmerling TM, Schmidt J, et al. Intraoperative monitoring of the recurrent laryngeal nerve in 151 consecutive patients undergoing thyroid surgery. *Anesth Analg* 2001;93:396–399.

70. Rosato L, Avenia N, et al. Complications of thyroid surgery: analysis of a multicentric study on 14,934 patients operated on in Italy over 5 years. *World J Surg* 2004;28:271–276.

71. Goncalves Filho J, Kowalski LP. Surgical complications after thyroid surgery performed in a cancer hospital. *Otolaryngol Head Neck Surg* 2005;132:490–494.

72. Chiang FY, Wang LF, et al. Recurrent laryngeal nerve palsy after thyroidectomy with routine identification of the recurrent laryngeal nerve. *Surgery* 2005;137:342–347.

73. Beldi G, Kinsbergen T, et al. Evaluation of intraoperative recurrent nerve monitoring in thyroid surgery. *World J Surg* 2004;28:589–591.

74. Filho JG, Kowalski LP. Postoperative complications of thyroidectomy for differentiated thyroid carcinoma. *Am J Otolaryngol* 2004;25:225–230.

75. Affleck BD, Swartz K, et al. Surgical considerations and controversies in thyroid and parathyroid surgery. *Otolaryngol Clin North Am* 2003;36:159–187.

76. Dralle H, Sekulla C, et al. Risk factors of paralysis and functional outcome after recurrent laryngeal nerve monitoring in thyroid surgery. *Surgery* 2004;136:1310–1322.

77. Yarbrough DE, Thompson GB, et al. Intraoperative electromyographic monitoring of the recurrent laryngeal nerve in reoperative thyroid and parathyroid surgery. *Surgery* 2004;136:1107–1115.

78. Thomusch O, Sekulla C, et al. Intraoperative neuromonitoring of surgery for benign goiter. *Am J Surg* 2002;183:673–678.

79. Myssiorek D. Recurrent laryngeal nerve paralysis: anatomy and etiology. *Otolaryngol Clin North Am* 2004;37:25–44.

80. Lombardi CP, Raffaelli M, et al. Early prediction of postthyroidectomy hypocalcemia by one single iPTH measurement. *Surgery* 2004;136:1236–1241.

81. Quiros RM, Pesce CE, et al. Intraoperative parathyroid hormone levels in thyroid surgery are predictive of postoperative hypoparathyroidism and need for vitamin D supplementation. *Am J Surg* 2005;189:306–309.

82. Schulz-Stubner S. Bilateral occipital neuropathy as a rare complication of positioning for thyroid surgery in a morbidly obese patient. *Acta Anaesthesiol Scand* 2004;48:126–127.

83. Carty SE. Prevention and management of complications in parathyroid surgery. *Otolaryngol Clin North Am* 2004;37:897–907.

84. Monchik JM, Barellini L, et al. Minimally invasive parathyroid surgery in 103 patients with local/regional anesthesia, without exclusion criteria. *Surgery* 2002;131:502–508.

85. Sokoll LJ, Wians FH Jr, et al. Rapid intraoperative immunoassay of parathyroid hormone and other hormones: a new paradigm for point-of-care testing. *Clin Chem* 2004;50:1126–1135.

86. Sippel RS, Becker YT, et al. Does propofol anesthesia affect intraoperative parathyroid hormone levels? A randomized, prospective trial. *Surgery* 2004;136:1138–1142.

87. Miccoli P, Barellini L, et al. Randomized clinical trial comparing regional and general anaesthesia in minimally invasive video-assisted parathyroidectomy. *Br J Surg* 2005;92:814–818.

88. Sonner JM, Hynson JM, et al. Nausea and vomiting following thyroid and parathyroid surgery. *J Clin Anesth* 1997;9:398–402.

89. Kinney MA, Narr BJ, et al. Perioperative management of pheochromocytoma. *J Cardiothorac Vasc Anesth* 2002;16:359–369.

90. Prys-Roberts C. Pheochromocytoma—recent progress in its management. *Br J Anaesth* 2000;85:44–57.

91. Lenders JW, Eisenhofer G, et al. Pheochromocytoma. *Lancet* 2005;366:665–675.

92. James MF, Cronje L. Pheochromocytoma crisis: the use of magnesium sulfate. *Anesth Analg* 2004;99:680–686.

93. Witteles RM, Kaplan EL, et al. Safe and cost-effective preoperative preparation of patients with pheochromocytoma. *Anesth Analg* 2000;91:302–304.

94. Kinney MA, Warner ME, et al. Perioperative risks and outcomes of pheochromocytoma and paraganglioma resection. *Anesth Analg* 2000;91:1118–1123.

95. Prys-Roberts C, Farndon JR. Efficacy and safety of doxazosin for perioperative management of patients with pheochromocytoma. *World J Surg* 2002;26:1037–1042.

96. Sparks JW, Seefelder C, et al. The perioperative management of a patient with complex single ventricle physiology

and pheochromocytoma. *Anesth Analg* 2005;100:972–975.

97. Connery LE, Coursin DB. Assessment and therapy of selected endocrine disorders. *Anesthesiol Clin North America* 2004;22:93–123.

98. Tauzin-Fin P, Sesay M, et al. Effects of perioperative alpha1 block on haemodynamic control during laparoscopic surgery for pheochromocytoma. *Br J Anaesth* 2004;92:512–517.

99. Lebuffe G, Dosseh ED, et al. The effect of calcium channel blockers on outcome following the surgical treatment of pheochromocytomas and paragangliomas. *Anaesthesia* 2005;60:439–444.

100. Poopalalingam R, Chin EY. Rapid preparation of a patient with pheochromocytoma with labetalol and magnesium sulfate. *Can J Anaesth* 2001;48:876–880.

101. James MF. Use of magnesium sulphate in the anaesthetic management of pheochromocytoma: a review of 17 anaesthetics. *Br J Anaesth* 1989;62:616–623.

102. Pivalizza EG. Magnesium sulfate and epidural anesthesia in pheochromocytoma and severe coronary artery disease. *Anesth Analg* 1995;81:414–416.

103. Minami T, Adachi T, et al. An effective use of magnesium sulfate for intraoperative management of laparoscopic adrenalectomy for pheochromocytoma in a pediatric patient. *Anesth Analg* 2002;95:1243–1244.

104. Steinsapir J, Carr AA, et al. Metyrosine and pheochromocytoma. *Arch Intern Med* 1997;157:901–906.

105. Del Pizzo JJ, Schiff JD, et al. Laparoscopic adrenalectomy for pheochromocytoma. *Curr Urol Rep* 2005;6:78–85.

106. Kercher KW, Novitsky YW, et al. Laparoscopic curative resection of pheochromocytomas. *Ann Surg* 2005;241:919–926.

107. Micali S, Peluso G, et al. Laparoscopic adrenal surgery: new frontiers. *J Endourol* 2005;19:272–278.

108. Wong AY, Cheung CW. Dexmedetomidine for resection of a large pheochromocytoma with invasion into the inferior vena cava. *Br J Anaesth* 2004;93:873.

109. Breslin DS, Farling PA, et al. The use of remifentanyl in the anaesthetic management of patients undergoing adrenalectomy: a report of three cases. *Anaesthesia* 2003;58:358–362.

110. Baraka A, Siddik S, et al. Remifentanyl for modulation of hemodynamics in a patient undergoing laparoscopic resection of pheochromocytoma. *Middle East J Anaesthesiol* 2004;17:585–592.

111. Fernandez-Cruz L, Taura P, et al. Laparoscopic approach to pheochromocytoma: hemodynamic changes and catecholamine secretion. *World J Surg* 1996;20:762–768.

112. Augoustides JG, Abrams M, et al. Vasopressin for hemodynamic rescue in catecholamine-resistant vasoplegic shock

- after resection of massive pheochromocytoma. *Anesthesiology* 2004;101:1022–1024.
113. Axelrod L. Perioperative management of patients treated with glucocorticoids. *Endocrinol Metab Clin North Am* 2003;32:367–83.
114. Brown CJ, Buie WD. Perioperative stress dose steroids: do they make a difference? *J Am Coll Surg* 2001;193:678–686.
115. Cooper MS, Stewart PM. Corticosteroid insufficiency in acutely ill patients. *N Engl J Med* 2003;348:727–734.
116. Shaw M. When is perioperative “steroid coverage” necessary? *Cleve Clin J Med* 2002;69:9–11.
117. Linder BL, Esteban NV, et al. Cortisol production rate in childhood and adolescence. *J Pediatr* 1990;117:892–896.
118. Esteban NV, Loughlin T, et al. Daily cortisol production rate in man determined by stable isotope dilution/mass spectrometry. *J Clin Endocrinol Metab* 1991;72:39–45.
119. Kerrigan JR, Veldhuis JD, et al. Estimation of daily cortisol production and clearance rates in normal pubertal males by deconvolution analysis. *J Clin Endocrinol Metab* 1993;76:1505–1510.
120. Nicholson G, Burrin JM, et al. Perioperative steroid supplementation. *Anaesthesia* 1998;53:1091–1104.
121. Jabbour SA. Steroids and the surgical patient. *Med Clin North Am* 2001;85:1311–1317.
122. Leopold SS, Casnellie MT, et al. Endogenous cortisol production in response to knee arthroscopy and total knee arthroplasty. *J Bone Joint Surg Am* 2003;85A:2163–2167.
123. Bromberg JS, Alfrey EJ, et al. Adrenal suppression and steroid supplementation in renal transplant recipients. *Transplantation* 1991;51:385–390.
124. Friedman RJ, Schiff CF, et al. Use of supplemental steroids in patients having orthopaedic operations. *J Bone Joint Surg Am* 1995;77:1801–1806.
125. Glowniak JV, Loriaux DL. A double-blind study of perioperative steroid requirements in secondary adrenal insufficiency. *Surgery* 1997;121:123–129.
126. Salem M, Tainsh RE et al. Perioperative glucocorticoid coverage. A reassessment 42 years after emergence of a problem. *Ann Surg* 1994;219:416–425.
127. Holte K, Kehlet H. Perioperative single-dose glucocorticoid administration: pathophysiologic effects and clinical implications. *J Am Coll Surg* 2002;195:694–712.
128. Klibanski A, Zervas NT. Diagnosis and management of hormone-secreting pituitary adenomas. *N Engl J Med* 1991;324:822–831.
129. Ezzat S, Asa SL, et al. The prevalence of pituitary adenomas: a systematic review. *Cancer* 2004;101:613–619.
130. Freda PU, Wardlaw SL. Clinical review 110: diagnosis and treatment of pituitary tumors. *J Clin Endocrinol Metab* 1999;84:3859–3866.
131. Melmed S. Pathogenesis of pituitary tumors. *Endocrinol Metab Clin North Am* 1999;28:1–12.
132. Nemerlut EC, Dumont AS, et al. Perioperative management of patients undergoing transsphenoidal pituitary surgery. *Anesth Analg* 2005;101:1170–1181.
133. Van Aken M, Lamberts S. Diagnosis and treatment of hypopituitarism: an update. *Pituitary* 2005;8:183–91.
134. Schlechte JA. Clinical practice. Prolactinoma. *N Engl J Med* 2003;349:2035–2041.
135. Minniti G, Moroni C, et al. Marked improvement in cardiovascular function after successful transsphenoidal surgery in acromegalic patients. *Clin Endocrinol (Oxf)* 2001;55:307–313.
136. Vianna CB, Vieira ML, et al. Treatment of acromegaly improves myocardial abnormalities. *Am Heart J* 2002;143:873–876.
137. Jane JA Jr, Thapar K, et al. Pituitary surgery: transsphenoidal approach. *Neurosurgery* 2002;51:435–442.
138. Ciric I, Rosenblatt S, et al. Transsphenoidal microsurgery. *Neurosurgery* 2002;51:161–169.
139. Barker FG 2nd, Klibanski A, et al. Transsphenoidal surgery for pituitary tumors in the United States, 1996–2000: mortality, morbidity, and the effects of hospital and surgeon volume. *J Clin Endocrinol Metab* 2003;88:4709–4719.
140. Singer PA, Sevilla LJ. Postoperative endocrine management of pituitary tumors. *Neurosurg Clin N Am* 2003;14:123–138.
141. Molitch M. Neuroendocrinology and pituitary disease. In: *Atlas of Clinical Endocrinology*, vol 4. Philadelphia: Current Medicine, 2000.

# CHAPTER 60

## Anesthetic Considerations for Genitourinary and Renal Surgery

Maurizio Cereda, MD, and  
Sean Kennedy, MD

Urologic surgery includes a broad variety of procedures of varying complexity, ranging from endoscopic diagnostic procedures to major cancer surgery. Patients who undergo urologic surgery often are of advanced age and have several comorbidities, which may render their perioperative management rather complicated. The anesthesiologist should have background knowledge of the indications, technical aspects, and complications of the major procedures used in urologic surgery in order to formulate a sound anesthetic plan. Additionally, complex patient positions may lead to complications such as nerve damage. The addition of laparoscopic and robotic surgery has further expanded the horizons of urologic surgery. Although the use of minimally invasive procedures may simplify anesthetic and perioperative management, they likely will permit surgery on patients who, because of comorbidities, are not good candidates for traditional procedures. This situation ultimately will render the perioperative management of these patients more challenging for the anesthesiologist.

### MACROSCOPIC ANATOMY OF THE URINARY TRACT

#### Kidney

The kidneys are located in the retroperitoneal space between T12 and L4, along the medial borders of the psoas muscles. Positioned inferior to the liver, the right kidney lies slightly lower than the left kidney. The kidneys are surrounded by the perirenal fat and are enclosed in the perirenal or Gerota fascia. The adrenal glands lie on top of each kidney, also contained by Gerota fascia. Diaphragmatic movement transmits to the kidneys, caus-

ing physiologic excursion of 4–5 cm with each respiration. Upon section, the kidney is composed of a cortex and a medullary section. The medulla is divided into several pyramids whose tips, the papillae, are indented with the minor calices. The latter converge in the major calices, then drain into the renal pelvis, which tapers into the ureter.

Each kidney receives its blood supply from a single renal artery, although variants with multiple arteries are encountered occasionally. The renal arteries originate just inferior to the superior mesenteric artery and enter the kidney at its hilum. The right artery crosses the midline behind the vena cava. The renal veins run in front of the arteries, with the left vein crossing the midline anterior to the

aorta. The lymphatic circulation of the kidney drains into lymph nodes located in the lumbar region.

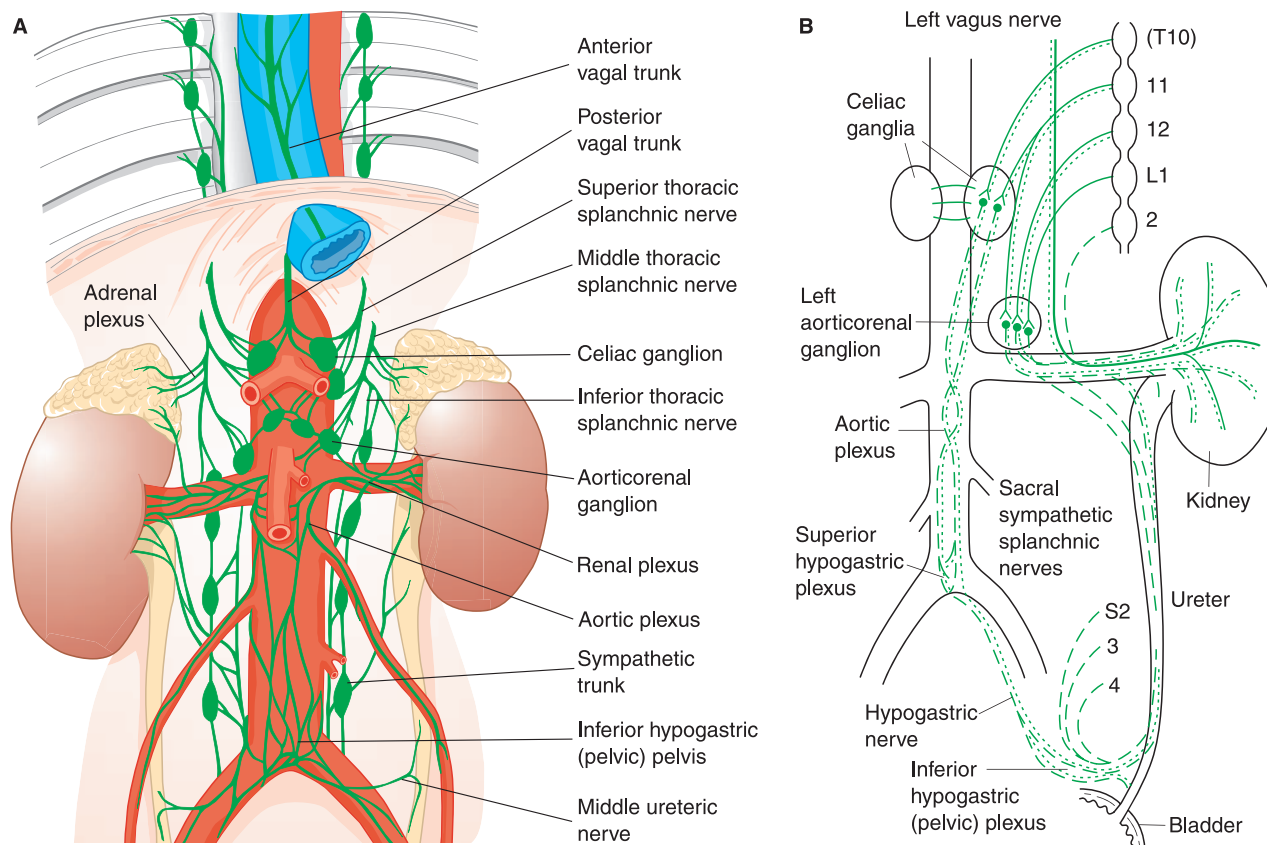
The kidneys receive vegetative (adrenergic and cholinergic) innervation (Fig. 60–1) from the renal plexus, which receives fibers mainly from the celiac plexus and the vagus nerve. Sympathetic vasoconstrictor and afferent fibers originate from T8 to L1. For this reason, kidney pain typically is perceived in the costovertebral angle and below the twelfth rib. Anesthesia for kidney surgery requires effective blockade of the nerve roots between T8 and L3 to allow incision through the overlying skin and abdominal wall.

#### Ureters

The ureters originate from the renal pelvis and run along the course of the

### KEY POINTS

1. Patient positioning is important in urologic surgery because of the variety and complexity of the positions used. Knowledge of the physiologic implications and the possible complications of these positions is critical to preventing untoward outcomes.
2. For most endourologic procedures, rapid anesthetic onset and recovery are desired. These goals can be reached with either general or neuraxial anesthesia, provided appropriate pharmacologic choices are made.
3. Use of neuraxial anesthesia for transurethral resection of the prostate (TURP) does not have proven outcome benefits over general anesthesia, but it may facilitate the detection of TURP syndrome. This is the most severe complication of TURP, although its frequency has decreased with the use of current irrigation fluids.
4. For extracorporeal shock wave lithotripsy, intravenous sedation can be effective when lower intensity waves are used. Intrathecal narcotics seem to be a valid alternative.
5. Epidural analgesia may offer some advantages when added to general anesthesia for radical prostatectomy and cystectomy, but no outcome benefits have yet been demonstrated.
6. Blood loss is a significant concern in urologic cancer procedures such as prostatectomy, cystectomy, nephrectomy, and lymph node dissections. A variety of techniques have been used to limit blood loss and transfusion requirement, but their clinical and financial advantages are unclear. Hemodynamic monitoring and volume status assessment are important during these procedures.
7. Patients undergoing surgery for testicular cancer usually are young and in relatively good health, but they may suffer from complications of previous chemotherapy and radiation therapy.
8. Protection of residual kidney function is one of the major concerns during radical nephrectomy. Other than maintenance of hemodynamic stability and use of partial resections, no “renal protection” strategy has proved to be effective in preventing postoperative renal dysfunction.
9. Minimally invasive and robotic urologic surgeries are likely to become common in the future because of their advantages in patient satisfaction and faster recovery. The anesthetic plan for these procedures should account for the physiologic alterations caused by laparoscopy, prepare for possible conversion to a traditional open procedure, and provide patient comfort and faster recovery times.



**FIGURE 60-1.** A. Gross anatomy of the kidneys. B. Autonomic and sensory nerve supply. (From Bonica JJ. *Management of Pain*. Philadelphia: Lea & Febiger, 1990, with permission.)

psoas muscle. They cross the course of the common iliac arteries and swing laterally in the lower pelvis, entering the base of the bladder. The ureteral blood supply derives from the renal arteries in their upper tract, from the spermatic or ovarian arteries in their midportion, and from hypogastric and vesical arteries in their terminal tract. Ureteral innervation originates from the renal, hypogastric, and pelvic plexuses. Sympathetic afferent fibers enter the spinal cord at T10 through L2 for the upper ureteral portion, whereas parasympathetic afferents reach the S2 through S4 levels. This distribution explains why pain from a ureteral stone is perceived in different locations depending on the position of the stone in the ureter.

## Bladder

The bladder is a hollow organ with a capacity of 400 to 500 mL and a wall mainly composed of smooth muscle tissue. When empty, the bladder lies behind the pubic symphysis, anterior to the rectum in males or to the vagina in females. When the bladder is full, it rises significantly above the pubic

bone and becomes palpable. The ureters enter the bladder posteriorly and emerge into the bladder cavity 2.5 cm apart, constituting the base of the vesical trigone. The dome of the bladder is covered by peritoneum, whereas the inferior portion lies on top of the prostate and seminal vesicles.

The blood supply of the bladder is provided mainly by the superior, middle, and inferior vesical arteries, arising from the hypogastric artery. The venous blood collects in a plexus located at the bladder neck, which drains into the hypogastric vein. This plexus is also joined by the prostatic venous plexus and by the deep dorsal vein of the penis, making this region prone to marked bleeding during surgical dissection. The lymphatics of the bladder drain in lymph nodes located near the iliac vessels.

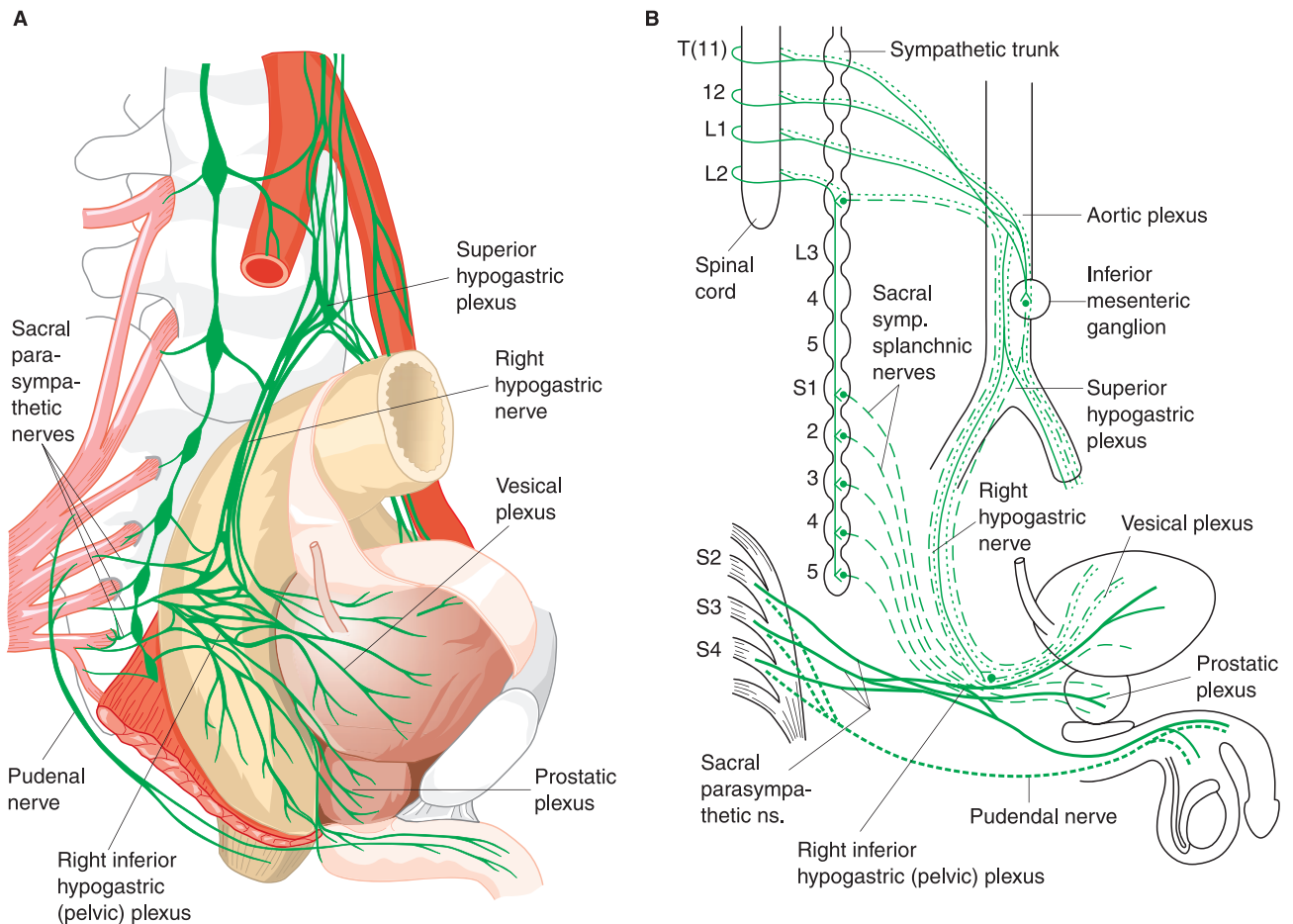
The bladder receives its nerve supply from the hypogastric plexus (Fig. 60-2). Sympathetic fibers from lumbar splanchnic nerve fibers originate at T11 to T12. Parasympathetic innervation originates at S2 to S4 and is carried by the pudendal nerves. Afferent fibers follow both the sympathetic and para-

sympathetic pathways. Somatic afferents are carried by the pudendal nerves to the sacral spinal cord. Efferent sympathetic stimulation relaxes the bladder muscle fibers and causes contraction of the involuntary internal bladder sphincter. Parasympathetic stimulation contracts the bladder muscle fibers and relaxes the internal sphincter. Additionally, the external (striated) bladder sphincter is under voluntary control through the somatic fibers of the pudendal nerves originating at S2 to S3. Although bladder function is mainly under autonomic control, there is voluntary control through descending pathways originating in suprapontine centers. Therefore, micturition and urine storage can be altered not only by lesions at various levels of the spinal cord but also by cerebral lesions.

## Prostate and Seminal Vesicles

The prostate gland has a strong fibromuscular component and normally weighs approximately 20 g. It is surrounded by a thick fibrous capsule and is located just beneath the bladder, behind the pubic symphysis, anterior to the rectum. The prostate contains





**FIGURE 60-2.** **A.** Gross anatomy of the bladder and the prostate. **B.** Autonomic and sensory nerve supply. (From Bonica JJ. Management of Pain. Philadelphia: Lea & Febiger, 1990, with permission.)

the prostatic portion of the urethra, which is approximately 2.5 cm long. The prostate can be seen as composed of five lobes (anterior, posterior, median, right lateral, left lateral). An alternative classification divides the prostate into a peripheral zone, a central zone, a transitional zone, an anterior segment, and a preprostatic sphincteric zone. The transitional zone is the closest to the urethra and is the zone where symptomatic prostatic adenomas usually are located.

Blood supply to the prostate derives from the inferior vesical arteries and drains into the prostatic venous plexus, which is in continuity with the vesical plexus and the dorsal vein of the penis. The prostate receives efferent sympathetic nerve supply from T11 through L2 through the hypogastric plexus and parasympathetic afferent fibers that run through the pelvic splanchnic nerves to reach S2 through S4 (Fig. 60-2).

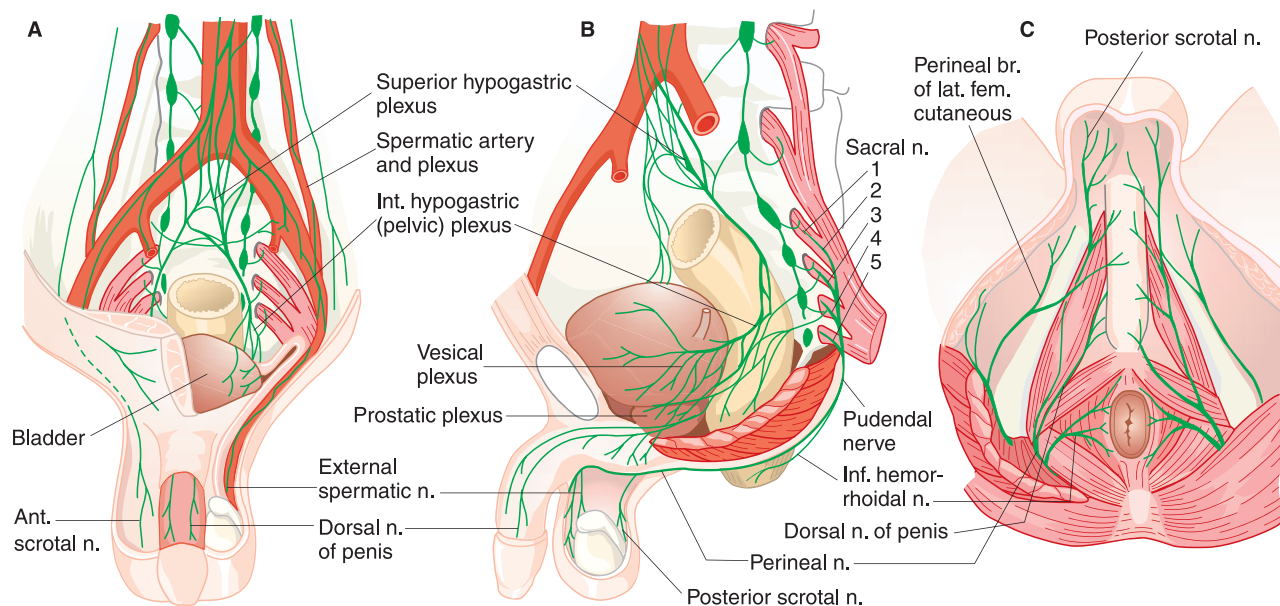
The lymphatic circulation of the prostate drains into the hypogastric, sacral, and external iliac lymph nodes.

The seminal vesicles are located under the base of the bladder, immediately above the prostate, anterior to the rectum. They join the ipsilateral vas deferens, forming the ejaculatory duct, which then perforates the prostate to empty into the prostatic urethra. The blood, nerve, and lymphatic distribution are in common with the prostate.

### Testes

The testicle is separated by connective tissue into approximately 250 lobules. It is covered by a dense fascia called the *tunica albuginea*, which is invaginated posteriorly and forms the mediastinum testis. The testicle is capped by the epididymis, composed of a convoluted tubule connected to the testis through the efferent ducts and, at its other end, continues in the vas deferens. The latter continues its ascent within the spermatic cord together with spermatic arteries and the venous pampiniform plexus. As a result of its embryogenesis near the kidneys, the blood and nerve supply of the kidneys and testicles are closely associated.

The arteries of the testicle originate from the aorta, below the renal arteries, and reach the testes after running near the ureters then through the spermatic cord. The venous blood ascends the spermatic cord through the pampiniform plexus, which forms the spermatic vein at the internal inguinal ring. The spermatic vein then drains into the vena cava on the right side and into the left renal vein on the left side. The testicular nerve supply originates at T10 and reaches the testis after joining the aortic plexus, located near the kidney. The anterior scrotum is supplied by the ilioinguinal nerve and by the genital branch of the genitofemoral nerve, with fibers originating from T12 through L2. The posterior face of the scrotum is supplied by fibers that originate at S1 through S4 and travel through branches of the perineal nerve and of the posterior femoral cutaneous nerve. Regional anesthesia for testicular surgery requires blockade up to the T10 level. The testicular lymphatic circulation drains into the lumbar nodes, which are con-



**FIGURE 60-3.** Gross anatomy and nerve supply of the male genitalia. **A.** Anterior view. **B.** Sagittal view. **C.** Transperineal view. (From Bonica JJ. Management of Pain. Philadelphia: Lea & Febiger, 1990, with permission.)

nected with the mediastinal nodes. The scrotal lymph circulation drains into the superficial inguinal and subinguinal nodes.

### Urethra and External Genitalia

The penis is composed of the corpus spongiosum, which contains the urethra, and two corpora cavernosa. Each of these elements is contained in the tunica albuginea. They are distally capped by the glans and proximally attached to the pelvic bone. Arterial blood supply to the penis is delivered by the two deep internal pudendal arteries, which divide in the deep artery of the penis, the dorsal artery, and the bulbourethral artery. Venous blood runs through the superficial and deep dorsal vein of the penis, which reaches the internal pudendal vein through the pudendal plexus. The ilioinguinal nerve innervates the root of the penis, whereas the body and glans are supplied by the paired dorsal nerves of the penis, a continuation of the pudendal nerves (Fig. 60-3). Parasympathetic and sympathetic innervation originate from S2 through S4 and from L1 to L2, respectively. Erection is promoted by parasympathetic stimulation that causes arterial vasodilatation.

The female urethra is much shorter than that of the male and is located between the pubic symphysis and the vagina. Its arterial supply derives from the inferior vesical, vaginal and internal pudendal arteries, whereas venous

blood drains into the internal pudendal veins.

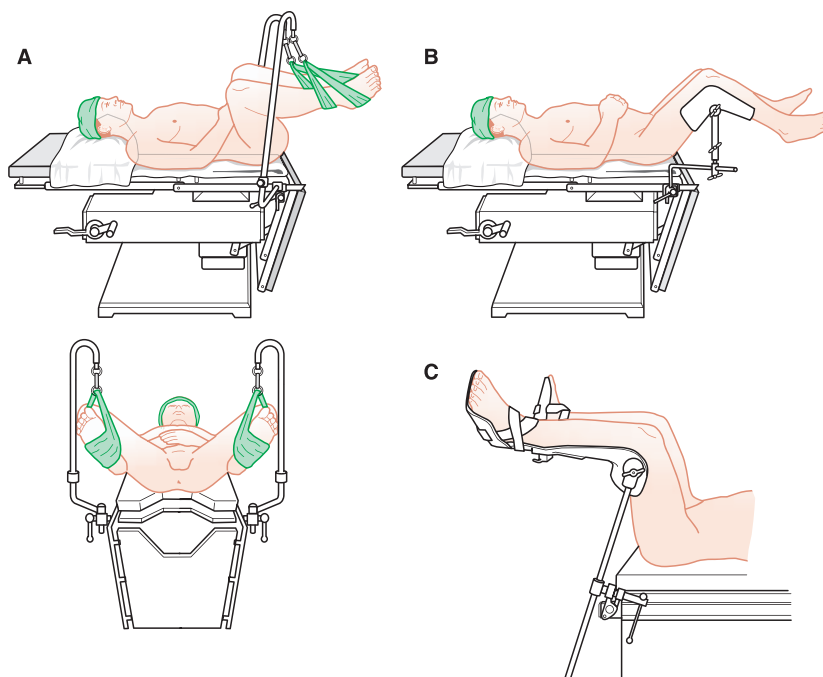
### PATIENT POSITIONING IN UROLOGIC SURGERY

Patient positioning often is complex during urologic surgery, and some of the positions adopted may result in

important complications such as nerve injury and rhabdomyolysis. The anesthesiologist must have detailed knowledge of these positions and their consequences in order to avoid significant morbidity.

### Lithotomy Position

The lithotomy position (Fig. 60-4) is used particularly for patients undergoing



**FIGURE 60-4.** Lithotomy position. **A.** Strap stirrups. **B.** Bier-Hoff stirrups. **C.** Allen stirrups. (Modified and reprinted from Martin JT. Positioning in Anesthesia. Philadelphia: WB Saunders, 1988, with permission from Elsevier.)

transurethral procedures, for bulbar urethral reconstructions, and occasionally for transperineal prostatectomy. In the lithotomy position, the patient is supine and the lower extremities are flexed at the hips and knees. The leg rest of the operating table is lowered. In the standard position, the hips are flexed approximately 90° and the legs are parallel to the floor. In the low lithotomy position, the hips are flexed only 30–45°, and in the extreme position the legs are extended and the hips are flexed on the trunk with the goal of having the perineal floor almost parallel to the ground. A variety of leg and foot supports are used, including ankle straps, boot supports, and knee supports. The lithotomy position often is associated with a degree of head-down tilt to increase perineal exposure.

The lithotomy positions have physiologic consequences on both the respiratory and cardiovascular systems. The increased intraabdominal pressure and the cephalad shifting of abdominal contents decrease chest wall and lung compliance, functional residual capacity, and vital capacity. The head-down position enhances these effects. Hypoxemia due to atelectasis may be observed. Although it is often said that both the head-down position and leg elevation increase venous return, cardiac output, and left ventricular work, little evidence indicates that these positions affect cardiac output.<sup>1</sup> Increases in arterial blood pressure are more likely caused by increased systemic vascular resistance.

Lower extremity neuropathies have been reported after surgery in the lithotomy position. In a prospective study of 991 patients, Warner et al.<sup>2</sup> reported a 1.5% incidence of neuropathy. All neuropathies were sensory only and resolved within 6 months. Placement in the lithotomy position for more than 2 hours was a risk factor for neuropathy in this study. Additionally, the onset of symptoms was within 4 hours of the end of the surgery, suggesting intraoperative factors may have been important. In a retrospective analysis of 1170 patients, Gumus et al.<sup>3</sup> reported 12 (1.02%) cases of neuropathy, of which only two were reversible. Older age and operative time were risk factors. Compression of the superficial peroneal nerve<sup>2</sup> on leg support, strain of the obturator and lateral femoral cutaneous nerves, and stretching of the sciatic plexus probably contribute to the genesis of postop-

erative neuropathies in the lithotomy position. An American Society of Anesthesiologists (ASA) task force recommended that, during lithotomy, hip flexion >90° be avoided to limit sciatic and femoral neuropathy.<sup>4</sup>

Back pain is reported as a relatively common complication of the lithotomy position, probably caused by the loss of lumbar lordosis in susceptible patients. Finger injury from trapping in the operative bed is possible when the leg rest of the operating table is lowered. “Well leg” compartment syndrome with rhabdomyolysis is considered an unusual but severe complication of lithotomy position. In a survey of 261 urologists, 61 cases of compartment syndrome were reported, the majority following radical cystectomy and procedures lasting longer than 4 hours.<sup>5</sup> These results suggest that this complication may be more severe than initially thought. Prolonged surgery, extreme lithotomy, and compressive leg supports seem to predispose to the development of compartment syndrome. The genesis of this complication seems to be related to a decrease in arterial pressure in the lower extremity, which, combined with an increased pressure in the muscle compartments, results in muscle hypoperfusion, ischemia, and subsequent swelling. Arterial pressure is decreased by leg elevation, and the change can be dramatic in hypotensive patients. At the same time, the use of leg or calf supports increases muscle pressure significantly, as opposed to ankle supports, which do not increase muscle pressure.<sup>6,7</sup> When hypoperfusion is prolonged, compartment syndrome may occur. Awareness of this complication in the postoperative period should prompt careful observation of the patient's lower extremity for swelling, hypoperfusion, and paresthesias, because loss of peripheral pulse is a late sign of compartment syndrome. Acute renal failure may result if fasciotomies are not performed in a timely manner. Well-padded leg or ankle supports will help prevent this complication during prolonged surgery.

### Head-Down Position

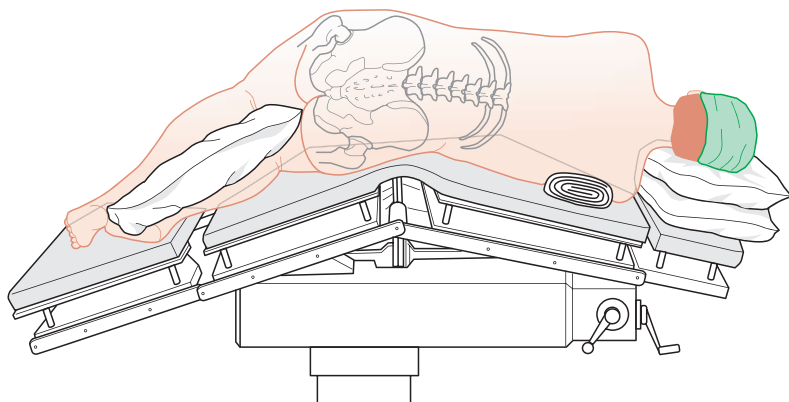
The head-down, Trendelenburg position is often used in urologic surgery to improve perineal exposure or facilitate lower abdominal laparoscopy. This position has physiologic consequences, particularly when a pro-

nounced head-down posture is adopted. Cephalad shifting of abdominal viscera limits diaphragmatic excursion, reduces lung volumes, and predisposes to atelectasis. Blood pooling in the upper part of the body increases intracranial pressure and should be avoided in patients with intracranial space occupying lesions.<sup>8</sup> Although this position has long been used to treat hypovolemia, its hemodynamic consequences are far from clear. It has long been assumed that venous return and cardiac output increase in the head-down position. However, the amount of blood shift from the lower extremities to the central circulation seems to be minimal in this position.<sup>9</sup> Sibbald et al.<sup>10</sup> demonstrated no beneficial hemodynamic effects in a study of critically ill patients with hypotension. The head-down position may predispose patients to venous air embolism, a complication occasionally reported during urologic procedures.<sup>11</sup> With pronounced head-down positioning, shoulder braces are often used to prevent downward displacement of the patient. Use of these devices has been associated with brachial plexus injuries.<sup>12</sup> This complication may result from increased stretching of the brachial plexus by the brace, particularly when the shoulder is simultaneously abducted.<sup>13</sup> Based on these considerations, an ASA task force has discouraged use of these devices.<sup>4</sup> When a shoulder brace cannot be avoided, the arms should not be abducted and should be left resting at the sides of the patient to avoid brachial plexus stretching.

### Lateral Position, Flexed Position, and Kidney Rest

In order to facilitate access to the kidney, a lateral position with flexion and kidney rest elevation is often used (Fig. 60–5). The patient is placed on the side with the dependent iliac crest on the break point of the table, where the kidney rest is located. The table top is angled approximately 30°, and the kidney rest is then elevated to raise the lower iliac crest and enhance exposure of the non dependent flank. An “axillary roll” is placed between the upper chest and the table to prevent brachial plexus compression. The dependent leg is flexed at the knee, while the other leg is left extended, to stabilize the patient on the table. Alternatively, a “bean bag” can be used.





**FIGURE 60-5.** Kidney rest position commonly used for renal surgery. (Modified and reprinted from Martin JT. Positioning in Anesthesia. Philadelphia: WB Saunders, 1988, with permission from Elsevier.)

Similar to other types of lateral positioning, this position may have effects on respiratory physiology, with dependent atelectasis and maldistribution of the ventilation/perfusion ratio. Hemodynamic consequences of the kidney position include decreased systemic arterial pressure, cardiac output, and renal arterial pressures. These changes have been specifically ascribed to the kidney position because they have not been detected in nonflexed lateral positions. Although the exact mechanism of these hemodynamic effects is not clear, decreased blood flow in the vena cava due to its compression and stretching is likely. Additionally, the right heart is placed at a higher level than the lower extremities in this position, a position that could transiently reduce venous blood flow. When this position is used, one should be aware of its hemodynamic effects. Hypotension should be promptly treated with fluid and, if severe, with immediate decrease of flexion.

Compartment syndrome and rhabdomyolysis have been reported with the nephrectomy position, likely related to excessive compression of the gluteal compartment.<sup>14</sup>

### Hyperextended Supine Position

This position is commonly used during retropubic prostatectomy to improve access to the pelvic organs (Fig. 60-6). The patient is supine with the iliac crests placed over the break of the operating table, which is then extended to increase the distance between the iliac crest and the ribs. The patient usually is placed in a head-down position, maintaining the operative field parallel to the floor. For thoracoabdominal incisions, the patient is placed in a

semisupine position with the shoulder on the operative side raised by a roll to approximately 30°, and the ipsilateral arm placed on an armrest. The nonoperative leg is semiflexed, while the contralateral leg is kept extended.

When the patient is placed in hyperextended position, nerve and back injuries are possible but probably are relatively rare. Similar to any head-down position, the hyperextended position has the potential for venous air embolism, which should be considered in case of otherwise unexplained hemodynamic instability.<sup>11</sup>

## ENDUROLOGIC PROCEDURES

### Cystoscopy and Transurethral Resection of Bladder Tumors

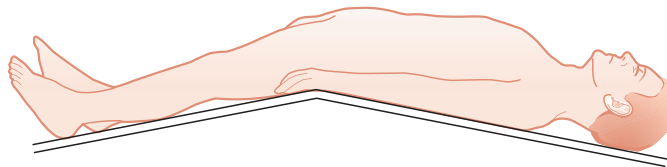
Cystoscopy and transurethral resection of bladder tumors are among the most common urologic procedures performed, particularly in the elderly population. These procedures are most commonly used to diagnose and resect bladder tumors in patients who have hematuria or voiding disturbances. Cystoscopy also is used to evaluate and treat other causes of urinary obstruction, to place ureteral stents, and to remove bladder and ureteral stones. Depending on the purpose of the pro-

cedure, the urologist may use either a rigid or a flexible cystoscope.

### Complications

**Bladder Perforation** Perforation of the bladder is one of the most serious complications of cystoscopy. It occurs more often as an extraperitoneal tear and, in this case, manifests as poor return of irrigation fluid. Patients who are conscious may complain of nausea and lower abdominal pain. When an intraperitoneal rupture occurs, alert patients may have diffuse abdominal pain. In patients who are undergoing general anesthesia, bladder perforation may present only as hemodynamic instability. High irrigation pressures can predispose to perforation by overdistending the bladder. The onset of obturator reflex can also predispose to bladder perforation. Obturator nerve stimulation by the electrocautery may provoke adduction and extrarotation of the thigh, which may cause perforation of the bladder by the cystoscope. The most reliable ways to prevent the obturator reflex are either by delivering general anesthesia and muscle relaxation or by performing a nerve block of the obturator nerve.

**Autonomic Hyperreflexia** Autonomic hyperreflexia is a life-threatening hypertensive emergency that may occur in patients with spinal cord injuries above the sixth thoracic vertebra. Up to 85% of patients with this type of lesion have symptoms of autonomic hyperreflexia, and with significantly improved survival from spinal cord injury, an increasing number of patients with autonomic hyperreflexia present for procedures. This syndrome is particularly frequent in spinal cord injury patients who undergo urologic procedures, particularly cystoscopy, because bladder overdistension is the most common trigger. In addition to surgical procedures, rectal impaction, intercourse, and labor and delivery can trigger this syndrome. Afferent stimu-



**FIGURE 60-6.** Hyperextended supine position commonly used for prostate and bladder surgery to facilitate pelvic exposure. (Modified and reprinted from Skinner DG, Lieskovsky G. Diagnosis and Management of Genitourinary Cancer, Philadelphia: WB Saunders, 1988, with permission from Elsevier.)

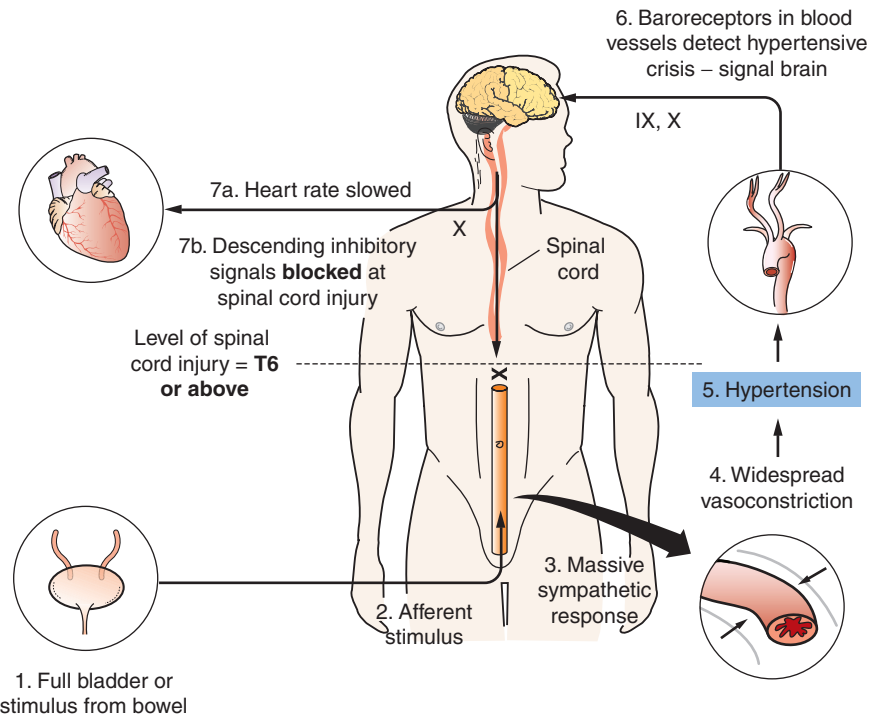


lation from the bladder and, less frequently, from the rectum and lower extremities ascends to the brain through the spinothalamic tract and dorsal columns. Interneurons project to sympathetic neurons between T5 and L2, causing reflex vasoconstriction, visceral contraction, and piloerection. Normally, these reflexes are inhibited by higher nervous centers and by control mechanisms originating in the carotid and aortic baroreceptors. However, in patients with a high spinal cord injury, inhibitory efferents cannot reach the thoracic sympathetic neurons, and the response to stimulation from the lower body cannot be modulated, resulting in uncontrolled vasoconstriction that can have catastrophic consequences if not corrected in a timely manner (Fig. 60–7). Hypertension can be dramatic, although an increase in blood pressure of only 50 mm Hg is required to diagnose autonomic hyperreflexia.<sup>15</sup> The clinical manifestations of autonomic hyperreflexia are headache, chest tightness, and piloerection (“gooseflesh”) in the body below the level of the lesion. Above the lesion, flushing, sweating, mucous membrane congestion, and conjunctival erythema due to a parasympathetic response to the hypertension are visible. For the same reason, bradycardia usually is observed.

Other than early recognition, there is no definitive recommendation guiding the management of autonomic hyperreflexia. When possible, moving the patient to the sitting position may provoke an orthostatic decrease in blood pressure. Antihypertensive drugs with rapid onset and short duration of action should be chosen. Calcium channel blockers such as nifedipine and nicardipine, hydralazine, nitroglycerine,  $\alpha$ - and  $\beta$ -blockers, and sodium nitroprusside usually achieve rapid blood pressure control.<sup>15</sup> Magnesium infusion also has been reported effective in controlling hypertension in autonomic hyperreflexia.<sup>16</sup>

### Anesthetic Management

The choice of anesthetic technique for cystoscopy depends on patient sex, age, medical condition, and type of procedure performed. Female patients are more likely to tolerate topical anesthesia for diagnostic studies. Males more often require regional or general anesthesia, particularly for operative procedures. Subarachnoid (spinal) an-



**FIGURE 60–7.** Mechanisms of autonomic hyperreflexia. In patients with spinal cord injury above T6, stimulation from the lower body triggers a sympathetic response that cannot be controlled by descending inhibitory efferents. Hypertension is accompanied by bradycardia caused by vagal response. (Blackmer J. *Rehabilitation medicine: 1. Autonomic dysreflexia.* CMAJ 2003;169:931–935, by permission of the publisher. © 2003 CMA Media Inc.)

esthesia is popular for endourologic procedures. The patient population is older and has multiple comorbidities. A common perception is that regional anesthesia affords better hemodynamic stability and potentially avoids cardiovascular complications compared with general anesthesia. However, no outcome studies have shown a significant difference in morbidity or mortality between regional and general anesthesia for cystoscopy. Indications for regional versus general anesthesia are clear for only a few circumstances. General anesthesia may be required for resections performed in the area of the obturator nerve. Patients who are prone to autonomic hyperreflexia may benefit from a neuraxial anesthetic, which can block the transmission of afferent impulses and prevent triggering of uncontrolled reflex vasoconstriction. However, performing a neuraxial block can be difficult in patients who have spinal deformities.

Most endourologic procedures are of short duration and are performed in an outpatient setting. The choice of anesthetic technique should be directed at allowing rapid onset and emergence and early discharge from the recovery room. Even though most urologic patients are elderly, these goals can be

achieved when appropriate anesthetic decisions are made. Whether the choice between regional and general anesthesia has an effect on the time of recovery and discharge is not clear. With general anesthesia, avoidance of muscle relaxation and relatively rapid induction can be accomplished with a laryngeal mask airway. The choice of inhaled anesthetic agent may have a role in achieving rapid recovery times. In a randomized controlled study of elderly patients undergoing short urologic procedures, significantly more patients reached criteria for postanesthesia care unit bypass when desflurane was used as a maintenance agent compared with isoflurane.<sup>17</sup> When spinal anesthesia is chosen, the anesthetic agent should allow rapid resolution of motor block with early ambulation and discharge. Lidocaine has been the drug of choice for these procedures for many years. The recent demonstration of an association of lidocaine with postoperative neurologic symptoms has decreased the appeal of this drug. Transient neurologic symptoms (TNS) is a spectrum of symptoms, characterized by pain and dysesthesia in the lower extremity after spinal anesthesia, that usually resolves within 72 hours. Although this complication is

transient and is not associated with abnormal nerve function by electromyography,<sup>18</sup> it causes significant patient discomfort and some functional impairment in a small percentage of patients.<sup>19</sup> TNS initially was observed after spinal anesthesia using 5% lidocaine, but the incidence of this complication is similar when either 5% or 1% lidocaine is used.<sup>19</sup> Alternative drugs and doses to achieve rapid resolution of spinal anesthesia for urologic surgery without using lidocaine have been investigated. Kuusniemi et al.<sup>20</sup> randomized 80 patients undergoing various urologic procedures to receive bupivacaine at different doses with or without the addition of intrathecal fentanyl. In this study, 5 mg bupivacaine with fentanyl 25 mg achieved a comparable block level (higher than T7) and similar anesthetic quality with shorter lasting motor block compared to 10 mg plain bupivacaine.<sup>20</sup>

## Transurethral Resection of the Prostate

### Preoperative Considerations

Benign prostatic hyperplasia (BPH) is the most common benign tumor in males. Its prevalence is age related and reaches 90% in men older than 80 years.<sup>21</sup> BPH develops in the transition zone, the part of the prostate closest to the urethra, and is histologically characterized by increased cellularity in a nodular pattern.<sup>21</sup> Not all patients with an enlarged prostate are symptomatic. The extent of symptoms is affected by the size of the gland, the extent of intrusion into the urethra, and the effect of  $\alpha$ -adrenergic tone. The presence of symptomatic BPH significantly affects quality of life and, if left untreated, predisposes to frequent urinary tract infections, development of bladder diverticula, and hydronephrosis and may cause nonreversible renal damage.

Patients with mild symptoms can be managed with watchful waiting because some patients improve spontaneously.<sup>21</sup> Pharmacologic treatment with selective and nonselective  $\alpha$ -blockers and with 5- $\alpha$ -reductase blockers is effective in patients with more significant symptoms. Both classes of drugs are more effective than placebo in improving lower urinary tract symptoms and, when used in combination, slowed the progression of disease and reduced the need for surgery.<sup>22</sup> Surgical treatment is chosen in

patients who do not respond to medical therapy. Open prostatectomy has the highest success rate in increasing urinary flow, but it also has the highest rate of complications and is performed in only 5% of cases.<sup>21</sup> Transurethral resection of the prostate (TURP) currently is considered the gold standard for prostate resection, reducing symptoms in 88% of cases. However, it has a small but significant risk of morbidity and mortality, including 5–10% risk of sexual dysfunction. Minimally invasive therapies for BPH have been recently introduced. These approaches include transurethral needle ablation (TUNA), transurethral microwave therapy, and interstitial laser therapy.<sup>23</sup> All these techniques use high energy to heat the prostate and cause tissue necrosis. Minimally invasive therapies are advantageous for older men for whom TURP has a considerable perioperative risk and for young patients who are sexually active. Minimally invasive therapy improves symptoms and quality of life without requiring general or neuraxial anesthesia or hospitalization. However, these techniques have a higher rate of recurrence of obstruction and of reoperation, compared with TURP. For these reasons, minimally invasive BPH treatment cannot yet be considered a replacement for TURP.

### Complications

Mortality from TURP is estimated between 0.1% and 0.2%, with a reported morbidity of 9.5%. Postoperative morbidity is related to patient age, operative time, and amount of tissue resected.<sup>24</sup> Patients undergoing TURP usually are of advanced age and have multiple risk factors for cardiovascular, respiratory, and renal morbidity.

**TURP Syndrome** TURP is performed by resecting prostatic tissue using a cautery loop introduced through a special cystoscope. Bladder distension with irrigation fluid is required. During the resection, venous sinuses are opened, and the irrigation fluid can be absorbed into the systemic circulation. As a result, a complication known as *TURP syndrome* may develop. TURP syndrome is potentially fatal. It has multiple manifestations, characterized by fluid overload, hyposmolality, hyponatremia, and neurologic disturbances. The reported rate of TURP syndrome is between 2% and 10%.<sup>25</sup>

Asymptomatic hyponatremia has been observed in 50% of patients undergoing TURP.<sup>26</sup>

Onset of TURP syndrome may occur as early as 15 minutes after the beginning of the procedure, but later onset has been observed. The syndrome may be due to fluid absorption through the peritoneal and retroperitoneal space. Delayed-onset TURP syndrome due to bladder rupture and transperitoneal fluid absorption has been reported after cystoscopy.<sup>27</sup>

Clinical signs of fluid overload include hypertension and reflex bradycardia. Patients with poor cardiac reserve are more likely to present with heart failure and pulmonary edema. In patients under general anesthesia, signs of fluid overload may be the only hint of the occurrence of TURP syndrome. Neurologic manifestations are common during TURP syndrome and in patients under regional anesthesia may be the first signs and allow early diagnosis. Otherwise, they may be observed at emergence (Table 60–1).

The manifestations of TURP syndrome depend on the type and amount of fluid absorbed. Fluid absorption is difficult to control but seems to be related to the duration of the procedure, number of vascular spaces opened, hydrostatic pressure in the bladder,<sup>28</sup> and elevation of the irrigation fluid container above the patient level. Regional anesthesia may increase the absorption of irrigation fluid compared to general anesthesia with mechanical ventilation because of lower bladder pressures when spontaneous breathing is maintained.<sup>29</sup> The irrigation fluid is chosen based on its electrical conductivity. Electrolyte solutions disperse cautery current and cannot be used for TURP, although they would be better tolerated in case

TABLE 60–1.

Signs of Transurethral Resection of the Prostate Syndrome

Awake Patient	Anesthetized Patient
Confusion	Hypertension
Nausea	Bradycardia
Visual loss	Electrocardiographic changes
Coma	Desaturation
Seizures	Delayed emergence

of systemic absorption. Distilled water was commonly used in the past and was associated with the highest morbidity. Absorption of significant amounts of distilled water leads to intravascular hemolysis and pronounced hyposmolality, causing acute renal failure and cerebral edema. The cerebral edema is severe because intracellular compensation mechanisms do not have time to act. Nausea, restlessness, confusion, coma, seizures, and hemispheric herniation may occur.

Since the adoption of alternative irrigation fluids, the incidence of TURP syndrome has decreased by 50%.<sup>30</sup> Solutions with near-physiologic osmolality, such as 1.5% glycine and 2.7% sorbitol with 0.54% mannitol are now routinely used. Plain sorbitol, mannitol, dextrose, and urea solutions also can be used. The osmolality of these solutions ranges from 195 mOsm/L to isotonic. Because some of these fluids are relatively hypotonic, plasma hyposmolality still may occur when irrigation fluid is absorbed in large amounts. Neurologic manifestations still may occur, even when serum osmolality is not significantly affected. It is commonly thought that hyponatremia is the main cause of the neurologic manifestations of TURP syndrome. However, low sodium levels do not cause cerebral edema if serum osmolality is maintained. Additionally, nerve conduction and transmembrane potentials are little altered, even in the presence of significant hyponatremia.<sup>31</sup> Direct toxic actions of some of the solutes used in irrigation fluids have been implicated. Glycine is the likely causative agent of postoperative blindness and seizures observed in some TURP patients. Variable but extremely elevated glycine blood levels have been observed in patients with neurologic symptoms of TURP syndrome. Glycine is an inhibitory neurotransmitter in the cortex and retina. In patients who have visual impairment after TURP, the pupillary reflexes often are sluggish or absent, unlike cortical blindness where reflexes are maintained. This finding suggests that the mechanism of blindness in these patients is direct inhibition of retinal potential transmission. Blindness resolves with decreasing blood levels of glycine.

Glycine metabolism in the liver produces ammonia. Hyperammonemia has been observed after TURP with glycine solutions and can be prevented

by intravenous administration of L-arginine. However, whether hyperammonemia has a significant role in the genesis of TURP syndrome is not clear.

Absorption of sorbitol can result in the development of hyperglycemia and lactic acidosis related to sorbitol metabolism.<sup>32</sup> Metabolic acidosis has been reported in patients who absorbed a significant amount of irrigation fluid during TURP. This effect was related to a decrease in the strong ion difference, as a result of relative dilution of sodium chloride, and plasma protein.<sup>33</sup> Although acidemia was modest in this study, a more significant disturbance may develop following absorption of higher volumes of fluid.

Management of TURP syndrome should rely on a high level of suspicion, especially when the patient is unconscious (Table 60–2). No monitors of irrigation fluid absorption are clinically available. Adding ethanol to the fluid and measuring its expired concentration enables detection and quantification of irrigation fluid absorption,<sup>34</sup> but this tool has not found wide use outside of clinical research. Hemodynamic changes that cannot be otherwise explained may be the only available clues. Once TURP syndrome is suspected, the procedure should be stopped. Serum sodium and potassium levels and measured osmolality should be obtained. The latter value is essential to distinguish between true hyposmolality and hyponatremia in the presence of circulating solutes such as glycine. Hemoglobin measurement should be obtained because it is an index of the extent of fluid absorption. Although rare, hemoglobinuria can occur even

with glycine irrigant absorption and should be ruled out by urinalysis.

Hyponatremia need not be treated aggressively when it is not accompanied by hyposmolality or when it occurs in the absence of neurologic symptoms. If hyponatremia must be treated, rapid correction should be avoided because it can cause pontine myelinolysis. Hypertonic saline should be used only in the presence of life-threatening manifestations such as coma and seizures. Otherwise, sodium levels can be increased by administration of normal saline in combination with a loop diuretic or mannitol. Sodium correction should never exceed a rate of 1–1.5 mEq/L/h. A diuretic also is used to treat fluid overload. Patients who had bladder perforation may have signs of hypovolemia due to transperitoneal loss of sodium and may require volume resuscitation.<sup>27</sup>

**Myocardial Ischemia** A relatively high frequency of myocardial ischemic events has been observed in TURP patients. Wong et al.<sup>35</sup> reported an 18% rate of ST-segment changes during the immediate postoperative period in patients undergoing TURP. Edwards et al.<sup>36</sup> observed a 26% rate of ischemic electrocardiographic (ECG) changes in patients undergoing TURP. The clinical relevance of these studies is unclear, and whether these ECG changes are associated with worsened clinical outcomes is not certain. The rate of ischemic events was greater in patients with increased risk factors for myocardial ischemia, suggesting that the high rate of comorbidities and the advanced age of the patient population contrib-

TABLE 60–2.

## Management of Transurethral Resection of the Prostate Syndrome

Inform surgeon	Consider ventilatory support if severe pulmonary edema
Stop procedure	Consider invasive hemodynamic monitoring if severe heart failure
Obtain electrolytes, arterial blood gases, hemoglobin, measured serum osmolality	Monitor electrolytes q1h
Support breathing and circulation	Limit sodium correction to < 1.5 mEq/L/h
Treat fluid overload	Maintain negative fluid balance in patients with fluid overload
If symptomatic hyposmolality:	Consider hemodialysis/ultrafiltration in symptomatic patients with poor urine output
Start 0.9% normal saline infusion	
Administer furosemide and/or mannitol	
In patients with convulsions or coma:	
Give hypertonic saline	

ute to the higher rate of myocardial ischemia during and after TURP.

**Other Complications** The risk of bleeding is related to prostate size and duration of resection. Estimation of intraoperative blood loss has been reported between 3 and 5 mL/min.<sup>37</sup> Blood for possible transfusion should be promptly available for patients with a very enlarged prostate. The amount of bleeding probably is not affected by the type of anesthesia.<sup>38</sup> Coagulopathies have been observed in 6% of patients undergoing TURP.<sup>39</sup> Disseminated intravascular coagulation arises occasionally, probably as a result of thromboplastin release by prostatic tissue.<sup>37</sup> Bladder perforation during TURP is possible, and its clinical aspects have been discussed in the section on Cystoscopy and Transurethral Resection of Bladder Tumors.

### Anesthetic Management

Neuraxial anesthesia probably is the anesthetic technique most commonly used for TURP and is preferred over general anesthesia. However, a paucity of data supports a specific anesthetic choice. Given the low mortality of this procedure, it is highly unlikely that an effect of anesthesia on outcome can be demonstrated. No association between anesthetic technique and morbidity of TURP has been reported. Although patients undergoing TURP have an increased risk of myocardial ischemia by ECG changes, the choice of regional versus general anesthesia did not affect the rate of this complication in a randomized study by Edwards et al.<sup>36</sup> Choosing a particular anesthetic technique may have an effect on outcomes such as patient satisfaction, postoperative pain and comfort, and discharge times. However, no data suggest that anesthetic choices affect these variables. In a matched cohort study of 267 patients undergoing TURP, the choice of general or regional anesthesia had no effect on the length of recovery room stay or on patient satisfaction with analgesia.<sup>40</sup> Therefore, TURP likely can be safely performed under either general or regional anesthesia. However, several theoretical advantages to regional anesthesia make it appealing for use with this procedure. Onset of the TURP syndrome can be recognized from its neurologic symptoms, and bladder perforation can present with

abdominal or shoulder pain if the patient is allowed to remain awake. Earlier recognition of these complications may allow interruption of the procedure and early treatment, which theoretically may translate into better outcome. Regional anesthesia may be associated with less blood loss than general anesthesia.<sup>41</sup> This effect has been attributed to the lower venous pressure during spontaneous breathing than during mechanical ventilation. However, a similar reduction of venous pressure can be obtained during general anesthesia if spontaneous breathing is allowed.

There is speculation that anesthesia depresses the immune system and predisposes to nosocomial infection and, in oncologic patients, to cancer recurrences. In patients undergoing TURP, a randomized controlled trial showed that spinal anesthesia and general anesthesia had opposite effects on T-helper lymphocyte populations, an effect that may suggest less immunosuppression with spinal anesthesia.<sup>42</sup> The clinical significance of these results is unclear.

Regional anesthesia may help reduce the incidence of deep vein thrombosis (DVT) after prostatectomy, but there is no evidence of this effect following TURP.

When general anesthesia is chosen, avoidance of muscle relaxation and relatively fast times of induction can be accomplished with a laryngeal mask airway. Although patients undergoing TURP usually are older and have significant comorbidities, a significant portion of these patients may have relatively short recovery times after general anesthesia, particularly if short-acting anesthetic agents are used.<sup>17</sup>

When a regional anesthetic technique is chosen, subarachnoid anesthesia usually is preferred to epidural for TURP because it allows better relaxation of the pelvic floor and reliable anesthesia of the sacral roots. Blocks higher than T9 are generally avoided because they do not allow the perception of pain due to rupture of the prostatic capsule, whereas a T10 level of sensory loss is required to avoid the sensation resulting from bladder distension from the irrigation fluid. Bladder sensation is conducted by sympathetic afferent fibers of the hypogastric plexus, which originate from T11 through L2. Lower-level blocks are possible as long as bladder pressure is

monitored and maintained at a low level. Beers et al.<sup>43</sup> showed that a level higher than L1, obtained with intrathecal hyperbaric bupivacaine 7.5 mg, is acceptable as long as bladder pressure is monitored and maintained below 15 mm Hg. This level of block had the advantage of less decrease in blood pressure and may be considered in patients with significant hemodynamic compromise. Monitoring bladder pressure is cumbersome and may not be convenient. An alternative approach to a low block is intrathecal administration of a small dose of local anesthetic together with a narcotic. In a randomized study of 45 patients undergoing TURP, administration of 4 mg intrathecal tetracaine with 10 mg fentanyl achieved a block level comparable to that of 8 mg plain tetracaine, but more hypotensive episodes occurred in the patients who received 8 mg tetracaine.<sup>44</sup> The combination of 5 mg bupivacaine with fentanyl 25 mg achieved a sensory block higher than T7 in 50% of patients anesthetized with this dose.<sup>20</sup> Adequate anesthesia for TURP also has been obtained with only 4 mg bupivacaine and 25 mg fentanyl.<sup>45</sup>

Prolonged postoperative analgesia may be beneficial after TURP as patients often complain of pain from detrusor muscle spasm. Intrathecal morphine along with a local anesthetic effectively provided postoperative pain in a trial on patients undergoing TURP.<sup>46</sup> In this study, 0.1 mg intrathecal morphine was as effective as 0.2 mg but had a lower incidence of nausea and vomiting. Compared to other types of surgical procedures, relatively small doses of intrathecal morphine seem to be effective during TURP. In a randomized controlled trial, 0.05 and 0.1 mg intrathecal morphine had similar effect in controlling post-TURP pain, but the incidence and intensity of pruritus were lower with the lower dose.<sup>47</sup> Alternative agents have been used in an attempt to avoid the side effects of intrathecal morphine, such as respiratory depression. Tramadol provides postoperative analgesia when administered epidurally.<sup>48</sup> However, compared to plain bupivacaine intrathecal tramadol with bupivacaine did not provide additional pain relief after TURP.<sup>49</sup>

### Extracorporeal Shock Wave Lithotripsy

Nephrolithiasis ranks third in frequency among the conditions affecting the



urinary tract, following infections and prostatic diseases.<sup>21</sup> The presence of urinary stones causes pain, urinary obstruction, hematuria, and infection. Although the mechanisms of formation are incompletely understood, the management of urinary stones has progressed greatly in the last 20 years. Surgical stone extraction has become an uncommon procedure, particularly since the introduction of extracorporeal shock wave lithotripsy (ESWL).

### **Preoperative Considerations and Technical Aspects**

ESWL uses acoustic shock waves to fragment stones. These waves are unharmonic and generate high-amplitude pressure oscillations that transfer impressive amounts of energy when the density of the medium changes significantly, such as at the interface between tissue and stones or between tissue and air. Stones are fragmented through erosion by cavitation forces at the entry and exit sites of the waves, and through shattering by energy absorption within the body of the stone. Application of this physical principle was developed by the German aeronautic company Dornier while studying supersonic aircraft. The Dornier HM3 lithotripter was the first commercially available machine.

Two types of shock wave generators are used clinically. Supersonic generators release high energy in a small space using a spark gap electrode, creating a small underwater explosion. The shock waves are then focused on the target stone using an ellipsoid reflector. Finite-amplitude generators create an acoustic wave by displacing a surface. This can be accomplished using piezoceramic emitters, where thousands of ceramic components placed on a spheric surface are elongated by an electric discharge, or by using electromagnetic systems, where an electric impulse displaces a metal membrane, similarly to loudspeaker woofers. An acoustic lens then focuses the waves on the target stone.

A key element of all lithotripters is the coupling that allows shock waves to progress from the site of formation to the surface of the patient's body. In waterbath models, the patient sits on a chair and is immersed in a tub full of heated water. Newer models transmit waves through a water cushion placed against the patient's skin, often with the interposition of a layer of coupling

gel. Inadequate coupling, particularly when air is entrapped between the skin and the coupling membrane, may result not only in insufficient wave transmission but also in skin ecchymosis and breakdown.

Stone localization and aiming of the shock waves can be accomplished by fluoroscopic imaging or by ultrasound. Successful stone fragmentation depends on stone size, location, and composition. Calcium oxalate dihydrate stones are generally easier to fragment than cystine and calcium oxalate monohydrate stones.<sup>21</sup> Larger stones may require percutaneous access or placement of ureteral stents prior to the procedure.

### **Complications**

**Cardiac Arrhythmias** Shock waves have the potential to trigger ventricular arrhythmias when they coincide with the repolarization period of the cardiac cycle. For this reason, ECG synchronization and shock delivery 20 ms after the R wave have been used. The onset of significant arrhythmias probably is rare, and many lithotripter models do not synchronize with ECG. Supraventricular arrhythmias may occur even with ECG synchronization.<sup>50</sup> Some machines synchronize with the respiratory cycle, to avoid loss of aim with respiratory movement of the kidney.

Shock waves occasionally inhibit or reprogram cardiac pacemakers. To avoid this complication, the patient should be positioned so that the pacemaker is not in the path of the wave. Resuscitation equipment, including an external pacemaker, should be available.<sup>51</sup>

### **Hemodynamic and Respiratory Effects**

Immersion in a waterbath can have hemodynamic effects, particularly in patients with heart failure or coronary artery disease. Increased hydrostatic pressure on the lower extremities and the abdomen may shift blood to the intrathoracic vessels, precipitating congestive heart failure in susceptible individuals. Systemic vascular resistance may increase during immersion, which could increase left ventricular work and precipitate ischemia.<sup>52</sup> Immersion in water increases intraabdominal pressure with consequent upward shifting of the diaphragm, increased work of breathing, and decreased tidal volume and arterial oxygenation.

**Renal Injury** Gross hematuria, which is the routine after ESWL, usually resolves within 1 week. Severe abdominal pain should alert for the rare presence of perinephric hematoma. Management is generally conservative but may require laparotomy in case of hypotension. A bleeding diathesis is a relative contraindication to ESWL, and coagulation times usually are checked routinely prior to the procedure.

**Other Complications** Patients with a high stone burden are prone to obstruction by fragments after ESWL. "Steinstrasse," the columnation of fragments along the ureter, may require nephrostomy drainage or endoscopic stone extraction to relieve obstruction. Fever and sepsis are possible after ESWL and are more common in patients with an infected urinary tract prior to the procedure. Pneumothorax may occur if the wave path crosses the lung and is more likely in children.

### **Anesthetic Management**

ESWL causes pain at the skin, where the waves enter the body, and at the visceral level, where the waves dissipate. Subjective pain reported by unanesthetized patients during ESWL is higher than during endoscopic urologic procedures.<sup>53</sup> The Dornier HM3 machine generates high-intensity waves and requires deeper levels of analgesia and anesthesia than required by newer models that generate lower-intensity waves and are tolerable with minimal or no analgesia. These newer machines are ideal for the ambulatory setting, although stone fragmentation may be less effective and requires longer procedure times. The goals for anesthesia are not only to provide patient comfort during and after the procedure but also to achieve rapid recovery times, as ESWL is performed as an outpatient procedure in the majority of cases. Additionally, postoperative pain usually is mild and, for these reasons, short-acting anesthetic and analgesic techniques usually are preferred.

Even after many years, the best anesthetic approach for ESWL is still a topic of debate. General anesthesia with muscle relaxation offers the advantage of optimizing stone targeting by avoiding patient movement and controlling respiration, but it is thought to prolong recovery times. Additionally, positioning of anesthetized and intubated patients in the waterbath can be complex

and presents some safety risks. For these reasons, epidural and spinal anesthesia have been widely used for ESWL. However, these techniques have longer induction times and may not accelerate recovery. Timing of recovery likely is more affected by pharmacologic choices than by the type of anesthesia delivered. A randomized comparison between epidural anesthesia with lidocaine and general anesthesia showed markedly longer recovery times in the group that received epidural anesthesia.<sup>54</sup> The results of this study may be explained by the fact that general anesthesia included the administration of propofol and nitrous oxide (N<sub>2</sub>O) and the use of a laryngeal mask airway, but no narcotics were given. Intrathecal lidocaine has been widely used for short procedures such as ESWL because of its rapidity of onset and of recovery. However, safety concerns have made the use of this technique less appealing. A possible alternative approach to the use of intrathecal local anesthetics is the injection of plain narcotics. In a randomized controlled study, intrathecal sufentanil was as effective as lidocaine in controlling pain during ESWL performed with the Dornier HM3 machine.<sup>55</sup> In this study, recovery times were strikingly shorter in the group of patients who received sufentanil compared to the group that received lidocaine. In a subsequent study, intrathecal sufentanil doses of 15–17.5 µg provided the best effectiveness/safety profile.<sup>56</sup> Intravenous analgesia and sedation with short-acting agents is widely used and presents several advantages in the ambulatory setting, particularly rapid recovery time. Deeper levels of sedation are required if high-intensity shock waves are used, and, consequently, side effects such as respiratory depression are more likely. Compared with desflurane general anesthesia through a cuffed oropharyngeal airway, sedation with propofol and remifentanil infusion was associated with more episodes of desaturation and greater narcotic requirement during ESWL performed with the Dornier HM3.<sup>57</sup> The time to discharge was no different in patients who received general anesthesia compared to those who received sedation. The success of a sedation regimen depends on the type of medication used. Use of propofol together with a short-acting narcotic is common. Remifentanil infusion is gain-

ing popularity because of the drug's rapid clearance with faster recovery times than with fentanyl and its other derivatives.<sup>58</sup> Remifentanil and sufentanil also have been used for single-agent sedation. The two drugs have similar analgesic properties, but remifentanil had lower incidences of respiratory depression and nausea than did sufentanil in a randomized controlled study.<sup>59</sup> Remifentanil infusion at 0.05 µg/kg/min with patient-controlled supplementation of 10-µg boluses has been effective in controlling pain during ESWL with a Dornier Lithotripter S machine.<sup>60</sup> No difference between infusion of remifentanyl alone and continuous infusion of propofol combined with intermittent fentanyl boluses has been reported.<sup>61</sup> In fact, patients who received remifentanil had a higher incidence of nausea and prolonged times to discharge. These results might be due to the relatively high rate of remifentanil infusion (0.2–0.4 µg/kg/min).

An alternative sedative technique for ESWL is patient-controlled sedation. Drugs with rapid onset and fast elimination allow the patient to titrate the level of sedation in the face of rapidly varying levels of discomfort. Patient-controlled sedation with remifentanil alone or with remifentanil and propofol were compared.<sup>62</sup> Both techniques had high effectiveness and comfort level; however, fentanyl with propofol had a higher incidence of respiratory depression. Remifentanil alone also had a higher incidence of nausea and vomiting, an effect that seems to be common with use of this drug and is effectively prevented by serotonin (5-HT<sub>3</sub>) antagonists.<sup>63</sup> Alternative anesthetic techniques, such as use of eutectic mixture of local anesthetics (EMLA) cream, skin infiltration with local anesthetics, and paravertebral blocks, have been proposed but are of dubious efficacy. In summary, no evidence supports any specific anesthetic choice for use with ESWL. The selection should be based on patient characteristics, machine type, and local preferences. Intravenous sedation provides adequate comfort in most patients, particularly if low-intensity waves are used. If neuraxial anesthesia is chosen, a technique that affords rapid resolution is preferred. Use of plain intrathecal narcotics is promising. Inhalation anesthesia via a laryngeal mask airway but without neuromuscular relaxants also provides good operating condi-

tions and rapid recovery in a predictable manner.

## CANCER SURGERY

### Surgery for Prostate Cancer

#### Preoperative Considerations

**Epidemiology** Radical prostatectomy is one of the most common major surgical procedures in the United States, with approximately 60,000 performed yearly. Prostate cancer is the most common cancer and is the second leading oncologic cause of death in men. The incidence increases progressively with age, has no definite peak age, and reaches 17% in men between 60 and 79 years old.<sup>64</sup> Probably as a result of prostatic-specific antigen screening and rectal examination, the mortality from prostate cancer has decreased during the last few years.<sup>65</sup> The histologic diagnosis is adenocarcinoma in 95% of cases, with most of the remaining cases being transitional cell carcinomas. The most popular grading system used for prostate carcinoma is the Gleason score, which assigns a grade to the appearance of the glandular architecture based on its level of differentiation.<sup>21</sup>

**Therapeutic Choices** Prostate cancer has a broad spectrum of activity that ranges from indolent to highly virulent. For this reason, management decisions often are difficult. The best management, particularly for patients with early localized disease, is unclear. Older patients tend to have well-differentiated cancers with a slow progression. At the same time they have significant comorbidities and increased surgical risk. Therefore, watchful waiting often is offered to this patient population. In a randomized trial, radical prostatectomy was compared to watchful waiting in a group of 695 patients with early prostate cancer.<sup>66</sup> During a 10-year followup, prostatectomy resulted in a 26% decrease in mortality and a 40% decrease in the rate of distant metastases compared to watchful waiting. However, the beneficial effects of surgery on mortality were limited to patients younger than 65 years. These results suggest that radical prostatectomy probably is the best option in this group of patients. Radical prostatectomy often is preceded by dissection of pelvic lymph nodes to stage the dis-

ease accurately. Patients with positive nodes are very likely to have distant metastases. These patients and patients with locally advanced disease are candidates for nonsurgical treatments such as endocrine therapy, radiation therapy, and chemotherapy. In patients with localized disease in whom prostatectomy is not desirable or is contraindicated, alternative forms of radiation therapy, such as brachytherapy, are becoming popular. This technique involves implanting radioactive needles or “seeds” into the prostate, guided by transrectal ultrasound.

Of the different approaches to prostatectomy, radical retropubic prostatectomy (RRP) currently is the most common. The prostate is approached through a low, midline abdominal incision. The whole prostate is removed together with the seminal vesicles, the ejaculatory ducts, and a section of the bladder neck. The bladder neck is then anastomosed to the urethra. At this stage, indigo carmine often is injected to identify the ureters. Injection of this drug can cause hypertension.<sup>67</sup> Among the long-term complications of RRP, the most frequently occurring probably is sexual dysfunction. A “nerve-sparing” prostatectomy is performed by approaching the prostate gland from the bladder side while preserving the neurovascular bundle, with the advantage of less postoperative sexual dysfunction. This procedure may result in a higher rate of cancer recurrence if extracapsular extension is present.<sup>21</sup>

Radical perineal prostatectomy is used only rarely. This technique does not allow simultaneous dissection of the perineal lymph nodes and, when performed in the extreme lithotomy position, is associated with a relatively high risk of musculoskeletal and neurologic injuries.

### Complications

**Bleeding** Hemorrhage is the most common complication and occurs more frequently with the retropubic approach. Bleeding during RRP can be substantial and is related to the operator, prostate size, anatomy, and technical factors such as division of the dorsal venous complex. Various techniques have been proposed to limit the amount of bleeding or the need for blood transfusion. Avoidance of red blood cell transfusion is desirable because of high cost, risks of immuno-

logic and infective complications, immune suppression that may predispose patients to nosocomial infections and cancer recurrence,<sup>68</sup> and its negative outcome effects.<sup>69</sup> Preoperative autologous donation (PAD) is among the most popular transfusion-sparing techniques for use with radical prostatectomy; however, its cost-effectiveness has been questioned. In particular, PAD has a high cost and does not eliminate the risk of transfusion errors. Additionally, a significant amount of PAD blood units are discarded when moderate blood loss makes transfusion unnecessary. Acute normovolemic hemodilution (ANH) has been advocated as a more cost-effective technique because it is as effective as PAD in avoiding allogenic transfusion but avoids the cost of blood storage and the waste of unused blood.<sup>70</sup> In a randomized study of patients undergoing radical prostatectomy, PAD was compared with ANH and with ANH combined with preoperative recombinant human erythropoietin administration.<sup>71</sup> The latter technique was the most effective in avoiding postoperative anemia, but the increased cost of erythropoietin eliminated the financial advantage of using ANH. Intraoperative cell salvage has been proposed as an alternative technique to PAD during radical prostatectomy because it has similar effectiveness but generally lower cost.<sup>72</sup> The concern of possibly spreading cancer cells in the circulation has limited the use of this technique. No evidence has indicated that use of cell salvage for prostatectomy affects cancer recurrence.<sup>73</sup>

### Anesthetic Management

**Monitoring** No definite recommendations guide the choice of monitoring techniques used during prostatectomy. The accuracy of central venous pressures in estimating blood volume is questionable.<sup>74</sup> The routine intraoperative use of pulmonary arterial catheters has no documented outcome benefit.<sup>75</sup> Therefore, hemodynamic monitoring should be chosen based on characteristics of the individual patient and should be directed at specific hemodynamic goals, such as optimization of cardiac output and organ perfusion. Urine output cannot be used to assess renal perfusion during prostatectomy because it is not measurable while the continuity of the urethra is

interrupted. Use of intraoperative transesophageal echocardiography (TEE) for hemodynamic and volume status monitoring may have a role in patients with renal disease.

**Anesthetic Choice** The choice of anesthesia may affect the rate of venous thromboembolism after RRP. Epidural analgesia maintained for 24 hours postoperatively significantly reduced the incidence of DVT compared with general anesthesia alone.<sup>76</sup> This effect probably is related to increased venous blood flow in the lower extremities occurring intraoperatively, detected by Doppler ultrasound.<sup>77</sup> Alternative hypotheses include local anesthetic effects on the hemostatic system, attenuation of the stress response, and direct effects on platelet aggregation and coagulation factors.<sup>78</sup>

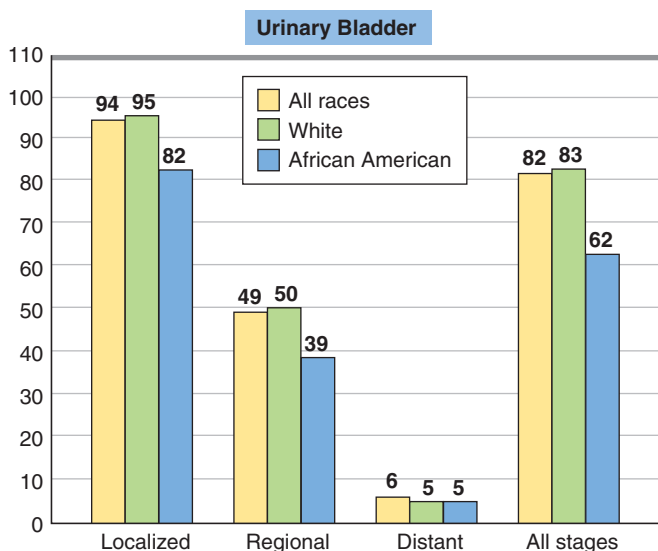
Use of epidural anesthesia, alone or in combination with general anesthesia, has been reported to be associated with less blood loss during prostatectomy.<sup>79</sup> This effect has been ascribed to higher venous pressure during general anesthesia and mechanical ventilation, alleviated by the use of epidural anesthesia. Complication rates in patients who received either general anesthesia alone or general anesthesia in combination with epidural anesthesia were similar.<sup>80</sup>

## Surgery for Bladder Cancer

### Preoperative Considerations

Bladder cancer is the fourth most common malignant tumor in men and the ninth most common among women in the United States. The mortality rate is strongly influenced by the stage at diagnosis and ethnicity (Fig. 60–8).<sup>64</sup> For this reason, emphasis has been placed on early diagnosis and aggressive management of early-stage disease. The most important risk factors for cancer of the bladder are sex, age, smoking history, and exposure to arylamines. Fluid intake may influence the risk of bladder cancer, as suggested by a prospective study in which the consumption of water or other beverages was inversely related to the odds of developing bladder cancer in a 10-year followup.<sup>81</sup>

The majority of patients with bladder cancer present with hematuria or voiding disturbances. The standard diagnostic method is cystoscopy and biopsy. Subsequent management depends on the degree of invasiveness. The majori-



**FIGURE 60–8.** Five-year relative rate of survival from bladder cancer according to stage of presentation and ethnicity. (Modified from Jemal et al.<sup>64</sup> with permission.)

ty of patients will have superficial disease managed by transurethral resection, often followed by intravesical administration of adjuvant chemotherapy or of bacille Calmette-Guérin instillation.<sup>21</sup> The surgical and anesthetic management of patients undergoing transurethral resections has been described in the section on Endourologic Procedures.

### Radical Cystectomy

Patients who have high-risk superficial tumors or who have invasive tumors are candidates for radical cystectomy, which is the most common procedure for invasive cancer of the bladder. Use of partial cystectomy has decreased considerably because of the high recurrence rate.<sup>82</sup> Radical cystectomy has a high rate of cure for patients with localized disease, with survival rates of approximately 70%. A significant portion of patients will have distant recurrence even after radical cystectomy; therefore, adjuvant or neoadjuvant chemotherapy often is given. A randomized study detected better survival rates in patients with locally advanced bladder cancer who received a course of chemotherapy prior to radical cystectomy as opposed to patients who underwent surgery alone.<sup>83</sup> During radical cystectomy, a low midline incision is performed, followed by removal of the bladder, peritoneum, perivesical fat, lower ureters, prostate, seminal vesicles, and, depending on tumor spread, the urethra. In women, the uterus, ovaries, tubes, urethra, and anterior vagi-

nal wall are removed. Pelvic lymph node dissection usually is performed during radical cystectomy because it provides important staging and prognostic information. It also may contribute to improved control of disease and survival rates. Finally, a type of urinary diversion or bladder reconstruction is performed. Creation of an orthotopic neobladder using a segment of ileum or colon anastomosed to the native urethra is the first-line choice because of the resulting improved quality of life. This approach may not be possible in patients who have urethral or prostatic involvement. Alternative approaches include continent cutaneous diversion, where a reservoir is created from a bowel segment and open to the abdominal wall, and a noncontinent diversion, such as ileal loop or cutaneous urostomy. A continent diversion affords better quality of life compared to a noncontinent diversion but requires intermittent self-catheterization. All patients with intestinal pouches have chronic bacteruria and are subject to recurrent urinary tract infections and pyelonephritis.<sup>84</sup> A radically new approach to bladder reconstruction has been recently proposed. Biosynthetic bladders were fabricated using collagen scaffolds seeded with urothelial and muscle cells obtained from patient's own bladder. The engineered bladders were implanted, resulting in acceptable urodynamic characteristics. Although this approach has been used only in patients with myelomeningocele, the promising results suggest a possible fu-

ture application of this technique for other indications, including cancer.<sup>85</sup>

### Complications

Radical cystectomy is considered a relatively high-risk procedure. Patients commonly are males of advanced age who have significant risk factors for complications and comorbidities, such as history of smoking, chronic pulmonary, and heart disease. In an observational study of more than 2500 veterans undergoing cystectomy, independent predictors of postoperative morbidity included age, preoperative renal failure, elevated ASA status, use of general anesthesia, operative time, intraoperative transfusions, alcohol use, dyspnea, and dependent status.<sup>86</sup> According to a smaller observational study, surgical factors predisposing to complications include blood loss, operative time, type of diversion, and stage of cancer.<sup>87</sup> In this study, the overall rate of complications was reported to be approximately 30%. Postoperative ileus is the most common minor complication and results in increased hospital stay.<sup>88</sup> Unlike other types of major abdominal surgery, cystectomy is not associated with a particularly elevated risk of postoperative pulmonary complications, probably because the site of incision is far from the diaphragm.<sup>89</sup>

### Anesthetic Management

**Monitoring** In spite of improvements in surgical technique, radical cystectomy continues to be associated with significant blood loss. In one study, blood transfusion was required in 30% of the cases. Female gender, preoperative anemia, and performance of ileal conduit were predictors of a higher need for transfusion.<sup>90</sup> Controlled hypotensive anesthesia has been advocated to reduce transfusion requirements, but the advantages of this practice should be critically compared to its risk in a population with significant cardiovascular risk.<sup>91</sup> The procedure is relatively lengthy, depending on the type of urinary diversion performed. Thorough monitoring of blood loss and attempts at estimating intravascular volume are necessary during the procedure. Invasive arterial blood pressure monitoring has the additional advantage of allowing frequent measurement of hematocrit levels. Volume status monitoring is hindered by the fact that the urinary tract is interrupted during most of the opera-



tion. In patients with heart dysfunction or renal disease, measuring central venous pressure may be indicated. Alternatively, monitoring blood pressure variations provides an accurate estimate of the need for fluid administration, with a predictive power superior to central venous and left atrial pressure monitoring in critically ill patients.<sup>74</sup> Pulmonary arterial catheters should not be used routinely but used only in selected cases to allow goal-directed hemodynamic management.

**Anesthetic Choices** Radical cystectomy usually is performed under general anesthesia, although use of neuraxial block is possible. Epidural anesthesia is more likely to be used in combination with general anesthesia because of the length of the procedure and patient discomfort during regional anesthesia alone. Use of epidural anesthesia together with general anesthesia has been reported to result in less blood loss and a lower transfusion rate compared with general anesthesia alone, but with no effect on the overall rate of complication, similar to radical prostatectomy.<sup>92</sup> In this study, postoperative pain control was also improved in patients who received epidural anesthesia. A large observational Veterans Health Administration study identified general anesthesia versus neuraxial block as a risk factor for complications after cystectomy.<sup>86</sup> No randomized controlled study has demonstrated an outcome benefit. A large well-conducted study on the outcomes of anesthetic choices in urologic surgery is needed.

Sympathectomy from neuraxial blockade promotes intestinal muscle spasm because of unopposed parasympathetic stimulation, which can render the fabrication of an ileal pouch technically difficult. Glycopyrrolate or papaverine has been used to obviate this problem.<sup>93</sup>

## Surgery for Testicular Cancer

### Preoperative Considerations

Malignant tumors of the testicle are relatively rare, with an incidence of 2–3 cases per 100,000 males each year.<sup>21</sup> Histologically, 95% of testicular cancers are germ cell tumors, of which 35 are seminomas. Nonseminomas, such as embryonal cell carcinomas, teratomas, choriocarcinomas, and mixed cell-type tumors, are clinically more invasive and require more aggressive management.<sup>94</sup> The incidence of germ

cell tumors is highest in patients in their third and fourth decades and is heavily affected by ethnicity. Germ cell tumors occur significantly more frequently in whites than in people of Asian or African descent. The only known risk factors are a history of cryptorchidism or Klinefelter syndrome. Orchiopexy reduces the risk of testicular cancer if performed prior to puberty.<sup>94</sup>

Testicular tumors may present with a painless testicular mass or, more often, with testicular pain and swelling, which may be confused with orchitis or epididymitis. Occasionally patients have germ cell tumors that do not originate in the testicle. The diagnosis of testicular cancer is confirmed by testicular ultrasound. Abdominal CT scans usually are obtained for clinical staging. Metastatic spread of testicular tumors follows a characteristic stepwise pattern along the retroperitoneal lymphatics.<sup>21</sup>

### Therapeutic Choices

Radical orchiectomy is required for all patients with testicular tumor. Further management depends on the extent of metastatic spread and tumor histology. The curability of germ cell tumors, particularly seminomas, is >90% with current management protocols. The stage at presentation and survival worsen with delay of recognition, which suggests the importance of early detection.<sup>94</sup> Low-stage seminomas are treated with retroperitoneal radiation therapy after orchiectomy, although observation only has been proposed. Nonseminomatous tumors are clinically more invasive and require more aggressive management, but the curability still is >90%. Retroperitoneal lymph node dissection (RPLND) is often used for these tumors, although observation also may be chosen because RPLND is often complicated by retrograde ejaculation and infertility. During RPLND, the lumbar sympathetic chain is ablated. Alternatively, a modified RPLND that spares the sympathetic nerves is used.<sup>21</sup> The response to therapy and the recurrence rate are evaluated following CT scan of the abdomen and the trend of biologic markers such as  $\alpha$ -fetoprotein, human chorionic gonadotropin, and lactate dehydrogenase. Combination chemotherapy is the standard protocol for recurrent or high-stage testicular cancer. It incorporates cisplatin, etoposide, and

bleomycin. Chemotherapy may be complicated by nerve and renal toxicity and by pulmonary fibrosis induced by bleomycin.

**Orchiectomy** Radical orchiectomy is performed by inguinal exploration, cross-clamping, and ligation of the spermatic cord at the internal inguinal ring. Transscrotal orchiectomy is not used because it predisposes to local and pelvic lymph node metastasis. This procedure can be safely performed with either general or regional anesthesia, depending on patient preferences.

### Retroperitoneal Lymph Node Dissection

Performed through a midline abdominal or thoracoabdominal incision, the standard RPLND involves removal of all lymphatic tissue between the ureters and between the superior mesenteric artery and the iliac vessels. The modified RPLND limits the extent of lymph node dissection and spares the sympathetic chain and hypogastric plexus on the side contralateral to the involved testicle. This technique preserves ejaculatory function in 80–90% of cases. General anesthesia is commonly used for this procedure. Pain management is particularly important for thoracoabdominal incisions and can be achieved with epidural anesthesia or intercostal nerve blocks. Blood and fluid losses can be significant during this procedure and should be replaced carefully. Large-bore intravenous access is strongly recommended.

Patients undergoing surgery for testicular cancer usually are young and do not have significant comorbidities; however, patients who have undergone combination chemotherapy before the procedure may suffer from the toxicities of the agents used. Bleomycin is associated with pulmonary toxicity. Patients at higher risk for this complication include those who received higher doses, are older, or have renal insufficiency. Acute respiratory distress syndrome has been reported after surgery in patients who had been exposed to bleomycin. according to evidence from animal studies and a series of patients, exposure to high concentrations of oxygen seems to favor the onset of this complication.<sup>95</sup> Little evidence indicates that a short exposure to high inspired oxygen results in acute pulmonary toxicity in patients with normal baseline pulmo-

nary function.<sup>96</sup> The lowest inspired oxygen concentration that achieves acceptable oxygen saturation values is a reasonable choice in patients who have been treated with bleomycin.<sup>97</sup>

During left-sided dissection, ligation of the intercostal arteries may lead to loss of circulation through the artery of Adamkiewicz, with consequent ischemia of the spinal cord. Therefore, motor function must be documented before and after surgery. When patients who received epidural anesthesia develop neurologic signs postoperatively, this diagnosis should be included in the differential.

### Surgery for Renal Cancer Preoperative Considerations

Renal carcinoma accounts for 2.6% of all cancers in the United States, and 85% of renal masses are renal cell carcinoma.<sup>64</sup> Only 2% of these cancers are associated with inherited conditions such as von Hippel-Lindau disease<sup>98</sup>; however, defects in the von Hippel-Lindau suppressor gene, an important regulator of cellular response to hypoxemia, may be responsible for a significant fraction of sporadic renal cell carcinomas. Tobacco smoking is an important risk factor for this disease. The peak incidence of renal carcinoma is 60 years, with a male-to-female ratio of 1.6:1.<sup>64</sup>

Approximately 50% of renal carcinomas are incidentally detected by abdominal imaging. A common presentation of this disease is hematuria, and its presence should always prompt further evaluation. The diagnostic and staging process includes contrast CT scan or gadolinium-enhanced MRI of the abdomen. In 5–10% of patients, tumor extension to the renal vein or vena cava occurs, worsening survival and complicating surgical management. Its presence and extent should be investigated.

Some patients present with paraneoplastic phenomena due to secretion of hormones by cancer cells. These conditions include erythrocytosis in 3–10% of patients, hypercalcemia in up to 20%, and hypertension refractory to medical treatment in up to 40%.<sup>21</sup> Determination of the prognosis of renal carcinoma in the individual patient is important in treatment and decision making. The survival rate worsens significantly with the stage of disease, from 95% at 5 years in tumors <7 cm and limited to the kidney to 20% in tumors that extend beyond

Gerota fascia or involve more than one lymph node.<sup>98</sup>

### Nephrectomy

Radical nephrectomy is the standard approach to renal cell carcinoma because this tumor is not responsive to chemotherapy. During a radical nephrectomy, the renal artery and renal vein are ligated, and then the kidney is removed along with the adrenal gland, perinephric fat, Gerota fascia, and regional lymph nodes. Nephron-sparing partial resections had been performed mainly in patients at high risk for postoperative renal failure due to preexisting chronic kidney disease, diabetes, or hypertension because of concern that these limited resections may be associated with higher rates of tumor recurrence. Partial resection is becoming more popular and is now often chosen for smaller tumors.<sup>99</sup> In the last 10 years, minimally invasive laparoscopic nephrectomy has received increasing attention. The technique minimizes pain and reduces postoperative recovery time. It is particularly appealing for living donor nephrectomy. Robot-assisted nephrectomy has been introduced in the last 5 years and probably will be used more often as the technique is perfected.<sup>100</sup> Chemotherapy, interferon, and interleukin therapy are sometimes used in metastatic disease or as adjuvant therapy, although their effectiveness is unclear.

**Anesthetic Management** Preoperative evaluation of the nephrectomy candidate should follow the standard approach for patients undergoing intermediate-risk surgery of the upper abdomen and should focus on cardiovascular and pulmonary risk factors. A significant fraction of this patient population is composed of smokers and elderly persons at increased risk for cardiac and respiratory complications. Preexisting renal dysfunction should be noted because its presence may influence intraoperative and anesthetic management. The majority of patients undergoing nephrectomy are anemic, so an adequate amount of red blood cells should be available prior to surgery, particularly when the renal mass is large.

During nephrectomy, the kidney usually is approached through a flank incision, although subcostal and thoracoabdominal incisions are also used. The thoracoabdominal incision is the

most commonly used if vena caval infiltration is known, because the flank incision allows adequate access only to the kidney and retroperitoneum but not to the vena cava. The most commonly used position for nephrectomy is lateral with kidney rest elevation. With the flank incision, the pleural space can be accidentally entered through a diaphragm tear, requiring chest tube placement. Routine postoperative chest radiographs should be obtained in the recovery room. With thoracoabdominal incision, a chest tube is placed routinely at the end of the procedure. Other intraoperative complications of radical nephrectomy are hollow viscus injuries and splenic lacerations.

Radical nephrectomy usually is performed under general endotracheal anesthesia. Both intraoperative and postoperative epidural analgesia also are used commonly, although little evidence suggests outcome benefits. Intercostal nerve blocks may be used for thoracoabdominal incision and can contribute to reducing the rate of postoperative atelectasis.<sup>101</sup>

Hemodynamic instability is common during open radical nephrectomy. The lateral kidney rest position can cause hypotension due to vena cava stretching and reduced venous return. This requires reduced flexion of the operating table and treatment with fluid loading. Compression of the vena cava by retractors can cause the same phenomenon. More importantly, nephrectomy patients are prone to significant blood loss, particularly if the mass is large or very vascular, a common finding in renal cell carcinoma. Large-bore intravenous access is mandatory, and central venous cannulation with a large-bore catheter may be helpful. Pulmonary arterial catheterization should not be used routinely but should be reserved for patients with significant cardiovascular comorbidities, or it should be used with the intent to reach and maintain specific hemodynamic goals, as discussed in the sections on surgery for prostate cancer or bladder cancer. Arterial cannulation also can be helpful for blood pressure monitoring and blood sampling. Hemodynamic monitoring and fluid management are particularly important in patients at significant risk for postoperative renal dysfunction, to prevent or treat renal hypoperfusion. Controlled hypotension may limit intraoperative blood loss but may not be

suitable for patients with preexisting chronic kidney disease. No evidence indicates that any pharmacologic strategy effectively provides perioperative renal protection. In particular, loop diuretics, mannitol, and renal vasodilators are not protective in patients undergoing vascular and cardiothoracic surgery. Currently no evidence supports the use of these agents in patients undergoing nephrectomy and other high-risk urologic procedures.

When minimally invasive nephrectomy is performed, the anesthetic management is similar to that for other types of laparoscopic procedures, as described in the next section. With a multimodal approach including local anesthetic injection at the port site and in the renal fossa, administration of nonopioid analgesics, and an early mobilization and nutrition schedule, Recart et al.<sup>102</sup> were able to discharge patients from the hospital at an average of 41 hours following surgery.

Nephrectomy is a very high-risk procedure in patients with vena cava invasion. However, this operation is frequently undertaken because patients have very poor life expectancy without surgery. The complexity of the procedure increases with the degree of tumor invasion. Patients at highest risk for mortality are those with tumor invasion above the diaphragm and into the right atrium. The procedure must be performed with cardiopulmonary bypass in these cases or when surgical control of the vena cava above the level of tumor invasion is not possible. Detachment of tumor fragments with pulmonary embolization is possible during the operation. These patients require large-bore intravenous access because massive blood loss is a possibility. Additionally, tumors partially or totally occluding the vena cava lumen cause distal elevation of venous pressures and formation of venous collaterals that, together, increase the extent of blood loss. Invasive hemodynamic monitoring is desirable, but central access is complicated by the risk of detaching tumor emboli when tumor extends to the right atrium, particularly for pulmonary arterial catheterization. Alternatively, TEE for hemodynamic monitoring may be useful. TEE allows intraoperative confirmation of the extent of tumor invasion and diagnosis of pulmonary embolization.<sup>103</sup>

Patients undergoing nephrectomy should always receive perioperative

thromboembolic prophylaxis. This and other major urologic procedures are associated with a high risk for venous thromboembolic complications, and this risk probably is not reduced with laparoscopic techniques.

## Minimally Invasive Urologic Surgery

### Techniques

The last 10 years have seen increasing interest in minimally invasive and laparoscopic urologic procedures. The first procedures accomplished through laparoscopy were procedures for undescended testis and varix ligation, followed by retroperitoneal node dissection for testicular, prostate, and bladder cancer.<sup>21</sup> Laparoscopic nephrectomy, prostatectomy, and cystectomy are currently performed in certain centers. Laparoscopic urologic surgery offers the obvious advantages of decreased postoperative pain and reduced postoperative hospitalization. Whether laparoscopic cancer surgery achieves the same degree of eradication as standard procedures such as retroperitoneal node dissection and radical nephrectomy is not entirely clear.<sup>21</sup> Therefore, the long-term outcome of these laparoscopic procedures is still being evaluated, and they are not yet recommended as the standard approach.

More recently, minimally invasive surgery has been enhanced by the introduction of robotic techniques (Fig. 60–9). These techniques allow operators to perform complex procedures in less time and with more reliability compared to nonrobotic laparoscopy, improving the learning

curve of the surgeon. Use of robotic techniques likely will become increasingly more common in urology.<sup>104</sup> Based on early reports, robot-assisted radical cystectomy with neobladder construction seems to be associated with a lower rate of complications and faster postoperative recovery.<sup>105</sup> This technique still requires prolonged operating time but likely will improve as experience accumulates.<sup>106</sup>

Laparoscopic radical prostatectomy, with and without the use of robots, has recently been introduced. Whether this surgical approach has improved outcome is not clear, and larger series are required. In a study that compared pain scores and narcotic use in patients undergoing robot-assisted radical prostatectomy versus standard RRP, no difference was observed between the two groups.<sup>107</sup>

Laparoscopic nephrectomy can be performed through a transperitoneal or retroperitoneal approach. With the latter, the patient is placed in a lateral or semilateral flexed position, and a working space is created in the retroperitoneum by inflating a balloon inserted through a small incision. This space is then distended by carbon dioxide (CO<sub>2</sub>) insufflation. Laparoscopic surgery for nephrectomy is particularly appealing for live kidney donor surgery because of reduced pain and disability. Laparoscopic partial and total nephrectomy also are possible.<sup>100,108</sup> Laparoscopic partial nephrectomy allows early discharge from the hospital when coupled with a multimodal pain management approach that includes narcotics, nonsteroidal



**FIGURE 60–9.** Typical operating room setup for robotic surgery. (Courtesy of 2006 Intuitive Surgical Inc.)



antiinflammatory drugs (NSAIDs), and local anesthesia to the port sites.<sup>102</sup>

### Anesthetic Management

There is no standard anesthetic management of patients undergoing minimally invasive urologic procedures. The physiologic changes and problems encountered by patients undergoing laparoscopic operations are well known from the experience acquired in other surgical specialties. In particular, the effects of pneumoperitoneum and CO<sub>2</sub> insufflation on the cardiovascular, respiratory, and central nervous systems are well characterized. Laparoscopy in urologic surgery poses additional challenges, such as those related to particular positions adopted in this specialty. Pneumoperitoneum causes an upward shift of the diaphragm and decreased chest wall compliance that result in reduced lung volumes and increased airway pressures.<sup>109</sup> In the head-down position, the diaphragmatic shift is exaggerated, further decreasing lung volume. Atelectasis may result but can be prevented by application of positive end-expiratory pressure or treated by inflation maneuvers. The increased airway pressure observed during pneumoperitoneum is the result of decreased chest wall compliance and not of lung hyperinflation, and it should not be considered as a factor predisposing to barotrauma. Transperitoneal absorption of CO<sub>2</sub> causes parallel increases in arterial and end-tidal PCO<sub>2</sub> that must be compensated by increased ventilation to avoid acidemia. This can be accomplished by increasing respiratory rate, tidal volume, or both. Pneumoperitoneum combined with head-down position causes increased systemic arterial resistance, systolic heart volumes, and ventricular systolic work.<sup>110</sup> These changes may lead to myocardial ischemia in patients at risk. Laparoscopy in the lateral flexed position may significantly decrease venous return, causing low cardiac output and hypotension. This condition can be promptly reversed by deflation and table deflection and prevented by fluid loading. During pneumoperitoneum in the head-down position, the resulting changes in venous pressures, together with hypercapnia, can lead to significant increases in intracranial pressure and, potentially, brain injury in selected patients.<sup>111</sup> Laparoscopic procedures in this position are best avoided in patients with space-occupying intracra-

nial lesions. In nephrectomy patients with preexisting renal disease, laparoscopy may create additional kidney injury as a result of elevated intraabdominal pressure and kidney manipulation. Kidney injury may be limited by maintaining adequate blood volume and hemodynamic stability. To date, none of the existing "renal protection" pharmacologic strategies has proven effective.

Depending on the surgeon's experience with these procedures, the anesthetic plan should anticipate the possibilities of conversion to open procedure and significant bleeding. Laparoscopy patients should undergo a preoperative evaluation identical to that for patients undergoing the equivalent open procedure. Cardiovascular monitoring should be appropriate for the planned procedure, based on the patient's clinical status. Central venous and pulmonary arterial wedge pressure measurements are biased during laparoscopy because of transmission of intraabdominal pressure to the mediastinal space. Use of TEE in high-risk patients allows more accurate assessment of cardiac volumes.<sup>112</sup> Bladder catheterization and nasogastric intubation usually are performed for laparoscopic procedures.

When laparoscopic procedures are performed in an ambulatory setting, the choice of induction and maintenance anesthetic agents reflects the need for prompt awakening and rapid recovery. In laparoscopic surgery, N<sub>2</sub>O is often avoided, to prevent bowel distension should the procedure become prolonged. Intraoperative and postoperative analgesia usually is performed with a combination of opioids and NSAIDs.<sup>102</sup> Epidural analgesia is not routinely offered.

Among the complications of laparoscopic procedures are bleeding, subcutaneous emphysema, pneumothorax, diaphragmatic tears, and gas embolism.<sup>113</sup> Although the use of CO<sub>2</sub> for pneumoperitoneum reduces the probability of massive embolism, it is a potentially fatal complication and should be considered in case of intraoperative hemodynamic deterioration.

### SUMMARY

Urologic surgery often is challenging for the anesthesiologist because of the complexity of the procedures performed and the increased frequency of comorbidities encountered in this pa-

tient population. However, this is also a rewarding field because the outcomes often are good and because it offers the opportunity to choose from among a relatively broad variety of anesthetic strategies. Ongoing progress in surgical techniques and particularly the recent interest for minimally invasive and robotic surgery likely will introduce more challenges and rewards in the future. An increasing number of patients with compromised health will present to the attention of the anesthesiologist. At the same time, the pressure for rapid anesthetic recovery times and high levels of patient comfort and satisfaction likely will increase.

### KEY REFERENCES

1. Practice advisory for the prevention of perioperative peripheral neuropathies: a report by the American Society of Anesthesiologists task force on prevention of perioperative peripheral neuropathies. *Anesthesiology* 2000;92:1168-1182.
2. Blackmer J. Rehabilitation medicine: 1. Autonomic dysreflexia. *CMAJ* 2003;169:931-935.
3. Gravenstein D. Transurethral resection of the prostate (TURP) syndrome: a review of the pathophysiology and management. *Anesth Analg* 1997;84:438-446.
4. Monk TG, Goodnough LT, Brecher ME, et al. A prospective randomized comparison of three blood conservation strategies for radical prostatectomy. *Anesthesiology* 1999;91:24-33.
5. Hahnenkamp K, Theilmeier G, Van Aken HK, et al. The effects of local anesthetics on perioperative coagulation, inflammation, and microcirculation. *Anesth Analg* 2002;94:1441-1447.
6. Arozullah AM, Daley J, Henderson WG, et al. Multifactorial risk index for predicting postoperative respiratory failure in men after major noncardiac surgery. The National Veterans Administration Surgical Quality Improvement Program. *Ann Surg* 2000;232:242-253.
7. Conacher ID, Soomro NA, Rix D. Anaesthesia for laparoscopic urological surgery. *Br J Anaesth* 2004;93:859-864.



## REFERENCES

- Reich DL, Konstadt SN, Raissi S, Hubbard M, et al. Trendelenburg position and passive leg raising do not significantly improve cardiopulmonary performance in the anesthetized patient with coronary artery disease. *Crit Care Med* 1989;17:313-317.
- Warner MA, Warner DO, Harper CM, et al. Lower extremity neuropathies associated with lithotomy positions. *Anesthesiology* 2000;93:938-942.
- Gumus E, Kendirci M, Horasanli K, et al. Neurapraxic complications in operations performed in the lithotomy position. *World J Urol* 2002;20:68-71.
- Practice advisory for the prevention of perioperative peripheral neuropathies: a report by the American Society of Anesthesiologists task force on prevention of perioperative peripheral neuropathies. *Anesthesiology* 2000;92:1168-1182.
- Simms MS, Terry TR. Well leg compartment syndrome after pelvic and perineal surgery in the lithotomy position. *Postgrad Med J* 2005;81:534-536.
- Meyer RS, White KK, Smith JM, et al. Intramuscular and blood pressures in legs positioned in the hemilithotomy position: clarification of risk factors for well-leg acute compartment syndrome. *J Bone Joint Surg Am* 2002;84-A:1829-1835.
- Pfeffer SD, Halliwill JR, Warner MA. Effects of lithotomy position and external compression on lower leg muscle compartment pressure. *Anesthesiology* 2001;95:632-636.
- Irgau I, Koyfman Y, Tikellis JI. Elective intraoperative intracranial pressure monitoring during laparoscopic cholecystectomy. *Arch Surg* 1995;130:1011-1013.
- Bivins HG, Knopp R, dos Santos PA. Blood volume distribution in the Trendelenburg position. *Ann Emerg Med* 1985;14:641-643.
- Sibbald WJ, Paterson NA, Holliday RL, et al. The Trendelenburg position: hemodynamic effects in hypotensive and normotensive patients. *Crit Care Med* 1979;7:218-224.
- Memtsoudis SG, Malhotra V. Catastrophic venous air embolus during prostatectomy in the Trendelenburg position. *Can J Anaesth* 2003;50:1084-1085.
- Cheney FW, Domino KB, Caplan RA, et al. Nerve injury associated with anesthesia: a closed claims analysis. *Anesthesiology* 1999;90:1062-1069.
- Coppieters MW, Van de Velde M, Stappaerts KH. Positioning in anesthesiology: toward a better understanding of stretch-induced perioperative neuropathies. *Anesthesiology* 2002;97:75-81.
- Mathes DD, Assimos DG, Donofrio PD. Rhabdomyolysis and myonecrosis in a patient in the lateral decubitus position. *Anesthesiology* 1996;84:727-729.
- Blackmer J. Rehabilitation medicine: 1. Autonomic dysreflexia. *CMAJ* 2003;169:931-935.
- Jones NA, Jones SD. Management of life-threatening autonomic hyper-reflexia using magnesium sulphate in a patient with a high spinal cord injury in the intensive care unit. *Br J Anaesth* 2002;88:434-438.
- Fredman B, Sheffer O, Zohar E, et al. Fast-track eligibility of geriatric patients undergoing short urologic surgery procedures. *Anesth Analg* 2002;94:560-564.
- Pollock JE, Burkhead D, Neal JM, et al. Spinal nerve function in five volunteers experiencing transient neurologic symptoms after lidocaine subarachnoid anesthesia. *Anesth Analg* 2000;90:658-665.
- Tong D, Wong J, Chung F, et al. Prospective study on incidence and functional impact of transient neurologic symptoms associated with 1% versus 5% hyperbaric lidocaine in short urologic procedures. *Anesthesiology* 2003;98:485-494.
- Kuusniemi KS, Pihlajamaki KK, Pitkanen MT, et al. The use of bupivacaine and fentanyl for spinal anesthesia for urologic surgery. *Anesth Analg* 2000;91:1452-1456.
- Smith DR, Tanagho EA, McAninch JW. *Smith's General Urology*. 15th ed. New York: Lange Medical Books/McGraw-Hill, Health Professions Division, 2000.
- McConnell JD, Roehrborn CG, Bautista OM, et al. The long-term effect of doxazosin, finasteride, and combination therapy on the clinical progression of benign prostatic hyperplasia. *N Engl J Med* 2003;349:2387-2398.
- Jepsen JV, Bruskewitz RC. Recent developments in the surgical management of benign prostatic hyperplasia. *Urology* 1998;51:23-31.
- Uchida T, Otori M, Soh S, et al. Factors influencing morbidity in patients undergoing transurethral resection of the prostate. *Urology* 1999;53:98-105.
- Ghanem AN, Ward JP. Osmotic and metabolic sequelae of volumetric overload in relation to the TUR syndrome. *Br J Urol* 1990;66:71-78.
- Okeke AA, Lodge R, Hinchliffe A, et al. Ethanol-glycine irrigating fluid for transurethral resection of the prostate in practice. *BJU Int* 2000;86:43-46.
- Dorotta I, Basali A, Ritchey M, et al. Transurethral resection syndrome after bladder perforation. *Anesth Analg* 2003;97:1536-1538.
- Gray RA, Lynch C, Hehir M, et al. Intravesical pressure and the TUR syndrome. *Anaesthesia* 2001;56:461-465.
- Gehring H, Nahm W, Baerwald J, et al. Irrigation fluid absorption during transurethral resection of the prostate: spinal vs. general anaesthesia. *Acta Anaesthesiol Scand* 1999;43:458-463.
- Emmett JL, Gilbaugh JH Jr, McLean P. Fluid absorption during transurethral resection: comparison of mortality and morbidity after irrigation with water and non-hemolytic solutions. *J Urol* 1969;101:884-889.
- Gravenstein D. Transurethral resection of the prostate (TURP) syndrome: a review of the pathophysiology and management. *Anesth Analg* 1997;84:438-446.
- Trepanier CA, Lessard MR, Brochu J, et al. Another feature of TURP syndrome: hyperglycaemia and lactic acidosis caused by massive absorption of sorbitol. *Br J Anaesth* 2001;87:316-319.
- Scheingraber S, Heitmann L, Weber W, et al. Are there acid base changes during transurethral resection of the prostate (TURP)? *Anesth Analg* 2000;90:946-950.
- Stalberg HP, Hahn RG, Jones AW. Ethanol monitoring of transurethral prostatic resection during inhaled anesthesia. *Anesth Analg* 1992;75:983-988.
- Wong DH, Hagar JM, Mootz J, et al. Incidence of perioperative myocardial ischemia in TURP patients. *J Clin Anesth* 1996;8:627-630.
- Edwards ND, Callaghan LC, White T, et al. Perioperative myocardial ischaemia in patients undergoing transurethral surgery: a pilot study comparing general with spinal anaesthesia. *Br J Anaesth* 1995;74:368-372.
- Hatch PD. Surgical and anaesthetic considerations in transurethral resection of the prostate. *Anaesth Intensive Care* 1987;15:203-211.
- McGowan SW, Smith GF. Anaesthesia for transurethral prostatectomy. A comparison of spinal intradural analgesia with two methods of general anaesthesia. *Anaesthesia* 1980;35:847-853.
- Smyth R, Cheng D, Asokumar B, et al. Coagulopathies in patients after transurethral resection of the prostate: spinal versus general anesthesia. *Anesth Analg* 1995;81:680-685.
- Reeves MD, Myles PS. Does anaesthetic technique affect the outcome after transurethral resection of the prostate? *BJU Int* 1999;84:982-986.
- Kirollos MM, Campbell N. Factors influencing blood loss in transurethral resection of the prostate (TURP): auditing TURP. *Br J Urol* 1997;80:111-115.
- Le Cras AE, Galley HF, Webster NR. Spinal but not general anesthesia increases the ratio of T helper 1, to T helper 2, cell subsets in patients undergoing transurethral resection of the prostate. *Anesth Analg* 1998;87:1421-1425.
- Beers RA, Kane PB, Nsouli I, et al. Does a mid-lumbar block level provide adequate anaesthesia for transurethral prostatectomy? *Can J Anaesth* 1994;41:807-812.
- Chen TY, Tseng CC, Wang LK, et al. The clinical use of small-dose tetracaine spinal anesthesia for transurethral prostatectomy. *Anesth Analg* 2001;92:1020-1023.
- Kararmaz A, Kaya S, Turhanoglu S, et al. Low-dose bupivacaine-fentanyl spinal anaesthesia for transurethral prostatectomy. *Anaesthesia* 2003;58:526-530.
- Kirson LE, Goldman JM, Slover RB. Low-dose intrathecal morphine for postoperative pain control in patients undergoing

- transurethral resection of the prostate. *Anesthesiology* 1989;71:192–195.
47. Sakai T, Use T, Shimamoto H, et al. Mini-dose (0.05 mg) intrathecal morphine provides effective analgesia after transurethral resection of the prostate. *Can J Anaesth* 2003;50:1027–1030.
48. Siddik-Sayyid S, Aouad-Maroun M, Sleiman D, et al. Epidural tramadol for postoperative pain after cesarean section. *Can J Anaesth* 1999;46:731–735.
49. Alhashemi JA, Kaki AM. Effect of intrathecal tramadol administration on postoperative pain after transurethral resection of prostate. *Br J Anaesth* 2003;91:536–540.
50. Billote DB, Challapalli RM, Nadler RB. Unintended supraventricular tachycardia induced by extracorporeal shock wave lithotripsy. *Anesthesiology* 1998;88:830–832.
51. Practice advisory for the perioperative management of patients with cardiac rhythm management devices: pacemakers and implantable cardioverter-defibrillators: a report by the American Society of Anesthesiologists task force on perioperative management of patients with cardiac rhythm management devices. *Anesthesiology* 2005;103:186–198.
52. Behnia R, Shanks CA, Ovassapian A, et al. Hemodynamic responses associated with lithotripsy. *Anesth Analg* 1987;66:354–356.
53. Jeong BC, Park HK, Kwak C, et al. How painful are shockwave lithotripsy and endoscopic procedures performed at outpatient urology clinics? *Urol Res* 2005;33:291–296.
54. Richardson MG, Dooley JW. The effects of general versus epidural anesthesia for outpatient extracorporeal shock wave lithotripsy. *Anesth Analg* 1998;86:1214–1218.
55. Lau WC, Green CR, Faerber GJ, et al. Intrathecal sufentanil for extracorporeal shock wave lithotripsy provides earlier discharge of the outpatient than intrathecal lidocaine. *Anesth Analg* 1997;84:1227–1231.
56. Lau WC, Green CR, Faerber GJ, et al. Determination of the effective therapeutic dose of intrathecal sufentanil for extracorporeal shock wave lithotripsy. *Anesth Analg* 1999;89:889–892.
57. Coloma M, Chiu JW, White PF, et al. Fast-tracking after immersion lithotripsy: general anesthesia versus monitored anesthesia care. *Anesth Analg* 2000;91:92–96.
58. Gesztesi Z, Rego MM, White PF. The comparative effectiveness of fentanyl and its newer analogs during extracorporeal shock wave lithotripsy under monitored anesthesia care. *Anesth Analg* 2000;90:567–570.
59. Beloeil H, Corsia G, Coriat P, et al. Remifentanyl compared with sufentanil during extra-corporeal shock wave lithotripsy with spontaneous ventilation: a double-blind, randomized study. *Br J Anaesth* 2002;89:567–570.
60. Medina HJ, Galvin EM, Dirckx M, et al. Remifentanyl as a single drug for extracorporeal shock wave lithotripsy: a comparison of infusion doses in terms of analgesic potency and side effects. *Anesth Analg* 2005;101:365–370.
61. Burmeister MA, Brauer P, Wintruff M, et al. A comparison of anaesthetic techniques for shock wave lithotripsy: the use of a remifentanyl infusion alone compared to intermittent fentanyl boluses combined with a low dose propofol infusion. *Anaesthesia* 2002;57:877–881.
62. Joo HS, Perks WJ, Kataoka MT, et al. A comparison of patient-controlled sedation using either remifentanyl or remifentanyl-propofol for shock wave lithotripsy. *Anesth Analg* 2001;93:1227–1232.
63. Burmeister MA, Standl TG, Wintruff M, et al. Dolasetron prophylaxis reduces nausea and postanesthesia recovery time after remifentanyl infusion during monitored anaesthesia care for extracorporeal shock wave lithotripsy. *Br J Anaesth* 2003;90:194–198.
64. Jemal A, Murray T, Ward E, et al. Cancer statistics 2005. *CA Cancer J Clin* 2005;55:10–30.
65. Nelson WG, De Marzo AM, Isaacs WB. Prostate cancer. *N Engl J Med* 2003;349:366–381.
66. Bill-Axelsson A, Holmberg L, Ruutu M, et al. Radical prostatectomy versus watchful waiting in early prostate cancer. *N Engl J Med* 2005;352:1977–1984.
67. Nguyen AC, Kost E, Framstad M. Indigo carmine-induced severe hypotension. *Anesth Analg* 1998;87:1194–1195.
68. Schriemer PA, Longnecker DE, Mintz PD. The possible immunosuppressive effects of perioperative blood transfusion in cancer patients. *Anesthesiology* 1988;68:422–428.
69. Hebert PC, Wells G, Blajchman MA, et al. A multicenter, randomized, controlled clinical trial of transfusion requirements in critical care. transfusion requirements in critical care investigators, Canadian Critical Care Trials Group. *N Engl J Med* 1999;340:409–417.
70. Monk TG, Goodnough LT, Brecher ME, et al. Acute normovolemic hemodilution can replace preoperative autologous blood donation as a standard of care for autologous blood procurement in radical prostatectomy. *Anesth Analg* 1997;85:953–958.
71. Monk TG, Goodnough LT, Brecher ME, et al. A prospective randomized comparison of three blood conservation strategies for radical prostatectomy. *Anesthesiology* 1999;91:24–33.
72. Waters JH, Lee JS, Klein E, et al. Preoperative autologous donation versus cell salvage in the avoidance of allogeneic transfusion in patients undergoing radical retroperitoneal prostatectomy. *Anesth Analg* 2004;98:537–542.
73. Davis M, Sofer M, Gomez-Marin O, et al. The use of cell salvage during radical retroperitoneal prostatectomy: does it influence cancer recurrence? *BJU Int* 2003;91:474–476.
74. Michard F, Boussat S, Chemla D, et al. Relation between respiratory changes in arterial pulse pressure and fluid responsiveness in septic patients with acute circulatory failure. *Am J Respir Crit Care Med* 2000;162:134–138.
75. Sandham JD, Hull RD, Brant RF, et al. A randomized, controlled trial of the use of pulmonary-artery catheters in high-risk surgical patients. *N Engl J Med* 2003;348:5–14.
76. Hendolin H, Mattila MA, Poikolainen E. The effect of lumbar epidural analgesia on the development of deep vein thrombosis of the legs after open prostatectomy. *Acta Chir Scand* 1981;147:425–429.
77. Poikolainen E, Hendolin H. Effects of lumbar epidural analgesia and general anesthesia on flow velocity in the femoral vein and postoperative deep vein thrombosis. *Acta Chir Scand* 1983;149:361–364.
78. Hahnenkamp K, Theilmeier G, Van Aken HK, et al. The effects of local anesthetics on perioperative coagulation, inflammation, and microcirculation. *Anesth Analg* 2002;94:1441–1447.
79. Shir Y, Raja SN, Frank SM, et al. Intraoperative blood loss during radical retroperitoneal prostatectomy: epidural versus general anesthesia. *Urology* 1995;45:993–999.
80. Shir Y, Frank SM, Brendler CB, et al. Postoperative morbidity is similar in patients anesthetized with epidural and general anesthesia for radical prostatectomy. *Urology* 1994;44:232–236.
81. Michaud DS, Spiegelman D, Clinton SK, et al. Fluid intake and the risk of bladder cancer in men. *N Engl J Med* 1999;340:1390–1397.
82. Carrion R, Seigne J. Surgical management of bladder carcinoma. *Cancer Control* 2002;9:284–292.
83. Grossman HB, Natale RB, Tangen CM, et al. Neoadjuvant chemotherapy plus cystectomy compared with cystectomy alone for locally advanced bladder cancer. *N Engl J Med* 2003;349:859–866.
84. Falagas ME, Vergidis PI. Urinary tract infections in patients with urinary diversion. *Am J Kidney Dis* 2005;46:1030–1037.
85. Atala A, Bauer SB, Soker S, et al. Tissue-engineered autologous bladders for patients needing cystoplasty. *Lancet* 2006;367:1241–1246.
86. Hollenbeck BK, Miller DC, Taub D, et al. Identifying risk factors for potentially avoidable complications following radical cystectomy. *J Urol* 2005;174:1231–1237.
87. Chang SS, Cookson MS, Baumgartner RG, et al. Analysis of early complications after radical cystectomy: results of a collaborative care pathway. *J Urol* 2002;167:2012–2016.
88. Chang SS, Baumgartner RG, Wells N, et al. Causes of increased hospital stay after radical cystectomy in a clinical pathway setting. *J Urol* 2002;167:208–211.
89. Arozullah AM, Daley J, Henderson WG, et al. Multifactorial risk index for predicting

postoperative respiratory failure in men after major noncardiac surgery. The National Veterans Administration Surgical Quality Improvement Program. *Ann Surg* 2000;232:242–253.

90. Chang SS, Smith JA Jr, Wells N, et al. Estimated blood loss and transfusion requirements of radical cystectomy. *J Urol* 2001;166:2151–2154.

91. Maffezzini M, Gerbi G, Campodonico F, et al. Peri-operative management of ablative and reconstructive surgery for invasive bladder cancer in the elderly. *Surg Oncol* 2004;13:197–200.

92. Ozyuvaci E, Altan A, Karadeniz T, et al. General anesthesia versus epidural and general anesthesia in radical cystectomy. *Urol Int* 2005;74:62–67.

93. Malkowicz SB, Avon MR, Thangathurai D, et al. Intravenous papaverine in constructing continent urinary reservoir. *Urology* 1989;33:431–432.

94. Bosl GJ, Motzer RJ. Testicular germ-cell cancer. *N Engl J Med* 1997;337:242–253.

95. Goldiner PL, Rooney SM. In defense of restricting oxygen in bleomycin-treated surgical patients. *Anesthesiology* 1984;61:225–227.

96. Mathes DD. Bleomycin and hyperoxia exposure in the operating room. *Anesth Analg* 1995;81:624–629.

97. Waid-Jones MI, Coursin DB. Perioperative considerations for patients treated with bleomycin. *Chest* 1991;99:993–999.

98. Cohen HT, McGovern FJ. Renal-cell carcinoma. *N Engl J Med* 2005;353:2477–2490.

99. Sengupta S, Zincke H. Lessons learned in the surgical management of renal cell carcinoma. *Urology* 2005;66:36–42.

100. Guillonneau B, Jayet C, Tewari A, et al. Robot assisted laparoscopic nephrectomy. *J Urol* 2001;166:200–201.

101. Crawford ED, Skinner DG. Intercostal nerve block with thoracoabdominal and flank incisions. *Urology* 1982;19:25–28.

102. Recart A, Duchene D, White PF, et al. Efficacy and safety of fast-track recovery strategy for patients undergoing laparoscopic nephrectomy. *J Endourol* 2005;19:1165–1169.

103. Mizoguchi T, Koide Y, Ohara M, et al. Multiplane transesophageal echocardiographic guidance during resection of renal cell carcinoma extending into the inferior vena cava. *Anesth Analg* 1995;81:1102–1105.

104. Binder J, Brautigam R, Jonas D, et al. Robotic surgery in urology: fact or fantasy? *BJU Int* 2004;94:1183–1187.

105. Hemal AK, Abol-Enein H, Tewari A, et al. Robotic radical cystectomy and urinary diversion in the management of bladder cancer. *Urol Clin North Am* 2004;31:719–729, viii.

106. Beecken WD, Wolfram M, Engl T, et al. Robotic-assisted laparoscopic radical cystectomy and intra-abdominal formation of

an orthotopic ileal neobladder. *Eur Urol* 2003;44:337–339.

107. Webster TM, Herrell SD, Chang SS, et al. Robotic assisted laparoscopic radical prostatectomy versus retropubic radical prostatectomy: a prospective assessment of postoperative pain. *J Urol* 2005;174:912–914.

108. Barrett PH, Fentie DD, Taranger LA. Laparoscopic radical nephrectomy with morcellation for renal cell carcinoma: the Saskatoon experience. *Urology* 1998;52:23–28.

109. Pelosi P, Foti G, Cereda M, et al. Effects of carbon dioxide insufflation for laparoscopic cholecystectomy on the respiratory system. *Anaesthesia* 1996;51:744–749.

110. Harris SN, Ballantyne GH, Luther MA, et al. Alterations of cardiovascular performance during laparoscopic colectomy: a combined hemodynamic and echocardiographic analysis. *Anesth Analg* 1996;83:482–487.

111. Rosenthal RJ, Hiatt JR, Phillips EH, et al. Intracranial pressure. effects of pneumoperitoneum in a large-animal model. *Surg Endosc* 1997;11:376–380.

112. Gannedahl P, Odeberg S, Brodin LA, et al. Effects of posture and pneumoperitoneum during anaesthesia on the indices of left ventricular filling. *Acta Anaesthesiol Scand* 1996;40:160–166.

113. Conacher ID, Soomro NA, Rix D. Anaesthesia for laparoscopic urological surgery. *Br J Anaesth* 2004;93:859–864.

# CHAPTER 61

## Anesthesia for Obstetric Care and Gynecologic Surgery

Lawrence C. Tsen, MD

Just a few months separated the introduction of anesthetics for general surgical procedures and obstetric care. Ether, then believed to be the panacea to “cure all ills,” was found to be efficacious, but not optimal, in both environments. Today, although the use of general volatile anesthetics remains popular, the advent of regional anesthetic techniques has greatly expanded the ability to provide analgesia and anesthesia for a wide spectrum of procedures and conditions. Selection

of the optimal anesthetic technique for the obstetric or gynecologic patient should consider the significant anatomic, hormonal, and physiologic adaptations that ultimately allow a female to conceive and carry a pregnancy. This chapter discusses the provision of analgesia and anesthesia for obstetric care and/or gynecologic surgery. Emphasis is placed on the three primary settings of care: provision of analgesia for labor and delivery, anesthesia for obstetric and nonobstetric surgery

### KEY POINTS

1. The use of epidural, spinal, and combined spinal–epidural techniques for obstetric care has increased dramatically because of the quality and safety of the analgesia and anesthesia produced, the ability to titrate the degree and duration of pain relief, and the expanding number of situations for which their use is appropriate. Labor analgesia and obstetric anesthesia can have beneficial effects on the outcomes of external cephalic version, in utero fetal and placental surgery, and parturients with significant comorbid conditions.
2. Teratogenicity, defined as any significant postnatal change in function or form in an offspring after prenatal treatment, is difficult to evaluate in prospective clinical trials given the low incidence of occurrence and the number of confounding factors. The list of agents or factors proven to be human teratogens does not include anesthetic agents used routinely in clinical practice.
3. Clinically used estimates of gestational age originate from the first day of the last menstrual period. However, fertilization does not occur until 2 weeks after this time, so 14 days are added to actual fetal development in order to fit within the clinical schemas. Thus, although the period of major fetal organogenesis is considered to occur between 5 and 55 days, within the clinically used schemas this period occurs in weeks 3–10 of gestation.
4. Although important reductions in anesthesia-related maternal mortality have occurred in the past 5 decades, a significantly greater risk (16.7 times) of maternal death is still witnessed with the use of general versus regional anesthesia. This finding can be partially explained by changes in the airway that occur over the course of pregnancy. Promotion of regional techniques, familiarity with alternate airway devices, and review of difficult airway algorithms are strongly encouraged.
5. Antenatal and postpartum maternal hemorrhage can be masked until significant blood loss has occurred. With the recognition that blood loss and physiologic deterioration can occur rapidly, a cogent plan of investigation and response can significantly affect the outcome. Interventional radiologists may place transcatheter occlusion balloons within the uterine or hypogastric arteries in high-risk parturients to allow for timely control of bleeding.
6. Preeclampsia is a multisystem disease characterized by hypertension, proteinuria, and generalized edema. The presence of systemic vasoconstriction, intravascular volume and protein depletion, organ dysfunction, abnormalities in coagulation, and edema of the brain, larynx, and lungs make this disease of particular concern prior to any anesthetic technique. Of interest, the incidence of spinal-induced hypotension may not be greater than with epidural techniques.
7. Although many procedures in gynecologic surgery are approached using standard surgical techniques, the care and anesthetic management should be provided with an understanding of gender-related differences, including sensitivity to pain and anesthetic agents, which ultimately may affect patient outcomes and satisfaction.
8. A basic understanding of the anatomy and specific procedures within gynecologic surgery, coupled with discussions with the surgeon, is helpful in planning the optimal anesthetic technique. This is particularly true given the variety of approaches and positioning requirements for certain procedures.
9. The uterus and other female visceral structures are highly vascular. Blood loss can be sudden and profuse, air emboli can occur unexpectedly, and, in pregnancy-related procedures, amniotic fluid emboli can occur without provocation.
10. Hysteroscopic and laparoscopic procedures can result in significant adverse outcomes from absorption of distending medium and carbon dioxide (CO<sub>2</sub>), respectively. CO<sub>2</sub> insufflation of the abdomen or pelvis may cause a number of disturbances in cardiac and respiratory physiology, which can be minimized if anticipated.
11. The Trendelenburg lithotomy position is commonly used for gynecologic procedures and may lead to a number of peripheral nerve injuries. Excessive hip flexion, abduction, and external rotation may cause femoral nerve, obturator, lateral femoral cutaneous, sciatic, and peroneal nerve injuries. Attention to positioning throughout the procedure, use of protective padding, and avoidance of contact with hard surfaces or supports are important elements of optimal care.



during pregnancy, and anesthesia for gynecologic surgery.

## ANALGESIA AND ANESTHESIA ASSOCIATED WITH PREGNANCY

With the application of diethyl ether to aid in a vaginal delivery in 1847, James Young Simpson, an obstetrician, ushered in the use of anesthetics for obstetrics. The next half-century was associated with increased acceptance and evolution of anesthetics and techniques for both labor and delivery. Regional anesthetic techniques, which deliver pain relief to a discrete region of the body, were introduced to obstetrics in 1900, when Oskar Kreis described the use of spinal anesthesia. Since that time, central neuraxial techniques have evolved from single, limited duration injections into the intrathecal (subarachnoid) space to titratable, controlled infusions through flexible catheters most commonly placed into the epidural space. These techniques are often the optimal method for providing analgesia for labor, anesthesia for obstetric or non-obstetric surgery during pregnancy, and analgesia for postoperative care. Because these techniques are so fundamental to the practice of anesthesia for the parturient, they are discussed initially, and then the rationale and details for their use are expanded throughout the chapter.

### Neuraxial Techniques

Regardless of which neuraxial technique is used for labor, delivery, or nonobstetric operations, a standardized approach is warranted. A preprocedure history and physical examination with notation of allergies, baseline vital signs, and assessment of the airway, body habitus, and hematologic system (e.g., preeclampsia-induced thrombocytopenia; see Hypertensive Disorders of Pregnancy below and Chapter 21) are mandatory, even if the situation is urgent. An intravenous (IV) catheter and fluid administration should be started, especially because hypotension can abruptly follow neuraxial technique placement and affect both maternal and fetal welfare. Whether crystalloid or colloid solutions are administered to minimize hypotension is controversial. Colloids have been observed to minimize, but

not eliminate, hypotension, but they are associated with increased costs and risk of allergies, and they can affect coagulation when given in large doses (hetastarch in doses >20 mL/kg). IV fluids, regardless of the amount administered, do not reliably minimize hypotension. Thus, in urgent situations, waiting for an arbitrary amount of fluid to be infused prior to the neuraxial anesthesia or analgesia is not necessary. The seated position is often selected for the purportedly enhanced ability to palpate the vertebral spinous processes and identify the midline plane. However, these landmarks can also be achieved in the lateral recumbent position. In addition, in the pregnant patient the lateral recumbent position has the particular advantage of minimizing venous plexus engorgement, resulting in reductions in vessel trauma, vessel cannulation, and placement attempts.<sup>1</sup> In certain emergent situations, such as cord prolapse or fetal head entrapment, the seated position is not a viable option. As such, a general anesthetic would be the only available method for delivering anesthesia if the anesthesiologist is not comfortable instrumenting the back in the lateral position.

Selection of the optimal neuraxial technique depends principally on the desired onset, reliability and titratability of the resulting analgesia or anesthesia, with catheter-based techniques offering the greatest flexibility. The spinal technique offers confirmation of the space via cerebrospinal fluid (CSF) flow, fast onset, and very reliable sensory and motor blockade; however, the

duration of blockade is time limited and may be associated with abrupt hemodynamic alterations. By contrast, the epidural technique has a slower onset, does not intentionally create a dural puncture, and, when used with a catheter, offers an almost unlimited duration of blockade; however, the resulting block may be patchy or one sided, and a large dural puncture may occur inadvertently. The dose, onset, and duration of various local anesthetics for epidural labor analgesia and anesthesia are well characterized (Table 61-1). The epidural technique may enable a lesser incidence and extent of maternal hypotension because of the ability to administer the dose of local anesthetic in a fractionated manner and allow compensatory cardiovascular mechanisms to respond to the more slowly developing sympathetic blockade. The combined spinal-epidural (CSE) technique, which consists of epidural needle placement, administration of subarachnoid medications via a spinal needle placed through the shaft of the epidural needle, and placement of an epidural catheter (Fig. 61-1),<sup>2</sup> appears to combine the best of both techniques with a blockade that is rapid in onset, is reliable, and can be prolonged. Because the spinal needle emerges 10–15 mm beyond the tip of the epidural needle,<sup>3</sup> the presence of CSF can confirm that the epidural needle is proximal to, or in, the epidural space. This information can be of value when multiple “losses of resistance” are encountered during epidural needle placement.

TABLE 61-1.

Local Anesthetics for Epidural Analgesia and Anesthesia

Anesthetic	Usual Concentration (%)	Onset	Duration
<b>Analgesia</b>			
Lidocaine	1–1.5	Moderate	Intermediate
Bupivacaine	0.0625–0.25	Slow	Slow
L-Bupivacaine	0.0625–0.25	Slow	Slow
Ropivacaine	0.1–0.2	Slow	Long
<b>Anesthesia</b>			
2-Chloroprocaine	2–3	Fast	Short
Lidocaine	2–5	Moderate	Intermediate
Mepivacaine	2	Moderate	Intermediate
Bupivacaine	0.5	Slow	Long
L-Bupivacaine	0.5	Slow	Long
Ropivacaine	0.5–1	Slow	Long
Tetracaine	1	Slow	Long

Intentional puncture of the dural ligament with an epidural needle and placement of a catheter into the subarachnoid space, called a “spinal catheter technique,” is a viable option. Spinal catheter techniques have the benefit of CSF confirmation and the ability to provide a highly reliable and titratable blockade.<sup>4</sup> Such techniques are often used in parturients who are morbidly obese, in those with significant cardiac disease, or following an unintentional dural puncture with an attempted epidural catheter placement. Because placement of a spinal catheter depends on use of epidural equipment (e.g., 17-gauge Tuohy needle and 20-gauge catheter), a significant postdural puncture headache (PDPH) risk exists. Smaller needles and catheters for labor and delivery are currently being used or evaluated in Europe and the United States, respectively, with the hope of avoiding the cauda equina syndrome observed during the earlier microcatheter trials. This complication most likely resulted from pooling of excessive amounts of local anesthetics.<sup>5,6</sup>

Use of epidural, spinal, and CSE techniques has increased dramatically, particularly for obstetric indications (Fig. 61-2). This increase has been driven in large part by the quality and safety of the analgesia and anesthesia produced, the ability to dictate the intensity and duration of pain relief as required by the circumstances, and an expanding number of situations in which their use is appropriate. Use of neuraxial opioids results in improved analgesia compared with IV opioid administration, likely due to actions on both supraspinal and spinal opioid receptors (Table 61-2).<sup>7</sup> Currently, in developed countries, central neuraxial techniques provide labor analgesia for 30–50% of all parturients and the anes-

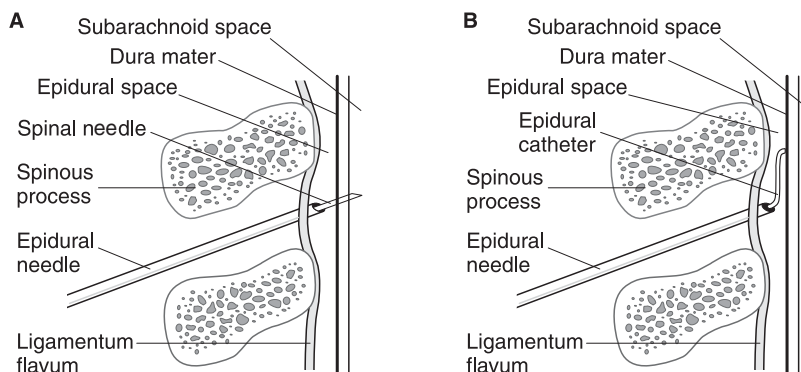


FIGURE 61-1. Combined spinal-epidural technique.

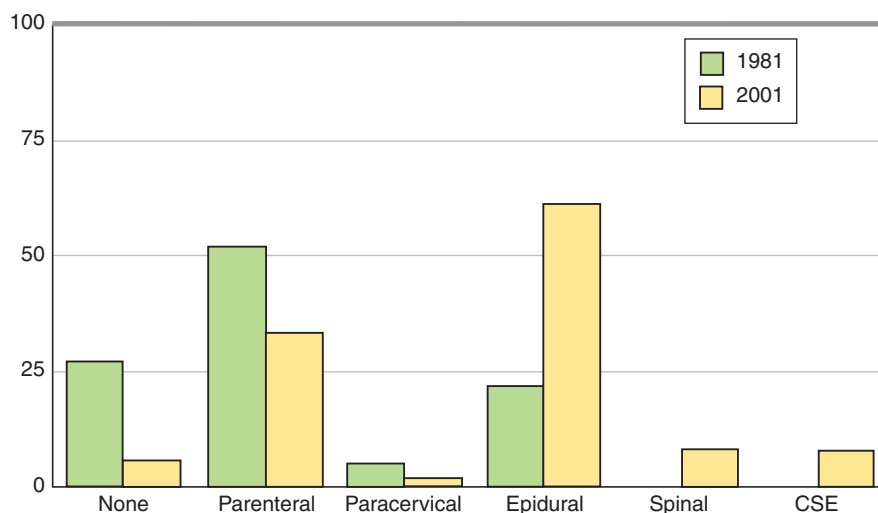


FIGURE 61-2. Types of analgesia provided for labor. Reported as percent of total cases in hospitals with more than 1500 births annually. (Based on data from Bucklin et al.<sup>45</sup>)

thesia for the majority of instrumental and operative deliveries.<sup>8,9</sup>

### Considerations on Maternally Administered Anesthetics

Although only a limited percentage of systemically or neuraxially administered anesthetics eventually reaches the fetus (see Chapter 21), an overlying concern during assisted reproduc-

tive technologies and pregnancy is the effect on fertilization and embryonic and fetal development. Teratogenicity, defined as any significant postnatal change in function or form in an offspring after prenatal treatment, is difficult to evaluate in prospective clinical trials given the low incidence of occurrence and the number of confounding factors; species susceptibility,

TABLE 61-2.

#### Opioids for Neuraxial Use in Obstetrics

Opioid	Epidural Dose	Spinal Dose	Duration (h)	Comments
Morphine	2.5–5 mg	0.1–0.2 mg	18–24	Useful primarily for postcesarean section analgesia
Fentanyl	50–100 µg	10–20 µg	3–4	Useful as labor and operative adjuvant
Sufentanil	10–20 µg	5–10 µg	3–4	Useful as labor and operative adjuvant
Meperidine	25 mg		2–3	
Hydromorphone	1 mg		12	
Methadone	4–5 mg		5–6	
Diamorphine	2.5–5 mg		5–15	Not available in the United States

genetic predisposition, and amount, timing, and duration of exposure all can affect reproductive outcome. The criteria for identifying an agent as a human teratogen requires (1) proven exposure to the agent at the critical time of development, (2) consistent findings in two or more high-quality epidemiologic studies, (3) careful delineation of the clinical cases, ideally with identification of a specific defect or syndrome, and (4) an association that makes “biologic sense.”<sup>10</sup> Of note, the list of agents or factors proven to be human teratogens does not include anesthetic agents used routinely in clinical practice (Box 61–1); however, the reader is encouraged to refer to package inserts provided by drug manufacturers and standard teratology reference sources for more specific information.<sup>10,11</sup> The effect of anesthetics on early cellular division has been reviewed extensively.<sup>12</sup>

Early studies of neurotropic agents (e.g., opioids, tricyclic antidepressants, phenothiazines, benzodiazepines, butyrophenones) demonstrated significant teratogenicity in rodents. Subsequent studies, however, questioned the relationship given the high doses of drugs administered and the result-

ing respiratory depression and impaired feeding. Using more elegant study designs at clinically relevant doses, often provided with chronically implanted osmotic minipumps, the absence of teratogenicity in the agents commonly used for induction (barbiturates, propofol, ketamine, benzodiazepines), analgesia (opioids), and muscle relaxation has been confirmed.<sup>10,13–15</sup> With the exception of the association of chronic cocaine exposure with congenital defects and adverse reproductive outcomes, local anesthetics per se are devoid of teratogenic effects in clinically used doses.<sup>10,16</sup> As described under Considerations on Maternal Physiology, however, uncorrected maternal hypotension that may result from local anesthetics provided via neuraxial techniques may lead to decreased fetal perfusion, fetal acidosis, and fetal death. The effects of volatiles demonstrate the importance of timing; exposure to nitrous oxide and halogenated agents during in vitro oocyte fertilization causes delays in division from the one- to two-cell stage and impaired spindle cell function during meiosis, respectively. In vivo, mice or rats exposed during pregnancy to 50% or 0.75 minimum alveolar concentration (MAC) halothane, isoflurane, or enflurane at various stages of pregnancy have resulted in increased fetal resorptions and altered body laterality with nitrous oxide, but no teratogenic effects with the halogenated agents.<sup>17</sup> The teratogenicity with nitrous oxide initially was believed to result from rapid inhibition of methionine synthase in both animals and humans. However, this likely is not the only route of activity for several reasons: maximal methionine synthase inhibition occurs at concentrations much lower than those required to produce teratogenic effects, use of folinic acid to bypass methionine synthase partially prevents minor skeletal defects, coadministration of isoflurane or halothane prevents almost all teratogenic effects without affecting methionine synthase activity, and replacement of methionine prevents malformations except for situs inversus defects.<sup>18</sup> As such, the weak teratogenic effects of nitrous oxide are multifactorial. Regardless, the threshold requirements for adverse effects with nitrous oxide (i.e., >50% concentrations for 24 hours) are not likely to be encountered clinically.

The animal and human experience with all drugs suggests critical periods of susceptibility to teratogens. In general, exposure to known teratogens during the first 2 weeks of embryonic development are marked by either death or minor cellular damage and ongoing survival; highly sensitive periods for developmental effects are during fetal organogenesis when major morphologic changes are occurring. Of note, clinical estimates of gestational age originate from the first day of the last menstrual period; however, because fertilization does not occur until 2 weeks after this time, 14 days are added to actual fetal development to correct for the discrepancy. Thus, whereas the period of major fetal organogenesis is considered to occur between 5 and 55 days of gestation, within the clinically used schemas this period occurs in weeks 3–10 of pregnancy. Overall, anesthetic agents have limited effects from their earliest applications in assisted reproduction throughout pregnancy. Despite their limited effects, it seems prudent to limit the dose of anesthetics by using drug combinations or regional techniques.

### Considerations on Maternal Physiology

The maternal and fetal consequences of anesthesia and surgery may be altered by pregnancy or pregnancy-related comorbid conditions (see Chapter 21). Even transient hypoxia, hypercapnia, stress, hypotension, and abnormalities in temperature and metabolism may adversely affect maternal and fetal outcomes. Alterations such as engorgement of the respiratory mucosa, increased consumption of oxygen, and hemodynamic effects of the gravid uterus represent important sources of concern in the provision of anesthesia during pregnancy.

Anesthesia-related maternal mortality has been declining over the last few decades but still accounts for 3–12% of maternal deaths; the majority occur as a result of failed intubation, ventilation and oxygenation, or pulmonary aspiration with general anesthesia. These statistics rank anesthesia as the sixth leading cause of peripartum maternal mortality in the United States, with a risk of maternal death 16.7 times greater with general versus regional anesthesia.<sup>19</sup> A comparison of maternal deaths due to anesthesia in

#### BOX 61–1.

##### Teratogenic Drugs and Chemicals in Humans

Aminopterin  
 Androgenic hormones  
 Busulphan  
 Captopril  
 Chlorobiphenyls  
 Cocaine  
 Coumarin anticoagulants  
 Cyclophosphamide  
 Diethylstilbestrol  
 Diphenylhydantoin  
 Enalapril  
 Etretinate  
 Iodides  
 Lithium  
 Mercury  
 Methimazole  
 Methylaminopterin  
 Penicillamine  
 13-Cis-Retinoic acid  
 Tetracycline  
 Thalidomide  
 Trimethadione  
 Valproic acid

the Confidential Enquiries data of 2000–2002 with the data from 1964–66 yields a 30-fold improvement associated with a reduction in general anesthesia use.<sup>20</sup> Maternal deaths associated with general anesthesia can be partially explained by the significant airway changes that occur over the course of pregnancy and even during labor.<sup>21</sup> The ability to secure the airway emergently has been associated with even greater difficulty,<sup>22</sup> often requiring the use of alternative airway devices and techniques.<sup>23</sup> These maternal outcome data strongly support the use of regional techniques in both elective and emergent delivery situations when no contraindications exist for their use (Box 61–2).

The gravid uterus leads to progressively increasing cardiac demand and compromise of venous return during gestation. The growing uterus ultimately receives 600–700 mL/min of blood flow, which is of major importance when uterine trauma, including surgery, occurs. Moreover, the association between hypotension and the supine position in pregnant women, particularly in the late gestational state, is well demonstrated.<sup>24</sup> Upon assuming the supine position, acute hypotension, with increased pulse rate, increased femoral venous pressure, pallor, and sweating, can occur within minutes, so use of left lateral displacement, even as little as 15°, can reduce the incidence of hypotension and ultimately improve uterine blood flow and fetal health, as evidenced by improved blood gas values.

### BOX 61–2.

#### Contraindications to Central Neuraxial Anesthesia

##### Absolute

- Patient refusal or inability to cooperate
- Localized infection at insertion site
- Sepsis
- Severe coagulopathy
- Uncorrected hypovolemia

##### Relative

- Mild coagulopathy
- Severe maternal cardiac disease (including congenital and acquired disorders)
- Neurologic disease (including intracranial and spinal cord pathologies)
- Severe fetal depression

This syndrome most likely is a manifestation of hormonal as well as mechanical changes. Hormonally, pregnancy-related alterations in renin, angiotensin II, cardiac natriuretic peptide, prostaglandins, progesterone, estrogen, and endothelin cause a relaxation in vascular tone, reduction in stroke volume, decrease in left ventricular compliance, and overall reduction in cardiovascular reserve. These changes ultimately make the cardiovascular system less able to compensate for any mechanical reductions in venous return by the gravid uterus, particularly when the patient is in the supine position. This difficulty in compensation is also observed following spinal anesthesia-induced hypotension.

Additional concerns witnessed only during pregnancy stem from the presence of trophoblastic tissue (i.e., outermost layer of cells of the developing embryo that attaches to the uterine wall) and amniotic fluid. Intravascular systemic distribution of amniotic fluid may accompany uterine rupture or placental separation, leading to sudden cardiovascular collapse accompanied by coagulation disorders. More commonly, however, trophoblastic tissue from the maternal–fetal interface is implicated in the complications associated with preeclampsia, an entity for which delivery of the fetus or fetal tissues remains the only definitive therapy. Hypertensive crises, potential for seizures, intravascular depletion, and thrombocytopenia witnessed with preeclampsia are concerns relevant to anesthetic care (see Hypertensive Disorders of Pregnancy below).<sup>25</sup>

### Considerations for Specific Situations

Concerns regarding the provision of analgesia and anesthesia for the obstetric patient begin prior to pregnancy and continue through pregnancy, the delivery, and the postpartum period. Throughout, anesthesia providers have the responsibility to consider the effects of their interventions during a variety of procedures, including assisted reproductive technologies, cerclage placement and removal, external cephalic version attempts, nonobstetric surgery during pregnancy, in utero fetal surgery, labor and vaginal delivery, cesarean delivery, and tubal ligation. Anesthesia care during dilatation and evacuation procedures, which are performed for pregnancy termination,

pregnancy loss and retained products, and procedures involving ectopic pregnancies, are discussed in Considerations for Specific Situations under gynecologic surgery.

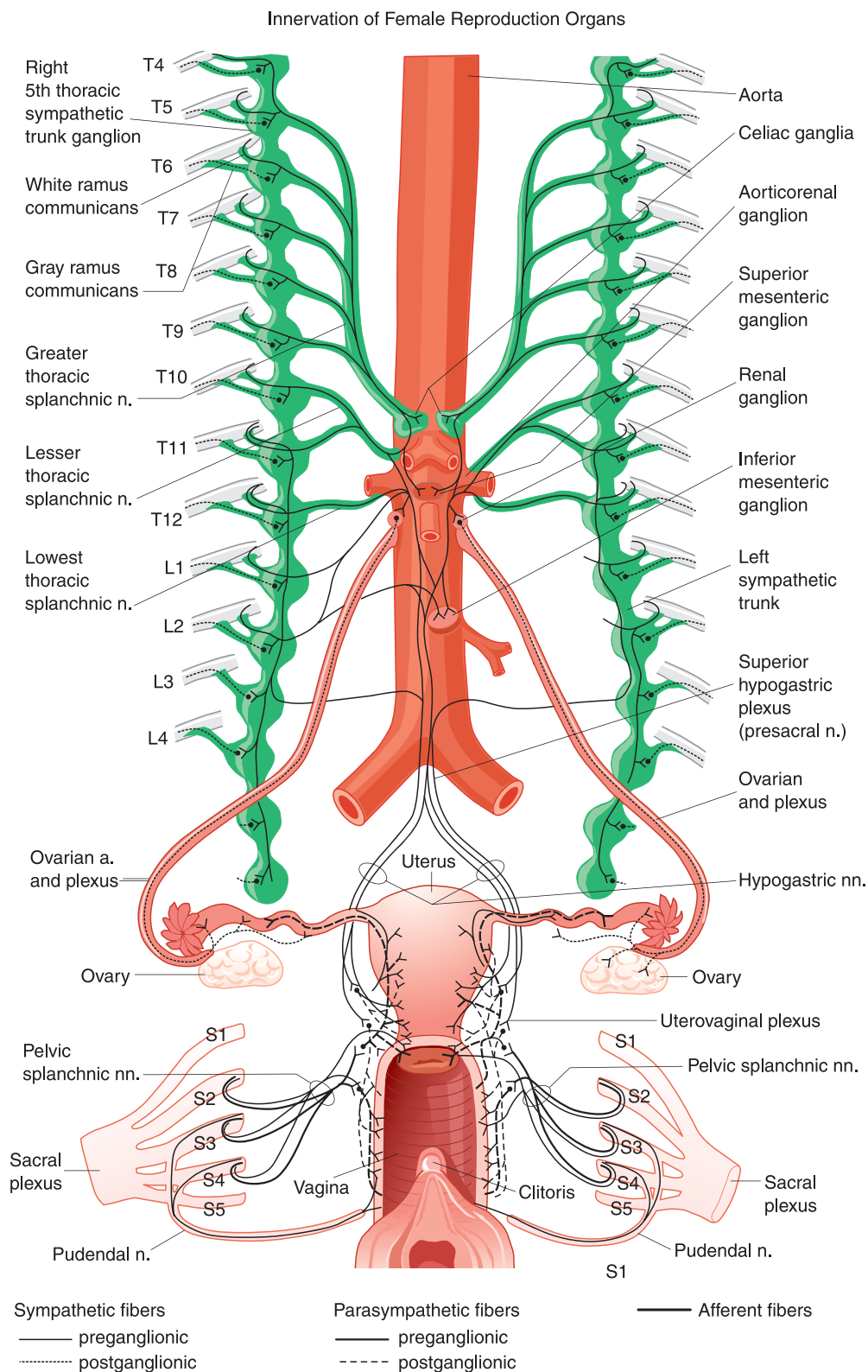
### Assisted Reproductive Technologies

Whereas most patients undergoing procedures related to assisted reproductive technologies are young and otherwise healthy, a growing percentage have significant comorbid states that are responsible for either infertility or the inability to carry a pregnancy. For these individuals, assisted reproduction represents a mechanism to preserve fertility or to obtain oocytes for later use or transfer to gestational carriers. Almost all interventions that require anesthesia are for the purposes of oocyte retrieval and gamete (i.e., sperm or oocyte) or embryo transfer. Most of these procedures are performed transvaginally with ultrasound guidance; on occasion, a transabdominal approach is used.

The anesthetic options for these procedures include paracervical, conscious sedation, spinal, epidural, and general anesthetic techniques.<sup>12</sup> Paracervical anesthesia, which blocks sensation from vaginal but not ovarian pain fibers, often requires additional analgesia (Fig. 61–3). Conscious sedation techniques are the most commonly used mode of analgesia for oocyte retrievals; however, loss of consciousness, patient movement at critical times, and prolonged recovery room stays may result.<sup>12</sup> Total IV general anesthesia provided with IV propofol (titrated) and fentanyl (50–100 µg) offers an optimal approach. Midazolam (1–2 mg) can be added if needed to allay patient anxiety. Most patients can be managed with spontaneous ventilation via a high-flow oxygen mask and continuous carbon dioxide (CO<sub>2</sub>) analysis to monitor the adequacy of ventilation. On rare occasion, as in individuals with multiple risk factors for aspiration or the need for laparoscopy, an endotracheal tube is placed. Inhalational anesthesia with enflurane and 70% nitrous oxide has been shown to produce significantly greater rates of nausea and emesis and more unplanned admissions compared to an IV technique of propofol and alfentanil combined with an inhaled air/O<sub>2</sub> mixture.<sup>12</sup>

Neuraxial techniques provide excellent pain relief with minimal oocyte





**FIGURE 61-3.** Innervation of female reproductive organs.

exposure to anesthetic agents. Compared to sedation with propofol and mask assisted ventilation with nitrous oxide, neuraxial techniques have been associated with fewer complications,

especially nausea and emesis. Spinal anesthesia may be preferable to epidural anesthesia because of the reduced failure rate, lower systemic and follicular levels of anesthesia, and faster

recovery profile.<sup>26</sup> Short-acting local anesthetics (1.5% concentrations of lidocaine or mepivacaine 45 mg) or low-dose longer-acting agents (0.75% bupivacaine 3.75 mg) can be used intrathe-

cally for these procedures, with good results. Use of low-dose bupivacaine may appeal to anesthesia providers hoping to reduce the incidence of transient radicular irritation associated with lidocaine or mepivacaine; however, a longer time to urination is witnessed and greater amounts of intrathecal opioids (25 µg) must be added.<sup>26</sup> The addition of small doses of intrathecal opioids (fentanyl 10 µg) to local anesthetics for spinal anesthesia improves postoperative analgesia for oocyte retrieval for the first 24 hours, with no increase in time to urination, ambulation, or discharge compared to local anesthetic alone.<sup>27</sup>

Pronuclear stage tubal transfer, zygote intrafallopian transfer, tubal embryo transfer, and gamete intrafallopian transfer are procedures that involve the transfer of gametes (sperm and oocytes) or embryos into the fallopian tubes during laparoscopy and local, regional, or general anesthesia. A general anesthetic with propofol and succinylcholine induction, intubation, and maintenance with isoflurane/oxygen and a short-acting muscle relaxant (e.g., atracurium or vecuronium) or a succinylcholine infusion can be used. A propofol with nitrous technique also can be used and has been observed to cause less postoperative sedation, lower pain scores, and less emesis compared to an isoflurane with nitrous technique.<sup>12</sup> Most embryo transfers occur 3–5 days after oocyte retrieval through a transcervical catheter technique that does not require sedation, analgesia, or anesthesia.

Postoperatively, especially following laparoscopic techniques, patients experience abdominal pain, uterine cramping, shoulder pain, nausea, and emesis. Pain is best treated with small doses of fentanyl (50–100 µg IV), as use of nonsteroidal antiinflammatory drugs may affect the prostaglandin milieu associated with embryo implantation.<sup>12</sup> Droperidol and metoclopramide for treatment of nausea and emesis should be avoided when possible because of the associated high prolactin levels and the potential for adverse fertility affects.<sup>28</sup> As with other outpatient procedures, patients should be able to drink and retain oral liquids, ambulate, and void before being discharged from the ambulatory procedure facility.

**Special Concerns** Based on the presence of preexisting disease states,

preoperative evaluations for patients requiring assisted reproductive technologies may range from simple, immediate preprocedural discussions to more complex investigations that require time to collect consultant reports, laboratory studies, electrocardiograms, chest radiographs, and other testing results. All patients should be required to remain nil per os (nothing by mouth [NPO]) from solid foods from the midnight prior to the time of retrieval, and, if they have risk factors for aspiration (e.g., obesity, history of reflux), a nonparticulate antacid should be administered orally prior to the procedure. Use of IV metoclopramide, as a gastric prokinetic agent or as prophylaxis for nausea, should be used sparingly because of its relationship to hyperprolactinemia and adverse fertility effects.<sup>28</sup> Occasionally, a patient may not adhere to NPO policies, and, although delaying or cancelling the case is a viable option, the decision should consider the risks of not proceeding, particularly with an oocyte retrieval. If the window for maximal oocyte retrieval (34–36 hours following human chorionic gonadotropin [hCG] administration) is missed, spontaneous ovulation and loss of oocytes can occur, invalidating the considerable effort and expense leading to the retrieval procedure. More importantly, if follicle aspiration is not performed, the patient is at increased risk for ovarian hyperstimulation syndrome, with its potential for tension ascites, thromboembolic phenomena, renal and hepatic dysfunction, and mortality.<sup>29</sup> By contrast, the reduction in aspiration risk produced by delay or cancellation of the procedure is difficult to quantify, and a spinal anesthetic, instead of a technique that impairs airway reflexes, has an exceptional safety profile. As with all ambulatory surgical procedures, the ideal anesthetic results in effective pain relief with minimal postoperative nausea, sedation, pain, and psychomotor impairment.

### Cerclage

A cervical cerclage is a circumferential suture placed around the cervical os to prevent pregnancy loss due to an incompetent cervix. It can be placed transvaginally or transabdominally with a laparoscopic technique. The clinical management guidelines from the American College of Obstetricians and Gynecologists acknowledge

the limited data available on the efficacy of cerclages, yet the College suggests that an elective cerclage should be performed at weeks 13–16 of gestation in patients with a viable fetus and a history of three or more otherwise unexplained second-trimester pregnancy losses or preterm deliveries.<sup>30</sup> Urgent, or therapeutic, cerclages are often recommended for women with ultrasonographic changes consistent with a short cervix or evidence of funneling (i.e., internal cervical os dilation).<sup>30</sup>

When the cerclage procedure is performed transvaginally, a hyperbaric subarachnoid anesthetic with a local anesthetic that produces approximately 30–45 minutes of anesthesia is a good option in order to avoid maternal airway manipulation and minimize fetal anesthetic exposure. By contrast, if the cerclage is performed transabdominally, a general anesthetic with endotracheal intubation is recommended.

**Special Concerns** Although cerclage procedures are performed before week 20 of gestation, when the uterus transitions from a pelvic to an abdominal organ, the implications of NPO status and aspiration prophylaxis should be considered. The risk of aspiration during pregnancy, particularly early pregnancy, is controversial (see Chapter 21). However, in most situations requiring a cerclage placement, time exists to allow for gastric clearance and/or administration of aspiration prophylaxis.

### External Cephalic Version

Use of external abdominal pressure to turn a fetus from a breech to cephalic presentation is called external cephalic version (ECV). Although the procedure is often performed in obstetric clinics without anesthetic intervention, improved maternal comfort, fetal safety, ECV success, and favorable cost-to-benefit analyses have been observed with neuraxial techniques.<sup>31</sup> Neuraxial techniques most likely improve ECV efficacy by relaxing the abdominal wall muscles, improving patient comfort during the attempt, and allowing the obstetrician to make a more concerted effort.<sup>31,32</sup>

Whereas most ECV attempts with epidural techniques are associated with significant increases in success and ultimate vaginal delivery with fewer total attempts,<sup>33</sup> spinal techniques have resulted in conflicting

outcomes. No improvement was observed with intrathecal bupivacaine 2.5 mg and sufentanil 10  $\mu\text{g}$  (44% vs. 42%),<sup>34</sup> but significant improvement was found with use of intrathecal sufentanil 10  $\mu\text{g}$  alone (80% vs. 33%).<sup>32</sup> The dichotomous outcomes most likely reflect obstetric provider or patient factors, including the amount of force applied and the extent of maternal discomfort tolerated for a given level of analgesia. In the more difficult setting of a repeat ECV after a previously failed attempt, a high success rate (83%) was reported with a spinal technique using lidocaine 45 mg with fentanyl 10  $\mu\text{g}$ .<sup>35</sup> A CSE technique with a short-acting local anesthetic (1.5% lidocaine 45 mg) is the optimal technique for an ECV attempt because it allows for timely discharge from the hospital in the event of a successful version without labor, and, if a trial of labor or an operative delivery is warranted or precipitated, the epidural catheter can be used for additional analgesia or anesthesia.<sup>35</sup>

**Special Concerns** ECV attempts may lead to maternal and fetal complications, including fetal heart decelerations, placental abruption, preterm labor, uterine rupture, amniotic fluid embolism, nausea, emesis, and fetal demise. These adverse outcomes should encourage an ECV attempt in the operating room with maternal and fetal monitoring and with anesthesia providers readily available. Even if neuraxial techniques are not used for the ECV attempt, rapid administration of anesthesia may be necessary for maternal or fetal intolerance. Moreover, although tocolytics (terbutaline, ritodrine) are frequently used to relax the uterus prior to ECV attempts, IV nitroglycerin (50- $\mu\text{g}$  bolus, wait 45 seconds prior to reattempt) has been reported to provide additional uterine relaxation.<sup>35</sup> Because nitroglycerin administration is often accompanied by hypotension, the anesthesia provider should encourage its use only with maternal and fetal monitoring and anesthesia provider presence.

### ***In Utero Fetal and Placental Surgery***

A growing number of interventions are being used to correct placental abnormalities and fetal defects in utero. Laser photocoagulation of placental vessels responsible for twin-to-twin

transfusion syndrome, percutaneous catheter dilation of fetal cardiac valvular defects, and open hysterotomy with fetal repair of diaphragmatic hernias or resection of tumors are a few currently available procedures.<sup>36</sup> Ex utero intrapartum therapy, most commonly performed for large fetal head and neck tumors or severe heart and lung disorders immediately before cesarean delivery, allows partial fetal surgical exposure while maintaining placental circulation until an airway or alternate circulatory arrangement, such as extracorporeal membrane oxygenation, is secured.

Minimally invasive approaches with laparoscopic or percutaneous catheter techniques can be performed under local field blocks or neuraxial techniques. By contrast, operations that involve partial fetal exteriorization are best performed under general anesthesia for uterine quiescence and fetal anesthesia.<sup>37</sup> Fetal anesthesia and immobility can be augmented through intramuscular administration of opioids, muscular relaxants, and atropine to the fetus. Maternal postoperative analgesia can be improved with neuraxial preservative-free morphine (3 mg epidural, 0.2 mg subarachnoid), even if a general anesthetic is planned. Occasionally, more invasive monitoring, as with an arterial or central venous catheter, is warranted to allow for more immediate blood pressure and central venous pressure (CVP) monitoring and vascular access for laboratory studies during the perioperative and intraoperative periods.

**Special Concerns** The ability and timing of sentience, the capacity to experience painful or unpleasant sensations, in the fetus is a subject of growing interest and controversy.<sup>38</sup> Because structural and behavioral maturation ultimately determine the capacity to feel pain, the presence of reflex responses and cortical connections may not necessarily represent the ability to experience nociception. Although synapses to and from the cortex are present as early as 8.5 weeks of gestation, structures believed necessary for conscious pain perception, such as thalamic projections, intracortex connections, and synchronous electroencephalographic activity, have not been observed until 20 to 30 weeks.<sup>38</sup> Fetal analgesia or anesthesia, however, should be considered to pre-

vent hormonal stress responses that may be associated with poor neonatal surgical outcomes or long-term neurodevelopmental and behavioral responses to pain and to inhibit fetal movement during procedures.<sup>39</sup> Fetal analgesia and anesthesia can be achieved by passive analgesic administration via maternal general anesthesia or by direct intramuscular injection into the fetus. Injection of narcotics directly into the amniotic fluid, which results in greater fetal than maternal concentrations in animal models, is a modality that may have application in the future.<sup>40</sup>

### ***Labor and Vaginal Delivery***

The pain of labor and vaginal delivery evolves through the first and second stages of labor (Fig. 61-3). The first stage of labor, defined as the onset of regular uterine contractions that result in progressive uterine cervical dilation, produces pain originating from both uterine and cervical stretching. Described as dull, aching, crampy, and poorly localized, the pain sensations are carried by visceral afferents entering the spinal cord at the T10 to L1 level. By contrast, the second stage of labor, defined as the time from complete cervical dilation to the delivery of the fetus, produces pain originating from vaginal and perineal stretching. More somatic in origin, the pain is sharp, discrete in location, and is carried by the lower lumbar and sacral fibers. Of interest, the contemporary pattern and progress of labor appear slower than previously described a half a century earlier.<sup>41</sup> Attributed to the greater maternal age and weight, increased fetal size, and significantly higher use of induction of labor, these factors may contribute to labor pain of longer duration.

A variety of techniques are used to provide analgesia during labor and delivery (Box 61-3). Neuraxial techniques have been demonstrated to be the most effective form for labor analgesia,<sup>42</sup> but there are some contraindications to their use (Box 61-2). Moreover, other techniques have been found to be useful or comforting for parturients and may add to overall maternal satisfaction with the birth experience. Various techniques are often used sequentially as labor progresses; however, their simultaneous use may not offer advantages greater than an epidural technique.

## BOX 61-3.

**Analgesic Techniques during Labor and Delivery****Nonpharmacologic Techniques**

- Psychologic preparation
- Emotional support
- Touch and massage
- Therapeutic heat and cold applications
- Hydrotherapy
- Biofeedback
- Vertical or alternative positioning
- Transcutaneous electrical nerve stimulation
- Acupuncture/acupressure
- Hypnosis

**Pharmacologic Techniques**

- Parenteral Agents**
  - Opioids, opioids antagonist/agonists
  - Nonsteroidal antiinflammatory drugs
  - Barbiturates
  - Phenothiazines
  - Hydroxyzine
  - Scopolamine
  - Benzodiazepines
  - Ketamine
- Inhalation Agents**
  - Nitrous oxide
  - Volatile halogenated agents
- Neuraxial Agents**
  - Opioids
  - Local anesthetics
  - $\alpha_2$ -Agonists

Transcutaneous nerve stimulation, for example, does not appear to augment either epidural or CSE techniques.<sup>43,44</sup> Clear communication between the patient and all members of the health-care team is essential for the proper timing of anesthetic care. In some cases, such as morbid obesity or preexisting back pathology, early placement of an epidural catheter with activation later during labor may be an optimal approach for maternal and fetal outcomes. The concern that neuraxial analgesia techniques could mask the pain of a uterine rupture in women with previous cesarean deliveries or uterine scars appears unfounded. Indeed, the presence of an epidural catheter in women undergoing vaginal birth after cesarean delivery may improve maternal and fetal outcomes by allowing for expedient cesarean delivery anesthesia if uterine rupture or

fetal distress occurs. Overall, the use of epidural, spinal, and CSE techniques should be evaluated for each parturient because the duration of labor and the mode of delivery are not known a priori in most cases. Should the patient desire or require analgesia or anesthesia, a catheter-based technique allows for the most flexibility.

**Epidural Analgesia** The epidural technique is the most common neuraxial technique used for labor analgesia because of relatively rapid sensory analgesia with minimal motor blockade, uterine effects, and maternal or fetal toxicity (Fig. 61-2).<sup>45</sup> Almost all local anesthetics can be used in low concentrations; however, the longer-acting agents allow for less variation in the quality of analgesia (Table 61-1). Bupivacaine, which provides a high ratio of sensory to motor block, is the most commonly used agent for labor epidural analgesia worldwide. Ropivacaine and levobupivacaine are newer long-acting agents that, when given in equipotent concentrations to bupivacaine, may result in slightly less motor blockade and fewer cardiotoxic effects should intravascular absorption occur.<sup>46,47</sup> Epidural narcotics alone provide sufficient analgesia for the first stage of labor (Table 61-2),<sup>48</sup> but the combination of small doses of sufentanil (0.2–0.3  $\mu\text{g}/\text{mL}$ ) or fentanyl (0.2  $\mu\text{g}/\text{mL}$ ) with low doses of bupivacaine (0.0625–0.125%) is necessary for second-stage labor and vaginal delivery. An epidural bolus of fentanyl 100  $\mu\text{g}$  with or without local anesthetic can improve maternal comfort during the second stage of labor when patchy analgesia or perineal sparing cannot be remedied with local anesthetics alone.<sup>49</sup>

Once the initial sensory blockade has been established, epidural analgesia can be maintained by intermittent bolus injections, continuous infusion, or both techniques simultaneously. The development of inexpensive infusion pumps has offered perhaps the optimal method: continuous infusion coupled with patient-controlled intermittent bolus injections through the epidural catheter. This combined method reduces the total amount of medication used, decreases the amount of motor blockade, and increases patient satisfaction compared to continuous infusions or intermittent bolus methods alone.<sup>50</sup>

Should an instrumental or operative delivery, laceration repair, or postpartum tubal ligation occur, labor epidural analgesia can be transitioned to anesthesia with a change in the concentration or type of local anesthetic used through the catheter (Table 61-1). Vacuum or forceps deliveries often require denser perineal sensory anesthesia for placement of instruments than offered by contemporary labor analgesia infusion concentrations as noted earlier in this section. This can be accomplished using 6–7 mL of 1% lidocaine solution with 8.4% bicarbonate in a 10:1 ratio. Increasing the sensory level from the tenth to the seventh or eighth thoracic dermatome also will allow for more rapid anesthetic extension to a fourth thoracic dermatome should the need for an emergent cesarean delivery develop.

**Spinal Analgesia** The limited duration of action of a single injection and the increased risk of PDPH with multiple injections limit the utility of spinal anesthesia for the management of labor. Spinal techniques, however, can be used successfully in the immediate peripartum period, especially in the event of a precipitous vaginal delivery, use of outlet forceps or vacuum extractions, or repair of extensive perineal lacerations. Short-acting, low-level spinal anesthesia can be used for many of these procedures; however, the range of likely obstetric outcomes should be evaluated carefully. A delivery by “trial of forceps,” for example, can quickly transition to an urgent cesarean delivery. Spinal techniques that offer more flexibility include the CSE technique and a spinal catheter technique.

**Combined CSE Analgesia** The CSE technique for labor analgesia has increased in popularity.<sup>45</sup> When placed early in labor and compared to parenteral opioid or standard epidural techniques, a CSE technique with narcotics alone or in combination with local anesthetics may have beneficial effects on motor ability and the progress of labor.<sup>51,52</sup> Used later in labor, the CSE technique can provide quick onset of analgesia and the ability to extend the duration or level of the blockade should delivery methods mandate such augmentation.

**Special Concerns Progress of Labor** Whether central neuraxial analgesia affects the progress and out-



come of labor remains a controversial topic. The myriad of maternal and fetal variables and the differences in anesthetic and obstetric practices are confounding factors in such studies. Moreover, methodologic problems, such as difficulties in randomization and blinding, make an association difficult to evaluate. Overall, however, the use of epidural analgesia appears to have little affect on the progress and outcome of labor. A meta-analysis of 10 trials comparing parturients of mixed parity randomized to epidural analgesia or parenteral opioids noted a prolongation of the first and second stages of labor by 42 and 14 minutes, respectively, in association with the use of epidurals.<sup>53</sup> Despite the belief that an arbitrary threshold of 5 cm of cervical dilation should be achieved prior to epidural analgesia administration to prevent cesarean delivery,<sup>54</sup> early (< 4 cm) placement of CSE labor analgesia versus parenteral opioids<sup>51</sup> or standard epidural techniques<sup>52</sup> has resulted in shorter times to achieve full cervical dilation with no alterations in the cesarean delivery rate. Overall, the risk of cesarean delivery does not appear to be increased with the use of neuraxial labor analgesia.<sup>55</sup>

**Anesthetic Complications** A number of complications may occur following neuraxial techniques (Table 61-3). Hypotension, defined as a 20–30% decrease in systolic blood pressure from baseline, can be observed in 20–100% of pregnant women as a result of the sympathetic vasomotor blockade associated with neuraxial analgesia and anesthesia.<sup>56</sup> Left uncorrected, hypotension may result in decreased uteroplacental perfusion, fetal hypoxia, and acidosis.<sup>57</sup> Preventive measures include maternal intravascular volume expansion with 500 mL of colloid (e.g., hetastarch) or 1000 mL of crystalloid (e.g., lactated Ringer solution) within 15 minutes of the neuraxial technique and positioning with a 15° left lateral tilt to avoid uterine aortocaval compression. Although IV titrated doses of vasopressors, such as ephedrine 5–10 mg or phenylephrine 40–100 µg, can be used prophylactically, the occurrence and extent of hypotension are unpredictable; thus, many regimens have focused on using these agents as treatments rather than prophylaxis. The nausea and vomiting following neuraxial techniques may be associated with

reductions in sympathetic tone, blood pressure, and cerebral blood flow and can be reduced significantly with vasopressor use.<sup>58</sup> PDPH occurs in approximately 1–3% of the obstetric population following dural puncture and is related to needle size and tip design, with larger, cutting (beveled) needles associated with a greater incidence.<sup>59</sup> Typically, PDPH presents as a positional headache that worsens and improves in the upright and recumbent positions, respectively. The differential diagnosis should include other types of headaches, hypertensive disorders, infectious diseases, dural venous sinus thromboses, and other intracranial pathologies. If the diagnosis of PDPH is made, bed rest may aid in pain relief,<sup>60</sup> and conservative measures of hydration and oral intake of caffeinated and analgesic products (including Fioricet or Fiorinal) can be used for 24–48 hours. An epidural blood patch, with 10–20 mL of autologous blood placed in the epidural space, has been associated with a >80% incidence of success in most trials.<sup>59,61</sup> Although significant complications (e.g., cauda equina syndrome, transverse myelitis, arachnoiditis, spinal-epidural abscesses, and vascular trauma) following neuraxial analgesia and anesthesia in the obstetric population are extremely rare,<sup>61</sup> when signs and symptoms are unclear or rapidly progressing, consultation with a neurologist may assist in diagnosis and treatment. Finally, an unexpected high level of anesthesia can result in hypotension, dyspnea, inability to speak, and loss of consciousness. Ventilatory and circulatory support should always be readily available when these techniques are provided.

Of interest, relatively few complications are inherent to CSE technique per se. The risks of a dural puncture with an epidural needle may actually be reduced, as CSF within the spinal needle can be used to confirm proximity to the epidural space. The likelihood of the epidural catheter passing through the spinal needle dural puncture site is low in laboratory and clinical studies.<sup>62</sup> Epidural analgesia following a dural puncture has been observed to have a faster onset and improved sacral spread, especially when epidural dosing is performed immediately after the dural puncture with surgical local anesthetic concentrations.<sup>63</sup> The timing and dose of the epidural bolus and the size of the dural puncture may have rele-

vance. Labor analgesia medications placed in the epidural space appear to have limited passage through a 27-gauge dural puncture.<sup>64</sup> The risk of a high spinal blockade as a result of a CSE technique appears negligible. The failure of an “untested” epidural catheter following the spinal portion of a CSE technique is a potential concern, but epidemiologic evidence suggests that CSE epidural catheters have a lower failure rate than does the epidural technique alone.<sup>65</sup> In parturients with difficult airway access or those with a high probability of an instrumental or operative delivery, a standard epidural technique, which tests the function of the catheter at the time of placement, may be a safer alternative.

### Cesarean Delivery

With the advent of fetal heart rate and tocodynamometric monitoring, a reduction in breech and forceps-assisted deliveries, and the changing social and medicolegal environment, cesarean deliveries now account for 25–30% of deliveries nationally and internationally.<sup>66</sup> Although anesthesia-related maternal mortality has been declining during the last few decades, it still accounts for 3–12% of maternal deaths, with the majority associated with general anesthesia secondary to failures in intubation, ventilation, and oxygenation. As such, the use of regional neuraxial techniques has been strongly preferred. However, the urgency of the procedure, the health and comorbidities of the mother and fetus, and the desires of the mother and healthcare providers must be considered when deciding on the optimal anesthetic technique.

Cesarean delivery is performed most commonly through a low transverse abdominal incision (Pfannenstiel) above the pubic crest, with dissection of the fascia and separation of the rectus muscles. Following opening of the peritoneum, a transverse uterine incision (hysterotomy) typically is used for delivery of the fetus. Advantages of the transverse incision include better cosmetic results, less pain, and low incidence of hernia formation. Disadvantages include limited access to the upper abdomen, a greater incidence of subfascial hematomas from small perforating vessels through the rectus muscle, and increased nerve injury resulting in overlying skin paresthesias. In the setting of a

**TABLE 61–3.**

**Major Complications of Neuraxial Analgesia and Anesthesia**

	<b>Transient Neurologic Syndrome</b>	<b>Cauda Equina Syndrome</b>	<b>Traverse Myelitis</b>	<b>Anterior Spinal Artery Syndrome</b>	<b>Arachnoiditis</b>	<b>Epidural Hematoma</b>	<b>Epidural Abscess</b>
<b>Signs and symptoms</b>	Pain in lower back and/or buttocks	Pain in low back with variable motor and sensory deficits	Pain in low back with motor weakness and sensory alterations	Painless loss of motor and sensory function	Pain in low back with variable motor and sensory deficits	Pain or pressure in low back with progressive motor or sensory blockade	Pain in low back that is tender on palpation and accompanied by sensory or motor deficits and fever; may progress
<b>Cause</b>	With/without unilateral or bilateral radicular pain described as aching, burning, or cramping  All contemporary local anesthetics	Unilateral or bilateral radicular pain, sensory loss particularly in the saddle region  Bladder and bowel dysfunction Ischemic compression by hematoma or abscess, or direct neurotoxicity, possibly due to prolong nerve exposure to high doses or concentrations of local anesthetics	Allodynia (heightened sensitivity to touch)  Bladder and bowel dysfunction Exact cause unknown; however, infections, abnormal immune reactions (e.g., lupus), ischemia, and multifocal neurologic disease (e.g., multiple sclerosis), and neuraxial techniques have been suggested	Preservation of vibration and joint position  Hypotension, disruption of blood supply, vasoconstrictors or vasospasm	Unilateral or bilateral pain that increases with activity  Disinfectants, local anesthetics, contrast media, blood, infections, vasoconstrictors, hemorrhage, multiple spinal surgeries	Unilateral or bilateral radicular pain  Bladder and bowel dysfunction May occur spontaneously, after trauma, or after instrumentation; higher risk if abnormal coagulation status at time of instrumentation or catheter removal	Unilateral or bilateral radicular pain  Bladder and bowel dysfunction Bacterial, immunocompromised patients are at higher risk; nonsterile techniques involving neuraxial technique
<b>Testing</b>	None	MRI	MRI or myelogram	MRI and angiogram	MRI or myelogram	MRI	MRI
<b>Consults</b>	Anesthesiologist	Neurologist and/or neurosurgeon	Neurologist	Neurologist	Neurologist	Neurologist and/or neurosurgeon	Neurologist and/or neurosurgeon
<b>Onset</b>	12–24 h after surgery		Acutely (hours to days) or subacutely (1–2 wk).	Following insult whether surgical or traumatic	May occur years after the precipitating cause	Spontaneously, or 0–2 days after insult,	2–7 days after instrumentation

*(continued)*

TABLE 61-3.

## Major Complications of Neuraxial Analgesia and Anesthesia (Continued)

	<b>Transient Neurologic Syndrome</b>	<b>Cauda Equina Syndrome</b>	<b>Traverse Myelitis</b>	<b>Anterior Spinal Artery Syndrome</b>	<b>Arachnoiditis</b>	<b>Epidural Hematoma</b>	<b>Epidural Abscess</b>
<b>Treatment</b>	Nonsteroidal anti-inflammatory drugs Opioids Heat Muscle relaxants Leg elevation	Corticosteroids (limited data)	Corticosteroids (no clinical data), pain management, physiotherapy, exercise, psychotherapy	Correction of any existing hypotension, correction of vasospasm, physiotherapy, exercise	Pain management, physiotherapy, exercise, psychotherapy Steroid injections and electrical stimulation may be helpful Surgical intervention usually not helpful	Surgical decompression usually is indicated within 6–12 hours of symptom onset	Intravenous antibiotics, percutaneous drainage, laminotomy with washout of epidural space, laminectomy
<b>Recovery</b>	Full	Limited clinical data	Within 2–12 wks of symptom onset and continue for up to 2 y; if no improvement within 3–6 mo, significant recovery unlikely	Variable, may have full, partial, or no recovery	No significant improvement with treatment; usually a chronic pain disorder that is not progressive	Variable and dependent on extent of neurologic involvement and treatment	Variable, dependent on extent of neurologic involvement and treatment
<b>Duration</b>	Symptoms last for 6 h to 7 days	Variable	Variable	Variable	Incurable	Variable	Variable
MRI, Magnetic resonance imaging.							

TABLE 61-4.

## Medications Used to Augment Uterine Tone in Obstetric and Gynecologic Surgery

Medication	Uses	Route of Administration	Risks
Oxytocin	Induces labor, increases uterine tone	IV infusion; no more than 20 units/1000 mL solution	Uterine hyperactivity; hypotension; reflex tachycardia; ADH-like response if given in high doses with risk of water intoxication; should be given in electrolyte-containing solutions, not dextrose in water
Ergonovine	Increases uterine tone	IM/oral	Peripheral vasoconstriction
Methylergonovine	Increases uterine tone	IM 0.2 mg	Acute hypertension, seizures, cerebrovascular accidents, retinal detachment if given IV; use with caution in patients with coronary artery disease, essential hypertension, preeclampsia, atherosclerotic disease; nausea and vomiting may reflect direct central nervous system effect
Prostaglandin E <sub>2</sub>	Increases uterine tone	Oral, rectal, or vaginal; dose depends on desired effect	Nausea, vomiting, diarrhea, fever, tetanic uterine contractions, hypotension; hypertension
Prostaglandin F <sub>2α</sub>	Increases uterine tone	IM 0.25 mg	Nausea, vomiting, bronchospasm; tetanic uterine contractions; hypotension; hypertension

ADH, Antidiuretic hormone; IM, intramuscular; IV, intravenous.

preterm cesarean delivery, especially prior to elongation of the lower uterine segment in the week 34 of gestation, the hysterotomy is sometimes performed with a vertical incision for greater surgical exposure. Because a vertical uterine incision is more prone to dehiscence or rupture with uterine contractions, all subsequent pregnancies must undergo a cesarean delivery.

Regardless of the type of incision, uterine tone may be compromised in preterm deliveries as the number of oxytocin receptors increases closer to term. Uterine tone may be further limited in conditions that augment the size of the uterus, such as polyhydramnios, multiple gestation, and fibroids. Uterine atony accounts for 75–90% of postpartum hemorrhage and remains a leading cause of postpartum hysterectomy and blood transfusion. In an attempt to reduce the incidence of uterine atony and its sequelae, initial efforts at time of cesarean delivery include uterine massage and IV oxytocin, a uterotonic medication (Table 61-4).<sup>67</sup> Doses of oxytocin range from 5–20 IU in 500 or 1000 mL of lactated Ringer solution at a rate of 10 mL/min until the uterus remains firmly contracted. The infusion rate is then reduced to 1–2 mL/min. Oxytocin, particularly when given as an IV bolus, has been associated with morbidity, including hypotension, nausea and vomiting, antidiuretic effects leading to fluid reten-

tion and pulmonary edema, and even death from cardiovascular collapse.<sup>68,69</sup> Other more powerful uterotonic agents, including prostaglandins (15-methyl-prostaglandin 250 µg) and ergot preparations (methylergotamine 200 µg) can be administered intramuscularly or directly into the myometrium at intervals of 15–20 minutes to a total dose of 1 mg. These agents, however, are associated with significant side effects, including nausea, bronchospasm (especially with prostaglandins), hypertension, pulmonary edema, and cerebral hemorrhage.<sup>70</sup> Should these medical therapies fail, uterine or hypogastric artery ligation, interventional arterial balloon catheterization, or hysterectomy may be necessary.

**Spinal Anesthesia** A simple and reliable technique with rapid onset, spinal (subarachnoid) anesthesia provides an awake and comfortable patient with minimal risks for pulmo-

nary aspiration of gastric contents. Despite the lower abdominal incision, a T4 sensory dermatome level is required to prevent referred pain from traction on the peritoneum and uterus. The type and dose of local anesthetic used to provide the spinal anesthetic must include consideration of the level of anesthesia desired, duration of surgery, postoperative analgesia plan, and preferences of the anesthesiologist. Spinal administration of hyperbaric 0.75% bupivacaine with fentanyl and preservative-free morphine may be the optimal combination (Box 61-4). The almost immediate onset of fentanyl reduces visceral discomfort and even nausea during the procedure, whereas the delayed onset and 18 to 20-hour duration of morphine provides prolonged relief following the procedure. Although ropivacaine and levobupivacaine can be used in similar concentrations and doses, the potential for reduced toxic-

## BOX 61-4.

## Optimal Neuraxial Medication Combinations for Cesarean Delivery

Medication	Spinal	Epidural
Local anesthetic	Bupivacaine 12 mg (range 9–15)	Lidocaine 2%; chloroprocaine 3% if urgent. Both added in 10:1 volume ratio to 8.4% bicarbonate
Fentanyl	15–35 µg	50–100 µg
Morphine	0.1 mg	3.75 mg



ity should intravascular absorption occur seems limited given the extremely small doses of agents used. Adjuvant spinal medications, including epinephrine, may augment the quality and duration of the anesthesia and analgesia.<sup>71,72</sup>

Following administration of a subarachnoid technique, the patient may complain of dyspnea. This can occur because of several factors, including blunting of thoracic proprioception, partial blockade of abdominal and intercostal muscles, and increased pressure of the abdominal contents against the diaphragm in the recumbent position. Despite these changes, significant respiratory compromise is unlikely as the blockade rarely affects the cervical nerves that control the diaphragm. Should the patient lose the ability to vocalize, give a strong hand grip, or demonstrate oxygen desaturation by pulse oximetry, a rapid sequence induction of general anesthesia, with cricoid pressure and placement of an endotracheal tube, can be performed to maintain ventilation and prevent pulmonary soiling with gastrointestinal contents.

The most common complications of spinal anesthesia have been described earlier under Anesthetic Complications and include hypotension, nausea and vomiting, and risk of PDPH.

**Epidural Anesthesia** Use of epidural anesthesia for cesarean delivery has increased during the past 2 decades, primarily as a result of its use for labor analgesia. Although medications used in the spinal and epidural space are identical, epidural doses are 5–10 times greater and given in much larger volumes to encourage adequate blockade and spread of the drug. Overall, a greater sensitivity of nerves to local anesthetics during pregnancy has been observed clinically through decreased anesthetic requirements for epidural blockade.<sup>73,74</sup> For cesarean delivery, the most commonly used agents are 2% lidocaine with epinephrine 1:200,000 or 3% 2-chloroprocaine. Chloroprocaine is the agent of choice for emergency cesarean deliveries because of its rapid onset and rapid maternal and fetal metabolism; fetal accumulation, especially when acidosis is present, is minimized.<sup>75</sup> By contrast, chloroprocaine is avoided for routine nonurgent deliveries because the short duration requires multiple doses, and its use can adversely affect the efficacy

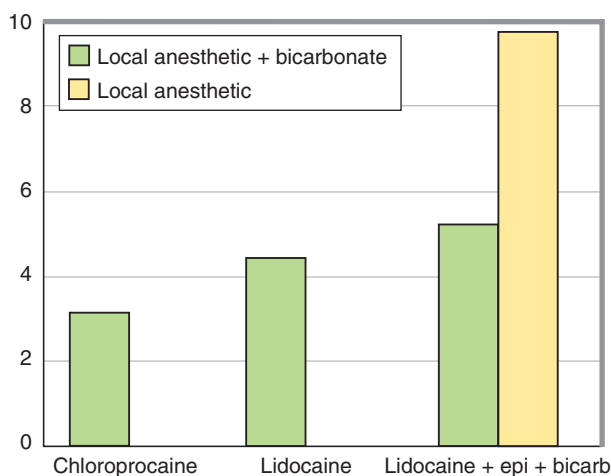
of subsequent epidural opioid analgesia.<sup>76</sup> In addition, chloroprocaine used in higher total volumes (>40 mL) can increase the incidence of back pain.<sup>77</sup> Alkalinization with sodium bicarbonate hastens the onset time of local anesthetics significantly and is recommended for use in urgent cesarean deliveries with 1 mL of 8.4% bicarbonate for every 10 mL of lidocaine or chloroprocaine (Fig. 61–4).<sup>78</sup> By contrast, 10 mL of bupivacaine, levobupivacaine, or ropivacaine precipitates out of solution with <0.5 mL of bicarbonate, leading to an inability to inject the local anesthetic through a needle or catheter; therefore, bicarbonate should not be added to these longer-acting local anesthetics.<sup>79</sup>

The complications of epidural anesthesia have been described previously under Anesthetic Complications and include hypotension, risk of PDPH, systemic toxic reactions, and, rarely, neurologic complications. Epidural techniques can provide patchy or inadequate blockade due to anatomic or technical reasons.<sup>80</sup> Often, these failures can be identified a priori through observation of the quality of labor epidural analgesia or quickly after partial augmentation of the blockade. Alternative techniques, such as supplementation with IV or inhalational agents, spinal anesthesia, or general anesthesia, must always be considered as options when analgesia is clearly inadequate.

**CSE Anesthesia** The principal advantage of the CSE technique for cesarean delivery is the ability to augment the density or duration of the anesthesia administered via the epidural catheter. This is particularly useful in obstetrics where a trial of labor may be attempted prior to an operative delivery, or the duration of the surgery may be prolonged (e.g., possible placenta accreta, history of multiple abdominal surgeries, high index of suspicion for gravid hysterectomy). A guiding principle in the selection of the CSE technique is whether the parturient appears to have an airway that would be difficult to intubate. A patient who presents as an intubation risk perhaps would be better served by avoiding the CSE technique, as the epidural catheter is “untested” and may not provide optimal anesthesia. In such cases, an epidural technique is often used to initiate and maintain anesthesia.

#### Special Concerns during Cesarean Delivery

Although regional anesthesia is used whenever possible to avoid the potential airway complications associated with general anesthesia, certain conditions or time constraints may contraindicate its use (Box 61–2).<sup>81</sup> Such comorbidities include localized infection or generalized sepsis, coagulation disorders, severe hypovolemia, and cardiac pathologies where hypotension may be especially



**FIGURE 61–4.** Extension of labor epidural analgesia for cesarean delivery. Onset (in minutes) for extension of T<sub>10</sub> labor analgesia to T<sub>4</sub> cesarean anesthesia. Note the values for chloroprocaine and bicarbonate. (Based on data from Gaiser RR, Cheek TG, Adams HK, et al. Epidural lidocaine for cesarean delivery of the distressed fetus. *Int J Obstet Anesth* 1998;7:27–31; Lam DT, Ngan Kee WD, Khaw KS. Extension of epidural blockade in labour for emergency Caesarean section using 2% lidocaine with epinephrine and fentanyl, with or without alkalinisation. *Anaesthesia* 2001;56:790–794.)

detrimental. Severe obstetric hemorrhage in the antepartum period, including uterine rupture and acute and severe fetal distress also may contraindicate the use of regional anesthesia procedures because of the time necessary to establish a surgical anesthetic.

Patients with severe preeclampsia or hypertension may undergo rapid hemodynamic changes with regional techniques; however, both epidural and spinal techniques can be used successfully in this setting.<sup>82,83</sup> In addition, gravid hysterectomies can be performed safely with regional techniques.<sup>84</sup> Overall, however, general anesthesia should be considered if questions exist regarding the ability of maternal compensatory mechanisms to react to the regional anesthetic or surgery.

Hypotension presents the greatest risk to maternal and fetal comfort and health.<sup>56</sup> Prevention and prompt treatment with IV fluids and administration of vasopressors have been beneficial but may not be completely successful.<sup>85,86</sup> In terms of volume expansion, spinal anesthesia in the urgent setting should not be delayed until a fixed arbitrary volume has been infused. In addition, aggressive hydration with large fluid volumes (>20 mL/kg crystalloid) may increase the risk of edema with only limited reductions in hypotension.<sup>85</sup> Colloid solutions appear to be more effective than crystalloids in preventing the hemodynamic consequences of spinal anesthesia.<sup>87</sup> However, in most cases the allergic, cost, and coagulation implications offset their benefit. Current investigations into the use of vasopressors for prevention and treatment of hypotension in this setting include use of phenylephrine, sometimes in combination with ephedrine, administered via bolus and infusion pump techniques.<sup>88,89</sup> Although most animal studies indicate combined  $\alpha$ - and  $\beta$ -adrenergic agonists (e.g., ephedrine) are more effective than  $\alpha$ -adrenergic agonists (e.g., metaraminol, phenylephrine) in terms of restoration of maternal blood pressure and fetal acid-base status, clinical investigations appear to favor the use of  $\alpha$ -adrenergic agonists.<sup>90</sup> Because clinical and animal data do not support a single agent in all circumstances, a rational strategy is vigilance and a proactive response with both ephedrine and phenylephrine as guided by maternal blood pressure and heart rate.

Nausea and emesis during and after cesarean delivery can have a number of causes but are best prevented by controlling hypotension, optimizing the use of neuraxial and IV opioids, improving the quality of surgical blockade, minimizing surgical stimuli, and judiciously administering uterotonic agents.<sup>91</sup>

Although pruritus following neuraxial blockade is attributed to a number of postulated mechanisms and has several treatments,<sup>92</sup> a narcotic antagonist or partial antagonist (e.g., nalbuphine 4 mg IV) appears more effective than some other modalities. Postoperative shivering also may have several etiologies and treatments. IV meperidine 25 mg, clonidine 150  $\mu$ g, doxapram 100 mg, ketanserin 10 mg, and alfentanil 250  $\mu$ g all have been used with success, although meperidine appears to be the most consistently effective.<sup>93</sup>

**General Anesthesia** There are few, if any, absolute contraindications to general anesthesia. However, regional anesthesia remains a preferred method to avoid the risks of airway management and allow the patient the ability to witness delivery of the fetus. General anesthesia, however, may offer advantages in cases where uterine relaxation would be beneficial, such as extracting difficult breech presentations, removing retained placentas, restoring uterine inversions, and performing in utero fetal operations.

The importance of proper airway evaluation during the antenatal period or in early labor, if possible, cannot be overemphasized, as failed intubation, failed ventilation and oxygenation, and/or pulmonary aspiration of gastric contents are the leading anesthetic causes of maternal death.<sup>94,95</sup> If the airway evaluation suggests a difficult intubation or risk factors for a difficult neuraxial placement (e.g., morbid obesity, scoliosis, dropping platelet count), the establishment of a continuous neuraxial technique early in labor should be strongly encouraged.<sup>96</sup> If the parturient does not desire epidural analgesia during labor, the epidural catheter still can be placed, tested for a bilateral sensory distribution with 6–7 mL of 1–2% lidocaine with bicarbonate, and then allowed to wear off until such time that analgesia or anesthesia is desired. If a difficult airway is discovered during a rapid sequence intubation attempt, options include allowing

the patient to awaken, using alternate techniques (e.g., fiberoptic- or light-guided intubation) to place an endotracheal tube, or using alternative airway devices (for a detailed review of airway management, see Chapter 35). Although the laryngeal mask airway (LMA) cannot prevent pulmonary soiling with gastric contents, it can be a lifesaving measure in failed intubation situations.<sup>97</sup> It has been used without adverse sequelae with continuous cricoid pressure held for the duration of cesarean delivery.<sup>98</sup> Emergency airway equipment should be readily available in all obstetric operating rooms.

Attempts should be made to minimize the risk of maternal aspiration, even when the need for intubation is not anticipated. With an elective cesarean delivery, adherence to an NPO policy for 8 hours prior to surgery is advised. A nonparticulate antacid is believed to decrease damage to the respiratory epithelium if aspiration occurs,<sup>99</sup> and  $H_2$  antagonists (cimetidine, ranitidine) and promotility agents (metoclopramide) can reduce gastric acid secretion and facilitate emptying, respectively.<sup>100,101</sup>

The patient should be placed supine with left uterine displacement and optimal airway positioning. Following the placement of routine monitors, including electrocardiography, pulse oximetry, blood pressure, and capnography, preoxygenation and denitrogenation with 100% oxygen should be performed to delay the onset of hypoxemia stemming from the parturient's decreased functional residual capacity and increased oxygen consumption. In urgent situations, four maximal (i.e., approaching vital capacity) breaths of 100% oxygen will provide adequate preoxygenation.<sup>102</sup> After the surgical drapes have been applied and the operating personnel are ready at the bedside, the surgeon should be instructed to delay the initial incision until the anesthesia provider confirms correct placement of the endotracheal tube and gives verbal confirmation to proceed with the operation. A rapid sequence induction with full cricoid pressure after induction with thiopental 4–5 mg/kg and succinylcholine 1–1.5 mg/kg is performed. Ketamine 1–1.5 mg/kg should be substituted for thiopental if hemodynamic instability is present prior to induction. Cricoid pressure should be continued until correct positioning of the endotracheal

tube is validated with auscultation and confirmation of carbon dioxide. A short-acting nondepolarizing agent or succinylcholine infusion can be used to maintain muscle relaxation. In most instances, <50% FiO<sub>2</sub> is sufficient, but 100% FiO<sub>2</sub> oxygen should be used if fetal compromise exists. Some evidence suggests that >60% FiO<sub>2</sub> may result in detrimental fetal oxygen free radical formation in the fetus.<sup>103</sup> Maintenance of anesthesia can be provided with volatile anesthetics titrated as necessary; however, upon delivery, concentrations should be reduced to <1–1.5 MAC, the threshold above which relaxation of uterine tone cannot be attenuated with oxytocin. No advantage in minimizing uterine tone relaxation or fetal effects has been found with the selection of specific volatile anesthetic agents (isoflurane, sevoflurane, or desflurane). Overall, a 25–40% reduction in halogenated agent requirements is witnessed during pregnancy.<sup>104</sup> Comparison of neonatal outcomes following general versus epidural anesthesia for cesarean delivery suggests small, transient differences.<sup>105</sup> However, with both techniques, a uterine incision to delivery time >180 seconds can result in lower Apgar scores and greater fetal acidosis (most likely reflecting the difficulty in delivering the baby rather than direct effects of the anesthetic agents).<sup>106</sup> General anesthetic agents can redistribute from the fetal fat to the fetal circulation and result in secondary depression of neonatal ventilatory effort. Thus, the presence of a pediatrician in such cases is advisable until a normal ventilatory pattern is observed.

### Postoperative Pain Management

By directly activating spinal and supraspinal opioid receptors, epidural and spinal opioids blunt nociceptive input and produce analgesia of greater intensity than doses administered parenterally or intramuscularly (see Chapter 74).<sup>7</sup> Morphine has emerged as the leading agent for postcesarean section analgesia because of its long duration of action and low cost (Table 61–2); optimal doses are 0.1 and 3.75 mg in the intrathecal and epidural spaces, respectively.<sup>71,107</sup> Because of its low lipid solubility, the peak analgesic effects of morphine are delayed 60–90 minutes but persist to provide reliable analgesia for up to 24 hours.<sup>107</sup> A sustained-release epidural morphine prep-

aration that can provide up to 48 hours of postcesarean section analgesia has been developed<sup>108</sup>; however, its use is limited by its immediate release when mixed with local anesthetics and the inability for its use in the intrathecal space. Thus, it is being used as a part of a CSE technique, where the local anesthetic is placed in the intrathecal space, followed by administration of morphine in the epidural space.

The choice of local anesthetic for epidural anesthesia may influence the efficacy of epidural morphine. In parturients who received 2-chloroprocaine (a short-acting, rapid-onset local anesthetic used primarily for emergent cesarean deliveries) versus other local anesthetics, postcesarean section analgesia was significantly reduced to <3 hours.<sup>109</sup> The mechanism by which chloroprocaine affects the duration of opioids, as well as other local anesthetics, is unknown. These interactions, coupled with the potential for neurotoxicity, especially when preserved with metabisulfite, limit the use of chloroprocaine to emergent situations where rapid augmentation is desired.<sup>110</sup> Patient-controlled epidural infusions of low-concentration local anesthetics with opioids (e.g., bupivacaine 0.125% with hydromorphone 0.2 mg/mL or fentanyl 2 µg/mL at 6 mL/h) may offer an analgesic option in patients in whom a prolonged analgesia is desired.<sup>111</sup>

Postoperative analgesia has been greatly improved through the use of central neuraxial techniques, most commonly provided through a single-dose administration of morphine. Given in the spinal and epidural compartments, opioids provide enhanced quality and duration, with a very acceptable side effect profile compared to oral or IV analgesics.

### Considerations for the High-Risk Parturient

#### Antenatal and Postpartum Hemorrhage

Vaginal bleeding occurs in up to 24% of clinically diagnosed pregnancies and most often is associated with minimal blood loss and limited pathology. Major antepartum and postpartum bleeding may occur at any time and is a leading cause of maternal and perinatal morbidity and mortality. What constitutes “bleeding” versus “hemorrhage” is an issue of semantics. More important is recognizing that blood loss and physiologic deterioration can

occur rapidly and that a cogent plan of investigation and response can significantly affect the outcome.

Divided by week 20 of gestation into early and late time periods, antepartum hemorrhage is associated with a number of etiologies. Early-pregnancy bleeding can result from implantation or miscarriage of the embryo, an ectopic pregnancy, gestational trophoblastic disease, dysfunctional uterine bleeding, and reproductive tract tumors. In first-trimester pregnancies complicated by bleeding, <50% will progress normally beyond 20 weeks of gestation, 10–15% will be an ectopic pregnancy, 0.2% will be a hydatidiform mole, and >30% will result in a miscarriage.<sup>112</sup> Bleeding during late pregnancy complicates 2–5% of pregnancies, with the most common causes being placental abruption (31%) and placenta previa (22%; Table 61–5).

Although obstetric hemorrhage can be masked by physiologic adaptations in blood volume and cardiac output (see Chapter 21), ultimately, the 600–700 mL of blood flow through the placental intervillous spaces each minute can result in signs of shock (Table 61–6).<sup>113</sup> Coagulopathy, initially dilutional from the ongoing loss of blood components and rapid volume replacement, may be accompanied by disseminated intravascular coagulation (DIC). Laboratory analysis of DIC includes a prolonged prothrombin time (PT), prolonged partial prothrombin time (PTT), hypofibrinogenemia, thrombocytopenia, and elevated fibrin degradation products (FDPs).

Underestimation of blood loss and inadequate resuscitation are common problems in cases of antepartum hemorrhage resulting in maternal mortality. In a report on maternal deaths in the United Kingdom, substandard responses were noted to be a contributing factor in 79% of maternal deaths resulting from hemorrhage.<sup>114</sup> Rapid volume replacement is more important for tissue perfusion and oxygenation than is the type of fluid given. Large-bore IV access with pressurized transfusion equipment is essential during severe hypovolemia. Intravascular expansion with colloids versus crystalloid preparations during pregnancy has been observed to be longer in duration and more effective in augmenting cardiac output. These qualities are helpful in cases of peripartum hemorrhage and may be an effective

TABLE 61–5.

## Characteristics of Early and Late Antepartum Hemorrhage Diagnoses

Early Pregnancy	
Miscarriage	Vaginal bleeding (+/– pain) >8 wks after last menstrual period Slight tenderness to uterine examination No adnexal mass
Ectopic pregnancy	May not have vaginal bleeding Pain <8 wk after last menstrual period Unilateral tenderness May present as shock with normal-sized uterus
Late Pregnancy	
Placenta previa	Painless vaginal bleeding (although 10% may have coexisting, painful abruption) Malpresentation of fetus (35%) Difficulty palpating presenting part
Placenta abruption	Painful vaginal bleeding Uterine irritability or tetany Coagulopathy Fetal distress/death
Uterine rupture	Vaginal bleeding (+/– pain) Hypotension Cessation of labor Fetal distress
Vasa previa	Painless vaginal bleeding Presence of fetal hemoglobin in shed blood
Unclassified bleeding	Painless vaginal bleeding Mild bleeding that often resolves spontaneously Often >37 wk of gestation

bridge until blood products are available.<sup>87</sup> Although many institutions require a type and screen for parturients who are at high risk for hemorrhage and undergoing vaginal delivery or for all parturients undergoing cesarean delivery, a cross-match for 2–4 U of

packed red blood cells should be considered when the potential for significant blood loss appears eminent. Such cases often involve abnormalities with placentation, including low implantation (previa), partial abruption, or adherence without a decidual layer, in-

vasion into the myometrium, or penetration through the myometrium (placenta accreta, increta or percreta, respectively). Imaging tests, especially ultrasound and magnetic resonance imaging (MRI), have dramatically altered the evaluation and outcome of these placental abnormalities. More recently, the use of interventional radiologic techniques for placement of prophylactic or treatment transcatheter occlusion balloons within the uterine or hypogastric arteries has allowed for timely control of bleeding.<sup>115</sup> When uterine bleeding occurs postpartum, use of an inflated Sengstaken-Blakemore esophageal balloon catheter placed in the uterine cavity and filled with 70–300 mL of warm saline has been demonstrated to tamponade and potentially treat intrauterine sources of bleeding and allow time to correct coagulopathies.<sup>116</sup>

In situations where the need for emergent blood transfusion precedes the availability of cross-matched blood, then uncross-matched, type O, Rh-negative blood should be used. Continued blood loss and hemodynamic instability despite transfusion of packed red blood cells often is an indication for an arterial line and more invasive monitoring. However, restoration of circulating volume takes precedence. Urine output, heart rate, and blood pressure assessments can assist in rapid assessment of volume resuscitation. The need for blood component therapy other than red cells may be more limited than previously thought. Following the delivery of the fetus when uterine perfusion and oxygenation become less relevant, parturients usually are able to tolerate low hemoglobin, coagulation proteins, and platelets. The task force on blood component therapy of the American Society of Anesthesiologists has stated that transfusion of packed red blood cells, platelets, and fibrinogen component therapy is rarely indicated unless the hemoglobin concentration is <6 g/dL, platelet count is <50 × 10<sup>9</sup>/L (unless platelet dysfunction and microvascular bleeding is present), and fibrinogen concentration is <80–100 mg/dL in the presence of microvascular bleeding (for details of transfusion therapy, see Chapter 85).<sup>117</sup>

Simultaneously with fluid resuscitation, a hemorrhaging parturient should be prepared for an operative delivery, if not already accomplished, and a pos-

TABLE 61–6.

## Assessment of Obstetric Hemorrhage

Severity of Shock	Findings	Blood Loss (%)
None	None	15–20
Mild	Tachycardia (<100 beats/min) Mild hypotension Peripheral vasoconstriction	20–25
Moderate	Tachycardia (100–120 beats/min) Hypotension (SBP 80–100 mm Hg) Restlessness Oliguria	25–35
Severe	Tachycardia (>120 beats/min) Hypotension (SBP < 60 mm Hg) Altered consciousness Anuria	>35

SBP, Systolic blood pressure.



sible hysterectomy. Complete replacement of blood loss before or during surgery is frequently an unrealistic goal because bleeding often continues until the offending pathology is corrected or removed. Although a regional anesthetic approach can be continued if the bleeding is modest and controllable, the case of a briskly bleeding, hemodynamically unstable patient requires induction of general anesthesia, controlled ventilation, and aggressive fluid resuscitation.

### **Hypertensive Disorders of Pregnancy**

Whether preexisting, gestational, or related to preeclampsia or eclampsia, hypertension is associated with a higher incidence of maternal, fetal, and neonatal mortality and morbidity. Preeclampsia, with its systemic vasoconstriction, intravascular volume and protein depletion, and simultaneous retention of extravascular sodium and water, is of particular concern to anesthesiologists. In addition to individual organ dysfunction, abnormalities in coagulation and edema of the brain, larynx, and lungs may occur. Medical management of blood pressure should be achieved prior to obstetric or anesthetic interventions if possible. Control of blood pressure with labetalol, hydralazine, or infusions of nitroglycerin or nitroprusside should be commenced with arterial and central venous monitoring in severe cases. Of note, use of magnesium for prevention of seizures and use of antihypertensive medications for control of severe hypertension (systolic pressure >160 mm Hg and/or diastolic pressure at least 110 mm Hg) may affect the duration of muscle relaxants and the response to induction medications, respectively.<sup>118</sup> Overall, the suggested goal of antihypertensive therapy is systolic pressure between 140 and 155 mm Hg and diastolic pressure between 90 and 105 mm Hg.<sup>118</sup>

Fluid management guided by CVP in severe cases has been demonstrated to improve urine output, maintain mean arterial pressure, and decrease diastolic pressure.<sup>119</sup> If oliguria persists after normalization of CVP (usually between 2 and 3 cm H<sub>2</sub>O) or the physiologic state is complicated by pulmonary edema or cardiovascular decompensation, a pulmonary arterial (PA) catheter may be helpful. A cardiology consultation and an assessment of cardiopulmonary function with a

transthoracic echocardiogram may assist with the diagnosis and management. The course of preeclampsia can be complicated by mild to severe coagulopathy even in the presence of a normal platelet count.<sup>120,121</sup> For the benefit of both obstetric and anesthetic management, if the initial platelet count is less than an arbitrary 70–75/L<sup>-9</sup>, the clinical history and the results of additional studies, such as PT/PTT or thromboelastography, should be reviewed. If the low (>70–75/L<sup>-9</sup>) platelet count has been stable or trending slowly downward for 2–3 weeks and the patient has no clinical history of bleeding gums, prolonged bleeding, or significant bruising with trauma, a neuraxial approach to analgesia or anesthesia appears reasonable. However, if the platelet count has rapidly fallen within the 2–3 weeks or the clinical signs noted are present, a few options exist. In patients who will undergo labor, the analgesia can be managed with a patient-controlled IV pump; fentanyl 13 µg q6min with a lockout of 300 mg per 4 hours has been used with some success. Of note, intramuscular administration of narcotics, a common method of analgesia used for labor, is not recommended because of the possibility of hematoma formation. If an instrumented or operative delivery is planned, additional laboratory testing, such as PT/PTT and thromboelastography, may provide information on the extent of coagulation dysfunction. If thrombocytopenia or prolonged PT/PTT indicates that pooled platelets or fresh-frozen plasma may reduce the risk of maternal hemorrhage with delivery, placement of neuraxial techniques should await the administration of these products.

During labor, epidural analgesia offers the advantage of limiting pain or stress, thus reducing catecholamine release, decreasing maternal blood pressure, and indirectly increasing placental perfusion.<sup>119</sup> Epidural anesthesia can also be a preferred technique for cesarean delivery because the dose of medications can be slowly titrated, resulting in more gradual blood pressure changes. Spinal anesthesia should not be avoided, particularly in urgent or emergent cases where rapid onset of anesthesia is important. Limited studies suggest that the incidence of hypotension is not significantly different compared to epidural anesthesia for cesarean deliv-

ery.<sup>82,122</sup> A CSE technique with a small initial spinal dose (bupivacaine 7.5 mg) followed by sequential epidural catheter dosing is another method that may produce rapid anesthetic onset with less profound hypotension; however, the value of this technique in limiting hypotension has not been validated in randomized controlled trials. Overall, neuraxial techniques represent an optimal approach to analgesia and anesthesia in the preeclamptic patient. This is particularly true when assessing awake, nonsedated patients during labor and delivery for the severity of disease and avoiding the risks of general anesthesia associated with airway narrowing that accompanies pregnancy, labor, and preeclampsia<sup>123</sup> and the increases in systemic and intracranial pressures that can occur during intubation and extubation.

Intravascular hypovolemia associated with preeclampsia, use of antihypertensive medications, and administration of magnesium for seizure prophylaxis may augment the hypotension produced by neuraxial techniques. When responding pharmacologically to hypotension, restraint is advocated because patients with hypertensive disorders may have an exuberant response. Small doses of vasopressors (i.e., ephedrine 5 mg or phenylephrine 20–40 µg) should be given initially. Similarly, the response to hypertension associated with the disease or reactive hypertension from labor pain, intubation, or emergence from general anesthesia should be treated judiciously. Labetalol 5–10 mg IV is a popular first-line agent that has a relatively wide margin of safety and can be doubled every 20 minutes until an effect is observed or 150–200 mg has been reached. At these thresholds, other agents such as hydralazine or calcium channel blockers can be used. Infusions of nitroglycerine, nitroprusside, and trimethaphan can be initiated, but arterial monitoring should be used to more carefully titrate the effect (see Invasive Monitoring in the Parturient).

### **Invasive Monitoring in the Parturient**

Whereas noninvasive measurement of blood pressure, heart rate, oxygen saturation, urinary output, and fetal cardiotocography is standard practice in most labor and delivery facilities, the use of invasive monitors is vari-

**BOX 61-5.****Diagnosis of Pulmonary Edema by Pulmonary Arterial Wedge Pressure**

<b>Etiology</b>	<b>PA Wedge</b>	<b>Stroke Work Index</b>
Left ventricular dysfunction	Increased	Decreased
Altered capillary permeability	Normal	Normal or increased
Low hydrostatic/oncotic pressure	Increased	Normal

able and controversial. Despite practice guidelines written by a number of professional organizations, including the joint task force of the American College of Physicians, the American College of Cardiology, and the American Heart Association,<sup>124</sup> poor collection and incorrect interpretation of hemodynamic data from invasive monitors remain the key problems with their use.<sup>125,126</sup>

In addition to correctly interpreting the data produced, knowing when to use invasive monitoring is a vital clinical skill. The indications for invasive arterial blood pressure monitoring during pregnancy include the desire to more carefully manage blood pressure, lack of reliable noninvasive cuff measurements, need for vascular access for blood studies, and planned use of certain hemodynamic agents (particularly drugs given by infusion, such as nitroglycerin and nitroprusside). By contrast, the indications for invasive central monitoring are not as clear or uniformly accepted. A CVP catheter is often placed to yield an approximation of volume status (or to follow a trend in blood loss or replacement therapy) and to give a greater understanding of the mechanical phases of the cardiac cycle. Management of oliguria unresponsive to a fluid challenge, pulmonary edema, and refractory hypertension are clinical situations where some clinicians desire CVP monitoring.

Although a PA catheter can assist in determining the etiology of pulmonary edema, oliguria with normal CVP, or cardiovascular failure, its use is the most controversial. Advocates of PA catheter use suggest that it can provide information on left and right ventricular function, systemic vascular resistance, and cardiac output. Detractors question the validity of the data, noting that in the setting of preeclampsia, for example, the correlation between CVP and pulmonary capillary wedge pressure is unreliable for CVP readings >6 cm H<sub>2</sub>O.<sup>127</sup> In deciding between a PA versus CVP catheter, the clinician

should recognize that although the insertion-related complications are similar,<sup>128</sup> the PA catheter is associated with more use-related complications, including balloon rupture, pulmonary infarction, valvular damage, and erosion of the PA. Thus, the benefits of PA catheter use should clearly outweigh its inherent risks before its use can be recommended. The 1999 practice guidelines of the American Society of Anesthesiologists Task Force on Obstetrical Anesthesia state that “the decision to perform invasive hemodynamic monitoring should be individualized and based on clinical indications that include the patient’s medical history and cardiovascular risk factors.”<sup>129</sup> To date, although PA catheter use has been reported in parturients (primarily with cardiac pathology), no controlled trials are available that confirm the benefit of PA catheter monitoring on maternal or fetal outcome. PA pressures are observed with different etiologies of pulmonary edema and oliguria (Boxes 61-5 and 61-6).<sup>130,131</sup> Renal and postrenal etiologies of oliguria, such as renal artery vasospasm, acute tubular necrosis, and postrenal obstruction, are less commonly encountered in the obstetric population. Future modalities for hemodynamic monitoring, such as Doppler ultrasound and three- and even four-dimensional echocardiography, are able

to provide detailed, dynamic information on cardiac structures and function and in the future may offer significant clinical advantages.<sup>132</sup>

**ANESTHESIA FOR GYNECOLOGIC SURGERY**

Although many of the procedures in gynecologic surgery are approached using standard surgical techniques, the care and anesthetic management should be provided with an understanding of gender-related differences that ultimately may affect patient outcomes and satisfaction. In addition to the many alterations discussed in the obstetric section of this chapter, gender-related changes in the sensitivity to pain and anesthetic agents is relevant to each case. Full appreciation should be given to the highly vascular uterus and other visceral structures found in women, which can result in sudden and profound blood loss, air emboli, and, in pregnancy-related procedures, amniotic fluid emboli.

**Preoperative Assessment and Evaluation**

A few elements in taking a gynecologic history deserve emphasis, particularly because a few weeks may have lapsed between the gynecologic surgeon’s assessment and the surgical date. The menstrual cycle can serve as a guide to other pathology and rule out the possibility of pregnancy. Abnormal or prolonged uterine bleeding can be produced by a variety of endocrine and metabolic disorders, including hypothyroidism, hyperprolactemia, coagulopathies, and insulin metabolism disorders, which in turn may impact anesthetic care. Because pregnancy

**BOX 61-6.****Diagnosis of Prerenal Oliguria by Pulmonary Arterial Wedge Pressures**

<b>Etiology</b>	<b>Pulmonary Arterial Wedge Pressure</b>	<b>Left Ventricular Function</b>	<b>Systemic Vascular Resistance</b>	<b>Treatment</b>
Hypovolemia	Low	Increased	Increased	Intravenous fluids
Sepsis	Low	Increased	Decreased	Intravenous fluids, vasopressors, inotropes
Congestive heart failure	Increased	Decreased	Increased	Fluid restriction, diuretics, inotropes

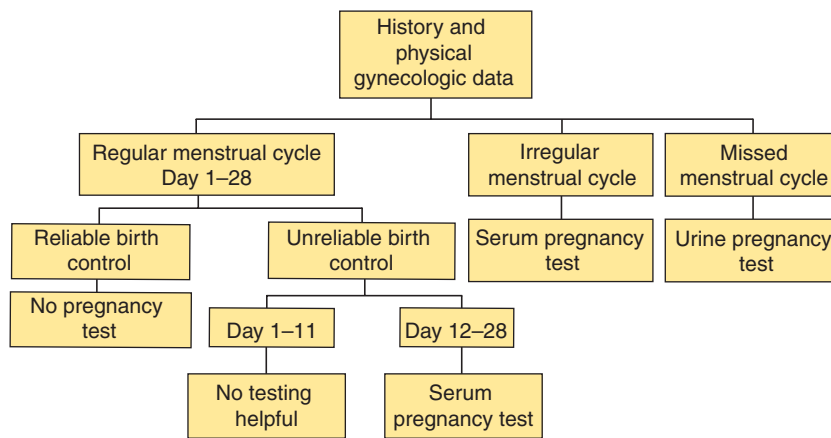


FIGURE 61-5. Preoperative pregnancy testing algorithm.

has implications on surgical interventions and anesthetic care, testing should be used in individuals with absent or irregular menses, unreliable knowledge of menstrual cycle or contraceptive use, noncompliance with hormonal birth control regimens, or if the report is desired. Algorithms for the use of serum and urine beta hCG pregnancy tests are helpful if applied appropriately (Fig. 61-5). The serum test uses a radioimmunoassay that can detect a pregnancy within 24–72 hours following conception at levels as low as 1–3 mIU/L.<sup>133</sup> By contrast, the urine test uses an antibody agglutination methodology that detects a level >25 mIU/L, which is achieved only after 10–12 days.<sup>133</sup> A positive serum hCG combined with a positive uterine ultrasound (demonstrating decidual thickening of the uterus) can diagnose pregnancy with 100% clinical accuracy.

The psychological impact of the surgical condition should be considered and managed with sensitivity. Fear, anxiety, embarrassment, and even guilt may be associated with some procedures. Infertility patients may exhibit

a number of emotions as they undergo an escalating series of tests, medications and procedures, including tubograms, laparoscopies, laparotomies, tubal reconstructions, and in vitro fertilization. Patients who have spontaneous, missed, or therapeutic abortions may have feelings of guilt or mourning. Patients with chronic pelvic pain may have concerns regarding complicated, multimodal pain therapies; such individuals often benefit from preoperative pain and psychiatric consultations. Patients with urinary or fecal incontinence may be acutely embarrassed by their condition. Patients with malignant breast or pelvic masses may have anxiety or fear of disfigurement and concern over loss of sexual function and desirability.

Patients who present for surgical management of gynecologic malignancies require additional considerations. The tumor mass may create anatomic and physiologic alterations, including aortocaval compression, respiratory embarrassment, changes in renal or hepatic function, and the potential for adhesions and scarring. The additional

comorbidity of prior surgeries, chemotherapy, or radiation therapy must be considered as well. Chemotherapy may be associated with disruptions in hematopoiesis, infection resistance, nausea and emesis, and myocardial, renal, and hepatic function (Table 61-7). Anemia, coagulation disorders, and platelet dysfunction also may be present. Alternatively, malignancies may result in hypercoagulable states, and the impact of various regimens for prophylaxis and treatment should be considered in the perioperative period.<sup>134,135</sup>

## Intraoperative Considerations and Management

### Gender Differences in Sensitivity to Pain

Gender differences in biologic, psychological, and sociocultural factors are believed to be responsible for women reporting pain that is more severe, frequent, and of longer duration than that experienced by men.<sup>136</sup> Although gender role expectations may be partially responsible for these observations, female gonadal hormones have been associated with pain sensitivity, albeit contradictory to most expectations. Female hormonal increases, as occur during pregnancy, have been associated with decreases in response to noxious stimuli. By contrast, hormonal decreases, such as those witnessed in menopause, have been associated with increases in pain sensitivity.<sup>137</sup> Although progesterone previously was demonstrated in animal and human studies to be the female gonadal hormone most responsible for modulating pain,<sup>138</sup> the demonstration of an inverse relationship between estrogen and  $\beta$ -endorphins and estrogen receptors in the noxious stimuli processing areas of the brain

TABLE 61-7.

Chemotherapeutic Agents with Unique Toxicities Affecting Anesthetic Management

Agent	Gynecologic Malignancy	Usual Dose	System Affected	Toxic Manifestation	Diagnostic Tests
Adriamycin (doxorubicin)	Endometrial carcinoma, ovarian carcinoma	500 mg/M <sup>2</sup>	Heart	Myocardial fibrosis, congestive heart failure	Echocardiogram, ejection fraction
Bleomycin (Blenoxane)	Cervical carcinoma, germ cell tumors of the ovary	400 U	Lung	Pulmonary fibrosis	Spirometry, diffusing capacity
cis-Platinum	Endometrial carcinoma, cervical carcinoma	50–75 mg/M <sup>2</sup>	Kidney	Renal tubular dysfunction	Creatinine clearance (dose-related)

and spinal cord suggests a greater role for estrogen. Acute estradiol exposure decreases the number of opioid binding sites, reduces the antinociception effect produced by morphine in ovariectomized rats, and diminishes the plasma, pituitary, and hypothalamic levels of  $\beta$ -endorphin.<sup>138,139</sup> In human clinical models, high estrogen levels alter noxious stimuli processing,<sup>140</sup> a finding that may be relevant to therapies that involve estrogen replacement or manipulation.

Gender-related differences in pain from the surgical exploration of abdominal and pelvic organs also may stem from the more complex anatomy and function of the female reproductive organs. The relative contributions of somatic and visceral sensory fibers to pain originating from the pelvic, uterine, cervical, and perineal structures have not been completely characterized. Investigations into visceral afferent contributions to pain have been particularly abbreviated because of the lack of suitable experimental models and noninvasive neurophysiologic techniques. Recent and future work, however, promises to more fully elucidate the contribution of female reproductive organs to gender-related pain.<sup>141</sup>

### Gender Differences in Sensitivity to Anesthetic Agents

Gender-related pharmacokinetic and pharmacodynamic alterations are produced by the greater percentage of body fat and the smaller body water content in females. In general, this results in a greater distribution per kilogram of body weight for lipophilic drugs, such as opioids and benzodiazepines, and a smaller distribution for water-soluble drugs, such as muscle relaxants.<sup>142</sup> Because the volume of distribution is the most important pharmacokinetic factor responsible for initial drug concentrations, the response to induction and bolus administration agents may be altered. Drug clearance, which is dependent on metabolism and excretion and is related to steady-state concentrations, also is affected by gender. Hepatic metabolism, which accounts for a major route of elimination of most IV anesthetic drugs, has gender-related alterations within the cytochrome P450 (CYP) and uridine diphosphate (UDP)-glucuronosyltransferase systems (Table 61–8). Glomerular filtration rate, the most

TABLE 61–8.

Gender Differences in Cytochrome Systems with Relevance to Anesthetic Drugs

Enzyme	Female Alteration	Drugs Affected
CYP 1A2	Decreased	Ropivacaine Theophylline
CYP 2C9	None	Propofol <sup>a</sup> Nonsteroidal anti-inflammatory drugs
CYP 2C19	Contradictory	Hexobarbital Diazepam Propranolol
CYP 2D6	Contradictory	Codeine Tramadol Oxycodone Hydrocodone Metoprolol Propranolol
CYP 2E1	Contradictory	Halothane Enflurane Isoflurane Sevoflurane
CYP 3A4	Increased	Fentanyl Alfentanil Sufentanil <sup>a</sup> Methadone Buprenorphine Lidocaine Ropivacaine Bupivacaine Midazolam Diazepam Verapamil Tirilazad Glucocorticoids
UGT	Decreased	

CYP, Cytochrome P450; UGT, UDP-glucuronosyltransferases.  
<sup>a</sup>Studied in vitro.  
 Adapted from Pleym et al.<sup>142</sup>

important renal parameter for excretion of nonactively secreted or reabsorbed drugs, is lower in females, but the impact of this change is not well characterized.<sup>142</sup>

Hormonal alterations from the use of contraceptive pills, in vitro stimulation regimens, pregnancy, menstrual cycles, and menopause may modify CYP enzyme activity. Although clearance of drugs may be higher in the middle of the menstrual cycle,<sup>143</sup> minimal to no menstrual phase variations have been noted with the disposition of certain anesthetic drugs, including alfentanil, alprazolam, and midazolam.<sup>144,145</sup> Menopause has been associated with decreases in midazolam and alfentanil clearance; however, this phenomenon is not entirely hormon-

ally mediated, as hormonal replacement does not return clearance to premenopausal levels.<sup>146</sup> Faster emergence from propofol anesthesia in women likely is related to a rapid decline in plasma levels<sup>147</sup>; whether this condition is due to elimination or intercompartmental distribution remains unclear. The analysis is further complicated by the greater sensitivity of women to given plasma concentrations of propofol.<sup>147</sup> These changes demonstrate that the effect of gender on pharmacokinetics and pharmacodynamics is a multimodal issue for which more information is needed.

### Anesthetic Selection and Care

Performing a history and physical examination, reviewing the chart, previ-



ous anesthetic records, and relevant testing, and discussing the overall plan with the surgeon are essential steps in selecting an appropriate anesthetic plan. This is particularly true given the variety of positioning requirements and surgical approaches for certain gynecologic procedures (e.g., abdominal, laparoscopic, vaginal hysterectomy).

All patients, including those who received local anesthesia, should be monitored with an electrocardiogram, blood pressure cuff, and pulse oximeter. Additional monitors include a capnography sampler, temperature probe, peripheral nerve stimulator, and Foley catheter as appropriate. Invasive monitors, such as an arterial catheter, central venous catheter, PA catheter, or transesophageal echocardiography probe, may be indicated in patients with serious medical problems or who are undergoing radical, prolonged procedures accompanied by extensive fluid shifts and volume replacement.

Monitored IV sedation, often used with a local anesthetic field block, is often appropriate for certain procedures, such as dilation and curettage (D&C), hymenotomy, and breast biopsy. IV sedative and analgesic medications may be beneficial prior to placement of the field block, particularly when the block is administered to the paracervical or perineal region. Because the cervix is highly vascular, field blocks in this region can result in high plasma local anesthetic concentrations, so vigilance should be given to signs of toxicity.

Neuraxial regional techniques are suitable for many operations, including conservative abdominal and pelvic procedures. However, the duration of the case, requirements for Trendelenburg position, and unanticipated need for extensive exploration may limit the use of spinal and epidural anesthesia. The selection of local anesthetics and the specific neuraxial technique depends on the magnitude and duration of the operation; however, a T4 to T6 level is advised for intraabdominal surgery. Prophylactic antiemetic and supplementary opioid use may prevent the nausea and discomfort that result from peritoneal stimulation. Catheter-based techniques, as opposed to single-dose techniques, offer the most control and flexibility. When provided as part of a combined spinal technique, a short-acting spinal anesthetic can be given for procedures of

potentially short, but unknown, duration. The catheter then can be used if the duration of the operative event is longer than anticipated or postoperatively for analgesia is appropriate. Whether these catheters should be placed intrathecally or epidurally is controversial. Microcatheters, which historically were passed through standard 25- to 32-gauge needles into the intrathecal space, were associated with cauda equina syndrome when used with 5% lidocaine in 7.5% dextrose. Speculation for this outcome has been placed on drug “pooling” by the nerve roots within the subarachnoid space. These outcomes were associated with clinical abandonment of these catheters in the United States but not in Europe. Since that time, slightly larger microcatheters, which pass through a 22- to 26-gauge spinal needle, have been evaluated. Microcatheters are believed to contribute to lesser risk for PDPH than standard macrocatheters (20-gauge) placed through a 17-gauge Tuohy or Weiss needle used in similar fashion. The combination of general anesthesia and an epidural catheter, whether used for intraoperative anesthesia or postoperative analgesia, can be advantageous for particularly large or painful procedures.

General anesthesia is best suited for procedures that require extensive abdominal dissection, steep Trendelenburg positioning, extended CO<sub>2</sub> insufflation for laparoscopy and pelviscopy, or deep levels of anesthesia for a short period of time. Although mask and LMA devices are often used, endotracheal intubation remains the conduit of choice for ventilation and anesthesia when pulmonary soiling is a risk. These cases include patients with suspected gastric contents (“full stomach”), obesity, severe anxiety, nausea, or vomiting, surgical cases that will result in aggressive Trendelenburg position or massive fluid shifts, or cases where emergent exploration is required. Overweight or obese patients are increasingly prevalent, even within younger age groups. The National Health and Nutrition Examination Survey (NHANES) found that obesity is becoming more common at younger ages and more prevalent with age.<sup>148</sup> Among women in their second, third, and fourth decades, the prevalence of obesity is 23.3%, 32.5% and 35.4%, respectively.<sup>148</sup> Should instrumentation of the airway present a concern,

alternative anesthetic options and the difficult airway algorithm should be invoked. An elective, awake fiberoptic intubation in a controlled environment with adequate assistance is often the optimal approach.

## Considerations for Specific Situations

In general, gynecologic surgery can be divided into four major categories: perineal, transvaginal, intraabdominal, and transabdominal (Box 61–7). Anesthetic management for these procedures depends on a number of factors specific to the procedure, patient, and healthcare providers.

### Perineal and Urologic Surgery

**Anatomy** The vulva includes all the structures visible externally from the pubis to the perineum, including the mons pubis, labia, clitoris, vestibule, urethra, and Skene and Bartholin glands. The primary blood supply to the vulva is via the internal pudendal artery, a branch of the internal iliac artery. The nerve supply is via the pudendal nerve that arises from the

#### BOX 61–7.

##### Common Gynecologic Procedures

- Transvaginal
  - Dilation and curettage
  - Dilation and evacuation
  - Cervical
    - Cone biopsy
    - Cerclage
  - Hysteroscopy
  - Vaginal reconstruction
- Perineal
  - Laser fulguration of condylomata
  - Hymenotomy
  - Marsupialization of Bartholin cyst
  - Anteroposterior repair
  - Vulvectomy
  - Stamey urethropexy (urologic)
- Intraabdominal
  - Oophorectomy
  - Cystectomy
  - Salpingectomy
  - Salpingostomy
  - Myomectomy
  - Hysterectomy
  - Radical hysterectomy
  - Ruptured ectopic pregnancy
- Transabdominal
  - Laparoscopy
  - Pelviscopy

sacral nerve roots (S2, S3, and S4; Fig. 61-3). The pudendal nerve, artery, and accompanying veins pass from the pelvis via the lesser sciatic foramen and along the lateral wall of the ischioanal fossa. The pudendal nerve, sometimes used in obstetrics for a vaginal delivery or perineal repair, can be readily blocked through a transperineal or transvaginal approach with local anesthetic placed posterior and medial to the ischial tuberosity.<sup>149</sup> The lymphatic drainage of the vulva is principally through the superficial inguinal lymph nodes to the deep inguinal and pelvic nodal systems.

**Specific Procedures** Although a number of minor vulvar procedures are routinely performed under local anesthesia, the majority of procedures performed in the operating room require regional or general anesthesia. Such procedures include biopsies, hymenectomies, drainage of Bartholin glands, and laser fulguration of intraepithelial neoplasia.

Surgical interventions to treat stress urinary incontinence in women include procedures to reestablish the posterior urethrovesical angle and re-suspend the urethra. Traditional approaches include retropubic (e.g., Marshall-Marchetti-Krantz or Burch procedures) and transvaginal approaches (e.g., Kelly plication or Pereyra and Stamey urethropexy). Most of these procedures involve suturing the vaginal epithelium to the rectus fascia above the pubis. During placement of the paraurethral suture, the patient must not cough or strain. Regional anesthesia, usually in the form of a spinal technique, provides a quiescent surgical field and good postoperative conditions. Prophylactic use of antiemetics (metoclopramide 10 mg IV, ondansetron 4 mg IV, and dexamethasone 8 mg IV) is recommended.

Major vulvar procedures, including operations for trauma or invasive carcinomas, often require extensive dissection into the tissues of the inferior fascia of the urogenital diaphragm, pelvis, and abdomen. These procedures frequently result in major blood loss from the vestibular bulbs, pudendal artery, and retropubic space of Retzius. Preparation for these cases should include use of large-bore IV catheters, immediate availability of resuscitation equipment and fluids, and use of invasive monitoring and blood products where appropriate. Anesthetic man-

agement that includes epidural catheter-based techniques allows for minimization of intraoperative general anesthetic agents and provision of superior postoperative analgesia. Patients with significant cardiac or pulmonary comorbid conditions, obesity, a potentially difficult airway, or an expectation for significant blood loss may benefit from induction of general anesthesia at the beginning of the case, when the intubation can be achieved in a controlled, stable environment.

**Special Considerations** Use of operative lasers entails risks to the patient and the operating room staff through thermal and retinal injury from reflected light, ignition of operative drapes, and possible viral inoculation from inhalation of laser plume particulates. Human papilloma viral DNA has been found in laser plumes, but whether this represents an infectious risk is unclear.<sup>150</sup> Regardless, the smoke contains bioaerosols that can cause lung irritation and other potentially adverse effects.<sup>150</sup> Therefore, appropriate eye protection, occlusive laser masks, and properly functioning smoke evacuators are necessary. For patient safety, surgical site immobilization is of great importance. Dense regional anesthesia or general anesthesia with ventilation by mask, LMA, or endotracheal intubation are reasonable approaches.

### Transvaginal Surgery

**Anatomy** The vagina is an 8- to 10-cm compliant musculomembranous canal that extends from the external genitalia to the uterine cervix. Anteriorly and posteriorly related to the urethra and bladder, respectively, the vagina is in close proximity to the rectal ampulla, perineum, and cul-de-sac of Douglas. The primary blood supply to the vagina is derived from branches of the uterine and pudendal arteries. Lymphatic drainage of the upper third of the vagina is predominately to the parametrial and pelvic lymph nodes, whereas the lower two thirds share the superficial inguinal lymph nodes with the vulva. The sensory nerve supply to the vagina arises from S2, S3, and S4 via the pudendal nerve. The sympathetic and parasympathetic nerve supplies originate from the hypogastric plexus (L1 to L3) and sacral nerves, respectively (Fig. 61-3).

The cervix enters the vagina at a variable angle through the anterosupe-

rior wall and is composed of myometrial muscle and dense stroma. The blood supply is derived from the descending branch of the uterine artery, and lymphatic drainage is through the paracervical nodes. Innervated by the nerves arising in the hypogastric plexus, the exocervix is poorly supplied by sensory nerves and thus are relatively insensate. By contrast, the endocervix has an abundant nerve supply and is very sensitive to surgical manipulation.

**Specific Procedures** D&C requires dilating the cervix and mechanically scraping or suctioning the uterine walls to obtain tissue for evaluation, perform an abortion, or investigate abnormal uterine bleeding. Frequently performed in an office setting, D&C procedures should be performed in an operative setting in patients with significant comorbid conditions, distorted anatomy, or inability to tolerate an office procedure. The major surgical risk of the procedure is uterine perforation and subsequent hemorrhage, particularly when the perforation occurs through the lateral wall and involves the uterine artery. Preexisting acute or chronic anemia may exacerbate the patient's condition. If a perforation is suspected, gentle probing to localize the defect, observation, and laparoscopy or laparotomy may be needed for surgical repair.

Dilation and evacuation (D&E) and dilation and extraction (D&X) are similar to D&C but usually are performed to interrupt pregnancy. From gestational week 16, fetal size and structure dictate the mechanical disruption and then evacuation of fetal tissue. Extraction involves evacuation of intracranial contents after delivery of the fetal body through the dilated cervix to minimize uterine or cervical injury. Because these procedures disrupt fetal and placental tissue, amniotic fluid emboli, disseminated intravascular coagulation, and uterine atony accompanied by maternal hemorrhage can follow.<sup>151</sup> Procedures being performed for an in utero fetal demise warrant coagulation studies, particularly if associated with an abortion or uterine dehiscence; however, a dead fetus per se does not result in coagulopathies for a period of days to weeks.<sup>152,153</sup> Complication rates correlate with the gestational age of the fetus and the experience of the surgeon. D&E procedures are also performed in patients with hydatidiform moles or persistent ges-

tational trophoblastic tissues, which are neoplastic conditions resulting from deranged placental growth. Such pregnancies are associated with vaginal bleeding, anemia, and the need for subsequent chemotherapy.<sup>154</sup>

D&C, D&E, and D&X procedures often are performed with a paracervical block, with the assumption that a uterine perforation would be accompanied by sudden, acute report of abdominal pain, but this has not been validated. Spinal and general anesthesia are viable options, with the notation that volatile halogenated anesthetics, including sevoflurane and desflurane, have a dose-dependent association with uterine atony in *in vitro* experiments.<sup>155</sup> No clinical differences in blood loss with volatile agent administration in doses up to 1 MAC have been observed. Moreover, oxytocin appears to successfully diminish these volatile effects up to 1.5 MAC.<sup>155</sup> A number of uterotonic agents, such as methylergonovine and prostaglandin F<sub>2</sub>α, also can be used to augment uterine tone (Table 61-4).

Diagnosis and therapy for preinvasive or invasive cervical lesions is often achieved with a cone biopsy, which provides concentric excision of both exocervical and endocervical stroma. Because the cervix is well vascularized, bleeding is common, especially in pregnant patients. Hemostatic sutures can be placed laterally in the descending cervical branches of the uterine artery. Dilute solutions of vasopressin (20 U in 20 mL of normal saline) or epinephrine (1:200,000) can be injected locally into the cervix to induce vasospasm; both of these agents may induce hypertension. Resulting hypertension that is severe and sustained may require a direct-acting vasodilator such as hydralazine; β-adrenergic blocking agents are less effective. Most cone biopsies are performed as day surgery procedures under spinal or general anesthesia. A mask or LMA technique can also be used with spontaneous or assisted ventilation.

Rigid or flexible hysteroscopic procedures are performed to evaluate the endocervix or endometrial cavity. The scope is inserted through the cervix into the uterine cavity. CO<sub>2</sub> or liquid then is used to distend the uterus for improved visibility and surgical access. Isoosmolar, nontoxic, nonconducting distending mediums, such as glycine, dextrose, sorbitol/mannitol, and sa-

line, are used, and accurate accounting of the volume used and returned are essential to minimize water intoxication, hyponatremia, and ammonia toxicity. Diagnostic examinations for evaluation of unexplained fertility or abnormal uterine bleeding are performed with minimal cervical dilation using small-caliber devices that are placed under a paracervical block. By contrast, operative procedures, such as ablation or resection of intracavity uterine lesions, septae, or adhesions, are performed with larger-caliber devices capable of electrocautery, wire loop cutting, or lasering and necessitate a neuraxial or general anesthetic.

Vaginal hysterectomies are performed for benign conditions or early-stage malignancies of the uterus and cervix. They also are used in patients with loss of pelvic support associated with uterine prolapse. Excessive uterine size, prior abdominal surgery, and suspicion of intrapelvic malignancies all are contraindications to a vaginal approach. The procedure requires entry into the anterior and posterior culs-de-sac to expose the broad ligament containing the uterine artery and can be performed in association with cystocele or rectocele (bladder or rectal prolapse, respectively) repair or an urethropexy (see Perineal and Urologic Surgery, Specific Procedures above). The ovaries may be conserved or removed vaginally. These procedures can be performed under a hyperbaric spinal anesthetic at a T6 to T8 level to block the peritoneal sensation of uterine traction (Fig. 61-3). If significant Trendelenburg positioning and laparoscopy-assisted techniques will be used, a general anesthetic with endotracheal intubation is recommended.<sup>156</sup>

**Special Concerns** The majority of transvaginal procedures are performed in the lithotomy position. Excessive hip flexion, abduction, and external rotation may allow the inguinal ligament to apply continuous pressure on the femoral nerve<sup>157</sup> or place the obturator and lateral femoral cutaneous nerves in a position where they are prone to stretch injury.<sup>158</sup> Extensive rotation of the thighs at the hip or extension of the legs without knee flexion may result in sciatic and peroneal nerves injury.<sup>157</sup> Compression of the lateral fibular head results in common peroneal nerve injury, which can result in foot drop and lateral lower

extremity paresthesias.<sup>157</sup> Protective padding, avoidance of contact with hard surfaces or supports, and attention to positioning are important elements of optimal care.<sup>159</sup>

The Trendelenburg position is often used in transvaginal procedures to assist with surgical visualization. This position is associated with potentially severe consequences, including venous air emboli, alterations in circulation and respiration, and upper extremity peripheral nerve injuries.<sup>156,159</sup> When combined with laparoscopy, further hemodynamic and respiratory encroachment may occur.<sup>156</sup>

Use of distending mediums for hysteroscopy may result in absorption of large volumes of irrigating fluid, leading to hypervolemia, hyponatremia, and decreased osmolarity. Together, these alterations may produce hypertension, bradycardia, altered mental status, nausea, vomiting, headache, agitation, and lethargy. These symptoms are masked if general anesthesia is used. If the resulting “hyposmolar hyponatremia” is not recognized, seizures, coma and death may occur. Treatment includes halting or rapidly completing the surgery, sending blood for a complete blood count, electrolytes, and osmolality, and administering normal saline and furosemide. Although severe hyponatremia (<120 mEq/L) has a significant association with mortality, correction with hypertonic saline (3% NaCl) should occur no faster than 1–2 mEq/L/h with a goal of 125–130 mEq/L. Overly rapid correction can lead to central pontine myelinolysis, with paresis, mutism, pseudobulbar palsy, and other neurologic disorders.<sup>160,161</sup>

## Intraabdominal Operations

**Anatomy** Intraabdominal operations relate mostly to the vagina, uterine cervix, uterus, fallopian tubes, and ovaries. On occasion, especially when associated with sepsis and/or tumor invasion, the rectum and bladder are involved through fistulous communications. The blood supply to the pelvis is largely derived from the internal iliac (hypogastric) artery, which in turn gives rise to the uterine arteries, the superior, middle, and inferior vesical arteries, the middle and inferior hemorrhoidal arteries, and the vaginal arteries. The extensive collateral circulation network to organs within the pelvic viscera alternatively allows extensive bleeding during pelvic dissec-

tion or obstetric hemorrhage as well as the possibility of ligating major arteries, including the internal iliac, with few untoward effects.

The pelvic organs are innervated by sympathetic fibers derived predominantly from the first through fourth lumbar nerves (L1 to L4) and enter the hypogastric or presacral plexus (Fig. 61-3). The presacral sympathetic plexus serves the uterine fundus, cervix, vagina, and excretory organs, including the rectosigmoid region of the colon, anus, bladder, and urethra. Parasympathetic preganglionic fibers arise from the second through fourth sacral nerves (S2 to S4). Sensory nerves from the pelvic viscera, including the uterus, arise from the T10 to L4 spinal cord segments. By contrast, the cervix is served by nerve fibers from the S2 to S4 spinal cord segments. Lymphatic drainage of the female reproductive organs is predominately through the pelvic and paraaortic lymph nodes in the retroperitoneum, although the superficial and deep inguinal lymph nodes may be involved as well.

**Specific Procedures** Ovarian surgery is performed for a variety of conditions, including removal of cystic masses, endometrial lesions, and neoplastic tissues. Ovarian carcinomas are the most lethal of all gynecologic malignancies because of their ability to grow silently until the disease is advanced and widespread.<sup>162</sup> With extensive ovarian cancer, subdiaphragmatic lymphatic obstruction often results in profound ascites that may impair diaphragmatic excursion, impede venous return, and delay gastric emptying. Cytoreductive procedures, which remove all visible tumor masses to improve the response to chemotherapy, can include extensive retroperitoneal dissections with bowel resections and bypasses.

Surgery of the fallopian tubes is performed most often for nonneoplastic processes; both benign and malignant neoplasias are rare. Salpingoscopies are becoming more common because of their association with infertility evaluations.<sup>163</sup> Tubal ectopic pregnancies, which occur in approximately 1:100 pregnancies, are associated with pelvic inflammatory disease, intrauterine device use, diethylstilbestrol exposure, and prior tubal procedures or pathology.<sup>164</sup> Ectopic pregnancies may be located throughout the fallopian tube, in-

cluding the uterine anastomosis; the pregnancy is surrounded by myometrial uterine tissue at this site and may grow significantly prior to becoming symptomatic. Ectopic pregnancies may rupture without warning, leading to acute hemoperitoneum and massive exsanguination. Management should center on providing rapid fluid resuscitation, securing the airway, and preparing for massive blood transfusion and immediate surgery. Procedures for removing ectopic gestations are time consuming because hemostasis may be difficult to obtain. On occasion, particularly if the ectopic gestation is implanted near the uterus, a salpingectomy and hysterectomy may be required.

Tuboovarian abscesses are managed surgically when they are >8 cm, nonresponsive to antibiotic therapy, or potentially ruptured. Ruptured tuboovarian abscesses may be accompanied by peritonitis, septic shock, respiratory distress, and coagulopathies. Surgical management of intact abscesses includes percutaneous or laparoscopic drainage. However, a laparotomy with a salpingo-oophorectomy and hysterectomy may be necessary, particularly when associated with a rupture or extensive pelvic inflammatory disease.

Uterine leiomyomas (fibroids) are the most common benign tumor in women and may be associated with menometrorrhagia, ureteral obstruction, pain, infertility, and, rarely, pregnancy loss. Usually well-circumscribed but nonencapsulated, fibroids occur in the submucosal, intramural, or subserosal layers (innermost to outermost layers, respectively) of the uterus. Patients often are placed preoperatively on leuprolide, a gonadotropin-releasing hormone agonist, in an attempt to reduce the size of the fibroids. Myomectomies can range from straightforward hysteroscopic procedures of pedunculated subserosal fibroids to prolonged dissections of intramural fibroids accompanied by extensive bleeding. Vasospastic solutions of vasopressin or epinephrine are sometimes injected directly into the myometrium to reduce blood loss. Myomectomies can be performed under regional or general anesthesia.

Uterine reconstructive surgeries are performed for congenital malformations of the uterus and include removal of uterine septa or reunification of duplicate uterine horns. Most are performed to enable fertility or gestation.

Abdominal hysterectomies, which include subtotal (supracervical), total, and radical types, are performed for a variety of benign and malignant diseases. Common indications include symptomatic uterine fibroids, pelvic pain, and endometriosis. Acute inflammatory disease, endometriosis, and malignancies may result in extensive adhesions, increased vascularity, and destruction of normal tissue planes. These alterations prolong surgery and increase blood loss. Because a steep Trendelenburg position is often required for these operations, general anesthesia with endotracheal intubation is used.

**Special Considerations** Although vertical and transverse approaches can be used for intraabdominal surgeries, the low transverse incision is selected when possible for its cosmetic acceptability and strength of repair. The Pfannenstiel incision, the most common approach for cesarean delivery, often is modified to include dissection of the rectus abdominis (Maylard or Cherney incisions) for improved access to the lateral margins of the pelvis. When access to the upper abdomen is required, vertical midline or paramedian incisions are used. Such incisions are avoided, when possible, because the intrinsic strength and structural integrity of the repair are less robust, and respiratory splinting may occur.

Blood loss in gynecologic surgery may be precipitous and unexpected, although such cases often can be anticipated. Additional vascular access, invasive monitoring, and blood conservation techniques, such as erythropoietin-induced red cell production, autologous donation, and acute normovolemic hemodilution, should be considered in advance.<sup>165,166</sup> Because preoperative autologous donation is limited by the maximum life span of stored blood, collection must occur within 6 weeks of the planned operation, with an average unit collection interval of 3-7 days.<sup>166</sup> Although the use of blood cell salvage technologies remains controversial, particularly in the presence of malignancies, recovery of 2-3 U of blood has been deemed to be cost effective.<sup>166</sup> Moreover, the irradiation of blood cells retrieved intraoperatively has been demonstrated to eliminate cancer cells.<sup>167</sup> Most recently, the placement of prophylactic bal-



loon catheters in major vessels by interventional radiologists may allow for timely control or embolization of intraoperative bleeding, particularly from the uterus.

The extent of surgery for gynecologic malignancies often depends on the clinical staging of the disease, the presence or absence of lymph node metastases, and an examination of involved tissues by a surgical pathologist. The gynecologic surgeon and the anesthesia provider should discuss the likelihood of progression to a more radical surgery prior to and during an operation. Such discussions help guide decisions about placement of invasive monitoring catheters, use of large doses of narcotics and neuromuscular blocking agents, and selection of an anesthetic technique that is inappropriate for the duration and surgical exposure necessary for the case. On occasion, if the malignancy is confined to the pelvis without fixation to the pelvic sidewall, a pelvic exenteration is performed. This massive procedure involves radical hysterectomy, cystectomy with urinary diversion, and proctocolectomy with a permanent colostomy. Major fluid and electrolyte shifts, blood and heat loss, and coagulopathies can occur. Low-flow or closed-circuit volatile agent techniques and use of passive humidifiers, heating blankets, and fluid warmers are encouraged. A combined epidural-general anesthetic technique offers the benefits of a sympathetic blockade during the surgery and optimal analgesia postoperatively. Epidural analgesia is a particularly effective technique for reducing pain following intraabdominal procedures. With the exception of a herniotomy, use of incisional local anesthesia is not consistently effective for reducing postoperative pain.<sup>168</sup>

### Transabdominal Surgery

In distinction to open surgical procedures, transabdominal surgery occurs through small incisions with rigid or flexible scopes and instrumentation. Advantages of these procedures include smaller incisional sites, lower risks of wound complications, reduced postoperative pain and complications, and improved recovery.<sup>169</sup> Disadvantages include poor visualization, injury to viscera and blood vessels, and complications from CO<sub>2</sub> insufflation. In some cases, such as hysterectomies, vaginal approaches may be superior to laparoscopic approaches; however, both have benefits over open laparotomy.<sup>170</sup>

Although initially developed as a means for diagnosis, laparoscopy and pelviscopy are used routinely for a variety of operative procedures, including tubal ligation and repair, endometriosis fulguration, ovarian cyst aspiration and resection, ectopic pregnancy removal, and fibroid excision. Laparoscopic-guided carcinoma staging and resection procedures have been demonstrated to result in improved short-term and long-term outcomes compared to open laparotomies.<sup>171</sup> Most recently, "hand-assisted laparoscopy," which uses laparoscopy combined with a small incision for insertion of a hand, has shown increased utility and benefit over open laparotomy.<sup>172</sup>

Laparoscopy and pelviscopies are performed, often after catheterization of the bladder, with the surgeon placing a needle with a stopcock periumbilically through the fascial layers into the peritoneum. CO<sub>2</sub> is insufflated through this needle to a pressure of approximately 19 mm Hg. If the pressure increases rapidly, the needle may be inappropriately located between the fascial planes of the muscle layers and will need to be replaced. In the proper location and with the appropriate degree of abdominal distension achieved, the hollow needle is replaced with a trocar with a self-sealing opening for the laparoscope. The laparoscope then is placed and connected to an insufflator that provides gas (CO<sub>2</sub>) flows at a rate of 200 mL/min to maintain pressure.

**Special Considerations** Although CO<sub>2</sub> is a biologically produced gas and is nonflammable and rapidly absorbed, a number of consequences and complications may result from CO<sub>2</sub> insufflation. During the routine practice of laparoscopy and pelviscopy, distension of the abdomen may cause a number of disturbances that have implications for the anesthesiologist (Box 61–8). Pressure on the diaphragm, coupled with the use of anesthetic agents, tends to impede respiration. If patients are breathing spontaneously, minimal to moderate respiratory acidosis and oxygen desaturation may occur. Use of controlled ventilation with increased minute volumes can compensate for increased CO<sub>2</sub>, however, higher inspiratory pressures are frequently observed, particularly in obese patients in the Trendelenburg position. Because sustained high plateau pressures

### BOX 61–8.

#### Concerns and Complications from Laparoscopy and Pelviscopy

##### Concerns

##### Cardiovascular Alterations

Low Pressure (14–20 mm Hg) Insufflation: Increased central venous pressure, stroke volume and blood pressure

High Pressure (40 mm Hg) Insufflation: Decreased venous return, hypotension

##### Ventilatory Alterations

Decreased functional residual capacity, increased airway pressures and closure, decreased lung compliance, right main stem intubation, hypoxemia

##### Other Alterations

Carbon dioxide absorption with possible increase in plasma catecholamines, tachycardia, arrhythmias, vasodilation  
Increased intraabdominal pressure

##### Complications

Carbon Dioxide Gas Embolism

Hemorrhage

Pneumothorax

Pneumomediastinum

Subcutaneous Emphysema

Perforated Viscus

Explosion

Retroperitoneal Emphysema

Cardiovascular Collapse

Carbon Monoxide Accumulation

Pulmonary Edema

can lead to bronchoalveolar damage, several changes may be necessary, such as modification of ventilatory settings to lower tidal volumes, release of some gas from the abdomen by the surgeon, and reduction of the degree of Trendelenburg positioning. Tension pneumothorax related to excessive inspiratory pressures can occur and must be ruled out if a sudden increase in inspiratory pressure is accompanied by decreasing oxygen saturations.

A massive CO<sub>2</sub> embolus, although rare, is rapidly fatal unless recognized and treated immediately. The usual sequence is the onset of sudden and severe hypotension, arterial desaturation, and cardiovascular collapse shortly after placement of the insufflation needle or laparoscope. A "mill wheel" murmur throughout the cardiac cycle from gas in the right heart and

pulmonary outflow tract has been reported; however, this is an unreliable sign. Capnography most likely will reveal a sudden decrease in expired CO<sub>2</sub> because an acute increase in “physiologic” dead space, and fulminant pulmonary edema may occur. Treatment is largely supportive, with immediate discontinuance of CO<sub>2</sub> insufflation, intubation (if not already part of the anesthetic technique), provision of 100% oxygen, and cardiovascular support. Placing the patient in a left lateral head-down position to trap the gas in the apex of the right ventricle rather than the pulmonary outflow tract (i.e., Durant maneuver) is controversial. Placement of a central venous catheter into the right atrium to remove gas or air acting as a mechanical obstruction is controversial. Fortunately, CO<sub>2</sub> is highly soluble and rapidly cleared, and more favorable outcomes have been observed than with massive air emboli. If pulmonary edema develops, 5–10 cm H<sub>2</sub>O of positive end-expiratory pressure and use of IV furosemide may be helpful. If significant CO<sub>2</sub> sequelae occur, the procedure should be rapidly terminated and the patient brought to an intensive care environment for continued observation and therapy.

Postoperatively, laparoscopy and pelviscopy have been significantly associated with postoperative nausea and vomiting. Moreover, laparoscopy may be a risk factor for superficial thrombophlebitis, deep venous thrombosis, and pulmonary embolism.<sup>173</sup>

## CONCLUSION

The care and management of women undergoing obstetric and gynecologic surgery involves an appreciation of the physiologic, pharmacologic, and anatomic differences. Because a growing amount of evidence-based research and clinical practice now indicates alterations in care and outcome based on gender, anesthesiologists should guide their practice with an appreciation of these differences for optimal patient safety, outcomes, and satisfaction.

## KEY REFERENCES

1. Briggs GG, Freeman RK, Sumner JY. *Drugs in Pregnancy and Lactation*. Philadelphia: Lippincott Williams & Wilkins, 2005.

tion. Philadelphia: Lippincott Williams & Wilkins, 2005.

2. Tsen LC. Darwin to desflurane: anesthesia for assisted reproductive technologies. *Anesth Analg* 2002;94(Suppl):109–114.

3. Hawkins JL, Koonin LM, Palmer SK, et al. Anesthesia-related deaths during obstetric delivery in the United States, 1979–1990. *Anesthesiology* 1997;86:277–284.

4. Confidential Enquiry into Maternal and Child Health: Why Mothers Die 2000–2002. The Sixth Report of the Confidential Enquiries into Maternal Deaths in the United Kingdom. London: Royal College of Obstetricians and Gynaecologists, 2004.

5. Marx GF. Aorticaval compression syndrome: its 50 year history. *Int J Obstet Anesth* 1992;1:60–64.

6. Lee SJ, Ralston HJ, Drey EA, et al. Fetal pain: a systematic multidisciplinary review of the evidence. *JAMA* 2005;294:947–954.

7. Halpern SH, Leighton BL, Ohlsson A, et al. Effect of epidural vs parenteral opioid analgesia on the progress of labor: a meta-analysis. *JAMA* 1998;280:2105–2110.

8. Lee A, Ngan Kee WD, Gin T. A quantitative, systematic review of randomized controlled trials of ephedrine versus phenylephrine for the management of hypotension during spinal anesthesia for Cesarean delivery. *Anesth Analg* 2002;94:920–926.

9. Ueyama H, He YL, Tanigami H, et al. Effects of crystalloid and colloid preload on blood volume in the parturient undergoing spinal anesthesia for elective Cesarean section. *Anesthesiology* 1999;91:1571–1576.

10. Sibai BM. Diagnosis and management of gestational hypertension and preeclampsia. *Obstet Gynecol* 2003;102:181–192.

11. Pleym H, Spigset O, Kharasch ED, et al. Gender differences in drug effects: implications for anesthesiologists. *Acta Anaesthesiol Scand* 2003;47:241–259.

12. Practice advisory for the prevention of perioperative peripheral neuropathies: a report by the American Society of Anesthesiologists Task Force on Prevention of Perioperative Peripheral Neuropathies. *Anesthesiology* 2000;92:1168–1182.

13. Esler MD, Douglas MJ. Planning for hemorrhage. Steps an anesthesiologist can take to limit and treat hemorrhage in the obstetric patient. *Anesthesiol Clin North America* 2003;21:127–144.

14. Practice guidelines for obstetrical anesthesia: an updated report by the American Society of Anesthesiologists Task Force on Obstetrical Anesthesia. *Anesthesiology* 2007;106(4):843–863.

## REFERENCES

1. Bahar M, Chanimov M, Cohen ML, et al. Lateral recumbent head-down posture for epidural catheter insertion reduces intravascular injection. *Can J Anaesth* 2001;48:48–53.
2. Cook TM. Combined spinal-epidural techniques. *Anaesthesia* 2000;55:42–64.
3. Castillo D, Tsen LC. Epidural blood patch placed in the presence of an unknown cervical epidural hematoma. *Anesth Analg* 2003;97:885–887.
4. Arkoosh VA. Continuous spinal analgesia and anesthesia in obstetrics. *Reg Anesth* 1993;18:402–405.
5. Huckaby T, Skerman JH, Hurley RJ, et al. Sensory analgesia for vaginal deliveries: a preliminary report of continuous spinal anesthesia with a 32-gauge catheter. *Reg Anesth* 1991;16:150–153.
6. Lambert DH, Hurley RJ. Cauda equina syndrome and continuous spinal anesthesia. *Anesth Analg* 1991;72:817–819.
7. Ginosar Y, Riley ET, Angst MS. The site of action of epidural fentanyl in humans: the difference between infusion and bolus administration. *Anesth Analg* 2003;97:1428–1438.
8. Palot M, Chale JJ, Colladon B, et al. Anesthesia and analgesia practice patterns in French obstetrical patients. *Ann Fr Anesth Reanim* 1998;17:210–219.
9. O'Connell MP, Tetsis AV, Lindow SW. The management of the second stage of labor. *Int J Gynaecol Obstet* 2001;74:51–56.
10. Shepard TH. *Catalog of Teratogenic Agents*. Baltimore: Johns Hopkins University Press, 2001.
11. Briggs GG, Freeman RK, Sumner JY. *Drugs in Pregnancy and Lactation*. Philadelphia: Lippincott Williams & Wilkins, 2005.

12. Tsen LC. Darwin to desflurane: anesthesia for assisted reproductive technologies. *Anesth Analg* 2002;94(Suppl):109-114.
13. Fujinaga M, Mazze RI, Jackson EC, et al. Reproductive and teratogenic effects of sufentanil and alfentanil in Sprague-Dawley rats. *Anesth Analg* 1988;67:166-169.
14. Fujinaga M, Mazze RI, Baden JM, et al. Rat whole embryo culture: an in vitro model for testing nitrous oxide teratogenicity. *Anesthesiology* 1988;69:401-404.
15. Fujinaga M, Baden JM, Mazze RI. Developmental toxicity of nondepolarizing muscle relaxants in cultured rat embryos. *Anesthesiology* 1992;76:999-1003.
16. Fujinaga M, Mazze RI. Reproductive and teratogenic effects of lidocaine in Sprague-Dawley rats. *Anesthesiology* 1986;65:626-632.
17. Mazze RI, Fujinaga M, Rice SA, et al. Reproductive and teratogenic effects of nitrous oxide, halothane, isoflurane, and enflurane in Sprague-Dawley rats. *Anesthesiology* 1986;64:339-344.
18. Mazze RI, Fujinaga M, Baden JM. Halothane prevents nitrous oxide teratogenicity in Sprague-Dawley rats; folic acid does not. *Teratology* 1988;38:121-127.
19. Hawkins JL, Koonin LM, Palmer SK, et al. Anesthesia-related deaths during obstetric delivery in the United States, 1979-1990. *Anesthesiology* 1997;86:277-284.
20. Confidential Enquiry into Maternal and Child Health: Why Mothers Die 2000-2002. The Sixth Report of the Confidential Enquiries into Maternal Deaths in the United Kingdom. London: Royal College of Obstetricians and Gynaecologists, 2004.
21. Farcon EL, Kim MH, Marx GF. Changing Mallampati score during labour. *Can J Anaesth* 1994;41:50-51.
22. Endler GC, Mariona FG, Sokol RJ, et al. Anesthesia-related maternal mortality in Michigan, 1972 to 1984. *Am J Obstet Gynecol* 1988;159:187-193.
23. Tsen LC, Pitner R, Camann WR. General anesthesia for Cesarean section at a tertiary care hospital 1990-1995: indications and implications. *Int J Obstet Anesth* 1998;7:147-152.
24. Marx GF. Aortocaval compression syndrome: its 50 year history. *Int J Obstet Anesth* 1992;1:60-64.
25. Ramanathan J, Bennett K. Pre-eclampsia: fluids, drugs, and anesthetic management. *Anesthesiol Clin North America* 2003;21:145-163.
26. Tsen LC, Schultz R, Martin R, et al. Intrathecal low-dose bupivacaine versus lidocaine for in vitro fertilization procedures. *Reg Anesth Pain Med* 2001;26:52-56.
27. Martin R, Tsen LC, Tzeng G, Hornstein MD, Datta S. Anesthesia for in vitro fertilization: the addition of fentanyl to 1.5% lidocaine. *Anesth Analg* 1999;88:523-526.
28. Kauppila A, Leinonen P, Vihko R, et al. Metoclopramide-induced hyperprolactinemia impairs ovarian follicle maturation and corpus luteum function in women. *J Clin Endocrinol Metab* 1982;54:955-960.
29. Delbaere A, Smits G, De Leener A, et al. Understanding ovarian hyperstimulation syndrome. *Endocrine* 2005;26:285-290.
30. ACOG practice bulletin. Cervical insufficiency. *Int J Gynaecol Obstet* 2004;85:81-89.
31. Carlan SJ, Dent JM, Huckaby T, et al. The effect of epidural anesthesia on safety and success of external cephalic version at term. *Anesth Analg* 1994;79:525-528.
32. Birnbach DJ, Matut J, Stein DJ, et al. The effect of intrathecal analgesia on the success of external cephalic version. *Anesth Analg* 2001;93:410-413.
33. Schorr SJ, Speights SE, Ross EL, et al. A randomized trial of epidural anesthesia to improve external cephalic version success. *Am J Obstet Gynecol* 1997;177:1133-1137.
34. Dugoff L, Stamm CA, Jones OW 3rd, et al. The effect of spinal anesthesia on the success rate of external cephalic version: a randomized trial. *Obstet Gynecol* 1999;93:345-349.
35. Cherayil G, Feinberg B, Robinson J, et al. Central neuraxial blockade promotes external cephalic version success after a failed attempt. *Anesth Analg* 2002;94:1589-1592.
36. Flake AW. Fetal surgery for congenital diaphragmatic hernia. *Semin Pediatr Surg* 1996;5:266-274.
37. Johnson MD, Birnbach DJ, Burchman C, et al. Fetal surgery and general anesthesia: a case report and review. *J Clin Anesth* 1989;1:363-367.
38. McCullagh P. Fetal sentience and fetal surgery. In: Adams AP, Cashman JN, eds. *Recent Advances in Anaesthesia and Analgesia*. Vol. 20. Edinburgh: Churchill Livingstone, 1998:107-121.
39. Lee SJ, Ralston HJ, Drey EA, et al. Fetal pain: a systematic multidisciplinary review of the evidence. *JAMA* 2005;294:947-954.
40. Strumper D, Durieux ME, Gogarten W, et al. Fetal plasma concentrations after intraamniotic sufentanil in chronically instrumented pregnant sheep. *Anesthesiology* 2003;98:1400-1406.
41. Zhang J, Troendle JF, Yancey MK. Reassessing the labor curve in nulliparous women. *Am J Obstet Gynecol* 2002;187:824-828.
42. Eltzschig HK, Lieberman ES, Camann WR. Regional anesthesia and analgesia for labor and delivery. *N Engl J Med* 2003;348:319-332.
43. Tsen LC, Thomas J, Segal S, et al. Transcutaneous electrical nerve stimulation does not augment combined spinal epidural labour analgesia. *Can J Anaesth* 2000;47:38-42.
44. Tsen LC, Thomas J, Segal S, et al. Transcutaneous electrical nerve stimulation does not augment epidural labor analgesia. *J Clin Anesth* 2001;13:571-575.
45. Bucklin BA, Hawkins JL, Anderson JR, et al. Obstetric anesthesia workforce survey: twenty-year update. *Anesthesiology* 2005;103:645-653.
46. Santos AC, DeArmas PI. Systemic toxicity of levobupivacaine, bupivacaine, and ropivacaine during continuous intravenous infusion to nonpregnant and pregnant ewes. *Anesthesiology* 2001;95:1256-1264.
47. Ohmura S, Kawada M, Ohta T, et al. Systemic toxicity and resuscitation in bupivacaine-, levobupivacaine-, or ropivacaine-infused rats. *Anesth Analg* 2001;93:743-748.
48. Camann WR, Denney RA, Holby ED, et al. A comparison of intrathecal, epidural, and intravenous sufentanil for labor analgesia. *Anesthesiology* 1992;77:884-887.
49. Celleno D, Capogna G. Epidural fentanyl plus bupivacaine 0.125 per cent for labour: analgesic effects. *Can J Anaesth* 1988;35:375-378.
50. van der Vyver M, Halpern S, Joseph G. Patient-controlled epidural analgesia versus continuous infusion for labour analgesia: a meta-analysis. *Br J Anaesth* 2002;89:459-465.
51. Wong CA, Scavone BM, Peaceman AM, et al. The risk of Cesarean delivery with neuraxial analgesia given early versus late in labor. *N Engl J Med* 2005;352:655-665.
52. Tsen LC, Thue B, Datta S, et al. Is combined spinal-epidural analgesia associated with more rapid cervical dilation in nulliparous patients when compared with conventional epidural analgesia? *Anesthesiology* 1999;91:920-925.
53. Halpern SH, Leighton BL, Ohlsson A, et al. Effect of epidural vs parenteral opioid analgesia on the progress of labor: a meta-analysis. *JAMA* 1998;280:2105-2110.
54. American College of Obstetricians and Gynecologists Task Force on Cesarean Delivery Rates. *Evaluation of Cesarean Delivery Rates*. Washington, DC: American College of Obstetricians and Gynecologists, 2000.
55. Segal S, Su M, Gilbert P. The effect of a rapid change in availability of epidural analgesia on the Cesarean delivery rate: a meta-analysis. *Am J Obstet Gynecol* 2000;183:974-978.
56. Tsen LC, Boosalis P, Segal S, et al. Hemodynamic effects of simultaneous administration of intravenous ephedrine and spinal anesthesia for Cesarean delivery. *J Clin Anesth* 2000;12:378-382.
57. Corke BC, Datta S, Ostheimer GW, et al. Spinal anaesthesia for Cesarean section. The influence of hypotension on neonatal outcome. *Anaesthesia* 1982;37:658-662.
58. Datta S, Alper MH, Ostheimer GW, et al. Method of ephedrine administration and nausea and hypotension during spinal anesthesia for Cesarean section. *Anesthesiology* 1982;56:68-70.
59. Turnbull DK, Shepherd DB. Post-dural puncture headache: pathogenesis, prevention and treatment. *Br J Anaesth* 2003;91:718-729.
60. Jones RJ. The role of recumbency in the prevention and treatment of postspinal headache. *Anesth Analg* 1974;53:788-796.



61. Abouleish E, Vega S, Blendinger I, et al. Long-term follow-up of epidural blood patch. *Anesth Analg* 1975;54:459-463.
62. Holmstrom B, Rawal N, Axelsson K, et al. Risk of catheter migration during combined spinal epidural block: percutaneous epiduroscopy study. *Anesth Analg* 1995;80:747-753.
63. Suzuki N, Koganemaru M, Onizuka S, et al. Dural puncture with a 26-gauge spinal needle affects spread of epidural anesthesia. *Anesth Analg* 1996;82:1040-1042.
64. Thomas JA, Pan PH, Harris LC, et al. Dural puncture with a 27-gauge Whitacre needle as part of a combined spinal-epidural technique does not improve labor epidural catheter function. *Anesthesiology* 2005;103:1046-1051.
65. Albright GA, Forster RM. The safety and efficacy of combined spinal and epidural analgesia/anesthesia (6,002 blocks) in a community hospital. *Reg Anesth Pain Med* 1999;24:117-125.
66. Hamilton BE, Martin JA, Sutton PD. National Vital Statistics Reports. Births: Preliminary Data for 2003. Washington, DC: US Department of Health and Human Services, National Center for Health Statistics, Center for Disease Control and Prevention, 2004.
67. Sarna MC, Soni AK, Gomez M, et al. Intravenous oxytocin in patients undergoing elective Cesarean section. *Anesth Analg* 1997;84:753-756.
68. Secher NJ, Arnsbo P, Wallin L. Haemodynamic effects of oxytocin (syntocinon) and methyl ergometrine (methergin) on the systemic and pulmonary circulations of pregnant anaesthetized women. *Acta Obstet Gynecol Scand* 1978;57:97-103.
69. Heytens L, Camu F. Pulmonary edema during Cesarean section related to the use of oxytocic drugs. *Acta Anaesthesiol Belg* 1984;35:155-164.
70. Park EH, Sachs blood pressure. Postpartum hemorrhage and other problems of the third stage. In: Gonik B, ed. *High Risk Pregnancy: Management Options*. London: WB Saunders, 1999:1231-1246.
71. Palmer CM, Emerson S, Volgoropolous D, et al. Dose-response relationship of intrathecal morphine for post-Cesarean analgesia. *Anesthesiology* 1999;90:437-444.
72. Abouleish EI. Epinephrine improves the quality of spinal hyperbaric bupivacaine for Cesarean section. *Anesth Analg* 1987;66:395-400.
73. Datta S, Lambert DH, Gregus J, et al. Differential sensitivities of mammalian nerve fibers during pregnancy. *Anesth Analg* 1983;62:1070-1072.
74. Bromage PR. Continuous lumbar epidural analgesia for obstetrics. *Can Med Assoc J* 1961;85:1136-1140.
75. Philipson EH, Kuhnert BR, Syracuse CD. Fetal acidosis, 2-chloroprocaine, and epidural anesthesia for Cesarean section. *Am J Obstet Gynecol* 1985;151:322-324.
76. Camann WR, Hartigan PM, Gilbertson LI, et al. Chloroprocaine antagonism of epidural opioid analgesia: a receptor-specific phenomenon? *Anesthesiology* 1990;73:860-863.
77. Stevens RA, Urmey WF, Urquhart BL, et al. Back pain after epidural anesthesia with chloroprocaine. *Anesthesiology* 1993;78:492-497.
78. Stevens RA, Chester WL, Schubert A, et al. pH-adjustment of 2-chloroprocaine quickens the onset of epidural anaesthesia. *Can J Anaesth* 1989;36:515-518.
79. Peterfreund RA, Datta S, Ostheimer GW. pH adjustment of local anesthetic solutions with sodium bicarbonate: laboratory evaluation of alkalization and precipitation. *Reg Anesth* 1989;14:265-270.
80. Portnoy D, Vadhera RB. Mechanisms and management of an incomplete epidural block for Cesarean section. *Anesthesiol Clin North America* 2003;21:39-57.
81. Tsen LC, Pitner R, Camann WR. General anesthesia at a tertiary care hospital 1990-1995: indications and implications. *Int J Obstet Anesth* 1998;7:147-152.
82. Aya AG, Mangin R, Vialles N, et al. Patients with severe preeclampsia experience less hypotension during spinal anesthesia for elective Cesarean delivery than healthy parturients: a prospective cohort comparison. *Anesth Analg* 2003;97:867-872.
83. Santos AC, Birnbach DJ. Spinal anesthesia in the parturient with severe preeclampsia: time for reconsideration. *Anesth Analg* 2003;97:621-622.
84. Chestnut DH, Dewan DM, Redick LF, et al. Anesthetic management for obstetric hysterectomy: a multi-institutional study. *Anesthesiology* 1989;70:607-610.
85. Park GE, Hauch MA, Curlin F, et al. The effects of varying volumes of crystalloid administration before Cesarean delivery on maternal hemodynamics and colloid osmotic pressure. *Anesth Analg* 1996;83:299-303.
86. Lee A, Ngan Kee WD, Gin T. A quantitative, systematic review of randomized controlled trials of ephedrine versus phenylephrine for the management of hypotension during spinal anesthesia for Cesarean delivery. *Anesth Analg* 2002;94:920-926.
87. Ueyama H, He YL, Tanigami H, et al. Effects of crystalloid and colloid preload on blood volume in the parturient undergoing spinal anesthesia for elective Cesarean section. *Anesthesiology* 1999;91:1571-1576.
88. Loughrey JP, Yao N, Datta S, et al. Hemodynamic effects of spinal anesthesia and simultaneous intravenous bolus of combined phenylephrine and ephedrine versus ephedrine for Cesarean delivery. *Int J Obstet Anesth* 2005;14:43-47.
89. Mercier FJ, Riley ET, Frederickson WL, et al. Phenylephrine added to prophylactic ephedrine infusion during spinal anesthesia for elective Cesarean section. *Anesthesiology* 2001;95:668-674.
90. Cooper DW, Carpenter M, Mowbray P, et al. Fetal and maternal effects of phenylephrine and ephedrine during spinal anesthesia for Cesarean delivery. *Anesthesiology* 2002;97:1582-1590.
91. Balki M, Carvalho JC. Intraoperative nausea and vomiting during Cesarean section under regional anesthesia. *Int J Obstet Anesth* 2005;14:230-241.
92. Szarvas S, Harmon D, Murphy D. Neuraxial opioid-induced pruritus: a review. *J Clin Anesth* 2003;15:234-239.
93. Kranke P, Eberhart LH, Roewer N, et al. Pharmacological treatment of postoperative shivering: a quantitative systematic review of randomized controlled trials. *Anesth Analg* 2002;94:453-460.
94. Ross BK. ASA closed claims in obstetrics: lessons learned. *Anesthesiol Clin North America* 2003;21:183-197.
95. Royal College of Obstetricians and Gynaecologists. *Why Mothers Die 1997-1999: The Confidential Enquiries into Maternal Deaths in the United Kingdom*. London: Royal College of Obstetricians and Gynaecologists, 2001.
96. Malan TP Jr, Johnson MD. The difficult airway in obstetric anesthesia: techniques for airway management and the role of regional anesthesia. *J Clin Anesth* 1988;1:104-111.
97. Practice guidelines for management of the difficult airway: an updated report by the American Society of Anesthesiologists Task Force on Management of the Difficult Airway. *Anesthesiology* 2003;98:1269-1277.
98. Han TH, Brimacombe J, Lee EJ, et al. The laryngeal mask airway is effective (and probably safe) in selected healthy parturients for elective Cesarean section: a prospective study of 1067 cases. *Can J Anaesth* 2001;48:1117-1121.
99. James CF, Modell JH, Gibbs CP, et al. Pulmonary aspiration—effects of volume and pH in the rat. *Anesth Analg* 1984;63:665-668.
100. Johnston JR, Moore J, McCaughey W, et al. Use of cimetidine as an oral antacid in obstetric anesthesia. *Anesth Analg* 1983;62:720-726.
101. Murphy DF, Nally B, Gardiner J, et al. Effect of metoclopramide on gastric emptying before elective and emergency cesarean section. *Br J Anaesth* 1984;56:1113-1116.
102. Norris MC, Dewan DM. Preoxygenation for Cesarean section: a comparison of two techniques. *Anesthesiology* 1985;62:827-829.
103. Khaw KS, Ngan Kee WD. Fetal effects of maternal supplementary oxygen during cesarean section. *Curr Opin Anaesthesiol* 2004;309-313.
104. Dogru K, Yildiz K, Dalgic H, et al. Inhibitory effects of desflurane and sevoflurane on contractions of isolated gravid rat myometrium under oxytocin stimulation. *Acta Anaesthesiol Scand* 2003;47:472-474.
105. Mattingly JE, D'Alessio J, Ramanathan J. Effects of obstetric analgesics and anesthetics on the neonate: a review. *Paediatr Drugs* 2003;5:615-627.



106. Datta S, Ostheimer GW, Weiss JB, et al. Neonatal effect of prolonged anesthetic induction for Cesarean section. *Obstet Gynecol* 1981;58:331–335.
107. Palmer CM, Nogami WM, Van Maren G, et al. Postcesarean epidural morphine: a dose-response study. *Anesth Analg* 2000;90:887–891.
108. Carvalho B, Riley E, Cohen SE, et al. Single-dose, sustained-release epidural morphine in the management of postoperative pain after elective Cesarean delivery: results of a multicenter randomized controlled study. *Anesth Analg* 2005;100:1150–1158.
109. Kotelko DM, Dailey PA, Shnider SM, et al. Epidural morphine analgesia after Cesarean delivery. *Obstet Gynecol* 1984;63:409–413.
110. Wang BC, Hillman DE, Spielholz NI, et al. Chronic neurologic deficits and Nescaine-CE—an effect of the anesthetic, 2-chloroprocaine, or the antioxidant, sodium bisulfite? *Anesth Analg* 1984;63:445–447.
111. Fischer RL, Lubenow TR, Liceaga A, et al. Comparison of continuous epidural infusion of fentanyl-bupivacaine and morphine-bupivacaine in management of postoperative pain. *Anesth Analg* 1988;67:559–563.
112. Cahill DJ, Wardle PG. Bleeding and pain in early pregnancy. In: James DK, Steer PJ, Weiner CP, et al., eds. *High Risk Pregnancy Management Options*. Philadelphia: Elsevier Saunders, 2006:84–104.
113. Gonik B. Intensive care monitoring of the critically ill pregnant patient. In: Creasy RK, Resnik R, eds. *Maternal-Fetal Medicine*. Philadelphia: WB Saunders, 1994:865–890.
114. Why Mothers Die 1997–1999: Confidential Enquiries into Maternal Deaths in the United Kingdom. London: Department of Health, HMSO, 2001:36–37.
115. Fuller AJ, Carvalho B, Brummel C, et al. Epidural anesthesia for elective Cesarean delivery with intraoperative arterial occlusion balloon catheter placement. *Anesth Analg* 2006;102:585–587.
116. Condous GS, Arulkumaran S, Symonds I, et al. The “tamponade test” in the management of massive postpartum hemorrhage. *Obstet Gynecol* 2003;101:767–772.
117. Practice guidelines for blood component therapy: a report by the American Society of Anesthesiologists Task Force on Blood Component Therapy. *Anesthesiology* 1996;84:732–747.
118. Sibai BM. Diagnosis and management of gestational hypertension and preeclampsia. *Obstet Gynecol* 2003;102:181–192.
119. Jouppila P, Jouppila R, Hollmen A, et al. Lumbar epidural analgesia to improve intervillous blood flow during labor in severe preeclampsia. *Obstet Gynecol* 1982;59:158–161.
120. VanWijk MJ, Boer K, Berckmans RJ, et al. Enhanced coagulation activation in preeclampsia: the role of APC resistance, microparticles and other plasma constituents. *Thromb Haemost* 2002;88:415–420.
121. Kelton JG, Hunter DJ, Neame PB. A platelet function defect in preeclampsia. *Obstet Gynecol* 1985;65:107–109.
122. Wallace DH, Leveno KJ, Cunningham FG, et al. Randomized comparison of general and regional anesthesia for Cesarean delivery in pregnancies complicated by severe preeclampsia. *Obstet Gynecol* 1995;86:193–199.
123. Izci B, Riha RL, Martin SE, et al. The upper airway in pregnancy and preeclampsia. *Am J Respir Crit Care Med* 2003;167:137–140.
124. Clinical competence in hemodynamic monitoring. A statement for physicians from the ACP/ACC/AHA Task Force on Clinical Privileges in Cardiology. *Circulation* 1990;81:2036–2040.
125. Sibbald WJ, Keenan SP. Show me the evidence: a critical appraisal of the Pulmonary Artery Catheter Consensus Conference and other musings on how critical care practitioners need to improve the way we conduct business. *Crit Care Med* 1997;25:2060–2063.
126. Connors AF Jr, Speroff T, Dawson NV, et al. The effectiveness of right heart catheterization in the initial care of critically ill patients. SUPPORT Investigators. *JAMA* 1996;276:889–897.
127. Newsome LR, Bramwell RS, Curling PE. Severe preeclampsia: hemodynamic effects of lumbar epidural anesthesia. *Anesth Analg* 1986;65:31–36.
128. Sise MJ, Hollingsworth P, Brimm JE, et al. Complications of the flow-directed pulmonary artery catheter: a prospective analysis in 219 patients. *Crit Care Med* 1981;9:315–318.
129. Practice guidelines for obstetrical anesthesia: a report by the American Society of Anesthesiologists Task Force on Obstetrical Anesthesia. *Anesthesiology* 1999;90:600–611.
130. Benedetti TJ, Kates R, Williams V. Hemodynamic observations in severe preeclampsia complicated by pulmonary edema. *Am J Obstet Gynecol* 1985;152:330–334.
131. Clark SL, Cotton DB. Clinical indications for pulmonary artery catheterization in the patient with severe preeclampsia. *Am J Obstet Gynecol* 1988;158:453–458.
132. Belfort MA, Mares A, Saade G, et al. Two-dimensional echocardiography and Doppler ultrasound in managing obstetric patients. *Obstet Gynecol* 1997;90:326–330.
133. Fischbach F. *A Manual of Laboratory and Diagnostic Tests*. 5th ed. Philadelphia: JB Lippincott, 1996:362–363.
134. Gao S, Escalante C. Venous thromboembolism and malignancy. *Expert Rev Anticancer Ther* 2004;4:303–320.
135. Schafer AI, Levine MN, Konkle BA, et al. Thrombotic disorders: diagnosis and treatment. *Hematology (Am Soc Hematol Educ Program)* 2003:520–539.
136. Riley JL 3rd, Robinson ME, Wise EA, et al. Sex differences in the perception of noxious experimental stimuli: a meta-analysis. *Pain* 1998;74:181–187.
137. Dawson-Basoa M, Gintzler AR. Nociceptin (Orphanin FQ) abolishes gestational and ovarian sex steroid-induced antinociception and induces hyperalgesia. *Brain Res* 1997;750:48–52.
138. Ratka A, Simpkins JW. Effects of estradiol and progesterone on the sensitivity to pain and on morphine-induced antinociception in female rats. *Horm Behav* 1991;25:217–228.
139. Weiland NG, Wise PM. Estrogen and progesterone regulate opiate receptor densities in multiple brain regions. *Endocrinology* 1990;126:804–808.
140. Tsen LC, Natale M, Datta S, et al. Can estrogen influence the response to noxious stimuli? *J Clin Anesth* 2001;13:118–121.
141. Tong C, Ma W, Shin SW, et al. Uterine cervical distension induces cFos expression in deep dorsal horn neurons of the rat spinal cord. *Anesthesiology* 2003;99:205–211.
142. Pleym H, Spigset O, Kharasch ED, et al. Gender differences in drug effects: implications for anesthesiologists. *Acta Anaesthesiol Scand* 2003;47:241–259.
143. Wilson K, Oram M, Horth CE, et al. The influence of the menstrual cycle on the metabolism and clearance of methaqualone. *Br J Clin Pharmacol* 1982;14:333–339.
144. Kirkwood C, Moore A, Hayes P, et al. Influence of menstrual cycle and gender on alprazolam pharmacokinetics. *Clin Pharmacol Ther* 1991;50:404–409.
145. Kashuba AD, Bertino JS Jr, Rocci ML Jr, et al. Quantification of 3-month intraindividual variability and the influence of sex and menstrual cycle phase on CYP3A activity as measured by phenotyping with intravenous midazolam. *Clin Pharmacol Ther* 1998;64:269–277.
146. Gustavson LE, Benet LZ. Menopause: pharmacodynamics and pharmacokinetics. *Exp Gerontol* 1994;29:437–444.
147. Hoymork SC, Raeder J. Why do women wake up faster than men from propofol anaesthesia? *Br J Anaesth* 2005;95:627–633.
148. Flegal KM, Carroll MD, Ogden CL, et al. Prevalence and trends in obesity among US adults, 1999–2000. *JAMA* 2002;288:1723–1727.
149. King JC, Sherline DM. Paracervical and pudendal block. *Clin Obstet Gynecol* 1981;24:587–595.
150. Alp E, Bijl D, Bleichrodt RP, et al. Surgical smoke and infection control. *J Hosp Infect* 2006;62:1–5.
151. Ray BK, Vallejo MC, Creinin MD, et al. Amniotic fluid embolism with second trimester pregnancy termination: a case report. *Can J Anaesth* 2004;51:139–144.
152. Maslow AD, Breen TW, Sarna MC, et al. Prevalence of coagulation abnormalities

- associated with intrauterine fetal death. *Can J Anaesth* 1996;43:1237–1243.
153. Kleiner GJ, Greston WM. Current concepts of defibrination in the pregnant woman. *J Reprod Med* 1976;17:309–317.
154. Sarwar N, Newlands ES, Seckl MJ. Gestational trophoblastic neoplasia: the management of relapsing patients and other recent advances. *Curr Oncol Rep* 2004;6:476–482.
155. Yildiz K, Dogru K, Dalgic H, et al. Inhibitory effects of desflurane and sevoflurane on oxytocin-induced contractions of isolated pregnant human myometrium. *Acta Anaesthesiol Scand* 2005;49:1355–1359.
156. Hirvonen EA, Nuutinen LS, Kauko M. Hemodynamic changes due to Trendelenburg positioning and pneumoperitoneum during laparoscopic hysterectomy. *Acta Anaesthesiol Scand* 1995;39:949–955.
157. Irvin W, Andersen W, Taylor P, et al. Minimizing the risk of neurologic injury in gynecologic surgery. *Obstet Gynecol* 2004;103:374–382.
158. Litwiller JP, Wells RE Jr, Halliwill JR, et al. Effect of lithotomy positions on strain of the obturator and lateral femoral cutaneous nerves. *Clin Anat* 2004;17:45–49.
159. Practice advisory for the prevention of perioperative peripheral neuropathies: a report by the American Society of Anesthesiologists Task Force on Prevention of Perioperative Peripheral Neuropathies. *Anesthesiology* 2000;92:1168–1182.
160. Bradley LD. Complications in hysteroscopy: prevention, treatment and legal risk. *Curr Opin Obstet Gynecol* 2002;14:409–415.
161. Verbalis JG. Adaptation to acute and chronic hyponatremia: implications for symptomatology, diagnosis, and therapy. *Semin Nephrol* 1998;18:3–19.
162. Stoff-Khalili MA, Dall P, Curiel DT. From gene therapy to virotherapy for ovarian cancer. *Minerva Ginecol* 2004;56:503–514.
163. Marana R, Catalano GF, Muzii L. Salpingoscopy. *Curr Opin Obstet Gynecol* 2003;15:333–336.
164. Ramirez NC, Lawrence WD, Ginsburg KA. Ectopic pregnancy. A recent five-year study and review of the last 50 years' literature. *J Reprod Med* 1996;41:733–740.
165. Rehm M, Orth V, Kreimeier U, et al. Changes in intravascular volume during acute normovolemic hemodilution and intraoperative retransfusion in patients with radical hysterectomy. *Anesthesiology* 2000;92:657–664.
166. Esler MD, Douglas MJ. Planning for hemorrhage. Steps an anesthesiologist can take to limit and treat hemorrhage in the obstetric patient. *Anesthesiol Clin North America* 2003;21:127–144, vii.
167. Hansen E, Bechmann V, Altmeyden J. Intraoperative blood salvage in cancer surgery: safe and effective? *Transfus Apher Sci* 2002;27:153–157.
168. Moiniche S, Mikkelsen S, Wetterslev J, et al. A qualitative systematic review of incisional local anaesthesia for postoperative pain relief after abdominal operations. *Br J Anaesth* 1998;81:377–383.
169. Medeiros L, Fachel J, Garry R, et al. Laparoscopy versus laparotomy for benign ovarian tumours. *Cochrane Database Syst Rev* 2005;CD004751.
170. Johnson N, Barlow D, Lethaby A, et al. Methods of hysterectomy: systematic review and meta-analysis of randomised controlled trials. *BMJ* 2005;330:1478.
171. Zapico A, Fuentes P, Grassa A, et al. Laparoscopic-assisted vaginal hysterectomy versus abdominal hysterectomy in stages I and II endometrial cancer. Operating data, follow up and survival. *Gynecol Oncol* 2005;98:222–227.
172. Krivak TC, Elkas JC, Rose GS, et al. The utility of hand-assisted laparoscopy in ovarian cancer. *Gynecol Oncol* 2005;96:72–76.
173. Holzheimer RG. Laparoscopic procedures as a risk factor of deep venous thrombosis, superficial ascending thrombophlebitis and pulmonary embolism—case report and review of the literature. *Eur J Med Res* 2004;9:417–422.

# CHAPTER 62

## Anesthesia for Newborn Surgical Emergencies

Myron Yaster, MD, and  
Mark I. Rossberg, MD

Except for extraordinary circumstances, all newborns require anesthesia for surgery.<sup>1-3</sup> In the past, it had been assumed that newborns neither experienced nor perceived painful stimuli to the same degree that adults do. Indeed, it was believed that the newborn did not have the neurologic substrate necessary for perception of pain because of lack of myelination, incomplete pain pathways from the periphery to the cortex, or immaturity of the cerebral cortex. Absolutely no evidence indicates any of these conditions is true.<sup>3-5</sup> By week 24 of gestation, the newborn responds to noxious stimuli with behavioral, physiologic, metabolic, and hormonal responses suggestive of substantial stress.<sup>6</sup> The neurophysiologic pathways for nociception from the peripheral receptors to the cerebral cortex are developed, even in premature infants. Furthermore, the primary pathways of pain transmission involve unmyelinated C and A delta fibers, so postnatal myelination is not required for most pain perception.<sup>7</sup> Finally, failure to provide anesthesia is associated with an increased incidence of circulatory, respiratory, and metabolic complications in newborns.<sup>8,9</sup> Thus, the preponderance of evidence suggests not only that newborns respond to noxious stimuli, but that the failure to provide analgesia and anesthesia significantly increases perioperative morbidity and mortality.

The newborn differs from the adult and older child with regard to the uptake, distribution, metabolism, and excretion of all drugs. During the first month of life (the “neonatal” period), the newborn must function independently and adapt to extrauterine life. This involves anatomic, physiologic, and pharmacologic changes to maintain homeostasis and to ensure the

infant's survival. Disease, congenital anomalies, surgery, and anesthesia may interfere with these adaptations and threaten survival. The important elements of the preoperative history and preanesthetic assessment, including a review of systems, developmental physiology, and the transition from intrauterine to extrauterine life, are discussed in Chapter 18. In this chapter, we discuss anesthetic pharmacology in the neonate, an approach to intraoperative management, and the specific management of commonly encountered surgical problems. The general principles of pharmacokinetics and pharmacodynamics are discussed in detail in Chapter 39. This chapter focuses on the unique aspects that apply specifically to the neonate.

### ANESTHETIC PHARMACOLOGY IN THE NEONATE

When physicians administer drugs to patients of any age, they do so with the expectation that an anticipated therapeutic effect will occur. Unfortunately, other less desired results can occur, namely, the patient may derive inadequate or no therapeutic benefit from

the administered drug, or, worse yet, they may develop a toxic reaction. The aim of modern clinical pharmacology is to take the guesswork out of this process and to establish the relationship between the dose of a drug given and the response elicited. To attain this goal, clinicians need a working knowledge of the principles of drug absorption, distribution, and elimination and how these processes are related to intensity and duration of drug action. Additionally, they need a thorough understanding of the history, chemical and physical properties, physiologic effects, disposition, mechanisms of action, and therapeutic uses of the drugs that are used to provide anesthesia in the newborn.

An understanding of the factors that determine drug concentrations within the body is crucial to rational drug use in patients and to achieving desirable plasma drug concentrations. *Pharmacokinetics* describes the study of drug disposition within the body. It includes absorption, distribution, metabolism, and elimination of drug molecules from the body. *Pharmacodynamics* describes the study of drug action within the body. It defines the relationship between the concentration of the drug

#### KEY POINTS

1. The preponderance of evidence suggests not only that newborns respond to noxious stimuli, but that the failure to provide analgesia and anesthesia significantly increases perioperative morbidity and mortality.
2. At equipotent doses, all of the potent inhalational anesthetics (e.g., halothane, sevoflurane, desflurane, and isoflurane) produce unacceptable hypotension in newborns, requiring emergency surgery. The risk of cardiovascular collapse during induction of general anesthesia is much greater in newborns than in older children and adults.
3. The newborn has a fixed stroke volume and can increase cardiac output only by increasing heart rate.
4. In our zeal to protect the eye, we must never compromise oxygen delivery to the neonate's brain!
5. In our experience, central venous pressure is very useful, particularly in surgery involving major blood or third space loss, shock, or when intraabdominal pressure is elevated.
6. Prior to induction of general anesthesia in neonates requiring emergency surgery, we routinely provide a fluid bolus of at least 20 mL/kg of lactated Ringer solution in an attempt to ensure an adequate preload.
7. Life-threatening hyperkalemia has occurred following large-volume blood transfusions in the newborn and may be prevented with washed red cells or fresh whole blood.
8. Infants younger than 6 months are obligate nose breathers.
9. Except for extraordinary circumstances, all newborns require anesthesia and analgesia for surgery.

at the site of action and the physiologic response. The relationship between pharmacokinetics and pharmacodynamics provides an understanding of the dose–response curves of the onset of action, magnitude of action, and duration of action of drugs used in treating patients.

## Drug Distribution

How much drug reaches a receptor site depends on the degree of protein binding, tissue volume, tissue solubility coefficients, and blood flow. Anatomic and maturational changes involving body composition, distribution of water, metabolism, protein binding, and organ function in health and in disease contribute to the unique responses of newborns to various drugs. In the blood, opioids (e.g., fentanyl, morphine), amide local anesthetics (e.g., bupivacaine, lidocaine), and muscle relaxants (e.g., pancuronium, rocuronium) bind to albumin and other serum proteins, such as  $\alpha_1$ -acid glycoprotein.<sup>10,11</sup> It is the unbound or “free” drug that is available to cross biologic membranes, bind to receptors, and initiate a pharmacologic effect. Concentrations of both albumin and  $\alpha_1$ -acid glycoprotein are lower in the newborn period than at any other moment in life. Additionally, the number of binding sites on these proteins is fewer and the affinity of the binding sites is less than in later life. Thus, a greater proportion of active or free drug is available to penetrate the brain, heart, and other viscera. Further, the biologic membranes that separate target receptors from the blood (e.g., the “blood–brain barrier”) may be immature at birth and thereby allow agonists with limited lipid solubility, such as morphine, greater access to the brain. Way et al<sup>12,13</sup> demonstrated that morphine concentrations were 2–4 times greater in the brains of younger rats than in older rats despite equal blood concentrations. On the other hand, decreased protein binding may contribute to the larger apparent volume of distribution of many drugs as well. A large apparent volume of distribution has the effect of diluting the plasma concentrations of parenterally administered drugs and explains, in part, why some drugs must be given in larger doses (on a milligram per kilogram basis) to achieve a therapeutic effect.<sup>14</sup>

Body composition changes with age. Eighty percent of the newborn’s

body mass is composed of water (Table 62-1).<sup>15</sup> In the very-low-birth-weight premature infant (<1000 g), total body water can be estimated at 100% of body weight. This increase in total body water occurs primarily in the extracellular fluid space, mostly in interstitial water, and also explains the larger apparent volume of distribution of most parenterally administered drugs in the newborn. In the newborn, interstitial water makes up 40% of the body weight and declines to 10–15% in adults.

Blood flow determines how much drug reaches a target receptor. As in the adult, a high proportion of cardiac output perfuses vessel-rich organs, such as the brain, kidney, and intestinal viscera. Very high brain concentrations are achieved following the administration of any lipophilic or inhalational anesthetic agent because the infant’s brain receives almost 30% of the cardiac output versus only approximately 15% in the adult. The very small muscle and fat mass of the infant provides less uptake of an administered drug and less of a reservoir to lower blood concentrations of drugs. Further, the potent vapors are less soluble in neonatal blood than in adult blood. This allows higher concentrations of an administered drug (e.g., halothane, sevoflurane) to be achieved more quickly than might be expected.<sup>16,17</sup> Finally, the perinatal adaptation to extrauterine life produces rapid changes in the circulation. This process may be inhibited by congenital heart disease or any condition that increases pulmonary vascular resistance more than systemic vascular resistance, such as hypoxia, hypercarbia, and acid–base problems. Uptake, distribution, metabolism, and excretion may be drastically affected when cardiovascular function is abnormal.

## Biotransformation and Elimination

Following administration, the disposition of a drug depends on distribution ( $t^{1/2V}$ ) and elimination. The terminal half-life of elimination ( $t^{1/2}$ ) is directly proportional to the volume of distribution ( $V_d$ ) and inversely proportional to the total body clearance ( $Cl$ ) by the following formula:

$$t^{1/2} = 0.693 \times (V_d/Cl) \quad (1)$$

Thus, prolongation of  $t^{1/2}$  may be due to either an increase in a drug’s volume of distribution or a decrease in its clearance.

Following redistribution, the major processes that lead to termination of a drug’s effect are biotransformation, metabolism, and excretion. Many anesthetic drugs (e.g., opioids, muscle relaxants, hypnotics) are biotransformed in the liver prior to excretion. Many of these reactions are catalyzed in the liver by microsomal mixed-function oxidases that require the cytochrome P450 system, nicotinamide adenine dinucleotide phosphate (NADPH), and oxygen. The cytochrome P450 system is very immature at birth and does not reach adult levels until the first month or two of life. This immaturity of this hepatic enzyme system may explain the prolonged clearance or elimination of some drugs in the first few days to weeks of life and the inability of the liver to convert a precursor into its active form (e.g., codeine into morphine).<sup>18,19</sup> On the other hand, the cytochrome P450 system can be induced by various drugs (e.g., phenobarbital) and substrates, and this enzyme system matures regardless of gestational age. Thus, it is the age from birth, and not the duration of gestation, that determines how

**TABLE 62-1.**

**Reference Values for Body Compartments by Age**

Body Compartment	Premature (<2.5 kg)	Full term (>2.5 kg)	Adult
Total body water (% body weight)	90–100	70–85	60
Extracellular fluid (% body weight)	40–60	40	20
Intracellular fluid (% body weight)	40	40	40
Blood volume (mL/kg)	90–105	80–95	50–65
Muscle mass (% body weight)	15	20	50
Fat (% body weight)	3	10	15–30



premature or full-term infants metabolize many drugs. Greeley et al.<sup>20</sup> demonstrated that sufentanil is more rapidly metabolized and eliminated in 2- to 3-week-old infants than in newborns younger than 1 week. Elimination may be further prolonged by abnormal or decreased hepatic blood flow, which may occur following an acute illness or abdominal surgery. Certain conditions that may raise intraabdominal pressure (e.g., closure of abdominal wall defect, such as omphalocele or gastroschisis) may further decrease hepatic blood flow by shunting blood away from the liver via the still patent ductus venosus.<sup>21,22</sup> Finally, in all newborns, excretion may be reduced compared to the older child and adult because both glomerular and tubular renal function, which are responsible for active secretion and passive resorption, are reduced in the newborn.<sup>23</sup>

## CHOICE OF ANESTHETIC AGENTS

### Inhalational Agents

At equipotent doses, all of the potent inhalational anesthetics (e.g., halothane, sevoflurane, desflurane, and isoflurane) produce unacceptable hypotension in newborns requiring emergency surgery.<sup>24–32</sup> The risk of cardiovascular collapse during induction of general anesthesia is much greater in newborns than in older children and adults. This greater decrease in blood pressure is due to differences in uptake and distribution of the anesthetic agents, anesthetic dose requirements, the intrinsic properties of anesthetic agents, and the sensitivity of the newborn's myocardium to these agents.<sup>33–35</sup> The newborn attains a greater absolute concentration of halothane (or any of the potent vapors) in the brain and heart and at a faster rate than does an adult at the same inspired concentration. If the inspired concentration of an inhaled agent is kept constant, the ratio of the inspired agent concentration to its alveolar end-tidal concentration (FA/FI) is significantly greater in the newborn compared to the adult because of differences in ventilation and anesthetic uptake. The infant has 3–4 times the minute ventilation of an older child and adult but the same functional residual capacity on a milliliter per kilogram basis (Table 62–2). Thus, inhalational anesthetics wash in

TABLE 62–2.

Pulmonary Function Variables by Age

Respiratory Variable	Newborn (mL/kg)	Adult (mL/kg)
Tidal volume	7	7
Respiratory rate	30–40	10–15
$V_D/V_T$	0.3	0.3
Functional residual capacity	20–30	20–30
Vital capacity	50–70	50–70
Alveolar ventilation: Functional residual capacity	5:1	1.5:1

(and wash out) rapidly because the time constant of the lung is so markedly reduced compared to that in the adult (0.19 minutes in the infant vs. 0.73 minutes in the adult). Controlled ventilation further exacerbates this phenomenon.

Uptake of a potent vapor is very rapid in the newborn as well. Because the mass of vessel-rich organs is so small, uptake of inhalational agents by the tissues is rapid, and tissue concentrations saturate quickly. Venous blood returning to the lung arrives at a relatively high anesthetic partial pressure compared to the adult, which further reduces FA/FI and increases the amount of potent agent in the alveolus. This allows a higher concentration of inhalational agent to be taken up by the blood for delivery to the major organs. End-tidal gas monitoring may help prevent inadvertent overdosage. Finally, both left-to-right and right-to-left shunting occurs in infants. A left-to-right shunt has little to no effect on anesthetic uptake. A right-to-left shunt may slow the rate of rise of the arterial concentration of an inhaled anesthetic.

The minimum alveolar concentration (MAC) of halothane or isoflurane is significantly lower in newborns than in infants 1–6 months old.<sup>24–32</sup> Further, premature infants have lower MAC requirements than do full-term infants. Thus, some of the hypotension associated with inhalational agents may have occurred because of anesthetic overdose. Nevertheless, even at “true” MAC concentrations, heart rate and blood pressure decrease by 12% and 30%, respectively, in the newborn for all vapor anesthetics. This can be partially attenuated by pretreating the infant with an intravenous anticholinergic such as atropine immediately prior to induction of anesthesia.<sup>36</sup> Atropine re-

quirements in the newborn are higher than in the adult (0.03–0.05 mg/kg vs. 0.01–0.02 mg/kg, respectively). Additionally, intravenous doses of atropine <0.1–0.15 mg may produce paradoxical bradycardia.

The other cause of the profound hypotension associated with inhalational agents relates to intrinsic properties of the newborn's myocardium.<sup>37</sup> The newborn's myocardium is less compliant than that of the older child and adult.<sup>37</sup> The newborn has a fixed stroke volume and can increase cardiac output only by increasing heart rate. The newborn's myocardium has decreased contractile mass and a decreased velocity of shortening. Therefore, the negative inotropic and chronotropic effects associated with inhaled anesthetics are poorly tolerated.<sup>38–40</sup> Furthermore, the baroreceptor reflexes are blunted or obliterated by these agents.<sup>25,41</sup> Reflex tachycardia, which is vital to supporting blood pressure and cardiac output, may not occur.

### Fentanyl(s)

Fentanyl and its structurally related relatives sufentanil, alfentanil, and remifentanil are highly lipophilic drugs that rapidly penetrate all membranes, including the blood–brain barrier. Following an intravenous bolus, fentanyl is rapidly eliminated from plasma as a result of its extensive uptake by body tissues. The fentanyls are highly bound to  $\alpha_1$ -acid glycoproteins in the plasma, which are reduced in the newborn.<sup>42,43</sup> The fraction of free unbound sufentanil is significantly increased in neonates and children younger than 1 year ( $19.5\% \pm 2.7\%$  and  $11.5\% \pm 3.2\%$ , respectively) compared to older children and adults ( $8.1\% \pm 1.4\%$  and  $7.8\% \pm 1.5\%$ , respectively), and this correlates to levels of  $\alpha_1$ -acid glycoproteins in the blood.<sup>42–44</sup>

Fentanyl pharmacokinetics differ among newborn infants, children, and adults. The total body clearance of fentanyl is greater in infants 3–12 months old than in children older than 1 year and in adults ( $18.1 \pm 1.4$  mL/kg/min,  $11.5 \pm 4.2$  mL/kg/min, and  $10.0 \pm 1.7$  mL/kg/min, respectively), and the half-life of elimination is longer ( $233 \pm 137$  minutes,  $244 \pm 79$  minutes, and  $129 \pm 42$  minutes, respectively).<sup>42–44</sup> The prolonged elimination half-life of fentanyl from plasma has important clinical implications. Repeated doses of fentanyl for maintenance of analgesia will lead to accumulation of fentanyl and its ventilatory depressant effects. Very large doses ( $0.05$ – $0.10$  mg/kg) may be expected to induce long-lasting respiratory depression because plasma fentanyl levels will not fall below the threshold level at which spontaneous ventilation occurs during the distribution phases.<sup>45</sup>

Robinson and Gregory<sup>46</sup> reported the first use of fentanyl ( $30$ – $50$   $\mu$ g/kg) as the principal anesthetic in neonates undergoing ductus ligation surgery. Using heart rate and blood pressure responses as indices of adequate anesthesia, these investigators demonstrated that the combination of fentanyl, oxygen, and pancuronium could provide anesthesia with minimal hemodynamic consequences. The hemodynamic stability associated with fentanyl (or sufentanil) administration in the newborn has been confirmed by several other investigators.<sup>8,9,47</sup> In all reported studies, both hypotension and bradycardia are rare, as long as a vagolytic agent (either pancuronium or atropine) is administered concomitantly. Furthermore, in the newborn lamb, fentanyl does not significantly affect heart rate, blood pressure, cardiac output, or regional distribution of blood flow to the major organs (e.g., brain and gastrointestinal tract) when it was administered in doses ranging between  $30$  and  $3000$   $\mu$ g/kg.<sup>48</sup> On the other hand, the safety of “fentanyl” anesthesia may be diminished when other anesthetics (e.g., nitrous oxide, barbiturates, or benzodiazepines) are administered concomitantly.<sup>49</sup>

Yaster<sup>47</sup> extended the observations of Robinson and Gregory<sup>46</sup> in a prospective study of premature and full-term infants younger than 7 days undergoing a variety of thoracic, abdominal, and genitourinary emergency operations. In his study, fentanyl in

doses from  $10$ – $12.5$   $\mu$ g/kg produced insignificant hemodynamic changes and provided reliable anesthesia for at least 75 minutes. There are several reasons for the discrepancies in fentanyl requirements in these studies. Robinson and Gregory studied premature infants varying in age from 1 day to 6 weeks undergoing thoracic surgery. Yaster's patients were younger (majority younger than 24 hours). Analgesic requirements are known to be reduced in the first few days of life. This may be caused by the release of endogenous opioids in response to birth or to fetal and neonatal distress. The blood–brain barrier is immature in the first few days of life, and this may allow more fentanyl to reach the  $\mu$ -opioid receptors within the central nervous system. However, this is more important for less lipid soluble agonists such as morphine. Alternatively, the increased fraction of free unbound fentanyl in the newborn may allow more drug to penetrate into the brain. Additionally, fentanyl clearance increases markedly in the first weeks of life, probably as a result of increasing activity of the cytochrome P450 system and increasing hepatic blood flow following closure of the ductus venosus. Thus, the increased fentanyl metabolism that occurs in older newborns may increase their anesthetic (fentanyl) requirements. Finally, many of the patients in Yaster's study underwent abdominal surgery and/or had significant abdominal pathology, such as necrotizing enterocolitis. Fentanyl clearance as well as analgesic requirements may be significantly decreased in these situations, particularly if intraabdominal pressure increases. Increased intraabdominal pressure ( $>15$ – $20$  mm Hg) markedly reduces hepatic and splanchnic blood flow and has been documented to occur following closure of abdominal wall defects, such as omphalocele or gastroschisis.<sup>21,22</sup> This decreased hepatic blood flow reduces fentanyl biotransformation and thereby anesthetic requirements. Therefore, fentanyl dose may be dependent on the neonate's postnatal age, type of surgery being performed, as well as patient “risk” factors such as acidosis, hypoxia, and circulatory stability.

Use of fentanyl in newborns may result in the need for postoperative intubation and ventilation, independent of the infant's medical or surgical

condition. All opioids produce profound respiratory depression in the newborn. A number of studies suggest that the respiratory depression and analgesia produced by  $\mu$ -opioid agonists involve different receptor subtypes. These receptors change in number in an age-related fashion and can be blocked by naloxone. Working with newborn rats, Pasternak et al.<sup>50,51</sup> showed that 14-day-old rats are 40 times more sensitive to morphine analgesia than are 2-day-old rats. Nevertheless, morphine depresses the respiratory rate in 2-day-old rats to a greater degree than in 14-day-old rats. Thus, the newborn may be particularly sensitive to the respiratory depressant effects of the commonly administered opioids in what may be an age-related receptor phenomenon.

The need for early extubation and minimal residual respiratory depression has led to the increased use of remifentanyl in newborn anesthesia practice.<sup>52,53</sup> Remifentanyl is primarily metabolized by plasma esterases. The pharmacokinetics of remifentanyl are characterized by small distribution volumes, rapid clearances, and low variability compared to other intravenous anesthetic drugs.<sup>54,55</sup> The drug has a rapid onset of action (half-time for equilibration between blood and the effect compartment = 1.3 minutes) and a short context-sensitive half-life (3–5 minutes). The latter property is attributable to hydrolytic metabolism of the compound by non-specific tissue and plasma esterases. Virtually all (99.8%) of an administered remifentanyl dose is eliminated during the  $\alpha$  half-life (0.9 minutes) and  $\beta$  half-life (6.3 minutes). The pharmacokinetics of remifentanyl suggest that, within 10 minutes of starting an infusion, remifentanyl will reach nearly steady state. Thus, changing the infusion rate of remifentanyl will produce rapid changes in drug effect. The rapid metabolism of remifentanyl and its small volume of distribution mean that remifentanyl will not accumulate. Discontinuing the drug rapidly terminates its effects regardless of the duration of administration.<sup>45,56</sup> Finally, the primary metabolite has little biologic activity, making it safe even in patients with renal disease.

## Muscle Relaxants

Structural and functional development of the neuromuscular system is incom-

plete at birth.<sup>57</sup> The newborn has decreased neuromuscular reserve compared to the older child and adult. At a stimulation rate of 20 Hz, many neonates demonstrate tetanic fade, and premature infants demonstrate posttetanic exhaustion.<sup>58,59</sup> At a higher stimulation rate (50 Hz), all newborns demonstrate posttetanic exhaustion. The train-of-four ratio and the magnitude of posttetanic facilitation all increase with age. Based on these findings and on clinical criteria, it has been suggested that the newborn is more “sensitive” to nondepolarizing muscle relaxants than are older patients.<sup>57</sup>

Several investigators have documented the sensitivity of infants to D-tubocurarine, even if one compensates for the newborn's increased extracellular fluid space and apparent volume of distribution.<sup>14</sup> However, a single dose of curare does not appear to have a longer duration of action in the newborn compared to the adult because, in neonates, the steady-state plasma concentration associated with 50% neuromuscular block is only one third of adult values.<sup>14</sup> This also means that subsequent doses of curare may lead to a prolonged duration of paralysis.

At appropriate doses, all of the nondepolarizing muscle relaxants are effective paralytics in newborns; thus, the choice is more often based on other properties of these drugs. Because pancuronium is a potent vagolytic, it remains one of the agents most commonly used in the newborn.<sup>60</sup> Unlike the adult, tachycardia is often a *desired* side effect because the infant responds to a variety of stimuli, such as hypoxia, intubation, and halothane and fentanyl administration, with bradycardia. Because the newborn's cardiac output is heart rate dependent, bradycardia has the potential to be catastrophic. Occasionally, other relaxants (e.g., atracurium and mivacurium) are selected because end-organ pathology (liver or kidney) may interfere with drug elimination or because the duration of paralysis or onset time of paralysis is inappropriate for the surgery being performed.

Interestingly, newborns are relatively resistant to succinylcholine even though plasma cholinesterase levels are reduced following birth.<sup>61</sup> Intravenous doses of 1–2 mg/kg, rather than 0.5 mg/kg, are required for complete paralysis. Intravenous succinylcholine produces myriad arrhythmias, including sinus bradycardia, sinus arrest,

nodal rhythms, and ventricular ectopy. Several neonates have developed pulmonary edema and hemorrhage in the absence of upper airway obstruction following intravenous use succinylcholine.<sup>62</sup> Other well-known complications of succinylcholine administration include malignant hyperthermia, hyperkalemia, myoglobinemia, and increased intraocular (and perhaps intracranial) pressure. Because of these effects, increasing numbers of pediatric anesthesiologists are discouraging the routine use of succinylcholine. Nevertheless, succinylcholine remains one of the most rapidly acting neuromuscular blocking agents available. Despite the problems associated with its use, there is no substitute for succinylcholine when “full stomach” precautions are required or laryngospasm occurs.<sup>63</sup> Thus, our practice is to “always have it, rarely use it.”

### Ketamine, General Anesthetics, Sedatives, and the Developing Brain

Ketamine produces tachycardia, hypertension, relative hemodynamic stability, analgesia, and an altered “dissociative” level of consciousness. It increases both systemic and pulmonary vascular resistance and is often used in infants with congenital heart disease, cardiovascular instability, or both. It is an *N*-methyl-D-aspartate (NMDA) receptor antagonist. In a series of major publications, Ikonomidou, Olney, and colleagues showed in rat pups that even brief exposure to NMDA antagonists, such as ketamine, causes apoptotic neurodegeneration during vulnerable developmental ages.<sup>64–67</sup> They have extended their findings to  $\gamma$ -aminobutyric acid (GABA<sub>A</sub>) agonists such as the vapor anesthetics and the benzodiazepines.<sup>65,68</sup> If these results are applicable in human newborns, and this is a very big “if,” the consequences may be enormous. Although others have disputed these findings, we are left with the dilemma: “Are these and other drugs that we routinely use in the newborn to provide anesthesia safe?”<sup>69</sup> Equally compelling is the alternative: “What are the consequences to the developing brain of not providing analgesia and anesthesia for surgery?”

### Local Anesthetics

Local anesthetics work by blocking initiation and propagation of action poten-

tials in axons. All currently available local anesthetics work by blocking sodium ion flux through open, voltage-gated sodium channels and are of two classes: amino amides and amino esters.<sup>70,71</sup> The amino amides lidocaine, bupivacaine, and ropivacaine are metabolized in the liver by the cytochrome P450 (CYP-linked) isoenzymes. Details of local anesthetic pharmacology are provided in Chapter 44. These metabolic pathways have markedly diminished in function in the neonatal period; therefore, clearance of these drugs is greatly reduced.<sup>72,73</sup> When combined with fewer plasma proteins and more free drug, the potential for severe toxicity is obvious. The amino esters, on the other hand, are metabolized by plasma esterases. Although these enzymes are reduced in quantity and function in the newborn period as well, the clearance of amino esters is much less impaired than that of amino amides.<sup>74</sup>

### Monitoring

Critically ill neonates undergoing emergency surgery require as much, if not more, monitoring during anesthesia and surgery than do critically ill adults because the margin of error is so small and because disaster can strike so quickly. Unfortunately, compromises are often made because of the technical difficulty in monitoring small children and because, once positioned and draped on the operating room table, observation, palpation, and even auscultation often are difficult, if not impossible. Meticulous attention to detail is absolutely necessary. It must be emphasized that no machine can replace a vigilant anesthesiologist who will evaluate, interpret, and analyze the patient's condition.

One of the simplest and most effective monitors in newborn anesthesia is the precordial or esophageal stethoscope. Stethoscopy provides beat-to-beat, breath-by-breath information on the patient's condition. For example, the first indication of cardiovascular deterioration in children may be a change in heart sounds, from brisk and close to muffled and distant. Loss of breath sounds may indicate a mechanical disconnection or an endobronchial intubation well before a mechanical alarm sounds. Despite its importance, this low-technology, inexpensive monitor is rapidly being discarded by anesthesiologists in favor of more glitzy and expensive monitors.

Only slightly less important than the precordial stethoscope is the pulse oximeter. This noninvasive, beat-to-beat monitor of oxygen saturation has revolutionized anesthesia monitoring and should be used not only in the operating room but in transport to and from the operating room as well.<sup>75,76</sup> In neonates, the probe is preferentially placed on the right hand, ear lobe, or on the buccal mucosa. It is used to maintain an oxygen saturation between 90% and 95% (PaO<sub>2</sub> 50–70 mm Hg). Higher oxygen saturations have been associated with retinopathy of prematurity (ROP). Because of intracardiac shunting, many anesthesiologists use two pulse oximeters, one on the right hand and one on the lower extremity, to measure preductal and postductal flows. Preductal arterial oxygen saturation reflects coronary and cerebral oxygen saturation, and it is the cerebral oxygenation that affects the eye and is responsible for ROP. Nevertheless, in our zeal to protect the eye, we must never compromise oxygen delivery to the neonate's brain!

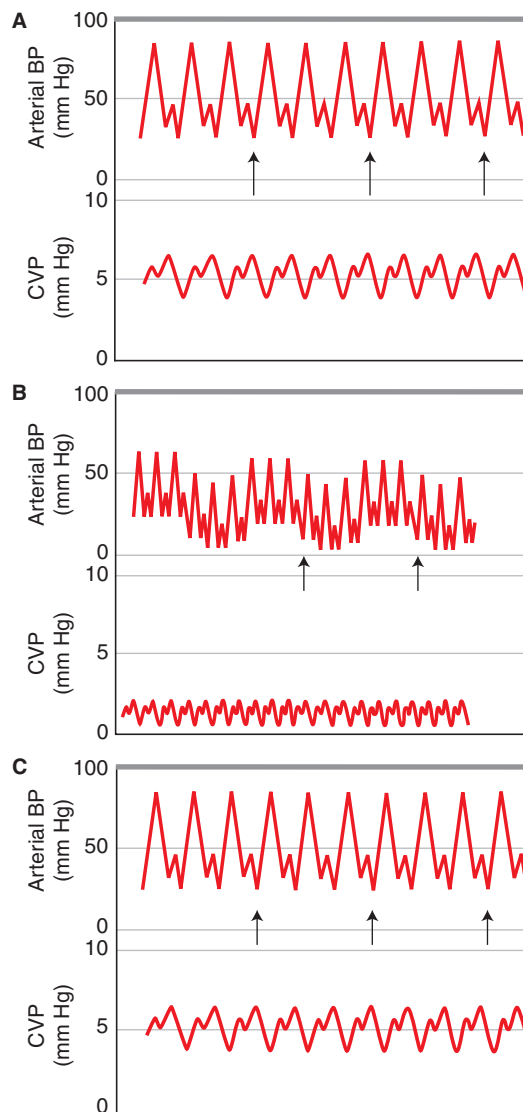
The next most important monitor is blood pressure. Newborns, particularly premature newborns weighing <1.5 kg, may have normal systolic blood pressures of only 40 mm Hg. Blood pressure measurement and control become herculean tasks. This is the reason why many pediatric anesthesiologists prefer fentanyl-based anesthetics to inhalational agents when providing anesthesia for newborn surgery. In most cases, blood pressure can be adequately measured with an appropriately sized blood pressure cuff and commonly available noninvasive automatic blood pressure devices. Occasionally, a Doppler ultrasonic transducer or a strategically placed oxygen saturation probe can help in blood pressure measurement. However, for most major operations, continuous invasive intraarterial monitoring is indicated for the safe conduct of anesthesia. Catheterization, preferably of the radial artery, is accomplished either percutaneously or by surgical cutdown. In general the temporal arteries must be avoided as intraarterial cannulation sites because catastrophic brain injury, presumably from embolization of clot and debris, has been associated with its use. Alternative catheterization sites include the dorsalis pedis, posterior tibial, and umbilical artery. The arterial catheter

provides beat-to-beat monitoring and a means for frequent sampling of blood gases, hematocrit, and glucose. It also is an extremely sensitive guide of the patient's intravascular volume status. Meticulous attention to detail and technique is needed when flushing these catheters. We recommend high-pressure, low-volume tubing and, following aspiration of blood for sampling, flushing the tubing with 0.5–1 mL of saline to minimize the risk of embolization into the cerebral circulation.

Judging intravascular volume clinically in the neonate is extremely difficult. During abdominal surgery (e.g., necrotizing enterocolitis), third space fluid losses may approach 100–200 mL/kg. The arterial waveform displayed on

a monitor or recorder is one of the best signs of early intravascular volume losses (Fig. 62–1). One looks for either a change in the shape of the arterial waveform (decreased area under the curve) or the development of respiratory variation in the waveform. During positive-pressure ventilation, decreased venous return causes a dramatic decrease or drift in the arterial waveform with each breath. Typically, this decrease occurs when the intravascular volume has been depleted.

In adults, the more commonly used monitor for intravascular volume is either a central venous or pulmonary arterial catheter. Historically, central venous pressure measurements in newborns have been considered not



**FIGURE 62–1.** Hypovolemia is detected on both the arterial and central venous waveforms. Following a positive pressure breath (arrow), decreased venous return produces a pulsus paradoxus and a fall in central venous pressure. With volume resuscitation the tracing returns to normal.



only technically difficult to obtain but also insensitive to volume status. Experiments during exchange transfusions performed in the 1960s demonstrated little correlation between blood losses of as much as 20% of the estimated blood volume and central venous pressure as measured by umbilical central venous catheters.<sup>77</sup> These experiments have never been repeated with central venous catheters placed in the internal or external jugular vein and pressure transduced with modern equipment. In our experience, the central venous pressure is very useful, particularly in surgery involving major blood or third space loss, shock, or when intraabdominal pressure is elevated.<sup>21,22</sup> Because these are large-bore catheters, securely inserted within the vascular tree, usually the internal jugular vein, they supply a reliable means for administering fluids and vasoactive drugs.

One of the mainstays in the assessment of volume status of the newborn is the measurement of urine output (or lack thereof). Bladder catheterization is easily accomplished using a 5F feeding tube (not a balloon-tipped Foley catheter). The catheter is secured to the skin with tape and connected to a calibrated urinometer by low-volume tubing. Minimum acceptable urine outputs range between 0.5 and 1.0 mL/kg/h.<sup>23,78</sup> In very small children, this small volume of urine may take hours to travel the length of the operating room table to reach the urinometer. Additionally, the drainage tubing usually is under the surgical drapes and not easily accessible to the anesthesiologist, making identification of kinks and disconnects almost impossible. Because of these factors, measurement of urine output during surgery may be of marginal value.

Because neonatal anesthesia virtually always is performed with controlled mechanical ventilation, respiratory monitoring with capnography is essential. Despite the many technical problems involved in measuring end-tidal carbon dioxide concentrations through small uncuffed endotracheal tubes, it is a “standard of care” and is a mandatory monitor for the provision of safe anesthesia.<sup>79,80</sup>

Last, but not least, is temperature monitoring. All newborns are at extraordinarily high risk for becoming cold during transport and while in the operating room. To minimize this risk, we routinely wrap children in plastic

bags, use forced-air heating mattresses, increase the ambient temperature of the operating room, warm up intravenous fluids, and use heated, humidified respiratory gases.<sup>81,82</sup> Temperature is routinely monitored with either a rectal or a nasopharyngeal temperature probe. We strive to maintain a core temperature at 36°C in order to avoid the consequences of hypothermia, which include hypoventilation or even apnea, relative anesthetic overdose (reduced MAC at lower temperatures), metabolic acidosis, norepinephrine secretion, and increased oxygen demand. Increased oxygen demand to maintain normal core temperature and increased norepinephrine secretion may cause pulmonary and peripheral vasoconstriction, right-to-left shunting, anaerobic metabolism, and increased acidosis and oxygen consumption, all of which may exacerbate preexisting cardiopulmonary insufficiency.

## Fluids

Intraoperative intravenous fluid therapy provides the infant with maintenance requirements of water, electrolytes, and glucose to replace preoperative deficits and ongoing intraoperative “third space” and blood losses. Maintenance fluid requirements are calculated based on the assumption that 100 mL of water is required for every 100 calories consumed.<sup>83–86</sup> The newborn’s energy (and fluid) requirements are 100 calories (mL) per 24 hours in the unanesthetized state or approximately 4 mL/kg/h. Although basal caloric requirements are significantly reduced under general anesthesia, we continue to provide maintenance fluid, usually with 5–10% (50–100 mg/mL) glucose at a rate of 4 mL/kg/h.

Because the majority of newborns who present for emergency surgery are in neonatal intensive care units and are receiving intravenous fluids prior to surgery, the logical presumption is that preoperative deficits are nonexistent. Unfortunately, this is rarely true. Most newborns are fluid restricted in the nursery despite the presence of a surgical emergency and third space fluid losses.<sup>84,85</sup> Furthermore, infants are rarely given solutions containing electrolytes, even though the newborn’s kidney cannot tolerate a water load and will waste sodium even when water overloaded. The maximum urine osmolality achievable by the neonatal kidney is only 800

mOsm/L. Unsuspected hypovolemia when combined with anesthetic drugs can be catastrophic. Thus, prior to induction of general anesthesia in neonates requiring emergency surgery, we routinely provide a fluid bolus of at least 20 mL/kg of lactated Ringer solution in an attempt to ensure an adequate preload.

Surgical trauma and manipulation, or inflammation of the bowel, result in internal sequestration of functional extracellular fluids and often are referred to as “third space” losses. The fluid and salt within the third space acts as sequestered fluid and is nonfunctional in terms of the duties of the extracellular fluid. Replenishment of this interstitial water and salt loss with balanced salt solutions (“isotonic crystalloid solutions”), such as lactated Ringer solution or normal saline, is essential. The magnitude of the third space loss depends on the site and extent of injury. Abdominal surgery, particularly if extensive bowel pathology or manipulation is involved, may require third space replacement therapy of 10–20 mL/kg/h, whereas peripheral or thoracic surgery may require only 3–5 mL/kg/h.

All blood loss must be replaced with balanced salt solutions, 5% albumin, or blood. Normally, infants are born with high hematocrit (>50%), which fall to 30% over the first 3 months of life. Additionally, these red cells are made primarily of hemoglobin F (HgbF), which has a greater affinity for oxygen than does adult hemoglobin (HgbA). The partial pressure at which 50% of hemoglobin is saturated ( $P_{50}$ ) is 19 for HgbF versus 27 for HgbA. Because the newborn has limited stores of iron and limited ability to replace lost red cells with new red cells, the hematocrit should not be allowed to fall below 35% during surgery. The allowable blood loss can be calculated by the following formula:

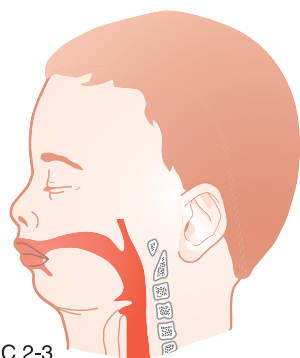
$$\begin{aligned} & \text{[Weight (kg)]} \times \text{[EBV*]} \times \\ & \left[ \frac{\text{Hct}_{\text{start}} - 0.35}{\text{Hct}_{\text{average}}^{**}} \right] \\ \text{Hct}_{\text{average}} &= \left[ \frac{\text{Hct}_{\text{start}} + 0.35}{2} \right] \end{aligned} \quad (2)$$

where EBV = estimated blood volume (Table 62-1), and  $\text{Hct}_{\text{average}} = (\text{Hct}_{\text{start}} + 0.35)/2$ .

Ideally, blood would be replaced with fresh whole blood because it contains



C 4-5



C 2-3

**FIGURE 62-2.** Comparative anatomy of the adult and infant airways.

platelets and clotting factors as well as red cells. Unfortunately, fresh whole blood is rarely, if ever, available. Packed red blood cells usually are used instead. This blood product typically has a hematocrit of 60–70%, high potassium concentration, and little, if any, factors V and VIII. Large blood losses and massive transfusion (2–3 times the estimated blood volume) often produce a secondary coagulopathy and hyperkalemia.<sup>87</sup>

This bleeding often is caused by either dilutional or consumptive thrombocytopenia. Platelets can be transfused based on the following formula:

$$\text{Platelet increment/} \frac{30,000 \times (\text{Number of units})}{\text{EBV (L)}} \text{ mm}^3 \quad (3)$$

Fresh-frozen plasma is rarely necessary and should be given only for legitimate indications. All blood products, including fresh-frozen plasma, may be contaminated with viruses. The newborn should be considered an immunocompromised host. Therefore, consideration should be given to irradiating any blood product that may contain white blood cells prior to transfusion because of the possibility of producing a graft-versus-host reaction. Finally, all banked blood (especially older blood) contains significant amounts of potassium.<sup>87,88</sup> Life-threatening hyperkalemia has occurred following large-volume blood transfusions in the newborn and may be prevented with washed red cells.

### Airway

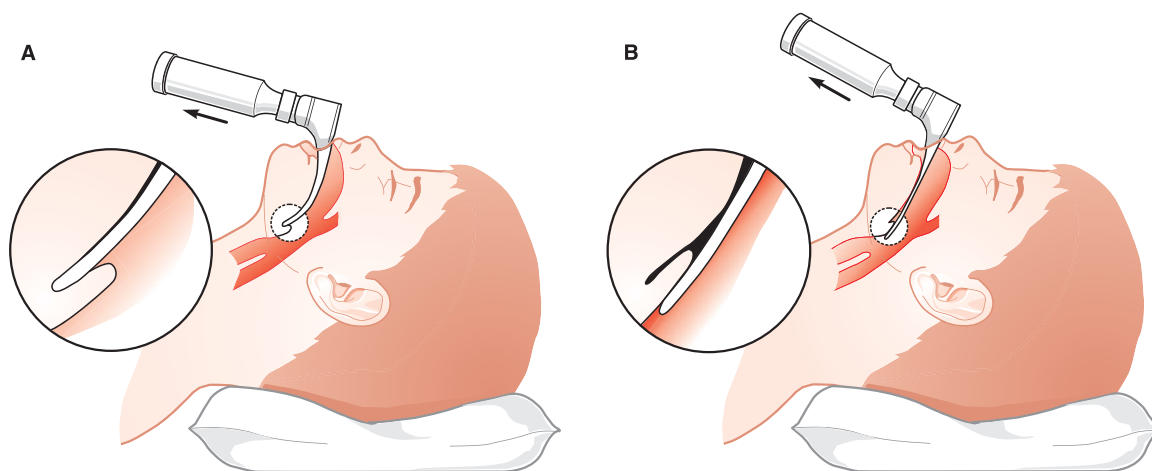
Understanding the anatomic differences among infants, children, and adults is crucial for successful airway management in the normal child and the child with a congenital anomaly (Fig. 62-2). Infants younger than 6 months are obligate nose breathers. Anatomic (e.g., choanal atresia), physical (e.g., nasogastric tube), or infectious obstruction of the nasopharynx will rapidly cause respiratory distress and/or failure. The abundant and friable lym-

phoidal tissue of the nasopharynx also precludes the routine placement of nasopharyngeal airways in patients in this age group when treating upper airway obstruction.

The tongue is relatively large in relation to the mandible in children younger than 2 years, making visualization of the larynx difficult. It is the tongue that most commonly obstructs the upper airway when consciousness is lost following induction of anesthesia. The larynx is difficult to visualize because it is anterior and more cephalad in the newborn. It is located at the second to third cervical vertebrae in infants and at the fourth to fifth cervical vertebrae in adults. The vocal cords also differ in appearance. In infants they are 40% ligament and 60% arytenoid cartilage. This ratio is reversed in adults.

The infant's epiglottis is omega shaped, floppy, and has a 45° angle of entry into the pharyngeal wall. Visualization of the larynx requires lifting the epiglottis directly with an appropriately sized straight laryngoscope blade (no. 0 or 1 Miller blade). In contrast, the adult's epiglottis is stiff, flat, and parallel to the tracheal wall. Visualization of the larynx can be made indirectly by placing the laryngoscope blade in the vallecula (Fig. 62-3).

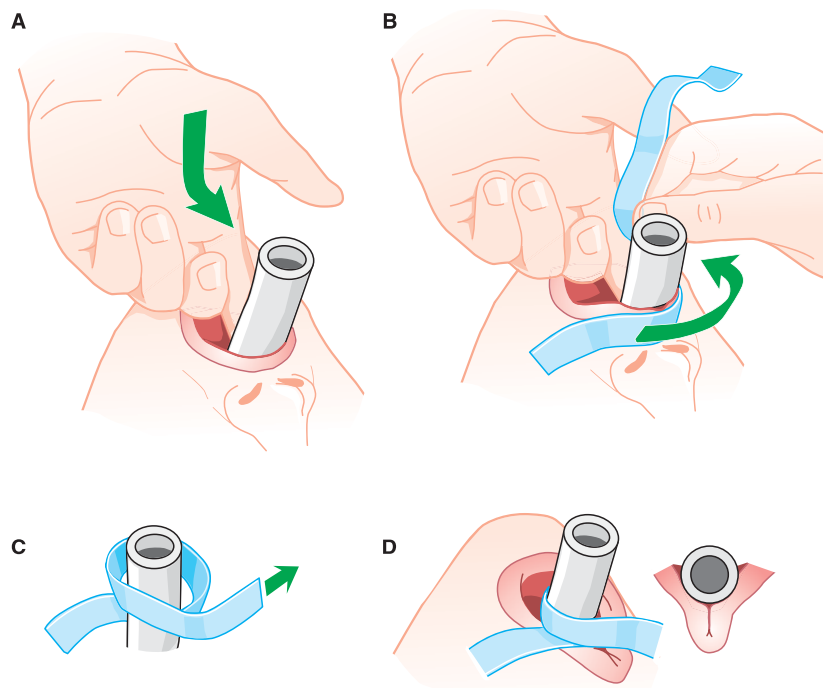
Finally, the trachea is different. The narrowest part of the airway in children younger than 10 years is the cricoid ring. Uncuffed endotracheal tubes, generally 2.5–3.5 mm in diameter, are used in neonates to prevent damage to the mucosa underlying this structure. Furthermore, the infant's trachea may be only 4–5 cm in total length. This makes inadvertent endo-



**FIGURE 62-3.** Laryngoscope blades. **A.** Curved (MacIntosh) inserted in the vallecula only. **B.** Straight (Miller) inserted either under the epiglottis or in the vallecula.

bronchial intubation extremely likely, even by highly experienced practitioners. To minimize this risk, we use the “1-2-3...7-8-9” rule to assist in correct endotracheal tube positioning. The “1-2-3” refers to the patient’s weight in kilograms, and the “7-8-9” refers to the position of the endotracheal tube in centimeters at the patient’s lip. Thus, a 1-kg infant would have the tip of his endotracheal tube taped at the 7-cm mark at the lip. Proper positioning of the endotracheal tube can be made by auscultation (return of breath sounds after a deliberate right mainstem intubation), palpation of the tip of the endotracheal tube in the sternal notch, inspection of the distal line marker at the level of the vocal cords, and chest x-ray film. Once positioned, the endotracheal tube must be secured in place with adhesive tape in a way that minimizes the likelihood of dislodgement or accidental extubation. The “fish-mouth” technique is our preferred method (Fig. 62-4).

How to intubate the trachea is controversial. Because of the anatomic considerations and because the newborn rapidly desaturates following only 15–20 seconds of apnea, in the past many anesthesiologists believed it was safer to intubate the newborn “awake.” However, recent evidence that awake intubation may cause intraventricular hemorrhage in fragile, premature newborns has counterbalanced this sentiment.<sup>89,90</sup> Furthermore, awake intubations are technically more difficult to accomplish and often result in trauma to the vocal cords, hemorrhage, bradycardia, and desaturation secondary to breath holding. We prefer to use a “rapid sequence” induction in infants requiring “full stomach” precautions, that is, infants who are at risk for aspirating their gastric contents (e.g., intestinal obstruction, necrotizing enterocolitis) and who have a normal airway on physical examination. After fluid volume resuscitation (10–40 mL/kg of lactated Ringer solution), preoxygenation, and pretreatment with atropine (0.15 mg), gentle cricoid pressure is applied to occlude the esophagus.<sup>91,92</sup> If cricoid pressure is applied too vigorously, the position of the larynx may be distorted or the trachea itself occluded. In hemodynamically stable patients, a rapid sequence intravenous induction can be accomplished by bolus administration of thiopental 4–7 mg/kg, propofol 2–3 mg/kg, ketamine 2–4 mg/kg, or



**FIGURE 62-4.** Using 1/2-inch adhesive tape, the endotracheal tube is secured with the “fish-mouth technique.” Starting at one zygoma, the tape is pulled, wrapped around the endotracheal tube, and then pulled to the opposite zygoma.

fenentanyl 12.5 µg/kg (note: chest wall rigidity may occur with this dose of fentanyl!), immediately followed by succinylcholine 2 mg/kg or rocuronium 0.9–1.2 mg/kg.<sup>93,94</sup> Newborns not requiring full stomach precautions are in the minority (e.g., myelomeningocele or bladder exstrophy), and in these patients anesthesia can be induced by inhalational agents delivered by mask or intravenously without cricoid pressure.

## SURGICAL EMERGENCIES IN THE NEWBORN

It is beyond the scope of this chapter to discuss the anesthetic management of every surgical emergency that occurs in the first few weeks of life. However, by concentrating on the most common, the basic principles provided can be applied to conditions that are not specifically discussed.

### Congenital Diaphragmatic Hernia

Congenital diaphragmatic hernia is the most challenging and frustrating of all neonatal surgical emergencies. This malformation, which by definition involves herniation of the abdom-

inal viscera into the thorax, has a high (20–50%) mortality regardless of the treatment method.<sup>95,96</sup> Even early prenatal ultrasound diagnosis and attempts at in utero, fetal surgical correction have done little, if anything, to affect outcome.<sup>96–98</sup> The incidence of this devastating problem, which has significant short- and long-term morbidity, is reported to be 1:2000–5000 live births.

In its most common presentation, the abdominal viscera, including the small bowel and colon, liver, and occasionally the kidney, herniate into the left hemithorax during the first or second trimester of affected pregnancies and interfere with the development of both the lung parenchyma and its blood supply. Infants born with this anomaly present with the classic triad of dyspnea, cyanosis, and apparent dextrocardia. Physical examination reveals a scaphoid abdomen, bowel sounds in the chest, distant or displaced heart sounds, and absent breath sounds in the affected chest. Chest radiography demonstrates loops of gas-filled bowel or a gastric tube in the affected chest, mediastinal shift, absent lung markings in the affected chest, and, most ominously, a contralateral pneumothorax. Pneumothorax is an iatrogenic compli-

cation that usually occurs as a result of vigorous attempts at oxygenation or resuscitation. The major differential diagnosis is a cystic adenomatoid malformation of the lung or congenital lobar emphysema. Approximately 20% of patients have associated congenital heart disease.

Surgical decompression of the herniated abdominal viscera (which may consist of midgut, stomach, colon, kidney, and/or liver) from the affected hemithorax and repair of the diaphragmatic defect, although essential in the management of this malformation, do not determine ultimate survival. Rather, outcome depends on the pulmonary vasculature and whether it will respond in an exaggerated, hyperreactive fashion to the stimuli that vasoconstrict and elevate pulmonary artery pressure.<sup>99</sup> Histologic studies of the lungs of children born with this anomaly reveal decreased number and size of bronchi, lung saccules, and alveoli, and abnormalities of the pulmonary vascular bed. The numbers of pulmonary blood vessels are reduced, and the arterial muscularis and media are hypertrophied. Hyperactive pulmonary arterial vasoconstriction caused by hypoxia, hypercarbia, acidosis, pain, or positive-pressure ventilation can set in motion a catastrophic cycle of events in which desaturated blood returning to the lung is preferentially shunted across the still patent ductus arteriosus and atrial septum into the systemic circulation. This shunting of blood across the ductus and atrial septum is a return of the circulation to the pattern that existed in utero and is referred to as *persistent fetal circulation* or persistent pulmonary hypertension of the newborn (PPHN).<sup>37</sup> The goal of anesthetic management is to prevent this catastrophic cascade from occurring by maximizing arterial oxygenation and preventing pain and metabolic or respiratory acidosis.

The most severely affected infants require immediate intubation and decompression of the stomach as soon as the diagnosis is suspected. This usually takes place in the delivery room or in the neonatal intensive care unit before surgery. Medical management is directed at improving oxygenation and increasing pulmonary blood flow. This is accomplished by the judicious use of muscle relaxants, analgesics, usually fentanyl (1–10 µg/kg as an initial bolus, followed by a continuous infusion

of 3–10 µg/kg/h), hyperventilation, using rapid rates (> 100 breaths/min) and low inflating pressures, and correction of acidosis with intravenous bicarbonate therapy.<sup>100</sup> Interestingly, this is also the basis of intraoperative anesthetic management. Nevertheless, aggressive proactive management may be harmful; barotrauma and volume trauma from too vigorous ventilation may induce alveolar and capillary damage and induce a catastrophic inflammatory cascade. Inhalational anesthetic agents are mostly avoided because of their hypotensive and cardiac depressant effects. Nitrous oxide is contraindicated because it can diffuse into the bowel and further compromise lung function. The importance of inadequate cardiac output in persistent fetal circulation should not be overlooked. Decreased cardiac output leads to decreased pulmonary perfusion and further hypoxemia. Blood returning to the heart from poorly perfused organs arrives with a lower oxygen content, which potentiates the hypoxemia caused by right-to-left shunting.

Bohn et al.<sup>101,102</sup> advocate the avoidance of the “mad dash” to the operating room and recommend instead a 24- to 48-hour period of stabilization. Furthermore, they contend that infants who do not respond to this therapy will fail to survive with surgery or any other therapy, including extracorporeal membrane oxygenation (ECMO). Bohn et al.<sup>102</sup> also suggest a nomogram to predict the extent of pulmonary hypoplasia present in these infants and their chance of survival. They used the preoperative PaCO<sub>2</sub> and correlated it and an index of ventilation that is determined by the mean airway pressure times the respiratory rate. If PaCO<sub>2</sub> could be reduced to <40 mm Hg and the ventilatory index was <1000, survival was almost universal. On the other hand, if PaCO<sub>2</sub> was >40 mm Hg and the ventilatory index was >1000, death was virtually inevitable. Interestingly, these latter infants were found at autopsy to have <10% of the normal number of alveoli bilaterally.

Others have approached the newborn with congenital diaphragmatic hernia with a different perioperative management strategy.<sup>103,104</sup> They work to stabilize these newborns preoperatively and bring them through their period of PPHN with a strategy of “gentle ventilation.” Using low peak inflating pressures and permissive hy-

percipnia, they are careful to avoid iatrogenic damage from barotrauma to the already hypoplastic lungs of these newborns. After a period of stabilization, during which pulmonary arterial pressure falls, the patient is electively taken to the operating room for surgical repair.

Blood loss is minimal during surgical repair of this problem, and third space losses can be assumed to average 8–10 mL/kg/h. Aside from routine monitoring, these patients require intravascular arterial and central venous catheters for continuous blood pressure monitoring and for blood gas, hemoglobin, and blood chemistry sampling. Central venous access is obtained either via an umbilical vein or from the jugular or subclavian veins. If the latter approach is attempted, it is essential to avoid a pneumothorax or hemothorax in the normal lung. A precordial stethoscope placed in the unaffected right axilla may help alert the anesthesiologist to one of the most feared intraoperative catastrophes, namely, the development of a contralateral pneumothorax. This is heralded by sudden hypoxia and/or hypotension. Placement of a chest tube when this condition occurs may be lifesaving. Some authors have suggested the insertion of a prophylactic chest tube on the contralateral side because this complication is so catastrophic.

Vasodilator therapy also has been advocated for perioperative control of increased pulmonary arterial pressures. Suggested intravenous agents include isoproterenol, nitroglycerin, tolazoline, adenosine, and adenosine triphosphate. These agents rarely are effective because the pulmonary vasodilatation produced is matched by an equal fall in systemic vascular resistance. They have been largely replaced by inhaled nitric oxide (NO).<sup>105,106</sup> NO diffuses across alveolar capillary membranes and stimulates cyclic guanylate cyclase, which increases cyclic guanosine monophosphate (cGMP). cGMP is a potent dilator of vascular smooth muscle. Because NO is rapidly metabolized by red blood cells, it has a potent local effect and should preferentially dilate only the pulmonary vascular musculature. NO can be used anytime during the perioperative or intraoperative period, as needed. Finally, the anesthesiologist should anticipate the possibility of a cardiac arrest during this operation. Vasopressors, including



dopamine (4–10 µg/kg/min) and epinephrine (0.1–1.0 µg/kg/min), should always be available for emergency intraoperative administration.

The most recent innovation in the treatment of congenital diaphragmatic hernia is perioperative use of ECMO.<sup>107–109</sup> The use of ECMO is both controversial and confusing.<sup>109–111</sup> Infants who would not survive according to Bohn criteria or who develop a persistent fetal circulation pattern following a “honeymoon” period can be placed on ECMO in order to allow the infant’s lungs time to develop and restructure. Unfortunately, the timing of when to initiate ECMO therapy (either before or after surgery), when to operate if a patient is on ECMO, and when to withdraw ECMO support constitute a very parochial decision that may differ among physicians, even those within the same institution. The utility (or lack thereof) of this therapeutic modality may remain unknown until controlled multicenter trials are performed in specialized centers of excellence.<sup>111</sup>

### Omphalocele/Gastroschisis

Abdominal wall defects are rare. Although at first glance they appear to be similar, in fact they are quite different. An omphalocele is a central, midline defect and is always associated with other congenital anomalies. It occurs because of failure of the gut to return to the abdominal cavity at week 10 of gestation. The herniated bowel is covered by the amnion, which protects it from fluid loss, infection, and a chemical, amniotic fluid burn. The apex of the herniated sac is the umbilical cord. A gastroschisis, on the other hand, is not a midline defect and therefore is rarely associated with other defects. It results from an intrauterine vascular accident that results in interruption of the abdominal wall and musculature. The herniated bowel is not covered by any membrane, is “burned” by the amniotic fluid, and is covered by an inflammatory coating or peel. It is subject to tremendous postnatal evaporative fluid losses as well as infection. In gastroschisis, the umbilical cord is found to the side of the herniated bowel.

The optimal method for operative management of congenital abdominal wall defects is controversial. Two options are available: either primary fascial closure, with or without intra-

operative and postoperative muscle paralysis, or a staged repair using either a silicone elastomer silo or a primary skin closure. Primary fascial closure of omphalocele or gastroschisis carries the risk of placing the abdominal contents under pressure, which may produce a reduction in cardiac output, hypotension, bowel ischemia, venous stasis, and postoperative respiratory and renal failure.<sup>21,22,112</sup> When primary fascial closure cannot be achieved, either because the defect is too large or because it critically compromises respiratory or cardiovascular function, the alternative approach is a staged repair using either a silicone elastomer silo or a skin closure with secondary fascial closure. When using the silo, the defect is reduced over several days until the stable infant with a small defect can be taken to the operating room for final repair. The staged silicone elastomer repair carries an increased risk of infection.

Traditional criteria for deciding on which course to use have been based on the size of the defect, the presence of associated congenital anomalies, or clinical observations of the infant’s respiratory rate, pulmonary compliance, blood pressure, skin color, and peripheral perfusion during fascial approximation. Unfortunately, these clinical observations may not be reliable, particularly in paralyzed, anesthetized infants.

### Anesthetic Management

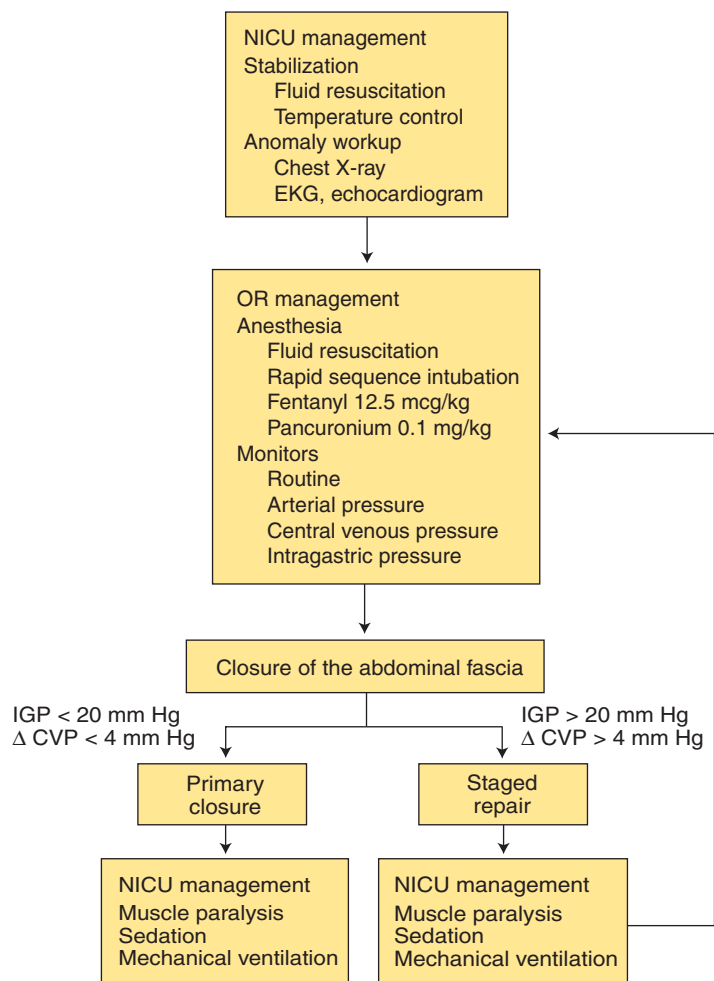
Infants are transported to the operating room by placing the exposed bowel in a bag designed for this purpose. It helps to maintain normothermia and reduce evaporative fluid losses. Patients are fluid resuscitated with a balanced salt solution, preoxygenated, anesthetized with fentanyl (10–12.5 µg/kg), pancuronium, and oxygen, and intubated. In addition to routine monitoring, we place catheters in the right radial artery, an internal jugular vein, and the stomach. An oral or nasal gastric tube both decompresses the abdomen and allows measurement of intragastric pressure by fluid filling the tube. Yaster et al.<sup>21,22</sup> suggest that management of omphalocele or gastroschisis can be successfully and reliably determined by intraoperative measurement of intragastric and central venous pressures (Fig. 62–5). In this treatment algorithm, primary repair is always attempted. However, if the intragastric

pressure rises above 20 mm Hg and/or central venous pressure increases by 4 mm Hg or more following closure of the abdominal fascia, the primary repair is abandoned and a staged repair with a silicone elastomer chimney is performed. This algorithm avoids the consequences of acutely elevating intraabdominal pressure. Following surgery, the patient is taken to the neonatal intensive care unit intubated and placed on controlled mechanical ventilation. In infants treated with a staged repair, the chimney is gradually reduced over 5–10 days. Central venous and intragastric pressure can be used to guide this therapy as well.

Newborn infants with abdominal wall defects have significantly increased fluid requirements because of the increase in insensible losses that occur when eviscerated bowel is exposed to the environment. Additionally, they have enormous “third space” losses due to the traumatized, inflamed bowel and adynamic ileus that develops perioperatively. Fluid requirements are even greater in gastroschisis patients because the herniated viscera lack a protective covering, resulting in a chemical burn preoperatively.

### Intestinal Obstruction/ Necrotizing Enterocolitis

Intestinal obstruction is among the most common surgical emergencies encountered in the newborn and is characterized by feeding intolerance, bilious vomiting, and abdominal distension. Common sites of obstruction include the duodenum, the jejunum-ileum, particularly the terminal ileum, and the anus. Necrotizing enterocolitis, on the other hand, is caused by bacterial invasion of previously injured or ischemic bowel wall. It is characterized by intestinal obstruction, gangrene, perforation, intramural air (“pneumatosis intestinalis”), and peritonitis.<sup>113,114</sup> Patients usually are premature and often are septic, hypotensive, thrombocytopenic, and in respiratory failure. Metabolic and respiratory acidosis and electrolyte disturbances are common. Although the initial management is nonoperative and supportive (i.e., decompression, antibiotics, correction of hematologic abnormalities), evidence of intestinal gangrene (e.g., positive results of paracentesis), pneumoperitoneum, and clinical deterioration results in the need for emergency exploratory laparotomy.



**FIGURE 62–5.** Algorithm for intraoperative and postoperative management of children with congenital abdominal wall defects. Note that intra gastric pressures and changes in central venous pressure are measured.

Duodenal obstruction typically presents within the first hours of life and is extremely common in children with trisomy 21 (Down syndrome). An abdominal x-ray film will show the classic “double bubble” sign (i.e., dilated air-filled stomach and proximal duodenum). Because these children present so early in life, usually within the first 12 hours, they rarely are dehydrated or hypochloremic. Small and large bowel obstructions typically present later, usually 2–7 days after birth, and often are associated with hemodynamic compromise and metabolic disturbances. Jejunal or ileal atresias are thought to be caused by intrauterine vascular accidents. Meconium ileus is an obstruction of the small bowel caused by inspissated abnormal meconium and is pathognomic of cystic fibrosis. At the time of presentation, these infants do not have the lung disease associated with this devastating condition. Malrotations of

the bowel also present with obstruction and are very common in patients with congenital diaphragmatic hernia and omphalocele/gastroschisis. Infants with Hirschsprung disease have a functional distal obstruction due to lack of ganglia in the rectum and distal colon. Imperforate anus, which should be readily obvious in the delivery room, requires special attention because of the many anomalies associated with it. At one time called the VATER (vertebral defects, anal atresia, tracheoesophageal fistula, esophageal atresia [see Esophageal Atresia and Tracheoesophageal Fistula below], renal anomalies) syndrome, this condition also has a 20% incidence of significant congenital heart disease. In patients diagnosed with the syndrome, an echocardiogram should be obtained prior to surgery.

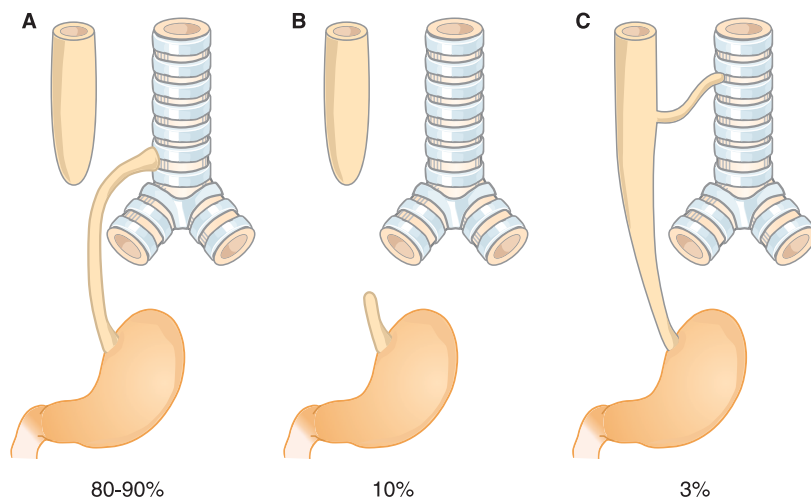
Regardless of the underlying pathology, the major anesthetic challenge with this group of surgical patients is

maintaining an adequate circulating blood volume and preventing pulmonary aspiration of gastric contents. Virtually all newborns presenting for emergency abdominal surgery are intravascularly depleted secondary to the enormous ongoing third space losses. Sepsis, bowel manipulation, peritonitis, use of contrast agents, and release of vasoactive peptides significantly deplete the circulating blood volume and extracellular fluid space of water and electrolytes. In necrotizing enterocolitis, third space fluid replacement therapy in the perioperative period may exceed 100–200 mL/kg/h! Fresh-frozen plasma, platelets, and packed red blood cells are often needed and should be used early in surgery in response to clinical and laboratory evidence of coagulopathy. Additionally, the critically ill, septic patient may not be able to tolerate these enormous fluid shifts, and dopamine 4–10  $\mu\text{g}/\text{kg}/\text{min}$  should be infused to help maintain blood pressure and blood flow. Both arterial and central venous pressure monitors are required to monitor intravascular volume in these situations.

All newborns presenting for emergency abdominal surgery may aspirate their abdominal contents at the induction of anesthesia. Therefore, methods that minimize these risks, such as awake intubation or rapid sequence induction with cricoid pressure, must be used. This has been described in the section Airway. We prefer to maintain anesthesia with the fentanyl, pancuronium, and oxygen technique for this group of patients. Potent inhalational anesthetics are often poorly tolerated in this group of infants. Nitrous oxide is almost never used in these patients because it will further distend the bowel and complicate intestinal perfusion and fascial closure.

### Esophageal Atresia and Tracheoesophageal Fistula

Ninety percent of infants born with a tracheoesophageal fistula have a blind esophageal pouch and a fistula connecting the distal esophagus and the distal trachea, usually within 1–2 cm of the carina (Fig. 62–6). From 30–50% of these infants have the associated anomalies of VATER syndrome (see Intestinal Obstruction/Necrotizing Enterocolitis above). The most common associated defect is cardiac and necessitates an echocardiogram



**FIGURE 62-6.** Three most common types of esophageal atresia and tracheoesophageal fistula (TEF). **A.** Proximal atresia and distal TEF account for 80–90% of cases. **B.** Pure esophageal atresia with no TEF accounts for 10% of cases. **C.** H-type TEF accounts for 3% of cases. (Reprinted from Ein SH. Esophageal atresia and tracheo-esophageal fistula. In Wyllie R, Hyam JS, eds. *Pediatric Gastrointestinal Disease*. Philadelphia: WB Saunders, 1993:318–336, with permission from Elsevier.)

prior to surgery.<sup>115</sup> Often suspected prenatally by polyhydramnios, infants present with excessive salivation (“mucousy mouth”), choking, coughing, aspiration pneumonia, and cyanosis. Attempts at feeding are met with explosive vomiting, and passing an oral (nasal) gastric tube is impossible. A chest radiograph of a coiled oral gastric tube in the cervical esophageal pouch is diagnostic of tracheoesophageal fistula. Because of the potential for aspiration, contrast media should not be instilled to confirm this diagnosis!

The tracheal to distal esophageal fistula aerates the gastrointestinal tract and allows for regurgitation of gastric juice up the fistula into the lung. Thus, pulmonary aspiration occurs by two methods. The first involves aspiration of saliva or attempted feedings from the blind esophageal pouch, and the second occurs by gastric juice contamination via the fistula tract. If significant aspiration pneumonia occurs, definitive corrective surgery is deferred, and a decompressing gastrostomy is placed under local or caudal anesthesia.<sup>116,117</sup>

As soon as the diagnosis is confirmed, the child is placed in a head-up position and the upper pouch is decompressed with a large-bore, sump (Repleg) tube. Following diagnostic workup, the child is transported to the operating room for corrective repair, which historically has been performed through a right-sided thoracotomy. Increasingly, thoracoscopic surgical re-

pair is being performed with excellent results in the hands of experts.<sup>118</sup> Routine monitors are placed. The precordial stethoscope is placed in the left axilla and carefully secured in place, with both “double-stick” and clear plastic adhesive dressing. Adequate intravenous access and a radial artery catheterization complete the preinduction preparation.

Immediately before intubation, the infant is given atropine 0.15 mg intravenously, and the esophageal pouch is suctioned. Then, with the infant in a semisitting position, the trachea is intubated while the patient is awake. This allows appropriate positioning of the endotracheal tube without positive-pressure ventilation, which can cause gastric distension through the fistula. Then, using the classic technique, with the infant spontaneously breathing sevoflurane, the endotracheal tube is positioned below the fistula but above the carina, by deliberately intubating the right mainstem bronchus and then slowly pulling the tube back until breath sounds are heard in the left axilla and not in the stomach. Isolation of the fistula is possible because, in the majority of cases, the fistula is approximately 0.5–1.0 cm above the carina on the posterior surface of the trachea. If the endotracheal tube has a side (“Murphy eye”) hole, it should be turned to the left, opposite its normal orientation, to maximize left lung ventilation. Even if the endotracheal tube does not have a side hole, it is helpful to turn

the bevel of the tube 180° so that the curve of the tube faces forward. This will reduce ventilation into the fistula and stomach. Once positioned, the endotracheal tube is secured with the “fishmouth” technique to avoid displacement of the endotracheal tube down the right mainstem bronchus or, more ominously, into the fistula tract itself (Fig. 62-4). For this reason, the precordial stethoscope is placed securely in the left axilla.

Once the endotracheal tube is positioned, anesthetic management is based on the presence or absence of a decompressive gastrostomy and by the preferential flow of gases down the path of least resistance, namely, through the fistula tract into the stomach. Positive-pressure ventilation may allow oxygen and other gasses to bypass the lungs and acutely dilate the stomach. This interferes with ventilation and venous return and can lead to cardiopulmonary arrest and gastric rupture. If this occurs, an emergency decompressive gastrostomy may be lifesaving. Unfortunately, insertion of a gastrostomy may be lifesaving, but it may substitute one problem for another. Airflow resistance through the fistula–stomach–gastrostomy may be so low that ventilation of the lungs becomes impossible. The gastrostomy may need to be intermittently clamped and unclamped or left partially clamped through the procedure. Some have advocated the use of a Fogarty catheter, placed through either a bronchoscope or a gastric endoscope, to occlude the fistula tract if this becomes a problem.<sup>119</sup> Great caution must be exercised when using a Fogarty catheter passed alongside an endotracheal tube. If the catheter slips out of the fistula tract into the trachea, it can completely occlude the end of the endotracheal tube. Because of these myriad problems with positive-pressure ventilation, many anesthesiologists recommend an anesthetic technique that uses spontaneous ventilation with sevoflurane. Alternatively, others believe that paralysis may be a safe and effective alternative, as long as the fistula can be effectively isolated by careful positioning of the endotracheal tube.

In our experience, sufficient anesthetization with sevoflurane of a spontaneously breathing newborn without compromising blood pressure and oxygenation is rarely possible. This is particularly true in the repair of an

esophageal atresia with tracheoesophageal fistula because this surgery is performed in the lateral position. An intriguing new option, which is our preferred technique, is to supplement the general inhalational anesthetic with a caudal (or thoracic) epidural anesthetic technique.<sup>120,121</sup>

The caudal approach to the epidural space is remarkably easy to perform in the newborn. It does not require specialized equipment even though small-diameter Crawford needles (19–20 gauge) and catheters (24–26F) are commercially available. The epidural space of young children and infants is filled with loosely packed fat and blood vessels, making possible the advancement of a caudally placed catheter as far as the thorax. Typically, either 0.5–1 mL/kg of 0.25% bupivacaine with epinephrine (5 µg/mL) or 0.5 mL/kg of 3% chloroprocaine (15 mg/kg) with epinephrine is administered, and the inspired sevoflurane concentration is significantly reduced.<sup>122</sup> Using this combination technique, patients can be adequately anesthetized and hemodynamically stable even while breathing spontaneously. Analgesia can be maintained with this technique postoperatively as well.

Surgery is performed in the left lateral decubitus position. During the surgical repair, the right lung is compressed and packed away, which may result in hypoxia. Additionally, the infant may become hypoxemic if the trachea and/or endotracheal tube is compressed and occluded by the surgeon. Alternatively, the endotracheal tube can become obstructed by blood clots or may migrate into the fistula tract. To provide a greater margin of safety, we routinely use 100% oxygen during these anesthetics, even in premature infants who are at risk for developing the ROP.

### Meningocele

Failure of neural tube closure early in intrauterine development results in a spectrum of abnormalities, ranging from spina bifida occulta, a relatively benign process, to myelomeningocele, an abnormality involving vertebral bodies, spinal cord, and brainstem.<sup>123</sup> The brainstem lesion—Arnold-Chiari malformation—may be the cause, rather than the effect, of the failure of neural tube closure. Ninety percent of infants with myelomeningocele have the Arnold-Chiari malformation, which

consists of downward displacement of the brainstem and cerebellar tonsils through the cervical spinal canal. This together with obliteration of the foramina of the fourth ventricle blocks the normal circulation of cerebral spinal fluid and leads to progressive hydrocephalus. Associated skeletal anomalies, particularly of the lower extremities, and urodynamic problems are common, and patients born with this defect undergo multiple corrective surgical procedures in their lifetimes.<sup>124</sup> For this reason, fetal corrective surgery has been proposed and has shown some preliminary positive results.

Infants with a meningocele are transported to the operating room in the prone position. The defect is covered with moist sterile dressings, and great care is taken to prevent contamination and infection. If the meningocele is ruptured, lactated Ringer solution is used to replace cerebral spinal fluid losses, milliliter for milliliter or at an approximate rate of 4–6 mL/kg/h.

The infant must be turned supine for intubation, and positioning is crucial to facilitate the intubation. A foam head ring, or operating room towels folded into a ring, is covered with a sterile drape or towel. The baby is turned to the supine position, with the defect resting in the pocket of the ring. Towels are placed under the child's back to build up a level platform for intubation (Fig. 62–7). Anesthesia is induced with either inhalational or intravenous agents (thiopental or propofol). Virtually any anesthetic technique is possible for this surgery as long as it allows for rapid extubation following surgery. Succinylcholine does not cause catastrophic hyperkalemia in patients with this defect.<sup>125</sup> Once the trachea is intu-

bated, the endotracheal tube is secured with a “fishmouth” technique (Fig. 62–4), and the child is turned to the prone position for surgery.

Spinal anesthesia can be used alone or in combination with general anesthesia for this surgery. When combined with a general anesthetic, the patient is induced as described previously. Once the patient is turned and surgery starts, the surgeon drops 0.5–0.7 mg/kg of hyperbaric tetracaine (5 mg/mL) directly into the open meningocele sac.<sup>126</sup> Within minutes the concentration of inhaled general anesthetic is reduced to a level that provides immobility and allows the child to tolerate the endotracheal tube. Less commonly, spinal anesthesia is used as the sole anesthetic for this repair. Using a small-gauge needle, 0.5–0.7 mg/kg of hyperbaric tetracaine (5 mg/mL) with epinephrine is injected into the most inferior region of the meningocele sac. Supplemental doses are administered as described for the combined approach.<sup>126</sup>

The decision to place a ventriculoperitoneal (VP) shunt at the time of initial surgery or several days later is a surgical one. Some surgeons defer placement of the VP shunt because of fear that the drain will become infected. Additionally because 5–10% of these patients do not develop hydrocephalus, some surgeons prefer to wait until the condition develops rather than treating it expectantly.

### Patent Ductus Arteriosus

Following birth, the increase in arterial oxygen that occurs by breathing room air results in closure of the ductus arteriosus. This process may not occur in premature infants and often results in a large left-to-right shunt, heart fail-

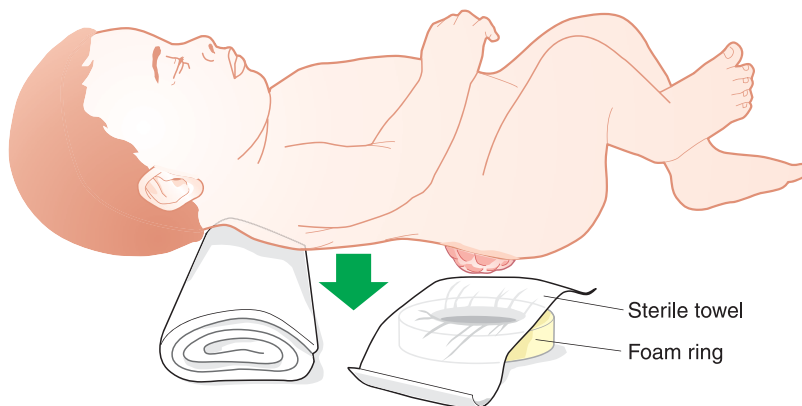


FIGURE 62–7. Positioning of newborn with myelomeningocele for endotracheal intubation.



ure, pulmonary edema, and an inability to be weaned from mechanical ventilation. Medical management consists of fluid restriction, diuretic therapy, digoxin, and the cyclooxygenase inhibitor indomethacin 0.2 mg/kg. Other cyclooxygenase inhibitors, such as ibuprofen, also may be effective.<sup>127</sup> When medical management fails, surgical correction becomes essential if the child is to be weaned from mechanical ventilation.<sup>128</sup> Unfortunately, in the smallest of premature infants (weight <1000 g), indomethacin often is unsuccessful because it significantly impairs renal function.

Because these children have been fluid restricted and are intravascularly volume depleted prior to surgery, volume expansion with lactated Ringer solution is essential to prevent profound hypotension on induction of anesthesia, even when a fentanyl anesthetic is used. Fentanyl 10–50 µg/kg has become the most common anesthetic technique used.<sup>8,46</sup> Obviously, nitrous oxide must be avoided, and 100% oxygen is often required to maintain oxyhemoglobin concentrations >90%, especially once the chest is opened and the lung is retracted. Lung retraction, which is necessary to provide surgical exposure, may result in vagal stimulation, and bradycardia and hypotension results if the child has not been pretreated with either atropine or pancuronium. During closure of the ductus, hemorrhage and exsanguination may occur if this fragile structure is inadvertently torn by the surgeon. Thus, type and crossed blood should always be available prior to the start of surgery. Additionally, closure of the ductus is associated with an abrupt rise in diastolic blood pressure, which may contribute to the development of intraventricular hemorrhage in this patient population.

Recently epidural anesthesia has been used to treat postoperative pain in these infants and to reduce intraoperative anesthetic requirements. Both local anesthetics and epidurally administered opioids are effective. Typically opioids are administered via a caudal approach, and local anesthetics are administered via a caudally placed catheter that has been advanced to the thorax. Because these infants are so fragile, many centers advocate closure of a patent ductus in the nursery rather than transporting the infant to the operating room.<sup>129</sup>

## SUMMARY

Except for extraordinary circumstances, all newborns require anesthesia and analgesia for surgery. During the first month of life, the newborn must function independently and adapt to extrauterine life. This process involves anatomic, physiologic, and pharmacologic changes to maintain homeostasis and to ensure the infant's survival. Disease, congenital anomalies, surgery, and anesthesia may interfere with these adaptations and threaten survival. This chapter provided an in-depth review of developmental physiology, pathophysiology, and pharmacology, as well as common management techniques that are essential in the provision of safe anesthesia to the newborn.

## KEY REFERENCES

1. Berde CB, Jaksic T, Lynn AM, et al. Anesthesia and analgesia during and after surgery in neonates. *Clin Ther* 2005;27:900–921.
2. Anand KJ, Hickey PR. Pain and its effects in the human neonate and fetus. *N Engl J Med* 1987;317:1321–1329.
3. Anand KJ, Hickey PR. Halothane-morphine compared with high-dose sufentanil for anesthesia and postoperative analgesia in neonatal cardiac surgery. *N Engl J Med* 1992;326:1–9.
4. Fisher DM, O'Keefe C, Stanski DR, et al. Pharmacokinetics and pharmacodynamics of d-tubocurarine in infants, children, and adults. *Anesthesiology* 1982;57:203–208.
5. Yaster M, Scherer TL, Stone MM, et al. Prediction of successful primary closure of congenital abdominal wall defects using intraoperative measurements. *J Pediatr Surg* 1989;24:1217–1220.
6. LeDez KM, Lerman J. The minimum alveolar concentration (MAC) of isoflurane in preterm neonates. *Anesthesiology* 1987;67:301–307.
7. Friesen RH, Lichter JL. Cardiovascular depression during halothane anesthesia in infants: study

of three induction techniques. *Anesth Analg* 1982;61:42–45.

8. Pang LM, Mellins RB. Neonatal cardiorespiratory physiology. *Anesthesiology* 1975;43:171–196.

9. Robinson S, Gregory GA. Fentanyl-air-oxygen anesthesia for ligation of patent ductus arteriosus in preterm infants. *Anesth Analg* 1981;60:331–334.

10. Yaster M. The dose response of fentanyl in neonatal anesthesia. *Anesthesiology* 1987;66:433–435.

## REFERENCES

1. Yaster M. Analgesia and anesthesia in neonates. *J Pediatr* 1987;111:394–6.
2. Berde CB, Jaksic T, Lynn AM, et al. Anesthesia and analgesia during and after surgery in neonates. *Clin Ther* 2005;27:900–921.
3. Anand KJ, Hickey PR. Pain and its effects in the human neonate and fetus. *N Engl J Med* 1987;317:1321–1329.
4. Anand KJ, Carr DB. The neuroanatomy, neurophysiology, and neurochemistry of pain, stress, and analgesia in newborns and children. *Pediatr Clin North Am* 1989;36:795–822.
5. Maxwell LG, Yaster M, Wetzel RC, et al. Penile nerve block for newborn circumcision. *Obstet Gynecol* 1987;70:415–419.
6. Lee SJ, Ralston HJ, Drey EA, et al. Fetal pain: a systematic multidisciplinary review of the evidence. *JAMA* 2005;294:947–954.
7. Fitzgerald M, Anand KJ. Developmental neuroanatomy and neurophysiology of pain. In Schechter NL, Berde CB, Yaster M, eds. *Pain in Infants, Children, and Adolescents*. Baltimore: Williams & Wilkins, 1993:11–32.
8. Anand KJ, Sippell WG, Aynsley-Green A. Randomised trial of fentanyl anaesthesia in preterm babies undergoing surgery: effects on the stress response. *Lancet* 1987;1:62–66.
9. Anand KJ, Hickey PR. Halothane-morphine compared with high-dose sufentanil for anesthesia and postoperative analgesia in neonatal cardiac surgery. *N Engl J Med* 1992;326:1–9.
10. Wilson AS, Stiller RL, Davis PJ, et al. Fentanyl and alfentanil plasma protein binding in preterm and term neonates. *Anesth Analg* 1997;84:315–318.
11. Lerman J, Strong HA, LeDez KM, et al. Effects of age on the serum concentration of alpha 1-acid glycoprotein and the binding of lidocaine in pediatric patients. *Clin Pharmacol Ther* 1989;46:219–225.
12. Kupferberg HJ, Way EL. Pharmacologic basis for the increased sensitivity of the

newborn rat to morphine. *J Pharmacol Exp Ther* 1963;141:105-109.

13. Way WL, Costley EC, Way EL. Respiratory sensitivity of the newborn infant to meperidine and morphine. *Clin Pharmacol Ther* 1965;6:454-461.

14. Fisher DM, O'Keeffe C, Stanski DR, et al. Pharmacokinetics and pharmacodynamics of d-tubocurarine in infants, children, and adults. *Anesthesiology* 1982;57:203-208.

15. Furman EB, Roman DG, Lemmer LA, et al. Specific therapy in water, electrolyte and blood-volume replacement during pediatric surgery. *Anesthesiology* 1975;42:187-193.

16. Lerman J, Gregory GA, Eger EI 2. Effects of anaesthesia and surgery on the solubility of volatile anaesthetics in blood. *Can J Anaesth* 1987;34:14-16.

17. Malviya S, Lerman J. The blood/gas solubilities of sevoflurane, isoflurane, halothane, and serum constituent concentrations in neonates and adults. *Anesthesiology* 1990;72:793-796.

18. Williams DG, Dickenson A, Fitzgerald M, et al. Developmental regulation of codeine analgesia in the rat. *Anesthesiology* 2004;100:92-97.

19. Williams DG, Patel A, Howard RF. Pharmacogenetics of codeine metabolism in an urban population of children and its implications for analgesic reliability. *Br J Anaesth* 2002;89:839-845.

20. Greeley WJ, de Bruijn NP. Changes in sufentanil pharmacokinetics within the neonatal period. *Anesth Analg* 1988;67:86-90.

21. Yaster M, Buck JR, Dudgeon DL, et al. Hemodynamic effects of primary closure of omphalocele/gastroschisis in human newborns. *Anesthesiology* 1988;69:84-88.

22. Yaster M, Scherer TL, Stone MM, et al. Prediction of successful primary closure of congenital abdominal wall defects using intraoperative measurements. *J Pediatr Surg* 1989;24:1217-1220.

23. Shaffer SE, Norman ME. Renal function and renal failure in the newborn. *Clin Perinatol* 1989;16:199-218.

24. Lerman J, Robinson S, Willis MM, et al. Anesthetic requirements for halothane in young children 0-1 month and 1-6 months of age. *Anesthesiology* 1983;59:421-424.

25. Gregory GA. The baroresponses of preterm infants during halothane anaesthesia. *Can Anaesth Soc J* 1982;29:105-107.

26. LeDez KM, Lerman J. The minimum alveolar concentration (MAC) of isoflurane in preterm neonates. *Anesthesiology* 1987;67:301-307.

27. Friesen RH, Lichtor JL. Cardiovascular depression during halothane anesthesia in infants: study of three induction techniques. *Anesth Analg* 1982;61:42-45.

28. Friesen RH, Lichtor JL. Cardiovascular effects of inhalation induction with isoflurane in infants. *Anesth Analg* 1983;62:411-414.

29. Friesen RH, Henry DB. Cardiovascular changes in preterm neonates receiving isoflurane, halothane, fentanyl, and ketamine. *Anesthesiology* 1986;64:238-242.

30. Crawford MW, Lerman J, Saldivia V, et al. Hemodynamic and organ blood flow responses to halothane and sevoflurane anesthesia during spontaneous ventilation. *Anesth Analg* 1992;75:1000-1006.

31. Lerman J, Sikich N, Kleinman S, et al. The pharmacology of sevoflurane in infants and children. *Anesthesiology* 1994;80:814-824.

32. Taylor RH, Lerman J. Minimum alveolar concentration of desflurane and hemodynamic responses in neonates, infants, and children. *Anesthesiology* 1991;75:975-979.

33. Murat I, Constant I, Maud'huy H. Perioperative anaesthetic morbidity in children: a database of 24, 165 anaesthetics over a 30-month period. *Paediatr Anaesth* 2004;14:158-166.

34. Morray JP, Geiduschek JM, Ramamoorthy C, et al. Anesthesia-related cardiac arrest in children: initial findings of the Pediatric Perioperative Cardiac Arrest (POCA) Registry. *Anesthesiology* 2000;93:6-14.

35. Morray JP. Anesthesia-related cardiac arrest in children. An update. *Anesthesiol Clin North America* 2002;20:1-28, v.

36. Murray DJ, Forbes RB, Dillman JB, et al. Haemodynamic effects of atropine during halothane or isoflurane anaesthesia in infants and small children. *Can J Anaesth* 1989;36:295-300.

37. Pang LM, Mellins RB. Neonatal cardiorespiratory physiology. *Anesthesiology* 1975;43:171-196.

38. Schieber RA, Namnoum A, Sugden A, et al. Hemodynamic effects of isoflurane in the newborn piglet: comparison with halothane. *Anesth Analg* 1986;65:633-638.

39. Murray DJ, Forbes RB, Mahoney LT. Comparative hemodynamic depression of halothane versus isoflurane in neonates and infants: an echocardiographic study. *Anesth Analg* 1992;74:329-337.

40. Murray D, Vandewalker G, Matherne GP, et al. Pulsed Doppler and two-dimensional echocardiography: comparison of halothane and isoflurane on cardiac function in infants and small children. *Anesthesiology* 1987;67:211-217.

41. Wear R, Robinson S, Gregory GA. The effect of halothane on the baroresponse of adult and baby rabbits. *Anesthesiology* 1982;56:188-191.

42. Meistelman C, Benhamou D, Barre J, et al. Effects of age on plasma protein binding of sufentanil. *Anesthesiology* 1990;72:470-473.

43. Singleton MA, Rosen JI, Fisher DM. Plasma concentrations of fentanyl in infants, children and adults. *Can J Anaesth* 1987;34:152-155.

44. Koehntop DE, Rodman JH, Brundage DM, et al. Pharmacokinetics of fentanyl in neonates. *Anesth Analg* 1986;65:227-232.

45. Hughes MA, Glass PS, Jacobs JR. Context-sensitive half-time in multicompartment pharmacokinetic models for intravenous anesthetic drugs. *Anesthesiology* 1992;76:334-341.

46. Robinson S, Gregory GA. Fentanyl-air-oxygen anesthesia for ligation of patent ductus arteriosus in preterm infants. *Anesth Analg* 1981;60:331-334.

47. Yaster M. The dose response of fentanyl in neonatal anesthesia. *Anesthesiology* 1987;66:433-435.

48. Yaster M, Koehler RC, Traystman RJ. Effects of fentanyl on peripheral and cerebral hemodynamics in neonatal lambs. *Anesthesiology* 1987;66:524-530.

49. Yaster M, Koehler RC, Traystman RJ. Interaction of fentanyl and pentobarbital on peripheral and cerebral hemodynamics in newborn lambs. *Anesthesiology* 1989;70:461-469.

50. Pasternak GW, Zhang A, Tecott L. Developmental differences between high and low affinity opiate binding sites: their relationship to analgesia and respiratory depression. *Life Sci* 1980;27:1185-1190.

51. Zhang AZ, Pasternak GW. Ontogeny of opioid pharmacology and receptors: high and low affinity site differences. *Eur J Pharmacol* 1981;73:29-40.

52. Davis PJ, Galinkin J, McGowan FX, et al. A randomized multicenter study of remifentanil compared with halothane in neonates and infants undergoing pyloromyotomy. I. Emergence and recovery profiles. *Anesth Analg* 2001;93:1380-1386.

53. Galinkin JL, Davis PJ, McGowan FX, et al. A randomized multicenter study of remifentanil compared with halothane in neonates and infants undergoing pyloromyotomy. II. Perioperative breathing patterns in neonates and infants with pyloric stenosis. *Anesth Analg* 2001;93:1387-1392.

54. Kapila A, Glass PS, Jacobs JR, et al. Measured context-sensitive half-times of remifentanil and alfentanil. *Anesthesiology* 1995;83:968-975.

55. Glass PS, Gan TJ, Howell S. A review of the pharmacokinetics and pharmacodynamics of remifentanil. *Anesth Analg* 1999;89:S7-S14.

56. Scholz J, Steinfath M, Schulz M. Clinical pharmacokinetics of alfentanil, fentanyl and sufentanil. An update. *Clin Pharmacokinet* 1996;31:275-292.

57. Goudsouzian NG, Standaert FG. The infant and the myoneural junction. *Anesth Analg* 1986;65:1208-1217.

58. Koenigsberger MR, Patten B, Lovelace RE. Studies of neuromuscular function in the newborn. I. A comparison of myoneural function in the full term and the premature infant. *Neuropadiatrie* 1973;4:350-361.

59. Crumrine RS, Yodlowski EH. Assessment of neuromuscular function in infants. *Anesthesiology* 1981;54:29-32.

60. Goudsouzian NG, Liu LM, Cote CJ. Comparison of equipotent doses of non-

depolarizing muscle relaxants in children. *Anesth Analg* 1981;60:862–866.

61. Cook DR. Muscle relaxants in infants and children. *Anesth Analg* 1981;60:335–343.

62. Cook DR, Westman HR, Rosenfeld L, et al. Pulmonary edema in infants: possible association with association with intramuscular succinylcholine. *Anesth Analg* 1981;60:220–223.

63. Cunliffe M, Lucero VM, McLeod ME, et al. Neuromuscular blockade for rapid tracheal intubation in children: comparison of succinylcholine and pancuronium. *Can Anaesth Soc J* 1986;33:760–764.

64. Ikonomidou C, Bosch F, Miksa M, et al. Blockade of NMDA receptors and apoptotic neurodegeneration in the developing brain. *Science* 1999;283:70–74.

65. Olney JW, Wozniak DF, Jevtovic-Todorovic V, et al. Drug-induced apoptotic neurodegeneration in the developing brain. *Brain Pathol* 2002;12:488–498.

66. Olney JW, Young C, Wozniak DF, et al. Anesthesia-induced developmental neuroapoptosis. Does it happen in humans? *Anesthesiology* 2004;101:273–275.

67. Young C, Jevtovic-Todorovic V, Qin YQ, et al. Potential of ketamine and midazolam, individually or in combination, to induce apoptotic neurodegeneration in the infant mouse brain. *Br J Pharmacol* 2005;146:189–197.

68. Ikonomidou C, Bittigau P, Koch C, et al. Neurotransmitters and apoptosis in the developing brain. *Biochem Pharmacol* 2001;62:401–405.

69. Anand KJ, Soriano SG. Anesthetic agents and the immature brain: are these toxic or therapeutic? *Anesthesiology* 2004;101:527–530.

70. Butterworth JF, Strichartz GR. Molecular mechanisms of local anesthesia: a review. *Anesthesiology* 1990;72:711–734.

71. Strichartz GR. Neural physiology and local anesthetic action. In Cousins MJ, Bridenbaugh PO, eds. *Neural Blockade in Clinical Anesthesia and Management of Pain*. 3rd ed. Philadelphia: Lippincott-Raven, 1998:35–54.

72. Mazoit JX, Denson DD, Samii K. Pharmacokinetics of bupivacaine following caudal anesthesia in infants. *Anesthesiology* 1988;68:387–391.

73. Larsson BA, Lonnqvist PA, Olsson GL. Plasma concentrations of bupivacaine in neonates after continuous epidural infusion. *Anesth Analg* 1997;84:501–505.

74. Henderson K, Sethna NF, Berde CB. Continuous caudal anesthesia for inguinal hernia repair in former preterm infants. *J Clin Anesth* 1993;5:129–133.

75. Cote CJ, Rolf N, Liu LM, et al. A single-blind study of combined pulse oximetry and capnography in children. *Anesthesiology* 1991;74:980–987.

76. Cote CJ, Goldstein EA, Cote MA, et al. A single-blind study of pulse oximetry in children. *Anesthesiology* 1988;68:184–188.

77. Wallgren G, Hanson JS, Lind J. Quantitative studies of the human neonatal circulation. 3. Observations on the newborn infants central circulatory responses to moderate hypovolemia. *Acta Paediatr Scand* 1967;(Suppl 179):45.

78. Cooke RJ, Werkman S, Watson D. Urine output measurement in premature infants. *Pediatrics* 1989;83:116–118.

79. Badgwell JM, McLeod ME, Lerman J, et al. End-tidal PCO<sub>2</sub> measurements sampled at the distal and proximal ends of the endotracheal tube in infants and children. *Anesth Analg* 1987;66:959–964.

80. Bissonnette B, Lerman J. Single breath end-tidal CO<sub>2</sub> estimates of arterial PCO<sub>2</sub> in infants and children. *Can J Anaesth* 1989;36:110–112.

81. Rowe MI, Taylor M. Transepidermal water loss in the infant surgical patient. *J Pediatr Surg* 1981;16:878–881.

82. Giesbrecht GG, Ducharme MB, McGuire JP. Comparison of forced-air patient warming systems for perioperative use. *Anesthesiology* 1994;80:671–679.

83. Furman EB. Intraoperative fluid therapy. *Int Anesthesiol Clin* 1975;13:133–147.

84. Baumgart S, Costarino AT. Water and electrolyte metabolism of the micropremie. *Clin Perinatol* 2000;27:131–vii.

85. Costarino A, Baumgart S. Modern fluid and electrolyte management of the critically ill premature infant. *Pediatr Clin North Am* 1986;33:153–178.

86. Hartnoll G. Basic principles and practical steps in the management of fluid balance in the newborn. *Semin Neonatol* 2003;8:307–313.

87. Blanchette VS, Gray E, Hardie MJ, et al. Hyperkalemia after neonatal exchange transfusion: risk eliminated by washing red cell concentrates. *J Pediatr* 1984;105:321–324.

88. Hall TL, Barnes A, Miller JR, et al. Neonatal mortality following transfusion of red cells with high plasma potassium levels. *Transfusion* 1993;33:606–609.

89. Friesen RH, Honda AT, Thieme RE. Changes in anterior fontanel pressure in preterm neonates during tracheal intubation. *Anesth Analg* 1987;66:874–878.

90. Friesen RH, Honda AT, Thieme RE. Perianesthetic intracranial hemorrhage in preterm neonates. *Anesthesiology* 1987;67:814–816.

91. Gambee AM, Hertzka RE, Fisher DM. Preoxygenation techniques: comparison of three minutes and four breaths. *Anesth Analg* 1987;66:468–470.

92. Morrison JE Jr, Collier E, Friesen RH, et al. Preoxygenation before laryngoscopy in children: how long is enough? *Paediatr Anaesth* 1998;8:293–298.

93. Cheng CA, Aun CS, Gin T. Comparison of rocuronium and suxamethonium for rapid tracheal intubation in children. *Paediatr Anaesth* 2002;12:140–145.

94. Mazurek AJ, Rae B, Hann S, et al. Rocuronium versus succinylcholine: are

they equally effective during rapid-sequence induction of anesthesia? *Anesth Analg* 1998;87:1259–1262.

95. Harrison MR, Adzick NS, Nakayama DK, et al. Fetal diaphragmatic hernia: pathophysiology, natural history, and outcome. *Clin Obstet Gynecol* 1986;29:490–501.

96. Harrison MR, Adzick NS, Estes JM, et al. A prospective study of the outcome for fetuses with diaphragmatic hernia. *JAMA* 1994;271:382–384.

97. Stege G, Fenton A, Jaffray B. Nihilism in the 1990s: the true mortality of congenital diaphragmatic hernia. *Pediatrics* 2003;112:532–535.

98. Adzick NS, Vacanti JP, Lillehei CW, et al. Fetal diaphragmatic hernia: ultrasound diagnosis and clinical outcome in 38 cases. *J Pediatr Surg* 1989;24:654–657.

99. Geggel RL, Murphy JD, Langleben D, et al. Congenital diaphragmatic hernia: arterial structural changes and persistent pulmonary hypertension after surgical repair. *J Pediatr* 1985;107:457–464.

100. Vacanti JP, Crone RK, Murphy JD, et al. The pulmonary hemodynamic response to perioperative anesthesia in the treatment of high-risk infants with congenital diaphragmatic hernia. *J Pediatr Surg* 1984;19:672–679.

101. Bohn D, Tamura M, Perrin D, et al. Ventilatory predictors of pulmonary hypoplasia in congenital diaphragmatic hernia, confirmed by morphologic assessment. *J Pediatr* 1987;111:423–431.

102. Bohn DJ, James I, Filler RM, et al. The relationship between PaCO<sub>2</sub> and ventilation parameters in predicting survival in congenital diaphragmatic hernia. *J Pediatr Surg* 1984;19:666–671.

103. Wung JT, Sahni R, Moffitt ST, et al. Congenital diaphragmatic hernia: survival treated with very delayed surgery, spontaneous respiration, and no chest tube. *J Pediatr Surg* 1995;30:406–409.

104. Boloker J, Bateman DA, Wung JT, et al. Congenital diaphragmatic hernia in 120 infants treated consecutively with permissive hypercapnia/spontaneous respiration/elective repair. *J Pediatr Surg* 2002;37:357–366.

105. Kinsella JP, Abman SH. Inhaled nitric oxide therapy in children. *Paediatr Respir Rev* 2005;6:190–198.

106. Kinsella JP, Ivy DD, Abman SH. Pulmonary vasodilator therapy in congenital diaphragmatic hernia: acute, late, and chronic pulmonary hypertension. *Semin Perinatol* 2005;29:123–128.

107. Heiss K, Manning P, Oldham KT, et al. Reversal of mortality for congenital diaphragmatic hernia with ECMO. *Ann Surg* 1989;209:225–230.

108. Connors RH, Tracy T Jr, Bailey PV, et al. Congenital diaphragmatic hernia repair on ECMO. *J Pediatr Surg* 1990;25:1043–1046.

109. Khan AM, Lally KP. The role of extracorporeal membrane oxygenation in the

- management of infants with congenital diaphragmatic hernia. *Semin Perinatol* 2005;29:118–122.
110. Moya FR, Lally KP. Evidence-based management of infants with congenital diaphragmatic hernia. *Semin Perinatol* 2005;29:112–117.
111. Rothenbach P, Lange P, Powell D. The use of extracorporeal membrane oxygenation in infants with congenital diaphragmatic hernia. *Semin Perinatol* 2005;29:40–44.
112. Oldham KT, Coran AG, Drongowski RA, et al. The development of necrotizing enterocolitis following repair of gastroschisis: a surprisingly high incidence. *J Pediatr Surg* 1988;23:945–949.
113. Henry MC, Moss RL. Current issues in the management of necrotizing enterocolitis. *Semin Perinatol* 2004;28:221–233.
114. Henry MC, Lawrence MR. Surgical therapy for necrotizing enterocolitis: bringing evidence to the bedside. *Semin Pediatr Surg* 2005;14:181–190.
115. Diaz LK, Akpek EA, Dinavahi R, et al. Tracheoesophageal fistula and associated congenital heart disease: implications for anesthetic management and survival. *Paediatr Anaesth* 2005;15:862–869.
116. Choudhury SR, Ashcraft KW, Sharp RJ, et al. Survival of patients with esophageal atresia: influence of birth weight, cardiac anomaly, and late respiratory complications. *J Pediatr Surg* 1999;34:70–73.
117. Healey PJ, Sawin RS, Hall DG, et al. Delayed primary repair of esophageal atresia with tracheoesophageal fistula: is it worth the wait? *Arch Surg* 1998;133:552–556.
118. Holcomb GW III, Rothenberg SS, Bax KM, et al. Thoracoscopic repair of esophageal atresia and tracheoesophageal fistula: a multi-institutional analysis. *Ann Surg* 2005;242:422–428.
119. Filston HC, Chitwood WR Jr, Schkolne B, et al. The Fogarty balloon catheter as an aid to management of the infant with esophageal atresia and tracheoesophageal fistula complicated by severe RDS or pneumonia. *J Pediatr Surg* 1982;17:149–151.
120. Bosenberg AT, Bland BA, Schulte-Steinberg O, et al. Thoracic epidural anesthesia via caudal route in infants. *Anesthesiology* 1988;69:265–269.
121. Bosenberg AT, Hadley GP, Murray WB. Epidural analgesia reduces postoperative ventilation requirements following esophageal atresia repair. *J Pain Symptom Management* 1991;6:209.
122. Tobias JD, Rasmussen GE, Holcomb GW 3, et al. Continuous caudal anaesthesia with chloroprocaine as an adjunct to general anaesthesia in neonates. *Can J Anaesth* 1996;43:69–72.
123. Noetzel MJ. Myelomeningocele: current concepts of management. *Clin Perinatol* 1989;16:311–229.
124. McLone DG. Care of the neonate with a myelomeningocele. *Neurosurg Clin North Am* 1998;9:111–120.
125. Dierdorf SF, McNiece WL, Rao CC, et al. Failure of succinylcholine to alter plasma potassium in children with myelomeningocele. *Anesthesiology* 1986;64:272–273.
126. Viscomi CM, Abajian JC, Wald SL, et al. Spinal anesthesia for repair of meningo-myelocele in neonates. *Anesth Analg* 1995;81:492–495.
127. Hammerman C, Kaplan M. Comparative tolerability of pharmacological treatments for patent ductus arteriosus. *Drug Saf* 2001;24:537–551.
128. Malviya M, Ohlsson A, Shah S. Surgical versus medical treatment with cyclooxygenase inhibitors for symptomatic patent ductus arteriosus in preterm infants. *Cochrane Database Syst Rev* 2003;CD003951.
129. Gould DS, Montenegro LM, Gaynor JW, et al. A comparison of on-site and off-site patent ductus arteriosus ligation in premature infants. *Pediatrics* 2003;112:1298–1301.



# CHAPTER 63

## Anesthesia for Children

Lucinda L. Everett, MD

### INTRODUCTION: HALLMARKS OF PEDIATRIC ANESTHESIA

Perioperative care of infants and children presents a number of special challenges. The anesthesia care team must evaluate and interface with both child and parents and must consider psychological as well as physiologic factors. In the United States, anesthesia for elective surgery in children is frequently initiated with an inhalation induction, which is significantly different from the intravenous induction commonly performed in adults. Physiologic differences, such as an increased rate of oxygen consumption, create the potential for rapid arterial blood desaturation with apnea or hemodynamic compromise. Finally, specific technical skills are required in infants and children.

### RISK AND OUTCOME IN PEDIATRIC ANESTHESIA

Overall, safety in pediatric anesthesia is excellent. Complications are uncommon and improvements over the past several decades are attributed to better monitoring (pulse oximetry and capnography), safer anesthetic agents, and better understanding of specific areas of increased risk. A number of large outcome studies dating from the late 1980s<sup>1</sup> to the current era<sup>2</sup> have identified increased rates of complications and cardiac arrest during anesthesia in children younger than 1 year, although in some studies the risk appears to be explained by coexisting diseases. American Society of Anesthesiologists (ASA) classification and emergency status also have been predictors of increased risk in pediatric anesthesia outcome studies.

#### Respiratory Risk

Anesthetic audits report that a high percentage of respiratory complications continue to occur in children, particu-

larly infants. These complications include laryngospasm, bronchospasm, airway obstruction, and decreased systemic oxygen saturation. Factors that may contribute to respiratory risk in-

clude younger age, concurrent disease (syndromes, airway anomalies, or obstructive sleep apnea), recent upper respiratory infection,<sup>3</sup> and airway procedures (tonsillectomy, airway surgery,

### KEY POINTS

1. Overall, pediatric anesthesia is extremely safe in the hands of experienced providers. Factors that may increase risk include age <1 year and coexisting disease. Careful attention to maintenance of a patent airway is critical to the safe care of infants and children.
2. One of the challenges of pediatric anesthesia for trainees is selecting appropriately sized equipment and supplies. Endotracheal tubes are generally selected to yield a leak at 15–30 cm H<sub>2</sub>O. Cuffed tubes are gaining wider use in young children as well as those older than 8 years. Straight blades are most commonly used for intubation in infants, with the usual choices being Miller 0 for neonates and Miller 1 for infants. A Wis-Hipple 1.5 blade is often used in toddlers, with progression to Macintosh size 2 for children 3 years and older.
3. The physiologic and psychological contexts must be considered in planning an anesthetic for any child. Premedication and/or parental presence may be appropriate for children. Induction of anesthesia for elective surgery in young children frequently is accomplished by inhalation of a volatile anesthetic. Sevoflurane is the most common choice in modern practice based on the drug's rapid effect, low degree of airway irritation, and cardiovascular stability.
4. Succinylcholine is no longer used routinely in children because of the potential for hyperkalemia in undiagnosed myopathy. Succinylcholine may still be used when indicated for rapid sequence induction or treatment of laryngospasm.
5. Regional anesthesia is a useful adjunct to general anesthesia in children for a variety of procedures. Surgery with a regional anesthetic alone is uncommon in young children; one exception is the use of spinal anesthesia in premature infants at risk for postoperative apnea. For common outpatient surgery such as hernia repair or orchidopexy, caudal blockade with a local anesthetic such as ropivacaine provides good intraoperative and postoperative analgesia. Epidural catheters also may be placed in children for more major procedures and generally are placed after induction of general anesthesia in children too young to cooperate.
6. Selection of an appropriate plan for postoperative analgesia is important for both inpatient and outpatient situations. Adequate doses of acetaminophen, nonsteroidal antiinflammatory drugs where not contraindicated, and regional anesthesia may be appropriate in addition to, or in place of, opioid analgesia, depending on the procedure. Postoperative vomiting is common in children and may occur more frequently during certain procedures, such as strabismus surgery, and in patients with a history of motion sickness or postoperative vomiting. Prophylaxis frequently includes use of a 5-hydroxytryptamine<sub>3</sub> (5-HT<sub>3</sub>) receptor antagonist and/or a steroid such as dexamethasone. Because of restrictions on the use of droperidol, 5-HT<sub>3</sub> receptor antagonists are generally used as first-line treatment of postoperative nausea and vomiting in children.
7. Emergence agitation occurs in a significant number of toddlers and young children, particularly after use of a volatile anesthetic. Appropriate analgesia and possibly supplemental sedation may be helpful. The results in the literature are mixed with regard to links with specific agents (e.g., sevoflurane); patient and parental anxiety may contribute to the development of agitation.
8. Many of the procedures performed in children involve concepts similar to those used in parallel adult cases (e.g., neurosurgery, thoracic surgery). The concepts related to the surgical subspecialty must be integrated with those specific to the anesthetic care of children. Procedures specific to the pediatric population are discussed.

cleft palate repair). With early detection and skillful management, few complicating events will result in adverse outcomes; therefore, screening for potential airway abnormalities, a backup plan for managing airway difficulties, and rapid attention to respiratory changes are critical components of pediatric anesthetic care.

Pulmonary aspiration of gastric contents is a rare but feared complication of anesthesia. Studies of pediatric patients report a range similar to that seen in adults (1–10 cases per 10,000 anesthetics).<sup>4</sup> Aspiration occurs more frequently in emergency cases and in “full stomach” situations such as bowel obstruction. The majority of cases of aspiration occur during laryngoscopy, particularly with coughing or unexpected airway difficulties, but some cases occur during maintenance or emergence from anesthesia. In pediatric cases reported to date, intraoperative aspiration while using a laryngeal mask has generally been related to a predisposing factor such as inadequate depth of anesthesia, GI disease or full stomach, lithotomy position, movement of the laryngeal mask airway (LMA), or multiple insertion attempts.<sup>5</sup> Clinical signs (decreased oxygen saturation, coughing, wheezing) and radiographic abnormalities that do occur generally develop in the first 2 hours after aspiration. The long-term outcome usually is good in healthy pediatric patients who aspirate gastric contents, but acutely these patients may require suctioning, intubation, and mechanical ventilation. The acuity of perioperative care may be higher than would otherwise have been planned.

Infants born prematurely have an increased risk of apnea and bradycardia following general anesthesia. The best available information comes from a combined analysis published by Cote et al.,<sup>6</sup> who demonstrated that risk was inversely proportional to both gestational and postconceptual age, and risk of apnea was increased by anemia. The administration of caffeine<sup>7</sup> or the use of spinal anesthesia without sedation<sup>8</sup> reduces the risk of postoperative apnea. Newer anesthetic agents, such as sevoflurane, are not free of the risk of apnea in infants born prematurely.<sup>9</sup> Many individual hospitals require postoperative overnight admission for monitoring until 50–60 weeks' postconceptual age in infants born before 37 weeks; they also may consider

anemia, prior apnea, and coexisting disease. Little specific evidence about apnea risk in term infants is available. Some facilities restrict the lower age for day surgery procedures to older than 44–46 weeks' postconceptual age in term infants or require a longer observation period (e.g., 4 hours) prior to discharge.

### Cardiac Risk

The ASA Closed Claims Study evaluates outcomes from closed malpractice claims. An analysis of pediatric cases from this database found claims in infants and children were more likely to be related to respiratory events, were more often classified as “preventable” (e.g., by better monitoring), and resulted in greater injury severity and mortality than adult claims.<sup>10</sup> The Pediatric Perioperative Cardiac Arrest (POCA) Registry was created in 1994 to gain further insight into the epidemiology of anesthetic-related cardiac arrest in patients aged 18 years and younger. Data from arrests as well as total numbers of pediatric anesthetics are reported from participating institutions. POCA data published in the year 2000 summarized the first 289 cases reported: the overall incidence of anesthetic-related cardiac arrest was 1.4 per 10,000 anesthetics, with a reporting base of just over one million anesthetics from 63 institutions.<sup>11</sup> Cardiac arrest was most frequent in patients younger than 1 year (55% of cases) and in those with severe underlying disease (ASA classes 3, 4, and 5). Among healthy patients (ASA classes 1 and 2), the most common causes of cardiac arrest were respiratory (20%) and medication related (64%). Cardiac arrest initiated by respiratory events divided into two major categories: laryngospasm (30%), occurring primarily in healthy patients, and “airway obstruction,” usually in the setting of congenital or acquired anatomic abnormalities (micrognathia, laryngeal papillomatosis). Medication-related cardiac arrests were primarily due to halothane, either alone or in combination with other drugs. In the more recent period, reports of cardiac arrests related to potent inhalational anesthetics have declined.<sup>12</sup> Several factors contributed to this decrease. Sevoflurane, now the agent most commonly used for anesthetic induction in children, causes less myocardial depression than halothane, and the vaporizer delivers

fewer minimum alveolar concentration equivalents at maximal output. Recognition of this pattern of anesthetic cardiac arrest may have changed practice, and/or children may be better hydrated prior to anesthetic induction since the ASA in 1999 liberalized the fasting guidelines with adoption of a 2-hour fasting from clear liquids.

Cardiac arrest related to succinylcholine administration was reported in several apparently healthy children in the late 1980s,<sup>13</sup> leading to a “black box” U.S. Food and Drug Administration (FDA) drug label warning regarding its use in pediatric anesthesia. The patients were found to have unrecognized myopathy with the development of hyperkalemia after succinylcholine administration. In the initial cases, a lack of understanding of the pathophysiology contributed to the failure to treat and resuscitate appropriately. Succinylcholine now is used with caution in pediatric patients but is considered an appropriate choice for muscle relaxation when rapid control of the airway is required, that is, when the history or physical examination dictates performing a rapid sequence induction, or for treatment of laryngospasm.

### Facility and Provider Expertise

One of the complex administrative issues in pediatric anesthesia is determining which patients require care by an anesthesiologist who specializes in the care of children, and just what is the precise definition of a pediatric anesthesiologist? In the United States, pediatric anesthesia fellowship programs are accredited by the Accreditation Council for Graduate Medical Education, but at this time there is no subspecialty board certification in pediatric anesthesia. Although the link between provider qualifications and outcomes has not been extensively studied, some evidence suggests that children have fewer adverse outcomes when cared for by anesthesiologists with frequent ongoing experience in anesthetizing children.<sup>14,15</sup> Several organizations have put forth guidelines for the care of pediatric patients. The American Academy of Pediatrics (AAP) suggests that each facility define the spectrum of pediatric patients and cases for which it will provide care and the number of cases of each required for the facility to maintain its competence.<sup>16</sup> The AAP further recommends that anesthesiologists caring

for children designated by the facility as being at increased risk either should be fellowship trained in pediatric anesthesiology or have equivalent experience. The ASA and the Society for Pediatric Anesthesia have made similar recommendations. Some states also are instituting requirements that anesthesiologists caring for children meet certain minimum annual number of cases. The AAP guidelines have implications for facilities providing anesthesia care of children. The guidelines recommend having airway and monitoring equipment in sizes suitable for pediatric patients, a separate preoperative area for children and their families, and operating room and recovery staff with age-specific competencies and resuscitation skills.

## EQUIPMENT FOR PEDIATRIC ANESTHESIA

### Breathing Circuits and Ventilators

Anesthetic breathing circuits for pediatric use, like other equipment for use in children, have evolved significantly. In traditional teaching of pediatric anesthesia, a valveless system such as the Mapleson D or Jackson Rees circuit was best for children to avoid respiratory resistance added by one-way valves. These systems, which are simple modifications of a T-piece, offer the advantages of being lightweight and flexible with minimal resistance to gas flow. Potential disadvantages include rebreathing of carbon dioxide (CO<sub>2</sub>) if the fresh gas inflow rate is inadequate to wash out the exhaled gas and significant tidal volume lost to expanding the expiratory limb during controlled ventilation. In addition, an adaptor generally is required in order to use a Mapleson circuit with modern anesthesia machines. The circle system is a unidirectional circuit with a CO<sub>2</sub> absorber; pediatric circle systems are now widely available. Although the work of breathing is higher with the pediatric circle than with a Jackson Rees circuit in spontaneously ventilating infants, with modern anesthesia machines the minor resistance of the valves is generally not clinically significant. However, avoidance of prolonged spontaneous respiration by small infants is prudent. Modern pediatric circle systems have a smaller diameter and lower compliance than

adult circuits. Lower fresh gas flows can be used with resultant conservation of volatile anesthetic agents and airway moisture. Even with low flows, the humidity in pediatric circle systems may be inadequate, causing drying of respiratory secretions. Use of a heat and moisture exchanger in the circuit may prove valuable.

Exothermic reactions have been reported when desiccated CO<sub>2</sub> absorbers interact with sevoflurane, in some cases resulting in an explosion or fire. Current recommendations are to avoid absorbents containing a strong base and to turn off fresh gas flows when machines are not in use to avoid drying the absorbent. Changing the absorbent frequently rather than waiting for it to be exhausted is prudent.

Performance varies widely among ventilator models. Circuit compliance does not significantly impact on delivered tidal volume when a peak inspiratory pressure is chosen that provides good chest movement.<sup>17</sup> However, with a compliant circuit on older anesthesia ventilators, the measured tidal volume will be much higher than the volume delivered to the patient. Some recent anesthesia ventilators measure and compensate for circuit compliance, thus more accurately delivering the set tidal volume. Pressure mode ventilation may be best in infants, particularly if there is a leak around an endotracheal tube. Leaks may require the use of higher fresh gas flow. When pressure mode ventilation is used, trends in delivered tidal volume must be followed because changes in pulmonary and chest wall compliance will result in significant changes in minute ventilation. In some older anesthesia ventilators, fresh gas flow contributes to tidal volume, so a large increase in gas flow can cause barotrauma. A good understanding of the characteristics of the ventilator and circuit being used are essential to safe ventilation of a child.

### Monitoring

Pulse oximetry has vastly improved the safety of pediatric anesthesia, but capnography, auscultation, feeling movement in the anesthesia bag, and observation of chest motion all contribute to the clinical assessment of airway patency and should detect airway obstruction prior to desaturation. Electrocardiographic (ECG) monitoring in healthy children is primarily geared

toward monitoring heart rate and rhythm. Ischemic changes are extremely rare except in pediatric cardiac surgery; however, should ischemic changes occur, rapid assessment of the etiology must be undertaken with efforts to improve coronary perfusion. Noninvasive blood pressure monitoring can be used on an upper or lower extremity in children. The decision to place invasive intravascular monitoring catheters (arterial or central venous lines) is based on the severity of illness or the extent and potential complications of the procedure. Temperature should be monitored for all but the shortest cases. For minor procedures, adhesive skin temperature indicators are sufficient. For longer or major procedures, an esophageal, rectal, nasopharyngeal, or tympanic membrane temperature indicator should be used.

### Warming Devices

Children are at relatively high risk for development of hypothermia if they are exposed in the operating room for significant periods (see Chapter 19). The operating room should be warm [80° F (27° C) for neonates and small infants], at least during induction and until the patient is covered with drapes. Radiant warmers may be helpful when small children require multiple procedures, such as line placement prior to the start of surgery. Fluid-filled warming blankets will warm the surface of the operating room table; forced hot-air warming is more effective overall in warming patients. Fluid warmers should be considered, particularly when large-volume intravenous fluid administration is anticipated, and should have small priming volumes for use in children.

## APPROACH TO THE PEDIATRIC PATIENT: THE ANESTHETIC PLAN

Developing an anesthetic plan for the pediatric patient involves several decisions. Is the procedure elective or emergent? Does the child have significant coexisting disease, airway concerns, or behavioral challenges? Are there expectations of how the anesthetic will be conducted based on prior experiences of the child and/or the child's family or friends? Time spent in exploring patient and family expectations and providing explana-

TABLE 63-1.

## Premedication Options

Drug	Route	Dose	Onset	Advantages	Disadvantages
Midazolam	Oral	0.5–0.75 mg/kg Max 15–20 mg	10–15 min	Effective Minimal effect on respiratory function in healthy patients	Bitter taste Possible contribution to postoperative delirium
Midazolam	Rectal	0.5–0.75 mg/kg	10–15 min	Effective Minimal effect on respiratory function in healthy patients	May not be appropriate route for older children Possible contribution to postoperative delirium
Midazolam	Nasal	0.2–0.3 mg/kg	5–10 min	Effective Minimal effect on respiratory function in healthy patients	Burns on administration; bitter Reduced effectiveness if crying or copious nasal secretions Possible contribution to postoperative delirium
Midazolam	Intravenous	0.05 mg/kg increments	1–2 min	Effective  Minimal effect on respiratory function in healthy patients	Requires intravenous access
Fentanyl	Oral transmucosal (Oralet or lozenge)	5–10 µg/kg	10–20 min	Better taste than midazolam Analgesia	Pruritus Nausea and vomiting Potential for “stiff chest” with large doses Variable absorption
Ketamine	Oral	6–9 mg/kg	15–20 min	Better taste than midazolam Analgesia	Nystagmus, possibility of hallucination Delayed emergence if combined with midazolam at this dose Increased salivation
Ketamine/midazolam combination	Oral	2.5 mg/kg ketamine with 0.25 mg/kg midazolam	10 min	May have slightly better onset and recovery than midazolam alone	Need to combine drugs
Ketamine	Intramuscular	2–3 mg/kg	3–5 min	Useful for combative or uncooperative patients	Secretions, may be diminished with antisialagogue
Ketamine	Intramuscular (induction)	10 mg/kg	3–5 min	Useful for combative or uncooperative patients Deeper sedation than smaller dose	Delayed emergence
Methohexital	Rectal (induction)	30 mg/kg	6 min	Smooth induction for frightened or uncooperative small children	Higher incidence of airway obstruction than with midazolam

tions and reassurance is time well spent.

### Preparation and Premedication

Many children younger than 6–9 months will separate from their parents easily if they are kept engaged. Older children, or those who seem anxious or fussy, may benefit from

premedication prior to entering the operating room. Midazolam is commonly given orally as a premedication; other routes and doses are summarized in Table 63-1. Oral transmucosal fentanyl is infrequently used because of its relatively common side effects of nausea/vomiting and pruritus, but it may be a reasonable option when other premedication is not well accepted or

when an opioid is indicated for analgesia. Oral ketamine is not commonly given but may be useful when analgesia is desired. Intramuscular ketamine is administered to patients who are combative or difficult to approach; a sedative dose usually will result in adequate cooperation to obtain intravenous access or complete induction by administering an inhalation agent. Fi-



nally, rectal administration of methohexital is really an induction rather than a premedication. If used, it should be given in a monitored setting with the anesthesiologist present and prepared to move the patient into the operating room or procedure area.

Parental presence during induction can be used in addition to, or in place of, pharmacologic premedication (see Chapter 19). Premedication and parental presence are approximately equivalent in producing cooperation with a mask induction.<sup>18</sup> The child's behavior and family dynamics must be considered; transmitted parental anxiety may limit the value of parental presence. Even with thorough preoperative teaching, some parents are distressed by the appearance of their child during an inhalation induction; however, most parents feel that they are contributing to the child's well-being and would choose to be present for future anesthetic induction.<sup>19</sup>

### Anesthetic Induction

Induction of anesthesia in elective situations for children younger than 8–10 years frequently occurs by inhalation to avoid venipuncture until the child is asleep. This is common practice in the United States but less so in other countries where topical anesthesia and intravenous induction have become the norm and are well accepted by children and parents. Regardless of the route of induction, interacting with the child in a quiet, reassuring voice is important; distraction such as storytelling or magic tricks can be used. Operating room personnel should have an understanding as to who will be interacting with the child so that multiple people will not be competing for the child's attention. Parents, if they are to be in the operating room, should be told that those present in the room must speak quietly and maintain a calming demeanor.

Sevoflurane provides a smooth, rapid inhalation induction with good cardiovascular stability and has largely replaced halothane for inhalation induction. Desflurane is contraindicated for inhalation induction and isoflurane is rarely used because both cause airway irritation. In a cooperative child, mask induction can be initiated with 50–70% nitrous oxide in oxygen, which will provide some initial sedation (Fig. 63–1). After 1–2 minutes, sevoflurane is introduced either incrementally or



FIGURE 63–1. Mask induction of anesthesia. (Courtesy of Scott Tolle.)

at 8%. If the child is agitated initially or becomes combative during the initial stages of induction, a rapid decision must be made either to stop and pursue premedication options or to proceed rapidly with a high inspired concentration of sevoflurane. As soon as the child's eyes close, parents (if present) are escorted out, and attention is turned to maintaining a patent airway. Nitrous oxide can be discontinued at this time to improve oxygen reserves. An "excitement phase" is frequently seen with inhalation induction and may include some degree of airway obstruction, spontaneous limb movement, rigidity, rapid respirations, and tachycardia, all of which usually disappear over several minutes as the anesthetic deepens. Epileptiform activity has been described during inhalation induction with sevoflurane.<sup>20</sup> When the child has passed the excitement phase, intravenous access is established for all but very brief cases.

As noted earlier, children often develop some degree of airway obstruction during inhalation induction. Keeping the right hand on the breathing bag to feel gas movement, auscultation by precordial stethoscope, and observation of the end-tidal CO<sub>2</sub> tracing and chest movement all provide the anesthesiologist with useful information. Lack of gas exchange during inhalation induction should be assessed rapidly to differentiate central apnea (from high concentration of anesthetic agent) from airway obstruction by attempting a gentle positive-pressure breath. If the patient is easily ventilated, slow manual ventilation using a lower concentra-

tion of volatile agent should result in resumption of spontaneous respiration. If airway obstruction is present, further evaluation must attempt to distinguish upper airway obstruction from laryngospasm. Upper airway obstruction in a child often can be managed by opening the mouth slightly to displace the tongue from the roof of the mouth and lifting the jaw anteriorly. Pressure on the soft tissues beneath the chin may worsen airway obstruction in a child. Administering continuous positive airway pressure (CPAP) of 5–10 cm H<sub>2</sub>O may help maintain airway patency. An oral airway can be inserted if anesthetic depth is sufficient or if the other maneuvers are unsuccessful. If these measures fail to open the airway, an LMA is inserted if upper airway obstruction is believed to be the cause of obstruction, or treatment of laryngospasm can be pursued with 100% oxygen, CPAP, and succinylcholine for muscle relaxation when necessary. Succinylcholine 4 mg/kg can be administered intramuscularly if intravenous access has not been established. Sublingual administration also has been described.

Sevoflurane provides excellent cardiovascular stability in most children, with less myocardial depression than is seen with halothane.<sup>21</sup> However, cardiac arrest is possible with high concentrations of any volatile agent. Maintaining spontaneous respiration during an anesthetic induction may afford a degree of safety in that apnea or marked respiratory depression is likely to precede cardiovascular depression, and hypoventilation will

TABLE 63-2.

## Induction Drugs for Children

Induction Drugs	Dose	Indications	Potential Side Effects
Propofol	1–3 mg/kg	Routine induction, particularly for shorter procedures or to decrease potential for postoperative nausea and vomiting	Burning on injection Occasional myoclonus
Thiopental sodium	3–6 mg/kg	Routine induction	Precipitation with other drugs, particularly steroidal nondepolarizing muscle relaxant
Etomidate	0.2–0.3 mg/kg	Cardiovascular instability	Mild discomfort on injection Myoclonus
Ketamine	1–2 mg/kg	Cardiovascular instability Bronchospasm	Adrenal suppression reported Increases cerebral blood flow Increases secretions Nystagmus Possible dysphoria

limit further uptake of volatile inhalational agents. If ventilation is assisted or controlled, the concentration of inspired agent should be reduced.

Intravenous induction is generally chosen for older children and adolescents, for children at risk for aspiration of gastric contents, and for children of any age who present with intravenous access already in place, unless airway considerations make an inhalation induction preferable. Preoxygenation is important in children but may be difficult to accomplish; judicious premedication may be helpful in gaining their cooperation. Propofol is frequently used as an induction agent in pediatric anesthesia unless there are hemodynamic contraindications. The sensation of burning upon injection of propofol into a peripheral IV may be distressing and may be minimized with earlier injection of lidocaine and/or an opioid. Thiopental is an alternative for induction and may cause less distress upon injection. Ketamine or etomidate is used for induction for specific indications such as hemodynamic instability. Pediatric dosing for induction drugs is summarized in Table 63-2.

Neuromuscular blockade can be used to facilitate endotracheal intubation or may be required to provide optimal surgical conditions. As noted earlier, in the section on cardiac risk, succinylcholine is indicated in infants and children only when rapid control of the airway is required (laryngospasm or rapid sequence intubation). Some practitioners administer atropine prior to succinylcholine in infants and young children to minimize the potential for

bradycardia. The nondepolarizing muscle relaxants all can be used safely in pediatric practice. Mivacurium has the shortest duration but does not provide as reliable an onset or intubating conditions as does succinylcholine; with larger doses, histamine release is frequently seen. Rocuronium is the best alternative for rapid sequence intubation, but the effective dose of 1 mg/kg will have a duration longer than 1 hour. Pediatric doses for muscle relaxants are listed in Table 63-3 and are generally similar to those used in adult practice. Infants appear to have a somewhat increased volume of distribution but also an increased sensitivity to relaxants, so the initial dose remains similar to that used for adults. Rocuronium may have a longer duration of action in infants compared with older children or adults when given in the standard 0.6 mg/kg dose; a smaller dose (0.45 mg/kg) has been shown to produce good intubating conditions with a shorter duration.<sup>22</sup>

Reversal of nondepolarizing neuromuscular blockade is advisable unless significant time has elapsed (2 hours

after a routine intubating dose) or unless the patient clearly exhibits clinical signs of completely regaining full neuromuscular function. An anticholinergic agent (atropine or glycopyrrolate) is administered with reversal agents to prevent bradycardia. If reversal is accomplished with edrophonium, atropine should be given first and a positive response noted prior to administration of edrophonium because of this agent's rapid onset and strong potential to cause bradycardia. Neostigmine in a dose of 0.05–0.075 mg/kg is most commonly administered for reversal. Alternatively, edrophonium can be given at 0.5–1.0 mg/kg, although it may be less effective for reversal of profound neuromuscular block.

### Airway Management

Unique anatomic and physiologic aspects of the pediatric airway are discussed in Chapter 19. Because infants and younger children have a large occiput, a cloth roll placed under their shoulders may help to maintain a neutral (and patent) airway (Fig. 63-2). If

TABLE 63-3.

## Neuromuscular Blockade in Children

Drug	Dose	Duration
Succinylcholine	1.5–2.0 mg/kg	Short
Mivacurium	0.2–0.25 mg/kg	Short
Cisatracurium	0.1–0.2 mg/kg	Intermediate
Vecuronium	0.1 mg/kg	Intermediate
Rocuronium	0.45–0.6 mg/kg routine 1 mg/kg rapid sequence	Intermediate Long
Pancuronium	0.1 mg/kg	Long



**FIGURE 63-2.** Positioning in infants and toddlers. Because of the relatively large head, a roll under the shoulders may avoid flexion at the neck and maintain a patent airway. (Courtesy of Scott Tolle.)

the mask airway is stable after inhalation induction, maintenance anesthesia can be administered by a face mask, as commonly done for ear tubes and other minor surgical procedures. An oropharyngeal airway can be inserted when needed to maintain airway patency or if positioning of the mask airway requires frequent manipulation. A properly selected oral airway will reach from the lips to the angle of the jaw when held next to the child's face and, when inserted, will lift the tongue off the posterior pharynx. If access to the face will be limited but intubation is not required, an LMA can be used. Use of the LMA may offer an advantage over endotracheal intubation by decreasing adverse respiratory events in children with an upper respiratory tract infection.<sup>23</sup> Appropriate LMA sizes for various patient weights are listed in Table 63-4. Newer laryngeal mask devices, such as those that afford the ability to vent the stomach, are now being produced in pediatric sizes.

Laryngoscopy in infants and young children has some technical differences from laryngoscopy in adults because

**TABLE 63-4.**

**Laryngeal Mask Airway Sizes for Pediatric Patients**

Weight (kg)	LMA Size
<5	1
5-10	1.5
10-20	2
20-30	2.5
30-50	3

LMA, Laryngeal airway mask.

of age-related anatomic differences (see Chapter 19). The glottis is higher in the infant and at laryngoscopy appears more "anterior." The child's epiglottis is longer and "U shaped," and although rigid it is "slippery" and may be difficult to control with the laryngoscope blade (Fig. 63-3). In the United States, a straight blade is most commonly used in patients younger than 2 years. When performing a laryngoscopy with a straight blade, it is important to sweep the tongue to the patient's left; passing the tube down the flange of the blade will obscure the view of the glottis and reduce the likelihood of successful tracheal intubation. If the glottis is not seen after passing under the epiglottis, most likely the blade has already gone too deep and posteriorly; withdrawing the blade slowly with gentle cricoid pressure often will bring the glottic opening into view. Choice of laryngoscope blade size by patient age is summarized in Table 63-5. Intubation can be accomplished with use of a muscle relaxant, with a volatile agent supplemented with propofol and/or narcotic, or with deep inhalation anesthesia alone. When intubation is performed with a volatile agent alone, particularly sevoflurane, it must be accomplished quickly while the patient is at an adequate depth of anesthesia.

Traditionally, pediatric endotracheal tubes are selected to allow a small paratracheal gas leak at 20-25 cm H<sub>2</sub>O. Because the narrowest portion of a young child's airway is subglottic, the tube must not be forced if any resistance is felt, even if the tube has passed the glottis easily. Approximate endotracheal tube sizes by age are listed in Table 63-5. Tube size can be



**FIGURE 63-3.** Infant glottis. (Courtesy of A. Inglis, MD.)

selected based on age or height, or by selecting a tube with an outer diameter similar to the child's fifth finger. Because tubes are packaged according to internal diameter, specialized endotracheal tubes, such as reinforced tubes, may have a much larger outer diameter for a given internal diameter.

Traditionally, uncuffed endotracheal tubes have been used in children younger than 8-10 years because of concerns of pressure injury to the tracheal mucosa. Recent reports suggest that inappropriately large tubes may cause mucosal injury, but that complications related to cuffed tubes per se are not a significant concern in children with modern tubes made of less reactive materials. A randomized trial in children (term newborns to age 8 years) undergoing elective surgery showed no difference in postoperative complications. When cuffed tubes were used, the need to change tubes in order to achieve an appropriate fit was less common.<sup>24</sup> Specific indications necessitating cuffed tubes include aspiration risk and poor pulmonary compliance requiring ventilation with high peak inspiratory pressures. Advantages of cuffed tubes include the ability to use lower fresh gas flow rates and a decrease in operating room pollution from volatile anesthetics. A potential disadvantage is the slightly smaller internal diameter, as a tube one-half size smaller is generally chosen when a cuffed tube is placed. Balloon inflation must be performed carefully, and ideally cuff pressure should be measured. Smaller pediatric endotracheal

TABLE 63-5.

## Laryngoscope Blade and Endotracheal Tube Sizes

Age	Blade	ETT
Premature neonate	Miller 0	2.5–3.0
Term neonate	Miller 0 or 1	3.0–3.5
6–12 mo	Miller 1	3.5–4.0
1–2 y	Miller 1 or Wis-Hipple 1.5	4.0–4.5
2–8 y	Wis 1.5–Macintosh 2	4 + Age/4
>8 y	Miller 2, Macintosh 3	≥6.0

ETT, Endotracheal tube.

tubes tend to have low-volume, high-pressure cuffs. Although the lower residual volume and reduced compliance offer some protection against size increases or herniation, a small increase in volume may cause a significant increase in pressure on the tracheal wall. In larger-size pediatric tubes with low-pressure, high-volume cuffs, care should be used with inflation because the cuff size may reach twice the age-corresponding internal diameter of the trachea.<sup>25</sup> If nitrous oxide is used, cuff pressures should be checked or the cuff inflation adjusted periodically because nitrous oxide can diffuse into the cuff.

The small distance from vocal cords to carina leaves relatively little margin between correct placement and endobronchial location in small children. For cuffed tubes, the cuff should pass just a short distance below the cords. With uncuffed tubes, options include positioning based on the line markings at the distal end of the tube, deliberate endobronchial intubation and withdrawal until bilateral breath sounds are heard, or use of various approximation formulas, with the most common being tracheal tube (TT) depth (cm) =  $3 \times$  TT size [mm inner diameter (ID)]. Auscultation of bilateral breath sounds does not guarantee proper TT position; a fluoroscopic study showed a 12% incidence of endobronchial intubation in children with bilateral breath sounds, possibly related to ventilation through the Murphy eye.<sup>26</sup>

We are fortunate that modern anesthetic practice has brought with it a wider range of options for dealing with the difficult pediatric airway. In contrast to adult practice, an inhalation induction with spontaneous respiration is used in most pediatric patients with a difficult airway, simply because

the majority do not readily cooperate with awake or sedated intubation. Insufflation of gas through a nasal airway or endotracheal tube advanced into the nasopharynx may provide a stable airway to allow fiberoptic intubation in an anesthetized child. Awake or sedated intubation can be performed in infants and children and should be considered when there is no obvious way to ventilate the patient, as in congenital abnormalities that may preclude achieving a mask seal or when an LMA cannot be inserted. Topical anesthesia can be provided by allowing an infant to suck on a gloved finger with a small amount of local anesthetic jelly or by nebulized administration. In anesthetized patients, the LMA can serve as a rescue device in the setting of upper airway obstruction; it also can be used as a conduit for fiberoptic intubation. Fiberoptic technology and operator facility with fiberoptic intubation have improved significantly over time. Rigid fiberoptic laryngoscopes such as the Bullard scope are made in pediatric sizes, and intubation guided by a flexible lighted stylet is another technique. Skill with these options should be gained first in patients with normal airways.

### Anesthetic Maintenance

The entire spectrum of maintenance anesthetic techniques may be appropriate in various pediatric cases depending on the patient's status and type of surgery. Opinion varies as to whether one volatile agent has a significant advantage over another for pediatric anesthetic use (see Emergence Delirium below). Total intravenous anesthesia is being used more frequently for a variety of pediatric indications, such as minor procedures with spontaneous respiration and long-

er cases such as neurosurgical procedures where monitoring, particularly of motor evoked potentials, may be less affected than with volatile anesthetics. Metabolic acidosis related to prolonged propofol infusion has been of concern in pediatric intensive care patients.<sup>27</sup> Although propofol infusion is widely used in pediatric anesthesia, no clear cutoff exists regarding safe case duration.

### Extubation Choices

Endotracheal tubes can be removed either when the patient awakens or while the child is deeply anesthetized. The choice depends partly on the preferences and experience of the practitioner. Those who advocate extubation under deep anesthesia cite a smoother emergence with less coughing. Risks include laryngospasm and airway obstruction as the child emerges, which could occur in a rapid turnover setting after the anesthesiologist has left the recovery area. Deep extubation is discussed in some detail not to advocate its routine use but to emphasize that it requires particular attention to detail and should not be undertaken by individuals inexperienced with the technique, in institutions without proper support for anesthetized pediatric patients in a recovery area, or in patients with full stomachs or who are unable to protect or maintain a patent airway. A nonirritating anesthetic agent (e.g., sevoflurane or halothane) may prevent coughing during emergence.<sup>28</sup> If deep extubation is chosen, a stable pattern of spontaneous respiration must be established while the patient still is breathing oxygen and anesthetic gas. The patient should be moved and positioned prior to discontinuation of the anesthetic, and the patient should have no response to suctioning the oropharynx, stimulation such as jaw thrust, or slight in and out movement of the endotracheal tube. If the patient meets all of these criteria, the tube is removed carefully, with close attention to gas exchange after extubation. Evidence supporting or refuting the safety of deep extubation is inconclusive; existing studies are small and cover variable patient populations. Smoother emergence, particularly decreased coughing, has also been suggested when an LMA is removed during deep anesthesia rather than in awake children.<sup>29</sup> The type of surgery may impact this decision if blood or secretions



are present in the oropharynx or airway. Suctioning the emerging patient may produce laryngospasm.

## Fluid Therapy

Fluid therapy in pediatric anesthesia is based on calculation and replacement of the fasting deficit, maintenance fluid requirement, insensible and third space losses, and blood loss. Maintenance fluid and fasting deficits are based on rates of 4 mL/kg/h for the first 10 kg, 2 mL/kg/h for the second 10 kg, and 1 mL/kg/hr for weight >20 kg. Insensible and third space losses can be high in abdominal surgery, where the starting replacement volume is 10 mL/kg/hr with titration to normal heart rate, blood pressure, urine output, and clinical signs of perfusion. No evidence favors colloid over crystalloid as a generalization, but colloid replacement may have a role in maintaining oncotic pressure when administered volumes are high. Fluid boluses for volume-depleted children are given in increments of 10–20 mL/kg, followed by assessment of clinical parameters. Fluids should be warmed if large volumes are given.

Most healthy children do not need supplemental dextrose to maintain plasma glucose levels unless they have undergone prolonged fasting,<sup>30</sup> and liberalization of fasting guidelines may have further reduced any risk of hypoglycemia in healthy children. Patients in whom intravenous dextrose administration should be strongly considered include neonates, critically ill children with limited metabolic reserve or hepatic failure, and children who receive concentrated tube feedings or intravenous hyperalimentation. If the choice is made to administer dextrose, then the dextrose preferably is administered at a maintenance rate after replacement of the deficit or as a separate infusion. For neonates or high-risk patients, concentrated dextrose solutions may be appropriate; for healthy older children, 1–2.5% dextrose solutions are preferred to prevent hyperglycemia.

## Blood and Blood Products

Calculation of circulating blood volume and allowable blood loss are covered in depth in Chapter 19. As a useful quick estimate, children who start at a relatively normal hematocrit can lose at least 20% of their blood volume before requiring transfusion if

they are kept normovolemic. The patient's clinical condition as well as the rapidity of blood loss and expected further loss should be considered in deciding when to begin transfusion. As in adults, blood loss that is being replaced with crystalloid should be given in a 3:1 ratio. Packed cells 10 mL/kg will raise the hematocrit by approximately 10 percentage points. The amount required to replace the estimated blood loss also can be calculated based on a hematocrit of 70% contained in packed cells:

$$\text{Transfusion volume} = \text{Patient's blood volume} \times [(\text{Desired} - \text{Current Hct}) / \text{Hct of unit pRBCs}]$$

where Hct = hematocrit, and pRBCs = packed red blood cells.

When total transfused volumes of packed cells approach the patient's blood volume, both thrombocytopenia and depletion of clotting factors are common occurrences. Ideally these parameters are measured intraoperatively to guide replacement therapy, but on occasion rapidly changing clinical circumstances dictate empirical blood component therapy. Platelets usually are administered in a volume of 5–10 mL/kg; 10 mL/kg can be expected to raise the platelet concentration by 100,000/mm<sup>3</sup>. Thawed fresh-frozen plasma when indicated is also started at 10 mL/kg. Infused packed cells and/or plasma may cause hypocalcemia if given too rapidly as a result of binding of ionized calcium by citrate. In the setting of large-volume transfusions, potassium release from banked blood may be significant; requesting fresh units or washing the cells may prevent hyperkalemia.

## PEDIATRIC REGIONAL ANESTHESIA

### Overview and Safety

Regional anesthesia can provide a useful adjunct to general anesthesia for a variety of procedures in pediatric patients, either as a single injection or with postoperative infusion of local anesthetic. Advantages of regional anesthesia, such as good postoperative analgesia, avoidance of narcotic therapy with decreased nausea and vomiting, and early discharge from the recovery area, apply to the pediatric patient. In this chapter, techniques with particular

application in pediatric anesthesia are presented. For details of standard regional anesthetic techniques, the reader is referred to Chapters 46–48.

Performing a regional anesthetic in children who are too young to cooperate may require that the block be done during deep sedation or general anesthesia. Using a nerve stimulator to perform “surface mapping” prior to placing the needle may improve accuracy and decrease the number of attempts required.<sup>31</sup> Ultrasound techniques for imaging both neuraxial and peripheral blocks in children are under development. Potential complications of regional techniques in anesthetized patients include intraneural injection, direct needle damage, and local anesthetic toxicity. Few reports of intraneural injection or direct nerve injury from a needle are available. One case of a pediatric patient with spinal cord edema that caused a deficit for nearly 2 months after placement of a thoracic epidural has been reported.<sup>32</sup> A large retrospective study in France identified five serious adverse neurologic outcomes in 24,000 pediatric regional anesthetics (16,100 caudal and 7200 epidural), which were believed due to cerebrovascular air embolism or ischemic injury.<sup>33</sup> Venous air embolism with hemodynamic consequences has been described during caudal or epidural placement in small children; loss of resistance to air is not a recommended technique in pediatric patients. The pediatric anesthesia community has endorsed epidural placement under anesthesia as appropriate practice when there is a risk that the patient might otherwise move during the block, and when it is perceived that the patient will benefit from having the regional anesthetic technique as a component of the anesthetic and/or for postoperative pain management.<sup>34</sup> The risks and benefits must be weighed in each individual pediatric patient, especially if the procedure is technically difficult.

Local anesthetic toxicity may result from intravascular injection, rapid absorption of an inappropriately large dose, or intravascular accumulation of drug over time. If combinations of local anesthetic agents are used, the toxicity of the agents should be considered to be additive. Local anesthetic blood levels after caudal blocks and peripheral blocks in pediatric patients are generally within acceptable limits.

Several cases of toxicity due to accumulation of high levels in blood occurred in the early 1990s in the setting of postoperative infusion of local anesthetics. As a result of these reports, the recommendations of doses for pediatric infusion were revised, with a maximum dose of 0.4–0.5 mg/kg/h bupivacaine.<sup>35</sup> Infants may be at higher risk for toxicity because of their lower levels of plasma binding proteins and/or diminished clearance; this enhances the risk with re-dosing or catheter infusion techniques. It is recommended that maximum infusion rates of 0.25–0.3 mg/kg/h bupivacaine be given to patients 6 months and younger.

Because signs of local anesthetic toxicity may not be obvious in the anesthetized patient, use of a test dose is recommended to detect inadvertent intravascular injection. Aspiration of blood may not reliably occur, and CNS signs usually are not present in the anesthetized child. Heart rate changes may be less sensitive in the pediatric population, particularly when volatile anesthetics are being administered; changes in T-wave morphology on the ECG are a useful indicator of intravascular injection. Criteria for a positive test dose in an anesthetized child are heart rate increase >10 bpm, systolic blood pressure increase >15 mm Hg, and change in T-wave amplitude >25% in lead II. The recommended test dose in children is 0.5 µg/kg epinephrine (0.1 mL/kg of local anesthetic containing 1:200,000 epinephrine),<sup>36</sup> up to the 15-µg adult test dose. Use of a short-beveled needle or Angiocath may minimize the risk of intravascular injection. In addition, a slow incremental injection of local anesthetic is recommended (after test dose, administer total dose over 1–2 minutes). Because small veins may easily collapse, observing for passive blood return may be useful in addition to aspiration.

## Specific Techniques for Pediatric Regional Anesthesia

### Caudal Blocks and Alternatives

Caudal blocks are frequently performed in young children. This approach to the epidural space is simple, easy to learn, and has a good safety record (Fig. 63–4). Several large series, when combined, report results for >17,000 pediatric caudal blocks without long-term neurologic complications. Potential complications in the



**FIGURE 63–4.** Surface landmarks for caudal block. Both sacral cornua and the lateral borders of the sacrococcygeal hiatus can be palpated and outlined. The needle is inserted at the midpoint of the triangle at an approximately 45° angle to start.

anesthetized patient include intravascular injection of local anesthetic, which occurs in approximately 4 in 10,000 patients, and intrathecal injection with total spinal, with a reported incidence of 2.6 per 10,000 cases.<sup>37</sup> Although subarachnoid injection of a small dose of local anesthetic will result in the onset of spinal anesthesia, which is readily detected in the awake patient, detection is more difficult in the anesthetized patient. Children may not develop hypotension or bradycardia, even in the presence of a total spinal, but apnea may still occur due to medullary blockade.

Caudal blocks provide excellent analgesia for lower extremity, lower abdominal, and penoscrotal surgery. A short-beveled needle is placed through the sacral hiatus until a typical “pop” is felt and the needle is anchored in the

sacrococcygeal ligament (Fig. 63–5). Aspiration and free drainage should be negative for blood and cerebrospinal fluid. With correct placement, injection will be easy and will not result in swelling of the subcutaneous tissue. After an epinephrine-containing test dose, the full dose is injected incrementally. Clinical signs of correct placement are generally adequate, but use of a nerve stimulator to confirm caudal needle placement has been described. Laxity of the anal sphincter after placement of a caudal block has been shown to predict success of the block.<sup>38</sup> If there is doubt as to efficacy this sign may assist with the decision to provide additional analgesia. Although time to first urination may be longer than without a caudal block, urinary retention is generally not a significant clinical problem. Hemodynamic changes after a



**FIGURE 63–5.** Caudal block. (Reprinted from Hahn MB, McQuillan PM, Sheplock GJ, eds. *Regional Anesthesia: An Atlas of Anatomy and Techniques*. St. Louis: Mosby, 1996, with permission.)

caudal block usually are minimal in normovolemic patients. In traditional teaching, children do not show the effects of a sympathectomy because of relatively low sympathetic tone; however, esophageal Doppler studies show that caudal block results in a decrease in lower body vascular resistance and that blood pressure is maintained through compensatory upper extremity vasoconstriction.<sup>39</sup>

Bupivacaine in concentrations of 0.125–0.25% traditionally has been used for caudal blocks in children. Freshly added epinephrine to a concentration of 1:200,000 (5 µg/mL) may improve the duration of analgesia. For simplicity of dilution and dosing, many practitioners choose 1 mL/kg of either 0.125% or 0.25%. Because the block will begin to regress after several hours, for longer procedures a more concentrated solution or re-dosing the block at the end of the case is appropriate. Duration of analgesia from a single-shot caudal injection ranges from 4–12 hours. Blocks often are performed just after anesthetic induction to gain the benefit of the regional technique intraoperatively. Use of a larger volume of local anesthetic to achieve a higher level may block stimulation from traction during procedures such as orchidopexy.<sup>40</sup> The newer local anesthetics ropivacaine and levobupivacaine offer the advantages of decreased cardiac toxicity (demonstrated in animal studies)<sup>41</sup> and reduced motor block. Ropivacaine and levobupivacaine have equivalent efficacy at either 0.2% or 0.25% compared with bupivacaine 0.25% (all given at 1 mL/kg); ropivacaine produced the least motor blockade.<sup>42</sup>

A number of drugs have been used for analgesia by the caudal route either in addition to local anesthetics or alone. Caudally administered clonidine has shown good efficacy for augmenting and prolonging the analgesia produced by local anesthetics in a variety of procedures,<sup>43</sup> although one study reported no added effect from clonidine when given in conjunction with dilute local anesthetic.<sup>44</sup> Another study reported no difference in efficacy and side effects between clonidine administered caudally or intravenously.<sup>45</sup> Most studies of caudal or epidural administration of clonidine in children have shown good safety at single doses of 1–2 µg/kg with a lower incidence of nausea and vomiting than

produced by opioids. Some sedation is seen at the higher dose of 5 µg/kg. Most studies have not shown respiratory depression with epidural or caudal clonidine. Two case reports suggest the possibility that postoperative apnea in premature infants resulted from clonidine, although a causal relationship was not clearly established. Use of epidural or caudal clonidine is fairly common in children in the United States, although an FDA “black box” label warning regarding its use in acute postoperative pain management remains on the package related to hypotension in adult patients following epidural clonidine administration.

Ketamine has been shown to have good efficacy by the caudal route, but appropriate preparations of preservative-free S-ketamine are not universally available. Ketamine prolongs analgesia when combined with local anesthetic for caudal block. One study suggests a higher incidence of hallucinations in children receiving ketamine 0.5 mg/kg with local anesthetic in a caudal block.<sup>46</sup>

Although “single-shot” caudals are commonly performed for relatively minor procedures, catheters can be threaded via the caudal route either to allow re-dosing for longer infraumbilical surgery or for the purpose of threading the tip of the catheter to a higher thoracic or lumbar level.<sup>47</sup> In general, the ability to thread the catheter cephalad is best in infants because the epidural fat is not as dense as in older patients. The type of catheter may affect the success rate, and some recommend using a styletted catheter. Radiographic confirmation of tip placement may be helpful.<sup>48</sup> Use of a nerve stimulator to monitor tip placement by stimulation of the trunk musculature has been described.<sup>49</sup>

Ilioinguinal/iliohypogastric nerve blocks can be performed for procedures such as hernia repair and orchidopexy in children. The block can be performed preoperatively by the anesthesiologist or intraoperatively by the surgeon. Some surgeons believe that the injected local anesthetic distorts the surgical dissection planes and prefer to perform the block at the end of surgery. In this situation, a caudal block might be preferable to allow a contribution of the block during the anesthetic period. Many studies have compared caudal block to ilioinguinal block for hernia repair, with an overall

equivalent efficacy. Ilioinguinal blocks are considered safe and easy to perform but may have a relatively high failure rate; the success rate will depend on the operator’s experience and approach. Cadaver dissection has shown that the optimal insertion site is more lateral than is generally taught and is located approximately 2.5 mm medial to the anterior superior iliac spine on both sides of a line drawn between the anterior superior iliac spine and the umbilicus.<sup>50</sup> Ilioinguinal/iliohypogastric nerve blocks can be performed with significantly smaller volumes of local anesthesia and a much higher success rate when ultrasound guidance is used.<sup>51</sup> Although quite safe, complications such as puncture of the bowel wall with hematoma formation have been reported after ilioinguinal block. Other techniques, such as paravertebral or lumbar plexus blockade, have been used in pediatric patients in select settings. Further experience with these techniques is needed before their use can be recommended outside of centers performing high volumes of these techniques.

Penile block is frequently performed for circumcision and sometimes for simple hypospadias repair. Epinephrine should never be injected in a penile block because of the risk for vascular compromise. As with ilioinguinal blocks, many studies have compared caudal and penile blocks with variable results; most suggest that they are approximately equal. In the traditional dorsal penile block, the needle is passed from the base of the penis until the symphysis pubis is contacted, then withdrawn slightly and redirected to each side of the midline before local anesthetic is deposited. Because of the small risk of hematoma or damage to the dorsal penile vessels, some advocate a “ring block” or subcutaneous injection around the base of the penis. A combination of dorsal and ring blocks may provide the best analgesia. Simple application of topical anesthetic cream [eutectic mixture of local anesthetics (EMLA)] provided equivalent analgesia to dorsal penile block, but the duration of blockade was significantly longer with the injected nerve block.<sup>52</sup>

### **Spinal Anesthesia**

The primary use of spinal anesthesia in the pediatric population is for her-



nia repair or other relatively minor surgery in infants considered to be at risk for postoperative apnea. The dose requirement on a weight basis is significantly higher than in adults, and the duration is relatively shorter: 1 mg/kg hyperbaric bupivacaine has a duration of 1–2 hours. Levobupivacaine and ropivacaine also have been used. Clonidine has been shown to prolong analgesia but may increase apnea risk.<sup>53</sup> The decision to administer spinal anesthesia should depend on the patient's medical condition and the extent of the procedure. The perceived benefit of a reduced apnea frequency in comparison to general anesthesia in premature or former premature infants is valid only if no sedation is given. Spinal anesthesia may not be a good choice for a large or incarcerated hernia because of the limited duration and the fact that unsedated babies may fuss and strain. Some centers use spinal anesthesia in older children, in conjunction with sedation, for lower abdominal or lower extremity procedures.<sup>54</sup>

### Epidural Analgesia

Either thoracic or lumbar epidural catheters can be placed in children; safety considerations for placement in anesthetized patients are discussed in Overview and Safety. Postoperative epidural analgesia may be of benefit to pediatric patients after major thoracic, abdominal, urologic, and lower extremity surgery. Various regression formulas have been developed to predict the depth of the epidural space based on either the patient's weight or age (Table 63–6). Very roughly, for patients between 10 and 25 kg, the approximate depth of the epidural space in millimeters will be predicted by the weight in kilograms. Postoperative infusions should be prescribed to optimize analgesia and minimize side effects. Patient-controlled epidural analgesia (PCEA) can be given to children and may decrease total drug administration.<sup>55</sup> Patients as young as 5 years may be capable of using PCEA. The pediatric orthopedic community has expressed concern that epidural analgesia may “mask” development of a compartment syndrome, but in the reported cases pain was out of proportion to what was expected and was unrelieved by the epidural.<sup>56</sup> Nevertheless, complications other than inadequate epi-

dural analgesia must always be considered and evaluated promptly.

### Extremity Blocks

Regional anesthesia of the upper extremity can be used in children for procedures that will be performed on the arm and hand. Axillary blockade is the most common brachial plexus approach in children, although various infraclavicular approaches have been reported. Because of case reports of syrinx formation in adults after interscalene blocks placed under general anesthesia or deep sedation,<sup>57</sup> this approach is not recommended unless the patient can cooperate with block placement with minimal sedation. Performing the entire surgical procedure under a regional technique is less common in children than in adults. In conjunction with general anesthesia, even distal blocks can provide excellent analgesia for hand procedures.

A number of regional techniques can be performed in children for lower extremity surgery. Psoas compartment approach to the lumbar plexus has been described in children using a nerve stimulator; this block can be used for unilateral surgery on the hip, thigh, or knee.<sup>58</sup> Description of this block suggests a relatively slow learning curve, with 36% of patients requiring two or more attempts.<sup>59</sup> No serious complications were observed; however, vascular puncture occurred in 16% of patients. Femoral nerve blocks are useful in managing pain from a femur fracture, even preoperatively. The “fascia iliaca” block has a high rate of success in children when anesthesia of the obturator and lateral femoral cutaneous nerves is needed in addition to the femoral nerve. The sciatic nerve can be blocked by the traditional posterior approach, at the mid thigh, or in the popliteal fossa.

## POSTOPERATIVE PAIN MANAGEMENT

The anesthetic plan should include management of pain both in the immediate postoperative period and during later recovery, whether the patient is admitted to the hospital or sent home following surgery. Managing pain in children is a special challenge because our ability to evaluate their pain, and their ability to communicate their needs, may be limited. Pain scales based

TABLE 63–6.

### Predicted Depth of Epidural Space in Children

Weight (kg)	Predicted Depth of L4–5 Epidural Space (cm)	
	$0.8 + 0.05 \times \text{Weight (kg)}$	$1.094 + 0.048 \times \text{Weight (kg)}$
5	1.05	1.33
10	1.3	1.57
15	1.55	1.81
20	1.8	2.05
25	2.05	2.29
30	2.3	2.53

From Hasan MA, Howard RF, Lloyd-Thomas AR. Depth of epidural space in children. *Anaesthesia* 1994;49:1085; and Ozer Y, Ozer T, Altunkaya H, et al. The posterior lumbar dural depth: an ultrasonographic study in children. *Agri* 2005;17:53.

on behavior and facial expressions are available for younger children. Comprehensive postoperative pain management may include opioid or nonopioid analgesics, regional or local anesthesia, or a multimodal approach. When a regional anesthetic is the primary analgesic for the early postoperative period, the patient and parent should be told what to expect in terms of duration of effect, and plans for a transition to other types of analgesia should be formulated. Particularly for the outpatient, parents should be instructed to begin administering oral analgesics before the child is in severe pain.

Acetaminophen and nonsteroidal antiinflammatory drugs (NSAIDs) can provide significant postoperative pain relief and may have an opioid-sparing effect. Recent pharmacokinetic research has given us new insights into dosing for acetaminophen, particularly for rectal administration, where the onset time is slow and absorption is variable. After a rectal loading dose of acetaminophen, peak plasma concentration occurs at approximately 200 minutes. The current recommendation for rectal acetaminophen is for a loading dose of 40 mg/kg followed by 20 mg/kg every 6 hours; this dose does not appear to result in drug accumulation in the first 24 hours.<sup>60</sup> Oral administration of acetaminophen provides a faster onset and more reliable absorption. An oral loading dose of 40 mg/kg (compared with the traditional dose of



15 mg/kg) resulted in plasma levels at 30 and 60 minutes in an effective range to treat pain (after tonsillectomy) and below levels considered to be toxic.<sup>61</sup> Although higher doses are considered safe and effective in healthy children, parents of outpatients must understand the instructions regarding the concentration and amount to be administered. Smaller doses may be appropriate in critically ill patients or those with impaired drug clearance. Injectable forms of acetaminophen are in development but are not available in the United States; these may offer an advantage in eliminating the variability of onset time.

NSAIDs are used in children where there is no contraindication. Ketorolac has been used in strabismus surgery, orthopedics, general pediatric surgery, and urologic surgery with good safety and efficacy. As with many drugs, detailed data are not available for infants, but in limited studies ketorolac appears to be a safe and effective analgesic for infants. NSAIDs appear to be effective in treating pain after tonsillectomy, but studies are mixed as to whether this causes an increased bleeding risk due to inhibition of platelet aggregation.

Opioid analgesics are needed after many pediatric procedures. Side effects include somnolence, vomiting, pruritus, and risk of respiratory depression. Codeine, which has commonly been prescribed to children after surgery, is dependent on conversion to morphine for its effect; genetic variability in metabolism makes dosing relatively unreliable.<sup>62</sup> Fentanyl is given intravenously at a dose of 1–2 µg/kg for short procedures. For more major procedures, a loading dose ≥5 µg/kg is followed by hourly dosing of 1–3 µg/kg as needed. Morphine can be administered as a sole analgesic in a total dose of 0.1 mg/kg or titrated in smaller increments (0.02 mg/kg) after the initial use of fentanyl or another opioid intraoperatively. Nasal administration of fentanyl has been shown to be effective and is useful for minor procedures where intravenous access is not established, such as myringotomy with tubes.<sup>63</sup> Remifentanyl can be infused as a component of a general anesthetic technique, offering intraoperative titration and rapid emergence, but it provides no residual postoperative analgesia. Tramadol, a synthetic codeine derivative with a low affinity for µ-opioid receptors, may produce a

lower incidence of side effects than traditional opioids. Tramadol has been shown to have some analgesic efficacy in pediatric patients but may not be as effective as morphine.<sup>64</sup> Other adjunctive drugs, such as ketamine, clonidine, and dexmedetomidine, are being explored for their role in pediatric postoperative pain management. Regardless of the technique chosen, frequent assessment of analgesic efficacy and side effects, as well as access to appropriate breakthrough pain medication, is important to providing postoperative pain relief for children.

## RECOVERY PROBLEMS

### Postoperative Nausea and Vomiting

Postoperative vomiting is distressing to children and their parents, and may delay or prevent discharge of postsurgical patients from the recovery room. In the pediatric population, because nausea may be difficult to quantify, most studies focus on the incidence of vomiting. Overall, the incidence of vomiting is higher in children than in adults; the incidence rate appears to increase with age up to puberty and then further decrease.<sup>65</sup> The traditional wisdom that postoperative nausea and vomiting was linked to specific high-risk procedures has become controversial in adults. Procedures with a high incidence of postoperative vomiting in children include strabismus surgery, adenotonsillectomy, and orchidopexy. Gender differences are not believed to be a major factor until puberty. Opioids even in small doses increase the incidence of postoperative vomiting in children.

Risk indices of vomiting developed in adult populations do not apply well to children.<sup>66</sup> A four-component pediatric risk score has been proposed using the following factors: surgery ≥30 minutes, age ≥3 years, strabismus surgery, and positive history of postoperative vomiting in the patient, parents, or siblings.<sup>67</sup> Prospective validation in >1200 patients showed incidences of vomiting of 9%, 10%, 30%, 55%, and 70% with 0, 1, 2, 3, or 4 risk factors, suggesting the value of giving prophylactic antiemetics to patients with ≥2 risk factors. This study did not report an increased risk of vomiting with adenotonsillectomy or middle ear surgery. Postoperative administration of an opi-

oid was linked to increased risk but was not identified as a major predictor.

For patients at risk for postoperative vomiting, tailoring the anesthetic technique may be of benefit, using propofol rather than volatile anesthetics<sup>68</sup> and regional anesthesia, NSAIDs, and acetaminophen rather than opioids. The impact of nitrous oxide use in pediatric patients is as controversial as in adults, but one comparison of sevoflurane-anesthetized children did not show an increase in postoperative vomiting when nitrous oxide was used.<sup>69</sup> Adequate hydration intraoperatively and avoiding early oral intake may help reduce postoperative vomiting.

In patients at moderate to high risk of postoperative vomiting, prophylactic antiemetic therapy may be cost-effective. Pediatric dosing for antiemetic agents is summarized in Table 63–7. Droperidol has a dose-related antiemetic effect and is best administered near the end of surgery. Studies vary as to the optimal droperidol dose to maximize efficacy and minimize side effects, but the majority found best efficacy in the range from 50–75 µg/kg. Meta-analysis suggested that droperidol was as effective as ondansetron in adults but not in children,<sup>70</sup> whereas several individual pediatric studies found equal efficacy at higher doses of droperidol. The FDA issued a “black box” drug label warning on droperidol related to case reports of torsade de pointes and recommended that droperi-

TABLE 63–7.

Antiemetic Doses for Children

Drug	Dose
Ondansetron	50–100 µg/kg up to 4 mg
Dolasetron	350 µg/kg up to 12.5 mg
Dexamethasone	150 µg/kg up to 8 mg
Droperidol	50–75 µg/kg up to 1.25 mg (reserve for refractory vomiting and use under monitored conditions)
Dimenhydrinate	0.5 mg/kg
Perphenazine	70 µg/kg

From Gan et al.<sup>65</sup> with permission.

dol use be reserved for refractory nausea and vomiting and administered under ECG-monitored conditions.

Ondansetron and the newer 5-hydroxytryptamine<sub>3</sub> (5-HT<sub>3</sub>) receptor antagonists dolasetron and granisetron have excellent efficacy for prophylaxis and treatment of postoperative vomiting in children. The FDA approved dose of ondansetron is 0.1 mg/kg, which appears equivalent to 0.35 mg/kg dolasetron.<sup>71</sup> Some dose-related improvement in antiemetic efficacy is seen, but for most patients the lack of a significantly important effect does not justify the added expense of a larger dose. As with droperidol, administering ondansetron early in a case appears to be of no “preemptive” value; effect duration relates to the half-life of the drug.

Dexamethasone initially was used in tonsillectomy to prevent edema but was noted to reduce postoperative vomiting and improve pain scores. Subsequent studies showed that dexamethasone was efficacious as a prophylactic antiemetic in strabismus and other surgical procedures. Whereas the initial doses of dexamethasone used were quite large, it appears not to have a significant dose–response relationship, and doses as small as 0.05 mg/kg have been shown to be effective.<sup>72</sup> A combination of dexamethasone and ondansetron is frequently given for antiemetic prophylaxis and may be more effective than ondansetron alone.<sup>73</sup>

Metoclopramide, which has commonly been given for postoperative emesis, is no more effective than placebo.<sup>74</sup> Finally, there is interest in nonpharmacologic antiemetic therapy in children; acupuncture or electrostimulation may be as effective as the available medications.<sup>75</sup>

### Emergence Delirium

Postanesthetic agitation is a common problem in toddlers and young children. Many studies of the problem have been reported, but most were small and descriptive, with often conflicting results. The clinical impression of many anesthesiologists and postanesthesia care unit (PACU) nurses is that agitation is significantly more common with sevoflurane, but it occurs with variable frequency after anesthetics with all volatile agents.<sup>76</sup> The overall incidence of agitation is lower after propofol, and crossover studies between sevoflurane and propofol show a

lower incidence with propofol in individual patients, but a small percentage of children receiving repeat anesthetics exhibit severe agitation after propofol.

Pain is a contributing factor in postanesthetic agitation, but emergence agitation also is exhibited after anesthesia for nonpainful procedures, such as MRI, in children.<sup>77</sup> Agents that provide analgesia as well as sedation have shown efficacy in reducing agitation; these include fentanyl, ketamine, clonidine, and dexmedetomidine. Results have been mixed as to whether residual postoperative sedation with benzodiazepines or propofol reduces agitation. One study found a higher incidence of emergence delirium in children who had received midazolam premedication.<sup>78</sup>

The perceived prominence of agitation after sevoflurane may be due to a higher incidence in the very early postoperative period, whereas the overall PACU incidence may be similar among the inhalation agents.<sup>79</sup> The actual rate of emergence does not appear to be the cause of postanesthetic delirium. Agitation may be exhibited by children who have arrived asleep in the recovery room. A comparison between sevoflurane and propofol with children emerging at the same rate showed a significantly higher agitation rate in the sevoflurane group.<sup>80</sup> Delaying emergence by continuing the volatile anesthetic into the postoperative period does not appear to decrease the incidence of agitation,<sup>81</sup> although using nitrous oxide during the washout period may reduce the incidence.<sup>82</sup>

In addition to acute postoperative agitation, children may develop postoperative maladaptive behavioral changes, such as changes in sleep or eating patterns, separation anxiety, and withdrawn or aggressive behavior. Two prospective comparisons found no difference in the incidence of these disturbances in children receiving halothane or sevoflurane, although the results were mixed as to the incidence of emergence delirium with sevoflurane and halothane.<sup>83,84</sup> Kain et al.<sup>85</sup> identified an association between preoperative anxiety in both the child and the parent, emergence delirium, and maladaptive behaviors after discharge. They suggest that some children, based on their own personality traits and those of their parents, may be more susceptible to developing these changes after the experience of anesthesia and surgery.

Negative behavioral changes are more common in younger children.

## SELECTED CLINICAL AREAS IN PEDIATRIC ANESTHESIA

The remainder of this chapter is devoted to certain specific clinical scenarios that are unique to pediatric anesthesia. In some situations, this may complement more thoroughly in chapters on other subspecialties of anesthesiology. For example, specific types of pediatric craniotomy are discussed in this chapter, but general concepts of the management of intracranial pressure and intracranial procedures are discussed in Chapter 50. Other cases in pediatric anesthesia are presented within specialty chapters in this text (spine surgery in Chapter 64, tonsillectomy and pediatric airway surgery in Chapter 66, and anesthesia for MRI, radiation therapy, etc. in Chapter 69).

### Pediatric General Surgery and Urology

Children present for a variety of general surgical and urologic procedures. Elective surgery in healthy children typically are initiated with an inhalational anesthetic and for shorter, simpler procedures maintained with a mask or LMA. General anesthesia may be supplemented with a regional technique. Hernia surgery is frequently performed in infants and children. Surgical practice varies with regard to indications for exploration of the contralateral side if no clinical evidence of a hernia is seen; this also can be done laparoscopically. For boys with undescended testes, orchidopexy is performed through a groin incision when the patient has a palpable testis or may be combined with laparoscopy when the testis cannot be distinctly palpated. Having a clear understanding of the surgical plan helps the anesthesiologist choose an appropriate anesthetic technique. Although orchidopexy is performed through a groin incision similar to herniorrhaphy, orchidopexy patients tend to have more severe pain of longer duration; multimodal analgesia including a regional technique may be helpful. During both of these procedures, the occurrence of sudden intraoperative stimulation due to traction on the spermatic cord should be anticipated.

Hypospadias comprises a spectrum of lesions, and repair may require from 30 minutes to several hours. Complex lesions may require skin grafting or staged repairs. Caudal or penile blocks are frequently performed for these anesthetics; a urethral stent may be left in at the end of surgery. Recognition of vesicoureteral reflux in children has led to an increasing number of ureteral reimplantation procedures. Surgery usually is performed through a low transverse abdominal incision. Children are hospitalized for 2–3 days and may have a urinary catheter in place overnight. Advances in the operative management of ureteral reimplantation (e.g., minimizing use of catheters) have shortened the postoperative course. Bladder spasms may occur and can be treated with ketorolac.<sup>86</sup> Caudal and epidural analgesia also are frequently used for this surgery. Congenital anomalies of the kidney and ureters may lead to infection; these usually are repaired either through a flank incision or by laparoscopy.

### Laparoscopy in Children

Laparoscopy has become a common procedure in children for a variety of indications. Laparoscopic operations performed in children include transperitoneal procedures such as cholecystectomy, fundoplication, appendectomy, and exploration for undescended testes; retroperitoneal approaches to the kidney and urinary tract; and use of the laparoscope to visualize the contralateral side in inguinal hernia repair. Before or during laparoscopy, producing a pneumoperitoneum with CO<sub>2</sub> may cause systemic hypercarbia, and a higher peak airway pressure may be needed to produce adequate ventilation and oxygenation. Hemodynamic compromise from impairment of venous return or from gas embolism during insufflation is possible. Another potential source of gas embolization is use of the argon beam coagulator during laparoscopic procedures such as partial nephrectomy.<sup>87</sup> Although early studies suggested a decrease in aortic blood flow and stroke volume with a compensatory increase in systemic vascular resistance, other studies in healthy children having low-pressure insufflation for laparoscopic procedures showed that the cardiac index is preserved or minimally affected.<sup>88</sup> Respiratory parameters are pre-

dictably impacted by CO<sub>2</sub> insufflation. In children undergoing laparoscopy for urologic surgery, significant increases in end-tidal CO<sub>2</sub> and peak airway pressures were measured.<sup>89</sup> Pulmonary mechanics of infants may be impaired even at low inflation pressures. Transient oliguria or anuria may occur during laparoscopy, particularly in younger children. This appears to be a reversible phenomenon in brief procedures.<sup>90</sup>

Laparoscopy in children usually is performed with general anesthesia. Many anesthesiologists prefer endotracheal intubation to control respiratory changes, although an LMA may be acceptable if low intraabdominal inflation pressures are used. Analgesia usually can be satisfactorily provided by some combination of local anesthetic infiltration, acetaminophen, and NSAIDs. Caudal or epidural analgesia can be used as a supplement, but for uncomplicated laparoscopy they may not provide any benefit over simple local infiltration.

### Thoracotomy and Thoracoscopy

Children present for thoracic procedures for a number of reasons, such as primary lung processes, tumor, or drainage of empyema, as well as for access to tracheal structures or vascular anomalies. Many of the same considerations apply to thoracic anesthesia in children as in adults; however, systemic hypoxia may be a problem in small children because of their nonrigid rib cage and the potential for compression of the dependent lung.<sup>91</sup>

Video-assisted thoracoscopic surgery (VATS) is used in pediatric patients for biopsy or limited resection of a tumor or infectious lesions and for drainage and decortication of an empyema. Empyema may develop as a complication of community-acquired pneumonia even in otherwise healthy patients. In the pediatric population, several studies have suggested that early VATS results in a shorter overall hospital stay in empyema patients compared with tube thoracostomy, with shorter time to intervention and fewer invasive interventions. Earlier intervention with VATS also resulted in shorter surgical time and fewer postoperative complications, perhaps because disease progression was minimized.<sup>92</sup>

Historically, thoracotomy in children was performed with the surgeon

packing one lung out of the surgical field. Technically, VATS is much easier to perform if one lung can be deflated. As surgeons gained more exposure to one-lung ventilation with these procedures, it has become more commonly requested for open thoracotomy as well. Improvements in equipment (bronchial blockers, fiberoptic bronchoscopes) have enhanced our ability to perform independent lung ventilation in children.

When selecting a method for one-lung ventilation in children, the outer diameter of available tubes must be considered carefully and compared to the expected tracheal and bronchial sizes.<sup>93</sup> Double-lumen tubes, when available in appropriate sizes, allow suctioning of each lung and provision of oxygen and CPAP to the deflated lung. The smallest available double-lumen tube is 26 F, with an outer diameter of 9.3 mm. This is slightly larger than a 6.5-mm ID endotracheal tube and can be used in children as young as 8 years. A double-lumen tube for infants has been described but is not in common use. The Univent tube, which is a single-lumen tube with a built-in bronchial blocker, has a significantly larger outer diameter than standard single-lumen tubes of the same internal diameter. A 3.5-mm ID Univent tube is roughly comparable to a standard 6.0 endotracheal tube and should be able to be used in children 6 years of age and older. In children younger than 6 years of age, options for one-lung ventilation include use of a bronchial blocker with a standard endotracheal tube or intentional mainstem bronchial intubation. A bronchial blocker or Fogarty embolectomy catheter can be placed with the assistance of rigid or fiberoptic bronchoscopy. If technically feasible, fiberoptic placement is preferred to minimize the risk of dislodgement with other instrumentation; adaptors allow ventilation during manipulation and positioning of the bronchial blocker. Mainstem bronchial intubation can be performed blindly or with fiberoptic guidance. If mainstem intubation is planned, a smaller endotracheal tube must be used than what would be chosen for tracheal placement. Use of a small cuffed tube in this situation will allow inflation of the cuff once the tube is withdrawn into the tracheal, thus allowing reinflation and two-lung ventilation without the need to reintubate.

Options for one-lung ventilation in children are summarized in Table 63–8.

Other considerations for pediatric thoracic surgery include adequate venous access and appropriate monitoring. Use of an arterial catheter depends on the extent of the procedure and the underlying lung function. With use of pulse oximetry and capnography, the majority of children having VATS may not require arterial monitoring. In infants or those with severe lung disease, the ability to obtain blood gas samples may be vital. Most children can be extubated after a thoracotomy or VATS unless respiratory function is severely impaired. Appropriate analgesia is helpful in speeding recovery; for open procedures, this may include administration of a local anesthetic with or without an opioid through a thoracic epidural catheter or via a caudal catheter threaded to the thoracic region in small children.

### Pectus Excavatum and the Nuss Procedure

Pectus excavatum is the most common congenital chest wall deformity of children. Left uncorrected, it can result in respiratory compromise and cardiac compression. Traditionally, pectus excavatum was corrected during the teenage years by an open approach. More recently, a convex steel bar is inserted (“Nuss procedure”) to mechanically raise the sternum. Cartilage remodels over time, and the bar is removed several years later. After bar removal, patients have a subjective improvement in functional status and quality of life and a small but significant improvement in pulmonary function studies.<sup>94</sup>

Early studies of the Nuss procedure included a moderate intraoperative complication rate, including cardiac compression, disruption of great vessels with significant hemorrhage, and tension pneumothorax. A very low rate of complications occurs now because of improved surgeon experience and refinement of the surgical technique, particularly the use of thoracoscopy to guide bar placement.<sup>95</sup> Postoperative complications include dislodgement of the bar (which has been minimized through use of lateral stabilizers), pneumothorax, pneumonia, and significant pain. Outcomes appear better in younger patients, and the trend is toward correcting these deformities in the preteen years.

**TABLE 63–8.**

**Tube Selection for Single Lung Ventilation in Children**

Age (y)	ETT (ID) (mm) <sup>a</sup>	BB (F) <sup>b</sup>	Univent (ID) (mm) <sup>c</sup>	DLT (F) <sup>d</sup>
0.5–1	3.5–4	5		
1–2	4.0–4.5	5		
2–4	4.5–5.0	5		
4–6	5.0–5.5	5		
6–8	5.5–6	6	3.5	
8–10	6.0 cuffed	6	4.5	26
10–12	6.5 cuffed	6	4.5	26–28
12–14	6.5–7.0 cuffed	6	4.5	32
14–16	7.0 cuffed	7	6.0	35
16–18	7.0–8.0 cuffed	7	7.0	35

BB, bronchial blocker; DLT, double-lumen tube; ETT, endotracheal tube; ID, internal diameter.  
<sup>a</sup>Sheridan, Tracheal Tubes, Kendall Healthcare, Mansfield, MA.  
<sup>b</sup>Arrow International Corp., Redding, PA.  
<sup>c</sup>Fuji Systems Corporation, Tokyo, Japan.  
<sup>d</sup>26 F: Rusch, Duluth, GA: 28–35 F: Mallinckrodt Medical, Inc., St. Louis, MO.  
 From Hammer et al.<sup>93</sup> with permission.

Preoperative evaluation should search for cardiorespiratory compromise. Most patients have some mild degree of exercise limitation, but significant dyspnea should prompt further evaluation. The mechanism of exercise limitation in pectus excavatum remains controversial but may reflect a combination of restrictive lung disease and impaired right ventricular function. Pulmonary function testing and echocardiography are frequently performed but probably are not essential except for patients with significant symptoms. In some centers, these tests are considered a part of the routine preoperative pathway before pectus excavatum repair.

A standard general anesthetic is provided, often in conjunction with a thoracic epidural. In the early years of pectus bar placement, arterial lines were frequently placed because of concern for hemodynamic compromise and blood loss. This step is rarely considered necessary today with the surgical advances noted. Duration of surgery is approximately 2 hours; patients can be extubated at the end of the procedure unless they experienced intraoperative difficulties. Although pectus bar placement is considered a minimally invasive procedure, the initial postoperative period can involve significant pain due to the pressure of the bar. Thoracic epidural analgesia is commonly used, infusing a combination of local anesthetic and opioid. Patients are generally hospitalized for

4–5 days after Nuss repair, and the epidural is maintained for the first 2–3 days.

### Cancer-Related Procedures in Children

#### Abdominal Tumors

Neuroblastoma, the most common extracranial solid tumor of childhood, arises from neural crest cells. Risk varies depending on clinical stage and biologic features of the individual tumor. Children with neuroblastoma require biopsy for diagnosis and multiple imaging studies during treatment. Treatment may include either limited or aggressive surgical resection, chemotherapy, and/or radiation therapy. High-risk patients may receive a bone marrow transplant. Considerations before anesthesia for resection include adequate venous access, arterial monitoring if extensive blood loss is expected, and a complete blood count if chemotherapy has been given prior to surgery. A subset of these tumors may produce significant catecholamine secretion causing perioperative hemodynamic lability.

Wilms tumor (nephroblastoma) most commonly occurs in young children. If diagnosed in its early stages, it can be approached by laparoscopic nephrectomy. However, the tumor may remain asymptomatic until the mass is quite large, and resection may involve a more extensive procedure. If vascular and intracardiac extension have oc-



curred, then cardiopulmonary bypass may be required for resection. Renin production or renovascular compression may result in hypertension. Treatment and prognosis are stratified by surgical stage and histologic type.

### **Mediastinal Mass**

One other specific scenario in the pediatric population is management of mediastinal masses. Tumors, particularly lymphoma, may develop rapidly and present with respiratory symptoms related to mediastinal involvement. Anesthetic management of the child with a mediastinal mass is challenging. Inducing general anesthesia may lead to compression of the airway and/or vascular structures when thoracic muscle tone is reduced, with catastrophic results. A careful history should include questioning for exercise tolerance and tolerance of the supine position. This may give some idea of the severity of disease, but absence of symptoms does not eliminate the possibility of difficulties during anesthetic induction. Where possible, respiratory flow-volume loops are helpful in delineating the extent of airway compression. Unless the possibility of airway and vascular compression can be ruled out with preoperative tests, serious consideration should be given to performing a minimal procedure with local anesthesia to obtain the diagnosis and deferring more major interventions until after initial treatment with radiation therapy to reduce the mass of the tumor. If general anesthesia is required, maintenance of spontaneous respiration is the preferred technique. This is most commonly accomplished with inhalational anesthesia but also can be provided with intravenous agents (propofol, opioids, ketamine). A head-up or lateral induction position may prove helpful. Rigid bronchoscopy and cardiopulmonary bypass are considered emergency backup, and a plan should be formulated prior to induction.<sup>96</sup>

### **Anesthesia for Diagnostic and Therapeutic Procedures**

Children with leukemia, lymphoma, neuroblastoma, and certain CNS tumors typically require repeated lumbar punctures and/or bone marrow biopsies for initial diagnosis and treatment followup. In some cases, intrathecal chemotherapy is administered as well. These procedures are frequently performed with sedation or a

brief general anesthetic. Use of topical local anesthetic cream over the site can be useful in minimizing anesthetic requirements. Sedation depends on the individual patient but might include a combination of benzodiazepine and opioid (e.g., midazolam and fentanyl). Intravenous anesthesia is commonly provided with propofol with or without a short-acting narcotic.

## **ANESTHESIA FOR PEDIATRIC NEUROSURGERY**

Even in the absence of overt signs or symptoms of increased intracranial pressure, children presenting for ventriculoperitoneal shunt revision, resection of a brain tumor, or posterior fossa decompression may be near the point of decompensation and should be managed so that intracranial pressure does not increase. The history should address recent nausea and vomiting and the potential for volume depletion as well as aspiration risk. Preoperatively, oversedation should be avoided because of the risk for hypercarbia, but individual patients may benefit from judicious premedication in a monitored setting to minimize agitation. Intraoperatively, the various inhalational agents may cause a slight increase of intracranial pressure; maintenance of mean arterial pressure is critical to maintain the cerebral perfusion pressure.<sup>97</sup> Continuation of steroids and/or anticonvulsant medications may be appropriate in the perioperative period. If acute treatment of increased intracranial pressure is needed, hyperventilation, mannitol infusion (0.5–1 gm/kg), increasing anesthetic depth, and drainage of cerebrospinal fluid (when feasible) all may be appropriate.

### **Ventriculoperitoneal Shunt**

Ventriculoperitoneal shunts in infants are discussed in detail in Chapter 62. Older children may require replacement or revision of shunts because of malfunction or growth, or they may require new shunts after tumor resection or discovery of other intracranial pathology. In some cases of cysts or other obstruction to cerebrospinal fluid outflow, endoscopic ventriculotomy may restore normal flow patterns and obviate the need for shunting. Patients with multiple shunts may have an acquired latex allergy or may be

receiving treatment in a latex-free environment to prevent development of an allergy.

### **Craniotomy for Tumor**

A higher percentage of brain tumors are infratentorial in pediatric patients than in adults, with medulloblastoma and astrocytoma being the common posterior fossa lesions. Other common tumors include the supratentorial counterparts of medulloblastoma (pineoblastoma and primitive neuroectodermal tumor), glioma, and ependymoma. Anesthetic management for craniotomy is discussed in more depth in Chapter 50. In general for a pediatric craniotomy, adequate peripheral venous access and an arterial line are needed. Central lines are of limited use for aspirating air in the pediatric population and usually are not placed for this purpose in smaller children. If the anatomy and positioning suggest a risk of venous air embolus, then precordial Doppler monitoring should be used. Depending on the location of the tumor and the course of surgery, development of diabetes insipidus or other endocrine abnormalities may occur during or after surgery.

### **Posterior Fossa Decompression**

Chiari type I malformation, a caudal displacement of the cerebellar tonsils through the foramen magnum into the spinal canal, may result in a variety of symptoms, including headache or other pain, weakness, ataxia, and sensory loss. Patients may have brainstem and spinal cord dysfunction, the latter often as a result of syrinx formation. Surgical management consists of suboccipital craniectomy with posterior fossa decompression. Extreme flexion should be avoided to minimize the risk of brainstem compression. Postoperatively, these patients may have respiratory abnormalities, perhaps related to ischemia or edema of the brainstem respiratory centers.

### **Craniosynostosis**

Craniosynostosis represents premature closure of one or more cranial sutures. The incidence is approximately 1 in 2000 births, with more males than females affected. Uncorrected, craniosynostosis may lead to increased intracranial pressure. Correction may be performed for cosmetic reasons. Simple craniosynostoses usually are corrected between 3 and 6 months of

age. More complex craniofacial reconstruction usually is performed after 9 months of age. Although reconstruction is an extradural procedure, significant blood loss from the scalp and cranium may occur. Adequate venous access, an arterial line for monitoring blood pressure and hemoglobin concentration, and availability of blood and blood products are critical to safe management. Overall, morbidity and mortality are low for craniostomy surgery. Adverse events are significantly associated with secondary versus primary operation and in patients with craniofacial syndromes.

Craniosynostosis may be an isolated defect or form part of a craniofacial syndrome, such as Crouzon or Apert syndrome, which can include a difficult airway, cleft palate, syndactyly, and cardiac or other abnormalities. Preoperative evaluation should be geared toward evaluation of the airway, vascular access, baseline neurologic status, and other anomalies. Children with uncorrected complex craniosynostosis may have increased intracranial pressure, decreased cerebral perfusion pressure, and obstructive respiratory symptoms, particularly during sleep.<sup>98</sup>

Preparation for the case includes consideration of positioning, including access to the patient and lines, and avoidance of soft-tissue or ischemic injury. Surgeons may request elevation of the head to enhance venous drainage; however, the advantage must be weighed against the risk of venous air entrainment. Goals of anesthetic management include minimizing severe increases in intracranial pressure. Hyperventilation and/or administration of mannitol may be indicated if the craniectomy is technically difficult. Monitoring must include evaluation of circulating blood volume status, blood loss, and associated metabolic changes, and maintenance of temperature. Ideally, an anesthetic technique is chosen so that surgery is completed with adequate analgesia and a calm patient, but with the ability to evaluate neurologic status.

Several studies suggest that venous air embolism occurs frequently during craniostomy repair, although the majority of episodes are not hemodynamically significant.<sup>99</sup> Sequelae of air embolus include hypotension and a paradoxical embolus if a right-to-left intracardiac shunt exists. Steps that may prevent a significant air embolus include maintenance of adequate vas-

cular volume, positive-pressure ventilation, and monitoring for early detection. Use of precordial Doppler has been shown to be effective in detecting air embolism and is more sensitive than end-tidal nitrogen measurement. Transesophageal echocardiography is extremely sensitive but may have some practical limitations. Management of venous air embolism includes communication with the surgeon to reposition the patient, flood the field with saline, and use bone wax in an attempt to limit the amount of entrained air. If nitrous oxide has been given, it should be discontinued. Compression of the jugular veins may increase venous pressure and prevent further air entrainment. Aspiration of air is technically difficult to achieve in small children. Factors contributing to the high frequency of air embolus in children include a relatively large head size, as a result of which the surgical field may be unintentionally positioned above the heart. The infant scalp is highly vascular, and when rapid blood loss and a decrease in central venous pressure occur, the pressure gradient will favor entrainment of air. The volume of entrained air is greater in comparison to the child's cardiac and vascular volume, leading to the possibility of more pronounced hypotension. In addition, the existence of a persistent patent foramen ovale in 50% of children younger than 5 years increases the potential for paradoxical air embolus.

Blood loss during craniostomy repair frequently requires transfusion, almost 95% of patients in most studies. Newer surgical techniques may result in reduced blood loss. These techniques include earlier surgical reconstruction, when the skull is less well formed; use of spring-mediated cranial expansion rather than full cranial vault reconstruction<sup>100</sup>; and endoscopic strip craniectomy, which may have a lower risk for air embolus. Techniques that have been used to minimize allogeneic blood transfusion include preoperative administration of erythropoietin, selection of an optimal age to achieve a favorable balance between fetal and adult hemoglobin, preoperative preparation of an autologous blood supply, and intraoperative and postoperative blood salvage and reinfusion. When massive transfusion is required, coagulopathy may develop. In one series of craniostomy patients, the subgroup requiring a large-

er than average amount of packed cells developed a coagulopathy that was primarily related to a dilutional lack of clotting factors.<sup>101</sup>

After routine craniostomy repair, most patients with a normal airway can be extubated. Ongoing blood loss from drains may require further transfusions during the next 24 hours. If the procedure was extensive or blood loss was very large, hemodynamic stability or swelling may suggest the need to leave the patient intubated and perhaps mechanically ventilated in the early postoperative period.

## Pediatric Ambulatory Surgery

Some of the procedures described here, as well as many ear, nose, and throat (ENT) and ophthalmologic procedures discussed elsewhere in this textbook, can be performed on an outpatient basis. Ambulatory surgery is frequently performed in a mixed adult/pediatric setting, but facilities, equipment, and staff competencies must be suitable for the pediatric population being treated. General concepts of ambulatory anesthesia are discussed in Chapter 67, and many of these concepts apply to children: the anesthetic should be tailored to rapid recovery with attention to pain management and control of postoperative vomiting. A qualified caregiver for the pediatric patient should be present at home for the remainder of the day and night, and parents must be given careful instructions about postoperative medications and any signs or symptoms that should evoke their concern or a return to the hospital.

## CONCLUSION

The practice of pediatric anesthesia encompasses a broad spectrum of surgery and patients and creates many challenges in terms of patient and family dynamics, technical skills, and anatomic and physiologic factors. Meticulous attention to detail and anticipation of common perioperative problems are essential, as are training and ongoing experience in the care of children.

## KEY REFERENCES

1. Murat I, Constant I, Maud'huy H. Perioperative anaesthetic morbidity

ty in children: a database of 24,165 anaesthetics over a 30-month period. *Paediatr Anaesth* 2004;14:158.

2. Tait AR, Malviya S. Anesthesia for the child with an upper respiratory tract infection: still a dilemma? *Anesth Analg* 2005;100:59.

3. Cote CJ, Zaslavsky A, Downes JJ, et al. Postoperative apnea in former preterm infants after inguinal herniorrhaphy. *Anesthesiology* 1995;82:809.

4. Morray JP, Geiduschek JM, Ramamoorthy C, et al. Anesthesia-related cardiac arrest in children: initial findings of the Pediatric Perioperative Cardiac Arrest (POCA) Registry. *Anesthesiology* 2000;93:6.

5. Hackel A, Badgwell JM, Binding RR, et al. Guidelines for the pediatric perioperative anesthesia environment. *Pediatrics* 1999;103:512.

6. Kain ZN, Mayes LC, Wang SM, et al. Parental presence and a sedative premedicant for children undergoing surgery: a hierarchical study. *Anesthesiology* 2000;92:939.

7. Krane E, Dalens B, Murat I, et al. Epidural catheters in anesthetized patients. *Reg Anesth Pain Med* 1998;23:433.

8. Giaufre E, Dalens B, Gombert A. Epidemiology and morbidity of regional anesthesia in children: a one-year prospective survey of the French-Language Society of Pediatric Anesthesiologists. *Anesth Analg* 1996;83:904.

9. Birmingham PK, Tobin MJ, Fisher DM, et al. Initial and subsequent dosing of rectal acetaminophen in children: a 24-hour pharmacokinetic study of new dose recommendations. *Anesthesiology* 2001;94:385.

10. Kain ZN, Caldwell-Andrews AA, Weinberg ME, et al. Sevoflurane versus halothane: postoperative maladaptive behavioral changes: a randomized, controlled trial. *Anesthesiology* 2005;102:720.

## REFERENCES

- Tiret L, Nivoche Y, Hatton F, et al. Complications related to anaesthesia in infants and children. *Br J Anaesth* 1988;61:263.
- Murat I, Constant I, Maud'huy H. Perioperative anaesthetic morbidity in children: a database of 24,165 anaesthetics over a 30-month period. *Paediatr Anaesth* 2004;14:158.
- Tait AR, Malviya S. Anesthesia for the child with an upper respiratory tract infection: still a dilemma? *Anesth Analg* 2005;100:59.
- Warner MA, Warner ME, Warner DO, et al. Perioperative pulmonary aspiration in infants and children. *Anesthesiology* 1999;90:66.
- Keller C, Brimacombe J, Bittersohl J, et al. Aspiration and the laryngeal mask airway: three cases and a review of the literature. *Br J Anaesth* 2004;93:579.
- Cote CJ, Zaslavsky A, Downes JJ, et al. Postoperative apnea in former preterm infants after inguinal herniorrhaphy. *Anesthesiology* 1995;82:809.
- Welborn LG, Hannallah RS, Fink R, et al. High-dose caffeine suppresses postoperative apnea in former preterm infants. *Anesthesiology* 1989;71:347.
- Welborn LG, Rice LJ, Hannallah RS, et al. Postoperative apnea in former preterm infants: prospective comparison of spinal and general anesthesia. *Anesthesiology* 1990;72:838.
- William JM, Stoddart PA, Williams SA, et al. Post-operative recovery after inguinal herniotomy in ex-premature infants: comparison between sevoflurane and spinal anaesthesia. *Br J Anaesth* 2001;86:366.
- Morray JP, Geiduschek JM, Caplan RA, et al. A comparison of pediatric and adult anesthesia closed malpractice claims. *Anesthesiology* 1993;78:461.
- Morray JP, Geiduschek JM, Ramamoorthy C, et al. Anesthesia-related cardiac arrest in children: initial findings of the Pediatric Perioperative Cardiac Arrest (POCA) Registry. *Anesthesiology* 2000;93:6.
- Bhananker SM, Ramamoorthy C, Posner KL, et al. Changing profile of anesthesia-related cardiac arrests in children: update from pediatric peri-operative cardiac arrest (POCA) registry. *Anesthesiology* 2005;103:A1310.
- Larach MG, Rosenberg H, Gronert GA, et al. Hyperkalemic cardiac arrest during anesthesia in infants and children with occult myopathies. *Clin Pediatr* 1997;36:9.
- Keenan RL, Shapiro JH, Kane FR, et al. Bradycardia during anesthesia in infants. An epidemiologic study. *Anesthesiology* 1994;80:976.
- Mamie C, Habre W, Delhumeau C, et al. Incidence and risk factors of perioperative respiratory adverse events in children undergoing elective surgery. *Paediatr Anaesth* 2004;14:218.
- Hackel A, Badgwell JM, Binding RR, et al. Guidelines for the pediatric perioperative anesthesia environment. *Pediatrics* 1999;103:512.
- Stevenson GW, Tobin MG, Horn BJ, et al. The effect of circuit compliance on delivered ventilation with use of an adult circle system for time cycled volume controlled ventilation using an infant lung model. *Paediatr Anaesth* 1998;8:139.
- Kain ZN, Mayes LC, Wang SM, et al. Parental presence and a sedative premedicant for children undergoing surgery: a hierarchical study. *Anesthesiology* 2000;92:939.
- Kain ZN, Caldwell-Andrews AA, Wang S. Parental intervention choices for children undergoing repeated surgeries. *Anesth Analg* 2003;96:970.
- Constant I, Seeman R, Murat I. Sevoflurane and epileptiform EEG changes. *Paediatr Anaesth* 2005;15:266.
- Holzman RS, van der Velde ME, Kaus SJ, et al. Sevoflurane depresses myocardial contractility less than halothane during induction of anesthesia in children. *Anesthesiology* 1996;85:1260.
- Rapp HJ, Altenmueller CA, Waschke C. Neuromuscular recovery following rocuronium bromide single dose in infants. *Paediatr Anaesth* 2004;14:329.
- Tait AR, Pandit UA, Voepel-Lewis T, et al. Use of the laryngeal mask airway in children with upper respiratory tract infections: a comparison with endotracheal intubation. *Anesth Analg* 1998;86:706.
- Khine HH, Corrdry DH, Kettrick RG, et al. Comparison of cuffed and uncuffed endotracheal tubes in young children during general anesthesia. *Anesthesiology* 1997;86:627.
- Bernet V, Dullenkopf A, Maino P, et al. Outer diameter and shape of paediatric tracheal tube cuffs at higher inflation pressures. *Anaesthesia* 2005;60:1123.
- Verghese ST, Hannallah RS, Slack MC, et al. Auscultation of bilateral breath sounds does not rule out endobronchial intubation in children. *Anesth Analg* 2004;99:56.
- Bray RJ. Propofol infusion syndrome in children. *Paediatr Anaesth* 1998;8:491.
- Valley RD, Freid EB, Bailey AG, et al. Tracheal extubation of deeply anesthetized pediatric patients: a comparison of desflurane and sevoflurane. *Anesth Analg* 2003;96:1320.
- Pappas AL, Sukhani R, Lurie J, et al. Severity of airway hyperreactivity associated with laryngeal mask airway removal: correlation with volatile anesthetic choice and depth of anesthesia. *J Clin Anesth* 2001;13:498.
- Leelanukrom R, Cunliffe M. Intraoperative fluid and glucose management in children. *Paediatr Anaesth* 2000;10:353.
- Bosenberg AT, Raw R, Boezaart AP. Surface mapping of peripheral nerves in children with a nerve stimulator. *Paediatr Anaesth* 2002;12:398.
- Kasai T, Yaegashi K, Hirose M, et al. Spinal cord injury in a child caused by an accidental dural puncture with a single-shot thoracic epidural needle (case report). *Anesth Analg* 2003;96:65.
- Flandin-Blety C, Barrier G. Accidents following extradural analgesia in children. The results of a retrospective study. *Paediatr Anaesth* 1995;5:41.



34. Krane E, Dalens B, Murat I, et al. Epidural catheters in anesthetized patients. *Reg Anesth Pain Med* 1998;23:433.
35. Berde C. Convulsions associated with pediatric regional anesthesia [Editorial]. *Anesth Analg* 1992;75:164.
36. Tanaka M, Nishikawa T. The efficacy of a simulated intravascular test dose in sevoflurane-anesthetized children: a dose-response study. *Anesth Analg* 1999;89:632.
37. Giaufre E, Dalens B, Gombert A. Epidemiology and morbidity of regional anesthesia in children: a one-year prospective survey of the French-Language Society of Pediatric Anesthesiologists. *Anesth Analg* 1996;83:904.
38. Vergheze ST, Mostello LA, Patel RI, et al. Testing anal sphincter tone predicts the effectiveness of caudal analgesia in children. *Anesth Analg* 2002;94:1161.
39. Larousse E, Asehnoune K, Dartayet B, et al. The hemodynamic effects of pediatric caudal anesthesia assessed by esophageal Doppler. *Anesth Analg* 2002;94:1165.
40. Vergheze ST, Hannallah RS, Rice LJ, et al. Caudal anesthesia in children: effect of volume versus concentration of bupivacaine on blocking spermatic cord traction response during orchidopexy. *Anesth Analg* 2002;95:1219.
41. Groban L, Deal D, Vernon J, et al. Cardiac resuscitation after incremental overdosage with lidocaine, bupivacaine, levobupivacaine, and ropivacaine in anesthetized dogs. *Anesth Analg* 2001;92:37.
42. Ivani G, DeNegri P, Conio A, et al. Comparison of racemic bupivacaine, ropivacaine, and levo-bupivacaine for pediatric caudal anesthesia: effects on postoperative analgesia and motor block. *Reg Anesth Pain Med* 2002;27:157.
43. Ivani G, De Negri P, Conio A, et al. Ropivacaine-clonidine combination for caudal blockade in children. *Acta Anaesthesiol Scand*; 2000;44:446.
44. Wheeler M, Patel A, Suresh S, et al. The addition of clonidine 2 microg·kg<sup>-1</sup> does not enhance the postoperative analgesia of a caudal block using 0.125% bupivacaine and epinephrine 1:200,000 in children: a prospective, double-blind, randomized study. *Paediatr Anaesth* 2005;15:476.
45. Hansen TG, Henneberg SW, Walther-Larsen S, et al. Caudal bupivacaine supplemented with caudal or intravenous clonidine in children undergoing hypospadias repair: a double-blind study. *Br J Anaesth* 2004;92:223.
46. Kumar P, Rudra A, Pan AK, et al. Caudal additives in pediatrics: a comparison among midazolam, ketamine, and neostigmine coadministered with bupivacaine. *Anesth Analg* 2005;101:69–73.
47. Bosenberg AT, Bland BA, Schulte-Steinberg O, et al. Thoracic epidural anesthesia via caudal route in infants. *Anesthesiology* 1988;69:265.
48. Valairucha S, Seefelder C, Houck CS. Thoracic epidural catheters placed by the caudal route in infants: the importance of radiographic confirmation. *Paediatr Anaesth* 2002;12:424.
49. Tsui BC, Wagner A, Cave D, et al. Thoracic and lumbar epidural analgesia via the caudal approach using electrical stimulation guidance in pediatric patients: a review of 289 patients. *Anesthesiology* 2004;100:683.
50. van Schoor AN, Boon JM, Bosenberg AT, et al. Anatomical considerations of the pediatric ilioinguinal/iliohypogastric nerve block. *Paediatr Anaesth* 2005;15:371.
51. Willschke H, Marhofer P, Bosenberg A, et al. Ultrasonography for ilioinguinal/iliohypogastric nerve blocks in children. *Br J Anaesth* 2005;95:226.
52. Choi WY, Irwin MG, Hui TW, et al. EMLA cream versus dorsal penile nerve block for postcircumcision analgesia in children. *Anesth Analg* 2003;96:396.
53. Rochette A, Troncin R, Raux O, et al. Clonidine added to bupivacaine in neonatal spinal anesthesia: a prospective comparison in 124 preterm and term infants. *Paediatr Anaesth* 2005;15:1072.
54. Puncuh F, Lampugnani E, Kokki H. Use of spinal anaesthesia in paediatric patients: a single centre experience with 1132 cases. *Paediatr Anaesth* 2004;14:564.
55. Antok E, Bordet F, Duffo F, et al. Patient-controlled epidural analgesia versus continuous epidural infusion with ropivacaine for postoperative analgesia in children. *Anesth Analg* 2003;97:1608.
56. Lejus C. What does analgesia mask? *Paediatr Anaesth* 2004;14:622.
57. Benumof JL. Permanent loss of cervical spinal cord function associated with interscalene block performed under general anesthesia. *Anesthesiology* 2000;93:1541.
58. Schuepfer G, Johr M. Psoas compartment block in children: part I—description of the technique. *Paediatr Anaesth* 2005;15:461.
59. Schuepfer G, Johr M. Psoas compartment block in children: part II—generation of an institutional learning curve with a new technique. *Paediatr Anaesth* 2005;15:465.
60. Birmingham PK, Tobin MJ, Fisher DM, et al. Initial and subsequent dosing of rectal acetaminophen in children: a 24-hour pharmacokinetic study of new dose recommendations. *Anesthesiology* 2001;94:385.
61. Bolton P, Bridge H, Montgomery C, et al. The analgesic efficacy of preoperative high dose (40 mg·kg<sup>-1</sup>) oral acetaminophen after bilateral myringotomy and tube insertion in children. *Paediatr Anaesth* 2002;12:29.
62. Williams DG, Patel A, Howard RF. Pharmacogenetics of codeine metabolism in an urban population of children and its implications for analgesic reliability. *Br J Anaesth* 2002;89:839.
63. Galinkin JL, Fazi LM, Cuy RM, et al. Use of intranasal fentanyl in children undergoing myringotomy and tube placement during halothane and sevoflurane anesthesia. *Anesthesiology* 2000;93:1378.
64. Ozalevli M, Unlugenc H, Tuncer U, et al. Comparison of morphine and tramadol by patient-controlled analgesia for postoperative analgesia after tonsillectomy in children. *Paediatr Anaesth* 2005;15:979.
65. Gan TJ, Meyer T, Apfel CC, et al. Consensus guidelines for managing postoperative nausea and vomiting. *Anesth Analg* 2003;97:62.
66. Eberhart LH, Morin AM, Guber D, et al. Applicability of risk scores for postoperative nausea and vomiting in adults to paediatric patients. *Br J Anaesth* 2004;93:386.
67. Eberhart LH, Geldner G, Kranke P, et al. The development and validation of a risk score to predict the probability of postoperative vomiting in pediatric patients. *Anesth Analg* 2004;99:1630.
68. Sarti A, Busoni P, Dell'Oste C, et al. Incidence of vomiting in susceptible children under regional analgesia with two different anaesthetic techniques. *Paediatr Anaesth* 2004;14:251.
69. Bortone L, Picetti E, Mergoni M. Anaesthesia with sevoflurane in children: nitrous oxide does not increase postoperative vomiting. *Paediatr Anaesth* 2002;12:775.
70. Domino KB, Anderson EA, et al. Comparative efficacy and safety of ondansetron, droperidol, and metoclopramide for preventing postoperative nausea and vomiting: a meta-analysis. *Anesth Analg* 1999;88:1370.
71. Olutoye O, Jantzen EC, Alexis R, et al. A comparison of the costs and efficacy of ondansetron and dolasetron in the prophylaxis of postoperative vomiting in pediatric patients undergoing ambulatory surgery. *Anesth Analg* 2003;97:390.
72. Mathew PJ, Madan R, Subramaniam R, et al. Efficacy of low-dose dexamethasone for preventing postoperative nausea and vomiting following strabismus repair in children. *Anaesth Intensive Care* 2004;32:372.
73. Splinter WM, Rhine EJ. Low-dose ondansetron with dexamethasone more effectively decreases vomiting after strabismus surgery in children than does high-dose ondansetron. *Anesthesiology* 1998;88:72.
74. Scuderi PE, Weaver RG, James RL, et al. A randomized, double-blind, placebo controlled comparison of droperidol, ondansetron, and metoclopramide for the prevention of vomiting following outpatient strabismus surgery in children. *J Clin Anesth* 1997;9:551.
75. Wang SM, Kain ZN. P6 acupoint injections are as effective as droperidol in controlling early postoperative nausea and vomiting in children. *Anesthesiology* 2002;97:359.
76. Voepel-Lewis T, Malviya S, Tait AR. A prospective cohort study of emergence agitation in the pediatric postanesthesia care unit. *Anesth Analg* 2003;96:1625.
77. Cravero J, Surgenor S, Whalen K. Emergence agitation in paediatric patients after sevoflurane anaesthesia and no surgery: a comparison with halothane. *Paediatr Anaesth* 2000;10:419.
78. Cole JW, Murray DJ, McAllister JD, et al. Emergence behaviour in children: defin-



ing the incidence of excitement and agitation following anaesthesia. *Paediatr Anaesth* 2002;12:442.

79. Weldon BC, Bell M, Craddock T. The effect of caudal analgesia on emergence agitation in children after sevoflurane versus halothane anesthesia. *Anesth Analg* 2004;98:321.

80. Cohen IT, Finkel JC, Hannallah RS, et al. Rapid emergence does not explain agitation following sevoflurane anaesthesia in infants and children: a comparison with propofol. *Paediatr Anaesth* 2003;13:63.

81. Oh AY, Seo KS, Kim SD, et al. Delayed emergence process does not result in a lower incidence of emergence agitation after sevoflurane anesthesia in children. *Acta Anaesthesiol Scand* 2005;49:297.

82. Shibata S, Shigeomi S, Sato W, et al. Nitrous oxide administration during wash-out of sevoflurane improves postanesthetic agitation in children. *J Anesth* 2005;19:160.

83. Kain ZN, Caldwell-Andrews AA, Weinberg ME, et al. Sevoflurane versus halothane: postoperative maladaptive behavioral changes: a randomized, controlled trial. *Anesthesiology* 2005;102:720.

84. Keaney A, Diviney D, Harte S, et al. Postoperative behavioral changes following anesthesia with sevoflurane. *Paediatr Anaesth* 2004;14:866.

85. Kain ZN, Caldwell-Andrews AA, Maranets I, et al. Preoperative anxiety, emergence delirium and postoperative maladaptive behaviors: are they related? *Anesth Analg* 2004;99:1648.

86. Park JM, Houck CS, Sethna NF, et al. Ketorolac suppresses postoperative bladder spasms after pediatric ureteral reimplantation. *Anesth Analg* 2000;91:11-15.

87. Weld KJ, Ames CD, Landman J, et al. Evaluation of intra-abdominal pressures and gas embolism during laparoscopic partial nephrectomy in a porcine model. *J Urol* 2005;174:1457.

88. Sakka SG, Huettemann E, Petrat G, et al. Transoesophageal echocardiographic assessment of haemodynamic changes during laparoscopic herniorrhaphy in small children. *Br J Anaesth* 2000;84:330.

89. Halachmi S, El-Ghoneimi A, Bissonnette B, et al. Hemodynamic and respiratory effect of pediatric urological laparoscopic surgery: a retrospective study. *J Urol* 2003;170:1651.

90. Gomez Dammeier BH, Karanik E, Gluer S, et al. Anuria during pneumoperitoneum in infants and children: a prospective study. *J Pediatr Surg* 2005;40:1454.

91. Hammer GB. Single-lung ventilation in infants and children. *Paediatr Anaesth* 2004;14:98.

92. Kalfa N, Allal H, Montes-Tapia F, et al. Ideal timing of thoracoscopic decortication and drainage for empyema in children. *Surg Endosc* 2004;18:472-477.

93. Hammer GB, Fitzmaurice BG, Brodsky JB. Methods for single-lung ventilation in pediatric patients. *Anesth Analg* 1999;89:1426.

94. Lawson ML, Mellins RB, Tabangin M, et al. Impact of pectus excavatum on pulmonary function before and after repair with the Nuss procedure. *J Pediatr Surg* 2005;40:174.

95. Nuss D. Recent experiences with minimally invasive pectus excavatum repair "Nuss procedure." *Jpn J Thorac Cardiovasc Surg* 2005;53:338.

96. Hammer GB. Anaesthetic management for the child with a mediastinal mass. *Paediatr Anaesth* 2004;14:95.

97. Sponheim S, Skraastad O, Helseth E, et al. Effects of 0.5 and 1.0 MAC isoflurane, sevoflurane and desflurane on intracranial and cerebral perfusion pressures in children. *Acta Anaesthesiol Scand* 2003;47:932-938.

98. Hayward R, Gonzalez S. How low can you go? Intracranial pressure, cerebral perfusion pressure, and respiratory obstruction in children with complex craniosynostosis. *J Neurosurg* 2005;102:16.

99. Faberowski LW, Black S, Mickle JP. Incidence of venous air embolism during craniectomy for craniosynostosis repair. *Anesthesiology* 2000;92:20.

100. Ririe DG, David LR, Glazier SS, et al. Surgical advancement influences perioperative care: a comparison of two surgical techniques for sagittal craniosynostosis repair. *Anesth Analg* 2003;97:699.

101. Williams GD, Ellenbogen RG, Gruss JS. Abnormal coagulation during pediatric craniofacial surgery. *Pediatr Neurosurg* 2001;35:5.

# CHAPTER 64

## Anesthesia for Orthopedic Surgery

Gavin Martin, MB,  
Dara Breslin, MB, and  
Todd Stevens, MD

Orthopedic anesthesia presents many challenges to the anesthesiologist. Patients range in age from infant to centurion. This patient population shows the full spectrum of comorbidities. Many of the procedures are associated with significant postoperative pain. Surgery on isolated extremities can be performed using a variety of regional anesthetic techniques for both anesthesia and postoperative analgesia. However, providing adequate analgesia using central neuraxial techniques can be challenging, especially when deep venous thrombosis (DVT) prophylaxis with low-molecular-weight heparin (LMWH) is needed. This challenge has led to the development of many peripheral nerve block techniques and advances in the equipment used for these techniques, including continuous nerve catheters and ultrasound for identification of nerve plexuses. Recent literature has shown a benefit of regional anesthesia over general anesthesia with respect to mortality, morbidity, postoperative analgesia, and functional recovery. In this chapter, we consider the factors pertinent to anesthesia for orthopedic surgery and review the appropriate management.

### SPECIFIC PROBLEMS IN THE ORTHOPEDIC PATIENT

#### Rheumatoid Arthritis

Because of the nature of the disease, patients with rheumatoid arthritis present for many orthopedic procedures, ranging from joint replacement surgery to cervical spine surgery. These patients can be very challenging to treat for a variety of reasons. Deformities of the extremities are common, which may make arterial and intravenous access and positioning of the patient more difficult. Great

care must be taken when positioning patients, with adequate padding needed to prevent pressure necrosis of the patient's skin. Positioning the patient while he/she is awake often is useful. Of major concern in any patient with rheumatoid arthritis is the possibility of cervical spine instability.<sup>1</sup> Cervical spine involvement occurs in more than half of patients with rheumatoid arthritis, with atlantoaxial dislocation the most common abnormality. Pain and evidence of spinal cord injury are the main symptoms and signs of cervical spine involvement. However, the presence of symptoms may not correlate with the severity of radiologic abnormalities. Computed tomography and magnetic resonance imaging provide detailed images of the bone and spinal cord and should be considered in at-risk patients before anesthesia is provided. Flexion and extension cervical x-ray views may be required to exclude instability. Cervical spine instability may be overlooked in some patients based on clinical examination alone. Temporomandibular involvement may further restrict the anesthesiologist's ability to gain adequate access to the airway.<sup>2</sup> Both atlantoaxial instability and temporomandibular involvement may necessitate an awake fiberoptic intubation. Another airway problem is related to the potential for cricoarytenoid arthritis, which makes passage of an endotracheal tube extremely difficult.<sup>2</sup> Passing of an endotracheal tube in itself may cause dislocation of the laryngeal cartilages. Hoarseness and inspiratory stridor may indicate the presence of cricoarytenoid arthritis.

As a systemic disease, rheumatoid arthritis may result in a variety of organ dysfunctions (Table 64-1). Pulmonary, cardiac, renal, and hematologic changes are important to the

anesthesiologist. All these systems must be thoroughly assessed before any surgical procedure. Patients with rheumatoid arthritis are commonly managed with a variety of drugs, including steroids and nonsteroidal anti-inflammatory drugs (NSAIDs). Thus, patients may require preoperative steroid supplementation to prevent acute adrenocortical insufficiency and cardiovascular collapse during anesthesia. However, use of NSAIDs is controversial because of implications with regard to their effects on gastric mucosa, renal toxicity, platelet dysfunction, and cardiovascular effects.

#### Blood Loss

Orthopedic surgery can be associated with significant blood loss, particularly trauma surgery, multilevel back surgery, redo arthroplasty surgery, or surgery in which tourniquet use is precluded. Spinal and joint replacement surgeries offer a unique problem because of the large surface of cancellous bone that is exposed during surgery. Bleeding from cancellous bone is not easily controlled using standard techniques such as vessel ligation and cautery.

Despite improvement in the screening process for allogenic blood donations, there still exists the potential for transmission of infectious diseases and transfusion reactions. Bierbaum et al.<sup>3</sup> investigated the need for blood transfusion in 9482 patients who had undergone total hip or total knee replacement surgery. Fifty-five percent of patients undergoing hip surgery and 39% of the knee replacement patients required some form of blood transfusion. Of these patients, 66% received autologous blood and 34% received allogenic blood. Patients who receive a blood product transfusion are more likely to have infections and thus an

#### KEY POINTS

1. Orthopedic surgery is associated with high incidences of deep venous thrombosis and pulmonary embolism.
2. The need for anticoagulation results in anesthesia issues specifically related to the potential for neuroaxial hematomas.
3. Unique complications in orthopedic surgery are related to tourniquet use and fat embolism.
4. Regional anesthesia is associated with lower morbidity and mortality than is general anesthesia.
5. Prone spinal surgery cases have unique complications related to patient positioning, such as nerve injuries, ventilation problems, and blindness.

TABLE 64-1.

## Extraarticular Manifestations of Rheumatoid Arthritis

Cardiovascular	Pericardial inflammation and effusions, myocarditis, vasculitis, valvular fibrosis
Pulmonary	Pleural effusions, pulmonary fibrosis, pulmonary granulomata, fibrotic nodules (Caplan syndrome)
Hematopoietic	Normocytic normochromic anemia, Felty syndrome (enlarged spleen, leucopenia, and recurrent infections), platelet dysfunction (nonsteroidal anti-inflammatory drug therapy)
Renal	Amyloidosis
Endocrine	Adrenal insufficiency (glucocorticoid therapy)

increased hospital stay. Techniques regularly used in orthopedic surgery to reduce the need for allogenic blood transfusion include hypotensive anesthesia, preoperative hemoglobin optimization using iron and erythropoietin, preoperative autologous blood donation, acute normovolemic hemodilution, and intraoperative and postoperative red blood cell salvage techniques.<sup>4-6</sup> Hypotensive anesthesia has been shown to significantly reduce blood loss during surgery. A study by Sharrock et al.<sup>7</sup> showed that intraoperative blood loss in 250 consecutive hip replacement patients was approximately 250 mL if the surgery was performed with hypotensive anesthesia. The lower arterial and central venous pressures and—importantly—lower peripheral venous blood pressure in the surgical wound may explain this difference. This study showed that hypotensive anesthesia produced by regional anesthesia is superior to general hypotensive anesthesia.<sup>7</sup> Of concern with any hypotensive technique is the potential for increasing ischemic cardiovascular and neurologic events, which was not seen in the study by Sharrock et al.<sup>7</sup> However, this technique should be used with caution in the elderly and in patients with a significant cardiovascular history.

Preoperative autologous blood donation has been widely used in orthopedic patients but has many drawbacks, including iatrogenic anemia, high cost, clerical errors resulting in transfusion reactions, and wastage of blood products. Its main benefit is the potential to reduce the transmission of infectious diseases and the avoidance of immune-mediated transfusion reactions such as acute lung injury. A benefit of intraoperative normovolemic hemodilution over autologous blood donation is that

the blood is taken off and replaced with crystalloid or colloid just before incision, and the blood remains with the patient at all times. This process reduces the potential for clerical errors that lead to transfusion reactions and substantially reduces cost. Downsides to this technique are that it is labor intensive and that excessive hemodilution may result in coagulation disturbances. Recombinant human erythropoietin used either in conjunction with autologous blood donation or normovolemic hemodilution or alone has the potential to ensure higher preoperative hematocrits and reduce the need for allogenic blood transfusion.<sup>8</sup> Use of procoagulants, such as tranexamic acid (proteinase inhibitor), is not routine but may reduce intraoperative blood loss.<sup>9,10</sup> The concern with use of any procoagulant, especially in joint replacement surgery, is the possibility of an increased incidence of DVT, although studies have not shown this side effect.<sup>11</sup>

### Cerebral Palsy and Pediatric Orthopedic Surgery

Cerebral palsy (CP) is a nonprogressive neurologic disorder that results from a variety of insults that may occur perinatally and during the first 2 years of life. The incidence of CP is estimated at 2.4 per 1000 live births.<sup>12</sup> Most cases of CP are of unknown etiology. Known causes of CP include antenatal infections, thyroid disease, asphyxia, meningitis, and trauma. Premature infants have a greater incidence of CP due to periventricular hemorrhages. A variety of classification systems for CP are available, with the Swedish classification the most commonly used.<sup>13</sup> Spastic CP constitutes 70% of cases, followed by dyskinetic CP (10%), ataxic CP (10%), and

mixed CP (10%). Children with CP commonly present for orthopedic procedures, such as tenotomies and osteotomies, to improve their gait and posture. Another common orthopedic procedure is surgery for scoliosis correction. A number of anesthetic considerations must be considered when anesthetizing children with CP. These pediatric patients have a high incidence of chronic respiratory infections because of repeated aspiration and a restrictive lung pattern caused by the presence of scoliotic spine. The high incidence of aspiration is related to gastroesophageal reflux and the presence of bulbar palsies, which limit the child's ability to cough and clear oropharyngeal secretions. In fact, the second most common cause for surgery after orthopedic procedures is Nissan fundoplication for gastroesophageal reflux. These children should be seen preoperatively, with special assessment of their respiratory function. They may require antibiotics, bronchodilators, and physiotherapy to optimize their conditions before they undergo surgery. Approximately 30% of children with CP also have epilepsy, most commonly the spastic hemiplegia variety. Anticonvulsant medication should be continued up to time of surgery and restarted as soon as possible after surgery. Latex allergy resulting from the number of procedures these children undergo is common and should be sought in all children with CP. A latex-free environment for all CP cases should be practiced. Benzodiazepines and baclofen all have been used in CP children to reduce muscle tone. Baclofen acts as an inhibitor of  $\gamma$ -aminobutyric acid, an inhibitory neurotransmitter, and has been shown to reduce pain and the development of contractures associated with increased muscle spasms.<sup>14</sup> Baclofen can be given orally, but an intrathecal pump is the preferred route of administration. Because abrupt withdrawal of baclofen can result in seizures and hallucinations, it should be continued in the perioperative period.<sup>14</sup> Baclofen has been implicated in delayed arousal, bradycardia, and hypotension during general anesthesia.<sup>15</sup> Pre-medication with sedatives should be considered, but care is necessary, especially in the hypotonic child, because a sedative may easily compromise the child's airway. Antacids and prokinetics should be used because of

the high incidence of gastroesophageal reflux. Antisialogogues, such as glycopyrrolate, also should be considered to reduce the oropharyngeal secretions. The presence of gastroesophageal reflux may necessitate a rapid sequence induction, but the muscle relaxant of choice is controversial. Studies have shown an increased number of extrajunctional acetylcholine receptors at the neuromuscular junction in children with CP, making hyperkalemia a potential problem when succinylcholine is used for muscle relaxation.<sup>16,17</sup> In addition, use of succinylcholine in children is controversial because of the potential for reaction. Nondepolarizing agents show less potency in children with CP, so larger doses of nondepolarizing agents may be needed to maintain a neuromuscular block during surgery.<sup>18</sup> The mean alveolar concentrations of the inhalational agents are lower in children with CP compared with normal children.<sup>19</sup> Intraoperative hypothermia due to hypothalamic dysfunction is often a problem, and extra care is needed to maintain normothermia. Postoperative pain management can be an issue because of the child's inability to communicate adequately. Regional anesthetic techniques, such as caudals, epidurals, and peripheral nerve blocks, are very useful in these situations. Because of the young age of pediatric patients, these regional techniques often must be administered while the children are under general anesthesia. However, evidence indicates that this can be performed safely.<sup>20</sup> Epidural combinations of local anesthetics, opioids, and clonidine may be useful for postoperative pain management but require adequate postoperative management to detect oversedation and respiratory depression.

## MAJOR ORTHOPEDIC PROCEDURES

### Anesthesia for Extremity Surgery

A general anesthetic can be used as the anesthetic of choice for all orthopedic procedures. However, a regional anesthetic technique can be used to provide both anesthesia and postoperative analgesia for a variety of orthopedic procedures, including arthroscopic, fracture, and joint replacement surgery. For lower limb surgery, cen-

tral neuroaxial techniques can be used in addition to peripheral nerve blocks.

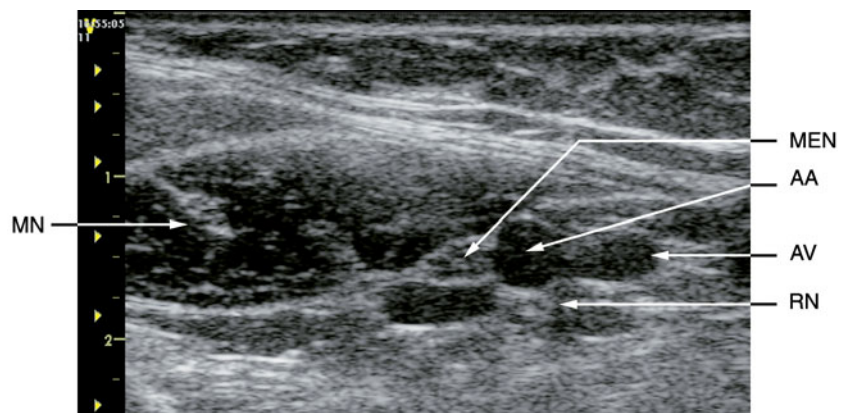
### Upper-Extremity Surgery

The variety of brachial plexus blocks available means that several options for block technique can be used for upper-extremity procedures.<sup>21</sup> The most important factor in choosing a block is the anticipated location of the incision, although other variables can affect the decision. Patient factors, such as weight, degree of pulmonary dysfunction, and coagulation status, also play a role. Choice of local anesthetic depends on balancing the time of onset with the desired duration of block. For procedures on the shoulder, interscalene block using 30–40 mL of local anesthetic is the preferred technique. This dose should ensure block of the suprascapular nerve, which branches off from the plexus quite proximally. Superficial cervical plexus block also is important, although it usually is achieved as an effect of an interscalene block. To cover anterior incision sites, supplemental intercostobrachial nerve block is needed as well. The sensory distribution of this nerve is highly variable. To cover posterior incision sites, paravertebral blocks of the T1 and T2 nerve roots or skin infiltration by the surgeon is necessary. If paravertebral blocks are used, separate injection of the intercostobrachial nerve is unnecessary. Anesthesia from the midhumerus to the hand can be achieved with a supraclavicular, infraclavicular, or axillary block. Each of these techniques has unique advantages and drawbacks that may make that technique particularly useful in a given patient.

Ultrasound is playing an increasing role, particularly in more superficial upper-extremity blocks (Fig. 64–1). Supplemental injection of the peripheral nerves more distally can be performed to salvage partially successful proximal blocks. Bier block can be used to perform short-duration forearm and hand surgery, but it does not provide postoperative analgesia. A description of the various peripheral nerve block techniques is given in Chapter 48.

### Shoulder Replacement Surgery

More than 80,000 shoulder arthroplasty procedures are performed annually in the United States. Shoulder replacement surgery, like knee and hip replacement surgery, can result in significant postoperative pain. Both general anesthesia and interscalene nerve blocks can be used for anesthesia, either alone or combination. Increasingly more shoulder procedures are performed on an outpatient basis, which has necessitated the use of a variety of techniques to improve postoperative pain. Use of interscalene nerve blocks alone for anesthesia and analgesia offers patients a significant advantage in terms of pain scores, time to ambulation, time to discharge, and need for unexpected admission compared with general anesthesia.<sup>22</sup> Other techniques used for postoperative pain include intraarticular infusions of local anesthetics and suprascapular nerve blocks. Suprascapular nerve blocks have been shown to be superior compared with patient-controlled intravenous analgesia.<sup>23</sup> Potential benefits of suprascapular nerve block compared with interscalene nerve block are ease of performance, lower volumes of local



**FIGURE 64–1.** Axillary nerve block using ultrasound. AA, axillary artery; AV, axillary vein; MEN, median nerve; MN, musculocutaneous; RN, radial nerve.



anesthetics needed, and fewer complications such as phrenic nerve paralysis and intrathecal injection. The major drawback of suprascapular block compared with interscalene nerve block is that suprascapular nerve block must be combined with general anesthesia, thus necessitating airway manipulation and exposing the patient to the deleterious physiologic changes associated with general anesthesia. In some studies, intraarticular infusion of bupivacaine has shown no benefit compared with placebo.<sup>24</sup>

Many shoulder surgeries are undertaken with the patient placed in a 45° semirecumbent position (beachchair position). This position presents problems related to potential difficulties with airway access if a regional anesthetic is the sole anesthetic technique. It is essential to test whether the interscalene block is adequate for the surgical procedure before the procedure is started, because access to the airway during the case can be difficult. Another problem with this position is reduced venous return to the right side of the heart resulting in reduced preload and potential hypotension, especially with use of general anesthesia. This condition may result in the need for increased fluid resuscitation. Patients with significant cardiovascular problems should be positioned slowly, and the anesthesiologist should always be aware of the potential for venous air embolism, particularly with patients in the sitting position.

The problems of embolic phenomenon, as seen in hip or knee replacement surgery, are generally not seen in shoulder replacement surgery. In general, use of invasive lines, such as central lines and arterial lines, is not required for these cases, depending on the presence of comorbidities.

### Lower-Extremity Surgery

Many different regional anesthesia techniques are available for lower-extremity orthopedic surgery.<sup>25</sup> Neuraxial techniques are appropriate for any lower-extremity procedure in most patients, but aggressive use of postoperative anticoagulation for prevention of DVT and pulmonary embolism may limit the use of postoperative epidural analgesia. Peripheral nerve blocks with or without continuous catheter use offer an alternative to neuraxial techniques, which may be safer in the setting of perioperative anticoagulation

with efficacy at least equal to that of epidural analgesia. For procedures on the hip and proximal femur, lumbar plexus block<sup>21</sup> in conjunction with a proximal sciatic nerve block<sup>26,27</sup> provides acceptable analgesia. A femoral nerve block can be used instead of a lumbar plexus block, although it is less likely to provide block of the obturator and lateral femoral cutaneous nerves.<sup>28</sup> Addition of paravertebral nerve blocks at the first and second lumbar levels may be needed to provide complete anesthesia. Alternatively, the procedure can be accomplished using a spinal anesthetic alone or a combination of spinal anesthesia with a lumbar plexus and sciatic blocks or catheters for postoperative analgesia. Epidural or combined spinal epidural anesthesia provides a simpler route of anesthesia and analgesia<sup>29</sup> and may be acceptable for postoperative use if the epidural is managed in accordance with 2003 guidelines of the American Society of Regional Anesthesia and Pain Medicine (ASRA).<sup>30</sup> In general, hip procedures are associated with less postoperative pain than are knee procedures, making prolonged regional analgesia less important. Anesthesia and analgesia for procedures involving the knee and distal femur can be accomplished with either neuraxial techniques or peripheral nerve blocks. Lumbar plexus block offers more complete anesthesia of the thigh than does femoral block but is deeper and may be more difficult in obese patients or those with a history of lumbar spine surgery (Figure 64-2).<sup>28</sup> Sciatic nerve block is crucial for coverage of the posterior cutaneous nerve of the thigh and for the knee joint itself.<sup>31</sup> Procedures involving the foot and ankle, as well as those involving the tibia and fibula, are primarily covered by a sciatic nerve block. This can be achieved by blockade of the sciatic nerve at the popliteal level. Figure 64-3 shows an ultrasound scan of the popliteal nerve. Block of the saphenous nerve may be necessary, depending on the location of the incision and the need for tourniquet. The saphenous nerve can be blocked via either femoral nerve block or a distal dedicated saphenous nerve block. Ankle block without the use of epinephrine is adequate for procedures on the foot if no tourniquet use is expected.

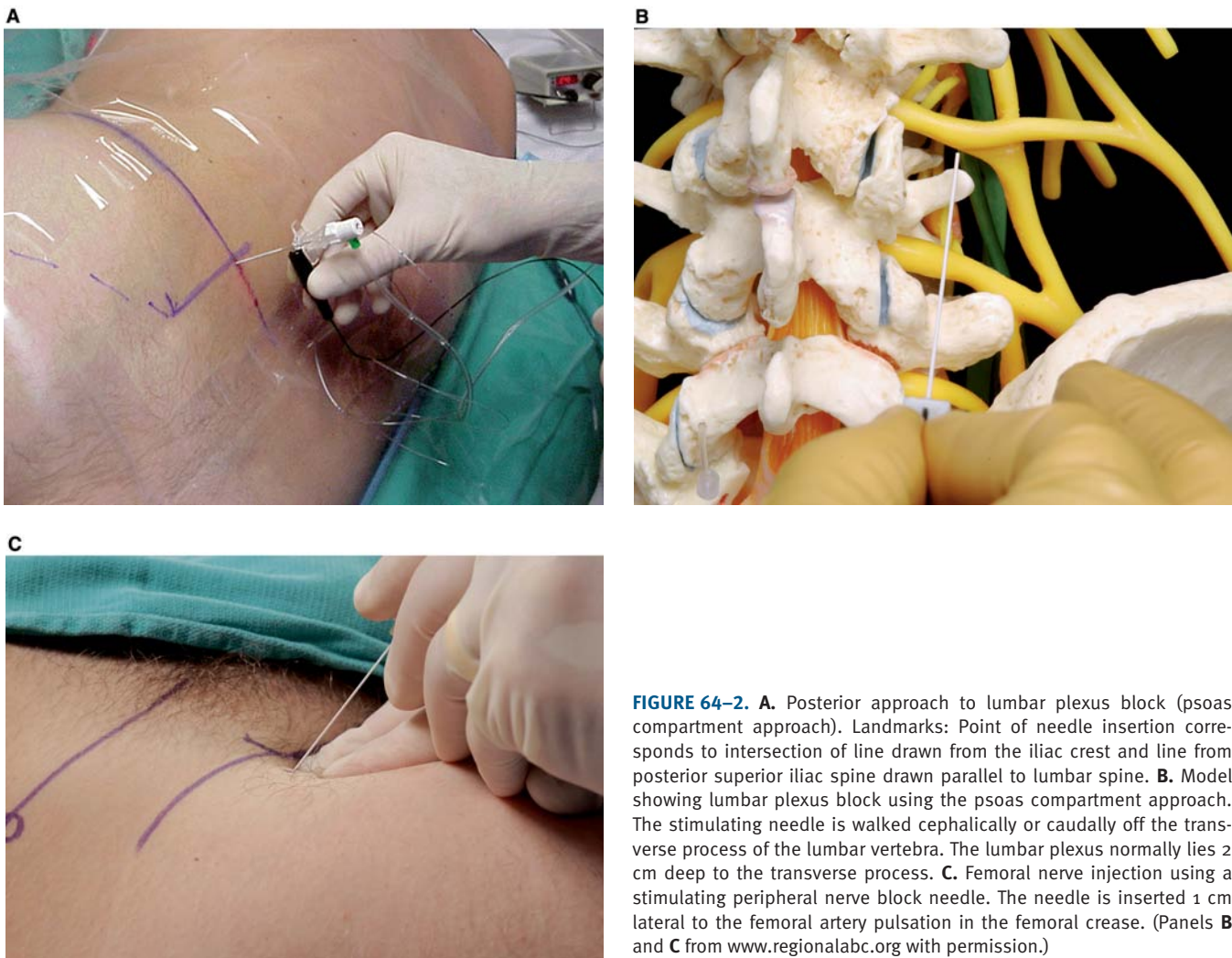
The question as to whether general or regional anesthesia is superior with respect to outcome is controversial. A

number of studies have shown no improvement in outcome with respect to mortality and morbidity.<sup>32,33</sup> However, other studies have shown that regional anesthesia and analgesia may reduce morbidity and mortality after surgery.<sup>34-36</sup> In a meta-analysis study, Rodgers et al.<sup>35</sup> showed a 33% reduction in mortality. They also showed a significant decrease in the incidences of myocardial ischemic events, respiratory depression, rate of DVT formation, and blood loss. Wu et al.<sup>37</sup> showed a death rate of 5.8 per 1000 [95% confidence interval (CI): 2.9-8.7] at 30 days postsurgery for cases using epidurals versus a death rate of 9.9 per 1000 (95% CI: 8.6-11.3) for cases using only general anesthesia. However, this benefit to patients must be considered in the context of the risk of epidural hematomas when neuroaxial anesthesia is given in the presence of anticoagulants such as LMWH. The risk, although small, has led to the publication of guidelines for use of regional anesthesia in patients receiving anticoagulants.<sup>30</sup> This has resulted in the reinvention and development of many peripheral nerve block techniques, including continuous peripheral nerve catheter techniques,<sup>38</sup> and use of ultrasound to place these regional nerve blocks.<sup>39,40</sup> Figure 64-2 shows ultrasound images of sciatic and femoral nerves.

### Hip and Knee Joint Replacement Surgery

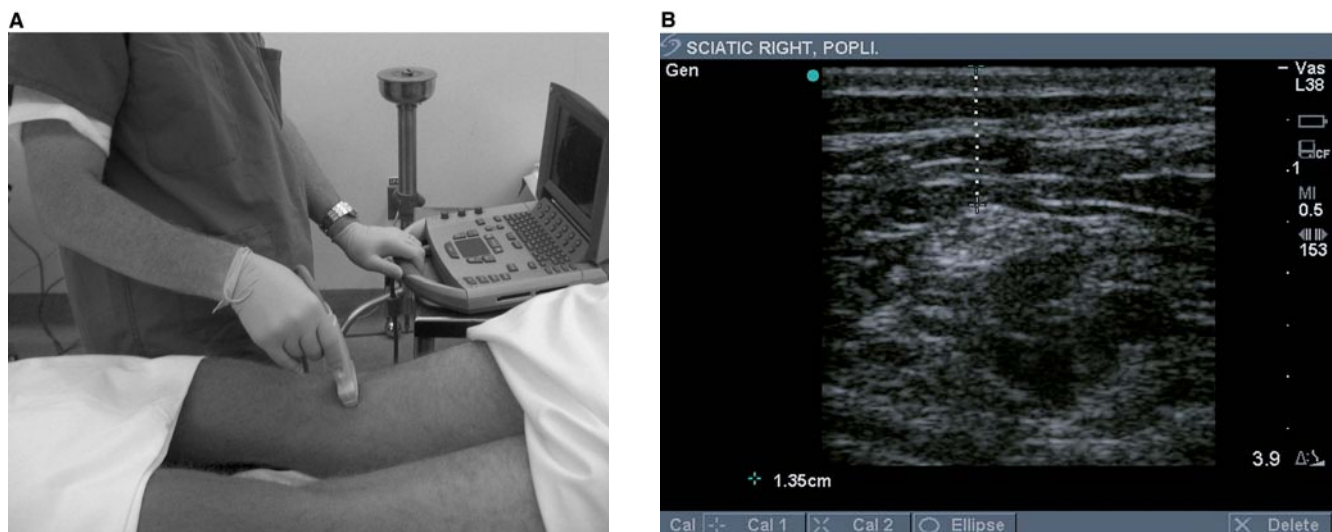
With the population of the United States aging and the prospect of “baby boomers” reaching retirement age in the next couple of decades, the number of patients requiring joint replacement will increase greatly. It is estimated that more than one million joint replacement procedures per year will be performed in the United States during the next decade. A variety of anesthetic techniques, consisting of general, spinal, epidural, combined spinal and epidural, and peripheral nerve blocks, are available to the anesthesiologist. These techniques have been shown to be superior to routine patient-controlled analgesia and as efficacious as epidural anesthesia but with fewer side effects.<sup>41-43</sup> Some evidence suggests that regional techniques may result in earlier discharge and improved functional outcome.<sup>42,44</sup>

Knee replacement surgery is especially associated with significant postoperative pain, and patients under-



**FIGURE 64-2.** **A.** Posterior approach to lumbar plexus block (psoas compartment approach). Landmarks: Point of needle insertion corresponds to intersection of line drawn from the iliac crest and line from posterior superior iliac spine drawn parallel to lumbar spine. **B.** Model showing lumbar plexus block using the psoas compartment approach. The stimulating needle is walked cephalically or caudally off the transverse process of the lumbar vertebra. The lumbar plexus normally lies 2 cm deep to the transverse process. **C.** Femoral nerve injection using a stimulating peripheral nerve block needle. The needle is inserted 1 cm lateral to the femoral artery pulsation in the femoral crease. (Panels **B** and **C** from [www.regionalabc.org](http://www.regionalabc.org) with permission.)

1545



**FIGURE 64-3.** **A.** Popliteal nerve block performed with ultrasound in a patient in the prone position. **B.** Ultrasound scan of the sciatic nerve 7 cm above the popliteal crease. Note that the nerve lies 1.5 cm below the skin (dotted line). Distal to this scan, the nerve divides into its two major branches—common peroneal and tibial. (Panel **A** from [www.regionalabc.org](http://www.regionalabc.org) with permission.)

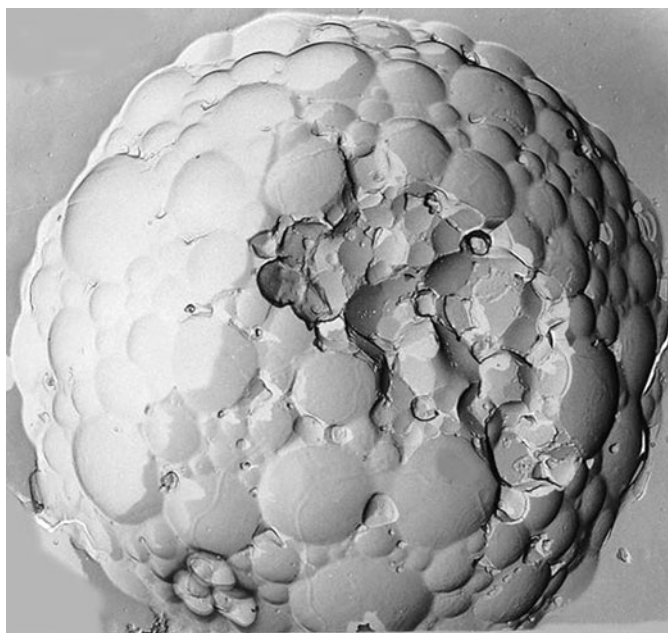
going this surgery benefit greatly from some form of postoperative regional analgesia. Use of epidurals in the joint replacement setting has been severely restricted by the widespread use of LMWH. A variety of peripheral nerve blocks have been used for analgesia in knee replacement surgery. They include psoas compartment blocks (lumbar plexus), femoral nerve blocks (Fig. 64–2), and sciatic nerve blocks. The psoas compartment approach may be superior to the femoral approach because it is associated with greater success in blocking the three main components of the lumbar plexus: femoral, obturator, and lateral femoral cutaneous nerves. Capdevila et al.<sup>45</sup> showed a 95% probability of blockade of all three nerves if the psoas compartment approach is used versus 33% if the femoral approach is used. A study by Macalou et al.<sup>46</sup> showed that addition of an obturator nerve block to a 3:1 femoral nerve block resulted in superior postoperative pain relief compared with a 3:1 femoral nerve block alone. The addition of a sciatic nerve block for postoperative pain management is controversial. Studies have shown a significant improvement in postoperative pain management if the sciatic nerve block is also used.<sup>47,48</sup> Other studies have shown no improvement in postoperative opioid requirements if a sciatic nerve block is used.<sup>49</sup>

Whether the addition of peripheral nerve blocks to general anesthesia or spinal anesthesia offers any benefit to patients undergoing hip arthroplasty surgery is not as clear as in the case of knee replacement surgery. Biboulet et al.<sup>50</sup> compared patient-controlled analgesia with morphine and a single injection of either a femoral or psoas compartment block. No difference in morphine consumption or pain scores was noted 4 hours after extubation. Other investigators have reported similar results using psoas compartment block for postoperative pain.<sup>44</sup> Thus, for hip replacement surgery, use of a spinal and/or epidural may offer benefits to patients compared with general anesthesia in terms of mortality, morbidity, and pain control, but the addition of peripheral nerve blocks for postoperative pain appears to be of limited benefit. This may be in part because the pain after hip replacement surgery is of much shorter duration than in knee replacement surgery.<sup>44,50</sup>

The maximum duration of a single-shot nerve block depends on the local anesthetic used and the site of injection (lidocaine 2%, mepivacaine 1.5%, 4–6 hours of analgesia vs ropivacaine 0.5%, bupivacaine 0.5%, 8–16 hours of analgesia). Administration of additives, such as clonidine (50–150 µg), may prolong the nerve block by another 2–3 hours. Use of continuous catheters in knee replacement surgery can extend the block indefinitely and can help patients avoid the severe pain experienced once the single-shot nerve block wears off. Evidence indicates that use of a stimulating nerve catheter improves the success rate of nerve catheters by avoiding subsequent failure of the catheter once the initial nerve block wears off (so-called “secondary block failure”). Salinas et al.<sup>38</sup> showed a 100% success block rate when using a stimulating nerve catheter compared with an 85% success rate when using a nonstimulating nerve catheter. Early mobilization and rehabilitation are important for the functional outcome of the patient. Use of a continuous catheter with local anesthetic causes motor weakness. Close collaboration among the anesthesia, orthopedic, and physiotherapy teams is needed to allow early mobilization with adequate analgesia. Lower concentrations of local anesthetic infusions produce less motor block but also may produce inferior analgesia. Starting patients on some

form of oral analgesics before discontinuing the peripheral nerve catheters is essential to maintain adequate postoperative analgesia. An alternative to peripheral nerve block catheters is the use of continuous intraarticular infusion of local anesthetics for postoperative pain after joint arthroplasty. An advantage of this technique is that it is simpler to perform than peripheral nerve block, but whether this technique offers any benefit to the patient is controversial.<sup>51</sup>

A new approach to postoperative pain management in patients undergoing lower limb joint replacement is the use of extended-release epidural morphine sulfate (DepoDur, SkyePharma, London, UK). This technology is based on liposomal products into which doses of morphine 10–20 mg are incorporated (Figure 64–4). This form allows the slow release of morphine into the epidural space over a 48-hour period without the need for an epidural catheter, thus avoiding anticoagulation issues. A study of hip replacement patients has shown a significant reduction in postoperative fentanyl requirements and pain scores.<sup>52</sup> The side effects are similar to those of other neuroaxial opioids. The most serious potential side effect is respiratory depression, so patients must be monitored closely for 48 hours. Further developments of slow-release preparations of local anesthetics are awaited.



**FIGURE 64–4.** DepoFoam (SkyePharma, London, UK), an example of a liposomal delivery system used for epidural administration of 10–15 mg preservative-free morphine.



Invasive monitoring with arterial or central venous lines is generally not required except in patients with significant comorbidities or in patients undergoing revision of a previous joint replacement. Blood loss tends to be higher during revision joint replacement procedures. Methods used to reduce the requirement for blood transfusion are relevant to all patients undergoing joint replacement surgery (discussed earlier in this chapter in the section on blood loss).

### Neck of Femur Fractures

Repairing neck of femur fractures is a common surgical procedure at trauma institutions. Management is generally surgical and involves either internal fixation with screws or plates or a hemiarthroplasty. Hip arthroplasty for management of femoral neck fractures is associated with a nearly 10-fold increase in the rate of perioperative mortality compared with elective hip arthroplasty. The 30-day mortality is 10%, and 20–30% of patients die within 1 year of surgery.<sup>53,54</sup> The reasons for this high mortality rate probably are the age of this population group (>70 years of age), the presence of comorbidities, and the high incidence of DVTs and pulmonary emboli. Optimization of patient medical conditions before surgery is generally but not always recommended, as delay of surgery because of the need for management of comorbidities may increase the mortality rate by 2.5 times.<sup>55</sup> Thus, appropriate and timely medical care is important before anesthesia and surgery.

Anesthesia involvement in the management of patients with neck of femur fractures can occur before the need for anesthesia for surgery and may involve the placement of a 3:1 femoral nerve block or fascia iliaca block in the emergency department for analgesia. Preoperative use of a femoral 3:1 block has been shown to be simple and to reduce the pain experienced, with few side effects.<sup>56</sup> The reduction in opioid doses required by patients can have substantial benefits. The question of whether general anesthesia or some form of regional anesthesia is best for these patients is controversial. We hold the opinion that regional anesthesia, including the use of spinal anesthesia, epidural anesthesia, combined spinal epidural anesthesia, or peripheral nerve blocks, is beneficial. Use of lumbar paravertebrals, lumbar plexus, and sciatic nerve block as the sole anesthet-

ic technique for neck of femur fracture is a beneficial technique, especially in patients who, because of their comorbidities, cannot tolerate the drop in preload or afterload caused by spinal or epidural anesthesia.<sup>27,57</sup> An alternate method in this group of patients is the use of a continuous spinal catheter.<sup>58</sup> This method allows the anesthesiologist to titrate intrathecally the local anesthetic in small amounts while still obtaining the desired effect without the usual hemodynamic changes associated with a single large dose of intrathecal local anesthetic. Invasive line monitoring, such as arterial and central lines, may be needed, depending on the presence of comorbidities. The need for blood transfusion is uncommon, but adequate intravenous access and a blood cross-match should always be available. Keeping patients warm during the procedure is especially important in this elderly population. Finally, this group is at a much higher risk for development of DVT and subsequent pulmonary embolism. All patients must be adequately anticoagulated during the postoperative period to prevent this complication (see Deep Vein Thrombosis).

### Spinal Surgery

Spinal surgery is frequently a challenge for the anesthesiologist, involving a wide variety of procedures for treatment of different pathologies in the young to the very old patient population. It may involve surgery on the vertebrae of the spine in addition to the neural structures of the spinal cord.<sup>59</sup> Common pathologic reasons for surgery are listed in Table 64–2.

The required position of patients frequently is prone. The prone position requires extra care and attention because it may be associated with an increased incidence of complications. Major spinal surgery can be associated with extensive blood loss. Although the majority of spinal surgery is elective, urgent surgery may be required after trauma or in situations where spinal cord viability is a concern. Some patients undergoing spinal procedures require repeat surgery and may have high requirements for analgesics in the postoperative period.

### Positioning

The majority of spinal surgery is performed with the patient in the prone position, although an anterior approach is sometimes used, particularly

TABLE 64–2.

#### Pathologic Reasons for Spine Surgery

- Degenerative disease/arthritis
- Congenital
- Idiopathic
- Trauma
- Malignancy
- Infection
- Vascular abnormalities

for cervical spine surgery. In addition, an anterior or lateral approach may be used for lumbar and thoracic spinal surgery. The ideal position allows easy access and maximal exposure to the site of surgery while allowing for a good operative field with minimal bleeding. Decompression of the stomach and bladder using an orogastric tube and a urinary catheter, along with avoiding compression of the abdomen, results in decreased pressure in the epidural veins and decreased blood loss. The site of surgery may be above the level of the heart, resulting in low venous pressure and decreased blood loss; however, it also is associated with a risk of venous air embolism. Hence, appropriate positioning of the patient is essential while being careful to avoid many of the potential complications. Although many different surgical tables and positions largely determined by surgeons' preference are available to improve exposure to the surgical site, many of the pertinent issues are common to all cases. First, extreme care must be taken when turning the patient, particularly the patient at risk for cord compromise. Particular attention should be paid to positioning of the head/neck and arms. Complications associated with malpositioning of the arms, including vascular and brachial plexus injury, have been reported (Table 64–3).<sup>60</sup> Such injuries are least likely to occur when the arms are placed by the patient's side. However, this position may invade the surgeon's space and restricts the anesthesiologist's access to arterial and venous access. Therefore, the patient is frequently positioned with the arms resting on padded arm boards and flexed at the elbow. The elbow should not be flexed more than 100° because such a position is associated with increased pressure within the cubital tunnel.<sup>61</sup> The abdomen, genitalia, and breasts all should be checked because



TABLE 64-3.

**Complications of Positioning for Spine Surgery**

Endotracheal tube dislodgement/ kinking
Eye injury
Corneal abrasion
Ischemic optic neuropathy
Edema (facial/orbital/airway)
Facial skin damage
Airway obstruction
Nerve damage (brachial/lumbar/sacral plexus)
Compression
Stretch
Compression of vessels
Ischemia
Thromboembolic complications
Compartment syndromes

prolonged surgery in the prone position can result in injury to these areas. Adequate protection and padding of the eyes and head are essential. Blindness resulting from surgery performed with the patient in the prone position has been reported. Although its etiology probably is multifactorial but still is incompletely understood, prolonged surgery, hypotension, large blood loss (>1 L), anemia, edema, and changes in intraocular perfusion pressure all may contribute to blindness.<sup>62</sup> Changes in ocular perfusion pressure resulting in decreased blood flow to the optic nerve may result in ischemic optic neuropathy. Increases in intraocular pressure or decreases in mean arterial pressure result in decreased ocular perfusion pressure.<sup>63,64</sup> Avoidance of prolonged periods of hypotension and perioperative anemia may reduce the risk of perioperative blindness in patients in the prone position.<sup>65</sup> In addition, direct pressure on the eye can result in injury to the eye. Tape marks and facial skin loss may result, especially in the prone patient with significant facial edema and friable skin.

The sitting position occasionally is used for surgery on the cervical spine. The risks and complications associated with surgery performed in the sitting position are described elsewhere in the textbook.

**Anesthetic Technique**

A standard preoperative assessment is essential in patients undergoing spinal surgery. In addition to standard Amer-

ican Society of Anesthesiologists monitoring, use of invasive monitoring depends on patient comorbidities and the anticipated complexity of the surgical procedure and anticipated blood loss.<sup>59</sup> Surgeries involving multiple levels, repeat operations, and procedures for treatment of trauma and neoplasms typically are associated with increased blood loss.

A thorough airway examination should be performed. This assessment is critical, particularly in patients presenting for cervical spinal surgery and in patients with disease processes that affect the vertebral column, such as rheumatoid arthritis, ankylosing spondylitis, or generalized osteoarthritis. In addition, patients who have undergone previous neck surgery may have increased difficulty at intubation. The aim is to safely secure the airway while avoiding any damage to the spinal cord. This can be achieved safely in both awake and anesthetized patients using a variety of techniques, such as standard laryngoscopy, intubating aids, manual in-line stabilization, laryngeal mask airways (LMA North America, Inc., San Diego, CA), and fiberoptic intubations. The precise technique depends on the clinical situation; management of the difficult airway is discussed in Chapter 35. Remember that the majority of movement in the cervical spine during intubation occurs at the atlantooccipital joint and between the first two cervical vertebrae.<sup>66,67</sup> Particular caution should be exercised in the airway management of patients with C1/C2 injury and at-risk patient populations (rheumatoid arthritis, Down syndrome) that are more prone to pathology of C1/C2. Use of rigid collars may increase the difficulty of intubation but does not affect the degree of cervical spine movement. Once the airway is secured, the cervical collar alerts staff that the patient may have a neck injury. Awake intubation allows neurologic examination after intubation and positioning of the patient, although this may be difficult in the uncooperative patient. Thoracic spinal surgery may require use of a double-lumen tube or bronchial blocker if one-lung ventilation is required with an anterior or lateral approach.

Anesthesia induction can be either intravenous or inhalational, with intravenous induction appropriate for the majority of patients. Intubation and

muscle relaxation can be facilitated with either nondepolarizing muscle relaxants or succinylcholine. Use of succinylcholine should be avoided in patients with muscular dystrophies and in patients with spinal cord injuries in whom an exaggerated hyperkalemic response may be seen. Use of succinylcholine probably is safe in the 48 hours immediately after spinal injury and again 9 months after the injury.<sup>68</sup> Intraoperative use of muscle relaxants may be avoided depending on whether motor-evoked responses are monitored and surgeon preference. This is relevant in patients at risk for nerve root injury during surgery in which nerve root stimulation results in muscle movement. Anesthesia can be maintained using either a potent volatile anesthetic in nitrous oxide/oxygen or air/oxygen mixture or intravenous anesthesia such as propofol infusions. Many opioids have been used as part of a balanced anesthetic technique, with remifentanyl having the advantage of providing potent analgesia and rapid offset of action. This may assist in the early assessment of the patient's neurologic status in the early postoperative period. Remember that all anesthetic agents may affect the use of somatosensory and motor evoked potentials, which can be used to monitor spinal cord function (see Chapter 88). Changes in anesthetic concentrations and arterial blood pressure also affect the interpretation of evoked potentials. Spinal cord monitoring is discussed in Chapter 88.

Measures for minimizing intraoperative blood loss and reducing allogeneic blood transfusion in spinal surgery are particularly important. Careful positioning, avoidance of abdominal compression, surgical technique, hypotensive techniques, use of preoperative autologous donation, intraoperative normovolemic hemodilution, and use of intraoperative cell savers all may help avoid the use of allogeneic blood products. However, combinations of these techniques to reduce requirements for homologous blood products have not produced consistent results.<sup>69,70</sup> Use of antifibrinolytics may reduce intraoperative blood loss.<sup>71</sup> Hypotensive anesthesia is very effective at reducing blood loss, although it may be a contributory factor to the rare but devastating complication of posterior optic neuropathy. These techniques are particularly

important in spinal surgeries associated with large blood loss.

Use of endoscopic spinal surgical procedures is likely to increase. These procedures may provide many of the benefits of other endoscopic procedures, such as less pain, decreased blood loss, decreased hospital stay, and fewer postoperative complications.

### Postoperative Care

Postoperative analgesia can be a challenge, particularly in patients who have experienced chronic back pain. Standard postoperative analgesia consists of the use of simple analgesics and opioids, especially patient-controlled opioid analgesia. Use of NSAIDs is controversial. They may reduce opioid requirements by up to 33% and reduce the incidence of opioid-related side effects such as nausea, vomiting, sedation, and respiratory depression.<sup>72</sup> However, they may interfere with bone healing.<sup>73</sup> Initial studies using cyclooxygenase-2 (COX-2) inhibitors suggest minimal effect on bone healing, particularly when used for short durations.

In some cases, surgeons insert a catheter under direct vision into the epidural space. Either epidural opioids or opioids in addition to local anesthetics may be infused. Low concentrations of local anesthetics typically are used to avoid a motor block, which may delay accurate diagnosis of motor dysfunction as a complication of surgery.<sup>74</sup>

The majority of patients undergoing spinal surgery can be managed in the post surgical unit postoperatively. Those who have undergone extensive surgery, suffered significant blood loss, received large fluid resuscitation, or experienced fluid shifts should be monitored postoperatively in an intensive care or step-down unit. Patients with significant facial and airway edema may require ventilation postoperatively. In addition, patients who have undergone certain cervical and thoracic spinal procedures may require postoperative ventilation, whereas those requiring extensive neurologic monitoring should be cared for in a monitored bed postoperatively.

Neurogenic shock is characterized by loss of sympathetic tone resulting in hemodynamic instability, as evident from significant hypotension and bradycardia. This may be accentuated by hypovolemia. Shock tends to occur in injuries above the T6 level, due to disruption of sympathetic outflow and

unopposed vagal tone. Arterial and central venous pressure monitoring is helpful in the management of these patients. Fluid administration in addition to vasopressors may be required to treat the hypotension along with appropriate management of the bradycardia. Autonomic dysreflexia is a syndrome of sympathetic imbalance that may occur after the phase of spinal shock. It occurs more commonly in males and may result in hypertension associated with myocardial ischemia, retinal/cerebral hemorrhage, and seizures.

### Ambulatory Orthopedic Surgery

The 1990's saw a dramatic increase in the number of surgical cases performed in the ambulatory setting. Nearly 60% of all cases now occur as outpatient procedures, with orthopedic surgery accounting for a large number of cases. This trend has huge socioeconomic implications, such as reduced costs, more rapid return to daily activity, and lower risk of nosocomial infections. Shoulder and knee procedures, including shoulder arthroplasty and anterior cruciate ligament repair, occur routinely on an outpatient basis. All ambulatory orthopedic surgical procedures can be performed under general anesthesia. However, these procedures may be most suited for a regional anesthetic technique. Despite the use of aggressive oral analgesics, postdischarge verbal analog pain scores range from 4–8 on a 10-point scale.<sup>75</sup> With more complicated procedures occurring on an outpatient basis, adoption of a multimodal approach to postoperative pain management is essential. This will allow better pain control with the need for less opioid medication, thus reducing the potential for side effects such as nausea and vomiting, which often can derail a timely discharge from the ambulatory center. The cornerstone of these techniques is frequently a peripheral nerve block. New disposable infusion devices allow patients to be discharged with peripheral nerve catheter infusions, further prolonging the effect of a single shot of peripheral nerve block.<sup>76</sup> When general anesthesia is required, the aim should be to provide adequate anesthesia and analgesia while minimizing perioperative-related side effects such as nausea and vomiting.

### POSTOPERATIVE ANALGESIA IN ORTHOPEDICS

Limited evidence indicates that improvements in postoperative pain control result in better functional outcome and reduced morbidity and mortality.<sup>35,42</sup> The best approach to postoperative pain management is a multimodal approach of different agents and routes of administration used in a synergistic manner.<sup>77,78</sup> Using a multimodal approach, we have the potential to reduce or eliminate the amount of opioids required by patients and thus reduce side effects such as nausea and vomiting, respiratory depression, and oversedation.<sup>78,79</sup> The cornerstone of any multimodal approach is a regional technique, including epidural and peripheral nerve blocks (see Chapter 48). Other possibilities include subcutaneous or intraarticular infusions of local anesthetics. These techniques have been shown to be superior to opioids but inferior to epidurals and peripheral nerve blocks.<sup>80,81</sup> Their effectiveness appears to be short lived, lasting 2–4 hours.<sup>82</sup> Use of intraarticular opioids, such as morphine, after joint surgery is controversial, with some evidence of benefit.<sup>83–88</sup> Use of intraarticular morphine is based on the presence of opioid receptors on peripheral nerve endings within the capsule of joints. Administration of intraarticular opioids produces analgesia only in the presence of inflammation, and it has been postulated that the inflammatory process is necessary for activation of the opioid receptors.<sup>89</sup> Morphine doses between 1 and 5 mg have been shown to have an analgesic effect until 24 hours after intraarticular administration.<sup>90</sup> The side effects normally seen with systemic opioids are not seen with these doses of intraarticular opioids. Cryotherapy devices have been used in both shoulder and knee surgery to further augment postoperative analgesia.<sup>85,91</sup> Nonsteroidal agents play an important role in reducing postoperative opioid requirements.<sup>92</sup> COX-2 inhibitors have largely displaced the nonselective COX inhibitors because of their improved side effect profile with regard to the potential for gastric bleeds and coagulation disturbance. The recent controversy regarding rofecoxib (Vioxx, Merck & Co., Whitehouse Station, NJ), which was found to result in an increased incidence of death due to myocardial infarcts when used at

high doses and for long periods, has significantly reduced the use of other COX-2 inhibitors in the perioperative period.<sup>93</sup> Data are insufficient to recommend the use of other COX-2 inhibitors, such as celecoxib (Celebrex, Pfizer, New York, NY), which should be given with caution in the perioperative period.<sup>94,95</sup> Another important issue with COX-2 inhibitors is their potential to reduce bone healing in animal models. In vitro studies have shown that the presence of COX-2, but not COX-1, is essential for adequate bone healing.<sup>96,97</sup> However, no clinical evidence in humans shows the effect of reduced bone formation, particularly when COX-2 inhibitors are used for short-term treatment.<sup>97</sup>

## FACTORS RELATED TO ORTHOPEDIC SURGERY

### Tourniquets

Tourniquets (derived from the French *tourner* "to turn") are routinely used in orthopedic surgery to provide a bloodless field. This practice is purported to improve visualization of critical structures and decrease operative blood loss.<sup>98</sup> However, tourniquets have significant risks, and these risks and the strategies to minimize them should be part of the knowledge base of all practicing anesthesiologists.<sup>99</sup>

By inflating a cuff around an extremity, arterial inflow to the extremity distal to the cuff is eliminated. Careful exsanguination of the limb distal to the cuff immediately before cuff inflation, either via application of an elastic Esmarch bandage or elevation of the extremity for 5 minutes, empties the vascular system. The distal limb is thus rendered ischemic, which may have significant physiologic and biochemical implications.

Limb exsanguination causes an increase in central blood volume that is reflected as a transient rise in central venous pressure.<sup>100</sup> This increase in preload can be significant if multiple tourniquets are used, as in simultaneous bilateral knee arthroplasties. Tourniquet inflation also causes an increase in afterload. Patients with diminished cardiac function may not be able to tolerate this combined insult of increased preload and afterload. After tourniquet deflation, preload decreases acutely as blood reenters the affected extremity, which undergoes a period of

postischemic reactive hyperemia. This is accompanied by an acute decrease in afterload that often produces hypotension.<sup>101</sup> Reperfusion of an extremity typically is associated with a drop in core temperature of up to 1.0°C.

During limb ischemia, oxygen and high-energy phosphate stores decrease progressively, and carbon dioxide and lactic acid levels rise as ischemic tissues convert to anaerobic metabolism.<sup>102</sup> The pH of the ischemic limb decreases as the duration of ischemia increases.<sup>103</sup> After tourniquet deflation, aerobic metabolism resumes, with marked increases in oxygen consumption and carbon dioxide production.<sup>104</sup> Systemic partial pressure of carbon dioxide increases in this interval, and pH transiently decreases as a result of combined metabolic and respiratory acidosis.<sup>105</sup> Spontaneously breathing patients increase minute ventilation markedly to compensate. The minute ventilation of mechanically ventilated patients must be increased to minimize the duration and magnitude of hypercapnia. The increase in carbon dioxide tension can produce a marked increase in cerebral blood flow, with potentially deleterious results in patients with increased intracranial pressure.<sup>106</sup> In this setting, it is especially critical to increase minute ventilation in patients who are unable to compensate effectively.

Ischemia of the affected limb causes significant changes on the cellular level. Tissue becomes progressively acidotic while the cuff is inflated.<sup>102</sup> Ultrastructural changes within the endothelium of the ischemic capillaries lead to diffuse capillary leak after reperfusion.<sup>102</sup> In conjunction with reactive hyperemia, significant edema can develop after tourniquet deflation. This can even lead to a compartment syndrome in the affected extremity. The coagulation system undergoes significant changes in the setting of tourniquet use. Platelet aggregation is increased by both tissue compression and pain due to the surgical insult and the tourniquet.<sup>107</sup> Capillary obstruction by red blood cells and platelets that accumulate during the period of stasis and the concomitant release of inflammatory mediators can lead to microvascular thrombosis, causing no-reflow phenomena and further exacerbating tissue injury.<sup>102</sup> Tissue acidosis also leads to release of tissue plasminogen activator, which

causes a brief period of fibrinolysis after tourniquet deflation.<sup>107</sup> This is postulated to play a role in posttourniquet bleeding. Muscle is most susceptible to injury secondary to ischemia, with the duration of ischemia correlating with the severity of injury. Injury is most severe under the cuff as a result of the combined effect of tissue compression and ischemia.<sup>108</sup> Fortunately, these injuries are generally reversible when tourniquet time is not excessive. Rhabdomyolysis has been reported after tourniquet use. A practical guideline is to limit tourniquet time to 2 hours if possible. Experiments have shown that a 10-minute period of reperfusion every hour allows for disposal of accumulated waste products and regeneration of adenosine triphosphate stores in the involved limb, facilitating tissue recovery after completion of surgery and minimizing the extent of muscle injury.<sup>102</sup>

Cuff pressure is the most significant risk factor for nerve injury after tourniquet use.<sup>109</sup> Use of a wider cuff allows arterial occlusion at lower cuff pressures. Conical rather than rectangular cuffs can produce the desired effect at lower inflation pressures.<sup>110,111</sup> Numerous methods for determining the inflation pressure to be used in a particular situation are recommended. Inflating the cuff 50–75 mm Hg above the systolic pressure for upper-extremity procedures and 100–150 mm Hg above systolic pressure for lower-extremity operations appears reasonable. Others have recommended empirically determining the appropriate inflation pressure by first ascertaining via Doppler ultrasonography the pressure at which arterial inflow is occluded and then setting the cuff pressure 50 mm Hg higher. Using the lowest pressure possible decreases the risk of nerve injury. The incidence of significant nerve injury in the upper extremity is estimated at 1 in 11,000, with radial nerve palsy representing the most common injury; lower-extremity nerve injuries are believed to occur at a much lower rate. Most nerve injuries are not permanent and resolve with time.<sup>112</sup> Detailed neurologic examination should be obtained in a timely fashion if such an injury is suspected to document any preexisting dysfunction.

Careful padding of the limb under the cuff with cast padding, with care taken to avoid any wrinkles, decreases

the risk of skin injury from compression or pinching. The tourniquet should not be manipulated after it is applied to avoid bunching up the padding underneath the tourniquet. Creating an impervious barrier with adhesive plastic drapes to prevent cleaning solutions from seeping under the tourniquet is helpful in minimizing the risk of skin injury. The vascular system is not immune to injury from tourniquet application. Patients with atherosclerosis appear to be at highest risk for this type of injury. Mechanical forces applied to these vessels are believed capable of fracturing calcified plaque within the vessel wall.<sup>113</sup> This can lead to vascular compromise and potentially to limb loss. Tourniquet use is relatively contraindicated in patients with risk factors for peripheral vascular disease, absent distal pulses, and previous vascular surgery on the operative extremity.<sup>114</sup>

Use of a tourniquet can affect the pharmacokinetics of other drugs given during an anesthetic procedure. Drugs administered before tourniquet inflation can become sequestered in the ischemic limb. When the tourniquet is deflated at the end of surgery, a bolus of that particular drug is delivered to the central circulation.<sup>115</sup> This effect can be significant in elderly patients who have received opioids or benzodiazepines before tourniquet inflation. The volume of distribution is decreased for drugs administered after the tourniquet is inflated. This can produce a greater-than-expected effect from a given dose. Antibiotic administration must be coordinated with tourniquet inflation to ensure that adequate tissue penetration occurs at the surgical site. For most antibiotics, a minimum interval of 5 minutes is recommended between completion of drug administration and tourniquet inflation.<sup>116</sup> Muscle relaxants sequestered in an ischemic limb have not proved to be as significant a problem upon tourniquet release as anticipated.

Tourniquet pain is the final major issue that complicates use of a tourniquet. In an unsedated patient, it presents as dull, aching pain that becomes intolerable within approximately 30 minutes. This time period can be extended somewhat by intravenous administration of sedatives and analgesics.<sup>117</sup> During a general anesthetic, tourniquet pain manifests as increases in heart rate and both systolic and

diastolic blood pressures 45–60 minutes after tourniquet inflation.<sup>118</sup> This typically is treated with only limited success by increasing the depth of anesthesia or administering additional analgesics. Ultimately, tourniquet deflation is the only factor that eliminates tourniquet pain, with resolution within 30 minutes. This phenomenon also has been reported during spinal and epidural anesthetics, with an apparently adequate level of anesthesia to pinprick.<sup>119</sup> An adequate level of anesthesia to touch is more predictive of prevention of tourniquet pain. The postulated mechanism for tourniquet pain is a differential conduction block of large myelinated A- $\delta$  fibers and small unmyelinated C fibers.

### Fat Embolism Syndrome

Fat embolism syndrome (FES) was first described by Zencker in an article published in 1862. Nearly all patients with long bone fractures or patients who have undergone hip or knee replacement surgery experience some degree of fat embolization.<sup>120,121</sup> However, the incidence of clinically significant FES is only 0.5–3%.<sup>122,123</sup> The incidence may be higher (30%) in patients with multiple long bone fractures. FES is much more likely to occur with long bone fractures of the lower limb than with fractures of the upper limb. Likewise, the incidence of FES in children is much lower than in adults. Changes in surgeons' preference for early operative reduction and fixation of fractures have led to a marked decrease in FES incidence.

Fracture of the long bone causes an increase in intramedullary pressure. This coupled with disruption of the venous sinusoids within the long bones results in fat and bone debris entering the venous circulation. Manipulation and surgical preparation of the long bones, such as reaming, also can cause an increase in intramedullary pressure and result in fat embolization. Careful attention by the surgeon in clearing the femoral canal with adequate lavage can reduce the incidence of fat embolization (see Methylmethacrylate). Commonly, fat globules lodge in the pulmonary vasculature, resulting in obstruction of pulmonary circulation. Fat globules are hydrolyzed into free fatty acids that are directly toxic to the pulmonary endothelium and pneumocytes, resulting in endothelial damage, plate-

let adhesion with clot formation, capillary leakage, and perivascular bleeding. Some evidence indicates that elevated C-reactive protein levels resulting from trauma may cause chylomicrons to coalesce and form fat globules. These fat particles may pass into the systemic circulation via intracardiac (foramen ovale) and pulmonary shunts, resulting in cerebral and cutaneous manifestations.

FES may present intraoperatively as cardiorespiratory collapse after femoral reaming, insertion of intramedullary cemented prosthesis, or tourniquet release. FES also may present postoperatively as a variety of clinical signs and symptoms. Gurd and Wilson<sup>124</sup> described major and minor features of FES (Table 64–4). To make the diagnosis of FES, at least one major and four minor features must be present. The three major symptoms of FES are respiratory distress, cerebral manifestations, and petechial rash. The minor symptoms are fever, renal damage, retinal changes, hemolysis, lipuria, and jaundice. The Gurd criteria were criticized for not including assessment of the patient's oxygenation with the use of an arterial blood gas, which may be a useful early indicator of FES. The criteria of both Schonfeld et al.<sup>125</sup> and Lindeque et al.<sup>126</sup> include the measurement of arterial blood gases to determine the presence of hypoxemia. Respiratory distress consists of tachypnea, hypoxia, and hyperventilation and is seen in

**TABLE 64–4.**

#### Major and Minor Features of Fat Embolism Syndrome<sup>a</sup>

<b>Major Features</b>
Respiratory distress
Cerebral changes
Petechial rash
Arterial blood gas <sup>b</sup>
<b>Minor Features</b>
Fever
Renal damage
Retinal changes
Hemolysis
Lipuria
Jaundice

<sup>a</sup>As described by Gurd and Wilson.<sup>124</sup>

<sup>b</sup>Not an original major feature but added by Schonfeld et al.<sup>125</sup> and Lindeque et al.<sup>126</sup> in their classifications.



75% of patients with the syndrome.<sup>127</sup> The majority of patients present with  $PO_2 < 50$  mm Hg. Chest radiographs classically show bilateral diffuse infiltrates, especially in the upper and middle lobes of the lung. Pulmonary function usually resolves in 7 days. Approximately 10% of patients require mechanical ventilation for respiratory failure. Cerebral involvement consists of a wide range of clinical symptoms, such as confusion, convulsions, drowsiness, and coma, and normally is present in 86% of presenting cases.<sup>121</sup> Petechial rash classically involves the conjunctiva, mucous membranes, and skin on the anterior aspect of the chest and neck and likewise is seen in 50–60% of cases.<sup>124</sup> Classically, these symptoms and signs do not present within the first 6–12 hours after the insult. Onset after 72 hours from the insult is unusual. The best treatment of this condition is prevention by early surgical reduction and immobilization of the fracture site. Management consists of supportive care that may include ventilation. Adequate fluid resuscitation is essential and may lessen the severity of the presentation. Steroids to reduce the inflammatory response caused by free fatty acids have long played an important role in the management of this condition, but studies that steroids are not as effective as previously believed.<sup>128,129</sup> There is no evidence supporting the use of heparin or intravenous alcohol in the management of FES. The overall mortality rate is high (7–20%), and death normally is related to pulmonary involvement.<sup>121</sup>

### Methylmethacrylate

Use of cement, with its main component of methylmethacrylate (MMA), has been linked to a clinical scenario consisting of hypotension, bronchoconstriction, hypoxia, cardiac arrest, and sudden death. The terms *bone implantation syndrome* and *bone cement implantation syndrome* have been coined to describe this phenomenon. A study has shown rates of death in hip arthroplasty procedures between 0.02% and 0.5%.<sup>130</sup> These rates initially were believed to be due to a hypersensitivity reaction to the MMA resulting in acute vasodilatation and cardiac collapse. MMA given during in vitro studies has been shown to result in vasodilatation; however, plasma levels during use of MMA in clinical practice have been

found to be 10- to 20-fold below the levels required to cause clinically significant vasodilatation and hypotension.<sup>131</sup> It has become clear that the phenomenon is due to embolization of fat particles and debris from the intramedullary canal of long bones during their manipulation, reaming, and cementing. During these procedures, intramedullary pressures may exceed pressures within the medullary venous plexuses, resulting in fat and debris entering the venous system. Use of transesophageal echocardiography can clearly demonstrate the increased load of debris entering the right atrium during cementing of the long bones.<sup>132</sup> Intramedullary pressure peaks are 680 mm Hg in humans with cement use compared with peaks <100 mm Hg with noncemented arthroplasties.<sup>133</sup> In an attempt to minimize increased intramedullary pressure, orthopedic surgeons have used various techniques, such as new cementing devices, drilling distal venting holes within the long bones, and aggressive lavage of the canal before insertion of the cement and prosthesis to reduce the amount of intramedullary debris. The technique of venting results in significant extravasation of cement, and none of the techniques has been found to reliably prevent this phenomenon. Some surgeons use uncemented techniques for joint replacement procedures. Cemented prosthesis and the need for revision procedures have made the use of uncemented devices more appealing to surgeons. Clinical signs of bone implantation syndrome/bone cement implantation syndrome are similar to those found in pulmonary embolism or fat embolism. They include fever, tachycardia, hypotension, hypoxemia, and, in spontaneously breathing patients, dyspnea and tachypnea; end-tidal carbon dioxide may decrease with a large embolus. Other signs of fat emboli also may be seen. The electrocardiogram may show right axis deviation or right bundle-branch block. These signs reflect increased pulmonary artery pressure and intrapulmonary shunt, potentially leading to right ventricular failure and cardiac arrest.

Management of this phenomenon is similar to that caused by fat emboli. It requires both support of the cardiovascular system with aggressive fluid management and inotropic and vasopressor support. Oxygen therapy and

ventilation often are required, depending on the severity of the response.

### Deep Vein Thrombosis

The incidence of DVT in unprotected patients can be extremely high, varying between 80% and 90%, with a 2% incidence of fatal pulmonary emboli in hip and knee replacement surgery.<sup>134</sup> Hip fractures have an even higher occurrence of fatal pulmonary embolism, with an incidence of 4–7%. Hip replacement surgery typically results in thrombosis of vessels above the knee, whereas knee replacement surgery commonly involves vessels below the knee. Fatal pulmonary emboli are normally associated with thrombosis above the knee. The Virchow triad has classically been used to describe the etiology of DVT. The three main causes of DVT are prolonged stasis, damage to the intima of blood vessels, and increased viscosity of blood. All these factors may play a role in causing DVT in joint replacement surgery, but the problem is increased greatly for two reasons: extended use of tourniquets in total knee replacements, and distortion of lower limb blood vessels during manipulation and preparation of both the femur and tibia. This increase has necessitated the use of a variety of pharmacologic drugs and pneumatic devices to reduce the high incidence of DVT. Different regimens are used at various of institutions, with no best way to manage this problem. Whether warfarin (Coumadin) is superior to LMWH or vice versa is controversial.<sup>135–137</sup> In a study by Freedman et al.,<sup>135</sup> the risk of proximal DVT was lowest with warfarin (6.3%) compared with LMWH (7.7%), but no differences in the incidence of pulmonary embolism and mortality were noted. Miric et al.<sup>136</sup> found that LMWH was better than warfarin in preventing DVT in total hip replacements (4% vs 12%, respectively). What is clear is that use of unfractionated heparin does not offer sufficient DVT prophylaxis in patients undergoing joint replacement procedures and that LMWH compared with warfarin is classically associated with an increased incidence of minor and major wound blood loss.<sup>135,138</sup> According to the latest recommendations from The Seventh American College of Chest Physicians Consensus Conference, only warfarin, fondaparinux, and LMWH are adequate forms of DVT prophylaxis when used alone for hip or

knee replacement surgery.<sup>139</sup> Pharmacologic agents should always be combined with mechanical prophylaxis, which should begin intraoperatively if possible. Mechanical prophylaxis should be used alone only when there is a significant risk of bleeding. Use of the newer anticoagulants, particularly LMWH, has resulted in the need for anesthesiologists to modify their anesthetic plan. Vandermeulen<sup>140</sup> demonstrated a significant increase in the incidence of epidural hematomas if epidural anesthesia is used in conjunction with LMWH. This finding resulted in the addition of an FDA black box warning to LMWH prescribing information and a review of the current practice of regional anesthesia, particularly neuroaxial anesthesia and analgesia in the presence of certain anticoagulants.<sup>141</sup> The ASRA has developed guidelines for the use of regional techniques in the presence of a variety of anticoagulants.<sup>30</sup> The guidelines include not performing a neuroaxial technique within 12 hours after a dose of LMWH and waiting 2 hours after removal of an epidural catheter before initiating LMWH. This guideline has severely limited the use of epidural anesthesia for postoperative pain and resulted in the development of a number of new techniques (discussed earlier in this chapter in the section on anesthesia for extremity surgery and in the section on blood loss).

### Compartment Syndrome

Volkman first described compartment syndrome in 1881. The disfigurement of the upper limb that may result from the condition is still called a Volkman contracture. Compartment syndrome is one of the most litigated topics in orthopedic surgery. A variety of injuries and medical conditions may initiate an acute compartment syndrome, including fractures, contusions, bleeding disorders, reperfusion injuries, burns, and trauma. Fractures of the tibial shaft are the most common fractures associated with compartment syndrome, accounting for 40% of cases, followed by forearm fractures, which account for 18%.<sup>142</sup> However, many cases of compartment syndrome can occur in the absence of a fracture and are solely related to soft-tissue damage (23%). Compartment syndrome occurs when the pressure within an osseofascial compartment increases to a level that decreases the perfusion gradient across tissue capillary beds, leading to cellular anoxia, muscle ischemia, and

death, with eventual replacement of the muscle with fibrous tissue, leading to contractures and a nonfunctional limb. The normal compartmental pressure is <10–12 mm Hg, with compartmental perfusion pressures normally >70–80 mm Hg. Compartmental perfusion pressures can be calculated by subtracting compartmental pressures from mean arterial pressures. Thus, increasing compartmental pressures and decreasing mean arterial pressures can lead to a situation in which the compartment perfusion pressure is inadequate. It is not possible to determine the compartmental pressure value critical to perfusion because compartmental pressure at which perfusion problems occur can vary greatly among individuals. Delta p ( $\Delta p$ ), which is diastolic pressure minus intracompartmental pressure, is much more reliable in determining the need for fasciotomy.<sup>143</sup>  $\Delta p < 30$  mm Hg in the presence of clinical signs of compartment syndrome requires a fasciotomy. Diagnosis is primarily clinical, supplemented by compartment pressure monitoring (Fig. 64–5). Signs include pain, especially with passive stretching of the involved muscle group, pallor of the limb, lack of a distal pulse, cold limb, paresthesia, paralysis, and a swollen and tense compartment.<sup>144</sup> The presence of a distal arterial pulse does not exclude the presence of compartment syndrome. These signs can be reliably diagnosed only in fully conscious or sedated patients. Patient who are unconscious or sedated should be monitored with continuous compartment pressures, and sometimes a prophylactic fasciotomy is needed. Complete fasciotomy of all

compartments involved is required to reliably normalize compartment pressures and restore perfusion to affected tissues. Recognizing compartment syndromes requires having and maintaining a high index of suspicion, performing serial examinations in patients at risk, and carefully documenting changes over time. The earlier the diagnosis the better the outcome, with neural structures being much more at risk than muscle. Anesthesiologists must be aware of this condition to allow for early diagnosis. Compartment syndrome should be considered in any patient in whom the intensity of pain is out of proportion to the injury and in any patient with a long bone fracture who is not responding to normal amounts of analgesia. In choosing the anesthetic technique for cases that normally are associated with compartment syndrome, the anesthesiologist must avoid any postoperative technique, such as epidurals or peripheral nerve blocks, that may delay diagnosis of the syndrome. If these techniques are used and there is a potential for compartment syndrome, consideration should be given to continuously monitoring compartment pressures. The effect of anesthetic techniques, such as spinals and epidurals, that cause sympathectomy (and thus vasodilatation) is unclear. The increased blood flow to muscle compartments may cause a further increase in compartment pressures. What is clear is that in cases of suspected or potential compartment syndrome, the anesthesiologist should maintain a high mean arterial blood pressure during the case. Use of mannitol has been shown to reduce the occur-



FIGURE 64–5. Compartment pressure monitoring.

rence of compartment syndromes in revascularization cases and may be of help in other patients with compartment syndrome.

## KEY REFERENCES

1. Enneking FK, Chan V, Greger J, et al. Lower-extremity peripheral nerve blockade: essentials of our current understanding. *Reg Anesth Pain Med* 2005;30:4.
2. Horlocker TT, Wedel DJ, Benzon H, et al. Regional anesthesia in the anticoagulated patient: defining the risks (the second ASRA Consensus Conference on Neuraxial Anesthesia and Anticoagulation). *Reg Anesth Pain Med* 2003;28:172.
3. Rodgers A, Walker N, Schug S, et al. Reduction of postoperative mortality and morbidity with epidural or spinal anaesthesia. *BMJ* 2000;321:1493.
4. Raw DA, Beattie JK, Hunter JM. Anaesthesia for spinal surgery in adults. *Br J Anaesth* 2003;91:886.
5. Kam PC, Kavanagh R, Yoong FF. The arterial tourniquet: pathophysiological consequences and anaesthetic implications. *Anaesthesia* 2001;56:534.
6. Gurd AR, Wilson RI. The fat embolism syndrome. *J Bone Joint Surg Br* 1974;56B:408.

## REFERENCES

1. Macarthur A, Kleiman S. Rheumatoid cervical joint disease—a challenge to the anaesthetist. *Can J Anaesth* 1993;40:154.
2. Brooker DS. Rheumatoid arthritis: otorhinolaryngological manifestations. *Clin Otolaryngol Allied Sci* 1988;13:239.
3. Bierbaum BE, Callaghan JJ, Galante JO, et al. An analysis of blood management in patients having a total hip or knee arthroplasty. *J Bone Joint Surg Am* 1999;81:2.
4. Colwell CW Jr, Beutler E, West C, et al. Erythrocyte viability in blood salvaged during total joint arthroplasty with cement. *J Bone Joint Surg Am* 2002;84-A:23.
5. Sculco TP. Global blood management in orthopaedic surgery. *Clin Orthop Relat Res* 1998;357:43.
6. Keating EM. Preoperative evaluation and methods to reduce blood use in orthopedic surgery. *Anesthesiol Clin North Am* 2005;23:305.

7. Sharrock NE, Mineo R, Urquhart B, et al. The effect of two levels of hypotension on intraoperative blood loss during total hip arthroplasty performed under lumbar epidural anesthesia. *Anesth Analg* 1993;76:580.
8. Gombotz H, Gries M, Sipurzynski S, et al. Preoperative treatment with recombinant human erythropoietin or predeposit of autologous blood in women undergoing primary hip replacement. *Acta Anaesthesiol Scand* 2000;44:737.
9. Hynes MC, Calder P, Rosenfeld P, et al. The use of tranexamic acid to reduce blood loss during total hip arthroplasty: an observational study. *Ann R Coll Surg Engl* 2005;87:99.
10. Hynes M, Calder P, Scott G. The use of tranexamic acid to reduce blood loss during total knee arthroplasty. *Knee* 2003;10:375.
11. Ho KM, Ismail H. Use of intravenous tranexamic acid to reduce allogeneic blood transfusion in total hip and knee arthroplasty: a meta-analysis. *Anaesth Intensive Care* 2003;31:529.
12. Kuban KC, Leviton A. Cerebral palsy. *N Engl J Med* 1994;330:188.
13. Mutch L, Alberman E, Hagberg B, et al. Cerebral palsy epidemiology: where are we now and where are we going? *Dev Med Child Neurol* 1992;34:547.
14. Albright AL. Intrathecal baclofen in cerebral palsy movement disorders. *J Child Neurol* 1996;11(Suppl 1):S29.
15. Gomar C, Carrero EJ. Delayed arousal after general anesthesia associated with baclofen. *Anesthesiology* 1994;81:1306.
16. Theroux MC, Akins RE, Barone C, et al. Neuromuscular junctions in cerebral palsy: presence of extrajunctional acetylcholine receptors. *Anesthesiology* 2002;96:330.
17. Theroux MC, Brandom BW, Zagnoev M, et al. Dose response of succinylcholine at the adductor pollicis of children with cerebral palsy during propofol and nitrous oxide anesthesia. *Anesth Analg* 1994;79:761.
18. Hepaguslar H, Ozzeybek D, Elar Z. The effect of cerebral palsy on the action of vecuronium with or without anticonvulsants. *Anaesthesia* 1999;54:593.
19. Frei FJ, Haemmerle MH, Brunner R, et al. Minimum alveolar concentration for halothane in children with cerebral palsy and severe mental retardation. *Anaesthesia* 1997;52:1056.
20. Horlocker TT, Abel MD, Messick JM Jr, et al. Small risk of serious neurologic complications related to lumbar epidural catheter placement in anesthetized patients. *Anesth Analg* 2003;96:1547.
21. Neal JM, Hebl JR, Gerancher JC, et al. Brachial plexus anesthesia: essentials of our current understanding. *Reg Anesth Pain Med* 2002;27:402.
22. Bishop J, Sprague M, Gelber J, et al. Interscalen Regional Anesthesia for shoulder surgery. *J Bone Joint Surg* 2005;87-A:974.

23. Ritchie E, Tong D, Chung F, et al. Suprascapular nerve block for postoperative pain relief in arthroscopic shoulder surgery. *Anesth Analg* 1997;84:1306.
24. Moote C. Random double-blind comparison of intra-articular bupivacaine and placebo for analgesia after outpatient shoulder arthroscopy. *Anesthesiology* 1994;81:A49.
25. Enneking FK, Chan V, Greger J, et al. Lower-extremity peripheral nerve blockade: essentials of our current understanding. *Reg Anesth Pain Med* 2005;30:4.
26. Mansour NY. Sub-sartorial saphenous nerve block with the aid of nerve stimulator. *Reg Anesth* 1993;18:266.
27. Ho AM, Karmakar MK. Combined paravertebral lumbar plexus and parasacral sciatic nerve block for reduction of hip fracture in a patient with severe aortic stenosis. *Can J Anaesth* 2002;49:946.
28. Tokat O, Turker YG, Uckunkaya N, et al. A clinical comparison of psoas compartment and inguinal paravascular blocks combined with sciatic nerve block. *J Int Med Res* 2002;30:161.
29. Turker G, Uckunkaya N, Yavasoglu B, et al. Comparison of the catheter-technique psoas compartment block and the epidural block for analgesia in partial hip replacement surgery. *Acta Anaesthesiol Scand* 2003;47:30.
30. Horlocker TT, Wedel DJ, Benzon H, et al. Regional anesthesia in the anticoagulated patient: defining the risks (the second ASRA Consensus Conference on Neuraxial Anesthesia and Anticoagulation). *Reg Anesth Pain Med* 2003;28:172.
31. Williams BA, Kentor ML, Vogt MT, et al. Femoral-sciatic nerve blocks for complex outpatient knee surgery are associated with less postoperative pain before same-day discharge: a review of 1,200 consecutive cases from the period 1996–1999. *Anesthesiology* 2003;98:1206.
32. Rigg JR, Jamrozik K, Myles PS, et al. Epidural anaesthesia and analgesia and outcome of major surgery: a randomised trial. *Lancet* 2002;359:1276.
33. Williams-Russo P, Sharrock NE, Mattis S, et al. Cognitive effects after epidural vs general anesthesia in older adults. A randomized trial. *JAMA* 1995;274:44.
34. Block BM, Liu SS, Rowlingson AJ, et al. Efficacy of postoperative epidural analgesia: a meta-analysis. *JAMA* 2003;290:2455.
35. Rodgers A, Walker N, Schug S, et al. Reduction of postoperative mortality and morbidity with epidural or spinal anaesthesia. *BMJ* 2000;321:1493.
36. Wu CL, Hurley RW, Anderson GF, et al. Effect of postoperative epidural analgesia on morbidity and mortality following surgery in Medicare patients. *Reg Anesth Pain Med* 2004;29:525.
37. Wu CL, Anderson GF, Herbert R, et al. Effect of postoperative epidural analgesia on morbidity and mortality after total hip replacement surgery in Medicare patients. *Reg Anesth Pain Med* 2003;28:271.



38. Salinas FV, Neal JM, Sueda LA, et al. Prospective comparison of continuous femoral nerve block with nonstimulating catheter placement versus stimulating catheter-guided perineural placement in volunteers. *Reg Anesth Pain Med* 2004;29:212.
39. Chan VW. Applying ultrasound imaging to interscalene brachial plexus block. *Reg Anesth Pain Med* 2003;28:340.
40. Sinha A, Chan VW. Ultrasound imaging for popliteal sciatic nerve block. *Reg Anesth Pain Med* 2004;29:130.
41. Singelyn FJ, Ferrant T, Malisse MF, et al. Effects of intravenous patient-controlled analgesia with morphine, continuous epidural analgesia, and continuous femoral nerve sheath block on rehabilitation after unilateral total-hip arthroplasty. *Reg Anesth Pain Med* 2005;30:452.
42. Capdevila X, Barthelet Y, Biboulet P, et al. Effects of postoperative analgesic technique on the surgical outcome and duration of rehabilitation after major knee surgery. *Anesthesiology* 1999;91:8.
43. Davies A, Segar E, Murdoch J, et al. Epidural infusion or combined femoral and sciatic nerve blocks as perioperative analgesia for knee arthroplasty. *Br J Anaesth* 2004;93:368.
44. Stevens R, Van Gessel E, Flory N, et al. Lumbar plexus block reduces pain and blood loss associated with total hip arthroplasty. *Anesthesiology* 2000;93:115.
45. Capdevila X, Biboulet P, Morau D, et al. Continuous three-in-one block for postoperative pain after lower limb orthopedic surgery: where do the catheters go? *Anesth Analg* 2002;94:1001.
46. Macalou D, Trueck S, Meuret P, et al. Postoperative analgesia after total knee replacement: the effect of an obturator nerve block added to the femoral 3-in-1 nerve block. *Anesth Analg* 2004;99:251.
47. Pham Dang C, Gautheron E, Guilley J, et al. The value of adding sciatic block to continuous femoral block for analgesia after total knee replacement. *Reg Anesth Pain Med* 2005;30:128.
48. Ben-David B, Schmalenberger K, Chelly JE. Analgesia after total knee arthroplasty: is continuous sciatic blockade needed in addition to continuous femoral blockade? *Anesth Analg* 2004;98:747.
49. Allen H, Liu S, Ware P, et al. Peripheral nerve blocks improve analgesia after total knee replacement surgery. *Anesth Analg* 1998;87:93.
50. Biboulet P, Morau D, Aubas P, et al. Postoperative analgesia after total-hip arthroplasty: comparison of intravenous patient controlled analgesia with morphine and single injection of femoral nerve or psoas compartment block. A prospective, randomized, double-blind study. *Reg Anesth Pain Med* 2004;29:102.
51. Nechleba J, Rogers V, Cortina G, et al. Continuous intra-articular infusion of bupivacaine for postoperative pain following total knee arthroplasty. *J Knee Surg* 2005;18:197.
52. Viscusi ER, Martin G, Hartrick CT, et al. Forty-eight hours of postoperative pain relief after total hip arthroplasty with a novel, extended-release epidural morphine formulation. *Anesthesiology* 2005;102:1014.
53. Goldacre MJ, Roberts SE, Yeates D. Mortality after admission to hospital with fractured neck of femur: database study. *BMJ* 2002;325:868.
54. Roberts SE, Goldacre MJ. Time trends and demography of mortality after fractured neck of femur in an English population, 1968–98: database study. *BMJ* 2003;327:771.
55. Moran CG, Wenn RT, Sikand M, et al. Early mortality after hip fracture: is delay before surgery important? *J Bone Joint Surg Am* 2005;87:483.
56. Fletcher AK, Rigby AS, Heyes FL. Three-in-one femoral nerve block as analgesia for fractured neck of femur in the emergency department: a randomized, controlled trial. *Ann Emerg Med* 2003;41:227.
57. de Visme V, Picart F, Le Jouan R, et al. Combined lumbar and sacral plexus block compared with plain bupivacaine spinal anesthesia for hip fractures in the elderly. *Reg Anesth Pain Med* 2000;25:158.
58. Michaloudis D, Petrou A, Bakos P, et al. Continuous spinal anaesthesia/analgesia for the perioperative management of high-risk patients. *Eur J Anaesthesiol* 2000;17:239.
59. Raw DA, Beattie JK, Hunter JM. Anaesthesia for spinal surgery in adults. *Br J Anaesth* 2003;91:886.
60. Ali AA, Breslin DS, Hardman HD, et al. Unusual presentation and complication of the prone position for spinal surgery. *J Clin Anesth* 2003;15:471.
61. Gelberman RH, Yamaguchi K, Hollstien SB, et al. Changes in interstitial pressure and cross-sectional area of the cubital tunnel and of the ulnar nerve with flexion of the elbow. An experimental study in human cadavera. *J Bone Joint Surg Am* 1998;80:492.
62. Lee LA, Roth S, Posner KL, et al. An analysis of 71 spine cases with ischemic optic neuropathy from the ASA postoperative visual registry. *Anesthesiology* 2005;103:A1.
63. Warner ME, Warner MA, Garrity JA, et al. The frequency of perioperative vision loss. *Anesth Analg* 2001;93:1417.
64. Cheng MA, Todorov A, Tempelhoff R, et al. The effect of prone positioning on intraocular pressure in anesthetized patients. *Anesthesiology* 2001;95:1351.
65. Roth S, Barach P. Postoperative visual loss: still no answers—yet. *Anesthesiology* 2001;95:575.
66. Lennarson PJ, Smith DW, Sawin PD, et al. Cervical spinal motion during intubation: efficacy of stabilization maneuvers in the setting of complete segmental instability. *J Neurosurg* 2001;94:265.
67. Lennarson PJ, Smith D, Todd MM, et al. Segmental cervical spine motion during orotracheal intubation of the intact and injured spine with and without external stabilization. *J Neurosurg* 2000;92:201.
68. Hambly PR, Martin B. Anaesthesia for chronic spinal cord lesions. *Anaesthesia* 1998;53:273.
69. Nuttall GA, Horlocker TT, Santrach PJ, et al. Predictors of blood transfusions in spinal instrumentation and fusion surgery. *Spine* 2000;25:596.
70. Cha CW, Deible C, Muzzonigro T, et al. Allogeneic transfusion requirements after autologous donations in posterior lumbar surgeries. *Spine* 2002;27:99.
71. Urban MK, Beckman J, Gordon M, et al. The efficacy of antifibrinolytics in the reduction of blood loss during complex adult reconstructive spine surgery. *Spine* 2001;26:1152.
72. Reuben SS, Ekman EF. The effect of cyclooxygenase-2 inhibition on analgesia and spinal fusion. *J Bone Joint Surg Am* 2005;87:536.
73. Radi ZA, Khan NK. Effects of cyclooxygenase inhibition on bone, tendon, and ligament healing. *Inflamm Res* 2005;54:358.
74. Kopacz DJ, Helman JD, Nussbaum CE, et al. A comparison of epidural levobupivacaine 0.5% with or without epinephrine for lumbar spine surgery. *Anesth Analg* 2001;93:755.
75. Reuben SS, Connelly NR, Maciolek H. Postoperative analgesia with controlled-release oxycodone for outpatient anterior cruciate ligament surgery. *Anesth Analg* 1999;88:1286.
76. Klein SM, Grant SA, Greengrass RA, et al. Interscalene brachial plexus block with a continuous catheter insertion system and a disposable infusion pump. *Anesth Analg* 2000;91:1473.
77. Skinner HB, Shintani EY. Results of a multimodal analgesic trial involving patients with total hip or total knee arthroplasty. *Am J Orthop* 2004;33:85.
78. Kehlet H, Dahl JB. The value of “multimodal” or “balanced analgesia” in postoperative pain treatment. *Anesth Analg* 1993;77:1048.
79. Buvanendran A, Kroin JS, Tuman KJ, et al. Effects of perioperative administration of a selective cyclooxygenase 2 inhibitor on pain management and recovery of function after knee replacement: a randomized controlled trial. *JAMA* 2003;290:2411.
80. De Andres J, Bellver J, Barrera L, et al. A comparative study of analgesia after knee surgery with intraarticular bupivacaine, intraarticular morphine, and lumbar plexus block. *Anesth Analg* 1993;77:727.
81. DeWeese FT, Akbari Z, Carline E. Pain control after knee arthroplasty: intraarticular versus epidural anesthesia. *Clin Orthop Relat Res* 2001;392:226.
82. Geutjens G, Hambidge JE. Analgesic effects of intraarticular bupivacaine after day-case arthroscopy. *Arthroscopy* 1994;10:299.



83. Stein C, Comisel K, Haimerl E, et al. Analgesic effect of intraarticular morphine after arthroscopic knee surgery. *N Engl J Med* 1991;325:1123.
84. Allen GC, St Amand MA, Lui AC, et al. Postarthroscopy analgesia with intraarticular bupivacaine/morphine. A randomized clinical trial. *Anesthesiology* 1993;79:475.
85. Reuben SS, Steinberg RB, Cohen MA, et al. Intraarticular morphine in the multimodal analgesic management of postoperative pain after ambulatory anterior cruciate ligament repair. *Anesth Analg* 1998;86:374.
86. Drosos GI, Vlachonikolis IG, Papoutsidakis AN, et al. Intra-articular morphine and postoperative analgesia after knee arthroscopy. *Knee* 2002;9:335.
87. Rosseland LA. No evidence for analgesic effect of intra-articular morphine after knee arthroscopy: a qualitative systematic review. *Reg Anesth Pain Med* 2005;30:83.
88. Kalso E, Smith L, McQuay HJ, et al. No pain, no gain: clinical excellence and scientific rigour—lessons learned from IA morphine. *Pain* 2002;98:269.
89. Stein C. Peripheral mechanisms of opioid analgesia. *Anesth Analg* 1993;76:182.
90. Joshi GP, McCarroll SM, Cooney CM, et al. Intra-articular morphine for pain relief after knee arthroscopy. *J Bone Joint Surg Br* 1992;74:749.
91. Cohn BT, Draeger RI, Jackson DW. The effects of cold therapy in the postoperative management of pain in patients undergoing anterior cruciate ligament reconstruction. *Am J Sports Med* 1989;17:344.
92. Malan TP Jr, Marsh G, Hakki SI, et al. Parecoxib sodium, a parenteral cyclooxygenase 2 selective inhibitor, improves morphine analgesia and is opioid-sparing following total hip arthroplasty. *Anesthesiology* 2003;98:950.
93. Sibbald B. Rofecoxib (Vioxx) voluntarily withdrawn from market. *CMAJ* 2004;171:1027.
94. Solomon SD, McMurray JJ, Pfeffer MA, et al. Cardiovascular risk associated with celecoxib in a clinical trial for colorectal adenoma prevention. *N Engl J Med* 2005;352:1071.
95. Hudson N, Richard H, Pilote L. Differences in outcomes of patients with congestive heart failure prescribed celecoxib, rofecoxib, or non-steroidal anti-inflammatory drugs: population based study. *BMJ* 2005;330:1370.
96. Simon A, Pillai S, Raghupathy P, et al. Leucocyte adhesion deficiency-1. *Indian Pediatr* 2002;39:963.
97. Einhorn TA. Cox-2: where are we in 2003? The role of cyclooxygenase-2 in bone repair. *Arthritis Res Ther* 2003;5:5.
98. Klenerman L. Is a tourniquet really necessary for knee replacement? *J Bone Joint Surg Br* 1995;77:174.
99. Kam PC, Kavanagh R, Yoong FF. The arterial tourniquet: pathophysiological consequences and anaesthetic implications. *Anaesthesia* 2001;56:534.
100. Bradford EM. Haemodynamic changes associated with the application of lower limb tourniquets. *Anaesthesia* 1969;24:190.
101. Townsend HS, Goodman SB, Schurman DJ, et al. Tourniquet release: systemic and metabolic effects. *Acta Anaesthesiol Scand* 1996;40:1234.
102. Newman RJ. Metabolic effects of tourniquet ischaemia studied by nuclear magnetic resonance spectroscopy. *J Bone Joint Surg Br* 1984;66:434.
103. Wilgis EF. Observations on the effects of tourniquet ischemia. *J Bone Joint Surg Am* 1971;53:1343.
104. Hoka S, Yoshitake J, Arakawa S, et al.  $VO_2$  and  $VCO_2$  following tourniquet deflation. *Anaesthesia* 1992;47:65.
105. Patel AJ, Choi CS, Giuffrida JG. Changes in end tidal  $CO_2$  and arterial blood gas levels after release of tourniquet. *South Med J* 1987;80:213.
106. Lam AM, Slee T, Hirst R, et al. Cerebral blood flow velocity following tourniquet release in humans. *Can J Anaesth* 37: S29, 1990.
107. Kohro S, Yamakage M, Arakawa J, et al. Surgical/tourniquet pain accelerates blood coagulability but not fibrinolysis. *Br J Anaesth* 1998;80:460.
108. Pedowitz RA, Gershuni DH, Friden J, et al. Effects of reperfusion intervals on skeletal muscle injury beneath and distal to a pneumatic tourniquet. *J Hand Surg [Am]* 1992;17:245.
109. Lundborg G. Structure and function of the intraneural microvessels as related to trauma, edema formation, and nerve function. *J Bone Joint Surg Am* 1975;57:938.
110. Pedowitz RA, Gershuni DH, Botte MJ, et al. The use of lower tourniquet inflation pressures in extremity surgery facilitated by curved and wide tourniquets and an integrated cuff inflation system. *Clin Orthop Relat Res* 1993;287:237.
111. Crenshaw AG, Hargens AR, Gershuni DH, et al. Wide tourniquet cuffs more effective at lower inflation pressures. *Acta Orthop Scand* 1988;59:447.
112. Rorabeck CH, Kennedy JC. Tourniquet-induced nerve ischemia complicating knee ligament surgery. *Am J Sports Med* 1980;8:98.
113. Rush JH, Vidovich JD, Johnson MA. Arterial complications of total knee replacement. The Australian experience. *J Bone Joint Surg Br* 1987;69:400.
114. Kumar SN, Chapman JA, Rawlins I. Vascular injuries in total knee arthroplasty. A review of the problem with special reference to the possible effects of the tourniquet. *J Arthroplasty* 1998;13:211.
115. Schmitt H, Batz G, Knoll R, et al. Plasma level changes of fentanyl and midazolam after release of a prolonged thigh tourniquet. *Acta Anaesthesiol Scand* 1990;34:104.
116. Bannister GC, Auchincloss JM, Johnson DP, et al. The timing of tourniquet application in relation to prophylactic antibiotic administration. *J Bone Joint Surg Br* 1988;70:322.
117. Fuselier CO, Binning T, Dobbs BM, et al. A study of the use of a double tourniquet technique to obtain hemostasis in combination with local standby sedation during podiatric surgery. *J Foot Surg* 1988;27:515.
118. Kaufman RD, Walts LF. Tourniquet-induced hypertension. *Br J Anaesth* 1982;54:333.
119. Dejong R, Cullen SC. Theoretical aspects of pain: bizarre pain phenomena during low spinal anesthesia. *Anesthesiology* 1963;24:628.
120. Levy D. The fat embolism syndrome. A review. *Clin Orthop Relat Res* 1990;261:281.
121. Robert JH, Hoffmeyer P, Broquet PE, et al. Fat embolism syndrome. *Orthop Rev* 1993;22:567.
122. ten Duis HJ, Nijsten MW, Klasen HJ, et al. Fat embolism in patients with an isolated fracture of the femoral shaft. *J Trauma* 1988;28:383.
123. Rokkanen P, Lahdensuu M, Kataja J, et al. The syndrome of fat embolism: analysis of thirty consecutive cases compared to trauma patients with similar injuries. *J Trauma* 1970;10:299.
124. Gurd AR, Wilson RI. The fat embolism syndrome. *J Bone Joint Surg Br* 1974;56B:408.
125. Schonfeld SA, Ploysongsang Y, DiLisio R, et al. Fat embolism prophylaxis with corticosteroids. A prospective study in high-risk patients. *Ann Intern Med* 1983;99:438.
126. Lindeque BG, Schoeman HS, Dommissse GF, et al. Fat embolism and the fat embolism syndrome. A double-blind therapeutic study. *J Bone Joint Surg Br* 1987;69:128.
127. Johnson MJ, Lucas GL. Fat embolism syndrome. *Orthopedics* 1996;19:41.
128. Kallenbach J, Lewis M, Zaltzman M, et al. "Low-dose" corticosteroid prophylaxis against fat embolism. *J Trauma* 1987;27:1173.
129. Byrick RJ, Mullen JB, Wong PY, et al. Prostanoid production and pulmonary hypertension after fat embolism are not modified by methylprednisolone. *Can J Anaesth* 1991;38:660.
130. Woo R, Minister G, Fitzgerald R, et al. Pulmonary fat embolism in revision hip arthroplasty. *Clin Orthop* 1995;319:41.
131. Rinecker H. New clinico-pathophysiological studies on the bone cement implantation syndrome. *Arch Orthop Trauma Surg* 1980;97:263.
132. Christie J, Burnett R, Potts H, et al. Echocardiography of transarterial embolism during cemented and uncemented hemiarthroplasty of the hip. *J Bone Joint Surg* 1994;71-A:1331.
133. Lamade WR, Friedl W, Schmid B, et al. Bone cement implantation syndrome. A

prospective randomised trial for use of antihistamine blockade. *Arch Orthop Trauma Surg* 1995;114:335.

134. Geerts WH, Heit JA, Clagett GP, et al. Prevention of venous thromboembolism. *Chest* 2001;119:132S.

135. Freedman KB, Brookenthal KR, Fitzgerald RH Jr, et al. A meta-analysis of thromboembolic prophylaxis following elective total hip arthroplasty. *J Bone Joint Surg Am* 2000;82-A:929.

136. Miric A, Lombardi P, Sculco TP. Deep vein thrombosis prophylaxis: a comprehensive approach for total hip and total knee arthroplasty patient populations. *Am J Orthop* 2000;29:269.

137. Fitzgerald RH Jr, Spiro TE, Trowbridge AA, et al. Prevention of venous thromboembolic disease following primary total knee arthroplasty. A randomized, multicenter, open-label, parallel-group comparison of enoxaparin and warfarin. *J Bone Joint Surg Am* 2001;83-A:900.

138. Stern SH, Wixson RL, O'Connor D. Evaluation of the safety and efficacy of enoxaparin and warfarin for prevention of deep vein thrombosis after total knee arthroplasty. *J Arthroplasty* 2000;15:153.

139. Hirsh J, Raschke R. Heparin and low-molecular-weight heparin: the Seventh ACCP Conference on Antithrombotic and Thrombolytic Therapy. *Chest* 2004;126:188S.

140. Vandermeulen E. Guidelines on anticoagulants and the use of LR anesthesia. *Acta Anaesthesiol Belg* 2001;52:425.

141. Dolenska S. Neuroaxial blocks and LMWH thromboprophylaxis. *Hosp Med* 1998;59:940.

142. McQueen MM, Gaston P, Court-Brown CM. Acute compartment syndrome. Who is at risk? *J Bone Joint Surg Br* 2000;82:200.

143. McQueen MM, Court-Brown CM. Compartment monitoring in tibial fractures. The pressure threshold for decompression. *J Bone Joint Surg Br* 1996;78:99.

144. Mubarak SJ, Hargens AR. Acute compartment syndromes. *Surg Clin North Am* 1983;63:539.

# CHAPTER 65

## Anesthesia for Ophthalmic Surgery

Salvatore J. Basta, MD

Ophthalmic surgery presents challenges to the anesthesiologist not seen in other surgical areas. Some of these challenges are listed in Box 65-1. Blind or potentially blind patients are especially apprehensive prior to surgery, and discussion of anesthetic procedures and expectations is extremely valuable. Ophthalmic surgery patients are especially likely to benefit from preoperative screening because they tend to be at the extremes of age, have a high incidence of systemic disease, and frequently are managed in an outpatient setting. In this chapter, we review the anatomy and physiology of the eye, preoperative medical preparation, regional and general anesthetic techniques, and anesthetic management of specific pediatric and adult surgical procedures.

### OCULAR ANATOMY

A working knowledge of the ocular anatomy is necessary for anesthesiologists to understand ophthalmic procedures, perform and evaluate ophthalmic regional nerve blocks, evaluate and manage complications from these blocks, and appreciate the importance of intraocular pressure (IOP).

The eyes lie within two bony cavities of the skull (termed *orbits*). The orbit is pear shaped. The orbital entrance is approximately 35 mm in height and 45 mm in width, giving a volume of approximately 30 mL. The depth of the orbit varies with race and gender but averages slightly more than 40 mm. The optic nerve, ophthalmic artery, and sympathetic fibers from the carotid plexus pass through the optic foramen. Just lateral to the optic foramen is the superior orbital fissure. It is 22 mm long and conducts the lacrimal, frontal, and nasociliary branches of cranial nerve (CN) III (oculomotor), CN IV (trochlear), CN V (trigeminal and CN VI (abducens); su-

perior ophthalmic vein; and sympathetic nerve plexus. The maxillary and pterygoid branches of CN V, a nerve from the pterygopalatine ganglion and the inferior ophthalmic vein, pass through the inferior orbital fissure,

which is located just below the superior fissure and extends laterally.

The adult globe averages 24 mm in diameter.<sup>1,2</sup> The normal anteroposterior diameter varies between 21 and 26 mm. At birth, the anteroposterior diameter is

### KEY POINTS

1. Cataract surgery under regional anesthesia is very-low-risk surgery. Patients often are high risk but can safely undergo surgery provided their medical condition is stable. They must be able to lie flat for approximately 1 hour, must be able to communicate with surgeon and anesthesiologist, must not have a major head and neck tremor, must not have a chronic, uncontrolled cough, and must understand that they will be awake.
2. Although ophthalmic surgery in general is low risk, general anesthesia may confer more risk than regional anesthesia. High-risk patients must be appropriately prepared to undergo the risks of general anesthesia and the needs of ophthalmic surgery.
3. The oculocardiac reflex (trigeminal–vagal) from pressure on the globe or traction on the extraocular muscles is more common during general than regional anesthesia. It can manifest as arrhythmias such as bradycardia, atrioventricular block, or asystole. High expectation of its potential for occurrence and prompt cessation of the inciting maneuver sometimes are sufficient therapy. Although it is a fatigable reflex, the oculocardiac reflex often must be blunted with atropine or glycopyrrolate. The reflex often can be abolished with a retrobulbar or peribulbar block.
4. Safe performance of regional block technique requires detailed knowledge of orbital and ocular anatomy and adequate education in, and supervision of, block technique by a qualified practitioner. Patients must be properly and adequately sedated and cooperative. A needle longer than 32 mm must never be used in the lateral orbit or 25 mm in the medial orbit.
5. Understand the complications (both local and systemic) that may be encountered during regional techniques and the treatment of those complications.
6. Know the axial length of the eye. Eyes >26 mm have greater potential for posterior or inferior staphyloma and scleral thinning and may not be appropriate for sub-Tenon block or injections within the muscular cone.
7. Nitrous oxide should be avoided, if possible, in vitreoretinal surgery when gas is being injected. At minimum, nitrous oxide should be discontinued at least 20 minutes prior to gas injection. Patients are at risk for bubble expansion for as long as 30 days.
8. Most vitreoretinal ophthalmic surgery requires akinesia. If necessary during regional techniques, a modified van Lindt block of the superior branch of facial nerve should be done.
9. General anesthesia must control hemodynamics intraoperatively to help prevent choroidal bleeding, prevent intraoperative coughing and patient movement, and provide a smooth wake-up. Control of pain and postoperative nausea and vomiting is essential. Regional anesthesia generally is not associated with pain and postoperative nausea and vomiting.
10. Pediatric ophthalmology requires knowledge of the comorbidities of prematurity as well as underlying congenital syndromes.
11. True ophthalmic emergencies are rare. Central retinal artery occlusion and chemical burns require immediate treatment. Medically uncontrolled glaucoma and threatened macula detachment should be accomplished within a few hours. Most other conditions, including some open globes, can be delayed to allow for improvement of the patient's condition.

## BOX 65-1.

## Special Concerns in Ophthalmic Anesthesiology

Elderly patients with multiple systemic diseases

Pediatric patients, often premature with congenital syndromes

Patients anxious from their loss of vision

Limited access to the airway

Oculocardiac reflex

Intraocular pressure and anesthetic interactions

Systemic effects of ophthalmic medications

Reprinted from Bruce RA Jr, McGoldrick KE, Oppenheimer P, eds. *Anesthesia for Ophthalmology*. Birmingham, Alabama: Aesculapius Publishing, 1982, with permission from Elsevier.

approximately 16 mm but reaches approximately 23 mm by age 3 years. The globe reaches maximum size at puberty.

The transparent cornea occupies the center of the anterior pole of the globe and is approximately 11 to 12 mm in diameter. The cornea, lens, and aqueous humor form the main refractive elements of the eye. The curvature of the cornea contributes approximately one third of the refractive power. The limbus borders the cornea and is gray and translucent in appearance. The sclera is opaque and white and covers the remaining 80% of the globe. Tendons of the rectus muscles insert into the superficial scleral collagen.

The wall of the globe is composed of three layers: (1) sclera, (2) uveal tract, and (3) retina (Fig. 65-1). The middle layer is the uveal tract. It is composed of three specialized structures: (1) iris, (2) ciliary body located in the anterior uvea, and (3) choroid located in the posterior uvea. The iris contains dilator and sphincter muscle fibers that control the central aperture, the pupil. Parasympathetic stimulation originating from the CN III nucleus contracts iris sphincter fibers, causing pupillary constriction or miosis. Conversely, sympathetic fibers traveling with the ophthalmic division of CN V stimulate iris dilator fibers, dilating the pupil. Directly adjacent and behind the iris is the ciliary body. The ciliary body had two primary functions: production of aqueous humor and accommodation. Ciliary muscles within the ciliary body are responsible for fine-tuning visual focus by releasing tension

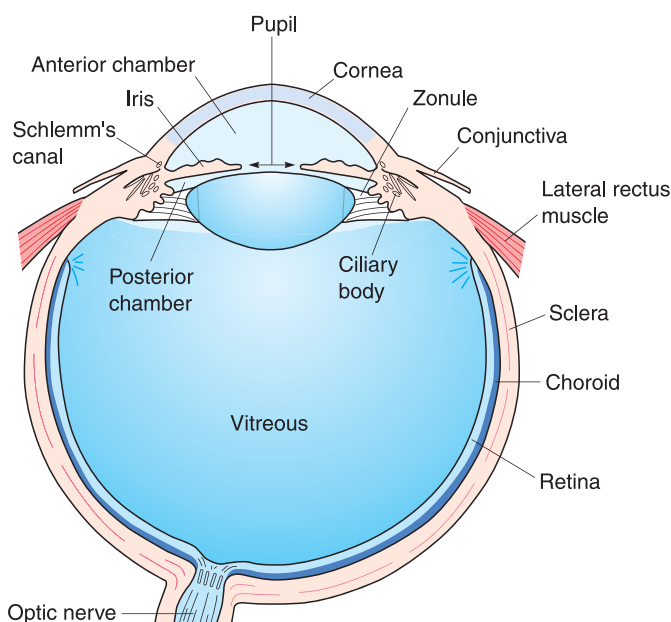
on the suspensory fibers or zonules of the lens, increasing the refractive power of the lens. The contraction of ciliary muscles also opens space for increased aqueous drainage. The posterior part of the uveal tract is a layer of blood vessels and capillaries called the *choroid*. These vessels nourish the outer portion of the retina, providing oxygen and nutrients. Bleeding from the choroid layer can cause catastrophic intraoperative expulsive hemorrhage.

The retina is a thin, transparent structure that differentiates from the optic cup and constitutes the inner layer of the medioposterior wall of the globe. Photoreceptors of the retinal layer convert light into neural signals, which are processed and carried to the brain via the optic nerve.

The vitreous cavity occupies >80% of the volume of the globe. The transparent vitreous humor is important in the metabolism of the intraocular tissues; it provides a passageway for metabolites used by the lens, the ciliary body, and the retina. Although it has a gel-like structure, the vitreous is composed of 99% water. Vitreous adheres to the retina peripherally at the vitreous base, the disk margin, and onto the posterior margin. Separation of the vitreous from the inner retina proceeds with age and is the most common event associated with retinal detachment. Scarring, bleeding, or opacification of the vitreous is treated by its removal, or vitrectomy.

Extraocular muscles arise from a fibrous ring at the orbital apex and insert onto the sclera approximately 6 mm posterior to the limbus. These muscles produce eye movements within the orbit. Together, they form what has been termed a “cone” within the orbit, which contains the optic nerve, ophthalmic artery and vein, oculomotor and abducens nerves, and ciliary ganglion. The extraocular muscles are composed of two different types of cells: Fibrillenstruktur and Felderstruktur. Fibrillenstruktur muscles fibrils are believed to produce fast or twitch movements. The Felderstruktur muscle fibers are responsible for slow or tonic movements. Felderstrukture appear to control the resting position of the extraocular muscles and may keep the eyes conjugate. These muscles are sensitive to the effects of acetylcholine and have been implicated in the exaggerated IOP response to succinylcholine and other depolarizing muscle relaxants. Extraocular movements are used to assess the success of ophthalmic nerve blocks. A summary of the function and innervation of the extraocular muscles is given in Table 65-1.

The conjunctiva is a mucous membrane that lines the inner surface of the eyelids and covers the anterior surface of the globe between the cornea and limbus. The bulbar extension of the conjunctiva fuses with the Tenon capsule and inserts into the limbus. The Tenon capsule is an incomplete fascial layer



**FIGURE 65-1.** Anatomy of the eye. (Reprinted from Bruce RA Jr, McGoldrick KE, Oppenheimer P, eds. *Anesthesia for Ophthalmology*. Birmingham, Alabama: Aesculapius Publishing, 1982, with permission from Elsevier.)



TABLE 65–1.

## Extraocular Muscles: Innervation and Function

Muscle	Innervation	Function
Superior rectus	III (oculomotor)	Elevation
Inferior rectus	III (oculomotor)	Depression
Medial rectus	III (oculomotor)	Adduction
Inferior oblique	III (oculomotor)	Elevation/abduction
Superior oblique	IV (trochlear)	Depression/adduction
Lateral rectus	VI (abducens)	Abduction

Reprinted from Bruce RA Jr, McGoldrick KE, Oppenheimer P, eds. *Anesthesia for Ophthalmology*. Birmingham, Alabama: Aesculapius Publishing, 1982, with permission from Elsevier.

composed of collagen fibers and fibroblasts. Anteriorly, it fuses with the conjunctiva and extends posteriorly, where it is perforated by the optic nerve sheath and the posterior ciliary vessels and nerves. The Tenon capsule and the intermuscular fibrous membranes surrounding the four rectus muscles fuse to form a type of fibrous sling or support. This structure may also be called the “cone,” but it is important to understand that the cone is not continuous.

The eyelids are composed of an outer layer of skin, a muscle layer, a cartilaginous tarsal plate, and an inner layer of conjunctiva. The upper lid can be raised 15 mm by the action of the levator palpebrae superioris muscle, which is innervated by CN III. The orbicularis oculi muscle, innervated by CN VII (facial), allows tight closure of the eyelids.

The lacrimal gland is located in a shallow depression within the orbital portion of the frontal bone. Tears are formed here by the serous secretion of acinar and myoepithelial cells. Under both reflex and psychogenic stimulation, tears pass from the surface of the eye via the puncta, through either the upper or the lower canaliculi to the lacrimal sac and duct, and drain into the nasopharynx below the inferior turbinate.

The blood supply to the ocular structures is primarily the ophthalmic artery. The ophthalmic artery is a branch of the internal carotid artery just before the circle of Willis. Venous drainage flows through the superior and inferior ophthalmic veins directly to the cavernous sinus.

The cranial nerves innervate ocular structures. The optic nerve (CN II) carries the sensory information from the retina. Cranial nerves III, IV, and VI supply the extraocular muscles.

The optic nerve is a special sensory nerve, but it is not a true nerve. Developmentally speaking, both the retina

and optic nerve are part of the brain. The optic nerve extends from the retina and enters the cranial cavity through the optic canal (optic foramen). The intraorbital part of the optic nerve is approximately 25 mm long. The optic nerve is enclosed by three sheaths that are continuous with the meninges of the brain. These sheaths extend as far as the back of the globe. The thick outer sheath is continuous with the dura mater of the brain and the sclera of the eye. The thin intermediate sheath is continuous with the arachnoid of the brain and is separated from the outer sheath by the subdural space and from the inner sheath by the subarachnoid space. The vascular inner sheath is continuous with the pia mater of the brain and closely invests the optic nerve. The inner sheath sends connective tissue partitions and blood vessels into the nerve. The ventral artery and vein of the retina pierce the dural and arachnoid coverings of the optic nerve approximately 1 cm behind the globe after a short course in the subarachnoid space, penetrate the optic nerve, and run within it to the inner aspect of the retina.

The oculomotor nerve (CN III) is the somatic motor nerve to four of the six muscles that move the eye and to the levator palpebrae superioris, the muscle that raises the eyelid. The oculomotor nerve was so named because it supplies most of the muscles that move the eye. It also contains parasympathetic fibers to the involuntary muscles that constrict the pupil and change the curvature of the lens (accommodation).

The trochlear (CN IV) nerve has the fewest nerve fibers of any cranial nerve, but it has the longest intracranial course. The trochlear nerve enters the orbit through the superior orbital fissure. It then extends superiorly to

innervate the superior oblique muscle. This location of the nerve, outside of the muscle cone, delays the abolition of depression and adduction of the globe following retrobulbar block.

The trigeminal nerve (CN V) provides sensory innervation to the skin and conjunctiva of the lower lid via that maxillary nerve and to the upper lid and conjunctiva via the frontal branch of the ophthalmic nerve. The nasociliary branch of the ophthalmic nerve provides sensory innervation to the medial canthus, lacrimal sac, and canaliculi and sends sensory fibers to the ciliary ganglion.

The ciliary ganglion provides sensory innervation of the cornea, iris, and ciliary body. Parasympathetic motor fibers originating from the oculomotor nerve synapse in the ciliary ganglion before innervating the sphincter muscle of the iris and the ciliary muscle. Sympathetic motor fibers originating from the carotid plexus travel through the ciliary ganglion to innervate the dilator muscle of the iris.

The abducens nerve (CN VI) passes through the superior orbital fissure to innervate the lateral rectus muscle on its ocular surface. No sympathetic or parasympathetic fibers appear to accompany the motor fibers.

The facial nerve (CN VII) is a mixed nerve, but it is predominantly motor in function. It was given its name because of large motor branches that spread across the face. The facial nerve exits the skull through the stylomastoid foramen (along with the internal carotid artery) and passes into the substance of the parotid gland, where it divides into five branches that supply the muscles of facial expression. The orbicularis oculi muscle, innervated by the zygomatic branch of the facial nerve, allows the patient to close the eyelid tightly. Local anesthetic blockade of the facial nerve can be important in intraocular surgery by eliminating squeezing caused by contraction of the orbicularis oculi.

## OCULOCARDIAC REFLEX

The oculocardiac reflex (OCR) is caused by traction on the extraocular muscles, manipulation of the globe, or increase in IOP. It is most commonly described as occurring during eye muscle surgery, but it also is prevalent during retinal detachment repair and enucle-

ation. The OCR has even been observed following retrobulbar block and retrobulbar hemorrhage. The OCR is most commonly manifested as bradycardia, but it also may appear as bigeminy, ectopic beats, nodal rhythms, atrioventricular block, or asystole. These dysrhythmias may persist as long as the stimuli are present. Repeated stimuli cause fatigue with diminished vagal effects.

The afferent pathway of the OCR is via the ciliary ganglion to the ophthalmic division of the trigeminal nerve, through the gasserian ganglion to the trigeminal nucleus in the fourth ventricle. The efferent pathway is exclusively through the vagus nerve. It is the vagus innervation to the abdominal viscera that causes nausea and vomiting that can accompany the cardiac manifestations. Alexander<sup>3</sup> reported that 90% of patients experienced OCR during traction of the extraocular muscles. The reported incidence of other cardiac dysrhythmias varies between 32% and 82%.

Diagnosis of the OCR relies upon continuous monitoring of the electrocardiogram (ECG). Treatment varies based upon the severity of the reflex. If the reflex manifests as bradycardia or infrequent ectopic beats and the blood pressure remains stable, no treatment may be warranted. If the dysrhythmias become significant, cessation of the surgical stimuli is indicated. Often the procedure may resume after a brief pause. The OCR fatigues easily and usually little or no OCR occurs after a brief pause in surgical stimuli. When the OCR is severe, treatment with anticholinergics (glycopyrrolate or atropine) is indicated. Caution must be exercised with large doses of atropine because more severe, prolonged tachydysrhythmias may result.<sup>4</sup>

## ANESTHESIA AND IOP

IOP is the pressure exerted by the contents of the eye upon the cornea and sclera of the globe. The sclera is inelastic, making compliance of the globe low; small changes in volume result in large changes in pressure. The volume of the globe is principally determined by the aqueous humor and the blood vessels of the eye, particularly of the choroid. Aqueous humor volume is determined by the production and drainage of aqueous. Excessive increases in IOP interfere with cho-

roidal and retinal blood supply as well as corneal metabolism, potentially causing retinal ischemia and corneal opacification. Decreased IOP or hypotony increases the risk of retinal detachment and vitreous hemorrhage.

The blood vessels of the choroid constitute a large and variable volume in the eye. Because choroidal vessels of the eye act much like intracranial vessels, it is useful to think of anesthetic effects upon IOP as being similar to anesthetic effects upon intracranial pressure. Choroidal vessels constrict with hyperventilation (hypocapnia) and cause a decrease in IOP. Hypoventilation (hypercapnia) causes vasodilation and an increase in IOP. Similarly, hypoxia may contribute to increased IOP through vasodilation of intraocular vessels.

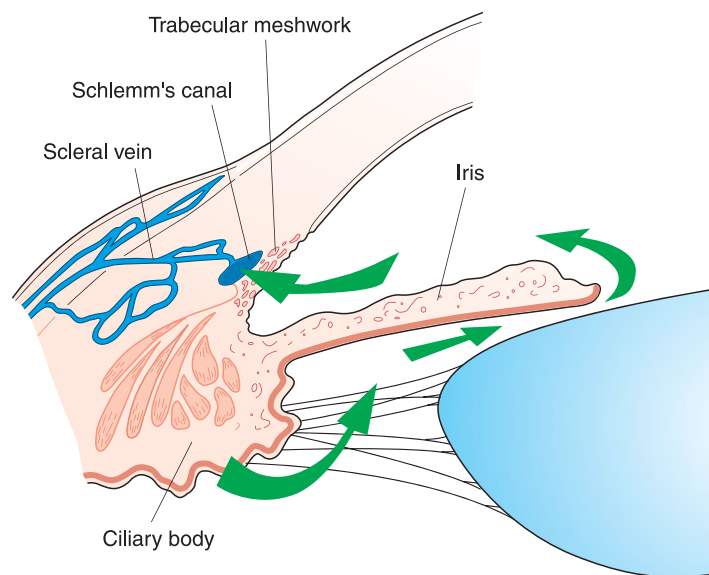
Normal IOP is  $16 \pm 5$  mm Hg in the sitting position and is generally maintained within this narrow range. IOP undergoes normal minor fluctuations because of (1) changes in body position (+1 mm Hg supine), (2) diurnal rhythm (2–3 mm Hg), (3) blood pressure oscillations (1–2 mm Hg), and (4) respiration (deep inspiration decreases IOP by 5 mm Hg). Changes in blood pressure are reflected in IOP: hypotension decreases IOP, whereas hypertension increases IOP.

The most severe increases in IOP usually are caused by blockage of aqueous outflow by acute venous congestion. Any straining, bucking, breathholding,

or obstructed airway during induction of or emergence from general anesthesia will increase venous congestion in the ophthalmic veins and therefore raise IOP. Coughing, Valsalva maneuvers, or straining can increase IOP to 30–40 mm Hg. Endotracheal intubation is another potent stimuli for increasing IOP. External pressure from face mask, fingers, orbital tumors, contraction of the orbicularis oculi muscle, or retrobulbar hemorrhage will increase IOP.

Aqueous humor is formed by the ciliary body, which is the vascular component of the uveal tract located in front of the pars plana and behind the fibers of the suspensory ligament of the lens (Fig. 65–2). The ciliary body is folded over into a series of 80 folds, each 2–3 mm, termed *processes*, which extend to the posterior aspect of the iris. This structure is supplied by a vascular plexus and covered with epithelium that is impervious to proteins and high-molecular-weight substances.

Aqueous humor is the major transport system in the eye for oxygen, glucose, proteins, medications, and inflammatory cells. It provides nourishment for the lens and the corneal endothelium. Approximately half of the cornea's oxygen supply comes from aqueous; the remainder comes from diffusion with the air. Drugs may enter the eye with aqueous humor via the cellular pumping action of the ciliary body, but as just noted, a distinct blood–aqueous barrier prevents



**FIGURE 65–2.** Anatomy of aqueous flow. Reprinted from Bruce RA Jr, McGoldrick KE, Oppenheimer P, eds. *Anesthesia for Ophthalmology*. Birmingham, Alabama: Aesculapius Publishing, 1982, with permission from Elsevier.

high-molecular-weight drugs from entering aqueous from the blood.

The aqueous flows forward from the suspensory ligament of the lens and passes between the anterior capsule of the lens and posterior surface of the iris through the pupil to the anterior chamber. Flow then proceeds laterally to the meshwork of the trabecula and into the circular canal of Schlemm. This lateral drainage area is termed the “angle.” Episcleral veins drain aqueous to the venous system. Approximately one third of the aqueous produced is reabsorbed through the veins in the iris and choroid.

Altered circulation of aqueous can produce an increase in IOP, termed *glaucoma*, or a decrease in IOP, termed *phthisis*. Glaucoma usually is caused by obstruction to outflow of aqueous humor. Glaucoma is rarely caused by an abnormal increase in aqueous production. In these cases, vascular abnormalities or diseases lead to increased vascularity of the eye.

*Acute glaucoma* is the sudden occlusion of the drainage angle. This occlusion often is associated with a narrow anatomic angle, a pupil dilated by atropine compounds, or an iris propelled anteriorly. Often the patient has a history of an episode of coughing or straining.

The onset of *chronic glaucoma* is insidious. Although peripheral vision is gradually lost in the early stages of the disease, the angle is found open and the trabecula appears to operate normally. Chronic glaucoma may be congenital, associated with a familial diathesis or increasing age.

IOP is clinically measured indirectly. Invasive measurements are not common because of the risk of eye damage, danger of infection, and likelihood that the measurement itself may alter IOP. IOP is measured via an indentation technique (Schiotz) or applanation (Goldmann).

The Schiotz technique uses a plunger activated by a small weight to indent the cornea. The plunger is connected to a lever that points to a number on an arbitrary scale. This number, along with the weight used in the measurement, allows determination of IOP from a nomogram. A small amount of aqueous is forced out of the eye with each indentation. Because of this action and because of the mechanical friction of the tonometer, Schiotz readings decrease as the measurements are repeated. The appla-

nation method exerts graduated pressures to the cornea and results in a more reproducible IOP measurement.

Many drugs alter the production or drainage of aqueous and consequently IOP (Table 65-2). The method and speed of administration of drugs is important. Inhalational and intravenous drugs have the most rapid and pro-

nounced effect upon IOP. Most medications exhibit a “dose–response” relationship with IOP. Initial dosing has minimal effects, then a rapid linear response occurs leading to a plateau effect, where increasing dosages have little or no effect upon IOP.

Deep inhalational or thiopental and propofol anesthesia reduces IOP 30–40%

TABLE 65-2.

## Effects of Drugs on Intraocular Pressure

	Dose	Route	Comments
<b>Drugs that increase intraocular pressure</b>			
Ketamine	1–2 mg/kg	IV	Increase
Ketamine	5 mg	IM	Slight increase
Succinylcholine	1–2 mg/kg	IV	18% increase
<b>No effect or unknown</b>			
Alfentanil	5 µg/kg	IV	No effect
Atracurium	0.4–0.5 mg/kg	IV	No effect
Atropine	0.4–1.0 mg	IM	No effect
Desflurane	6–12%	Inhalation	Unknown, probable decrease
Flumazenil	0.0025 mg/kg	IV	No effect
Glycopyrrolate	0.2–0.4 mg	IV	No effect
Meperidine	50–100 mg	IM	May increase, normally no effect
Nitrous oxide	70%	Inhalation	No effect
Remifentanil	0.5 µg/kg	IV	No effect
Scopolamine	0.4 mg	IM	No effect
Vecuronium	0.08–0.1 mg/kg	IV	No effect
<b>Drugs that decrease intraocular pressure</b>			
Chlorpromazine	10–25 mg	IM	20–30% decrease
Curare	0.5–0.6 mg/kg	IV	Slight decrease
Dexmedetomidine	1 µg/kg	IV	40% decrease
Diazepam	10 mg	IV	Decrease
Dilaudid	1–2 mg	IV	Decrease
Droperidol	5–10 mg	IV	12% decrease
Enflurane	1% with N <sub>2</sub> O	Inhalation	35–40% decrease
Etomidate	0.3 mg/kg	IV	30% decrease
Fentanyl	50–100 mg	IM	20% decrease
Haloperidol	0.5 mg	IV	15% decrease
Halothane	1 MAC	Inhalation	14–33% decrease
Isoflurane	1–3%	Inhalation	40% decrease
Lidocaine	1.5 mg/kg	IV	Decrease
Methohexital	6 mg/kg	IV	Decrease
Metocurine	0.3–0.4 mg/kg	IV	Slight decrease
Midazolam	0.15 mg/kg	IV	25% decrease
Morphine	8–15 mg	IM	Decrease
Pancuronium	0.05 mg/kg	IV	Slight decrease
Pentothal	3–5 mg/kg	IV	30% decrease
Propofol	1–2 mg/kg	IV	Decrease
Sevoflurane	1–3% with N <sub>2</sub> O	Inhalation	40% decrease
Sufentanil	1–2 µg/kg	IV	Decrease
Thiamylal	4–5 mg/kg	IV	Decrease
Thiopentone	2.5 mg/kg	IV	30% decrease

Reprinted from Bruce RA Jr, McGoldrick KE, Oppenheimer P, eds. *Anesthesia for Ophthalmology*. Birmingham, Alabama: Aesculapius Publishing, 1982, with permission from Elsevier.

in a dose-related manner.<sup>5,6</sup> Narcotics generally cause a small decrease in IOP. Atropine in usual doses is not a problem, even in patients with open-angle glaucoma. Ketamine may cause a modest-to-significant increase in IOP. Most of this increase can be explained by increased blood pressure.<sup>7</sup>

Succinylcholine causes a 6–12 mm Hg increase in IOP, which can be sustained for 5–10 minutes.<sup>8–11</sup> This increase has been ascribed to contraction of the extraocular muscles leading to compression of the globe. This contraction could potentially extrude globe contents in a patient with an open-globe injury. Katz et al.<sup>12</sup> studied patients undergoing elective enucleation and compared IOP between the normal eye and the diseased eye, in which all extraocular muscles were detached, after administration of succinylcholine. No difference between the two eyes was found in baseline or peak IOP. Nonetheless, both eyes exhibited a precipitous rise in IOP, leading the authors to conclude that extraocular muscle contraction does not contribute to the increase in IOP after succinylcholine administration. “Self-taming” doses,<sup>13,14</sup> precurarization,<sup>15</sup> diazepam,<sup>16</sup> and lidocaine do not completely abolish the response. Use of succinylcholine for induction in cases of open-globe injury is controversial, although vitreous loss in precurarized patients due to succinylcholine has not been reported.

## SYSTEMIC EFFECTS OF OPHTHALMIC DRUGS

Some ophthalmic medications given in the perioperative period are sufficiently potent to have systemic effects. Ocular drugs applied topically can act as readily as if they were given intravenously. Although the medication is absorbed slowly from the conjunctival sac, much more rapid absorption can occur via the mucosal surfaces of the nasolacrimal duct. Systemic absorption may be altered in a diseased or postsurgical eye.

*Phenylephrine* is commonly used as a mydriatic. There is little increase in mydriasis when solutions with concentrations >5% are used.<sup>17</sup> This response is important because significant complications have been reported with 10% phenylephrine. A single drop of this high-concentration solution may contain 5 mg of phenylephrine (100

mg/mL ÷ 20 drops/mL). Complications seen include myocardial infarction, hypertension, reflex bradycardia, and cardiac dysrhythmias.<sup>18</sup>

Topical application of 2% *epinephrine* solution to the eye causes a decrease in aqueous secretion and improves outflow, both of which act to reduce IOP in open-angle glaucoma. Complications include hypertension, tachycardia, dysrhythmias, and fainting. Because a single drop of 2% solution contains 0.5–1.0 mg of epinephrine, it is reasonable to expect systemic complications to occur. *Intraocular* epinephrine administered during halothane anesthesia is poorly absorbed and has no significant cardiac effects.<sup>19</sup>

$\beta$ -*Adrenergic antagonists* (e.g., timolol) are used in the treatment of glaucoma. This class of medication acts to reduce aqueous humor secretion, with minimal effects on aqueous outflow. Pupilary size is not affected. Patients may complain of lightheadedness, fatigue, and disorientation and may exhibit a general depression of central nervous system function. Excessive dosage of  $\beta$ -adrenergic antagonists may lead to cardiovascular dysfunction, including bradycardia, palpitations, syncope, increase in heart block, and congestive heart failure.<sup>20</sup> Rare exacerbations of asthma have been reported.<sup>21</sup> Particular caution should be exercised with neonates receiving timolol eye drops because cases of apnea have been reported.<sup>22</sup>

*Apraclonidine* is a relatively new  $\alpha_2$ -adrenergic agonist that has found a role as a topical antiglaucoma medication. Like epinephrine, it causes a decrease in aqueous formation and improves aqueous outflow. Systemic absorption may cause significant sedation and drowsiness. Hypotension is a possible complication but has not been reported. Acute withdrawal from long-term therapy may result in rebound hypertension.

*Echothiophate iodide* is a long-acting anticholinesterase drug still used to treat glaucoma. The pupil is constricted and aqueous drainage is increased. Its duration of action is 4–6 weeks. Three weeks after cessation of treatment with echothiophate, plasma cholinesterase activity remains at 50% of normal.<sup>23</sup> If a patient receives succinylcholine, a relative overdose of succinylcholine leads to 2–3 times the usual duration of action. Careful titration of succinylcholine with use of a

peripheral nerve stimulator will avoid prolonged paralysis. The effects of ester local anesthetics (procaine and chlorprocaine) may be significantly prolonged. Amide-type local anesthetics may be a better choice for regional anesthesia.

Muscarinic agonists are given to cause prolonged mydriasis. A drop of *atropine* 1% solution contains 0.2–0.5 mg of the drug. One drop of 0.5% *scopolamine* contains 0.2 mg of the drug. Systemic reactions have been seen in both young and elderly patients following administration of topical ocular atropine or scopolamine. These reactions are manifest by tachycardia, flushing, thirst, and dry skin. Elderly patients may show agitation. CNS excitement and agitation can be treated with incremental doses of physostigmine 0.15 mg/kg IV.

Carbonic anhydrase inhibition of *acetazolamide* interferes with the formation of aqueous humor and lowers IOP. Aside from a metabolic acidosis with depletion of sodium and potassium, long-term therapy may result in dyspepsia. Given rapidly IV, the patient may exhibit an acute decrease in blood pressure. Caution should be exercised in patients with renal disease, dehydration, and sodium or potassium depletion.

## PREOPERATIVE EVALUATION

By virtue of the nature of the surgical specialty, patients coming to the operating room for ophthalmologic surgery tend to be extremely young, very old, or have comorbid conditions. Very fragile, tiny infants often present with apnea, respiratory distress (later bronchopulmonary dysplasia), patent ductus arteriosus, or persistent pulmonary hypertension. Congenital glaucoma often is associated with other conditions, such as Hurler syndrome. Congenital strabismus may signify a myopathy that often is associated with malignant hyperthermia. The elderly present with coronary artery disease, atherosclerosis, hypertension, vascular heart disease, chronic obstructive pulmonary disease, type 1 or type 2 diabetes, cerebrovascular disease, dementia, Parkinson disease, renal or hepatic disease, arthritis, osteoporosis, or cancer. Moreover, since 1990 the proportion of Medicare patients requiring surgical treatment of chronic eye dis-



eases grew from 13.4% to 45.4%.<sup>24</sup> In a study by Kraushar and Turner<sup>25</sup> on medical litigation in cataract surgery, failure of proper coordination of preoperative care among anesthesiologists, surgeons, and internists resulted in indemnity findings in 16% of patients. Couple this situation with the fact that a large number of *adult* ophthalmologic patients are operated on as outpatients, and especially as outpatients in free-standing day surgery facilities, the degree of preoperative evaluation often is an informed negotiation among primary care physicians, ophthalmic surgeons, consultant physicians, and anesthesiologists.

Fortunately most ophthalmologic procedures are of low risk because there are no major physiologic derangements, blood loss, or fluid shifts. Much of the systemic risk to patients occurs with general anesthesia during induction and emergence, and most of the risk to the eye associated with anesthesia relates to patient movement, changes in IOP, and postoperative nausea and vomiting (PONV). Thus, the morbidity and mortality of ophthalmic surgery is low<sup>26</sup> despite the high-risk population. The anesthesiologist can draw on several sources as guides when designing an appropriate and safe preoperative evaluation<sup>27-31</sup> using as one's basis that surgical risk is low and that for routine patients only the highest risk is excluded.

All patients must provide a history and undergo physical examination assessing chronic medical conditions, any acute conditions, and their current state (Table 65-3). Ideally these assessments should be performed by the patient's primary care physician and should be available for review 1-2 days prior to the procedure by the anesthesiologist. In the absence of a primary care physician, the assessments can be subsumed by the existing local perioperative protocols for credentialed practitioners for history and physical.<sup>32</sup>

If the case is a cataract, the patient has no acute medical issues, and the procedure will be performed under local anesthesia, no laboratory testing, including an ECG, need be done.<sup>31</sup> However, the patient must meet the following criteria: able to lie flat for 45 minutes, have no or treated gastric reflex, have no neuropsychiatric disturbances (e.g., claustrophobia or dementia), have no tremor affecting the head and neck, have no chronic uncontrollable cough, have sufficient

TABLE 65-3.

## Preoperative Basic Health Assessment

<b>Medical History</b>
Indications for surgery
Allergies to medications
Intolerance to medications
Allergies or intolerance to foods, environments
Known chronic medical problems
Prior surgical history
Current medications and reason for taking
<b>Acute Medical History</b>
Status of known problems
Cardiac
Pulmonary
Hemostatic
Symptomatic anemia
Smoking and alcohol
Possibly pregnancy
Personal/familial history of anesthesia problems
<b>Functional status</b>
>4 METS
<4 METS secondary to physical limitations
<b>Physical Exam</b>
Height and weight
Blood pressure, each arm
Pulse (rate and regularity)
Respiratory rate
Heart sounds
Breath sounds

command of English or some other common language so as to be able to communicate, follow commands, understand the nature of local/regional anesthesia and be able to consent to it, and comprehend he/she will be awake and at most will be only mildly sedated (Table 65-4).<sup>30</sup>

TABLE 65-4.

## Basic Requirements for Cataract Surgery

Lie flat for 45 minutes
No symptomatic reflux
No head and neck tremor
Ability to control cough
No dementia or claustrophobia
Knowledge of English or other common language
• follow directions
• communicate
• understand will be awake

For patients undergoing prolonged (>3 hours) procedures under regional or general anesthesia, additional history documenting the ability to achieve 4 METS (metabolic equivalents) should be sought. This level is equivalent to walking four blocks without stopping or climbing two flights of stairs. Inability to achieve 4 METS might be indicative of significant coronary artery disease or congestive heart failure and left ventricular dysfunction. At minimum, this finding should trigger at least a discussion with the primary care physician or medical consultant on the potential need for further evaluation, as both Reilly et al.<sup>33</sup> and Sgura et al.<sup>34</sup> have demonstrated increased risk in patients unable to achieve the plateau of 4 METS.

Routine laboratory tests are of no proven value unless indicated by the history and physical examination.<sup>31</sup> Suggestions drawn from the Institute for Clinical Systems Improvement<sup>32</sup> and American Society of Anesthesiologists Task Force on Preoperative Evaluation<sup>28</sup> are listed in Table 65-5. Of note, for most patients without acute changes in medical history,

TABLE 65-5.

## Lab Tests Indicated by History and Surgical/Anesthesia Risk

Test	Possible Indication
Hematocrit	History suggesting severe anemia or recent severe blood loss
Potassium	Digoxin Diuretics and myocardial irritability
Coagulation studies	History of coagulopathy Anticoagulation as a medical treatment
ECG	None within last year in patients with diabetes, hypertension, angina, CHF, smoking, PVD, inability to exercise Signs of new or unstable cardiac disease

ECGs are not needed if they were recorded within the past year.

Anesthesiologists should at minimum review these data in advance according to local protocol. If possible, a preoperative visit should be conducted to allay anxiety, explain the anesthesia plan, and educate the patient regarding medications to be continued on the day of surgery ( $\beta$ -blockers, antihypertensives, insulin therapy) and medications that may be of value to discontinue (antiplatelet agents and other anticoagulants). In patients with severe life-threatening diseases who are further compromised by their inability to see and who compassionately seek care in order to have some continued functionality, an attempt should be made to improve their emotional condition and to have a frank discussion with them of the risks of anesthesia. After obtaining detailed informed consent, one can proceed with the surgery and anesthesia.

Hypertension is a major risk factor for coronary artery disease, congestive heart failure, renal disease, and cerebrovascular disease. In an extensive literature review and meta-analysis of 30 observational studies, Glanz et al.<sup>35</sup> reasoned that hypertensive patients experienced a 1.31 times greater incidence of adverse cardiac experiences. This is a modest increase, is fraught with analytical challenges, and, in most cases, does not support the cancellation of surgery based only on uncontrolled hypertension. What then is the approach to high-risk patients who, on the day of their low-risk surgical procedure, such as cataract extraction or intraocular lens placement under regional anesthesia, arrive with blood pressure >185 systolic mm Hg or >110 mm Hg diastolic? Part of the thought process is the safety of administering topical phenylephrine ( $\leq 5\%$  solution) in these cataract patients or epinephrine (2% solution) in open-angle glaucoma patients, knowing that further hypertension and bradycardia in the former and further hypertension, tachycardia, and arrhythmias in the latter are assured. In an elective case of an untreated and uncontrolled hypertensive patient, the choice usually is made to refer the patient to a primary care physician or an internist at our institution prior to discharge for treatment and investigation of any end-organ damage. In treated hyperten-

sive, elderly patients, the offending eye drops will not be administered unless the pressure is <180/90. In obviously frightened and anxious patients at the Massachusetts Eye and Ear Infirmary, treatment is started with mild sedation and anxiolysis. Subsequently, if a patient is taking  $\beta$ -blockers (or there is no contraindication to them), these or the patient's own medication can be given orally. We try not to give slow-onset, long-acting compounds for fear of postural hypotension later, when the patient is in transit or at home. Should these methods be ineffective, the patient is referred back to the primary care physician for better control and anxiolysis prior to rescheduling the procedure.

## REGIONAL ANESTHESIA TECHNIQUES

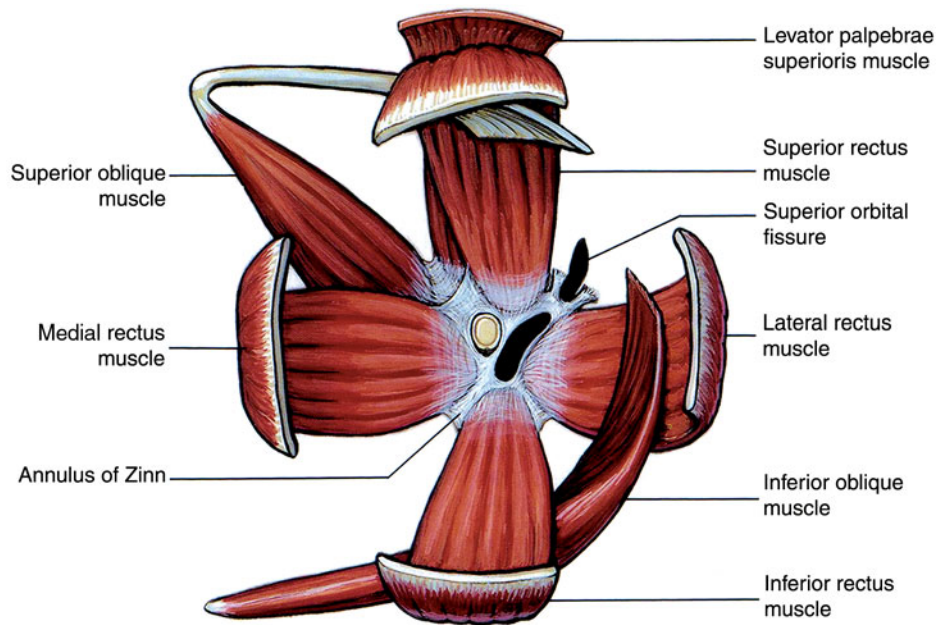
Technical advances in ophthalmologic surgery have changed many of the requirements for ophthalmic anesthesia. Phacoemulsification extraction of cataracts with lens replacement via tiny incisions has lessened the need for eye akinesia and IOP control. IOP control is much more under the surgeon's control. Regional anesthesia has been associated with lower perioperative morbidity compared with general anesthesia for ophthalmic surgery as long as heavy sedation is avoided.<sup>35,36</sup> This has made care for our especially ill patients systematically safe, even when ophthalmic surgery is performed on an outpatient basis. In fact, more than two million people undergo cataract surgery in the United States every year. At the Massachusetts Eye and Ear Infirmary, >8500 ophthalmic procedures are performed every year. Of these procedures, approximately 8000 are done with some form of regional anesthesia, and of those >80% are performed by the anesthesiologist. A brief review of ocular and orbital anatomy is given prior to discussion of the anesthetic procedures themselves.

In simplest terms, each orbital cavity is a truncated pyramid with an orbital axis of  $45^\circ$  measured medially at the apex. The orbit averages 35 mm high, 45 mm wide, and 42 mm deep. However, in an anatomic study by Katsev et al.,<sup>37</sup> up to 11% of orbits were on the order of 40 mm. Furthermore, the ciliary ganglion is consis-

tently 7 mm anterior to the orbital apex. Consequently, these structures as well as the optical foramen could be reached by a 38-mm ( $1\frac{1}{2}$ -inch) retrobulbar needle. For this reason, any needle >32 mm ( $\frac{1}{4}$  inch) should not be used. The orbit is mainly filled with adipose tissue suffused with fibrous septa. The globe, which occupies only 30% of the orbit, is suspended anteriorly within the orbit in this cushioning tissue mass. The optic nerve enters the orbit at its apex at the optical foramen and passes through the fibrous annulus of Zinn from which the four rectus muscles originate. These muscles insert anteriorly near the equator of the globe. The anterior attachments, the muscles themselves, and the posterior attachments form the so-called "cone." However, because no complete fibrous tissues connect the rectus muscles to each other, this "cone" space is not enclosed but communicates with the rest of the orbital adipose tissue.

Sensory innervation of the globe comes from the ophthalmic nerve (first branch of the trigeminal nerve). This nerve passes through the conal area. The cornea, iris, and sclera are innervated by the long ciliary branch of this same nerve. Motor innervation of the lateral rectus is supplied by the abducens nerve (CN VI). Motor supply to the superior oblique muscle is by the trochlear nerve (CN IV). The oculomotor nerve (CN III) supplies all others. Only the trochlear nerve does not pass within the cone. Also within the confines of the rectus muscles are the ophthalmic artery and veins, the optic nerve with its meningeal coverings, and the ciliary ganglion. The motor nerve to the orbicularis oculi muscle (which squeezes the lids closed) is from the zygomatic branch of the facial nerve. It is extraorbital and branches superiorly and inferiorly 1 cm posterior to the junction of the superior and inferior orbital rims laterally. Figures 65-3 to 65-20 assist in visualizing these relationships.

The Tenon capsule comprises a fibroelastic layer that encloses the whole scleral structure of the globe from the corneal limbus anteriorly to the optic nerve posteriorly. It encapsulates a potential space called the *episcleral* or *sub-Tenon space*. It has no actual volume until fluid is injected into it. At the globe's equator, where the oblique and rectus muscles insert, is a continu-



**FIGURE 65-3.** Extraocular muscles, front view. Area between rectus muscles is the “cone.” (Reprinted from Dutton JJ. Atlas of Clinical Surgical Orbital Anatomy. Philadelphia: WB Saunders, 1994, with permission from Elsevier.)

1566

ity between the Tenon capsule and the fascial sheaths of the muscles.

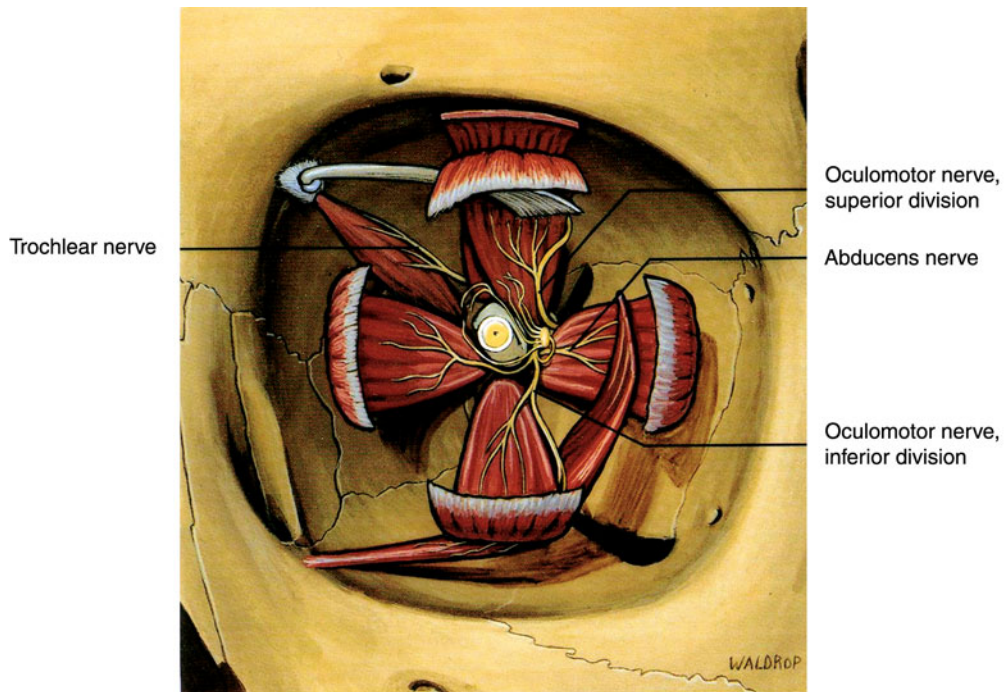
### Topical Anesthesia

Topical anesthesia for phacoemulsification cataract surgery involves instillation of local anesthesia eye drops or gel. In this manner, the cornea, iris, sclera, and some conjunctiva are rapidly anesthetized via absorption through

the corneal epithelium via the long ciliary nerve. Tetracaine 0.5%, proparacaine 0.5%, lidocaine 4%, and lidocaine gel 2–4% are often used. Most patients like the fact that no preprocedural injection is involved, and, because vision is retained, visual improvement is immediate after lens placement, with only a clear plastic eye protector used postprocedure. The

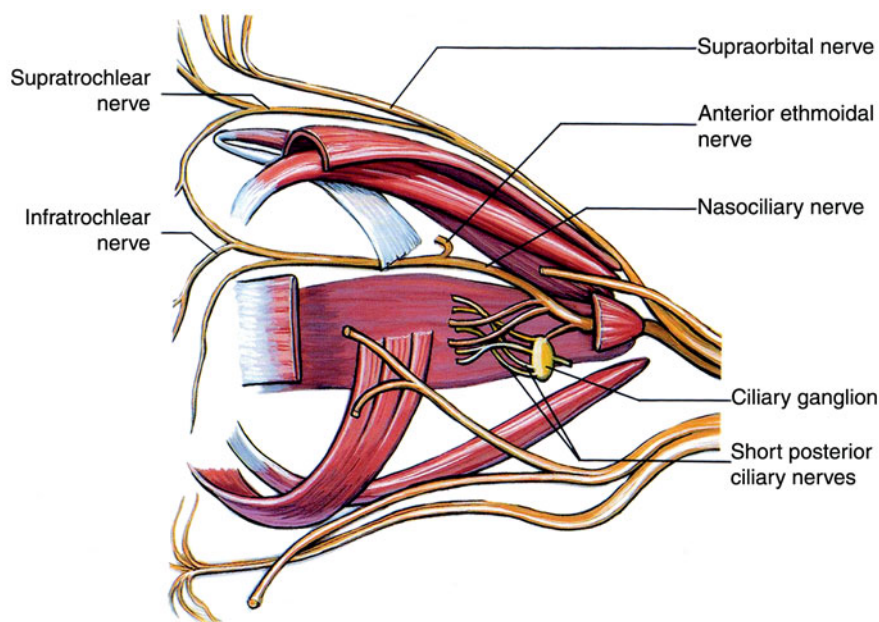
duration of analgesia is brief and often requires supplementation with topical instillation or intracorneal injection.

Disadvantages include eyelid sensations, bright ophthalmic lights, and vision of surgical instruments, which can be bothersome to patients. Potentially bothersome to surgeons is the lack of IOP control, lack of akinesia, ability of patients to close the lids, and the poten-



**FIGURE 65-4.** Frontal view of bony orbit showing motor nerves. Note trochlear nerve is outside the cone. Ciliary ganglion and optic nerve and sheath are seen. (Reprinted from Dutton JJ. Atlas of Clinical Surgical Orbital Anatomy. Philadelphia: WB Saunders, 1994, with permission from Elsevier.)





**FIGURE 65-5.** Orbital sensory nerves. (Reprinted from Dutton JJ. *Atlas of Clinical Surgical Orbital Anatomy*. Philadelphia: WB Saunders, 1994, with permission from Elsevier.)

tial need for heavy sedation in uncooperative patients. Intraoperative comfort is more reliable with needle-based and sub-Tenon blocks. Interestingly, patients experiencing bilateral cataract extractions who were randomly assigned to topical for one eye and retrobulbar block for the other eye preferred the block technique by 71% to 10%.<sup>38</sup>

Topical anesthesia for phacoemulsification cataract extraction is appropriate for uncomplicated procedures,

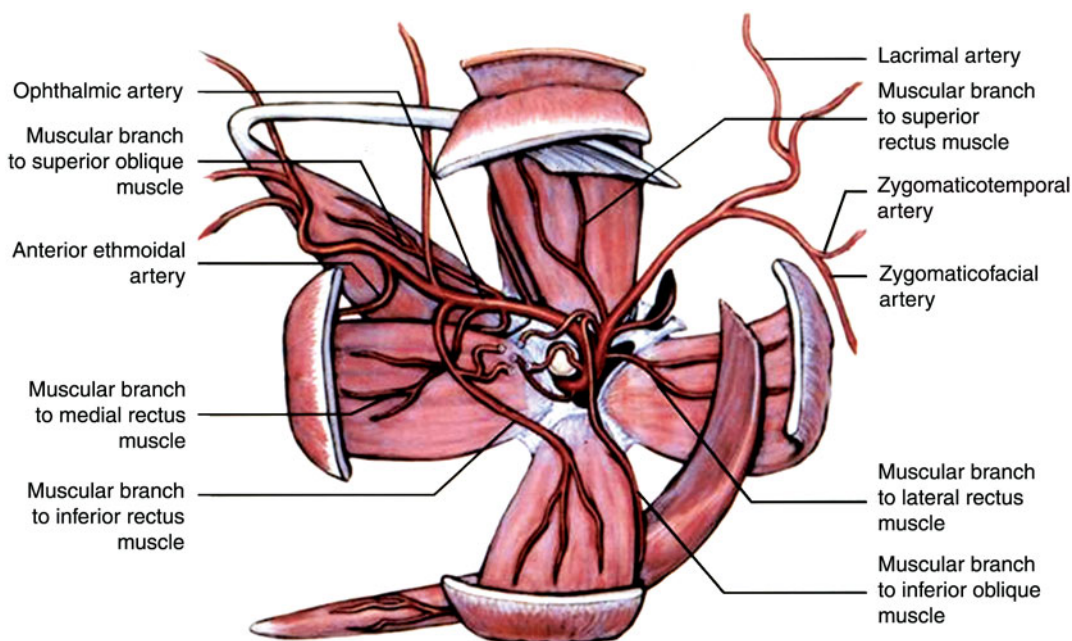
properly educated and cooperative patients, and procedures performed by surgeons adept at and comfortable with such techniques.

### Sub-Tenon Anesthesia

Sub-Tenon block (also termed *episcleral block*) is accomplished by injecting local anesthetic into the episcleral space via needle or canula. Low-volume injection (3–5 mL) allows for good total globe analgesia, appropriate for

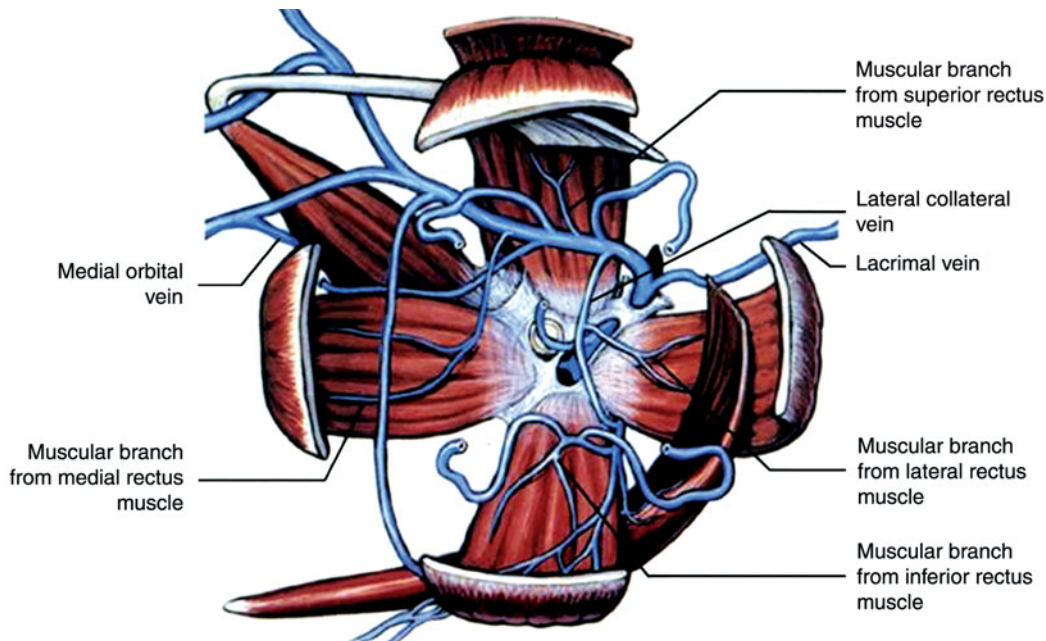
most anterior chamber surgeries. Increasing the amount of local anesthetic (5–12 mL) will give reliable motor block as well, as this allows spread to the extraocular muscle sheaths. At this volume, some degree of chemosis (subconjunctival spread) is usually seen. Vitreoretinal surgery can readily be accomplished as well. Some surgeons also desire orbicularis oculi blocks, which will require block of the zygomatic branch of the facial nerve. The two techniques of sub-Tenon block are needle based and cannula based.

Needle-based sub-Tenon block has been described by Ripart et al.<sup>39</sup> and Mouvellon et al.<sup>40</sup> The needle is placed into the fornix between the semilunar fold of the conjunctiva and the globe, tangential to the globe (Fig. 65-16). After the conjunctiva is entered, the needle is shifted slightly medially and advanced strictly posteriorly. This moves the globe medially. Once a small click is perceived (loss of resistance), the globe returns to primary gaze position. Ripart et al. describe this as a depth marker, indicating a depth of 10–15 mm prior to injection. At this time, local anesthetic is injected up to a volume of 10 mL. Volumes >6 mL produce reliable globe analgesia and eye akinesia. Mouvellon et al. report no serious complications in their review of 2000 cases. However, because the technique is needle based, it is not immune to needle misplacement and subsequent serious globe



**FIGURE 65-6.** Orbital arteries. (Reprinted from Dutton JJ. *Atlas of Clinical Surgical Orbital Anatomy*. Philadelphia: WB Saunders, 1994, with permission from Elsevier.)





**FIGURE 65-7.** Orbital veins. (Reprinted from Dutton JJ. *Atlas of Clinical Surgical Orbital Anatomy*. Philadelphia: WB Saunders, 1994, with permission from Elsevier.)

1568

injury. This block has not yet achieved wide popularity among anesthesiologists in the United States.

Cannula-based sub-Tenon block originally was described as a supplement to poor-quality or receding retrobulbar anesthesia.<sup>41</sup> Small volumes (3–5 mL) reliably produce good globe anesthesia, do not raise IOP pressure, and can be used with the globe open. In addition, it can be used as the primary anesthetic with larger volumes (5–10 mL) of local anesthesia.<sup>42</sup> The larger volumes are associated with better akinesia. This technique was developed as a way to avoid complications of retrobulbar blocks, but retrobulbar hemorrhage, globe perforation, and extraocular muscle injury have been reported. This technique may be contraindicated in patients with staphylomas or scleral thinning, highly myopic eyes, previous pterygium repairs, prior scleral buckling procedures, or prior vitreoretinal surgery. Orbicularis oculi often must be blocked separately.

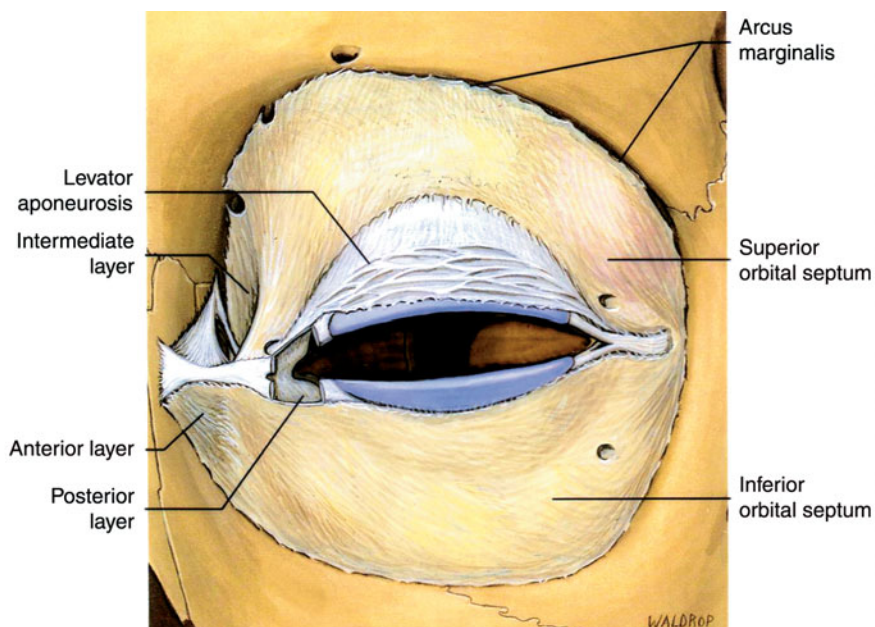
Cannula-based sub-Tenon block is a minisurgical approach. The technique can be performed in the inferonasal, superonasal, superior, or temporal quadrants after sterile preparation and application of topical anesthetic drops or gel to the surface of the globe. The bulbar conjunctiva is grasped 5–10 mm from the limbus, and blunt Westcott scissors are used to create an opening into the conjunctiva and Tenon capsule to access the episcleral space. Specially

designed blunt, often curved cannulas are advanced into the episcleral space, and the local anesthesia mixture is injected. Most often this technique is performed by the ophthalmologist, but more anesthesiologists are being trained on and are using the technique.

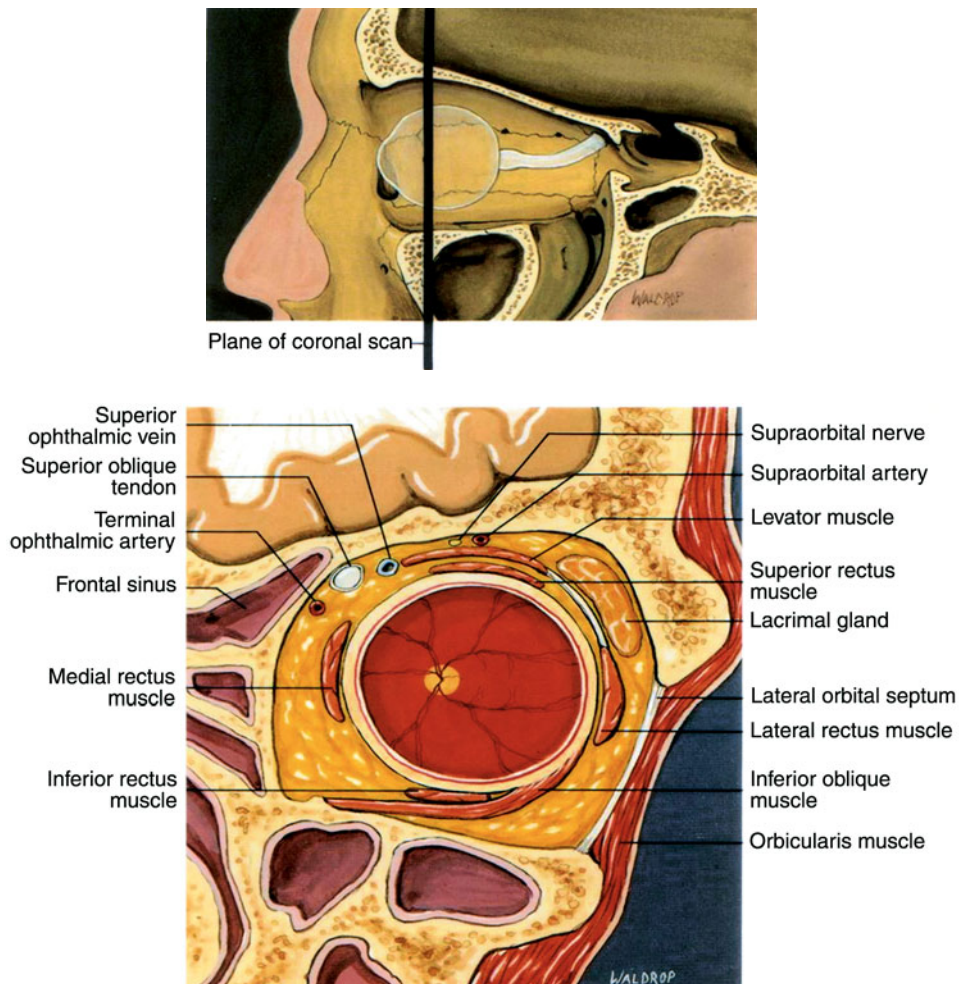
### Retrobulbar or Peribulbar Anesthesia

Both retrobulbar block and peribulbar block are needle-based blocks that rely

on local anesthetic installation into the orbit to bathe the nerves and muscles and provide analgesia and akinesia. Retrobulbar block is believed to have fast onset and provide reliable akinesia with use of small volumes (2–4 mL) of local anesthetic within the area behind the globe, demarcated by the insertions of the oblique and rectus muscles anteriorly and, as they pass posteriorly, to their origin at the annulus of Zinn. All sensory and motor



**FIGURE 65-8.** Preorbital septum. Disruption of levator aponeurosis by local anesthetic may lead to ptosis. (Reprinted from Dutton JJ. *Atlas of Clinical Surgical Orbital Anatomy*. Philadelphia: WB Saunders, 1994, with permission from Elsevier.)



**FIGURE 65-9.** Coronal section through anterior globe and orbit. Note especially small space and important structures superonasally, superiorly, superotemporally, and inferomedially. Paucity of structures are located inferotemporally at the lateral canthus and medial canthus. (Reprinted from Dutton JJ. *Atlas of Clinical Surgical Orbital Anatomy*. Philadelphia: WB Saunders, 1994, with permission from Elsevier.)

nerves of the globe, except the motor nerve to the superior oblique, pass within this virtual cone. All important vascular and nervous structures, including the optic nerve and ciliary ganglion, pass within this cone and become more compact with proximity to the apex of the orbit. Certainly  $\frac{1}{2}$ -inch ophthalmic needles can contact these structures, and in smaller orbits ( $<40$  mm) even  $\frac{1}{4}$ -inch ophthalmic needles may reach these structures. Furthermore, small volumes of local anesthetic will always spare the extraorbital branch of the facial nerve to the orbicularis oculi.

Peribulbar block is predicated on the anatomic basis that the muscular cone is not an isolated enclosed space between the rectus muscles and that local anesthesia instilled more anteriorly in the orbit and external to the muscle cone will easily diffuse to reach the appropriate muscles and

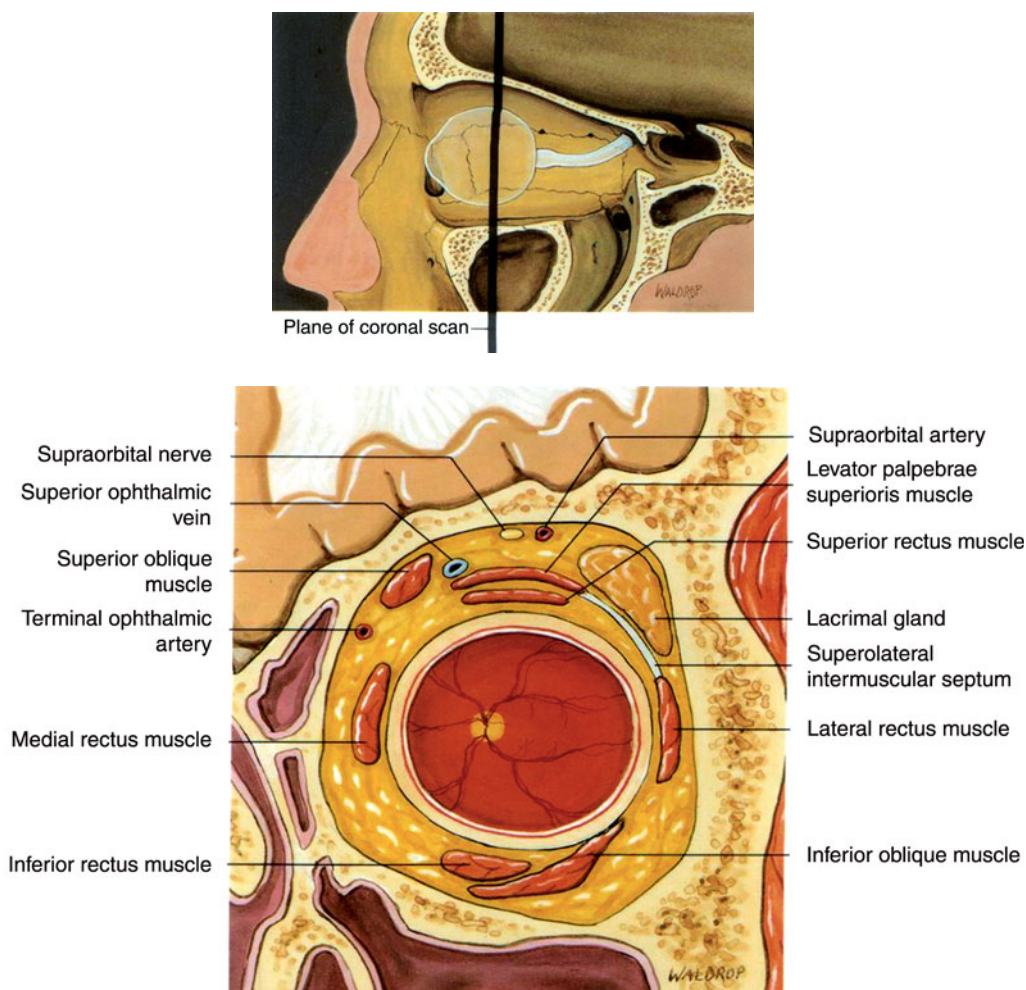
nerves. This premise enables use of ophthalmic needles  $\leq \frac{7}{8}$  inch (23 mm). Note that peribulbar blocks require volumes of 5–10 mL. At higher volumes, local anesthetic often finds its way extraorbitally to reach the facial nerve branch to the orbicularis oculi. Provided sufficient volumes are used, peribulbar blocks are equally as efficacious as retrobulbar blocks.<sup>43</sup> Retrobulbar blocks, secondary to longer needles, have an inherently greater probability of block related serious life- or sight-threatening complications. On this basis, it is the practice of the Massachusetts Eye and Ear Infirmary to use peribulbar blocks with shorter needles unless there is reason not to do so. In patients presenting for multiple procedures, scarring or adhesions formed in the orbital adipose tissue after many blocks may be indications for a retrobulbar block. Additionally, if raising IOP is a concern,

small volumes of local anesthesia placed retrobulbarly will avoid that problem. Peribulbar blocks can cause significant chemosis (potentially a problem for glaucoma procedures or pterygium excision), disruption of the preorbital septum, or disruption of the levator aponeurosis leading to exophthalmos or entropion (Fig. 65-8).

Before describing the technique for needle-based blocks, a few cautions are indicated. Do not use certain quadrants because of the ease of causing injury secondary to smaller insertion spaces and the presence of important structures: superonasal (superior oblique tendon, superior ophthalmic vein), superior (supraorbital nerve, levator muscle), and superotemporal (lacrimal gland). Use only ophthalmic needles that are  $\leq 32$  mm. Most peribulbar needles are  $<24$  mm.

Most needle-based techniques use the inferotemporal quadrant and pri-





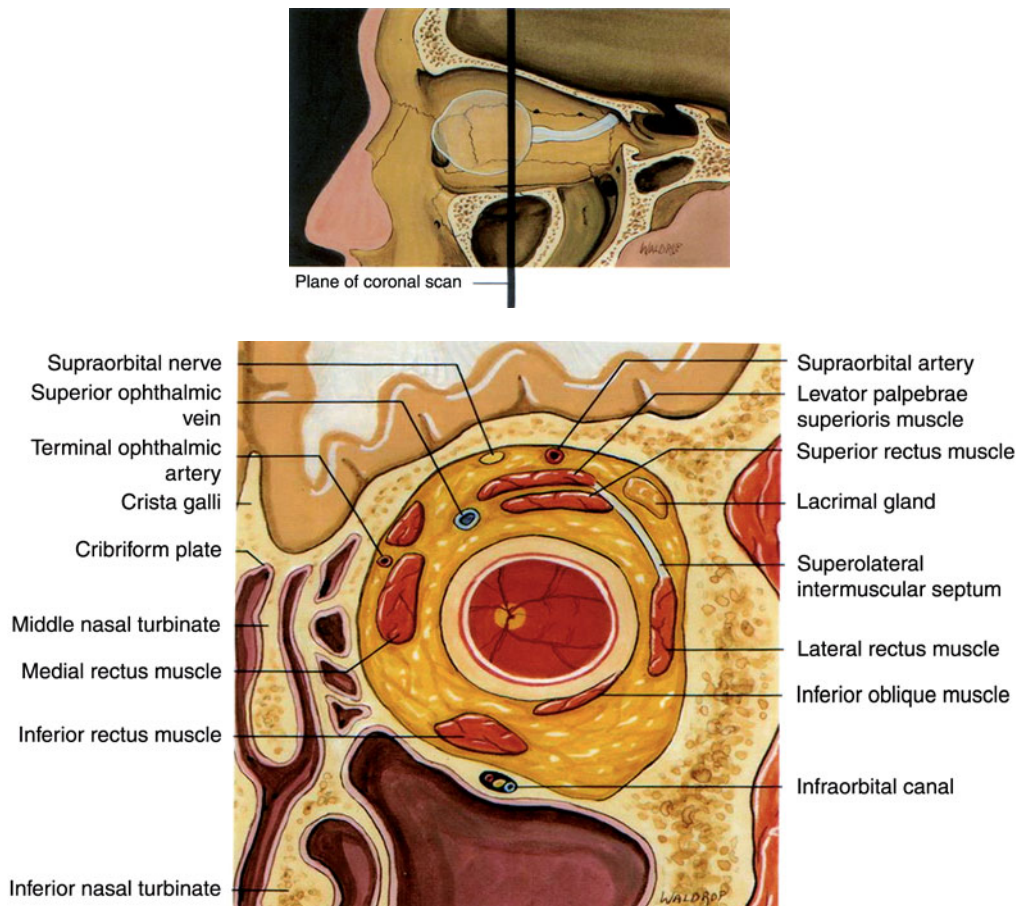
**FIGURE 65-10.** Coronal section through midglobe and anterior orbit. Figures 65-10, -11, -12 all use relationships first depicted in Fig. 65-9 (i.e. top panel is location of cut through orbit, which is shown in cross-section in lower panel). (Reprinted from Dutton JJ. *Atlas of Clinical Surgical Orbital Anatomy*. Philadelphia: WB Saunders, 1994, with permission from Elsevier.)

mary gaze position. Primary gaze is used because the Atkinson up-and-in position brings the optic nerve closer to the path of the needle, placing it under tension so that it is in danger of penetration by retrobulbar needles.<sup>44</sup> For both retrobulbar and peribulbar blocks, a single injection technique is used, and the same entrance point is used in the inferotemporal quadrant. For both blocks, patients look straight ahead (primary gaze), and the operator's palpating finger identifies the lower part of the globe and elevates it slightly. The needle is inserted, with the bevel angled toward the globe, below the lateral canthus and just above the inferior orbital rim (Figs. 65-17 to 65-19). This modified (M) insertion point, rather than the traditional (T) insertion point at the junction of the middle and lateral third of the orbital rim, is used because it lessens the possibility of injuring the inferior rectus or inferior oblique mus-

cle along with its neurovascular bundle (Fig. 65-14).<sup>45</sup> For both blocks, the needle initially is directed perpendicular to the skin in all planes. Resistance is encountered at the skin, and a "pop" may be felt upon passing through the orbital septum. The needle should seem to float in after this point. In retrobulbar blocks, once the needle passes the inferior equator of the globe, it should be directed slightly more superiorly to enter the "cone." To minimize the potential for injury to the optic nerve, never advance the retrobulbar needle past the ocular axis midline. After negative aspiration, 2-3 mL of anesthetic is administered. If blood is aspirated, withdraw the needle, apply intermittent digital pressure, and reevaluate the orbit with the ophthalmologist before proceeding further. After the block, tape the lids closed in order to protect the eye.

Technically, a peribulbar block is performed in much the same manner

as a retrobulbar block but using a shorter needle (typically 23 mm). Insert below the lateral canthus above the inferior orbital rim after digitally elevating the globe slightly. Pass the needle perpendicular to the skin in all planes, through skin resistance and orbital septum "pop." At this point, no attempt is made to change the direction of the needle to enter the muscular "cone"; remain moving posteriorly and parallel with it. Aspirate and inject 5-10 mL of anesthetic solution. Stop and retract the needle 1-2 mm if resistance to injection is encountered. Inject slowly, no faster than 1 mL every 3 seconds. After the block, protect the eye from potential abrasion by taping the lids closed. Manual compression or a mechanical device such as a Honan balloon at 30 mm HG pressure is used for short periods to help decrease IOP resulting from the larger volumes of fluids. Check the block for efficacy in 5-10 minutes for developing akinesis.



**FIGURE 65-11.** Coronal section, posterior globe. (Reprinted from Dutton JJ. *Atlas of Clinical Surgical Orbital Anatomy*. Philadelphia: WB Saunders, 1994, with permission from Elsevier.)

Complete akinesia usually is needed for vitreoretinal surgery, whereas partial akinesia is generally adequate for phacoemulsification cataract extraction. If required, a repeated block can be applied either at this site or at the medial canthus at the medial junction of the lids and nasal to the lacrimal caruncle as described by Husted et al.<sup>46</sup> (Fig. 65-16). For a supplemental injection, 3–6 mL can be used.

### Modified Van Lindt Block

Any time paralysis of the orbicularis oculi is necessary to prevent squeezing the lids closed and the peribulbar block has been partially or totally ineffective, a modified van Lindt block is performed. The orbicularis oculi is innervated by the superior branch of the facial nerve given that it is extraorbital. The needle is inserted 1 cm lateral to the lateral junction of the superior and inferior orbital rims, and 2–4 mL of anesthetic is injected deeply on the periosteum just lateral to the superolateral and inferolateral orbital rim.

### Regional Postoperative Analgesia

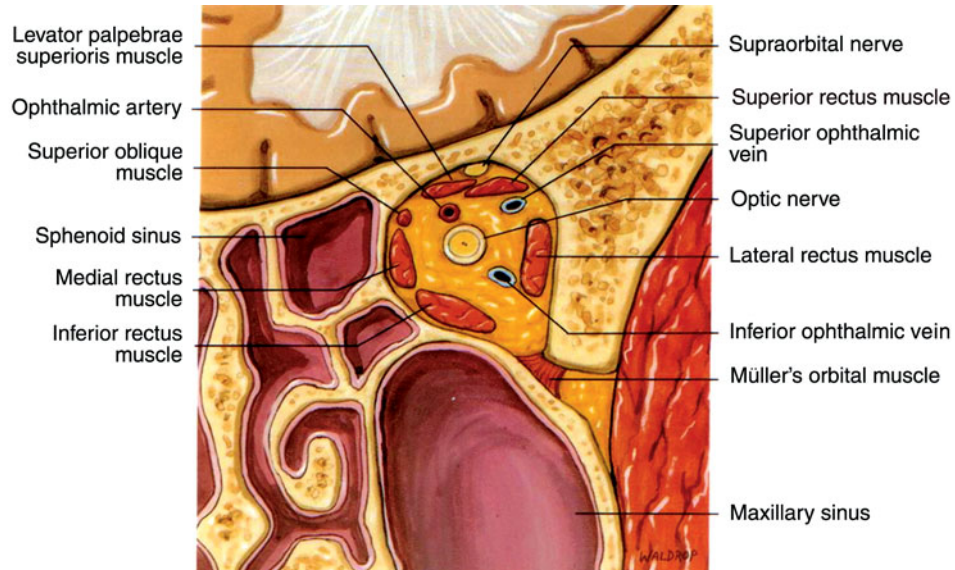
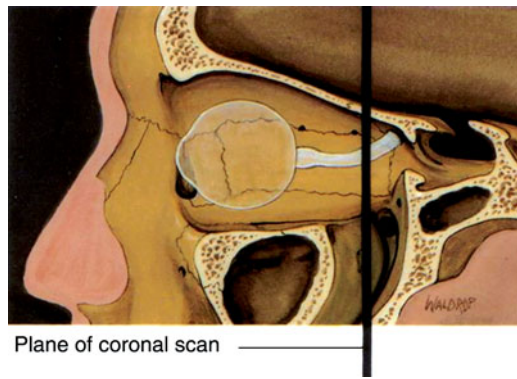
Postoperative pain relief is not an issue for most anterior segment surgery. Pain following cataract surgery is decidedly abnormal. In fact, such pain should prompt an urgent visit to the ophthalmologist because it may indicate infection or increased IOP. Postoperative pain is greater after posterior segment surgery. Inadequate pain relief can lead to nausea, vomiting, crying, and restlessness in children, hematoma formation, prolonged recovery and hospital admission, and reduced patient satisfaction. Use of opioids to treat pain also can lead to nausea and vomiting, resulting in admission or surgical complications. Currently, local anesthesia often is used at the end of prolonged vitreoretinal surgery to extend analgesia well into the postoperative period, most commonly via sub-Tenon block or retrobulbar irrigation. In adults and children undergoing appropriate ophthalmic procedures with general anesthesia, administration of

sub-Tenon, retrobulbar, or peribulbar anesthesia should be considered. Some centers advocate the use of indwelling catheters associated with retrobulbar, peribulbar, and sub-Tenon blocks<sup>47,48</sup> to relieve postoperative pain, but this practice has not yet gained wide acceptance.

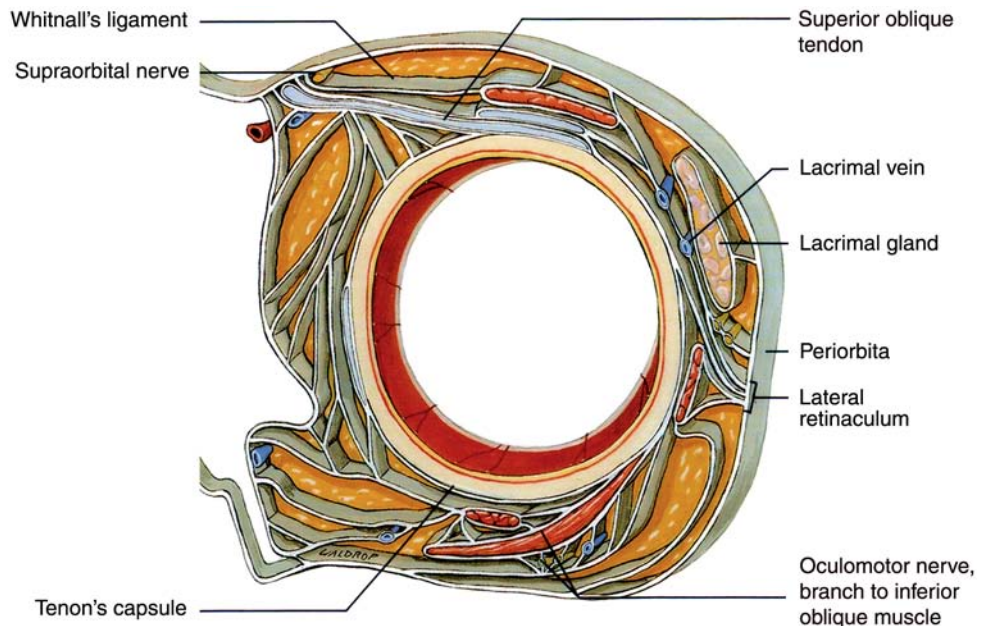
### Commonly Used Drugs and Adjuvants

All available local anesthetic drugs have been used either alone or in combination. Onset and durations follow their usual pharmacologic profiles. Lidocaine, mepivacaine, ropivacaine, and bupivacaine are used most commonly. Lidocaine in concentrations >2% are potentially myotoxic and are not used.<sup>45</sup> A common combination is lidocaine 2% and bupivacaine 0.75% in equal amounts. Epinephrine 1:400,000 is sometimes used to prolong duration. Vasospasm with retinal ischemia does not seem to be a concern but is not universally accepted because of fear of optic nerve

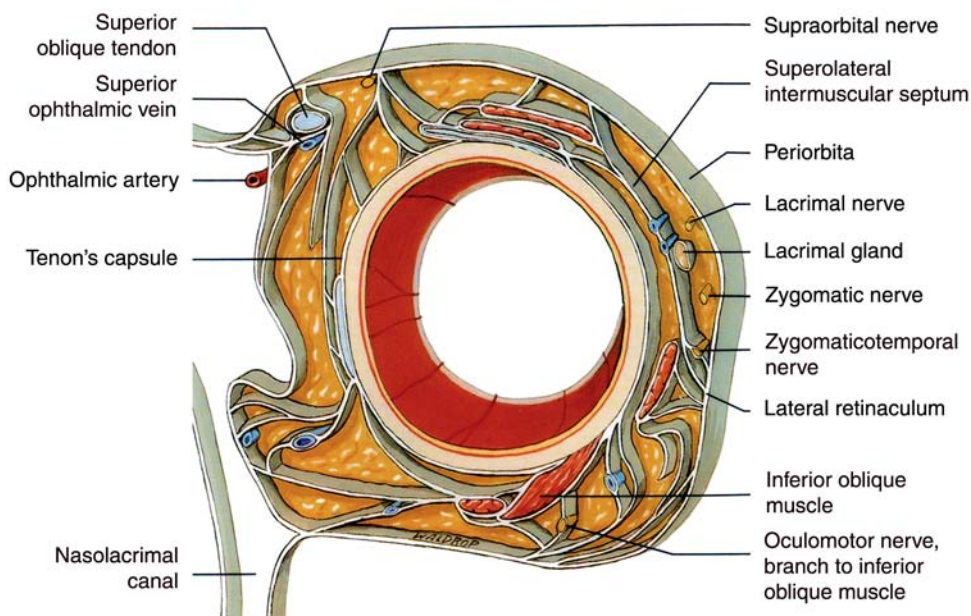




**FIGURE 65-12.** Coronal section, apex at annulus of Zinn. High-density, important structures can be penetrated with 1/2-inch needles or with 1/4-inch needles in shallow orbits. (Reprinted from Dutton JJ. Atlas of Clinical Surgical Orbital Anatomy. Philadelphia: WB Saunders, 1994, with permission from Elsevier.)



**FIGURE 65-13.** Anterior orbit, midlobe. Orbital facial system. Note inferior oblique muscle along with its nerve and a vein, which are near the traditional site at the junction of the mid and lateral junctions of the lower orbital rim. Needle-based blocks should be performed closer to the lateral canthus. (Reprinted from Dutton JJ. Atlas of Clinical Surgical Orbital Anatomy. Philadelphia: WB Saunders, 1994, with permission from Elsevier.)



**FIGURE 65-14.** Anterior/mid orbit, posterior globe. Structures are packed more closely, especially around the muscular cone. (Reprinted from Dutton JJ. Atlas of Clinical Surgical Orbital Anatomy. Philadelphia: WB Saunders, 1994, with permission from Elsevier.)

ischemia in patients with vascular disease.<sup>49</sup>

Hyaluronidase is an enzyme that facilitates more rapid and wider spread within the tissues of the orbit. Although there is no obvious dose–effect relationship, most evidence suggests hyaluronidase increases the speed of onset of blocks, reduces the risk of extraocular muscle injuries, and contributes to a more rapid decrease in intraorbital pressure and hence IOP.<sup>50–52</sup> Common concentrations of hyaluronidase vary from 5–50 cc per milliliter. Until recently, hyaluronidase was available only through compounding pharmacies. The U.S. FDA has approved the manufacture and sale of hyaluronidase by two pharmaceutical companies.

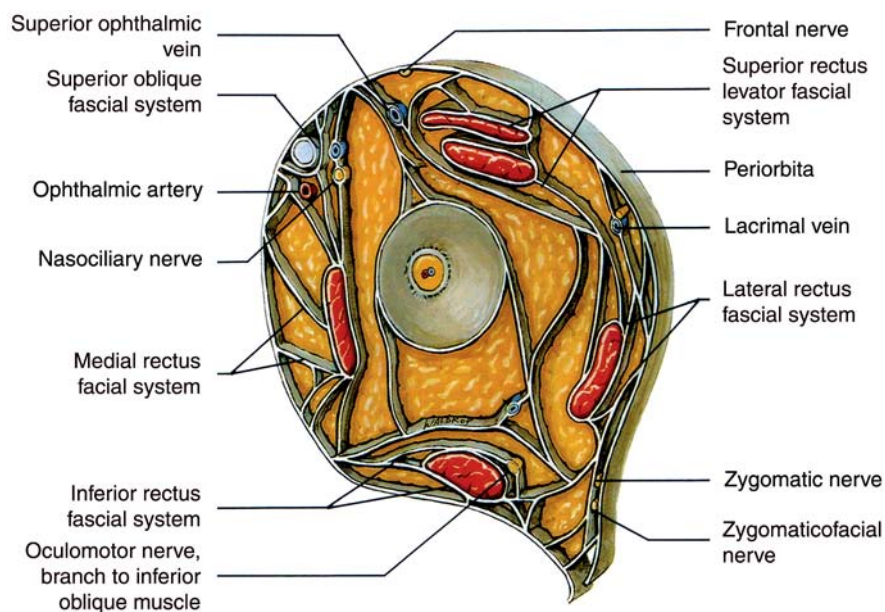
Clonidine is often used in IV regional anesthesia for soft-tissue surgery to enhance the duration of postoperative analgesia. The same is true for ophthalmic anesthesia. Clonidine at a dose of 1 mg/kg is not associated with an increased incidence of somnolence or systemic hypotension.<sup>53</sup> It may help prevent intraoperative hypertension and may lower IOP.

## COMPLICATIONS OF REGIONAL TECHNIQUES

The complications of regional ophthalmic nerve blocks are rare but have

serious implications. They can be sight threatening and life threatening. The primary cause is needle misplacement. Risk factors include inadequate education of the practitioner, inadequate knowledge of orbital anatomy, anatomic variation, previous ophthalmic surgery, uncooperative patient, and failure to fastidiously adhere to safe techniques. By far the greatest risk is inadequate training and experience (Tables 65-6 and 65-7).

Spread of local anesthesia to the central nervous system can cause life-threatening problems. Inadvertent intraarterial injection allows retrograde flow into the cerebral circulation, usually from the ophthalmic artery through anterior cerebral or carotid artery. As little as 2 mL can produce seizures that require symptomatic treatment. This condition usually is associated with longer retrobulbar needle injections within the muscle cone



**FIGURE 65-15.** Orbital fascial system, midorbit, posterior globe. (Reprinted from Dutton JJ. Atlas of Clinical Surgical Orbital Anatomy. Philadelphia: WB Saunders, 1994, with permission from Elsevier.)





**FIGURE 65-16.** Right eye. Arrow 1 indicates site of dissection for medial canthus episcleral (sub-Tenon) block. Arrow 2 indicates entry point at lateral canthus on inferior orbital rim for inferotemporal peribulbar block. Arrow 3 indicates entry point for medial canthus peribulbar block.

and failure to aspirate prior to injection. The second potentially life-threatening complication is inadvertent injection under the dural sheath of the optic nerve or directly through the optic foramen. Katsev et al.<sup>37</sup> indicated that this complication is possible in up to 11% of the population with orbital apices  $\leq 40$  mm. However, this complication has been reported following peribulbar anesthesia as well.<sup>54</sup> The result is subarachnoid spread of local anesthesia causing partial or complete brainstem anesthesia.<sup>55</sup> Onset usually is

rapid but can occur as late as 20 minutes. Symptoms can progress through sympathetic activation, confusion, and restlessness to hypotension, bradycardia, total spinal anesthesia, and respiratory arrest. Oxygen, vasopressors, intubation, and ventilation all may be required until the anesthetic has worn off. The possibility of these complications dictates that resuscitation equipment and medications be available and that patients be fully monitored prior to block with blood pressure, ECG and pulse oximetry. This finding also serves as sufficient justification to observe appropriate nothing by mouth (NPO) guidelines.

Retrolbulbar hemorrhage results from arterial injury. This may lead to a compressive hematoma sufficient to cause retinal ischemia. Intermittent manual compression should be instituted and

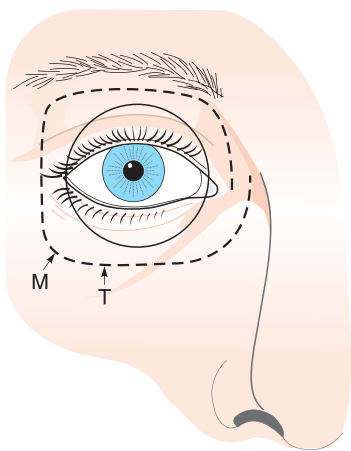
the ophthalmologist consulted. Often a case need only be postponed but sometimes will require surgical decompression. Venous injury rarely results in a compressive hematoma.

Direct optic nerve injury secondary to needle trauma is rare but does occur, with resultant poor visual outcome, including blindness, from direct nerve injury or intraneural hematoma formation.

Unintentional globe perforation occurs with a variable frequency.<sup>56,57</sup> Often, the sedated patient experiences minimal pain or shows minimal reaction, necessitating a high degree of suspicion. The visual outcome depends on prompt consultation, location of injury, and presence of retinal detachment. Injection into the globe following a penetration leads to devastating injury to the eye. A risk factor for penetrating injuries is long axial length of the eye ( $>26$  mm), but even more is the additional association of scleral thinning and posterior or inferior staphylomas common in severely myopic eyes ( $>26$  mm).

Ocular and orbital muscle injuries are possible. Ptosis can be caused by surgical sutures on the lid speculum as well as disruption of the levator aponeurosis from trauma or stretching of the periorbital septum. Strabismus can be seen after injury to the rectus muscle by direct needle trauma, injection into the muscles, or toxicity from local anesthetics (less common with lidocaine  $<4\%$  and use of hyaluronidase as an adjuvant to anesthetic dispersal).

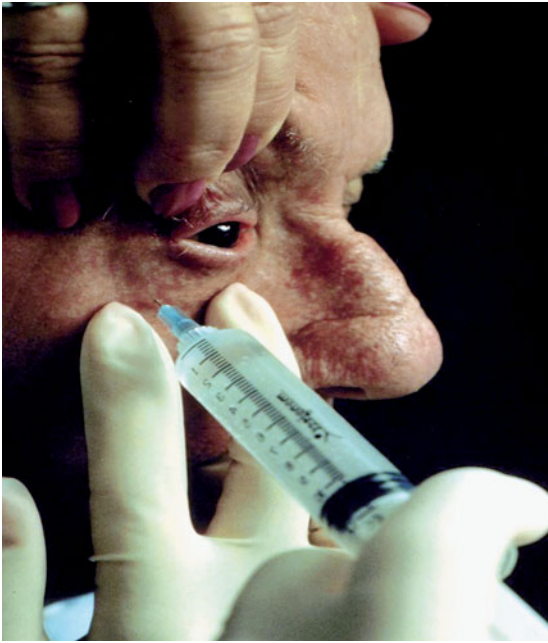
Sub-Tenon block (via surgical technique) was developed to avoid complications from needle-based techniques; however, serious eye complications



**FIGURE 65-17.** Traditional needle insertion site (T) for retrobulbar or peribulbar block at the junction of the medial and lateral third of the inferior orbital rim. Recommended insertion site is at the modified (M) location, 4–5 mm inferior to the lateral canthus. The risk of injuring the inferior rectus, inferior oblique, and its nerve is lessened. (Reprinted from Hamilton RC. Retrobulbar block revisited and revised. *J Cataract Refract Surg* 1996;22:1147-1150, with permission from the ASCRS & ESCRS.)



**FIGURE 65-18.** Modified insertion site below lateral canthus on inferior orbital rim.



**FIGURE 65-19.** Modified insertion site as shown in Figures 65-17 and 65-18.

have been reported.<sup>58-61</sup> Note that prior scleral buckling prevents posterior spread of anesthetic, prior retinal surgery may do the same secondary to scarring, sub-Tenon block may interfere with lifting of a flap in glaucoma surgery, and sub-Tenon block has not been evaluated in patients with coagulopathy.

Despite a very large study investigating anticoagulant and antiplatelet use in cataract surgery, no consensus exists regarding the dangers of hemorrhagic injury in the anticoagulated patient or the risk of thrombotic events in at-risk patients.<sup>62</sup> The incidence of events of any kind is very low. However, among patients whose eyes were actually examined within 24 hours of surgery, three times more hemorrhagic events than thrombotic events occurred in patients who continued taking aspirin < 14 days before operation and in those who continued warfarin (Coumadin) use < 4 days before operation. At the Massachusetts Eye and Ear Infirmary, the current protocol encourages discontinuation of warfarin 4 days before surgery and administration of an appropriate dose of fractionated heparin to patients 12 hours prior to surgical procedures. Our institution considers an international normalized ratio < 2.5 to be safe for needle-based blocks, although scant data in the literature support or refute this number. No information

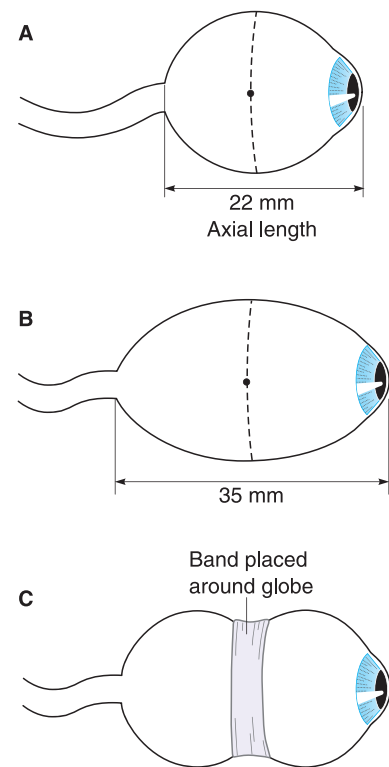
related to the newer antiplatelet medications is available.

### SEDATION FOR NERVE BLOCKS

There are many reasons to sedate patients prior to performing needle-based regional anesthesia. Most basically, patients (especially the elderly) are extremely anxious about surgery on their eyes, particularly with regard to the needle under the eye. Second, the performance of these blocks can be moderately to very painful. Third, sedation and analgesia tend to keep the patient relaxed even after the block has been placed. Last, patient cooperation and immobility are important for the safe performance of a block. At the Massachusetts Eye and Ear Infirmary, a combination of midazolam and remifentanyl appropriate for patient age and condition (0-2 mg midazolam and 0-90 mg remifentanyl) is used. As is the case with other procedures, sedation is imprecise, so patients must be appropriately NPO and be fully monitored, and resuscitation equipment and drugs must be immediately available.

### GENERAL ANESTHESIA

General anesthesia is used in approximately 35% of the ophthalmic surgery



**FIGURE 65-20.** **A.** “Normal” eye and axial length. **B.** Severely myopic eye, often associated with scleral thinning or staphylomas. Blocks intended to be intraconal rather than peribulbar have a higher incidence of global penetration, perforation, and global rupture from needle injury or intraocular injection. **C.** Representation of an eye with a prior scleral buckle, which is associated with the same complications as B.

cases at our institution, the most common of which are lengthy retinal surgery and pediatric strabismus surgery. Indications for general anesthesia include the following:

- Inability of the patient to cooperate with monitored anesthesia care (MAC; e.g., children, adults with mental or psychologic deficits, tremor, inability to lie supine)
- Complete ocular akinesia desired by the surgeon
- Lengthy procedure (> 3-4 hours)
- Surgical field not amenable to regional, local, or topical anesthesia (e.g., large myopic globe, coagulopathy)
- Intrathecal or intravascular injection of local anesthetic
- Surgeon or patient preference

Controversy exists regarding the relative safety of general and regional anesthesia in ophthalmic surgery. Two techniques have shown no postoperative differences with regard to memory<sup>63</sup>; cognitive function<sup>64</sup> and oxygen satura-



TABLE 65–6.

## Complications of Regional Blocks

Rare	
<b>Sight-Threatening</b>	<b>Life-Threatening</b>
Corneal injury	Seizures
Myotoxicity/injury	Brain stem anesthesia
Direct nerve trauma	
Ocular penetration/perforation	
Detached retina	
Globe rupture	
Retrobulbar hemorrhage	
Peribulbar hemorrhage	
Retinal vascular occlusion	

tion.<sup>65</sup> The incidences of mortality and major complications are similar.<sup>9</sup> Regional anesthesia has been reported to be associated with fewer episodes of intraoperative oxygen desaturation, hemodynamic fluctuation, PONV,<sup>9</sup> and less initial postoperative pain.<sup>66</sup> Regional anesthesia for ophthalmic surgery also has been shown to be free of the hormonal stress response associated with general anesthesia.<sup>67,68</sup> With these considerations in mind, it seems prudent to avoid general anesthesia, if possible, in patients with severe cardiovascular or pulmonary disease, as well as those who are particularly prone to PONV.

The goals of general anesthesia for ophthalmic surgery include a smooth induction with a stable IOP, avoidance or treatment of severe OCRs, maintenance of a motionless field, a smooth emergence, and avoidance of PONV. These goals can be accomplished in a variety of ways, using inhalation anesthesia, IV agents, or a combined technique. Muscle relaxants are especially useful during intraocular microsurgery, when the slightest patient movement can be disastrous.

“Deep extubation” is a term used to describe the extubation of a patient before complete awakening has occurred. Other centers may define “deep extubation” somewhat differently. It is indicated in the presence of a compromised globe or intravitreal gas, or whenever an increase in IOP from tracheal stimulation must be avoided. Deep extubations are performed just after the patient has passed through stage 2 (classically described as “delirium”) to stage 1 (“analgesia”). This stage of anesthesia is characterized by slow regular breathing with diaphragm

and intercostal muscles, and the presence of a lid reflex. A patient extubated at this time experiences amnesia, analgesia, and sedation. Extubations at this point have minimal tracheal stimulation, but there is a small possibility of aspiration because airway reflexes have not completely returned. As such, patients with full stomachs (having recently ingested food or drink prior to surgery) or patients with a compromised airway are not good candidates for deep extubation.

## ANESTHESIA FOR PEDIATRIC OPHTHALMOLOGY

Anesthesia for pediatric ophthalmology encompasses a diverse group of patients and procedures. It has been said that pediatric ophthalmic anesthesiology can be considered a separate subspecialty.<sup>69</sup> Patients range from newborns with medical problems associated with prematurity, to children with congenital syndromes, to healthy adolescents. The procedures performed on pediatric ophthalmic patients also are diverse. Many of the ophthalmic procedures performed in adults with MAC require general anesthesia in the pediatric population.

Measurement of IOP in the awake child is difficult because of their lack of cooperation and frequently requires general anesthesia (examination under anesthesia). IOP is affected by most anesthetic drugs and practices such as laryngoscopy and intubation. Therefore, most ophthalmologists prefer to measure IOP before a deep level of anesthesia has been reached and intubation has been performed. It is our practice to allow measurement of IOP

TABLE 65–7.

## Avoidance of Regional Complications

Clear knowledge of orbital anatomy/individual variation
Clear knowledge of ocular anatomy/individual variation
Individual patient’s ocular history e.g., Extreme myopia
Multiple eye surgeries
Presence of scleral buckle
Training, supervision, practice under qualified instructor
Fastidious technique every block
Appropriate peri-block sedation
Full basic monitoring
Availability of emergency equipment and medication

soon after induction of anesthesia and before instrumentation of the airway has taken place. This is accomplished by positioning the mask and hand of the anesthesiologist so that the ophthalmologist has unobstructed access to the eye. Instillation of topical anesthetic drops into the eye may allow earlier IOP measurement than otherwise possible. If necessary, the mask can be removed to allow IOP measurement and then replaced. If further examination is required (e.g., ultrasound, gonioscopy), either the trachea is intubated or a laryngeal mask airway is inserted.

Measurement of IOP in the pediatric patient is performed to diagnose glaucoma or to follow the efficacy of therapy. Congenital glaucoma can be associated with several systemic syndromes (e.g., rubella, oculocerebrorenal [Lowe] syndrome). In addition, Sturge-Weber disease or congenital capillary hemangioma may affect the skin of the face, neck, mucous membranes, meninges, and choroid plexus. If the affected areas include the distribution of the fifth cranial nerve, glaucoma is commonly found. These patients also have seizure disorders. Children with Sturge-Weber disease come to the operating room for frequent examinations under anesthesia to follow the efficacy of surgical and medical interventions. Good rapport and appropriate use of premedicants allow a smooth induction of anesthesia and the most accurate measurement of IOP.

Strabismus surgery is the most common type of ophthalmic surgery performed in children. Numerous studies

have reported the incidence of PONV be >50%.<sup>70,71</sup> Many different anesthetic techniques and antiemetic regimens have been used in an attempt to decrease this high incidence of nausea and vomiting. Nothing found is absolutely preventative, and nothing has been found to be effective when children are at home and the incidence of PONV within 24–72 hours is high. Immediately perioperatively, Wachta et al.<sup>70</sup> showed that patients anesthetized solely with propofol following halothane induction had an incidence of emesis in the first 24 hours of 23%, compared to 50% in those who received halothane, nitrous oxide (N<sub>2</sub>O), and droperidol. All patients in all groups received opioids for pain relief, a technique that undoubtedly contributed to the high incidence of PONV. At the Massachusetts Eye and Ear Infirmary, the standard practice with such high-risk groups is to change from inhalation anesthetic after induction to infusions of remifentanyl and propofol and administration of serotonin (5HT<sub>3</sub>) antagonists and dexamethasone (Decadron) in appropriate doses. Pain is minimized with nonopioid analgesics, most commonly ketorolac 0.2–0.5 mg/kg IV (not >30 mg and less in patients with compromised renal function). Remember that pediatric patients with congenital strabismus may have a tendency for malignant hyperthermia, which should be factored into anesthetic management.

The OCR is frequently elicited during strabismus surgery by traction on the extraocular muscles. The incidence of OCR appears to be higher in patients receiving propofol anesthesia compared with halothane anesthesia.<sup>70</sup>

Nasolacrimal duct probing for obstruction is another common procedure performed in pediatric ophthalmic patients. Successful relief of obstruction diminishes after the first year of life, so many of these patients are infants. Use of the laryngeal mask airway provides the surgeon with unobstructed access to the patient and protects the airway from the fluorescein dye that is injected into the nasolacrimal duct.

When an infant or young child presents with poor vision but normal ocular structures, electroretinography can help differentiate among retinal disorders. This procedure is generally performed in a completely dark laboratory and requires a period of approximately 20 minutes for the retina to dark adapt.

General anesthesia or sedation is required because the child usually is not able to cooperate for the examination. Before beginning of the procedure, the anesthesiologist must become familiar with the location of the various pieces of equipment and power outlets and be completely satisfied with the setup.

Retinopathy of prematurity, previously called *retrolental fibroplasia*, usually occurs in premature infants. Although a disease of complex etiologies, it is believed to be primarily related to hyperoxic periods during neonatal intensive care. Nonetheless, full-term infants can have this condition, as can premature infants who have never received oxygen therapy. Following initial examination in the intensive care unit, the child may come to the operating room for multiple examinations under anesthesia and vitreoretinal procedures such as scleral buckling or vitrectomy. The care of the ex-premature infant is complex and must start with a thorough history and physical examination. Important historical data include gestational age at birth, birth weight, duration of intubation and ventilation, history of apneic episodes, and other congenital anomalies.<sup>72</sup> Hyaline membrane disease occurs in 60–80% of infants born at <28 weeks' gestation. Hyaline membrane disease may progress to the chronic pulmonary disease of prematurity called *bronchopulmonary dysplasia*. Although bronchopulmonary dysplasia improves with growth and development, these children should be considered at risk for increased airway reactivity.

If an inhalation induction is chosen, intravenous or inhalation anesthesia can be used for maintenance. Intravenous access is rapidly secured so that the amount of inhalational agent can be decreased and muscle relaxant administered. For retinal cases, paralysis is maintained throughout the procedure because a motionless field is critical. Conservative amounts of opioids, most commonly fentanyl, are administered. The very premature infant who required intubation and controlled ventilation after birth and who has recently been extubated may be difficult to extubate at the end of retinal surgery. Although extubation should be the goal at the conclusion of surgery, the endotracheal tube should be left in place if the child does not have a regular respiratory pattern or is much less vigorous than preoperatively.

In 1982, anesthesiologists were first alerted to the occurrence of postoperative apnea in the ex-premature infant recovering from minor surgical procedures after general anesthesia.<sup>73</sup> Exactly when these infants are no longer at risk is not definitely known<sup>74</sup>; however, the incidence of apnea is known to be strongly related to gestational age and postconceptual age. Criterion for hospital admission for apnea monitoring after general anesthesia varies from institution to institution. A conservative range for admission is infants <50–54 weeks' postconceptual age.

Especially important in pediatric patients is calculating the amount of local anesthetic drug that is allowable to avoid toxicity. Also important is knowing whether these solutions contain epinephrine and the amount contained within. The dosages are calculated on a per kilogram basis and can be easily exceeded in the very small child. The recommended safe maximal dose of the commonly used local anesthetics in ophthalmology are as follows:

Lidocaine: 7 mg/kg

Bupivacaine: 3 mg/kg

In a patient anesthetized with halothane, 1.5 µg/kg epinephrine should not be exceeded; when isoflurane is used, up to 3 µg/kg is acceptable. These dosages of epinephrine are conservative and can be repeated after 10 minutes if no untoward effects are observed.

As noted earlier under Systemic Effects of Ophthalmic Drugs, drugs used in ophthalmology have systemic effects. Most of these drugs come in varying concentrations, and the least concentrated effective form should be used in small children to avoid toxicity. One drug used often in the operating room to produce mydriasis is phenylephrine hydrochloride. Only the 2.5% solution should be used in pediatric patients because excessive absorption can cause hypertension.

## OPHTHALMIC PROCEDURES

### Strabismus

Strabismus means ocular misalignment or deviation of one eye relative to the visual axis of the other. The etiology may be related to abnormalities in binocular vision or neuromuscular problems of ocular motility. A detailed nomenclature has evolved to describe the various patterns of stra-

bismus. The prefix “*eso-*” denotes deviation nasally, whereas “*exo-*” denotes temporal deviation. The suffix “*-phoria*” describes the tendency of one eye to turn outward, and “*-tropia*” describes inward deviation.

The surgical correction of strabismus is a repositioning of the extraocular muscles. To strengthen a muscle, a resection is performed. To weaken a muscle, a recession is performed. In severe cases, a resection may be performed on one muscle and a recession on the opposing muscle. Because visual maturation occurs by age 5 years, strabismus correction usually is attempted early in childhood. If left uncorrected, amblyopia, or a defect in central vision, occurs. Adjustable sutures are sometimes used to improve the chances of alignment with a single operation. The adjustment is performed in the immediate postoperative period, when the patient is fully awake and able to focus.

Pediatric patients undergoing strabismus surgery require general anesthesia. Some adult patients do well with a regional technique and intravenous sedation. Most patients prefer general anesthesia and have a particularly satisfactory result with propofol, remifentanyl, 5HT<sub>3</sub> antagonists, and/or dexamethasone, and nonopioids for pain.

## Cornea

### Penetrating Keratoplasty

Penetrating keratoplasty refers to surgical replacement of a portion of the cornea with donor tissue. Donor tissue that comes from the patient is called an *autograft*. Tissue that comes from another person is called an *allograft*. The indications for this procedure are many—corneal opacity, keratoconus, infection, and scarring are a few. Either regional or general anesthesia may be appropriate for this procedure. The importance of cough when the anterior chamber is open cannot be overemphasized.

### Pterygium

A pterygium is a fold of conjunctiva and fibrovascular tissue that has invaded the superficial cornea. Excision is indicated when vision becomes impaired or the lesion causes irritation. Topical or injection anesthesia, with or without intravenous sedation, is satisfactory for removal.

### Radial Keratotomy

Radical keratotomy is the surgical procedure used to correct myopia. Recall

that the cornea contributes approximately 30% of the refractive element of vision. Under topical anesthesia, a series of incisions is made in the cornea in a spoke-like manner, causing positive diopter change in vision. The indications and rationale for radical keratotomy remain controversial. Typically, these procedures are performed with topical anesthesia only.

## Cataracts

Cataracts are a common cause of visual impairment in older individuals. The pathogenesis of cataracts is multifactorial but basically results in opacity of the lens. Extracapsular cataract extraction (ECCE) is the preferred method of routine cataract extraction. The procedure is performed through a smaller incision and is less traumatic to the corneal endothelium. Removal of the lens with an intact posterior capsule provides for better positioning of an intraocular lens implant. Phacoemulsification is an ECCE technique performed through a 3- to 4-mm incision. The nucleus of the cataract is fragmented with an ultrasonic needle and then aspirated. Intracapsular cataract extraction (ICCE) is a technique that completely removes the lens with the capsule through a much larger incision. ICCE is performed in selected cases and in locations where sophisticated equipment is not available. Cataract extraction usually is performed with a retrobulbar or peribulbar injection and, if needed, a facial nerve block. Intravenous sedation and analgesia should be given for placement of the block. The procedure can be performed under topical anesthesia in selected patients.

## Glaucoma

Glaucoma is a general term for a group of eye diseases characterized by increased IOP. Goniotomy is a procedure performed to treat infantile glaucoma. A superficial incision is made in the trabecular meshwork to improve outflow of aqueous humor from the anterior chamber. Infants and children require general anesthesia for this procedure. Trabeculectomy is the most commonly performed filtering procedure in adults. A block of limbal tissue is removed beneath a scleral flap, permitting outflow of aqueous. Antimetabolites, such as mitomycin, can be injected intraoperatively to help prevent surgical failures secondary to scarring. Many different tubes

or shunts have been used to divert aqueous (e.g., Molteno valve). These implants are generally reserved for patients who have not responded to other management. Implants in current use have a plastic tube placed in the anterior chamber connected to a plate placed posterior to the limbus. Iridectomy usually is performed with an yttrium-aluminum-garnet (YAG) laser; however, an incisional iridectomy occasionally is required. Iridectomy is the definitive treatment for angle-closure glaucoma.

Anesthesia for glaucoma surgery in adults usually is performed with a retrobulbar or peribulbar injection and, if needed, a facial nerve block.

## Vitreoretinal Surgery

Vitrectomy refers to surgical extraction of the contents of the vitreous chamber and their replacement with a physiologic solution. An anterior segment vitrectomy is performed for vitreous loss during cataract surgery and for late anterior segment vitreous complications. A posterior segment vitrectomy is indicated for removal of an intraocular foreign body, management of complicated retinal detachments with intraocular membranes, removal of media opacities, and alleviation of vitreous traction on the retina. Because the surgery may be prolonged and many patients have coexisting medical conditions (e.g., diabetes, renal disease, or cardiac disease), vitrectomy can offer difficult challenges to the anesthesiologist.

General anesthesia has been traditionally used for vitreoretinal surgery. However, using local anesthesia with MAC has become an attractive alternative. A retrobulbar or peribulbar block under MAC offers several advantages to the ophthalmologist.<sup>75</sup> Following retrobulbar block, the OCR usually is absent. The rapid recovery associated with MAC allows early prone positioning in the recovery room after posterior chamber gas injection. Patient comfort is increased because of less nausea and vomiting along with diminution of postoperative pain. Unfortunately, MAC is not suitable for long procedures. Procedures lasting longer than 3–4 hours exceed the tolerance of patients to lie supine and motionless. If necessary, a retrobulbar block can be supplemented during surgery with a sub-Tenon injection using a blunt, 19-gauge needle.

General anesthesia is appropriate for longer cases. It is a useful technique

when communication with the patient is difficult (e.g., those who are young, hard of hearing, infirm). General anesthesia has some disadvantages. An increase in IOP risks retinal repair, at induction and during extubation. The OCR is much more common during general anesthesia, frequently requiring anticholinergic treatment. Following general anesthesia, patients require more systemic postoperative analgesics and antiemetics. Somnolence, pain, and nausea may delay the proper positioning of patients postoperatively.

When general anesthesia is administered, use of long-acting retrobulbar blockade has significant advantages. Retrobulbar “irrigation” with 0.75% bupivacaine greatly reduces the need for parenteral analgesics within the first 24 hours after surgery.<sup>76</sup> In a prospective double-masked study of patients receiving general anesthesia with or without retrobulbar block with 0.5% bupivacaine, the group receiving the bupivacaine had significantly less pain and nausea postoperatively.<sup>77</sup> Alternatively, under direct vision, a blunt 19-gauge cannula can be used to directly inject the anesthetic agent into the retrobulbar space via a sub-Tenon approach. This technique minimizes the risk of scleral perforation.

It is important to recognize the danger of N<sub>2</sub>O use when intravitreal gas is administered. To provide internal tamponade of the retina after reattachment, an intravitreal gas bubble [e.g., air, sulfur hexafluoride (SF<sub>6</sub>), or Octafluoropropane (C<sub>3</sub>F<sub>8</sub>)] replaces some of the vitreous. N<sub>2</sub>O is a very insoluble gas in blood but is 117 times more soluble than SF<sub>6</sub>. N<sub>2</sub>O enters the intraocular gas bubble more rapidly than SF<sub>6</sub> can exit. If N<sub>2</sub>O administration continues after injection of SF<sub>6</sub> gas into the vitreal cavity, the injected gas bubble can expand up to three times its original volume. Similar effects can be seen when C<sub>3</sub>F<sub>8</sub> is used. Within 19 minutes after placement in a closed eye, IOP will increase by 14–30 mm Hg. If N<sub>2</sub>O is then discontinued, the bubble size will decrease by half within 18 minutes. The resulting decrease in IOP can lead to redetachment of the retina. Washout of N<sub>2</sub>O from the lungs is 90% complete within 10 minutes, but to provide a margin of safety, N<sub>2</sub>O should be discontinued at least 20 minutes *before* intravitreal injection of gas. It is important that patients returning for surgery within 3–4 weeks caution

anesthesiologists that they have received an intravitreal gas injection. A similar hazard exists with air transport of patients. Because the aircraft cabin is pressurized to an altitude of approximately 2000 m above sea level, the gas bubble will expand, resulting in elevated IOP. Therefore, patients should avoid air travel for 3–4 weeks after infection of intravitreal gas.<sup>78</sup>

### Oculoplastic Surgery

All of the following oculoplastic procedures can be performed with regional anesthesia on adult patients.

#### Ectropion Repair

An ectropion results from excess, loose eyelid tissue or scarring that causes the margin of the lid to turn outward, away from the globe (eversion). Repair consists of excising excess tissue and tightening the remaining lid, or release of the related scar tissue.

#### Entropion Repair

An entropion usually is caused by senile or involuntional changes, primarily in the lower eyelids, which result in weakening of the lid retractor muscles and horizontal laxity. The lid margin is turned inward toward the globe (inversion). The goal of surgical repair is to increase the tension of the retractor muscles (e.g., by reattaching them) and tighten any horizontal laxity.

#### Ptosis Repair

Ptosis is a congenital or acquired drooping of the eyelid. Most often it is repaired by shortening or reattaching the levator palpebrae aponeurosis. In cases where levator function is inadequate, the upper lid can be suspended from the frontalis by a sling of fascia lata.

#### Blepharoplasty

Blepharoplasty is any plastic surgery of the eyelids, usually to remove redundant tissue. The procedure is performed to remove visual field obstruction and for cosmesis.

#### Dacryocystorhinostomy

Dacryocystorhinostomy is the creation of a communication between the lacrimal sac and the nasal cavity to allow for tear drainage. A Jones tube is sometimes used to bypass the canaliculi and form a conjunctivorhinostomy. Nasolacrimal duct probing is performed in children with congenital nasolacrimal duct obstruction. The

duct is probed with a wire, then dye is injected into the duct and aspirated from the nasal cavity to test the patency of the duct. Silicon tubes can be inserted to act as stents.

### Orbital Surgery

Most orbital surgery requires general anesthesia unless the procedure is limited to the anterior orbit and does not involve the bones of the orbit.

#### Orbitotomy

An orbitotomy is performed to gain surgical access to the orbit. Approaches include transconjunctival, transseptal, and transperiosteal. Indications for orbitotomy include tumor, abscess, foreign body, and orbital fractures.

#### Orbital Decompression

Orbital decompression is indicated for correction of exophthalmos resulting from Graves disease. Access to the orbit is obtained by either a transconjunctival or transperiosteal approach. Some surgeons use a coronal incision with reflection of the scalp anteriorly to the level of the orbit. Cases can be length (4+ hours), and blood loss can be large enough to require transfusion.

### Open Globe, Full Stomach

Open globe, full stomach is a topic of interest primarily because of the theoretical problems with succinylcholine and its effects on IOP, its contractile effects on the extraocular muscles, and its fasciculatory effects on the other skeletal muscles. The fear is harm to the eye from extrusion of intraocular contents. Vachon et al.<sup>79</sup> reviewed the controversies surrounding this issue and the lack of actual evidence linking succinylcholine to extrusion of eye contents, and retrospective case reports support many of his contentions.<sup>80,81</sup> Does succinylcholine cause an increase in IOP? Yes, by 6–12 mm Hg for up to 10 minutes.<sup>8–11</sup> In the intact eye, the increase is caused directly by contraction of the extraocular muscles, fasciculations of the orbicularis oculi, venous congestion within the eye from abdominal muscle fasciculations affecting venous return, as well as changes in intraocular blood flow stemming from increases secondary to the hemodynamic effects of succinylcholine. These effects may be mitigated by a well-designed anesthetic induction. First, most anesthetic agents (except ketamine) reduce IOP and thus lessen the response to succinylcholine.



Second, the well-anesthetized patient has blunted hemodynamic responses to laryngoscopy, mitigating any rise in IOP. Finally, by pretreatment with a nondepolarizing relaxant, contraction and fasciculations can be abolished. However, when nondepolarizing agents are used in this manner, the anesthesia provider must administer a sufficient dose of succinylcholine to achieve flaccid paralysis (1.5 mg/kg) and wait a sufficient time period (90 seconds) to ensure equal quality muscle relaxation and good intubating conditions without coughing or bucking (which can raise IOP by 30–40 mm Hg). In this regard, Libonati et al.<sup>80</sup> and Donlon<sup>81</sup> are most instructive. In instances where succinylcholine is contraindicated, nondepolarizing relaxants can be used in higher doses to provide good intubating conditions. Anesthetists should be aware of the hemodynamic consequences of large doses of mivacurium and atracurium given rapidly, as well as the need for monitoring of neuromuscular function and adequate reversal before extubation.

Remember that not all open globes are equal. Injuries can range from very minor injuries to eyes that are unsalvageable. Discussion with the consultant surgeon is important in this regard, especially when dealing with a salvageable eye or a known or suspected difficult intubation. Not all bad outcomes are related to surgery and anesthesia. Vomiting, coughing, crying, rubbing the eye, and squinting all can result in further damage prior to anesthesia and surgical treatment.

The goals of anesthesia in these patients can be summarized as follows.

- Provide adequate preoperative anxiety, if safe to perform in the patient, to help prevent rubbing and squeezing the eye.
- Avoid excessive narcotic dosing so as to prevent hypercarbia-induced increases in IOP.
- Prevent coughing during induction and emergence.
- Avoid direct pressure on the eye from the mask or fingers.
- Ensure adequate depth of anesthesia and muscle relaxation prior to laryngoscopy and intubation.
- Ensure lack of movement and coughing during the procedure using neuromuscular blockade as necessary.
- Maintain appropriate hemodynamics to prevent choroidal hemorrhage.

- Extubate awake (for full-stomach patient) while minimizing coughing and bucking by judicious use of adjuvant medications such as lidocaine and remifentanyl.

## KEY REFERENCES

1. Ahmad S, Ahmad A. Complications of ophthalmic nerve blocks: a review. *Clin Anesth* 2003;15:564.
2. McGoldrick KE. Eye, ear, nose, and throat diseases. In Fleisher LA, ed. *Anesthesia and Uncommon Diseases*. 5th ed. New York: Elsevier, 2005:1.
3. McGoldrick KE, ed. *Anesthesia for Ophthalmic and Otolaryngologic Surgery*. Philadelphia: WB Saunders, 1992.
4. Kumar C, Dodds C, Fenning G, eds. *Ophthalmic Anesthesia*. Lisse, The Netherlands: Swets and Zeitlinger, 2002.
5. Ripart J, Nouvellet E, Chaumeron A. Regional anesthesia for eye surgery. *Reg Anesth Pain Med* 2005;30:72.
6. Stead SW. Complications in ophthalmic anesthesiology. *Semin Anesth* 1996;15:171.

## REFERENCES

1. Bruce RA Jr. Ocular anatomy. In Bruce RA Jr, McGoldrick KE, Oppenheimer P, eds. *Anesthesia for Ophthalmology*. Birmingham, AL: Aesculapius Publishing, 1982;3–17.
2. Jag JL. Fundamental organization of the human eye. *Br J Anaesth* 1980;52:649.
3. Alexander JP. Reflex disturbances of cardiac rhythm during ophthalmic surgery. *Br J Ophthalmol* 1975;59:518.
4. Katz RL, Bigger JT. Cardiac arrhythmias during anesthesia and operation. *Anesthesiology* 1970;33:193.
5. Duncalf D, Foldes FF. Effect of anesthetic drugs and muscle relaxants on intraocular pressure. *Int Ophthalmol Clin* 1973;13:21.
6. Duncalf D, Weitzner SW. The influence of ventilation and hypercapnia on intraocular pressure during anesthesia. *Anesth Analg* 1963;42:232.
7. Antal M. Ketamine anesthesia and intraocular pressure. *Ann Ophthalmol* 1978;10:1281.
8. Cook JH. The effect of suxamethonium on intraocular pressure. *Anaesthesia* 1981;36:359.
9. Lynch S, Wolf GL, Berlin I. General anesthesia for cataract surgery: a comparative review of 2217 consecutive cases. *Anesth Analg* 1974;53:909.

10. Petruscak I, Smith RB, Breslin P. Mortality related to ophthalmic anesthesia. *Arch Ophthalmol* 1973;89:106.
11. Wynands JE, Crowell, DE. Intraocular tension in association with succinylcholine and endotracheal intubation. *Can Anaesth Soc J* 1960;7:39.
12. Katz RE, Dinner M, Turner LS, et al. Succinylcholine increases intraocular pressure in the human eye with the extraocular muscles detached. *Anesthesiology* 1993;79:948.
13. Meyers EF, Singer P, Otto A. A controlled study of the effect of succinylcholine self-taming on intraocular pressure. *Anesthesiology* 1980;53:72.
14. Verma RS. "Self-taming" of succinylcholine-induced fasciculations on intraocular pressure. *Anesthesiology* 1979;50:245.
15. Meyers EF, Krupin T, Johnson M, et al. Failure of nondepolarizing neuromuscular blockers to inhibit succinylcholine induced increased intraocular pressure. *Anesthesiology* 1978;48:149.
16. Feneck RO, Cook JH. Failure of diazepam to prevent the suxamethonium-induced rise in intraocular pressure. *Anaesthesia* 1983;38:120.
17. Haddad, NJ, Moyer NJ, Riley FC Jr. Mydriatic effect of phenylephrine hydrochloride. *Am J Ophthalmol* 1970;70:729.
18. Fraunfelder FT, Scafidi AF. Possible adverse effects from topical 10% phenylephrine. *Am J Ophthalmol* 1978;85:447.
19. Smith RB, Douglas, H, Petruscak J, et al. Safety of intraocular adrenaline. *Br J Anaesth* 1972;44:1314.
20. Kim JW, Smith, PH. Timolol-induced bradycardia. *Anesth Analg* 1980;59:301.
21. Jones JL Jr, Ekberg NL. Exacerbation of asthma by timolol. *N Engl J Med* 1979;301:270.
22. Bailey PL. Timolol and postoperative apnea in neonates and young children. *Anesthesiology* 1984;61:622.
23. DeRoeth A, Dettbary WD, Rosenberg P. Effect of phospholine iodide on blood cholinesterase levels. *Am J Ophthalmol* 1965;59:586.
24. Lee PP, Feldman ZW, Osterman J, et al. Longitudinal prevalence of major eye disease. *Arch Ophthalmol* 2003;121:1303.
25. Kraushar MF, Turner MF. Medical malpractice litigation in cataract surgery. *Arch Ophthalmol* 1987;105:1339.
26. Havi-Viander M. Death associated with anesthesia in Finland. *Br J Anaesth* 1980;52:483.
27. Eagle KA, Berger PB, Calkins H, et al. ACC/AHA guidelines for perioperative cardiovascular evaluation for noncardiac surgery—executive summary. *J Am Coll Cardiol* 2002;39:542–545.
28. Pasternak LR, Arens JG, Caplan RA, et al. Task force on preoperative evaluation. Practice advisory for preanesthesia evaluation. *Anesthesiology* 2002;96:485–486.
29. Roizen MF. The surgical burden: how to prevent a crisis in preoperative medicine. *Cleve Clin J Med* 2006;73:58.

30. MacPherson R. Structured assessment tool to evaluate patient suitability for cataract surgery under local anesthesia. *Br J Anaesth* 2004;93:521.
31. Schein OD, Katz J, Bass EB, et al. The value of routine preoperative medical testing before cataract surgery. *N Engl J Med* 2000;342:168.
32. Roth P, Marr B, Boback C, et al. Preoperative Evaluation. Bloomington, Institute for Clinical Systems Improvement. 2003. Available at: [www.guideline.gov](http://www.guideline.gov). Last accessed June, 2006.
33. Reilly DG, McNeely MJ, Doerner D, et al. Self-reported exercise tolerance and the risk of serious perioperative complications. *Arch Intern Med* 1999;159:2185.
34. Sgura FA, Kopecky SL, Grill JP, et al. Supine exercise capacity identifies patients at low risk for perioperative cardiovascular event and predicts long-term survival. *Am J Med* 2000;108:334.
35. Glanz L, Drenger B, Gozal Y. Perioperative myocardial ischemia in cataract patients: general vs. local anesthesia. *Anesth Analg* 2000;91:1415.
36. Katz J, Feldman MA, Bass EB, et al. Adverse intraoperative medical events and their association with anesthesia management strategies in cataract surgery. *Ophthalmology* 2001;108:1721.
37. Katsev DA, Drews RC, Rose BT. Anatomic study of retrobulbar needle path length. *Ophthalmology* 1989;96:1221.
38. Boezaart A, Berry R, Mell M. Topical anesthesia vs. retrobulbar block for cataract surgery: the patient's perspective. *J Clin Anesth* 2000;12:58.
39. Ripart J, Jefrant JY, Vivien B, et al. Ophthalmic regional anesthesia: medial canthus episcleral anesthesia is more efficient than peribulbar anesthesia. A double-blind randomized study. *Anesthesiology*. 2000;92:1278.
40. Mouvellon E, L'Hermite J, Chaumeron A, et al. Medial canthus single injection sub-Tenon's anesthesia a 2000 case experience. *Anesthesiology* 2004;100:370.
41. Mein CE, Hymn HW. Augmentation of local anesthesia during retinal detachment surgery [Letter]. *Arch Ophthalmol* 1989; 107:1084.
42. Stevens JD. A new local anesthesia technique for cataract extraction by one quadrant sub-Tenon's infiltration. *Br J Ophthalmol* 1992;76:670.
43. Demediuk OM, Dhaliwal RS, Papworth DP, et al. A comparison of peribulbar and retrobulbar anesthesia for vitreoretinal surgical procedures. *Arch Ophthalmol* 1995; 113:908.
44. Liu C, Youl B, Mosely I. Magnetic resonance imaging of the optic nerve in the extremes of gaze. Implications for the positioning of the globe for retrobulbar anesthesia. *Br J Ophthalmol* 1992;76:728.
45. Hamilton RC. A discourse on the complications of retrobulbar and peribulbar blockade. *Can J Ophthalmol* 2000;35:363.
46. Husted RF, Hamilton RC, Loken RG. Periocular local anesthesia: median orbital block as an alternative to superior nasal injection. *J Cataract Refract Surg* 1994;20:197.
47. Jonas JB, Jäger M, Hammerling T. Continuous retrobulbar anesthesia for scleral surgery using an ultra fine spinal anesthesia catheter. *Can J Anaesth* 2002;49: 487.
48. Merbs SL, Grant MP, Iliff NT. Simple outpatient postoperative analgesia using an orbital catheter after enucleation. *Arch Ophthalmol* 2004;122:349.
49. Troll GF. Regional ophthalmic anesthesia: safe techniques and avoidance of complications. *J Clin Anesth* 1995;7:163.
50. Strouthidis NG, Sobka S, Lanigan LP, et al. Vertical diplopia following peribulbar anesthesia: the role of hyaluronidase. *J Pediatr Ophthalmol Strabismus* 2004;41:25.
51. Jehan FS, Hagen JC III, Whittaker TJ, et al. Diplopia and ptosis following injection of local anesthesia without hyaluronidase. *J Cataract Refract Surg* 2001;27:1876.
52. Brown SM, Brooks SE, Mazlow ML, et al. Cluster of diplopia cases after periocular anesthesia without hyaluronidase. *J Cataract Refract Surg* 1999;25:1245.
53. Bharti N, Madan R, Kaul HL, et al. Effect of addition of clonidine to local anesthetic mixture for peribulbar block. *Anesth Intens Care* 2002;30:438.
54. Singer SB, Preston R, Hodge WG. Respiratory arrest following peribulbar anesthesia for cataract surgery: case report and review of the literature. *Can J Ophthalmol* 1997;32:450.
55. Micoll JMV, Acharya PA, Ahlen K, et al. Central nervous system complications after 6000 retrobulbar blocks. *Anesth Analg* 1987;66:1298.
56. Hamilton RC, Gimbel HV, Strunin L. Regional anesthesia for 12,000 cataract extraction and intraocular lens implantation procedures. *Can J Anaesth* 1988;35:615.
57. Edge R, Naven S. Scleral perforation during retrobulbar and peribulbar anesthesia: risk factor and outcome in 50,000 consecutive injections. *J Cataract Refract Surg* 1999;25:1237.
58. Ruschen H, Brenner FD, Carr C. Complications after sub-Tenon's eye block. *Anesth Analg* 2003;96:273.
59. Jaycock PD, Mather CM, Ferris JD, et al. Rectus muscle trauma complicated sub-Tenon's local anesthesia. *Eye* 2001;15:583.
60. Spierer A, Schwall E. Superior oblique muscle paresis after sub-Tenon's anesthesia for cataract surgery. *J Cataract Refract Surg* 1999;25:144.
61. Olitsky SE, Juneja RG. Orbital hemorrhage after the administration of sub-Tenon's infusion anesthesia. *Ophthalmic Surg Lasers* 1997;28:145.
62. Katz J, Feldman MA, Bass EB, et al. Risks and benefits of anticoagulant and antiplatelet medication use before cataract surgery. *Ophthalmology* 2003;110:1784.
63. Karhunen U, John G. A comparison of memory function following local and general anesthesia for extraction of senile cataract. *Acta Anaesthesiol Scand* 1982;26:291.
64. Campbell DNC, Lim M, Kess Muir M, et al. A prospective randomized study of local vs. general anesthesia for cataract surgery. *Anaesthesia* 1993;48:422.
65. McCarthy GJ, Mirakhur RK, Elliot P. Postoperative oxygenation in the elderly following general or local anaesthesia for ophthalmic surgery. *Anaesthesia* 1992;47: 1090.
66. Koay P, Laring A, Adams K, et al. Ophthalmic pain following cataract surgery: a comparison between local and general anesthesia. *Br J Ophthalmol* 1992;76: 225.
67. Barker J, Robinson GC. Local anesthesia prevents the cortisol and glycemic response to cataract surgery. *Br J Anaesth* 1990;64:442.
68. Barker JP, Vafdis GC, Robinson PN, et al. Plasma catecholamine response to cataract surgery: a comparison between general and local anaesthesia. *Anaesthesia* 1991; 46:642.
69. Arthur DS, Dewar KMS. Anaesthesia for eye surgery in children. *Br J Anaesth* 1980; 52:681.
70. Wachta WF, Simeon RM, White PF. Effect of propofol on the incidence of postoperative vomiting after strabismus surgery in pediatric patients. *Anesthesiology* 1991;75:204.
71. Davis PJ, McGowan FX Jr, Landsman I, et al. Effect of antiemetic therapy on recovery and hospital discharge time. *Anesthesiology* 1995;83:956.
72. Nelson PJ, Vaughn VC III, McKay RJ Jr, et al. *Textbook of Pediatrics*. Philadelphia: WB Saunders, 1992.
73. Steward DJ. Preterm infants are more prone to complications following minor surgery that are term infants. *Anesthesiology* 1982;56:304.
74. Cote CJ, Zaslavsky A, Downes JJ, et al. Postoperative apnea in former preterm infants after inguinal herniorrhaphy. *Anesthesiology* 1995;82:809.
75. Brucker AJ, Saran BR, Maguire AM. Perilimbal anesthesia for pars plana vitrectomy. *Am J Ophthalmol* 1994;117:599-602.
76. Duker JS, Nielson J, Vander JF, et al. Retrobulbar bupivacaine irrigation for postoperative pain after scleral buckling surgery. *Ophthalmology* 1991;98:514.
77. Gottfrethsdottir MS, Gislason I, Stefansson E, et al. Effects of retrobulbar bupivacaine on post-operative pain and nausea in retinal detachment surgery. *Acta Ophthalmologica* 1993;71:544-547.
78. Dieckert JP, O'Connor PS, Schaklett DE, et al. Air travel and intraocular gas. *Ophthalmology* 1986;93:642.
79. Vachon CA, Warner DO, Bacon DR. Succinylcholine and the open globe: tracing the teaching. *Anesthesiology* 2003;99: 220.
80. Libonati MM, Leahy JJ, Ellison N. The use of succinylcholine in open eye surgery. *Anesthesiology* 1986;64:517.
81. Donlon JV. Succinylcholine and open eye injuries. *Anesthesiology* 1986;65:526.

# CHAPTER 66

## Anesthesia for Otorhinolaryngologic (Ear, Nose, and Throat) Surgery

Bil Ragan, MD

Surgical procedures for otorhinolaryngology will challenge the creativity and skills of the finest anesthesiologist. On a routine basis, the anesthesiologist will provide mask anesthetics, spontaneous or jet ventilation, controlled hypotension, and extubations during deep levels of anesthesia. Most of these cases will be performed with little or no muscle relaxation. Moreover, in the contemporary surgical environment, the majority of these cases will be performed in an outpatient setting. This presents its own challenges in the areas of analgesia and the prevention of postoperative nausea and vomiting (PONV). The patient population will vary from neonates to the elderly, with a significant number of pediatric cases.

As a unique feature of this subspecialty, the anesthesiologist will work with a physician colleague who has an understanding and appreciation of the airway. This is unlike most other surgical experience. The complicated nature of these procedures demands nothing less than complete cooperation between these two specialties. Frequently the airway will be shared, and not uncommonly one practitioner will assist the other in times of difficulty. When a compromised airway is involved, any pretensions of ego are best removed from the setting.

For purposes of clarity and ease of use, this chapter is organized by anatomic regions. When anesthesia is being provided for a particular procedure, the performance of an additional, different procedure at the same time is unlikely. Furthermore, from an anesthesia point of view, the concerns for a particular anatomic region differ from those for other regions and should be discussed separately. Final-

ly, recall that the first anesthetic was provided for removal of a neck tumor from patient James Venable. Therefore, it is only fitting that all subsequent anesthetic techniques have descended from the care of an ear, nose, and throat (ENT) patient.

### ANESTHESIA FOR EAR SURGERY

As in other subspecialties, a broad range of interventional surgical techniques can be performed for the patient's benefit. For these procedures, patient positioning, facial nerve preservation, hemostasis, smooth emergence, prevention of PONV, and use of nitrous oxide (N<sub>2</sub>O) become primary concerns for the anesthesiologist.

### Ear Canal and Tympanic Membrane Disorders

Disorders of the ear canal and tympanic membrane all involve processes

that interfere with the reception and transmission of sound from an external source to the middle ear. These cases are routinely performed under general anesthesia, but some patients can tolerate local anesthesia with sedation. After induction of anesthesia and with the airway secured, the patient's head is turned and fixed with the operative ear up. These cases are not necessarily lengthy. Some practitioners use a laryngeal mask airway (LMA), but most prefer endotracheal intubation. With canalplasties, use of N<sub>2</sub>O is permitted but not encouraged. However, with tympanoplasties, use of N<sub>2</sub>O is best avoided in order to prevent expansion and dislocation of the surgical graft.

### Conductive Hearing Loss

These are disorders of the middle ear, with resulting decline in hearing due to compromised sound conduction. Commonly they are caused by either infectious or inflammatory processes.

### KEY POINTS

1. Successful middle ear surgery depends upon: controlled hypotension to minimize blood loss and maintain a clear surgical field, use of short-acting muscle relaxants to promote facial nerve monitoring, avoidance of nitrous oxide to prevent graft disruption, and smooth extubations to prevent prosthesis displacement.
2. Middle ear surgery can result in profound postoperative nausea and vomiting, which require an aggressive, multimodal, pharmacologic approach for prevention and treatment.
3. Complications of sinus surgery include hemorrhage, eye injury, vision loss, venous air embolism, cerebrospinal fluid leak, permanent neurologic injury, and death.
4. Pediatric patients with obstructive sleep apnea syndrome may present with altered right ventricular diastolic function, pulmonary hypertension, arrhythmias, and silent carditis.
5. Posttonsillectomy hemorrhage is a surgical emergency. Patients may be profoundly hypovolemic and tachycardic before the complication is recognized, and anesthetic care includes both fluid resuscitation and meticulous airway management.
6. Careful preoperative planning will prevent the conversion of a partial airway obstruction into a complete airway obstruction when managing foreign body aspiration.
7. After radiation therapy to the head and neck, tissues become fixed, firm, and fibrotic. Despite a normal appearance, direct laryngoscopy may be extraordinarily difficult, if not impossible. Fiberoptic laryngoscopy is often the preferred approach for tracheal intubation.
8. Lasers can produce thermal injury, cause photochemical reactions, have mechanical effects, and release toxins including viable microorganisms. Most laser injuries result from reflected beams, with the eye being the most vulnerable organ.
9. No laser tube is perfect, and airway fires can occur under any condition. Precautions can reduce the risk of a surgical fire but cannot eliminate the risk.
10. Use of a Nerve Integrity Monitor (NIM<sup>®</sup>) endotracheal tube can greatly reduce the risk of recurrent laryngeal nerve injury during thyroid and parathyroid surgery.



Myringotomy is among the most frequently performed pediatric surgeries. In the hands of an experienced surgeon, bilateral myringotomies can be completed in as few as 3 minutes. Because of this, both induction and maintenance usually are performed with mask anesthesia using either halothane or sevoflurane. Postoperative discomfort can be addressed by acetaminophen given as a 40 mg/kg dose.<sup>1,2</sup> Recently the use of intranasal fentanyl has been advocated. Studies by Finkel et al.<sup>3</sup> and Galinkin et al.<sup>4</sup> both demonstrated a reduction in postoperative agitation when using fentanyl at a dose of 2 µg/kg. In certain patients, chronic otitis media can result in temporomandibular joint ankylosis,<sup>5</sup> which can make laryngoscopy difficult, if not impossible. Although instrumentation of the airway is not expected with this procedure, it is prudent to be aware of this possibility and to evaluate accordingly.

Stapedectomy is the removal or freeing of the stapes superstructure and replacement with a prosthesis. In most cases, this condition is caused by otosclerosis. Typically this procedure is performed under general anesthesia, although local anesthesia with sedation can be done. Lasers are frequently used to free the stapes, and appropriate precautions must be taken (see Lasers below). These cases usually last between 1 and 2 hours, and facial nerve monitoring may be performed. Hence, a short-acting muscle relaxant, if any, should be used. Ho et al.<sup>6</sup> found that facial twitch was quite vigorous when the ulnar nerve train of four began to return, suggesting that the surgeon should be able to identify the facial nerve by electrical stimulation even in the presence of some neuromuscular relaxation. Despite this, most practitioners limit the use of longer-acting relaxants to assure that neuromuscular blockade does not contribute to potential surgical complications.

Another goal is to reduce bleeding during this procedure. This is accomplished by injecting a mixed local anesthetic and epinephrine solution, by elevating the patient's head to improve venous drainage, and often by applying deliberate hypotension. A study by Marchal et al.<sup>7</sup> addressing these concerns found that preoperative clonidine reduced blood loss, blunted the response to intubation, and reduced isoflurane and fentanyl requirements. In similar studies by

Degoute et al.<sup>8</sup> and Dal et al.,<sup>9</sup> the combination of remifentanyl with a volatile agent provided mild hypotension and reduced blood loss.

While the surgeon is placing the prosthesis, it is absolutely essential that the patient be motionless. This requires a deeper plane of anesthesia using volatile anesthetics alone or in combination with a remifentanyl infusion. Although N<sub>2</sub>O can be used for earlier portions of the procedure, it should be avoided in the last portion to prevent tympanic membrane graft disruption and possible nausea and vomiting. Extubation must be smooth, without any bucking or violent motions, thus preventing displacement of the prosthesis. The success of the procedure may depend upon these details. It is best to have the patient breathing spontaneously and extubated during a deep plane of anesthesia.

The anesthesia concerns for ossiculoplasty are similar to those for stapedectomy. However, this procedure may last longer because these patients typically have long-standing disease that requires a lengthy dissection.

Looking to the future, it has been suggested that total intravenous anesthesia (TIVA) may allow better control and smoother emergence for these procedures. The results in a comparison trial by Mukherjee et al.<sup>10</sup> are promising. This investigation found that TIVA (i.e., by propofol and remifentanyl infusions) provided better conditions for surgery and significantly less PONV in the early postoperative interval. However, patients who received TIVA had higher pain scores during recovery. Those who received balanced anesthesia had been given fentanyl and experienced less discomfort.

### Nitrous Oxide Concerns

Nitrous oxide has been used as an anesthetic in millions of patients for more than 150 years. As with any drug, it has both beneficial and detrimental qualities. There are serious concerns with the use of N<sub>2</sub>O in middle ear surgery.

The healthy middle ear contains airspaces that are intermittently ventilated and thus decompressed via the eustachian tube. If disease or trauma interferes with this venting, middle ear pressure can rise rapidly. When N<sub>2</sub>O is used in any concentration, it can enter these airspaces much faster than nitrogen can exit. Likewise, once N<sub>2</sub>O is discontinued, rapid absorption

can result in profound negative pressure within the middle ear. Both of these processes reflect the 34-fold difference between the blood/gas partition coefficients of N<sub>2</sub>O and nitrogen.<sup>11</sup>

These sudden changes in middle ear pressure can result in impaired middle ear function, with a decline in hearing, tympanic membrane rupture, graft disruption, or nausea and vomiting. Patients who are especially susceptible include those with concurrent upper airway infections, enlarged adenoids, otitis media, and a history of otologic surgery. For these reasons, N<sub>2</sub>O should be used judiciously during middle ear surgery. If used at all, concentrations should be <50%. It should be discontinued a minimum of 20 minutes before expected closure of the middle ear. It is helpful if the surgeon flushes the ear with air before closing the surgical incision. Given all of these factors, prudent practice implies that N<sub>2</sub>O should be used only with considerable caution and for clear indications that cannot be met with other approaches.

## Sensorineural Hearing Loss Disorders

### Cochlear Implant

Patients who are profoundly deaf may have sufficient spiral ganglion cells for stimulation and thus possible recovery of hearing. With advances in electrode and processing technology, placement of cochlear implants has become a common procedure. These are lengthy cases that last anywhere from 4–6 hours. The surgeon will need to perform a mastoidotomy in order to place the signal coupler. Surgeons prefer the use of controlled hypotension, if appropriate and tolerated by the patient, to minimize blood loss. N<sub>2</sub>O is not contraindicated from the surgical perspective but should be avoided to decrease PONV. Placement of electrodes must be precise, and a smooth, motionless extubation is expected. Any untoward movement can compromise the entire procedure.

### Perilymphatic Fistula and PONV

Perilymph leakage has been implicated in sudden hearing loss, tinnitus, aural fullness, and both episodic and positional vertigo. Surgical treatment usually involves an exploratory tympanotomy, which is performed under



general anesthesia with endotracheal intubation.

These patients may have profound PONV. The approaches to prevention and treatment of PONV are considered in detail in Chapters 67 and 72. The association between middle ear surgery and this undesired complication should be prominent in the planning and management of anesthesia. In addition to avoiding N<sub>2</sub>O use, limiting opioids, and administering aggressive hydration, prevention will require a multimodal pharmacologic approach,<sup>12</sup> including preoperative use of metoclopramide and postinduction gastric suctioning. For these and other reasons, our preferred anesthesia technique includes a volatile agent, oxygen, and air supplemented with a propofol infusion.

### Mastoid Disorders and Other Ear Disorders

The introduction of antibiotics has greatly reduced the incidence of mastoiditis. However, it remains a disease with significant morbidity and even mortality. Untreated chronic otitis media remains the most common cause. Failed antibiotic response requires surgical intervention.

These procedures are performed under general anesthesia with endotracheal intubation. The surgeon's goal is to reestablish ventilation of the middle ear, debride infected material, and drain subperiosteal abscesses. Removal of osteitic bone can result in substantial blood loss. Controlled hypotension is helpful for the majority of the procedure. Facial nerve exposure is a possibility, and frequently the surgeon will seek to identify the nerve using a nerve stimulator. Short-acting muscle relaxants should be used. The return of neuromuscular responses should be documented and reported to the surgeon prior to attempted identification of the facial nerve and subsequent aggressive dissection.

Depending upon the clinical presentation, a mastoidectomy may last anywhere from 3–6 hours. Nitrous oxide is permitted but must be removed at least 20 minutes before tympanoplasty begins. Postoperatively these patients will have a large head dressing that takes 5–10 minutes to place. As with other anesthetics, if the patient is lightly anesthetized, this head movement can result in significant bucking and bleeding, which contribute to postoperative

complications. Therefore, deeper planes of anesthesia should be maintained until these dressings are in place, even at the cost of a prolonged emergence.

Effort has been made to determine whether these cases can be performed as outpatient procedures. A study by Rowlands et al.<sup>13</sup> determined that the need for inpatient admission was significantly related to the extent of surgery. However, comparing outpatient complications and overall success, no significant differences were found between outpatient versus inpatient management. It is suggested that mastoidectomies can be done safely as outpatient procedures in selected patients. In a study by Suresh et al.,<sup>14</sup> regional block of the greater auricular nerve was investigated for postoperative pain relief. The initial study suggested benefit but a subsequent study was inconclusive, leaving the matter unresolved.

### Patulous Eustachian Tube

Classically, a patulous eustachian tube will result in autophony (“rushing air” sound) that disappears in the supine position. Occasionally this experience is disturbing enough for the patient to seek surgical intervention. This is a rarely performed and challenging procedure for any otologist. With the patient in a supine position, this correction is accomplished by an intraoral approach. All the concerns and precautions of oral surgery (discussed later under Throat Surgery) apply to this technique.

### Microtia

Auricular malformations, either congenital or acquired, can be severe. A normal-appearing ear is important to all patients young and old. The Centers for Disease Control and Prevention estimates the incidence of microtia to be 1:10,000. Although it may occur as an isolated finding, microtia can occur with a variety of syndromes, including Goldenhar and Treacher Collins. A study by Uezono et al.<sup>15</sup> noted that 42% of patients with bilateral microtia were likely to pose significant intubation challenges (i.e., probable “difficult intubation”). Any associated dysmorphic features should prompt a thorough evaluation of the patient prior to reconstruction.

Depending upon its extent, microtia usually is managed as a multistage repair. Initially a rib graft is obtained and carved to resemble a matching template. This is then placed subcuta-

neously and allowed to heal. The patient then returns for additional skin grafts and refinement to the superior auricle. General anesthesia is necessary, and postoperative pain relief frequently requires patient-controlled analgesia after rib harvest. Typically the surgeon infiltrates the donor site with local anesthetic, but it will remain a source of significant discomfort in the postoperative period.

Reconstruction in adults usually follows traumatic injury or excision of neoplastic disease; thus, the airway concerns associated with congenital microtia usually are not present. Depending upon the presentation and the patient, this operation can be accomplished with either general anesthesia or local anesthesia with sedation.

### Temporal Bone Disorders

Within the temporal bone lies the facial nerve. Of the cranial motor nerves, it has the longest intraosseous course and is threatened by any disruption of the temporal bone. Tumors are relatively rare but can result in significant morbidity upon resection. Blunt trauma with fractures is far more common. Approximately 80% are longitudinal fractures caused by a blow to the front or side of the head. A blow to the occiput results in a transverse fracture, accounting for another 15%. The remaining types consist of complex or combination fractures. Prior to operation, the patient must be fully evaluated for any other injuries, such as cervical instability, other fractures, and cerebrospinal fluid (CSF) leaks. Besides hemostasis, the major postoperative concern with these procedures is persistent CSF leak with infection. Not uncommonly, neurosurgeons are involved with the repair.

### ANESTHESIA FOR NOSE SURGERY

Procedures described in this section include those of the nose and sinuses. These structures are important components of the airway, and disorders can have a significant impact upon a patient's well-being. Nasal and sinus surgery is conducted with the airway secured by endotracheal intubation and general anesthesia. Recently, use of LMAs has become more common, but potential pulmonary aspiration remains a concern. If the patient is

debilitated and at increased risk for complications with general anesthesia, these procedures can be performed under local anesthesia with sedation.

### External and Internal Nasal Deformity

Rhinoplasty is reconstruction of the external nose. Indications include trauma, neoplastic excision, deformity, and/or perceived malformation. Typically these patients are young and healthy. Following induction of anesthesia and intubation, the surgeon requests that the endotracheal tube be secured to the mandible in the midline position. This neutral position will prevent any soft-tissue distortion of the nose and allow the surgeon a more accurate reconstruction. Lubricant (“artificial tears”) will be placed in the eyes, or the eyes will be taped at the lateral margins. This will minimize the risk of corneal abrasion and provide access to the bridge of the nose. Slight elevation of the head is common to provide better access and to promote venous drainage.

Despite the use of local anesthetics with vasoconstrictors, bleeding can be brisk. Suction of the gastric and oral cavities prior to emergence and extubation will decrease the likelihood of PONV. Swallowed blood on an empty stomach is a well-known emetic. From an analgesia point of view, this procedure is relatively benign, with one exception. Toward the latter part of the procedure the surgeon will do an osteotomy, which depends upon the patient's specific anatomy and what the surgeon wishes to accomplish. If the patient's anesthetic depth is inadequate, patient movement or bucking may occur, both of which are undesirable.

At the end of the procedure, nasal packs or stents are placed, and a small plastic or fiberglass cast is fitted. Nasal stents are preferred because they allow ventilation through the nasal passages postoperatively. Care must be taken not to press upon the nasal bridge with the face mask. Gently place the mask on the mandible with the superior portion free. The seal will not be good, but when combined with a jaw thrust sufficient gas exchange should occur. As an alternative, Erbay et al.<sup>16</sup> reported the beneficial use of a pediatric mask as a mouth mask in this scenario.

Rarely, neoplastic lesions require wide excision involving the entire nose and possibly underlying structures. These patients will subsequently

present for total reconstruction. Each patient's airway must be fully examined. Depending upon their initial disease, the majority of patients will have patent posterior nasal passages. Other patients may present after partial reconstruction and have a completely obstructed nasal airway, or a maxillary prosthesis may obstruct the nasal passages. It is wise to discuss these cases well in advance with the surgeon to understand the surgical plan and the patient's pathology. The anesthetic arrangements and concerns are as previously described. Reconstructions usually involve a forehead flap and are performed as multistage repairs.

Septoplasty is a functional procedure intended to correct a deviated septum. This condition may have occurred due to trauma, deformity, or malformation. A malpositioned septum can lead to complete airway obstruction on the affected side. It also can lead to poor sinus drainage and result in chronic sinusitis. The anesthesia arrangements and concerns are the same for a septoplasty, open nasal fracture reduction, and rhinoplasty. These usually are brief cases lasting anywhere from 30 minutes to 1 hour.

Finally we must consider closed reduction of a nasal fracture. This is a very brief procedure that requires the surgeon to place his or her instrument against the fracture and apply vigorous pressure to realign structures. The definitive procedure literally takes seconds. To the awake patient, those seconds can be frightening and quite painful. An intense but brief general anesthetic usually is preferred. I prefer to have the patient in a semisitting position and premedicated with midazolam and fentanyl. Once the surgeon is in position with instrument ready, a single bolus of lidocaine and propofol is administered. Upon loss of consciousness, the reduction is accomplished. Typically emergence occurs as the cast is being fitted. This technique works very well as long as blood loss is minimal. If the reduction is expected to be more complicated or if blood loss is a concern, then the airway should be protected by LMA or preferably an endotracheal tube.

### Choanal Atresia

This is an uncommon anomaly that occurs in approximately 1:5000–8000 births. Unilateral obstruction is more likely on the right and is twice as com-

mon as bilateral obstruction. Moreover, this condition is more frequent in female neonates. Other congenital anomalies are present in 20–50% of patients.

Bilateral choanal atresia classically presents as a newborn who experiences complete airway obstruction that is relieved by crying. Gujrathi et al.<sup>17</sup> have written a series review of the surgical techniques involved in these repairs. Recently an endoscopic approach has been promoted, but the “puncture, dilation, and stent” technique remains the standard. Specific to this repair, the anesthesiologist must be vigilant that the stents are secured postoperatively. If one or both become dislodged, complete airway obstruction can occur as with any other foreign body (FB). These stents will remain in the patient for several weeks.

Lim et al.<sup>18</sup> described a case of unilateral atresia repair complicated by a persistent buccopharyngeal membrane. One should remain wary for other sources of airway obstruction. These patients may return to the operating room multiple times for stent cleaning and granuloma debridement.

### Sinus Disorders

Contemporary sinus surgery is performed almost entirely by fiberoptic endoscopy [fiberoptic endoscopic sinus surgery (FESS)]. An exception is open maxillary sinusotomy (Caldwell-Luc procedure). Indications for surgery include persistent sinusitis, recurrent nasal polyps, obstructed nasal ventilation, and CSF leak.

The anesthetic approach is similar to that used with other nasal procedures, except that the surgeon may desire the endotracheal tube to be secured on the left margin of the oral cavity. It is common for the surgeon to stand (or sit) on the patient's right with the patient's head turned slightly toward the operator. The surgeon also will request that the patient's eyes be lubricated and left open or taped on the lateral borders. The operator will want to observe the patient's eyes throughout the procedure, because some situations require activity in close proximity to the orbit. Any change in the eyes' appearance requires an extensive investigation before progressing further. Unfortunately, intraorbital eye injury has occurred in these cases, including vision loss secondary to intraorbital hematomas, eye muscle injury, and proptosis. Other complications include

venous air embolism, CSF leak, excessive bleeding, and permanent neurologic injury. Superficially, FESS appears to be a benign procedure, but the complications can be devastating. The advent of image-guided endoscopy (e.g., StealthStation®, Medtronic, Inc., Minneapolis, MN) has reduced some of the risks.

This is another procedure where controlled hypotension may be helpful. The sinuses are well vascularized, and blood loss of 300–500 mL is not uncommon in a routine case. If the patient has a bleeding disorder or is severely anemic, then transfusion of blood products may be warranted.

Surgeons will attempt to minimize bleeding by using local vasoconstriction, but such approaches are not without consequences. A study by Yang et al.<sup>19</sup> noted that low-dose epinephrine and lidocaine solutions caused brief but marked decreases in blood pressure. Often the vasoconstrictor is in the form of 4% topical cocaine. Cocaine is rapidly absorbed from the mucous membranes, and brief tachycardia and hypertension may occur. The effects of cocaine and other ester-linked local anesthetics can be prolonged in a patient who has pseudocholinesterase deficiency or one using pseudocholinesterase inhibitors (i.e., echthiophate). Systemic toxicity can result in seizures, coronary vasospasm, myocardial ischemia, and arrhythmias. Aggressive treatment with short-acting mixed  $\alpha$ - $\beta$ -blockers, oxygen, and deeper anesthesia may become necessary.

At the end of the case, the surgeon will desire a smooth extubation with minimal movement or bucking of the patient. This can be a challenge when the oral cavity is filled with secretions and blood. A deep extubation can be performed, but this will place the patient at risk for laryngospasm as the anesthesia lightens. Deep extubations can be achieved with confidence if complete hemostasis has been obtained and if oral and gastric suctioning have been extensive. Stents or packing may be placed, and the mouth remains the most reliable airway.

In addition to PONV, analgesia must be addressed. FESS procedures are not known for being particularly painful. Local anesthetic will have used, and minimal amounts of narcotics can be added. Other analgesics also have been used. Turan achieved good results with a cyclooxygenase (COX)-2

inhibitor that is no longer available. Perhaps new studies with celecoxib will demonstrate similar success. In a later study, Turan et al.<sup>20</sup> found gabapentin to be useful for postoperative pain control, but patient dizziness was a limiting side effect.

### Frontal Sinus Obliteration

Frontal sinus obliteration is a procedure for patients who have frontal sinusitis not responsive to other therapies. An internal approach can be used, or the scalp can be lowered and a bone flap raised over the frontal sinus. Following complete and meticulous debridement of the sinuses, they are packed or obliterated with donor adipose tissue harvested from the abdomen. Typically blood loss is not as severe as with a FESS procedure. Other concerns and anesthetic approaches are similar to those described for sinus disorders.

### Cerebrospinal Fluid Leak

For various reasons, including trauma, neoplastic disease, and prior surgery, a patient may present with a persistent sinus CSF leak. A successful repair requires locating the precise source of the drainage. While in the preoperative holding area, the patient is prepped and draped for subarachnoid access. After a spinal needle is placed successfully, 0.5 mL of a 10% fluorescein dye is diluted with 9.5 mL of CSF and injected slowly. The patient then proceeds to the operating room and undergoes induction of general anesthesia. The fluorescein dye is expected to emerge in the sinuses approximately 20 minutes after injection, thus indicating the source of the leak. Other anesthetic considerations are similar to those for sinus disorders.

## ANESTHESIA FOR THROAT SURGERY

The words “shared airway” evoke a subtle anxiety in the most experienced anesthesiologist. As a specialty we are known for our skills to secure, maintain, and control the airway. Any activity that threatens a secure airway is a source of concern, if not annoyance. All aspects of throat surgery involve sharing the airway with another airway expert. Like any relationship, it requires communication, understanding, and trust.

## Abnormal Airway Disorders

Surgery to correct the abnormal airway will exercise all of the anesthesiologist's skills. Myriad disorders affect the airway, and patients can be of any age and present under any circumstances. The potential combinations of patient and airway are too numerous to allow detailed consideration of each possible scenario. This overview focuses on the most common disorders associated directly with supraglottic, glottic and subglottic structures.

As a conceptual approach, consider that the abnormal airway is any airway compromised by an acquired disorder, such as an infection, mass lesion, foreign body, and therapy (radiation), or by an anatomic disorder, such as congenital malformations, the malacias, and stenoses. These definitions are not strict, as it is apparent that some lesions share features of both disorders. They are characterized in this manner only for ease of understanding. Yellon<sup>21</sup> has summarized an excellent approach to management of the pediatric patient with an abnormal airway. The guiding principles include a thorough preoperative evaluation of the patient and careful planning between surgical and anesthesia teams. Physical examination may include endoscopy, laryngoscopy, and bronchoscopy to identify both dynamic and fixed lesions prior to performing any definitive surgical procedure. Safe, successful surgical and anesthetic outcomes depend upon these efforts. Many of the same considerations apply to the adult patient as well.

## Acquired Airway Disorders

### Infections

Epiglottitis is an acute bacterial infection that untreated can become a life-threatening disease. Most commonly it affects pediatric patients in the 2 to 7 year age range. *Haemophilus influenzae* (type B) usually is the causative organism. With the use of *H. influenzae* vaccine in children, epiglottitis is becoming a disease of adults. Age notwithstanding, epiglottitis is a serious condition that must be treated aggressively.

In the classic presentation, the patient arrives with an abrupt high fever, sore throat, stridor, dysphagia, and drooling. Physical examination reveals an anxious, pale patient sitting in the sniffing position. Epiglottitis can be distinguished from croup by the lack of a spontaneous cough. A lateral neck

film will show a thickened, flat epiglottis akin to a “thumbprint.” Supraglottitis is a newer term suggested for this condition as the inflammation involves all supraglottic structures.

Adult patients are admitted and treated conservatively. Rarely do they require intubation. In the pediatric population, total airway obstruction can occur at any time. These patients cannot be left unattended until the airway is secured. Once in a controlled setting with an ENT surgeon and anesthesiologist present, an inhalational induction is done in the sitting position. Muscle relaxation is to be avoided. Laryngoscopy confirms the diagnosis, and endotracheal intubation immediately follows. It is suggested that the endotracheal tube be 0.5–1 size smaller than usual. If the airway obstructs and intubation becomes impossible, rigid bronchoscopy or tracheotomy must be performed immediately. Epiglottitis usually responds to cephalosporin therapy after several days.

Croup is a benign disease typically affecting pediatric patients in the 3-month to 3-year age range. It follows 2–3 days after a respiratory tract infection (RTI), and parainfluenza virus is the most common cause. The subglottic structures are involved, and the patient will present with stridor, dyspnea, and the classic “barking cough.” Croup can be distinguished from epiglottitis on clinical grounds, and lateral neck films are rarely needed. If obtained they should reveal a normal epiglottis. Treatment is conservative with oxygen, nebulized racemic epinephrine, and intravenous dexamethasone. Endotracheal intubation is indicated only for respiratory fatigue, progressive intercostal retractions, and cyanosis. As with epiglottitis, endotracheal intubation should be done in the operating room under similar controlled conditions and with surgical expertise immediately available.

### Adenotonsillar Hypertrophy Pediatric and Preoperative Concerns

A tonsillectomy probably is the most frequently performed airway surgical procedure. It is estimated that >300,000 tonsillectomies are done annually in North America alone. Indications for surgery include obstructive tonsillar hyperplasia, recurrent or chronic tonsillitis, and peritonsillar abscess. Often, a combined procedure

including the adenoids is performed at the same time. Adenoidectomy is done to relieve nasopharyngeal obstruction caused by adenoid hyperplasia. Frequently these patients also suffer from reflux.

Encountering a young adult patient for tonsillectomy is not uncommon. However; the vast majority of patients will be in the pediatric age range. Pediatric patients are not “small adults.” Compared with older patients, children have different physiologic responses and different psychological needs. When providing anesthesia to a child, one’s primary focus is the child. In addition, one must address the concerns of the parents.

Typically the parents meet the anesthesiologist shortly before surgery. They are about to release the care of their child to a complete stranger. Even lay persons understand that undergoing anesthesia is a “near-death experience” and that their loved one will be “on the machine” for a while. This can be quite disturbing. Many times parents confess that their greatest fear is the anesthesia. A tremendous amount of trust is required for any parent to relinquish the care of their child to another person. Bear this in mind during the preoperative consultation. Remember, it is the duty of the practitioner to ease the parents of their fears. Remember too that there is another person observing this interaction.

Now consider the pediatric patient. Children are far more aware of their surroundings than we think. On the morning of surgery they know that something is different. Usually they were awakened earlier than normal and were not allowed to have breakfast. Then they realize their parents have a certain amount of anxiety and urgency. Finally they arrive in the preoperative area. It is here that they are surrounded by complete strangers who are dressed alike and who know their name. It is surprising that this experience does not evoke even greater fear than that observed.

On the morning of surgery, the parents will be asked whether or not the child has or has had a recent RTI. These infections are frequent in this population, and a concurrent illness can affect the anesthetic management. In the past, the presence of an RTI would result in immediate cancellation of an elective procedure. This issue has been the source of much

investigation. In current practice, each child is evaluated on the day of surgery, and a decision is determined on a case-by-case basis. Most practitioners agree that children with a concurrent RTI have more respiratory complications. Most studies suggest that factors associated with these adverse events include endotracheal intubations, age <6 years, and an RTI within the past 2 weeks prior to planned surgery. According to the view of Tait and Malviya,<sup>22</sup> children with an RTI have more respiratory complications, but they are not associated with serious morbidity. The child who presents with an uncomplicated RTI can be managed safely as long as the practitioner understands and anticipates any likely adverse events, such as laryngospasm or bronchospasm. This view is further maintained in a review article by Mamie et al.<sup>23</sup>

Another preoperative issue is the anxiety or agitation level of the child. The day of surgery may be the only operating room experience for the patient and the child’s parents. Although a thorough preoperative consultation can relieve much concern, some patients are still inconsolable. Should the child be premedicated? Any premedication will sedate the patient and can contribute to both preoperative and postoperative respiratory complications. Premedication also will delay emergence and the return of protective airway reflexes. It can also delay discharge from the recovery unit. Conversely, any child who has a very frightening experience will be difficult to bring back to the operating room, and this may contribute to a lifelong fear of the healthcare profession. Sedative premedication should not be given on a routine basis. Only very anxious and agitated children should be treated. For example, consider the child who is violently upset and presents a danger to himself and the staff. Orally administered midazolam (0.5 mg/kg, maximum 10 mg) given at least 20 minutes prior to operation is the most common sedative. Other sedatives that have been investigated include rectal ketamine, oral fentanyl, nasal fentanyl, clonidine, diazepam with midazolam, and dexmedetomidine. Oral dexmedetomidine was found to be especially effective in patients with neurobehavioral disorders resistant to previous sedative attempts.



### **Obstructive Sleep Apnea Syndrome (OSAS)**

Pediatric patients with obstructive sleep apnea syndrome present additional challenges. These patients can demonstrate cardiovascular involvement, with altered right ventricular diastolic function, pulmonary hypertension, arrhythmias, and silent carditis. This diagnosis increases the risk of postoperative respiratory complications from approximately 1% to 20%. It is suggested that nocturnal oximetry studies be obtained in these patients prior to surgery. Other significant risk factors include abnormal sleep studies, carbon dioxide (CO<sub>2</sub>) tension >50 mm Hg during rest while awake, witnessed severe upper airway obstruction, and nocturnal oxygen desaturations (<90%). These patients are not candidates for outpatient procedures and should be admitted for overnight observation.

Tonsillectomy can be performed in adults with obstructive sleep apnea, but the more common procedure for treatment of adult obstructive sleep apnea syndrome is uvulopalatopharyngoplasty (UPPP). This is a partial resection of the soft palate and is not a lengthy procedure. Extensive preoperative evaluation of the patient's airway is required. If the patient reports that nightly continuous positive airway pressure (CPAP) use relieves the symptoms, that is a good indication that the patient will be able to be ventilated with a mask. However, when in doubt, awake fiberoptic intubation remains the technique of choice for airway management. It also is suggested that intraoperative narcotics be kept to a minimum, if used at all, and that the trachea be extubated when the patient is awake. These patients are likely to be sensitive to sedatives. Moreover, they will be admitted for observation. Postoperatively, the uvulopalatopharyngoplasty procedure is known to be the most painful of ENT procedures. Pain control is a challenge because of the desire to limit the use of narcotics. Monitoring and careful observation are required to manage patient discomfort.

### **Adenotonsillectomy Anesthesia Induction**

Pediatric anesthesia induction requires two persons. Both must be skilled in airway management and intravenous catheter placement. To

perform a mask induction in a child by oneself is to invite disaster. Apart from the usual concerns of pediatric induction (laryngospasm, bradycardia-hypotension, lack of intravenous access), significant numbers of these patients will suffer from obstructive sleep apnea syndrome (OSAS). Several investigators have looked at different airway maneuvers to improve mask ventilation in this situation. Reber et al.<sup>24</sup> compared chin lift with continuous positive airway pressure versus jaw thrust with CPAP and found the latter to be superior. Meier et al.<sup>25</sup> was able to demonstrate that airway patency was improved predominately by CPAP. The opposite results were obtained in a study by Bruppacher et al.,<sup>26</sup> who found jaw thrust with CPAP better. Regardless of one's preferred technique, it is apparent that CPAP is effective in the partially obstructed child.

After the patient is anesthetized and intravenous access obtained, the airway must be secured by endotracheal intubation. Tonsillar hypertrophy can be extensive, and the challenge of laryngoscopy should not be underestimated. What may appear to be a routine intubation can quickly manifest as a difficult airway. Another source of difficulty is the presence of lingual tonsillar hypertrophy. Furthermore, trauma to fragile inflamed tonsils during laryngoscopy can cause bleeding.

There is no uniformity of opinion regarding the use of muscle relaxants during these procedures. An uncomplicated tonsillectomy will last anywhere from 15–30 minutes with an

experienced surgeon. Relaxants, if used, should be of the short-acting variety. These patients will also receive narcotics for postoperative analgesia. Either alone or in combination, these drugs affect the child's ability to breathe. In a related issue, Khan and Memon<sup>27</sup> compared spontaneous with controlled ventilation for tonsillectomy. Their results suggest that controlled ventilation offers more hemodynamic stability and rapid recovery. It is my practice to give morphine immediately after intravenous access has been obtained and to intubate the trachea under the effects of both morphine and inhaled sevoflurane, thus avoiding muscle relaxants altogether.

Different techniques and drugs have been evaluated to facilitate tracheal intubation without the use of neuromuscular blockade. Woods and Allam<sup>28</sup> have provided an excellent review. Of the inhaled anesthetics, sevoflurane has emerged as the best choice, especially when combined with remifentanyl. A study by Simon et al.<sup>29</sup> showed sevoflurane to be superior to a propofol-opioid combination. Of the intravenous agents, giving remifentanyl followed by propofol seems to provide the best intubating conditions. Whatever approach is used, the avoidance of muscle relaxants allows the rapid return of spontaneous ventilation and protective airway reflexes (Figure 66–1).

### **Intraoperative Management**

After the airway is secured, the surgeon places a mouth gag in the oral cavity to better expose the tonsils.



**FIGURE 66–1.** Twelve-year-old girl prepared for tonsillectomy. The endotracheal tube is secured midline on the mandible, and the mouth gag is in position with the handle placed on the operating room tray. (Courtesy of Michael Cunningham, MD, Massachusetts Eye and Ear Infirmary.)

Great care must be taken to accomplish this maneuver. This is a stimulating event with the potential for complications. Some surgeons disconnect the anesthetic circuit prior to placing the mouth gag. Others work around the endotracheal tube. During this manipulation, the endotracheal tube can be compressed, kinked, or displaced. Rarely, an unexpected extubation occurs. After the mouth gag is in place, one should recheck to verify bilateral breath sounds. The endotracheal tube is secured to the midline mandible; any extension can result in the tube moving several centimeters. Once the mouth gag is in position, the surgeon places the inferior handle of the mouth gag on the operating room instrument tray. If the child is lightly anesthetized and moves, potential cervical injury can occur. The other option is to place the handle on a stack of towels placed upon the patient's sternum. Should the child move, the mouth gag will move with him or her. This does place counterpressure on the patient's chest, which can affect spontaneous ventilation. Prior to incision, the surgeon usually requests that an antibiotic and antiinflammatory steroid be given.

Surgical techniques for tonsillectomy include guillotine resection (rare), cold dissection, bipolar dissection, and cold ablation (coblation) dissection. Each approach has its particular merits. Blood loss is greater but pain is less with the first two techniques. Bipolar dissection allows immediate coagulation and less blood loss. However, thermal injury to the surrounding healthy tissue is responsible for greater postoperative discomfort. Coblation is a relatively new technique. With this approach, a radiofrequency bipolar current is passed through a saline medium to produce a plasma field of sodium ions. Using a much lower frequency than standard bipolar diathermy, these ions essentially vaporize soft tissue at only 140° F (60° C). It also requires no electrical ground, and irrigating saline reduces thermal injury to adjacent tissue. Coblation offers the advantages of both cold dissection and bipolar diathermy, with less postoperative pain and blood loss.

### **Postoperative Management**

At the end of the procedure, the patient should be breathing spontaneously. In addition to morphine, I also give ondansetron for emesis control. Once

hemostasis has been achieved, the patient's stomach and oral cavity are suctioned. An awake extubation can be performed to ensure that the protective airway reflexes have returned. These children are at high risk for laryngospasm secondary to blood and secretions in the oral cavity. Some practitioners have advocated using intravenous lidocaine to suppress this complication. In a study by Gulhas et al.,<sup>30</sup> intravenous magnesium was used to good effect. An investigation by Tsui et al.<sup>31</sup> explored a "no touch" extubation technique. The patients were turned to a head-down lateral recovery position while they still were anesthetized. If the nondependent hip is flexed, the patient will easily stay in this position. The importance of the head-down position cannot be overemphasized. This arrangement allows pooling of blood and secretions to occur on the side of the mouth rather than midline. In addition, the upper airway of a child widens in the lateral position and is less likely to obstruct. Aside from oximetry monitoring, no additional stimulation was allowed with the technique. After the patient emerged from anesthesia confirmed by eye opening, extubation of the trachea was performed. No incidences of laryngospasm, oxygen desaturation, or coughing were observed.

Complications of tonsillectomy include hemorrhage (discussed below in Posttonsillectomy Hemorrhage), postoperative airway obstruction secondary to laryngeal edema, and dental trauma.

### **Analgesia and Antiemesis**

Postoperative analgesia of some type is required after this procedure. Local anesthetic infiltration prior to incision has provided satisfactory results. However, bupivacaine infiltration has been implicated in short-term vocal cord paralysis, and large quantities of local anesthetic can suppress protective airway reflexes for several hours. Naja et al.<sup>32</sup> attempted to precisely identify specific anatomic areas for infiltration that will promote adequate analgesia while limiting the total amount of anesthetic injected. A follow-up study confirmed their earlier findings, and the technique appears promising.

Of the intravenous agents, ketamine, morphine, and meperidine all are proven potent analgesics. However, each has its own undesired side effects. Ketamine can cause an ex-

treme dysphoric reaction if the patient is not pretreated with a benzodiazepine. It also can cause increased oral secretions, which is undesired in this patient group. The narcotics morphine and meperidine are very effective but they provoke nausea. They also have sedative effects, can cause pruritus, and are respiratory depressants. Mukherjee et al.<sup>33</sup> compared fentanyl with morphine and noted less PONV with fentanyl in the first 4 hours but a similar incidence at 24 hours. A study by White et al.<sup>34</sup> using fentanyl but not morphine noted a significant decrease in the incidence of PONV, while analgesia remained excellent.

Tramadol is a synthetic codeine derivative that behaves as a centrally acting atypical opioid. It lacks many of the opioid side effects while exhibiting both opioid and monoaminergic mechanisms of action. For adenotonsillectomy procedures, tramadol has been favorably compared to ketamine, morphine, and meperidine. Tramadol has been shown to have analgesic properties that are similar to those of morphine but without the associated respiratory depression. It is well tolerated with less nausea. Good results have been obtained when tramadol was combined with acetaminophen. However, a study by Arcioni et al.<sup>35</sup> noted that ondansetron has an inhibitory effect when used simultaneously with tramadol. Despite this concern, tramadol remains a promising analgesic agent.

The COX-2 inhibitors also have been studied for this scenario. These drugs are advantageous in this setting because they do not inhibit platelet aggregation or prolong bleeding time. Unfortunately, only celecoxib remains available for use in the United States; other COX-2 inhibitors were withdrawn from the market over concerns of adverse cardiac events when using high doses. Prior to its withdrawal, rofecoxib was the subject of several investigations. In essence, although increased bleeding was not found, the analgesic benefits were unimpressive.

Other nonsteroidal antiinflammatory drugs (NSAIDs) have been considered for postoperative analgesia. They provide excellent pain relief without the side effects of narcotics. NSAIDs also cause platelet dysfunction and prolonged bleeding time. Their use in adenotonsillectomies remains controversial. Moiniche et al.<sup>36</sup> did a quantitative review of 25 studies to examine

the relationship between NSAID use and postoperative bleeding. They concluded that NSAIDs offer similar analgesia and significantly less emesis than opioids, but they also contribute to more reoperations for hemostasis. A review by Marret et al.<sup>37</sup> went even further and suggested NSAIDs should not be used after tonsillectomy. Both of those reports contrast with a review by Cardwell et al.,<sup>38</sup> which found no increase in bleeding requiring a return to the operating room. Overall, the weight of the evidence appears to support avoidance of NSAIDs in adenotonsillectomy patients.

In addition to pain, PONV must be expected and treated. Even if narcotics are not used, swallowed blood can cause nausea. Several agents are available and should be used to aggressively treat this condition.

The last several years have seen a number of studies that promote dexamethasone as a potent antiemetic. It usually is requested by the surgeon to reduce postoperative swelling and pain. A study by Aouad et al.<sup>39</sup> found dexamethasone significantly better than placebo for both decreasing vomiting and promoting postoperative oral intake. Elhakim et al.<sup>40</sup> confirmed these findings and noted an analgesic benefit as well. Dexamethasone was also found to act synergistically when combined with serotonin (5-HT<sub>3</sub>) antagonists.<sup>41,42</sup>

### **Posttonsillectomy Hemorrhage**

Posttonsillectomy hemorrhage remains the most serious complication of this procedure. It is expected that a routine patient will lose approximately 4 mL/kg of blood. Posttonsillectomy hemorrhage occurs in approximately 5% of all cases and most often within 24 hours (primary hemorrhage). Secondary hemorrhage can occur anytime thereafter. A study by Brown et al.<sup>43</sup> noted that nearly half of posttonsillectomy hemorrhage cases occurred in patients with previously undiagnosed coagulation disorders. Typically posttonsillectomy hemorrhage is characterized by slow oozing. These patients can be hypovolemic and tachycardic before the complication is recognized. Bleeding can be quite brisk. I have seen a clot dislodge upon intubation and in a matter of seconds the entire oral cavity filled with blood. These patients also may demonstrate orthostatic hypotension and may have swallowed a large volume of blood.

Posttonsillectomy hemorrhage is a surgical emergency and should be treated as such. Windfuhr<sup>44</sup> reviewed several cases of lethal posttonsillectomy hemorrhage. He concluded that immediate surgical intervention may have prevented mortality in most cases. Before anesthesia induction, intravascular fluid expansion should be accomplished using either crystalloids or blood products if indicated. Failure to do so can result in fatal outcomes. Consider these patients to have full stomachs and secure the airway after a rapid sequence induction. Large-bore, high-volume suction should be available. The patient's stomach should be emptied after the airway is secured.

Windfuhr also described treatment of excessive posttonsillectomy hemorrhage by ligation of the external carotid artery. Berlucchi et al.<sup>45</sup> reported using the drug 1-deamino-8-D-arginine-vasopressin (DDAVP) with good results in patients with von Willebrand disease. All tonsillectomy patients should be carefully observed and evaluated prior to discharge.

## **Mass Lesions**

### **Pharyngeal Abscesses (Peritonsillar, Retropharyngeal)**

Patients who present with a pharyngeal abscess can have significant coexisting morbidity. As an example, I have seen an elderly man who arrived with progressive quadriplegia and somnolence. The underlying etiology was a retropharyngeal abscess compressing the patient's brainstem. Although of infectious origin, pharyngeal abscesses are "mass lesions."

In the majority of these cases, the patients either are pediatric age or young adults. Incision and drainage of the abscess usually are performed under general anesthesia, with the airway secured by endotracheal intubation. Conversely, if the abscess is relatively small and not compromising the airway, some surgeons perform the procedure in the emergency room under local anesthesia alone. This requires a cooperative patient with a high pain tolerance. Under this condition, the patient is at risk for aspiration and additional complications. For patient care and comfort reasons, these cases are best handled in the operating room.

Once a general anesthetic has been decided upon, a thorough examination of the airway is required. This includes reviewing the relevant CT

scans with the surgeon. Airway obstruction can occur, and intubation can be difficult. Depending upon its extent, a retropharyngeal abscess can cause atlantoaxial subluxation. Furthermore, the underlying tissue may be quite friable, and the goal is to prevent any abscess contents from entering the trachea prior to securing the airway. This step should be a gentle intubation, attempting not to disturb the abscess. After the abscess is drained, the surgeon irrigates and suctions the oral cavity multiple times. These cases are not lengthy, and an awake extubation is indicated.

In a related scenario, patients who present with deep neck infections are considered to have compromised airways despite their appearance. The classic example is Ludwig's angina, which is a severe cellulitis involving the sublingual and submental spaces. Symptoms include tongue elevation, rapid breathing, difficulty swallowing, glottic edema, leukocytosis, and fever. Airway assessment is similar to that described above. An analysis and review by Ovassapian et al.<sup>46</sup> examined this problem and concluded that an awake fiberoptic intubation is the safest approach. If an awake fiberoptic intubation is not feasible, an awake tracheostomy under local anesthesia should be pursued.

### **Benign and Malignant Tumors**

In addition to infectious masses, a wide variety of benign and malignant tumors may affect the throat and related structures. Hemangiomas can be found anywhere in the oral cavity. They are not treated unless they compromise the airway or interfere with function. Lasers are frequently used in the surgical management of these hemangiomas. Other benign masses include lymphangiomas of cavernous or cystic hygroma origin, and papillomas. Malignant tumors are no less diverse and can be ulcerative, exophytic, or infiltrative lesions. Patients may present prior to diagnosis or after multiple excisions and chemotherapy/radiation therapy.

It is essential to thoroughly review these cases with the surgeon prior to bringing the patient to the operating room. This includes discussing the surgical plans and the airway issues involved or expected. Examination of any relevant CT and MRI scans also is indicated. Any previous anesthesia records



should be located and reviewed, especially if prior diagnostic or therapeutic procedures have been performed, because the experiences of others can be helpful in guiding the anesthetic plan.

Finally, evaluation of the patient is mandatory. This is the most important portion of the preoperative plan. One must determine the extent of mouth opening and attempt to visualize the mass lesion. An awake fiberoptic intubation is suggested if any signs of obstruction, limited neck extension, or any other factor is encountered that can interfere with a direct laryngoscopy. Conversely, a small lesion in an otherwise normal-appearing airway is reassuring. When managing a mass lesion, regardless of origin, one must be prepared with multiple plans that can be invoked to secure the airway, including emergent surgical intervention.

### Foreign Body Aspiration

Foreign body aspiration is a life-threatening emergency and a leading cause of death in 1- to 3-year-old children. The literature reviewing FB diagnosis and management is extensive. The variety of possible FBs is limited only by the imagination and, seemingly, local culture. If an object can be picked up and placed in the mouth, it will be. Where it may travel after that becomes the onus of the ENT surgeon and anesthesiologist. Most commonly FB ingestion or aspiration is encountered in the pediatric patient in the age range from 6 months to 5 years. Occasionally, one meets the young adult attempting to do a “party trick” while under the influence of alcohol and questionable friends. Alternatively, trauma to the neck can result in bone, cartilage, or soft tissue occupying previously open space akin to an FB. Airway assessment and management are similar.

Complete airway obstruction is rarely seen by the tertiary care team. Primary intervention by a Heimlich maneuver is the therapy of first choice, followed by digital extraction. Be aware that digital manipulation can push an obstructing FB further into the airway. If the patient has become hypoxic, cyanotic, and moribund, the only lifesaving option is emergent tracheotomy.

Partial airway obstruction is the clinical entity most frequently encountered. The guiding principle of management should be, “Do not convert a partial airway obstruction into a complete airway obstruction.” The patient and fam-

ily will arrive in an emotionally charged state. The child may be dyspneic, drooling, sitting forward, and frightened. Prominent, stridorous breathing may be noted and is indicative of supraglottic or glottic involvement. Wheezing is heard more often with subglottic obstruction. The nature of the FB and the context of its ingestion must be determined. Non-metallic objects are difficult to visualize on plain films. Secondary radiographic findings, such as a hyperinflated lung or lobe, can help localize the object. If the patient is stable and the FB is fixed in position, one can wait and allow the stomach to empty before going to the operating room. However, this is not often the case.

### Bronchoscopy and FB Management

Once the FB has been identified and located, a definitive management plan can be made. If the object lies near or within the trachea, the patient will require a laryngoscopy and bronchoscopy. Should the patient be cooperative, it is possible to perform a bronchoscopy under topical anesthesia, but most patients will require general anesthesia. Most practitioners advocate an inhalation induction for the patient with a partially obstructed airway, in order to avoid positive pressure that might displace the FB and convert partial obstruction to total obstruction or cause the FB to migrate more distally in the airway. After induction, a rigid ventilating bronchoscope allows maintenance gases and oxygenation to continue. However, there is a significant leak around the end of the bronchoscope, and the entrained air often dilutes the inhaled anesthetic gases. Inhalation anesthesia may be supplemented by intravenous drugs, given as a continuous infusion or intermittent boluses. Either alone or in combination, propofol, remifentanyl, and fentanyl have been studied in this scenario. It appears that remifentanyl provides greater hemodynamic stability and rapid recovery. An interesting study by Farrell<sup>47</sup> found good results with both spontaneous and positive-pressure ventilation. A report by Soodan et al.<sup>48</sup> suggested that controlled ventilation with muscle relaxation provided a more stable anesthetic.

Bronchoscopy under general anesthesia is a delicate procedure. Complications arise from poor ventilation (hypercapnia, hypoxemia) and light anesthesia (bronchospasm, bucking).

Despite the intensity of the procedure, these cases should be handled in a deliberate calm manner that aims to provide appropriate surgical and anesthetic conditions.

### Esophagoscopy and FB Management

Any FB ingestion posterior to the glottis will be managed by esophagoscopy. If the airway is not compromised, a rapid sequence induction with cricoid pressure can be performed. Once the airway is secured, there is no fear of aspiration. Rigid esophagoscopy is used for diagnostic purposes, FB removal, and tumor localization. The most serious complication is esophageal perforation, which frequently occurs in the hypopharynx. The consequences are significant; resulting mortality can range from 34–84%. Appropriate muscle relaxation can reduce the incidence by preventing unwanted movement or “bucking” during the procedure. In addition to perforation, other complications are compression of the endotracheal tube, dysrhythmias, and aspiration.

Flexible esophagoscopy is more of a diagnostic procedure and can be done as a minimum alveolar concentration (MAC) anesthetic with sedation. It is not indicated for FB management.

### Iatrogenic Causes Surgery and Radiation Therapy

Acquired airway disorders may result from other therapeutic activities that permanently alter the airway. Many otolaryngologic malignancies are treatable, and patients do survive. They will return to the operating room for additional biopsies and surveillance endoscopies, but their airways may be significantly deformed.

Common surgical procedures include wide intraoral excisions, laryngectomies, and radical neck dissections with free flap reconstruction. Many of these patients will present with a preexisting tracheotomy that makes their management straightforward. Others will present with an intact airway that has been greatly altered. As emphasized earlier, the case must be discussed well in advance with the surgeon. Previous anesthesia records must be reviewed, and the patient must be carefully examined.

These patients understand their postsurgical condition. They will be cooperative once the anesthesia concerns are explained to them. Unless the patient



has a near-normal airway (unlikely), an awake fiberoptic intubation is the approach of choice. Upon laryngoscopy, the glottis rarely is found in the midline position. It typically is displaced to one side, and, depending upon coexisting morbidity, the surrounding structures may be unrecognizable.

Another airway abnormality is caused by radiation therapy. Radiation, which can be imagined as a form of burn, leads to fibrosis and shrinkage of the affected tissues. A study by Schmitt et al.<sup>49</sup> described factors that better identify potential difficult fiberoptic intubations in patients after radiotherapy. Factors they cited include laryngeal edema, hoarseness, and stridor. The patient may appear to have a normal neck and mouth, but the difficulty of laryngoscopy should not be underestimated. After radiation, muscle tissue becomes very firm and fixed. The patient likely will not be able to extend the neck. The patient also will likely not be able to open the mouth more than a few millimeters. Muscle relaxants will be of little or no benefit in this scenario. Much like scar contractures caused by burn injuries, these patients have small, fixed upper airways. Laryngoscopies are extraordinarily difficult, if not impossible. Again, awake fiberoptic intubation is frequently the technique of choice.

### Vocal Cord Disorders

Disorders of the vocal cords can profoundly affect a patient's quality of life and in certain conditions can threaten life itself. Lesions can be of infectious origin, such as papillomas; they can be

benign masses, such as hemangiomas and granulomas; or they can be neoplastic masses. Besides mass mechanical effects, mobility can be affected by fibrosis, inflammation, and nerve injury. Whereas some diagnostic procedures can be accomplished by flexible endoscopy, most surgical procedures are done by laryngoscopy and microlaryngoscopy. Medialization or voice restoration operations (phonosurgery) typically are conducted under MAC. The patient must be able to phonate (e.g., say "EEE...") in order to guide the repair. If the lesion is well defined, general anesthesia can be used. Special techniques, such as apneic oxygenation and jet ventilation, may be necessary. Frequently, the surgeon requests profound muscle relaxation for a relatively brief procedure. Vocal cord surgery often uses lasers as the primary surgical instrument.

Using a combination of local and topical anesthesia can prepare the airway for laryngoscopy and some minor procedures. This will require blocking both superior laryngeal nerves and the glossopharyngeal nerves, and injecting the trachea with local anesthetic. More commonly, these procedures are done under general anesthesia. Laryngoscopy is a stimulating event. It can elicit hypertension and tachycardia, which in vulnerable patients can lead to myocardial ischemia or even infarction. Conversely, laryngeal stimulation in a lightly anesthetized patient can cause bradycardia and dysrhythmias. The mechanism is a reflex pathway between the superior laryngeal nerve afferent fibers and vagal cardio-

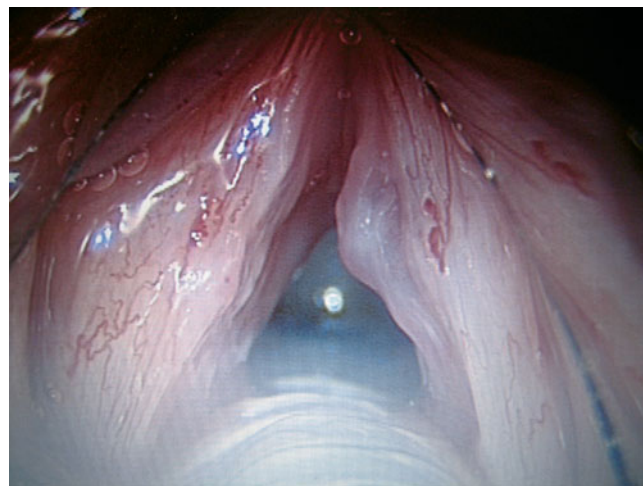
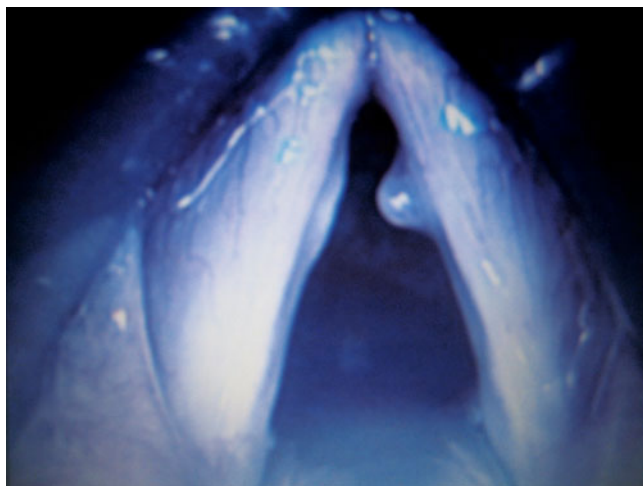
inhibitory fibers. As with any general anesthetic, the patient must be sufficiently anesthetized before laryngoscopy begins. Giving  $\beta$ -blockers or other agents may blunt the hemodynamic effects (Figure 66-2).

### Microlaryngoscopy

Microlaryngoscopy with suspension is a technique that uses both a surgical laryngoscope and an operating room microscope. The surgical laryngoscope is attached to either an instrument tray or the operating room table by extension, and the patient's upper torso is practically suspended for the duration of the procedure. A small-diameter, laser-compatible endotracheal tube with a large cuff volume is used. The head and neck are padded and braced; should the patient move, injury can occur. Muscle relaxation is required for these procedures. Once the microscope is in position, this arrangement provides excellent exposure of the vocal cords. By using the microscope and laser, the surgeon can make precise excisions. Prolonged suspension can cause glottic edema resulting in airway obstruction in the recovery room. Intravenous steroids can reduce this risk (Figure 66-3).

### Ventilation

Ventilation during this procedure is a challenge. Unless a cuffed endotracheal tube is used, all volatile anesthetics will be diluted by entrainment of air. Pollution of the operating room also may occur. Induction and maintenance of anesthesia are best accomplished using intravenous techniques.



**FIGURE 66-2.** Left, Vocal cord cyst. Right, Bilateral vocal cord hemangiomas. (Courtesy of Christopher Hartnick, MD, Massachusetts Eye and Ear Infirmary.)



**FIGURE 66–3.** Patient positioned for microlaryngoscopy under suspension. Note that the patient has a tracheostomy and that a Xomed® laser endotracheal tube is being used. The laser is to the left. (Courtesy of Ramon Franco, MD, Massachusetts Eye and Ear Infirmary.)

Some anesthesiologists have used apneic oxygenation for brief procedures. Others have advocated an intermittent ventilation technique whereby an endotracheal tube is placed and removed multiple times until the operation is complete. This places the airway at risk and prolongs the time needed to finish the procedure. It also can lead to additional vocal cord irritation and trauma.

### Jet Ventilation

Other practitioners have used jet ventilation to good effect. Jet ventilation was introduced in 1967 and has since undergone many refinements. Essentially, a volume of gas is compressed and delivered under high pressure through a small tube or catheter. In a tubeless technique, this gas can be given through a side port in the laryngoscope. Depending upon the needs of the particular patient, jet ventilation may be administered above, at, or below the glottis. Various devices are available to provide jet ventilation and all have at least three common components. A compressor provides a blend of oxygen and N<sub>2</sub>O (or nitrogen, helium, etc.) under high pressure. This mixture then passes through a pressure regulator prior to patient exposure. For adults, the initial jet pressure should be ≤ 20 pounds per square inch (psi) and for children should be ≤ 10 psi. Actual gas delivery is controlled by a hand-operated valve.

Jet ventilation is advantageous because it provides an unobstructed operating field to the surgeon and increases safety during laser procedures. However, there are some significant concerns. Jet ventilation requires additional time, effort, and skill to set up and operate. Because ambient air is being entrained with the high-pressure gas via the Venturi principle, the patient will receive a diluted mixture. This can lead to operating room pollution and is insufficient for general anesthesia alone. General anesthesia must be maintained by intravenous agents when jet ventilation is used. Respiratory gas monitoring is inaccurate, and one must rely upon chest movement and pulse oximetry to assess ventilation. Air trapping can lead to barotrauma if a mass blocks expiration in a “ball-valve” phenomenon. Carbon dioxide can accumulate, leading to respiratory acidosis and its unwanted effects (tachycardia, arrhythmias, etc.). Moreover, the exit opening for the high-pressure gas, whether it is a needle, tube, or catheter, should not lie near the mucosa. The Hunsaker tube has extensions to keep it away from the airway surface. Barotrauma associated with jet ventilation can result in subcutaneous emphysema, pneumothorax, and pneumomediastinum. Biro et al.<sup>50</sup> investigated the effects of airway-occluding instruments on airway pressure during jet ventilation for bronchoscopy. They concluded that barotrauma should not

occur as long as end-expiratory pressure never exceeds peak inspiratory pressure.

Most recent research on jet ventilation has focused upon ventilatory frequency. Hand-operated valves allow delivery of low-frequency jet ventilation, whereas newer, automated devices allow delivery of up to 600-Hz, high-frequency jet ventilation. First described in 1976, Ihra et al.<sup>51</sup> have written a thorough review of the development and use of high-frequency jet ventilation. This mode of jet ventilation is advantageous with certain types of airway pathology and in patients with severe pulmonary failure. High-frequency jet ventilation allows easy positioning in airway stenosis, decreases risks in laser surgery (no tube), decreases aspiration risk because of continuous outflow of gas, provides continuous ventilation, and allows cricthyroid rescue ventilation (see Unzueta et al.).<sup>51a</sup>

High-frequency jet ventilation has disadvantages. In a study by Hautman et al.,<sup>52</sup> complications of high-frequency jet ventilation included hypertension, hypotension, bronchospasm, hypercarbia, and hypoxia. Insufficient humidification is another concern. Histologic injury correlates with frequency of jet pulses and manifests as mucosal edema, congestion, and epithelial cell flattening, all of which can contribute to necrotizing tracheobronchitis. Aside from barotrauma, other complications include dysrhythmias, pneumoperitoneum, and gastric rupture secondary to misdirected gas flows. Some studies have suggested that preterm infants receiving high-frequency jet ventilation have a greater incidence of necrotizing enterocolitis. With these concerns in mind, other investigators have examined the benefits of using combined-frequency jet ventilation. These techniques use both low-frequency jet ventilation and high-frequency jet ventilation in differing ratios and have given satisfactory results. Regardless of the approach used, jet ventilation remains a useful and specialized anesthetic technique. It requires experience and should not be attempted by the unaccompanied novice.

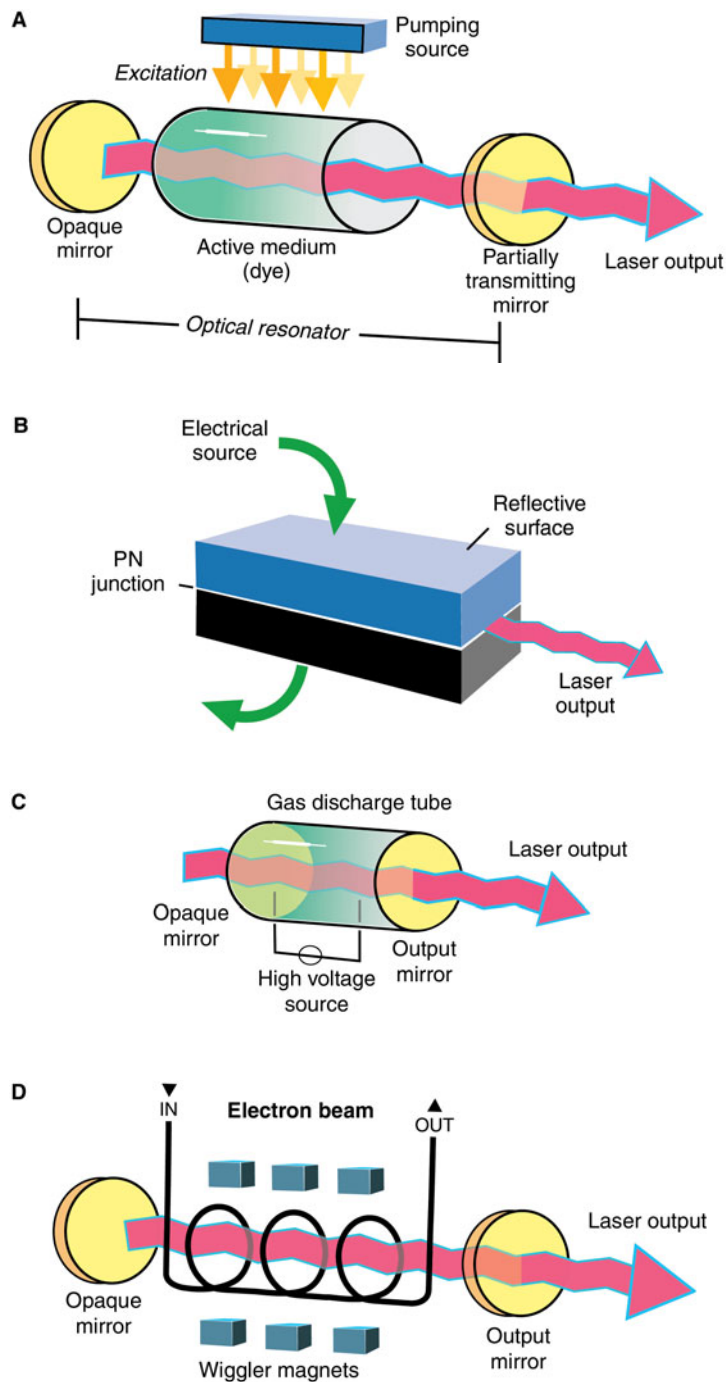
### Lasers

Schawlow and Townes first theoretically proposed lasers (Light Amplification by Stimulated Emission of Radia-

tion) as an optical variant of masers in 1958. Development followed rapidly, and in 1960 Maimon produced a laser by using a ruby crystal pumped with light from a flash lamp. Since that time, lasers have become commonplace and can be found transmitting phone calls, reading bar codes, providing precision cuts in industry, reading compact disks (CDs)/digital video disks (DVDs), and, of course, in the operating room. To provide appropriate anesthetic care, one must have a basic understanding of how lasers function and how they can be beneficial and harmful.

Visible light consists of a blend of wavelengths that spread in all directions. It can be described as incoherent (out of phase) and diffuse. Laser light is distinctly different. It can be described as monochromatic (same wavelength), coherent (in phase), and collimated (parallel waves). Among his many contributions, Einstein in 1917 suggested that such light could be a product of stimulated emission. By using energy to stimulate molecules of a particular medium, one can push their electrons to a higher state. This produces a "population inversion" with fewer electrons in the ground state. As these electrons fall to their original state, they release a photon of a specific wavelength. Such radiation leads other molecules in the medium to release photons of the same wavelength. When this occurs in a cylindrical chamber with reflective mirrors, the light becomes amplified. A laser beam created by this process can focus a large amount of energy on a small discrete area and produce its effects.

The components of each laser include an optical resonator with both an opaque mirror and partially transmitting mirror, a pumping or energy source, and an excitation or active medium. Laser modes include continuous, pulsed, and Q-switched. Most lasers are one of four types. *Dye lasers* use an active material (usually an organic dye) in a liquid suspension as the lasing medium. By changing the chemical composition of the dye, the laser can be "tuned" to different wavelengths. *Diode lasers* use an optical cavity to amplify light emitted from the energy-based gap that exists in semiconductors. *Gas lasers* consist of a gas-filled tube upon which a voltage is applied to excite molecules to a state of population inversion. *Free electron*



**FIGURE 66-4.** Schematic diagrams illustrating the components and types of common medical lasers. **A.** Dye laser **B.** Diode laser **C.** Gas laser **D.** Free electron laser. (Courtesy of Bob Galla, Massachusetts Eye and Ear Infirmary.)

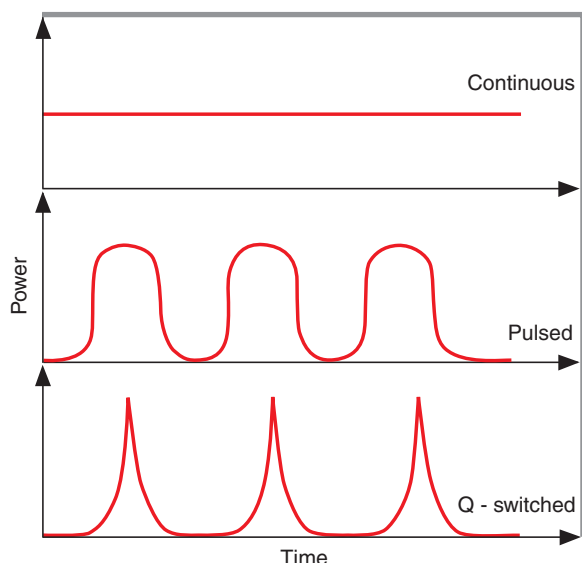
lasers function by having an electron beam in an optical cavity pass through a wiggler-magnetic field. Free electron lasers can produce a wide variety of wavelengths (Figures 66-4 and 66-5).

### Laser Effects and Safety

Lasers can focus a large amount of energy upon a discrete area to exert

their effects. In biologic tissue, this can result in thermal effects via energy absorption, photochemical effects by the reaction of radiant energy with specific molecules, and mechanical effects by disruption secondary to propagation of photo acoustic shock waves. In addition, the smoke, or laser "plume," can contain known car-





**FIGURE 66-5.** Power versus time graphs illustrating different laser modes. (Courtesy of Bob Galla, Massachusetts Eye and Ear Infirmary.)

cinogens, toxic gases, and viable microorganisms (Table 66-1).<sup>53</sup>

Every facility that uses medical lasers should have a laser safety officer or committee. The responsibilities should include education of healthcare providers, protocol formulation, and implementation of safety policies. When a laser is in use, signs and appropriate safety glasses must be available at all entrances. All persons in the operating room should wear safety glasses, and the patient's eyes should be taped closed and covered with soaked gauze.

As with any medical device, national standards have been established to ensure the safe use of lasers. In the United States, these can be found in the industry publication American National Standards Institute ANSI Z136.3-2005, *Safe Use of Lasers in Health Care Facilities*.<sup>54</sup> Two important concepts are empha-

sized in this handbook. One is the *nominal hazard zone* (NHZ). This is the minimal distance in which laser beams can have effects. For the majority of medical lasers, this distance varies between 0.46 and 178 m. The other concept is borrowed from radiation safety studies and is the *maximum permissible exposure* (MPE). This represents the maximal laser energy that can be absorbed without resulting in harm. Most laser injuries result from reflected beams, and the eye is most vulnerable. Eye injuries include photokeratitis, photochemical cataracts, thermal retinal injuries, and corneal burns. Within the eye, the retina is vulnerable to laser wavelengths of 400–1400 nm [argon, neodymium:yttrium-aluminum-garnet (Nd:YAG) lasers]. Wavelengths  $\geq 1400$  nm can damage the cornea. Aside from wavelength, the extent of eye injury is determined by pupil size, degree of pigmentation, size of retinal image, pulse duration, and pulse repetition rate (Table 66-2).

The safety glasses needed are wavelength specific and depend upon the laser being used. Argon (514 nm) pulse lasers exhibit a green beam and cause thermal effects. They require orange glasses. The potassium titanyl phosphate (KTP; 532 nm) diode pulse laser also has thermal effects and requires orange glasses. Dye pulse lasers have both mechanical and thermal effects and require blue glasses. Nd:YAG (1064 nm) and CO<sub>2</sub> (10,600 nm) pulse lasers cause thermal effects and clear glasses are needed for protection (Table 66-3).

**TABLE 66-2.**

#### Determinants of Eye Injury

1. Pupil size
2. Degree of pigmentation
3. Size of retinal image
4. Pulse duration
5. Pulse repetition rate
6. Wavelength

#### Laser Fire and Laser Endotracheal Tubes

The greatest danger caused by a laser is an endotracheal tube airway fire. Although rare, the results of endotracheal tube airway fire can be catastrophic and fatal. If the endotracheal tube is penetrated by the laser beam, the oxygen-rich environment within the tube can produce a vivid intense flame. Every practitioner should have the image of a “blow torch” in his or her mind to appreciate the danger. All of the elements to support a fire are found in this setting: oxygen (supports combustion, along with N<sub>2</sub>O), combustible material (endotracheal tube), and an ignition source (laser). Much effort has been expended to develop a laser-safe endotracheal tube but as of yet there are no “perfect” laser endotracheal tubes (Figure 66-6).

Metal endotracheal tubes are laser resistant but have other disadvantages. They are not as pliable or as easy to handle as conventional polyvinyl chloride (PVC) tubes. This characteristic can lead to unnecessary manipulation and potential vocal cord trauma. Metal endotracheal tubes do not have a cuff, and one cannot seal the trachea. Furthermore, the laser beam can reflect off the tube and damage healthy adjacent tissue. Metal tubes can transmit heat to surrounding tissue. A Mallinckrodt Laser-Flex® is a metal tube containing an inner PVC endotracheal tube fitted with tandem cuffs. Should one cuff be damaged, the remaining cuff still can maintain a seal. Despite its other advantages, the PVC cuff still conveys a risk of laser ignition.

The Xomed® Laser Shield II is a silicone endotracheal tube covered with metallic particles. Its cuff also has a metallic covering to improve its survivability. This is the endotracheal tube most commonly used at my institution, with safe, reliable results obtained. However, under certain circumstances this tube can burn.<sup>55</sup>

**TABLE 66-1.**

#### Laser Effects

**Thermal Injury:** Burns secondary to energy adsorption

**Photochemical Reactions:** Secondary to interaction between specific molecules and radiant energy

**Mechanical Effects:** Tissue disruption secondary to photoacoustic shock waves

**Toxin release:** Toxic gases, carcinogens, and viable microorganisms within the laser “plume”



TABLE 66-3.

Commonly Used Medical Lasers (Pulse Mode)

Type of Laser	Wavelength (nm)	Primary Effect	Protective Eyewear
CO <sub>2</sub>	10,600	Thermal	Clear
Nd-YAG	1064	Thermal	Clear
Dye	583–587	Therm/mech	Blue (dye specific)
KTP-Diode	532	Thermal	Orange
Argon	514	Thermal	Orange (argon specific)

Typically, a cool saline–blue dye mixture is used to inflate the cuff. This allows easy visualization of any cuff damage and provides a “heat sink” to slow potential ignition of the cuff.

A Sheridan 2® is a polyvinyl acetate (Merocel), copper foil-wrapped endotracheal tube. Red rubber tubes wrapped with metallic tape have been used safely for many years. One advantage is that ignited rubber tends to char rather than melt. In addition, more energy is required to ignite rubber than PVC. Great care must be taken when applying the metallic tape. Any exposed areas are liable to ignition. Rough or loose edges can injure the patient's airway. Like a metal tube, certain metallic tapes can reflect the laser beam onto healthy tissue.

### Airway Fire Precautions and Management

To reduce the risk of an airway fire, certain precautions should be observed:

1. Consider a tubeless technique using spontaneous ventilation,<sup>56</sup> apneic techniques, or jet ventilation.
2. Use an appropriate laser endotracheal tube, such as metal, Mallinckrodt®, Xomed®, Sheridan®, or Red Rusch®.
3. Reduce inspired oxygen as tolerated by the patient to <30%, ideally 21%.
4. Use either air or helium to dilute the oxygen; N<sub>2</sub>O supports combustion.
5. Fill the endotracheal tube cuff with a saline–dye mixture or lidocaine jelly.
6. Completely soaked gauze should be placed within and around the airway to reduce ignition risk.
7. Use H<sub>2</sub>O-based ointments; petroleum-based ointments are flammable.

8. Limit the duration and intensity of laser exposure; continuous mode allows heat buildup.
9. Maintain a ready source of water in case of fire (multiple 60-mL filled syringes).

These steps will not eliminate the risk of an airway fire, but they will reduce it.

Despite these precautions, what should the anesthesiologist do in the event of an airway fire? The ANSI has developed the following protocol:

1. Stop ventilation.
2. Disconnect the oxygen source and flood the airway with water.
3. Remove the burned endotracheal tube and examine the airway.
4. Mask ventilate the patient and reintubate.
5. Survey the extent of injury using a flexible bronchoscope.
6. Monitor the patient for 24 hours.

7. Administer steroids to reduce inflammation and edema.
8. Provide antibiotics and ventilatory support if indicated.

It is common practice at my institution not to tape or secure the endotracheal tube to the patient's face. This will allow rapid removal of the tube in the event of an airway fire; however, this raises a controversial point. In my own research (unpublished observations), it appears that the first step would be to remove the endotracheal tube as rapidly as possible, even if gas flows and ventilation are still occurring. Once ignited, even without gas flow, the endotracheal tube will continue to burn and cause injury. By the time an endotracheal tube fire is recognized, approximately 3–4 seconds have passed. It will take another 3–4 seconds to stop ventilation, stop gas flows, and flood the airway prior to removing the endotracheal tube. In contrast, simply removing an untaped endotracheal tube will take approximately 1 second, thus potentially reducing the amount of injury to the patient.

Besides endotracheal tubes, lasers can ignite surgical drapes and other flammable items within the operating room. Electrocautery can be a source of surgical fires. Barker and Polson<sup>57</sup> reviewed a case report of surgical fire and described a laboratory study that successfully replicated the original incident. Under the right conditions, drapes, towels, ointments, and gowns can be combustible. Only by taking all



**FIGURE 66-6.** Standard polyvinyl chloride 7.5 endotracheal tube 3 seconds after ignition while receiving 1 L of oxygen and 2 L of nitrous oxide. The tip has collapsed downward and a “blow torch” is emerging, accompanied by a large volume of combustible products. Note that the flame is beginning to rise within the endotracheal tube. (Courtesy of Bil Ragan, MD, Massachusetts Eye and Ear Infirmary, and Artem Grush, MD, Massachusetts Eye and Ear Infirmary.)

possible precautions and practicing due diligence are surgical fires prevented. Every member of the operating room team must be aware and prepared to intervene if necessary (Tables 66-4 and 66-5).

## Anatomic Airway Disorders

### Congenital Malformations

These malformations were alluded to in the discussion of choanal atresia. In contemporary obstetric practice, it now is possible to identify and diagnose many airway lesions in the prenatal period. Polyhydramnios can be associated with atresia, webs, gastrointestinal obstruction, and neurologic disorders. Mass lesions include teratomas, cystic hygromas, and hemangiomas. If an airway lesion is undetected and the delivery unexpected, securing the airway may be difficult or impossible. Fatal outcomes can be prevented with advance planning.

A report by Farrell<sup>58</sup> examined this problem. Once a diagnosis has been established, an elective cesarian section is the preferred technique for delivering the fetus. It is scheduled early enough to avoid spontaneous labor and yet late enough to allow pulmonary maturation to occur. Such a complicated delivery requires two surgical teams: an obstetric team and a neonatal team. The neonatal team should include a pediatrician, pediatric anesthesiologist, and pediatric otorhinolaryngologist. Each team will have its own setup and equipment. The operating room for the procedure should be large enough to comfortably accommodate both groups. Careful planning and practice are necessary prior to delivery. Once the infant's head emerges, the neonate team will secure the airway as pre-

planned. This often will occur before umbilical separation.

Craniofacial abnormalities range from an incomplete cleft lip to complete centrofacial dysgenesis. Congenital malformations include Beckwith-Wiedemann syndrome, cleft lip and palate, cranio-carpotarsal dysplasia/ Freeman-Sheldon/whistling face syndrome, craniofacial dystosis, fibrodysplasia ossificans progressiva, hemifacial microsomia, Klippel-Feil syndrome, mandibulofacial dystosis/Treacher-Collins syndrome, mucopolysaccharidosis, Pierre-Robin syndrome, trisomy 21/Down's syndrome, and vascular malformations. Nargozián<sup>59</sup> has written an excellent paper describing an approach to airway management in these special patients. Carezni et al.<sup>60</sup> described the use of LMAs in two cases involving centrofacial dysgenesis. This overview briefly discusses cleft lip and palate repair.

### Cleft Lip and Palate

Cleft malformations of the lip and palate affect 1:500 to 1:2000 births. They may be an isolated finding or associated with other syndromes. These infants have difficulty feeding and fail to gain weight. Aspiration may lead to pulmonary problems. Aside from feeding issues, cleft malformations are associated with chronic serous otitis, which can lead to hearing deficits and speech delay.

Parents of these infants will desire a timely repair for functional as well as cosmetic reasons. Initial lip repair may be done as a "lip adhesion" at approximately 6 weeks of age. This repair is simply a sutured approximation of the cleft edges. This will promote better feeding and weight gain prior to later procedures. The defini-

tive repair will be done at approximately 12 weeks of age, with revisions after that as needed.

Like lips, cleft palates may be unilateral or bilateral, and they may be complete or incomplete (only soft palate involved). There is a strong association between an incomplete cleft palate, micrognathia, and various syndromes. A submucous cleft only involves the muscles beneath the mucous membranes and cannot be seen on visual examination. Some surgeons repair the soft palate with the lip at 12 weeks of age. Hard palate repair will be accomplished between 9 and 18 months; most surgeons prefer approximately 1 year of age. The maxilla will have better growth with later repair, but the infant will develop better speech with early repair. These procedures are managed with general anesthesia and endotracheal tube intubation. Securing the airway is not difficult if no other syndromic abnormalities are present.

### Malacias

With the exception of reactive airway disease, the malacias are unique among airway disorders in exerting their effects by dynamic processes. These disorders can lead to significant morbidity and mortality and are a rare condition characterized by softness of the airway structures. A review article by Austin and Ali<sup>61</sup> fully describes the assessment, treatment, and management of tracheomalacia and bronchomalacia in children. Laryngomalacia can produce similar symptoms.<sup>62</sup> Malacias refer to conditions caused by cartilage softness that leads to airway collapse and obstruction (Figure 66-7).

Excessive intrathoracic pressure during expiration creates narrowing and airway collapse. The patient will have wheezing unresponsive to bronchodilators. Less commonly, extrathoracic causes produce collapse during inspiration demonstrated by stridor. Most patients suffering from airway malacia are neonates who have aortopulmonary malformations, bronchopulmonary dysplasia, or tracheoesophageal malformations. Congenital airway malacia may be an isolated finding or part of a syndrome. Acquired airway malacia results from chronic compression that limits cartilage growth. Thus, even after a "pexy procedure," airway collapse may still occur (Figure 66-8).

Being a dynamic airway disorder, malacia assessment is best accom-

**TABLE 66-4.**

#### Airway Fire Precautions

1. Use a laser endotracheal tube, or consider tubeless technique, apnea, or jet ventilation.
2. Reduce inspired O<sub>2</sub> <30%.
3. Avoid N<sub>2</sub>O; use air or helium.
4. Fill endotracheal tube cuff with saline dye or lidocaine jelly.
5. Place soaked gauze around airway.
6. Use only H<sub>2</sub>O-based solvents.
7. Limit laser exposure.
8. Maintain ready source of H<sub>2</sub>O.

**TABLE 66-5.**

#### Airway Fire Protocol

1. Stop ventilation.
2. Stop O<sub>2</sub> flow and flood airway with water.
3. Remove endotracheal tube and examine the airway.
4. Mask ventilate the patient and reintubate.
5. Determine injury via bronchoscopy.
6. Monitor the patient for 24 hours.
7. Consider steroid administration.
8. Provide antibiotics and ventilatory support as needed.



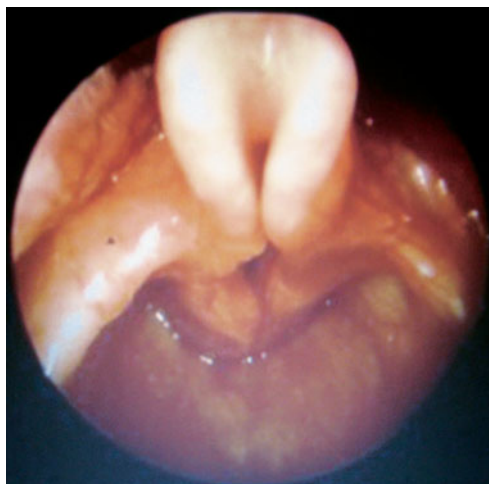
**FIGURE 66-7.** Tracheomalacia as seen in an 11-month-old girl. Note how the posterior wall has collapsed into the tracheal lumen. (Courtesy of Christopher Hartnick, MD, Massachusetts Eye and Ear Infirmary.)

plished by flexible bronchoscopy in a spontaneously breathing patient. Typically this is accomplished by performing a mask induction on the neonate. Once the patient is under anesthesia, a bronchoscope is introduced to observe and record airway structures while the child is breathing. The patient receives 100% oxygen under insufflation and supplemental intravenous anesthesia during the study. Combinations of propofol and remifentanyl, when titrated to effect, work very well. The goal of the anesthetic is to prevent airway collapse by using positive end-expiratory pressure/CPAP and to avert coughing. Videofluoroscopy with or without contrast can be useful. CT and MRI scans cannot show the dynamic processes but can reveal which anatomic structures may be compressing the airway.

Spirometry data allow one to assess the functional impact of the disorder. As discussed by Austin and Ali, treatment can be (1) long-term ventilation/CPAP, (2) resection of the affected segment, (3) external splinting, (4) pexy procedures, and (5) stenting. At present, the last two modalities appear to offer the most promising results.

### Subglottic Stenosis

Subglottic stenosis refers to any condition in which the trachea is narrowed by a fixed lesion that compromises air flow. Pediatric subglottic stenosis can result from congenital causes, such as abnormal cartilage, or acquired causes, such as prolonged intubation, trauma, burns (thermal and chemical), gastroesophageal reflux disease, and mass compression. Adult subglottic



**FIGURE 66-8.** Laryngomalacia as seen in a 1-day-old neonate presenting with stridor. (Courtesy of Christopher Hartnick, MD, Massachusetts Eye and Ear Infirmary.)

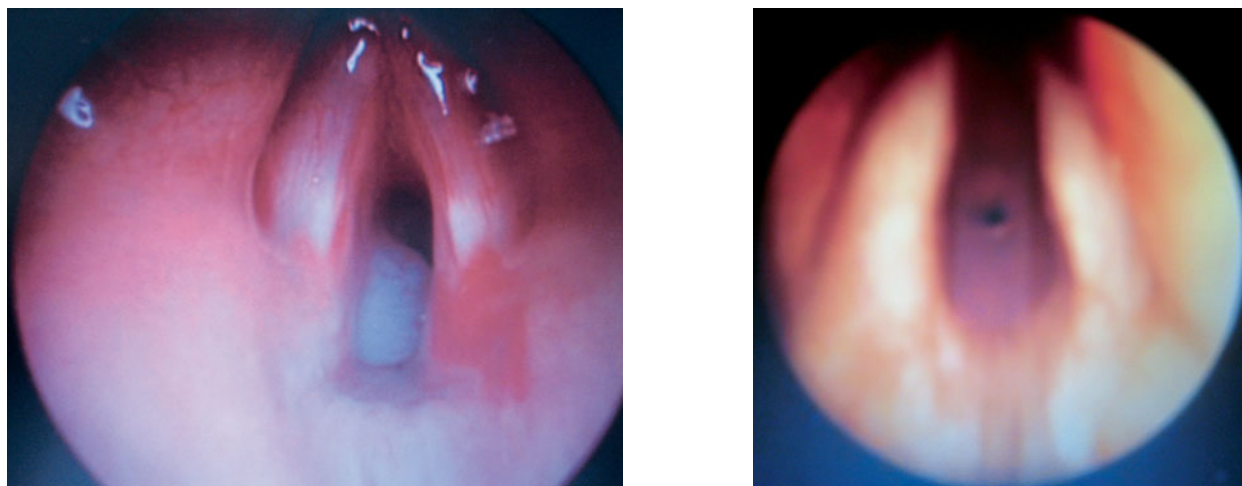
stenosis is almost entirely of the acquired variety. There are few experiences as frustrating to the anesthesiologist as an inability to advance an endotracheal tube beyond the vocal cords following what appeared to be a routine laryngoscopy.

A full-term infant has a subglottic diameter of approximately 5–6 mm. Congenital subglottic stenosis is defined as a subglottic diameter <4 mm or the inability to pass a 3.0-mm bronchoscope or 3.0-mm endotracheal tube. For premature infants weighing <1500 g, consider a smaller diameter, for example, the inability to pass a 2.5-mm endotracheal tube. A simple grading system is used to classify the severity of subglottic stenosis. Grade I lesions exhibit 0–50% obstruction. Grade II lesions exhibit 51–70% obstruction. Grade III lesions exhibit 71–99% obstruction. Grade IV lesions exhibit no detectable lumen and are incompatible with life unless a fistula or cleft is present, permitting air exchange. Typically, grade I and II lesions are mildly symptomatic. Grade III and IV lesions will require surgical repair (Figure 66-9).

The short-term solution is to intubate the patient's trachea. Long-term treatment options include observation (only for grade I and II lesions), endoscopic dilation, CO<sub>2</sub> laser ablation, tracheostomy, anterior cricoid split, laryngotracheal reconstruction, and cricotracheal resection. Endoscopic dilation may be of benefit in early stenosis but is ineffective in treating firm stenosis. CO<sub>2</sub> laser has been used for circumferential soft stenosis but is limited in other conditions. Zawadzke-Glos et al.<sup>63</sup> demonstrated promising results using argon plasma coagulation for treatment of laryngeal stenosis. A tracheostomy often is the initial step in management. It provides a safe airway, allows the infant to grow, optimizes the patient's pulmonary status, and allows for treatment of gastroesophageal reflux disease. Tracheostomy is not a benign procedure. Aside from quality-of-life issues, complications can result in significant morbidity and mortality. For these reasons, early airway reconstruction is desired.

The anterior cricoid split is a procedure that can be used with or without a cartilage graft. Duration of stenting is based upon the infant's weight. If the infant weighs <2000 g, the stent will remain in place for at least 2 weeks. For infants weighing >2500 g, the stent will





**FIGURE 66-9.** Left. Type II subglottic stenosis in a neonate caused by an hemangioma. Right. Type III subglottic stenosis secondary to trauma in an otherwise healthy 4-year-old boy. (Courtesy of Christopher Hartnick, MD, Massachusetts Eye and Ear Infirmary.)

be removed after 1 week. Indications for an anterior cricoid split include two or more previous extubation failures because of subglottic stenosis, weaned from the ventilator for at least 10 days, supplemental oxygen <30%, normotensive for at least 10 days, and no acute upper respiratory tract infection or congestive heart failure within the previous month. Ultimate decannulation success rates are approximately 75–80%. As an alternative to an anterior cricoid split, Forte et al.<sup>64</sup> achieved excellent results with thyroid ala cartilage reconstruction.

### Tracheal Reconstruction or Resection

Laryngotracheal reconstruction is considered once an infant reaches a weight of 10 kg. A laryngotracheal reconstruction can be an anterior, posterior, or lateral repair, and the graft may be of rib, thyroid ala, or auricular origin. Single-stage laryngotracheal reconstruction procedures are indicated for older children with minimal glottic involvement and no pulmonary pathology. Usually only a single graft is involved. Indications for two-stage laryngotracheal reconstruction procedures include extensive grafting, concomitant glottic pathology, and significant tracheomalacia. Decannulation rates for grade II and III lesions vary from 91–97%. For grade IV lesions, the rate declines to 71% (see Walner).<sup>64a</sup>

Cricotracheal resection is an alternative in select patients with discrete grade III or IV lesions. The stenosis should be at least 4 mm distal to the vocal cords. This location will ensure

later voice quality. Some investigators suggest these patients have less speech pathology compared to laryngotracheal reconstruction patients.<sup>65,66</sup> Triglia et al.<sup>67</sup> have provided an extensive review of the technique. The duration of postoperative stenting remains controversial, and there is a greater risk of recurrent laryngeal nerve injury with this procedure. Various studies have demonstrated decannulation rates of 85–100% for grade III and IV lesions.

At my institution, anterior cricoid split, single-stage, and two-stage laryngotracheal reconstructions are frequently performed. The patient typically arrives with a tracheostomy. Following an inhalation induction and establishment of intravenous access, the trach cannula is removed and replaced with an appropriate-size reinforced endotracheal tube. The graft is harvested next; this is the source of most postoperative discomfort. Once the graft is obtained and shaped, the resection and reconstruction begin. Depending upon the location of the lesion, the endotracheal tube may be advanced or withdrawn small distances to provide better surgical access. Once the reconstruction is complete, a nasal intubation is performed. The patient then is taken to the intensive care unit and kept intubated for 7–10 days. The entire operation takes from 4–6 hours to complete.

### Tracheotomy and Tracheostomy

A tracheotomy is an incision or opening into the trachea. A tracheostomy is

the creation of a permanent opening in the trachea such that the mucous membrane becomes continuous with the external epithelium. Tracheostomies are common surgical procedures familiar to every anesthesiologist and are not discussed at length. There are many indications for a surgical airway, and once established there is palpable relief within the operating room. A tracheostomy is rarely performed on the ideal 70-kg, otherwise healthy patient. Patients who are obese, who have undergone previous neck surgery, or have experienced trauma may present the surgeon with a significant technical challenge. If a patient is unstable and needs an urgent surgical airway, a tracheostomy can be performed using only local anesthesia with sedation.

Patients who require tracheostomy are brought to the operating room and placed in the supine position with the back slightly elevated. This position promotes respiratory effort and provides better surgical access. An inflatable shoulder roll or stack of towels is placed under the shoulders to extend the head and further expose the neck. If the patient is already intubated, the surgeon proceeds directly to the tracheotomy. This procedure is not without its complications. Rarely, the surgeon pierces the endotracheal tube cuff and produces a large leak. If ventilation becomes compromised, a throat pack can be placed or the endotracheal tube replaced. The surgeon also can approximate the wound to reduce the leak. Airway fires are known to occur, particularly if 100% oxygen or high concentrations of N<sub>2</sub>O are used in the



presence of electrocautery. Once the trachea is fully exposed, the surgeon requests that the endotracheal tube cuff be deflated and the tube slowly retracted cephalad, but with the tube tip still below the glottis so that it can be advanced again if necessary. After electrocautery is completed, ventilation with 100% oxygen is performed for at least 60 seconds prior to withdrawal of the endotracheal tube and insertion of the tracheostomy cannula. After the tube is withdrawn cephalad, the surgeon inserts the tracheostomy cannula and passes the new circuit to the anesthesiologist. Great resistance to ventilation should immediately alert the practitioner to incorrect cannula placement. The presence of CO<sub>2</sub> via capnography, the presence of bilateral breath sounds, and the ability to ventilate the patient all indicate a successful tracheostomy. Only after ventilation is verified should the endotracheal tube be removed entirely.

The approach to pediatric tracheostomy is similar to that for adults, except that children will not cooperate for this procedure under local anesthesia. Indications for pediatric tracheostomy include prolonged ventilation, laryngotracheal malacia, subglottic stenosis, respiratory papillomatosis, alkali ingestion, and craniofacial syndromes.<sup>68</sup> A common technique is the percutaneous dilational tracheostomy first described by Ciaglia in 1985. A modified percutaneous dilational tracheostomy set called the Ciaglia Blue Rhino<sup>®</sup> has been introduced and used with good results.<sup>69</sup> Other tracheostomy sets include the Percu-Twist<sup>®70</sup> and Fanconi<sup>®</sup> translaryngeal tracheostomy.<sup>71</sup> Pediatric tracheostomies frequently are accomplished using bronchoscopic guidance.

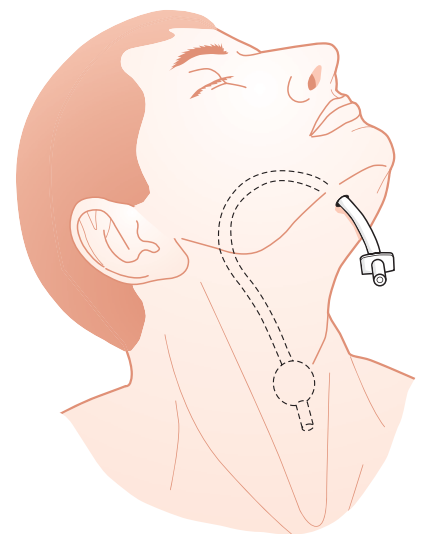
### Maxillofacial Reconstruction

Maxillofacial surgery is performed to repair facial trauma or correct facial deformity. Midface fractures are described using the Le Fort classification. In this approach, a class I fracture involves the lower third of the nasal septum and maxilla passing above nasal floor, and mobilizes the maxillary alveolar process, palate, part of the palatine bone, and lower third of the pterygoid plates. Oral or nasal intubation can be established, and the airway usually is intact. Nasal intubation is contraindicated in a Le Fort II fracture, which involves the upper

nasal bone, under the zygomaticomaxillary suture and through the pterygoid plate. A Le Fort class III fracture separates the base of the skull from the midface and is another contraindication to nasal intubation. Prior to surgery, the patient must be fully evaluated for any airway compromise, other traumatic injury, and other pre-existing medical problems. Depending on the nature of the injuries, a facial fracture repair may be delayed to stabilize the patient's condition.

Often, a nasal intubation is requested to provide better surgical access. As mentioned, however, nasal intubations are contraindicated in Le Fort II and III fractures and in the presence of CSF leak. Nasal intubations are not entirely benign. They can lead to bleeding, damage turbinates, increase the risk of sinusitis and otitis, and may be difficult to perform in the presence of a traumatized airway. It is unwise to blindly pass a nasal endotracheal tube into a potentially disrupted nasopharynx. The tube can be directed into a sinus, the orbit, the hypopharynx, and even intracranially. Nasal intubations are discussed in a separate section. A tracheostomy can be performed if facial trauma is too severe or in the presence of a basal skull fracture. Tracheostomies have complications, and the anterior neck itself may be injured.

Other options for securing the airway are available. Kannan et al.<sup>72</sup> described using an intubating LMA to facilitate an awake fiberoptic intubation in a severe facial trauma case. In another approach, in 1986 Altemir<sup>73</sup> first described placing a submental intubation. A submental intubation is a secure surgical airway that gives open access to the oral cavity and does not elicit the complications of a nasal intubation or tracheostomy. Essentially, a submental intubation is an oral intubation with the proximal end of the endotracheal tube passed through an incision in the floor of the mouth and connected externally to the anesthesia circuit. It is a useful airway technique for maxillofacial surgery in patients with severe oral, nasal, and neck trauma. In an interesting case, Arya et al.<sup>74</sup> described using a pharyngeal loop to place a retrograde submental intubation. It also is appropriate for patients undergoing elective procedures who are not expected to need prolonged postoperative ventilation. Submental intubations are used in European practice but have yet to be



**FIGURE 66–10.** Submental intubation. Note that the proximal end of the endotracheal tube emerges just medial to the mandible. (Courtesy of Bob Galla, Massachusetts Eye and Ear Infirmary.)

fully accepted in North American practice (Figure 66–10).

An uncommon surgical procedure is facial bipartition. This is done to correct severe deformities or malformations. Mallory et al.<sup>75</sup> reviewed a series of 22 cases and noted the most significant complication was hemorrhage. Every patient required an intraoperative blood transfusion. Four of the 22 patients required postoperative ventilation, which was associated with younger age and major blood loss.

### Oral and Dental Surgery

Orthognathic reconstructions are elective procedures to correct malocclusion or facial deformity. These cases are performed by oral or maxillofacial surgeons. Typically a sagittal split osteotomy of the mandible is done to advance or retract the lower jaw. The maxilla also can be moved forward or in a transverse direction. Care must be taken with the intubation. These patients may present to the operating room with semipermanent orthodontic devices in place. In addition, they may have anatomic abnormalities, such as prominent incisors, retrognathia, or small mouths.

### Nasal intubations

Orthognathic surgery is an oral procedure, and the patient will require a nasotracheal intubation. As mentioned above in Maxillofacial Recon-

struction, nasal intubations are more traumatic than oral intubations and have their own complications. Hall and Shutt<sup>76</sup> have provided a complete and excellent review of nasotracheal intubations. Epistaxis, bacteremia, and possible posterior pharyngeal wall laceration are possible. It is also possible to enter the hypopharynx and create a false passage. Rarely, the tube becomes obstructed with avulsed tissue from the inferior turbinate. Other problems include maxillary sinusitis, otitis, and possible cuff rupture from passage through the turbinates or by the MacGill forceps.<sup>76,77</sup>

Contraindications to nasal intubation include the presence of a CSF leak, basal skull fracture (Le Fort III), Le Fort II fracture, presence of a nasal FB, and a traumatized nasopharynx. Relative contraindications include bleeding coagulopathy, cardiac valve disease, and immunocompromised condition.

Prior to a nasotracheal intubation, the patient should assist the practitioner and identify the more patent nasal passage prior to induction. If the patient is uncooperative, a steel blade can be placed beneath the nostrils and the side that steams greater is more open. It is helpful to administer vasoconstrictors to both sides and to use a local anesthetic lubricant. Other techniques are available to assist the anesthesiologist.<sup>78</sup> Use of a soft red rubber nasal tube to expand the nostril and spread the lubricant is helpful.

After induction and prior to laryngoscopy, the anesthesiologist should gently place the endotracheal tube in the selected nostril and advance the tube parallel to the palate. The endotracheal tube should not be advanced in a superior direction toward the nasal bridge. Advancement should stop once the tube is in the pharynx. There will be resistance in the nasal passage until deep posterior, where a sudden "give" is felt as the nasotracheal tube passes the inferior turbinate. Upon laryngoscopy, bloody secretions may be present in the oral cavity. Suctioning should reveal the tip of the endotracheal tube lying on the posterior pharyngeal wall. Examination of its location and the glottis will determine if the tube can be advanced into the trachea without using the MacGill forceps. This will lessen the chances of a torn cuff or more trauma from airway instruments. Once the trachea is intubated, inflate the cuff, ventilate, observe for CO<sub>2</sub> and

condensation, and listen for bilateral breath sounds. When the tube is being secured, it should not pull upon the nose or pressure necrosis may occur. I like to place a band of tape completely around the patient's head just above the ears. This becomes the foundation on which the tube tape is secured. The circuit is brought down from the forehead and underneath the operating room table. The endotracheal tube and circuit should be secured in a manner that will allow flexion and extension of the head without jeopardizing their position.

Other problems may arise after surgery begins. During maxillary osteotomy, the osteotome may slice through the endotracheal tube and pilot tube. When this occurs, a secure airway must be quickly reestablished to prevent a life-threatening event. In a brief communication, Davies and Dyer<sup>79</sup> reported the successful use of an Obwegieser nasal septal osteotome. This instrument has two blunt horns that prevent direct contact with the endotracheal tube. I am familiar with a case in which extubation of a trachea became impossible after a palate expansion. CT scan revealed surgical wires passing through the nasotracheal tube, preventing its removal. These complications do occur, and one should be prepared.

### Orthognathic Surgery

Hemorrhage may be significant with orthognathic surgery, especially when maxillary procedures are involved. Blood loss can vary between 300 and >2000 mL. Depending upon the procedure, it is recommended that autologous blood be available. Moreover, controlled hypotension with isoflurane or other agents may be helpful. These patients generally are young and otherwise healthy and will tolerate such techniques.

At the conclusion of surgery, the pharyngeal packs are removed and the stomach is suctioned. As with nasal or sinus procedures, swallowed blood can provoke nausea. Appropriate antiemetics should be administered well in advance of the expected extubation. Only after the patient is fully awake with airway reflexes intact should the endotracheal tube be removed. Rigid internal fixation is beginning to replace intermaxillary fixation and provides more postoperative comfort. Intermaxillary fixation will still be encountered and will result in the patient's jaws

being "wired shut" using elastic bands or wires. This obviously blocks access to the airway, restricts suctioning, and makes reintubation practically impossible until the mandible is free. When intermaxillary fixation is used, without exception the patient must be fully awake prior to extubation. As long as the patient has intermaxillary fixation in place, cutting instruments to free the airway must be immediately available at the bedside.

Pain management begins early. Narcotics are supplemented by the surgeon providing local anesthetic infiltration directly into the wound. Enlund et al.<sup>80</sup> reported unintentional hypotension during this infiltration. Besides the usual narcotics, other analgesic classes have been investigated. Moller et al.<sup>81</sup> obtained good results with intravenous propacetamol. These results were supported by Van Aken et al.,<sup>82</sup> who found the analgesic qualities of propacetamol similar to those of morphine and better tolerated. The COX-2 inhibitors in general have shown promise as well. However, only celecoxib is available, and additional studies of this specific drug are required to document its efficacy in this circumstance.

### Dental Surgery

In recent years dentists have reduced the use of N<sub>2</sub>O in the office setting. This was prompted by a number of unfortunate events resulting in patient harm and subsequent increased legal liability. Most office procedures now are performed using a topical anesthetic supplemented by local anesthetic injections. If needed, a preoperative oral sedative (usually a benzodiazepam) can be prescribed.<sup>83</sup>

Because of this trend, it is becoming more common to provide general anesthesia to certain dental patients in a hospital operating room. The vast majority are pediatric patients who are uncooperative and have behavioral problems or who need an extensive amount of repair that is easier to accomplish in one operating room visit rather than multiple office visits.

All of the concerns regarding pediatric anesthesia and oral surgery apply here. Furthermore, the dentist may request a nasal intubation to provide better access to a small oral cavity. These patients may not have seen a pediatrician prior to arrival, and the preoperative physical examination may yield unexpected findings.<sup>84</sup> Pre-

operative anxiety may be an issue with any pediatric patient. In the dental patient with behavioral problems who has a preexisting “fear” of the dentist, this anxiety may manifest as sheer terror. In that circumstance, it may be best to cancel the procedure and reschedule for another day, after appropriate preparation of the patient, family, and clinicians. Appropriate doses of midazolam can be quite effective in this situation. Interestingly, Ong et al.<sup>85</sup> reported an additional analgesic benefit with midazolam.

In most older patients, these procedures are possible with conscious sedation as MAC anesthetics. Certainly the elderly patient needing total extractions prior to a cardiac valve replacement is a candidate for MAC. Some practitioners have reported success using combinations of propofol, midazolam, and even low concentrations of sevoflurane.<sup>86,87,87a</sup>

A final concern is the assistant to the dentist. This person usually is someone from the office who is not trained in standard operating room procedures. Instrument and supply counts are not routinely done. For example, it is not uncommon to find throat packs left behind. Great care and vigilance must be taken to ensure the mouth is empty and free of blood and foreign bodies prior to extubation.

### Plastic Surgery

Plastic surgery is a broad surgical field that includes any procedure intended to repair or restore a structure to its perceived normal form. Many of the procedures already discussed as well as those in the section on head and neck surgery can be included in this category. This brief discussion focuses only on rhytidoplasty, commonly called “facelift.”

Rhytidoplasty is an elective procedure, and the patient requires a routine preoperative evaluation. Frequently the patients are older, and some will have abused themselves with alcohol and tobacco use. Chronic bronchitis, chronic obstructive pulmonary disease, and coronary artery disease are not uncommon in this population. Conversely, one may encounter the young, otherwise healthy patient. Whereas some procedures can be done under local anesthesia with sedation, rhytidoplasty is commonly performed using general endotracheal anesthesia.

Typically the surgeon requests that the endotracheal tube be secured in

the midline, to avoid distorting the face from one side or the other. The endotracheal tube must be well secured because the surgeon will move the head from side to side during the operation. This presents its own challenges in taping, as the surgeon will want to have the face maximally exposed. For this reason, most anesthesiologists will not use an LMA. In the classic technique, the surgeon will “elevate and advance” the skin toward the preauricular region. In addition, liposuction may be used in the submental and submandibular areas. Forehead wrinkles are addressed in the same manner. Initially a midscalp incision is made with the anterior scalp and forehead lowered over the face. The skin is freed, and the flap is raised again. Blepharoplasties can be accomplished by the ENT surgeon or an ophthalmologist specializing in oculoplastics. Chemodenervation by injection of botulin toxin may be done last. As with the use of any medication, anaphylactic reactions can occur.

Once the procedure is complete, the surgeon will be especially concerned about bleeding and edema in the subcutaneous tissues. The anesthetic goals include prevention of patient coughing and “bucking” during tracheal extubation and avoidance of retching associated with PONV. Both coughing and vomiting contribute to facial and orbital ecchymoses. Rama-Maceiras et al.<sup>88</sup> reported less PONV using propofol with remifentanyl compared to propofol and fentanyl. Pretreatment with metoclopramide and ondansetron can decrease this risk. In addition, the patient should be fluid loaded and fully suctioned. Once spontaneous ventilation is well established and with the patient's upper torso slightly elevated, the trachea should be extubated during a moderately deep plane of anesthesia. Not uncommonly the face is wrapped in soft gauze and the eyes are covered with ice packs. This gauze may be wrapped tight enough to constrict the patient's airway, a matter that should receive special attention from the anesthesia provider.

## ANESTHESIA FOR HEAD AND NECK SURGERY

Patients who present for head and neck surgery may undergo many of the procedures discussed previously

as separate operations. The parotid gland, thyroid and parathyroid glands, and a variety of head and neck masses are included under this heading. Various macrosurgical and microsurgical techniques involving both soft tissue and bone may be used. Furthermore, reconstruction may include adjacent tissue or free tissue transfer. These cases can be complex and lengthy, lasting from a few hours to >30 hours on occasion. For the anesthesiologist, airway management, tissue preservation, and nerve monitoring become primary concerns.

### Parotid Surgery

Of the three salivary glands, the parotid gland is the largest. Patients may have inflammatory disorders or, more commonly, mass lesions of the parotid gland. Parotid tumors may be classified as of epithelial origin or mesenchymal origin. The majority of patients arrive in the operating room with a presumptive diagnosis. Occasionally anesthesiologists have managed the airway with an LMA for some of these procedures. However, considering the length of the operation (2–4 hours) and a nonneutral head position, most anesthesiologists prefer endotracheal intubation to assure airway access, especially when subsequent access is compromised by the sterile surgical field. After the airway is secured, the patient is positioned with the operative side up and the back slightly elevated.

### Facial Nerve Concerns

For the anesthesiologist and surgeon, preservation of the facial nerve is of utmost importance. Early in the dissection, the surgeon seeks to identify the facial nerve by electrical stimulation. With this in mind, it is essential to use a short-acting muscle relaxant or none at all. The surgeon should not begin dissection until a demonstrated train of four has returned. If for any reason the patient must be paralyzed, the operator should be informed of the patient's neuromuscular paralysis status.

### Thyroid Surgery

Thyroid surgery is addressed here only briefly (for a more detailed discussion, see Chapter 59). Triiodothyronine (T<sub>3</sub>) and thyroxine (T<sub>4</sub>), acting in response to thyroid-stimulating hormone, have significant effects on growth and metabolic rates by increas-

ing carbohydrate and fat metabolism. Farling<sup>89</sup> has provided an excellent discussion of thyroid disease and its implications. Thyroid disease is common and is managed medically in the majority of cases. Surgical intervention is indicated for malignancy, obstructive symptoms, retrosternal goiter, unresponsive or recurrent hyperthyroidism, or cosmetic reasons.

Preoperative assessment of the patient undergoing thyroidectomy should include evaluation of coexisting morbidity. Cardiovascular disease can be exacerbated by untreated or poorly treated hyperthyroidism. The patient should be euthyroid prior to operation. Medullary carcinoma is rarely associated with pheochromocytoma. Apart from the routine concerns, the major focus of preoperative assessment is determining airway status. One should examine the patient and review radiographic images to look for any signs of tracheal compression or deviation. The surgeon should inform the anesthesiologist if airway difficulties are suspected. If so, more sophisticated imaging, such as CT or MRI scans, are indicated. If the patient experiences airway obstruction while supine, an awake fiberoptic intubation in the partially recumbent ("beach chair") position may be indicated. It is potentially catastrophic to perform a rapid sequence induction and fail to intubate or ventilate, then expect the surgeon to obtain an emergent tracheostomy through a large goiter. In an interesting study, Bouaggard et al.<sup>90</sup> found that a cancerous goiter but not a large goiter was associated with difficult intubation.

### **Recurrent Laryngeal Nerve and the NIM® Endotracheal Tube**

Recurrent laryngeal nerve injury is a preventable surgical complication in most circumstances. In a study by Yumoto et al.,<sup>91</sup> 40% of surgically related recurrent laryngeal nerve palsies were due to thyroid procedures. The exceptions were patients in whom the malignancy had completely invested the nerve. With meticulous dissection and current monitoring techniques, one should not encounter a recurrent laryngeal nerve palsy after extubation, provided the palsy does not result from the tumor itself. For monitoring purposes, a short-acting muscle relaxant should be used, if at all. However, in a contrasting perspective, Marusch et al.<sup>92</sup> investigated the difference in paralysis between

the adductor pollicis and vocalis muscles. They suggest reliable recurrent laryngeal nerve monitoring can be achieved even in the presence of some paralysis. That said, most anesthesiologists advocate recurrent laryngeal nerve monitoring without any evidence of relaxation, in order to assure that neuromuscular blockade is eliminated as an etiologic factor if nerve palsy should occur. A number of investigators have suggested that propofol induction alone can provide excellent conditions for intubation without paralysis.<sup>93,94</sup>

At my institution, a "nerve integrity monitor" (NIM®) endotracheal tube is routinely used for thyroid surgery (NIM® EMG Endotracheal Tube, Medtronic Xomed Surgical Products, Jacksonville, FL). This particular endotracheal tube has electrodes embedded within a band located just superior to the cuff. Under direct visualization, these electrodes are placed in contact with the vocal cords during intubation. The NIM® tube is softer than standard endotracheal tubes, making it more difficult to handle. It also is slightly larger than a standard endotracheal tube, and it is my practice to use a size smaller than that usually indicated for the individual patient (e.g., if inner diameter = 6.0 mm, then outer diameter = 8.8 mm, which is still large for an adult female). Just after induction and intubation, the patient's anesthesia is lightened and spontaneous ventilation is allowed to return. After the patient is positioned and prior to first incision, the nerve signal strength is confirmed and measured by the monitoring technician. Although reliable, the NIM® tube is expensive. As an alternative, Hemmerling et al.<sup>95</sup> used a disposable surface electrode attached to a standard endotracheal tube. They obtained good results in a series of 151 patients. In another approach, Hillerman et al.<sup>96</sup> used a microlaryngeal endotracheal tube, LMA, and fiberoptic scope to continuously observe arytenoid movement.

### **Complications of Thyroid Surgery**

Complications of thyroid surgery can be life threatening. Postoperative hemorrhage can result in a rapidly expanding hematoma, which can directly compress the trachea. Venous and lymphatic obstruction by the hematoma also can produce laryngeal and pharyngeal edema. Recurrent laryngeal nerve injury can cause unilateral

vocal cord paralysis, which manifests as hoarseness, breathlessness, glottic incompetence, poor cough, and aspiration. Bilateral recurrent laryngeal nerve injury producing bilateral vocal cord paralysis will lead to immediate stridor and require reintubation and probable tracheostomy. Chronic compression by a large goiter can lead to tracheomalacia. This condition leads to tracheal collapse, resulting in partial or complete obstruction. Unintentional parathyroidectomy can result in hypocalcemia. This may reveal itself several hours postoperatively. Hypocalcemia is suggested by a positive Chvostek's sign (painful facial twitching after tapping the facial nerve) or Trousseau's sign (carpopedal spasm following tourniquet inflation above systolic blood pressure for 3 minutes) and is confirmed by laboratory testing. Treatment involves intravenous administration of calcium chloride.

Thyroidectomies are well tolerated by most patients. They may have complaints of a stiff neck related to surgical positioning. Nonnarcotic analgesics, such as ketoprofen and COX-2 inhibitors, have been studied, with encouraging results, although only one COX-2 inhibitor currently remains on the market in the United States. In an interesting approach, Dieudonne et al.<sup>97</sup> used bilateral superficial cervical plexus blocks to treat postoperative pain. Although somewhat effective, it did not provide the best analgesia by itself. PONV remains a significant issue with these patients. Both 5-HT blockers and dexamethasone have been shown to be effective.

### **Parathyroid Surgery**

Calcium metabolism is regulated by the parathyroid gland. Its hormonal product, parathyroid hormone (PTH), when released, elevates serum calcium levels via increased gastrointestinal absorption, bone resorption, inhibition of renal calcium excretion, and stimulation of renal hydroxylase. It also leads to increased phosphate excretion. Primary hyperparathyroidism is the enlargement and hyperfunction of one or more parathyroid glands. It typically is caused by an adenoma, carcinoma, or hyperplasia. It is manifested by hypercalcemia, hypophosphatemia, hyperchloremic acidosis, polyuria, and polydipsia. Secondary hyperparathyroidism usually results during renal failure following prolonged PTH secretion due to



low calcium concentrations. Other causes include rickets, malabsorption, osteomalacia, and abnormal vitamin D metabolism. Parathyroid surgery is discussed only briefly here. For greater details, see Chapter 59 and the review by Mihai and Farndon.<sup>98</sup>

The anesthesia concerns are similar to those encountered in thyroid surgery. A NIM® endotracheal tube or similar device should be used to assess recurrent laryngeal nerve function. Prior to anesthetic induction, the patient's volume status should be normalized. The greatest danger is cardiac dysrhythmias due to increased calcium levels. Use of normal saline and furosemide can decrease calcium concentrations to reasonable levels. If this method is not effective, intravenous biphosphates, plicamycin, glucocorticoids, calcitonin, or even dialysis can be used. Acidosis increases serum calcium, so hypoventilation should be avoided. Muscle relaxants should be used judiciously in the presence of hypercalcemia. Chronic hyperparathyroidism can result in weakened bones. Care must be taken during patient positioning, movement, and laryngoscopy.

Parathyroid surgery can be tedious, and even experienced surgeons can have difficulty identifying the glands. Prior to incision, a PTH level is drawn. Once the suspected gland is removed, a second PTH level is obtained. A significant decrease in PTH levels while the patient is still in the operating room indicates the offending source has been removed.

## Head and Neck Cancers

Malignant disease of the head and neck represents approximately 5% of all human cancers. Surgical intervention includes laryngectomy, pharyngectomy, glossectomy, hemimandibulectomy, and neck dissection. Neck dissections are further described as "radical" or "modified radical." A modified radical neck dissection is intended to spare one or more of the nonlymphatic structures within the neck. This may include the sternocleidomastoid muscle, spinal accessory nerve, and jugular vein. Reconstruction follows dissection, and some of these cases may last anywhere from 12 to >30 hours.

Most patients who present for surgery are between 50 and 80 years old, with males exceeding females by a 2:1 margin. Frequently these patients have

significant coexisting illness, including cardiovascular disease, chronic obstructive pulmonary disease, and renal disease. They often are heavy smokers and likely abuse alcohol. Consistent with this profile is poor nutrition; the patient may appear wasted and cachectic. If the patient appears to be an unreliable or devious historian, he or she should be observed closely for delirium tremens postoperatively. An extensive medical evaluation, including possible diagnosis and treatment of malnutrition, is indicated in an unusual number of these patients (see Chapter 16 for details regarding the preoperative evaluation of patients with malnutrition).

Patients may exhibit mass lesions that complicate their management. In an editorial review, Mason and Fielder<sup>99</sup> have given a practical approach to the assessment and management of these patients. A key point is that if a patient presents with severe stridor and gross anatomic distortion limiting endoscopic views, then the airway should be secured by a tracheostomy performed under local anesthesia. To illustrate what may be encountered, Bonner and Taylor<sup>100</sup> describe two cases of almost complete laryngeal obstruction (2 and 3 mm) resulting from tumor recurrence in the neck. Fiberoptic intubation proved impossible. One case was managed by an urgent awake tracheostomy. The other case was managed using a reinforced LMA and controlled ventilation. Awake fiberoptic intubation and an awake tracheostomy remain the techniques of choice with questionable airways. Preparation and sedation for an awake fiberoptic intubation are essential for success. Besides the usual agents, other medications have been examined in this setting, with remifentanyl, dexmedetomidine, and low-dose ketamine showing promise. Finally, Bhatnager et al.<sup>101</sup> demonstrated the usefulness of the Fastrach LMA to facilitate fiberoptic intubation. Well before surgery, the anesthesiologist should be prepared with multiple plans for securing the airway.

## Free Flap Reconstruction

If a reconstruction is planned, it is necessary to know the donor site prior to placing any intravenous or arterial cannulas. Donor tissue (flap) is used to reconstruct defects of the oral cavity, mandible, laryngopharynx, craniofa-

cial region, and facial skin. Common pedicle flaps include the cervicothoracic skin, pectoralis major myocutaneous, sternocleidomastoid myocutaneous, temporoparietal fascial, and pericranial. A free flap is donor tissue removed entirely from a distant site, with loss of prior blood supply, and transplanted to the area of defect. Microsurgery techniques are used to reconstruct the vascular supply to ensure flap survival. Typical free flaps include the radial forearm, rectus abdominus, and latissimus dorsi. Composite free flaps contain both soft tissue and bone and are used for oromandibular reconstruction. These complex flaps include the scapular osteocutaneous, iliac crest osteomyocutaneous, and, most useful, the fibular osteocutaneous. The fibular flap contains up to 25 cm of bone, making total mandibular reconstruction possible.

Because these cases often are lengthy, temperature maintenance and fluid management are just two of many concerns. In addition to the standard monitors, one may wish to place a central venous or pulmonary arterial catheter if indicated by the patient's condition. Antecubital, femoral, or subclavian approaches may be used, depending upon the source of the free flap. Early in the procedure, a tracheostomy is performed to secure the airway and provide unrestricted access to the oropharyngeal cavity and neck. Blood loss can be substantial and rapid. An arterial cannula will provide continuous blood pressure monitoring, and allow blood gas, electrolyte, and hematocrit measurements. Slight elevation of the head may decrease venous bleeding but increases the risk of venous air embolism. A Foley catheter is needed to assess urine output and guide fluid replacement. Anesthesia is maintained by a combination of narcotics and volatile agents. Nerve monitoring is performed, so short-acting muscle relaxants should be used at least until the surgeon determines that nerve stimulation at the surgical site will no longer be necessary. Some investigators have examined continuous nerve blocks as a supplement to intravenous analgesics.<sup>102,103</sup>

The anesthesiologist's efforts should include a focus on factors that will promote flap survival. Success of the operation depends partially on maintaining intravascular volume and adequate blood pressure to enhance perfu-

sion in the donor tissue. This can be a challenge in the unhealthy patient who does not tolerate anesthesia well. Fluid management and perfusion pressure should be the mainstays of cardiovascular management; however, overloading runs the risk of pulmonary edema and flap congestion. Vasoconstrictors should be used only rarely to prevent vasoconstriction in the flap microcirculation. Use of fluids, lighter levels of anesthesia, and, briefly, a slight head-down position all contribute to donor graft circulation. To minimize microthrombosis, blood transfusions should be limited.

### Complications of Neck Dissection

Both medical and surgical complications are not uncommon in these patients. Hemorrhage can be acute or delayed. It may warrant surgical exploration for a hematoma, which can compromise the airway as well as the vascular supply to the flap. If a tracheostomy has not been performed, laryngeal edema can produce rapid airway obstruction. Pneumothorax can occur by air entering at the apex of the lung or rupture of the mediastinal pleura. Because the head and neck are commonly elevated above the heart, venous air embolism can occur with potentially fatal results. Furthermore, I have witnessed asystole in a patient when cold irrigation was used on exposed carotid sinuses. Immediate administration of warm irrigation restored sinus rhythm within several seconds. Other cardiac abnormalities can occur.<sup>104,105</sup> Neck dissection can result in injury of the following nerves: superior laryngeal, facial, vagus, phrenic, hypoglossal, cervical sympathetics, spinal accessory, lingual, and brachial plexus. Rarer complications include a chylous fistula, subcutaneous emphysema, increased intracranial pressure, salivary fistula, wound infection, and gangrenous flap tissue. In spite of these issues, neck dissection with flap reconstruction has a success rate >90% (flap survival).

### SUMMARY

Anesthesia for ENT surgery provides an extensive range of challenges for the anesthesiologist. It is absolutely essential to develop an open working relationship with one's surgical colleague. There are perhaps few other anesthesia subspecialties where intraoperative communication is so crucial.

Many of the skills used on a routine basis have applications in other areas. One can use mask, spontaneous, controlled, and jet ventilation in a single procedure. Likewise, it is not uncommon in one's daily practice to use controlled hypotension, perform deep extubations, assist in nerve monitoring, and treat seemingly intractable PONV.

The challenges are great, as are the rewards. When a patient is safely and successfully discharged home you may be the only who knows the difficulty encountered. That in itself can be immensely satisfying.

### KEY REFERENCES

1. Austin J, Ali T. Tracheomalacia and bronchomalacia in children: pathophysiology, assessment, treatment, and anesthesia management. *Paediatr Anaesth* 2003;13:3–11.
2. Gan TJ, Meyer T, Apfel CC, et al. Consensus guidelines for managing postoperative nausea and vomiting. *Anesth Analg* 2003;97:62–71.
3. Hadfield PJ, Lloyd-Faulconbridge RV, Almeyda J, et al. The changing indications for paediatric tracheostomy. *Int J Pediatr Otorhinolaryngol* 2003;67:7–10.
4. Hall CEJ, Shutt LE. Nasotracheal intubation for head and neck surgery. *Anaesthesia* 2003;58:249–256.
5. Hemmerling TM, Schmitt J, Bosert C, et al. Intraoperative monitoring of the recurrent laryngeal nerve in 151 consecutive patients undergoing thyroid surgery. *Anesth Analg* 2001;90:396–399.
6. Ihra G, Gockner G, Kashanipour A. High frequency jet ventilation in European and North American institutions: developments and clinical practice. *Eur J Anaesthesiol* 2000;17:418–430.
7. Nargoizian C. The airway in patients with craniofacial abnormalities. *Paediatr Anaesth* 2004;14:53–59.
8. Orr R. Anesthesia for microlaryngoscopy. *Paediatr Anaesth* 2005;15:81.
9. Schmitt HJ, Mang H, Schmitt J. Fiberoptic intubation in patients after radiotherapy for carcinoma of the head and neck: difficulty and

predictability. *Eur J Anaesthesiol* 2004;21:914–927.

10. Soodan A, Pawar D, Subramaniam R. Anesthesia for the removal of inhaled foreign bodies in children. *Paediatr Anaesth* 2004;14:947–952.

11. Yellon RF. Prevention and management of complications of airway surgery in children. *Paediatr Anaesth* 2004;14:107–111.

### REFERENCES

1. Bolton P, Bridge HS, Montgomery CJ, et al. The analgesic efficacy of preoperative high dose (40 mg/kg) oral acetaminophen after bilateral myringotomy and tube insertion in children. *Paediatr Anaesth* 2002;12:29–35.
2. Pappas AL, Fluder EM, Creech S, et al. Postoperative analgesia in children undergoing myringotomy and placement of equalization tubes in ambulatory surgery. *Anesth Analg* 2003;96:1621–1624.
3. Finkel JC, Rose JB, Schmitz ML, et al. An evaluation of the efficacy and tolerability of oral tramadol hydrochloride tablets for the treatment of postsurgical pain in children. *Anesth Analg* 2002;94:1469–1473.
4. Galinkin JL, Fazi LM, Cuy RM, et al. Use of intranasal fentanyl in children undergoing myringotomy and tube placement during halothane and sevoflurane anesthesia. *Anesthesiology* 2000;93:1378–1383.
5. Kawasaki T, Sata T, Kawasaki C, et al. Airway management of a child with temporomandibular joint ankylosis following otitis media. *Anaesthesia* 2002;57:294–295.
6. Ho LC, Crosby G, Sundaram P, et al. Ulnar train-of-four stimulation in predicting face movement during intracranial facial nerve stimulation. *Anesth Analg* 1989;69:242–244.
7. Marchal JM, Gomez-Luque A, Martos-Crespo F, et al. Clonidine decreases intraoperative bleeding in middle ear microsurgery. *Acta Anesth Scand* 2001;45:627–633.
8. Degoutte CS, Ray MJ, Gueugniaud PY, et al. Remifentanyl induces consistent and sustained controlled hypotension in children during middle ear surgery. *Can J Anaesth* 2003;50:270–276.
9. Dal D, Celiker V, Ozer E, et al. Induced hypotension for tympanoplasty: a comparison of desflurane, isoflurane, and sevoflurane. *Eur J Anaesthesiol* 2004;21:902–906.
10. Mukherjee K, Seavell C, Rawlings E, et al. A comparison of total intravenous with balanced anesthesia for middle ear surgery: effects on postoperative nausea and vomiting, pain, and conditions of surgery. *Anaesthesia* 2003;58:176–182.
11. Davis I, More JRM, Lahiri SK. Nitrous oxide and the middle ear. *Anaesthesia* 1979;34:147–151.
12. Gan TJ, Meyer T, Apfel CC, et al. Consensus guidelines for managing postopera-

- tive nausea and vomiting. *Anesth Analg* 2003;97:62-71.
13. Rowlands RG, Harris R, Hern JD, et al. Day-case pediatric mastoid surgery. *Int J Pediatr Otorhinolaryngol* 2003;67:771-775.
  14. Suresh S, Barcelona SL, Young NM, et al. Postoperative pain relief in children undergoing tympanomastoid surgery: is a regional block better than opioids? *Anesth Analg* 2002;94:859-862.
  15. Uezono S, Holzman RS, Goto T, et al. Prediction of difficult airway in school-aged patients with microtia. *Paediatr Anaesth* 2001;11:409-413.
  16. Erbay H, Kara CO, Kara IG, et al. Breathing or ventilation via a mouth mask for rhinoplasty operations in the early postanesthetic period. *Eur J Anaesthesiol* 2003;20:753-759.
  17. Gujrathi CS, Daniel SJ, James AL, et al. Management of bilateral choanal atresia in the neonate: an institutional review. *Int J Pediatr Otorhinolaryngol* 2004;68:399-407.
  18. Lim EH, Tan S, Lim SL. Anesthesia for a neonate with persistent buccopharyngeal membrane and unilateral choanal atresia. *Paediatr Anaesth* 2005;15:509-511.
  19. Yang JJ, Li WY, Wang ZY, et al. Local anesthesia for functional endoscopic sinus surgery employing small volumes of epinephrine-containing solutions of lidocaine produces profound hypotension. *Acta Anesth Scand* 2005;49:1471-1476.
  20. Turan A, Memis D, Karamanlioglu B, et al. The analgesic effects of gabapentin in monitored anesthesia care for ear-nose-throat surgery. *Anesth Analg* 2004;99:375-378.
  21. Yellon RF. Prevention and management of complications of airway surgery in children. *Paediatr Anaesth* 2004;14:107-111.
  22. Tait AR, Malviya S. Anesthesia for the child with an upper respiratory tract infection: still a dilemma? *Anesth Analg* 2005;100:59-65.
  23. Mamie C, Habre W, Delhumeau C, et al. Incidence and risk factors of perioperative respiratory adverse events in children undergoing elective surgery. *Paediatr Anaesth* 2004;14:218-224.
  24. Reber A, Paganoni R, Frei FJ. Effects of common airway maneuvers on upper airway dimensions and clinical signs in anesthetized, spontaneously breathing children. *Br J Anaesth* 2001;86:217-222.
  25. Meier S, Geiduschek J, Paganoni R, et al. The effect of chin lift, jaw thrust, and continuous positive airway pressure on the size of the glottic opening and on stridor score in anesthetized, spontaneously breathing children. *Anesth Analg* 2002;94:494-499.
  26. Bruppacher H, Reber A, Keller JP. The effects of common airway maneuvers on airway pressure and flow in children undergoing adenoidectomies. *Anesth Analg* 2003;97:29-34.
  27. Khan FA, Memon GA. Comparison of spontaneous with controlled mode of ventilation in tonsillectomy. *Paediatr Anaesth* 2001;11:185-190.
  28. Woods AW, Allam S. Tracheal intubation without the use of neuromuscular blocking agents. *Br J Anaesth* 2005;94:150-158.
  29. Simon L, Boucebc KJ, Orliaguet G, et al. A survey of practice of tracheal intubation without muscle relaxant in pediatric patients. *Paediatr Anaesth* 2002;12:36-42.
  30. Gulhas N, Durmus M, Demirbilek S, et al. The use of magnesium to prevent laryngospasm after tonsillectomy and adenoidectomy: a preliminary study. *Paediatr Anaesth* 2003;13:43-47.
  31. Tsui BCH, Wagner A, Cave D, et al. The incidence of laryngospasm with a "no-touch" extubation technique after tonsillectomy and adenoidectomy. *Anesth Analg* 2004;98:327-329.
  32. Naja MZ, El-Rajab M, Sidani H, et al. Modified infiltration technique in tonsillectomy: expanded case report of 25 children. *Int J Pediatr Otorhinolaryngol* 2005;69:35-41.
  33. Mukherjee K, Esuvaranathan V, Streets C, Johnson A, et al. Adenotonsillectomy in children: a comparison of morphine and fentanyl for peri-operative analgesia. *Anaesthesia* 2001;56:1193-1197.
  34. White MC, Nolan JA. An evaluation of pain and postoperative nausea and vomiting following the introduction of guidelines for tonsillectomy. *Paediatr Anaesth* 2005;15:683-688.
  35. Arcioni R, Rocca MD, Romano S, et al. Ondansetron inhibits the analgesic effects of tramadol: a possible 5-HT<sub>3</sub> spinal receptor involvement in acute pain in humans. *Anesth Analg* 2002;94:1553-1557.
  36. Moiniche S, Romsing J, Dahl JB, et al. Nonsteroidal anti-inflammatory drugs and the risk of operative site bleeding after tonsillectomy: a quantitative systematic review. *Anesth Analg* 2003;96:68-77.
  37. Marret E, Flahault A, Samama CM, et al. Effects of postoperative, nonsteroidal, anti-inflammatory drugs on bleeding risk after tonsillectomy. *Anesthesiology* 2003;98:1497-1502.
  38. Cardwell M, Siviter G, Smith A. Nonsteroidal anti-inflammatory drugs and perioperative bleeding in pediatric tonsillectomy. *Anesth Analg* 2005;101:1558.
  39. Aoaud MT, Siddik SS, Rizk LB, et al. The effect of dexamethasone on postoperative vomiting after tonsillectomy. *Anesth Analg* 2001;92:636-640.
  40. Elhakim M, Ali NM, Rashed I, et al. Dexamethasone reduces postoperative vomiting and pain after pediatric tonsillectomy. *Can J Anaesth* 2003;50:392-397.
  41. Holt R, Rask P, Coulthard KP, et al. Tropisetron plus dexamethasone is more effective than tropisetron alone for the prevention of postoperative nausea and vomiting in children undergoing tonsillectomy. *Paediatr Anaesth* 2000;10:181-188.
  42. Sukhani R, Pappas AL, Lurie J, et al. Ondansetron and dolasetron provide equivalent postoperative vomiting control after ambulatory tonsillectomy in dexamethasone-pretreated children. *Anesth Analg* 2002;95:1230-1235.
  43. Brown KA, Morin I, Hickey C, et al. Urgent adenotonsillectomy. *Anesthesiology* 2003;99:586-595.
  44. Windfuhr JP. Lethal post-tonsillectomy hemorrhage. *Auris Nasus Larynx* 2003;30:391-396.
  45. Berlucchi M, Tomenzoli D, Nicolai P, et al. Adenotonsillectomy in children with von Willebrand's disease: how and when. A case report with review of the literature. *Int J Pediatr Otorhinolaryngol* 2002;65:253-256.
  46. Ovassapian A, Tuncbilek M, Weitzel EK, et al. Airway management in adult patients with deep neck infections: a case series and review in the literature. *Anesth Analg* 2005;100:585-589.
  47. Farrell PT. Rigid bronchoscopy for foreign body removal: anaesthesia and ventilation. *Paediatr Anaesth* 2004;14:84-89.
  48. Soodan A, Pawar D, Subramaniam R. Anesthesia for removal of inhaled foreign bodies in children. *Paediatr Anaesth* 2004;14:947-952.
  49. Schmitt HJ, Mang H, Schmitt J. Fiberoptic intubation in patients after radiotherapy for carcinoma of the head and neck: difficulty and predictability. *Eur J Anaesthesiol* 2004;21:914-927.
  50. Biro P, Layer M, Becker HD, et al. Influence of airway occluding instruments on airway pressure during jet ventilation for rigid bronchoscopy. *Br J Anaesth* 2000;85:462-465.
  51. Ihra G, Gockner G, Kashanipour A. High-frequency jet ventilation in European and North American institutions: developments and clinical practice. *Eur J Anaesthesiol* 2000;17:418-430.
  - 51a. Unzueta MC, Casas I, Merten A, et al. Endobronchial high frequency jet ventilation for endobronchial laser surgery: an alternative approach. *Anesth Analg* 2003;96:298-300.
  52. Hautmann H, Gamarra F, Henke M, et al. High frequency jet ventilation interventional fiberoptic bronchoscopy. *Anesth Analg* 2000;90:1436-440.
  53. Sawchuk WS, Weber PJ, Lowy DR, et al. Infectious papillomavirus in the vapor of warts treated with CO<sub>2</sub> laser or electrocoagulation: detection and protection. *J Am Acad Dermatol* 1989;21:41-49.
  54. American National Standards Institute. Safe Use of Lasers in Health Care Facilities. ANSI Z136.3-2005. Washington, DC: ANSI, 2005.
  55. Sosis MB. Airway fire during CO<sub>2</sub> laser surgery using a Xomed® laser endotracheal tube. *Anesthesiology* 1990;72:747-749.
  56. Richards SD, Kaushik V, Rothera MP, et al. A tubeless anaesthetic technique for paediatric laryngeal laser surgery. *Int J Pediatr Otorhinolaryngol* 2005;69:513-516.
  57. Barker SJ, Polson JS. Fire in the operating room: a case report and laboratory study. *Anesth Analg* 2001;93:960-965.
  58. Farrell PT. Prenatal diagnosis and intrapartum management of neck masses causing airway obstruction. *Paediatr Anaesth* 2004;14:48-52.
  59. Nargozian C. The airway in patients with craniofacial abnormalities. *Paediatr Anaesth* 2004;14:53-59.
  60. Careni B, Corso RM, Stellino V, et al. Airway management in an infant with congenital centrofacial dysgenesis. *Br J Anaesth* 2001;87:726-728.



61. Austin J, Ali T. Tracheomalacia and bronchomalacia in children: pathophysiology, assessment, treatment, and anesthesia management. *Paediatr Anaesth* 2003;13:3–11.
62. Hoeve LJH, van der Eerden PA. Pitfalls in preoperative management of acquired laryngeal stenosis. The problem of the hidden obstruction in the airway. *Int J Pediatr Otorhinolaryngol* 2002;64:29–33.
63. Zawadzka-Glos LChielik M, Gabryszevska A. The endoscopic treatment of postintubation laryngeal stenosis in children, using argon plasma coagulation. *Int J Pediatr Otorhinolaryngol* 2003;67:609–612.
64. Forte, V Chang MB, Papsin BC. Thyroid ala cartilage reconstruction in neonatal subglottic stenosis as a replacement for the anterior cricoid split. *Int J Pediatr Otorhinolaryngol* 2001;59:181–186.
- 64a. Walner DL. Advances in laryngotracheal reconstruction in children. *Cur Opin Otolaryngol Head Neck Surg* 1999;7:308–312.
65. Preciado D, Cotton RT, Rutter MJ. Single-stage tracheal resection for the severe tracheal stenosis in older children. *Int J Pediatr Otorhinolaryngol* 2004;68:1–6.
66. Hartley BEJ, Rutter MJ, Cotton RT. Cricotracheal resection as a primary procedure for laryngotracheal stenosis in children. *Int J Pediatr Otorhinolaryngol* 2000;54:133–136.
67. Triglia JM, Nicollas R, Roman S. Primary cricotracheal resection in children: indications, technique and outcome. *Int J Pediatr Otorhinolaryngol* 2001;58:17–25.
68. Hadfield PJ, Lloyd-Faulconbridge RV, Almeyda J, et al. The changing indications for paediatric tracheostomy. *Int J Pediatr Otorhinolaryngol* 2003;67:7–10.
69. Byhahn C, Wilke HJ, Halbig S, et al. Percutaneous tracheostomy: Ciaglia Blue Rhino® versus the basic Ciaglia technique of percutaneous dilational tracheostomy. *Anesth Analg* 2000;91:882–886.
70. Sengupta N, Ang KL, Prakash D, et al. Twenty months' routine use of a new percutaneous tracheostomy set using the controlled rotating dilation. *Anesth Analg* 2004;99:188–192.
71. Zawadzka-Glos L, Rawicz M, Chmielik M. Percutaneous tracheostomy in children. *Int J Pediatr Otorhinolaryngol* 2004;68:1387–1390.
72. Kannan S, Chesnut N, McBride G. Intubating LMA guided awake fiberoptic intubation in severe maxillofacial injury. *Can J Anaesth* 2000;47:989–991.
73. Altemir FH. The submental route for endotracheal intubation. A new technique. *J Max Fac Surg* 1986;14:64–65.
74. Arya VK, Kumar A, Makkar S, et al. Retrograde submental intubation by pharyngeal loop technique in a patient with faciomaxillary trauma and restricted mouth opening. *Anesth Analg* 2005;100:534–537.
75. Mallory S, Yap LH, Jones BM, et al. Anaesthetic management in facial bipartition surgery: The experience of one centre. *Anaesthesia* 2004;59:44–51.
76. Hall CEJ, Shutt LE. Nasotracheal intubation for head and neck surgery. *Anaesthesia* 2003;58:249–256.
77. Onca Q, Cokmez B, Aydemir O, et al. Investigation of bacteremia following nasotracheal intubation. *Paediatr Anaesth* 2005;15:194–198.
78. Smith JE, Reid AP. Identifying the more patent nostril before nasotracheal intubation. *Anaesthesia* 2001;56:258–261.
79. Davies JR, Dyer PV. Preventing damage to the tracheal tube during maxillary osteotomy. *Anaesthesia* 2003;58:914–915.
80. Enlund M, Mentell O, Krekmanov L. Unintentional hypotension from lidocaine infiltration during orthognathic surgery and general anesthesia. *Acta Anesth Scand* 2001;45:294–297.
81. Moller PL, Sindet-Pedersen S, Petersen CT, et al. Onset of acetaminophen analgesia: comparison of oral and intravenous routes after third molar surgery. *Br J Anaesth* 2005;94:642–648.
82. Van Aken H, Thys L, Veekman L, et al. Assessing analgesia in single and repeated administrations of propacetamol for postoperative pain: comparison with morphine after dental surgery. *Anesth Analg* 2004;98:159–165.
83. Ansari A. Personal communication, 2006.
84. Rutherford J, Stevenson R. Careful physical examination is essential in the preoperative assessment of children for dental extractions under general anesthesia. *Paediatr Anaesth* 2004;14:920–923.
85. Ong CKS, Seymour RA, Tan JMH. Sedation with midazolam leads to reduced pain after dental surgery. *Anesth Analg* 2004;98:1289–1293.
86. Averley PA, Girdler NM, Bond S, et al. A randomized controlled trial of pediatric conscious sedation for dental treatment using intravenous midazolam combined with inhaled nitrous oxide or nitrous oxide/sevoflurane. *Anaesthesia* 2004;59:844–852.
87. Leitch JA, Anderson K, Gambhir S, et al. A partially blinded randomized controlled trial of patient maintained propofol sedation and operator controlled midazolam sedation in third molar extractions. *Anaesthesia* 2004;59:853–860.
- 87a. Wilson KE, Welbury RR, Girdler NM. A randomized, controlled, crossover trial of oral midazolam and nitrous oxide for pediatric dental sedation. *Anaesthesia* 2002;57:860–867.
88. Rama-Maceiras P, Ferreira TA, Molins N, et al. Less postoperative nausea and vomiting after propofol + remifentanyl versus propofol + fentanyl anaesthesia during plastic surgery. *Acta Anesth Scand* 2005;49:305.
89. Farling PA. Thyroid disease. *Br J Anaesth* 2000;85:15–28.
90. Bouaggad A, Nejmi SE, Bouderk MA, et al. Prediction of difficult tracheal intubation in thyroid surgery. *Anesth Analg* 2004;99:603–606.
91. Yumoto E, Minoda R, Hyodo M, et al. Causes of recurrent laryngeal nerve paralysis. *Auris Nasus Larynx* 2002;29:41–45.
92. Marusch F, Hussock J, Harling G, et al. Influence of muscle relaxation on neuromonitoring of the recurrent laryngeal nerve during thyroid surgery. *Br J Anaesth* 2005;94:596–600.
93. Erhan E, Ugur G, Gunusen I, et al. Propofol—not thiopental or etomidate—with remifentanyl provides adequate intubating conditions in the absence of neuromuscular blockade. *Can J Anaesth* 2003;50:108–115.
94. Taha S, Siddik-Sayyid S, Alameddine M, et al. Propofol is superior to thiopental for intubation without muscle relaxants. *Can J Anaesth* 2005;52:249–253.
95. Hemmerling TM, Schmitt J, Bosert C, et al. Intraoperative monitoring of the recurrent laryngeal nerve in 151 consecutive patients undergoing thyroid surgery. *Anesth Analg* 2001;93:396–399.
96. Hillermann CL, Tarpey J, Phillips DE. Laryngeal nerve identification during thyroid surgery—feasibility of a novel approach. *Can J Anaesth* 2003;50:189–192.
97. Dieudonne N, Gomola A, Bonnichon P, et al. Prevention of postoperative pain after thyroid surgery: a double-blind randomized study of bilateral superficial cervical plexus blocks. *Anesth Analg* 2001;92:1538–1542.
98. Mihai R, Farndon JR. Parathyroid disease and calcium metabolism. *Br J Anaesth* 2000;85:29–43.
99. Mason RA, Fielder CP. The obstructed airway in head and neck surgery. *Anaesthesia* 1999;54:625–628.
100. Bonner S, Taylor M. Airway obstruction in head and neck surgery. *Anaesthesia* 2000;55:290–291.
101. Bhatnagar S, Mishra S, Jha RR, et al. The LMA Fastrach® facilitates fiberoptic intubation in oral cancer patients. *Can J Anaesth* 2005;52:641–645.
102. Kumar A, Banerjee A. Continuous maxillary and mandibular nerve block for perioperative pain relief: the excision of a complicated pleomorphic adenoma. *Anesth Analg* 2005;101:1531–532.
103. Kohase H, Umino M, Shibaji T, et al. Application of a mandibular nerve block using an indwelling catheter for intractable cancer pain. *Acta Anesth Scand* 2004;48:382–383.
104. Choi SS, Lim YJ, Bahk JH, et al. Coronary artery spasm induced by carotid sinus stimulation during neck surgery. *Br J Anaesth* 2003;90:391–394.
105. Strong MS, Vaughn CW, Mahler DL, et al. Cardiac complications of microsurgery of the larynx: etiology, incidence and prevention. *Laryngoscope* 1974;84:908–920.



# CHAPTER 67

## Outpatient Anesthesia

J. Lance Lichtor, MD, and  
Suhas V. Kalghatgi, MBBS,  
MD, FFARCSI

Historians dispute whether Crawford Long, in 1842, or William Morton, in 1846, first used ether for anesthesia in the United States. What these two pioneers had in common was that their patients were outpatients. After that time and for more than 100 years after, hospitalization of patients both before and after operation was the norm. Although the primary reason was patient safety, current evidence shows that for most operations, safety is no different—or perhaps is better—when surgery is performed on an outpatient basis.

The majority of operations today are performed on an outpatient basis. The cynic might assert that the anesthetic used for an outpatient procedure is no different than that used for an inpatient procedure. However, some aspects of outpatient or office-based care are different from hospital care. For example, if an inpatient or outpatient undergoes a procedure in the hospital and experiences nausea, the patient simply is transferred to a hospital room. If an individual undergoes the same procedure in a doctor's office and requires hospital admission because of nausea, the patient must be transferred by ambulance to a hospital. For most freestanding ambulatory surgery centers (ASCs), the anesthesiologist must stay in the facility until the last patient leaves. In a hospital, on-call physicians usually are available, and a patient's anesthesiologist usually can leave at some point after the procedure has been completed.

Patient selection for an outpatient procedure is important both to ensure that the patient undergoing an outpatient procedure remains an outpatient after the procedure has been completed and to improve the efficiency of the outpatient facility. Preoperative screening, performed either in a clinic or by telephone, is essential for ensuring that

medical management of any preexisting condition is optimized and that the patient is an appropriate candidate for outpatient surgery. Preoperative screening also reduces patient anxiety. Morbidity from an outpatient procedure performed on a patient with preexisting disease should be no greater than if the patient were hospitalized.

The length and complexity of operations performed in the ambulatory setting have increased. Although in the past only patients evaluated as American Society of Anesthesiologists (ASA) physical class I or II were candidates for ambulatory surgery, today patients in ASA physical class III or IV whose systemic disease is medically stable are candidates for outpatient procedures. This chapter addresses patient management and the selection of appropriate patients and procedures for ambulatory surgery.

### PLACE, PROCEDURES, AND PATIENT SELECTION

Ambulatory procedures can be performed in a hospital, in a freestanding satellite facility that is either independent or affiliated with a hospital, or in a physician's office. Although the procedure may be the same wherever it is performed, the cost typically is less if the procedure is not performed in a

hospital. One example is a study performed for the Federated Ambulatory Surgery Association in 2003.<sup>1</sup> Medicare claims that included at least one surgical procedure payable by Medicare in both ambulatory and outpatient settings were analyzed. The authors re-priced the hospital outpatient claims to Medicare rules and rates for ASCs and found that the average claim was \$320 less for a procedure performed in an ASC than in a hospital. Given the total number of procedures that could be switched, Medicare could have saved almost \$1.6 billion in 2005. The article estimated that >80% of operations performed in the United States were performed as outpatient procedures and 20% were performed in ASCs.

For outpatient surgery, patients arrive and leave on the day of the procedure. If postoperative complications normally are high or intensive physician or nursing management is required after the procedure, then the procedure is not really an outpatient procedure. Postoperative management is changing, though; procedures that in the past were performed only on inpatients can be successfully managed today as outpatient procedures. For example, patients can be sent home with catheters (i.e., as in continuous regional techniques) for controlling postoperative pain that previously could be managed only in a hospital.

### KEY POINTS

1. The majority of operations today are performed on an outpatient basis.
2. Although restrictions on the types of cases appropriate for ambulatory surgery have been reduced, hospital admissions after outpatient procedures should not be common.
3. Preoperative administration of the combination of midazolam and fentanyl can make patients sleepy up to 8 hours later. Preoperative sedation is not required for every patient.
4. Postoperative pain is less after regional anesthesia, although performing a block requires more time than does induction of general anesthesia and has a higher incidence of failure.
5. Even when thiopental is used only for induction, psychomotor impairment can be evident up to 5 hours after administration compared to only 1 hour after propofol.
6. Although some drugs have faster recovery time than others, actual discharge from an ambulatory center may depend more on administrative issues, such as obtaining the written discharge order from the surgeon or anesthesiologist.
7. Nausea probably is the most important factor contributing to a delay in discharge and an increase in admission after ambulatory surgery. Combination therapy probably is the most effective way to control postoperative nausea and vomiting.
8. Pain may be associated with nausea, and treatment of the pain frequently decreases nausea.

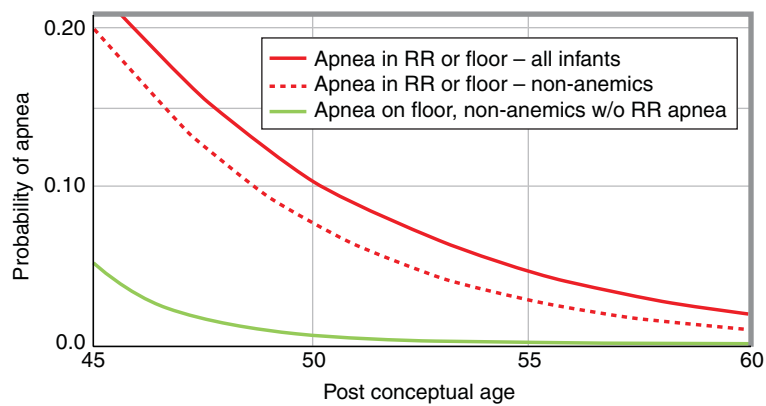
The list of procedures that can be performed appropriately only in outpatients can quickly become outdated. Length of surgery, and thus length of time for recovery, is not strictly a criterion for excluding a surgery as an outpatient procedure because there is little relationship between length of surgery and time to awakening after a procedure. If the intention is to close an outpatient facility at a certain time of day, then longer procedures should be performed earlier in the day. Most facilities would not perform an outpatient procedure if the need for a blood transfusion is anticipated.

An infant with a history of prematurity may not be an appropriate candidate for outpatient surgery. If an infant was born prematurely and at the time of the procedure is younger than 50 weeks postconception, then admission for 23 hours is recommended because of the strong relationship between apnea and postconceptual age (Fig. 67-1).<sup>2</sup> Spinal anesthesia is appropriate for some procedures, and the incidence of apnea after spinal anesthesia without the use of additional drugs for sedation is much less than after general anesthesia.<sup>3</sup> Because apnea might not be apparent for up to 12 hours, hospital admission probably is best for this group of patients.

Advanced age is not a reason to exclude a patient from undergoing an outpatient procedure, although the risk of concomitant systemic disease increases with age. No evidence indicates that recovery is longer with increasing age, although patient age certainly affects drug pharmacokinetics, and appropriate adjustments are necessary. Increased age is a risk factor for unexpected admission after ambulatory surgery.<sup>4,5</sup>

ASA physical status should not be a reason to avoid treatment in an outpatient facility. In a study of patients undergoing outpatient surgery, ASA I and II patients were compared with ASA III patients. The authors found no significant differences in unplanned admission rates, unplanned contact with healthcare services, or postoperative complications in the first 24 hours after discharge.<sup>6</sup> Specifically, when patients with specific diseases (e.g., morbid obesity and obstructive sleep apnea) were studied, no greater incidence of unplanned admissions or other adverse postoperative events were apparent.<sup>7,8</sup>

An ambulatory surgical procedure, whether performed in a hospital, office,



**FIGURE 67-1.** Risk for apnea after surgery is a function of gestational age, hematocrit, and presence of apnea in the postanesthesia care unit (PACU). The predicted probability for apnea by weeks postconception is shown for all infants (solid line), nonanemic infants (irregular line), and infants who were not anemic and did not have apnea in the PACU (broken line). (From Cote et al.<sup>2</sup> with permission.)

or ASC, is performed on an outpatient basis. Patients must understand that they will go home on the day of surgery. They must have with them a responsible person who can escort them from the facility and ensure that postoperative instructions are followed. The patient must be able to tolerate pain from the procedure, assuming adequate pain therapy is provided. For certain operations performed on an outpatient basis, such as laparoscopic cholecystectomy or transurethral prostate resection, the patient must remain close to the medical facility in case he or she requires urgent care. Appropriate time or distance from a facility must be defined by the facility.

With proper patient selection and assuming no untoward intraoperative complications occur, hospital admission after an outpatient procedure should not be common. In ASCs connected to a hospital, admission after an ambulatory procedure is not difficult; a patient can simply be transferred to a hospital room. In freestanding ASCs, hospital admission entails transfer by ambulance. Such a transition may be traumatic to the patient and his or her family, as well as to the anesthesia practitioner. For these reasons, all patients, whether young or old, require a careful preoperative evaluation that includes a history and physical examination.

## PREOPERATIVE EVALUATION AND REDUCTION OF PATIENT ANXIETY

Before an outpatient procedure, a patient can be screened either at the

facility or by telephone. Preoperative screening will identify patient medical problems and suggest appropriate diagnostic and therapeutic measures; educate the patient on requirements that must be followed before surgery, such as abstaining from food or drink and wearing appropriate attire; educate the patient on transportation needs after the procedure; identify patient dependent care issues after the procedure; and instruct the patient on proper post-procedural care. Airway assessment is another important factor accomplished by a face-to-face interview. During the screening period, on the day before the procedure, the anesthesiologist possibly may speak with and establish rapport with the patient but may not be able to do because of clinical demands. Automatic history taking is useful, particularly when preoperative tests are ordered based on patient's history. Preoperative screening can help alleviate the patient's anxiety, particularly through reassurance from nonanesthesia staff. A patient who comes to the facility for preoperative screening can receive booklets or audiovisual instructions. Management of anxiety in pediatric patients is unique. Information modeling and coping-based programs have been shown to reduce anxiety in children, with maximal anxiety reduction obtained if performed immediately before surgery.

## Upper Respiratory Tract Infection

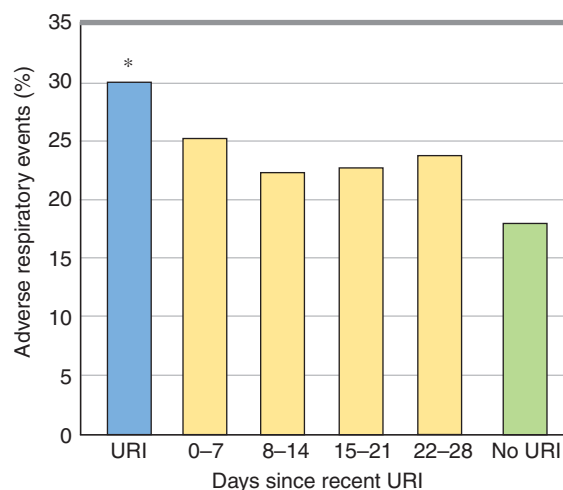
If on the day of surgery a patient, particularly a child, presents with an upper respiratory tract infection (URI), it probably is safe to proceed

with the planned procedure as long as the patient does not have a fever or elevated respiratory rate (possibly indicating pneumonia), has a normal appetite, and does not appear toxic. In one study of more than 1000 children (ages 1 month to 18 years) examining the risk factors for adverse respiratory events in children with URIs, the authors found no difference in laryngospasm or bronchospasm if the children had active URIs, URI within the past 4 weeks, or no symptoms.<sup>9</sup> However, the children with active or recent URIs had more episodes of breathholding, more incidences of desaturation <90%, and more respiratory events compared to children without symptoms (Fig. 67-2). Independent risk factors for adverse respiratory events in children with URIs included use of an endotracheal tube [versus laryngeal mask airway (LMA) or face mask]; history of prematurity, reactive airway disease, or parental smoking; surgery involving the airway; presence of copious secretions; and nasal congestion.

### Restriction of Food and Liquids before Ambulatory Surgery

To decrease the risk of aspiration of gastric contents, patients are routinely asked not to eat or drink anything [nothing by mouth (NPO)] for at least 6–8 hours before surgery. However, prolonged fasting can be detrimental to the patient. One study showed that infants who fasted >8 hrs had greater drops in intraoperative blood pressure (Fig. 67-3).<sup>10</sup> No trial has shown that a shortened fluid fast increases the risk of aspiration. Gastric volumes actually are less when patients are allowed to drink some fluids before surgery. Admittedly, however, the majority of studies were not specifically performed in individuals at increased risk for aspiration. An excellent review of this topic has been published.<sup>11</sup>

The ASA has published practice guidelines for preoperative fasting.<sup>12</sup> The guidelines allow a patient to have a light meal up to 6 hours before an elective procedure. In one survey of anesthesiologist practices in outpatient settings based on the practice guidelines, only 35% of those surveyed said that their institution had a policy that would allow a light breakfast 6 hours before elective surgery, although 65% said they would proceed without delay.<sup>13</sup> The guidelines sup-



**FIGURE 67-2.** Adverse respiratory events are similar between children with an upper respiratory tract infection (URI) at the time of their anesthetic and those with a recent URI. The similarity persists for at least 4 weeks after the URI resolves. \* $P < 0.05$  vs no URI. (From Tait et al.<sup>9</sup> with permission.)

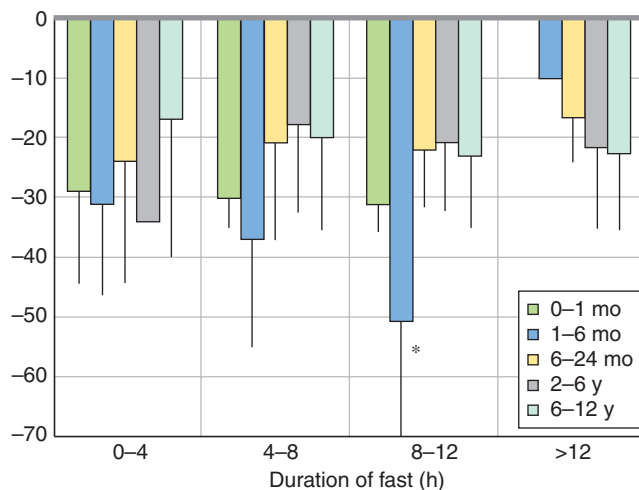
port a preoperative fasting period of 2 hours for clear liquids in all patients. Coffee is not transparent but is free of particulate matter and is accepted as a clear liquid. Coffee drinkers should follow fasting guidelines but should be encouraged to drink coffee prior to their procedure because physical signs of caffeine withdrawal (e.g., headache) can easily occur.<sup>14</sup> Because some surgeons are not aware of these guidelines, patients still may fast for longer periods of time. Some evidence indicates that shorter periods of preoperative fasting are accompanied by less postoperative nausea and vomiting (PONV), but whether rehydration during surgery is equivalent to a shorter

fast before surgery in terms of PONV is unclear.

To ensure that patients receive optimal medical management before outpatient surgery given the guidelines that clear liquids can be consumed up to 2 hours before surgery, patients should be encouraged to take their usual chronic medications.

### MANAGING THE ANESTHETIC: PREMEDICATION

The outpatient is not that different from the inpatient undergoing surgery. In both, premedication is useful to control anxiety, postoperative pain, and



**FIGURE 67-3.** Blood pressure is lower in children 1–6 months old who fast for >8 hours compared to those who fast for <4 hours. Changes in systolic blood pressure from baseline to the time when 2 minimum alveolar anesthetic concentration (MAC) halothane was reached in 250 infants and children are shown. \* $P < 0.05$  vs group that fasted 0–4 hours. (From Friesen et al.<sup>10</sup> with permission.)

PONV and to reduce the risk of aspiration during induction of anesthesia. Because the outpatient is going home on the day of surgery, the drugs given before anesthesia should not hinder recovery afterward. Most premedicants do not prolong recovery when given in appropriate doses for correct indications, although drug effects may be apparent even after discharge.

## Controlling Anxiety

Patients scheduled to undergo surgery may be anxious and may have been so long before coming to the outpatient area; however, not all outpatients actually are anxious. Insomnia and anxiety are related, and in a study of sleep characteristics of outpatients before elective surgery, no differences in sleep quality between patients before surgery and individuals in a community control group were seen.<sup>15</sup> Indeed, physicians tend to overestimate the anxiety actually experienced by their patients.<sup>16</sup> Some operations certainly can generate more anxiety than others. Even removing dentures is associated with increased preoperative stress. If in doubt about patient anxiety, ask. Visual analogue scales are an easy-to-use, accurate tool for assessing anxiety.<sup>17</sup>

Like adults, children should be given some idea of what to expect during a procedure. However, much of a child's anxiety before surgery is caused by concern over separation from a parent(s). A child is more likely to demonstrate problematic behavior from the time of separation from parents to induction of anesthesia if a procedure has not been explained preoperatively. Parents and children must be involved in some preoperative discussions together so that the anxiety of the parents is not transmitted to the child. The transmission of anxiety is at least as problematic as is the separation itself (e.g., experiences of children left with babysitters). If the parents are calm and can effectively manage the physical transfer to a warm and playful anesthesiologist or nurse, premedication is not necessary. Semisedation may be awkward, and recovery after premedication may be prolonged. A parent accompanying a child during induction of anesthesia can reduce the child's anxiety provided the parent is not overly anxious.

Although historically many classes of drugs (e.g., barbiturates and antihistamines) have been used to reduce anxiety and induce sedation, presently

benzodiazepines are the drugs most commonly used. Propofol also has some anxiety-reducing properties.

## Benzodiazepines

Midazolam is the benzodiazepine most commonly used preoperatively. It can be used intravenously (IV) and orally. In adults, midazolam can be used to control preoperative anxiety; it also can be used either alone or in combination with other drugs during a procedure for IV sedation. For children, oral midazolam in doses as low as 0.25 mg/kg produces effective sedation and reduces anxiety.<sup>18</sup> At this dose, most children can be effectively separated from their parents after 10 minutes, and satisfactory sedation can be maintained for 45 minutes.

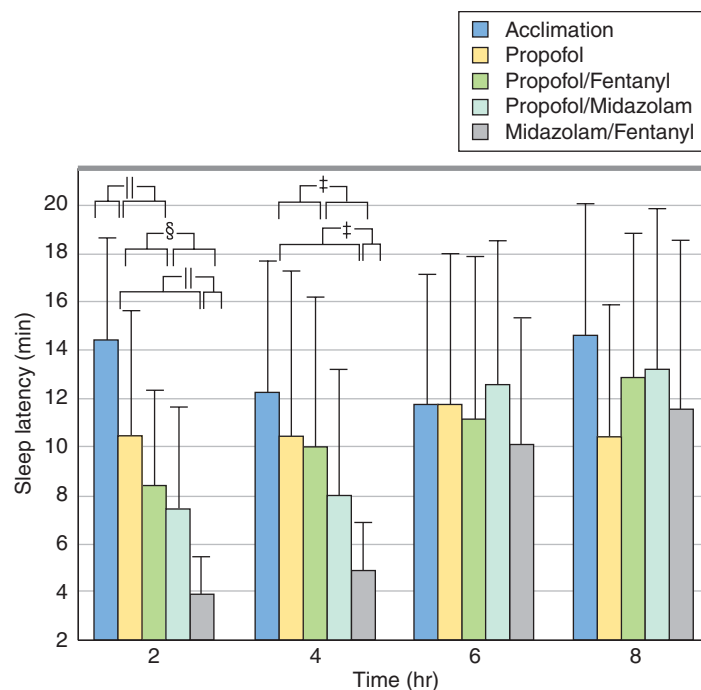
Fatigue associated with the effects of anxiolytics may delay or prevent the discharge of patients on the day of surgery, although more frequently patients are not discharged because of the effects of the operation. With regard to anesthesia effects, patients normally stay in the hospital not because they are too sleepy but because they are nauseous. In adults, particularly when midazolam is combined with fentanyl,

patients can remain sleepy for up to 8 hours (Fig. 67-4).<sup>19</sup> Although children may be sleepier after oral midazolam than if midazolam is not prescribed, discharge times are not affected.<sup>20</sup>

Oral diazepam is useful for controlling anxiety in adult patients, given either the day before or the day of surgery for which an IV line will be inserted. In one study, investigators believed that insertion of an IV line was easier after the patient was given 5 mg oral diazepam.<sup>21</sup>

At proper doses, midazolam places patients at no additional risk for cardiovascular and respiratory depression than does diazepam. Decreased oxygen saturation has been reported after midazolam injection. Routine administration of supplemental oxygen with or without continuous monitoring of arterial oxygenation is recommended whenever benzodiazepines are given IV. This precaution is important not only when midazolam is given as a premedicant but also when midazolam is used either alone or in combination with other drugs for conscious sedation.

The potential for amnesia after premedication is another concern, espe-



**FIGURE 67-4.** Patients can remain sleepy up to 8 hours after administration of midazolam and fentanyl. The abscissa represents time (in hours) after sedation. The ordinate represents sleep latency (i.e., time to fall asleep). Data are mean times to fall asleep. An individual is considered sleepier if less time is required to fall asleep. Subjects who received the midazolam and fentanyl combination were much sleepier than were subjects who received the other types of sedation. Up to 8 hours after sedation, some subjects were sleepier than before they received drug (data not shown). (From Lichtor et al.<sup>19</sup> with permission.)



cially for patients undergoing ambulatory surgery. Anterograde amnesia certainly occurs, but benzodiazepines actually facilitate retrograde memory.<sup>22</sup> For midazolam, amnesia is a function of serum concentration, and the effects on memory are separate from the effects on sedation.<sup>23</sup> In addition, amnesia is not simply an effect of drug administration but, among other factors, is a function of stimulus intensity.

### Opioids and Nonsteroidal Analgesics

Opioids can be administered preoperatively to sedate patients, to control hypertension during tracheal intubation, and to decrease pain before surgery. Meperidine (but not morphine or fentanyl) is sometimes helpful in controlling shivering in the operating room or postanesthesia care unit (PACU), although treatment usually is instituted at the time of shivering and not in anticipation of the event. The effectiveness of opioids in relieving anxiety is controversial and probably nonexistent, particularly in adults.

Opioids are useful in controlling hypertension during tracheal intubation. Opioid premedication prevents increases in systolic pressure in a dose-dependent fashion. After tracheal intubation, however, systolic, diastolic, and mean arterial blood pressures sometimes decrease below baseline values.

Preoperative administration of opioids or nonsteroidal antiinflammatory drugs (NSAIDs) is useful for controlling pain in the early postoperative period. For example, controlled-release oxycodone 10 mg, when given before surgery, was very effective in managing pain after laparoscopic tubal ligation surgery and was associated with less PONV.<sup>24</sup> Celecoxib, up to 400 mg, is effective in reducing postoperative pain.<sup>25</sup> In a comparison of celecoxib 200 mg and rofecoxib 50 mg, rofecoxib was more effective.<sup>26</sup> Ibuprofen or acetaminophen can be given rectally to children around the time of induction. Nonsteroidal analgesics are associated with less nausea compared to narcotics.<sup>27</sup> If rectal acetaminophen is used, an initial loading dose of 40 mg/kg is appropriate; subsequent doses of 20 mg/kg every 6 hours can be used.<sup>28</sup>

Preoperative sedation is not needed for every patient. The following is our practice when patients require drugs to relieve anxiety. For the patient who was seen at least 24 hours before a

scheduled procedure and expresses a desire for medication to relieve anxiety or has anxiety that cannot be relieved with comforting, oral diazepam 2–5 mg per 70 kg of body weight is prescribed for the night before surgery and for 6:00 AM on the day of surgery (even if surgery is scheduled for 1:00 PM or later). For patients seen for the first time in the preoperative holding area who seem to need medication, midazolam 0.03 mg/kg is administered IV, or the patient is brought into the operating room and propofol 0.7 mg/kg is injected IV. For children, oral midazolam 0.5 mg/kg is administered in the preoperative holding area, when necessary.

### Controlling the Risk of Aspiration

Patients who undergo ambulatory surgery may be at some small risk for aspiration of gastric contents, although the risk is no greater for outpatients than for inpatients. Pregnant or morbidly obese patients or patients with hiatal hernia are at greater risk for aspiration. Preoperative anxiety probably has no effect on gastric acidity in individuals without a history of duodenal ulcer. H<sub>2</sub>-receptor antagonists, such as cimetidine and ranitidine, omeprazole, sodium citrate, or metoclopramide can be used to control the risk of aspiration.

### INTRAOPERATIVE MANAGEMENT: CHOICE OF ANESTHETIC METHOD

The choices among anesthetic methods are general anesthesia, regional anesthesia, and local anesthesia. Regional and local anesthesia can be used with or without sedation. Except for obstetric cases for which regional anesthesia may be safer than general anesthesia, all three types are equally safe. However, even for experienced anesthesiologists, there is a failure rate associated with regional anesthesia.

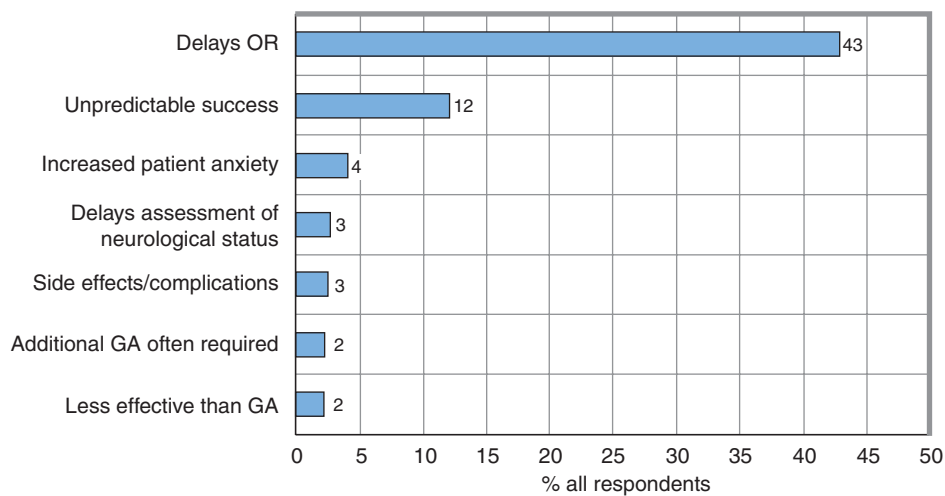
Some procedures are possible only with a general anesthetic. For other procedures, the preference of the patient, surgeon, or anesthesiologist may determine selection. Cost may be a factor; the cost of local or regional anesthesia with sedation usually is less than the cost of a general anesthetic. Time to recovery may influence the

choice of anesthetic method. For example, in a study of adult patients undergoing strabismus surgery with either propofol sedation and local anesthesia or general anesthesia with inhalational agents, time to leave the hospital was much less after sedation.<sup>29</sup> For some procedures such as arthroscopy, patients might prefer a regional anesthetic simply because they are curious and wish to be awake during the procedure.<sup>30</sup> Postoperative pain is less after regional anesthesia (discussed in more detail below). Regional anesthesia or sedation may avoid some of the side effects of general anesthesia, although no form of medical care is without side effects. Whenever drugs that affect memory are given, patients may complain that they have difficulty remembering things after the procedure. With regional anesthesia, more time is required to place a block than is required to induce with a general anesthetic, and the success rate with regional anesthesia is not 100%. In one survey of orthopedic surgeons, the majority of surgeons who direct their patient's choice of anesthetic select regional anesthesia, yet delay in establishing a block and the unpredictable success detracted from their enthusiasm (Fig. 67–5).<sup>31</sup> In most instances after regional anesthesia, PACU time is shorter and patients frequently can bypass the first phase of the PACU.

One adverse effect associated with spinal anesthesia is headache, but patients also experience headaches after general anesthesia. The incidence of headache after either technique may be similar, especially when smaller-gauge spinal needles are used. In one study, the incidence of headache ranged between 11% and 15% after either method of anesthesia.<sup>32</sup> In that study, the incidence of backache was higher (26%) after spinal anesthesia than after general anesthesia (4%). However, the incidences of sore throat and nausea were higher after general anesthesia than after spinal anesthesia (24% vs 6% and 22% vs 6%, respectively). More studies comparing sedation with regional and general anesthesia in larger numbers of patients undergoing ambulatory surgery are needed.

### Regional Techniques

Local anesthesia and regional anesthesia have long been used for ambulatory surgery. As early as 1963, 56% of ambulatory procedures were performed



**FIGURE 67-5.** Operating room delays are the major reason why orthopedic surgeons do not favor regional anesthesia. GA, general anesthesia. (From Oldman et al.<sup>31</sup> with permission.)

using these techniques.<sup>33</sup> Regional techniques commonly used for ambulatory surgery, in addition to spinal and epidural anesthesia, are local infiltration, brachial plexus and other peripheral nerve blocks, and IV regional anesthesia. General anesthesia can be supplemented with regional nerve blocks.

Performing a block requires more time than inducing general anesthesia, and the incidence of failure is higher. Performing the block in a preoperative holding area, provided monitored care is available, can obviate unnecessary delays. In addition, because a postoperative nursing intervention, usually associated with general anesthesia, is associated with a 27- to 45-minute delay, the increased setup time may be associated with a shorter time to discharge.<sup>34</sup> Even though the duration of effect of the newer general anesthetics and muscle relaxants is very short, postoperative pain control is best with regional techniques.

Occasionally a patient experiences syncope when the needle for regional block is inserted. In the experience of oral and maxillofacial surgeons in Massachusetts in the late 1990s, one of 160 patients fainted when local anesthesia was injected.<sup>35</sup> When sedation accompanies local anesthesia injection, the incidence of syncope is reduced. Patients usually experience less postoperative pain when local or regional anesthesia has been used. Patients still might have a numb extremity (e.g., after a brachial plexus block) but otherwise might meet all criteria for discharge. In such instances, the extremity must be well protected with a sling,

and patients must be cautioned to protect against injury because they are without normal sensations that would warn them of vulnerability. Reassurance that sensation will return should be provided. Subsequent followup either by a visiting nurse or by telephone to assess the duration and effect of the regional block not only is good anesthetic practice but may help detect any complications attributable to the block.

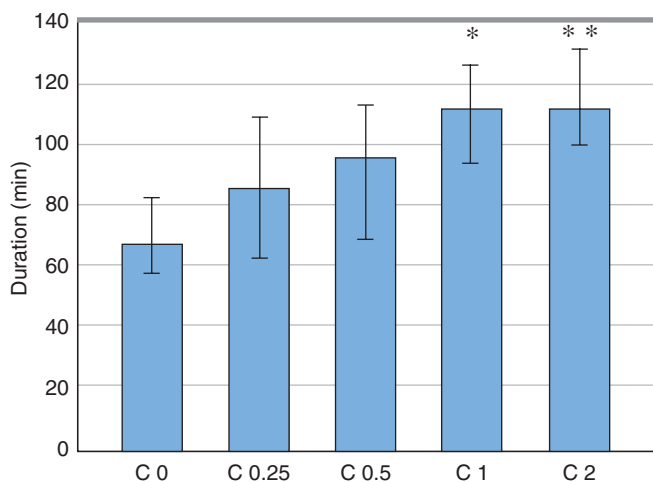
### Spinal Anesthesia

Spinal anesthesia is useful for ambulatory procedures in children born prematurely. The procedure is best performed with the child in the sitting position, with the head supported and somewhat extended, to prevent occlusion of the airway. Bupivacaine 0.5% hyperbaric, 1 mg/kg; or tetracaine, isobaric 1%, mixed with an equal volume of 10% dextrose, is injected into the L4–5 interspace with a 22-gauge, 3.75-cm Quincke needle. It is useful to apply an eutectic mixture of lidocaine and prilocaine (EMLA) patch to the lumbar puncture site 1 hour before the procedure. Because a leg raised may drive the spinal higher, the child must be kept flat, for example, when the Bovie pad is placed on the back. Hypotension is less common after spinal anesthesia in infants than in adults; when it occurs, typically the level of spinal anesthesia is very high. An IV line can be started in a lower extremity after the spinal has been placed, the extremity is anesthetized, and vasodilatation is present. The duration of spinal anesthesia with a local anesthetic alone may not be sufficient. In one

study, when clonidine was added to bupivacaine, the length of spinal block increased from an average of 67 minutes to 111 minutes after 1 µg/kg clonidine (Fig. 67-6).<sup>36</sup> For a discussion as to whether a neonate should be discharged home on the same day of a spinal anesthetic, see section above (Place, Procedures, and Patient Selection).

Use of spinal needles with pencil-point, noncutting tips has prompted a resurgence in the use of spinal anesthesia for ambulatory surgery in adults. Epidural or spinal anesthesia is suitable for pelvic, lower abdominal, and lower-extremity surgery but not for laparoscopic procedures because most people have difficulty breathing in the head-down position with the abdomen distended with air. Motor block of the legs using either technique may delay a patient's ability to walk; however, use of a short-acting local anesthetic through an epidural catheter will minimize this problem while allowing the duration of anesthesia to match the sometimes unpredictable duration of surgery. Nausea is less frequent after epidural or spinal anesthesia than after general anesthesia.

Different drugs and drug concentrations have been used for spinal anesthesia. Lidocaine and mepivacaine are ideal for ambulatory surgery because of their short duration of action, although lidocaine use has been problematic because of transient neurologic symptoms. In one study comparing patients who underwent knee arthroscopy given either 45 mg 1.5% mepivacaine or 60 mg 2% lidocaine, 22% of patients who received lidocaine had



**FIGURE 67-6.** Clonidine prolongs spinal anesthesia in newborns. Median durations of spinal block with 25–75% confidence intervals are shown. Co, spinal with 0.5% isobaric bupivacaine 1 mg/kg; Co.25, bupivacaine with 0.25  $\mu$ g/kg clonidine; Co.5, C1, C2, bupivacaine with 0.5, 1, and 2  $\mu$ g/kg clonidine, respectively. \* $P < 0.003$ ; \*\* $P < 0.006$  vs Co. (From Rochette et al.<sup>36</sup> with permission.)

transient neurologic symptoms (back pain or dysesthesia).<sup>37</sup> The symptoms were treated by NSAIDs and resolved within 5 days. No patients who received mepivacaine developed transient neurologic symptoms. Chloroprocaine spinal anesthesia has rapid onset. In a study of nonpatient volunteers, after administration of 40 mg 2-chloroprocaine, the participants could void after 110 minutes.<sup>38</sup> In that study, when 20  $\mu$ g fentanyl was included, regression time to L1 was lengthened and tourniquet tolerance was improved, although overall block length was minimally affected. Administration of 40 mg preservative-free 2-chloroprocaine produces similar onset time and block height compared to 40 mg lidocaine.<sup>39</sup> In that study, transient neurologic symptoms occurred in seven of eight volunteers who received lidocaine and in none of the volunteers who received 2-chloroprocaine. Low-dose bupivacaine is useful for some outpatient procedures, such as inguinal herniorrhaphy; however, in one study, patients could not be discharged until almost 7 hours after block initiation.<sup>40</sup>

Although headache is a known complication of lumbar puncture, smaller-gauge needles result in a lower incidence of postdural puncture headache. For patients who do receive spinal anesthesia, it is incumbent upon the anesthesiologist and the facility to initiate followup with telephone calls to ensure that no disabling symptoms of headache have developed. If the head-

ache does not respond to bedrest, analgesics, and oral hydration, the patient must return to the hospital for a course of caffeine IV therapy or an immediate epidural blood patch.

Spinal anesthesia should not be avoided in ambulatory surgery patients simply because they may be more active postoperatively than inpatients. Bedrest does not reduce the frequency of headache. Indeed, early ambulation may decrease the incidence. Further study is needed to assess the relative risk-to-benefit ratio of spinal anesthesia as a technique for ambulatory surgery patients.

### Epidural and Caudal Anesthesia

Epidural anesthesia require more time to perform than spinal anesthesia. Onset with spinal anesthesia is more rapid, although recovery may be the same with either technique. In one study of patients undergoing knee arthroscopy, spinal anesthesia with small-dose lidocaine and fentanyl was compared with 3% 2-chloroprocaine administered in the epidural space. Intraoperative conditions, discharge characteristics and times, and recovery profiles were similar.<sup>41</sup> Failure rates for the two techniques, although low, were the same. Some studies suggest that bicarbonate can be added to solutions for faster onset of epidural anesthesia. An advantage of the epidural block is that it can be performed outside the operating room and thus may help the surgeon commence the procedure earlier. The problem of

postdural puncture headache usually is avoided.

Caudal anesthesia is a form of epidural anesthesia commonly used in children before surgery below the umbilicus as a supplement to general anesthesia and for control of postoperative pain. Bupivacaine 0.175–0.25% or ropivacaine 0.2%, in a volume of 0.5–1.0 mL/kg, can be used; the safe maximal dose is 2.5 mg/kg. Epinephrine 1:200,000, when added to the anesthetic solution, may allow earlier detection of IV, rather than epidural, injection. Other additives that are useful, albeit controversial, for increasing duration of blockade include narcotics, ketamine, clonidine, and neostigmine.<sup>42</sup> The block may be more difficult in children, particularly those who weigh >10 kg and are obese, if landmarks for the block are difficult to locate. The block usually is administered while the child is anesthetized. After injection, the depth of general anesthesia can be reduced. Because of better pain control after a caudal block, children usually can ambulate earlier and be discharged sooner than can children without a caudal block. Pain control and discharge times are no different whether the caudal block is placed before surgery or after surgery was completed.

Spinal and epidural blocks may cause urinary retention. It is important to ensure that the patient has voided before he or she is sent home.

### Nerve Blocks

Nerve blocks control pain during surgical procedures, but certain procedures are quite painful, and hospitalization may be required to control the pain. An exciting new area in outpatient surgery pain control is the use of continuous infusion of low-dose analgesic solutions through catheters left in situ in the postoperative period. A paravertebral somatic nerve block can be used for breast surgery, followed by continuous perineural infusion of local anesthetic at home for 24–48 hours.<sup>43</sup> Perineural catheters in the sciatic nerve through the popliteal fossa can be used to control pain after foot surgery.<sup>44</sup> Interscalene perineural catheters have been used for patients undergoing moderately painful shoulder surgery.<sup>45</sup> Continuous cervical paravertebral block also may be useful for analgesia after shoulder surgery. The early return of motor function in

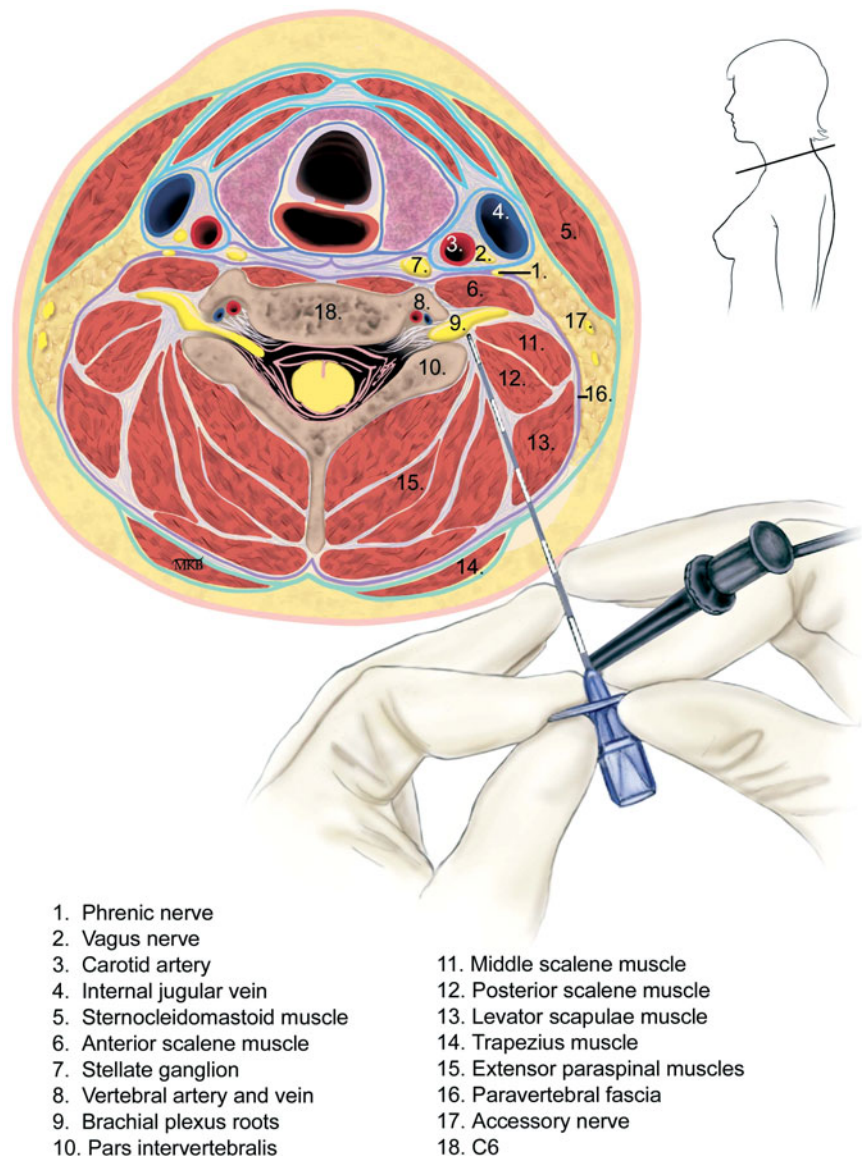


the hand, wrist, and elbow, seen with use of this block, may be useful for recovery after shoulder surgery (Fig. 67-7).<sup>46</sup> Patients must be taught about pump function, know the signs of local anesthesia toxicity, and have someone available at home who can provide assistance. In addition, patients must be able to communicate with someone by phone. The number of patients who have been sent home with catheters is not large; more study, particularly with regard to optimizing patient safety, is needed.

A survey mailed to members of the Society for Ambulatory Anesthesia in 2001 revealed widespread use of axillary and interscalene blocks for upper-extremity surgery and ankle and femoral blocks for lower-extremity surgery.<sup>47</sup> Using different nerve blocks improves postoperative patient satisfaction because postoperative pain and PONV are less. In addition, costs are reduced. In one nonrandomized study of outpatients in a university setting who received nerve blocks for anterior cruciate ligament reconstruction, PACU admissions, hospital cost, and unexpected hospital admission all were reduced.<sup>48</sup> For knee arthroscopy, psoas compartment block or spinal anesthesia is superior to general anesthesia in terms of postoperative pain management and patient satisfaction.<sup>49</sup> After more complex knee surgery, patients who received femoral-sciatic nerve block required fewer nursing interventions for pain. If patients received either femoral-sciatic nerve block or only a femoral nerve block, unplanned hospital admissions were less compared to patients who underwent the procedure without a block.<sup>50</sup> In a comparison of patients who underwent either infraclavicular brachial plexus block or general anesthesia for upper-extremity surgery, after brachial plexus block more patients were able to bypass phase I PACU care, patients had less pain on PACU arrival, and patients were discharged home much sooner (Fig. 67-8).<sup>51</sup>

## Sedation and Analgesia

Many patients who undergo surgery with local or regional anesthesia prefer to be sedated and to have no recollection of the procedure. Sedation is important, in part because injection with local anesthetics can be painful, and lying on a hard operating room table for any length of time can be



- |                               |                                 |
|-------------------------------|---------------------------------|
| 1. Phrenic nerve              | 11. Middle scalene muscle       |
| 2. Vagus nerve                | 12. Posterior scalene muscle    |
| 3. Carotid artery             | 13. Levator scapulae muscle     |
| 4. Internal jugular vein      | 14. Trapezius muscle            |
| 5. Sternocleidomastoid muscle | 15. Extensor paraspinal muscles |
| 6. Anterior scalene muscle    | 16. Paravertebral fascia        |
| 7. Stellate ganglion          | 17. Accessory nerve             |
| 8. Vertebral artery and vein  | 18. C6                          |
| 9. Brachial plexus roots      |                                 |
| 10. Pars intervertebralis     |                                 |

**FIGURE 67-7.** Continuous cervical paravertebral block can be placed prior to induction of anesthesia for shoulder surgery and then left in place for up to 7 days after surgery.<sup>46</sup> Path followed by the sheathed Tuohy needle, using the posterior approach, from the skin and then between the trapezius and levator scapulae muscles to the paravertebral space is shown. (From Boezaart AP, ed. *Anesthesia and Orthopaedic Surgery*. New York: McGraw-Hill, 2006, with permission.)

uncomfortable. Levels of sedation vary from light, during which a patient's consciousness is minimally depressed, to very deep, in which protective reflexes are partially blocked and response to physical stimulation or verbal command may not be appropriate. When patients are unsuitable for outpatient general anesthesia, surgery often can be performed if local or regional anesthesia is supplemented with conscious sedation. Serious risk, such as death, probably is no different after sedation than after general anesthesia. Children undergoing surgery usually will not remain immobile un-

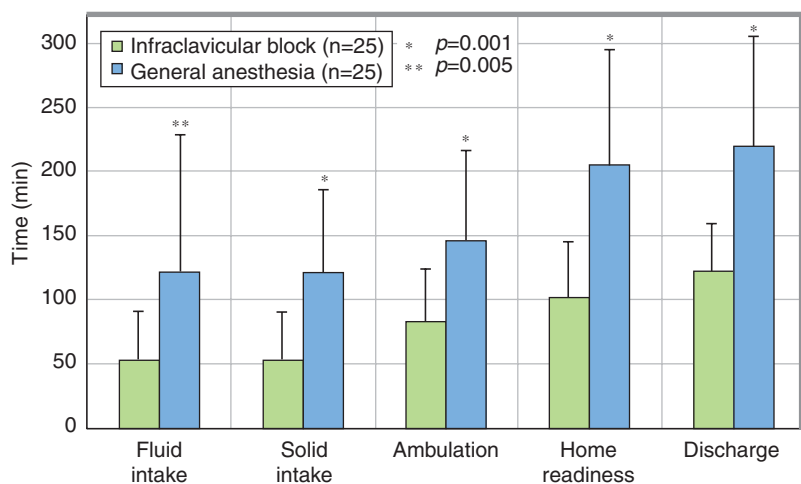
less they are deeply sedated or receive general anesthesia.

For adults, the proper dosage might be controlled by the patient. However, at least for ambulatory surgical procedures, patient-controlled sedation is not as popular as patient-controlled analgesia, possibly because a member of the anesthesia care team must always be present regardless of the circumstances.

## General Anesthesia

The drugs selected for general anesthesia determine how long patients stay in the PACU after surgery and, for





**FIGURE 67-8.** Recovery was faster when an infraclavicular brachial plexus block with a short-acting local anesthetic was used, compared with general anesthesia and wound infiltration for outpatients undergoing hand and wrist surgery. Times are calculated from the end of anesthesia. (From Hadzic et al.<sup>51</sup> with permission.)

some patients, whether or not they can be discharged home.

### Induction

The popularity of propofol as an induction agent for outpatient surgery is related in part to its half-life. The elimination half-life of propofol is 1–3 hours, shorter than that of methohexital (6–8 hours) and thiopental (10–12 hours). Although the effect of drugs given for induction seems to be transient, these drugs can depress psychomotor performance for several hours. When induction doses of propofol and thiopental were compared, psychomotor impairment in patients was evident for up to 5 hours after thiopental but for only 1 hour after propofol.<sup>52</sup>

Pain on injection can be a problem with propofol. Pain is more likely on injection into dorsal hand veins but is minimized if forearm or larger antecubital veins are used. Some individuals experience pain if the drug is injected into proximal larger veins. Nonetheless, thrombophlebitis does not appear to be a problem after IV administration of this agent but can be evident after thiopental. IV lidocaine 0.2 mg/kg or 1% lidocaine mixed with propofol in a 10:1 volume ratio can be used to decrease the incidence and severity of pain.

Most children and some adults prefer not to have an IV catheter inserted before the start of anesthesia. Sevoflurane has a relatively low blood/gas partition coefficient, and its speed of induction is similar to, albeit somewhat

slower than, that of propofol. Induction with sevoflurane can be hastened if the patient is told to breathe out to residual volume, take a vital capacity breath through a primed anesthesia circuit, and then hold the breath.

Parental presence is becoming more accepted during induction of anesthesia in children, even though scientific evidence of its advantages is not conclusive. Some studies show that children are less upset and have fewer behavioral changes after surgery if a parent is present during induction. Other studies have suggested that parents can become upset when they see their anesthetized child, who appears to be dead, albeit breathing and with a beating heart. Separation anxiety on the part of the parents probably is no different if the child is awake or asleep.

For short procedures, some patients may not require neuromuscular blocking drugs; others may need brief paralysis (i.e., with succinylcholine) to facilitate tracheal intubation. Nondepolarizing drugs can be used to facilitate intubation and during the procedure. Nondepolarizing drugs, such as rapacuronium (withdrawn from the market because of bronchospasm) and rocuronium, have rapid onset times similar to those of succinylcholine. Paralysis is not needed for insertion of an endotracheal tube; drug combinations such as propofol, alfentanil, and lidocaine obviate the need for paralysis.<sup>53</sup> Succinylcholine should be used with caution in children because of the possibility of cardiac ar-

rest related to malignant hyperthermia or unsuspected muscular dystrophy, particularly Duchenne disease.

### Anesthesia Maintenance and Wake-Up Times

Although many factors affect the choice of agents for maintenance of anesthesia, two primary concerns about ambulatory anesthesia are speed of wake-up and incidence of PONV.

### Anesthesia Maintenance and Wake-Up Times

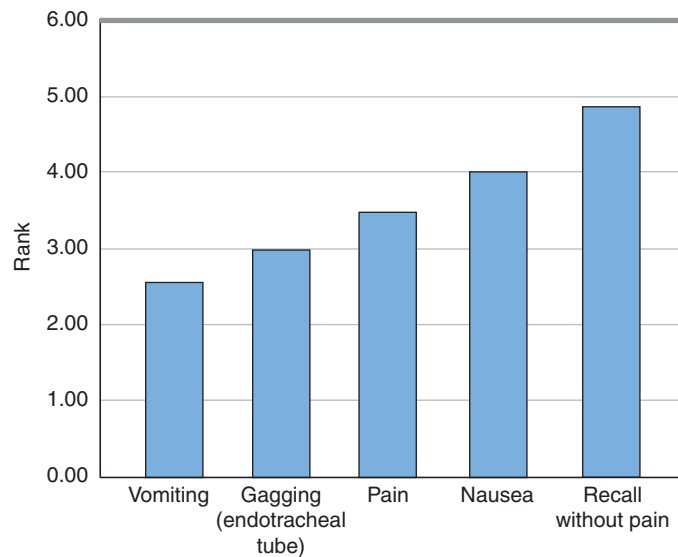
Time to recovery can be measured using various criteria; however, for an ambulatory center, a patient may be considered awake when he or she is able to leave the center. Actual discharge from an ambulatory center may depend on administrative issues, such as obtaining the written order from the surgeon or anesthesiologist. The time needed before a patient can be taken from the operating room after completion of surgery, or a patient's ability to skip the PACU and go directly to a step-down unit, may be directly related to the anesthetic used and result in cost savings for an institution. Does the choice of maintenance agent affect recovery after anesthesia? Propofol, desflurane, and sevoflurane have characteristics that make them ideal for maintenance of anesthesia for ambulatory surgery. Propofol has a short half-life and, when used as a maintenance agent, results in rapid recovery and few side effects. Desflurane and sevoflurane, which are halogenated ether anesthetics with low blood/gas partition coefficients, seem to be ideal for general anesthesia for ambulatory surgery. Sevoflurane, unlike desflurane, facilitates a smooth inhalation induction of anesthesia, the preferred technique to ensure rapid recovery of children in ASCs. For children who receive either sevoflurane or halothane (or halothane and then desflurane) for induction and maintenance of anesthesia, recovery times are significantly shorter after sevoflurane or desflurane.

It is important to distinguish between wake-up time and discharge time. In a study of patients who had undergone laparoscopic surgery, patients emerged from anesthesia with desflurane and nitrous oxide (N<sub>2</sub>O) significantly faster than after propofol or sevoflurane and N<sub>2</sub>O, although their ability to sit up, stand, and tolerate fluids and their time to fitness for

discharge were not different.<sup>54</sup> When the bispectral index (BIS) or other guide of anesthetic depth is used, the difference among drugs and wake-up times may not be as great. Conversely, if fast wake-up times can translate to bypass of phase I PACU care, there may be cost savings.

**Intraoperative Management of PONV** Nausea, with or without vomiting, probably is the most important factor contributing to a delay in discharge of patients and an increase in unanticipated admissions of both children and adults after ambulatory surgery. Patients hate vomiting. In one survey taken before surgery, patients rated vomiting as most undesirable and indicated that if they were given \$100, they would spend most of the money to prevent it (Fig. 67-9).<sup>55</sup> Women, especially those who are pregnant, have a higher incidence of PONV. Other risk factors include a history of motion sickness or postanesthetic emesis; surgery within 1-7 days of the menstrual cycle; not smoking; and procedures such as laparoscopy, lithotripsy, major breast surgery, and ear, nose, or throat surgery. The greater the number of risk factors, the greater the risk for nausea or vomiting after surgery.<sup>56</sup> Inhalational agents are associated with an increased risk for PONV, particularly in the early stages of recovery. Postoperative narcotic use is associated with PONV more than 2 hours after surgery.<sup>57</sup>

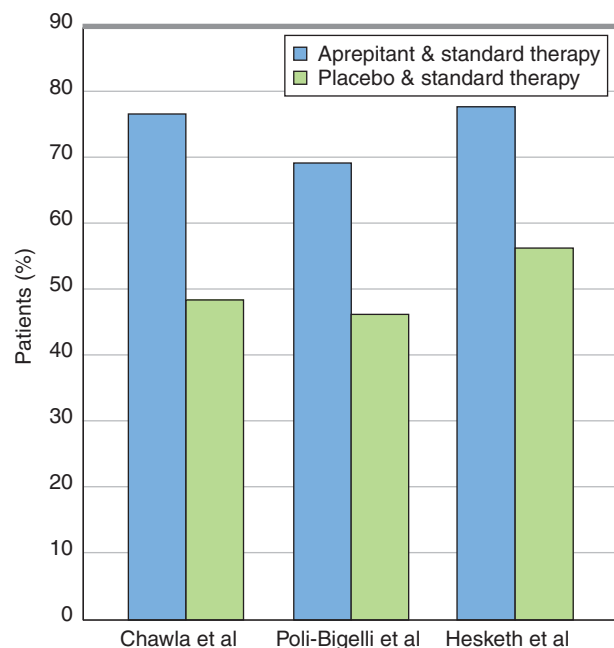
The pathway for vomiting starts peripherally, where emetogens through enterochromaffin cells in the GI tract and/or other sensory neurons activate vagal afferents to the group of brainstem nuclei in the area postrema, nucleus tractus solitarius, and dorsal motor nucleus of the vagus. This area in the brain is also known as the *vomiting center*. Although the pathways for vomiting are not completely understood, the area postrema is highly vascular, lacks a complete blood-brain barrier, and has receptors for neurotransmitters and hormones.<sup>58</sup> Receptor antagonists, specifically selective serotonin antagonists (ondansetron, dolasetron, and granisetron), have similar efficacy in helping to alleviate the condition. Dopamine antagonists, antihistamines, and anticholinergic drugs are useful and generally less expensive, but they are associated with extensive side effects. Neurokinin-1 receptor (NK1) antagonists also may be useful for controlling PONV.



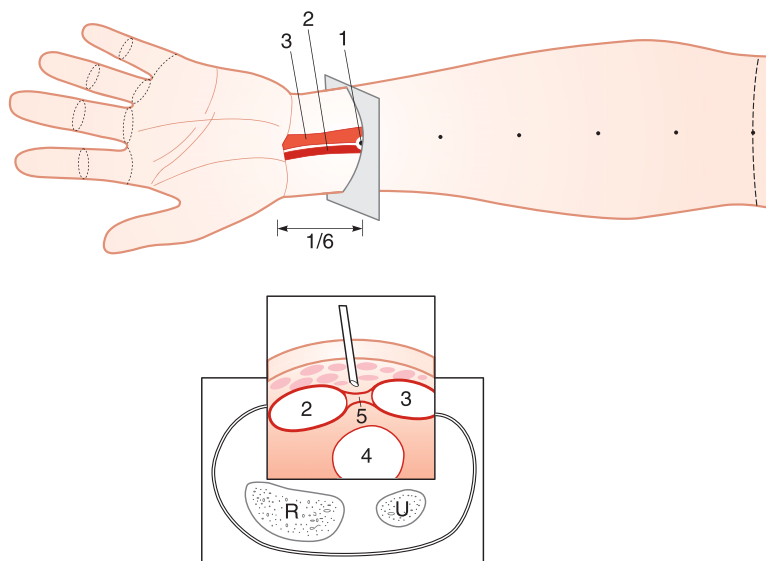
**FIGURE 67-9.** Patients were asked to rank 10 possible outcomes on a scale from most desirable to most undesirable. Shown in relative rank order are the top five undesirable outcomes; the lower the rank, the more undesirable is the outcome. (Adapted from Macario et al.<sup>55</sup> with permission.)

At this time, aprepitant, an NK1-receptor antagonist, has been shown to be more effective than standard therapy (ondansetron and dexamethasone) after highly emetogenic chemotherapy (Fig. 67-10),<sup>59</sup> but the drug's effectiveness in controlling PONV has not been demonstrated. Other therapies useful in controlling PONV include

acupuncture (Fig. 67-11),<sup>60</sup> acupressure,<sup>61</sup> supplemental fluid therapy,<sup>62</sup> clonidine (perhaps in part because it decreases anesthesia requirement),<sup>63</sup> and dexamethasone.<sup>64,65</sup> Some investigators suggest that acupuncture therapy may be effective in controlling both PONV and postoperative pain.<sup>66</sup> Acupressure also might be useful.



**FIGURE 67-10.** Based on three different multicenter randomized double-blind studies,<sup>87-89</sup> when oral aprepitant was combined with IV ondansetron and oral dexamethasone in adult patients who received one cycle of cisplatin-based chemotherapy, overall emetic events were significantly reduced (all  $P < 0.01$ ) compared to standard therapy. (Adapted from Dando and Perry<sup>59</sup> with permission.)



**FIGURE 67-11.** P6 acupunctive point in relation to other hand structures. 1, P6 acupunctive point; 2, palmaris long tendon; 3, flexor carpi radialis tendon; 4, median nerve; 5, palmar aponeurosis. (From Wang and Kain<sup>60</sup> with permission.)

Combination therapy probably is the most effective way to control PONV. In a study of children, low-dose ondansetron and dexamethasone was more effective than high-dose ondansetron in reducing PONV.<sup>67</sup> In another study, the need for treatment of symptomatic PONV in PACU patients was less when a total IV anesthetic without N<sub>2</sub>O or paralysis, aggressive IV hydration, and three antiemetics was used, compared to both an inhalation-based anesthetic with paralysis and ondansetron and a third placebo group that was treated similarly to the previous group but did not receive ondansetron.<sup>68</sup> In a third study of women after laparoscopic surgery, ondansetron with cyclizine was more effective in reducing postoperative vomiting and the need for a rescue antiemetic than was ondansetron alone.<sup>69</sup> However, not all investigators have found combination therapy to be more effective. In a study of patients undergoing abdominal surgery, ondansetron with droperidol was not better than ondansetron alone.<sup>70</sup>

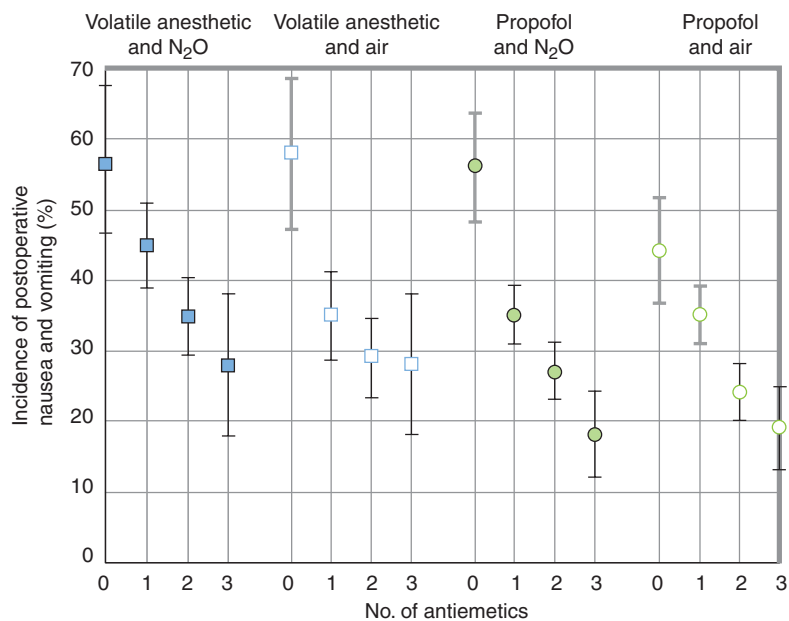
Because of its ability to decrease PONV, propofol is the best general anesthetic for ambulatory anesthesia. In a study of 5161 patients, propofol reduced nausea and vomiting by 19% compared to a volatile anesthetic, and nitrogen reduced the incidence by 12% compared to N<sub>2</sub>O (Fig. 67-12).<sup>65</sup> Despite the greater initial cost of propofol, overall costs may be less because treatment of nausea and vomiting is eliminated. In a study of patients

undergoing office-based surgical procedures, patients received either propofol or sevoflurane for induction and maintenance.<sup>71</sup> The costs of drugs used for anesthesia were the same, but when wasted propofol was considered, propofol costs were greater by approximately \$5.00 per patient. Overall, however, average cost per patient was lowest when propofol was used for both induction and maintenance, pri-

marily because of the costs of treating nausea and vomiting (\$46 for propofol induction and maintenance, \$63 for propofol induction and sevoflurane maintenance, \$72 for sevoflurane induction and maintenance).

Use of N<sub>2</sub>O for ambulatory anesthesia is an issue because the incidence of emesis may be greater after use of N<sub>2</sub>O than after other inhalational agents. However, many studies have shown that N<sub>2</sub>O can be used successfully for ambulatory anesthesia. A meta-analysis that included 26 trials from 24 studies was designed to determine if N<sub>2</sub>O significantly reduced the odds of PONV.<sup>72</sup> Overall, use of N<sub>2</sub>O increased the risk of PONV by 28%. The maximal benefit of N<sub>2</sub>O avoidance was seen in female patients (46%).

**Paralysis** Muscle paralysis for ambulatory anesthesia extends beyond the time of paralysis for intubation, particularly when nondepolarizing drugs have been used. The clinical effect of the nondepolarizing agent mivacurium, given as a bolus injection to 25% recovery, lasts 12–18 minutes, the shortest duration of effect among the neuromuscular blockers. The duration of action of rocuronium, vecuronium, rapacurium, and atracurium ranges from 25–40 minutes. Because mivacurium is dependent on plasma cholinesterase



**FIGURE 67-12.** Postoperative nausea and vomiting (PONV) occurs least after a propofol anesthetic with air. Incidences of PONV after administration of different anesthetics and different numbers of prophylactic antiemetic treatments are shown. (Apfel CC, Korttila K, Abdalla M, et al. A factorial trial of six interventions for the prevention of postoperative nausea and vomiting. *N Engl J Med* 2004;350:2441. Copyright, 2004 Massachusetts Medical Society. All rights reserved.)

terase for metabolism, recovery can be prolonged in the presence of atypical plasma cholinesterase concentrations. In patients with normal plasma cholinesterase levels, postoperative vomiting might be reduced if reversal of mivacurium is not required. Mivacurium should not be used in patients with a history of bronchospasm.<sup>73</sup> Some controversy exists regarding the association of neostigmine with PONV.<sup>74</sup> Nonetheless, reversal agents must be used unless there is no doubt that muscle relaxation has been fully reversed. Mivacurium may not be indicated when an ambulatory surgery case is expected to last >30 minutes. Longer-acting drugs, such as pancuronium, can be used without sequelae, particularly in children in whom muscle relaxants generally have decreased potency, thereby enabling more rapid recovery.

**Intraoperative Management of Postoperative Pain** Opioids given intraoperatively are useful for supplementing both intraoperative and postoperative analgesia. Fentanyl probably is the most popular drug, although all other available narcotics have been tried. All narcotics can cause nausea, sedation, and dizziness, which can delay a patient's discharge. Nonsteroidal analgesics are not effective as supplements during general anesthesia, although they are useful in controlling postoperative pain, particularly when given before a skin incision. Combination therapy is most useful for control-

ling postoperative pain. In a study of outpatients undergoing inguinal hernia repair under general anesthesia, triple preincisional therapy that included rofecoxib 50 mg PO, ketamine 0.2 mg/kg IV, and a local anesthetic field block reduced pain scores and analgesic use in the first 24 hours after discharge compared to a placebo group.<sup>75</sup>

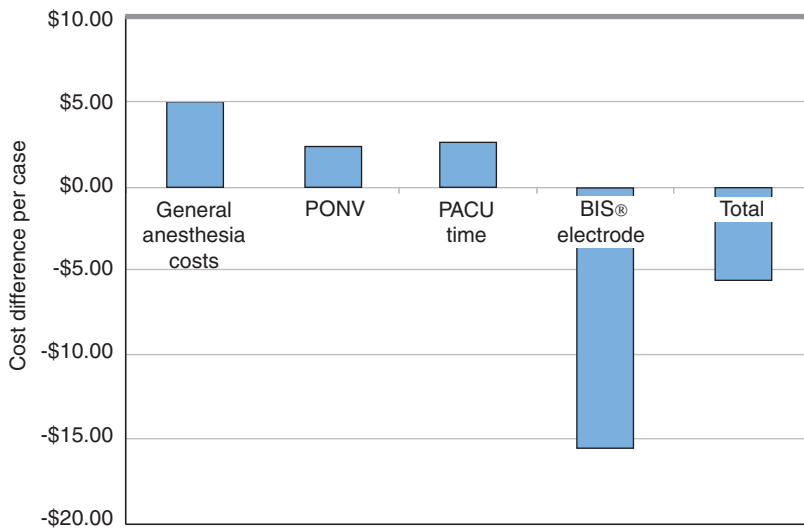
**Depth of Anesthesia** BIS, entropy, or auditory evoked potential monitors are believed to decrease the anesthesia requirement without sacrificing amnesia during general anesthesia. Because less anesthesia is used, titration of anesthesia with these monitors results in earlier emergence from anesthesia. In a meta-analysis of BIS monitoring for ambulatory anesthesia, BIS monitoring was shown to reduce anesthetic use by 19%, with more modest decreases in PACU duration (4 minutes) and PONV (6%; Fig. 67-13).<sup>76</sup> Results are even more modest, albeit mixed, in terms of later recovery end points. Because these monitors result in less anesthesia use, intraoperative awareness and myocardial ischemia might be increased. Sympatholytic drugs, instead of anesthesia, can be used to control autonomic responses to anesthesia. In fact, recovery is faster and side effects are fewer in ambulatory patients whose blood pressure is controlled by sympatholytics rather than inhalational agents.<sup>77</sup> In a study of almost 5000 patients who underwent general anesthesia and were paralyzed and/or intu-

bated, awareness was significantly reduced in the group of patients who were monitored with BIS compared to the group of patients who were not monitored with BIS (Fig. 67-14).<sup>78</sup>

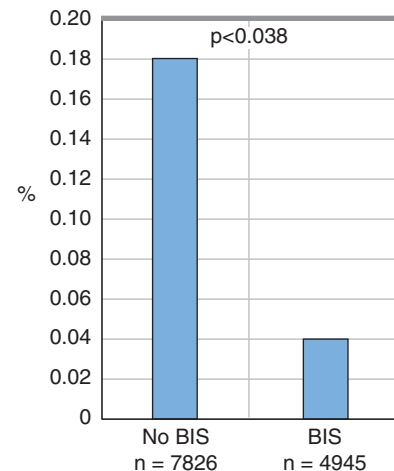
**Airways** Using an LMA or similar type of airway device offers several advantages that allow a patient to quickly return to baseline status. Muscle relaxants required for intubation can be avoided. Coughing is less than with tracheal intubation. Anesthetic requirements are reduced. Hoarseness and sore throat are reduced. Overall, cost savings result with use of LMAs, but nausea and vomiting may be greater because of gastric insufflation. LMA use has been described for laparoscopic procedures, although the potential for aspiration exists because of an inflated abdomen during laparoscopy.

## MANAGEMENT OF POSTANESTHESIA CARE

Many issues associated with recovery are part of the patient selection process and perioperative management and must be considered before the patient enters the PACU. Quick and effective management of common problems occurring in the PACU is as important as appropriate patient selection and choice of anesthetic technique if the patient is to return home on the day of surgery. The three most common reasons for delay in patient discharge from the PACU are drowsiness, nausea and vomiting, and pain. All three are a function of intraoperative manage-



**FIGURE 67-13.** Bispectral index (BIS) monitoring reduces anesthetic consumption, cost of treatment nausea and vomiting, and postanesthesia care unit time; however, the cost of the electrode reverses savings. The ordinate represents cost difference per case pooled from three studies (i.e., costs for control group minus cost for group that used BIS). The capital cost for the BIS monitor was not included. (From Liu<sup>76</sup> with permission.)



**FIGURE 67-14.** The incidence of awareness is reduced when a bispectral index monitor is used. (From Ekman et al.<sup>78</sup> with permission.)



ment, but pain and nausea and vomiting also can be treated in the PACU.

### Reversal of Drug Effects

Reversal of muscle relaxants is not unique to the ambulatory surgery patient and is not discussed here. Reversal of opioids sometimes is necessary. Flumazenil, a benzodiazepine receptor antagonist, has been used primarily to reverse the effects of sedation after endoscopy and spinal anesthesia. Reversal of psychomotor impairment with flumazenil is not complete, and the subjective experience of sedation is not necessarily attenuated. Reversal of amnesia with flumazenil is only partial, and the duration of the reversal effect may not be sufficiently long to be clinically significant. Flumazenil should not be used routinely as a benzodiazepine antagonist; it should be used only when sedation appears to be excessive. Reversal of benzodiazepine-induced sedation by flumazenil should not replace appropriate ventilatory assistance and, if necessary, placement of an endotracheal tube.

### Nausea and Vomiting

Nausea and vomiting are the most common reasons both children and adults have protracted stays in the PACU or unexpected hospital admission due to anesthesia. Nausea and vomiting also are the most common adverse effects in PACU patients. Much research has focused on prophylactic treatment of nausea and vomiting before surgery and on practice techniques used in the operating room that can minimize nausea and vomiting in the PACU. Treatment of this problem, once it occurs in the PACU, has not received as much study. A variety of drugs are effective in treating the problem. The serotonin (5-HT<sub>3</sub>) antagonists seem particularly effective. In a study of children who underwent strabismus surgery and then were nauseous during the first 3 hours after recovery from anesthesia, emesis-free episodes were greater after granisetron 40 µg/kg (88%) compared to droperidol 50 µg/kg (63%) or metoclopramide 0.25 mg/kg (58%).<sup>79</sup> Similar findings were seen in a study of patients who underwent laparoscopic cholecystectomy and then experienced PONV during the first 3 hours after the procedure. Complete control was seen more commonly after granisetron 40 µg/kg (88%) compared to droperidol

20 µg/kg (60%) or metoclopramide 0.2 mg/kg (55%).<sup>80</sup> Hydroxyzine 25 mg also is effective. Midazolam and propofol are used more commonly for sedation, but their antiemetic effects are longer in duration than their effects on sedation. For example, when patients in the PACU were nauseous and then received either propofol 15 mg or midazolam 1 or 2 mg, subsequent nausea was no different than with ondansetron 4 mg.<sup>81</sup> Other authors have found that propofol 10 mg is effective. When a ReliefBand acustimulation device was compared to ondansetron in patients who had undergone laparoscopic surgery and then were nauseous in the PACU after receiving metoclopramide or droperidol, nausea was treated most effectively with the combination of ReliefBand and ondansetron, although either therapy was equally effective in treating PONV.<sup>82</sup> If patients already have received ondansetron prophylaxis in the operating room and then are nauseous in the PACU, another repeat dose might not be effective. In a multicenter study of patients who received ondansetron 4 mg during an outpatient procedure that included N<sub>2</sub>O and then were nauseous in the PACU, complete response to treatment was no different if patients received either another dose of ondansetron 4 mg or placebo.<sup>83</sup> More work is needed to study effective therapies for treatment of PONV in the PACU. Because pain may be associated with nausea, treatment of pain frequently decreases nausea.

### Pain

Postsurgical pain must be treated quickly and effectively. It is important that the practitioner differentiate postsurgical pain from the discomfort of hypoxemia, hypercapnia, or full bladder. Factors that correlate with greater postoperative pain are younger patient age, less serious illness, greater body mass index, operative site, and duration of surgery.<sup>84</sup> Medications for pain control should be given in small IV doses (e.g., morphine 1–3 mg per 70 kg body weight or fentanyl 10–25 µg per 70 kg body weight). Intramuscular (IM) injection of opioid for pain control in the PACU probably is not necessary. Onset of drug action is faster after IV than oral administration. Control of postoperative pain may include administration of opioid analgesics or NSAIDs, which are not associated with respiratory depression, nausea, or vomiting. Fentanyl is

the narcotic most frequently used to control postoperative pain, although the effects of morphine last longer. Patients who receive fentanyl for pain control may require additional injections and go home no sooner than patients who receive morphine. NSAIDs (e.g., ketorolac and ibuprofen) can effectively control postoperative pain. Compared to narcotics, NSAIDs can provide longer periods of pain relief and are associated with less nausea and vomiting. NSAIDs can increase bleeding, although currently no evidence indicates such danger for most ambulatory surgery procedures. NSAIDs can be more effective than opioids in relieving postoperative swelling and pain.

We manage pain in both adults and children initially with either a short-acting opioid analgesic such as fentanyl 25 µg per 70 kg body weight or an injection (IM or IV) of ketorolac 60 mg per 70 kg body weight. Administration of fentanyl is repeated at 5-minute intervals until the pain is controlled. For children, we also use an elixir of acetaminophen containing codeine (120 mg acetaminophen and 12 mg codeine per 5 mL of solution), with 5 mL administered to children 3–6 years old and 10 mL to children 7–12 years old. Children are returned to parental care as soon as they are awake. We find that infants younger than 6 months usually need to be reunited with their mothers for nursing (or bottle feeding) after a procedure not associated with severe pain. For older infants and young children in the PACU, acetaminophen 60 mg per year of age (given orally or rectally) is commonly used to relieve mild pain. IV fentanyl (up to 2 µg/kg) is preferred for more severe pain. Meperidine 0.5 mg/kg and codeine 1–1.5 mg/kg can be given IM if an IV route has not been established.

### Preparation for Discharging the Patient

In addition to having the PACU, many ASCs in the United States have another area, often known as a *phase II recovery room*, where patients can stay until they are able to tolerate liquids, walk, and/or void. With the anesthetics typically used in ambulatory surgery operating rooms, patients who are awakened in the operating room and are evaluated with a score of 9 or 10 according to the modified Aldrete scoring system can be transferred di-

rectly to phase II recovery from the operating room. Patients who undergo procedures under monitored anesthesia care usually can go straight from the operating room to the phase II area. After general anesthesia, LMA use and pain control with nonopioid analgesics facilitate fast tracking. In one study, 35–53% of patients who underwent laparoscopic gynecologic surgery were able to bypass the PACU.<sup>85</sup> In that study, residual sedation was the most common reason why the PACU was not bypassed. In a study of patients who underwent outpatient knee surgery, 31% of those in the phase II recovery area who bypassed the PACU required nursing interventions and were three times more likely to need a nursing intervention compared to 16% of patients who first went to the PACU and then required a nursing intervention. However, discharge times were shorter and unplanned hospital admissions were fewer among patients who were able to bypass the PACU.<sup>86</sup>

Some criteria for discharge to home have been created without scientific basis. One criterion is the patient's ability to tolerate liquids before discharge. Postoperative nausea may be greater if patients are required to drink liquids prior to discharge. Even though the ability to void is warranted after spinal or epidural anesthesia, the requirement that low-risk patients void before discharge may only lengthen stay in the hospital, particularly given that earlier discharged patients would be willing to return to a medical facility if they were unable to void. Practical criteria for patient discharge from the operating room, PACU, and phase II recovery area that in no way compromise patient safety are needed. The value of psychomotor tests to measure different phases of recovery (except for research purposes) is questionable.

Although scoring systems can be used to guide transfer from the PACU to the phase II recovery room and from phase II recovery room to home, they do little to test higher levels of function, such as the patient's ability to use the hands, drive a car, or remain alert long enough to drive. Patients may feel fine after they leave the hospital, but they should be advised against driving for at least 24 hours after a procedure. Patients and responsible parties should be reminded that patients should not operate power tools or be involved in major

business decisions for up to 24 hours after a procedure. Once patients leave the medical facility, supervision may not be as extensive as it was in the hospital. Therefore, dressings should be checked before patients are discharged. The responsible person should be informed of all discharge instructions, which are best made available on printed forms.

Patients should be informed that they may experience pain, headache, nausea, vomiting, dizziness, and, if succinylcholine was used, muscle aches and pains apart from the incision for at least 24 hours after a procedure. Patient will be less stressed if they are told to expect the described symptoms during the course of a normal recovery. Written instructions are important. Providing written and oral informational techniques at discharge has a significant impact on improving patient compliance.

For patients whose native language is not English (e.g., in populations with a high percentage of immigrants), consent forms, procedural explanation, and discharge information written in languages other than English and/or the services of an interpreter may be necessary. Nursing staff should assess the adult who will take the patient home to determine whether the companion is, in fact, a responsible person. A responsible person is someone who is physically and intellectually able to take care of the patient at home. Facilities should develop a method for followup after the patient has been discharged. At some facilities, staff members telephone the patient the next day to determine the progress of recovery; others use followup postcards.

Whenever we become innovative in the management of our outpatients, we must assess how a cost-effective, “no frills” approach to patient care affects patient safety. We must determine what we can do for the patient who lives alone, for the patient whose responsible person is unable to manage his or her needs, for the patient without means of transportation, and for the patient with limited insurance coverage. Hospital beds can be set aside for patients who require observation. Patients who occupy these beds after an ambulatory surgical procedure still are considered outpatients. They are charged for the hours spent in the observation area. Some hospi-

tals have joined with management firms to build a hospital hotel or medical motel close to the hospital itself. The hotel, usually a nonmedical facility, offers the outpatient a comfortable, inexpensive, convenient place to recuperate while receiving care by family or nurses. Home healthcare nursing may be appropriate after surgical procedures such as reduction mammaplasty, abdominoplasty, vaginal hysterectomy, and major open ligament repairs of the knee. The various services for management and/or observation of outpatients after surgery stand today where techniques for management of outpatients during surgery stood in the healthcare delivery system 20 years ago. Prospective studies are needed to assess the quality of care and the effect of these innovative approaches on patient safety.

On rare occasions, a patient requires unanticipated admission to an inpatient facility. Factors such as intractable pain, vomiting, failure of a responsible escort to show up, or more serious surgical complications may prevent discharge to home. In these circumstances, arrangements for safe transfer and subsequent proper management and followup of the patient are mandatory.

The patient, the procedure, the availability and quality of aftercare, and the anesthetic technique to be used must be assessed individually and collectively to determine the patient's acceptability for ambulatory surgery. A delicate balance must be maintained among the patient's physical status, the proposed surgical procedure, and the appropriate anesthetic technique, along with the expertise level of the anesthesiologist caring for a patient.

Anesthesia for ambulatory surgery is a rapidly evolving specialty. Patients once thought unsuitable for ambulatory surgery now are considered appropriate candidates. Operations once thought unsuitable for outpatients now are routinely performed in the morning so that patients can be discharged in the afternoon or evening of the same day. The appropriate anesthetic management of these patients before, during, and after their operation is the key to success. The availability of both shorter-acting anesthetics and longer-acting analgesics and antiemetics enables us to care effectively for patients in ambulatory centers.

## KEY REFERENCES

1. Klein SM, Evans H, Nielsen KC, et al. Peripheral nerve block techniques for ambulatory surgery. *Anesth Analg* 2005;101:1663–1676.
2. Bryson GL, Chung F, Cox RG, et al. Patient selection in ambulatory anesthesia—an evidence-based review: part II. *Can J Anaesth* 2004;51:782–794.
3. Gupta A. Strategies for outpatient anaesthesia. *Best Pract Res Clin Anaesthesiol* 2004;18:675–692.
4. Ferrari LR. Preoperative evaluation of pediatric surgical patients with multisystem considerations. *Anesth Analg* 2004;99:1058–1069.
5. Gupta A, Stierer T, Zuckerman R, Sakima N, et al. Comparison of recovery profile after ambulatory anesthesia with propofol, isoflurane, sevoflurane and desflurane: a systematic review. *Anesth Analg* 2004;98:632–641.
6. Bryson GL, Chung F, Finegan BA, et al. Patient selection in ambulatory anesthesia—an evidence-based review: part I. *Can J Anaesth* 2004;51:768–781.
7. Ghatge S, Lee J, Smith I. Sevoflurane: an ideal agent for adult day-case anesthesia? *Acta Anaesthesiol Scand* 2003;47:917–931.
8. Boezaart AP. Continuous interscalene block for ambulatory shoulder surgery. *Best Pract Res Clin Anaesthesiol* 2002;16:295–310.
9. Crews JC. Multimodal pain management strategies for office-based and ambulatory procedures. *JAMA* 2002;288:629–632.

## REFERENCES

1. Study finds Medicare could save an additional \$1.6 billion by providing more procedures in ambulatory surgery centers rather than hospitals. *Science Letter* 2005;1078.
2. Cote CJ, Zaslavsky A, Downes JJ, et al. Postoperative apnea in former preterm infants after inguinal herniorrhaphy. A combined analysis. *Anesthesiology* 1995;82:809–822.
3. Shenkman Z, Hoppenstein D, Litmanowicz I, et al. Spinal anesthesia in 62 premature, former-premature or young infants—technical aspects and pitfalls. *Can J Anaesth* 2002;49:262–269.
4. Junger A, Benson M, Klases J, et al. Influences and predictors of unanticipated admission after ambulatory surgery. *Anaesthesist* 2000;49:875–880.
5. Twersky R, Fishman D, Homel P. What happens after discharge? Return hospital visits after ambulatory surgery. *Anesth Analg* 1997;84:319–324.
6. Ansell GL, Montgomery JE. Outcome of ASA III patients undergoing day case surgery. *Br J Anaesth* 2004;92:71–74.
7. Davies KE, Houghton K, Montgomery JE. Obesity and day-case surgery. *Anaesthesia* 2001;56:1112–1115.
8. Sabers C, Plevak DJ, Schroeder DR, et al. The diagnosis of obstructive sleep apnea as a risk factor for unanticipated admissions in outpatient surgery. *Anesth Analg* 2003;96:1328–1335.
9. Tait AR, Malviya S, Voepel-Lewis T, et al. Risk factors for perioperative adverse respiratory events in children with upper respiratory tract infections. *Anesthesiology* 2001;95:299–306.
10. Friesen RH, Wurl JL, Friesen RM. Duration of preoperative fast correlates with arterial blood pressure response to halothane in infants. *Anesth Analg* 2002;95:1572–1576.
11. Brady M, Kinn S, Stuart P. Preoperative fasting for adults to prevent perioperative complications. *Cochrane Database Syst Rev* 2003;4:CD004423.
12. Practice guidelines for preoperative fasting and the use of pharmacologic agents to reduce the risk of pulmonary aspiration: application to healthy patients undergoing elective procedures: a report by the American Society of Anesthesiologist Task Force on Preoperative Fasting. *Anesthesiology* 1999;90:896–905.
13. Pandit SK, Loberg KW, Pandit UA. Toast and tea before elective surgery? A national survey on current practice. *Anesth Analg* 2000;90:1348–1351.
14. Evans SM, Griffiths RR. Caffeine withdrawal: a parametric analysis of caffeine dosing conditions. *J Pharmacol Exp Ther* 1999;289:285–294.
15. Kain ZN, Caldwell-Andrews AA. Sleeping characteristics of adults undergoing outpatient elective surgery: a cohort study. *J Clin Anesth* 2003;15:505–509.
16. Shafer A, Fish MP, Gregg KM, et al. Preoperative anxiety and fear: a comparison of assessments by patients and anesthesia and surgery residents. *Anesth Analg* 1996;83:1285–1291.
17. Kindler CH, Harms C, Amsler F, et al. The visual analog scale allows effective measurement of preoperative anxiety and detection of patients' anesthetic concerns. *Anesth Analg* 2000;90:706–712.
18. Cote CJ, Cohen IT, Suresh S, et al. A comparison of three doses of a commercially prepared oral midazolam syrup in children. *Anesth Analg* 2002;94:37–43.
19. Lichtor JL, Alessi R, Lane BS. Sleep tendency as a measure of recovery after drugs used for ambulatory surgery. *Anesthesiology* 2002;96:878–883.
20. Richardson MG, Wu CL, Hussain A. Midazolam premedication increases sedation but does not prolong discharge times after brief outpatient general anesthesia for laparoscopic tubal sterilization. *Anesth Analg* 1997;85:301–305.
21. Wittenberg MI, Lark TL, Butler CL, et al. Effects of oral diazepam on intravenous access in same day surgery patients. *J Clin Anesth* 1998;10:13–16.
22. Fillmore MT, Kelly TH, Rush CR, et al. Retrograde facilitation of memory by triazolam: effects on automatic processes. *Psychopharmacology (Berl)* 2001;158:314–321.
23. Veselis RA, Reinsel RA, Feshchenko VA, et al. The comparative amnestic effects of midazolam, propofol, thiopental, and fentanyl at equisedative concentrations. *Anesthesiology* 1997;87:749–764.
24. Reuben SS, Steinberg RB, Maciolek H, et al. Preoperative administration of controlled-release oxycodone for the management of pain after ambulatory laparoscopic tubal ligation surgery. *J Clin Anesth* 2002;14:223–227.
25. Recart A, Issioui T, White PF, et al. The efficacy of celecoxib premedication on postoperative pain and recovery times after ambulatory surgery: a dose-ranging study. *Anesth Analg* 2003;96:1631–1635.
26. Watcha MF, Issioui T, Klein KW, et al. Costs and effectiveness of rofecoxib, celecoxib, and acetaminophen for preventing pain after ambulatory otolaryngologic surgery. *Anesth Analg* 2003;96:987–994.
27. Wennstrom B, Reinsfelt B. Rectally administered diclofenac (Voltaren) reduces vomiting compared with opioid (morphine) after strabismus surgery in children. *Acta Anaesthesiol Scand* 2002;46:430–434.
28. Birmingham PK, Tobin MJ, Fisher DM, et al. Initial and subsequent dosing of rectal acetaminophen in children: a 24-hour pharmacokinetic study of new dose recommendations. *Anesthesiology* 2001;94:385–389.
29. Greenberg MF, Pollard ZF. Adult strabismus surgery under propofol sedation with local versus general anesthesia. *J AAPOS* 2003;7:116–120.
30. Pelinka LE, Pelinka H, Leixnering M, et al. Why patients choose regional anesthesia for orthopedic and trauma surgery. *Arch Orthop Trauma Surg* 2003;123:164–167.
31. Oldman M, McCartney CJ, Leung A, et al. A survey of orthopedic surgeons' attitudes and knowledge regarding regional anesthesia. *Anesth Analg* 2004;98:1486–1490.
32. Dahl JB, Schultz P, Anker-Moller E, et al. Spinal anaesthesia in young patients using a 29-gauge needle: technical considerations and an evaluation of postoperative complaints compared with general anaesthesia. *Br J Anaesth* 1990;64:178–182.
33. Cohen DD, Dillon JB. Anesthesia for outpatient surgery. *JAMA* 1966;196:1114–1116.



34. Williams BA, Kentor ML. Making an ambulatory surgery centre suitable for regional anaesthesia. *Best Pract Res Clin Anaesthesiol* 2002;16:175–194.
35. D'eraimo EM, Bookless SJ, Howard JB. Adverse events with outpatient anesthesia in Massachusetts. *J Oral Maxillofac Surg* 2003;61:793–800.
36. Rochette A, Raux O, Troncin R, et al. Clonidine prolongs spinal anesthesia in newborns: a prospective dose-ranging study. *Anesth Analg* 2004;98:56–59.
37. Liguori GA, Zayas VM, Chisholm MF. Transient neurologic symptoms after spinal anesthesia with mepivacaine and lidocaine. *Anesthesiology* 1998;88:619–623.
38. Vath JS, Kopacz DJ. Spinal 2-chloroprocaine: the effect of added fentanyl. *Anesth Analg* 2004;98:89–94.
39. Kouri ME, Kopacz DJ. Spinal 2-chloroprocaine: a comparison with lidocaine in volunteers. *Anesth Analg* 2004;98:75–80.
40. Gupta A, Axelsson K, Thorn SE, et al. Low-dose bupivacaine plus fentanyl for spinal anesthesia during ambulatory inguinal herniorrhaphy: a comparison between 6 mg and 7.5 mg of bupivacaine. *Acta Anaesthesiol Scand* 2003;47:13–19.
41. Pollock JE, Mulroy MF, Bent E, et al. A comparison of two regional anesthetic techniques for outpatient knee arthroscopy. *Anesth Analg* 2003;97:397–401.
42. de Beer DA, Thomas ML. Caudal additives in children—solutions or problems? *Br J Anaesth* 2003;90:487–498.
43. Buckenmaier CC 3rd, Klein SM, Nielsen KC, et al. Continuous paravertebral catheter and outpatient infusion for breast surgery. *Anesth Analg* 2003;97:715–717.
44. Zaric D, Boysen K, Christiansen J, et al. Continuous popliteal sciatic nerve block for outpatient foot surgery—a randomized, controlled trial. *Acta Anaesthesiol Scand* 2004;48:337–341.
45. Ilfeld BM, Morey TE, Wright TW, et al. Continuous interscalene brachial plexus block for postoperative pain control at home: a randomized, double-blinded, placebo-controlled study. *Anesth Analg* 2003;96:1089–1095.
46. Boezaart AP, De Beer JF, Nell ML. Early experience with continuous cervical paravertebral block using a stimulating catheter. *Reg Anesth Pain Med* 2003;28:406–413.
47. Klein SM, Pietrobon R, Nielsen KC, et al. Peripheral nerve blockade with long-acting local anesthetics: a survey of the Society for Ambulatory Anesthesia. *Anesth Analg* 2002;94:71–76.
48. Williams BA, Kentor ML, Vogt MT, et al. Economics of nerve block pain management after anterior cruciate ligament reconstruction: potential hospital cost savings via associated postanesthesia care unit bypass and same-day discharge. *Anesthesiology* 2004;100:697–706.
49. Jankowski CJ, Hebl JR, Stuart MJ, et al. A comparison of psoas compartment block and spinal and general anesthesia for outpatient knee arthroscopy. *Anesth Analg* 2003;97:1003–1009.
50. Williams BA, Kentor ML, Vogt MT, et al. Femoral-sciatic nerve blocks for complex outpatient knee surgery are associated with less postoperative pain before same-day discharge: a review of 1, 200, consecutive cases from the period 1996–1999. *Anesthesiology* 2003;98:1206–1213.
51. Hadzic A, Arliss J, Kerimoglu B, et al. A comparison of infraclavicular nerve block versus general anesthesia for hand and wrist day-case surgeries. *Anesthesiology* 2004;101:127–132.
52. Korttila K, Nuotto EJ, Lichtor JL, et al. Clinical recovery and psychomotor function after brief anesthesia with propofol or thiopental. *Anesthesiology* 1992;76:676–681.
53. Jabbour-Khoury SI, Dabbous AS, Rizk LB, et al. A combination of alfentanil-lidocaine-propofol provides better intubating conditions than fentanyl-lidocaine-propofol in the absence of muscle relaxants. *Can J Anaesth* 2003;50:116–120.
54. Song D, Joshi GP, White PF. Fast-track eligibility after ambulatory anesthesia: a comparison of desflurane, sevoflurane, and propofol. *Anesth Analg* 1998;86:267–273.
55. Macario A, Weinger M, Carney S, et al. Which clinical anesthesia outcomes are important to avoid? The perspective of patients. *Anesth Analg* 1999;89:652–658.
56. Apfel CC, Laara E, Koivuranta M, et al. A simplified risk score for predicting postoperative nausea and vomiting: conclusions from cross-validations between two centers. *Anesthesiology* 1999;91:693–700.
57. Apfel CC, Kranke P, Katz MH, et al. Volatile anesthetics may be the main cause of early but not delayed postoperative vomiting: a randomized controlled trial of factorial design. *Br J Anaesth* 2002;88:659–668.
58. Saito R, Takano Y, Kamiya HO. Roles of substance P and NK(1) receptor in the brainstem in the development of emesis. *J Pharmacol Sci* 2003;91:87–94.
59. Dando TM, Perry CM. Aprepitant: a review of its use in the prevention of chemotherapy-induced nausea and vomiting. *Drugs* 2004;64:777–794.
60. Wang SM, Kain ZN. P6 acupoint injections are as effective as droperidol in controlling early postoperative nausea and vomiting in children. *Anesthesiology* 2002;97:359–366.
61. White PF, Issioui T, Hu J, et al. Comparative efficacy of acustimulation (Relief-Band) versus ondansetron (Zofran) in combination with droperidol for preventing nausea and vomiting. *Anesthesiology* 2002;97:1075–1081.
62. Magner JJ, McCaul C, Carton E, et al. Effect of intraoperative intravenous crystalloid infusion on postoperative nausea and vomiting after gynaecological laparoscopy: comparison of 30 and 10 ml kg<sup>-1</sup>. *Br J Anaesth* 2004;93:381–385.
63. Oddby-Muhrbeck E, Eksborg S, Bergendahl HT, et al. Effects of clonidine on postoperative nausea and vomiting in breast cancer surgery. *Anesthesiology* 2002;96:1109–1114.
64. Henzi I, Walder B, Tramer MR. Dexamethasone for the prevention of postoperative nausea and vomiting: a quantitative systematic review. *Anesth Analg* 2000;90:186–194.
65. Apfel CC, Korttila K, Abdalla M, et al. A factorial trial of six interventions for the prevention of postoperative nausea and vomiting. *N Engl J Med* 2004;350:2441–2451.
66. Gan TJ, Jiao KR, Zenn M, et al. A randomized controlled comparison of electro-acupoint stimulation or ondansetron versus placebo for the prevention of postoperative nausea and vomiting. *Anesth Analg* 2004;99:1070–1075.
67. Splinter WM, Rhine EJ. Low-dose ondansetron with dexamethasone more effectively decreases vomiting after strabismus surgery in children than does high-dose ondansetron. *Anesthesiology* 1998;88:72–75.
68. Scuderi PE, James RL, Harris L, et al. Multimodal antiemetic management prevents early postoperative vomiting after outpatient laparoscopy. *Anesth Analg* 2000;91:1408–1414.
69. Ahmed AB, Hobbs GJ, Curran JP. Randomized, placebo-controlled trial of combination antiemetic prophylaxis for day-case gynaecological laparoscopic surgery. *Br J Anaesth* 2000;85:678–682.
70. Bugeo G, Gonzalez J, Asenjo C, et al. Ondansetron and droperidol in the prevention of postoperative nausea and vomiting. *Br J Anaesth* 1999;83:813–814.
71. Tang J, Chen L, White PF, et al. Recovery profile, costs, and patient satisfaction with propofol and sevoflurane for fast-track office-based anesthesia. *Anesthesiology* 1999;91:253–261.
72. Divatia JV, Vaidya JS, Badwe RA, et al. Omission of nitrous oxide during anesthesia reduces the incidence of postoperative nausea and vomiting. A meta-analysis. *Anesthesiology* 1996;85:1055–1062.
73. Bishop MJ, O'Donnell JT, Salemi JR. Mivacurium and bronchospasm. *Anesth Analg* 2003;97:484–485.
74. Cheng CR, Sessler DI, Apfel CC. Does neostigmine administration produce a clinically important increase in postoperative nausea and vomiting? *Anesth Analg* 2005;101:1349–1355.
75. Pavlin DJ, Horvath KD, Pavlin EG, et al. Preincisional treatment to prevent pain after ambulatory hernia surgery. *Anesth Analg* 2003;97:1627–1632.
76. Liu SS. Effects of bispectral index monitoring on ambulatory anesthesia: a meta-analysis of randomized controlled trials and a cost analysis. *Anesthesiology* 2004;101:311–315.
77. White PF, Wang B, Tang J, et al. The effect of intraoperative use of esmolol and



- nicardipine on recovery after ambulatory surgery. *Anesth Analg* 2003;97:1633–1638.
78. Ekman A, Lindholm ML, Lennmarken C, et al. Reduction in the incidence of awareness using BIS monitoring. *Acta Anaesthesiol Scand* 2004;48:20–26.
79. Fujii Y, Tanaka H, Ito M. Treatment of vomiting after paediatric strabismus surgery with granisetron, droperidol, and metoclopramide. *Ophthalmologica* 2002;216:359–362.
80. Fujii Y, Tanaka H, Kawasaki T. Randomized clinical trial of granisetron, droperidol and metoclopramide for the treatment of nausea and vomiting after laparoscopic cholecystectomy. *Br J Surg* 2000;87:285–288.
81. Unlugenc H, Guler T, Gunes Y, et al. Comparative study of the antiemetic efficacy of ondansetron, propofol and midazolam in the early postoperative period. *Eur J Anaesthesiol* 2004;21:60–65.
82. Coloma M, White PF, Ogunnaike BO, et al. Comparison of acustimulation and ondansetron for the treatment of established postoperative nausea and vomiting. *Anesthesiology* 2002;97:1387–1392.
83. Kovac AL, O'Connor TA, Pearman MH, et al. Efficacy of repeat intravenous dosing of ondansetron in controlling postoperative nausea and vomiting: a randomized, double-blind, placebo-controlled multicenter trial. *J Clin Anesth* 1999;11:453–459.
84. Chung F, Ritchie E, Su J. Postoperative pain in ambulatory surgery. *Anesth Analg* 1997;85:808–816.
85. Coloma M, Zhou T, White PF, et al. Fast-tracking after outpatient laparoscopy: reasons for failure after propofol, sevoflurane, and desflurane anesthesia. *Anesth Analg* 2001;93:112–115.
86. Williams BA, Kentor ML, Williams JP, et al. PACU bypass after outpatient knee surgery is associated with fewer unplanned hospital admissions but more phase II nursing interventions. *Anesthesiology* 2002;97:981–988.
87. Chawla SP, Grunberg SM, Gralla RJ, et al. Establishing the dose of the oral NK1, antagonist aprepitant for the prevention of chemotherapy-induced nausea and vomiting. *Cancer* 2003;97:2290–2300.
88. Poli-Bigelli S, Rodrigues-Pereira J, Carides AD, et al. Addition of the neurokinin 1, receptor antagonist aprepitant to standard antiemetic therapy improves control of chemotherapy-induced nausea and vomiting. Results from a randomized, double-blind, placebo-controlled trial in Latin America. *Cancer* 2003;97:3090–3098.
89. Hesketh PJ, Grunberg SM, Gralla RJ, et al. The oral neurokinin-1, antagonist aprepitant for the prevention of chemotherapy-induced nausea and vomiting: a multinational, randomized, double-blind, placebo-controlled trial in patients receiving high-dose cisplatin—the Aprepitant Protocol 052 Study Group. *J Clin Oncol* 2003; 21:4112–4119.

# CHAPTER 68

## Monitored Anesthesia Care and Conscious Sedation

Robert S. Harris, MD, and  
Peter S. Sebel, MB, BS, PhD,  
MBA

### DEFINITIONS

#### MAC

*Monitored anesthesia care (MAC)*, a term first defined by the American Society of Anesthesiologists (ASA) in 1986, represents a comprehensive physician service provided to patients undergoing diagnostic or therapeutic procedures.<sup>1</sup> The ASA Position Statement, last updated in 1998, is as follows<sup>1</sup>:

*Monitored anesthesia care is a specific anesthesia service in which an anesthesiologist has been requested to participate in the care of a patient undergoing a diagnostic or therapeutic procedure.*

*Monitored anesthesia care includes all aspects of anesthesia care—a preprocedure visit, intraprocedure care and postprocedure anesthesia management.*

*During monitored anesthesia care, the anesthesiologist or a member of the anesthesia care team provides a number of specific services, including but not limited to:*

- *Monitoring of vital signs, maintenance of the patient's airway and continual evaluation of vital functions*
- *Diagnosis and treatment of clinical problems which occur during the procedure*
- *Administration of sedatives, analgesics, hypnotics, anesthetic agents or other medications as necessary to ensure patient safety and comfort*
- *Provision of other medical services as needed to accomplish the safe completion of the procedure*

*Monitored anesthesia care often includes the administration of doses of medications for which the loss of normal protective reflexes or loss of consciousness is likely. Monitored anesthesia care refers to those clinical*

*situations in which the patient remains able to protect the airway for the majority of the procedure. If, for an extended period of time, the patient is rendered unconscious and/or loses normal protective reflexes, then anesthesia care shall be considered a general anesthetic.*

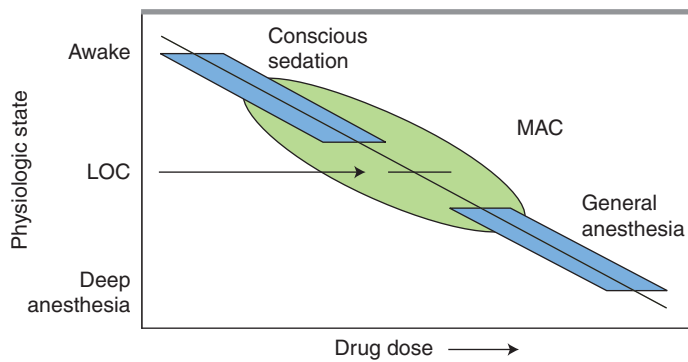
*Because monitored anesthesia care is a physician service provided to an individual patient and is based on medical necessity, it should be subject to the same level of reimbursement as general or regional anesthesia. Accordingly, the ASA Relative Value Guide provides for the use of proper basic procedural units, time units and age and risk modifier units as the basis for determining reimbursement.*

### Conscious Sedation

*Conscious sedation* is an obsolete term first introduced by the American Dental Association (ADA) and refers to a “minimally depressed level of consciousness that is produced by a pharmacologic method, a nonpharmacologic method, or a combination of both, in which the patient retains the ability to maintain an airway independently and continuously and to respond appropriately to physical stimulation or verbal command.”<sup>2</sup> The term *conscious sedation* has been replaced by *moderate sedation*. Although the level of sedation and analgesia obtainable under moderate sedation may seem identical to that considered to be MAC by most healthcare providers, there are several

### KEY POINTS

1. Monitored anesthesia care (MAC) is a comprehensive physician service that includes all aspects of anesthetic care—preprocedural visit, intraoperative care, and postprocedure anesthetic management.
2. The American Society of Anesthesiologists (ASA) practice guidelines for MAC have been established. These guidelines frequently are consistent with those for general or regional anesthesia and should be followed accordingly.
3. Although MAC is safe when administered by well-trained anesthesia personnel, ASA closed claims data demonstrate that rare and severe injuries or death can occur during MAC.
4. Clinicians must understand the pharmacokinetic and pharmacodynamic principles of drug administration (e.g., context-sensitive half-time, effect-site half-time) so that cognitive errors can be avoided. Proper drug dosing can optimize patient safety and recovery and discharge times.
5. Therapeutic windows for drugs administered during MAC are much smaller than those for general anesthesia.
6. When a drug combination is used, the combination itself should be regarded as a novel drug, and it may have unpredictable properties that are markedly different from the properties of the individual drugs composing it.
7. Considering drug relationships to be either additive or synergistic is overly simplistic. Two drugs may be additive in one ratio and synergistic or even antagonistic in another. Response surface methodology is the technique by which the entire three-dimensional drug relationship can be elucidated. Although clinicians may not construct these models, they should use existing models reported in the literature to facilitate optimal drug dosing.
8. Drug administration via constant infusion allows more predictable plasma concentration, decreased total drug usage, and faster recovery time than administration via multiple bolus techniques.
9. Target-controlled infusion devices, by incorporating patient covariates (e.g., age, weight) into pharmacokinetic models, may improve the accuracy of drug administration.
10. Sedation with propofol is classified as deep sedation by the ASA. When used in doses consistent with MAC, significant changes occur in airway anatomy and cardiopulmonary physiology. These changes occur even in healthy patients and are amplified in the elderly and in patients with preexisting systemic disease. Propofol should be administered only by clinicians qualified to rescue patients from any level of sedation, including general anesthesia.



**FIGURE 68-1.** Graphical depiction of the distinct difference between conscious sedation and general anesthesia with regard to level of consciousness and dose of drugs usually involved. Monitored anesthesia care fills the gap and may overlap, to some extent, both of the other services. Novak LC. ASA updates its position on monitored anesthesia care. ASA Newsletter 1998; 62:22–23. Reprinted with permission of the American Association of Anesthesiologists, 520 N. Northwest Highway, Park Ridge, Illinois 60068-2573.

important distinctions between the two entities. MAC involves the continuous presence of a second independently functioning physician/anesthesiologist who either personally provides or medically directs care. In addition, the provider of MAC must be both prepared and qualified to convert any anesthetic to general anesthesia when required.<sup>1</sup> In contrast, moderate sedation may be directed by the same physician (or by nonphysician personnel) performing the procedure, and the depth of anesthesia attained should not lead to loss of the patient's ability to maintain airway integrity.<sup>3</sup> Furthermore, MAC implies a full array of preoperative and postoperative responsibilities, from the diagnosis and treatment of coexisting medical problems to the relief of postoperative pain. Finally, although there may be commonality in the depths of sedation achieved with moderate sedation and MAC, clearly MAC permits the safe administration of a maximal depth of seda-

tion, even in fragile patients who might reach such levels after minimal sedation (Fig. 68-1).

### Other Terminology

The ASA has developed a continuum of sedation states, ranging from minimal sedation (anxiolysis) to general anesthesia (Table 68-1). With the advent of improved pharmacologic agents and delivery devices, monitors, and medical technology, these techniques are being used increasingly in nontraditional anesthetic locations (e.g., endoscopy and interventional radiology suites).

*Minimal Sedation (Anxiolysis):* Drug-induced state during which patients respond normally to verbal commands. Although cognitive function and coordination may be impaired, ventilatory and cardiovascular functions are unaffected.

*Moderate Sedation/Analgesia (Conscious Sedation):* Drug-induced depres-

sion of consciousness during which patients respond purposefully to verbal commands, either alone or accompanied by light tactile stimulation. No interventions are required to maintain a patent airway, and spontaneous ventilation is adequate. Cardiovascular function usually is maintained.

*Deep Sedation/Analgesia:* Drug-induced depression of consciousness during which patients cannot be easily aroused but respond purposefully following repeated or painful stimulation. The ability to independently maintain ventilatory function may be impaired. Patients may require assistance in maintaining a patent airway, and spontaneous ventilation may be inadequate. Cardiovascular function usually is maintained.

*General Anesthesia:* Drug-induced loss of consciousness during which patients are not arousable, even by painful stimulation. The ability to independently maintain ventilatory function often is impaired. Patients often require assistance in maintaining a patent airway, and positive-pressure ventilation may be required because of depressed spontaneous ventilation or drug-induced depression of neuromuscular function. Cardiovascular function may be impaired.

## PREOPERATIVE CONSIDERATIONS

### Patient Selection

Because patients will be conscious during MAC, evaluation of the patient's ability to cooperate and remain still during the procedure is important.

**TABLE 68-1.**

Continuum of Depth of Sedation: Definition of General Anesthesia and Levels of Sedation/Analgesia<sup>2</sup>

	Minimal Sedation (Anxiolysis)	Moderate Sedation/Analgesia (Conscious Sedation)	Deep Sedation/Analgesia	General Anesthesia
Responsiveness	Normal responses to verbal stimulation	Purposeful, <sup>a</sup> response to verbal or tactile stimulation	Purposeful, <sup>a</sup> response after repeated or painful stimulation	Unarousable, even with painful stimulation
Airway	Unaffected	No intervention required	Intervention may be required	Intervention often required
Spontaneous ventilation	Unaffected	Adequate	May be inadequate	Frequently inadequate
Cardiovascular function	Unaffected	Usually maintained	Usually maintained	May be impaired

<sup>a</sup>Reflex withdrawal from a painful stimulus is not considered a purposeful response.

Although no patient is “too sick” for sedation and MAC, certain cognitive deficits or the presence of other conditions (e.g., severe cough) may confer an advantage to general anesthesia. Communication during the procedure may be of paramount importance, as a means of both monitoring the depth of sedation and reassuring or calming a moving or agitated patient. For this reason, the presence of a significant language barrier between patient and clinician may confer an advantage to general anesthesia in many cases.

## Safety

Although public perception, if not heuristic reasoning, suggests that MAC is safer than either general or regional anesthesia, no consensus in the literature supports this view. Certainly selection bias (sickest and oldest patients undergoing MAC) is a consideration, but similar complications can occur regardless of type of anesthesia (e.g., airway obstruction, adverse drug reaction). In the ASA Closed Claims Database, MAC claims constitute 3% of all claims. The proportion of claims for MAC increased from 1.6% in the 1970s to 6.0% in the 1990s.<sup>4</sup> Because the denominator is unknown, the increase may just represent an increase in the number of MAC anesthetics relative to other anesthetics. Patients who had injuries during MAC were older and sicker than those who had injuries during other types of anesthesia.<sup>4</sup> Although MAC injuries represent a small proportion of the total claims, most claims for MAC involved severe injuries (Table 68–2). A greater proportion of permanent injuries was notable among MAC claims, along with a higher proportion of brain damage (19% vs 12% for general/regional claims) and death rate (34%) similar to general/regional claims.<sup>4</sup>

The cause or mechanism of the adverse outcome in MAC closed claims was respiratory in 26% of patients and cardiovascular in 10% (Table 68–3). The standard of care was judged to be appropriate in nearly half of MAC claims, and it was stated that better monitoring would not have prevented most injuries associated with MAC in the 1990s, albeit a decade in which pulse oximetry and capnometry became standards of care.<sup>5</sup> Payment for MAC claims ranged from \$2000 to \$6.3 million, and the median payment (\$75,000) was similar to payments for claims associated with regional anesthesia and slightly lower than for

**TABLE 68–2.**

**American Society of Anesthesiologists Closed Claims Database: Monitored Anesthesia Care Claims and Outcomes of Injury<sup>4</sup>**

Outcome	n	Percent
Death	28	34
Brain damage	16	19
Nerve damage	6	7
Eye damage	10	12
Prolonged ventilatory support	4	5
Myocardial infarction	3	4
Stroke	3	4
Burn	3	4
Emotional distress/fright	3	4
Aspiration	3	4

claims associated with general anesthesia (\$110,000).<sup>4</sup> In general, despite the rare risk of an adverse outcome, it appears that MAC anesthesia is safe when administered by well-trained anesthesia personnel.

## Preoperative Assessment

Every patient undergoing MAC should have a thorough preanesthetic evaluation, equivalent to that for a general or regional anesthetic. Although no data link outcomes with the performance of a patient evaluation, ASA practice guidelines strongly stress its importance,<sup>2</sup> and the Joint Commission on Accreditation of Healthcare Organizations (JCAHO) mandates an evaluation prior to moderate or deep sedation.<sup>6</sup> Pertinent components of the patient's medical history include (1) abnormalities of the major organ systems; (2) previous adverse experience with sedation/anesthesia or any anesthesia; (3) current medications and drug allergies; (4) time and nature of last oral intake; and (5) history of tobacco, alcohol, or illicit substance abuse. It is important to elicit if patients are using herbal medicines as well, because some phytopharmaceuticals can prolong or augment the effects of anesthesia, increase bleeding risk, or raise blood pressure, among many interactions.<sup>7</sup> The preoperative visit is an appropriate time to inform patients of the risks, benefits, and alternatives of MAC. Informed consent can increase patient satisfaction and align patient and provider expecta-

**TABLE 68–3.**

**American Society of Anesthesiologists Closed Claims Database: Damaging Events from Monitored Anesthesia Care Claims<sup>4</sup>**

Event	n	Percent
Respiratory event	22	26
Cardiovascular event	8	10
Intravenous complications	6	7
Other equipment	8	10
Patient moved	8	10
Incorrect drug or dose	7	8
Allergic reaction	2	3
None/unknown	19	25

tions such that the patient is not anticipating a general anesthetic and the absence of all sensation.

All patients should undergo a focused physical examination, including vital signs, auscultation of the heart and lungs, and evaluation of the airway. Preprocedural laboratory testing should be guided by the patient's underlying medical conditions and should not be based upon age, outdated institutional guidelines, or protection from legal liability. It is suggested that 60–70% of all ordered preoperative laboratory tests are unnecessary according to the patient's history and physical examination.<sup>8</sup> A landmark study in 2000 by Schein et al.<sup>9</sup> randomly assigned over 19,000 patients undergoing cataract surgery at nine centers to be tested either routinely or only if indicated. No difference in outcome, hospitalization, morbidity, or mortality was found between the two groups. An important qualifier was that patients in the “no test” group underwent tests “when the history or a finding on the physical examination would have indicated the need for a test even if surgery had not been planned.” A followup case-cohort study by Imasogie et al.<sup>10</sup> examined >1200 patients undergoing cataract surgery. Unlike the previous study, no “crossovers” or patients in the non-testing group underwent subsequent testing. No differences in the perioperative event rate were observed, and a 90% reduction in laboratory costs per patient was achieved. The ASA Practice Advisory for Preanesthesia Evaluation, last modified in 2003, strongly opines against routine preoperative testing.<sup>11</sup> Selective preoperative testing is recommended after consideration of the pa-



patient's history, physical examination, and type or invasiveness of the planned procedure. The presence of a significant language barrier between provider and patient may preclude MAC and confer an advantage to general anesthesia, particularly during cases in which patient communication, cooperation, or lack of movement is paramount to the success of the procedure.

### Preprocedural Fasting

Patients should receive instructions regarding fasting requirements during the preoperative assessment. It is important to convey the reasons for the nothing by mouth (NPO) recommendations, because patients may not appreciate that the level of "sedation" they might receive may impair airway protective mechanisms. The ASA practice guidelines (Table 68-4) apply to healthy patients undergoing elective procedures, and no distinction is noted between general anesthesia and sedation/analgesia.<sup>12</sup> The guidelines acknowledge, "there is insufficient published evidence to address the safety of any preoperative fasting period."<sup>12</sup> The guidelines have been extrapolated outside the operating room to include procedural sedation in the emergency room and other locations, although it may be impractical for a patient requiring an emergent procedure to adhere to a 6- to 8-hour preprocedural fasting protocol. Other patients

with coexisting diseases or conditions that affect gastric emptying or fluid volume (e.g., pregnancy, diabetes, bowel obstruction) require special attention and modification of guidelines. Although prudent practice dictates that the ASA practice guidelines be followed, it is possible that no period of preprocedural fast or level of planned sedation short of general anesthesia will be safe to administer to some of these patients.

## MONITORING DURING MAC

### ASA Standards

The ASA standards for basic anesthetic monitoring, approved in 1986 and last modified in 2004, apply to all anesthetics, including MAC (Box 68-1).<sup>13</sup> Although no definitive prospective, randomized studies have validated or refuted any relationship between the advent of specific monitors and decreased morbidity or mortality, circumstantial evidence suggests that routine noninvasive basic monitoring can improve patient safety.<sup>2</sup> Ethical concerns may preclude the undertaking of such investigations in the future. Retrospective data from the ASA Closed Claims Database suggest that approximately one third of MAC claims from the 1970s and 1980s would have been prevented by better monitoring, whereas an examination of claims from the 1990s (after the universal adoption of pulse oximetry and capnometry) failed to reveal substandard monitoring as a contributing factor.<sup>4</sup> Tinker et al.<sup>14</sup> examined the entire closed claims database to determine whether the application of additional monitoring at the time of injury would have prevented "anesthetic mishaps." They found that 17.7% of adverse outcomes in regional or MAC cases could have been prevented by the application of better monitoring (specifically pulse oximetry and/or capnometry in 97% of instances), with a disproportionate number of cases involving death or brain damage. Although retrospective in nature, these data underscore the potential importance of noninvasive monitoring during MAC anesthesia. It is useful to examine each component of the ASA standards and its application to MAC anesthesia.

### Presence of "Qualified Anesthesia Personnel"

Arguably the most important "monitor" for MAC or sedation/analgesia proce-

#### BOX 68-1.

#### American Society of Anesthesiologists Standards for Basic Anesthetic Monitoring

**Standard 1:** Qualified anesthesia personnel shall be present in the room throughout the conduct of all general anesthetics, regional and monitored anesthesia care

**Standard 2:** Oxygenation, ventilation, circulation, and temperature shall be continually\* evaluated

##### Oxygenation

- Oxygen analyzer for inspired gases
- Observation of the patient
- Pulse oximetry

##### Ventilation

- Auscultation
- Observation of the patient
- Observation of the reservoir bag
- End-tidal carbon dioxide analysis

##### Circulation

- Continuous electrocardiogram display
- Heart rate and blood pressure recorded every 5 min
- Evaluation of circulation: auscultation of heart sounds, palpation of pulse, pulse plethysmography, pulse oximetry, intraarterial pressure tracing

##### Temperature

- Core temperature and/or skin temperature

\*The term continually means prolonged without interruption while continually means repeated regularly and frequently. Data from Anonymous. Standards for Basic Anesthetic Monitoring. ASA Directory of Members, 2004.

dures is a well-trained anesthesia provider, whose sole responsibility should be monitoring the patient. Although his or her effectiveness may be improved by the application of additional noninvasive monitoring, the presence of sophisticated monitoring in an operating room suite or ancillary facility may not adequately protect patients if the clinician responsible for interpreting the monitors is focused on performing other tasks. Continual observation of the patient's mucosal color, movement of the chest wall, rate and depth of respirations, presence of shivering or diaphoresis, and response to painful stimuli is necessary. In addition to observing the patient, it is critically important to assess the response to verbal or physical stimuli. Spoken responses

TABLE 68-4.

Summary of American Society of Anesthesiologists Fasting Recommendations for Reducing the Risk of Pulmonary Aspiration<sup>12</sup>

Ingested Material	Minimum Fasting Period (h)
Clear liquids <sup>a</sup>	2
Breast milk	4
Infant formula	6
Nonhuman milk	6
Light meals (e.g., toast and clear liquids) <sup>b</sup>	6

<sup>a</sup>Examples of clear liquids include water, fruit juices without pulp, carbonated beverages, clear tea, and black coffee.

<sup>b</sup>A light meal typically consists of toast and clear liquids. Meals that include fried or fatty foods or meat may prolong gastric emptying time. Both the amount and type of foods ingested must be considered when determining an appropriate fasting period.

confirm a lack of general anesthesia as well as adequate ventilation and cerebral perfusion. During procedures in which access to the patient is limited or when patient movement might be hazardous or disruptive, a nonverbal cue such as a handgrip or “thumbs up” can suffice. During major vascular procedures, such as endovascular aortic stenting or carotid endarterectomy, communication with the patient is of paramount importance so that myocardial or cerebral ischemia can be diagnosed quickly. Unexpected patient discomfort, agitation, or loss of verbal responses demands rapid assessment. Although it is enticing to initially regard these patients as oversedated or undersedated, agitation during MAC should be considered to be related to hypoxia, hypercarbia, or major organ hypoperfusion until proven otherwise.

## Oxygenation

In addition to observing the patient for signs of hypoxemia (e.g., cyanosis), the ASA standards<sup>13</sup> and JCAHO standards<sup>6</sup> mandate the use of a quantitative method of assessing oxygenation. Pulse oximetry was introduced in the mid-1980s and was rapidly and universally adopted. It is easy to interpret and allows continuous monitoring of patient oxygenation. Although retrospective closed claims data suggest that pulse oximetry has been a revolutionary advancement in patient monitoring and safety,<sup>5</sup> these data (e.g., “could have been prevented”) are speculative and based on assumptions.<sup>15</sup> Moller et al.<sup>16,17</sup> published what may eventually be the only multiinstitutional, large-scale, prospective, randomized controlled study of the effect of pulse oximetry on the outcome of anesthesia. During the study of 20,802 patients, use of pulse oximetry was associated with a 19-fold increase in the incidence of diagnosed hypoxemia and related events (i.e., hypoventilation, bronchospasm). Patients in the oximetry group also received higher flows of supplemental oxygen. Despite these findings, no significant difference in clinical outcome could be identified.<sup>17</sup> Although no statistical significance was achieved in this study, issues with sample size limitations (beyond the  $P < 0.05$  “proof” of efficacy) and selection bias (90% of patients were ASA I or II) preclude the invalidation of existing standards.<sup>18</sup> Eichhorn<sup>19</sup> emphasizes that the arduous burden of statistical

“proof” ( $P < 0.05$ ) lies in proving whether *any* monitor can prevent the occurrence of extremely rare events. Short of such evidence, it remains prudent to base our practices and standards of care on the synthesis of the best information available. Today, pulse oximetry is so strongly perceived as beneficial that it probably would remain a de facto standard of care, even if all published standards were to remove all references to it.<sup>19</sup>

## Ventilation

ASA standards mandate that clinical signs of the adequacy of ventilation (chest excursion, auscultation of breath sounds) be continually monitored during MAC.<sup>13</sup> In addition to observing the patient, applying a simple precordial stethoscope to the suprasternal notch is a valuable and time-tested technique for continuous detection of airway obstruction, bronchospasm, hypoventilation (or apnea), and arrhythmias. According to Prielipp et al.,<sup>20</sup> the frequency of usage of the precordial stethoscope has fallen from  $\geq 70\%$  in the mid 1980s to as little as 11% (1995 data). The notable trend was that providers were *substituting* (rather than *supplementing*) pulse oximetry and capnography for continuous auscultation via a precordial stethoscope. Although the technique remains noninvasive, inexpensive, and useful, this trend is not likely to spontaneously reverse, as a “detraining” effect upon trainees from their mentors favors the preservation of the status quo.

Under the ASA monitoring standards, monitoring for the presence of exhaled carbon dioxide ( $\text{CO}_2$ ) by capnography or capnometry is optional for MAC/sedation cases. During MAC, it is difficult to quantitatively measure expired  $\text{CO}_2$  because dead space in the atmosphere mixes with the patient's expired gases. However, capnometry is a reliable *qualitative* monitor of respiratory rate and apnea during MAC.<sup>21</sup> Measures of tidal volume or minute ventilation are not obtainable with current techniques. Sampling of  $\text{CO}_2$  can be performed through nasal cannulas for oxygen delivery that have been commercially modified with a port for respiratory gas sampling. Alternatively, the sampling lines from the capnograph can be attached to IV catheters and placed inside nasal oxygen probes or inside a face mask.

It remains important to emphasize that oxygenation and ventilation are separate physiologic processes. Monitoring oxygenation via pulse oximetry is not a substitute for monitoring ventilatory function. There is no ideal  $\text{CO}_2$  monitor for the patient undergoing MAC. Optimal assessment of ventilation should utilize vigilance and observation, a precordial stethoscope, and capnography.

## Circulation

ASA standards dictate that for all anesthetics, an electrocardiogram (ECG) must be continuously displayed throughout the procedure.<sup>13</sup> In addition, blood pressure and heart rate must be measured and recorded at least every 5 minutes. The pulse should be monitored by palpation, oximetry, or auscultation. The selection of additional monitoring (e.g., invasive blood pressure monitoring) should depend upon the cardiovascular status of the patient and the nature of the procedure.

Although the ECG provides valuable information on heart rate and rhythm, the detection of myocardial ischemia (generally via ST-segment changes) depends upon the choice and configuration of leads used for monitoring. When a common three-lead ECG is used, sensitivity is low. In pediatric or young healthy patients, this technique may suffice, as significant ST-segment changes in this population are not likely to represent myocardial ischemia. More commonly, a five-lead ECG with one precordial lead placed at  $V_5$  is used. This convention is based on previous observations in which up to 90% of ischemic episodes occurring during exercise testing and up to 75% of intraoperative ischemic episodes were detected by  $V_5$  alone.<sup>22</sup> Several studies have shown that visual detection of significant ST-segment changes (particularly those of short duration) is extremely poor, ranging from 0–46% of episodes.<sup>23</sup> Even experienced cardiologists, when comparing visual versus computerized analysis of ST-segment analysis on exercise ECGs, demonstrate intraobserver agreement in only 61–85%.<sup>24</sup> These data indicate that a clinician providing MAC anesthesia will fail to diagnose a percentage of myocardial ischemic episodes. Fortunately, modern anesthesia machines incorporate computerized ST-segment analysis. The advent of this technology has increased the accuracy

(when compared with standard Holter recordings) of readings, but there are differences in the proprietary algorithms used by various manufacturers. Leung et al.<sup>25</sup> found the overall average sensitivity and specificity of detection of ischemia to be 74% (range 60–78%) and 73% (range 69–89%), respectively. Anesthesia providers should augment the computerized ST-segment readings with their clinical acumen and risk assessment of the patient's particular likelihood of an ST-segment change representing true ischemia. Additionally, it is vital to realize that the isoelectric and J points are set by computer algorithm, and their accuracy should be manually determined for each individual patient prior to the start of the procedure.

## Temperature

ASA standards state that patient temperature should be monitored “when clinically significant changes in body temperature are intended, anticipated, or suspected.”<sup>13</sup> Hyperthermia is not a major concern under MAC because triggering agents (e.g., volatile anesthetics and succinylcholine) are not used. Hyperthermia occurring under MAC is most likely iatrogenic in origin, as overzealous application of warming blankets and sheets in combination with a small exposed surgical site can make patients unexpectedly warm and uncomfortable. These conditions are easily correctable if they occur.

A common misperception exists regarding the relationship between MAC or neuraxial anesthesia and hypothermia. Although most clinicians believe that patients can verbalize subjective feelings of coldness, neuraxial anesthesia impairs behavioral thermoregulation and central autonomic thermoregulatory control.<sup>26</sup> Thus, patients cannot always accurately perceive hypothermia. Decreased core temperatures during anesthesia in patients given sedatives preoperatively have been demonstrated, and there is evidence that propofol,<sup>27,28</sup> midazolam,<sup>29,30</sup> and opioids<sup>31,32</sup> reduce vasoconstriction and shivering thresholds when used at doses consistent with MAC anesthesia.

Studies on temperature monitoring and MAC are lacking, but a survey by Frank et al.<sup>33</sup> found that only one third of patients were monitored during neuraxial anesthesia. An ancillary finding was that <15% of those surveyed used core temperature monitoring

techniques and instead relied upon skin-surface temperatures [typically 36–39°F (2–4°C) less than the core temperature]. Although manufacturers compensate for this difference by adjusting the offset to the displayed reading, the monitors are inept at both fever screening and malignant hyperthermia detection.<sup>34</sup> Arkilic et al.<sup>35</sup> conducted an observational study on temperature monitoring and neuraxial anesthesia and found that initial postoperative tympanic membrane temperatures in patients having neuraxial anesthesia were <97°F (<36°C) in 77% of patients and <95°F (<35°C) in 22% of patients. Body temperature was monitored intraoperatively in only 27% of patients, and no correlation between the magnitude or duration of surgery and initial postoperative temperatures was observed.

Even mild intraoperative hypothermia [<95°F (35°C)] has been associated with myocardial ischemia and cardiac morbidity in high-risk patients. In addition, hypothermia increases postoperative wound infection and bleeding risk.<sup>36</sup> The morbidity associated with perioperative hypothermia likely is independent of anesthetic technique (e.g., general vs MAC). In most patients, redistribution of heat from the core to the periphery is the major source of intraoperative hypothermia. Cold procedure or operating room suites and unwarmed IV fluids compound the heat loss. Measures to prevent hypothermia should include forced air heaters, radiant heat lamps, fluid warmers, and increasing the ambient temperature where feasible. Because hypothermia appears to be common and unpredictable in patients undergoing MAC, most, if not all, patients should have temperature monitoring. Most measures of core temperature are inconvenient (e.g., pulmonary artery, esophageal) and impractical during MAC cases. Forehead skin surface temperature remains the most common modality despite its limitations. Sessler<sup>34</sup> recommends axillary or intermittent oral temperature readings.

## Monitoring Depth of Sedation during MAC

Accurate assessment of sedation depth is important in minimizing the risks of MAC and procedural sedation both inside and outside the operating room. Many patients, particularly the elderly or very ill, may rapidly move from a

plane of light sedation to obtundity. Practitioners should have the means to effectively monitor depth of sedation. Clinicians traditionally have relied upon subjective and imprecise measures or autonomic signs of patient responsiveness to judge depth of sedation and analgesia. Unfortunately, this approach has flaws. Because the direct effect of sedatives and hypnotics on the brain cannot be measured, clinicians usually rely on indirect measures of the level of sedation, such as frequent patient stimulation [e.g., Observer's Assessment of Alertness/Sedation Scale (OAA/S), Box 68–2] to measure the depth of sedation. These techniques require persistent patient cooperation and are subject to testing fatigue. Additionally, there are procedures and cases (e.g., MRI) during which periodical patient movement and speech might preclude the successful completion of the procedure. Changes in autonomic signs (e.g., hypertension and tachycardia) do not reliably predict awareness and discomfort during general anesthesia,<sup>37–39</sup> and, for reasons previously stated, would not be helpful even if they accurately preceded patient anxiety or movement.

An objective measure of sedation depth theoretically could decrease the incidence of patient undersedation and oversedation, decrease anesthetic wastage, and shorten recovery and discharge times. Because the brain is the target of anesthetic action, and electrical activity of the cerebral cortex can be measured via the electroencephalogram (EEG), most depth-of-anesthesia monitors have focused on measuring changes in the EEG. The Bispectral Index Scale (BIS) was the first clinically available depth-of-anesthesia monitoring device. BIS is a proprietary algorithm (Aspect Medical Systems, Natick, MA) that generates a linear dimensionless number ranging from 0–100 that decreases in proportion to increased anesthetic depth. The BIS does not correlate with movement, heart rate, or blood pressure. Although BIS has been used more commonly during general anesthesia, it has been evaluated during depth of sedation with propofol,<sup>40,41</sup> midazolam,<sup>39,42</sup> and even sevoflurane.<sup>43</sup> During propofol-induced sedation, BIS was shown to correlate with OAA/S scores,<sup>41,42</sup> loss of response to verbal commands,<sup>40</sup> suppression of learning,<sup>44</sup> and propofol blood concentrations.<sup>44</sup> Gan et al.<sup>45</sup>

## BOX 68–2.

## Observer's Assessment of Alertness/Sedation Scale

Assessment Categories				Composite Score Level
Responsiveness	Speech	Facial Expression	Eyes	
Responds readily to name spoken in normal tone	Normal	Normal	Clear, no ptosis	5
Lethargic response to name spoken in normal tone	Mild slowing or thickening	Mild relaxation	Glazed or mild ptosis (less than half the eye)	4
Responds only after name is called loudly and/or repeatedly	Slurring or prominent slowing	Marked relaxation	Glazed and marked ptosis (half the eye or more)	3
Responds only after mild prodding or shaking	Few recognizable words			2
Does not respond to mild prodding or shaking				1

demonstrated faster recovery times and decreased propofol usage with the addition of the BIS monitor, although formal cost-effectiveness studies during MAC or regional anesthesia have not been done. BIS monitoring accurately and objectively measures patient sedation level during endoscopy<sup>46</sup> and during procedural sedation in the emergency room.<sup>47</sup>

In contrast to the expected BIS readings for patients undergoing general anesthesia (BIS values 40–60), BIS readings of 60–80 are targeted during MAC; BIS values approaching 60 are associated with a low probability of recall.<sup>40,42,48</sup> Recall is impaired at much higher BIS values than is response to command.<sup>49</sup> It is important to realize that BIS measurements are slightly dependent upon the type of anesthetic agents used. Several authors have shown higher BIS values for loss of consciousness when opioids were added to an anesthetic.<sup>43,49,50</sup> This phenomenon, which extends to other agents (e.g., ketamine, nitrous oxide), exists because noncortical structures underrepresented in the EEG contribute to the mechanism of hypnosis and sedation with opioids.<sup>51</sup> Another drug, ketamine, can cause loss of response to verbal command in doses as low as 0.25 mg/kg without altering BIS measurements.<sup>52</sup> It also has been suggested that spinal and epidural anesthesia may affect BIS measurements independent of other anesthetics.<sup>53,54</sup> Morley et al.<sup>53</sup> demonstrated a small but detectable EEG suppression in patients receiving spinal anesthesia without concomitant IV sedation. The mechanism appears to be related to de-

creased afferent stimulation of the reticular activating system and is independent of block height.

A priori we believe there is a selective subset of patients undergoing MAC in whom BIS monitoring is a valuable *adjunctive* clinical monitor to standard clinical evaluation. As previously implied, BIS monitoring would be particularly beneficial during procedures in which patients should not move or speak, procedures of prolonged duration, or those involving patients of advanced age or ill health. Whenever possible, patients should be monitored via behavioral methods (e.g., continual assessment of response to commands) in addition to BIS. Because both the general public and many nonanesthesiologists have difficulty distinguishing between deep levels of sedation and general anesthesia, it is advisable to discuss patient concerns about “awareness” or “being awake” during the patient's preanesthetic assessment and interview. Patients insisting on guaranteed amnesia and hypnosis for procedures under MAC should be offered general anesthesia if feasible.

### PRINCIPLES OF PHARMACOKINETICS AND PHARMACODYNAMICS APPLIED TO MAC

The concentration of drug achieved in a patient is dependent upon the dose administered and the disposition of the drug in the body. The process that describes this disposition is called the drug's *pharmacokinetics*. This dose-con-

centration relationship, although important, must be considered in conjunction with the response that a drug elicits at a given dose. This relationship between concentration and response is referred to as *pharmacodynamics*. A full discussion of these principles lies elsewhere in this volume (see Chap. 39). Anesthesiologists must be familiar with the principles of both pharmacokinetics and pharmacodynamics in order to effectively and safely sedate patients during MAC. During MAC, the therapeutic window for many drugs is smaller than that for drugs used during general anesthesia. For example, the intubating dose of muscle relaxants used during general anesthesia typically is 2–3 times the ED<sub>95</sub> median effective dose. One dose fits most people in these instances. However, if this principle were applied to sedation under MAC, the risk of overdose and the accompanying complications of loss of the airway and hypoxia would be unacceptable. Closed claims data discussed earlier in this chapter (see Safety) prove that complications during MAC can arise from excessive or inadequate sedation. Variability in population pharmacokinetics and pharmacodynamics is only one cause of misuse of drugs. Failure to understand and apply these basic principles to MAC is another factor, and it will be useful to review some concepts here.

### Pharmacokinetic Applications

#### Plasma Concentration and Drug Distribution

During MAC, clinicians typically are called upon to administer potent IV drugs in response to changing patient

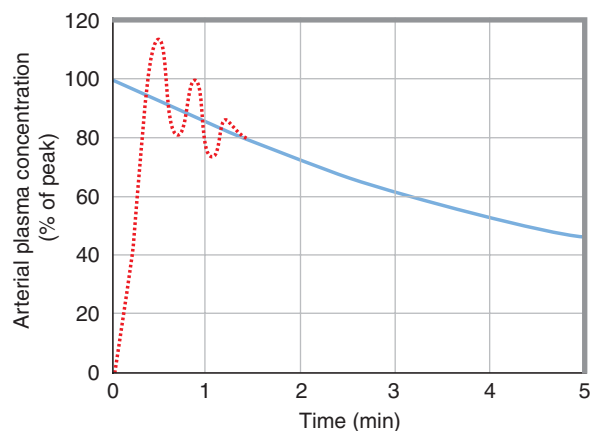


and surgical needs. IV drugs can be administered via a bolus or via infusion, and typically the therapeutic window for drugs is much smaller than that during general anesthesia. It is dangerously simplistic to consider only the amount of drug administered or only the infusion rate when considering the effect on a patient.

An important consideration after the initial bolus of a drug is that there is no homogenous plasma compartment into which a drug equilibrates. As shown in Fig. 68–2, traditional studies assumed that the arterial plasma concentration of a drug decreased monotonically from a peak plasma level (solid line). Studies have indicated not only that arteriovenous differences in peak plasma levels are achieved,<sup>55,56</sup> but that plasma levels oscillate during the first 2 minutes of administration.<sup>57,58</sup>

The distribution phase shows a rapid decline in the plasma concentration. This reflects the fact that drug dosing in man can be estimated by (and therefore based upon) complicated pharmacokinetic modeling. Although it is easier to consider dosing based upon a one-compartment or “bathtub” analogy, virtually none of the drugs used in anesthesia can be described by a one-compartment model.<sup>59</sup> Hence, the relationship between plasma level and half-life, clearance, and elimination becomes more complicated. Extrapolating the abscissa of Fig. 68–2 over a period of hours typically would yield a graph with differing slopes, as indicated in Fig. 68–3. The distribution phase reflects both the rapid movement of the drug from the blood to the vessel-rich tissues and a slower equilibrating compartment composed of less well-perfused tissues, such as muscle and skin. Although the latter compartment is poorly perfused, significant drug accumulation can occur during long infusions, and this compartment can release drug back into the central compartment after administration ceases. This can prolong recovery and change the elimination kinetics of the drug. The elimination phase after a bolus injection is represented by the straight line, and, when drawn on a log scale, the slope or rate is independent of dose.

It should be noted that the “compartments” discussed are not anatomic nor physiologic entities; they are a mathematical concept derived from pharma-



**FIGURE 68–2.** After bolus drug administration, arterial plasma concentrations were traditionally assumed to decrease monotonically (solid line). However, recent studies demonstrate that plasma concentrations may increase during the initial 30–60 seconds, then oscillate (dashed line) before decreasing monotonically.<sup>57</sup>

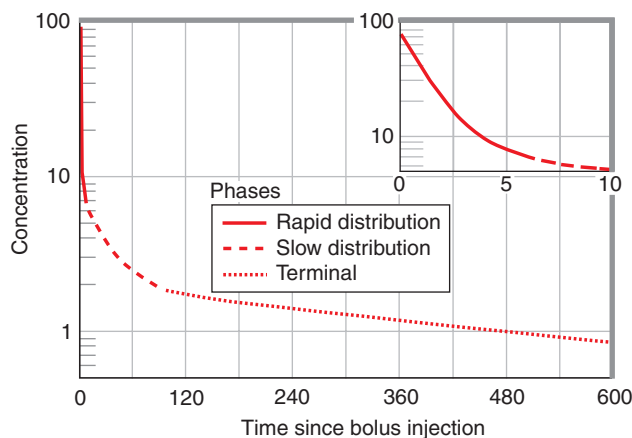
cokinetic models, which in turn describe drug concentrations over time. A sample three-compartment hydraulic model is shown in Fig. 68–4.<sup>60</sup> Note the different transfer constants or “clearances” among the different compartments.

### Effect-Site Concentration

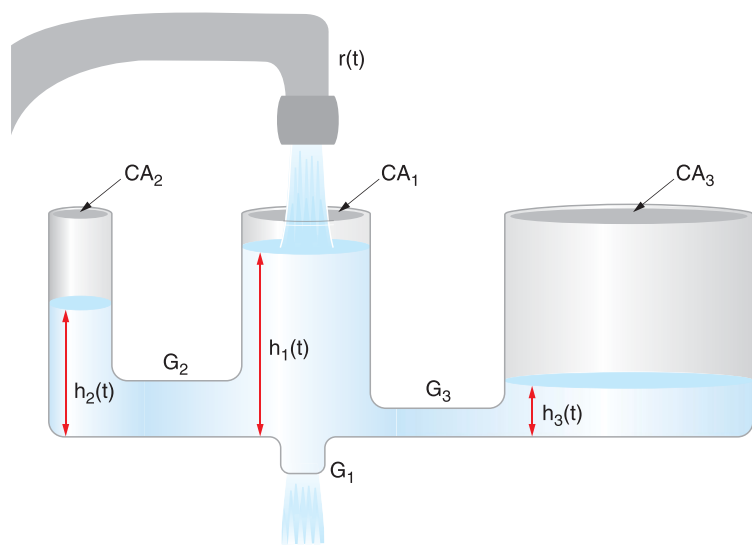
For IV anesthetics, the plasma is not the site of action. The effect site or biophase is the site of drug activity. The anatomic site of a drug’s biophase may be difficult to identify; even if the biophase is known, the concentration of drug can never be directly measured physically. Despite this limitation, it is important to consider the delay or hys-

teresis between the peak in plasma concentration and effect-site concentration. By continuously measuring the effect of a drug (e.g., EEG analysis, patient response) and its plasma concentration, it is possible to mathematically compute  $k_{e0}$ , the rate of equilibration of the drug concentration between the biophase and the plasma. The  $t_{1/2} k_{e0}$  is the time needed for half the equilibration to occur between the biophase and the plasma concentration. The  $t_{1/2} k_{e0}$  of some common IV anesthetics are listed in Table 68–5.<sup>61</sup>

The clinical relevance of these data can be seen by using propofol as an example. If a desired effect-site concentration of 4  $\mu\text{g}/\text{mL}$  is desired, an



**FIGURE 68–3.** Three phases of drug distribution following an intravenous bolus. The rapid distribution phase (solid line) begins immediately after a bolus injection and is characterized by movement of drug from plasma to rapidly equilibrating tissues. The slow distribution phase (dashed line) is bidirectional; drug moves into slower-equilibrating tissues and returns from rapidly equilibrating tissues. During the terminal phase (dotted line), drug returns to the plasma from both compartments and is eliminated such that the relative proportion of drug in plasma and peripheral volumes remains constant.



**FIGURE 68-4.** Hydraulic model analogy to three-compartment pharmacokinetic model. Water enters bucket 1 at the rate of  $r(t)$  and leaks irreversibly through  $G_1$ . The height of the water level in each bucket is dependent on  $r(t)$ , the differing cylindrical areas ( $CA_{1-3}$ ), and the relative conductance levels  $G_{1-3}$ .<sup>60</sup>

infusion started in order to obtain a plasma concentration of  $4 \mu\text{g}/\text{mL}$  would achieve an effect-site concentration of  $2 \mu\text{g}/\text{mL}$  after 2.4 minutes, and four distribution time constants or almost 10 minutes would be required to achieve an effect-site concentration of  $4 \mu\text{g}/\text{mL}$ . This dosing scheme is infeasible during MAC cases during which frequent and significant changes in effect-site concentrations are desired. In practical terms, this implies that one either administers a bolus prior to beginning the infusion or starts with a high infusion rate (decreasing the rate with time in order to maintain stable plasma levels). Clinicians must be knowledgeable of the time to peak effect for any drug that will be administered. Additionally, when giving IV drugs by intermittent bolus dosing, the interval between

doses needs to be of sufficient duration such that the peak effect after one dose can be observed prior to redosing. Clinically, an example of this would be to compare remifentanyl and fentanyl. Remifentanyl, which has a much shorter  $t_{1/2} k_{e0}$  than fentanyl, will have a more rapid onset to peak effect and therefore can be given as an intermittently bolus at shorter intervals. Bolus administration of fentanyl in a similar fashion would be hazardous during MAC because the effect-site concentration would peak only after multiple doses had been given, increasing the likelihood of apnea or hypoventilation. Finally, it is important to consider the time to peak effect of each drug given in a combination, given that most of the drugs in Table 68-5 act in an additive or synergistic interaction.

**TABLE 68-5.**

$t_{1/2} k_{e0}$ , Time to Peak Effect Following Bolus Dose, and Volume of Distribution ( $V_d$ ) Incorporating the Effect Compartment.<sup>61</sup>

Drug	Time to Peak Effect (min)	$t_{1/2} k_{e0}$ (min)	$V_d$ (L) incorporating the effect compartment
Dentanyl	3.6	4.7	75
Alfentanil	1.4	0.9	5.9
Sufentanil	5.6	3	89
Remifentanyl	1.2	1	
Propofol	2.2	2.4	37
Thiopentone	1.7	1.5	
Midazolam	2.8	4	
Eomidate	2	1.5	

## Drug Elimination

The elimination half-time, or the time required for a drug to reach half of its initial concentration (after a bolus or termination of an infusion), used to be the predominant measure of a drug's duration of action. It was thought that dosing intervals and time to reach steady-state concentrations could be predicted from such a value. However, it is relevant only in single-compartment models or during prolonged infusions in which a steady state is reached (which almost never occurs during the course of an anesthetic). Because most drugs are lipophilic and follow a multi-compartmental model of distribution and elimination, the elimination of a drug is only one contributor to changing plasma levels; intercompartmental changes frequently are significant as well. The contribution of these compartments depends upon the duration of the infusion (discussed below under Context-Sensitive Half-Time).

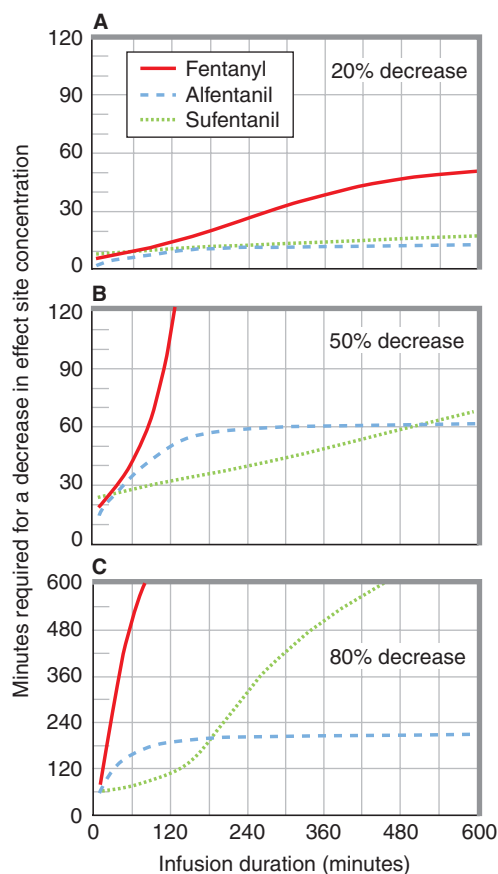
## Context-Sensitive Half-Time

In 1990, Shafer and Varvel<sup>62</sup> were the first to publish comparative simulations of the pharmacokinetics of three synthetic opioids (alfentanil, fentanyl, and sufentanil). They found that the times required for various decrements in plasma concentration (20%, 50%, and 80%) after discontinuation of drug infusions were dependent upon the duration of administration. They also demonstrated that these decrement times could not be predicted from elimination half-life parameters. The clinical relevance of this can be ascertained from Fig. 68-5.

Although fentanyl has a shorter elimination half-life than sufentanil (475 vs 562 minutes), its 50% decrement time is much greater than that for sufentanil if the infusion duration is  $>2$  hours. Note also from Fig. 68-5 that the decrement times are not linear (50% or 80% decrement time cannot be predicted based upon drug's 20% decrement time).

Following the work of Shafer and Varvel, the term *context-sensitive half-time* was introduced by Hughes et al.<sup>60</sup> in 1992. The context-sensitive half-time is the time required for the plasma concentration of a drug to decrease by 50% after discontinuing a drug infusion. The term is synonymous with the 50% decrement time (Fig. 68-6).

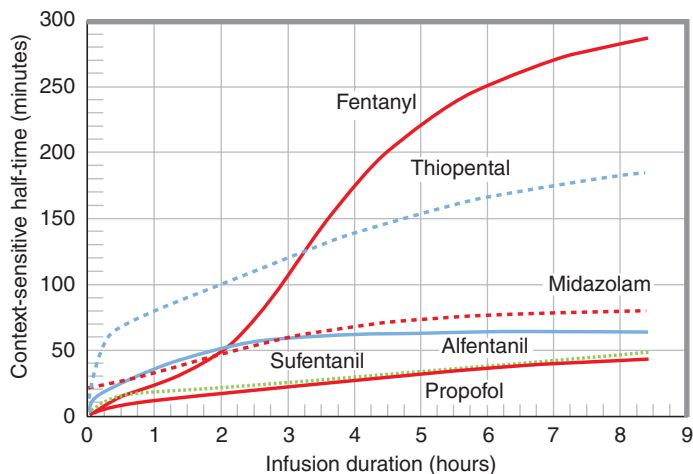
The context-sensitive half-time (or any decrement time) is not specifically



**FIGURE 68-5.** Overlay of the fentanyl, alfentanil, and sufentanil recovery curves showing the time required for decreases of 20%, 50%, and 80% from the maintained intraoperative effect-site concentration after termination of infusion.<sup>62</sup>

identified with any clinical recovery end point. Thus, although sufentanil has the shortest 50% decrement time after an 8-hour infusion, alfentanil has a much shorter 80% decrement time at the same duration of infusion, and this may be associated with a faster recovery time. This has been suggested by

Shafer and Varvel<sup>62</sup> and Youngs and Shafer.<sup>63</sup> Schraag et al.<sup>64</sup> compared two groups of patients (alfentanil/propofol and sufentanil/propofol) and noted no difference in mean extubating times but shorter times to discharge recovery criteria in the alfentanil group after discontinuation of the infusions. The



**FIGURE 68-6.** Context-sensitive half-times as a function of infusion duration for various intravenous anesthetics. Curves are based on simulated pharmacokinetic models. Solid and dashed lines are used only to distinguish overlapping curves.<sup>60</sup>

relative decrement values to tracheal extubation were 62% for sufentanil and 48% for alfentanil, compared with 76% and 65% for discharge, respectively. These findings demonstrate that decrement times and their clinical correlates are drug specific. They also bring into question the effect of compounding numerous drugs, as is performed during most anesthetics.

### Pharmacokinetic Concerns in the Obese Patient

Obesity is a common, major health problem throughout the developed world. The prevalence of obesity in middle-aged adults in the United States approaches 25%,<sup>65</sup> and anesthesiologists frequently encounter these patients. The physiologic changes induced by obesity can have marked effects on the distribution and elimination of anesthetics, and adverse events can occur if dosing is based on actual body weight. This is particularly important during MAC cases because concomitant sleep apnea is common in obese patients. Despite these circumstances, studies on which anesthesiologists rely upon to guide drug dosing frequently describe the drug's pharmacokinetics in healthy, nonobese patients.

### Scaling Drug Dosages to Lean Body Mass

One strategy for attenuating the risk of drug overdose in the obese patient is to scale the drug dosage to lean body mass (LBM) instead of total body weight (TBW). Scaling drugs for LBM has been recommended for thiopental and methohexital,<sup>66,67</sup> remifentanyl,<sup>68</sup> and propofol.<sup>58,69</sup>

LBM can be calculated as follows<sup>70</sup>:

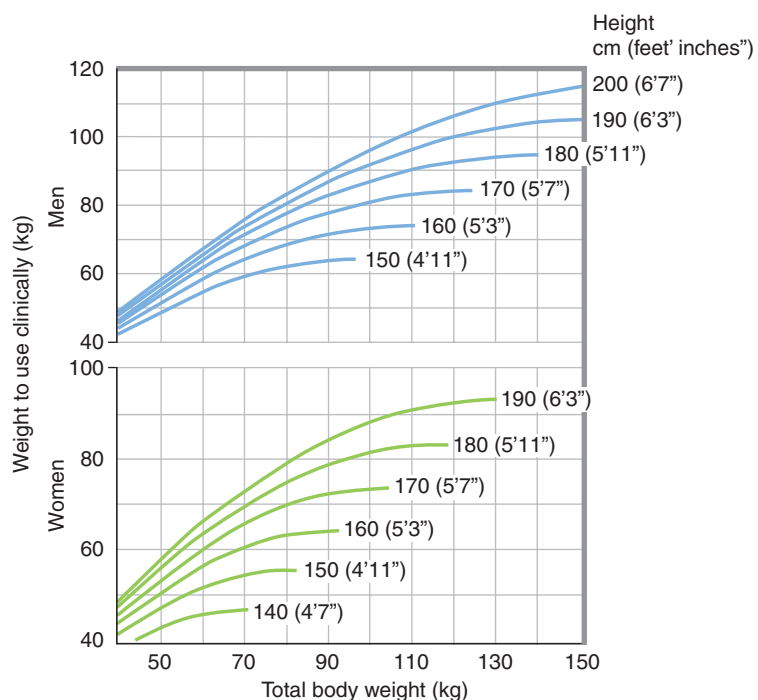
$$\text{Men: LBM (kg)} = 1.1 * \text{TBW (kg)} - 120 * [\text{TBW/height (cm)}]^2$$

$$\text{Women: LBM (kg)} = 1.07 * \text{TBW (kg)} - 148 * [\text{TBW/height (cm)}]^2$$

These formulas not only are complex but also fallacious; in cases where TBW significantly exceeds ideal body weight, TBW increasingly overestimates LBM.<sup>66</sup> Bouillon and Shafer<sup>66</sup> have provided a scaled nomogram (Fig. 68-7) that adjusts for both LBM and the fact that recommended doses in package inserts are scaled to TBW.

### “Pharmacokinetic Mass”

A second method that can assist the clinician with adjusting drug doses in



**FIGURE 68-7.** Scaled nomogram relating total body weight, height, and gender to the body weight that should be used to calculate drug dosages in the obese patient. The clinical weights on the ordinate are calculated from lean body mass and then scaled upward to compensate for the fact that recommended drug doses are similarly scaled to total body weight rather than lean body mass.<sup>66</sup>

the obese patient is use of the concept of “pharmacokinetic mass.” Shibutani et al.<sup>71</sup> used this concept to quantify adjustments in fentanyl dosing for obese patients. The pharmacokinetic mass is an appropriate dosing weight derived from TBW and a quantified departure from linearity.<sup>71</sup> It can be seen from Fig. 68-8 that the slope linking TBW and pharmacokinetic mass becomes significantly flatter with increases in TBW; thus, the pharmacokinetic mass may be a particularly helpful concept to consider in the morbidly obese patient. However, the concept was tested for fentanyl exclusively; similar studies on other anesthetics may be forthcoming.

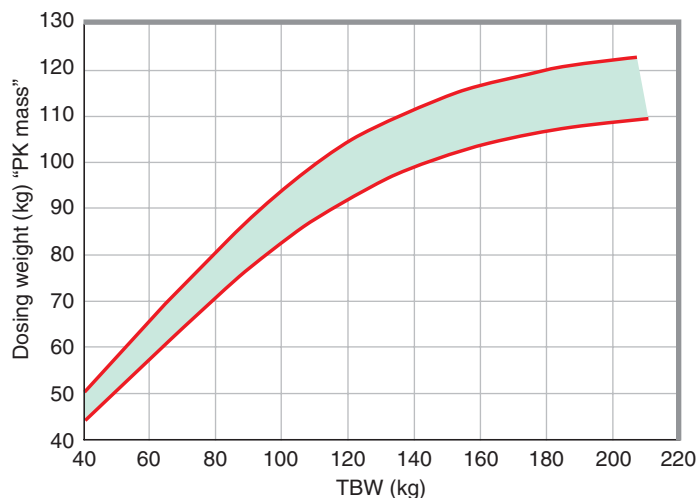
## Drug Interactions and Pharmacodynamic Applications

### Principles of Drug Interactions

Anesthesia for MAC frequently involves the concomitant administration of multiple drugs. Interactions between these agents can have a pharmacokinetic or pharmacodynamic basis. Despite similar mechanisms of clearance for many anesthetics, pharmacokinetic interactions usually are minor and incidental. In contrast, pharmacodynamic drug interactions often are

introduced by design when incorporating multidrug regimens for MAC. Synergistic interactions, produced when two drugs with differing mechanisms of action produce a common effect,<sup>72</sup> can be advantageous because the goals of the anesthetic can be achieved with decreased drug dosages, less toxicity, and faster recovery than when the individual drugs are used alone.

Published evidence demonstrates synergism between benzodiazepines and barbiturates,<sup>73,74</sup> propofol,<sup>75</sup> and opioids.<sup>75,76</sup> Propofol has been shown to act synergistically with opioids.<sup>77,78</sup> It is a gross oversimplification to consider the aforementioned relationships (i.e., synergism) out of context. The clinical end point (amnesia, analgesia, apnea) must be considered, as MAC end points differ from those of general anesthesia. The interaction between two or more drugs can potentially be multidimensional and complex. The interaction also can depend upon the fractions of drugs administered and may not be predictable from the behavior of the individual drugs when used alone. Smith et al.<sup>77</sup> examined the addition of fentanyl to a propofol infusion and the subsequent required change in propofol concentration for loss of consciousness and lack of response to skin incision. They found that with the addition of fentanyl 3 ng/mL, the propofol ED<sub>50</sub> median effective dose required to inhibit response to verbal command and incision was reduced 40% and 90%, respectively. There was considerable patient-to-patient variation in propofol dose requirements (for both end points), and a ceiling effect was seen at this concentration of fentanyl. Short et al.<sup>75</sup> proposed that when drug combinations are used, “the combination should be regarded as a new drug with individual properties, rather than merely reflecting the known properties of the individual agents.” An example of this phe-



**FIGURE 68-8.** Nomogram relating appropriate dosing weight or “pharmacokinetic mass” to total body weight for fentanyl. Slope of curve is based upon nonlinear regression analysis of two established pharmacokinetic models (solid lines) and actual arterial blood gas samples in both lean and obese patients.<sup>71</sup>



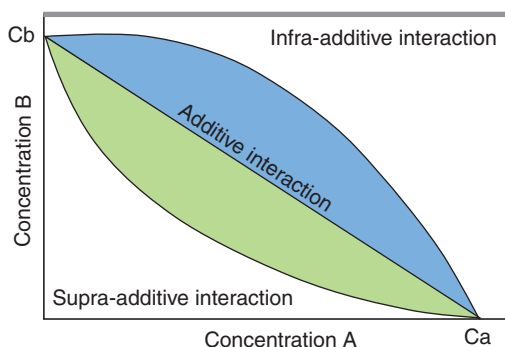
nomenon can be seen with combined sedation using midazolam and fentanyl. Bailey et al.<sup>76</sup> examined the effects of midazolam and fentanyl upon respiration in healthy volunteers. Whereas midazolam alone produced no significant respiratory effects, fentanyl alone produced hypoxemia (oxygen saturation < 90%) in 50% of volunteers. The combination of midazolam 0.05 mg/kg and fentanyl 2.0 µg/kg resulted in hypoxemia in 11 of 12 subjects and apnea in 6 of 12 subjects. The clinical implications of this study are bolstered by the fact that the study examined only healthy volunteers. Elderly patients, patients with preexisting respiratory disease, and patients with obstructive sleep apnea are at greater risk, particularly during MAC anesthesia.

What tools can aid the clinician in elucidating complex pharmacodynamic interactions between anesthetic agents?

### Isobolograms

The isobologram provides a convenient graphic display of the respective doses of two drug doses by using rectangular coordinates (a, b) to represent equieffective pairs of doses (isoboles) of drugs A and B, respectively.<sup>79</sup> If two equieffective combinations lie on a straight line, the interaction is additive. Any individual point or combination (a, b) below this line, or a concave-up shaped isobole (Fig. 68–9), represents a synergistic (supra-additive) interaction, as smaller amounts of both drugs are needed to produce the combined drug effect. Conversely, individual points above the line or a concave-down isobole are characteristic of an infra-additive interaction.

The isobologram, although visually appealing, is of limited utility with regard to complex anesthetic interactions. First, it lacks a means for assessing statistical significance. The points of an isobole are pairs of numbers presumably obtained from experimental testing; these are subject to both random and systematic errors.<sup>79</sup> These inherent errors in the dose–effect data are present for both drugs (i.e., both axes). In addition, it is possible that experiments using different fixed-ratio mixtures demonstrate datapoints both above and below the line of additivity. Extrapolating these data to an isobologram requires regression analysis of data from each drug and the mixture. In other words, it is nearly impossible to design an experiment such that each combination point on the isobologram (e.g., ED<sub>50</sub>, ED<sub>80</sub>) would be



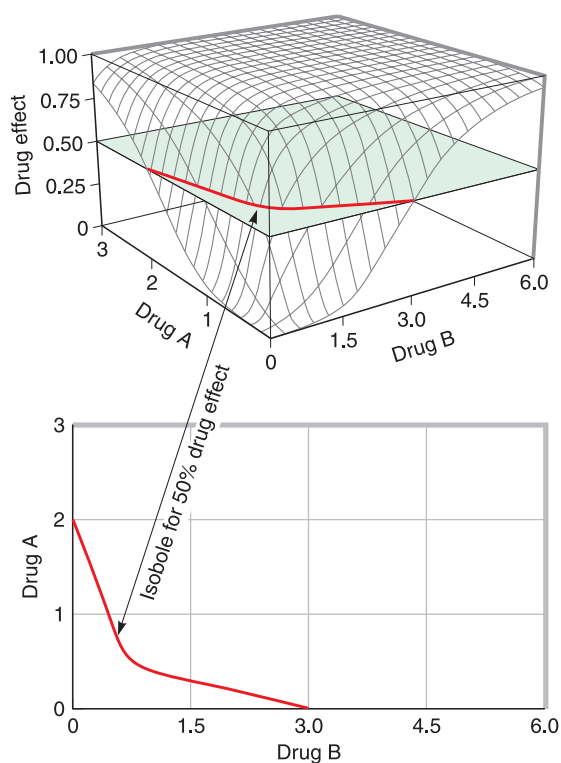
**FIGURE 68–9.** Isobolographic diagram with the x- and y-axes showing the concentrations of the compounds studied (A and B) and the lines of additivity, infra-additivity, and supra-additivity (synergy). The lines connect concentration combinations of the two drugs that exert a similar effect. Reprinted from, Vuylk J. Pharmacokinetic and pharmacodynamic interactions between opioids and propofol. *J Clin Anesth* 1997;9:23S–26S, with permission from Elsevier.

individually investigated. Regression analysis bridges this gap, but the technique is beset with flaws.<sup>72,80</sup> Because drug combinations can be synergistic in certain areas and antagonistic in others, it is more useful to characterize the entire surface response.

### Response Surface Methodology

Response surface methodology involves three-dimensional plotting of the doses of two drugs (independent variables) and the effect that results from the combination (dependent variable).

The response surface is the graph of the mathematical equation that characterizes the full concentration–response relationship between two drugs. In addition to describing the complex interaction, response surface analysis can assist the clinician in determining where the optimum response occurs. An example of the relationship between a three-dimensional response surface and the conventional two-dimensional isobologram is shown in Fig. 68–10. As illustrated, the isobologram is only a single “slice” at the 50%



**FIGURE 68–10.** Relationship between the response surface and an isobologram. The two-dimensional isobologram is generated from a single slice through the three-dimensional surface, generally taken at the 50% response level. Isobolographic analysis fails to capture the full complex surface shape and hence the entire spectrum of interactivity between the two drugs.<sup>80</sup>

response level through the entire complex drug interaction “surface.”<sup>80,81</sup>

Because most clinicians will never perform computer simulations to produce response surfaces, what is the importance of such a graphic depiction? Fig. 68–11 illustrates an experiment by Vuyk et al.<sup>82</sup> in which alfentanil and propofol were administered during general anesthesia for lower abdominal surgery. It can be seen from Fig. 68–11 that the shortest recovery time for patients occurred at infusion concentrations of propofol 3.5  $\mu\text{g}/\text{mL}$  and alfentanil 85  $\text{ng}/\text{mL}$ .<sup>83</sup> Interaction models such as these can be used to develop optimal dosing guidelines and can allow the clinician to administer IV anesthetics more rationally.

## SEDATION TECHNIQUES AND DRUG DELIVERY SYSTEMS

### Bolus Administration

MAC increasingly is involving the use of IV sedatives and evolving tech-

niques for administration. This trend has been driven by the introduction of anesthetic drugs that can be rapidly titrated (e.g., propofol) and by technologically advanced delivery systems that approach the ease and reliability of an agent-specific vaporizer for inhaled anesthetics. The goals of any technique are patient comfort with or without amnesia, improved operative conditions, rapid recovery, and minimal side effects from drug overdose. MAC is provided by an anesthesiologist and the range of sedation and complexity of techniques can be greatly expanded compared to care provided by a nonanesthesiologist during sedation outside the operating room suite. Nonetheless, studies involving minimally invasive procedures such as colonoscopy and dental treatments have examined the role of patient-controlled sedation (PCS) techniques. These techniques are inherently limited by feedback loops that should stop drug administration should patients become oversedated.<sup>84</sup> Despite this

safety measure, Campbell et al.<sup>85</sup> found 7 of 20 colonoscopy patients attempting PCS were either under-sedated or oversedated. Imperfections in PCS are due to variances in both population pharmacokinetics of drugs and the fact that the technique considers only pharmacokinetics and not pharmacodynamics.

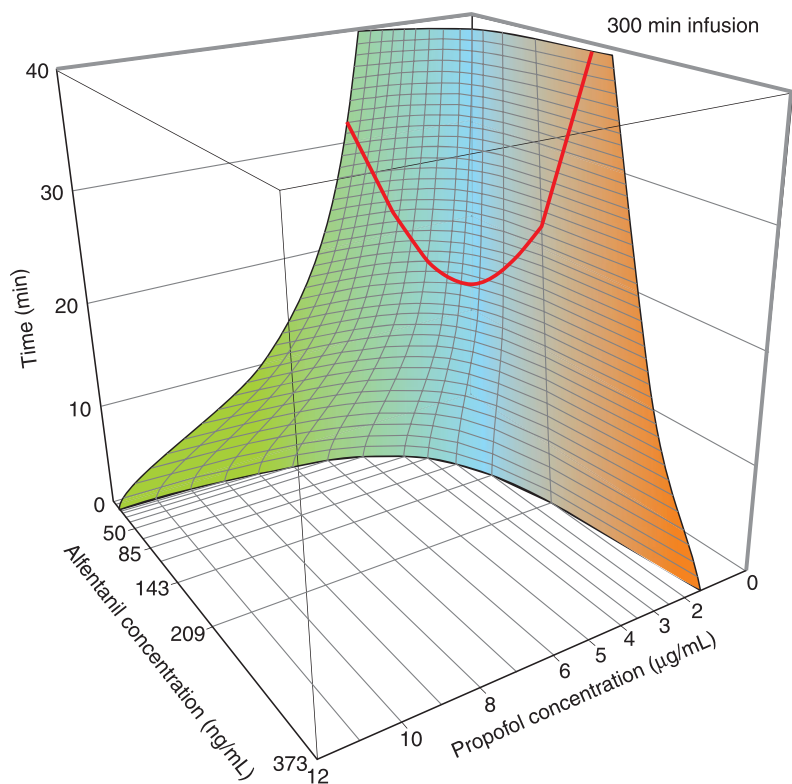
### Continuous Infusions

Classically, IV anesthetics have been administered as a large bolus or by multiple intermittent doses during a procedure. However, clinical studies have demonstrated that IV anesthetics given by variable-rate continuous infusion provide certain advantages over intermittent bolus techniques. They include (1) improved cardiopulmonary stability, (2) more predictable plasma drug concentrations, (3) reduced need for supplemental anesthetics or vasoactive drugs, (4) faster recovery times, and (5) lower total drug doses used.<sup>61,86</sup> The differences in achieving a therapeutic concentration between single or multiple bolus doses and a variable rate continuous infusion are illustrated in Fig. 68–12.

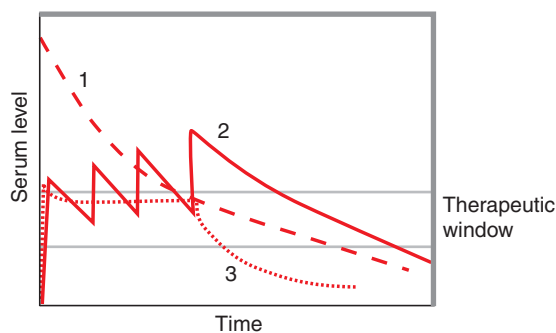
### Target-Controlled Infusions

In 1983, Schuttler et al.<sup>87</sup> used a computer-assisted infusion system to administer a constant plasma concentration of alfentanil and etomidate for surgical anesthesia. At the time the concept was novel, because drugs usually were dosed at a constant infusion rate irrespective of expected changes in plasma concentrations over time. Many research groups have since developed their own systems for a variety of anesthetics, and a commercial system for propofol is available outside of the United States (Diprifusor; AstraZeneca, United Kingdom). By delivering a target concentration of drug rather than a target infusion rate, these target-controlled infusion (TCI) systems can effectively and rapidly achieve, maintain, and adapt plasma concentrations of drugs to changing patient and surgical needs.

A TCI device is a computerized infusion pump. As illustrated in Fig. 68–13, the selected drug is administered according to its known therapeutic window, the patient response, and the predicted (via computer modeling) drug concentration. The computer is programmed with a pharmacokinetic model as well as pharmacokinetic data.



**FIGURE 68–11.** Computer simulation of the decay in blood propofol and alfentanil concentrations during the first 40 minutes after termination of 300-minute propofol and alfentanil target-controlled infusions of the two drugs to levels associated with a 50% probability of no response to surgical stimuli. Bold line represents the blood propofol and plasma alfentanil concentrations at which 50% of patients regain consciousness postoperatively. The time interval between termination of infusion and regaining of consciousness is shortest after a 300-minute infusion of propofol and alfentanil at concentrations of 3.5  $\mu\text{g}/\text{mL}$  and 85  $\text{ng}/\text{mL}$ , respectively. Reprinted from, Vuyk J. Pharmacokinetic and pharmacodynamic interactions between opioids and propofol. *J Clin Anesth* 1997;9:23S–26S, with permission from Elsevier.

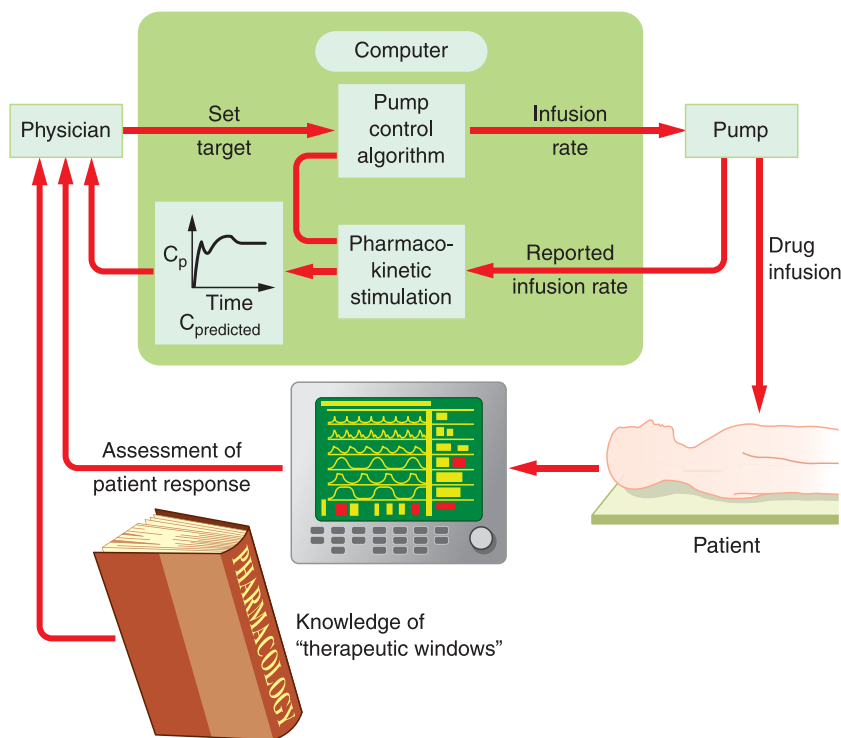


**FIGURE 68-12.** Resultant serum or blood concentration following intravenous drug administration by a large single bolus (1), repeat bolus injections (2), or variable-rate continuous infusion (3).<sup>61</sup>

The computer automatically controls the infusion pump in order to maintain the target plasma concentration. Target concentrations can be increased or decreased over time based on clinical need.<sup>88</sup>

Pharmacokinetic data used in TCI systems have generally been derived from the literature, and the effectiveness and accuracy of TCI systems are dependent upon such data. Often these pharmacokinetic parameters are derived from small sample sizes of

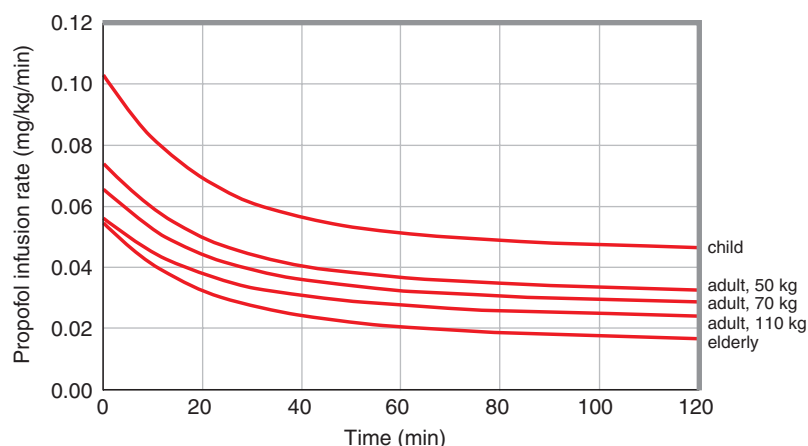
healthy individuals.<sup>89</sup> Larger population studies have been performed. One such study by Schuttler and Ihmsen<sup>56</sup> examined the effects of age and weight on the pharmacokinetics of propofol. They noted that inclusion of age and weight as covariates into the TCI system improved the predictability of the model. As graphically depicted in Fig. 68-14, with propofol used as an example, infusion rates required to maintain steady-state conditions should decrease over time in all population groups.



**FIGURE 68-13.** Schematic representation of a target-controlled infusion system for anesthetic drugs. According to knowledge of therapeutic windows, patient response, and predicted drug concentration, the physician sets the drug concentration target. Using a pharmacokinetic model for the drug, the computer calculates the appropriate infusion rates over time to achieve and maintain the target concentration and directs the infusion pump to administer the appropriate amount of drug. The pump reports to the computer the amount of drug administered so that the computer's pharmacokinetic simulation can be updated.<sup>88</sup>

There is considerable interpatient variability in both pharmacokinetics and pharmacodynamics. The United States Food and Drug Administration (FDA), which classifies TCI systems as a drug and not a device, have not approved the Diprifusor and other TCI systems outside of the research milieu based on concerns regarding safety and the lack of predictability in drug dosing.<sup>90</sup> No evidence in the literature suggests an increased risk of adverse events with TCI systems, and numerous published papers have compared the safety of TCI systems with manual infusions.<sup>88</sup> Because variability in the pharmacodynamic response for all drugs will be greater in routine clinical practice than in healthy volunteers from whom standard parameters (i.e., minimum alveolar concentration for inhaled anesthetics) are derived, it can be argued that TCI devices actually decrease, rather than increase, biologic variability.<sup>91</sup> Compared to standard infusion pumps, TCI systems allow the incorporation of patient covariates (e.g., weight, age, hepatic function, cardiac output) into dosing models that would otherwise be impossible to replicate without TCI systems. Another method by which TCI systems can reduce biologic variability in pharmacokinetics is by programming systems to reflect the multicompartment distribution of drugs. By taking into account uptake and distribution of drug across several compartments and by taking into consideration the time of the infusion, TCI systems can more accurately guide drug administration.

Even if FDA approval of TCI devices were forthcoming, controversies about TCI systems must be addressed prior to widespread adoption of the technology. As mentioned, the TCI system is only as efficacious and accurate as the pharmacokinetic model with which it is programmed. Despite the wealth of literature on the subject, it is evident that models are more accurate for some drugs than for others. Additionally, there is some disagreement over the existence and magnitude of the dysequilibrium between plasma and effect site. Simply stated, the idea that the plasma concentration of drug after a bolus peaks instantaneously and homogeneously is an anachronism. Both cardiac output and the peripheral distribution of drugs (multicompartment models) are important determinants of the drug concentration-time rela-



**FIGURE 68-14.** Propofol infusion rates required to maintain a plasma concentration of  $1 \mu\text{g}/\text{mL}$  in a child (body weight 20 kg, age 5 years), a lean adult (50 kg, 30 years), an adult of average weight (70 kg, 30 years), an obese adult (110 kg, 30 years), and an elderly individual (65 kg, 80 years). Infusion rates were calculated from population pharmacokinetic modeling and actual plasma levels from 270 individuals in the study.<sup>56</sup>

tionship, particularly for rapidly acting agents. Avram and Krejcie<sup>92</sup> demonstrated that TCI systems based on such fallacies of early drug distribution kinetics overestimate drug dosages and exceed target concentrations. Newer TCI systems target the effect site or biophase concentration, because this is the site of action and can be clinically measured via patient response or EEG parameters. These models will require rigorous analysis prior to implementation. Fortunately, the effect-site concentration of propofol (the most commonly used anesthetic for TCI) has already been shown to correlate with loss of consciousness or loss of responsiveness<sup>93</sup> and with EEG changes.<sup>39,93,94</sup> A final concern with TCI devices is that the terminology that would define an appropriate IV

anesthetic target is either fatuous by nature (e.g., “MAC” for IV agents) or has not been standardized.  $\text{CP}_{50}$  or the plasma concentration required to produce a 50% probability of some specific event (e.g., loss of consciousness) is frequently used, and values for some anesthetics have been published,<sup>77,96</sup> but frequently the conditions among study protocols (i.e., different OAA/S thresholds to demonstrate loss of consciousness vs patient response) preclude standardization of such values.

### DRUGS ADMINISTERED DURING MAC

During MAC, the practitioner frequently administers a variety of anesthetics, including sedative-hypnotics,

opioid and nonopioid analgesics, benzodiazepines, barbiturates, and other adjuvants (i.e.,  $\alpha_2$ -agonists). These drugs often are combined with local anesthetics. As previously mentioned, clinicians must be careful when titrating combinations of drugs. Selecting drugs with regard to concepts as the context-sensitive half-time and effect-site half-times will permit adroit dosing while avoiding hemodynamic and respiratory depression. Generally, agents from numerous classes are combined to achieve maximum patient comfort. It will be useful here to focus on the use of these agents specifically during MAC. Table 68-6 lists common dosing strategies for various agents used during MAC.

### Local Anesthetics

Local anesthetics may be administered during MAC by local infiltration, via topical application, via IV regional anesthesia (Bier block), or during peripheral or central neuraxial blockade. Patients usually complain of discomfort during local anesthetic injection, and it can be difficult for patients to lay immobile during prolonged procedures. Additionally, even in the presence of adequate local infiltration, traction on certain structures (i.e., inguinal ligament) can be painful. Finally, many patients express significant anxiety about remaining “awake” during surgery and would otherwise require a general anesthetic. For these reasons, local anesthetics frequently are combined with IV drugs to provide anxiolysis, sedation, and supplemental analgesia.

**TABLE 68-6.**

**Drugs Commonly Used during Monitored Anesthesia Care**

Drug Class	Drug	Bolus Dose	Infusion Rate
Sedative anxiolytic	Diazepam	5–10 mg	
	Midazolam	0.5–7.5 mg	1–2 $\mu\text{g}/\text{kg}/\text{min}$
	Propofol	10–80 mg	25–100 $\mu\text{g}/\text{kg}/\text{min}$
	Methohexital	10–20 mg	20–60 $\mu\text{g}/\text{kg}/\text{min}$
	Thiopental	25–150 mg	
Sedative/analgesic Analgesic	Ketamine	10–50 mg	5–15 $\mu\text{g}/\text{kg}/\text{min}$
	Fentanyl	25–100 $\mu\text{g}$	0.01–0.03 $\mu\text{g}/\text{kg}/\text{min}$
	Sufentanil	5–30 $\mu\text{g}$	0.005–0.01 $\mu\text{g}/\text{kg}/\text{min}$
	Alfentanil	0.25–0.75 mg	0.25–1 $\mu\text{g}/\text{kg}/\text{min}$
	Remifentanil	12.5–25 $\mu\text{g}$	0.025–0.15 $\mu\text{g}/\text{kg}/\text{min}$
Benzodiazepine antagonist	Flumazenil	0.5–1 mg	
Opioid antagonist	Naloxone	20–400 $\mu\text{g}$	



The choice of local anesthetic depends upon the desired duration of effect. Lidocaine is the most commonly used local anesthetic in the United States.<sup>97</sup> When administered via local infiltration, it will provide anesthesia for 1–2 hours; if administered via peripheral nerve block or with epinephrine, the duration will be slightly longer. Infiltration with bupivacaine will provide sensory anesthesia with a duration of 2–4 hours or greater. Use of bupivacaine for peripheral nerve block will provide anesthesia for up to 10–12 hours, with occasional extended action up to 24 hours. Bupivacaine's utility is limited somewhat by its cardiotoxicity. Almost 20 years ago came the observation that sudden cardiac arrest with bupivacaine (via inadvertent IV injection) was associated with considerable morbidity and mortality. Cardiovascular collapse is caused by the specific accumulation of the drug in the conduction system of the heart, activating reentrant pathways and causing intractable ventricular arrhythmia, including ventricular tachycardia and ventricular fibrillation. These arrhythmias are refractory to conventional treatments. Two newer agents, ropivacaine (a chemical analogue of mepivacaine and bupivacaine) and levobupivacaine (the pure S-enantiomer of bupivacaine), have been developed to circumvent the cardiotoxicity of bupivacaine while maintaining the potency and favorable characteristics of bupivacaine. Whether these agents will supplant bupivacaine remains to be seen. Future areas of interest in this field include long-lasting local anesthetics, encapsulated drugs, and continuous-infusion techniques via catheters.<sup>98</sup>

### Propofol

Propofol is a rapid, short-acting IV anesthetic that has many of the ideal properties of a sedative-hypnotic for use during MAC. It has a short effect-site equilibration time, and the biophase or effect-site concentration can be ascertained from either clinical signs (i.e., OAA/S) or bispectral analysis.<sup>42,44</sup> Propofol has increasingly become the drug of choice for sedation during MAC, supplanting the previous popular combination of opioids and midazolam.<sup>99</sup> Although midazolam has a short elimination half-life, its context-sensitive half-time is approximately twice as long as that for propofol (Fig. 68–6).

Benzodiazepines are frequently associated with prolonged sedation and psychomotor impairment, particularly in the elderly. Opioids alone generally fail to provide adequate sedation, and combining therapy with benzodiazepines can produce profound respiratory depression.

Propofol plasma levels appropriate for sedation (0.5–1.5 µg/mL) or hypnosis (2–6 µg/mL) can be reliably delivered at infusion rates of 25–100 µg/mL/min.<sup>99</sup> Subhypnotic doses of propofol, achieved with median plasma levels of 343 ng/mL, possess antiemetic properties.<sup>100</sup> This level can be rapidly and safely achieved by a 10-mg bolus dose followed by continuous infusion of 10 µg/kg/min.<sup>101</sup> Propofol can be given alone or in combination with a benzodiazepine or opioid, with which it has supra-additive or synergistic effects.<sup>75,102</sup> Additionally, propofol has been shown to alter the pharmacokinetics of alfentanil in healthy volunteers, possibly via changes in cardiovascular function.<sup>103</sup> Smith et al.<sup>104</sup> demonstrated that subhypnotic doses of propofol will not reliably produce amnesia. The same study also noted a poor relationship between plasma propofol levels and the degree of somnolence in individual patients. Premedication with a small dose of midazolam (1–2 mg IV) provides additional sedation, anxiolysis, and amnesia with respect to intraoperative effects.<sup>105</sup> Propofol does not have analgesic properties.<sup>106</sup> The literature on the effect of propofol on pain perception is conflicting; oversedation is a confounding variable in some studies. Frolich et al.<sup>107</sup> assessed the effect of propofol sedation on pain perception and found that propofol caused a dose-dependent increase in pain intensity (Visual Analogue Scale) and unpleasantness (subjective). Patients during MAC often receive supplemental propofol rather than an analgesic for procedure-related discomfort; future research may induce a paradigm shift if the findings of Frolich et al. are confirmed. Propofol-induced injection pain, a separate phenomenon from hyperalgesia, occurs in approximately 70% of patients.<sup>108</sup> Useful interventions include IV lidocaine (as little as 40 mg, preferably as a Bier block with a rubber tourniquet for 30–120 seconds prior to propofol injection), IV opioids (particularly meperidine), and metoclopramide. A systemic review on the subject deemed speed of the injection, size of

the IV catheter or the vein, and temperature of the propofol as insignificant.<sup>108</sup>

Although propofol is well suited for long procedures, propofol has favorable qualities that make it a preferred hypnotic for endoscopy,<sup>109</sup> retrobulbar block,<sup>110</sup> and emergency department procedural sedation.<sup>111</sup> It should be noted that the ASA Practice Guidelines for Sedation and Analgesia by Non-Anesthesiologists distinguishes sedation with opioid/benzodiazepine combinations (“moderate sedation”) from sedation with propofol (“deep sedation”). The ASA guidelines recommend that, during deep sedation, “a designated individual, other than the practitioner performing the procedure, should be present to monitor the patient...” and that “practitioners administering these drugs should be qualified to rescue patients from any level of sedation, including general anesthesia.”<sup>112</sup> Although these recommendations fall short of precluding the use of propofol during procedures in which the patient is not monitored by a separate clinician, they have instigated significant debate and disagreement in the non-anesthesiology literature.<sup>111,112</sup> The potential cost ramifications are significant, because 15 million endoscopic procedures are performed yearly in the United States alone.<sup>109</sup> In our opinion, the ASA practice guidelines are appropriate, and we believe that nonanesthesia personnel should not administer deep sedation.

The growing interest from nonanesthesia providers in using propofol rather than the previously popular benzodiazepine-opioid combinations for sedation is potentially concerning. Any false confidence based upon propofol's short duration of action is mitigated by the potential side effects of the drug. When used in sedative doses, the most common side effect is pain on injection, followed by excitatory phenomena or involuntary movements. Other psychological phenomena, such as euphoria, amorous and disinhibited behavior,<sup>113</sup> and sexual hallucinations,<sup>114</sup> have been described under MAC with propofol. Propofol in subhypnotic doses has been shown to increase pharyngeal motor dysfunction<sup>115</sup> and increase collapsibility of the upper airway.<sup>116</sup> Upper airway collapse is dose dependent and seems to have both central and peripheral components. More serious side effects include alterations in cardiopulmonary and respiratory physiology. Propofol in-

fusions targeted to moderate sedation have been shown to lower sympathetic nerve activity<sup>117</sup> and baroreflex responses to hypotension.<sup>118</sup> Propofol infusion for moderate sedation has been shown to depress the hypoxic ventilatory response.<sup>119</sup> A published gastroenterologist's protocol for "safe and effective administration of propofol during endoscopic examinations" found the incidence of hypotension (>20 mm Hg decline in blood pressure) and hypoxia (oxygen saturation <90%) to be 27% and 9% of 819 patients, respectively.<sup>109</sup> Although all episodes were transient, all subjects were ASA I or II; these findings amplify concerns about propofol use by nonanesthesia personnel, particularly in the seriously ill or elderly.

## Ketamine

Ketamine was first used in humans in 1965. It was hoped that it could function as a monoanesthetic drug (i.e., analgesia, amnesia, loss of consciousness, immobility), but because of its psychotropic side effects and the advent of additional IV anesthetics, it fell into disfavor and its role rapidly diminished by the mid 1980s.<sup>120</sup> A 2000 survey of graduating anesthesiology residents found that only 30% of 119 residents had used ketamine for MAC cases >10 times during their training.<sup>121</sup> It has a relatively short distribution and elimination half-life; the  $\alpha$ -elimination phase lasts only a few minutes. Ketamine administration leads to a state of dissociation, amnesia, and analgesia, with or without loss of consciousness.

Ketamine can be a useful analgesia adjuvant during MAC. Unlike other IV anesthetics, ketamine has potent analgesic effects at subanesthetic plasma concentrations.<sup>122</sup> Ketamine-induced analgesia can outlast the drug's anesthetic effects, and these effects have been attributed to antagonism at the *N*-methyl-D-aspartate (NMDA) receptor. Animal and human studies have shown that hyperalgesia after tissue injury and opioid tolerance both involve activation of the NMDA receptor.<sup>123</sup> Studies with ketamine have focused on determining whether administration of the drug prior to a noxious stimulus (preemptive analgesia) can reduce subsequent pain. Suzuki et al.<sup>122</sup> demonstrated that a single intraoperative dose of ketamine 50–100  $\mu\text{g}/\text{kg}$  given 15 minutes before the end of surgery reduced postoperative morphine requirements by 40%.

A systemic review of ketamine and postoperative pain demonstrated a 9–47% reduction in postoperative morphine consumption<sup>124</sup> with intraoperative administration of ketamine (median dose 0.4 mg/kg). The clinical significance of preemptive analgesia with ketamine is controversial.

Other studies have described the use of ketamine in combination with other anesthetics for MAC. The interaction of ketamine and propofol at sedative doses appears to be additive.<sup>125,126</sup> Administration of ketamine 4–18  $\mu\text{g}/\text{kg}/\text{min}$  in combination with propofol 30–90  $\mu\text{g}/\text{kg}/\text{min}$  attenuated the respiratory depression produced by propofol/opioid anesthesia, while producing positive mood effects.<sup>127,128</sup> Ketamine maintains protective airway reflexes better in sedative doses than do other IV anesthetics and, through its central sympathetic stimulative effects, diminishes propofol-induced hypotension and decreases inotropic effects.<sup>125</sup>

Ketamine as a sole agent is associated with a dose-dependent incidence of psychic disturbances ranging from 5–30%.<sup>129</sup> Symptoms can vary from alterations in mood state and body image to vivid dreams and hallucinations. Extracorporeal experiences also have been reported. Benzodiazepines and propofol seem to be effective in attenuating the psychomimetic actions of ketamine, as long as they are administered before the drug. Titrating propofol to loss of verbal response and lid reflex prior to ketamine administration has been recommended to significantly attenuate the psychotropic side effects of ketamine.<sup>130</sup> Ketamine can increase oral secretions; we recommend use of glycopyrrolate 0.2 mg IV prior to administration.

Despite the well-founded fear of ketamine's unique side effect profile, ketamine used at doses appropriate for MAC cases and as an adjuvant anesthetic is a safe and efficacious addition to the armamentarium of the anesthesiologist. It should never be used as a sole agent during MAC. Continuing research on preemptive analgesia and NMDA antagonists may increase the utility of ketamine and lead to its widespread use again.

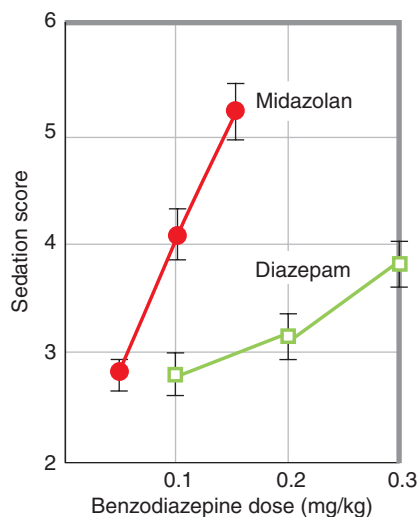
## Benzodiazepines

Benzodiazepines remain widely used during MAC. They provide both anxiolysis and dose-dependent anterograde amnesia, but they have no analgesic

activity. Diazepam is the prototypic benzodiazepine, but it has a very long elimination half-life (20–50 hours). The active metabolite desmethyldiazepam contributes to the prolonged activity of diazepam, making it unsuitable in the outpatient setting. Its duration of clinical effect ranges from 1–6 hours. Midazolam has replaced diazepam as the most commonly used benzodiazepine during MAC anesthetics and is the most frequent premedication used in the United States.<sup>131</sup> Rapid onset (within 1–2 minutes of IV administration), time to peak effect (3–5 minutes), and short duration of activity (15–80 minutes) make it an attractive adjunct or sole agent during MAC. Midazolam produces more profound amnesia than diazepam. Premedication with midazolam in subhypnotic doses has been shown to decrease the incidence of postoperative nausea and vomiting,<sup>132,133</sup> although the mechanism is poorly understood.

Despite the beneficial effects of benzodiazepines, it appears that they may be best used as an adjunctive sedative for anxiolysis and amnesia in conjunction with a propofol infusion. Benzodiazepines reduce anesthetic requirements (hypnotic effects) for propofol<sup>75,134</sup> and opioids<sup>75,102</sup> in a synergistic fashion. Comparisons between propofol and midazolam infusions as sole agents for MAC have demonstrated superior anesthetic properties with midazolam but a more rapid recovery profile with propofol.<sup>135,136</sup> Premedication with midazolam 1–3 mg prior to propofol sedation during MAC has been associated with increased amnesia<sup>137</sup> and patient satisfaction,<sup>132,138</sup> without altering perioperative vital signs or prolonging discharge time from the postanesthesia care unit.<sup>105,132,138</sup>

Benzodiazepines in doses appropriate for MAC are relatively well tolerated; hemodynamic changes are uncommon in healthy patients. Caution should be used in patients with hypoalbuminemia (from hepatic cirrhosis or renal dysfunction), because the unbound fraction of midazolam will increase. The principal active metabolite of midazolam,  $\alpha$ -hydroxymidazolam, is cleared by the kidneys and can prolong the drug's action in patients with renal dysfunction.<sup>139,140</sup> The slight hysteresis in the dose–response relationship may lead to oversedation if repeated boluses are administered over a short time interval. Midazolam has a steep dose–response curve and thus must be care-



**FIGURE 68-15.** Relationship between the sedation score (2 = awake/relaxed to 6 = asleep/unarousable) and the initial dose of midazolam or diazepam (in milligrams per kilogram). Values are given as mean  $\pm$  SEM. The narrower therapeutic dosage range for midazolam should be appreciated and warrants careful titration to avoid excessive sedation or apnea.<sup>141</sup>

fully titrated using small IV boluses or (less commonly) continuous infusion (Fig. 68-15).<sup>141</sup> Aging has been shown to increase the pharmacodynamic sensitivity to midazolam, independent of pharmacokinetic factors.<sup>142</sup> Despite the synergy between opioids and benzodiazepines with respect to hypnosis, sedation, and respiratory depression, the analgesic action of opioids may be *reduced* in the presence of benzodiazepines.<sup>105,143</sup> Interestingly, flumazenil, a benzodiazepine antagonist, has been shown to enhance the postoperative analgesic effects of morphine.<sup>143</sup>

## Opioids

Opioid analgesics are frequently administered during MAC for a variety of reasons. They are useful adjuvants during local or regional anesthesia to decrease the pain that frequently accompanies the injection of local anesthetics or central neuraxial blockade. In addition to the obvious indication for treatment of surgical pain, opioids can alleviate discomfort from nonincisional sources, such as uncomfortable positioning or pneumatic tourniquet pain. When administered alone, opioids do not reliably produce sedation in the absence of ventilatory depression.<sup>144</sup> Opioids have little, if any, amnestic activity. Veselis et al.<sup>145</sup> demonstrated that hypnotics such as midazolam and

propofol affect memory differently via their sedative effects, and that fentanyl is virtually devoid of amnestic effects at equisedative concentrations of other sedative-hypnotics.<sup>146</sup> Additional reasons for avoiding the use of opioids as sole agents during MAC are dose-dependent increased respiratory depression and postoperative nausea and vomiting.

Opioids are best suited for the analgesic component of a well-balanced MAC anesthetic. The choice of opioid depends upon the desired pharmacokinetic profile; lipophilic opioids such as fentanyl and its analogues (alfentanil and sufentanil) demonstrate rapid blood-brain equilibration and onset of action. Conversely, water-soluble drugs such as morphine have a slower onset of action. For the majority of short procedures, the duration of action for opioids is dependent upon redistribution. Therefore, highly lipid soluble drugs (e.g., fentanyl) will have a shorter duration of action.

## Fentanyl

Fentanyl is the opioid most commonly used during MAC. It is administered in 25- to 50- $\mu$ g increments every 2-3 minutes to a loading dose of 0.5-3  $\mu$ g/kg. The onset of fentanyl's effects is within 3-5 minutes, but peak effect lags behind peak plasma concentrations. This delay must be appreciated by the clinician in order to avoid excessive respiratory depression during MAC. When fentanyl is administered during MAC, the duration of analgesia of a typical dose of fentanyl is 30-60 minutes. When multiple doses or long infusions of fentanyl are administered, progressive saturation of peripheral tissues can occur, and the duration of action (and side effects) may be prolonged (see Context-Sensitive Half-Time above). The respiratory depressant effects of fentanyl may last longer than the analgesic effects, and even small doses of fentanyl (50  $\mu$ g) can cause respiratory depression when combined with other sedatives.<sup>76</sup>

## Sufentanil

Sufentanil is the most potent synthetic opioid. It is approximately 5-15 times more potent than fentanyl and has a similar onset of effect. Both sufentanil and fentanyl are formulated with the same concentration (50  $\mu$ g/mL), and an overdose resulting in severe respiratory depression could occur if sufenta-

nil were mistaken for fentanyl. Sufentanil can be given as a bolus (0.1-0.5  $\mu$ g/kg) or infusion (0.005-0.01  $\mu$ g/kg/min) during MAC. Bailey et al.<sup>147</sup> compared the effects of sufentanil and fentanyl on volunteers and showed that sufentanil produced longer lasting analgesia but less depression of ventilation than did fentanyl. Despite these findings, few other studies have focused on sufentanil in the setting of MAC, particularly since the advent of alfentanil and remifentanyl. One possible reason is unpredictable cardiovascular depression associated with sufentanil use, including bradycardia and hypotension; however, these effects do not appear to be dose dependent.<sup>148</sup>

## Alfentanil

Alfentanil, another synthetic analogue of fentanyl, is one fifth to one tenth as potent as the parent compound. Effect-site equilibration with alfentanil is extremely rapid compared with fentanyl (1.4 minutes vs 6.8 minutes for fentanyl). This rapid peak effect of alfentanil is useful during anesthetics in which the response to a brief intense stimulus must be blunted (e.g., retrobulbar block). The rapid onset is due to the drug's low degree of ionization at physiologic pH. Alfentanil is less lipid soluble than fentanyl and sufentanil, a quality that results clinically in a smaller volume of distribution and a *longer* context-sensitive half-time than that of sufentanil for infusions up to 8 hours.<sup>60</sup> Alfentanil can be given via bolus or continuous infusion during MAC. White et al.<sup>149</sup> found that using continuous infusion (vs bolus dosing) of alfentanil reduced perioperative dose requirements by 41% and improved recovery times and postoperative psychomotor function. In the same study, an equianalgesic dose of alfentanil was associated with less respiratory depression than fentanyl. Alfentanil used as a sole agent is associated with an unacceptable incidence of postoperative nausea and vomiting. Pavlin et al.<sup>150</sup> found that alfentanil infusions in healthy volunteers elicited nausea and vomiting rates of 50% and 30%, respectively; administration of a concomitant propofol infusion decreased the rates to 10% (nausea) and 0% (vomiting). Avramov and White<sup>151</sup> found that addition of propofol infusion 50  $\mu$ g/kg/min to alfentanil 0.3-0.4  $\mu$ g/kg/min reduced postoperative nausea and vomiting from 33% to 0%.

Both of the aforementioned studies also described an opioid-sparing effect from concomitant administration of propofol, with requirements decreasing 22–50%.

### Remifentanyl

Remifentanyl is an ultrashort-acting opioid that is metabolized by nonspecific tissue esterases. Its clearance is unaffected by cholinesterase deficiency, cholinesterase inhibitors, or hepatorenal dysfunction.<sup>152</sup> Remifentanyl has analgesic potency similar to fentanyl but has an effect-site equilibration time (1.0–1.5 minutes) similar to that of alfentanil.<sup>153</sup> Remifentanyl has an extremely short (3–4 minutes) context-sensitive half-time that is independent of the dose or duration of infusion (Fig. 68-16).<sup>154,155</sup> More importantly, compared with alfentanil, even the 80% decrement time of remifentanyl is unchanged with long infusions.<sup>155</sup> The clinical significance of this observation is that 60–80% decrement times (rather than 50%) may be required to discharge patients following a procedure.

Remifentanyl is generally given by continuous infusion during MAC. Bolus or loading doses are not necessary for most cases because a continuous infusion will approach steady-state concentrations within 10 minutes. Current product labeling recommends bolus administration of remifentanyl only in patients undergoing general anesthesia. Studies comparing bolus doses of remifentanyl to continuous infusions in volunteers<sup>156</sup> and patients undergoing extracorporeal shock wave lithotripsy (ESWL)<sup>157</sup> found that manual bolus doses were as effective and safe as administration via continuous infusion. However, several subjects in these studies experienced respiratory depression at low doses. In addition to respiratory depression and apnea, which occur more frequently than with propofol,<sup>158</sup> other concerns with bolus dosing of remifentanyl are chest wall rigidity, hypotension, and bradycardia. These side effects are not seen when remifentanyl is administered via continuous infusion in analgesic doses (0.025–0.15  $\mu\text{g}/\text{kg}/\text{min}$ ) during MAC.<sup>156,159</sup> If bolus dosing of remifentanyl is deemed necessary, it should be low dose (12.5–50  $\mu\text{g}$ ) and slowly administered over 30–60 seconds.

Use of remifentanyl as a sole agent during MAC does not produce ade-

quate sedation without an unacceptably high incidence of chest wall rigidity and respiratory depression. When combined with midazolam, adequate sedation and analgesia can be obtained without hemodynamic perturbations, excessive respiratory depression, or prolonged discharge times.<sup>160</sup> Avrimov et al.<sup>160</sup> observed that preoperative administration of midazolam 2–8 mg IV prior to infusion of remifentanyl during breast biopsy reduced the dose requirements of remifentanyl by up to 50%. A similar study with remifentanyl and propofol during ESWL revealed a 37% reduced remifentanyl dose with the addition of propofol.<sup>161</sup>

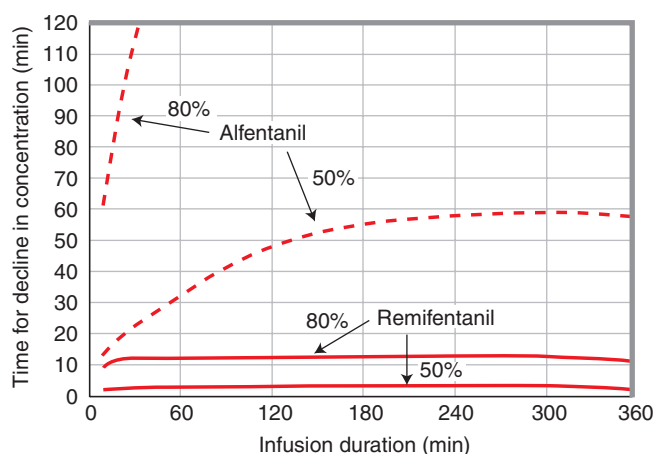
Postoperative nausea and vomiting is a common complication with remifentanyl, particularly when it is used as a sole agent. When compared with propofol as adjunctive sedation for regional anesthesia, the nausea and vomiting rates were much higher with remifentanyl (60% and 21%, respectively) than with propofol (17%, 6%).<sup>162</sup> When used as an analgesic adjunct during MAC, nausea and vomiting rates are higher with remifentanyl alone (42% and 17%, respectively) than with remifentanyl/midazolam (21% and 6%) or propofol (27% and 15%).<sup>159</sup> Addition of preoperative midazolam<sup>163</sup> or intraoperative propofol<sup>161,164</sup> to a remifentanyl infusion attenuates the risk of nausea and vomiting. Holas et al.<sup>164</sup> and Joo et al.<sup>161</sup> noted a 0% incidence of postoperative vomiting in patients who received propofol and remifentanyl simultaneously and underwent eye surgery and ESWL, respectively.

Remifentanyl is supplied as a lyophilized powder and must be reconsti-

tuted and diluted before using. Errors in dilution of the drug can easily result in overdosage or underdosage, particularly in awake patients with an unprotected airway. When administered as a continuous infusion during MAC, remifentanyl should be titrated to provide analgesia rather than sedation. If bolus dosing is anticipated, it should replace, rather than supplement, a continuous infusion. Remifentanyl is a useful adjunct during MAC that is best combined with a hypnotic to minimize respiratory depression and postoperative nausea and vomiting. Because of the risk of apnea and hypoventilation, it is recommended that only clinicians specifically trained in the use of anesthetic drugs and airway management use remifentanyl.

### $\alpha_2$ -Agonists

$\alpha_2$ -Agonists produce sedative, analgesic, and anxiolytic effects by reducing central sympathetic outflow.<sup>165</sup> At low or sedative dosages, they produce sympatholysis (i.e., bradycardia and hypotension). They do not cause respiratory depression at sedative dosages and can attenuate ketamine-induced cardiostimulatory and psychotropic effects.<sup>166</sup> Clonidine, the prototypical  $\alpha_2$ -agonist and antihypertensive agent, has been shown to reduce anesthetic and analgesic properties during the perioperative period. Use of clonidine as an anesthetic adjuvant during MAC is limited by its long elimination half-life of 8–12 hours. Dexmedetomidine, a relatively new  $\alpha_2$ -agonist, is 8- to 10-fold more potent than clonidine for the  $\alpha_2$  receptor<sup>167</sup> and has an elimination half-life of only 2 hours. The only approved



**FIGURE 68-16.** Time for an 80% decrease in plasma concentration and the context-sensitive half-time of remifentanyl and alfentanil for an infusion maintained at a constant plasma concentration for 1–360 minutes.<sup>155</sup>



sedative indication for dexmedetomidine is ICU treatment of postoperative surgical patients for up to 24 hours.<sup>168</sup> Despite the potentially desirable side-effect profile, dexmedetomidine compared with commonly used sedatives is associated with prolonged recovery time<sup>169,170</sup> and significant bradycardia and hypotension.<sup>169,171</sup> A study by Jaakola<sup>171</sup> assessed the efficacy of IV dexmedetomidine 1 µg/kg as a premedication before IV regional anesthesia. Although dexmedetomidine produced opioid-sparing and anxiolytic effects, 20% of patients required atropine for bradycardia (heart rate <45 beats/min). Jalowiecki et al.<sup>169</sup> evaluated dexmedetomidine for sedation during colonoscopy. The study was interrupted for safety concerns; 3 of 19 patients experienced bradycardia and hypotension of sufficient severity such that they were admitted to the hospital for observation. It is evident that although some properties of  $\alpha_2$ -agonists are attractive during MAC, these agents are potentially dangerous and possess unacceptable risk-to-benefit profiles. Other agents discussed in this chapter can be used alone or in tandem to adequately sedate patients during MAC. Clinicians should be mindful that  $\alpha_2$ -agonists remain off-label for conscious sedation and MAC.

## RECOVERY AND DISCHARGE CRITERIA AFTER MAC

Anesthetics used during MAC should permit rapid recovery with minimal or no residual cognitive or psychomotor impairment. In turn, each patient care facility should develop recovery and discharge criteria that are suitable for its specific patients and procedures. ASA Practice Guidelines for Postanesthetic Care, revised in 2001, consider the recovery and discharge criteria for MAC to be no different from those for general or regional anesthesia.<sup>172</sup> Other requirements are that medial supervision of recovery and discharge is the responsibility of the supervising practitioner, and that an individual trained to monitor patients and recognize complications should be in attendance until all discharge criteria are fulfilled. One of these persons must be qualified to handle complications and trained in airway management. All outpatients should be discharged to a responsible adult who will accompany them home and be able to report complications. Written discharge

instructions, including an emergency phone number, should be given to all patients.

Physicians should be able to assess home readiness in a simple, clear, reproducible manner. Medicolegal considerations mandate that physicians have evidence that the patient's discharge criteria were met, and that all discharge instructions have been signed by the patient and documented in the medical record. Patients should be duly informed that home readiness does not confer the ability to drive a car or return to work. Qualitative discharge criteria have guided the assessment of home readiness. The most commonly used method, developed in 1970 by Aldrete and Kroulik<sup>173</sup> (Box 68-3) and still known as the Aldrete Score, assesses activity, respirations, circulation, consciousness, and skin color (since replaced by pulse oximetry in 1995).<sup>174</sup> In 1995, the Modified Aldrete Score added assessment of dressing appearance/surgical bleeding, severity of pain, ability to ambulate, tolerance of oral fluids, and ability to void.<sup>174</sup> Chung et al.<sup>175</sup> developed the Post-Anesthetic Discharge Scoring System in 1995 specifically to

assess home readiness after ambulatory surgery (Box 68-4). These scoring systems are beneficial because they encourage continual reevaluation of patients, but they should be tailored to individual patients. For example, a patient undergoing foot or ankle surgery should not be expected to ambulate prior to discharge. After central neuraxial blockade, normal sensory and motor function should be confirmed. Requiring patients to void is prudent because of the risk of urinary retention (which may be asymptomatic) and subsequent bladder damage. After major peripheral nerve block, patients may benefit from long-acting local anesthetics; therefore,

### BOX 68-3.

#### Aldrete Post-Anesthetic Recovery Score

Activity: Able to move voluntarily or on command	
4 extremities	2
2 extremities	1
0 extremities	0
Respiration	
Able to deep breathe and cough freely	2
Dyspnea, shallow or limited breathing	1
Apneic	0
Circulation	
BP $\pm$ 20 mm of preanesthesia level	2
BP $\pm$ 20 to 50 mm of preanesthesia level	1
BP $\pm$ 50 mm of preanesthesia level	0
Consciousness	
Fully awake	2
Arousable on calling	1
Not responding	0
Color	
Normal	2
Pale, dusky, blotchy	1
Cyanotic	0

BP, blood pressure.

### BOX 68-4.

#### Post-Anesthesia Discharge Scoring System

Vital signs	
2	Within 20% of preoperative value
1	20-40% of preoperative value
0	40% of preoperative value
Activity, mental status	
2	Oriented and steady gait
1	Oriented or steady gait
0	Neither
Pain, nausea, vomiting	
2	Minimal
1	Moderate
0	Severe
Surgical bleeding	
2	Minimal
1	Moderate
0	Severe
Intake and output	
2	PO fluids and voided
1	PO fluids or voided
0	Neither

The total score is 10; patients scoring  $\geq 9$  are considered fit for discharge to home. PO, per os (by mouth).

Reprinted from Chung F, Chan VW, and Ong D, A post-anesthetic discharge scoring system for home readiness after ambulatory surgery. *J Clin Anesth* 1995;7:500-506, with permission from Elsevier.

it would be purposeless to await return of sensory and motor function prior to discharge. Patients should be warned of the loss of protective reflexes and sensation in the affected limb.

The ability to void and the ability to tolerate oral fluids prior to discharge are two controversial clinical criteria. ASA Practice Guidelines for Postanesthetic Care state that requirements for voiding and drinking are necessary only for selected patients.<sup>172</sup> The decision to discharge a patient who does not satisfy these criteria should be individualized and based upon factors such as age, medical condition, availability of adult assistance at home, and potential severity of consequences of decreased oral intake or urinary retention. Patients not required to void should be informed of potential signs and symptoms of urinary retention and should be given detailed instructions regarding emergency care if needed.

## KEY REFERENCES

1. Anonymous. Practice guidelines for sedation and analgesia by non-anesthesiologists. *Anesthesiology* 2002;96:1004–1017.
2. Anonymous. ASA Practice advisory for preanesthesia evaluation (Approved by the House of Delegates on October 17, 2001, and last amended on October 15, 2003). A report by the American Society of Anesthesiologists Task Force on Preanesthesia Evaluation, 2003.
3. Sessler DI. Perioperative heat balance. *Anesthesiology* 2000;92:578–596.
4. Hughes MA, Glass PSA, Jacobs JR. Context-sensitive half-time in multicompartment pharmacokinetic models for intravenous anesthetic drugs. *Anesthesiology* 1992;76:334–341.
5. Shafer SL, Varvel JR. Pharmacokinetics, pharmacodynamics, and rational opioid selection. *Anesthesiology* 1991;74:53–63.
6. Tallarida RJ. Drug synergism: its detection and applications. *J Pharmacol Exp Ther* 2001;298:865–872.
7. Minto CF, Schnider TW, Short TG, et al. Response surface model for anesthetic drug interactions. *Anesthesiology* 2000;92:1603–1616.

8. Egan TD. Target-controlled drug delivery: progress toward an intravenous “vaporizer” and automated anesthetic administration. *Anesthesiology* 2003;99:1214–1219.

## REFERENCES

1. Novak LC. ASA updates its position on monitored anesthesia care. *ASA Newsletter* 1998;62:22–23.
2. Anonymous. Practice guidelines for sedation and analgesia by non-anesthesiologists. *Anesthesiology* 2002;96:1004–1017.
3. Anonymous. Distinguishing monitored anesthesia care (“MAC”) from moderate sedation/analgesia (conscious sedation). *ASA Directory of Members*, 2004.
4. Domino KB. Trends in anesthesia litigation in the 1990s: monitored anesthesia care claims. *ASA Newsletter* 1997;61:6.
5. Cheney FW. The American Society of Anesthesiologists Closed Claims Project: what have we learned, how has it affected practice, and how will it affect practice in the future? *Anesthesiology* 1999;91:552–556.
6. JCAHO. Standards for Moderate and Deep Sedation and Anesthesia. Hospital Accreditation Standards. Oak Brook, IL: Joint Commission Resources, 2003:116–119.
7. Ang-Lee MK, Moss J, Yuan CS. Herbal medicines and perioperative care. *JAMA* 2001;286:208–216.
8. Kaplan EB, Sheiner LB, Boeckmann AJ, et al. The usefulness of preoperative laboratory screening. *JAMA* 1985;253:3576–3581.
9. Schein OD, Katz J, Bass EB, et al. The value of routine preoperative medical testing before cataract surgery. *N Engl J Med* 2000;342:168–175.
10. Imasogie N, Wong DT, Luk K, et al. Elimination of routine testing in patients undergoing cataract surgery allows substantial savings in laboratory costs. A brief report. *Can J Anaesth* 2003;50:246–248.
11. Anonymous. ASA Practice advisory for preanesthesia evaluation (Approved by the House of Delegates on October 17, 2001, and last amended on October 15, 2003). A report by the American Society of Anesthesiologists Task Force on Preanesthesia Evaluation, 2003.
12. Anonymous. Practice Guidelines for Preoperative Fasting and the Use of Pharmacologic Agents to Reduce the Risk of Pulmonary Aspiration. *Anesthesiology* 1999;90:896–905.
13. Anonymous. Standards for Basic Anesthetic Monitoring. *ASA Directory of Members*, 2004.
14. Tinker JH, Dull DL, Caplan RA, et al. Role of monitoring devices in prevention of anesthetic mishaps: a closed claims analysis. *Anesthesiology* 1989;71:541–546.
15. Brodsky JB. What intraoperative monitoring makes sense? *Chest* 1999;115:101S–105S.
16. Moller JT, Pedersen T, Rasmussen LS, et al. Randomized evaluation of pulse oximetry in 20,802 patients: I. Design, demography, pulse oximetry failure rate and overall complication rate. *Anesthesiology* 1993;78:436–444.
17. Moller JT, Johannessen NW, Espersen K, et al. Randomized evaluation of pulse oximetry in 20,802 patients: II. Perioperative events and postoperative complications. *Anesthesiology* 1993;78:445–453.
18. Orkin FK, Cohen MM, Duncan PG. The quest for meaningful outcomes. *Anesthesiology* 1993;78:417–422.
19. Eichhorn JH. Pulse oximetry as a standard of practice in anesthesia. *Anesthesiology* 1993;78:423–426.
20. Prielipp RC, Kelly JS, Roy RC. Use of esophageal or precordial stethoscopes by anesthesia providers: are we listening to our patients? *J Clin Anesth* 1995;7:367–372.
21. Soto RG, Fu ES, Vila HJ, et al. Capnography accurately detects apnea during monitored anesthesia care. *Anesth Analg* 2004;99:379–382.
22. London MJ, Hollenberg M, Wong MG, et al. Intraoperative myocardial ischemia: localization by continuous 12-lead electrocardiography. *Anesthesiology* 1988;69:232–241.
23. Fleisher LA. Real-time intraoperative monitoring of myocardial ischemia in noncardiac surgery. *Anesthesiology* 2001;92:1183–1188.
24. Walamies MA, Koobie T, Hamalainen LI, et al. Visual versus computerized analysis of upsloping ST segment depression in the exercise electrocardiogram. *Cardiology* 1999;92:264–268.
25. Leung JM, Voskanian A, Bellows WH, et al. Automated electrocardiograph ST segment trending monitors: accuracy in detecting myocardial ischemia. *Anesth Analg* 1998;87:4–10.
26. Sessler DI, Ponte J. Shivering during epidural anesthesia. *Anesthesiology* 1990;72:816–821.
27. Leslie K, Sessler DI, Bjorksten AR, et al. Propofol causes a dose-dependent decrease in the thermoregulatory threshold for vasoconstriction but has little effect on sweating. *Anesthesiology* 1994;81:353–360.
28. Matsukawa T, Kurz A, Sessler DI, et al. Propofol linearly reduces the vasoconstriction and shivering thresholds. *Anesthesiology* 1995;82:1169–1180.
29. Kurz A, Sessler DI, Annadata R, et al. Midazolam minimally impairs thermoregulatory control. *Anesth Analg* 1995;81:393–398.
30. Toyota K, Sakura S, Saito Y, et al. The effect of pre-operative administration of midazolam on the development of intraoperative hypothermia. *Anaesthesia* 2004;59:116–121.
31. Kurz A, Ikeda T, Sessler DI, et al. Meperidine decreases the shivering threshold twice as much as the vasoconstriction threshold. *Anesthesiology* 1997;86:1046–1054.
32. Kurz A, Go JC, Sessler DI, et al. Alfentanil slightly increases the sweating threshold

and markedly reduces the vasoconstriction and shivering thresholds. *Anesthesiology* 1995;83:293-299.

33. Frank SM, Nguyen JM, Garcia CM, et al. Temperature monitoring practices during regional anesthesia. *Anesth Analg* 1999;88:373-377.

34. Sessler DI. Temperature monitoring and management during neuraxial anesthesia. *Anesth Analg* 1999;88:243-245.

35. Arkilic CF, Ozan A, Taguchi A, et al. Temperature monitoring and management during neuraxial anesthesia: an observational study. *Anesth Analg* 2000;91:662-666.

36. Sessler DI. Perioperative heat balance. *Anesthesiology* 2000;92:578-596.

37. Kearse LA, Manberg PJ, Chamoun N, et al. Bispectral analysis of the electroencephalogram correlates with patient movement to skin incision during propofol/nitrous oxide anesthesia. *Anesthesiology* 1994;81:1365-1370.

38. Pomfrett CJ. Heart rate variability, BIS and "depth of anaesthesia." *Br J Anaesth* 1999;82:659-662.

39. Glass PS, Bloom M, Kearse L, et al. Bispectral analysis measures sedation and memory effects of propofol, midazolam, isoflurane, and alfentanil in healthy volunteers. *Anesthesiology* 1997;86:836-847.

40. Kearse LA, Rosow CE, Zaslavsky A, et al. Bispectral analysis of the electroencephalogram predicts conscious processing of information during propofol sedation and hypnosis. *Anesthesiology* 1998;88:25-34.

41. Liu J, Harbhej S, White PF. Electroencephalographic bispectral index correlates with intraoperative recall and depth of propofol-induced sedation. *Anesth Analg* 1997;84:185-197.

42. Liu J, Singh H, White PF. Electroencephalogram bispectral analysis predicts the depth of midazolam-induced sedation. *Anesthesiology* 1996;84:64-69.

43. Ibrahim AE, Taraday JK, Kharasch ED. Bispectral index monitoring during sedation with sevoflurane, midazolam, and propofol. *Anesthesiology* 2001;95:1151-1159.

44. Leslie K, Sessler DI, Schroeder M, et al. Propofol blood concentration and the bispectral index predict suppression of learning during propofol/epidural anesthesia in volunteers. *Anesth Analg* 1995;81:1269-1274.

45. Gan TJ, Glass PSA, Windsor A, et al. Bispectral index monitoring allows faster emergence and improved recovery from propofol, alfentanil, and nitrous oxide anesthesia. *Anesthesiology* 1997;87:808-815.

46. Bower AL, Ripepi A, Dilger J, et al. Bispectral index monitoring of sedation during endoscopy. *Gastrointest Endosc* 2000;52:192-196.

47. Gill M, Green SM, Krauss B. A study of the Bispectral Index Monitor during procedural sedation and analgesia in the emergency department. *Ann Emerg Med* 2003;41:234-241.

48. Liu J, Singh H, White PF. Electroencephalographic bispectral index correlates with intraoperative recall and depth of propofol-induced sedation. *Anesth Analg* 1997;84:185-189.

49. Iselin-Chaves IA, Flaishon R, Sebel PS, et al. The effect of the interaction of propofol and alfentanil on recall, loss of consciousness and the Bispectral Index. *Anesth Analg* 1998;87:949-955.

50. Mi WD, Sakai T, Kudo T, et al. Performance of bispectral index and auditory evoked potential monitors in detecting loss of consciousness during anaesthetic induction with propofol with and without fentanyl. *Eur J Anaesthesiol* 2004;21:807-811.

51. Dahaba AA. Different conditions that could result in the bispectral index indicating an incorrect hypnotic state. *Anesth Analg* 2005;101:765-773.

52. Suzuki M, Edmonds HL, Tsueda K, et al. Effect of ketamine on bispectral index and levels of sedation. *J Clin Monit* 1998;14:373.

53. Morley AP, Chung DC, Wong ASY, et al. The sedative and electroencephalographic effects of regional anesthesia. *Anaesth* 2000;55:864-869.

54. Pollock JE, Neal JM, Liu SS, et al. Sedation during spinal anesthesia. *Anesthesiology* 2000;93:728-734.

55. Major E, Aun C, Yate PM, et al. Influence of sample site on blood concentrations of ICI 35868. *Br J Anaesth* 1983;55:371-375.

56. Schuttler J, Ihmsen H. Population pharmacokinetics of propofol: a multicenter study. *Anesthesiology* 2000;92:727-738.

57. Fisher DM. (Almost) everything you learned about pharmacokinetics was (somewhat) wrong! *Anesth Analg* 1996;83:1065-1071.

58. Schnider TW, Minto CF, Gambus PL, et al. The influence of method of administration and covariates on the pharmacokinetics of propofol in adult volunteers. *Anesthesiology* 2000;88:1170-1182.

59. Stanski DR, Shafer SL. Quantifying anesthetic drug interaction. Implications for drug dosing. *Anesthesiology* 1995;83:1-5.

60. Hughes MA, Glass PSA, Jacobs JR. Context-sensitive half-time in multicompartment pharmacokinetic models for intravenous anesthetic drugs. *Anesthesiology* 1992;76:334-341.

61. Glass PSA. Intravenous infusion techniques: how to do it and why we should do it. *Can J Anaesth* 1998;45:R117-R137.

62. Shafer SL, Varvel JR. Pharmacokinetics, pharmacodynamics, and rational opioid selection. *Anesthesiology* 1991;74:53-63.

63. Youngs EJ, Shafer SL. Pharmacokinetic parameters relevant to recovery from opioids. *Anesthesiology* 1994;81:833-842.

64. Schraag S, Mohl U, Hirsch M, et al. Recovery from opioid anesthesia: the clinical implication of context-sensitive half-times. *Anesth Analg* 1998;86:184-190.

65. Flegal KM, Williamson DF, Pamuk ER, et al. Estimating deaths attributable to obe-

sity in the United States. *Am J Public Health* 2004;94:1486-1489.

66. Bouillon T, Shafer SL. Does size matter? *Anesthesiology* 1998;89:557-560.

67. Casati A, Putzu M. Anesthesia in the obese patient: pharmacokinetic considerations. *J Clin Anesth* 2005;17:134-145.

68. Egan TD, Huizinga B, Gupta SK, et al. Remifentanyl pharmacokinetics in obese versus lean patients. *Anesthesiology* 1998;89:562-573.

69. Leslie K, Sessler DI, Smith WD, et al. Prediction of movement during propofol/nitrous oxide anesthesia. *Anesthesiology* 1996;84:52-63.

70. Cheymol G. Effects of obesity on pharmacokinetics implications for drug therapy. *Clin Pharmacokinet* 2000;39:215-231.

71. Shibutani K, Inchiosa MA, Sawada K, et al. Accuracy of pharmacokinetic models for predicting plasma fentanyl concentrations in lean and obese surgical patients: derivation of dosing weight ("pharmacokinetic mass"). *Anesthesiology* 2004;101:603-613.

72. Tallarida RJ. Drug synergism: its detection and applications. *J Pharmacol Exp Ther* 2001;298:865-872.

73. Tverskoy M, Fleyshman G, Bradley EL Jr, et al. Midazolam-thiopental anesthetic interaction in patients. *Anesth Analg* 1988;67:342-345.

74. Kissin I, Mason III JO, Bradley EL Jr. Pentobarbital and thiopental anesthetic interactions with midazolam. *Anesthesiology* 1987;67:26-33.

75. Short TG, Plummer JL, Chui PT. Hypnotic and anaesthetic interactions between midazolam, propofol and alfentanil. *Br J Anaesth* 1992;69:162-167.

76. Bailey PL, Pace NL, Ashburn MA, et al. Frequent hypoxemia and apnea after sedation with midazolam and fentanyl. *Anesthesiology* 1990;73:826-830.

77. Smith C, McEwan AI, Jhaveri R, et al. The interaction of fentanyl on the Cp50 of propofol for loss of consciousness and skin incision. *Anesthesiology* 1994;81:820-828.

78. Vuyk J. Pharmacokinetic and pharmacodynamic interactions between opioids and propofol. *J Clin Anesth* 1997;9:235-268.

79. Tallarida RJ, Porreca F, Cowan A. Statistical analysis of drug-drug and site-site interactions with isobolograms. *Life Sci* 1989;45:947-961.

80. Minto CF, Schnider TW, Short TG, et al. Response surface model for anesthetic drug interactions. *Anesthesiology* 2000;92:1603-1616.

81. Greco WR, Bravo G, Parsons JC. The search for synergy: a critical review from a response surface perspective. *Pharmacol Rev* 1995;47:331-385.

82. Vuyk J, Lim T, Engbers FHM, et al. The pharmacodynamic interaction of propofol and alfentanil during lower abdominal surgery in women. *Anesthesiology* 1995;83:8-22.

83. Vuyk J, Mertens MJ, Olofsen E, et al.



- Propofol anesthesia and rational opioid selection: determination of optimal EC50-EC95 propofol-opioid concentrations that assure adequate anesthesia and a rapid return of consciousness. *Anesthesiology* 1997;87:1549-1562.
84. Oei-Lim VLB, Kalkman CJ, Makkes PC, et al. Patient-controlled versus anesthesiologist-controlled conscious sedation with propofol for dental treatment in anxious patients. *Anesth Analg* 1998;86:967-972.
85. Campbell L, Imrie G, Doherty P, et al. Patient maintained sedation for colonoscopy using a target controlled infusion of propofol. *Anaesthesia* 2004;59:127-132.
86. Newson C, Joshi GP, Victory R, et al. Comparison of propofol administration techniques for sedation during monitored anesthesia care. *Anesth Analg* 1995;81:486-491.
87. Schuttler J, Schwilden H, Stoekel H. Pharmacokinetics as applied to total intravenous anaesthesia. Practical implications. *Anaesthesia* 1983;38:53-56.
88. Egan TD. Target-controlled drug delivery: progress toward an intravenous "vaporizer" and automated anesthetic administration. *Anesthesiology* 2003;99:1214-1219.
89. van den Nieuwenhuyzen MC, Engbers FH, Vuyk J, et al. Target-controlled infusion systems: role in anaesthesia and analgesia. *Clin Pharmacokinet* 2000;38:181-190.
90. Bazaral MG, Ciarkowski A. Food and Drug Administration regulations and computer-controlled infusion pumps. *Int Anesthesiol Clin* 1995;33:45-63.
91. Hu C, Horstman DJ, Shafer SL. Variability of target-controlled infusion is less than the variability after bolus injection. *Anesthesiology* 2005;102:639-645.
92. Avram MJ, Krejcie TC. Using front-end kinetics to optimize target-controlled drug infusions. *Anesthesiology* 2003;99:1078-1086.
93. Wakeling HG, Zimmerman JB, Scott H, et al. Targeting effect compartment or central compartment concentration of propofol: what predicts loss of consciousness? *Anesthesiology* 1999;90:92-97.
94. Struys MMRF, De Smet T, Depoorter B, et al. Comparison of plasma compartment versus two methods for effect compartment-controlled target-controlled infusion for propofol. *Anesthesiology* 2000;92:399-406.
96. Kodaka M, Handa F, Kawasaki J, et al. Cp50 of propofol for laryngeal mask airway insertion using predicted concentrations with and without nitrous oxide. *Anaesthesia* 2002;57:956-959.
97. Tetzlaff JE. The pharmacology of local anesthetics. *Anesthesiol Clin North America* 2000;18:217-233.
98. White JL, Durieux ME. Clinical pharmacology of local anesthetics. *Anesthesiol Clin North America* 2005;23:73-84.
99. Smith I, White PF, Nathanson MH, et al. Propofol: an update on its clinical use. *Anesthesiology* 1994;81:1005-1043.
100. DeBalli P. The use of propofol as an antiemetic. *Int Anesthesiol Clin* 2003;41:67-77.
101. Gan TJ, Glass PSA, Howell ST, et al. Determination of plasma concentrations of propofol associated with 50% reduction in postoperative nausea. *Anesthesiology* 1997;87:779-784.
102. Vinik HR, Bradley EL Jr, Kissin I. Triple anesthetic combination: propofol-midazolam-alfentanil. *Anesth Analg* 1994;78:354-358.
103. Mertens MJ, Vuyk J, Olofsen E, et al. Propofol alters the pharmacokinetics of alfentanil in healthy male volunteers. *Anesthesiology* 2001;94:949-957.
104. Smith I, Monk TG, White PF, et al. Propofol infusion during regional anesthesia: sedative, amnestic and anxiolytic properties. *Anesth Analg* 1994;79:313-319.
105. Oxorn DC, Ferris LE, Harrington E, et al. The effects of midazolam on propofol-induced anesthesia: propofol dose requirements, mood profiles, and perioperative dreams. *Anesth Analg* 1997;85:553-559.
106. TerRiet MF, Jacobs JS, Lewis MC, et al. Propofol and analgesia. *Anesth Analg* 2000;90:1455.
107. Frolich MA, Price DD, Robinson ME, et al. The effect of propofol on thermal pain perception. *Anesth Analg* 2005;100:481-486.
108. Picard P, Tramer MR. Prevention of pain on injection with propofol: a quantitative systematic review. *Anesth Analg* 2000;94:963-969.
109. Cohen LB, Dubovsky AN, Aisenberg J, et al. Propofol for endoscopic sedation: a protocol for safe and effective administration by the gastroenterologist. *Gastrointest Endosc* 2003;58:725-732.
110. Ferrari LR, Donlon JV. A comparison of propofol, midazolam, and methohexital for sedation during retrobulbar and peribulbar block. *J Clin Anesth* 1992;4:93-96.
111. Green SM, Krauss B. Propofol in emergency medicine: pushing the sedation frontier. *Ann Emerg Med* 2003;42:792-797.
112. Rex DK. The science and politics of propofol. *Am J Gastroenterol* 2004;99:2080-2083.
113. Whitehead C, Sanders LD, Oldroyd G, et al. The subjective effects of low-dose propofol. A double-blind study to evaluate dimensions of sedation and consciousness with low-dose propofol. *Anaesthesia* 1994;49:490-496.
114. Balasubramaniam B, Park GR. Sexual hallucinations during and after sedation and anaesthesia. *Anaesthesia* 2003;58:549-553.
115. Sundman E, Witt H, Sandin R, et al. Pharyngeal function and airway protection during subhypnotic concentrations of propofol, isoflurane, and sevoflurane: volunteers examined by pharyngeal videoradiography and simultaneous manometry. *Anesthesiology* 2001;95:1125-1132.
116. Eastwood PR, Platt PR, Shepherd K, et al. Collapsibility of the upper airway at different concentrations of propofol anesthesia. *Anesthesiology* 2005;103:470-477.
117. Ebert TJ, Muzi M. Propofol and autonomic reflex function in humans. *Anesth Analg* 1994;78:369-375.
118. Ebert TJ. Sympathetic and hemodynamic effects of moderate and deep sedation with propofol in humans. *Anesthesiology* 2005;103:20-24.
119. Blouin RT, Seifert HA, Babenco HD, et al. Propofol depresses the hypoxic ventilatory response during conscious sedation and isohypercapnia. *Anesthesiology* 1993;79:1177-1182.
120. White PF. The role of non-opioid analgesic techniques in the management of pain after ambulatory surgery. *Anesth Analg* 2002;94:577-585.
121. Green SM. Modern anesthesiologists receive limited training with ketamine—implications for emergency medicine. *Acad Emerg Med* 2000;7:839-841.
122. Suzuki M, Tsueda K, Lansing PS, et al. Small-dose ketamine enhances morphine-induced analgesia after outpatient surgery. *Anesth Analg* 1999;89:98-103.
123. Himmelseher S, Durieux ME. Ketamine for perioperative pain management. *Anesthesiology* 2005;102:211-220.
124. Elia N, Tramer MR. Ketamine and postoperative pain—a quantitative systematic review of randomised trials. *Pain* 2004;113:61-70.
125. Hui TW, Short TG, Hong W, et al. Additive interactions between propofol and ketamine when used for anesthesia induction in female patients. *Anesthesiology* 1995;82:641-648.
126. Sakai T, Singh WD, Kudo T, et al. The effect of ketamine on clinical endpoints of hypnosis and EEG variables during propofol infusion. *Acta Anaesthesiol Scand* 1999;43:212-216.
127. Mortero RF, Clark LD, Tolan MM, et al. The effects of small-dose ketamine on propofol sedation: respiration, postoperative mood, perception, cognition, and pain. *Anesth Analg* 2001;92:1465-1469.
128. Badrinath S, Avramov MN, Shadrack M, et al. The use of a ketamine-propofol combination during monitored anesthesia care. *Anesth Analg* 2000;90:858-862.
129. White PF. Comparative evaluation of intravenous agents for rapid sequence induction—thiopental, ketamine, and midazolam. *Anesthesiology* 1982;57:279-284.
130. Friedberg BL. Hypnosis first, then dissociation. *Anesth Analg* 2003;96:913-914.
131. Kain ZN, Mayes LC, Bell C, et al. Premedication in the United States: a status report. *Anesth Analg* 1997;84:427-432.
132. Bauer KP, Dom PM, Ramirez AM, et al. Preoperative intravenous midazolam: benefits beyond anxiolysis. *J Clin Anesth* 2004;16:177-183.



133. Unlugenc H, Guler T, Gunes Y, et al. Comparative study of the antiemetic efficacy of ondansetron, propofol and midazolam in the early postoperative period. *Eur J Anaesthesiol* 2004;21:60–65.
134. McClune S, McKay AC, Wright PMC, et al. Synergistic interaction between midazolam and propofol. *Br J Anaesth* 1992;69:240–245.
135. White PF, Negus JB. Sedative infusions during local and regional anesthesia: a comparison of midazolam and propofol. *J Clin Anesth* 1991;3:32–39.
136. Pratala MG, Fischer ME, Alagesan R. Propofol versus midazolam for monitored sedation: a comparison of intraoperative and recovery parameters. *J Clin Anesth* 1993;5:268–274.
137. Taylor E, Ghouri AF, White PF. Midazolam in combination with propofol for sedation during local anesthesia. *J Clin Anesth* 1992;4:213–216.
138. van Vlymen JM, Sa Rego MM, White PF. Benzodiazepine premedication: can it improve outcome in patients undergoing breast biopsy procedures? *Anesthesiology* 1999;90:740–747.
139. Mandema JW, Tuk B, van Steveninck AL, et al. Pharmacokinetic-pharmacodynamic modeling of the central nervous system effects of midazolam and its main metabolite alpha-hydroxymidazolam in healthy volunteers. *Clin Pharmacol Ther* 1992;51:715–728.
140. Bauer TM, Ritz R, Haberthur C, et al. Prolonged sedation due to accumulation of conjugated metabolites of midazolam. *Lancet* 1995;346:145–147.
141. White PF, Vasconez LO, Mathes SA, et al. Comparison of midazolam and diazepam for sedation during plastic surgery. *Plast Reconstr Surg* 1988;81:703–712.
142. Jacobs JR, Reves JG, Marty J, et al. Aging increases pharmacodynamic sensitivity to the hypnotic effects of midazolam. *Anesth Analg* 1995;80:143–148.
143. Gear RW, Miaskowski C, Heller PH, et al. Benzodiazepine mediated antagonism of opioid analgesia. *Pain* 1997;71:25–29.
144. Duthie DJ, Nimmo WS. Adverse effects of opioid analgesic drugs. *Br J Anaesth* 1987;59:61–77.
145. Veselis RA, Reinsel R, Feshchenko VA. Drug-induced amnesia is a separate phenomenon from sedation: electrophysiological evidence. *Anesthesiology* 2001;95:896–907.
146. Veselis RA, Reinsel RA, Feshchenko VA, et al. The comparative amnesic effects of midazolam, propofol, thiopental and fentanyl at equisedative concentrations. *Anesthesiology* 1997;87:749–764.
147. Bailey PL, Streisand JB, East KA, et al. Differences in magnitude and duration of opioid-induced respiratory depression and analgesia with fentanyl and sufentanil. *Anesth Analg* 1990;70:8–15.
148. Monk JP, Beresford R, Ward A. Sufentanil. A review of its pharmacological properties and therapeutic use. *Drugs* 1988;36:286–313.
149. White PF, Coe V, Shafer A, et al. Comparison of alfentanil with fentanyl for outpatient anesthesia. *Anesthesiology* 1986;64:99–106.
150. Pavlin DJ, Coda B, Shen DD, et al. Effects of combining propofol and alfentanil on ventilation, analgesia, sedation, and emesis in human volunteers. *Anesthesiology* 1996;84:23–37.
151. Avramov MN, White PF. Use of alfentanil and propofol for outpatient monitored anesthesia care: determining the optimal dosing regimen. *Anesth Analg* 1997;85:566–572.
152. Dershwitz M, Rosow CE. The pharmacokinetics and pharmacodynamics of remifentanil in volunteers with severe hepatic or renal dysfunction. *J Clin Anesth* 1996;8:88S–90S.
153. Glass PSA, Gan TJ, Howell S. A review of the pharmacokinetics and pharmacodynamics of remifentanil. *Anesth Analg* 1999;89:S7–S14.
154. Kapila A, Glass PS, Jacobs JR, et al. Measured context-sensitive half-times of remifentanil and alfentanil. *Anesthesiology* 1995;83:968–975.
155. Glass PSA, Hardman D, Kamiyama Y, et al. Preliminary pharmacokinetics and pharmacodynamics of an ultra-short-acting opioid: Remifentanil (GI87084B). *Anesth Analg* 1993;77:1031–1040.
156. Egan TD, Kern SE, Muir KT, et al. Remifentanil by bolus injection: a safety, pharmacokinetic, pharmacodynamic, and age effect investigation in human volunteers. *Br J Anaesth* 2004;92:335–343.
157. Sa Rego MM, Inagaki Y, White PF. Remifentanil administration during monitored anesthesia care: are intermittent boluses an effective alternative to a continuous infusion? *Anesth Analg* 1999;88:518–522.
158. Smith I, Avramov MN, White PF. A comparison of propofol and remifentanil during monitored anesthesia care. *J Clin Anesth* 1997;9:148–154.
159. Servin F, Desmots JM, Watkins WD. Remifentanil as an analgesic adjunct in local/regional anesthesia and in monitored anesthesia care. *Anesth Analg* 1999;89:S28–S32.
160. Avramov MN, Smith I, White PF. Interactions between midazolam and remifentanil during monitored anesthesia care. *Anesthesiology* 1996;85:1283–1289.
161. Joo HS, Perks WJ, Kataoka MT, et al. A comparison of patient-controlled sedation using either remifentanil or remifentanil-propofol for shock wave lithotripsy. *Anesth Analg* 2001;93:1227–1232.
162. Mingus ML, Monk TG, Gold MI, et al. Remifentanil versus propofol as adjuncts to regional anesthesia. Remifentanil 3010 Study Group. *J Clin Anesth* 1998;10:46–53.
163. Gold MI, Watkins WD, Sung YF, et al. Remifentanil versus remifentanil/midazolam for ambulatory surgery during monitored anesthesia care. *Anesthesiology* 1997;87:51–57.
164. Holas A, Krafft P, Marcovic M, et al. Remifentanil, propofol or both for conscious sedation during eye surgery under regional anaesthesia. *Eur J Anaesthesiol* 1999;16:741–748.
165. Bhana N, Goa KL, McClellan KJ. Dexmedetomidine. *Drugs* 2000;59:263–268.
166. Levanen J, Makela ML, Scheinin H. Dexmedetomidine premedication attenuates ketamine-induced cardiostimulatory effects and postanesthetic delirium. *Anesthesiology* 1995;82:1117–1125.
167. Ebert TJ, Hall JE, Barney JA, et al. The effects of increasing plasma concentrations of dexmedetomidine in humans. *Anesthesiology* 2000;93:382–394.
168. Kamibayashi T, Maze M. Clinical uses of alpha2-adrenergic agonists. *Anesthesiology* 2000;93:1345–1349.
169. Jalowiecki P, Rudner R, Gonciarz M, et al. Sole Use of dexmedetomidine has limited utility for conscious sedation during outpatient colonoscopy. *Anesthesiology* 2005;103:269–273.
170. Arain SR, Ebert TJ. The efficacy, side effects, and recovery characteristics of dexmedetomidine versus propofol when used for intraoperative sedation. *Anesth Analg* 2002;95:461–466.
171. Jaakola ML. Dexmedetomidine premedication before intravenous regional anesthesia in minor outpatient hand surgery. *J Clin Anesth* 1994;6:204–211.
172. Anonymous. Practice guidelines for postanesthetic care: a report by the American Society of Anesthesiologists Task Force on Postanesthetic Care. *Anesthesiology* 2002;96:742–752.
173. Aldrete JA, Kroulik D. A postanesthetic recovery score. *Anesth Analg* 1970;49:924–934.
174. Aldrete JA. The post-anesthesia recovery score revisited. *J Clin Anesth* 1995;7:89–91.
175. Chung F, Chan VW, Ong D. A post-anesthetic discharge scoring system for home readiness after ambulatory surgery. *J Clin Anesth* 1995;7:500–506.

# CHAPTER 69

## Anesthesia Care for Diagnostic or Therapeutic Procedures Outside of the Operating Room

Monica Davis, MD

For many years, the realm of choice for most anesthesiologists has been the operating room. We have spent the past few decades painstakingly equipping this environment with the appropriate monitors and machines that will help to ensure the safety of our patients. Many of us have trained almost exclusively in this domain and have gained confidence in the increasing quality of service and skill sets that we provide to our patients. However, because of recent advances in other medical practices, we have seen an exponential growth in the need for anesthesia services outside of the operating room. Each area presents its own unique challenges for the anesthesia care team, from the patient population seen (extremes of age, critically ill) to the very nature of the location itself (presence of bulky equipment, small area, radiation exposure, etc.). The trend to perform interventional procedures outside of the operating room will continue, and the demand for safe and effective anesthesia will undergo tremendous growth. For this reason, the anesthesia care team must become involved not only in the care of the patient but also in the details of the area into which they are called to administer their services. This includes ensuring that the same standards and codes held in the operating room are present in these remote locations prior to administration of an anesthetic.<sup>1</sup> This chapter reviews procedures that often require the expertise of trained anesthesia personnel and the specific challenges faced by the anesthesia care team in these remote areas. The role of the anesthesia provider in designing and developing these nonoperating room locales in accordance with the basic

safety standards as set forth by the American Society of Anesthesiologists (ASA) is discussed.

### PREANESTHETIC CONSIDERATIONS

#### Preanesthetic Assessment

Patients who are scheduled to undergo an interventional procedure often are outpatients or same-day admissions. In these circumstances, the anesthesia provider usually sees the patient for the first time on the day of the procedure. It is important that a current history and results of the physical examination be available to the anesthesia provider so that he or she can accurately assess the anesthetic risk of the patient. In many instances, patients undergoing interventional procedures are deemed to be at “high risk” for surgery because of multiple comorbid conditions or a specific life-threatening condition (e.g., primary pulmonary hypertension, recent myocardial infarction). Interviewing this type of patient 10 minutes before an elective procedure without having sufficient information on the nature of the patient’s physical status is not ideal. Because many of these procedures either require or have a high probability of requiring general anesthesia in order to be successful, these patients should receive the same level of attention given to patients being prepared for a surgical procedure. In addition, nothing by mouth (NPO) guidelines should be addressed, with patients receiving an anesthetic in the remote setting. To accomplish these goals, many patients require a scheduled visit to a dedicated preoperative clinic prior to any elective procedure.

#### Airway

First and foremost, a thorough airway examination should be performed during this encounter. Any gross abnormalities as well as any other possible concerns should be documented because they may greatly affect the type of anesthetic given to the patient. Many procedures involve a degree of patient isolation, and the anesthesia provider may not have instant access to the patient’s head; this should be taken into consideration when evaluating the airway. For example, if a patient has obvious anatomic irregularities or a known history of a difficult airway, rescue airway equipment [e.g., fiberoptic scope, oral airway device, laryngeal mask airway (LMA)] must be readily available if needed to secure the airway, even if monitored anesthesia care (MAC) or sedation is planned. Other concerns with the airway should be considered for patients with obstructive sleep apnea (OSA), morbid obesity, cervical spine issues, or a history of radiation to the head or neck region. Of particular importance are patients diagnosed with OSA, who present many additional challenges to the anesthesia care team. The ASA has published guidelines on the perioperative management of individuals with OSA. The purpose of these guidelines is to aid in the perioperative care of individuals diagnosed with various degrees of OSA (mild, moderate, and severe) because it affects the anesthesia for the procedure itself as well as the management of the postprocedural course. One of the most important recommendations is the use of general anesthesia with a secured airway, as opposed to deep or moderate sedation for superficial procedures, because these patients often have difficulty maintaining a

### KEY POINTS

1. Many patients who present for nonoperating room procedures are considered “high risk” for surgical procedures.
2. The same monitoring and equipment standards used in the operating room apply to remote locations.
3. Preanesthetic assessment should be just as thorough for procedural patients as for surgical patients.
4. Issues such as patient recovery and admission status should be discussed prior to the procedure.
5. Length and type of procedure, patient compliance, and remoteness of location should be considered when choosing the anesthetic technique.
6. Involvement of the anesthesia care team in institutional sedation policy is essential.

patent airway.<sup>2</sup> This possibility must be discussed with the patient and the primary physician, because a general anesthetic in these patients may lead to a longer recovery time or possible postprocedural admission.

### Comorbid Conditions

Many patients undergoing interventional procedures are deemed “unsuitable” for more invasive surgery because of the severity of preexisting comorbid illnesses. Many have poorly controlled hypertension or diabetes, uncompensated heart failure, severe chronic obstructive pulmonary disease, or end-stage renal/hepatic failure. These issues should not be taken lightly when preparing for nonoperating room procedures. Appropriate optimization or quantification of these conditions should be attempted prior to the intervention. Electrocardiograms, chest x-ray films, cardiac examinations, or laboratory tests can be performed as indicated by the severity of symptoms, especially if significant blood loss or hemodynamic changes are expected [electroconvulsive therapy (ECT), pulmonary stents/ablations, vessel rupture, etc.] The results of any examinations should be documented and members of the anesthesia and procedural teams made aware of any acute processes. Once the anesthetic risk has been estimated and the physical status of the patient determined, an anesthetic plan can be developed that will help optimize patient safety throughout the procedure.

## Requirements for Anesthesia in Remote Locations

### Space Allocation and Equipment Needs

Equipment and space considerations often impact anesthetics in an off-site location. These sites can range anywhere from a state-of-the-art interventional radiology suite to a private hospital room. More often than not, these areas initially were developed by the primary service or hospital administration and likely did not consider the needs of the anesthesia team. The presence of large, bulky equipment may greatly limit the space available for carts, monitors, or the providers themselves. The area may lack sufficient lighting or electrical outlets for additional equipment needed. Importantly, the anesthesia providers may find themselves distanced and isolated

from other anesthesia personnel. Prior to administering any type of anesthetic, an experienced anesthesia provider should survey the proposed area and determine if anesthesia services can be safely provided. The ASA has published guidelines to assist the anesthesiologist in these matters. The guidelines include the following<sup>3</sup>:

- Availability of a reliable oxygen source and delivery method (nasal cannulas, face masks), along with backup supply of oxygen in the form of a full E cylinder
- Availability of adequate suction
- Ability to scavenge waste gases when inhaled anesthetic agents are required
- Presence of a self-inflating resuscitator bag that can administer at least 90% oxygen and deliver positive-pressure ventilation in the event of respiratory distress
- Adequate anesthetic drugs, monitoring equipment, and supplies for the duration of the case
- Adequate lighting and electrical outlets for proper visualization and operation of anesthesia equipment
- Availability of a sufficient amount of space for the anesthesia provider and any other necessary personnel, as well as unobstructed access to the patient, anesthesia equipment, and emergency supplies
- Emergency cart with a defibrillator and emergency drugs for cardiopulmonary resuscitation
- Observance of all applicable building codes and facility standards
- Availability of adequately trained staff for immediate assistance of the anesthesia provider, as well as reliable two-way communication with which to request additional assistance
- Provision of adequate postanesthesia care, which should include appropriately trained staff and equipment that ensures safe transport of the patient to the designated recovery area

Once these conditions have been met, the anesthesia caregiver can focus on the actual care of the patient undergoing the proposed procedure.

### Monitoring Requirements

Any patient receiving an anesthetic, whether in an operating room or a

procedural suite, must have basic anesthetic monitoring as described by the ASA. The standards include the presence of qualified anesthesia staff during the conduct of a general/regional anesthetic or MAC and constant evaluation of the patient's oxygenation, circulation, ventilation, and temperature.<sup>4</sup> This is accomplished using standard equipment (pulse oximetry, expired carbon dioxide, electrocardiogram, blood pressure monitors) and by direct observation of the patient by the anesthesia provider. A study by Soto et al.<sup>5</sup> found that a significant percentage of patients undergoing MAC experienced approximately 20 seconds of apnea that was not detected by the anesthesia provider but was detected by capnography and impedance (respiratory rate) monitoring. Although the widespread use of capnography and pulse oximetry has reduced the morbidity associated with anesthesia administered in nonoperating room settings, these monitors should be used as adjuncts to clinical observation. The patient's color and chest excursion should be noted. If the patient is able to respond appropriately, then verbal communication with the patient can be used to continually assess patient status. More invasive monitoring may be necessary, depending on the physical status of the patient and the nature of the procedure. This should be anticipated beforehand because many nonoperating room areas do not provide storage for such equipment. Extenuating circumstances may require modification of these standards, with appropriate adjustments made. In situations where the anesthesia provider may not be able to remain in the procedural area [e.g., during magnetic resonance imaging (MRI), radiation therapy], the patient must be constantly visualized through a window or by video cameras. All machines and monitoring equipment must be tested on a regular basis to protect against untimely malfunction in these remote areas. Personnel assigned to these locations should familiarize themselves with the area and note the most expeditious routes to the operating room or postanesthesia care unit (PACU) should an emergency arise.

Careful attention must be given to the patient's body temperature because hypothermia occurs frequently during many of the lengthy procedures. This is of special concern in the

elderly and pediatric populations and in locations where large equipment must be kept cool. In these situations, monitoring of the patient's temperature, regardless of the type of anesthetic used, should be routine.<sup>6</sup> Forced air warming, if available, is ideal; however, any means of maintaining normothermia (warm blankets, increasing the room temperature, or other skin surface warming techniques) should be instituted during the procedure and in the immediate postprocedural period.

### Postanesthesia Concerns

The postprocedural course in some patients can be just as challenging as for operating room surgical patients. For this reason, all postanesthesia recovery areas should exhibit the same standards of care as areas devoted to the care of postsurgical patients. These standards are promulgated by the ASA and are directed to all aspects of postanesthesia care. The guidelines state that the patient who receives an anesthetic must be admitted to a postanesthesia recovery unit for appropriate management, the patient must be continually evaluated and supported during transport, and an appropriate report must be given to the PACU nurse.<sup>7</sup> Under certain circumstances, an individual will meet the discharge criteria soon after completion of the procedure and can be discharged to the care of a responsible individual. In these situations, the anesthesiologist can use his or her best clinical judgment to determine whether or not the patient requires additional monitoring in a postprocedural recovery area. The key is that discharge criteria should remain the same for all postanesthetic patients, regardless of the location of the procedure.

### Pharmacologic Agents

The anesthesia provider's choices of pharmacologic agents for nonoperating room procedures are as varied as those for use in the operating room itself. The types of procedures range from imaging studies under MAC to complicated interventional processes that may require general anesthesia with intubation. The majority of nonoperating room anesthetics involve the use of intravenous agents to achieve the level of amnesia and analgesia required to successfully perform these procedures. Among the

most commonly used drugs are those in the sedative-hypnotic category. Benzodiazepines are the most widely used by nonanesthesia personnel for minimally invasive procedures. Their properties of anxiolysis and amnesia, as well as the existence of the reversal agent flumazenil, make these drugs (often used in conjunction with a narcotic) an ideal combination for conscious sedation in these circumstances. However, the agent that virtually dominates the landscape of procedural anesthesia is propofol. In the hands of trained individuals, propofol can be easily titrated to produce mild sedation or to induce general anesthesia, in both instances demonstrating rapid recovery and return to baseline mentation.

The quality of amnesia produced by propofol during its administration is a desirable effect in these procedures. A study by Veselis et al.<sup>8</sup> at Memorial Sloan-Kettering investigated the effect of propofol, thiopental, and dexmedetomidine on memory using continuous tasks involving auditory word recognition before and during the administration of the agent. Retention of material into long-term memory, as associated with minimal sedation (which was purported to define drug-induced amnesia), was found to be impaired during propofol administration.

Because of the low analgesic properties associated with propofol, narcotics often are added to the regimen in order to produce a balanced anesthetic technique. For most of these procedures, short-acting opioids are preferred, most notably remifentanyl. Despite its brief half-life, remifentanyl still produces the same side-effect profile as the other opioid agents, although the effects are short lived. This can be a concern when remifentanyl is used with another hypnotic, such as propofol, because their cardiovascular and respiratory depressant effects may be additive. Moerman et al.<sup>9</sup> performed a prospective randomized study to determine if supplementation of a propofol anesthetic with remifentanyl had any advantage over the use of propofol alone in patients undergoing colonoscopy. They found that the propofol-remifentanyl combination offered no benefit over propofol alone in spontaneously ventilating patients. This finding is in contrast to an earlier study that noted an advanta-

geous relationship of the two drugs when used in patients under controlled ventilation.<sup>10</sup>

Another agent that is gaining popularity for use in the sedation arena is dexmedetomidine. It is a highly selective  $\alpha_2$ -adrenoceptor agonist that possesses both sedative and analgesic properties. Its ability to provide profound sedation while preserving respiratory drive makes it a useful anesthetic method in patients with a difficult airway.<sup>11</sup> Additional study is needed to better determine the drug's utility in remote procedural areas.

## COMMON PROCEDURAL AREAS

### ECT

ECT has long been a treatment modality for patients suffering from some psychiatric illnesses. Conditions include schizophrenia, major depressive disorder, bipolar, and schizoaffective disorders. ECT itself involves the induction of generalized seizure activity by introduction of an electrical stimulus through electrodes strategically placed along the cranium.

In order to be clinically efficacious, the seizure must reach a specific level of intensity duration. The patient typically must undergo several treatments. Because of the nature of the therapy and the associated physiologic responses to generalized seizures, anesthesia is required for the first and all subsequent sessions involving ECT. Many patients have comorbid illnesses in addition to their psychiatric disorders; anesthesiologists must be aware of the physical status of their patients and minimize complications during the course of therapy. Considering the large number of cases performed in the United States, the morbidity and mortality associated with ECT are surprisingly low. These low rates largely result from the use of standard monitors during the course of treatments as well as the recent advances in pharmacologic agents used for anesthetic management and control of hypertensive and cardiac responses to seizure activity. A large retrospective review by Nuttall et al.<sup>12</sup> at the Mayo Clinic reported a low of incidence of complications associated with anesthesia for ECT. The most notable complications associated with ECT were prolonged seizures, which



in this study were successfully treated with benzodiazepines. Anesthetic management for ECT is straightforward, although certain aspects vary among institutions. The goal of the anesthesia provider is to institute adequate airway support, suppress any recall or awareness of the session, and attenuate the physiologic responses to the stimulus. Once the patient is ready to begin the session, the appropriate monitors are placed and oxygen is delivered to the patient via face mask. General anesthesia is induced via an intravenous induction agent. Once the patient loses consciousness, a muscle relaxant, generally succinylcholine, is administered in preparation for the induced seizure. For patients with a pseudocholinesterase deficiency, a suitable non-depolarizing muscle relaxant is used in lieu of succinylcholine. Once general anesthesia has commenced, the patient's airway and breathing are supported via face mask and positive-pressure ventilation.

The anesthesia provider continues to support respiratory function until the return of spontaneous ventilatory effort by the patient. In some instances, other forms of airway intervention may be necessary, such as placement of an LMA. Because the ECT treatment course can last from several days to several weeks, any difficulties with the airway should be duly noted for any subsequent sessions and appropriate arrangements made.

Methohexital has been the most widely used induction agent in recent times. All hypnotic agents cause some reduction in seizure activity, but methohexital affects such activity to a lesser degree than the other agents. However, methohexital alone fails to prevent the resulting tachycardia and hypertension associated with ECT. The increase in systolic blood pressure and heart rate immediately following the stimulus may be as much as 30–40% and 20%, respectively.<sup>13</sup> In patients with known cardiovascular disease or significant risk factors, these responses should be kept to a minimum in order to prevent any untoward cardiac events during the course of treatment. Several studies have been performed to determine which agents or combinations of agent's best suppress this hyperdynamic response to ECT stimulation. A study by Gazdag et al.<sup>14</sup> examined the difference in duration of

seizure activity and hemodynamic response to ECT between methohexital and propofol. Although propofol significantly lowered the duration of seizure activity compared to methohexital, the clinical efficacy of the treatment was not diminished, and the resultant lower mean arterial pressure associated with propofol could be beneficial to patients who demonstrate a higher cardiovascular risk profile. Other studies investigated anesthetic regimens that included methohexital with adjunct therapies. Locala et al.<sup>15</sup> performed a prospective, randomized, double-blind study on the use of methohexital alone and remifentanyl supplemented with a dose of methohexital sufficient to suppress recall. Patients who received remifentanyl demonstrated a significant reduction in systolic blood pressure and heart rate associated with ECT. In addition to the ability of remifentanyl to suppress the sympathetic response to seizure activity, some reports in the literature have indicated that remifentanyl may increase the duration of seizure activity, making it an attractive agent in the anesthesia provider's arsenal.<sup>16</sup>

Other means of attenuating the hemodynamic response to ECT in patients with cardiovascular disease include the use of antihypertensive medications, most notably  $\beta$ -blockers. A study by Zhang et al.<sup>17</sup> examined the effect of different doses of nicardipine administered prior to induction of seizure activity. They discovered that a dose of nicardipine 40  $\mu\text{g}/\text{kg}$  IV in addition to labetalol 0.15  $\mu\text{g}/\text{kg}$  sufficiently blunted the hyperdynamic response without a significant decrease in seizure duration or postprocedural hypotensive effects.

Most patients who present for ECT either are currently taking or have taken antidepressants or other psychiatric agents. Historically, the agents of most concern with regard to anesthesia have been the monoamine oxidase inhibitors (MAOIs). According to previous recommendations, these medications were to be discontinued 2 weeks prior to any elective procedure.<sup>18</sup> However, in a series of case reports presented by Dolenc et al.,<sup>19</sup> patients had no adverse effects from general anesthesia with concurrent use of an MAOI.<sup>19</sup> Furthermore, no difference in hemodynamic response to ECT sessions was noted in patients either currently receiving or not receiving an

MAOI. Much debate is ongoing regarding the discontinuance of any psychiatric medication, most notably MAOIs, in preparation for ECT. In the current understanding, ceasing MAOI use prior to the procedure is prudent if the medication is of no benefit to the patient. Avoidance of any known contraindicated drugs (indirect acting sympathomimetics, meperidine) is most important in these instances.

## Endoscopy

The number of diagnostic and therapeutic procedures performed in the gastroenterology suite has increased greatly as the benefit of early screening for, and treatment of, both benign and malignant conditions has been well established. The vast majority of cases use some form of anesthesia, either conscious sedation administered by the gastroenterologist or deep sedation/general anesthesia administered by the anesthesia provider. Some cases still are performed without any type of sedation, but they are becoming more infrequent as patients have shown an unwillingness to undergo what may be unpleasant procedures without some form of anxiolysis or anesthesia.<sup>20</sup> The anesthesia team usually becomes involved in the more complicated or emergent cases. To that effect, most patients who present to the anesthesia provider for periprocedural care often are elderly or tend to have multiple comorbid conditions that should be addressed prior to commencement of the anesthetic.

The most common procedures performed in the gastroenterology suite are upper endoscopy, colonoscopy, sigmoidoscopy, and endoscopic retrograde cholangiopancreatography (ERCP). Each of these procedures carries its own unique challenges for the anesthesia provider. Colonoscopy traditionally is performed either without sedation or under conscious sedation administered by the endoscopist. A deeper level of anesthesia is required in some patients because of their increased apprehension or severe discomfort experienced during the procedure. Important considerations for the anesthesiologist during colonoscopy include hemodynamic instability due to dehydration from a preparatory bowel regimen or uncompensated anemia from severe gastrointestinal (GI) bleeding. Upper endoscopy procedures involve placement of a scope into the esophagus and

stomach (and biliary tract in the case of ERCP) via the oropharynx. Patients usually are placed in the extreme lateral or prone position. The combination of patient positioning and the nature of the procedure itself limits access to the head and, consequently, the airway. Airway obstruction and apnea during sedation may develop, so the endoscopist and the anesthesia provider must have a clear understanding between them that emergency management of the airway supersedes continuation of the procedure until the situation has been safely controlled. Bradycardia or other arrhythmias can result from distension of the GI tract from probe insertion.<sup>21</sup> Other complications include bleeding, perforation, and infection.<sup>22</sup> Because these procedures often cause a great deal of anxiety and initiate a strong gag reflex in patients, most GI physicians use both a topical anesthetic spray and some form of intravenous sedation, usually midazolam and a narcotic (meperidine or fentanyl), to blunt these responses. Some procedures require the use of more potent agents because the procedures are longer and more complex and necessitate a high degree of patient cooperation.<sup>23</sup> Propofol, with its potent amnestic properties and rapid recovery time, has become an ideal choice for these procedures. It can be titrated to produce any level of anesthesia, from anxiolysis to general anesthesia. Its tendency to produce deep sedation with subsequent loss of protective airway reflexes at standard doses should limit its use to anesthesiologists and other individuals trained in airway management.<sup>24</sup> The level of sedation needed to successfully complete endoscopic procedures varies among populations. A study by Kazama et al.<sup>25</sup> found that, in general, elderly patients tolerated these procedures well at propofol concentrations associated with conscious sedation, whereas younger patients typically required larger doses (deep sedation) to suppress the somatic response to endoscopy. Although most GI procedures can be completed successfully under MAC or total intravenous anesthesia (TIVA), general anesthesia with endotracheal intubation may be necessary, for example, in patients who have airway difficulties or are at high risk for aspiration. The need for intubation should be discussed with the endoscopist because the presence of an endotracheal tube

(ETT) may make the procedure awkward or difficult to perform.

### Cardiopulmonary Suite

One of the main factors responsible for the phenomenal growth in nonoperating room procedures has been the need for interventional therapy in what traditionally have been considered nonsurgical candidates. This trend is definitely evident in the area of cardiopulmonary medicine. Many of these patients do not qualify for surgical intervention because of their poor physical status or the extent of their disease. Other patients simply refuse to undergo a surgical procedure that carries a high risk of mortality. The most common procedures requiring anesthesia generally involve patients diagnosed with some type of pulmonary malignancy. The interventions used in this population of patients range from rigid bronchoscopy to laser ablation; each intervention has its associated risks and complications. Most cardiac procedures are performed in the cardiac laboratory and involve treatment of arrhythmia via cardioversion or an implantable device.

### Pulmonary Suite

Various techniques have been used for treatment of airway obstruction. One of the earlier treatment modalities involved use of the neodymium:yttrium-aluminum-garnet (Nd:YAG) laser. This procedure initially was used for treatment of endobronchial lesions. It consisted of coagulation of the tumor by the laser and subsequent coring and removal of the tumor by forceps or the tip of the bronchoscope. The Nd:YAG laser can be used with either a rigid or a flexible bronchoscope. The preferred method is rigid bronchoscopy because it lends itself to simultaneous use of the laser and suction.<sup>26</sup> Possible complications of laser therapy include hemorrhage, pneumothorax, airway perforation, arrhythmia, and myocardial infarction.<sup>27-30</sup> Airway fire is a rare complication, but high concentrations of oxygen should be avoided during the laser portion of the procedure.

Electrocautery is a more recent technique used for treatment of central airway lesions. Its use is gaining in popularity because of its wide availability, cost effectiveness, and ability to use either a rigid or a flexible bronchoscope.<sup>31</sup> Sutedja et al.<sup>32</sup> reported rapid relief of symptoms and ease of the

technique when the procedure was performed on several patients with central airway obstruction.

Although the aforementioned techniques can successfully relieve symptoms caused by intrinsic obstruction, airway stents are the only devices that can provide relief and structural support for airway compression caused by extrinsic tumors or stenosis. The most common conditions that require stenting are tracheomalacia, polychondritis, tracheal stricture secondary to prolonged intubation, and bronchial stenosis after lung transplantation. The two main types of stents currently in use are silicone and metallic. Both have advantages and disadvantages. Metallic stents are considered permanent and normally are used to treat obstruction caused by malignancy. They are flexible and expandable, and they allow for normal ciliary movement once they are in place. These stents can be placed using a flexible bronchoscope with or without the use of general anesthesia. The major disadvantage of metallic stents is the difficulty in removing or repositioning them once they are deployed. Silicone stents can be removed or displaced with relative ease, and they are generally used to treat more acute processes, such as infection and inflammation.<sup>33</sup> However, these stents are much more rigid than their metallic counterparts and require prior airway dilation before deployment. This is accomplished using rigid bronchoscopy and subsequently requires the use of a general anesthetic.

Thorough preoperative evaluation of all patients undergoing interventional pulmonary procedures should be performed. In many cases, large masses are compressing vital airway structures, and the extent of compromise must be determined prior to the procedure. Pulmonary function tests with flow-volume loops are pivotal in differentiating between fixed and variable obstructions. Imaging studies include chest radiography or computed tomographic (CT) scan to determine the extent of obstruction. In emergent situations, the anesthesia provider may not have the luxury of extensive testing and will need to rely on physical symptomatology to determine the type of lesion present. Inspiratory stridor is indicative of an extrathoracic obstruction, whereas expiratory stridor is associated with intrathoracic

obstruction. For anesthetic management of these cases, the anesthesia provider must be prepared for airway emergencies. Several ETTs of various sizes as well as LMAs should be readily available. The provider should be prepared for emergency rigid bronchoscopy or tracheostomy.<sup>34</sup> Patients should be well oxygenated, and spontaneous ventilation should be maintained, especially in patients with severe obstruction or large mediastinal masses, until the airway is secured. Additional management includes the use of topical agents to anesthetize the airway prior to induction (through a nebulizer or spray) and careful titration of intravenous agents to achieve a satisfactory level of sedation. When general anesthesia is necessary, a small dose of succinylcholine usually is sufficient to facilitate placement of a rigid bronchoscope or ETT in patients in whom muscle relaxation is not contraindicated. Once the airway is secure, the anesthetic agents (including paralytics) can be titrated to prevent excessive movement and coughing during the procedure. Infusions of propofol and remifentanyl are commonly used for TIVA in these instances.<sup>35</sup> Because of leak caused by rigid bronchoscopy, manual intermittent positive-pressure ventilation through the side port of the bronchoscope or swivel connector is normally used as opposed to mechanical ventilation. Hyperventilation with 100% oxygen (when not contraindicated) also is necessary to compensate for prolonged periods of apnea. Postoperatively, these patients should be transported with the appropriate monitors to the PACU, where they can be closely monitored for any sign of airway compromise and a chest x-ray film can be obtained to search for evidence of barotrauma.

### **Cardiac Laboratory**

An increasing number of patients are undergoing invasive cardiology procedures that require the presence of trained anesthesia providers. In the past, certain procedures, such as placement of pacemakers/defibrillators, were performed in the operating room by a cardiovascular surgeon with a cardiac anesthesiologist in attendance.<sup>36</sup> Recently, however, implantation of these devices is being performed by the interventional cardiologist in the cardiac/evoked potentials laboratory with the assistance of a noncardiac

anesthesiologist. The physiologic status of patients presenting for placement of implantable cardioverter-defibrillators vary from young, otherwise healthy individuals with supraventricular dysrhythmias (Wolff-Parkinson-White syndrome) to elderly patients with significant coronary artery disease/congestive heart failure who have survived a life-threatening arrhythmia (ventricular tachycardia, ventricular fibrillation). Many have severe ventricular dysfunction (ejection fraction 10–35%) and are taking antiarrhythmic or cardiac medications. The extent of their cardiac disease should be assessed preoperatively by the anesthesia care team and appropriate consultations obtained from the cardiologist involved in the patient's care. Anesthetic management for these cases ranges from sedation to general anesthesia with an ETT. Once the device is implanted, ventricular tachycardia or ventricular fibrillation is induced in the patient and a corresponding shock is delivered. This process can be quite uncomfortable to the patient, especially if multiple cycles are necessary. In circumstances where sedation is used, the anesthesia provider must be prepared for a brief period of general anesthesia to allow for device testing.<sup>37</sup> Antiarrhythmic drugs and an external defibrillator should be present at all times should the device fail to restore normal sinus rhythm. Standard monitors usually are sufficient for these cases, with more invasive monitoring reserved for patients in a more tenuous physical status. A postprocedural chest radiograph should be obtained to rule out pneumothorax or pericardial effusion and to confirm lead placement. Patients may recover in either the cardiac catheterization laboratory or the PACU, if necessary.

Electrical cardioversion is used to convert patients to normal sinus rhythm. The usual indications are atrial fibrillation, atrial flutter, supraventricular tachycardia, or other ventricular arrhythmias. Cardioversion can be performed either emergently (unstable arrhythmias) or electively (failed medical therapy). Because of the physical discomfort and psychological distress caused by the procedure, electrical cardioversions are performed either under deep sedation or with general anesthesia. For emergent cases, patients should be treated as having “full stomachs” and appropriate

aspiration precautions taken. In elective cases, deep sedation is adequate, accompanied by a brief period of general anesthesia for the actual delivery of the stimulus. Gradual induction of anesthesia can be accomplished with careful titration of either etomidate or propofol, depending on the patient's hemodynamic status.<sup>38</sup> Respiratory assistance during this time is provided by mask ventilation; however, patients with airway difficulties may require an LMA or ETT for ventilatory management during the procedure. The postprocedural recovery time is generally brief, and outpatients may be discharged home as soon as 1–2 hours after cardioversion. In some patients, particularly those with hemodynamic instability, recall of the procedure may be an issue. This possibility should be discussed with the patient and the appropriate support and information concerning recall should be made available by the anesthesia provider.

### **Interventional Radiology**

As a result of rapid advances in the areas of medical and computer technology as well as biophysics, the field of interventional radiology currently is exhibiting unprecedented growth. From state-of-the-art imaging studies to placement of vascular stents, the procedural possibilities in this specialty appear nearly infinite. As interventional radiologists continue to expand their scope of practice to the limits of modern medicine, the role of the anesthesiologist in this medical odyssey has become increasingly prominent. Initially, the majority of interventional procedures were performed with local anesthesia and minimal sedation administered by the radiologist. However, as the nature of the procedures became increasingly complex and the need for total patient compliance became necessary, the level of sedation required to successfully perform these interventions gradually began to increase. The frequent need for deeper sedation coupled with the increasing number of high-risk patients presenting for these “minimally invasive” procedures has led to the growing involvement of trained anesthesia personnel in perioperative management in the radiology suite. The radiology community generally believes that the presence of a separate anesthesia provider responsible for pain control and continuous resuscitation during technical-

ly challenging procedures, especially in the critically ill, should be mandatory.<sup>39</sup> A wide variety of cases are performed in the radiology suite, many of which involve the services of the anesthesiologist. For this discussion, we focus on the most common and technically demanding procedures and their complications as they relate to the anesthetic management.

### **Radiofrequency Ablation**

Radiofrequency ablation (RFA) is widely used as a noninvasive treatment of primary and metastatic tumors and painful bone and neural lesions. A limitation to this form of therapy has been the relatively small area of tumor destruction achieved in a single treatment. Recent technologic advances in this modality have allowed for destruction of larger lesions (>5 cm in diameter) during a given session.<sup>40</sup> This has led to the expanded use of RFA in the treatment of many malignant tumors, including pulmonary, hepatic, bone, and renal cancers.

The technique of RFA involves placement of either a single electrode or multiple electrodes that are contained in a single needle into the lesion targeted for ablation. Once in place, tissue coagulation is induced through an electromagnetic source within the electrode.<sup>41</sup> Correct positioning of the electrode into the lesion of interest is accomplished through guidance from various imaging techniques, which include ultrasonography, CT, CT with fluoroscopy, or MRI. The choice of imaging depends on the availability of the technology at that center and the technical expertise of the interventionalist performing the procedure. A study by Ahrar et al.<sup>42</sup> at MD Anderson Cancer Center investigated the success of treating renal cell carcinoma through RFA. Image guidance using CT or CT fluoroscopy was the modality of choice because it allowed for accurate visualization of the tumor and surrounding structures and the image was not obscured by bleeding or vaporization of surrounding tissue, as is the case with ultrasonography. MRI has the advantage of clear delineation of the tumor and surrounding structures in addition to its capability of real-time multiplanar imaging and temperature monitoring.<sup>43</sup> However, its limited availability in most centers prevents its widespread use in this arena.

Anesthetic management of RFA depends on the size and location of the

tumor. For most cases, MAC is sufficient and is generally well tolerated by patients. For larger lesions or lesions near vascular structures, general anesthesia with placement of ETT may be required to prevent patient movement during critical portions of the procedure. Complications of RFA include hemorrhage, pneumothorax, hemothorax, thermal injury, electrical shock, and hyperthermia, as the patient may exhibit significant increases in body temperature in response to direct heating of large masses.<sup>44</sup> Patients can be taken to the PACU or kept in the recovery area of the interventional suite, if appropriate, for postoperative monitoring and pain control.

### **Interventional Neuroradiology**

Perhaps one of the most challenging and exciting fields of interventional medicine is the area of interventional neuroradiology. Noninvasive treatment of neurovascular disease has evolved significantly, and it seems that no vessel is unreachable with today's arsenal of catheters and imaging techniques. The most common treatments are embolization or sclerotherapy of tumors and arteriovenous malformations (AVMs), angioplasty for cerebral vasospasm, and coil embolization of cerebral aneurysms. In most of these cases, general anesthesia is the preferred method of anesthetic management because patients are often required to remain motionless for extended periods. Each of these procedures carries its own patient and risk profiles that the anesthesia provider should consider in formulating a management plan. Common complications of interventional neuroradiologic procedures include cerebral ischemia, hemorrhage, catheter displacement, and pulmonary embolism.<sup>45</sup> The goals of perioperative management in these procedures are no different than those set for any neurosurgical case: maintenance of hemodynamic stability, preservation of cerebral blood flow and cerebral perfusion pressure, respectively, and rapid emergence following completion of the procedure to assess the patient's neurologic status.<sup>46</sup>

AVMs are vascular structures in which one or more aberrant arteries feed into a nidus that then is drained by coexisting aberrant veins. In the past, embolization of AVMs was performed prior to surgical resection of the abnormality. However, many of

these lesions now are being treated by embolization alone given the presence of experienced neuroradiologists.<sup>47</sup> Embolization can be accomplished by deployment of thrombosing coils or permanent balloons or by injection of sclerosing agents, glues, or particulate material. Complications following embolization include cerebral hemorrhage or edema resulting from sudden reperfusion into areas that previously were underperfused.<sup>48</sup>

Careful management of arterial blood pressure and, thus, cerebral perfusion pressure is important. This is best accomplished under general anesthesia with use of muscle relaxation to avoid the sudden increase in blood pressure and intracranial pressure associated with coughing or involuntary paroxysmal movement. Some patients may require preoperative and intraoperative pharmacologic agents to assist in controlling blood pressure during the procedure. Propranolol, in addition to its known hemodynamic effects, has been shown to possibly reduce cerebral metabolic rate and cerebral blood flow without significant impairment of metabolism–flow coupling.<sup>49</sup> Invasive blood pressure monitoring is recommended for patients in whom deliberate hypotension is planned. Placement of other invasive monitors will depend on the current physical status of the patient and the need for postprocedural hemodynamic monitoring.

Although surgical clipping remains the treatment of choice for ruptured cerebral aneurysms, the endovascular approach via coil placement is gaining popularity in the treatment of unruptured aneurysms.<sup>50</sup> The basic goal of this approach is obliteration of the aneurysm sac through the placement of coils.<sup>51</sup> Possible complications associated with coil embolization include hemorrhage, thromboembolism, and vasospasm, which is most notably problematic in the case of aneurysm rupture. Nimodipine still is considered the agent of choice for prevention or continued treatment of vasospasm. Patients who undergo these procedures are taken to the ICU for monitoring of their neurologic status.

### **Transjugular Intrahepatic Portosystemic Shunting**

Transjugular intrahepatic portosystemic shunting (TIPS) is a technique that involves the creation of a shunt through the liver between one of the



hepatic veins and either the right or left portal vein.<sup>52</sup> TIPS traditionally has been used to treat esophageal varices, but its utilization has been expanded to include the treatment of several other hepatic conditions, such as portal vein thrombosis and Budd-Chiari syndrome. TIPS can be performed under MAC or general anesthesia, depending on the patient's physical status and the practitioner's comfort level with the technique. Patients who present for TIPS may have a large number of ascites or other complications of hepatic disease (pleural effusions, intrapulmonary shunting) that can restrict ventilatory effort and decrease oxygenation.<sup>53</sup> Patients who have a significant amount of ascites or a recent episode of GI bleeding are at increased risk for aspiration. The procedure itself may take several hours to perform, which requires a cooperative and stable patient. All of these factors must be taken into consideration when choosing an appropriate anesthetic method. Standard monitors usually are sufficient, but more invasive techniques may be required in emergent cases or in hemodynamically unstable patients (active bleeding, severe cardiomyopathy, acid-base disturbances). Adequate IV access in the form of a large-bore catheter should be established, because one of the complications of the procedure is hemorrhage and the patient may experience hemodynamic instability. Recovery usually takes place in the PACU or ICU setting, as many seriously ill patients fail to improve in the immediate postprocedural period.

## Diagnostic Imaging

In the previous section, we discussed therapies in the radiology suite that involve some type of invasive technique. For many of these procedures, the need for sedation or anesthesia is self-explanatory. However, the services of the anesthesia provider may be required for various noninvasive diagnostic modalities. For these imaging studies, total patient cooperation is needed in order for the studies to have optimal diagnostic value. This section discusses the most frequently performed examinations: MRI and CT scan.

### MRI

MRI is a diagnostic imaging tool that uses both static and gradient magnetic fields with the addition of radiofre-

quency pulses to provide clear and anatomically correct body images. The strength of the magnetic field used in MRI ranges from 0.15–3.0 T, with stronger fields producing a higher quality image. Although MRI does not use ionizing radiation (as in CT) and is not known to produce any harmful physiologic effects, the scan involves certain risks of which all personnel in the area should be aware. The most important are those involving ferromagnetic objects or equipment near the magnetic field. Many of the reports of injury or fatality are related to these objects, which become projectiles when exposed to the strong magnetic field. In addition, patients who have any indwelling metallic device, such as a pacemaker, implantable cardioverter-defibrillator, aneurysm clip, or infusion pump, are generally contraindicated for MRI.<sup>54</sup>

Because of the need for absolute immobility and the length of some types of scans, some patients, most notably pediatric patients, require deep sedation or anesthesia for successful completion of the study. In the adult population, claustrophobia and movement disorders are the most common reasons for the involvement of anesthesia services. Studies have shown that a fairly large percentage of adults (14–20%) require some anesthesia in order to tolerate MRI.<sup>55</sup> In these cases, anesthetic techniques range from conscious sedation for adults with mild claustrophobia or anxiety to general anesthesia for patients in whom airway issues are expected (e.g., patients with OSA). One of the more effective and popular techniques is TIVA with propofol as the drug of choice. Whatever the preferred method, the presence of MRI-compatible airway equipment is a must during any anesthetic in this location. Ideally, an MRI-compatible anesthesia machine and monitors also should be available. In the event such availability is not feasible, the area can be adapted with extra long tubing for the monitors and an extended breathing circuit for the machine that is stationed outside of the scanning room. Additional anesthetic considerations for MRI include limited access to the patient and decreased visibility.<sup>56</sup> Most institutions have a window or video equipment with which to view the patient throughout the examination, as well as an intercom with which to

talk to the patient who is mildly sedated. The technicians or other personnel in the area should clearly understand that the scan should be halted if any issue arises. If designated space is available, patients may recover in the radiology area.

### CT Scans

CT scans are generally of shorter duration than MRI scans and rarely require the presence of an anesthesia provider. Most young children still require some form of anxiolysis, which can be accomplished in most centers by a specially trained sedation nurse. In instances where a longer scan is needed or oral contrast is required, general anesthesia is used. Sargent et al.<sup>57</sup> performed an interesting study that examined CT scans of the chest in children receiving sedation versus general anesthesia with ETT. They discovered that patients who received general anesthesia displayed areas of atelectasis large enough to obscure possible metastases. Subsequent study found that adding 5 cm H<sub>2</sub>O positive end-expiratory pressure was sufficient to prevent this degree of atelectasis.<sup>58</sup> As with MRI, access to the patient undergoing a CT scan is limited because of the ionizing radiation being used to produce the required images. However, use of specialized anesthesia equipment is not necessary, and the patient is much more visible to the anesthesia provider because the patient is not completely enclosed in a cylinder. Propofol is the drug of choice, because the procedures often are short, and lingering sedative effects are undesirable. Patients who receive oral contrast should be intubated and the contents of their GI tract suctioned prior to extubation. Recovery time usually is short, depending on the agent used. Many patients can bypass the PACU and recover on site, if stable.

## PEDIATRIC PATIENTS

In order to successfully diagnose and treat the myriad of disease processes that we see in medicine today, patients must sometimes experience a rather grueling process of multiple diagnostic studies and procedures. Pediatric patients are no exception. Adult patients can endure many of these processes without the use of anesthetic intervention. However, children

often lack the emotional maturity and mental resolve to cooperate with many of these basic procedures. Because their treatment plan should be no less comprehensive than that of their adult counterparts, the services of a qualified anesthetic provider often are elicited in order to complete the pediatric treatment course. In this section, we focus on the current standards for anesthetic management in the more common nonoperating room procedures performed in the pediatric population.

### History of Pediatric Sedation

Prior to the 1980s, the involvement of the anesthesiologist in pediatric sedation was sporadic. However, with increasing reports of pediatric morbidity and mortality in settings where sedation was used in the absence of individuals trained in resuscitative techniques, the need for monitoring guidelines was clear. The first of these guidelines was developed in cooperation with the American Academy of Pediatric Dentistry and the ASA. The guidelines addressed issues such as informed consent, fasting requirements, availability of appropriately sized equipment, standard physiologic monitoring, frequent documentation of vital signs, and proper recovery and discharge protocols.<sup>59</sup> The establishment of these guidelines greatly improved the safety of children undergoing anesthesia in these remote locations but still left room for improvement. With the introduction of pulse oximetry and more comprehensive discussion of the various levels of sedation by the ASA, the guidelines have undergone revisions over the years, most recently in 2002.<sup>60</sup> This last compilation has eliminated the term *conscious sedation* with regard to the pediatric population (because this state was rarely achieved in children) and stressed the use of the new terminology of *minimal*, *moderate*, and *deep sedation*, in keeping with the language of the ASA and the Joint Commission on Accreditation of Healthcare Organizations.<sup>61</sup>

### Current Practice

Although the ASA was actively involved in providing the necessary sedation guidelines, the majority of sedation in pediatric patients still was performed by nonanesthesia providers (dentists, nursing personnel). Al-

though mortality associated with sedation in remote locations decreased, the problems of prolonged recovery from comparatively short procedures and failure to complete a study because of inadequate sedation were common. These problems largely were related to the fact that the majority of agents used for sedation by nonanesthesia providers in the procedural areas (pentobarbital, ketamine, midazolam, methohexital) were used for general anesthesia in the operating room setting.<sup>62</sup> It comes as no surprise that many of these “sedations” often drift into the realm of a general anesthetic, which may necessitate more aggressive airway management.

With the more stringent guidelines for sedation in nonoperating room locations and the growing number of treatment modalities and studies available for the pediatric population, increasingly more departments have been eliciting the services of the anesthesia provider for their rising case load.<sup>63</sup> The advent of propofol and the use of TIVA greatly decreased the procedure failure rate and increased patient satisfaction, as patients had the dual benefit of deep sedation/general anesthesia for uncomfortable procedures and short recovery times.

### Oncology Procedures and Imaging Studies

This combination is particularly beneficial to pediatric oncology patients, who often must undergo multiple painful procedures or numerous radiation therapy sessions during a potentially lengthy treatment process.<sup>64</sup> A study by Glaisyer and Sury<sup>65</sup> compared the technique of TIVA using propofol and remifentanyl versus propofol and inhalational agents in pediatric patients undergoing lumbar punctures and bone marrow aspiration. They found that the propofol-remifentanyl method allowed for quick induction, adequate anesthesia and analgesia, and shorter recovery times than the inhalational method.

In addition to the more invasive oncology procedures, many pediatric patients require anesthesia for diagnostic imaging studies. Many of these procedures require a lengthy period of immobility in an area resonant with strange sounds and ominous appearing equipment. Many small children cannot be compliant with in-

structions in this situation, and light-to-moderate sedation may be inadequate. In these instances, deep sedation often is required. Depending on the institution, the pediatric department may or may not provide specific procedural instruction (e.g., NPO instruction) or IV access for the patient. For this reason, the patient should undergo the same preanesthetic assessment and preparation required for patients scheduled for more complex procedures. The same anesthetic concerns apply for both adults and children in these remote imaging locations. The appropriate monitors and equipment should be available, and the anesthesia provider should have an unobstructed view of the patient, either through a window or via video surveillance equipment. In most circumstances the presence of a pediatric trained anesthesiologist is not required, but the providers who are present should be comfortable with straightforward procedures on pediatric patients and be familiar with the strengths and deficiencies of that particular location.

### CONCLUSION

The role of the anesthesiologist has greatly expanded outside of the arena of the operating room. Our services are being requested constantly as the area of interventional medicine continues its phenomenal growth. As a result, we must leave the protective auspices of the operating theater and venture into the unfamiliar territory of hospital policy and procedures to ensure that our nonoperating room patients receive the same level of care that would be available to them in the operating room. Our specialized training and thorough knowledge of the physiologic effects of anesthetic agents in various disease processes give us a distinct advantage over many of the personnel who currently provide sedation services in these remote areas. Although an increasing amount of literature regarding our role and current practices in nonoperating room locations is available, still more needs to be done to enable us to further increase our efficiency in this field and accommodate the growing number of patients and specialists requiring our services.

## KEY REFERENCES

1. Alspach D. Monitoring patients during procedures conducted outside the operating room. *Int Anesthesiol Clin* 2004;42:95–111.
2. Guidelines for Nonoperating Room Anesthetizing Locations. Park Ridge, IL: American Society of Anesthesiologists, 2003 (approved by the House of Delegates on October 19, 1004, last amended on October 15, 2003).
3. Kelhoffer ER, Osborn IP. The gastroenterology suite and TIPS. *Int Anesthesiol Clin* 2003;41:51–61.
4. Brodsky JB. Anesthesia for pulmonary stent insertion. *Curr Opin Anaesthesiol* 2003;16:65–67.
5. Osborn IP. Anesthetic considerations for interventional neuroradiology. *Int Anesthesiol Clin* 2003;42:69–77.
6. Cravero JP, Blike GT. Review of pediatric sedation. *Anesth Analg* 2004;99:1355–1364.
7. Bell C, Sequeira PM. Nonoperating room anesthesia for children. *Curr Opin Anaesthesiol* 2005;18:271–276.
8. Everett LL. Anesthesia for diagnostic procedures. *Curr Opin Anaesthesiol* 2001;14:629–633.

## REFERENCES

1. Alspach D. Monitoring patients during procedures conducted outside the operating room. *Int Anesthesiol Clin* 2004;42:95–111.
2. Practice Guidelines for the Perioperative Management of Patients with Obstructive Sleep Apnea. Park Ridge, IL: American Society of Anesthesiologists, 2005 (approved by the House of Delegates on October 25, 2005).
3. Guidelines for Nonoperating Room Anesthetizing Locations. Park Ridge, IL: American Society of Anesthesiologists, 2003 (approved by the House of Delegates on October 19, 1004, last amended on October 15, 2003).
4. Standards for Basic Anesthetic Monitoring. Park Ridge, IL: American Society of Anesthesiologists (approved by the ASA House of Delegates on October 21, 1986, last amended on October 25, 2005).
5. Soto RG, Fu ES, Vila H, et al. Capnography accurately detects apnea during moni-

tored anesthesia care. *Anesth Analg* 2004;99:379–382.

6. Missant C, Van de Velde M. Morbidity and mortality related to anaesthesia outside the operating room. *Curr Opin Anaesthesiol* 2004;17:323–327.
7. Standards for Post Anesthesia Care. Park Ridge, IL: American Society of Anesthesiologists, 2004 (approved by the House of Delegates on October 12, 1998, last amended on October 27, 2004).
8. Veselis RA, Reinsel RA, Feshchenko VA, et al. Information loss over time defines the memory defect of propofol: a comparative response with thiopental and dexmedetomidine. *Anesthesiology* 2004;101:831–841.
9. Moerman AT, Struys MRF, Vereecke HE, et al. Remifentanyl used to supplement propofol does not improve quality of sedation during spontaneous respiration. *J Clin Anesth* 2004;16:237–243.
10. Vuyk J, Mertens MJ, Olofsen E, et al. Propofol anesthesia and rational opioid selection: determination of optimal EC50-EC95 propofol-opioid concentrations that assure adequate anesthesia and a rapid return of consciousness. *Anesthesiology* 1997;87:1549–1562.
11. Ramsay MAE, Luterma DL. Dexmedetomidine as a total intravenous anesthetic agent. *Anesthesiology* 2004;101:787–790.
12. Nuttall GA, Bowersox MR, Douglas SB, et al. Morbidity and mortality in the use of electroconvulsive therapy. *J ECT* 2004;20:237–241.
13. Ding Z, White PF. Anesthesia for electroconvulsive therapy. *Anesth Analg* 2002;94:1351–1364.
14. Gazdag G, Kocis N, Tolna J, et al. Etomidate versus propofol for electroconvulsive therapy in patients with schizophrenia. *J ECT* 2004;20:225–229.
15. Locala JA, Ireffin SA, Malone D. The comparative hemodynamic effects of methohexital and remifentanyl in electroconvulsive therapy. *J ECT* 2005;21:12–15.
16. Andersen FA, Arslan D, Holst-Larsen H. Effects of combined methohexitone-remifentanyl anaesthesia in electroconvulsive therapy. *Acta Anaesthesiol Scand* 2001;45:830–833.
17. Zhang Y, White PF, Thornton L, et al. The use of nicardipine for electroconvulsive therapy: a dose-ranging study. *Anesth Analg* 2005;100:378–381.
18. Freese KJ. Can patients safely undergo electroconvulsive therapy while receiving monoamine oxidase inhibitors? *Convuls Ther* 1985;1:190–194.
19. Dolenc TJ, Habl SS, Barnes RD, et al. Electroconvulsive therapy in patients taking monoamine oxidase inhibitors. *J ECT* 2004;20:258–261.
20. Madan A, Minocha A. Who is willing to undergo endoscopy without sedation: patients, nurses, or the physicians? *South Med J* 2004;97:800–805.

21. Chokhavatia S, Nguyen L, Williams R, Kao J, Heavner JE. Sedation and analgesia for gastrointestinal endoscopy. *Am J Gastroenterol* 1993;88:393–396.

22. ASGE guidelines: complications of upper GI endoscopy. *Gastrointest Endosc* 2002;55:784.
23. Hutchinson RC, Kenny GNC. Sedation for endoscopy. *Curr Opin Anaesthesiol* 2000;13:415–419.
24. Cohen LB, Hightower CD, Wood DA, et al. Moderate level sedation during endoscopy: a prospective study using low-dose propofol, meperidine/fentanyl and midazolam. *Gastrointest Endosc* 2004;59:795–803.
25. Kazama T, Takeuchi K, Ikeda k, et al. Optimal propofol plasma concentration during upper gastrointestinal endoscopy in young, middle-aged, and elderly patients. *Anesthesiology* 2000;93:662–669.
26. Chan AL, Yoneda KY, Allen RP. Advances in the management of endobronchial lung malignancies. *Curr Opin Pulm Med* 2003;9:301–308.
27. Chan AL, Tharratt RS, Siefkin AD, et al. Nd:YAG laser bronchoscopy. Rigid or fiberoptic mode? *Chest* 1990;98:271–275.
28. Cavaliere S, Foccoli P, Toninelli C. Nd:YAG laser therapy in lung cancer: an 11 year experience with 2253 applications in 158 patients. *J Bronchol* 1994;1:105–111.
29. Cavaliere S, Venuta F, Foccoli P, et al. Endoscopic treatment of malignant airway obstructions in 2,008 patients. *Chest* 1996;110:1536–1542.
30. Hanowell LH, Martin WR, Savelle JE, et al. Complications of general anesthesia for Nd:YAG laser resection of endobronchial tumors. *Chest* 1991;99:72–76.
31. Beamis JF. Interventional pulmonology techniques for treating malignant large airway obstruction: an update. *Curr Opin Pulm Med* 2005;11:292–295.
32. Sutudja G, van Kralingen, Schramel FM, et al. Fiberoptic bronchoscopic electro surgery under local anesthesia for rapid palliation in patients with central airway malignancies: a preliminary report. *Thorax* 1994;49:1243–1246.
33. Brodsky JB. Anesthesia for pulmonary stent insertion. *Curr Opin Anaesthesiol* 2003;16:65–67.
34. Jaffe RA, Samuels SI. Tracheobronchial stenting. In Jaffe RA, Samuels SI, eds. *Anesthesiologist's Manual of Surgical Procedures*. 3rd ed. Philadelphia: Lippincott Williams & Wilkins, 2004:1178.
35. Ledowski T, Paech MJ, Patel B. Bronchial mucus transport velocity in patients receiving propofol and remifentanyl versus sevoflurane and remifentanyl anesthesia. *Anesth Analg* 2006;102:1427–1430.
36. Conlay LA. Special concerns in the cardiac catheterization lab. *Int Anesthesiol Clin* 2003;41:63–67.
37. Jaffe RA, Samuels SI. Implantation of cardioverter-defibrillator (ICD). In Jaffe RA, Samuels SI, eds. *Anesthesiologist's Manual of*

- Surgical Procedures. 3rd ed. Philadelphia: Lippincott Williams & Wilkins, 2004:1165.
38. Jaffe RA, Samuels SI. Direct current (DC) cardioversion. In Jaffe RA, Samuels SI, eds. *Anesthesiologist's Manual of Surgical Procedures*. 3rd ed. Philadelphia: Lippincott Williams & Wilkins, 2004:1163.
39. Watkinson AF, Francis IS, Torrie P, et al. The role of anaesthesia in interventional radiology. *Br J Radiol* 2002;75:105-106.
40. Jaffe RA, Samuels SI. Radiofrequency ablation. In Jaffe RA, Samuels SI, eds. *Anesthesiologist's Manual of Surgical Procedures*. 3rd ed. Philadelphia: Lippincott Williams & Wilkins, 2004:1185.
41. Goldberg SN, Grassi CJ, Cardella JF, et al. Image-guided tumor ablation: standardization of terminology and reporting criteria. *J Vasc Interv Radiol* 2005;16:765-778.
42. Ahrar K, Matin S, Wood CG, et al. Percutaneous radiofrequency ablation of renal tumors: technique, complications, and outcomes. *J Vasc Interv Radiol* 2005;16:679-688.
43. Nour SG, Lewin JS. Radiofrequency thermal ablation: the role of MR imaging in guiding and monitoring tumor therapy. *Magn Reson Imaging Clin N Am* 2005;13:561-81.
44. Poggi G, Riccardi A, Quaretti P, et al. Complications of percutaneous radiofrequency thermal ablation of primary and secondary lesions of the liver. *Anticancer Res* 2007;27:2911-2916.
45. Manninen PH, Gignac EM, Gelb AW, et al. Anesthesia for interventional neuroradiology. *J Clin Anesth* 1995;7:448-452.
46. Osborn IP. Anesthetic considerations for interventional neuroradiology. *Int Anesthesiol Clin* 2003;42:69-77.
47. The Arteriovenous Malformation Study Group. Current concepts: arteriovenous malformations of the brain in adults. *N Engl J Med* 1999;340:1812-1818.
48. Martin NA, Khanna R, Doberstein C, et al. Therapeutic embolization of arteriovenous malformations: the case for and against. *Clin Neurosurg* 1998;41:81-85.
49. Chi OZ, Liu X, Weiss HR. The effect of propranolol on heterogeneity of rat cerebral small vein oxygen saturation. *Anesth Analg* 1999;89:690-695.
50. Krayer S. Anaesthesia for interventional Neuroradiology. *Curr Opin Anaesthesiol* 2000;13:421-427.
51. Van de Velde M. Interventional neuro-radiology. *Curr Opin Anaesthesiol* 2003;16:417-420.
52. Ong JP, Sands M, Younossi Z. Transjugular intrahepatic portosystemic shunts. *J Clin Gastroenterol* 2000;30:14-28.
53. Kelhoffer ER, Osborn IP. The gastroenterology suite and TIPS. *Int Anesthesiol Clin* 2003;41:51-61.
54. Shellock F. *Reference Manual for Magnetic Resonance Safety*: 2003 Edition. Salt Lake City, UT: Amirsys Inc., 2003.
55. Osborn IP. Magnetic resonance imaging anesthesia: new challenges and techniques. *Curr Opin Anesthesiol* 2002;15:443-448.
56. Gooden CK. Anesthesia for magnetic resonance imaging. *Curr Opin Anaesthesiol* 2004;17:339-342.
57. Sargent MA, McEachern AM, Jamieson DH, et al. Atelectasis on pediatric chest CT: comparison of sedation techniques. *Pediatr Radiol* 1999;29:509-513.
58. Funk W, Taeger K. Anaesthesia for magnetic resonance imaging/computed tomography. *Curr Opin Anaesthesiol* 2000;13:429-432.
59. Cravero JP, Blike GT. Review of pediatric sedation. *Anesth Analg* 2004;99:1355-1364.
60. Committee on Drugs, American Academy of Pediatrics. Guidelines for monitoring and management of pediatric patients during and after sedation for diagnostic and therapeutic procedures: addendum. *Pediatrics* 2002;110:836-838.
61. Joint Commission on Accreditation of Healthcare Organizations. *Sedation and Anesthesia Care Standards*. Oakbrook Terrace, IL: Joint Commission on Accreditation of Healthcare Organizations, 2003.
62. Bell C, Sequeira PM. Nonoperating room anesthesia for children. *Curr Opin Anaesthesiol* 2005;18:271-276.
63. Smallman B. Pediatric sedation in satellite locations. *Int Anesthesiol Clin* 2003;4:17-27.
64. Everett LL. Anesthesia for diagnostic procedures. *Curr Opin Anaesthesiol* 2001;14:629-633.
65. Glaisyer HR, Sury MRJ. Recovery after anesthesia for short pediatric oncology procedures: propofol and remifentanyl compared with propofol, nitrous oxide, and sevoflurane. *Anesth Analg* 2005;100:959-963.



## CHAPTER 70

## Anesthesia for Trauma Patients

John K. Stene, MD, PhD, and  
Christopher M. Grande, MD,  
MPH

Many anesthesia practitioners encounter trauma patients at odd hours, such as nights and weekends, when they are practicing alone or have limited access to colleagues. Thus, they must be prepared to handle challenging patients based on a firm understanding of the pathophysiology and consequences of trauma and the approaches to modifying these processes to assure best outcomes. Although trauma can be viewed as a disease entity per se, injured patients present as a nonhomogeneous collection of surgical patients. Furthermore, trauma care is not limited to the immediate care phase; anesthesiologists are as likely to anesthetize trauma patients for scheduled post trauma reconstructive surgery as for emergency lifesaving procedures. These patients have a wide variety of preexisting chronic medical conditions that interact with the traumatic injury and alter their physiologic responses. Typical preexisting medical problems include ethanol abuse, cigarette smoking, drug abuse, heart disease, chronic obstructive pulmonary disease, and a variety of mobility issues in elderly patients injured in falls. In fact, a large part of the anesthesiologist's effort is directed toward counteracting the "normal" response typically mounted by a person in reaction to an injury (i.e., the "flight or fight" response). Although tachycardia and hypotension noted as part of the primary survey signify significant blood loss and the potential need for emergency surgery, preexisting disease states will modify these responses. For example, very fit athletes often present with heart rates in the normal range after significant blood loss, an effect that also can be present in patients taking  $\beta$ -adrenergic blocking drugs for heart disease. Cocaine intoxication leads to tachycardia and hypertension, and alcohol intoxication,

## KEY POINTS

1. Early involvement of the anesthesia provider in the perioperative care of the trauma patient will benefit the patient. A full understanding of the mechanisms of injury, preexisting medical conditions, requirements for airway management, fluid and blood resuscitation, and medications will be gained, and likely pitfalls in management will be avoided.
2. The anesthesia caregiver should carefully consider all background medical conditions of the trauma patient and factor these issues into the perioperative care plan.
3. Evaluation of the airway in trauma patients includes asking patients to speak and assessing whether the larynx and/or trachea have been injured.
4. The anesthesia care team must understand the necessity of evaluating the patient's cervical spine and the exact meaning of clinical and radiologic "clearing" of the cervical spine. The anesthesia care team must understand how to obtain and maintain a patent airway in a patient whose cervical spine has not yet been "cleared."
5. Direct laryngoscopy can be performed in the presence of cervical spine injury, provided proper "manual inline axial stabilization" is maintained. It is not mandatory to move immediately to fiberoptic intubation, blind nasal intubation, or surgical airway. However, it is mandatory to have a series of contingency plans ready to be executed in every patient should the initial airway management strategy fail or not be fully satisfactory.
6. Caregivers who often deal with emergency trauma patients must be facile with the full range of airway management techniques, including "surgical options," and should be familiar with the concepts and techniques of both "classic" and "modified" rapid sequence induction and the implications of each in the setting of acute trauma management.
7. Every trauma patient should be considered to have a full stomach, regardless of when he or she had the last meal.
8. Caregivers should be thoroughly familiar with the complications of massive transfusion, which include hypothermia, impaired oxygen release, coagulopathies, electrolyte and acid-base abnormalities, and citrate intoxication.
9. Anesthesia providers should have a solid plan for preoperatively assessing the volume status of any traumatized patient. Assuming that a "tilt test" can be performed or that it will provide adequate assessment of volume status in a patient with an uncertain volume status is an invitation for disaster.
10. The benefits, risks, and complications associated with succinylcholine use should be thoroughly understood in patients who may present with massive trauma, spinal cord injury, burns, eye injury, or similar conditions. Hyperkalemia after succinylcholine administration can occur on the first day in cases involving crush or degloving injuries, burns, trauma, and abdominal sepsis. The so-called *safe period* for succinylcholine should be viewed with skepticism.
11. Intraoperative awareness is a definite possibility in hemodynamically unstable trauma patients during anesthesia and surgery. The primary goal is patient safety, but with adequate analgesia and hypnosis to prevent awareness. Use of "cardiostable" anesthetics, analgesics, and neuromuscular blockers usually achieves an adequate compromise.
12. Intravenous fluid administration should not be restricted in patients with head injury and elevated intracranial pressure if there is evidence of hypovolemia. The goal is to ensure normovolemia and adequate arterial and cerebral perfusion pressures.
13. Prevention of renal failure is especially important in trauma patients. Simply administering diuretics to achieve urine output will not suffice. Adequately assessing volume status and replacing and maintaining circulating blood volume are key.
14. Standard coagulation tests are temperature corrected to 99°F (37°C) and may not reflect hypothermia-induced coagulopathy. Hypothermia impairs coagulation because of slowed enzymatic rates and reduced platelet function. Treatment of hypothermia-induced coagulopathy consists of rewarming the patient, not administration of fresh-frozen plasma or platelets.

*Continued*

*Key Points—continued*

15. Preventing hypothermia is a high priority during trauma resuscitation and surgery. The anesthesia provider should be thoroughly aware of the complications resulting from hypothermia and the advantages and disadvantages of the various modalities used to prevent and treat hypothermia.
16. The effects of pain and the related stress response almost always are detrimental to the trauma patient. Methods of pain relief range from simple continuous or on-demand IV opioids to more sophisticated techniques such as regional or neuraxial blocks. Use of adjuvant drugs, such as dexmedetomidine, gabapentin, or celecoxib, may decrease opioid dose and improve analgesia.
17. Hyperventilating head-injured patients may cause regional or global

cerebral ischemia as a result of hypocapnia-induced cerebral vasoconstriction and has been shown to worsen outcome after head trauma. Measurements of intracranial pressure, in conjunction with monitoring of jugular venous oxygen saturation, may help guide therapy aimed at improving cerebral perfusion.

18. The anesthesia provider should consider early placement of invasive monitors in severely injured trauma patients to measure and manage cardiovascular, respiratory, and metabolic parameters. Patients who attain supranormal values of cardiac index, oxygen delivery, and oxygen consumption may have enhanced survival and decreased organ failure, perhaps because of the ability to meet the increased metabolic requirements of trauma and to repay a previous “oxygen debt.”

cation is associated with a biphasic blood pressure response—initial hypotension followed by hypertension. The diagnosis of head injury is further complicated by ingestion of mind-altering substances.

Multiple injury patterns cause a wide variety of direct organ damage that interacts with the patient's physiologic response. These injury patterns are broadly classified into penetrating

trauma, blunt trauma, or a combination of blunt and penetrating trauma (Table 70-1). Other injury classifications include burns, inhalation injury, and a range of environmental exposures. These various categories have some prognostic value to the anesthesiologist in understanding potential organ injuries. Examples of the prognostic value to the anesthesiologist of knowing the mechanism of injury are

penetrating trauma to the trunk, which may cause serious hemorrhage along a knife or bullet track, and high-energy blunt trauma (e.g., pedestrian struck by car), which is associated with long bone and pelvic fractures, closed head injury, rib fractures and pulmonary contusions, and intraabdominal solid organ injuries. Thus, the anesthesiologist should be ready to immediately transport the patient to the operating room to explore the wound track and stop hemorrhage associated with penetrating trauma to the trunk; prepare a patient for prolonged mechanical ventilation, prolonged shock resuscitation, and hypothermia; and deal with significant issues associated with posttraumatic analgesia in the patient with high-energy blunt trauma.

Despite the nonhomogeneous nature of traumatic injury, all trauma patients exhibit some effects of cellular hypoxia and shock. These effects normally are accompanied by varied degrees of characteristic neurohumoral responses to trauma, which frequently initiate a self-destructive cascade of other phenomena (Table 70-2).<sup>1</sup> For example, profound vasoconstriction induced by large amounts of epinephrine and norepinephrine released in response to hemorrhagic shock leads to organ ischemia and increased anaerobic metabolism. This in turn causes metabolic acidosis, which can be confused with diabetic ketoacidosis when accompanied by hyperglycemia caused by decreased insulin secretion and elevated glucagon secretion. The treatment is restoration of the patient's hydration, blood volume, and cardiac output, not insulin injection.

**TABLE 70-1.****Mechanism of Injury vs. Common Injury Patterns**

Injury Pattern	Typical Etiology	Characteristics
Blunt trauma	Motor vehicle crashes Falls	Multiple fractures Closed head injuries Widespread microvascular hemorrhage
Penetrating trauma	Knife wounds Gunshot wounds	Localized tearing of tissues along wound track Major blood vessel hemorrhage
Blunt and penetrating trauma	Blast injury with shrapnel	Hemorrhage along penetrating wound tracks Disruption of air filled organs
Burns	Thermal burns Electrical burns	Deep partial thickness of skin burn Full-thickness skin burn Muscle coagulation (electrical)
Inhalation injury	Smoke inhalation Poison gas	Respiratory distress
Environmental exposure	Extreme cold	Hypothermia Frost bite

**TRAUMATIC SHOCK**

Shock, defined as a sudden physical or mental disturbance,<sup>2</sup> describes the appearance of a patient with cardiovascular collapse as if he or she suffering from a great blow or sudden mental trauma. Although the origins of the term *shock* are incorporated in this definition, the understanding of what constitutes shock has changed in response to pathophysiologic research after the term was coined centuries ago. Our current understanding of shock involves inadequate cellular oxygenation from hemorrhage (hemorrhagic shock), cardiac failure (cardiogenic shock), and massive vasodi-

lation (neurogenic shock), although no precise pathophysiologic definition exists.

Traumatic hemorrhage causes shock principally through loss of circulating blood volume. Early physiologists described the tachycardia, hypotension, ashen complexion, and cool moist skin of the injured patient suffering from hemorrhagic shock.<sup>3</sup> Walter Cannon, who served as an army surgeon in World War I before becoming a Professor of Physiology at Harvard, recognized that loss of blood reduced cardiac output and caused traumatic shock.<sup>3</sup> Cannon<sup>4</sup> proposed that the term *shock* be replaced by the term *exemia* to emphasize that blood loss was the cause of shock following wounding. A mechanical model developed by Henderson<sup>5</sup> advanced the understanding of the role of blood loss in hemorrhagic shock. Arthur Guyton refined this concept with the venous return curve, which was severely depressed following hemorrhage with a reduction in the mean filling pressure of the circulation, thus limiting maximum cardiac output (Fig. 70-1).<sup>6</sup> The majority of a person's blood volume resides in the venules as the "unstressed volume" (blood that fills the anatomic space of the veins and venules without stretching the vascular structures and, therefore, does not generate pressure; Fig. 70-2).<sup>7</sup> A trauma patient can lose as much as 25–30% of his or her blood volume before developing systolic hypotension, as the available vascular space contracts to reduce the unstressed volume (Box 70-1).

In addition to hypotension, loss of a significant portion of the unstressed blood volume will result in decreased cardiac output and thereby restrict oxygen delivery to various organs. This in turn causes anaerobic metabolism and metabolic acidosis and eventually triggers a series of characteristic neurohumoral responses to the insult.<sup>1,8,9</sup> These neurohumoral responses range from increases in circulating levels of epinephrine, norepinephrine, growth hormone, glucagon, adrenocorticotropic hormone, and cortisol (and a reduction in insulin) to activation of various cytokines and white blood cells, modulation of coagulation, and more. Tachycardia, hyperglycemia, increased white blood cell count, and hypokalemia all result from these neurohumoral responses to trauma.

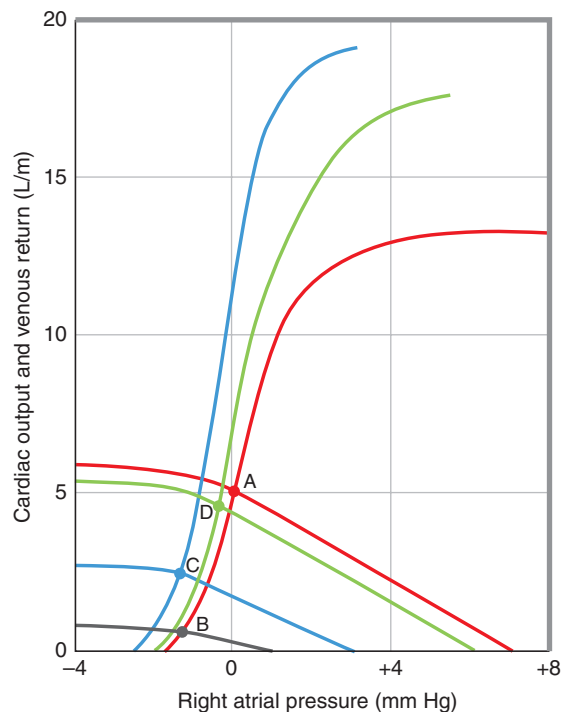
Decreased tissue blood flow following hemorrhage causes decreased oxy-

TABLE 70-2.

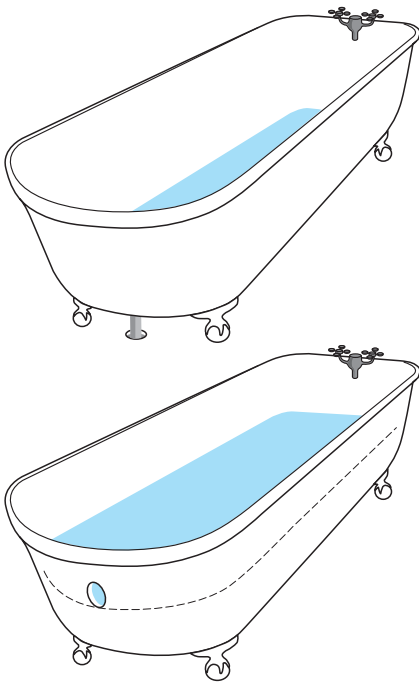
## Neurohumoral Response to Trauma

Humoral Response	Metabolic Effect
Epinephrine increase	Tachycardia, vasoconstriction, hyperglycemia, hypokalemia
Norepinephrine increase	Tachycardia, vasoconstriction
Adrenocorticotropic hormone increase	Cortisol increase
Cortisol increase	Hyperglycemia, hypertension, fluid retention
Insulin decrease	Hyperglycemia, hyperkalemia
Glucagon increase	Hyperglycemia
Acute phase response	Cytokine release: Tumor necrosis factor- $\alpha$ , IL-1, IL-2, IL-6, and interferon; prostaglandins (regulate inflammatory response); increase C-reactive protein, fibrinogen, complement C3, haptoglobin

IL, interleukin.



**FIGURE 70-1.** Effects of hemorrhagic shock on control of cardiac output. Graphic intersection of the cardiac function curve (sigmoid shaped line) shows increase in cardiac output as right atrial pressure increases (Starling curve), and linear negatively sloped venous return curve shows venous return to the heart decreases with increasing right atrial pressure until venous return ceases when right atrial pressure equals mean vascular filling pressure. Venous return limits maximal cardiac output independent of the cardiac inotropic state, and the intersection of the two curves sets the cardiac output and right atrial pressure. Point A represents right atrial pressure and cardiac output under normal conditions. Point B represents the effects of acute hemorrhage, which reduces mean vascular filling pressure of the circulatory system, and severely depressed venous return. Point C represents sympathetic nervous compensation for reduced cardiac output with mobilization of unstressed blood volume, which increases mean vascular filling pressure and venous return, and increased inotropic stimulation of the heart shifts the cardiac function curve to the left (increased cardiac output for any given right atrial pressure). Point D represents the state of the circulatory system after transcapillary refill of interstitial water and/or intravenous fluid replacement with increased mean vascular filling pressure, increased venous return, and somewhat relaxed inotropic state of the heart. (Reprinted from Guyton AC, Jones CE, Coleman TG. *Circulatory Physiology: Cardiac Output and Its Regulation*. Philadelphia: WB Saunders, 1973, with permission from Elsevier.)



**FIGURE 70–2.** Bathtub representing the concept of unstressed volume. **Top:** drain in the bottom removes all the water. Flow through the drain is determined by the water level in the tub at any time. **Bottom:** drain in the side—water drains only to the level of the hole. Flow through the hole is determined by the level above the hole, and the volume below the hole is necessary to get the water to that level but does not affect flow. (From Magder and De Varennes<sup>7</sup> with permission.)

gen delivery to the cells and mitochondria.<sup>10,11</sup> As the mitochondria become starved for oxygen, aerobic production of adenosine triphosphate (ATP) ceases, and cells become dependent on their small stores of ATP and phosphocreatine for energy. Anaerobic glycolysis replaces some of the lost ATP as long as an adequate supply of glucose can be maintained by the reduced blood flow. Initial changes in cellular structure and function occur when the cells no longer have the energy stores to maintain transmembrane ion gradients. Under optimum conditions, these changes are reversible for up to 1 hour and then the cells proceed to irreversible changes and cell death, thus the origins of the concept of the “golden hour.” Inability to restore adequate circulating supplies of oxygen and glucose within a relatively short time leads to massive cell death and irreversible shock, followed by death of the patient.

Cell death in response to traumatic hemorrhagic shock is primarily necrosis, not apoptosis. Necrosis, which oc-

### BOX 70–1.

#### Pathophysiology of Shock

- Loss of circulating blood volume causes decreases in venous return and cardiac output.
- Arterial pressure decreases.
- Sympathetic nervous system is activated by reduced cardiac output and reduced arterial pressure at aortic and carotid baroreceptors.
- Catecholamines are released from the adrenal medulla.
- Heart rate increases in response to circulating and intramyocardial catecholamines.
- Stroke volume decreases in response to decreased venous return and increased heart rate.
- Available blood volume stores are mobilized from unstressed blood volume because of arterial inflow diverted by vasoconstriction from vascular beds with large venous capacitance such as cutaneous and splanchnic vascular beds.
- Clinical picture consists of increasing heart rate and decreasing pulse pressure; diastolic pressure rises before further hemorrhage causes systolic pressure to fall. Renal vasoconstriction and secretion of antidiuretic hormone decrease urinary output.
- Increasing hemorrhage leads to progressive increases in heart rate. Heart rates  $>140$  beats/min are common with  $\leq 40\%$  loss of blood volume.
- Loss of  $>30\%$  blood volume is required to consistently cause systolic hypotension in the supine position.
- Mental status changes to confusion and then lethargy with  $>30\%$  loss of blood volume.
- Urinary output decreases with increasing blood loss and becomes negligible with  $40\%$  loss of blood volume.

curs when a cell is deprived of an essential nutrient for a critical time period (the golden hour), results in fluid swelling of the mitochondria, loss of high-energy phosphate compounds, disintegration of the cell membrane, and rupture of the cell and cellular organelles. In a review on cell death, Sedlak likens this process to murder of the cell compared to cellular suicide or apoptosis.<sup>12,13</sup> Apoptosis, which is not an important response to shock, is characterized by maintenance of cellular membrane architecture, albeit in a highly permeable state, condensed nuclear chromatin, disintegration of the nucleus, and finally the death of the cell. Other differences between apoptosis and necrosis are that apoptosis requires cellular energy whereas necrosis occurs in the absence of cellular energy, and necrosis triggers an inflammatory response whereas apoptosis does not.

Reactive oxygen species, the final common pathway for cell death, are triggered by many insults, including tissue ischemia and inflammation, both of which are associated with trauma. High levels of oxidants released from mitochondria are associated with necrosis, whereas low levels can lead

to apoptosis in susceptible cells. Interestingly, bilirubin is a potent cytoprotective antioxidant whose effects are comparable to those of glutathione.<sup>13</sup>

#### Treatment of Shock

An appreciation of the relationships among these issues is important for the anesthesiologist who must manage an injured patient, because restoration of circulating blood volume is critical to restoring tissue oxygen delivery. Restoration of tissue oxygenation is required to first arrest and then reverse impending organ death. World War I era surgeons realized that blood loss reduced venous return, cardiac filling, and ultimately cardiac output, but it was not until the seminal work during the 1950s of replacing interstitial and intracellular fluid losses that intravenous fluids were routinely administered to restore circulating blood volume. Cellular dehydration following traumatic blood loss was a significant issue, and administration of excess electrolyte solutions after traumatic hemorrhage was required to restore interstitial and cellular hydration.<sup>14</sup> Rapid replenishment of shed blood volume restored sufficient tissue oxygen delivery and improved organ function.<sup>15–17</sup> The concept of a “golden



hour,” which seeks to establish a limited time frame in which to restore hemodynamic and metabolic homeostasis to prevent irreversible shock, promoted a concerted improvement in trauma resuscitation and survival.

### Delayed Fluid Resuscitation

Careful observation of the injured patient's response to resuscitation gave rise to the concept of “delayed fluid resuscitation,” which emphasized the notion that overzealous fluid administration to a traumatized patient often can worsen outcome by disrupting natural hemostasis with clot dilution and generate high-pressure gradients for blood loss.<sup>18,19</sup>

In some ways, this concept is intuitive and actually represents a renaissance or rediscovery of a similar idea presented almost a century ago. Thus, current dogma is that, based upon the mechanisms of injury, rapid replacement of some of the shed blood volume (within the golden hour) is critical to assuring survival of an injured patient with hemorrhagic shock. However, fluid resuscitation must be used judiciously prior to surgical hemostasis to minimize ongoing hemorrhage and avoid compounding the adverse development of dilutional coagulopathy with anemia, hypothermia, and other iatrogenic sequelae.<sup>20–22</sup>

Although both laboratory and clinical trials have shown that modulating fluid resuscitation until surgical hemostasis is underway decreases the extent of hemorrhage and its sequelae, there is concern that prolonged hypotension may compromise renal function and compound the “secondary injury” effects on head injury.<sup>23–25</sup> Because of the concerns about prolonged hypotension, delayed fluid resuscitation is most successfully applied in locations where emergency medical systems (EMS) transport distances and times are short. This concern limits the universal applicability of strict delayed fluid resuscitation. However, patients with extensive blunt trauma in rural settings benefit from limited fluid resuscitation in the EMS phase of care. For example, administering very large volumes of crystalloid fluids in an attempt to achieve an arterial pressure of 140/90 mm Hg is no longer acceptable.

### Small Volume Resuscitation

Another theme developed to achieve rapid restoration of blood volume

without fluid overload and dilution of hemostatic elements is so-called *small volume resuscitation*.

Hypertonic saline (3–7%) has the ability to draw interstitial free water into the circulation and thereby rapidly restore perfusing volume and pressure. The hypertonic solution can be combined with colloidal solution to prolong the effect, helping to retain intravascular volume despite diffusive forces that promote capillary leaks.

Small volume resuscitation with 4 mL/kg of 7.5% NaCl in 6% dextran 40 or hydroxyethyl starch has achieved clinical success in several emergency medical programs. RescueFlow (6% dextran 70 dissolved in 7.5% NaCl; BioPhausia, Stockholm, Sweden) is a commercial product available in many countries outside of the United States that provides a convenient source of small volume resuscitation.<sup>26–28</sup> This resuscitation regimen is especially useful for patients with head injuries in whom hypertonic and/or hyperoncotic fluid helps reduce the development of brain edema.

Following on the issues related to delayed resuscitation discussed earlier, there is some concern that the hypertonic/hyperosmotic fluid may restore blood pressure and tissue flow too quickly in patients with penetrating trauma, thereby causing increased hemorrhage. Patients with crush injuries (in whom toxic products of rhabdomyolysis and reperfusion are circulating throughout their systems) may benefit from small volume hypertonic resuscitation, but administration of saline, bicarbonate, and mannitol may be just as effective.<sup>24–28</sup>

### Other Shock Therapy

Blood gas analysis of the “typical” major trauma patient in shock admitted to the emergency department reveals a metabolic acidosis (the extent of which often correlates with the amount of blood loss), a mild degree of hypocarbia, and a moderate hypoxic state. Because of decreased tissue oxygen delivery, respiratory muscles perform very poorly during shock. Moreover, there are myriad reasons for compromise of the entire respiratory system, ranging from mechanical (e.g., rib fracture, flail chest) to central drive (e.g., head injury, narcotics) to parenchymal (e.g., pulmonary contusion) to physiologic (i.e., ventilation-perfusion  $\dot{V}/\dot{Q}$  mismatching due to lung and/or heart trauma).

Characteristically the injured patient with hemorrhage develops a marked increase in pulmonary dead space and must mount an increased minute ventilation to effectively excrete additional carbon dioxide (CO<sub>2</sub>) produced. Further influencing the patient's “optimum minute ventilation” is the need to buffer the metabolic acidosis with hypocarbia. The poorly perfused ventilatory muscles soon fatigue and further contribute to a feedback situation that compounds ventilatory failure, with worsening hypoxia and eventually death.

Therefore, for a variety of reasons, it is prudent that the anesthesiologist view traumatic hemorrhagic shock as an indication for urgent endotracheal intubation and mechanical ventilation. Mechanical ventilation supports the patient's gas exchange needs while “unloading” the ventilatory muscles and not diverting precious supplies of blood from other vital organs.

Hemostasis is critical for survival from traumatic injury; however, patients who lose large volumes of blood exhibit coagulopathy.<sup>29</sup> Part of the neurohumoral response to trauma may lead to disseminated intravascular coagulopathy, which is a combination of blood hypercoagulability causing clot formation that leads to depletion of fibrin and coagulopathy from clot lysis in the small arteries. Thus, trauma patients may exhibit the paradoxical state of systemic anticoagulation but local thrombus formation, possibly causing a variety of thromboembolic phenomena. Hypothermia adds to the coagulopathic component because the various clotting factors have temperature-dependent kinetics.<sup>30</sup> Therefore, the goals for management of the trauma patient during both resuscitation and emergency surgery include restoration and/or maintenance of normothermia as well as replacement of depleted coagulation factors.<sup>31,32</sup>

A number of strategies for rewarming hypothermic trauma patients in order to restore or maintain normothermia have been studied. Arteriovenous perfusion through a hot water heat exchanger has been used successfully to rewarm cold trauma patients.<sup>31</sup> The less invasive technique of applying a vacuum to dilate cutaneous veins of a limb surrounded by a hot water heat exchanger has worked well in experimental settings but has not yet achieved clinical application, partially

because of the lack of commercial practicality.<sup>32</sup>

The classic therapy for posttraumatic coagulopathy has been monitoring of prothrombin time, international normalized ratio, partial thromboplastin time, and platelet count. Replacement therapy with fresh-frozen plasma, platelet concentrates, and/or cryoprecipitate is used in an attempt to restore normal coagulation states.

Some trauma anesthesiologists have used activated factor VII to rapidly improve hemostasis without using large volumes of replacement factors.<sup>33</sup> Although activated factor VII theoretically accelerates thrombus formation at sites of hemorrhage and initiation of coagulation, its use in traumatic injury is controversial. There is concern that thrombus formation stimulated by activated factor VII may not be confined to the injured hemorrhaging blood vessels and may cause venous and/or arterial thromboembolic disease. A large, randomized, prospective clinical trial would be useful in determining the utility of this expensive therapy but, like all research in acute trauma, would be difficult to organize and implement, thus the dearth of evidence-based medicine in this practice area.

Although activated factor VII is most active at the location of disrupted blood vessel endothelium and triggers coagulation at sites of posttraumatic bleeding, it can place the patient at risk for thrombus at a distant site, especially in light of the general inflammatory, hypercoagulable state following injury.<sup>33</sup> Both arterial and venous thromboembolic disease are potential complications of uncontrolled use of activated factor VII.

### Patients Taking Anticoagulants

In highly industrialized nations such as the United States, the median age of the trauma population has been growing older as the number of elderly people has been increasing. Because of the increase in the geriatric trauma population, the number of patients taking warfarin (Coumadin) for anticoagulation prior to injury is increasing. These patients require an especially intensive effort to restore the coagulation cascade, including the use of intravenous vitamin K therapy and fresh-frozen plasma. When these formerly anticoagulated patients arrive

in the ICU following resuscitation of traumatic injuries, they require continued frequent monitoring and control of coagulation status, not only to correct the initial coagulopathy but often to reestablish anticoagulation for chronic conditions such as atrial fibrillation, cardiac valve replacement, or previous venous thromboembolism, which led to anticoagulation prior to the acute traumatic injury.

### Blood Glucose Control

The neurohumoral response to trauma frequently leads to hyperglycemia when insulin secretion decreases and glucagon and epinephrine, which increase blood glucose, are secreted in great excess. Although posttraumatic hyperglycemia was ignored historically, recent evidence indicates that controlling blood sugar levels improves outcomes of critical care patients and cardiac surgical patients.<sup>34,35</sup> Therefore, it seems prudent for the anesthesiologist to monitor blood glucose levels when anesthetizing a trauma patient. Continuous intravenous infusions of regular insulin, adjusted by hourly glucose measurements, are an effective method for maintaining euglycemia, which is defined as a blood glucose level from 80–120 mg/dL. Hourly glucose measurements allow the anesthesiologist to identify and treat hypoglycemia before the patient suffers significant sequelae. Thus, the fear that insulin infusions might lead to undiagnosed hypoglycemia during anesthesia is more than balanced by the potential improvement in outcome resulting from hyperglycemia control.

### Monitoring

At a minimum, trauma patients undergoing anesthesia require the standard monitoring recommended by the American Society of Anesthesiologists, including blood pressure, heart rate, single-lead electrocardiography, pulse oximetry, core temperature, and capnography. These basic monitors will provide a “first-level profile” of the trauma patient’s physiologic response to injury and therapy. However, it is crucial that the anesthesiologist maintain a low threshold for intensifying the range and extent of specialized monitoring systems to more intensively and accurately follow cardiopulmonary and metabolic changes (Table 70–3).

Invasive hemodynamic monitoring provides opportunities for more fre-

TABLE 70–3.

#### Monitoring the Trauma Patient

Basic monitoring
Pulse oximeter
Blood pressure cuff
Electrocardiogram
Capnography
Temperature
Intravenous access
Advanced Monitoring
Urinary output
Intraarterial pressure
Pulmonary arterial pressure
Cardiac output
Mixed venous oximeter
Intracranial pressure monitoring
Jugular bulb oxygenation

quent assessment of blood pressure, and measurement of cardiac output and cardiac filling pressures allows assessment of myocardial performance. Additionally, vascular access provides a route for blood sampling of biochemical markers of shock and cellular ischemia or hypoxia. Intraarterial catheters (“a-lines”) are the most basic invasive hemodynamic monitors and should be used liberally in seriously injured trauma patients. As always, the choice of monitors should be guided by an informed appreciation of the mechanisms of injury, extent of injury and/or blood loss, and subsequent response to shock and tissue injury.<sup>36</sup>

In unstable multiple-injured patients, the directly measured arterial pressure is more accurate than the indirectly measured arterial pressure, which is estimated by cuff and oscillometric device. Intraarterial pressure can be followed from beat to beat to track the results of resuscitation more closely than indirect arterial pressure measured episodically. An indwelling catheter facilitates frequent blood analysis and likely causes less patient discomfort and arterial trauma than do repeated multiple arterial punctures for blood sampling, particularly during extended stays in the ICU.<sup>37</sup>

Arterial blood gases are essential to monitor the patient’s acid–base balance and ventilatory status. Restoration of the arterial base deficit to zero is one of the more sensitive indicators of adequate shock resuscitation and a practical therapeutic goal when evaluating the efficacy of shock resuscitation.<sup>38–42</sup> Because base deficit changes

rapidly in response to hemorrhage and resuscitation, it is a very useful parameter to follow during shock resuscitation. The base deficit usually is quite negative when shock resuscitation starts and approaches zero when the patient's blood volume is restored.<sup>39-41</sup> Although trauma patients with significant blood loss and hypoperfusion frequently have base deficits lower than -10 mEq/L, the correct treatment is replacement of blood and fluid losses, not administration of sodium bicarbonate. Buffers such as bicarbonate are reserved for patients with high plasma myoglobin or free hemoglobin levels who need alkalinized urine. More recently, a number of commercially available devices have become available that either invasively (by being mated to an indwelling arterial line system) or noninvasively measure pH and/or oxygen (O<sub>2</sub>) and CO<sub>2</sub> gas tensions.

Large-bore central venous catheters should be placed in patients admitted with significant shock following injury. Central venous pressure (CVP) and pulmonary arterial pressure (PAP) monitoring also are indicated in certain trauma resuscitations, especially those in which there is a question of cardiac performance. Tracking cardiac output and left ventricular filling pressures is useful if cardiac function is compromised by preexisting heart failure, myocardial contusion, or aortic injury requiring cross-clamping of the thoracic aorta. CVP varies with blood volume, and measurement of this parameter supplements other estimates of blood volume restoration.<sup>37</sup>

Large-bore catheters placed into the large central veins (subclavian, internal jugular, or femoral) provide excellent venous access for high-volume fluid resuscitation with or without venous pressure monitoring. However, placement of such catheters is not without complication, especially in hypovolemic patients. Complications include catheterization of the subclavian or carotid artery and pneumothorax. For this reason, the femoral route has been most recently suggested by the Advanced Trauma Life Support (ATLS) protocols.

More specifically, pulmonary artery catheters can be introduced through a large-bore sheath in a central vein (usually subclavian or internal jugular) to monitor cardiac output as well as pressures in the superior vena cava (CVP) and pulmonary artery (PAP).

When the pulmonary artery is occluded by wedging the catheter balloon tip (i.e., wedge pressure), PAP reflects the pressure in the left atrium and ventricle at diastole. Therefore, the filling pressures of both the right heart (CVP) and the left heart (wedge P) can be compared to cardiac output for evaluation of cardiac performance.<sup>43</sup> Blood gases sampled from the distal (PAP) lumen of the pulmonary artery catheter provide a measure of mixed venous oxygen and CO<sub>2</sub> and can be compared to simultaneous arterial samples to determine the efficiency of pulmonary gas exchange (Box 70-2). Mixed venous oxygen tension provides a monitor of the adequacy of oxygen delivery to the tissues relative to oxygen demand and reflects issues such as oxygen consumption and the efficiency of oxygen delivery to the periphery.<sup>44-46</sup> For example, normal mixed venous oxygen tension is approximately 40 mm Hg but decreases significantly if oxygen extraction is increased due to decreased oxygen delivery associated with hypovolemia.

Body temperature monitoring is a simple clinical measurement that has a significant impact on outcome in trauma patients. Hypothermia is extremely common in trauma victims with serious injuries. Although shock reduces blood flow to the skin and thus should decrease heat loss, thermogenesis is significantly decreased by hypoperfusion of skeletal muscle and abdominal viscera. In addition to having prognostic value, hypothermia causes significant physiologic changes. Coagulopathy induced by hypothermia increases uncontrolled hemorrhage during traumatic shock resuscitation and is considered part of the "triad of death" (hypothermia, acidosis, and coagulopathy).<sup>29,30</sup> The combination of these three responses to trauma is associated with a high mortality rate.

Because the coagulation cascade is composed of interacting enzymes, its effectiveness decreases significantly at temperatures <91° F (33° C). Therefore, rewarming a patient's core temperature improves blood coagulability and helps control hemorrhage.<sup>30</sup> Rewarming is performed by a variety of techniques. Infusing the patient with warm intravenous fluids (limited to 108° F [42° C]) is important in preventing and treating hypothermia. A variety of fluid warmers are available, and the

## BOX 70-2.

### Use of Pulmonary Artery Catheter

#### Useful Equations

Oxygen Delivery:  $Q_T \times CaO_2$

Oxygen Consumption:

$$Q_T (CaO_2 - CvO_2)$$

Pulmonary Shunt:  $Q_s/Q_T =$

$$\frac{C_A O_2 - CaO_2}{$$

$$C_A O_2 - CvO_2}$$

Extraction Ratio:  $O_{2FR} =$

$$(CaO_2 - CvO_2)/CaO_2$$

Oxygen Content Calculated By:

$$\text{Oxygen Content} = (\text{O}_2 \text{ saturation}/100 \times \text{Hemoglobin} \times 1.39) + PO_2 \times 0.003$$

Use: Arterial PO<sub>2</sub> and saturation for CaO<sub>2</sub>

Pulmonary artery PO<sub>2</sub> and saturation for CvO<sub>2</sub>

Calculated alveolar PO<sub>2</sub> and saturation (usually 100%) for C<sub>A</sub>O<sub>2</sub>

CaO<sub>2</sub>, arterial O<sub>2</sub> content; C<sub>A</sub>O<sub>2</sub>, pulmonary capillary O<sub>2</sub> content; CvO<sub>2</sub>, mixed venous O<sub>2</sub> content; Q<sub>s</sub>, pulmonary shunt flow; Q<sub>T</sub>, total cardiac output.

anesthesiologist must select from several having the capacity to warm at flow rates typical for trauma resuscitation. Excess capacity may counter intuitively allow fluids infused at lower rates to cool before they reach the patient's vein. Convective warming also is important and is achieved by keeping the emergency department and operating room warm and/or using a hot air convective warming blanket.

## Anesthetic Drugs of Choice

Anesthesia induction in the trauma patient is similar in concept to anesthesia induction of other surgical patients but often is complicated by the presence of a full stomach, associated head, neck, thoracic, or abdominal injuries, and hypovolemia. The resultant scenario poses significant issues for the well-being of the patient and the practice of the clinician. The more hemodynamically unstable the trauma patient, the more careful the anesthesiologist must be with titrating the induction drugs to effect (Table 70-4). Occasionally in the past, some investigators implied that the combination of only oxygen and a neuromuscular blocking drug was adequate for the severely hypovolemic trauma patient, but that viewpoint has been replaced by the judicious use of intravenous anesthetics because of the high inci-

TABLE 70-4.

## Anesthetic Drug for Trauma Patient

Function	Drugs	Trauma Dose (mg/kg)
Hypnosis (induction of anesthesia)	Etomidate	0.1–0.2
	Thiopental	0.5–2.0
	Propofol	0.5–1.0
	Ketamine	0.5–1.0
Analgesia	Fentanyl	0.001–0.003
	Morphine	0.05–0.1
	Sufentanil	0.1–0.5 µg/kg
Muscle relaxation	Vecuronium	0.15–0.3
	Rocuronium	0.9–1.2
	Succinylcholine	1.0–1.5
	Cisatracurium	0.10
Anesthesia maintenance	Isoflurane	Titrate to blood pressure
	Total intravenous anesthesia (propofol, fentanyl, dexmedetomidine)	50–100 µg/kg/min, 1–2 µg/kg/h, 0.5 µg/kg/h
	Ketamine, propofol	50–100 µg/kg/min propofol, 10–20 µg/kg/min ketamine

dence of unpleasant recall of perioperative events (and concomitant risk of punitive malpractice actions).

Ketamine has been recommended because of its perceived property of stimulating or at least stabilizing the sympathetic nervous system. Although ketamine usually causes hypertension and tachycardia secondary to increased sympathetic nervous system activity in unstressed patients, it can cause hypotension by direct myocardial depression in patients with maximally stimulated sympathetic responses secondary to shock. Thus, even ketamine must be used in small, preferably titrated, doses.

Etomidate similarly should be titrated to effect. Many clinicians believe that etomidate does not cause hypotension, but we have observed that etomidate may decrease blood pressure when administered to hypovolemic and maximally sympathetically stressed patients, similar to the clinical scenario noted with ketamine.

Thiopental or propofol can be titrated to effect without causing excessive hypotension. Often the doses needed to induce anesthesia in the patient with reduced blood volume and cardiac output (and possibly other abnormal pharmacodynamic and pharmacokinetic derangements) are so small that profound hypotension can be avoided. Overall, the operating principle should be small titrated doses of

whatever induction agent is selected. Given the state of current evidence, this is perhaps more important than the specific choice of drug.

The combination of ketamine and propofol (i.e., “ketafol”) is gaining popularity for induction of trauma anesthesia and as an intravenous infusion to supplement regional anesthesia for repair of traumatic injury. Typically, 200 mg of propofol is mixed with 40–100 mg of ketamine in the same syringe (the drugs are compatible). In practice, the mixture is carefully injected intravenously until the patient is in the desired state of sedation or until anesthesia is induced, depending on the desired end point (Table 70-4). Ketamine and propofol appear to be somewhat synergistic in inducing anesthesia, and the sympathetic stimulation associated with ketamine is thought to counteract the cardiovascular depression associated with propofol.<sup>47</sup>

Careful attention to both adequacy of ventilation and protection of the airway is required when inducing anesthesia in the trauma patient, especially when incremental doses are administered while “titrating” to effect, an approach that minimizes the potential cardiovascular instability that commonly results with use of typical doses of induction agents. The patient’s gas exchange should be supplemented by hand ventilation through a face mask while an assistant administers effective cricoid

pressure. Cricoid pressure (i.e., Sellick maneuver) has been used for many years to prevent both insufflation of ventilatory gases into the stomach during mask ventilation and regurgitation and aspiration of gastric contents from the hypopharynx.<sup>48,49</sup> Control of ventilation while titrating induction drugs to effect will result in unconsciousness of the patient at the lowest efficacious dose, with less drug-induced hypotension. An additional benefit is an increase in alveolar oxygen and decrease in alveolar CO<sub>2</sub> immediately preceding the obligatory apneic period during intubation of the trachea. Some of the disadvantages of “classic” rapid sequence induction include the hypoxia hypercarbia that may occur during the 60- to 90-second apneic interval associated with endotracheal intubation. This often is further complicated in trauma patients by poor visualization (e.g., blood in the hypopharynx) or the need for special protection of the cervical spine in patients with head or neck injuries. Modified rapid sequence induction using cricoid pressure and sustained mask ventilation avoids this substantial insult.

The choice of muscle relaxant remains controversial. Proponents of succinylcholine tout its rapid onset, whereas those who favor nondepolarizing neuromuscular blocking drugs cite the undesirable side effects of succinylcholine, such as hyperkalemia, cardiac arrest (“black box” warning in package insert), and malignant hyperthermia. Because many trauma patients present for anesthesia without a complete medical/anesthetic history, the side effects of succinylcholine must be taken seriously and balanced against the benefits of that drug.

The possibility that a patient who cannot be ventilated or intubated would recover to spontaneous ventilation prior to sustaining brain damage secondary to cerebral hypoxia probably is not one of the benefits of succinylcholine. The 1–1.5 mg/kg dose of succinylcholine needed to achieve relatively rapid onset will require at least 5 minutes before recovery to meaningful spontaneous ventilation. In the trauma patient in shock who has increased pulmonary shunt, dead space, and all the other hemodynamic and metabolic issues noted above, this interval is long enough to result in profound hypoxia. Rapid onset of neuromuscular blockade can be achieved with nondepolarizing



relaxants by increasing the dose administered to multiples of the ED<sub>95</sub>. The most commonly used nondepolarizing neuromuscular blockers are vecuronium (noted for its cardiovascular stability), rocuronium, and cisatracurium.

Opioid analgesics are an important component of trauma anesthesia practice, not only for critically injured patients who require immediate anesthesia induction for a variety of urgent imaging studies and/or surgery but also for less critically injured patients who need only analgesia, sedation, and monitoring of vital signs but require appropriate opioid analgesics for pain management. Fentanyl is an opioid useful for trauma care because its high lipophilicity, potency, and rapid redistribution make it easy to titrate to effect without causing hemodynamic deterioration. Morphine has a long history of use in trauma care, but its relatively slow onset makes it difficult to titrate and avoid subsequent overdose. Hydromorphone may be a more attractive option.

### Regional Anesthesia

Although opioids reduce afferent stimulation in the neurohumoral response to trauma and thus reduce some of the proinflammatory stress responses, regional anesthesia may be even more effective for blunting these responses. Regional anesthesia can be an important adjunct to the total anesthetic management of the trauma patient, especially for its ability to reduce inflammatory triggers from the site of injury. Epidural anesthesia has been documented to reduce systemic stress from surgery, but it must be used especially carefully in trauma patients. Because many trauma patients have direct thoracic or lung injury and/or shock-induced pulmonary dysfunction ( $\dot{V}/\dot{Q}$  mismatch, etc.), they often benefit greatly from mechanical ventilation. They may be hypovolemic as well, and sympathectomy accompanying neuraxial anesthesia can result in significant hypotension; if used, it must be initiated with small incremental doses of local anesthetic while frequently monitoring arterial pressure (and perhaps CVP). Furthermore, a generalized posttraumatic anticoagulated state will put some trauma patients at risk for epidural hematoma formation and thus be a relative contraindication for an epidural as a component of their anesthetic and critical care management. Thus, the

decision to use epidural anesthesia depends on a variety of considerations, but it can be particularly helpful for the postoperative care of patients who suffer multiple rib fractures and/or flail chest.

However, peripheral nerve blocks that deafferent an injured limb can be safely applied to supplement general anesthesia for most trauma patients, except those who arrive in extremis. Peripheral nerve blocks will reduce the need for systemic opioids in the postoperative phase and in many instances allow earlier extubation of the trauma patient with painful injuries. Indwelling catheters can be placed at peripheral nerve block sites to provide continuous analgesia for postoperative pain management. Electrodes implanted in stimulating catheters allow the use of nerve stimulation to accurately place these catheters near major nerves (femoral nerve, brachial plexus, etc.) (Arrow International Inc., Reading, PA).

Some uses of regional anesthesia to enhance the anesthetic care of trauma patients are summarized in Table 70–5. Patients with isolated limb injuries often can be managed with peripheral nerve blocks as their sole anesthetic. This is especially useful in austere conditions where backup help for airway management problems may not be available or where the full gamut of anesthetic equipment and agents might not be available (e.g., fiberoptic intubation devices, etc.). Isolated peripheral nerve blocks have less propensity than neuraxial blocks (spinal and epidural) to cause hypotension and thus are less likely to cause cardiovascular problems with anesthesia administered for trauma surgery.<sup>50</sup>

However, patients who suffer severe injuries to the chest or abdomen

will require intubation and ventilatory support. These patients will need airway support to provide a route for the requisite general anesthesia and to protect the airway from soilage.

## SPECIFIC INJURY PATTERNS

### Damage Control Surgery

Patients with profound hemodynamic instability and intraabdominal hemorrhage benefit from “damage control surgery,” an operative strategy designed to rapidly achieve hemostasis without attempting definitive repair of solid organ injury.<sup>51</sup> For example, a patient with a grade 5 liver laceration (involving hepatic veins) would undergo an exploratory celiotomy for repair of the hepatic venous laceration and packing of the liver wound for hemostasis. The patient then would be transferred to the ICU. After rewarming the patient and completing hemodynamic resuscitation in the ICU, the trauma team returns the patient to the operating room 24–48 hours later for a “second look.” During the second look, packs are removed and the wound in the liver is judiciously débrided. The patient may require several more trips to the operating room to complete repairs of all the intraabdominal injuries.

This approach to resuscitating the injured patient with major intraabdominal hemorrhage is consistent with the ATLS philosophy of delivering simultaneous emergency lifesaving treatment with definitive diagnosis of injuries. Thus, uncontrolled hemorrhage is contained, and the patient is allowed to stabilize and return to the operating room for definitive correction of major injuries when he or she is sufficiently stable to undergo lengthy surgical re-

TABLE 70–5.

#### Regional Anesthesia

Type of Regional Anesthesia	Purpose of Block
Pure regional anesthesia	Useful for isolated injuries, e.g., hand injury, ankle fractures
Combination regional/general anesthesia	Reduced brain response to injury stimulation plus controlled ventilation
Continuous regional blocks	Supplement general anesthesia to reduce neurohumoral response to injury plus postoperative pain
Peripheral nerve blocks (single-dose and continuous catheter nerve blocks)	Alternative to neuraxial block, less risk in coagulopathic/anticoagulated patient

pair. This avoids the often fatal triad of ongoing massive transfusion—hypothermia, coagulopathy, and persistent metabolic acidosis—while the surgeon struggles to débride and repair massive liver lacerations or other extensive intraabdominal organ injury during the initial operation.<sup>29,51</sup>

The anesthesia team must continually monitor fluid replacement and the effectiveness of resuscitation efforts by tracking the status of metabolic acidosis during damage control surgery. General anesthesia, including neuromuscular blockade to facilitate surgery, and judicious use of analgesic and hypnotic drugs (either inhalation or intravenous), as tolerated by the patient, are required for damage control surgery. These patients require controlled ventilation, large-bore intravenous access (infusion into both the superior and inferior vena cavae systems is recommended), and direct monitoring and control of blood pressure (with an intraarterial catheter used also for blood sampling), core temperature, and urinary output. Maintenance of body temperature and/or rewarming requires keeping the room temperature  $>72^{\circ}\text{F}$  ( $>22^{\circ}\text{C}$ ), as well as use of hot air convective body warmers and fluid warming devices. Following initial damage control surgery, these patients will be managed with heavy sedation and/or neuromuscular blockade in the postoperative ICU phase. Therefore, the anesthetic plan should incorporate transportation from operating room to ICU, with the patient remaining intubated and fully monitored during transport.

## Head and Spinal Cord Injuries

Head injuries lead to increased mortality and morbidity in victims of both blunt and penetrating trauma. Therapeutic goals for patients with central nervous system (CNS) injuries are designed to minimize the amount of injured tissue, prevent secondary CNS injury, and facilitate rehabilitation and recovery. The critical points in head injury resuscitation are maintaining adequate perfusion pressure and preventing hypoxia and hyperglycemia. Cerebral perfusion pressure (CPP), which is the mean arterial pressure minus the intracranial pressure (ICP), is recognized as a more important parameter to monitor than ICP alone.<sup>52</sup> This is because an increased ICP is deleterious to trauma victims by reduc-

ing nutrient blood flow perfusing the brain. As the high ICP obstructs cerebral perfusion, ischemia develops, and regions of the brain may suffer necrosis.<sup>53,54</sup> Maintaining CPP  $>70$  mm Hg provides sufficient pressure for perfusion through arteries partially obstructed by elevated ICP and prevents ischemia. Evidence indicates that even CPP  $>60$  mm Hg may be adequate to prevent secondary brain injury. Loss of adequate CPP, usually resulting from arterial hypotension, is one of the more ominous events in the early treatment of head injury. Thus, anesthesia induction should be planned and implemented to minimize hypotension. Ketamine, an antagonist of the *N*-methyl-D-aspartate (NMDA) receptors associated with secondary brain injury, is being investigated as a potential neuroprotective anesthetic for head injury.<sup>55</sup> Some investigations have shown that the *S*-isomer has neuroregenerative properties,<sup>56</sup> although this form remains unavailable for clinical use in the United States. Ketamine tends to elevate ICP in normovolemic patients, but this effect is unlikely in those who are hypovolemic (studies in animals confirm this concept). Thus, ketamine is being reevaluated as an induction agent for patients with traumatic brain injury. The combination of NMDA antagonism produced by ketamine and  $\gamma$ -aminobutyric acid agonism produced by propofol is particularly appealing from a theoretical viewpoint in the anesthetic management of traumatic brain injury.

Hypoxia is deleterious to all organs and tissues, although the brain is relatively resistant to arterial hypoxia if perfusion is well maintained to clear the toxic byproducts of anaerobic metabolism from the brain.<sup>57</sup> The patient with traumatic brain injury and multi-system trauma may become hypoxic because of chest trauma or  $\dot{V}/\dot{Q}$  mismatch; therefore, it is imperative to prevent hypotension and maintain CPP to allow the brain to tolerate the period of hypoxia. Hypotension is treated with pressors and fluid loading because hypovolemia rapidly leads to hypotension and loss of adequate CPP, leaving the injured brain starved for blood flow. Although the past dogma for treating traumatic brain injury emphasized induced dehydration through aggressive diuresis in an attempt to extract water from edematous regions of the injured brain, little was

achieved except a vicious circle of positive feedback with cerebral ischemia leading to higher ICP and further diuresis to dehydrate the patient, which in turn caused worsening ischemia and further increases in ICP and so on until brain death occurred.

The concept of reducing ICP as another method of enhancing cerebral perfusion remains viable. Reduction of ICP usually involves draining cerebrospinal fluid through a ventriculostomy catheter. Other methods for reducing ICP, such as diuretics, barbiturates, or extreme hyperventilation to reduce intracerebral blood volume, may be poorly tolerated in trauma patients and must be used with caution. Mannitol has a long tradition as an emergency drug used to reduce ICP and is well tolerated in moderate doses. Drugs that increase mean arterial pressure will help restore perfusion to the non-injured brain and possibly help reduce the size of the injury. The future will see the development of anesthesia strategies for reducing secondary brain injury from excitatory neurotransmitters; the earlier discussion regarding ketamine and propofol is an example of these potential strategies.

## Spinal Cord Injuries

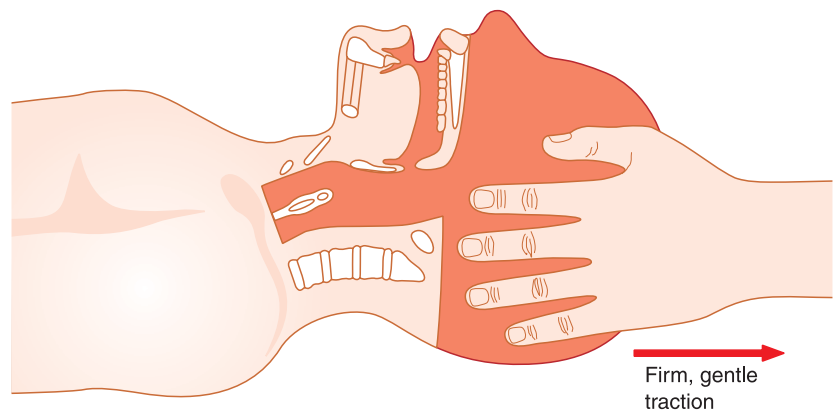
The general principles of anesthetic management described for patients with traumatic brain injury also apply to the care of patients with spinal cord injury. However, in addition there are significant concerns about mechanical injury from movement of the cervical, thoracic, or lumbar spine, depending on the site of injury. Stabilizing the spine is critical to preventing additional injury to the spinal cord and to fostering potential healing of spinal cord lesions. A short (48-hour) course of steroids usually is administered to patients with “incomplete” spinal cord injuries to reduce peri-injury edema and in theory to promote reperfusion and healing of injured spinal cord tissue.

Anesthesia management of patients with potential spinal cord injury can be challenging because of the critical need to prevent motion of the spine. It is during airway management when the anesthesiologist has perhaps the highest probability of extending the injury. Most maneuvers used to secure a patent airway with either an oral airway or an endotracheal tube are associated with some motion of the cervical vertebrae.<sup>58</sup> There are

several recommendations for stabilizing the cervical spine during anesthesia induction and endotracheal intubation. These maneuvers vary from awake fiberoptic intubation to direct laryngoscopy controlled by manual inline axial stabilization (Fig. 70-3 and Box 70-3). The anesthesiologist's decision on the technique to use depends on the stability of the fracture and the urgency of airway management.<sup>58</sup> (Details of airway management are presented in Chapter 35 the guiding principles that apply to patients with head or spine injuries are discussed here.)

Unstable fractures with disruption of both anterior and posterior elements of the spine require more caution in choice of intubation method, especially in patients with fracture but no spinal cord injury or in those with incomplete injury. A flexible fiberoptic bronchoscope can be used to direct the endotracheal tube through the larynx with minimal movement of the cervical spine. However, the fiberoptic bronchoscope is vulnerable to blood or secretions that obscure the operator's vision and render intubation very difficult. Direct laryngoscopy provides better vision in patients with copious bloody secretions but frequently causes an obligatory extension of the upper cervical vertebrae, even with application of manual inline axial stabilization. Indirect fiberoptic laryngoscopes (e.g., Bullard, Wu, or Upsher scope) often can expose the larynx with little to no motion of the cervical vertebrae. Other techniques, such as intubating laryngeal mask airway and transtracheal retrograde wire technique, have been used with generally good results.

Although blind nasal intubation once was the technique of choice for injured patients with cervical spine fracture, it has several drawbacks in patients with acute trauma. Achievement of blind nasal intubation requires a spontaneously breathing patient, and adequate sedation for this procedure is difficult to achieve without depressing respiration and thus adding to the potential for hypoxemia or hypotension. In contrast, inadequate sedation or analgesia may result in excess cervical motion in a patient who actively resists the painful procedure. Acute head injury associated with blunt trauma presents additional risks for blind nasal intubation, with the potential for introduction of a for-



**FIGURE 70-3.** Manual inline axial stabilization (MIAS) applied for immobilization of the cervical spine during endotracheal intubation. (From Grande CM, Smith CE, Stene JK. Trauma anesthesia. In: Longnecker DE, Tinker JH, Morgan GE Jr, eds. Principles and Practice of Anesthesiology. 2nd ed. St. Louis: Mosby, 1998:2142, with permission.)

eign body (endotracheal tube) through a basilar skull fracture that extends into the nasopharynx as well as increased risks of a serious sinus infection that may spread into meningitis. For these reasons, nasal tracheal intubation is reserved for patients who require intraoral surgery and postoperative intramaxillary fixation. In these cases, a controlled nasotracheal intubation guided by a fiberoptic bronchoscope is preferable to a blind nasal intubation. The patient with maxillofacial fractures and traumatic brain inju-

ry who will require prolonged ventilatory support will be best served by preoperative controlled tracheostomy for ongoing airway management.

Anesthetic drugs that aid awake/sedated intubation include midazolam, fentanyl, ketamine, lidocaine (topical and nerve blocks), and dexmedetomidine. Blocks of the superior laryngeal nerve and/or transtracheal injection of local anesthetic render the patient's upper airway insensate and reduces the need for systemic sedation. Generous amounts of 5% lidocaine ointment

### BOX 70-3.

#### Modified Rapid Sequence Induction and Intubation for Trauma Patients

1. Be familiar with evaluation of the difficult airway and the American Society of Anesthesiologists practice guidelines for management of the difficult airway.
2. Be familiar with noninvasive and invasive techniques of airway management.
3. Evaluate the airway and be prepared to execute multiple contingency plans.
4. Preoxygenate the patient with 100% O<sub>2</sub> by face mask.
5. Remove anterior portion of the cervical spine collar and apply manual inline axial stabilization of the head and neck if suspected cervical spine injury.
6. Give appropriate medications IV, as indicated by the clinical setting and hemodynamic status:
  - Lidocaine 1.5 mg/kg if suspected head injury
  - Sedative-hypnotics (see Table 70-4)
  - Muscle relaxants (see Table 70-4)
7. Apply cricoid pressure until intubation is completed.
8. Manually ventilate the patients' lungs with 100% O<sub>2</sub> using inflation pressures <20 cm H<sub>2</sub>O to prevent (or treat) hypoxemia and hypercarbia before (or between) intubation attempt(s). Continue cricoid pressure during bag-mask ventilation.
9. Confirm correct position of endotracheal tube by visualizing tube passing through cords, sustained presence of end-tidal CO<sub>2</sub>, auscultation of breath sounds, and self-inflating bulb
10. After successful intubation, administer additional increments of sedative-hypnotics and analgesics or begin a potent volatile agent, as dictated by clinical need. Consider using a longer-acting relaxant once the effects of succinylcholine, if used, have worn off.

coating an oral airway has been used successfully to provide topical anesthesia to the pharynx and upper airway, as has aerosolized lidocaine breathed by the patient for several minutes prior to initiation of the intubation procedure. Benzocaine sprays also have been used to topically numb the upper airway but are associated with the risk of methemoglobinemia.

Dexmedetomidine, an  $\alpha_2$ -agonist, provides sedation and analgesia without respiratory depression and is an attractive choice for sedation prior to awake intubation. However, it has a relatively long half-life and requires some infusion time to achieve steady-state blood levels. Boluses have been used to shorten the time to adequate sedation but are associated with an increased risk of bradycardia, hypotension, and/or hypertension. Dexmedetomidine is especially useful for patients who will undergo neuromonitoring with evoked potentials because a continuous infusion will potentiate propofol and opioids but will not affect the quality of the electroencephalographic response. Thus, a dexmedetomidine infusion used for sedation during intubation can be continued through the entire anesthetic.

After anesthesia induction, the fractured spine must be carefully immobilized during other patient movements, such as transfer to the operating table. Patients who must be placed in the prone position need special care to prevent flexing or extending the spine during turning, and a neurosurgeon or orthopedic surgeon should supervise this procedure. Following stabilization surgery, patients are less vulnerable to spine motion when being transferred out of the operating room. However, they still will require external stabilization during patient movements throughout the period of bone fracture healing.

## Airway Injuries

The true incidence of airway injury is unknown because many patients with such injuries presumably die at the accident scene or during transport, but airway injuries present one of the greatest of challenges for trauma anesthesia care. Airway injuries may dramatically complicate the preoperative preparation and anesthetic induction of trauma patients. These injuries often require extreme measures of ingenuity and innovation on the part of the anesthesiologist to safely manage a

patient with an airway injury for emergency surgery; the situation represents a continuous high risk until the airway is secured. Although in most cases intubation via the mouth or nose is recommended, upper airway injuries associated with disruption of laryngeal cartilage may be best treated with primary tracheostomy. However, in truly emergent situations of ventilatory distress, translaryngeal intubation with a small endotracheal tube can be lifesaving and support the patient's ventilation during subsequent tracheostomy.

An initial triage assessment that assigns patients with airway injuries into relative categories of "stable" or "unstable" is important because it facilitates subsequent evaluation and management planning. In patients who are stable, obtaining imaging studies that elucidate the site (i.e., tracheobronchial level) and extent of injury to the airway will allow more comprehensive anesthetic management and formulation of a treatment plan in concert with surgical colleagues.

In urgent situations that include suspected injuries to the trachea, intubation with a fiberoptic bronchoscope may allow inspection of tracheal integrity as well as assist in guiding an endotracheal tube into position. A majority (approximately 80%) of blunt tracheobronchial lacerations occur within 1 cm of the carina, and fiberoptic bronchoscopy can easily view most of these lacerations. Clinical signs of tracheal or bronchial lacerations include pneumomediastinum, subcutaneous emphysema, pneumothorax, and persistent air leak.

In less urgent presentations, serious consideration should be given to full bronchoscopic examination of the tracheal bronchial tree of patients who suffered blunt chest trauma and have a persistent air leak.

Although chest trauma potentially compromises a patient's ventilation and hemodynamic status, the vast majority of chest injuries are managed outside of the operating room. However, the anesthesiologist must be familiar with devices used for chest tube drainage and management, because many patients with chest trauma and hemothorax or pneumothorax require operative care of other injuries.

## Long Bone and Pelvic Fractures

Fat embolism is a potential cause of respiratory compromise in patients

with major lower extremity or pelvic fractures. The full fat embolism syndrome starts with respiratory failure and then proceeds to a diffuse distribution of petechia and neurologic dysfunction. Release of bone marrow contents from long bone and pelvic fractures first affects pulmonary gas exchange and then leads to systemic manifestations, multiple cutaneous hemorrhages, and cerebral dysfunction. Fat globules can be found in the urine and observed in retinal blood vessels. Early fracture fixation with hardware combined with intubation and mechanical ventilation prevents continued leaching of marrow fat into the venous and pulmonary circulation and reverses pulmonary dysfunction from fat emboli before the full syndrome develops.<sup>59</sup> Fat released into the venous circulation from fractures through the marrow compartments of long bones also releases mediators that react with pulmonary blood vessels, leading to  $\dot{V}/\dot{Q}$  mismatching and hypoxia. These injuries, especially pelvic fractures, cause major hemorrhage and ongoing blood loss. Although closed fractures can be stabilized and treated with bed rest, open fractures require prompt operative intervention, preferably within 6 hours of injury. Patients with blunt trauma often will require multiple trips to the operating room for debridement of contaminated open fractures as well as operative stabilization of complex highly comminuted fractures, so their management commonly involves multiple frequent anesthetics.

Patients with blunt trauma and multiple systems injuries have improved outcomes with early operative fixation of fractures. Prolonged bed rest with femur traction is associated with increased risk of both pneumonia and venous thromboembolic disease. Additionally, stabilizing long bone fractures seems to reduce the risk of fat embolization by minimizing motion of the fracture site. Although the incidence of fat embolism varies based on multiple considerations (location, extent of injury, comorbidities, medications, etc.), mortality from fat embolism remains high and is a serious threat that must be guarded against and managed aggressively.

Arterial blood gases of patients with long bone fractures should be measured following hospital admission. Patients with hypoxia (low  $P_{aO_2}/F_{iO_2}$



ratio) should be intubated and mechanically ventilated. These patients should be monitored with an arterial catheter ("a-line") during anesthesia and surgery to facilitate measurements of blood gases. Patients with a low  $P_{aO_2}/F_{iO_2}$  ratio should remain intubated and ventilated in the ICU postoperatively.

### Abdominal Compartment Syndrome

Critical care observation has demonstrated the importance of increased intraabdominal pressure in the genesis of multiorgan failure, including acute respiratory distress syndrome.<sup>60</sup> Intraabdominal pressure is monitored by measuring the pressure in the urinary bladder after instillation of 50 mL of saline. Classically, intraabdominal pressure >40 mm Hg has been called *abdominal compartment syndrome*. This syndrome is associated with increased ventilatory pressure to expand the lungs adequately and with oliguria, as the high pressure compresses the renal veins (thus decreasing renal perfusion) and possibly the ureters as well. Evidence indicates that intraabdominal pressures as low as 20 mm Hg may be associated with the systemic inflammatory response syndrome and multiorgan failure. Left unchecked, high intraabdominal pressure is associated with release of inflammatory mediators from the relatively ischemic intestines and subsequent development of multiple organ failure.

Patients with abdominal compartment syndrome require urgent surgical decompression to relieve the tension and to allow improved parenchymal blood flow and restoration of renal function. Continuous neuromuscular blockade can relax the abdominal wall and reduce mild increases in intraabdominal pressure. More persistent and serious increases will require surgical intervention. Relief of increased intraabdominal pressure also allows improved ventilation because motion of the diaphragm is no longer impeded.

### CONCLUSION

Trauma patients present the anesthesiologist with many clinical challenges because of the varied nature of traumatic injury. Although no two injuries are exactly alike, traumatic injury causes a characteristic physiologic and

metabolic response usually recognized as hemorrhagic shock. Without resuscitation within the "golden hour," post-traumatic hemorrhagic shock leads to cellular hypoxia and irreversible organ ischemia. Although excess fluid administration prior to surgical hemostasis can lead to further uncontrolled hemorrhage, administering some fluid resuscitation in the "golden hour" is critical. Head-injured patients require somewhat higher blood pressure than do patients who are not head injured. Because CPP of 60 mm Hg may be adequate to maintain perfusion following head injuries, a target mean arterial pressure of 80 mm Hg prior to surgical hemostasis should provide adequate cerebral perfusion, assuming an ICP of 20 mm Hg.

Airway management presents special challenges in trauma patients, especially in those with potential cervical spine injury and/or airway injury. Modified rapid sequence intubation with cricoid pressure, gentle mask ventilation before oral intubation, and manual inline spine stabilization is the technique of choice for most trauma patients.

Metabolic management of the trauma patient includes aggressive rewarming and maintenance of normothermia, maintenance of a euglycemic state, and prevention of base deficit.

### KEY REFERENCES

1. Abrams KJ, Grande CM, eds. *Perioperative Trauma Anesthetic and Critical Care Management of Neurologic Injury*. Armonk, NY: Futura Publishing, 1997.
2. Adams AP, Grande CM, Hewitt PB. *Emergency Anaesthesia*. 2nd ed. London: Arnold Publishers, 1997.
3. Berman JM, Hall J, eds. *Pediatric Trauma Anesthesia and Critical Care*. Armonk, NY: Futura Publishing, 1996.
4. Grande CM, ed. *Textbook of Trauma Anesthesia and Critical Care*. St. Louis: Mosby-Year Book, 1993.
5. Hanowell LH, Grande CM, eds. *Critical care management of the ill and injured*. *Semin Anesth* 1994;13:167-275.

6. Hastings RH, Marks JD. Airway management for trauma patients with potential cervical spine injuries. *Anesth Analg* 1991;73:471.

7. Rosenberg AM, Bernstein R, Grande CM, eds. *Trauma anesthesia and critical care for orthopedic injuries*. *Probl Anesth* 1994;8(3).

8. Rosenberg AM, Bernstein R, Grande CM, eds. *Perioperative Pain Management and Regional Anesthesia for the Trauma Patient*. London: WB Saunders, 1997.

9. Soreide E, Grande CM, eds. *Pre-hospital Trauma Care*. New York: Marcel Dekker, 2001.

10. Stene JK, Grande CM, eds. *Trauma anesthesia*. Baltimore: Williams & Wilkins, 1991.

### REFERENCES

1. Desborough JP. The stress response to trauma and surgery. *Br J Anaesth* 2000;85:109-117.
2. *Stedman's Medical Dictionary*. Baltimore: Williams & Wilkins, 1982:1281.
3. Cowell EM. The initiation of wound shock. *JAMA* 1918;70:607-610.
4. Cannon WB. A consideration of the nature of wound shock. *JAMA* 1918;70:611-617.
5. Henderson YA. Acapnia and shock—VII. Failure of the circulation. *Am J Physiol* 1910;27:152-176.
6. Guyton AC, Jones CE, Coleman TG. *Circulatory Physiology: Cardiac Output and Its Regulation*. Philadelphia: WB Saunders, 1973.
7. Magder S, De Varennes B. Clinical death and the measurement of stressed vascular volume. *Crit Care Med* 1998;26:1061-1064.
8. Oestern H-J, Trentz O, Hempelmann G, et al. Cardiorespiratory and metabolic patterns in multiple trauma patients. *Resuscitation* 1977;7:169-184.
9. Gann DS, Lilly MP. The neuroendocrine response to multiple trauma. *World J Surg* 1983;7:101-118.
10. McMillen MA, Huribal M, Sumpio B. Common pathway of endothelial-leukocyte interaction in shock, ischemia, and reperfusion. *Am J Surg* 1993;166:557-562.
11. Shoemaker WC, Peitzman AB, Bellamy R, et al. Resuscitation from severe hemorrhage. *Crit Care Med* 1996;24:S12-S23.
12. Trump BP, Valigorsky JM, Dees JH, et al. Cellular changes in human disease: a new method of pathological analysis. *Hum Pathol* 1973;4:89-109.
13. Sedlak TW, Snyder SH. Messenger molecules and cell death *JAMA* 2006;295:81-89.

14. Champion DS, Lynch LJ, Rector FC Jr, et al. Effect of hemorrhagic shock on transmembrane potential. *Surgery* 1969;66:1051–1059.
15. Dantzker DR. Adequacy of tissue oxygenation. *Crit Care Med* 1993;21:S40–S43.
16. Moore FD. The effects of hemorrhage on body composition. *N Engl J Med* 1965;273:567–577.
17. Adamson J, Hillman RS. Blood volume and plasma protein replacement following acute blood loss in normal man. *JAMA* 1968;205:63–66.
18. Capone AC, Safar P, Stezoski W, et al. Improved outcome with fluid restriction in treatment of uncontrolled hemorrhagic shock. *J Am Coll Surg* 1995;180:49–56.
19. Bickell WH, Wall MJ Jr, Pepe PE, et al. Immediate versus delayed fluid resuscitation for hypotensive patients with penetrating torso injuries. *N Engl J Med* 1994;331:1105–1109.
20. Dries DJ. Hypotensive resuscitation. *Shock* 1996;6:311–316.
21. Kowalenko T, Stern S, Dronen S, et al. Improved outcome with hypotensive resuscitation of uncontrolled hemorrhagic shock in a swine model. *J Trauma* 1992;33:349–353.
22. Conger JD. Interventions in clinical acute renal failure: what are the data? *Am J Kidney Dis* 1995;26:565–576.
23. Krausz MM, Bar-Ziv M, Rabinovici R, et al. “Scoop and run” or stabilize hemorrhagic shock with normal saline or small-volume hypertonic saline? *J Trauma* 1992;33:6–10.
24. Smith CD, Moir CR, Mucha P Jr. Rhabdomyolysis and renal failure following a wolf attack: case report. *J Trauma* 1991;31:423–425.
25. OzGuc H, Kahvecci N, Akkose S, et al. Effects of different resuscitation fluids on tissue blood flow and oxidant injury in experimental rhabdomyolysis. *Crit Care Med* 2005;33:2579–2586.
26. Kramer GC, Perron PR, Lindsey DC, et al. Small volume resuscitation with hypertonic saline dextran solution. *Surgery* 1986;100:239–246.
27. Strecker U, Dick W, Madjidi A, et al. The effect of the type of colloid on the efficacy of hypertonic saline colloid mixtures in hemorrhagic shock: dextran versus HES. *Resuscitation* 1993;25:41–57.
28. Pope A, French G, Longnecker DE. *Fluid Resuscitation: State of the Science for Treating Combat Casualties and Civilian Injuries*. Washington, DC: National Academy Press, 1999.
29. Ku J, Brasel KJ, Baker CC, et al. Triangle of death: hypothermia, acidosis, and coagulopathy. *New Horiz* 1999;7:61–72.
30. Rohrer MJ, Natale AM. Effect of hypothermia on the coagulation cascade. *Crit Care Med* 1992;20:1402–1405.
31. Gentilello LM, Cobean RA, Offner PJ, et al. Continuous arteriovenous rewarming: rapid reversal of hypothermia in critically ill patients. *J Trauma* 1992;32:316–327.
32. Grahn D, Brock-Utne, Watenpaugh DE, et al. Recovery from mild hypothermia can be accelerated by mechanically distending blood vessels in the hand. *J Appl Physiol* 1998;85:1643–1648.
33. Martinowitz U, Kenet G, Segal E, et al. Recombinant activated factor VII for adjunctive hemorrhage control in trauma. *J Trauma* 2001;51:431–439.
34. Van den Berghe G, Wouters P, Weekers F, et al. Intensive insulin therapy in critically-ill patients. *N Engl J Med* 2001;345:1359–1367.
35. Ouattara A, Lecmte P, LeManach Y, et al. Poor intraoperative blood glucose control is associated with a worsened hospital outcome after cardiac surgery in diabetic patients. *Anesthesiology* 2005;103:687–694.
36. Cornwell EE, Kennedy F, Rodriguez J. The critical care of the severely injured patient—I: assessing and improving oxygen delivery. *Surg Clin North Am* 1996;76:959–969.
37. Asensio JA, Demetriades D, Berne TV, et al. Invasive and noninvasive monitoring for early recognition and treatment of shock in high-risk trauma and surgical patients. *Surg Clin North Am* 1996;76:985–997.
38. Mizock BA, Falk JL. Lactic acidosis in critical illness. *Crit Care Med* 1992;20:80–93.
39. Schultz SC, Hamilton IN, Malcolm DS. Use of base deficit to compare resuscitation with lactated ringer's solution, Haemaccel, whole blood, and diaspirin cross-linked hemoglobin following hemorrhage in rats. *J Trauma* 1993;35:619–626.
40. Rutherford EJ, Morris JA Jr, Reed GW, et al. Base deficit stratifies mortality and determines therapy. *J Trauma* 1992;33:417–423.
41. Davis JW, Shackford SR, Holbrook TL. Base deficit as a sensitive indicator of compensated shock and tissue oxygen utilization. *Surg Gynecol Obstet* 1991;173:473–476.
42. Gabow PA, Kaehny WD, Fennessey PV, et al. Diagnostic importance of an increased serum anion gap. *N Engl J Med* 1980;303:854–858.
43. Swan HJ. The pulmonary artery catheter in anesthesia practice. *Anesthesiology* 2005;103:890–893.
44. Edwards JD. Practical application of oxygen transport principles. *Crit Care Med* 1990;18:S45–S48.
45. Hayes MA, Timmins AC, Yau EHS, et al. Elevation of systemic oxygen delivery in the treatment of critically ill patients. *N Engl J Med* 1994;330:1717–1722.
46. Ronco JJ, Fenwick JC, Tweeddale MC, et al. Identification of the critical oxygen delivery for anaerobic metabolism in critically ill septic and nonseptic humans. *JAMA* 1993;270:1724–1730.
47. Schuttler J, Schuttler M, Kloos S, et al. Optimal dosage strategies in total intravenous anesthesia using propofol and ketamine. *Anaesthetists* 1991;40:199–204.
48. Sellick BA. Cricoid pressure to control regurgitation of stomach contents during induction of anaesthesia. *Lancet* 1961;II:404–406.
49. Salem MR, Sellick BA, Elam JO. The historical background of cricoid pressure in anesthesia and resuscitation. *Anesth Analg* 1974;53:230–232.
50. Williams R. Army Physicians Working Toward Bringing Wounded Troops Home Pain-Free. American Forces Information Service News Articles, Washington, DC, May 24, 2004. Available at: [www.defenselink.mil](http://www.defenselink.mil). Last accessed August 30, 2006.
51. Brasel KJ, Ku J, Baker CC, et al. Damage control in the critically-ill and injured patient. *New Horiz* 1999;7:73–86.
52. Rosner MJ, Rosner SD, Johnson AH. Cerebral perfusion pressure: management protocol and clinical results. *J Neurosurg* 1995;83:949–962.
53. Juul N, Morris GF, Marshall SB, et al. Intracranial and outcome in severe head injury. The Executive Committee of the International Selfotel Trial. *J Neurosurg* 2000;92:1–6.
54. Young JS, Blow O, Turrentine F, et al. Is there an upper limit of intracranial pressure in patients with severe head injury if cerebral perfusion pressure is maintained? *Neurosurg Focus* 2005;15:1–10.
55. Himmelscher S, Durieux ME. Revising a dogma: ketamine for patients with neurologic injury? *Anesth Analg* 2005;101:524–534.
56. Siesjo BK. Mechanisms of ischemic brain damage. *Crit Care Med* 1988;16:954–963.
57. Proescholdt M, Heimann A, Kempfski O. Neuroprotection of S(+) ketamine isomer in global fore brain ischemia. *Brain Res* 2001;904:245–251.
58. Crosby ET. Airway management in adults after cervical spine trauma. *Anesthesiology* 2006;104:1293–1318.
59. Burgess AR, Mandelbaum BR. Acute orthopedic injuries. In: Siegel JH, ed. *Trauma: Emergency Surgery and Critical Care*. New York: Churchill Livingstone, 1987:1049–1074.
60. Cheatham ML. Intra-abdominal hypertension and the abdominal compartment. *New Horiz* 1999;7:96–115.

## CHAPTER 71

## Anesthetic Management of the Burned Patient

Edward A. Bittner, MD, PhD,  
Loreta Grecu, MD, and J.A.  
Jeevendra Martyn, MD, FCCM

Major burn injury results in pathophysiologic changes in most organ systems. The perioperative care of burn patients requires knowledge of these changes from the initial injury until wounds have been covered and healed. Patients suffering from burn injuries often require surgical treatment for years following their initial injury.

## PREOPERATIVE EVALUATION

Patients are often brought to the operating room in the early phase of burn injury, when they are undergoing significant fluid shifts, with cardiovascular instability and/or respiratory insufficiency. The most frequently performed surgical procedure is excision and grafting of the burned area. Other procedures that may be required during their hospital stay include escharotomies, tracheostomy, and exploratory procedures related to accompanying trauma. During this time, the postburn physiology is not optimal for maintenance of normal homeostasis. Nevertheless, attempt should be made to optimize organ function. The physiologic and psychological changes resulting from burn injury must be taken into account in addition to the usual considerations for a patient undergoing anesthesia and surgery. Useful and important preoperative information include the time and extent of burn injury, coexisting medical problems, medications, drug allergies, problems with anesthetics and family anesthetic history and NPO status (Table 71-1). In addition, the anesthesiologist must be cognizant of the problems unique to burn patients including altered responses to anesthetics and muscle relaxants, difficul-

ties with airway management, altered ventilatory status, difficult intravascular access and monitoring, positioning, potentially significant transfusion requirements and methods of safe transport to and from the operating room.

## KEY POINTS

1. Major burn injury results in pathophysiologic changes in virtually all organ systems. The perioperative care of burn patients requires knowledge of these changes from the initial period of injury through the period until wounds have been covered and healed.
2. In patients with severe burn injury, massive heat loss can occur through the open wounds, making the maintenance of normothermia challenging. Multiple strategies are used to maintain body temperature in the operating room, including use of warming blankets, radiant warmers, blood/fluid warmers, and wrapping the head and extremities with plastic or thermal insulation.
3. Securing the endotracheal tube in a patient with facial burns can be difficult. It is essential to secure the endotracheal tube with a carefully secured tie harness to avoid the potential catastrophe of accidental extubation.
4. Use of cuffed endotracheal tubes in pediatric patients with significant burn injury is not unusual. Considerable fluctuations in airway diameter can occur throughout the patient's hospital course. With fluctuations in airway diameter, the endotracheal tubecuff should be adjusted to facilitate mechanical ventilation without a leak.
5. Because of their hypermetabolic state, oxygen consumption and CO<sub>2</sub> production can be significantly increased in patients with major burns. Consequently, the minute ventilation can exceed 20 L/min in an adult patient with a large burn. This large minute volume may exceed the capacity of some anesthesia machine ventilators; an ICU ventilator may be needed in the operating room.
6. Transport of a burn patient to and from the operating room can be a time of high risk. A systematic approach to maintenance of the patient's respiratory, hemodynamic, and general support helps insure patient safety. The need for continual observation by the anesthesia team during patient transport cannot be overemphasized.
7. Burn patients develop tolerance to most narcotics and sedatives thus requiring higher doses than for patients without thermal injury. Sedatives and narcotics should be titrated to effect while the patient is carefully monitored.
8. In burn patients, exposure to succinylcholine can result in an exaggerated hyperkalemic response that can induce cardiac arrest. The general recommendation is to avoid succinylcholine administration in patients 24 hours after burn injury. The duration of this dangerous response to succinylcholine is unknown.
9. Blood loss during burn wound excision can be deceptively large. It is not difficult for the surgical team to remove eschar so rapidly that the patient becomes hypovolemic and unstable. Good communication between the surgical and anesthesia teams as well as limiting the operative duration and extent of excision can prevent such problems.
10. Burn injury leads to increased susceptibility to infection through multiple mechanisms including loss of the physical barrier of intact skin, damage to lining of respiratory tract from inhalation, altered gut permeability and function. Maintaining strict aseptic technique both in the operating room and during transport is essential.
11. Nearly every aspect of treatment of burn injury is associated with pain. Poorly controlled pain and anxiety can have significant adverse physiologic and psychological effects. Standardized pain and anxiety guidelines have been used successfully to provide appropriate, consistent patient comfort.

## PATHOPHYSIOLOGY OF BURNS

## Effects on Cardiopulmonary Function

Hemodynamic function in the early burn period is characterized by a reduc-



TABLE 71-1.

**Major Preoperative Concerns for Burn Patients**

Age of patient
Extent of burn injury (total body surface area, depth, and location)
Mechanism of injury
Presence of inhalational injury
Airway patency
Adequacy of resuscitation
Presence of organ dysfunction
Elapsed time from injury
Associated injuries
Presence of infection
Coexisting diseases
Surgical plan

tion in cardiac output, and an increase in systemic and pulmonary vascular resistance, possibly with pulmonary edema (see Chap. 77). These effects are the result of hypovolemia caused by increased vascular permeability, reduced cardiac contractility from reduced responsiveness to circulating catecholamines, and circulating myocardial depressant factors. Increased circulating catecholamines, histamine, serotonin, and thromboxane lead to increased vascular resistance. Early and adequate fluid resuscitation is the hallmark of successful early burn management. Approximately 3–5 days after major burn injury, a hyperdynamic and hypermetabolic state occurs, with tachycardia, increased stroke volume, hyperthermia, and increased protein catabolism.

Pulmonary dysfunction after burn injury can be caused by increased pulmonary vascular permeability, and increased airway reactivity. Inhalational injury may lead to upper airway swelling, toxicity from carbon monoxide (CO) and other combustion products, and direct injury to the lower respiratory tract from inhaled chemicals. Pulmonary function may further worsen days later as a consequence of sloughing of bronchial mucosa, impaired clearance of secretions, and development of pneumonia.<sup>1</sup>

**Effects on Renal Function**

The incidence of acute renal failure (ARF) in burn patients has been reported to range from 1–30% with mortality exceeding 70% in the presence of renal failure.<sup>2,3</sup> Acute renal failure in burn patients can be categorized as

early (within first few days of injury) or late. The early stage of ARF is related to hypovolemia, low cardiac output, and systemic vasoconstrictive effects and/or myoglobinuria. Elevated stress hormones, catecholamines, angiotensin, aldosterone, and vasopressin have also been implicated in the pathogenesis of ARF. Early, appropriate fluid resuscitation has decreased the incidence of early ARF. Patients with large, deep burns and those with electrical injury are at increased risk. Late ARF has a more complicated pathogenesis and is usually related to sepsis, multisystem organ failure, or the effects of nephrotoxic drugs. It is reported more frequently in patients with inhalational injury.

Factors associated with decreased incidence of ARF include early adequate fluid resuscitation, early wound excision, and prevention and treatment of infection.<sup>4</sup> Assessing renal function in burn patients is essential to the development of a comprehensive anesthetic plan. During the hyperdynamic period, renal blood flow and glomerular filtration rate increase, both of which are related to the increased cardiac output in response to the hypermetabolic phase (Table 71-2).

**THERMOREGULATION**

In addition to conductive and convective heat loss, considerable evaporative heat loss can occur through the open wounds, making maintenance of normothermia challenging. This is especially true during transport to and from the operating room. Patients should be covered with warm blankets during transport. Children have greater surface-area-to-body-weight ratios, resulting in more rapid heat loss. Temperature of the environment should be maintained at above-normal levels.

Burn patients, if given a thermostat, will set their environmental temperature higher than normal.<sup>5</sup> Multiple strategies are used to maintain body temperature in the operating room, including use of warming blankets, radiant warmers, blood/fluid warmers, and wrapping the head and extremities with plastic or thermal insulation. Temperature in the operating room is commonly maintained at 90–100°F (32.2–37.8°C), depending on the age and severity of the burn. Although a hot operating room can be

uncomfortable for the medical staff, maintaining the patient's temperature is essential to minimize metabolic demand, maintain normal coagulation, and prevent shivering on emergence. The latter issue has the potential to dislodge recently placed grafts.

**SURGICAL MANAGEMENT**

Early excision of dead tissue and closure of burn wounds are the greatest advance in management of patients with severe burns during the last two decades. Early excision and closure results in decreased metabolic rate, incidence of sepsis, and pain. In addition, early surgical therapy before extensive bacterial colonization, may decrease operative bleeding and transfusion requirements.<sup>6</sup>

At present, most full-thickness burn wounds are best closed with split-thickness autografts. Nonetheless, the split-thickness autograft is an imperfect replacement for full-thickness skin, and harvesting of normal skin is associated with pain and donor-site morbidity.<sup>7</sup> Consequently skin substitutes, either temporary or permanent may be needed. Temporary skin substitutes provide transient physiologic wound closure providing protection from mechanical trauma, minimizing evaporative water and heat losses, and acting as a physical barrier to bacteria. These skin substitutes can also be used as a dressing on donor sites to decrease pain, enhance epithelialization, and to provide temporary closure while awaiting healing of underlying, widely meshed autografts. These skin substitutes can also be used as a “test” graft in questionable wound beds. No ideal permanent skin substitute exists at present, although a number of techniques are in use, including cultured epithelial cells and dermal analogues.<sup>7,8</sup>

**ANESTHETIC MANAGEMENT****Airway Management**

If injuries allow standard airway management (mask fit, mouth opening, neck extension), direct laryngoscopy and intubation can be performed. Gastric emptying may or may not be delayed in burn patients.<sup>9</sup>

If bowel sounds are present and there is no ileus, rapid sequence induction may not be necessary. Infection/sepsis, edema, and opioids may slow



TABLE 71-2.

## Systemic Effects of Burn Injury

System	Early	Late
Cardiovascular	Hypovolemia Impaired cardiac contractility Decreased cardiac output	Increased cardiac output Hypertension
Pulmonary	Upper/lower airway obstruction Bronchospasm Decreased pulmonary/chest wall compliance Complications of resuscitation (pulmonary edema)	Complications of ventilation (pneumonia, barotrauma) Tracheal stenosis
Renal	Decreased renal blood flow/function Myoglobinuria	Increased renal blood flow
Hepatic	Impaired function as a result of decreased circulation, blood volume, hypoxia, hepatotoxins	Altered function as a result of hypermetabolism, increased cardiac output, enzyme induction Hepatic steatosis
Hematologic	Hemoconcentration Hemolysis Activation of fibrinolytic and thrombotic systems	Anemia Low platelets or clotting factors
Neurologic	Encephalopathy Seizures Acute pain	Encephalopathy ICU psychosis Chronic pain
Metabolic	Increased metabolic rate Impaired thermoregulation Hypocalcemia	Increased O <sub>2</sub> consumption and CO <sub>2</sub> production
Skin	Increased heat and fluid losses	Contractures, scar formation
Gastrointestinal	Stress ulceration (Curling ulcers) Impaired intestinal barrier function	
Pharmacologic	Altered volume of distribution Altered protein binding Altered pharmacokinetics and pharmacodynamics	Increased tolerance to sedatives, narcotics Enzyme induction, alteration of receptors Drug interactions

gastric emptying, which can result in increased risk of aspiration. Laryngeal mask airways (LMAs) have been used successfully in burn patients.<sup>10</sup> Use of the LMA for airway management may help avoid further laryngeal injury associated with tracheal intubation. It can also serve as an aid to fiberoptic intubation.

Securing the endotracheal tube in a patient with facial burns can be difficult. Tape or ties crossing burned areas can irritate the wound or cause graft injury. It is essential to secure the endotracheal tube with a carefully secured tie harness (Fig. 71-1) to avoid unintentional extubation. Placement of a circumferential tie around the patient's head, using wire to secure the tube to a tooth, or use of arch bars can provide safe fixation.<sup>11,12</sup>

Use of cuffed endotracheal tubes in pediatric patients with significant burn injury is not unusual. Use of cuffed endotracheal tubes (ETTs) in the pediatric population, both in the operating room and in the intensive care unit, is



**FIGURE 71-1.** Photo of secured endotracheal tube. It is essential to secure the endotracheal tube with a carefully secured tie harness to avoid accidental extubation.

safe.<sup>13,14</sup> In the younger age group, considerable fluctuations in airway diameter can occur throughout the patient's hospital course, with narrowing of the airway during the acute resuscitation phase because of laryngeal and bronchial tissue edema. With fluctuations in airway diameter, the ETT cuff should be adjusted to facilitate mechanical ventilation without a leak. The proper timing and indication of tracheostomy in burn patients remains controversial. Early studies of tracheostomy reported complications to be more frequent and severe in burn patients.<sup>15-19</sup> Several factors contribute to the complications, particularly when tracheostomies are performed through burned tissue or in the presence of edema. The tracheal stoma allows the passage of secretions from the wound areas to the lungs leading to pneumonia. Tracheostomy however, can be helpful particularly when weaning from mechanical ventilation is difficult or when thick secretions require frequent pulmonary toilet. Ideally, the tracheostomy is performed under controlled conditions with the patient adequately anesthetized and positioned. Resolution of neck edema and absence of burns over the planned tracheostomy site are preferable. Recent reports examining the use of tracheostomy in severely burned children indicate that tracheostomy is appropriate.<sup>20,21</sup> Palmieri et al., in a case series of 38 severely burned pediatric patients undergoing early tracheostomy, found no tracheal site infections, tracheostomy-related deaths, or tracheal stenoses.<sup>22</sup>

## Vascular Access

Managing vascular access in burn patients can be difficult. In the setting of acute burn injury, patients can be hypovolemic, making venous access technically difficult. In addition, the typical vascular access sites can be involved in the burn injury. In pediatric patients, the task can be even more difficult. Central venous access is usually necessary in patients with large burn injuries. Because burn patients undergo multiple surgical procedures during their hospitalization, access is required multiple times. Furthermore, frequent catheter changes are often performed to minimize the risk of catheter-related sepsis. The sites of these lines can be rotated. Localization of vessels using ultrasonography guidance can be useful in placing peripheral

and central catheters in patients when access is difficult.<sup>23</sup> For excision and grafting procedures, securing adequate vascular access before the surgical procedure begins is necessary as blood loss can be rapid and substantial.

## Ventilatory Management

Respiratory failure is common after serious burns caused by inhalation injury, inflammatory mediators from the burn, effects of fluid resuscitation, and infection. In providing mechanical ventilation, care must be exercised to provide adequate oxygenation and ventilation without inducing further morbidity from oxygen toxicity, hemodynamic compromise, barotrauma or alveolar overdistension. A growing appreciation of the effects of ventilator-related morbidity has triggered a search for the optimum strategy for mechanical ventilation for critically ill patients with respiratory failure. The ARDS Network trial was the first large randomized study demonstrating a reduction in mortality with the use of lower tidal volumes in patients with acute respiratory distress syndrome (ARDS).<sup>24</sup> The strength of their findings has changed ventilatory strategies and is becoming the standard of care for burn patients with acute lung injury. The empiric use of a tidal volume of 6 mL/kg ideal body weight and plateau airway pressure below 30 cm H<sub>2</sub>O are recommended in all patients with acute lung injury. Furthermore, lower tidal volume ventilation may decrease the incidence of the development of acute lung injury that develops after the initiation of mechanical ventilation.<sup>25</sup> In the ARDS Network trial, positive end-expiratory pressure (PEEP) was assigned on the basis of the requirement for inspired oxygen concentration (FiO<sub>2</sub>); in the low-tidal-volume group, the average PEEP was 9 cm H<sub>2</sub>O. Although the assessment of optimal PEEP is still a topic of ongoing investigation, in patients with refractory hypoxemia, trial of high PEEP may be useful.

Permissive hypercapnia is a common consequence of low-tidal-volume ventilation because of decreased minute ventilation and an increased dead-space-to-tidal-volume ratio. Permissive hypercapnia is an acceptable side effect of lung-protective ventilation and is associated with excellent outcomes in burn patients.<sup>26</sup> Contraindications to permissive hypercapnia include predisposition to increased in-

tracranial pressure and hemodynamic instability.

Because of their hypermetabolic state, oxygen consumption and CO<sub>2</sub> production can be significantly increased in patients with major burns. Consequently, the minute ventilation can exceed 20 L/min in an adult patient with a large burn. This large minute volume may exceed the capacity of some anesthesia machine ventilators; an ICU ventilator may be needed in the operating room.

Extensive excision and grafting procedures may cause such a physiologic change that postoperative mechanical ventilation is needed. The decision to wean from mechanical ventilation and extubate after burn surgery is based on the same considerations as in the non-burn patient. Weaning is not performed in the presence of hemodynamic instability, significant metabolic derangement, hypothermia, sepsis or worsening pulmonary function. In addition, in these patients assessment of the status of airway edema is essential.

High-frequency percussive ventilation is a newer ventilatory strategy that combines features of conventional ventilation with jet ventilation. Standard pressure-controlled breaths (10-30 breaths/min) are superimposed on high-frequency delivery of breaths (200-600 breaths/min) adding a percussive element to conventional pressure control ventilation.<sup>27</sup> Theoretical advantages include better mobilization of airway secretions and provision of gas exchange at lower airway pressures. Studies show improvements in oxygenation and rate of pneumonia with decreased work of breathing and lower airway pressures. This method seems particularly effective in patients with inhalational injury.<sup>28-31</sup>

## Monitoring

As with any patient suffering from multiorgan system dysfunction, monitoring of a burn patient depends on the patient's physiologic status and extent of planned surgery.

Difficulty may be encountered in adherence of standard electrocardiogram (ECG) electrodes to the skin of burn patients as a result of exudation of fluid from the injured sites or of the presence of topical antibiotic ointment. Use of needle electrodes or surgical staples over skin to fix the electrodes can be effective. Alternatively, placing the electrodes on the

back or dependent sites may hold them in place.

Application of pulse oximetry probes can also be difficult when standard sites are burned or within the surgical field. Alternative sites, such as the ear, nose, or tongue, can be used in such circumstances. Reflectance oximetry has been suggested as an alternative if skin sites for monitoring are limited.<sup>32</sup>

In an extensively burned patient, a blood pressure cuff may have to be placed directly over injured or recently grafted tissue. In these cases, great care should be taken to protect the underlying area and the cuff should be sterile before application. If blood loss is expected to be rapid and extensive, an arterial line should be placed for continuous and direct measurement of blood pressure and blood sampling. An arterial catheter provides easy access for repeated measurements of blood gases, electrolytes, and hemoglobin. In addition, the arterial pressure waveform and its alterations in relation to respiration provide continuous hemodynamic information about preload and cardiac output and can be used to guide volume and vasoactive therapy.<sup>33</sup> Insertion of invasive monitors through burned tissue is sometimes necessary. Temperature monitoring is important as burned patients are quite prone to hypothermia, which carries its own morbidity.

Neuromuscular function monitoring in patients receiving neuromuscular blocking drugs is required as dose requirements can be significantly altered in burn patients.

In patients with more severe burns, a central venous catheter may be helpful for administration of blood and fluid, vasoactive medications, and monitoring. Although blood sampled from a central venous catheter provides central venous and not mixed venous oxygen content, this value may be helpful in assessing adequacy of tissue perfusion. Furthermore, central venous pressure may provide additional information on the status of intravascular volume. Central pressures should be interpreted carefully as PEEP, pleural, or pericardial fluid and abdominal distension can effect measured pressures. More recently esophageal Doppler monitoring (Cardio Q<sup>™</sup>, Deltex Medical Ltd., Chichester, UK) has been used to monitor cardiac output in burn patients undergoing early burn wound excision.<sup>34</sup> However its use is not routine.

## Patient Transport

Transport of a burn patient to and from the operating room can be a time of increased risk. A systematic approach to maintenance of the patient's respiratory, hemodynamic, and general support will optimize patient safety. Continual observation by the anesthesia team during patient transport is required. In patients with major burns who require mechanical ventilation, at least two anesthesia personnel are required to manage ventilation, observe the monitors, and administer medications during transport.

Providing adequate sedation and analgesia is essential before moving patients to or from the bed or operating room. Intravenous narcotics and benzodiazepines are often used in combination to provide analgesia and sedation. Burn patients develop tolerance to most narcotics and sedatives thus requiring higher doses than for patients without thermal injury. Sedatives and narcotics should be titrated to effect while the patient is monitored.

## PHARMACOLOGIC CONSIDERATIONS

### Clinical Pharmacology

Burn injury causes pathophysiologic changes in the cardiovascular, pulmonary, renal, and hepatic systems, as well as concentrations of circulating plasma proteins. These changes result in altered pharmacokinetic and pharmacodynamic responses to drugs. Consequently changes in the usual dosages of drugs may be necessary to ensure efficacy or avoid toxicity.

There are two distinct phases of metabolic response to burn injury that affect pharmacokinetics in different ways. During the acute injury phase (0–72 hours) there is rapid loss of fluid from the intravascular space, resulting in decreased cardiac output and blood flow to organs and tissues. Fluid resuscitation during this phase dilutes plasma proteins and expands the intravascular volume. Despite adequate resuscitation, patients may continue to have decreased cardiac output. Decreased renal and hepatic blood flow reduces drug elimination by these organs. Following the resuscitation phase, the hypermetabolic, hyperdynamic phase begins, which is characterized by increased cardiac output, oxygen

consumption, and temperature. Because increased blood flow to the kidneys and liver may increase drug clearance, drug doses may have to be adjusted.

Plasma protein concentrations are altered in the resuscitation and hypermetabolic phases of burn injury. The two major drug-binding proteins, albumin and  $\alpha_1$ -acid glycoprotein (AAG), have different responses to burn injury. Albumin binds to mostly acidic and neutral drugs and is decreased in burn injury.<sup>35</sup> AAG is an acute-phase reactant and its concentration may double after an acute burn. Cationic drugs (lidocaine, propranolol, muscle relaxants, and some opioids) bind to AAG, resulting in decreases in free fraction.

Hepatic clearance of drugs highly extracted by the liver depends primarily on hepatic blood flow and is relatively insensitive to alterations in protein binding. Clearance of these drugs may decrease during the early postburn phase as a result of hypoperfusion from hypovolemia and hypotension. Similarly, clearance of these drugs may increase during the hyperdynamic phase when hepatic blood flow increases (e.g., fentanyl).<sup>36</sup> In contrast, clearance of drugs that have a low hepatic extraction coefficient is unaffected by changes in hepatic blood flow, but is sensitive to alterations in plasma protein levels as it is the unbound fraction of drug that is metabolized. Hepatic clearance of drugs with low extraction coefficients is also sensitive to alterations in hepatic enzyme activity. Hepatic enzyme activity appears to be altered in patients with burns.<sup>37</sup> Phase I reactions, which include oxidation, reduction, hydroxylation, and demethylation, are impaired in burn patients. Phase II reactions involve conjugation and seem to be relatively unaffected.<sup>38</sup> Other excretion pathways may result in altered drug clearance. Thus some antibiotics and H<sub>2</sub>-receptor antagonists will have enhanced clearance because of increased renal blood flow and glomerular filtration rate.<sup>39,40</sup> Additionally, systemically administered drugs may leach out through the burn wound and blood loss during surgery can potentially exaggerate the elimination of drugs from the skin.

### Muscle Relaxants

Muscle relaxant pharmacology is significantly altered after burn injury.<sup>41</sup>

In burn patients, exposure to succinylcholine can result in an exaggerated

hyperkalemic response, which can induce cardiac arrest. The general recommendation is to avoid succinylcholine administration in patients 24 hours after burn injury.<sup>42,43</sup> An increase in the number of extrajunctional acetylcholine receptors has been suggested as the mechanism for increased hyperkalemia after succinylcholine administration and decreased sensitivity to the effects of nondepolarizing muscle relaxants. The duration of this response to succinylcholine is unknown. However resistance to nondepolarizing relaxants was reported in a pediatric patient 463 days after burn injury, suggesting that the hyperkalemic response to succinylcholine could also persist for more than a year.<sup>44</sup> Although a hyperkalemic response to succinylcholine may be seen, whether lethal levels would be reached is unknown. Consequently, even in the treatment of laryngospasm, succinylcholine should be avoided. Whether extremely small doses (0.1 mg/kg) of succinylcholine will result in less hyperkalemia has been inadequately studied. Martyn and Ritchfield have reviewed this subject.<sup>45</sup> Nondepolarizing muscle relaxants are the relaxants of choice in burn patients.

Rocuronium or high doses of other nondepolarizing muscle relaxants can be used if rapid intubation is needed and one is confident that the patient can be ventilated. It must be remembered, however, that even with a dose of 1.2 mg/kg of rocuronium, the onset time to effective paralysis approximates 90 seconds in burn patients compared with <60 seconds in nonburned patients.<sup>46</sup>

The dose of nondepolarizing muscle relaxant necessary to achieve paralysis in burn patients can be substantially elevated in a patient with burn injury. Studies with nondepolarizing muscle relaxants have demonstrated that resistance to the muscle relaxants is highly correlated with the magnitude of the burn (Figure 71-2). One study demonstrated the dose of *d*-tubocurarine and the serum concentration necessary to achieve a given degree of twitch depression was 3–5 times greater in patients with burn injury than in nonburn patients.<sup>47</sup> Studies with intermediate- and short-acting muscle relaxants have shown resistance to the neuromuscular effects of the drugs, but less pronounced than with long-acting relaxants. Pharmacologic reversal of neuromuscular blockade poses no special problems in patients with burn injury.

Recovery of neuromuscular blockade has been observed at serum concentrations that would cause 100% twitch depression in nonburned patients.<sup>47</sup>

## Anesthetic Agents

Many anesthetic agents have been used successfully for the induction and maintenance of anesthesia in burn patients. Choice of agent should be based on the patient's hemodynamic and pulmonary status and potential difficulty in securing the patient's airway. Because of its rapid onset and lack of pungency, sevoflurane offers advantages for smooth inhalational induction in children or adults with abnormal airways. The choice of volatile anesthetic does not appear to influence outcome in burn patients. All anesthetics cause dose-dependent depression of cardiac output.

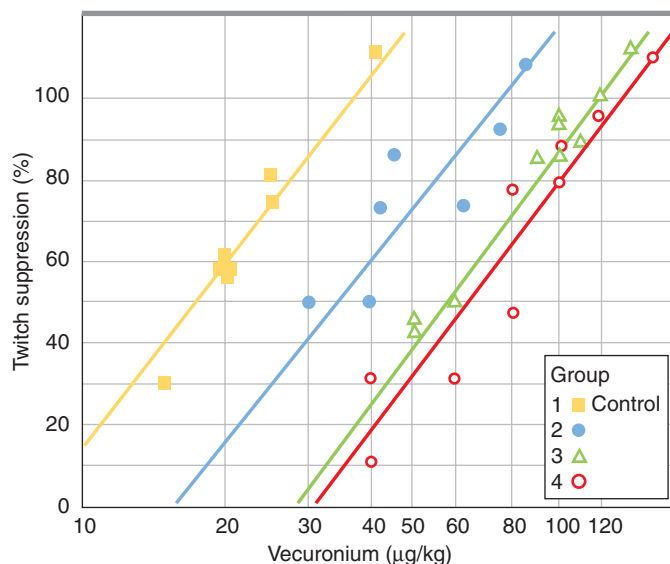
Ketamine has many potential advantages for induction and maintenance of anesthesia in burn patients and is used by some centers as the primary anesthetic. Ketamine often is associated with hemodynamic stability, preserving hypoxic and hypercapnic responses, and decreasing airway resistance. Ketamine occasionally causes a hypotensive response, particularly in patients with major burns who have desensitized adrenoceptors.<sup>48</sup> Ketamine may be the agent of choice if one wishes to avoid

manipulation of the airway (e.g., after placement of fresh facial grafts, for brief procedures such as dressing changes or for patients with toxic epidermal necrolysis syndrome).<sup>49</sup> Ketamine can also be used as supplement to other anesthetics because of its effects as an analgesic acting via the *N*-methyl-D-aspartate (NMDA) receptor.<sup>50</sup> The major disadvantage of ketamine is production of dysphoria. The addition of benzodiazepines is often recommended to reduce the incidence of dysphoria. Because of the increased secretions associated with ketamine, glycopyrrolate is frequently coadministered.<sup>50</sup>

Regional anesthesia may have a role in burn surgery, either alone or in combination with general anesthesia, but is usually limited to patients with small burns. An epidural catheter offers the advantage of prolonged postoperative analgesia. Lumbar paravertebral blocks have been used successfully to manage postoperative pain from skin donor sites.<sup>52</sup> Patients with major burns may have multiple areas of injury or donor sites that cannot be easily blocked by a regional technique.

## METABOLIC AND NUTRITIONAL MANAGEMENT

Severe burn injury results in a hypermetabolic response with profound



**FIGURE 71-2.** Dose–response curves for vecuronium in normal and burned children. Logarithm of dose versus twitch suppression for vecuronium in control subjects and burned children. With acute injury, the vecuronium effective dose values increased with increasing burn size. *Solid squares*, children without burn injury; *solid circles*, children with <40% burn injury; *open triangle*, children with 40–60% burn injury; *open circles*, children with >60% burn injury. (Reproduced with permission from Mills AK, Martyn JAJ. Neuromuscular blockade with vecuronium in paediatric patients with burn injury. *Br J Clin Pharmacol* 1989;28:155–159.)



wasting of lean body mass that can last for more than a year after injury.<sup>53</sup> A number of strategies are employed to minimize this catabolic response, including early wound excision and grafting, prompt treatment of sepsis, maintenance of high environmental temperature, early institution of feeding, and exercise programs.<sup>54</sup>

Early excision and grafting is the treatment that has the greatest impact on decreasing the hypermetabolic response to burn injury. If a large burn (>50%) is excised and covered within 2–3 days of injury, the metabolic rate is decreased by 40% compared with a burn that is not covered until 1 week postinjury.<sup>55</sup>

Sepsis in burn patients can be difficult to diagnose because even in the absence of sepsis, patients are hypermetabolic with hyperdynamic physiology. Septic patients can have an additional 40% increase in metabolic rate and catabolism compared to nonseptic patients.<sup>55</sup> Therefore prevention, early diagnosis, and treatment of infection are essential to reducing hypermetabolism.

Burn patients can have substantial water loss (4000 mL H<sub>2</sub>O/m<sup>2</sup> total body surface area [TBSA] per day in adults) from unhealed wounds.<sup>56</sup> The hypermetabolic response is further increased by the body's effort to generate heat to offset the inevitable temperature loss that occurs with evaporation. Consequently, maintaining environmental temperature with high humidity is important to minimize the hypermetabolism.

Continuous enteral or parenteral nutrition partially abates the hypermetabolic response to burns and maintains total body weight. A high-carbohydrate, high-protein diet (82% carbohydrate, 15% protein, 3% fat) stimulates protein synthesis, increases endogenous insulin production, and improves lean body mass.<sup>57</sup> Enteral feeding is preferable to parenteral feeding as it maintains GI motility and reduces bacterial translocation and sepsis. Parenteral feeding is associated with impaired liver function, hepatic steatosis, reduced immune function, and increased mortality.<sup>58,59</sup> Consequently parenteral nutrition is reserved for patients with intolerance for enteral feeding or prolonged ileus.

Children have higher energy needs per unit body weight than adults and tolerate periods of inadequate nutrition poorly. Consequently, early nutritional support is essential.

Because metabolic rate rises significantly with pain or anxiety, optimal use of analgesics and anxiolytics, together with psychological support during burn care, are of great importance. A number of pharmacologic adjuncts have been proposed to minimize loss of lean body mass after burn injury, including administration of anabolic agents, recombinant human growth hormone, insulin, oxandrolone, and propranolol.<sup>60,61</sup>

## FLUID MANAGEMENT AND BLOOD LOSS DURING BURN WOUND EXCISION

The goal of surgical management is to remove layers of burned eschar until bleeding dermis is reached. Blood loss during burn wound excision can be deceptively large. It is not uncommon for the surgical team to remove eschar so rapidly that the patient becomes hypovolemic and unstable. Children have thinner skin than adults, making burns relatively deeper. This may result in relatively greater bleeding during excision and grafting procedures. Correction of intravascular volume before induction of anesthesia is essential. Good communication between the surgical and anesthesia teams, as well as limiting the operative duration and extent of excision, can prevent such problems. Blood should be readily available before extensive burn excision is initiated. Published estimates of the amount of blood loss during burn excision operations are in the range of 3.5–5% of the blood volume for every 1% TBSA excised.<sup>62,63</sup> This amount of blood loss results because diffuse bleeding is used as an endpoint for excision, informing the surgeon that the tissue is viable. However diffuse bleeding is not the only sign of tissue viability. The experienced surgeon can identify viability with other signs, including the presence of moist yellow fat, patent small blood vessels, and absence of extravascular hemoglobin.<sup>64</sup> Blood loss during these procedures can be minimized by the use of an intraoperative tourniquet for limb surgery, injection of dilute epinephrine, and brisk operative pace. Injection of higher-than-usual doses of epinephrine is permissible because the adrenoreceptors in burn patients are desensitized.<sup>48</sup> The dose limitation of epinephrine in normal patients is ap-

proximately 15–20 µg/kg. In burn patients, even with twice this dose, no arrhythmias and a mild rise (15%) in blood pressure have been observed with this technique. If blood loss appears significant, it is prudent to assess the patient's hematologic status regularly.

## CALCIUM HOMEOSTASIS

Depression in ionized calcium levels is common with acute burn injury and abnormalities in calcium metabolism may persist for several weeks after injury, depending on the burn size.<sup>65</sup> These levels can be further diminished by the administration of citrate-containing blood products that bind calcium. Normal calcium levels are necessary for optimal myocardial and smooth muscle contraction. Severe hypocalcemia can lead to dysrhythmias, hypotension, and/or electromechanical dissociation. Consequently the administration of supplemental calcium is important in the management of severely burned patients, particularly during rapid administration of (citrate) fresh-frozen plasma or albumin, both of which bind calcium.<sup>66</sup>

## TEMPERATURE MANAGEMENT

Intraoperative consequences of hypothermia include decrease in cardiac output, arrhythmias, including ventricular fibrillation if severe enough, abolition of hypoxic pulmonary vasoconstriction, left shift of the hemoglobin dissociation curve, release of catabolic hormones, interference with the normal blood clotting mechanism, and reduction of hepatic and renal function. Postoperative consequences include shivering, impairment of drug clearance, and masking of hypovolemia.<sup>67</sup> Furthermore, shivering can dislodge grafts and increase O<sub>2</sub> consumption by 400–500%, resulting in increased stress to the cardiopulmonary system which already has increased demands.<sup>68</sup>

## INFECTION CONTROL

Infection in burn patients is a leading cause of morbidity and mortality. The patients are immunocompromised and therefore susceptible to colonization

and infection from organisms in the environment. Sources of organisms that can cause infection include the patient's own (endogenous) flora, exogenous environmental sources, and transmission by healthcare personnel. Burn injury leads to increased susceptibility to infection through multiple mechanisms, including loss of the physical barrier of intact skin, damage to lining of respiratory tract from inhalation, and altered gut permeability and function. Invasive devices, including endotracheal tubes, intravascular catheters, and urinary catheters, bypass the body's normal defense mechanisms.

Central line-related infection may be associated with significant morbidity and mortality in burn patients. One large study of 1183 burn patients and 1346 central venous catheters reported an incidence of catheter-related infection of 19.5% and mortality of 14%.<sup>69</sup> The American Society of Anesthesiologists and the Centers for Disease Control have published guidelines for preventing catheter-related infections.<sup>70,71</sup> These guidelines recommend strict sterile technique during placement, use of single-lumen catheters, and placement in the subclavian site when possible. Despite this recommendation, it is not unusual to place multiport catheters in patients with burn injury, because of

the need for simultaneous administration of fluid, sedatives/narcotics, parenteral nutrition and other drugs. Both groups recommend against routine changing of central lines as a method to prevent catheter infection.

Microorganisms causing infection in burn patients include gram-positive and gram-negative bacteria, as well as yeast and fungi. The typical burn wound is colonized early on with gram-positive organisms, which are fairly rapidly replaced by antibiotic-susceptible gram-negative organisms. With persistence of open wounds, these flora are replaced by resistant bacteria, yeast, and fungi. Strategies to prevent infection include strict aseptic techniques, including use of sterile gloves and dressings, wearing masks, and spacial separation of patients.<sup>72,73</sup> Maintaining sterile technique both in the operating room and during transport is essential.

## BURN WOUND MANAGEMENT

### Considerations of Topical Agents

Microorganisms grow rapidly in burn wounds as a result of damage to the normal skin barrier, as well as from

impaired immunologic function. Because burn eschar is often distant from patent microvasculature, systemically administered antimicrobial agents may be ineffective in the prevention of colonization or treating infection at the wound surface. Topical antimicrobials, however, provide high concentrations of drug at the wound surface and penetrate the eschar to varying degrees, depending on the agent. Topical antimicrobials delay the interval between injury and colonization and reduce levels of wound flora. Considerations in choice of topical agents include antimicrobial spectrum, degree of eschar penetration, patient comfort and toxicity.<sup>74</sup> Topical agents commonly used in the treatment of major burns are mafenide acetate (Sulfamylon), silver nitrate, and silver sulfadiazine (Silvadene) (Table 71-3).

### Methemoglobinemia

Some strains of gram negative bacteria can reduce nitrates from silver nitrate to nitrites. These nitrites can diffuse into the bloodstream, converting hemoglobin to methemoglobin.<sup>75</sup> Methemoglobin decreases the oxygen carrying capacity of hemoglobin and shifts the oxyhemoglobin dissociation curve to the left, resulting in decreased oxygen delivery to the tissues. Therefore, methemoglobin should be

TABLE 71-3.

Topical Antimicrobial Agents and Their Toxicities

	Effectiveness	Side Effects	Ease of Use	Pain
Silver nitrate (AgNO <sub>3</sub> ) 0.5% aqueous solution	Broad spectrum Inhibits cell wall growth Penetrates 2–4 mm into wound	Hypoallergenic Leeches plasma electrolytes	0.5-inch-thick wet dressings Change daily and soak q2h to keep damp Stains tissue and environment black	Stings briefly
Mafenide acetate (Sulfamylon aqueous solution)	Broad spectrum Effective for resistant organisms (i.e., <i>Pseudomonas</i> )	Causes dose-related metabolic acidosis as a result of HCO <sub>3</sub> wasting Sensitivity rash	0.5-inch-thick wet dressings Change daily and soak q6h to keep damp	Stings briefly
Silver sulfadiazine (Silvadene 1% cream)	Broad spectrum Chemical debriding agent	Dose-related neutropenia Contains sulfur	Change daily To prevent buildup, remove residue with each dressing change	Stings briefly
Bacitracin ointment	Broad spectrum antibiotic ointment for partial-thickness wounds	Sensitivity rash Hypoallergenic (does not contain sulfur compounds)	Daily dressing change Apply and cover with dressing	No pain

considered in the differential diagnosis of cyanosis in this setting. Blood that contains more than 10% methemoglobin usually appears dark red or brown despite high  $P_{aO_2}$ . Pulse oximetry, although showing a decreased saturation, will be falsely elevated. Treatment of methemoglobinemia consists of removing the silver nitrate, delivery of additional oxygen, and administration of methylene blue (2 mg/kg).<sup>76</sup>

### Postoperative Care

A phone call to the burn unit should be made at least 30 minutes before completion of the procedure in the operating room to allow the care team adequate time to warm the room and to obtain necessary supplies and equipment (e.g., infusions, ventilator) that will be needed on the patient's arrival to the burn unit.

Ensuring adequate sedation and analgesia is essential in the immediate postoperative period. The presence of newly excised tissue and harvested donor sites can be very painful, requiring higher doses of analgesics and sedatives. As indicated previously, it is common for burn patients to become quite tolerant of sedatives over time and thus doses substantially larger than normal may be required.

Patients should be recovered in a prewarmed room as considerable heat loss can develop during transport. Radiant heaters, fluid warmers, and warming blankets are useful in maintaining normothermia.

### Pain Management

Nearly every aspect of treatment of burn injury (e.g., dressing changes, excision and grafting procedures, physical therapy) is associated with pain. Pain results from direct treat-

ment itself and is exacerbated by anxiety from patient anticipation. Poorly controlled pain and anxiety can have significant adverse physiologic and psychological effects. Posttraumatic stress disorder has been reported to occur in up to 30% of patients with severe burn injury, often developing in the setting of inadequate treatment of anxiety and pain.<sup>77,78</sup> The amount of pain associated with burn injury has been reported to be directly proportional to the size of the thermal injury. Early concerns over fear of addiction to opioids were unwarranted. No studies of pediatric patients have documented addiction and the addiction rate in adult patients is very low.<sup>79</sup> Patient-controlled analgesia has been shown to be a safe and effective method of opioid delivery for acute or procedure related pain in both children and adults with burn injury.<sup>80-82</sup>

In the early stages of burn injury there may be an increased potency of analgesic medications, but over time marked increases in analgesic requirements occur. Continuous administration of analgesics by itself can result in opioid-induced hyperalgesia. This will accentuate the need for higher opioid levels.<sup>83</sup>

To provide appropriate, consistent patient comfort, standardized pain and anxiety guidelines are used in many burn centers. The ideal characteristics of such a guideline include (a) safety and efficacy over a broad range of ages and burn injury severities, (b) explicit recommendations for drug selection, dosing, and increases in dosing, (c) a limited formulary to promote staff familiarity with drugs used, and (d) regular assessment of pain and anxiety levels with guidance for intervention through adjusted drug dosing.<sup>84</sup> Table

71-4 gives one example of a pain treatment guideline. Adjustments to treatment of opioid tolerance include switching of opioids (morphine- > fentanyl- > methadone) and coadministration of drugs acting on nonopioid receptors (ketamine-NMDA antagonist, dexmedetomidine- $\alpha_2$ -agonist).

Acetaminophen is a useful first line analgesic for minor burns. Nonsteroidal antiinflammatory drugs (NSAIDs) and benzodiazepines are commonly combined with opioids to relieve procedural pain. Pain is exacerbated by anxiety which may be reduced by benzodiazepines. Antidepressants appear to enhance opiate-induced analgesia, especially in patients with chronic (neuropathic) pain. Antidepressants have potential cardiovascular effects and for this reason are contraindicated in the early stages of burn treatment. Anticonvulsants may be useful in the pain following burns. Clonidine, an  $\alpha_2$ -agonist, may be a useful adjunct in reducing pain without causing pruritus or respiratory depression. However, it can cause hypotension in higher doses and therefore should not be given to hemodynamically unstable patients.<sup>85</sup> Dexmedetomidine has been used to provide sedation-analgesia for burned patients and to decrease opioid requirements.<sup>86,87</sup> Its usefulness and side effects in burn patients have not been thoroughly studied.

As a patient recovers, the painful stimuli decrease and opioid dosing is gradually reduced. Prompt, definitive wound closure is the most effective treatment for minimizing pain and narcotic requirements. When a patient is being weaned, opioid and benzodiazepine dosages are decreased to allow adequate sensorium for airway protection yet still allowing adequate analge-

TABLE 71-4.

Pain Treatment Guidelines

Stage of Injury	Background Anxiety	Background Pain	Procedural Anxiety	Procedural Pain
Acute burn mechanically ventilated	Midazolam infusion Dexmedetomidine	Morphine infusion	Midazolam bolus	Morphine bolus Ketamine
Acute burn not mechanically ventilated	Scheduled lorazepam PO or IV	Scheduled morphine PO or IV	Lorazepam PO or IV	Morphine PO or IV Ketamine
Chronic acute burn	Scheduled lorazepam PO	Scheduled morphine or methadone PO	Lorazepam PO	Morphine PO
Reconstructive burn surgery	Scheduled lorazepam PO	Scheduled morphine PO	Lorazepam PO	Morphine PO

sia and anxiolysis. Patients may be safely extubated while still receiving opioid infusions.<sup>88</sup>

Pruritus is a common problem during the healing process. The causes of pruritus are multifactorial, often being triggered or worsened by heat, physical activity, and stress. Pruritus usually diminishes gradually with time but sometimes persists even after complete wound healing. A variety of approaches can control itching including systemic antihistamines, moisturizing lotions, and wearing loose-fitting clothing.

Children have unique developmental and psychosocial needs that should be considered. Pain and anxiety may be more difficult to assess but should be anticipated and treated. Support and involvement of parents and family members are important adjuncts to care and recovery.

## SUMMARY

The anesthetic and intensive care management of burn patients requires detailed knowledge of the pathophysiologic effects of burn injury on multiple organ systems. Optimal treatment of the burn patient requires the cooperation and care from anesthesiologists, surgeons, nurses, psychiatrists, and family members. Awareness of the alterations in pharmacokinetics and pharmacodynamics in patients with burn injury is essential. Safe care can be provided by understanding, appreciating, and anticipating the unique preoperative, intraoperative, and postoperative issues and problems of the burn patient.

## KEY REFERENCES

1. McCall J, Cahill T. Respiratory care of the burn patient. *J Burn Care Rehabil* 2005;26:200–206.
2. MacLennan N, Heimbach DM, Cullen BF. Anesthesia for major thermal injury. *Anesthesiology* 1998;89:749–770.
3. Martyn J, Ritchfield M. Succinylcholine-induced hyperkalemia in acquired pathologic states. *Anesthesiology* 2006;104:158–169.
4. Pereira, CT, Murphy KD, Herndon DN. Altering metabolism. *J Burn Care Rehabil* 2005;26:194–199.

5. Budny P, Regan P, Roberts A. The estimation of blood loss during burn surgery. *Burns* 1993;19:134–137.

6. Martyn JA, Szyfelbein SK. Anesthetic management of the burned patient. In: Martyn JA, ed. *Acute Management of the Burned Patient*. Philadelphia: WB Saunders, 1990: 217–230.

7. Weber J, McManus A. Infection control in burn patients. *Burns* 2004;30:A16–A24.

8. Stoddard FJ, Sheridan RL, Saxe GN, King BS, et al. Treatment of pain in acutely burned children. *J Burn Care Rehabil* 2002;23:135–156.

## REFERENCES

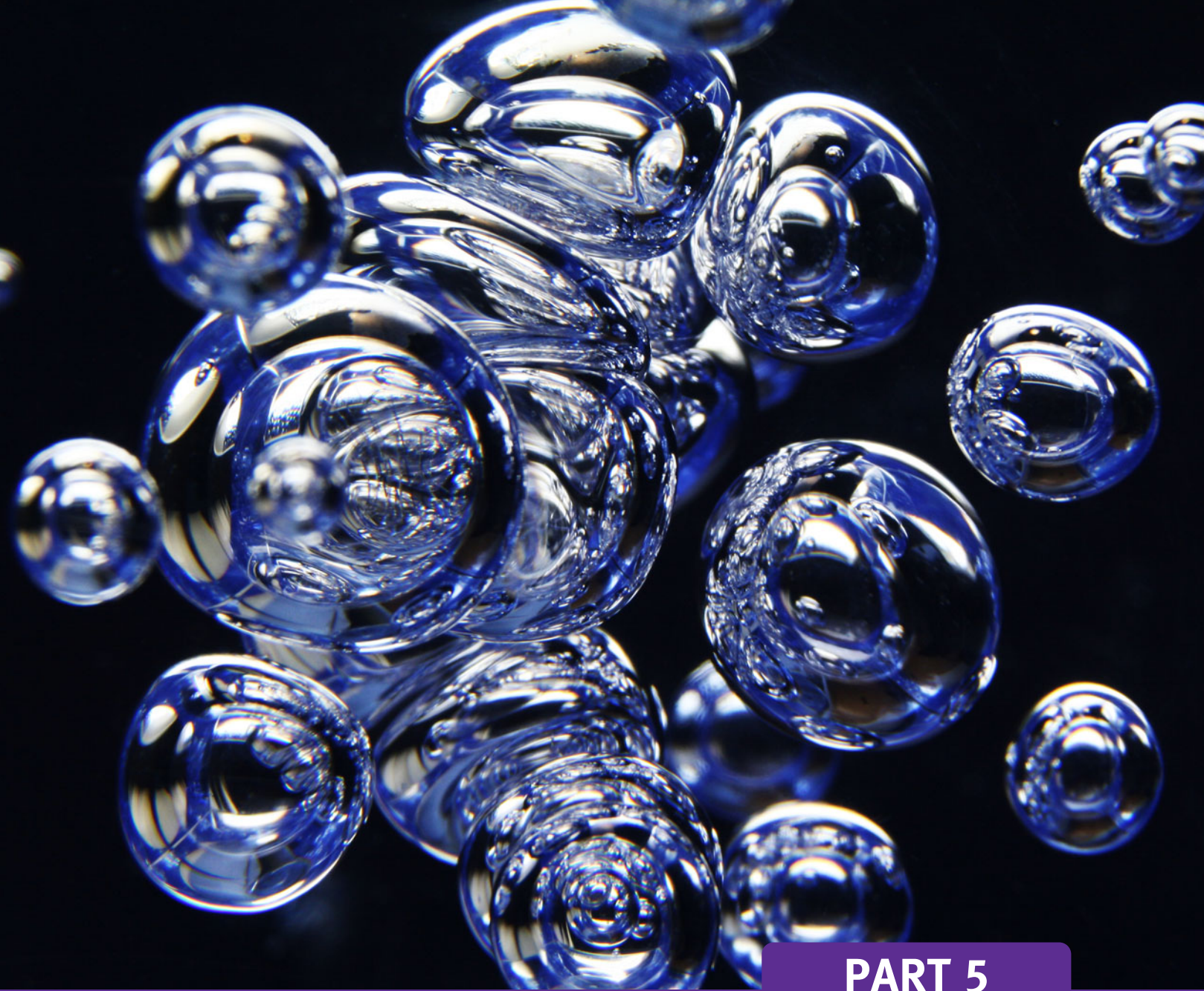
1. McCall J, Cahill T. Respiratory care of the burn patient. *J Burn Care Rehabil* 2005; 26:200–206.
2. Holm C, Horbrand F, von Donnersmarck GH, Muhlbauer W. Acute renal failure in severely burned patients. *Burns* 1999;25: 171–178.
3. Jeschke MG, Barrow RE, Wolf SE, Herndon DN. Mortality in burned children with acute renal failure. *Arch Surg* 1998;133:752–756.
4. Chrysopoulou MT, Jeschke MG, Dziewulski P, Barrow RE, Herndon DN. Acute renal dysfunction in severely burned patients. *J Trauma* 1999;46:141–144.
5. Kelemen JJ, Cioffi WG, Mason AD, Mozingo DW, McManus WF, Pruitt BA. Effect of ambient temperature on metabolic rate after thermal injury. *Ann Surgery* 1996;223: 406–412.
6. Hart DW, Wolf SE, Beauford RB, Lal SO, Chinkes DL, Herndon DN. Determinants of blood loss during primary burn excision. *Surgery* 2001;130:396–402.
7. Sheridan RL, Tompkins RG. Skin substitutes in burns. *Burns* 1999;25:97–103.
8. Sheridan RL, Tompkins RG. Alternative wound coverings. In: Herndon DN, ed. *Total Burn Care*. London: Harcourt Publishers, 2002:212–218.
9. Hu OY, Ho ST, Wang JJ, Ho W, Wang HJ, Lin CY. Evaluation of gastric emptying in severe, burn-injured patients. *Crit Care Med* 1993;21:527–531.
10. McCall VE, Fischer CG, Schomaker E, Young VM. Laryngeal mask airway use in children with acute burns: intraoperative airway management. *Paediatr Anaesth* 1999;9:515–520.
11. Perrotta VJ, Stern JD, Lo AK, Mitra A. Arch bar stabilization of endotracheal tubes in children with facial burns. *J Burn Care Rehabil* 1995;16:437–439.
12. Gordon MD. Burn care protocols: anchoring endotracheal tubes on patients with facial burns. *J Burn Care Rehabil* 1987; 8:233–237.
13. Khine H, Corddy D, Ketrwick RG, et al. Comparison of cuffed and uncuffed endotracheal tubes in young children during general anesthesia. *Anesthesiology* 1997; 86:627–631.
14. Deakers T, Reynolds G. Cuffed endotracheal tubes in pediatric intensive care. *J Pediatr* 1994;125:57–62.
15. Eckhauser FE, Billote J, Burker JF, Quinby WC. Tracheostomy complicating massive burn injury: a plea for conservatism. *Am J Surg* 1974;127:418–423.
16. Moylan JA, West JT, Nash G, Bowen JA, Pruitt BA. Tracheostomy in thermally injured patients: a review of 5 years' experience. *Am Surg* 1972;38:119–123.
17. Majeski JA, Macmillan BG. Tracheoinnominate artery erosion in a burned child. *J Trauma* 1978;18:137–139.
18. Jones WG, Madden M, Finkelstein J, Yurt RW, Goodwin CW. Tracheostomies in burn patients. *Ann Surg* 1989;209:471–474.
19. Saffle JR, Morris SE, Edelman L. Early tracheostomy does not improve outcome in burn patients. *J Burn Care Rehabil* 2002;23: 431–438.
20. Coln CE, Purdue GF, Hunt JL. Tracheostomy in the young pediatric burn patient. *Arch Surg* 1998;133:537–539.
21. Barret JP, Desai MH, Herndon DN. Effects of tracheostomies on infection and airway complications in pediatric burn patients. *Burns* 2000;26:190–193.
22. Palmieri TL, Jackson W, Greenhalgh DG. Benefits of early tracheostomy in severely burned children. *Crit Care Med* 2002;30:922–924.
23. Wait M, Hunt J, Purdue G. Duplex scanning of central vascular access sites in burn patients. *Ann Surg* 1990;211:499–503.
24. The Acute Respiratory Distress Syndrome Network. Ventilation with lower tidal volumes as compared with traditional tidal volumes for acute lung injury and the acute respiratory distress syndrome. *N Engl J Med* 2000;342:1301–1308.
25. Gajic O, Dara SI, Mendez JL, et al. Ventilator associated lung injury in patients without acute lung injury at the onset of mechanical ventilation. *Crit Care Med* 2004;32:1817–1824.
26. Sheridan RL, Kacmarek RM, McEttick MM, et al. Permissive hypercapnia as a ventilatory strategy in burned children: effect of barotraumas, pneumonia and mortality. *J Trauma* 1995;39:854–859.
27. Cioffi WG, Graves TA, McManus WF, Pruitt BA Jr. High frequency percussive ventilation in patients with inhalation injury. *J Trauma* 1989;29:350–354.
28. Cartotto R, Cooper AB, Esmond JR, Gomez M, Fish JS, Smith T. Early clinical experience with high-frequency oscillatory ventilation for ARDS in adult burn patients. *J Burn Care Rehabil* 2001;22:325–333.



29. Cortiella J, Mlcak R, Herndon D. High frequency percussive ventilation in pediatric patients with inhalation injury. *J Burn Care Rehabil* 1999;20:232-235.
30. Mlcak R, Cortiella J, Desai M, Herndon D. Lung compliance, airway resistance, and work of breathing in children after inhalational injury. *J Burn Care Rehabil* 1997;18:531-534.
31. Reper P, Van Bos R, Van Loey K, Van Laeke P, Vanderkelen A. High frequency percussive ventilation in burn patients: hemodynamics and gas exchange. *Burns* 2003;29:603-608.
32. Sheridan RL, Prelack KM, Petras LM, Szyfelbein SK, Tomkins RG. Intraoperative reflectance oximetry in burn patients. *J Clin Monit* 1995;11:32-34.
33. Michard F, Teboul JL. Predicting fluid responsiveness in ICU patients: a critical analysis of the evidence. *Chest* 2002;121:2000-2008.
34. Kim K, Kwok I, Chang H, Han T. Comparison of cardiac outputs of major burn patients undergoing extensive esophagectomy: esophageal Doppler monitor versus thermodilution cardiac output. *J Trauma* 2004;57:1013-1017.
35. Martyn JA, Abernethy DR, Greenblatt DJ. Plasma protein binding of drugs after severe burn injury. *Clin Pharmacol Ther* 1984;35:535-539.
36. Han TH, Greenblatt DJ, Harmartz J, Martyn JAJ. Enhanced clearance of fentanyl in patients with major burns. *J Clin Pharmacol* 2007 (in press).
37. Jaehde U, Sorgel F. Clinical pharmacokinetics in patients with burns. *Clin Pharmacokinet* 1995;29:15-28.
38. Bonate PL. Pathophysiology and pharmacokinetics following burn injury. *Clin Pharmacokinet* 1990;18:118-130.
39. Martyn JA, Bishop AL, Oliveri MF. Pharmacokinetics and pharmacodynamics of ranitidine after burn injury. *Clin Pharmacol Ther* 1992;51:408-414.
40. Martyn J, Greenblatt DJ. Lorazepam conjugation is unimpaired in burn trauma. *Clin Pharmacol Ther* 1988;43:250-255.
41. Martyn JAJ, Fukushima Y, Chou J, Yang HS. Muscle relaxants in burns, trauma and critical illness. *Int Anesth Clin* 2006;44:123-143.
42. Martyn J. Succinylcholine hyperkalemia after burns. *Anesthesiology* 1999;91:321-322.
43. MacLennan N, Heimbach DM, Cullen BF. Anesthesia for major thermal injury. *Anesthesiology* 1998;89:749-770.
44. Martyn JA, Matteo RS, Szyfelbein SK, Kaplan RF. Unprecedented resistance to neuromuscular blocking effects of metocurine with persistence after complete recovery in a burned patient. *Anesth Analg* 1982;61:614-617.
45. Martyn J, Ritchfield M. Succinylcholine-induced hyperkalemia in acquired pathologic states. *Anesthesiology* 2006;104:158-169.
46. Han T, Kim H, Bae J, Kim K, Martyn JA. Neuromuscular pharmacodynamics of rocuronium in patients with major burns. *Anesth Analg* 2004;99:386-392.
47. Martyn JA, Szyfelbein SK, Ali HA, Matteo RS, Savares JJ. Increased d-tubocurarine requirement following major thermal injury. *Anesthesiology* 1980;52:352-355.
48. Wang C, Martyn JA. Burn Injury alters beta-adrenergic receptor and second messenger function in rat ventricular muscle. *Crit Care Med* 1996;24:118-124.
49. Maldini B. Ketamine anesthesia in children with acute burns and scalds. *Acta Anaesthesiol Scand* 1996;40:1108-1111.
50. Martyn JA. Burn care protocols: administration of ketamine. *Ketamine pharmacology and therapeutics. J Burn Care Rehabil* 1987;8:146-148.
52. Cuignet O, Pirson J, Boughrough J, Duville D. The efficacy of continuous fascia iliaca compartment block for pain management in burn patients undergoing skin grafting procedures. *Anesth Analg* 2004;98:1077-1081.
53. Hart DW, Wolf SE, Mlcak R, et al. Persistence of muscle catabolism after severe burn. *Surgery* 2000;128:312-319.
54. Herndon DN, Tomkins RG. Support of the metabolic response to burn injury. *Lancet* 2004;363:1895-1902.
55. Hart DW, Wolf SE, Chinkes DL, et al. Determinants of skeletal muscle catabolism after severe burns. *Ann Surg* 2000;232:455-465.
56. Zawacki BE, Spitzer KW, Mason AD, Johns LA. Does increased evaporative water loss cause hypermetabolism in burned patients? *Ann Surg* 1970;171:236-240.
57. Hart DW, Wolf SE, Zhang XJ, et al. Efficacy of high-carbohydrate diet in catabolic illness. *Crit Care Med* 2001;29:1318-1324.
58. Herndon DN, Barrow RE, Stein M, et al. Increased mortality with intravenous supplemental feeding in severely burned patients. *J Burn Care Rehabil* 1989;10:309-313.
59. Jeejeebhoy KN. Total parenteral nutrition: potion or poison? *Am J Clin Nutr* 2001;74:160-163.
60. Pereira C, Murphy K, Jeschke M, Herndon DN. Post burn muscle wasting and the effects of treatments. *Int J Biochem Cell Biol* 2005;37:1948-1961.
61. Pereira, CT, Murphy KD, Herndon DN. Altering metabolism. *J Burn Care Rehabil* 2005;26:194-199.
62. Budny P, Regan P, Roberts A. The estimation of blood loss during burns surgery. *Burns* 1993;19:134-137.
63. Housinger T, Lang D, Warden G. A prospective study of blood loss with excisional therapy in pediatric burn patients. *J Trauma* 1993;34:262-263.
64. Sheridan RL, Szyfelbein SK. Trends in blood conservation in burn care. *Burns* 2001;27:272-276.
65. Szyfelbein SK, Drop LJ, Martyn JAJ. Persistent ionized hypocalcemia in patients during resuscitation and recovery phases of body burns. *Crit Care Med* 1981;9:454-458.
66. Cote CJ, Drop LJ, Hoaglin DC, Daniels AL, Young ET. Ionized hypocalcemia after fresh frozen plasma administration to thermally injured children: effects of infusion rate, duration and treatment with calcium chloride. *Anesth Analg* 1988;67:152-160.
67. Sessler DI. Mild Perioperative Hypothermia. *N Engl J Med* 1997;336:1730-1737.
68. Martyn JA, Szyfelbein SK. Anesthetic management of the burned patient. In: Martyn JA, ed. *Acute Management of the Burned Patient*. Philadelphia: WB Saunders, 1990:217-230.
69. Lesseva M. Central venous catheter-related bacteremia in burn patients. *Scand J Infect Dis* 1998;30:585-589.
70. American Society of Anesthesiologists. Recommendations for infection control for the practice of anesthesiology. Prevention of infection during insertion and maintenance of central venous catheters. ASA 1999. <http://www.asahq.org/publicationsAndServices/infectioncontrol.pdf> (11 May 2007).
71. O'Grady NP, Alexander M, Dellinger EP, et al. Guidelines for the prevention of intravascular catheter-related infections. *MMWR Recomm Rep* 2002;51:1-29.
72. Weber J, McManus A. Infection control in burn patients. *Burns* 2004;30:A16-A24.
73. Hegggers JP, Hawkins H, Edgar P, Villarreal C, Herndon DN. Treatment of infection in burns. In: Herndon DN, ed. *Total Burn Care*. London: Harcourt Publishers, 2002:120-169.
74. Hegggers JP, Hawkins H, Edgar P, Villarreal C, Herndon DN. Treatment of infection in burns. In: Herndon DN, ed. *Total Burn Care*. London: Harcourt Publishers, 2002:120-169.
75. Chou TD, Gibran NS, Urdahl K, et al. Methemoglobinemia secondary to topical silver nitrate therapy—a case report. *Burns* 1999;25:549-552.
76. Wright RO, Lewander WJ, Woolf AD. Methemoglobinemia: etiology, pharmacology, and clinical management. *Ann Emerg Med* 1999;646-656.
77. Patterson DR, Carrigan KA, Questad KA, Robinson R. Posttraumatic stress disorder in hospitalized patients with burn injuries. *J Burn Care Rehabil* 1990;11:181-184.
78. Saxe GN, Stoddard F, Hall E, et al. Pathways to PTSD, part 1: children with burns. *Am J Psychiatry* 2005;162:1299-1304.
79. Perry S, Heidrich G. Management of pain during debridement: a survey of U.S. burn units. *Pain* 1982;13:267-280.
80. Gaukroger PB, Chapman MJ, Davey RB. Pain control in paediatric burns—the use of patient-controlled analgesia. *Burns* 1991;17:396-399.
81. Kinsella J, Glavin R, Reid WH. Patient-controlled analgesia for burn patients: a preliminary report. *Burns* 1988;14:500-503.

82. Rovers J, Knighton J, Neligan P, Peters W. Patient-controlled analgesia in burn patients: a critical review of the literature and case report. *Hosp Pharm* 1994;29:108–111.
83. Angst MS, Clark D. Opioid-induced hyperalgesia: a qualitative systematic review. *Anesthesiology* 2006;104:570–587.
84. Stoddard FJ, Sheridan RL, Saxe GN, et al. Treatment of pain in acutely burned children. *J Burn Care Rehabil* 2002;23:135–156.
85. Pal SK, Cortiella J, Herdon D. Adjunctive methods of pain control in burns. *Burns* 1997;23:404–412.
86. MacCallum M, Walker J, Fischer C, McCall J, Kopcha R. Long term ICU sedation with dexmedetomidine in pediatric burn patients. *Anesthesiology* 2005;103:A1390.
87. Walker J, MacCallum M, Fischer C, Kopcha R, Saylor R, McCall J. Sedation using dexmedetomidine in pediatric burn patients. *J Burn Care Res* 2006;27:206–210.
88. Sheridan R, Stoddard F, Querzoli E. Management of background pain and anxiety in critically burned children requiring protracted mechanical ventilation. *J Burn Care Rehabil* 2001;22:150–153.

*This page intentionally left blank*



## **PART 5**

### **POSTOPERATIVE CARE OF THE ANESTHESIA PATIENT**



## CHAPTER 72

### Recovery of the Healthy Patient

Loreta Grecu, MD,  
Edward A. Bittner, MD, PhD,  
and Edward George, MD, PhD

Recovery of patients after procedures requiring anesthesia or sedation is most commonly performed in a postanesthesia care unit (PACU) or recovery room. These specialized areas are designed for the observation, treatment, and discharge of postoperative patients. The PACU optimally is located near the operating room, thereby minimizing transport time for the patient and affording rapid access to anesthesiologists and surgeons. The PACU is staffed by nurses trained in the care of patients in the immediate postoperative period. Under the supervision of an anesthesiologist, the PACU provides care to a broad cross-section of postprocedural patients, with the majority subsequently transferred in a timely manner from the PACU to a general care floor of the hospital or, in the case of an ambulatory care facility, discharged home. The diversity of patients and surgical procedures admitted to the PACU is quite varied. Many are healthy and have an uneventful hospital course, whereas some experience a more complex perioperative course influenced by their preexisting medical history and/or a complicated intraoperative course.

Patients are admitted into the PACU at the conclusion of procedures requiring anesthesia or sedation. With some exceptions, such as healthy patients receiving only local anesthetics or carefully selected patients capable of bypassing the PACU (see PACU Discharge), most patients undergoing surgical procedures do experience a period of postprocedural observation. Patients are admitted after surgical procedures in the operating room, but interventions under anesthesia also may take place outside of the operating room in other departments, such as radiology, cardiology, or gastroenterology. These patients may be cared

for in areas removed from the hospital's main recovery areas. Personnel trained and experienced in the recovery of these patients should be present to oversee the recovery phase and must be able to obtain immediate help in the event of an urgent or acute change in a patient's condition.<sup>1</sup>

Given the wide range of patients undergoing recovery in the PACU, the potential issues also are quite varied. Being able to anticipate common issues in advance may facilitate the initiation of appropriate action(s) in a timely manner and help prevent the complications associated with more urgent interventions.

Healthy patients may undergo procedures as either inpatients or outpatients, depending upon the severity of the surgical intervention. Some complex surgical procedures, even in an otherwise healthy subject, may require prolonged postoperative care in the hospital. In such cases, the planned length of the hospital stay is influenced by the period required for functional recovery, as well as possible postoperative complications. An uncomplicated recovery in the PACU is generally anticipated for most patients. However, patients often present to the PACU with comorbid conditions that may influence their postoperative course, both in the PACU and during their subsequent hospital stay. Although patients with multiple medical conditions are routinely discharged home on the same day as surgery, comorbidities often are a major factor in the decision to admit patients to the hospital after surgery. This chapter reviews the clinical scenarios most commonly encountered during routine postoperative re-

covery of surgical patients.<sup>2</sup> Less common and often more clinically demanding issues associated with the recovery of the postoperative patient are discussed in Chapter 73. The recovery of pediatric patients is discussed in Chapter 63.

#### ORGANIZATION OF THE PACU

The PACU is staffed by anesthesiologists, specially trained recovery room nursing staff,<sup>3</sup> and support personnel. General principles summarizing recovery criteria are listed in Table 72-1. In addition to providing the ability to appropriately monitor patients and administer routine postoperative care, the PACU affords the capability for mechanical ventilation and invasive monitoring, as well as the emergency equipment and skilled personnel able to conduct emergency resuscitation and provide advanced care.

The staff assigned to the PACU must have a thorough understanding of the procedures performed and be familiar with potential complications<sup>4</sup> associated with both the anesthetic provided and the surgical procedure, as well as the patient's pertinent past medical and surgical history. The American Society of Anesthesiology's (ASA) standards for postanesthesia care specifically identify five principles of care intended to encourage quality patient care (Table 72-2). Standards for PACU operations were established in 1988 by the ASA's House of Delegates and amended in 2002.<sup>5</sup> Standards include guidelines for admission, patient transport and transfer of care from the operating room team to the PACU

#### KEY POINTS

1. Postanesthesia care units (PACUs) require specially trained personnel to recognize and respond to clinical issues associated with the patient in the immediate postoperative period.
2. The PACU should be located in reasonable proximity to the operating rooms for access to key personnel in a timely manner.
3. The majority of patients admitted to the PACU experience an unremarkable recovery and are discharged from the PACU without incident.
4. Prophylaxis for postoperative nausea and vomiting is far more effective than rescue therapy.
5. Effective postoperative analgesia should be initiated during the surgical procedure.
6. Hypoxia most often is the result of residual effects of anesthetic agents.
7. Hypotension unresponsive to fluid resuscitation in the postoperative patient most often is due to hemorrhage until proven otherwise.

TABLE 72-1.

## General Principles of Recovery

- Medical supervision of recovery and discharge is the responsibility of the supervising physician.
- The recovery area should be equipped with appropriate monitoring and resuscitation equipment.
- Patients should be monitored until appropriate discharge criteria are satisfied.
- Level of consciousness, vital signs, and oxygenation (when indicated) should be recorded at regular intervals.
- A nurse or other individual trained to monitor patients and recognize complications should be in attendance until discharge criteria are fulfilled.
- An individual capable of managing complications should be immediately available until discharge criteria are met.

General principles of recovery provide a structure upon which an institution may develop a system to manage the recovery of the immediate postoperative patient. Capable of modification to best serve the clinical requirements of the specific patient population and nature of surgery, these principles should be used as a framework that can be integrated with a formalized system for recovery and discharge of the patient.<sup>5</sup>

team, patient care in the PACU, and discharge guidelines and procedures.

Specialized nurses, certified by the American Society of Peri-Anesthesia Nurses (ASPAN), are essential to providing care for postoperative patients. Nursing standards for recovery established by ASPAN<sup>6</sup> are similar to those developed by the ASA for physicians. These standards are designed to optimize the care of postoperative patients. The similarity between the ASA and ASPAN standards for patient care represents a significant convergence for physicians and nurses in providing optimum care to the patient in the immediate postoperative period.

Standard monitors capable of displaying vital signs are used for all patients arriving in the PACU. An oxygen supply and a method for providing suction are required. Adequate supplies used for patient care (dressings, intravenous [IV] fluids, drains, etc.) and medications must be available. A method for providing emergency positive-

pressure ventilation (i.e., self-inflating bag valve mask or Ambu bag) must be present at each bed station. Importantly, emergency equipment and personnel trained in emergency resuscitation must be immediately available.

## PACU OPERATIONS

Patients receiving general anesthesia, deep or moderate sedation, or regional anesthesia should be admitted into the PACU at the completion of their procedure. Patients, monitored in the PACU until free from the effects of the administered anesthetic and who are clinically stable, usually are transferred to a general care floor in the hospital or are discharged to home. Patients undergoing surgical procedures without sedation (i.e., local anesthetics) may not require admission to the PACU as dictated by institutional policy.

In many institutions, recovery may be conducted in varied facilities: a main PACU for inpatients, a separate facility for children, and an ambulatory PACU specifically designed for patients not requiring postoperative admission to the hospital. The focus of these units may differ, but there is a large degree of overlap of characteristics. This is particularly important because patients from the various groups may be recovered in multiple sites, depending upon the characteristics of the case, operational tempo, and institutional procedures.

Early recovery (phase I) takes place in the PACU, lasting from the time of admission to the PACU until protective airway reflexes and motor functions have recovered. Phase I mirrors the immediate postemergence phase of recovery conducted in the operating room by the team providing the intraoperative anesthetic. The patients is always monitored during this stage, and acute treatment of clinical issues such as nausea and vomiting, pain, respiratory compromise, and hemodynamic liability may be required. Phase II of the recovery of ambulatory patients consists of patient education and preparation for home discharge. Ambulatory patients may be recovered in the PACU (phase I) or may bypass the PACU and go directly to a phase II recovery facility (see Fast-Tracking below). Phase II recovery of the patient who is being admitted to the hospital constitutes a period dur-

TABLE 72-2.

## Standards for Postanesthesia Care

- I. All patients who have received general anesthesia, regional anesthesia, or monitored anesthesia care shall receive appropriate postanesthesia management.
- II. A patient transported to the PACU shall be accompanied by a member of the anesthesia care team who is knowledgeable about the patient's condition. The patient shall be continually evaluated and treated during transport with monitoring and support appropriate to the patient's condition.
- III. Upon arrival in the PACU, the patient shall be reevaluated and a verbal report provided to the responsible PACU nurse by a member of the anesthesia team who accompanies the patient.
- IV. The patient's condition shall be evaluated continuously in the PACU.
- V. A physician is responsible for the discharge of the patient from the PACU.

PACU, Postanesthesia care unit. These standards apply to postanesthesia care in all locations. The standards may be exceeded based on the judgement of the responsible anesthesiologist. They are intended to encourage enhanced quality of patient care but cannot guarantee a specific patient outcome. They are subject to revision from time to time as warranted by the evolution of technology and practice. Under extenuating circumstances the responsible anesthesiologist may waive requirements, but it should be so stated and a note to that effect placed in the patient's medical record.<sup>5</sup> Excerpted and adapted from <http://www.asahq.org/publicationsAndServices/standards/36.pdf>

ing which the patient's vital signs remain stable, with adequate pain control, control of nausea and vomiting, and a return to an appropriate level of consciousness.

*Fast-tracking* refers to the recovery of patients in areas other than a formal PACU, for example, by direct transfer from the operating room to a postrecovery lounge.<sup>7</sup> This system can be used for patients undergoing ambulatory anesthesia. With the increase in surgical procedures being performed on an outpatient basis, fast-tracking is being used more commonly. The process can offer faster recovery without direct involvement of the PACU. This

results in the safe and appropriate recovery of the postoperative patient in an efficient and resource-sensitive manner.<sup>8</sup> For a detailed discussion of fast-tracking of the postoperative patient, see Chapter 67.

The personnel resources used in the various phases of recovery may differ based on the acuity of illness of patients after surgery and are defined by standards established by ASPAN. In phase I recovery, the staffing may range from one nurse per two patients to two nurses for one unstable or complex recovering patient. In phase II of recovery, the staffing ratio can similarly vary. Phase III recovery is designated for patients requiring continued observation in preparation for discharge from the hospital or transfer to a general care ward. Normally a ratio of one nurse per three to five patients is used in this final stage of recovery prior to discharge.

## ADMISSION TO THE PACU

### Transfer to the PACU

Transport from the operating room is carried out under the direct supervision of an anesthetist. If possible, the head of the bed is elevated or the patient is placed in the lateral decubitus position to maximize airway patency and minimize aspiration risk. Oxygen delivered via a face mask or nasal cannula is indicated for most patients to prevent hypoxemia due to hypoventilation. Unstable patients, such as those receiving vasoactive medications, will require monitoring of vital signs during the transport. In transporting unstable patients, additional resources are required, including airway devices and a self-inflating bag valve mask (Ambu bag), emergency drugs, and appropriate means for monitoring oxygen saturation, heart rate, blood pressure, and respiratory rate. The anesthesiologist accompanying the patient to the PACU must provide care until a set of vital signs is obtained, the patient is deemed stable for the PACU to assume care, and a full handoff report is given to the PACU staff. The anesthetist should remain in charge of the care of the patient until the PACU team is ready to assume full responsibility for his/her care. This level of monitoring and transport can be similar to that required by a critically ill patient and is discussed in detail in Chapter 80.

### Reporting to the PACU Staff

The verbal report (handoff) is most often provided directly to the nurse in the PACU, who will then assume responsibility for providing supervised care to the patient. Ideally the report should not be interrupted, and the provider and receiver of the report should be able to concentrate on transferring this important information. Depending upon institutional guidelines, the PACU nurse may accept responsibility for care of the patient on behalf of the physician overseeing the PACU or as a representative of the surgical care team. In the event of an intraoperative complication or in the setting of a complex procedure, the report should be provided directly to the physician in charge of the PACU. The report to the PACU staff may include, but is not limited to, the guidelines listed in Table 72-3. This table is a suggested template for the transfer of information components and can be modified as dictated by institutional practice. Upon arrival in the PACU, vital signs are recorded by the staff, and the anesthetist provides a complete report to the PACU team. At the Massachusetts General Hospital, a member of the surgical team also accompanies the patient from the op-

erating room and provides pertinent details of the surgical procedure to the PACU staff.

The formal face-to-face report is a vital component of the process of transferring the responsibility of care for the patient from the team in the operating room to the team in the PACU. This report often may be the sole formal account of the intraoperative events between the team providing care in the operating room and the personnel who will provide the immediate postoperative care.<sup>9</sup>

Report should include the following:

1. Two forms of patient identification,<sup>10</sup> age, surgical procedure, diagnosis, a summary of prior medical history, medications, allergies, and preoperative vital signs. When present, specific features such as deafness, poor vision, psychiatric issues, language barriers, or precautions for infection control also should be mentioned.
2. Location and size of intravascular catheters.
3. Premedication, antibiotics, anesthetic drugs given for induction and maintenance, opioids, muscle relaxants, and reversal agents. Vasoactive drugs, bronchodilators, and other relevant drugs administered

TABLE 72-3.

#### Guidelines for Report to the PACU Staff

Significant Preoperative Issues	Intraoperative Issues
Patient's demographics	Access and invasive monitoring
Diagnosis	Special catheters (epidural, cooling)
Surgical procedure/urgency	Airway management issues
Past medical history	Induction and maintenance medications
Allergies and medications	Paralytics and reversal agents
Social history	Vasoactive agents
Past medical history relevant to anesthetic	Anticoagulants
Complications (personal or familial)	Antibiotics
Last meal	Analgesics/anxiolytics
Preoperative medications	Ventilatory parameters
Anxiolytics	Events of note
Antibiotics	Cardiopulmonary instability/hemorrhage
Analgesics	Emergence (pain, consciousness level)
	Estimated blood loss and urine output
	Fluids and blood products
	Tubes, lines, and drains
	Infectious precautions

A concise report must be provided to the postanesthetic care unit (PACU) team accepting responsibility for the care of the patient. The suggested information should be used as a framework to report pertinent information. The nature and extent of the information provided will be influenced by multiple factors, including the patient's overall medical condition, the surgical procedure, and any intraoperative factors that could influence postoperative recovery.



should be listed and the reasons for their use described.

4. Exact nature of the surgical procedure. If relevant surgical issues exist (e.g., adequacy of hemostasis, care of drains, restrictions on positioning, etc.), the PACU staff should be informed.
5. Anesthetic course, with emphasis on problems that may impact on the immediate postoperative course, including laboratory values, difficult IV access, difficult airway management, intraoperative or postoperative hemodynamic instability, electrocardiographic (ECG) changes, etc.
6. Fluid balance, including amount, type, and rationale of fluid replacement, urine output, and estimated fluid and blood loss.

### Complex Patients

As dictated by the clinical situation, the accompanying anesthetist may elect to speak directly to the anesthesiologist in charge of the PACU or to a consultant regarding issues of particular importance for the patient. Issues commonly communicated directly to the anesthesiologist responsible for the patients in the PACU or a consultant can include intraoperative instability, pertinent comorbidities, excessive blood loss, or airway difficulties, as well as persistent paralysis and other indications for continued mechanical ventilation.<sup>11</sup> The surgical team should be informed on admission to the PACU of any potential clinical issues that may impact the postoperative course of the patient.

### Monitoring in the PACU

The ASA recommends that during the emergence and recovery phases of care, periodic assessments be made of multiple parameters, including monitoring of respiratory and cardiovascular function, neuromuscular function, mental status, temperature, pain, nausea and vomiting, drainage and bleeding, and urine output. The frequency and duration of monitoring is dictated by the clinical status of the patient.<sup>5</sup>

### COMMON POSTOPERATIVE ISSUES

Clinical situations encountered in the postoperative patient may range from common events, such as inadequate

analgesia, to less frequently experienced clinical issues, such as negative pressure pulmonary edema. This chapter addresses the more commonly experienced postoperative clinical events. For detailed discussion of less frequently encountered issues, see Chapter 73.

### Postoperative Nausea and Vomiting

One of the most common complications of general anesthesia—postoperative nausea and vomiting (PONV)—is less of an issue with regional anesthetic techniques.<sup>12</sup> Apfel et al.<sup>13</sup> showed that the overall incidence of PONV is approximately 34% in patients receiving a general anesthetic without preoperative antiemetic therapy, with reductions of postoperative PONV risk by 26% with prophylactic administration of ondansetron, dexamethasone, or droperidol. Prevention of PONV is much more effective than treatment administered after symptoms occur.<sup>13,14</sup>

Patients are commonly stratified preoperatively (see Chapter 4) with regard to their risk of PONV; the incidence of PONV is greater in women, nonsmokers, and patients with a history of PONV or motion sickness.<sup>15,16</sup> Additional risk factors involve the use of narcotics, nitrous oxide, volatile anesthetics, and neostigmine as components of the anesthetic.<sup>17</sup> Certain types of surgery,

such as abdominal, breast, ear nose and throat (ENT), neurosurgery, and correction of strabismus, may also increase the risk for PONV. Prolonged surgery is associated with an increased incidence of PONV. Apfel et al.<sup>18</sup> showed that, after administration of an anesthetic consisting of a volatile anesthetic, nitrous oxide, and fentanyl without prophylactic antiemetics, the incidence of PONV was as high as 59%. In contrast, anesthetic techniques not using nitrous oxide but using propofol, remifentanyl, ondansetron, dexamethasone, and droperidol reduced the incidence of PONV to 17%.

If PONV occurs in the untreated patient in the PACU, therapy should be initiated with an IV serotonin antagonist and supplemented, if necessary, with medications from other classes of drugs (Table 72-4). In patients who have received prophylaxis, PONV rescue therapy should consist of drugs given from classes other than those previously administered.<sup>19</sup> Administration of drugs from the same class within the first 6 hours after surgery has not been found to be effective in the treatment of PONV. Tramer et al.<sup>20</sup> suggests that treatment of nausea and vomiting may be more cost-effective than prophylaxis. This view is based, in part, on the poor results associated with prophylaxis using a single agent.<sup>21</sup> Com-

**TABLE 72-4.**

**Antiemetic Treatment for Patients with PONV Who Did Not Receive Prophylaxis or in Whom Prophylaxis Failed—Exclude Inciting Medication or Mechanical Causes of PONV**

Initial Therapy	Failed Prophylaxis
No prophylaxis or dexamethasone SA plus second agent Triple therapy with SA plus two other agents when PONV occurs <6 h after surgery Triple therapy with SA plus two other agents when PONV occurs >6 h after surgery	Small doses of SA Use drug from a different class Do not repeat initial therapy Use drug from different class or... Propofol 20 mg as needed in the PACU Repeat SA and droperidol (not dexamethasone or transdermal scopolamine) Use drug from a different class
SA, Serotonin antagonist. Table describes a sequential approach to the treatment of patients experiencing postoperative nausea and vomiting (PONV) with the level of supporting evidence based on original student design as noted by Gan et al. <sup>71</sup> Patients may be naïve to antiemetic therapy on arrival to the postanesthesia care unit (PACU; initial therapy) or may have failed preoperative use of antiemetic agents (failed prophylaxis) based upon preoperative risk stratification for PONV. Escalation of antiemetic therapy, as required, is based on the introduction of additional agents from categories of medications (described in the text) not previously administered. Repeated dosing of a previously ineffective agent will yield little success in the treatment of PONV. Inciting medication and mechanical causes may include the use of morphine patient-controlled analgesia, blood draining down the back of the throat, and/or abdominal distension.	



mon categories of agents used for treatment of PONV<sup>2</sup> include the following:

1. *Serotonin antagonists* are efficient as prophylactic antiemetics when administered prior to the use of narcotics or before the completion of surgery. About one fourth of the dose used for prophylaxis can be given for rescue therapy.
2. *Phenothiazines* (Compazine) have been given both for prevention and treatment of PONV. This class of antiemetics can be associated with significant sedation.
3. *Dexamethasone* is most effective for prophylaxis if administered before the induction of anesthesia. It also can be given as a rescue drug.
4. *Droperidol* is no longer used as a first-line drug for the prevention and treatment of PONV. A “black box” warning was issued in 2001 by the FDA, associating droperidol with QT-segment prolongation and torsade de pointes in some patients.<sup>22</sup> When droperidol is given, documentation of a normal QT segment before administration and continuous ECG monitoring for 2–3 hours after administration is currently recommended. Droperidol now is used for treatment of PONV that has been refractory to other drugs. Charbit et al.<sup>23</sup> demonstrated that patients with PONV have a high incidence for a prolonged QTc interval because of a variety of factors associated with anesthesia, even before administration of an antiemetic such as droperidol or ondansetron. Both of these agents may increase the QTc interval after administration for treatment of PONV. Given this concern about cardiac arrhythmias, clinicians have sought alternatives to droperidol and have given *haloperidol* in lower dosages than used for antipsychotic therapy. In a meta-analysis, Buttner et al.<sup>24</sup> demonstrated that low-dose IV haloperidol is an effective drug for treatment of PONV with minimal side effects.

## Respiratory and Airway Complications

Most surgical patients arrive in the PACU following tracheal extubation in the operating room, with supplemental oxygen provided. Supplemental oxygen delivered by nasal cannulas or a

face mask during transport of the patient from the operating room is generally well tolerated by the patient. Most patients wean from the supplementary oxygen soon after arrival in the PACU. However, some patients have a continued requirement for supplemental inspired oxygen in the PACU and may require more aggressive respiratory therapy, such as a high-flow oxygen (O<sub>2</sub>) mask, noninvasive mechanical ventilation, or even reintubation. For treatment of hypoxemia not responsive to oxygen therapy and for management of the intubated patient, see Chapters 73 and 83.

Respiratory and airway complications are some of the most common perioperative complications occurring in the immediate postoperative period. The predominant issues include inadequate oxygenation and/or ventilation, upper airway obstruction, laryngospasm, and aspiration.<sup>25</sup>

General anesthesia inhibits hypoxic and hypercapnic ventilatory drive and reduces the lung's functional residual capacity (FRC). These changes may persist for variable periods of time postoperatively and predispose the patient to hypoventilation and hypoxemia. In the immediate postoperative period, hypoxia may be primarily explained by the presence of residual anesthetic agents. After sufficient time for recovery from anesthetic effects, hypoxia may be caused by the side effects of other depressant medications prescribed for the patient. Analgesia and the degree of respiratory depression can differ based upon the route of analgesic administration. The effects may range from a slight decrease in oxygen saturation (SpO<sub>2</sub>) requiring supplemental oxygen, to severe hypoventilation requiring treatment with the opioid antagonist naloxone, to reverse respiratory depression. Using decreased oxygen saturation as an indicator, the incidence of respiratory depression is less (11.5%) for patient-controlled analgesia (PCA) compared to epidural analgesia (15.1%).<sup>26</sup> The standard of care suggests that all patients receive supplemental oxygen in the immediate postoperative period.<sup>5</sup> However, although supplemental oxygen may mask and delay the detection of hypoventilation by pulse oximetry,<sup>27</sup> evidence also suggests that use of supplemental oxygen in the immediate postoperative period may be associated with a reduced rate of wound infection.<sup>28–30</sup>

Clinical signs of hypoxemia include dyspnea, cyanosis, altered mental status, agitation, obtundation, tachycardia, hypertension, and arrhythmias. Causes of hypoxemia include the following:

1. *Atelectasis*, with a subsequent increase of right-to-left intrapulmonary shunting, is a predictable effect of the decreased FRC caused by general anesthesia. A reduction of FRC occurs frequently in obese patients and after thoracic or upper abdominal procedures because these patients are prone to develop atelectasis in the postoperative period. Patients undergoing procedures with epidural anesthesia but without general anesthesia have minimal atelectasis formation as a function of the level of neuromuscular blockade.<sup>31</sup> Deep breathing and incentive spirometry are equally effective in reexpanding small regions of alveolar collapse. Noninvasive ventilation has been used to reduce atelectasis and augment oxygenation in postoperative patients.<sup>32</sup> Occasionally, in patients with profuse secretions and a poor cough reflex, hypoxemia may persist and chest radiography may reveal a segmental or lobar collapse. Chest physiotherapy or fiberoptic bronchoscopy may be required to facilitate the expansion of the atelectatic segment.
2. *Hypoventilation* due to inappropriately low minute ventilation causes hypoxemia by promoting alveolar collapse and increases the carbon dioxide (CO<sub>2</sub>) partial pressure in arterial blood, resulting in hypercapnia and acute respiratory acidosis. Hypoventilation, when severe, can produce hypoxemia, CO<sub>2</sub> narcosis, and ultimately apnea. Supplemental oxygen may mask the early detection of hypoventilation and, by reducing alveolar nitrogen concentration, can augment atelectasis. A decline in oxygen saturation (SpO<sub>2</sub>), as a sign of hypoventilation, has been found to be useful only in patients breathing air.<sup>27</sup> Therefore, monitoring the ventilatory status of postoperative patients should not rely solely on pulse oximetry.

Etiologies of postoperative hypoventilation can be divided into two groups:

1. *Decreased ventilatory drive*, as a result of medications and agents ad-

ministered during the intraoperative and postoperative course, normally is short lived and resolves shortly after the patient's arrival in the PACU.

*Pulmonary and respiratory muscle insufficiency* or compromise due to conditions such as chronic obstructive pulmonary disease, obesity, or surgical manipulation can limit the patient's ventilatory capability in the postoperative setting. Additionally, the effect of inadequately reversed neuromuscular blockade can markedly inhibit the patient's respiratory efforts in the immediate postoperative setting.

2. *Upper airway obstruction* is most often caused by inadequate recovery of the airway reflexes and muscle tone. Principal signs are lack of adequate air movement, intercostal and suprasternal retractions, and discoordinate abdominal and chest wall motion during inspiration. Complete upper airway obstruction is silent, whereas partial obstruction often is accompanied by snoring (if the obstruction is above the larynx) or inspiratory stridor (if perilaryngeal). Obstruction is more commonly seen in patients with obstructive sleep apnea, obesity, or nasal obstruction due to tonsillar or adenoidal hypertrophy.<sup>33</sup> To treat obstruction, 100% O<sub>2</sub> is given by mask, and rapid airway management is required. A chin lift, with or without jaw thrust, often resolves the obstruction; however, some patients (e.g., patients with obstructive sleep apnea) may benefit from continuous positive airway pressure. This is most common in patients already using such therapy at home. Additional conditions with the potential to impact respiratory function in postoperative patients include laryngospasm, bronchospasm, pulmonary edema, and aspiration of gastric contents. For a detailed discussion of specific complications that can compromise respiratory function in the postoperative patient, see Chapter 73.

## Hypotension

The differential diagnosis of hypotension is aided by a review of the patient's history and intraoperative management. Preoperative dehydration in the setting of an aggressive bowel preparation or intraoperative fluid restriction during a thoracic resection

are often the causes of hypotension in the immediate postoperative patient. As such, the patient's intraoperative course may offer insights into postoperative signs/symptoms, and discussion with patient's anesthetist may yield insights into the pathogenesis of postoperative hypotension. Common causes of postoperative hypotension include the following:

1. *Hypovolemia* is the most common cause of hypotension in the PACU, and hemorrhage must be considered as the cause until proven otherwise. Inadequate fluid replacement, osmotic polyuria, and fluid sequestration (intestinal obstruction, ascites) are common causes of hypovolemia in the postoperative patient. Nonspecific signs of insufficient fluid resuscitation include hypotension, tachycardia, tachypnea, decreased skin turgor, dry mucous membranes, oliguria, and thirst. An IV volume challenge (250–1000 mL of crystalloid or an equivalent volume of a colloid) should be considered therapeutic in the setting of a patient suspected of underresuscitation during surgery. Persistent hypotension following seemingly adequate volume replacement mandates further assessment, to include placement of a urinary catheter and, if persistent, invasive hemodynamic monitoring.
2. *Impaired venous return* occurs when mechanical forces decrease venous return to the heart. Common causes include positive-pressure ventilation and increased intraabdominal compartment pressure due to edema or a fluid collection. Signs of obstruction to venous return may be differentiated from those of true hypovolemia by the presence of jugular vein distension in the setting of decreased breath sounds and heart tones. Volume administration is the mainstay of symptomatic therapy, but treatment of the cause is the ultimate intervention.
3. *Vasodilatation*. Neuraxial anesthesia, residual inhalation agents, rewarming after hypothermia, transfusion reactions, adrenal insufficiency, anaphylaxis, systemic inflammation, sepsis syndrome, hepatic failure, and administration of vasodilatory agents all can cause hypotension due to systemic vasodilatation. Hypovolemia accentuates the hypotension caused by vasodila-

tion, and volume replacement alone may not fully restore the systemic blood pressure. Pharmacologic treatment can include  $\alpha$ -adrenergic receptor agonists such as phenylephrine or norepinephrine. Use of these IV agents mandates close monitoring of the blood pressure. Diagnosis and treatment of the specific etiology of vasodilatation must be concurrent with symptomatic treatment.

4. Additional causes of hypotension are cardiac dysfunction, sepsis, and chronic antihypertensive therapy. For a detailed discussion of many of the causes of postoperative hypotension, see Chapter 73.

## Cardiac Dysrhythmia

An enormous number of stimuli, including increased sympathetic or vagal nervous outflow, hypoxemia, hypercarbia, electrolyte and acid-base imbalance, myocardial ischemia, elevated intracranial pressure (ICP), drug toxicity, thyrotoxicosis, and malignant hyperthermia, are possible etiologies of perioperative dysrhythmias. Premature atrial contractions and unifocal premature ventricular contractions generally do not require treatment.<sup>34</sup> Assessment and definitive therapies are discussed in Chapters 73 and 84.

Commonly occurring cardiac dysrhythmias seen in the immediate postoperative setting include the following:

1. *Supraventricular dysrhythmias*
  - A. *Sinus tachycardia* may be secondary to pain, agitation, hypovolemia, fever, hyperthermia, hypoxemia, hypercarbia, congestive heart failure, and pulmonary embolism. Pharmacologic treatment of tachycardia with  $\beta$ -blockers or calcium channel blockers should be instituted only after the underlying etiology is addressed. However, the hazard of myocardial ischemia may dictate early therapeutic intervention.
  - B. *Sinus bradycardia* may result from high-level neuraxial anesthetic blockade, opioid administration (except meperidine), vagal stimulation,  $\beta$ -adrenergic blockade, and increased ICP. Symptomatic treatment with anticholinergic muscarinic agents is indicated when hypotension is present or bradycardia is marked with compromising cardiac output.

2. *Stable ventricular dysrhythmias.* Premature ventricular contractions and stable nonsustained ventricular tachycardia do not routinely require intervention. However, reversible causes of dysrhythmia, such as hypoxemia, myocardial ischemia, acidosis, hypokalemia, hypomagnesemia, and ventricular irritation caused by the stimulation of a central venous catheter, should be treated immediately. For further discussion and therapy, see Chapters 73 and 84.

### Other Cardiac-Related Events

Myocardial ischemia and infarction may be observed in the PACU as the patient is recovering after an anesthetic. Postoperative pain, respiratory distress, hypovolemia, and anemia are common clinical conditions that may result in excess cardiovascular stress and can result in ischemia or a myocardial infarction. Changes in the ECG may provide an early indication of cardiac compromise. Common findings on the ECG include the following:

1. *T-wave changes* (inversion, flattening, pseudonormalization) may be associated with myocardial ischemia and infarction, electrolyte imbalance, hypothermia, surgical manipulation of the mediastinum, or incorrect lead placement. Isolated T-wave changes must be considered within the clinical context of each patient, as such changes may be benign in the postoperative setting. It is essential that postoperative changes in the ECG be compared to a recent preoperative ECG.<sup>35</sup>
2. *ST-segment elevation or depression* generally indicates myocardial infarction or ischemia, respectively. ST-segment elevation can be a normal variant or may occur in other conditions, such as left ventricular hypertrophy, left bundle-branch block, or hyperkalemia.<sup>36</sup> Unlike myocardial infarctions occurring in the nonsurgical setting, most myocardial infarctions occurring in the postoperative period are associated with ST depression and have a non-Q-wave pattern. Supplemental oxygen should be administered and a 12-lead ECG obtained, and any potential precipitating factors for the ST-segment changes must be reviewed and corrected. Common etiologies of these ECG changes include hypoxemia, anemia, tachy-

cardia, hypotension, and hypertension. Cardiac enzyme levels should be monitored sequentially in patients with persistent ECG changes. If clinically appropriate,  $\beta$ -blockade and IV nitroglycerin should be considered. Consultation with a cardiologist is indicated in the setting of hemodynamic instability, and transfer to an intensive care unit (ICU) may be required for prolonged monitoring and therapy. Ongoing myocardial ischemia mandates the institution of invasive monitoring and/or specialized treatments (thrombolysis, percutaneous angioplasty, etc.).

3. In patients at high risk for adverse cardiac events (patients with ischemic heart disease, cerebrovascular disease, renal insufficiency, diabetes mellitus, or patients undergoing intrathoracic, intraperitoneal, or suprainguinal vascular surgical procedures),  $\beta$ -blockade has been found to decrease the risk of adverse cardiac events.<sup>37-39</sup> An institutional perioperative  $\beta$ -blockade protocol may be useful to standardize care for these patients.<sup>40,41</sup> For patients receiving vasoactive agents for hemodynamic support in the setting of hypotension, the addition of  $\beta$ -blockade should be considered in the context of the clinical situation.
4. The patient with a *permanent pacemaker* or *implantable cardioverter-defibrillator* (ICD) requires special consideration in the perioperative setting.<sup>42</sup> Information regarding the patient's pacemaker dependency state and the specialized features of the particular device must be obtained from the operating room team or the patient's cardiologist. Continuous ECG monitoring is essential, with particular attention to the patient's rhythm, rate, and hemodynamic status. Electrocautery used during the surgery can electrically reset the pacemaker, with older models likely more susceptible (see Chapter 27). Placement of a magnet over the permanent pacemaker or ICD during surgery can temporarily or permanently deactivate or reset the device, depending upon the age and specific nature of the device. Newer pacemakers may have rate-adaptive capabilities requiring a selective intervention by the electrophysiology service prior to surgery. Given the potential for

inadvertent program modification in the perioperative setting, interrogation of the device and communication with the electrophysiology service both before and after surgery is generally recommended. Reprogramming of the device to the original parameters may be required in the PACU. For a more detailed discussion of patients with cardiac pacemakers and ICDs, see Chapter 51.

### Hypertension

Commonly observed in patients not receiving scheduled antihypertensives preoperatively, systemic hypertension is often seen in patients having undergone vascular surgery (carotid endarterectomy) or intrathoracic procedures. Additional postoperative etiologies for hypertension include pain, bladder distension, fluid overload, hypoxemia, hypercarbia, hypothermia, increased ICP, or excessive administration of vasoconstrictor agents. Hypertension usually is asymptomatic but may present as headache, visual disturbances, dyspnea, restlessness, and chest pain. The initial physician's assessment should include a review of the patient's history and operative course and verification of the accuracy of blood pressure measurement (e.g., comparing both arms). Management of systemic hypertension usually is targeted to restoring blood pressure to within 20% of the patient's baseline. Strict postoperative blood pressure control often is required following intracranial aneurysm surgery, creation of vascularized muscular flaps, or microvascular surgery, and in patients with severe vascular disease. When appropriate, resumption of the patient's chronic antihypertensive oral drug therapy is ideal. If necessary, the therapy can be supplemented or substituted with parenteral medication. Commonly used medications include the following:

1.  $\beta$ -adrenergic antagonists: *Labetalol* (an  $\alpha$ - and a  $\beta$ -blocker), *esmolol*, *metoprolol*, and *propranolol* are effective in controlling heart rate and systemic blood pressure.
2. *Calcium-channel blockers.* *Verapamil* or *diltiazem* can be given as either a bolus or an infusion; *nicardipine* can be administered enterally. Sublingual *nifedipine* is no longer recommended because it can be associated with rapid and



severe hypotension resulting in myocardial ischemia.

3. *Hydralazine* is a potent vasodilator that may induce reflex tachycardia.
4. *Nitrates*. Nitroglycerin is primarily a venodilator at low infused doses and is quite useful in patients with known myocardial ischemia. Sodium nitroprusside is a potent vasodilator and requires invasive blood pressure monitoring.
5. *Fenoldopam*, a selective peripheral dopaminergic receptor agonist, can be administered as an IV infusion. Side effects include tachycardia, headache, and increased intraocular pressure.
6. *Enalaprilat*, administered parenterally, is useful in patients routinely treated with angiotensin-converting enzyme inhibitors or angiotensin receptor blockers in the postoperative setting where oral medications are not possible.

## Neurologic Complications

1. *Delayed awakening* is most often due to the persistent effects of anesthetic agents.<sup>43</sup> Metabolic causes of delayed awakening include hypothermia, sepsis, preexisting encephalopathies, hypoglycemia, and electrolyte or acid-base derangements. Additional causes of delayed awakening or obtundation include decreased cerebral perfusion, during or after surgery, which may cause diffuse or localized injury to the brain. In patients with cerebrovascular disease, brief periods of hypotension may cause a critical reduction of cerebral perfusion and brain damage. If such an event is suspected, a neurologic consultation should be obtained as soon as possible, with specific tests (e.g., computed tomography [CT], magnetic resonance imaging [MRI], or angiography) considered. If cerebral edema is suspected, treatment should begin immediately (see Chapter 50).
2. Neurologic damage may be the result of a *stroke* or may be due to peripheral nerve injury. Strokes have an incidence of 0.08–2.9% in the perioperative period and may be either ischemic or hemorrhagic.<sup>44</sup> Early diagnosis of a stroke may be difficult because symptoms and signs, such as slurred speech, visual changes, dizziness, agitation, confusion, psychosis, numbness, and

muscular weakness or paralysis, may overlap with the manifestations of residual anesthetic agents. Ischemic strokes are more common in patients with cerebrovascular disease, hypercoagulable states, atrial fibrillation, and they may be associated with intraoperative hypotension. Fat embolism secondary to long bone fractures can lead to strokes. Hemorrhagic strokes are more common in patients with coagulopathies, uncontrolled hypertension, cerebral aneurysms or arteriovenous malformations, and head trauma. Strokes are more frequent following intracranial surgery, carotid endarterectomy, cardiac surgery, or major traumatic injury. Neurologic consultation in conjunction with appropriate imaging studies is mandatory to guide the possible choice of treatment options.

3. *Emergence delirium* is characterized by excitement alternating with lethargy, disorientation, and inappropriate behavior. Delirium may occur in any patient but is more frequent in the elderly and patients with a history of drug or alcohol dependency, dementia, Alzheimer disease, or other psychiatric disorders. Many pharmacologic agents used commonly in the perioperative period, such as ketamine, opioids, benzodiazepines, metoclopramide, anticholinergics (atropine or scopolamine), and droperidol, may precipitate delirium. Delirium may be a symptom of many intercurrent complicating clinical and metabolic conditions, such as hypoxemia, acidemia, hyponatremia, hypoglycemia, intracranial injury, sepsis, severe pain, and alcohol or drug withdrawal and, as such, mandates investigation to exclude each of these causes.<sup>45</sup> Treatment usually is symptomatic by providing supplemental oxygen, fluid and electrolyte replacement, and adequate analgesia. Antipsychotic medications such as haloperidol can be given to patients refractory to symptomatic treatment. Physostigmine administration may reverse delirium due to anticholinergic agents.
4. *Peripheral neurologic lesions* may result from improper intraoperative positioning or direct surgical damage, or it may be a complication of regional anesthetic techniques. In the ASA closed claim analysis, ulnar nerve injury accounted for approxi-

mately one third of the cases of nerve injury, followed by damage to the brachial plexus and the common peroneal nerve. Risk factors for nerve injury after surgery include slender body habitus and history of neuropathy, smoking, or diabetes. Additional sites of potential nerve damage are discussed in Chapter 26.

5. *Intraoperative awareness and recall* are uncommon complications of general anesthesia (0.13% incidence in a large multicenter trial) that initially may be detected in the PACU.<sup>46,47</sup> Awareness and recall are most commonly associated with trauma and with cardiac and obstetric surgery.<sup>48</sup> Risk factors include young age, history of substance abuse, ASA physical status III–V, and use of muscular relaxants. A modified Brice Questionnaire (Table 72–5) can be used as a screening tool in the PACU to identify patients at risk for intraoperative recall. Patients with evidence of recall should receive reassurance and sympathetic care. They may require referral for psychological counseling, as required.<sup>49</sup>

## Principles of Pain Management

Adequate analgesia usually begins in the operating room and continues in

TABLE 72–5.

### Modified Brice Questionnaire to Screen for Intraoperative Awareness

- What is the last thing you remember before going to sleep for the operation?
- What is the first thing you remember upon waking after the operation?
- Do you remember anything between going to sleep and waking up?
- Did you have any dreams?
- What was the most unpleasant thing you remember from the operation and anesthesia?

The Brice questionnaire can be used in the immediate postoperative period to explore issues that suggest the possibility of intraoperative awareness. Although the first indications that intraoperative recall may have occurred can be noted in the postanesthesia care unit, it is important to ensure that the patient has recovered adequately from the effects of anesthesia and is able to appropriately cooperate with the examiner.<sup>71</sup>



the PACU.<sup>50</sup> Apfelbaum et al.<sup>51</sup> reported that most patients experience pain in the recovery room; approximately 20% describe the pain as severe, suggesting that pain often is inadequately treated before arrival in the PACU. In the postoperative period, incisional pain is the most common discomfort experienced by patients.<sup>52,53</sup> A detailed discussion of the management of postoperative pain is given in Chapter 74. A brief overview of some of the most common therapeutic modalities is given here.

1. *Opioids* (IV or epidural) are the mainstay of postoperative analgesia. Fentanyl, a potent synthetic opioid with rapid onset of action, is commonly administered in the operative setting. However, small parenteral doses can be titrated postoperatively to establish rapid analgesia. Morphine, hydromorphone and meperidine are effective as longer-acting agents. Meperidine must be avoided in patients taking monoamine oxidase inhibitors.
2. *Nonsteroidal antiinflammatory drugs* (NSAIDs) and *acetaminophen* can be effective complements to opioids, with ketorolac providing potent postoperative analgesia. Potential toxicities of all NSAIDs include decreased platelet aggregation, gastrointestinal bleeding, and nephrotoxicity.<sup>54</sup> Regional and peripheral sensory blockade (see Chapter 48) can be effective postoperatively and offers flexibility for patients in whom opioids may be contraindicated.
3. *IV patient-controlled analgesia* (IV-PCA) has been shown to be superior in patient satisfaction compared with intermittent analgesia administered by the medical staff. Continuous epidural analgesia should be continued postoperatively or promptly initiated in the PACU when indicated.<sup>55</sup>

## Temperature Control

1. *Hypothermia* is a common occurrence in the PACU as a result of the cool environment of the operating room combined with temporary pharmacologic impairment of effective thermoregulation. A core body temperature between 34°C and 36°C will be perceived as uncomfortable by a conscious patient. Additional side effects associated with hypothermia include shivering,<sup>56</sup>

increased duration of muscle relaxation, coagulopathy, cardiac dysrhythmias, and increased duration of postanesthetic recovery.<sup>57</sup> Treatment with warmed blankets or with forced-air warming systems is generally effective.<sup>58</sup> In the setting of major parenteral fluid administration, one must ensure that a fluid warming system is used to prevent cooling the patient.

2. *Hyperthermia* is less common than hypothermia in the immediate postoperative period. Fever in the PACU can be associated with postoperative atelectasis and is responsive to incentive spirometry. However, the presence of an elevated temperature in the immediate postoperative patient can be associated with conditions such as sepsis or reactions to medications and requires appropriate investigation. Although extremely rare, hypermetabolic states such as malignant hyperthermia or thyrotoxicosis may be first noted as a fever in the PACU. Hypothermia and hyperthermia are discussed further in Chapter 89.

## Fluid Administration and Hemorrhage

All patients in the PACU must be evaluated for the adequacy of intraoperative fluid resuscitation. Parameters indicating that the patient requires additional fluid administration include hypotension, tachycardia, and low urine output. Hypovolemia is the most common cause of postoperative hypotension, and, until proven otherwise, hemorrhage must be a primary concern in postoperative hypotension. Gan et al.<sup>59</sup> demonstrated that intraoperative goal-directed fluid administration can decrease postoperative complications and is associated with earlier return of gastrointestinal function and shorter length of hospital stay.

There is significant debate in the literature regarding the nature of the appropriate fluid for resuscitation of postoperative patients. A possible advantage to using colloid solutions for resuscitation is that they ensure rapid and effective expansion of intravascular volume and do not instantly cross capillary membranes into the interstitial space. However, investigators in a Saline versus Albumin Fluid Evaluation (SAFE) trial demonstrated that albumin and saline both are safe and

clinically equivalent, rendering the same 28-day outcome for resuscitation of critically ill patients in the ICU.<sup>60</sup>

Blood transfusion carries specific risks, which include but are not limited to viral infections, contamination with bacteria, parasites, and prions, hemolytic transfusion reactions, alloimmunization, autoimmunization, immunosuppression, transfusion-related lung injury, and errors associated with the processing and administration of blood products. Hebert et al.<sup>61</sup> showed that critically ill patients who undergo a restrictive approach to blood transfusion have a better outcome than do patients who receive liberal blood transfusions, thereby driving a trend to lower the transfusion hemoglobin threshold and ultimately reducing the number of blood transfusions in critically ill patients. Clinicians must consider the risks and benefits to the individual patient of using a volume replacement strategy that may involve blood component therapy.<sup>62</sup>

Unrecognized or ongoing hemorrhage, although uncommon in the immediate postoperative patient, is an emergency requiring immediate treatment and can tax the resources of any PACU. Coordination with the blood bank, the surgery and anesthesia teams, and the operating room staff must be performed in a timely manner. Personnel assigned to the PACU should have a clear plan established to address the requirements of the hemorrhaging postoperative patient.

Hemorrhage may present in an obvious manner, such as rapid saturation of a dressing or an increase in chest tube drainage. However, the presentation may be subtle, as in the case of increased abdominal tension, hypotension, decreased urine output, or downward trend of hematocrit or hemoglobin values.

In laparoscopic procedures involving the abdomen and thorax, signs of internal bleeding may not be obvious initially and may be identified only later in the PACU.<sup>63</sup> Bleeding of a delayed nature may be associated with any procedure requiring the insertion of trocars.<sup>64</sup>

Patients receiving chronic anticoagulation therapy with warfarin (Coumadin) may be at greater risk for postoperative bleeding complications. In a study of 600 surgical patients chronically anticoagulated with warfarin, wherein anticoagulation was either discontinued pre-

operatively or reversed, Torn et al.<sup>65</sup> demonstrated an increased incidence of hemorrhage-related complications, especially in surgical procedures involving the thorax. A detailed discussion regarding the management of fluid and blood component replacement therapy is given in Chapters 34 and 85.

## PACU DISCHARGE

As described in the ASA's Standard's for Postoperative Care, a physician should be responsible for the discharge of each patient from the PACU.<sup>5</sup> In the absence of a physician present in the PACU, a nurse may determine that the patient meets the institutionally established discharge criteria and can discharge the patient, noting the physician responsible and appropriate instructions for the patient upon discharge from the hospital.

A variety of discharge criteria and systems for evaluation of a patient prior to discharge from the PACU are

**TABLE 72-6.**

### General Guidelines for PACU Discharge

- Patients should be alert and oriented.
- Patients whose mental status initially was abnormal should have returned to their baseline.
- Vital signs should be stable and within acceptable limits.
- Discharge should occur after the patients have met specified criteria.
- Use of a composite scoring system may assist in documentation of fitness for discharge and shorten PACU length of stay.
- Outpatients should be discharged to a responsible adult who will accompany them home and be able to report any postprocedural complications.
- Outpatients should be provided with written instructions regarding postprocedural diet, medications, activities, and a physician phone number to be called in case of emergency.

PACU, Postanesthesia care unit. General guidelines for discharge describe some of the basic principles that might be incorporated into a formalized system to aid in the evaluation of the patient for discharge. The criteria that are developed should be designed to minimize the risks of central nervous system and cardiorespiratory depression after discharge.<sup>5</sup>

used and must be approved by the anesthesia department and the medical staff of each institution. Table 72-6 gives generalized principles summarizing PACU discharge criteria. These criteria may require modification to address the specifics of a discharge. For example, criteria for a patient being discharged to a surgical ward will vary from criteria for a patient to be discharged from the hospital.<sup>66</sup>

Discharge criteria may be based on length of stay in the PACU (time based) or may be based on a clinical scoring system. A variety of parameters are included in PACU discharge scoring systems, such as vital signs, adequate control of pain, nausea, and return to baseline level of consciousness. Each can be evaluated and assigned a score to set minimum values for discharge eligi-

bility. Although no set of criteria or scoring system has been shown to be better than another, evidence suggests that a clinical-based scoring system may reduce overall length of stay in the PACU, without adding risk to the patient's course. Predictors of an increased length of stay in the PACU include length of the surgical procedure, use of opioids, tracheal intubation, and administration of antiemetics. Of note, age, gender, ASA classification, and urgency of surgery did not predict a longer PACU stay.<sup>67</sup> In the 1970s, a scoring system was developed to assess the appropriateness of discharge to an ambulatory unit or to phase II recovery. Later modified to condense discharge criteria into a more effective scoring system, use of the Aldrete recovery score (Table 72-7) appears to decrease the PACU length of stay.<sup>67,68</sup>

**TABLE 72-7.**

### Postanesthesia Recovery (PAR) Scoring Criteria: Modified Aldrete Recovery Score

PAR Score	Admission	15 min	30 min	60 min	Discharge
<b>Activity</b>					
Able to move voluntarily					
4 extremities					2
2 extremities					1
0 extremities					0
<b>Respiration</b>					
Breathes deeply, coughs freely					2
Dyspnea, shallow or limited respirations					1
Apnea					0
<b>Circulation</b>					
BP $\pm$ 20% of preop					2
BP $\pm$ 20–49% of preop					1
BP $\pm$ 50% of preop					0
<b>Consciousness</b>					
Fully awake					2
Arousable with minimal stimulation					1
Not responding to noxious stimulus					0
<b>O<sub>2</sub> Saturation</b>					
>92% on room air					2
Needs O <sub>2</sub> to maintain >90%					1
<90% even with O <sub>2</sub>					0
<b>Total</b>					0–10

BP, Blood pressure; preop, preoperative value.

The primary shortfall of the Aldrete scoring system is that it does not consider pain, or nausea or vomiting, both common occurrences in the postanesthesia care unit (PACU).<sup>66</sup> Institutions may create individual systems, with similar parameters for evaluation. The goal of any system is to reliably define the time when a patient can be safely transferred from observation in the PACU, either for transfer to a hospital ward or for accompaniment home. A minimum composite score of 8 is required for discharge.<sup>67</sup>

Reprinted from Aldrete J. The post-anesthesia recovery score revisited. *J Clin Anesth* 1995;7:89, with permission from Elsevier.

The decision to admit a PACU patient to the hospital for additional care or to discharge the patient to home is based upon a number of factors, including the nature of the surgical procedure, complications encountered, the patient's comorbidities, and the home care situation. In our hospital, patients who will be admitted to the ICU after a surgical procedure are transferred directly to that unit from the operating room, thereby avoiding an extra handoff. However, these patients can be initially transferred to the PACU while awaiting postoperative radiographic testing, such as CT or MRI. Occasionally patients require a period of close observation of airway issues, which is best carried out in the PACU.

Given the ever-increasing pressure of throughput in hospitals, there is often a shortage of beds in the ICU. Consequently, doctors often will use the PACU as a short-term ICU for patients who are expected to recover within a 24- to 36-hour period to permit safe care on a hospital ward.<sup>69,70</sup>

## KEY REFERENCES

1. Diaconescu I, Grecu L. The post anesthesia care unit. In Dunn PF, ed. *Clinical Anesthesia Procedures of the Massachusetts General Hospital*. 7th ed. Philadelphia: Lippincott, Williams & Wilkins, 2007: 623–644.
2. American Society of Anesthesiologists Task Force on Postanesthetic Care. Practice guidelines for postanesthetic care: a report by the American Society of Anesthesiologists Task Force on Postanesthetic Care. *Anesthesiology* 2002;96:742–752.
3. Gan TJ. Risk factors for postoperative nausea and vomiting. *Anesth Analg* 2006;102:1884–1898.
4. Hines R, Barash PG, Watrous G, et al. Complications occurring in the postanesthesia care unit: a survey. *Anesth Analg* 1992;74:503–509.
5. Cashman JN, Dolin SJ. Respiratory and haemodynamic effects of acute postoperative pain management: evidence from published data. *Br J Anaesth* 2004;93:212–223.

## REFERENCES

1. Thompson JS, Baxter BT, Allison JG, et al. Temporal patterns of postoperative complications. *Arch Surg* 2003;138:596–602.
2. Diaconescu D, Grecu L. The post anesthesia care unit. In Dunn PF, ed. *Clinical Anesthesia Procedures of the Massachusetts General Hospital*. 7th ed. Philadelphia: Lippincott, Williams & Wilkins, 2007:623–644.
3. Kiekkas P, Pouloupoulou M, Papahatzi A, et al. Workload of postanesthesia care unit nurses and intensive care overflow. *Br J Nurs* 2005;14:434–438.
4. Kluger MT, Bullock MF. Recovery room incidents: a review of 419 reports from the Anaesthetic Incident Monitoring Study (AIMS). *Anaesthesia* 2002;57:1060–1066.
5. American Society of Anesthesiologists Task Force on Postanesthetic Care. Practice guidelines for postanesthetic care: a report by the American Society of Anesthesiologists Task Force on Postanesthetic Care. *Anesthesiology* 2002;96:742–752.
6. Sullivan EE. Standards of perianesthesia nursing practice 2002. *J Perianesth Nurs* 2002;17:275–276.
7. White PF, Rawal S, Nguyen J, et al. PACU fast-tracking: an alternative to “bypassing” the PACU for facilitating the recovery process after ambulatory surgery. *J Perianesth Nurs* 2003;18:247–253.
8. Marshall SI, Chung F. Discharge criteria and complications after ambulatory surgery. *Anesth Analg* 1999;88:508–517.
9. Anwari JS. Quality of handover to the postanaesthesia care unit nurse. *Anaesthesia* 2002;57:488–493.
10. Metules TJ, Bauer J. Part 2. JCAHO's patient safety goals: preventing med errors. *RN* 2007;70:39–43.
11. Hodge S. Provision of care for patients. Mechanical ventilation in the PACU. *J Periop Pract* 2006;16:376.
12. Borgeat A, EkatoDRAMIS G, Schenker CA. Postoperative nausea and vomiting in regional anesthesia: a review. *Anesthesiology* 2003;98:530–547.
13. Apfel CC, Korttila K, Abdalla M, et al. A factorial trial of six interventions for the prevention of postoperative nausea and vomiting. *N Engl J Med* 2004;350:2441–2451.
14. Habib AS, White WD, Eubanks S, et al. A randomized comparison of a multimodal management strategy versus combination antiemetics for the prevention of postoperative nausea and vomiting. *Anesth Analg* 2004;99:77–81.
15. Gan TJ. Risk factors for postoperative nausea and vomiting. *Anesth Analg* 2006;102:1884–1898.
16. Habib AS, Chen YT, Taguchi A, et al. Postoperative nausea and vomiting following inpatient surgeries in a teaching hospital: a retrospective database analysis. *Curr Med Res Opin* 2006;22:1093–1099.
17. Dershwitz M, Michalowski P, Chang Y, et al. Postoperative nausea and vomiting after total intravenous anesthesia with propofol and remifentanyl or alfentanil: how important is the opioid? *J Clin Anesth* 2002;14:275–278.
18. Apfel CC, Kranke P, Eberhart LH. Comparison of surgical site and patient's history with a simplified risk score for the prediction of postoperative nausea and vomiting. *Anaesthesia* 2004;59:1078–1082.
19. Gan TJ. Postoperative nausea and vomiting—can it be eliminated? *JAMA* 2002;287:1233–1236.
20. Tramer MR. A rational approach to the control of postoperative nausea and vomiting: evidence from systematic reviews. Part II. Recommendations for prevention and treatment, and research agenda. *Acta Anaesthesiol Scand* 2001;45:14–19.
21. Rusch D, Eberhart L, Biedler A, et al. Prospective application of a simplified risk score to prevent postoperative nausea and vomiting. *Can J Anaesth* 2005;52:478–484.
22. Gan TJ, White PF, Scuderi PE, et al. FDA “black box” warning regarding use of droperidol for postoperative nausea and vomiting: is it justified? *Anesthesiology* 2002;97:287.
23. Charbit B, Albaladejo P, Funck-Brentano C, et al. Prolongation of QTc interval after postoperative nausea and vomiting treatment by droperidol or ondansetron. *Anesthesiology* 2005;102:1094–1100.
24. Buttner M, Walder B, von Elm E, et al. Is low-dose haloperidol a useful antiemetic?: a meta-analysis of published and unpublished randomized trials. *Anesthesiology* 2004;101:1454–1463.
25. Hines R, Barash PG, Watrous G, et al. Complications occurring in the postanesthesia care unit: a survey. *Anesth Analg* 1992;74:503–509.
26. Cashman JN, Dolin SJ. Respiratory and haemodynamic effects of acute postoperative pain management: evidence from published data. *Br J Anaesth* 2004;93:212–223.
27. Fu ES, Downs JB, Schweiger JW, et al. Supplemental oxygen impairs detection of hypoventilation by pulse oximetry. *Chest* 2004;126:1552–1558.
28. Belda FJ, Aguilera L, Garcia de la Asuncion J, et al. Supplemental perioperative oxygen and the risk of surgical wound infection: a randomized controlled trial. [published erratum appears in *JAMA* 2005;294:2973]. *JAMA* 2005;294:2035–2042.
29. Suttner S, Boldt J, Piper S. Supplemental oxygen and risk of surgical wound infection. *JAMA* 2006;295:1641–1642.
30. Tornero-Campello G. Letter: randomized clinical trial to evaluate the effects of perioperative supplemental oxygen administration on the colorectal anastomosis (*Br J Surg* 2006;93:698–706). *Br J Surg* 2006;93:1148.
31. Duggan M, Kavanagh BP. Pulmonary atelectasis: a pathogenic perioperative entity. *Anesthesiology* 2005;102:838–854.



32. Hedenstierna G, Rothen HU. Atelectasis formation during anesthesia: causes and measures to prevent it. *J Clin Monit Comput* 2000;16:329–335.
33. Hillman DR, Platt PR, Eastwood PR. The upper airway during anaesthesia. *Br J Anaesth* 2003;91:31–39.
34. Thompson A, Balsler JR. Perioperative cardiac arrhythmias. *Br J Anaesth* 2004;93:86–94.
35. Breslow M, Miller CF, Parker SD, et al. Changes in t-wave morphology following anesthesia and surgery: a common recovery room phenomenon. *Anesthesiology* 1986;64:398–402.
36. Wang K, Asinger RW, Marriott HJ. ST-segment elevation in conditions other than acute myocardial infarction. *N Engl J Med* 27 2003;349:2128–2135.
37. Akhtar S, Barash PG. Perioperative use of beta-blockers: past, present, and future. *Int Anesthesiol Clin* 2002;40:133–157.
38. Lindenauer PK, Fitzgerald J, Hoople N, et al. The potential preventability of postoperative myocardial infarction: underuse of perioperative beta-adrenergic blockade. *Arch Intern Med* 2004;164:762–766.
39. Lindenauer PK, Pekow P, Wang K, et al. Perioperative beta-blocker therapy and mortality after major noncardiac surgery. *N Engl J Med* 2005;353:349–361.
40. Dunn PF. Massachusetts General Hospital Beta Blockade Guidelines. Available at: <http://ccmu.massgeneral.org/pathway>. Last accessed 3/15/07.
41. Mangano DT, Layug EL, Wallace A, et al. Effect of atenolol on mortality and cardiovascular morbidity after noncardiac surgery. Multicenter Study of Perioperative Ischemia Research Group. [published erratum appears in *N Engl J Med* 1997;336:1039]. *N Engl J Med* 1996;335:1713–1720.
42. American Society of Anesthesiologists Task Force on Perioperative Management of Patients with Cardiac Rhythm Management Devices. Practice advisory for the perioperative management of patients with cardiac rhythm management devices: pacemakers and implantable cardioverter-defibrillators: a report by the American Society of Anesthesiologists Task Force on Perioperative Management of Patients with Cardiac Rhythm Management Devices. *Anesthesiology* 2005;103:186–198.
43. Debaene B, Plaud B, Dilly MP, et al. Residual paralysis in the PACU after a single intubating dose of nondepolarizing muscle relaxant with an intermediate duration of action. *Anesthesiology* 2003;98:1042–1048.
44. Selim M. Perioperative stroke. *N Engl J Med* 15 2007;356:706–713.
45. Lepouse C, Lautner CA, Liu L, et al. Emergence delirium in adults in the post-anaesthesia care unit. *Br J Anaesth* 2006;96:747–753.
46. Bergman IJ, Kluger MT, Short TG. Awareness during general anaesthesia: a review of 81 cases from the Anaesthetic Incident Monitoring Study. *Anaesthesia* 2002;57:549–556.
47. Sebel PS, Bowdle TA, Ghoneim MM, et al. The incidence of awareness during anesthesia: a multicenter United States study. *Anesth Analg* 2004;99:833–839.
48. Gan TJ, Ing RJ, de L Dear G, et al. How much are patients willing to pay to avoid intraoperative awareness? *J Clin Anesth* 2003;15:108–112.
49. American Society of Anesthesiologists Task Force on Intraoperative Awareness. Practice advisory for intraoperative awareness and brain function monitoring: a report by the American Society of Anesthesiologists Task Force on Intraoperative Awareness. *Anesthesiology* 2006;104:847–864.
50. American Society of Anesthesiologists Task Force on Acute Pain Management. Practice guidelines for acute pain management in the perioperative setting: an updated report by the American Society of Anesthesiologists Task Force on Acute Pain Management. *Anesthesiology* 2004;100:1573–1581.
51. Apfelbaum JL, Chen C, Mehta SS, et al. Postoperative pain experience: results from a national survey suggest postoperative pain continues to be undermanaged. *Anesth Analg* 2003;97:534–540.
52. Brennan TJ, Zahn PK, Pogatzki-Zahn EM. Mechanisms of incisional pain. *Anesthesiol Clin North America* 2005;23:1–20.
53. Gan TJ, Lubarsky DA, Flood EM, et al. Patient preferences for acute pain treatment. *Br J Anaesth* 2004;92:681–688.
54. Gajraj NM, Joshi GP. Role of cyclooxygenase-2 inhibitors in postoperative pain management. *Anesthesiol Clin North America* 2005;23:49–72.
55. Flisberg P, Rudin A, Linner R, et al. Pain relief and safety after major surgery. A prospective study of epidural and intravenous analgesia in 2696 patients. *Acta Anaesthesiol Scand* 2003;47:457–465.
56. Eberhart LH, Doderlein F, Eisenhardt G, et al. Independent risk factors for postoperative shivering. *Anesth Analg* 2005;101:1849–1857.
57. Sessler DI. Complications and treatment of mild hypothermia. *Anesthesiology* 2001;95:531–543.
58. Kabbara A, Goldlust SA, Smith CE, et al. Randomized prospective comparison of forced air warming using hospital blankets versus commercial blankets in surgical patients. *Anesthesiology* 2002;97:338–344.
59. Gan TJ, Soppitt A, Maroof M, et al. Goal-directed intraoperative fluid administration reduces length of hospital stay after major surgery. *Anesthesiology* 2002;97:820–826.
60. Finfer S, Bellomo R, Boyce N, et al. A comparison of albumin and saline for fluid resuscitation in the intensive care unit. *N Engl J Med* 27 2004;350:2247–2256.
61. Hebert PC, Wells G, Blajchman MA, et al. A multicenter, randomized, controlled clinical trial of transfusion requirements in critical care. Transfusion Requirements in Critical Care Investigators, Canadian Critical Care Trials Group. [published erratum appears in *N Engl J Med* 1999;340:1056]. *N Engl J Med* 1999;340:409–417.
62. Vincent JL, Piagnerelli M. Transfusion in the intensive care unit. *Crit Care Med* 2006;34(5 Suppl):S96–S101.
63. Rosevear HM, Montgomery JS, Roberts WW, et al. Characterization and management of postoperative hemorrhage following upper retroperitoneal laparoscopic surgery. *J Urol* 2006;176(4 Pt 1):1458–1462.
64. Lohan D, Walsh S, McLoughlin R, et al. Imaging of the complications of laparoscopic cholecystectomy. *Eur Radiol* 2005;15:904–912.
65. Torn M, Rosenthal FR. Oral anticoagulation in surgical procedures: risks and recommendations. *Br J Haematol* 2003;123:676–682.
66. Awad IT, Chung F. Factors affecting recovery and discharge following ambulatory surgery. *Can J Anaesth* 2006;53:858–872.
67. Truong L, Moran JL, Blum P. Post anaesthesia care unit discharge: a clinical scoring system versus traditional time-based criteria. *Anaesth Intensive Care* 2004;32:33–42.
68. Aldrete J. The post-anesthesia recovery score revisited. *J Clin Anesth* 1995;7:89.
69. Carlson K. Night watch. *J Perianesth Nurs* 2005;20:399–403.
70. Dexter F, Wachtel RE, Epstein RH. Impact of average patient acuity on staffing of the phase I PACU. *J Perianesth Nurs* 2006;21:303–310.
71. Gan TJ, Meyer T, Apfel CC, et al. Consensus guidelines for managing postoperative nausea and vomiting. *Anesth Analg* 2003;97:62–71.



## CHAPTER 73

## Postoperative Complications

Edward A. Bittner, MD, PhD,  
Loreta Grecu, MD, and  
Edward George, MD

Complications in the postanesthesia care unit (PACU) are common. In a study of 18,473 patients entering the PACU at a university teaching hospital, Hines et al.<sup>1</sup> reported a complication rate of 23%, with nausea and vomiting (9.8%), need for upper airway support (6.9%), and hypotension (2.7%) the most frequently encountered problems (Fig. 73-1). Despite pharmacologic and medical advances over the last 10 years, the incidence of postoperative complications appears largely unchanged.<sup>2</sup>

Even minor postoperative complications are important to patients (Table 73-1), and greater efforts at preventing and treating complications should lead to improved postoperative recovery and patient satisfaction.<sup>3,4</sup>

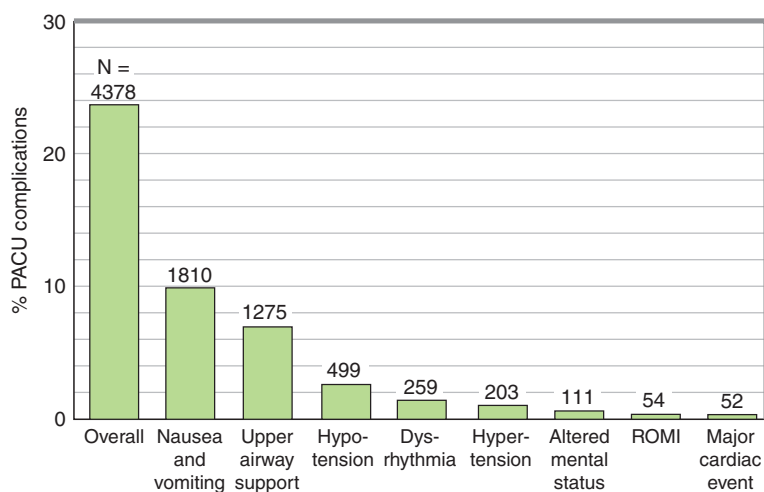
This chapter focuses on postoperative complications commonly encountered in the PACU setting, with emphasis on early diagnosis and treatment. Naturally there is some overlap with events that occur during routine recovery (see Chapter 72). Many of the specific details

## KEY POINTS

1. Complications in the postanesthesia care unit (PACU) are common. Despite pharmacologic and medical advances over the last 10 years, the incidence of postoperative complications appears largely unchanged. Even minor postoperative complications are important to patients, and greater efforts at preventing and treating such complications should lead to improved postoperative recovery and patient satisfaction.
2. Knowledge of the expected postoperative course for a given operation is essential to identifying and managing problems when they occur. Awareness of the temporal patterns of complications is important to anticipating periods of increased perioperative risk.
3. Airway obstruction is common in the postoperative period. Upper airway obstruction arises in the pharynx (posterior tongue displacement, soft tissue collapse), larynx (laryngeal edema, laryngospasm, vocal cord paralysis), or trachea due to extrinsic compression. Anesthetics, and even minimal residual neuromuscular blockade, may lead to upper airway obstruction.
4. Hypoxemia is common in postoperative patients not receiving supplemental oxygen.
 

Following general anesthesia or sedation all patients should receive supplemental oxygen (O<sub>2</sub>) during their transport from the operating room and during their initial PACU stay. Continuous monitoring of oxygen saturation with pulse oximetry is essential for early detection of hypoxemia.
5. Several conditions may necessitate continued intubation after surgery. They include delayed emergence
 

from general anesthesia, inadequate reversal of neuromuscular blockade, potential for airway obstruction, inadequate gas exchange, and hemodynamic instability.
6. Hypotension is a common postoperative complication that results from hypovolemia (most common), decreased vascular tone, and/or reduced cardiac output. Causes of hypovolemia in the PACU include inadequate fluid replacement, ongoing hemorrhage, and fluid sequestration (“third spacing”). Clinical evaluation of a patient’s intravascular volume status requires consideration of preoperative status, type and duration of surgery, estimated blood loss, fluid replacement, and evidence of hemostasis.
7. Cardiac dysrhythmias are common during the perioperative period, and most dysrhythmias are benign. The precipitating factor is usually a transient imbalance such as hypoxia, ischemia, increased catecholamines, altered acid–base status, or electrolyte abnormalities. The management strategy for a new dysrhythmia is focused on stabilizing hemodynamics and treating the underlying problem.
8. Hypertension is a very common problem in the postoperative period. Sympathetic nervous system activation resulting from noxious stimuli, such as pain, anxiety, bladder distension, fluid overload, hypoxemia, hypercarbia, and hypothermia, are common precipitants. The decision to treat hypertension should take into consideration the patient’s baseline blood pressure, coexisting diseases, and perceived risk of complications.
9. Urinary retention and oliguria are common problems in the PACU. Oliguria is most commonly caused by hypovolemia (prerenal) in the immediate postoperative period, but postrenal and intrinsic renal causes also should be considered.
10. Patients who develop bleeding postoperatively require rapid evaluation to differentiate poor surgical hemostasis (perhaps requiring immediate reoperation) from a diffuse coagulopathy. It is important to appreciate that surgical and nonsurgical bleeding often coexist. If there is evidence of significant bleeding, diagnosis and treatment usually occur simultaneously. Adequate IV access should be established, availability of appropriate blood products ensured, and a diagnostic evaluation performed.
11. Hypothermia remains a common PACU problem. Even mild hypothermia (core temperature between 34°C and 36°C) has been associated with adverse outcomes, including myocardial ischemia, arrhythmias, coagulopathy, wound infection, decreased drug metabolism, and poor patient satisfaction.
12. The major causes of delayed awakening after general anesthesia can be divided into three groups:
  - (1) prolonged pharmacologic effects,
  - (2) metabolic abnormalities, and
  - (3) neurologic injury.
13. Awareness with recall of intraoperative events is an infrequent but recognized complication of general anesthesia that can result in significant distress to patients and long-term psychological sequelae. In cases of possible awareness, the patient should be offered counseling and psychological support.



**FIGURE 73–1.** Major postanesthesia care unit complications by percentage of occurrence from a prospective study of 18,473 patients. From Hines R et al.<sup>1</sup> with permission.

of diagnosis and management are covered in other chapters of this book and will not be repeated here.

As with intraoperative anesthetic care, knowledge of the expected postoperative course for a given operation is essential to identifying and managing problems when they occur. Awareness of the temporal patterns of complications is important to anticipating periods of increased perioperative risk

**TABLE 73–1.**

**Temporal Patterns of Postoperative Complications**

Complications	Time/Interval of Greatest Risk
Hypotension Myocardial infarction Respiratory depression	Day 1
Congestive heart failure Pulmonary embolism Respiratory failure	Days 1–3
Pneumonia	Days 4–7
Cerebrovascular accident Sepsis	Days 8–30
Renal failure	Days 1–3, 8–30

Results of 1021 patients undergoing intra-abdominal operations in Veterans Administration (VA) medical centers. Data from Thompson JS et al.<sup>5</sup> Temporal patterns of postoperative complications. Arch Surg 2003;138:596–603.

(Table 73–2).<sup>5</sup> When complications do occur, early communication with the surgical team is essential.

## AIRWAY COMPLICATIONS

### Upper Airway Obstruction

Upper airway obstruction can arise in the pharynx (posterior tongue displacement, soft tissue collapse), larynx (laryngeal edema, laryngospasm, vocal cord paralysis), or large airways due to extrinsic compression. Anesthetics, and even minimal residual neuromuscular blockade, may lead to upper airway obstruction.<sup>6</sup> Principal signs are lack of adequate air movement, intercostal and suprasternal retractions, and discoordinate abdominal and chest wall movements during inspiration.

### Pharyngeal Obstruction

Simple maneuvers such as a chin lift, jaw thrust, and lateral decubitus positioning, as well as decreasing the level of sedation usually are successful in relieving pharyngeal obstruction. Oropharyngeal or nasopharyngeal airways are useful adjuncts. Nasopharyngeal airways are better tolerated than oral airways at light levels of sedation because of less tendency to provoke a gag reflex. Careful insertion of nasal airways is necessary to avoid creating a nosebleed.

### Laryngeal Obstruction

**Laryngeal Edema** Laryngeal or subglottic edema can create airway obstruction, especially in children because of their smaller airway diameter and in patients recovering from neck

surgery. Treatment of partial airway obstruction resulting from airway edema includes head-up positioning to promote venous drainage and administering nebulized epinephrine and steroids. Treatment of severe airway edema may require emergency reintubation or tracheostomy.

Prolonged surgery in a head-down position can result in significant airway swelling. The common practice of listening for an air leak after a positive pressure breath (with the endotracheal cuff deflated) is a reliable way to determine that extubation likely will be successful if a leak is present.<sup>7</sup> However, a failed leak test does not preclude uneventful extubation.<sup>8</sup> Patients at risk for significant swelling should be evaluated (using direct or fiberoptic laryngoscopy) prior to extubation because they are at risk for complete airway obstruction. Patients with significant obstruction should remain intubated until airway edema resolves.

**Laryngospasm** Laryngospasm is a reflex resulting from prolonged glottic closure. Although the cords are adducted, the primary obstruction is caused by tonic contraction of the laryngeal muscles and descent of the epiglottis over the laryngeal inlet. Laryngospasm may be precipitated by light anesthesia and the presence of an airway irritant such as secretions, blood, or a foreign body. It also can be caused by stimulation from an elongated uvula, may be sleep related, or may be stimulated by distal esoph-

**TABLE 73–2.**

**Ranking of Patient's Preferences for Postoperative Anesthesia Outcomes**

Outcome	Rank (Mean) <sup>a</sup>
Vomiting	2.56
Gagging on endotracheal tube	2.97
Pain	3.46
Nausea	4.02
Recall without pain	4.85
Residual weakness	5.34
Shivering	5.36
Sore throat	8.02
Somnolence	8.28

<sup>a</sup>Outcomes are ranked in relation to each other on a scale from 1 (most undesirable) to 10 (most desirable).

Modified from Macario et al.<sup>3</sup> with permission.

ageal afferents.<sup>9</sup> Partial laryngospasm allows for some air movement and may be difficult to distinguish from other causes of upper airway obstruction. Complete laryngospasm prevents all air movement and is a prominent cause of negative pressure pulmonary edema (see Pulmonary Edema below). Management of laryngospasm consists of jaw thrust, positive-pressure ventilation, and possibly administration of intravenous propofol or a small dose of succinylcholine (0.1 mg/kg).

**Vocal Cord Paralysis** Vocal cord paralysis can be due to nerve injury or mechanical injury and may be unilateral or bilateral. Injury to the recurrent laryngeal nerve prevents abduction of the ipsilateral vocal cord, which becomes fixed in a paramedian position because of the unopposed action of the cricothyroid muscle. An inflated endotracheal tube cuff in the subglottic larynx can compress the anterior branch of the recurrent laryngeal nerve as it enters between the cricoid and thyroid cartilage, resulting in nerve injury. Recurrent laryngeal nerve injury may occur after operations such as a rigid bronchoscopy, thyroid and parathyroid surgery, or laryngeal and thoracic surgery. Arytenoid avulsion can result in vocal cord immobility.<sup>10</sup>

Hoarseness usually is noted immediately after extubation. Healthy patients generally tolerate the resulting increased airway resistance, but it may become a problem in patients with preexisting pulmonary compromise. Bilateral recurrent laryngeal nerve injuries result in inadequate glottic opening and require emergent reintubation or tracheostomy. Vocal cord paralysis usually is associated with spontaneous recovery, but this may take a period of days to months. Otolaryngologic evaluation in the acute setting is generally warranted.

### Extrinsic Airway Compression

Acute extrinsic neck compression from an expanding neck hematoma can be life threatening. Neck hematomas can develop after carotid endarterectomy, thyroid or parathyroid surgery, or other neck surgery. Although many neck hematomas can be treated conservatively, they should be closely monitored for progression and signs of airway compromise. A rapidly expanding hematoma can cause marked tracheal deviation and make emergency reintubation extremely difficult. If possible, a subcu-

taneous clot should be decompressed by removing surgical sutures. Definitive treatment usually requires returning to the operating room for hematoma evacuation and exploration.

## PULMONARY DYSFUNCTION

General anesthesia inhibits hypoxic and hypercapnic ventilatory drive and reduces the lung's functional residual capacity. These changes may persist for variable periods of time postoperatively and predispose to hypoventilation and hypoxemia. Additional causes of hypoxemia and hypercapnia that are encountered in the PACU include aspiration, pulmonary edema, pulmonary embolism (PE), and pneumothorax.

### Hypoxemia

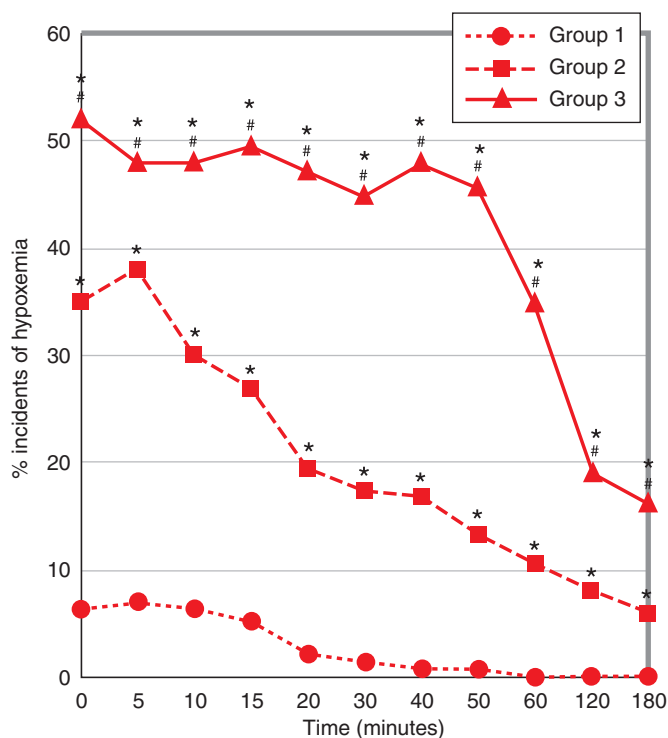
Hypoxemia is common in postoperative patients not receiving supplemental oxygen. In a study of patients undergoing transfer from the operating room to the PACU, Tyler et al.<sup>11</sup> found that 30% of patients had oxygen saturations ( $SpO_2$ ) <90% while breathing air. The most common causes of hypoxemia in the early postoperative period include hypoventilation

and atelectasis. Patients with preexisting lung disease or obesity and those recovering from thoracic and upper abdominal surgery are at increased risk (Fig. 73-2).<sup>12</sup>

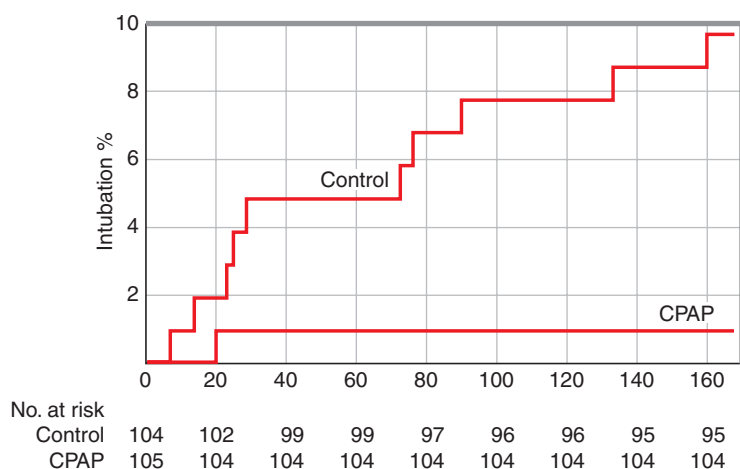
Following general anesthesia or sedation, all patients should receive supplemental oxygen ( $O_2$ ) during transport from the operating room and during their initial PACU stay. Continuous monitoring of oxygen saturation with pulse oximetry is essential to early detection of hypoxemia. It is important to remember that supplemental oxygen can prolong the time to desaturation, which may delay the detection of hypoventilation. Hypoxemia is treated by increasing the inspired oxygen concentration, elevating the head of the bed, performing lung expansion maneuvers, and eliminating other reversible causes (e.g., bronchospasm, secretions, and mucous plugs). Continuous positive airway pressure may be effective in treating more severe hypoxemia in some patients and decrease the need for endotracheal intubation (Fig. 73-3).<sup>13,14</sup>

### Hypoventilation

Hypoventilation is characterized by an inappropriately low minute ventila-



**FIGURE 73-2.** Incidence of hypoxemia in the first 180 minutes after surgery while patients were breathing room air. Group 1, Superficial plastic surgery; group 2, upper abdominal surgery; group 3, thoracoabdominal surgery. Points are incidence of hypoxemia ( $SpO_2$  85–90%). \* $P < .01$  vs group 1. # $P < .05$  vs group 2. From Xue FS et al.<sup>12</sup> with permission.



**FIGURE 73-3.** Intubation rates: continuous positive airway pressure + oxygen (CPAP) versus oxygen alone (control) for treatment of postoperative hypoxemia. The CPAP group had a significantly lower intubation rate ( $P = .005$ , log rank test) than did the group treated with oxygen alone. From Squadrone V et al.<sup>13</sup> with permission.

tion with resulting hypercapnia and respiratory acidosis. Severe hypoventilation results in hypoxemia, carbon dioxide ( $\text{CO}_2$ ) narcosis, and ultimately apnea. Causes of postoperative hypoventilation include decreased ventilatory drive, respiratory muscle insufficiency, increased  $\text{CO}_2$  production, and acute or chronic lung disease.

### Decreased Ventilatory Drive

The typical combination of inhaled anesthetics, opioids, and benzodiazepines can depress both the hypercarbic and hypoxic drive, resulting in hypoventilation. Development of postoperative hypercarbia can be deceptive, as patients may appear awake and even complain of pain while experiencing significant hypoventilation. Ventilatory depression from opioids and sedatives will become significantly worse, however, if the patient falls asleep (see Chapter 41). A balance must be achieved between adequate analgesia and an acceptable level of respiratory depression. Opioid-induced hypoventilation can be reversed by small incremental doses of naloxone (0.04–0.08 mg) while preserving some analgesia. Reversal usually occurs within 1–2 minutes and lasts for 30–60 minutes. Caution should be exercised as the duration of action of naloxone is shorter than that of most opioids, and repeated doses of naloxone or an infusion may be required. Flumazenil can reverse the sedative effects of benzodiazepines, but it does not reverse the depression of hypoxic drive (see Chapter 40). Flumazenil does not reverse opioid-induced depression.

### Respiratory Muscle Insufficiency

Incomplete reversal of neuromuscular blockade can result in airway obstruction and hypoventilation. The patient may exhibit dis-coordinated movements, generalized weakness, hypoxemia, or shallow breathing. Residual block is more common in patients who receive long-acting muscle relaxants such as pancuronium and those not treated with reversal agents (Fig. 73-4).<sup>15,16</sup>

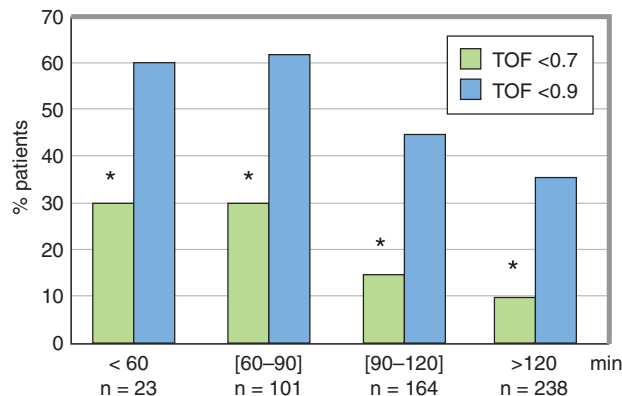
Limited chest expansion may be caused by pain (splinting) after thoracic and upper abdominal surgery, resulting in atelectasis and consequently right-to-left shunting. Better analgesia (particularly that produced by neuraxial and intercostal blocks) facilitates deep breathing and significantly reduces hypercapnia and hypoxemia.

Many factors increase the work of breathing for postoperative patients.

For example, the functional residual capacity can be reduced by airway closure and collapse, and significant muscular effort then is required for lung reexpansion. Other intrathoracic factors, such as pulmonary edema, pneumothorax, restrictive lung diseases, and skeletal abnormalities, can reduce lung compliance and increase energy expenditure for breathing. Obesity, gastric distension, and restrictive dressings on the chest or abdomen are extrathoracic factors that result in increased work of breathing and the potential for inadequate ventilation. Incentive spirometry, chest physiotherapy, upright positioning, and continuous positive airway pressure may be effective therapeutic maneuvers for these patients.

### Acute or Chronic Lung Disease

Preexisting pulmonary disease is an important risk factor for developing postoperative pulmonary complications.<sup>17</sup> Respiratory diseases usually are categorized according to the manner in which they alter pulmonary mechanics, producing either a limitation of expiratory airflow (obstructive disease) or a limitation of lung expansion (restrictive disease). Exacerbations of obstructive diseases, such as asthma and chronic obstructive pulmonary disease (COPD), are frequently accompanied by increasing hypercapnia and worsening hypoxemia. The key management issues are similar in both acute asthma and COPD exacerbations. They include treating bronchospasm and airway inflammation, correcting hypoxemia and respiratory acidosis, clearing secretions, and removing/treating pre-



**FIGURE 73-4.** Residual paralysis rate. Partial paralysis rate (percent) according to delay between administration of an intermediate-duration muscle relaxant (atracurium, vecuronium, rocuronium) and arrival in the postanesthesia care unit. Train-of-four (TOF) ratios < 0.7 and < 0.9 were examined as criteria for partial paralysis. Neuromuscular blockade was not reversed at the end of the procedure. From Bebaene B et al.<sup>16</sup> with permission.



precipitating factors. The concerns for CO<sub>2</sub> retention and respiratory depression resulting from administration of supplemental oxygen to patients with COPD have been overemphasized.<sup>18</sup> In all cases, correction of hypoxemia should take precedence over concerns for carbon dioxide retention.

Restrictive pulmonary disorders are characterized by decreased lung compliance resulting from intrinsic disease of the lungs (e.g., pulmonary fibrosis, pulmonary edema) or extrinsic disorders (e.g., pleural effusions, obesity, scoliosis, abdominal distension, massive ascites) that impair normal lung expansion. Management is directed at treating the underlying disease process (e.g., steroids for pulmonary fibrosis, draining the pleural space, etc.) and supportive respiratory care.

## Aspiration

General anesthesia and surgery depress airway protective reflexes and predispose patients to aspiration. Gastric contents or objects such as dislodged teeth can enter the trachea during induction or emergence, and even after PACU admission. Perioperative pulmonary aspiration is an infrequent event (1: 2000–3000 general anesthetics), but it can result in severe morbidity and mortality.<sup>19</sup> Signs of significant aspiration include bronchospasm, hypoxemia, atelectasis, tachypnea, tachycardia, and hypotension. Radiographic evidence of aspiration (usually infiltrates in the upper lobes of supine patients) may take some time to appear.

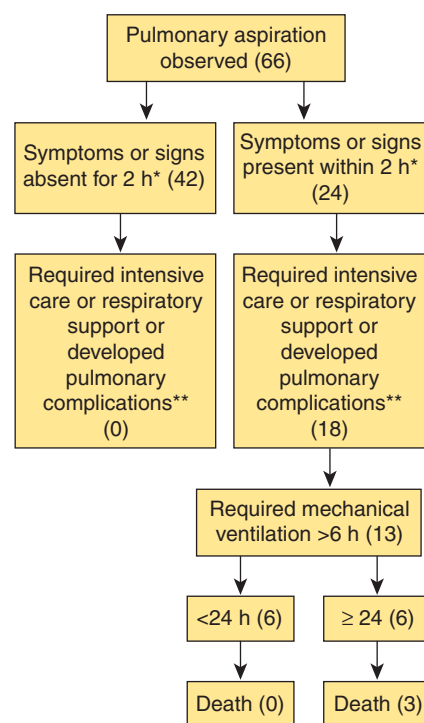
The severity of symptoms depends on the type and volume of material aspirated. *Aspiration pneumonia* (Mendelson syndrome) is a chemical injury to the lungs that is caused by inhalation of sterile acidic gastric contents, whereas *aspiration pneumonia* refers to inhalation of contents that are colonized by pathogenic bacteria.<sup>20</sup> Initial treatment of a significant aspiration consists of oropharyngeal suctioning, administration of bronchodilators for bronchospasm, and supplemental oxygen. Plans should be made for transfer of the patient to an intensive care unit (ICU). Bronchoscopy may be beneficial to remove particulate matter from the tracheobronchial tree, but pulmonary lavage with large volumes of saline is generally believed to be detrimental. Mechanical ventilatory support with positive end-expiratory pressure may be necessary if hypoxemia is severe.

Administration of empiric antibiotics for aspiration is not recommended unless the material aspirated has a high bacterial load, as with a small bowel obstruction. Steroids are not beneficial for treatment if administered after an aspiration has occurred. In cases of mild or uncertain aspiration, close postoperative observation should be undertaken with continuous pulse oximetry monitoring and chest radiography. Patients with clinical evidence of aspiration who do not develop signs or symptoms (cough, wheeze, hypoxia on room air, or radiologic abnormalities) within 2 hours of aspiration are unlikely to develop pulmonary complications (Fig. 73–5).<sup>21,22</sup>

## Pulmonary Edema

Pulmonary edema is the accumulation of fluid in the interstitium and alveoli of the lungs that can hinder gas exchange. Cardiac pulmonary edema results from increased pulmonary capillary pressure secondary to elevated left atrial pressure that may be precipitated by fluid overload, left ventricular dysfunction, or mitral valve disease. A careful physical examination, chest x-ray film, electrocardiography (ECG), and arterial blood gas analysis are useful for diagnosis. Evaluation by a cardiologist may be indicated when myocardial ischemia or acute valvular disease is considered to be the cause of the pulmonary edema. Noncardiac pulmonary edema usually is due to increased pulmonary capillary permeability. Mainstays of treatment include supplemental oxygen, diuretics, vasodilators, and mechanical ventilatory support with positive end-expiratory pressure.

Pulmonary edema can occur in the operating room or PACU secondary to acute upper airway obstruction (*negative-pressure pulmonary edema*). During upper airway obstruction, forceful inspiratory efforts against a closed glottis can result in large negative intrathoracic pressures with an increased left ventricular preload and afterload. In addition, hypoxia and increased circulating catecholamine levels may elevate pulmonary and systemic vascular resistance, shift the intraventricular septum to the left, and cause left ventricular diastolic dysfunction. These result in negative-pressure pulmonary edema, a rapid onset of copious pink fluid with bubbles due to acute fluid filtration into the lung, and capillary



**FIGURE 73–5.** Relationship of symptoms or signs of perioperative pulmonary aspiration that develop within 2 hours of aspiration to pulmonary outcomes. \*Symptoms or signs of pulmonary aspiration include development of a new cough or wheeze, decrease in SpO<sub>2</sub> while breathing room air  $\geq 10\%$  preoperative value, alveolar-arterial oxygen tension  $\geq 300$  mmHg, and radiologic evidence of pulmonary aspiration. \*\*Pulmonary complications included development of radiologic evidence of acute respiratory distress syndrome, pneumonia, or pneumonia. From Warner MA et al.<sup>21</sup> with permission.

failure resulting in alveolar hemorrhage and hemoptysis.<sup>23,24</sup>

## Pulmonary Embolism

PE contributes to 50,000–200,000 deaths annually.<sup>25</sup> The mortality rate exceeds 15% in the first 3 months after the diagnosis is made, and in nearly 25% of patients with PE, the initial clinical sign is sudden death.<sup>26</sup> Under pathologic conditions, thrombi escape the normal fibrinolytic system, propagate in the deep veins of the lower extremities and pelvis, and then dislodge and embolize blocking pulmonary vessels. Thrombosis is triggered by venous stasis, hypercoagulability, and vessel wall inflammation (Virchow's triad). The diagnosis of PE can be challenging because the clinical presentation can vary substantially. Dyspnea is the most frequent symptom, although patients may be asymptomatic. A patient with a massive PE may present with hypotension, severe

hypoxemia, cardiogenic shock, or cardiac arrest. ECG may reveal signs of right ventricular strain but may be entirely normal in previously healthy patients, and the chest x-ray film is often normal. Chest CT has become the primary diagnostic imaging modality to evaluate suspected PE. Alternate imaging modalities include a ventilation-perfusion lung scan, magnetic resonance angiography, echocardiography, and pulmonary angiography. Treatment of PE is supportive (volume infusion, vasopressors, and mechanical ventilation) because anticoagulation or thrombolytic therapy often is not an option in the immediate postoperative period. Inhaled nitric oxide has been given experimentally to reverse pulmonary vasospasm. Insertion of an inferior vena cava filter may be beneficial to prevent further embolism in patients in whom anticoagulation is contraindicated. In patients with severe hypoxemia and/or hypotension, emergency pulmonary embolectomy may be required.

## Pneumothorax

*Pneumothorax* is the accumulation of gas within the pleural space. It can result from surgical entrance into the pleural space during thoracic, upper abdominal, or retroperitoneal surgery, tracheostomy, or surgery on the chest wall or neck. Other causes include blunt or penetrating trauma, rupture of blebs or bulla, barotrauma from positive-pressure ventilation, and as a complication of procedures such as central line placement, thoracentesis, or upper extremity neural blockade.

A *tension pneumothorax* occurs when the site of pulmonary air leak forms a one-way valve, allowing airflow into the pleural space during inspiration but preventing its elimination during expiration. The rapid unilateral increase in intrathoracic pressure can be life threatening because it can produce a contralateral mediastinal shift with a rapid deterioration in gas exchange, diminished cardiac output, and marked hemodynamic instability. Diminished or absent chest sounds on auscultation may be present over one hemithorax. If a tension pneumothorax is suspected and hemodynamic or respiratory status is compromised, then decompression should be performed immediately, without waiting for confirmation of the diagnosis by chest radiography. A 14-gauge angiocath can be placed through

the chest wall in the second intercostal space at the midclavicular line or the fourth intercostal space at the midaxillary line. The needle is removed, and the catheter is held securely in position until a tube thoracostomy can be performed. A rush of released air and immediate improvement in respiratory and hemodynamic status should occur when decompression is successful.

A disposable one-piece suction device (e.g., Pleurovac) is commonly used for chest tube drainage. The underlying principle of drainage is the same as the original “three-bottle” system, but the apparatus is more compact with fewer connections. The proximal compartment collects drainage, the middle prevents flow of air back into the thorax by forming a water seal, and the distal compartment regulates the amount of suction that is applied to the pleural cavity (Fig. 73-6). General-

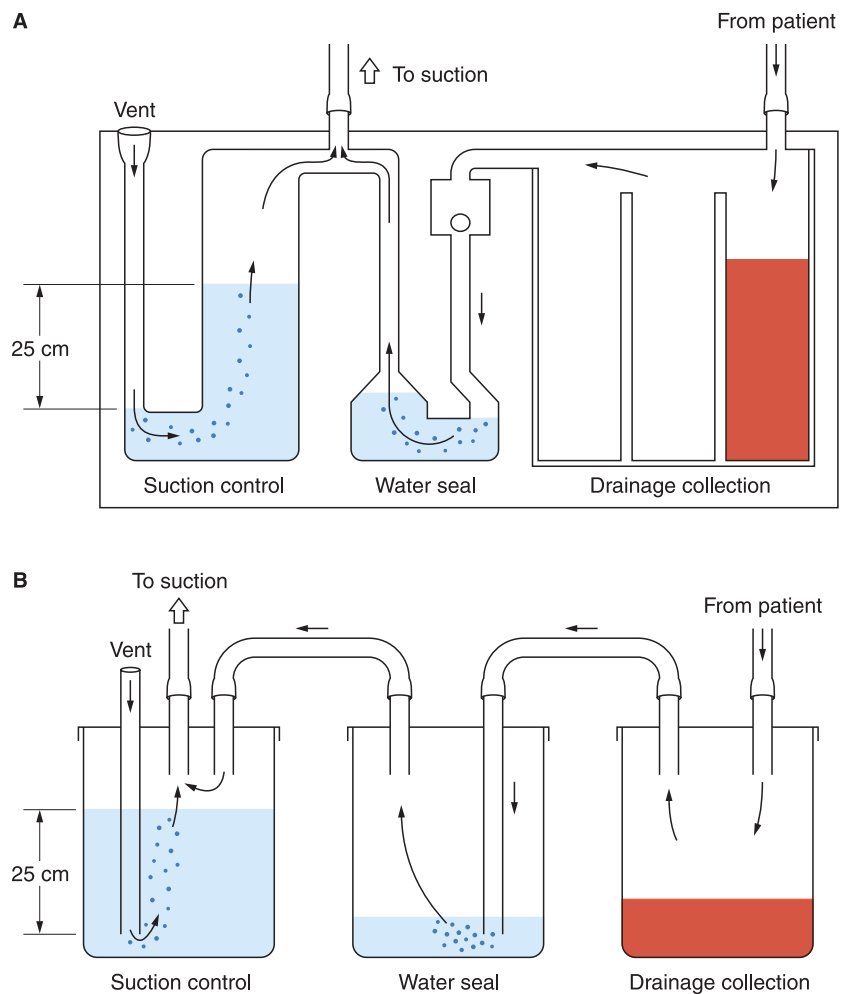
ly, the chest tube initially is given active suction of 20 cm H<sub>2</sub>O. If no bubbles are observed in the water seal (i.e., no air leak is detected), active suction may not be necessary.

Chest tubes should be monitored continuously to ensure that they are functioning properly and achieving the desired therapeutic effect. The position of the chest tube, lung expansion, and fluid content of the pleural space should be evaluated by chest radiography.

## Prolonged Intubation

Several conditions may necessitate continued intubation after surgery. They include delayed emergence from general anesthesia, inadequate reversal of neuromuscular blockade, potential for airway obstruction, inadequate gas exchange, and hemodynamic instability.

Delayed emergence from general anesthesia due to volatile or IV agents



**FIGURE 73-6.** Chest tube drainage system. **A.** Commercial apparatus. The proximal chamber is for pleural drainage, the middle chamber (water seal) prevents air or fluid from being driven in to the thorax, and the distal chamber regulates the level of suction. **B.** Traditional “three-bottle” system for comparison. From Davignon et al.<sup>86</sup> with permission.

is an indication to delay extubation (see Delayed Awakening below). Reversal may be facilitated pharmacologically, but generally it is prudent to provide support with controlled or assisted ventilation until the patient spontaneously emerges. Spontaneous ventilation of the intubated patient through a “T-piece” may be sufficient when prolonged emergence is not foreseen. The presence of a full stomach mandates that laryngeal reflexes and consciousness be fully recovered before extubation to avoid aspiration.

The potential for airway obstruction is highest after head and neck procedures, drainage of pharyngeal abscesses, or when the jaws are wired closed following facial trauma. As stated previously, obstruction from glottic edema can occur after prolonged surgery, especially in the prone or head-down position. Hemodynamic instability, when severe, may be associated with a variable degree of impaired gas exchange or impaired consciousness that requires continuation of mechanical ventilation. A cardiovascular system that is stressed by hypovolemia, hypothermia, or myocardial ischemia may not be able to compensate for marginal oxygenation or ventilation. Early admission to an ICU should be considered for patients who are not anticipated to improve after a few hours in the PACU.

## CARDIOVASCULAR DYSFUNCTION

### Hypotension

Hypotension is a common postoperative complication that can result from hypovolemia, decreased systemic vascular tone, and/or reduced cardiac output. Hypotension can result in myocardial ischemia or infarction, stroke, acute renal failure (ARF), and bowel ischemia. During hypotension, the body attempts to redirect blood flow toward the brain, heart, and kidneys, so signs of hypoperfusion of these organs suggest that compensatory mechanisms have failed. Hypotension may be defined as a >20% decline of blood pressure from baseline or evidence of end-organ hypoperfusion.

Accurate measurement of blood pressure is essential to making a correct diagnosis of hypotension. An inappropriately large blood pressure cuff or an arterial transducer that is im-

properly zeroed, positioned, or dampened can lead to falsely low blood pressure readings.

### Hypovolemia

Causes of hypovolemia in the PACU include inadequate fluid replacement, ongoing hemorrhage, and fluid sequestration (“third spacing”). Clinical evaluation of a patient’s intravascular volume status requires consideration of preoperative status and comorbid conditions, type and duration of surgery, estimated blood loss, fluid replacement, and evidence of hemostasis. Signs of hypovolemia include hypotension, tachycardia, orthostasis, decreased skin turgor, oliguria, and dry mucus membranes. Administration of a fluid bolus during the initial assessment is generally a safe maneuver. Persistent hypotension despite seemingly adequate fluid replacement requires further assessment and may require monitoring of central venous and pulmonary artery pressures or echocardiography.

### Systemic Vasodilatation

Neuraxial anesthesia, residual inhalation agents, administration of vasodilators, rewarming after hypothermia, transfusion reactions, systemic inflammation, and sepsis can cause hypotension by decreasing systemic vascular resistance and impairing venous return. Hypovolemia increases systemic hypotension due to vasodilatation, but fluid resuscitation often does not fully restore the blood pressure. Pharmacologic treatment includes administration of a peripheral vasoconstrictor. A pure  $\alpha_1$ -agonist, such as phenylephrine, often is chosen because it is unlikely to cause dysrhythmias and can be administered through a peripheral intravenous line. Administering powerful pressor agonists, such as norepinephrine, usually requires a central venous line for administration. Diagnosis and treatment of the specific etiology of the vasodilatation should be concurrent with symptomatic treatment.

### Myocardial Ischemia and Infarction

A variety of factors in the perioperative period may alter the balance between myocardial oxygen supply and demand. The body’s physiologic response to surgery is an increase in circulating catecholamines that increases myocardial demand by in-

creasing heart rate, myocardial contractility, and peripheral vascular resistance. Myocardial oxygen supply may be decreased by perioperative factors such as hypoxemia and hypotension. Patients with coronary artery disease or those at risk for coronary disease have significantly higher rates of perioperative myocardial ischemia, infarction, and cardiac death.<sup>27</sup> Manganò et al.<sup>28</sup> reported that the incidence and severity of perioperative myocardial ischemia were greatest during the first 48 hours after surgery. Badner et al.<sup>29</sup> reported that the peak incidence of perioperative myocardial infarction (MI) occurred during the first 24 hours following surgery.

The diagnosis of perioperative ischemia can be difficult because the condition often is silent. Postoperative chest pain may be masked by residual anesthesia or analgesics, and pain perception may be altered by the competing stimulus of incisional pain. The patient at high risk for perioperative myocardial ischemia and MI should be assessed by ECG preoperatively, immediately after surgery, and daily for the first 2 postoperative days.<sup>30</sup> In patients with suspicion of a silent perioperative MI, serial markers of myocardial injury (troponin, creatine phosphokinase) should be followed. Therapy for perioperative ischemia or MI is similar to that for other medical patients with MI and includes aggressive pain control,  $\beta$ -blockade, aspirin, and nitrates.

### Dysrhythmias

Cardiac dysrhythmias are common during the perioperative period; transient dysrhythmias reportedly occur in 62–84% of patients.<sup>31</sup> Most perioperative dysrhythmias are benign. They are most likely to occur in patients with underlying structural heart disease; however, the precipitating factor is usually a transient imbalance such as hypoxia, ischemia, increased circulating catecholamine levels, altered acid-base status, or electrolyte abnormalities. The clinical significance of a dysrhythmia depends on the patient’s underlying cardiac function. Bradycardia may cause a clinically significant reduction in cardiac output in a patient with relatively fixed stroke volume. Tachycardia may reduce cardiac output by decreasing diastolic filling time and increasing myocardial oxygen consumption, resulting in myocardial ischemia. Loss of atrial contrac-

tion in atrial fibrillation may decrease cardiac output by decreasing diastolic filling. The management strategy for a new dysrhythmia is focused on stabilizing hemodynamics and treating the underlying problem. Significant hemodynamic instability resulting from a dysrhythmia is an indication for emergent cardioversion.

Specific antiarrhythmic therapy in the postoperative setting is similar to that in the nonoperative setting, but it will generally not be effective unless the precipitants are identified and treated.

### Tachycardia

Tachyarrhythmias usually are classified according to their anatomic origin as either supraventricular or ventricular. Supraventricular arrhythmias include sinus tachycardia, atrial fibrillation and flutter, ectopic atrial tachycardia, multifocal atrial tachycardia, junctional tachycardia, atrioventricular nodal reentrant tachycardia, and accessory pathway reciprocating tachycardias. Ventricular arrhythmias consist of ventricular premature beats, ventricular tachycardia, and ventricular fibrillation. For a comprehensive discussion of cardiac arrhythmias, see Chapters 43 and 51.

Sinus tachycardia is the most common dysrhythmia in the immediate postoperative period. Increased sympathetic discharge resulting from pain, hypovolemia, anemia, anxiety, hypoxia, and hypercarbia are common causes. Sinus tachycardia usually is benign; however, it may precipitate myocardial ischemia in a patient with coronary artery disease. Treating the underlying cause(s) (e.g., with analgesics for pain, intravenous fluids for hypovolemia, sedatives for anxiety) usually is adequate for resolution. In patients at risk for myocardial ischemia,  $\beta$ -blockade usually is effective in reducing the heart rate.

Supraventricular tachyarrhythmias are more common after thoracic surgery, than after other types of noncardiac surgery with a reported incidence  $\geq 15\%$ .<sup>32</sup> In these patients, prophylaxis with calcium channel blockers or  $\beta$ -blockers has been shown to significantly reduce the occurrence of atrial fibrillation.<sup>32</sup>

Atrial fibrillation is the most common supraventricular dysrhythmia after both cardiac and noncardiac surgery and has the greatest potential for serious consequences.<sup>33</sup> For unstable

patients with atrial fibrillation and a rapid ventricular rate, urgent cardioversion is indicated. In hemodynamically stable patients,  $\beta$ -blockers, calcium channel blockers, or amiodarone are alternatives for rate control. In most patients, atrial fibrillation will resolve within 36–48 hours. New-onset atrial fibrillation raises risks for embolism, but anticoagulation may not be possible in a postoperative patient at risk for bleeding.

### Bradycardia

Bradycardia usually is associated with sinus node or atrioventricular node dysfunction. The various possible presentations are sinus bradycardia, sinus pause, sinoatrial block, sinus arrest, junctional rhythms, and varying degrees of heart block. At sufficiently slow heart rates, ventricular escape beats may be seen. In the postoperative setting, bradycardia is often due to increased vagal tone as a result of hypoxemia, pain, nausea, drugs (e.g., neostigmine,  $\beta$ -blockers, or opioids), or the effects of neuraxial anesthesia. Sinus bradycardia can be a normal rhythm in a young healthy patient. Bradycardia without hypotension usually is benign, and no treatment is needed. If the bradycardia is associated with hemodynamic compromise (hypotension, low cardiac output) then treatment with antimuscarinic agents (glycopyrrolate or atropine) or  $\beta$ -agonists (ephedrine) can restore normal sinus rhythm.

Development of complete heart block can occur in patients with preexisting conduction disease, and the resulting idioventricular bradycardia often will compromise systemic hemodynamics. Atropine may improve atrioventricular nodal conduction to allow supraventricular impulse transmission. Epinephrine, isoproterenol, and ventricular pacing will increase the ventricular rate. In the setting of complete heart block, the need to provide either external or internal pacing must be anticipated. Consultation with a cardiologist in anticipation of pacing requirements is recommended.

### Ectopy

Ectopic beats, whether atrial or ventricular, are common and by themselves do not necessarily imply underlying cardiac disease. In the postoperative period, ectopic beats often are associated with electrolyte imbalances, hy-

poxia, acid–base abnormalities, and hypertension. They may result from drug therapy (e.g., digitalis toxicity) or cardiac irritation from central venous catheters. Hypokalemia and hypomagnesemia are the most common electrolyte abnormalities associated with ectopy. Care should be taken when correcting these abnormalities because rapid administration of large quantities of either potassium or magnesium can cause greater problems than the original ectopy.

Frequent premature atrial contractions usually are of minor hemodynamic significance but may be harbingers of supraventricular tachycardia or atrial fibrillation. Medical therapy is generally not needed, but the patient should be monitored closely.

Similarly, premature ventricular contractions in an asymptomatic patient generally do not require treatment. Ventricular ectopy that was present preoperatively usually reappears postoperatively and does not predict an adverse outcome.<sup>34</sup>

### Postoperative ECG Changes

ECG changes are common after anesthesia and surgery. Changes in P- or T-wave morphology, intraventricular conduction, or ST segments may occur in the absence of a cardiac abnormality or ischemia. These changes result from the cardiac effects of anesthetics and other administered drugs, increased sympathetic tone, hypothermia, and electrolyte imbalances. Breslow et al.<sup>35</sup> reported an 18% incidence of T-wave changes in a postoperative population. These changes occurred with equal frequency in all age groups and were not more common in patients with preexisting coronary artery disease. During postoperative followup, these patients did not show any evidence of myocardial ischemia or injury, and most of the ECG changes resolved with 24 hours. Of course, when there is a suspicion of perioperative ischemia, T-wave changes should be treated as a potential MI, adding therapeutic control of heart rate and blood pressure, obtaining serial ECGs and cardiac enzyme levels, as well as a cardiology consultation.

### Hypertension

Hypertension is a very common problem in the postoperative period. It typically has an early onset (usually within 2 hours after surgery) and requires treatment for 6 hours or less. It



occurs most commonly after vascular, head and neck, and neurosurgical procedures (Table 73-3).<sup>36</sup> Patients with pre-existing hypertensive disease are more likely to develop postoperative hypertension, especially if antihypertensive medications were withheld preoperatively. Sympathetic nervous system activation resulting from noxious stimuli, such as pain, anxiety, bladder distension, fluid overload, hypoxemia, hypercarbia, and hypothermia, are other common precipitants. Complications of severe postoperative hypertension include myocardial ischemia/infarction, dysrhythmias, congestive heart failure, stroke, and increased surgical bleeding. For some of these complications, whether systemic hypertension was the cause or the consequence is unclear.

The decision to treat hypertension should take into consideration the patient's baseline blood pressure, coexisting diseases, and perceived risk of complications. Systolic or diastolic blood pressure >20% above baseline, signs or symptoms of complications such as chest pain or dysrhythmias, or a perceived increased risk of complications are indications for treatment. Reversible causes of hypertension (e.g., pain, anxiety, bladder distension) should be ruled out before antihypertensive therapy is initiated. For patients with preexisting hypertension, resumption of chronic antihypertensive therapy is a sensible option. Short-term control of blood pressure in the PACU is best accomplished with drugs that have a rapid onset and possess a short-to-intermediate duration of action. Intravenous agents such as labetalol, esmolol, propranolol, and hydralazine are commonly used for short-term blood pressure control. For persistent or refractory hypertension, continuous infusions of vasodilators such as nitroprusside, nitroglycerin, or fenoldopam may be needed.

## URINARY AND RENAL DYSFUNCTION

Postoperative bladder distension with associated urinary retention may induce pain, restlessness, and delirium and may delay PACU discharge. Furthermore, severe or prolonged bladder distension may cause permanent damage to the detrusor muscle. The prevalence of postoperative bladder distension, which ranges from 1% to >50% of patients, depends on the population,

type of surgery, and method of estimating bladder distension.<sup>37</sup> A study of predictive factors for early postoperative urinary retention in the PACU found older age ( $\geq 50$  years), bladder volume on entry to PACU ( $\geq 270$  mL), and quantity of intraoperative fluids administered ( $> 750$  mL) each independently increased the risk of urinary retention.<sup>38</sup> Based on these results, it was suggested that regular evaluation of bladder volume with ultrasound should occur in the PACU, especially in patients with the enumerated risk factors.

Oliguria, defined as a urine output  $< 0.5$  mL/kg/h, is a frequent postoperative occurrence. Oliguria may be a sign of ARF, a condition associated with a markedly increased morbidity and mortality in the postoperative patient.

- Prerenal ARF is caused by decreased renal perfusion due to a decreased effective circulating blood volume or impaired renal hemodynamics. Hypovolemia is the most common prerenal cause of oliguria in this setting. Administration of a 250- to 500-mL IV fluid bolus helps to rule out hypovolemia. Maintenance of adequate systemic blood pressure (based on preoperative values) is essential to allow sufficient renal perfusion. If urine output does not improve despite what appears to be an adequate fluid resuscitation and blood pressure, then a more extensive investigation is warranted. Central monitoring and/or echocardiography may provide better assessment of intravascular filling and cardiac function.
- Postrenal ARF is caused by obstruction of urinary flow. In patients without a bladder catheter, it is important to determine the time since last voiding. Placement of a urinary catheter helps to differentiate insufficient urine production from the inability to void. Assessing the urinary catheter for kinking, obstruction (by irrigation), or migration is important to exclude common postrenal causes of oliguria.
- Intrinsic ARF is divided into tubular (acute tubular necrosis [ATN]), interstitial, glomerular, and vascular etiologies. Analysis of urine electrolytes, osmolality, and cast formation may be helpful in this assessment. Diuretics should be given sparingly because they may worsen preexisting renal injury, and forced diuresis does not improve the prognosis of ARF. Intra-

TABLE 73-3.

### Frequency of Acute Postoperative Hypertension by Surgical Procedure

Procedure	Frequency
Carotid endarterectomy	9-64%
Cardiac surgery	22-54%
Abdominal aortic surgery	33-75%
Radical neck dissection	10-20%
Intracranial surgery	57-91%
Elective general surgery	3-20%
Flexion contracture release	46%

Originally published in and adapted from Haas CE, LeBlanc JM. Acute postoperative hypertension: a review of therapeutic options. *Am J Health-Syst Pharm* 2004;61:1661[comp:en dash]1673. © 2004, American Society of Health-Systems Pharmacists, Inc. All rights reserved. Reprinted with permission. (R0710)

operative events that could result in ARF (e.g., extended aortic cross-clamping, prolonged systemic hypotension, possible ureteral ligature, or trauma) should be investigated. Imaging studies such as ultrasonography, CT, angiography, or radionuclide scanning may be indicated to clarify renal status and exclude reversible causes of injury. Early consultation with a nephrologist is indicated.

Entrance of irrigation fluid into the intravascular space during cystoscopy may lead to substantial fluid and electrolyte shifts. This is best described for the setting of *transurethral resection of the prostate (TURP) syndrome*.<sup>39</sup> A similar syndrome has been described in women undergoing transcervical endometrial ablation. In both cases, irrigation is performed with solutions of glycine that are nonconductive and permit use of electrocautery. Signs and symptoms result from acute changes in intravascular volume, increases in levels of plasma glycine, and rapid decreases in plasma sodium concentration. At the extreme, hyponatremia may produce convulsions, coma, and death. Cardiovascular findings can include hypertension (from hypervolemia) or hypotension (from congestive heart failure), dysrhythmias, pulmonary edema, and cardiac arrest. The diagnosis is confirmed by measuring plasma sodium and osmolality. Management involves providing supportive care, including diuretics for

volume overload and administration of isotonic saline. Hypertonic saline therapy may be warranted when the plasma sodium level falls to  $<120$  mmol/L or when acute neurologic deterioration occurs.<sup>40</sup> Caution should be exercised when infusing hypertonic saline because overly rapid correction has been linked to central pontine myelinolysis.

## CNS DYSFUNCTION

### Delirium

Delirium is a transient, fluctuating disturbance of consciousness, attention, cognition, and perception. Postoperative delirium is a common problem in the PACU, with a reported incidence of 3–5% in adults.<sup>41,42</sup> The delirious patient often is hypertensive and tachycardic, and the accompanying agitation can have serious consequences, including trauma, disruption of suture lines or surgical repairs, and accidental removal of catheters, tubes, and drains. Healthcare providers are also at risk for injury. Postoperative delirium is more common in the elderly, in whom it may delay recovery and prolong hospital stay.<sup>43,44</sup> Other preoperative risk factors include organic brain disease, alcohol and sedative withdrawal, anxiety, and depression. Intraoperative risk factors include specific types of surgery (e.g., cardiac, orthopedic, ophthalmologic) and administration of certain drugs (e.g., anticholinergics, barbiturates, benzodiazepines). Perioperative hypoxemia, hypotension, and sepsis are believed to be risk factors. There appears to be no difference in the incidence of postoperative delirium with either neuraxial or general anesthesia.<sup>45</sup>

The first priority in management of postoperative delirium is to rule out physiologic causes, including hypoxemia, hypotension, and acidemia. Postoperative pain often plays a significant role and should be treated adequately.<sup>46</sup> Other causes include hypoglycemia, electrolyte disturbances, sepsis, and sensory overload. Bladder or gastric distension, or other nonsurgical pain sources (e.g., corneal abrasion, infiltrated IV, poor positioning) should be excluded. Delirium should be treated supportively with verbal reassurance that the surgery is over and that the patient is doing well. Symptomatic medications may be indicated in some circumstances. Physostigmine is helpful when delir-

ium is believed to be the result of central anticholinergic drugs such as scopolamine. Although haloperidol does not improve the disordered thinking, the catatonia that it produces may protect the patient from physical harm.

### Delayed Awakening

The major causes of delayed awakening after general anesthesia can be divided into three groups: (1) prolonged pharmacologic effects, (2) metabolic abnormalities, and (3) neurologic injury. The residual effects of anesthetic drugs are the most common cause of delayed awakening. It is important to obtain information on the patient's preoperative level of arousal, the timing and dosage of sedatives and opioids administered, and use of volatile anesthetics and muscle relaxants. Volatile anesthetics, especially those with high solubility, are more likely to result in delayed awakening after longer procedures or in obese patients. If residual sedative effects of opioids or benzodiazepines are suspected, then pharmacologic reversal with naloxone or flumazenil, respectively, can be used for evaluation. Administration of physostigmine (1.25 mg IV) nonspecifically reverses the anesthetic effects of some sedative and inhalational agents. The effects of profound neuromuscular blockade can mimic unconsciousness by preventing a motor response to stimuli. In this situation, spontaneous ventilation and movement will be absent, although autonomic responses may remain present. Possible causes of prolonged paralysis include an overdose of neuromuscular blocking agents, their impaired clearance, a drug interaction (e.g., with certain antibiotics), or a failure to reverse. The possibility that the patient has pseudocholinesterase abnormality or an unrecognized neuromuscular disease also be should considered. Evaluation with a train-of-four nerve stimulator is straightforward.

Metabolic causes of delayed awakening include hypoxemia, hypercapnia, hepatic, renal or endocrine dysfunction, and glucose and electrolyte abnormalities. Hypoglycemia should be considered early, and 50% dextrose should be administered immediately if hypoglycemia is suspected. Hyperglycemia, resulting in hyperosmolar coma or diabetic ketoacidosis, also can be a cause. Obtaining arterial blood gas and plasma chemistries are the first steps in identifying metabolic etiologies.

Sleep deprivation and disruption of normal sleeping patterns in children can result in difficulty with arousal (see Chapter 63). Profound hypothermia ( $<33^{\circ}\text{C}$ ) can cause unconsciousness and increase the sedative effects of medications. Extreme hypothermia can cause fixed dilated pupils and areflexia. Overdosage with local anesthetics or inadvertent subarachnoid injection during retrobulbar block can cause unconsciousness.

If the diagnosis remains uncertain, then neurologic consultation should be sought. Urgent radiologic imaging (e.g., CT, MRI) can be performed to rule out a structural abnormality or hypoxic injury. Trauma patients may be found to have unrecognized intracranial injury. Cerebral vascular accidents, although uncommon after general surgery, can occur in the perioperative period.<sup>47,49</sup> Subclinical generalized seizures are an uncommon cause of postoperative unconsciousness. Patients often are slow to awaken after long intracranial procedures; however, consideration should be given to the occurrence of complications such as intracranial hemorrhage or increased intracranial pressure. Rarely, psychiatric causes can result in impaired consciousness.<sup>48</sup>

### Stroke

The incidence of perioperative stroke varies with the type and complexity of the surgical procedure, with the reported incidence ranging from as low as 0.08% after general surgical procedures to  $>9\%$  in complicated cardiac and vascular surgery.<sup>49</sup> Perioperative strokes are predominately embolic and ischemic. Approximately half of perioperative strokes are identified within the first postoperative day.<sup>49</sup> These early strokes generally result from emboli from manipulations of the heart or the aorta or from particulate matter emanating from cardiopulmonary bypass. Strokes occurring after the first postoperative day generally are caused by emboli resulting from atrial fibrillation, MI resulting in cerebral hypoperfusion, and coagulopathy. Surgery-induced hypercoagulopathy, general anesthesia, dehydration, bedrest, and perioperative withholding of antiplatelet and anticoagulant medications are factors contributing to thrombotic events such as stroke. Early diagnosis and management is essential to improving outcome after stroke. However, diagnosis may

be difficult because symptoms such as somnolence, slurred speech, visual changes, agitation, confusion, numbness, and muscular weakness or paralysis may overlap with the effects of residual anesthetics. Neurologic consultation in conjunction with radiologic imaging is mandatory to guide therapy. Administration of intravenous thrombolytics may be contraindicated in patients who have recently undergone major surgery. However, intraarterial administration of tissue plasminogen activator and endovascular mechanical clot disruption are potentially safer options in the postoperative period.<sup>50,51</sup>

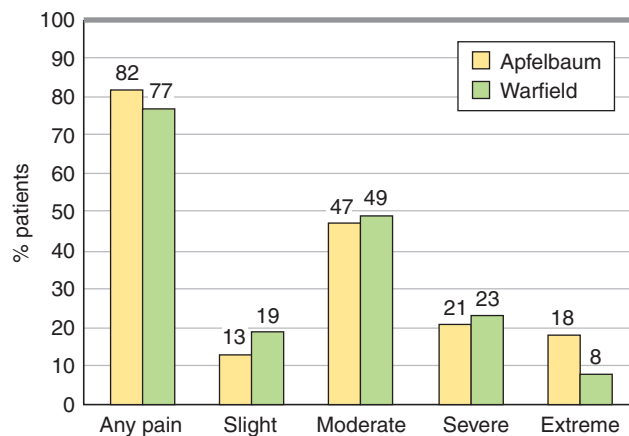
## INTRAOPERATIVE AWARENESS

Awareness with recall of intraoperative events is an infrequent but recognized complication of general anesthesia, with a reported incidence of 0.1–0.2%.<sup>52</sup> Awareness can result in significant distress to patients and long-term psychological sequelae, including symptoms associated with post-traumatic stress disorder. Certain patient characteristics (e.g., younger age, higher American Society of Anesthesiologists [ASA] physical status, history of alcohol or drug tolerance, history of difficult intubation), types of procedures (e.g., cesarean section, cardiac surgery, trauma surgery), and anesthetic techniques (e.g., rapid sequence induction, reduced anesthetic doses) are associated with an increased risk of intraoperative awareness.<sup>53</sup> A questionnaire such as that proposed by Brice et al.<sup>54</sup> is a useful way to screen for intraoperative awareness in the PACU and during the postoperative visit.

For the patient indicating possible awareness, the clinician should speak with the patient to obtain specific details of the event and to learn possible reasons for its occurrence. The patient should be offered counseling and psychological support.

## COMPLICATED ACUTE PAIN MANAGEMENT

Despite increased knowledge of the mechanisms of acute pain and increased emphasis on pain management programs, postoperative pain continues to be undermanaged (Fig. 73–7).<sup>55,56</sup> Inadequate pain relief may have harmful physiologic and psychologic conse-



**FIGURE 73–7.** Severity of postoperative pain. Results from a national survey of patients who had recently undergone surgical procedures. Patients reported intense pain after surgery, and the incidence of reported pain did not decrease compared with a similar survey reported 8 years earlier. From Apfelbaum et al.<sup>55</sup> with permission.

quences resulting in increased postoperative morbidity. In addition, inadequate pain control delays PACU recovery and discharge home, and it may result in development of a chronic pain syndrome, all of which increase resource use and healthcare costs.<sup>57,58</sup>

In order for patients to function well postoperatively, it is important that they have adequate pain relief at rest and with movement. Multimodal analgesic approaches that combine regional techniques, nonsteroidal antiinflammatory drug (NSAID), and opioid therapies are recommended to provide pain relief during movement while producing a low incidence of side effects.<sup>59</sup> Procedure-specific guidelines for pain therapy may be helpful because pain intensity, as well as the risks and benefits of different analgesics, clearly are procedure related.<sup>60,61</sup> A thorough discussion of acute postoperative pain management is given in Chapter 83.

Patients who are opioid tolerant (either from substance abuse or legitimate medical therapy) often present a management challenge in the immediate postoperative period. These patients may be receiving large doses of long-acting oral opioid agonists or even high doses of the opioid partial agonist buprenorphine (see Chapters 23 and 41). When possible, regional anesthetic techniques and nonopioid adjuncts (e.g., NSAIDs, clonidine) should be used to provide multimodal therapy. If a regional technique is used as the primary anesthetic in a patient known to be physically dependent upon opioids, it is important to provide a supplemental opioid to prevent the symptoms of withdrawal.

Sometimes opioid-tolerant patients require parenteral opioids as a primary mode of analgesia after surgery. Tolerant and nontolerant patients are at similar risk for opioid-induced respiratory depression if comparable levels of pain relief are achieved (see Chapter 48). Unfortunately, assessing pain relief in opioid-tolerant patients can be difficult and sometimes inaccurate. Relying on a “pain score” as an analgesic end point may be unwise, because these individuals report higher pain scores even when quite sedated.<sup>62</sup> For this reason, patients requiring very large doses of opioids should undergo careful monitoring of oxygen saturation and respiratory rate for signs of respiratory depression. Patients with coexisting respiratory diseases such as sleep apnea may be best managed in an ICU during the early postoperative period.<sup>63</sup> In addition, consultation with a specialist in addiction medicine may assist with acute management as well as followup during or after patient hospitalization.

## HEMORRHAGE

Patients who develop bleeding postoperatively require rapid evaluation to differentiate poor surgical hemostasis (perhaps requiring immediate reoperation) from a diffuse coagulopathy. It is important to appreciate that surgical and nonsurgical bleeding often coexist. Visible bleeding from wounds or drains makes the diagnosis simpler, whereas bleeding into the chest, pelvis, thigh, or retroperitoneum can be difficult to detect. Drains can become

blocked, kinked, or malpositioned, resulting in a false sense of security.

The patient should be examined for tachycardia, diminished urine output, and delayed capillary refill. Blood pressure may be preserved, especially in the young patient, despite loss of up to 40% of total blood volume.<sup>64</sup> Orthostatic hypotension and tachycardia may provide an early indication of intravascular volume depletion. Hemoglobin levels may remain stable for a time, and initial declines may be attributed to hemodilution despite significant hemorrhage.

If there is evidence of significant bleeding, diagnosis and treatment usually occur simultaneously. Adequate IV access should be established and the availability of appropriate blood products ensured. Diagnostic studies that should be considered early include measurement of filling pressures (i.e., central venous pressure or pulmonary capillary wedge pressure) and imaging techniques (ultrasound, CT). Angiography eventually may be required for definitive diagnosis, localization, and therapy.

The diagnosis of a coagulopathy in the surgical setting commonly occurs with a dilutional thrombocytopenia and loss of clotting factors. Coagulation tests should be guided by a knowledge of preexisting medical illnesses (e.g., hepatic disease, bone marrow suppression) or specific surgical factors (e.g., sepsis leading to disseminated intravascular coagulation). Hypothermia should be corrected because it can cause platelet dysfunction, and urine and blood should be checked for signs of hemolysis, possibly indicating a transfusion reaction. Laboratory test results can change rapidly, and serial measurements are often required.

## TEMPERATURE ABNORMALITIES

### Hypothermia

Hypothermia remains a common postoperative problem despite the ASA requirement for the “availability” of intraoperative temperature monitoring and the improved technology for patient warming in the operating room. Multiple sources of heat loss, decreased heat production, and impairment of thermoregulatory control all contribute to intraoperative hypothermia. Even mild hypothermia (core temperature be-

tween 34°C and 36°C) has been associated with adverse outcomes, including myocardial ischemia, arrhythmias, coagulopathy, wound infection, and decreased drug metabolism.<sup>65</sup> Furthermore, hypothermia can result in substantial discomfort, rated by some patients as worse than their surgical pain. Mild hypothermia may increase the duration of PACU stay by 40 minutes or more.<sup>66</sup> Violent shivering may increase the risk of trauma or subcutaneous bleeding. It also may dislodge medical devices and interfere with ECG and pulse oximetry monitoring.

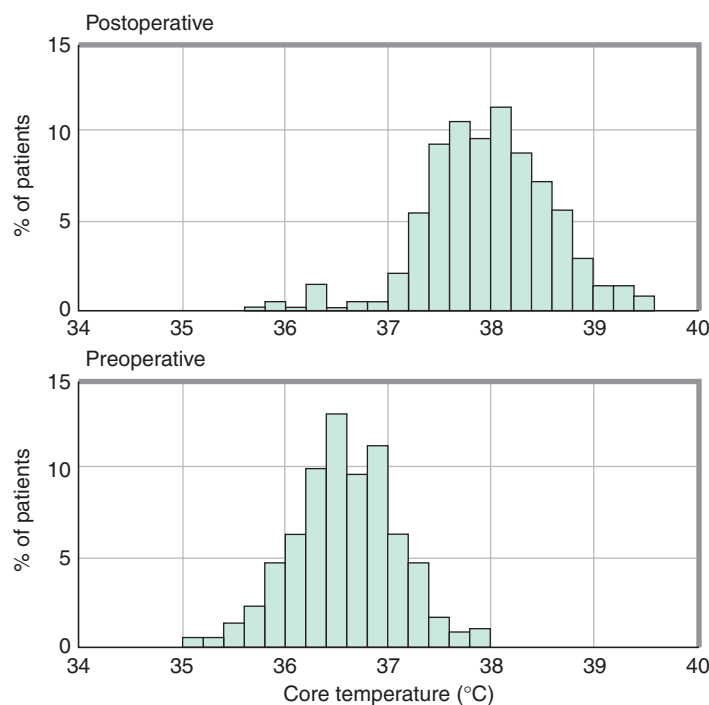
Restoration of normothermia is an important goal during the postoperative period. For patients with mild hypothermia, warm blankets and verbal reassurance usually are adequate treatment. Forced-air warming devices are more efficient, if available. Shivering can be rapidly suppressed with small doses of meperidine, which acts by stimulating  $\alpha 2B$  receptors (see Chapter 41). This will decrease heat production but will make the patient more comfortable. Clonidine, dexmedetomidine, and doxapram also have been used successfully to treat shivering.<sup>67</sup>

### Hyperthermia

Although fever is common during the first few days after surgery, significant

hyperthermia is relatively uncommon in the PACU. Most early postoperative fever is caused by cytokine release in response to surgery, and it resolves spontaneously. A 1.4°C average increase of the core temperature setpoint occurs in patients undergoing major surgical procedures (Fig. 73–8).<sup>68</sup> Brief periods of hyperthermia also can occur when patients are closely draped and aggressive warming techniques are used in the operating room. Infection is always a concern but is less likely in the PACU unless the patient had a preexisting infection or bacteremia was provoked by the surgical procedure. Another possibility to consider is a febrile reaction to a medication or blood product given during surgery. Less common etiologies include hyperthyroidism, malignant hyperthermia, and the neuroleptic malignant syndrome. Fever can be associated with other adverse events, including PE, adrenal insufficiency, and ethanol withdrawal.

Evaluation of fever in the early postoperative period begins with a careful history and physical examination. Did the patient have a fever or leukocytosis preoperatively? What preoperative and intraoperative medications were given? Did surgery involve drainage of an abscess, cause



**FIGURE 73–8.** Histograms illustrating preoperative and maximum postoperative core temperature in the first 24 hours after surgery in 271 patients. Data indicate a postoperative shift in the setpoint to a higher core temperature. From Frank et al.<sup>68</sup> with permission.



fecal spillage, etc.? Routine use of blood and urine cultures, urinalysis, and chest radiography is costly, and these tests should be ordered only when indicated by the history and physical examination. The decision to administer additional antibiotics depends upon the perceived urgency of treatment and the level of clinical suspicion of infection. Symptomatic treatment with rectal or oral acetaminophen is useful for patient comfort and to minimize the increased metabolic demands of fever.

## HYPERGLYCEMIA

Increasing evidence indicates that close perioperative glycemic control can improve patient outcome, including reduced rates of surgical site infections and decreased mortality of critically ill patients.<sup>69</sup> The American College of Endocrinology and the American Diabetes Association have published goals for glycemic control in hospitalized patients that can be applied postoperatively.<sup>70,71</sup> These guidelines include maintenance of blood glucose levels <180 mg/dL for all patients and between 80 and 110 mg/dL in ICU patients; avoiding oral hypoglycemic agents when not on a regular diet; providing basal insulin doses for patients who are insulin deficient; and implementing a program to prevent and manage hypoglycemia. These issues are covered more completely in Chapters 12 and 59.

## INJURIES

### Ocular

Visual changes after anesthesia for nonocular surgery are relatively infrequent, with an incidence of 0.0008% after all noncardiac surgery and 0.2% following spine surgery.<sup>72,73</sup> Severity ranges from transient blurring of vision to irreversible blindness. Transient blurring of vision can be due to cycloplegia from anticholinergic medications, use of ocular lubricants, excessive corneal drying, or a corneal abrasion.<sup>74</sup> Corneal abrasion is suggested by symptoms of tearing, miosis, photophobia, and the sensation of a foreign body in the eye. The diagnosis is confirmed by fluorescein staining of the cornea. Ophthalmologic consultation is recommended, and manage-

ment usually consists of patching and administration of topical antibiotics, anesthetics, and cycloplegics.

Prolonged or permanent visual loss is a recognized complication after head/neck, neurovascular, cardiopulmonary bypass, and spine surgery. Impairment of retinal perfusion may result from direct ocular compression, but it also is associated with acute anemia, hypotension, emboli, and large-volume crystalloid administration in the absence of direct compression. The risk is higher in patients with preexisting vascular disease and in those receiving long anesthetics and surgery in the prone position.<sup>75</sup>

If there is a postoperative concern regarding potential visual loss, urgent ophthalmologic consultation should be obtained to determine its cause. Optimizing hemodynamics, hemoglobin levels, and arterial oxygenation may improve recovery, but this has not been confirmed prospectively. MRI may be needed to detect intracranial causes of vision loss.<sup>76</sup>

### Oropharyngeal

Sore throat, hoarseness, and dysphagia are common postoperative complaints following tracheal intubation and laryngeal mask airway (LMA) insertion. In most cases, the laryngeal or pharyngeal trauma is minor, and symptoms resolve without treatment. Gargling with viscous lidocaine may provide symptomatic relief but increases the risk of aspiration during recovery. Severe or persistent pain, dysphagia, or hoarseness may suggest more significant pathology warranting otolaryngologic consultation. Pathologic changes from laryngoscopy and intubation include epithelial loss, glottic hematoma and edema, submucosal tears, and granuloma formation. Oropharyngeal injuries resulting from LMA insertion include pharyngeal abrasion, nerve palsy, arytenoid dislocation, epiglottitis, and uvular bruising.<sup>77</sup>

### Dental

Perioperative dental injury has a reported incidence of 1:4500 general anesthetics.<sup>78</sup> Risk factors include preexisting poor dentition and a difficult laryngoscopy/intubation.<sup>79,80</sup> The upper incisors are most often involved. Damage to teeth should be carefully documented and a dental consultation obtained. If a tooth is missing and cannot be found, a chest x-ray film should

be obtained to rule out a pulmonary aspiration.

## Nerve

Sixteen percent of claims in the ASA closed claims project database were for anesthesia-related nerve injuries.<sup>81</sup> Nerve injury may result from improper intraoperative positioning, direct surgical damage, or as a complication of needles and drugs used in regional anesthesia. Preexisting nerve abnormalities also may play a role. Many perioperative neuropathies have no identifiable cause. Examination of the patient in the PACU may lead to earlier recognition of a peripheral neuropathy.<sup>82</sup> The patient should be positioned in a manner to prevent further compression or stretch of the involved nerve. Evaluation for potentially treatable sources of injury, such as constrictive dressings or improperly applied casts, is important. Prompt neurologic consultation should be obtained when a new deficit is identified in order to document the patient's status, arrange additional testing or intervention, and provide followup. Neurophysiologic assessment, such as nerve conduction studies, evoked potentials, and electromyography, may be helpful in localizing the injury and establishing the diagnosis and prognosis. This information may be helpful in directing a treatment plan.

Major neurologic complications after spinal or epidural anesthesia are rare but can be devastating. The etiology may be traumatic injury to the spinal cord or nerve roots during needle or catheter placement, spinal hematoma or abscess, or a direct toxic effect of injected medications or contaminants.<sup>83</sup> Several of these possibilities require urgent MRI and neurologic evaluation. Lack of recovery from spinal or epidural anesthesia may indicate spinal cord compression from a hematoma. Persistent motor blockade after recovery of sensory anesthesia may be due to spinal artery occlusion or spasm. In both cases, prompt diagnosis with MRI and early intervention greatly increase the likelihood of a successful outcome.

## Hearing

Hearing loss has been reported after general and neuraxial anesthesia, but it is often subclinical and goes unnoticed unless audiometry is performed. Hearing loss after spinal anesthesia or

lumbar puncture is reported most frequently, with 10–50% of patients experiencing an audiometrically measurable low-frequency hearing loss.<sup>84</sup> The etiology appears to be related to cerebrospinal fluid leak, so impairment is increased with use of larger-gauge and cutting-tip needles. Hearing loss after dural puncture generally resolves completely within days to weeks. In severe cases, an epidural blood patch may hasten recovery.

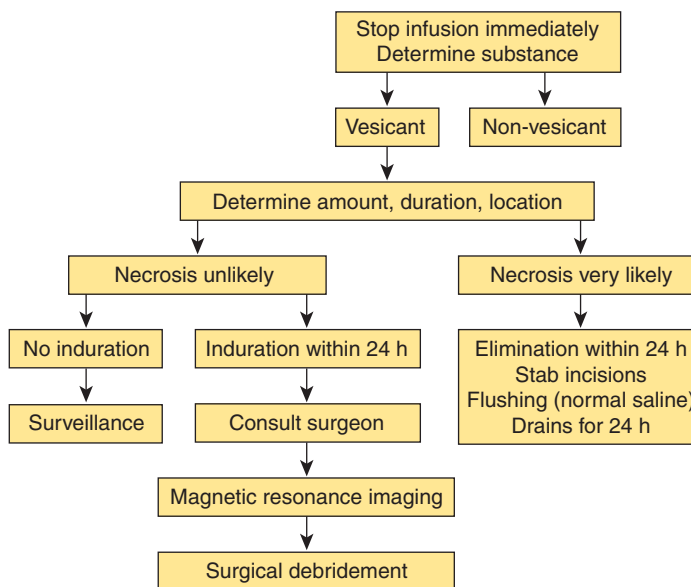
Hearing loss after general anesthesia has been reported after both cardiac and noncardiac surgery. The etiology often is unclear but may be related to changes in middle ear pressure, injury to the inner ear microcirculation, embolism, or the effects of ototoxic drugs. Some patients who received nitrous oxide may actually have hyperacusis (increased sensitivity to sound), presumably from changes in middle ear pressure.

### Extravasation Injury

Extravasation injury can result from unintentional injection or leakage of intravenous fluids or medications into the perivascular or subcutaneous space. The amount of injury depends on the specific drug and concentration, the site of injury, the infusion pressure, and the duration of tissue exposure.<sup>85</sup> Extravasation of vasoconstrictors, alkaline solutions such as thiopental, and hyperosmolar or concentrated electrolyte solutions may cause significant tissue necrosis. Pain, swelling, and local hyperthermia are not reliable predictors of the degree of tissue damage. The intravenous infusion should be stopped immediately. Conservative measures such as elevating the involved extremity or applying heat or cold have not been shown to be beneficial, although early aspiration of the intravenous cannula and flushing with saline may be useful. In the case of extravasation of vasopressors, early infiltration with phentolamine may be effective. Surgical consultation and radiologic imaging (e.g., MRI) may be helpful if there is concern regarding tissue damage (Fig. 73-9).

#### KEY REFERENCES

1. Hines R, Barash PG, Watrous G, et al. Complications occurring in the postoperative care unit: a survey. *Anesth Analg* 1992;74:503–509.



**FIGURE 73-9.** Algorithm for managing extravasation injury in the perioperative setting. Vesicants refer to drugs that can cause tissue destruction. Common vesicants used in the perioperative setting include vasoconstrictors (e.g., epinephrine, dopamine, norepinephrine), concentrated electrolyte solutions (e.g., calcium chloride, potassium chloride, sodium bicarbonate), and hyperosmolar solutions (e.g., glucose 20%, mannitol, phenytoin [Dilantin]). From Schummer W et al.<sup>85</sup> with permission.

2. Macario A, Weinger M, Carney S, et al. Which clinical anesthesia outcomes are important to avoid? The perspective of patients. *Anesth Analg* 1999;89:652–658.

3. Thompson JS, Baxter BT, Allison JG, et al. Temporal patterns of postoperative complications. *Arch Surg* 2003;138:596–603.

4. Warner MA, Warner ME, Weber JG. Clinical significance of pulmonary aspiration during the perioperative period. *Anesthesiology* 1993;78:56–62.

5. Eagle KA, Berger PB, Calkins H, et al. ACC/AHA guideline update for perioperative cardiovascular evaluation for noncardiac surgery—executive summary. A report of the American College of Cardiology/American Heart Association task force on practice guidelines. *Anesth Analg* 2002;94:1052–1064.

6. Hollenberg SM, Dellinger RP. Noncardiac surgery: postoperative arrhythmias. *Crit Care Med* 2000;28:N145–N150.

7. Breslow MJ, Miller CF, Parker SD, et al. Changes in t-wave morphology following anesthesia and surgery: a common recovery room phenomenon. *Anesthesiology* 1986;64:398–402.

8. Selim M. Perioperative stroke. *N Engl J Med* 2007;356:706–713.

9. Practice advisory for intraoperative awareness and brain function monitoring. *Anesthesiology* 2006;104:847–864.

10. Sessler DI. Complications and treatment of mild hypothermia. *Anesthesiology* 2001;95:531–543.

11. Practice advisory for the prevention of perioperative peripheral neuropathies: a report by the American Society of Anesthesiologists task force on prevention of perioperative peripheral neuropathies. *Anesthesiology* 2000;92:1168–1182.

#### REFERENCES

1. Hines R, Barash PG, Watrous G, et al. Complications occurring in the postoperative care unit: a survey. *Anesth Analg* 1992;74:503–509.

2. Mayson KV, Beestra JE, Choi PT. The incidence of postoperative complications in the PACU. *Can J Anesth* 2005;52:A62.

3. Macario A, Weinger M, Carney S, et al. Which clinical anesthesia outcomes are important to avoid? The perspective of patients. *Anesth Analg* 1999;89:652–658.

4. Myles PS, Williams DL, Hendrata M, et al. Patient satisfaction after anaesthesia and surgery: results of a prospective survey of 10811 patients. *Br J Anaesth* 2000;84:6–10.

5. Thompson JS, Baxter BT, Allison JG, et al. Temporal patterns of postoperative complications. *Arch Surg* 2003;138:596-603.
6. Eikermann M, Blobner M, Groeben H, et al. Postoperative upper airway obstruction after recovery of the train of four ratio of the adductor pollicis muscle from neuromuscular blockade. *Anesth Analg* 2006;102:937-942.
7. Fisher MM, Raper RF. The "cuff leak" test for extubation. *Anaesthesia* 1992;47:10-12.
8. Krimer EJ, Shafazand S, Colice GL. The endotracheal tube cuff-leak test as a predictor for postextubation stridor. *Respir Care* 2005;50:1632-1638.
9. Mevorach DL. The management and treatment of recurrent postoperative laryngospasm. *Anesth Analg* 1996;83:1110-1111.
10. Weber S. Traumatic complications of airway management. *Anesthesiol Clin North America* 2002;20:503-512.
11. Tyler IL, Tantisira B, Winter PM, et al. Continuous monitoring of arterial oxygen saturation with pulse oximetry during transfer to the recovery room. *Anesth Analg* 1985;64:1108.
12. Xue FS, Li BW, Zhang GS, et al. The influence of surgical sites on early postoperative hypoxemia in adults undergoing elective surgery. *Anesth Analg* 1999;88:213-219.
13. Squadrone V, Cocha M, Cerutti E, et al. Continuous positive airway pressure for treatment of postoperative hypoxemia. *JAMA* 2005;293:589-595.
14. Caples SM, Gay PC. Noninvasive positive pressure ventilation in the intensive care unit: a concise review. *Crit Care Med* 2005;33:2651-2658.
15. Berg H, Viby-Mogensen J, Roed J, et al. Residual neuromuscular block is a risk factor for postoperative pulmonary complications: a prospective, randomized and blinded study of postoperative pulmonary complications after atracurium, vecuronium, and pancuronium. *Acta Anaesthesiol Scand* 1997;41:1095-1103.
16. Debaene B, Plaud B, Dilly MP. Residual paralysis in the PACU after a single intubating dose of nondepolarizing muscle relaxant with an intermediate duration of action. *Anesthesiology* 2003;98:1042-1048.
17. Warner DO. Preventing postoperative pulmonary complications: the role of the anesthesiologist. *Anesthesiology* 2000;92:1467-1472.
18. American Thoracic Society-European Respiratory Society. Standards for the diagnosis and management of patients with COPD 2004. Available at: <http://www.thoracic.org/sections/copd/resources/copd-doc.pdf>. Last accessed Feb. 11, 2007.
19. Warner MA. Is pulmonary aspiration still an important problem in anesthesia? *Curr Opin Anaesth* 2000;13:215-218.
20. Marik PE. Aspiration pneumonitis and aspiration pneumonia. *N Engl J Med* 2001;344:665-671.
21. Warner MA, Warner ME, Weber JG. Clinical significance of pulmonary aspiration during the perioperative period. *Anesthesiology* 1993;78:56-62.
22. Sakai T, Planinsic RM, Quinlan JJ, et al. The incidence and outcome of perioperative pulmonary aspiration in a university hospital: a 4-year retrospective analysis. *Anesth Analg* 2006;103:941-947.
23. Broccard AF, Liaudet L, Aubert JD, et al. Negative pressure post-tracheal extubation alveolar hemorrhage. *Anesth Analg* 2001;92:273-275.
24. McConkey PP. Postobstructive pulmonary edema: a case series and review. *Anaesth Intensive Care* 2001;28:72-76.
25. Horlander KT, Mannino DM, Leeper KV. Pulmonary embolism mortality in the United States, 1979-1998: an analysis using multiple cause mortality data. *Arch Intern Med* 2003;163:1711-1717.
26. Piazza G, Goldhaber SZ. Acute pulmonary embolism part I. Epidemiology and diagnosis. *Circulation* 2006;114:e28-e32.
27. Adesanya AO, De Lemos JA, Greilich NB, et al. Management of perioperative myocardial infarction in noncardiac surgical patients. *Chest* 2006;130:584-596.
28. Mangano DT, Hollenberg M, Fegert G, et al. Perioperative myocardial ischemia in patients undergoing noncardiac surgery: I. Incidence and severity during the 4 day perioperative period. The Study of Perioperative Ischemia (SPI) Research Group. *J Am Coll Cardiol* 1991;17:843-850.
29. Badner NH, Knill RL, Brown JE, et al. Myocardial infarction after noncardiac surgery. *Anesthesiology* 1998;88:572-578.
30. Eagle KA, Berger PB, Calkins H, et al. ACC/AHA guideline update for perioperative cardiovascular evaluation for noncardiac surgery-executive summary. A report of the American College of Cardiology/American Heart Association task force on practice guidelines. *Anesth Analg* 2002;94:1052-1064.
31. Sloan SB, Weitz HH. Postoperative arrhythmias and conduction disorders. *Med Clin North Am* 2001;85:1171-1189.
32. Sedrakyan A, Treasure T, Browne J, et al. Pharmacologic prophylaxis for postoperative atrial tachyarrhythmia in general thoracic surgery: evidence from randomized clinical trials. *J Thorac Cardiovasc Surg* 2005;129:997-1005.
33. Hollenberg SM, Dellinger RP. Noncardiac surgery: postoperative arrhythmias. *Crit Care Med* 2000;28:N145-N150.
34. Mahla E, Rotman B, Rehak P, et al. Perioperative ventricular dysrhythmias in patients with structural heart disease undergoing noncardiac surgery. *Anesth Analg* 1998;86:16-21.
35. Breslow MJ, Miller CF, Parker SD, et al. Changes in t-wave morphology following anesthesia and surgery: a common recovery room phenomenon. *Anesthesiology* 1986;64:398-402.
36. Haas CE, LeBlanc JM. Acute postoperative hypertension: a review of therapeutic options. *Am J Health-Syst Pharm* 2004;61:1661-1673.
37. Lamonerie L, Marret E, Deleuze A, et al. Prevalence of postoperative bladder distension and urinary retention detected by ultrasound measurement. *Br J Anaesth* 2004;92:544-546.
38. Keita H, Diouf E, Tubach F, et al. Predictive factors of early postoperative urinary retention in the postanesthesia care unit. *Anesth Analg* 2005;101:592-596.
39. Gravenstein D. Transurethral resection of the prostate (TURP) syndrome: a review of pathophysiology and management. *Anesth Analg* 1997;84:438-446.
40. Kluger MT, Szekely SM, Singleton RJ, et al. Crisis management during anaesthesia: water intoxication. *Qual Saf Health Care* 2005;14:e23.
41. Rose DK. Recovery room problems or problems in the PACU. *Can J Anaesth* 1996;43:R116-R128.
42. Lepouse C, Lautner CA, Liu L, et al. Emergence delirium in adults in the postanesthesia care unit. *Br J Anaesth* 2006;96:747-753.
43. Inouye SK, Rushing JT, Foreman MD, et al. Does delirium contribute to poor hospital outcomes? A three-site epidemiologic study. *J Gen Intern Med* 1998;13:234-242.
44. McCusker J, Cole MG, Dendukuri N, et al. Does delirium increase hospital stay? *J Am Geriatr Soc* 2003;51:1539-1546.
45. Bryson GL, Wyand A. Evidence-based clinical update: General anesthesia and the risk of delirium and postoperative cognitive dysfunction. *Can J Anesth* 2006;53:669-677.
46. Lynch EP, Lazor MA, Gellis JE, et al. The impact of postoperative pain on the development of postoperative delirium. *Anesth Analg* 1998;86:781-785.
47. Parikh S, Cohen JR. Perioperative stroke after general surgical procedures. *N Y S J Med* 1993;93:162-165.
48. Albrecht RF, Wagner SR, Leicht CH, et al. Factitious disorder as a cause of failure to awaken after general anesthesia. *Anesthesiology* 1995;83:201-204.
49. Selim M. Perioperative stroke. *N Engl J Med* 2007;356:706-713.
50. Moazami N, Smedira NG, McCarthy PM, et al. Safety and efficacy of intraarterial thrombolysis for perioperative stroke after cardiac operation. *Ann Thorac Surg* 2001;72:1933-1937.
51. Chalela JA, Katzan I, Liebeskind DS, et al. Safety of intra-arterial thrombolysis in the postoperative period. *Stroke* 2001;32:1365-1369.
52. Sebel PS, Bowdle TA, Ghoneim MM, et al. The incidence of awareness during anesthesia: a multicenter United States study. *Anesth Analg* 2004;99:833-839.
53. Practice advisory for intraoperative awareness and brain function monitoring. *Anesthesiology* 2006;104:847-864.
54. Brice DD, Hetherington RR, Utting JE. A simple study of awareness and dreaming during anaesthesia. *Br J Anaesth* 1970;42:535-541.

55. Apfelbaum JL, Chen C, Mehta SS, et al. Postoperative pain experience: results from a national survey suggest postoperative pain continues to be undermanaged. *Anesth Analg* 2003;97:534–540.
56. Warfield CA, Kahn CH. Acute pain management: programs in U.S. hospitals and experiences and attitudes among U.S. adults. *Anesthesiology* 1995;83:1090–1094.
57. Pavlin DJ, Chen C, Penaloz DA, et al. Pain as a factor complicating recovery and discharge after ambulatory surgery. *Anesth Analg* 2002;95:627–634.
58. Joshi GP, Ogunnaike BO. Consequences of inadequate postoperative pain relief and chronic persistent postoperative pain. *Anesthesiol Clin North America* 2005;23:21–36.
59. Mitra S, Sinatra RS. Perioperative management of acute pain in the opioid dependent patient. *Anesthesiology* 2004;101:212–227.
60. Procedure specific postoperative pain management (PROSPECT) working group: recommendations for the management of postoperative pain. Available at: <http://www.postoppain.org>. Last accessed Feb. 11, 2007.
61. Kehlet H. Procedure-specific postoperative pain management. *Anesthesiol Clin North America* 2005;23:203–210.
62. Rapp SE, Ready LB, Nessly ML. Acute pain management in patients with prior opioid consumption: a case-controlled retrospective review. *Pain* 1995;61:195–201.
63. Swenson JD, Davis JJ, Johnson KB. Postoperative care of the chronic opioid-consuming patient. *Anesthesiol Clin North America* 2005;23:37–48.
64. Dagi TF. The management of postoperative bleeding. *Surg Clin North Am* 2005;85:1191–1213.
65. Sessler DI. Complications and treatment of mild hypothermia. *Anesthesiology* 2001;95:531–543.
66. Lenhardt R, Marker E, Goll V, et al. Mild intraoperative hypothermia prolongs post-anesthetic recovery. *Anesthesiology* 1997;87:1318–1323.
67. Kranke P, Eberhart LH, Roewer N, et al. Pharmacological treatment of postoperative shivering: a quantitative systematic review of randomized controlled trials. *Anesth Analg* 2002;94:453–460.
68. Frank SM, Kluger MJ, Kunkel SL. Elevated thermostatic setpoint in postoperative patients. *Anesthesiology* 2000;93:1426–1431.
69. American College of Endocrinology and American Diabetes Association consensus statement on inpatient diabetes and glycaemic control: a call to action. *Diabetes Care* 2006;29:1955–1962.
70. Garber AJ, Moghissi ES, Bransome ED Jr, et al. American College of Endocrinology task force on inpatient diabetes metabolic control. American College of Endocrinology position statement on inpatient diabetes and metabolic control. *Endocr Pract* 2004;10:4–9.
71. Martinez EA, Williams KA, Provonost PJ. Think like a pancreas: perioperative glycaemic control. *Anesth Analg* 2006;104:4–5.
72. Warner ME, Warner MA, Garrity JA, et al. The frequency of perioperative vision loss. *Anesth Analg* 2001;93:1417–1421.
73. Stevens WR, Glazer PA, Kelley SD, et al. Ophthalmic complications after spinal surgery. *Spine* 1997;22:1319–1324.
74. Warner ME, Fronapfel PJ, Hebl JR, et al. Perioperative visual changes. *Anesthesiology* 2002;96:855–859.
75. Lee LA. Postoperative visual loss data gathered and analyzed. *ASA Newsletter* 2000;64:25–27.
76. Practice advisory for perioperative visual loss associated with spine surgery: a report by the American Society of Anesthesiologists task force on perioperative blindness. *Anesthesiology* 2006;104:1319–1328.
77. McHardy FE, Chung F. Postoperative sore throat: cause, prevention and treatment. *Anaesthesia* 1999;54:444–453.
78. Warner ME, Benenfeld SM, Warner MA, et al. Perianesthetic dental injuries: frequency, outcomes and risk factors. *Anesthesiology* 1999;90:1302–1305.
79. Givol N, Gershtansky Y, Halamish-Shani T, et al. Perianesthetic dental injuries: analysis of incident reports. *J Clin Anesth* 2004;16:173–176.
80. Owen H, Waddell-Smith I. Dental trauma associated with anaesthesia. *Anaesth Intensive Care* 2000;28:133–145.
81. Cheney FW, Domino KB, Caplan RA, et al. Nerve injury associated with anesthesia: a closed claims analysis. *Anesthesiology* 1999;90:1062–1069.
82. Practice advisory for the prevention of perioperative peripheral neuropathies: a report by the American Society of Anesthesiologists task force on prevention of perioperative peripheral neuropathies. *Anesthesiology* 2000;92:1168–1182.
83. Horlocker TT. Complications of spinal and epidural anesthesia. *Anesthesiol Clin North America* 2000;18:461–485.
84. Sprung J, Bourke DL, Contreras MG, et al. Perioperative hearing impairment. *Anesthesiology* 2003;98:241–257.
85. Schummer W, Schummer C, Bayer O, et al. Extravasation injury in the perioperative setting. *Anesth Analg* 2005;100:722–727.
86. Davignon K, Haspel KL. Chapter 37: Thoracic Surgery. In: Bigatello LM, ed. *Critical Care Handbook of the Massachusetts General Hospital*, 4th ed. Philadelphia: Lippincott Williams & Wilkins, 2006.



# CHAPTER 74

## Management of Acute Postoperative Pain

Jane C. Ballantyne, MD, FRCA

After the first public demonstration of ether anesthesia at the Massachusetts General Hospital in 1846, the news that “We have conquered pain” spread around the world. What was not understood at the time is that the potent hypnotics merely suspend pain perception, but do little to change pain transmission. The addition of neural blockade or strong analgesics (notably opioids) is needed to halt the pain processes that excite the nervous system, trigger neuroendocrine stress responses, and produce pain once it can be perceived. The provision of analgesia, during and after surgery, is now considered a vital and integral part of anesthesia and its central goal to reduce the stress and derangements of surgery. Anesthesiologists apply their knowledge of pharmacology, anatomy, physiology, pathophysiology, surgery, and medicine toward optimizing pain relief. Whether by means of an informal relationship with surgical colleagues, or a more structured service—an acute pain service—they play a key role in managing postoperative pain.<sup>1</sup> As experts, they help educate others in the tools of pain management, and teach the importance of pain control in terms of postoperative recovery.

taught nurses and others how to manage these new therapies. Soon surgeons and nurses became familiar with the use of PCA, so that this component of postoperative management, at least for routine cases, largely has been taken over by them. Epidurals and other continuous perineural techniques remain the province of anesthesiologists, and the core function of most acute pain services is to manage postoperative epidural analgesia. The acute pain service is also available to help with complex cases, notably cases that cannot be managed using routine measures. Naturally, each institution will structure its pain service differently, according to institutional and local factors—smaller hospitals and ambulatory facilities may not have a service as such.

Acute pain services are usually staffed by a mixture of attending physicians (sometimes pain trained and commonly anesthesiologists), nurses, and pain fellows in academic centers, and anesthesia residents. Rotation to the acute pain service is a valuable component of residency training, as this is likely the only point during training that anesthesia residents have the opportunity to daily follow patients postoperatively. The allocation of roles on the service will depend to a large extent on factors such as reimbursement, hospital policies, the relationship between anesthesia and surgery departments, and the expectations and support of both the hospital and the department of surgery. For example, funding for nursing on the service will vary according to institution, and the provision of non-billable services, such as daily followup of PCA, may only be feasible if

nurses are available and funded. Epidural management remains the most favorably reimbursed of acute pain services. Unfortunately, as pain management becomes increasingly challenging because of rising numbers of opioid-tolerant patients (both substance abusers and opioid-treated chronic pain patients), and because of mandated pain management, reimbursement often fails to cover the realistic costs of ideal pain management.

### **Joint Commission on Accreditation of Healthcare Organizations and Pain Management**

The Joint Commission on Accreditation of Healthcare Organizations (JCAHO) evaluates and accredits more than 19,000 healthcare organizations in the United States and its status as an accreditation body is such that it serves as an alternative to state and federal inspection mechanisms. Because of its wide reach, it was chosen for collaboration when various bodies seeking to improve pain management—including the American Pain Society, the Agency for Healthcare Policy and Research (now the Agency for Healthcare Research and Quality), and the University of Wisconsin Medical School (supported by a grant from the Robert Wood Johnson Foundation)—determined that the accreditation body could potentially improve pain care visibility by mandating the development of processes that increase provider accountability for the assessment and treatment of pain. Five elements were established that were considered essential for establishing institutional responsibility for making pain management a priority<sup>2</sup>:

1716

### BACKGROUND

#### Institutional Considerations

##### ***The Role of the Acute Pain Service***

The idea of the acute pain service arose during the 1980s when “walking” epidurals made epidural analgesia suddenly more feasible for postoperative patients, and when the microchip made patient-controlled analgesia (PCA) pumps small enough to have wide applicability. Initially, pain services ran both these modalities, developed treatment protocols, and

### KEY POINTS

1. Analgesia, as distinct from hypnosis, is a vital and integral component of anesthesia.
2. Anesthesiologists must plan for the continuum of intra- and postoperative pain.
3. The principles of “opioid-sparing” or “multimodal analgesia” are central to the goal of rapid recovery as opioid side effects delay recovery.
4. Patient-controlled analgesia has greatly facilitated acute pain management at both provider and institutional levels.
5. Epidural analgesia continues to play an important role in the treatment of pain after major intraabdominal and thoracic surgery, although the benefit versus risk should be reexamined in an era of potent thrombosis prophylaxis.
6. Chronic opioid use and abuse are emerging as prominent challenges during acute pain treatment.

1. Pain must be recognized and treated promptly.
2. Information about analgesics should be readily available to clinicians in a way that facilitates order writing and interpretation of orders.
3. Patients must be assured of attentive pain care.
4. Explicit policies should be developed for the use of advanced analgesic technologies.
5. Processes and outcomes should be examined for continued improvement.

The idea was to make pain management a priority in the healthcare system and to establish systems to support, reinforce, and reward good pain management practice. The standards were approved in 1999 and formally introduced into the accreditation process in 2001.<sup>3</sup> Perhaps the most obvious manifestation of the mandate, was the introduction of “pain as a fifth vital sign,” part of the effort to “make pain visible.” Many hospitals have now introduced a requirement to record a pain score on the vital signs chart. Although it was never the intention of JCAHO or the pain advocates that this should become the focus of the pain mandate, and indeed there is no written requirement for the “fifth vital sign” in current JCAHO standards, nevertheless it has become the hallmark of the JCAHO mandate. Of course, the recording of a pain score does nothing to advance pain management unless the pain score is acted on, but at least it raises general awareness of pain and gives patients the opportunity to express pain complaints. The question that naturally follows is this: Has the mandate succeeded in improving patients’ access to adequate pain care?

There has been a great deal of concern expressed by dissenters that the mandate represents an unreasonable intrusion into clinical practice, an excessive burden on healthcare facilities that will ultimately drive up the cost of healthcare, and an encouragement to patients that they have a “right” to the elusive goal of pain abolishment or to opioid treatment. Surveys to date show a high rate of compliance with the JCAHO mandate, meaning there are demonstrable improvements in pain assessment. However, it is less easy to determine if the standards have resulted in improvements in pain relief. With the support of the

American Medical Association, and the continued support of pain advocates, JCAHO continues to work with hospitals and specialty organizations to clarify and update the standards and strongly encourages improvements in undergraduate medical education and evidence-based performance measurement for pain management.

## Preparation

### Patient Education

Patients who are informed about their likely postoperative experience are much better able to cope with pain and the other discomforts of the postoperative state than those who enter the experience uninformed.<sup>4</sup> Whether it is the surgeon, the anesthesiologist, or the nurse who talks to the patient about the postoperative course, the message should always be that the team will use all methods available to make the experience tolerable, but that a goal of total pain abolition is unrealistic. This approach makes patients less fearful when they find that pain has not been completely removed. Anxious and fearful patients do not handle pain well, patients become fearful very quickly if they experience unexpected pain, and telling patients that the methods we have available are good enough to remove all pain is unhelpful. How often do we hear enthusiastic residents or nurses tell patients that if they accept an epidural, they will not have any pain?

Patients should be informed of their options with regard to pain management, preferably early in the preoperative course. The use of brochures or pamphlets describing analgesic options is helpful. A description of risks as well as benefits is necessary. Some patients expect to be informed and to take an active role in decisions regarding their care; others prefer that decisions are made by their medical team. In either case, informed patients are better prepared psychologically than those who are not informed.

The preoperative visit is also an opportunity to teach patients how to communicate their pain. For example, if they are likely to be asked to relate pain using a verbal pain score, they should be taught about this. They should be encouraged to express pain and not try to be stoical. They should learn that uncontrolled pain may have undesirable consequences such as splinting of the diaphragm, atelectasis

and possible chest infection. They should learn how to use a PCA pump if they are likely to receive one. In particular, they should be aware that early on, they will need supplementary analgesia and should not expect that pressing the button will necessarily remove the severe pain that can occur in the immediate postoperative period. They should also be aware of the inherent safety of PCA, and that overdose is unlikely.

### Anesthesia Planning

Anesthesiologists can have a significant impact on patients’ postoperative pain experience, even if they are only involved in intraoperative care. This is not only by means of sustainable analgesia (epidurals and other catheter treatments), but also by careful anesthesia planning that results in a pain-free or near pain-free emergence from anesthesia. The importance of a pain-free emergence cannot be overemphasized; patients who wake from anesthesia in severe pain, especially those who are not expecting pain, are already disadvantaged in terms of being able to control their pain—again, fear and anxiety intervene to make pain control difficult.

Every anesthetic plan should incorporate planning for postoperative analgesia. The first question is whether a nerve block, a spinal, an epidural, or a plexus catheter treatment would help. This decision must also involve whether these treatments can additionally be used intraoperatively to provide analgesia or even anesthesia. How does the risk weigh against the benefit of these procedures when considering their role for both intraoperative and postoperative use? When one of these techniques is chosen, it becomes necessary to plan the exact injection regime. Will a nerve block last into the postoperative period or need to be supplemented by systemic analgesics? Can spinal analgesia be prolonged by using an opioid in the injectate? How will an epidural or other catheter treatment be used so that both its intra- and postoperative effects are optimized?

Despite the usefulness of neural blockade and catheter treatments, the vast majority of cases will be managed without these. Planning for intraoperative and postoperative analgesia remains important. The basic principles of opioid-sparing and preemptive analgesia, described in the following sections, are incorporated into the analge-

sia plan. Opioids are the only strong analgesics capable of controlling severe pain with systemic use, and are the mainstay of both intra- and postoperative pain relief. Opioids can be used liberally during anesthesia, but less liberally postoperatively because of side effects. Individual practices vary, but the goal of a pain-free emergence should always be incorporated into the plan. Provided they are not contraindicated, nonsteroidal antiinflammatory drugs (NSAIDs), including injectable ketorolac, or other adjuncts, can be used when predicted pain is mild or as an adjunct to opioids for moderate to severe pain.

### Pain Assessment

Pain is a complex, multidimensional symptom resulting from a combination of tissue damage and nociception, previous pain experience, personal beliefs, culture and mood. This explains why patients with the same degree of tissue damage can differ widely in their pain reports. Because there is no objective measure of pain, we must trust that patients' report of pain reflects their pain experience or distress. Acute pain is relatively straightforward to assess as, unlike chronic pain, it generally bears a predictable relationship to obvious tissue damage. Because the level of postoperative pain tends to change rapidly throughout the postoperative course, especially early after surgery, a policy of regular assessment of pain using simple measurement tools is the best way to ensure that pain treatment can be appropriately titrated. Side effects and recovery milestones are also measured so as to optimize analgesia and recovery.

Many institutions record pain as a "fifth vital sign" on the vital signs chart, especially since the introduction of the JCAHO mandate; others have a policy of recording a pain level in the medical record. Wherever it is documented, the recorded level is useful for communication between medi-

cal professionals, and for assessing trends in an individual's pain level.

Verbal numeric rating scales are most commonly chosen to measure acute pain. The patient is asked to rate pain on a numeric scale, usually 0–10, where 0 is no pain and 10 is the worst pain imaginable. Verbal descriptive scales could also be used, but are difficult for postoperative patients to cope with. Examples would be "mild, moderate, or severe" or "mild, discomforting, distressing, horrible, or excruciating." Visual analog scales are used in research, and unlike verbal numeric rating scales, are validated for this purpose. The patient marks on a measured line labeled "no pain" at one end and "worst pain imaginable" at the other. Visual analog scales are rarely used in clinical practice, again because compliance is difficult for postoperative patients. Although the use of pain scales is necessary for documentation purposes, the clinical assessment of pain should always include asking patients to describe their pain and their pain experience since the last assessment. This is likely to reveal more information than the simple level. At the same time, the clinician should assess pain location, radiation, quality, and etiology. It is always important to expand the assessment to identify or exclude sources of pain not accounted for by the primary and expected source.

Assessment of pain in children, especially young children, is much more difficult. Although developmentally normal children older than 6–7 years of age will respond to adult assessment tools, children younger than this need a different approach. Infants, neonates, and very young children (0–4 years of age) are the most challenging. Children as young as 3 years old may be able to express pain, and point to a painful area, but are unlikely to be able to rate their pain. Children younger than this are unable to express pain other than by crying or screaming, posturing, grimacing, palmar sweating,

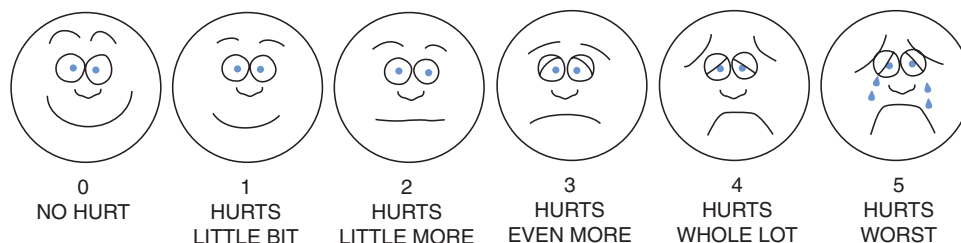
and respiratory and heart rate changes—signs that are not specific to pain. Older children (4–7 years of age) are usually able to rate their pain, but it is helpful to use a scale designed for children, such as the Wong-Baker FACES Pain Rating Scale (Fig. 74–1). Parents are usually better able to recognize the presence of pain in their children than are any of the other caregivers, and they should always be asked to contribute to the assessment process.

### Basic Principles

Two important principles influence our choice of drug, dose, route of delivery, and timing for the treatment of acute pain. These are the principles of preemptive analgesia and opioid sparing.

### Preemptive Analgesia

Preemptive analgesia is described by Igor Kissin as "an antinociceptive therapy that prevents establishment of altered processing of afferent input, which amplifies postoperative pain."<sup>6</sup> In simpler terms, a preemptive analgesic intervention is one that stops or alters pain transmission so that pain will not become amplified by the nervous system. Kissin's definition embraces the fundamental principles necessary for understanding the concept of preemptive analgesia: (a) that the central nervous system is capable of changing so that pain becomes either improved and worsened via central processes such as desensitization and sensitization, and (b) that alterations in sensory and pain transmission can effect such changes. The idea that pain treated early in its course is easier to control than established pain is not new; in fact it is a truism passed down through generations. The new idea is that in addition to psychological factors, which remain important, especially in humans, a central process—central sensitization—can be altered by altering afferent input using analgesic drugs or neural



**FIGURE 74–1.** Wong-Baker FACES Pain Rating Scale. (From Hockenberry MJ, Wilson D, Winkelstein ML, eds. *Wong's Essentials of Pediatric Nursing*, 7th ed. St. Louis: Mosby, 2005. Used with permission. Copyright, Mosby.)

blockade. Animal studies show strong and convincing effects after preemptive interventions including nerve blocks and systemic analgesics.<sup>7</sup> Human studies are less convincing.<sup>8,9</sup> But the idea that our interventions, before, during, and after surgery, could attenuate pain responses, is too attractive to lay to rest. Studies are still being conducted, and the clinical role of preemptive analgesia is still uncertain and much debated.

A systematic review published by Moiniche et al. in 2002<sup>8</sup> found no support for preemptive analgesia when 80 trials assessing preemptive administration of epidural analgesia, systemic opioids, NSAIDs, local infiltration, and *N*-methyl-D-aspartate (NMDA) antagonists were grouped and analyzed, finding no overall benefit to any of the preemptive treatments. (The last intervention may have a special effect in that central sensitization is mediated by NMDA receptor activity).<sup>10,11</sup> In all 80 trials selected here, preincision treatment was compared with postincision treatment. Despite this disappointing result, Ong et al. went on to conduct a new meta-analysis, which included 10 newly published randomized controlled trials (RCTs).<sup>9</sup> Their methods differed from those of Moiniche et al. in several respects: They included trials that compared the preemptive intervention with no intervention as well as the comparison with postincision interventions;<sup>12</sup> they used a different approach for analyzing pain scores; and they used different exclusion criteria (fewer studies met the inclusion criteria). And in this case, several preemptive treatments—epidural analgesia, NSAIDs and wound infiltration—were strongly effective. Preemptive opioid and NMDA antagonists were ineffective.

The preemptive analgesia concept may seem simple—stop central sensitization and pain will improve. But it is far from simple: central sensitization itself is a complex process; NMDA antagonists may alter central sensitization but not necessarily because they are given prior to, versus after, an incision; opioids may actually cause central sensitization under some circumstances;<sup>13–15</sup> and neural blockade does not always succeed in preventing all afferent input from a surgical process.<sup>6,12</sup> It is no surprise, then, that study results seem conflicting and meta-analyses do not provide

clear answers to the question of whether preemptive analgesia has an important clinical role. We have a lot to learn about how preemptive analgesia studies should be designed and how to combine them rationally in meta-analyses. Until we have better answers, we should be guided by preliminary data that suggest that there is little to lose, and possibly much to gain, from early use of neural blockade and NSAIDs.

### **Opioid-Sparing and Multimodal Analgesia**

Opioid drugs mimic endogenous analgesic responses so it is not surprising that they are our most powerful analgesics. Centuries of opioid (opium) use have provided humans with relief from pain and suffering. Yet, throughout this long history, there have been concerns about the opioids' toxic effects—particularly their addictive effects, and the potentially fatal side effect respiratory depression. The extent to which opioids have been used for the relief of pain has fluctuated, not only throughout history, but also between cultures. In the United States and other industrialized nations, opioid use for severe pain has been strongly encouraged, especially since the 1980s when it was recognized that antidrug regulations had severely inhibited opioid use, to the detriment of pain control. Current teaching states that good pain relief during and after surgery, using opioids whenever necessary, can improve surgical recovery.<sup>16</sup> Pain relief is an important component of accelerated recovery programs that aim to achieve early return of mobility, coughing, and bowel and bladder function, and to restore normal physiologic functioning as rapidly as possible, thereby reducing complication rates.<sup>17,18</sup> Yet herein lies a paradox: although opioids are our most effective analgesics, they can delay recovery because of their sedative effects, their nauseating effects, and, most importantly, by slowing bowel activity. Opioid-sparing interventions reduce opioid requirements, and in some cases obviate the use of opioids altogether. Such interventions include the use of adjunctive medications, epidurals, and other nerve blocks, as well as nondrug interventions. The concept of “multimodal analgesia”<sup>19</sup>—using several analgesic modes together—is similar to the concept of opioid sparing.

## **TREATMENT OPTIONS**

### **Systemic Treatments**

#### **Opioids**

Opioids remain the mainstay of acute pain treatment, despite concerns about their side effects. Systemic opioids are used alone or in combination with other analgesics. Generally, higher doses of parenteral opioids are given during the first 24–48 hours after surgery, when pain tends to be severe and patients are unable to tolerate oral medications. The intravenous (IV) route is the preferred parenteral route, as most hospitalized patients already have intravenous catheters in place. Later, oral opioids, often in combination preparations such as Percocet (oxycodone with acetaminophen) replace the parenteral opioid. Side effects may limit opioid use, but there are few absolute contraindications, and true allergy to opioids is rare. Meperidine should not be used with monoamine oxidase inhibitors (MAOIs).

**Choice of Opioid** *Morphine* is the main constituent of opium, it was the first opioid alkaloid to be identified, and it is the standard opioid to which other opioids are often compared. Codeine is the only other naturally occurring opioid in common usage. The other familiar opioids are *semisynthetic*, derived from opium constituents (hydromorphone, hydrocodone, and oxycodone) or *synthetic*, synthesized de novo (meperidine, methadone, fentanyl, and fentanyl derivatives). These drugs are all opioid agonists, chiefly at the  $\mu$  opioid receptor. Other opioids are mixed agonists–antagonists or partial agonists (buprenorphine, butorphanol, pentazocine, nalbuphine), and are generally used for treating chronic rather than acute pain (or addiction), at least in the United States. They are not described in detail here. Naloxone is a pure opioid antagonist and can be useful to treat opioid overdose. Table 74-1 lists the commonly used opioid agonists with recommended doses; Table 74-2 summarizes opioid effects. The opioids described below are  $\mu$  agonists with essentially similar effects. Choice of opioid depends as much on the familiarity and preference of the treating physician as on the generally subtle differences in pharmacology between these drugs.

Morphine is the standard, most widely used of the opioids, and in



TABLE 74-1.

## Standard Doses of Commonly Used Opioids

Generic Name	Trade Name	Equianalgeic Doses		Typical First Dose	
		Oral	Parenteral	Oral	Parenteral
Codeine		200 mg	120 mg	30 mg q3-4h	10 mg q3-4h
Fentanyl patch	Duragesic	N/A	N/A	N/A	25 µg/h patch q72h <sup>a</sup>
Fentanyl Oralet	Actiq	N/A	N/A	N/A	200 µg <sup>b</sup>
Hydrocodone	Vicodin, <sup>c</sup> Lorcet, <sup>c</sup> Lortab, <sup>c</sup> Norco <sup>c</sup>	N/A	N/A	10 mg q3-4h	N/A
Hydromorphone	Dilaudid	7.5 mg	1.5 mg	2-4 mg q3-4h	1.5 mg q3-4h
Levorphanol	Levo-Dromoran	4 mg	2 mg	4 mg q6-8h	2 mg q6-8h
Meperidine	Demerol	300 mg	100 mg	100 mg q3h	100 mg q3h
Methadone <sup>d</sup>	Dolophine	2-4 mg	10 mg (acute) 2-4 mg (chronic)	5 mg q8-12h	5 mg q8-12h
Morphine		30 mg	10 mg	15 mg q3-4h	10 mg q3-4h
Morphine SR	MS Contin	N/A	N/A	15 mg q8-12h	N/A
Oxycodone	Percocet, <sup>c</sup> Percodan <sup>c</sup>	N/A	N/A	5 mg q3-4h	N/A
Oxycodone CR	OxyContin	N/A	N/A	10 mg q8-12h	N/A

<sup>a</sup>Lowest available does. Risk of overdoses in opioids-naïve patients. 24 µg/h patch = 50-75 mg oral morphine per 24-hour period. Conversions should be made conservatively (consult product literature) and titrated slowly.

<sup>b</sup>Lowest available does. Contraindicated in opioids-naïve patients, especially children. Not for use in children <10 kg. 200 µg Oralet = 2 mg IV morphine. 800 µg Oralet = 10 mg IV morphine.

<sup>c</sup>Combination formulations, with either acetaminophen or aspirin.

<sup>d</sup>The equianalgesic conversion does for methadone decreases significantly with increasing does of previous opioids. Caution guided by experience is mandatory.

Reproduced with permission from Black DR, Brenner GJ, Abdi S, et al.<sup>20</sup>

some countries, it is the only available opioid. It is the least lipophilic opioid (Table 74-3), which delays its peak effect (occurs at 20 minutes after IV injection) but makes it a good choice for epidural administration when a widespread effect is desirable. Morphine is highly metabolized, and has at least two active metabolites (morphine-6-glucuronide and morphine-3-glucuronide), which can delay normalization after morphine administration, especially during renal compromise

and continuous administration. (Morphine metabolites may also contribute to morphine toxicity and morphine-induced hyperalgesia in the special circumstance of sustained use.) Morphine induces histamine release and rapid bolus injection may produce local erythema, hypotension, or, rarely, bronchospasm. The normal duration of a standard dose (10 mg) is 3-4 hours. Morphine has poor oral bio-

availability, and the oral dose is 3 times the parenteral dose. Morphine may cause biliary and urinary tract spasm, and a different opioid is often substituted (meperidine or fentanyl) during treatment for gallstones and renal stones, or during biliary tract and urinary tract surgery, although recent studies suggest that the effect is an opioid effect, not specifically a morphine effect.<sup>21,22</sup>

TABLE 74-2.

## Opioid Effects

Analgesia
Respiratory depression
Nausea and vomiting
Sedation
Direct bowel effects
Dizziness
Pruritus
Meiosis
Euphoria
Dysphoria
(Biliary spasm—typically morphine)
(Urinary retention—uncertain)

TABLE 74-3.

## Opioid Lipophilicities

Opioid	Coefficients	Coefficient (cm/min × 10 <sup>-3</sup> )	MEAC <sup>a</sup> (ng/mL)
Morphine	1	0.6	30
Meperidine	525	NA	455
Hydromorphone	525	NA	4
Fentanyl	955	0.9	0.6
Sufentanil	1737	0.75	0.04
Alfentanil	129	2.3	41
Bupivacaine	560	1.6	NAP

MEAC, minimum effective analgesia concentration; NA, not available; NAP, not applicable.

<sup>a</sup>MEAC represents a range of plasma levels, not a specific value. MEAC plasma levels may vary up to 5-fold between different patients and with time and activity in specific patients.

Reproduced with permission from de Leon-Casasola OA and Lema MJ.<sup>60</sup>

*Codeine* is less potent, although more constipating, than morphine. Constipation limits the recommended dose to 30 mg, which has only mild analgesic (and respiratory depressant) effects. Codeine is available for oral use only, and is commonly found in combination analgesics such as Tylenol No. 3 (acetaminophen with codeine). In many countries, codeine is available over the counter, as it is considered to have low abuse potential and a good safety record. Its main usage is for pain of moderate severity, especially for children.

*Hydromorphone* (Dilaudid) is a useful alternative to morphine. For ill-defined reasons, many patients seem to prefer hydromorphone and claim they feel more clear headed, less dizzy, and less nauseated. At present, these can only be considered anecdotal observations. There are no active metabolites, therefore hydromorphone is a good choice for continuous administration, especially in patients with renal compromise.

*Hydrocodone* is used for mild to moderate pain, most commonly in the oral combination formulation Vicodin (hydrocodone with acetaminophen).

*Oxycodone* is not available for parenteral use in the United States, although it is elsewhere. It is a familiar opioid in the United States in the form of Percocet (oxycodone with acetaminophen), and is widely used for the treatment of moderately severe acute pain, including home treatment. More recently, oxycodone was formulated as a long-acting preparation (OxyContin), and this became a useful alternative to morphine and MS Contin (long-acting morphine) for the treatment of cancer and selected chronic pain. OxyContin and other long-acting oxycodone preparations have also been used for the treatment of acute pain, to aid sleep at night and function during the day. OxyContin availability has been limited by constraints associated with its popularity as a drug of abuse.

*Meperidine* (Demerol) was widely used for sedation and analgesia during procedural treatments, particularly in the office setting, as well as for hospital treatment of intra- and postoperative pain, until in the early 1980s several problems with the drug became clear. The first was normeperidine toxicity, normeperidine being a toxic metabolite capable of inducing central nervous system excitation and seizures,

and liable to accumulate in the elderly and those with impaired renal function. The second was the propensity of meperidine to cause addiction—probably related to its lipophilicity and rapid onset of both analgesia and euphoria. Published guidelines began to state that meperidine should not be used routinely,<sup>23,24</sup> and many hospitals withdrew it from their formularies. When it is available, meperidine remains a useful drug; its ability to produce fast onset analgesia and euphoria is its great advantage, especially during the treatment of postoperative pain. It also has an idiosyncratic and little understood advantage for treating postoperative shivering. It must, however, be used cautiously, being particularly mindful of normeperidine toxicity, which can occur with repeated or continuous use. Meperidine has mild anticholinergic, antihistaminic and local anesthetic effects. There may be a dangerous interaction (serotonin syndrome) with MAOIs, producing seizures, coma, and possibly death, even after a single meperidine dose.

*Methadone* is a complex drug, rarely used for acute pain, except in patients already treated with this drug. Important considerations are its multiple interactions with other drugs, especially with antibiotics and antifungals, and its propensity to prolong the QT interval, especially at high doses.<sup>25,26</sup> The reader should refer to more detailed texts if faced with a patient requiring high-dose methadone, or receiving methadone as part of a complex drug treatment regime.

*Fentanyl* use in the postoperative setting is largely confined to PCA and epidurals, where its high lipophilicity and short duration can be used to advantage.

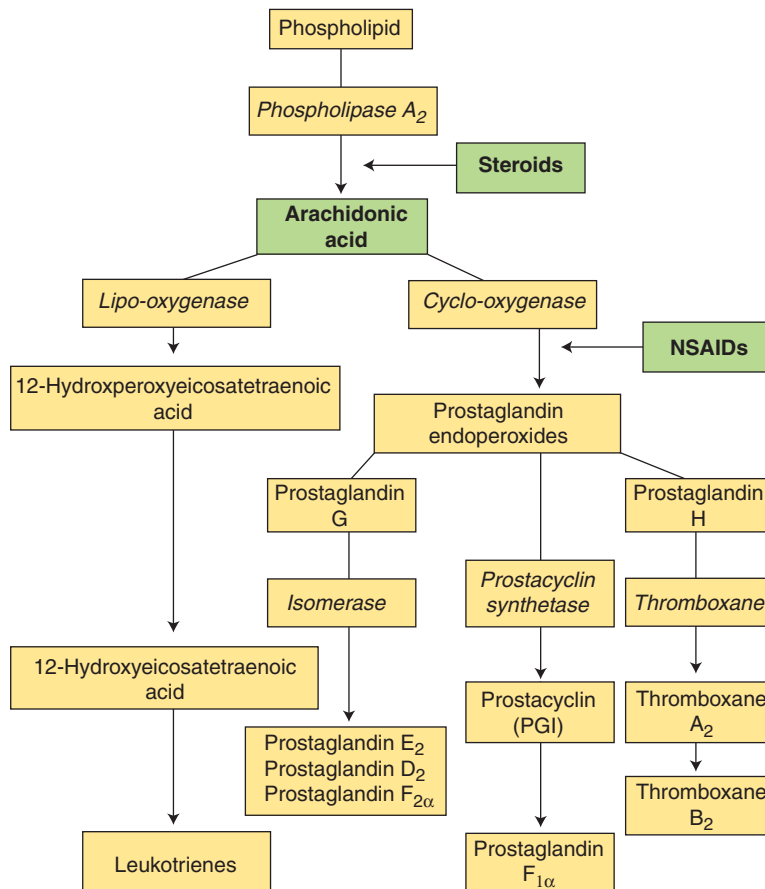
*Tramadol* (Ultram) is an interesting drug with weak opioid activity and additional norepinephrine and serotonin reuptake inhibition. It has low abuse potential and is not a controlled substance. It is widely used in Europe to treat acute and postoperative pain, but is less favored in the United States, where it is only available for oral use. Its use for severe pain is limited by the fact that it has a ceiling effect, but it may be useful for mild to moderate pain, particularly in patients who refuse opioids or tolerate them badly.

**Adverse Effects** Respiratory depression is the most feared of the opioid

side effects, and rightly so, as this is a potentially fatal side effect. The possibility of respiratory depression occurring produces a real conflict when trying to balance effective analgesia with safety. A key issue is to understand the likelihood of the event, and therefore the risk, and to provide adequate monitoring in high-risk situations. The immediate postoperative period is a period of high risk: the patient is often opioid-naïve, has been given multiple sedating drugs during surgery, may be weak, and may have high analgesic requirements. Neonates and infants are always at increased risk because of their immature nervous systems, propensity to apnea, and poor ability to metabolize opioid drugs. The elderly are at similar risks. Patients established on a stable opioid regime are at lower risk. The level of monitoring required is a matter of judgment, whether this consists of frequent checks by a nurse, or the application of a monitor such as an apnea monitor or pulse oximeter.

Other side effects are less catastrophic, but can significantly compromise the success of opioid therapy. Patients may prefer to be in pain rather than feel disorientated, dizzy, or nauseated; physicians may undertreat pain rather than delay hospital discharge because of ileus or nausea. Secondary treatments such as antiemetics may help, but it is the principles of opioid sparing that play a key role in minimizing opioid side effects and optimizing pain control.

**Tolerance, Dependence, and Addiction** It is important to understand tolerance, dependence, and addiction, and the differences between these three phenomena. Drug *tolerance* arises when an increase in dose is required to achieve the effect of a prior dose. Opioid tolerance arises through a combination of receptor desensitization (nonassociative tolerance) and psychological factors (associative tolerance).<sup>27,28</sup> Apparent tolerance could also result from opioid-induced hyperalgesia.<sup>15</sup> The development of tolerance and hyperalgesia during acute treatment is rare, but can occur, especially when opioid infusions are used (e.g., remifentanyl during surgery, or opioid infusions on an intensive care unit [ICU]).<sup>29</sup> More importantly, many patients now enter hospital or present for surgery who are already opioid



**FIGURE 74–2.** A schematic showing the metabolism of phospholipid and arachidonic acid. Nonsteroidal antiinflammatory drugs (NSAIDs) inhibit cyclooxygenase and thereby suppress the synthesis of prostaglandin E, prostacyclin, and thromboxane, and alter the balance between these eicosanoids and the leukotrienes. (Reproduced with permission from Ballantyne JC and Barna SB.<sup>31</sup>)

tolerant as a result of chronic opioid use or abuse. The management of these patients is further described under Special Populations below. *Dependence*, also known as *physical dependence*, arises after chronic opioid use, and is thought to reside in the norepinephrine pathways of the locus ceruleus, and results in a typical withdrawal syndrome when an opioid-dependent patient is deprived of opioid. The typical opioid withdrawal syndrome comprises central neurologic arousal and sleeplessness, irritability, psychomotor agitation, diarrhea, rhinorrhea, and piloerection. In the management of acute pain, withdrawal may occur if habitual doses are not maintained during acute pain treatment. Patients who use opioids illicitly are not typically honest about their usage, so physicians must be watchful for the signs of withdrawal if there is any suspicion of illicit usage. Treatment consists of reestablishing previous opioid levels, before a gradual taper. Clonidine can be a useful ad-

juvant, and effectively treats many of the manifestations of opioid withdrawal. *Addiction*, a behavioral syndrome with a neurobiologic basis, virtually never arises out of hospital treatment of pain with opioids—patients who are worried about the addiction risk can be assured of this.<sup>30</sup> However, addicted patients present for surgery and with acute trauma-related pain, and require skillful pain management. The management of these patients is further described under Special Populations below.

### Nonsteroidal Antiinflammatory Drugs and Acetaminophen

The NSAIDs are a group of drugs that inhibit cyclooxygenase (COX), an enzyme in the arachidonic acid pathway, thereby inhibiting prostaglandin and thromboxane production (Fig. 74–2). Table 74–4 summarizes prostaglandin and thromboxane actions. Inhibition of prostaglandin and thromboxane accounts for the analgesic and antiinflammatory effects of NSAIDs,

**TABLE 74–4.**

### Prostaglandin and Thromboxane Actions

Fever  
vascular smooth muscle relaxation (predominant action) (PGI<sub>1</sub> and PGE) and contraction (PGF<sub>1</sub> and TXA)  
Increased capillary permeability (LTB)  
Uterine smooth muscle contraction (PGE, PGF<sub>2</sub>)  
Bronchial smooth muscle relaxation (PGE) and contraction (PGF<sub>2</sub>, TXA, LTC, LTD)  
Increased GI contraction and motility (PGE<sub>1</sub>, PGI)  
Protection of GI tract by inhibiting gastric acid secretion and enhancing gastric mucous secretion (PGE<sub>1</sub>, PGI)  
Regulation of renal blood flow and sodium/potassium exchange (PGE<sub>1</sub>, PGI)  
Marked potentiation of the effects of other mediators of inflammation and pain (serotonin, bradykinin, histamine) (PGE<sub>1</sub>, PGI)  
Sensitization of nociceptors (PGE<sub>1</sub>, PGI)  
Inhibition of platelet aggregation (PGI)  
Increased platelet aggregation (TXA)  
Constriction of vascular smooth muscle (TXA)

LTB, LTC, and LTD, leukotriene B, C, and D; PGE and PGF, prostaglandin E and F; PGI, prostacyclin; TXA, thromboxane A.  
Reproduced with permission from Ballantyne JC and Barna SB.<sup>31</sup>

as well as for their adverse effects. Acetaminophen is not strictly an antiinflammatory drug, but is included here because it shares many of the properties of the NSAIDs. In contrast to the true NSAIDs, which are polarized and therefore do not readily cross the blood-brain barrier, acetaminophen is nonacidic and crosses the blood-brain barrier. Its action resides mainly in the central nervous system where prostaglandin inhibition produces analgesia and antipyresis. Its peripheral and antiinflammatory effects are weak. Table 74–5 list commonly used NSAIDs and their doses.

The NSAIDs and acetaminophen are commonly used over-the-counter analgesics, and have a long history of use for mild to moderate surgical pain, especially during home treatment. They are also used with opioids in oral combination formulations. The advent of ketorolac, the first injectable NSAID with Federal Drug Administration

TABLE 74-5.

## Standard Doses of Commonly Used Oral NSAIDs

Generic Name	Trade Name	Adult Oral Dosage
Acetaminophen	Tylenol	650–975 mg q4–6h
Acetylsalicylic acid	Aspirin	650–975 mg q4–6h
Celecoxib	Celebrex	100–200 mg BID
Diclofenac sodium	Voltaren	25–75 mg q8–12h
Diflunisal	Dolobid	250–500 mg q8–12h
Etodolac	Lodine	200–400 mg q6–8h
Fenoprofen calcium	Nalfon	200 mg q4–6h
Flurbiprofen	Ansaid	100 mg q8–12h
Ibuprofen	Motrin	400–800 mg q6–8h
Indomethacin	Indocin	25–50 mg q8–12h
Ketoprofen	Orudis	25–75 mg q6–8h
Ketorolac	Toradol	10–50 mg q6–8h
Meclofenamate sodium	Meclomen	50 mg q4–6h
Meloxicam	Mobic	7.5–15 mg qd
Naproxen	Naprosyn	250–500 mg q8–12h
Naproxen sodium	Anaprox	250–550 mg q6–8h
Phenylbutazone	Butazolidin	100 mg q6–8h
Piroxicam	Feldene	10–20 mg qd
Sulindac	Clinoril	150–200 mg q12h
Tolmetin	Tolectin	200–600 mg q8h

Reproduced with permission from Black DR, Brenner GJ, Abdi S, et al.<sup>20</sup>

(FDA) approval for use in surgical patients, triggered a surge in interest in the use of NSAIDs as sole analgesics and as adjuncts for the treatment of moderate to severe acute and surgical pain. Ketorolac is a potent NSAID, unfortunately with a side-effect profile that reflects its potency, which can be used as a sole analgesic, even for severe pain. The NSAIDs and acetaminophen have emerged as useful adjuncts in multimodal analgesic regimes, and have a possible role as preemptive analgesics.<sup>9</sup>

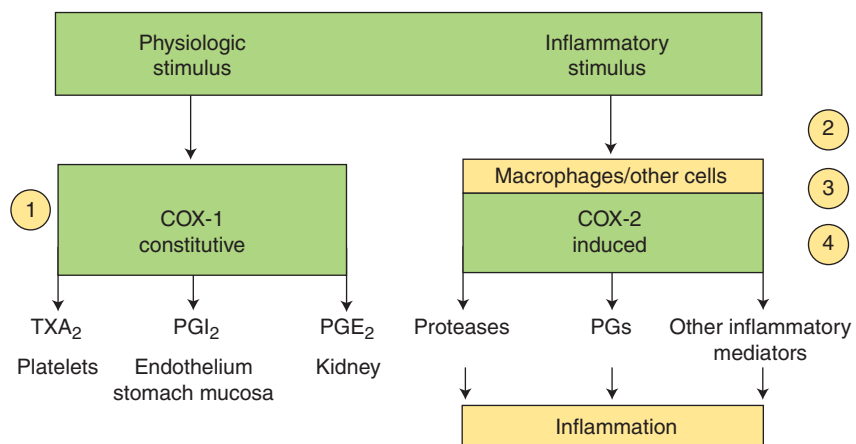
A new subclass of NSAIDs has recently been released for clinical use—the selective COX-2 inhibitors. COX-2 is an inducible isoenzyme, and a source of prostaglandins during inflammatory processes. COX-1, in contrast, is a constitutive isoenzyme, and has protective effects on the stomach where it mediates the production of cytoprotective prostaglandins (Fig. 74-3).<sup>32</sup> The selective COX-2 inhibitors were developed in the hope of being able to reduce NSAID side effects, particularly the damaging gastrointestinal (GI) effects. Early clinical trials, and clinical experience confirmed the analgesic efficacy and favorable side-effect profile of these drugs with regard to

their effect on the gastric mucosa and their platelet effects, although some of the early trial results have now been brought into question. The great hope

for these drugs was that they would replace standard NSAIDs and reduce complications, particularly NSAID-induced GI bleeding which is thought to account for up to 100,000 hospitalizations and 20,000 deaths per year in the United States. However, these hopes have been crushed by the steady emergence of evidence that deleterious cardiovascular and thrombotic effects preclude the use of these drugs in many patients.<sup>34,35</sup> In fact, most are now withdrawn, and the only selective COX-2 inhibitor on the market in the United States at the time of writing is celecoxib (Celebrex).

### Adverse Effects and Limitations on Perioperative Use

Table 74-6 lists the adverse effects of NSAIDs in surgical patients. Contraindications arise out of these adverse effects, and these are listed in Table 74-7. Acetaminophen is relatively safe, and not associated with the adverse effects listed for standard NSAIDs. The COX-2 inhibitors are less likely to cause bleeding (platelet effects), particularly GI bleeding (unprotected GI mucosa), but carry the same risk as standard NSAIDs of the other listed adverse effects, and additional cardiovascular and thrombotic risks. Consequently, these drugs have similar contraindications to the standard NSAIDs.



**FIGURE 74-3.** Relationships between the pathways leading to the generation of eicosanoids by COX-1 and COX-2. Under physiologic conditions, activation of COX-1, for instance in platelets, endothelium, stomach mucosa, or kidney, results in the release of thromboxane A<sub>2</sub> (TXA<sub>2</sub>), prostacyclin (PGI<sub>2</sub>), or prostaglandin E<sub>2</sub> (PGE<sub>2</sub>). The release of these eicosanoids is selectively inhibited by drugs such as aspirin (1). Inflammatory stimuli release cytokines, such as interleukin-1, that induce the synthesis of COX-2 in cells such as macrophages, resulting in the release of prostaglandins (PGs). The release of PGs together with proteases and other inflammatory mediators (such as reactive oxygen radicals) results in inflammation. The COX-2 pathway can be interrupted at several levels by antagonists or antibodies to cytokines and mitogens (2), inhibitors of the induction of COX-2 (e.g., glucocorticoids) (3), or selective inhibitors of COX-2 (4). (Reprinted from Van Der Ouderaa FJ, Buytenhek M, Nugteren DH. Purification and characterization of prostaglandin endoperoxide synthetase from sheep vesicular glands. *Biochim Biophys Acta* 1977;487:315–331, with permission from Elsevier.)



TABLE 74–6.

**Adverse Effects of NSAIDs in Surgical Patients**

Gastrointestinal hemorrhage (occasionally catastrophic)  
 Renal dysfunction or failure  
 Decreased hemostasis and hematoma formation  
 Asthma in susceptible individuals (due to blockade of the cyclooxygenase pathway, leading to exaggerated effects of the metabolites of the lipoxygenase pathway [i.e., leukotrienes])  
 Anaphylaxis (risk of immune-related anaphylactoid reactions is small, although some individuals suffer anaphylaxis-like symptoms that are unrelated to an immune process)  
 Decreased healing of gastrointestinal anastomoses (proposed)  
 Delayed fracture healing (not established in humans, but demonstrated in animals)

Reproduced with permission from Ballantyne JC and Barna SB.<sup>31</sup>

Patients should be advised to stop taking NSAIDs before surgery, chiefly because of their platelet effects, and their propensity to increase surgical bleeding. Aspirin, whose platelet effects are not reversible, should be stopped for up to 10 days before elective surgery. Other NSAIDs have rapidly reversible platelet effects, and 24 hours cessation is probably sufficient, although 2–3 days cessation is usual. Acetaminophen and COX-2 inhibitors can be continued because they do not have platelet effects.

A factor that makes perioperative NSAID use relatively safe is the fact that they are used for a short period while most adverse effects are associated with prolonged use. This is true of platelet, GI, and renal effects. Thus even in patients chronically treated with NSAIDs who have stopped the treatment to minimize surgical bleeding, short-term perioperative use may be appropriate. This brings into question the issue of timing of NSAID administration, which is linked to the drugs' liabilities. There are theoretical advantages to giving NSAIDs early in the surgical course, even preoperatively. These include the drugs' pharmacokinetics—for example, the peak effect

of ketorolac may occur as late as 4 hours after administration—and the consideration that the drugs may have preemptive effects.<sup>9</sup> However, for major surgery, where there is a likelihood that there will be bleeding and/or hypotension with deleterious effects on clotting and renal function, it is probably better to wait until the extent of any derangement is clear. Surgical considerations are also important when deciding whether to use an NSAID. These include possible postoperative bleeding, especially into closed cavities such as the knee joint, as well as retardation of bone remodeling, a consideration after bone fusion, especially of the spine.

**Use of NSAIDs and Acetaminophen for Postoperative and Acute Pain**

For mild postoperative or acute pain, NSAIDs or acetaminophen can be used as sole analgesics. In addition, even though they are considered weak analgesics, they have an important role as adjuncts and in multimodal analgesic regimens. Their mechanism of action—prostaglandin inhibition—means that they are synergistic with many other analgesic interventions, particularly with opioid analgesia. Multiple studies and meta-analyses confirm an average 30–50% opioid-sparing effect of NSAIDs.<sup>36–42</sup> Whether this reduction in opioid dose with NSAIDs translates into improved recovery and morbidity is less clear. The most recent meta-analysis of 22 RCTs by Marret et al. affirms a 30% reduction in nausea and a 29% reduction in sedation, but effects on urinary retention and respiratory complications were inconclusive. Overall, studies assessing the effects on adjunctive NSAID use on recovery have had mixed results.<sup>36,37,43–45</sup> The availability of the injectable NSAID ketorolac has extended perioperative use to the many patients who cannot tolerate oral medications after surgery. Initially, the side effects of this drug seemed unacceptable, but this was an effect of an initial recommendation to use a 60-mg first dose with 30-mg repeat doses. Now that the recommended dose has been halved (30-mg first dose, 15-mg repeat doses) and a 5-day limit has been placed on ketorolac use, the early problems of catastrophic bleeding (GI, surgical, and joint) seem to be resolved. Injectable acetaminophen is available and widely used periopera-

TABLE 74–7.

**Contraindications to NSAIDs Use**

History of peptic ulcer disease or intolerance to NSAIDs  
 Bleeding, bleeding diatheses, or anti-coagulant therapy  
 Renal failure, renal dysfunction or risk factors for renal dysfunction (i.e., hypovolemia, sodium depletion, congestive heart failure, hepatic cirrhosis, concurrent use of nephrotoxic drugs including aminoglycosides)  
 Old age, particularly in the presence of any of the above<sup>a</sup>  
 Prophylactic use in major surgery (i.e., preoperative or intraoperative use, particularly if there is a potential for bleeding)

<sup>a</sup>The elderly (>60 years of age) appear to be especially vulnerable to the effects of prostaglandin inhibition by NSAIDs. Reproduced with permission from Ballantyne JC and Barna SC.<sup>31</sup>

tively in Europe, but is not available in the United States.

**Novel Adjuncts**

Although the NSAIDs are the most widely used and useful systemic analgesic adjuncts in postoperative pain regimens, there has recently been interest in testing other possible adjuncts.

*NMDA receptor antagonists* are known to reduce central sensitization, hyperalgesia, and opioid tolerance.<sup>11,15</sup> This makes them theoretically an attractive option for treating acute pain: By reducing central sensitization they might reduce postoperative pain and possibly reduce the likelihood of developing chronic pain; they could also reduce opioid requirements and opioid tolerance. Ketamine is the most widely tested of currently available NMDA receptor antagonists (ketamine, dextromethorphan, and amantadine), but usage has been limited by this drug's side effects (psychomimetic effects, including nightmares and hallucinations). These side effects can be reduced by concomitant use of benzodiazepines and by dose restriction; efforts to study the possible usefulness of ketamine as an adjunct analgesic for postoperative pain have centered on dose-finding and regime modeling. A recent detailed study suggests that although ketamine has demonstrable

antihyperanalgesic effects (as shown by skin measurements around the surgical incision), this may not translate into a useful opioid-sparing effect.<sup>18,46</sup> A 2005 systematic review by Elia and Tramer incorporating 53 trials (2839 patients) found a small difference (<1 cm on a 0–10-cm visual analog scale) in postoperative pain level, a significant difference in opioid use during the first 24 hours after surgery, and no difference in opioid side effects.<sup>47</sup> The highest risk of hallucinations occurred in awake or sedated patients receiving ketamine without a benzodiazepine. Given the mixed results of published trials (other studies), and the small (clinically insignificant) difference in pain plus a lack of difference in opioid side effects (lack of important opioid sparing) in a large systematic review, the role of ketamine and other NMDA receptor antagonists in postoperative pain regimes remains uncertain.

*Neuropathic pain medications* (anticonvulsants and antidepressants), as their name suggests, have their chief pain indication for the treatment of chronic neuropathic pain. “Neuropathic pain” is caused by a primary lesion or dysfunction in the nervous system. Because neuropathic pain medications act by modifying hyperactivity in the nervous system, and because acute injury does result in neural changes both peripherally and centrally, it seems logical that neuropathic pain medications might also help acute, even nociceptive, pain. This premise has been tested in multiple studies using gabapentin, currently the most widely used neuropathic pain medication, favored because of its excellent safety record.<sup>48</sup> Published RCTs consistently show reduced opioid consumption after a typical dose of 1200 mg given as a single dose before surgery, but there is no reduction in opioid side effects. Side effects (dizziness and sedation being the most common gabapentin side effects) did not appear to interfere with treatment efficacy in these trials. Without a demonstrable reduction in opioid side effects, the value of this treatment must remain questionable. However, this is an interesting area worthy of further study, especially as newer neuropathic pain medications become available.

## Patient Controlled Analgesia

Simple though it seems, PCA technology represents a huge advance in acute

pain management. Computer-controlled pumps allow patients to control their own injections, and to do this safely. Additionally, microchips have made controllable pumps easily portable. PCA satisfies the needs of patients to receive pain medication easily and quickly, when needed. Nursing time spent obtaining, checking, documenting, drawing up, giving, and monitoring frequent doses is eliminated. The hospital’s need to comply with JCAHO’s pain mandate is greatly aided. Most moderate to severe postoperative pain in hospitalized patients can be managed satisfactorily using routine intravenous opioid PCA for 24–48 hours after surgery, with or without adjuncts. A proviso is that pain in the immediate postoperative period is controlled by nurse bolus injections until it is under adequate control; patient-triggered boluses using standard settings may be inadequate for treating immediate postoperative pain, and early failed analgesia can prove difficult to overcome. Ideally, patients should be educated in the use of PCA before surgery.

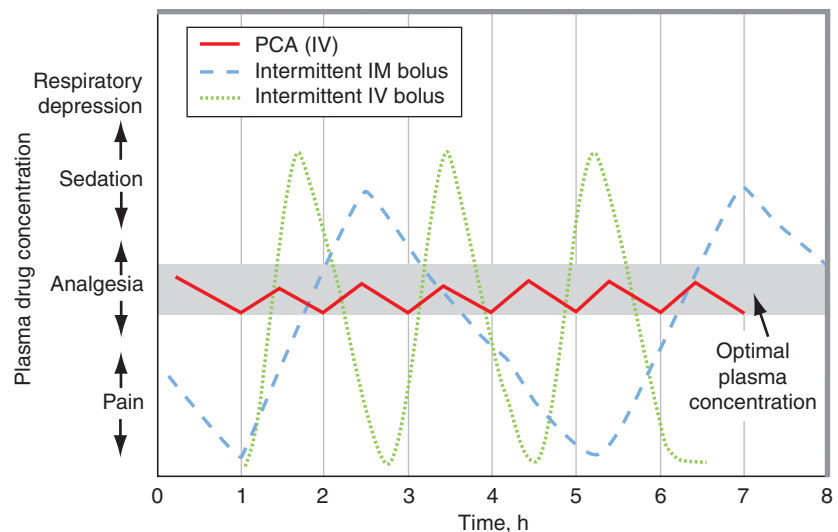
### The Inherent Safety of PCA

Because of the ease with which each PCA bolus dose can be given, PCA dosing regimes were devised using small frequent doses. For example, a standard regime for morphine is 1 mg every 6 minutes. A maximum hourly limit can be used, as can a background infusion if

desired (the latter is particularly useful at night so that the patient can sleep). Part of the logic was to avoid the large swings between high peaks and low troughs associated with less frequent and larger doses (Fig. 74–4), but another was to improve safety. Small patient-controlled doses are inherently safe because a single dose is too small to produce overt sedation or respiratory depression, and an obtunded patient will stop pushing the button so that there will be no further dosing beyond this early warning stage. The inherent safety of PCA also means that there is less need for monitoring, and no need to use the intramuscular route (with its slower absorption) for the sake of safety. Naturally, no method of delivery of opioids is completely safe, so a degree of vigilance is always required. The inherent safety of PCA is lost if persons other than the patient are permitted to push the button.

### Benefits of PCA

Since PCA became popular in the 1980s, many studies have been conducted to assess whether the use of PCA results in better analgesia, lower opioid requirements, fewer side effects, better surgical outcome, or superior patient satisfaction. Two meta-analyses of PCA versus “conventional analgesia” (intermittent large-dose opioid injection) have been published, the first in 1993<sup>50</sup> and the second in 2001.<sup>51</sup> The second analysis added 17



**FIGURE 74–4.** Serum drug levels from frequent small dosing using PCA compared with large, intramuscular or intravenous dosing given every 2–4 hours. Ideally, serum drug levels are kept within the “analgesic” range, avoiding the high peaks associated with oversedation and respiratory depression and the low troughs associated with inadequate analgesia. Frequent small dosing would not be practicable without PCA. (Reprinted from Ballantyne JC. Systemic opioids and patient controlled analgesia. In: Neal JM, Rathmell JP, eds. *Complications in Regional Anesthesia and Pain Management*. Philadelphia: Elsevier, 2006:1667–175. Copyright 2006, with permission from Elsevier.)

new trials to the first, but its results were essentially similar to those of the first. There was slightly better analgesia associated with PCA use (difference of 5.6 on a 0–100 scale,  $p = 0.006$ , debatably not a clinically important difference), and a large difference in patient satisfaction favoring PCA (42% improvement,  $p = 0.02$ ). There was no difference in opioid usage, side effects, or surgical outcome. Thus, the overriding benefit of PCA seems to be that patients like it. It has, in fact, become a standard of care in a majority of U.S. hospitals.

**Cost of PCA** The issue of cost of PCA is frequently analyzed and debated.<sup>52–54</sup> It has proven difficult to come up with a global assessment of PCA costs and the cost savings associated with reduced nursing involvement, improved safety, and other factors. This is because all related costs, including the initial outlay or rental of the PCA systems and their hardware, and including nursing costs, vary from location to location. Overall, it seems that the literal costs to a hospital are slightly higher for PCA versus “conventional analgesia,” but imponderables such as increased safety and greater patient satisfaction, are hard to translate into cost benefits.

**Patient-Controlled Epidural Analgesia** PCA technology can also be used for epidural analgesia. As with intravenous PCA, the main advantage is that patients like the sense of control offered by the patient triggered pump.

**Novel PCA Technologies** New methods of providing PCA that use iontophoretic transdermal and intranasal delivery systems are now in development.<sup>55,56</sup> The most advanced of these is the fentanyl patient-controlled transdermal system, which is a noninvasive, needle-free, credit card size, self-contained drug-delivery system. A small imperceptible electric current drives ionized drug across the normally impenetrable stratum corneum—the outer layer of skin. The adhesive system can be placed on any patch of hairless skin, and for convenience, the upper arm is usually chosen. The system is preprogrammed to deliver 40  $\mu\text{g}$  fentanyl per dose and can deliver up to 6 doses per hour for 24 hours, or 80 doses, whichever comes first. Each

dose is triggered by the patient pushing a button on the system twice (twice so it is not triggered accidentally). Cost is likely to play a large part in whether this type of system is adopted for hospital versus home use, or acute versus cancer/chronic pain.

## Epidural Analgesia

The provision of epidural analgesia is probably the single most important contribution that anesthesiologists currently make to postoperative pain management for individual patients. There are two reasons for this: (a) after major surgical procedures, particularly abdominal and thoracic, epidural analgesia has proven analgesic superiority,<sup>57</sup> an effective opioid-sparing effect, and probably a beneficial effect on surgical outcome,<sup>17,58,59</sup> and (b) the ease with which the alternative (systemic opioid) can be provided using PCA has diminished the role of anesthesiologists in the provision of standard treatment. A perplexing thought, however, is how much we truly understand the risk versus benefit of epidural analgesia, especially in an era of potent thrombosis prophylaxis, and some further risk of epidural hematomas. How do we weigh rare but catastrophic outcomes against common benefits of debatable value? This is one of the most important issues we face as we continue the use of epidural analgesia.

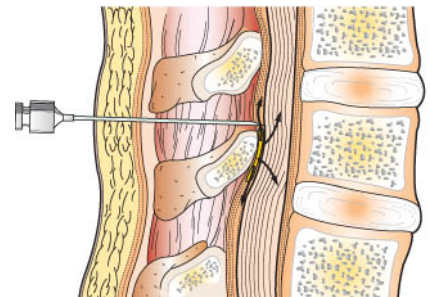
**Indications** A review of indications for intraoperative epidural use is outside the remit of this chapter, but there are also independent indications for postoperative epidural analgesia, including patients having thoracic or abdominal surgery, patients having lower-limb surgery in whom early mobilization is important, patients having lower-body vascular procedures in whom a sympathetic block is desirable, and patients with compromised cardiac or pulmonary function.

**Contraindications** Epidural placement is always contraindicated in patients who refuse this option. It is also contraindicated in patients with coagulopathy, concurrent or planned treatment with low-molecular-weight heparin or with potent antiplatelet agents that will not allow adherence to American Society of Regional Anesthesia and Pain Medicine (ASRA) guidelines,<sup>67</sup> and in patients with bacteremia

or local infection at the insertion site. The presence of spine pathology is a relative contraindication: the placement may be technically challenging and the treatment may fail if distorted anatomy prevents good distribution of the epidural medications. Neurologic disease is considered a relative contraindication by some because if there is a change in neurologic status—which is not uncommon after the stress of surgery—diagnosis of the deterioration can be confused in the presence of an epidural.

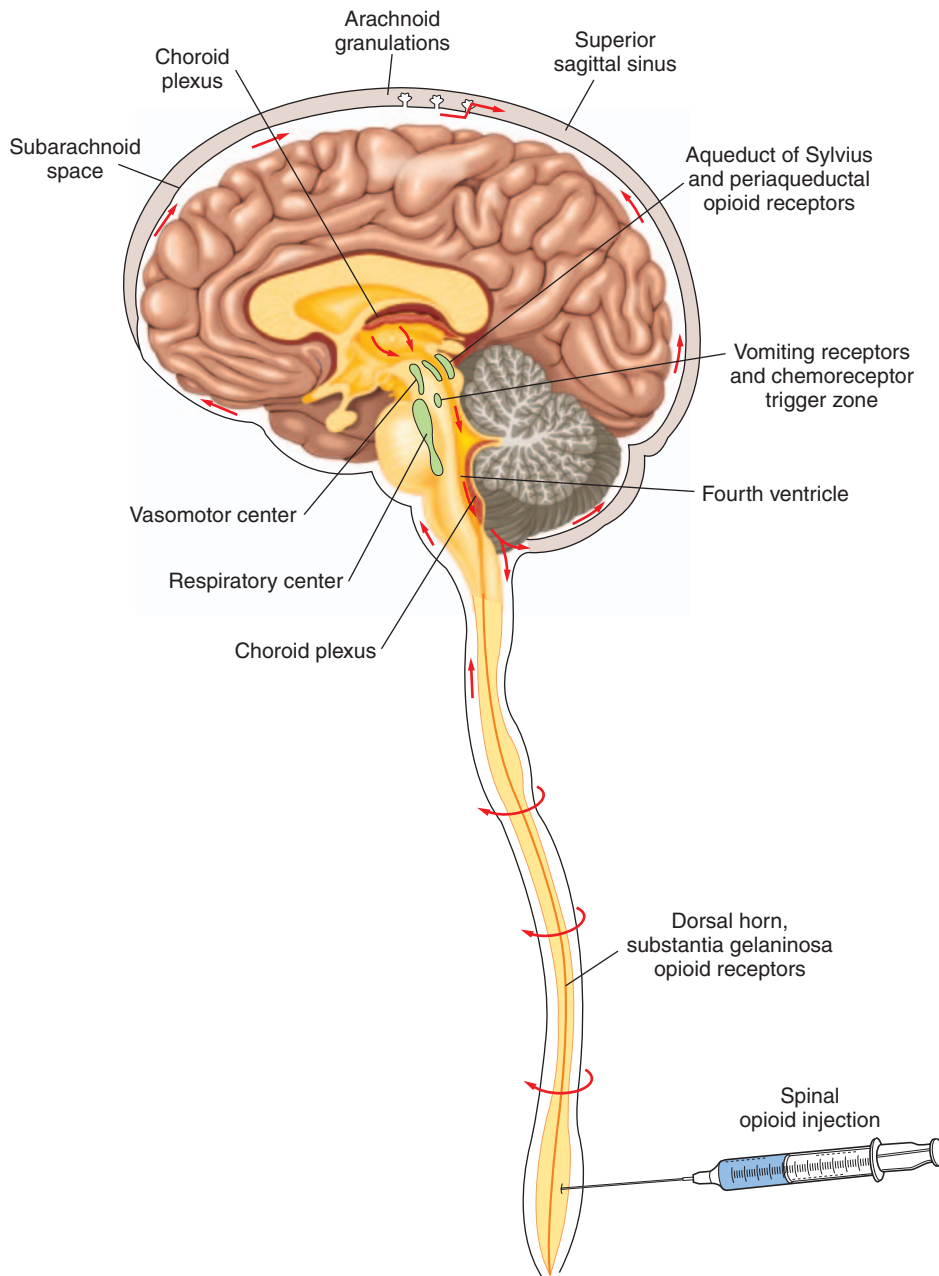
## Drug Choices and Drug Effects

Drugs injected or infused into the epidural space will diffuse and spread according to their pharmacokinetics profile. The epidural space is complex because it contains arteries, veins, and lymphatics that are capable of absorbing drugs into the systemic circulation, nerve roots upon which drugs can act directly, and fat in which drugs can form a reservoir (Fig. 74–5). The intrathecal space is a close neighbor of the epidural space, and diffusion into this space brings the epidural drugs access to more nerve roots, to the spinal cord, and if spread is extensive enough, into the ventricular system of the brain (Fig. 74–6). When planning epidural



**FIGURE 74–5.** The epidural space. The space is always approached via the elastic and resistant ligamentum flavum. The space itself contains fat, veins, arteries, lymphatics, and nerve roots. Drugs injected or infused into the space will diffuse into all the tissues and structures within the epidural space, as well as to neighboring structures. Thus, local anesthetics will have a direct effect on nerve roots within the space, as well as diffusing through the dura and arachnoid membranes to cerebrospinal fluid and intrathecal nerve roots. Opioids have little activity in the epidural space itself, but will diffuse into the systemic circulation (the more lipophilic the opioid, the more the systemic uptake), and across to the opioid receptors in the substantia gelatinosa of the dorsal horn.





**FIGURE 74–6.** Cerebrospinal fluid flow. Drugs injected into the epidural space or intrathecal space will tend to accumulate in cerebrospinal fluid (CSF) at the level of injection. The accumulation of hydrophilic drugs such as morphine tends to be greater than that of more lipophilic drugs such as fentanyl. Slowly diffusing drugs such as morphine is subject to bulk flow of CSF, and tend to move cephalically toward the ventricular system in the brain. Bulk CSF flow varies markedly from patient to patient. If drug does reach the ventricular system, notably the fourth ventricle, it is likely to cause respiratory depression, and possibly nausea, as the respiratory center and chemoreceptor trigger zone are at the base of the fourth ventricle. Slowly diffusing drugs are likely to provide a good spread of analgesia, as drug spreads widely to the opioid receptors concentrated in the substantia gelatinosa of the dorsal horn.

infusion regimes, one has to consider not only local effects, but also distant effects, as related to the individual drug's epidural pharmacokinetics.

*Local anesthetics* act directly on nerve axons to block sodium channels and thus block saltatory conduction. They can block nerves in the epidural space itself, or more widely once they cross into the intrathecal space. Because of the arrangement of nerve fibers within the nerve roots, with

small fibers lying outside larger fibers, small fibers are the first to be blocked and the most sensitive to local anesthetics. This characteristic of the spinal nerve roots means that differential blockade can be achieved using low dose local anesthetics to block only small fibers (C-fibers—sympathetic, pain, and temperature fibers), and high-dose local anesthetics to achieve total sensory blockade, often accompanied by motor blockade ( $A\alpha$  and  $\beta$

fibers). To achieve analgesia without sensory decrement, low-dose local anesthetic (e.g., 0.1% bupivacaine) is chosen for postoperative use. Epidurals with low-dose local anesthetic infusion are sometimes termed “walking epidurals”—a useful term because it emphasizes that patients can and should be walking around to hasten recovery and minimize complications.

*Opioids* have a completely different target—the opioid receptors in the dor-



sal horn of the spinal cord. Epidural opioid analgesia is also more likely to be complicated by systemic effects as, in contrast to the local anesthetics, which also undergo a degree of systemic absorption, there are clinically relevant systemic effects, especially when highly lipophilic opioids such as fentanyl are used. The degree to which opioids are absorbed systemically versus into cerebrospinal fluid (CSF) versus onto spinal cord receptors depends almost entirely on their lipophilicity (Table 74-3). As Table 74-3 shows, morphine is several-fold less lipophilic than all the other commonly used opioids. Because of this, it tends to be less readily absorbed into the systemic circulation, providing a better selective spinal effect, and also tends to spread more within the intrathecal space as it will favor staying in the watery medium of the CSF. This has advantages—more widespread spinal analgesia—and disadvantages—a higher risk that the drug will reach the ventricular system and cause respiratory depression (Fig. 74-6). In contrast, more lipophilic opioids, such as fentanyl, tend to have much greater systemic absorption (less selective spinal analgesia) and absorption onto spinal cord receptors tends to be localized, with poor spread. There is a great deal of experience using morphine and other opioids safely and effectively, and individual institutions must design suitable regimens on the basis of the published experience and their ability to adequately evaluate and monitor patients receiving epidural analgesia.

The addition of *clonidine* to the local anesthetic and opioid significantly improves the quality and duration of neuraxial analgesia.<sup>61</sup> The effect is mediated by descending modulatory pathways to the spinal dorsal horn. Despite the low doses used for neuraxial administration, systemic side effects (hypotension, bradycardia and sedation) can occur. Dose finding studies are still underway, and the therapeutic window for useful analgesia without side effects seems to be narrow. A reasonable regime uses a 1–2 µg/kg bolus followed by 0.4 µg/kg/h.

**Management Principles** The management of epidural catheters should always be under the direct supervision of anesthesiologists. Patients should be evaluated daily to ensure that catheters and medications are working ef-

fectively, and that possible complications are recognized, and recognized early. Pain reports should be satisfactory, and side effects, such as pruritus, sedation, and changes in sensation or motor function, should be carefully evaluated. Medication charts should be checked, especially for unintentional anticoagulant administration. Catheters and their insertion sites should be inspected for migration, integrity of the dressing, and for inflammation or back tenderness. Anesthesia personnel should make changes to the analgesic regime and administer specific medication as necessary. At the end of treatment, the anesthesia team should be responsible for removing the catheter and ensuring that it is removed intact. Nurses should be properly educated before they care for patients with epidural catheters. Important teaching points include typical medication doses and concentrations, anticoagulation issues, assessment parameters, the normal appearance of the catheter and catheter site, operation of the infusion pumps, common medication side effects that can be treated by them, and side effects requiring a call to the physician in charge.

If an epidural does not appear to be functioning well, it is first necessary to test whether the catheter is well positioned. The ideal way to do this is to attempt to produce a discernible level using a bolus dose of local anesthetic. However, the dose of local anesthetic needed to produce a sensory level may also induce hypotension, which would not be desirable in an unmonitored situation such as a regular floor, particularly if there are no means readily available to treat the hypotension. A surprisingly helpful test is to inject 5–7 mL of the analgesic infusion (low-dose local anesthetic), in which case no special monitoring is needed because the low-dose anesthetic is unlikely to produce extreme hypotension. If the catheter is well positioned, analgesia should be noticeably improved by the injection.

Once good catheter function is established, several approaches to improve analgesia can be taken. Bolus injections can be continued until good analgesia is achieved. The infusion rate can be titrated upwards, as tolerated. Systemic analgesic can be added to the regime. NSAIDs are useful adjuncts to epidural analgesia, especially when the epidural level does not cover

the entire area of surgical pain, for example when the incision is high, or when pain is referred outside the epidural area as occurs when chest tubes irritate the diaphragm and produce shoulder pain via the phrenic nerve. Systemic opioids (including PCA) can also be added, in which case it is preferable to remove the opioid from the epidural infusate, if used.

**Managing Side Effects** Hypotension, mild sensory and/or motor changes and urinary retention are the most common side effects of epidural local anesthetic, whereas pruritus, sedation, dizziness, and urinary retention are the most common side effects of epidural opioids. Most side effects are alleviated by either lowering the infusion rate, or changing the drug or dose. Hypotension can become a considerable nuisance during epidural analgesia, even though the sympathectomy from low-dose local anesthetics is theoretically minimal. Some patients are particularly sensitive to the local anesthetic, and manifest hypotension that does not respond to the primary measure of fluid replacement. For these patients, the local anesthetic can be removed from the epidural mix, or the epidural treatment may have to be abandoned altogether. Pruritus is a common side effect and usually responds well to antihistamine treatment. The mixed agonist–antagonist nalbuphine (Nubain) (5–10 mg IV, given every 4–6 hours) also works well, as does low-dose naloxone infusion. Contrary to popular belief, nausea rarely occurs because opioid doses are low. Gut mobility is in fact improved by epidural therapy, because of opioid sparing and the favorable effects of neuraxial local anesthetic on bowel motility. Urinary retention is common, and it is common practice to keep a urinary catheter in place until epidural therapy is discontinued.

Unilateral lower-extremity numbness with occasional weakness or motor block occurs fairly frequently. It is often a result of the epidural catheter tip migrating along a nerve root so that the local anesthetic is concentrated in one area. Pulling the catheter back, or lowering the infusion rate, often rectifies the problem. However, one should always remain vigilant and continue to watch for more serious complications.

**Complications** The most common complications are failed block/analge-

sia, and postdural puncture headache (PDPH). Both are considered benign, although they may be devastating to patients who have committed to an epidural in order to optimize their surgical recovery. The exact incidence of these common complications is difficult to establish as reports vary, and the occurrences likely vary according to reporting and practice habits. Recent reports suggest that failed analgesia occurs in as many as 15% of cases.<sup>62–64</sup> PDPH may occur in up to 86% of patients after accidental dural puncture (rate 0.16–1.3%).<sup>65</sup> The incidence of other self-limiting neurologic complications such as radicular pain and peripheral nerve lesions is difficult to determine, because these occurrences are rarely reported.

PDPH is thought to result from a small CSF leak secondary to unintentional dural puncture. Typically, there is a delay in onset of the headache of up to 24 hours, so that the complication tends to manifest on the first postoperative day. Because PDPH tends to worsen on sitting up, and particularly on walking, it may not present itself until the patient gets out of bed for the first time after surgery. Other characteristics of the headache are that it tends to occur at the back of the head (occiput) and neck, and produces a tight, pulling and throbbing sensation. Conservative management consists of bedrest (up to bathroom only), plenty of fluids (IV or oral) and headache medication (NSAIDs, acetaminophen, Fioricet, caffeine, and theophylline all work well). If there is no resolution, or if conservative measures are contraindicated, a blood patch is recommended. This consists of an epidural injection of up to 20 mL of the patient's own blood (drawn under aseptic conditions). The exact mechanism by which an epidural blood patch works is uncertain, but is probably either a pressure effect, or a laying down of clot or fibrosis onto the puncture site.

Epidural hematoma with consequent paraplegia is extremely rare, but is a catastrophic complication of epidural therapy. Permanent paraplegia can occur even when a hematoma is diagnosed and treated in a timely manner—although early intervention usually reverses the neurologic injury. Persistent lower-extremity neurologic changes or cauda equina syndrome (loss of bowel and bladder

control) should always be taken seriously, especially if there is accompanying back pain and tenderness, which are cardinal signs of epidural hematoma and abscess in nonanalgesia patients, thus symptoms and signs cannot be counted on in patients receiving epidural analgesia, although neurologic consultation can be obtained, but early imaging, preferably with MRI (second choice, CT), should always be instituted. The presence of a space-occupying intracanal spinal lesion should always herald immediate transfer to the operating room for surgical decompression.

The incidence of epidural hematoma after neuraxial injection, catheter placement, or catheter removal is estimated to be 1 in 190,000 cases, with many of the reported cases associated with anticoagulant use.<sup>66–68</sup> A rash of reports of epidural hematoma occurring after neuraxial interventions in patients receiving low-molecular-weight heparin (LMWH) alerted physicians to the dangers of epidural injections and catheters in patients receiving highly effective thrombosis prophylaxis. More problems followed when chronic treatment with potent and long-acting antiplatelet agents such as clopidogrel became more widespread.<sup>67</sup> In view of the rapidity with which new agents are being introduced, and the time lag before the extent of a problem can be assessed, we are left with a great deal of uncertainty about how to best mix anticoagulant prophylaxis and epidural analgesia. Table 74–8 summarizes guidelines for managing epidurals in patients receiving anticoagulants. These recommendations are based on the consensus guidelines published by ASRA. The guidelines are updated periodically and published on ASRA's website. Epidural bleeding is known to occur secondary to single shot neuraxial techniques as well as neuraxial catheter insertion and removal, so recommendations are needed for the start and end of neuraxial therapy, as well as for starting anticoagulant therapy after neuraxial instrumentation or catheter removal.

Epidural abscess occurs less often than epidural hematoma, but can be equally catastrophic, and may cause permanent and serious neurologic injury, even death.<sup>45</sup> Fever is a likely accompaniment to epidural abscess, otherwise it presents much as epidural

hematoma. In fact, it may not be clear whether a neuraxial mass is blood or pus until it is exposed during surgery. The mortality of spinal abscess can be as high as 18%.<sup>70</sup> The incidence of epidural abscess secondary to neuraxial blockade is estimated at 1 in 250,000 cases in healthy patients, but 1 in 2000 cases in diabetic or immunocompromised patients.<sup>43,71</sup> Other serious complications such as anterior spinal artery syndrome, transverse myelitis and meningitis have been reported, but are extremely rare.

### **Epidurals and Surgical Outcomes**

In terms of truly understanding the benefit versus the risk of epidural analgesia in any individual patient, it is important to understand whether or not the benefit extends beyond that of the simple provision of excellent analgesia. Is mortality improved? Is recovery hastened? Are high-risk patients such as those with serious cardiac disease less susceptible to cardiac morbidity? Do the bowels recover function quicker? Do epidurals reduce thromboembolism? Is postoperative pulmonary function improved? These are all questions that have been asked in countless trials often with conflicting results.<sup>58,59</sup> Perhaps the clearest result is that epidural analgesia (particularly that from thoracic epidurals) does improve bowel mobility and reduce the period of ileus, with consequent earlier hospital discharge.<sup>72</sup> There is also considerable support for improved pulmonary function.<sup>73–77</sup> But support for a beneficial effect on other outcomes, particularly catastrophic outcomes, is less clear. Large multicenter studies published relatively recently found no advantage to epidural analgesia in terms of mortality or major morbidity.<sup>75,77</sup> Yet earlier trials and meta-analyses had suggested significant improvements in mortality and serious morbidity.<sup>73,74,76,78,79</sup> Has some of the earlier advantage of neuraxial anesthesia and analgesia dissipated because they no longer provide the benefit of reduced thromboembolism in this era of improved thromboprophylaxis? And could general improvements in perioperative care such as better preoperative optimization, shorter-acting anesthetic drugs, improved standards of vigilance and monitoring, and accelerated recovery programs, have diminished the role of neuraxial anesthesia and analgesia?<sup>59</sup>

TABLE 74–8.

## Guidelines for Epidural Placement and Removal during Anticoagulant Therapy

Drug	Monitoring	Time after Last Dose before Placing or Removing Catheter	Time after Placing or Removing Catheter before Restarting Medication
Warfarin	INR (<1.5)	Check INR if treatment >24 hours	Same day
NSAID, ASA	No significant risk		
Thrombolytics	None	10 days	10 days
SC heparin	No significant risk		
IV heparin	PTT	2–4 hours	1 hour
LMWH	Anti-Xa (however, not predictive of risk of bleeding)	12 hours	2 hours
<i>Low dose</i>			
Dalteparin (Fragmin) (<5000 U qd)			
Enoxaparin (Lovenox) (<60 mg qd)			
<i>High dose</i>			
BID dosing			
Ticlopidine (Ticlid)	None	14 days	24 hours
Clopidogrel (Plavix)	None	7 days <sup>a</sup>	24 hours
Abciximab (Reopro)	None	48 hours	12 hours
Tirofiban (Aggrastat)	None	8 hours	4 hours
Eptifibatide (Integrilin)	None	8 hours	4 hours

ASA, acetylsalicylic acid; INR, international normalized ratio; LMWH, low-molecular-weight heparin; NSAID, nonsteroid antiinflammatory drug; PTT, partial thromboplastin time; SC, subcutaneous.

NOTE: Regional anesthesia is contraindicated in patients receiving fondaparinux (Arixtra).

<sup>a</sup>After a single dose, catheter can be removed within 24–48 hours. If this window is missed, it is necessary to wait 7 days before catheter removal.

Reproduced with permission from Ballantyne JC and Ryder E.<sup>69</sup>

1730

**Epidural or No?** Despite all the blows against epidurals—incompatibility with modern thromboprophylaxis and dwindling returns in terms of improvements in mortality and major morbidity—they remain a beneficial and helpful intervention for selected patients undergoing invasive surgical procedures. For patients who accept the risks because of a promise of good postoperative pain relief, that promise is usually fulfilled. Patients with serious respiratory disease, and those undergoing extensive lung resection, benefit from opioid sparing and the favorable effects of epidural analgesia on pulmonary mechanics. Recovery can be hastened after bowel surgery because of favorable effects on bowel mobility. And patients with cardiac ischemia or failure can benefit from the moderate reductions in afterload and the negative inotropy and chronotropy of a well-managed thoracic epidural.

### Nerve Blocks

The primary indication for nerve blocks is for the provision of surgical anesthesia. But there are secondary

benefits in terms of pain relief in the postoperative period, and in some cases analgesic effects can be prolonged using perineural catheters. As nerve blocks wear off, there remains some degree of analgesia (probably from residual small fiber blockade), and surprisingly, these effects appear prolonged beyond the known half-life of the local anesthetic, especially in the case of distal peripheral blocks such as hand and ankle blocks. Certain nerves are accessible enough to be injected intermittently should the need arise: femoral nerve blocks provide good but incomplete analgesia after knee surgery, and intercostal nerve blocks can be useful after thoracic surgery or chest trauma, when epidural analgesia is contraindicated. The analgesia from single-shot neuraxial blocks can be prolonged by injecting an opioid at the time of placing the block. Injection or infiltration of local anesthetic into the wound by the surgeon can provide helpful analgesia during the early postoperative phase. The two techniques that are particularly useful for postoperative pain control are prolongation of neural block-

ade using catheters and neuraxial opioid injections.

### Prolongation of Neural Blockade Using Catheters

Continuous analgesic/anesthetic infusions can be administered at various sites, offer an alternative to neuraxial techniques, and are particularly useful when active mobilization is needed. Infusion near the brachial plexus is useful after shoulder or hand surgery, and infusion near the femoral nerve is useful after knee surgery. Patients are most often hospitalized, at least while the treatment is stabilized, and bupivacaine 0.1% at 10–20 mL/h is used initially. If that is ineffective, a higher concentration (0.25%) can be used, and/or a bolus injection of 20 mL of 0.25–0.375% bupivacaine can be tried. Bolus injection is useful prior to physical therapy. Patients may also use supplemental analgesics. Increasingly patients are allowed home with a plexus catheter, either with a home pump, or reserving the catheter for injection prior to physical therapy sessions.

Infusion into joints may be useful after joint surgery, and infusion into

wounds may also be useful. Pumps for use at home have been developed (e.g., the Pain Buster Pain Management System) for infusing into joints and wounds. Local anesthetics and opioids have been used. Patients seem enthusiastic about these pumps, but they are still considered investigational because they have not been shown to improve pain or reduce systemic analgesic used in trials to date.

### **Neuraxial Opioid Injections**

Neuraxial morphine does not increase risk of analgesia provided dosing is reasonable and patients are appropriately monitored. A single shot of morphine into the epidural space (1–4 mg) or intrathecal space (0.1–0.4 mg) can provide prolonged analgesia (up to 24 hours), but carries a risk of delayed respiratory depression. Morphine is poorly lipophilic, tends to stay in CSF once there, and is subject to CSF bulk flow with passage to higher centers including the respiratory center (Fig. 74–6). At the same time, the fact that morphine tends to remain in CSF is the reason that it produces excellent selective spinal analgesia (i.e., good spread to spinal cord receptors). Single-shot neuraxial morphine is an excellent means of providing analgesia when there is no epidural catheter. Patients should be monitored in the same way as those receiving epidural opioid infusions. PCA can be used to provide supplementary analgesia if necessary, but for safety, only demand doses should be used, and continuous background infusions should be avoided.

### **Nondrug Approaches**

#### **Transcutaneous Electrical Nerve Stimulation**

The transcutaneous electrical nerve stimulation (TENS) device consists of a series of electrodes that are placed on the site of the pain (either side of the surgical incision in the case of postoperative pain) through which a low-voltage electrical stimulus is passed. Stimulation analgesia has been used since the 1950s when Melzack and Wall proposed that stimulation of large sensory fibers (A $\beta$  fibers) could somehow shut down transmission through the smaller pain fibers (C fibers). TENS is the original, simplest, and most widely used stimulation technique and is applicable to surgical pain. TENS does not stand up against drug therapies as a sole treatment for anything

other than mild postoperative pain, but it may be useful for reducing analgesic requirements and possibly for improving pulmonary function in selected patients. Randomized controlled trials have confirmed its efficacy in postoperative pain compared with controls (no TENS), but it appears to be no better than sham TENS (electrodes with no current). Sham TENS is better than no TENS, suggesting there is a strong placebo effect.<sup>80,81</sup> TENS can be useful in patients who do not tolerate or choose to avoid medications and invasive interventions.

#### **Behavioral Therapy**

The goal of behavioral therapy is to provide patients with a sense of control over their pain. All patients benefit from being well-prepared psychologically for the experience of surgery and postoperative pain.<sup>4</sup> Simple relaxation strategies and imagery can be helpful for patients who find such interventions appealing. Other strategies, such as brief jaw relaxation, music-assisted relaxation, and recall of peaceful images, can reduce anxiety and analgesic requirements; they take only a few minutes to teach, although they may require continual practice and reinforcement. Patients who wish to learn simple relaxation exercises can be given a brochure describing the exercises. Therapeutic touch is another popular method and is particularly helpful when postoperative pain is refractory to other modalities. Elaborate behavioral therapy techniques (i.e. biofeedback or counseling), have limited place in the treatment of acute postoperative pain.

## **SPECIAL POPULATIONS**

### **Neonates, Infants, and Children**

Throughout childhood, the management of pain presents special challenges. Very young children—neonates and infants—tolerate opioids poorly because they are prone to apnea, and their handling of this and other groups of drugs is altered by several factors, including slow conjugation by the liver. It is no longer acceptable to avoid giving opioids to neonates on the basis that they don't feel pain, as there is now a great deal of evidence that they do feel pain just as do adults, and that untreated pain can produce an imprint

that may have long-term psychological, and even physical, consequences.<sup>82–85</sup> Older children can also be scarred by traumatic and painful experiences, and it is sometimes difficult for adult caregivers to understand childhood and adolescent psychology and to communicate effectively so as to optimize pain management. Pain assessment is challenging, particularly in preverbal children (see Pain Assessment above). Good pediatric pain management requires a great deal of time and patience, and is therefore labor intensive; unlike adults, children, especially young children, cannot simply be left with a PCA pump. Unfortunately, the resources for providing excellent and safe pain care for children, which often must be done at the bedside, may be lacking other than in specialty hospitals and centers of excellence.

#### **Planning for the Postoperative Experience**

Anesthesiologists play a key role in preparing children and their parents for the postoperative period and the pain the children are likely to experience. First, they can explain what is going to happen and how pain will be managed and assessed. They can explain treatment options and help parents (and older children) select the right approach. Often an intervention such as an epidural, a single-shot caudal, or a nerve block is helpful, and these options can be discussed. For children who are old enough for PCA (generally 6 years and older), this should certainly be discussed, and the children should understand how to use the pump. Parents should understand that the inherent safety of PCA will be bypassed if they press the button themselves, and that it is better if they do not intervene other than to encourage the children to take doses. If the child has had past surgery, it is helpful to know what pain treatments worked well.

#### **Treatment Choices**

Essentially the treatment options available to adults are available to children. However, there are differences in the way neonates and infants metabolize drugs, particularly opioids, and these must be understood. In general, smaller, more frequent dosing is needed in the very young, but there is no substitute for referring to pediatric dosing guidelines. As in adults, opioids are the mainstay for treating severe pain, but



given the safety issues, especially in young children, it is always preferable to reduce opioid requirements whenever possible by using adjunctive treatments such as NSAIDs and acetaminophen which are generally well tolerated. Epidurals, caudals, and other nerve blocks, even single-injection techniques can be helpful and are usually successful because patient anatomy is straightforward. However, catheters can be difficult to maintain, especially if they are small-diameter catheters (when they have a tendency to block) and especially if the insertion site is within the diaper area (when the skin can become macerated and the catheter tends to migrate). Opioids can be given as a low-dose infusion in neonates and infants, which obviates the need for intermittent injections and is generally safe and effective, provided breakthrough pain is controlled by bedside bolus injections and the temptation to try and overcome uncontrolled pain by repeatedly increasing an infusion rate is resisted.

### Safety

Maintaining safety while providing good pain relief is an especial challenge in children, chiefly because of their sensitivity to opioids. Young children require extra vigilance, and great care with dosing. Dosing is calculated on a per-kilogram basis, and because children's weights and sizes vary considerably, always warrants careful calculation. Frequent checking of vital signs is mandatory in neonates and infants receiving opioids, and the use of respiratory rate and oxygen saturation monitors may improve safety and is a standard of care for this population in many institutions.

### The Elderly and Infirm

Just as children present a special challenge, so do the elderly and infirm. Again, this is a group of patients that is particularly sensitive to opioids: they are prone not only to opioids' respiratory depressant effects, but also to their central dysphoric and euphoric effects. Opioid-induced confusion is common in this age group. The elderly are liable to become confused with other psychotropic drugs such as benzodiazepines, and are sensitive to NSAID side effects, particularly GI bleeding and renal dysfunction. They can also develop a confusional state simply because they are moved from

familiar surroundings. These factors combined make good pain control hard to achieve. Pain control may become a low priority because it is hard to assess pain in confused patients, and drugs are blamed for the confusional state and therefore withdrawn.

The elderly tend to appear stoical and it is not clear whether they have a different threshold for pain, whether past experience has altered their attitude toward pain, or whether they truly do not feel pain to the same extent as younger adults. It is probably best to treat pain according to the patients' demands, and not to project pain on them because of a preconceived notion that their pain must be worse than they say it is. PCA is not a suitable technique for confused patients, and may not work well even in nonconfused elderly patients because they tend to under-medicate. A simple approach, such as nurse-determined intermittent low-dose opioid with acetaminophen as an adjunct, is often the best approach. Epidurals and nerve blocks are useful for reducing reliance on poorly tolerated systemic medications.

### Opioid-Tolerant Patients

Pain specialists and acute pain services are increasingly preoccupied treating patients who are opioid tolerant and who get into difficulty when an episode of acute pain, notably because of surgery or trauma, proves refractory to standard treatments.<sup>86</sup> Nonspecialists are often uncomfortable prescribing the high doses of opioid that may be needed to overcome acute pain in opioid-tolerant patients. There are several reasons that the numbers of patients presenting with opioid tolerance is increasing, some related to societal factors, others to changes in medical practice. (a) All efforts to control drug and heroin abuse by means of regulation have failed, and illicit drug trading, distribution, and use steadily increase as high illicit drug prices and profits are maintained. (b) Prescription drug abuse increased exponentially during the 5 years before 2001,<sup>42</sup> largely because opioid use for chronic pain was liberalized during the late 1990s, resulting in a greater availability of prescription opioids in homes, pharmacies, and on the streets. Addicts choose prescription drugs over illicit drugs because of their greater reliability and safety. (c) In the 1980s and 1990s, pain advocates, carrying

the success of their much needed lobbying for the use of opioids for acute and cancer pain, extended the principle to the treatment of chronic non-cancer pain. Consequently, today there are many more patients with chronic pain conditions who are treated with opioids than there were just 20 years ago. (d) Cancer is now a curable disease for many patients, and others experience long remissions. They often need treatment for pain associated with their primary disease, or with its treatments, and may need this treatment for years. Because of a tradition of opioid use for cancer pain, opioids are being used for long-term treatment of cancer-related pain.

Managing pain in opioid-treated patients, whether they are substance abusers or chronic pain patients, can be extremely challenging. There are issues related to opioid tolerance and pain refractoriness, and a withdrawal syndrome could further complicate the clinical picture. In addition, there may be difficult behavioral issues in both groups of patients, so that the dedication and professionalism, particularly of the nursing staff, can be severely tested. The possibility that drugs are being diverted complicates matters even further. Prejudices set in about the veracity of pain complaints, there is a breakdown in trust, and the simplicity of treating pain according to the patient's report is lost.

### Substance Abusers

Substance abusers are notorious deceivers, but they recognize that they put themselves at risk if they deny use, and are usually honest about whether or not they are currently using drugs, including opioids. They are less honest about past use, and unreliable in terms of reporting doses. The treating physician must be cognizant that opioid requirements for pain are unknown and can only be learned by titration; that a withdrawal syndrome may arise if doses are underestimated; and that manifestations of other abused drugs (e.g., cocaine, amphetamines, alcohol) or withdrawal from these, may also require treatment. Treatment for withdrawal syndromes is generally supportive, but in the surgical setting, opioid withdrawal should be treated with opioid. An  $\alpha_2$ -agonist such as clonidine may help reduce norepinephrine effects.

The period of hospitalization for surgery or trauma is not the time for

tackling an entrenched addiction problem. Nevertheless, if the patient agrees (and they often do not), the involvement of a psychiatrist or addictionologist during the hospitalization can be helpful. The surgical and pain teams should focus on optimizing pain management, and direct the patient to the appropriate resource after discharge, assuming the patient wants treatment. An opioid-abusing patient may have an inadequate response to the opioids given for pain, and it is helpful to make maximum use of alternatives such as epidurals, nerve blocks, and NSAIDs. At the same time, opioids should not be withheld, particularly if there has been recent usage. Patients in methadone programs should continue their normal dose of methadone, and this should be supplemented with whatever is needed to treat pain. Buprenorphine (Subutex) and buprenorphine with naloxone (Suboxone) are increasingly used for office-based treatment of addiction (detoxification and opioid maintenance).<sup>87,88</sup> Although oral naloxone is quickly degraded and does not present a problem, buprenorphine, which is a partial opioid agonist with high receptor affinity and slow dissociation, can interfere significantly with the treatment of acute pain. Supplemental buprenorphine may be adequate for treating mild acute pain, but severe pain is likely to require standard opioids at high dose. PCA is a useful modality for acute pain treatment in substance abusers because of the sense of control it offers, and its ability to reduce demands on the nursing staff.

Some past abusers (not on methadone or buprenorphine) present real and justified concerns about the risk of relapse if they use opioids for the treatment of surgical pain. The risk of relapse is higher the longer the period of abuse, and diminished the longer the patient has not been using. Relapse is unlikely as long as opioid use for surgical pain is confined to the period of severe pain, and not continued beyond this. A good way to contain this is to use opioids in hospital but not after discharge. It will also satisfy the patients and their pain needs to maximize the use of alternative analgesics and interventions.

### **Chronic Opioid-Treated Pain**

Opioid-tolerant chronic and cancer pain patients are among the most difficult patients to treat for pain after

surgery, particularly if they are being treated with high doses of opioids. Despite there now being convincing evidence that the analgesic efficacy of high-dose opioid therapy may diminish over time, and has unacceptable side effects such as gonadal suppression, there are still patients admitted to hospital on doses exceeding the common upper limit of 180 mg morphine or morphine equivalent per day.<sup>15</sup> The addition of chronic intrathecal opioid treatment may further complicate and compromise the treatment of acute pain.

Principles of treatment are similar to those for substance abusers. The normal regime should be continued if possible, and if not, should be converted to an intravenous regime. Nonopioid treatments should be used to as great an extent as possible, to minimize reliance on opioids. Neuraxial interventions should be avoided in patients with implanted stimulators or pumps, unless the position of the implanted system is clear, because the needle can cut or damage electrodes, leads, or catheters. PCA is again a useful mode of delivery for opioids because a background infusion can be used to whatever level is needed, and the ability to get extra bolus doses reassures the patients. High dose boluses are likely to be needed.

The period of hospitalization is not a good time to change the chronic pain regime, and most efforts should focus on treating the acute pain. However, if the surgical or pain team is having difficulty managing a patient, it may be very helpful to talk to the patient's pain physician, or whoever normally manages the patient's pain. Sometimes issues are revealed that are relevant to the management of pain in hospital, but not necessarily clear from the patient or the patient's chart. It is also helpful to have a plan for treating pain after discharge, which could involve the patient's normal physician, or could involve rehabilitation or a pain program.

Behavioral problems can arise in opioid-treated chronic pain patients, although these will be different from those in substance abusers. Chronic pain patients tend to have difficulty coping, and when they are faced with uncontrolled and excruciating pain, which they have not necessarily predicted, they can be angry, mistrustful, demanding, or uncooperative. They

may display typical opioid seeking behaviors (frequent demands for pain medication, refusal of all but opioid treatments, accusations against the medical staff for undertreating pain), and these behaviors appear much like addictive behaviors. Yet it will be difficult to determine whether the behaviors have arisen because of undertreated pain (pseudoaddiction) or because there is, in fact, an underlying addiction problem.

### **Pain Management in the Intensive Care Unit**

There are several challenges associated with managing postoperative pain in patients requiring ICU care. In many cases, these patients are unable to communicate, because of severe illness, extensive surgical trauma or because they are ventilated and sedated. Continuous infusion is the most frequently chosen means of delivery for opioids, but prolonged use of opioid infusions may lead to rapid development of tolerance or opioid-induced hyperalgesia, making pain control and weaning from opioids difficult.<sup>14</sup> An obvious manifestation of opioid-induced hyperalgesia is the ICU patient who is treated with high-dose opioid infusion, who cannot tolerate touch, or even the bedsheets. Patients with compromised renal function may accumulate opioid metabolites, notably the active metabolite morphine-6-glucuronide and the toxic metabolite normeperidine: Meperidine is not a good choice for prolonged infusions; if morphine is used, the possible accumulation of active metabolites must be considered in the weaning protocol. Epidural analgesia is an extremely useful option that is opioid sparing and can help during weaning from ventilation.<sup>76,89-91</sup> However, epidurals are often contraindicated in ICU patients because of a need to treat with anticoagulant therapy. Use of activated protein C, our current best agent for severe sepsis, also precludes the use of epidurals.

It is important to treat pain in ICU patients so as to reduce the anxiety associated with pain and inability to communicate pain. When it is impossible to assess pain, as in heavily sedated or unconscious patients, it is reasonable to assess analgesic requirements on the basis of the amount of surgical or other trauma the patient has undergone. Ventilated patients can be treat-

ed with higher-than-normal doses of opioids (if desired) because there is no risk of respiratory depression. However, it is important to remember that prolonged infusions may lose their efficacy if tolerance or hyperalgesia develop, and all opioid-sparing strategies are helpful. Methadone may also be useful for prolonged ICU stays as there is less development of tolerance. It has been found beneficial to use the  $\alpha_2$ -agonist dexmedetomidine for ICU sedation, not only because of its hypnotic effects, but also because of its analgesic synergy with opioids (opioid sparing), and possibly a contribution to minimizing opioid withdrawal at the time of weaning.<sup>92,93</sup> Alert or unventilated ICU patients can be treated as normal patients, with the proviso that ill patients may handle drugs inefficiently.

## CONCLUSION

Advances in surgery, anesthesia, drugs, and technology have combined to markedly reduce the trauma and morbidity of surgery. Part of this success can be attributed to improvements in pain management, both during and after surgery. In the 1980s, several changes revolutionized postoperative pain management. Portable PCA pumps became available, and gradually PCA was adopted widely. Experimentation with neuraxial opioids began after endogenous opioids and opioid receptors were identified in the 1970s. It was soon recognized that neuraxially administered opioids provide excellent targeted analgesia at low doses without the need for larger systemic doses and associated side effects, or the sensory and motor blockade from the high-dose local anesthetics previously needed for adequate epidural pain relief when local anesthetics were used alone. "Walking epidurals" began to be widely used for postoperative pain control. Several professional and political bodies, recognizing that good pain control was an important component of perioperative care, developed guidelines in order to propagate good evidence-based practice (Agency for Health Care Policy and Research). Insurers, spearheaded by Medicare, also recognized the importance of good pain control and began to reimburse pain management services, allowing for the development of acute pain services. Later, pain advocates succeeded in enlisting JCAHO in the war on pain and their

2001 mandate requires that all accredited hospitals have a systematic means of recognizing and assessing pain, and treating it appropriately. Postsurgical pain may not be fully conquered, and there is certainly room for more research and further improvement. But tremendous progress has been made since the not-so-distant days when uncontrolled pain meant that patients routinely remained motionless in bed for days after surgery, prone to complications of immobility such as thromboembolism, atelectasis, and protein wasting.

## KEY REFERENCES

1. Acute Pain Management: Operative or Medical Procedures and Trauma. Clinical Practice Guideline. AHCPR Pub No 92-0032. Rockville, MD: Agency for Health Care Policy and Research, Public Health Service, US Department of Health and Human Services, 1992.
2. American Pain Society Quality of Care Committee. Quality improvement guidelines for the treatment of acute pain and cancer pain. *JAMA* 1995;23:1874-1880.
3. Carr DB, Goudas LC. Acute pain. *Lancet* 1999;353(9169):2051-2058.
4. Kissin I. Preemptive analgesia at the crossroad. *Anesth Analg* 2005;100(3):754-756.
5. Kehlet H, Dahl JB. Anaesthesia, surgery, and challenges in postoperative recovery. *Lancet* 2003;362(9399):1921-1928.
6. Ballantyne JC, Carwood C. Optimal postoperative analgesia. In: Evidence-Based Practice of Anesthesiology. Fleisher LA, Ed. Philadelphia: WB Saunders Company, 2004; 449-57.
7. Ballantyne JC, Kupelnick B, McPeck M, Lau J. Does the evidence support the use of spinal and epidural anesthesia for surgery? *J Clin Anesth* 2005;17:382-391.
8. Mitra S, Sinatra RS. Perioperative management of acute pain in the opioid-dependent patient. *Anesthesiology* 2004;101:212-227.

## REFERENCES

1. Warfield CA, Kahn CH. Acute pain management: programs in the US hospitals and

experiences and attitudes among US adults. *Anesthesiology* 1995;83(5):1090-1094.

2. Dahl JL, Gordon DB. Joint Commission pain standards: a progress report. *APS Bull* 2002;12(6):1-8.
3. Phillips DM. JCAHO pain management standards are unveiled. Joint Commission on Accreditation of Healthcare Organizations. Pain management standards. *JAMA*, 2000;284(4):428-9.
4. Egbert LD, Battist GE, Welch CE, et al. Reduction of postoperative pain by encouragement and instruction of patients. A study of doctor-patient rapport. *N Engl J Med* 1964;270:825-827.
5. Hockenberry MJ, Wilson D, Winkelstein ML, eds. *Wong's Essentials of Pediatric Nursing*. 7th ed. St. Louis: Mosby, 2005.
6. Kissin I. Preemptive analgesia. *Anesthesiology* 2000;93(4):1138-1143.
7. Woolf CJ. Evidence for a central component of postinjury pain hypersensitivity. *Nature* 1983;308:686-688.
8. Moiniche S, Kehlet H, Dahl JB. A qualitative and quantitative systematic review of preemptive analgesia for postoperative pain relief. *Anesthesiology* 2002;96:725-741.
9. Ong CK, Lirk P, Seymour RA, et al. The efficacy of preemptive analgesia for acute postoperative pain management: a meta-analysis. *Anesth Analg* 1999;100(3):757-773, table of contents 2005.
10. Price DD, Mao J, Mayer DJ. Central mechanisms of normal and abnormal pain states. In: Fields HL, Liebeskine JC, eds. *Progress in Pain Research and Management*. Seattle: IASP Press, 1994;1:61-84.
11. Mao J. NMDA and opioid receptors: their interactions in antinociception, tolerance and neuroplasticity. *Brain Res Brain Res Rev* 1999;30(3):289-304.
12. Kissin I. Preemptive analgesia at the crossroad. *Anesth Analg* 2005;100(3):754-756.
13. Eisenach JC. Preemptive hyperalgesia, not analgesia? *Anesthesiology* 2000;92:308-309.
14. Mao J. Opioid induced abnormal pain sensitivity: implications in clinical opioid therapy. *Pain* 2002;100:213-217.
15. Ballantyne JC, Mao J. Opioids for chronic pain. *N Engl J Med* 2003;349:1943-1953.
16. Carr DB, Goudas LC. Acute pain. *Lancet* 1999;353(9169):2051-2058.
17. Kehlet H, Dahl JB. Anaesthesia, surgery, and challenges in postoperative recovery. *Lancet* 2003;362(9399):1921-1928.
18. Brennan TJ, Kehlet H. Preventive analgesia to reduce wound hyperalgesia and persistent postsurgical pain. Not an easy path. *Anesthesiology* 2005;103:681-683.
19. Kehlet H. A multi-modal approach to control postoperative pathophysiology and rehabilitation. *Br J Anaesth* 1997;78:606-617.
20. Black DR, Brenner GJ, Abdi S, et al. Drugs commonly used in pain practice



- (appendix VII). Ballantyne JC, Ed. In: *The Massachusetts General Hospital Handbook of Pain Management*. 3rd ed. Philadelphia: Lippincott, Williams & Wilkins, 2006;565–587.
21. Lee F, Cundiff D. Meperidine vs morphine in pancreatitis and cholecystitis. *Arch Intern Med* 1998;158(21):2399.
  22. Thompson DR. Narcotic analgesic effects on the sphincter of Oddi: a review of the data and therapeutic implications in treating pancreatitis. *Am J Gastroenterol* 2001;96(4):1266–1272.
  23. *Acute Pain Management: Operative or Medical Procedures and Trauma. Clinical Practice Guideline*. AHCPR Pub No 92-0032. Rockville, MD: Agency for Health Care Policy and Research, Public Health Service, US Department of Health and Human Services, 1992.
  24. American Pain Society Quality of Care Committee. Quality improvement guidelines for the treatment of acute pain and cancer pain. *JAMA* 1995;23:1874–1880.
  25. Herrlin K, Segerdahl M, Gustafsson LL, et al. Methadone, ciprofloxacin, and adverse drug reactions. *Lancet* 2000;356(9247):2069–2070.
  26. Fishman SM, Wilsey B, Mahajan G, et al. Methadone reincarnated: novel clinical applications with related concerns. *Pain Med* 2002;3:339–348.
  27. Grisel JE, Watkins LR, Maier SF. Associative and non-associative mechanisms of morphine analgesic tolerance are neurochemically distinct in the rat spinal cord. *Psychopharmacology (Berl)* 1996;128:248–255.
  28. Mitchell JM, Basbaum AI, Fields HL. A locus and mechanism of action for associative morphine tolerance. *Nat Neurosci* 2000;3:47–53.
  29. Vinik HR, Kissin I. Rapid development of tolerance to analgesia during remifentanyl infusion in humans. *Anesth Analg* 1998;86(6):1307–1311.
  30. Porter J, Jick H. Addiction rare in patients treated with narcotics [letter]. *N Engl J Med* 1992;302(123):1980.
  31. Ballantyne JC, Barna SB. Non-steroidal anti-inflammatory drugs. Ballantyne JC, Ed. In: *The Massachusetts General Hospital Handbook of Pain Management*. 3rd ed. Philadelphia: Lippincott, Williams & Wilkins, 2006;89–103.
  32. Gajraj NM. Cyclooxygenase-2 inhibitors. *Anesth Analg* 2003;96:1720–1738.
  33. Van Der Ouderaa FJ, Buytenhek M, Nugteren DH. Purification and characterization of prostaglandin endoperoxide synthetase from sheep vesicular glands. *Biochim Biophys Acta* 1977;487:315–331.
  34. Weir M, Sperling R, Reicin A. Selective COX-2, inhibition and cardiovascular effects: a review of the rofecoxib development program. *Am Heart J* 2003;146:591–604.
  35. FitzGerald GA. Coxibs and cardiovascular disease. *N Engl J Med* 2004;351:1709–1711.
  36. Moote C. Efficacy of nonsteroidal anti-inflammatory drugs in the management of postoperative pain. *Drugs* 1992;44(Suppl 5):14–30.
  37. Ballantyne JC. Use of nonsteroidal anti-inflammatory drugs for acute pain management. *Probl Anesth* 1998;10(1):23–36.
  38. Marret E, Kurdi O, Zufferey P, et al. Effects of nonsteroidal antiinflammatory drugs on patient-controlled analgesia morphine side effects: meta-analysis of randomized controlled trials. *Anesthesiology* 2005;102(6):1249–1260.
  39. Kehlet H. Postoperative opioid sparing to hasten recovery: what are the issues? *Anesthesiology* 2005;102(6):1083–1085.
  40. Ballantyne JC, Carwood C. Optimal postoperative analgesia. In: Fleisher LA, ed. *Evidence-Based Practice of Anesthesiology*. Philadelphia: WB Saunders, 2004;449–457.
  41. Ballantyne, JC, Chalmers TC, Dear KBG, Mosteller F, Carr DB. The opioid sparing effects of adjunctive NSAID therapy in postoperative pain: a meta-analysis. Qualitative analysis of drug interventions: adult postoperative and trauma patients. In: *Acute Pain Management: Guidelines Technical Report*. Agency for Healthcare Policy and Research (US Department of Health and Human Services) 1995;80–82.
  42. Kehlet H, Rung GW, Callesen T. Postoperative opioid analgesia: time for a reconsideration? *J Clin Anesthesia* 1996;8:441–445.
  43. Reasbeck PG, Rice ML, Reasbeck JC. Double-blind controlled trial of indomethacin as an adjunct to narcotic analgesia after major abdominal surgery. *Lancet* 1982;2(8290):115–118.
  44. Gillies GW, Kenny GN, Bullingham RE, McArdle CS. The morphine sparing effect of ketorolac tromethamine. A study of a new, parenteral non-steroidal anti-inflammatory agent after abdominal surgery. *Anaesthesia* 1987;42(7):727–731.
  45. Higgins MS, Givogre JL, Marco AP, Blumenthal PD, Furman WR. Recovery from an outpatient laparoscopic tubal ligation is not improved by preoperative administration of ketorolac or ibuprofen. *Anesth Analg* 1994;79:274–280.
  46. Lavand'homme P, De Kock M, Waterloo H. Intraoperative epidural analgesia combined with ketamine provides effective preventive analgesia in patients undergoing major digestive surgery. *Anesthesiology* 2005;103:813–820.
  47. Elia N, Tramer MR. Ketamine and postoperative pain—a quantitative systematic review of randomised trials. *Pain* 2005;113(1–2):61–70.
  48. Habib AS, Gan TJ. Role of analgesic adjuncts in postoperative pain management. *Anesthesiol Clin North America* 2005;23(1):85–107.
  49. Ballantyne JC. Systemic opioids and patient controlled analgesia. In: Neal JM, Rathmell JP, eds. *Complications in Regional Anesthesia and Pain Management*. Philadelphia: Elsevier, 2006:167–175.
  50. Ballantyne JC, Carr DB, Chalmers TC, et al. Postoperative patient-controlled analgesia: meta-analyses of initial randomized control trials. *J Clin Anesth* 1993;5:182–193.
  51. Walder B, Schafer M, Henzi I, et al. Efficacy and safety of patient-controlled opioid analgesia for acute postoperative pain: a quantitative systematic review. *Acta Anaesthesiol Scand* 2001;45(7):795–804.
  52. Chan VWS, Chung F, McQuestion M, et al. Impact of patient-controlled analgesia on required nursing time and duration of post-operative recovery. *Reg Anesth* 1995;20(5):506–514.
  53. Choiniere M, Rittenhouse BE, Perreault S, et al. Efficacy and costs of patient-controlled analgesia versus regular administered intramuscular opioid therapy. *Anesthesiology* 1999;91(3):891–894.
  54. Vercauteren M, Vereecken K, La Malfa M, et al. Cost-effectiveness of analgesia after caesarean section. A comparison of intrathecal morphine and epidural PCA. *Acta Anaesthesiol Scand* 2002;46:85–89.
  55. Chelly JE, Grass J, Houseman TW, et al. The safety and efficacy of a fentanyl patient-controlled transdermal system for acute postoperative analgesia: a multicenter, placebo-controlled trial. *Anesth Analg* 2004;98:427–433.
  56. Viscusi ER, Reynolds L, Chung F, et al. Patient-controlled transdermal fentanyl hydrochloride vs intravenous morphine pump for postoperative pain: a randomized controlled trial. *JAMA* 2004;291:1333–1341.
  57. Block BM, Liu SS, Rowlingson AJ, et al. Efficacy of postoperative epidural analgesia: a meta-analysis. *JAMA* 2003;290(18):2455–2463.
  58. Ballantyne JC. Does epidural analgesia improve surgical outcome? *Br J Anaesth* 2004;92(1):4–6.
  59. Ballantyne JC, Kupelnick B, McPeck M, et al. Does the evidence support the use of spinal and epidural anesthesia for surgery? *J Clin Anesth* 2005;17:382–391.
  60. de Leon-Casasola OA, Lema MJ. Postoperative epidural opioid analgesia: what are the choices? *Anesth Analg* 1996;83(4):867–875.
  61. Eisenach JC, De Kock M, Klimscha W. Alpha(2)-adrenergic agonists for regional anesthesia. A clinical review of clonidine (1984–1995). *Anesthesiology* 1996;85(3):655–674.
  62. Ready LB. Acute pain: lessons learned from 25,000 patients. *Reg Anesth Pain Med* 1999;24:499–505.
  63. Andersen G, Rasmussen H, Rosenstock C, et al. Postoperative pain control by epidural analgesia after transabdominal surgery. Efficacy and problems encountered in daily routine. *Acta Anaesthesiol Scand* 2000;44:296–301.
  64. Ballantyne JC, McKenna JM, Ryder E. Epidural analgesia—experience of 5628 patients in a large teaching hospital derived through audit. *Acute Pain* 2003;4:89–97.
  65. Turnbull DK, Shepehr DB. Post-dural puncture headache: pathogenesis, preven-



- tion and treatment. *Br J Anaesth* 2003;91:718-729.
66. Wulf H. Epidural anaesthesia and spinal haematoma. *Can J Anaesth* 1996;43:1260-1271.
67. Horlocker TT, Wedel DJ, Benzon H, et al. Regional anesthesia in the anticoagulated patient: defining the risks (The second ASRA Consensus Conference on neuraxial anesthesia and anticoagulation). *Reg Anesth Pain Med* 2003;28(3):172-197.
68. Bergqvist D, Wu CL, Neal JM. Anticoagulation and neuraxial regional anesthesia: perspectives. *Reg Anesth Pain Med* 2003;28(3):163-166.
69. Ballantyne JC, Ryder E. Postoperative pain in adults. Ballantyne JC, Ed. In: *The Massachusetts General Hospital Handbook of Pain Management*. 3rd ed. Philadelphia: Lippincott, Williams & Wilkins, 2006;279-301.
70. Reihnsaus E, Waldbaur H, Seeling W. Spinal epidural abscess: a meta-analysis of 915 patients. *Neurosurg Rev* 2000;232(175-204).
71. Wang L P, Hauerberg J, Schmidt JF. Incidence of spinal epidural abscess after epidural analgesia: a national 1-year survey. *Anesthesiology* 1999;91(6):1928-1936.
72. Jorgensen H, Wetterslev J, Moiniche S, et al. Epidural local anaesthetics versus opioid based analgesia regimens on postoperative gastrointestinal paralysis, PONV and pain after abdominal surgery. *Cochrane Database of Systemic Reviews*, 2002, 4.
73. Yeager MP, Glass DD, Neff RK, et al. Epidural anesthesia and analgesia in high-risk surgical patients. *Anesthesiology* 1987;66:729-736.
74. Ballantyne JC, Carr DB, DeFerranti S, et al. The comparative effects of postoperative analgesic therapies on pulmonary outcome: cumulative meta-analyses of randomized, controlled trials. *Anesth Analg* 1998;86(3):598-612.
75. Park WY, Thompson JS, Lee K. Effect of epidural anesthesia and analgesia on perioperative outcome. A randomized, controlled Veterans Affairs Cooperative Study. *Ann Surg* 2001;234(4):560-571.
76. Scott NB, Turfrey DJ, Ray DAA, et al. A prospective randomized study of the potential benefits of thoracic epidural anesthesia and analgesia in patients undergoing coronary artery bypass grafting. *Anesth Analg* 2001;93:528-535.
77. Rigg JRA, Jamrozik K, Myles PS, et al. Epidural anaesthesia and analgesia and outcome of major surgery: a randomised trial. *Lancet* 2002;359(9314):1276-1282.
78. Rodgers A, Walker W S, McKee A, et al. Reduction of postoperative mortality and morbidity with epidural or spinal anaesthesia: results from overview of randomised trials. *BMJ* 2000;321:1493-1497.
79. Beattie W, Badner N, Choi P. Epidural analgesia reduced postoperative myocardial infarction: a meta-analysis. *Anesth Analg* 2001;93:853-858.
80. Carroll D, Tramer M, McQuay H, et al. Randomization is important in studies with pain outcomes: systematic review of transcutaneous electrical nerve stimulation in acute postoperative pain. *Br J Anaesth* 1996;77(6):798-803.
81. Bjordal JM, Johnson MI, Ljunggreen AE. Transcutaneous electrical nerve stimulation (TENS) can reduce postoperative analgesic consumption. A meta-analysis with assessment of optimal treatment parameters for postoperative pain. *Eur J Pain* 2003;7(2):181-188.
82. Anand KJS, Hickey PR. Pain and its effects in the human neonate and fetus. *N Engl J Med* 1987;317:1321-1329.
83. McGrath PJ, Craig KD. Developmental and psychological factors in children's pain. *Pediatr Clin North Am* 1989;36:823-826.
84. Anand KJ, Maze M. Fetuses, fentanyl, and the stress response: signals from the beginnings of pain? *Anesthesiology* 2001;95(4):823-825.
85. Peters JW, Schouw R, Anand KJ, et al. Does neonatal surgery lead to increased pain sensitivity in later childhood? *Pain* 2005;114(3):444-454.
86. Mitra S, Sinatra RS. Perioperative management of acute pain in the opioid-dependent patient. *Anesthesiology* 2004;101:212-227.
87. Johnson RE, Fudula PJ, Payne R. Buprenorphine considerations for pain management. *J Pain Symptom Manage* 2005;29:297-326.
88. Fiellin DA, O'Connor PG. Office-based treatment of opioid-dependent patients. *N Engl J Med* 2002;347:817-823.
89. Boylan JF, Katz J, Kavanagh BP, et al. Epidural bupivacaine-morphine analgesia versus patient-controlled analgesia following abdominal aortic surgery. Analgesic, respiratory, and myocardial effects. *Anesthesiology* 1998;89:585-593.
90. Norris EJ, Beattie C, Perler BA, et al. Double-masked randomized trial comparing alternate combinations of intraoperative anesthesia and postoperative analgesia in abdominal aortic surgery. *Anesthesiology* 2001;95(5):1054-1067.
91. Priestley MC, Cope L, Halliwell R, et al. Thoracic epidural anesthesia for cardiac surgery: the effects on tracheal intubation time and length of hospital stay. *Anesth Analg* 2002;94:275-282.
92. Martin E, Ramsay G, Mantz J, et al. The role of the alpha<sub>2</sub>-adrenoceptor agonist dexmedetomidine in postsurgical sedation in the intensive care unit. *J Intensive Care Med* 2003;18(1):29-41.
93. Maze M, Angst MS. Dexmedetomidine and opioid interactions: defining the role of dexmedetomidine for intensive care unit sedation. *Anesthesiology* 2004;101(5):1059-1061.



## PART 6

### THE CRITICALLY ILL PATIENT



## CHAPTER 75

## The Pathophysiology of Critical Illness

Luca M. Bigatello, MD,  
Judith Hellman, MD,  
David Liu, MD, PhD, and  
Warren M. Zapol, MD

The term *critical illness* defines a variety of clinical situations that are cared for primarily in intensive care units (ICUs), and have in common varying degrees of dysfunction of single or multiple organs and systems, and a guarded immediate prognosis. Because the term *critical illness* refers to the predicted outcome rather than a discrete entity, the pathophysiology and clinical manifestations are very inclusive. Anesthesiologists care for critically ill patients in the operating room, in the ICU, and during procedures in areas outside of the operating room, such as radiographic and endoscopic suites. Thus it is crucial that anesthesiologists have an in-depth understanding of the pathophysiologic processes encountered in critical illness in order to contribute effectively to the perioperative management of critically ill patients.

This chapter focuses on a number of basic elements of critical illness, including inciting factors, pathophysiology leading to dysfunction of organs and systems, the role of the immune system in critical illness, and current and potential future therapies for different aspects and stages of critical illness. We analyze the progression of critical illness examining common types of primary injuries, the body's response to them, and the progression of the response either toward healing and recovery or to deterioration and death. Epidemiologic and therapeutic considerations are also reviewed. The chapter begins with a case report of a patient at different stages of critical illness that is referred to in subsequent sections of the chapter.

## CASE REPORT

A 77-year-old woman with a history of severe chronic obstructive pulmonary disease and hypertension was admitted to the surgical ICU from a general ward with acute respiratory distress. She had been recovering uneventfully from a Whipple procedure until that morning, when she experienced nausea and general malaise, then vomited a large amount of dark material, and immediately complained of shortness of breath.

Upon arrival at the surgical ICU, she was in obvious respiratory distress, with a marginal (87–89%) arterial oxygen saturation as measured by pulse oximetry (SpO<sub>2</sub>) on a non-rebreathing oxygen mask. Following a rapid sequence endotracheal intubation, a large amount of dark green material was suctioned from her airways; the material was similar in appearance to that suctioned from her stomach. A bronchoscopy revealed diffuse staining of the tracheobronchial mucosa with biliary material, down to the lobar bronchi bilaterally. Over the next 4–6 hours, the patient's condition deteriorated. She developed respiratory failure requiring high levels of ventilatory support, and hemodynamic instability that was treated with high-dose intravenous (IV) infusions of vasopressors in order to maintain an adequate systemic arterial blood pressure. A pulmonary artery catheter revealed moderate to severe pulmonary artery hypertension and a low cardiac output, primarily a result of right ventricular dysfunction, which was confirmed by

transthoracic echocardiography. She was treated with broad-spectrum antibiotics, recombinant human activated protein C, and inhaled nitric oxide (NO), and was ventilated using a “lung protective” strategy of low tidal volumes. Over the next few days, she remained extremely unstable from the cardiovascular and pulmonary standpoints: she had three episodes of pulseless electrical activity requiring cardiopulmonary resuscitation, and she became hypoxemic with minimal stimulation, which greatly impeded nursing care. By the tenth day her cardiovascular and respiratory function began to stabilize, and a computed tomogram of her chest was taken (Fig. 75–1). Subsequently, hemodynamic and ventilatory support was tapered, and she was transitioned to assisted ventilation; vasopressors were discontinued, and she started to interact with ICU personnel. On ICU day 13, she had a bedside percutaneous tracheostomy. On ICU day 15 her bronchial secretions became purulent, she developed a fever and leukocytosis, and required an increase in ventilatory support. She was diagnosed with ventilator-associated pneumonia from *Pseudomonas aeruginosa* based on bacteriologic, radiographic, and clinical criteria. She was again treated with antibiotics and continued ventilatory support, and she gradually improved and was discharged from the surgical ICU on day 24. She was transferred to a semi-intensive respiratory unit to complete weaning from mechanical ventilation.

Thirty-eight days after ICU admission, and 45 days after her surgery,

## KEY POINTS

1. Acute injuries of various etiologies—trauma, infection, shock, etc.—cause immediate local and systemic physiologic responses involving all major organ systems.
2. The timing and intensity of the physiologic response to injury is affected by host factors as well as the virulence of the injury. Often, an initial activation of the inflammatory–immune system is followed by late immunosuppression.
3. Nosocomial infections are a major cause of death of critically ill patients and can be significantly decreased by adopting best practices of antibiotic use and infection control.
4. The vascular endothelium is a major organ system in the initial response to injury, activating vasomotor, inflammatory, and procoagulant phenomena.
5. Our increased understanding of the molecular biology of the immune response to injury will lead to new and effective therapies that may include effective oxygen or nitrogen free-radical scavenging, mitochondrial protection, blocking apoptosis, and enhancing immunity.



**FIGURE 75–1.** Computed tomography of the chest at the level of the upper thorax shows diffuse bilateral ground-glass parenchymal opacities consistent with acute lung injury/acute respiratory distress syndrome.

she was transferred to a rehabilitation facility. Although she was weaned off mechanical ventilation, she was extremely debilitated: she could not stand for more than a few minutes or walk more than a few steps, and was unable to feed herself. In addition, she continued to require narcotic-based analgesics and antipsychotic medications to allow some sleep at night and diminish her recurring episodes of hyperactive delirium.

### PATHWAYS OF INJURY: THE STRESSES LEADING TO CRITICAL ILLNESS

A variety of acute injuries can result in critical illness and a need for ICU care. In the following material, we classify these “stresses” as related to a few main categories: surgery and trauma, metabolic disorders, and infection. In many patients, as in the case described above, multiple stresses (e.g., surgery, inflammation, and infection) coexist.

#### Direct Tissue Injury During Surgery and Trauma

Direct tissue injury during surgery and trauma can produce major perturbations of the body’s homeostasis, including hemodynamic instability, respiratory abnormalities, and marked fluid shifts. Pain, immobility, and prolonged bedrest can contribute to perioperative morbidity. Only a few decades ago, these phenomena constituted a formidable challenge for surgeons and anesthesiologists, and made many surgical procedures complex and dangerous for the patient. Today, the physiologic

changes associated with “routine” surgery can be flawlessly managed by the proper administration of perioperative anesthesia care. However, certain situations still carry a significant risk of perioperative complications, including complex elective procedures (e.g., pneumonectomy, thoracoabdominal aneurysm repair), major trauma, emergency surgery, and procedures performed in patients with significant comorbidity. These patients constitute the majority of the population admitted to a surgical ICU.

Trauma is the primary cause of death in individuals below 40 years of age in the United States.<sup>1</sup> In underdeveloped countries, trauma victims may have limited or no access to intensive care, which could save thousands of lives every year. Traumatic injuries are classified as penetrating and blunt injuries (see Chap. 70 and 78). *Penetrating injuries* (stab and gunshot wounds) require immediate control of hemorrhage, drainage of blood or air under pressure, and rapid transfer to a trauma center. Immediate appropriate care increases survival and can reduce the need for intensive care.<sup>2,3</sup> *Blunt trauma* (e.g., motor vehicle accidents, falls) can produce a combination of injuries that may require immediate treatment, such as a ruptured spleen or an open bone fracture, and others that are best treated conservatively. A “damage control” approach minimizes the time of surgical intervention and emphasizes perioperative surgical ICU care, including volume resuscitation, temperature control, hemodynamic monitoring, nutrition, and protocols

for the prevention of nosocomial infectious complications. This approach often requires the participation of an anesthesia team during repeated trips to the operating room. The injuries associated with major surgery and trauma derive from three main mechanisms: hemorrhage, tissue injury, and hypoperfusion.

*Hemorrhage* causes an immediate physiologic response to preserve circulating blood volume and oxygen delivery to vital organs. In healthy individuals, symptoms of shock develop when acute blood loss exceeds 20% of the blood volume (approximately 1 L of blood in a 70-kg adult). Immediate resuscitation is necessary to prevent cardiovascular collapse and death. Even at the low hemoglobin (Hgb) levels often following this degree of bleeding, what limits the tolerability of hemorrhage is the reduced blood volume and cardiac output, and not the decreased oxygen-carrying capacity of the blood. For example, a 30–40% blood loss would eventually reduce the plasma Hgb concentration to a level that still produces ample delivery of oxygen to the tissues. With an adequate cardiac output and arterial oxygen tension ( $P_{aO_2}$ ), a Hgb concentration as low as 5 g/dL still provides ample oxygen delivery to tissues supplied by normal vessels (Table 75–1).

Implementing early and effective therapies has critical importance in determining the subsequent clinical course. Despite a long-standing belief that aggressive volume resuscitation should be included in the initial care of the bleeding patient, this approach is now being challenged for several reasons. First, the infusion of large volumes of crystalloids can cause a dilutional coagulopathy, characterized by thrombocytopenia and decreased concentrations of circulating clotting factors.<sup>4</sup> Counteracting these defects by infusing platelets and fresh-frozen plasma, in conjunction with massive crystalloid resuscitation,<sup>5</sup> may foster intravascular volume overload and edema in vital organs. Second, there is evidence that massive volume resuscitation for penetrating trauma of the torso may exacerbate bleeding from the site of injury and actually increase mortality.<sup>2</sup> Third, transfusion of blood products may suppress native immunity and increase the risk of infection, cause acute lung injury/acute respira-



TABLE 75-1.

Values of Oxygen Delivery ( $\dot{D}O_2$ ) at Different Levels of Anemia

	Hgb (g/dL)	CO (L/min)	$\dot{D}O_2$ (mL/min)
Normal	14	5	900
Anemia	9	6	700
Severe anemia	5	7	450

$\dot{D}O_2$  = arterial O<sub>2</sub> content (CaO<sub>2</sub>) × cardiac output (CO)  
 CaO<sub>2</sub> = Hg × 1.34 × oxygen saturation (SpO<sub>2</sub>) + PaO<sub>2</sub> × 0.003.  
 Normal CaO<sub>2</sub> = 14 g/dL × 1.34 × 0.98 + negligible dissolved O<sub>2</sub> = 19 mL O<sub>2</sub> per dL of blood; × CO of 5 L/min,  $\dot{D}O_2$  = 900 mL/min.  
 With severe anemia: Hgb 5 g/dL, normal SpO<sub>2</sub>, and increased CO, e.g., 7 L/min,  $\dot{D}O_2$  is ≥350 mL/min, still above the resting average oxygen demand of tissues  $\dot{V}O_2 \approx 250$  mL/min). We assumed a moderate increase of CO for each level of anemia.

tory distress syndrome (ALI/ARDS), and death.<sup>6-8</sup>

Tissue injury produces local and systemic perturbations that are minimized during elective surgery by using proper anesthetic and surgical techniques, but can produce major damage in the random, unprotected situation of a traumatic injury. Then tissue damage, loss of perfusion, and cell necrosis will result in the immediate release of tissue factors into the bloodstream, which trigger a systemic inflammatory response characterized by the synthesis and release of cytokines. Tumor necrosis factor (TNF)- $\alpha$  and interleukin (IL)-6 are among the earliest cytokines to appear in the systemic circulation immediately after tissue trauma, and amplify the complex inflammatory response that is an integral part of critical illness.<sup>9</sup> Tissue trauma of different types can produce both direct and systemic effects leading to critical illness. One well-documented example occurs in injuries to the lung. In our case report, the initial cause of the patient's complex critical illness was a chemical injury to the alveolar epithelium caused by the aspiration of gastric contents. A similar evolution to critical illness can occur with other lung injuries, such as a lung contusion from blunt chest trauma or pneumonia. Despite the variety of inciting factors, the lung responds to acute injury in a stereotypical fashion, leading to the pathologic picture of "diffuse alveolar damage"<sup>10</sup> and the clinical picture of ALI/ARDS, which is a syndrome combining local and systemic inflammation.<sup>11</sup> Although not as well studied, a similar sequence of events appears to follow major acute injury to the kidneys<sup>12</sup> and the gut.<sup>13,14</sup>

*Hypoperfusion* and *ischemia* may result from direct tissue trauma, impaired regional blood flow, or a generalized decrease of blood flow—a "low-flow state." A severe reduction of oxygen supplied to the tissues is marked by the local production of lactate from anaerobic glycolysis, and may cause or exacerbate metabolic acidosis. However, even when profound ischemia occurs, tissue viability can often be reestablished. The effects of restoration of blood flow after ischemic injury has been best characterized in the heart, where reversal of arterial occlusion is common with advanced techniques of coronary revascularization.<sup>15</sup> Myocardial *stunning* describes the acute ischemic dysfunction caused by acute cessation of regional coronary circulation, and can be fully reversed by rapid restoration of blood flow.<sup>16</sup> Myocardial *hibernation*, a chronic state of dysfunction caused by insufficient coronary perfusion, can also, but less predictably, be improved with coronary revascularization procedures.<sup>17</sup> However, global hypoperfusion is often irreversible: In the "post-resuscitation syndrome" that occurs following prolonged cardiopulmonary resuscitation, stunning of the cardiac muscle (*stony heart*)<sup>15</sup> is largely responsible for the high fatality rate observed early after cardiopulmonary resuscitation, and is characterized by severely depressed contractility and malignant arrhythmias.

Although restoration of tissue blood supply may prevent cell death and reestablish function, acute reperfusion of ischemic tissues can cause significant cellular injury, known as *ischemia-reperfusion injury*. In the absence of adequate oxygen supply, mitochondrial production of adeno-

sine triphosphate (ATP) decreases, causing an increase in adenosine monophosphate (AMP) and its byproduct hypoxanthine, and the conversion of the enzyme xanthine dehydrogenase to xanthine oxidase. Upon reperfusion with oxygen-rich blood, hypoxanthine is oxidized by xanthine oxidase at a high rate, producing large quantities of cytotoxic oxygen free radicals, including molecular oxygen, superoxide, and hydrogen peroxide ions.<sup>18</sup> Ischemia-reperfusion injury has been described in patients with the crush syndrome,<sup>19</sup> organ transplantation,<sup>20</sup> reestablishment of blood flow to limbs or splanchnic organs,<sup>21</sup> and during experimental alterations of ventilation and perfusion of the lung.<sup>22,23</sup>

### Metabolic Failure

Metabolic failure is a less common reason for admission to a surgical ICU. The most representative metabolic derangements include the consequences of severe malnutrition, such as extreme weight loss, kwashiorkor, and avitaminosis. These diseases, although prevalent throughout the world, are rarely seen in industrialized societies.

A different metabolic derangement, morbid obesity, has become more prevalent in the United States and other industrialized countries.<sup>24</sup> Morbid obesity (defined as weight 30% in excess of ideal body weight, or a body mass index >40 [body mass index = weight in kg ÷ height in m<sup>2</sup>]) increases the risk of complications related to surgery and anesthesia. Morbidly obese patients are increasingly admitted to the ICU because of complications following bariatric surgery or unrelated events, such as trauma. Prevalent comorbidities of obesity include hypertension, diabetes, obstructive sleep apnea, chronic lung disease, and heart failure, which increase their postoperative risk for cardiovascular and respiratory complications. In addition, morbid obesity often presents logistical problems, such as the need for a special bed, a limited ability to perform important diagnostic tests such as MRI and CT scans, difficulty of vascular access and monitoring,<sup>25,26</sup> and complex issues of proper drug dosing.<sup>27</sup>

Common metabolic derangements requiring ICU care include those related to chronic diseases such as diabetes mellitus, diabetic ketoacidosis and hyperosmolar nonketotic coma. See Chaps. 12 and 16 for management

recommendations for diabetes mellitus and its complications.

## Infection

Infection contributes importantly to both the onset and the progression of critical illness. In a survey of 198 European ICUs, 25% of the admissions were because of sepsis, and 37% of ICU patients experienced sepsis and septic shock at some time during their stay.<sup>28</sup> Infection is the leading cause of death in ICU patients. It is estimated that approximately 750,000 people develop sepsis annually in the United States, and 30–40% of these patients will die.<sup>29</sup> The presence of a proven infection in patients who remain in the ICU for more than 48 hours increases their mortality rate from 22% to 35%.<sup>30</sup> The terms *sepsis*, *severe sepsis*, *septic shock*, and *refractory septic shock* describe the spectrum of severity of sepsis. Multiorgan dysfunction syndrome (MODS) is a severe complication of sepsis and other inflammation-driven critical illnesses. MODS is associated with a high mortality. These terms were reviewed in a recent consensus conference of the Society of Critical Care Medicine and the American College of Chest Physicians<sup>31</sup> and are thoroughly discussed in Chap. 76. In many cases, it is difficult to define the ultimate cause of the ICU patient's death, which is seldom hypoxemia, uncorrectable hypotension, or a sudden fatal arrhythmia, because respiratory function can usually be supported with a mechanical ventilator or an artificial lung, and renal function can be replaced by hemofiltration and hemodialysis. The majority of patients who die from or with a severe infection in the ICU,<sup>32,33</sup> die after care is withdrawn by mutual agreement of their physicians and families, based on futility as a consequence of persistent MODS.

Table 75-2 lists common infections that require ICU admission. Other infections are also important because of their enormous impact on public health, current (tuberculosis, malaria, and AIDS) or potential (severe acute respiratory syndrome [SARS], avian influenza), and are summarized in Table 75-3. See Chap. 17 for a systematic description of the clinical features and treatment of these conditions.

Hospital-acquired, or *nosocomial* infections, are prevalent in the ICU, and contribute to the demise of a large number of critically ill patients. In our

TABLE 75-2.

### Community-Acquired Infections That May Require ICU Admission

Community-Acquired Infection	Common Etiologic Agent
Pneumonia	<i>Streptococcus pneumoniae</i> , <i>Haemophilus influenzae</i> , <i>Staphylococcus aureus</i> , <i>Moraxella catarrhalis</i> . Atypical pathogens: <i>Mycoplasma pneumoniae</i> , <i>Legionella pneumophila</i>
Peritonitis from perforation, necrosis, or suppurative infection	Gut flora: Gram-positive cocci predominate proximally ( <i>Streptococcus</i> spp., <i>Enterococcus</i> spp., anaerobes); gram-negative rods ( <i>Escherichia coli</i> , <i>Enterobacter</i> spp.), anaerobes ( <i>Bacteroides</i> spp.) in small and large bowel
Acute cholecystitis, cholangitis	Enteric flora: <i>Klebsiella</i> spp., <i>Enterobacter</i> spp., <i>E. coli</i> , <i>Enterococcus</i> spp., <i>Bacteroides</i> spp., <i>Clostridium</i> spp.
<i>Clostridium difficile</i> colitis	<i>C. difficile</i> : anaerobic bacillus producing exotoxins
Necrotizing soft-tissue infections	<i>Streptococcus</i> spp., <i>Clostridium</i> spp., or polymicrobial flora
Urinary tract infections	Enteric gram-negative rods: <i>E. coli</i> , <i>Klebsiella</i> spp., <i>Proteus</i> spp.
Infective endocarditis	<i>Streptococcus viridans</i> , <i>Enterococcus</i> spp., <i>Staphylococcus aureus</i>
Meningitis	<i>Streptococcus pneumoniae</i> , <i>Haemophilus influenzae</i> , <i>Neisseria meningitidis</i>
Viral infections	Cytomegalovirus, herpes simplex virus-1 and -2, hepatitis A, B, and C
Infections in the immunocompromised host	Bacteria (including mycobacteria), fungi ( <i>Candida</i> spp., <i>Aspergillus</i> spp., <i>Torulopsis glabrata</i> ), viruses (Cytomegalovirus, herpes simplex virus, Epstein-Barr virus), and parasites.

case report, the development of a *Pseudomonas aeruginosa* pneumonia halted the course of recovery from ARDS, and most likely prolonged the patient's ICU stay and increased her time of ventilator-dependence. Fortunately, she recovered from her ventilator-associated pneumonia, despite an inherent mortality rate of 20–50%.<sup>34</sup> Nosocomial infections are often caused by multiresistant bacteria that are transmitted to patients by healthcare providers and result from widespread use of antimicrobial agents.<sup>35,36</sup> Indwelling devices such as central venous catheters, endotracheal tubes, and urinary catheters contribute to the development of infections. These factors can be minimized by the implementation of standard but hard-to-enforce clinical practices, such as frequent hand decontamination, use of gloves and gowns when examining patients, proper care of indwelling devices, and appropriate use of antibiotics.<sup>37</sup>

Many nosocomial infections are preventable iatrogenic injuries. Following the publication by the Institute of Medicine of the landmark report *To*

*Err is Human—Building a Safer Health System*,<sup>38</sup> healthcare organizations have focused on maximizing the safety and efficacy of ICU care. As a result, an increasing amount of research is being published on improving ICU patient safety; in addition, there is increasing compliance with safety guidelines. Over the next few years, the tangible effects of safer ICU practices, including decreased iatrogenic infections, will be recorded.<sup>39</sup>

## SHOCK—THE ULTIMATE STRESS

The term *shock* describes the pathophysiologic manifestations of a catastrophic event that causes a profound, protracted reduction of perfusion to vital organs. Originally used to describe refractory hypotension, a more modern definition of shock indicates a state of tissue hypoperfusion caused by low blood flow, toxic agents, or both, where the circulation fails to meet the metabolic requirements of the cell. Initially, neurohumoral com-

TABLE 75-3.

## Infections That Constitute a Public Health Threat

Disease	Spread	Current Status	Treatment
TB (bacterial)	Person to person droplets	14,000 cases in the U.S. in 2003; enormous public health problem in Africa, Asia; on the rise in Europe; association with HIV	Antibacterial combinations are effective, but induced resistance develops
Malaria (parasite)	Anopheles (mosquito) bites	Widespread to warm and humid areas; sub-Saharan Africa has highest prevalence	Prevention and treatment with oral chloroquine and IV quinine; resistance is a problem
AIDS (virus)	Blood and body fluids, sexual	Relatively contained in U.S.; enormous public health problem in Africa, Asia, South America	Antiretroviral therapy slows progression, but is not universally available
SARS (virus)	Person to person droplets	Worldwide outbreak in 2003; little in U.S., now quiescent	Supportive
Avian flu	Birds to humans; sporadically person to person	Isolated cases; small outbreaks in Asia and Eastern Europe	Supportive

SARS, severe acute respiratory syndrome; TB, tuberculosis.

Data from [http://www.cdc.gov/nchstp/tb/faqs/qa\\_introduction.htm#Introl](http://www.cdc.gov/nchstp/tb/faqs/qa_introduction.htm#Introl); <http://www.cdc.gov/ncidod/sars/factsheet.htm>; <http://www.cdc.gov/malaria/faq.htm>; <http://www.cdc.gov/hiv/topics/surveillance/index.htm>; <http://www.cdc.gov/flu/avian/outbreaks/current.htm>. Last accessed October, 2006.

compensatory mechanisms maintain perfusion to vital organs. However, if appropriate supportive treatment is not promptly instituted, these compensatory mechanisms are overwhelmed, and progressive tissue ischemia leads to organ failure. Clinically, signs and symptoms of end-organ hypoperfusion include mental status changes, loss of skin turgor, cool extremities, oliguria, acidemia, a high serum lactate concentration, and a reduced mixed or central venous oxygen saturation.

Shock is classified on the basis of its cause and characteristic hemodynamic pattern. *Hypovolemic shock* is caused by an acute volume loss of  $\geq 20\text{--}25\%$  of the circulating blood volume, from events such as hemorrhage, heat stroke, and sequestration of fluid within the body following bowel obstruction. Hemodynamically, there is a decrease in arterial blood pressure, central vascular pressures, and cardiac output. *Cardiogenic shock* is caused by primary heart failure. The most common cause of cardiogenic shock is myocardial infarction and its acute complications. Cardiogenic shock is characterized by systemic hypotension and a low cardiac output in the face of an adequate or increased blood volume, as indicated by increased central venous and pulmonary artery wedge pressures, or equivalent indices of volemia. *Distributive shock* is characterized by general-

ized vasodilatation, venous pooling, and redistribution of systemic blood flow, and is characteristically associated with a high cardiac output. It may be caused by the body's response to circulating live bacteria and their byproducts during septic shock, by inflammatory mediators in the absence of infection, by endogenous circulating vasoactive compounds during anaphylactic shock, or by a loss of vascular tone as a result of neurogenic shock or bilateral adrenal hemorrhage. *Obstructive shock* is associated with a mechanical impediment to venous return and/or arterial outflow of the heart, and may occur because of a tension pneumothorax, pericardial tamponade, abdominal compartment syndrome, and, occasionally, as a consequence of iatrogenic positive pressure ventilation and auto-positive end-expiratory pressure. Obstructive shock is characterized by a low systemic blood pressure, low cardiac output and increased central vascular pressures.

*Traumatic shock* is a useful teaching model of shock, because it may present with coexistent and diverse physiologic features, including hypovolemia, hypoxemia, myocardial dysfunction, vasodilatation, and neurologic failure, and, after blood volume resuscitation, a hyperdynamic pattern.<sup>3</sup> It has been demonstrated on the battlefield that immediate control of hemorrhage, pain

relief, avoidance of profound hypothermia, and rapid transport to an appropriate treatment facility can prevent the development of shock, and reduce mortality (see also Chap. 78). Similarly, in the hospital environment, appropriate fluid resuscitation and airway management, timely administration of antibiotics, damage-control surgery, and admission to the ICU may prevent the onset of shock and increase survival rates.

### QUANTIFYING SEVERITY OF ILLNESS AND RELATIONSHIP TO OUTCOME

Although ICUs grew in number and complexity in the 1970s, there were scant data to support the effectiveness of ICU care. The necessity that ICU outcomes be quantified was multifold, including optimizing resource use, quality analysis, and the need to explain to critically ill patients, their families, and their treating clinicians what to realistically expect from intensive care. Obtaining meaningful outcome data examining complex medical practices is intrinsically difficult, because of the variability of the underlying severity of illness, which changes over time whereas treatment varies between different units. For example, a review from 1973 showed that the

death rates in several surgical ICUs in North America varied from 2% to 44%,<sup>40</sup> although the quality of care may have been responsible for some of the observed difference in mortality rates, it was impossible to determine this with certainty from the available data.

The development of the Acute Physiology and Chronic Health Evaluation (APACHE) scoring system by Knaus et al. began in 1978 with a grant from the U.S. Health Care Financing Administration. The goal was to develop better methodology for measuring severity of illness among ICU patients. The result was the development of a comprehensive and prognostic scoring system that estimates the pretreatment risk of death of acutely ill hospitalized patients based on the patient's major disease process, their physiologic reserve, and the contribution from the acute severity of disease as determined by derangements of important physiologic parameters.<sup>41</sup>

After the initial validation of this instrument, the original APACHE, which was based on 33 potential physiologic measurements to define the degree of physiologic derangement, was streamlined to the current 12 physiologic variables. With further changes in weighting for age, definitions for chronic health status, and whether or not the admission to the ICU was after elective surgery, the resultant system was the APACHE II prognostic scoring system. Over the ensuing two decades, a number of other systems have been developed and validated to aid in predicting survival, allocating resources, and verifying the quality of our practice.<sup>42–44</sup> Each of these instruments has its advantages and flaws. Nevertheless, it is clear that the capability to categorize patients early in their course based on the severity of their illness, even if imperfect, has enhanced the quality of clinical research trials of critically ill patients, and more importantly, has chronicled the extremely poor prognosis of patients with very high scores.

## HOST RESPONSES DURING CRITICAL ILLNESS

The body responds to an acute injury—such as the aspiration of gastric contents into the lungs as in our case report, or a bacterial infection, or a surgical wound—in a reproducible way.

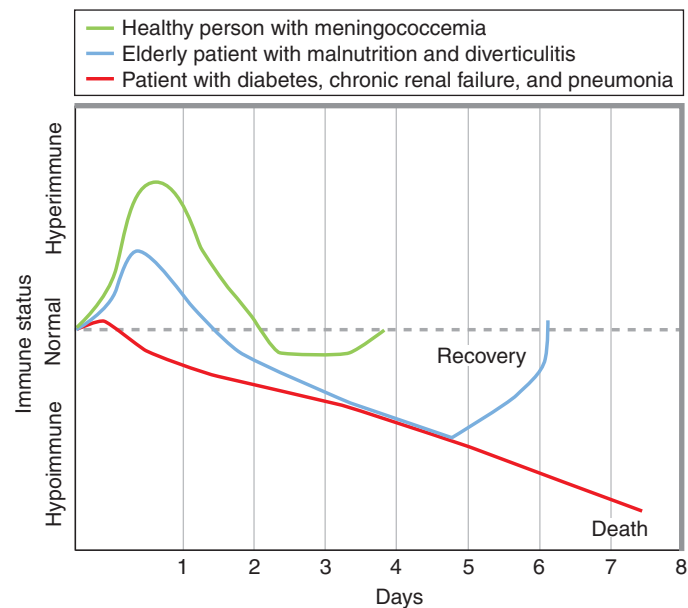
The initial local inflammatory response aims to control the immediate effects of the injury, and generates signals from various cells at the site of injury that activate a systemic response. Hence, an injury of sufficient severity triggers a combined response from nerve endings and endothelial and immune cells, which rapidly extends to the entire organism. When these homeostatic responses are coupled with our correct interventions, they enable us to maintain or restore the function of vital organs, expedite repair, and lead to healing and rehabilitation. When the injury hampers the host's regulatory processes, or when our intervention is inadequate or delayed, the attempt to preserve the body's integrity is overwhelmed by the injury and organ dysfunction, and death ensues.

### Timing

The complexity of the body's response to injury over time constitutes a major challenge to our ability to develop effective treatments that will inhibit the progression of traumatic, inflammatory, and infectious injuries to MODS and death. The classical view of an

initial “ebb” (hypodynamic) and a subsequent “flow” (hyperdynamic) phase of the cardiovascular and metabolic responses to injury<sup>45</sup> now appears simplistic. It seems likely that the timing and intensity of this complex response varies widely among patients, and is influenced by the magnitude of the injury, the patient's physiologic status, and our therapies. Figure 75–2 illustrates three hypothetical time sequences of the evolution of critical illness, showing different patterns of activation and suppression of the immune system following an infectious injury. Although studied thoroughly in the case of sepsis, this sequence of events is likely to be applicable to other noxious events, such as after major surgery, trauma, and shock.<sup>9,46,47</sup>

Physical examination following a serious injury may reveal changes of skin color and turgor, body temperature, arterial blood pressure, breathing pattern, and mental function. Other easily measured parameters, including urine output, base deficit, and serum lactate level, may also be abnormal. These findings likely reflect the complex underlying homeostatic re-



**FIGURE 75–2.** The immune–inflammatory response to injury: hypothetical time course of three representative patients. The healthy individual with a severe infection (e.g., meningococemia, *top line*) shows a robust inflammatory response; if this patient survives the initial phase, there will be only a short hypoimmune period, and the patient will progress along the path of recovery. For an elderly, malnourished patient with a moderate infection (e.g., acute diverticulitis, *middle line*), the initial inflammatory response is limited and, if the infection is not promptly eradicated, a prolonged hypoimmune state ensues, and death can occur from further infectious complications. For a patient with significant comorbidity (e.g., diabetes, obesity, chronic obstructive pulmonary disease, and a pneumonia, *bottom line*) the initial inflammatory response may be completely blunted, and the clinical course is dominated by a hypoimmune state, where the risk of death from persistent or new infection is high. (Hotchkiss RS, Karl IE. The pathophysiology and treatment of sepsis. *N Engl J Med* 2003;348:138–150. Copyright 2003, Massachusetts Medical Society. All rights reserved.)



sponses that are initiated by injury. Although we separately describe the characteristic responses of various organ systems, in the body these systems are highly interconnected and have certain similar characteristic responses, such as upregulation of inflammatory mediators. Dysfunction of one system will often impair the functions of other organs; a classic example is the development of functional renal failure because of decompensated hepatic failure (hepatorenal syndrome) as can arise in a cirrhotic patient with intraabdominal infection.

### The Immune–Inflammatory Response

The immune–inflammatory response plays a central role in the evolution of critical illness. The *innate* immune system is the first line of defense, but both innate and *adaptive* immune responses are activated by injury and infection.

Immediately following acute tissue injury, a variety of inflammatory mediators are released by activated leukocytes—in particular, monocytes and macrophages—as well as endothelial cells and fibroblasts. These mediators include cytokines, arachidonic acid metabolites, complement fractions, various acute phase proteins, and oxygen and nitrogen free radicals.<sup>48</sup> Cytokines are polypeptide messengers of this huge cascade of reactions that have been extensively studied, and have been identified as critical mediators of physiologic and laboratory manifestations of inflammation, including fever, leukocytosis, hypotension and tachycardia, changes in mental status, and catabolism. Unlike hormones, which are produced by specialized endocrine tissues, cytokines are not stored, and their acute increase following tissue injury reflects upregulated gene transcription, translation, and synthesis by activated immune and/or endothelial cells. A characteristic of this type of response is that it tends to modulate itself by upregulating the expression of both pro- and antiinflammatory cytokines and acute-phase reactants. There continues to be considerable debate over the ultimate role of an overzealous inflammatory response in the pathogenesis of critical illness. Over the past three decades there has been a prevailing view that the pathogenesis of traumat-

ic and infectious injury is based on an excessive and uncontrolled response to the initial insult (“cytokine storm”) that turns a beneficial defense system into the actual offender, and, ultimately, causes critical illness. This appealing view, brought forward by Lewis Thomas in the 1970s<sup>49</sup> and further championed by the late Roger Bone in the 1990s,<sup>50</sup> lead to the development and testing of many therapies that targeted or modulated inflammatory mediators, including high-dose corticosteroids, ibuprofen, antibodies against bacterial endotoxin (lipopolysaccharide [LPS]), TNF- $\alpha$ , and IL-1 receptor antagonists.<sup>51–53</sup> However, human trials with these agents were largely unsuccessful. Given the complexity of the inflammatory response, it is not surprising that an agent that inhibits the activity of a single mediator may not provide sufficient benefit. More recently, some degree of success has been achieved by supplementing individual substances or pathways that seem deficient during certain phases of critical illness, and treating these “relative insufficiencies” with natural or synthetic equivalents of the undersupplied substance. Examples of such strategies are described in the following sections.

### The Central Nervous System

The central nervous system (CNS) response to major injury and stress involves activation of the autonomic system, as well as interactions with the endocrine and the immune systems. The classical neurohumoral response to acute injury includes early activation of the autonomic sympathetic system resulting in tachycardia, increased myocardial contractility, tachypnea, splanchnic and cutaneous vasoconstriction, and increased availability of metabolic substrates. This “fight-or-flight” response is closely linked to activation of the hormonal pathways of the adrenal medulla, the pituitary–adrenal axis, antidiuretic hormone (ADH), and angiotensin–aldosterone (see The Hormonal Response below); all these physiologic pathways, in various ways, tend to preserve perfusion to vital organs.<sup>54</sup>

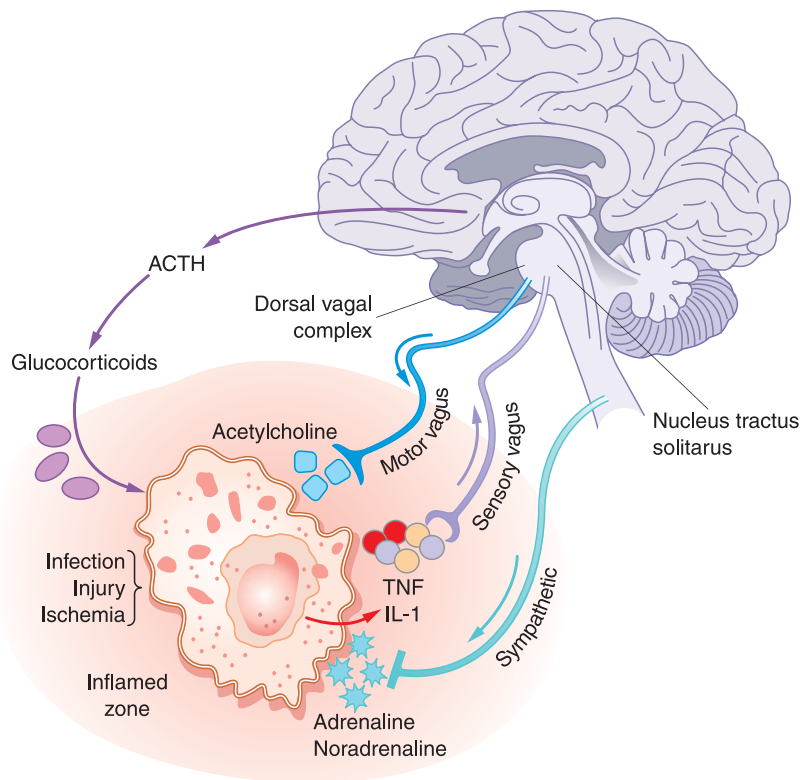
The brain also interacts with the immune system, and recent experimental observations have identified a vagal-mediated neural pathway that participates in the regulation of inflammation. Figure 75–3 shows a

schematic of this “cholinergic antiinflammatory pathway.”<sup>55</sup> Inflammatory stimuli (including LPS, TNF- $\alpha$  and IL-1) activate visceral vagal afferents that reach multiple vagal nuclei in the medulla and hypothalamus. This neural input elicits an immediate antiinflammatory response mediated by the same autonomic, parasympathetic system. Experimental activation of the cholinergic–antiinflammatory pathway inhibits function and reduces the expression of TNF during endotoxemia through the binding of nicotinic receptors on macrophages.<sup>56</sup> Knowledge of this cholinergic–antiinflammatory pathway has possible therapeutic implications: experimental activation of vagal output by electrical, as well as pharmacologic, vagal stimulation has inhibited macrophage activation and cytokine release.<sup>55</sup>

### The Hormonal Response

The hormonal response to acute injury tends to increase vascular pressures, preserve circulating blood volume, and provide substrates for tissue metabolism and regeneration. These hormonal pathways include the synthesis and release of adrenal corticosteroids and catecholamines, ADH and aldosterone–angiotensin, prolactin, growth hormone, and other antiinsulin hormones. The role of these hormones in the acute response is complex, and significant understanding of their role has been gained over the past several decades.<sup>57</sup> Recent evidence reveals that some of these pathways may be key determinants of survival for critically ill patients, and suggests they may be successfully modulated pharmacologically.<sup>58</sup>

The output of the *pituitary–adrenal axis* increases several-fold as a normal response to acute illness.<sup>59</sup> Any malfunction of this axis, whether at the level of the precursors, the end-product (cortisol) or the cellular receptors, leads to an ineffective response and may be associated with a reduced chance of survival.<sup>60</sup> The term *relative adrenal insufficiency* refers to a state wherein the pituitary–adrenal axis fails to mount a sufficient response in the presence of an acute and severe stress, despite functioning adequately in health.<sup>61</sup> A recent randomized controlled trial demonstrated that treatment with physiologic doses of a combination of glucocorticoids and mineralocorticoids improved survival in patients with septic shock and a



**FIGURE 75-3.** The cholinergic–antiinflammatory pathway. Inflammatory products produced at the site of injury activate neural signals that are relayed to the nucleus of the *tractus solitarius*. From there, efferent vagal activity (the cholinergic–antiinflammatory pathway) inhibits cytokines expression. In addition, vagal afferents can also be relayed to the hypothalamus and stimulate adrenocorticotropic hormone (ACTH) release. (Tracey K. The inflammatory reflex. *Nature* 2002;420:853–859. Reprinted by permission from Macmillian Publishers Ltd.)

depressed adrenal response.<sup>62</sup> However, debate remains over the proper patients to select for steroid treatment.<sup>63</sup>

Similarly, ADH is insufficiently synthesized in a significant fraction of critically ill patients.<sup>64</sup> The administration of a low dose of vasopressin, a synthetic analogue of ADH, appears to improve general systemic hemodynamics, reduce the need for infusing other vasopressor medications such as norepinephrine, and possibly increase gastric and renal perfusion in septic shock.<sup>65,66</sup>

Recent evidence suggests that tight control of plasma glucose levels in critically ill patients, by infusing *insulin*, improves survival in critically ill surgical patients.<sup>67</sup> Insulin incretion is deficient in the early phases of critical illness because of an increased synthesis of hormones such as catecholamines, glucocorticoids, glucagon, and growth hormone. This surge of antiinsulin hormones increases the availability of glucose to tissues during a time of forced starvation; however, the

resulting high blood glucose levels may be associated with an increased susceptibility to infections, immunosuppression, and neurologic damage.<sup>68,69</sup> In a seminal clinical trial in cardiac surgery ICU patients in Belgium, Vandenberghe et al. demonstrated that by maintaining the blood sugar level between 80 and 120 mg/dL via a continuous insulin infusion, they significantly decreased the incidence of bacteremia, critical illness polyneuropathy, and mortality.<sup>67</sup> This study and its more recent companion in medical ICU patients<sup>70</sup> have encountered criticism, but it has affected the way we treat hyperglycemia in the ICU. Time and additional studies should lead to more uniform practices over the next few years.

### The Hemodynamic Response

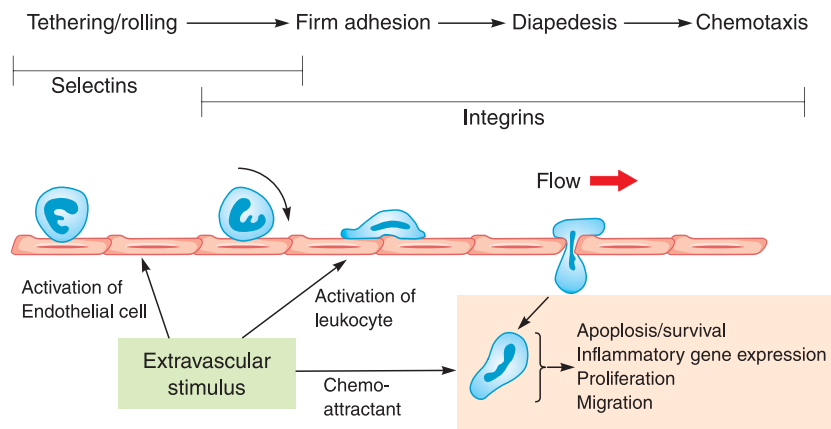
The hemodynamic response to injury has been extensively investigated by monitoring central vascular pressures, cardiac output, and indices of oxygen delivery and consumption.<sup>71</sup>

Systemic vasoconstriction commonly predominates in the immediate period following an acute injury, most likely as a response to intravascular hypovolemia from hemorrhage or sequestration of body fluids outside the vascular compartment. After normovolemia is restored, a hyperdynamic pattern of high cardiac output and normal-to-low blood pressure ensues. The extent of this hyperdynamic response varies with the type and magnitude of the injury. It is important to note that hyperdynamic states occur in other conditions, such as hyperthyroidism, liver cirrhosis, and with large arteriovenous fistulae, even if acute injury and/or inflammation are not present.

This hyperdynamic response may be part of a systemic inflammatory response syndrome (SIRS) that is associated with acute injury of various etiologies, and is caused by the release of cytokines and other inflammatory mediators such as prostaglandins, bradykinins, and complement fractions.<sup>31</sup> The cardinal manifestations of SIRS include hyper- or hypothermia, tachycardia, leukocytosis or leukopenia, and hyperventilation. In addition, a number of other signs and symptoms, such as hypotension, platelet and coagulation abnormalities, and changes in mental status, are characteristic of SIRS, although each taken individually lacks specificity both as a diagnostic sign and as an end point for defining therapy.

### Systemic Vasodilatation, Inflammation, and Coagulation: The Endothelium

A number of substances are believed responsible for the decrease in systemic vascular tone that is part of the hyperdynamic response. The vascular endothelium plays an important role in the inflammatory and procoagulant state that can result from an acute traumatic or infectious injury (see The Immune–Inflammatory Response above).<sup>72,73</sup> The endothelium contributes to the maintenance of homeostasis in a number of ways, including the prevention of coagulation, the regulation of vascular tone and permeability, and the orchestration of the migration of leukocytes into the tissues by the expression of adhesion molecules. Figure 75-4 is a schematic of the interaction between inflammatory stimuli, the endothelium, and leukocytes.



**FIGURE 75–4.** Schematic of leukocyte adhesion to the activated endothelium during inflammation. Leukocytes are initially tethered, and roll along the endothelium predominantly via interactions with selectins. Once on the endothelium, leukocytes' integrin receptors are activated and bind to ligands on the extracellular matrix, favoring migration of leukocytes between endothelial cells. Signaling from integrin receptors also modulates leukocytes survival or apoptosis and gene expression and proliferation. (Reproduced with permission from Harlan and Winn.<sup>143</sup>)

Immediately following injury there is upregulation of adhesion molecule expression on endothelial cells and leukocytes leading to increased endothelial cell–leukocyte interactions and eventual migration of leukocytes across the vessel wall into the adjacent tissues (Fig. 75–4).<sup>74,75</sup> Direct injuries and inflammatory mediators cause the endothelium to lose its anticoagulant properties; there is concomitant imbalance between thrombin and plasmin, and increased platelet stickiness, ultimately resulting in clot formation on the endothelial surface. Widespread activation of the coagulation system in response to stress may lead to disseminated intravascular coagulation (DIC), intravascular formation of fibrin, decreased fibrinolytic activity, and widespread thrombosis.<sup>76</sup> Although the full syndrome of diffuse vascular thrombosis is rare, DIC often presents a considerable clinical challenge because of the concomitant presence of a consumptive coagulopathy and thrombosis. The coagulation system has been targeted therapeutically in patients with sepsis and septic shock. Antithrombin III and *protein C* are both anticoagulants that are maintained in an active state by endothelial activity, and are decreased in conditions of stress such as SIRS and sepsis. Although a clinical trial of the therapeutic administration of antithrombin III was unsuccessful,<sup>77</sup> the infusion of recombinant human activated protein C (drotrecogin- $\alpha$ ) significantly increased the survival rate of critically ill

patients with severe sepsis and septic shock by 6%.<sup>78</sup>

The endothelium produces multiple mediators that have diverse functions. Some mediators have multiple effects, such as protein C, vasodilator mediators like the gas NO and prostacyclin (both also inhibit platelet aggregation), and the vasoconstrictor endothelins, all have potent vasoactive and immunologic properties. NO is produced constitutively in endothelial cells by the isozyme nitric oxide synthase (NOS-3, endothelial nitric oxide synthase [eNOS]). Following stimulation of various kinds, there is upregulation of an inducible form of NOS (NOS-2, iNOS), which results in greatly increased production of NO, and contributes to the profound vasodilatation that occurs with severe systemic inflammatory processes.<sup>79</sup> Activation of endothelial cells also results in the production of mediators with opposing effects, such as the endothelins, which can cause vasoconstriction while NO causes vasodilatation.<sup>80</sup> When the induction of iNOS is overwhelming, such as in septic shock, the massive vasodilatation of the extreme hyperdynamic syndrome results in profound hypotension that may compromise vital tissue perfusion and lead to MODS and death (see Chap. 76). Nitric oxide-induced vasodilatation has been reversed by the administration of non-specific NOS-inhibitors such as methylene blue,<sup>81</sup> L-nitroarginine methyl ester (L-NAME)<sup>82</sup> and N-methyl-L-arginine hydrochloride.<sup>83</sup> However, this

clinical strategy has been unsuccessful, possibly as a result of the importance of the constitutive isoenzymes of NO that were also inhibited by these nonselective compounds.

## The Metabolic Response

The metabolic response to traumatic injury is characterized by hypercatabolism and increased urinary nitrogen excretion. Once initial hemodynamic resuscitation and stabilization are achieved, substrates are used to enhance tissue repair and preserve vital organ function. Tissues that do not have a high resting energy requirement, such as fat and skeletal muscle, release nutrients from storage (glucose and fatty acids), or proceed to break down their structural proteins to provide fuel for visceral organs. High levels (3- to 4-fold increase) of circulating catecholamines coexist with this metabolic response. Epinephrine, in particular, promotes glycogenolysis in muscle and liver, lipolysis and ketogenesis in adipose tissue, and hepatic gluconeogenesis.<sup>84,85</sup> These processes provide energy for the high metabolic requirements during the phases of recovery and repair. In addition, epinephrine induces insulin resistance in skeletal muscle, which contributes to the development of hyperglycemia. Like many homeostatic responses, this high catecholaminergic state has dual and opposing effects; although catecholamines promote healing and repair, high catecholamine levels may cause excessive catabolism, hyperglycemia, muscle wasting, and reduced host defenses. One clinical study that was carried out in children with acute burn injuries has shown the benefits of blocking the catecholaminergic response to acute burn injury. Because children with burns have a particularly high metabolic demand,<sup>86</sup> it remains uncertain whether or not this benefit can be extrapolated to critically ill adults without burns.

## THE CELLULAR RESPONSE TO INJURY

At the tissue level, the ability to live or die can be simply reduced to the ability of the body to supply adequate amounts of oxygen and nutrients (e.g., glucose) for cellular respiration and to remove metabolic by-products (CO<sub>2</sub> and toxins). These two seemingly sim-

ple end points are reached through enormously complex phenomena. This section reviews several aspects of this process that are relevant to acute injury, whether traumatic, inflammatory, or infectious.

### The Cellular Response to Traumatic Injury

The extent of the damage caused by a traumatic injury (e.g., amount of energy received on impact, size of the wound) often determines the immediate outcome of a patient. An uncontrollable hemorrhage will result in early death, with the possible salvage strategy being very simple—a tourniquet and immediate transport, not ICU care. A complex but not immediately lethal injury will then evolve over time, and the outcome will depend on the adequacy of the endogenous response to injury and the ability to support it successfully.

The body's immediate response to traumatic injury requires the generation of signals that communicate the presence of a threat to the rest of the body. These danger signals, which may include necrotic tissue byproducts and local changes in pH and temperature, activate endothelial cells, monocytes, and macrophages to produce and release inflammatory mediators. Production and release of cytokines commences within a few minutes of injury, and facilitates a systemic response that has protean clinical manifestations. Early measurements of plasma cytokine levels in trauma and surgical patients indicate that the degree of increase in IL-6, one of the earliest responders, correlates with the degree of injury.<sup>9,87</sup> In addition to the immediate synthesis and release of cytokines, soluble receptors and antagonist mediators are released following trauma, further modulating the effects of the cytokines, and initiating a competitive antiinflammatory, immunosuppressive response.<sup>88,89</sup> This balance between the activation and suppression of inflammation continues throughout the course of critical illness, and likely affects the ultimate evolution toward recovery or death.<sup>90</sup> Better understanding of the determinants of this balance between the pro- and antiinflammatory responses could guide the generation of effective therapeutic strategies. A state of immunosuppression or anergy is well described

after severe trauma and surgery and may increase susceptibility to nosocomial infections, a common determinant of further morbidity and a longer ICU stay.<sup>91</sup>

### Infection

Like traumatic injury, wherein the extent of damage determines the bodily response, a sufficient inoculum of pathogenic microorganisms triggers the host's systemic inflammatory response, manifesting in its most severe form as septic shock. The host response to infection is initiated by interactions between structural components of the invading organism (pathogen-associated molecular patterns [PAMPs]) and the immune cells of the host. All classes of microbes, including gram-positive and gram-negative bacteria, fungi, viruses, and parasites, have PAMPs, although their exact PAMPs vary. For instance, gram-negative bacteria have endotoxin (LPS) in the outer membrane of their cell walls. LPS is a potent bacterial toxin that is thought to play an important role in gram-negative sepsis. Gram-positive bacteria do not have LPS, but they have other PAMPs that have inflammatory effects, such as peptidoglycan and lipoteichoic acid. Other PAMPs include nucleic acids from bacteria and viruses, and zymosan from yeast.

LPS is the best-characterized and most extensively studied microbial PAMP. LPS is a complex glycolipid in the outer membrane of the gram-negative bacterial cell wall. Injection of LPS into animals and human volunteers elicits inflammation and other responses that are similar to those that occur in septic patients. Because of the high toxicity of LPS, it has been targeted for many novel therapies over the last few decades. LPS is composed of a lipophilic domain (lipid A) and a polysaccharide tail that varies considerably between different bacteria. Because lipid A is conserved among different bacteria, therapeutic strategies have targeted the lipid A portion of LPS for antibody development.<sup>92</sup> However, despite promising results in animal and early clinical trials, phase 3 clinical trials failed to establish significant improvement in patients given antilipid A antibodies. Although LPS is a highly potent toxin, the fact that LPS is not present in a large number of microorganisms that cause sepsis clearly indicates that

other microbial components contribute to the pathogenesis of sepsis.

A variety of host mediators, including soluble mediators in the blood, cell surface receptors, and intracellular signaling pathways, are involved in PAMP-induced activation of inflammation. For instance, both LPS-binding protein and the monocyte surface antigen CD14<sup>93</sup> bind LPS, and are involved in initiating inflammatory responses to LPS. CD14 is vital for LPS-induced activation of immune cells, and has both membrane-bound, and soluble forms. Soluble CD14 is required for LPS-induced activation of CD14-negative cells.<sup>94</sup> CD14 also seems to play a role in cell signaling by gram-positive bacterial PAMPs, such as peptidoglycan.<sup>95</sup>

Over the last decade, a great deal has been discovered about the mechanisms of inflammation induced by microorganisms. Despite considerable structural heterogeneity, inflammatory responses to different microbial components are mediated through common receptors and intracellular pathways. Toll-like receptors (TLRs) recognize various classes of PAMPs and are critical proximal mediators of inflammation during infection. TLRs are evolutionarily conserved innate immune receptors that are present in both insects and mammals. They are pattern recognition receptors (PRRs) that sense common motifs in components of microorganisms (PAMPs). Toll receptors were initially discovered in *Drosophila melanogaster* in 1985, and were found to be important embryologically in dorsoventral polarity.<sup>96,97</sup> Subsequently, the *Drosophila* toll receptor was shown to be required for fly immunity to *Aspergillus*.<sup>98</sup> Mammalian TLRs were discovered in 1998. TLR4 was identified as the LPS receptor, based on studies using strains of mice that were known to be hyporesponsive to the effects of LPS, but were highly susceptible to infection.<sup>99</sup> The same year, human TLRs 1–5 were cloned, and were postulated to be involved in immunity based on sequence homology with the *Drosophila* toll receptor.<sup>100</sup> Since that time multiple mammalian TLRs have been identified, each recognizing a different PAMP. For example, TLR2 mediates effects of microbial lipoproteins, peptidoglycan, lipoteichoic acid, and zymosan, a component of yeast; TLR3 responds to double-stranded RNA;



TLR4 mediates the effects of LPS; TLR5 responds to flagellin; TLRs 7 and 8 sense single-stranded RNA; and TLR 9 recognizes unmethylated DNA.

Extensive knowledge of TLR structure and signaling pathways has rapidly been gained since their discovery (Fig. 75-5). TLRs are transmembrane proteins with two primary domains. The extracellular amino-terminal contains leucine-rich repeats and is involved in the recognition of PAMPs. The intracellular carboxy-terminal toll-IL-1 receptor (TIR) domain is required for intracellular signaling. Most TLRs signal exclusively through the adapter molecule MyD88, which ultimately leads to nuclear transcription factor- $\kappa$ B (NF- $\kappa$ B) translocation to the nucleus, which induces transcription of inflammatory genes, ultimately leading to the production of cytokines and other mediators of inflammation. TLR3 signals through a different adapter molecule than MyD88, and ultimately leads to nuclear translocation of interferon regulatory factor 3 (IRF3) and upregulation of  $\beta$ -interferon genes. TLR4, the LPS receptor, signals through both pathways. It is believed that through the coordinated sensing of different TLRs, the host is able to

discriminate between different types of infections and to mount an appropriate inflammatory response to the particular pathogen.

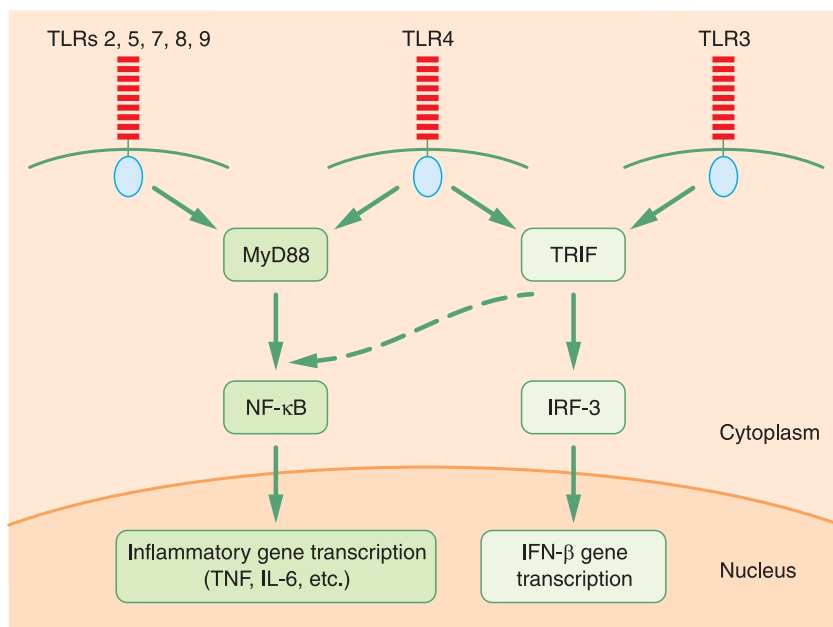
Because most PAMPs signal through NF- $\kappa$ B, blocking NF- $\kappa$ B seems a potential strategy for antiseptic therapies. Although in animal models of pure endotoxemia the inhibition of NF- $\kappa$ B has been shown to improve survival and limit organ damage,<sup>101-103</sup> there has not been a clear-cut benefit of NF- $\kappa$ B inhibition demonstrated in models of live bacterial sepsis such as infectious peritonitis from cecal ligation and puncture.<sup>104</sup> Likely, NF- $\kappa$ B has tissue- and time-specific functions, and global inhibition is too nonselective a strategy that may interfere with the native beneficial effects of this mediator.

As with all biologic systems, intercellular signaling in early inflammation and infection has an intrinsic redundancy. In addition to the TLRs, other innate immune receptors and signaling pathways also seem to be important in the recognition of and response to infection, including NOD receptors, scavenger receptors, mannose binding lectins, and dectin. Please refer to recent reviews for a more inclusive discussion.<sup>105-108</sup>

## Immunomodulation: From Inflammatory Response to Immunosuppression

Within the first 30-90 minutes after exposure to LPS, mononuclear cells release proinflammatory cytokines such as TNF- $\alpha$ , IL-6 and IL-1 $\beta$ .<sup>48</sup> This activates inflammatory cascades that stimulate further production and release of cytokines, chemokines (chemoattractant cytokines), lipid mediators, and free radicals, which are involved in leukocyte migration and adhesion, and in tissue injury.<sup>74,75</sup> A similar inflammatory response can be triggered by all of the stressors or insults described in earlier sections of this chapter. The failure of early therapies aimed at blocking isolated aspects of the inflammatory response, such as infusing high-dose corticosteroids, TNF antagonists, IL-1 receptor antagonists, and non-isozyme-specific inhibitors of NO synthesis, has led investigators to search for a deeper understanding of this extraordinarily complex and redundant system.

There is mounting evidence to support the concept of immunomodulation, that is, an equilibrium between activation and suppression of the immune system, during critical illness. It is postulated that a state of immunoparalysis occurs, whereby the host has inadequate immune responses to microorganisms, plays an important role in subsequent morbidity and mortality following injury or infection. Antiinflammatory mediators and altered cellular responses are believed to predispose patients to the development of nosocomial infections and subsequent MODS.<sup>109,110</sup> At various times after the initial proinflammatory state of traumatic and infectious injury, counter-regulatory cytokines, soluble decoy receptors for cytokines, and antagonists of proinflammatory cytokines are secreted. Immunosuppression is believed to occur when this response supersedes its function of restoring immunologic balance. This is exemplified by studies that indicate that blood from septic patients has reduced LPS-induced cytokine production, unlike blood from control patients.<sup>111</sup> Anergy, or the inability of T cells to proliferate and secrete lymphokines upon stimulation, is often observed in severe trauma and septic patients.<sup>112-114</sup> In trauma, a decrease in the number of T cells probably results from interactions between T cells and immunosup-



**FIGURE 75-5.** Overview of the toll-like receptors (TLRs) and schematic of TLR signaling pathways. TLRs sense components of microorganisms and are centrally involved in innate immune responses during infection. Activation through TLRs results in production of early inflammatory mediators such as the cytokines tumor necrosis factor (TNF) and interleukin (IL)-6, and in some cases production of interferon- $\beta$ . Different TLRs sense different microbial structures, and there are distinct but interconnected intracellular signaling pathways that are activated by TLRs.

pressive mediators such as IL-10.<sup>115,116</sup> Regulator T cells (T-reg), which are important elements of the normal immunologic equilibrium, may play a role in the immunosuppression resulting from burn injury.<sup>115,117</sup>

In acute infection, adaptive immunity may be impaired because of apoptosis of T lymphocytes<sup>118</sup> rather than cell necrosis. The term *necrosis* refers to *accidental* cell death, whereas the term *apoptosis* refers to *programmed* cell death. In contrast to necrosis (an *accidental* cell death), which generally has a stimulating effect on the innate immune system, apoptosis (a *programmed* cell death) can induce secretion of antiinflammatory cytokines leading to immunosuppression and anergy. It has been shown that the B lymphocytes, CD4 T lymphocytes, and dendritic cells undergo apoptosis, but that CD8 T lymphocytes or natural killer (NK) cells do not undergo apoptosis.<sup>118</sup> After the initial decrease in the number of CD4 T-cells, the subset of these cells that recovers are selectively T-reg and not T-helper (Th) cells.<sup>119</sup> T-reg cells (see above) have multiple negative regulatory effects on immune function, and can contribute to immunosuppression.<sup>115</sup> The importance of immune cell apoptosis in sepsis has also been demonstrated in animal models. Strains of mice that produce the antiapoptotic protein Bcl-2 are protected from death after intra-abdominal sepsis induced by cecal ligation and puncture.<sup>120</sup>

With late immunosuppression as the predominating state after the initial injury, critically ill patients become a target for nosocomial infections, which can lead to vital organ failure and death.

### Metabolic Disturbances and Cytopathic Hypoxia

Critically ill patients may develop metabolic disturbances that lead to the inability to generate sufficient energy to maintain body homeostasis. ATP is the primary fuel source for cellular respiration. The mitochondria are the principle sites of aerobic ATP production. Here, the end-product pyruvate, a product of glucose metabolism, is used in the citric acid cycle to generate the reducing agents reduced form of nicotinamide adenine dinucleotide (NADH) or the reduced form of flavin adenine dinucleotide (FADH<sub>2</sub>) and provide the flow of electrons neces-

sary to synthesize ATP by oxidative phosphorylation. Ultimately, 36 or 38 moles of ATP are generated from the oxidation of 1 mole of glucose. Conversely, anaerobic glycolysis occurs in the cytoplasm, and generates only 2 moles of ATP per mole of glucose, with the production of lactate or ethanol as end-products. During critical illness, the failure to generate adequate amounts of ATP can lead to cellular and organ dysfunction.

Several studies describe a decrease in ATP production in septic patients,<sup>121–123</sup> and lower ATP levels in the tissues of critically ill septic patients who died, when compared to tissues of those who survived.<sup>124</sup> One reason for the failure to generate ATP during critical illness is inadequate delivery of oxygen to vital tissues, secondary to impaired oxygenation and perfusion. During SIRS and septic shock, multiple factors may decrease tissue perfusion, including inadequate cardiocirculatory performance, hypoxemia from acute lung injury, mediator- or vasopressor-induced vasoconstriction, and/or coagulation derangements causing microvascular obstruction.

### Cytopathic Hypoxia

Cytopathic hypoxia is also postulated to contribute to the failure to generate adequate ATP, because of the inability of the cells to use available oxygen.<sup>125</sup> Experimental and clinical studies show that tissue oxygen tension during sepsis is often higher than in nonseptic states.<sup>126–128</sup> Mitochondrial dysfunction is hypothesized to underlie the apparent disconnection between the cellular oxygen tension, which is usually adequate, and the low ATP levels. Mitochondrial dysfunction is reported in cells exposed to macrophages, inflammatory cytokines, LPS, and infection.<sup>129–131</sup> Multiple factors may contribute to mitochondrial dysfunction in acute injury, including the production of NO and reactive oxygen species. Low doses of LPS can increase iNOS messenger RNA activity in the intestinal tissues of experimental animals,<sup>130</sup> and physiologic concentrations of NO can reversibly inhibit the activity of cytochrome oxidase by competition with oxygen.<sup>132,133</sup> In addition, NO can damage mitochondria by generating peroxynitrite when reacting with the molecular oxygen of the superoxide radical anion. Peroxynitrite is a potent oxidizing and nitrating

agent, which can inhibit multiple mitochondrial functions.<sup>134</sup> Mitochondria normally produce a low basal level of superoxide anion, which can increase during inflammation.<sup>135</sup> The presence of peroxynitrite is associated with mitochondrial inhibition, DNA breakage, and activation of poly(ADP-ribose)polymerase (PARP), an enzyme responsible for repair of single-strand DNA breaks.<sup>136</sup> PARP activation can lead to energetic failure by causing a decrease in the oxidized form of nicotinamide adenine dinucleotide (NAD<sup>+</sup>) and NADH, an important electron donor in mitochondrial oxidative phosphorylation (see above).<sup>137</sup>

### ORGAN FAILURE, SURVIVAL, AND DEATH

At present there is limited understanding of the nature and degree of organ dysfunction during critical illness. An autopsy study of patients who died from sepsis showed discordance between the clinical manifestations and histologic findings in various organs.<sup>120</sup> In the heart, there was no histologic evidence of injury to myocytes despite the reduced contractility that is often observed clinically; in the kidneys there was only focal injury with preservation of normal glomerular and tubular architecture despite the acute impairment in indices of renal function. Furthermore, it is a common observation that most patients who survive septic shock recover baseline function of their heart, lungs, and kidneys, suggesting that reversible factors, rather than cell death, are responsible for organ dysfunction.<sup>138</sup> Similarly, death from sepsis is also poorly understood. As discussed at the beginning of this chapter, death of critically ill patients occurs most often by voluntary withdrawal of care rather than being caused by refractory shock, extreme hypoxia, or a malignant arrhythmia.

The mechanisms of the organ failure of critical illness are described in detail in Chap. 76. Here we provide a schema of pathophysiologic events occurring in the progression of critical illness. At successive steps, different therapeutic approaches may be useful for influencing the progression of illness toward survival and away from death (Fig. 75–6).

*Initially*, the inciting “stress” should be countered with resuscitation as per

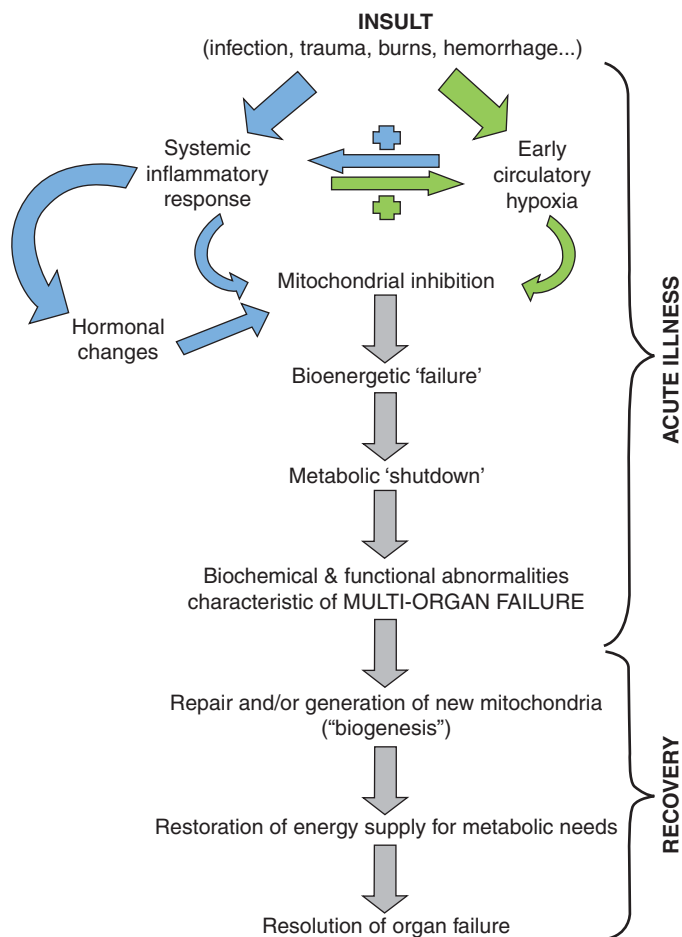


FIGURE 75-6. A proposed paradigm of the evolution of critical illness (see text).

early goal-directed therapy,<sup>139</sup> ensuring that no tissue hypoxia occurs. However, even this principle is not universal, as exemplified by the successful use of limited fluid resuscitation in selected trauma patients.<sup>2</sup> In our case report, the presence of pulmonary hypertension and right ventricular insufficiency further complicated the management of resuscitation per goal-directed therapy, prompting the use of invasive monitoring with a pulmonary artery catheter, which may not be indicated routinely in the management of ALI/ARDS.<sup>140</sup>

Subsequently, therapies supporting the natural response to acute stress, such as the infusion of activated protein C as was done in our case report, may improve survival of the most critically ill patients. In the future, therapies targeting mitochondrial protection, such as the administration of PARP inhibitors, superoxide and peroxynitrite scavengers, or selective NOS-2 inhibitors, can attenuate the cytopathic effects of oxygen and nitro-

gen free radicals, and decrease mitochondrial dysfunction. Immunosuppression, a persistent catabolic state, and poor nutritional status can both decrease host defenses and cause increased susceptibility to infectious complications. Inappropriate use of antibiotics and lack of adequate attention to basic procedures to prevent transmission of antibiotic-resistant bacteria may further increase the chances of nosocomial infections at this stage. In our case report, a *Pseudomonas* pneumonia hindered the progression of our patient's course toward recovery, although ultimately our patient survived. Future therapies may target various aspects of immunosuppression, including apoptotic mechanisms (e.g., by manipulation of Bcl-2), and may provide an appropriate balance of nutrients that can stimulate immune function. In addition, stimuli to increase mitochondrial energy generation can potentially play a role, so that cellular energy production regains baseline levels.

As the basic mechanisms of critical illness are further defined through basic and clinical research, it is likely that the therapeutic algorithms for treating critical illness will evolve, from a gross physiologic approach supporting respiration and circulation to a more targeted mechanistic approach.

## CONCLUSION

Acute injuries of various etiologies, such as the aspiration of gastric contents into the lungs, cause immediate local and systemic physiologic responses that are mediated by well-characterized inflammatory and humoral phenomena. Despite the complexity of these phenomena, our understanding of the evolution of critical illness has greatly increased in recent years, as investigators have started to elucidate the cellular and molecular mechanisms of the host's response to injury. The interaction between the initial "stress" (usually trauma, surgery, or infection) and the response of the host determines the evolution of a critical illness towards either healing and recovery or complications and death. Although a robust inflammatory response is necessary to fend off the most severe injuries, a subsequent decrease in its intensity, and the onset of a hypoimmune state favor the onset of late infections that may lead to dysfunction of organs and death.

The outcome of large ICU patient populations can be predicted using validated systems that score the severity of illness, but these systems are not accurate on a patient-by-patient basis. Hence, critically ill patients often undergo complex therapies and invasive interventions until they, their families, and their doctors believe that it is no longer worthwhile to pursue recovery versus allowing a comfortable death. The effectiveness of our therapies depends on a number of factors, including our ability to intervene properly and at the optimal time. Recent therapeutic interventions have improved the probability of survival of many critically ill patients. As knowledge of the basic mechanisms that underlie critical illness evolves, additional effective therapeutic strategies should emerge that will improve the care and outcome of critically ill patients.

## KEY REFERENCES

1. Chastre J, Fagon J-Y. Ventilator-associated pneumonia. *Am J Respir Crit Care Med* 2002;165:867-903.
2. Kohn K, Corrigan J, Donaldson M. *To Err Is Human: Building a Safer Health System*. Washington, DC: National Academy Press, 1999.
3. Hotchkiss RS, Karl IE. The pathophysiology and treatment of sepsis. *N Engl J Med* 2003;348:138-150.
4. Tracey K. The inflammatory reflex. *Nature* 2002;420:853-859.
5. Russell J, Phang P. The oxygen delivery/consumption controversy. Approaches to management of the critically ill patient. *Am J Respir Crit Care Med* 1994;149:533-537.
6. Gay NJ, Keith FJ. *Drosophila* toll and IL-1 receptor. *Nature* 1991;351:355-356.
7. Ochoa JB, Makarenkova V. T lymphocytes. *Crit Care Med* 2005;33:S510-S513.
8. Fink MP. Bench-to-bedside review: cytopathic hypoxia. *Crit Care Med* 2002;30:491-499.
9. Wheeler AP, Bernard GR. Treating patients with severe sepsis. *N Engl J Med* 1999;340:207-214.

## REFERENCES

1. Mokdad A, Marks J, Stroup D, Gerberding J. Actual causes of death in the United States in 2000. *JAMA* 2004;291:1238-1245.
2. Bickell W, Wall M, Pepe P, et al. Immediate versus delayed fluid resuscitation for hypotensive patients with penetrating injuries. *N Engl J Med* 1994;331:1105-1109.
3. Moore F, McKinley B, Moore E. The next generation of shock resuscitation. *Lancet* 2004;363:1988-1996.
4. Spahn D, Rossaint R. Coagulopathy and blood component transfusion in trauma. *Br J Anaesth* 2005;95:130-139.
5. Rhee P, Kustova E, Alam H. Searching for the optimal resuscitation method: recommendations for the initial fluid resuscitation of combat casualties. *J Trauma* 2003;54:552-562.
6. Moore F, Moore E, Saunia A. Blood transfusion. An independent risk factor for postinjury multiple organ failure. *Arch Surg* 1997;132:620-624.
7. Toy P, Popovsky M, Abraham W, et al. Transfusion-related acute lung injury: definition and review. *Crit Care Med* 2005;33:721-726.
8. Zallen G, Offner P, Moore E, et al. Age of transfused blood is an independent risk factor for postinjury multiple organ failure. *Am J Surg* 1999;178:570-572.
9. Lin E, Calvano S, Lowry S. Inflammatory cytokines and cell response in surgery. *Surgery* 2000;127:117-126.
10. Katzenstein A, Asken F. Acute lung injury patterns: diffuse alveolar damage, acute interstitial pneumonia, bronchiolitis obliterans-organizing pneumonia. In: Katzenstein AAF, ed. *Surgical pathology of the non neoplastic lung diseases*. 2nd ed. Philadelphia: WB Saunders, 1990:9-56.
11. Ware L, Matthay M. The acute respiratory distress syndrome. *N Engl J Med* 2000;342:1334-1349.
12. Wan L, Bellomo R, Giantomasso D, Ronco C. The pathogenesis of septic acute renal failure. *Curr Opin Crit Care* 2003;9:496-502.
13. Jakob SM, Takala J. Gut perfusion in the critically ill. *Intensive Care Med* 2000;26:813-815.
14. Alverdy J, Laughlin R, Wu L. Influence of the critically ill state on host-pathogen interactions within the intestine: gut-derived sepsis redefined. *Crit Care Med* 2003;31:598-607.
15. El-Menyar A, Ayman A. The resuscitation outcome: revisit the story of the stony heart. *Chest* 2005;128:2835-2846.
16. Bolli R, Marban E. Molecular and cellular mechanisms of myocardial stunning. *Physiol Rev* 1999;79:609-634.
17. Heusch G, Schulz R, Rahimtoola S. Myocardial hibernation: a delicate balance. *Am J Physiol* 2005;288:H984-H999.
18. McCord JM. Oxygen-derived free radicals in postischemic tissue injury. *N Engl J Med* 1985;312:159-163.
19. Gonzalez D. Crush syndrome. *Crit Care Med* 2005;33:S34-S41.
20. Kupiec-Weglinski J, Busuttill R. Ischemia and reperfusion injury in liver transplantation. *Transplant Proc* 2005;37:1653-1656.
21. Seal J, Gewertz B. Vascular dysfunction in ischemia-reperfusion injury. *Ann Vasc Surg* 2005;19:572-584.
22. Baudouin S. Lung injury after thoracotomy. *Br J Anaesth* 2003;91:132-142.
23. Hamvas A, Park C, Palazzo R, Liptay M, Cooper J, Shuster D. Modifying pulmonary ischemia-reperfusion injury by altering ventilatory strategies during ischemia. *J Appl Physiol* 1992;73:2112-2119.
24. Calle E, Thun M, Petrelli J, Rodriguez C, Heath C. Body-mass index and mortality in a prospective cohort of U.S. adults. *N Engl J Med* 1999;341:1097-1105.
25. Brown C, Neville A, Rhee P, Salim A, Velmahos G, Demetriades D. The impact of obesity on the outcomes of 1,153 critically ill injured blunt trauma patients. *J Trauma* 2005;59:1048-1051.
26. Ei-Solh A. Clinical approach to the critically ill, morbidly obese patient. *Am J Respir Crit Care Med* 2004;169:557-561.
27. Erstad B. Dosing of medications in morbidly obese patients in the intensive care unit. *Intensive Care Med* 2004;30:18-32.
28. Vincent J-L, Sakr Y, Sprung C, et al. Sepsis in European intensive care units: results of the SOAP study. *Crit Care Med* 2006;34:344-353.
29. Angus DC, Linde-Zwirble WT, Lidicker J, Clermont G, Carcillo J, Pinsky MR. Epidemiology of severe sepsis in the United States: analysis of incidence, outcome, and associated costs of care. *Crit Care Med* 2001;29:1303-1310.
30. Osmon S, Warren D, Seiler S, Shannon W, Fraser P, Kollef M. The influence of infection on hospital mortality for patients requiring more than 48 hours of intensive care. *Chest* 2003;124:1021-1029.
31. Levy M, Fink M, Marshall J, et al. 2001 SCCM/EISCM/ACCP/ATS/SIS International Sepsis Definitions Conference. *Crit Care Med* 2003;31:1250-1256.
32. Keenan S, Busche K, Chen L, McCarthy L, Ininan K, Sibbald W. A retrospective review of a large cohort of patients undergoing the process of withholding or withdrawal of life support. *Crit Care Med* 1997;25:1324-1331.
33. Prendergast T, Luce J. Increasing incidence of withholding and withdrawal of life support from the critically ill. *Am J Respir Crit Care Med* 1997;155:15-20.
34. Chastre J, Fagon J-Y. Ventilator-associated pneumonia. *Am J Respir Crit Care Med* 2002;165:867-903.
35. Grundmann H, Barwolff S, Tami A, et al. How many infections are caused by patient-to-patient transmission in the intensive care units? *Crit Care Med* 2005;33:946-951.
36. Kollef M, Fraser V. Antibiotic resistance in the intensive care unit. *Ann Intern Med* 2001;134:298-314.
37. Goldman D. System failure versus personal accountability—the case for clean hands. *N Engl J Med* 2006;355:121-123.
38. Kohn K, Corrigan J, Donaldson M. *To Err Is Human: Building a Safer Health System*. Washington, DC: National Academy Press, 1999.
39. Leape L, Berwick D. Five years after *To Err Is Human*. What have we learned? *JAMA* 2005;293:2384-2390.
40. Pessi TT. Experiences gained in intensive care of surgical patients. A prospective clinical study of 1,001 consecutively treated patients in a surgical intensive care unit. *Ann Chir Gynaecol Fenn Suppl* 1973;185:3-72.
41. Knaus W, Draper E, Wagner D, et al. APACHE II—a severity of disease classification system. *Crit Care Med* 1985;13:818-829.
42. Knaus WA, Wagner DP, Draper EA, et al. The APACHE III prognostic system. Risk prediction of hospital mortality for critically ill hospitalized adults. *Chest* 1991;100:1619-1636.



43. Legall J, Lameshow S, Saulnier F. A new simplified acute physiologic score (SAPS II) based on a European/North American multicenter study. *JAMA* 1993;270:2478-2486.
44. Zimmerman J, Kramer A, McNair D, Malila F. Acute physiology and health evaluation (APACHE) IV. Hospital mortality assessment for today's critically ill patients. *Crit Care Med* 2006;34:1297-1310.
45. Cuthbertson D. Intensive care metabolic response to injury. *Br J Surg* 1970;57:718-721.
46. Hotchkiss RS, Karl IE. The pathophysiology and treatment of sepsis. *N Engl J Med* 2003;348:138-150.
47. Sheeran P, Hall G. Cytokines in anesthesia. *Br J Anaesth* 1997;78:201-219.
48. Gabay C, Kushner I. Acute-phase proteins and other systemic responses to inflammation. *N Engl J Med* 1999;340:448-454.
49. Thomas L. Germs. *N Engl J Med* 1972;287:553-555.
50. Bone R. Toward a theory regarding the pathogenesis of the systemic inflammatory response syndrome: what we do and do not know about cytokine regulation. *Crit Care Med* 1996;24:163-172.
51. Bone RC, Fisher CJ Jr, Clemmer TP, Slotman GJ, Metz CA, Balk RA. A controlled clinical trial of high-dose methylprednisolone in the treatment of severe sepsis and septic shock. *N Engl J Med* 1987;317:653-658.
52. Fisher CJ Jr, Agosti JM, Opal SM, et al. Treatment of septic shock with the tumor necrosis factor receptor: fc fusion protein. The Soluble TNF Receptor Sepsis Study Group. *N Engl J Med* 1996;334:1697-1702.
53. Fisher CJ Jr, Dhainaut JF, Opal SM, et al. Recombinant human interleukin 1 receptor antagonist in the treatment of patients with sepsis syndrome. Results from a randomized, double-blind, placebo-controlled trial. Phase III rhIL-1ra Sepsis Syndrome Study Group. *JAMA* 1994;271:1836-1843.
54. Herd J. cardiovascular response to stress. *Physiol Rev* 1991;71:305-330.
55. Tracey K. The inflammatory reflex. *Nature* 2002;420:853-859.
56. Borovikova L. Role of the vagus nerve signaling in CNI-1493-mediated suppression of acute inflammation. *Nature* 2000;405:458-462.
57. Wilmore D. From Cuthbertson to fast-track surgery: 70 years of progress in reducing stress in surgical patients. *Ann Surg* 2002;236:643-648.
58. Van den Berghe G. Novel insights into the neuroendocrinology of critical illness. *Eur J Endocrinol* 2000;143:1-13.
59. Cooper M, Stewart P. Corticosteroid insufficiency in acutely ill patients. *N Engl J Med* 2003;348:727-734.
60. Briegel J, Forst H, Haller M, et al. Stress doses of hydrocortisone reverse hyperdynamic septic shock: a prospective, randomized, double-blind, single-center study. *Crit Care Med* 1999;27:723-732.
61. Annane D, Sebille V, Troche G, Raphael J, Gajdos P, Bellissant E. A 3-level prognostic classification in septic shock based on cortisol levels and cortisol response to corticotropin. *JAMA* 2000;283:1038-1045.
62. Annane D, Sebille V, Charpentier C, et al. Effect of treatment with low doses of hydrocortisone and fludrocortisone on mortality in patients with septic shock. *JAMA* 2002;288:862-871.
63. Dellinger R, Carlet J, Masur H, et al. Surviving sepsis campaign guidelines for management of severe sepsis and septic shock. *Crit Care Med* 32:858-873.
64. Landry D, Levin H, Gallant E, et al. Vasopressin deficiency contributes to the vasodilation of septic shock. *Circulation* 1997;95:1122-1125.
65. Dunser M, Mayr A, Ulmer H, et al. Arginine vasopressin in advanced vasodilatory shock. A prospective, randomized, controlled study. *Circulation* 2003;107:2313-2319.
66. Holmes C, Walley K, Chittock D, Lehman T, Russell J. The effects of vasopressin on hemodynamics and renal function in severe septic shock: a case series. *Intensive Care Med* 2001;27:1416-1421.
67. Van den Berghe G, Wouters P, Weekers F, et al. Intensive insulin therapy in critically ill patients. *N Engl J Med* 2001;345:1359-1367.
68. Cely C, Arora P, Quartin A, Kett D, Schein R. Relationship of baseline glucose homeostasis to hyperglycemia during critical illness. *Chest* 2004;126:879-887.
69. Van den Berghe G. How does blood glucose control with insulin save lives in intensive care? *J Clin Invest* 2004;115:2277-2286.
70. Van den Berghe G, Wilmer A, Hermans G, et al. Intensive insulin therapy in the medical ICU. *N Engl J Med* 2006;354:449-461.
71. Russell J, Phang P. The oxygen delivery/consumption controversy. Approaches to management of the critically ill patient. *Am J Respir Crit Care Med* 1994;149:533-537.
72. Hack C, Zeerleder S. The endothelium in sepsis: source of and target for inflammation. *Crit Care Med* 2001;29:S21-S27.
73. Vallet B, Weil E. Endothelial cell dysfunction and coagulation. *Crit Care Med* 2001;29:S36-S41.
74. Butcher E. Leukocyte-endothelial cell recognition: three (or more) steps to specificity and diversity. *Cell* 1991;67:1033-1036.
75. Springer T. Adhesion receptors of the immune system. *Nature* 1990;346:425-434.
76. Levi M, Cate HT. Disseminated intravascular coagulation. *N Engl J Med* 1999;341:586-592.
77. Warren B, Eid A, Singer P, et al. High-dose anti-thrombin III in severe sepsis. A randomized controlled trial. *JAMA* 2001;286:1869-1878.
78. Bernard GR, Vincent JL, Laterre PF, et al. Efficacy and safety of recombinant human activated protein C for severe sepsis. *N Engl J Med* 2001;344:699-709.
79. Vincent J-L, Zhang H, Preiser J-C. Effects of nitric oxide in septic shock. *Am J Respir Crit Care Med* 2000;161:1781-1785.
80. Wanecek M, Weitzberg E, Rudehill A, Oldner A. The endothelin system in septic and endotoxic shock. *Eur J Pharmacol* 2000;407:1-15.
81. Kirov M, Evgenov O, Evgenov N, et al. Infusion of methylene blue in human septic shock: a pilot, randomized, controlled study. *Crit Care Med* 2001;29:1860-1867.
82. Avontuur J, Nolthenius R, van Bodegom J, Bruining H. Prolonged inhibition of nitric oxide synthesis in severe septic shock: a clinical study. *Crit Care Med* 1998;26:660-667.
83. Lopez A, Lorente J, Steingrub J, et al. Multiple-center, randomized, placebo-controlled, double-blind study of the nitric oxide inhibitor 546C88: effect on survival in patients with septic shock. *Crit Care Med* 2004;32:21-30.
84. Beal A, Cerra F. Multiple organ failure syndrome in the 1990s. Systemic inflammatory response and organ dysfunction. *JAMA* 1994;271:226-233.
85. Clowes G, Hirsch E, George B, et al. Survival from sepsis. The significance of altered protein metabolism regulated by proteolysis inducing factor, the circulating cleavage product of interleukin-1. *Ann Surg* 1985;202:446-458.
86. Herndon D, Hart D, Wolf S, Chinkes D, Wolfe R. Reversal of catabolism by beta-blockade after severe burns. *N Engl J Med* 2001;345:1223-1229.
87. Pullicino EA, Carli F, Poole S, Rafferty B, Malik ST, Elia M. The relationship between the circulating concentrations of interleukin 6 (IL-6), tumor necrosis factor (TNF) and the acute phase response to elective surgery and accidental injury. *Lymphokine Res* 1990;9:231-238.
88. Krohn CD, Reikeras O, Aasen AO. The cytokines IL-1beta and IL-1 receptor antagonist, IL-2 and IL-2 soluble receptor-alpha, IL-6 and IL-6 soluble receptor, TNF-alpha and TNF soluble receptor I, and IL10 in drained and systemic blood after major orthopaedic surgery. *Eur J Surg* 1999;165:101-109.
89. Cinat M, Waxman K, Vaziri ND, et al. Soluble cytokine receptors and receptor antagonists are sequentially released after trauma. *J Trauma* 1995;39:112-118; discussion 118-120.
90. Mokart D, Capo C, Blache JL, et al. Early postoperative compensatory anti-inflammatory response syndrome is associated with septic complications after major surgical trauma in patients with cancer. *Br J Surg* 2002;89:1450-1456.
91. Keel M, Trentz O. Pathophysiology of polytrauma. *Injury* 2005;36:691-709.
92. Ziegler E, Fisher C, Sprung C, et al. Treatment of gram-negative bacteremia and septic shock with HA-1A human monoclonal antibody against endotoxin. A randomized, double-blind, placebo-controlled trial. *N Engl J Med* 1991;324:429-436.
93. Wright SD, Ramos RA, Tobias PS, Ulevitch RJ, Mathison JC. CD14, a receptor for complexes of lipopolysaccharide (LPS) and LPS binding protein. *Science* 1990;249:1431-1433.

94. Fenton MJ, Golenbock DT. LPS-binding proteins and receptors. *J Leukoc Biol* 1998;64:25–32.
95. Pugin J, Heumann ID, Tomasz A, et al. CD14 is a pattern recognition receptor. *Immunity* 1994;1:509–516.
96. Anderson KV, Jurgens G, Nusslein-Volhard C. Establishment of dorsal-ventral polarity in the *Drosophila* embryo: genetic studies on the role of the toll gene product. *Cell* 1985;42:779–789.
97. Gay NJ, Keith FJ. *Drosophila* toll and IL-1 receptor. *Nature* 1991;351:355–356.
98. Lemaitre B, Nicolas E, Michault L, Reichart J, Hoffman J. The dorsoventral regulatory gene cassette *spatzle/toll/cactus* controls the potent antifungal response in *Drosophila* adults. *Cell* 1996;86:973–983.
99. Poltorak A, He X, Smirnova I, et al. Defective LPS signaling in C3H/HeJ and C57BL/10ScCr mice: mutations in Tlr4 gene. *Science* 1998;282:2085–2088.
100. Rock F, Hardiman G, Timans J, Kastelein R, Bazan J. A family of human receptors structurally related to *Drosophila* toll. *Proc Natl Acad Sci U S A* 1998;95:588–593.
101. Sheehan M, Wong HR, Hake PW, Malhotra V, O'Connor M, Zingarelli B. Parthenolide, an inhibitor of the nuclear factor-kappaB pathway, ameliorates cardiovascular derangement and outcome in endotoxic shock in rodents. *Mol Pharmacol* 2002;61:953–963.
102. Haudek SB, Spencer E, Bryant DD, et al. Overexpression of cardiac I-kappaB $\alpha$  prevents endotoxin-induced myocardial dysfunction. *Am J Physiol* 2001;280:H962–H968.
103. Sheehan M, Wong HR, Hake PW, Zingarelli B. Protective effects of isohelenin, an inhibitor of nuclear factor kappaB, in endotoxic shock in rats. *J Endotoxin Res* 2002;8:99–107.
104. Joshi AR, Chung CS, Song GY, Lomas J, Priester RA, Ayala A. NF-kappaB activation has tissue-specific effects on immune cell apoptosis during polymicrobial sepsis. *Shock* 2002;18:380–386.
105. Sarkar SN, Smith HL, Rowe TM, Sen GC. Double-stranded RNA signaling by toll-like receptor 3 requires specific tyrosine residues in its cytoplasmic domain. *J Biol Chem* 2003;278:4393–4396.
106. Hayashi F, Smith KD, Ozinsky A, et al. The innate immune response to bacterial flagellin is mediated by toll-like receptor 5. *Nature* 2001;410:1099–1103.
107. Hemmi H, Takeuchi O, Kawai T, et al. A toll-like receptor recognizes bacterial DNA. *Nature* 2000;408:740–745.
108. Hajjar AM, O'Mahony DS, Ozinsky A, et al. Cutting edge: functional interactions between toll-like receptor (TLR) 2 and TLR1 or TLR6 in response to phenol-soluble modulins. *J Immunol* 2001;166:15–19.
109. Lederer JA, Rodrick ML, Mannick JA. The effects of injury on the adaptive immune response. *Shock* 1999;11:153–159.
110. Meakins JL, Pietsch JB, Bubenick O, et al. Delayed hypersensitivity: indicator of acquired failure of host defenses in sepsis and trauma. *Ann Surg* 1977;186:241–250.
111. Ertel W, Kremer JP, Kenney J, et al. Downregulation of proinflammatory cytokine release in whole blood from septic patients. *Blood* 1995;85:1341–1347.
112. Ochoa JB, Makarenkova V. T lymphocytes. *Crit Care Med* 2005;33:S510–513.
113. Pellegrini JD, De AK, Kodys K, Puyana JC, Furse RK, Miller-Graziano C. Relationships between T lymphocyte apoptosis and anergy following trauma. *J Surg Res* 2000;88:200–206.
114. Heidecke CD, Hensler T, Weighardt H, et al. Selective defects of T lymphocyte function in patients with lethal intraabdominal infection. *Am J Surg* 1999;178:288–292.
115. Wahl SM, Swisher J, McCartney-Francis N, Chen W. TGF-beta: the perpetrator of immune suppression by regulatory T cells and suicidal T cells. *J Leukoc Biol* 2004;76:15–24.
116. Menger MD, Vollmar B. Surgical trauma: hyperinflammation versus immunosuppression? *Langenbecks Arch Surg* 2004;389:475–484.
117. Murphy TJ, Choileain NN, Zang Y, Mannick JA, Lederer JA. CD4<sup>+</sup> CD25<sup>+</sup> regulatory T cells control innate immune reactivity after injury. *J Immunol* 2005;174:2957–2963.
118. Hotchkiss RS, Tinsley KW, Swanson PE, et al. Sepsis-induced apoptosis causes progressive profound depletion of B and CD4<sup>+</sup> T lymphocytes in humans. *J Immunol* 2001;166:6952–6963.
119. Venet F, Pachot A, Debarb AL, et al. Increased percentage of CD4<sup>+</sup> CD25<sup>+</sup> regulatory T cells during septic shock is due to the decrease of CD4<sup>+</sup> CD25 lymphocytes. *Crit Care Med* 2004;32:2329–2331.
120. Hotchkiss RS, Tinsley KW, Swanson PE, et al. Prevention of lymphocyte cell death in sepsis improves survival in mice. *Proc Natl Acad Sci U S A* 1999;96:14541–14546.
121. Liaw KY, Askanazi J, Michelson CB, Kantrowitz LR, Furst P, Kinney JM. Effect of injury and sepsis on high-energy phosphates in muscle and red cells. *J Trauma* 1980;20:755–759.
122. Bergstrom J, Bostrom H, Furst P, Hultman E, Vinnars E. Preliminary studies of energy-rich phosphagens in muscle from severely ill patients. *Crit Care Med* 1976;4:197–204.
123. Tresadern JC, Threlfall CJ, Wilford K, Irving MH. Muscle adenosine 5-triphosphate and creatine phosphate concentrations in relation to nutritional status and sepsis in man. *Clin Sci (Lond)* 1988;75:233–242.
124. Brealey D, Brand M, Hargreaves I, et al. Association between mitochondrial dysfunction and severity and outcome of septic shock. *Lancet* 2002;360:219–223.
125. Fink MP. Bench-to-bedside review: cytopathic hypoxia. *Crit Care* 2002;6:491–499.
126. Sair M, Etherington PJ, Peter Winlove C, Evans TW. Tissue oxygenation and perfusion in patients with systemic sepsis. *Crit Care Med* 2001;29:1343–1349.
127. Boekstegers P, Weidenhofer S, Pilz G, Werdan K. Peripheral oxygen availability within skeletal muscle in sepsis and septic shock: comparison to limited infection and cardiogenic shock. *Infection* 1991;19:317–323.
128. Hotchkiss RS, Rust RS, Dence CS, et al. Evaluation of the role of cellular hypoxia in sepsis by the hypoxic marker [18F]fluoromisonidazole. *Am J Physiol* 1991;261:R965–R972.
129. Bankey PE, Hill S, Geldon D. Sequential insult enhances liver macrophage-signalized hepatocyte dysfunction. *J Surg Res* 1994;57:185–191.
130. Unno N, Wang H, Menconi MJ, et al. Inhibition of inducible nitric oxide synthase ameliorates endotoxin-induced gut mucosal barrier dysfunction in rats. *Gastroenterology* 1997;113:1246–1257.
131. Zingarelli B, Day BJ, Crapo JD, Salzman AL, Szabo C. The potential role of peroxynitrite in the vascular contractile and cellular energetic failure in endotoxic shock. *Br J Pharmacol* 1997;120:259–267.
132. Borutaite V, Brown GC. Rapid reduction of nitric oxide by mitochondria, and reversible inhibition of mitochondrial respiration by nitric oxide. *Biochem J* 1996;315:295–299.
133. Torres J, Darley-Usmar V, Wilson MT. Inhibition of cytochrome c oxidase in turnover by nitric oxide: mechanism and implications for control of respiration. *Biochem J* 1995;312:169–173.
134. Radi R, Rodriguez M, Castro L, Telleri R. Inhibition of mitochondrial electron transport by peroxynitrite. *Arch Biochem Biophys* 1994;308:89–95.
135. Poderoso JJ, Carreras MC, Lisdero C, Riobo N, Schopfer F, Boveris A. Nitric oxide inhibits electron transfer and increases superoxide radical production in rat heart mitochondria and submitochondrial particles. *Arch Biochem Biophys* 1996;328:85–92.
136. Szabo C, Zingarelli B, O'Connor M, Salzman AL. DNA strand breakage, activation of poly (ADP-ribose) synthetase, and cellular energy depletion are involved in the cytotoxicity of macrophages and smooth muscle cells exposed to peroxynitrite. *Proc Natl Acad Sci U S A* 1996;93:1753–1758.
137. Khan AU, Delude RL, Han YY, et al. Liposomal NAD(+) prevents diminished O(2) consumption by immunostimulated Caco-2 cells. *Am J Physiol Lung Cell Mol Physiol* 2002;282:L1082–L1091.
138. Wheeler AP, Bernard GR. Treating patients with severe sepsis. *N Engl J Med* 1999;340:207–214.
139. Rivers E, Nguyen B, Havstad S, et al. Early goal-directed therapy in the treatment of severe sepsis and septic shock. *N Engl J Med* 2001;345:1368–1377.
140. National Heart, Lung, and Blood Institute ARDS Clinical Trials Network, Wheeler AP, Bernard GR, et al. Pulmonary artery versus central venous catheter to guide treatment of acute lung injury. *N Engl J Med* 2006;354:2213–2224.
141. Harlan J, Winn R. Leukocyte-endothelial interactions: clinical trials of anti-adhesion therapy. *Crit Care Med* 2002;30:S214–S219.

## CHAPTER 76

## Evaluation of the Patient with Multiple Organ Dysfunction Syndrome

Jean Kwo, MD, and  
Judith Hellman, MD

Progress in medical therapies, in particular life support therapies, has led to the recognition of pathophysiologic states that are unique to critically ill patients, and an increasing number of critically ill patients can now undergo surgical procedures. Diverse disease states can cause progressive dysfunction and ultimately complete failure of various organs and systems (Table 76-1). This condition is commonly referred to as the multiple organ dysfunction syndrome (MODS). High-grade organ failure that necessitates life-sustaining therapies, continuous venovenous hemofiltration (CVVH) or hemodialysis (HD) for renal failure, vasopressors and/or inotropes for circulatory failure, and maximal ventilatory support for respiratory failure, is often referred to as multiorgan system failure. It is generally recognized that the development of MODS is often lethal and portends a poor outcome, particularly if the underlying process that triggers the syndrome cannot be identified or treated. In fact, MODS has become the leading cause of death for intensive care unit patients.<sup>1,2</sup>

The first part of this chapter reviews basic aspects of MODS, including its epidemiology, pathophysiology, etiologies, manifestations, management, and the types of surgical and nonsurgical procedures that are commonly performed in patients with MODS. Subsequent sections address the evaluation, preoperative preparation, and optimization of patients with MODS for surgery.

### MULTIORGAN DYSFUNCTION SYNDROME

The development of organ dysfunction as a separate disease process, both

temporally and physically, from the initial injury was first appreciated during World War II. Wounded soldiers were rapidly and aggressively resuscitated with blood products to normal blood pressure levels, and they were more promptly evacuated and treated at medical facilities than in previous wars. Although initial survival was improved, some proportion of soldiers that survived the initial trauma subsequently died of renal failure.<sup>3,4</sup> This led to changes in fluid resuscitation practices in subsequent wars, including the rapid infusion of crystalloids and more aggressive resuscitation. During the Vietnam War, many soldiers who survived their initial trauma developed “shock lung” (acute respiratory failure). At the same time, acute lung injury (ALI) and acute respiratory distress syndrome (ARDS) were increasingly being described in civilian ICUs.<sup>5</sup> During the 1970s advances in the care of various organs, systems, and injuries resulted in improved initial survival from many injuries. However, some patients that survived the initial resuscitation subsequently developed sequential progressive dysfunction and failure of various organs and systems.<sup>6,7</sup>

Over the last several decades various terms have been used to describe the spectrum of dysfunction causing the failure of different organs and systems (reviewed in ref. 8), including “multiple organ failure,”<sup>9</sup> “multiple-organ-failure-syndrome,”<sup>11</sup> “multiple system organ failure,”<sup>10</sup> “progressive or se-

quential organ failure,”<sup>6</sup> or “MODS.”<sup>8,11</sup> The term *MODS* is now most widely used because it encompasses the entire spectrum from mild organ dysfunction to complete organ failure.

In addition, various scoring systems have been devised to assess critically ill patients and to predict outcome.<sup>4,12-16</sup> Although the definitions have varied slightly over time as our understanding of the syndrome has evolved, the basic syndrome described by all these terms reflects the same pathophysiologic processes. In this chapter the term *MODS* is used as an inclusive definition for all the studies and papers that have used all of these terms over the past several decades.

### Definitions

#### ACCP/SCCM Consensus Conference

In 1992, a series of recommendations for the definitions of sepsis, systemic inflammatory responses, and organ dysfunction were published based on a consensus conference of the American College of Chest Physicians (ACCP) and Society of Critical Care Medicine (SCCM).<sup>8</sup> The goal of the consensus conference was to gain uniformity in definitions and criteria used by clinicians and researchers to describe these processes and to enter patients into research studies. The acronyms SIRS (the systemic inflammatory response syndrome) and MODS were coined at the consensus conference, and continue to be widely used in the

### KEY POINTS

1. Multiple organ dysfunction syndrome (MODS) is common in critically ill patients and is associated with a high mortality rate.
2. There are many underlying etiologies of MODS. In the overall ICU population, sepsis is the most common cause of MODS.
3. MODS is characterized by dysfunction of 2 or more organs or systems. The respiratory system is most frequently involved.
4. The pathophysiology of MODS is still not well understood. Systemic inflammation and microvascular abnormalities are involved in the development of MODS.
5. Therapies for MODS should target the underlying cause and attempt to support the physiologic and metabolic derangements that are caused by dysfunction of the various organs and systems.
6. Patients with MODS often require surgery and other invasive procedures to correct the underlying causes and to manage complications of MODS.
7. Whenever possible, optimize MODS patients preoperatively.
8. Methods of optimization are dictated by the specific organs that are affected and the pattern and severity of consequent physiologic and metabolic derangements.



TABLE 76-1.

## Etiologies of Multiorgan Dysfunction Syndrome

Infection: bacterial, fungal, viral, protozoal  
 Trauma  
 Pancreatitis  
 Burns  
 Transfusion  
 Surgery  
 Cardiac arrest  
 Ischemia–reperfusion  
 Necrosis  
 Malignancy  
 Disseminated intravascular coagulation  
 Aspiration pneumonitis  
 Vasculitis  
 Other

care of critically ill patients and in the design of clinical studies and trials.

**SIRS** The term *SIRS* describes a complex inflammatory process that is driven by many differing disease states. Underlying etiologies of *SIRS* include, but are not limited to, infection, trauma, burns, aspiration, pancreatitis, vascular compromise with resultant ischemia and/or necrosis, malignancy, and multiple blood transfusions. Table 76-2 lists the criteria for *SIRS*. *SIRS* is frequently complicated by the development of organ system dysfunction.

**Sepsis** Sepsis was defined as the systemic inflammatory response to infection. Sepsis was further stratified based on its severity, with severe sepsis and septic shock representing the spectrum of progressively worsening status.

**MODS** The term *MODS* was coined to describe a pattern of progressive dysfunction of organs that is related pathogenically regardless of the inciting process and that requires intervention to maintain homeostasis.

## Etiologies

There are two broad categories of *MODS*.<sup>17</sup> Primary *MODS* results from direct injury to organs, such as might occur following major direct trauma; primary *MODS* occurs early after the injury. Secondary *MODS* results from the systemic host response to an injury as opposed to direct injury to the organ, and occurs later than primary *MODS*. For the remainder of the chap-

TABLE 76-2.

## Systemic Inflammatory Response Syndrome (SIRS) Criteria

Diagnosis of *SIRS* requires at least 2 of these criteria

1. Tachycardia—heart rate  $>90$  beats/min
2. Leucocytosis (white blood cell count  $>12,000$ ), leucopenia (white blood cell count  $<4000$ ), or high band count ( $>10\%$ )
3. Fever (temperature  $>100.4^{\circ}\text{F}$  [ $38^{\circ}\text{C}$ ]) or hypothermia (temperature  $<96.8^{\circ}\text{F}$  [ $36^{\circ}\text{C}$ ])
4. Tachypnea (respiratory rate  $>20$  breaths/min), low  $\text{PaCO}_2$  ( $<32$  mmHg), or mechanically ventilated

Data from Bone RC, Balk RA, Cerra FB, et al.<sup>8</sup> and Levy MM, Fink MP, Marshall JC, et al.<sup>11</sup>

ter, the term *MODS* is used to describe secondary *MODS*, which is a far more frequent occurrence than primary *MODS* in the ICU.

*MODS* is believed to be mediated by a systemic inflammatory process that may be initiated by one or more of a multitude of injuries (Table 76-1).

Common etiologies include infection, trauma, aspiration, pancreatitis, transfusion of multiple units of blood, ischemia–necrosis, and burns.<sup>18</sup> *MODS* occurs in both surgical and nonsurgical patients. In patients with *MODS* who are not receiving surgery, the most frequent ICU admission diagnoses are cardiac arrest, sepsis, pneumonia, congestive heart failure, upper gastrointestinal (GI) bleeding, and nonoperative head trauma.<sup>19</sup> Postoperative *MODS* occurs most frequently following surgery for head trauma, elective abdominal aneurysm repairs, aortic dissection or rupture, GI perforation, GI inflammatory diseases, and GI malignancy. Other risk factors for the development of *MODS* include preexisting organ dysfunction, delayed or inadequate resuscitation, an ongoing infection or focus of inflammation, major hematoma, age  $\geq 65$  years, surgical complications, seriously deranged physiologic parameters on admission to the ICU, and chronic health problems (e.g., cancer or alcoholism).<sup>12,13,18–21</sup>

Sepsis is a pathophysiologic response to overwhelming infection and has a wide spectrum of presentations (Table 76-3). Sepsis is the most common cause of *MODS*. In septic shock,

TABLE 76-3.

Spectrum of Sepsis<sup>a</sup>

Systemic inflammatory response syndrome (SIRS)	2 or more of the following:	<ul style="list-style-type: none"> <li>• Body temperature <math>&gt;101.3^{\circ}\text{F}</math> (<math>38.5^{\circ}\text{C}</math>) or <math>&lt;95^{\circ}\text{F}</math> (<math>35.0^{\circ}\text{C}</math>)</li> <li>• Heart rate <math>&gt;90</math> beats/min</li> <li>• Respiratory rate <math>&gt;20</math> breaths/min or <math>\text{PaCO}_2</math> <math>&lt;32</math> mmHg or need for mechanical ventilation</li> <li>• White blood cell count <math>&gt;12,000/\text{mm}^3</math> or <math>&lt;4000/\text{mm}^3</math></li> </ul>
Sepsis	SIRS and:	<ul style="list-style-type: none"> <li>• Documented source of infection</li> </ul>
Severe sepsis	Sepsis and at least one sign of organ hypoperfusion or organ dysfunction:	<ul style="list-style-type: none"> <li>• Areas of mottled skin</li> <li>• Capillary refill <math>\geq 3</math> sec</li> <li>• Urine output <math>&lt;0.5</math> mL/kg/h or renal replacement therapy</li> <li>• Lactate <math>&gt;2</math> mmol/L</li> <li>• Abrupt change in mental status</li> <li>• Platelet count <math>&lt;100,000/\text{mL}</math> or disseminated intravascular coagulation (DIC)</li> <li>• Acute lung injury (ALI) or acute respiratory distress syndrome (ARDS)</li> </ul>
Septic shock	Severe sepsis and either:	<ul style="list-style-type: none"> <li>• Cardiac dysfunction</li> <li>• Mean arterial pressure <math>&lt;60</math> mmHg after adequate fluid resuscitation</li> <li>• Need for vasopressor to maintain mean arterial pressure <math>&gt;60</math> mmHg</li> </ul>

Levy MM, Fink MP, et al. 2001 SCCM/ESICM/ACCP/ATS/SIS International Sepsis Definitions Conference. *Crit Care Med* 2003;31:1250.



systemic inflammation triggers pathophysiological processes that cause vasodilatation, relative or absolute hypovolemia, myocardial dysfunction, and an altered systemic blood flow distribution.<sup>22</sup> Despite the restoration of intravascular volume, microcirculatory abnormalities in important organs may persist, leading to a maldistribution of cardiac output and a failure to maintain adequate cellular perfusion. About half of the patients who succumb to septic shock die of multiple organ failure.

## Epidemiology

MODS occurs in approximately 15% of ICU admissions<sup>23</sup> and is associated with up to 80% of ICU deaths.<sup>2,19,24</sup> MODS appears to occur more frequently and have a higher mortality in patients who are admitted to the ICU for medical problems as opposed to patients who are admitted to the ICU for surgical problems or following trauma.<sup>2,25</sup> A large multicenter study of the risks and outcomes of MODS found that approximately 75% of patients with MODS had nonoperative underlying diagnoses.<sup>19</sup> In addition, Acute Physiology and Chronic Health Evaluation (APACHE) III scores were found to be significantly higher on the first day for patients with multiple organ system failure than for patients without MODS.<sup>19</sup>

Studies suggest that there are differences in the patterns of organ dysfunction based on the reason for the admission to the ICU. For the general ICU population, the risk of MODS is related to age >65 years, severity of coexisting diseases, and a nonoperative ICU admission diagnosis.<sup>2,19</sup> However, trauma patients who develop MODS do not seem to fit this profile. A prospective study of multiple organ failure (MOF) following major trauma showed that age, a large red blood cell transfusion requirement, a high Injury Severity Score, a large base deficit, and elevated lactate levels all are risk factors for the subsequent development of MOF.<sup>26</sup>

## MODS Scoring Systems

Over the last several decades, many scoring systems have been devised to assist with the diagnosis and quantification of severity of MODS. Two such scoring systems, the sepsis-related or sequential organ failure assessment (SOFA) score<sup>14</sup> and the MODS score<sup>15</sup> are currently widely used systems that take into ac-

count not only the number of dysfunctional organs or systems, but also the degree of dysfunction of each organ. Both MODS and SOFA scores are generated using the same basic systems.

### SOFA Score

The SOFA score was created to describe organ dysfunction in individual patients and groups of patients over time.<sup>14</sup> The SOFA score is calculated based on the degree of dysfunction of 6 organ systems (respiratory, hepatic, cardiovascular, coagulation, renal, and CNS) and is commonly used to follow the progression of organ dysfunction rather than to predict outcome.

### MODS Score

The MODS score was developed to provide a “reliable and meaningful index of the severity” of MODS in individual ICU patients and to attempt to quantify the association between the degree of dysfunction and the risk of mortality.<sup>15</sup> The MODS score also incorporates 6 organ systems (respiratory, renal, cardiovascular, hematologic, CNS, and hepatic), each of which is assigned a number from 0 to 4 based on the severity of dysfunction. A unique feature of the MODS score is the use of the pressure-adjusted heart rate to represent the cardiovascular (CV) system. The pressure-adjusted heart rate is calculated by multiplying the heart rate times the ratio of central venous to mean arterial pressure. Data is collected repeatedly during the ICU stay. The highest possible score is 24, which indicates the most severe MODS.

### Denver Multiple Organ Failure Score

The Denver MOF score was devised to provide an end point for clinical studies of trauma and is widely used in outcome studies of trauma patients.<sup>4</sup> The revised Denver MOF score takes into account 4 organ systems: pulmonary, cardiac, renal, and hepatic. Each organ system is assigned a grade based on the degree of dysfunction (0 = none, 3 = severe).

## Prognosis of MODS

The overall mortality of MODS is in excess of 50%.<sup>16,26,27</sup> Studies consistently show that across all ICU populations, mortality in MODS is proportional to the number of failing organs. Whereas single-organ failure is associated with a low mortality, the mortality in patients with 3 failing organs is

80–90% in most studies, and approaches 100% with 4 failing organs.<sup>2,17,19,23</sup> In the study described above that developed and validated the MODS scoring system, mortality was correlated in a graded fashion to the MODS score.<sup>15</sup> Patients with MODS scores of 9–12, 13–16, 17–20, and >20, had ICU mortality rates of 25%, 50%, 75%, and 100%, respectively.

Neurologic failure is associated with the highest mortality.<sup>23</sup> In the general ICU population, a very high mortality rate has been shown when there is concomitant renal failure and either cardiovascular or respiratory failure.<sup>2,28</sup> In addition, mortality is higher in MODS patients that are ≥65 years old.

Other factors also influence mortality, especially the inciting diagnosis. For example, in the prospective study of MOF following major trauma described earlier, the mortality was lower for MODS associated with trauma (45%) than for MODS associated with sepsis or cardiac arrest (75–80%).<sup>19</sup> In addition, the degree of physiologic derangement on the first day of failure of the organ is an important determinant of mortality.<sup>19</sup>

## Pathogenesis

The precise mechanisms underlying MODS are still not fully understood. It is believed that some combination of uncontrolled generalized inflammation (SIRS), microcirculatory abnormalities, and impaired oxygen delivery and/or use play important roles in the initiation and perpetuation of MODS (reviewed in refs. 18, 29, and 30). SIRS is believed to be initiated by release of locally produced inflammatory mediators into the circulation. The localized inflammatory responses are triggered by infection, trauma, or other process, and are in place to protect the host against toxins and infection or to initiate normal healing processes. Once inflammatory mediators circulate, they can gain access to organs that are remote from the inciting site.

White blood cells, platelets, and endothelial cells are also involved in the generalized inflammation of SIRS. These cells secrete or express on their surface a variety of inflammatory mediators including, but not limited to, cytokines, reactive oxygen species, nitric oxide, adhesion molecules, and factors that are involved in coagulation and anticoagulation. The endothelium is believed to play a critical role

in systemic inflammation and organ dysfunction in several ways.<sup>31</sup> Endothelial cells are involved in maintaining a balance between coagulation and anticoagulation.<sup>31–34</sup> An imbalance in coagulation and anticoagulation can result in disseminated intravascular coagulation (DIC) and is believed to be important in the development of microvascular thrombosis leading to abnormal microcirculation and impaired oxygen delivery to organs.<sup>35,36</sup> The endothelium also plays an active role in recruiting inflammatory cells to sites of infection and inflammation through the secretion of chemokines and the expression of adhesion molecules.

The GI tract has been postulated to contribute to MODS through both failure of GI mucosal integrity with translocation of bacteria and their products out of the lumen, and/or through increased production of inflammatory mediators by the gut.<sup>29,37</sup> It has long been believed that various stresses, such as trauma, hemorrhage, burns, and septic shock impair gut perfusion and cause failure of GI barrier function. The hypothesis that bacteria or bacterial products translocate from the GI lumen into the bloodstream under clinical circumstances was originally suggested by Fine.<sup>38</sup> Although there is some suggestive data that bacterial translocation may occur in some situations, clinical studies have not thus far proven this phenomenon of bacterial or endotoxin translocation into the blood.<sup>29,39,40</sup>

It is also believed that there are destructive interactions between different organs, such that dysfunction of one organ will amplify or contribute to dysfunction of other organs. Preexisting organ dysfunction, such as chronic obstructive pulmonary disease or end-stage liver disease, also negatively impacts on the development and outcome of MODS. Similarly, many of the supportive therapies used in MODS can contribute to organ dysfunction. For example, mechanical ventilation can cause or contribute to direct lung damage and can reduce cardiac output by impairing venous return.

## MODS: MANIFESTATIONS, COMPLICATIONS, PREVENTION, AND THERAPIES

### Manifestations

MODS can affect any organ or system (Table 76–4). The pattern, degree, and

progression of organ dysfunction are variable. Dysfunction can range from mild, requiring minimal intervention, to complete failure requiring aggressive support. The lungs and circulatory system are most commonly involved, and one or both of these systems are involved in the majority of cases.<sup>2</sup> Trauma patients often follow a different course than medical and nontraumatic surgical patients. In trauma patients, a biphasic pattern of organ failure occurs.<sup>26,41</sup> Early organ failure (within 3 days of trauma) results from the initial shock, resuscitation, and tissue injury, whereas later organ failure (more than 3 days after trauma) frequently results from infection.<sup>41</sup>

### Acute Respiratory Failure

ALI and ARDS form a continuum and can comprise a lethal syndrome of hypoxemia and diffuse progressive pulmonary edema.<sup>42</sup> Overall respiratory failure occurs in approximately 70% of patients with MODS. Risk factors for the development of ARDS include pneumonia, aspiration, trauma, sepsis, and pancreatitis. Patients with respiratory failure in the context of MODS have a very high mortality rate.<sup>2</sup> The degree of respiratory impairment varies in severity, from mild pulmonary dysfunction to full blown ARDS. ALI and ARDS occur most frequently in patients with sepsis as the underlying diagnosis, particularly when the source of the sepsis is pulmonary.<sup>43–45</sup> In addition,

mortality is highest when ARDS is caused by sepsis.<sup>46</sup> A recent large study reported a 99% incidence of respiratory failure in trauma patients with multiple organ failure.<sup>47</sup> They also found that the severity of respiratory failure correlated with the degree of other organ impairment, but that the presence of respiratory failure did not correlate with mortality.

### Cardiovascular

Cardiovascular dysfunction occurs in approximately 87% of MODS cases, and the in-hospital mortality rate of MODS patients with CV dysfunction is approximately 58%.<sup>2</sup> A variety of cardiovascular abnormalities may be present in patients with MODS, including hemodynamic instability and dysrhythmias.

**Hemodynamic** Patients may manifest hemodynamic instability secondary to hypovolemia, vasodilatation, and/or myocardial dysfunction. Hypovolemia can result from blood or fluid losses, inadequate fluid intake or replacement, or capillary leakage with extravasation of fluid out of the intravascular space, and inadequate replacement of fluids. Septic patients who have been volume resuscitated often manifest a “high output” state and are described as being “hyperdynamic,” that is, they have an elevated cardiac output and stroke volume associated with a decreased systemic vascular resistance. These classic

TABLE 76–4.

### Organs and Systems Affected by Multiorgan Dysfunction Syndrome

Organ or System	Manifestations
Lung	Acute lung injury, acute respiratory distress syndrome, ventilator dependence
Cardiovascular	Arterial hypotension, hyperdynamic physiology, vasodilatation, myocardial dysfunction, pulmonary hypertension, shunting
Kidneys	Oliguria, anuria, renal failure, acute tubular necrosis, renal tubular acidoses, acid–base abnormalities, electrolyte abnormalities
Neurologic	Confusion, lethargy, agitation, coma
Liver	Elevated liver enzymes, hyperbilirubinemia, coagulopathy, hepatic encephalopathy
Hematologic	Anemia, thrombocytopenia, coagulation abnormalities, disseminated intravascular coagulation
Endocrine	Hyperglycemia, inappropriate adrenal response to stress (“relative adrenal insufficiency”)
Metabolic	Electrolyte and glucose abnormalities, hyper- and hypokalemia, hyper- and hyponatremia, hypomagnesemia, hyper- and hypophosphatemia, hypocalcemia
GI Tract	Hypomotility, inability to tolerate enteral nutrition, GI hemorrhage, stress ulcers

CV manifestations of sepsis may also be present in patients with MODS caused by other systemic inflammatory processes. Nitric oxide (NO) is believed to be a key mediator of the systemic vasodilatation and hypotension in patients with systemic inflammatory processes such as sepsis.

Although cardiac output is usually maintained or elevated in volume-resuscitated patients with sepsis or other systemic inflammatory processes, patients often develop myocardial dysfunction. This myocardial dysfunction is characterized by a decreased left ventricular ejection fraction, ventricular dilation, and an impaired contractile response to volume loading. The mechanisms of cardiac dysfunction are complex and not well understood. Myocardial edema, alterations of sarcolemmal or intracellular calcium homeostasis, and uncoupling or disruption of adrenergic signal transduction may all be involved. Systemic inflammatory mediators such as cytokines, nitric oxide, prostanoids, and platelet-activating factor are postulated to be involved in the pathogenesis of myocardial dysfunction in SIRS. Although myocardial dysfunction is not uncommon, death from myocardial failure is rare.

**Dysrhythmias** Patients with MODS may develop dysrhythmias on the basis of metabolic abnormalities, intravascular volume disturbances, hypoxemia, and myocardial ischemia in patients with coronary artery disease. Atrial dysrhythmias are common. Although immediate interventions, such as cardioversion, may be required for hemodynamically unstable dysrhythmias, correction of the underlying stimulus is usually required to prevent further occurrences.

### Renal

Renal disturbances are common in MODS patients and range from mild renal dysfunction leading to an elevated blood urea nitrogen (BUN) and creatinine, to frank anuric renal failure with uremia, severe electrolyte disturbances, metabolic acidosis, and hypervolemia.<sup>48</sup> In a large, multicenter ICU study, acute renal failure occurred in approximately 25% of patients who remained in the ICU for more than 48 hours, and approximately 65% of patients with acute renal failure had MODS.<sup>28</sup> Preoperative renal dysfunction is the single most important predictor of renal failure

postoperatively. The nature of the surgical procedure also significantly affects the incidence of postoperative acute renal failure with the highest incidence in patients who have undergone cardiopulmonary bypass or surgery on the aorta and other major vessels.

Renal dysfunction commonly results from acute tubular necrosis (ATN) and/or decreased perfusion caused by hypovolemia or shock. The urine sediment can be helpful in diagnosing ATN, which causes granular or “muddy” casts in the urine. Urine electrolytes can be useful for diagnosing a low flow state or prerenal azotemia which, provided that the patient is not receiving a diuretic and does not have intrinsic renal disease, will show a low fractional excretion of sodium. Other causes of acute renal dysfunction in MODS patients include circulatory endogenous toxins such as myoglobin in patients with rhabdomyolysis, nephrotoxic drugs such as aminoglycosides or amphotericin B, IV contrast agents for imaging procedures, and cholesterol emboli caused by manipulation of the diseased aorta. The mortality in MODS patients with renal failure is high, particularly in the context of either cardiovascular or respiratory failure.<sup>2,28</sup>

### Hepatic

A variety of hepatic disturbances may occur in noncirrhotic patients with MODS. These include elevation of liver enzymes, hyperbilirubinemia, hypoglycemia, and impaired synthesis of proteins, including clotting factors. Hepatic dysfunction may complicate MODS in several ways. First, patients with cirrhosis fare poorly when they develop MODS and have a particularly high mortality. Mortality rates in excess of 80% have been reported in cirrhotic patients with either coma, renal failure, CV instability, or acute respiratory failure.<sup>49</sup> Second, liver failure often worsens in critically ill cirrhotic patients. Third, a coagulopathy and a propensity for bleeding may result from decreased synthesis of clotting factors by the liver, in addition to DIC (described in the following section on Hematologic Disseminated Intravascular Coagulation). Fourth, acute liver failure can also cause MODS. MODS resulting from acute liver failure has a very poor prognosis.<sup>50</sup>

### Hematologic

Multiple hematologic abnormalities occur in MODS patients, including

platelet and coagulation derangements, anemia, and white blood cell abnormalities. Patients commonly exhibit either leucocytosis or leucopenia. Coagulation problems in patients with MODS may arise from impaired hepatic synthesis and/or from increased consumption of coagulation factors, as occurs in DIC. Thrombocytopenia often occurs in DIC, but may also result from decreased production or increased destruction from other causes.

**Anemia** Anemia may result from acute blood loss after trauma, GI hemorrhage, or surgery. Critically ill patients are often exposed to frequent phlebotomy. Furthermore, inflammatory cytokines may contribute to anemia by limiting the endogenous production of erythropoietin, by directly hindering the production of red blood cells in the bone marrow, and by altering iron metabolism. These observations have led to the development of the term *anemia of critical illness*.

**Coagulation Disturbances** Coagulopathies are commonly evaluated by measuring the prothrombin time (PT), activated partial thromboplastin time (aPTT), and fibrinogen levels. The PT assesses the function of the extrinsic coagulation pathway and the final common pathway, which requires adequate levels of tissue thromboplastin (tissue factor), factors V, VII, and X, and prothrombin and fibrinogen. The aPTT is used to evaluate intrinsic coagulation and the degree of anticoagulation by heparin, lepirudin, and argatroban. The aPTT is sensitive to deficiencies of factors VIII, IX, XI, and XII.

A prolonged PT or aPTT can be caused by either an absence of coagulation factors or the presence of factor inhibitors. Transfusion with normal plasma should correct a factor deficiency. Factor inhibitors should be suspected when the prolonged PT or aPTT does not correct, or only partially corrects, when measured using a 1:1 mix of the patient's and normal plasma. Antiphospholipid antibodies (e.g., lupus anticoagulant) can also produce a prolonged aPTT that is not corrected by normal plasma infusions. Paradoxically, lupus anticoagulants and the antiphospholipid antibody syndrome carry an increased risk of thrombosis and not bleeding.

**Platelet Abnormalities** Platelets play a vital role in hemostasis by form-



ing a mechanical plug at the site of vascular injury. Three basic mechanisms are responsible for thrombocytopenia in critically ill patients: decreased platelet production, increased platelet destruction or sequestration, or dilution. Decreased platelet production may be caused by underproduction of thrombopoietin caused by liver disease, suppression or damage of the bone marrow by viral infection, drugs, or toxins (e.g., alcohol, chemotherapy, radiation therapy), nutritional deficiencies (folate, cobalamin), and congenital or acquired disorders of hematopoiesis. Increased platelet destruction can cause thrombocytopenia in patients with the systemic inflammatory response syndrome (Table 76-2 lists the SIRS criteria) resulting from infectious and noninfectious processes. Possible mechanisms include a shortened life span because of immune-mediated platelet destruction and DIC. Transfusion with banked blood for massive blood loss can cause dilutional thrombocytopenia. Thrombocytopenia may also be a result of sequestration of platelets in the liver, spleen, and in patients with acute respiratory failure, lungs.<sup>51</sup>

Drug-induced thrombocytopenias may be hard to diagnose because many drugs can impair platelet production rates, and critically ill patients often receive multiple medications. Heparin-induced thrombocytopenia (HIT) is common in critically ill patients. There are two types of HIT. Type I HIT occurs in 10–20% of patients who receive unfractionated heparin. Nonimmune mechanisms cause a decrease in platelet counts from 1–4 days after initiating heparin therapy. The platelet nadir in type I HIT is  $>100,000/\mu\text{L}$ , and platelet counts generally normalize promptly after discontinuation of heparin. Type I HIT is not associated with hemorrhagic or thrombotic sequelae.

Type II HIT occurs in 1–3% of patients who receive unfractionated heparin and is associated with more catastrophic sequelae. Type II HIT generally occurs 5–10 days after initiation of heparin therapy, and is mediated by antibodies. Type II HIT is diagnosed by testing for heparin-platelet-associated antibodies. In type II HIT, 30–80% of patients experience thrombotic sequelae, including venous and arterial thromboses. Life-threatening pulmonary embolism occurs in 25% of

patients who exhibit thrombosis.<sup>52</sup> Treatment of HIT involves discontinuation of all heparin administration, including both unfractionated heparin and low-molecular-weight heparins, to avoid thrombotic sequelae, and the use of alternative anticoagulants. Anticoagulant alternatives for patients with HIT include lepirudin, argatroban, and fondaparinux. Lepirudin and argatroban are direct thrombin inhibitors.<sup>53</sup> Lepirudin is cleared by the kidneys, whereas argatroban is cleared by the liver. Thus the choice of one agent over another depends on the patient's renal and hepatic function. Both agents have short plasma half-lives (80 minutes for lepirudin and 40 minutes for argatroban) allowing for rapid reversal of anticoagulation after administration is stopped. Platelets should never be given to patients with type II HIT because of an increased risk of thrombosis after platelet transfusions.

**Disseminated Intravascular Coagulation** The coagulation–fibrinolytic systems are active in SIRS. DIC is common in sepsis, occurring in up to 70% of patients with septic shock.<sup>54</sup> In DIC, there is simultaneous activation of both the coagulation and fibrinolytic systems. Activation of the fibrinolytic portion of the clotting system can lead to hemorrhage including widespread oozing of blood, and excessive bleeding from surgical wounds and sites of other invasive procedures. The activation of coagulation can result in thrombosis, particularly of the microvasculature. One dramatic manifestation of thrombosis is digital necrosis, which can be severe enough to require amputation. It is believed that microvascular thrombosis causes impaired oxygen delivery to tissues and resultant ischemia, which is postulated to contribute to the development of organ dysfunction.

The diagnosis of DIC is suggested by prolongation of the PT and/or the partial thromboplastin time (PTT) and a reduction in the platelet count. Elevated D-dimer and reduced plasma fibrinogen levels provide useful supplemental diagnostic tests, but they may not be diagnostic of DIC. For instance, D-dimers are elevated in patients with DIC, but are also increased in postoperative patients and in patients with deep venous thrombosis (DVT) or pulmonary emboli. Fibrino-

gen levels are often decreased in patients with DIC, but may be increased by inflammatory processes leading to normal or even elevated fibrinogen levels in some patients with DIC.

### Neurologic

Alterations of consciousness frequently occur in patients with MODS. Central nervous system manifestations range in severity from mild confusion and lethargy or agitation to frank coma. It is estimated that CNS disturbances occur in approximately 70% of patients with sepsis.<sup>55</sup> The presence of severe neurologic impairment, as manifested by a Glasgow Coma Scale score  $<6$ , in the context of MODS has been shown to be associated with a high mortality rate ( $\geq 70\%$ ).<sup>2</sup>

Patients with MODS may also develop neuromuscular disorders including profound weakness. Complications of these neuromuscular disorders include difficulty weaning from mechanical ventilation and a prolonged rehabilitation period.<sup>56</sup>

Critically ill patients frequently require sedative–hypnotic agents and analgesics to treat anxiety, delirium, and pain. Adequate treatment of pain and anxiety is associated with an improved quality of life in ARDS survivors.<sup>57</sup> Patients may receive either intermittent bolus sedation or continuous infusion sedation. Typical sedative medications include narcotics, benzodiazepines, barbiturates, and hypnotic agents such as propofol and ketamine.<sup>58</sup> Delirium is frequently treated with haloperidol. However, atypical antipsychotic agents such as olanzapine, risperidone, and quetiapine are being prescribed with increasing frequency because of their low incidence of side effects in the elderly population.

### Metabolic/Endocrine

Patients with MODS may have a variety of plasma electrolyte abnormalities, including hyperkalemia, hypokalemia, hypernatremia, hyponatremia, hypocalcemia, hypomagnesemia, hyperphosphatemia, and/or hypophosphatemia. These abnormalities can result from organ dysfunction, nutritional issues, intravenous fluid composition, and hormonal abnormalities. Renal dysfunction causes a variety of electrolyte abnormalities. Electrolyte abnormalities should be monitored and treated.



Glucose disturbances, including both hyper- and hypoglycemia, are common in critically ill patients. Glucose abnormalities may result from endogenous issues, such as hypoglycemia with liver failure, or from exogenous issues, such treatment with steroids. There is evidence that insulin therapy to achieve tight glycemic control improves outcome in septic patients,<sup>59</sup> and many ICU physicians employ insulin infusion protocols to treat their patients.

Adrenal dysfunction is believed to complicate the course of many critically ill patients, particularly patients with septic shock. Although frank adrenal insufficiency is uncommon, there is evidence that critically ill patients experience a state of “relative adrenal insufficiency,” which is characterized by an insufficient adrenal response for the augmented level of stress.<sup>60,61</sup> Many critical care units now use protocols for assessing and treating patients with septic shock for adrenal dysfunction based on studies that suggest an improved outcome with steroid replacement. The evaluation, role, and optimal management of adrenal dysfunction in critically ill patients is an area of intensive current investigation.

### Gastrointestinal

Common gastrointestinal disturbances in MODS patients include GI hypomotility and GI bleeding. GI dysmotility may lead to gastric distension, which places these patients at risk of aspiration of regurgitated stomach contents, particularly during intubation. Critically ill patients frequently require nasogastric decompression. In addition, GI dysmotility may lead to an inability to tolerate enteral nutrition and a poor nutritional status.

GI hemorrhage may result from stress ulceration, and critically ill patients that are at risk of stress ulceration should be treated with prophylactic agents ( $H_2$  blockers, proton pump inhibitors, or sucralfate) to reduce their propensity to develop stress ulcerations. Patients may also develop low-grade GI bleeding from mucosal breakdown related to indwelling nasogastric tubes.

### MODS and Predisposition to Infections

In addition to MODS frequently being caused by infection, patients with

organ dysfunction are at high risk of developing infectious complications.<sup>4</sup> The propensity for patients with MODS to develop infections is postulated to be related to a state of immunosuppression, sometimes called the *compensatory antiinflammatory response*, that occurs in patients with systemic inflammation.

### Preventive Strategies

Prevention of MODS is a major goal in managing critically ill patients. Preventive strategies include prompt therapy targeting the underlying source of inflammation, optimizing oxygen delivery to balance the increased demands that accompany SIRS, maintaining adequate tissue perfusion, and providing physiologic support to maintain homeostasis when required. The failure of GI tract barrier function is believed to be involved in the development of sepsis, and studies suggest that early enteral nutrition and special supplements, such as glutamine, may reduce infectious complications in ICU patients.<sup>62–64</sup> The role of selective gut decontamination with antibiotics to prevent bacterial translocation, a process that some believe plays a role in the development of MODS, remains controversial.<sup>65–67</sup>

### Managing Patients with Established MODS

#### Supportive Therapies

Once MODS is established, therapy is primarily supportive and targets specific organs and systems. Consequently, respiratory failure is managed with mechanical ventilation, and the cardiovascular system is supported with transfusion of fluids, vasopressors, and inotropic agents, whereas renal failure is managed with renal replacement therapies. Management of specific organs and systems is discussed later in Preoperative Preparation of Patients with MODS.

#### Adjunctive Therapies

Numerous studies have tested the effects of agents that interfere with inflammatory responses. Most of these studies focused on SIRS caused by sepsis.

**Antimediator therapies** Experimental therapies that have targeted specific inflammatory mediators including cytokines such as tumor necrosis factor- or interleukin-1, have not

improved patient outcomes in large clinical trials (reviewed in ref. 68).

#### Adrenal Replacement Therapy

Although still somewhat controversial, recent studies suggest that physiologic steroid supplementation improves the outcome in patients with vasopressor-dependent septic shock.<sup>61</sup>

**Activated Protein C** Activated protein C (APC) infusion is reported to reduce the absolute mortality from 30.8% to 24.7% in patients with severe sepsis,<sup>36</sup> and is approved by the FDA for the treatment of patients with severe sepsis. The results of the APC trial<sup>36</sup> are provocative, particularly given the postulated effects of APC in preventing microvascular thrombosis and subsequent impaired-organ microcirculation. The results of these trials underscore the potential importance of coagulation and the microcirculation in SIRS, and the need to increase the depth of our understanding of the roles of the microcirculation, the endothelium, and the coagulation and inflammatory cascades in MODS. It is not yet clear whether steroids or APC will be useful in the management of MODS as a result of noninfectious causes.

**Insulin Therapy** Recent studies suggest that surgical ICU patients may benefit from tight glycemic control.<sup>59</sup> Although target plasma glucose values may vary, many ICU physicians use protocols to regulate insulin infusions for glycemic control. A prospective, randomized ICU trial associated the maintenance of plasma glucose concentration between 80 and 100 mg/dL with improved outcome, including lower mortality, fewer infections, decreased transfusion requirements and a shorter duration of mechanical ventilation.<sup>59</sup> More recent data suggest that less stringent glycemic control with target blood glucose levels of less than 140 mg/dL may provide a similar survival advantage to the “tighter” control described in the earlier study.<sup>69</sup>

**Nutritional Support** Patients with MODS are often profoundly malnourished and require nutritional support. The GI tract is the preferred route of nutrition, in part because it is believed that enteral feeding may have a protective effect by maintaining GI mucosal integrity. MODS patients often do not tolerate enteral feedings well, and

require total parenteral nutrition. Many practitioners advocate continuing tube feeds at a low rate for patients who do not tolerate high-rate feeding to facilitate mucosal integrity.

**Hemofiltration for Toxin Removal** Recently there has been interest in using continuous venovenous hemofiltration as a means of clearing toxins and inflammatory mediators in sepsis.<sup>70,71</sup>

## SURGICAL AND NONSURGICAL PROCEDURES IN PATIENTS WITH MODS

Patients with MODS may require a variety of procedures during their ICU stay. Some procedures may be required to correct the underlying cause of the MODS, such as pancreatic debridement for necrotizing pancreatitis or exploratory laparotomy for bowel necrosis or perforation. Other procedures may be necessary to deal with complications of MODS, for instance a tracheostomy for respiratory failure, a gastrostomy or jejunostomy feeding tube placement for enteral nutrition and medication administration. The timing of procedures should be based on the urgency of the intervention balanced against the precariousness of the physiologic status of the patient. It may be appropriate for nonemergent procedures to be delayed to stabilize patients and to optimize the function of various systems and organs. However, if it is anticipated that a patient will continue to deteriorate, or will fail to improve without a prompt intervention, for instance as with necrotizing fasciitis, immediate surgery may be required, even in the unstable patient.

### Common Surgical Procedures in Patients with MODS Based on Etiology

#### Infection

Infection is the most common cause of MODS. Although some infections, such as urinary tract infections or pneumonia may be treated with antibiotics alone, many infections require either surgical debridement, or surgical or percutaneous catheter drainage. Immediate debridement for necrotizing fasciitis and infectious myonecrosis is of paramount importance, even in unstable patients. Similarly, exploratory laparotomies are performed immediately on patients with sepsis as a

result of perforation of the intestines. Other infections that may require surgery include toxic megacolon caused by *Clostridium difficile* colitis, empyema that has failed thoracostomy drainage as a result of a pleural peel or adhesions, and mediastinitis. Abscesses located in the thorax, abdomen, and pelvis may be treated with drainage, either with surgery or using catheters placed under CT or ultrasound guidance.

#### Pancreatitis

Patients with pancreatitis may require surgery for a variety of reasons, including pancreatic necrosis, drainage of pancreatic abscesses or infected pseudocysts, and pancreatic hemorrhage.<sup>72</sup>

#### Trauma

There are a multitude of processes requiring surgery in trauma patients. Often surgery is performed early in the trauma patient's course, prior to the development of MODS. However, in some situations, surgery may be delayed while the patient is stabilized after the acute injury. Some of these patients will develop MODS prior to definitive procedures for their traumatic injuries, for instance, before pinning of hip fractures or prior to definitive procedures for spine stabilization.

#### Limb Ischemia–Necrosis

Patients with limb ischemia–necrosis may require fasciotomies, vessel exploration with revascularization (embolectomy or bypass procedures), or amputation.

#### Burns

Patients require excision and grafting, and other treatments.

### Surgical Procedures Stemming from MODS

Patients with MODS often require procedures to deal with their complications or long-term care needs. Common procedures include tracheostomy tube placement for ventilator dependence as a consequence of persistent acute respiratory failure, or issues with profuse secretions, or muscular weakness, and placement of gastric or jejunal feeding tubes for nutritional support and drug administration. Other surgical procedures that are sometimes required include amputa-

tions to remove gangrenous digits or distal limbs as a consequence of severe DIC and debridement of secondarily infected wounds.

### Nonsurgical Procedures in Patients with MODS

Patients with MODS can require a variety of procedures during their ICU stay. Some procedures are required to treat the underlying etiology of MODS, such as catheter drainage of infected fluid collections in the abdomen, pelvis, or chest. Other nonsurgical procedures may be required to facilitate basic care and to optimize physiologic parameters and implement supportive therapies for failing organs. For instance, central venous, pulmonary arterial, and peripheral arterial catheters may be placed for hemodynamic monitoring and drug administration, and central venous lines for renal replacement therapy. Bronchoscopy may be performed to assist with secretion clearance, and chest tubes may be placed for management of pneumothorax or drainage of pleural fluid collections.

### PREOPERATIVE ASSESSMENT AND CONSENT

A thorough preoperative evaluation with prioritization of the importance of the various physiologic derangements is essential in anticipating the needs for every phase of the perioperative period (Table 76–5). Based on a comprehensive preoperative evaluation, the anesthesiologist should (a) determine whether or not additional therapies should be initiated to optimize the patient's condition prior to going to the operating room, (b) anticipate and arrange for appropriate transportation of the patient to the operating room, (c) prepare an anesthetic plan for the patient, (d) prepare the operating room in advance for the arrival of the patient, and (e) set up tentative plans for postoperative care. Several of these issues are discussed in more detail in Chaps. 79, 80, and 81.

The preoperative assessment should include a review of past and present medical problems, a targeted physical examination, a complete review of the medications and available laboratory and radiographic data, assessment of the ventilator settings, determining which tubes and lines are present, and, in some cases, clarifying issues

TABLE 76-5.

## Preoperative Assessment and Optimization

Organ System	Questions to Answer
Cardiovascular	<ul style="list-style-type: none"> <li>• Is the patient adequately volume resuscitated?</li> <li>• Does the patient require pressors or inotropic agents to maintain an adequate blood pressure and cardiac output?</li> <li>• Is there any clinical evidence of hypoperfusion?</li> </ul>
Respiratory	<ul style="list-style-type: none"> <li>• What are the ventilator settings?</li> <li>• Does the patient need a critical care ventilator intraoperatively?</li> </ul>
Neurologic	<ul style="list-style-type: none"> <li>• What is the patient's baseline neurologic status?</li> <li>• What sedative medication is the patient receiving and will they be continued intraoperatively?</li> </ul>
Renal	<ul style="list-style-type: none"> <li>• Does the patient exhibit renal dysfunction?</li> <li>• If the patient is on renal replacement therapy, what is the volume status, electrolyte balance, and acid–base status?</li> </ul>
Endocrine	<ul style="list-style-type: none"> <li>• Is there any evidence of adrenal insufficiency?</li> <li>• How is the patient's glycemic control?</li> </ul>
Hematologic	<ul style="list-style-type: none"> <li>• What is the patient's hemoglobin/hemacrit?</li> <li>• What is the patient's coagulation status?</li> <li>• Is the patient receiving anticoagulants? Type?</li> </ul>

regarding the plan for resuscitation in the operating room.

### Review of Past Medical History

The basic aspects of the past medical history that are important in planning any anesthetic should be reviewed, with careful attention to processes that may complicate the management of the current problems. Preexisting vascular disease, cardiac dysfunction, dysrhythmias, the presence of pacemakers or an implantable cardioverter-defibrillator, preexisting respiratory disease, and cirrhosis may all profoundly impair the response of MODS patients to anesthesia and surgery.

### Review of Recent History

Clearly identifying the underlying diagnosis and a thorough knowledge of the inciting event(s) and all of the organs and systems that are involved is a crucial part of the preoperative assessment.

### Respiratory

The respiratory system is frequently involved in MODS. Information about the degree and nature of respiratory dysfunction and past responses to different ventilation strategies should be actively sought out. In addition, the chart should be reviewed for information on the airway, including anatomical issues with intubation, difficulties with the endotracheal tube or cuff,

quantity and frequency of suctioning of respiratory secretions, and any need for cervical spine immobilization.

### Circulation

Critically ill patients have myriad cardiovascular problems, including hypotension, hypertension, dysrhythmias, and myocardial ischemia/infarction. The preoperative assessment should seek knowledge about the patient's current hemodynamic status, including intravascular volume status, myocardial function, and peripheral vascular tone. Bedside clinical assessment can provide useful information about global perfusion. Indications of decreased perfusion include oliguria, clouded sensorium, delayed capillary refill, and cool skin. However, organ dysfunction and regional hypoperfusion can occur in the absence of overt signs of global hypoperfusion.<sup>73</sup> Elevated blood lactate concentrations may reflect anaerobic metabolism caused by hypoperfusion and an increasing trend of lactate concentrations may be an excellent indicator of septic shock. The central venous pressure may adequately reflect intravascular volume status in some patients, but may not correlate well with intravascular volume status in the context of cardiac dysfunction, pulmonary hypertension, or elevated intraabdominal or intrathoracic pressures. Patients with these problems may require a pulmonary artery catheter or echocardiography to

help estimate their volume status, ventricular filling, myocardial function, and vasomotor tone.

The preoperative assessment should gain information about hemodynamic lability and dysrhythmias, and responses to vasopressors, inotropes, and fluids. The electrocardiogram (ECG) should be examined for evidence of myocardial ischemia or infarction, conduction delays or blocks, and dysrhythmias.

### Renal

Renal dysfunction or failure should be noted and consequent metabolic and intravascular volume disturbances should be identified. Volume status, electrolyte balance, and acid–base status should be assessed. The heart should be auscultated for the presence of a pericardial friction rub, which is evidence of significant uremia, and lungs should be examined for evidence of pulmonary edema resulting from volume overload or increased vascular permeability. Patients with renal failure may be hypervolemic, hypovolemic, or euvolemic, and they may have a narrow margin for error in fluid management. Although physical examination may be used to help determine the fluid status in the stable patient, in critically ill patients, continuous invasive hemodynamic monitoring is often required. Although these patients are often total-body-volume overloaded, they may also be intravascularly depleted. The degree of renal failure, including the BUN and creatinine, plasma potassium, arterial blood pH, and urine output rate, should be assessed.

In patients receiving renal replacement therapy, the type of therapy—CVVH, CVVHD, or intermittent HD—should be noted. If the patient is on HD, the frequency and timing of the last dialysis should be noted. The ability of the patient to tolerate being without continuous forms of renal replacement therapies should be assessed to guide decisions regarding continuation of CVVH or CVVHD in the operating room. Because hemofiltration removes virtually all the ions from the plasma, including calcium, magnesium, and bicarbonate, their levels should be measured often and replaced when appropriate. Phosphate elimination is dependent on renal excretion. Phosphate binders and dietary restriction are often used to control the phosphate levels of patients with chronic renal failure. Because phosphate is also cleared by CVVH, pro-

found hypophosphatemia may occur leading to muscle weakness, increased susceptibility to muscle relaxants, and respiratory muscular insufficiency. Potassium elimination is also dependent on renal excretion. Hyperkalemia can lead to life-threatening arrhythmias. Aggressive preoperative dialysis can cause hypokalemia, producing increased myocardial excitability, a reduced arrhythmia threshold, and the precipitation of supraventricular or ventricular arrhythmias.

A chronic metabolic acidosis can occur in patients with chronic renal failure. While the acidosis is usually mild and well-compensated, profound acidemia can occur in patients with shock because of a diminished buffering capacity. During hemofiltration, bicarbonate is lost to the ultrafiltrate and is usually replaced in the form of lactate which is metabolized to bicarbonate. In patients with severe lactic acidosis, lactate will increase the plasma lactate concentration and decrease arterial pH. In these patients, bicarbonate ions should be provided directly and lactate should not be given.

Uremia is associated with platelet dysfunction due to impaired release of a macromolecular complex of von Willebrand factor and factor VIII from the capillary endothelium, which is necessary for normal platelet aggregation and clot formation. This form of platelet dysfunction is improved by dialysis, or the infusion of cryoprecipitate, 1-deamino-8-D-arginine-vasopressin (DDAVP), or estrogen conjugates.

### **Hepatic**

The presence of hepatic dysfunction can have important effects on a patient's response to stress and surgery. Hepatic failure can cause diverse problems, including hypoglycemia, coagulation disturbances, and impair processing of drugs and toxins. A variety of blood studies should be performed preoperatively, including: plasma coagulation studies (PT/PTT), blood glucose, bilirubin, and transaminase levels to assess the degree of liver injury and failure.

### **Hematologic**

Anemia, thrombocytopenia, and coagulation dysfunction are common problems in the ICU that should be identified, and in some cases corrected, preoperatively. It may be necessary to assess the hemoglobin, platelet count,

and coagulation studies immediately prior to surgery. The patient's medication record should be reviewed for anticoagulants such as heparin (high- or low-molecular-weight), Coumadin (warfarin), thrombolytic agents, and antiplatelet drugs.

### **Metabolic/Endocrine**

Major metabolic and endocrine disturbances and recent use of steroids should be identified preoperatively. The acid-base status should be analyzed. Appropriate preoperative chemical studies in MODS patients should include plasma potassium, sodium, chloride, bicarbonate, calcium, magnesium, phosphate, glucose, and arterial blood gases (pH,  $P_{aCO_2}$ ,  $P_{aO_2}$ ).

Insulin infusions are often used in critically ill patients to achieve glucose control. The insulin infusion rate should be noted as well as how frequently the rate needs to be adjusted.

### **Neurologic**

The preoperative evaluation should include an assessment of baseline neurologic function and the frequency and dose of sedative-hypnotic and analgesic agents. Dosages and rates of infusions should be noted, and decisions should be made whether or not these agents should be continued intraoperatively. Narcotic, benzodiazepine, and hypnotic infusions used in the ICU may be titrated intraoperatively as part of the anesthetic, or alternative agents can be used.

### **Infection**

The presence of infection, including the site and severity should be noted. Patients who are actively infected often have more pronounced hemodynamic depression with anesthetic administration. In addition, if the purpose of the surgery is source control, manipulation of the infected site may precipitate instability, including hypotension, metabolic acidosis, DIC, and/or worsening respiratory dysfunction. This is postulated to result from the release of bacteria and/or bacterial toxins into the circulation. Patients with baseline hemodynamic instability may become profoundly unstable during or after manipulation of the infected site.

### **Physical Examination**

The respiratory system evaluation should include visual assessment of

the airway and the respiratory pattern and auscultation of breath sounds. Visual inspection should be performed to assess for respiratory distress, as evidenced by tachypnea, labored breathing with use of accessory respiratory muscles, and the inability to clear respiratory secretions. The airway should be examined with attention to positioning and fixation of the endotracheal tube, ability to open the mouth, degree of oropharyngeal edema, deviation of the trachea, and the dental situation. The chest should be auscultated, and abnormalities such as wheezing caused by bronchospasm, rales caused by pulmonary edema, and rhonchi caused by secretions, should be noted.

The positions of drainage tubes and catheters (e.g., chest tubes, percutaneous catheters) and the locations of arterial, peripheral venous, central venous, and pulmonary arterial catheters should be noted. Pressure sores and areas of skin breakdown should be identified in order to plan for appropriate padding to provide protection in the operating room.

### **Review of Monitors**

A review of the monitors and lines already present, including locations, trends of important hemodynamic parameters (e.g., blood pressure, heart rate, central venous pressure, peak airway pressure, pulmonary capillary wedge pressure, cardiac output, stroke volume), and any issues with the monitors is necessary to plan for the perioperative period. In addition to standard ICU monitors, including a pulse oximeter, ECG, and noninvasive blood pressure, monitors that are commonly used in patients with MODS include intraarterial catheters, central venous and/or pulmonary artery catheters, and intracranial pressure monitors.

### **Review of Scheduled Medications and Infusions**

All medications should be reviewed. There should be close attention to continuous drug infusions, including rates of infusions, the lines being used for infusions, and their compatibility with drugs that will be infused in the operating room. Because abrupt cessation of total parenteral nutrition (TPN) can cause hypoglycemia, plans should be made to either continue the TPN infusion in the operating room, or to



provide another continuous source of sugar, such as an infusion of a 10% aqueous dextrose solution (D<sub>10</sub>W).

### Laboratory and Radiographic Data

As MODS can involve many different organs, the basic laboratory data to review should include recent values of electrolytes (Na<sup>+</sup>, K<sup>+</sup>, Cl<sup>-</sup>, HCO<sub>3</sub><sup>-</sup>, ionized Ca<sup>2+</sup>, Mg<sup>2+</sup>), BUN and creatinine, hemoglobin or hematocrit, coagulation studies, and an electrocardiogram. Liver-function studies, including transaminases and bilirubin levels also may be useful. All pertinent radiographic data should be reviewed, and the chest radiograph should be visualized to assess appropriate endotracheal tube positioning and seek evidence of infiltrates, pulmonary edema, pneumothorax, and pleural fluid.

### Ventilator Settings

Most patients with established MODS have respiratory dysfunction or failure requiring mechanical ventilation. Ventilator settings should be noted in detail, including the mode of ventilation (controlled vs. spontaneous ventilation, pressure vs. volume ventilation), the ventilator rate, the FiO<sub>2</sub>, the level of positive end-expiratory pressure (PEEP), tidal volume and airway pressures, and inspiratory-to-expiratory (I:E) ratios or inspiratory time.

Patients who are intubated for airway protection, to facilitate secretion clearance, or for profound weakness may be on minimal ventilatory support and should not have major issues related to ventilation. In contrast, patients with moderate to severe respiratory failure (ALI or ARDS) may be receiving high levels of ventilatory support, and may not tolerate changes of ventilation strategies or even abbreviated periods without ventilation. For patients with major ventilatory requirements, it may be necessary to continue the same mode of ventilation in the operating room as was used in the ICU. Often the standard operating room ventilators are inadequate for patients with severe respiratory failure. Thus arrangements should be made to transport the ICU ventilator to the operating room, or the operating room should be equipped with a ventilator that can produce identical ventilatory conditions.

Generally, patients receiving ventilation with high levels of PEEP should

travel with a PEEP valve in place. In patients with severe respiratory failure, it may be necessary to perform a trial of manual ventilation in the ICU prior to transporting to the operating room, and in some situations it may be appropriate to perform the surgical procedure in the ICU. For instance, in many centers, percutaneous tracheostomies are now performed at the bedside in the ICU.

### Consent for Anesthesia

Unless the surgery is emergent, informed consent must be obtained from either the patient or from a designated surrogate if the patient is unable to give consent.

### Resuscitation Status

Occasionally, critically ill patients who have a do not resuscitate (DNR) order require surgical procedures. In some cases, based on the wishes of the patient or their surrogate decision maker, the DNR status is suspended for the intraoperative and immediate postoperative period. This is based on the notion that acute, but reversible intra- and postoperative events, as opposed to the underlying process, may precipitate a cardiac arrest during and immediately after surgery. It is important to clarify whether or not the ICU DNR status will remain in effect or will be suspended in the operating room.

## PREOPERATIVE PREPARATION OF PATIENTS WITH MODS

Whenever possible, efforts should be made to correct reversible physiologic derangements and optimize the patient's condition prior to surgery (see Table 76-5). Some examples of situations that may require preoperative optimization include cardiovascular instability, respiratory failure, bronchospasm, renal failure, coagulopathy, severe thrombocytopenia, significant electrolyte imbalances, and hyperglycemia or hypoglycemia.

### Immediate versus Delayed Surgery

Depending on the degree of physiologic/metabolic derangements resulting from organ dysfunction and the urgency of a surgical procedure, it may be appropriate to delay surgery to provide time for optimization. The risk-to-benefit ratio of doing immediate sur-

gery, versus delaying surgery for optimization must be carefully assessed. The extremes are usually fairly obvious: Totally elective surgery should not be performed until the patient's physiologic/metabolic situation has been fully optimized, whereas emergency surgery, such as for a ruptured aortic aneurysm or necrotizing fasciitis, needs to be performed before or during optimization. For urgent surgery, there may be a few hours available to improve preoperative physiologic/metabolic parameters. The amount of time available for optimization depends on the surgical procedure and the patient's status, among other variables (e.g., operating room availability). Decisions regarding the timing of urgent surgery should be made with close communication between the anesthesiologist, the surgeon, and the intensivist.

### Respiratory

A variety of respiratory issues may complicate transport, intraoperative management, and postoperative care of patients with MODS. Bronchospasm should be treated aggressively with bronchodilators. For intractable bronchospasm, a short course of steroids should be considered. Copious secretions should be treated with suctioning, and possibly bronchoscopy, and the secretions should be cultured. Antibiotics may be appropriate if cultures of purulent secretions are positive and the clinical scenario is consistent with pneumonia or tracheobronchitis. Consideration should be given to intubating patients that have a tenuous respiratory status prior to transport to the operating room. A chest tube should be placed if a pneumothorax is present and the patient is to be given positive pressure ventilation.

Because mechanical ventilation with positive pressure is not a normal physiologic process, it can reduce cardiac output or lead to ventilator-associated lung injury<sup>74</sup> and may play a role in causing or worsening MODS.<sup>75</sup> The precise manner in which patients with ARDS are mechanically ventilated can significantly affect their outcome. A large, multicenter, prospective trial demonstrated that in patients with ALI, mechanical ventilation with low tidal volumes (6 mL/kg ideal body weight) was associated with decreased mortality, improved respiratory function, and decreased MODS.<sup>76</sup> The

ARDS Network strategy of limiting tidal volumes and airway pressures is employed by most ICU physicians. The current standard for mechanical ventilation (Table 76-6) for patients with ARDS includes setting the tidal volume to  $\leq 6$  mL/kg predicted body weight, the plateau pressure to  $\leq 30$  cm H<sub>2</sub>O, and adjusting the respiratory rate to achieve an arterial pH  $\geq 7.30$  when possible.<sup>77</sup> These volume and pressure goals may need to be modified based on the patient's thoracoabdominal compliance, which can markedly affect chest wall compliance. PEEP should be titrated to maintain the FiO<sub>2</sub> below 60% to reduce the toxic effects of oxygen exposure on the lung. Recommended oxygenation goals are to achieve an arterial partial pressure of oxygen (PaO<sub>2</sub>) from 55–80 mm Hg or an oxyhemoglobin saturation (SpO<sub>2</sub>) by pulse oximetry from 88–95%. A minimum amount of positive end-expiratory pressure (PEEP) of 5–10 cm H<sub>2</sub>O should be applied to prevent lung collapse at end-expiration.

Hypercapnia may be required in patients with ALI/ARDS to minimize plateau pressures and tidal volumes. No upper limit for the arterial partial pressure of CO<sub>2</sub> (Paco<sub>2</sub>) has been established. Although some authorities recommend maintaining an arterial pH of 7.20–7.25, this has not been prospectively established. The use of hypercapnia should be limited in patients with preexisting metabolic acidosis and is contraindicated in patients with an increased intracranial pressure.

Several other therapies have been investigated in patients with severe ARDS. Inhaled NO selectively vasodilates areas of the pulmonary vasculature that are in contact with ventilated alveoli and thus decreases ventilation-perfusion mismatch and improves oxygenation. Because studies have not shown a reduction in mortality rate with NO treatment, and because the effect of inhaled NO on oxygenation may be limited to the first 24–48 hours of therapy, the use of NO is usually limited to rescue therapy in patients with life-threatening hypoxemia or pulmonary hypertension who are not responding to traditional therapy.<sup>78</sup> Similarly, prone positioning in respiratory failure is considered to be a rescue option for patients who are particularly difficult to oxygenate.<sup>79</sup> High-frequency oscillation ventilation has theoretical advantages of providing

TABLE 76-6.

## Optimal Ventilator Setting for Patients with Acute Lung Injury or Acute Respiratory Distress Syndrome

Ventilator Mode	Volume Assist Control
Tidal volume	6 mL/kg of predicted body weight
Plateau pressure	$\geq 30$ cm H <sub>2</sub> O
Ventilator rate	6–35 breaths/min to achieve pH goal of 7.3–7.45
I:E ration	1:1–1:3
Oxygenation	PaO <sub>2</sub> 55–80 mmHg SpO <sub>2</sub> 88–95%
FiO <sub>2</sub> /PEEP combinations	0.3 and 5 0.4 and 5 0.4 and 8 0.5 and 8 0.5 and 10 0.6 and 10 0.7 and 10 0.7 and 12 0.7 and 14 0.8 and 14 0.9 and 14 0.9 and 16 0.9 and 18 1.0 and 18 1.0 and 20 1.0 and 22 1.0 and 24 PEEP could be increased up to 34 cm H <sub>2</sub> O

FiO<sub>2</sub>, fraction of inspired oxygen; I:E, inspiration-to-expiration ration; PEEP, positive end-expiratory pressure; SpO<sub>2</sub>, oxygen saturation as measure by pulse oximetry.  
Brower RG, Matthay MA, Morris A, et al. Ventilation with lower tidal volumes as compared with traditional tidal volumes for acute lung injury and the acute respiratory distress syndrome. The Acute Respiratory Distress Syndrome Network. *N Engl J Med* 2000;342:1301. Copyright 2000, Massachusetts Medical Society. All rights reserved.

low tidal volumes, thus mitigating the adverse effects of conventional ventilation, such as overdistension and the repetitive opening and closing of collapsed lung units. Although high frequency oscillation used as salvage therapy may improve oxygenation, especially in patients with large bronchopleural fistulas, it has not been shown to improve mortality rates in ARDS.<sup>15</sup> Whether these adjunctive therapies are continued in the operating room requires a risk-to-benefit assessment. For example, gradual weaning from inhaled NO may be required to avert adverse rebound effects such as acute oxyhemoglobin desaturation, increased pulmonary artery pressures, and systemic hypotension.<sup>16</sup>

Patients with an abdominal compartment syndrome may develop severe respiratory dysfunction as a result of high intraabdominal pressures. These patients often benefit from a strategy of controlled ventilation with

moderate PEEP, and may require neuromuscular blocking agents. In addition, distension of the abdominal contents into the thorax may alter airway anatomy with a resultant mainstem intubation. This possibility should be considered if there is a sudden increase in airway pressures or reduction in tidal volume when these patients are receiving volume-controlled and pressure-controlled modes of ventilation, respectively.

Ventilators on conventional anesthesia machines may be unsuitable for use in the critically ill patient with respiratory failure. For example, some ventilators do not have an integrated method of applying varying quantities of PEEP. Other ventilators may predispose the patient to barotrauma because while they may have a high-pressure alarm, they do not have a pressure-limiter in the breathing circuit. The set tidal volume may not be the delivered volume be-

cause of gas compression losses in the breathing circuit due to its compliance. Furthermore, at high gas flow rates, the contribution of fresh gas during the inspiratory phase may significantly increase tidal volumes and airway pressures. In addition, advanced modes of ventilation such as pressure control ventilation may not be available. Thus, one must preoperatively assess whether the patient can be adequately ventilated using the ventilator present on the anesthesia machine or whether a critical care ventilator should be supplied in the operating room. The main disadvantage of employing a critical care ventilator is that inhaled anesthesia agents cannot be easily given.

### Cardiovascular

Patients with MODS may have hemodynamic instability as a result of impaired myocardial function, decreased systemic vascular tone, hypovolemia, and/or restrictive and obstructive processes that impair ventricular filling. Anesthesia and surgery may further exacerbate the hemodynamic issues, or may introduce new hemodynamic problems. For instance, many anesthetics can impair myocardial contractility and reduce vascular tone. Also, patients may become more hemodynamically unstable during and after the manipulation of infected sites. The hemodynamic effects of blood loss and third-space fluid losses may be more pronounced, particularly in patients with underlying myocardial dysfunction, a low peripheral vascular tone, or pulmonary hypertension.

Preoperative optimization should focus on correcting intravascular hypovolemia. Prior to volume repletion, patients with septic shock may have a combination of low peripheral vascular tone, low cardiac filling pressures, and decreased stroke volume. A hyperdynamic picture only emerges after volume resuscitation. Often patients with MODS have significant ongoing volume requirements because of bleeding or extravasation of intravascular fluid into the extravascular space resulting from capillary leakage following systemic inflammation. Such patients may require up to 10 L of crystalloid or other solutions for initial resuscitation. Hypovolemia should be corrected with balanced electrolyte solutions and/or blood products, de-

pending on the etiology and associated issues (such as a coagulopathy).

Fluid infusion alone will reverse the hypotension and restore hemodynamic stability in roughly half of the septic patients who present with hypotension.<sup>73</sup> However, infusion of pressors and/or inotropic agents may be required in patients with myocardial dysfunction and/or low peripheral vascular tone to optimize cardiac performance and tissue perfusion. If appropriate amounts of fluid resuscitation fail to promptly restore adequate systemic blood pressure and organ perfusion, therapy with vasopressor agents should be immediately commenced.<sup>73</sup> Inotropic agents such as dobutamine can be added to augment cardiac output, particularly in patients with a low cardiac output.

Patients with MODS will often have peripheral arterial and central venous catheters inserted in the ICU. In some cases thermodilution pulmonary artery catheters (PACs) may be indicated for preoperative optimization, and/or for intraoperative and postoperative care. For example, a PAC may be extremely helpful in patients with significant myocardial dysfunction, pulmonary hypertension, constrictive or restrictive cardiac processes, or renal failure who are undergoing major surgery. In addition, patients with underlying cardiac disease or pulmonary hypertension undergoing vascular procedures that will involve cross-clamping of the aorta may benefit from a PAC to optimize management of the extreme hemodynamic perturbations that occur with clamping and unclamping the proximal aorta.

It is often appropriate to place the PAC in the patient in the ICU prior to surgery. The data from the PAC will provide information about the patient's current hemodynamic state and physiologic reserves, as well as responses to therapy. In addition, the hemodynamic data measured with the PAC may be used to optimize the patient's volume status, myocardial function, and level of systemic vasomotor tone. A full description of indications for PAC placement is found in Chap. 79.

### Renal

Patients with renal failure may have a variety of metabolic and physiologic problems. Goals for renal optimization prior to surgery include correction of

metabolic and physiologic derangements related to renal failure, and protecting the kidneys from further damage.

Whenever possible, acid-base and electrolyte disturbances, including hyperkalemia and hyponatremia, should be corrected prior to surgery. Some patients with renal failure may require preoperative renal replacement therapy to treat metabolic acidosis, electrolyte imbalances, uremic pericarditis, or volume overload. Hyperkalemia should be corrected, either with binding agents such as sodium polystyrene sulfonate, or with renal replacement therapy. Consideration should be given to infusing DDAVP to correct uremic platelet dysfunction.

Both CVVH and intermittent hemodialysis are employed in critically ill patients who require renal replacement therapy. However, in the unstable patient, CVVH is preferred because it is better tolerated hemodynamically and allows continuous control of fluid balance and toxin removal. In hemofiltration, blood under pressure passes along one side of a highly permeable membrane that allows transfer of both water and substances below a molecular weight of approximately 20,000 daltons.<sup>80</sup> Urea, creatinine, and phosphate are cleared from the blood at similar rates. Larger molecules, such as heparin, insulin, and vancomycin, are also cleared. The filtrate is discarded and the patient receives a replacement fluid comprised of physiologic levels of the major crystalloid components of plasma. Total-body-fluid balance is regulated by varying the amount of replacement fluid the patient is given.

A variety of factors may negatively impact on kidney function, particularly the already failing kidney. The intravascular volume status, ongoing systemic inflammation, infusions of nephrotoxins such as intravenous contrast agents for vascular procedures and aminoglycosides for infections, and manipulation of the aorta which can lead to cholesterol emboli to the kidneys all can contribute to worsening renal dysfunction in the perioperative period. Preventive measures include preoperative optimization of intravascular volume and when possible, avoidance of nephrotoxins. In patients with acute renal failure who are to receive an IV contrast agent, preemptive strategies, including volume loading, alkalization

using IV NaHCO<sub>3</sub>, and/or administration of *N*-acetylcysteine should be undertaken.<sup>81</sup>

## Hepatic

Patients with hepatic dysfunction have a variety of issues that should be dealt with prior to surgery if possible. Hypoglycemia should be identified and plasma glucose levels should be maintained in a normal range using a dextrose infusion. Severe coagulopathy should be corrected prior to major surgery. Hepatic encephalopathy should be treated with lactulose.

## Hematologic

Critically ill patients often have hematologic disturbances, including anemia, coagulopathy, and thrombocytopenia. The preoperative management of anemia, coagulation disturbances, and thrombocytopenia will depend on the cause and severity of the disturbance, and the nature of the surgery. The anesthetic plan should take into account the anticipated blood loss for the procedure, the risks and benefits of stopping anticoagulant therapy preoperatively, and the need for transfusing red cells or other blood products both preoperatively and intraoperatively. If transfusion of blood or blood products is anticipated, an adequate recipient sample should be available in the blood bank for typing and cross-matching and the availability of sufficient supplies of blood products should be confirmed preoperatively. Patients who have had multiple transfusions may have developed circulating antibodies to non-ABO antigens. A consultation with a blood bank physician may be needed to select appropriate blood components for transfusion.

## Anemia

Red blood cell transfusions are given to augment the delivery of oxygen to the tissues and avoid the deleterious effects of oxygen debt. However, critically ill patients are at increased risk for complications of transfusion therapy, including the immunosuppressive effects that may predispose to infections, and microcirculatory complications. Current recommendations are that in the absence of active coronary artery disease red blood cell transfusion should only be given when the hemoglobin level decreases to 7.0 g/dL and should target a circulating hemoglobin level of 7.0–9.0 g/dL.<sup>82,83</sup>

## Coagulopathy

A coagulopathy may result from consumptive processes, such as DIC, or from decreased factor production, as occurs in hepatic failure. Plasma product infusions are indicated to correct hemostasis when bleeding arises from malfunction, consumption, or underproduction of plasma coagulation proteins.<sup>82,84</sup> Prophylactic administration of plasma products may be indicated to correct a coagulopathy before invasive procedures or surgery. If there is active bleeding that is associated with a coagulopathy, plasma products should be administered until bleeding stops or the coagulopathy is reversed. Vitamin K administration is indicated if vitamin K deficiency is present in order to raise the levels of vitamin K-dependent clotting factors (II, VII, IX, and X).

The choice of the plasma product for transfusion depends on the clinical circumstances. In the absence of coagulation inhibitors (including heparin) and in the presence of adequate fibrinogen levels (>100 mg/dL), hemostasis can usually be achieved when the activity of coagulation factors is at least 25–30% of normal. Fresh-frozen plasma (FFP) contains all the plasma clotting factors and is used to correct coagulopathies that result from a factor deficiency, such as occur in liver disease, DIC, or anticoagulation with warfarin. Cryoprecipitate is rich in von Willebrand factor (vWF), factor VIII, factor XIII, and fibrinogen, and is administered to treat congenital and acquired deficiencies of fibrinogen and factor XIII. Cryoprecipitate is a preferred source of vWF and required to manage von Willebrand disease.

Some patients may be receiving anticoagulation therapy (e.g., unfractionated or low-molecular-weight heparin, argatroban, lepirudin) because of DVT, atrial fibrillation/flutter, presence of prosthetic valves, or HIT. If possible, time should be allowed for Coumadin (warfarin) anticoagulation to reverse prior to surgery, which may require several days. For emergent or urgent procedures, the PT can be rapidly corrected with infusions of FFP. If vitamin K is used to reverse the effects of Coumadin (warfarin), very low doses should be administered (~1 mg), as larger doses may make it difficult to re-anticoagulate after the procedure. Patients with severe vascular disease or with coronary artery stents may be receiving antiplatelet agents

such as Plavix (clopidogrel) and aspirin. When possible, surgery should be delayed in patients who are on these agents until 7 days after the last dose.

## Thrombocytopenia

Platelet transfusions are used to manage patients who are bleeding or who are at risk of bleeding as a consequence of thrombocytopenia or impaired platelet function. Surgical bleeding solely caused by thrombocytopenia usually occurs when platelet counts are below 50,000/μL, and spontaneous bleeding occurs when platelet counts drop below 10,000/μL. However, additional factors, such as a concomitant coagulopathy, fever, renal failure, or treatment with nonsteroidal antiinflammatory drugs, may increase the bleeding risk from severe thrombocytopenia. Consequently, the threshold platelet count for triggering a prophylactic platelet transfusion should take into account these clinical considerations.<sup>82,84</sup>

## Metabolic/Endocrine Acid–Base Status

A variety of acid–base disturbances may be present in patients with MODS, and may complicate intraoperative management and/or be exacerbated by major surgery. For instance, metabolic acidosis may occur during and after surgery that involves significant volume or blood losses during periods of hypovolemia and decreased organ perfusion. Metabolic acidosis may also result from ischemia–reperfusion events, such as relief of vascular occlusion, opening an aortic cross clamp, or releasing a tourniquet on a limb at the conclusion of a peripheral orthopedic procedure.

In the preoperative period, acid–base disturbances should be identified, classified, and if severe should be corrected. Common causes of metabolic acidosis in MODS patients include impaired tissue perfusion due either to hypovolemia and/or hypotension, limb or GI vascular occlusion (e.g., ischemic bowel), renal failure, and administration of large volumes of normal saline. The preoperative management will depend on the degree of acidemia and the underlying etiology. GI or limb ischemia may require surgical intervention. Metabolic acidosis as a result of renal failure may be treated with hemodialysis (or CVVH) and/or bicarbonate, often given as a continu-



ous infusion. Metabolic acidosis caused by hypoperfusion may be treated medically by increasing intravascular volume and/or correcting myocardial or vascular tone problems with inotropic agents or vasopressors, depending on the underlying physiology. Hypovolemia can also cause metabolic alkalosis caused by decreased renal perfusion, and resultant increased secretion of aldosterone, and should be corrected by volume administration.

Depending on the mode of ventilation, respiratory acidosis caused by respiratory failure is often dealt with by increasing the ventilator rate, or by increasing the tidal volume or level of pressure control. However, some patients with severe hypercapnic respiratory failure do not have improved CO<sub>2</sub> exchange with increased rates (high  $V_{DS}/V_T$  [dead space gas volume-to-tidal gas volume ratio]). Moreover, currently used ventilation strategies often require patients to have a high PaCO<sub>2</sub>, in an effort to protect the lungs from ventilator-induced lung injury. Although permissive hypercapnia may decrease ventilator-induced lung injury, in the perioperative period, baseline respiratory acidosis may be more problematic because of the propensity to develop a superimposed metabolic acidosis.

### **Electrolytes**

If time permits, electrolyte abnormalities should be corrected prior to surgery. The method of correction is dictated by the nature and source of the abnormality. For instance, CVVH or hemodialysis may be required to correct hyperkalemia. Hypokalemia and hypomagnesemia can generally be corrected using IV supplementation. If surgery is emergent, intravenously treatment with insulin and glucose, and rectal or oral administration of sodium polystyrene sulfonate may be required to treat hyperkalemia.

### **Glucose**

Hyperglycemia and hypoglycemia should be corrected with insulin and glucose infusions respectively. As mentioned earlier in Insulin Therapy, strict glycemic control is practiced in many ICUs, and patients will frequently be receiving insulin infusions to maintain normoglycemia. All patients who are receiving an insulin infusion should also receive an infusion of glucose to prevent hypoglycemia. Con-

sideration should be given to continuing insulin infusions and obtaining frequent blood sugar levels both intra- and postoperatively.

### **Adrenal Dysfunction**

Adrenal insufficiency should be considered in patients that have persistent vasopressor requirements despite adequate intravascular volume repletion and other appropriate therapies. A cosyntropin stimulation test may help to identify patients with inappropriate adrenal responses. Baseline low cortisol levels or a failure to respond appropriately to cosyntropin should prompt consideration of treating patients with persistent vasopressor dependence with low-dose steroids. Patients that have been receiving steroids for sustained periods of time may have suppressed adrenal function, and should receive perioperative “stress-dose” steroids, depending on the nature of their surgery.

## **PLANNING THE ANESTHETIC AND PREPARING THE OPERATING ROOM FOR PATIENTS WITH MODS**

### **Planning the Anesthetic**

As is the case for all procedures, the anesthetic should be carefully planned and should be tailored to the individual patient's constellation of problems/issues. Specific issues regarding developing the anesthesia plan in critically ill patients, and pharmacologic issues in patients with MODS is reviewed in Chaps. 79. Decisions regarding the goals for fluid management can be difficult in patients with MODS. In particular, fluid management of patients with concomitant respiratory failure, worsening renal function, and/or cardiac dysfunction must take into account the often conflicting goals of these systems, and a thermodilution PAC may be useful in achieving an appropriate balance.

### **Decisions Regarding Continuation of ICU Therapies in the Operating Room**

During the preoperative visit, the anesthesiologist should decide whether or not to continue various therapies that are ongoing in the ICU. Some therapies, although required for longer-term management, may not be required for intraoperative management, and may be quite cumbersome to transport. For

instance, because CVVH requires equipment and fairly extensive education in its use, it may be appropriate to discontinue CVVH prior to surgery, and to make plans to resume CVVH immediately after the operation. If CVVH is to be continued in the operating room, arrangements will need to be made to have someone with CVVH expertise (usually not the anesthesiologist) to manage CVVH in the operating room. Decisions should be made regarding continuation of TPN, and infusions of drugs such as sedatives, narcotics, vasoactive agents, inotropic agents, and insulin in the operating room. As mentioned in Table 76-5 and in Transporting Patients with MODS to the Operating Room, if the patient requires high levels of ventilatory support or a complicated mode of ventilation, arrangements should be made to have the ICU ventilator accompany the patient to the operating room, and to have someone who is skilled in its use immediately available to assist with ventilatory changes in the operating room.

### **Preparing the Operating Room**

The operating room should be completely ready to receive the patient prior to leaving the ICU. With some patients, arrangements should be made to equip the operating room with the patient's ventilator, or with another ventilator that can achieve identical ventilatory conditions. The operating room should be stocked with the same vasopressors and inotropic agents that the patient is receiving in the ICU.

## **TRANSPORTING PATIENTS WITH MODS TO THE OPERATING ROOM**

Transportation to the operating room can be risky for patients with MODS. This topic is reviewed in detail in Chap. 80. The anesthesiologist should plan to accompany the patient from the ICU to the operating room, and should carefully plan the trip. Arrangements should be made to continue monitoring appropriate parameters, such as systemic arterial, pulmonary artery, and intracranial pressures. It may be necessary to transport the patient with severe respiratory failure who is receiving high levels of ventilatory support with a ventilator. Transport with a PEEP valve may be appropriate in patients who are PEEP-dependent and who can tolerate

short periods of manual ventilation. If there is uncertainty as to whether or not a patient can tolerate transportation from a respiratory standpoint, a trial of manual ventilation in the ICU prior to transport can be helpful.

## SUMMARY

As technology and therapies for basic diseases and acute processes such as shock and respiratory failure advance, a more modern syndrome has evolved. Multiorgan dysfunction syndrome is an enigmatic process that seems to be caused by generalized inflammation and microvascular circulatory abnormalities. The similarity in MODS resulting from either infectious or non-infectious diseases suggests that common pathways are involved. Defining these pathways will likely yield new targets for treatment in critically ill patients.

Anesthesiologists are frequently involved in the care of patients with MODS, either in the ICU or in the operating room. MODS patients often require surgery, either for the primary process or to deal with complications. The anesthesiologist will be involved in the decisions regarding the timing of surgery, and in optimizing the patient for surgery. Communication between the anesthesiologist, the ICU team, and the surgeon is crucial as part of the preoperative preparation.

Prior to transport to the operating room a comprehensive plan that is tailored to the patient's individual constellation of abnormalities should be in place. Preoperative planning should include decisions regarding continuation of therapies such as CVVH, TPN, insulin; arrangements for the patient's ventilator to accompany the patient to the operating room if appropriate; sedation and analgesia; availability of appropriate fluids, blood products and monitoring equipment; and a clear understanding of the plan regarding perioperative resuscitation for cardiac arrest or catastrophic events. Preoperative and intraoperative interventions will be dictated by the pattern and intensity of organ failure.

## KEY REFERENCES

1. Bone RC, Balk RA, Cerra FB, et al. Definitions for sepsis and organ fail-

ure and guidelines for the use of innovative therapies in sepsis. The ACCP/SCCM Consensus Conference Committee. American College of Chest Physicians/Society of Critical Care Medicine. *Chest* 1992;101:1644.

2. Levy MM, Fink MP, Marshall JC, et al. 2001 SCCM/ESICM/ACCP/ATS/SIS International Sepsis Definitions Conference. *Crit Care Med* 2003;31:1250-1256.

3. Beal AL, Cerra FB. Multiple organ failure syndrome in the 1990s. Systemic inflammatory response and organ dysfunction. *JAMA* 1994;271:226.

4. Wolfe BM, Moore PG. Preparation of the intensive care patient for major surgery. *World J Surg* 1993;17:184.

5. Jodka PG, Heard SO. Management of the septic patient in the operating room. *Int Anesthesiol Clin* 2000;38:1.

6. Brower RG, Matthay MA, Morris A, et al. Ventilation with lower tidal volumes as compared with traditional tidal volumes for acute lung injury and the acute respiratory distress syndrome. The Acute Respiratory Distress Syndrome Network. *N Engl J Med* 2000;342:1301.

7. Bernard GR, Vincent JL, Laterre PF, et al. Efficacy and safety of recombinant human activated protein C for severe sepsis. *N Engl J Med* 2001;344:699.

8. Annane D, Sebille V, Charpentier C, et al. Effect of treatment with low doses of hydrocortisone and fludrocortisone on mortality in patients with septic shock. *JAMA* 2002;288:862.

9. Moore FA, Moore EE. Postinjury multiple organ failure. In: Moore EE, Feliciano DV, Mattox KL, eds. *Trauma*. 5th ed. New York: McGraw-Hill, 2004:1397.

10. Pinsky MR. Pathophysiology and therapy of end-organ failure in critical illness. *Proc Assoc Am Physicians* 1995;107:353.

11. van den Berghe G, Wouters P, Weekers F, et al. Intensive insulin therapy in the critically ill patients. *N Engl J Med* 2001;345:1359-1367.

## REFERENCES

1. Carrico CJ, Meakins JL, Marshall JC, et al. Multiple-organ-failure syndrome. *Arch Surg* 1986;121:196.

2. Tran DD, Groeneveld AB, van der MJ, et al. Age, chronic disease, sepsis, organ system failure, and mortality in a medical intensive care unit. *Crit Care Med* 1990;18:474.

3. Pruitt BA Jr. Centennial changes in surgical care and research. *Ann Surg* 2000;232:287.

4. Moore FA, Moore EE. Postinjury multiple organ failure. In: Moore EE, Feliciano DV, Mattox KL, eds. *Trauma*. 5th ed. New York: McGraw-Hill, 2004:1397.

5. Ashbaugh DG, Bigelow DB, Petty TL, et al. Acute respiratory distress in adults. *Lancet* 1967;2:319.

6. Baue AE. Multiple, progressive, or sequential systems failure. A syndrome of the 1970s. *Arch Surg* 1975;110:779.

7. Baue AE. Multiple organ failure, multiple organ dysfunction syndrome, and systemic inflammatory response syndrome. Why no magic bullets? *Arch Surg* 1997;132:703.

8. Bone RC, Balk RA, Cerra FB, et al. Definitions for sepsis and organ failure and guidelines for the use of innovative therapies in sepsis. The ACCP/SCCM Consensus Conference Committee. American College of Chest Physicians/Society of Critical Care Medicine. *Chest* 1992;101:1644.

9. Eiseman B, Beart R, Norton L. Multiple organ failure. *Surg Gynecol Obstet* 1977;144:323.

10. Fry DE, Pearlstein L, Fulton RL, et al. Multiple system organ failure. The role of uncontrolled infection. *Arch Surg* 1980;115:136.

11. Levy MM, Fink MP, Marshall JC, et al. 2001 SCCM/ESICM/ACCP/ATS/SIS International Sepsis Definitions Conference. *Crit Care Med* 2003;31:1250.

12. Knaus WA, Draper EA, Wagner DP, et al. APACHE II. A severity of disease classification system. *Crit Care Med* 1985;13:818.

13. Knaus WA, Wagner DP, Draper EA, et al. The APACHE III prognostic system. Risk prediction of hospital mortality for critically ill hospitalized adults. *Chest* 1991;100:1619.

14. Vincent JL, Moreno R, Takala J, et al. The SOFA (sepsis-related organ failure assessment) score to describe organ dysfunction/failure. On behalf of the Working Group on Sepsis-Related Problems of the European Society of Intensive Care Medicine. *Intensive Care Med* 1996;22:707.

15. Marshall JC, Cook DJ, Christou NV, et al. Multiple organ dysfunction score: a reliable descriptor of a complex clinical outcome. *Crit Care Med* 1995;23:1638.

16. Martin CM, Hill AD, Burns K, et al. Characteristics and outcomes for critically ill patients with prolonged intensive care unit stays. *Crit Care Med* 2005;33:1922.

17. Fry DE. Multiple system organ failure. *Surg Clin North Am* 1988;68:107.

18. Beal AL, Cerra FB. Multiple organ failure syndrome in the 1990s. Systemic inflammatory response and organ dysfunction. *JAMA* 1994;271:226.
19. Zimmerman JE, Knaus WA, Wagner DP, et al. A comparison of risks and outcomes for patients with organ system failure: 1982–1990. *Crit Care Med* 1996;24:1633.
20. Knaus WA, Draper EA, Wagner DP, et al. Prognosis in acute organ-system failure. *Ann Surg* 1985;202:685.
21. Tran DD, Cuesta MA, van Leeuwen PA, et al. Risk factors for multiple organ system failure and death in critically injured patients. *Surgery* 1993;114:21.
22. Annane D, Bellissant E, Cavaillon JM. Septic shock. *Lancet* 2005;365:63.
23. Knaus WA, Wagner DP. Multiple systems organ failure: epidemiology and prognosis. *Crit Care Clin* 1989;5:221.
24. Deitch EA. Multiple organ failure. Pathophysiology and potential future therapy. *Ann Surg* 1992;216:117.
25. Zimmerman JE, Knaus WA, Sun X, et al. Severity stratification and outcome prediction for multisystem organ failure and dysfunction. *World J Surg* 1996;20:401.
26. Faist E, Baue AE, Dittmer H, et al. Multiple organ failure in polytrauma patients. *J Trauma* 1983;23:775.
27. Pine RW, Wertz MJ, Lennard ES, et al. Determinants of organ malfunction or death in patients with intra-abdominal sepsis. A discriminant analysis. *Arch Surg* 1983;118:242.
28. De Mendonca A, Vincent JL, Suter PM, et al. Acute renal failure in the ICU. risk factors and outcome evaluated by the SOFA score. *Intensive Care Med* 2000;26:915.
29. Livingston DH, Deitch EA. Multiple organ failure: a common problem in surgical intensive care unit patients. *Ann Med* 1995;27:13.
30. Pinsky MR. Pathophysiology and therapy of end-organ failure in critical illness. *Proc Assoc Am Physicians* 1995;107:353.
31. McGill SN, Ahmed NA, Christou NV. Endothelial cells: role in infection and inflammation. *World J Surg* 1998;22:171.
32. Reinhart K, Bayer O, Brunkhorst F, et al. Markers of endothelial damage in organ dysfunction and sepsis. *Crit Care Med* 2002;30:S302–S312.
33. Ruan QR, Zhang WJ, Hufnagl P, et al. Anisodamine counteracts lipopolysaccharide-induced tissue factor and plasminogen activator inhibitor-1, expression in human endothelial cells: contribution of the NF-kappa B pathway. *J Vasc Res* 2001;38:13.
34. Doshi SN, Marmur JD. Evolving role of tissue factor and its pathway inhibitor. *Crit Care Med* 2002;30:S241–S250.
35. Matthay MA. Severe sepsis—a new treatment with both anticoagulant and anti-inflammatory properties. *N Engl J Med* 2001;344:759.
36. Bernard GR, Vincent JL, Laterra PF, et al. Efficacy and safety of recombinant human activated protein C for severe sepsis. *N Engl J Med* 2001;344:699.
37. Deitch EA, Winterton J, Li M, et al. The gut as a portal of entry for bacteremia. Role of protein malnutrition. *Ann Surg* 1987;205:681.
38. Fine J, Palmerio C, Rutenburg S. New developments in therapy of refractory traumatic shock. *Arch Surg* 1968;96:163.
39. Brathwaite CE, Ross SE, Nagele R, et al. Bacterial translocation occurs in humans after traumatic injury: evidence using immunofluorescence. *J Trauma* 1993;34:586.
40. Moore FA, Moore EE, Poggetti R, et al. Gut bacterial translocation via the portal vein: a clinical perspective with major torso trauma. *J Trauma* 1991;31:629.
41. Moore FA, Sauaia A, Moore EE, et al. Postinjury multiple organ failure: a bimodal phenomenon. *J Trauma* 1996;40:501.
42. Bernard GR, Artigas A, Brigham KL, et al. The American-European Consensus Conference on ARDS. Definitions, mechanisms, relevant outcomes, and clinical trial coordination. *Am J Respir Crit Care Med* 1994;149:818.
43. Hudson LD, Milberg JA, Anardi D, et al. Clinical risks for development of the acute respiratory distress syndrome. *Am J Respir Crit Care Med* 1995;151:293.
44. Hyers TM. Prediction of survival and mortality in patients with adult respiratory distress syndrome. *New Horiz* 1993;1:466.
45. Luce JM. Acute lung injury and the acute respiratory distress syndrome. *Crit Care Med* 1998;26:369.
46. Fein AM, Lippmann M, Holtzman H, et al. The risk factors, incidence, and prognosis of ARDS following septicemia. *Chest* 1983;83:40.
47. Ciesla DJ, Moore EE, Johnson JL, et al. The role of the lung in postinjury multiple organ failure. *Surgery* 2005;138:749.
48. Cariou A, Vinsonneau C, Dhainaut JF. Adjunctive therapies in sepsis: an evidence-based review. *Crit Care Med* 2004;32:S562–S570.
49. Arabi Y, Ahmed QA, Haddad S, et al. Outcome predictors of cirrhosis patients admitted to the intensive care unit. *Eur J Gastroenterol Hepatol* 2004;16:333.
50. Gill RQ and Sterling RK. Acute liver failure. *J Clin Gastroenterol* 2001;33:191.
51. Schneider RC, Zapol WM, Carvalho AC. Platelet consumption and sequestration in severe acute respiratory failure. *Am Rev Respir Dis* 1980;122:445.
52. Comunale ME, Van Cott EM. Heparin-induced thrombocytopenia. *Int Anesthesiol Clin* 2004;42:27.
53. Di Nisio M, Middeldorp S, Buller HR. Direct thrombin inhibitors. *N Engl J Med* 2005;353:1028.
54. Kreger BE, Craven DE, McCabe WR. Gram-negative bacteremia. IV. Re-evaluation of clinical features and treatment in 612 patients. *Am J Med* 1980;68:344.
55. Bolton CF. Neuromuscular complications of sepsis. *Intensive Care Med* 1993;19(Suppl 2):S58–S63.
56. Bolton CF. Sepsis and the systemic inflammatory response syndrome: neuromuscular manifestations. *Crit Care Med* 1996;24:1408.
57. Schelling G, Stoll C, Haller M, et al. Health-related quality of life and posttraumatic stress disorder in survivors of the acute respiratory distress syndrome. *Crit Care Med* 1998;26:651.
58. Jacobi J, Fraser GL, Coursin DB, et al. Clinical practice guidelines for the sustained use of sedatives and analgesics in the critically ill adult. *Crit Care Med* 2002;30:119.
59. van den Berghe G, Wouters P, Weekers F. Intensive insulin therapy in the critically ill patients. *N Engl J Med* 2001;345:1359.
60. Cooper MS, Stewart PM. Corticosteroid insufficiency in acutely ill patients. *N Engl J Med* 2003;348:727.
61. Annane D, Sebille V, Charpentier C, et al. Effect of treatment with low doses of hydrocortisone and fludrocortisone on mortality in patients with septic shock. *JAMA* 2002;288:862.
62. Moore FA, Feliciano DV, Andrassy RJ, et al. Early enteral feeding, compared with parenteral, reduces postoperative septic complications. The results of a meta-analysis. *Ann Surg* 1992;216:172.
63. Marik PE, Zaloga GP. Early enteral nutrition in acutely ill patients: a systematic review. *Crit Care Med* 2001;29:2264.
64. Singer M. Management of multiple organ failure: guidelines but no hard-and-fast rules. *J Antimicrob Chemother* 1998;41(Suppl A):103–112.
65. van Saene HK, Stoutenbeek CP, Hart CA. Selective decontamination of the digestive tract (SDD) in intensive care patients: a critical evaluation of the clinical, bacteriological and epidemiological benefits. *J Hosp Infect* 1991;18:261.
66. Ledingham IM, Alcock SR, Eastaway AT, et al. Triple regimen of selective decontamination of the digestive tract, systemic cefotaxime, and microbiological surveillance for prevention of acquired infection in intensive care. *Lancet* 1988;1:785.
67. Ramsay G, van Saene RH. Selective gut decontamination in intensive care and surgical practice: where are we? *World J Surg* 1998;22:164.
68. Hotchkiss RS, Karl IE. The pathophysiology and treatment of sepsis. *N Engl J Med* 2003;348:138.
69. Krinsley JS. Effect of an intensive glucose management protocol on the mortality of critically ill adult patients. *Mayo Clin Proc* 2004;79:992.

70. Kellum JA, Venkataraman R. Application of blood purification to non-renal organ failure. *Int J Artif Organs* 2005;28:445.
71. Kellum JA, Bellomo R, Mehta R, et al. Blood purification in non-renal critical illness. *Blood Purif* 2003;21:6.
72. Dugernier T, Reynaert M, Laterre PF. Early multi-system organ failure associated with acute pancreatitis: a plea for a conservative therapeutic strategy. *Acta Gastroenterol Belg* 2003;66:177.
73. Hollenberg SM, Ahrens TS, Annane D, et al. Practice parameters for hemodynamic support of sepsis in adult patients: 2004 update. *Crit Care Med* 2004;32:1928.
74. Dreyfuss D, Saumon G. Ventilator-induced lung injury: lessons from experimental studies. *Am J Respir Crit Care Med* 1998;157:294.
75. Slutsky AS, Tremblay LN. Multiple system organ failure. Is mechanical ventilation a contributing factor? *Am J Respir Crit Care Med* 1998;157:1721.
76. Brower RG, Matthay MA, Morris A, et al. Ventilation with lower tidal volumes as compared with traditional tidal volumes for acute lung injury and the acute respiratory distress syndrome. The Acute Respiratory Distress Syndrome Network. *N Engl J Med* 2000;342:1301.
77. Sevransky JE, Levy MM, Marini JJ. Mechanical ventilation in sepsis-induced acute lung injury/acute respiratory distress syndrome: an evidence-based review. *Crit Care Med* 2004;32:S548–S553.
78. Dellinger RP, Zimmerman JL, Taylor RW, et al. Effects of inhaled nitric oxide in patients with acute respiratory distress syndrome: results of a randomized phase II trial. Inhaled Nitric Oxide in ARDS Study Group. *Crit Care Med* 1998;26:15.
79. Gattinoni L, Tognoni G, Pesenti A, et al. Effect of prone positioning on the survival of patients with acute respiratory failure. *N Engl J Med* 2001;345:568.
80. Forni LG, Hilton PJ. Continuous hemofiltration in the treatment of acute renal failure. *N Engl J Med* 1997;336:1303.
81. Weisbord SD, Palevsky PM. Radiocontrast-induced acute renal failure. *J Intensive Care Med* 2005;20:63.
82. Zimmerman JL. Use of blood products in sepsis: an evidence-based review. *Crit Care Med* 2004;32:S542–S547.
83. Hebert PC, Wells G, Blajchman MA, et al. A multicenter, randomized, controlled clinical trial of transfusion requirements in critical care. Transfusion Requirements in Critical Care Investigators, Canadian Critical Care Trials Group. *N Engl J Med* 1999;340:409.
84. Stehling LC, Doherty DC, Faust RJ, et al. Practice guidelines for blood component therapy: A report by the American Society of Anesthesiologists Task Force on Blood Component Therapy. *Anesthesiology* 1996;84:732.



## CHAPTER 77

### Evaluation of the Burned Patient

Edward A. Bittner, MD, PhD,  
Loreta Grecu, MD, and  
J.A. Jeevendra Martyn, MD, FCCM

#### EPIDEMIOLOGY

In the United States each year, approximately 1.25 million people are burned, of whom 55,000 are hospitalized and 5500 die.<sup>1</sup> The natural history of serious burns is characterized by burn shock, which can be fatal within the first few hours to days, particularly in those with untreated large burns. Burn wound sepsis is the major cause of mortality among those who survive the burn shock. After recovery from the acute inflammatory phase, postburn deformities delay full functional recovery.<sup>2</sup> In-hospital fatality rates are approximately 4% among patients with major injuries who are treated in specialized burn units. Survival and outcome after major burn injury have improved over the last 20 years because of improved understanding of the pathophysiologic nature of burn injury, better and early resuscitation, development of multidisciplinary burn-treatment teams, and advances in control of postburn sepsis including early, aggressive surgical treatment and improved perioperative care.<sup>2</sup>

#### BURN INJURY PATHOPHYSIOLOGY

Severe burn injury results in significant hypovolemic shock and tissue trauma. The intravascular volume loss is related to the formation and release of local and systemic inflammatory mediators. In addition, pathophysiologic changes occur at local and distant sites even when the hypovolemia is corrected. Increases in pulmonary and systemic vascular resistance in association with myocardial depression occur despite adequate fluid resuscitation.<sup>3-6</sup> Mediators implicated in the pathogenesis of burn injury include histamine (HA), serotonin (5-HT<sub>3</sub>), ki-

nins, O<sub>2</sub> free radicals, and products of the arachidonic acid cascade.<sup>7</sup> Cytokines are primary mediators of inflammation after burns. Endogenous mediators that alter cardiovascular function are elevated several-fold after burn injury and include epinephrine, norepinephrine, vasopressin, angiotensin II, and neuropeptide Y.<sup>8</sup> Most recently, vascular endothelial growth factor (VEGF) has been implicated in tissue edema following ischemia-reperfusion injury.<sup>9</sup> Its relevance to burn edema is unknown.

#### Hypovolemia and Rapid Edema Formation

The generalized capillary leak leads to decreased plasma volume, cardiac output, urine output and increased systemic vascular resistance (SVR). In contrast to nonburn trauma, the fluid loss with burn injury leads to hemoconcentration. The initial therapeutic goal is res-

toration of intravascular volume so as to preserve tissue perfusion and minimize the inflammatory response. The fluid loss of burns occurs not only at the area of burn wound but also at distant nonburned tissues. Continued loss of plasma volume with hypovolemia as a result of edema formation can occur up to the first 48 hours—or even longer—after major burn injury. The immediate and rapid increase in the edema of burn tissue is followed by a more gradual increase in fluid extravasation in both burned and nonburned tissues. The edema in noninjured tissues occurs when the injury exceeds 25% of total body surface area (TBSA).<sup>10</sup>

#### Mechanisms of Burn Edema

Burn injury causes direct and indirect mediator-modulated changes in the capillary integrity leading to increases in protein and water permeability.<sup>11</sup> Circulating endogenous mediators play

#### KEY POINTS

1. Hemodynamics in the early phase of severe burn injury are characterized by a reduction in cardiac output, increased systemic and pulmonary vascular resistance with or without pulmonary edema. Approximately 3–5 days after major burn injury, a hyperdynamic and hypermetabolic state is seen with tachycardia, increased stroke volume, hyperthermia and increased protein catabolism.
2. Patients with severe burn injury often suffer from nonthermal traumatic injuries. Failure to diagnose these associated injuries during initial evaluation can lead to serious morbidity and mortality. All burn patients should be approached initially as multiple-trauma patients.
3. Inhalation injury is a major source of mortality in burn patients. If the history and physical examination are suggestive of inhalation injury one should have a low threshold for early intubation.
4. Multiple fluid resuscitation formulae exist for estimating fluid needs differing somewhat in their recommendations of the amount of crystalloid and colloid. The Parkland formula, one of the most popular, uses 4 cc per %TBSA (percent total body surface area) burn per kg administered over the first 24 hours with one-half of the calculated volume administered during the first 8 postinjury hours. The remaining half is administered over the next 16 hours.
5. The magnitude of burns is classified according to the total body surface area (TBSA) involved, depth of the burn, and the presence or absence of inhalational injury. TBSA burned in adults can be estimated using the “rule of nines,” an age-specific diagram, or by estimation using palmar surface of the hand.
6. Prophylactic antibiotics have no proven role in burn care and are not routinely given. All burn injuries are potentially contaminated soft-tissue wounds, and therefore tetanus toxoid should be given to all burned patients.
7. Electrical burns can have acute and chronic effects not seen with other types of burn injury, and with morbidity much higher than expected based on burn size alone. High-voltage injuries are typically associated with loss of consciousness, arrhythmias, myoglobinuria, and extensive deep tissue damage that can result in compartment syndromes. However, significant injury can result from low- and mid-range voltage sources.

pivotal roles in the pathogenesis of edema formation and the cardiovascular abnormalities associated with burn injury. These mediators alter vascular permeability directly and/or indirectly by increasing microvascular hydrostatic pressure or surface area via arteriolar vasodilatation. Because of the multiplicity of mediators, therapy to antagonize one single mediator (e.g., histamine) has not proved successful.

### Hypermetabolic Response to Burns

Severe burn injury results in a hypermetabolic response that is more severe and sustained than any other form of trauma.<sup>12</sup> The resting metabolic rate ranges from near normal with burns <10% TBSA to twice normal in burns >40% TBSA.<sup>13,14</sup> The early phase of burn injury (first 1–2 days) is characterized by decreased cardiac output, and metabolic rate. Cardiac output and metabolic rate increase over time plateauing around postburn day 5. This increase in metabolism in association with muscle catabolism lasts through the convalescent period—even as long as 12 months postinjury in patients with major burns.<sup>15</sup> As a result, lean muscle mass continues to decrease with a negative nitrogen balance despite aggressive nutritional support. This is concerning as loss of a quarter of total body nitrogen balance can be fatal and this limit can easily be reached within 3–4 weeks in burn patients who are not receiving maximal nutritional support.<sup>16</sup> Nutritional support, even with exogenous insulin, cannot, in isolation, prevent or reverse the catabolic response to burn injury.

### HEMODYNAMIC RESPONSE TO BURNS

#### Altered Cardiac Output

There is an immediate depression of cardiac output even before any detectable reduction in plasma volume. This rapid depression suggests a neurogenic response and/or increased circulating mediators. Soon after, the hypovolemia contributes to the depressed cardiac output. The persistence of reduced cardiac output with repletion of fluid volume has been attributed to circulating myocardial depressant factors.<sup>17–20</sup> In addition, decreased adrenoceptor affinity and second-messenger function may result in an attenuated re-

sponse to catecholamines.<sup>21,22</sup> Approximately 3–5 days after major burn injury, supranormal cardiac output (sometimes more than double) is seen. This correlates with the onset of the hypermetabolic state.

### Increased Systemic Vascular Resistance

Sympathetic stimulation and hypovolemia related to burn injury result in release of catecholamines, vasopressin, angiotensin II, and neuropeptide Y, leading to increased vasoconstriction and SVR.<sup>8</sup> Increased SVR immediately after burn injury is also partly the result of increased blood viscosity secondary to hemoconcentration. Organs particularly susceptible to ischemia and dysfunction secondary to inadequate resuscitation and vasoconstriction are the kidneys and gastrointestinal (GI) tract. Myoglobinemia as a consequence of muscle destruction can also contribute to the renal injury.<sup>23,24</sup> Sustained vasoconstriction of the GI tract can occur even with adequate resuscitation leading to ischemia and bacterial translocation.<sup>25,26</sup>

### Pulmonary Edema

There is an increase in pulmonary vascular resistance (PVR) following major burns. Pulmonary edema may occur, especially after the fluid resuscitation phase and restoration of capillary integrity (48–72 hours after burn injury), when the edema fluid is reabsorbed leading to hypervolemia. Initially the edema results mainly from increased capillary pressure secondary to increased PVR. Pulmonary capillary wedge pressure is increased greater than left atrial pressure after experimental burn injury caused by postcapillary venoconstriction.<sup>27</sup> It is likely that some left-heart failure also contributes to the pulmonary edema. Developing hypoproteinemia may be an important contributing factor for postburn pulmonary edema.<sup>27</sup> Pulmonary dysfunction from inhalation injury may also occur.

### INITIAL EVALUATION

#### Primary Survey

Between 5% and 7% of patients admitted to burn centers suffer from non-thermal traumatic injuries.<sup>28</sup> Because failure to diagnose these associated injuries during the initial evaluation

can lead to unnecessary morbidity and mortality, all burn patients should be approached initially as multiple-trauma patients.

Securing the airway is the first priority during the initial evaluation; safe airway management begins with its assessment. The presence of airway injury, signs of airway obstruction and presence of preexisting airway abnormality should be assessed as soon as the patient arrives at the hospital. Airway injuries may not be evident initially but with massive fluid resuscitation airway edema may result. As a general rule it is safer to intubate the patient early than risk a difficult intubation after airway swelling has occurred. With injuries of the face or neck, direct laryngoscopy may be difficult or impossible. When the upper airway is severely damaged and the laryngoscopy and endotracheal intubation are anticipated to be difficult, a direct surgical approach to the airway may be indicated. Options include a cricothyroidotomy or tracheostomy.

### INHALATION INJURY

Inhalation injury increases the resuscitation fluid requirements by up to 50% and is a major source of mortality in burn patients.<sup>29</sup> A history of exposure to fire in a closed space, loss of consciousness, and presence of chemical irritants in combination with the physical examination revealing carbonaceous sputum, and singed nasal or facial hair are all suggestive of inhalational injury. Chest radiographs are usually normal until secondary complications, such as atelectasis or pneumonia, develop. Fiberoptic bronchoscopy may be used to support the diagnosis, which may reveal carbonaceous debris, erythema, or ulceration.<sup>30</sup> The mechanism of inhalation injury consists of a combination of (a) direct thermal injury to the upper airway from inhalation of hot gases, (b) damage to the cellular and oxygen transport processes by inhalation of carbon monoxide and cyanide, (c) chemical injury to the lower airways caused by inhalation of the toxic products from the fire.<sup>31</sup>

#### Direct Injury to the Upper Airway

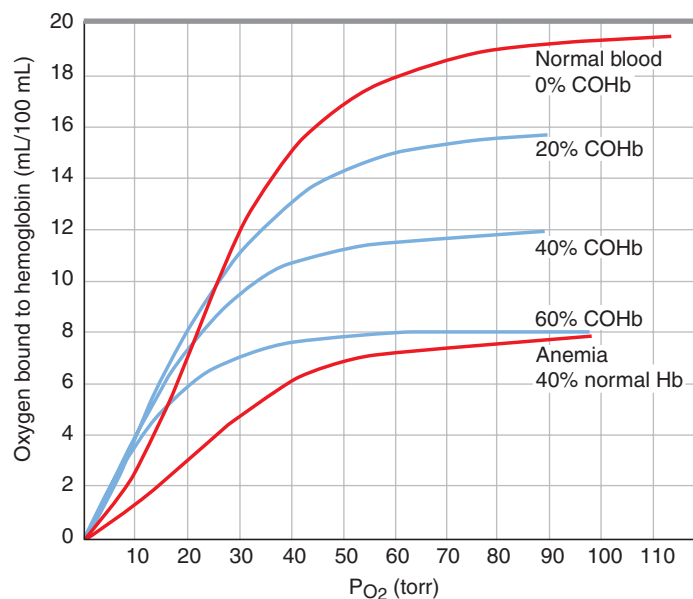
Direct heat injury to the airway usually only occurs to the depth of the carina because of efficient dissipation

of heat by the upper airway, low specific heat of air, and reflex closure of the glottis as a result of the irritant. Direct heat injury to the upper airway can lead to marked swelling of the tongue, epiglottis, and glottic opening, resulting in airway obstruction.<sup>31</sup> Because airway swelling may not occur immediately but may develop over a period of hours (especially with concurrent fluid resuscitation), a high index of suspicion and frequent re-evaluations are essential. Upper airway edema will have more immediate consequences in smaller children. Signs of impending upper airway obstruction include hoarseness, retractions and stridor. If the history and physical examination are suggestive of inhalational injury, one should have a low threshold for early intubation, particularly in children. If intubation is delayed and significant swelling occurs, intubation can become difficult or impossible. Upper airway edema usually resolves in 3–6 days and is facilitated by elevation of the head of the bed and avoidance of excessive fluid administration.

### Carbon Monoxide Poisoning

Carbon monoxide (CO) causes tissue hypoxia; the oxygen-carrying capacity of blood is decreased because both CO and oxygen compete for the same binding sites on hemoglobin (Hgb). Because CO binds to Hgb 200 times more readily than oxygen, it can significantly reduce the oxygen carrying capacity of blood.<sup>32</sup> Binding of CO to Hgb also shifts the oxyhemoglobin dissociation curve to the left and alters its shape (Fig. 77-1). In addition, CO interferes with peripheral oxygen use by binding to molecules such as myoglobin, nicotinamide adenine dinucleotide phosphate reductase, and cytochrome oxidase system, resulting in impaired oxidative phosphorylation at the mitochondrial level.<sup>33</sup> The mitochondrial dysfunction caused by CO has been best documented in the heart where it has been shown to produce myocardial stunning.<sup>34</sup> The consequence of these changes is decreased oxygen delivery to the tissues, impaired release of the available oxygen at the capillaries, and weakened ability to use the delivered oxygen resulting in tissue hypoxia and metabolic acidosis.

CO poisoning can be difficult to detect. CO is an odorless, tasteless, non-



**FIGURE 77-1.** Carboxyhemoglobin dissociation curve. The changes in the oxygen–hemoglobin dissociation curve that occur with carbon monoxide poisoning. The oxygen bound to hemoglobin is decreased depending on the CO concentration and oxygen–hemoglobin dissociation curve is shifted to the left, resulting in less oxygen being delivered to tissues and the oxygen carried by hemoglobin being more tightly bound. (Reproduced with permission from McCall J, Cahill T. Respiratory care of the burn patient. *J Burn Care Rehab* 2005;26:200–206.)

irritating gas. The clinical findings of CO poisoning are variable and largely nonspecific. Clinical signs and symptoms of tissue hypoxia as a result of CO poisoning include headache, nausea, shortness of breath, tachypnea, angina, and changes in mental status.<sup>35</sup> The half-life of carboxyhemoglobin is 4 hours for a person breathing room air. This is reduced to 40–60 minutes when breathing 100% oxygen. Hyperbaric oxygen will further reduce the half-life of carboxyhemoglobin to 23 minutes.<sup>36</sup> In those patients with more severe exposures (carboxyhemoglobin level greater than 30% or evidence of neurologic changes), hyperbaric oxygen has been suggested to diminish the incidence of long-term neurologic sequelae.<sup>37,38</sup> Unfortunately, hyperbaric oxygen chambers are not uniformly available.

The absorbance spectrum of carboxyhemoglobin and oxyhemoglobin are similar therefore standard pulse oximeters cannot distinguish between the two forms of hemoglobin. Consequently, oximeter readings will be normal even when lethal amounts of carboxyhemoglobin are present in blood.<sup>39</sup> The Pao<sub>2</sub> measured from arterial blood gas sample reflects the amount of oxygen dissolved in blood and does not indicate oxygen bound to

hemoglobin (saturation). Thus the Pao<sub>2</sub> can be normal even with high levels of carboxyhemoglobin. The diagnosis of CO poisoning is made by measuring the carboxyhemoglobin level in arterial blood, expressed as a percent saturation of hemoglobin. Carboxyhemoglobin levels >15% are toxic; those exceeding 50% are lethal.<sup>40</sup> Because of the inevitable time delay between exposure and testing, the levels of carboxyhemoglobin measured may not reflect the true extent of poisoning especially when the patient has been breathing a high concentration of oxygen.

### Cyanide Poisoning

Hydrogen cyanide is a toxic gas produced in fires by the burning of nitrogenous materials, including natural fibers (wool and silk) and synthetic polymers (polyurethane, polyacrylonitrile, and acrocyanate). Cyanide binds to mitochondrial cytochrome oxidase, which catalyzes the last step in the oxidative phosphorylation (adenosine triphosphate [ATP] formation) pathway, preventing use of oxygen by mitochondria. Cyanide also arrests the tricarboxylic acid cycle. The pathophysiologic sequel of cyanide poisoning is that cells can only generate ATP via anaerobic metabolism, which re-

sults in a metabolic acidosis from lactic acid production.

As with CO poisoning, cyanide toxicity can be difficult to diagnose. Cyanide toxicity should be suspected in any patient with a history of inhalation injury. Concentrations greater than 20 ppm are considered dangerous. Early symptoms include headache, dizziness, tachypnea, and tachycardia. Cardiac toxicity may manifest as ST-segment elevation on electrocardiogram (ECG), which can mimic an acute myocardial infarction. Cyanide increases minute ventilation through carotid body and peripheral chemoreceptor stimulation. Concentrations of 100 ppm can lead to seizures, coma, respiratory failure, and death.<sup>41</sup> Laboratory findings include an anion gap metabolic acidosis that does not respond to oxygen administration. The mixed venous oxygen saturation in cyanide poisoning is often elevated, suggesting inability to use oxygen.<sup>42,43</sup> Direct detection of cyanide poisoning in blood is difficult. Cyanide has a short half-life in blood and measurement is not universally available.

The treatment of cyanide toxicity has generated controversy as treatment may in itself be hazardous. The deleterious effects of cyanide are normally neutralized by the conversion of cyanide to thiocyanate, which is excreted in the urine. This can be enhanced by the administration of exogenous thiosulfate.<sup>44</sup> Cyanide can also combine with hydroxocobalamin (vitamin B<sub>12</sub>), which forms cyanocobalamin. Nitrate administration results in the oxidation of hemoglobin to methemoglobin which can combine with cyanide to form cyanomethemoglobin. Methemoglobin, however, does not transport oxygen and may thus be harmful in a patient whose oxygen carrying capacity is already compromised because of carboxyhemoglobin.<sup>45</sup>

### Chemical Injury to the Lower Airways

The burning of many materials in a house fire can release combustion products that are toxic and damaging to the lower airways, including respiratory epithelium and capillary endothelium of the airway and alveoli. The damage to epithelium results in destruction of mucociliary transport which impairs clearance of bacteria and mucosal debris. Alveolar collapse and atelectasis can occur because of loss of surfactant

production or from plugging because of mucus debris.<sup>46</sup> Chemical damage to alveoli and its capillaries will lead to extravasation of plasma protein. Activation of injury-induced alveolar macrophages will lead to further inflammatory response and damage. Bronchial swelling and bronchospasm can lead to obstruction of both large and small airways. The end result is respiratory failure from increased ventilation-perfusion mismatch, decreased lung compliance, and increased dead-space ventilation, generally occurring 12–48 hours after the inhalation event.<sup>31</sup> The respiratory failure may further worsen several days later from continued airway mucosal sloughing, barotrauma, bacterial invasion, and pneumonia.<sup>47,48</sup>

### INDIRECT RESPIRATORY INJURY

Injury to the lung can occur in patients with severe cutaneous burns in the absence of inhalational injury.<sup>49,50</sup> Mechanisms include inflammatory mediators from the burn-injured area, effects of fluid resuscitation, and infection. Pulmonary edema often occurs after a large burn injury as a result of decreased oncotic pressure and increase in pulmonary hypertension. After restoration of the capillary integrity, the edema fluid from throughout the body is resorbed and can lead to hypervolemic pulmonary edema.

### FLUID RESUSCITATION

In 1930, Underhill first described “burn shock” that results from intravascular fluid loss as a cause of early

death.<sup>51</sup> The appreciation of the exaggerated fluid requirements of burn patients and formulae for their estimation subsequently evolved. Multiple fluid resuscitation formulae exist for estimating fluid needs (Table 77-1). As a general rule, burns of <15% TBSA are not associated with extensive capillary leak and can be managed with fluid of 1.5 times maintenance rate and careful attention to their hydration status.

The commonly used resuscitation formulae differ somewhat in their recommendations of the amount of crystalloid and colloid. Most formulae recommend isotonic crystalloid initially and later use of colloids.<sup>52</sup> The times at which colloid administration is initiated varies from institution to institution, on the size of the burn, patient age, and other cardiorespiratory parameters. Lactated Ringer solution is often the crystalloid chosen as it contains physiologic concentrations of major electrolytes and lactate replaces some of the chloride in the solution, resulting in less hyperchloremic metabolic acidosis. In younger children and in patients where hypoglycemia is a potential concern, 5% dextrose solution can be added to the lactated Ringer solution.

Once capillary integrity returns, generally within 24–48 hours, most resuscitation formulae recommend administration of colloid. Most authorities advocate 5% albumin in isotonic crystalloid, which is ideally administered by continuous infusion at a dose adjusted by burn size. Some clinicians advocate use of fresh-frozen plasma but it is better used to correct significant coagulopathy as it has the added risks of transfusion. Side effects of

**TABLE 77-1.**  
Formulae for Estimating Burn Resuscitation Fluid Needs

Crystalloid formulas		
Parkland	Lactated Ringer	4 mL/kg/%TBSA burn
Modified Brooke	Lactated Ringer	2 mL/kg/%TBSA burn
Colloid formulas		
Evans	Normal Saline	4 mL/kg/%TBSA burn
	Colloid	1 mL/kg/%TBSA burn
Brooke	5% Dextrose	2000 mL/24 h
	Lactated Ringer	1.5 mL/kg/%TBSA burn
	Colloid	0.5 mL/kg/%TBSA burn
	5% Dextrose	2000 mL/24 h
TBSA, total body surface area.		



large-volume crystalloid resuscitation include pleural and pericardial effusions and intestinal ileus with abdominal compartment syndrome. Thus more burn units are advocating early use of colloids.

Hypertonic saline has been advocated for resuscitation in burn injury, especially for patients with large burns, inhalational injury, or circumferential burns, because the administered fluid volume is smaller and tissue edema is reduced.<sup>53</sup> However, in one study comparing hypertonic saline to lactated Ringer solution for resuscitation, there was a significant increase in renal failure and deaths in the hypertonic saline group.<sup>54</sup> Consequently, resuscitation with hypertonic saline is not part of most burn units' practice.

The Parkland formula remains the most widely used resuscitation formula for burn injury in the United States. The Parkland formula, 4 mL per %TBSA burn per kg, is administered over the first 24 hours with one-half of the calculated volume administered during the first 8 postinjury hours.<sup>55</sup> The remaining half is administered over the next 16 hours. If resuscitation is delayed, this volume is administered so that infusion is completed by the 8th postinjury hour. No matter which formula is used, it should serve only as a guideline and fluid resuscitation titrated to physiologic end points (see Table 77-4). Actual fluid requirements can vary, depending on size of the burn, patient's weight, interval from injury to start of resuscitation, presence of associated injuries, and presence of inhalational injury.

Cardiac index and oxygen delivery have been investigated as end points to guide fluid resuscitation.<sup>56,57</sup> Bernard et al. showed that patients who survived large burns had higher cardiac index and better oxygen delivery than did nonsurvivors.<sup>58</sup> Subsequently, some investigators proposed supranormal oxygen delivery as a means of ensuring adequate tissue delivery. Schiller et al. demonstrated improved survival in burn patients by maintaining hyperdynamic circulation using fluids and inotropes.<sup>57</sup> However, the literature on achieving supranormal cardiac output and oxygen delivery has failed to consistently show an improvement in survival or decrease in organ failure. One study, which used dobutamine to augment cardiac out-

put and oxygen delivery, demonstrated increased mortality.<sup>59</sup>

Blood lactate and base deficit have been proposed as global markers of oxygen delivery and tissue perfusion in burn patients.<sup>60,61</sup> Lactic acid is produced during anaerobic metabolism and indicates inadequate oxygen delivery or use. Holm et al. found lactate level to be the most predictive index of tissue perfusion. Lactate levels  $<2$  mmol/L in the first 24–48 hours after burn injury correlated with improved survival.<sup>62</sup> Base deficit is another indicator of global tissue perfusion and is calculated from an arterial blood gas using normograms. In a retrospective study in burn patients, Kaups showed the base deficit was predictive of fluid requirements and survival.<sup>63</sup>

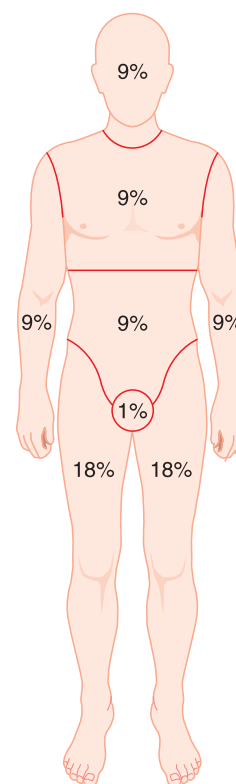
In burn injury, when tissue perfusion is not uniform throughout the body, an indirect measure of less-well-perfused tissues may prove useful. One such measure that has been described is the intramucosal gastric pH, as measured by gastric tonometry. After burn injury blood flow to the heart, brain, and kidneys is maintained at the expense of splanchnic blood flow. Several studies show that a lower intramucosal pH is predictive of organ failure and increased mortality and have suggested the use of mucosal pH as a guide to resuscitation.<sup>64–66</sup> This technique, however, has not become routine in clinical practice.

A small percentage of patients fail to respond to conventional fluid resuscitation. These patients frequently have large, deep burns, are at extremes of age, and have inhalational injury or coexisting medical conditions.<sup>67</sup> If the total fluid requirement exceeds 6 mL/kg/%TBSA/24 h, it is advisable to obtain more information regarding intravascular volume. This information can be obtained by physical exam or by measurement of central venous pressure and/or pulmonary artery pressure. Based on the information, inotropic support may be required. Echocardiographic evaluation of ventricular volume and function has been used in burns.<sup>68</sup> After 24–48 hours, capillary integrity returns to normal in nonburned areas especially with repletion of circulating volume. At this stage, fluid requirements dramatically decrease; it is important to decrease fluid administration promptly as overzealous administration of fluid can be associated with substantial morbidity.

A great deal of recent interest has focused on the use of antioxidants as adjuncts to fluid resuscitation. Reactive oxygen species generated by thermal injury are involved in edema formation associated with burns. In particular, high-dose vitamin C infusion during resuscitation has been studied in animals and shown to significantly reduce total fluid requirements.<sup>69</sup> Tanaka et al. demonstrated a 45% reduction in required fluid resuscitation using a vitamin C infusion in a small group of patients.<sup>70</sup> Antioxidant usage is not a standard adjunct to resuscitation at this time.

### ESTIMATION OF SIZE/DEPTH OF BURN

The magnitude of burns are classified according to the TBSA involved, depth of the burn, and the presence or absence of inhalational injury. TBSA burned in adults can be estimated using the “rule of nines” (Fig. 77-2). The Lund Browder chart is an age-specific diagram that accounts for the changing body surface area with age (Fig. 77-3).<sup>71</sup> Estimation by palmar



**FIGURE 77-2.** The rule of nines for estimating the percentage of body surface area burned in adults.

**Burn estimate and diagram**  
**Age and area**

**Initial evaluation\***

Signature \_\_\_\_\_

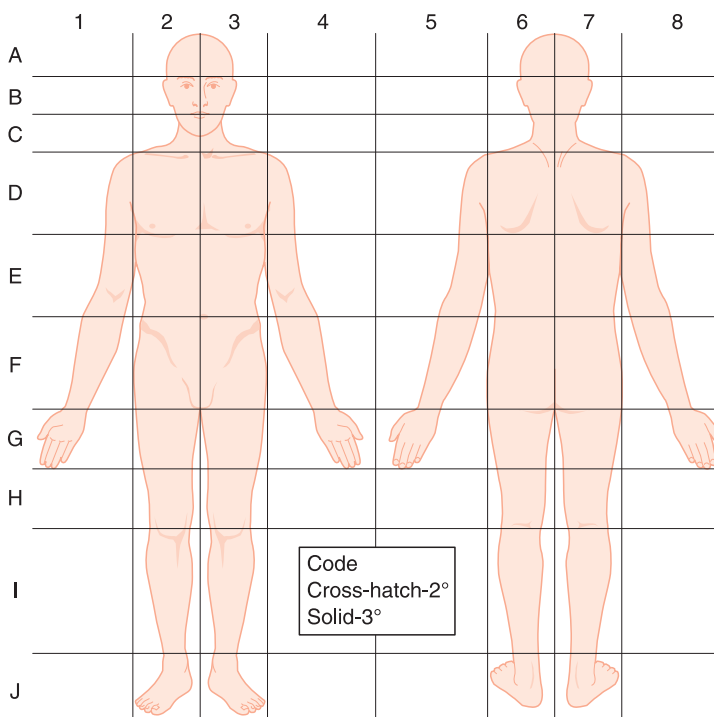
Date of burn \_\_\_\_\_

Date completed \_\_\_\_\_

\*To be completed by the admitting resident or LIP on admission

N/A, please refer to QPD COMPlan or 1<sup>st</sup> admission burn diagram

This is a working burn estimate diagram only, and is not as accurate as photography.



Area	Birth-1 yr.	1-4 yrs.	5-9 yrs.	10-14 yrs.	15 yrs.	Adult	2°	3°	Total	
Head	19	17	13	11	9	7				
Neck	2	2	2	2	2	2				
Anterior trunk	13	13	13	13	13	13				
Posterior trunk	13	13	13	13	13	13				
Right buttock	2.5	2.5	2.5	2.5	2.5	2.5				
Left buttock	2.5	2.5	2.5	2.5	2.5	2.5				
Genitalia	1	1	1	1	1	1				
Right upper arm	4	4	4	4	4	4				
Left upper arm	4	4	4	4	4	4				
Right lower arm	3	3	3	3	3	3				
Left lower arm	3	3	3	3	3	3				
Right hand	2.5	2.5	2.5	2.5	2.5	2.5				
Left hand	2.5	2.5	2.5	2.5	2.5	2.5				
Right thigh	5.5	6.5	8	8.5	9	9.5				
Left thigh	5.5	6.5	8	8.5	9	9.5				
Right lower leg	5	5	5.5	6	6.5	7				
Left lower leg	5	5	5.5	6	6.5	7				
Right foot	3.5	3.5	3.5	3.5	3.5	3.5				
Left foot	3.5	3.5	3.5	3.5	3.5	3.5				
**Only 2° and 3° burns are included in the total TBSA burn percent							Total			

**FIGURE 77-3.** Burn diagram. A careful burn diagram should be completed at the time of initial evaluation including wound size, location, and estimated burn depth.

surface of the hand (without the fingers, 0.5% TBSA) is age invariant and can also provide a quick estimate.<sup>72</sup> The depth of skin destruction is characterized as first-, second-, or third-degree, based on whether there is superficial, partial-thickness, or full-thickness destruction of the skin (Table 77-2). *Fourth degree* is used to describe burns that have injured deeper structures such as muscle, fascia, and bone. Deep second- and third-degree burns require surgical debridement and grafting, whereas more superficial burns

do not. Revisions of burn-depth estimations are often necessary in the first 24–72 hours. This is especially true in patients with thin skin, who often sustain deeper burn injuries than may be evident on the initial examination of the wound. Skin can be presumed to be thin in young children and the elderly. Mortality from burn injury is related to the TBSA of deep second-degree or third-degree burns. A recent large analysis revealed three risk factors as predictive for death after burns: age older than 60 years,

burn size greater than 40% body surface area, and inhalation injury. Mortality is a function of the number of risk factors present. The mortality was 0.3, 3, 33, or 90% depending on whether 0, 1, 2, or 3 risk factors were present, respectively.<sup>73</sup>

**BURN CENTER REFERRAL**

Data exist linking improved outcomes from major burns with early referral to a burn center.<sup>74</sup> It is recognized that

TABLE 77-2.

## Classification of Burn Depth

Depth	Level of Injury	Clinical Features	Result/Treatment
Superficial	Epidermis	Dry, red; blanches; painful	Healing time 3–6 days
Superficial partial thickness	Papillary dermis	Blisters; moist, red, weeping; blanches; painful	Cleaning; topical agent; sterile dressing; healing time 7–12 days; hypertrophic scar rare; return of full function
Deep partial thickness	Reticular dermis	Blisters; wet or waxy dry; does not blanch; absent pain sensation	Treatment as for superficial partial-thickness burns; possible surgical excision and grafting; hypertrophic scar common; earlier return of function with surgery
Full thickness	Subcutaneous fat, fascia, muscle, or bone	Waxy white to leathery dry and inelastic; does not blanch; absent pain sensation	Treatment as for superficial partial-thickness burns plus surgical excision and grafting at earliest possible time; functional limitation more common

burn care requires specialized expertise, personnel, and equipment that are not cost-effectively maintained in low-volume centers. Table 77-3 lists the criteria for referral to a regional burn center.

## SECONDARY SURVEY

The burn-specific secondary survey complements the trauma secondary survey and focuses on aspects of the neurologic, otolaryngologic, ophthalmic, chest, cardiac, abdomen, genitourinary, and extremity issues as related to patients with acute burn injury.

### Neurologic

Central nervous system function (CNS) can be altered by inhalation of neurotoxic chemicals, effects of hypoxia and hypotension, and from the effects of anxiety and pain or their treatment. Signs of CNS dysfunction include delirium, hallucinations, personality changes, seizures, and coma. It is essential to rule out coexisting intracranial injury by history, clinical examination, and radiologic imaging. Patients with serious injuries commonly become obtunded because of hemodynamic instability as well as from the administration of drugs for sedation and analgesia, making it important to know that this change does not represent a missed intracranial injury. The need for radiologic evaluation of the neck is based on mechanism of injury. In rare instances, patients with deep neck burns may need escharotomies at that site to facilitate venous drainage.

### Ear, Nose, Throat, and Eye

The primary otolaryngologic and ophthalmic evaluation includes assessment and initial treatment of burns to the airway, corneal epithelium, and the external ear. Signs of airway involvement include perioral and oropharyngeal burns, presence of carbonaceous sputum and signs of hoarseness. Hot liquid can be aspirated in conjunction with a scald injury to the face and can result in rapid airway compromise. One should have a low threshold for intubation when potential airway involvement exists. The globes of the eye should be examined early because adnexal swelling can make the examination difficult. Severe corneal burns are usually obvious by the cloudy appearance they impart, but less severe injury to the cornea is more often subtle requiring fluorescein staining. Topical antibiotics are the initial treatment if an injury is present. Burns to the external ear can be complicated by suppurative chondritis. Treatment with topical mafenide acetate cream may decrease its development.<sup>75</sup>

### Chest

The focus of the initial evaluation of the chest is to ensure chest wall compliance of both hemithoraces. Impaired chest wall compliance can result from deep circumferential eschar impairing chest wall excursion and/or bronchospasm resulting from inhalation of airway irritants. The inhalation of toxic fumes may precipitate a bronchospastic attack in a patient with a previous history of asthma. A patient with decreased compliance because of a circumferential eschar will exhibit rapid shallow respirations. A patient requiring

mechanical ventilation will show an increase in peak airway pressures. Escharotomy is the treatment of choice for the latter condition whereas bronchodilators, pulmonary toilet, and ventilation strategies to minimize breath stacking are used to treat bronchospasm. Severe inhalational injury may result in thick secretions and the sloughing of airway mucosa, which can occlude the endotracheal tube or distant bronchi resulting in atelectasis and collapse. In these instances, suctioning and bronchoscopy may be required.

### Cardiac

If adequate intravascular volume and oxygenation are maintained and electrolyte abnormalities corrected, significant arrhythmias are unusual in otherwise healthy patients. Coexisting cardiac disease can result in the resuscitation and acute care being less well tolerated. Direct myocardial injury and arrhythmias resulting from electrical injury are discussed in Special Situations: Electrical Injuries below.

### Abdomen

Primary objectives in the evaluation of the abdomen are to exclude associated injuries, ensure adequate compliance to permit ventilation, and decrease the risk of gastric dilation and gastrointestinal ulceration. Coincident abdominal trauma should be evaluated with imaging studies or diagnostic peritoneal lavage if indicated. Occult abdominal trauma can explain excessive fluid resuscitation requirements or a paradoxical fall in hematocrit in the early phase of burn injury. In some cases, torso escharotomies may

TABLE 77-3.

**American Burn Association Burn Center Transfer Criteria**

- Second and third degree burns on >10% of total body surface area (TBSA) in patients under 10 or over 50 years of age.
- Second and third degree burns on >20% of TBSA in other age groups
- Second and third degree burns that involve the face, hands, feet, genitalia, perineum, and major joints
- Third degree burns on >5% TBSA in any age group
- Electrical burns including lightning injury
- Chemical burns
- Inhalation injury
- Burn injury in patients with pre-existing medical disorders that could complicate management, prolong recovery, or affect mortality
- Any patients with burns and concomitant trauma (such as fractures) in which the burn injury poses the greatest risk of morbidity or mortality; in such cases, if the trauma poses the greater immediate risk, the patient may be treated initially in a trauma center until stable before being transferred to a burn center; physician judgment will be necessary in such situations and should be in concert with the regional medical control plan and triage protocols
- Hospitals without qualified personnel or equipment for the care of children should transfer children with burns to a burn center with these capabilities
- Burn injury in patients who will require special social/emotional and/or long-term rehabilitative support, including cases involving suspected child abuse and substance abuse

be necessary to facilitate spontaneous respiration or mechanical ventilation in patients with deep circumferential eschars. Circumferential abdominal eschar, accumulation of intraperitoneal fluid, or bowel edema can lead to abdominal compartment syndrome, which leads to diminished urine output, decreased pulmonary compliance, and hemodynamic instability.<sup>76</sup> Obtaining bladder pressure measurements can be useful in the diagnosis.<sup>77</sup> In some cases, abdominal decompression may be necessary.

Patients with severe burns often develop a paralytic ileus and require nasogastric decompression for varying lengths of time. Gastroduodenal ulceration, likely due to reduced splanchnic blood flow, is a risk in severe burn injury and ulcer prophylaxis with H<sub>2</sub> receptor antagonists or proton pump inhibitors should be initiated as early as possible.

**Genitourinary**

Catheterization of the bladder is important in patients with moderate to severe burns who require intravenous fluid resuscitation, because it facilitates the use of urine volume as a indicator of adequacy of resuscitation. Soft-tissue swelling in the genital area can be significant with severe burn injury whether or not the burn involves the genital region. This can make urinary catheterization more difficult as time passes in the acute resuscitation phase. For this reason an appropriate-size Foley catheter should be inserted as early as possible. In males it is important to ensure that the foreskin is reduced over the urinary catheter after its insertion to prevent the development of paraphimosis as soft-tissue edema develops.<sup>78</sup>

**Extremities**

Exclusion of associated (nonburn) injuries and monitoring of peripheral perfusion are the initial priorities in evaluation of the extremities. Careful clinical examination and radiologic imaging, if necessary, should be performed. Extremity perfusion can be compromised by soft-tissue swelling in the noncompliant fascial compartments or by a circumferential eschar.

Extremities that are at risk for ischemia, especially in those with circumferential burns or with electrical injury, should be monitored closely for tense fascial compartments and signs of impaired perfusion. Frequent checks of pulses, capillary filling, venous congestion, and Doppler blood flow are important. Dressings should be loosely applied to facilitate frequent examination. Tense extremities should be decompressed by escharotomy and/or fasciotomy when clinical examination reveals signs of impaired perfusion. Escharotomies can be performed at the bedside with use of electrocautery to minimize blood loss. The need for escharotomy usually becomes apparent in the early hours of acute resuscitation. Fasciotomies are generally performed in the

operating room so as to minimize damage to the underlying structures that can be obscured by the tissue edema.

**ANTIBIOTICS**

Prophylactic antibiotics have no proven role in burn care and are not routinely given.<sup>79</sup> All burn injuries are potentially contaminated soft-tissue wounds, and therefore tetanus toxoid should be given to all burned patients.<sup>80,81</sup> If the patient has not been previously immunized, tetanus immunoglobulin as well as tetanus toxoid should be administered.

**PEDIATRIC CONSIDERATIONS**

Children suffering burn injuries have unique physiologic, medical, surgical, and psychosocial issues requiring additional considerations. Younger children are at higher risk of burn injury and up to 20% of their injuries are a result of abuse or neglect.<sup>82</sup> Approximately 70% of pediatric burns are caused by hot liquid, whereas flame burns are more common in working-age adults.<sup>83</sup>

Airway and respiratory considerations in children include the smaller airway, which can rapidly occlude with airway edema and swelling. In pediatric patients with scald injury, respiratory failure can occur during and after fluid resuscitation, even in the absence of inhalational injury.<sup>50</sup> Stridor and retractions should be taken as signs of airway compromise and need for intubation. The trachea in children is shorter and small changes in endotracheal tube positioning are more likely to lead to bronchial intubation. Bronchospasm, common in children suffering inhalational injury, should be treated early and aggressively. Fluid considerations include greater susceptibility to fluid overload, especially in young children, particularly if all administered fluids (flush solutions, medications, carrier fluids) are not taken into account. The kidneys of young infants have less concentrating ability. They are particularly susceptible to cerebral edema if they become hyponatremic, which can result in seizures or brain herniation.<sup>84</sup>

**GERIATRIC CONSIDERATIONS**

Caring for geriatric patients with burn injuries requires consideration of their



unique issues and needs. Burn injury in elderly patients is more likely the result of impaired dexterity or mobility and may indicate the inability to live independently.<sup>85</sup> Older patients do not have the physiologic reserve of the young. Coexisting cardiac and pulmonary disease can result in resuscitation and acute burn care being less-well tolerated. Preexisting renal disease can result in greater sensitivity to nephrotoxic drugs and hypotensive episodes. Resuscitation should be considered carefully in elderly patients with large burn injuries, especially in the presence of inhalation injury, as mortality can reach 90%.<sup>73</sup> Advanced directives, healthcare proxies, and families should be consulted as early as possible. Nutritional requirements are less-well-predicted by standard equations.<sup>86</sup> The skin of elderly patients is thinner and is therefore more susceptible to deeper burn injury. In addition, harvesting of donor skin repeatedly may not be possible because of poor healing. Finally, elderly patients may live alone or have a spouse who is unable to provide the care needed after discharge, including wound care, transportation, and support.

## SPECIAL SITUATIONS

### Electrical Injuries

Electrical burns can have acute and chronic effects not seen with other types of burn injury, and with morbidity much higher than expected based on burn size alone.<sup>87</sup>

Electrical burns are classified as high-voltage (>1000 V) or low-voltage (<1000 V) injuries. High-voltage injuries are typically associated with loss of consciousness, arrhythmias, myoglobinuria, and extensive deep tissue damage that can result in compartment syndromes. However, significant injury can result with low- and mid-range voltage sources.

Approximately 15% of patients who sustain electrical injury suffer other traumatic injury in addition to their burn.<sup>88</sup> These injuries often involve falls, being thrown against an object, or result from tetanic muscle contractions.

Both arrhythmias and direct myocardial injury can result from electrical injury. Creatine kinase and creatine kinase myocardial band enzymes are poor indicators of myocardial injury in the absence of ECG findings, particularly if muscle injury is present.<sup>89</sup> The diagnostic value of cardiac troponin levels has

not been evaluated in this setting. The myocardial injury behaves more like a cardiac contusion than a myocardial infarction, with minimal hemodynamic consequences. This may be related to the fact that the heart, unlike the skeletal muscle cannot sustain tetanic contractions. Virtually any cardiac arrhythmia may be associated with electrical injury. Ventricular fibrillation is the most common cause of death at the scene of the injury. Arrhythmias from electrical injury are managed using the same medical therapies as those resulting from any other cause. Patients with electrical injury should have ECG monitoring during transport to the hospital, in the emergency room, and afterwards. Indications for more prolonged cardiac monitoring include (a) documented cardiac arrest, (b) cardiac arrhythmia on transport or in the emergency department, and (c) an abnormal ECG.<sup>90,91</sup>

The hidden (deeper) injury associated with electrical burn makes the standard fluid resuscitation formulae inaccurate. Adequate fluid resuscitation is achieved by reaching the standard resuscitation end points (Table 77-4).

Myoglobinuria as a result of muscle damage will manifest as pigmented urine and usually indicates more severe muscular damage. Myoglobin and hemoglobin pigments pose risk for acute renal failure and require prompt treatment with crystalloid loading to a target urine output of 2 mL/kg/h. Addition of sodium bicarbonate to intravenous fluid may facilitate pigment clearance and minimize renal injury. Mannitol and furosemide are also effective in promoting a prompt diuresis, but compromises the value of urine output as an indicator of adequacy of resuscitation.

### Chemical Burns

Although only 3% of all burns are caused by chemical exposures, approximately 30% of burn deaths are as a consequence of chemical injuries.<sup>92</sup> The range of chemical injuries is vast. However, an understanding of general principles of treatment is essential to those caring for patients with these injuries. First aid begins with removing the offending agent from contact with the patient. This involves removing all clothing and removal (dusting off) of any powder. It is important for healthcare personnel to protect themselves from injury by wearing gloves and aprons. Copious irrigations with tap water should be performed for at

TABLE 77-4.

#### Burn Resuscitation End Points

Arousable and comfortable
Warm extremities
Systolic blood pressure: for infants 60 mm Hg; for older children, 70– 90 + 2 × age (in years) mm Hg; for adults, mean arterial pressure >65 or within 20% of baseline
Heart rate 80–150 beats/min (age dependent)
Urine output 0.5–2 mL/kg/h (glucose negative)
Base deficit <2 mEq/L

least 30 minutes. Because alkaline substances are less soluble in water, longer irrigation times may be required.

The large-volume lavage required to dilute chemical exposures can lead to hypothermia because of conductive and evaporative cooling particularly from unwarmed irrigation fluid. Recognition of this potential complication is essential for its avoidance.

Litmus paper can be used to verify the completeness of irrigation of acid or alkali. There is no role for neutralization of acid or alkali burns because such reactions generate heat which can further exacerbate the injury. Because of the wide range of chemicals involved in chemical injuries, consultation with a poison control center should be initiated early, as there may be systemic toxicities in addition to the burn itself.

### Cold Injuries

Frostbite is a traumatic injury caused by failure of the normal protective mechanisms to protect against an environment that results in tissue temperatures falling below freezing. Terminology to describe cold injuries is not standardized. A number of factors have been associated with development of frostbite, including ethanol consumption, psychiatric disease, smoking, diabetes, fatigue, and extremes of age.<sup>93</sup> Cold injuries are initially managed by rewarming in water warmed to 104 °F (40 °C).<sup>94</sup> Injured parts are then elevated and protected from further injury. Topical wound care is performed until area of necrotic tissue is demarcated. Nonviable tissue is excised and reconstruction performed with primary closure, grafting or flaps.<sup>95</sup>

## Toxic Epidermal Necrolysis

Toxic epidermal necrolysis syndrome (TENS) and Stevens-Johnson syndrome (SJS) are severe exfoliative diseases of the skin and underlying structures caused by immunologic reactions usually triggered by a medication or viral syndrome. Most authorities consider TENS and SJS to be the same disease entity, differing only in total body surface area involved. Cases with less than 10% TBSA involved are labeled as SJS; those with 30% TBSA involvement are labeled as TENS; and cases with between 10% and 30% involvement are labeled as overlap SJS-TENS.<sup>96</sup> The disease consists of cutaneous exfoliation together with varying degrees of mucosal and conjunctival involvement. Mortality for TENS has been reported in the range of 25–80%.<sup>97–99</sup> Because of their expertise in management of patients suffering skin loss from thermal injury, burn centers often provide care for patients with TENS. Treatment consists of airway protection if needed, fluid resuscitation, nutritional support, close monitoring for septic complications, and eye care.<sup>100,101</sup>

## Purpura Fulminans

Purpura fulminans is a complication of systemic bacterial infection in which areas of skin and soft tissue become necrotic as a result of microvascular thrombosis, most likely related to dysfunction of the protein C anticoagulant system.<sup>102</sup> It is associated with infection by meningococcus, gram-negative bacilli, staphylococcus, streptococcus, and *Rickettsia* organisms. Involved areas begin with petechiae, which rapidly progress to hemorrhagic bullae and frank skin necrosis. Management includes fluid resuscitation, treatment with systemic and topical antimicrobials, and prompt wound excision to facilitate control of sepsis.<sup>102,103</sup> The use of anticoagulants, vasodilators, and thrombolytic agents remains controversial.<sup>104</sup>

## KEY REFERENCES

1. Sheridan R. Burns. *Crit Care Med* 2002;30(Suppl):S500–S514.
2. Demling R. The burn edema process: current concepts. *J Burn Care Rehabil* 2005;26:207–227.
3. Pereira CT, Murphy KD, Herndon DN. Altering metabolism. *J Burn Care Rehabil* 2005;26:194–199.

4. McCall J, Cahill T. Respiratory care of the burn patient. *J Burn Care Rehabil* 2005;26:200–206.
5. Ernst A, Zibrak JD. Carbon monoxide poisoning. *N Engl J Med* 1998;339:1603–1608.
6. Yowler CJ, Fratianno RB. Current status of burn resuscitation. *Clin Plast Surg* 2000;27:1–10.
7. Sheridan R. Comprehensive treatment of burns. *Curr Probl Surg* 2001;38:643–676.
8. Arnoldo BD, Purdue GF, Kowalske K, Helm PA, Burris A, Hunt JL. Electrical injuries: a 20-year review. *J Burn Care Rehabil* 2004;25:479–484.

## REFERENCES

1. Brigham P, McLoughlin E. Burn incidence and medical care in the United States: estimates, trends, and data sources. *J Burn Care Rehabil* 1996;17:95–107.
2. Sheridan R. Burns. *Crit Care Med* 2002;30(Suppl):S500–S514.
3. Demling RH. Fluid replacement in burned patients. *Surg Clin North Am* 1987;67:15–30.
4. Demling RH, Will JA, Belzer FO. Effect of major thermal injury on the pulmonary microcirculation. *Surgery* 1978;83:746–751.
5. Baxter CR, Cook WA, Shires GT. Serum myocardial depressant factor of burn shock. *Surg Forum* 1966;17:1–2.
6. Hilton JG, Marullo DS. Effects of thermal trauma on cardiac force of contraction. *Burns Incl Therm Inj* 1986;12:167–171.
7. Youn YK, LaLonde C, Demling R. The role of mediators in the response to thermal injury. *World J Surg* 1992;16:30–36.
8. Crum RL, Dominic W, Hansbrough JF. Cardiovascular and neurohumoral responses following burn injury. *Arch Surg* 1990;125:1065–1070.
9. Weis, SM, Cheresch DA. Pathophysiological consequences of VEGF-induced vascular permeability. *Nature* 2005;437(7058):497–504.
10. Monafu W. Initial management of burns. *N Engl J Med* 1996;335:1581–1586.
11. Demling R. The burn edema process: current concepts. *J Burn Care Rehabil* 2005;26:207–227.
12. Kelemen JJ, Cioffi WG, Mason AD, Mazingo DW, McManus WF, Pruitt BA. Effect of ambient temperature on metabolic rate after thermal injury. *Ann Surg* 1996;223:406–412.
13. Wilmore D, Aulick L. Metabolic changes in burned patients. *Surg Clin North Am* 1978;58:1173–1187.
14. Pereira CT, Murphy KD, Herndon DN. Altering metabolism. *J Burn Care Rehabil* 2005;26:194–199.
15. Hart DW, Wolf SE, Mlcak R, et al. Persistence of muscle catabolism after severe burn. *Surgery* 2000;128:312–319.
16. Kinney JM, Long CL, Gump FE, Duke JH Jr. Tissue comparison of weight loss in surgical patients: I—elective operation. *Ann Surg* 1968;168:459–474.
17. Giroir BP, Horton JW, White DJ, McIntyre KL, Lin CQ. Inhibition of tumor necrosis factor prevents myocardial dysfunction during burn shock. *Am J Physiol* 1994;267:H118–H124.
18. Horton JW, White J, Baxter CR. The role of oxygen-derived free radicals in burn-induced myocardial contractile depression. *J Burn Care Rehabil* 1988;9:589–598.
19. Huribal M, Cunningham ME, D'Aiuto ML, Pleban WE, McMillen MA. Endothelin-1, and prostaglandin E<sub>2</sub> levels increase in patients with burns. *J Am Coll Surg* 1995;180:318–322.
20. Horton JW. Left ventricular contractile dysfunction as a complication of thermal injury. *Shock* 2004;22:495–507.
21. Kaufman TM, Horton JW. Burn-induced alterations in cardiac beta-adrenergic receptors. *Am J Physiol* 1992;262:H1585–H1591.
22. Wang C, Martyn JA. Burn Injury alters beta-adrenergic receptor and second messenger function in rat ventricular muscle. *Crit Care Med* 1996;24:118–124.
23. Chrysopoulou MT, Jeschke MG, Dziewulski P, Barrow RE, Herndon DN. Acute renal dysfunction in severely burned patients. *J Trauma* 1999;46:141–144.
24. Holm C, Horbrand F, von Donnersmarck GH, Muhlbauer W. Acute renal failure in severely burned patients. *Burns* 1999;25(2):171–178.
25. Cui X, Sheng Z, Guo Z. Mechanisms of early gastrointestinal ischemia after burn: hemodynamic and hemorheologic features [Chinese]. *Chin J Plast Surg Burns* 1998;14:262–265.
26. Tokyay R, Zeigler ST, Traber DL, et al. Postburn gastrointestinal vasoconstriction increases bacterial and endotoxin translocation. *J Am Physiol* 1993;152:1521–1527.
27. Demling RH, Wong C, Jin LJ, Hechtman H, Lalonde C, West K. Early lung dysfunction after major burns: role of edema and vasoactive mediators. *J Trauma* 1985;25:959–966.
28. Rosenkranz K, Sheridan R. Management of the burned trauma patient: balancing conflicting priorities. *Burns* 2002;28:665–669.
29. Navar PD, Saffle JR, Warden GD. Effect of inhalation injury on fluid resuscitation requirements after thermal injury. *Am J Surg* 1985;150:716–720.
30. Hunt JL, Agee RN, Pruitt BA. Fiberoptic bronchoscopy in acute inhalational injury. *J Trauma* 1975;15:641–649.

31. McCall J, Cahill T. Respiratory care of the burn patient. *J Burn Care Rehabil* 2005;26:200-206.
32. Rodkey FL, O'Neal JD, Collison HA, Uddin DE. Relative affinity of hemoglobin S and hemoglobin A for carbon monoxide and oxygen. *Clin Chem* 1974;20:83-84.
33. Hardy KR, Thom SR. Pathophysiology and treatment of carbon monoxide poisoning. *J Toxicol Clin Toxicol* 1994;32:613-629.
34. Tritapepe L, Macchiarelli G, Rocco M, et al. Functional and ultrastructural evidence of myocardial stunning after acute carbon monoxide poisoning. *Crit Care Med* 1998;26:797-801.
35. Ernst A, Zibrak JD. Carbon monoxide poisoning. *N Engl J Med* 1998;339:1603-1608.
36. Pace N, Strajman E, Walker EL. Acceleration of carbon monoxide elimination in man by high pressure oxygen. *Science* 1950;111:652-654.
37. Thom SR, Taber RL, Mendiguren II, Clark JM, Hardy KR, Fisher AB. Delayed neuropsychologic sequelae after carbon monoxide poisoning: prevention by treatment with hyperbaric oxygen. *Ann Emerg Med* 1995;25:474-480.
38. Tibbles PM, Perotta PL. Treatment of carbon monoxide poisoning: a critical review of human outcome studies comparing normobaric oxygen with hyperbaric oxygen. *Ann Emerg Med* 1994;24:269-276.
39. Vegfors M, Lennmarken C. Carboxyhemoglobinaemia and pulse oximetry. *Br J Anaesth* 1991;66:625-626.
40. Winter PM, Miller JN. Carbon monoxide poisoning. *JAMA* 1976;236:1502.
41. Weiss SM, Lakshminarayan S. Acute inhalation injury. *Clin Chest Med* 1994;15:103-116.
42. Ellenhorn MJ, Schonwald S, Ordog G, Wasserberger J, eds. *Ellenhorn's Medical Toxicology: Diagnosis and Treatment of Human Poisoning*. 2nd ed. Baltimore: Williams & Wilkins, 1997.
43. Baud FJ, Barriot P, Toffis V, et al. Elevated blood cyanide concentrations in victims of smoke inhalation. *N Engl J Med* 1991;325:1761-1766.
44. Baskin SI, Horowitz AM, Nealley EW. The antidotal action of sodium nitrite and sodium thiosulfate against cyanide poisoning. *J Clin Pharmacol* 1992;32:368-375.
45. Moore SJ, Norris JC, Walsh DA, Hume AS. Antidotal use of methemoglobin forming cyanide antagonists in concurrent carbon monoxide/cyanide intoxication. *J Pharmacol Exp Ther* 1987;242:70-73.
46. Herndon DN, Thompson PB, Traber DL. Pulmonary injury in burned patients. *Crit Care Clin* 1985;1:79-96.
47. Pruitt BA, Erikson DR, Morris A. Progressive pulmonary insufficiency and other pulmonary complications of thermal injury. *J Trauma* 1975;15:369-379.
48. Rue LW III, Cioffi WG Jr, Mason AD Jr, et al. Improved survival of burned patients with inhalation injury. *Arch Surg* 1993;128:772-778.
49. Lykens MG, Haponik EF. Direct and indirect lung injuries in patients with burns. *Crit Care Rep* 1990;2:101-114.
50. Zak AL, Harrington DT, Barillo DJ, et al. Acute respiratory failure that complicated the resuscitation of pediatric patients with scald injuries. *J Burn Care Rehabil* 1999;20:391-399.
51. Underhill FP. The significance of anhydremia in extensive superficial burns. *JAMA* 1930;95:852-857.
52. Yowler CJ, Fratianna RB. Current status of burn resuscitation. *Clin Plast Surg* 2000;27:1-10.
53. Pruitt BA. Does hypertonic burn resuscitation make a difference? *Crit Care Med* 2005;28:277-278.
54. Huang PP, Stucky FS, Dimick AR, Treat RC, Bessey PQ, Rue LW. Hypertonic sodium resuscitation is associated with renal failure and death. *Ann Surg* 1995;221:543-554.
55. Warden GD. Burn shock resuscitation. *World J Surg* 1992;16:16-23.
56. Holm C, Melcer B, Horbrand F, von Donnersmark GH, Muhlbauer W. The relationship between oxygen delivery and oxygen consumption during fluid resuscitation in burn related shock. *J Burn Care Rehabil* 2000;21:147-154.
57. Schiller WR, Bay RC, Garren RL, Parker I, Sagraves SG. Hyperdynamic resuscitation improves survival in patients with life threatening burns. *J Burn Care Rehabil* 1997;18:10-16.
58. Bernard F, Gueugniard PY, Bertin-Maghit M, Bouchard C, Vilasco B, Petit P. Prognostic significance of early cardiac index measurements in severely burned patients. *Burns* 1994;20:529-531.
59. Hayes MA, Timmins AC, Yau EH, Palazzo M, Hinds CJ, Watson D. Elevation of systemic oxygen delivery in the treatment of critically ill patients. *N Engl J Med* 1994;330:1717-1722.
60. Jeng JC, Jablonski K, Bridgeman A, Jordan MH. Serum lactate, not base deficit, rapidly predicts survival after major burns. *Burns* 2002;28:161-166.
61. Kamolz LP, Andel H, Schramm W, Meissl G, Herndon DN, Frey M. Lactate: early predictor of morbidity and mortality in patients with severe burns. *Burns* 2005;31:986-990.
62. Holm C, Melcer B, Horbrand F, Worl HH, von Donnersmarck GH, Muhlbauer W. Haemodynamic and oxygen transport responses in survivors and nonsurvivors following thermal injury. *Burns* 2000;26:25-33.
63. Kaups KL, Davis JW, Dominic WJ. Base deficit as an indicator of resuscitation needs in patients with burn injuries. *J Burn Care Rehabil* 1998;19:346-348.
64. Miller PR, Kincais EH, Meredith JW, Chang MC. Threshold values of intramucosal pH and mucosal-arterial CO<sub>2</sub> gap during shock resuscitation. *J Trauma* 1998;45:868-872.
65. Lorente JA, Ezpeleta A, Esteban A, et al. Systemic hemodynamics, gastric intramucosal Pco<sub>2</sub> changes and outcome in critically ill burn patients. *Crit Care Med* 2000;28(6):1728-1735.
66. Venkatesh B, Meacher R, Muller MJ, Morgan TJ, Fraser J. Monitoring tissue oxygenation during resuscitation of major burns. *J Trauma* 2001;50:485-494.
67. Cancio LC, Chavez S, Alvarado-Ortega M, et al. Predicting increased fluid requirements during the resuscitation of thermally injured patients. *J Trauma* 2004;56:404-414.
68. Kim K, Kwok I, Chang H, Han T. Comparison of cardiac outputs of major burn patients undergoing extensive esophagectomy: esophageal Doppler monitor versus thermodilution cardiac output. *J Trauma* 2004;57:1013-1017.
69. Dubick MA, Williams C, Elgjo GI, Kramer GC. High-dose vitamin C infusion reduces fluid requirements in the resuscitation of burn injured sheep. *Shock* 2005;24:139-144.
70. Tanaka H, Matsuda T, Miyagantani Y, Yukioka T, Matsuda H, Shimazaki S. Reduction of resuscitation fluid volumes in severely burned patients using ascorbic acid administration: a randomized, prospective study. *Arch Surg* 2000;135:326-331.
71. Lund CC, Browder NC. The estimation of areas of burns. *Surg Gynecol Obst* 1944;79:352-358.
72. Sheridan RL, Petras L, Basha G, et al. Planimetry study of the percent body surface represented by the hand and palm: sizing irregular burns is more accurately done with the palm. *J Burn Care Rehabil* 1995;16:605-606.
73. Ryan CM, Schoenfeld DA, Thorpe WP, Sheridan RL, Cassem EH, Tompkins RG. Objective estimates of the probability of death from burn injuries. *N Engl J Med* 1998;338:362-366.
74. Sheridan R, Weber J, Prelack K, Petras L, Lydon M, Tompkins R. Early burn center transfer shortens length of hospitalization and reduces complications in children with serious burn injuries. *J Burn Care Rehabil* 1999;20:347-350.
75. Mills DC, Roberts LW, Mason AD, McManus WF, Pruitt BA Jr. Suppurative chondritis: its incidence, prevention, and treatment in burn patients. *Plast Reconstr Surg* 1988;82:267-276.
76. Hobson KG, Young KM, Ciraulo A, Palmieri TL, Greenhalgh DG. Release of abdominal compartment syndrome improves survival in patients with burn injury. *J Trauma* 2002;53:1129-1134.
77. Ivy ME, Atweh NA, Palmer J, Possenti PP, Pineau M, D'Aiuto M. Intra-abdominal hypertension and abdominal compartment syndrome in burn patients. *J Trauma* 2000;49:387-391.

78. Sheridan R. Comprehensive treatment of burns. *Curr Probl Surg* 2001;38:643–676.
79. Durtschi MB, Orgain C, Counts GW, Heimbach DM. A prospective study of prophylactic penicillin in acutely burned hospitalized patients. *J Trauma* 1982;22:11–14.
80. Larkin JM, Moylan JA. Tetanus following a minor burn. *J Trauma* 1975;15:546–548.
81. American Academy of Pediatrics. Tetanus (Lockjaw). In: Pickering LK, Baker CJ, Long SS, McMillan JA, eds. *Red Book: 2006 Report of the Committee on Infectious Disease*. 27th ed. Elk Grove Village, IL: American Academy of Pediatrics; 2006.
82. Sheridan RL, Ryan CM, Petras LM, et al. Burns in children younger than two years of age: an experience with 200 consecutive admissions. *Pediatrics* 1997;100:721–723.
83. Rossignol AM, Boyle CM, Locke JA, Burke JF. Hospitalized burn injuries in Massachusetts: an assessment of incidence and product involvement. *Am J Public Health* 1986;76:1341–1343.
84. McManus WF, Hunt JL, Pruitt BA Jr. Postburn convulsive disorders in children. *J Trauma* 1974;14:396–401.
85. Ryan CM, Thorpe W, Mullin P, et al. A persistent fire hazard for older adults: cooking-related clothing ignition [letter]. *J Am Geriatr Soc* 2000;45:1283–1285.
86. Sheridan RL, Prelack K, Yin L. Energy needs are poorly predicted in critically ill elderly. *J Intensive Care Med* 1997;12:45–49.
87. Arnoldo BD, Purdue GF, Kowalske K, Helm PA, Burris A, Hunt JL. Electrical injuries: a 20-year review. *J Burn Care Rehabil* 2004;25:479–484.
88. Lee RC, Capelli-Schellpfeffer M. Electrical and lightning injuries. In: Cameron JL, ed. *Current Surgical Therapy*. St. Louis, MO: Mosby 1998:1021–1023.
89. McBride JW, Labrosse KR, McCoy HG, Ahrenholz DH, Solem LD, Goldenberg IF. Is serum creatine kinase-MB in electrically injured patients predictive of myocardial injury? *JAMA* 1986;255:764–768.
90. Purdue GF, Hunt JL. Electrocardiographic monitoring after electrical injury: necessity or luxury. *J Trauma* 1986;26:166–167.
91. Baily B, Gaudreault P, Thivierge RL. Experience with guidelines for cardiac monitoring after electrical injury in children. *Am J Emerg Med* 2000;18:671–675.
92. Sanford AP, Herndon DN. Chemical burns. In: Herndon D, ed. *Total Burn Care*. London: Harcourt Publishers 2002:475–480.
93. Centers for Disease Control and Prevention. Hypothermia related deaths—United States 2003–2004. *MMWR Morb Mortal Wkly Rep* 2005;54:173–175.
94. Britt LD, Dascombe WH, Rodriguez A. New Horizons in the management of hypothermia and frostbite injury. *Surg Clin North Am* 1991;71:345–370.
95. Murphy JV, Branwell P, et al. Frostbite: pathogenesis and treatment. *J Trauma* 2000;48(1):171–178.
96. Becker DS. Toxic epidermal necrolysis. *Lancet* 1998;351:1417–1420.
97. Revuz J, Penson D, Roujeau JC, et al. Toxic epidermal necrolysis: clinical findings and prognostic factors in 87 patients. *Arch Dermatol* 1987;123:1160–1166.
98. Murphy JT, Purde GF, Hunt JL. Toxic epidermal necrolysis. *J Burn Care Rehabil* 1997;18:417–420.
99. McGee T, Munster A. Toxic epidermal necrolysis syndrome: mortality rate reduced with early referral to regional burn center. *Plast Recon Surg* 1998;102:1018–1022.
100. Sheridan RL, Weber JM, Schulz JT, Ryan CM, Low HM, Tompkins RG. Management of severe toxic epidermal necrolysis in children. *J Burn Care Rehabil* 2000;20:497–500.
101. Schulz JT, Sheridan RL, et al. A 10-year experience with toxic epidermal necrolysis. *J Burn Care Rehab* 2000;21(May-June):199–204.
102. Sheridan RL, Briggs SE, Remensnyder JP, Tompkins RG. Management strategy in purpura fulminans with multiple organ failure in children. *Burns* 1996;22:53–56.
103. Chasan PE, Hansbrough JF, Cooper ML. Management of cutaneous manifestations of extensive purpura fulminans in a burn unit. *J Burn Care Rehabil* 1992;13:410–413.
104. Aiuto LT, Barone SR, Cohen PS, Boxer RA. Recombinant tissue plasminogen activator restores perfusion in meningococcal purpura fulminans. *Crit Care Med* 1997;25:1079–1082.



# CHAPTER 78

## Evaluation of the Trauma Patient

Edward George, MD, PhD

Providing care to the trauma patient can be one of the most challenging situations encountered by an anesthesiologist. The urgency of the event, often in a setting with little or no advance notice, places special burdens on the care team. Given the unpredictable nature of trauma, the anesthesiologist may be faced with caring for these patients in settings ranging from a level 1 academic hospital center with a complete array of specialists and capabilities, to a small rural hospital, with limited resources, where the anesthesiologist may be the only physician present. Adding to these complexities is the emerging awareness of the special burdens imposed by the scenario of mass casualties. Prior to September 11, 2001, medical centers planned for large traumatic events on the scale of an airline crash at the airport or an industrial accident involving dozens of injured patients arriving over a brief period of time. Now with heightened awareness as a result of events such as the World Trade Tower disasters and the recent events centered around Hurricane Katrina, it is critical that all medical personnel become familiar with the evaluation and care of the trauma patient.

To better understand the challenges of evaluating the trauma patient, it is important to appreciate the evolution of trauma care over the history of modern medicine. While trauma has been a major cause of morbidity throughout history, until quite recently, most progress in the area of trauma care was closely tied to the experience and expertise gained by providing care to the casualties of war. By examining the progress made in these arenas, coupled with the insights gained over the past few decades by investigators in the evaluation and care of the trauma patient, the anesthesiologist will be better positioned to contribute as a member of the trauma team.

Trauma is currently viewed, not as a specific insult to a restricted region of the body but rather as a process or disease, triggered by the traumatic event.<sup>1-3</sup> By appreciating the full nature of trauma and the resultant pathophysiology, the anesthesiologist will be better positioned to participate in the management of the trauma patient. Understanding the complex nature of these patients and the specialized approaches, such as injury severity scoring systems, resuscitation strategies, and organized trauma teams, enables all physicians to better contribute to the care of these patients. Ultimately, the systematic evaluation of the trauma patient will expose the anesthesiologist to the many new areas of investigation currently being undertaken in trauma medicine.

### EVOLUTION OF TRAUMA CARE

Trauma remains one of the most common causes of death in modern society.<sup>4</sup> In the history of modern medicine, research and advancement in the care of the trauma patient has lagged well behind developments in other areas of science and technology. To better appreciate the issues underlying this discrepancy in comparison to the great strides made over the past 2 centuries in other areas of medicine, it is important to understand the context under which a large component of trauma research has been conducted.

Many of the significant advances in the care of the trauma patient have

evolved from experience gained in the care of the military casualty. The Mexican-American War and the Civil War marked the first major experiences of U.S. military surgeons operating on patients receiving a general anesthetic. The advent of surgical anesthesia using ether and chloroform, discovered less than 2 decades before the war, offered a new opportunity. Surgery could be undertaken, not in the fastest manner possible to minimize the agony inflicted upon the unanesthetized patient, but rather in a manner permitting the surgeon time and an opportunity to perform a more detailed and delicate procedure.<sup>5</sup> This period also marked the development of a casualty evacuation system using ambulances to deliver casualties from the battlefield to the field hospital, the integration of nursing care into the field hospitals, and the use of antiseptics, such as bromine, to reduce the risk of wound infection.

With the advent of trench warfare in World War I came further advances in trauma care. Typed blood transfusions were now being given in field hospitals. Rapid evacuation of the casualty to treatment facilities to initiate care as soon as possible after injury and the dawn of the specialty of reconstructive surgery were a few of the major advances in trauma care that evolved from this conflict.

Advances after World War I, such as the discovery of penicillin and the development of the specialties of hand surgery and blood banking, further impacted the care of the combat casualty.

### KEY POINTS

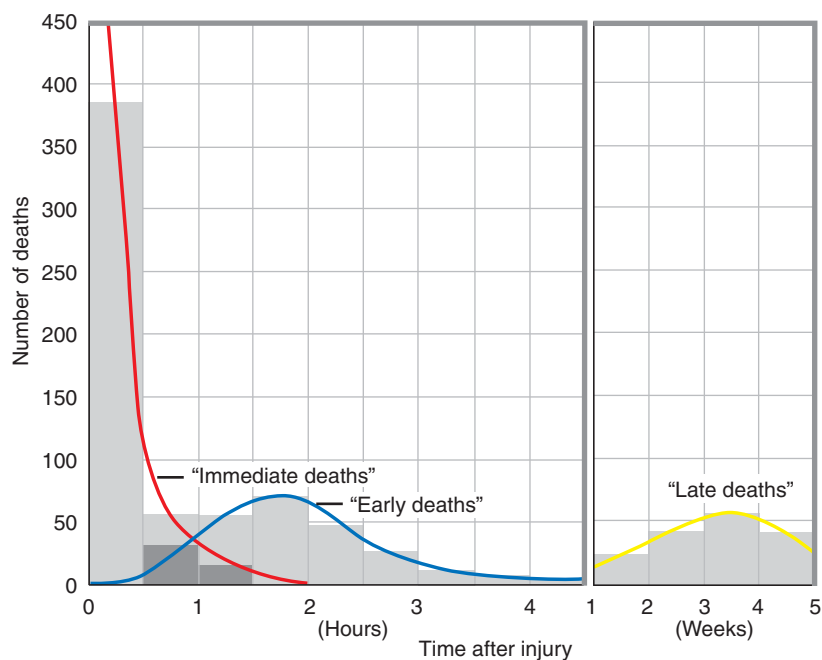
1. The impact of a traumatic injury(s) on the patient must not be considered a discrete injury, but rather a physical insult with the potential for major systemic complications.
2. Over the past decades improvements in trauma care, including the increased number of level 1 Trauma Centers, have contributed to increased patient survival.
3. Acute trauma life support (ATLS) provides a systematic approach to the evaluation and emergent treatment of the trauma patient, and a vital framework for the care of the trauma patient.
4. The inherently chaotic nature of traumatic injury places special burdens on the members of the trauma team, with the anesthesiologist playing a critical role.
5. Hypothermia remains one of the most significant issues to be addressed in the care of the trauma patient, extending from the time of injury through the period of immediate care.
6. Ongoing investigations in areas such as oxygen-transporting blood substitutes, resuscitation strategies, and control of hemorrhage offer possible new therapies for the care of the trauma patient.

Despite these major advances, the inability to treat shock adequately in the field during World War II remained a major cause of mortality in the battlefield casualty. During the Korean War deployment of surgical facilities in forward areas, closer to the front lines, along with the more widespread use of casualty evacuation by helicopter, reduced the delay in the treatment of casualties. New techniques in vascular surgery helped reduce the number of amputated limbs. The concept of the Mobile Army Surgical Hospital (MASH unit) now known as Forward Surgical Teams and Forward Resuscitative Surgical Sites, still remains as the entrance to modern-day battlefield surgical care. The Vietnam War saw greater improvements in the evacuation systems and a new understanding of the need for early resuscitation of the trauma patient. However the underlying physiology regarding respiratory distress syndrome (Da Nang lung) and hemorrhagic shock and resuscitation were still not well understood and these problems remained a major cause of mortality.<sup>6,7</sup>

The period leading up to and including the second Gulf War resulted in greater appreciation of issues impacting the trauma patient. Investigations of resuscitation and pharmacologic treatment for the hemorrhaging patient, and understanding the underlying pathophysiology became areas of active investigation. These investigations herald a new era of collaboration between military and civilian academic centers, perhaps even more robust than those seen during previous major conflicts.<sup>8</sup>

## NATURE OF TRAUMA

Trauma, both accidental and intentional, is the fourth leading cause of death in the United States.<sup>4</sup> Over the past several decades, death from trauma has been described by a trimodal pattern of distribution (Fig. 78-1), with peaks corresponding to deaths occurring at the time of injury (immediate), within several hours after injury (early), and finally those that occur days to weeks (late) after injury.<sup>9</sup> Deaths in the immediate group are most likely a result of severe injury to the central nervous system, the heart, or a major blood vessel. Early victims have often suffered injuries resulting in internal



**FIGURE 78-1.** Trimodal distribution of trauma deaths is observed when the death rate for a large enough sample of such deaths is plotted as a function of time after injury. The first peak (*immediate deaths*) corresponds to people who die very soon after an injury; the deaths in this category are typically caused by lacerations of the brain, the brainstem, the upper spinal cord, the heart, or one of the major blood vessels. The second peak (*early deaths*) corresponds to people who die within the first few hours after an injury; most of these deaths are attributable to major internal hemorrhage or to multiple lesser injuries resulting in severe blood loss. The third peak (*late deaths*) corresponds to people who die days or weeks after an injury; these deaths are usually caused by infection or multiple organ failure. The graph is based on a sample of 862 trauma deaths recorded over a 2-year period by the author's group at San Francisco General Hospital (Trunkey DD, Trauma. *Sci Am* 1983;249(2):28-35).

hemorrhage into the brain, the lungs, or other internal organs. These injuries may be amenable to treatment if the patient arrives in an appropriate facility in a timely manner, where ongoing resuscitation may later transition into more definitive therapy. It is during this "golden hour," the first hour after injury, that these patients are most vulnerable from delays in treatment. The late group is comprised of those patients with multiple injuries, often progressing to multiorgan system failure or death as a result of systemic infection, often occurring over the ensuing several days to weeks. The nature of the treatment facility and the degree of experience of the staff in dealing with victims of major trauma may well impact the survival rate of these patients.<sup>10</sup>

Recent analysis suggests that the original trimodal pattern of trauma deaths may not be uniformly applicable.<sup>11</sup> In the setting of modern-day urban trauma centers, the distribution of death appears bimodal, with late-occurring deaths far less common. This may in part be a result of the

trimodal pattern being described in an era prior to the widespread development of major centers focusing on care of the trauma patient. This bimodal pattern suggests that experienced and accessible centers may have a marked positive impact on the survival of the trauma victim.

Although a trauma patient often presents at the hospital with multiple injuries, it is important to appreciate that the nature of these injuries may be diverse and present different challenges to the urgent and emergent management of the patient. Injuries caused by trauma are broadly categorized into three main types, as a function of the mechanism of injury. Injuries are penetrating, blunt, or caused by burns, or produced by a combination of these modalities. Injuries can be further subdivided, as in the case of penetrating trauma, along the lines of high energy, such as a gunshot wound, versus lower energy, as in a stabbing. Burn injuries can be subdivided into those caused by chemical agents, flames, or electrical injury. Injuries are often complex and it may be vital to learn that a patient

presenting with several fractures from a motor vehicle accident, in the setting of a prolonged extraction from a burning vehicle, may have inhaled a great deal of smoke during the rescue.

A detailed and systematic method for the evaluation of the trauma patient is discussed in subsequent sections of this chapter. However a generalized description of the various types of injuries aids in the appreciation of the mechanism and forces involved in the traumatic insult. It is also important to appreciate that any categorization is only partially helpful in understanding the underlying forces associated with the various injuries. Trauma patients often present with multiple injuries inflicted by diverse mechanisms, and, as a result may be far more complex in their management than apparent on initial arrival.

### Blunt Trauma

A common scenario involving blunt trauma, or circumstances where blunt trauma should be suspected, is a motor vehicle accident. The unrestrained occupants in a vehicle, particularly individuals not afforded protection by an air bag system, may present with blunt injuries to the chest, thorax, abdomen, or any other part of the body. It is important to understand that the outward appearance of the injury, such as a seemingly minor bruise on the abdomen or thorax, may belie the severity of the underlying injury. A minor bruise on the abdomen could signal a lacerated spleen or liver and the faint impression of a steering wheel on the anterior chest wall may signal underlying pulmonary contusions or a deceleration injury of the great vessels. A small contusion on the flank of a blast victim may not at first glance appear to be a serious injury. However in the setting of an attendant tympanic membrane injury or pneumothorax,<sup>12</sup> this injury may suggest a significant degree of force associated with the mechanism of injury and may signal the presence of severe and potentially life-threatening injuries. Additionally blunt trauma can be complicated by problems such as rhabdomyolysis, which are often associated with crushing injuries to the thorax and extremities.

### Penetrating Trauma

Whether caused by a high-velocity projectile, such as a rifle bullet, or lower-energy insult such as a knife wound, it

is vital to appreciate that the external appearance may mask the extent of the internal injury. In the case of knife wound to the left flank, a small wound, with little visible bleeding may mask a trajectory that injures the bowel, spleen, diaphragm, and heart. Similarly, a small entry wound caused by a gunshot, with no apparent exit wound and scant visible bleeding, may be associated with multiple internal injuries because of internal fragmentation of the projectile.

### Burns

Although the care of the burn patient is addressed in detail in other chapters (see Chap. 71), basic issues regarding the challenges of evaluating and caring for the burn victim are briefly addressed here. Thermal injury can result in a severe physiologic impact on the patient, despite the minor outward appearance. Evaluation and care of burn patients require a thorough understanding of the insult caused by the burn; the disruption of the body's ability to maintain a normal fluid balance and the enhanced risk of infection are two areas of major importance. Chemical burns, often requiring specialized debridement, present special risks to the patient and the care team. Inhalation injury caused by smoke or toxic or high temperature gases can be life-threatening in a patient who may otherwise appear unhurt. These patients may be the most challenging to support with mechanical ventilation. Patients with an electrical burn may appear to have a small injury at the sites of contact and exit, yet may have experienced severe damage to internal structures and organs.<sup>13</sup>

### PATHOPHYSIOLOGY OF TRAUMA

The physiologic response to trauma is complex and tightly regulated. A detailed discussion of these processes is offered in a separate chapter (see Chap. 70). However an understanding of the range and nature of the involved mechanisms is critical in the evaluation of the trauma patient.

Multiple injuries (polytrauma) in the trauma patient have long been associated with an increased morbidity and mortality. Patients, who survive the initial insult, are subject to a number of physiologic challenges that can

induce immunologic and/or host defense responses. Both the initial physiologic challenges, such as hypoxemia, hypotension, fractures, and soft-tissue injuries, as well as subsequent insults because of reperfusion injury, a compartment syndrome, multiple operations, and infections all play a role in this response. The systemic inflammatory response (SIRS) is associated with the release of proinflammatory cytokines, arachidonic acid metabolites, proteins of the contact phase and coagulation systems, hormonal mediators, complement factors, and acute phase proteins.<sup>14</sup> However, in the body's attempts to maintain homeostasis, a parallel mechanism of antiinflammatory mediators is released. This compensatory antiinflammatory response syndrome involves the release of antiinflammatory mediators that serve to quench the initial inflammatory response. T-cell cytokines, such as interleukin (IL)-4, IL-10, and IL-13 are known to modulate monocyte activity. However, defective T cells, released after trauma, may synergize with activated monocytes and contribute to a further deterioration of the patient's clinical condition, impairing the body's ability to fight infection.<sup>15</sup> An imbalance of these two response systems may be an underlying element in the organ dysfunction and increased susceptibility to infections seen after trauma. Over time, endothelial damage, leukocyte accumulation, disruption in the microcirculation, and disseminated intravascular coagulation can lead to widespread apoptosis and necrosis. This can result in multiorgan dysfunction syndrome or multiple organ failure (MOF). While the early use of antiinflammatory agents in the trauma patient has not been encouraging, research into the detailed understanding of the immune response to trauma is providing new insight into the complexities of response with great interest in specific inhibitors of key steps in the cascade.<sup>16</sup> This may also serve to identify individuals at risk for posttraumatic complications and assist in creating early and specific interventions. This cascade of events can be characterized by two distinct mechanisms of cell death: apoptosis and necrosis. A better understanding of these naturally occurring processes may facilitate the development and testing of new therapies for use in the trauma patient.

## Apoptosis

Programmed cell death, an energy-dependent mechanism, functions as a normal component of the development of the heart, brain, and the immune system. Regulation of apoptosis occurs at a number of levels and is characterized by DNA cleavage, nuclear condensation, and the degradation of specific proteins. Apoptosis may be initiated by extracellular receptors such as those of the tumor necrosis factor group of receptors, as well as a response to cellular stress, such as free radical generation or degradation secondary to irradiation. A highly ordered process, it is characterized by the presence of unaffected adjacent cells and may serve to isolate damaged from undamaged tissue. Apoptosis may represent an early response to injury and may serve as a trigger to subsequent necrosis.<sup>17</sup>

## Necrosis

Typically necrosis is a more disorganized process that is characterized by disruption of intracellular organelles, disruption of nuclear and plasma membranes, and disintegration of nuclear and cytoplasmic structures. The overall degradation is disorganized, in contrast to apoptotic mechanisms, and is associated with the destruction of adjacent tissue. The process of necrosis is a likely response to tissue hypoxia, ischemia, and reperfusion, and may represent a later response to the initial insult of trauma. With advances in resuscitative care, the rapid ability to reverse the effects of shock suggests a possible role in attenuating the process of necrosis in a manner limiting the destruction of potentially compromised tissue to a point that may allow survival.<sup>18</sup>

Cell death and the destruction of tissue ultimately determine mortality. However the impact of trauma effects several systems vital to the potential survival of the victim. Complement activation and the coagulation pathway are systems vital to survival that are markedly altered in the trauma patient.

## Complement Activation

A complex system of more than 30 proteins involved in the lysis of pathogens, complement is activated in the earliest phase of trauma. The extent of activation is a function of the severity of the injury. While activation is a vital

mechanism of defense against pathogens, inappropriate complement activation may result in excessive tissue destruction. Activated by means of the classical, alternative and lectin pathways, complement activation is an important component of the immune response. Commonly seen as a result of binding to an antigen–IgG or–IgM complex, in the case of the classical pathway, the complement system is also activated by lectins binding to polysaccharide moieties on bacterial surfaces and by the exposure of cyto-keratin to ischemic endothelial cells. In contrast to these specific interactions for activation, the alternative pathway uses a spontaneous mechanism of autoactivation. Thus, the alternative pathway represents a continuous complement activation process and, in the setting of impaired regulatory processes,<sup>19</sup> may represent the basis of several autoimmune diseases.

The mechanism of complement activation in the trauma patient is not well understood. While commonly known to be triggered by microbial infection, both the classical and alternative pathways are overactivated in the trauma patient in the absence of bacterial infection. In addition to complement activation during the clotting cascade, additional causes of activation in the setting of tissue injury may include triggering by reactive oxygen metabolites, exposed collagen, and adenosine triphosphate. Mechanisms of activation notwithstanding, the potential for over activation results in an inflammatory reaction. This process can be a local phenomenon or it may result in a SIRS, adult respiratory distress syndrome (ARDS), or MOF. Complement activation may be a critical factor in injuries commonly associated with the trauma patient such as ischemia–reperfusion injury, trauma associated ischemia to the myocardium, intestine and central nervous system structures.<sup>20,21</sup> Targeted complement inhibition may provide a means to attenuate underlying issues related to the morbidity and mortality of trauma patients.<sup>16</sup>

## Coagulation System

There is a marked physiologic reserve of the factors associated with the coagulation system in the healthy individual. Several issues common to the trauma patient can dramatically compromise coagulation and negatively impact the survival of the victim.

While the reserve of coagulation factors in the healthy individual provides a significant buffer in the capacity of the system to correct for hemorrhage, the patient suffering from large scale blood loss as a result of injury is faced with a rapid exhaustion of the factors associated with coagulation. In the setting of aggressive crystalloid resuscitation, the resulting dilution of available coagulation factors can limit the ability of the patient to achieve hemostasis. An environmental factor further impacting the function of the coagulation system in the trauma patient is that of hypothermia. Trauma victims are often hypothermic because of factors associated with prolonged exposure, massive blood loss and resuscitation with fluids well below 98.6°F (37°C). Conditions for enzymatic pathways associated with coagulation are then less than optimal, resulting in further compromise of function. The combination of such events can result in disseminated intravascular coagulopathy and is often associated with a dismal prognosis for the trauma patient.<sup>22</sup>

## TRAUMA MANAGEMENT

Improvements in both prehospital and emergency department care have resulted in a reduction in morbidity and mortality, as well as the identification of critical areas of vulnerability in the care of the trauma patient.

### Prehospital Care

The scope of care in the prehospital setting ranges from ambulances in more rural areas, often staffed by local volunteers, to the more extensive emergency services systems seen in large metropolitan areas. These may be run under the direction of state or regional agencies, often in close coordination with major trauma centers. While there is diversity in the nature of assets available in any specific setting, there has been a major effort over the past few decades to improve standards of care, methods of delivery and the training available to the care providers across the United States. The evolution of air evacuation systems using helicopters has further extended our ability to rapidly respond to the challenges of the trauma patient.

First responders trained in basic cardiopulmonary resuscitation (CPR) and



first aid are often local law enforcement and fire department personnel. With the arrival of one or more emergency medical technicians (EMTs), a more detailed evaluation of the patient's condition takes place, integrating the mechanism of injury with the physical findings, making diagnoses and initiating treatment. Although the level of training and certification of the EMT ranges from a basic EMT to a paramedic capable of providing advanced cardiac life support (ACLS), the EMT provides early treatment, often guided by the treatment facility designated to receive the patient. In addition to airway, breathing, and circulation support, the EMT is able to address issues related to wounds and fractures, supplementing the basics of securing an airway, obtaining intravenous access, initiating resuscitation, and administering medications as indicated.

At the scene the overall process undertaken by emergency medical personnel is focused on assessment and management. An initial assessment for site safety is performed to ensure that any potential risks to cause further injury to the patient, or to emergency personnel are identified. Requirements for additional personnel or specialized equipment may be identified at this point. An appreciation of the nature of the incident resulting in the trauma also provides the EMT insight into potential patterns of injury. At this point, a primary survey of the patient is performed to identify and treat life-threatening injuries. In critically injured patients, minimizing delay in transport is critical. As such, treatment and resuscitation are instituted as quickly as possible, with transport measures often being instituted in a parallel process.<sup>23</sup>

Intuitively, the ability to provide more advanced care in the prehospital setting would be expected to positively impact patient outcome. However, studies suggest that the ability to provide more advanced care, such as tracheal intubation and ACLS has little impact on survival, whereas minimal resuscitation and rapid transport to a trauma center appears to make a positive effect improving outcome.<sup>24,25</sup> Certain interventions, such as tracheal intubation of the patient with a severe head injury and intravenous resuscitation of the hypotensive patient in shock caused by penetrating trauma, may represent special categories of

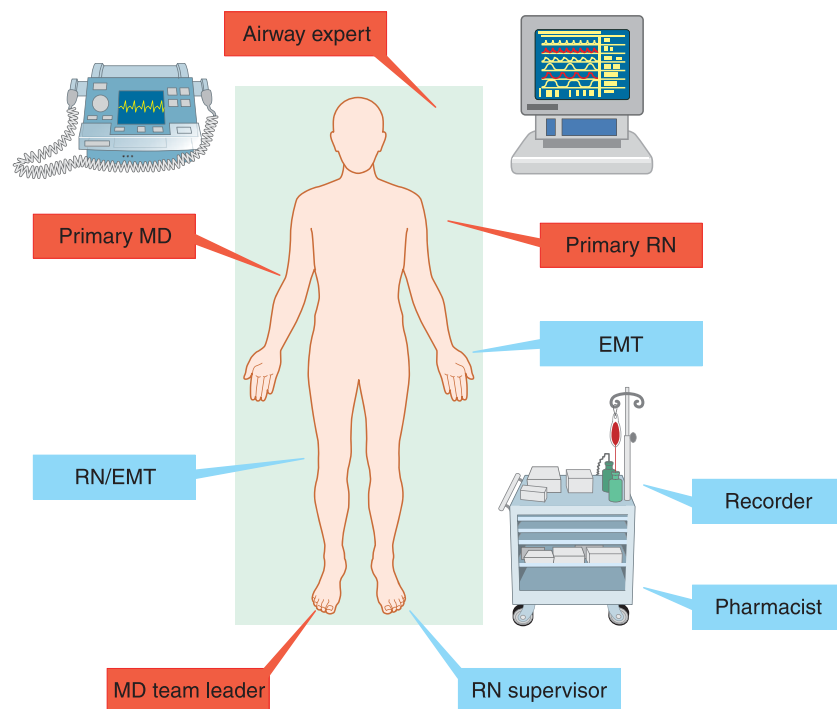
patients who will benefit from field interventions.<sup>26</sup> However, the survival of severely head-injured patients who are not intubated in the field may be higher when compared to a similarly injured group of patients who are intubated in the field with rapid sequence induction.<sup>27,28</sup> It would appear that in the setting of improved capabilities for the delivery of prehospital care, the apparent lack of benefit to the patient suggests that there are underlying issues contributing to the morbidity and mortality of the trauma patient that are, as yet, not well understood.<sup>29</sup>

### Hospital Care

The nature and setting of care for the trauma patient in the hospital can vary. While a markedly unstable patient may be brought directly from the ambulance entrance of the hospital to the operating room, the more commonly encountered sequence involves the arrival of the patient to the emergency department for a detailed evaluation, resuscitation, and development of a course of treatment. The effective organization of the emergency department is vital to the delivery of appropriate care to the patient. Figure 78–2

depicts the typical configuration of a trauma bay. Often a near-chaotic environment, a team of key personnel, with appropriate equipment and support services, is required to ensure the most expeditious assessment and treatment of the patient.

Organized around a team leader, the emergency team requires designated personnel with specific skills. Task organized in a manner to provide critical expertise and capabilities, this group often draws upon personnel from services throughout the institution. The team leader, often an emergency medicine physician, is responsible for directing all components of patient care, as well as obtaining pertinent information from the prehospital phase of care regarding patient information and mechanisms of traumatic injury. The team leader is also responsible for the conduct of the primary and secondary surveys of the patient. An airway expert from the department of anesthesia, respiratory therapy, emergency medicine, or surgery is tasked with securing the airway and regulating mechanical ventilation as required. The team leader may often function as the airway expert as well. In the setting of



**FIGURE 78–2.** Configuration of a typical trauma bay. Designed to maximize efficiency of multiple key personnel and associated equipment for the care of an acutely injured patient. Specific roles and coordination are critical in effectively functioning in an often chaotic environment.

a trauma patient with obvious requirements for surgical intervention, the trauma surgeon will assume the role of the team leader. Procedural personnel may be used for placing intravenous access, obtaining lab samples, coordinating with the blood bank, the placing of monitors and performing additional tasks as determined by the team leader. Depending on the extent of the trauma, multiple personnel may play a role in performing procedures in the emergency department. Nurses comprise an integral portion of the trauma team. Responsibilities run from direct involvement in resuscitation to key roles in the interaction with supporting services as well as with patient families. Additional personnel involved in the trauma team may include radiography technician, recorder, family and patient care support personnel, mental health providers, pharmacist, specialty surgeon(s), and clergy.

One of the most important aspects of the trauma team is the ability to immediately respond to an injured patient in a timely, efficient, and reliable manner. This response capability is born of a specific training plan, with clearly identified roles and requirements for each team member.<sup>30</sup> This facilitates a coordinated approach to a trauma patient, in a setting that often requires multiple parallel tracks of assessment and intervention (Fig. 78-3).

The disposition of the trauma patient in the emergency department varies. A patient injured in a motor vehicle collision who is stable on arrival in the emergency department, may be sent to the radiology department for studies and then taken immediately to the operating room or admitted to the hospital for further treatment and/or evaluation. These patients must be carefully observed for acute changes in clinical conditions while being transferred from the emergency department to other sites within the hospital (e.g., CT scanner, interventional radiology). A similar patient, with unstable vital signs, may require resuscitation in the emergency department before proceeding to additional studies or the operating room. Some patients arrive emergently and are brought directly to the operating room for a lifesaving intervention or undergo emergency surgery in the emergency department. This serves to illustrate the diversity of presentations by a trauma patient, and the need for emer-



**FIGURE 78-3.** Trauma team caring for an acutely injured patient in the emergency department. Clockwise from left foreground: team leader (emergency department attending), primary physician. Respiratory therapist at the head of the stretcher, with assistance provided by an emergency department nurse at the patient's right, and primary nurse at patient's left.

gency departments to provide experienced and well-trained personnel capable of immediate adaptation of therapeutic plans to rapidly changing clinical conditions.

## PATIENT ASSESSMENT

The emergent presentation of an acutely injured patient presents one of the greatest clinical challenges for the anesthesiologist. The need to perform a critical assessment rapidly, often in a chaotic setting, requires that the anesthesiologist approach the situation in an efficient and focused manner. Additionally, the uncertainty associated with a trauma patient requires that the anesthesiologist be vigilant for changes in the clinical situation (Table 78-1). Typically, the most severely compromised patients offer the least amount of time to perform an in-depth survey.

Since the late 1960s, the American College of Surgeons Committee on Trauma has developed a systematic and stylized approach to the trauma patient. The advanced trauma life support system (ATLS) evolved from the experience of an orthopedic surgeon and his family involved in a private plane crash. The evaluation and treatment provided to this family in a small community hospital was disorganized and haphazard. The efforts precipitated by this experience have led to a system that facilitates a prioritized approach to the trauma patient. This

has resulted in a standardized and widely accepted protocol to initially address potentially life-threatening issues, using the principles of airway, breathing, and circulation (ABCs), followed by a more extensive survey to better determine the extent and nature of the injuries. This process also facilitates communication within an institution, as well as between institutions in the case of patient transfer requirements, providing assistance in the subsequent disposition.<sup>31</sup>

## Primary Survey and Resuscitation

The well-established approach to the ABCs remains the standard of approaching the trauma patient. Prioritization is based upon the immediacy of the threat to life. The need to support and/or secure the airway remains the highest priority. The inability to oxygenate a patient can result in irreversible damage to the brain in as little as 4

**TABLE 78-1.**

### Trauma Team Roles for the Anesthesiologist

Anesthesiologist
Team leader
Critical care specialist
Transport coordinator
Pain management
Mass casualty coordinator



**FIGURE 78-4.** Massive facial injury. High-energy injury resulting in multiple fractures of the mandible, maxilla, tongue, hard palette, sinus, and nose, and enucleation of the right eye. Patient was awake and alert immediately prior to intubation.

minutes. Supporting the airway may be as simple as opening the mouth and clearing away debris, to as complicated as securing the airway in a patient with severe trauma to the head and neck requiring the need of an emergency surgical airway. Managing the airway in a trauma patient often involves the physical constraints of maintaining cervical spine precautions. Protocols for clearance of the cervical spine may vary across institutions. However it is likely that the majority of trauma patients requiring intubation will also require cervical spine stabilization.<sup>32</sup> Specific issues regarding the approach to the difficult airway in the trauma patient are addressed in Chapter 35. Even in the setting of a protected airway, the respiratory drive may be impaired from an injury to the head, metabolic compromise, or depressant

drug administration, and the anesthesiologist must ensure that adequate oxygenation and ventilation are maintained (Fig. 78-4). Issues affecting circulation are also addressed in this initial survey. Although the sequence of emergency treatment prioritizes airway and breathing, in the setting of the trauma bay, parallel efforts are often directed toward circulatory issues at the same time the airway issues are being addressed. The threat to life by hemorrhage can also occur as rapidly as a few minutes to a few hours after injury and, as such, occupies a priority following oxygenation (Table 78-2). The most commonly encountered issue in the hypotensive trauma patient is hypovolemia. In the setting of a stable cardiac rhythm a fluid challenge of 1-2 L of warm crystalloid is administered. A plan to treat ongoing hemor-

rhage needs to be developed and is roughly delineated along the lines of compressible versus noncompressible hemorrhage. Controlling or temporizing bleeding from an extremity may provide adequate time to obtain necessary studies (radiography, angiography), whereas an incompressible hemorrhage (torso, cranium) may require emergent treatment in the operating room or the emergency department.

This initial assessment phase requires that personnel be able to immediately recognize and treat issues that present an imminent threat to survival. The mechanism of injury, if known during this phase, may provide some insight to the team, however the primary issues in a systematic approach are

#### Airway

Inadequacy

Obstruction

#### Breathing

Pneumothorax

Hemothorax

Tension pneumothorax

Flail chest

#### Circulation

Hemorrhage

Cardiac tamponade

#### Shock

Cardiogenic

Neurogenic

Obstructive

Septic

Recognition and timely treatment of these conditions usually requires urgent intervention. It is imperative that the trauma team have the personnel, equipment, and supplies immediately available to intervene as needed.<sup>33</sup> The initial assessment then continues to

**TABLE 78-2.**

#### Physiologic Effects of Hemorrhage for 70-kg Male

	Class I	Class II	Class III	Class IV
Blood loss (mL)	<750	750-1500	1500-2000	>2000
Blood loss (% blood vol.)	<15%	15-30%	30-40%	>40%
Pulse rate	<100	>100	>120	>140
Blood pressure	Normal	Normal	Decreased	Decreased
Pulse pressure	Normal or increased	Decreased	Decreased	Decreased
Respiratory rate	14-20	20-30	30-40	>35
Urine output (mL/h)	>30	20-30	5-15	Negligible
Mental status	Slightly anxious	Mildly anxious	Anxious/confused	Confused/lethargic
Fluid replacement	Crystalloid	Crystalloid	Crystalloid/blood	Crystalloid/blood



address issues with regard to the extent of neurologic compromise, commonly referred to as D for disability, in the conventionally accepted ABCDE format. A brief examination, using the Glasgow Coma Scale (GCS) can coarsely evaluate the patient's neurologic condition with regard to verbal and gross motor function (Table 78-3). Pupillary response is also determined at this phase. A GCS score of less than 8 usually requires immediate tracheal intubation to protect the airway.<sup>34</sup> The final component of the initial assessment is termed as E for exposure and environment. Clothing is removed while attention is directed toward preventing hypothermia by ensuring that the patient's environment is adequately warmed.

During this initial phase resuscitation is initiated, monitoring is established, to include a Foley catheter and an orogastric tube for the intubated patient and any available history is obtained (often referred to as F, G, and H of the ABC... mnemonic). Information regarding the nature of the events resulting in the patient's injury and transport is obtained in coordination with the prehospital care team. At this point, samples for critical lab values, such as arterial blood gas tensions and pH, blood glucose, and hematocrit, if not obtained during the earlier establishment of intravenous access, are sent with additional lab tests. Plans for radiographs and/or additional studies are formulated. Throughout the primary survey, the evaluating physician is obtaining information and may determine that there is a need to transfer the patient to another facility. Support personnel, after direction by the team leader, may initiate the process of transfer. Physician-to-physician direct communication remains a critical factor in transferring a patient between institutions.<sup>35</sup>

A common error in management during the primary survey involves delay in securing the patient's airway. Trauma team leaders may be hesitant to secure the airway, because of distraction or inexperience. It is important for the anesthesiologist to be appropriately aggressive in this arena.<sup>36-38</sup> An unrecognized pneumothorax is another common error. Excessive fluid resuscitation often occurs to the trauma patient. Once again, the anesthesiologist can guide the fluid management of the trauma patient. As discussed in

the section on resuscitation, the area of hypotensive resuscitation is being examined as a more appropriate management strategy in the trauma patient.<sup>39</sup> Failure to establish adequate intravenous access and failure to involve a surgeon early may also become problematic in situations such as a difficult or lost airway, as well as in the case of a patient with a noncompressible hemorrhage.

### Resuscitation

Prehospital guidelines suggest the placement of 2 large-bore (14-16-gauge) intravenous cannulae and the infusion of warmed lactated Ringer solution for the resuscitation of the trauma patient. Field conditions limit the ability to treat many of the conditions underlying hypotension; as a result, emergency medical personnel are encouraged to avoid delays in transport, continuing fluid resuscitation as clinically indicated. Currently, the goal for resuscitation of the trauma patient upon arrival to the hospital is the restoration or optimization of oxygen delivery to the tissues in the face of hemorrhagic shock. Warmed crystalloids (normal saline, lactated Ringer solution), with the addition of specific blood products as clinically indicated are the rule. Initiated in what may be a chaotic field environment, resuscitation is often carried out without any laboratory values. Although crystalloid infusion may be the only means initially available for the treating of systemic hypotension, the hemodilution associated with massive crystalloid resuscitation is often accompanied by hypothermia, coagulopathy and acidosis. An additional concern is the inflammatory cascade initiated by trauma that is believed to be an underlying issue in the subsequent multiorgan failure of the trauma patient. In the face of ongoing uncontrolled hemorrhage, blood flow to tissue may be markedly reduced. Avoidance of tissue ischemia is likely to limit the impact of ischemic reperfusion. As such a goal of resuscitation to less than the normal physiologic state may offer some protection from the sequela of ischemia. The impact of resuscitation to less than optimal physiologic parameters may prove beneficial to the long-term survival of the trauma patient. Resuscitation targeted to lower mean arterial pressures may provide a greater margin of safety in the early attempts to

TABLE 78-3.

#### Glasgow Coma Score

Eye-opening response	
4	Spontaneous
3	To speech
2	To pain
1	None
Verbal response	
5	Oriented to name
4	Confused
3	Inappropriate speech
2	Incomprehensible sounds
1	None
Motor response	
6	Follows commands
5	Localizes to painful stimuli
4	Withdraws to painful stimuli
3	Abnormal flexion (decorticate)
2	Abnormal extension (decerebrate)
1	None

The Glasgow Coma Score is the sum of the highest score in all categories.

locate and control hemorrhage. And permissive hypercapnia may help limit the negative hemodynamic impact of positive pressure ventilation on the hypovolemic/hemorrhaging patient. Current investigations may suggest a role for the targeted use of antiinflammatory therapies in early resuscitation.<sup>40</sup> During resuscitation limitation of crystalloid solution, a known activator of neutrophils, may also serve to attenuate the early inflammatory response. The use of hypertonic saline with dextran is beneficial, particularly in the setting of trauma patients with closed-head injuries.<sup>41</sup>

The manner of resuscitation has been a major topic for debate over the entire history of research into the care of the trauma patient. Knowledge gained through the care of the combat casualty and more recent investigations suggest that the tradition of resuscitation to normal physiologic values using isotonic fluids may be detrimental to the long-term survival of the trauma patient.<sup>42</sup>

During the past decade, controversy over the appropriate end points of intravenous fluid resuscitation in the



trauma patient has led to investigations regarding optimal resuscitation strategies. From the Vietnam War era, it was appreciated that systemic perfusion pressures needed to be maintained in the hemorrhaging patient. However there was a concern that in the setting of uncontrolled hemorrhage, aggressive fluid administration could interfere with thrombus formation and decrease the survival rate.<sup>43</sup> Several years ago an effort by the National Institutes of Health led to the establishment of the Post-Resuscitative and Initial Utility of Life-Saving Efforts (PULSE) Workshop. A Trauma Work Group has undertaken to endorse strategies and priorities for research into trauma resuscitation.<sup>44</sup>

### Secondary Survey

The secondary survey only takes place after the primary survey has been completed, resuscitation is then underway and the patient's vital signs should demonstrate a trend toward normalization/stabilization. In the setting of treating a trauma patient, it is critical to continually review the vital signs for any indication of change or deterioration in the patient's condition. The secondary survey is a thorough head-to-toe examination of the patient in conjunction with a more detailed history of the patient's general health in the context of the mechanism(s) of traumatic injury. This purposeful and systematic evaluation reduces the likelihood of a serious injury being overlooked, particularly in the unresponsive patient.<sup>45</sup>

A comprehensive description of the secondary survey is provided in the advanced trauma life support manual.<sup>31</sup> However an overview of the systematic approach with the most common issues of concern for the preoperative patient is presented herein to sensitize the anesthesiologist to critical issues that can impact the preoperative trauma patient.

### Head

The head requires a complete neurologic exam. An examination of the eyes (to include visual acuity), if possible, should be assessed as facial swelling may later preclude an eye examination. The possibility of fractures to the head must be considered.

Face: Assess for bony and soft tissue injury. Continue to reassess the airway for patency and security of any

airway appliances and sources of supplemental oxygen.

### Neck

Blunt trauma to the neck region may result in injuries that are not immediately appreciated, such as certain nerve and vascular injuries. Patients with distracting injuries, including intoxicated patients, are presumed to have an unstable neck and cervical spine precautions against injury must be maintained.

### Chest

Recheck the chest for rib fractures. A pneumothorax may not be clinically significant until the patient is intubated and is being maintained on positive pressure ventilation. Also injuries to the great vessels may not become evident during the primary survey.

### Abdomen

Special attention must be directed to the retroperitoneum as well as the genitalia. A diagnostic peritoneal lavage or a focused abdominal ultrasound for trauma may be performed in the emergency department.

### Spine

The patient must be log-rolled for a complete examination of the spine. This process also facilitates examination of the back for evidence of injuries not appreciated during the primary survey.

### Soft Tissues

Abrasions and contusions, often a consequence of the mechanism of injury, may provide insight into the presence of an occult injury.

It is also during the secondary survey that further investigation is considered. Additional imaging, computerized tomography, angiography, bronchoscopy and transesophageal echocardiography may be indicated. It is critical that the patient's hemodynamic status is stabilized before any attempt at further testing occurs.

At the conclusion of the secondary survey, the plans for further care of the trauma patient should be well-formulated. As the patient is being prepared for additional tests or transfer to the operating room, the tertiary phase is entered. This phase is designed to ensure regular reevaluation of the patient in recognition of the dynamic clinical situation of the trauma patient.<sup>46</sup>

## TRAUMA SCORING

Since the 1950s attempts have been made to develop a scoring system to effectively characterize traumatic injury. In the 1970s, with the development of trauma centers and the appreciation of the epidemic nature of trauma, the need for a more effective means to quantify the severity of trauma was identified. Used as part of a field triage system, the scoring system can help the clinician decide the appropriate evacuation of a patient, or while in the hospital, it may be used to evaluate the impact of therapy, the appropriateness of intervention and/or to determine the patient's inclusion into a research study.

There are three major categories of trauma scoring systems (Table 78–4). These are divided into physiologic or anatomic groups, with a third group being a combined or specialized group.<sup>47</sup>

### Anatomic Scores

These systems are based on the anatomic sites of injury. These scoring systems have evolved to correlate reasonably with in-hospital morbidity and mortality data. A disadvantage to using these systems is the relative complexity involved in the calculation process.<sup>48</sup>

TABLE 78–4.

#### Trauma Scoring Systems

<b>Anatomic</b>
Abbreviated Injury Score (AIS)
Injury Severity Score (ISS)
New Injury Severity Code (NISS)
Anatomic Profile (AF)
Penetrating Abdominal Trauma Index (PATI)
ICD-based Injury Severity Code (ICES)
<b>Physiologic</b>
Glasgow Coma Scale (GCS)
Trauma Score (TS)
Revised Trauma Score (RTS)
Acute Physiological and Chronic Health Evaluation (APACHE)
Systemic Inflammatory Response System (SIRS) Score
<b>Combined</b>
Trauma and Injury Severity Score (TRISS)
A Severity Characterization of Trauma (ASCOT)
Harborview Assessment to Risk of Mortality (HARM)

## Physiologic Scores

Using data that can be obtained noninvasively in the field, such as systemic blood pressure and heart rate, the physiologic scoring systems are often used by prehospital personnel in triage decisions (Table 78-5). Disadvantages are associated with the issue that physiologic patterns often change rapidly and the scoring system requires the conversion of measured values into standardized scores.<sup>49</sup>

## Combined Scores

By combining assessment of both anatomic and physiologic compromise after an injury, these scoring systems have been used as predictors of mortality. While the most common of the systems is used to predict outcome in trauma patients, the combined systems require more complex calculations and bear the same limitations as the anatomic and physiologic based systems.<sup>50,51</sup>

## CRITICAL ISSUES IN TRAUMA MANAGEMENT

Myriad issues may impact the trauma patient, during both the prehospital and in-hospital phases of care. Although the algorithm of the ABCs remains the primary focus of any approach to the trauma patient, the risks imposed by hypothermia and the con-

sequences of resuscitation merit special consideration in any discussion of the approach to or evaluation of the trauma patient.

## Hypothermia

Trauma patients are often hypothermic by the time emergency medical personnel assume care for the individual. Exposure to the extremes of environmental cold, as well as the physiologic effects of blood loss, and changes in mental status can lead to a marked reduction in core body temperature.<sup>52</sup> Coupled with cold fluid resuscitation in the field, this can place the patient at risk for the multiple physiologic effects of low body temperature (Table 78-6).

## Resuscitation Strategies

Emergency medical personnel are often limited by field conditions in their ability to treat trauma patients in hypovolemic shock caused by hemorrhage. Fluid, most often isotonic crystalloids, are administered in a manner that is usually guided by the ability to monitor vital signs during transport. In the emergency department, the ability to use more advanced monitoring and to obtain laboratory data markedly improves the ability to measure the effects of intravenous infusion therapy. These methods of assessment, coupled with the less austere and controlled environment of the hospital setting, permit a more guided and controlled approach to fluid resuscitation.

## FUTURE TRENDS

The care of the trauma patient has become a major subject of analysis and investigation over the past several decades. Areas of opportunity to improve care for the trauma patient, as well as the training of personnel involved in the care of these patients, have emerged over the past 15 years. Some of these topics offer the potential to markedly impact the care of the trauma patient.

## Blood Substitutes

Acute hemorrhage remains one of the most challenging factors in the care of the trauma patient. In the setting of massive blood loss, resuscitation with crystalloid solutions is ineffective for the treatment of shock. Although the use of blood products is the standard of care, the nature and lack of availability of these products in the field

TABLE 78-6.

### Effects of Hypothermia

- Coagulopathy
- Cardiac dysrhythmias
- Peripheral vasoconstriction
- Increased metabolic demand (shivering)
- Decreased metabolic demand (attenuated metabolic rate)

presents cause for concern. An inherent risk of infection with transfusion, although small, is present and the potential for blood incompatibility must also be considered. Also, evidence suggests that reductions in morbidity and mortality over the past decade are associated with a decreased use of blood transfusion during resuscitation.<sup>53</sup> In circumstances where blood products are not readily available, such as in rural settings, there is a need for the development of effective blood substitutes with the ability to transport oxygen to tissues.

Particularly in the area of trauma care, blood substitutes offer obvious advantages over conventional blood products. Availability would be markedly improved as these agents would require minimum storage requirements, offer extended shelf-life, and would eliminate compatibility issues. Infectious risk and immunologic concerns would be eliminated and the potential for enhanced oxygen-carrying capability and improved rheologic properties would be beneficial.<sup>54</sup> Although this is obviously an exciting and needed area of development, investigation into blood substitutes is not without controversy. No synthetic blood substitute has been approved by the FDA. A current clinical trial in the United States is examining the use of a blood substitute during prehospital resuscitation and transport. Ethical concerns remain in the area of community, rather than individual, consent for the procedure, and the possibility that minority and socioeconomically disadvantaged groups may be unfairly targeted.<sup>55</sup>

## Resuscitation Strategies

In the case of the exsanguinating patient, medical personnel in both prehospital and hospital settings infuse isotonic fluids to reverse hypovolemic shock until definitive surgical repair can be achieved. Evidence suggests

TABLE 78-5.

### Revised Trauma Score (RTS)

Parameter	Range	Score
A. Respiratory rate (breaths/min)	10–29	4
	>29	3
	6–9	2
	1–5	1
	0	0
B. Systolic blood pressure (mm Hg)	>89	4
	76–89	3
	50–75	2
	1–49	1
	0	0
C. Glasgow Coma Scale Score	13–15	4
	9–12	3
	6–8	2
	4–5	0
	<4	0

The Revised Trauma Score is the summation of the 3 categories above:  $RTS = A + B + C$ .

that hypotensive resuscitation reduces the risk of death.<sup>56,57</sup> End points or targets for resuscitation are varied and include a normal mean arterial pressure, systolic blood pressure, and urine flow rate. Although there is some debate as to the appropriate or best target for resuscitation, there also may be implications in the choice of fluids used for resuscitation. As noted in the era of the Vietnam War, aggressive resuscitation with large volumes of isotonic crystalloid solutions led to “Da Nang” or “shock” lung, now commonly known as ARDS. Thus the inappropriate choice of fluids for resuscitation may potentiate the cellular injury caused by hemorrhagic shock.<sup>42,58</sup> A recent investigation reports that the removal of D-lactate from Ringer solution is associated with a reduction in apoptotic cell death in swine liver and lung models of hemorrhagic shock.<sup>59</sup> Hypertonic saline, alone and in combination with dextran, improves the survival rate after traumatic brain injury. The development of blood substitutes offers additional potential for improved resuscitation without the deleterious effects of crystalloid solutions.<sup>41</sup>

### Hemorrhage Control

Uncontrolled bleeding remains a primary cause of mortality in both the prehospital and early in-hospital course of the trauma patient. Although surgical control of bleeding is the paramount approach to the exsanguinating patient, attendant conditions, such as coagulopathy, anemia, and acidosis further complicate the timely resolution of hemorrhage. The infusion of recombinant activated factor VII, initially developed for the treatment of hemophiliacs, has been a subject of interest for the control of hemorrhage in the trauma patient.<sup>60</sup> Infusion of factor VII has been used as a therapy of last resort in trauma patients with active hemorrhage and clinical coagulopathy in which surgically accessible hemorrhage has been controlled.<sup>61</sup> Activated factor VII infusion markedly reduces blood loss and mortality in trauma patients with massive bleeding. However, given the desperate nature of the conditions under which factor VII has been administered, the ability to perform a controlled trial has been ethically limited.<sup>62</sup> The use of activated factor VII in the care of trauma patients with uncontrolled bleeding appears to be a valuable therapeutic modality and continues to be an area of active inves-

tigation. The usefulness of activated factor VII has been demonstrated in elective surgery. There is a need for well-designed prospective randomized trials in trauma patients.<sup>63</sup>

### Hypothermic Resuscitation

Hypothermia and the associated physiologic changes of homeostatic mechanisms are critical factors in the acute care of the trauma patient. As a result of prolonged exposure, extrication and transport times, and resuscitation with cold fluids in the field, the severity of injuries in the trauma patient is further complicated by this physiologic compromise. However, controlled hypothermia has been effectively used in the treatment of refractory intracranial hypertension and traumatic brain injury.<sup>64</sup> Hypothermia has reduced morbidity and mortality in infants with hypoxic-ischemic encephalopathy.<sup>65</sup> Profound hypothermia is associated with intact survival after prolonged lethal hemorrhage and trauma in animal models. This approach of emergency preservation and resuscitation may offer the ability to extend the time from severe injury in the field to definitive therapy after evacuation to a hospital.<sup>66</sup>

### Simulation Training

The past decade has seen a marked increase in interest regarding the use of simulation in many areas of medicine. Evolving in part from military applications, the use of simulation training, using computer-controlled mannequins, has been shown to be an effective means for trauma assessment and trauma team training.<sup>67</sup> The ability to reproducibly evaluate team performance also has been demonstrated using a human patient simulator. Additionally, using human performance-assessment tools, resuscitation training has been shown to improve after a focused refresher course in a simulator.<sup>68</sup> While continued investigation is needed to further develop and validate the use of simulation training, the potential to improve behavior and performance by trauma team members suggests the possibility of improved refinement of simulation as a critical component for team training in trauma care.<sup>69</sup>

### Mass Casualties

The events of the last decade have brought a new interest in the management of incidents involving multiple

casualties. Mass casualties may be the result of natural disasters, acts of terrorism, as well as result from industrial accidents.<sup>70</sup> Although victims of a hurricane may have different medical needs than victims of a terrorist act using a chemical or biologic agent, the demands placed on public health assets can be very similar. Augmenting the training of emergency healthcare providers and increasing their logistical support, as well as increasing the capacity and numbers of healthcare facilities, can maximize the emergency healthcare system's ability to rapidly expand capacity and capability, and can help reduce the severe strains being placed on medical resources.<sup>71,72</sup> The need to develop new strategies in anticipation of the large-scale burdens imposed by mass casualties remains an area of major concern to public health sector and hospital managers.

### KEY REFERENCES

1. Holcomb JB, et al. Prehospital physiologic data and lifesaving interventions in trauma patients. *Mil Med* 2005;170(1):7-13.
2. Kaufmann C. *Advanced Trauma Life Support for Doctors*. 7th ed. Chicago: American College of Surgeons, 2004:391.
3. Keel M, Trentz O. Pathophysiology of polytrauma. *Injury* 2005; 36(6):691-709.
4. Kunisaki SA, McCabe CJ. Initial evaluation and resuscitation: primary survey and immediate resuscitation. In: Sheridan RL, ed. *The Trauma Handbook of The Massachusetts General Hospital*. Philadelphia: Lippincott, Williams & Wilkins, 2004:71-88.
5. Trunkey DD. Trauma. *Sci Am* 1983;249(2):28-35.

### REFERENCES

1. Balogh Z, et al. Secondary abdominal compartment syndrome is an elusive early complication of traumatic shock resuscitation. *Am J Surg* 2002;184(6):538-543; discussion 543-544.
2. DeLong WG Jr, Born CT. Cytokines in patients with polytrauma. *Clin Orthop Rel Res* 2004;(422):57-65.



3. Kolata G. Trauma medicine: stepchild no more. *New York Times*, 2003:1.
4. Hoyert DL, et al. Deaths: final data for 2003. *Natl Vital Stat Rep* 2006;54(13):1-120.
5. Metcalfe NH. Military influence upon the development of anaesthesia from the American Civil War (1861-1865) to the outbreak of the First World War. *Anaesthesia* 2005;60(12):1213-1217.
6. Cameron AMA. Brief history of trauma surgery. In: Sheridan RL, ed. *The Trauma Handbook of The Massachusetts General Hospital*. Philadelphia: Lippincott, Williams & Wilkins, 2004:1-9.
7. Pruitt BAJ, Pruitt JH, Davis JH. Trauma. In: Moore EE, Feliciano DV, Mattox KL, eds. *Trauma*. New York: McGraw-Hill, 2004:3-19.
8. Holcomb JB, et al. Prehospital physiologic data and lifesaving interventions in trauma patients. *Mil Med* 2005;170(1):7-13.
9. Trunkey DD. *Trauma*. *Sci Am* 1983; 249(2):28-35.
10. MacKenzie EJ, et al. A national evaluation of the effect of trauma-center care on mortality. *N Engl J Med* 2006;354(4):366-378.
11. Demetriades D, et al. Trauma deaths in a mature urban trauma system: is "trimodal" distribution a valid concept? *J Am Coll Surg* 2005;201(3):343-348.
12. Peleg K, Aharonson-Daniel L. Blast injuries [comment]. *N Engl J Med* 2005;352(25): 2651-2653.
13. Sheridan RL, et al. Initial evaluation and management of the burn patient. In: Sheridan RL, ed. *The Trauma Handbook of The Massachusetts General Hospital*. Philadelphia: Lippincott, Williams & Wilkins, 2004:148-173.
14. Keel M, Trentz O. Pathophysiology of polytrauma. *Injury* 2005;36(6):691-709.
15. Laudanski K, Wyczechowska D. Monocyte-related immunopathologies in trauma patients. *Arch Immunol Ther Exp (Warsz)* 2005;53(4):321-328.
16. Atkinson C, et al. Targeted complement inhibition by C3d recognition ameliorates tissue injury without apparent increase in susceptibility to infection. *J Clin Invest* 2005;115(9):2444-2453.
17. Wong HK, Apoptosis. In: Tsokos GC, Atkins JL, eds. *Combat Medicine: Basic and Clinical Research in Military, Trauma and Emergency Medicine*. Totowa, NJ: Humana Press, 2003:3-21.
18. Szabo C. Mechanisms of cell necrosis. *Crit Care Med* 2005;33(12 Suppl):S530-S534.
19. Thurman JM, Holers VM. The central role of the alternative complement pathway in human disease. *J Immunol* 2006; 176(3):1305-1310.
20. Szebeni J, et al. Complement activation during hemorrhagic shock and resuscitation in swine. *Shock* 2003;20(4):347-355.
21. Fleming SD. Complement inhibitors in trauma. In: Tsokos GC, Atkins JL, eds. *Combat Medicine: Basic and Clinical Research in Military, Trauma and Emergency Medicine*. Totowa, NJ: Humana Press, 2003:131-148.
22. Holcomb JB, Hoots K, Moore FA. Treatment of an acquired coagulopathy with recombinant activated factor VII in a damage-control patient. *Mil Med* 2005;170(4): 287-290.
23. Biddinger PD, Thomas SH. Prehospital care and transport. In: Sheridan RL, ed. *The Trauma Handbook of The Massachusetts General Hospital*. Philadelphia: Lippincott, Williams & Wilkins, 2004:29-49.
24. Stiell IG, et al. Advanced cardiac life support in out-of-hospital cardiac arrest. *N Engl J Med* 2004;351(7):647-656.
25. Wang HE, Yealy DM. How many attempts are required to accomplish out-of-hospital endotracheal intubation? *Academic Emergency Medicine* 2006;13(4):372-377.
26. Salomone JP, et al. Opinions of trauma practitioners regarding prehospital interventions for critically injured patients. *J Trauma* 2005;58(3):509-515; discussion 515-517.
27. Davis DP, et al. The impact of hypoxia and hyperventilation on outcome after paramedic rapid sequence intubation of severely head-injured patients. *J Trauma* 2004;57(1):1-8; discussion 8-10.
28. Shafi S, Gentilello L. Pre-hospital endotracheal intubation and positive pressure ventilation is associated with hypotension and decreased survival in hypovolemic trauma patients: an analysis of the National Trauma Data Bank. *J Trauma* 2005;59(5): 1140-1145; discussion 1145-1147.
29. Wang HE, Yealy DM. Out-of-hospital endotracheal intubation: where are we [see comment]? *Ann Emerg Med* 2006;47(6): 532-541.
30. Peak DL, Gervasini AA. Organization of the emergency department and trauma team. In: Sheridan RL, ed. *The Trauma Handbook of The Massachusetts General Hospital*. Philadelphia: Lippincott, Williams & Wilkins, 2004:50-57.
31. Kaufmann C. *Advanced Trauma Life Support for Doctors*. 7th ed. Chicago: American College of Surgeons, 2004:391.
32. Crosby ET. Airway management in adults after cervical spine trauma. *Anesthesiology* 2006;104(6):1293-1318.
33. Parks SP. Initial assessment. In: Moore EE, Feliciano DV, Mattox KL, eds. *Trauma*. New York: McGraw-Hill, 2004:159-176.
34. Davis DP, et al. The association between field Glasgow Coma Scale score and outcome in patients undergoing paramedic rapid sequence intubation. *J Emerg Med* 2005;29(4):391-397.
35. Nathens AB, et al. The effect of interfacility transfer on outcome in an urban trauma system. *J Trauma* 2003;55(3):444-449.
36. Kunisaki SA, McCabe CJ. Initial evaluation and resuscitation: primary survey and immediate resuscitation. In: Sheridan RL, ed. *The Trauma Handbook of The Massachusetts General Hospital*. Philadelphia: Lippincott, Williams & Wilkins, 2004:71-88.
37. Harris MB, Sethi RK. The initial assessment and management of the multiple-trauma patient with an associated spine injury. *Spine* 2006;31(11 Suppl):S9-S15; discussion S36.
38. Kaufman HJ, Ciraulo DL, Burns RP. Traumatic fracture of the hyoid bone: three case presentations of cardiorespiratory compromise secondary to missed diagnosis. *Am Surg* 1999;65(9):877-880.
39. Krausz MM. Fluid resuscitation strategies in the Israeli army. *J Trauma* 2003; 54(5 Suppl):S39-S42.
40. Brundage SI, et al. Interleukin-6 infusion blunts proinflammatory cytokine production without causing systematic toxicity in a swine model of uncontrolled hemorrhagic shock. *J Trauma* 2004;57(5):970-977; discussion 977-978.
41. Moore FA, McKinley BA, Moore EE. The next generation in shock resuscitation. *Lancet* 2004;363(9425):1988-1996.
42. Rhee P, Koustova E, Alam HB. Searching for the optimal resuscitation method: recommendations for the initial fluid resuscitation of combat casualties. *J Trauma* 2003;54(5 Suppl):S52-S62.
43. Bickell WH, et al. Immediate versus delayed fluid resuscitation for hypotensive patients with penetrating torso injuries. *N Engl J Med* 1994;331(17):1105-1109.
44. Carrico CJ, et al. Scientific priorities and strategic planning for resuscitation research and life saving therapy following traumatic injury: report of the PULSE Trauma Work Group [see comment]. *Acad Emerg Med* 2002;9(6):621-626.
45. Buduhan G, McRitchie DI. Missed injuries in patients with multiple trauma. *J Trauma* 2000;49(4):600-605.
46. Noble VE, Peak DA. Secondary survey evaluation of the trauma patient. In: Sheridan RL, ed. *The Trauma Handbook of The Massachusetts General Hospital*. Philadelphia: Lippincott, Williams & Wilkins, 2004:108-119.
47. Maurer A, Morris JAJ. Injury severity scoring. In: Moore EE, Feliciano DV, Mattox KL, eds. *Trauma*. New York: McGraw-Hill, 2004:87-91.
48. Hannan EL, et al. A comparison among the abilities of various injury severity measures to predict mortality with and without accompanying physiologic information. *J Trauma* 2005;58(2):244-251.
49. Gill MR, Reiley DG, Green SM. Inter-rater reliability of Glasgow Coma Scale scores in the emergency department. *Ann Emerg Med* 2004;43(2):215-223.
50. Luk SS, et al. Outcome assessment of physiologic and clinical predictors of survival in patients after traumatic injury with a trauma score less than 5. *J Trauma* 1999; 46(1):122-128.
51. Meredith JW, et al. A comparison of the abilities of nine scoring algorithms in pre-



- dicting mortality [see comment]. *J Trauma* 2002;53(4):621–628; discussion 628–629.
52. Wang HE, et al. Admission hypothermia and outcome after major trauma. *Crit Care Med* 2005;33(6):1296–1301.
53. Ciesla DJ, et al. A 12-year prospective study of postinjury multiple organ failure: has anything changed? *Arch Surg* 2005; 140(5):432–438; discussion 438–440.
54. Moore EE, et al. Insights from studies of blood substitutes in trauma. *Shock* 2005; 24(3):197–205.
55. Dalton R. Trauma trials leave ethicists uneasy. *Nature* 2006;440(7083):390–391.
56. Dutton RP, Mackenzie CF, Scalea TM. Hypotensive resuscitation during active hemorrhage: impact on in-hospital mortality [see comment]. *J Trauma* 2002;52(6):1141–1146.
57. Mapstone J, Roberts I, Evans P. Fluid resuscitation strategies: a systematic review of animal trials. *J Trauma* 2003;55(3): 571–589.
58. Alam HB, Koustova E, Rhee P. Combat casualty care research: from bench to the battlefield. *World J Surg* 2005;29(Suppl 1): S7–S11.
59. Ayuste EC, et al. Hepatic and pulmonary apoptosis after hemorrhagic shock in swine can be reduced through modifications of conventional Ringer's solution. *J Trauma* 2006;60(1):52–63.
60. Martinowitz U, Michaelson M, The Israeli Multidisciplinary rFVIIa Task Force. Guidelines for the use of recombinant activated factor VII (rFVIIa) in uncontrolled bleeding: a report by the Israeli Multidisciplinary rFVIIa Task Force [see comment]. *J Thromb Haemost* 2005;3(4): 640–648.
61. Dutton RP, et al. Factor VIIa for correction of traumatic coagulopathy. *J Trauma* 2004;57(4):709–718; discussion 718–719.
62. Grounds RM, et al. Use of recombinant activated factor VII (NovoSeven) in trauma and surgery: analysis of outcomes reported to an international registry. *J Intensive Care Med* 2006;21(1):27–39.
63. Holcomb JB. Use of recombinant activated factor VII to treat the acquired coagulopathy of trauma. *J Trauma* 2005;58(6): 1298–1303.
64. Kochanek PM, Safar PJ. Therapeutic hypothermia for severe traumatic brain injury [comment]. *JAMA* 2003;289(22): 3007–3009.
65. Shankaran S, et al. Whole-body hypothermia for neonates with hypoxic-ischemic encephalopathy [see comment]. *N Engl J Med* 2005;353(15):1574–1584.
66. Wu X, et al. Induction of profound hypothermia for emergency preservation and resuscitation allows intact survival after cardiac arrest resulting from prolonged lethal hemorrhage and trauma in dogs. *Circulation* 2006;113(16):1974–1982.
67. Lee SK, et al. Trauma assessment training with a patient simulator: a prospective, randomized study. *J Trauma* 2003;55(4): 651–657.
68. Holcomb JB, et al. Evaluation of trauma team performance using an advanced human patient simulator for resuscitation training. *J Trauma* 2002;52(6):1078–1085; discussion 1085–1086.
69. Cooper JB. Are simulation and didactic crisis resource management (CRM) training synergistic?[comment]. *Qual Saf Health Care* 2004;13(6):413–414.
70. Relman DA. Bioterrorism-preparing to fight the next war [perspective]. *N Engl J Med* 2006;354(2):113–115.
71. Born CT, DeLong WG Jr. Organizing the orthopaedic trauma association mass casualty response team. *Clin Orthop Rel Res* 2004;(422):114–116.
72. Hirshberg A, et al. How does casualty load affect trauma care in urban bombing incidents? A quantitative analysis. *J Trauma* 2005;58(4):686–693; discussion 694–695.

# CHAPTER 79

## Developing the Anesthetic Plan for the Critically Ill Patient

Jean Kwo, MD

Each day 55,000 patients are being cared for in 6000 intensive care units (ICUs) across the United States. Many of these patients will undergo a surgical procedure during their hospitalization either to correct the underlying cause of their illness or to deal with the complications of their illness. Similar to the healthy patient, the anesthesia plan for the critically ill patient should include a clear delineation of the goals of management, an assessment of the priorities of care, and alternative strategies to avoid or treat complications.

Many studies show that the patient's outcome depends on the interaction of several factors, including the type and extent of the procedure, the physiologic reserves of the patient, the presence of chronic health problems, and the nature of the acute physiologic derangements.<sup>1</sup> The number of complications attributable to anesthesia is 8 times greater for patients with American Society of Anesthesiologists (ASA) Physical Status grades P3 and P4 rather than for patients with ASA grade P1 or P2. Furthermore, patients with higher ASA physical status grades were more likely to have a negative outcome because of anesthetic-related complications.<sup>2</sup> One study found that the presence of an anesthesiologist intraoperatively, and certain characteristics of intraoperative and postoperative care were associated with a decreased risk for severe postoperative morbidity and mortality.<sup>3</sup> Thus, the plan for the critically ill patient should include preoperative optimization of the patient's condition, a chronologic plan for the treatment that the patient will receive intraoperatively, coordination of the timing of surgery to allow for the presence of adequate support personnel, ensuring the availability of additional equipment needed to adequately care for the patient, and a plan for postoperative care.

The critically ill patient often has many caregivers skilled in several medical and surgical specialties. Advance planning for the care of the critically ill patient is essential. There should be open communication regarding the likely outcomes and realistic goals of treatment between the anesthesiologists, surgeons, critical care team, and the patient and the patient's family. Preoperatively, one person or team should be designated as the coordinator of the patient's care and should ensure that everyone taking care of the patient in the perioperative period understands the goals and priorities of treatment. Because these may change with time, frequent communication to all is vital.

This chapter focuses on the key points in preoperative planning and some considerations for intraoperative management and optimization for the delivery of a safe anesthetic to the critically ill patient.

### PREOPERATIVE ASSESSMENT AND OPTIMIZATION

Critically ill patients may have impaired function of some or all organ

systems. An assessment of the degree of organ dysfunction and, whenever possible, optimization of the patient's condition should be undertaken before surgery to ensure that the patient is in the best possible condition to undergo the additional stresses associated with surgery and anesthesia.

### Hemodynamic Considerations

A variety of cardiovascular abnormalities may be present in critically ill patients, including hemodynamic instability and dysrhythmias. Patients may manifest shock secondary to hypovolemia, vasodilatation, and/or myocardial dysfunction. Because shock represents the failure of the circulatory system to maintain adequate delivery of oxygen and other nutrients to tissues, cellular and organ dysfunction may ensue. Thus the ultimate goals of hemodynamic therapy in shock are to maintain or restore adequate tissue perfusion and organ function. Evaluation of the hemodynamic status of the critically ill patient should include the following: assess the patient's volume status, determine whether pressors or inotropic agents are needed to maintain an adequate blood pressure and cardiac output, and

### KEY POINTS

1. Critically ill patients often need surgery to correct the underlying cause of their illness or to deal with the complications of their illness.
2. Advanced planning and open communication between the anesthesiologists, surgeons, the critical care team, and the patient and the patient's family is crucial to understanding the goals and priorities of treatment.
3. Critically ill patients may have impaired function of multiple organ systems. Preoperative evaluation of the degree of organ dysfunction and optimization of the patient's condition ensures that the patient is in the best possible condition to undergo the additional stresses associated with surgery and anesthesia.
4. The simplest surgical procedure resulting in the least physiologic upset is generally the best option for the critically ill patient.
5. Planning for the transport to the operating room is essential because patients are at high risk for adverse events during transport.
6. The anesthesiologist must decide which monitors are necessary for the assessment of the patient's condition taking into account the advantages and pitfalls of the different options.
7. While general anesthesia is most often necessary for surgery in the critically ill patient, regional anesthesia can play a valuable adjunctive role to achieve patient comfort and reduce physiologic stress.
8. There should be specific goals and end points defined in the management of the critically ill patient to optimize hemodynamics and minimize further end-organ damage.
9. The anesthesia team is responsible for the care of the critically ill patient until a full report is given to the ICU team and the team can accept care of the patient.

learn whether there are any clinical indicators of hypoperfusion.

### Respiratory Failure and Ventilator Management

Critically ill patients may have respiratory failure and require mechanical ventilation. The preoperative evaluation should include a review of the ventilator settings, including the mode of ventilation, the ventilator rate, the  $\text{FiO}_2$ , the level of positive end-expiratory pressure (PEEP), tidal volume and airway pressures, and inspiratory-to-expiratory (I:E) ratios or inspiratory time. Arterial blood gas values should be reviewed for adequacy of oxygenation and ventilation on the ventilator settings. Because standard operating room anesthesia machine ventilators can be inadequate for patients with severe respiratory failure, if the patient's mode of ventilation cannot be supported by the operating room ventilator, arrangements should be made to transport the ICU ventilator to the operating room.

### Neurologic Assessment

The critically ill patient may have compromised neurologic function because of a myriad of causes including drugs, infection, metabolic derangements, trauma, and cerebrovascular accidents. The preoperative evaluation should include an assessment of baseline neurologic function. Dosages and rates of infusions of sedative hypnotic and analgesic agents should be noted, and decisions should be made whether or not these agents should be continued intraoperatively.

Neuromuscular blocking agents are associated with critical illness polymyopathy/neuropathy. In general, the recommendation is that these agents should be avoided if at all possible in the septic patient because of the risk of prolonged neuromuscular blockade following their discontinuation.<sup>4,5</sup> However, because neuromuscular blocking agents may be needed to facilitate surgery, monitoring the depth of blockade with a train-of-four monitor is advised.

Because critical illness can be associated with prolonged immobilization and a severe myopathy, life-threatening responses after succinylcholine administration may occur. In these patients, the use of succinylcholine can precipitate severe hyperkalemia and/or rhabdomyolysis.

### Evaluation of Renal Function

Critically ill patients often have renal dysfunction. Evaluation of the patient with renal failure should include an assessment of volume status, electrolyte balance, and acid-base status. As renal ischemia is the primary cause of acute renal failure in the perioperative setting, intraoperative maintenance of adequate intravascular volume, mean arterial pressure, and cardiac output are important measures to preserve renal perfusion. Furthermore, nephrotoxic drugs should be avoided to prevent further renal injury in these patients. Although the measurement of urine output is usually the primary means of evaluating renal function, invasive monitoring may be required to assure adequate volume repletion in the critically ill patient who is at risk for postoperative renal dysfunction.

### Endocrine Abnormalities in the Critically Ill Patient

Recent clinical trials have focused on two particular endocrine abnormalities in critically ill patients, "functional" adrenal insufficiency and "tight" glycemic control (see Chap. 12).

#### Adrenal Insufficiency

Patients with septic shock frequently exhibit relative adrenal insufficiency. In a randomized, placebo-controlled, prospective trial, 229 of the 300 patients who were enrolled demonstrated adrenal insufficiency.<sup>6</sup> In those patients, corticosteroid therapy resulted in a reduction of the mortality rate. Currently, intravenous corticosteroids (hydrocortisone 200–300 mg/d, for 7 days, given either in 3 or 4 divided doses or by continuous infusion) are recommended for patients with septic shock who, despite adequate fluid replacement, require vasopressor therapy to maintain an adequate blood pressure. Intraoperatively, clinicians may consider administering a dose of dexamethasone until such time that an adrenocorticotropic hormone stimulation test can be administered in the ICU because dexamethasone, unlike hydrocortisone, does not interfere with the usual cortisol assay.

#### Glucose Control

Critically ill patients are frequently hyperglycemic. Whereas previous practice was to only treat marked hyperglycemia (e.g.,  $\geq 200$  mg/dL), more recent

evidence suggests that maintaining plasma glucose concentration between 80 and 100 mg/dL is associated with decreased ICU mortality.<sup>7</sup> As ICU patients will often receive insulin infusions to achieve these goals, consideration should be given to continuing these infusions intraoperatively. Patients receiving an insulin infusion should be given an external source of glucose to prevent hypoglycemia and blood sugar levels need to be checked frequently intraoperatively.

### Coagulation Dysfunction and Anemia

Evaluation of the critically ill patient should include an assessment of their circulating hemoglobin or hematocrit levels and the patient's coagulation status.

Anemia is often present in patients with critical illness. Although the current recommendations for critically ill patients are that red blood cell transfusions should be given only when the hemoglobin level decreases to  $\leq 7.0$  mg/dL,<sup>8,9</sup> these recommendations should not be applied to individuals who are undergoing short-term resuscitation. In the operating room, the decision to transfuse must be based on how the patient responds to other interventions, including early, aggressive fluid resuscitation. In patients with evidence of hypoperfusion (e.g., low central venous oxygen saturation or lactic acidosis), a target hemoglobin of 10 g/dL has been suggested to maximize tissue oxygen delivery.<sup>10</sup>

Thrombocytopenia can occur in critically ill patients and may be a result of sepsis, drugs (Table 79-1), or hemodilution caused by massive transfusion. Platelet transfusions are given to patients who are bleeding or at risk of bleeding as a consequence of thrombocytopenia or impaired platelet function. Surgical bleeding may occur when platelet counts are less than 50,000/ $\mu\text{L}$ . Furthermore, factors such as a coagulopathy, fever, and renal failure may increase the bleeding risk from severe thrombocytopenia. Therefore, the threshold platelet count for triggering a prophylactic platelet transfusion should take these clinical considerations into account.<sup>8,11</sup> Platelets should never be given to patients with type II heparin-induced thrombocytopenia because of an increased risk of thrombosis after platelet transfusions.

Coagulopathies can occur in the critically ill patient and are evaluated by

TABLE 79-1.

## Drugs That Can Cause Thrombocytopenia

Acetaminophen	Antimicrobials/antivirals	Antineoplastic drugs	Heparin
Antidepressants	Acyclovir	Benzodiazepines	Unfractionated Heparin
Amitriptyline	Cephalosporins	Diazepam	Low-molecular weight Heparin
Desipramine	Cefamandazole	Cardiac medications	Illicit drugs
Doxepin	Cefotetan	Amiodarone	Cocaine
Impramine	Ceftazidime	Diltiazem	Heroin
Antiepileptic drugs	Cephalothin	Digoxin	Iodinate contrast agents
Carbamazepine	Ciprofloxacin	Procainamide	Quinine/quinidine
Phenytoin	Clarithromycin	Enalapril	Miscellaneous drugs
Valproic acid	Fluconazole	Captopril	Tamoxifen
Antiinflammatory drugs	Ganciclovir	Diazoxide	Desmopressin
Diclofenac	Gentamicin	$\alpha$ -Methyldopa	Cyclosporine
Fenoprofen	Penicillins	Diuretics	Levamisole
Ibuprofen	Ampicillin	Acetazolamide	Lidocaine
Indomethacin	Methicillin	Chlorothiazide	Morphine
Meclofenamate	Penicillin	Furosemide	Papaverine
Mefenamic acid	Piperacillin	Hydrochlorothiazide	Ticlopidine
Naproxen	Rifampin	Spirolactone	Octreotide
Piroxicam	Sulfa group	H <sub>2</sub> -antagonists	Ondansetron
Salicylates	Sulfamethoxazole	Cimetidine	
Aspirin	Sulfamethoxy-pyridazine	Famotidine	
Diflunisal	Sulfisoxazole	Ranitidine	
Sulfasalazine	Vancomycin		
Sulindac			
Tolmetin			

measuring the prothrombin time, activated partial thromboplastin time, and fibrinogen levels. Plasma product infusions (fresh-frozen plasma or cryoprecipitate) are infused to stop active bleeding associated with a coagulopathy or to correct coagulopathies before invasive or surgical procedures. Vitamin K may be administered to raise the levels of vitamin K-dependent clotting factors (II, VII, IX, and X).

Recombinant human coagulation factor VIIa (rFVIIa) is used to treat bleeding and promotes hemostasis by activating the extrinsic pathway of the coagulation cascade (Table 79-2). It bypasses inhibitors to factors VIII and IX in patients with hemophilia A and B, and treats patients who have severe von Willebrand factor (vWF) deficiency caused by antibodies to vWF. Other uses of rFVIIa include treatment of congenital or acquired factor VII deficiency, congenital factor XI or factor V deficiency, the coagulopathy of severe liver dysfunction, hemostatic changes that arise from extensive surgery, trauma, and bleeding, reversal of warfarin-induced excessive anticoagulation, certain inherited disorders of

platelet function (e.g., Glanzmann and Bernard-Soulier thrombasthenias), and bleeding from thrombocytopenia that is a result of antiplatelet glycoprotein antibodies that thwart the effects of platelet transfusion.<sup>12</sup> The minimum effective rFVIIa dose for managing these hemorrhagic disorders is uncertain. rFVIIa dose depends on the specific hemorrhagic disorder being treated; in studies the dose has ranged from 3–320  $\mu\text{g}/\text{kg}$ .

Recombinant activated protein C (drotrecogin alfa) is a critical protein that functions to regulate excessive thrombosis in the microcirculation and has been shown to reduce the mortality from severe sepsis that is associated with organ dysfunction in adults who are at high risk for death (Acute Physiology and Chronic Health Evaluation [APACHE] II scores  $\geq 25$ ).<sup>13,14</sup> Because of its anticoagulant effects, bleeding is the most common serious adverse effect associated with drotrecogin alfa therapy. Drotrecogin alfa should be discontinued 2 hours prior to undergoing an invasive surgical procedure or performing procedures with an inherent risk of bleeding. Once ade-

quate hemostasis has been achieved, initiation of drotrecogin alfa may be reconsidered 12 hours after major invasive procedures or surgery, or re-

TABLE 79-2.

## Uses of Recombinant Factor VIIa

- Hemophilia
- Hemophilia with inhibitors and acquired inhibitors of factors VIII and X
- Other conditions
  - Liver failure
  - Liver transplantation
  - Drug-induced coagulopathies
  - Platelet disorders (thrombocytopenia and thrombasthenia)
  - After bone marrow transplantation
  - Renal failure
  - Factor VII deficiency
  - Factor XI deficiency
  - Severe von Willebrand disease
  - Amyloidosis with factor X deficiency
  - Postsurgical bleeding or bleeding as a result of trauma
  - Disseminated intravascular coagulation



started immediately following uncomplicated minor procedures.

### The Elderly Critically Ill Patient

Increasing age is associated with an increased incidence of intercurrent diseases and declining physiologic reserve. Until the age of 60 years, both basal organ function and physiologic reserve (the difference between basal and maximal organ function) are generally well maintained. Subsequently, physiologic reserve diminishes. Both aging and a higher ASA Physical Status classification score are associated with an increased incidence of postoperative complications. In the healthiest patients, those who are ASA classifications P1 (free of systemic disease) and P2 (mild systemic disease), the major complication frequency increases gradually with age until about age 70 years. For ASA classification P3 patients, which includes less healthy patients, the incidence of major complications commences at an earlier age and increases rapidly with age. For ASA classification P4 patients (a patient with disease that is a constant threat to the patient's life), the complication curve rises even more steeply. Many studies show that age and comorbidity are independent predictors of mortality in both the general surgical population and in the critically ill patient.<sup>15-17</sup>

Mortality and complication rates have been well studied in the elderly (age  $\geq 65$  years) general surgical population.<sup>18-20</sup> Baseline characteristics in the elderly population include a reduced functional status, more emergency operations, a higher ASA classification (20% of patients age 80 years and older were ASA P4), and more frequent do-not-resuscitate (DNR) orders. Mortality rates vary widely across many types of operations and are higher for those age 80 years and older. Postoperative complications were also more common in patients of age  $\geq 80$  years (20% had one or more complications) and mortality was higher in those who suffered complications postoperatively. One study reported a 5% increase in perioperative mortality risk for every year of age after 80.<sup>19</sup>

Morbidity and mortality rates in elderly patients admitted to the ICU are higher than in younger patients. Compared with younger patients, elderly patients are more severely ill on admission, and more likely to have shock and

renal dysfunction. One study reported that hospital mortality was more than doubled for patients age 75 years and older in comparison with patients younger than age 65 years.<sup>21-24</sup>

### CONSIDERATIONS OF THE SURGICAL PROCEDURE

Critically ill patients may undergo myriad surgical procedures, including a tracheostomy for respiratory failure, surgery to remove a septic focus, or procedures for traumatic injuries. Whether definitive measures should be undertaken during the operative procedure or whether that should be preferentially delayed and performed electively when the patient has recovered depends on the stability of the patient and the nature of the intervention that is needed. In general, the simplest intervention resulting in the least physiologic upset is the best option for the critically ill patient. The decision to proceed to surgery and the extent of the surgical procedure must weigh the benefits and risks of the specific intervention as they may cause further complications, such as bleeding or inadvertent injury to other organs or tissues. Ideally, surgery should only be undertaken following adequate resuscitation. However, timely and emergent intervention may be vital and lifesaving in certain conditions, for example, patients with necrotizing soft-tissue infection or intestinal ischemia.

### INTRAOPERATIVE MANAGEMENT

#### Transporting the Critically Ill Patient

Unless the surgical procedure is planned to occur in the ICU, the critically ill patient will need to be transported from the ICU to the operating room. These patients are at high risk for complications en route. Adverse events during transport include serious mishaps such as the loss of intravenous access, accidental extubation, occlusion of the endotracheal tube, and exhaustion of the oxygen supply, as well as physiologic deterioration of the patient's state (e.g., worsening hypotension or hypoxemia). Studies report adverse events rates of 5.9-66% during transport of critically ill patients.<sup>25,26</sup> One study reported a high

incidence of hemodynamic changes requiring therapeutic intervention during and after transport from the operating room to the ICU.<sup>27</sup> Clearly, planning and acting to reduce or minimize this risk is an important area of patient safety (Table 79-3).

Prior to transport the anesthesiologist should check the size and placement of the patient's intravenous (IV) access. Patency of the IV routes should be assessed. The type of monitoring needed for transportation will depend on the patient's clinical status. Patients with arrhythmias should have continuous electrocardiogram (ECG) monitoring. Patients who are hemodynamically unstable should have continuous blood pressure monitoring.

The infusion rates of pressors should be noted and the patient should be hemodynamically stable before transportation. There should also be an adequate volume of drug to last during transport. Common drugs needed for resuscitation, such as epinephrine and atropine, should be readily available.

The patient should have a secured airway to allow safe transport. Patients should be assessed for their need for intubation prior to transport. Intubated patients are usually taken off mechanical ventilation and switched to manual ventilation with a self-inflating Ambu bag during transport. Adequate PEEP should be applied during manual ventilation. The oxygen tank should be checked to ensure an adequate supply at the required flow rate for transport. A mask, laryngoscope, and extra endotracheal tubes should be available should an accidental extubation occur during transport.

All drug infusions (e.g., sedatives, pressors, insulin), their rates, and the IV route that they are infused via should be noted. If total parenteral nutrition (TPN) is stopped, an alternate source of glucose must be provided. If a sedative and/or muscle relaxant is needed for transport, it should be administered in the ICU and the patient monitored for hemodynamic and respiratory side effects (e.g., hypotension) prior to transport.

Finally all infusion pumps should be securely attached to the bed or to specialized transfer devices. There should be adequate assistance to transport the patient and treat minor problems. The operating room should be ready to receive the patient prior to leaving the ICU.

TABLE 79-3.

## Transport Checklist

Intravenous access	<ul style="list-style-type: none"> <li>• Check size and placement</li> <li>• Check patency</li> </ul>
Monitors—depends on patient's clinical status	<ul style="list-style-type: none"> <li>• Consider               <ul style="list-style-type: none"> <li>Continuous electrocardiogram monitoring</li> <li>Continuous blood pressure monitoring</li> <li>Continuous pulse oximetry monitoring</li> </ul> </li> </ul>
Infusions	<ul style="list-style-type: none"> <li>• Note infusion rate of medications</li> <li>• Is there an adequate volume to last during transportation?</li> <li>• Are infusions pumps securely attached to bed or transport unit?</li> <li>• If total parenteral nutrition is stopped, check that glucose infusion is running</li> </ul>
Drugs for transport	<ul style="list-style-type: none"> <li>• Consider               <ul style="list-style-type: none"> <li>Resuscitation drugs</li> <li>Sedatives</li> <li>Pressors</li> <li>Antihypertensive agents</li> </ul> </li> </ul>
Airway	<ul style="list-style-type: none"> <li>• Assess airway; consider need for intubation prior to transport</li> <li>• Have self-inflating bag for ventilation available</li> <li>• Assess need for positive end-expiratory pressure</li> <li>• Oxygen—ensure adequate supply for transport</li> <li>• Have mask, laryngoscope, extra endotracheal tubes available for transport</li> </ul>
Assess need for sedatives/muscle relaxant	<ul style="list-style-type: none"> <li>• If needed, administer and monitor for side effects prior to transport</li> </ul>
Ensure adequate help to transport patient	
Ensure operating room is ready to receive patient	

## Monitoring Options

**Standard Monitors**

Basic standards for monitoring have been established by the ASA (Table 79-4) and should be adhered to in the critically ill patient.<sup>28</sup> The patient's systemic oxygenation (SpO<sub>2</sub>), ventilation, circulation (blood pressure, heart rate) and core temperature should be continually evaluated during all anesthesia procedures.

Use of an oxygen analyzer to measure the oxygen concentration in the patient breathing system and a quantitative assessment of systemic blood oxygenation (e.g., SpO<sub>2</sub> via pulse oximetry) can ensure adequate oxygenation. Ventilation should be evaluated with clinical signs (e.g., chest excursion or auscultation of breath sounds) as well as quantitative continuous monitoring of the level of expired carbon dioxide (PETCO<sub>2</sub>). Monitoring the tidal volume of expired gas is strongly encouraged. There should be a rapid audible alarm

if any of the components of the breathing system is disconnected.

Every patient should have their electrocardiogram continuously displayed, and arterial blood pressure and heart rate should be determined and assessed every 5 minutes at a minimum. To ensure the adequacy of the patient's circulatory function, the patient should be continuously evaluated by either palpation of an arterial pulse, auscultation of heart sounds, observing the trace of intraarterial pressure, ultrasound peripheral pulse velocity monitoring, pulse plethysmography, or oximetry.

Core temperature monitoring should be employed when clinically significant changes of body temperature are possible.

Because of the possibly rapid changes of hemodynamic status occurring during anesthesia, the ASA standards also require the presence of qualified anesthesia personnel to monitor the

patient and provide care throughout the conduct of all general and/or regional anesthetics and monitored anesthesia care.

**Invasive Monitors**

Additional monitors may be needed to provide an accurate picture of the patient's hemodynamic status. Invasive monitors may also be necessary to guide therapy to optimize the patient's condition. However, there are limitations to all these monitors and potentially some risk to the patient with the use of invasive monitors. Thus, the anesthesiologist must be cognizant of these limitations and weigh the risks and benefits of invasive monitoring in order to choose the appropriate monitors for the critically ill patient (Table 79-5).

**Invasive Arterial Pressure Monitoring** Because shock represents the failure of the circulatory system to maintain an adequate delivery of blood flow to tissues, and the goal of hemodynamic therapy is to restore adequate tissue perfusion, systemic pressure measurement is the most frequently used parameter to indirectly assess perfusion.

In healthy individuals, blood pressure as determined by noninvasive blood pressure (NIBP) monitors is, on average, within 5 mm Hg of those obtained from direct arterial pressure monitoring. Sources of error in NIBP measurements include incorrect cuff size or a highly irregular or rapid cardiac rhythm. However, in shock states, NIBP measurements are very often inaccurate. Therefore, inserting an arterial catheter provides a more accurate and reproducible measurement of arterial pressure. Invasive arterial monitoring allows beat-to-beat display so decisions regarding therapy can be based on continuous blood pressure analysis.

Blood pressure does not always directly equate to tissue blood flow, and the level of mean arterial pressure to aim for is not necessarily the same in all patients. Below a mean arterial pressure of 60 mm Hg, autoregulation of the coronary, renal, and central nervous system vascular beds is compromised and organ flow becomes linearly dependent on pressure. Thus, in adults, maintenance of a mean arterial pressure of  $\geq 60$  mm Hg is usually required to maintain and optimize flow. However, because the loss of

TABLE 79-4.

## American Society of Anesthesiologists Standard Monitors

Parameter	Recommendation
Oxygenation	<ul style="list-style-type: none"> <li>• Oxygen analyzer</li> <li>• Pulse oximetry</li> </ul>
Ventilation	<ul style="list-style-type: none"> <li>• Clinical signs</li> <li>• Chest excursion</li> <li>• Auscultation of breath sounds</li> <li>• Exhaled CO<sub>2</sub> monitoring</li> <li>• Notification of breathing system disconnection with audible alarm</li> </ul>
Electrocardiogram	<ul style="list-style-type: none"> <li>• Continuous display</li> </ul>
Blood pressure	<ul style="list-style-type: none"> <li>• Evaluation every 5 minutes</li> </ul>
Heart rate	<ul style="list-style-type: none"> <li>• Evaluation every 5 minutes</li> </ul>
Circulatory function	<ul style="list-style-type: none"> <li>• Assess adequacy</li> <li>• Palpate pulse</li> <li>• Auscultate heart sounds</li> <li>• Monitor intraarterial pressure trace</li> <li>• Pulse plethysmography or oximetry</li> </ul>
Core temperature	<ul style="list-style-type: none"> <li>• Use when clinically significant changes in body temperature is anticipated</li> </ul>
Personnel	<ul style="list-style-type: none"> <li>• Qualified anesthesia personnel should monitor conduct of all general anesthetics, regional anesthetics and monitored anesthesia care</li> </ul>

Excerpted from ASA Standards for Basic Anesthetic Monitoring: [www.asahq.org/publicationsAndServices/standards/o2.pdf](http://www.asahq.org/publicationsAndServices/standards/o2.pdf) of the American Society of Anesthesiologists. A copy of the full text can be obtained from ASA, 520 N. Northwest Highway, Park Ridge, Illinois 60068-2573.

autoregulation may occur at different levels in different organs, some patients may require higher blood pressures to maintain adequate tissue perfusion. Furthermore, the degree to which autoregulation remains intact in septic patients is uncertain. It is may be necessary at times to supplement blood pressure measurement with other means of assessing regional and global perfusion (e.g., urine output).

**Central Venous Pressure Catheter** Systemic hypotension is the most common reason to initiate invasive central hemodynamic monitoring in the critically ill patient. The central venous pressure (CVP) reflects the pressure in the large systemic veins. Although the CVP is used to reflect intravascular volume, it does not measure blood volume directly and is influenced by right-heart function,

venous return, right-heart compliance, intrathoracic pressure, and patient positioning. Consequently, the CVP level should always be interpreted along with other measures of cardiac function and fluid state (e.g., pulse, blood pressure, urine output). The absolute CVP value may not be as important as serial CVP measurements or the change in response to therapy.

Measurement of the CVP may provide useful information in patients with normal cardiac function who are hypotensive because of blood loss or widespread vasodilatation, as a decreased venous return will result in a falling right atrial pressure and CVP. A central venous catheter should also be inserted if infusion of vasopressors or inotropes is planned.

**Pulmonary Artery Catheter** In addition to the CVP, the pulmonary artery catheter (PAC) allows measurement of the pulmonary artery pressure, the pulmonary artery occlusion pressure (PAOP), the cardiac output, and the mixed-venous oxygen saturation (SvO<sub>2</sub>). The PAOP reflects the pulmonary venous pressure and left ventricular end-diastolic pressure (LVEDP), and therefore provides a crude estimate of left ventricular end-diastolic volume (LVEDV). Blood gas and saturation measurements performed on specimens obtained from the superior vena cava and/or pulmonary artery (mixed venous) can serve as a reflection of global perfusion. Special pulmonary artery catheters are available which allow the continuous measurement of mixed venous

TABLE 79-5.

## Comparison of Monitors Used in Critically Ill Patients

Monitor	Indications	Limitations
Central venous pressure (CVP)	<ul style="list-style-type: none"> <li>• Reflects intravascular volume</li> </ul>	<ul style="list-style-type: none"> <li>• Depends on right-heart function, venous return, right-heart compliance, intrathoracic pressure, patient positioning</li> </ul>
Pulmonary artery catheter (PAC)	<ul style="list-style-type: none"> <li>• Measures pulmonary artery pressure, cardiac output, and pulmonary artery occlusion pressure, which reflects left ventricular end-diastolic volume</li> </ul>	<ul style="list-style-type: none"> <li>• Depends on right- and left-heart compliance, intrathoracic pressures, valvular lesions</li> </ul>
Transesophageal echocardiography (TEE)	<ul style="list-style-type: none"> <li>• Qualitative measurement of ventricular function, ventricular volume, and valvular abnormalities</li> </ul>	<ul style="list-style-type: none"> <li>• Requires training to perform procedure and correctly interpret images</li> <li>• Can consume anesthesiologist's time and attention</li> </ul>
Gastric tonometry	<ul style="list-style-type: none"> <li>• Indication of regional hypoperfusion</li> <li>• Reflects blood flow-to-demand ratio</li> </ul>	<ul style="list-style-type: none"> <li>• pH<sub>im</sub> calculation affected by both systemic and respiratory alterations</li> <li>• Unproven utility to guide therapy</li> </ul>

saturation, cardiac output, and even right ventricular volumes and contractile function (by thermodilution).

Indications for placement of the pulmonary artery catheter may be related to the planned procedure, or the patient's state of health, or both (Table 79-6). The pulmonary artery catheter may provide useful information in any procedure associated with acute, severe changes of preload, afterload, or the contractile state. For example, procedures where blood loss may be massive, or where partial or complete caval occlusion might occur can cause acute changes of cardiac preload. Similarly, proximal aortic cross-clamping can cause a rapid increase of afterload. Patient factors that can lead to the insertion of a PAC include septic shock or other significant cardiac, respiratory, or renal disease. In septic shock, hypovolemia and myocardial dysfunction can be important factors contributing to impaired tissue perfusion. The pulmonary artery catheter is often used to monitor cardiac output and assess ventricular stroke volume.

The use of the pulmonary artery catheter has been called into question by the publication of an observational study that demonstrated an increased mortality associated with the use of the pulmonary artery catheter in critically ill patients during the first 24 hours of intensive care as compared with case matched controls.<sup>29</sup> Multiple randomized controlled trials evaluating the use of the PAC in many different patient populations have shown neither an increased overall mortality nor any conferred benefit.<sup>30-32</sup> In all these studies, the PAC has proven to be a diagnostic tool. The studies highlight our lack of consensus and data about therapeutic interventions that will improve the outcome of the critically ill patient.

A major pitfall of central pressure monitoring is that pressure is used to estimate volume. Important variables other than the volume of the systemic and pulmonary circulations can affect the central pressure measurement. The relationship between pressure and volume is controlled by the compliance of the chamber. In patients with abnormal left ventricular compliance, the PAOP may over- or underestimate the LVEDV. Right ventricular (RV) dysfunction is common in critically ill patients and can be a result of pulmonary embolism, acute respiratory

distress syndrome (ARDS), or other conditions that increase RV afterload, such as high levels of PEEP or an increased pulmonary vascular resistance as a consequence of other vascular, cardiac, metabolic, or pulmonary causes. Because the right and left ventricles are both enclosed within the relatively stiff pericardium, pressure and volume overload of the RV can lead to abnormal motion of the interventricular septum and impair left ventricular (LV) relaxation. In this situation, the pressure-volume relationship of the left ventricle is altered, and information obtained from the PAC may be misleading. Other factors that can affect the ability of central pressures to reflect ventricular filling volumes include increased intrathoracic pressures and valvular lesions. Increased intrathoracic pressure caused by positive pressure ventilation with PEEP or caused by increased intraabdominal pressures can elevate central pressures. Stenotic lesions of the atrioventricular valves can also elevate central vascular pressures.

Other potential pitfalls include problems with the transducer system (e.g., improper transducer placement or reference level zeroing), improper interpretation of waveforms, and erroneous thermodilution cardiac output measurements because of problems with the injectate volume or temperature. The presence of marked tricuspid valve regurgitation, which can occur in the critically ill patient as a consequence of high pulmonary artery pressures, can also lead to erroneous cardiac output measurements. Blood gas and saturation measurements may be invalid if the blood gas analysis is inaccurate or if the pulmonary artery specimen is "arterialized" by being withdrawn from a wedged or partially wedged pulmonary artery catheter.

There are major but uncommon complications associated with the presence of the pulmonary artery catheter itself. Rupture of the pulmonary artery is a rare occurrence (<1%) but a potentially catastrophic one with a mortality rate of 50%. Patients who have pulmonary hypertension, or are >60 years, or who are receiving anticoagulation therapy are at greater risk. The sudden onset of hemoptysis (especially after inflation of the pulmonary artery catheter balloon) is a sign of possible pulmonary artery rupture. Immediate manage-

TABLE 79-6.

### Indications for Use of Pulmonary Artery Catheter

- Determination of cause of shock
  - Cardiogenic
  - Hypovolemic
  - Distributive (sepsis)
  - Obstructive (massive pulmonary embolism)
- Determination of cause of pulmonary edema
  - Cardiogenic
  - Capillary leak
- Evaluation of pulmonary hypertension
- Diagnosis of pericardial tamponade
- Management of complicated myocardial infarction
- Guide to pharmacologic therapy
  - Vasopressors
  - Inotropes
  - Vasodilators (for patients with pulmonary hypertension)
- Guide to fluid management
- Guide to management of patients with burns
- Guide to management of patients with sepsis
- Guide to management of patients with renal failure
- Guide to management of patients with heart failure
- Guide to management of patients with decompensated cirrhosis

ment includes lateral decubitus positioning with the bleeding side down, intubation with a double-lumen endotracheal tube, and increasing PEEP. Embolization via angiography, or even a lobectomy may be necessary if bleeding continues or is massive. The incidence of pulmonary infarction associated with the use of the pulmonary artery catheter is less than 7% and usually caused by unintentional distal migration of the PAC tip. Catheter-related thrombi also may cause pulmonary infarction. Infection related to the pulmonary artery catheter is fairly common with a risk for clinical sepsis of <0.5% per day of catheter use.

Thus hemodynamic measurements obtained from a pulmonary artery catheter should be interpreted with the full knowledge of possible confounding factors. It may often be more



appropriate to respond to trends of change in central hemodynamic measurement (e.g. a slowly falling pulmonary capillary wedge pressure or CVP) rather than to the absolute values themselves.

### Echocardiography

In view of the concerns regarding the risks and benefits of pulmonary artery catheterization, other methods of assessing the adequacy of resuscitation have been developed and evaluated. Echocardiography has been used in the operating room since the 1970s. Transesophageal echocardiography (TEE) is preferred in the operating room because the acoustic images of transthoracic echocardiography (TTE) are generally poorer than those of TEE.<sup>33</sup> Patients who are mechanically ventilated and require PEEP may be inadequately imaged by TTE, especially if more than 10 cm H<sub>2</sub>O of PEEP is required. Furthermore, factors such as patient positioning, the surgical field, and surgical equipment, drapes, or monitors may block access to the chest, limiting the usefulness of TTE.

There are some important limitations to TEE.<sup>33</sup> Some regions of the heart and great vessels cannot be well visualized. Insertion and manipulation of the TEE probe can produce pharyngeal and/or laryngeal trauma, dental injuries, esophageal trauma, arrhythmias, and hemodynamic effects. The inaccurate interpretation of TEE images can generate incorrect information and may potentially result in improper clinical decisions by the anesthesiologist and surgeon. The performance of TEE can also consume the anesthesiologists' time and attention and detract them from other intraoperative responsibilities and delay important interventions.

Nevertheless, the role of TEE in the operating room, especially to monitor patients during cardiac surgery, is expanding. Current indications for the use of TEE intraoperatively include the diagnosis of myocardial ischemia, confirmation of the adequacy of valve reconstruction and other surgical repairs, and determination of the cause of hemodynamic instability and other intraoperative complications.<sup>33</sup> TEE can readily provide information on ventricular volume and contractility, valvular problems and wall-motion abnormalities.

The perioperative period is a time of increased risk of myocardial is-

chemia as a result of hemodynamic and other physiologic stresses associated with surgery. Wall-motion abnormalities generally precede ECG changes during myocardial ischemia<sup>34</sup> and thus may allow earlier detection of ischemia. The incidence of regional ventricular dysfunction detected by TEE ranges from 10–60%<sup>33</sup> in various surgical populations. Intraoperative TEE detection of ischemia may permit corrective interventions, including alterations in surgery, anesthetic management, and postoperative triage, which may prevent perioperative complications. There is a lack of studies demonstrating that the detection and treatment of regional ventricular dysfunction or other TEE evidence of ischemia can result in an improved perioperative clinical outcome or increased long-term survival.

Perioperative TEE is often used emergently to determine the cause of acute persistent, life-threatening hemodynamic disturbances. However, elective use of the TEE should be considered in the care of the critically ill surgical patient. TEE is largely a tool for assessing hemodynamic function qualitatively and for imaging the heart (e.g., to diagnose a hemopericardium, tamponade). It provides an assessment of LV function and an indirect measurement of cardiac output, contractility, and left, and possibly right, ventricular volume. Because of the limitations in using catheter-derived pressure data to estimate LVEDV, TEE may be better for determining the precise cause of hemodynamic instability (e.g., a low cardiac output) in patients with left ventricular dysfunction than the pulmonary artery catheter.

### Gastric Tonometry

Sepsis is associated with microcirculatory abnormalities that may persist despite restoration of intravascular volume. These abnormalities can lead to a maldistribution of cardiac output, inadequate regional perfusion, and multiple organ system failure. Indices of organ function, such as ECG evidence of myocardial ischemia, urine output, chemical measurements of blood urea nitrogen and creatinine, and liver function tests can be used to indirectly assess the adequacy of regional perfusion.

Gastric tonometry is a method to assess regional perfusion in the gut. A balloon is placed in the stomach to measure the intramucosal partial pres-

sure of carbon dioxide (PCO<sub>2</sub>). This is, in turn, used to indirectly determine gastrointestinal mucosal pH (pH<sub>im</sub>). Hypoperfusion causes mucosal carbon dioxide (CO<sub>2</sub>) to increase and produces tissue acidosis. Because CO<sub>2</sub> readily diffuses across membranes, the PCO<sub>2</sub> in the gut lumen leads to an increase in the gradient between arterial and luminal PCO<sub>2</sub>. Tonometry provides an indicator of the blood flow-to-CO<sub>2</sub> production ratio as hypoperfusion may arise as a result of either a decreased blood flow or an increased CO<sub>2</sub> production. A low gastric pH<sub>im</sub> and increased gastric luminal PCO<sub>2</sub> are highly predictive of postoperative complications.<sup>35</sup> However, despite its promise, tonometry has not become a routine intensive care monitoring technique because of uncertainties related to both its physiologic basis and methodology.<sup>36</sup> Calculation of the pH<sub>im</sub> involves both locally derived and systemic variables and therefore can be affected by systemic metabolic and respiratory alterations. Methodologic concerns include whether gastric acid secretion affects the measurement of pH<sub>im</sub>, whether gastric feeding affects pH<sub>im</sub>, and whether blood gas analyzers calibrated for blood or calibration fluids can accurately measure PCO<sub>2</sub> in saline or air. Although tonometry is a reasonably good predictor of mortality in critically ill patients,<sup>37</sup> its usefulness as a therapy guide in patients with sepsis and septic shock has not been proven.

### Airway Evaluation and Management

There are myriad indications for endotracheal intubation of the critically ill patient. These patients may lose their airway, develop an inadequate respiratory drive because of central nervous system disease or the administration of sedative drugs, suffer disruption of the rib cage as a consequence of trauma, develop lung parenchymal disease secondary to ARDS or aspiration, or have an impaired ability to cough or protect their airway against the aspiration of gastric or pharyngeal contents.

As in the healthy patient, preparation for endotracheal intubation should begin with an assessment of airway anatomy. If a difficult intubation is anticipated, fiberoptic intubation should be considered early. Airway adjuncts such as a laryngeal mask airway, and oral and nasal airways of various sizes should be immediately

available. Additional personnel should be on hand and a surgeon should be available to perform a cricothyrotomy or tracheostomy should endotracheal intubation be unsuccessful and ventilation be inadequate via mask or laryngeal mask airway.

Studies show that an increased ASA classification and emergency surgery are associated with an increased risk of aspiration.<sup>38</sup> Information such as recent vomiting, bowel obstruction, morbid obesity, diabetes mellitus, or a depressed mental status should be factored into the assessment of aspiration risk in the critically ill patient. Prior to intubation, *nil per os* (NPO) status should be confirmed if possible. Consider placing a nasogastric tube to empty liquid gastric contents. In the conscious patient, an awake intubation is preferred although a rapid sequence intubation may also be considered.

Direct laryngoscopy to facilitate tracheal intubation produces a marked stress response.<sup>39</sup> Although these responses are short-lived, they may produce detrimental effects on the coronary or cerebral circulation of high-risk patients.<sup>40</sup> Thus, patients should first be assessed for the presence of angina or ischemia, dysrhythmias, and congestive heart failure. The patient's neurologic status including the presence of an increased intracranial pressure, intracranial aneurysms and hemorrhage should be determined. In these patients, hypertension should be avoided and heart rate and blood pressure should be maintained within a narrow range during laryngoscopy and intubation. Before intubation, adjuncts such as airway blocks with local anesthetics, use of adequate  $\beta$ -adrenergic blockade, and deep anesthesia with opioids or barbiturates should be considered.

In trauma patients, the presence of cervical and mandibular fractures and instability should be determined. All patients with multiple trauma, head, or facial injury should be presumed to have a cervical spine injury unless it has been excluded by a thorough radiographic and physical evaluation. A second skilled person should be present during intubation to provide in-line stabilization to maintain the head and neck in a neutral position. Nasotracheal intubations are relatively contraindicated in patients with oropharyngeal and facial trauma because of the possibility of cranial vault disruption.

Patients with recent spinal cord denervation injuries, crush injuries, or burns should not be given depolarizing muscle relaxants because of the risk of life-threatening hyperkalemia. The patient's coagulation status should be evaluated as mucosal trauma and subsequent bleeding associated with laryngoscopy can result in loss of visualization of the airway and an increased risk of aspiration.

### Anesthetic Choices

General anesthesia is most often used for surgery in the critically ill patient because of multiple factors, among them surgical and hemodynamic considerations. However, a regional anesthetic can play a role as a valuable adjunct to general anesthesia, and in the management of postoperative pain in the critically ill patient to achieve optimum patient comfort and to reduce physiological stress.<sup>41</sup>

Epidural analgesia is probably the regional analgesic technique most often used in the intensive care unit. It has been employed to manage pain after chest trauma, thoracic and abdominal surgery, major orthopedic surgery, and intractable anginal pain. Studies show that to manage patients after chest trauma, thoracic epidural analgesia provided superior analgesia and improved measurements of lung function.<sup>42</sup> High levels of thoracic epidural analgesia (T1-T4) can provide effective treatment of myocardial ischemia refractory to conventional medical therapy.<sup>43</sup> Benefit probably occurs through both increased myocardial oxygen delivery as a result of coronary artery vasodilatation and decreased myocardial oxygen demand because of reduced heart rate and blood pressure. Issues such as local or systemic infection and coagulopathy can limit or prevent the use of epidural analgesia. Furthermore, there remains controversy over the safety of placing epidural catheters in sedated patients, and confirmation of catheter position can be difficult if sensory level testing is unreliable.

The use of peripheral nerve blocks to produce anesthesia in the critically ill population has not been evaluated by randomized, controlled trials. Continuous interscalene, infraclavicular, and axillary catheters may provide good postoperative analgesia for the shoulder and upper extremity. Similarly, a femoral nerve catheter in com-

bination with a sciatic block can provide pain relief for the whole leg. These techniques can be used to provide surgical anesthesia for procedures such as external fixation, painful dressing changes, or debridement of burns and large soft-tissue wounds. Regional analgesia may be particularly advantageous in the patient with brain injury where opioid analgesic agents might mask the neurologic examination.<sup>41</sup> Although there are concerns in placing regional blocks in patients with an impaired mental status because of neurologic injury or sedation, ultrasonography and nerve stimulation to guide placement of the needle or catheter may minimize the risk of complications.

### INTRAOPERATIVE MANAGEMENT

There should be specific goals and end points defined for the hemodynamic management of the critically ill patient. Therapies such as fluid administration, and vasopressor and inotropic support should be titrated to reach those end points. The results of these interventions should be evaluated on an ongoing basis by monitoring a combination of variables reflecting global and regional tissue perfusion.

#### Hemodynamic Management Early Goal-Directed Therapy

The care of the critically ill patient is largely supportive. Based on the old observation that improved survival was associated with the ability to sustain a hypermetabolic state by increasing cardiac output and oxygen delivery, the hypothesis was proposed that by proactively increasing the systemic oxygen delivery rate, oxygen debt could be reversed and mortality from multiple organ failure might be reduced. Although a large, randomized, controlled trial investigating the effect of increasing oxygen transport on the outcome of the critically ill patient found no overall benefit,<sup>44</sup> some studies have found that the perioperative hemodynamic optimization of high-risk surgical patients appears to be associated with a reduction in morbidity and mortality.<sup>45,46</sup> This finding is consistent with another study that showed that early goal-directed therapy in patients with septic shock resulted in decreased in-hospital mortality.<sup>10</sup>

One of the challenges is to define the goals of goal-directed therapy. Some studies have targeted a systemic oxygen delivery rate of 600 mL/min/m<sup>2</sup> body surface area.<sup>46</sup> Others have used a central venous oxygen saturation of greater than 70% as the goal.<sup>10</sup> Another challenge is determining the best therapeutic maneuvers to achieve the targeted goal. Most studies have used fluid (either crystalloid or colloid) infusion and inotropic agents (dobutamine and dopexamine). One study required blood transfusions to a hematocrit of  $\geq 30\%$  to help achieve the goal of achieving a central venous oxygen saturation of greater than 70% (Fig. 79-1).<sup>10</sup> Although the goals of treatment and the ideal therapies needed to achieve those goals remain uncertain, it is clear that early optimization of hemodynamic status can have a significant benefit in reducing the mortality rate in patients with severe sepsis and septic shock.

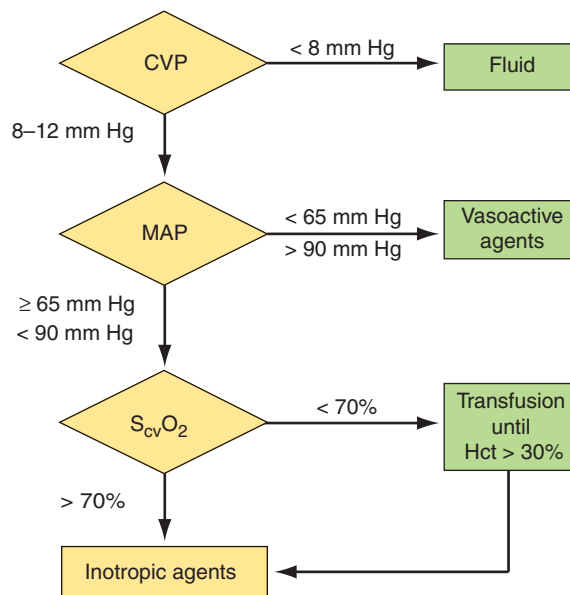
### Fluid Management

Fluid resuscitation may consist of natural or artificial colloids or crystalloids. Meta-analyses of clinical studies comparing crystalloid and colloid resuscitation in general and surgical patient populations show no difference of clinical outcome between colloids and crystalloids.<sup>47,48</sup> This would appear to be generalizable to the critically ill patient. As the volume of distribution is much larger for crystalloids than for colloids, resuscitation with crystalloids requires more fluid to achieve the same end points and may result in more edema.

### Pharmacologic Management

Although hypovolemia is the major common factor contributing to shock in the patient with sepsis, below a certain mean systemic arterial pressure, perfusion becomes linearly dependent on pressure because of the loss of autoregulation. Therefore, it is frequently necessary to infuse vasopressors to maintain an adequate blood pressure in patients with severe shock. Patients with a low cardiac output despite an adequate fluid resuscitation (e.g., high CVP or pulmonary capillary wedge pressure) may require an inotropic agent to increase their cardiac output.

**Pressor Support** Norepinephrine is the first-choice vasopressor agent to



**FIGURE 79-1.** Goal-directed therapy. (Rivers E, Nguyen B, Havstad S, et al. Early Goal-Directed Therapy in the Treatment of Severe Sepsis and Septic Shock. *N Engl J Med* 2001;345:1368. Copyright 2001, Massachusetts Medical Society. All rights reserved.)

reverse the hypotension of septic shock.<sup>49</sup> Human and animal studies suggest some advantages of norepinephrine over epinephrine and phenylephrine. Epinephrine can produce a tachycardia and may have disadvantageous effects on the splanchnic circulation because of vasoconstriction. Use of phenylephrine may result in a decreased stroke volume because of its characteristics as a pure  $\alpha$ -agonist, but it is least likely to cause tachycardia. Norepinephrine increases mean systemic arterial pressure due to its vasoconstrictor effects with little change of heart rate and stroke volume, as it has only weak  $\beta$ -adrenergic effects. Dopamine is also an acceptable pressor agent. Dopamine increases the mean arterial pressure and cardiac output primarily as a consequence of an increase in stroke volume and heart rate. Its use may be limited because it causes tachycardia and can be arrhythmogenic. Norepinephrine is more potent than dopamine and may be more effective at reversing the hypotension of patients suffering septic shock.

Vasopressin infusion should be considered in patients with refractory shock despite the infusion of adequate fluid volumes and administering high doses of conventional vasopressors.<sup>49</sup> Its vasoconstrictor effects are mediated by actions on peripheral vasopressin receptors. In contrast to catecholamine-mediated vasoconstriction, the ef-

fects of vasopressin are preserved despite hypoxia and severe acidosis. Exogenous infusion of vasopressin can reverse the natural arginine vasopressin deficiency that occurs in prolonged shock.<sup>50</sup> However, whether this is important to its mechanism of action is unclear. Additional vasopressin mechanisms that might be important in septic shock include facilitation of myocyte depolarization and vasoconstriction of vascular smooth muscle, attenuation of nitric oxide generation by cytokines and inflammatory mediators, enhanced adrenergic responsiveness, and stimulation of synthesis of endothelin-1, a potent endogenous vasoconstrictor.<sup>51</sup> When infused in adults, vasopressin should be administered at infusion rates of 0.01–0.04 units/min. Doses of vasopressin greater than 0.04 units/min are associated with myocardial ischemia, significant decreases of cardiac output, and splanchnic hypoperfusion.

**Inotropic Support** Dobutamine is the first-choice inotropic agent for critically ill patients with measured or suspected low cardiac output in the presence of an adequate left ventricular filling pressure or adequate fluid resuscitation.<sup>49</sup> Because a low arterial blood pressure may be caused by both a low cardiac output as well as vasodilatation, the use of both an inotropic agent such as dobutamine to augment cardiac output and a vasopressor such

as norepinephrine to achieve an adequate mean arterial pressure may be needed.

Dopexamine is a dopamine receptor agonist developed for use in the treatment of heart failure and low cardiac output states. It is not available for clinical use in the United States. Dopexamine has been used to increase oxygen delivery in some goal-directed therapy studies.<sup>44</sup> Dopexamine increases splanchnic blood flow in the critically ill patient and may possess intrinsic antiinflammatory properties. These additional actions may contribute to the reported reduction in sepsis-related mortality associated with the use of dopexamine. Additional controlled trials are needed to demonstrate these clinical effects of dopexamine.

### Preservation of Renal Function

Patients with sepsis, cirrhosis, jaundice, hepatorenal syndrome, congestive heart failure, malignant hypertension, preeclampsia and toxemia, hypotension as a consequence of hemorrhage, or recent exposure to IV radiopaque agents are predisposed to develop acute renal failure when exposed to a subsequent intraoperative ischemic insult. There are few large randomized trials assessing the effectiveness of many of the current strategies of possibly preventing renal injury in the surgical patient and thus all must remain experimental.

#### Sodium Bicarbonate and N-Acetylcysteine

The most extensive literature on renal failure protection comes from studies of radiocontrast nephropathy. Radiocontrast dye induces severe changes of intrarenal hemodynamics leading to ischemic injury. Studies show that hydration prior to the administration of contrast is effective in lowering the rate of acute renal injury.<sup>52–54</sup> Furthermore, hydration with sodium bicarbonate has been shown to be more effective than hydration with sodium chloride for the prophylaxis of contrast-induced renal failure.<sup>55</sup> The purported mechanism is by inhibition of free radical formation at the higher pH. The prophylactic administration of N-acetylcysteine, an antioxidant, improves renal outcome after radiocontrast administration.<sup>56</sup> Although there is no evidence that these maneuvers improve outcomes in the surgical

ICU because of other types of renal injuries, these studies are often extrapolated to high-risk surgical procedures.

#### Dopamine

Many studies demonstrate that “renal dose” dopamine (1–2 µg/kg/min) has no beneficial effect on renal outcome perioperatively.<sup>57</sup> However, urine output frequently increases during dopamine administration. Unfortunately, urine output may not correlate with adequate oxygenation of the renal medulla. Dopamine causes an increase in renal cortical blood flow, leading to increased glomerular filtration, solute excretion, and urine output. These actions increase renal oxygen consumption. However, dopamine also has a diuretic and natriuretic effect, believed to be a result of inhibition of the sodium-potassium adenosine triphosphatase (ATPase) of the proximal tubule and medullary thick ascending limb. This inhibitory effect would decrease tubular energy requirements and medullary oxygen requirements. Thus, the net effect of a dopamine infusion on renal medullary oxygenation is unclear.

#### Mannitol

Mannitol has traditionally been given intravenously to patients considered at high risk for acute renal failure. It increases tubular diameter and decreases tubular resistance to fluid flow by decreasing endothelial cell swelling by dehydration. The enhanced urine flow is believed to help prevent tubular obstruction and further renal injury. Mannitol is a weak free radical scavenger. Although mannitol is beneficial in animal studies and small clinical trials,<sup>58</sup> there are no large, prospective, controlled trials demonstrating any benefit in surgical patients who are at high risk of renal damage.

Mannitol is usually administered as a single IV dose (0.5–1.0 g/kg) intraoperatively before the application of the cross-clamp in aortic surgery patients, or included in the cardiopulmonary bypass prime in cardiac surgery. Volume status and electrolyte balance, especially plasma potassium shifts, should be monitored after the administration of mannitol.

#### Furosemide

Furosemide inhibits the energy-dependent reabsorptive work in the medullary thick ascending limb and

thus ameliorates hypoxia in the renal medulla. Because it can also cause cortical vasodilatation resulting in medullary hypoperfusion, prolonged administration of furosemide may be more deleterious than protective to renal function. Thus it may be prudent to administer furosemide in a single large-bolus dose shortly before the anticipated ischemic stress. There are no randomized studies evaluating furosemide as a sole renal protectant agent in surgical patients.

#### Fenoldopam Mesylate

Fenoldopam is a selective dopamine-1 (DA1) receptor agonist used to treat hypertension.<sup>59</sup> Unlike dopamine, it has no activity at dopamine-2 (DA2) or at  $\alpha$ - or  $\beta$ -adrenergic receptors, and thus does not cause either tachycardia or hypertension. Fenoldopam reduces blood pressure in a dose-dependent manner while preserving renal perfusion and glomerular filtration rate.<sup>60</sup> It inhibits sodium reabsorption and thus may attenuate medullary oxygen demand while enhancing its supply. Large prospective trials evaluating fenoldopam as a renal protectant in humans have not yet been published.

#### Dopexamine

Dopexamine, a dopaminergic (DA1 and DA2) agonist with  $\beta_2$ -adrenergic activity, has generated interest as a renal protectant based on the hypothesis that it could improve renal perfusion without the risk of  $\alpha$ -adrenergic stimulation.<sup>61</sup> Dopexamine lacks the myocardial side effects of dopamine although it may cause hypotension. Large, well-designed trials are needed to assess its usefulness as a renal protectant.

#### Future Agents

Renal vasodilators such as atrial natriuretic peptide, urodilatin, and prostaglandin E<sub>1</sub> have been tested as renal protectants in radiocontrast nephropathy.<sup>62</sup> Insulin-like growth factor-1 is an endogenous substance that improves recovery from acute renal failure in animal studies. Acidic fibroblast growth factor-1 (FGF-1) attenuates experimental myocardial ischemia-reperfusion injury and also attenuates acute renal failure after experimental ischemia-reperfusion injury of the kidney in rats. The antiinflammatory and vasodilating effects of nitric oxide may mediate the protective effect of FGF-1. None of these agents has been studied



in patients who are undergoing surgery associated with a high risk of renal damage. Further large investigations are warranted before adopting any of the previously discussed agents as a perioperative renoprotective strategy.

### Intraoperative Glucose Management

Anesthesia and surgery are associated with increased catecholamine levels resulting in increased glycogenolysis, gluconeogenesis, and lipogenesis. Furthermore, glucagon levels increase and insulin secretion decreases. Thus, patients undergoing anesthesia and surgery are at risk for hyperglycemia caused by both an increased insulin resistance and decreased insulin secretion. Data regarding the outcome of intraoperative “tight” glucose control is lacking. One randomized study in diabetic patients undergoing coronary artery bypass grafting found that “tight” glycemic control (plasma glucose levels held between 125 and 200 mg/dL) resulted in a lower incidence of atrial fibrillation and a shorter postoperative hospital length of stay. Tight glycemic control was also associated with a survival advantage for the initial 2 years after surgery, decreased episodes of recurrent ischemia, and fewer wound infections.<sup>63</sup> Other studies have demonstrated the adverse effects of hyperglycemia on neurologic outcome<sup>64</sup> and renal failure<sup>65</sup> in patients who are undergoing cardiac procedures requiring cardiopulmonary bypass.

Perioperative normoglycemia can be hard to achieve despite infusion of large doses of insulin. One study showed that normoglycemia could be maintained during cardiac surgery by employing the hyperinsulinemic normoglycemic clamp. With this technique, insulin is infused at a constant rate to increase plasma insulin, and, concurrently, IV glucose is titrated to clamp the blood glucose concentration at the specific level.<sup>66</sup>

### Awareness

Awareness is the postoperative recollection of events occurring during general anesthesia. The incidence of awareness is rare in the general surgical population (0.1–0.2%).<sup>67</sup> However, the incidence of awareness is greater in certain at-risk populations, especially those in patients who receive light anesthesia, usually because of hemo-

dynamic instability. The incidence of awareness in patients who undergo surgery for major trauma is reported as high as 43%. Awareness can be difficult to detect clinically because the typical indicators of “light” anesthesia such as increased heart rate, hypertension, or movement may be masked by drugs or the patient's overall status. More than half of the patients who report experiencing intraoperative awareness have subsequent mental distress, including posttraumatic stress syndrome, after surgery. If light anesthesia is required because of hemodynamic considerations, then amnestic drugs such as midazolam, scopolamine, or subanesthetic doses of ketamine should be administered. When possible, neuromonitoring technologies to detect the presence of awareness should be considered. One randomized, controlled study found that bispectral index (BIS) monitoring of the electroencephalogram (EEG) of high-risk patients (defined as patients undergoing cesarian section or high-risk surgery, patients with a history of chronic benzodiazepine, opioid, or heavy alcohol use, and patients with acute trauma and hypovolemia) reduced their risk of awareness by 82%.<sup>68</sup>

### POSTOPERATIVE CARE AND HANDOFF TO THE ICU TEAM

The critically ill patient should be transported back to the ICU from the operating room by an anesthesiologist. The considerations for transport back to the ICU should be similar to those for transport to the operating room. The patient should be hemodynamically stable and have a secure airway prior to transport. Emergency medications, ample oxygen, and supplies for airway management must be available. There should be ample and functional intravenous access. All infusions should be running well and sufficient medication to last the time needed for transportation to and restabilization in the ICU should be available.

The anesthesia team is responsible for the care of the patient until a full verbal report is given to the ICU team and the ICU team accepts the care of the patient. At this point, the anesthesiologist is the caregiver who is most aware of the patient's status and therefore should be available to assist with any problems that arise immediately

postoperatively. A full report, including the patient's medical history, location of monitors and lines, anesthesia technique, including the amounts and types of drugs administered, surgical procedure, other medications administered, estimated fluid and blood volume loss and replacement, anesthetic and surgical complications, and any special issues (e.g., allergies, isolation precautions) should be given to the nurses and physicians who will be caring for the patient in the ICU. The report should include specific problems (e.g., oxygenation, ventilation, hemodynamic instability) that were encountered intraoperatively, the maneuvers, whether successful or unsuccessful, made to resolve the problems, and the rationale behind the maneuvers attempted. A well-considered plan for postoperative pain management should be conveyed. The ICU team should be informed of any special care plans for the postoperative period as well as any potential postoperative problems.

### SUMMARY

Anesthesiologists may be involved in the care of critically ill patients in the operating room as they often need surgery to correct the underlying cause of their illness or to deal with the complications of their illness. Planning for the anesthesia management of critically ill patients begins with the preoperative evaluation as these patients may have impaired function of multiple organ systems. Ideally, optimization of the patient's condition should occur preoperatively to ensure that the patient is in the best possible condition to undergo the additional stresses associated with surgery and anesthesia.

Preoperative planning should include a plan for the transport to the operating room because patients are at high risk of adverse events during transport. The anesthesiologist must decide which monitors are necessary for the assessment of the patient's condition, taking into account the advantages and pitfalls of various different options. General anesthesia is most often planned for surgery in the critically ill patient. The anesthesiologist may need to plan a total intravenous anesthetic technique if the patient has severe respiratory failure and requires

an ICU ventilator intraoperatively for adequate oxygenation and ventilation. Regional anesthesia should be given due consideration as it can play a valuable adjunctive role to achieve optimum patient comfort and reduce physiologic stress.

There should be specific goals and end points defined in the intraoperative management of the critically ill patient to optimize hemodynamics and minimize further end-organ damage. Finally, advanced planning and communication between the anesthesiologists, surgeons, critical care team, and the patient and the patient's family are crucial to understanding the goals and priorities of treatment.

## KEY REFERENCES

1. Arbous MS, Meursing AE, van Kleef JW, et al. Impact of anesthesia management characteristics on severe morbidity and mortality. *Anesthesiology* 2005;102:257.
2. Dellinger RP, Carlet JM, Masur H, et al. Surviving Sepsis Campaign: guidelines for management of severe sepsis and septic shock. *Crit Care Med* 2004;32:858.
3. Annane D, Sebille V, Charpentier C, et al. Effect of treatment with low doses of hydrocortisone and fludrocortisone on mortality in patients with septic shock. *JAMA* 2002;288:862.
4. van den Berghe G, Wouters P, Weekers F, et al. Intensive insulin therapy in critically ill patients. *N Engl J Med* 2001;345:1359.
5. Rivers E, Nguyen B, Havstad S, et al. Early goal-directed therapy in the treatment of severe sepsis and septic shock. *N Engl J Med* 2001;345:1368.
6. American Society of Anesthesiologists Task Force on Blood Component Therapy. Practice guidelines for blood component therapy. *Anesthesiology* 1996;84:732.
7. Sandham JD, Hull RD, Brant RF, et al. A randomized, controlled trial of the use of pulmonary-artery catheters in high-risk surgical patients. *N Engl J Med* 2003;348:5.
8. ASA practice guidelines for perioperative transesophageal echocar-

diography. *Anesthesiology* 1996;84:986.

9. Choi PT, Yip G, Quinonez LG, et al. Crystalloids vs. colloids in fluid resuscitation: a systematic review. *Crit Care Med* 1999;27:200.

10. Beale RJ, Hollenberg SM, Vincent JL, Parrillo JE. Vasopressor and inotropic support in septic shock: an evidence-based review. *Crit Care Med* 2004;32:S455.

11. Merten GJ, Burgess WP, Gray LV, et al. Prevention of contrast-induced nephropathy with sodium bicarbonate: a randomized controlled trial. *JAMA* 2004;291:2328.

12. Tepel M, van der Giet M, Schwarzfeld C, et al. Prevention of radiographic-contrast-agent-induced reductions in renal function by acetylcysteine. *N Engl J Med* 2000;343:180.

13. Myles PS, Leslie K, McNeil J, et al. Bispectral index monitoring to prevent awareness during anesthesia: the B-Aware randomized controlled trial. *Lancet* 2004;363:1757.

## REFERENCES

1. Aitkenhead AR. Injuries associated with anesthesia. A global perspective. *Br J Anaesth* 2005;95:95.
2. Pedersen T. Complications and death following anaesthesia. *Dan Med Bull* 1994;41:391.
3. Arbous MS, Meursing AE, van Kleef JW, et al. Impact of anesthesia management characteristics on severe morbidity and mortality. *Anesthesiology* 2005;102:257.
4. Society of Critical Care Medicine and American Society of Health-System Pharmacists. Clinical practice guidelines for sustained neuromuscular blockade in the adult critically ill patient. *Crit Care Med* 2002;30:142.
5. Dellinger RP, Carlet JM, Masur H, et al. Surviving Sepsis Campaign: guidelines for management of severe sepsis and septic shock. *Crit Care Med* 2004;32:858.
6. Annane D, Sebille V, Charpentier C, et al. Effect of treatment with low doses of hydrocortisone and fludrocortisone on mortality in patients with septic shock. *JAMA* 2002;288:862.
7. van den Berghe G, Wouters P, Weekers F, et al. Intensive insulin therapy in critically ill patients. *N Engl J Med* 2001;345:1359.
8. Zimmerman JL. Use of blood products in sepsis: an evidence-based review. *Crit Care Med* 2004;32:S542.
9. Hebert PC, Wells G, Blajchman MA, et al. A multicenter, randomized, controlled clinical trial of transfusion requirements in critical care. *N Engl J Med* 1999;340:409.
10. Rivers E, Nguyen B, Havstad S, et al. Early Goal-Directed Therapy in the Treatment of Severe Sepsis and Septic Shock. *N Engl J Med* 2001;345:1368.
11. American Society of Anesthesiologists Task Force on Blood Component Therapy. Practice guidelines for blood component therapy. *Anesthesiology* 1996;84:732.
12. Barletta JF, Ahrens CL, Tyburski JG, Wilson RF. A review of recombinant factor VII for refractory bleeding in nonhemophilic trauma patients. *J Trauma* 2005;58:646.
13. Bernard GR, Vincent JL, Laterre PF, et al. Efficacy and safety of recombinant human activated protein C for severe sepsis. *N Engl J Med* 2001;344:699.
14. Fourrier F. Recombinant human activated protein C in the treatment of severe sepsis: an evidence-based review. *Crit Care Med* 2004;32:S534.
15. Tiret L, Desmots JM, Hatton F, Vourcâh G. Complications associated with anaesthesia: a prospective survey in France. *Can Anesth Soc J* 1986;33:336.
16. Arvidsson S, Ouchterlony J, Nilsson S, et al. The Gothenburg study of perioperative risk. I. Preoperative findings, postoperative complications. *Acta Anaesthesiol Scand* 1994;38:679.
17. Mangano DT. Perioperative cardiac morbidity. *Anesthesiology* 1990;72:153.
18. Polanczyk CA, Marcantonio E, Goldman L, et al. Impact of age on perioperative complications and length of stay in patients undergoing noncardiac surgery. *Annals Intern Med* 2001;134:637.
19. Walsh TH. Audit of outcome of major surgery in the elderly. *Br J Surg* 1996;83:92.
20. Hamel MB, Henderson WG, Khuri SF, et al. Surgical outcomes for patients aged 80, and older: morbidity and mortality from major noncardiac surgery. *J Am Geriatr Soc* 2005;53:424.
21. Hennessy D, Juzwishin K, Yergens D, et al. Outcomes of elderly survivors of intensive care: a review of the literature. *Chest* 2005;127:1764.
22. Chelluri L, Pinsky MR, Grenvik AN. Outcome of intensive care of the "oldest-old" critically ill patients. *Crit Care Med* 1992;20:757.
23. Chelluri L, Grenvik A, Silverman M. Intensive care for critically ill elderly: mortality, costs, and quality of life. Review of the literature. *Arch Intern Med* 1995;155:1013.
24. Kass JE, Castriotta RJ, Malakoff F. Intensive care unit outcome in the very elderly. *Crit Care Med* 1992;20:1666.
25. Szem JW, Hydo LJ, Fischer E, et al. High-risk intrahospital transport of critically ill patients: safety and outcome of the necessary "road trip." *Crit Care Med* 1995;23:1660.

26. Smith I, Fleming S, Cernaianu A. Mishaps during transport from the intensive care unit. *Crit Care Med* 1990;18:278.
27. Insel J, Weissman C, Kemper M, et al. Cardiovascular changes during transport of critically ill and postoperative patients. *Crit Care Med* 1986;14:539.
28. ASA Standards for Basic Anesthetic Monitoring. Available at: [www.asahq.org/publicationsAndServices/standards/02.pdf](http://www.asahq.org/publicationsAndServices/standards/02.pdf). Last accessed April 11, 2006.
29. Connors AF, Speroff T, Dawson NV, et al. The effectiveness of right heart catheterization in the initial care of critically ill patients. *JAMA* 1996;276:889.
30. Richard C, Warszawski J, Anguel N, et al. Early use of the pulmonary artery catheter and outcomes in patients with shock and acute respiratory distress syndrome: a randomized controlled trial. *JAMA* 2003;290:2713.
31. Harvey S, Harrison DA, Singer M, et al. PAC-Man study collaboration. Assessment of the clinical effectiveness of pulmonary artery catheters in management of patients in intensive care (PAC-Man): a randomised controlled trial. *Lancet* 2005;366:472.
32. Sandham JD, Hull RD, Brant RF, et al. A randomized, controlled trial of the use of pulmonary-artery catheters in high-risk surgical patients. *N Engl J Med* 2003;348:5.
33. ASA practice guidelines for perioperative transesophageal echocardiography. *Anesthesiology* 1996;84:986.
34. Hauser AM, Gangadharan V, Ramos RG, et al. Sequence of mechanical, electrocardiographic and clinical effects of repeated coronary artery occlusion in human beings: echocardiographic observations during coronary angioplasty. *J Am Coll Cardiol* 1985;5:193.
35. Bennett-Guerrero E. Automated detection of gastric luminal partial pressure of CO<sub>2</sub>. *Anesthesiology* 2000;92:38.
36. Kolkman JJ, Otte JA, Groeneveld ABJ. Gastrointestinal luminal Pco<sub>2</sub> tonometry: an update on physiology, methodology, and clinical applications. *Br J Anaesth* 2000;84:74.
37. Gutierrez G, Palizas F, Doglio G, et al. Gastric intramucosal pH as a therapeutic index of tissue oxygenation in critically ill patients. *Lancet* 1992;339:195.
38. Warner MA, Warner ME, Weber JG. Clinical significance of pulmonary aspiration during the perioperative period. *Anesthesiology* 1993;78:56.
39. Stoelting R. Circulatory changes during direct laryngoscopy and tracheal intubation: influence of duration of laryngoscopy with or without lidocaine. *Anesthesiology* 1977;47:381.
40. Fox EJ, Sklar GS, Hill CH, et al. Complications related to the pressor response to endotracheal intubation. *Anesthesiology* 1977;47:524.
41. Schulz-Stubner S, Boezaart A, Hata S. Regional analgesia in the critically ill. *Crit Care Med* 2005;33:1400.
42. Moon MR, Luchette FA, Gibson SW, et al. Prospective, randomized comparison of epidural versus parenteral opioid analgesia in thoracic trauma. *Ann Surg* 1999;229:684.
43. Gramling-Babb P, Miller MJ, Reeves ST, et al. Treatment of medically and surgically refractory angina pectoris with high thoracic epidural analgesia: initial clinical experience. *Am Heart J* 1997;133:648.
44. Gattinoni L, Brazzi L, Pelosi P, et al. A trial of goal-oriented hemodynamic therapy in critically ill patients. *N Engl J Med* 1995;333:1025.
45. Boyd O, Grounds RM, Bennett ED. A randomized clinical trial of the effect of deliberate perioperative increase of oxygen delivery on mortality in high-risk surgical patients. *JAMA* 1993;270:2699.
46. Shoemaker WC, Appel PL, Kram HB, et al. Prospective trial of supranormal values of survivors as therapeutic goals in high-risk surgical patients. *Chest* 1998;94:1176.
47. Choi PT, Yip G, Quinonez LG, et al. Crystalloids vs. colloids in fluid resuscitation: a systematic review. *Crit Care Med* 1999;27:200.
48. Alderson P, Schierhout G, Roberts I, et al. Colloids versus crystalloids for fluid resuscitation in critically ill patients. *Cochrane Database Syst Rev* 2000;2:CD000567.
49. Beale RJ, Hollenberg SM, Vincent JL, Parrillo JE. Vasopressor and inotropic support in septic shock: an evidence-based review. *Crit Care Med* 2004;32:S455.
50. Landry DW, Levin HR, Gallant EM, et al. Vasopressin deficiency contributes to the vasodilation of septic shock. *Circulation* 1997;95:1122.
51. Holmes CL, Patel BM, Russell JA, Walley KR. Physiology of vasopressin relevant to management of septic shock. *Chest* 2001;120:989.
52. McCollough PA, Wolyn R, Rocher RR, et al. Acute renal failure after coronary intervention: incidence, risk factors, and relationship to mortality. *Am J Med* 1997;103:368.
53. Baker CSR, Baker LRI. Prevention of contrast nephropathy after cardiac catheterization. *Heart* 2001;85:361.
54. Solomon R, Werner C, Mann D, et al. Effects of saline, mannitol, and furosemide to prevent acute decreases in renal function induced by radiocontrast agents. *N Engl J Med* 1994;331:1416.
55. Merten GJ, Burgess WP, Gray LV, et al. Prevention of contrast-induced nephropathy with sodium bicarbonate: a randomized controlled trial. *JAMA* 2004;291:2328.
56. Tepel M, van der Giet M, Schwarzfeld C, et al. Prevention of radiographic-contrast-agent-induced reductions in renal function by acetylcysteine. *N Engl J Med* 2000;343:180.
57. Perdue PW, Balsler JR, Lipsett PA, Breslow MJ. "Renal dose" dopamine in surgical patients: dogma or science. *Ann Surg* 1998;227:470.
58. Nicholson ML, Baker DM, Hopkinson BR, et al. Randomized controlled trial of the effect of mannitol on renal reperfusion injury during aortic aneurysm surgery. *Br J Surg* 1996;83:1230.
59. Murphy MB, Murray C, Shorten GD. Fenoldopam: a selective peripheral dopamine-receptor agonist for the treatment of severe hypertension. *N Engl J Med* 2001;345:1548.
60. O'Connell DP, Ragsdale NV, Boyd DG, et al. Differential human renal tubular responses to dopamine type 1, receptor stimulation are determined by blood pressure status. *Hypertension* 1997;29:115.
61. Sear JW. Kidney dysfunction in the postoperative period. *Br J Anaesth* 2005;95:20.
62. Sadovnikoff N. Perioperative acute renal failure. *Int Anesthesiol Clin* 2001;39:95.
63. Lazar HL, Chipkin SR, Fitzgerald CA, et al. Tight glycemic control in diabetic coronary artery bypass graft patients improves perioperative outcomes and decreases recurrent ischemic events. *Circulation* 2004;109:1497.
64. Lanier WL. Glucose management during cardiopulmonary bypass: cardiovascular and neurological implications. *Anesth Analg* 1991;72:423.
65. Mangano CM, Diamondstone LS, Ramsey JG, et al. Renal dysfunction after myocardial revascularization: risk factors, adverse outcomes, and hospital resource utilization. *Ann Intern Med* 1998;128:194.
66. Carvalho G, Moore A, Qizilbash B, et al. Maintenance of normoglycemia during cardiac surgery. *Anesth Analg* 2004;99:319.
67. Sebel PS, Bowdle TA, Ghoneim MM, et al. The incidence of awareness during anesthesia: a multicenter United States study. *Anesth Analg* 2004;99:833.
68. Myles PS, Leslie K, McNeil J, et al. Bispectral index monitoring to prevent awareness during anesthesia: the B-Aware randomized controlled trial. *Lancet* 2004;363:1757.



# CHAPTER 80

## Monitoring and Transport of the Critically Ill Patient

Michael G. Fitzsimons, MD, FCCP, and Nathaniel Sims, MD

Transport is assuming a more important role in the medical and surgical management of critically ill adult and pediatric patients. The first structured ground evacuation of the wounded occurred during the Napoleonic Wars when two of Napoleon's medical officers designed practical horse-drawn carriages for the swift evacuation of battlefield casualties.<sup>1</sup> Major John Letterman created an independent ambulance corps during the Civil War and a system of evacuation to clearing stations with secondary transfer to field hospitals as needed. Balloon evacuation of the injured first occurred during the Franco-Prussian War in the 1870s.<sup>2</sup> Specific air medical training was started during World War II along with the first helicopter transport. The Korean and Vietnam Wars saw the increased use and benefits of helicopter transport. In 1972, St. Anthony's Hospital in Denver, Colorado established the first civilian rotor-wing transport program.<sup>3</sup> Today patients with severe injuries are transported over long distances, between countries and continents, and across time zones for advanced care. Advances in medical technology and treatment options have resulted in the need to move critically ill patients within large hospitals for specialty care.

The anesthesiologist and critical care physician commonly encounter issues of transfer of the critically ill patient. Intrahospital transfer may be performed to the operating room urgently for surgery, the radiology suite for diagnostic and therapeutic procedures, and from the emergency department throughout the hospital for additional care. Interhospital transfer involves the movement of a critically ill patient from one treatment facility to another. Transport exposes these patients to multiple stresses that may

### KEY POINTS

1. Transport of even the sickest patients can be accomplished safely between and within hospitals.
2. Intrahospital transport is performed within the same hospital to different sites for diagnostic and therapeutic interventions. Interhospital transport involves the movement of a critically ill individual from one treatment facility to another.
3. Clinical management is altered in approximately 40% of patients requiring transport out of the ICU for diagnostic procedures and facilitated interventions. Abdominal CT and angiography were most likely to result in a change of management, thus such transport is often well justified.
4. The incidence of complications occurring with patient transport has historically been high and constant vigilance is required both by caregivers and institution system engineers to keep these to a minimum. System-based and human-based problems can occur in equal proportions.
5. Hemodynamic changes commonly encountered in transport include systemic hypertension, hypotension, and tachycardia. No clear factors helping to predict hemodynamic deterioration during transport have been identified, other than the level of overall pre-transport morbidity, instability, or the presence of a recent myocardial infarction.
6. Respiratory deterioration including hypercarbia, hypocarbia, and hypoxemia may occur in a significant fraction of transported patients. Factors that predict changes include the need for positive end-expiratory pressure (PEEP), an  $\text{FiO}_2$  greater than 50%, and age  $> 43$  years.
7. There is no evidence that "scoop-and-run" rapid transport without appropriate assessment and preparation is either safe or effective.
8. Appropriate assessment and management of the patient's airway is paramount in safe movement. Intubation during transport can be highly successful when performed by trained personnel, although patients with potentially difficult-to-manage airways are best intubated prior to transport.
9. Mechanical ventilation may maintain respiratory stability better than manual ventilation. Individuals trained in optimum manual ventilation (e.g., respiratory therapists, anesthesiologists) and those with excellent patient assessment skills tend to maintain satisfactory respiratory parameters in patients undergoing transport. On the other hand, transport ventilatory systems may lack optimum alarms and may require constant surveillance for malfunction.
10. Sedation with small doses of intravenous short-acting benzodiazepines and opiates can safely be administered in transport and may reduce the inherent stress of transport, but persons skilled in monitoring and managing of oversedation should be in constant attendance.
11. The U.S. Emergency Medical Treatment and Active Labor Act (EMTALA, 1986) was established to mitigate financially motivated transport, and requires that hospitals with emergency medical departments provide appropriate medical screening examinations within the capability of that hospital's emergency department, including ancillary services, to any individual who enters the department. If an acute medical condition is found, the department must either provide care or stabilize the patient prior to transferring to another facility.
12. Current regulations and good medical practice require that the competent patient or a legally authorized representative give informed consent prior to transfer to another hospital.
13. Physiologic monitoring of patients during transport should be maintained at the current level of care in the interest of patient's safety.
14. Individuals skilled in basic and advanced cardiac life support should perform transport of the critically ill patient within the hospital.

*Continued*



*Key Points—continued*

15. The advantages of air transport include reduced transport time over long distances and the ability to transfer many patients at one time. The primary disadvantages include a need for dedicated landing space, vibration, and expense. Potential insults related to transport by air include hypoxemia, decreases in ambient pressure, and hypothermia. “Altitude restrictions” are commonly ordered for patients with eye trauma, pneumothorax, intracerebral air, and sinusitis.
16. When the decision to move a patient by ground transport is made, a decision about the necessary level of life support must also be made. Ground transport services commonly provide a choice of basic life support (BLS), advanced life support (ALS), or critical care transport.
17. Acute neurologic injuries, which may benefit from transfer to higher levels of care, include head injury, acute stroke, and spinal cord injury. Secondary insults are common during transport of the neurologic patient and include systemic hypertension, hypotension, hypoxemia, raised intracranial pressure (ICP), and a reduced cerebral perfusion pressure. The number of secondary insults correlates with instability prior to movement, and for these patients specialized neuromedical transport is indicated.
18. Up to 5% of transports are for high-risk obstetric conditions. In general, outcome is improved if the mother is transported prior to delivery of the fetus.
19. Joint Commission on Accreditation of Healthcare Organizations (JCAHO) requires that hospitals have protocols for dealing with hazardous materials exposures. These protocols must address transport of patients contaminated by such materials, and criteria for reopening of affected patient care areas.
20. Pediatric patients (newborns and older children) are transferred most commonly for pulmonary insufficiency, cardiovascular compromise and congenital heart disease, or neurologic injury. This population benefits from dedicated specialty transport teams with specialized equipment.
21. Transport system design must involve integration of space, monitors, and support equipment that is compatible among the various sites to which a patient will be moved. Equipment engineering teams must design systems that minimize discontinuation of monitoring, disconnection of infused medications and mechanical ventilation, and prevents loss of continuous hemodynamic measurements.
22. Dedicated specialty transport teams may improve outcomes for interhospital transport of critically ill patients with uncommon or complex, unstable illnesses. The benefits of a specialized transport team for moving patients within a hospital are less clear and require further study.
23. Protocols that outline the appropriate practices for movement of patients with a variety of specific conditions are well established among emergency medical services but are less common within hospitals. Protocol development is critical to quality and should address planning, preparation, care during transport, issues on arrival, appropriate documentation, education, and quality improvement.
24. Transfer of all known current medical information about the patient can be as imperative as safe patient movement.
25. Critical incident evaluation at single centers, coupled with reporting and collection of events among many facilities is expected to reveal system errors that, upon correction, should improve patient outcome with transport. Such systems must stress “fixing system problems” and not “searching for an individual to blame.”

result in alterations of blood pressure, hypoxemia, arrhythmias, and potential airway compromise. These and other adverse events of transport can occur far from the skilled personnel, equipment, and monitoring of the intensive care unit (ICU) or operating room.

Effective and safe transport of a patient does not simply involve movement but also the creation of compatible systems to minimize transport time, eliminate monitoring and medication interruptions, and reduce distractions that take the focus off patient care.<sup>4</sup>

**INTERHOSPITAL TRANSPORT**

Transfer of a patient to a referral center occurs when the perceived benefit exceeds the risks associated with moving the patient. The Society of Critical Care Medicine convened a task force to examine the benefits of regionalization of medical care based on benefits demonstrated in neonatal and perinatal medicine,<sup>5</sup> trauma,<sup>6,7</sup> and burn care. The quality of care benefits seen at referral centers includes a higher level of training of physicians, around-the-clock staffing, wider range of consultative services, increased exposure and experience with critically ill patients, data collection, clinical research, and the potential for improved outcomes in both medical and surgical patients.<sup>8,9</sup> Such a transfer is commonly referred to as *secondary transport*.<sup>10</sup> The reasons for transport vary among individual hospitals, within medical systems and across countries. Indications vary over time as technologic advances result in better care.

**INTRAHOSPITAL TRANSPORT**

Intrahospital transport involves the movement of a patient throughout the same hospital for additional care that cannot be performed safely or adequately at the patient's bedside. Certain technology has brought procedures that previously required transport (e.g., right-heart catheterization, certain computed tomographic studies, echocardiography, ultrasonography, closure of patent ductus arteriosus, tracheostomy, and inferior vena cava filter placement) to the patient. Other studies and treatment may require movement of the critically ill patient to distant and more isolated areas of the hospital (Table 80-1). The duration of the trip may be long because of complicated diagnostic and therapeutic procedures. Patients who are “too ill” for a procedure in the operating room are frequently taken to radiology or other sites by a single nurse and respiratory therapist.

The overall benefit of transporting a patient out of the safety of the intensive care unit for studies or procedures has been studied. The necessary “travel” results a change in patient management in 24–39% of cases.<sup>11,12</sup> Abdominal computed tomography and angiography most commonly result in changes.

TABLE 80-1.

## Intrahospital Destinations

Operating suite  
Radiology  
  Angiography  
  Computed tomography  
  MRI  
  Interventional radiology  
Cardiac catheterization  
Gastroenterology  
Intensive care unit  
Nuclear medicine

## RISKS OF PATIENT TRANSFER

Knowledge of the risks of patient transfer within a hospital or between facilities is imperative for informed decision making. Contraindications to transport may include the inability to oxygenate or ventilate a patient, uncontrolled hemodynamic instability, inadequate monitoring, inability to maintain an airway, and inadequate personnel. Despite these complicating circumstances the life-threatening condition may still necessitate transfer to other facilities or sites of treatment. Morbidity and mortality are primarily related to hemodynamic and respiratory deterioration, but also include interruption of medication administration, disconnection of intravenous access, loss of airway support, and human error (Table 80-2).

We do not know whether physiologic changes during transport are a result of preexisting morbidity, environmental change, or a continuation of the normal course of critical illness, or, in contrast, truly preventable mishaps or near-misses representing care that could have been better.

Patients transported within a particular hospital commonly experience hemodynamic and respiratory changes that can be associated with adverse outcomes or unexpected morbidity. These “complications” may be defined as inconsequential such as minor hemodynamic perturbations or may include major events resulting in death. In previously reported studies, the incidence of hemodynamic and respiratory changes varies widely from 5–68%.<sup>11–15</sup> The majority of mishaps occur at the destination (Table 80-3). Many complications occur in radiology where the physical isolation, need

TABLE 80-2.

## Hazards and Complications of In-Hospital Transport

Cardiovascular	Pulmonary	Other Physiologic	Equipment
Hypotension	Hypercarbia	Hyperthermia	Power failure
Hypertension	Hypocardia	Hypothermia	Oxygen supply failure
Arrhythmias	Aspiration	Pain	Dislodgement of vascular access
Cardiac arrest	Extubation Hypoxemia Pneumonia Airway obstruction Increased risk of pneumonia	Anxiety Intracranial hypertension Physical injury	

to move the patient from the stretcher to the imaging table and back, duration of the procedure, and delay at the site, may contribute to the occurrence of a mishap.<sup>14</sup> There appears to be no correlation of the mishap rate with severity of illness as defined by the Acute Physiology and Chronic Health Evaluation (APACHE) score, number of escorts, number of lines, monitoring, or time spent out of the ICU.<sup>14</sup> Szem found an overall mortality rate of 28.6% for patients requiring transport out of the ICU that was significantly higher than the control group (11.4%).<sup>15</sup> There were no deaths directly related to transport, although patients who required transport out of the ICU may have been sicker.

The Australian Incident Monitoring Study in Intensive Care evaluated all reports from 91 units submitted in relation to incidents occurring during transport within the hospital between 1993 and 1999. Of 7525 submitted reports, 176 described 191 incidents during intrahospital transport. Analysis revealed that 39% of the incidents were equipment-related and 61% were patient/staff management issues. System-based and human-based problems occurred equally.<sup>16</sup> Significant adverse outcomes to the patients occurred in nearly a third of the events. The high incidence of system-based problems may have arisen from a need to disconnect a patient from ventilation, interrupt the delivery of vital infusions while changing to pumps and monitors specific to the transport process, and the limited battery life of transport devices. Often another monitoring system was in place at the site

of treatment or destination, requiring further interruptions. The anesthesiologist is often simultaneously responsible for monitoring the patient and making adjustments to medications to maintain hemodynamic stability.

Patient movement between hospitals may be associated with longer transport times, greater isolation from advanced care, stresses related to vibration, noise, and gravitational forces if transport is accomplished by air. In addition these patients may be more ill and transfer undertaken with more limited monitoring than usual within a hospital. Adverse events occurred in at least one-third of interhospital transports with 30% of these attributable to technical problems.<sup>17</sup>

TABLE 80-3.

## Distribution of Locations on Transport when Mishaps Occur

Location	% Mishaps
In ICU, preparing for transport	2
On transport to the destination	19
At destination before procedure	29
During the procedure	41
At destination, preparing to return to ICU	5
During return transport	2
Arrival in ICU	2

Reproduced with permission from Smith I, Flemming S, Cernaianu A. Mishaps during transport from the intensive care unit. *Crit Care Med* 1990;18:278–281.

## Hemodynamic Changes

Adverse hemodynamic alterations are among the most common events during both intrahospital and interhospital transport. The cause of the instability may be interruption of vasopressor infusions, stress and anxiety, pain, inadequacy of sedation, or fluid redistribution with patient movement.

Hypotension or hypertension occurs in 25–50% of intrahospital transports.<sup>12,18,19</sup> Factors demonstrated to contribute include emergence from the effects of anesthetic agents, manual ventilation and spinal anesthesia in the obstetric patient.<sup>18,20,21</sup> Arrhythmias requiring treatment may occur in up to one-half of patients transported for “high-risk” cardiovascular conditions.<sup>22</sup> The care provider is often confronted with these changes while dealing with unfamiliar drug delivery systems, the need to disconnect and reconnect to a new monitor, and the need to search for therapeutic medications in an unfamiliar area or while maneuvering a stretcher through halls or elevators.

Hemodynamic changes are at least as common with secondary transport between hospitals. Unless blood pressure is monitored by invasive means, these changes may be missed with noninvasive means as a consequence of vibration and noise.

High-risk cardiac patients, including those with recent myocardial infarctions, may demonstrate instability when transferred to higher levels of care, often manifested as arrhythmias, pump failure, or cardiogenic shock.<sup>23</sup> The intubated patient may be “safer” from an “airway management” point of view, but pretransport intubation in this group of patients tends to be a marker for precarious and unstable hemodynamics. The era of thrombolysis means that many patients will have had some degree of reperfusion prior to transport to a center capable of definitive management and actually a lower incidence of difficulties than in earlier years.<sup>24</sup> Rubenstein’s study of 755 acutely ill cardiac patients, the majority with class III or class IV New York Heart Association (NYHA) heart failure, transported from community hospitals to tertiary care centers showed no complications. However, half required urgent intervention (coronary artery bypass graft or percutaneous transluminal coronary angioplasty) upon arrival.

Studies show, however, that even the most tenuous patients can be safe-

ly transported including those on extracorporeal life support (ECLS).<sup>25</sup> The University of Michigan Medical Center reviewed the transport of patients on ECLS for various indications, including cardiac failure. Transport-related complications occurred in 17 of 100 trips, yet none were believed to have had an adverse effect on outcome.

## Respiratory Impairment

Respiratory compromises encountered in patient transport include hypoxemia, hypercarbia with respiratory acidosis, hypocarbia with respiratory alkalosis, drying of secretions, plugging or displacement of the endotracheal tube, and unexpected extubation. The incidence of respiratory changes during transport varies widely in reported studies. Of note, data from Kollef shows an increased risk of subsequent ventilator-associated pneumonia compared to nontransported controls.<sup>26</sup> Factors potentially responsible for these changes include changes in the pattern of ventilation, mode of ventilation (manual versus mechanical), loss or absence of positive end-expiratory pressure (PEEP) with disconnection, endotracheal tube displacement, and equipment failure.

Hypoxemia (defined as a decreased  $\text{PaO}_2:\text{FiO}_2$  ratio) occurs in up to 86% of transports involving patients artificially ventilated.<sup>27</sup> The need for PEEP and higher  $\text{FiO}_2$  before transport correlates with a higher risk of deterioration.<sup>27,28</sup> Even brief interruptions of PEEP for connection and disconnection can be detrimental to systemic oxygenation. Decreases in measured  $\text{PaO}_2$  end points of oxygenation may be less frequent with manual ventilation as the  $\text{FiO}_2$  is more commonly increased to 100%, whereas transport ventilators may maintain the pretransport  $\text{FiO}_2$ .<sup>29</sup>

Inadequate or excessive ventilation may compromise the outcome of certain patients. Hypercarbia may have detrimental effects on patient populations including those with increased intracranial pressure, pulmonary hypertension, or an existing acidosis. Hypercarbia and a resulting acidosis do occur in a very high percentage of critically ill intubated patients transported within and between hospitals.<sup>20,30,31</sup> The incidence of respiratory acidosis and alkalosis appears to be less with mechanical as compared to manual ventilation during transport. Hypocarbia may result from overly

aggressive ventilation and may be detrimental in patients with neurologic injury. Hyperventilation may also result in air trapping or dynamic hyperinflation, which is especially dangerous in the setting of hypovolemia. Failure of a ventilator during transport may be catastrophic, and yet transport ventilator alarms may be less sophisticated and not well heard in a noisy transport environment, hence a need for heightened team vigilance.

Drying of secretions and damage to the tracheobronchial tree as a result of prolonged exposure to desaturated air has been demonstrated.<sup>32</sup> Dried secretions may result in occlusion of the airways or endotracheal tube. Efforts should be made to humidify the air that intubated patients receive, especially those subject to the very dry dehumidified environment during flight at altitude (tank gas is always dry unless actively humidified).

Extubation can be a major catastrophe during transportation. Up to 15% of all extubations in the critically ill patient are accidental.<sup>33</sup> Patient transport is among the factors responsible. Difficulty was encountered in 20% of reintubations.<sup>33</sup> Moving the head or repositioning of the patient commonly results in accidental extubation even in the presence of sedation or restraints.<sup>34</sup> Transport of a patient with a new tracheostomy needs to be considered an especially dangerous event if extubation occurs.

Either manual or mechanical ventilation can be effective and safe in transport. One disadvantage to manual ventilation is that a care provider must focus on management of ventilation and the airway while potentially neglecting hemodynamic monitoring and other support activities. Other disadvantages include the need for 2 hands, management of decreased lung compliance, and fatigue with long transport.

## Temperature and Injury

Patient transport removes the individual from the controlled setting of the ICU or operating room with both inter- and intrahospital movement. Use of fluid warmers is generally interrupted, warming blankets are disconnected, transport oxygen is commonly inhaled dry, and patients may require exposure for procedures in settings where room temperature cannot be optimally adjusted to protect the patient from hypothermia. Higher death rates are



reported among those individuals who develop hypothermia in transport between hospitals or from the scene of an accident to the hospital. The reduction of temperature does not necessarily correlate with gender, age, flight time, outside air temperature, or type of patient.<sup>35</sup> Hypothermia can contribute to coagulopathy, arrhythmias, tissue hypoxia caused by vasoconstriction, increases of pulmonary vascular resistance, and depression of neurologic status. Precautions are especially important in patients who are prone to hypothermia, including children and the elderly, burn patients, and victims of spinal cord injury. Shivering in an attempt to maintain body temperature increases oxygen consumption, and this may prove detrimental in patients with myocardial ischemia.

Other risks of transport include exacerbation of injury by displacement of fractures, movement of an unstable cervical spine, and dislodgement of tubes or drains. Finally, pressure injuries to limbs, eyes, and skin may result from contact with equipment or accidental trauma.

## PATIENT ASSESSMENT AND PREPARATION

Appropriate assessment and preparation is imperative prior to transporting the patient within or between hospitals. Research has shown that even the sickest patients can be transported when appropriate interventions are established early. General assessment for transport between hospitals includes a review of the medical history, current condition, recent interventions, hemodynamic and respiratory status and stability, current monitors and therapeutic device settings and function, and any changes prompting transfer. Consent for transport from the family or guardian must be obtained for the critically ill and communication with the receiving physician, nurse, or hospital must be established. Assessment also includes planning for possible deterioration and establishing a course of action to deal with physiologic compromise. Wallace and Ridley identified 9 principles of safe patient transfer, which are listed in Table 80–4.<sup>36</sup>

Much effort has been expended to predict the physiologic deterioration and mortality associated with patient transport. Some studies examined he-

modynamics, respiratory status, monitoring, pharmacologic support, and lab analysis but failed to predict which patient will do poorly.<sup>37,38</sup> Other studies looked at PEEP, Injury Severity Score, and Therapeutic Intervention Score before transport and demonstrated that the more ill a patient is, the more likely the patient is to demonstrate instability with transport.<sup>39,40</sup> Generally speaking there is no accurate and reproducible method to accurately predict which patients will experience difficulty with transport. Those patients who demonstrate hemodynamic and respiratory instability prior to transport are more likely to manifest these changes during movement. The difficulty in predicting instability may be a result of a bias that results in sicker patients being transported by specialized transport teams whereas those thought to be more stable may be subject to less-vigilant care and treated by more inexperienced personnel. Logically the more ill a patient and the more interventions required to maintain that patient, the more at risk the patient is for complications during transport.

The need for stabilization prior to transport within and between hospitals cannot be sufficiently stressed. There is no evidence that a “scoop-and-run” approach to interhospital transport of critically ill patients is beneficial. Stabilization before transport is similar to any resuscitation and follows the traditional ABCs (airway, breathing, and circulation). Checklists can prove invaluable in assuring that appropriate steps have been taken (Table 80–5).

## Airway and Intubation

The benefits of appropriately securing a patient’s airway prior to transport include avoiding the potentially difficult conditions for intubation found during ground transport, aeromedical evacuation, and in remote sites within the hospital. A patient whose airway is judged to be stable should receive supplemental oxygen in nearly all circumstances. Patients that are intubated prior to transport should be assessed for endotracheal tube (ETT) position, adequacy of tube function, and that it is appropriately secured. Auscultation of lung fields, exhalation fogging of the ETT, rise and fall of the chest, nail bed or lip color, and pulse oximetry, help to confirm effective intubation. Chest

TABLE 80–4.

### Principles of Safe Transfer

- Experienced staff
- Appropriate equipment and vehicle
- Full assessment and investigation
- Extensive monitoring
- Careful stabilization of patient
- Reassessment
- Continuing care during transfer
- Direct handover
- Documentation and audit

Adapted from Wallace PG, Ridley SA. ABC of intensive care: transport of critically ill patients. *BMJ* 1999;319:368–371. With permission from BMJ Publishing Group.

radiography confirms not only the ETT position but also may define underlying lung pathology. Colorimetric or infrared end-tidal CO<sub>2</sub> detection serves as an additional confirmation of appropriate tube position.

Certain patients may be successfully managed without intubation but are at risk for airway compromise during movement. These patients may benefit from intubation prior to transfer. Common indications for “elective intubation” in anticipation of transport include a Glasgow Coma Score of less than 9, respiratory acidosis or impending respiratory failure, status asthmaticus, severe hypoperfusion, or shock. Patients with anatomic airway compromise arising from burns, epiglottitis, angioedema, anaphylaxis, or tracheolaryngeal trauma can benefit from intubation as the course subsequent to injury may be downhill. Certain stable but combative patients may require airway intubation and paralysis or sedation to assure safety.

Emergency medical personnel are particularly skilled in management of the airway and their advanced training includes intubation.<sup>41,42</sup> The 97% success rate for intubation during transport by emergency medical services (EMS) personnel is the same as intubation prior to transport. Experienced and highly trained care providers are more likely to intubate those patients whose airway appeared to be difficult to manage prior to transport. This may account for the high rate of success and neglect the true difficulty that would be encountered if the same patients were transported without prior intubation.

The laryngeal mask airway (LMA) serves as a valuable alternative or



TABLE 80–5.

## Pretransport Assessment Checklist

<p><b>Risk management</b></p> <ul style="list-style-type: none"> <li>Correct identification of patient</li> <li>Correct destination for correct therapy</li> </ul> <p><b>Airway/breathing</b></p> <ul style="list-style-type: none"> <li>Endotracheal tube if present secured appropriately</li> <li>Assesses need for intubation if not secure</li> <li>Current ventilator settings (mode/<math>V_T</math>/RR/<math>FiO_2</math>/PEEP)</li> <li>Current status (ABG/CXR)</li> <li>Trends in stability</li> <li>Airway supplies available</li> <li>Plan for manual versus mechanical ventilation</li> <li>Definitive plan for management of compromise</li> <li>Adequate oxygen</li> <li>Backup airway supplies present and functioning</li> </ul> <p><b>Circulation</b></p> <ul style="list-style-type: none"> <li>Current monitoring</li> <li>“Zero” reference established for all monitors</li> <li>Current hemodynamic status (blood pressure, pulmonary artery, pressure, CVP, rhythm)</li> <li>Intravenous access functioning properly</li> <li>Current and recently used vasopressors</li> <li>Blood available if indicated</li> <li>Resuscitation drugs available</li> <li>Adequate electrical supply for monitors</li> <li>Definitive plan for compromise</li> </ul>	<p><b>Neurologic status</b></p> <ul style="list-style-type: none"> <li>Current function/Glasgow Coma Score</li> <li>Cervical stability if indicated</li> <li>Assessment of level of sedation</li> <li>ICP monitor functioning is present</li> <li>Appropriate “zero” reference on ICP monitors</li> <li>Pain control/adequacy of sedation</li> <li>Definitive plan for treatment of increases in ICP, hypotension, changes in mental status</li> </ul> <p><b>Extra</b></p> <ul style="list-style-type: none"> <li>Assessment of stability of traction/fractures</li> <li>Tubes, lines, and drains all functioning properly, secure</li> <li>Precautions?</li> </ul> <p><b>Investigations</b></p> <ul style="list-style-type: none"> <li>Radiography</li> <li>Medical records</li> <li>Operative reports/discharges summary</li> <li>Most recent labs, radiography, studies</li> <li>Consent</li> </ul> <p><b>Communication</b></p> <ul style="list-style-type: none"> <li>Receiving team made aware of receiving time</li> <li>Contact numbers</li> <li>Alternative destination known</li> </ul>
---	--

ABG, arterial blood gas; CVP, central venous pressure; CXR, chest radiography; ICP, intracranial pressure; PEEP, positive end-expiratory pressure; RR, respiratory rate;  $V_T$ , end-tidal volume.

“backup option” to the endotracheal tube in the setting of difficult intubation. The LMA is not a definitive airway and does not protect against aspiration nor allow prolonged positive pressure ventilation. Routine suctioning of the airway is not possible. Generally the LMA does not depend on facial and tracheal anatomy and placement can be successful from almost any position.<sup>43</sup> Emergency medical personnel have used the LMA successfully in managing the airway in 89% of failed intubations.<sup>44</sup>

The American College of Critical Care Medicine and the Society of Critical Care Medicine recommend certain airway supplies be transported with patients (Table 80–6).<sup>45</sup> These supplies must be available even with a “secured airway” as inadvertent dislodgment

and loss of an airway can occur. Appropriate-size bag-valve systems with an oxygen reservoir are imperative for transport in addition to a variety of masks, laryngoscope blades, endotracheal tubes, oral and nasal airways, and a portable oxygen supply.

### Breathing and Ventilation

Adequacy of breathing and ventilation should be assessed prior to transport. It is imperative that tidal volume, respiratory rate, inspired oxygen concentration, positive end-expiratory pressure, and mode of ventilation be noted and recorded. The respiratory trend may actually be more important than the actual current status of the patient. Increases in  $Paco_2$  may indicate pending ventilatory failure whereas decreases in arterial oxygen saturation

TABLE 80–6.

## Recommended Airway Supplies for Transport

- Appropriate adult or pediatric bag-valve systems with oxygen reservoir
- Appropriate variety of masks
- Flexible adaptors
- End-tidal carbon dioxide detector
- Variety of sizes of MacIntosh and Miller laryngoscope blades and handles
- Appropriate endotracheal tubes (cuffed and uncuffed)
- Magill forceps
- Nasopharyngeal and oral airways
- Scalpel blade for cricothyroidotomy
- Nasal cannula
- Oxygen tubing
- Positive end-expiratory pressure

Adapted from Warren J, Fromm RE, Orr RA, Rotello LC, Horst M, American College of Critical Care Medicine. Guidelines for the inter- and intrahospital transport of critically ill patients. *Crit Care Med* 2004;32:256–262.

or  $Pao_2$  may herald further failure of oxygenation. Sedation or deepening of sedation should be considered to facilitate oxygenation and ventilation. Transfer at altitude by reducing alveolar oxygen concentration can contribute to hypoxemia.

The risks of positive pressure ventilation include barotrauma, hypercarbia and hypocarbia, and dynamic hyperinflation (auto-PEEP), resulting in a reduced venous return and hypotension. The benefits of manual ventilation versus mechanical ventilation during transport are commonly debated. Traditional volume-controlled ventilators used for transport cannot deliver the specialized modes, such as pressure support and inverse ratio ventilation, that may be required for critically ill patients. Comparisons between mechanical and manual ventilation for pediatric transport found greater variation in parameters with manual ventilation.<sup>46</sup> These changes may be more significant for longer- than shorter-duration transport and more important in patients who are subject to compromise of pulmonary or cerebral blood flow, such as newborns with persistent pulmonary hypertension or victims of traumatic brain injury. Weg and Hass compared manual and mechanical ventilation and concluded that manual ventilation can be both

safe and effective if the inspired oxygen concentration and minute ventilation are known prior to transport and ventilation performed by skilled care providers.<sup>29</sup> Most transport services use a combination of manual and mechanical ventilation. Some use mechanical ventilation exclusively. Only a small number of services use only manual support.<sup>47</sup> Austin has identified the ideal characteristics of a transport ventilator (Table 80-7).<sup>48</sup>

Both manual and mechanical ventilation are satisfactory for most patients. Those requiring complicated modes of ventilation or high PEEP, or who are subject to long transport times, should be transported with mechanical ventilatory support.

Transport within the hospital is commonly done on a stretcher with the patient in a supine position. The benefits of a slightly head up position in the ICU may be lost for several hours during transport increasing the risk of aspiration and pneumonia.<sup>49</sup> The supine position may need to be maintained for minutes to hours while a procedure is performed within the hospital. Patients transported between hospitals by ground or air may encounter turbulence that may exacerbate pain and interfere with the ability to cough. Precautions to protect the airway from aspiration must be taken, especially when sedatives are administered.

Continuous monitoring of saturation by pulse oximetry is imperative during transport for all patients. End-tidal carbon dioxide monitors are recommended for all intubated patients. Capnography may serve two purposes: to

confirm appropriate placement of an endotracheal tube and to monitor respiration in an environment in which direct auscultation is difficult. Quantitative capnography may especially benefit head-trauma victims who are at risk from either hyper- or hypocarbia.<sup>50</sup> Less physiologic variability occurs when end-tidal carbon dioxide is continuously monitored during manual ventilation.<sup>51</sup> Continuous capnography is associated with a lower incidence of false alerts and malfunction as compared with pulse oximetry and is not as subject to motion artifact or loss of signal due to vasoconstriction.<sup>52</sup>

The options for treatment of a respiratory/airway complication during transport must be considered. Elevation of  $FiO_2$  to 100% during brief periods of transport may avoid hypoxemia. Increasing PEEP levels to compensate for hypoxemia may be necessary but decreased venous return and barotrauma must be avoided. Administration of skeletal muscle relaxation may increase chest wall compliance and facilitate ventilation.

### Cardiovascular

The hemodynamic stability of a patient prior to transport is imperative. Many of the hemodynamic changes seen with patient transport are reflections of the course prior to movement. Monitors of hemodynamic function should include displays of the electrocardiogram and blood pressure by either invasive or noninvasive means. Monitors must have visible and audible alarms, a long battery life, and illuminated displays. Transport defibrillators are essential

for transport between hospitals and for patients within the hospital who are at a high risk of an arrhythmia (myocardial infarction, cardiac surgery). If transcutaneous pacing is possible (and likely to be needed) adequate capture should be confirmed.

Oscillotonometric or noninvasive measurement of blood pressure facilitates monitoring in the operating theater, postanesthesia care unit, and treatment wards. This form of monitoring may be subject to error during the movement of patients. Although this might not be important in hemodynamically stable, nonventilated patients, it may be critical for others. If invasive arterial monitoring is expected, it should be secured prior to movement. Invasive monitors must be calibrated to a "zero" reference point. Zero points change with patient positioning. Reestablishing the appropriate "zero" reference upon patient transfer or at altitude during flight is imperative.

Adequate IV access for delivery of fluids, continuous medication delivery, and intermittent treatment must be established. The confines and motion of any transport vehicle or stretcher can make placement en route difficult (Fig. 80-1). Adequate function and placement of backup or secondary lines should be considered. If transfusion is anticipated during transport blood should be brought with the patient.

Hemodynamic compromise may result from inadequate preload, afterload, impaired myocardial contractility, or disturbances of cardiac rate and rhythm. Assessment must include a strategy for addressing the hemody-

TABLE 80-7.

#### Ideal Characteristics of a Transport Ventilator

- Person portable (4–6 kg)
- Durable
- Pneumatically powered or electrically powered
- Low oxygen consumption
- Easy-to-read controls that are not easy to accidentally adjust
- Safety features, including a high-pressure relief valve and functional high-visibility alarms
- Cost-efficient

Data from Austin PN, Campbell RS, Johanningman JA, Branson RD. Transport ventilators. *Respir Care Clin* 2002;8:119–150.



FIGURE 80-1. Confines of rotor-wing transport. (Courtesy of Boston MedFlight.)

dynamic instability by: assessment, volume resuscitation, and infusion of inotropic or vasopressor support as needed. The resources needed to provide these therapies must be provided during transport.

### Neurologic Status and Sedation

Secondary insults during transport of head-injured patients are common and may include hypoxemia, hypotension, and intracranial hypertension, each of which worsens neurologic outcome. Although physiologic instability during transport is correlated with instability prior to movement, anticipation of problems, and preparation for the management of problems is imperative.<sup>53</sup> Appropriate physiologic monitoring of oxygenation and ventilation is necessary. Transport patients may benefit from continuous end-tidal carbon dioxide analysis to avoid detrimental periods of hyper- and hypocarbia. In the patients with significant head trauma and cerebral swelling, invasive arterial access is necessary as even brief episodes of hypotension are detrimental to the brain. If an intracranial bolt or catheter drain is placed, an appropriate “zero” level must be established. Protection of the device must be assured to avoid dislocation. Increases of intracranial pressure (ICP) are detrimental in head injury. ICP is a dynamic measurement and the importance of a single measurement is unclear. A plan and resources for addressing an increase in ICP are necessary. Interventions include head elevation, hyperventilation, mannitol and/or Lasix infusions, and cerebrospinal fluid drainage. The effects of these interventions on other parameters (e.g., cardiovascular) must be considered. The effects of sedation on the neurologic assessment must be taken into consideration.

Sedation and pain control are rarely addressed in the transport literature despite the fact that transport subjects a patient to significant stress. The levels of epinephrine and norepinephrine in healthy male volunteers subject to EMS protocols are increased without sedatives, as compared with individuals receiving midazolam during the same protocol.<sup>54</sup> Increased catecholamine levels can increase myocardial oxygen consumption, cardiac ischemia, and infarction. Short-acting benzodiazepines are generally chosen as sedatives because of their ease of titration, intense

analgesia, and historical success. Develis et al. studied the use of small doses of fentanyl (0.33–5.0 µg/kg) in pediatric trauma victims. There was a statistically significant decrease in systolic blood pressure but no other major complications.<sup>55</sup> Small doses of fentanyl (25–200 µg per administration) with a total dose of 1.0–5.0 µg/kg were well tolerated in patients transported by air.<sup>56</sup> Complications associated with prehospital sedation seemed to occur more often in patients receiving both sedation and analgesia and are more common in patients who received sedation for endotracheal intubation.<sup>57</sup> Sedation during patient transport within the hospital has not been well studied. Planning must take into account the side effects of the medication and the potential pain and anxiety that the patient will experience during a procedure.

### Consent

Many care providers do not consider transport of the critically ill patient a high-risk procedure despite its high complication rate. Although consent is commonly implied when a patient must be moved, good medical care requires that the patient or a proxy be aware of the risks. Current guidelines suggest that a competent patient or legally authorized representative of a patient give informed consent prior to transfer to another hospital.<sup>45</sup> Despite these recommendations a minority of patients actually give consent for a hospital transfer.<sup>58</sup> Unfortunately, at the time of the study, transfer of patients from private to public hospitals of minorities, the unemployed, and those without insurance was a common practice. The Emergency Medical Treatment and Active Labor Law (EMTALA, 1986) required that hospitals appropriately screen patients and provide treatment. If transfer is necessary the hospital is liable to ensure that within medical probability, no worsening of the patient's condition occurs during transfer.<sup>59</sup> Three principles result in compliance with EMTALA: avoidance of financially motivated transfer, transfer only in the best interest of the patient, and maintenance of standards of care during all transport.

### Communication

Communication between those initiating patient transfer and those ultimately receiving the patient is imperative. The referring physician should

identify and contact an admitting physician at the receiving hospital to accept the patient in transfer and confirm before the transfer occurs that an appropriate higher-level resource is available.<sup>45</sup> The patient remains the responsibility of the transferring team until a formal nursing and medical hand over has occurred in the receiving department.<sup>10</sup> Continual communication to provide guidance for transport personnel must be established. Mahoney recently analyzed the 2003 Rhode Island fire disaster and noted that poor communication between hospitals and emergency personnel resulted in the inappropriate transfer of several patients.<sup>60</sup>

Communication not only refers to the verbal transfer of information but that appropriate records, images, and consent accompany the patient. Duplication of records and studies is often needed and should be done early to avoid delaying transfer. The advent of regional health information systems may mitigate the problem of difficulty with transfer of information.

### EQUIPMENT AND MONITORING

No specific national standards exist for monitoring or required equipment for the transport of patients. Guidelines for transport have been published by several organizations including the American College of Critical Care Medicine and the Society of Critical Care Medicine.<sup>45</sup> In general, the equipment for transport must be similar to that used in the ICU yet it must be portable, small, lightweight, and rugged.<sup>61</sup> Additionally equipment intended for aeromedical transport must be low in weight, compact, and should not interfere with navigation, communication, or control mechanisms. The electrical load must not overwhelm the aircraft's system. Incompatibility of monitors and medication infusion systems creates time delays and results in periods of inadequate monitoring in critical situations. Transport personnel are frequently required to disconnect and reconnect cables and reestablish zero references for invasive pressures. Medical infusion pumps may need to be discontinued briefly as a device capable of transport is prepared. Upon arrival at the receiving site another change in patient care technology may again be necessary.

## TRANSPORT PERSONNEL

Personnel accompanying a patient in transport within the hospital and between hospitals must at a minimum possess all the skills of basic life support. Potential transport personnel include physicians, nurses, respiratory therapists, paramedics, and emergency medical technicians. Guidelines published by the Society of Critical Care Medicine for interhospital transport state that a minimum of 2 people in addition to the vehicle operator shall accompany the patient and at least one shall be a registered nurse, physician, or advanced medical technician skilled in airway management, IV therapy, and dysrhythmia interpretation and management.<sup>62</sup> Recently revised guidelines recommend that a physician with advanced skills in airway management and advanced cardiac life support accompany all unstable patients.<sup>45</sup> The safety of transport of routine patients without a physician has been demonstrated.<sup>63</sup> Of note, transport which mandates that a physician be in attendance may remove an essential healthcare provider from the transporting facility, so backup coverage should be provided.<sup>23</sup>

The efficacy of specially trained teams responsible for transport has also been demonstrated for adult<sup>13</sup> and pediatric patients.<sup>64</sup> Use of speciality teams allows continual training, development of specialized skills, and the ability to cross-train in the skills of others.

## MODES OF TRANSPORT

The risks and benefits of ground versus air transport must be considered when transporting a patient between hospitals. Gray suggested 7 factors that should influence the choice of the mode of transport (Table 80–8).<sup>10</sup> Staff responsible for initiating and performing evacuation should be familiar with the physiologic factors that may potentially affect the patient in transport, especially when considering air transport. The special needs of neonates and pediatric patients must be understood. The American College of Emergency Physicians endorsed the following principle regarding patient transfer: “The health and well being of the patient must be the overriding concern when any patient transfer is considered. The patient should be

TABLE 80–8.

### Influencing Factors on Choice of Transport

The nature of illness  
Urgency of transfer  
Availability of transport  
Mobilization times  
Geographical factors  
Traffic and weather conditions  
Cost

Gray A, Bush S, Whitley S. Secondary transport of the critically ill and injured adult. *Emerg Med J* 2004;21:28:281–285. With permission from the BMJ Publishing Group.

transferred in a vehicle that is staffed by qualified personnel and contains appropriate equipment.”<sup>65</sup>

### Air Transport

Air transport can be divided into fixed-wing (aircraft) and rotor-wing (helicopter). Fixed-wing transport tends to cover distances greater than 250 miles whereas rotor-wing transport covers distances less than 250 miles.<sup>66</sup> Helicopter transport is primarily beneficial for distances greater than 45 miles when compared with ground transport.<sup>67</sup> Specific advantages of transport by airplane include long-distance capabilities, larger areas for patient care, space for more care providers, the ability to transport and care for many patients, less vibration, and generally less noise than rotor-wing transport. Disadvantages include the need to transport the patient by ground to and from the aircraft and the need for dedicated landing facilities. Advantages of transport by helicopter include the capability for rapid mobilization, vertical take-off and landing, ease of transport at lower altitudes, and the ability to transfer patients at speeds of up to 150 miles per hour.<sup>66</sup> The disadvantages include limited space for patient care, vibration, and noise, as well as greater dependence on good weather for flying (Fig. 80–1). Awareness of altitude sensitive conditions and specific preparation for transport by air will decrease complications (Table 80–9; see also Table 80–12).

Hypoxemia is a risk to any patient in transport but especially those with coronary ischemia, pulmonary compromise (acute respiratory distress syndrome [ARDS]), or neurologic injury. Hypoxemia commonly results in

TABLE 80–9.

### Preparation for Transport By Air Checklist

Patient appropriate for air transport  
Critically ill  
Benefit justifies risk  
No contraindications to air transport (weather, hostile environment, dangerous patient, contaminated area)

#### Airway

Airway secure  
Endotracheal tube cuff pressure adequate for transport but unlikely to cause mucosal injury  
Ability to humidify gases if long transport time or high altitude transport  
End-tidal carbon dioxide monitor present

#### Breathing

Consideration of chest tube in setting of simple pneumothorax  
Impact of altitude on respiratory dynamics (increases FiO<sub>2</sub> requirement, positive end-expiratory pressure, increased minute ventilation)

#### Circulation

Hemodynamics at risk with altitude (pneumothorax/pneumopericardium, gas embolism)  
Monitors calibrated with plan to reestablish “zero” reference at altitude  
Volume status optimized to prevent drastic changes with acceleration/deceleration

#### Neurologic

Condition at risk with altitude (pneumocephaly/decompression sickness/middle ear dysfunction)?  
Risk of secondary brain injury from hypoxemia

#### Others

Fractures stabilized?  
Gastric decompression (nasogastric tube) for intubated patients

tachycardia and hypertension that may increase myocardial oxygen consumption. The barometric pressure of ambient air declines as altitude increases although oxygen concentration remains at a constant 21%.<sup>68</sup> At sea level, barometric pressure is 760 mm Hg with a partial pressure of oxygen of 160 mm Hg. Most aircraft cabins are usually pressurized to a pressure



equivalent to 5000–8000 feet, giving an atmospheric partial pressure of oxygen of 118 mm Hg.<sup>69</sup> This accounts for the fact that the oxygen requirement ( $\text{FiO}_2$ ) of a patient on mechanical ventilation may increase at altitude. Lawless and colleagues demonstrated that animals with chemically induced ARDS were resistant to increases of  $\text{FiO}_2$  yet responded to increased PEEP during transport.<sup>70</sup> Benumof suggests that hypoxemia, even at low altitudes (3281–9843 feet), may contribute to global hypoxic pulmonary vasoconstriction and pulmonary edema.<sup>71</sup> Helicopter transport may allow a patient to be transported at lower altitudes so as to minimize this effect.

The decrease in ambient pressure at altitude contributes to the expansion of air within a cavity in accordance with the Boyle law.<sup>66</sup> This effect may result in hemodynamic compromise (tension pneumothorax), barotrauma (sinuses), equipment malfunction (blood pressure cuffs), and possible patient injury or compromised monitoring.<sup>66</sup> Conditions such as pneumopericardium, subcutaneous emphysema, gas gangrene, systemic air emboli, decompression sickness, and gastric distension may be worsened at altitude. Equipment considered “altitude-sensitive” includes endotracheal and tracheostomy cuffs, pneumatic antishock garments (e.g., medical antishock trousers), air splints, colostomy bags, Foley catheters, orogastric and nasogastric tubes, ventilators, invasive monitors, and intraaortic balloon pumps. Additionally patients with a closed head injury may experience increases in ICP. An experimental model showed an increase in intracranial air volume by 30% at the usual maximum cabin altitude of 8000 feet.<sup>72</sup> “Altitude restrictions” are commonly ordered for patients with eye trauma, pneumothorax, intracerebral air, and sinusitis.<sup>73</sup> These restrictions and flying at low levels may result in more turbulence and longer transport times.

Temperature decreases with altitude. Cold air holds far less moisture than warm air. This contributes to the drying of secretions, potential occlusion of endotracheal tubes, and dehydration during transport at altitude.

The flight environment subjects the patient to other unique physiologic challenges. Acceleration and deceleration may induce hemodynamic changes, stress, and injury. These may be

exacerbated in patients suffering from hypovolemia and spinal cord injury. Aircraft vibrations contribute to fatigue and discomfort along with interference with the appropriate function of equipment.<sup>66</sup>

The risks to transport personnel are rarely considered. Bledsoe studied helicopter evacuation of patients between 1993 and 2000. There were 84 medical helicopter accidents with 72 total fatalities and 64 injuries. The major cause was pilot error.<sup>74</sup> Kroesen also determined that human error was the leading cause of accidents. Special problems with aviation that may have contributed included take-off without “situational awareness” of terrain or navigation issues, low-level flight below minimum safety altitude, bad-weather flight conditions when saving a life takes priority, unknown landing areas, and acceptance of higher levels of risk by the flight crew.<sup>75</sup>

### Ground Transport

Most patient transports can be safely accomplished by ground transfer. The advantages of ground transfer are primarily related to lower cost, rapid mobilization of resources, less dependency upon weather conditions, and easier patient monitoring. The disadvantages include limited space to perform interventions and procedures, potential for delays because of traffic, and vehicle accidents with further injury to the patient and care providers (Fig. 80–2).

Modes of ground transport are not equivalent, and optimization of ground transport depends in part on equipment availability and to a larger extent

on care provider skill levels available. Skills range from simple basic life support (BLS) to advanced cardiac life support (ALS), to specialized transport teams. The skills of the transport team must be known when transfer is arranged, and there must be optimum matching of patient acuity and type of illness with the transport team’s skills and resources.<sup>76</sup> The critically ill patient with conditions requiring care at the level of a physician or specially trained nurse should be transported by a specifically trained physician or Critical Care Transport Team. The Commission on Accreditation of Medical Transport Systems (CAMTS) defines critical care transport as “the transport of a patient from an emergency department or a critical care unit who receives care commensurate with the scope of practice of a physician or registered nurse.”<sup>77</sup> The Association of Air Medical Services defines 6 conditions appropriate for transport by a specially trained critical care ground team:

1. Patient in critical condition.
2. Potential for deterioration into critical condition during transport.
3. Unstable vital signs.
4. Patient is intubated and ventilated for an acute medical condition.
5. Patient is receiving continuous infusion pharmacologic blood pressure support.
6. Conditions require time-sensitive treatment.

Prior to ground transport it is imperative that the transferring physician be



FIGURE 80–2. Limited space of ground transport vehicle. (Courtesy of Boston MedFlight.)

aware of the strengths and limitations of the team with respect to personnel, equipment, and training.

## SPECIAL CONSIDERATIONS

Certain patient disease categories deserve discussion including neurologic injury, obstetrical patients, chemical injuries and toxic agent exposure, pediatric patients, and transport for mass casualty.

### Neurologic Conditions

Three populations of neurologic patients are commonly transferred, traumatic brain injury, spinal injury, and stroke.

Patients transported with traumatic brain injury are commonly subject to secondary insults that can potentially worsen the injury, including systemic hypertension, hypotension, raised ICP, reduced cerebral perfusion pressure, hypoxemia, and hyperthermia. The most common of these are hypertension and raised intracranial pressure. In a study by Andrews, complications occurred in about half of transfers for neurologic injury.<sup>78</sup> The number of insults during transport mimics the number of insults both before and after the move. The higher an individual's injury score (based on systemic and mean blood pressure, intracranial pressure and cerebral perfusion pressure, temperature, heart rate, oxygenation, and ventilation) prior to transport, the more likely the occurrence of a transport complication. The Working Group on Neurosurgical Intensive Care of the European Society of Intensive Care Medicine has recommended guidelines for pretransport stabilization of the head injury patient (Table 80–10).<sup>79</sup>

Benefits of transport for the patient with acute spinal cord injury to centers skilled in this type of specialized care have been reported.<sup>80</sup> The earlier the transfer, the greater the benefit.<sup>81</sup> Outcome is best for patients transported within 12 hours. Benefits are less certain for those transferred more than 48 hours after a cord injury. The Congress of Neurologic Surgeons recommends that patients with acute spinal cord injury be expeditiously and carefully transferred from the site of injury to the nearest capable definitive medical care facility. The mode of transport should be chosen based on the clinical

characteristics of the patient, distance to the receiving facility, and geography.<sup>82</sup> Despite the best efforts of health-care providers, additional movement of the spine-injured patient is associated with risk of further cord injury. Del Rossi demonstrated that both a log roll and lift-and-slide technique of movement can cause additional injury at the site of cord damage.<sup>83</sup>

Patients with acute stroke are commonly transferred for specialized medical care to provide diagnostic angiography and intraarterial thrombolysis after a hemorrhagic stroke has been ruled out.<sup>84</sup> Studies demonstrate that thrombolysis delivered within 3 hours after the onset of an occlusive stroke significantly improves outcome. Benefit may be seen with treatment up to 6 hours after occlusion but these are inconsistent. Delays in transport commonly occur because of geographic characteristics, delayed patient/physician awareness of stroke symptoms, slow referral pathways, and in-hospital factors. Nedeltchev notes that patients with symptoms consistent with stroke may benefit from direct referral to a tertiary care center equipped to provide thrombolysis without delaying them at a community hospital for CT imaging.

### High-Risk Obstetrics

Obstetric patient transfers comprise only a small percentage of transports between hospitals, approximately 5% in one study.<sup>85</sup> Common indications include premature labor, premature rupture of membranes, eclampsia, pre-eclampsia, and multiple gestations. The

greatest concerns of those transferring these patients include in-flight delivery of the fetus, inadequate fetal monitoring, and inexperience with this type of transport. General crew configuration is frequently a nurse and paramedic. A physician is directly involved in only 5% of transfers. Complicating factors include systemic hypertension, hypotension, increased contractions, and decreased maternal respiratory drive.<sup>86</sup> Nausea and vomiting occur often. The potential for a difficult airway to be managed must be recognized. Placenta previa and placenta accreta have the potential for sudden deterioration and such patients should be transported rapidly with appropriate volume line access. Outcome is improved if the mother is transferred prior to delivery of the fetus.<sup>87</sup>

### Chemical Injury and Disaster Transport

Exposure to toxic chemical substances occurs in a variety of ways including industrial accidents and the deliberate release of toxic substances by terrorists. The health service must assure that appropriate care is provided to the injured without endangering the lives of healthcare providers. The Department of Health Emergency Planning Coordination Unit of the United Kingdom released a series of consensus statements addressing transfer and transport of chemical casualties (Table 80–11).<sup>88</sup> According to a study in Washington State,

**TABLE 80–10.**

#### Pretransport Stabilization of the Head Injured Patient

Pulse oximetry  $>95\%$   
 End-tidal  $\text{Paco}_2$  35 mm Hg  
 Mean arterial blood pressure  $>90$   
 (adults) and systolic blood pressure  $>120$  mm Hg  
 Intracranial pressure  $\leq 20$  mm Hg  
 Cerebral perfusion pressure  $>70$  mm Hg (adults)  
 Central body temperature  $96.8^\circ\text{F}$  ( $36^\circ\text{C}$ )

Data from Ferdinande P, Recommendation for intra-hospital transport of the severely head injured patient. *Intensive Care Med* 1999;25:1441–1443. With kind permission of Springer and Business Media.

**TABLE 80–11.**

#### Consensus Statement on Transport for Chemical Incidents

Transportation requirements depend on the number of casualties  
 Once decontaminated, priority for transport is determined as for nonchemical incidents  
 Chemical casualties should only be transported to hospitals with chemical personal protective equipment and decontamination facilities  
 Vehicles should be reused at the incident  
 Helicopters are not acceptable as a mode of transport

Adapted from Crawford IW, Mackway-Jones K, Russel DR, Carley SD. Delphi-based consensus study into planning for chemical incidents. *Emerg Med J* 2004;21:24–28. With permission from the BMJ Publishing Group

the majority of victims of hazardous material events will be transported to a hospital (70%) yet only a small percentage will be admitted for further care (5%).<sup>89</sup> Victims of trauma, thermal burns, dizziness, or CNS symptoms such as headache are most likely to require admission. Burgess studied the evacuation of patients and personnel from hospitals due to hazardous material exposure. The emergency room was the site of 64% of the evacuations. In the majority of evacuations the local fire department hazardous materials team responded to assist in the evacuation and subsequently determined when the emergency department could be safely reopened. Standards of the Joint Commission on Accreditation of Health Care Organizations require that all hospitals have protocols for hazardous materials incidents and staff be drilled for emergency preparedness.<sup>90</sup> It is imperative that physicians involved in the care of critically ill patients be familiar with the hospital's plan for evacuation and transport of such patients.

### Pediatric Transport

The development of neonatal transport systems in the 1970s preceded the focus on pediatric transport programs in the 1980s and 1990s.<sup>91</sup> The primary indications for pediatric transport to referral centers are respiratory failure and cardiovascular insufficiency followed by neurologic compromise.<sup>92</sup> Today improved care at centers of excellence in the management of pediatric conditions such as congenital heart disease results in more transfers.<sup>93</sup> Common complications encountered during transport in the pediatric population include hypotension, decreased arterial oxygen saturation, and hyperthermia.<sup>94</sup> Adverse technical events such as loss of intravenous access, failure of monitors, and dislodgement or malposition of the endotracheal tube occur in nearly 36% of transfers. Clinically adverse events such as hypotension, hypoxia, or hypoglycemia occurred in 27% of transfers reported by Hatherill.<sup>95</sup>

Pediatric transport is highly specialized. Interviews with pediatricians reveal that nearly one-half report insufficient knowledge of sophisticated transport equipment.<sup>92</sup> Transport complication frequencies are higher in children transported by a referring physician compared with children transported by a specialized pediatric

transport team. The higher rate of complications is believed due to a lower rate of appropriate pretransport interventions, lack of expertise with equipment, insufficient specialized equipment, materials, and lack of medications usually available to specialized teams and indeed all transport teams. The complexity of neonatal and pediatric transport and improved outcomes at tertiary care centers has resulted in the creation of specialist retrieval teams comprised of physicians and nurses. Bellingan et al. compared transport by a pediatric specialist retrieval team to standard practice. Patients transported by standard support teams commonly led by a trainee physician were more acidotic and demonstrated more hypotension than those moved by specialist teams.<sup>96</sup> Patients transported by standard teams also had a higher mortality within the first 12 hours. Transport of the complicated pediatric patient is an area where clear benefit is demonstrated by specialized teams.

The key to safe pediatric transport is adequate preparation. A high percentage of patients require some preparatory intervention prior to transport.<sup>94</sup> Those who receive these interventions have a lower rate of decompensation during transport or upon arrival at the receiving center. Routine resuscitation priorities take precedence. Preparation requires appropriately securing the airway and assuring correct ventilation. More than one-third of pediatric transport patients require a change of the mode of ventilation prior to departure, whereas intubation is required by the transport team in 16.1% of patients.<sup>94</sup> Fluid resuscitation is initiated in nearly one-third of transports and approximately one-quarter require the IV infusion of vasoactive drugs.<sup>94</sup>

Several factors increase a child's susceptibility to hypoxemia and respiratory compromise, including a more compliant lung cage, reduced diameter of the airways, increased pulmonary vascular reactivity to hypoxia (infancy), and a predisposition to a decreased respiratory drive in the setting of hypoxia (up to 1–2 months of age), and reduced surfactant production (neonates).<sup>67</sup>

### Coordination, Integration, Data Collection, and Quality Assurance

Changes in the system of patient transport over the years have resulted in many improvements, including an

ability to transport sicker patients over long distances for specialized care. This need for transport will continue and will likely expand as technology results in increasingly sophisticated treatment. Smaller hospitals and medical centers may not be able to support the financial burden of expensive technology and teams, resulting in the expanded regionalization of services. Improvements have been made but an apparent threshold of morbidity has been reached that will not be reduced unless systemwide changes are implemented. These changes should include the integration of technology and transport system design, generalized use of critical care transport teams for certain categories of patients that can benefit from advanced care, establishment of key protocols and guidelines, establishment of Internet-based electronic medical records for efficient transfer of information, collection of data and analysis of the metrics that indicate a satisfactory or unsatisfactory transfer, and critical care reporting systems which track the outcome of inter and intrahospital transfer.

### Technology and Transport System Design

Safe movement of a critically ill patient requires the coordinated effort of numerous trained individuals. Often the patient, monitors, and infusion pumps must be changed several times during one movement. Poorly designed or antiquated systems may even require the disconnection of medications and monitors and reconnection to completely different infusion systems and monitoring systems even within the same hospital, increasing transport time as well as subjecting the patient to periods without observation of vital signs or infusion of vital drugs. Systems that are not efficient, compact, and uncluttered can harm patients. Current work is being done on "mobile ICU" models that have integrated monitoring and support systems including ventilators, defibrillators, suction, point-of-care blood chemistry analysis, invasive monitoring of blood pressures, pulse oximetry, temperature, oxygen flow, and electrocardiography. The benefits of such compact, contained systems include the need for fewer transport personnel, shorter preparation time, reduced periods of manual ventilation, and the potential



to provide continuity of care and monitoring from the site of injury, transport to the hospital, emergency department admission, studies and transport to the intensive care unit.<sup>97,98</sup> Not only must equipment be compact and standardized for transport, ideally it should be compatible among and between the emergency department, operating room, intensive care unit, and common sites of patient treatment (e.g., cardiac catheterization, radiology). It is recognized that a system of universal compatibility among different hospitals may be too costly and difficult, but within a single transport system and hospital it is not only feasible, but should be imperative.

The Cleveland Clinic Foundation and the Massachusetts General Hospital have established systems that allow the easy transfer of support equipment without interruptions in therapy or the flow of vital information.<sup>4</sup> The same monitors and infusion pumps used in the operating room are used during transfer and upon arrival in the intensive care unit. Transport monitoring merely becomes an extension of the familiar bedside monitor. The benefits seen include more rapid preparation of the patient for movement, fewer personnel needed for transfer, and improved patient care.<sup>99</sup>

### Critical Care Transport Teams

Teams specialized in the transport of distinct categories of patients have proven to be beneficial by decreasing morbidity and mortality while increasing provider satisfaction. Specialist retrieval teams were initially developed to transport critically ill pediatric patients. Such studies suggest that specialized transport teams are needed to provide consistent safe care with a low rate of transport-associated complications and morbidity. Other populations best served by specialized teams include patients with ARDS or who require extracorporeal oxygenation or left ventricular assist devices, and perhaps those with head injuries. Factors to consider in the creation of these teams include the quality and scope of patient care, costs, medical justification, medicolegal issues, and return on investment based on the analysis of patient volume, overhead, and logistics.<sup>100</sup>

### Protocols and Guidelines

Multiple organizations have developed and published guidelines for the

transfer of critically ill patients.<sup>45,62</sup> These guidelines are general in nature and have not been adopted as standards. Four critical elements are required for the development of transfer plans: a multidisciplinary planning team, a medical needs assessment, a written standardized transfer plan, and continual evaluation and refinement as needed.<sup>45</sup>

Emergency medical services have established protocols. Transfer protocols are detailed in nature and address not only common populations (pediatric patients, traumatic brain injury, asthma, myocardial infarction) but also specialized conditions and devices (intraaortic balloon pumps, ventricular assist devices, inhaled nitric oxide).

Boston MedFlight has developed complete protocols for both air and ground transport of patients. All protocols have 6 “organizing principles” (Table 80–12). Protocols may lead to improved outcomes when conditions are repeatedly encountered. Protocols also allow the stocking of standardized medications and acquisition of equipment based on these plans. Over time care providers develop comfort working within a common framework, and systematic “reiteration” of the protocols leads to improved quality and efficiency.

### Transfer of Medical Information

Transfer involves not only the efficient movement of the patient but the exchange of vital information from the transferring physician, care provider in route, and to the final receiving system. Direct verbal communication between the transferring and receiving physicians along with nurse-to-nurse reporting prior to patient movement ensures that the receiving facility is appropriate for current patient needs or condition and is prepared for receipt of the patient (medications, ventilation, studies, surgery if necessary). Clinical course may dictate that transfer be delayed or changed to another facility. Other factors important to communicate include directions to the receiving station or unit within a facility.

Electronic medical records and teleradiology should allow easier exchange of complete vital information. Internet-based record systems facilitate the receiving physician's ability to fully assess whether a transfer is appropriate.

**TABLE 80–12.**

#### Protocol Outline

1. Planning prior to arrival
  - a. Specialized equipment
  - b. Vehicle type or configuration
  - c. Changes in disposition, destination, weather
2. Preparation of patient for transport
  - a. Full assessment
  - b. Monitoring
  - c. Pretransport interventions
3. Intratransport care
  - a. Issues specific to condition prompting transfer
  - b. Medical/procedural interventions during the transfer
4. Arrival at the receiving facility
  - a. Communication
  - b. Transfer of care
5. Documentation issues
  - a. Medications administered and side effects
  - b. Deviation from established protocols
6. Education/quality improvement

Courtesy of Boston MedFlight.

### Reporting and Critical Incident Evaluation

Reporting of unsafe practices, complications during patient transport, and critical analysis of patient safety practices is imperative if the etiology of adverse events and errors are to be determined and rectified. The Australian Incident Monitoring Study in Intensive Care was developed in 1993 as an anonymous voluntary reporting system to identify critical incidents and determine their underlying causes and contributing factors.<sup>16</sup> A review of events related to patient transfer was carried out in 2004. The study revealed a high rate of serious outcomes (nearly one-third of the incidents had significant adverse outcomes) almost evenly divided between system-based and human-based factors. Most events occurred between the ICU and operating theater or radiology. Failure of equipment was primarily related to either battery or drug infusion pump failure. Other significant events included insufficient oxygen reserve within canisters. The most common patient/staff management issues were problems related to communication between the ICU



TABLE 80-13.

## Recommendations from the Australian Incident Monitoring Study in Intensive Care

**Recommendations for transportation**

- a. The decision to move a critically ill patient within the hospital should be made by a senior medical practitioner after careful consideration of the benefits to be gained weighed against possible risks.
- b. A dedicated team should be available for the entire duration of the transport. The team members need to be familiar with the critically ill patients, skilled in airway management and resuscitation, patient monitoring and moving, and be familiar with all equipment.
- c. Adequate monitoring of the critically ill patient should include electrocardiogram, blood pressure, oxygen saturation, and, if ventilated, end-tidal carbon dioxide monitoring.
- d. Careful preparation for transport is essential, including patient and equipment checks and liaison with staff at the destination. A checklist should be used to assist in preparation. Oxygen supply, including the amount of oxygen in cylinders, and battery-life assessments are imperative. Transferring the patient to or from his/her bed must be carefully planned and appropriate equipment used by trained staff. All lines and tubes should be checked and simplified if possible.
- e. All battery-operated transport equipment should have charge indicators and backup batteries. Regular servicing and checking of transport equipment is essential. The use of specialized transport trolleys, which include improved power supply, has been advocated.
- f. Patient observations should be documented during transport.
- g. Guidelines by professional bodies need to be updated in line with recommendations. Guidelines should develop a pretransport checklist.

**Recommendations for monitoring outcomes**

Local units need to be able to monitor compliance with these standards, including adequate in-servicing/training of staff, enhanced communication between destination sites, as well as monitoring the occurrence of incidents and their contributing factors.

**Other recommendations**

Because of the documented hazards and the expense of intrahospital transport, it is important to continue to develop the technology with which to perform diagnostic and therapeutic procedures at the bedside.

Reproduced with permission from Beckman U, Gillies DM, Berenholtz SM, Wu AW, Pronovost P. Incidents relating to the intrahospital transfer of critically ill patients. An analysis of the reports submitted to the Australian Incident Monitoring Study in Intensive Care. *Intensive Care Med* 2004;30:1579-1585.

and site of destination or origin. The value of incident monitoring lies not only in the systematic gathering of information but in the detailed analysis of the root causes of the events.<sup>16</sup> Several key recommendations arose from this important study (Table 80-13). These recommendations primarily emphasize careful consideration of the risks, careful preparation, dedicated transport teams, checklists, careful documentation of events in transport, and monitoring of compliance with established standards.

Incident reporting systems in health-care arose from examinations of the benefits of safety reporting systems in the aviation industry. The aviation systems have been characterized by an

organized process for collecting, analyzing, and dissemination of events, sentinel events, and near-miss events in a "no-fault" environment that focuses on fixing "systems" rather than identifying and blaming individual operators. Recently the Institute of Medicine of the National Academy of Science has emphasized this strategy, reporting that system failures rather than individual incompetence are the primary cause of healthcare errors.<sup>100</sup> A reporting system optimized for the area of patient transport should be voluntary, nonpunitive, easy to carry out, and capable of providing feedback to participants.<sup>101</sup> Holzmüller et al. developed an Internet-based reporting system to deal with common barriers to success

in reporting systems including under-reporting, fear of reprisal, patient confidentiality, time pressure, duplication, and a generalized opinion that efforts were wasted because of little feedback. Their work, although preliminary, has demonstrated that an Internet-based system that collects data from multiple different intensive care units across the United States is possible. Internet-based reporting systems may allow collection of data easily at multiple centers and facilitate sharing the findings. Although a single event at a particular reporting center may not lead to prompt action, the discovery of several similar events at various locations may acquire significance and require action.

Critical incident reporting and review results in better training of staff, implementation of guidelines for the maintenance and readiness of equipment, and a reduction in the number of adverse events.<sup>102</sup>

**KEY REFERENCES**

1. AARC Practice Guideline. In-hospital transport of the mechanically ventilated patient—2002 revision and update. *Respir Care* 2002;47:721-723.
2. Beckmann U, Gillies DM, Berenholtz SM, et al. Incidents Relating to the intra-hospital transfer of critically ill patients. Analysis of the reports submitted to the Australian Incident Monitoring Study in Intensive Care. *Intensive Care Med* 2004;30:1579-1585.
3. Indeck M, Peterson S, Smith J, et al. Risk, cost, and benefit of transporting ICU patients for special studies. *J Trauma* 1988;28:1020-1025.
4. Smith I, Fleming S, Cernaianu A. Mishaps during transport from the intensive care unit. *Crit Care Med* 1990;18:278-281.
5. Szem JW, Hydo LJ, Fischer E, et al. High-risk intrahospital transport of critically ill patients: safety and outcome of the necessary "road trip." *Crit Care Med* 1995;23:1660-1666.
6. Warren J, Fromm RE, Orr RA, et al. Guidelines for the inter- and intrahospital transport of critically

ill patients. *Crit Care Med* 2004;32:256–262.

7. Waydhas C. Intrahospital transport of critically ill patients. *Crit Care* 1999;3:R83–R89.

8. Woodward GA, Insoft RM, Pearson-Shaver AL, et al. The state of pediatric interfacility transport: consensus of the second National Pediatric and Neonatal Interfacility Transport Medicine Leadership Conference. *Pediatr Emerg Care* 2002;18:38–43.

## REFERENCES

- Meier DR, Samper ER. Evolution of civil aeromedical helicopter aviation. *South Med J* 1989;82:885–891.
- Hansen PJ. Safe practice for aeromedical evacuation patients. *Mil Med* 1987;152:281–283.
- Thomas F. The development of the nation's oldest operating civilian hospital-sponsored aeromedical helicopter service. *Aviat Space Environ Med* 1988;59:567–570.
- Petre JH, Bazaral MG, Estafanous FG. Patient transport: an organized method with direct clinical benefits. *Biomed Instrum Technol* 1989;23:100–107.
- Grassi LC. Life, money, and quality: the impact of regionalization on perinatal/neonatal intensive care. *Neonatal Netw* 1988;6:53–59.
- Shackford SR, Mackersie RC, Hoyt DB, et al. Impact of a trauma system on outcome of severely injured patients. *Arch Surg* 1987;122:523–527.
- Biewener A, Aschenbrenner U, Rammelt S, et al. Impact of helicopter transport and hospital level on mortality of polytrauma patients. *J Trauma* 2004;56:94–98.
- Thompson DR, Clemmer TP, Applefield JJ, et al. Members of the American College of Critical Care Medicine Task Force on Regionalization of Critical Care Medicine. Regionalization of critical care medicine: task force report of the American College of Critical Care Medicine. *Crit Care Med* 1994;22:1306–1313.
- Hannan E, O'Donnel J, Kilburn H. Investigation of the relationship between volume and mortality for surgical procedures performed in New York State Hospitals. *JAMA* 1989;262:503–510.
- Gray A, Buch S, Whiteley S. Secondary transport of the critically ill and injured adult. *Emerg Med J* 2004;21:281–285.
- Hurst JM, Davis K, Johnson DJ, et al. Cost and complications during in-hospital transport of critically ill patients: a prospective cohort study. *J Trauma* 1992;33:582–585.
- Indeck M, Peterson S, Smith J, et al. Risk, cost, and benefit of transporting ICU patients for special studies. *J Trauma* 1988;28:1020–1025.
- Stearly HE. Patients' outcomes: intrahospital transportation and monitoring of critically ill patients by a specially trained ICU nursing staff. *Am J Crit Care* 1998;7:282–287.
- Smith I, Fleming S, Cernaianu A. Mishaps during transport from the intensive care unit. *Crit Care Med* 1990;18:278–281.
- Szem JW, Hydo LJ, Fischer E, et al. High-risk intrahospital transport of critically ill patients: safety and outcome of the necessary "road trip." *Crit Care Med* 1995;23:1660–1666.
- Beckmann U, Gillies DM, Berenholtz SM, et al. Incidents relating to the intrahospital transfer of critically ill patients. Analysis of the reports submitted to the Australian Incident Monitoring Study in Intensive Care. *Intensive Care Med* 2004;30:1579–1585.
- Ligtenberg JJ, Arnold LG, Stienstra Y, et al. Quality of interhospital transport of critically ill patients: a prospective audit. *Critical Care* 2005;9:R446–R451.
- Insel J, Weissman C, Kemper M, et al. Cardiovascular changes during transport of critically ill and postoperative patients. *Crit Care Med* 1986;14:539–542.
- Evans A, Winslow EH. Oxygen saturation and hemodynamic response in critically ill, mechanically ventilated adults during intrahospital transport. *Am J Crit Care* 1995;4:106–111.
- Braman SS, Dunn SM, Amico CA, et al. Complications of intrahospital transport in critically ill patients. *Ann Intern Med* 1987;107:469–473.
- Bandi ES, Weeks S, Carli F. Spinal block levels and cardiovascular changes during post-cesarean transport. *Can J Anaesth* 1999;46:736–740.
- Taylor JO, Landers CF, Chulay JD, et al. Monitoring high-risk cardiac patients during transportation in hospital. *Lancet* 1970;2:1205–1208.
- Hooi H. Safety of interhospital transport of patients with acute myocardial infarction. *Emerg Med* 1999;11:133–138.
- Rubenstein DG, Treister NW, Kapoor AS, et al. Transfer of acutely ill cardiac patients for definitive care, demonstrated safety in 755 cases. *JAMA* 1988;259:1695–1698.
- Foley DS, Pranikoff T, Younger JG, et al. A review of 100 patients transported on extracorporeal life support. *ASAIO J* 2002;48:612–619.
- Kollef MH, Von Harz B, Pretentise D, et al. Patient transport from intensive care increases the risk of developing ventilator-associated pneumonia. *Chest* 1997;112:765–773.
- Waydhas C, Schneck G, Duswald KH. Deterioration of respiratory function after intra-hospital transport of critically ill patients. *Intensive Care Med* 1995;21:784–789.
- Marx G, Vangerow B, Hecker H, et al. Predictors of respiratory function deterioration after transfer of critically ill patients. *Intensive Care Med* 1998;24:1157–1162.
- Weg JG, Haas CF. Safe intrahospital transport of critically ill ventilator-dependent patients. *Chest* 1989;96:631–635.
- Waddell G, Scott PD, Lees NW, et al. Effects of ambulance transport in critically ill patients. *Br Med J* 1975;1:386–389.
- Uusaro A, Parviainen I, Takala J, et al. Safe long-distance interhospital ground transfer of critically ill patients with acute severe unstable respiratory and circulatory failure. *Intensive Care Med* 2002;28:1122–1125.
- Chalon J, Loew DA, Malebranche J. Effects of dry anesthetic gases on tracheobronchial ciliated epithelium. *Anesthesiology* 1972;37:338–343.
- Christie JM, Dethlefsen M, Cane RD. Unplanned endotracheal extubation in the intensive care unit. *J Clin Anesth* 1996;8:289–293.
- Coppolo DP, May JJ. Self-extubations: a 12-month experience. *Chest* 1990;98:165–169.
- Hatfield ML, Lang AM, Han ZQ, et al. The effect of helicopter transport on adult patients' body temperature. *Air Med J* 1999;18:103–106.
- Wallace PG, Ridley SA. ABC of intensive care: transport of critically ill patients. *BMJ* 1999;319:368–371.
- Ehrenwerth J, Sorbo S, Hackel A. Transport of critically ill patients. *Crit Care Med* 1986;14:543–547.
- Kreeftenberg HG, Ligtenberg JJ, Arnold LG, et al. Condition on arrival of transferred critically ill patients. *Neth J Med* 2000;57:180–184.
- Kanter RK, Tomkins JM. Adverse events during interhospital transport: physiologic deterioration associated with pre-transport severity of illness. *Pediatrics* 1989;84:43–48.
- Waydhas C. Intrahospital transport of critically ill patients. *Crit Care* 1999;3:R83–R89.
- Slater EA, Weiss SJ, Ernst AA, et al. Preflight versus en route success and complications of rapid sequence intubation in an air medical service. *J Trauma* 1998;45:588–592.
- Harrison T, Thomas SH, Wedel SK. In-flight oral endotracheal intubation. *Am J Emerg Med* 1997;15:558–561.
- Briacombe JR, De Maio B. Emergency use of the laryngeal mask airway during hospital transfer of a neonate. *J Clin Anesth* 1995;7:689.
- Pattinson K, Todd I, Wyse M. A two-year review of laryngeal mask use by the Warwickshire ambulance service. *Emerg Med J* 2004;21:397–398.
- Warren J, Fromm RE, Orr RA, et al. Guidelines for the inter- and intrahospital transport of critically ill patients. *Crit Care Med* 2004;32:256–262.

46. Dockery WK, Futterman C, Keller SR, et al. A comparison of manual and mechanical ventilation during pediatric transport. *Crit Care Med* 1999;27:802-806.
47. Perez L, Klofas E, Wise L. Oxygenation/ventilation of transported intubated adult patients: a national survey of organizational practices. *Air Med J* 2000;19:55-58.
48. Austin PN, Campbell RS, Johannigman JA, et al. Transport ventilators. *Respir Care Clin* 2002;8:119-150.
49. Drakulovic MB, Torres A, Bauer TT, et al. Supine body position as a risk factor for nosocomial pneumonia in mechanically ventilated patients: a randomized trial. *Lancet* 1999;354:1851-1858.
50. Bacon CL, Corriere C, Lavery RF, et al. The use of capnography in the air medical environment. *Air Med J* 2001;20:27-29.
51. Palmon SC, Liu M, Moore LE, et al. Capnography facilitates tight control of ventilation during transport. *Crit Care Med* 1996;24:608-611.
52. Kober A, Schubert B, Bertalanffy P, et al. Capnography in non-tracheally intubated emergency patients as an additional tool in pulse oximetry for prehospital monitoring of resuscitation. *Anesth Analg* 2004;98:206-210.
53. Andrews PJ, Piper IR, Dearden NM, et al. Secondary insults during intrahospital transport of head-injured patients. *Lancet* 1990;335:327-330.
54. Dorges V, Wenzel V, Dix S, et al. The effect of midazolam on stress levels during simulated emergency medical service transport: a placebo-controlled, dose-response study. *Anesth Analg* 2002;95:417-422.
55. Devillis P, Thomas SH, Wedel SK, Set al. Prehospital fentanyl in air-transported pediatric trauma patients. *Ped Emerg Care* 1998;14:321-323.
56. Thomas SH, Benevelli W, Brown DF, et al. Safety of fentanyl for analgesia in adults undergoing air medical transport from trauma scenes. *Air Med J* 1996;15:57-59.
57. Ricard-Hibon A, Chollet C, Belpomme V, et al. Epidemiology of adverse effects of prehospital sedation analgesia. *Am J Emerg Med* 2003;21:461-466.
58. Schiff RL, Ansell DA, Schlosser JE, et al. Transfers to a public hospital. A prospective study of 467 patients. *N Engl J Med* 1986;314:552-557.
59. Diekema DS. What is left of futility? the convergence of anencephaly and the emergency medical treatment and active labor act. *Arch Pediatr Adolesc Med* 1995;149:1156-1159.
60. Mahoney EJ, Harrington DT, Biffi WL, et al. Lessons learned from a nightclub fire: institutional disaster preparedness. *J Trauma* 2005;58:487-491.
61. Branson RD. Intrahospital transport of critically ill mechanically ventilated patients. *Respir Care* 1992;37:775-795.
62. Guidelines Committee of the American College of Critical Care Medicine; Society of Critical Care Medicine and American Association of Critical-Care Nurses Transfer Guidelines Task Force. Guidelines for the transfer of critically ill patients. *Crit Care Med* 1993;21:931-937.
63. Hamman BL, Cue' JI, Miller FB, et al. Helicopter transport of trauma victims: does a physician make a difference? *J Trauma* 1991;31:490-494.
64. Wirtz MH, Cayten CG, Kohrs DA, et al. Paramedic versus nurse crews in the helicopter transport of trauma patients. *Air Med J* 2002;21:17-21.
65. American College of Emergency Physicians. Principles of appropriate patient transfer position statement. *Ann Emerg Med* 1990;19:337.
66. Fromm RE, Varon J. Critical care transport. *Crit Care Clin* 2000;16:695-705.
67. Diaz MA, Hendey GW, Bivins HG. When is the helicopter faster? A comparison of helicopter and ground ambulance transport times. *J Trauma* 2005;58:148-153.
68. Chang D-M. Intensive care air transport: the sky is the limit; or is it [editorials]? *Crit Care Med* 2001;29:2227-2230.
69. Samuels MP. The effects of flight and altitude. *Arch Dis Child* 2004;89:448-455.
70. Lawless N, Tobias S, Mayorga MA. FiO<sub>2</sub> and positive end-expiratory pressure as compensation for altitude-induced hypoxemia in acute respiratory distress syndrome model: implications for air transportation of critically ill patients. *Crit Care Med* 2001;29:2149-2155.
71. Benumof JL. Helicopter transport of patients with marginal respiratory function/status. *J Clin Anesth* 1996;8:621.
72. Andersson N, Grip H, Lindvall P, et al. Air transport of patients with intracranial air: computer model of pressure effects. *Aviat Space Environ Med* 2003;74:138-144.
73. Hansen PJ. Safe practice for our aeromedical evacuation patients. *Mil Med* 1987;152:281-283.
74. Bledsoe BE, Smith MG. Medical helicopter accidents in the united states: a 10-year review. *J Trauma* 2004;56:1325-1329.
75. Kroesen G. Risks and safety standards of flying intensive care units: M43. *Acta Anaesth Scand* 1996;109:108-109.
76. Fromm RE, Dellinger RP. Transport of critically ill patients. *Intensive Care Med* 1992;7:223-233.
77. Commission on Accreditation of Medical Transport Systems (CAMTS). Accreditation Standards of CAMTS, 5th ed. Anderson, South Carolina, USA.
78. Andrews PJ, Piper IR, Dearden NM, et al. Secondary insults during intrahospital transport of head-injured patients. *Lancet* 1990;335:327-330.
79. Ferdinande P. Recommendation for intra-hospital transport of the severely head injured patient. *Intensive Care Med* 1999;25:1441-1443.
80. Hachen HJ. Idealized care of the acute injured spinal cord in Switzerland. *J Trauma* 1977;17:931-936.
81. Zach GA, Seiler W, Dollfus P. Treatment results of spinal cord injury in the Swiss Paraplegic Centre of Basle. *Paraplegia* 1976;14:58-65.
82. Transportation of patients with acute traumatic cervical spine injuries. *Neurosurgery* 2002;50:S18-S20.
83. Del Rossi G, Horodyski MB, Heffernan TP, et al. Spine-board transfer techniques and the unstable cervical spine. *Spine* 2004;29:E134-E138.
84. Nedeltchev K, Arnold M, Brekenfeld C, et al. Pre- and in-hospital delays from stroke onset to intra-arterial thrombolysis. *Stroke* 2003;34:1230-1234.
85. Jones AE, Summers RL, Deschamp C, et al. A national survey of the air medical transport of high-risk obstetric patients. *Air Med J* 2001;20:17-20.
86. O'Brien DJ, Hooker EA, Hignite J, et al. Long-distance fixed-wing transport of obstetric patients. *South Med J* 2004;97:816-818.
87. Low RB, Martin D, Brown C. Emergency air transport of pregnant patients: the national experience. *J Emerg Med* 1988;6:41-48.
88. Crawford IW, Mackway-Jones K, Russel DR, et al. Delphi based consensus study into planning for chemical incidents. *Emerg Med J* 2004;21:24-28.
89. Burgess JL, Kovalchick DF, Harter L, et al. Hazardous materials events: evaluation of transport to health care facility and evacuation decisions. *Am J Emerg Med* 2001;19:99-105.
90. Burgess JL. Hospital evacuations due to hazardous materials incidents. *Am J Emerg Med* 1999;17:50-52.
91. Woodward GA Insoft RM, Pearson-Shaver AL, et al. The state of pediatric interfacility transport: Consensus of the Second National Pediatric and Neonatal Interfacility Transport Medicine Leadership Conference. *Pediatr Emerg Care* 2002;18:38-43.
92. Vos GD, Nieman FHM, Meurs AMB, et al. Problems in interhospital intensive care transport in The Netherlands: results from a survey of general pediatricians. *Intensive Care Med* 2003;29:1555-1559.
93. Helstrom-Westas L, Hanseus K, Lundstrom N-R, et al. Long-distance transports of newborn infants with congenital heat disease. *Pediatr Cardiol* 2001;22:380-384.
94. Vos GD, Nissen AC, Meurs MMB, et al. Comparison of interhospital pediatric intensive care transport accompanied by a referring specialist or specialist retrieval team. *Intensive Care Med* 2004;30:302-308.
95. Hatherill M, Waggie Z, Reynolds L, et al. Transport of critically ill children in a resource-limited setting. *Intensive Care Med* 2003;29:1547-1554.

96. Bellingan G, Olivier T, Batson S, et al. Comparison of a specialist retrieval team with current United Kingdom practice for the transport of critically ill patients. *Intensive Care Med* 2000;26:740-744.
97. Velmahos GC, Demetriades D, Ghilardi M, Rhee P, Petrone P, Chan LS. Life support for trauma and transport: a mobile ICU for safe in-hospital transport of critically injured patients. *J Am Coll Surg* 2004;199:62-68.
98. Gebremichael M, Borg U, Habashi NM, et al. Interhospital transport of the extremely ill patient: the mobile intensive care unit. *Crit Care Med* 2000;28:79-85.
99. Sandberg WS, Daily B, Egan M, et al. Deliberate perioperative systems design improves operating room throughput. *Anesthesiology* 2005;103:406-418.
100. Holzmüller CG, Pronovost PJ, Dickman F, et al. Creating the web-based intensive care unit safety reporting system. *J Am Med Inform Assoc* 2005;12:130-139.
101. Billings CE. NASA aviation safety reporting system: Lessons learned from voluntary incident reporting. In: *Enhancing Patient Safety and Reducing Errors*. Chicago, IL: National Patient Safety Foundation, 1999;97-100.
102. Moss SJ, Embleton ND, Fenton AC. Towards safer neonatal transfer: the importance of critical incident review. *Arch Dis Child* 2005;90:729-732.



# CHAPTER 81

## Postoperative Care of the Noncardiac Surgical ICU Patient

Michael C. Banks, MD, and  
C. William Hanson, III, MD

The surgical intensive care unit (SICU) is a specialized patient care floor designed to manage and treat critically ill surgical patients, and care may include preoperative, postoperative, and postinjury management. Critical care is an increasingly expensive and constrained resource because of shortages in qualified physicians, nurses, and ancillary personnel, and it is ever more necessary to find models of care delivery that ensure the provision of optimal care most efficiently.

The kinds of patients admitted to intensive care units have changed dramatically over the past several decades. The evolution of trauma systems, with rapid transportation of critically injured patients has resulted in the concentration of complex, multi-trauma patients in trauma centers. The development of ventricular-assist devices, aortic surgery, and lung transplantation has revolutionized cardiothoracic surgery and changed the nature of cardiac intensive care. New approaches to the management of head injury and respiratory failure require increased technological sophistication in cerebral monitoring and mechanical ventilation, as well as increased expertise on the part of intensivists, nurses and respiratory therapists. At the same time, endoscopic approaches to thoracic surgery and epidural analgesia have allowed many thoracic patients to be sent directly to the hospital floor after surgery rather than the ICU. Aortic stents have had the same effect on vascular surgical patients who would have undergone a laparotomy and several day ICU stay a decade ago and may now go directly to a general floor.

As our ability to prolong life has improved, so has the complexity of ethical decision making in ICU care. The fact that we can replace the func-

tion of the heart, kidney or lung increases the frequency with which we are confronted by questions about the appropriateness of doing so.

### ICU TRIAGE

Critical care bed occupancy can have a major effect on the flow of patients through the operating room, and it is essential to make optimal use of this often scarce and invariably expensive resource. The criteria used for ICU admission should be based on prioritizing care for those patients who would benefit the most from ICU care.<sup>1,2</sup> Ideally, this would eliminate from consideration those who are “too well” and those who are “too sick” to benefit from care.

### Screening Tools

The Task Force of the American College of Critical Medicine and the Society of Critical Care Medicine ICU developed admission screening tools based on three different models: prioritization, diagnosis, and objective parameters. The *prioritization* model

classifies patients into 4 priorities (Table 81-1).

The *diagnosis* model (Table 81-2) identifies 8 systems: cardiac, pulmonary, neurologic, drug ingestion and drug overdose, gastrointestinal disorders, endocrine, surgical, and miscellaneous, and divides them into admissible disease states.

The *objective* model (Table 81-3) is based on 5 objective criteria for admission into the ICU, as opposed to the subjective criteria in the prior two models. The five categories are vital signs, laboratory values, radiology, electrocardiogram, and physical findings.

These criteria were requested and reviewed by multiple healthcare centers in an effort to comply with the Joint Commission on Accreditation of Healthcare Organizations review of special care units. These criteria are used by many healthcare organizations in the United States and abroad.<sup>3,4</sup>

When the demand for an ICU bed is greater than the number of beds available it becomes necessary to triage patients in and out of the unit and a triage plan should be developed by the

### KEY POINTS

1. ICU bed management is increasingly important because of escalating demands for beds. Both anesthesiologists and intensivists play a major role in ensuring that this expensive resource is used responsibly.
2. New approaches to pain management have revolutionized certain fields of surgery (e.g., thoracic and major vascular), permitting patients to undergo major procedures without the need for prolonged high-intensity intensive care following surgery.
3. Critical illness *polyneuropathy* and *myopathy* are acute illnesses that result in weakness and paralysis in intensive care patients.
4. Critically ill patients are at risk for a variety of pulmonary complications including aspiration, ventilator-associated pneumonia and acute lung injury. Intensive care management is directed at minimizing the risk factors that predispose patients to these complications
5. Pulmonary artery catheter (PAC)-guided therapy does not improve outcomes in critically ill patients with acute lung injury. Conservative fluid management approach improves lung function and shortens the duration of both mechanical ventilation and intensive care stay without altering the rate of nonpulmonary organ failures.
6. The stress response after major surgery or injury is often accompanied by a period of impaired endothelial cell function and loss of plasma volume into the “third space.” The reasons for this are varied, but include tissue hypoperfusion caused by inadequate fluid therapy, ischemia-reperfusion injury, cytokine activation, and, in some cases, exposure of the blood to extracorporeal circuits (i.e., cardiopulmonary bypass).
7. Renal replacement therapy is a field that has changed significantly over the past decade, and venovenous ultrafiltration and dialysis are now the predominant modalities.

TABLE 81-1.

## Prioritization Model

Priority 1	Patient requires vaso-pressors, ventilatory support, and/or invasive monitoring.
Priority 2	Patient with acute disease complicating a chronic condition; patient needs monitoring.
Priority 3	Patient with acute disease complicating a severe chronic condition.
Priority 4	Too well or too ill to benefit from ICU care.

hospital, perhaps by an ICU committee.<sup>5</sup> The ICU committee should be composed of healthcare professionals, ethic advisors, and legal advisors.

Triage should be directed by a triage officer and the principles of triage should be available to the public and to patients and/or their surrogates.<sup>5</sup> The triage plan should not be arbitrary or prejudicial. The triage officer should evaluate patients in the ICU to determine which patients are receiving the greatest benefit from ICU care. An example of a patient who might be deemed inappropriate for ICU admission is the patient with an advanced directive directing that cardiopulmonary resuscitation and/or mechanical ventilation not be initiated. A brain-dead organ-donor patient may, although legally dead, be kept in an ICU until organ harvest. The creation of explicit guidelines for ICU admission, discharge, and triage facilitate bed management when a family or physician wishes to admit a patient to an ICU bed for inappropriate reasons.

The triage plan should prioritize admissions to the ICU. The hospital has an obligation to treat patients who are already admitted to the institution and inpatients who have suffered an acute decompensation should be evaluated for ICU admission as top priority. A level 1 trauma center has obligations to the state and community to admit critically injured patients as a top priority. A hospital may also choose to prioritize admissions of certain patients for specialty care. These priorities may require the deferral or cancellation of elective surgical cases on rare occasions. Third the triage plan

TABLE 81-2.

## Diagnosis Model

System	Disease State
Cardiac	Acute myocardial infection with complications; cardiogenic shock; complex dysrhythmias requiring monitoring or intervention; acute congestive heart failure with respiratory failure; hypertensive emergencies, unstable angina; cardiac arrest; cardiac tamponade; complete heart block
Pulmonary	Acute respiratory failure requiring mechanical ventilation; pulmonary emboli with hemodynamic instability; massive hemoptysis
Neurologic	Acute stroke with mental status change; coma; intracranial hemorrhage with possible herniation; acute subarachnoid hemorrhage; meningitis with altered mental status; central or peripheral nervous system disorder with deteriorating function; status epilepticus; vasospasm; traumatic head injury; brain death with organ donation potential
Gastrointestinal	GI bleed with hypotension, angina, or continued bleeding; fulminant hepatic failure, severe pancreatitis; esophageal perforation
Endocrine	Diabetic ketoacidosis; thyroid storm, myxedema coma with hemodynamic instability; hyperosmolar state with coma or hemodynamic instability; adrenal crisis with hemodynamic instability; severe hypercalcemia with altered mental status; hypo- or hypernatremia with seizures and altered mental status; hypo- or hyperkalemia with dysrhythmias or hemodynamic instability; hypophosphatemia with muscular weakness
Surgical	Postoperative patients requiring hemodynamic monitoring, ventilatory support, and/or extensive nursing care
Drug ingestion or overdose	Seizures; hemodynamic instability; altered mental status with inadequate airway protection
Miscellaneous	Septic shock; hemodynamic monitoring; environmental injuries (lightning strike, near drowning, hyper-/hypothermia); experimental therapies with potential complications; conditions requiring extensive nursing care

Data from Egol A, Fromm R, et al. Guidelines for intensive care unit admission discharge and triage. *Crit Care Med* 1999;27:633-638.

should evaluate the capacity of all ICU beds in the hospital in addition to beds in the post anesthesia care unit and the emergency department. In times of great demand, all critical care beds must be used with appropriate patients being placed in specialty intensive care areas that can care for the patient's disease. The triage plan must also facilitate the transfer of patients to outside healthcare centers should the need arise.

### Intraoperative Evaluation for ICU Care

Certain operative procedures routinely necessitate postoperative ICU care for the patient, such as cardiac surgical procedures and certain neurosurgical procedures. These patients have predictable postoperative periods of insta-

bility during which intensive nursing and physician care is required. Many other patient populations, including those who have undergone major vascular or general surgical procedures typically go to the intensive care unit following surgery. Patients may also have intraoperative events that necessitate unplanned admission to the SICU. Finally, some patients who are scheduled to go to the SICU postoperatively may end up not needing critical care because, for example, a planned procedure was aborted or went better than expected. Decisions as to the necessity for a postoperative ICU bed can be made by the anesthesiologist or surgeon either prospectively or as dictated by the intraoperative course.

A variety of intraoperative events may prompt unexpected admission to

TABLE 81–3.

## Objective Parameter Model

Objective Parameter	Value/Limit
Vital signs	Pulse <40 or >150 beats/min; systolic arterial pressure <80 mm Hg or 20 mm Hg below baseline; mean arterial pressure <60 mm Hg; diastolic arterial pressure >120 mm Hg; respiratory rate >35 breaths/min
Laboratory values	Serum sodium <110 mEq/L or >170 mEq/L; serum potassium <2.0 mEq/L or >7.0 mEq/L, PaO <sub>2</sub> <50 torr; pH <7.1 or >7.7; serum glucose >800 mg/dL; serum calcium >15 mg/dL
Radiological findings	Cerebral vascular hemorrhage, contusion, or subarachnoid hemorrhage with altered mental status or focal signs; ruptured viscera, bladder, liver, esophageal varices, or uterus with hemodynamic instability; dissecting aortic aneurysm
Electrocardiogram	Myocardial infarction with complex dysrhythmia, congestive heart failure, or hemodynamic compromise; sustained ventricular tachycardia or fibrillation; complete heart block
Acute-onset physical findings	Unequal pupils in an unconscious patient; burns covering >10% of body surface area; anuria; airway obstruction; coma; continuous seizures; cyanosis; cardiac tamponade

Data from Egol A, Fromm R, et al: Guidelines for intensive care unit admission discharge and triage. *Crit Care Med* 1999;27:633–638.

the ICU, including airway management problems, intraoperative aspiration of gastric contents, major blood loss, drug reactions, and cardiac events. The ICU admission criteria described in the previous section can serve as objective guides as to whether ICU admission is necessary or warranted. For example, a patient with an unexpectedly difficult airway discovered during induction of anesthesia typically would not require ICU admission in the absence of some physiologic derangement such as hypotension or hypoxia. Categorized by the three admission models described above, the patient would be admitted for:

**Prioritization model—Priority 1.** The patient is hemodynamically unstable and needs ventilatory support

**Diagnosis model—Pulmonary:** acute respiratory failure requiring ventilatory support

**Surgical:** postoperative patient requiring vent support and hemodynamic monitoring

**Objective model—Vital signs:** mean arterial pressure <60 mm Hg, pulse <40 beats/min, PaO<sub>2</sub> <50 torr

Another common occurrence in the operating room is the patient who

develops an unexpected requirement for large volumes of crystalloid or blood products. This patient is at risk for the development of postoperative complications from fluid shifts such as congestive heart failure, respiratory failure, and hypoxia. These complications may warrant ICU admission for the following admission criteria:

**Prioritization model—**

**Priority 1:** The patient requires intensive monitoring to assess hemodynamic stability and end-organ perfusion

**Priority 2:** If the patient has chronic comorbid conditions that were exacerbated, such as coronary artery disease

**Diagnosis model—**

**Cardiac system:** acute congestive heart failure

**Pulmonary system:** acute respiratory failure

**Miscellaneous:** hemodynamic monitoring

**Objective Model:** respiratory rate >35 breaths/min; PaO<sub>2</sub> <50 torr (on 40% FiO<sub>2</sub>)

Objective ICU admission guidelines can be used to assure appropriate use of this costly and often scarce resource.

## MANAGEMENT OF THE POSTOPERATIVE ICU PATIENT

### Transport Between the Operating Room and the ICU

Intrahospital transport of critically ill patients is recognized as a hazardous maneuver associated with complications that include hypoxia, hypotension, cardiac arrest, and ventilator-associated pneumonia.<sup>6–8</sup> Studies show that a majority of transport-related complications occur during travel between the ICU and the operating room or the radiology suite.<sup>8</sup> The first step made prior to transporting a patient is to assess the need for transport. For example, certain procedures can be performed in the ICU or postponed rather than subjecting a patient to a potentially hazardous transport. Many procedures can be done at the bedside, such as a tracheostomy or percutaneous gastrostomy tube. A review by Braxton et al. describes three studies where care plans changed within 48 hours after transport for 24%, 30%, and 39% of transports.<sup>9</sup> Thus the portability of the test or procedure should be considered before transporting a patient.

After determining the requirement for patient transport to or from the ICU, a comprehensive transfer plan should be used. The transfer plan should include pretransport preparation, transfer personnel, communication, and monitoring. Pretransport preparation is a crucial step in safe patient transport. A checklist is recommended to prevent steps from being missed. A checklist should include evaluation of oxygen supply, emergency resuscitation drugs, IV fluids and pressors (if needed), monitors with charged batteries, portable ventilator or ventilatory device with airway management equipment, and pretransport vital sign check.

Appropriate personnel are necessary for transport. Some institutions require a critical care nurse and a respiratory therapist, whereas others have dedicated transport teams trained to care for critically ill patients and experienced in transport of these patients. There should be a minimum of two people for the transport of a critically ill patient. One person should be an experienced healthcare provider, such as a critical care-trained nurse or physician. Studies show that major causes of transport complications are failure to follow protocol and failure to recognize

a problem has occurred during transport.<sup>9</sup> If the patient is physiologically unstable, a physician should be present during transport.

Communication is the next step to a safe transport. The transport team must notify the receiving unit or location that the patient is coming and communicate details about the patient's history and present status. Doing so ensures that the receiving area has the appropriate monitors, equipment, and drugs ready for the patient. The last step to safe transport is appropriate monitoring during transport. This should include continuous electrocardiogram, blood pressure (invasive or noninvasive as appropriate), oxygen saturation, and end-tidal CO<sub>2</sub> (if the patient is ventilated) measuring . All portable monitoring devices should have fully charged batteries with a charge light-emitting diode (LED) to indicate the need to recharge the battery.

Each patient care unit should have written transport policies as recommended by the American College of Critical Care Medicine, Society of Critical Care Medicine, and the American Association of Critical Nurses.<sup>10</sup> These policies should be modified for each healthcare institution.

### Postoperative Labs and Vital Signs

Standard ICU monitoring includes heart rate, blood pressure, pulse oximetry, respiratory rate, and electrocardiogram. Frequent labs that are checked include complete blood count, electrolytes, coagulation panel, and arterial blood gas (as warranted by the patient's respiratory condition). Capnography is used in some ICUs as a respiratory monitor as well as an adjunct to the assessment of respiratory dead space in acute and chronic diseases of the critically ill, such as chronic obstructive pulmonary disease and pulmonary embolism. A variety of laboratory studies are used to evaluate the critically ill patient, including serum electrolytes, glucose, blood urea nitrogen and creatinine, hemoglobin and hematocrit, platelets, and clotting studies. Serum lactate can be used to follow the adequacy of resuscitation and diagnose conditions such as ischemic bowel. Serum calcium (ionized or unionized) and magnesium are important cations. When checking lab values and physiologic parameters, it is often not the actual value that is most important, but the trends in values.

### MANAGEMENT OF POSTOPERATIVE ANALGESIA AND SEDATION IN THE ICU

Pain management in the ICU is important both for patient comfort and satisfaction, as well as an increasingly recognized contributor to patient outcomes—the combination of epidural analgesia and endoscopic techniques, for example, have revolutionized thoracic surgery in the past decade. There are many ways to manage postoperative pain, including patient-controlled epidural analgesia (PCEA) and intravenous patient-controlled analgesia (PCA). The caveat to this type of pain control is that the patient must be awake, alert, and oriented in order to use the pump effectively. There are risks particular to each of these techniques. PCA can cause somnolence and narcotization, but this is rare if the basal and bolus rates are set appropriately. PCEA is extremely effective after certain surgical procedures, particularly those involving the chest and upper abdomen. One disadvantage of PCEA in critically ill patients is the hypotension and bradycardia caused by sympathectomy, even at therapeutic levels. These physiologic responses must be differentiated from pathologic problems (e.g., evolving myocardial infarction). Hypotension and bradycardia do not mandate discontinuation of the infusion; rather the level of the block should be evaluated, and the infusion rate adjusted if it is too high. If the patient is still hypotensive, the concentration of the local anesthetic can be decreased and blood pressure can be managed with fluid boluses or pressors. In a recent meta-analysis by Wu et al., epidural analgesia provided better analgesia than intravenous PCA.<sup>11</sup>

In mechanically ventilated patients, a continuous opioid infusion can also be used to help control pain. The advantage of a continuous infusion is that at high enough doses, the attendant sedation may make it easier for the patient to tolerate the endotracheal tube. Frequent nursing assessment and dosage adjustment is needed to avoid overnarcotization, particularly with long-acting opioids, which can lead to prolonged intubation, wake-up, and hospital stay.

Continuous infusion of propofol, benzodiazepines, and muscle relaxants are also used in the ICU to sedate or immobilize postoperative patients, particularly following procedures where

excess movement can be harmful to the patient, such as certain muscle flaps or tracheal repairs. Propofol, benzodiazepines, and muscle relaxants have no analgesic properties and should therefore be supplemented with a narcotic where appropriate. Also muscle relaxants have no sedative properties, and should never be used without concurrent administration of a sedative/amnestic.

Another analgesic/anxiolytic drug that is used in the ICU for postoperative pain and sedation is dexmedetomidine. Dexmedetomidine is a centrally acting  $\alpha_2$ -agonist that is more potent than clonidine, and with a faster onset and shorter length of action. Dexmedetomidine is also a potent analgesia and anxiolytic.

To objectively and reproducibly evaluate a patient's degree of anxiety and discomfort, many units make use of a sedation/analgesia protocol. Although there are many approaches to the measurement of sedation/analgesia they can be divided into objective and subjective methods. Objective measurements include plasma drug concentration, frontalis electromyogram, and bispectral index (BIS) electroencephalographic analysis. Plasma drug levels are not a reliable method because the concentration of drug that is needed for analgesia varies from patient to patient. Frontalis electromyogram (EMG) is not sensitive for monitoring sedation. BIS analysis method has been studied as a monitor for sedation, but its results have not been confirmed in critically ill patients.

Subjective methods include scales such as the Ramsay scale, visual analog pain scales, the modified Glasgow coma scale by Cook and Palma, and the sedation-agitation scale. The Ramsay scale is the most widely used scale for sedation monitoring (Table 81-4).<sup>12</sup> It has shown good interobserver agreement and reliability. The Glasgow coma scale modified by Cook and Palma (Table 81-5) gives a numerical score to patients who are mechanically ventilated. This scale has proven reproducibility and interobserver reliability.

Potential complications of poorly managed analgesia and sedation range from prolonged intubation to ICU delirium or myocardial ischemia. Over-sedated patients can require longer ventilator support, and a longer ICU and hospital stay. Prolonged ventilation increases the patient's risk of ventilator-



TABLE 81-4.

## The Ramsey Sedation Scale

Level	Characteristics
1	Patient awake, anxious, agitated or restless
2	Patient awake, cooperative, oriented and tranquil
3	Patient drowsy, with response to commands
4	Patient asleep, brisk response to glabella tap or loud auditory stimulus
5	Patient asleep, sluggish response to stimulus
6	Patient has no response to firm nail-bed pressure or other noxious stimuli

Reproduced with permission from Carrasco. Crit Care 2000;4:217-225.

associated pneumonia, which increases morbidity and mortality. Studies also show that inadequate pain control can lead to ICU delirium, which leads to increased morbidity and hospital stay.

## MANAGEMENT OF ORGAN-SPECIFIC ISSUES AND SYSTEMS IN POSTOPERATIVE ICU PATIENTS

### Neurologic Issues

Management of the postoperative neurosurgical patient is beyond the scope of this chapter.

This section addresses the management of common neurologic disorders seen in postoperative ICU patients.

New-onset seizures are a major postoperative comorbidity in ICU patients. The incidence has been reported to be 12% in ICU patients without a neurologic primary diagnosis.<sup>13</sup> The causes of postoperative seizures include medications, metabolic disorders, primary neurologic disorders, infection, hypoxia, and drug withdrawal (Table 81-6).

Accurate diagnosis of new-onset seizures is important. One must first differentiate seizure from myoclonus and other rhythmic movements. This can be done with electroencephalogram evaluation. Once new-onset seizure has been diagnosed, laboratory tests, CT or MRI of the brain, and, in patients suspected of an infectious etiology, a lumbar puncture are needed to elucidate the etiology. The most com-

TABLE 81-5.

## The Glasgow Coma Scale as Modified by Cook and Palma

Characteristic	Score
Eyes open	
Spontaneously	4
In response to speech	3
In response to pain	2
None	1
Response to nursing procedures	
Obeys commands	5
Purposeful movements	4
Nonpurposeful flexion	3
Nonpurposeful extension	2
None	1
Cough	
Spontaneous strong	4
Spontaneous weak	3
On suction only	2
None	1
Respiration	
Obeys commands	5
Spontaneous intubated	4
Spontaneous intermittent mandatory ventilator triggering	3
Respiration against ventilator	2
No respiratory effects	1

Reproduced with permission from Carrasco. Crit Care 2000;4:217-225.

mon causes of new-onset seizures in ICU patients are metabolic disturbances with an incidence of 28.6%.<sup>13</sup> The initial treatment for new-onset seizures is to stop the seizure with benzodiazepines like lorazepam or midazolam, barbiturates such as thiopental, or with propofol.<sup>14</sup> The patient should

then be started on a primary anticonvulsant medication. First-line anticonvulsants include phenytoin, Keppra, and carbamazepine.

Critical illness neuromuscular diseases are relatively rare but important complications seen in ICU patients. These abnormalities are divided into polyneuropathies and myopathies of critical illness. Critical illness *polyneuropathy* is an acute degenerative disorder of motor and sensory nerve axons. Symptoms are flaccid tetraparesis and failure to wean from the ventilator. Critical illness *myopathy* is an acute degenerative illness of the myocyte that results in weakness and paralysis. There are three histologic types of myopathy: diffuse necrotizing, necrotizing, and myosin thick-filament loss. The risk factors for development of critical illness neuromuscular abnormalities include systemic inflammatory response syndrome (SIRS)/sepsis, multiorgan dysfunction, corticosteroids, neuromuscular blocking agents, hyperglycemia, and aminoglycosides. The mechanisms by which these risk factors contribute to neuromuscular abnormalities are unknown, but there are some theories. Balton et al. suggest that cytokines, free radicals and complement that are released during SIRS/sepsis, lead to axonal injury.<sup>15</sup>

The incidence of critical illness polyneuropathy in patients varies substantially depending on the diagnostic method used, the patient case mix, and the timing of the diagnosis. In septic patients, the incidence has been stated to be as high as 70-80%.<sup>16</sup> Studies show an association between corticosteroids and critical illness myopathy in patients with severe asthma,<sup>16</sup> however, no mechanism has been found. Neuromuscular-blocking agents are also associated

TABLE 81-6.

## Causes of New-Onset Seizures in Postoperative Patients

Hypoxia/ischemia	
Metabolic disorders	Eclampsia, hyponatremia, hypophosphatemia, renal dysfunction, hepatic dysfunction
Medications	Antibiotics, antidepressants, antipsychotics, local anesthetics, cocaine, amphetamines, phencyclidine
Traumatic head injury	Contusion, hemorrhage
Infection	Febrile seizures, abscess, encephalitis
Drug withdrawal	Barbiturates, benzodiazepines, opioids, alcohol
Surgical injury	Craniotomy

Adapted from Mirski MA, Varelas PA. Diagnosis and treatment of seizures in the adult intensive care unit. Contemporary Critical Care 2003;1(4):1-12.

with acute myopathies. Concurrent administration of a neuromuscular blocking agent (NMBA) with steroids or aminoglycosides increases incidence of myopathies. High blood glucose is associated with critical illness polyneuropathy in one study of septic patients with multiorgan dysfunction. Van den Berghe reported that axonal injuries were decreased by 50% in patients who received intensive insulin therapy.<sup>17</sup> It is not clear if catecholamines and hyperglycemia lead to polyneuropathy, or if insulin or euglycemia protects neuronal axons.

The diagnosis of critical illness neuromuscular abnormalities by clinical presentation can be extremely difficult in critically ill patients as a result of the presence of encephalopathy or sedation. Consequently, objective studies can be used to help diagnose the disease. Nerve and muscle biopsies can help identify pathologic evidence of disease. Nerve biopsies, however can lead to permanent neurologic deficits. Electrophysiologic studies such as nerve conduction studies and electromyography are the gold standard for diagnosis of critical illness neuromuscular abnormalities. Nerve conduction studies measure the latency and amplitude of the response. The muscle's electrical response can also be evaluated. This is called *compound muscle action potential* (CMAP). In critical illness polyneuropathy CMAPs are reduced and abnormal spontaneous activity is present, which is indicative of axonal neuropathy. Electromyography records the electrical activity of active and resting muscle. In patients affected by critical illness neuromuscular abnormalities, abnormal fibrillation occurs. To differentiate between neuropathy and myopathy, motor unit action potentials are evaluated using EMG. If a motor unit shows increased amplitude and latency, critical illness polyneuropathy is diagnosed. If the motor unit shows decreased amplitude and latency, critical illness myopathy is diagnosed.

Treatment of critical illness neuromuscular abnormalities is very limited. It consists of intensive physical therapy with minimized use of muscle relaxants, corticosteroids and tight glucose control. The long-term outcome of this disease is not well studied. Recovery depends on the severity of the disease. Although patients with critical illness neuromuscular abnormalities may regain normal strength

after weeks to months, some never recover.

### Pulmonary Issues in the Postoperative ICU Patient

Postoperative patients almost invariably undergo a period of relative hypoxemia because of the effects of anesthetics and or surgery, and critically ill postoperative patients are no exception. The most significant respiratory issues specific to postoperative critically ill patients pertain to mechanical ventilation, the timing of its termination and the prevention of complications.

Postoperative patients often come to the intensive care unit following surgery with an endotracheal tube in place. The importance of safe intrahospital transportation has already been addressed above. The newly arrived patient should have chest radiography performed on arrival to determine the location of intraoperatively placed central lines and the endotracheal tube, specifically to look for proper line and tube placement and to rule out pneumothorax. If the tip of the endotracheal tube is at or above the level of the clavicles on a standard anteroposterior chest film, it should be advanced. The tube should be withdrawn if it is at the level of the carina or in one of the (typically right) mainstem bronchi.

So-called fast-track weaning, where ventilatory support is withdrawn automatically as the patient meets certain milestones, is prevalent and reduces the duration of mechanical ventilation in routine patients.<sup>18</sup> The development of new approaches to noninvasive ventilation and their application to a variety of patient populations has lowered the barrier to extubation. Continuous positive airway pressure and bilevel positive airway pressure (BiPAP) are effective in preventing reintubation in marginal patients who develop respiratory insufficiency after extubation. BiPAP can be administered by face or nasal mask and is used in patients with obesity, chronic obstructive pulmonary disease, and respiratory muscle weakness by allowing them to be extubated and then rested with periods of noninvasive ventilation.<sup>19</sup>

Nosocomial pneumonias include ventilator-associated pneumonia and hospital-acquired pneumonia. Technically speaking, in-hospital aspiration

pneumonia is a form of nosocomial pneumonia, although it is usually discussed separately. Both of these diseases occur in postoperative critically ill patients. The definition for the former is an infection occurring greater than 48 hours after admission that is radiographically consistent with pneumonia. Aspiration pneumonia can develop after endotracheal intubation in patients who regurgitate gastric contents; and it is more likely to occur when the pH of the aspirated material is low and the volume is greater than 0.3 mL/kg of body weight. Critically ill patients are at risk for the development of both of these conditions; predisposing factors include inadequate endotracheal cuff seal, supine position, increased gastric contents, and bacterial colonization of the oropharynx.

Acute lung injury and adult respiratory distress syndrome (ARDS) occur in the postoperative patient population. The two diseases represent different points on a continuum of lung diseases and have a multitude of etiologies, including trauma, transfusion reactions, and sepsis. Although a variety of approaches have been investigated for the prevention and treatment of these diseases, the most effective therapy is "protective ventilation," in which low tidal volumes are used to prevent overdistension of the alveoli. The ARDS Network, funded by the National Institutes of Health, published the results of a landmark study of the disease in 1999,<sup>20</sup> which showed that the use of lower (6 mL/kg) volume breaths conferred a mortality benefit compared to traditional (12 mL/kg) volume ventilation. The same group recently published data from a factorially designed study comparing ARDS patients managed with a pulmonary arterial catheter (PAC) versus a ventral venous line and patients with a conservative versus liberal approach to fluid management.<sup>21</sup> The results of this study showed that PAC-guided therapy did not improve outcomes and was associated with more complications (than patients managed with a central venous catheter), specifically those associated with the placement of a PAC. The fluid management data showed that the conservative approach improved lung function and shortened the duration of both mechanical ventilation and

intensive care stay without altering the rate of nonpulmonary organ failures.

### Cardiovascular Issues in the Postoperative ICU Patient

Postoperative cardiac management is directly analogous to intraoperative management in terms of the indications for and methods of treating abnormalities such as intravascular volume depletion, hemorrhage, and brady- and tachydysrhythmias. Intensive care monitoring invariably includes noninvasive or invasive blood pressure measurement, continuous electrocardiography, and pulse oximetry. The stress response after major surgery or injury is often accompanied by a period of impaired endothelial cell function and loss of plasma volume into the “third space.” The reasons for this are varied, but include tissue hypoperfusion as a result of inadequate fluid therapy, ischemia-reperfusion injury, cytokine activation, and, in some cases, exposure of the blood to extracorporeal circuits (i.e., cardiopulmonary bypass).

Third-space losses of intravascular fluid from the vascular and intracellular spaces can occur into the bowel, peritoneum, and thoracic cavities, as well as into the extracellular fluid. Postoperative patients require ongoing fluid resuscitation commensurate with the magnitude of their surgical or traumatic injury, and in some cases the requirement may exceed 10 mL/kg/h. In healthy patients, the need for fluid resuscitation typically ends after a period of 24–48 hours, and the accumulated excess volume and solute load is eliminated during a period of diuresis over the following days. The time courses of these phases may be altered in patients with underlying diseases such as hepatic or renal failure, and in some instances, extend to weeks. As distinct from the volume requirement, a progressive decrease in the serum hemoglobin suggests ongoing bleeding.

Patients in whom routine intensive care monitoring is insufficient for comprehensive evaluation of a patient's cardiovascular state may require invasive or radiographic monitoring. Patients with unexplained hypotension may require an intrarterial, central venous, or pulmonary arterial catheter to better assess intravascular volume status and cardiac performance. The usefulness and safety of the pulmonary artery catheter is the subject of

much recent debate,<sup>22</sup> but newer catheters permit concurrent measurement of continuous cardiac output, right ventricular performance, and mixed venous oxygen saturation—all of which can be used to guide short-term fluid resuscitation.

Monitors such as the central line (venous pressure), pulmonary artery catheter (pulmonary pressures, wedge pressure, mixed venous oximetry, cardiac output), or echocardiography (ventricular filling and performance, valve abnormalities) can be used to guide resuscitation and the prescription of inotropes or vasopressors. In some circumstances, the cause of a hemodynamic abnormality may be self-evident (e.g., hypotension in a patient with a PCEA), and treatment with volume resuscitation or a vasopressor may be empiric.

Cardiac dysrhythmias are relatively frequent in the operating room and ICU, where metabolic, ischemic and neurohormonal stresses may cause premature atrial and ventricular contractions, conduction block, or atrial fibrillation. Dysrhythmias are more prevalent in a patient with structural heart disease<sup>23</sup> and the dysrhythmias may be a result of surgical stress, electrolyte abnormalities, sympathetic stimulation, or device malfunction.<sup>24</sup> Dysrhythmias can be separated into narrow and wide QRS rhythms. Narrow QRS rhythms are almost always supraventricular dysrhythmias and include sinus tachycardia, premature atrial complexes, atrial flutter/fibrillation, accessory pathway tachycardia, and sinus bradyrhythmias.

In patients with wide complex QRS rhythms, it is often difficult to differentiate between supraventricular dysrhythmias and ventricular dysrhythmias. Premature ventricular contractions (PVCs) are common and can be caused by structural heart disease, electrolyte imbalances, acidosis, and hypoxia. PVCs are usually benign and do not require antiarrhythmic treatment in patients without structural heart disease.<sup>25</sup> However, studies show that when PVCs have a frequency of 10 or more per hour, there is an increased risk of developing a life-threatening dysrhythmia, especially in patients with structural heart disease.<sup>26,27</sup>

Atrial fibrillation is far and away the most common perioperative dysrhythmia.<sup>28</sup> The differential diagnosis for postoperative atrial fibrillation is long,

and includes increases in catecholamine levels caused by the stress response, electrolyte disorders, hypo- and hypervolemia, and hypoxia. The incidence in cardiac surgical patients is as high as 30–40%, and 3–4% of routine perioperative patients may develop the problem. The first line of therapy is to identify and remedy correctable causes. Pharmacologic treatments include  $\beta$ -blockers, calcium channel blockers, and amiodarone. In most instances the dysrhythmia is self-limited, but in some patients anticoagulation may be appropriate.

Myocardial ischemia and infarction can occur in the postoperative period as a consequence of anemia, underresuscitation, tachycardia, volume overload or the relatively hypercoagulable state that occurs 2–3 days after surgery. Proactive management of hyper- or hypovolemia,  $\beta$ -blockade in selected patient populations, and anticoagulants decreases the incidence of these problems.

### Gastrointestinal Issues in the Postoperative ICU Patient

The most common gastroenterologic issues in the perioperative intensive care patient relate to the timing of enteral feeding and gastrointestinal bleeding caused by stress ulceration.

Following surgery, patients go through an inflammatory phase proportionate to the magnitude of surgical injury. The patient often becomes hypermetabolic as the reparative process begins. When glucose and glycogen-based energy stores are depleted, the body begins to breakdown protein from muscle to meet energy demands, becoming hypercatabolic. Nutritional therapy is designed to meet daily energy requirements in critically ill postoperative patients and prevent protein loss. Several questions typically arise when discussing nutrition, including when to start, how to assess nutritional needs, and what route.

The timing of initiation of supplemental nutrition depends on both the baseline nutritional status of the patient and the magnitude of the injury. Patients with hypercatabolic diseases states like burns, sepsis, and cancer, and malnourished patients have different requirements from most other ICU patients. They require more calories and need nutritional support more urgently in order to heal and prevent infection. Laboratory parameters are

often used to help clinicians determine when to start nutrition. Albumin, prealbumin, and transferrin are some of the common laboratory assays used to determine a patient's nutritional status. The inflammatory response to surgery or trauma alters the reliability of these laboratory values, however. Depending on the route of delivery, nutritional support has different complications. Enteral nutrition may result in pulmonary aspiration, enteral anastomotic leak, or intestinal ischemia. Parenteral nutrition can result in central line infections. It is common to initiate nutritional support 1–5 days following surgery in patients.

The advantage of enteral nutrition is that it is physiologic and preserves the gut's barrier function and thereby translocation of bacteria from the intestinal lumen into the vasculature. In addition, enteral nutrition preserves the immunologic function of gut-associated lymphoid tissue, and it is less expensive than IV nutrition. There are several contraindications to enteral feeds. Enteral nutrition should not be given to patients who have an intestinal obstruction and it is riskier to give to patients with altered mental status. These patients are at increased risk of aspiration. Parenteral nutrition can be given through a peripheral vein or central vein. Central delivery of nutrition allows for the delivery of higher concentration of carbohydrates and protein that would otherwise irritate peripheral veins. The disadvantages of parenteral nutrition are risk of infection and sepsis, intestinal atrophy, and risk associated with obtaining central venous access.

Abdominal compartment syndrome (ACS) is an increasingly recognized entity in critically ill patients. The intraabdominal compartment is a potential space and when it fills with fluid or blood, pressure increases and impairs perfusion to intraabdominal

organs. Intubated patients often demonstrate elevated peak airway pressures during positive pressure breaths. Unintubated patients may become dyspneic. Renal function can be compromised as evidenced by decreased urine output which is thought to be due to decreased renal blood flow and decreased glomerular filtration rate. Increased renal parenchymal and vascular pressure can cause release of renin aldosterone and alcohol dehydrogenase. Signs of increased intrathoracic pressure can also develop with increased central venous or pulmonary capillary wedge pressure, suggesting that the patient is volume overloaded. The elevated pressures actually are transmitted from the abdominal compartment and the patient is actually volume deficient because of compression of the inferior vena cava and decreased venous return. Abdominal compartment syndrome also decreases ventricular compliance and increases peripheral vascular resistance. Together these intrathoracic effects decrease cardiac output.

Early detection of ACS relies on a strong clinical suspicion. In the postoperative ICU patient, abdominal compartment syndrome can be observed in the trauma patient with bleeding and large resuscitation requirements, in the GI surgery patient who requires abdominoplasty, and in the patient with edematous bowel from fluid resuscitation. Intraabdominal pressure is measured using bladder pressures. A urinary catheter is placed in the bladder and the bladder is filled with 50 mL of saline. Bladder, and therefore intraabdominal, pressure is then measured.

Abdominal compartment syndrome can be temporarily treated medically in the ICU with fluids, vasopressors, and pharmacologic muscle relaxation to relax the abdominal wall. Definitive therapy is decompressive laparotomy. There is controversy as to when to

take the patient to the operating room for laparotomy. Opening the abdomen for decompression has several risks: infection, sepsis, dehydration from large insensible losses, and fistula formation if the abdominal contents are covered with synthetic mesh material to prevent evisceration. Although the pressure at which the abdomen should be opened is not clearly defined, a grading system has been proposed (Table 81–7).

Following laparotomy, there is often a dramatic improvement in the cardiac performance and the organ perfusion, although in some cases, reperfusion injury ensues. The open abdomen may be covered with a VAC dressing, or a Bogota bag. The VAC dressing helps to quantify abdominal fluid losses, protects the abdominal contents from infection, and helps prevent the abdominal wall musculature from contracting laterally; thus preventing future fascial closure. The Bogota bag only helps protect from infection. Once the edema has resolved, the abdomen can be closed primarily or with mesh.

### Hematologic Issues in the Postoperative ICU Patient

Anemia is a common problem in surgical intensive care unit. It is a risk factor for morbidity and mortality in critically ill patients. Transfusion of packed red blood cells is essential to maintain end-organ perfusion. However, red blood cell transfusion is also associated with risks in critically ill patients. Transfusion of blood products can lead to virus transmission, transfusion reactions, graft versus host disease, and depression of natural killer cell function. Poor wound healing, risk of anastomotic leak, and postoperative infections are associated with perioperative blood transfusion. Because of the divergent opinions on transfusion practices for critically ill patients, clinical studies were performed to develop

TABLE 81–7.

#### Diagnosis and Treatment of Abdominal Compartment Syndrome

Grade	IAP (mm Hg)	Associated Signs	Treatment
I	10–15	No signs of ACS	Normovolemia
II	16–25	May have increased PAP and oliguria	Hypervolemic resuscitation with caution
III	26–35	Anuria, decreased CO, increased PAP	Consider abdominal decompression
IV	>35	Anuria, decreased CO, increased PAP	Abdominal decompression

ACS, abdominal compartment syndrome; CO, carbon monoxide; IAP, intraabdominal pressure; PAP, positive airway pressure.



transfusion practices for various types of critically ill patients.

In 1999, Hebert et al.<sup>29</sup> conducted a randomized multicenter clinically controlled trial of transfusion requirements in critical care (also known as the TRICC trial). The purpose of this study was to determine if a restrictive transfusion protocol that maintained hemoglobin of 7.0–9.0 g/dL had an equivalent risk of morbidity and 30-day mortality as a liberal transfusion protocol that maintained a hemoglobin of 10–12 g/dL. The results showed that although there was no mortality difference between the two groups, in a subgroup of patients who were younger than age 55 years and who had a low predicted risk 30-day mortality was decreased in the restrictive group and survival was greater in that same group.

In 2001,<sup>30</sup> the same group did a subgroup analysis of the TRICC trial to compare the morbidity and mortality of restrictive transfusion strategy and liberal transfusion strategy in critically ill patients with cardiovascular disease. Cardiovascular disease was defined as patients with a primary or secondary diagnosis of myocardial infarction, angina, congestive heart failure, dysrhythmias, and cardiogenic and other forms of shock, vascular procedures and cardiac procedures (except open heart surgery). The study results showed that there was no statistical difference in either strategy with respect to survival, ICU mortality, and 30- and 60-day mortality, suggesting that the lower hemoglobin did not confer additional harm to this subpopulation with cardiovascular disease.

Several other studies looked at transfusion strategies in patients with acute coronary syndrome. Patients with acute coronary syndrome have myocardial ischemia, angina, or myocardial infarction and it was thought that this was caused by the imbalance in O<sub>2</sub> supply and demand attributable to anemia. In 2001, Wu et al.<sup>31</sup> conducted a retrospective study of 78,974 Medicare patients older than age 65 years with confirmed acute myocardial infarction. To determine the risk associated with anemia in these patients and the effect of blood transfusion on mortality. The results showed that 3680 patients (4.7%) received blood transfusions. It also showed that transfusion was associated with a lower 30-day mortality in patients who had admission hematocrits  $\leq$ 33% and an in-

creased mortality in patients with hematocrits  $\geq$ 36.1%.

In another study in 2005, Rao et al.<sup>32</sup> looked at the association between blood transfusions and mortality among patient with acute coronary syndrome who developed bleeding, anemia, or both during their hospital course. This was a retrospective analysis of 24,112 patients compiled from three separate glycoprotein IIb/IIIa inhibitors trials: GUSTO (Global Use of Strategies To Open Occluded Coronary Arteries in Acute Coronary Syndromes) IIb, PURSUIT (Platelet Glycoprotein IIb/IIIa in Unstable Angina: Receptor Suppression Using Integrilin Therapy), and PARAGON B (the Platelet IIb/IIIc Antagonist for the Reduction of Acute coronary syndrome events in a Global Organisation Network). The study showed that 2401 (10%) of the patients had received transfusions and that these patients had a significantly higher unadjusted risk of 30-day mortality and 30-day myocardial infarction. At a hematocrit of 30% or greater, there was a significantly higher risk of 30-day mortality.

Given the conflicting data and the absence of studies specifically applicable to postoperative patients, it is prudent to transfuse blood to maintain hemoglobin above 7 g/dL in patients without a history of cardiac disease. In patients with cardiac disease, it is reasonable to transfuse blood to maintain hemoglobin greater than 10 g/dL.

Coagulopathies that are commonly seen in postoperative ICU patients include dilutional coagulopathy, heparin-induced thrombocytopenia, and disseminated intravascular coagulation. Dilutional coagulopathy is often seen after massive transfusion in patients with exsanguination. Clinical findings include diffuse oozing of blood from mucosal and serosal surfaces, as well as wounds and vascular access sites. Transfusion of multiple units of packed red blood cells leads to the dilution of clotting factors, platelets and prolongation of prothrombin time/partial thromboplastin time.<sup>33</sup> A study by Cosgriff et al.<sup>34</sup> described several risk factors for severe coagulopathy. In a 2-year prospective study that evaluated patients who received >10-unit transfusion of packed red blood cells and performed multiple logistic regression analysis showed that there were 4 significant risk factors: (a) pH <7.10, (b) temperature <93.2°F (34°C), (c) injury severity score >25, and (d) systolic blood pres-

sure <70 mm Hg. Patients with no risk factors had a 1% chance of life-threatening coagulopathy, whereas 1 risk factor was associated with a 10–40% chance, and patients with all 4 risk factors had 100% incidence of life-threatening coagulopathy.

Disseminated intravascular coagulation (DIC) is a consumptive coagulopathy that can appear in the postoperative ICU patient. Triggers of DIC include sepsis, marrow fat embolization from bone fractures, amniotic fluid embolization, and brain material. Embolized material contains tissue factor and thromboplastins, which leads to the initiation of the clotting cascade and consumption of clotting and anticoagulating factors. There is loss of localized clot formation and intravascular thromboembolism. DIC is treated by addressing the triggering problem, as for example by fracture fixation or administration of antibiotics in sepsis. Blood products may be administered if the patient actively bleeding.

Hemodilutional thrombocytopenia resulting from crystalloid administration paradoxically causes enhanced coagulation as measured by thromboelastogram.<sup>35–37</sup> The mechanism responsible for this hypercoagulability is unknown.

Thrombocytopenia is common in critically ill patients. Although sepsis and hemodilution are the most common causes, heparin-induced thrombocytopenia (HIT) is a relatively unusual, but significant cause due to its thrombotic aspects. There are two types of HIT. Type 1 which has an incidence of 10–20%, has a nonimmune mechanism, and is not associated with thrombosis. Type 2 HIT, has a 30–80% incidence and is an autoimmune-mediated thrombocytopenia associated with thrombosis. Treatment for HIT consists of discontinuing all forms of heparin and starting anticoagulation with an alternative anticoagulant, argatroban or lepirudin.

Therapeutic anticoagulation (as for the patient with atrial fibrillation) is typically interrupted during the perioperative period, when the risks of bleeding outweigh those of clotting. Patients who are at high risk for thrombosis or embolism are started on intravenous heparin concurrent with discontinuation of oral anticoagulation. Heparin is then discontinued for the immediate operative and perioperative period and resumed as soon as the risk of bleeding from operative sites has stopped, typically around 12 hours following surgery. Oral anticoagulation is

resumed at the same time and the heparin is then discontinued when the international normalized ratio (INR) has reached the desired target.

### Renal Issues in the Postoperative ICU Patient

Acute renal failure (ARF) increases the morbidity, mortality, and length of hospital stay in affected patients. In critically ill patients, the mortality from ARF ranges from 23–64% depending on the criteria used to define ARF. Currently, there is no universally accepted definition of ARF. The incidence can range from 17.2%<sup>38</sup> to 24.7%<sup>39</sup> in critically ill patients. There are several causes of ARF in ICU patients, but in postoperative patients, there are a few that are common: sepsis, ischemic acute tubular necrosis, drug-induced acute tubular necrosis, and pigment nephropathy. All of these are subgroups of acute tubular necrosis (ATN), which is caused by the injury and death of tubular epithelial cells that slough off and obstruct the tubule and the vasculature reactively constrict.

Common causes of ischemic acute tubular necrosis are cardiac arrest, hypotension from shock, and hypovolemia, as can be seen postoperatively after large abdominal procedures with third-space losses, or vascular procedures with large fluid shifts. The treatment of ischemic ATN is to increase the mean arterial pressure by fluid administration for hypovolemic patients, vasoactive pressors to increase vascular tone in shock patients, or inotropes to improve cardiac function in patients with cardiac insufficiency.

Drug-induced ATN is commonly caused by radiocontrast agents. Although the exact mechanism of injury is unknown, it is believed contrast induces the production of free radicals that injure the nephron. Several studies have looked at ways to prevent ATN from radiocontrast agents. In 2000, Tepel et al.<sup>40</sup> showed that oral administration of the antioxidant *N*-acetylcysteine actually decreased the serum creatinine in patients with chronic renal insufficiency. In 2004, a study by Merten et al.<sup>41</sup> showed that giving a patient sodium bicarbonate before and after exposure to intravenous radiocontrast, decreased the incidence of contrast-induced nephropathy when compared to equal mEq/L of sodium chloride. Merten's hypothesis was that free radical production is increased in

an acidic environment, and by raising pH, the production of free radicals is decreased. Other treatments, such as mannitol and Lasix, are ineffective in preventing ATN. Dopamine has also been used to treat various causes of acute renal failure. Extensive research shows that dopamine increases renal blood flow, short-term glomerular filtration, and urine output. The rationale for the use of "renal dose" dopamine (1–3 µg/kg/min) stems from the hypothesis that increased blood flow will restore oxygen delivery to hypoxic areas of the kidney and help treat ATN. In 2001, Kellem and Decker<sup>42</sup> did a meta-analysis to determine whether low-dose dopamine decreased the incidence of acute renal failure, the need for dialysis, or the mortality in critically ill patients. They showed that dopamine did not significantly decrease the risk of mortality (relative risk [RR] 0.83 [0.39–1.77]), development of acute renal failure (RR 0.79 [0.54–1.13]), or the requirement for dialysis (RR 0.89 [0.66–1.21]).

Patients dependent on renal replacement therapy are defined as having end-stage renal disease (ESRD). The ICU mortality of ESRD ranges from 11–40% in various studies.<sup>38,43</sup> It is interesting to note the ICU mortality associated with ESRD is less than the mortality associated with ARF. In a study by Clermont et al., ICU mortality was 5% for patients with no renal failure, 20.4% for patients with ARF and no renal replacement therapy (RRT) needed, 57% for patients with ARF requiring RRT, and 11% for patients with ESRD. This suggests that increased mortality associated with ARF often results from more systemic diseases.

There is no consensus regarding the appropriate timing of initiation of RRT in the ICU. There are, however, a set of common indications for starting RRT: (a) excessive intravascular fluid in a patient with ventilatory or hemodynamic compromise, (b) electrolyte abnormalities (i.e., hyperkalemia), (c) metabolic acidosis, (d) uremia, and (e) treatment for overdose of a dialyzable toxin/drug. The dialytic techniques that are used most frequently in the ICU are intermittent hemodialysis and continuous venovenous hemodialysis (CVVHD). Continuous arteriovenous and peritoneal dialysis, where once prevalent, are no longer standard therapy. There are

conflicting opinions concerning the survival advantages of CVVHD versus intermittent hemodialysis in acutely ill patients. In a retrospective study by Gangji et al. in 2005,<sup>44</sup> CVVHD was associated with decreased mortality in the subgroup of patients with multiorgan dysfunction syndrome.

### Endocrine Issues in the Postoperative ICU Patient

Postoperative patients have a complex endocrine response to surgical stimulus. The sympathetic response to surgery results in the release of epinephrine, glucagon, and cortisol to help repair the injured tissue and fight off infection. However, critically ill postoperative patients often have an abnormal response to stress, which leads to increased morbidity and mortality in the ICU. Tight glucose control and steroid replacement therapy are ICU protocols used to help decrease morbidity and mortality of the ICU patient.

In 2001, Van Den Berghe et al.<sup>45</sup> studied the effects of intensive insulin therapy on critically ill patients. They hypothesized that hyperglycemia during critical illness would increase the risk of severe infections, multiorgan failure, and death. They found that by maintaining glucose levels between 80 and 100 mg/dL, the risk of mortality in the ICU decreased by 32%. This observed risk reduction occurred in patients who stayed longer than 5 days in the ICU.

Corticosteroid replacement therapy was first studied in 1952 when Fraser et al.<sup>46</sup> described a patient with perioperative shock secondary to adrenal insufficiency. Cortisol is a natural corticosteroid that is produced by the adrenals. It is integral in the maintenance of vascular tone, vascular integrity, distribution of total body water, glucose metabolism, electrolyte homeostasis, catecholamine production and immunity (just to name a few). In healthy patients during nonstress periods, cortisol levels follow a circadian rhythm, increasing in the early morning and decreasing in the evening. After an operation, cortisol levels increase and there is no circadian rhythm. During periods of severe stress (burns, trauma, and sepsis), serum cortisol concentration reach their highest level. When cortisol production is insufficient, as in patients suffering from Addison disease, the body shows signs of shock (decreased

systemic vascular resistance and myocardial contractility and increased cardiac output) during stress states. In postoperation patients, as well as the critically ill patients, the incidence of total adrenal insufficiency is rare (2–3%).<sup>47</sup> However, functional or relative adrenal insufficiency is much more common, with an incidence of 30%.<sup>48</sup> The serum cortisol level fails to increase appropriately during stress states in patients with relative adrenal insufficiency. Diagnosing these patients is critical to their survival. They may present with signs of shock and do not respond to volume resuscitation and escalating vasopressors. A laboratory test to identify these patients is a corticotrophin stimulation test where 250 µg of cosyntropin is given IV. A cortisol level is drawn at  $t_0$ ,  $t_{30}$  and  $t_{60}$  minutes. If the cortisol response in 1 hour is  $\leq 9$  µg/dL, the patient is considered a nonresponder. Annane et al.<sup>49</sup> showed that nonresponders have a decreased risk of death when given 50 mg of hydrocortisone every 6 hours and 50 µg/d of fludrocortisone for 7 days.

### PROPHYLAXIS AND PREVENTION BEST PRACTICES IN POSTOPERATIVE ICU PATIENTS

Nosocomial infections are a major source of morbidity and mortality in the ICU. Nosocomial infections increase ICU length of stay and health-care costs. A report from the Centers for Disease Control and Prevention (CDC) on nosocomial infection control

states that a third of all nosocomial infections may be preventable through infection control practices.<sup>50</sup> As this evidence has emerged, a series of best-practice infection-control measures have developed, including handwashing before and after examining patients, periodic surveillance of patients for antibiotic-resistant organisms, colonization of patients infected with or colonized with antibiotic-resistant organisms, and gowning and gloving when caring for patients with antibiotic-resistant organisms. In addition, the CDC recommends wearing a sterile gown and gloves and fully draping a patient when placing any invasive monitoring devices. Finally, the development of antibiotic guidelines is important; the guidelines will vary depending on the bacterial flora of a given institution. The first 5 measures noted above are designed to decrease the horizontal transmission of nosocomial infections from healthcare worker to patient. Antibiotic guidelines are designed to help physicians choose the appropriate antibiotic therapy and length of therapy for a particular infectious disease. These guidelines help decrease the inappropriate use of antibiotics and decrease the risk of developing antibiotic resistant organisms. Other prophylactic measures that help decrease the nosocomial infection rate relates to central line placement and maintenance. The following measures decrease catheter-related bloodstream infections: full barrier precautions during central line insertions, preparation of the insertion site with chlorhexidine,<sup>51</sup> and using single-lumen instead of multi-lumen catheters when possible.<sup>52</sup>

Stress-related gastrointestinal mucosal damage occurs in many critically ill patients and can develop within 24 hours. The incidence of clinically significant GI bleeding with hemodynamic changes and decreasing hemoglobin as a result of stress ulceration has been estimated at 1.5% in the ICU population.<sup>53</sup> The incidence for occult bleeds is near 100% in the ICU population. ICU stays can increase by 8 days because of clinically significant bleeds, and mortality can increase by 4-fold. Gastric hypoperfusion plays a major role in the pathogenesis of stress ulcers. Decreasing blood flow impairs the ability of gastric mucosal cells from regenerating, which leads to ulcers. While gastric acidity may exacerbate stress ulcers, it does not cause them. Risk factors for stress ulcers in critically ill patients include major trauma, burns, respiratory failure, coagulopathy, hypotension, sepsis, hepatic failure, renal failure, and surgery. Prophylaxis is the best option for ICU patients at risk for stress ulcers. Therapies that are proven to decrease the risk for stress ulcers are antacids, sucralfate,  $H_2$  blockers, and proton pump inhibitors. The goal of these therapies is to maintain a gastric pH of 4.0 or higher.<sup>54</sup>

Deep venous thrombosis (DVT) is a common medical problem seen in all hospitalized patients, especially the critically ill. The risk of DVT in general surgery patients is 15–40%. Patients who have sustained a major trauma, spinal cord injury, or who are critically ill, can have a risk as high as 80%. DVTs occur more frequently with increasing age, with an incidence of 200

TABLE 81–8.

Deep Venous Thrombosis Prophylaxis in At-Risk Populations

Level of Risk	Risk of DVT	Risk of PE%	Antithrombotic Therapy
Low (e.g., minor surgery in patients <40 years with no risk factors)	0.4–2%	0.2%	Ambulation only
Moderate (e.g., minor surgery in patients with risk factors or age 40–60 years)	2–20%	1–2%	UH BID, LMWH daily, or ECS
High (e.g., surgery in patients >60 years, major surgery in patients 40–60 years with risk factors)	8–40%	2–4%	UH TID, LMWH daily, IPC if anticoagulant contraindicated
Very high (e.g., major surgery in patients >40 years with risk factors, major orthopedic surgery, neurosurgery, major trauma, or spinal cord injury)	20–80%	4–10%	LMWH daily plus ECS/IPC, or warfarin (INR 2–3)

DVT, deep venous thrombosis; ECS, elastic compression stockings; INR, international normalized ratio; IPC, intermittent pneumatic compression; LMWH, low-molecular-weight heparin; PE, pulmonary embolism; UH, unfractionated heparin.  
Risk factors: prior venous thromboembolus, cancer, metabolic hypercoagulable state.

per 100,000 in persons older than age 70 years.<sup>55</sup> Prevention of DVTs not only decreases the risk of fatal pulmonary embolisms, but also prevents the long-term sequelae of DVT: leg swelling, dermatitis, leg ulcers, decreased quality of life. Therapy for the prevention of DVT varies and has been stratified based on risk of acquiring DVT. Table 81-8 describes the thrombotic risk stratification for surgical patients and evidence-based guidelines for the use of antithrombotic prophylaxis.

## CONCLUSIONS

Intensive care is a rapidly evolving specialty, particularly so in the perioperative population. As new surgical procedures develop, and as we are increasingly able to safely anesthetize high-risk populations such as the elderly, morbidly obese, patients with respiratory disease, and patients with heart failure, the demand for critical care services escalates. Critical care practitioners have specialized, with anesthesia- and surgery-based intensivists staffing surgical critical care units. Areas of subspecialization have emerged in certain centers, where some practitioners focus on cardiothoracic critical care, others on neurocritical care and still others on transplant, burns, or trauma. As the promise of and the demand for critical care services has increased, so has its potential expenses. New therapies with niche applications come at great cost. Modern intensivists must act as responsible stewards of these life-giving, or sometimes merely life-prolonging, expensive resources.

## KEY REFERENCES

1. Society of Critical Care Medicine Ethics Committee. Consensus statement on the triage of critically ill patients. *JAMA* 1994;271(15):1200-1203.
2. Mirski MA, Varelas PA. Diagnosis and treatment of seizures in the adult intensive care unit. *Contemporary Critical Care* 2003;1(4):1-12.
3. National Heart, Lung, and Blood Institute Acute Respiratory Distress Syndrome (ARDS) Clinical Trials Network. Pulmonary artery versus central venous catheter to guide

treatment of acute lung injury. *N Engl J Med* 2006;354:2213-2224.

4. Hébert PC, Wells G, et al. A multicenter, randomized, controlled clinical trial of transfusion requirements in critical care. *N Engl J Med* 1999;340(6):409-417.

5. Hébert PC, Yetisir E, et al. Is Low transfusion threshold safe in critically ill patients with cardiovascular diseases? *Crit Care Med* 2001;29(2):227-234.

6. Clearmont G. Renal failure in the ICU. *Kidney Int* 2002;62:986-996.

7. van den Berghe G, et al. Intensive insulin therapy in the critically ill patients. *N Engl J Med* 2001;8;345(19):1359-1367.

8. Annane D, Sebille V, Charpentier C, et al. Effect of treatment with low doses of hydrocortisone and fludrocortisone on mortality in patients with septic shock [see comment]. *JAMA* 2002;288(7):862-871.

## REFERENCES

1. Egol A, Fromm R, et al. Guidelines for intensive care unit admission discharge and triage. *Crit Care Med* 1999;27(3):633-638.
2. Garrouste-Orageas M, Montuclard L, et al. Predictors of Intensive care unit refusal in French intensive care units: a multiple-center study. *Crit Care Med* 2005;33(4):750-755.
3. Simchen E, Sprung C, et al. Survival of critically ill patients hospitalized in and out of intensive care units under paucity of intensive care unit beds. *Crit Care Med* 2004;32:1654-1661.
4. Nathens A, Curtis J, et al. Management of the critically ill patient with severe acute pancreatitis. *Crit Care Med* 2004;32:2524-2536.
5. Society of Critical Care Medicine Ethics Committee. Consensus statement on the triage of critically ill patients. *JAMA* 1994;271(15):1200-1203.
6. Beckman U, Gillies DM, Berenholtz SM, Wu AW, Pronovost P. Incidents relating to the intra-hospital transfer of critically ill patients. *Intensive Care Med* 2004;30:1579-1585.
7. Uusaro A, Parvainen I, Takala J, Ruokonen E. Safe long-distance interhospital ground transfer of critically ill patients with acute severe unstable respiratory and circulatory failure. *Intensive Care Med* 2002;28:1122-1125.
8. Braman SS, Dunn SM, Amico CA, Millman. Complications during intrahospital

transport in critically ill patients. *Ann Intern Med* 1987;107:469-473.

9. Braxton CC, Reilly PM, Schwab CW. The traveling intensive care unit patient: road trips. *Surg Clin North Am* 2000;80(3):949-956.

10. American College of Critical Care Medicine. Guidelines for the transfer of critically ill patients. *Am J Crit Care* 1993;2(3);189-195.

11. Wu CL, Cohen SR, et al. Efficacy of postoperative patient-controlled and continuous infusion epidural analgesia versus intravenous patient-controlled analgesia with opioids: a meta-analysis. *Anesthesiology* 2005;103(5):1079-1088.

12. Carrasco, G. Instruments for monitoring intensive care unit sedation. *Crit Care Med* 2000;4:217-225.

13. Bleck TP, Smith MC, et al. Neurological complications of critical medical illness. *Crit Care Med* 1993;21:98-103.

14. Mirski MA, Varelas PA. Diagnosis and treatment of seizures in the adult intensive care unit. *Contemporary Critical Care* 2003;1(4):1-12.

15. Bolton CF, Gilbert JJ, et al. Polyneuropathy in critically ill patients. *J Neurol Neurosurg Psychiatry* 1984;47:1223-1231.

16. Behbehani NA, Al-Mane F, D'yachkova Y, Pare P, FitzGerald JM. Myopathy following mechanical ventilation for acute severe asthma: the role of muscle relaxants and corticosteroids [see comment]. *Chest* 1999;115(6):1627-1631.

17. van den Berghe G, Wouters P, et al. Intensive insulin therapy in the critically ill patients. *N Engl J Med* 2001;345:1359-1367.

18. MacIntyre NR. Current issues in mechanical ventilation for respiratory therapy. *Chest* 2006;128(Suppl):561S-567S.

19. Ferrer M. Non-invasive ventilation as a weaning tool. *Minerva Anestesiol* 2005;71:243-247.

20. NIH ARDS Network. Ventilation with lower tidal volumes as compared to traditional tidal volumes in acute lung injury and acute respiratory distress syndrome. *N Engl J Med* 2000;342:1301-1308.

21. NIH News Release. The FACTT Trial. May 21, 2006. Available at: <http://www.nhlbi.nih.gov/new/press/06-05-22.htm>. Last accessed December 22, 2006.

22. Connors AF, Speroff T, Dawson NV, et al. The effectiveness of right heart catheterization in the initial care of critically ill patients. SUPPORT Investigators. *JAMA* 1996;276:889-897.

23. Atlee J. *Dysrhythmias and Pacemakers*. Philadelphia: WB Saunders, 1996:25-104.

24. Atlee J. Perioperative cardiac dysrhythmias: diagnosis and management. *Anesthesiology* 1997;86:P1397-P1424.

25. Hebban AK, Hueston WJ. Management of common dysrhythmias: part II. Ventricular dysrhythmias and dysrhythmias in special populations. *Am Fam Physician* 2002;65:249-246.



26. Schulze RA, Strauss HW, Pitt B. Sudden death in the year following myocardial infarction. *Am J Med* 1977;62:192-199.
27. Bigger JT, Fleiss JL, Kleiger R, Miller JP, Rolnitzky LM. The relationships among ventricular dysrhythmias, left ventricular dysfunction, and mortality in the two years after myocardial infarction. *Circulation* 1984;69:250-258.
28. Jahangiri M, Weir G, Mandal K, Saveleva I, Camm J. Current strategies in the management of atrial fibrillation. *Ann Thorac Surg* 2006;82:357-364.
29. Hébert PC, Wells G, et al. A multicenter, randomized, controlled clinical trial of transfusion requirements in critical care. *N Engl J Med* 1999;340(6):409-417.
30. Hébert PC, Yetisir E, et al. Is Low transfusion threshold safe in critically ill patients with cardiovascular diseases? *Crit Care Med* 2001;29(2):227-234.
31. Wu W-C, Rathore SS, et al. Blood transfusion in elderly patients with acute myocardial infarction. *N Engl J Med* 2001;345(17):1230-1236.
32. Rao SV, Jollis JG, et al. Relationship of blood transfusion and Clinical outcomes in patients with acute coronary syndrome. *JAMA* 2005;292(13):1555-1562.
33. Hess JR. The coagulopathy of trauma versus disseminated intravascular coagulation. *J Trauma* 2006;60:S12-S19.
34. Cosgriff N. Predicting life-threatening coagulopathy in the massively transfused trauma patient: hypothermia and acidosis revisited. *J Trauma* 1997;42(5):857-862.
35. Boldt J. Are lactated Ringer's solution and normal saline solution equal with regard to coagulation? *Anesth Analg* 2002;94:378-384.
36. Ruttman TG. Effects of intravascular crystalloid or colloid in patients undergoing peripheral vascular surgery. *Br J Anaesth* 2002;89:266-230.
37. Ng KFJ. In vivo effect of haemodilution with saline on coagulation: a randomized controlled trial. *Br J Anaesth* 2002;88:475-480.
38. Clearmont G. Renal failure in the ICU. *Kidney Int* 2002;62:986-996.
39. de Mendonça A, Vincent JL, Suter PM, et al. Acute renal failure in the ICU. Risk factors and outcome evaluated by the SOFA Score. *Intensive Care Med* 2000;26:915-921.
40. Tepel M, Van Der Giet M, et al. Prevention of radiographic-contrast-agent-induced reductions in renal function by acetylcysteine. *N Engl J Med* 2000;343(3):180-184.
41. Merten GJ, Burgess WP, et al. Prevention of contrast-induced nephropathy with sodium bicarbonate. *JAMA* 2004;291(19):2328-2334.
42. Kellum JA, Decker JM. Use of dopamine in acute renal failure: a meta-analysis. *Crit Care Med* 2001;29(8):1526-1531.
43. Bagshaw SM, Mortis G, Doig CJ, et al. One year mortality in critically ill patients by severity of kidney dysfunction. *Am J Kidney Dis* 2006;48:402-409.
44. Gangji AS. Benefit of continuous renal replacement therapy in subgroups of acutely ill patients: a retrospective analysis. *Clin Nephrol* 2005;63(4):267-275.
45. van den Berghe G, et al. Intensive insulin therapy in the critically ill patients. *N Engl J Med* 2001;8;345(19):1359-1367.
46. Fraser CG, Preuss FS, Bigford WD. Adrenal Atrophy and irreversible shock associated with cortisone therapy. *JAMA* 1952;149:1542-1543.
47. Lamberts SWJ, Bruining HA, De Jong FH. Corticosteroid therapy in severe illness. *N Engl J Med* 1997;337(18):1285-1292.
48. Michaels RK, Berenholtz SM. Improving care of the patient with severe sepsis and septic shock. *Contemporary Critical Care* 2005;3..
49. Annane D, Sebille V, Charpentier C, et al. Effect of treatment with low doses of hydrocortisone and fludrocortisone on mortality in patients with septic shock [see comment]. *JAMA* 2002;288(7):862-871.
50. Centers for Disease Control (CDC). Public health focus: surveillance, prevention, and control of nosocomial infections. *MMWR Morb Mortal Wkly Rep* 1992;41:783-787.
51. Mermel LA, et al. Prevention of intravascular catheter-related infections. *Ann Intern Med* 2000;132(5):391-402.
52. Zurcher M, Tramer MR, Walder B, et al. Colonization and bloodstream infection with single- versus multi-lumen central venous catheters: a quantitative systematic review. *Anesth Analg* 2004;99(1):177-182.
53. Robertson MS, Cade JF, Clancy RL, et al. Analysis of two human leukocyte antigen-linked polymorphic heat shock protein 70, genes in patients with severe sepsis. *Crit Care Med* 1999;27(7):1265-1270.
54. Vorder Bruegge WF, Peura DA, et al. Stress-related mucosal damage: review of drug therapy. *J Clin Gastroenterol* 1990;12(Suppl 2):S35-S40.
55. Gutt CN, Oniu T, Wolkener F, Mehrabi A, Mistry S, Buchler MW. Prophylaxis and treatment of deep vein thrombosis in general surgery. *Am J Surg* 2005;189(1):14-22.

# CHAPTER 82

## Hemodynamic Support of the Critically Ill Patient

Jean-Louis Vincent MD, PhD

The most common cause of organ failure in the critically ill patient is inadequate tissue perfusion related to acute circulatory failure. This may result from persistent fluid deficits and/or alterations in regional blood flow or tissue oxygen use. Whatever the cause, early and adequate hemodynamic support of these patients is crucial if organ function is to be preserved and multiple organ failure, a common cause of death in critically ill patients, prevented. This chapter briefly reviews the main causes and symptoms of acute circulatory failure before focusing on the hemodynamic support of such patients.

### ACUTE CIRCULATORY FAILURE (SHOCK)

#### Clinical Signs of Shock

Circulatory shock can be considered as a state of generalized circulatory failure resulting in tissue hypoxia. It is a major cause of organ failure. A diagnosis of shock can be based on a combination of various clinical, hemodynamic, and biochemical signs, which can broadly be summarized into:

1. *Arterial hypotension*: Hypotension is perhaps the hallmark of acute circulatory failure, but may be only moderate, especially in patients with chronic hypertension. Usually the systolic arterial pressure is below 90 mm Hg or the mean arterial pressure below 70 mm Hg.
2. *Signs of tissue hypoperfusion*: These are usually recognized at three levels:
  - (a) Cutaneous: The skin is usually vasoconstricted, cold, and clammy.
  - (b) Renal: A reduction in renal perfusion is manifested in adults by a fall in urine output below

0.5 mL/kg/h and, in more severe cases, below 20 mL/h.

- (c) Neurologic: This can, of course, be appreciated only in the unanesthetized, unседated patient. Decreased cerebral perfusion is demonstrated by an altered intellect, with disorientation and confusion, and lack of collaboration; there is often obtundation, but coma develops only in advanced stages of multiple organ failure.
3. *Biologic signs of altered cellular oxygen availability*: The development of anaerobic metabolism is manifested by the development of hyperlactatemia. The normal blood lactate level is around 1 mEq/L (or 1 mmol/L), but is usually increased above 1.5 mEq/L in acute circulatory failure.

### Pathophysiologic Classification of Shock

Essentially, shock can be classified according to four pathophysiologic mechanisms<sup>1</sup>: hypovolemic, cardiogenic, obstructive, or distributive. Many patients with acute circulatory failure will have a combination of two or more of the four mechanisms. For example, a patient with severe pancreatitis may have characteristics of hypovolemic, distributive, and even cardiogenic shock. Similarly, patients with severe sepsis or anaphylaxis often have elements of hypovolemic and cardiogenic shock in addition to the baseline distributive mechanism.

Whatever the specific type of acute circulatory failure, the result is an imbalance between the oxygen requirements and tissue oxygen availability, resulting in regional tissue hy-

poxia, an important contributor to the development of organ dysfunction and multiple organ failure. In hypovolemic, cardiogenic, and obstructive types of shock, the primary abnormality is the reduced cardiac output and hence inadequate oxygen transport. However, in septic shock, the main fault is increased oxygen requirements because of the inflammatory response, in addition to altered oxygen extraction capabilities and myocardial contractility. Hence, although cardiac output may be normal or even increased in such patients, it may still be inadequate to provide sufficient oxygen for the cells' increased requirements.

#### Hypovolemic Shock

This form of shock occurs when the intravascular volume is depleted as a result of internal or external fluid loss. Hypovolemic shock is the most common form of circulatory shock. The most obvious cause of hypovolemic shock is acute hemorrhage, but it can also occur as a result of severe dehydration caused by severe vomiting or diarrhea, particularly in children and the elderly. The hemodynamic pattern is characteristically one of a low cardiac output (because of reduced venous return), associated with decreased cardiac filling pressures and increased systemic vascular resistance (SVR).

#### Cardiogenic Shock

This form of shock is characterized by primary failure of the cardiac pump. Cardiogenic shock is most commonly the result of acute myocardial infarction, but other causes include severe cardiac valvular disease, severe myocarditis, end-stage cardiomyopathy, and severe cardiac arrhythmia. Cardiogenic shock is associated with mor-

### KEY POINTS

1. Early and adequate resuscitation of patients with acute circulatory failure is important to restore a balance between oxygen needs and delivery and can result in improved outcomes.
2. Fluid resuscitation should be guided by repeated fluid challenges.
3. If fluid administration is insufficient to restore an adequate tissue perfusion pressure, vasopressors may be required; currently, dopamine and norepinephrine are considered the best first-line choices.
4. Inotropes or vasodilator drugs may be needed to improve myocardial contractility and cardiac output.
5. Hemodynamic support should be titrated to the individual patient according to global parameters of hemodynamic and oxygenation status, supported by regional parameters when available.

tality rates in the region of 75%, the highest of the four types of shock. Cardiogenic shock is characterized by a low cardiac output, elevated cardiac filling pressures, and a high SVR.

### **Obstructive Shock**

This form of shock is the result of an impediment to the normal flow of blood, either because of an obstruction to the outflow of blood from the heart, such as in massive pulmonary embolism, severe aortic coarctation, or severe aortic stenosis, or because of an increased resistance to cardiac filling during diastole, such as in cardiac tamponade or tension pneumothorax. Obstructive shock is typically characterized by a low cardiac output and high SVR. Right cardiac filling pressures are increased in pulmonary embolism and right and left pressures are increased in tamponade. Pulmonary arterial hypertension is also present in cardiogenic shock associated with pulmonary embolism.

### **Distributive Shock**

This type of shock is characterized by an increase in the vascular capacity. It is most commonly caused by sepsis, secondary to the release of inflammatory mediators. Other causes include anaphylactic shock, neurogenic shock, and acute adrenal insufficiency. The typical hemodynamic pattern is a normal or high cardiac output, reduced SVR (as vascular tone is reduced), and reduced cardiac filling pressures.

## **RESUSCITATION OF THE PATIENT WITH SHOCK**

Intensive, early resuscitation is essential to restore the imbalance between oxygen requirements and supply in the patient with acute circulatory failure, and therapy should be initiated while investigations are ongoing to determine and correct the underlying cause of the shock. Early resuscitation of patients with severe sepsis and septic shock is associated with improved outcomes.<sup>2</sup>

A useful aid to describe the important steps of hemodynamic resuscitation is the VIP (ventilation, infusion, pump) rule introduced by Weil and Shubin in 1969.<sup>3</sup>

### **Ventilatory Support**

Oxygen should be started immediately with the aim of increasing oxygen

delivery and reducing pulmonary vasoconstriction as a consequence of hypoxia. Importantly, oxygen should be administered even if the patient is not very hypoxemic. Although prolonged administration of high inspired oxygen fractions ( $\text{FiO}_2$ ) can be toxic, this is not a problem in the acute situation, and once blood gas results are available, oxygen therapy can be adjusted accordingly. If mask ventilation is not possible, for example, because of facial trauma, or provides inadequate oxygenation, mechanical ventilation should be started. In addition to ensuring adequate oxygenation, mechanical ventilation has the additional benefit of reducing left ventricular afterload by increasing intrathoracic pressures, and resting the respiratory muscles, hence reducing oxygen requirements. The aim of oxygen administration should be to maintain  $\text{PaO}_2$  above 8 kilopascals (kPa) (60 mm Hg), and arterial oxygen saturation ( $\text{SaO}_2$ ) above 90%. Although hypoxia should be avoided, hyperoxia can also be harmful, causing peripheral vasoconstriction with reduced regional perfusion and oxygenation.

### **Fluid Resuscitation**

Fluid therapy is an essential part of the treatment of any form of shock, the rationale being to improve microvascular blood flow by increasing plasma volume, and to increase cardiac output by the Frank-Starling effect. However, too much fluid also carries risks, principally of pulmonary edema.

There are many fluids available for use in resuscitation, and which, if any, is optimal remains controversial.<sup>4</sup> Crystalloid solutions (e.g., normal saline, Ringer's lactate) are inexpensive and well tolerated but leak more into the interstitial space than colloid solutions, thus causing more tissue edema. Increased edema is associated with compromised lung function, reduced systemic oxygen availability, impaired wound healing, myocardial function, and gut function.<sup>5-7</sup> As colloids persist longer in the intravascular space, less colloid solution (e.g., albumin, gelatin, hydroxyethyl starch [HES]) than crystalloid is needed to achieve the same hemodynamic goal; consequently, colloids have theoretical advantages over crystalloids. However, the clinical relevance of this potential advantage has not been clearly demonstrated, with no study convincingly demonstrating

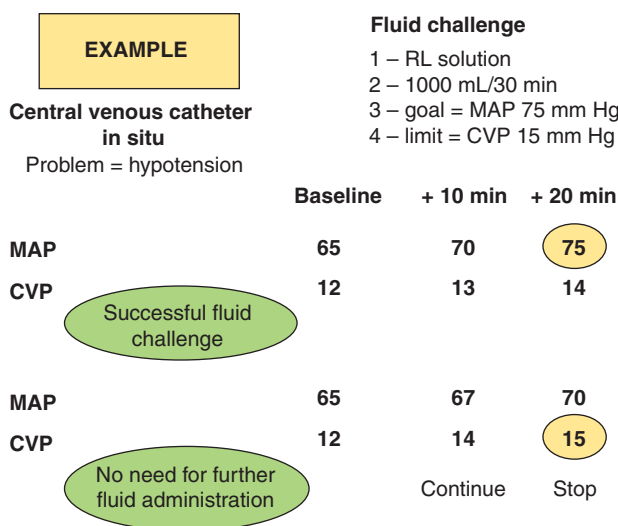
that one fluid type is superior to another. In addition, colloid solutions are more expensive, especially human albumin.

Controversy has surrounded the use of albumin in intensive care patients for many years and was fuelled by a Cochrane review in 1998 that suggested increased mortality rates occurred in critically ill patients who received albumin.<sup>8</sup> A propensity score analysis of 339 patients from a recent database of 3147 patients admitted to European ICUs, showed that patients who received albumin had greater mortality rates than those who did not.<sup>9</sup> However, in the Saline versus Albumin for Fluid Resuscitation in the Critically Ill (SAFE) study,<sup>10</sup> there were no differences in the mortality rates for ICU patients who had received albumin compared to those who had received crystalloid solution as the initial resuscitation fluid. Moreover, hypoalbuminemia is known to be associated with increased morbidity,<sup>11</sup> and a recent meta-analysis of 71 randomized controlled trials indicated that albumin administration may reduce complications in critically ill patients.<sup>12</sup> Clearly further studies assessing the role of albumin, particularly in certain subgroups of patients, for example, those with hypoalbuminemia, are needed to clarify this issue.

HES solutions have been promoted as having particularly beneficial effects on oxygen delivery to the tissues,<sup>7</sup> and potentially reducing endothelial activation and inflammation in critically ill patients.<sup>13</sup> HES solutions may also have beneficial effects on the transcapillary leakage of fluids by properties other than the increase in oncotic pressure.<sup>14</sup>

Further study is necessary to clearly define optimal fluid choices. Until the results of such studies become available, the choice is best made according to the severity of the circulatory failure, the underlying disease, the type of fluid that has been lost, the serum albumin concentration of the patient, and the risk of bleeding.

Having selected the fluid, the physician is then faced with deciding on how much to give. Precise end points for fluid resuscitation are difficult to define as sensitive tools for monitoring the regional microcirculation and oxygenation are not available, and, although systemic parameters appear to have stabilized, regional tissue per-



**FIGURE 82–1.** Example of a fluid challenge in a hypotensive patient. The figure gives an example of orders and two theoretical responses. In the first case, the patient benefited from fluid administration; in the second the patient did not. CVP, central venous pressure; MAP, mean arterial pressure; RL, Ringer's lactate.

fusion may still be inadequate.<sup>15</sup> In addition, the quantity of fluid needed will vary among patients and in the same patient over time. A fluid challenge technique<sup>16</sup> is the best method of determining a patient's ongoing need for fluids. Figure 82–1 is an example of the fluid challenge technique. The fluid challenge approach incorporates four phases:<sup>16</sup>

1. *The type of fluid:* As discussed above, the optimal fluid remains controversial and either crystalloid or colloid can be used, the selection being determined on an individual patient basis.
2. *The rate of fluid administration:* It is important to define the amount of fluid to be administered over a defined interval. The Surviving Sepsis Campaign Guidelines for the management of severe sepsis and septic shock recommend 500–1000 mL of crystalloids or 300–500 mL of colloids over 30 minutes.<sup>17</sup>
3. *The goal to be achieved:* The primary defect(s) that prompts the fluid challenge should be identified and quantitated so that a goal can be determined; most commonly this will be restoration of an adequate mean arterial pressure.
4. *Safety limits:* Pulmonary edema as a consequence of congestive heart failure is the most serious complication of fluid infusion. A safety limit, generally the central venous

pressure (CVP), must be set to avoid this complication.

Repeated fluid challenges will enable the physician to continuously reassess a patient's ongoing fluid needs and limit the risks of adverse effects.

### Blood Transfusions

Blood transfusions should be given as necessary, although there is again some debate as to what triggers should be used to determine the need for a blood transfusion. The aim of transfusion is to improve oxygen delivery and thereby to limit tissue hypoxia. However, although oxygen delivery is improved, tissue oxygenation or oxygen use do not necessarily improve.<sup>18–20</sup> In addition, there are risks associated with blood transfusions including transmission of microorganisms and prions, transfusion-related acute lung injury (TRALI), transfusion-related immunomodulation (TRIM), which may increase the risk of infections, and administration errors, including wrong type and crossmatch and incorrect patient identification, which can cause hemolytic reactions.

In 1999, Hebert et al.<sup>21</sup> published the results of the Transfusion Requirements in Critical Care (TRICC) trial, which encouraged many to rethink their transfusion practice. This landmark study enrolled 838 critically ill patients with euvolemia who had hemoglobin concentrations of less than 9.0 g/dL and randomly assigned

them to a restrictive strategy of transfusion in which red cells were transfused if the hemoglobin concentration decreased below 7.0 g/dL and hemoglobin concentrations were maintained at 7.0–9.0 g/dL, or a liberal strategy in which transfusions were given when the hemoglobin concentration fell below 10.0 g/dL and hemoglobin concentrations were maintained at 10.0–12.0 g/dL. The results suggested that the restrictive strategy, maintaining a hemoglobin of 7–9 g/dL, was adequate for most critically ill patients,<sup>21</sup> with the possible exception of patients with acute myocardial infarcts and unstable angina.<sup>22</sup>

Since that study, several epidemiologic studies have shown that patients who receive blood transfusions in the ICU have increased mortality rates.<sup>23,24</sup> In addition, studies in human volunteers show that isovolemic hemodilution to a hemoglobin of 5 g/dL or less does not result in biochemical evidence of anaerobic metabolism<sup>25</sup> and studies in Jehovah's Witness patients show that survival is possible with markedly decreased hemoglobin concentrations; one case study reported survival of a patient with a hemoglobin concentration of only 1.8 g/dL.<sup>26</sup>

Current recommendations for the management of patients with severe sepsis support a transfusion trigger of 7 g/dL.<sup>17</sup> However, the Sepsis Occurrence in Acutely Ill Patients (SOAP) study, which evaluated data on 3147 patients in 198 ICUs across Europe in May 2002, reported that, unlike earlier studies, blood transfusion was not associated with an increased mortality in multivariate analysis or by propensity case matching.<sup>27</sup> In addition, in a study by Rivers et al.<sup>2</sup> on early goal-directed therapy (EGDT), patients managed according to the EGDT protocol, who had lesser mortality rates than patients receiving standard therapy, received more transfusions, suggesting that at least some patients may benefit from receiving more blood transfusions.

The pendulum therefore seems to be swinging in favor of blood transfusions once again, and this apparent change may be related to the widespread introduction of leukoreduction in recent years. This technique is a process in which the white cells in blood units are intentionally reduced in number using centrifugation or filtration, with the aim of reducing some



of the inflammatory response to transfusion and the transmission of infections. Leukocyte counts can be reduced by more than 99% and the technique is effective in reducing the transmission of cell-associated viruses, especially cytomegalovirus, herpes viruses, and Epstein-Barr virus.<sup>28</sup> It may also reduce parasite and prion transmission, transfusion-related febrile reactions, and TRALI. In a before-and-after cohort study of 14,786 patients who received red blood cell transfusions following cardiac surgery or repair of hip fracture, or who required intensive care following a surgical intervention or multiple trauma, transfusion of leukoreduced blood was associated with fewer febrile reactions and reduced posttransfusion antibiotic use.<sup>29</sup> However, the evidence supporting the benefits of leukoreduction is not yet completely clearcut. In a meta-analysis of 14 randomized controlled trials comparing standard blood with leukoreduced or autologous blood, Vamvakas<sup>30</sup> reported no consistent effect of leukoreduction on long-term mortality, whereas in another meta-analysis of 10 randomized controlled trials, the authors concluded that “patients who were transfused leukoreduced red blood cells might benefit from a decrease in postoperative infections.”<sup>31</sup> Many countries have now adopted leukoreduction as routine, although leukoreduced blood is more expensive and it is not clear whether it is necessary in all patients.<sup>32</sup>

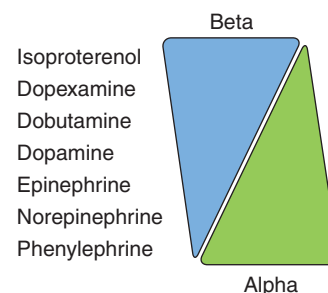
In view of the continuing uncertainty about the optimal transfusion trigger, a multicenter European study is currently underway in critically ill patients with euvoemia, comparing a strategy of maintaining hemoglobin concentrations above 9 g/dL with one maintaining hemoglobin concentrations between 7–9 g/dL. This study will essentially revisit the study by Hebert et al.<sup>21</sup> but in conditions of widespread leukoreduction, which was not the case when that study was conducted.

### Vasopressors

If hypotension persists despite fluid administration, the use of vasopressors will be required. In severe conditions, a vasopressor could be administered early in combination with fluids, but it should be discontinued as soon as the hypovolemia has been corrected.

Adrenergic agonists represent the first type of drug to be considered

because of their potency and their short half-life, which allows easy titration. A range of drugs is available and can be considered for this purpose (Fig. 82–2). The specific effects of the various agonists are largely determined by the extent to which they act on  $\alpha$ ,  $\beta$ , and dopaminergic receptors (Table 82–1), although the precise action of any catecholamine varies among individuals. In addition, chronic sympathetic stimulation and the presence of inflammatory mediators, such as those that occur in sepsis, can reduce receptor response to stimulation. There are two forms of  $\alpha$  receptor:  $\alpha_1$ , found primarily on the smooth muscle cells of arterioles and veins, and  $\alpha_2$ , found at the presynaptic terminals of adrenergic nerves. Stimulation of  $\alpha_1$  receptors usually causes smooth muscle contraction with vasoconstriction. Stimulation of  $\alpha_2$  receptors decreases the subsequent release of adrenergic transmitter. There are three major forms of  $\beta$  receptor:  $\beta_1$ , found in heart muscle and in the kidney,  $\beta_2$ , found in smooth muscle and metabolic tissue, and  $\beta_3$ , found in adipose tissue. Stimulation of  $\beta_1$  receptors results in increased heart rate and contractility, whereas  $\beta_2$  receptor stimulation causes vasodilatation in skeletal and cardiac muscle, bronchodilation, and decreased gastrointestinal motility.  $\beta_3$  activation stimulates lipolysis. Consequently, stimulation of each group of receptors has potentially beneficial and potentially harmful effects. For example,  $\beta$ -adrenergic stimulation will increase blood flow, but can also increase heart rate and carries a risk of ischemia, whereas  $\alpha$ -adrenergic stimulation will increase blood pressure but may decrease cardiac output and cause peripheral vasoconstriction, with decreased renal and hepatosplanchnic blood flow.



**FIGURE 82–2.** Various adrenergic agents available today, with schematic representation of their predominant effects on  $\beta$ - and  $\alpha$ -adrenergic receptors.

### Phenylephrine

Although not a catecholamine, phenylephrine is an almost pure  $\alpha$ -adrenergic agent, except at very high doses where some  $\beta$  activity is seen. Phenylephrine is a very powerful vasoconstrictor, but this carries the risk of decreasing blood flow and reducing tissue perfusion. In patients with septic shock, phenylephrine was associated with reduced splanchnic blood flow and oxygen delivery.<sup>33</sup> In the intensive care unit, this drug should be reserved for the occasional management of severe refractory hypotension.

### Epinephrine

Epinephrine is an endogenous catecholamine secreted by the adrenal medulla with potent  $\alpha$  and  $\beta_1$  activity and moderate  $\beta_2$  effects. At lower doses,  $\beta$  effects predominate with  $\alpha$  effects becoming more significant at higher doses. In acute hypotension, epinephrine is sometimes preferred to norepinephrine because of its stronger  $\beta$ -adrenergic effects, which are useful for maintaining or increasing cardiac output. It is also the drug of choice in cardiac arrest, where it can be administered via the endotracheal tube if intravenous access is difficult, and in acute

**TABLE 82–1.**

**Effects of the Common Adrenergic Agents on  $\alpha$ ,  $\beta$ , and Dopaminergic Receptors**

	$\alpha$	$\beta_1$	$\beta_2$	Dopaminergic
Phenylephrine	+++	0	0	0
Epinephrine	+++	+++	++	0
Norepinephrine	+++	++	+	0
Dopamine	++	++	+	+++
Dobutamine	+	+++	+	0
Isoproterenol	0	+++	+++	0
Dopexamine	0	+	+++	++

anaphylaxis (0.1–0.5 mg subcutaneously). However, epinephrine is associated with a decrease in splanchnic blood flow or gastric intramucosal pH (pHi).<sup>34–36</sup> Epinephrine treatment is also associated with an increase in cellular metabolism mediated by the increase in intracellular cyclic adenosine monophosphate (cAMP) and leading to increased blood lactate levels;<sup>35</sup> it is probably best avoided in critically ill patients except in the specific circumstances mentioned above.

### Norepinephrine

Norepinephrine is an endogenous amine secreted by the adrenal medulla and the terminal endings of postganglionic nerve fibers. Norepinephrine has predominantly  $\alpha$ -adrenergic properties, although its weak  $\beta$ -adrenergic effects can help to maintain cardiac output. Norepinephrine administration thus generally results in a clinically significant increase in mean arterial pressure, with little change in heart rate or cardiac output. The normal dose range is 0.05–2  $\mu\text{g}/\text{kg}/\text{min}$  intravenously. The increased afterload because of the vasoconstriction caused by norepinephrine can increase myocardial workload and norepinephrine can precipitate cardiac failure, myocardial ischemia, and pulmonary edema. Although there are concerns that excessive vasoconstriction with norepinephrine may have negative effects on blood flow, particularly in the hepatosplanchnic and renal circulations, studies suggest that it can successfully increase blood pressure without causing any deterioration in organ function, particularly in the presence of decreased vascular tone, as in septic shock.<sup>36,37</sup>

### Dopamine

Dopamine is another naturally occurring compound (the precursor of norepinephrine) that also combines  $\alpha$ - and  $\beta$ -adrenergic properties, but has several specific features. First, dopamine also has dopaminergic effects, which predominate at very low doses (<3  $\mu\text{g}/\text{kg}/\text{min}$  IV), and may dilate the hepatosplanchnic and renal circulations, thereby selectively increasing flow in these important regions. Second, the adrenergic effects of dopamine vary with the dose; at lower doses (3–10  $\mu\text{g}/\text{kg}/\text{min}$  IV),  $\beta$ -adrenergic effects predominate, so that blood flow may increase together with blood

pressure. At higher doses,  $\alpha$ -adrenergic effects become increasingly powerful, which may be necessary in more severe cases of hypotension. Importantly, these dose ranges are not cut-off values at which one set of receptors are activated at the expense of another, but are ranges in which the effects of one group of receptors predominate over another. Dopamine increases arterial pressure primarily by increasing cardiac index, as a consequence of an increase in stroke volume and, to a lesser extent, to increased heart rate, with minimal effects on systemic vascular resistance. However, dopamine also has drawbacks. First, it is a relatively weak agent, so that norepinephrine or epinephrine must often be added to control hypotensive states. Second, although dopamine may increase blood flow more effectively than other vasopressors, it also increases heart rate. A study in patients undergoing coronary artery bypass grafting with cardiopulmonary bypass suggests that dopamine, even at low doses, is associated with an increased risk of developing atrial fibrillation.<sup>38</sup> Third, the advantage of the dopaminergic effects may be more theoretical than practical. Thus the routine administration of low-dose dopamine to prevent renal failure is not recommended.<sup>39</sup> Finally, dopaminergic stimulation may have undesired endocrine effects on the hypothalamopituitary gland, resulting in immunosuppressant effects, primarily by a reduction in prolactin release.<sup>40</sup>

There is currently no evidence to suggest that either norepinephrine or dopamine is superior to the other in the resuscitation from shock<sup>41</sup> and both are recommended as first-line treatments.<sup>17,42</sup> Whether one or the other will be shown to be superior in future studies remains to be determined, but that remains academic at present; the most important issue is to reach the desired arterial pressure goal. A multicenter study is currently ongoing in Europe to compare these two drugs and has already enrolled more than 1200 patients. The results from this study should help clarify the optimal choice of vasopressor.

### Vasopressin and Terlipressin

Vasopressin is an endogenous stress hormone with a wide range of functions, including effects on blood osmolality and volume, body temperature,

insulin release, corticotropin release, memory, and social behavior; as a vasoconstrictor of vascular smooth muscle, it also has an important role in regulating blood pressure.<sup>43,44</sup> Patients with septic shock appear to develop relative vasopressin deficiency, with lower vasopressin levels than patients with cardiogenic shock for the same degree of hypotension.<sup>45</sup> This deficiency may be partly a result of decreased central stores of vasopressin,<sup>46</sup> and administration of low doses of vasopressin to restore normal vasopressin levels can result in substantial increases in arterial pressure and reduced requirements for other catecholamines.<sup>45,47–53</sup> A recent study suggests that vasopressin administration may improve outcome in patients with septic shock of moderate severity.

Vasopressin has also been assessed in patients with other forms of vasodilatory shock, for example, after cardiopulmonary bypass. In such patients, administration of low doses of vasopressin increases arterial blood pressure and reduces vasopressor requirements.<sup>54,55</sup> Interestingly, Morales et al.<sup>56</sup> found that giving vasopressin (0.03 U/min IV) prophylactically before cardiopulmonary bypass to avoid vasopressin deficiency resulted in reduced requirements for norepinephrine and a shorter ICU length of stay, suggesting that early use may be beneficial.

Vasopressin has also been investigated as a potential alternative to epinephrine for use in cardiorespiratory arrest. A randomized controlled study of vasopressin versus epinephrine in in-hospital cardiac arrest reported no advantage of vasopressin over epinephrine,<sup>57</sup> although a later, larger study comparing the two agonists in out-of-hospital cardiac arrest suggested improved outcomes for patients with asystole who received vasopressin,<sup>58</sup> and a cohort study has suggested that using a combination of epinephrine and vasopressin may be better, allowing the beneficial effects of both drugs but avoiding the harmful effects of excessive doses of either.<sup>59</sup> The risk with vasopressin is a reduction in cardiac output because of excessive vasoconstriction and a selective reduction in hepatosplanchnic blood flow. Studies are in progress to further evaluate the role of vasopressin in various shock states.

Terlipressin is an analogue of vasopressin that has been available in Europe for more than 20 years, but is

undergoing phase III clinical trials in the United States at the time of this writing. Terlipressin has a half-life of 6 hours and a duration of action of 2–10 hours, whereas the half-life of vasopressin is 6 minutes and its duration of action is 30–60 minutes. Terlipressin has been compared to norepinephrine in patients with hyperdynamic septic shock. Both drugs increased mean arterial blood pressure and improved renal function, but terlipressin administration was associated with a decrease in cardiac output,<sup>60</sup> and the authors suggested that terlipressin may need to be used with an inotrope such as dobutamine to maintain cardiac output. Terlipressin may also be useful for the treatment of hypotension occurring after induction of anesthesia in patients who have received long-term treatment with renin-angiotensin system inhibitors.<sup>61</sup>

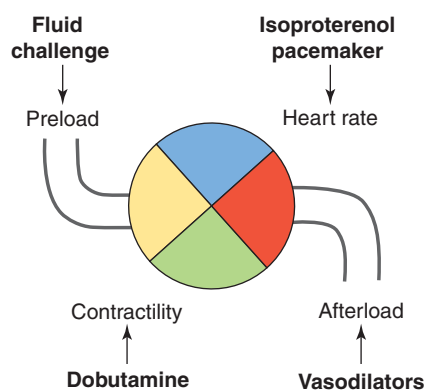
### Restoring and Maintaining Cardiac Output

An adequate cardiac output is essential to ensure sufficient tissue perfusion and oxygen delivery. However, a normal cardiac output is difficult to define and the adequacy of cardiac output varies among individuals and in the same individual over time. To increase cardiac output, one must remember its four determinants (Fig. 82–3):

1. **Heart rate:** Bradycardia can limit cardiac output, but only when severe; thus this is easily recognized at the bedside. The management of bradycardia is beyond the scope of this chapter, but the principles of treatment consist primarily of a pacemaker, possibly with isoproterenol as a temporary measure. Outside these extreme situations, increasing

heart rate by changing the rate of an in situ pacemaker usually does not increase cardiac output, because stroke volume decreases concurrently. It may even be the opposite: cardiac output may decrease if cardiac filling is impaired by a too short diastolic time, especially in cases of diastolic dysfunction.

2. **Preload:** Fluid administration should be considered in all cases of inadequate cardiac output, and if uncertain of the need for fluid, a fluid challenge technique must be used as described under Fluid Resuscitation above, in which a given amount of fluids is given rapidly under control of cardiac filling pressures.<sup>16</sup>
3. **Contractility:** If the increase in cardiac output is limited by impaired contractility, the use of inotropics may be considered. The major risk is increased oxygen demand as a result of the increased work of the myocardium, which may precipitate myocardial ischemia.
4. **Afterload:** By reducing the factors that oppose ejection of blood by the ventricles, principally using vasodilators, cardiac output may be increased without increasing myocardial oxygen demand. The major limitation of this approach is the risk of decreasing arterial pressure to levels that may compromise tissue perfusion in the peripheral organs as well as in the myocardium, and vasodilators should be avoided in hypotensive states. In addition, all vasodilators may induce some increase in heart rate, especially in the presence of underlying hypovolemia. Such an increase in heart rate should raise the possibility of underlying hypovolemia and suggest the need for a fluid challenge.



**FIGURE 82–3.** Various options to increase cardiac output, based on its four determinants.

### Dobutamine

Dobutamine is the first-choice inotropic agent for patients with low cardiac output who have received adequate fluid resuscitation. A decrease in arterial pressure during dobutamine administration should raise the possibility of underlying fluid deficits requiring another fluid challenge trial. With predominant  $\beta$ -adrenergic properties, dobutamine also possesses some  $\alpha$ -adrenergic effects that limit the increase in heart rate seen with pure  $\beta$ -adrenergic stimulation using isoproterenol. An initial dose of just a few  $\mu\text{g}/\text{kg}/\text{min}$  may increase cardiac

output significantly. Doses in excess of 20  $\mu\text{g}/\text{kg}/\text{min}$  IV are seldom used as they add little benefit and may lead to excessive tachycardia. Dobutamine has limited effects on arterial pressure, although arterial pressure may increase slightly if heart failure is the primary abnormality. Dobutamine formed part of the EGDT protocol used by Rivers et al. in their study of emergency department patients presenting with septic shock.<sup>2</sup> Dobutamine was used in addition to fluids and red cell transfusion to increase superior venacaval oxygen saturation ( $\text{ScvO}_2$ ) to more than 70%, and this protocol was associated with improved outcomes compared to standard care.<sup>2</sup> However, dobutamine should not routinely be used to increase oxygen delivery to supranormal levels as this approach is associated with worse outcomes,<sup>62</sup> rather it should be titrated on an individual basis to achieve acceptable oxygenation parameters. Interestingly, in a recent clinical study using orthogonal polarization spectral imaging, De Backer et al. showed that dobutamine improved capillary perfusion in patients with septic shock, independent of its systemic effects,<sup>15</sup> suggesting that it may have additional specific effects on regional blood flow.

### Dopexamine

Dopexamine hydrochloride is a newer synthetic catecholamine, structurally similar to dopamine. It has marked  $\beta_2$ -adrenergic agonist activity, some dopaminergic receptor activity, weak  $\beta_1$ -adrenergic activity, and no direct  $\alpha$ -adrenergic effects. It also inhibits the neuronal uptake of endogenous catecholamines. Dopexamine's positive inotropic effects combined with its vasodilating effects make it useful in acute exacerbations of chronic heart failure and in heart failure associated with cardiac surgery. However, its use is limited by the development of marked tachycardia, particularly at higher doses. Although it was suggested that because of its dopaminergic effects it may have beneficial effects on renal and splanchnic blood flow, a meta-analysis of 21 randomized controlled studies found no evidence to support the use of dopexamine to improve hepatosplanchnic or renal blood flow in critically ill patients.<sup>63</sup>

### Phosphodiesterase Inhibitors

The phosphodiesterases (PDEs) are a group of enzymes that degrade the cy-

clis nucleotides, cAMP and cyclic guanosine monophosphate (cGMP). PDE inhibitors can thus prolong or enhance the effects of physiologic processes mediated by cAMP or cGMP. PDEIII inhibitors, such as enoximone and milrinone, have inotropic and vasodilating properties. These drugs may be poorly tolerated by patients with arterial hypotension and their administration can be difficult because of their long half-life. Intermittent administration may be preferable to continuous infusion. The administration of very small doses of PDEIII inhibitors may reinforce the effects of dobutamine.<sup>64</sup> Short-term administration of PDEIII inhibitors has been associated with a high incidence of complications, including arrhythmias, especially in patients with ischemia cardiac disease, likely related to their effects on cAMP and Ca<sup>2+</sup> levels. Dobutamine and milrinone provided equally effective inotropic support in patients awaiting cardiac transplantation with no differences in right heart hemodynamics, death, need for additional vasodilator/inotropic therapy, need for mechanical cardiac support before transplantation, or occurrence of ventricular arrhythmias requiring increased antiarrhythmic therapy.<sup>65</sup> In critically ill patients with catecholamine-dependent heart failure, milrinone improved central hemodynamics and was associated with a reduction in dobutamine dose, although there was a tendency for milrinone-treated patients to require higher doses of vasopressors and more fluids.<sup>66</sup> Some studies suggest that milrinone may have additional antiinflammatory effects and beneficial effects on hepatosplanchnic perfusion.<sup>67,68</sup> Clearly, further studies are needed to determine the exact place of these drugs in the management of patients with severe heart failure and shock.

### **Levosimendan**

Levosimendan is a relatively new agent that provides inotropic effects by increasing calcium sensitivity of myocytes by binding to cardiac troponin-C, and vasodilator effects by opening (adenosine triphosphate)-sensitive potassium channels in vascular smooth muscle.<sup>69</sup> Levosimendan has a long half-life that may limit the practicality of its use. Levosimendan may be useful in patients with severe heart failure, where it has been shown to improve hemodynamic performance more effectively than dobutamine and to re-

duce mortality.<sup>70</sup> It may also be of use for inotropic support after myocardial ischemia, after myocardial stunning during and after cardiac surgery, and in patients with right ventricular dysfunction.<sup>69</sup> However, its place in acutely ill patients has not been well studied and remains poorly defined. In addition, the high costs of the drug limit its use. Several large phase III studies are ongoing to assess the use of levosimendan in various conditions.

### **Sodium Nitroprusside**

Sodium nitroprusside has a direct, short-acting relaxing effect on vascular smooth muscle and has been used primarily to reduce afterload, although by reducing venous return it also reduces preload. It has significant effects on arterial pressure, so that it is also used in the management of hypertensive crises. Sodium nitroprusside has the advantage of a short half-life, allowing easy titration. Administration should start at 20 µg/min IV, and the dose can be progressively increased to 150–200 µg/min. The administration of nitroprusside is complicated by the fact that it is very light sensitive, so that infusion sets must be opaque. Nitroprusside is rapidly metabolized to cyanide and thiocyanate and accumulation of these metabolites can lead to cyanide or thiocyanate toxicity during prolonged administration, especially in patients with renal failure.

### **Nitrates**

Nitrate products include nitroglycerin and isosorbide dinitrate. They cause relaxation of vascular smooth muscle and hence reduce afterload. Low doses (30–40 µg/min IV) predominantly produce venodilation; high doses (150–500 µg/min) lead to arteriolar dilation as well. These drugs are widely used intravenously in the treatment of recurrent ischemia, hypertensive emergencies, and congestive heart failure associated with myocardial infarction (MI). Nitroglycerin is the preferred vasodilator in acute MI, especially when infarction is complicated by congestive heart failure.<sup>71</sup> Nitrates are also indicated in patients with cardiogenic pulmonary edema for their strong relieving effects on venous congestion. Their dose is similar to that of nitroprusside.

### **Angiotensin-Converting Enzyme Inhibitors**

Angiotensin-converting enzyme (ACE) catalyses the conversion of angiotensin

I to angiotensin II, a potent vasoconstrictor, and is also involved in the inactivation of bradykinin, a potent vasodilator. Consequently, ACE inhibitors cause reduced formation of angiotensin II and increased levels of bradykinin, thus reducing vascular resistance. ACE inhibitors are widely used in the treatment of chronic heart failure and may be helpful in the acute care setting as well. However, they have two limitations in the acute setting. One is the risk of renal failure that can be precipitated by ACE inhibition, especially in the presence of fluid shifts that may result in relative hypovolemia. The second is the lack of availability of an intravenous preparation. Enalapril was available as the only parenteral preparation in some countries, but its administration resulted in marked decreases in arterial pressure, so that it is no longer used.

### **Hydralazine**

In contrast to nitrates, hydralazine has greater effects on the arteriolar side of the vasculature, and is therefore more likely to increase cardiac output by decreasing SVR. It also increases heart rate, so may be useful in patients with a relatively slow heart rate. Its use requires close cardiovascular monitoring. Long-term administration may be complicated by the development of iatrogenic lupus. Hydralazine is not often prescribed for prolonged therapy of heart failure as there are other drugs with a better benefit-to-risk ratio. However, it can still be considered as an alternative to ACE inhibitors in patients with heart failure.

## **END POINTS AND GOALS OF HEMODYNAMIC SUPPORT**

### **Indices of Global Perfusion Mean Arterial Pressure**

Arterial hypotension represents a marker of serious disease and a systolic pressure of less than 90 mm Hg (or a mean arterial pressure less than 70 mm Hg) or a decrease in mean arterial pressure of greater than 30 mm Hg are indications of acute circulatory failure. Noninvasive measurement of blood pressure with the sphygmomanometer is perhaps one of the most widely used procedures in clinical medicine. However, in critically ill patients, especially those with significant hypotension, invasive intraarterial moni-



toring of pressure is more accurate and continuous,<sup>72</sup> allowing rapid assessment of response to treatments.

### Cardiac Output

A “normal” cardiac output is difficult to define as what is normal or adequate may vary widely among patients and even in the same patient over time. For example, one cardiac output value may be perfectly adequate for an anesthetized, mechanically ventilated patient, but inadequate should that same patient develop severe sepsis with increased oxygen requirements. The measurement of cardiac output provides an assessment of global systemic blood flow but provides no information on regional flow. Cardiac output can be judged inadequate when tissue perfusion is altered, as shown clinically by cutaneous vasoconstriction, decreased urine output attributed to kidney underperfusion, or altered mental status. Biochemical signs of reduced tissue perfusion include decreased mixed venous oxygen saturation (SvO<sub>2</sub>) or its surrogate central venous oxygen saturation (ScvO<sub>2</sub>) or increased blood lactate concentrations (see Blood Lactate Levels).

Cardiac output can be measured using various techniques each of which has its own benefits and drawbacks. For many years, the thermodilution cardiac output measured using a pulmonary artery catheter (PAC) has been the gold standard, but with concerns about the safety and overall benefits with PAC insertion and use,<sup>73</sup> less-invasive techniques, including echocardiography and Doppler measurements, pulse contour analysis, partial carbon dioxide rebreathing, and electrical bioimpedance, are being used more commonly. Nevertheless, although the PAC is not indicated in all patients, it remains valuable in more complex cases, allowing almost continuous measurement, not only of cardiac output, but also of other important parameters including cardiac filling pressures and SvO<sub>2</sub>. Accurate absolute measures of cardiac output are perhaps less important than monitoring the trends in cardiac output in response to treatment and time, and if one wants to accurately define the adequacy of cardiac output, measures of SvO<sub>2</sub> are essential.<sup>74</sup> Importantly, targeting predefined cardiac output values for all patients or even for groups of patients is not advisable as adequacy of cardiac output will vary

among patients and in the same patient over time.

### Mixed Venous Oxygen Saturation

SvO<sub>2</sub> can be measured using a PAC. The normal value is 70–75%. SvO<sub>2</sub> depends on cardiac output, oxygen consumption, hemoglobin, and arterial oxygen saturation. Measurements of SvO<sub>2</sub> are very useful for the correct interpretation of cardiac output (Fig. 82–4). SvO<sub>2</sub> is typically decreased in low flow states, but normal or high in inflammatory conditions.

ScvO<sub>2</sub>, measured in the superior vena cava using a central venous catheter, may represent a useful surrogate for patients who do not require a PAC. However, it must be remembered that as ScvO<sub>2</sub> reflects the oxygenation of the venous blood from the upper half of the body and not of the lower half of the body, it is an estimate of the true SvO<sub>2</sub>, which measures whole-body venous oxygen saturation. Physiologically, ScvO<sub>2</sub> is slightly less than SvO<sub>2</sub>, but in critically ill patients it is often greater. This effect is explained by an increased oxygen extraction in the kidneys (where blood flow is often reduced) and in the gut (where oxygen consumption is often increased), whereas oxygen extraction in the liver is more constant. A recent study has

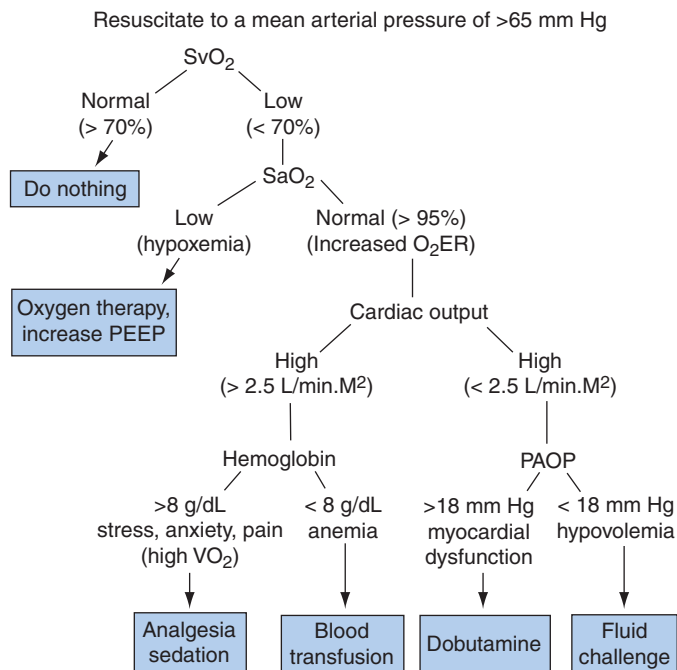
suggested that early therapy in patients with severe sepsis or septic shock targeting an ScvO<sub>2</sub> ≥ 70% may be associated with improved outcomes.<sup>2</sup> As with many other parameters, trends in ScvO<sub>2</sub> over time are of more use than individual values, and values must be interpreted in the light of clinical assessment and other hemodynamic and oxygenation parameters.

### Blood Lactate Levels

Blood lactate levels provide a useful indication of the presence of anaerobic metabolism caused by hypoperfusion, and, although changes in blood lactate levels occur too slowly to guide therapy, repeating measurements every hour or so can provide useful information on the ongoing adequacy of global tissue oxygenation. In patients with sepsis, the interpretation of blood lactate levels is not always straightforward in that increased lactate levels may result from cellular metabolic failure as well as from global hypoperfusion. However, the prognostic value of increased blood lactate levels is well established in septic shock patients, particularly if the high levels persist.<sup>75</sup>

### Indices of Regional Perfusion

Although measurement and monitoring of cardiac output, SvO<sub>2</sub>, and blood



**FIGURE 82–4.** Diagnostic and therapeutic algorithm based on mixed venous oxygen saturation (SvO<sub>2</sub>) measurements: therapeutic options to be considered are presented in the *rectangles*. O<sub>2</sub>ER, oxygen extraction ratio; PAOP, pulmonary artery occlusion pressure; PEEP, positive end-expiratory pressure; SaO<sub>2</sub>, arterial oxygen saturation; VO<sub>2</sub>, oxygen consumption. (Reproduced with permission from Pinsky MR and Vincent JL.<sup>74</sup>)

lactate levels provide valuable information regarding global adequacy or perfusion and oxygenation, they do not provide detail on the adequacy of regional microcirculatory blood flow or oxygen delivery and use, which is believed to be a crucial factor in the development of multiple organ failure in patients with shock. Measuring regional parameters is of particular importance, as they can remain inadequate even when global parameters have returned to normal. However, even though considerable progress is being made in this field, there is as yet no ideal technique that can be used in critically ill patients to assess regional blood flow or oxygenation.

### Gut Tonometry

The measurement of regional perfusion initially focused on the splanchnic circulation as the hepatosplanchnic circulation is particularly sensitive to changes in blood flow and oxygenation, and may have a higher critical oxygen delivery threshold than other organs. In addition, a countercurrent exchange mechanism operates in the villus, making the tip particularly sensitive to changes in regional flow and oxygenation. However, gastric tonometry is limited by measurement errors, doubts regarding the validity of pHi calculations, and unreliability of results during patient feeding.<sup>76</sup> Calculations of gastric pHi were replaced by gastric mucosal PCO<sub>2</sub> because this measure is not confounded by arterial bicarbonate, but because gastric mucosal PCO<sub>2</sub> is influenced by systemic arterial PCO<sub>2</sub>, the gastric-arterial PCO<sub>2</sub> difference may be of more interest.<sup>77</sup> An early trial suggested that tonometry derived parameters may be useful in guiding therapy,<sup>78</sup> but these findings were not confirmed in a later study,<sup>79</sup> and many investigators have emphasized the limited sensitivity, and especially specificity, of these measurements. Different vasoactive agents have divergent effects on gut PCO<sub>2</sub> and pHi that are neither consistent nor predictable.<sup>80</sup>

### Sublingual Capnography

The methodologic limitations of gastric tonometry encouraged researchers to look elsewhere for another easily accessible tissue where local PCO<sub>2</sub> could be measured, and the sublingual circulation has been suggested for this purpose. Several clinical studies have suggested that sublingual PCO<sub>2</sub> (PslCO<sub>2</sub>) is

a reliable marker of tissue hypoperfusion. However, as with gut PCO<sub>2</sub>, PslCO<sub>2</sub> may also be influenced by arterial CO<sub>2</sub> and the gradient (i.e., gap) between PslCO<sub>2</sub> and PaCO<sub>2</sub> may be more specific for tissue hypoperfusion.<sup>81</sup> In a recent study, the PslCO<sub>2</sub> gap was found to correlate with the alterations in microcirculatory blood flow seen in patients with severe sepsis.<sup>82</sup> Further work is clearly needed to define normal and pathologic PslCO<sub>2</sub> levels and to establish whether targeting treatments to restore a normal PslCO<sub>2</sub> can improve outcomes.

### CONCLUSION: THE GLOBAL PICTURE

Multiple organ failure is a serious problem in intensive care unit patients, resulting in high morbidity and mortality and associated resource use and costs. Multiple organ failure can arise from many causes, but a key factor in its development appears to be an imbalance between tissue oxygen requirements and uptake. Tissue oxygen uptake can be limited by inadequate oxygen delivery and availability, and also by altered oxygen extraction ability. Appropriate hemodynamic support can improve both global and regional blood flow and, hence, oxygen delivery. Early studies suggested that those patients with greater cardiac index and oxygen delivery values were more likely to survive conditions associated with the development of multiple organ failure.<sup>83,84</sup> This observation was the rationale behind several studies in the early 1990s, which assessed the benefits of increasing oxygen delivery to supranormal values using inotropes and fluids. Although this approach was shown to improve outcomes in some groups of critically ill patients, notably surgical and trauma patients,<sup>85,86</sup> routine application to all critically ill patients does not confer a uniform survival benefit and may worsen outcomes in some patients.<sup>62,87</sup> However, a protocol targeting adequate oxygen transport, as reflected by the ScvO<sub>2</sub>, in patients who are at risk of multiple organ failure, has been shown to result in improved survival<sup>2</sup> and adequate oxygenation clearly remains an important parameter to target. Unfortunately, at present there is no clear marker of adequate tissue oxygenation so we must rely on surro-

gate markers of tissue perfusion and oxygenation as discussed above. Adequate oxygen delivery is likely to vary among patients and in the same patient over time so that hemodynamic support must be titrated and adjusted carefully based on each individual's response to the therapy.

### KEY REFERENCES

1. Dellinger RP, Carlet JM, Masur H, et al. Surviving sepsis campaign guidelines for management of severe sepsis and septic shock. *Crit Care Med* 2004;32(3):858–873.
2. Hollenberg SM, Ahrens TS, Annane D, et al. Practice parameters for hemodynamic support of sepsis in adult patients: 2004 update. *Crit Care Med* 2004;32(9):1928–1948.
3. Vincent JL, Weil MH. Fluid challenge revisited. *Crit Care Med* 2006;34:1333–1337.

### REFERENCES

1. Weil MH, Shubin H. Proposed reclassification of shock states with special reference to distributive defects. *Adv Exp Med Biol* 1971;23:13–23.
2. Rivers E, Nguyen B, Havstad S, et al. Early goal-directed therapy in the treatment of severe sepsis and septic shock. *N Engl J Med* 2001;345(19):1368–1377.
3. Weil MH, Shubin H. The “VIP” approach to the bedside management of shock. *JAMA* 1969;207:337–340.
4. Vincent JL. Strategies in body fluid replacement. *Minerva Anesthesiol* 2000;66(5):278–284.
5. Heughan C, Niinikoski J, Hunt TK. Effect of excessive infusion of saline solution on tissue oxygen transport. *Surg Gynecol Obstet* 1972;135:257–260.
6. Hunt TK. Surgical wound infections: an overview. *Am J Med* 1981;70(3):712–718.
7. Lang K, Boldt J, Suttner S, Haisch G. Colloids versus crystalloids and tissue oxygen tension in patients undergoing major abdominal surgery. *Anesth Analg* 2001;93(2):405–409.
8. Cochrane Injuries Group. Human albumin administration in critically ill patients: systematic review of randomized controlled trials. *BMJ* 1998;317:235–240.
9. Vincent JL, Sakr Y, Reinhart K, Sprung CL, Gerlach H, Ranieri VM. Is albumin administration in the acutely ill associated with increased mortality? Results of the SOAP study. *Crit Care* 2005;9(6):R745–R754.

10. Finfer S, Bellomo R, Boyce N, French J, Myburgh J, Norton R. A comparison of albumin and saline for fluid resuscitation in the intensive care unit. *N Engl J Med* 2004;350(22):2247–2256.
11. Vincent JL, Dubois MJ, Navickis RJ, Wilkes MM. Hypoalbuminemia in acute illness: is there a rationale for intervention? A meta-analysis of cohort studies and controlled trials. *Ann Surg* 2003;237(3):319–334.
12. Vincent JL, Navickis RJ, Wilkes MM. Morbidity in hospitalized patients receiving human albumin: a meta-analysis of randomized, controlled trials. *Crit Care Med* 2004;32(10):2029–2038.
13. Boldt J, Ducke M, Kumle B, Papsdorf M, Zurmeyer EL. Influence of different volume replacement strategies on inflammation and endothelial activation in the elderly undergoing major abdominal surgery. *Intensive Care Med* 2004;30(3):416–422.
14. Dieterich HJ, Weissmuller T, Rosenberger P, Eltzschig HK. Effect of hydroxyethyl starch on vascular leak syndrome and neutrophil accumulation during hypoxia. *Crit Care Med* 2006;34(6):1775–1782.
15. De Backer D, Creteur J, Dubois MJ, et al. The effects of dobutamine on microcirculatory alterations in patients with septic shock are independent of its systemic effects. *Crit Care Med* 2006;34:403–408.
16. Vincent JL, Weil MH. Fluid challenge revisited. *Crit Care Med* 2006;34:1333–1337.
17. Dellinger RP, Carlet JM, Masur H, et al. Surviving sepsis campaign guidelines for management of severe sepsis and septic shock. *Crit Care Med* 2004;32(3):858–873.
18. Lorente JA, Landin L, De Pablo R, Renes E, Rodriguez-Diaz R, Liste D. Effects of blood transfusion on oxygen transport variables in severe sepsis. *Crit Care Med* 1993;21:1312–1318.
19. Fernandes CJ Jr, Akamine N, De Marco FV, De Souza JA, Lagudis S, Knobel E. Red blood cell transfusion does not increase oxygen consumption in critically ill septic patients. *Crit Care* 2001;5(6):362–367.
20. Walsh TS, McArdle F, McLellan SA, et al. Does the storage time of transfused red blood cells influence regional or global indexes of tissue oxygenation in anemic critically ill patients? *Crit Care Med* 2004;32(2):364–371.
21. Hebert PC, Wells G, Blajchman MA, et al. A multicenter, randomized, controlled clinical trial of transfusion requirements in critical care. *N Engl J Med* 1999;340:409–417.
22. Hebert PC, Yetisir E, Martin C, et al. Is a low transfusion threshold safe in critically ill patients with cardiovascular diseases? *Crit Care Med* 2001;29(2):227–234.
23. Vincent JL, Baron JF, Reinhart K, et al. Anemia and blood transfusion in critically ill patients. *JAMA* 2002;288(12):1499–1507.
24. Corwin HL, Gettinger A, Pearl RG, et al. The CRIT study: anemia and blood transfusion in the critically ill—current clinical practice in the United States. *Crit Care Med* 2004;32(1):39–52.
25. Weiskopf RB, Viele MK, Feiner J, et al. Human cardiovascular and metabolic response to acute, severe isovolemic anemia. *JAMA* 1998;279(3):217–221.
26. Howell PJ, Bamber PA. Severe acute anaemia in a Jehovah's Witness. Survival without blood transfusion. *Anaesthesia* 1987;42(1):44–48.
27. Vincent JL, Sakr Y, Le Gall J-R, et al. Is red blood cell transfusion associated with worse outcome? Results of the SOAP study [abstract]. *Chest* 2003;124:125S.
28. Shapiro MJ. To filter blood or universal leukoreduction: what is the answer? *Crit Care* 2004;8 Suppl 2:S27–S30.
29. Hebert PC, Fergusson D, Blajchman MA, et al. Clinical outcomes following institution of the Canadian universal leukoreduction program for red blood cell transfusions. *JAMA* 2003;289:1941–1949.
30. Vamvakas EC. WBC-containing allogeneic blood transfusion and mortality: a meta-analysis of randomized controlled trials. *Transfusion* 2003;43(7):963–973.
31. Fergusson D, Khanna MP, Tinmouth A, Hebert PC. Transfusion of leukoreduced red blood cells may decrease postoperative infections: two meta-analyses of randomized controlled trials. *Can J Anaesth* 2004;51(5):417–424.
32. Corwin HL, AuBuchon JP. Is leukoreduction of blood components for everyone? *JAMA* 2003;289(15):1993–1995.
33. Reinelt H, Radermacher P, Kiefer P, et al. Impact of exogenous  $\beta$ -adrenoreceptor stimulation on hepatosplanchnic oxygen kinetics and metabolic activity in septic shock. *Crit Care Med* 1999;27:325–331.
34. Meier-Hellmann A, Reinhart K, Bredle DL, Specht M, Spies CD, Hannemann L. Epinephrine impairs splanchnic perfusion in septic shock. *Crit Care Med* 1997;25:399–404.
35. Levy B, Bollaert PE, Charpentier C, et al. Comparison of norepinephrine and dobutamine to epinephrine for hemodynamics, lactate metabolism, and gastric tonometric variables in septic shock. *Intensive Care Med* 1997;23:282–287.
36. De Backer D, Creteur J, Silva E, Vincent JL. Effects of dopamine, norepinephrine, and epinephrine on the splanchnic circulation in septic shock: which is best? *Crit Care Med* 2003;31:1659–1667.
37. Martin C, Papazian L, Perrin G, Saux P, Gouin F. Norepinephrine or dopamine for the treatment of hyperdynamic septic shock? *Chest* 1993;103:1826–1831.
38. Argalious M, Motta P, Khandwala F, et al. “Renal dose” dopamine is associated with the risk of new-onset atrial fibrillation after cardiac surgery. *Crit Care Med* 2005;33(6):1327–1332.
39. Bellomo R, Chapman M, Finfer S, Hickling K, Myburgh J. Low-dose dopamine in patients with early renal dysfunction: a placebo-controlled randomised trial. Australian and New Zealand Intensive Care Society (ANZICS) Clinical Trials Group. *Lancet* 2000;356(9248):2139–2143.
40. Bailey AR, Burchett KR. Effect of low-dose dopamine on serum concentrations of prolactin in critically ill patients. *Br J Anaesth* 1997;78:97–99.
41. Mullner M, Urbanek B, Havel C, Losert H, Waechter F, Gamper G. Vasopressors for shock. *Cochrane Database Syst Rev* 2004;(3):CD003709.
42. Hollenberg SM, Ahrens TS, Annane D, et al. Practice parameters for hemodynamic support of sepsis in adult patients: 2004 update. *Crit Care Med* 2004;32(9):1928–1948.
43. Treschan TA, Peters J. The vasopressin system: physiology and clinical strategies. *Anesthesiology* 2006;105(3):599–612.
44. Vincent JL. Vasopressin in hypotensive and shock states. *Crit Care Clin* 2006;22(2):187–197.
45. Landry DW, Levin HR, Gallant EM, et al. Vasopressin deficiency contributes to the vasodilation of septic shock. *Circulation* 1997;95(5):1122–1125.
46. Sharshar T, Carlier R, Blanchard A, et al. Depletion of neurohypophyseal content of vasopressin in septic shock. *Crit Care Med* 2002;30:497–500.
47. Landry DW, Levin HR, Gallant EM, et al. Vasopressin pressor hypersensitivity in vasodilatory septic shock. *Crit Care Med* 1997;25(8):1279–1282.
48. Malay MB, Ashton RC Jr, Landry DW, Townsend RN. Low-dose vasopressin in the treatment of vasodilatory septic shock. *J Trauma* 1999;47(4):699–703.
49. Holmes CL, Walley KR, Chittock DR, Lehman T, Russell JA. The effects of vasopressin on hemodynamics and renal function in severe septic shock: a case series. *Intensive Care Med* 2001;27(8):1416–1421.
50. Tsuneyoshi I, Yamada H, Kakihana Y, Nakamura M, Nakano Y, Boyle WA III. Hemodynamic and metabolic effects of low-dose vasopressin infusions in vasodilatory septic shock. *Crit Care Med* 2001;29(3):487–493.
51. Patel BM, Chittock DR, Russell JA, Walley KR. Beneficial effects of short-term vasopressin infusion during severe septic shock. *Anesthesiology* 2002;96(3):576–582.
52. Hall LG, Oyen LJ, Taner CB, et al. Fixed-dose vasopressin compared with titrated dopamine and norepinephrine as initial vasopressor therapy for septic shock. *Pharmacotherapy* 2004;24(8):1002–1012.
53. Dunser MW, Mayr AJ, Ulmer H, et al. The effects of vasopressin on systemic hemodynamics in catecholamine-resistant septic and postcardiotomy shock: a retrospective analysis. *Anesth Analg* 2001;93(1):7–13.
54. Argenziano M, Chen JM, Cullinane S, et al. Arginine vasopressin in the management of vasodilatory hypotension after cardiac transplantation. *J Heart Lung Transplant* 1999;18(8):814–817.



55. Morales DL, Gregg D, Helman DN, et al. Arginine vasopressin in the treatment of 50 patients with postcardiotomy vasodilatory shock. *Ann Thorac Surg* 2000;69(1):102–106.
56. Morales DL, Garrido MJ, Madigan JD, et al. A double-blind randomized trial: prophylactic vasopressin reduces hypotension after cardiopulmonary bypass. *Ann Thorac Surg* 2003;75(3):926–930.
57. Stiell IG, Hebert PC, Wells GA, et al. Vasopressin versus epinephrine for in-hospital cardiac arrest: a randomised controlled trial. *Lancet* 2001;358(9276):105–109.
58. Wenzel V, Krismer AC, Arntz HR, Sitter H, Stadlbauer KH, Lindner KH. A comparison of vasopressin and epinephrine for out-of-hospital cardiopulmonary resuscitation. *N Engl J Med* 2004;350(2):105–113.
59. Grmec S, Mally S. Vasopressin improves outcome in out-of-hospital cardiopulmonary resuscitation of ventricular fibrillation and pulseless ventricular tachycardia: a observational cohort study. *Crit Care* 2006;10(1):R13.
60. Albanese J, Leone M, Delmas A, Martin C. Terlipressin or norepinephrine in hyperdynamic septic shock: a prospective, randomized study. *Crit Care Med* 2005;33(9):1897–1902.
61. Boccard G, Ouattara A, Godet G, et al. Terlipressin versus norepinephrine to correct refractory arterial hypotension after general anesthesia in patients chronically treated with renin-angiotensin system inhibitors. *Anesthesiology* 2003;98(6):1338–1344.
62. Hayes MA, Timmins AC, Yau EH, Palazzo M, Hinds CJ, Watson D. Elevation of systemic oxygen delivery in the treatment of critically ill patients. *N Engl J Med* 1994;330:1717–1722.
63. Renton MC, Snowden CP. Dopexamine and its role in the protection of hepatosplanchnic and renal perfusion in high-risk surgical and critically ill patients. *Br J Anaesth* 2005;94(4):459–467.
64. Vincent JL, Leon M, Berre J, Melot C, Kahn RJ. Addition of phosphodiesterase inhibitors to adrenergic agents in acutely ill patients. *Int J Cardiol* 1990;28 Suppl 1:S7–11.
65. Aranda JM Jr, Schofield RS, Pauly DF, et al. Comparison of dobutamine versus milrinone therapy in hospitalized patients awaiting cardiac transplantation: a prospective, randomized trial. *Am Heart J* 2003;145(2):324–329.
66. Siostrzonek P, Koreny M, Delle-Karth G, Haumer M, Koller-Strametz J, Heinz G. Milrinone therapy in catecholamine-dependent critically ill patients with heart failure. *Acta Anaesthesiol Scand* 2000;44(4):403–409.
67. Mollhoff T, Loick HM, Van Aken H, et al. Milrinone modulates endotoxemia, systemic inflammation, and subsequent acute phase response after cardiopulmonary bypass (CPB). *Anesthesiology* 1999;90(1):72–80.
68. Kern H, Schroder T, Kaulfuss M, Martin M, Kox WJ, Spies CD. Enoximone in contrast to dobutamine improves hepatosplanchnic function in fluid-optimized septic shock patients. *Crit Care Med* 2001;29(8):1519–1525.
69. Toller WG, Stranz C. Levosimendan, a new inotropic and vasodilator agent. *Anesthesiology* 2006;104(3):556–569.
70. Follath F, Cleland JG, Just H, et al. Efficacy and safety of intravenous levosimendan compared with dobutamine in severe low-output heart failure (the LIDO study): a randomised double-blind trial. *Lancet* 2002;360(9328):196–202.
71. The American Heart Association in collaboration with the International Liaison Committee on Resuscitation. Guidelines 2000 for Cardiopulmonary Resuscitation and Emergency Cardiovascular Care. Part 6: advanced cardiovascular life support: section 6: pharmacology II. Agents to optimize cardiac output and blood pressure. *Circulation* 2000;102(8 Suppl):I129–I135.
72. Bennett D. Arterial pressure: a personal view. In: Pinsky MR, Payen D, eds. *Functional Hemodynamic Monitoring*. Heidelberg: Springer, 2005:89–97.
73. Connors AF, Speroff T, Dawson NV, et al. The effectiveness of right heart catheterization in the initial care of critically ill patients. *JAMA* 1996;276:889–897.
74. Pinsky MR, Vincent JL. Let us use the PAC correctly and only when we need it. *Crit Care Med* 2005;33:1119–1122.
75. Friedman G, Berlot G, Kahn RJ, Vincent JL. Combined measurements of blood lactate concentrations and gastric intramucosal pH in patients with severe sepsis. *Crit Care Med* 1995;23(7):1184–1193.
76. Creteur J. Gastric and sublingual capnometry. *Curr Opin Crit Care* 2006;12(3):272–277.
77. Russell JA. Gastric tonometry: does it work [editorial]? *Intensive Care Med* 1997;23(1):3–6.
78. Gutierrez G, Palizas F, Doglio G, et al. Gastric intramucosal pH as a therapeutic index of tissue oxygenation in critically ill patients. *Lancet* 1992;339:195–199.
79. Gomersall CD, Joynt GM, Freebairn RC, Hung V, Buckley TA, Oh TE. Resuscitation of critically ill patients based on the results of gastric tonometry: a prospective, randomized, controlled trial. *Crit Care Med* 2000;28(3):607–614.
80. Silva E, De Backer D, Creteur J, Vincent JL. Effects of vasoactive drugs on gastric intramucosal pH. *Crit Care Med* 1998;26:1749–1758.
81. Marik PE, Bankov A. Sublingual capnometry versus traditional markers of tissue oxygenation in critically ill patients. *Crit Care Med* 2003;31(3):818–822.
82. Creteur J, De Backer D, Sakr Y, Koch M, Vincent JL. Sublingual capnometry tracks microcirculatory changes in septic patients. *Intensive Care Med* 2006;32(3):516–523.
83. Bland RD, Shoemaker WC, Abraham E, Cobo JC. Hemodynamic and oxygen transport patterns in surviving and nonsurviving postoperative patients. *Crit Care Med* 1985;13:85–90.
84. Bishop M, Shoemaker WC, Appel P, Wo CJ, Zwick C, Kram H, et al. Relationship between supranormal circulatory values, time delays and outcome in severely traumatized patients. *Crit Care Med* 1993;21:56–63.
85. Boyd O, Grounds M, Bennett ED. A randomized clinical trial of the effect of deliberate perioperative increase of oxygen delivery on mortality in high-risk surgical patients. *JAMA* 1993;270:2699–2707.
86. Fleming A, Bishop M, Shoemaker WC, et al. Prospective trial of supranormal values as goals of resuscitation in severe trauma. *Arch Surg* 1992;127:1175–1181.
87. Gattinoni L, Brazzi L, Pelosi P, et al. A trial of goal-oriented hemodynamic therapy in critically ill patients. *N Engl J Med* 1995;333:1025–1032.



## CHAPTER 83

## Mechanical Ventilation for the Surgical Patient

Robert M. Kacmarek, PhD, RRT,  
and Dean R. Hess, PhD, RRT

The vast majority of surgical patients do not require support of the respiratory system once they are past the immediate postoperative period. However, others with preexistent chronic respiratory diseases, trauma patients, and patients who require extensive surgical procedures may require more lengthy periods of respiratory support. This chapter focuses on mechanical ventilation of the postoperative patient. The chapter primarily discusses invasive ventilation but also reviews selected data for noninvasive respiratory support and the application of noninvasive positive pressure ventilation (NPPV) and continuous positive airway pressure (CPAP) by mask.

## INDICATIONS FOR INTUBATION AND MECHANICAL VENTILATION

The main objectives of mechanical ventilation in the postoperative patient are to decrease the work of breathing and the load on the cardiovascular system, and to reverse life-threatening hypoxemia or respiratory acidosis. Table 83-1 summarizes some of the specific indications for mechanical ventilation.<sup>1,2</sup> Esteban et al. reported an international survey of 1638 patients requiring mechanical ventilation. Acute respiratory failure was the indication for mechanical ventilation in the majority of patients (66%), followed by coma (15%), an acute exacerbation of chronic obstructive pulmonary disease (13%), and neuromuscular disorders (5%).<sup>3</sup> Included under the heading of respiratory failure were postoperative respiratory failure, acute respiratory distress syndrome (ARDS), heart failure, pneumonia, sepsis, and complications of trauma.<sup>3</sup>

## MECHANICAL VENTILATION TARGETS

## Pressure Versus Volume Ventilation

During all forms of mechanical ventilation the ventilator must be programmed to deliver gas to achieve specific target values. The format for gas delivery in most ventilator modes is to either a targeted pressure or volume (Table 83-2).<sup>1</sup> In volume-targeted ventilation (the original approach to ventilatory support), a specific tidal volume is set by the clinician and the ventilator ensures that the volume is delivered regardless of inspiratory pressure (up to a clinician-set limit). In addition to tidal volume, the flow waveform and peak flow or inspiratory time must be set. With this approach to ventilatory support the focus is on ensuring that ventilation is maintained at a targeted level.

Pressure ventilation is essentially an opposite approach to ventilatory gas delivery. A peak airway pressure is set, with the result that the peak alveolar

pressure is limited. That is, with each breath pressure increases to the set level before the breath terminates. However, the tidal volume and gas flow are allowed to vary from breath to breath. During pressure ventilation the clinician must set the targeted pressure, and in some modes, the allowed inspiratory time. Flow is provided rapidly at first, then in an exponentially decelerating pattern where the rate of deceleration is dependent upon the patient's inspiratory demand and lung mechanics.<sup>4</sup> Essentially, the ventilator rapidly delivers gas flow to establish the targeted pressure but once the pressure target is met, the flow must decrease to avoid exceeding the set pressure. This approach to ventilatory support focuses on ensuring a targeted pressure is met and never exceeded.

As noted in Table 83-3 pressure and volume ventilation respond differently to changes of the impedance to gas delivery. With volume ventilation pressure increases if the patient becomes more difficult to ventilate, whereas with pressure ventilation the tidal volume is decreased. Most modes of ven-

## KEY POINTS

1. Patients require mechanical ventilation because of apnea, acute or impending acute respiratory failure, or severe refractory hypoxemia.
2. The two basic forms of mechanical ventilation are pressure ventilation (peak airway pressure constant, tidal volume variable) and volume ventilation (tidal volume constant, peak airway pressure variable).
3. Although numerous modes of ventilation exist little data is available to differentiate the benefits of one over the other and no mode has been shown to improve outcome.
4. A major concern during assisted ventilation is patient-ventilator synchrony—the ventilator should be set to match the patients ventilatory demands.
5. Autopositive end-expiratory pressure (PEEP) is a common cause of patient-ventilator dyssynchrony; in patients with obstructive lung disease, properly set applied PEEP improves synchrony and decreases patient effort.
6. It is unnecessary to achieve normal  $\text{PaO}_2$  and  $\text{PaCO}_2$ . In most critically ill patients, a  $\text{PaO}_2 \geq 60$  mm Hg is usually acceptable and permissive hypercapnia may be necessary in some patients.
7. Ventilator-induced lung injury is primarily caused by localized overdistension and the opening and closing of unstable lung units.
8. In the vast majority of patients who are ventilated, the tidal volume should be 5–10 mL/kg predicted body weight (PBW) and the plateau pressure should be  $<30$  cm  $\text{H}_2\text{O}$ , PEEP should be set to avoid collapse of unstable lung units.
9. High-frequency ventilation and airway pressure release ventilation, although useful in managing patients with acute respiratory distress syndrome (ARDS), show no benefit over conventional pressure or volume ventilation.
10. Noninvasive positive pressure ventilation is useful to transition patients who are at high risk of extubation failure from invasive ventilation to spontaneous breathing.

TABLE 83-1.

## Indications and Select Specific Clinical Causes for the Need of Mechanical Ventilation

Pathophysiologic Indications	Specific Clinical Cause
Apnea	Anesthesia, head trauma, drug overdose
Acute or impending ventilatory failure; PaCO <sub>2</sub> >50 mm Hg and pH <7.30	Anesthesia, asthma, acute exacerbation of chronic obstructive pulmonary disease, flail chest, postoperative respiratory failure
Severe refractory hypoxemia; PaO <sub>2</sub> <60 mm Hg (SaO <sub>2</sub> , 90%) with FiO <sub>2</sub> >0.8	Postoperative respiratory failure, acute respiratory distress syndrome, severe pneumonia, sepsis, pulmonary edema

TABLE 83-2.

## Pressure- versus Volume-Targeted Ventilation

	Pressure	Volume
Peak airway pressure	Constant	Variable
Peak alveolar pressure	Constant	Variable
Tidal volume	Variable	Constant
Peak flow	Variable	Constant
Flow pattern	Decelerating	Preset
Inspiratory time	Preset	Preset
Minimum rate	Preset	Preset

Reprinted from Kacmarek RM, Dimas S, Mack C. Essentials of Respiratory Care. 4th ed., St. Louis: Elsevier, 2005:690-714, with permission from Elsevier.

TABLE 83-3.

## Effect of Changing Compliance and Resistance during Pressure and Volume Ventilation

	Pressure	Volume
Decreased compliance	↓Volume	↑Pressure
Increases compliance	↑Volume	↓Pressure
Increased auto-PEEP	↓Volume	↑Pressure
Decreased auto-PEEP	↑Volume	↓Pressure
Pneumothorax	↓Volume	↑Pressure
Bronchospasm	↓Volume	↑Pressure
Mucosal edema	↓Volume	↑Pressure
Secretions	↓Volume	↑Pressure
Pleural effusion	↓Volume	↑Pressure
Increased patient effort	↑Volume	↓Pressure
Decreased patient effort	↓Volume	↑Pressure

PEEP, positive end-expiratory pressure.  
Reprinted from Kacmarek RM, Dimas S, Mack C. Essentials of Respiratory Care. 4th ed., St. Louis: Elsevier, 2005:690-714, with permission from Elsevier.

tilation currently available essentially function based on one of these two formats.

### Combined Pressure and Volume Targeted Modes

Some of the newer modes of ventilation (see New Modes of Ventilation below) attempt to combine the beneficial effects of volume ventilation (deliv-

ering a constant tidal volume) and pressure ventilation (the maximum airway pressure is limited).<sup>4</sup> With these modes both volume and pressure are targeted. Their gas delivery algorithms are designed to ensure on average that the set tidal volume is delivered but also to ensure that the peak airway pressure does not exceed the set level.<sup>4</sup> In other novel ventilatory modes, gas may be

delivered initially in a volume ventilation format, but if the patient's demand is increased, the gas delivery mode changes to a pressure format to ensure that ventilatory demand is met.<sup>4</sup>

### CLASSIC MODES OF VENTILATION

The classic modes of ventilation include control, assist/control, assist (pressure support), and synchronized intermittent mandatory ventilation (Table 83-4). All of these modes have been available on mechanical ventilators for more than 25 years and generally can provide the basic approaches to ventilatory support for the vast majority of surgical patients.

#### Control Mode

This is the original mode of mechanical ventilation. Controlled ventilation is available in both pressure and volume ventilation formats (Figs. 83-1 and 83-2). In this mode, the ventilator controls *all* aspects of gas delivery. That is, the patient is assumed to be a passive recipient of mechanical ventilation.<sup>5</sup> With these earliest ventilators, patients were not able to trigger the ventilator to produce an inspiration. However, with today's modern ventilators, even when the airway sensitivity is set at the most insensitive setting, patients with a strong ventilatory drive can still trigger the ventilator. The control mode of ventilation is achieved today by sedating the patient to apnea.

#### Assist/Control Mode

This mode is essentially the control mode with the sensitivity level set to trigger on a spontaneous negative airway pressure ensuring that the patient initiates his or her own gas delivery (Fig. 83-3). The sensitivity control adjusts the level of patient effort (spontaneous negative airway pressure) required to trigger the mechanical breath. Although the patient determines the ventilatory rate, a "backup" rate is set to insure a minimum rate of ventilation.<sup>5</sup> Worldwide this is the most commonly used mode of ventilation.<sup>3</sup> During volume assist/control the following variables are usually set: tidal volume, flow waveform, backup rate, peak inspiratory flow rate or inspiratory time, inspiratory trigger sensitivity, FiO<sub>2</sub>, and positive end-expiratory pres-

TABLE 83-4.

## Available Modes of Mechanical Ventilation

## Classic modes of ventilation

Control  
 Assist/control  
 Assist/pressure support  
 Synchronized intermittent mandatory ventilation

## New modes of ventilation

## Within breath adjustments

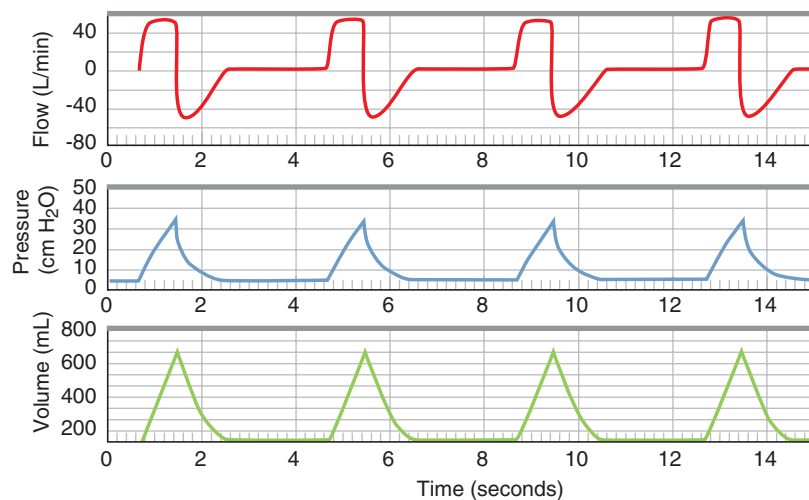
Automatic tube compensation  
 Proportional assist ventilation  
 Volume-assured pressure support

## Between breath adjustments

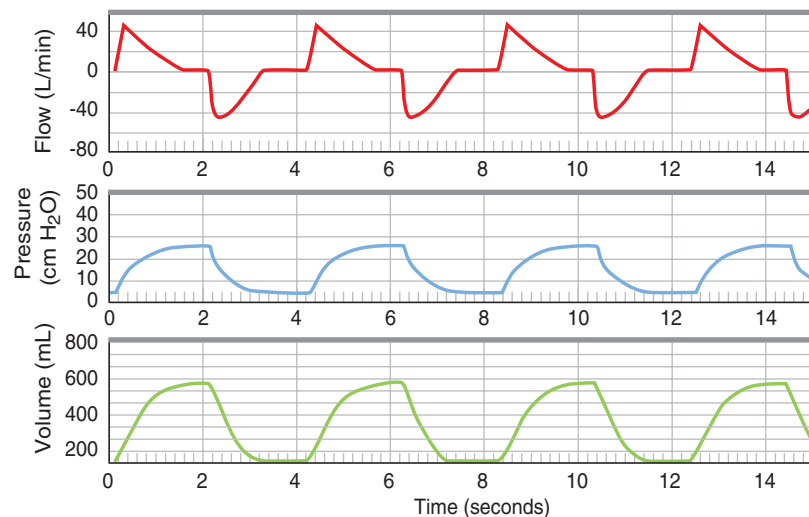
Pressure-regulated volume control  
 Volume support  
 Adaptive support ventilation

## Pressure targeted

Airway pressure release ventilation  
 Bi-level pressure ventilation



**FIGURE 83-1.** Volume-targeted square-wave flow-controlled mode ventilation. Note there is no negative deflection in airway pressure at the start of the breath. (Reprinted from Hess DR, MacIntyre NR, Mishoe SC, et al. *Respiratory Care: Principles and Practice*. Philadelphia: WB Saunders, 2002:786–791, with permission from Elsevier.)



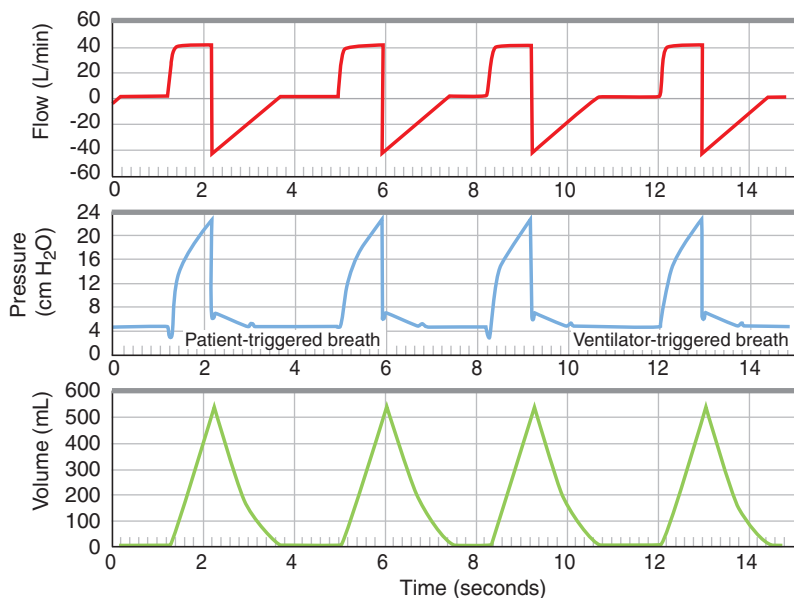
**FIGURE 83-2.** Pressure-targeted controlled-mode ventilation. Note there is no negative deflection in airway pressure at the start of the breath. (Reprinted from Hess DR, MacIntyre NR, Mishoe SC, et al. *Respiratory Care: Principles and Practice*. Philadelphia: WB Saunders, 2002:786–791, with permission from Elsevier.)

sure (PEEP). With the pressure assist/control mode the peak pressure, inspiratory time, backup rate, inspiratory trigger sensitivity,  $\text{FiO}_2$ , PEEP, and rise time must be set.

### Pressure Support

The closest mode to true assist ventilation available on modern ventilators is pressure support (Fig. 83-4). With assist ventilation there is no backup rate. In pressure support, backup safety modes of ventilation take over if patients become apneic for  $\geq 20$  seconds but no true backup rate is available.<sup>5</sup> Pressure support is very similar to pressure assist/control.<sup>6</sup> The major feature of gas delivery that differs in this mode is the mechanism that terminates inspiration. With pressure assist/control the inspiration is always terminated by time, whereas with pressure support, inspiration is usually terminated by decreasing gas flow. That is, when tracheal flow decreases to a specific level (usually 25% of the peak flow for that breath) the breath is terminated. There are, however, two alternate methods of terminating inspiration in pressure support: pressure exceeding the set level after about 300 milliseconds of inspiration or the inspiratory time exceeding the manufacturer's set level, usually 2–3 seconds. However, newer ventilators allow the clinician to set the maximum inspiratory time during pressure support ventilation. Both of these secondary termination criteria are valuable for patient safety and prevent lengthy inspiratory times and prolonged elevation of airway pressures which can reduce the cardiac output.

Of the classic modes of ventilation, pressure support allows the patient the greatest control over the process of



**FIGURE 83-3.** Volume-targeted assist/control mode ventilation. Note each breath is patient triggered as observed by the deflection in airway pressure at the onset of each breath. (Reprinted from Hess DR, MacIntyre NR, Mishoe SC, et al. *Respiratory Care: Principles and Practice*. Philadelphia: WB Saunders, 2002:786–791, with permission from Elsevier.)

ventilation. Not only does the patient trigger each breath, but the ending of the breath is based on the patient's demand. As with all pressure-targeted approaches to ventilation, the pressure support mode allows the patient to vary the tidal volume of each delivered breath. The only gas delivery variable set other than sensitivity is the pressure level. Pressure support may be used to ventilate any patient with a stable ventilatory drive.

### Inspiratory Termination Criteria

Inspiratory termination criteria, also referred to as E-sens or expiratory sensitivity, is an adjunct to pressure support available on many ventilators as a method of ensuring that the patient and ventilator end their inspiration simultaneously. As Fig. 83-5 illustrates, an increase in pressure at the end of a pressure support breath is abnormal and usually indicates that the patient has begun exhalation be-

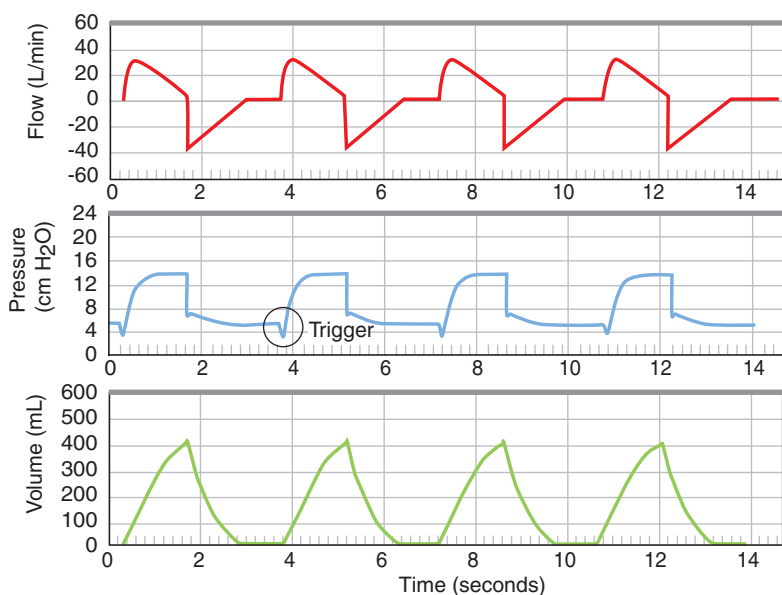
fore the ventilator has allowed exhalation to occur.<sup>7</sup> When this increase in inspiratory pressure is observed, the patient is contracting the accessory muscles of exhalation during the terminal aspect of the ventilator's inspiratory phase.<sup>8</sup> This results in an increased ventilatory drive and ventilatory rate, and the development of patient-ventilator dyssynchrony. E-sens allows adjustment of the percentage of peak flow terminating the breath. Whenever a spike at the end of a pressure support breath is present, a greater percentage of the peak flow should be set to terminate the breath. Whenever a spike is present the E-sens percentage should be slowly increased until there is a smooth transition from inspiration to expiration.<sup>9</sup>

### Rise Time

Patient-ventilator synchrony at the onset of a pressure-targeted breath (e.g., pressure assist/control, pressure support, pressure-regulated volume control) can be improved by adjusting the rise time. As noted in Fig. 83-6 the flow rise time varies the slope of the pressure increase at the onset of a breath by varying the time it takes gas flow to increase from zero to peak.<sup>7</sup> Rise time should be adjusted to ensure that airway pressure rises rapidly to the peak level without any concavity during the initial airway pressure waveform. If the airway pressure waveform is concave the rise time should be increased (made more rapid), however, if peak pressure exceeds the set level at the onset of inspiration the rise time should be decreased. An increase in rise time generally results in an increase of peak flow and a decreased inspiratory time (with pressure support ventilation). In most patients with a strong ventilatory drive the rise time should be set between the mid and most rapid level. Proper setting of rise time usually results in a decreased mechanical ventilatory rate.

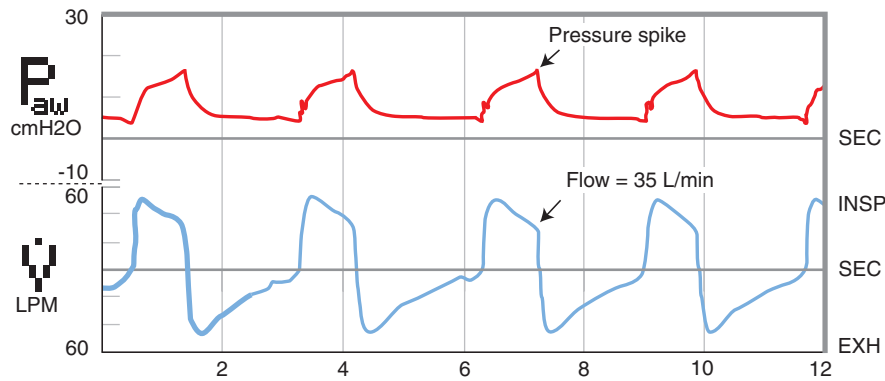
### Synchronized Intermittent Mandatory Ventilation

This mode of ventilation combines spontaneous unsupported breathing with the assist/control mode. As with the assist/control mode, the mandatory positive pressure breaths can be either pressure or volume targeted. Figure 83-7 illustrates the typical volume-targeted synchronized intermittent mandatory ventilation (SIMV). A mandatory respiration rate is set, and



**FIGURE 83-4.** Pressure support mode ventilation. (Reprinted from Hess DR, MacIntyre NR, Mishoe SC, et al. *Respiratory Care: Principles and Practice*. Philadelphia: WB Saunders, 2002:786–791, with permission from Elsevier.)





**FIGURE 83-5.** Pressure and flow tracings during pressure support ventilation with the Nellcor Puritan Bennett 7200ae demonstrating pressure cycling in pressure support. The pressure spike at the end of inspiration indicates the patient desires to end the breath before the ventilator will allow exhalation. (Reproduced with permission from Branson RD, Campbell RS, Davis K, et al. Altering flow rate during maximum pressure support ventilation (PSV<sub>max</sub>): effects on cardiorespiratory function. *Respir Care* 1990;35:1056–1064.)

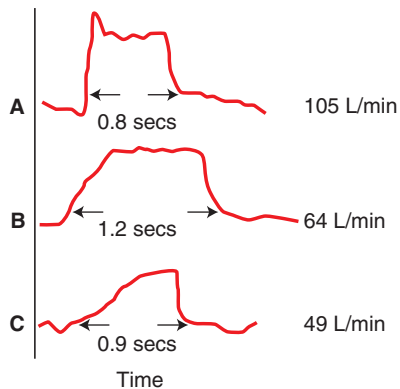
between the mandatory breaths the patient can breath spontaneously.<sup>5</sup> As noted in Fig. 83-8 an assist/control window is open at specific intervals based on the selected mandatory respiration rate.<sup>10</sup> Within each window the patient is able to trigger positive pressure breaths, if the ventilator does not sense a patient's efforts during this time period a controlled positive pressure breath is delivered. Ventilator adjustment is the same as with control

mode except that the sensitivity must also be properly set.

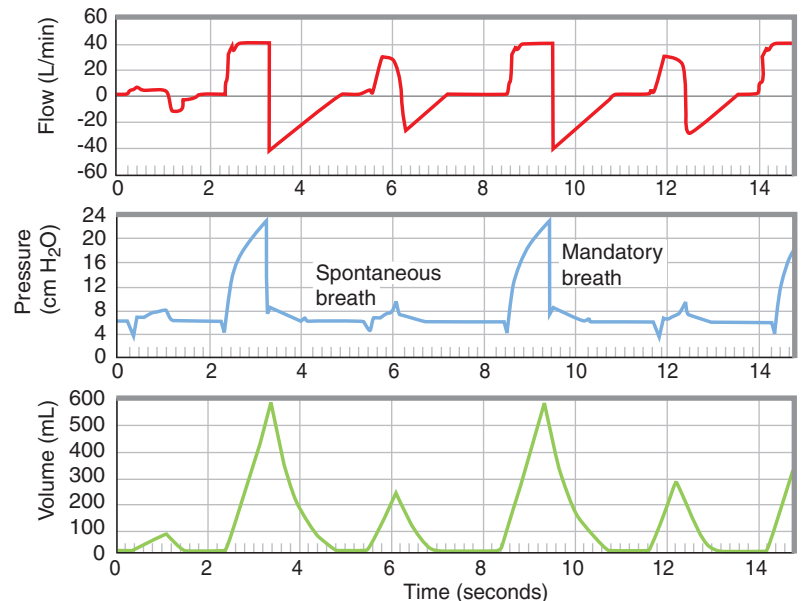
Advocates of SIMV emphasize the benefits of spontaneous breathing between mandatory breaths. As shown in Fig. 83-8, spontaneous breathing can improve ventilation-perfusion (V/Q) matching by producing an improved distribution of ventilation to dependent lung regions.<sup>10</sup> In addition, the negative intrathoracic pressure generated during spontaneous breathing decreases the mean intrathoracic pressure, thereby improving cardiac output. However, the work of breathing dur-

ing SIMV can be excessive. As noted in Fig. 83-9, as the mandatory rate is reduced the work of breathing for both mandatory and spontaneous breaths increases.<sup>11</sup> The surprising reason for this, is that the patient's respiratory center has a difficult time rapidly changing its output based on ventilatory load as the mandatory rate decreases. Essentially, each breath is interpreted as being at the higher load and requiring the higher muscular work output. This is nicely illustrated in Fig. 83-10; note that the electromyogram (EMG) activity of the diaphragm and the sternocleidomastoid muscles, as well as the esophageal pressure changes, are the same for both mandatory and spontaneous breaths.<sup>12</sup> In other words, the patient's effort is the same regardless of breath type, although the efficiency of gas delivery may be better during the mandatory breaths. Unfortunately, this set of circumstances increases the patient's ventilatory drive and increases the level of patient-ventilatory dyssynchrony.

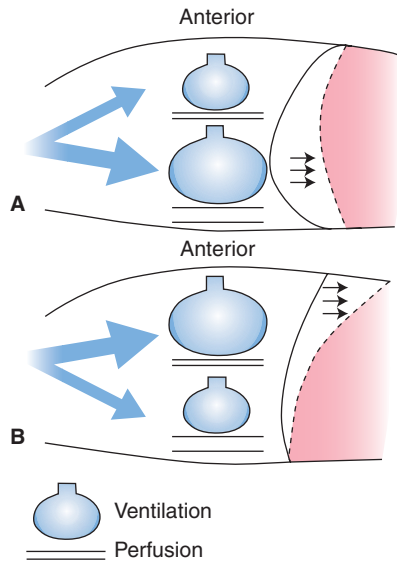
With most modern ventilators, the pressure support mode can be applied during spontaneous patient breaths, however, this negates the benefits of unassisted spontaneous breathing and increases the complexity of weaning patients from ventilatory support. In general, the lower the mandatory rate



**FIGURE 83-6.** Effect of changing rise time in a lung model preferring a midrange rise time. **A.** Flow is in excess of demand, and a pressure spike is seen. **B.** As flow rate is decreased, inspiratory time ( $T_i$ ) lengthens, and the pressure spike is absent—machine output matches patient demand. **C.** When flow rate is further reduced, patient demand exceeds machine flow rate, and  $T_i$  decreases. Peak flow is inadequate to establish the expected pressure waveform. (Reproduced with permission from Branson RD, Campbell RS. Pressure support ventilation, patient-ventilator synchrony, and ventilator algorithms. *Respir Care* 1998; 43:1045.)



**FIGURE 83-7.** Volume-targeted synchronized intermittent mandatory ventilation (SIMV), showing spontaneous unsupported and mandatory (assist/control) breaths. (Reprinted from Hess DR, MacIntyre NR, Mishoe SC, et al. *Respiratory Care: Principles and Practice*. Philadelphia: WB Saunders, 2002:786–791, with permission from Elsevier.)



**FIGURE 83-8.** Effect of spontaneous ventilation and positive-pressure ventilation on gas distribution in a supine subject. During spontaneous ventilation (A) diaphragmatic action distributes most ventilation to the dependent zones of the lungs, where perfusion is greatest. The result is good matching of ventilation to perfusion. During positive-pressure ventilation (B) because the diaphragm is doing little to no contraction, ventilation is primarily distributed to nondependent lung, increasing the level of ventilation to perfusion mismatch. (Reprinted from Wilkens RL, Stoller JK, Scamillon CC. *Egan's Fundamentals of Respiratory Care*. 8th ed. St. Louis, MO: Mosby, 2003:972, with permission from Elsevier.)

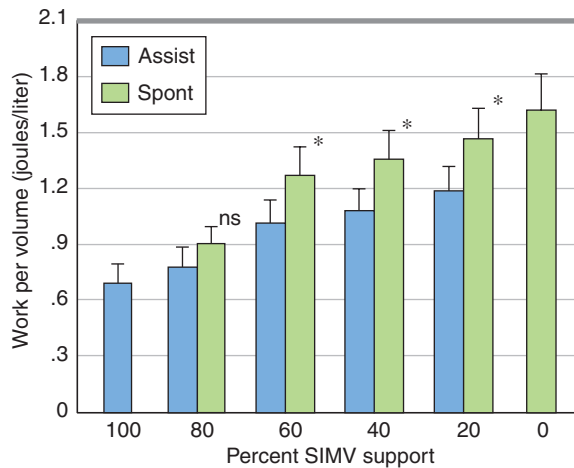
during SIMV the greater the likelihood that the patient's effort will be excessive and dyssynchrony will be present.

## NEW MODES OF VENTILATION

Table 83-4 lists the latest modes of ventilation currently available on the newest generation of mechanical ventilators. These modes are designed to take advantage of the beneficial aspects of both volume and pressure ventilation. As noted in Table 83-4, they are divided into modes that adjust gas delivery during a given breath and those that adjust gas delivery on the subsequent breath. In this latter group, adjustment is based on the ability of current settings to achieve gas delivery targets.

### Pressure-Regulated Volume Control

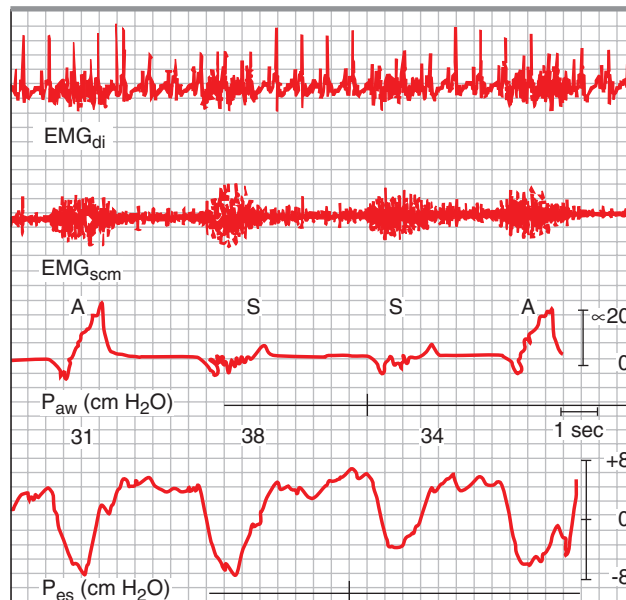
This mode of ventilatory support targets both a maximum airway pressure and a tidal volume and is a variation of the pressure assist/control mode. This same mode is referred to on some



**FIGURE 83-9.** Inspiratory work per unit volume (work per liter [Wp/L]) done by the patient during assisted cycles (*open bars*) and spontaneous cycles (*reverse cross-hatched bars*). Wp/L increased with decreasing synchronized intermittent mandatory ventilation percentage for both types of breath. Wp/L for spontaneous breaths tended to exceed Wp/L for machine-assisted breaths. (Marini JJ, Smith TC, Lamb VJ. External work output and force generation during synchronized intermittent mechanical ventilation. *Am Rev Respir Dis* 1988;138:1169. © American Thoracic Society)

ventilators as autoflow, volume control plus, or possibly another term.<sup>4,5</sup> It accomplishes its goals by varying the pressure applied on the subsequent breath based on the tidal volume achieved on the current breath. All of the ventilators providing this mode of ventilation first deliver a test breath at some low level of pressure and from the volume delivered calculate the

pressure required to deliver the targeted tidal volume. The ventilator then automatically adjusts the pressure in 1 or 2 steps to the pressure level needed to deliver the targeted tidal volume. During every subsequent breath, the tidal volume that is delivered is reassessed, and based on this assessment the pressure on the subsequent breath is adjusted  $\pm 3$  cm H<sub>2</sub>O to ensure that



**FIGURE 83-10.** Electromyograms of the diaphragm (*EMGdi*) and of the sternocleidomastoid muscles (*EMGscm*) in a representative patient, showing similar intensity and the duration of electrical activity in successive assisted (A) and spontaneous (S) breaths during synchronized intermittent mandatory ventilation. Also, note that esophageal (*Pes*) pressure changes are equal (equal effort) during A and S breaths. *Paw*, Airway pressure. (Reproduced with permission from Imsand C, Feihl F, Perret C, et al. Regulation of inspiratory neuromuscular output during synchronized intermittent mechanical ventilation. *Anesthesiology* 1994;80:13-22.)

the targeted volume is delivered on the next breath.<sup>4,5</sup> Pressure during pressure-regulated volume control (PRVC) can be increased to a maximum level that is selected and can be decreased with some ventilators all the way to the CPAP/PEEP level, thereby allowing unassisted spontaneous breathing. Herein lies our major concern with PRVC: If a patient has a strong ventilatory drive and the additional stimulus of, for example, hypoxemia, fever, or sepsis, the level of ventilatory support could decrease inappropriately to either a very low level or to no support. As a result, be cautious when using this mode with patients who have a strong ventilatory drive.<sup>13</sup> Marked improvement in the operation of this mode could be made by adding a minimum pressure limit. That is, setting a low pressure limit.<sup>4</sup> As a result, this mode is most useful in those patients who are receiving control mode ventilation or for those patients who have limited ventilatory demand. To use PRVC, first set all variables used during pressure assist/control, then add the target tidal volume and maximum pressure limit.

### Volume Support

The volume support mode operates similar to PRVC, but is based on a pressure-support mode and not a pressure assist/control format.<sup>4,5</sup> Ventilator software must assess the pressure needed to deliver the tidal volume and provide breath-to-breath pressure adjustment to ensure the targeted tidal volume. The same safety concern regarding a patient with a strong ventilatory demand exists with volume support (as with PRVC). The adjustments made to the ventilator during setup are the same as with pressure support with the addition of setting the target volume and maximum airway pressure.

Two randomized controlled studies of PRVC and/or volume support have been conducted—one in neonates<sup>14</sup> and the other in pediatric patients.<sup>15</sup> In the study of newborns,<sup>14</sup> PRVC was compared to intermittent mandatory ventilation (without synchronization of the mandatory breath). In this study, neonates who were studied weaned faster with PRVC. In the second,<sup>15</sup> volume support was compared to pressure support with and without a protocol for weaning the children from mechanical ventilation. No difference in the rate of weaning was

observed regardless of the mode of ventilation. As a result, there is little enthusiasm for the use of either of these new modes of ventilation.

### Adaptive Support Ventilation

This is a very unique new mode of ventilatory support. It attempts to adjust ventilator settings to ensure that an ideal ventilatory pattern is achieved,<sup>16</sup> with *ideal* being defined as the pattern requiring the least patient and ventilator work based on the patient's measured mechanical lung characteristics and breathing effort. The goal of adaptive-support ventilation (ASV) is to provide a preset level of minute ventilation while minimizing the total work of breathing expended by both the ventilator and the patient. It can be applied to both patients who require controlled ventilation and to those who are actively breathing.

During set up the clinician must indicate the patient's ideal body weight (males: predicted body weight [PBW] (kg) = 50 + 2.3 [height (inches) (60)]; females: PBW (kg) = 45.5 + 2.3 [height (inches) (60)]<sup>17</sup> and the percentage of minimal minute volume (% min MV) to be delivered. The % min MV can be adjusted between 25% and 350%.<sup>16</sup> From the ideal body weight (IBW) and % min MV the maximum rate is calculated as:

$$22 \times \% \text{ min MV} / 100 \text{ if IBW} > 15 \text{ kg}$$

or

$$45 \times \% \text{ min MV} / 100 \text{ if IBW} < 15 \text{ kg}$$

whereas the maximum tidal volume delivered is the targeted MV/5.<sup>16</sup> With this information the ventilator determines the optimal breathing pattern that will minimize the work of breathing; that is, a ventilatory pattern that results in minimum work of breathing based on the lung and chest wall mechanics of the patient.

With the initial application of ASV the ventilator provides a series of 5 pressure-limited test breaths at a rate of about 10 breaths/min with a maximum pressure of 15 cm H<sub>2</sub>O. During these breaths, the ventilator measures dynamic compliance, the respiratory time constant, tidal volume, and the patient's respiratory rate.<sup>16</sup> These measurements are used to determine the initial targets for breathing rate and tidal volume. As ventilation con-

tinues the ventilator software recalculates the above variables from each breath and determines the new rate and tidal volume targets. Targets are based on the original work by Otis for estimating the patients' minimal ventilatory work.<sup>18</sup>

This mode of ventilation is designed to ensure an ideal ventilatory pattern is maintained and can be used in all phases of ventilatory support. It continually adjusts mechanical ventilation characteristics as the patient's status changes because it monitors the patient's lung mechanics on a breath-to-breath basis.

### Automatic Tube Compensation

This mode of ventilation has been referred to as electronic extubation. Automatic tube compensation (ATC) is designed to provide sufficient mechanical ventilatory support during inspiration and sufficient decompression of the ventilatory circuit during expiration to maintain the tracheal pressure equal to the set PEEP level. The ventilator software accomplishes this by having the resistance properties of various endotracheal and tracheostomy tube sizes programmed into its memory and continually measuring gas flow. From this data, the pressure needed to overcome the resistance (resistance = change in pressure divided by flow) of the endotracheal tube is continually calculated and applied.<sup>19</sup>

Upon activation of the ATC mode, the clinician must indicate the type and size of artificial airway and the desired percentage of automatic tube compensation (20–100% on most ventilators).<sup>4,5</sup> In addition, some ventilators only apply the ATC correction during inspiration, others during both inspiration and expiration. The precise clinical indications for ATC are still unclear. Because this mode responds only to the patient's demand, if demand is low, ventilatory support is low; that is, if the patient generates a low inspiratory effort then little pressure is applied, whereas if the patient generates great effort, the applied pressure is greater.<sup>20</sup> ATC, like proportional-assist ventilation, does not force a ventilatory pattern, but is only designed to unload the flow resistive properties of the artificial airway. Its use is recommended for patients ready to wean from the ventilator. If the ATC pressure level is stable and

remains at a low pressure (5–7 cm H<sub>2</sub>O), then extubation is indicated.

The use of expiratory ATC does raise some concerns when used in patient's with airways obstruction. The decompression of the airway during early exhalation may precipitate greater airways collapse and obstruction. As with many of these newer modes of ventilation, additional research is required before clinical indications and contraindications can be clearly defined.

### Proportional-Assist Ventilation

This mode of ventilation is similar to ATC but the software weighs both the mechanics of the total respiratory system plus the resistive properties of the artificial airway; that is, the ventilator delivers a pressure assist in proportion to the patient's desired tidal volume (volume assist) and to the patient's instantaneous inspired flow (flow assist).<sup>21</sup> The level of these two aspects of ventilatory assistance are automatically adjusted to meet changes in the patient's ongoing ventilatory demand. This algorithm is based on the law of motion as it applies to the respiratory system:

$$P_{\text{mus}} + P_{\text{appl}} = (\text{volume} \times E) + (\text{flow} \times R)$$

where  $P_{\text{mus}}$  is pressure generated by the respiratory muscles,<sup>21</sup>  $P_{\text{appl}}$  is pressure applied by the ventilator, and  $E$  and  $R$  are elastic and resistance properties of the respiratory system. Assuming that  $E$  and  $R$  are linear during inspiration, the instantaneous flow and volume to be delivered are proportional to the resistive and elastic work of breathing respectively. The ventilator measures the instantaneous flow and volume, whereas the clinician must measure and set values for  $E$  and  $R$ . Ideally, the ventilator should be able to measure on a breath-by-breath basis  $E$  and  $R$ , and software should adjust gas delivery accordingly by estimating  $P_{\text{mus}}$  and assisting  $P_{\text{mus}}$  in a proportional manner.<sup>22</sup> Thus the patient is the determinant of the ventilatory pattern. Patients are given the freedom to select a ventilatory pattern that is rapid and shallow or slow and deep.<sup>22</sup> The ventilator does not force any control variable except the unloading of  $E$  and  $R$  in a proportional manner.

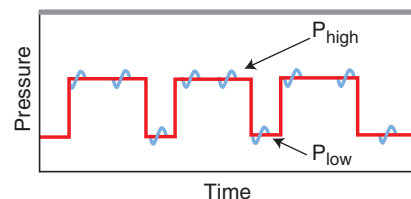
Proportional-assist ventilation (PAV) is only useful in patients with a stable

ventilatory drive who choose an acceptable ventilatory pattern. Of concern is the inability of most mechanical ventilators to reassess  $E$  and  $R$  on an ongoing basis. As a result, the level of unloading may be inappropriate if respiratory system mechanics are dynamically changing. There are a number of clinical reports that compare the effects of PAV with those of pressure support, and PAV functions equivalently.<sup>23,24</sup> In addition, the PAV mode has been shown to be useful during noninvasive ventilation.<sup>25,26</sup>

### Airway Pressure Release Ventilation

This mode of ventilation is a combination of pressure-targeted SIMV and inverse-ratio pressure-control ventilation.<sup>27</sup> As illustrated in Fig. 83–11, airway pressure release ventilation (APRV) applies two levels of CPAP and allows spontaneous unassisted breathing at each CPAP level. There are two approaches to setting APRV based upon the belief that spontaneous breathing should only occur at the high CPAP level,<sup>28</sup> or at both CPAP levels.<sup>29</sup> If the clinician desires spontaneous breaths only at the high CPAP level, the time spent at the low CPAP level is kept brief to prevent complete exhalation, hence an inverse ratio between high and low CPAP levels. In this setting, the high CPAP level is set to maintain oxygenation and the lower level assists ventilation by periodically decreasing the lung volume.

The alternate approach is to set the low CPAP level to maintain oxygenation (as if setting a PEEP level) and the high CPAP level to provide ventilatory assistance, as in SIMV.<sup>29</sup> In this latter approach, the time spent at low CPAP levels is sufficient to allow complete exhalation and spontaneous breathing at the lower CPAP levels. Proponents of APRV cite the salutary benefits of spontaneous unsupported breathing to improve ventilation-perfusion matching, increase cardiac output and reduce the need for sedation.<sup>27–29</sup> However, as noted in Fig. 83–12, the effort associated with spontaneous breathing under these conditions can result in very high esophageal pressure swings and a high work of breathing for the patient. Accounting in part for the greater cardiac output.<sup>30</sup> In addition, dyssynchrony is common with APRV. Dyssynchrony occurs at the mandatory transition from high-to-low or low-to-high CPAP



**FIGURE 83–11.** Airway pressure release ventilation (APRV).  $P_{\text{high}}$ , high continuous positive airway pressure (CPAP) level;  $P_{\text{low}}$ , low CPAP level. Note spontaneous breaths at both levels of CPAP. (Reprinted from Kacmarek RM, Dimas S, Mack C. *Essentials of Respiratory Care*. 4th ed. St. Louis, MO: Elsevier, 2005: 690–714, with permission from Elsevier.)

levels. If the patient is exhaling when the ventilator increases airway pressure, or inhaling when the ventilator decreases airway pressure, dyssynchrony results. Although this mode of ventilation is most commonly used in the management of acute lung injury or the acute respiratory distress syndrome, it has not been shown to be more beneficial than the assist/control mode.<sup>29</sup>

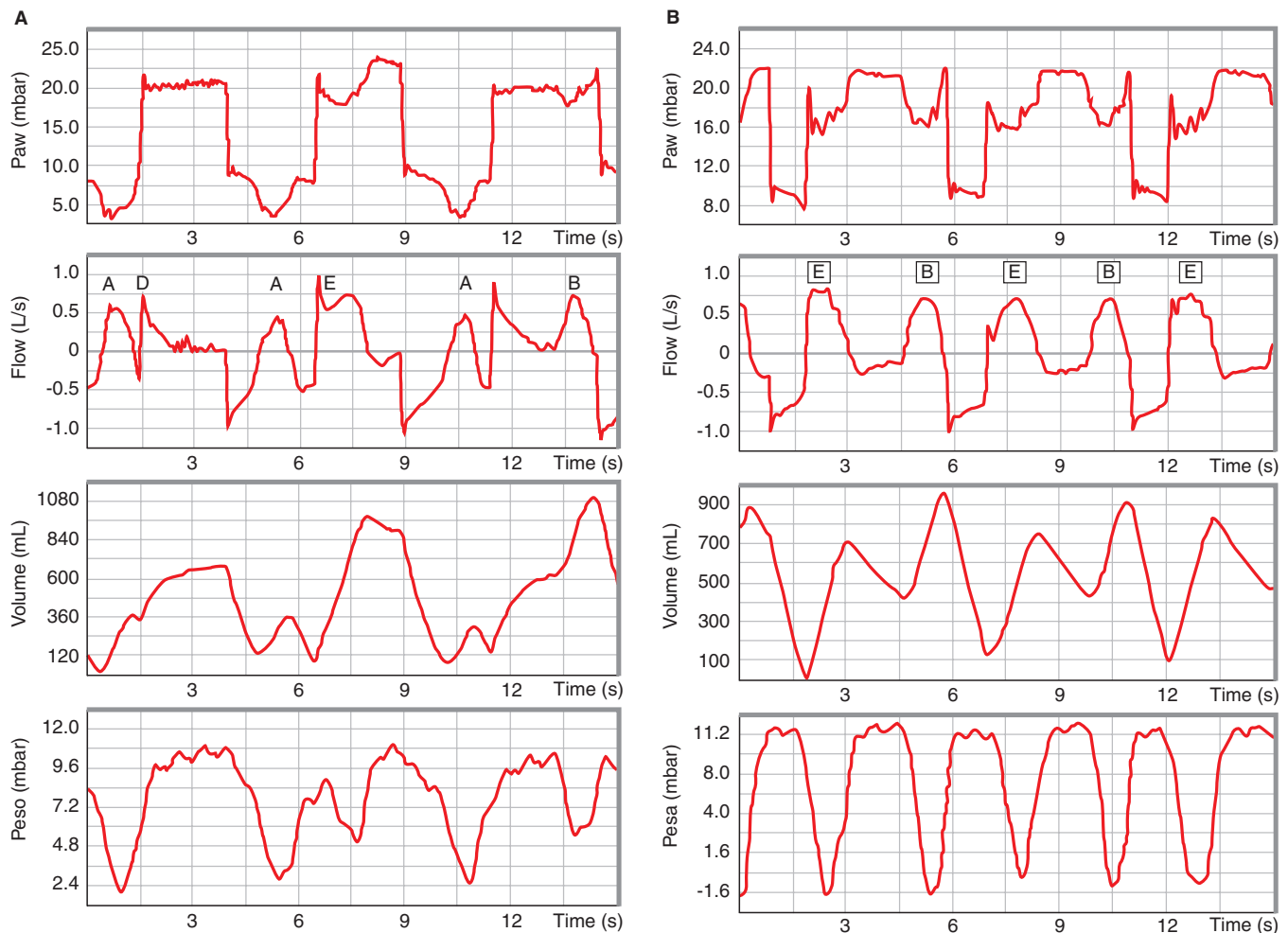
### Bilevel Pressure Ventilation

This is a modification of APRV. As noted in Fig. 83–13, pressure support can be added to spontaneous breaths at either the high or low CPAP level or both.<sup>4</sup> This reduces the patient's effort and esophageal pressure swings but it also increases the mean intrathoracic pressure, negating somewhat the increased cardiac output and beneficial augmentation of ventilation to perfusion matching. In addition, the transition from high-to-low and low-to-high CPAP levels is coordinated with the patient's muscular effort (as in SIMV), markedly decreasing dyssynchrony. Like APRV, the bilevel ventilation mode is primarily employed in the management of acute lung injury and the acute respiratory distress syndrome.

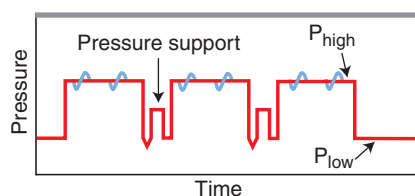
### VENTILATOR SETTINGS AND PATIENT-VENTILATOR SYNCHRONY

Patient-ventilator synchrony is a critical issue for every patient triggering the ventilator for a mechanically supported inspiration. A lack of synchrony increases ventilatory effort, respiratory rate, and the patient's work of breathing as the ventilator is not providing flow to match the patient's inspiratory demand. Pressure-targeted modes of ventilation are generally better than





**FIGURE 83-12.** Airway pressure release ventilation actual patient tracings. A synopsis of airway pressure ( $P_{aw}$ ), flow, volume, and esophageal pressure ( $P_{es}$ ) is shown. **A.** Time intervals of the upper ( $P_{high}$ ) and lower airway pressure ( $P_{low}$ ) set to 2.5 seconds each. **B.** Time intervals of  $P_{high} = 4.0$  seconds and  $P_{low} = 1.0$  second in the same patient. Note that spontaneous breathing occurs on the upper and lower CPAP levels in A and that tidal volumes varied considerably, depending on the pressure level from which an inspiration started. When  $P_{low}$  was decreased to 1.0 second, as shown in B, spontaneous breaths occurred almost exclusively during  $P_{high}$ . This results in a more regular breathing pattern as compared with A. Note, however, the large esophageal pressure swings (10–12 mbar or cm  $H_2O$ ) per breath, indicating high patient effort on each spontaneous breath. Breaths are classified as type A, spontaneous breath at the lower CPAP level; type B, spontaneous breath on the upper CPAP level; type C, the pressure increase from the lower to the upper CPAP level triggered by an inspiratory effort of the patient; type D, mechanical breath; and type E, combined mechanical and spontaneous inspiration without a triggered pressure increase from  $P_{low}$  to  $P_{high}$ . (Newman P, Golisch J, Strohmeyer A, et al. Influence of different release times on spontaneous breathing pattern during airway pressure release ventilation. *Intensive Care Med* 2002;28:1742, with kind permission of Springer Science and Business Media.)



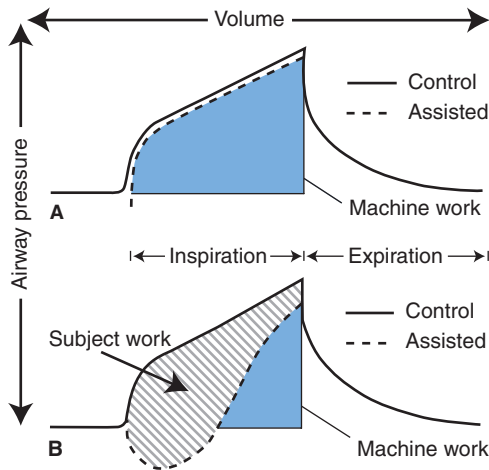
**FIGURE 83-13.** Bilevel ventilation upper airway pressure ( $P_{high}$ ). High continuous positive airway pressure (CPAP) level and lower airway pressure ( $P_{low}$ ) low CPAP level. Note spontaneous breaths at both levels of CPAP, but in this case pressure support is applied to the breaths at the  $P_{low}$ . Pressure support could also be applied to  $P_{high}$ . (Reprinted from Kacmarek RM, Dimas S, Mack C. *Essentials of Respiratory Care*. 4th ed. St. Louis, MO: Elsevier, 2005: 690–714, with permission from Elsevier.)

volume-targeted modes at reducing the likelihood of dyssynchrony, as pressure ventilation allows the ventilator to deliver a variable flow with each breath based on the patient's inspiratory demand.<sup>31</sup> In addition, most ventilators now allow adjusting the slope of the increase of flow delivery (rise time) to ensure gas delivery is matched to patient's inspiratory flow demand.<sup>5,32</sup> Patient-ventilator synchrony is also affected by the inspiratory time. The ventilator's inspiratory time and the patient's inspiratory time should be equal. Trigger sensitivity should always be set to be as sensitive as possible without causing spontaneous autotriggering. In general, flow triggering is to

be recommended over pressure triggering.<sup>33</sup> A final factor affecting patient-ventilator synchrony is auto-PEEP,<sup>34</sup> which normally is only a problem in patients with airways obstruction, although it is a potential concern in all patients. If the patient's inspiratory efforts fail to trigger the ventilator, the problem is usually auto-PEEP.<sup>35</sup>

### Peak Flow and Flow Waveform

If a patient is spontaneously triggering the ventilator, peak flow delivery during volume ventilation should match the patient's inspiratory flow demand.<sup>36</sup> Most adult patients with moderate to strong ventilatory demands require a peak flow of  $\geq 80$  L/min. As



**FIGURE 83-14.** A. Depiction of an actual pressure-time curve (*dotted line*) during volume control ventilation superimposed on the ideal curve reflecting total work of breathing (*solid line*). B. Note the scooped-out actual pressure waveform when patient demand increases. The *hatched area* reflects the work performed by the patient during assisted volume-targeted ventilation. (Marini JJ, Rodrigues RM, Lamb V. The inspiratory workload of patient-initiated mechanical ventilation. *Am Rev Respir Dis* 1986;134:902-909. © American Thoracic Society.)

clearly demonstrated by Marini et al. (Fig. 83-14), if the peak flow does not meet the patient's inspiratory demand the work of breathing performed by the patient increases. The efficiency of the work may be greater than during spontaneous breathing but the overall patient work may be similar.<sup>36</sup>

It is important to remember that if the patient is triggering the positive-pressure breaths, the work of breathing is shared between the patient and the ventilator. It is for this reason that patients originally receiving assisted ventilation demonstrate altered gas-delivery patterns after they are sedated to apnea. With the transition to controlled ventilation, the peak airway and plateau pressures usually increase during volume ventilation, and tidal volumes decrease in the pressure ventilation mode.<sup>37</sup> Because the patient is no longer performing a portion of the work of breathing, the work performed by the ventilator must increase.

Most ventilators during volume ventilation mode can deliver gas flow in a decelerating or square wave flow pattern. If the patient is triggering inspiration, we recommend a decelerating flow pattern, especially when a small tidal volume ( $V_T$ ) is being delivered.<sup>4,37</sup> A decelerating flow pattern allows a high peak flow to be delivered, but also ensures that the inspiratory time can be adequately set.

In patients who are sedated and who are not triggering the ventilator, the

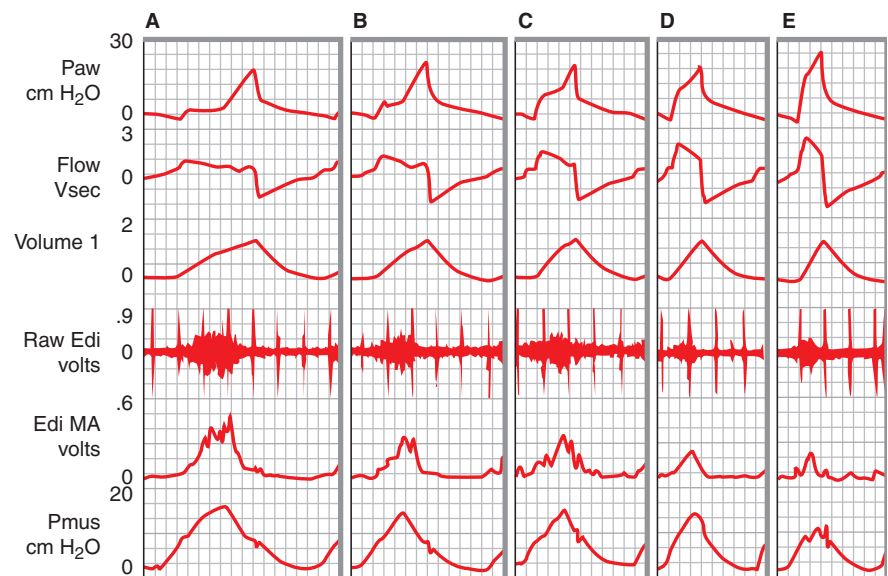
choice of flow waveform is unimportant, and the setting of peak flow is dependent on the predetermined inspiratory time and tidal volume.

### Inspiratory Time

In patients self-triggering every breath, the set inspiratory time should equal the patient's neuroinspiratory time.<sup>38</sup> As illustrated in Fig. 83-15, when the inspiratory time is decreased to equal

the patient's desired inspiratory time and peak flow is increased to match the patient's demand, then the patient's work of breathing and effort correspondingly decrease. It is rare that a patient with a moderate to high ventilatory demand desires an inspiratory time less than 1 second.<sup>38</sup> In fact, many adults with moderate or high ventilatory demands desire an inspiratory time of between 0.6 and 0.9 seconds.<sup>37</sup> Carefully matching the patient's inspiratory time with the ventilator's inspiratory time generally markedly improves patient-ventilator synchrony.

In patients who are receiving controlled mechanical ventilation, inspiratory time is set based on the tidal volume and the clinician's perceived optimal time of inspiration. In most settings, an inspiratory time of about 1.0 second is ideal. Some clinicians prefer to lengthen the inspiratory time in ARDS/acute lung injury (ALI), thereby inverting the usual inspiratory-to-expiratory (I:E) time ratio; however, there are no data to indicate that longer inspiratory times result in better oxygenation or better outcomes in these syndromes than an appropriately set PEEP level.<sup>39,40</sup> Prolongation of the inspiratory time can have a minor positive effect of increasing  $\text{CO}_2$  elimination by allowing time for inspired gas



**FIGURE 83-15.** Representative example of the effect of alternations in peak flow and inspiratory time on airway pressure ( $P_{aw}$ ), the raw diaphragmatic electromyography (EMG) signal ( $R_{aw}$  Edi), the diaphragmatic EMG signal after removal of the electrocardiographic interference and rectification (Edi MA), and the calculated pressure output of the inspiratory muscles ( $P_{mus}$ ). Note the reduction in EMG activity and muscle output as flow increases. (Fernandez R, Mendez M, Younes M. Effect of ventilatory flow rates on respiratory timing in normal humans. *Am J Respir Crit Care Med* 1999;159:710-719. © American Thoracic Society.)

to transfer from fast time constant lung units to adjacent slower time constant units (“pendelluft”). In patients with severe asthma, the inspiratory time may need to be increased to 1.2–1.5 seconds to ensure ventilation passes beyond markedly obstructed airways.<sup>37</sup> Note that in asthma the airways resistance is not only increased during exhalation but also during inspiration.

### Tidal Volume

Over the past 10 years, emphasis has been placed on the relationship between elevated tidal volumes and ventilator-induced lung injury (VILI; see Ventilator-Induced Lung Injury below).<sup>41</sup> Recent epidemiologic studies indicate that the most common tidal volume used to manage patients in acute respiratory failure is about 10 mL/kg PBW.<sup>42</sup> However, it is also important to emphasize that normal healthy relaxed mammals breathe at a tidal volume of about 6–7 mL/kg of PBW.<sup>43</sup> There is no evidence indicating that tidal volumes >10 mL/kg PBW are useful in the management of critically ill patients. In fact, evidence from a recent retrospective review indicates that the development of ALI is linked to large tidal volume ventilation (>10 mL/kg PBW).<sup>44,52</sup> As a general rule, all critically ill patients should be ventilated with  $\leq 10$  mL/kg PBW of  $V_T$  regardless of the cause of their acute ventilatory failure. Patients with ALI/ARDS ideally should be ventilated with a  $V_T$  4–8 mL/kg of PBW.<sup>45</sup>

### Plateau Pressure

The plateau pressure (end-inspiratory equilibration pressure) is a function of the mean peak alveolar pressure and is a reflection of the transpulmonary pressure. Similar to  $V_T$ , it is unknown if there is a specific plateau pressure that is safe. Because of the high shear forces associated with the ventilation of heterogeneously diseased lung, mechanical lung injury is theoretically possible, even with transpulmonary pressures below 30 cm H<sub>2</sub>O. However, most clinicians would agree that a plateau pressure less than 25 cm H<sub>2</sub>O is unlikely to produce an injurious level of alveolar overdistension, and that a plateau pressure in this range and a tidal volume  $\leq 10$  mL/kg PBW will not produce VILI regardless of the cause of respiratory failure. However, as plateau pressure increases, the delivered tidal volume should be decreased, re-

gardless of the cause of respiratory failure.  $V_T$  should be kept  $\leq 8$  mL/kg PBW if the plateau pressure is 25–30 cm H<sub>2</sub>O and  $V_T$  should be  $\leq 6$  mL/kg PBW if plateau pressures are >30 cm H<sub>2</sub>O. Ideally, all patients should be managed with a plateau pressure of <30 cm H<sub>2</sub>O unless there is a marked decrease of their chest wall compliance (e.g., burns, abdominal distension). If the chest wall compliance is decreased, the transpulmonary pressure is decreased and the risk of overdistension is reduced. In patients with stiff noncompliant chest walls and abdomens because of sepsis, abdominal distension, fluid resuscitation, and the like, a plateau pressure >30 cm H<sub>2</sub>O may be required and would not be associated with an increased risk of VILI.<sup>46</sup> However, in all patients the plateau pressure should ideally be maintained below 40 cm H<sub>2</sub>O. Alternatively, some have advocated the use of an esophageal balloon to estimate pleural pressure and guide mechanical ventilation strategies to limit transpulmonary pressure.

### Auto-PEEP

Auto-PEEP, also known as *occult PEEP*, is defined as an alveolar pressure above the airway opening pressure. Auto-PEEP can be caused by flow limitation, dynamic hyperinflation, a high minute ventilation, expiratory muscle activity, and/or a high intraabdominal pressure (Fig. 83–16).<sup>34,47</sup> *Occult auto-PEEP* is a term that is used to describe those lung units with trapped gas that do not communicate with the airway following a prolonged end expiratory pause.<sup>48</sup> Occult auto-PEEP is likely a function of airway closure or occlusion secondary to mucus plugging, and can be difficult to clinically diagnose. The performance of an end-expiratory occlusion maneuver can be helpful in estimating auto PEEP levels if the patient is not making expiratory muscle efforts (passive-controlled ventilation). However, the absence of auto-PEEP by this technique should not be completely reassuring, because occult auto-PEEP may still be present. In severe asthma, it is frequently better to monitor the level of plateau pressure, as the plateau pressure will increase or decrease as total auto-PEEP increases or decreases.<sup>48</sup>

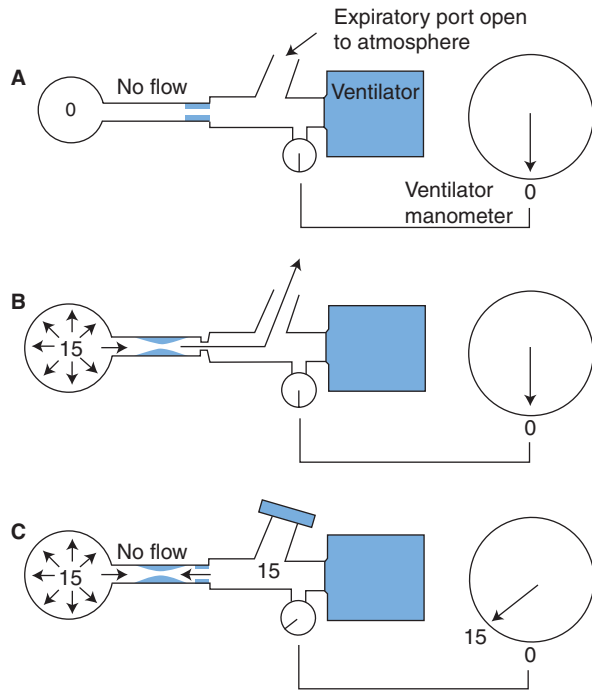
Auto-PEEP is a major cause of dyssynchrony. As noted in Fig. 83–17, when auto-PEEP is present, patients

frequently cannot generate a sufficient inspiratory effort to decompress the auto-PEEP and trigger a breath.<sup>35,49</sup> Whenever, the patient's respiratory rate exceeds the ventilator's response rate, this problem is almost always caused by auto-PEEP.

When auto-PEEP is caused by dynamic airflow limitation of exhalation volume as in chronic obstructive pulmonary disease, the application of applied PEEP reduces the patient's effort to trigger the ventilator,<sup>35</sup> that is, applied PEEP can be titrated up to approximately 80% of the measured auto-PEEP without increasing the overall level of air trapping. Applying PEEP in the presence of auto-PEEP caused by dynamic airflow limitation increases central airway pressure without increasing auto-PEEP, so that the pressure change needed to trigger the ventilator is reduced, thereby increasing patient-ventilator synchrony; that is, decreasing the pressure difference across the obstruction. From a practical perspective because auto-PEEP is difficult to measure in the spontaneously breathing patient, the applied PEEP is increased in 1–2 cm H<sub>2</sub>O steps until every inspiratory effort made by the patient triggers the ventilator. In some patients, this may require more than 10 cm H<sub>2</sub>O of applied PEEP. During controlled ventilation, a controversy exists over the benefit of applying PEEP to balance the auto-PEEP, because no spontaneous ventilatory efforts are present.

### GAS EXCHANGE TARGETS

Target blood gas tensions during mechanical ventilation are theoretically the normal range for the individual patient. This is usually a PaCO<sub>2</sub> of about 35–45 mm Hg for all patients except those with chronic CO<sub>2</sub> retention. In patients with chronically elevated CO<sub>2</sub> levels, the PaCO<sub>2</sub> should be maintained at the patient's normal level up to 90 mm Hg.<sup>1</sup> If the arterial pH and PCO<sub>2</sub> are reset in these patients to “normal” values, the patients may become impossible to wean from ventilatory support, because during spontaneous unassisted breathing they will maintain CO<sub>2</sub> levels at their baseline, which now results in an acute acidosis. In patients with ARDS, permissive hypercapnia may be unavoidable, as the effect of increasing the



**FIGURE 83-16.** Relationship between alveolar, central airway, and ventilator circuit pressure under (A) normal conditions and (B and C) in the presence of severe dynamic airway obstruction, (B) with expiratory port open, and (C) with expiratory port occluded. Autopositive end-expiratory pressure (PEEP) level is identified by creating an end-expiratory hold, allowing alveolar, central airway, and ventilator circuit pressure to equilibrate. Note that during equilibration, auto-PEEP level can be read on the system manometer. (Pepe PE, Marini JJ. Occult positive end-expiratory pressure in mechanically ventilated patients with airflow obstruction: the auto-PEEP effect. *Am Rev Respir Dis* 1982;126:166–170. © American Thoracic Society.)

level of ventilation to reduce  $\text{CO}_2$  levels may produce lung injury.

One factor limiting an increase in  $\text{PaCO}_2$  with a permissive hypercapnic ventilatory strategy is the acidosis induced by the elevated  $\text{CO}_2$ .<sup>50</sup> Most

healthy young adults can tolerate a pH as low as 7.20 without adverse effect.<sup>51</sup> In fact, in acute lung injury or asthma, the increased cardiac output induced by the acidosis may be beneficial. Some clinicians have proposed that

the acidosis associated with permissive hypercapnia protects the cell from hypoxemic injury.<sup>52</sup> In older or cardiovascularly unstable patients, the level of acceptable acidosis must be individually gauged based on the response of the patient's cardiovascular system. In all patients the more gradual the permissive hypercapnia is allowed to develop, the greater the likelihood it will be well tolerated.

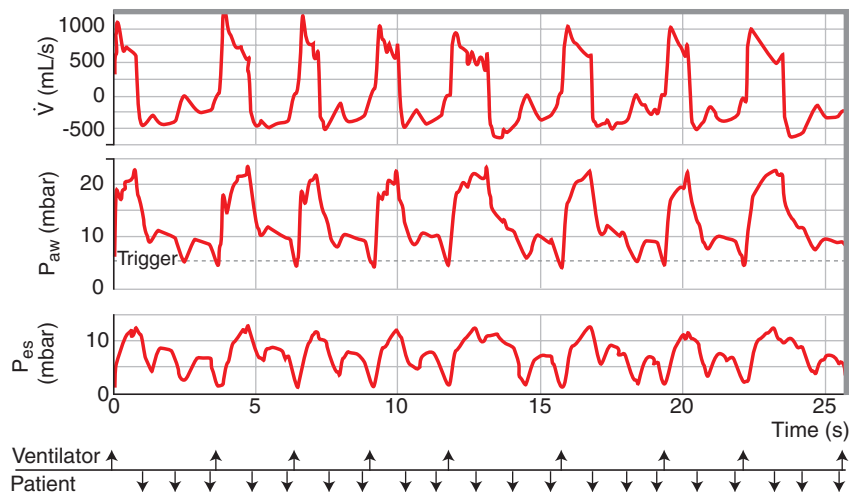
Tissue oxygenation is dependent on appropriate blood levels of oxygen and cardiac output. Assuming a normal cardiac output,  $\text{PaO}_2$  values in critically ill patients need only to be maintained  $>60$  mm Hg, whereas for some patients, a  $\text{PO}_2$  of  $>50$  mm Hg may be acceptable.<sup>1</sup> There is no value in the vast majority of patients to maintaining a  $\text{PaO}_2$  of  $\geq 100$  mm Hg.

## VENTILATOR-INDUCED LUNG INJURY

Although the application of mechanical ventilation can be lifesaving, it has become increasingly clear that the mechanical ventilator can induce lung injury. Laboratory data have defined two primary settings in which the mechanical ventilator can induce lung injury, by producing overdistension of the lung at end inspiration and by collapse and reexpansion of unstable lung regions during ventilation.

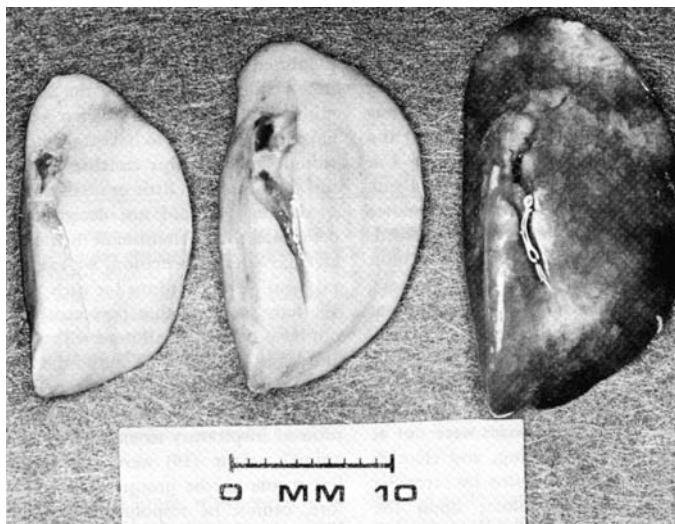
### Overdistension

Figure 83-18 depicts the impact of a large tidal volume without PEEP on a rat lung as compared to a rat lung ventilated with a small tidal volume and one with 10 cm  $\text{H}_2\text{O}$  PEEP and a large tidal volume.<sup>53</sup> One hour of ventilation with a large tidal volume at zero PEEP caused marked hemorrhagic edema of the lung. This type of injury was termed *volutrauma* by Dreyfuss and Saumon because it is believed that the injury is primarily caused by an excessive tidal volume.<sup>54</sup> However, as described above, an excessive tidal volume is accompanied by an excessive transpulmonary pressure, making the distinctions between pressure and volume injury somewhat semantic. VILI is defined as an increase in the permeability of the alveolar capillary membrane, the development of pulmonary edema, the accumulation of neutrophils and protein within the



**FIGURE 83-17.** Gas flow, airway pressure, and esophageal pressure during pressure-supported ventilation with marked patient–ventilator dyssynchrony. Pressure spikes at the onset and termination of the breath indicate dyssynchrony, as well as the difference between patient inspiratory efforts (arrows) and the ventilator response (arrows). (Reproduced with permission from Fabry BE, Guttman J, Eberhard LE, et al. An analysis of dyssynchrony between the spontaneously breathing patient and ventilator during inspiratory pressure support. *Chest* 1995;107:1387–1384.)





**FIGURE 83-18.** Comparison of lungs excised from rats ventilated with peak pressure of 14 cm H<sub>2</sub>O, zero positive end-expiratory pressure (PEEP); peak pressure 45 cm H<sub>2</sub>O, 10 cm H<sub>2</sub>O PEEP; and peak pressure 45 cm H<sub>2</sub>O, zero PEEP (left to right). The perivascular groove is distended with edema in the lungs from rats ventilated with peak pressures of 45 cm H<sub>2</sub>O, 10 cm H<sub>2</sub>O PEEP. The lung ventilated at 45 cm H<sub>2</sub>O peak pressure zero PEEP is grossly hemorrhaged. (Webb HH, Tierney D. Experimental pulmonary edema due to intermittent positive pressure ventilation, with high inflation pressure protection by positive end expiratory pressure. *Am Rev Respir Dis* 1974;110: 556-565. © American Thoracic Society.)

lung parenchyma and airway, the disruption of surfactant production, and a decreased lung compliance.<sup>54</sup> VILI is indistinguishable from human ARDS and can be produced in rats within minutes by large tidal volume ventilation.<sup>55</sup> Indeed, VILI caused by inflation with large tidal volumes has been demonstrated in many small- and large-animal models. Parker et al.,<sup>56</sup> in isolated perfused dog lungs, demonstrated that ventilatory pressures greater than 30 cm H<sub>2</sub>O peak alveolar pressure resulted in VILI. Hernandez et al.,<sup>57</sup> Egan,<sup>58</sup> and Kolobow et al.<sup>59</sup> also demonstrated similar injuries in large-animal models. Ventilation of many species with large tidal volumes results in the development of VILI and an increase in the severity of preexisting lung injury.

The single factor most responsible for the development of VILI appears to be the transpulmonary pressure (pressure inside minus pressure outside the lung or alveolar minus pleural pressure).<sup>55</sup> In a now classic experiment, Dreyfuss et al.<sup>55</sup> demonstrated that rats with strapped chest walls were protected from VILI as compared with those ventilated with the same peak pressure but without chest wall binding. In fact the lung injury was similar regardless of the use of positive or negative pressure ventilation provided high transpulmonary pressures were established. As a

result, we reason higher ventilating pressures can be used in the presence of a decreased chest wall compliance without the development of VILI, as the reduced chest wall compliance decreases transpulmonary pressure at peak airway pressure and results in a lower delivered tidal volume.

### Recruitment/Derecruitment Injury: “Atelectrauma”

As noted in Fig. 83-18, the application of 10 cm H<sub>2</sub>O PEEP in spite of a peak airway pressure of 45 cm H<sub>2</sub>O decreased the level of VILI as compared with similar animals ventilated with the same peak pressure but at zero PEEP.<sup>61</sup> Only mild interstitial edema developed in animals ventilated at 10 cm H<sub>2</sub>O PEEP. Similar findings have been reported by Corbridge et al. in dogs with hydrochloric acid-induced lung injury.<sup>60</sup> Dogs ventilated with 12.5 cm H<sub>2</sub>O PEEP and a V<sub>T</sub> of 15 mL/kg after lung injury had far less pulmonary edema at autopsy than dogs ventilated with 3.2 cm H<sub>2</sub>O PEEP and 30 mL/kg tidal volumes, in spite of the fact that peak alveolar pressure (33 cm H<sub>2</sub>O) was the same for both groups during the 5 hours of ventilation.

### Biotrauma

Slutsky et al.<sup>61</sup> has referred to the activation of pulmonary and systemic inflammatory mediators by an inappro-

priate ventilatory pattern as *biotrauma*. Increasing data from both animal and clinical studies indicate that a traumatic ventilatory strategy can augment the level of the pulmonary and systemic inflammatory response. Tremblay et al.,<sup>62</sup> in an ex vivo healthy and injured rat lung model, demonstrated that both pro- and antiinflammatory mediators are activated by ventilatory patterns associated with high peak alveolar pressure and zero PEEP. For ventilated animals in which PEEP was set greater than P<sub>flex</sub> (lower inflection point on the respiratory system pressure-volume curve) and overdistension was avoided, minimal mediator activation was observed. Similar data were reported by Bethmann et al. in an ex vivo perfused mouse lung model.<sup>63</sup> Hyperventilation at 2.5 times the normal transpulmonary pressure using either positive or negative pressure ventilation resulted in a 1.75-fold increased expression of tumor necrosis factor  $\alpha$  (TNF- $\alpha$ ) and interleukin-6 messenger RNA (mRNA). Imai et al.<sup>64</sup> and Takata et al.,<sup>65</sup> studying rats, noted greater TNF- $\alpha$  mRNA expression with conventional ventilation at low peak pressure (30 cm H<sub>2</sub>O) and low PEEP (5 cm H<sub>2</sub>O) as compared to high-frequency oscillation at a mean airway pressure of 15 cm H<sub>2</sub>O (same as with conventional ventilation). Ranieri et al. showed the same effect of ventilatory pattern on pulmonary lavage and plasma TNF- $\alpha$  level in ARDS patients.<sup>66</sup> In a randomized comparison, patients ventilated with PEEP set greater than P<sub>flex</sub> and peak alveolar pressure kept below the upper inflection point of the pressure-volume curve had reduced TNF- $\alpha$  levels in both plasma and lung lavage fluid after 36 hours. Patients randomized to PEEP based on oxygenation with V<sub>T</sub> set to produce eucapnia increased their TNF- $\alpha$  levels after 36 hours. In addition the ARDSnet<sup>45</sup> demonstrated a lower systemic proinflammatory mediator response in a low tidal volume group of patients as compared to a high tidal volume group. Most recently, Chu et al.<sup>67</sup> demonstrated that lung maintained at a high lung volume either by CPAP or ventilated at the same high peak pressure resulted in the same marked activation of inflammatory mediators.

Based on these data both Slutsky and Tremblay<sup>61</sup> and Dreyfuss and Saumon<sup>68</sup> proposed that the lung was the “engine” that drives the development of multisystem organ failure in

ARDS patients. The additional lung injury resulting from inappropriate mechanical ventilation causes the movement of inflammatory mediators into the systemic circulation increasing the systemic production of mediators influencing and damaging the function of distal organs and tissues.

As a result, it seems reasonable to conclude, as discussed by Marini,<sup>46</sup> that “excessive mechanical forces produce lung damage by at least three mechanisms: (a) the signaling of proinflammatory mediator release by mechanical stress, (b) trauma to the epithelium of the lung parenchyma by repetitive opening at high pressures and subsequent closing with each breath, and (c) physical stress on the parenchyma by high peak alveolar pressures.” Marini also points out that there is some evidence that high ventilatory frequency<sup>69</sup> (higher frequency, greater injury), high pre- and postalveolar microvascular pressures,<sup>70</sup> decreased surfactant production,<sup>71</sup> supine body position,<sup>72</sup> high body temperature,<sup>73</sup> and immune suppression<sup>74</sup> all enhance the development and severity of VILI.

## LUNG-PROTECTIVE VENTILATION

As already discussed, a primary aim of ventilatory support of the surgical patient is to achieve “lung protection”; that is, to insure that the process of mechanical ventilation does not amplify the extent of lung injury. Care should always be exercised to ensure that the plateau pressure and tidal volume do not result in overdistension. In general, based on current information the tidal volume should be maintained  $\leq$  10 mL/kg in all acutely ill patients or patients undergoing anesthesia. In ARDS, as presented in the previous section, it is certain that smaller tidal volumes are required. At least three clinical trials have demonstrated a benefit of ventilating at 6–7 mL/kg (PBW) tidal volumes in ARDS.<sup>45,75,76</sup> In conjunction with these small tidal volumes, the plateau pressures should be maintained below 30 cm H<sub>2</sub>O unless the chest wall is stiff.<sup>46</sup> However, the lower the plateau pressure, the less likely tidal volumes of 8–9 mL/kg will present concern.

Outside of the clinical setting of ARDS the data are less clear; however, Hubmayr et al. performed a retrospective analysis of data on mechani-

cal ventilation in the ICU<sup>44</sup> and intraoperatively<sup>77</sup> at the Mayo Clinic, and on data from an international ventilation survey<sup>78</sup> that would indicate that small tidal volume (<10 mL/kg) ventilation should be the norm used in most critically ill patients. In two of these analyses,<sup>44,78</sup> they found that patients in the ICU had a greater probability of developing acute lung injury when ventilated with large tidal volumes ( $\geq$  10 mL/kg). In their most recent review,<sup>77</sup> they demonstrated that patients undergoing pneumonectomy at the Mayo Clinic who were ventilated intraoperatively with larger tidal volumes (median: 8.3 mL/kg) versus smaller tidal volumes (median: 6.7 mL/kg,  $p < 0.001$  groups differ) were more likely to develop postoperative respiratory failure and require ventilatory support for longer than 48 hours postoperatively.

In general, rapid respiratory rates (20–40 breaths/min) are needed to maintain gas exchange at low tidal volumes. The smaller the tidal volume and the more severe the lung injury, the greater the probability that patients will require permissive hypercapnia.<sup>54,93,94</sup>

The most appropriate method of setting PEEP in ARDS is still highly controversial.<sup>45,75,76,79</sup> However, there is no question that PEEP is necessary in lung injury to prevent derecruitment. The ARDSnet<sup>45,79</sup> recommends the use of a PEEP/FiO<sub>2</sub> table for setting PEEP, but these tables do not take into consideration the patient’s lung mechanics. Incremental PEEP trials have been used for years to provide a reasonable estimate of the necessary PEEP for many patients,<sup>80</sup> but may not be the best approach to setting PEEP in lung injury. Three prospective randomized trials have demonstrated positive outcomes when PEEP was set at  $P_{flex} + 2$  cm H<sub>2</sub>O.<sup>66,75,76</sup> In two studies,<sup>75,76</sup> mortality was decreased in the group ventilated with PEEP at  $P_{flex} + 2$  cm H<sub>2</sub>O along with a small delivered tidal volume, and in one pulmonary and systemic inflammatory mediators were attenuated when this ventilatory strategy was used.<sup>66</sup>

In lung injury, the method of setting PEEP that appears best is a decremental PEEP trial following a lung recruitment maneuver.<sup>81</sup> That is, PEEP is titrated downward from a level higher than is needed to determine the minimum level that maintains the benefit of the lung recruitment maneuver.

A number of groups have demonstrated the ability of a lung recruitment maneuver to open the lung in ARDS/ALI patients and the ability of a decremental PEEP trial to keep the lung open.<sup>82,83,86</sup> However, no outcome benefit has been attributed to lung recruitment maneuvers. The two lung recruitment approaches that have received the most study are the use of a sustained CPAP level of 40–50 cm H<sub>2</sub>O for 30–40 seconds<sup>82,84</sup> and the use of pressure-controlled ventilation at a peak pressure of 40–50 cm H<sub>2</sub>O along with PEEP of 20–30 cm H<sub>2</sub>O for 1–3 minutes.<sup>83</sup> Lung recruitment maneuvers can open the lung of patients with lung injury and should be applied in the first few days after lung injury but only in patients who are hemodynamically stable with appropriate fluid resuscitation without the presence of, or an increased likelihood of developing barotrauma.

## HIGH-FREQUENCY VENTILATION

Various approaches to high-frequency ventilation (HFV) have been employed over the last 30 years to manage patients intraoperatively, as well as to ventilate critically ill ICU patients. Although these techniques have demonstrated their ability to ventilate in both of these settings no beneficial outcome data regarding any of these techniques is available. The three common methods reported are high-frequency jet ventilation (HFJV), high-frequency percussive ventilation (HFPV), and high-frequency oscillatory ventilation (HFO).

### High-Frequency Jet Ventilation

HFJV has been the approach to HFV that has been used most commonly intraoperatively.<sup>85,86</sup> With this technique, gas under high pressure is injected via a small-bore nozzle placed within the endotracheal tube or in the airway itself. The velocity of the gas delivery stream creates a “jet drag effect” entraining secondary gases. This technique can provide ventilatory support with or without a sealed or closed airway. As a result, it has been used successfully during upper-airway surgery, tracheal reconstruction, unilateral surgical procedures, and other procedures in which the airway is not sealed.<sup>85,86</sup> In addition, simple HFJV systems have been used to pro-

vide emergency ventilatory support in settings where immediate access to the airway via the pharynx is impossible.<sup>87</sup> This is accomplished by placing the injector through the cricothyroid membrane; however, an escape pathway for injected gases via the upper airway must be present.

### High-Frequency Oscillatory Ventilation

HFO is the most commonly used high-frequency technique in the ICU. However, most of the successful applications of this ventilatory mode have been in neonates.<sup>88</sup> Randomized, controlled trials evaluating the use of HFO during ARDS/ALI in pediatric<sup>89</sup> and adult<sup>90</sup> populations have been negative, and HFO is considered equivalent to conventional ventilation in these settings. With HFO a high mean airway pressure is established because gas delivery is achieved by oscillating about the mean airway pressure. Tidal volumes as low as 1 mL/kg are delivered at high frequencies (8–12 Hz) in neonates. In adults, generally larger tidal volumes (2–4 mL/kg) are delivered at lower frequencies of 4–8 Hz. All clinical approaches to HFV require the use of ventilators specially designed to provide HFV.

### High-Frequency Percussive Ventilation

HFPV is a unique form of ventilation that combines the effects of conventional mechanical ventilation with HFO.<sup>91</sup> That is, a typical pressure targeted breath is delivered but during the breath, oscillations are provided. Oscillations can also occur during the expiratory phase. The goal is to increase the distribution of ventilation and mobilization of secretions by adding the oscillations to conventional ventilation. Most of the data on HFPV has been accumulated in burn or trauma patients.<sup>91,92</sup> As with HFO this approach to managing critically ill patients is effective but thus far no benefit over conventional mechanical ventilation has been demonstrated.<sup>93</sup>

## MECHANICAL VENTILATION OF THE POSTOPERATIVE PATIENT

### Normal Preoperative Pulmonary Function

Surgical procedures that require general anesthesia and invade the thorax

or abdominal cavity can result in impaired ventilatory function. As a result, well over 50% of cardiac and thoracic surgical patients show postoperative radiographic evidence of atelectasis.<sup>94</sup> In patients with normal preoperative pulmonary function, this normally does not result in any compromise. But in patients with preexisting pulmonary disease, acute respiratory failure is more common.

### Initial Management

In patients without prior pulmonary disease, ventilatory management is normally uneventful. Pressure or volume assist/control is preferred with tidal volumes as large as the patient desires (6–10 mL/kg IBW) because lung function is normal and the period of total mechanical ventilation time is usually brief.<sup>37</sup> Five cm H<sub>2</sub>O PEEP is applied to maintain the functional residual capacity, and the FiO<sub>2</sub> and rate are adjusted to maintain adequate gas exchange.

### Maintenance

Ventilatory management is short-term in most patients. The FiO<sub>2</sub> is titrated to maintain PaO<sub>2</sub> >70 mm Hg and the rate or tidal volume is adjusted to maintain baseline PaCO<sub>2</sub>. Patients can frequently be rapidly transitioned to pressure support and extubated quickly.

### Chronic Obstructive Pulmonary Disease

#### Pathophysiology

Postoperative chronic obstructive pulmonary disease (COPD) patients are commonly encountered in the ICU and are challenging to ventilate. Of primary concern is patient-ventilator synchrony.<sup>1</sup> The single most significant factor affecting synchrony in these patients is air trapping and auto-PEEP.<sup>47,49</sup> In COPD patients auto-PEEP is caused by dynamic airway compression; that is, unstable airways dilate during positive-pressure inspiration but are compressed by the increased intrathoracic pressure during exhalation. Because auto-PEEP occurs distal to airways obstruction, the airway pressure proximal to the obstruction at end exhalation is normally equal to baseline ventilator circuit pressure. This means during spontaneous inspiration the patient must first decompress the auto-PEEP level, and then trigger the ventilator. This results in a marked increase in patient efforts to trigger the ventilator and dyssynchrony. Many of

the patient's inspiratory efforts may not produce sufficient negative force to trigger the ventilator. The patient's actual respiratory rate is then greater than the ventilator's response rate. This increases ventilatory drive, patient respiratory rate, and the patient's overall ventilatory effort. The dyssynchrony associated with auto-PEEP can best be managed at the bedside by applying PEEP as discussed earlier (see Ventilation Settings and Patient-Ventilator Synchrony—Auto-PEEP).<sup>35</sup>

A second major concern is assurance that the ventilator's gas delivery rate meets the patient's inspiratory demand. COPD patients who are spontaneously triggering the ventilator have their ventilatory demands best supplied with pressure, as opposed to volume ventilation.<sup>37</sup> However, in either case gas delivery (rise time during pressure ventilation, and peak flow and flow waveform during volume ventilation) should be set to match inspiratory demand. Inspiratory time should coincide with the patient's desired inspiratory time. In assist/control ventilation, the inspiratory time is generally set from 0.6–1.0 seconds, and with pressure-support ventilation, the inspiratory termination criteria should be adjusted to ensure a synchronous ending of inspiration.<sup>38</sup>

COPD patients require ventilatory support because of their inability to perform the work needed to maintain normal (“for them”) gas exchange. As a result, the ventilator should ensure adequate rest but should always allow the patient to trigger the ventilator. In general, it is advisable not to use ventilatory modes that do not support every inspiratory effort, because they do not provide sufficient rest for the patient. Thus, synchronized intermittent mandatory ventilation, airway pressure-release ventilation, and bilevel ventilation should not be used in COPD.

#### Initial Setting

Initially, intubated, mechanically ventilated COPD patients should be managed with pressure support or assist/control (volume or pressure with pressure preferred). The delivered tidal volume should be 6–10 mL/kg PBW, dependent on plateau pressure and patient demand. Most COPD patients can be ventilated with a plateau pressure of ≤25 cm H<sub>2</sub>O. The respiratory rate is patient determined; however, in assist/control, a backup rate sufficient to maintain the appropriate PaCO<sub>2</sub> should be set. In volume-venti-



lation mode, the peak flow should be set  $\geq 80$  L/min with a decelerating waveform. With pressure-ventilation mode, the rise time and inspiratory termination criteria (pressure support only) should be properly set. Inspiratory time is set equal to the patient's neuroinspiratory time (0.6–1.0 seconds) and the PEEP level adjusted to ensure that all of the patient's inspiratory efforts trigger the ventilator.<sup>38</sup>

### Maintenance

In many COPD patients the key medical management issue is to provide rest for the patient. After 48–72 hours of ventilatory support, many patients are ready for ventilator discontinuation. In all cases, the focus should be on providing a level of ventilatory support consistent with minimal overall ventilatory effort to ensure recovery from ventilatory muscle dysfunction. As patients recover their PEEP level, pressure support or pressure assist/control level and  $\text{FiO}_2$  can be decreased, provided that ventilation targets can be met without markedly increasing the patient's work of breathing.

Patients requiring long-term ventilation should be considered for extensive rehabilitation, including generalized muscle retraining. Patients should be weaned with a spontaneous breathing trial and most COPD patients can be extubated after a successful 30–120-minute trial. However, those requiring long-term ventilatory support ( $>4$  weeks) should be given a tracheotomy and will require successful 12–16-hour spontaneous breathing periods before being allowed to breathe without ventilatory support during the night.

For COPD patients who are ventilated for short periods, who meet all the criteria for weaning, and who clinically seem ready for ventilator discontinuation but continue to fail spontaneous breathing trials, carefully consider extubation to NPPV.<sup>95–97</sup> Some COPD patients can be successfully transitioned to ventilator independence using NPPV. (See Weaning and Noninvasive Positive Pressure below.)

## Acute Respiratory Distress Syndrome

### Pathophysiologic Issues

ARDS and ALI are acute lung diseases characterized by atelectasis, edema, decreased compliance, and severe arterial hypoxemia. As a result, a most important issue during mechanical ventila-

tion is to avoid inducing greater lung injury either by end-inspiratory overdistension or by the repetitive opening and closing of unstable lung units. Other important issues are the recruitment of lung, the reversal of atelectasis, and the assurance of adequate systemic oxygenation and  $\text{CO}_2$  exchange while avoiding pulmonary oxygen toxicity.

The end-inspiratory plateau pressure should be  $<30$  cm  $\text{H}_2\text{O}$  to avoid lung injury unless chest wall compliance is decreased. This means for most ARDS/ALI patients the tidal volume should be set to 5–8 mL/kg PBW.<sup>45,75,76</sup> However, if the plateau pressure can be maintained below 25 cm  $\text{H}_2\text{O}$  and the patient desires a tidal volume up to 10 mL/kg PBW, it is more acceptable to meet the patient's demand than to force the patient to accept a low tidal volume (which may require IV sedation to apnea).

Some of the atelectasis in ARDS/ALI patients is recruitable by the use of short-term application of a "high" airway pressure (a recruitment maneuver).<sup>82,83,84</sup> These maneuvers work best on the initial day of identification of ARDS/ALI. The longer the patient has ARDS/ALI the less likely that recruitment maneuvers will succeed and the greater the likelihood of hemodynamic compromise. Following a recruitment maneuver, sufficient levels of PEEP should be applied to maintain the benefits of lung recruitment.

### Initial Settings

Assist/control mode (Table 83–5), either pressure or volume, can be used with pressure-targeting recommended if the patient is triggering each breath and has a variable ventilatory demand. A maximum plateau pressure of 30 cm  $\text{H}_2\text{O}$  should be set at a tidal volume of 5–8 mL/kg IBW unless the plateau pressure is less than 25 cm  $\text{H}_2\text{O}$ . The rate should be set to ensure adequate  $\text{CO}_2$  elimination. Respiratory rates can be set as high as 40 breaths/min. The rate-limiting factor is the development of auto-PEEP. In most patients, a normal  $\text{PaCO}_2$  of 35–50 mm Hg can be established by adjusting the rate. In some patients with a low compliance, permissive hypercapnia may be necessary. Tolerance of hypercapnia depends on the pH, it is better to allow the  $\text{PaCO}_2$  to gradually increase over a day or two to prevent the development of a marked respiratory acidosis.

TABLE 83–5.

### Initial Management of ARDS/ALI

- Mode—assist/control (volume or pressure)
- Plateau pressure— $<30$  cm  $\text{H}_2\text{O}$
- Tidal volume—5–8 mL/kg ideal body weight
- Inspiratory time—0.7–1.2 sec, if triggering equal to neuroinspiratory time
- Rate— $\leq 40$ /min to manage  $\text{PaCO}_2$
- PEEP—10–12 cm  $\text{H}_2\text{O}$
- $\text{FiO}_2$ —1.0 once stabilized
- Lung recruitment—35–45 cm  $\text{H}_2\text{O}$  CPAP for 30–40 sec
- $\text{FiO}_2$ —to maintain  $\text{PaO}_2 >60$  mm Hg
- PEEP—set by decremental trial to minimal level maintaining benefits of lung recruitment
  - ARDS—usually 12–18 cm  $\text{H}_2\text{O}$
  - ALI—usually 8–12 cm  $\text{H}_2\text{O}$

ALI, acute lung injury; ARDS, acute respiratory distress syndrome; CPAP, continuous positive airway pressure; PEEP, positive end-expiratory pressure.

$\text{FiO}_2$  should initially be set at 1.0 and PEEP at 10–12 cm  $\text{H}_2\text{O}$  until hemodynamic stability is achieved. Once the patient is hemodynamically stable a lung recruitment maneuver should be considered, using either a CPAP or pressure-assist/control approach as discussed earlier (in Lung Protective Ventilation). Before recruitment the patient should be stable hemodynamically, sedated to near apnea, and breathing 100% oxygen. Careful monitoring of the hemodynamic response and oxygenation level during the recruitment maneuver should be performed and the maneuver should be stopped if hemodynamic compromise is observed. Following the maneuver, the minimum PEEP level maintaining the oxygenation benefit of the recruitment maneuver should be applied. This is best determined by a decremental PEEP trial.<sup>81</sup> First, the PEEP level is set at 18–20 cm  $\text{H}_2\text{O}$  and the  $\text{FiO}_2$  is reduced until the  $\text{PaO}_2$  is about 70 mm Hg or the oxygen saturation as measured by pulse oximetry ( $\text{SpO}_2$ ) approximately 92%. The PEEP level is then decreased in 1–2-cm  $\text{H}_2\text{O}$  steps every 10–15 minutes until the  $\text{PaO}_2$  drops 10% from the highest level after adjusting the  $\text{FiO}_2$  or the



arterial oxygen saturation ( $\text{SaO}_2$ ) decreases below 90%. The PEEP level immediately above that resulting in the critical reduction of  $\text{PaO}_2$  or  $\text{SaO}_2$  is the minimal PEEP level needed to maintain the benefit of the recruitment maneuver.<sup>82–84</sup> At this point another recruitment maneuver is performed, after which the PEEP and  $\text{FiO}_2$  are set at the identified levels or 2 cm  $\text{H}_2\text{O}$  higher. If another method of setting PEEP is used and the oxygenation benefit of the recruitment maneuver is lost over a brief period, the PEEP level is set too low and should be increased. Many ARDS patients will require a PEEP level of 12–18 cm  $\text{H}_2\text{O}$  and ALI patients often require a PEEP level of 8–12 cm  $\text{H}_2\text{O}$ .

Regardless of the use of pressure or volume mode ventilation the inspiratory time should be set about 0.7–1.2 seconds, depending on the patient's ventilatory demand. In patients who are breathing spontaneously, the inspiratory time should be set equal to the patient's neuroinspiratory time. In volume ventilation, adequate peak flow should be provided to meet the patient's ventilatory demand ( $\geq 80$  L/min) using a decelerating waveform.

### Maintenance

The  $\text{FiO}_2$  should be decreased before PEEP when oxygenation improves. PEEP generally should not be decreased until the  $\text{FiO}_2$  is  $< 0.50$ . If the  $\text{PaO}_2$  decreases as PEEP is lowered, the prior PEEP level should be reestablished, and the  $\text{FiO}_2$  should not be increased. When this occurs, decreasing PEEP resulted in derecruitment of lung, indicating that the higher PEEP level is needed.

Once the patient's ventilatory drive has normalized and spontaneous triggering of the ventilator can be maintained, patients with ARDS/ALI can usually be maintained with pressure-support ventilation. As with assist/control, the peak pressure should be maintained as low as possible and always  $< 30$  cm  $\text{H}_2\text{O}$ .

In patients with reduced chest wall compliances as a result of abdominal sepsis, ascites, obesity, thoracic deformity, or massive fluid resuscitation following trauma, a plateau pressure greater than 30 cm  $\text{H}_2\text{O}$  may be necessary for adequate ventilation. This is acceptable as the transpulmonary pressure is lower with the stiff chest wall preventing overdistension of the lung. However, when the plateau pres-

sure is  $> 30$  cm  $\text{H}_2\text{O}$ , the tidal volume should be reduced to  $\leq 6$  mL/kg PBW.

In ARDS/ALI, care should be exercised to never disconnect the ventilator circuit. Whenever the circuit is disconnected from the airway, lung derecruitment occurs within seconds. Inline suction catheters should always be used and the use of manual resuscitators (Ambu bags) should be avoided. Suctioning should only occur when the presence of secretions is observed, and when performed, the suction pressure should be regulated to 120 mm Hg and performed gently to avoid lung derecruitment.

If lung recruitment and an appropriate PEEP setting is achieved but the  $\text{FiO}_2$  remains  $\geq 0.60$  to achieve adequate oxygenation, then consider prone positioning of the patient. Although neither prone positioning nor lung recruitment have been shown to improve survival rates, both can recruit lung and may improve oxygenation. The recruitment of regions of atelectasis reduces the plateau pressure and  $\text{FiO}_2$ , improves surfactant function, and decreases the risk of pneumonia. At this time, the use of high-frequency oscillation or airway pressure-release ventilation does not appear to improve outcome in ARDS, but both modes can provide adequate management of ARDS/ALI patients. Neither mode has been shown to be superior to conventional assist/control ventilation.

### Unilateral Lung Disease

Patients with unilateral lung disease present a particularly difficult challenge for mechanical ventilation. The postoperative patient after single-lung transplantation illustrates these problems. One lung has relatively normal pulmonary mechanics (the transplanted lung), whereas the native lung has mechanics reflecting either obstructive or restrictive disease. In these patients, the ventilator should be set to ensure maximum function of the native lung, as this lung will present the greatest ventilatory challenge. If the native lung has chronic obstruction, ventilate with moderate volume and slow rates. With pulmonary fibrosis of the native lung, a smaller  $V_T$  and more rapid rate are indicated. In the case of pulmonary fibrosis, there is less concern about air trapping. However, peak alveolar pressure may be high because of the reduced lung compliance.

The greatest ventilatory challenge is the patient with a single-lung transplant where the native lung is obstructed and the transplanted lung has become stiff (low compliance) as a consequence of infection, rejection, or acute lung injury. In this setting, it is difficult to determine the ideal ventilator settings because of the differing pathology of each lung. Careful attention needs to be paid to two variables as adjustments are made. First, concern about peak alveolar pressure because of ventilator imposed lung injury, damaging the transplanted lung and its bronchial anastomosis, and second, air trapping in the obstructed lung resulting in grossly compromised ventilation/perfusion ratios, overdistension, and the like. In this setting, permissive hypercapnia is often necessary with the final ventilator settings being a compromise between the conflicting needs of each lung.

### WEANING

Recent guidelines recommend the use of spontaneous breathing trials for weaning all patients from ventilatory support.<sup>98</sup> These guidelines also recommend that protocols be developed to allow assessment for weaning from the first day of ventilatory support. Table 83–6 lists the criteria for initiation of a spontaneous breathing trial for any patient requiring ventilatory support. Table 83–7 lists guidelines to identify those patients having failed a trial of spontaneous breathing.

If a patient meets the guidelines in Table 83–6 by midnight, sedation should

TABLE 83–6.

#### Criteria for Conducting a Spontaneous Breathing Trial

- Partial reversal of factors contributing to ventilator dependence
- Assessment of oxygenation
  - $\text{PaO}_2/\text{FiO}_2 \geq 150$  mm Hg
  - Positive end-expiratory pressure  $\leq 8$  cm  $\text{H}_2\text{O}$
  - $\text{FiO}_2 \leq 0.5$
  - $\text{pH} \geq 7.25$
- Hemodynamic stability—only low-dose vasopressors required
- Spontaneous inspiratory efforts present

Adapted from Evidence-based guidelines for weaning and discontinuing ventilatory support.<sup>98</sup>

TABLE 83–7.

**Criteria Defining Failure of a Spontaneous Breathing Trial**

- Respiratory Rate  $\gt 35$  breaths/min
- $\text{SaO}_2 < 90\%$
- Pulse  $\gt 140$  beats/min or sustained increase of 20%
- Systolic blood pressure  $\gt 180$  mm Hg or diastolic blood pressure  $\gt 90$  mm Hg
- Increased anxiety
- Increased diaphoresis

Adapted from Evidence-based guidelines for weaning and discontinuing ventilatory support.<sup>98</sup>

be adjusted to ensure spontaneous breathing by early morning. A 30–120-minute spontaneous breathing trial is performed, and if the patient does not fail the trial based upon the criteria in Table 83–7, consider the patient for extubation.<sup>98</sup> After short-term ventilatory support most clinicians do not recommend measuring lung mechanics. Even the rapid shallow breathing index has not proven universally useful in identifying those patients who are ready for weaning. All of the current data indicates that the use of other approaches to weaning simply results in prolongation of the ventilatory support period.<sup>95</sup> Patients failing weaning trials should be carefully assessed for the specific factors causing failure. Table 83–8 from Ely lists areas of concern that should be assessed in the patient falling multiple weaning trials.<sup>99</sup> Finally, in some patients, the use of NPPV may facilitate the process of transition to unsupported spontaneous breathing.<sup>95–97</sup>

**NONINVASIVE POSITIVE PRESSURE**

Over the last 15 years increasing emphasis has been placed on the use of noninvasive (without tracheal intubation) positive-pressure to support patients developing respiratory failure.<sup>100</sup> Although, much of the emphasis in such studies has focused on the patient with COPD in an acute exacerbation,<sup>101</sup> a number of trials over the years have focused on the use of NPPV<sup>102</sup> or CPAP for the management of postoperative patients.<sup>103–107</sup>

The primary mechanism producing arterial hypoxemia after surgery is im-

paired ventilation-to-perfusion matching as a result of the development of atelectasis.<sup>107</sup> Atelectasis in this setting is a result of recumbent positioning, ventilation with high oxygen concentrations, diaphragmatic dysfunction, and incisional pain producing impaired secretion clearance.<sup>103</sup> Several studies show that mask CPAP ventilation in this setting improves gas exchange, minimizes the development of atelectasis, and increases functional residual capacity.<sup>103–107</sup> Most of these studies were case series;<sup>103–106</sup> the most recent study, however, was a randomized controlled trial.<sup>107</sup> Squadrone et al.<sup>107</sup> demonstrated that mask CPAP at 7.5 cm  $\text{H}_2\text{O}$  at 0.5  $\text{FiO}_2$  for 6 hours in all patients following major elective abdominal surgery with a  $\text{PO}_2/\text{FiO}_2 < 300$  mm Hg prevented intubation compared to those receiving 50% oxygen by a venturi mask (1% vs. 10% intubation rate;  $P < 0.005$ ). In addition, significant decreases in subsequent pneumonia and sepsis rates were observed.

In postoperative lung resection patients with hypoxemic respiratory failure, Auriant et al.<sup>102</sup> demonstrated that the use of NPPV versus standard care prevented intubation ( $P = 0.030$ ) and decreased hospital mortality ( $P = 0.045$ ). Although CPAP and NPPV are useful in treating postoperative respiratory failure, they should be cautiously applied and tracheal intubation for patients not responding to these therapies should not be delayed.<sup>108</sup> These concerns were recently illustrated by Delclaux et al.<sup>108</sup> They randomized patients with hypoxemic respiratory failure to either CPAP or standard therapy. They found no difference in the subsequent intubation rate or the mortality rate but a greater incidence of cardiac arrest and stress ulcers in those managed with CPAP.

A number of recent studies have focused on the use of NPPV in the weaning process. The most commonly studied patients are those with COPD. At least two groups have shown beneficial results with COPD patients who were failing weaning trials and who were extubated and ventilated with NPPV; that is, NPPV provided a bridge from invasive ventilation to spontaneous breathing in these patients failing weaning trials.<sup>95,96</sup> However, it must be emphasized that these COPD patients were not postoperative patients.

The most encouraging use of NPPV during weaning are the results reported

TABLE 83–8.

**Factors Contributing to Ventilator Dependence in Difficult-to-Wean Patients****WHEANS NOT**

- Wheezes
- Heart disease
- Electrolyte imbalance
- Anxiety, aspiration, alkalosis
- Neuromuscular weakness
- Sepsis, sustained sedation
- Nutritional deficits
- Opiates not reversed, obesity
- Thyroid disease

Adapted from Ely WE.<sup>99</sup>

by Nava<sup>109</sup> and Ferrer.<sup>110</sup> In both of these studies patient's passing their weaning trials and who were then extubated but at risk for failing extubation were studied. Those managed postextubation for 24–48 hours with NPPV had a significant decrease in their likelihood of needing reintubation. In these settings, the increased risks were defined as COPD, congestive heart failure, an Acute Physiology and Chronic Health Evaluation (APACHE) score  $> 12$ , age  $> 65$  years, ineffective cough, and excessive secretions, 1 or more weaning failures, upper airway obstruction, or more than 1 comorbid condition. Of note, however, very few of these patients were postoperative patients.

There is considerable concern over the use of NPPV for the patient developing postextubation hypoxemic respiratory failure. Keenan et al.<sup>111</sup> demonstrated no benefit from the use of NPPV as compared to standard therapy in about 160 randomized patients. No differences were observed in the length of mechanical ventilation, hospital stay or hospital mortality. Of even more concern was the increased mortality reported by Esteban et al.<sup>112</sup> in patients with postextubation hypoxemic respiratory failure who were managed with NPPV. These authors argue that the primary reason for the increased mortality was the delay in intubating those who were treated with NPPV (12 vs. 2 hours).

Based on the current data from these randomized controlled trials, NPPV is best employed for patients passing weaning trials who are at an increased risk of developing respiratory failure as described by Nava<sup>109</sup> and Ferrer.<sup>110</sup>

## KEY REFERENCES

1. Tobin MJ, ed. History of mechanical ventilation. In: Principle and Practice of Mechanical Ventilation. 2nd ed. New York: McGraw-Hill, 2006.
2. Smith TC, Marini JJ. Impact of PEEP on lung mechanics and work of breathing in severe airflow obstruction. *J Appl Phys* 1988;64:1488–1496.
3. Dreyfuss D, Saumon G. Ventilator induced lung injury: lessons from experimental studies. *Am J Respir Crit Care Med* 1998;157:294–323.
4. The Acute Respiratory Distress Syndrome Network. Ventilation with lower tidal volumes as compared with traditional tidal volumes for acute lung injury and the acute respiratory distress syndrome. *N Engl J Med* 2000;342:1301–1308.
5. Villar J, Kacmarek RM, Perez-Mendez L, Aguirre-Jaime A, for the ARIES Network. A high positive end-expiratory pressure, low tidal volume ventilatory strategy improves outcome in persistent acute respiratory distress syndrome: a randomized, controlled trial. *Crit Care Med* 2006;34:1311–1318.
6. Fernandez-Perez ER, Keegan MT, Brown DR, Hubmayr RD, Gajic O. Intraoperative tidal volume as a risk factor for respiratory failure after pneumonectomy. *Anesthesiology* 2006;105:14–18.
7. Borges JB, Okamoto V, Gustavo M, et al. Reversibility of lung collapse and hypoxemia in early acute respiratory distress syndrome. *Am J Respir Crit Care Med* 2006;174:268–278.
8. Ferrer M, Esquinas A, Arancibia F, et al. Noninvasive ventilation during persistent weaning failure. *Am J Respir Crit Care Med* 2003;168:70–76.

## REFERENCES

1. Colice GL. History of mechanical ventilation. In: Tobin MJ, ed. Principle and Practice of Mechanical Ventilation. 2nd ed. New York: McGraw-Hill, 2006:1–36.
2. Slutsky AS. Mechanical ventilation. American College of Chest Physicians' Consensus Conference. *Chest* 1993;104:1833–1862.
3. Esteban A, Anzueto A, Alia I, et al. How is mechanical ventilation employed in the intensive care unit? An international review. *Am J Respir Crit Care Med* 2000;161:1450–1459.
4. Kacmarek RM, Dimas S, Mack C. Essentials of Respiratory Care. 4th ed. St. Louis, MO: Elsevier, 2005.
5. Hess DR, MacIntyre NR, Mishoe SC, Galvin WF, Adams AB, Saposnick AB. Respiratory Care: Principles and Practice. Philadelphia: WB Saunders, 2002.
6. Williams P, Muelver M, Kratochvil J, et al. Pressure support and pressure assist/control are there differences? An evaluation of the newest ICU ventilators. *Respir Care* 2000;45:1169–1181.
7. Branson RD, Campbell RS, Davis K, Johannigman JA, Johnson DJ, Hurst JM. Altering flow rate during maximum pressure support ventilation (PSV<sub>max</sub>): effect on cardiorespiratory function. *Respir Care* 1990;35:1056–1069.
8. Parthasarathy S, Jubran A, Tobin MJ. Cycling of inspiratory and expiratory muscle groups with the ventilator in airflow limitation. *Am J Respir Crit Care Med* 1998;158:1471–1478.
9. Branson RD, Campbell RS. Pressure support ventilation, patient-ventilatory synchrony and ventilator algorithms. *Respir Care* 1998;43:1045–1053.
10. Wilkens RL, Stoller JK, Scanlan CL. Egan's Fundamentals of Respiratory Care. 8th ed. St. Louis, MO: Mosby 2003, 972.
11. Marini JJ, Smith TC, Lamb VJ. External work output and force generation during synchronized intermittent mechanical ventilation. *Am Rev Respir Dis* 1988;138:1169–1177.
12. Imsand C, Feihl F, Perret C, Fitting JW. Regulation of inspiratory neuromuscular output during synchronized intermittent mechanical ventilation. *Anesthesiology* 1994;80:13–22.
13. Jaber S, Delay JM, Matecki S, Sebbane M, Eledjam JJ, Brochard L. Volume-guaranteed pressure-support ventilation facing acute changes in ventilatory demand. *Intensive Care Med* 2005;31:1181–1188.
14. Piotrowski A, Sobala W, Kawczynski P. Patient-initiated, pressure-regulated, volume-controlled ventilation compared with intermittent mandatory ventilation in neonates: a prospective, randomised study. *Intensive Care Med* 1987;23:975–981.
15. Randolph AG, Wypig D, Venkataraman S, et al. Effect of mechanical ventilator weaning protocols on respiratory outcomes in infants and children: a randomized controlled trial. *JAMA* 2002;288:2561–2568.
16. Camball RS, Branson RD, Johannigman JA. Adaptive support ventilation. *Respir Care Clin N Am* 2001;3:425–440.
17. Devine BJ. Gentamicin Therapy. *Drug Intell Clin Pharm* 1974;8:650–655.
18. Otis AB, Fenn WD, Rahn H. Mechanics of breathing in man. *J Appl Physiol* 1950;2:592–607.
19. Gutman J, Eberhard L, Fabry B. Continuous calculation of intratracheal pressure in tracheally intubated patients. *Anesthesiology* 1993;79:503–511.
20. Fabry B, Haberthur C, Zappe D. Breathing pattern and additional work of breathing in spontaneously breathing patients with different ventilatory demands during inspiratory pressure support and automatic tube compensation. *Intensive Care Med* 1997;23:545–552.
21. Younes M. Proportional assist ventilation, a new approach to ventilatory support. *Am Rev Respir Dis* 1992;145:114–120.
22. Grasso S, Ranieri VM. Proportional assist ventilation. *Respir Care Clin N Am* 2001;3:465–473.
23. Hart N, Hunt A, Polkey MI, Fauroux B, Lofaso F, Simonds, AK. Comparison of proportional assist ventilation and pressure support ventilation in chronic respiratory failure due to neuromuscular and chest wall deformity. *Thorax* 2002;57:979–981.
24. Ranieri VM, Giuliani R, Mascia L, et al. Patient-ventilator interaction during acute hypercapnia: pressure-support vs. proportional-assist ventilation. *J Appl Physiol* 1996;81:426–436.
25. Serra A, Polese G, Braggion C, Rossi A. Non-invasive proportional assist and pressure support ventilation in patients with cystic fibrosis and chronic respiratory failure. *Thorax* 2002;57:50–54.
26. Polese G, Vitacca M, Bianchi L, Rossi A, Ambrosino N. Nasal proportional assist ventilation unloads the inspiratory muscles of stable patients with hypercapnia due to COPD. *Eur Respir J* 2000;16:491–498.
27. Stock MC, Downs JB, Frolicher DA. Airway pressure release ventilation. *Crit Care Med* 1987;15:462–466.
28. Downs JB, Stock MC. Airway pressure release ventilation: a new concept in ventilatory support. *Crit Care Med* 1987;15:459–461.
29. Putensen C, Zech S, Wrigge H, et al. Long-term effects of spontaneous breathing during ventilatory support in patients with acute lung injury. *Am J Respir Crit Care Med* 2001;164:43–49.
30. Newman P, Golisch J, Strohmeyer A, Buscher H, Burchardi H, Sydow M. Influence of different release times on spontaneous breathing pattern during pressure release ventilation. *Intensive Care Med* 2002;28:1742.
31. McIntyre NR, McConnell R, Cheng KC, Sane A. Patient-ventilator flow dyssynchrony: flow-limited versus pressure-limited breaths. *Crit Care Med* 1997;25:1671–1677.
32. Chatburn RL. Mechanical ventilators. In: Branson RD, Hess DR, Chatburn RL, eds. Respiratory Care Equipment. 2nd ed. St. Louis, MO: Lippincott, 1999.
33. Goulet R, Hess D, Kacmarek RM. Pressure vs. flow triggering during pressure



- support ventilation. *Chest* 1997;111:1649-1654.
34. Pepe PE, Marini JJ. Occult positive end-expiratory pressure in mechanically ventilated patients with airflow obstruction: the auto-PEEP effect. *Am Rev Respir Dis* 1982;126:166-170.
35. Smith TC, Marini JJ. Impact of PEEP on lung mechanics and work of breathing in severe airflow obstruction. *J Appl Phys* 1988;64:1488-1496.
36. Marini JJ, Rodrigues RM, Lamb V. The inspiratory workload of patient-initiated mechanical ventilation. *Am Rev Respir Dis* 1986;134:902-909.
37. Hess D, Kacmarek RM. *Essentials of Mechanical Ventilation*. 2nd ed. New York: McGraw-Hill, 2002.
38. Fernandez R, Mendez M, Younes M. Effect of ventilator flow rate on respiratory timing in normal humans. *Am J Respir Crit Care Med* 1999;159:710-719.
39. Mang H, Kacmarek RM, Ritz R, et al. Cardiorespiratory effects of volume- and pressure-controlled ventilation at various I/E ratios in an acute lung injury model. *Am J Respir Crit Care Med* 1995;151:731-736.
40. Munoz J, Guerrero JE, Escalante JL, et al. Pressure-controlled ventilation versus controlled mechanical ventilation with decelerating inspiratory flow. *Crit Care Med* 1993;21:1143-1148.
41. Dreyfuss D, Saumon G. Ventilator-induced lung injury: lessons from experimental studies. *Am J Respir Crit Care Med* 1998;157:294-323.
42. Brun-Buisson C, Minelli C, Bertolini G, et al. Epidemiology and outcome of acute lung injury in European intensive care units. Results from the ALIVE Study. *Intensive Care Med* 2004;30:51-61.
43. Tenney SM, Remmers JE. Comparative quantitative morphology of the mammalian lung: diffusing area. *Nature* 1963;197:54-56.
44. Gajic O, Dara SI, Mendez JL, et al. Ventilator associated lung injury in patients without acute lung injury at the onset of mechanical ventilation. *Crit Care Med* 2004;32:1817-1824.
45. The Acute Respiratory Distress Syndrome Network. Ventilation with lower tidal volumes as compared with traditional tidal volumes for acute lung injury and the acute respiratory distress syndrome. *N Engl J Med* 2000;342:1301-1308.
46. Marini J. Relative importance of stretch and shear in ventilator-induced lung injury. *Crit Care Medicine* 2004;32:302-304.
47. Chao D, Scheinhorn DJ, Stearn-Hassenpflug M. Patient-ventilator trigger asynchrony in prolonged mechanical ventilation. *Chest* 1997;112:1592-1599.
48. Lethermann JW, Ravenscraft SA. Low measured auto-positive end expiratory pressure during mechanical ventilation of patients with severe asthma: hidden auto-PEEP. *Crit Care Med* 1996;24:541-546.
49. Fabry BE, Guttmann J, Eberhard LE, Bauer T, Haberthur C, Wolff G. An analysis of desynchronization between the spontaneously breathing patient and ventilator during inspiratory pressure support. *Chest* 1971;107:1387-1384.
50. Laffey J, Kavanagh BP. Permissive hypercapnia. In: Tobin MJ. *Principles and Practice of Mechanical Ventilation*. 2nd ed. New York: McGraw-Hill, 2006:373.
51. Hickling KG. Permissive hypercapnia. *Respir Care Clin North America* 2002;8:155-169.
52. Kregenow DA, Swenson ER. The lung and carbon dioxide: implications for permissive and therapeutic hypercapnia. *Eur Respir J* 2002;20:6-11.
53. Webb HH, Tierney D. Experimental pulmonary edema due to intermittent positive pressure ventilation, with high inflation pressures, protection by positive end-expiratory pressure. *Am Rev Respir Dis* 1974;110:556-565.
54. Dreyfuss D, Soler P, Saumon G. Mechanical ventilation-induced pulmonary edema: interaction with previous lung alterations. *Am J Respir Crit Care Med* 1995;151:1568-1575.
55. Dreyfuss D, Basset G, Soler P, Saumon G. Intermittent positive-pressure hyper-ventilation with high inflation pressures produces pulmonary microvascular injury in rats. *Am Rev Respir Dis* 1985;132:880-884.
56. Parker JC, Hernandez LA, Longenecker GL, et al. Lung edema caused by high peak inspiratory pressures in dogs. *Am Rev Respir Dis* 1990;142:321-328.
57. Hernandez LA, Coker PJ, May S. Mechanical ventilation increases microvascular permeability in oleic acid-injured lungs. *J Appl Physiol* 1990;69:2057-2061.
58. Egan A. Lung inflation, lung solute permeability, and alveolar edema. *J Appl Physiol* 1982;53:121-125.
59. Kolobow T, Moretti MP, Fumagalli R, et al. Severe impairment in lung function induced by high peak airway pressure during mechanical ventilation. *Am Rev Respir Dis* 1987;135:312-315.
60. Corbridge TC, Wood DH, Crawford GP. Adverse effects of large tidal volume and low PEEP in canine acid aspiration. *Am Rev Respir Dis* 1990;142:311-315.
61. Slutsky A, Tremblay L. Multiple organ system failure: is mechanical ventilation a contributing factor? *Am Rev Respir Crit Care Med* 1998;157:1721-1725.
62. Tremblay L, Valenza F, Riberiro S, et al. Injurious ventilatory strategies increases cytokines and c-fos mRNA expression in an isolated rat lung model. *J Clin Invest* 1997;99:944-952.
63. Bethmann AN, Brasch F, Nusing R, et al. Hyperventilation induces release of cytokines from perfused mouse lung. *Am J Respir Crit Care Med* 1998;157:263-272.
64. Imai Y, Kawawo T, Miyasaka K, et al. Inflammatory chemical mediators during conventional ventilation and during high frequency oscillatory ventilation. *Am J Respir Crit Care Med* 1994;150:1550-1554.
65. Takata M, Abe J, Tanaka H, et al. Intraalveolar expression of tumor necrosis factor alpha gene during conventional and high-frequency ventilation. *Am J Respir Crit Care Med* 1997;156:272-279.
66. Ranieri VM, Tortorella D, DeTullio R, et al. Limitation of mechanical lung stress decreased BAL cytokines in patients with ARDS. *JAMA* 1999;282:54-61.
67. Chu EK, Whitehead T, Slutsky AS. Effects of cyclic opening and closing, and low and high volume ventilation on bronchoalveolar lavage cytokines. *Crit Care Med* 2004;32:168-174.
68. Dreyfuss D, Saumon G. From ventilator-induced lung injury to multiple organ dysfunction? *Intensive Care Med* 1998;24:102-104.
69. Hotchkiss JR, Blanch LL, Murias G, et al. Effects of increased respiratory frequency on ventilator induced lung injury. *Am J Respir Crit Care Med* 2000;161:463-468.
70. Broccard A, Vannay C, Feihl F, et al. Impact of low pulmonary vascular pressure on ventilator-induced lung injury. *Crit Care Med* 2002;30:2183-2190.
71. Parker JC, Hernandez LA, Peevy KJ. Mechanisms of ventilator-induced lung injury. *Crit Care Med* 1993;21:131-143.
72. Broccard A, Shapiro R, Schmitz L, et al. Prone positioning attenuates and redistributes ventilator-induced lung injury in dogs. *Crit Care Med* 2000;28:2295-2303.
73. Suzuki S, Hotchkiss JR, Marini JJ, et al. Effect of body temperature on ventilator-induced lung injury. *Crit Care Med* 2000;161:463-468.
74. Sinclair SE, Kregenow DA, Lamm WJ, et al. Hypercapnic acidosis is protective in an in vivo model of ventilator-induced lung injury. *Am J Respir Crit Care Med* 2002;166:403-408.
75. Amato MBP, Barbas CSV, Medeiros DM, et al. Effect of a protective-ventilation strategy on mortality in the acute respiratory distress syndrome. *N Engl J Med* 1998;338:347-354.
76. Villar J, Kacmarek RM, Perez-Mendez L, Aguirre-Jaime A, for the ARIES Network. A high positive end-expiratory pressure, low tidal volume ventilatory strategy improves outcome in persistent acute respiratory distress syndrome: a randomized, controlled trial. *Crit Care Med* 2006;34:1311-1318.
77. Fernandez-Perez ER, Keegan MT, Brown DR, Hubmayr RD, Gajic O. Intraoperative tidal volume as a risk factor for respiratory failure after pneumonectomy. *Anesthesiology* 2006;105:14-18.
78. Gajic O, Frutos-Vivar F, Esteban A, Hubmayr RD, Anzueto A. Ventilator settings as a risk factor for acute respiratory distress syndrome in mechanically ventilated patients. *Intensive Care Med* 2005;31:922-926.



79. Brower RG, Lanken PN, MacIntyre N, et al. National Heart, Lung, and Blood Institute ARDS Clinical Trials Network. Higher versus lower positive end-expiratory pressures in patients with the acute respiratory distress syndrome. *N Engl J Med* 2004;351:327–336.
80. Downs JB, Klein EF, Modell JH. The effect of incremental PEEP on Pao<sub>2</sub> in patients with respiratory failure. *Anesth Analg* 1973;52:210–215.
81. Hickling KD. Best compliance during a decremental, but not incremental, positive end-expiratory pressure trial is related to open-lung positive end-expiratory pressure: a mathematical model of acute respiratory distress syndrome lung. *Am J Respir Crit Care Med* 2001;163:69–78.
82. Tugrul A, Akinçi O, Ozcan PE, et al. Effects of sustained inflation and postinflation positive end-expiratory pressure in acute respiratory distress syndrome: focusing on pulmonary and extrapulmonary forms. *Crit Care Med* 2003;31:738–744.
83. Borges JB, Okamoto V, Gustavo M, et al. Reversibility of lung collapse and hypoxemia in early acute respiratory distress syndrome. *Am J Respir Crit Care Med* 2006;174:268–278.
84. Girgis K, Hamed H, Khater Y, Kacmarek RM. A decremental PEEP trial identifies the PEEP level that maintains oxygenation post lung recruitment. *Respir Care* 2006;51:1132–1139.
85. Gerig HJ, Schnider T, Heidegger T. Prophylactic percutaneous transtracheal catheterization in the management of patients with anticipated difficult airways: a case series. *Anaesthesia* 2005;60:801–805.
86. Bacher A, Pichler K, Aloy A. Supraglottic combined frequency jet ventilation versus subglottic monofrequent jet ventilation in patients undergoing microlaryngeal surgery. *Anesth Analg* 2000;90:460–462.
87. Gulleth Y, Spiro J. Percutaneous transtracheal jet ventilation in head and neck surgery. *Arch Otolaryngol Head Neck Surg* 2005;131:886–890.
88. Bollen CW, Uiterwaal CSPM, van Vught AJ. Cumulative metaanalysis of high-frequency versus conventional ventilation in premature neonates. *Am J Respir Crit Care Med* 2003;168:1150–1155.
89. Arnold J, Anas N, Lockett P, et al. High-frequency oscillatory ventilation in pediatric respiratory failure: A multicenter experience. *Crit Care Med* 2000;28:3913–3919.
90. Derdak S, Mehta S, Stewart TE, et al. High-frequency oscillatory ventilation for acute respiratory distress syndrome in adults: a randomized, controlled trial. *Am J Respir Crit Care Med* 2002;166:801–808.
91. Lucangelo U, Zin W, Antonaglia, et al. High-frequency percussive ventilation during surgical bronchial repair in a patient with one lung. *Br J Anaesth* 2006;96:533–536.
92. Velmahos G, Chan L, Tatevossian R, et al. High-frequency percussive ventilation improves oxygenation in patients with ARDS. *Chest* 1999;116:440–446.
93. Hurst JM, Branson RD, David K, et al. Comparison of conventional mechanical ventilation and high-frequency ventilation: a prospective, randomized trial in patients with respiratory failure. *Ann Surg* 1990;211:486–491.
94. Davis K, Johnson DJ. Effects of anesthesia and surgery on the respiratory system. In: Pierson DJ, Kacmarek RM, eds. *Foundations of Respiratory Care*. New York: Churchill Livingstone, 1992:389–395.
95. Nava S, Ambrosino N, Clini E, et al. Noninvasive mechanical ventilation in the weaning of patients with respiratory failure due to chronic obstructive pulmonary disease. *Ann Intern Med* 1998;128:721–728.
96. Girault C, Daudenthun I, Chevron V, et al. Noninvasive ventilation as a systematic extubation and weaning technique in acute-on-chronic respiratory failure. *Am J Respir Crit Care Med* 1999;160:86–92.
97. Ferrer M, Esquinas A, Arancibia F, et al. Noninvasive ventilation during persistent weaning failure. *Am J Respir Crit Care Med* 2003;168:70–76.
98. Evidence-based guidelines for weaning and discontinuing ventilatory support: a collective task force facilitated by the American College of Chest Physicians; the American Association for Respiratory Care; and the American College of Critical Care Medicine. *Chest* 2001;120:375S–395S.
99. Ely WE. The utility of weaning protocols to expedite liberation from mechanical ventilation. *Respir Care Clin N Am* 2000;6:303–319.
100. Brochard L, Mancebo J, Wysocki, M, et al. Noninvasive ventilation for acute exacerbations of chronic obstructive pulmonary disease. *N Engl J Med* 1995;333:817–822.
101. Girou E, Schortgen F, Delclaux C, et al. Association of noninvasive ventilation with nosocomial infections and survival in critically ill patients. *JAMA* 2000;284:2361–2357.
102. Auriant I, Jallot A, Herve P, et al. Noninvasive ventilation reduces mortality in acute respiratory failure following lung resection. *Am J Respir Crit Care Med* 2001;164:1231–1235.
103. Stock MD, Downs JB, Gauer PK, et al. Prevention of postoperative pulmonary complications with CPAP, incentive spirometry, and conservative therapy. *Chest* 1985;87:151–157.
104. Dehaven CB, Hurst JM, Branson RD. Postextubation failure treated with a continuous positive pressure airway mask. *Crit Care Med* 1985;13:46–48.
105. Lindner KH, Lotz P, Ahnefeld FW. Continuous positive airway pressure effect on functional residual capacity, vital capacity and its subdivisions. *Chest* 1987;92:66–70.
106. Rusca M, Proitti S, Schnyder P, et al. Prevention of atelectasis formation during induction of general anesthesia. *Anesth Analg* 2003;97:1835–1839.
107. Squadrone V, Cocha M, Cerutti E, et al. Continuous positive airway pressure for treatment of postoperative hypoxemia: a randomized controlled trial. *JAMA* 2005;293:589–595.
108. Delclaux C, L'Her E, Alberti C, et al. Treatment of acute hypoxemic nonhypercapnic respiratory insufficiency with continuous positive airway pressure delivered by a face mask: a randomized controlled trial. *JAMA* 2000;284:2352–2360.
109. Nava S, Gregoretti C, Fanfulla F, et al. Noninvasive ventilation to prevent respiratory failure after extubation in high-risk patients. *Crit Care Med* 2005;33:2465–2470.
110. Ferrer M, Valencia M, Nicolas JM, et al. Early noninvasive ventilation averts extubation failure in patients at risk. *Am J Respir Crit Care Med* 2005;173:164–170.
111. Keenan SP, Powers C, McCormack DG, Block G. Noninvasive positive-pressure ventilation for postextubation respiratory distress. *JAMA* 2002;287:3238–3244.
112. Esteban A, Frutos-Vivar F, Ferguson, N, et al. Noninvasive positive-pressure ventilation for respiratory failure after extubation. *N Engl J Med* 2004;350:2452–2460.

# CHAPTER 84

## Cardiopulmonary Resuscitation

Charles W. Otto, MD, FCCM

In the hospital, resuscitation from cardiac arrest depends on the rapid response of a well-trained cardiopulmonary resuscitation (CPR) team that usually includes physicians, nurses, respiratory care providers, and pharmacists. The anesthesiologist is usually a team member and frequently is expected to be the leader. The team must communicate readily and be coordinated. Providing the knowledge base and framework for effective teamwork are the goals of published CPR guidelines and widely taught courses in basic life support (BLS), advanced cardiac life support (ACLS), and pediatric advanced life support (PALS).<sup>1</sup> The anesthesiologist must be thoroughly familiar with ACLS protocols to function within the team. Team leadership requires in-depth, current knowledge of physiology, pharmacology, and alternative CPR techniques. This chapter provides the scientific background on which current CPR practice is based. It focuses exclusively on cardiac arrest. Other circumstances requiring cardiovascular support, such as shock and dysrhythmias, are discussed in other chapters.

Approximately 50% of patients suffering in-hospital cardiac arrest are resuscitated and 18% of adults and 27% of children survive to discharge.<sup>2</sup> The operating room is the location where CPR has the highest rate of success. Cardiac arrest occurs approximately 7 times for every 10,000 anesthesia events.<sup>3</sup> The cause for the arrest is anesthesia-related approximately 4.5 times for every 10,000 anesthesia events but mortality from these arrests is only 0.4 per 10,000 anesthesia events. Resuscitation is successful approximately 90% of the time in anesthesia-related cardiac arrests. Excluding the operating room, the best initial resuscitation rates are found in the intensive care unit (ICU), while the best survival rates are for patients arresting in the emergency department.

The in-hospital success is similar to resuscitation and survival rates from out-of-hospital arrest in cities with rapid response emergency medical systems.<sup>4</sup> In out-of-hospital arrests, poor outcomes are associated with (a) long arrest times before CPR is begun, (b) prolonged ventricular fibrillation without definitive therapy, and (c) inadequate coronary and cerebral perfusion during CPR.<sup>5</sup> Optimum survival from ventricular fibrillation is obtained only if basic CPR is started within 4 minutes and defibrillation applied within 8 minutes.<sup>4</sup> A better outcome might be expected for in-hospital

arrests because of rapid response times and expert personnel. Intercurrent illnesses of hospitalized patients reduce the likelihood of survival and the arrest victim is more likely to be elderly, a factor that may reduce survival. The cause of arrest associated with the best outcome and the most common cause of out-of-hospital arrest is ventricular fibrillation secondary to myocardial ischemia. This initiating event is less common in hospitalized patients. When applying CPR, attention to the details of effective resuscitation is important. However, CPR is only symptomatic therapy; attention should

### KEY POINTS

1. In many resuscitation attempts, both in- and out-of-hospital, chest compressions are performed for less than 50% of the time. Interrupting compressions is detrimental to maintaining myocardial perfusion and, therefore, to the ultimate success of the resuscitation attempt.
2. Fluctuations in intrathoracic pressure play a significant role in blood flow during most resuscitations and the cardiac pump mechanism contributes under some circumstances.
3. Cardiac output is severely depressed during cardiopulmonary resuscitation (CPR), ranging from 10–33% of prearrest values in experimental animals. Nearly all of the cardiac output is directed to organs above the diaphragm.
4. During CPR, measurement of blood gases reveals an arterial respiratory alkalosis and a venous respiratory acidosis because the arterial  $PCO_2$  is reduced and the venous  $PCO_2$  is elevated.
5. The critical myocardial blood flow is associated with aortic “diastolic” pressure exceeding 40 mm Hg.
6. Exhaled end-tidal  $CO_2$  is an excellent noninvasive guide to the effectiveness of standard CPR.
7. Immediate defibrillation is only effective if applied within 4–5 minutes of collapse. Otherwise, a brief period of 2–3 minutes of chest compressions before defibrillation is necessary.
8. Lidocaine and amiodarone are used during cardiac arrest to aid defibrillation when ventricular fibrillation is refractory to electrical countershock therapy or when fibrillation recurs following successful conversion.
9. Of the drugs used during CPR, only vasopressors have been acknowledged to help restore spontaneous circulation.
10. Outcome studies prospectively comparing standard and high-dose epinephrine have not demonstrated conclusively that higher doses will improve survival.
11. Evidence currently suggests that, like other potent vasopressors, vasopressin is equivalent to but not better than epinephrine for use during CPR.
12. Calcium is not indicated for use during cardiac arrest in adults or children. It may be useful for treatment of hyperkalemia, ionized hypocalcemia, hypermagnesemia, or calcium channel blocker toxicity.
13. Sodium bicarbonate should be considered for use during CPR only in arrests associated with hyperkalemia, severe preexisting metabolic acidosis, and tricyclic or phenobarbital overdose. It may be considered for use in protracted resuscitation attempts after other modalities have been instituted.
14. In contrast to pharmacologic therapy, two studies demonstrate improved neurologic outcome when mild therapeutic hypothermia (89.6–93.2°F [32–34°C]) is induced for 12–24 hours in cardiac arrest survivors who remained comatose after admission to the hospital.

not be paid to the mechanics of CPR only, but also should include a search for a treatable cause of the arrest.

## HISTORY

Discoveries contributing to modern CPR have a long history recorded in many famous works.<sup>6,7</sup> They begin with the Bible story of Elisha breathing life back into the son of a Shunammite woman (II *Kings* 4:34) and continue with Andreas Vesalius' description of tracheotomy and artificial ventilation, William Harvey's manual manipulation of the heart, and the teachings of the Society for the Recovery of Persons Apparently Drowned, founded in London in 1774. Nevertheless, the combined techniques of modern CPR are less than 50 years old. Although there were significant contributions from other centers in the United States and Europe, modern CPR developed primarily from the fortuitous assemblage of innovative clinicians and researchers in Baltimore in the 1950s and early 1960s. In the late 1950s, Elam, Safar, and Gordon established mouth-to-mouth ventilation as the only effective means of artificial ventilation.<sup>8-11</sup> The internal defibrillator was developed in 1933,<sup>12</sup> but not applied successfully until 1947.<sup>13</sup> It was another decade before general use was made possible by the development of external transthoracic defibrillation.<sup>14,15</sup> Despite these advances, widespread resuscitation from cardiac arrest was not possible until Kouwenhoven, Jude, and Knickerbocker described success with closed chest cardiac massage in a series of patients.<sup>16</sup> The final major component of modern CPR was added in 1963 when Redding and Pearson described the improved success obtained by administering epinephrine or other vasopressor drugs.<sup>17</sup>

## BASIC LIFE SUPPORT

BLS consists of those elements of resuscitation that can be performed without additional equipment: airway management, ventilation, and chest compressions. Physiologically, the objective of performing CPR is to provide oxygen to the vital organs, especially the heart, and the brain until normal circulation is restored. Common practice is to approach a victim with the

### BOX 84-1.

#### Basic Cardiopulmonary Resuscitation

##### Airway

Assess  
Call for help  
Activate EMS system

##### Position

Open airway  
Head tilt/chin lift  
Jaw thrust

##### Breathing

Determine breathlessness  
Perform rescue breathing  
Two breaths (1 second each)

##### Circulation

	Adult	Child	Infant
Pulse Check Site	Carotid	Carotid	Brachial or Femoral

##### Chest compressions

	Adult	Child	Infant
Placement	Two hands	One hand	Two or three fingers or encircling method
Depth of compression	1.5-2 in	$\frac{1}{3}$ - $\frac{1}{2}$ depth of chest	—
Rate/min	100	100	100
Compression/ ventilation ratio	30:2	30:2	30:2

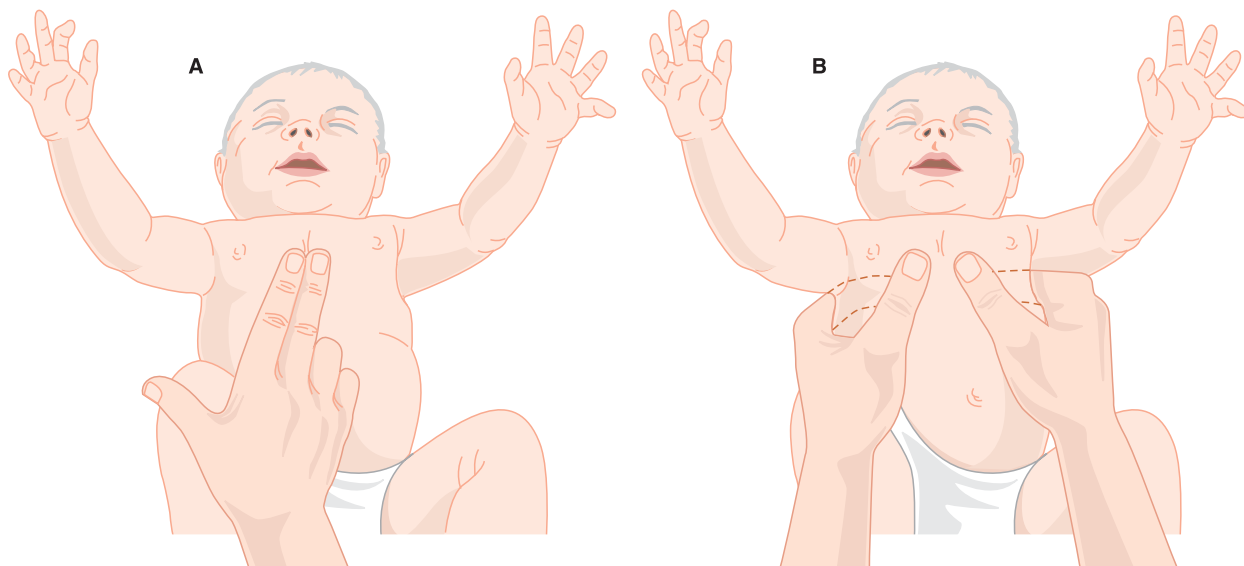
ABC (airway, breathing, circulation) sequence although the CAB (circulation, airway, breathing) sequence has been used in some countries with comparable results. Box 84-1 gives the full sequence for initiating CPR in an apparent arrest victim and Fig. 84-1 illustrates the technique of infant chest compressions. If complete resuscitation equipment and expertise in its use is available, the overall priorities of resuscitation may dictate altering this sequence (Box 84-2).

## THE IMPORTANCE OF THE TIMING OF INTERVENTIONS DURING CPR

It is now clear that cardiac arrest caused by ventricular fibrillation can be characterized in three phases (Table 84-1).<sup>21</sup> The electrical phase occurs during the first 4-5 minutes of the arrest and early defibrillation is critical for success during this time. The hemodynamic phase follows for the next 10-15 minutes when perfusing the myocardium with oxygenated blood is critical. This is followed by what has been called the metabolic phase when the ischemic injury to the heart is so

great that it is not clear what interventions will be successful. What is obvious from this timeline is that early intervention is necessary for resuscitation attempts to be successful. This requires not only rapid response emergency medical systems for out-of-hospital arrests and appropriate code teams for in-hospital arrests, but it requires immediate intervention by bystanders when cardiac arrest victims collapse. Unfortunately, the incidence of bystander CPR has been falling for 3 decades. The reasons for this reluctance to intervene are multiple but seem to be primarily (a) lack of training, (b) the complexity of the task, and (c) fear of harm. Many of these concerns focus on the mouth-to-mouth ventilation part of the CPR intervention and many experts are now stressing the importance of continuous chest compressions, even at the expense of ventilation, by bystanders and early rescuers. There is no doubt that chest compression-only CPR by bystanders is more acceptable for most, easier to learn and retain, and provides better hemodynamic support.

Early studies in anesthetized humans suggested that the airway would not remain open in the unconscious,



**FIGURE 84-1.** **A.** Two-finger method of external chest compression in infants. Rescuer places 2 fingers on the sternum and 1 finger-breadth below the line intersecting the nipples and compresses 0.5–1 inch at a rate of 100 compressions per minute. Ventilation is not shown for the sake of clarity. **B.** Encircling method of external chest compression in infants. Rescuer places thumbs over sternum 1 fingerbreadth below the line intersecting the nipples and clasps hands behind infant's back.

leading to the teaching that airway control and artificial ventilation must accompany chest compressions.<sup>8–11</sup> However, there is now considerable data to suggest that eliminating mouth-to-mouth ventilation early in the resuscitation of witnessed fibrillatory cardiac arrest is not detrimental to outcome and may improve survival. Data from the Belgian CPR Registry demonstrates that 14-day survival and neurologic outcome are the same regardless of whether bystanders initiate full basic life support or only do chest compressions. Both are significantly better than if the bystanders only do mouth-to-mouth ventilation or attempt no CPR.<sup>22,23</sup> The necessity for ventilation during basic life support

has been studied in animal models. Multiple studies have been reported by two research groups of 169 swine with up to 5 minutes untreated *fibrillatory* cardiac arrest and 10 minutes of BLS, comparing chest compressions without airway control or ventilation to standard CPR with ventilation.<sup>24–26</sup> Both techniques resulted in approximately 75% neurologically normal 24–48-hour survival. A similar study in an *asphyxial* arrest model showed that assisted ventilation during bystander CPR was critical for survival.<sup>27</sup> The animal studies are supported by a study of telephone dispatcher instructions in CPR techniques to inexperienced bystanders. Instruction in chest compressions only resulted in the same survival as instruction in both compressions and ventilation.<sup>28</sup> These observations suggest that when arrest is witnessed, likely to be of cardiac (rather than respiratory) cause, and intubation will be available within a short time, closed chest compressions alone may be as efficacious as com-

pressions and mouth-to-mouth ventilation. In many venues, basic life support teaching for the lay rescuer is being simplified to eliminate mouth-to-mouth ventilation. Just as importantly, there is renewed interest in importance of not interrupting chest compressions. Compressions are interrupted for repeated patient assessment, ventilations, intubation, central line placement, changing rescuers, and defibrillation (especially with automatic external defibrillators [AEDs]). In many resuscitation attempts both in- and out-of-hospital, chest compressions are performed for less than 50% of the time. Interrupting compressions is significantly detrimental to maintaining myocardial perfusion and, therefore, to the ultimate success of the resuscitation attempt.

#### BOX 84-2.

##### Interventional Priorities during CPR If All Necessary Equipment and Expertise Are Available

- Diagnose ventricular fibrillation and defibrillate
- Open airway
- Begin ventilation
- Begin chest compressions
- Administer supplemental oxygen
- Obtain intravenous access
- Administer epinephrine or vasopressin
- Assess adequacy of CPR efforts
- Secure airway
- Additional drug therapy

**TABLE 84-1.**

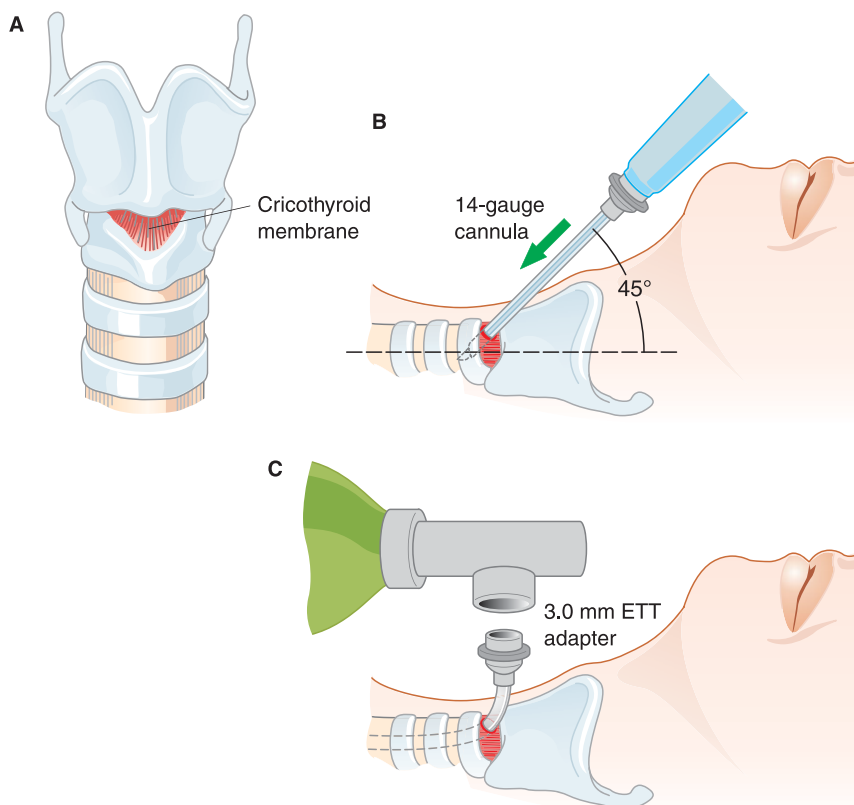
##### Phases of Cardiac Arrest

Phase	Time from Collapse	Intervention
Electrical	4–5 minutes	Defibrillation
Hemodynamic	15–20 minutes	Myocardial perfusion
Metabolic	>20 minutes	Unknown



same as during general anesthesia: to provide a clear path for respiratory gas exchange while minimizing gastric insufflation and the risk of pulmonary aspiration. Airway maintenance in an unconscious patient is a basic part of anesthesia practice and all the techniques learned for use during anesthesia are applicable to the cardiac arrest victim. Just as in the operating room, the most commonly used technique for opening the airway is the “head tilt–chin lift” method. If this is ineffective, the “jaw thrust” maneuver is frequently helpful. Oropharyngeal and nasopharyngeal airways are useful for helping maintain an open airway in patients that are not intubated. Care must be used to ensure they are correctly inserted and do not worsen airway obstruction. Insertion in the semi-conscious can induce vomiting or laryngospasm.

Effective airway management during CPR is a major problem, even for medical professionals. Many individuals cannot manage a self-inflating resuscitation bag and mask effectively. Larger tidal volumes at lower pressures are delivered by mouth-to-mouth or mouth-to-mask ventilation.<sup>18</sup> The bag and mask apparatus is more effective if two individuals manage the airway: one to hold the mask and maintain the airway and one to squeeze the bag.<sup>19</sup> A number of airway devices designed for blind placement have been described for use by individuals who are not skilled laryngoscopists. The combination esophageal-tracheal tube (Combitube) and the laryngeal mask airway (LMA) have been studied for use during CPR. None of these methods allow the degree of airway control that is obtained with an endotracheal tube. However, no method of ventilation has been proven to be superior to the others in promoting successful resuscitation.<sup>20</sup> Intubation may be performed in prolonged resuscitations if a skilled laryngoscopist is available. However, it should not be performed until adequate ventilation by other means (preferably with supplemental oxygen) and circulation by chest compressions have been established and defibrillation performed, if appropriate (Box 84-2). When other methods of establishing an airway are unsuccessful, translaryngeal ventilation or tracheotomy by cricothyroid puncture may be lifesaving (Fig. 84-2).



**FIGURE 84-2.** Cricothyroidotomy. **A**, Anatomic view. **B**, Insertion of 14-gauge IV cannula. **C**, Bag attached to 3.0 endotracheal tube (ETT) adaptor connected to IV cannula.

## VENTILATION

Currently, airway management and ventilation remain the standard first steps of CPR. Mouth-to-mouth or mouth-to-nose ventilation is the most expeditious and effective method immediately available. Although inspired gas with this method contains approximately 4% carbon dioxide and only approximately 17% oxygen (composition of exhaled air), it is sufficient to maintain viability. Mouth-to-mask ventilation using a simple anesthesia face mask also is very effective. If the mask is fitted with a nipple adapter, a flow of oxygen can also supplement inspired oxygen concentration. The self-inflating resuscitation bag with mask also can be used with or without supplemental oxygen. Recommendations for ventilation are 2 breaths to 30 chest compressions during basic life support, as summarized in Box 84-3. Once an advanced airway (endotracheal tube, LMA, Combitube) is in place, ventilation should proceed at 8–10 breaths/min without

concern for synchronizing ventilation with chest compressions. Do not hyperventilate. Blood flow during CPR slows rapidly when chest compressions are stopped and recovers slowly when they are restarted. Consequently, unless the cause of arrest is hyp-

### BOX 84-3.

#### Ventilation during Basic Life Support

- A. Healthcare provider(s) without advanced airway**
  1. 6–8 breaths/min, each delivered over 1 second
  2. Pause 2.0 seconds for 2 breaths after every 30 chest compressions
  3. Tidal volume adequate to cause chest rise (~0.5–0.6 L)
- B. Healthcare provider(s) with advanced airway**
  1. 8–10 breaths/min adequate to make chest rise (~0.5–0.6 L)
  2. Do not pause chest compressions for ventilation
  3. Avoid hyperventilation

poxia, emphasis should be on maintaining chest compressions with as little interruption as possible.

### Physiology of Ventilation during CPR

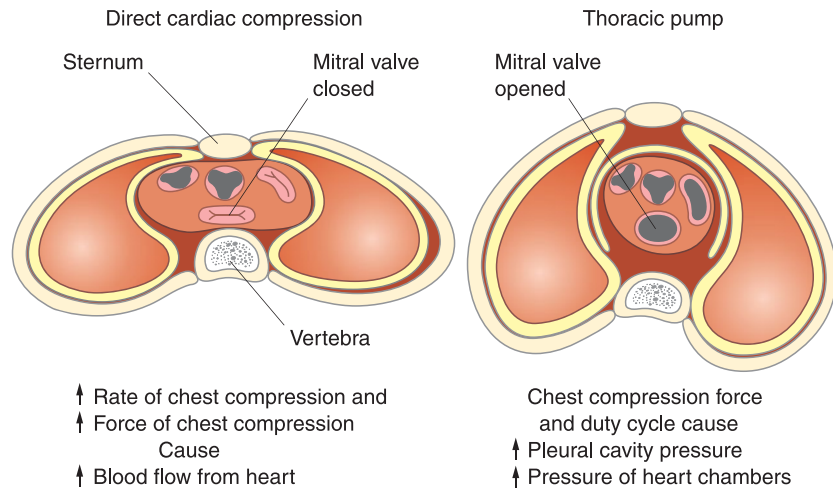
In the absence of an endotracheal tube, the distribution of gas between the lungs and stomach during mouth-to-mouth or mask ventilation will be determined by the relative impedance to flow into each; that is, the opening pressure of the esophagus and the lung-thorax compliance. It is likely that esophageal opening pressure during cardiac arrest is no more than that found in anesthetized individuals ( $\sim 20$  cm H<sub>2</sub>O) and lung-thorax compliance likely is reduced. To avoid gastric insufflation, inspiratory airway pressures must be kept low.

Insufflation of air into the stomach during resuscitation leads to gastric distension, impeding ventilation and increasing the danger of regurgitation and gastric rupture. If gastric insufflation is to be avoided, inspiratory airway pressures must be kept low. Partial airway obstruction by the tongue and pharyngeal tissues often leads to increased airway pressures and gastric insufflation. A useful aid to minimizing gastric insufflation is the use of cricoid pressure (Sellick maneuver).<sup>29</sup> Pressure applied over the anterior arch of the cricoid cartilage can prevent air from entering the stomach at airway pressures up to 100 cm H<sub>2</sub>O.<sup>30</sup> Meticulous attention to maintaining an open airway is necessary during rescue breathing. To cause a rise in the chest of most adults, a tidal volume of 0.5–0.6 L will be needed. Rescue breaths should be given as quickly as possible without causing gastric insufflation.

## CIRCULATION

### Physiology of Circulation during Closed Chest Compressions

Two mechanisms of blood flow during closed chest compression have been described.<sup>15,31</sup> In the cardiac pump mechanism, the heart is compressed between the sternum and spine, resulting in ejection of blood from the heart into the aorta with the atrioventricular valves preventing backward blood flow. In the thoracic pump mechanism, chest compression raises intrathoracic pressure, forcing blood out of



**FIGURE 84-3.** Possible mechanisms for blood flow during CPR include direct cardiac compression and the thoracic pump. With direct cardiac compression, an increase in chest compression rate causes an increase in blood flow by squeezing the heart between the vertebral column and sternum. With the thoracic pump mechanism, factors that increase pleural pressure cause an increase in pressure within the heart chambers and, ultimately, an increase in blood flow.

the chest, with venous valves and dynamic venous compression preventing backward flow and the heart acting as a passive conduit. The two mechanisms are not mutually exclusive (Fig. 84-3). Fluctuations in intrathoracic pressure play a significant role in blood flow during most resuscitations and the cardiac pump mechanism contributes under some circumstances. Which mechanism predominates probably varies from victim to victim and even during the resuscitation of the same victim.

Cardiac output is severely depressed during CPR, ranging from 10–33% of prearrest values in experimental animals. Nearly all of the cardiac output is directed to organs above the diaphragm. Brain blood flow is 50–90% of normal and myocardial blood flow 20–50% of normal, while lower extremity and abdominal visceral flow is reduced to less than 5% of normal. Total blood flow tends to decrease with time but the relative distribution of flow does not change. Flow to the brain and heart are improved by the administration of vasopressors, while flow to organs below the diaphragm is unchanged or further reduced.

### Physiology of Gas Transport during CPR

During CPR, measurement of blood gases reveals an arterial respiratory alkalosis and a venous respiratory acidosis because the arterial PCO<sub>2</sub> is re-

duced and the venous PCO<sub>2</sub> is elevated. The cause is not respiratory in origin. Rather, these changes result from decreased cardiac output. During the low-flow condition of CPR, excretion of CO<sub>2</sub> (mL of CO<sub>2</sub>/min in exhaled gas) is decreased approximately to the same extent as cardiac output is reduced. This reduced CO<sub>2</sub> excretion is primarily a result of shunting of blood flow away from the lower half of the body. The exhaled CO<sub>2</sub> reflects only the metabolism of the part of the body that is being perfused. In the nonperfused areas, CO<sub>2</sub> accumulates during CPR. When normal circulation is restored, the accumulated CO<sub>2</sub> is washed out and a temporary increase in CO<sub>2</sub> excretion is seen.

Although CO<sub>2</sub> excretion is reduced during CPR, the mixed venous partial pressure of CO<sub>2</sub> (PvCO<sub>2</sub>) usually is increased.<sup>32</sup> Two factors account for this elevation. Buffering acid causes a reduction in serum bicarbonate, so that the same blood CO<sub>2</sub> content results in a higher PvCO<sub>2</sub>. In addition, the mixed venous CO<sub>2</sub> content is elevated. When flow to a tissue is reduced, not all the produced CO<sub>2</sub> is removed, and CO<sub>2</sub> accumulates, increasing the tissue partial pressure of CO<sub>2</sub>. This allows more CO<sub>2</sub> to be carried in each aliquot of blood, and mixed venous CO<sub>2</sub> content increases. If flow remains constant, a new equilibrium is established where all CO<sub>2</sub> produced in the tissue is removed but at a higher venous CO<sub>2</sub>

content and partial pressure. In contrast to the venous blood, arterial CO<sub>2</sub> content and partial pressure (Paco<sub>2</sub>) are decreased during CPR. This accounts for most of the observed increase in arterial-venous CO<sub>2</sub> content difference. Although venous blood may have an increased CO<sub>2</sub>, the marked reduction in cardiac output with maintained ventilation results in very efficient CO<sub>2</sub> removal.

Decreased pulmonary blood flow during CPR causes lack of perfusion to many nondependent alveoli. The alveolar gas of these lung units has no CO<sub>2</sub>. Consequently, mixed alveolar CO<sub>2</sub> (i.e., end-tidal CO<sub>2</sub>) will be very low and correlate poorly with arterial CO<sub>2</sub>. However, end-tidal CO<sub>2</sub> does correlate well with cardiac output during CPR. As flow increases, more alveoli become perfused, there is less alveolar dead space, and end-tidal CO<sub>2</sub> measurements rise.

### Technique of Closed Chest Compression

Cardiac arrest should be presumed in the absence of a pulse in the major arteries (carotid, femoral, axillary) of an unconscious patient. After opening the airway and providing two ventilations, search for a pulse should be made before starting chest compressions. If weak circulation exists in a patient with a primary respiratory arrest, pulses may return after adequate ventilation and compressions may not be necessary (Box 84-1).

Standard chest compression technique consists of the rhythmic application of pressure over the lower half of the sternum. For compressions to be effective in providing blood flow to the brain and heart, the patient must be on a firm surface with the head level with the heart. The rescuer should stand or kneel at the side of the patient so that the hips are on a level with the victim's chest. Using the weight of the entire upper body, the compression is delivered straight down with enough force to depress the sternum 3.5–5.0 cm in adults and one-third to one-half the depth of the chest in children and infants. Following maximal compression, pressure is released completely from the chest. Chest compressions should be performed at a rate of 100 per minute. They are most effective if the compression and relaxation phases of the cycle are equal in length. This 50% compression time is easier to achieve at faster compression rates.

### Alternative Techniques of Circulatory Support

Better understanding of circulatory physiology during CPR, especially involving the thoracic pump mechanism, has resulted in several proposals for alternative techniques or adjunct devices in recent years. Most are intended to provide better hemodynamics and extend the duration during which CPR can support viability. Unfortunately, none has proven reliably superior to the standard technique, and no improvement in survival from cardiac arrest has been demonstrated consistently. Initial studies suggested hemodynamic advantages for techniques that raised intrathoracic pressure (simultaneous ventilation/compression, abdominal binding with compression, pneumatic antishock garment). Further investigations found that right atrial pressure and intracranial pressure were raised by these techniques, frequently more than aortic pressure. Consequently, there was no improvement in cerebral or myocardial blood flow. Outcome studies with these techniques found no improvement in resuscitation success compared to standard CPR. They are currently not recommended for support of the cardiac arrest victim.

### Interposed Abdominal Compression CPR

Interposed abdominal counterpulsation (IAC) CPR consists of a dedicated rescuer providing manual abdominal compression between the xiphoid and umbilicus during the relaxation phase of conventional CPR.<sup>33</sup> IAC-CPR increases venous return and compresses the abdominal aorta to produce retrograde aortic flow, closing the aortic valve and augmenting diastolic pressure. Although initial hemodynamic studies were encouraging, a large randomized study of out-of-hospital arrest found no improvement in survival compared to standard CPR.<sup>34</sup> Two subsequent in-hospital studies using trained providers found improved return of spontaneous circulation (ROSC) and short-term survival with IAC-CPR compared to the standard technique.<sup>35,36</sup> In general, there has not been improvement in long-term survival with the use of this technique. Reports of human studies demonstrate the frequency of complications, including laceration of abdominal viscera or esophageal regurgitation, is not

increased with IAC-CPR. During in-hospital resuscitation, IAC-CPR may be considered when there are sufficient personnel trained in its use. Its use for out-of-hospital arrest remains experimental.

### Active Compression–Decompression CPR

Active compression–decompression (ACD) CPR developed from the anecdotal report of CPR performed with a plumber's helper applied to the anterior chest wall.<sup>37</sup> This suggested that active decompression of the chest wall might reduce intrathoracic pressure during the relaxation phase of chest compressions, leading to improved venous return, increased stroke volume with compression, and better blood flow. Devices that can be applied to the chest wall in order to enable active compression and decompression have been developed but none is currently approved by the FDA for sale in the United States. Hemodynamic studies in animals and humans show that coronary and cerebral perfusion may be somewhat improved with this method compared to standard CPR, although when epinephrine is used, there is no difference between techniques.<sup>38,39</sup> Clinical trials have found mixed results, with 4 showing improved resuscitation and 5 demonstrating no difference from the standard technique. A meta-analysis of 4162 patients in 10 out-of-hospital trials and 826 patients in 2 in-hospital trials found no difference in early or late survival with ACD-CPR compared to standard CPR.<sup>40</sup>

### Impedance Threshold Device

The impedance threshold device (ITD) is a valve that limits the flow of air into the lungs during the relaxation phase of chest compressions, reducing intrathoracic pressure during chest recoil and enhancing venous return.<sup>41</sup> Originally designed for use with an endotracheal tube, it has been adapted for use with a face mask assuming a tight seal with the face is maintained. It has frequently been studied in association with ACD-CPR in the belief that the two techniques would act synergistically to improve venous return. Two randomized trials of the combined techniques found improved ROSC and 24-hour survival compared to the standard technique.<sup>42,43</sup> One randomized trial of adding the ITD to standard CPR found improved admission to the ICU



and 24-hour survival.<sup>44</sup> No studies have demonstrated improved long-term survival.

### **Pneumatic Vest CPR and Load-Distributing Band CPR**

Pneumatic vest CPR is a method of increasing intrathoracic pressure by phasically inflating a bladder around the chest (with or without simultaneous ventilation), without significantly changing the dimensions of the chest.<sup>45,46</sup> Experimental animal studies show excellent hemodynamics and the ability to maintain viability for prolonged periods. The technique continues to be investigated with a number of modifications from the original method. A recent modification is the load-constricting band (LCB) device consisting of a pneumatically or electrically actuated constricting band and backboard. One preliminary report using this device found improved survival to emergency department admission compared to standard CPR in out-of-hospital cardiac arrest.<sup>47</sup>

### **Invasive Techniques**

In contrast to the closed chest techniques, two invasive methods have been able to maintain cardiac and cerebral viability during long periods of cardiac arrest. In animal models, open-chest cardiac massage and cardiopulmonary bypass (through the femoral artery and vein using a membrane oxygenator) can provide better hemodynamics and myocardial and cerebral perfusion than closed chest techniques.<sup>48,49</sup> When performed after 15 minutes of closed-chest CPR, open-chest CPR significantly improves coronary perfusion pressure and the rate of successful resuscitation.<sup>50</sup> When initiated early (probably within 20–30 minutes of arrest) following failure of closed-chest CPR, open-chest CPR may improve resuscitation.<sup>53–55</sup> However, if open chest massage is begun after 30 minutes of ineffective closed chest compressions, there is no better survival even though hemodynamics are improved.<sup>56</sup>

Preliminary trials of percutaneous cardiopulmonary bypass for refractory human cardiac arrest have been reported<sup>51</sup> and this is a technique available in some institutions. Prompt restoration of blood flow and perfusion pressure with cardiopulmonary bypass can provide resuscitation with minimal neurological deficit after 20 minutes of fibrillatory cardiac arrest in canines.<sup>52</sup>

### **Monitoring during CPR**

Assessment of the patient during CPR is similar to other clinical situations; Box 84–4 lists the major points. A basic clinical examination and adherence to basic principles, including inspection, palpation, and auscultation of the patient, are performed. The chest is carefully observed for adequacy of chest expansion with artificial ventilation and for equal and normal breath sounds. In addition, the depth of compression and the position of the rescuer's hands in performing chest compressions should be reevaluated constantly.

Successful resuscitation in experimental models is associated with myocardial blood flows of 15–20 mL/min/100 g (Table 84–2).<sup>57</sup> Obtaining such flows requires that closed chest compressions generate adequate cardiac output and coronary perfusion pressure. During CPR, coronary perfusion occurs primarily during the relaxation phase (diastole) of chest compression. The critical myocardial blood flow is associated with aortic “diastolic” pressure exceeding 40 mm Hg and coronary perfusion pressure (aortic diastolic minus right atrial diastolic pressure) exceeding 25 mm Hg in animal models.<sup>57–67</sup> One report has confirmed similar findings in humans, noting that all patients with successful return of spontaneous circulation had coronary perfusion pressures higher than 15 mm Hg.<sup>67</sup> The use of an indwelling arterial catheter, when available, is an invaluable monitor in assessing the arterial blood pressure and estimating these critical perfusion pressures. In addition, an arterial line allows for determination of arterial blood gases. If pressures are below the critical levels (Table 84–2), adjustments should be made to improve chest compressions and/or additional epinephrine should be administered. Greater pressures do not ensure success. Damage to the myocardium from underlying disease may preclude survival no matter how effective the CPR efforts. However, inadequate vascular pressures consistently result in poor outcomes.

Although invasive pressure monitoring may be the ideal, exhaled end-tidal CO<sub>2</sub> is an excellent noninvasive guide to the effectiveness of standard CPR.<sup>68</sup> Carbon dioxide excretion during CPR with an endotracheal tube in place is dependent primarily on flow rather than ventilation. Since alveolar dead

#### **BOX 84–4.**

#### **Assessment of Patient during Cardiopulmonary Resuscitation**

- A. Inspection**
  - Chest rise
  - Depth of compression
  - Position of rescuer's hands
- B. Palpation**
  - Establish pulselessness
  - Assess peripheral pulses
  - Locate landmarks
- C. Auscultation**
  - Breath sounds
  - Heart sounds
- D. Monitoring**
  - Electrocardiogram
  - Arterial catheter
  - Central venous catheter
  - Pulse oximeter
  - End-tidal CO<sub>2</sub>
  - Temperature

space is large during low-flow conditions, end-tidal CO<sub>2</sub> is very low (frequently <10 mm Hg). If cardiac output increases, more alveoli are perfused and end-tidal CO<sub>2</sub> rises (usually to >20 mm Hg during successful CPR). When spontaneous circulation resumes, the earliest sign is a sudden increase in end-tidal CO<sub>2</sub> to greater than 40 mm Hg. Within a wide range of cardiac outputs, end-tidal CO<sub>2</sub> during CPR correlates with coronary perfusion pressure,<sup>69</sup> cardiac output,<sup>70</sup> initial resuscitation<sup>71,72</sup> and survival.<sup>73</sup> End-tidal CO<sub>2</sub> measured during human CPR has been used to predict outcome. No patient with an end-tidal CO<sub>2</sub> <10 mm Hg could be successfully resuscitated.<sup>73</sup> In the absence of invasive pressure monitoring, end-tidal CO<sub>2</sub> monitoring can be used to judge the effectiveness of chest com-

**TABLE 84–2.**

#### **Physiological Indicators of Effective Cardiopulmonary Resuscitation**

Variables	Amount
Myocardial blood flow	15–20 mL/min/ 100 g
Arterial diastolic pressure	40 mm Hg
Coronary perfusion pressure	15–25 mm Hg
End-tidal carbon dioxide	>10 mm Hg



pressions. Attempts should be made to maximize the value by alterations in technique or drug therapy. Sodium bicarbonate administration results in the liberation of CO<sub>2</sub> in the venous blood and a temporary rise in end-tidal CO<sub>2</sub>. Therefore, end-tidal CO<sub>2</sub> monitoring will not be useful for judging the effectiveness of chest compressions for 3–5 minutes following bicarbonate administration.

## ADVANCED LIFE SUPPORT

Advanced life support encompasses all technical skills and cognitive resources required to restore spontaneous circulatory function. In addition to BLS skills, it includes use of adjunctive equipment and techniques for assisting ventilation and circulation, electrocardiogram (ECG) monitoring with arrhythmia recognition and defibrillation, establishment of IV access, and drug therapy.

## DEFIBRILLATION

### Duration and Electrical Pattern of Fibrillation

Ventricular fibrillation is the most common rhythm disturbance in cardiac arrest; it is caused by reentry impulse generation with multiple circuits with changing pattern. The only consistently effective treatment is electrical defibrillation. The fibrillating heart consumes considerable oxygen, increasing myocardial ischemia, and decreasing the time to irreversible cell damage. The longer fibrillation continues, the more difficult it is to defibrillate and the less likely is successful resuscitation.<sup>5,53,74–77</sup> During the electrical phase of arrest (within 5 minutes of collapse), defibrillation should be the first priority of resuscitation (Box 84–2). Initial resuscitation success following out-of-hospital fibrillation and survival to hospital discharge are improved the earlier that defibrillation is accomplished.<sup>5,76</sup>

The application of defibrillation during the electrical phase has been facilitated by the development of AEDs that recognize ventricular fibrillation, charge automatically, and give a defibrillatory shock. Minimally trained individuals can incorporate defibrillation into BLS skills using an AED, thus improving survival in out-of-hospital arrest by

reducing time to delivery of the first shock.<sup>5,77–80</sup> The value of public access defibrillation was dramatically demonstrated by the early results of installing AEDs in Las Vegas casinos where there was a 53% survival to discharge from the hospital<sup>78</sup> and in Chicago airports where there was a 55% one-year neurologically intact survival over the first two years.<sup>79</sup>

Early defibrillation is the paramount intervention during the electrical phase of cardiac arrest. However, in the usual out-of-hospital rescue with EMTs or paramedics doing the defibrillation and in many in-hospital arrests, the first shock frequently is delayed until 6–10 minutes following collapse, well into the hemodynamic phase of arrest. A retrospective analysis in Seattle found that, when response time was greater than 4 minutes, survival was improved if CPR was provided before defibrillation.<sup>81</sup> In a randomized trial of 200 out-of-hospital cardiac arrests in Oslo, there was a highly significant improvement in outcome if CPR was provided before defibrillation when the response time was greater than 5 minutes.<sup>82</sup> Consequently, it now appears that immediate defibrillation is only effective if applied within 4–5 minutes of collapse. Otherwise, a brief period of 2–3 minutes of chest compressions before defibrillation is necessary.

The coarseness of the fibrillatory waves on the ECG may reflect the severity and duration of the myocardial insult and, thus, have prognostic significance.<sup>83</sup> Increasing myocardial ischemia results in less-vigorous fibrillation, reduced amplitude electrical activity, and more difficult defibrillation. Low-amplitude and low-frequency fibrillatory waveforms are associated with poor outcome and the median frequency of the waveform correlates with myocardial perfusion during CPR and with success of defibrillation.<sup>83,84</sup> Catecholamines with  $\beta$ -adrenergic activity, such as epinephrine, increase the amplitude of the electrical activity but have no influence on the ability to defibrillate.<sup>75,85</sup> Consequently, defibrillation should not be delayed for drug therapy.

### Defibrillators

The modern defibrillator is a variable transformer that stores a direct current in a capacitor until discharged through the electrodes. Until recently, the cur-

rent waveform of most defibrillators used for transthoracic defibrillation was a monophasic (single direction of current flow between paddle electrodes), damped sinusoid, although some delivered truncated exponential waves. Nearly all AEDs and defibrillators sold today deliver a biphasic current (direction of flow reverses during the shock) in either a truncated, exponential, or rectilinear waveform.<sup>86</sup> The output of most defibrillators is indicated in *energy* units (joules or watt-seconds). At a constant stored energy, the energy delivered to the patient will be inversely related to the impedance (resistance) between the paddle electrodes. For consistency, the energy level indicated on most commercially available defibrillators is the output when discharged into a 50-ohm load.

### Transthoracic Impedance

Defibrillation is accomplished by the *current* passing through a critical mass of myocardium causing simultaneous depolarization of the myofibrils. Even at a constant delivered energy, delivered current will be reduced as impedance increases. At high impedance and relatively low energy levels, current could be too low for defibrillation.

Transthoracic impedance has been measured at 15–143 ohms in human defibrillation.<sup>87</sup> The major determinants of transthoracic impedance are known, and many are under the control of rescuers (Box 84–5). Impedance decreases with increasing electrode size, but concern has been expressed that a too large a paddle size may diffuse the current over too great an area for effective defibrillation. The most common paddle size remains an 8–10-cm diameter for adults and children and a 4.5-cm diameter for infants. The high impedance between metal electrode and skin requires that carefully applied self-adhesive defibrillation pads or electrode paste/gel pads specifically designed to conduct elec-

#### BOX 84–5.

##### Factors Reducing Transthoracic Impedance during Defibrillation

- Large paddle size ( $\geq 8$ -cm diameter)
- Defibrillation paste
- Firm pressure on paddles ( $\geq 11$  kg)
- Defibrillation during exhalation
- Successive shocks

tricity in the defibrillation setting be used. When paste or gel is used, it should be applied liberally to the paddle surface to prevent burns and obtain the maximum reduction in impedance. However, it must not form a continuous path from one paddle to the other, allowing the electric circuit to follow the path of least resistance and bypass the heart. Transthoracic impedance decreases with successive shocks, a partial explanation for why an additional shock of the same energy can cause defibrillation when previous shocks have failed. Transthoracic impedance is slightly but significantly higher during inspiration than during exhalation. Air is a poor electrical conductor. Firm paddle pressure of at least 11 kg reduces resistance by improving paddle-skin contact and by expelling air from the lungs.<sup>87</sup>

Optimum success of defibrillation is obtained by keeping impedance as low as possible. The average transthoracic impedance in human defibrillation is 70–80 ohms. Impedance is probably of little clinical significance when reasonably proper technique and high-energy shocks are used. For lower-energy shocks, great care should be taken to minimize resistance. Defibrillators have been developed that measure transthoracic impedance during the charge cycle, allowing the use of low-energy shocks in appropriate patients and identification of victims needing higher energy.<sup>88</sup> Although not clinically available, current-based defibrillation may be a better way describe defibrillation dose.<sup>89</sup>

### Energy Requirements and Adverse Effects

The incidence and severity of myocardial damage from defibrillation in humans is not clear. In studies using the traditional monophasic defibrillator, repeated high-level shocks in animals result in dysrhythmias, ECG changes, and myocardial necrosis.<sup>90,91</sup> Whether such injuries occur in humans is unknown. In humans, dysrhythmia frequency and the degree of ST-segment depression is greater with increased energy doses.<sup>92</sup> Although there is no definitive evidence demonstrating myocardial damage within the range of clinically used doses, it would seem prudent to keep energy levels as low as possible during defibrillation attempts. However, if energy is too low, the delivered current may be insufficient for

defibrillation, especially when transthoracic impedance is high.

With monophasic defibrillation, there is a general relationship between body size and energy requirements for defibrillation.<sup>93</sup> Children need lower energies than adults, perhaps as low as 0.5 J/kg.<sup>94</sup> However, over the size range of adults, body size does not seem to be a clinically important variable.<sup>95</sup> Multiple studies have demonstrated high rates of successful defibrillation using relatively low levels (160–200 J) of delivered energy. Studies of out-of-hospital and in-hospital arrests have demonstrated equal success when using 200 J or less initial energy compared to administering all shocks at energies of 300 J or greater.<sup>92,96</sup>

Biphasic defibrillators with different waveforms have been demonstrated to be effective over specific dose ranges. AEDs have the shock energy preselected within the defibrillator algorithm. For manual biphasic defibrillation, most manufacturers display the effective dose range on the defibrillator. For biphasic truncated exponential waveforms, initial energies of 150–200 J have been shown to be successful >90% of the time.<sup>1</sup> For rectilinear biphasic waveforms, initial energy of 120 J has had similar success. Escalating doses of biphasic shocks have not been shown to improve success of defibrillation.

Immediate defibrillation is indicated if it can be applied within 4–5 minutes of collapse. Beyond that time, results are likely to be better if a brief (~2 minutes) period of chest compressions is provided before defibrillation. The current recommendation in adult patients using a monophasic defibrillator is to give a single shock of 360 J followed by immediate resumption of CPR for 2 minutes before rechecking rhythm and pulse (Box 84–6).<sup>1</sup> Because most defibrillations result in asystole or pulse electrical activity (PEA), a period of CPR will be necessary; beginning compressions immediately following the shock minimizes interruption of critical blood flow. With an AED or biphasic defibrillator, use the preset or manufacturers recommended energy. If that is unknown or unclear, a dose of 200 J may be selected. In children, with a manual defibrillator (monophasic or biphasic), an initial dose of 2 J/kg is used. As with adults, CPR is immediately restarted after a shock for 2 minutes

#### BOX 84–6.

##### Defibrillation Recommendations

###### Adults

2 minutes CPR if >5 minutes since collapse

###### Countershock:

Monophasic: 360 J

AED: Preset

Biphasic: Device recommended (if unknown, 200 J)

Immediately restart CPR for 2 minutes

Recheck rhythm and pulse

Repeat countershock

Immediately restart CPR, oxygen, drugs

Repeat sequence

###### Children

2 minutes CPR if >5 minutes since collapse

First countershock: 2.0 J/kg monophasic or biphasic

Immediately restart CPR for 2 minutes

Recheck rhythm and pulse

Repeat countershock with 4.0 J/kg

Immediately restart CPR, oxygen, drugs

Repeat sequence, all subsequent shocks: 4.0 J/kg

before repeat rhythm and pulse check. If the first shock is unsuccessful, additional shocks of 4 J/kg are given separated by at least 2 minutes of CPR and appropriate drug and other therapy. If defibrillation attempts are unsuccessful, attention should be directed to the oxygenation, acid–base status, and administration of CPR and drugs such as epinephrine. In addition, factors that may increase transthoracic impedance should be evaluated, including pneumothorax, inadequate paddle–chest wall interface, improper paddle position, excessive distance between paddles, and inadequate paddle pressure on the chest.

Open-chest defibrillation can be used in the operating room when the thorax is already opened during surgery. Appropriate internal paddle sizes are 6-cm diameter for adults, 4-cm for children, and 2-cm for infants. The paddles are applied with saline-soaked pads, one placed behind the left ventricle and the other over the right ventricle. When defibrillation is performed in this manner, 5 J should be used on the first attempt. If unsuccessful, repeated doses can be used with energy levels up to 50 J.

## Supplemental Therapy

Lidocaine and amiodarone are used during cardiac arrest to aid defibrillation when ventricular fibrillation is refractory to electrical countershock therapy or when fibrillation recurs following successful conversion. However, no antiarrhythmic agent has been shown superior to electrical defibrillation or more effective than placebo in the treatment of ventricular fibrillation. Consequently, defibrillation should not be withheld or delayed for drug therapy, but should be applied at the earliest possible time when treating ventricular fibrillation (Box 84-2).

### Lidocaine and Amiodarone

Lidocaine is primarily an antiectopic agent with few hemodynamic effects. It depresses automaticity by reducing the slope of phase 4 depolarization and reducing the heterogeneity of ventricular refractoriness. It tends to restore the ventricular fibrillation threshold decreased by ischemia or infarction. It has no effect on conduction times through the atrioventricular node or on intraventricular conduction time. Amiodarone is a pharmacologically complex drug with sodium, potassium, calcium, and  $\alpha$ - and  $\beta$ -adrenergic blocking properties that is useful for treatment of atrial and ventricular arrhythmias. Amiodarone can cause hypotension and bradycardia when infused too rapidly in patients with an intact circulation. This can usually be prevented by slowing the rate of drug infusion, or treated with fluids, vasopressors, chronotropic agents, or temporary pacing.

Lidocaine is effective in terminating ventricular premature beats (VPBs) and ventricular tachycardia associated with cardiac surgery, acute myocardial infarction, and digitalis intoxication. It is also effective in preventing and treating ventricular dysrhythmias during cardiac catheterization. Lidocaine is not effective in the treatment of atrial or atrioventricular junctional dysrhythmias (Box 84-7). In contrast, amiodarone is effective in treating multiple types of supraventricular and ventricular dysrhythmias.

In cardiac arrest, intravenous lidocaine and/or amiodarone are administered following return of spontaneous circulation for prophylaxis or when ventricular tachycardia or ventricular fibrillation have not responded to or have recurred following epinephrine and defibrillation. There are two ran-

### BOX 84-7.

#### Indications for Use of Lidocaine

- Frequent ventricular premature beats ( $>10$  beats/min)
- Coupled VPBs
- Multiform VPBs
- Ventricular tachycardia
- Prophylaxis during cardiac catheterization
- Prophylaxis following resuscitation

domized, blinded, clinical trials in shock-resistant cardiac arrest victims demonstrating improved admission alive to hospital with amiodarone treatment compared to placebo or lidocaine, although there was no difference in survival to discharge.<sup>97,98</sup> Amiodarone is initially administered as a 300-mg rapid infusion. Supplemental infusions of 150 mg can be repeated as necessary for recurrent or resistant arrhythmias to a maximum total daily dose of 2 g. Lidocaine is an alternative therapy in refractory fibrillation. To rapidly achieve and maintain therapeutic blood levels during CPR, relatively large doses are necessary. An initial bolus of 1–1.5 mg/kg should be given and additional boluses of 0.5–0.75 mg/kg can be given every 5–10 minutes during CPR up to a total dose of 3 mg/kg. Only bolus dosing should be used during CPR but an infusion of 2–4 mg/min can be started after successful resuscitation.

### Temporary Pacemaker Therapy

When emergency pacing is indicated, intravenous or transthoracic pacing can be initiated. Temporary pacing can usually be quickly instituted using external, noninvasive, temporary pacemakers that use large, high-impedance electrodes, allowing relatively nonpainful stimuli.<sup>99</sup>

Temporary pacing is indicated for patients with preserved myocardial function whose primary problem is impulse formation or conduction, such as patients with severe bradycardia or high-grade heart block who have a palpable pulse. Studies of temporary pacing during cardiac arrest (out-of-hospital or in the emergency department) have found no improvement in admission to hospital or survival. Consequently, withholding chest compressions in patients with asystole to attempt pacing is not recommended.<sup>1</sup>

## PULSELESS ELECTRICAL ACTIVITY AND ASYSTOLE

Although ventricular fibrillation is the most common ECG rhythm seen in cardiac arrest, PEA and asystole do occur as either the presenting rhythm or following defibrillation. They are seen more often in children and are associated with a poor outcome. PEA is the circumstance where no palpable pulse is present but an ECG rhythm is detectable. This includes a number of different rhythms, most commonly electromechanical dissociation (EMD; Box 84-8). Asystole is the absence of electrical activity on the ECG. Fine ventricular fibrillation can masquerade as asystole if the ECG lead being monitored is located at right angles to the fibrillatory wave.<sup>100</sup> For this reason, the trace from a second lead or from a different position of paddle electrodes should always be inspected before a decision is made not to defibrillate.

The predominant cause of primary PEA and asystole is severe myocardial ischemia. These rhythms may represent a failure of myocardial contractility caused by a depletion of intracellular energy stores and carry a very poor prognosis. These ECG patterns also may be secondary, caused by a variety of noncardiac mechanisms that are amenable to treatment (Boxes 84-9 and 84-10). Therapy directed at the underlying disorder may result in a successful outcome. Consequently, consideration of a noncardiac cause for arrest should always be part of the resuscitation sequence when these rhythms are detected (Box 84-11).

## DRUG THERAPY

During cardiac arrest, drug therapy is secondary to more fundamental inter-

### BOX 84-8.

#### Pulseless Electrical Activity

Pulseless electrical activity (PEA) includes:

EMD

Pseudoelectromechanical dissociation

Idioventricular rhythms

Ventricular escape rhythms

Bradyasystolic rhythms

Postdefibrillation idioventricular rhythms



**BOX 84–9.****Causes of Pulseless Electrical Activity (PEA)**

Cardiac (primary)  
 Failure of myocardial contractility  
 Noncardiac (secondary)  
 Hypovolemia  
 Tension pneumothorax  
 Cardiac tamponade  
 Massive pulmonary embolism  
 Hypothermia  
 Drug overdose  
 Hypoxia  
 Hyperkalemia  
 Acidosis

ventions (Box 84–2). Chest compressions, defibrillation (if appropriate), and ventilation should take precedence over medications. Establishing IV access and administering drugs, although important, should not interrupt sustained chest compressions and ventilation. Of the drugs used during CPR, only vasopressors are acknowledged to help restore spontaneous circulation.<sup>1</sup>

**Oxygen**

Patients in cardiac arrest or low cardiac output states should receive 100% oxygen as soon as possible. Oxygen will increase arterial oxygen tension and hemoglobin saturation if ventilation is supported and improve tissue oxygenation when circulation is supported.

**Vasopressor Agents****Mechanism of Action**

Epinephrine has been used in resuscitation since the 1890s and has been the vasopressor of choice in modern CPR since the studies of Redding and Pearson in the 1960s.<sup>17,101</sup> Its efficacy lies entirely in its  $\alpha$ -adrenergic properties.<sup>64</sup> When epinephrine is administered during CPR, peripheral vasoconstriction results in higher aortic pressure causing an increase in coro-

nary and cerebral perfusion pressures and myocardial and brain blood flows.<sup>63,102,103</sup> Flow to other organs either does not improve or diminishes further when epinephrine is given, despite the increase in aortic pressure. Animal studies demonstrate that all strong  $\alpha$ -adrenergic drugs (epinephrine, phenylephrine, methoxamine, dopamine, norepinephrine) and nonadrenergic vasopressors (vasopressin) are equally successful in aiding resuscitation regardless of the  $\beta$ -adrenergic potency.  $\beta$ -Adrenergic agonists without  $\alpha$  activity (isoproterenol, dobutamine) are no better than placebo.<sup>17,59,101,104,105</sup>  $\alpha$ -Adrenergic blockade precludes resuscitation, whereas  $\beta$ -adrenergic blockade has no effect on the ability to restore spontaneous circulation.<sup>61,62</sup> Although it has been suggested that the ability of epinephrine to increase the amplitude of ventricular fibrillation (a  $\beta$ -adrenergic effect) makes defibrillation easier, animal studies show that epinephrine does not improve the success of or decrease the energy necessary for defibrillation.<sup>75,85</sup> Retrospective clinical studies show no effect of epinephrine on defibrillation success.<sup>83</sup>

$\beta$ -Adrenergic stimulation during cardiac arrest is potentially deleterious. In the fibrillating heart, epinephrine increases oxygen consumption. Myocardial lactate production in the fibrillating heart is unchanged after epinephrine administration during CPR suggesting that the increased coronary blood flow does not improve the oxygen supply-to-demand ratio.<sup>106</sup> Large doses of epinephrine increased deaths in swine early after resuscitation as a consequence of tachyarrhythmias and hypertension, an effect partially offset by metoprolol treatment.<sup>107</sup> Despite these theoretical considerations, survival and neurologic outcome studies show no difference when epinephrine is compared to a pure  $\alpha$ -agonist (methoxamine or phenylephrine) or to a nonadrenergic vasopressor (vasopressin) during CPR in animals or humans.<sup>108–111</sup>

**Epinephrine**

When added to chest compressions, epinephrine helps to develop the critical coronary perfusion pressure necessary to provide enough myocardial blood flow for restoration of spontaneous circulation. If invasive monitoring is present during CPR, an arterial diastolic pressure of 40 mm Hg or coronary perfusion pressure of 20 mm Hg

**BOX 84–11.****Treatment of Asystole/Pulseless Electrical Activity**

Begin cardiopulmonary resuscitation  
 ↓  
 Intravenous access  
 ↓  
 Epinephrine or vasopressin (repeat every 3–5 minutes)  
 ↓  
 Consider noncardiac causes  
 ↓  
 Consider atropine (repeat every 3–5 minutes up to 3 doses)  
 ↓  
 Secure airway without interrupting compressions, when possible

must be obtained with good chest compression technique and/or epinephrine therapy (Table 84–1). In the absence of such monitoring, the dose of epinephrine must be chosen empirically. The standard dose used in animals and humans for many years has been 0.5–1.0 mg intravenously. On a weight basis, this dose is approximately 0.1 mg/kg in animals but only 0.015 mg/kg in humans. Animal studies in the 1980s suggested that higher doses of epinephrine in human CPR might improve myocardial and cerebral perfusion and improve success of resuscitation. Case reports on a series of children (with historical controls) were published demonstrating return of spontaneous circulation when large doses (0.1–0.2 mg/kg) of epinephrine were given to patients who had failed resuscitation with standard doses.

Outcome studies prospectively comparing standard and high-dose epinephrine do not demonstrate conclusively that higher doses improve survival. Two randomized, blinded animal studies (one with fibrillatory arrest and one with asphyxial arrest) comparing standard and high-dose epinephrine found no difference in 24-hour survival or neurologic outcome but more of the high-dose epinephrine animals died in the early postresuscitation period as a result of a hyperdynamic state.<sup>107,112</sup> Eight adult prospective randomized clinical trials involving more than 9000 cardiac arrest patients have found no improvement in survival to hospital discharge or neurologic outcome, even in subgroups, when initial high-dose epinephrine (5–18 mg) is compared to standard

**BOX 84–10.****Causes of Asystole**

Hypoxia  
 Hypothermia  
 Drug overdose  
 Hyperkalemia  
 Hypokalemia  
 Acidosis  
 Myocardial electrical failure



doses (1–2 mg).<sup>113–120</sup> Some of the studies (and the cumulative data) suggest that there may be an improvement in immediate resuscitation with high-dose epinephrine. None of the studies found improvement in survival to hospital discharge.

Because of the long experience with epinephrine, it remains the vasopressor of choice in CPR. It should be administered whenever resuscitation has not occurred after adequate chest compressions and ventilation have been started and defibrillation attempted, if appropriate (Box 84–2). High doses of epinephrine apparently are not needed as initial therapy for most cardiac arrests and potentially could be deleterious under some circumstances. However, the successful case reports were in patients with prolonged CPR and the high doses were given as “rescue” therapy when standard doses had failed. This may be the appropriate place for higher doses of epinephrine in CPR practice. Current recommendations are to give intravenous epinephrine, 1 mg in the adult or 0.01 mg/kg in children, every 3–5 minutes. Higher doses may be indicated in specific circumstances, or if treatment has been delayed and the standard dose seems ineffective.

### Vasopressin

The newest addition to the pharmacologic armamentarium in CPR is arginine vasopressin. It is currently recommended as an alternative to either the first or second dose of epinephrine in a dose of 40 units intravenously. If additional vasopressor doses are needed, epinephrine should be used. Vasopressin is a naturally occurring hormone (antidiuretic hormone) that, when administered in high doses, is a potent nonadrenergic vasoconstrictor, acting by stimulation of smooth muscle V1 receptors. The half-life in the intact circulation is 10–20 minutes, and longer than epinephrine during CPR. Animal studies demonstrate that vasopressin is as effective as, or more effective than, epinephrine in maintaining vital organ blood flow during CPR.<sup>121–123</sup> Repeated doses during prolonged CPR in swine were associated with significantly improved rates of neurologically intact survival compared to epinephrine and placebo.<sup>124</sup> Postresuscitation myocardial depression and splanchnic blood flow reduction are more marked with vasopressin than epinephrine but

they are transient and can be treated with low-doses of dopamine.<sup>125</sup> Clinical studies indicate that vasopressin is as effective as epinephrine, but have not definitively shown it to be superior. A small, randomized, blinded study comparing vasopressin and standard-dose epinephrine in 40 patients with out-of-hospital ventricular fibrillation found improved 24-hour survival with vasopressin but no difference in ROSC or survival to hospital discharge.<sup>126</sup> A larger clinical trial of 200 in-patients found no difference between the drugs in survival for 1 hour or to hospital discharge.<sup>127</sup> In this study, response times were short, indicating that CPR outcome achieved with both vasopressin and epinephrine in short-term cardiac arrest may be comparable. The hemodynamic effects of vasopressin, compared to epinephrine, are especially impressive during long cardiac arrests. Thus vasopressin may find most use in CPR during prolonged resuscitation. A multicenter, randomized study of 1186 patients comparing vasopressin 40 U and epinephrine 1 mg for the first two doses of vasopressor during resuscitation from out-of-hospital cardiac arrest found no overall difference in survival to hospital admission (36% vs. 31%) or discharge (10% vs. 10%).<sup>111</sup> However, in subgroup analysis, in patients presenting in asystole, there was a significant improvement in survival to hospital admission (29% vs. 20%) and discharge (4.7% vs. 1.5%). In those patients who did not resuscitate following two doses of study drug, approximately 60% received additional epinephrine. In these difficult-to-resuscitate patients, irrespective of presenting rhythm, those who received vasopressin followed by epinephrine had better outcomes than those who received only epinephrine, suggesting that the combination of the drugs may have advantages. Overall, evidence currently suggests that, like other potent vasopressors, vasopressin is equivalent to, but not better than, epinephrine for use during CPR.

### Atropine

Atropine sulfate enhances sinus node automaticity and atrioventricular conduction by its vagolytic effects. Atropine is indicated when bradycardia coexists with hypotension, ventricular ectopy, or symptoms associated with myocardial ischemia. The drug can also be used to treat second-degree and

third-degree heart block, and slow idioventricular rates. Although atropine is frequently given during cardiac arrest associated with an ECG pattern of asystole or slow PEA, neither animal nor human studies provide evidence that it actually improves outcome from asystolic or bradysystolic arrest.<sup>127–130</sup> The predominant cause of asystole and EMD is severe myocardial ischemia. Excessive parasympathetic tone probably contributes little to these rhythms during cardiac arrest in adults. Even in children, the significance of autonomic tone during arrest is doubtful. The most effective treatment for asystole or PEA is improvement in coronary perfusion and myocardial oxygenation with chest compressions, ventilation, and epinephrine. However, cardiac arrest with these rhythms has a very poor prognosis. Because atropine has few adverse effects, it can be tried in arrest refractory to epinephrine and oxygenation. The recommended dose for bradycardia in adults is 0.5 mg IV every 3–5 minutes to a total dose of 3.0 mg. The pediatric dose for treating bradycardia is 0.02 mg/kg with a minimum dose of 0.1 mg and a maximum total dose of 1.0 mg in a child and 3.0 mg in an adolescent. The dose may be repeated every 3–5 minutes. When treating pulseless arrest in the adult, the dose is 1.0 mg IV every 3–5 minutes to a total dose of 3.0 mg. Atropine is no longer recommended for use in pulseless arrest in children. Full vagolytic doses may be associated with fixed mydriasis following successful resuscitation confounding neurologic examination. Occasionally, a sinus tachycardia following resuscitation may be caused by use of atropine during CPR.

### Calcium Salts

With normal cardiovascular physiology, calcium increases myocardial contractility and enhances ventricular automaticity. Consequently, calcium salts have been administered during attempted resuscitation of asystole and EMD for many years. However, multiple clinical studies have found that calcium is no better than placebo in promoting resuscitation and survival from asystole or EMD.<sup>131,132</sup> Calcium is not indicated for use during cardiac arrest in adults or children. It may be useful for treatment of hyperkalemia, ionized hypocalcemia, hypermagnesemia, or calcium channel blocker toxicity (Box 84–12). If calcium is adminis-

**BOX 84–12.****Indications for Use of Calcium**

Hypocalcemia, ionized  
Hyperkalemia  
Calcium channel blocker overdose  
Hypermagnesemia

tered, the chloride salt (2–4 mg/kg) is recommended because it produces higher and more consistent levels of ionized calcium than other salts.

**Sodium Bicarbonate**

Although sodium bicarbonate was used commonly during CPR in the past, there is little evidence to support its efficacy. Its use during resuscitation was predicated on the adverse cardiovascular consequences of acidosis, including impaired myocardial function, decreased catecholamine responsiveness, and peripheral vasodilatation. However, most studies have been unable to demonstrate improvement in success of defibrillation or resuscitation with the use of bicarbonate.<sup>133–135</sup> The observation that metabolic acidosis develops very slowly during CPR may explain the absence of effect of buffer therapy. Acidosis does not become severe until 15–20 minutes of cardiac arrest have passed.<sup>32,136,137</sup>

Sodium bicarbonate use during CPR should be restricted not only because of its lack of efficacy but because of the documented complications from excessive use, including hyperosmolality, hypernatremia, metabolic alkalosis and hypercapnia from CO<sub>2</sub> liberation (Box 84–13).<sup>136,138</sup> These abnormalities are associated with low resuscitation rates and poor survival. However, if sodium bicarbonate is given judiciously according to standard recommendations, no significant metabolic abnormalities should occur.<sup>139</sup>

Theoretically, sodium bicarbonate could cause a paradoxical worsening of

intracellular and intracerebral acidosis as the CO<sub>2</sub> liberated during the reaction with acid readily diffuses across cell membranes and the blood–brain barrier whereas bicarbonate diffuses much more slowly. Direct evidence for this effect has not been found. Animal studies have found no change in spinal fluid acid–base status with clinically relevant doses of sodium bicarbonate<sup>140</sup> and no worsening of myocardial intracellular acidosis during bicarbonate administration.<sup>141</sup> Consequently, paradoxical acidosis from sodium bicarbonate remains a concern primarily on theoretical grounds.

Current practice suggests sodium bicarbonate should be considered for use during CPR only in arrests associated with hyperkalemia, severe preexisting metabolic acidosis, and tricyclic or phenobarbital overdose. It may be considered for use in protracted resuscitation attempts after other modalities have been instituted (Box 84–14). These recommendations stem from its unproven efficacy in increasing patient survival and the known side effects. When bicarbonate is used, 1 mEq/kg should be given as the initial dose and no more than half this dose given every 10 minutes thereafter. However, dosing of sodium bicarbonate should be guided by blood gas determination, whenever possible.

**Routes of Administration and Vascular Access**

The preferred route of administration of all drugs during CPR is intravenous or intraosseous. If one of these routes cannot be established rapidly because of technical difficulties, one of the other alternatives—endotracheal or intracardiac—can be used.

**Intravenous Access**

The most rapid and highest drug levels occur with administration into a central vein. Therefore, when a central venous catheter is available during CPR, as is often the case in the operating room, it should be used for drug therapy. However, peripheral intravenous administration also is effective. The antecubital or external jugular vein should be the site of first choice for starting an infusion during resuscitation because starting a central line usually necessitates stopping CPR. Sites in the upper extremity and neck are preferred because of the paucity of blood flow below the diaphragm dur-

**BOX 84–14.****Indications for Sodium Bicarbonate during Cardiopulmonary Resuscitation**

Severe preexisting metabolic acidosis  
Hyperkalemia  
Tricyclic or phenobarbital overdose  
Protracted resuscitation

ing CPR. Drugs administered in the lower extremity may be extremely delayed or not reach the sites of action. Even in the upper extremity, drugs may require 1–2 minutes to reach the central circulation.<sup>142</sup> Onset of action may be speeded if a peripheral drug bolus is followed by a 20–30-mL bolus of intravenous fluid.

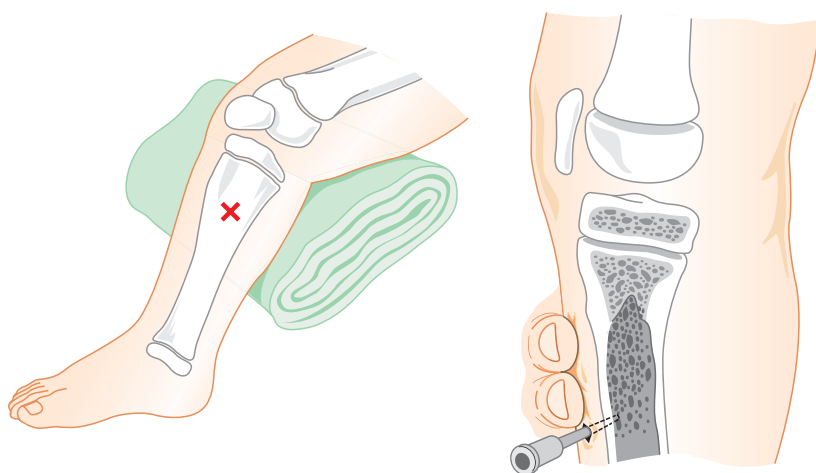
**Intraosseous Administration**

The intraosseous route of fluid and medication administration, originally described in 1934,<sup>143</sup> has regained popularity recently in the CPR literature. All medications used during CPR and fluids, including whole blood, have been given by the intraosseous route. This technique should be considered a temporary measure during emergencies when other vascular sites are not available.

The technique of placing an intraosseous line is straightforward. A standard 16- or 18-gauge needle, spinal needle with stylet, or bone marrow needle is inserted into the anterior surface of the tibia, 1–3 cm below the tibial tuberosity. The needle is directed to a 90° angle to the medial surface of the bone or slightly inferior to avoid the epiphyseal plate. There is a loss of resistance after the needle passes through the bony cortex of the tibia. Placement is successful if the needle is in the marrow cavity as evidenced by the needle standing upright without support and bone marrow can be aspirated into a syringe connected to the needle. It will lose the upright position if it has slipped into the subcutaneous tissue. Free flow of the drug or fluid infusion without significant subcutaneous infiltration also should be demonstrated (Fig. 84–4).<sup>144</sup> There are a number of reports of successful intraosseous infusions in children with minimal complications. Animal models have demonstrated successful reversal of hemorrhagic shock,<sup>145</sup> effective buffering with sodium bicarbonate,<sup>146</sup> and equal hemodynamic response to epinephrine with intraosseous and central intravenous administration.<sup>147</sup>

**BOX 84–13.****Side Effects from Excessive Use of Sodium Bicarbonate**

Hyperosmolality  
Hypernatremia  
Metabolic alkalosis  
Hypercapnia  
Decreased unloading of oxygen from hemoglobin  
Paradoxical intracellular acidosis



**FIGURE 84-4.** Intraosseous needle placement. Insert needle at the level of tibial tubercle on the medial portion of the tibia. The needle is aimed carefully and laterally.

### Endotracheal Administration

Drugs that can be absorbed from tracheal mucosa include lidocaine, atropine, naloxone, and epinephrine (Box 84-15). During CPR the rapid establishment of an intravenous line can be difficult, especially in the obese or in infants and small children. The endotracheal route can be used as an alternative following intubation in these settings. The time to effect and drug levels achieved are inconsistent using this route during CPR.<sup>148-150</sup> Better results may be obtained by administering 5-10-mL volumes. It is unclear whether deep injection is better than simple instillation into the endotracheal tube.<sup>57</sup> Doses 2-2.5 times higher than the recommended IV dose should be administered when this route is used.

### POSTRESUSCITATION CARE

The major factors contributing to mortality following successful resuscitation are progression of the primary disease and cerebral damage suffered as a result of the arrest. There is growing awareness that any cardiac arrest, even of

brief duration, causes a generalized decrease in myocardial function similar to the regional hypokinesia seen following periods of regional ischemia. This is usually referred to as global myocardial stunning and can be mitigated with inotropic agents, if necessary. Active management following resuscitation appears to mitigate postischemic brain damage and improve neurologic outcome without increasing the number of patients surviving in a vegetative state.<sup>151</sup> When flow is restored following a period of global brain ischemia, 3 stages of cerebral reperfusion are seen in ensuing 12 hours. There are multifocal areas of the brain with no-reflow immediately following resuscitation. Within an hour there is global hyperemia followed quickly by prolonged global hypoperfusion.

Postresuscitation support is focused on providing stable oxygenation and hemodynamics so as to minimize any further cerebral insult. A comatose patient should be maintained on mechanical ventilation for several hours to ensure adequate oxygenation and ventilation. Restlessness, coughing, or seizure activity should be aggressively treated with appropriate medications including neuromuscular blockers, if necessary. Arterial PaO<sub>2</sub> should be maintained above 100 mm Hg and moderate hypocapnia (PvCO<sub>2</sub> 25-35 mm Hg) may be helpful. Blood volume should be maintained normal and moderate hemodilution to a hematocrit of 30-35% may be helpful. A brief 5-minute period of hypertension

to mean arterial pressure of 120-140 mm Hg may help overcome the initial cerebral no-reflow. This frequently occurs secondary to the effects of epinephrine given during CPR. However, both prolonged hypertension (>110 mm Hg) and hypotension are associated with a worsened outcome. Hyperglycemia during cerebral ischemia is known to result in increased neurologic damage. Thus, it seems prudent to control glucose in the 100-300 mg/dL range. Specific pharmacologic therapy directed at brain preservation has not been shown to have further benefit. Although animal trials of barbiturates and calcium channel blockers were promising, large, multicenter trials found no improvement in neurologic status when drugs were given following cardiac arrest.<sup>151,152</sup>

In contrast to pharmacologic therapy, two studies have demonstrated improved neurologic outcome when mild therapeutic hypothermia (89.6-93.2° F [32-34° C]) is induced for 12-24 hours in cardiac arrest survivors who remained comatose after admission to the hospital.<sup>153,154</sup> Both investigations studied only patients whose initial rhythm was ventricular fibrillation and the larger of the trials included only witnessed arrests. Nevertheless, these are the first studies to document improved neurological outcome with a specific post-arrest intervention. The International Liaison Committee on Resuscitation (ILCOR) now recommends "unconscious adult patients with return of spontaneous circulation after out-of-hospital cardiac arrest should be cooled to 32-34° C for 12 to 24 hours when the initial rhythm was ventricular fibrillation. Such cooling may also be beneficial for other rhythms or in-hospital cardiac arrest."

### PROGNOSIS

For the comatose survivor of CPR, the question of ultimate prognosis is important. One retrospective study demonstrated that the admission neurologic examination of comatose victims is highly correlated with the likelihood of awakening.<sup>155</sup> If there was no pupillary light response and no spontaneous eye movement, and if the motor response to pain was absent or extensor posturing, there was only a 5% chance the patient would ever awaken. A companion study demonstrated

#### BOX 84-15.

##### Endotracheal Administration of Drugs

Lidocaine	<i>Do not administer:</i>
Atropine	Sodium bicarbonate
Naloxone	Calcium chloride
Epinephrine	



**BOX 84-16.****Prognosis of Comatose Survivors of Cardiac Arrest****Signs predicting death or poor neurologic outcome**

- Absent corneal reflex at 24 hours
- Absent pupillary response at 24 hours
- Absent withdrawal response to pain at 24 hours
- No motor response at 24 hours
- No motor response at 72 hours

that the chance of ever awakening fell rapidly in the days following arrest.<sup>156</sup> If the patient was not awake by 4 days following arrest, the chance of ever awakening was less than 20%, and all those awakening had marked neurologic deficits. Most patients who completely recover show rapid improvement in the first 48 hours. A meta-analysis of 11 clinical studies involving 1914 patients identified 5 clinical signs that strongly predict death or poor neurologic outcome (Box 84-16).<sup>157</sup>

**KEY REFERENCES**

1. Berg RA, Kern KB, Sanders AB, et al. Bystander cardiopulmonary resuscitation: is ventilation necessary? *Circulation* 1993;88:1907.
2. Booth CM, Boone RH, Tomlinson G, et al. Is this patient dead, vegetative, or severely neurologically impaired? Assessing outcome for comatose survivors of cardiac arrest. *JAMA* 2004;291:870.
3. Emergency Cardiac Care Committee, Subcommittees and Task Forces, American Heart Association. 2005 American Heart Association guidelines for cardiopulmonary resuscitation and emergency cardiac care. *Circulation* 2005;112:IV-1-IV-211.
4. Holzer M, The Hypothermia After Cardiac Arrest Study Group. Mild therapeutic hypothermia to improve the neurologic outcome after cardiac arrest. *N Engl J Med* 2002;346:549.
5. International Liaison Committee on Resuscitation and The American Heart Association. 2005 International consensus on cardiopulmonary resuscitation (CPR) and emergency cardiovascular care (ECC)

science with treatment recommendations. *Circulation* 2005;112:III-1-III-136.

6. Longstreth WT, Diehr P, Inui TS. Prediction of awakening after out-of-hospital cardiac arrest. *N Engl J Med* 1983;308:1378.
7. Otto CW, Yakaitis RW, Blitt CD. Mechanism of action of epinephrine in resuscitation from asphyxial arrest. *Crit Care Med* 1981;9:321.
8. Ralston SH, Voorhees WD, Babbs CF. Intrapulmonary epinephrine during prolonged CPR. Improved regional blood flow and resuscitation in dogs. *Ann Emerg Med* 1984;13:79.
9. Sanders AB, Kern KB, Otto CW, et al. End-tidal carbon dioxide monitoring during cardiopulmonary resuscitation: a prognostic indicator for survival. *JAMA* 1989;262:1347.
10. Valenzuela TD, Roe DJ, Nichol G, et al. Outcomes of rapid defibrillation by security officers after cardiac arrest in casinos. *N Engl J Med* 2000;343:1206.
11. Weil MH, Rackow EC, Trevino R, et al. Difference in acid-base state between venous and arterial blood during cardiopulmonary resuscitation. *N Engl J Med* 1986;315:153.
12. Weisfeldt ML, Becker LB. Resuscitation after cardiac arrest: a 3-phase time-sensitive model. *JAMA* 2002;288:3035.
13. Wenzel V, Krismer AC, Arntz HR, et al. A comparison of vasopressin and epinephrine for out-of-hospital cardiopulmonary resuscitation. *N Engl J Med* 2004;350:105.
14. Wik L, Hansen TB, Fylling F, et al. Delaying defibrillation to give basic cardiopulmonary resuscitation to patients with out-of-hospital ventricular fibrillation. *JAMA* 2003;289:1389.

**REFERENCES**

1. Emergency Cardiac Care Committee, Subcommittees and Task Forces, American Heart Association: 2005 American Heart Association guidelines for cardiopulmonary resuscitation and emergency cardiac care. *Circulation* 2005;112:IV-1-IV-211.
2. Nadkarni VM, Larkin GL, Peberdy, MA, et al. First documented rhythm and clinical

outcome from in-hospital cardiac arrest among children and adults. *JAMA* 2006;295:50.

3. Olsson GI, Hallen B. Cardiac arrest during anaesthesia. A computer-aided study of 250,543 anaesthetics. *Acta Anaesthesiol Scand* 1988;32:653.
4. Weaver WD, Hill D, Fahrenbruch CE, et al. Use of the automatic external defibrillator in the management of out-of-hospital cardiac arrest. *N Engl J Med* 1988;319:661.
5. Eisenberg MS, Bergner L, Hallstrom A. Cardiac resuscitation in the community: importance of rapid provision and implications for program planning. *JAMA* 1979;241:1905.
6. Brooks DK. Resuscitation: Care of the Critically Ill. London: Edward Arnold, 1986.
7. Wood Library Museum. Resuscitation: An Historical Perspective. Park Ridge, IL: Wood Library Museum, 1976.
8. Elam JO, Brown ES, Elder JD Jr. Artificial respiration by mouth to mask method: a study of the respiratory gas exchange of paralyzed patients ventilated by operator's expired air. *N Engl J Med* 1954;250:749.
9. Gordon AS, Frye CS, Gittelsohn L, et al. Mouth-to-mouth versus manual artificial respiration for children and adults. *JAMA* 1958;167:320.
10. Safar P, Escarraga LA, Elam JO. A comparison of the mouth-to-mouth and mouth-to-airway methods of artificial respiration with the chest pressure arm-lift methods. *N Engl J Med* 1958;258:671.
11. Safar P. Failure of manual respiration. *J Appl Physiol* 1959;14:84.
12. Hooker DR, Kouwenhoven WB, Langworthy OR. The effects of alternating current on the heart. *Am J Physiol* 1933;103:444.
13. Beck CS, Pritchard WH, Feil HS. Ventricular fibrillation of long duration abolished by electric shock. *JAMA* 1947;135:985.
14. Zoll PM, Linenthal AJ, Gibson W, et al. Termination of ventricular fibrillation in man by an externally applied electric shock. *N Engl J Med* 1956;254:727.
15. Kouwenhoven WB, Milnor WR, Knickerbocker GG, et al. Closed chest defibrillation of the heart. *Surgery* 1957;42:550.
16. Kouwenhoven WB, Jude JR, Knickerbocker GG. Closed-chest cardiac massage. *JAMA* 1960;173:1064.
17. Redding JS, Pearson JW. Evaluation of drugs for cardiac resuscitation. *Anesthesiology* 1963;24:203.
18. Harrison RR, Maull KI, Keenan RL, et al. Mouth-to-mask ventilation: a superior method of rescue breathing. *Ann Emerg Med* 1982;11:74.
19. Hess D, Baran C. Ventilatory volumes using mouth-to-mouth, mouth-to-mask, and bag-valve mask techniques. *Am J Emerg Med* 1985;3:292.
20. International Liaison Committee on Resuscitation and The American Heart Association



ciation. 2005 International consensus on cardiopulmonary resuscitation (CPR) and emergency cardiovascular care (ECC) science with treatment recommendations. *Circulation* 2005;112:III-1–III-136.

21. Weisfeldt ML, Becker LB. Resuscitation after cardiac arrest: a 3-phase time-sensitive model. *JAMA* 2002;288:3035.

22. Bossaert L, Van Hoeyweghen R, The Cerebral Resuscitation Study Group. Bystander cardiopulmonary resuscitation (CPR) in out-of-hospital cardiac arrest. *Resuscitation* 1989;17(Suppl):S55.

23. Van Hoeyweghen RJ, Bossaert LL, Mullie A, et al. Quality and efficiency of bystander CPR. *Resuscitation* 1993;26:47.

24. Berg RA, Kern KB, Sanders AB, et al. Bystander cardiopulmonary resuscitation: is ventilation necessary? *Circulation* 1993;88:1907.

25. Berg RA, Wilcoxson D, Hilwig RW, et al. The need for ventilatory support during bystander cardiopulmonary resuscitation. *Ann Emerg Med* 1995;24:342.

26. Berg RA, Kern KB, Hilwig RW, et al. Assisted ventilation does not improve outcome in a porcine model of single-rescuer bystander CPR. *Circulation* 1997;95:1635.

27. Berg RA, Hilwig RW, Kern KB, et al. Assisted ventilation during "bystander" CPR improves outcome in a swine model of pediatric asphyxial cardiac arrest. *Circulation* 1997;96:4364.

28. Hallstrom A, Cobb L, Johnson E, Copass M. Cardiopulmonary resuscitation by chest compressions alone or with mouth-to-mouth ventilation. *N Engl J Med* 2000;342:1546.

29. Sellick BA. Cricoid pressure to control regurgitation of stomach contents during induction of anaesthesia. *Lancet* 1961;2:404.

30. Salem MR, Wong AY, Fizzotti GF. Efficacy of cricoid pressure in preventing aspiration of gastric contents in paediatric patients. *Br J Anaesth* 1972;44:401.

31. Babbs CF. New versus old theories of blood flow during CPR. *Crit Care Med* 1980;8:191.

32. Weil MH, Rackow EC, Trevino R, et al. Difference in acid-base state between venous and arterial blood during cardiopulmonary resuscitation. *N Engl J Med* 1986;315:153.

33. Babbs CF, Tacker WA. Cardiopulmonary resuscitation with interposed abdominal compression. *Circulation* 1986;74(Suppl IV):IV-37.

34. Mateer JR, Stueven HA, Thompson BM, et al. Pre-hospital IAC-CPR versus standard CPR. Paramedic resuscitation of cardiac arrests. *Am J Emerg Med* 1985;3:143.

35. Sack JB, Kesselbrenner MB, Bregman D. Survival from in-hospital cardiac arrest with interposed abdominal counterpulsation during cardiopulmonary resuscitation. *JAMA* 1992;267:379.

36. Sack JB, Kesselbrenner MB, Jarrad A. Interposed abdominal compression-cardio-

pulmonary resuscitation and resuscitation outcome during asystole and electromechanical dissociation. *Circulation* 1992;86:1692.

37. Lurie KG, Lindo C, Chin J. CPR. The P stands for plumber's helper [letter]. *JAMA* 1990;264:1661.

38. Linder KH, Pfenniger EG, Lurie KG, et al. Effects of active compression-decompression resuscitation on myocardial and cerebral blood flow in pigs. *Circulation* 1993;88:1254.

39. Shultz JJ, Coffeen P, Sweeney M, et al. Evaluation of standard and active compression-decompression CPR in an acute human model of ventricular fibrillation. *Circulation* 1994;89:684.

40. Lafuente-Lafuente C, Melero-Bascones M. Active compression-decompression for cardiopulmonary resuscitation. *Cochrane Database Syst Rev* 2004;CD002751.

41. Lurie KG, Mulligan KA, McKnite S, et al. Optimizing standard cardiopulmonary resuscitation with an inspiratory impedance threshold valve. *Chest* 1998;113:1084.

42. Wolcke BB, Mauer DK, Schoefmann MF, et al. Comparison of standard cardiopulmonary resuscitation versus the combination of active compression-decompression cardiopulmonary resuscitation and an inspiratory impedance threshold device for out-of-hospital cardiac arrest. *Circulation* 2003;108:2201.

43. Plaisance P, Lurie KG, Vicaut E, et al. Evaluation of an impedance threshold device in patients receiving active compression-decompression cardiopulmonary resuscitation for out of hospital cardiac arrest. *Resuscitation* 2004;61:265.

44. Aufderheide TP, Pirralo RG, Provo TA, et al. Clinical evaluation of an inspiratory impedance threshold device on hemodynamics during conventional manual cardiopulmonary resuscitation. *Crit Care Med* 2005;33:734.

45. Criley JM, Niemann JT, Rosborough JP, et al. Modifications of cardiopulmonary resuscitation based on the cough. *Circulation* 1986;74(Suppl IV):IV-42.

46. Halperin HR, Guerci AD, Chandra N, et al. Vest inflation without simultaneous ventilation during cardiac arrest in dogs: improved survival from prolonged cardiopulmonary resuscitation. *Circulation* 1986;74:1407.

47. Casner M, Anderson D, et al. Preliminary report of the impact of a new CPR assist device on the rate of return of spontaneous circulation in out of hospital cardiac arrest. *Prehosp Emerg Med* 2005;9:61.

48. Bircher N, Safar P, Stewart R. A comparison of standard, MAST-augmented, and open-chest CPR in dogs. a preliminary investigation. *Crit Care Med* 1980;8:147.

49. DeBehnke DJ, Angelos MG, Leasure JE. Comparison of standard external CPR, open-chest CPR, and cardiopulmonary bypass in a canine myocardial infarct model. *Ann Emerg Med* 1991;20:754.

50. Sanders AB, Kern KB, Ewy GA, et al. Improved resuscitation from cardiac arrest

with open-chest massage. *Ann Emerg Med* 1984;13:672.

51. Mooney MR, Arom KV, Joyce LD, et al. Emergency cardiopulmonary bypass support in patients with cardiac arrest. *J Thorac Cardiovasc Surg* 1991;101:450.

52. Angelos M, Safar P, Reich H. A comparison of cardiopulmonary resuscitation with cardiopulmonary bypass after prolonged cardiac arrest in dogs: Reperfusion pressures and neurologic recovery. *Resuscitation* 1991;21:121.

53. Sanders AB, Kern KB, Atlas M, et al. Importance of the duration of inadequate coronary perfusion pressure on resuscitation from cardiac arrest. *J Am Coll Cardiol* 1985;6:113.

54. Kern KB, Sanders AB, Ewy GA. Open-chest cardiac massage after closed-chest compression in a canine model: when to intervene. *Resuscitation* 1987;15:51.

55. Kern KB, Sanders AB, Janas W, et al. Limitations of open-chest cardiac massage after prolonged, untreated cardiac arrest in dogs. *Ann Emerg Med* 1991;20:761.

56. Kern KB, Sanders AB, Badylak SF, et al. Long term survival with open-chest cardiac massage after ineffective closed-chest compression in a canine preparation. *Circulation* 1987;75:498.

57. Ralston SH, Voorhees WD, Babbs CF. Intrapulmonary epinephrine during prolonged CPR. Improved regional blood flow and resuscitation in dogs. *Ann Emerg Med* 1984;13:79.

58. Crile G, Dolley DH. Experimental research into resuscitation of dogs killed by anesthetics and asphyxia. *J Exp Med* 1906;8:713.

59. Pearson JW, Redding JS. Influence of peripheral vascular tone on cardiac resuscitation. *Anesth Analg* 1965;44:746.

60. Redding JS. Abdominal compression in cardiopulmonary resuscitation. *Anesth Analg* 1971;50:668.

61. Yakaitis RW, Otto CW, Blitt CD. Relative importance of alpha and beta adrenergic receptors during resuscitation. *Crit Care Med* 1979;7:293.

62. Otto CW, Yakaitis RW, Blitt CD. Mechanism of action of epinephrine in resuscitation from asphyxial arrest. *Crit Care Med* 1981;9:321.

63. Michael JR, Guerci AD, Koehler RC, et al. Mechanisms by which epinephrine augments cerebral and myocardial perfusion during cardiopulmonary resuscitation in dogs. *Circulation* 1984;69:822.

64. Otto CW, Yakaitis RW. The role of epinephrine in CPR. a reappraisal. *Ann Emerg Med* 1984;13:840.

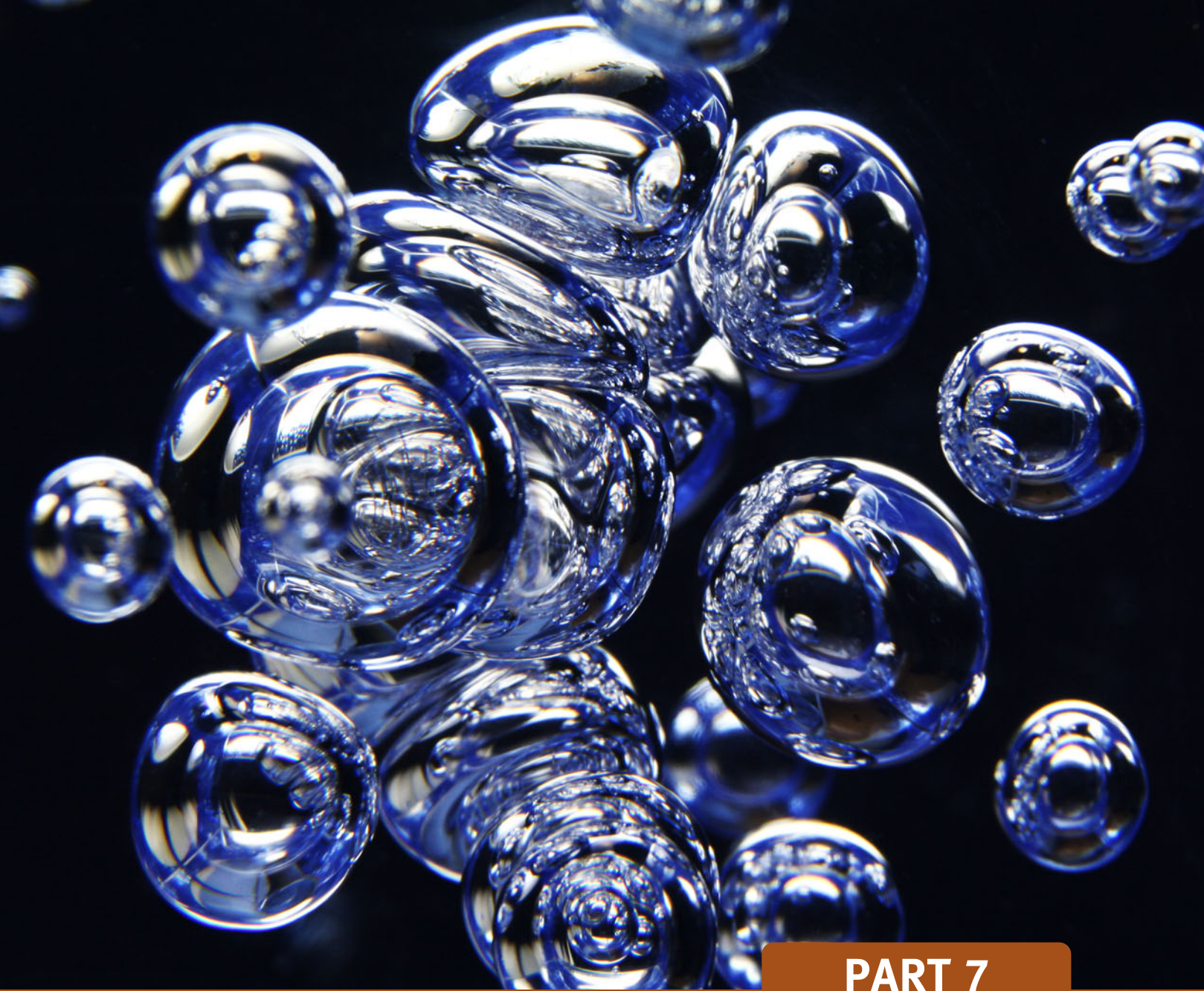
65. Sanders AB, Ewy GA, Taft TV. Prognostic and therapeutic importance of the aortic diastolic pressure in resuscitation from cardiac arrest. *Crit Care Med* 1984;12:871.

66. Niemann JT, Criley JM, Rosborough JP, et al. Predictive indices of successful cardiac resuscitation after prolonged arrest and

- experimental cardiopulmonary resuscitation. *Ann Emerg Med* 1985;14:521.
67. Paradis NA, Martin GB, Rivers EP, et al. Coronary perfusion pressure and the return of spontaneous circulation in human cardiopulmonary resuscitation. *JAMA* 1990;263:1106.
68. Kalenda Z. The capnogram as a guide to the efficacy of cardiac massage. *Resuscitation* 1978;6:259.
69. Sanders AB, Atlas M, Ewy GA, et al. Expired PCO<sub>2</sub> as an index of coronary perfusion pressure. *Am J Emerg Med* 1985;3:147.
70. Sanders AB, Atlas M, Ewy GA, et al. Expired PCO<sub>2</sub> as an index of coronary perfusion pressure. *Am J Emerg Med* 1985;3:147.
71. Sanders AB, Ewy GA, Bragg S, et al. Expired PCO<sub>2</sub> as a prognostic indicator of successful resuscitation from cardiac arrest. *Ann Emerg Med* 1985;14:948.
72. Trevino RP, Bisera J, Weil MH, et al. End-tidal CO<sub>2</sub> as a guide to successful cardiopulmonary resuscitation: a preliminary report. *Crit Care Med* 1985;13:910.
73. Sanders AB, Kern KB, Otto CW, et al. End-tidal carbon dioxide monitoring during cardiopulmonary resuscitation: a prognostic indicator for survival. *JAMA* 1989;262:1347.
74. Kerber RE, Sarnat W. Factors influencing the success of ventricular defibrillation in man. *Circulation* 1979;60:226.
75. Yakaitis RW, Ewy GA, Otto CW, et al. Influence of time and therapy on ventricular defibrillation in dogs. *Crit Care Med* 1980;8:157.
76. Weaver WD, Copass MD, Bui D, et al. Improved neurologic recovery and survival after early defibrillation. *Circulation* 1984;69:943.
77. Weaver WD, Cobb LA, Hallstrom AP, et al. Factors influencing survival after out-of-hospital cardiac arrest. *J Am Coll Cardiol* 1986;7:752.
78. Valenzuela TD, Roe DJ, Nichol G, et al. Outcomes of rapid defibrillation by security officers after cardiac arrest in casinos. *N Engl J Med* 2000;343:1206.
79. Caffrey SL, Willoughby PJ, Pepe PE, et al. Public use of automated external defibrillators. *N Engl J Med* 2002;347:1242.
80. The Public Access Defibrillation Trial Investigators. Public-access defibrillation and survival after out-of-hospital cardiac arrest. *N Engl J Med* 2004;351:637.
81. Cobb LA, Fahrenbruch CE, Walsh TR, et al. Influence of CPR prior to defibrillation in out-of-hospital ventricular fibrillation. *JAMA* 1999;281:1182.
82. Wik L, Hansen TB, Fylling F, et al. Delaying defibrillation to give basic cardiopulmonary resuscitation to patients with out-of-hospital ventricular fibrillation. *JAMA* 2003;289:1389.
83. Weaver SC, Cobb LA, Dennis D, et al. Amplitude of ventricular fibrillation waveform and outcome after cardiac arrest. *Ann Intern Med* 1985;102:53.
84. Stewart AJ, Allen JD, Adgey AAJ. Frequency analysis of ventricular fibrillation and resuscitation success. *Q J Med* 1992;306:761.
85. Otto CW, Yakaitis RW, Ewy GA. Effects of epinephrine on defibrillation in ischemic ventricular fibrillation. *Am J Emerg Med* 1985;3:285.
86. Bardy GH, Marchlinski FE, Sharma AD, et al. Multicenter comparison of truncated biphasic shocks and standard damped sine wave monophasic shocks for transthoracic ventricular defibrillation. *Circulation* 1996;94:2507.
87. Kerber RE, Grayzel J, Hoyt R, et al. Transthoracic resistance in human defibrillation: influence of body weight, chest size, serial shocks, paddle size and paddle contact pressure. *Circulation* 1981;63:676.
88. Kerber RE, McPherson D, Charbonnier R, et al. Automatic impedance-based energy adjustment for defibrillation: experimental studies. *Circulation* 1985;71:136.
89. Lerman BB, DeMarco JP, Haines DE. Current-based versus energy-based ventricular defibrillation: a prospective study. *J Am Coll Cardiol* 1988;12:1259.
90. Dahl CF, Ewy GA, Warner ED, Thomas ED. Myocardial necrosis from direct current countershock. *Circulation* 1974;50:956.
91. Warner ED, Dahl CF, Ewy GA. Myocardial injury from transthoracic defibrillator countershock. *Arch Pathol* 1975;99:55.
92. Weaver WD, Cobb LA, Copass MK, et al. Ventricular defibrillation—a comparative trial using 175-J and 320-J shocks. *N Engl J Med* 1982;307:1101.
93. Geddes LA, Tacker WA, Rosborough JP, et al. Electrical dose for ventricular defibrillation of large and small animals using precordial electrodes. *J Clin Invest* 1974;53:310.
94. Gutgesell HP, Tacker WA, Geddes LA, et al. Energy dose for defibrillation in children. *Pediatrics* 1976;58:898.
95. Kerber RE, Sarnat W. Factors influencing the success of ventricular defibrillation in man. *Circulation* 1979;60:226.
96. Kerber RE, Jensen SR, Gascho JA, et al. Determinants of defibrillation: prospective analysis of 183 patients. *Am J Cardiol* 1983;52:739.
97. Kudenchuk PJ, Cobb LA, Copass MK, et al. Amiodarone for resuscitation after out of hospital cardiac arrest due to ventricular fibrillation. *N Engl J Med* 1999;341:871.
98. Dorian P, Cass D, Schwartz B, et al. Amiodarone as compared with lidocaine for shock-resistant ventricular fibrillation. *N Engl J Med* 2002;346:884.
99. Zoll PM, Zoll RH, Falk RH, et al. External noninvasive temporary cardiac pacing: clinical trials. *Circulation* 1985;71:937.
100. Ewy GA, Dahl CF, Zimmermann M, et al. Ventricular fibrillation masquerading as ventricular standstill. *Crit Care Med* 1981;9:841.
101. Redding JS, Pearson JW. Resuscitation from ventricular fibrillation (drug therapy). *JAMA* 1968;203:255.
102. Schleien CL, Dean JM, Koehler RC, et al. Effect of epinephrine on cerebral and myocardial perfusion in an infant animal preparation of cardiopulmonary resuscitation. *Circulation* 1986;73:809.
103. Schleien CL, Koehler RC, Gervais H, et al. Organ blood flow and somatosensory evoked potentials during and after cardiopulmonary resuscitation with epinephrine or phenylephrine. *Circulation* 1989;79:1332.
104. Otto CW, Yakaitis RW, Redding JS, Blitt CD. Comparison of dopamine, dobutamine, and epinephrine in CPR. *Crit Care Med* 1981;9:640.
105. Lindner KH, Prengel AW, Pfenninger EG, et al. Vasopressin improves vital organ blood flow during closed-chest cardiopulmonary resuscitation in pigs. *Circulation* 1995;91:215.
106. Ditchey RV, Lindenfeld J. Failure of epinephrine to improve the balance between myocardial oxygen supply and demand during closed chest resuscitation in dogs. *Circulation* 1988;78:382.
107. Berg RA, Otto CW, Kern KB, et al. High dose epinephrine results in greater early mortality following resuscitation from prolonged cardiac arrest in pigs: a prospective, randomized study. *Crit Care Med* 1994;22:282.
108. Brillman JC, Sanders AB, Otto CW, et al. A comparison of epinephrine and phenylephrine for resuscitation and neurologic outcome of cardiac arrest in dogs. *Ann Emerg Med* 1987;16:11.
109. Olson DW, Thakur R, Stueven HA. Randomized study of epinephrine versus methoxamine in prehospital ventricular fibrillation. *Ann Emerg Med* 1989;18:250.
110. Silvast T, Saarnivaara L, Kinnunen A, et al. Comparison of adrenaline and phenylephrine in out-of-hospital CPR. A double-blind study. *Acta Anaesthesiol Scand* 1985;29:610.
111. Wenzel V, Krismer AC, Arntz HR, et al. A comparison of vasopressin and epinephrine for out-of-hospital cardiopulmonary resuscitation. *N Engl J Med* 2004;350:105.
112. Berg RA, Otto CW, Kern KB, et al. A randomized, blinded trial of high-dose epinephrine versus standard-dose epinephrine in a swine model of pediatric asphyxial cardiac arrest. *Crit Care Med* 1996;24:1695.
113. Linder KH, Ahnefeld FW, Prengel AW. Comparison of standard and high-dose adrenaline in the resuscitation of asystole and electromechanical dissociation. *Acta Anaesthesiol Scand* 1991;35:253.
114. Brown CG, Martin DP, Pepe PE, et al. A comparison of standard-dose and high-dose epinephrine in cardiac arrest outside the hospital. *N Engl J Med* 1992;327:1051.
115. Callahan M, Madsen CD, Barton CW, et al. A randomized clinical trial of high-dose epinephrine and norepinephrine vs standard-dose epinephrine in prehospital cardiac arrest. *JAMA* 1992;268:2667.
116. Stiell IG, Hebert PC, Weitzman BN, et al. High-dose epinephrine in adult cardiac arrest. *N Engl J Med* 1992;327:1045.

117. Choux C, Gueugniaud P-Y, Barbieux A, et al. Standard doses versus repeated high doses of epinephrine in cardiac arrest outside the hospital. *Resuscitation* 1995;29:3.
118. Gueugniaud P-Y, Mols P, Goldstein P, et al. A comparison of repeated high doses and repeated standard doses of epinephrine for cardiac arrest outside the hospital. *N Engl J Med* 1998;339:1595.
119. Lipman J, Wilson W, Kobilski S, et al. High-dose adrenaline in adult in-hospital asystolic cardiopulmonary resuscitation: a double-blind randomized trial. *Anaesth Intensive Care* 1993;21:192.
120. Sherman BW, Munger MA, Foulke GE, et al. High-dose versus standard-dose epinephrine treatment of cardiac arrest after failure of standard therapy. *Pharmacotherapy* 1997;17:242.
121. Lindner KH, Brinkmann A, Pfenninger EG, et al. Effect of vasopressin on hemodynamic variables, organ blood flow, and acid-base status in a pig model of cardiopulmonary resuscitation. *Anesth Analg* 1993;77:427.
122. Lindner KH, Prengel AW, Pfenninger EG, et al. Vasopressin improves vital organ blood flow during closed-chest cardiopulmonary resuscitation in pigs. *Circulation* 1995;91:215.
123. Wenzel V, Lindner KH, Krismer AC, et al. Repeated administration of vasopressin, but not epinephrine, maintains coronary perfusion pressure after early and late administration during cardiopulmonary resuscitation in pigs. *Circulation* 99:1379-1999.
124. Wenzel V, Lindner KH, Krismer AC, et al. Survival with full neurologic recovery and no cerebral pathology after prolonged resuscitation in pigs. *J Am Coll Cardiol* 2000;35:527.
125. Prengel AW, Lindner KH, Keller A, Lurie KG. Cardiovascular function during the post-resuscitation phase after cardiac arrest in pigs: A comparison of epinephrine versus vasopressin. *Crit Care Med* 1996;24:2014.
126. Lindner KH, Dirks B, Strohmenger HU, et al. Randomized comparison of epinephrine and vasopressin in patients with out-of-hospital ventricular fibrillation. *Lancet* 1997;349:535.
127. Stiell IG, Hebert PC, Wells GA, et al. Vasopressin versus epinephrine for in-hospital cardiac arrest: a randomized controlled trial. *Lancet* 2001;358:105.
128. Iseri LT, Humphrey SB, Siner EJ. Pre-hospital bradysystolic cardiac arrest. *Ann Intern Med* 1978;88:741.
129. Coon GA, Clinton JE, Ruiz E. Use of atropine for bradysystolic prehospital cardiac arrest. *Ann Emerg Med* 1981;10:462.
130. Stueven HA, Tonsfeldt DJ, Thompson BM, et al. Atropine in asystole: human studies. *Ann Emerg Med* 1984;13:815.
131. Stueven HA, Thompson BM, Aprahamian C, et al. Calcium chloride: reassessment of use in asystole. *Ann Emerg Med* 1984;13:820.
132. Stueven HA, Thompson BM, Aprahamian C, et al. The effectiveness of calcium chloride in refractory electromechanical dissociation. *Ann Emerg Med* 1985;14:626.
133. Federiuk CS, Sanders AB, Kern KB, et al. The effect of bicarbonate on resuscitation from cardiac arrest. *Ann Emerg Med* 1991;20:1173.
134. Guerci AD, Chandra N, Johnson E, et al. Failure of sodium bicarbonate to improve resuscitation from ventricular fibrillation in dogs. *Circulation* 1986;74(Suppl IV):IV-75.
135. Stacpoole PW. Lactic acidosis: the case against bicarbonate therapy. *Ann Intern Med* 1986;105:276.
136. Bishop RL, Weisfeldt ML. Sodium bicarbonate administration during cardiac arrest: effect on arterial pH, pCO<sub>2</sub>, and osmolality. *JAMA* 1976;235:506.
137. Weil MH, Grundler W, Yamaguchi M, et al. Arterial blood gases fail to reflect acid-base status during cardiopulmonary resuscitation. a preliminary report. *Crit Care Med* 1985;13:884.
138. Mattar JA, Weil MH, Shubin H, et al. Cardiac arrest in the critically ill. II. Hyperosmolal states following cardiac arrest. *Am J Med* 1974;56:162.
139. White BC, Tintinalli JE. Effects of sodium bicarbonate administration during cardiopulmonary resuscitation. *JACEP* 1977;6:187.
140. Sanders AB, Otto CW, Kern KB, et al. Acid-base balance in a canine model of cardiac arrest. *Ann Emerg Med* 1988;17:667.
141. Kette F, Weil MH, von Planta M, et al. Buffer agents do not reverse intramyocardial acidosis during cardiac resuscitation. *Circulation* 1990;81:1660.
142. Hedges JR, Barsan WB, Doan LA, et al. Central versus peripheral intravenous routes in cardiopulmonary resuscitation. *Am J Emerg Med* 1984;2:385.
143. Josefson LM. A new method of treatment— intraosseal injections. *Acta Med Scand* 1934;81:550.
144. Berg RA. Emergency infusion of catecholamines into bone marrow. *Am J Dis Child* 1984;138:810.
145. Morris RE, Schonfeld N, Haftel AJ. Treatment of hemorrhagic shock with intraosseous administration of crystalloid fluid in the rabbit model. *Ann Emerg Med* 1987;16:1321.
146. Spivey WH, Lathers CM, Malone DR, et al. Comparison of intraosseous, central, and peripheral routes of sodium bicarbonate administration during CPR in pigs. *Ann Emerg Med* 1985;14:1135.
147. Andropoulos DB, Soifer SJ, Schreiber MD. Plasma epinephrine concentrations after intraosseous and central venous injection during cardiopulmonary resuscitation in the lamb. *J Pediatr* 1990;166:312.
148. McDonald JL. Serum lidocaine levels during cardiopulmonary resuscitation after intravenous and endotracheal administration. *Crit Care Med* 1985;13(11):914.
149. Ralston SH, Tacker WA, Showen L, et al. Endotracheal versus intravenous epinephrine during electromechanical dissociation with CPR in dogs. *Ann Emerg Med* 1985;14:1044.
150. Hornchen U, Schuttler J, Stoeckel H, et al. Endobronchial instillation of epinephrine during cardiopulmonary resuscitation. *Crit Care Med* 1987;15:1037.
151. Abramson NS, Safar P, Detre KM, et al. Randomized clinical study of cardiopulmonary-cerebral resuscitation: thiopental loading in comatose cardiac arrest survivors. *N Engl J Med* 1986;314:397.
152. Brain Resuscitation Clinical Trial II Study Group. A randomized clinical study of a calcium-entry blocker (lidoflazine) in the treatment of comatose survivors of cardiac arrest. *N Engl J Med* 1991;324:1225.
153. Holzer M, The Hypothermia After Cardiac Arrest Study Group. Mild therapeutic hypothermia to improve the neurologic outcome after cardiac arrest. *N Engl J Med* 2002;346:549.
154. Bernard SA, Gray TW, Buist MD, et al. Treatment of comatose survivors of out-of-hospital cardiac arrest with induced hypothermia. *N Engl J Med* 2002;346:557.
155. Longstreth WT, Diehr P, Inui TS. Prediction of awakening after out-of-hospital cardiac arrest. *N Engl J Med* 1983;308:1378.
156. Longstreth WT, Inui TS, Cobb LA, Copass MK. Neurologic recovery after out-of-hospital cardiac arrest. *Ann Intern Med* 1983;98:588.
157. Booth CM, Boone RH, Tomlinson G, et al. Is this patient dead, vegetative, or severely neurologically impaired? Assessing outcome for comatose survivors of cardiac arrest. *JAMA* 2004;291:870.





## **PART 7**

### **SPECIAL CONSIDERATIONS IN ANESTHESIA CARE**



# CHAPTER 85

## Blood and Blood Component Therapy

Ian J. Welsby, BSc, MBBS,  
FRCA, and  
Steven J. Bredehoeft, MD

### HISTORY OF BLOOD TRANSFUSION

Practical, safe transfusion derives from centuries of experimentation and discovery. Although the first known animal transfusion experiments took place in both England and France in the 17th century, early efforts to translate the technique to humans failed with such spectacular flair that the learned societies on both sides of the English Channel flatly banned the practice.

The first “modern” transfusion is attributed to John Syng Physick in Philadelphia in 1795. English physician James Blundell claimed success for 5 of 10 transfused patients during his professional career (1820–1840).

The 19th century saw rapid expansion of bacteriology and growing understanding of antisera. In 1900, Karl Landsteiner significantly advanced the cause of blood compatibility with his landmark discovery of the ABO blood groups, with O being derived from the German “ohne” or without, for which he received the 1930 Nobel Prize in Medicine and Physiology. Four decades later, in collaboration with Alex Weiner, Philip Levine, and R.E. Stetson, Landsteiner played an instrumental role in the recognition of Rh(D), a major cause of hemolytic disease of the newborn (HDN) and non-ABO-related hemolytic transfusion reactions.

Prior to effective schemes for anticoagulation, Alexis Carrel explored vascular anastomosis as a possible strategy for moving blood from donor to recipient. Although eclipsed by other approaches, this pioneering techniques formed the basis of contemporary vascular anastomoses in solid-organ transplantation and won Carrel the 1912 Nobel Prize.

The use of citrate to anticoagulate stored blood by means of calcium che-

lation was a landmark, as heparin was unsuitable to transfuse into bleeding patients, and citrate’s rapid metabolic elimination in vivo proved ideal for purposes of transfusion. Its adoption paved the way for transition from direct to indirect transfusion. By 1916, Rous and Turner introduced glucose in addition to sodium citrate, extending ex vivo storage by several days.

The first blood depots were established during the First World War by the British and were stocked prior to major campaigns. The Soviets established the first permanent blood bank in a Leningrad hospital in 1932, and 5 years later Bernard Fantus established the first U.S. blood bank at the Cook County Hospital in Chicago.

Although clinical efforts had focused largely on transfusion of whole blood, Professor Edwin Cohn at Harvard explored fractionation of plasma proteins using cold ethanol treatment and centrifugation. By 1940, these techniques yielded concentrated fractions of albumin, immunoglobulins, and fibrinogen. With the outbreak of war in Europe, the U.S. War Department and American Red Cross launched *Plasma for Britain*, under the direction of Dr. Charles Drew.

Despite highly successful initial resuscitation, casualties with significant blood loss treated exclusively with plasma developed “air hunger” from anemia. Improved logistics enabled a shift to use of whole blood. With this transition, volume tolerance emerged as the next constraint to adequate re-

placement of oxygen-carrying capacity. Large-scale availability of red blood cell concentrates (and more general exploitation of blood component therapy) awaited development of the plastic, integrated, blood-collection systems of the 1950s and 1960s.

Success was tempered by the identification of transfusion borne infections. “Serum” hepatitis followed approximately 10% of transfusions. Worse, in some communities posttransfusion hepatitis reached rates of 30%, an observation that was explained by reliance on monetarily compensated donors. In parallel with these epidemiologic discoveries, advances in virology and radio-immunochemistry brought to market by 1969 limited supplies of tests for detection of hepatitis B surface antigen (HBsAg, the “Australia Antigen”). With transition in the United States to an all-volunteer blood supply, rates of hepatitis B virus (HBV) transmission fell dramatically, and with full deployment of HBsAg testing in 1972, rates of transfusion-transmitted hepatitis B fell to between 0.3% and 0.9%. Although remarkably high by today’s standards, this represented risk reduction by an order of magnitude.

Following the emergence of HIV/AIDS, an epidemic that transformed public perceptions of blood safety occurred. Lessons learned for dealing with hepatitis led to rapid progress toward securing the safety of the blood supply. The answer to a patient’s question, “Will this transfusion give me AIDS?” is, “No.”

### KEY POINTS

1. ABO compatibility remains the major safety consideration for blood transfusion. Clerical errors of patient identification and sample labeling remain the primary cause of mistransfusion of ABO-incompatible units.
2. Prestorage leukoreduction of cellular blood products has greatly reduced, but not eliminated, the incidence of febrile reactions, transfusion-related immunosuppression, and cytomegalovirus transmission, and has led to improved outcomes in surgical patients compared to the use of non-leukoreduced products.
3. Rigorous donor screening, serologic testing and nucleic acid amplification testing have proven extremely effective in reducing the risk of transfusion-transmitted infections in developed nations. However, transfusion-transmitted infection remains a serious concern throughout the developing world.
4. International travel and associated exposure to pathogens not addressed by existing screening mechanisms will increasingly limit suitable blood donors. These and other pressures on the blood supply make imperative strategies for blood conservation and promotion of blood-less surgical techniques.

Although infectious risks of blood transfusion have diminished enormously in developed nations, high rates of endemic disease and limited testing resources in developing countries paint a variegated global picture of blood product safety. Today's tools include effective donor screening and testing. Tomorrow holds promise of pathogen inactivation and improved controls of bedside transfusion practice as further steps on the long path toward safe transfusion.

## CLINICALLY AVAILABLE BLOOD PRODUCTS

### Whole Blood

Despite some clinicians' desires for fresh whole blood, especially for use in pediatric cardiac anesthesiology, the optimal use for a limited resource demands the use of red cells for oxygen-carrying capacity, plasma for coagulation proteins, and platelets for thrombocytopenia or platelet dysfunction. The component therapy approach maximizes the number of recipients benefiting from transfusion and optimally preserves the function of essential blood elements. Colloid replacement can be provided by synthetic colloids, such as gelatins and starches, or albumin products fractionated from plasma. The time required to perform federally mandated testing makes fresh whole blood practically unavailable to most clinicians; consequently, discussion is primarily focused on blood components.

A unit of whole blood is collected in citrate-phosphate-dextrose-adenine 1 (CPDA-1) anticoagulant, giving it a shelf-life of 35 days and a volume of approximately 510 mL (450 mL of blood plus 63 mL of CPDA-1). Within 24 hours of collection, the platelets are dysfunctional,<sup>1</sup> and several plasma coagulation factors are below optimal levels,<sup>2</sup> emphasizing the importance of the component products despite the disadvantage of increased donor exposure.

### Red Cell Concentrates

Red cell concentrates, or packed red blood cells (PRBCs), are obtained from CPDA-1-anticoagulated whole blood after centrifugation of most of the plasma and platelets. At most blood centers, the red cells are then mixed with 100 mL of an additive nutrient con-

taining an additional dextrose and adenine (NutriCell or AS-3) or dextrose, adenine, and mannitol (Adsol or AS-1) solution that extends the storage period to 42 days<sup>3</sup> and results in flow properties similar to those of whole blood. PRBCs from CPDA-1-anticoagulated blood are stored for up to 35 days. Loss of viability during storage is caused by cellular adenosine triphosphate (ATP) depletion, which leads to loss of membrane phospholipids, increased rigidity, and reduced life span, with current standards requiring 75% of transfused cells to survive in the circulation for 24 hours.<sup>4</sup> At 35 days, 70% of cells survive in CPDA-1 versus 88% in Adsol, with a pH of 6.7 in both solutions; intracellular ATP is 45% baseline in CPDA-1 versus 75% in Adsol, whereas 2,3-diphosphoglycerate (2,3-DPG) levels are at 10% baseline in both. In vivo, 2,3-DPG levels rapidly normalize over 24 hours and recover to more than 50% within 1 or 2 hours.<sup>5</sup> PRBCs are the product of choice for the correction of an isolated defect in oxygen-carrying capacity, as in chronic anemia, with the advantage of lower volume load in this setting. During acute perioperative blood loss, however, attention must be paid to volume status as well as restoring oxygen-carrying capacity using crystalloid or colloid volume expanders.

### Leukocyte-Reduced Red Cells

Leukocyte-reduced red cells (LRRCs) can be prepared by a variety of methods, with varying efficiency of white cell removal. The minimum standard, established by the American Association of Blood Banks (AABB), is a leukocyte number in the final component of  $<5 \times 10^6$ .<sup>6</sup> Early techniques involved centrifugation and washing with saline, repeatedly removing the buffy coat. Next, the "spin-cool-filter" method was introduced, using 1-week-old red cells that were centrifuged and then cooled for 4 hours to enhance microaggregate formation, then passed through a microaggregate filter. Currently, the most widely used method of leukoreduction is filtration, which can be performed either in the laboratory or at the bedside. The various filters on the market result in  $>99\%$  leukocyte reduction while depleting  $<10\%$  of the red cells. Most recently, blood bags with in-line filters that allow prestorage leukoreduction have become available. Simple removal of the buffy coat from red cells

(a routine procedure during component preparation in Europe) may provide a sufficient degree of leukoreduction.<sup>7</sup> Because component preparation in the United States does not include buffy coat removal and because soluble white cell fragments may be capable of mediating immunosuppression, a prestorage leukoreduction method might be required to abrogate this adverse effect in transfusion recipients in the United States. Introduction of leukoreduction in the United States began around 1998. Confirmation with individual blood banks is necessary to determine their policies, as there are often regional differences.

The major indication for the use of LRRCs has been the prevention of the nonhemolytic febrile transfusion reaction, which is the most common adverse effect of transfusion, particularly in multiply transfused patients or multiparous females. It is believed to be a result of preexisting antihuman leukocyte antigen (anti-HLA) antibodies. Use of LRRCs reduces the incidence of such reactions.<sup>8</sup> Cytokines may cause these reactions, suggesting that prestorage leukodepletion may be more helpful.

A second important indication for LRRCs is the prevention of alloimmunization to HLA antigens that can adversely affect posttransfusion platelet increments.<sup>9</sup> Platelets components also require leukodepletion. The current AABB standards mandate  $<5 \times 10^6$  leukocytes for this indication, possibly with third-generation leukoreduction filters for both red cells and platelets.<sup>6</sup> A large, multicenter study (TRAP, Trial to Reduce Alloimmunization to Platelets) confirmed that the use of leukoreduction filters significantly decreased but did not eliminate alloimmunization.<sup>10</sup>

**Washed Red Cells** Red cells are washed using isotonic saline solutions with some degree of red cell loss with each wash cycle. This open system requires the resulting product to be transfused within 24 hours. The primary aim of washing is to remove plasma proteins (with some leukocytes and platelets also removed) to prevent severe allergic transfusion reactions mediated by recipient antibodies (most likely IgE) to donor plasma proteins or preformed antibodies to IgA in donor plasma, which can cause anaphylaxis in IgA-deficient patients.<sup>11</sup> Washed cells may also be indicated in paroxysmal nocturnal hemoglobinuria.

**Frozen Red Cells** Red cells can be frozen (with glycerol used as a cryoprotective agent) and stored in liquid nitrogen or mechanical freezers.<sup>12</sup> Thawing and washing away the glycerol using a series of progressively less hypertonic saline solutions allows glycerol to diffuse gradually from the cells to prevent hemolysis before transfusion. This process removes most of the plasma, and any debris and red cells can be frozen for more than 10 years with good viability.<sup>6</sup> As with washed cells, frozen red cells need to be transfused within 24 hours; posttransfusion survival rate is 85–90%.<sup>12</sup> Freezing, ideally using fresh blood, maintains ATP and 2,3-DPG levels, but solutions containing pyruvate, glucose, phosphate, and adenine can restore older blood.<sup>13</sup> The major use of frozen cells is to store units of a rare phenotype. In addition, the military can transport large volumes of frozen units.

#### Indications for RBC Transfusion

A unit of PRBCs should increase the hemoglobin (Hgb) level by 1 g/dL or the hematocrit level by approximately 3%. However, continued blood loss causes suboptimal response to transfusion. More chronically, hemolysis caused by either immune red cell damage or mechanical trauma shortens the survival of transfused cells, and hypersplenism can lead to sequestration and increased destruction of red cells. Also, transfusion suppresses erythropoiesis; thus sustained results of transfusion may be less than expected.

**Chronic Anemia** Generally, the signs and symptoms of anemia develop at a Hgb level of <7–8 g/dL. With gradual onset, the body's compensatory mechanisms for maintaining oxygen delivery to the tissues are effective. Cardiac output and intracellular 2,3-DPG are increased; thus oxygen unloads at a lower oxygen saturation of Hgb. When chronic anemia is a result of red cell destruction, the healthy bone marrow can respond by increasing production by up to sixfold, provided sufficient dietary iron, folate, and vitamin B<sub>12</sub> is ingested. The decision to transfuse depends on how a given individual manifests the signs and symptoms of anemia, determined by underlying health status, cardiorespiratory reserve, and activity level. In the perioperative setting, it is important to cross-match sufficient units to compensate for the

lower initial Hgb, particularly in a multiply transfused patient with alloantibodies that may be difficult to match.

**Perioperative Period** Much of the dogma surrounding perioperative transfusion has few supporting data. One example is the use of 10 g/dL of Hgb as the gold standard for the red cell transfusion trigger during the perioperative period.<sup>14</sup> A rule of thumb is that assuming no preoperative anemia, blood losses of 5–10% of total blood volume require minimal replacement therapy, losses of up to 20% can be replaced exclusively with volume expansion, whereas losses of >25% generally require red cell transfusion to restore oxygen-carrying capacity, along with volume expansion to restore intravascular volume and maintain perfusion. The availability of hemoglobin measurement, acid–base status, and central venous and mixed venous oximetry, combined with tools to assess intravascular volume in most hospital environments, supersedes such rules, allowing more individually tailored, closely monitored transfusion therapy designed to provide sufficient tissue oxygenation. This is still vague and subjective; thus when to transfuse remains a clinical decision. The American Society of Anesthesiologists provides extensive guidelines, available at <http://www.asahq.org>. Societies, such as the Society for the Advancement of Blood Management (<http://www.sabm.org>), champion blood conservation techniques and appropriate safe but lower transfusion triggers aimed at minimizing allogeneic blood product usage in the perioperative period. The National Institutes of Health suggest that most surgical patients who are not actively bleeding do not need transfusion unless the Hgb level decreases to <7 g/dL, and such levels of Hgb may not interfere with wound healing or automatically make general anesthesia a risk.<sup>14</sup>

Nonetheless, questions concerning an objective measurement to determine a safe transfusion trigger still arise. Animal models of acute normovolemic anemia can be helpful and describe the whole body oxygen extraction ratio (OER) as an indicator of when to transfuse:<sup>15</sup>

$$\text{OER} = ((\text{CaO}_2 - \text{CvO}_2) / \text{CaO}_2) \times 100, \text{ normally } 22\text{--}32\%$$

$$\text{CaO}_2 = (0.0134 \times \text{Hgb} \times \text{SaO}_2) + 0.003 \times \text{PaO}_2 \text{ mL/dL}$$

$$\text{CvO}_2 = (0.0134 \times \text{Hgb} \times \text{SvO}_2) + 0.003 \times \text{PvO}_2 \text{ mL/dL}$$

$$\text{O}_2 \text{ consumption} = \text{Cardiac output} \times (\text{CaO}_2 - \text{CvO}_2) \text{ mL/min}$$

These studies make the seemingly valid assumption that the heart is the major organ at risk. With progressive hemodilution, healthy animals with normal coronary trees were able to maintain normal levels of oxygen consumption (200–250 mL/min) through a moderate increase in cardiac output, an increase in coronary blood flow, and a linear increase in the OER up to a ratio of 50%. As the hematocrit decreased to <10%, however, oxygen consumption began to decrease, and the animals were no longer able to increase the OER. An OER of 50% was the critical point at which the myocardium converted from aerobic to anaerobic metabolism, reflected in net lactate production. At that point, metabolic acidosis developed, resulting in hemodynamic instability. Dogs with critical coronary stenosis converted to anaerobic metabolism and went into congestive heart failure at an OER of >50%, but that an OER of >50% occurred at a hematocrit of 17.0% in the dogs with critical stenosis, compared with a hematocrit of 8.6% in the healthy group, is consistent with the 10% above.<sup>16,17</sup> Dog hearts with normal coronary arteries developed subendocardial ischemia then cardiac failure at a hematocrit <10%; hypertrophied hearts, at higher risk of subendocardial ischemia, may fail at higher hematocrits, although this was not studied.<sup>16</sup> OER can be calculated whenever a pulmonary artery catheter is being used, and therefore mixed venous oximetry can be performed and thus used to help assess transfusion need. An OER of 50% can be used as a red cell transfusion trigger because it appears to be a valid indicator of marginal myocardial oxygen reserve in both healthy people and individuals with coronary artery disease if it is reasonable to directly extrapolate the above animal data to humans. Given the complexity that this adds to clinical practice, most clinicians follow published guidelines based on Hgb levels.

The controversies surrounding transfusion triggers in neonates are beyond the scope of this chapter and are complicated by uncertainties concerning the diagnosis of symptomatic anemia

TABLE 85-1.

## Classification of Transfusion Reactions

Acute	
Immune mediated	
Acute hemolytic transfusion reaction (AHTR)	
Transfusion-related acute lung injury	
Febrile nonhemolytic transfusion reaction	
Urticarial reaction	
Anaphylactic	
Nonimmune mediated	
Nonimmune hemolysis	
Bacterial contamination	
Volume overload	
Metabolic	
Embolic	
Delayed	
Immune mediated	
Delayed hemolytic transfusion reaction (DHTR)	
Posttransfusion purpura	
Graft-versus-host disease	
Nonimmune mediated	
Transfusion-transmitted infection	
Iron overload	

in this group. Similarly, there are fewer data addressing transfusion in pediatric patients compared with adults. Of interest, the humoral and cellular immune systems of the neonate are immature, particularly with prematurity. This introduces a small but real risk of transfusion-induced graft-versus-host disease or thrombocytopenia after transfusion of leukocytes (PRBCs or platelet transfusions) in premature infants or in a fetus undergoing intrauterine transfusion.<sup>18</sup>

Irradiated cells are indicated in these settings. Another risk in premature infants is the development of clinical cytomegalovirus (CMV) infection in infants of CMV-seronegative mothers.<sup>19</sup> CMV-seronegative blood is now routinely used in these neonates. The only setting in which there may be some data to support use of CMV seronegative units is in severe combined immune deficiency infants undergoing bone marrow transplantation. Otherwise, contemporary leukoreduced products are considered "CMV safe," equivalent to seronegative products. Leukoreduction by filtration reduces but does not eliminate the risk of these complications.<sup>20</sup>

**Safety of Blood Transfusion**

Transfusion safety relies on the avoidance of transfusion reactions, as classified in Table 85-1, that have multiple etiologies. Immune-mediated reactions are a result of transfusion of an incompatible blood product, as described below. The single most important contribution to transfusion safety is uncompromising attention to all details of patient, sample, and blood product identification.

**Red Blood Cell Compatibility**

Compatibility relies on the recipient not recognizing the allogeneic blood transfusion as foreign. Sensitization to alloantigens, with formation of the alloantibodies that determine incompatibility, can occur after transfusion, transplantation, or pregnancy. The most clinically important antibodies, or isohemagglutinins, react with antigens of the ABO system, are naturally occurring, complement-fixing antibodies that require no prior sensitization, and typi-

cally result in immediate intravascular hemolysis of transfused erythrocytes and a severe hemolytic transfusion reaction (HTR). The chance of ABO incompatibility with an unmatched transfusion is 1 in 3, leading to a life-threatening HTR with approximately 10% mortality.<sup>21</sup> Anti-A and anti-B antibodies are classically associated with severe HTRs, but reactions to anti-Rh (D, C, E, c, e, f, or ce), Kell, Duffy, or Kidd system antibodies are actually more common.<sup>22</sup> Table 85-2 details ABO compatibility of blood products.

**Alloimmunization** The likelihood of sensitization to other antigens depends on both the variable immunogenicity of the particular red cell antigen and the immune response of the host; HTRs are three times more common in females.<sup>22</sup> Such alloimmunization is best understood for the Rhesus (Rh) D antigen, studied extensively because of the important role played in hemolytic disease of the newborn. It is a highly immunogenic and clinically important antigen associated with severe HTRs. Up to 80% of RhD-negative individuals, and up to 95% after massive transfusion, produce anti-D antibodies after exposure.<sup>23</sup> Those who generate anti-D after an exposure are more likely to develop other red cell alloantibodies, whereas those not generating anti-D rarely develop other alloantibodies.<sup>24</sup> Other antigen systems are less immunogenic; Kell (K) antigens stimulate anti-K in 10% of cases followed in order of magnitude by Rh c and E, Duffy (Fy<sup>a</sup>), and Kidd (Jk<sup>a</sup>). Antibodies recognizing antigens from the Kell, Duffy, Kidd, Lutheran, and MNSU systems can cause HTRs, typically delayed, although in many pa-

TABLE 85-2.

ABO Compatibility of Blood Products<sup>a</sup>

Recipient blood group	Recipient alloantibodies	ABO-compatible blood products				
		Whole blood	Packed red cells	FFP	Cryoprecipitate	Platelets
A	Anti-B	A	A or O	A or AB	Any	Any
B	Anti-A	B	B or O	B or AB	Any	Any
AB	Nil	AB	O, A, B, or AB	AB	Any	Any
O	Anti-A and anti-B	O	O	A, B, AB, or O	Any	Any

FFP, fresh-frozen plasma.

<sup>a</sup>Compatibility differs with components, as whole blood contains all components, packed red cells contain minimal plasma and antibodies. Donor antibodies are present in FFP, which is a component of platelet products; cryoprecipitate does not contain donor antibodies. ABO compatibility may, however, increase the life span of transfused platelets, and platelet units with high plasma volume should be ABO matched like FFP to avoid hemolysis of recipient native red cells. Patients with blood group O express the H antigen on the red cell surface but anti-H is very rare.



tients they only result in reduced red cell survival.

In terms of alloantibodies detected by blood banks, the most commonly recognized antigens are in the ABO blood group system followed by anti-D, anti-K, anti-E, anti-K, anti-c, anti-Fy,<sup>a</sup> anti-C, anti-Jk,<sup>a</sup> anti-S, and anti-Jk.<sup>b</sup> The incidence of others is <1%.<sup>25</sup> Studies of alloimmunization after transfusion have focused on chronically transfused patients with hemoglobinopathies (such as thalassemia or sickle cell disease), and an approximate 1% risk of alloimmunization has been attributed to every unit transfused.<sup>26</sup> The incidence of red blood cell (RBC) alloimmunization is up to 50% in adults with sickle cell disease,<sup>27</sup> increasing the likelihood of delayed HTRs, which can present as sickle crises.<sup>28</sup>

**HLA Alloimmunization** Alloimmunization to antigens in the human leukocyte antigen (HLA) system occurs in multiply transfused or multiparous individuals and can be detected in 30–70% of patients given nonleukoreduced RBC or platelet transfusions.<sup>29</sup> The almost ubiquitous adoption of leukoreduction techniques for RBCs and platelets during the 1990s can reduce the incidence of HLA alloimmunization, which can cause febrile non-hemolytic transfusion reactions, platelet transfusion refractoriness, and increased risk of subsequent transplant rejection.<sup>29</sup> Alloantibodies to the human platelet antigen systems (HPA-1 to HPA-5) cause neonatal alloimmune thrombocytopenia and post-transfusion purpura; they may also lead to platelet transfusion refractoriness but are clinically far less important than HLA alloantibodies.

**Hemolytic Transfusion Reactions** Immune-mediated HTRs result from recipient alloantibodies reacting to transfused RBC surface alloantigens. HTRs can be classified as acute (within hours of transfusion), delayed (within days or weeks of transfusion), intravascular, and extravascular.

**Acute HTRs** Acute HTRs are a result of existing, circulating alloantibodies to alloantigens on transfused RBCs. If the alloantibody fixes complement (such as anti-A or anti-B), acute, intravascular, hemolysis occurs, which is a medical emergency. Acute HTRs have an estimated frequency of 1 per 25,000 RBC units.<sup>30</sup> The mortality of 1 in

600,000 RBC units<sup>31</sup> is primarily caused by ABO incompatibility.<sup>32</sup>

Signs and symptoms of an acute HTR can be nonspecific and confounded by the patient's clinical condition; consequently, a high index of suspicion and meticulous identification of patients and blood products is essential. Although chills; infusion site, abdominal, chest, or back pain; nausea; anxiety; and dyspnea may be reported by a conscious patient, fever, hypo- or hypertension, hemoglobinuria, anuria, shock, or coagulopathic bleeding may be the first signs of an acute HTR in anesthetized patients. The etiology of profound shock is the activation of the complement cascade with bradykinin production from factor XII activation, C3a- and C5a-induced histamine and serotonin release from mast cells leading to increased vascular permeability, bronchial and intestinal smooth muscle contraction and neutrophil degranulation, and C5a-mediated capillary vasodilatation. Numerous cytokines (tumor necrosis factor, interleukin [IL]-1, IL-6, IL-8) also play a role.<sup>33</sup> Disseminated intravascular coagulation (DIC) results from complement-mediated activation of factor XII and extrinsic pathway activation by stromal thromboplastins from lysed erythrocytes.

Free hemoglobin does not appear to have direct toxic effects,<sup>34</sup> and shock-induced renal failure and DIC convey most of the morbidity and mortality.<sup>35</sup> Therefore, prompt supportive therapy with fluids, inotropes, and vasopressors as indicated is crucial, and corti-

costeroids may be considered in the setting of resistant vasoplegic shock. DIC can be managed with hemostatic blood products as required; the efficacy of heparin or activated protein C in this setting is not established.<sup>36</sup>

Immediate notification of the blood bank is essential, as another patient is likely to erroneously receive the unit intended for the patient experiencing the acute HTR. An anticoagulated ethylenediaminetetraacetic acid (EDTA) and a serum specimen, as well as a posttransfusion urine sample, should be sent with all suspected blood units and infusion tubing. Table 85–3 details laboratory testing for suspected HTRs.

**Delayed HTRs** Delayed HTRs require a secondary or anamnestic antibody response to a transfused RBC alloantigen in a recipient previously sensitized by transfusion or pregnancy. Detectable antibody levels are not present at the time of pretransfusion serologic testing or transfusion, but appear within days of the transfusion, which is why transfused patients need to have serologic testing repeated after 4–5 days.<sup>37</sup>

The frequency of delayed HTRs is estimated to be 1 per 1500 units. Although fatalities have been associated with delayed HTRs, they were not believed to be causative.<sup>32</sup> Alloantibodies are typically against antigens in the Rhesus, MNS, Kell, Kid, or Duffy systems, but rarer antigens may also be involved.

TABLE 85–3.

Diagnosis of Hemolytic Transfusion Reactions

	Onset	Duration
Plasma free hemoglobin	Immediate	5–12 Hours
Methemalbumin <sup>a</sup>	1 Hour	24 Hours
Direct antiglobulin test (DAT) <sup>b</sup>	Immediate	Hours
Indirect antiglobulin (IAT)	Days	Weeks
Bilirubin <sup>c</sup>	1 Hour	12 Hours
LDH <sup>c</sup>	1 Hour	24 Hours
Haptoglobin <sup>c</sup>	Hours	Days
Urine free hemoglobin	1 Hour	24 Hours

HTR, hemolytic transfusion reaction.  
<sup>a</sup>Primarily for acute hemolytic transfusion reactions  
<sup>b</sup>The DAT will only be positive until all incompatible cells have been destroyed; frank hemolysis (free hemoglobin > 50 mg/dL) is visible as “pink” plasma. ABO incompatibility causes a positive DAT, whereas other alloantibodies (e.g., anti-Kell) cause a positive IAT.  
<sup>c</sup>May be seen in acute HTRs but more useful for confirming delayed hemolysis. When testing urine for free hemoglobin, distinguish from hematuria or myoglobinuria. The time course of urine hemoglobin is dependent on plasma hemolysis and bladder clearance, i.e., urine output.

Oposonized RBCs are cleared by the reticuloendothelial system, resulting in a slower and less severe extravascular hemolysis. A history of fever, anemia, and recent blood transfusion may be the only clue to a delayed HTR, and many pass undetected.<sup>22</sup> Rarely, a delayed HTR causes intravascular hemolysis with the clinical picture described for acute HTRs. Erythrocyte destruction is maximal 4–13 days posttransfusion; a positive direct antiglobulin test is found after 2–3 days, followed by spherocytes in peripheral blood (3–4 days) and antibodies detectable by indirect antiglobulin test, anemia, jaundice, and possible hemoglobinuria (5–7 days).

**Pseudo HTRs** Poor transfusion practices, such as transfusion of aged, overheated, or frozen cells, osmotic hemolysis by hypotonic solutions, mechanical hemolysis from inappropriate administration equipment, hemolysis from bacterial or parasitic contamination, or coincidental presentation of congenital hemolytic conditions (e.g., sickle trait or glucose-6-phosphate dehydrogenase deficiency) presenting at the time of transfusion (e.g., surgery), all lead to a nonimmune-mediated or “pseudo” HTR. Nonimmune hemolysis can be induced by mishandling of blood, overheating, and mixing with nonisotonic solutions.

### Plasma Component Derivatives

Plasma is separated from PRBCs through centrifugation of whole blood at the time of collection, or collected by apheresis as a single product or as a byproduct of platelet or red blood cell apheresis. Plasma can be further processed into its derivatives through the cold ethanol fractionation method of Cohn. This chapter discusses features and uses of fresh-frozen plasma (FFP), cryoprecipitate, and other products derived from pooled plasma.

**Fresh-Frozen Plasma** Plasma is the fluid compartment of blood and consists of 90% water, 7% protein and colloids, and 2–3% nutrients, crystalloids, hormones, and vitamins. The protein fraction also contains the soluble clotting factors. Plasma frozen at 0.4 °F (18 °C) or colder within 6 hours of donation is labeled FFP. This product may be stored up to 1 year before use, at which time it is thawed over 20–30 minutes. The activities of the

labile coagulation factors (V and VIII) decrease after thawing but remain adequate for at least 24 hours. Plasma that is not immediately frozen as FFP becomes either “liquid plasma” (stored at 33.8–42.8 °F [1–6 °C]) or “source plasma” (stored at 0.4 °F [18 °C] or colder) and is used for the preparation of plasma derivatives: albumin, clotting-factor concentrates, and immunoglobulin preparations. When FFP is thawed at 39.2 °F (4 °C), a precipitate separated by centrifugation forms, resulting in cryoprecipitate and cryo-poor supernatant.

Solvent detergent (SD) plasma is an alternative to FFP. SD plasma is a pooled product (2500 donor units per pool) and subjected to a solvent detergent treatment process combining the organic solvent tri(n-butyl)phosphate with a nonionic detergent, Triton X. This inactivates lipid-enveloped viruses, including human immunodeficiency virus (HIV) types 1 and 2, HBV, hepatitis C virus (HCV), human T-cell lymphotropic virus (HTLV) types 1 and 2, hepatitis G virus (HGV), vesicular stomatitis virus, and Sendai virus, while preserving the structural and functional integrity of most plasma proteins. However, it does not inactivate nonenveloped viruses, such as parvovirus B19 and hepatitis A virus (HAV), or the causative agents of various rare encephalopathies, including Creutzfeldt-Jakob disease. The increased prevalence of parvovirus B19 and HAV makes transmission by transfusion of pooled blood components a potential concern, although pooled SD plasma also contains significant amounts of neutralizing antibody to both parvovirus B19 and HAV. It is unclear what the real value and risk of SD plasma is compared with FFP, but, at present, the cost of SD plasma is much more than FFP.

**Indications for FFP** Audits of transfusion practices have consistently demonstrated that FFP is commonly used inappropriately.<sup>38</sup> Such inappropriate use includes reconstituting “whole blood” by coadministration with RBCs, volume expansion, and as a source of nutrients. Acceptable indications are discussed below.

**Liver Disease and Transplantations** Patients with severe liver disease have low levels of the vitamin K-dependent clotting factors (II, VII, IX, and X) in addition to thrombocytope-

nia associated with hypersplenism and a hyperfibrinolytic state. These patients develop a prolonged prothrombin time (PT) and partial thromboplastin time (PTT). In addition, the thrombin time (TT) may be prolonged, fibrin split products may be elevated, and in later stages, the fibrinogen level decreases. Hemorrhage from portosystemic varices is complicated by this multifactorial coagulopathy.

Infusion of FFP is indicated during bleeding episodes to normalize the PT or PTT. In the absence of anatomic lesions, bleeding does not usually occur until the PT is >16–18 seconds or the PTT is >55–60 seconds and prophylactic FFP (e.g., before a liver biopsy) is not indicated at lower values. The PT and PTT are poor predictors of surgical bleeding, and mild abnormalities in these coagulation tests may not correct despite large volumes of FFP; platelet transfusion, cryoprecipitate, antifibrinolytic drugs, and even recombinant-activated factor VII may be required.<sup>39</sup> This scenario is exaggerated in the setting of orthotopic liver transplantation complicated by an anhepatic stage, massive PRBC transfusion, and DIC. Large volumes of FFP are typically used, ideally guided by clinical assessment of bleeding and coagulation test results.<sup>40</sup>

**Massive Transfusion** This is the most common situation during which anesthesiologists administer combinations of blood products. FFP is often required after large quantities of PRBC (>1 blood volume in 24 hours) because of the dilutional coagulopathy arising from the PRBC and crystalloid solutions, both of which lack coagulation factors. A predetermined algorithm for FFP transfusion per units of PRBCs is often unreliable, as dilutional thrombocytopenia also complicates the coagulopathy after massive transfusion.<sup>41,42</sup> As recommended in the transfusion guidelines published by the American Society of Anesthesiologists, FFP transfusion should ideally be guided by abnormal PT and PTT results when available as the degree of coagulopathy can be unpredictable.

Disseminated intravascular coagulation may be secondary to sepsis, liver disease, hypotension, perioperative hypoperfusion, trauma, obstetric complications, leukemia, or underlying malignancy. Successful treatment of the underlying cause is paramount. Pa-

tients with DIC leading to coagulopathic bleeding should be given FFP to correct PT and PTT abnormalities, but as in severe liver disease, FFP alone may fail to normalize PT and PTT.<sup>43</sup> The need for cryoprecipitate or platelet transfusion should also be evaluated.

**Rapid Reversal of Vitamin K Antagonists** Warfarin (Coumadin) inhibits the hepatic synthesis of vitamin K-dependent clotting factors (II, VII, IX, and X), inducing functional deficiencies of these factors that can correct within 48 hours after drug discontinuation if diet and vitamin K absorption are normal. Vitamin K administration corrects the coagulopathy in 12–18 hours. In an emergency, the deficiency of clotting factors can immediately be corrected by FFP transfusion. However, a large volume of FFP may be required, and if unlikely to be tolerated, smaller volumes of FFP can be augmented with a bypassing agent such as prothrombin complex concentrates or more commonly recombinant activated factor VII.<sup>44</sup> In the absence of bleeding, the potential danger of excessively prolonged PTs must be weighed against the risks of FFP infusion, and FFP is rarely indicated.<sup>45</sup>

**Thrombotic Thrombocytopenic Purpura and Hemolytic Uremic Syndrome** In some patients with thrombotic thrombocytopenic purpura (TTP), hemolytic uremic syndrome (HUS), or the syndrome of hemolysis, elevated liver enzymes, and low platelets associated with preeclampsia (HELLP) syndrome, FFP exchange transfusion has been clinically therapeutic; plasmapheresis is preferred if there is concern for fluid overload.<sup>46,47</sup> The mechanism of the therapeutic effect of FFP is likely to involve transfused anticoagulant proteins such as protein C and antithrombin III, which may restore endothelial prostaglandin I<sub>2</sub> (prostacyclin) production and inhibit the agglutinating activity of the abnormal plasma.<sup>48</sup> Alternatively, it may inhibit the release of large-molecular-weight von Willebrand factor (vWF) multimers or restore their normal processing in the circulation by deficient ADAMTS13 enzyme.<sup>49</sup> The use of cryo-poor supernatant for refractory TTP has been suggested, but the advantage is unestablished.<sup>50</sup>

**Dosage** One unit of FFP derived from a unit of whole blood contains 200–280

mL; apheresis may contain as much as 800 mL. On average, there are 0.7–1 unit/mL of activity of each coagulation factor per mL of FFP and 1–2 mg/mL fibrinogen. For perioperative use, the FFP dose may be estimated at 8–10 mL/kg and should be ordered as the number of milliliters to be infused for pediatric patients or units for adults. Laboratory measurements and clinical response determine the need for additional doses.

#### **Compatibility and Side Effects**

Fresh-frozen plasma is screened for unexpected RBC antibodies and should be ABO-type compatible as it contains anti-A (groups O and B) and anti-B (groups O and A). Cross-matching is not performed. The Rh(D) type is not always matched because immunization to Rh(D) antigen has rarely been reported as a result of transfusion of Rh(D)-positive plasma to Rh(D)-negative individuals. Hemolytic reactions as a consequence of infusion of an undetected antibody directed toward recipient RBC antigens are rarely seen, as is alloimmunization to RBC antigens.<sup>51</sup>

Fever, chills, and allergic reactions may occur and are treated symptomatically. Typical urticarial reactions are believed to result from recipient antibodies interacting with donor plasma protein antigens. Rarely, severe allergic reactions occur. Some are believed to be caused by donor antibodies reacting with recipient leukocytes or protein antigens. Anaphylactic reactions may occur after infusion of plasma (containing IgA) into patients with IgA deficiency and antibodies to IgA.<sup>52</sup> IgA-deficient plasma from donors in the national registry can be obtained for these occasional patients. Transmission of infectious disease by FFP has been significantly reduced but not eliminated. Cell-associated CMV is not transmitted by FFP.<sup>53</sup>

**Immunoglobulin Preparations** Intravenous immunoglobulin (IVIg) is prepared by fractionation of large pools of human plasma. Indications for IVIg use include primary congenital immunodeficiency syndromes, children with HIV infection,<sup>54</sup> chronic lymphocytic leukemia complicated by hypogammaglobulinemia, CMV pneumonia complicating bone marrow transplantation (in combination with ganciclovir),<sup>55</sup> a possible role in preventing severe graft-versus-host dis-

ease after bone marrow transplantation, acute and chronic idiopathic thrombocytopenic purpura, and mucocutaneous lymph node syndrome (Kawasaki disease).<sup>56</sup>

Hyperimmune immunoglobulin (HIg) is prepared from large pools of plasma known to contain elevated antibody titers against specific infectious agents. Specifically, CMV HIg is indicated in transplantation recipients seronegative for CMV who receive a seropositive donor organ or in bone marrow transplantation patients with CMV interstitial pneumonia.<sup>55</sup> Hepatitis B HIg is used to provide passive immunity to hepatitis B virus associated with inoculation by or a liver transplantation in HBsAg-positive individuals.

Rhesus HIg is used when fetal Rh(D)-positive RBCs may have entered the maternal circulation of an Rh(D)-negative mother. Rhesus HIg is given to Rh(D)-negative mothers after abortion or amniocentesis as well as before delivery and again postpartum if the child proves to be Rh(D) positive.<sup>57,58</sup> The therapeutic effect is believed to be caused by antibody feedback with T-cell suppression of the B-cell clone responsible for the formation of anti-Rh antibody. Its routine use in obstetrical practice has virtually eliminated alloimmunization of Rh-negative mothers.

Antithymocyte globulin (ATG) is purified from the hyperimmune serum of horses immunized with human T lymphocytes. ATG is used in transplant patients as an adjunct therapy in the treatment of graft rejection.

**Cryoprecipitate** Cryoprecipitate is prepared from 1 unit of FFP thawed at 39.2°F (4°C). The precipitate is then refrozen in 10–15 mL of plasma and stored at 0.4°F (18°C) or colder for up to 1 year. Cryoprecipitate contains 80–100 units of factor VIII, 100–250 mg of fibrinogen, 50–60 mg of fibronectin, 40–70% of normal vWF levels, and anti-A and anti-B antibodies.

Cryoprecipitate is effectively the blood component containing the highest concentration of factor VIII, vWF, factor XIII, fibrinogen, and fibronectin. Cryoprecipitate may be used to treat bleeding associated with hypo- or dysfibrinogenemia or factor XIII deficiency states, although an equivalent amount of fibrinogen to the usual adult dose of 100 mL is also found in 4 units of FFP. Its use in vWF and factor VIII deficien-

cy has been superseded by individual factor replacement therapy.

### **Indications: Fibrinogen Deficiency**

Fibrinogen deficiency may be a result of rare congenital afibrinogenemias or dysfibrinogenemias or more commonly as a result of severe liver disease, DIC, or massive transfusion.<sup>45</sup> These patients often have multifactorial coagulopathies and may require the coadministration of FFP, platelets, and antifibrinolytic agents. Fibrinogen measurements are an important component of a coagulation screen because levels < 100 mg/dL can cause prolongation of both the PT and PTT despite adequate levels of other clotting factors. Low levels of fibrinogen occur during liver transplantation, necessitating cryoprecipitate transfusion.<sup>40</sup>

**von Willebrand Disease** Initial platelet adhesion to disrupted endothelium is mediated by von Willebrand factor (vWF) interacting with the platelet surface GPIb complex; vWF is low or dysfunctional in the various types of von Willebrand disease. DDAVP (desmopressin acetate; 1-deamino-8-D-arginine vasopressin), which releases stored vWF from platelet granules and endothelial cells, is the initial treatment, but severe bleeding requires cryoprecipitate or vWF concentrate.<sup>59</sup>

**Fibrin Glue** Fibrin glue results from the mixture of a fibrinogen source (FFP, platelet-rich plasma, heterologous, or more recently autologous, cryoprecipitate) with bovine thrombin, which leads to fibrin formation and enhanced local hemostasis. It has been used for diffuse local bleeding during cardiac surgery<sup>60</sup> and to reduce blood loss and the factor concentrate requirement in surgical patients with von Willebrand disease.<sup>61</sup> Other uses include meniscal tear repair and sealing postoperative neonatal chylothorax.<sup>62</sup> Autologous cryoprecipitate avoids any infectious risks; bovine thrombin can cause anaphylaxis, formation of antibodies to factor V, or activation of coagulation.<sup>63</sup>

**Uremic Bleeding** Uremia causes coagulopathy, and historically, cryoprecipitate or DDAVP has been used to treat bleeding associated with this.<sup>64</sup> There are no data to support this, although cryoprecipitate could be considered if unresponsive to other therapies.<sup>65</sup>

**Dosage** The dosage of cryoprecipitate is calculated on the basis of the amount of fibrinogen present in 1 unit of cryoprecipitate, the plasma volume, and the desired increment. The fibrinogen content of cryoprecipitate is variable but, even if relatively low, sufficient response is seen with transfusion of 2–4 units/10 kg. In practice, most adults are given a pooled 10-unit or 100-mL dose that is repeated if the desired response is not seen.

### **Compatibility and Side Effects**

Cryoprecipitate can contain anti-A or anti-B antibodies; thus infused units should be ABO plasma compatible. The risks of fevers, chills, allergic reactions, and infectious disease transmission are similar to those of FFP.

**Factor Concentrates** In the 1940s, Dr. Edwin Cohn developed an ethanol fractionation procedure (the Cohn fractionation procedure) that allowed the fractionation of human plasma into various components, greatly expanding this limited resource by deriving more products from each unit of donated plasma. Sufficient amounts of factor concentrates, however, require pooling of plasma. Present pathogen inactivation technologies have virtually eliminated infectious risks associated with plasma derivatives.

Development of recombinant products has been fueled by concerns of infectious disease risks, but recombinant expression processes are complex and expensive. Mammalian cell culture is most commonly used to optimize posttranslational modifications required for biologic activity, with transgenic recombinant technology being developed to decrease or eliminate reliance on donated human plasma resources or mammalian cell-culture-based recombinant production methods. Recombinant transgenic human antithrombin expressed in goat milk and human  $\alpha_1$ -antitrypsin produced in sheep's milk are currently clinically available.

The most common congenital deficiencies of coagulation proteins are hemophilia A (classic hemophilia or factor VIII deficiency) or hemophilia B (Christmas disease or factor IX deficiency). The genes for these coagulation factors are located in close proximity on the long arm of the X chromosome. Limited to males, hemophilia A affects 1 in 10,000 males,

whereas hemophilia B affects 1 in 30,000. Familial cases predominate, but more than 30% of cases arise from spontaneous mutations.

Arthropathy is the major morbidity of the hemophiliac secondary to recurrent spontaneous joint bleeding, and such patients are frequently encountered for orthopedic surgery. The major cause of mortality (other than transfusion-related infection) is bleeding, with central nervous system (CNS) hemorrhage occurring in 3–14% of patients, conferring a mortality of 20–50%. CNS hemorrhage occurs predominantly in patients with severe disease (< 1% factor level).

Citrated plasma was first used in 1923 for the treatment of hemophilia by Feissly in Paris, and the development of modern blood banking in the 1930s and expansion of transfusion during and after World War II allowed for more widespread use of whole blood and, subsequently, frozen plasma in the treatment of these fatal hemophilias. The advent of cryoprecipitate revolutionized hemophilia therapy. Cryoprecipitate derived from a single whole-blood collection contains approximately 125 U of factor VIII, and it quickly replaced frozen plasma to treat hemophilia.

The fractionation of plasma using ethanol, glycine, polyethylene glycol, or a combination of glycine and polyethylene glycol, and calcium or barium to precipitate plasma proteins led to the production of factor VIII and factor IX concentrates for clinical use.<sup>66</sup> This enabled high concentration, low volume, intensive infusion therapy for serious and life-threatening bleeding complications, such as intracranial, retroperitoneal, and retropharyngeal hemorrhages, and major surgery. From an infectious standpoint, these large pools of > 1000 donations were universally contaminated with viral pathogens, such as hepatitis B or C, and between 1978 and 1985 most hemophiliacs were tragically infected with HIV from concentrates. Pasteurization and dry heat inactivate HIV and limit hepatitis B transmission; other strategies to limit infection include screening of potential donors for risk factors, surveillance of the blood supply for new pathogens, screening for markers of infectious agents, and other purification steps, including physical and chemical viral inactivation methods.



After cloning of the genes factor VIII and factor IX, recombinant factor VIII and factor IX products were made available that are effective and free from pathogens.<sup>67</sup>

**Treatment Regimens** The use of prophylactic regimens to maintain trough factor levels at more than 1% of normal reduces the incidence of arthropathy and CNS hemorrhage but requires dosing every 2–3 days with attendant problems and complications associated with long-term venous access.<sup>68</sup>

For the treatment of bleeding, the goal of therapy is to achieve a plasma factor VIII or IX level of between 30% and 50% for non-life-threatening bleeding episodes and a level of 100% for life-threatening bleeds or prophylaxis for surgical procedures using repeated boluses or continuous infusion for a duration of 10–14 days or longer, depending on the severity of the bleed or surgical intervention.

Adjunctive therapy includes DDAVP, a vasopressin analogue used for treatment of patients with mild or moderate hemophilia A. This synthetic octapeptide causes a release of factor VIII (and von Willebrand factor) from endothelial cells, raising plasma factor VIII by approximately 3-fold (range, 2–12-fold) in patients with hemophilia in whom the disease is caused by decreased production or secretion of a functional protein or a protein that has decreased activity. Patients with severe hemophilia do not benefit from its use, as the mutation results in no synthesis, secretion, or a protein with no activity. The DDAVP response is unpredictable but reproducible in a given individual and should be documented by measuring factor VIII levels. The recommended intravenous dose is 0.3 µg/kg infused slowly, as vasodilatation may occur. There have been reports of myocardial infarction and cerebral thrombosis with its use in patients at risk of arterial thrombosis, therefore it should only be used in the setting of a documented coagulopathy.<sup>69</sup>

Dosing of factor VIII concentrates assumes an increase in plasma factor VIII activity of 2% for every 1 IU/kg infused. Cryoprecipitate replacement assumes approximately 80–150 IU per bag of factor VIII per bag of cryoprecipitate (derived from a 450-mL single whole-blood donor collection unit). Thus, a typical 1750-IU dose (50% correction for a 70-kg patient) requires between 10 and 21 units.

Highly purified plasma-derived factor VIII concentrates or recombinant factor VIII concentrates have been available in North America, Europe, and Japan since 1992. These are either full-length or B-domain deleted molecules (the B domain is not required for activity in coagulation) that are expressed in mammalian cell culture (Chinese hamster ovary or baby hamster kidney cell lines) and are purified using immunoaffinity techniques. These products are formulated with added albumin as a stabilizer, but some have been developed that stabilize the factor VIII molecule with nonprotein molecules; despite no reliance on donated blood, the supply of these products is not abundant because of the complex manufacturing process.

**Factor IX Concentrates** Intermediate- and high-purity plasma products and a recombinant factor IX product are available for the treatment of hemophilia B, all of which undergo at least one viral inactivation or exclusion step in manufacture. Recovery of factor IX after infusion is therefore approximately 1%/IU/kg. The recovery observed with recombinant factor IX is approximately 20% lower than that observed with plasma-derived factor IX, likely because of differences in posttranslational modifications between the recombinant and plasma-derived factor proteins.

Intermediate-purity factor IX products use anion exchange chromatography-selecting proteins containing highly negatively charged epitopes such as the vitamin K-dependent coagulation factors with γ-carboxyglutamic acid-rich domains. Therefore, the other vitamin K-dependent coagulation factors, factor VII, factor X, and prothrombin, are copurified with factor IX and referred to as “prothrombin complex concentrates” (PCCs). PCCs are contaminated with trace amounts of activated forms of these factors, which is the likely explanation for thromboses complicating their use.<sup>70</sup> To minimize the risk of thrombosis with the use of PCCs, it is advisable to achieve a peak factor IX level no higher than 50%; some manufacturers have formulated PCCs with heparin or antithrombin III.<sup>71</sup>

High-purity factor IX products are produced from plasma using techniques of ligand affinity or immunoaffinity chromatography and typically have specific activities greater than

150 IU/mg. A single high-purity recombinant factor IX product has been marketed. Thrombotic complications have not been reported with these high-purity products.

**Hemophilia with Circulating Inhibitors** Replacement therapy may be complicated by the development of inhibitory antibodies against the infused factors that interfere with factor activity. The incidence of factor VIII inhibitors is approximately 30%, although titers and inhibitory activity vary.<sup>72</sup>

Treatment of acute bleeding episodes can be accomplished by two methods. For patients with low titer inhibitors, hemostasis can be accomplished with large doses of factor VIII or factor IX (e.g., as high as 200 IU/kg given at frequent intervals) in an effort to neutralize, or “override,” the circulating inhibitor. Porcine factor VIII can be used to treat an actively bleeding patient with inhibitors to human replacement factors, but problems include inhibitors cross-reacting with porcine factor VIII, allergic reactions, anaphylaxis, and thrombocytopenia caused by binding of porcine von Willebrand factor present in the concentrate to human platelets.

Alternatively, a bypassing agent is required. These bypass agents include PCCs in which contaminant-activated forms of these proteins, factors VIIa, Xa, IXa, and IIa (thrombin), likely enhance the production of a fibrin clot by activating the coagulation pathway later than the level of action of factors VIII and IX. Activated PCCs (aPCCs) have been treated to increase the levels of these activated factors and may be more effective in the treatment of bleeding episodes in patients with inhibitors. They were used as first-line therapy for patients with inhibitors but because of the risk of thrombotic complications with aPCCs,<sup>70</sup> recombinant activated factor VII (rFVIIa) has been licensed as an alternative bypass agent in the treatment of hemophiliacs with inhibitors.<sup>73</sup> The dosage of rFVIIa is 90 µg/kg every 2 hours as necessary, compared with 50–75 IU/kg every 8–12 hours for PCCs or aPCCs. Thrombosis has also been reported with the use of rFVIIa.<sup>74</sup> Coadministration of antifibrinolytic agents, such as ε-aminocaproic acid, is often used as an adjunct to replacement or bypass therapy.

**von Willebrand Disease** von Willebrand disease (vWD) is an autosomal dominant mucosal, platelet-type bleeding disorder first described by Erik von Willebrand in 1926, which has a prevalence of up to 2% of the general population. The penetrance and severity of the disease vary depending on the type of vWD (type 1, 2, or 3), the specific mutation, the number of affected genes, the patient's blood type, and numerous drug, hormonal, and other parameters. The type of vWD and the patient's response to DDAVP influence the recommended treatment for acute bleeding episodes or for prophylaxis against bleeding.<sup>66</sup> DDAVP releases stored vWF as well as factor VIII from platelets and endothelium, and is often effective for type 1 disease and may be useful in certain patients with type 2 disease. It is not appropriate for use in patients with type 3 disease in whom no stores of vWF exist.

As described for hemophilia A, antifibrinolytic agents are useful adjuncts for replacement therapy for vWD such as in the setting of dental surgery to inhibit fibrinolysis. Estrogens upregulate vWF synthesis and may be useful, especially in women, and may ameliorate menorrhagia.

#### **Plasma-Protein Based Therapy:**

**Factor VIII Concentrates** Some intermediate-purity factor VIII concentrates are manufactured from plasma using methods that copurify significant amounts of vWF, but no product has the pattern of multimers that is present in normal plasma.

**von Willebrand Factor Concentrates (Plasma-Derived and Recombinant)** Several chromatography-purified plasma-derived concentrates enriched in vWF have been studied and may be effective and amenable to viral inactivation steps. Recombinant vWF has been successfully isolated and partially characterized; it is being developed clinically.

Cryoprecipitate was the mainstay of plasma-based therapy for bleeding in patients with vWD until the availability of virally inactivated intermediate-purity factor VIII concentrates that retained functional vWF protein. The factor VIII concentrates are the products of choice for the treatment of bleeding in patients with types 1 and 2 vWD that are unresponsive to DDAVP, and for bleeding in patients with type

3 vWD, as they have a lower risk of transfusion-associated infection than cryoprecipitate.

**Acquired Disease** Antibodies that inhibit the activity of factor VIII can develop in previously normal patients. Most of these patients have no underlying disease; however, factor VIII antibodies can arise in the setting of autoimmune disorders or in the postpartum period. One-third of these inhibitors resolve spontaneously, but supportive therapy is required while they persist.

Acquired vWD is a rare autoimmune disorder that can occur in association with other autoimmune disorders or lymphoproliferative disease. Antibodies may interact with functional epitopes, and the immune complexes increase the clearance of vWF. Plasmapheresis or immunoadsorption can reduce the circulating levels of inhibitors. Immunosuppressive agents and intravenous immunoglobulin (IgG) are useful adjuncts to abrogate production of the autoantibody. Otherwise, the treatment of these conditions is as for congenital disease with associated circulating inhibitors.

**Other Factor Deficiencies** Approximately 15% of inherited bleeding disorders are caused by deficiencies of fibrinogen and factors II, V, VII, X, XI, and XIII.<sup>66</sup> As the genes for these factors are not located on the X chromosome, homozygous defects are typically required for symptomatic disease. Hereditary deficiencies of factor XII, prekallikrein, and high-molecular-weight kininogen do not result in bleeding diatheses. The mainstays of therapy for these disorders are cryoprecipitate (for fibrinogen and factor XIII deficiencies) and plasma. Bypass therapy with PCCs, aPCCs, or rFVIIa can be considered for refractory bleeding, and adjunctive therapy with antifibrinolytics may be useful.

**Anticoagulant Proteins** Plasma-derived concentrates enriched in protein C and antithrombin III are available for treatment of congenital deficiencies that result in thrombosis, and FFP contains normal levels of these circulating anticoagulants. Recombinant-activated protein C (Xigris, Eli Lilly and Company, Indianapolis, IN) is now licensed for the treatment of severe sepsis, and recombinant, transgenic antithrombin III is also available for

the treatment of venoocclusive disease in patients who are undergoing bone marrow transplantation, heparin resistance in patients who are undergoing cardiopulmonary bypass, and sepsis.<sup>75</sup>

### **Platelets**

**Preparations** In 1910, W.W. Duke described the Duke bleeding time, the importance of platelets in hemorrhagic disease, and the value of platelet transfusion. However, it was not until the 1970s before certain specialized centers could reliably offer platelet transfusions because of the preparation and storage problems resulting in loss of platelet viability. Platelets are prepared by centrifuging whole blood, then separating the buffy coat (in Europe) or platelet-rich plasma (United States) for a second centrifugation to produce platelet concentrates (~50 mL per unit). A typical adult dose pools units from 6 donors. Apheresis platelets are collected from single donors using various pheresis devices and reduce donor exposure and thus infection risk. Leukocyte counts are less in apheresis or buffy coat-derived units than in U.S. concentrates ( $10^6$  rather than  $10^8$ ), but the introduction of leukoreduction techniques makes this distinction obsolete. Similarly, the risk of alloimmunization to HLA antigens is equal for concentrates or apheresis platelets undergoing leukoreduction.<sup>10</sup> Platelets are stored at room temperature in plastic containers porous to the atmosphere to avoid anaerobic metabolism and acidosis and are licensed for only 5 days of storage.<sup>76</sup> Beyond this time, a storage lesion develops that limits platelet viability.

Platelet preparations contain appreciable volumes of plasma. If inventory constraints or HLA compatibility considerations lead to transfusion of plasma-incompatible products, mild recipient hemolysis may result. This is rarely clinically important unless large volumes are transfused in small patients. Crystalloid-based preservation solutions may allow removal of plasma; such processes could also facilitate viral inactivation by photosensitive dyes. Cryopreserved and lyophilized platelets are areas of future development, with lyophilized platelets close to clinical trials.<sup>77</sup>

**Transfusion Triggers** Anesthesiologists encounter the need for platelet

transfusions in intensive care and operative settings. The majority (86%) of platelets are given to patients with hematologic malignancies; 68% are given prophylactically, and 32% to treat bleeding episode.<sup>78</sup> Other indications include dilutional thrombocytopenia after massive transfusion-, autoimmune-, or drug-induced thrombocytopenia. Use may be relatively contraindicated in microangiopathic platelet destruction because of TTP, HUS, or DIC. Certain qualitative platelet disorders, either rare congenital conditions (Glanzmann thrombasthenia, Bernard-Soulier) or drug-induced dysfunction (aspirin, clopidogrel, Persantine, abciximab), respond to platelet transfusion. In contrast, high circulating plasma levels of eptifibatid or clopidogrel also render transfused platelets dysfunctional.

The current transfusion trigger for the most common indication of prophylaxis in oncology patients is 10,000/mm<sup>3</sup>;<sup>79</sup> in patients who are bleeding or undergoing invasive procedures the trigger is typically higher.<sup>80</sup> A platelet count < 50,000/mm<sup>3</sup> is quoted from the American Society of Anesthesiologists' guidelines. The use of recombinant activated factor VII has been used to augment or replace platelet transfusion, especially in patients refractory to transfusion.<sup>81,82</sup>

**Refractoriness to Platelet Transfusion** Refractoriness to platelet transfusion can be caused by immune or nonimmune mechanisms.<sup>83</sup> In immune mechanisms, alloantibodies, autoantibodies, drug-associated antibodies, or immune complexes can be responsible. Platelet membrane-associated anti-class I HLA-A and B antibodies are responsible for the majority of platelet refractoriness, and matching of so-called "public" HLA antigens, such as Bw4 or Bw6, forms the mainstay of compatibility testing. Importantly, ABO incompatibility can reduce platelet survival by up to 20%. Other rarer antibodies are HPA or human platelet antigens (polymorphic platelet surface glycoproteins) or platelet surface glycoproteins absent in the recipient (such as GPIb in Bernard-Soulier syndrome or GPIIb/IIIa in Glanzmann thrombasthenia). An antibody does not guarantee refractoriness, and underlying disease processes or immunosuppressive therapy may modulate the clinical picture.<sup>10</sup> Nonimmune mechanisms include microangiopathic de-

struction (HUS or TTP), sepsis, or fever, especially in the presence of DIC, splenic sequestration, hepatic dysfunction, and certain drugs (such as vancomycin and amphotericin).

Posttransfusion purpura is a rare complication occurring 7–10 days after an immunogenic blood transfusion. It most often affects previously non-transfused, multiparous women. As with neonatal alloimmune thrombocytopenia, the risk for developing posttransfusion purpura is increased among HLA-DR3-positive individuals, and HPA-1a is the antigen most often implicated (in Western populations). At this time, there is no clear understanding of the exact pathology of posttransfusion purpura.

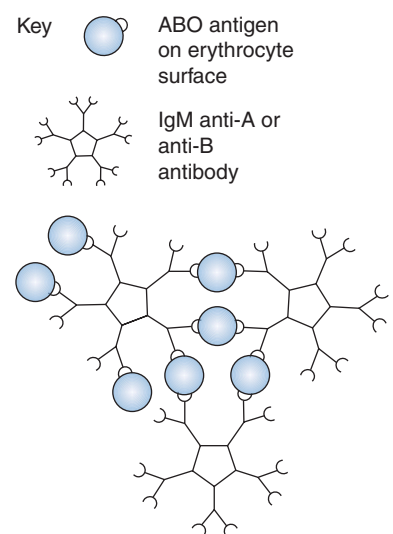
## COMPATIBILITY TESTING

Human error is the root cause of almost all fatal acute HTRs, with transfusion of a unit into the wrong patient occurring in 50% of cases. Mislabeling of patient specimens sent to the blood bank and clerical errors in the blood bank occur more often than serologic testing errors, thus attention to design and implementation of safe transfusion practice is of paramount importance, more so than technological advances in serotyping. The aim of compatibility testing is to avoid immune-mediated HTRs resulting from recipient alloantibodies reacting to transfused RBC surface alloantigens. The direct (Fig. 85-1) and indirect (Fig. 85-2) agglutination tests are the mainstay of laboratory compatibility testing.

Pretransfusion testing assures ABO and Rh(D) compatibility and screens recipient plasma for antibodies to less common but clinically important antigens. Figure 85-3 describes the laboratory testing involved in grouping, typing, and crossmatching blood prior to transfusion. When performed in the setting of appropriate controls to prevent clerical error, compatibility determination effectively eliminates risk of acute intravascular hemolytic transfusion reactions. However, it does not eliminate the risk of alloimmunization to non-ABO/Rh antigens, nor does it afford complete protection against delayed hemolytic reactions.

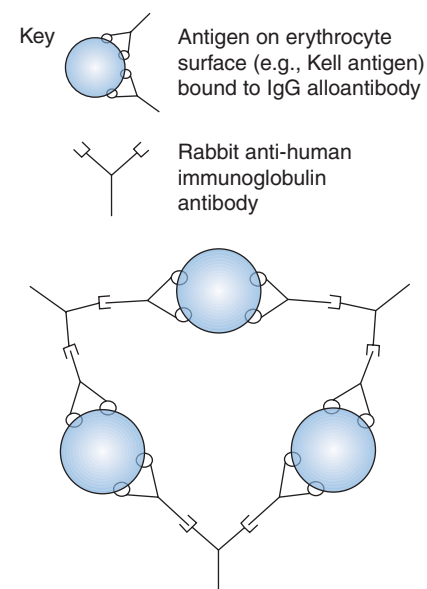
## Bacterial Contamination

Bacterial contamination of blood components can be asymptomatic or in-

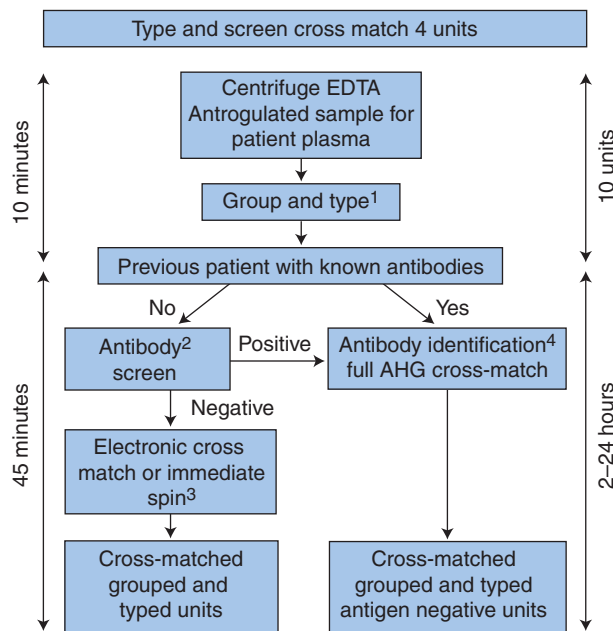


**FIGURE 85-1.** IgM alloantibodies cross link via surface antigens leading to direct agglutination. Occasionally, IgG antibodies will cause a positive DAT if there is high antigen density.

duce sepsis with a high mortality. It occurs in random donor-pooled platelets (5–30 in 10,000 units) and apheresis platelets (0.5–23 in 10,000 units) stored at room temperature, PRBCs (0.25 in 10,000 units) stored at 39.2°F (4°C), and, rarely, in FFP or cryoprecipitate contaminated during thawing in water baths.<sup>84</sup> Bacterial contamination of platelet products is acknowledged as the most frequent infectious risk from transfusion, occurring in approximately 1 of 2000–3000 platelet



**FIGURE 85-2.** Antibodies only cross link after addition of rabbit antihuman IgG, causing indirect agglutination.



**FIGURE 85-3.** This schematic depicts the steps taken to type, screen, and crossmatch blood.

- To determine ABO group and rhesus type, commercial anti-A, anti-B, anti-Rh(D) agglutinate patient cells. This direct agglutination test and hemolysis is visible.
- “Antibody Screening Test.” A panel of commercial red cells of known antigen type (each cell carries numerous antigens) are incubated with patient plasma. In North America, a typical panel of 3 cells (e.g., Immunor Gamma, Immuncor Inc., Norcross, GA) will detect alloantibodies to rhesus (C, c, E, e, f, V, C<sup>w</sup>) Kell (K, k, Kp,<sup>a</sup> Kp,<sup>b</sup> Js,<sup>a</sup> Js<sup>b</sup>), Kidd (Jk,<sup>a</sup> Jk<sup>b</sup>), Duffy (Fy,<sup>a</sup> Fy<sup>b</sup>), Lewis (Le<sup>a</sup>, Le<sup>b</sup>) MN (M, N, S, s), Lutheran (Lu,<sup>a</sup> Lu<sup>b</sup>), P<sub>1</sub>, and Xg<sup>a</sup> antigens. The mostly IgG alloantibodies that bind cells then need rabbit antihuman IgG (antiglobulin reagent or Coombs serum) to agglutinate (indirect agglutination test).
- Electronic or computer crossmatch requires no history of a positive antibody screen, a previous group, type and negative antibody screen from blood bank records, a current group, type and negative antibody screen. An immediate spin is a final check ABO compatibility, looking for direct agglutination (visible clumping or hemolysis) on mixing patient plasma with donor cells.
- “Antibody identification.” A more extensive panel of up to eight commercial red cells of known antigen type (e.g., Ortho Clinical Diagnostics Inc., Raritan, NJ) are tested against patient plasma to identify which antigens are responsible for the agglutination. This process may need to be extended to panels expressing rarer antigens not listed above (such as anti-U seen in some sickle cell patients) to identify alloantibodies. Occasionally, this process may take days for multiply transfused patients such as those with sickle cell disease. However, current U.S. practice is to antigen-match patients needing repeat transfusions for all rhesus and Kell antigens to prevent common alloantibody formation, and to reduce the development of subsequent “rarer” alloantibodies and the need for difficult crossmatching.

units, and is considered the second most common cause of death overall from transfusion (after clerical errors) with mortality rates ranging from 1:20,000 to 1:85,000 donor exposures.<sup>85</sup> The incidence of severe septic episodes has not been clearly established but is probably approximately 1 per 50,000 platelet units transfused.<sup>86</sup>

Bacteria can enter the blood bag during venipuncture as a result of inadequate skin preparation; during component preparation, transient bacteremia concurrent with the blood donation, or a break in technique during pooling or sealing; or through disruption of container integrity. Bacterial proliferation occurs more rapidly in platelet concentrates stored for up to 5 days at room

temperature than in red cells refrigerated for up to 42 days.

The clinical response may include fever, rigors, skin flushing, abdominal cramps, myalgia, DIC, renal failure, cardiovascular collapse, and cardiac arrest; reactions may be immediate or delayed by several hours. This may be clinically indistinguishable from a febrile nonhemolytic transfusion reaction (FNHTR). If this picture presents, blood samples must be sent to rule out incompatible transfusion, and simultaneously the blood unit must be sent for culture. Patient evaluation includes blood culture; treatment includes stopping the transfusion, supportive measures for developing shock, and broad-spectrum antibiotics.

Although bacterial contamination rate estimates vary, they are generally approximately 0.2–0.3%.<sup>87,88</sup> Clinically recognized septic reactions have been reported at a rate of 1:2,500 to 1:11,400 for whole-blood-derived platelet concentrate pools and 1:15,400 for apheresis platelets. Symptoms occurred after 17–42% of contaminated platelet transfusions, with a 17% mortality rate.<sup>88</sup>

Gram-negative bacteria, including *Pseudomonas*, *Yersinia*, *Enterobacter*, and *Flavobacterium*, are organisms commonly associated with a contaminated unit of refrigerated blood. In contrast, platelet concentrates contaminated with *Bacillus*, *Escherichia coli*, *Klebsiella*, *Staphylococcus aureus*, *Staphylococcus epidermidis*, *Serratia marcescens*, and *Streptococcus* account for 85% of fatal reactions.<sup>87,89</sup> Bacterial contamination may be masked clinically by concomitant antibiotic administration.

## Syphilis

Screening for syphilis was mandated in 1958, but the last reported case of transfusion-related disease was in 1966. Any risk of transmission is reduced by sensitivity to most penicillin or cephalosporin antibiotics. *Treponema pallidum* is not currently a threat to the U.S. blood supply.

## Viral Contamination

The risk for infection by HIV and hepatitis C viruses is extremely rare in the United States (less than 1 case per 2 million units transfused) after implementation of nucleic acid testing (NAT) in 1999.<sup>90,91</sup> Contrast this blood safety record to the risk of morbidity or mortality in people with indications for transfusion for which blood products are withheld, and HIV or HCV should not affect transfusion decisions. However, a rare but real risk exists, so inappropriate transfusion should be avoided.

## Other Viral Pathogens

The HAV, a nonenveloped RNA virus in the *Picornaviridae* family, is transmitted predominantly through the fecal-oral route. Because acute HAV infection is generally symptomatic, infected prospective donors are typically eliminated before donation.

## Hepatitis B

The HBV is a DNA virus in the *Hepadnaviridae* family. The infective virion



is known as the Dane particle and has surface and core components: HBsAg and hepatitis B core antigen (HBcAg). Among blood donors, the prevalence of new HBV infections declined from 1.97 per 100,000 *person years* to 1.27 between 1998 and 2001. Most current HBV transfusion transmission cases correspond to blood donations by asymptomatic donors during acute infections before HBsAg appearance and therefore detection (a “window period” of 37–87 days). With current screening, the risk of HBV transmission per unit is approximately 1:205,000 units, with likely reduction in risk with the introduction of NAT testing.<sup>90,91</sup>

### Hepatitis C

The HCV is an RNA virus in the *Flaviviridae* family that has 6 genotypes. In the United States, genotypes 1, 2, and 3 cause 75%, 10%, and 10% of infections, respectively, and have similar replication and transmission rates and natural history. The risk of HCV transmission by transfusion declined after the introduction of serologic testing for HCV antibody in May 1990, and NAT testing for the HCV viral genome in 1999 reduced the test negative window period to 40 days. Combined NAT and serologic testing reduced the risk from an estimated 1:276,000 units to 1:1,935,000 units.

### Hepatitis D

Originally called the delta agent, hepatitis D virus is a defective RNA-containing passenger virus that requires HBV to act as a “helper” for assembly of envelope proteins. Screening for hepatitis B therefore helps prevent transfusion-associated hepatitis D.

### Hepatitis E

The hepatitis E virus (HEV) is an RNA calicivirus associated with fecally contaminated water supplies, which usually causes a self-limited illness; it is not a known transfusion-related pathogen.

### Human Immunodeficiency Virus-1

The Centers for Disease Control and Prevention (CDC) report 9352 AIDS cases in the United States linked to transfusion through December 31, 2001, including 41 adults or adolescents and 2 children who received blood from HIV-seronegative donors. In addition, during the 1980s, 4799 hemophiliacs and other patients with coagulation

deficiencies acquired AIDS as a result of therapy with plasma derivatives.

Among 37 million donations screened for HIV-1 RNA by NAT between 1999 and 2002, only 12 were NAT positive and antibody negative.<sup>91</sup> The risk with plasma derivatives, such as coagulation factor concentrates and albumin and immunoglobulin preparations, can be expected to be even lower because of additional viral inactivation processes, including heat (pasteurization), physicochemical processes (SD treatment), and nanofiltration, that have been implemented since the mid-1980s; since then, no new HIV infections have been attributed to manufactured blood products.

### Human Immunodeficiency Virus-2

Human immunodeficiency virus-2, a retrovirus linked more closely to the simian immunodeficiency virus than to HIV-1, was recognized initially in West Africa. In 1998, the CDC reported 79 cases of HIV-2 infection in the United States, mostly in natives of West African countries. Transmissibility of HIV-2 appears to be lower, the course of infection milder, and the interval between infection and AIDS and disease longer than associated with HIV-1, presenting a lower risk for HIV-2 transmission by transfusion.

### Human T-Lymphotropic Virus-I and -II

HTLV-I and -II are closely related retroviruses in the *Oncovirinae* group. In contrast with HIV, HTLV is rarely present in cell-free plasma and shows little active replication in infected humans. HTLV is found around the globe, with endemic foci in southern Japan, the Caribbean, South America, and the Middle East. A sensitive HTLV-I/II combination assay was introduced in 1998, and the threat of acquiring HTLV infection from screened blood is currently minimal.

### Human Herpesvirus

Human herpesviruses (HHVs) are enveloped, structurally complex, double-stranded DNA viruses that cause common infectious diseases, usually associated with lifelong carrier states and the possibility of recurrent reactivation infections. However, the common alpha herpesviruses, herpes simplex and varicella zoster, are not linked to transfusion-transmitted infections.

### Cytomegalovirus Infection

CMV, a beta herpesvirus (HHV-5), can infect a wide range of cell types, primarily leukocytes; cell-depleted blood components (plasma, cryoprecipitate) do not transmit CMV. In immunocompetent people, this community-acquired infection is either asymptomatic or associated with a mild, self-limited infectious mononucleosis-like syndrome. However, latent virus persists permanently intracellularly, allowing lifelong potential for reactivation of infections or viral transmission by transfusion of cellular blood products or transplanted donor organs.

In immunosuppressed patients, CMV infection leads to morbid and occasionally lethal pneumonitis, hepatitis, gastroenteritis, retinitis, and other inflammatory conditions requiring treatment with ganciclovir and other antiviral agents. Primary infection in pregnancy may be associated with severe fetal malformations and congenital infections complicated by jaundice, hepatosplenomegaly, microencephaly, and thrombocytopenia with significant mortality. Screening for CMV status is essential for neonates, bone marrow transplant recipients, and transplant recipients. A CMV-seronegative transplant recipient is not denied an organ from a seropositive donor but is treated prophylactically and tested for infection. If leukoreduced blood components are not available, transfusion from CMV seropositive donors is avoided to reduce viral load.

At least 50% of blood donors have antibodies against CMV, thereby indicating previous CMV infection. CMV infection develops in 2% of CMV-seronegative transplant recipients given CMV-seronegative blood, compared with 30–60% historically seen after infusion of CMV-unscreened blood components.<sup>66</sup> Additional safety is conferred by pre-storage leukocyte reduction and apheresis platelet collection.

### Epstein-Barr Virus

Epstein-Barr virus (EBV), a gamma herpesvirus (HHV-4), causes infectious mononucleosis and is closely associated with Burkitt lymphoma, nasopharyngeal carcinoma, and posttransplantation lymphoproliferative disease. More than 90% of the adult population has evidence of previous exposure, and virus-specific cytotoxic T lymphocytes lyse EBV-infected B lymphocytes, so transfusion-transmitted EBV infection

is rare in both immunocompetent and immunosuppressed recipients.

### Parvovirus

Patients with sickle cell anemia, thalassemia, and other conditions associated with shortened red blood cell survival are at risk for developing acute aplastic or hypoplastic anemia after infection. Others at risk for aplasia after parvovirus infection include immunodeficient patients, HIV-infected patients, solid-organ transplant recipients, and children with malignancies. Persistent parvovirus infection may cause severe chronic anemia in immunocompromised patients. Acute parvovirus infection during pregnancy may result in fetal loss, neurologic abnormalities, and congenital infection. Red blood cell aplasia and chronic anemia caused by parvovirus infection often respond to infusion with immunoglobulin preparations.

Parvovirus can be expected to be present in 1:20,000 to 1:50,000 blood donors or a higher incidence during epidemic periods. Reactive antibodies may be present in the donor or the recipient, and only three cases of transfusion-related transmission have been reported. Pooled plasma products theoretically pose a greater threat, and factor VIII concentrates demonstrated a 40% risk of parvovirus infection.<sup>92</sup> The pasteurization process inactivates virus in albumin-based products.

### West Nile Virus

West Nile virus (WNV) is a member of the *Flaviviridae* family, the genus *Flavivirus*, and the Japanese encephalitis virus serocomplex that includes Japanese encephalitis virus and St. Louis encephalitis virus. Viruses in this complex are arthropod-borne viruses, or arboviruses (i.e., transmitted by mosquitoes and other arthropod vectors), with the potential to cause meningoencephalitis. WNV was first isolated in 1937 in the West Nile district of northern Uganda and derives its name from that region. The natural life cycle of the virus includes female mosquitoes as vectors, with birds serving as the primary vertebrate hosts. Humans are incidental hosts, with transmission occurring through bites of infected mosquitoes. Peak transmission occurs in the late summer and early fall.

Since 1999, there have been sporadic outbreaks in the United States, with more than 4000 cases—277 attributed

to a 2002 epidemic. In 2002, 23 cases of transfusion (any blood component) or transplant-related transmission were reported; 12 patients developed meningoencephalitis and more severe outcomes were seen in immunocompromised patients.<sup>93</sup>

Currently, donors are asked about fevers or exposure to endemic areas, and recommendations exclude donors with suspected or confirmed diagnosis of WNV within 120 days of donation. Since June 2003, NAT was instituted on pooled donor samples, and 800 of 6 million U.S. blood donations were WNV NAT positive. Despite this, 6 cases of transfusion-transmitted WNV infection occurred in susceptible individuals.<sup>94</sup> The risk of WNV infection depends on the immune status of the recipient, presence of donor antibodies, and the rate of endemic disease prevalence.

### Lyme Disease and Other Tick-Borne Illnesses

*Borrelia burgdorferi*, the agent responsible for Lyme disease, is transmitted to humans by deer tick bites. Spirochetemia probably occurs after infection and may be present in asymptomatic individuals, but again, only rarely documented transfusion-related transmissions have been reported for this or other tick-borne pathogens: *Babesia* species (babesiosis) and *Rickettsia rickettsii* (Rocky Mountain spotted fever).

### Malaria

Malaria in the United States is typically limited to travelers, military personnel, and immigrants from endemic countries. Prevention of transfusion-transmitted malaria relies on deferral of blood donors immigrating or returning from malaria-endemic regions; there are no available screening tests. Approximately 3 transfusion-associated malaria cases occur per year in the United States, with a reported incidence of 0–0.2 cases per million units.

### Babesiosis

Babesiosis is a malaria-like zoonosis in which humans are infected incidentally, usually through the bite of an infected tick. *Babesia* infections are usually asymptomatic or cause mild flu-like symptoms but can be fatal in the immunocompromised. Endemic throughout the United States, more than 40 cases of cellular transfusion-transmitted babesiosis have occurred since

1980. A history of babesiosis precludes blood donation, but no screening test is available.

### Toxoplasmosis

Toxoplasmosis is caused by the intracellular protozoal parasite *Toxoplasma gondii*, whose usual host is the domestic cat. Transmission is via cats or from undercooked pork, goat, lamb, beef, or wild game. There is evidence of infection in 20–25% of the U.S. population, but transfusion-associated disease has only been described in immunocompromised patients.

### Chagas Disease

The flagellate protozoal parasite *Trypanosoma cruzi* causes Chagas disease. The disorder is widespread in Latin America. Severe complications include myocarditis, meningoencephalitis, cardiomyopathy, megacolon, or achalasia. Infection is not endemic in the United States, but 50,000 to 100,000 infected Latin American immigrants reside in the United States. Transfusion-associated cases of Chagas disease are rarely reported in immunocompromised patients in North America, and even testing of donors with risk factors or those from endemic areas has not been implemented.

### Creutzfeldt-Jakob Disease

Variant Creutzfeldt-Jakob disease (vCJD) is a fatal, degenerative neurologic disease occurring in a younger age group than the rarer Creutzfeldt-Jakob disease (CJD). The United Kingdom first reported vCJD in 1996, and the etiologic agent of vCJD (a prion) is the same agent that causes bovine spongiform encephalopathy (BSE or “mad cow disease”). Transmission of the BSE prions to humans occurs by consuming products containing reticular endothelial or neural tissue from infected cattle, and 158 cases of vCJD had been diagnosed in the United Kingdom and other countries by 2004. A potentially long incubation period increases the theoretical possibility of transfusion-related transmission. For example, 15 patients with vCJD had donated blood while asymptomatic, and 2 (4% overall) recipients of these blood components developed the disease.<sup>66</sup> In the United States, blood donors who spent more than 6 months in the United Kingdom from 1980 to 1996 or 5 years in Europe since 1980 are deferred.

New molecular assays, such as NAT, can enhance safety but at a high cost compared with the serologic screening that was effective for virtually negating the HBV, HIV, and HCV risk of transfusion. The advent of newer infectious agents, such as vCJD, WNV, severe acute respiratory syndrome (SARS), and potentially Avian influenza A (H5N1) virus, may lead to deferral of increasing numbers of potential blood donors, with implications for blood supply.

The discussion of infectious agents is mostly based on North American data, but additional challenges exist for ensuring a safe blood supply in developing countries. With global travel and immigration, proactive and collaborative surveillance on an international level is essential to protect any country's blood supply.<sup>95</sup>

### FEBRILE NONHEMOLYTIC TRANSFUSION REACTIONS

A FNHTR occurs when temperature increases  $>33.8^{\circ}\text{F}$  ( $1^{\circ}\text{C}$ ) during or after transfusion when no other cause can be found. These reactions are either caused by cytotoxic or agglutinating antibodies in the patient's plasma reacting against antigens present on transfused donor lymphocytes, granulocytes, or platelets or by donor plasma containing antibodies against the recipient's cellular antigens. These antigens are typically, but not always, HLA antigens.<sup>96</sup> The febrile reaction results from antibody–leukocyte or antibody–platelet interactions leading to the release of inflammatory cytokines and pyrogens.

These cytokines are released from recipient leukocytes or donor leukocytes in response to antigen–antibody interaction but could also be in the supernatant of the transfused unit, derived from the donor leukocytes during storage before transfusion.<sup>97</sup> Such generation of cytokines, mostly from mononuclear leukocytes, occurs during storage and is proportional to the leukocyte count of the unit and the duration of storage.<sup>98</sup> Febrile reactions to platelet transfusions are more likely caused by proinflammatory cytokines in the supernatant than to cellular elements.<sup>99</sup> Use of prestorage, leukocyte reduction lowers the incidence of febrile reactions, as leukoreduction filters do not remove cytokines.<sup>100</sup>

The frequency of febrile reactions is approximately 0.5% per unit transfused, most commonly in recipients exposed to multiple white cell or platelet antigens such as oncology patients or multiparous women.<sup>30</sup> Previous alloimmunization leads to anti-HLA, granulocyte, or platelet-specific antibodies that react with white cells or platelets on subsequent exposure.

Clinically, an FNHTR is characterized by fever and chills occurring shortly after the transfusion begins. FNHTRs are usually self-limited, with fever persisting for no more than 8–10 hours. Elderly patients with a tenuous cardiovascular status and critically ill patients may develop respiratory complications, hypotension, or shock. With any transfusion reaction, the transfusion must be stopped, antipyretics and supportive measures instituted as necessary, and laboratory evaluation initiated.

A febrile reaction may be the first sign of an acute hemolytic reaction or infusion of a unit of red cells or platelets contaminated with bacteria. Repeat crossmatching is performed to confirm patient–donor ABO compatibility, examining the results of pre- and posttransfusion direct antiglobulin tests (DATs), evaluating the serum for hemolysis, and confirming the accuracy of paperwork. The posttransfusion DAT should yield negative findings, as an FNHTR does not involve red cell alloantibodies. Sending blood cultures from the patient and the blood product and administration of broad spectrum antibiotics can be considered depending on the severity of the reaction.

The diagnosis of FNHTR is one of exclusion after ruling out a hemolytic reaction, a septic transfusion, or other miscellaneous causes of fever. Routine premedication is not indicated, but antipyretics and corticosteroids can be reserved for patients with a prior history of FNHTR. The use of leukocyte-depleted blood components is not universal, but as discussed earlier, this practice reduces the incidence of FNHTRs and should be mandated for patients with a previous history of FNHTRs.<sup>101</sup>

### ALLERGIC TRANSFUSION REACTIONS

Allergic transfusion reactions are most commonly caused by infusion of plasma proteins. Manifestations include

skin erythema with associated mild urticaria and pruritus, a confluent rash that is intensely pruritic, extensive urticaria, severe vasomotor instability, bronchospasm, and anaphylaxis. The severity of these reactions may not be dose related, so a patient developing hives or a mild allergic reaction during a blood transfusion may not necessarily progress to severe anaphylaxis by completing the transfusion.

Causative antibodies have not been conclusively demonstrated, but milder allergic reactions are usually IgG or IgE mediated; anaphylactic reactions are most often IgG mediated. Allergic transfusion reactions are quite common, occurring in approximately 1% of all transfusions and typically leading to pruritus followed by hives. Treatment involves holding the transfusion, administering antihistamines, and assessing the wisdom of continuing the transfusion based on improvement of symptoms and no progression to more serious symptoms such as fever, chills, bronchospasm, dyspnea, or hemodynamic instability.

Such mild urticarial reactions rarely progress to serious reactions and often do not recur with subsequent transfusions. The pathogenesis is believed to be recipient antibody directed against donor plasma proteins, although the etiologic antibody is rarely detected, making the diagnosis of an allergic transfusion reaction a diagnosis of exclusion. Leukocyte depletion filters do not remove plasma proteins, so washed red cells are required to prevent reactions.<sup>102</sup> However, washed cells are reserved for patients with severe or recurrent reactions.

### Anaphylactic Reactions

Other anaphylactic reactions can occur when plasma containing IgA is transfused to patients with IgG anti-IgA antibodies or after transfusion of red cells or, more commonly, platelets administered through certain bedside leukoreduction filters.<sup>103</sup> The latter scenario is believed to be a consequence of contact activation by the negatively charged surface of the filter converting prekallikrein to kallikrein, in turn converting high-molecular-weight kininogen to bradykinin. Bradykinin causes pain, cutaneous flushing, and hypotension without fever or chills, and its effects are exaggerated in patients taking angiotensin-converting enzyme (ACE) inhibitors, as ACE is identical to kininase



II, which is responsible for degrading bradykinin. A common theme throughout this chapter is that prestorage leukoreduction avoids this problem.

## OTHER ADVERSE EFFECTS OF TRANSFUSION

### Microaggregate Debris and Adult Respiratory Distress Syndrome

Microaggregate debris consists of dead platelets, granulocytes, and fibrin strands that form in blood during storage. Theoretically, this debris (20–120  $\mu\text{m}$ ) passes through standard 170- $\mu\text{m}$  pore filters, infusing these microaggregates into the pulmonary vasculature, obstructing pulmonary capillaries, and causing pulmonary failure. Microaggregate filters have been suggested to prevent adult respiratory distress syndrome (ARDS) after massive transfusion, but they may reduce transfusion flow rates and do not appear to alter the onset of ARDS.<sup>104</sup> Hypotension and sepsis are postulated to trigger ARDS rather than microaggregate debris, and improvements in general care of the critically ill treating shock and sepsis have likely decreased the incidence of postperfusion respiratory distress syndrome more than the use of microaggregate filters.

### Circulatory Overload (Hypervolemia)

It is obvious to any practicing anesthesiologist that rapidly transfusing a patient who is euvolemic and not actively bleeding is unlikely to be of benefit and may cause harm. Infants, patients with cardiovascular disease, and the elderly are especially at risk. Importantly, transfusion-induced hypervolemia may be initially difficult to distinguish from hemolytic transfusion reaction, a febrile nonhemolytic transfusion reaction, or allergic reactions. Hypervolemia results in headache, dyspnea, tachycardia, tachypnea, and congestive heart failure. The absence of hemoglobinuria and hemoglobinemia or a positive posttransfusion DAT distinguishes hypervolemia from immune hemolysis, and the absence of fever, chills, or urticaria from febrile or allergic reactions.

Treatment involves stopping transfusion until the diagnosis is determined, administering diuretics and supportive therapy as indicated, and resuming the

transfusion at a slower rate while monitoring for recurrence of symptoms and signs of hypervolemia.

### Transfusion-Related Acute Lung Injury (Noncardiogenic Pulmonary Edema)

Transfusion of red cells or platelets may cause noncardiac pulmonary edema (with low intravascular pressures) within 4 hours of administration.<sup>105</sup> Such transfusion-related acute lung injury (TRALI) may cause fever, chills, cyanosis, dyspnea, tachypnea, or hypotension and copious amounts of pulmonary edema fluid, characteristic of hypervolemia but after infusion of volumes of blood too small to produce fluid overload or without the development of elevated left-sided cardiac pressures. The pathophysiology is believed to be a reaction between donor anti-HLA or antileukocyte antibodies and recipient leukocytes (or vice versa) with complement activation and leukocyte aggregation. As a result of the HLA/anti-HLA reaction, the activated leukocytes generate adhesive molecules on their surfaces (CD11/CD18). These proteins permit the activated leukocytes to attach to the pulmonary endothelial cells by a CD11/CD18-dependent mechanism, enter the interstitial space by diapedesis, and degranulate leading to pulmonary edema as a result of microvascular leukostasis/occlusion and capillary leakage. TRALI is estimated to occur in 1 in 4500 transfusions.<sup>106</sup>

When a patient shows signs of pulmonary insufficiency, as with all other reactions, transfusion should be stopped, diagnosis sought, and supportive measures (including mechanical ventilation) initiated as indicated. These HLA/leukocyte antigen-antibody reactions are idiosyncratic and may not recur; again, leukoreduced blood components remove donor antigens, but washed cells may be required to remove donor antibodies. Multiparous women or multiply transfused donors should not be used as plasma donors, as his or her serum may contain high titers of leukoagglutinating antibodies.

### Hypothermia

Hypothermia can occur with rapid infusion of large quantities of cold blood. Rapid infusion of cold blood ( $\sim 5$  minutes per unit) may lower the temperature of the sinoatrial node to  $< 86^\circ\text{F}$

( $30^\circ\text{C}$ ), leading to serious arrhythmias. Numerous inline, blood-warming devices are available for clinically indicated rapid transfusion, as in major trauma, and may reduce the incidence of hypothermia-induced coagulopathy and platelet dysfunction that occurs with temperatures  $< 95^\circ\text{F}$  ( $35^\circ\text{C}$ ). Only approved blood warmers should be used for this purpose. Such devices monitor and regulate temperature to  $< 107.6^\circ\text{F}$  ( $42^\circ\text{C}$ ) to avoid causing hemolysis. The use of hot water or microwave devices is unacceptable, as hot spots develop that can cause hemolysis.

### Electrolyte Toxicity

Citrate is used for anticoagulation during storage, acting by chelating calcium and interfering with the coagulation cascade. Rapid transfusion of citrated blood thus can be associated with a decrease in ionized calcium levels. Typically, citrate is rapidly metabolized in the liver to bicarbonate, but mild to severe citrate toxicity can be seen after infusion of large volumes of citrated products or in the setting of transient or established liver dysfunction.

The effects of hypocalcemia range from mild circumoral paresthesia to frank tetany. If prolonged Q-T intervals or signs of tetany are seen, calcium can be administered. In practice, the routine availability of arterial blood gas analysis with ionized calcium measurement allows close monitoring and guided treatment of developing hypocalcemia. Calcium should never be added to a unit of blood, as it recalcifies the unit and leads to clot formation; similarly, the use of calcium containing solutions, such as Ringier lactate, should not be coadministered with blood products.

Hypomagnesemia, presumably caused by chelation of magnesium by citrate, has also been reported, but its clinical relevance has not been determined. In practice, administration of magnesium can accompany calcium administration in response to a large citrate load.

Hyperkalemia caused by infusion of stored blood is rare, and hypokalemia may be more common. With storage, leakage of potassium from red cells to the extracellular fluid occurs. However, after infusion into a recipient, the red cells reverse the biochemical storage lesion, and intracellular potassium levels are restored. In addition, citrate is metabolized to bicarbonate, causing



alkalosis contributing to hypokalemia. In massive transfusion, this may not uncommonly result in the need for administration of potassium. Extracellular potassium increases at the rate of approximately 1 mEq/d during the first few weeks of storage. However, hyperkalemia is still a concern for neonates or patients with renal failure, and washed or fresher units can be requested. Potassium leakage from red cells is increased after exposure to 25-Gy irradiation to prevent posttransfusion graft-versus-host disease; the shelf-life of irradiated units is a maximum of 28 days.

### Plasticizers

Plasticizers are chemicals used to make the rigid polyvinyl chloride plastic used in blood bags more malleable; traditionally, diethylhexyl phthalate (DEHP) is used. After concerns about carcinogenic properties and the possible production of peroxisomes by the metabolite monoethylhexyl phthalate, DEHP is being replaced with a citrate-based plasticizer.<sup>107</sup>

### Graft-Versus-Host Disease

Graft-versus-host disease (GVHD) occurs when immunologically competent lymphocytes are introduced into an immunoincompetent host who cannot destroy the donor lymphocytes. The immunocompetent donor lymphocytes engraft, recognize the host as foreign, and then attack host tissues. GVHD occurs after allogeneic bone marrow transplantation and less often after transfusion of nonirradiated cellular blood components, especially when the blood donor and recipient share some HLA antigens. There is an increased danger from posttransfusion GVHD in part because of the frequent failure of physicians to recognize and treat the reaction promptly. Another major factor, however, is the propensity of the donor's lymphocytes to attack and produce recipient bone marrow aplasia in contrast to after bone marrow transplantation GVHD, in which the bone marrow is of donor origin, and bone marrow aplasia does not occur.

Posttransfusion GVHD is fatal in >90% of cases, primarily because of aplasia of the recipient's bone marrow. Reports have shown that haploidentical-directed donor units of blood may produce fatal posttransfusion GVHD even in immunocompetent recipients.

The use of irradiated blood (>2500 cGy) is now recommended in clinical situations in which transfusion poses risk of GVHD such as when patients receive blood transfusions from their relatives or HLA-matched donors. Leukocyte reduction is not adequate prophylaxis against GVHD, as the exact number of leukocytes needed to produce the disease is unknown.<sup>108</sup>

### Hemosiderosis

A unit of red cells contains approximately 250 mg iron and 1 g iron is roughly the amount stored in the bone marrow; men and nonmenstruating women lose only approximately 1 mg iron per day. Consequently, repeated transfusion in individuals with an extravascular hemolytic anemia, such as thalassemia or sickle cell anemia, in which iron is recycled rather than excreted, can result in the accumulation of excessive tissue stores of iron. Chronically, iron stored in parenchymal cells results in cell death and eventual organ failure. Iron chelation therapy, such as deferoxamine, is the mainstay of therapy to avoid predictable iron overload and maintain patients with chronic hemolytic anemias in negative iron balance.

### Air Emboli

Air is currently expelled from plastic blood bags but still may be pumped into patients by pressurized transfusion devices, especially after apheresis and intraoperative salvage. All such devices currently manufactured, however, contain air in-line sensors. Regardless, clinicians must remain alert to the potential risk of air embolization at all times while the patient is being treated. Patients suffering large air emboli (boluses of 3–8 mL/kg) can experience acute cyanosis, pain, cough, arrhythmia, acute right ventricular outflow obstruction, cardiogenic shock, and circulatory arrest. Infusions should be stopped and checked for air, and the patient should be placed head down on the left side. This usually displaces the air bubble from the pulmonary valve and may be amenable to aspiration via a central venous catheter.

### Transfusion-Related Immunomodulation

Deleterious effects of transfusion can be caused by a reaction to or incompatibility with a component of the trans-

fused blood product or by the more subtle transfusion-related immunomodulation (TRIM) believed to predispose patients to infectious complications. TRIM has a number of postulated immunosuppressive mechanisms related to leukocytes and cytokines present in blood components limiting the potential effect to transfused red cell concentrates and platelets. Leukocytes and leukocyte-derived bioactive substances, such as histamine, myeloperoxidase (MPO), eosinophil cationic protein (ECP), eosinophil protein X, plasminogen activator inhibitor 1 (PAI-1), and IL-6, are known to contaminate PRBCs<sup>109</sup> and platelet units,<sup>110</sup> accumulating in a storage time-dependent manner. Suppression of lymphocyte proliferation has been induced by these mediators, and PRBC supernatant inhibits *in vitro* proinflammatory cytokine release in a storage time-dependent manner. Length of storage of transfused allogeneic PRBCs, but not plasma, is associated with pneumonia after coronary artery bypass graft surgery.<sup>111</sup>

In addition, phosphatidylserine is expressed on the surface of apoptotic leukocytes in PRBCs and platelets and erythrocytes, mediating phagocytosis of apoptotic cells. This induces transforming growth factor secretion, resulting in an antiinflammatory effect and suppression of proinflammatory mediators;<sup>112</sup> enhanced production of the antiinflammatory cytokines IL-4, IL-10, and transforming growth factor is observed after blood transfusion. Antiinflammatory cytokine release and decreased cellular immune function occur after allogeneic, but not autologous, transfusions.

Prestorage leukofiltration appears to reduce storage time-dependent immunosuppression after blood transfusion and the incidence of febrile transfusion reactions.<sup>113</sup> Indeed, leukoreducing PRBCs decreases postoperative mortality after cardiac surgery and the incidence of multiorgan failure after major surgery.<sup>114</sup> However, leukoreduction is not a panacea, as leukocytes are not eliminated. Leukoreduced PRBCs can still cause hypotensive transfusion reactions, HLA alloimmunization, and express surface phospholipids. It may be that a greater volume of leukoreduced products are required to produce the deleterious effects of transfusion compared with nonleukoreduced products.

## CONCLUSION

In summary, the safety of the U.S. blood supply is exemplary, with the chance of a fatal reaction to transfusion in the realm of 1 in every 100,000 patients transfused. Such risk is acceptable should there be definite benefit, which emphasizes the responsibility placed on the physician to use appropriate triggers for blood component therapy with physiologic evidence of a deficiency in oxygen-carrying capacity for red cell transfusion and an accurately defined coagulopathy for hemostatic blood product transfusion. Second only to hematology nurses, anesthesiologists transfuse more blood products than any physician group, and it is incumbent on them to lead blood conservation strategies, including research into safe and effective blood substitutes, and reinforce surgical philosophies that avoid unnecessary blood loss at all costs. Such approaches provide the best possible care for patients and prepare anesthesiologists well for practice in areas with less safe blood supplies or during unforeseen safety concerns with the U.S. blood supply.

## KEY REFERENCES

1. Any of The Trial to Reduce Alloimmunization to Platelets (TRAP) study group articles (for example *N Engl J Med* 1997;337:1861–1869) present a systematic approach to reducing alloimmunization.
2. Hoeltge GA, Domen RE, Rybicki LA, et al. Multiple red cell transfusions and alloimmunization. Experience with 6,996 antibodies detected in a total of 159,262 patients from 1985 to 1993. *Arch Pathol Lab Med* 1995;119:42–45.
3. Practice parameter for the use of fresh-frozen plasma, cryoprecipitate, and platelets. Fresh-Frozen Plasma, Cryoprecipitate, and Platelets Administration Practice Guidelines Development Task Force of the College of American Pathologists. *JAMA* 1994;271:777–781.
4. Lusher JM. Use of prothrombin complex concentrates in management of bleeding in hemophiliacs with inhibitors—benefits and limitations. *Semin Hematol* 1994;31:49–52.

5. Kleinman S, Chan P, Robillard P. Risks associated with transfusion of cellular blood components in Canada. *Transfus Med Rev* 2003;17:120–162.
6. Allain JP, Bianco C, Blajchman MA, et al. Protecting the blood supply from emerging pathogens: the role of pathogen inactivation. *Transfus Med Rev* 2005;19:110–126.
7. Goldman M, Delage G. The role of leukodepletion in the control of transfusion-transmitted disease. *Transfus Med Rev* 1995;9:9–19.
8. Vamvakas EC. Possible mechanisms of allogeneic blood transfusion-associated postoperative infection. *Transfus Med Rev* 2002;16:144–160.
9. Hebert PC, Fergusson D, Blajchman MA, et al. Clinical outcomes following institution of the Canadian universal leukoreduction program for red blood cell transfusions. *JAMA* 2003;289:1941–1949.

## REFERENCES

1. Baldini M, Costea N, Dameshek W. The viability of stored human platelets. *Blood* 1960;16:1669–1692.
2. Rapaport SI, Ames SB, Mikkelsen S. The levels of antihemophilic globulin and proaccelerin in fresh and bank blood. *Am J Clin Pathol* 1959;31:297–304.
3. Valeri CR, Pivacek LE, Ouellet R, et al. A comparison of methods of determining the 100 percent survival of preserved red cells. *Transfusion* 1984;24:105–108.
4. Nakao K, Wada T, Kamiyama T, et al. A direct relationship between adenosine triphosphate-level and in vivo viability of erythrocytes. *Nature* 1962;194:877–878.
5. Beutler E, Wood L. The in vivo regeneration of red cell 2,3-diphosphoglyceric acid (DPG) after transfusion of stored blood. *J Lab Clin Med* 1969;74:300–304.
6. American Association of Blood Banks. Standards for Blood Banks and Transfusion Services. 24th ed. Washington, DC: AABB, 2006.
7. Blajchman MA. Allogeneic blood transfusions, immunomodulation, and postoperative bacterial infection: do we have the answers yet? *Transfusion* 1997;37:121–125.
8. Menitove JE, McElligott MC, Aster RH. Febrile transfusion reaction: what blood component should be given next? *Vox Sang* 1982;42:318–321.
9. Tejada F, Bias WB, Santos GW, et al. Immunologic response of patients with acute leukemia to platelet transfusions. *Blood* 1973;42:405–412.
10. Leukocyte reduction and ultraviolet B irradiation of platelets to prevent alloimmunization and refractoriness to platelet transfusions. The Trial to Reduce Alloimmunization to Platelets Study Group. *N Engl J Med* 1997;337:1861–1869.
11. Yap PL, Pryde EA, McClelland DB. IgA content of frozen-thawed-washed red blood cells and blood products measured by radioimmunoassay. *Transfusion* 1982;22:36–38.
12. Valeri CR. Factors influencing the 24-hour posttransfusion survival and the oxygen transport function of previously frozen red cells preserved with 40 per cent W-V glycerol and frozen at  $-80^{\circ}\text{C}$ . *Transfusion* 1974;14:1–15.
13. Valeri CR, Zaroulis CG. Rejuvenation and freezing of outdated stored human red cells. *N Engl J Med* 1972;287:1307–1313.
14. Consensus conference. Perioperative red blood cell transfusion. *JAMA* 1988;260:2700–2703.
15. Wilkerson DK, Rosen AL, Sehgal LR, et al. Limits of cardiac compensation in anemic baboons. *Surgery* 1988;103:665–670.
16. Levy PS, Kim SJ, Eckel PK, et al. Limit to cardiac compensation during acute isovolemic hemodilution: influence of coronary stenosis. *Am J Physiol* 1993;265:H340–349.
17. Levy PS, Chavez RP, Crystal GJ, et al. Oxygen extraction ratio: a valid indicator of transfusion need in limited coronary vascular reserve? *J Trauma* 1992;32:769–773; discussion 773–774.
18. Sanders MR, Graeber JE. Posttransfusion graft-versus-host disease in infancy. *J Pediatr* 1990;117:159–163.
19. Hillyer CD, Emmens RK, Zago-Novaretti M, et al. Methods for the reduction of transfusion-transmitted cytomegalovirus infection: filtration versus the use of seronegative donor units. *Transfusion* 1994;34:929–934.
20. Goldman M, Delage G. The role of leukodepletion in the control of transfusion-transmitted disease. *Transfus Med Rev* 1995;9:9–19.
21. Murphy WG, McClelland DB. Deceptively low morbidity from failure to practice safe blood transfusion: an analysis of serious blood transfusion errors. *Vox Sang* 1989;57:59–62.
22. Pineda AA, Taswell HF, Brzica SM Jr. Transfusion reaction. An immunologic hazard of blood transfusion. *Transfusion* 1978;18:1–7.
23. Silberstein L, Spitalnik QS. Blood Group Antigens and Antibodies. Baltimore: Williams & Wilkins, 1996.
24. Mollison P, Engelfriet C, Contreras M. Blood Transfusion in Clinical Medicine. Oxford, UK: Blackwell Science, 1993.
25. Hoeltge GA, Domen RE, Rybicki LA, et al. Multiple red cell transfusions and alloimmunization. Experience with 6,996 antibodies detected in a total of 159,262 patients from 1985 to 1993. *Arch Pathol Lab Med* 1995;119:42–45.

26. Schulman I. Controversies in red cell compatibility testing. In: Nance S, ed. *Immune Destruction of Red Blood Cells*. Arlington, Washington, DC: American Association of Blood Banks, 1989:171–199.
27. Garratty G. Factors affecting the pathogenicity of red cell auto- and alloantibodies. In: Nance S, ed. *Immune Destruction of Red Blood Cells*. Arlington, VA: American Association of Blood Banks, 1987:109–157.
28. Ramsey G, Cornell FW, Hahn LF, et al. Red cell antibody problems in 1000 liver transplants. *Transfusion* 1989;27:552.
29. Lane TA, Anderson KC, Goodnough LT, et al. Leukocyte reduction in blood component therapy. *Ann Intern Med* 1992;117:151–162.
30. Walker RH. Special report: transfusion risks. *Am J Clin Pathol* 1987;88:374–378.
31. Linden JV, Paul B, Dressler KP. A report of 104 transfusion errors in New York state. *Transfusion* 1992;32:601–606.
32. Sazama, K. Reports of 355 transfusion-associated deaths: 1976 through 1985. *Transfusion* 1990;30:583–590.
33. Davenport RD, Kunkel SL. Cytokine roles in hemolytic and nonhemolytic transfusion reactions. *Transfus Med Rev* 1994;8:157–168.
34. Beauregard P, Blajchman MA. Hemolytic and pseudo-hemolytic transfusion reactions: an overview of the hemolytic transfusion reactions and the clinical conditions that mimic them. *Transfus Med Rev* 1994;8:184–199.
35. Jenner P, Holland P. Diagnosis and management of transfusion reactions. In: Petz L, Swisher S, Kleinman S, eds. *Clinical Practice of Transfusion Medicine*. New York: Churchill Livingstone, 1996:905–927.
36. Goldfinger D. Acute hemolytic transfusion reactions—a fresh look at pathogenesis and considerations regarding therapy. *Transfusion* 1977;17:85–98.
37. Fudenberg H, Allen FH Jr. Transfusion reactions in the absence of demonstrable incompatibility. *N Engl J Med* 1957;256:1180–1184.
38. Consensus Conference. Fresh-frozen plasma. Indications and risks. *JAMA* 1985;253:551–553.
39. McVay PA, Toy PT. Lack of increased bleeding after paracentesis and thoracentesis in patients with mild coagulation abnormalities. *Transfusion* 1991;31:164–171.
40. Nusbacher J. Blood transfusion support in liver transplantation. *Transfus Med Rev* 1991;5:207–213.
41. Harke H, Rahman S. Haemostatic disorders in massive transfusion. *Bibl Haematol* 1980;(46):179–188.
42. Mannucci PM, Federici AB, Sirchia G. Hemostasis testing during massive blood replacement. A study of 172 cases. *Vox Sang* 1982;42:113–123.
43. Colman RW, Robboy SJ, Minna JD. Disseminated intravascular coagulation: a reappraisal. *Annu Rev Med* 1979;30:359–374.
44. Welsby IJ, Monroe DM, Lawson JH, et al. Recombinant activated factor VII and the anaesthetist. *Anaesthesia* 2005;60:1203–1212.
45. Practice parameter for the use of fresh-frozen plasma, cryoprecipitate, and platelets. *Fresh-Frozen Plasma, Cryoprecipitate, and Platelets Administration Practice Guidelines Development Task Force of the College of American Pathologists*. *JAMA* 1994;271:777–781.
46. Martin JN Jr, Files JC, Blake PG, et al. Postpartum plasma exchange for atypical preeclampsia-eclampsia as HELLP (hemolysis, elevated liver enzymes, and low platelets) syndrome. *Am J Obstet Gynecol* 1995;172:1107–1125; discussion 1125–1127.
47. Novitzky N, Jacobs P, Rosenstrauch W. The treatment of thrombotic thrombocytopenic purpura: plasma infusion or exchange? *Br J Haematol* 1994;87:317–320.
48. Cowan PJ, Aminian A, Barlow H, et al. Protective effects of recombinant human antithrombin III in pig-to-primate renal xenotransplantation. *Am J Transplant* 2002;2:520–525.
49. Tsai HM, Lian EC. Antibodies to von Willebrand factor-cleaving protease in acute thrombotic thrombocytopenic purpura. *N Engl J Med* 1998;339:1585–1594.
50. Rock G, Shumak KH, Sutton DM, et al. Cryosupernatant as replacement fluid for plasma exchange in thrombotic thrombocytopenic purpura. Members of the Canadian Apheresis Group. *Br J Haematol* 1996;94:383–386.
51. Ching EP, Poon MC, Neurath D, et al. Red blood cell alloimmunization complicating plasma transfusion. *Am J Clin Pathol* 1991;96:201–202.
52. Pineda AA, Taswell HF. Transfusion reactions associated with anti-IgA antibodies: report of four cases and review of the literature. *Transfusion* 1975;15:10–15.
53. Bowden R, Sayers M. The risk of transmitting cytomegalovirus infection by fresh-frozen plasma. *Transfusion* 1990;30:762–763.
54. Intravenous immune globulin for the prevention of bacterial infections in children with symptomatic human immunodeficiency virus infection. *N Engl J Med* 1991;325:73–80.
55. Reed EC, Bowden RA, Dandliker PS, et al. Treatment of cytomegalovirus pneumonia with ganciclovir and intravenous cytomegalovirus immunoglobulin in patients with bone marrow transplants. *Ann Intern Med* 1988;109:783–788.
56. Ratko TA, Burnett DA, Foulke GE, et al. Recommendations for off-label use of intravenously administered immunoglobulin preparations. University Hospital Consortium Expert Panel for Off-Label Use of Polyvalent Intravenously Administered Immunoglobulin Preparations. *JAMA* 1995;273:1865–1870.
57. Keith L, Bozorgi N. Small dose anti-Rh therapy after first trimester abortion. *Int J Gynaecol Obstet* 1977;15:235–237.
58. Bowman JM, Chown B, Lewis M, et al. Rh isoimmunization during pregnancy: antenatal prophylaxis. *Can Med Assoc J* 1978;118:623–627.
59. Rodeghiero F, Castaman G, Meyer D, et al. Replacement therapy with virus-inactivated plasma concentrates in von Willebrand disease. *Vox Sang* 1992;62:193–199.
60. Martinowitz U, Schulman S, Horoszowski H, et al. Role of fibrin sealants in surgical procedures on patients with hemostatic disorders. *Clin Orthop Relat Res* 1996;328:65–75.
61. McCarthy PM. Fibrin glue in cardiothoracic surgery. *Transfus Med Rev* 1993;7:173–179.
62. Spotnitz WD, Dalton MS, Baker JW, et al. Successful use of fibrin glue during 2 years of surgery at a university medical center. *Am Surg* 1989;55:166–168.
63. Berguer R, Staerckel RL, Moore EE, et al. Warning: fatal reaction to the use of fibrin glue in deep hepatic wounds. Case reports. *J Trauma* 1991;31:408–411.
64. Janson PA, Jubelirer SJ, Weinstein MJ, et al. Treatment of the bleeding tendency in uremia with cryoprecipitate. *N Engl J Med* 1980;303:1318–1322.
65. Triulzi DJ, Blumberg N. Variability in response to cryoprecipitate treatment for hemostatic defects in uremia. *Yale J Biol Med* 1990;63:1–7.
66. Hoffmann R, Benz EJ, Shattil SJ, eds. *Hematology: Basic Principles and Practice*. Philadelphia: Elsevier, 2005.
67. Gitschier J, Wood WI, Goralka TM, et al. Characterization of the human factor VIII gene. *Nature* 1984;312:326–330.
68. Teitel JM. Safety of coagulation factor concentrates. *Haemophilia* 1998;4:393–401.
69. Mannucci PM, Carlsson S, Harris A. Desmopressin, surgery and thrombosis. *Thromb Haemost* 1994;71:154–155.
70. Lusher JM. Use of prothrombin complex concentrates in management of bleeding in hemophiliacs with inhibitors—benefits and limitations. *Semin Hematol* 1994;31:49–52.
71. Roberts H, Bingham M. Other coagulation factor deficiencies. In: Loscalzo J, Schaffer AI, eds. *Thrombosis and Hemorrhage*. Oxford, UK: Blackwell Scientific, 1999.
72. Ehrenforth S, Kreuz W, Scharrer I, et al. Incidence of development of factor VIII and factor IX inhibitors in haemophiliacs. *Lancet* 1992;339:594–598.
73. Roberts HR. Clinical experience with activated factor VII. focus on safety aspects. *Blood Coagul Fibrinolysis* 1998;9:S115–S118.
74. Aledort LM. rFVIIa—its thrombogenicity. *Thromb Haemost* 2000;84:522–523.
75. Bernard GR, Vincent JL, Laterre PF, et al. Efficacy and safety of recombinant human activated protein C for severe sepsis. *N Engl J Med* 2001;344:699–709.
76. Murphy S. Platelet function, kinetics, and metabolism: impact on quality assessment, storage, and clinical use. In: McLeod B, Price T, Drew M, eds. *Apheresis: Principles*



- ples and Practice. Bethesda, MD: AABB Press, 1997:123.
77. Read MS, Reddick RL, Bode AP, et al. Preservation of hemostatic and structural properties of rehydrated lyophilized platelets: potential for long-term storage of dried platelets for transfusion. *Proc Natl Acad Sci U S A* 1995;92:397-401.
78. McCullough J, Steeper TA, Connelly DP, et al. Platelet utilization in a university hospital. *JAMA* 1988;259:2414-2418.
79. Rebullia P, Finazzi G, Marangoni F, et al. The threshold for prophylactic platelet transfusions in adults with acute myeloid leukemia. Gruppo Italiano Malattie Ematologiche Maligne dell'Adulto. *N Engl J Med* 1997;337:1870-1875.
80. NIH consensus conference. Platelet transfusion therapy. *Transfus Med Rev* 1987;1:195-199.
81. Poon MC, d'Oiron R. Recombinant activated factor VII (NovoSeven) treatment of platelet-related bleeding disorders. *International Registry on Recombinant Factor VIIa and Congenital Platelet Disorders Group. Blood Coagul Fibrinolysis* 2000;11:S55-S68.
82. Poon MC, D'Oiron R, Von Depka M, et al. Prophylactic and therapeutic recombinant factor VIIa administration to patients with Glanzmann's thrombasthenia: results of an international survey. *J Thromb Haemost* 2004;2:1096-1103.
83. Heyman M, Schiffer C. Platelet transfusion to patients receiving chemotherapy. In: Rossi E, Simon T, Moss G, et al., eds. *Principles of Transfusion Medicine*. Baltimore: Williams & Wilkins, 1996:263.
84. Popovsky MA. Quality of blood components filtered before storage and at the bedside: implications for transfusion practice. *Transfusion* 1996;36:470-474.
85. Hillyer CD, Josephson CD, Blajchman MA, Vostal JG, Epstein JS, Goodman JL. Bacterial contamination of blood components: risks, strategies, and regulation: joint ASH and AABB educational session in transfusion medicine. *Hematology Am Soc Hematol Educ Program* 2003;575-589.
86. Blajchman MA, Goldman M. Bacterial contamination of platelet concentrates: incidence, significance, and prevention. *Semin Hematol* 2001;38:20-26.
87. Brecher ME, Holland PV, Pineda AA, et al. Growth of bacteria in inoculated platelets: implications for bacteria detection and the extension of platelet storage. *Transfusion* 2000;40:1308-1312.
88. Kleinman S, Chan P, Robillard P. Risks associated with transfusion of cellular blood components in Canada. *Transfus Med Rev* 2003;17:120-162.
89. Brecher ME, Hay SN. Bacterial contamination of blood components. *Clin Microbiol Rev* 2005;18:195-204.
90. Zou S, Notari EP 4th, Stramer SL, et al. Patterns of age- and sex-specific prevalence of major blood-borne infections in United States blood donors, 1995 to 2002: American Red Cross blood donor study. *Transfusion* 2004;44:1640-1647.
91. Stramer SL, Glynn SA, Kleinman SH, et al. Detection of HIV-1 and HCV infections among antibody-negative blood donors by nucleic acid-amplification testing. *N Engl J Med* 2004;351:760-768.
92. Koenigbauer UF, Eastlund T, Day JW. Clinical illness due to parvovirus B19 infection after infusion of solvent/detergent-treated pooled plasma. *Transfusion* 2000;40:1203-1206.
93. Hollinger FB, Kleinman S. Transfusion transmission of West Nile virus: a merging of historical and contemporary perspectives. *Transfusion* 2003;43:992-997.
94. Macedo de Oliveira A, Beecham BD, Montgomery SP, et al. West Nile virus blood transfusion-related infection despite nucleic acid testing. *Transfusion* 2004;44:1695-1699.
95. Allain JP, Bianco C, Blajchman MA, et al. Protecting the blood supply from emerging pathogens: the role of pathogen inactivation. *Transfus Med Rev* 2005;19:110-126.
96. de Rie MA, van der Plas-van Dalen CM, Engelfriet CP, et al. The serology of febrile transfusion reactions. *Vox Sang* 1985;49:126-134.
97. Stack G, Snyder EL. Cytokine generation in stored platelet concentrates. *Transfusion* 1994;34:20-25.
98. Stack G, Baril L, Napychank P, et al. Cytokine generation in stored, white cell-reduced, and bacterially contaminated units of red cells. *Transfusion* 1995;35:199-203.
99. Heddle NM, Klama L, Singer J, et al. The role of the plasma from platelet concentrates in transfusion reactions. *N Engl J Med* 1994;331:625-628.
100. Mangano MM, Chambers LA, Kruskall MS. Limited efficacy of leukopoor platelets for prevention of febrile transfusion reactions. *Am J Clin Pathol* 1991;95:733-738.
101. Snyder EL, Mechanic S, Baril L, et al. Removal of soluble biologic response modifiers (complement and chemokines) by a bedside white cell-reduction filter. *Transfusion* 1996;36:707-713.
102. Meryman HT, Hornblower M. The preparation of red cells depleted of leukocytes. Review and evaluation. *Transfusion* 1986;26:101-106.
103. Shiba M, Tadokoro K, Sawanobori M, et al. Activation of the contact system by filtration of platelet concentrates with a negatively charged white cell-removal filter and measurement of venous blood bradykinin level in patients who received filtered platelets. *Transfusion* 1997;37:457-462.
104. Snyder EL, Bookbinder M. Role of microaggregate blood filtration in clinical medicine. *Transfusion* 1983;23:460-470.
105. Popovsky MA, Moore SB. Diagnostic and pathogenetic considerations in transfusion-related acute lung injury. *Transfusion* 1985;25:573-577.
106. Popovsky MA, Chaplin HC Jr, Moore SB. Transfusion-related acute lung injury: a neglected, serious complication of hemotherapy. *Transfusion* 1992;32:589-592.
107. Snyder EL, Hedberg SL, Napychank PA, et al. Stability of red cell antigens and plasma coagulation factors stored in a non-diethylhexyl phthalate-plasticized container. *Transfusion* 1993;33:515-519.
108. Akahoshi M, Takanashi M, Masuda M, et al. A case of transfusion-associated graft-versus-host disease not prevented by white cell-reduction filters. *Transfusion* 1992;32:169-172.
109. Hammer JH, Mynster T, Reimert CM, et al. Reduction of bioactive substances in stored donor blood: prestorage versus bedside leukofiltration. *Eur J Haematol* 1999;63:29-34.
110. Edvardsen L, Taaning E, Dreier B, et al. Extracellular accumulation of bioactive substances during preparation and storage of various platelet concentrates. *Am J Hematol* 2001;67:157-162.
111. Vamvakas EC. Possible mechanisms of allogeneic blood transfusion-associated postoperative infection. *Transfus Med Rev* 2002;16:144-160.
112. Huynh ML, Fadok VA, Henson PM. Phosphatidylserine-dependent ingestion of apoptotic cells promotes TGF-beta1 secretion and the resolution of inflammation. *J Clin Invest* 2002;109:41-50.
113. Hebert PC, Fergusson D, Blajchman MA, et al. Clinical outcomes following institution of the Canadian universal leukoreduction program for red blood cell transfusions. *JAMA* 2003;289:1941-1949.
114. van Hiltten JA, van de Watering LM, van Bockel JH, et al. Effects of transfusion with red cells filtered to remove leukocytes: randomised controlled trial in patients undergoing major surgery. *BMJ* 2004;328:1281.



# CHAPTER 86

## Cognitive Dysfunction after Anesthesia and Surgery

Mark F. Newman, MD, and  
Joseph P. Mathew, MD

The brain is often a window to early changes in blood flow, tissue perfusion, and early neural damage manifested by decline in higher cortical functions, including recall memory and cognitive processing. In particular, the elderly population is at risk for cognitive deterioration as a consequence of reduced cognitive reserve seen with aging-related cognitive decline. These changes in cognitive function are associated with reduced activities of daily living that substantially reduce the quality of life of the elderly, and can be magnified by physical or emotional stress in high-risk individuals.

The safety of anesthesia and surgery has progressed over several decades to the point that elderly and debilitated patients may safely undergo increasingly complex procedures with low risk of major morbidity or mortality. However, anesthesia and surgery appear to be associated with changes in cognitive functioning that outlast the effects of anesthesia or pain medications, inflammation and the healing response. Several excellent studies have investigated changes in cognitive functioning associated with cardiac and noncardiac surgery.<sup>1-3</sup> Understanding this decline and its etiology is complicated by the realization that anesthesia and surgery are rarely separated, indicating that the differences may be caused by either the stress response associated with surgery or the administration of anesthetics. This chapter discusses the complex field of cognitive neurosciences in the elderly population and the intricate process of measuring and defining change in the perioperative period. Different types of surgery, implications for quality of life, as well as etiologic factors and how they relate to treatment, are outlined.

### COGNITIVE FUNCTION

Cognition is an expanding field with increasing research to define the key elements of intellectual functioning, that allow us to learn, reason, and plan. The increasing body of literature typically defines cognition as a processing of information applying both knowledge and preference. The processes include such dimensions as memory, attention, perception, problem solving, and mental imagery. Cognitive functioning is key to the activities of daily living and quality of life; cognitive dysfunction is thus an impairment of these processes that lead to a decline in the activities of the individual.<sup>4,5</sup> The patient or the family often define a decline in activity as the inability to perform or a delayed ability to perform cognitive tasks. In many cases, the changes are more notable to family members than to patients. Thus, studies describing the importance of cognitive change to quality of life are essential in defining the importance of further investigation. Studies show significant associations between quality of life and perioperative cognitive decline even when other physical or emotional factors are taken into consideration.<sup>4,6</sup>

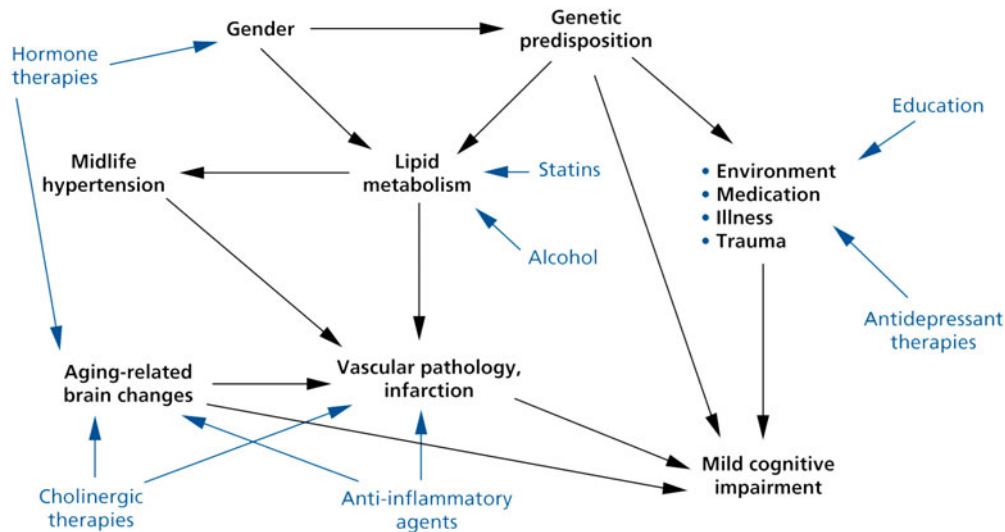
In addition to aging and surgery, many disease entities alter cognitive function, especially in high-risk elderly populations.<sup>7,8</sup> Figure 86-1 shows the complex interaction proposed for the development of mild cognitive impairment.<sup>9</sup>

Diabetes is associated with an increased incidence of mild cognitive dysfunction.<sup>7</sup> Increasing literature points to the impact of chronic elevations in blood sugar on the brain; however, it is difficult to differentiate this effect from the increased probability of atherosclerosis that is also associated with progression of aging-related cognitive decline.<sup>10,11</sup> Even at ages at which atherosclerosis is less likely, diabetes is associated with acceleration in cognitive decline (Fig. 86-2).<sup>7</sup>

Understanding susceptibility to aging-related decline has been a key area of investigation, and overlaps substantially with the investigation of Alzheimer disease development and progression. Although the association between the occurrence of apolipoprotein E  $\epsilon$ -4 (Apo E4) and the development of late-onset Alzheimer disease has been clearly demonstrated,<sup>12,13</sup> the association between the presence of the E4 allele and the progression of aging-related cognitive decline in the

### KEY POINTS

1. Cognition represents key processes of memory, attention, perception, problem-solving, and mental imagery that define who we are as individuals.
2. Cognitive functioning is key to the activities of daily living and our overall quality of life.
3. Cognitive assessment occurs by a number of well-validated measurements outlined from the field of neuropsychology. Assessment of cognitive functioning in the perioperative period is often less complete than normal; however, understanding what is measured by each individual test and how they change over time is essential in understanding the implications of perioperative cognitive decline to our patients.
4. Incidence of perioperative cognitive dysfunction varies based on the sensitivity of the tests used and the timeframe for evaluation. Correlation with appropriate control groups gives the best idea of the relative impact of surgery and anesthesia on changes in cognition and quality of life.
5. The etiology of cognitive function and/or cognitive dysfunction is complex and associated with disease severity including atherosclerosis and diabetes, as well as surgery and anesthesia. The effect of anesthetic agents on short- and long-term cognition is controversial.
6. New studies indicate an association between patient factors including disease severity and genetic predisposition with perioperative cognitive decline.
7. Understanding risk for perioperative cognitive decline will enhance the probability of developing interventions to reduce cognitive decline and provide a level of persistent improvement and quality of life that can be provided by surgery overall.



**FIGURE 86-1.** Hypothetical etiological model of mild cognitive impairment (MCI) in black, and possible treatment or lifestyle intervention points in blue. (Adapted from Ritchie<sup>9</sup> with permission.)

normal aging population is more controversial. The preponderance of data points to poorer learning and memory and other impairments in cognitive functioning associated with the presence of the allele.<sup>14–20</sup> Furthermore, while initial association between presence of Apo E4 and perioperative decline in cognitive decline has been seen, larger trials have been unable to relate this association with acute perioperative changes.<sup>21</sup>

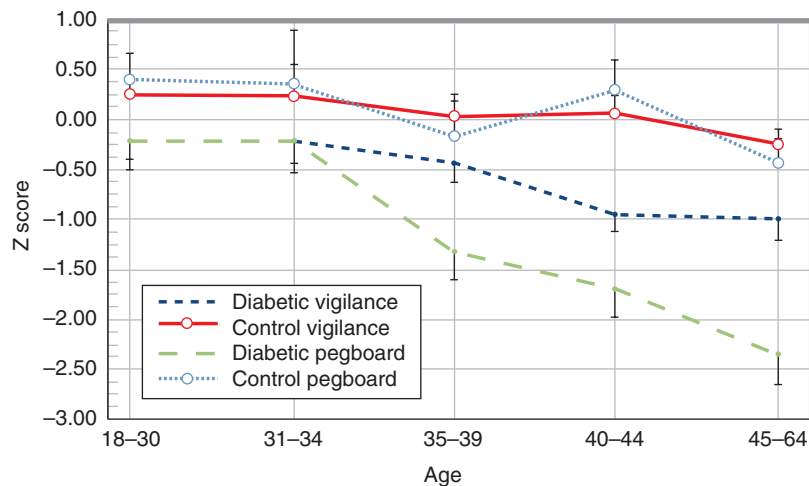
As has been noted in most investigations of biologic function, both genetic and environmental factors alter the progression of cognitive decline outlined in the previous sections. Atherosclerosis and associated vascular disease are highly correlated factors associated with cognitive decline in some works.<sup>22</sup> The influence of cardiovascular diseases and their risk factors on cognitive decline is of substantial importance in the search for prevention of cognitive deterioration and dementia. Haan et al., as well as Slooter et al. in the Rotterdam study, assessed these interactions by measuring cognitive function using the Mini Mental Status Examination (MMSE) and other cognitive measures.<sup>23,24</sup> Following a group of 5888 randomly selected Medicare-eligible patients for 5–7 years, Haan et al. demonstrated that 70% of the population showed no significant cognitive decline.<sup>23</sup> However, in the 30% of patients who did, the severity of atherosclerosis, diabetes, and peripheral vascular disease was associated with cognitive decline. The rate of this environmentally or disease-related cognitive decline was increased by the

presence of the Apo E4 allele.<sup>23</sup> The authors note that although many elderly individuals did not experience cognitive decline over the longitudinal study, cardiovascular disease and the presence of the Apo E4 allele increased both the likelihood and severity of cognitive function decline (Fig. 86-3).<sup>23</sup>

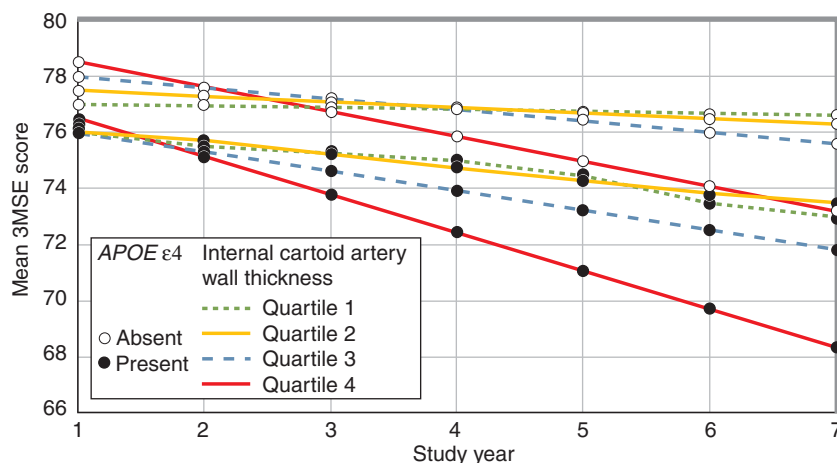
Slooter et al.'s results, although from a smaller sample size of 838 patients, are similar.<sup>24</sup> Slooter et al. investigated the association of atherosclerosis, Apo E4, and their interaction on cognitive change over 3 years in a group of patients 55 years of age and older. The main effects of the two predictors approach, but do not reach, statistical significance independently. However, the interaction of the two predictors

show a statistically significant correlation with cognitive decline over time. Slooter et al. suggest that the effects of Apo E4 and atherosclerosis are not independent, and that Apo E4 carriers with atherosclerosis are at increased risk for progressive cognitive decline.<sup>24</sup> Despite this association, no studies define whether treatment of coronary artery bypass graft (CABG) or angioplasty, alters the progression of cognitive function in an appreciable way, or if the risk factors are unable to be adjusted.

Cognitive enrichment is a broad term that defines tasks or practices that when undertaken appear to enhance measures of crystallized intelli-



**FIGURE 86-2.** Performance (mean  $\pm$  stand error of mean [SEM]) of diabetic and nondiabetic adults, stratified into five age bands, on two measures of psychomotor efficiency: the mean time taken by the dominant and nondominant hand to complete the Grooved Pegboard, and the total time taken to complete two pages of the Digit Vigilance Test. Reprinted from Ryan CM. Diabetes, aging, and cognitive decline. *Neurobiol Aging* 2005;26:21–25. Copyright 2005 Elsevier.



**FIGURE 86-3.** Change in modified Mini Mental State Examination scores by presence of Apo E $\epsilon$ 4 alleles and the quartile of carotid atherosclerosis.<sup>23</sup>

gence and cognitive reserve. Cognitive enrichment is often broadly defined as the amount of education or the complexity of the work environment or leisure activities. Several studies show the value of education and an increased intensity of cognitive activity at work as significant factors in the delay of aging-related cognitive decline and dementia.<sup>25</sup> This protection against decline has also been demonstrated in multiple perioperative studies defining educational level as a protective factor in perioperative cognitive decline.<sup>3,26</sup> Education differs from intelligence level, which does not appear to provide protection from perioperative cognitive decline.

## ASSESSMENT OF COGNITIVE FUNCTIONING

The measurement of cognitive dysfunction occurs via a large group of well-validated tests occurring over a broad range of cognitive domains. One of the difficulties in interpreting the results of studies to date is that different tests with different scales or criteria are often used within the same populations to try and define outcome.<sup>27,28</sup> Several consensus statements and reviews have described these issues and put forward recommendations to allow consistent comparisons and sharing of data that would help us to draw accurate conclusions. The consensus statements<sup>29-31</sup> suggest minimal batteries of tests, as well as the use of individual change scores versus group mean, to define postoperative cognitive dysfunction. The diffi-

culty arises in that the “cut-off,” the number of tests employed and the domains assessed can change the overall incidence of decline.<sup>27,28</sup> Furthermore, recent reviews strongly suggest the use of age-matched controls to define the significance of this change to a similar population.<sup>28</sup> This is especially true when conclusions are to be drawn relative to the incidence of decline compared to a similar population. The value of this control or repeated control groups when interventions are compared is lessened.

Cognitive dysfunction is often identified by the family's recognition of a patient's inability to perform what would have previously been normal activities. These include complex tasks, memory, and other daily activities that are often part of a patient's overall enjoyment. Many problems exist in detecting changes in cognitive function in the perioperative period, including a lack of suitable control groups to define practice effects, tests with variable degrees of sensitivity to detect change, lack of adequate time for assessment, and the lack of potential disease-matched controls to understand the importance of disease, as well as the anesthesia and surgery.

In addition to the difficulties defined in the different types of tests utilized and the definition of decline,<sup>1</sup> other difficulties include lack of correlation between cognitive testing and the patient's assessment and the family's assessment of the patient's status. This may indicate other behavioral factors that could define a patient's assessment of their current state or quality of life, such as anxiety, depression or

other factors that must be taken into account in the assessment of perioperative cognitive decline.

## INCIDENCE AND SIGNIFICANCE OF PERIOPERATIVE COGNITIVE DYSFUNCTION

Many factors outlined in the previous sections alter the measured incidence of cognitive decline. Our group investigated the effect of different definitions of cognitive decline on incidence of postoperative cognitive decline and found large differences in event rates based on the definition.<sup>27</sup> The relative rates as previously defined vary based on the sensitivity of the test used and the degree of representation of the more sensitive and time specific domains assessed.<sup>2,27</sup> Concern has been expressed that early dysfunction within the immediate perioperative period may be related to the use of narcotics, benzodiazepines, or other related anesthetics. Therefore, many individuals have reduced the degree of testing occurring early postoperatively. However, this practice is criticized by some investigators, as later decline may be associated with factors other than perioperative neurologic injuries, such as sleep deprivation, depression, or other issues that may not indicate neurologic injury associated with cardiac surgery.

Defining decline based on different cognitive domains begins to sort out the areas of function more sensitive to perioperative neurologic injury. Visuospatial orientation and other aspects of visual construction seem to be some of the hardest hit domains, as well as aspects of executive function requiring multitasking or involving multiple areas of the brain for completion of an overall task. Although assessment of different domains may point to an area of the brain most affected, logistical limitations in the perioperative period and patient burden at a stressful time limit the ability to investigate decline as thoroughly as most neuropsychologists would like.

Although few would question the significance of a stroke in the perioperative period, the importance of cognitive decline after surgery has long been debated. Despite the many studies showing cognitive decline after cardiac surgery, it is frequently minimized or dismissed because of its

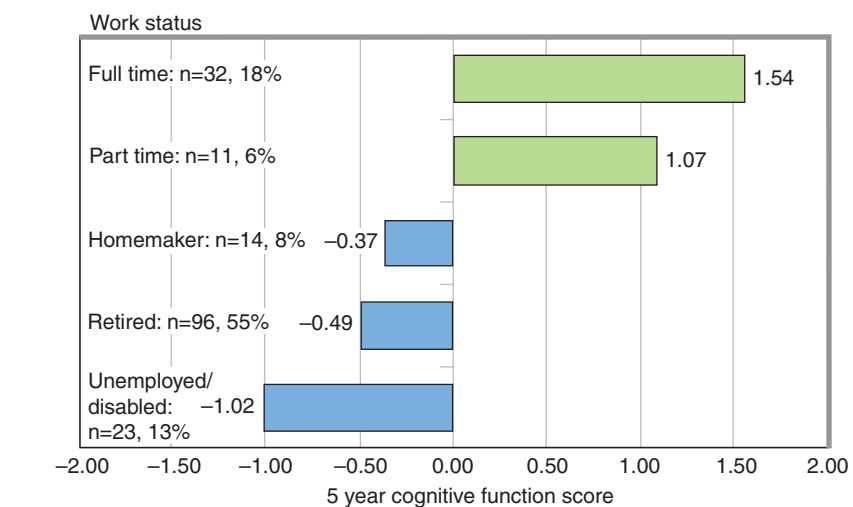
transient nature in most patients. To address the importance of perioperative cognitive dysfunction, we investigated a broad range of quality of life measures in tandem with cognition at 5 years' followup.<sup>4</sup>

Using a number of standardized, validated assessments<sup>4</sup> in patients undergoing cardiac surgery, significant univariate and multivariate correlations between cognitive function and multiple quality of life measures were detected. Furthermore, multivariable logistic regression on a two-way classification of employment status adjusted for age, gender, educational level, and diabetes revealed the 5-year overall cognitive function score to be a significant predictor of the likelihood of being productively working (Fig. 86-4). Finally, perception of general health also varied directly with cognitive functioning where patients with lower cognitive function score at 5 years self-reported a lower quality of general health. Postoperative cognitive decline has also been shown to affect daily activities such as driving.<sup>32,33</sup> Cognitive impairment following cardiac surgery clearly has long-term consequences.

## CARDIAC SURGERY PERIOPERATIVE COGNITIVE DYSFUNCTION

Stroke and incapacitating central nervous system (CNS) dysfunction after cardiopulmonary bypass (CPB) remain devastating complications, highlighted by significant reduction in overall cardiac morbidity and mortality associated with cardiac surgery.<sup>34</sup> Recent studies suggest that elderly patients with greater comorbidities and advanced cardiovascular disease benefit most from cardiac surgery compared with medical therapy,<sup>35,36</sup> yet they have greater morbidity and mortality after cardiac surgery, specifically neurologic dysfunction.<sup>34,37-39</sup>

Neurologic injury ranges from severely incapacitating or life-ending stroke and coma, to encephalopathy or delirium and cognitive decline. While stroke after cardiac surgery, with or without cardiopulmonary bypass, continues to represent a substantial concern for both short- and long-term disability, more subtle neurologic deficits, such as encephalopathy and cognitive dysfunction, are associated with



**FIGURE 86-4.** Patient work status and 5-year composite cognitive index. The 5-year cognitive function score is the sum of the four domain scores, including cognitive decline and learning effects.<sup>4</sup>

increased medical costs and decreases in short- and long-term cognitive function and quality of life. In fact, nothing may be more disappointing to the physician team, the patient, and the patient's family than to have an operation that appears successful end with the patient exhibiting substantial neurologic or cognitive deficits that limit the patient's ability to function independently.

We performed neurologic and cognitive testing on 261 patients before they underwent CABG, as well as at discharge, 6 weeks, 6 months, and 5 years. Patients who had a deficit at baseline were excluded. Four domains of cognitive function were identified that accounted for almost 80% of the variability found:

- Verbal memory and language comprehension (short-term and delayed)
- Abstraction and visuospatial orientation
- Attention, psychomotor processing speed, and concentration
- Visual memory

Cognitive outcomes were defined in two ways:

- Cognitive deficit—a decline in performance in any one of the domains by 1 standard deviation or more (a reduction of 1 standard deviation represented an approximately 20% decline in function)
- Composite cognitive deficit—the reduction in the sum of scores of the four domains

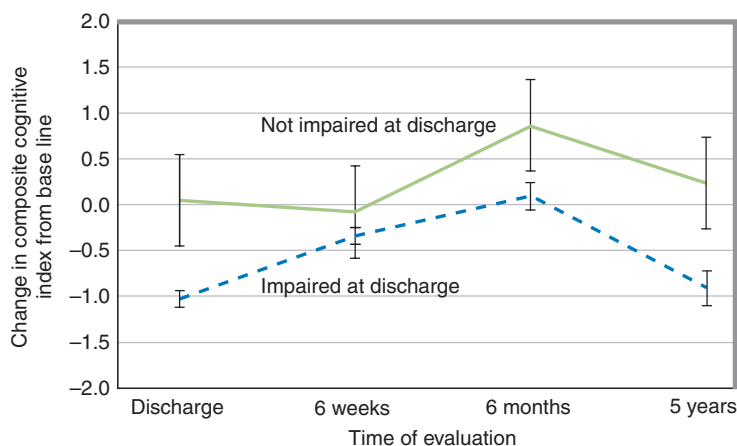
Figure 86-5 outlines the pattern of cognitive deficits.

Half of patients showed cognitive deficits at discharge in one or more domains; at 6 weeks, the percentage dropped to 36%; at 6 months, 24%; and at 5 years, 42% of the patients again had a deficit. Therefore, the pattern is one of early improvement followed by later decline. Cognitive deficit at discharge predicted long-term outcome, even if short-term gains occurred in the meantime. At 6 weeks, patients who initially had a deficit improved to a level similar to those who never deviated from baseline levels. But after 5 years, patients who had deficits at discharge had significantly worse outcomes than did those patients without initial deficits. In addition to cognitive deficit at discharge, predictors of cognitive dysfunction at 5 years included baseline cognitive level, age, and years of education. Ejection fraction, history of hypertension, diabetes, and surgical variables were not found to be significant factors. As the population ages, patients have a greater fear of mental disability and loss of independence more so than death, defining the importance of further work to improve perioperative CNS outcomes.

However, some question whether cognitive decline after CABG is related to surgery or only to disease state. A consensus panel from the Outcomes Key West Meeting addressed this issue as a group and responded as outlined below.

1. Many studies have documented that cardiac surgery leads to more serious





**FIGURE 86-5.** Change in composite cognitive index from baseline. The composite cognitive index is the sum of the scores for the four domains and includes cognitive decline, as well as increases in scores as a result of learning. Positive change represents an overall improvement (learning), whereas negative values indicate overall decline. Newman MF, Kirchner JL, Phillips-Bute B, et al. Longitudinal assessment of cognitive function after coronary-artery bypass surgery. Neurological Outcome Research Group and CARE Investigators. *N Engl J Med* 2001;344:395-402. Copyright 2001, Massachusetts Medical Society

consequences in a small but significant proportion of patients. This includes death through neurologic consequences, nonfatal stroke, transient ischemic attacks, coma, or stupor.<sup>40-43</sup> Patients who survive these consequences are subject to significantly increased healthcare costs.

2. A large number of studies have demonstrated cognitive decline after CABG surgery and related procedures, in contrast to the small number of studies that have failed to find a decline. The major difference between these studies is in the patient groups studied, the tools used to assess cognitive function and the methods of analysis used. Where the studies are appropriately designed and the tools of measurement appropriate and appropriately analyzed, there is a consistent finding that cognitive function is impaired.
3. Formal neuropsychological testing prior to and at various times after surgery provides a sensitive measure of cognitive function and has revealed more subtle deficits in 20-70% of patients who are undergoing cardiac surgery.<sup>44</sup> For some patients these changes are transient, with assessments in the days after surgery yielding the highest number of patients with deficits. In some patients, these difficulties persist.<sup>3,45</sup> It is possible that in some patients the longer-term changes are related to effects of aging and the cerebrovascular disease.<sup>46,47</sup>

4. Neuropsychological assessment demonstrates differences in patients according to their biologic characteristics (e.g., EndoCABG<sup>48</sup>) and their postoperative clinical characteristics (e.g. postoperative atrial fibrillation<sup>49</sup>), as well as an association with aspects of the surgical or anesthesia protocols (e.g., postoperative hyperthermia).<sup>50</sup>
5. The clearest evidence for the impact of CABG on the brain and its possible amelioration comes from randomized controlled trials that have contrasted the impact of different surgical or anesthesia procedures on neuropsychological outcome. Evidence of a difference as a result of these types of interventions attests to the fact that CABG surgery can have an impact, and in the case of positive findings, a differential impact, on the brain. For example, various studies show that the pH management by alpha-stat results in less neuropsychological disturbance in comparison to pH-stat,<sup>51,52</sup> neuropsychological outcome improves with the use of arterial line filters,<sup>53</sup> there is an advantage in using leucocyte filtration,<sup>54</sup> and neuroprotective pharmacologic agents do have an impact.<sup>55</sup>
6. Underpinning the findings of the neuropsychological impact of cardiac surgery is the evidence from:
  - a. Magnetic resonance imaging (MRI) studies showing that in a proportion of patients new lesions appear after CABG,<sup>56,57</sup> that

MRI abnormalities are clearly seen in patients in the hours after CABG surgery,<sup>58</sup> and that there is a relationship between MRI findings and cognitive deficits.<sup>59</sup>

- b. Pathologic evidence of small capillary arteriolar dilations in animals and humans after CABG.<sup>60</sup>
  - c. Animal research demonstrating the differential impact of surgical manipulations and the neuroprotective impact of pharmacologic interventions on animals undergoing CABG surgery.<sup>61</sup>
7. The putative causes of the cognitive deterioration following coronary artery bypass surgery include the risk of atheromatous emboli, the risks of air bubbles and thrombotic emboli, the systemic inflammatory response, and disturbances of cerebral perfusion. Dominant amongst these is the occurrence of microemboli. The panel considered it important that some studies demonstrate that the number of microemboli delivered during CPB is correlated with the postoperative cognitive decline seen immediately and 8 weeks after CPB.
  8. Changes in surgical practice to reduce embolic load, and so to limit potential for cerebral injury, have been based in part on studies where the primary outcome has been postsurgery cognitive loss.
  9. There is some evidence to suggest that these cognitive difficulties are associated with increased hospital stay and poorer quality of life.
  10. The panel noted that the American College of Cardiologists/American Heart Association (ACC/AHA) 2004 guidelines include cognitive loss into the ACC/AHA type II neurologic injury category emphasizing, from the perspective of a senior specialist body in the United States, the clinical relevance of this neuropsychological domain as one adverse consequence of cardiac surgery.

### Variation in CNS Injury after Cardiac Surgery

The importance of different cardiac surgical procedures on cognitive decline is a controversial topic. Initial studies point to a higher degree of cognitive injury in valve procedure patients; however, more recent trials do not show a substantial difference. Patients who are undergoing com-

bined procedures, CABG and valve, typically have a higher incidence of cognitive decline and overall neurologic injury compared to patients who are undergoing other procedures.<sup>62</sup> Off-pump coronary artery bypass grafting is a procedure with fewer neurologic complications. Cleveland reported data from the Society of Thoracic Surgery database showing a substantial reduction in stroke.<sup>63</sup> However, despite attempts to use control for demographic and perioperative differences, the patient demographics of on- and off-pumps were not similar. In the only large-scale randomized trial to date, the Octopus trial was not able to demonstrate a substantial difference in neurologic or cognitive injury. However, the trial was underpowered for neurologic injury, and likely neurocognition as well, and further investigation is required.

### NONCARDIAC SURGERY PERIOPERATIVE COGNITIVE DYSFUNCTION

Postoperative cognitive dysfunction (POCD) is an accepted complication of cardiac surgery, but less appreciated or defined after noncardiac surgery. In 1998, the International Study of Postoperative Cognitive Dysfunction (ISPOCD-1) evaluated cognitive decline in 1218 elderly patients who underwent major noncardiac surgery and found that cognitive dysfunction was present in 25% of patients 1 week after surgery and in 10% of patients 3 months after surgery.<sup>1</sup> Unfortunately, there were significant differences in the incidence of POCD at the 13 hospitals participating in the study. This variability makes generalization of the results to any single medical institution ill advised. In addition, in a letter to the editor, Bonke<sup>64</sup> pointed out numerous errors in the data reported in this manuscript. This combination of poor reliability and errors raises questions about the validity of this study.

To further investigate the findings of the ISPOCD in noncardiac surgery, Monk et al. completed a prospective assessment of 1064 patients undergoing elective noncardiac surgery divided among young (18–39 years of age), middle-aged (40–59 years of age), and elderly (60 years and older) patients. A group of 210 control primary family members were used in order to

provide a change score similar to that used in the ISPOCD. Inclusion of criteria for our study included age 18 years and older, major abdominal thoracic or orthopedic surgery, general anesthesia greater than 2 hours, and a MMSE score of 24 or greater at baseline. Exclusion criteria included cardiac or neurosurgical procedures, history of CNS disease with persistent deficits, history of alcoholism or drug dependence, history of major depression requiring treatment, and patients who were not expected to live 3 months or longer.<sup>65</sup>

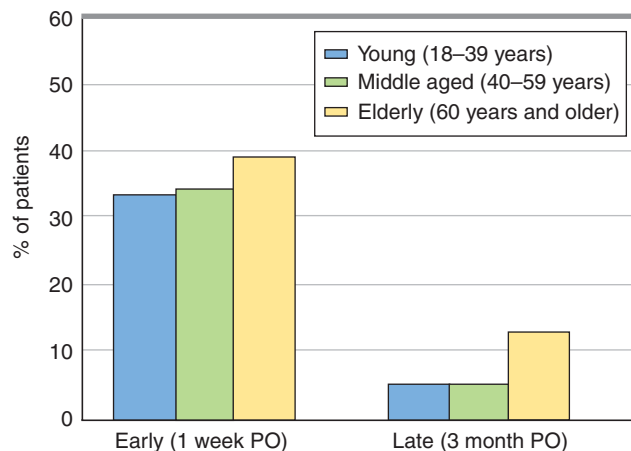
The patients completed a cognitive battery at baseline (preoperatively), and both 1 week and 3 months postoperatively. To quantify the practice effect, we compared the changes in performance for control subjects in each age group for each measure between baseline and subsequent tests 1 week and 3 months later.

Figure 86-6 presents the incidence of POCD at the hospital discharge and 3-month postoperative neuropsychological evaluations. At hospital discharge, the incidence of POCD was 36.6% in the young, 30.4% in the middle-aged, and 41.4% in the elderly patients. The incidence of cognitive decline was significantly lower in middle-aged patients compared to elderly patients ( $p = 0.01$ ), but was not different for young versus elderly or young versus middle-aged patients. The incidence of cognitive decline was similar for control subjects of all age groups at the first postoperative testing session 4.1% in young, 2.8% in the middle-

aged, and 5.1% in the elderly. However, the differences between cognitive decline in age-matched controls and patients were significant for all age groups ( $p < 0.001$ ).

At 3 months after surgery, POCD was identified in 5.7% of young, 5.6% of middle-aged, and 12.7% of elderly patients. POCD was significantly higher in elderly compared to young or middle-aged patients ( $p = 0.001$ ). The incidence of cognitive decline in the control subjects was similar for all age groups at the 3-month testing interval and was 6.3% in young, 4.8% in the middle-aged, and 1.8% in the elderly. At this testing interval, there was no difference in the incidence of POCD between age-matched control subjects and patients in the young and middle-aged groups. However, elderly patients exhibited a significantly greater incidence of cognitive decline at 3 months after surgery compared to elderly control subjects ( $p < 0.001$ ). Of the significant univariate predictive factors for POCD at 3 months after surgery, only increasing age, lower educational level, and POCD at hospital discharge remained significant in the multiple logistic regression analysis.

Postoperative cognitive dysfunction after noncardiac surgery demonstrated a significant increase in the elderly, especially at 3 months postoperatively. This trial indicates that postoperative cognitive dysfunction is common in all age groups at 1 week. However, at 3 months after surgery it is more common in elderly with lower educational achievement.



**FIGURE 86-6.** Incidence of POCD in adult patients after noncardiac surgery: Z score definition. (Modified from data from Monk<sup>65</sup> with permission.)

## COMPARISON OF PERIOPERATIVE COGNITIVE DECLINE IN CARDIAC AND NONCARDIAC SURGERY

Much of the work investigating perioperative cognitive decline has centered on cardiac surgery. Historically cardiac surgery was accomplished on more elderly individuals with progressive cardiovascular disease who were at higher risk for cerebrovascular complications, including stroke and cognitive decline, than seen for other surgery. With advances in the safety of anesthesia and surgery, the population now able to receive noncardiac vascular, orthopedic, and general surgery safely is progressively older with increasing comorbidity. The result has been a greater recognition of the presence of cognitive decline after noncardiac surgery as outlined in the previous section. However, little direct comparison with similar testing, same institution, and same age range has occurred to allow direct comparison. After Institutional Review Board approval and patient informed consent, we investigated 675 patients who were undergoing cardiac surgery and 342 patients who were undergoing noncardiac surgery during a 5-year period from 2000 to 2005.

Cognitive testing was accomplished at baseline (before surgery), as well as 6 weeks and 1 year postoperatively. We used a previously published neuropsychologic battery, with cognitive decline defined as a standard deviation decline on any of four independent domains established in a factor analysis of the nine measures used.<sup>3,27</sup> Factor analysis provided for no substantial overlap between domains and, therefore, a standard deviation decline in any one of four unique domains was identified as cognitive decline. To allow comparison of the two groups, a single factor analysis was used for comparison of the two groups.

Although demographic composition of the two groups was similar, the cardiac surgical population had lower cognitive scores at baseline, possibly because of the risk of cerebrovascular disease. Despite expectations for a higher incidence of cognitive decline after cardiac versus noncardiac surgery, the results were actually reversed: 49.1% of noncardiac surgical patients experienced cognitive decline at 6 weeks compared to 36.6% of cardi-

ac patients. This trend continued through 1-year testing, with 42.0% of noncardiac patients showing decline compared to only 32.2% of cardiac surgical patients.

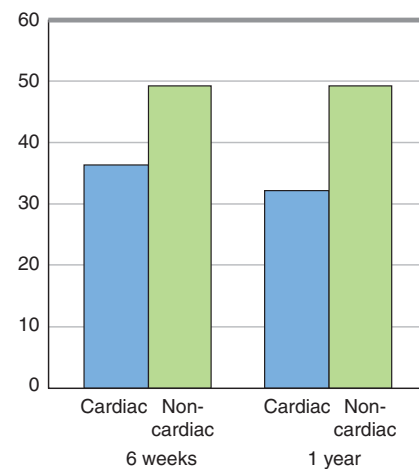
Contrary to our previous assumptions the incidence of cognitive decline after noncardiac surgery appears to occur at similar rates to that seen after cardiac surgery, potentially a result of the fact that our samples were normalized for age. Because baseline scores were different in the two groups, the implications of a similar change may be different and requires further investigation to define the relative importance of the measured change to quality of life (Fig. 86-7).

## ETIOLOGY OF NEUROLOGIC DYSFUNCTION INCLUDING PERIOPERATIVE COGNITIVE DYSFUNCTION

Understanding patient risk factors associated with perioperative CNS injury is an important first step in understanding the etiology of this disease continuum.

### Aortic Atherosclerosis and Cerebral Embolization

Multiple investigators have identified proximal aortic atherosclerosis, as identified by cardiac surgical palpation or, more importantly, by transesophageal and epiaortic scanning, as a risk factor associated with a manyfold increase in stroke risk.<sup>41,66,67</sup> There is little doubt that embolization of aortic atheroma or other debris from the surgical field is an important etiologic factor in stroke and major neurologic injury after cardiac surgery. In studies by Roach and others before the widespread use of transesophageal echocardiography, those patients with surgical palpated aortic atherosclerosis were found to have a 5-times greater risk of overall stroke.<sup>41</sup> Further pathologic diagnoses have also defined small capillary arterial dilatations in the brains of patients or animals having recently undergone cardiac surgery with CPB.<sup>57</sup> Most of these presumed embolic changes disappear over time, and they are not typically seen in patients or animals who are investigated or who die weeks to months after the surgery. A number of investigators with the use of transesophageal echocardiography, as well



**FIGURE 86-7.** Comparison of the incidence of cognitive decline between cardiac and noncardiac surgery at 6 weeks and 1 year. (Data from personal communication between M.F. Newman and colleagues.)

as epiaortic scanning, have defined an association between neurologic injury and the degree of aortic atherosclerosis, especially in the ascending and transverse aorta, whereas the descending aorta has been used more as a factor predictive of a need to use epiaortic scanning. Further support for embolization as a major factor in neurologic injury comes from the use of transcranial Doppler and carotid ultrasound studies that show substantial numbers of cerebral emboli occurring, especially during aortic interventions such as cannulation, aortic cross-clamping or unclamping, partial side-biting clamps, and other cardiac non-aortic manipulations. However, as might be expected, the correlation with neurologic injury and the number of emboli is not as robust as the correlation that we previously defined for transesophageal or epiaortic determined aortic atherosclerosis. This differentiation probably relates to our inability to differentiate between air and particulate emboli, and thus demonstrates the importance of these factors in defining overall injury.

The last and most defining evidence for embolization, an important part in neurologic injury, are recent studies with the use of new diffusion-weighted imaging (DWI) and perfusion-weighted imaging (PWI) techniques that have defined that after coronary artery bypass or aortic valve surgery, up to 45% of patients have new DWI lesions on postoperative imaging.<sup>68</sup> This demonstrates that ongoing neurologic injury is occurring, but the clinical implica-

tion for stroke or cognitive decline may relate to the injury location in defining the expression. A small injury occurring in the internal capsule may produce a profound stroke, in comparison to large frontal or cerebellar infarcts that may appear silent without extensive functional investigation.

Despite the significant correlation between aortic atherosclerosis and stroke, the association with POCD has been tenuous at best. Our group and others have failed to demonstrate a clear relationship between the severity of aortic atherosclerosis and the incidence of POCD.<sup>69</sup> However, several investigators have associated increased cerebral emboli with degree of cognitive decline.<sup>53</sup>

### Hypoperfusion

Since the time of Gilman's classic study in 1965, the presence of nonpulsatile perfusion and lower pressure during cardiac surgery has been blamed for much of the neurologic injury that we have previously described.<sup>70</sup> Watershed infarcts in older individuals, especially those with carotid disease have been an important factor in this association.<sup>70</sup> Furthermore, Caplan determined that lower pressure may be associated with a reduced washout of smaller emboli from the watershed areas, thus increasing the probability that hypoperfusion would play a role in causing watershed infarcts that we may see in cardiac surgery.<sup>71</sup>

Gold et al. performed a randomized prospective trial of high (mean arterial pressure [MAP]: 80–100 mm Hg) versus lower perfusion pressure (50–70 mm Hg) during CPB for patients undergoing CABG.<sup>72</sup> This trial of 240 patients, comparing myocardial and neurologic outcomes between the two CABG groups, was unable to reach statistical significance when the individual outcomes were assessed. The combined cardiovascular outcome (myocardial and neurologic) shows a benefit for higher pressure, indicating that at least in part, cardiovascular injury was increased with lower perfusion pressure.<sup>72</sup> However, looking at a subset of 188 of these patients and comparing transesophageal assessment of aortic atherosclerosis severity, Hartman shows that the primary driving factor for neurologic injury was aortic atherosclerosis.<sup>73,74</sup> He further determined that for individuals

with severe aortic atherosclerosis, higher perfusion pressure is associated with a reduced incidence of neurologic injury. This indicates that in individuals who are at high risk for embolization, perfusion pressure may determine the extent of measurable injury of the severity of that injury.<sup>73</sup> While the relationship between stroke and MAP appears present in situations of severe aortic atherosclerosis, the association between reduced perfusion pressure and cognitive decline has not been well defined. We examined the relationship between MAP during hypothermic CPB and postoperative cognitive function using new and more sophisticated recordings of blood pressure than previously used. Moreover, because advanced age is an important predisposing variable,<sup>74,75</sup> we analyzed the interaction of age with MAP.

After institutional review board approval and written, informed consent, 260 patients requiring elective cardiac surgery with CPB were enrolled. All patients were 21 years of age or older without a history of cerebral vascular disease (previous stroke, symptomatic carotid bruit, or documented transient ischemic attacks), alcohol or substance abuse, psychiatric illness (previous hospitalization or requirement for medication at the present hospitalization), uncontrolled hypertension (diastolic pressure >110 mm Hg or requiring interventions while hospitalized to reduce blood pressure), renal disease (creatinine >1.8), active liver disease (abnormal liver function tests if they were performed), or literacy at the seventh grade level or above. A neuropsychologic test battery, including mood and cognitive function, was administered the day prior to surgery and the day prior to hospital discharge (approximately 7–10 days after surgery).<sup>76</sup>

Of the 260 patients enrolled, 237 completed pre- and postoperative neuropsychologic tests and had MAP and temperature data to allow analysis (19 patients refused postoperative testing, and data retrieval for intraoperative MAP and temperature was inadequate for analysis in 4 patients). The charts of the 237 patients were reviewed for temperature and MAP data at 1-minute resolution. A total of 26,642 minute points were evaluated, with 0.5% of the points (136 points) discarded as artifactual. MAP and temperature data including initial MAP, MAPavg, AREA50, T5AREA50,

minimum temperature, maximum temperature, maximum rate of rewarming over 5 minutes, and temperature area >98.6°F (37°C) were measured for all patients.

Multivariable regression analysis for all 7 cognitive measures showed no significant associations between MAP or rewarming rate and cognitive decline. Similar to previously published reports on a portion of this database, consistently significant associations were found between preoperative score (all 7 measures), age (5 of 7), years of education (5 of 7), and maximum C(a-v)O<sub>2</sub> (2 of 7).<sup>76</sup> Despite the lack of primary effects of MAP and rewarming rate on cognitive decline, the interaction of age with these variables showed significant associations ( $p < 0.05$ ) on two tests. With increasing age, AREA50 predicted increased decline in the Digit Symbol Test at discharge ( $p = 0.005$ ). Characterization of MAP based on 5-minute or greater hypotension episodes presented no additional primary effects or interactions. These interactions without significant primary effects would indicate a differential effect of these variables on cognitive function as an effect of age. In elderly individuals who are at increased risk of cognitive decline, hypoperfusion may be associated with an increased risk of cognitive decline.

### Systemic Inflammatory Response

Cardiac surgery is known to be associated with a profound systemic inflammatory response, especially when cardiopulmonary bypass is used. Although it is likely that systemic inflammatory response may play a role in the overall severity of injury, there is very little data to support that it alone is the causative factor. Westaby studied a group of patients undergoing CABG and found no significant association between inflammatory markers and cognitive injury, and we also were unable to find this.<sup>77,78</sup> However, it is likely that these factors were contributory and not causal. Thus as we look at and better understand the severity of injury and other susceptibility factors, we may be able to further determine the importance of these factors in neurologic and cognitive injury. Two recent trials evaluating the use of complement inhibitors in cardiac surgery have defined a small but measurable



positive effect on cognitive decline with the use of the C-5 complement inhibitor continued for the surgical period and 24 hours postoperatively. However, in neither case was the overall decline in neurologic or cognitive function statistically altered.

### Depression

Our group and others have studied depression as it relates to cardiac surgery and found that depression is an important factor in defining long-term survival after cardiac surgery.<sup>6</sup> However, when we have investigated depression as a factor in short-term cognitive change, we've been unable to demonstrate a significant association between a low-level of depression and acute changes in cognitive function. On the other hand, many groups, including our own, have been able to show an association between depression and long-term cognitive decline.<sup>79</sup> Whether cognitive decline leads to a greater degree of depression, or depression defines cognitive function over time is a phenomenon that requires longitudinal studies to ascertain.

### Genetic Factors

An intriguing development in the field of neuroprotection is in the area of genetic predisposition or susceptibility in cardiac surgery-associated cerebral injuries. Expanding discoveries in this relatively new field of perioperative genetics and neurologic outcomes include our recent study of 1635 patients by the PEGASUS investigative group, in which patients undergoing cardiac surgery using cardiopulmonary bypass surgery were studied. DNA was isolated from preoperative blood and analyzed for 26 different single-nucleotide polymorphisms. Multivariable logistic regression modeling was used to determine the association of clinical and genetic characteristics with stroke.

Permutation analysis was used to adjust for multiple comparisons inherent in genetic association studies. Of the 1635 patients, 28 patients (1.7%) suffered stroke and were included in the final genetic model. The combination of the 2 minor alleles of C-reactive protein (CRP; 3'UTR 1846C/T) and interleukin-6 (IL-6; -174G/C) polymorphisms, occurring in 583 (35.7%) patients, was significantly associated with stroke (odds ratio [OR]: 3.3; 95% confidence interval [CI]: 1.4–8.1;  $p = 0.0023$ ). In a multivariable logistic

model adjusting for age, the CRP and IL-6 single-nucleotide polymorphism combination remained significantly associated with stroke ( $p = 0.0020$ ). Genetic factors associated with inflammation predicted a 3-fold increase in stroke rate over and above other clinical risk factors, defining the possibility of future risk stratification to focus neuroprotective strategies.

The possibility that one's genetic makeup might alter cognitive outcome after cardiac surgery was first delineated in a 1997 study.<sup>21</sup> In that study, the apolipoprotein E hypothesis was born, that is, that patients possessing the Apo E4 allele had worse cognitive outcomes after CPB. Although somewhat controversial,<sup>80</sup> this hypothesis may likely be the beginning of our understanding of the complex role of individual genetic variations, represented by single nucleotide polymorphisms (SNPs), in moderating cerebral responses to surgery. Despite this initial positive association, others have been unable to replicate it in primarily white populations, making these findings "controversial."<sup>80</sup>

Mathew et al.<sup>81</sup> characterized phospholipase A<sub>2</sub> (PLA<sub>2</sub>) a polymorphism of the glycoprotein (GP) IIIa constituent of the platelet integrin receptor GP IIb/IIIa, and examined its influence on cognitive outcome after cardiac surgery. In their study, a multivariate analysis revealed that the PLA<sub>2</sub> genotype was significantly associated with greater decline on the Mini Mental State Examination ( $p = 0.036$ ). The mechanism this association with adverse cerebral outcome may be related to is an increased prothrombotic role, which has been shown in investigations of coronary artery thrombosis and myocardial infarction.<sup>82,83</sup> The progression of genetic predictors of perioperative cognitive decline have mimicked the progression of the field of genetic association moving from the investigation of single candidate genes to multiple candidate genes and then to genome wide scans as technology advances.

Mathew and colleagues have also hypothesized that candidate gene polymorphisms in biological pathways regulating inflammation, cell matrix adhesion/interaction, coagulation-thrombosis, lipid metabolism and vascular reactivity are associated with postoperative cognitive deficit (POCD).<sup>81</sup> In a prospective cohort

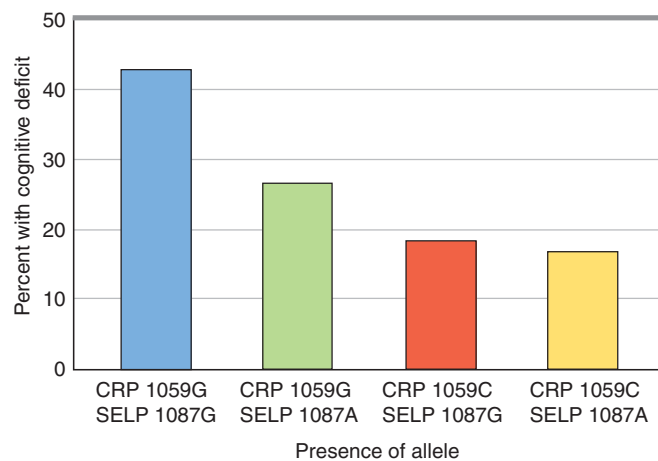
study of 513 patients (86% European American) undergoing CABG surgery with cardiopulmonary bypass, a panel of 37 SNPs was genotyped by mass spectrometry.<sup>84</sup> Association between these SNPs and cognitive deficit at 6 weeks after surgery was tested using multiple logistic regression accounting for age, level of education, baseline cognition, and population structure. Permutation analysis was used to account for multiple testing.

We found that minor alleles of the CRP 1059G/C SNP (OR: 0.37; 95% CI: 0.16–0.78;  $p = 0.013$ ) and the SELP 1087G/A SNP (OR: 0.51; 95% CI: 0.30–0.85;  $p = 0.011$ ) were associated with a reduction in cognitive deficit in European Americans ( $n = 443$ ). The absolute risk reduction in the observed incidence of POCD was 20.6% for carriers of the CRP 1059C allele and 15.2% for carriers of the SELP 1087A allele. This compared to a greater than 40% incidence of decline in those patients who did not possess either allele (Fig. 86–8).<sup>84</sup>

Perioperative serum CRP and degree of platelet activation were also significantly lower in patients with a copy of the minor alleles, providing biologic support for the observed allelic association. These results suggest a contribution of P-selectin and CRP genes in modulating susceptibility to cognitive decline following cardiac surgery, with potential implications for identifying populations at risk who might benefit from targeted perioperative antiinflammatory strategies. Identifying genetic and mechanistic factors associated with lower rates of injury and sequelae define for us pathways to protection, as well as provide the opportunity for preoperative genetic screening to identify patients who are at risk for cerebral injury and who will most likely benefit from interventional strategies for protection.

### Anesthesia

Cognitive impairment occurring up to 6 weeks after cardiac surgery has been likened to the cognitive decline seen after noncardiac surgery by the ISPOCD group and Monk et al.<sup>1,85</sup> The incidence in noncardiac surgery originally appeared lower than that seen in cardiac surgery defined by our group and others, and is comparable to a group younger than 60 years old. However, as the noncardiac population has aged, there has been increased recog-



**FIGURE 86-8.** Incidence of postoperative cognitive deficit by *CRP* 1059G/C and *SELP* 1087G/A genotypes. The incidence of cognitive deficit was 16.7% in carriers of minor alleles at both of these loci, compared to 42.9% in patients homozygous for the major allele (N = 386). Reprinted from Journal of American College of Cardiology, in press, Mathew J, Podgoreanu MD, Grocott GP, et al. Genetic variants in p-selectin and c-reactive protein influence susceptibility to cognitive decline after cardiac surgery, Copyright 2007 American College of Cardiology.

dition of the cognitive decline occurring in elderly surgical patients, demonstrating that cognitive decline is observed in major noncardiac surgery after general anesthesia.<sup>85</sup>

While surgical stress and many of the previously identified etiologic factors likely apply in cardiac as well as noncardiac surgery, anesthesia as a possible etiologic factor has been incriminated by cell culture and whole animals studies.<sup>86,87</sup> General anesthesia agents, especially inhaled agents, may cause amyloid deposition or protein folding differences that could alter either short-term or long-term cognitive function.<sup>86,88-92</sup>

In addition to the described ability of isoflurane to enhance  $\beta$ -amyloid protein (A $\beta$ ) oligomerization and generation, and to potentiate the cytotoxicity of A $\beta$ , it has also been shown in a recent investigation to induce apoptosis. Xie et al., in a neuroglioma cell culture model exposed to 2% isoflurane for 6 hours, found that isoflurane induces cellular apoptosis in a dose-dependent manner, and that Congo red inhibits isoflurane-induced apoptosis in H4 human neuroglioma cells.<sup>90</sup> The authors conclude that isoflurane contributes to well-described mechanisms of Alzheimer neuropathogenesis and provides a plausible link between the acute effects of anesthesia, a well-described risk factor for delirium and the more long-term sequelae of dementia.

Despite the cellular evidence, there is little clinical data to support the claim that repeated exposure to general anesthesia markedly alters cognitive

function. Further longitudinal trials as well as animal studies are needed to define whether any of the changes that have been identified to date are associated with true clinical sequelae.

### Preexisting Cerebrovascular Disease or Documented Brain Abnormalities

A number of investigators have performed investigations on patients scheduled for cardiac surgery preoperatively, including MRI or CT scans in asymptomatic elderly individuals. The presence of silent infarcts in this population is not uncommon and may be associated with later decline in cognition or dementia.<sup>68</sup> Goto et al. have done the largest study. Their study had 421 candidates who were scheduled for coronary artery bypass grafting, of whom 126 (30%) had small brain infarctions preoperatively and 83 (20%) had multiple infarctions.<sup>93</sup> A surprising 50% of the sample had evidence of brain abnormalities before surgery. Thus it is likely that patient characteristics have a significant role in determining the probability of a patient exhibiting neurologic injury after surgery, both by defining the degree of atherosclerotic disease as well as potentially defining individuals with less cognitive or neurologic reserve who will express symptoms of injury to a much greater extent. This association between preoperative MRI lesions and risk of new postoperative lesions was confirmed by Floyd et al.<sup>68</sup> In a small study of 34 patients, they found that 6 patients had evidence of

new lesions defined by MRI. The severity of preexisting white matter disease was associated with a higher probability of new lesion occurrence. They defined that preoperative MRI lesions were one of the best predictors of new postoperative lesions.<sup>68</sup>

## CONCLUSIONS

Although controversies exist around the incidence and the significance of POCD after cardiac and noncardiac surgery, those patients who experience cognitive decline have measurable reductions in quality of life that offset the benefits provided by surgery. This chapter discusses a number of possible etiologies, including anesthesia and surgery; however, until we have better understanding of how all of these factors interact to define outcome, aggressive intervention is difficult unless the intervention is low-risk. Understanding individuals at risk, intervening in the group at high risk, reproducing the biochemical or physiologic responses in low-risk individuals, and effectively intervening in those who are at risk for long-term decline are measures that hold the greatest potential for benefit with the lowest risk.

## KEY REFERENCES

1. Newman MF, Kirchner JL, Phillips-Bute B, et al. Longitudinal assessment of cognitive function after coronary-artery bypass surgery. Neurological Outcome Research Group and CARE Investigators. *N Engl J Med* 2001;344(6):395-402.
2. Moller JT, Cluitmans P, Rasmussen LS, et al. Long-term postoperative cognitive dysfunction in the elderly ISPOCD1, study. ISPOCD investigators. International Study of Post-Operative Cognitive Dysfunction. *Lancet* 1998;351(9106):857-861.
3. Mathew JP, Podgoreanu MV, Grocott HP, et al. Genetic variants in p-selectin and c-reactive protein influence susceptibility to cognitive decline after cardiac surgery. *J Am Coll Cardiol* 2007;(In press).
4. Rasmussen LS. Defining postoperative cognitive dysfunction. *Eur J Anaesthesiol* 1998;15:761-764.

5. Roach GW, Kanchuger M, Mangano CM, et al. Adverse cerebral outcomes after coronary bypass surgery. Multicenter Study of Perioperative Ischemia Research Group and the Ischemia Research and Education Foundation Investigators. *N Engl J Med* 1996;335(25):1857-1863.

6. Eckenhoff RG, Johnansson JS, Wei H, et al. Inhaled anesthetic enhancement of amyloid-beta oligomerization and cytotoxicity. *Anesthesiology* 2004;101:703-709.

7. Newman MF, Mathew JP, Grocott HP, et al. Central nervous system injury associated with cardiac surgery. *Lancet* 2006;368:694-703.

## REFERENCES

- Moller JT, Cluitmans P, Rasmussen LS, et al. Long-term postoperative cognitive dysfunction in the elderly ISPOCD1 study. ISPOCD investigators. International Study of Post-Operative Cognitive Dysfunction. *Lancet* 1998;351(9106):857-861.
- Rasmussen LS. Defining postoperative cognitive dysfunction. *Eur J Anaesthesiol* 1998;15:761-764.
- Newman MF, Kirchner JL, Phillips-Bute B, et al. Longitudinal assessment of cognitive function after coronary-artery bypass surgery. Neurological Outcome Research Group and CARE Investigators. *N Engl J Med* 2001;344(6):395-402.
- Newman MF, Grocott HP, Mathew JP, et al. Report of the substudy assessing the impact of cognitive function on quality of life five years after cardiac surgery. Neurologic Outcome Research Group and Cardiothoracic Anesthesia Research Endeavors (CARE) Investigators of the Duke Heart Center. *Stroke* 2001;32:2874-2881.
- Hanning CD. Postoperative cognitive dysfunction. *Br J Anaesth* 2005;95(1):82-87.
- Phillips-Bute B, Mathew JP, Blumenthal JA, et al. Association of cognitive function and quality of life 1 year after coronary artery bypass graft (CABG) surgery. *Psychosom Med* 2006;68(3):369-375.
- Ryan CM. Diabetes, aging, and cognitive decline. *Neurobiol Aging* 2005;26(Suppl 1):21-25.
- Holm K, Foreman M. Analysis of measures of functional and cognitive ability for aging adults with cardiac and vascular disease. *J Cardiovasc Nurs* 2006;21(5 Suppl 1):S40-S45; quiz S46-S47.
- Ritchie K. Mild cognitive impairment: an epidemiological perspective. *Dialogues Clin Neurosc* 2004;6(4):401-408.
- Di Bonito P, Di Fraia L, Di Gennaro L, et al. Impact of impaired fasting glucose and other metabolic factors on cognitive function in elderly people. *Nutr Metab Cardiovasc Dis* 2007;17(3):203-208.
- Panza F, Solfrizzi V, Colacicco AM, et al. Cerebrovascular disease in the elderly: lipoprotein metabolism and cognitive decline. *Aging Clin Exp Res* 2006;18(2):144-148.
- Strittmatter WJ, Saunders AM, Goedert M, et al. Isoform-specific interactions of apolipoprotein E with microtubule-associated protein tau: implications for Alzheimer disease. *Proc Natl Acad Sci U S A* 1994;91(23):11183-11186.
- Strittmatter WJ, Roses AD. Apolipoprotein E and Alzheimer disease. *Proc Natl Acad Sci U S A* 1995;92(11):4725-4727.
- Bondi MW, Salmon DP, Monsch AU, et al. Episodic memory changes are associated with the Apo E-epsilon4 allele in nondemented older adults. *Neurology* 1995;45(12):2203-2206.
- Bondi MW, Salmon DP, Galasko D, Thomas RG, Thal LJ. Neuropsychological function and apolipoprotein E genotype in the preclinical detection of Alzheimer's disease. *Psychol Aging* 1999;14(2):295-303.
- Schuff N, Amend DL, Knowlton R, Norman D, Fein G, Weiner MW. Age-related metabolite changes and volume loss in the hippocampus by magnetic resonance spectroscopy and imaging. *Neurobiol Aging* 1999;20(3):279-285.
- Flory JD, Manuck SB, Ferrell RE, Ryan CM, Muldoon MF. Memory performance and the apolipoprotein E polymorphism in a community sample of middle-aged adults. *Am J Med Genet* 2000;96(6):707-711.
- Caselli RJ, Osborne D, Reiman EM, et al. Preclinical cognitive decline in late middle-aged asymptomatic apolipoprotein E-epsilon4/epsilon4, homozygotes: a replication study. *J Neurol Sci* 2001;189(1-2):93-98.
- den Heijer T, Oudkerk M, Launer LJ, van Duijn CM, Hofman A, Breteler MM. Hippocampal, amygdalar, and global brain atrophy in different apolipoprotein E genotypes. *Neurology* 2002;59(5):746-748.
- Greenwood PM, Lambert C, Sunderland T, Parasuraman R. Effects of apolipoprotein E genotype on spatial attention, working memory, and their interaction in healthy, middle-aged adults: results From the National Institute of Mental Health's BIOCARD study. *Neuropsychology* 2005;19(2):199-211.
- Tardiff BE, Newman MF, Saunders AM, et al. Preliminary report of a genetic basis for cognitive decline after cardiac operations. The Neurologic Outcome Research Group of the Duke Heart Center. *Ann Thorac Surg* 1997;64:715-720.
- Breteler MM, van Swieten JC, Bots ML, et al. Cerebral white matter lesions, vascular risk factors, and cognitive function in a population-based study: the Rotterdam Study. *Neurology* 1994;44(7):1246-1252.
- Haan MN, Shemanski L, Jagust WJ, Manolio TA, Kuller L. The role of Apo E epsilon4, in modulating effects of other risk factors for cognitive decline in elderly persons. *JAMA* 1999;282(1):40-46.
- Slooter AJ, van Duijn CM, Bots ML, et al. Apolipoprotein E genotype, atherosclerosis, and cognitive decline: the Rotterdam Study. *J Neural Transm Suppl* 1998;53:17-29.
- Milgram NW, Siwak-Tapp CT, Araujo J, Head E. Neuroprotective effects of cognitive enrichment. *Ageing Res Rev* 2006;5(3):354-369.
- Newman MF, Wolman R, Kanchuger M, et al. Multicenter preoperative stroke risk index for patients undergoing coronary artery bypass graft surgery. Multicenter Study of Perioperative Ischemia (McSPI) Research Group. *Circulation* 1996;94(9 Suppl):II74-II80.
- Mahanna EP, Blumenthal JA, White WD, et al. Defining neuropsychological dysfunction after coronary artery bypass grafting. *Ann Thorac Surg* 1996;61:1342-1347.
- Rasmussen LS, Larsen K, Houx P, Skovgaard LT, Hanning CD, Moller JT. The assessment of postoperative cognitive function. *Acta Anaesthesiol Scand* 2001;45(3):275-289.
- Murkin JM. The role of CPB management in neurobehavioral outcomes after cardiac surgery. *Ann Thorac Surg* 1995;59(5):1308-1311.
- Murkin JM, Stump DA, Blumenthal JA, McKhann G. Defining dysfunction: group means versus incidence analysis—a statement of consensus. *Ann Thorac Surg* 1997;64(3):904-905.
- Newman S, Arrowsmith JE, Grocott H, Murkin JM, Stump D, Wingerhoets G. Statement of consensus on cognitive difficulties following coronary artery bypass surgery. <http://www.outcomeskeywest.com/ConsensusStatement/tabid/247/Default.aspx>
- Ahlgren E, Lundqvist A, Nordlund A, Aren C, Rutberg H. Cognitive impairment and driving performance after coronary artery bypass surgery. *Eur J Cardiothorac Surg* 2003;23(3):334-340.
- Whelihan WM, DiCarlo MA, Paul RH. The relationship of neuropsychological functioning to driving competence in older persons with early cognitive decline. *Arch Clin Neuropsychol* 2005;20(2):217-228.
- Cosgrove DM, Loop FD, Lytle BW, et al. Primary myocardial revascularization. Trends in surgical mortality. *J Thorac Cardiovasc Surg* 1984;88(5 Pt 1):673-684.
- Califf RM, Harrell FE, Lee KL, et al. Changing efficacy of coronary revascularization: implications for patients selection. *Circulation* 1988;78:1-185-191.
- Gersh B, Kornmal R, Schaff H, et al. Comparison of coronary artery bypass surgery and medical therapy in patients 65 years of age or older. *N Engl J Med* 1985;313:217-224.
- Mohan R, Amsel BJ, Walter PL. Coronary artery bypass grafting in the elderly: a review of studies on patients older than 64, 69, or 74 years. *Cardiology* 1992;80:215-225.
- Hammermeister KE, Burchfiel C, Johnson R, Grover FL. Identification of



- patients at greatest risk for developing major complications at cardiac surgery. *Circulation* 1990;82:IV-380-IV-389.
39. Jones EL, Weintraub WS, Carver JM, Guyton RA, Cohen CL. Coronary bypass surgery: Is the operation different today? *J Thorac Cardiovasc Surg* 1991;101:108-115.
  40. Mathew J, Grocott H, Phillips-Bute B, et al. Lower endotoxin immunity predicts increased cognitive dysfunction in elderly patients after cardiac surgery. *Stroke* 2003;34:508-513.
  41. Roach GW, Kanchuger M, Mangano CM, et al. Adverse cerebral outcomes after coronary bypass surgery. Multicenter Study of Perioperative Ischemia Research Group and the Ischemia Research and Education Foundation Investigators. *N Engl J Med* 1996;335(25):1857-1863.
  42. Newman SP, Harrison MJ. Coronary-artery bypass surgery and the brain: persisting concerns. *Lancet Neurol* 2002;1(2):119-125.
  43. Harrison MJG. Neurological complications of cardiac surgery. In: Newman SP, Harrison MJG, eds. *The Brain and Cardiac Surgery*. Amsterdam: Harwood Academic Publishers; 2000:21-50.
  44. ACC/AHA. 2004 Guideline update for coronary artery bypass graft surgery: a report of the American College of Cardiology/American Heart Association Task Force on Practice Guidelines: American College of Cardiology/American Heart Association. 2004;100:e340-437.
  45. Stroobant N, Van Nooten G, Van Belleghem Y, Vingerhoets G. Relation between cognitive impairment, embolic load, and cerebrovascular reactivity following on- and off-pump coronary artery bypass grafting. *Chest* 2005;127(6):1967-1976.
  46. Stygall J, Newman SP, Fitzgerald G, et al. Cognitive change 5, years after coronary artery bypass surgery. *Health Psychol* 2003;22(5):579-586.
  47. McKhann GM, Grega MA, Borowicz LM, et al. Is there cognitive decline 1, year after CABG? Comparison with surgical and non-surgical controls. *Neurology* 2005;65:991-999.
  48. Mathew JP, Grocott HP, Phillips-Bute B, et al. Lower endotoxin immunity predicts increased cognitive dysfunction in elderly patients after cardiac surgery. *Stroke* 2003;34(3):508-513.
  49. Stanley T, Mackensen G, Grocott H, et al. The impact of postoperative atrial fibrillation on cognitive outcome after coronary artery bypass graft surgery. *Anesth Analg* 2002;94(2):290-295.
  50. Grocott HP, Mackensen GB, Grigore AM, et al. Postoperative hyperthermia is associated with cognitive dysfunction after coronary artery bypass graft surgery. *Stroke* 2002;33(2):537-541.
  51. Murkin JM, Martzke JS, Buchan AM, Bentley C, Wong CJ. A randomized study of the influence of perfusion technique and pH management strategy in 316, patients undergoing coronary artery bypass surgery. II. Neurologic and cognitive outcomes. *J Thorac Cardiovasc Surg* 1995;110(2):349-362.
  52. Patel RL, Turtle MR, Chambers DJ, James DN, Newman S, Venn GE. Alpha-stat acid-base regulation during cardiopulmonary bypass improves neuropsychologic outcome in patients undergoing coronary artery bypass grafting. *J Thorac Cardiovasc Surg* 1996;111(6):1267-1279.
  53. Pugsley W, Klinger L, Paschalis C, Treasure T, Harrison M, Newman S. The impact of microemboli during cardiopulmonary bypass on neuropsychological functioning. *Stroke* 1994;25(7):1393-1399.
  54. Whitaker DC, Newman SP, Stygall J, Hope-Wynne C, Harrison MJ, Walesby RK. The effect of leucocyte-depleting arterial line filters on cerebral microemboli and neuropsychological outcome following coronary artery bypass surgery. *Eur J Cardiothorac Surg* 2004;25(2):267-274.
  55. Arrowsmith JE, Harrison MJ, Newman SP, Stygall J, Timberlake N, Pugsley WB. Neuroprotection of the brain during cardiopulmonary bypass: a randomized trial of remacemide during coronary artery bypass in 171 patients. *Stroke* 1998;29(11):2357-2362.
  56. Toner I, Peden CJ, Hamid SK, Newman S, Taylor KM, Smith PL. Magnetic resonance imaging and neuropsychological changes after coronary artery bypass graft surgery: preliminary findings. *J Neurosurg Anesthesiol* 1994;6(3):163-169.
  57. Moody DM, Brown WR, Challa VR, Stump DA, Reboussin DM, Legault C. Brain microemboli associated with cardiopulmonary bypass: a histologic and magnetic resonance imaging study. *Ann Thorac Surg* 1995;59(5):1304-1307.
  58. Harris DN, Bailey SM, Smith PL, Taylor KM, Oatridge A, Bydder GM. Brain swelling in first hour after coronary artery bypass surgery [see comments]. *Lancet* 1993;342(8871):586-587.
  59. Bendszus M, Reents W, Franke D, et al. Brain damage after coronary artery bypass grafting. *Arch Neurol* 2002;59:1090-1095.
  60. Moody DM, Bell MA, Challa VR, Johnston WE, Prough DS. Brain microemboli during cardiac surgery or aortography [see comments]. *Ann Neurol* 1990;28(4):477-486.
  61. Ma D, Yang H, Lynch J, Franks NP, Maze M, Grocott HP. Xenon attenuates cardiopulmonary bypass-induced neurologic and cognitive dysfunction in the rat. *Anesthesiology* 2003;98(3):690-698.
  62. Wolman RL, Nussmeier NA, Aggarwal A, et al. Cerebral injury after cardiac surgery: identification of a group at extraordinary risk. *Stroke* 1999;30(3):514-522.
  63. Cleveland JC, Shroyer LW, Chen A, Peterson E, Grover FL. Off-pump coronary artery bypass grafting significantly decreases risk-adjusted mortality and morbidity. *Ann Thorac Surg* 2001;72:1282-1288; discussion 1288-1289.
  64. Bonke B. Postoperative cognitive dysfunction in the elderly [letter]. *Lancet* 1998;351(9119):1889.
  65. Monk TG, Weldon BC, Garvan CW, et al. Predictors of cognitive dysfunction after major noncardiac surgery. *Anesthesiology* 2007;(In press).
  66. Wareing TH, Davila-Roman VG, Barzilay B, Murphy SF, Kouchoukos NT. Management of the severely atherosclerotic ascending aorta during cardiac operations: A strategy for detection and treatment. *J Thorac Cardiovasc Surg* 1992;103:453-462.
  67. Kanchuger MS, Sweeney MN, Grossi E, Marschall KE. Aortic atheromatous disease, atherectomy and outcome in patients undergoing cardiac surgery. *Anesth Analg* 1996;82:SCA31.
  68. Floyd TF, Shah PN, Price CC, et al. Clinically silent cerebral ischemic events after cardiac surgery: their incidence, regional vascular occurrence, and procedural dependence. *Ann Thorac Surg* 2006;81(6):2160-2166.
  69. Kadoi Y, Goto F. Factors associated with postoperative cognitive dysfunction in patients undergoing cardiac surgery. *Surg Today* 2006;36(12):1053-1057.
  70. Gilman S. Cerebral disorders after open heart operations. *N Engl J Med* 1965;272:489-498.
  71. Caplan LR, Hennerici M. Impaired clearance of emboli (washout) is an important link between hypoperfusion, embolism, and ischemic stroke. *Arch Neurol* 1998;55:1475-1482.
  72. Gold JP, Charlson ME, Williams-Russo P, et al. Improvement of outcomes after coronary artery bypass. A randomized trial comparing intraoperative high versus low mean arterial pressure. *J Thorac Cardiovasc Surg* 1995;110:1302-1311.
  73. Hartman GS, Yao FS, Bruefach M 3rd, et al. Severity of aortic atheromatous disease diagnosed by transesophageal echocardiography predicts stroke and other outcomes associated with coronary artery surgery: a prospective study. *Anesth Analg* 1996;83(4):701-708.
  74. Newman MF, Croughwell ND, Blumenthal JA, et al. Effect of aging on cerebral autoregulation during cardiopulmonary bypass: association with postoperative cognitive dysfunction. *Circulation* 1994;90(II):243-249.
  75. Tuman KJ, McCarthy RJ, Najafi H, Ivankovich AD. Differential effects of advanced age on neurologic and cardiac risks of coronary artery operations. *J Thorac Cardiovasc Surg* 1992;104:1510-1517.
  76. Newman MF, Kramer D, Croughwell ND, et al. Differential age effects of mean arterial pressure and rewarming on cognitive dysfunction after cardiac surgery. *Anesth Analg* 1995;81:236-242.
  77. Westaby S, Saatvedt K, White S, Katsumata T, van Oeveren W, Halligan PW. Is there a relationship between cognitive dysfunction and systemic inflammatory re-



- sponse after cardiopulmonary bypass? *Ann Thorac Surg* 2001;71:667–672.
78. Grocott HP, Newman MF, El-Moalem H, Bainbridge D, Butler A, Laskowitz DT. Apolipoprotein E genotype differentially influences the proinflammatory and anti-inflammatory response to cardiopulmonary bypass. *J Thorac Cardiovasc Surg* 2001;122:622–623.
79. Ebmeier K, Rose E, Steele D. Cognitive impairment and fMRI in major depression. *Neurotox Res* 2006;10(2):87–92.
80. Steed L, Kong R, Stygall J, et al. The role of apolipoprotein E in cognitive decline after cardiac operation. *Ann Thorac Surg* 2001;71(3):823–826.
81. Mathew JP, Rinder CS, Howe JG, et al. Platelet PLA2, polymorphism enhances the risk of cognitive decline after cardiopulmonary bypass. Multicenter Study of Perioperative Ischemia (McSPI) Group. *Ann Thorac Surg* 2001;71:663–666.
82. Ridker PM, Hennekens CH, Schmitz C, Stampfer MJ, Lindpaintner K. PLA1/A2, polymorphism of platelet glycoprotein IIIa and risks of myocardial infarction, stroke, and venous thrombosis. *Lancet* 1997;349:385–388.
83. Weiss EJ, Bray PF, Tayback M, et al. A polymorphism of a platelet glycoprotein receptor as an inherited risk factor for coronary thrombosis [see comments]. *N Engl J Med* 1996;334(17):1090–1094.
84. Mathew J, Podgoreanu MD, Grocott GP, et al. Genetic variants in p-selectin and c-reactive protein influence susceptibility to cognitive decline after cardiac surgery. *J Am Coll Cardiol* 2007;49(19):1934–1942.
85. Monk TG, Saini V, Weldon BC, Sigl J, C. Anesthetic management and one-year mortality after noncardiac surgery. *Anesth Analg* 2005;100(1):4–10.
86. Eckenhoff RG, Johnansson JS, Wei H, et al. Inhaled anesthetic enhancement of amyloid-beta oligomerization and cytotoxicity. *Anesthesiology* 2004;101:703–709.
87. Olney JW, Wozniak DF, Jevtovic-Todorovic V, Farber NB, Bittigau P, Ikonomidou C. Drug-induced apoptotic neurodegeneration in the developing brain. *Brain Pathol* 2002;12(4):488–498.
88. Xie Z, Dong Y, Maeda U, et al. The common inhalation anesthetic isoflurane induces apoptosis and increases amyloid beta protein levels. *Anesthesiology* 2006;104(5):988–994.
89. Xie Z, Dong Y, Maeda U, et al. The inhalation anesthetic isoflurane induces a vicious cycle of apoptosis and amyloid beta-protein accumulation. *J Neurosci* 2007;27(6):1247–1254.
90. Xie Z, Dong Y, Maeda U, et al. Isoflurane-induced apoptosis: a potential pathogenic link between delirium and dementia. *J Gerontol A Biol Sci Med Sci* 2006;61(12):1300–1306.
91. Marcantonio ER, Rudolph JL, Culley D, Crosby G, Alsup D, Inouye SK. Serum biomarkers for delirium. *J Gerontol A Biol Sci Med Sci* 2006;61(12):1281–1286.
92. Mandal PK, Williams JP, Mandal R. Molecular understanding of Abeta peptide interaction with isoflurane, propofol, and thiopental: NMR spectroscopic study. *Biochemistry* 2007;46(3):762–771.
93. Goto T, Yoshitake A, Baba T, Shibata y, Sakata R, Uozumi H. Cerebral ischemic disorders and cerebral oxygen balance during cardiopulmonary bypass surgery: preoperative evaluation using magnetic resonance imaging and angiography. *Anesth Analg* 1997;84(1):5–11.

# CHAPTER 87

## Protection of the Central Nervous System in Surgical Patients

W. Andrew Kofke, MD, MBA,  
FCCM

Neural function is essential to human existence. Loss of any neural element during the course of a critical illness represents a major loss to an individual. Neurons or supporting elements may be lost in a small, virtually unnoticeable manner or manifest as cognitive or behavioral deficit. Widespread selective neuronal loss or tissue infarction may occur with more apparent and disabling deficits. Based on the notion that neural function is the essence of acceptable survival from critical illness, perioperative management must include considerations of neural viability and the effect and interactions of primary diseases and therapeutics on the nervous system.

There are numerous perioperative scenarios wherein a patient may be at risk for neurologic damage. In general, these scenarios involve ischemia, trauma, or neuroexcitation. Each of these conditions, as it progressively worsens, at some point typically involves a period of decreased cerebral perfusion pressure (CPP), either regionally or globally. The latter usually is associated with elevated intracranial pressure (ICP), eventually compromising global cerebral blood flow (CBF) enough to produce permanent neuronal loss, infarction, and possibly brain death. A variety of biochemical pathways play a major role. This chapter reviews the important pathophysiologic factors and ICP considerations and neuroprotective therapeutic options critical to contemporary perioperative care of the surgical patient at risk for central nervous system (CNS) injury.

## PERIOPERATIVE STROKE

### Types of Stroke

Stroke is the third leading cause of death in the United States. For every patient who dies of stroke, approximately 13 survivors live with the effects of neural tissue loss.<sup>1</sup> The 2-year incidence of stroke is 10 in 1000, and the incidence due to atherothrombotic brain infarction is 4.4 in 1000.<sup>1</sup> Strokes are either ischemic or hemorrhagic. Hemorrhagic strokes are caused by subarachnoid hemorrhage (SAH), intraparenchymal (intracerebral) hemorrhage (ICH), or subdural/epidural hemorrhage. Eighty-four percent of strokes are ischemic, and 16% are hemorrhagic (6% SAH, 10% ICH). Ischemic strokes are caused by embolism, thrombosis, or hemodynamic factors such as anemia or hypotension in the setting of proximal stenosis or brain edema. Atrial fibrillation is a major risk factor for embolic ischemic stroke, comprising approximately 18% of first strokes. Notably, the 3-month mortality of strokes associated with atrial fibrillation is approximately 33% compared with 20% in patients without atrial fibrillation.<sup>2</sup> Genomic polymorphisms are important in the risk of stroke.<sup>3</sup> Another important risk factor in the predisposition to stroke is the cerebrovascular reserve. In the non-surgical setting, cerebrovascular reserve has been related to increased risk of stroke. In the perioperative context, the inability to compensate for common stresses that require vasodilatation, such as hypotension, anemia, fever, hypoxemia, and hypogly-

cemia, risks the development of a so-called *hemodynamic stroke*.<sup>4</sup>

### Epidemiology of Perioperative Stroke

Perioperative stroke incidence is related to the patient's underlying risk factors (Table 87-1) and the risk factors associated with specific procedures (Table 87-2). Cardiac, thoracic aortic, and vascular neurosurgery have the highest risk of perioperative stroke. An increased risk is reported with procedures on the neck; the lowest risk is associated with general surgery. Cardiac surgery is associated with a 1–5% stroke rate, which increases to  $\geq 7\%$  in the elderly. Similar stroke rates are reported with or without the use of cardiopulmonary bypass. Several patient-specific risk factors further increase risk (Table 87-1).<sup>5–7</sup> Stroke rates after thoracic aortic surgery were reported by Goldstein et al.<sup>8</sup> Clearly, the incidence increases when the procedure is performed emergently.

After carotid endarterectomy (CEA), an expected stroke rate is 3–5%.<sup>9,10</sup> Data from the two major multiinstitutional studies examining the efficacy of stroke were reviewed and summarized by Naylor et al.<sup>11</sup> However, Bond et al.<sup>12</sup> report a stroke range that can be larger depending on the degree of carotid stenosis. For unclear reasons, the rate is highest with midrange stenoses. Other factors that increase stroke rate after CEA include female gender,<sup>12–14</sup> age >75 years, global ischemia symptoms (vs. monocular),<sup>12,14</sup> systolic hypertension,<sup>12,14</sup> and peripheral vascular disease.<sup>12,14</sup> Heyer

### KEY POINTS

1. The incidence of perioperative stroke without predisposing factors is approximately 0.1%, but specific risk factors and procedures can increase the risk by 10-fold or more.
2. Cerebrovascular reserve refers to the capability of the brain's vasculature to dilate in order to compensate for perioperative physiologic stresses.
3. Attention to maintenance of a normal physiologic milieu is the first principle of brain-oriented perioperative care.
4. Fever kills vulnerable neurons, and hypothermia is protective in cases of cardiac arrest and possibly traumatic brain injury.
5. Glycemic control improves outcome after severe critical illness and probably optimizes neurologic outcome.
6. Some anesthetics are neuroprotective, but some anesthetic drugs may have neurotoxic potential.

TABLE 87-1.

**Patient-Specific Risk Factors for Stroke after Cardiac Surgery**

Aortic arch atheroma  
 Renal insufficiency  
 Recent myocardial infarction  
 Prior stroke  
 Carotid disease  
 Hypertension  
 Age > 75 years  
 Left ventricular dysfunction  
 Low cardiac output  
 Atrial fibrillation

et al.<sup>15</sup> reported an association of post-CEA cognitive deficits with apolipoprotein E single nucleotide polymorphism, suggesting a significant role for genetic polymorphisms in ischemic injury after CEA.

From a review of the literature, Thompson et al.<sup>16</sup> reported that surgery on the neck is an important risk factor for stroke, identifying a rate as high as 4.8%. However, they could identify a rate of only 0.2% in their own patients. Nonetheless, these reports of an unexpectedly high perioperative stroke rate after neck surgery have led to the suggestion that extreme turning or extension of the head may introduce a vascular risk factor for perioperative stroke. This is supported by MRI studies of the anatomic consequences of such head positions,<sup>17</sup> transcranial Doppler studies showing the potential for flow decrements with head extension,<sup>18</sup> a brainstem-evoked potential case report,<sup>19</sup> and the beauty parlor stroke syndrome wherein vertebrobasilar ischemic symptoms are associated with head extension during head shampoo in a beauty parlor.<sup>20</sup>

Lanska and Kryscio<sup>21</sup> report a stroke rate of 0.01% in the puerperium. Strokes in this context tend to be due to venous thrombosis. Risk factors include cesarean section, fluid and electrolyte abnormalities, hypertension, and infections.

Ogilvy et al.<sup>22</sup> reported cerebral aneurysm surgery to be associated with a perioperative stroke rate of 5–25% (overall rate 5.2%). However, the rate increases to 38% if intraoperative rupture of the aneurysm occurs. Increases in stroke risk also are associated with longer periods of temporary proximal occlusion of the artery feeding the aneurysm.

TABLE 87-2.

**Possible Mechanisms of Perioperative Stroke**

Intraoperative	Postoperative
Hypotension	Hypotension
Anemia	Emboli: myocardial infarction, subacute bacterial endocarditis, patent foramen ovale
Hypoxemia	Hypercoagulable
Hypocapnia	Atrial fibrillation
Hypercapnia	Anemia
Hypoglycemia	Iatrogenic polycythemia
Hypercoagulable	Hypoxemia
Head position	Hypertension
Hypertension	

General surgery probably is not a high-risk procedure for stroke if the patient does not have any risk factors. Parikh and Cohen<sup>23</sup> reviewed almost 25,000 general surgery procedures reporting a stroke rate of 0.08%. Eighty-four percent of strokes occurred in the 7 days postoperatively, and the mortality associated with a perioperative stroke was 26%. The authors suggest that most of these strokes likely were embolic in origin. They identified pre-existing hypertension, prior neurologic symptoms, smoking, and an abnormal rhythm on electrocardiogram, especially atrial fibrillation, as risk factors. Notably, they were unable to identify a relationship between preoperative carotid bruit and the development of perioperative stroke.

The importance of previous neurologic symptoms was underscored by Landercasper et al.<sup>24</sup> and Larsen et al.,<sup>25</sup> both of whom reported an approximately 2% stroke incidence in such patients after general surgery, an approximately 10-fold increase in risk.<sup>24,25</sup> In comparing 61 strokes occurring in patients after general surgery with a group of matched general surgery patients who did not have a perioperative stroke, Limburg and Wijdicks<sup>26</sup> also identified previous neurovascular disease as an important risk factor. These observations underscore the importance of ascertaining the anatomy and circulatory pathology of any patient with a history of stroke or transient ischemic attack. This practice is analogous to that taken in any patient complaining of angina or past evidence of coronary artery disease. In addition, Limburg and Wijdicks identified peripheral vascular disease and chronic obstructive

lung disease as other important risk factors. They could not correlate the occurrence of perioperative hypotension with stroke.

**Pathophysiology of Perioperative Stroke**

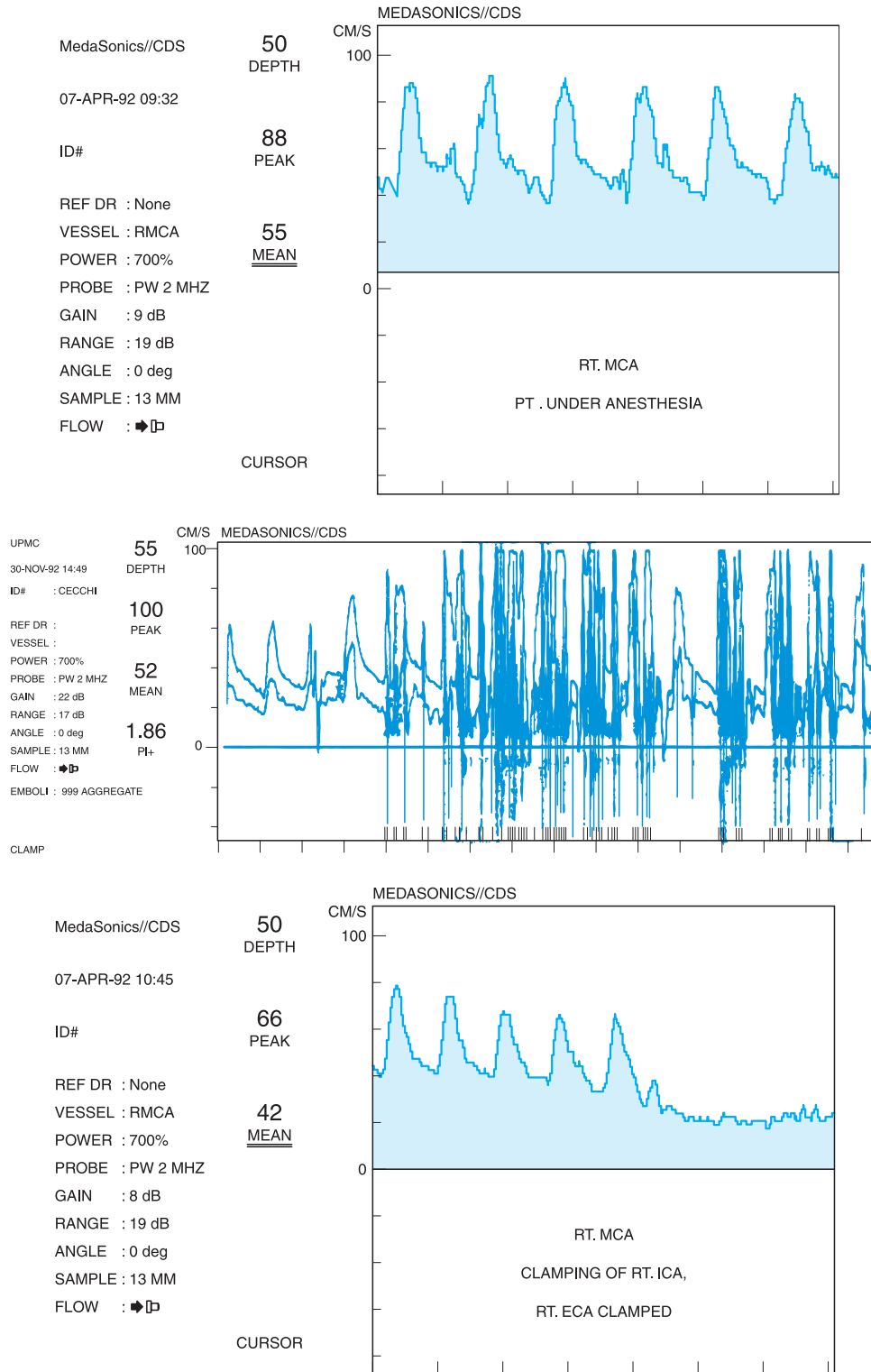
The mechanisms of perioperative stroke have not been firmly elucidated in any large prospective studies. Kam and Calcroft<sup>27</sup> suggest that the most likely mechanisms include perioperative hypotension, cardiogenic embolism especially with atrial fibrillation (or cardiac wall-motion abnormalities), in situ atheromatous plaques leading to thrombosis or emboli (or hemodynamic strokes related to impaired cerebrovascular reserve), and increased perioperative coagulability. Perioperative stroke tends to occur in the first week after surgery.<sup>23,27</sup> Presumably, the sequelae of surgical interventions are important in the genesis of stroke. Most ischemic strokes arise from emboli or thrombosis, although some arise from problems with insufficient cerebrovascular reserve in the context of a perioperative physiologic challenge.

A hypercoagulable state is one consequence of the perioperative stress response.<sup>28</sup> This state combines with patient and surgical factors to increase the propensity to create emboli or thromboses that can produce an ischemic stroke. Patients with anatomic pathways from the veins to the great arteries may be at particular risk. Local low-flow conditions may be related to surgical manipulations, inflowing stenotic cerebral or carotid arteries, positioning, or low-output cardiac states with ventricular hypokinesis or dyskinesis that may transiently occur. In particular, head posi-

tion may place the vertebrobasilar system at risk, as described above. Cardiac arrhythmias, most notably atrial fibrillation, are important factors. Atrial fibrillation is relatively common postoperatively and can be

another reason for stroke occurrence after surgery. Although unusual, perioperative polycythemia (from endogenous disease, dehydration, or iatrogenic factors) can increase viscosity, adding another low-flow state that can

lead to thrombosis. Procedures that entail work on or near the carotid arteries are at particular risk for embolic phenomena. One example from the author's practice is illustrated in Fig. 87-1.



**FIGURE 87-1.** Transcranial Doppler ultrasonography of the middle cerebral artery during carotid endarterectomy. Flow velocity decrement after internal carotid clamping was transient, with flow restored by a shunt. Unclamping initially was associated with a shower of debris, followed by a transient period of hyperemia. (continued)



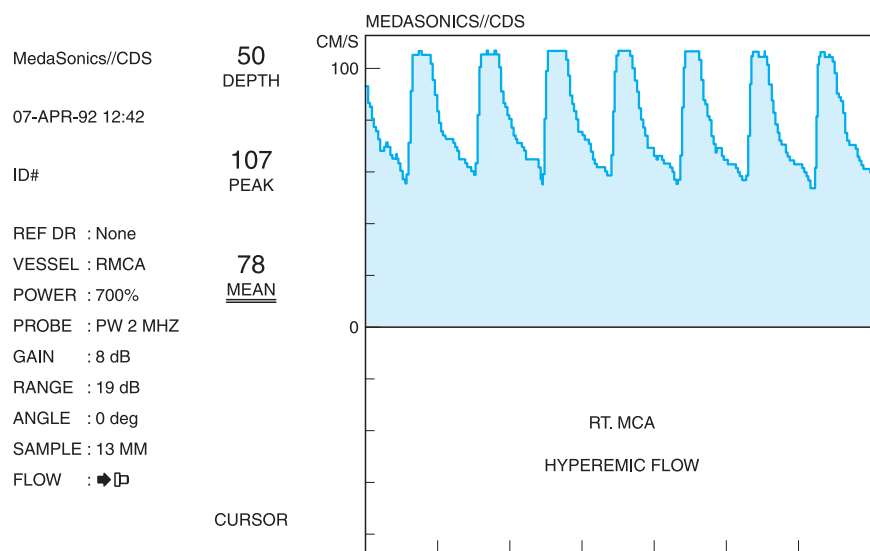


FIGURE 87-1. (Continued)

### Cerebrovascular Reserve

Central to physiologic considerations in management of the acutely injured brain are considerations of cerebrovascular reserve. Simply stated, cerebrovascular reserve is the brain's capacity to successfully compensate for physiologic stresses such as hypoglycemia, hypoxemia, hypotension, and anemia. In all of these situations, vasodilatation occurs to provide a compensatory increase in CBF. Inability to sustain vasodilatation in response to such physiologic stresses can result in brain damage.

Animal experiments indicate that it is possible to produce a condition in which cerebrovascular reserve is compromised, with increased tendency to cerebral infarction.<sup>29</sup> For example, occlusion of one carotid artery or production of moderate hypoxemia each by itself does not produce symptoms, as cerebral vasodilatation occurs to compensate. Some investigators contend that arterial hypoxemia occurring with normal cerebral vascular compensatory mechanisms does not cause brain damage. Of course, one contributing factor to this notion is that hypoxic myocardial dysfunction produces organismic death such that isolated neuronal injury cannot occur. However, add hypoxemia to carotid occlusion, or vice versa, and a stroke occurs because compensatory mechanisms, already fully used, cannot accommodate the further decrease in oxygen (O<sub>2</sub>) supply.<sup>29</sup> Examples of variants of this situation abound clinically.<sup>30</sup> Examples of attenuated cerebrovascular

reserve include cerebral edema, hypoxemia, anemia, carotid stenosis, and peri-infarct penumbra. In each of these situations, although not easy to quantitate, it is clear that added compromise of O<sub>2</sub> supply to the brain risks neuronal injury.<sup>31</sup> The phenomenon is demonstrated in Fig. 87-2.

One way to evaluate the extent of cerebrovascular reserve is through administration of acetazolamide with CBF assessment before and after acetazolamide. An example is shown in Fig. 87-2. Acetazolamide produces a

local brain tissue respiratory acidosis that in turn produces local vasodilatation, if this capability is present.<sup>32</sup> If reserve then is impaired even though baseline flow is normal, impaired regional vasodilatation indicates that area of the brain may be susceptible to injury from a perioperative physiologic challenge that requires a vasodilatory response.<sup>33-35</sup> The clinical relevance of this is supported by studies that have associated stroke with hypoxemia,<sup>29</sup> hypotension,<sup>36-39</sup> fever,<sup>40,41</sup> and anemia.<sup>42</sup> This leads to the notion that the practitioner should actively consider the extent of cerebrovascular reserve in every patient. If the patient has arterial stenoses, brain edema, a brain tumor, or other factors that may impair the ability to vasodilate in response to hypoxemia, hypotension, hypoglycemia, fever, or anemia, then a so-called hemodynamic stroke with no emboli or thrombosis may arise.

### Role of Head Position

From a review of the literature, Thompson et al.<sup>16</sup> reported that surgery on the neck is an important risk factor for stroke, identifying a rate as high as 4.8%. However, they could identify a rate of only 0.2% in their own patients. Several reviews and reports have led to the suggestion that extreme turning or extension of the head may introduce a vascular risk factor for periop-

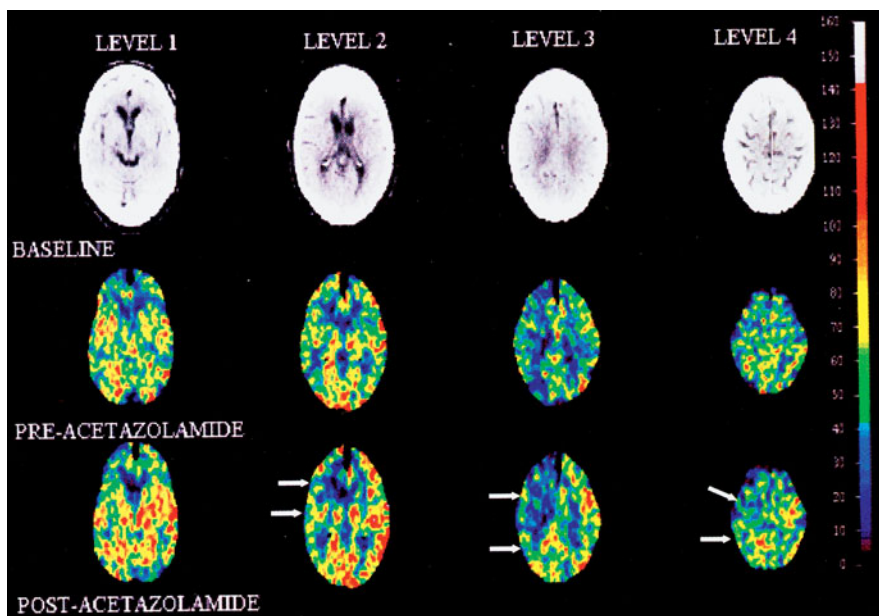


FIGURE 87-2. Stable xenon CT cerebral blood flow was performed before and after administration of intravenous acetazolamide. Areas of the brain with a suboptimal increase in flow in response to the vasodilatory stimulus (arrows) have impaired cerebrovascular reserve. (Courtesy of Howard Yonas, MD, University of New Mexico.)

erative stroke. This is supported by MRI studies of the anatomic consequences of such head positions,<sup>17</sup> transcranial Doppler studies showing the potential for flow decrements with head extension,<sup>18</sup> a brainstem-evoked potential case report,<sup>19</sup> and the beauty parlor stroke syndrome wherein vertebral-basilar ischemic symptoms are associated with head extension during head shampoo in a beauty parlor.<sup>20</sup> Another graphic demonstration of this effect was reported by Grundy et al.<sup>19</sup> Her group showed a loss of brainstem-evoked response that clearly was related to head turning for a posterior fossa procedure and was believed to have a vascular cause.

### Perioperative Intracranial Hemorrhage

Definitive studies on the pathogenesis of perioperative intracranial hemorrhage have not been published outside of the neurosurgical context. In a retrospective review of >11,000 craniotomy patients, Basali et al.<sup>43</sup> found a 0.77% incidence of ICH postcraniotomy. They evaluated the role of hypertension and determined that systolic blood pressure >160 mm Hg after intracranial surgery is a risk factor for development of ICH.

Eng et al.<sup>44</sup> reported an example of intraoperative rerupture of a previously ruptured cerebral aneurysm during induction of anesthesia. This patient already was intubated, and no significant hemodynamic changes were reported with induction of anesthesia. Nonetheless, aneurysmal rupture was observed and documented with concurrent transcranial Doppler ultrasonography. Temporary transient intracranial circulatory arrest was observed. Although these authors did not observe an association between high blood pressure and this event, there is sufficient correlation of SAH with chronic hypertension as a risk factor to suggest that it similarly is a perioperative risk factor. Ohkuma et al.<sup>45</sup> reported an association between hypertension and early aneurysmal rebleeding. This finding supports the practice of vigorously preventing hypertension in patients with cerebral aneurysms.

### Perioperative Stroke Prevention and Treatment

The factors regarding the pathophysiology of perioperative stroke can be used as a guide in preventing perioper-

ative stroke. First and perhaps most important, the anesthesiologist and surgeon should have information regarding previous incidents of cerebral ischemia. Such information should prompt a search for prior evaluations that may include computed tomography, angiography, ultrasound, and other types of assessments of intracranial circulation. This information can be used to decide whether to proceed or to adjust anesthetic management in an attempt to deal with the risk factors.

In the process of making such a determination, assessment of cerebrovascular reserve should be undertaken. Any patient with carotid or intracranial atherosclerotic lesions can be assumed to have impaired cerebrovascular reserve, as can anyone with a history of transient ischemic attack not followed by an evaluation. Any patient with intracranial edema also should be considered to have impaired reserve. Any patient judged to have impaired cerebrovascular reserve requires special attention by the anesthesiologist to ensure that stroke-causing physiologic stresses are avoided, although they may be tolerated in the routine management of healthy patients. Examples of this include hemoglobin (Hgb) concentration <10 g% or mean arterial pressure (MAP) less than the awake baseline. Use of additional monitors, such as electroencephalography (EEG), evoked potentials, or transcranial Doppler, to confirm intraoperative flow should be considered a reasonable course, although no prospective study has proved that such monitoring affects outcome.

Arrhythmias, especially atrial fibrillation, place a patient at particularly high risk for perioperative stroke, perhaps because of an adverse synergistic interaction between the hypercoagulable state and this arrhythmia. It is prudent to consider the possibility that a patient with perioperative atrial fibrillation has an atrial thrombus that is ready to become a perioperative embolus. Atrial fibrillation that arises in the perioperative course must be addressed immediately, with every effort made to produce rapid cardioversion back to sinus rhythm.

Perioperative intracranial hemorrhage most likely is related to hypertensive episodes in the context of individual risk factors. Thus, in patients with known cerebral aneurysm, hypertension (which might otherwise be

tolerated) should be aggressively treated. ICH also likely is related to perioperative hypertension. In the context of intracranial surgery, systolic blood pressure >160 mm Hg has been linked to postoperative intracranial hemorrhage<sup>43</sup> and in this specific context is a reasonable limit in the goal to prevent ICH. No other studies like this have been performed in non-neurosurgical settings, but adhering to this guideline seems appropriate in other settings as well.

### PRINCIPLES OF BRAIN-ORIENTED PHYSIOLOGIC MANAGEMENT

The essence of satisfactory perioperative neurologic care is to provide a physiologic and biochemical milieu that promotes a good recovery.

#### Oxygenation *Pao<sub>2</sub> Physiology*

Hypoxemia, usually  $P_{aO_2} < 50\text{--}60$  mm Hg, is associated with vasodilatation.<sup>46</sup> Conversely, Floyd et al.<sup>47</sup> demonstrated the vasoconstrictive effect of hyperoxia and its accompanying hypocapnia in a group of healthy volunteers. Nakajima et al.<sup>48</sup> evaluated this phenomenon in patients with cerebrovascular disease and found that areas of the brain with impaired cerebrovascular reserve were not adversely affected by hyperoxia.

The optimal  $P_{aO_2}$  in a brain-injured patient is unclear. Some data support hyperoxic therapy, but other data suggest that such an approach is deleterious. In addition, the bedside decision about  $P_{aO_2}$  management is further coupled to cerebrovascular reserve issues previously discussed. Thus, a low  $P_{aO_2}$  that normally is tolerated through vasodilatation may not be so well tolerated if vasodilatory reserve is compromised by carotid occlusion, brain edema, or anemia.

Fiskum et al.<sup>49</sup> reported in laboratory studies that hyperoxic therapy promotes generation of free radicals and that such oxidative stress causes mitochondrial injury that acts to impair neurologic recovery. This notion from in vitro considerations is supported by in vivo studies in rodents and dogs that demonstrated worse neurologic outcome when hyperoxia was used before or after an ischemic insult.<sup>50-52</sup>

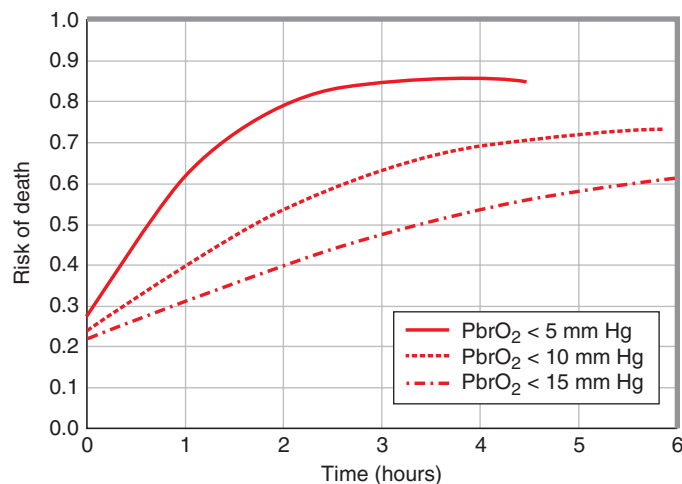
Conversely, with the advent of reports supporting the feasibility and reliability of brain tissue  $\text{PO}_2$  ( $\text{PbrO}_2$ ) monitoring, increased brain tissue oxygen monitoring data are accumulating that normoxic therapy, in the context of cerebral tissue hypoxia, may promote ischemic injury.<sup>53</sup> Many reports of nonrandomized retrospective and prospective series of both traumatic and SAH patients have described an association between  $\text{PbrO}_2 < 20\text{--}30$  mm Hg and worsened neurologic outcome (Fig. 87-3).<sup>53-58</sup> Notably, however, these studies did not examine for the effects of hyperoxia, which is the situation identified by Fiskum et al. Rather, these studies point out the value of avoiding tissue hypoxia, perhaps at the cost of systemic hyperoxia but not intracranial hyperoxia. However, one side observation from these studies is the effect of avoiding hyperoxia, as brain tissue oxygen monitoring allows the anesthesiologist to provide the minimal fraction of inspired oxygen ( $\text{FiO}_2$ ) that permits the optimal (not too high, not too low) brain tissue oxygen level.

Given these potentially conflicting therapeutic priorities, it seems that the most sensible approach at this time is as follows. If a  $\text{PbrO}_2$  monitor is available, adjust physiologic parameters to keep  $\text{PbrO}_2 > 20$  mm Hg. This may entail the use of  $\text{FiO}_2 > 60\%$  with concomitant risk of pulmonary oxygen toxicity.<sup>59</sup> It seems that this risk can be incurred for 1-2 days, but continued dependence on pulmonary toxic oxygen concentrations should produce a time-dependent increased pressure on caregivers to decrease  $\text{FiO}_2$ , even if this means use of higher airway pressure or allowing  $\text{PbrO}_2$  to decrease after a few days.

If a  $\text{PbrO}_2$  monitor is not available, the clinician must base therapy on assumptions about brain oxygenation. If many brain areas are believed to be well perfused and at risk for hyperoxia, then pulmonary management should aim for  $\text{PaO}_2$  just sufficient to produce arterial oxygen saturation ( $\text{SaO}_2$ )  $> 95\%$ . Conversely, if ICP is elevated and/or areas of brain are hypoperfused, then a reasonable empiric approach is use of  $\text{FiO}_2 = 0.60$ . This maximizes  $\text{PaO}_2$  and  $\text{PbrO}_2$  but is not associated with significant risk of acute pulmonary injury.

### Positive End-Expiratory Pressure

Positive end-expiratory pressure (PEEP) is a modality commonly used to control



**FIGURE 87-3.** Relative risk of death as related to initial low brain  $\text{PO}_2$  values categorized into groups  $< 5$ ,  $< 10$ , and  $< 15$  mm Hg. Characterization follows from layering the curves, where  $< 5$  worse  $< 10$  worse  $< 15$ . Note that the curves stabilize at long durations of hypoxia. (From van den Brink et al.<sup>54</sup> with permission.)

$\text{PaO}_2$ , and it is known to have important effects on ICP. The mechanism is cardiovascular and is discussed in greater detail in Cardiovascular Issues below.

## Ventilation

### $\text{Paco}_2$ Physiology

Arterial partial pressure of carbon dioxide ( $\text{Paco}_2$ ) is determined by the balance between carbon dioxide ( $\text{CO}_2$ ) production and elimination.  $\text{CO}_2$  production is determined by metabolic rate and respiratory quotient ( $\text{CO}_2$  production divided by  $\text{O}_2$  consumption) and ordinarily is 0.8. Factors that may increase  $\text{CO}_2$  production are hyperthyroidism, fever, elevated catecholamine levels, exercise, sepsis, and some pharmacologic stimulants. Respiratory quotient is affected by energy metabolism such that intake of calories in excess of needs results in lipogenesis, which is a  $\text{CO}_2$ -producing process that leads to more  $\text{CO}_2$  produced than oxygen consumed.<sup>60</sup>

$\text{CO}_2$  elimination is determined by minute ventilation and dead space. There is a linear relationship between minute ventilation and  $\text{Paco}_2$  such that a simple proportion can be described to predict the  $\text{Paco}_2$  that will result with a given change in minute ventilation. Dead space effects are more complex. There are two types of dead space: anatomic and physiologic. Anatomic dead space is the portion of the airways that does not participate in gas exchange because of no proximity to pulmonary capillaries. Structures include the mouth, trachea, bronchi, and other large airways. Notably, ana-

tomically dead space is roughly halved via endotracheal intubation and halved again by conversion from translaryngeal intubation to tracheostomy. Physiologic dead space is that portion of non-gas-exchanging ventilation that occurs in alveoli that are suboptimally perfused. Thus, physiologic dead space is increased by anything that increases the amount of gas in alveoli without commensurate increase in alveolar perfusion or by anything that may decrease perfusion to alveoli without commensurate decrease in ventilation. Physiologic situations associated with elevated physiologic dead space include use of PEEP in compliant lungs, pulmonary emboli, or shock. A more detailed overview of this physiology is given by West.<sup>60</sup>

In healthy brain, CBF varies linearly with  $\text{Paco}_2$  between approximately 20 and 60 mm Hg.<sup>61</sup> The mechanism of effect is believed to be related to the effects of  $\text{Paco}_2$  on the pH of cerebrospinal fluid.<sup>62</sup> Thus, patients who are chronically hypercapnic and sustain pH adjustment in the cerebrospinal fluid may not be hyperemic. These patients may be expected to sustain even more profound decreases in CBF with decrements in  $\text{Paco}_2$  to equivalent levels.

The  $\text{Paco}_2$ -mediated changes in CBF are generally without any neurologic consequences to health. However, in the context of head injury or other cause of ICP elevation, the effects can be profound, as the changes in CBF induce changes in intracranial blood volume. In the brain with little capaci-



tance for such a change in intracranial contents, the change in  $Paco_2$  can have a significant effect on ICP.

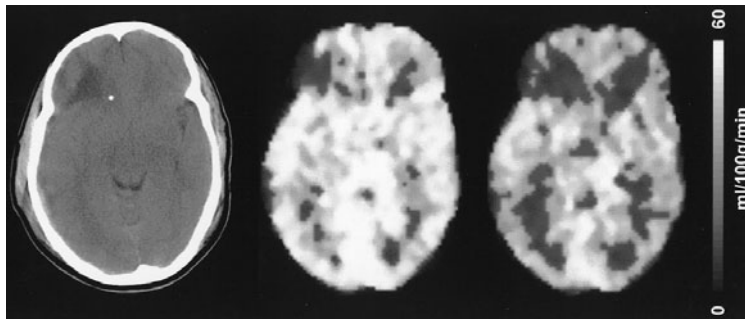
For many years, hyperventilation was embraced as the mainstay of treatment of intracranial hypertension.<sup>63</sup> However, such therapy was observed to produce significant cerebral oligemia with the lowered ICP, often developing from a low CBF baseline. Conversely, at times, elevated  $Paco_2$  in patients with brain injury was noted to produce both high ICP and high CBF, producing a therapeutic quandary.<sup>64</sup> Moreover, adding to the dilemma were observations from the basic science literature of some neuroprotective side effects associated with hypercapnic cerebral acidosis (Fig. 87-4).<sup>65</sup>

### Optimal $Paco_2$

Relatively recent studies debunked the previously accepted verity that hyperventilation is an automatic element in the treatment of head injury. Muizelaar et al.<sup>66</sup> performed a prospective randomized study of the efficacy of hyperventilation in traumatic brain injury. Their outcome data showed a persuasively negative effect of hyperventilation, such that hyperventilation has been abandoned as a routine therapy in traumatic brain injury (Fig. 87-5). However, it still is accepted in some situations. Some authors suggest that brain oxygen monitoring by either jugular oximetry or tissue  $PbrO_2$  can be used to guide the use of hyperventilation.<sup>67</sup> Direct CBF measuring techniques also could be used. Notably, such information can allow the clinician to identify if the patient has an element of hyperemia contributing to the elevated ICP—a situation that logically seems appropriate for hyperventilation therapy, although this notion has not undergone rigorous study.

### Temperature

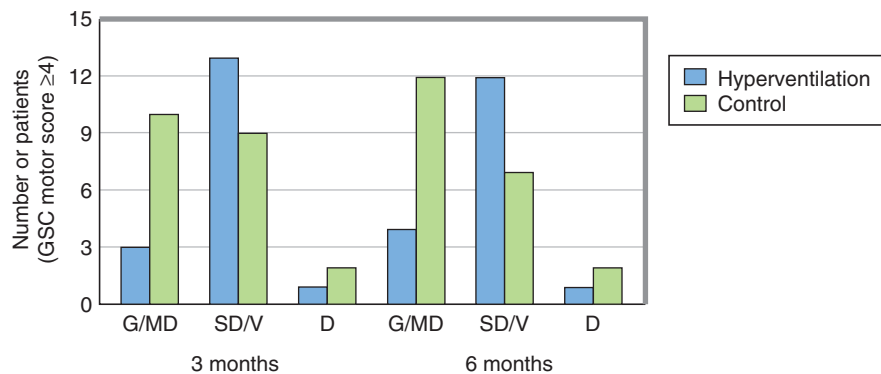
Temperature has a profound effect on the brain. Fever is convincingly associated with worsened outcomes, with greater release and toxicity of neurotoxic amino acids, mismatch between flow and metabolism, oxidative stress, and many other likely unknown processes.<sup>68,69</sup> In normal brain, hypothermia produces a 7% reduction in cerebral metabolic rate for oxygen with every 1 °C reduction in brain temperature, thus decreasing consumption of energy metabolites and increasing the time until a hypoxic stress leads to high-energy phosphate depletion and



**FIGURE 87-4.** Effect of hyperventilation on the burden of hypoperfusion. Radiographic computed tomography (left) and gray scale positron emission tomographic imaging of cerebral blood flow obtained from a 31-year-old man 7 days after injury at relative normocapnia (middle),  $Paco_2$  35 torr (4.7 kPa), and hypocapnia (right) 26 torr (3.5 kPa). Voxels with cerebral blood flow  $< 10$  mL/100 g/min are shaded in black. Note right frontal contusion and small parietal subdural hematoma. Baseline intracranial pressure (ICP) was 21 mm Hg, and baseline cerebral perfusion pressure (CPP) was 74 mm Hg. Baseline jugular venous oxygen saturation ( $SjvO_2$ ) values of 70% and arteriovenous oxygen content difference (AVDO<sub>2</sub>) of 3.7 mL/dL are consistent with hyperemia and support the use of hyperventilation for ICP control. Hyperventilation resulted in decrease of ICP to 17 mm Hg and increase of CPP to 76 mm Hg, with maintenance of  $SjvO_2$  and AVDO<sub>2</sub> within desirable ranges (58% and 5.5 mL/dL, respectively). However, despite these values of  $SjvO_2$  and AVDO<sub>2</sub>, baseline critically hypoperfused brain volume was 141 mL and increased to 428 mL with hyperventilation. These increases were observed in both perilesional and normal regions of brain tissue. (From Coles et al.<sup>64</sup> with permission.)

thus increasing the time that the hypoxia can be tolerated.<sup>70</sup> This reduction in cerebral metabolic rate for oxygen cannot explain the neuroprotective effect of mild hypothermia, which must result from the synergism of many physicochemical mechanisms. If the neuroprotective efficacy of hypothermia is compared with that produced by an anesthetic producing an equivalent decrement in cerebral metabolic rate, greater protection by hypothermia is always observed. This is believed to be somehow related to the differential effects of hypothermia and anesthetics on the compartments of brain energy metabolism.<sup>72</sup> Anesthetics decrease metabolic processes related to the work of the neuron—that is, neu-

rotransmitter synthesis and metabolism—whereas hypothermia also affects the compartment responsible for constitutive activities of the cell such as membrane integrity and ionic concentration homeostasis. In addition, other biochemical processes contribute to hypothermic protection. For example, with mild hypothermia, the release of neurotoxic dicarboxylic amino acids such as glutamate and aspartate is blunted substantially.<sup>73</sup> Thus, it is not surprising that countless case reports and basic science studies show the neuroprotective potential of hypothermia across a broad range of neurologic insults. Of interest, clinical studies do not uniformly show comparable efficacy.



**FIGURE 87-5.** Head trauma patients were randomized to receive hyperventilation or normoventilation. Outcome was worse in hyperventilated patients. Outcomes: G, good; MD, moderate disability; SD, severe disability; V, vegetative; D, dead. (Data from Muizelaar J, Marmarou A, Ward J, et al. Adverse effects of prolonged hyperventilation in patients with severe head injury: a randomized clinical trial. *J Neurosurg* 1991;75:731.<sup>66</sup>)



Hypothermia has been studied and clinically used for much of the 20th century. This interest arose from anecdotes describing miraculous recovery from drowning and other brain ischemia situations in cold environments. For many years, deep hypothermic conditions have been used for neuroprotection during cardiac surgery and during therapeutically induced deep hypothermic cardiac arrest for a variety of procedures.<sup>74,75</sup> At less extreme levels, hypothermia has been reported to be neuroprotective, although not uniformly so in recent studies. This discussion focuses on moderate hypothermia [86–93°F (30–34°C)].

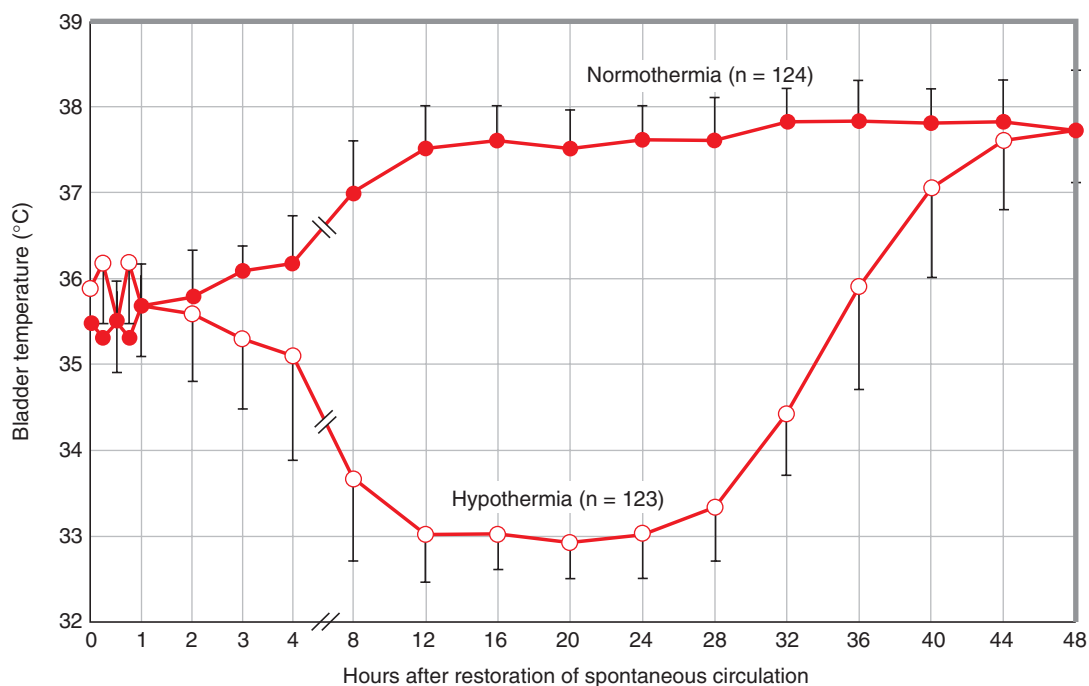
There are many reports of neuroprotection with hypothermia in traumatic brain injury. However, all these reports are single-institution studies. When hypothermia was examined in multiinstitutional studies, protection could not be demonstrated.<sup>76</sup> However, a study by Clifton et al. reported neuroprotection if the patient arrived already hypothermic, and rapid rewarming may have contributed to some of the negative findings.<sup>77,78</sup> This finding supports the notion that speed of induction and suspension of hypothermia may not have been uniformly applied across the participating institutions in the multiinstitutional stud-

ies. Clifton et al.<sup>78</sup> make a persuasive argument in this regard, asserting that significant degradation of the signal-to-noise ratio may have made detection of hypothermic neuroprotection very difficult. The factors contributing to this argument, which they documented, are the extensive practice variations that occur across the United States in the approach to management of head trauma, many of which likely affect outcome, and differences in admission temperature. This latter factor may have important geographic and climactic origins. Moreover, with respect to the hypothermia itself, rapid and safe induction of hypothermia requires an attentive multidisciplinary approach. Hypothermia is associated with coagulopathy, immune suppression, and worse pneumonia, among other factors.

Induction of moderate hypothermia [82–90°F (28°–32°C)] before cardiac arrest has been used successfully since the 1950s to protect the brain against the global ischemia that occurs during some open-heart surgeries. Data from Cheung et al.<sup>79</sup> provide biochemical support for this method, with a safe limit for deep hypothermic arrest identified at approximately 30 minutes neurophysiologically. In other unpublished studies at the University of Pennsylvania, Cheung's

group further correlated this 30-minute time limit for deep hypothermic arrest with retrograde perfusion of the brain between evoked potentials and biomarkers for brain injury taken from blood flowing from the ischemic human brain. Induction of hypothermia after return of spontaneous circulation after cardiac arrest has been associated with improved functional recovery and reduced cerebral histologic deficits in various animal models of cardiac arrest.<sup>80–83</sup> These and similar studies led to concurrent publication in the *New England Journal of Medicine* of two studies showing a neuroprotective effect of moderate hypothermia applied to patients sustaining out-of-hospital cardiac arrest.<sup>84,85</sup> These patients sustained a return of spontaneous circulation but on initial examination were not responsive and thus were randomized to the protocol. The protection was found with the target hypothermic temperature successfully achieved up to 6 hours after the return of spontaneous circulation (Fig. 87-6). A summary of these two studies is given in Table 87-3.

On the basis of published evidence, the Advanced Life Support (ALS) Task Force of the International Liaison Committee on Resuscitation (ILCOR) made the following recommendations in October 2002<sup>86</sup>:



**FIGURE 87-6.** Time course for temperature in control and hypothermic patients after cardiac arrest. (From Group HaCAS. Mild therapeutic hypothermia to improve the neurological outcome after cardiac arrest. *NEJM* 2002;346:549–56. Copyright 2002, Massachusetts Medical Society. All rights reserved.)

- “Unconscious adult patients with spontaneous circulation after out-of-hospital cardiac arrest should be cooled to 32°C to 34°C for 12 to 24 hours when the initial rhythm was ventricular fibrillation (VF).”
- Such cooling may also be beneficial for other rhythms or in-hospital cardiac arrest.”

Although these data supporting the use of hypothermia after global brain ischemia in various contexts seem compelling, some potential issues must be considered when applying these observations to the perioperative situation. These studies were highly selective in their entry criteria. Thus, up to 92% of cardiac arrests were excluded. Moreover, the two studies were not blinded, a practice that is believed to be essential to such investigations but clearly impossible for this specific therapy. In addition, Darby<sup>87</sup> suggests that nonuniform neurologic entry criteria were used. There has been some doubt as to whether these studies investigated normothermia or simply prevention of fever, as the normothermia group had an increase in core temperature of up to 38°C, as is often seen after cardiac arrest. Also important to note is that the therapy is not trivial to implement and is associated with some morbidity. Hypothermia was associated with higher systemic vascular resistance, lower cardiac output, and higher blood glucose level. Twenty-two percent of hypothermic patients had complications, especially pneumonia, although statistical significance was not achieved.

One controversial issue is whether findings from animal experiments and published clinical studies are sufficient to extend the use of therapeutic mild hypothermia to patients who remain comatose after cardiac arrest from any rhythm, after in-hospital or perioperative cardiac arrest, and after cardiac arrest in children. Moreover, many perioperative cardiac arrests have noncardiac causes (e.g., bleeding, anesthesia). Because the use of therapeutic hypothermia has not been studied to a significant extent in this population, its relative risks and benefits are unknown. Kofke<sup>88</sup> suggests that, in cases like this, the value of the benefit—preservation of neural function—is so important as to merit the risk due to uncertainty. Further research is needed to determine optimal

TABLE 87-3.

Summary of Post-Cardiac Arrest Hypothermia Studies

Study	Europe <sup>164</sup>		Australia <sup>165</sup>	
	Cold	Warm	Cold	Warm
Percent dead	41	55	51	68
Percent good neurological outcome	55	39	49	26
Time of assessment	6 months		Discharge	
N	136	137	43	34
Target temperature (°C)	32–34	Normal	33	
How cooled/warmed	Custom cold air mattress; ice	Nothing	Cold packs	
Time to target temperature (h)	4		2	
Duration of cold (h)	24		12	
Mode of rewarm	Passive		Active at 18 h	

duration of therapeutic hypothermia, optimum target temperature, and rates of cooling and rewarming. Animal data suggest that the sooner cooling is initiated after reperfusion from cardiac arrest, the better the outcome, although an impressive therapeutic benefit was seen in clinical studies when cooling was delayed for several hours. One important finding from these studies in traumatic brain injury work is that normothermia should be restored only slowly because rebound hyperthermia is common and should be avoided.

Focal ischemia can be categorized as temporary or permanent. Temporary ischemia occurs often during aneurysm clipping surgery when a large cerebral artery may be temporarily occluded to facilitate clipping of the aneurysm. Typically, this lasts only a few minutes but occasionally lasts more than 15 minutes and risks the development of ischemic injury. Ample animal data support the potential value of hypothermia in this context and are the reason why most neuroanesthesiologists in the United States routinely used hypothermia prophylactically in patients undergoing cerebral aneurysm clipping until 2005.<sup>89–91</sup> At that time, the Intraoperative Hypothermia for Aneurysm Surgery Trial (IHAST), another multiinstitutional study of >1000 patients randomized to moderate hypothermia or normothermia, was unable to detect a difference in either stroke rate or cognitive deficits.<sup>92</sup> Thus, moderate hypothermia for this clinical context has been largely abandoned.

However, one critique is that IHAST, by examining all aneurysm patients without measuring the degree of intraoperative ischemia, similar to some of the issues with the traumatic brain study by Clifton et al.,<sup>78</sup> also may have a signal-to-noise problem. Only a small subset of the study group may have actually had a risk of stroke-inducing ischemia. Arguing against this was the scrupulous oversight given to the physiologic support of all the patients at the various sites and the power analysis that was performed on the pilot data patients who presumably were reflective of the entire group. Notably, the pilot data came from a single-institution study that showed a protective effect.<sup>93</sup> Nonetheless, this negative study supports the practice of not using moderate hypothermia in unselected cases.

Therefore, in my opinion, left unresolved is whether hypothermia is useful in a case that is expected to be complex with a high likelihood of significant focal ischemia and whether rapid induction of moderate hypothermia could be of value in the patient in whom significant focal ischemia is actively occurring. I believe that a neuroprotective effect in this situation may have been missed in IHAST. Taking into account the many neuroprotective animal studies and the possible therapeutic gain versus expected outcome and risks of the intervention, this seems a reasonable approach in cases where temporary focal ischemia is believed to be very likely.<sup>88</sup>

Fever is the opposite situation that has been convincingly associated with

exacerbation of neurologic outcome in the injured brain in both animal and clinical studies. Many neuro-ICU patients have recurrent problems with significant fever  $>102^{\circ}\text{F}$  ( $>39^{\circ}\text{C}$ ) in the absence of identifiable sepsis. In a prospective quantification of 428 consecutive patients admitted to the neurovascular or neurotrauma ICU, 46.7% of patients had at least one febrile episode.<sup>94</sup> This most likely is a sequela of the neurologic process believed by one group of authors to sometimes reflect autonomic dysfunction<sup>95</sup> induced by the neurologic injury.<sup>96</sup> SAH is an independent risk factor for development of fever without identifiable cause.<sup>97</sup> The notion that fever kills neurons is gaining widespread acceptance and is based on many clinical studies that show improvement in neurologic outcome associated with fever prevention.

The mortality rate in patients who had hyperthermia within the first 72 hours after stroke was 15.8% versus 1% in patients who were normothermic during that time. Hyperthermia that occurred within the first 24 hours after stroke—without respect to infectious or noninfectious origin—was independently related to larger infarct volume and worse neurologic deficits and dependency 3 months after injury.<sup>98</sup> Azzimondi et al.<sup>99</sup> reported that a fever  $\geq 100.2^{\circ}\text{F}$  ( $\geq 37.9^{\circ}\text{C}$ ) proved to be an independent risk factor predicting a worse outcome, and patients with high fever were far more likely to die within the first 10 days than those with lower temperatures. A prospective study by Reith et al.<sup>100</sup> of 390 consecutive cases of acute stroke classified patients into three admission-temperature groups: hypothermic ( $\leq 97.7^{\circ}\text{F}$  [ $36.5^{\circ}\text{C}$ ]), normothermic ( $97.9\text{--}99.5^{\circ}\text{F}$  [ $36.6\text{--}37.5^{\circ}\text{C}$ ]), and hyperthermic ( $>99.5^{\circ}\text{F}$  [ $>37.5^{\circ}\text{C}$ ]). They showed that admission body temperature was highly correlated with initial stroke severity, infarct size, mortality rate, and poor outcome. For a  $1^{\circ}\text{C}$  difference in body temperature, the relative risk of poor outcome was more than doubled. This finding was supported by Ginsberg and Busto,<sup>101</sup> who reported that fever that occurs soon after the development of stroke in patients is most strongly associated with poor outcome. Body temperature was significantly higher in patients who died within 3 days after admission compared with the rest of the study population. Moreover, in ICH patients

who survived the first 72 hours after hospital admission, the duration of fever is associated with poor outcome and seems to be a prognostic factor in these patients.<sup>102</sup> In SAH, fever is associated with vasospasm and poor outcome independent of hemorrhage severity or presence of infection.

Pharmacologic methods can be used to control fever. Drugs include acetaminophen<sup>103</sup> and ibuprofen,<sup>104</sup> although some evidence suggests that ibuprofen is not efficacious in the context of ischemic stroke.<sup>105</sup> The value of acetaminophen can be limited by its hepatotoxicity and the theoretic concern that acetaminophen is an oxidizing agent that, even at subhepatotoxic levels, may decrease glutathione, lessening potentially helpful free radical scavenging processes.<sup>106</sup> Ibuprofen is associated with gastric ulceration and bleeding.<sup>107</sup>

An alternate method is use of a hypothermia blanket or indwelling hypothermia catheters.<sup>108</sup> Both techniques are based on a servocontrolled system in which the cooling bath temperature decreases when the patient temperature starts to increase. In our neuro ICU, we have generated temperature curves indicating that it is possible to virtually eliminate fever from the pathophysiology of severe brain injury. Notably, this has produced a new vital sign,  $T_{\text{bathmin}}$ , which indicates the minimum bath temperature needed to prevent fever in a given patient. Ascertaining  $T_{\text{bathmin}}$  indicates the need to commence an investigation for the presence of infection.

### Glycemic Control

Hyperglycemia has been associated with exacerbation of brain damage with both head trauma and cerebral ischemia.<sup>109–112</sup> However, the issue is not straightforward. Clearly, neuronal damage after global cerebral ischemia is exacerbated by hyperglycemia.<sup>110,113–116</sup> Some studies suggest that a blood glucose level  $>120\text{ mg}\%$  in stroke patients is deleterious.<sup>109</sup> However, subsequent studies suggest a threshold of approximately  $180\text{ mg}\%$  in subhuman primates subjected to global ischemia.<sup>116</sup> Clearly, a blood glucose level  $>400\text{ mg}\%$  causes striking worsening of neurologic outcome with global ischemia.<sup>110,115</sup> Moreover, the general critical care literature supports prevention of hyperglycemia based on overall mortality, with a sug-

gested goal of  $120\text{ mg}\%$ .<sup>108,117</sup> This is such a tight control that some worry of diminishing returns due to hypoglycemic complications.<sup>118</sup>

With focal cerebral ischemia, the issue of hyperglycemia is much less clear. Animal and human studies have shown that brain damage is worsened, not affected, or improved with hyperglycemia.<sup>109,119–136</sup> One study of rats by Prado et al.<sup>133</sup> suggests that the discriminating factor in whether brain damage is worsened with hyperglycemia is the presence of collateral flow. Areas of the brain with minimal collaterals were not affected or were improved with hyperglycemia. Brain areas with a continued trickle of flow sustained worsened brain damage. Presumably, the continued substrate supply in oligemic (not ischemic) areas allowed greater accumulation of organic acids in the cells, leading to worsening of brain damage.<sup>111,124</sup> However, these observations are difficult to apply clinically to patients with focal ischemia.

Even if low levels of hyperglycemia were deleterious, the treatment is not straightforward. Aggressive therapy of hyperglycemia imposes a risk of hypoglycemia, which causes deleterious effects.<sup>118</sup> Thus, given the data in the general critical care literature, it seems that a reasonable approach is to aim for a blood glucose level of approximately  $120\text{--}150\text{ mg}\%$  in all acutely ill hyperglycemic patients at risk for cerebral ischemia but to be less stringent in blood glucose control, perhaps aiming for  $150\text{--}180\text{ mg}\%$  in less acutely ill patients who are expected to be in the ICU for  $<3$  days. In any event, blood glucose levels should not be allowed to undergo wide variations; that is, swing between  $<80\text{ mg}\%$  or  $>400\text{ mg}\%$ . Thus, an insulin infusion with frequent glucose assessment should be used in acutely ill patients at risk for cerebral anaerobic metabolism who develop hyperglycemia  $>150\text{ mg}\%$ , with the infusion titrated to keep blood glucose at approximately  $120\text{--}150\text{ mg}\%$ . Once the hyperacute phase has resolved, the intensity of glucose monitoring can be lessened to match the lowered acuity such that a sliding scale insulin paradigm can be used, and somewhat less stringent goals can be used as the patient is readied for discharge from the ICU setting.

Hyperglycemia has not been shown to have deleterious or protective ef-

fects in two animal models of status epilepticus.<sup>137,138</sup> The model used in the report by Swan et al.<sup>138</sup> produced limbic system damage, whereas the report by Kofke et al.<sup>137</sup> used a model that produced substantia nigra damage. Nigral damage in this model is associated with hypermetabolic lactic acidosis,<sup>139</sup> which should be exacerbated with hyperglycemia. The fact that nigral damage was not exacerbated with hyperglycemia suggests that metabolic acidosis may not be an important factor in the development of brain damage after seizure or that the lactic acidosis associated with hyperglycemic exacerbation of ischemic brain damage is not the true pathogenetic culprit but rather is an epiphenomenon.

## Cardiovascular Issues

### **Blood Pressure Effects on ICP—Plateau Waves and Determination of Blood Pressure Optimum**

In 1960, Lundberg<sup>140</sup> monitored ICP in hundreds of patients, identifying characteristic pressure waves. One of these waves has been identified as a plateau wave and is known to be associated with increased cerebral blood volume (CBV).<sup>141</sup> Plateau waves occur when the ICP abruptly increases to nearly systemic levels for approximately 15–30 minutes, occasionally accompanied by neurologic deterioration. Rosner and Becker<sup>142</sup> provided data, and a synthesis of the data that convincingly suggests that intracranial blood volume dysautoregulation is responsible for plateau waves. They induced mild head trauma in cats and subsequently intensively monitored the animals after the insult. With normal fluctuations in blood pressure while in the normal range, they observed that mild blood pressure decrements to approximately 70–80 mm Hg preceded the development of plateau waves. CBV in normally autoregulating brain tissue increases due to vasodilatation with decreasing blood pressure, and the increase in CBV is nonlinear. CBV increases exponentially as blood pressure decreases to <80 mm Hg.<sup>143</sup> A small decrease in blood pressure, although in the normotensive range, produces exponential increases in CBV in the setting of abnormal intracranial compliance, with ICP at the elbow of the ICP–intracranial volume relation. Thus, a small decrease in blood pressure introduces an exponential CBV change on an expo-

ponential ICP relation such that ICP increases abruptly and significantly. Plateau waves spontaneously resolve with a hypertensive response or with hyperventilation that acts to oppose the increase in CBV. Clearly, development of a plateau wave requires a portion of the brain with normally reactive vasculature in the setting of other brain areas with a mass effect and elevated ICP—a situation of heterogeneous autoregulation. In addition to preventing and treating plateau waves, maintaining MAP in the range from 80–100 mm Hg in patients with high ICP probably is important.

Conversely, hypertension also can increase ICP. Within the normal autoregulatory range and normal ICP, changes in blood pressure have no effect on ICP. However, with brain injury and associated vasoparalysis, blood pressure increases mechanically producing cerebral vasodilatation to increase ICP.<sup>144</sup>

Notably, the Lund group suggests that hypertension-induced exacerbation of brain edema increases ICP.<sup>145</sup> The increase in ICP occludes venous outflow, increasing venous pressure, which in turn worsens the brain edema, constituting a positive feedback cycle initially started by arterial hypertension.<sup>145</sup> Thus it appears that both increasing and decreasing blood pressure can increase ICP, suggesting the presence of a CPP optimum for ICP. In the absence of any patient-specific physiologic information, the value probably is 80–100 mm Hg, although this value has not been definitively determined experimentally. These considerations underlie a current controversy with respect to blood pressure management in the context of elevated ICP. One argument is that blood pressure should be maintained at a high level to ensure adequate CBF and minimize the probability of plateau waves. The contrary argument is for ample fluids and low blood pressure to promote CBF primarily rather than pressure. In my opinion, the preferred approach is to induce the lowest blood pressure that allows sufficient CBF as indicated by repeated (preferably bedside) measurement. However, lacking such technology, it seems best to aim for CPP of approximately 80 mm Hg.

### **Blood Pressure Management**

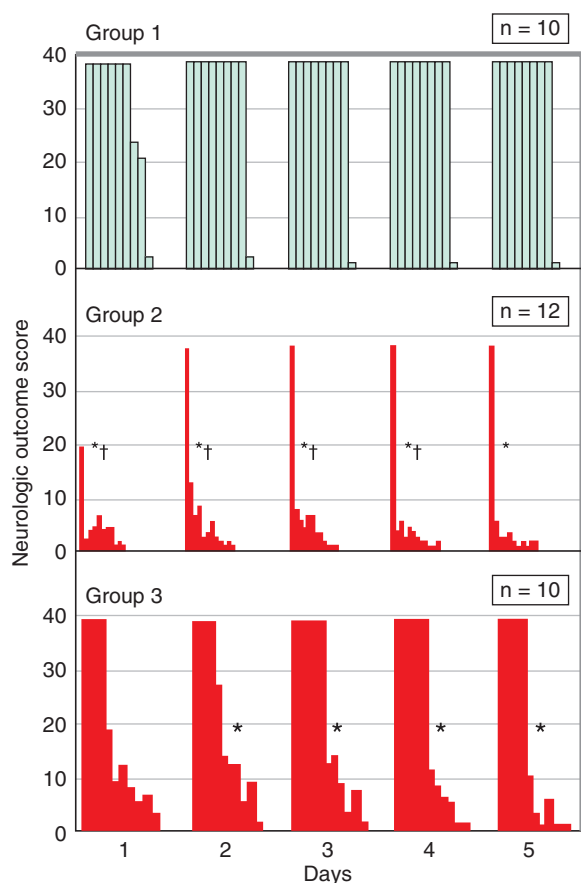
Blood pressure management is an important issue in most neuro-ICU pa-

tients. Concern exists that systemic hypertension may exacerbate cerebral edema or intracranial hemorrhage or have deleterious cardiopulmonary effects, such as pulmonary edema or myocardial ischemia. Conversely, blood pressure decreases can lead to insufficient perfusion even at pressures in the normal range of autoregulation. Moreover, mild blood pressure decreases have been implicated in the genesis of plateau waves. Several important principles apply to management of blood pressure in neuro ICU patients.

**Hypertension** When blood pressure is high, a central question that must be addressed initially is whether the pressure is elevated as a result of normal homeostatic mechanisms to maintain adequate perfusion. For example, with conditions of inadequate brainstem perfusion, a compensatory hyperadrenergic state may occur, resulting in increased blood pressure and thus maintaining sufficient perfusion to maintain aerobic metabolism in the brainstem. If a decision is made to decrease blood pressure, then brainstem failure and death may ensue.

Animal data from cerebral ischemia models strongly support the notion that sympatholytic drugs should be used to decrease blood pressure if cerebral ischemia is a possibility. Compared with hemorrhagic-induced hypotension, ischemic damage was decreased with ganglionic blockade with hexamethonium,<sup>36</sup> central adrenergic blockade with  $\alpha_2$ -agonists,<sup>146</sup> and angiotensin-converting enzyme inhibitors.<sup>38</sup> Hemorrhaged controls were noted to sustain an increase in exogenous catecholamine concentrations. To test the hypothesis that these catecholamines contributed to brain damage, some of the animals treated with hexamethonium also received IV catecholamine infusions. Reversal of the hexamethonium brain protective effect was observed in these animals (Fig. 87–7).<sup>36</sup> Similarly, brain protection has been observed in laboratory studies with preischemic<sup>147</sup> and pre-seizure<sup>148</sup> treatment with reserpine, a drug that depletes presynaptic catecholamine stores. In a report by Neil-Dwyer et al.,<sup>149</sup> SAH patients received therapy with phentolamine/propranolol compared with no sympatholytic therapy (Fig. 87–8). Subjects who received sympatholytic therapy had significantly better neurologic

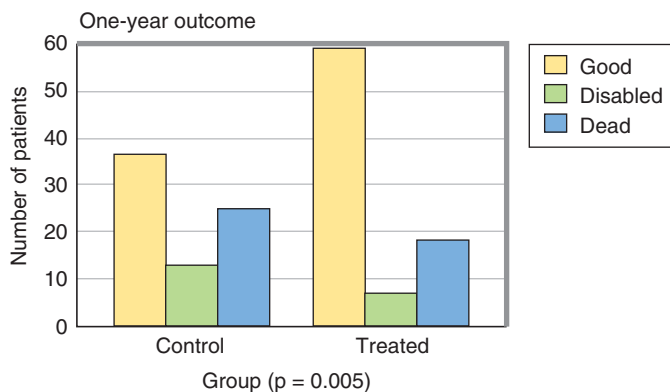




**FIGURE 87-7.** Neurologic deficit scores after incomplete focal cerebral ischemia in rats over a 5-day examination period. Each bar represents the neurologic score for each rat. \* $P < 0.05$  vs group 1; † $P < 0.05$  vs group 3. Rats are ranked according to total outcome score in descending order (0 = normal). Cerebral ischemia was induced with occlusion of one carotid artery with hemorrhagic hypotension. Group 1 rats received no vasoactive drugs; group 2 rats received preischemic hexamethonium; group 3 rats received hexamethonium plus intravenous epinephrine and norepinephrine. Protection was conferred by hexamethonium in a catecholamine-reversible manner. (From Werner et al.<sup>35</sup> with permission.)

outcome than did controls. In addition,  $\beta$ -adrenergic blocking drugs have not been reported to produce cerebral vasodilatation or increase ICP.<sup>150-152</sup>

Calcium channel antagonist drugs, which may have brain protective effects, also are available for antihypertensive therapy. Nimodipine and ni-



**FIGURE 87-8.** Subarachnoid hemorrhage patients were randomly treated with propranolol or placebo. Neurologic outcome was better in patients receiving  $\beta$ -blockade. Graph generated from data of Neil-Dwyer et al.<sup>149</sup> (Reprinted from Kofke WA. *Critical Neuropathophysiology*. In: Fink MP, Abraham E, Vincent J-L, et al., eds. *Textbook of Critical Care*, 5th ed. Philadelphia: Elsevier, 2005: 285, with permission from Elsevier.)

cardipine, developed specifically for brain protection purposes, have been assessed in numerous studies, with several reports of their conferring protection against vasospasm and ischemic brain damage.<sup>153-159</sup> Thus, they have become reasonable choices for use as antihypertensive drugs based solely on these observations. They are vasodilators and can modestly increase ICP.<sup>160,161</sup> As vasodilators, they may be expected to produce compensatory catecholamine release, which, based on the previous discussion, may obviate some of their protective qualities.<sup>162</sup> Moreover, nimodipine has been observed to decrease  $PbrO_2$ .<sup>163</sup> Whether this phenomenon can alter outcome is not known.

Peripheral vasodilators (e.g., nitroprusside, nitroglycerin, and hydralazine) have the potential to induce cerebral vasodilatation and thus cause hyperemic intracranial hypertension.<sup>164-167</sup> Moreover, they are associated with compensatory increases in peripheral catecholamines and rennin,<sup>162</sup> factors that theoretically may worsen ischemic brain damage.<sup>36,147</sup> However, the lack of bradycardia and bronchoconstriction associated with their use may make them the optimal choice in some patients with these conditions. If such a drug is chosen and the patient is at risk for neurologic deterioration from ischemia or high ICP, close clinical observation is indicated. Any deterioration mandates discontinuation of the drug. Such concerns are important in deciding from among these three drugs. Although hydralazine is convenient to use, it cannot be reversed at the receptor, and its effects can last hours. Thus, nitroprusside may be preferable in such situations, because adverse effects can be treated quickly simply by discontinuing the infusion. It should be clear that the choice of antihypertensive agent in a patient at risk for cerebral ischemia is not straightforward. Therapeutic urgency, sympatholytic and brain protective side effects, and potential to increase ICP all are important considerations in the choice of antihypertensive drug.

If blood pressure must be decreased very quickly (i.e., within minutes), 100- to 500- $\mu$ g boluses of nicardipine are very effective and safely titratable. Once the blood pressure is reduced, a maintenance regimen of nicardipine or another drug can be started. Alternatively, sodium nitroprusside can be

started. However, nitroprusside has a variety of deleterious side effects (discussed above) that decrease its desirability as an antihypertensive agent in a neurologic patient. However, nitroprusside perhaps is the most potent and reliable antihypertensive drug available.

Plateau waves, which were first reported by Lundberg,<sup>140</sup> are associated with neurologic deterioration and were demonstrated by Risberg et al.<sup>141</sup> to be associated with cerebral vasodilatation. Rosner and Becker<sup>142</sup> reported that mild decreases in blood pressure to the range from 60–80 mm Hg can be associated with plateau waves. Presumably, the decrease in blood pressure prompts vasodilatation in normally autoregulating tissue. The increase in CBV, which is an exponential function versus CPP superimposed on the exponential ICP versus intracranial volume relationship, then is associated with an explosive hyperemic increase in ICP—a plateau wave.<sup>142</sup> This introduces concern with use of any antihypertensive agent (aside from specific, direct cerebrovascular effects) that normal autoregulation may also increase ICP as CPP decreases to approximately 80 mm Hg or less.

Clearly, whenever hypotensive therapy is used in a patient with altered intracranial compliance, edema, or ischemia, close and recurrent observation of the patient is mandatory. Deterioration should prompt consideration of one of the processes that occurs with corrective therapy and reconsideration of the need to decrease blood pressure.

**Hypotension and Induced Hypertension** In hypotensive patients, low blood pressure should be treated and ongoing efforts made to ascertain the cause of the hypotension. In head trauma patients, consideration must be given to other injuries with hemorrhage or spinal shock. Loss of blood flow to the brainstem can be associated with hypotension, which can be difficult to treat. The usual nonneurologic causes of hypotension in an ICU, such as pneumothorax, sepsis, and cardiogenic causes, also should be considered.

The need for therapy to increase blood pressure, as in the case of vasospasm, must be seriously contemplated. Excessive increases in blood pressure can exacerbate cerebral edema.<sup>168–172</sup> This presumably occurs in brain areas with dysautoregulation and blood brain

barrier (BBB) disruption, such that increasing the blood pressure, rather than producing vasoconstriction and no change in regional CBF, causes vascular distension, increased regional CBF, and transudation of fluid across the damaged BBB. In addition, increases in blood pressure risk producing or exacerbating intracranial hemorrhage.

Catecholamines used to increase blood pressure are neurotransmitters or are chemically similar to neurotransmitters. Thus, if catecholamines cross the BBB, neural effects arising secondary to their use are expected. Normally, exogenously administered catecholamines do not cross the BBB and have no effect on CBF and metabolism.<sup>173</sup> However, it has been demonstrated that catecholamine infusion in the presence of BBB disruption leads to increased blood flow and metabolism.<sup>174</sup> In SAH patients, catecholamine infusions produce a variety of disparate and unpredictable effects on CBF,<sup>175</sup> and adrenergic blockade confers neurologic protection.<sup>149</sup> Finally, catecholamines have direct neurotoxic potential, as indicated by data showing neurotoxicity with application directly to the cortex *in vivo*.<sup>176</sup> However, catecholamines are the only clinically accepted routine pharmacologic means for increasing blood pressure in neuro-ICU patients.

Increasing preload to the heart is one nonpharmacologic method for increasing blood pressure. Crystalloid or colloid infusion is generally associated with hemodilution, and the effects on the patient's status should be considered when use of this method is contemplated. Hemodilution may improve flow to areas with compromised microcirculation. However, it may be associated with increased CBV and hyperemic intracranial hypertension if hematocrit decreases excessively with compensatory vasodilatation.

Whether to use crystalloid or colloid for this purpose remains controversial. The BBB is functionally an osmometer,<sup>177–182</sup> so the added trivial increase in osmolarity with colloid is not a sufficient reason to use colloid. A sensible approach supported by animal studies is use of isoosmolar or slightly hyperosmolar fluids to decrease the possibility of increasing brain edema secondary to fluid administration.

Some advocate the use of induced systemic hypertension with high ICP to prevent plateau waves. As blood

pressure increases, incremental increases in vasoconstriction occur in normally reactive tissue to decrease CBV and thus ICP. However, the advantage of this therapy may be offset by increased edema in injured brain regions.

SAH is an entity particularly notable for catecholamine effects, some of which are described here. However, catecholamine effects also occur with other intracranial processes, including increased ICP, stroke, head trauma, and any conditions of compromised midbrain–hindbrain O<sub>2</sub> delivery. Serum catecholamine levels increase dramatically after SAH, notably peaking at the same time as the peak incidence of post-SAH vasospasm with symptom development corresponding to serum catecholamine levels.<sup>183–186</sup> This leads to the notion that hypothalamic injury with excess catecholamine release may be an important factor in the genesis of post-SAH spasm and stroke, observations that may be relevant to other intracranial processes previously elaborated.<sup>184</sup> Several lines of evidence further support this hypothesis:

- A. The cerebral vasculature is invested somewhat with adrenergic nerves. With SAH, the adrenergic receptors in cerebral vessels decrease in quantity.<sup>38,187</sup> This suggests that denervation hypersensitivity may be occurring such that the increase in humoral catecholamines with SAH produces spasm in hyperreactive vessels.
- B. Catecholamine release after SAH is sufficient to produce electrocardiographic changes<sup>147,183</sup> with ventricular wall-motion abnormalities<sup>148,176</sup> and myocardial injury.<sup>188,189</sup>
- C. Treatment with  $\beta$ - and  $\alpha$ -adrenergic antagonists of patients with SAH is associated with an improvement in neurologic outcome (Fig. 87–8)<sup>190</sup> and electrocardiographic abnormalities.<sup>148</sup>
- D. In animal models, selective destruction of hindbrain adrenergic nuclei with cephalad projections prevents the development of vasospasm.<sup>189</sup> Moreover, laboratory studies indicate an important role for vasopressin in vasospasm, as vasospasm cannot be produced in vasopressin-deficient rats.<sup>191</sup>
- E. Animal data with cerebral ischemia models provide strong support for the

notion that catecholamines can exacerbate cerebral ischemia. Compared with hemorrhage-induced hypotension, ischemic damage was decreased with hypotension induced through the use of ganglionic blockade with hexamethonium,<sup>192</sup> central adrenergic blockade with  $\alpha_2$ -agonists,<sup>193</sup> and angiotensin-converting enzyme inhibition.<sup>194</sup> Hemorrhaged controls were noted to sustain an increase in exogenous catecholamine concentrations. To test the hypothesis that these catecholamines contributed to brain damage, some of the animals treated with hexamethonium also received IV catecholamine infusions. Reversal of the hexamethonium brain protective effect was observed in these animals (Fig. 87-7).<sup>192</sup>

- F. Brain protection has been observed in laboratory studies with preischemic<sup>195</sup> and preseizure<sup>196</sup> treatment using reserpine, a drug that depletes presynaptic catecholamine stores.
- G. Application of catecholamines directly to nonischemic cortical tissue has been observed to have neurotoxic potential.<sup>197</sup> In addition, IV administration can exacerbate brain swelling after head trauma, although this most likely is a direct effect of blood pressure on a dysautoregulating brain (Fig. 87-8) rather than a manifestation of biochemical neurotoxicity.<sup>198</sup>

**PEEP and Intracranial Hypertension** PEEP can increase ICP.<sup>199</sup> Two mechanisms can be posited. The first is through impedance of cerebral venous return to increase cerebral venous pressure and ICP. The second is through decreased blood pressure and reflex increase in CBV to increase ICP. Data by Huseby et al.<sup>200</sup> suggest that cerebral venous effects occur only with very high PEEP.

Shapiro<sup>201</sup> demonstrated ICP increases in head-injured humans with intracranial hypertension upon application of PEEP. Examination of their data indicates that the most profound decreases in CPP occurred in patients with PEEP-induced decrements in MAP consistent with the notion put forth by Rosner and Becker<sup>142</sup> that decreases in blood pressure increase CBV to increase ICP. In studies of cats, Aidinis et al.<sup>202</sup> confirmed these observations in a more controlled setting. In addition, they assessed the role of pulmonary compliance and found that decreased pulmonary compliance with

oleic acid injections results in less of an effect of PEEP in increasing ICP. Such observations indicate that in situations where PEEP likely will be needed, often accompanied by decrements in pulmonary compliance, any adverse effects on ICP are less likely to be manifest. This may be related to observations that the hemodynamic effects of PEEP are less apparent with non-compliant lungs such that hypotensive-mediated increases in CBV do not occur.<sup>203</sup>

The intuitive notion that PEEP increases cerebral venous pressure to increase ICP is not as straightforward as some may indicate. For PEEP to increase cerebral venous pressure to levels that will increase ICP, the cerebral venous pressure must equal at least the ICP. Thus, the higher the ICP, the higher the PEEP needed to have such a direct hydraulic effect on ICP. This concept was nicely proven by Huseby et al.<sup>200</sup> in dog studies in which PEEP was increased progressively with different starting levels of ICP (Fig. 87-9). It is important to note that they prevented PEEP-induced decrements in blood pressure, thus avoiding any reflex increases in CBV. They suggested a hydraulic model to better conceptualize this process (Fig. 87-9). For example, if all of a 10-cm H<sub>2</sub>O PEEP application was transmitted to the cerebral vasculature, which is unlikely given the decreased pulmonary compliance associated with the need for such PEEP, then ICP is affected only if it is  $\leq$  10 cm H<sub>2</sub>O (7.7 mm Hg) and increases to a level no higher than the applied PEEP. Such observations are consistent with the notion that a Starling resistor regulates cerebral venous outflow.<sup>203</sup>

### Optimal Hgb Level

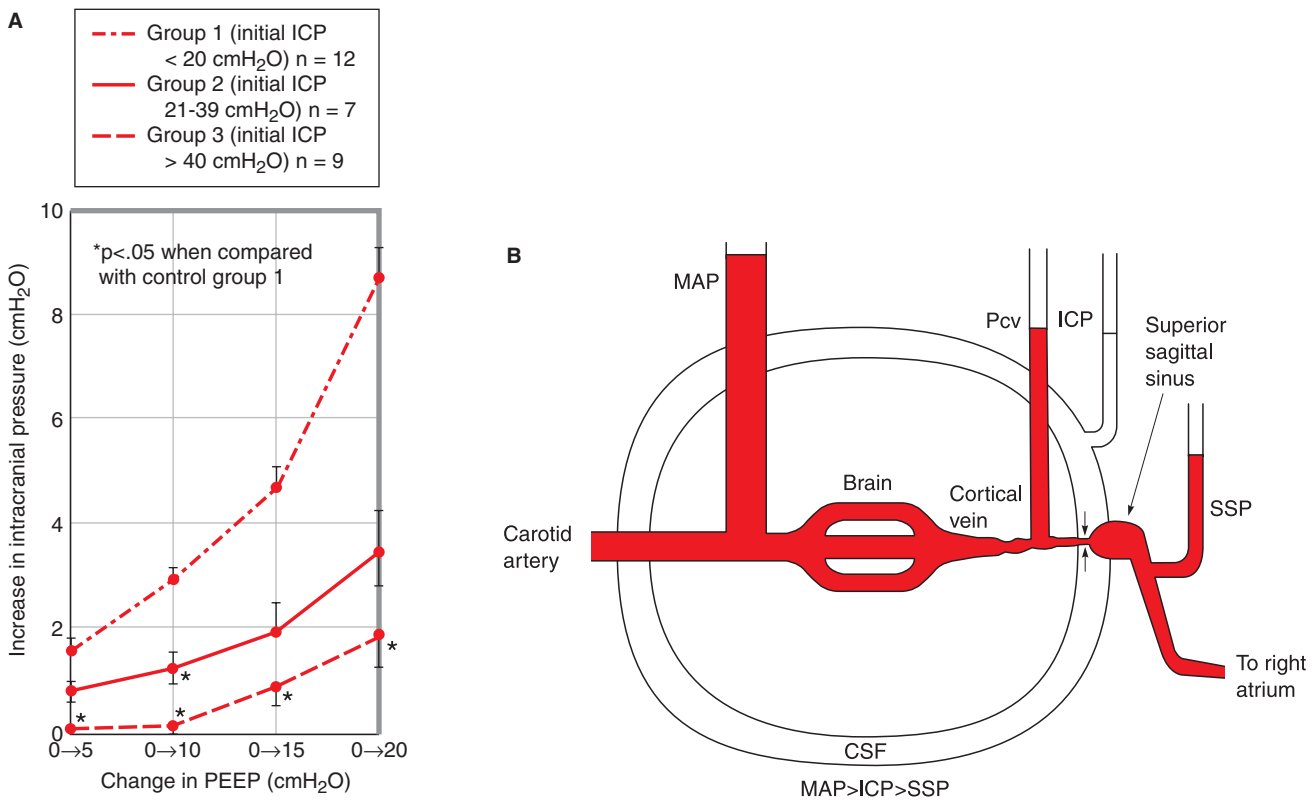
Anemia is generally well tolerated neurologically except at extreme levels. This finding indicates the enormous cerebrovascular reserve that, in health, is in place to compensate for this and similar physiologic stresses. Observations by Borgstrom et al.<sup>206</sup> in rodents indicate that decreasing Hgb levels produce an increase in CBF that initially is primarily due to decreased viscosity, but as Hgb continues to decrease to  $<10$  g%, then active vasodilatation arises (Fig. 87-10). If the brain vasculature already is maximally vasodilated because of other stresses, such as hypoxemia or low CPP, then

the anemic stress may not be well tolerated and may produce hypoxic/ischemic brain damage.

Supporting observations of anemia-associated cerebral vasodilatation have been reported in humans after cardiac surgery (Fig. 87-11).<sup>205</sup> Dexter and Hindman modeled these competing issues mathematically using data agreeing with laboratory and empiric observations that Hgb  $<10$  g%, associated with vasodilatation, can be expected to be deleterious in conditions of altered cerebrovascular reserve.<sup>206</sup> Observations of post-GI hemorrhage anemia-associated stroke by Kim and Kang<sup>207</sup> support Dexter and Hindman's calculations. Another supporting point is the observation in brain-injured patients of increased PbrO<sub>2</sub> with transfusion to Hgb  $>10$  g%.<sup>208</sup> One approach to managing low PbrO<sub>2</sub> is to transfuse to Hgb  $>10$  g%, based on observations that such therapy can significantly improve brain oxygenation in the context of severe brain injury. Notwithstanding reports that 7 g% is optimal in a general critical care population,<sup>209</sup> these observations taken altogether suggest that transfusion to a goal of 10 g% is reasonable in the context of impaired cerebrovascular reserve.

## NEUROPROTECTIVE/NEUROTOXIC EFFECTS OF ANESTHETICS

Anesthetics for neuroprotection have been studied at least since the 1960s. Goldstein et al.<sup>210</sup> initially were interested in the potential protective effects of barbiturates for global ischemia. A variety of studies on the efficacy of barbiturates eventually were published. A review of these studies makes clear that the genesis of much of the confusion was related to the timing of barbiturate therapy, the type of ischemia (focal vs. global), and the duration of the ischemia. The studies, all performed in animals, suggest that barbiturates may have a protective effect when given before or shortly after the onset of focal temporary ischemia, as may occur during aneurysm surgery. The studies are conflicting regarding the efficacy of barbiturates in focal permanent ischemia. For global ischemia, there were some initial encouraging canine studies by Goldstein et al.<sup>210</sup> and subhuman pri-



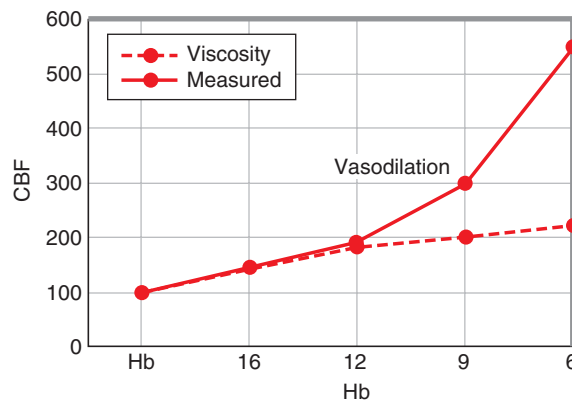
**FIGURE 87-9.** A. Increases in intracranial pressure (ICP) with positive end-expiratory pressure (PEEP) in dogs. Values are given as mean  $\pm$  SEM. Group 1 included 12 animals with initial ICP <20 cm H<sub>2</sub>O; group 2 included 7 animals with initial ICP 21–39 cm H<sub>2</sub>O; group 3 included 9 animals with initial ICP >40 cm H<sub>2</sub>O. Blood pressure was maintained constant in all animals. Note that when blood pressure was maintained constant, the most significant increases in PEEP occurred in the animals with the lowest starting PEEP level. B. Schematic illustration of the intracranial space during increased ICP. Arrows indicate the position of the hypothesized Starling resistor. Here, mean arterial pressure (MAP) is greater than ICP, which is greater than sagittal sinus pressure (SSP). Cortical vein pressure (Pcv) cannot fall below ICP; thus, flow is dependent on MAP ICP and independent of small changes in SSP. (From Huseby et al.<sup>200</sup> with permission.)

mate studies by Bleyaert et al.<sup>211</sup> However, the subhuman primate studies were criticized for the more intense care given to the treated animals that may have accounted for the improved outcome. Indeed, this study was unable to be reproduced by Gisvold et al.<sup>212</sup> Moreover, an attempt some 13 years later to reproduce the original study by Goldstein et al. was similarly unsuccessful.<sup>213</sup> Notably, in the original study by Goldstein et al., the control group had only local anesthetic infiltration for thoracic surgery, with the dog under neuromuscular blockade and ventilated at the time of onset of ischemia, such that the barbiturates were compared to a likely highly sympathetically activated animal.<sup>210</sup> Without such activation in the controls, Steen et al.<sup>213</sup> were unable to reproduce this seminal study. Nonetheless, the Brain Resuscitation Clinical Trial Group evaluated the efficacy of thiopental loading immediately after return of spontaneous circulation after cardiac arrest in humans.<sup>214</sup> They were unable to demonstrate a protective ef-

fect in this multiinstitutional study. It was suggested that, in some subsets of patients, a protective effect was lost in the signal to noise inherent in the design of such studies. Nonetheless, at this time, the data do not provide suffi-

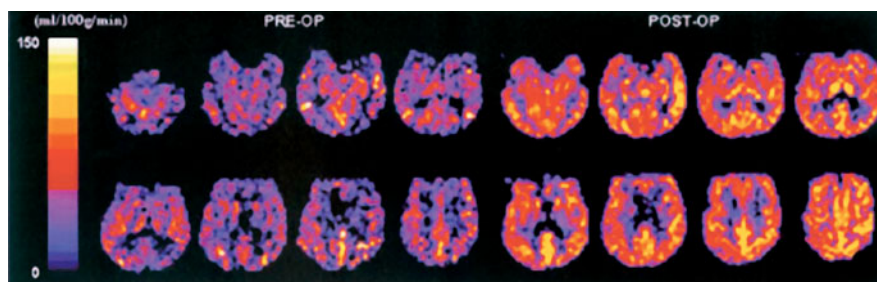
cient support for the general use of barbiturates for global brain ischemia.

If barbiturates are to be used, the available data suggest a range of doses. Initial studies examined only high-dose barbiturates, associated with an



**FIGURE 87-10.** Rats underwent isovolemic anemia with measurement of per change in global cerebral blood flow (CBF). The theoretic CBF that arises solely from changes in viscosity is indicated by the viscosity curve. Measurement CBF follows this line until the hemoglobin level falls to <10, below which active vasodilatation was observed. (Adapted from Borgström L, Jóhannsson H, Siesjö BK. The influence of acute normovolemic anemia on cerebral blood flow and oxygen consumption of anesthetized rats. *Acta Physiol Scand* 1975;93:505–514.)





**FIGURE 87-11.** Preoperative (PRE-OP) and postoperative (POST-OP) (cardiac surgery) continuous arterial spin labeling perfusion magnetic resonance images show cerebral blood flow with color scale for subject 5, an 81-year-old man. Global cerebral blood flow has increased from baseline of 36 to 62 mL/100 g/min on the fifth day after surgery. Multiple regression over all subjects revealed a significant and inverse relationship between cerebral blood flow and hematocrit. (Reprinted from Floyd T, McGarvey M, Ochroch E, et al. Perioperative changes in cerebral blood flow after cardiac surgery: influence of anemia and aging. *Ann Thorac Surg* 2003;76:2037–2042, with permission from Society of Thoracic Surgeons.<sup>205</sup>)

isoelectric EEG. Studies by Selman et al.<sup>215–217</sup> showing neuroprotection for focal temporary ischemia in subhuman primates used very high doses of barbiturates given over at least 24 hours, enough to suppress any edema-mediated ICP elevations. However, Warner et al.<sup>218</sup> found similar protective efficacy for a focal temporary ischemic insult in rats at doses sufficient to produce an isoelectric EEG and doses about half that associated only with significant EEG change and not an isoelectric state.

These data suggest the occasional value of using barbiturates for neuroprotection for focal temporary ischemia. If the amount of ischemic tissue is large and possibly associated with elevated ICP, then higher, isoelectric EEG-producing doses seem appropriate. If the ischemic insult is less severe, then lower doses may be appropriate. These recommendations are not based on randomized human studies but on theoretical gain, which is significant when considering prevention of stroke versus the possible risk of therapy that may or may not be considerable.<sup>88</sup>

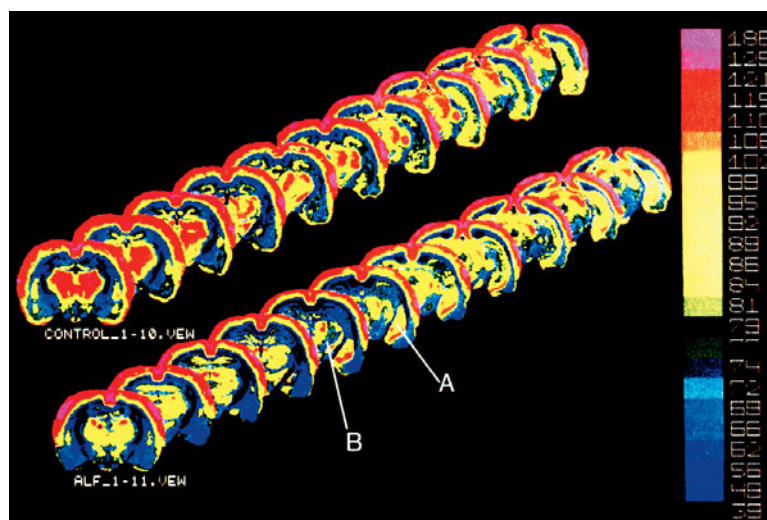
Other  $\gamma$ -aminobutyric acid (GABA)-ergic drugs, such as etomidate,<sup>219,220</sup> benzodiazepines,<sup>221–223</sup> and propofol,<sup>223–226</sup> have shown similar results, although the number and breadth of the studies are not at all comparable to those performed with barbiturates. Indeed, in some reports etomidate has been suggested to be deleterious when given for cerebral ischemia,<sup>227</sup> and propofol worsened injury in an in vitro model<sup>221</sup> but not in another in vitro report.<sup>228</sup> In the context of seizure-induced injury, Kofke et al.<sup>229</sup> reported that midazolam reduced substantia

nigra injury, whereas thiopental and isoflurane, although they also stopped the seizure, conferred no neuroprotection. Ketamine had an intermediate effect, and an effect may have been missed because of small sample size.

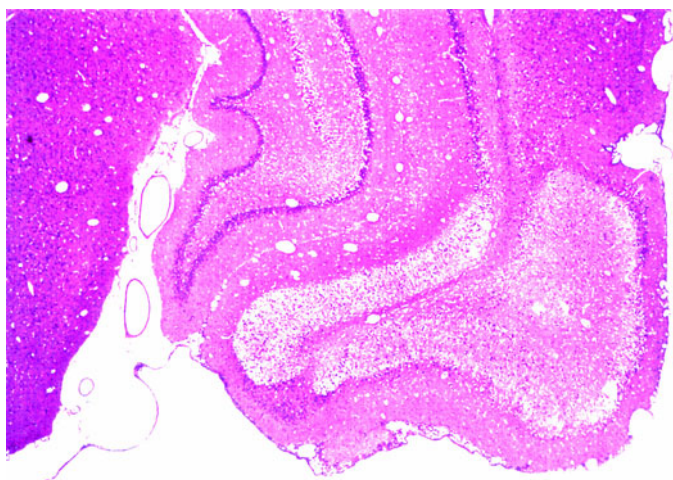
Using isoflurane as a prototype, the volatile anesthetics have been demonstrated to clearly prolong the amount of time that an animal's brain can tolerate an anaerobic condition.<sup>230</sup> Other reports in animals also have reported a capability of volatile anesthetics to confer early histologic protection against a variety of types of ischemic insults.<sup>231–237</sup> However, when the evaluations are extended to 2 weeks after focal ischemia, the protective efficacy can no longer be demonstrated.<sup>238</sup> These data seem to suggest that initial damaging processes can be favorably altered by a volatile

anesthetic but that other deleterious postischemic processes, such as apoptosis, are not altered by isoflurane.<sup>239</sup> However, this temporary protection was not observed in a global ischemia model.<sup>240</sup> At this time, the capability of isoflurane and other volatile anesthetics to contribute to permanent perioperative neuroprotection remains unsettled.

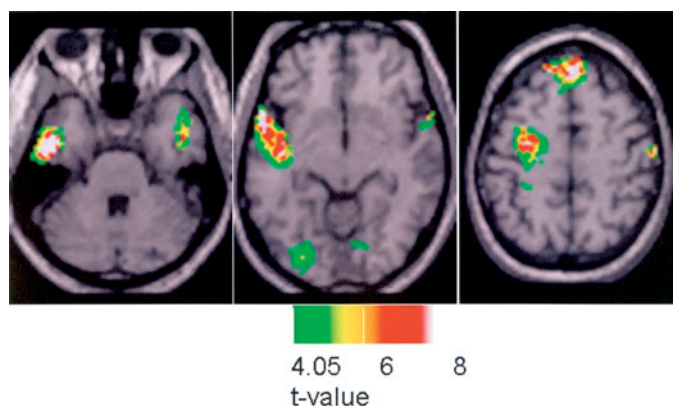
Opioids have not been shown to have any neuroprotective effects. Several studies by Kofke et al.<sup>241–244</sup> demonstrated the capability of fentanyl and congeners given in high doses to produce limbic system activation (Fig. 87-12) and damage (Fig. 87-13). Comparable limbic activation was shown when patients were given brief high-dose remifentanyl (Fig. 87-14).<sup>244</sup> Cingulate activation was noted with sedative-dose remifentanyl in volunteers.<sup>245</sup> Notably, cingulate activation did not occur in patients with the apolipoprotein E (ApoE) genotype, although hippocampal activation did arise with this single nucleotide polymorphism. Moreover,  $\mu$  opioids in humans have been reported to have proconvulsant properties<sup>246</sup> that are expected to be deleterious in the context of cerebral ischemia, as demonstrated in one laboratory report of opioid use with cerebral ischemia<sup>247</sup> and another on opioid use with traumatic brain injury.<sup>248</sup> These studies investigated isolated opioid use. The negative effects appear to be attenuated with concomitant hypnotic drug administration.<sup>249</sup> Although provoca-



**FIGURE 87-12.** Glucose autoradiography during administration of high-dose alfentanil with epileptiform activity of paralyzed ventilated rats. Ventral hippocampal (A) activation and thalamic depression (B) were produced by alfentanil. (From Kofke et al.<sup>243</sup> with permission.)



**FIGURE 87-13.** Histologic slide from a paralyzed ventilated rat that received high-dose alfentanil. Infarction of the amygdala is evident. (Unpublished slide from experiments by Kofke et al.<sup>243</sup>)



**FIGURE 87-14.** Fluorodeoxyglucose positron emission tomographic functional brain mapping statistical parametric map images from four ventilated healthy individuals who received brief high-dose remifentanil. Baseline awake scans were subtracted from scans acquired during remifentanil infusion. Areas with significant increases in cerebral metabolic rate for glucose ( $t > 4.05$ ,  $P < 0.05$ ) are displayed in lighter shades overlaid on a normalized magnetic resonance image. Scale for t values also is shown. Hippocampal and cingulate activation occurred. (Adapted from Kofke et al.<sup>244</sup>)

tive, the relevance of these observations to clinical practice remains to be established.

## KEY REFERENCES

1. Yonas H, Pindzola R. Physiological determination of cerebrovascular reserves and its use in clinical management. *Cerebrovasc Brain Metab Rev* 1994;6:325-340.
2. Kim J, Kang S. Bleeding and subsequent anemia: a precipitant for cerebral infarction. *Eur Neurol* 2000;43:201-208.
3. Muizelaar J, Marmarou A, Ward J, et al. Adverse effects of prolonged hyperventilation in patients

with severe head injury: a randomized clinical trial. *J Neurosurg* 1991;75:731.

4. Marion D. Moderate hypothermia in severe head injuries: the present and the future. *Curr Opin Crit Care* 2002;8:111-114.
5. Nolan JP, Morley PT, Vanden Hoek TL, et al. Therapeutic hypothermia after cardiac arrest: an advisory statement by the advanced life support task force of the International Liaison Committee on Resuscitation Writing Group. *Circulation* 2003;108:118-121.
6. Dinger M, Neurocritical Care Fever Reduction Trial Group. Treatment of fever in the neurologic intensive care unit with a catheter-based heat exchange system. *Crit Care Med* 2004;32:559-564.

ter-based heat exchange system. *Crit Care Med* 2004;32:559-564.

7. Rosner M, Becker D. Origin and evolution of plateau waves. Experimental observations and a theoretical model. *J Neurosurg* 1984;50:312.
8. Neil-Dwyer G, Walter P, Cruickshank J. Beta-blockade benefits patients following a subarachnoid hemorrhage. *Eur J Clin Pharmacol* 1985;28:25.
9. Kofke W, Attaallah A, Kuwabara H, et al. Neuropathologic effects in rats and neurometabolic effects in humans of high-dose remifentanil. *Anesth Analg* 2002;94:1229-1236.
10. Selman W, Spetzler R, Roessmann U, et al. Barbiturate-induced coma therapy for focal cerebral ischemia. Effect after temporary and permanent MCA occlusion. *J Neurosurg* 1981;55:220.

## REFERENCES

1. Wolf PA, Cobb J, D'Agostino R. Epidemiology of stroke. In Barnett H, Mohr J, Stein B, et al., eds. *Stroke: Pathophysiology, Diagnosis, and Management*. 2nd ed. New York: Churchill Livingstone, 1992:3-27.
2. Lamassa M, Di Carlo A, Pracucci G, et al. Characteristics, outcome, and care of stroke associated with atrial fibrillation in Europe: data from a multicenter multinational hospital-based registry (The European Community Stroke Project). *Stroke* 2001;32:392-398.
3. Markus HS, Alberts MJ. Update on genetics of stroke and cerebrovascular disease 2005. *Stroke* 2006;37:288-290.
4. Silvestrini M, Vernieri F, Pasqualetti P, et al. Impaired cerebral vasoreactivity and risk of stroke in patients with asymptomatic carotid artery stenosis. *JAMA* 2000;283:2122-2127.
5. Cheng W, Denton T, Fontana G, et al. Off-pump coronary surgery: effect on early mortality and stroke. *J Thorac Cardiovasc Surg* 2002;124:313-320.
6. Stern A, Tunick P, Culliford A, et al. Protruding aortic arch atheromas: risk of stroke during heart surgery with and without aortic arch endarterectomy. *Am Heart J* 1999;138:646-652.
7. Stamou S, Hill P, Dangas G, et al. Stroke after coronary artery bypass: incidence, predictors, and clinical outcome. *Stroke* 2001;32:1508-1513.
8. Goldstein L, Davies R, Rizzo J, et al. Stroke in surgery of the thoracic aorta: Incidence, impact, etiology, and prevention. *J Thorac Cardiovasc Surg* 2001;122:935-945.



9. Rothwell P, Slattery J, Warlow C. A systematic comparison of the risks of stroke and death due to carotid endarterectomy for symptomatic and asymptomatic stenosis. *Stroke* 1996;27:266–269.
10. Rothwell P, Goldstein L. Carotid endarterectomy for asymptomatic carotid stenosis: asymptomatic carotid surgery trial. *Stroke* 2004;35:2425–2457.
11. Naylor A, Rothwell P, Bell P. Overview of the principal results and secondary analyses from the European and North American randomised trials of endarterectomy for symptomatic carotid stenosis. *Eur J Vasc Endovasc Surg* 2003;26:115–129.
12. Bond R, Narayan S, Rothwell P, et al. Clinical and radiographic risk factors for operative stroke and death in the European Carotid Surgery Trial. *Eur J Vasc Endovasc Surg* 2002;23:108–116.
13. Bond R, Rerkasem K, Cuffe R, et al. A systematic review of the associations between age and sex and the operative risks of carotid endarterectomy. *Cerebrovasc Dis* 2005;20:69–77.
14. Rothwell P, Slattery J, Warlow C. Clinical and angiographic predictors of stroke and death from carotid endarterectomy: systematic review. *BMJ* 1997;315:1571–1577.
15. Heyer E, Sahlein D, Rampersad A, et al. Apoe ε4 may be associated with cognitive dysfunction after carotid endarterectomy. *Anesthesiology* 2003;99:A364.
16. Thompson S, Southern D, McKinnon J, et al. Incidence of perioperative stroke after neck dissection for head and neck cancer: a regional outcome analysis. *Ann Surg* 2004;239:428–431.
17. Weintraub M, Khoury A. Critical neck position as an independent risk factor for posterior circulation stroke. A magnetic resonance angiographic analysis. *J Neuroimaging* 1995;5:16–22.
18. Petersen B, von Maravic M, Zeller J, et al. Basilar artery blood flow during head rotation in vertebralbasilar ischemia. *Acta Neurol Scand* 1996;94:294–301.
19. Grundy B, Procopio P, Jannetta P, et al. Evoked potential changes produced by positioning for retromastoid craniectomy. *Neurosurgery* 1982;10:766–770.
20. Weintraub M. Beauty parlor stroke syndrome: report of five cases. *JAMA* 1993;269:2085–2086.
21. Lanska D, Kryscio R. Risk factors for peripartum and postpartum stroke and intracranial venous thrombosis. *Stroke* 2000;31:1274–1282.
22. Ogilvy C, Carter B, Kaplan S, et al. Temporary vessel occlusion for aneurysm surgery: risk factors for stroke in patients protected by induced hypothermia and hypertension and intravenous mannitol administration. *J Neurosurg* 1996;84:785–791.
23. Parikh S, Cohen J. Perioperative stroke after general surgical procedures. *N Y State J Med* 1993;93:162–165.
24. Landercasper J, Merz B, Cogbill T, et al. Perioperative stroke risk in 173 consecutive patients with a past history of stroke. *Arch Surg* 1990;125:986–989.
25. Larsen S, Zaric D, Boysen G. Postoperative cerebrovascular accidents in general surgery. *Acta Anaesth Scand* 1988;32:698–701.
26. Limburg M, Wijdicks E, Li H. Ischemic stroke after surgical procedures: clinical features, neuroimaging, and risk factors. *Neurology* 1998;50:895–901.
27. Kam P, Calcroft R. Peri-operative stroke in general surgical patients. *Anaesthesia* 1997;52:879–883.
28. Collins GJ, Barber J, Zajchuk R, et al. The effects of operative stress on the coagulation profile. *Am J Surg* 1977;133:612–616.
29. Levine S. Anoxic-ischemic encephalopathy in rats. *Am J Pathol* 1960;36:1–17.
30. Schroeder T. Cerebrovascular reactivity to acetazolamide in carotid artery disease. Enhancement of side-to-side CBF asymmetry indicates critically reduced perfusion pressure. *Neurol Res* 1986;8:231.
31. Yonas H, Pindzola R. Clinical application of cerebrovascular reserve assessment as a strategy for stroke prevention. *Keio J Med* 2000;49:A4–A10.
32. Hojer-Pedersen E. Effect of acetazolamide on CBF in subacute and chronic cerebrovascular disease. *Stroke* 1987;18:887.
33. Yonas H, Pindzola R. Physiological determination of cerebrovascular reserves and its use in clinical management. *Cerebrovasc Brain Metab Rev* 1994;6:325–340.
34. Nemoto E, Yonas H, Kuwabara H, et al. Identification of hemodynamic compromise by cerebrovascular reserve and oxygen extraction fraction in occlusive vascular disease. *J Cereb Blood Flow Metab* 2004;24:1081–1089.
35. Imaizumi M, Kitagawa K, Hashikawa K, et al. Detection of misery perfusion with split-dose 123I-iodoamphetamine single-photon emission computed tomography in patients with carotid occlusive diseases. *Stroke* 2002;33:2217–2223.
36. Werner C, Hoffman W, Thomas C, et al. Ganglionic blockade improves neurologic outcome from incomplete ischemia in rats: partial reversal by exogenous catecholamines. *Anesthesiology* 1990;73:923.
37. Hoffman W, Kochs E, Werner C, et al. Dexmedetomidine improves neurologic outcome from incomplete ischemia in the rat. Reversal by the alpha 2-adrenergic antagonist atipamezole. *Anesthesiology* 1991;75:328.
38. Werner C, Hoffman W, Kochs E, et al. Captopril improves neurologic outcome from incomplete cerebral ischemia in rats. *Stroke* 1991;22:910.
39. Sugawara T, Kawase M, Lewen A, et al. Effect of hypotension severity on hippocampal CA1 neurons in a rat global ischemia model. *Brain Res* 2000;877:281–287.
40. Castillo J, Davalos A, Noya M. Aggravation of acute ischemic stroke by hyperthermia is related to an excitotoxic mechanism. *Cerebrovasc Dis* 1999;9:22–27.
41. Szczudlik A, Turaj W, Slowik A, et al. Microalbuminuria and hyperthermia independently predict long-term mortality in acute ischemic stroke patients. *Acta Neurol Scand* 2003;107:96–101.
42. Kim J, Kang S. Bleeding and subsequent anemia: a precipitant for cerebral infarction. *Eur Neurol* 2000;43:201–208.
43. Basali A, Mascha E, Kalfas I, et al. Relation between perioperative hypertension and intracranial hemorrhage after craniotomy. *Anesthesiology* 2000;93:48–54.
44. Eng C, Lam A, Byrd S, et al. The diagnosis and management of a perianesthetic cerebral aneurysmal rupture aided with transcranial Doppler ultrasonography. *Anesthesiology* 1993;78:191–194.
45. Ohkuma H, Tsurutani H, Suzuki S. Incidence and significance of early aneurysmal rebleeding before neurosurgical or neurological management. *Stroke* 2001;32:1176–1180.
46. Brown M, Wade J, Marshall J. Fundamental importance of arterial oxygen content in the regulation of cerebral blood flow in man. *Brain* 1985;108:81093.
47. Floyd T, Clark J, Gelfand R, et al. Independent cerebral vasoconstrictive effects of hyperoxia and accompanying arterial hypocapnia at 1 ATA. *J Appl Physiol* 2003;95:2453–2461.
48. Nakajima S, Meyer J, Amano T, et al. Cerebral vasomotor responsiveness during 100% oxygen inhalation in cerebral ischemia. *Arch Neurol* 1983;40:271–276.
49. Fiskum G, Rosenthal R, Vereczki V, et al. Protection against ischemic brain injury by inhibition of mitochondrial oxidative stress. *J Bioenerg Biomembr* 2004;36:347–352.
50. Halsey JJ, Conger K, Garcia J, et al. The contribution of reoxygenation to ischemic brain damage. *J Cereb Blood Flow Metab* 1991;11:994–1000.
51. Mickel H, Kempfski O, Feuerstein G, et al. Prominent white matter lesions develop in Mongolian gerbils treated with 100% normobaric oxygen after global brain ischemia. *Acta Neuropathol* 1990;79:465–472.
52. Marsala J, Marsala M, Vanicky I, et al. Post cardiac arrest hyperoxic resuscitation enhances neuronal vulnerability of the respiratory rhythm generator and some brainstem and spinal cord neuronal pools in the dog. *Neurosci Lett* 1992;146:121–124.
53. Dings J, Meixensberger J, Jager A, et al. Clinical experience with 118 brain tissue oxygen partial pressure catheter probes. *Neurosurgery* 1998;43:1982–1995.
54. van den Brink W, van Santbrink H, Steyerberg E, et al. Brain oxygen tension in severe head injury. *Neurosurgery* 2000;46:868–878.
55. Valadka A, Gopinath S, Contant C, et al. Relationship of brain tissue PO<sub>2</sub> to outcome after severe head injury. *Crit Care Clin* 1998;26:1576–1581.
56. van Santbrink H, van den Brink W, Steyerberg E, et al. Brain tissue oxygen response in severe traumatic brain injury. *Acta Neurochir (Wien)* 2003;145:429–438.
57. Stiefel M, Spiotta A, Gracias V, et al. Reduced mortality rate in patients with severe traumatic brain injury treated with

- brain tissue oxygen monitoring. *J Neurosurg* 2005;103:805–811.
58. Meixensberger J, Vath A, Jaeger M, et al. Monitoring of brain tissue oxygenation following severe subarachnoid hemorrhage. *Neurol Res* 2003;25:445–450.
  59. Klein J. Normobaric pulmonary oxygen toxicity. *Anesth Analg* 1990;70:195–207.
  60. West J. *Respiratory Physiology: The Essentials*. Baltimore: Williams & Wilkins, 1974.
  61. Harper A, Glass H. Effect of alterations in the arterial carbon dioxide tension on the blood flow through the cerebral cortex at normal and low arterial blood pressures. *J Neurol Neurosurg Psychiatry* 1965;28:449–452.
  62. Koehler R, Traystman R. Bicarbonate ion modulation of cerebral blood flow during hypoxia and hypercapnia. *Am J Physiol* 1982;43:H33–H40.
  63. Heffner J, Sahn S. Controlled hyperventilation in patients with intracranial hypertension. Application and management. *Arch Intern Med* 1983;143:765–769.
  64. Coles J, Minhas P, Fryer T, et al. Effect of hyperventilation on cerebral blood flow in traumatic head injury: clinical relevance and monitoring correlates. *Crit Care Med* 2002;30:1950–1959.
  65. Simon R, Niro M, Gwinn R. Brain acidosis induced by hypercarbic ventilation attenuates focal ischemic injury. *J Pharmacol Exp Ther* 1993;267:1428–1431.
  66. Muizelaar J, Marmarou A, Ward J, et al. Adverse effects of prolonged hyperventilation in patients with severe head injury: a randomized clinical trial. *J Neurosurg* 1991;75:731.
  67. Gopinath S, Valadka A, Uzura M, et al. Comparison of jugular venous oxygen saturation and brain tissue PO<sub>2</sub> as monitors of cerebral ischemia after head injury. *Crit Care Clin* 1999;27:2337–2345.
  68. Thompson H, Tkacs N, Saatman K, et al. Hyperthermia following traumatic brain injury: a critical evaluation. *Neurobiol Dis* 2003;12:163–173.
  69. Suehiro E, Fujisawa H, Ito H, et al. Brain temperature modifies glutamate neurotoxicity in vivo. *J Neurotrauma* 1999;16:285–297.
  70. Rosomoff H, Holaday D. Cerebral blood flow and cerebral oxygen consumption during hypothermia. *Am J Physiol* 1954;179:85–88.
  71. Michenfelder J, Theye R. The effects of anesthesia and hypothermia on canine cerebral ATP and lactate during anoxia produced by decapitation. *Anesthesiology* 1970;33:430–439.
  72. Nemoto E, Klementavicius R, Melick J, et al. Suppression of cerebral metabolic rate for oxygen (CMRO<sub>2</sub>) by mild hypothermia compared with thiopental. *J Neurosurg Anesth* 1996;8:52–59.
  73. Busto R, Globus M, Dietrich W, et al. Effect of mild hypothermia on ischemia-induced release of neurotransmitters and free fatty acids in rat brain. *Stroke* 1989;20:904–910.
  74. Wypij D, Newburger J, Rappaport L, et al. The effect of duration of deep hypothermic circulatory arrest in infant heart surgery on late neurodevelopment: the Boston Circulatory Arrest Trial. *J Thorac Cardiovasc Surg* 2003;126:1397–1403.
  75. Haverich A, Hagl C. Organ protection during hypothermic circulatory arrest. *J Thorac Cardiovasc Surg* 2003;125:460–462.
  76. Clifton G, Miller E, Choi S, et al. Lack of effect of induction of hypothermia after acute brain injury. *N Engl J Med* 2001;344:556–563.
  77. Marion D. Moderate hypothermia in severe head injuries: the present and the future. *Curr Opin Crit Care* 2002;8:111–114.
  78. Clifton G, Choi S, Miller E, et al. Inter-center variance in clinical trials of head trauma—experience of the National Acute Brain Injury Study: hypothermia. *J Neurosurg* 2001;95:751–755.
  79. Cheung A, Bavaria J, Weiss S, et al. Neurophysiologic effects of retrograde cerebral perfusion used for aortic reconstruction. *J Cardiothorac Vasc Anesth* 1999;12:252–259.
  80. Horn M, Schlote W, Henrich H. Global cerebral ischemia and subsequent selective hypothermia. *Acta Neuropathol* 1991;81:443–449.
  81. Sterz F, Safar P, Tisherman S, et al. Mild hypothermic cardiopulmonary resuscitation improves outcome after prolonged cardiac arrest in dogs. *Crit Care Med* 1991;19:379–389.
  82. Hicks S, DeFranco D, Callaway C. Hypothermia during reperfusion after asphyxial cardiac arrest improves functional recovery and selectively alters stress-induced protein expression. *J Cereb Blood Flow Metab* 2000;20:520–530.
  83. Nozari A, Safar P, Stezoski S, et al. Mild hypothermia during prolonged cardiopulmonary cerebral resuscitation increases conscious survival in dogs. *Crit Care Med* 2004;32:2110–2116.
  84. Hypothermia After Cardiac Arrest Study Group. Mild therapeutic hypothermia to improve the neurologic outcome after cardiac arrest. *N Engl J Med* 2002;346:549–556.
  85. Bernard S, Gray T, Buist M, et al. Treatment of comatose survivors of out-of-hospital cardiac arrest with induced hypothermia. *N Engl J Med* 2002;346:557–563.
  86. Nolan JP, Morley PT, Vanden Hoek TL, et al. Therapeutic hypothermia after cardiac arrest: an advisory statement by the advanced life support task force of the International Liaison Committee on Resuscitation Writing Group. *Circulation* 2003;108:118–121.
  87. Darby J. Letter to the editor. *N Engl J Med* 2002;347:63.
  88. Kofke W. Making clinical decisions based on animal research data: pro. *J Neurosurg Anesth* 1996;8:68–72.
  89. Minamisawa H, Nordstrom C, Smith M, et al. The influence of mild body and brain hypothermia on ischemic brain damage. *J Cereb Blood Flow Metab* 1990;10:365–374.
  90. Dietrich W, Busto R, Valdes I, et al. Effects of normothermic versus mild hypothermic forebrain ischemia in rats. *Stroke* 1990;21:1318–1325.
  91. Minamisawa H, Smith M, Siesjo B. The effect of mild hyperthermia and hypothermia on brain damage following 5, 10, and 15 minutes of forebrain ischemia. *Ann Neurol* 1990;28:26–33.
  92. Todd M, Hindman B, Clarke W, et al. Intraoperative Hypothermia for Aneurysm Surgery Trial (IHAST) Investigators. Mild intraoperative hypothermia during surgery for intracranial aneurysm. *N Engl J Med* 2005;352:135–145.
  93. Hindman B, Todd M, Gelb A, et al. Mild hypothermia as a protective therapy during intracranial aneurysm surgery: a randomized prospective pilot trial. *Neurosurgery* 1999;44:23–32.
  94. Marion D, Penrod L, Kelsey S, et al. Treatment of traumatic brain injury with moderate hypothermia. *N Engl J Med* 1997;336:540–546.
  95. Oliveira-Filho J, Ezzeddine M, Segal A, et al. Fever in subarachnoid hemorrhage. *Neurology* 2001;56:1299–1304.
  96. Rossitch EJ, Bullard D. The autonomic dysfunction syndrome: aetiology and treatment. *Br J Neurosurg* 1988;2:471–478.
  97. Commichau C, Scarneas N, Mayer S. Risk factors for fever in the neurologic intensive care unit. *Neurology* 2003;60:837–841.
  98. Castillo J, Davalos A, Marrugat J, et al. Timing for fever-related brain damage in acute ischemic stroke. *Stroke* 1998;29:2455–2460.
  99. Azzimondi G, Bassein L, Nonino F, et al. Fever in acute stroke worsens prognosis: a prospective study. *Stroke* 1995;26:2043–2050.
  100. Reith J, Jorgensen H, Pedersen P, et al. Body temperature in acute stroke: relation to stroke severity, infarct size, mortality, and outcome. *Lancet* 1996;347:422–425.
  101. Ginsberg M, Busto R. Combating hypothermia in acute stroke: a significant clinical concern. *Stroke* 1998;29:529–534.
  102. Schwarz S, Aschoff A, Schwab S. Incidence and prognostic significance of fever following cerebral hemorrhage. *Neurology* 2000;54:354–361.
  103. Bachert C, Chuchalin A, Eisebitt R, et al. Aspirin compared with acetaminophen in the treatment of fever and other symptoms of upper respiratory tract infection in adults: a multicenter, randomized, double-blind, double-dummy, placebo-controlled, parallel-group, single-dose, 6-hour dose-ranging study. *Clin Ther* 2005;27:993–1003.
  104. Grebe W, Ionescu E, Gold M, et al. A multicenter, randomized, double-blind, double-dummy, placebo- and active-controlled, parallel-group comparison of diclofenac-K and ibuprofen for the treatment of adults with influenza-like symptoms. *Clin Ther* 2003;25:444–458.
  105. Dippel D, van Breda E, van der Worp H, et al. Effect of paracetamol (acetaminophen) and ibuprofen on body temperature in acute ischemic stroke PISA, a phase II double-blind, randomized, placebo-controlled trial [ISRCTN98608690]. *BMC Cardiovasc Disord* 2003;3:2.
  106. Johnston S, Pelletier L. Enhanced hepatotoxicity of acetaminophen in the alcoholic patient: two case reports and a review of the literature. *Medicine* 1997;75:185–191.



107. Diring M, Neurocritical Care Fever Reduction Trial Group. Treatment of fever in the neurologic intensive care unit with a catheter-based heat exchange system. *Crit Care Med* 2004;32:559-564.
108. Van den Berghe G, Wouters P, Weekers F, et al. Intensive insulin therapy in critically ill patients. *N Engl J Med* 2001;345:1359-1367.
109. Pulsinelli W, Levy D, Sigsbee B, et al. Increased damage after ischemic stroke in patients with hyperglycemia with or without established diabetes mellitus. *Am J Med* 1983;74:540.
110. Siemkowicz E. Hyperglycemia in the reperfusion period hampers recovery from cerebral ischemia. *Acta Neurol Scand* 1981;64:207.
111. Rehn Crona S, Rosen I, Siesjo B. Brain lactic acidosis and ischemic cell damage: 1. Biochemistry and neurophysiology. *J Cereb Blood Flow Metab* 1981;1:297.
112. De Salles A, Muizelaar J, Young H. Hyperglycemia, cerebrospinal fluid lactic acidosis, and CBF in severely head-injured patients. *Neurosurgery* 1987;21:45.
113. Li P, Shamloo M, Smith M, et al. The influence of plasma glucose concentrations on ischemic brain damage is a threshold function. *Neurosci Lett* 1994;177:63.
114. Warner D, Gionet T, Todd M, et al. Insulin-induced normoglycemia improves ischemic outcome in hyperglycemic rats. *Stroke* 1992;23:1775.
115. Siemkowicz E, Gjedde A. Post-ischemic coma in rat: effect of different pre-ischemic blood glucose levels on cerebral metabolic recovery after ischemia. *Acta Physiol Scand* 1980;110:225.
116. Lanier W, Stangland K, Scheithauer B, et al. The effects of dextrose infusion and head position on neurologic outcome after complete cerebral ischemia in primates: examination of a model. *Anesthesiology* 1987;66:39.
117. Van den Berghe G, Wouters P, Bouillon R, et al. Outcome benefit of intensive insulin therapy in the critically ill: insulin dose versus glycemic control. *Crit Care Clin* 2003;31:359-366.
118. Bhatia A, Cadman B, Mackenzie I. Hypoglycemia and cardiac arrest in a critically ill patient on strict glycemic control. *Anesth Analg* 2006;102:549-551.
119. Murros K, Fogelholm R, Kettunen S, et al. Serum cortisol and outcome of ischemic brain infarction. *J Neuro Sci* 1993;116:12.
120. Broderick J, Hagen T, Brott T, et al. Hyperglycemia and hemorrhagic transformation of cerebral infarcts. *Stroke* 1995;26:484.
121. Murros K, Fogelholm R, Kettunen S, et al. Blood glucose, glycosylated haemoglobin, and outcome of ischemic brain infarction. *J Neuro Sci* 1992;111:59.
122. Matchar D, Divine G, Heyman A, et al. The influence of hyperglycemia on outcome of cerebral infarction. *Ann Intern Med* 1992;117:449.
123. de Courten-Myers G, Kleinholz M, Holm P, et al. Hemorrhagic infarct conversion in experimental stroke. *Ann Emerg Med* 1992;21:120.
124. Sieber F, Traystman R. Special issues: glucose and the brain. *Crit Care Med* 1992;20:104.
125. Yip P, He Y, Hsu C, et al. Effect of plasma glucose on infarct size in focal cerebral ischemia-reperfusion. *Neurology* 1991;41:899.
126. Vazquez-Cruz J, Marti-Vilalta J, Ferrer I, et al. Progressing cerebral infarction in relation to plasma glucose in gerbils. *Stroke* 1990;21:1621.
127. Kushner M, Nencini P, Reivich M, et al. Relation of hyperglycemia early in ischemic brain infarction to cerebral anatomy, metabolism, and clinical outcome. *Ann Neurol* 1990;28:129.
128. Kraft S, Larson CJ, Shuer L, et al. Effect of hyperglycemia on neuronal changes in a rabbit model of focal cerebral ischemia. *Stroke* 1990;21:447.
129. Zasslow M, Pearl R, Shuer L, et al. Hyperglycemia decreases acute neuronal ischemic changes after middle cerebral artery occlusion in cats. *Stroke* 1989;20:519.
130. de Courten-Myers G, Myers R, Schoolfeld L. Hyperglycemia enlarges infarct size in cerebrovascular occlusion in cats. *Stroke* 1988;19:623.
131. Duverger D, MacKenzie E. The quantification of cerebral infarction following focal ischemia in the rat: influence of strain, arterial pressure, blood glucose concentration, and age. *J Cereb Blood Flow Metab* 1988;8:449.
132. Nedergaard M. Mechanisms of brain damage in focal cerebral ischemia. *Acta Neurol Scand* 1988;77:81.
133. Prado R, Ginsberg M, Dietrich W, et al. Hyperglycemia increases infarct size in colaterally perfused but not end-arterial vascular territories. *J Cereb Blood Flow Metab* 1988;8:186.
134. Ginsberg M, Prado R, Dietrich W, et al. Hyperglycemia reduces the extent of cerebral infarction in rats. *Stroke* 1987;18:570.
135. Nedergaard M. Transient focal ischemia in hyperglycemic rats is associated with increased cerebral infarction. *Brain Res* 1987;408:79.
136. Nedergaard M, Astrup J. Infarct rim: effect of hyperglycemia on direct current potential and  $^{14}\text{C}$ -deoxyglucose phosphorylation. *J Cereb Blood Flow Metab* 1986;6:607.
137. Kofke W, Ahdab-Barmada M, Rose M, et al. Substantia nigra damage after flurothyl-induced seizures in rats worsens after post seizure recovery: no exacerbation with hyperglycemia. *Neurol Res* 1993;15:333.
138. Swan J, Meldrum B, Simon R. Hyperglycemia does not augment neuronal damage in experimental status epilepticus. *Neurology* 1986;36:1351.
139. Ingvar M, Folbegrava J, Siesjo B. Metabolic alterations underlying the development of hypermetabolic necrosis in the substantia nigra in status epilepticus. *J Cereb Blood Flow Metab* 1987;7:103.
140. Lundberg N. Continuous recording and control of ventricular fluid pressure in neurosurgical practice. *Acta Psychiatr Neurol Scand* 1960;36(Suppl 149):1.
141. Risberg J, Lundberg N, Ingvar D. Regional cerebral blood volume during acute rises in the intracranial pressure (plateau waves). *J Neurosurg* 1969;31:303.
142. Rosner M, Becker D. Origin and evolution of plateau waves. Experimental observations and a theoretical model. *J Neurosurg* 1984;50:312.
143. Rosner M, Becker D. The etiology of plateau waves: A theoretical model and experimental observations. In Ishii S, Nagai H, Brock M, eds. *Intracranial Pressure*. New York: Springer-Verlag, 1983:301.
144. Matakas F, Von Waechter R, Knupling R, et al. Increase in cerebral perfusion pressure by arterial hypertension in brain swelling. A mathematical model of the volume-pressure relationship. *J Neurosurg* 1975;42:282.
145. Grande P, Asgeirsson B, Nordstrom C. Volume-targeted therapy of increased intracranial pressure: the Lund concept unifies surgical and non-surgical treatments. *Acta Anaesth Scand* 2002;46:929-941.
146. Manno E, Atkinson J, Fulgham J, et al. Emerging medical and surgical management strategies in the evaluation and treatment of intracerebral hemorrhage. *Mayo Clin Proc* 2005;80:420-433.
147. Busto R, Harik S, Yoshida S, et al. Cerebral norepinephrine depletion enhances recovery after brain ischemia. *Ann Neurol* 1985;18:329.
148. Kofke WA, Garman RH, Garman R, Rose M. Opioid neurotoxicity: role of neurotransmitter systems. *Neurol Res* 2000;22:733-737.
149. Neil-Dwyer G, Walter P, Cruickshank J. Beta-blockade benefits patients following a subarachnoid hemorrhage. *Eur J Clin Pharmacol* 1985;28:25.
150. Schroeder T, Schierbeck J, Howardy P, et al. Effect of labetalol on CBF and middle cerebral arterial flow velocity in healthy volunteers. *Neurol Res* 1991;13:10.
151. Orlowski J, Shiesley D, Vidt D, et al. Labetalol to control blood pressure after cerebrovascular surgery. *Crit Care Med* 1988;16:765.
152. Van Aken H, Puchstein C, Schweppe M-L, et al. Effect of labetalol on intracranial pressure in dogs with and without intracranial hypertension. *Acta Anaesth Scand* 1982;26:615.
153. Kakarieka A, Schakel E, Fritze J. Clinical experiences with nimodipine in cerebral ischemia. *J Neural Transm Suppl* 1994;43:13.
154. Rosenbaum D, Zabramski J, Frey J, et al. Early treatment of ischemic stroke with a calcium antagonist. *Stroke* 1991;22:437.
155. Anonymous. A multicenter trial of the efficacy of nimodipine on outcome after severe head injury. The European Study Group on Nimodipine in Severe Head Injury. *J Neurosurg* 1994;80:797.
156. Pickard J, Murray G, Illingworth R, et al. Effect of oral nimodipine on cerebral infarction and outcome after subarachnoid

- haemorrhage: British aneurysm nimodipine trial. *BMJ* 1989;298:636.
157. Kucharczyk J, Chew W, Derugin N, et al. Nicardipine reduces ischemic brain injury. Magnetic resonance imaging/spectroscopy study in cats. *Stroke* 1989;20:268.
158. Alps B, Calder C, Hass W, et al. Comparative protective effects of nicardipine, flunarizine, lidoflazine and nimodipine against ischaemic injury in the hippocampus of the Mongolian gerbil. *Br J Pharmacol* 1988;93:877.
159. Grotta J, Spydell J, Pettigrew C, et al. The effect of nicardipine on neuronal function following ischemia *Stroke* 1986;17:213.
160. Bedford R, Dacey R, Winn H, et al. Adverse impact of a calcium entry-blocker (verapamil) on intracranial pressure in patients with brain tumors. *J Neurosurg* 1983;59:800.
161. Hayashi M, Kobayashi H, Kawano H, et al. Treatment of systemic hypertension and intracranial hypertension and intracranial hypertension in cases of brain hemorrhage. *Stroke* 1988;19:314.
162. Stanek B, Zimpfer M, Fitzal S, et al. Plasma catecholamines, plasma renin activity and haemodynamics during sodium nitroprusside-induced hypotension and additional beta-blockage with bunitrolol. *Eur J Clin Pharmacol* 1981;19:317.
163. Stiefel M, Heuer G, Abrahams J, et al. The effect of nimodipine on cerebral oxygenation in patients with poor-grade subarachnoid hemorrhage. *J Neurosurg* 2004;101:594-599.
164. Overgaard J, Skinhoj E. A paradoxical cerebral hemodynamic effect of hydralazine. *Stroke* 1975;6:402.
165. Griswold W, Roznik V, Mendoza S. Nitroprusside induced intracranial hypertension. *JAMA* 1981;246:2679.
166. Marsh M, Shapiro H, Smith R, et al. Changes in neurologic status and intracranial pressure associated with sodium nitroprusside administration. *Anesthesiology* 1979;51:336.
167. Dohi S, Matsumoto M, Takahashi K. The effects of nitroglycerin on cerebrospinal fluid pressure in awake and anesthetized humans. *Anesthesiology* 1981;54:511.
168. Meinig G, Reulen H, Hadjidimos A, et al. Induction of filtration edema by extreme reduction of cerebrovascular resistance associated with hypertension. *Eur Neurol* 1972;8:97.
169. Langfitt T, Marshall W, Kassell N, et al. The pathophysiology of brain swelling produced by mechanical trauma and hypertension. *Scand J Clin Lab Invest Suppl* 1968;102:B.
170. Marshall W, Jackson J, Langfitt T. Brain swelling caused by trauma and arterial hypertension. Hemodynamic aspects. *Arch Neurol* 1969;21:545.
171. Schutta H, Kassell N, Langfitt T. Brain swelling produced by injury and aggravated by arterial hypertension. A light and electron microscopic study. *Brain* 1968;91:281.
172. Marshall W, Weinstein J, Langfitt T. The pathophysiology of brain swelling produced by mechanical trauma and hypertension. *Surg Forum* 1968;19:431.
173. Olesen J. The effect of intracarotid epinephrine, norepinephrine, and angiotensin on the regional CBF in man. *Neurology* 1972;22:978-87.
174. MacKenzie E, McCulloch J, Harper A. Influence of endogenous norepinephrine on CBF and metabolism. *Am J Physiol* 1976;231:489.
175. Darby J, Yonas H, Marks E, et al. Acute CBF response to dopamine-induced hypertension after subarachnoid hemorrhage. *J Neurosurg* 1994;80:857.
176. Stein S, Cracco R. Cortical injury without ischemia produced by topical monoamines. *Stroke* 1982;13:74.
177. Hindman B, Funatsu N, Cheng D, et al. Differential effect of oncotic pressure on cerebral and extracerebral water content during cardiopulmonary bypass in rabbits. *Anesthesiology* 1990;73:951.
178. Kaieda R, Todd M, Warner D. Prolonged reduction in colloid oncotic pressure does not increase brain edema following cryogenic injury in rabbits. *Anesthesiology* 1989;71:554.
179. Kaieda R, Todd M, Cook L, et al. Acute effects of changing plasma osmolality and colloid oncotic pressure on the formation of brain edema after cryogenic injury. *Neurosurgery* 1989;24:671.
180. Zornow M, Scheller M, Todd M, et al. Acute cerebral effects of isotonic crystalloid and colloid solutions following cryogenic brain injury in the rabbit. *Anesthesiology* 1988;69:180.
181. Tommasino C, Moore S, Todd M. Cerebral effects of isovolemic hemodilution with crystalloid or colloid solutions. *Crit Care Med* 1988;16:862.
182. Zornow M, Todd M, Moore S. The acute cerebral effects of changes in plasma osmolality and oncotic pressure. *Anesthesiology* 1987;67:936.
183. Cruickshank J, Neil-Dwyer G, Lane J. The effect of oral propranolol upon the ECG changes occurring in subarachnoid hemorrhage. *Cardiovasc Res* 1975;9:236.
184. Kono T, Morita H, Kuroiwa T, et al. Left ventricular wall motion abnormalities in patients with subarachnoid hemorrhage: neurogenic stunned myocardium. *J Am Coll Cardiol* 1994;24:636.
185. Kolin A, Norris J. Myocardial damage from acute cerebral lesions. *Stroke* 1984;15:990.
186. Svengaard N, Brismar J, Delgado T, et al. Subarachnoid hemorrhage in the rat: effect on the development of cerebral vasospasm of lesions in the central serotonergic and dopaminergic systems. *Stroke* 1986;17:86.
187. Svengaard N, Delgado T, Arbab M. Catecholaminergic and peptidergic systems underlying cerebral vasospasm: CBF and CMRgl changes following an experimental subarachnoid hemorrhage in the rat. In: Wilkins R, ed. *Proceedings of the Charlottesville Conference held April 29-May 1, 1987, Cerebral Vasospasm*. New York: Raven Press, 1987:175.
188. Oldendorf W, Kitano M. Radioisotope measurement of brain blood turnover time as a clinical index of brain circulation. *J Nucl Med* 1967;8:570.
189. Karpman H, Sheppard J. Effect of papaverine hydrochloride on CBF as measured by forehead thermograms. *Angiology* 1975;26:592.
190. Minhas P, Menon D, Herrod N, et al. Cerebral ischemia associated with hyperventilation: A PET study. *J Neurosurg Anesth* 1997;9:380.
191. Dickman C, LP C, Baldwin H, et al. Continuous regional cerebral blood flow monitoring in acute craniocerebral trauma. *Neurosurgery* 1991;28:467.
192. Stringer W, Hasso A, Thompson J, et al. Hyperventilation-induced cerebral ischemia in patients with acute brain lesions: demonstration by xenon-enhanced CT. *Am J Neurorad* 1993;14:475-484.
193. Gupta A, Gupta S, Swart M, et al. Comparison of brain tissue oxygen with jugular venous oxygen saturation during hyperventilation in head-injured patients. *J Neurosurg Anesthesiol* 1997:399 (Abstract).
194. Merrick M, Ferrington C, Cowen S. Parametric imaging of cerebral vascular reserves. 1. Theory, validation and normal values. *Eur J Nucl Med* 1991;18:171.
195. Frerichs K, Feurestein G. Laser-Doppler flowmetry. A review of its application for measuring cerebral and spinal cord blood flow. *Mol Chem Neuropathol* 1990;12:55.
196. Gould R. Perfusion quantitation by ultrafast computed tomography. *Invest Radiol* 1992;27(Suppl 2):S18.
197. Hartmann A, Dettmers C, Schuler F, et al. Effect of stable xenon on regional CBF and the electroencephalogram in normal volunteers. *Stroke* 1991;22:181.
198. Burcar P, Norenberg M, Yarnell P. Hyponatremia and central pontine myelinolysis. *Neurology* 1977;27:223.
199. Shapiro H, Marshall L. Intracranial pressure responses to PEEP in head-injured patients. *J Trauma* 1978;18:254.
200. Huseby J, Luce J, Cary J, et al. Effects of positive end-expiratory pressure on intracranial pressure in dogs with intracranial hypertension. *J Neurosurg* 1981;55:704.
201. Shapiro H. Intracranial hypertension: therapeutic and anesthetic considerations. *Anesthesiology* 1975;43:445.
202. Aidinis S, Lafferty J, Shapiro H. Intracranial responses to PEEP. *Anesthesiology* 1976;45:275-278.
203. Harken A, Brennan M, Smith B, et al. The hemodynamic response to positive end-expiratory ventilation in hypovolemic patients. *Surgery* 1974;76:786-793.
204. Luce J, Huseby J, Kirk W, et al. A Starling resistor regulates cerebral venous outflow in dogs. *J Appl Physiol* 1982;53:1496.
205. Floyd T, McGarvey M, Ochroch E, et al. Perioperative changes in cerebral blood flow after cardiac surgery: influence of anemia and aging. *Ann Thorac Surg* 2003;76:2037-2042.

206. Dexter F, Hindman BJ. Effect of haemoglobin concentration on brain oxygenation in focal stroke: a mathematical modelling study. *Br J Anaesth* 1997;79:346-351.
207. Kim J, Kang S. Bleeding and subsequent anemia: a precipitant for cerebral infarction. *Eur Neurol* 2000;43:201-208.
208. Smith M, Maggee S, Stiefel M, et al. Packed red blood cell transfusion increases local cerebral oxygenation. *Crit Care Clin* 2005;33:1104-1108.
209. McIntyre L, Hebert P, Wells G, et al. Is a restrictive transfusion strategy safe for resuscitated and critically ill trauma patients? *J Trauma* 2004;57:563-568.
210. Goldstein A, Wells B, Keats A. Increased tolerance to cerebral anoxia by pentobarbital. *Arch Int Pharmacodyn Ther* 1966;138:138.
211. Bleyaert A, Nemoto E, Safar P, et al. Thiopental amelioration of brain damage after global ischemia-in-monkeys. *Anesthesiology* 1978;49:390.
212. Gisvold S, Safar P, Hendrickx H, et al. Thiopental treatment after global brain ischemia in monkeys. *Anesthesiology* 1981;55:A97.
213. Steen P, Milde J, Michenfelder J. No barbiturate protection in a dog model of complete cerebral ischemia. *Ann Neurol* 1979;5:343.
214. Anonymous. Randomized clinical study of thiopental loading in comatose survivors of cardiac arrest. *Brain Resuscitation Clinical Trial I Study Group*. *N Eng J Med* 1986;314:397-403.
215. Selman W, Spetzler R, Roessmann U, et al. Barbiturate-induced coma therapy for focal cerebral ischemia. Effect after temporary and permanent MCA occlusion. *J Neurosurg* 1981;55:220.
216. Selman W, Spetzler RF, Roski RA, et al. Barbiturate coma in focal cerebral ischemia. *J Neurosurg* 1982;50:85.
217. Spetzler R, Selman WR, Roski RA. Cerebral revascularization during barbiturate coma in primates and humans. *Surg Neurol* 1982;17:111.
218. Warner D, Takaoka S, Wu B, et al. Electroencephalographic burst suppression is not required to elicit maximal neuroprotection from pentobarbital in a rat model of focal cerebral ischemia. *Anesthesiology* 1996;84:1475-1484.
219. Watson J, Drummond J, Patel P, et al. A comparison of the cerebral protective effects of etomidate in a model of incomplete forebrain ischemia. *Neurosurgery* 1992;30:540-544.
220. Sano T, Patel P, Drummond J, et al. A comparison of the cerebral protective effects of etomidate, thiopental and isoflurane in a model of forebrain ischemia in the rat. *Anesth Analg* 1993;76:990-997.
221. Xue Q, Yu B, Wang Z, et al. Effects of ketamine, midazolam, thiopental, and propofol on brain ischemia injury in rat cerebral cortical slices. *Acta Pharmol Sin* 2004;25:115-120.
222. Chen L, Gong Q, Xiao C. Effects of propofol, midazolam and thiopental sodium on outcome and amino acids accumulation in focal cerebral ischemia-reperfusion in rats. *Chin Med J* 2003;116:292-296.
223. Ito H, Watanabe Y, Isshiki A, et al. Neuroprotective properties of propofol and midazolam, but not pentobarbital, on neuronal damage induced by forebrain ischemia, based on the GABAA receptors. *Acta Anaesth Scand* 1999;43:153-162.
224. Engelhard K, Werner C, Eberspacher E, et al. Influence of propofol on neuronal damage and apoptotic factors after incomplete cerebral ischemia and reperfusion in rats: a long-term observation. *Anesthesiology* 2004;101:912-917.
225. Bayona N, Gelb A, Jiang Z, et al. Propofol neuroprotection in cerebral ischemia and its effects on low-molecular-weight antioxidants and skilled motor tasks. *Anesthesiology* 2004;100:1151-1159.
226. Wang J, Yang X, Camporesi C, et al. Propofol reduces infarct size and striatal dopamine accumulation following transient middle cerebral artery occlusion: a microdialysis study. *Eur J Pharmacol* 2002;452:303-308.
227. Drummond J, Cole D, Patel P, et al. Focal cerebral ischemia during anesthesia with etomidate, isoflurane, or thiopental: a comparison of the extent of cerebral injury. *Neurosurgery* 1995;37:742-748.
228. Velly L, Guillet B, Masmajeun F, et al. Neuroprotective effects of propofol in a model of ischemic cortical cell cultures: role of glutamate and its transporters. *Anesthesiology* 2003;99:368-375.
229. Kofke W, Towfighi J, Garman R, et al. Effects of anesthetics on neuropathologic sequelae of status epilepticus in rats. *Anesth Analg* 1993;77:330.
230. Newberg L, Michenfelder J. Cerebral protection by isoflurane during hypoxemia or ischemia. *Anesthesiology* 1983;59:29-35.
231. Warner D, McFarlane C, Todd M, et al. Sevoflurane and halothane reduce focal ischemic brain damage in the rat. *Anesthesiology* 1993;79:985-992.
232. Warner D, Ludwig P, Pearlstein R, et al. Halothane reduces focal ischemic injury in the rat when brain temperature is controlled. *Anesthesiology* 1995;82:1237-1245.
233. Baughman V, Hoffman W, Thomas C, et al. Comparison of methohexital and isoflurane on neurologic outcome and histopathology following incomplete ischemia in rats. *Anesthesiology* 1990;72:85-94.
234. Baughman V, Hoffman W, Miletich D, et al. Neurologic outcome in rats following incomplete cerebral ischemia during halothane, isoflurane or N<sub>2</sub>O. *Anesthesiology* 1988;69:192-198.
235. Miura Y, Grocott H, Bart R, et al. Differential effects of anesthetic agents on outcome from near-complete but not incomplete global ischemia in the rat. *Anesthesiology* 1998;89:391-400.
236. Soonthan-Brant V, Patel P, Drummond J, et al. Fentanyl does not increase brain injury after focal cerebral ischemia in rats. *Anesth Analg* 1999;88:49-55.
237. Saito R, Graf R, Hubel K, et al. Reduction of infarct volume by halothane: Effect on cerebral blood flow or perifocal spreading depression-like depolarizations. *J Cereb Blood Flow Metab* 1997;17:857-864.
238. Kawaguchi M, Kimbro J, Drummond J, et al. Isoflurane delays but does not prevent cerebral infarction in rats subjected to focal ischemia. *Anesthesiology* 2000;92:1335-1342.
239. Inoue S, Drummond J, Davis D, et al. Combination of isoflurane and caspase inhibition reduces cerebral injury in rats subjected to focal cerebral ischemia. *Anesthesiology* 2004;101:75-81.
240. Elsersy H, Sheng H, Lynch J, et al. Effects of isoflurane versus fentanyl-nitrous oxide anesthesia on long-term outcome from severe forebrain ischemia in the rat. *Anesthesiology* 2004;100:1160-1166.
241. Kofke W, Garman R, Janosky J, et al. Opioid neurotoxicity: neuropathologic effects of different fentanyl congeners and effects of hexamethonium-induced normotension. *Anesth Analg* 1996;83:141-146.
242. Kofke W, Garman R, Stiller R, et al. Opioid neurotoxicity: fentanyl dose response effects in rats. *Anesth Analg* 1996;83:1298-1306.
243. Kofke W, Garman R, Tom W, et al. Alfentanil-induced hypermetabolism, seizure, and neuropathology in rats. *Anesth Analg* 1992;75:953.
244. Kofke W, Attaallah A, Kuwabara H, et al. Neuropathologic effects in rats and neurometabolic effects in humans of high-dose remifentanyl. *Anesth Analg* 2002;94:1229-1236.
245. Kofke W, Blissitt P, Rao H, et al. Remifentanyl-induced cerebral blood flow effects in normal humans: dose and ApoE genotype effects. *Anesth Analg* 2007;105:167-175.
246. Kearse LJ, Koski G, Husain M, et al. Epileptiform activity during opioid anesthesia. *Electroencephalogr Clin Neurophysiol* 1993;87:374.
247. Kofke W, Garman R, Garman R, et al. Opioid neurotoxicity: fentanyl-induced exacerbation of forebrain ischemia in rats. *Anesthesiology* 1994;81:A820.
248. Statler K, Kochanek P, Dixon C, et al. Isoflurane improves long-term neurologic outcome versus fentanyl after traumatic brain injury in rats. *J Neurotrauma* 2000;17:1179-1189.
249. Sinz E, Kofke W, Garman R. Phenytoin, midazolam, and naloxone protect against fentanyl-induced brain damage in rats. *Anesth Analg* 2000;91:1443-1449.



# CHAPTER 88

## Anaphylactic Reactions and Anesthesia

Robert S. Holzman, MD, FAAP

Anaphylaxis is an acute, severe, potentially life-threatening allergic reaction. The word “allergy,” introduced by Baron Dr. Clemens von Pirquet in 1906, was meant to describe the uncommitted biologic response that may lead to immunity or allergic disease. This concept is very much in keeping with our evolving understanding a century later. Preceding von Pirquet’s neologism, Portier and Richet in 1902 reported that the second injection of sea anemone extract into dogs resulted in a fatal systemic reaction after the first injection had no directly observable effect, a finding totally unexpected at the time. Richet fashioned the word “anaphylaxis” by combining the Greek *ana* (“contrary to”) and *phylaxis* (“protection”) to describe an adverse reaction following repeated exposure to a foreign protein rather than the intended immunization, or prophylaxis.

This chapter takes the view of the anesthesiologist as perioperative specialist, focusing on preoperative evaluation of the patient with a possible history of allergy, diagnosis and intervention in the operating room and perioperative environment, and bridge to the patient’s further care and evaluation by primary care physicians and additional specialists.

### BIOLOGY OF MAST CELL ACTIVATION

Why are some of us destined for a life of allergy and others not? We now know that our immune systems can choose from two pathways to express reactions to antigens, either a low-grade or high-grade immunologic response (Table 88-1). *Low-grade responders* produce allergen-specific IgG1 and IgG4 antibodies and their T cells respond to the allergen with a moderate proliferation and production of interferon- $\gamma$  by type 1 T-helper (Th1) cells.

*High-grade responders*, however, have an exaggerated response, with increased production of allergen-specific IgE antibodies as well as increased serum levels of IgE-specific antibodies to common allergens. In this group, cytokines produced by Th2 cells, including interleukin (IL)-4, IL-5, and IL-13, are produced rather than cytokines such as interferon- $\gamma$  and IL-2 from Th1 cells.<sup>1</sup>

### IgE-Mediated Mast Cell Activation

Antigenic molecules (usually proteins) capable of stimulating IgE antibody

production may cause IgE-mediated anaphylaxis after initial sensitization and subsequent reexposure. Haptens, molecules too small to stimulate immune responses themselves, may bind to endogenous proteins such as albumin and become antigenic. Once produced, IgE antibodies to these antigens become fixed to tissue mast cells and/or circulating basophils, both of which contain high-affinity IgE receptors (Fig. 88-1).<sup>2</sup> Reexposure to antigens or haptens, with subsequent cross-linking of cell surface IgE antibody, induces activation of membrane-associated

### KEY POINTS

1. Anaphylaxis is an acute reaction leading to severe physiologic derangements of multiple systems. True anaphylaxis denotes an IgE antibody-mediated reaction.
2. Non-IgE-mediated reactions resembling true anaphylaxis occur and are commonly called anaphylactoid reactions. These reactions can be of identical severity to anaphylactic reactions, may be clinically indistinguishable during the time of occurrence, and should be treated in an identical manner to anaphylactic reactions.
3. Clinical symptoms include urticaria, flushing, nausea, vomiting, abdominal pain, laryngeal edema, bronchospasm, and cardiovascular collapse. Under anesthesia, cardiovascular collapse and respiratory distress are the most common clinical signs.
4. Treatment consists of discontinuing the suspected initiating agent, securing the compromised airway, and establishing intravenous access. Bronchospasm and laryngeal edema are treated with epinephrine. Hypotension and cardiovascular collapse are treated with volume, epinephrine, and cardiopulmonary resuscitation if needed.
5. Evaluation of an anaphylactic reaction starts with a detailed history and may include skin testing, radioallergosorbent testing, and/or provocative challenge. Such efforts should be coordinated in consultation with the primary physician and an allergy specialist. The anesthesiologist’s information about the timing and administration of the various medications and the signs and symptoms observed will be invaluable for the ultimate diagnosis of specific allergy.
6. Most serious and fatal allergic reactions to penicillin and  $\beta$ -lactam antibiotics occur in individuals who have never had a previous allergic reaction.
7. Many commonly used anesthetic agents and other drugs administered during anesthesia, including neuromuscular blocking agents, hypnotics, opiates, and antibiotics, lead to non-immunologic histamine release.
8. True allergic reactions to local anesthetics are exceedingly rare, and cases labeled as such usually are due to other causes (vasovagal response, intravenous injection) or possibly metabolites (para-aminobenzoic acid) preservatives (methylparaben) or antioxidant additives (metabisulfite). If the previous drug is unknown, an amide-type local anesthetic should be chosen.
9. Diabetics exposed to protamine-containing insulin have a 40- to 50-fold increased risk for life-threatening reactions to protamine. Fish-allergic individuals and vasectomized men also may be at increased risk.
10. Healthcare workers regularly exposed to latex have a substantially increased risk of latex-specific IgE positivity (up to 18%), and 28–67% of children with spina bifida have a positive skin test result to latex proteins. Life-threatening anaphylaxis can occur intraoperatively in highly sensitive patients because of mucosal absorption of latex protein allergens from surgical gloves.



TABLE 88–1.

## Characteristics of Immunological Responses to Allergens

Low-Grade Responders	High-Grade Responders
<b>Th1 Expression</b>	<b>Th2 Expression</b>
Small amount of antigen or low-affinity interaction between T cells and antigen-presenting cells	Large amount of antigen or high-affinity interaction between T cells and antigen-presenting cells
Mediated by IL-12	Mediated by IL-4
Presence of cytidine-phosphate-guanosine (CpG) repeats from bacteria favor Th1 phenotype	Presence of transcription factors such as GATA-3, c-maf, and PGE2 favors Th2 phenotype
IL-10 and transforming growth factor- $\beta$ inhibit responses of Th1 and Th2	Nitric oxide favors Th2 expression by being less inhibitory to Th2 cells than to Th1 cells
IL-4 inhibits expression of Th1 cells	Interferon- $\gamma$ inhibits Th2 expression
Th2 cells mediate atopy and allergic inflammation. In view of the reciprocity of the relationship, one theory about the rising incidence of allergy in Western countries is the cleanliness of the environment and the ubiquitous presence of antibiotics.	IL-12 and IL-18 both release Interferon- $\gamma$ from T cells
	IL-4 promotes expression of Th2 cells
IL, Interleukin; Th1, type 1 T-helper cells; Th2, type 2 T-helper cells.	

enzymes, causing complex biochemical cascades that lead to influx of extracellular calcium and mobilization of intracellular calcium with subsequent release of preformed granule-associated mediators and generation of new mediators from cell membrane phospholipids.

Cytokines are low-molecular-weight chemicals that modulate cell function locally. The cytokines that promote IgE isotype switching (IL-4 and IL-13) are generated by T-lymphocytes with a Th2 cytokine profile. T cells that generate a Th1 cytokine profile—by secreting interferon- $\gamma$ —inhibit B-cell isotype switching for IgE synthesis. Th1 and Th2 cells reciprocally inhibit each other's development. When IgE production is increased, such as in atopy (from the Greek *atopos* or “out of place”), an imbalance in the Th2/Th1 ratio control is likely. Th2-associated cytokines, such as IL-4, IL-5, IL-9 and IL-13, are associated with many stigmata of chronic allergic inflammation. IL-4 and IL-13 stimulate production of IgE and vascular cell adhesion molecule (VCAM)-1. IL-5 and IL-9 are involved in the development of eosinophils. IL-4 and IL-9 promote the development of mast cells. IL-9 and IL-13 promote air-

way hyperresponsiveness. IL-4, IL-9, and IL-13 promote overproduction of mucus. In their turn, eosinophils injure mucosal surfaces by releasing toxic basic proteins, cysteinyl leukotrienes, and platelet activating factor. They also damage inhibitory MK2 muscarinic receptors, ultimately leading to airway hyperresponsiveness. IL-5 also releases mature and immature eosinophils from bone marrow.

IgE molecules then bind to high-affinity receptors for IgE [Fc epsilon receptor 1 (Fc $\epsilon$ RI)] on circulating basophils and mast cells. This binding itself does not induce the allergic reactions; a second step is required. The allergens, because of their multivalency, express multiple epitopes recognized by specific IgEs and IgGs. *Simultaneous multivalent binding of allergens to several membrane-bound IgEs* induces receptor aggregation,<sup>2</sup> triggering a signaling cascade that leads to production and release of allergic and inflammatory mediators (histamine, leukotrienes, chemokines, and cytokines). Release of these mediators is rapid (in minutes) and produces immediate symptoms.

There is a balance of activating and inhibitory cell-surface receptors, but how is the signaling cascade generat-

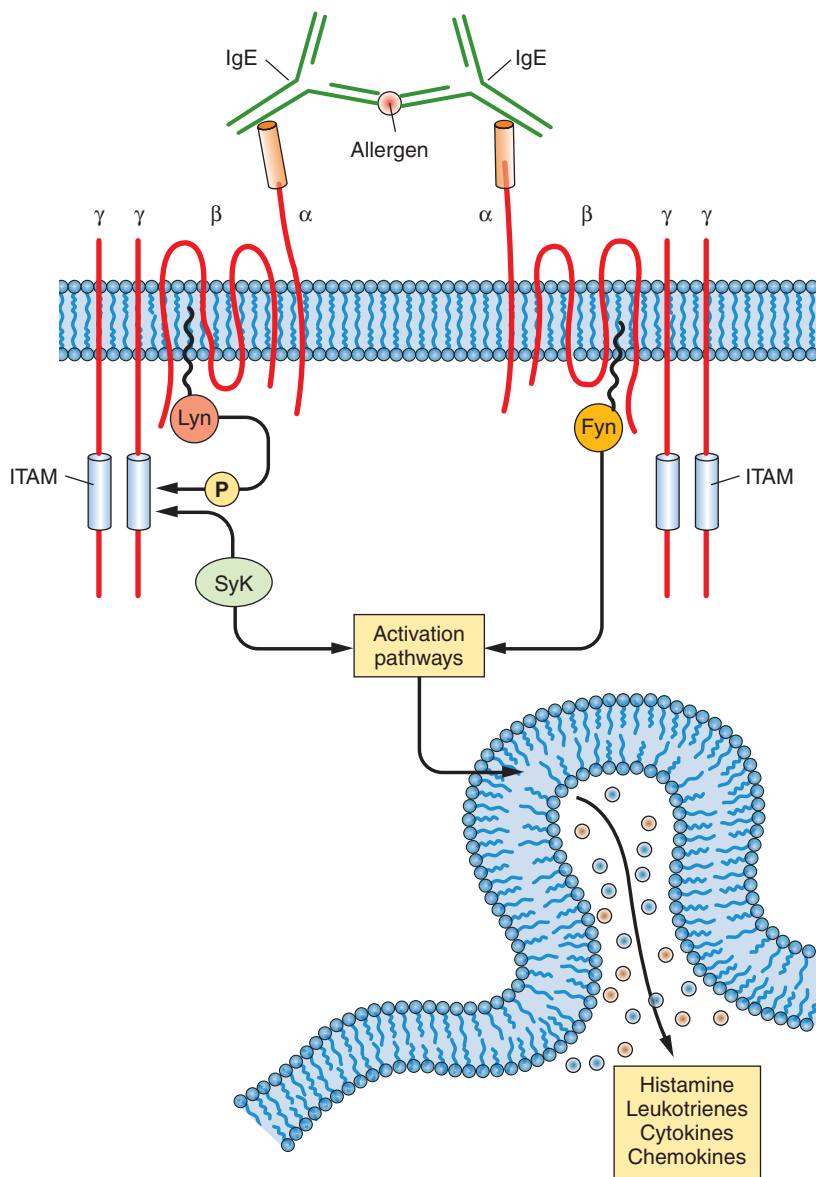
ed? Fc $\epsilon$ RI has an IgE binding unit (the  $\alpha$ -chain) and a signaling unit (one  $\beta$ -chain and two  $\gamma$ -chains). Aggregation of Fc $\epsilon$ RI induces activation of a tyrosine kinase bound to the  $\beta$ -chain; the tyrosine kinase then phosphorylates two tyrosine residues in the  $\gamma$ -chains. These tyrosine residues are a central feature of the *immunoreceptor tyrosine-based activation motif* (ITAM), a feature of many receptors throughout the immune system. After phosphorylation, the ITAMs of the  $\gamma$ -chains activate *Syk tyrosine kinase*, which, through activation of downstream pathways, induces release of allergic mediators.

Modulation of these Fc $\epsilon$ RI pathways occurs via inhibition mediated by the IgG receptor Fc $\gamma$  receptor IIb (Fc $\gamma$ RIIb). Allergen-specific IgGs form complexes with allergens that can, in turn, form a bridge between Fc $\epsilon$ RI and Fc $\gamma$ RIIb. This bridge induces aggregation of activating Fc $\epsilon$ RI with inhibitory Fc $\gamma$ RIIb, which inhibits the activation pathways activated by Fc $\epsilon$ RI. *This delicate balance of IgG counteracting IgE is putatively the central mechanism behind successful allergen desensitization.* In its inhibition of ITAM, Fc $\gamma$ RIIb contains an immunoreceptor tyrosine-based inhibitory motif (ITIM), a modified version of ITAM present in Fc $\epsilon$ RI.

Making use of this membrane architecture, a chimeric molecule designed to bind both Fc $\gamma$ RIIb and a specific IgE bound to Fc $\epsilon$ RI has been shown to create a bridge and inhibit allergic reactions, including allergen-mediated activation of basophils and mast cells in vitro as well as in a mouse model.<sup>3</sup> Such a strategy not only could provide prophylaxis for specific allergic reactions but in addition could displace allergens already bound to IgE, in which case it would help terminate ongoing anaphylactic reactions following initial exposure.

### Complement-Mediated Mast Cell Activation

Complement was first identified as a heat-labile “principal” in serum that “complemented” antibodies in the killing of bacteria. Complement consists of a series of plasma and cell membrane proteins that lyse susceptible targets, promote phagocytosis, and generate peptide mediators of the inflammatory response. These anaphylotoxins cause mast cell and basophil mediator release, directly increase vascular permeability, make smooth



**FIGURE 88-1.** Mast cell activity. (Kinet J. A new strategy to counter allergy. *N Engl J Med* 2005;353:310–312. © 2005 Massachusetts Medical Society. All rights reserved.)

muscles contract, cause platelet activation, and stimulate macrophages to produce thromboxane, effects almost identical to IgE-mediated mast cell activation. The job of the complement system is challenging: it provides host defense through opsonization, chemotaxis and activation of leukocytes, and lysis of bacteria and cells. It also acts to augment the antibody response and enhancement of immunologic memory. Finally, it must dispose of waste through clearance of immune complexes from tissues and clearance of apoptotic cells.

The complement cascade may be activated through either the classic alternative pathway or the mannose-binding lectin pathway (Fig. 88-2). Complement activation through the

classic pathway is initiated through IgG or IgM antibody binding to antigens, as in hemolytic ABO-incompatible blood transfusion reactions. Heparin-protamine complexes have been shown *in vivo*<sup>4</sup> and *in vitro*<sup>5</sup> to activate complement via the classic pathway. Injection of preformed immune complexes or IgG aggregates can activate complement and mimic clinical anaphylaxis. Patients with selective IgA antibody deficiency may develop IgG anti-IgA antibodies after receiving multiple transfusions, which may result in complement activation and anaphylactic reactions.<sup>6</sup>

Complement activation via the alternative pathway may be stimulated by lipopolysaccharides (endotoxin),<sup>7</sup> althesin,<sup>8</sup> radiocontrast media, and

membranes used for cardiopulmonary bypass and dialysis.

The initiators of the mannose binding lectin pathway are microbes with terminal mannose groups. Young children with recurrent infections may have low levels of mannose binding lectin, thus suggesting the importance of the mannose-binding lectin pathway in the loss of passively acquired maternal antibody and the acquisition of a mature immunologic repertoire.<sup>9</sup>

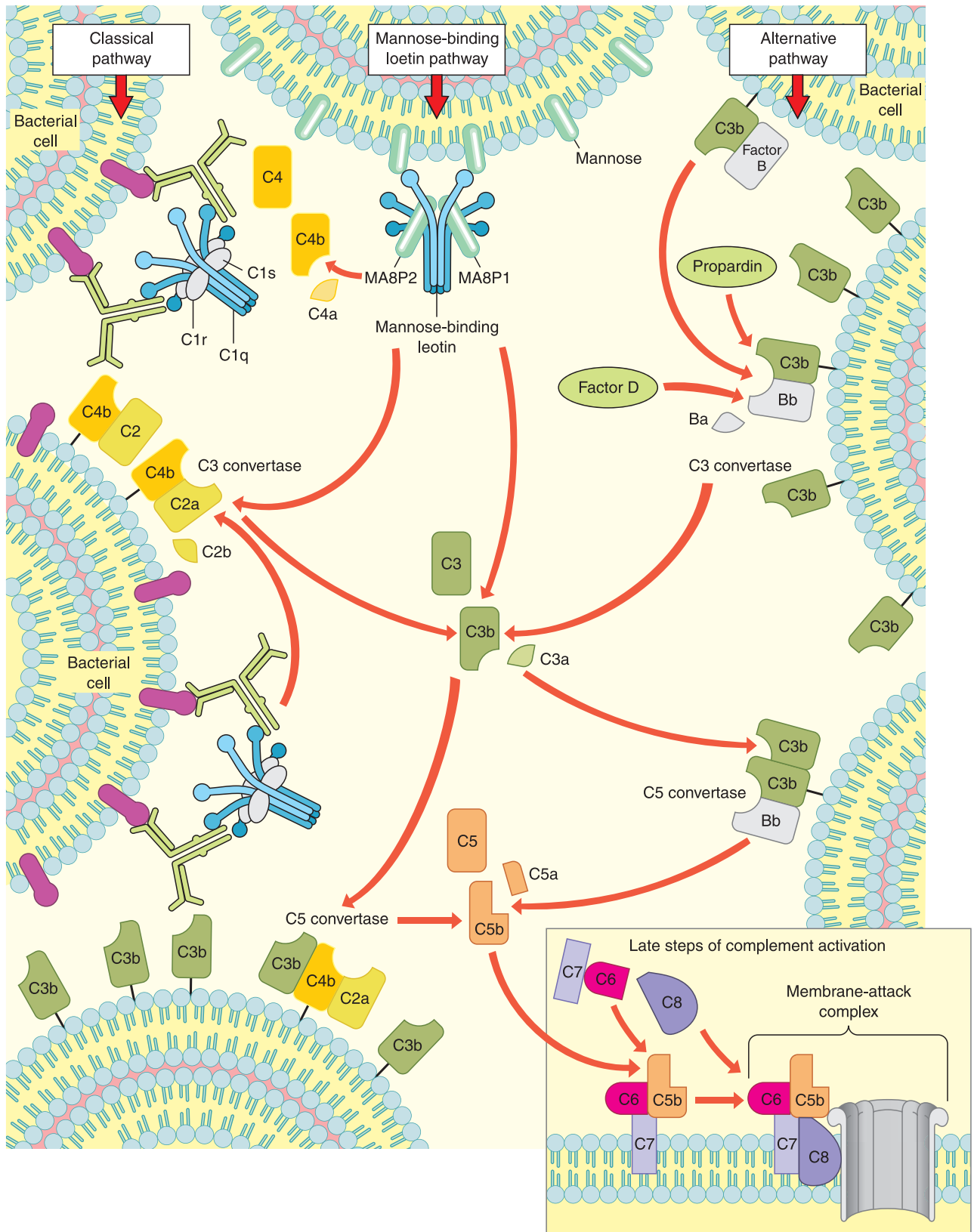
The three pathways converge at the point of cleavage of C3, leading to formation of the membrane attack complex that directly affects the integrity of mast cell and basophil cell membranes. In addition, complement activation has an adjunctive role in amplifying the antibody response.

### Nonimmunologic Mast Cell Activation

Certain drugs can cause mast cell mediator release by nonimmunologic means, the exact mechanism of which is poorly understood. Drugs that induce nonimmunologic mast cell activation include opiates (especially morphine and codeine)<sup>10,11</sup> and neuromuscular blocking agents such as atracurium and D-tubocurarine.<sup>12</sup> Evidence suggests that neuromuscular blockers such as atracurium, vecuronium, and succinylcholine also may induce mast cell mediator release via IgE antibodies directed against quaternary or tertiary ammonium ion epitopes.<sup>13–15</sup>

### Mediators of Anaphylaxis

Once the mast cell, basophil, or eosinophil is activated by any of the mechanisms, release of mediators results in attraction, accumulation, and activation of other cellular elements. Mediators released include those preformed and stored in granules and those newly generated upon appropriate stimulation. Release of these mediators may cause various pathophysiologic responses that may result in acute or chronic reactions. The complex of allergen, IgE, and high-affinity receptor for IgE on the surface of the mast cell triggers noncytotoxic, energy-dependent release of preformed, granule-associated histamine and tryptase and the membrane-derived lipid mediators leukotrienes, prostaglandins, and platelet-activating factor. Mast cells produce the three cysteinyl leukotrienes C4, D4, and E4, which cause contraction of smooth



**FIGURE 88-2.** Activation of the complement pathway. (Walport M. Complement: first of two parts. *N Engl J Med.* 2001;344(14):1058-1066. © 2001 Massachusetts Medical Society. All rights reserved.)

TABLE 88–2.

## Incidence of Anaphylaxis during Anesthesia

Location	Incidence	Mortality	Reference
Australia	0.5–1:10,000	3.4%	20
United States	3.3:10,000		
France, single institution	16.3:10,000		26
France	1–2:10,000		110
Germany	0.5–3:10,000	3–6%	111
Boston Collaborative Drug Program (United States, New Zealand, Scotland)	4.5:10,000	5%	112

muscles, vasodilatation, increased vascular permeability, and hypersecretion of mucus. Collateral sources of cysteinyl leukotrienes are eosinophils, macrophages, and monocytes. Mast cell tryptase activates receptors on endothelial and epithelial cells, which causes upregulation of adhesion molecules that selectively attract eosinophils and basophils.

### EPIDEMIOLOGY OF ANAPHYLAXIS DURING ANESTHESIA

Allergic disease is on the increase in western countries. Environment may have a great deal to do with this increase; allergic disease was less common in East Germany than West Germany prior to reunification.<sup>16</sup> This finding supports the intriguing notion that when the developing immune system is deprived of microbial antigens that stimulate Th1 cells, the so-called “hygiene hypothesis,” the opportunity to prolong sensitization of Th2 cells ensues. By promoting a Th1 response, infection downregulate the tendency for development of Th2-related disease.<sup>17</sup> Other factors that may favor a greater Th2 response in infants include diet and birth dates during high pollen counts. Additional environmental influences such as viral infections, allergen exposure, tobacco smoke, and air pollutants also may play a role. Epidemiologic data have shown an increased prevalence and severity of pediatric atopic diseases (asthma, eczema, and allergic rhinitis) during the past 15–20 years.<sup>18,19</sup>

Anaphylaxis during anesthesia has a unique epidemiology and subset of etiologic factors. The incidence of

anaphylaxis during anesthesia is variable within an order of magnitude but ranges between 0.5:10,000 and 16.3:10,000 (Table 88–2). Anaphylaxis during anesthesia has been attributed primarily to muscle relaxants. A review of 826 patients referred to an anesthetic allergy clinic in Australia over a 17-year period revealed severe immediate anaphylactic reactions in 54%; in 59% a muscle relaxant was involved.<sup>20</sup> Of 452 patients evaluated in an allergy–anesthesia clinic in Nice, France, 62 patients experienced anaphylaxis, 57 due to muscle relaxants, 4 to latex, and 1 to gelatin. By avoiding reexposure and offering alternate methods of anesthesia (e.g., regional block), subsequent allergic reactions were prevented.<sup>21</sup> A 20-year review of the French and English language literature (1964–1984) yielded 975 cases of immediate life-threatening reactions, with the greatest number of cases due to muscle relaxants (51%) and hypnotic drugs (42.3%).<sup>22</sup> In another series, the substances involved were muscle relaxants (70%), latex (12.6%), hypnotics (3.6%), benzodiazepines (2.0%), opioids (1.7%), colloids (4.7%), and antibiotics (2.6%).<sup>23</sup> Once again, these proportions have remained consistent in followup surveys among the collaborating institutions in France, with the most common causes of anaphylaxis remaining muscle relaxants (58.2%), latex (16.7%), and antibiotics (15.1%). Rocuronium (43.1%) and succinylcholine (22.6%) were the most frequently incriminated muscle relaxants (Table 88–3).<sup>24</sup>

Patients who react have a greater incidence of allergy, atopy, asthma, and previous reactions than do nonreactors, suggesting these are significant predictive factors. However, although

a history of drug allergy was found in 37% of cases and atopy in 38%,<sup>22</sup> the majority of patients do not have such a history, and the majority of patients with such a history do not react.<sup>25</sup> A multicenter survey carried out in France in 1990 and 1991 revealed in a series of 1585 patients a 3:1 ratio of females to males. The reactions occurred mostly in adults (80%); 9% occurred in children.<sup>26</sup> Cardiovascular collapse has consistently been described as the most common presenting problem, and evidence indicates that this form of shock is substantially different at the cellular level and potentially more harmful than other causes of shock.<sup>27</sup>

Fifty-seven cases of possible allergic reactions in the perioperative period have been reported to the Australian Incident Monitoring Study, representing approximately 3% of the first 2000 incidents. Nineteen were judged as “very likely allergic responses,” representing nearly 1% of the first 2000 incidents. Suspected causative agents included “induction drug” (38/57), antibiotic (19/57), nondepolarizing relaxant (14/57), opiate (12/57), blood/plasma/Hemacel (11/57), and “other” (16/57).<sup>25</sup>

### CLINICAL MANIFESTATIONS OF ANAPHYLAXIS

Evaluation and treatment of patients who develop anaphylaxis in the operating room is challenging even for the experienced physician. In the perioperative period, multiple medications frequently are given in close proximity, making causative factors more difficult to interpret. Patients usually are unconscious, draped, and cold, situations that often hide early signs and symptoms of anaphylaxis. Anesthetics themselves alter mediator release, possibly delaying early recognition.<sup>28</sup>

In general, symptoms begin soon (within minutes) after introduction of the causative agent but may be delayed for 1–2 hours. Along with other symptoms, conscious patients frequently describe a sense of impending doom. The primary anaphylactic target organs in humans are the cutaneous, gastrointestinal, respiratory, and cardiovascular systems (Box 88–1). *During general and regional anesthesia or during deep sedation, cardiovascular signs predominate.*<sup>20,29</sup>



TABLE 88-3.

## Etiologic Agents of Anaphylaxis

Reference	Year	No. of Reactions	Muscle Relaxant	Succinylcholine	Rocuronium	Alcuronium	Atracurium	Cisatracurium	d-Tubocurarine
Clarke	1993	529		45%		10%	16%		3%
Vuitton	1985	21		38%		5%			
Boileau	1985	975		63%		33%	100%		60%
Occelli	1992	62		65%					
Binkley	1992	23		0%					
Laxenaire	1993	813		43%		8%	7%		
Fisher	1993	443		27%		44%	8%		7%
Kurtz	1985	35		91%					
<b>GERAP (Group d'étude des réactions anaphylactoides peranesthésiques)</b>									
	1984-1989	821	81%						
Laxenaire	1990-1991	813	70%						
1993									
Laxenaire	1992-1996/ 1994	1030	59%						
Laxenaire	1994-1996	734	62%						
1999									
Laxenaire	1997-1998	467	69%						
2001									
Mertes 2003	1999-2000	518	58%	23%	43%		19%	1%	
Mertes	2001-2002	491	55%	38	26%				
2004									

## DIFFERENTIAL DIAGNOSIS

In a conscious patient, anaphylaxis is most easily confused with a vasovagal reaction, which may occur when a patient collapses after an injection or painful procedure (Box 88-2). During a vasovagal reaction, the patient looks pale and complains of nausea before syncope but does not report pruritus or become cyanotic. Respiratory difficulty does not occur, and symptoms are relieved almost immediately once the patient is supine. Vasovagal reactions often are accompanied by profuse diaphoresis and bradycardia, without flushing, urticaria, angioedema, pruritus, or wheezing. The differential diagnosis of sudden collapse includes dysrhythmias, myocardial infarction, aspiration of food or foreign body, pulmonary embolism, seizure disorder, hypoglycemia, and stroke. In the presence of laryngeal edema, especially when accompanied by abdominal pain, the diagnosis of hereditary angioedema should be considered. *Globus hystericus* and fictitious asthma must be considered when respiratory symptoms are present. Other condi-

tions that can mimic anaphylaxis are overdose of medication, cold urticaria (especially if generalized), idiopathic urticaria, carcinoid tumors, and systemic mastocytosis.

## TREATMENT OF ANAPHYLAXIS

Anaphylactic reactions must be recognized early because death may occur within minutes; the longer initial therapy is delayed, the greater the incidence of fatality.<sup>30,31</sup> Treatment of anaphylactic reactions can be divided into initial and secondary therapies (Box 88-3).

## Initial Treatment

When possible, steps should be taken to interrupt further exposure to and absorption of the offending agent. Intravenous infusions of suspected allergens should be stopped immediately. Airway maintenance with 100% oxygen should be administered; adequate oxygenation should be assured by continuous monitoring and arterial blood gas levels. If there is any suggestion of airway compromise due to laryngeal edema, the trachea should be intubat-

ed immediately. If laryngeal edema is present, aerosolized epinephrine (three inhalations of 0.16-0.20 mg epinephrine per inhalation from a metered dose inhaler) or epinephrine by nebulizer (8-15 drops of 2.25% epinephrine in 2 mL normal saline) may be useful. If laryngeal edema is refractory to these measures or progresses too rapidly, a needle catheter cricothyrotomy or emergency surgical cricothyrotomy may be necessary.

Upon suspicion of a severe reaction, intravenous access should be established (if not already in place), and intravascular volume should be maintained with administration of isotonic crystalloid (normal saline) or colloidal solutions.

Epinephrine is the cornerstone of initial pharmacologic treatment. In cases of *severe hypotension or airway obstruction*, 0.1-mL (100 µg of a 1:1000 dilution) increments of epinephrine should be given intravenously, usually not exceeding 0.5 mg total. Depending on the patient's condition, however, a lower or higher dosage may be needed. Risks include cardiac dysrhythmias (especially during halothane an-

Vecuronium	Pancuronium	Hypnotics	Thiopental	Propofol	Etomidate	Latex	Opioids	Antibiotic	Penicillin	Cephalosporin	Vancomycin	Colloids
12%	2% 5%		57% 10% 69%	23%	4%							
						6%						
37%	13%		74% 62%	34%		4%						
1%	3%		53% 60%	1%		13%						
		11%				1%	3%	2%				1%
		6%				13%	2%	3%				5%
		8%				19%	4%	3%				5%
		5%				17%	3%	8%				3%
		4%				12%	1%	8%				3%
9%	3%	3%				17% 22%	1%	15% 15%	42%	39%	11%	4%

esthesia), myocardial infarction, and stroke. In the rare instance when an intravenous line is not in place, 0.3 mL of 1:1000 epinephrine can be given subcutaneously or intramuscularly, or 10 mL of 1:10,000 epinephrine can be administered through the endotracheal tube. However, when a patient is in shock, absorption of intramuscular or subcutaneous epinephrine is unreliable. For persistent hypotension, catecholamine infusions can be used. Epinephrine also will be useful if both hypotension and bronchospasm persist. Suggested starting doses of epinephrine are given in Box 88-3. If >8–10  $\mu\text{g}/\text{min}$  is required, tachycardia may be a significant side effect, and norepinephrine may be more effective. The suggested starting dosage for norepinephrine is 0.05  $\mu\text{g}/\text{kg}/\text{min}$  (2–4  $\mu\text{g}/\text{min}$ ) and should be titrated to maintain tissue perfusion. Dopamine can be used to maintain blood pressure. A dosage of 5–20  $\mu\text{g}/\text{kg}/\text{min}$  may help maintain cardiac output, thereby improving coronary, cerebral, renal, and mesenteric blood flow.

Potent volatile anesthetic agents should be discontinued. Anesthetic

agents have negative inotropic properties, may decrease systemic vascular resistance, and may interfere with the reflex compensatory response to hypotension. Halothane specifically sensitizes the heart to circulating catecholamines, which are required for treatment of severe anaphylactic reactions; therefore, change of agents to an ether anesthetic such as isoflurane, sevoflurane, or desflurane may be desirable.

### Secondary Treatment

Once the patient's condition begins to stabilize, administration of other pharmacologic agents may be warranted. An antihistamine such as diphenhydramine will be helpful for symptomatic relief of itching. Although no evidence has demonstrated the effectiveness of  $\text{H}_2$ -receptor antagonists in the treatment of anaphylaxis, ranitidine (1 mg/kg IV) may be useful<sup>32</sup> when hypotension is persistent because peripheral vasodilatation may be exacerbated by the effects of histamine on endothelial  $\text{H}_2$  receptors.

Glucocorticoids are useful for preventing potential late-phase reactions

and treating persistent bronchospasm, but they have no immediate effects. Hydrocortisone 5 mg/kg (up to 200 mg initial dose) and then 2.5 mg/kg every 6 hours or methylprednisolone 1 mg/kg initially and every 6 hours as indicated can be given.

Treatment with bicarbonate is controversial and probably should be reserved for profound acidosis, preexisting hyperkalemia, or use immediately after intubation following prolonged cardiac arrest.<sup>33</sup> Acid-base status must be monitored using arterial blood gas levels to guide further therapeutic interventions.

The response to therapy usually is prompt, but despite all of the measures mentioned previously, some patients do not respond quickly. Treatment of anaphylaxis may be complicated by increased use of  $\beta$ -adrenergic blocking agents, particularly in older patients.

### DETERMINING THE CAUSE OF ANAPHYLACTIC REACTIONS

Patients who have had anaphylactic reactions to drugs administered in the

## BOX 88–1.

## Target Organs of Anaphylaxis

System	Signs and Symptoms	
Cutaneous	Pruritus	
	Flushing <sup>a</sup>	
	Erythema <sup>a</sup>	
	Urticaria/angioedema <sup>a</sup>	
	Gastrointestinal	Nausea
		Abdominal pain
		Diarrhea
	Respiratory	Vomiting
		Laryngeal edema
		Hoarseness
Dysphonia		
“Lump” in throat		
Chest tightness		
Dyspnea		
Cough		
Wheezing <sup>a</sup>		
Cyanosis <sup>a</sup>		
Cardiovascular	Increase in peak airway pressure <sup>a</sup>	
	Nasal itching	
	Sneezing	
	Rhinorrhea	
	Nasal obstruction	
	Hypersecretion of mucus	
	Light-headedness	
	Faintness	
	Syncope	
	Tachycardia <sup>a</sup>	
Hypotension <sup>a</sup>		
Dysrhythmias <sup>a</sup>		

<sup>a</sup>Most likely to occur in patients during anesthesia.

operating room require evaluation to identify the causal agents and to guide selection and use of future medications. The evaluation starts with a detailed history, including concurrent illness and earlier allergic and anesthetic encounters. It is helpful to prepare a flow diagram of the patient's reaction temporally depicting the clinical manifestations of the reaction and the medications received, including indications, when initiated, doses, and duration of therapy. Equally important information includes previous exposure to the same or structurally related medications, effect of drug discontinuation, response to treatment, and any previous diagnostic testing or rechallenge. Medications should be considered with regard to their known propensity for causing anaphylaxis. The proximity of drug administration to

## BOX 88–2.

## Differential Diagnosis of Anaphylaxis

Vasovagal reaction  
Dysrhythmia  
Myocardial infarction  
Overdose of medication or illicit drugs  
Pulmonary embolism  
Seizure disorder  
Cerebral vascular accident  
Aspiration  
Globus hystericus  
Fictitious asthma  
Hereditary angioedema  
Physical or idiopathic urticaria  
Serum sickness  
Carcinoid tumors  
Systemic mastocytosis

the onset of acute reactions should be documented. In general, agents that have been used for long continuous periods before the onset of an acute reaction are less likely to be implicated than are agents recently introduced or reintroduced. However, in the perioperative period, patients commonly receive many medications in close temporal proximity, making a diagnosis by history alone difficult.

### Immunodiagnostic Tests

#### Skin Testing for Immediate Hypersensitivity Reactions

Although standardized and commonly used by allergists in the diagnosis of immediate hypersensitivity to aeroallergens and Hymenoptera, evaluation of drug allergy is hampered by the unavailability of relevant drug metabolites or appropriate multivalent testing reagents. Intradermal skin tests still are the most readily available and generally useful diagnostic tests for drug allergy. Skin testing clearly has an established role in the evaluation of IgE-mediated penicillin allergy.<sup>34</sup> Skin testing also is useful in the evaluation of allergy to muscle relaxants,<sup>35,36</sup> barbiturates,<sup>35,37</sup> chymopain,<sup>38</sup> streptokinase,<sup>39</sup> insulin,<sup>40</sup> latex,<sup>41,42</sup> and miscellaneous drugs. Specific protocols for skin testing are well documented. Skin testing must be performed in the absence of medications that will affect the skin test response (especially H<sub>1</sub> antihistamines, tricyclic antidepressants, and sympathomimetic agents). Appropriate positive (histamine) and negative (diluent) controls should be used.

### Other In Vivo Tests

Delayed (tuberculin-like) skin tests have little, if any, place in the evaluation of drug allergy. Patch tests may be of value in cases of contact dermatitis.

### In Vitro Tests

#### Total Serum IgE Levels

Although increases in total serum IgE levels have been reported after allergic reactions,<sup>43</sup> the level of antigen-specific IgE is rarely, if ever, helpful in establishing the diagnosis of an allergic drug reaction.

#### Assays to Measure Complement Activation

Assessment of complement activation includes measurement of the decrease in complement components (C4, C3, or total hemolytic complement [C<sub>H</sub>50]) and increases in the generation of products of complement activation (C3a, C4a, C5a, and so on). If positive, these assays may implicate complement activation in specific reactions.

#### Release of Histamine and Other Mediators

Washed leukocytes containing basophils with IgE antibody on their cell surfaces release histamine and other mediators when incubated with relevant antigens. Although this in vitro basophil-histamine release assay avoids drug exposure to the patient, the assay is clinically impractical because it requires whole blood drawn immediately before the test; presently the test is limited in availability to research laboratories.

During or shortly after allergic reactions, blood can be obtained and analyzed for release of various mediators. Urine also can be analyzed for metabolites of histamine or prostaglandin D<sub>2</sub> (PGD<sub>2</sub>). Plasma histamine and PGD<sub>2</sub> levels remain increased only briefly, limiting their clinical use. Measurement of serum tryptase, a protease released specifically from mast cells, appears promising in the clinical assessment of mast cell-mediated allergic reactions.<sup>44–47</sup> Serum tryptase may remain elevated for hours after release from mast cells.

#### Radioallergosorbent Testing

The radioallergosorbent test (RAST) was first introduced in 1967. It measures circulating allergen-specific IgE antibody. The basic principle of the RAST is simple: the allergen is attached to a solid-phase (carbohydrate

## BOX 88-3.

## Management of Anaphylaxis

## Initial Therapy

1. Stop administration or reduce absorption of offending agent
  - If antigen given subcutaneously:
    - Venous tourniquet proximal to site
    - Epinephrine (dilute solution) infiltrated into antigen site
  - If latex is suspected:
    - Consider potential routes of administration, including mucosal contact and inhalation
    - Remove all latex from surgical field
    - Change to nonlatex gloves
2. Maintain airway and administer 100% oxygen
  - Aerosolized epinephrine if not already intubated
  - Intubation, cricothyrotomy, or tracheostomy
3. Rapid intravascular volume expansion
  - 25–50 mL/kg (2–4 L) of crystalloid or colloid for hypotension
4. Administer epinephrine
  - Initial dose 0.1 µg/kg (0.001 mg/kg) IV
  - 10 mL of 1:10,000 endotracheal administration in adults
5. Discontinue all anesthetic agents

## Secondary Therapy

1. Administer antihistamine
  - Diphenhydramine 1 mg/kg IV or IM (maximum dose 50 mg)
  - Ranitidine 1 mg/kg IV (maximum dose 50 mg)
2. Administer glucocorticoids
  - Hydrocortisone 5 mg/kg IV initially, then 2.5 mg/kg IV q4–6h
  - Methylprednisolone 1 mg/kg IV initially, then 0.8 mg/kg IV q4–6h
3. Administer aminophylline

## Loading dose 5–6 mg/kg IV

- Continuous infusion 0.4–0.9 mg/kg/h IV (check blood level)
4. Administer inhaled  $\alpha_2$ -adrenergic agonists
  5. Continuous catecholamine infusion
    - Epinephrine 0.02–0.05 µg/kg/min IV (2–4 µg/min)
    - Norepinephrine 0.05 µg/kg/min IV (2–4 µg/min)
    - Dopamine 5–20 µg/kg/min IV
  6. Administer sodium bicarbonate
    - 0.5–1 mEq/kg initially, then titrate according to arterial blood gas levels

particle, paper disk, or wall of polystyrene test tubes or plastic microtiter wells) and incubated with the serum under study, during which time a specific antibody of all immunoglobulin classes is bound. The particles are washed, and a second incubation is undertaken with a radiolabeled, highly specific anti-IgE antibody. After washes, the bound radioactivity is directly related to the allergen-specific IgE antibody content in the original serum. When performed appropriately, the RAST correlates well with skin test end point titration, basophil–histamine release, and provocation tests. Results from the serum under study are compared with a positive reference serum and a negative control serum. False-positive tests may occur because of high nonspecific bind-

ing, high total serum IgE levels, or poor technique. False-negative tests may occur because of interference of high levels of IgG “blocking antibodies” or inability to maximize assay sensitivity.

Anesthesiologists should seek consultation with allergists for such evaluations; they should avoid informal and uncontrolled allergy evaluations using dilute intradermal solutions or patch tests performed without proper controls.

### REQUIREMENT OF DRUG IN THE FUTURE AND SPECIFIC IMMUNOTHERAPY

If a patient has experienced an allergic reaction to a medication in the past but must use that medication again, the physician must evaluate the risks and benefits of readministration of the medication in question. If equally effective and non-cross-reacting alternative drugs are available, they should be used. If alternative drugs fail, induce unacceptable side effects, or are clearly less effective, then cautious administration of the drug using a premedication regimen (Box 88-4) or a desensitization protocol (prescribed by an expert allergist) may be considered.

Premedication regimens (Box 88-4) have been tested, validated, and used most often in patients with previous reactions to radiocontrast media who again require administration of radiocontrast.<sup>48</sup> These reactions are not IgE mediated.

Specific immunotherapy, consisting of administration of increasing concentrations of allergen, has three mechanisms of action: downregulation of the cytokines produced by Th2 cells, upregulation of the cytokines produced by Th1 cells, and upregulation of regulatory T cells. As a result, allergic inflammation is inhibited, cytokines that control the production of IgE (interferon- $\gamma$  and IL-12) are increased, IgG-blocking antibodies are enhanced, and cytokines

## BOX 88-4.

## Efficacy of Premedication for Patients with Previous Radiocontrast Media Reactions

Premedication with	Repeat Reaction Rate
A. No premedication	A: 33% (range 17–60%)
B. Prednisone (50 mg Po) 13, 7, and 1 h before	B and C: 9% (mild reactions)
C. Diphenhydramine (50 mg IM or Po) 1 h before	B, C, and D: 3.1% (historical controls)
D. Ephedrine (25 mg PO) 1 h before	B, C, D, and E: <0.5%
E. Low osmolar ionic contrast media	

Reprinted from Greenberger P, Patterson R. The prevention of immediate generalized reactions to radiocontrast media in high-risk patients. *J Allergy Clin Immunol* 1991;87:867–872, with permission from the American Academy of Allergy, Asthma, and Immunology.



involved in allergen-specific hyporesponsiveness (IL-10 and transforming growth factor- $\beta$ ) are increased. Specific immunotherapy is not without its risks, with anaphylaxis being the most prominent because of the relative crudeness of the allergen extracts. As recombinant technology becomes more available, hypoallergenic isoforms in immunotherapy may minimize the risk of anaphylaxis. Additional strategies include naturally occurring hypoallergenic isoforms, DNA vaccines, blockade of IgE or its synthesis, and interruption of the Th2-dependent allergic cascade. In addition, several ways of inhibiting IL-4 and IL-5 currently are being investigated.<sup>17</sup> This basic understanding informs our targeting of new approaches to treatment.

## SPECIFIC ANAPHYLACTIC REACTIONS SEEN IN THE PERIOPERATIVE ENVIRONMENT

### Neuromuscular Blocking Agents

Muscle relaxants are a common cause of anaphylactic reactions during anesthesia, although there remains some debate.<sup>24,29,49–52</sup> Evidence supporting an IgE-mediated mechanism includes positive Prausnitz-Kustner tests, basophil-histamine release studies, inhibition of basophil-histamine release after desensitization to anti-IgE, and demonstration of drug-specific IgE antibodies in sera from patients who had adverse reactions to muscle relaxants.<sup>13–15,36</sup>

Extensive *in vitro* cross-reactivity has been reported between muscle relaxants and other compounds that contain quaternary and tertiary ammonium ions. Insofar as these compounds are found in many drugs, foods, cosmetics, disinfectants, and industrial materials, patients may become sensitized through environmental contact. Sensitization to ammonium ion epitopes in cosmetics has been postulated to explain the predominance of reactions in women.<sup>13</sup> Although the exact incidence of allergic reactions caused by muscle relaxants is unknown, reactions to muscle relaxants are less common in the United States than in France and Australia.

### Hypnotics

Acute allergic reactions have been reported after administration of thiobar-

biturates, especially thiopental. Proposed mechanisms for thiobarbiturate reactions include nonimmunologically induced mediator release and IgE-mediated reactions. Positive immediate skin tests to thiopental have been reported in patients who had anaphylactic reactions after induction of general anesthesia.<sup>35,37,53</sup> A thiopental RAST has been developed,<sup>54</sup> and mast cell histamine release to thiopental *in vitro* has been described.<sup>55,56</sup> The predictive value of the RAST to thiopental is uncertain and requires further study, but skin testing appears to be useful.

Anaphylaxis to propofol with subsequent laboratory confirmation has been reported in only two patients,<sup>57,58</sup> without laboratory confirmation (presumptive diagnosis) in an infant with egg and peanut allergy,<sup>59</sup> and in two adult patients, one of whom had a pruritic maculopapular rash around the eyes (for 3 months)<sup>60</sup> and one of whom died from cardiovascular collapse, with increased serum tryptase and methylhistamine levels at postmortem.<sup>61</sup> Although warnings about administration of propofol to patients with egg allergy can be strident, the lecithin in the propofol emulsion containing ethylenediaminetetraacetic acid (EDTA) as a preservative is derived from egg yolk, which is distinct from egg albumin found in egg white. In the majority of patients with egg allergies, egg albumin is the sensitizing protein. In the propofol emulsion using metabisulfite as the preservative, metabisulfite may be the allergenic component. Because the propofol emulsion also contains soybean oil, patients with soybean oil allergy should not receive propofol.

### Local Anesthetics

Despite patients commonly reporting “allergic reactions” to local anesthetics, true allergic reactions to injected local anesthetics are exceedingly rare. Adverse reactions to local anesthetics often are the result of vasovagal reactions, toxic reactions (probably caused by accidental intravenous injection), side effects from epinephrine, or psychomotor responses such as hyperventilation. Toxic symptoms often involve the central nervous and cardiovascular systems and may produce slurred speech, euphoria, dizziness, excitement, nausea, nemesia, disorientation, or convulsions.<sup>62</sup> Vasovagal reactions usually are associated with

bradycardia, sweating, pallor, and rapid improvement in symptoms when the patient is supine. Sympathetic stimulation, either from epinephrine or anxiety, may result in tremors, diaphoresis, tachycardia, and hypertension. Rarely, symptoms of reactions to local anesthetics are consistent with IgE-mediated reactions, such as urticaria, bronchospasm, and anaphylactic shock.<sup>63</sup> IgE-mediated sensitivity has, on rare occasions, been reported to parabens, preservatives used in local anesthetics.

Local anesthetics are divided into two general chemical classes, the esters and the amide compounds (Box 88–5). Those containing benzoate esters may cross-react with each other but not with the amide compounds. Ester local anesthetics are metabolized to para-aminobenzoic acid (PABA); therefore, ester local anesthetics cross-react and present with allergic or hypersensitivity reactions. In addition, individuals allergic to other drugs metabolized to PABA, such as sunscreens and methylparaben preservatives, may cross-react. In contrast, the amino amide local anesthetics do not substantially cross-react with each other. Epinephrine-containing local anesthetics with the antioxidant metabisulfite may be allergenic because of the metabisulfite component.<sup>64,65</sup>

Evaluation of the patient with a history of adverse reactions to local anesthetics should include a complete history of the episode, skin testing, and incremental drug challenge. The local anesthetic tested should be appropriate for the proposed procedure and not expected to cross-react with the drug implicated in the previous reaction. If the previous drug is unknown, an amide-type local anesthetic should be chosen. In a patient with a history suggestive of an IgE-mediated reaction or possible paraben sensitivity, preparations without paraben should be

#### BOX 88–5.

##### Classification of Local Anesthetics

Amino Esters	Amino Amides
Benzocaine	Bupivacaine
Chloroprocaine	Etidocaine
Cocaine	Lidocaine
Procaine	Mepivacaine
Tetracaine	Prilocaine
	Ropivacaine

used for testing, challenge, and treatment. Preparations with epinephrine should not be used for skin testing because they may mask a positive skin test and induce toxic effects.

### Narcotics

Narcotics most commonly cause non-immunologically mediated histamine release from skin mast cells rather than anaphylaxis. In vitro studies suggest that skin mast cells are uniquely sensitive to narcotics, whereas gastrointestinal and lung mast cells and circulating basophils do not release histamine when exposed to narcotics.<sup>10,11,66</sup> Most opiate-induced reactions are self-limited, cutaneous, and restricted to hives and pruritus or mild hypotension treated by fluid administration, although some evidence suggests that IgE antibodies may be induced that bind epitopes contained in opiate narcotics.<sup>67–69</sup> Nonimmunologic release of mediators is a far more common clinical occurrence than are the rare reactions induced by morphine-specific IgE antibody. Because codeine, morphine, and meperidine routinely cause positive skin responses, skin tests must be interpreted cautiously and must be accompanied by skin testing of normal control subjects.

### Antibiotics

#### Penicillin Antibiotics

Outside of the operating room but also within our sphere of responsibility, penicillin antibiotics are the most common medications causing allergic drug reactions (0.7–8% of treatment cases).<sup>70,71</sup> From 0.004–0.015% of treatment courses end in anaphylaxis, resulting in 400–800 deaths per year in the United States. Only 10–20% of patients who claim an allergy to penicillin react to skin testing with the major and minor determinants.

A low-molecular-weight chemical, penicillin must covalently combine with tissue macromolecules to produce multivalent hapten-protein complexes. The  $\beta$ -lactam ring, which opens spontaneously under physiologic conditions, forms the penicilloyl group. Other metabolic pathways result in additional antigenic determinants known as the “minor determinants.” Anaphylactic reactions to penicillin usually are mediated by IgE antibodies directed against minor determinants, although some anaphylactic reactions have occurred in

patients with only penicilloyl-specific IgE antibodies.

Individuals with a history of penicillin reactions have a 4- to 6-fold increased risk for subsequent reactions to penicillin compared to those without previous reactions.<sup>72</sup> *However, most serious and fatal allergic reactions to penicillin and  $\beta$ -lactam antibiotics occur in individuals who have never had a previous allergic reaction.* Sensitization of these individuals may have occurred from their last therapeutic course of penicillin or (less likely) by occult environmental exposures. Approximately 10–20% of hospitalized patients claim a history of penicillin allergy. However, studies have shown that many of these patients either have been incorrectly labeled as allergic to penicillin or have lost their sensitivity. The most useful single piece of information in assessing an individual's potential for an immediate IgE-mediated reaction is the skin test response to major and minor penicillin determinants.

Penicillin anaphylaxis has not been reported in patients with negative skin tests. Therefore, negative skin tests indicate that penicillin antibiotics can be safely given. A limited number of patients with positive skin tests have been treated with therapeutic doses of penicillin. The risk of an anaphylactic

or accelerated allergic reaction ranges from 50–70% in such patients.<sup>34</sup> Therefore, if skin tests are positive, equally effective non-cross-reacting antibiotics should be substituted when available. If alternative drugs fail, induce unacceptable side effects, or clearly are less effective, then administration of penicillin using a desensitization protocol to reduce the risk of anaphylaxis should be considered.

#### Cephalosporins

Like penicillins, cephalosporins possess a  $\beta$ -lactam ring (Box 88–6). Shortly after cephalosporins came into clinical use, allergic reactions were reported, and the question of cross-reactivity between cephalosporins and penicillins was demonstrated. During the initial clinical trials with first-generation cephalosporins and cefamandole, 8.1% of patients with a history of allergy to penicillin had a possible allergy to a cephalosporin versus 4.5% of patients without a history, so standard teaching was to avoid treatment with cephalosporins for those with a possible penicillin anaphylaxis. Evidence has accumulated that the side chain rather than the  $\beta$ -lactam ring is the antigen in cephalosporin allergic reactions. Among patients with a history of penicillin allergy, the rate of allergic reaction to any other antibiotic

#### BOX 88–6.

##### $\beta$ -Lactam Antibiotics

###### Penicillins

###### $\beta$ -Lactamase susceptible

Narrow-spectrum	Penicillin G
Enteric-active	Ampicillin
Enteric-active and antipseudomonal	Ticarcillin

###### $\beta$ -Lactamase resistant

Antistaphylococcal	Methicillin, oxacillin, nafcillin
Combined with $\beta$ -lactamase inhibitors	Ticarcillin plus clavulanic acid, ampicillin plus sulbactam, piperacillin plus tazobactam

###### Cephalosporins

###### First-generation

Cefazolin, cephalothin, cephapirin

###### Second-generation

Hemophils-active	Cefamandole, cefuroxime, cefonicid, ceforanide
Bacteroides-active	Cefoxitin, cefotetan, cefmetazole

###### Third-generation

Extended-spectrum	Ceftriaxone, cefotaxime, ceftizoxime
Extended-spectrum and antipseudomonal	Ceftazidime, cefepime

###### Carbapenems

Imipenem-cilastatin, meropenem, ertapenem

###### Monobactams

Aztreonam

is three times the rate than among control subjects. Primary cephalosporin allergy in non-penicillin-allergic patients also has been reported, but the exact incidence is not clear. There is evidence for a marked variation in history assessment, requests for penicillin testing, and prescribing practices among physicians, even with patients reporting anaphylaxis to penicillin.<sup>73</sup> In general, patients with positive skin tests to any penicillin reagent or a history compatible with immediate hypersensitivity should not receive first-generation cephalosporin antibiotics unless alternative drugs are clearly less desirable.

Two new classes of  $\beta$ -lactam antibiotics are the carbapenems and monobactams (aztreonam). Cross-reactivity between penicillin and carbapenems would be expected on the basis of the structure of the drugs. There are no published data on allergy to meropenem in patients who are allergic to carbapenem or penicillins. Allergic reactions to the monobactam aztreonam are thought to involve the side chain, so cross-reactivity with other  $\beta$ -lactams should be rare. Investigations suggest weak cross-reactivity between aztreonam and other  $\beta$ -lactam antibiotics and indicate that aztreonam can be administered safely to most, if not all, penicillin-allergic subjects. Cross-reactivity between penicillins and second- or third-generation cephalosporins (excluding cefamandole) probably is no greater than the cross-reactivity between penicillins and other classes of antibiotics.<sup>74</sup> Third-generation cephalosporins have a very low risk of serious allergic reactions. Cross-reactivity between penicillins and cephalosporins with similar side chains appear to be more frequent. In a patient with known allergy to a cephalosporin, substituting another cephalosporin with a different side chain structure usually is safe.

### **Vancomycin**

Hypotension is the most serious immediate adverse effect associated with vancomycin use. Direct myocardial depression<sup>75</sup> and nonimmunologically mediated histamine release<sup>76</sup> have been reported as mechanisms of vancomycin-induced hypotension, and not IgE-mediated anaphylaxis. In patients, hypotension occurs most commonly when the drug is rapidly infused or is administered in a concentrated solu-

tion. Vancomycin-associated hypotension that occurs intraoperatively may be exacerbated by concurrent use of other drugs (e.g., anesthetics) that cause vasodilatation and/or have a negative inotropic effect.<sup>75</sup> In addition to hypotension, vancomycin can produce the "red neck" or "red man" syndrome, an intense erythematous discoloration of the upper trunk, arms, and neck that may be associated with pruritus in conscious patients. Vancomycin also has been associated with the sudden development of throbbing pain or spasm in the chest or parasternal muscles without evidence of myocardial ischemia. To minimize the risk of reactions, vancomycin should be infused over a period of at least 60 minutes and in a dilute solution (500 mg/100 mL). Reactions should be treated by discontinuation of vancomycin infusion, administration of an antihistamine for pruritus, and use of medications and other interventions that counteract the hypotension.

### **Sulfonamides and Trimethoprim**

Sulfonamides are generally safe and are often used for chronic prophylaxis. Occasionally, they cause allergic reactions such as minor skin rashes after approximately 1 week of therapy. Life-threatening reactions have been described in HIV-infected infants who were reexposed to sulfamethoxazole-trimethoprim (SMX-TMP). Stevens-Johnson syndrome and toxic epidermal necrolysis have been associated with SMX-TMP treatment, presumably mediated by an immune reaction similar to graft-versus-host disease.<sup>77</sup> Some patients have been acutely desensitized with 10-day or 48-hour regimens.

### **Other Classes of Antibiotics**

Development of a serious allergic reaction to non- $\beta$ -lactam antibiotics, such as the aminoglycosides, is rare. Non-urticarial rashes can be treated with antihistamines.

### **Multiple Antibiotic Allergy Syndrome**

An evolving entity is the multiple antibiotic allergy syndrome, wherein certain individuals are recognized to make a *igenerici* allergic antibody to unrelated antibiotics<sup>78</sup> Female gender, a history of multiple antibiotic reactions, and reactions to nonsteroidal antiinflammatory drugs appear to be the main risk factors.<sup>79</sup>

## **Radiocontrast Media**

The incidence of reactions induced by radiocontrast media injections is between 5% and 8%.<sup>48</sup> Urticaria, angioedema, wheezing, dyspnea, hypotension, or death occurs in 2–3% of patients receiving intravenous or intra-arterial infusions. Fatal reactions after radiocontrast administration occur in approximately 1:50,000 intravenous procedures, resulting in an estimated 500 deaths per annum. Most reactions begin 1–3 minutes after intravascular administration. Patients with a previous reaction to radiocontrast media have an approximately 33% (range 17–60%) chance of a repeat reaction on reexposure.<sup>80</sup>

The exact mechanism of adverse reactions to radiocontrast media is unknown. Intravascular injection of radiocontrast material activates complement, either by the classic or the alternative pathway.<sup>81</sup> Therefore, production of anaphylatoxins with subsequent mast cell and basophil mediator release has been suggested as the cause of these reactions. However, radiocontrast media are capable of inducing nonimmunologic histamine release from mast cells and basophils in the absence of complement activation. The hypertonicity of these materials has been suggested to result in nonimmunologic mediator activation from mast cells and basophils. There is no evidence that IgE-mediated mechanisms play a role in radiocontrast media reactions.

Pretreatment of high-risk patients with oral prednisone (50 mg) and diphenhydramine (50 mg) 1 hour before radiocontrast administration reduces the risk of reactions to 9%.<sup>82</sup> Almost all reactions in pretreated patients are of no clinical importance (e.g., mild urticaria). The addition of oral ephedrine (25 mg) 1 hour before radiocontrast administration (in patients without angina, dysrhythmias, or other contraindications for ephedrine administration) further reduces the reaction rate to 3.1%.<sup>48</sup> Combining premedication with nonhyperosmolar contrast media may be of additional benefit in preventing reactions in high-risk individuals (Box 88–4).<sup>83</sup>

### **Protamine**

Protamine sulfate is a polycationic protein extracted from salmon milt. It is used to reverse heparin anticoagulation and retard the absorption of cer-

tain insulins (NPH and PZI). Use of intravenous protamine following cardiopulmonary bypass, cardiac catheterization, hemodialysis, or pheresis has resulted in increasing reports of life-threatening adverse reactions.

Diabetic patients receiving daily subcutaneous injections of insulins containing protamine have a 40- to 50-fold increased risk for life-threatening reactions when given protamine intravenously.<sup>84,85</sup> In diabetic patients who had received protamine-insulin injections, the presence of serum antiprotamine IgE antibody is a significant risk factor for acute protamine reactions (relative risk 95).<sup>86</sup> Moreover, patients allergic to protamine also may be allergic to protamine-containing (NPH) insulin.<sup>87</sup> Another group that may be at increased risk for protamine reactions are men who have undergone vasectomies. In addition, because protamine is produced from the matured testis of salmon or related species of fish belonging to the family *Salmonidae* or *Clupeidae*, it has been suggested that individuals allergic to fish may have serum antibodies directed against protamine.<sup>88</sup> Finally, previous exposure to intravenous protamine given for reversal of heparin anticoagulation may increase the risk for a reaction with subsequent protamine administration.<sup>89,90</sup> Following cardiopulmonary bypass, risk factors found to correlate with adverse events following protamine administration included NPH insulin use (odds ratio = 8.18; 95% confidence interval [CI] 2.08–32.2), fish allergy (odds ratio = 24.5; CI 1.24–482.3), and a history of nonprotamine medication allergy (odds ratio = 2.97; CI 1.25–7.07).<sup>91</sup>

The exact mechanisms by which acute protamine reactions occur are incompletely understood. Some protamine reactions may be associated with complement activation, either through protamine-heparin complexes or through the interaction of protamine and complement fixing, antiprotamine IgG antibody, leading to pulmonary artery pressure elevation through generation of thromboxane.<sup>92,93</sup>

### Topical Preparations

Cutaneous hypersensitivity and eczema may occur from chronic exposure to topical preparations. Of 50 case reports of chlorhexidine anaphylaxis, one third occurred during surgery.<sup>94</sup> However, the risk of development of

type I and type IV allergy to chlorhexidine, even with daily occupational exposure of healthcare workers in Denmark, likely is extremely rare.<sup>95</sup>

Concerns are often expressed about allergy to povidone iodine preparation solutions in patients with a history of seafood allergy. Similar concerns are voiced about patients with allergy to radiocontrast media, because iodine is present in both. The allergen responsible for sensitization probably is the povidone component of povidone iodine, the carrier molecule for iodine atoms. In the first reported case of anaphylaxis to povidone iodine preparation solution, a 32-year-old man had a positive skin prick and intradermal test to Betadine and povidone. A basophil activation test and leukotriene release test also were positive for Betadine and povidone. A 9-year-old child has been confirmed to have eosinophilia, elevated specific IgE level, and positive skin prick test for povidone iodine.<sup>96</sup> Fish allergy is due to protein M, and tropomyosin probably is the cross-reactive allergen in various species of shellfish.<sup>97</sup>

### Transfusion-Related Anaphylaxis

Transfusion-related anaphylaxis, a serious, life-threatening condition, is discussed in Chapter 85.

### Natural Rubber Latex

Natural rubber latex present in various materials, especially surgical gloves, is responsible for a dramatic change in the etiology of intraoperative anaphylactic shock, increasing in one series from 0.5% in 1989 to 22.3% of cases in 2002 (Table 88–3). Although it is possible that the connection to latex exposure and reactions was never made in the past, it is more likely that the increased general use of latex products for medical and nonmedical applications has resulted in some change in the manufacturing process that has led to increased antigenicity of latex products, particularly gloves.<sup>98,99</sup>

Natural rubber latex is a complex suspension of polyisoprene, lipids, phospholipids, and proteins. The proteins are found in three physical states: water soluble, starch bound, or latex bound, and there are at least 240 potentially allergenic proteins in the processed latex product. The protein content of latex gloves can vary up to 1000-fold among different lots market-

ed by the same manufacturer and 3000-fold between gloves from different manufacturers.<sup>100</sup> A number of chemicals, including preservatives, accelerators, antioxidants, and vulcanizing compounds, are added during the manufacturing process to yield the final product. Although the chemicals added to latex have long been associated with contact dermatitis and type IV reactions, it was only after the embracing of universal precautions that alarming reports from around the world describing generalized urticaria, angioedema, upper and lower respiratory obstructions, and cardiovascular collapse first appeared. Patients who have suffered severe systemic reactions often have a history of contact urticaria or angioedema to rubber products such as gloves or rubber balloons, or atopy.

Certain populations are at significantly increased risk for latex allergy. These include healthcare workers, who have had increased exposure to latex usually in the form of gloves, patients with prolonged or frequent exposure to latex products such as urinary catheters, and latex factory workers.<sup>101</sup> Patients with meningomyelocele or congenital urologic anomalies seem particularly susceptible, with an estimated incidence of latex allergy averaging 50%.

IgE antibodies play a major role in the immunopathogenesis of latex-induced allergy and anaphylaxis. The diagnosis of latex allergy is made by a combination of medical history, physical examination, and reliable in vivo or in vitro tests. Although skin prick testing is both sensitive (100%) and specific (99%),<sup>102</sup> this method should be restricted to patients with a compelling history and an inconclusive serologic test result because of possible systemic reactions.<sup>103</sup> The RAST for latex-specific IgE is recommended, although it is less sensitive than skin prick testing.<sup>104</sup>

Serum tryptase levels in the immediate postanaphylaxis period may be helpful in confirming the diagnosis following a clinical episode.<sup>29,46,47,49,105–108</sup> The positive predictive value of tryptase for diagnosis of anaphylaxis is 92.6%, and the negative predictive value is 54.3%.<sup>24</sup> A provocative challenge to latex has been described that involves placing a latex glove on a dampened hand for 15 minutes and comparing the response of the contra-



lateral hand wrapped in a vinyl glove. Provocation tests should be avoided if severe systemic reactions have occurred. Multiple allergies are often found in latex allergic patients. Cross-reactivity of latex with tropical fruits is not uncommon,<sup>109-113</sup> and such findings in the history can be used to heighten suspicion about a patient's potential for latex allergy.

Patients who have had serious allergic reactions to latex and patients at high risk (e.g., patients with meningo-myeloceles) should avoid contact with latex products. Because prophylactic drug protocols have proven ineffective, a latex-safe environment is advocated. Box 88-7 provides a checklist for dealing with the latex-allergic patient. Moreover, patients in identified high-risk pediatric groups, such as children with urologic birth defects and myelomeningocele, should be offered latex-free exposure in the operating room from birth to avoid subsequent sensitization. The American Society of Anesthesiologists has a brochure available on its website summarizing current recommendations for anesthesiologists caring for latex-allergic patients.

## CONCLUSIONS AND THERAPEUTIC IMPLICATIONS

1. **Once an allergen is identified, the most important clinical strategy is avoidance of that allergen.** As perioperative specialists, anesthesiologists have a critical role in understanding the etiology, treatment, and evaluation of patients' allergic reactions.
2. **Epinephrine is the most important medication to have available and to provide in the setting of anaphylaxis.** Early administration of the appropriate dose is crucial for optimum outcome because the outcome of shock due to anaphylaxis may be far worse than other forms of shock. For prophylaxis or attenuation of an anticipated allergic response, effective protocols exist that reduce the risk of anaphylaxis to <0.5%. Following primary treatment, adjunctive, or secondary, treatment (antihistamines, anticholinergics,  $\beta$ - and  $\alpha$ -agonists) is important for patient comfort and reduction of symptoms of anaphylaxis.

### BOX 88-7.

#### Checklist for Latex-Allergic Patients

##### Preoperative

- History of chronic care with latex-based products
- History of spina bifida, urologic reconstructive surgery
- History of multiple surgical procedures (e.g., ♀)
- History of intolerance to latex-based products: balloons, rubber gloves, condoms, dental dams, rubber urethral catheters
- History of allergy to tropical fruits
- History of intraoperative anaphylaxis of uncertain etiology
- Healthcare workers, especially with a history of atopy or hand eczema
- Consider allergy consultation
- In vitro testing
- In vivo testing
- Minimize latex exposure for at-risk patients
- Latex alert:** Patients with significant risk factors for latex allergy but no overt signs or symptoms
- Latex allergy:** Patients with or without significant risk factors for latex allergy and positive history, signs, symptoms, and confirmatory laboratory test
- Carefully coordinate care among surgical, anesthesia, and nursing teams
- Have lists available of non-latex product alternatives
- First case of the day is preferable to decrease aeroallergen concentration
- Display "Latex Allergy" or "Latex Alert" signs inside and outside the operating room

##### Intraoperative

- Anesthesia equipment
- Latex-free gloves, airways, endotracheal tubes
- Masks (polyvinylchloride if available, or old, well-washed, black rubber masks)
- Rebreathing bags (neoprene if available, or old, well-washed black rubber bags)
- Ventilator bellows (neoprene or silicone if available, or old, well-washed black rubber bellows)
- Breathing circuit (disposable, polyvinylchloride, packaged separately from latex rebreathing bag)
- Beware of latex intravenous injection ports, natural rubber latex tourniquets, and rubber bands; use nontoxic latex glove as tourniquet; tape latex inject ports, or use silicone injection ports or stopcock
- Blood pressure cuffs (if new latex, cover with soft cotton)
- Ambu-type bag (assure that bag and valve do not have latex components)
- Alternative is silicone self-inflating bag
- Dilute concentration of epinephrine (0.01 mg/mL or 1:100,000) readily available
- Surgical equipment
- Avoid latex surgical gloves
- Avoid latex drains (e.g., Penrose)
- Avoid latex urinary catheters
- Avoid latex instrument mats
- Avoid rubber-shod clamps
- Avoid latex vascular tags
- Avoid latex-bulb syringes for irrigation
- Avoid rubber bands

##### Postoperative

- Medical Alert tag
- Warning sign posted on chart
- Warning sign posted on bed

From Holzman RS. *Anesth Anal* 1993;76:635-641, with permission.

3. **Specific immunotherapy strategies are emerging** for a variety of allergens to which patients and healthcare workers have become exposed. Chronic as well as acute desensitization strategies exist that reorganize an individual's profile from primarily a Th2 to a Th1 type of response. Because of the increasing understanding of the immune response, strategies now can be developed for therapeutically interfering with the interaction of IgE and allergen, inhibiting cytokine function and T-cell activation, or modifying allergy cell responsiveness.
4. There is an important epidemiologic challenge in explicating the reasons for the **increasing incidence of allergic disease**, particularly in western countries.

## KEY REFERENCES

1. Dewachter P, Jouan-Hureau V, et al. Anaphylactic shock: a form of distributive shock without inhibition of oxygen consumption. *Anesthesiology* 2005;103:40–49.
2. Thong B, Yeow-Chan. Anaphylaxis during surgical and interventional procedures. *Ann Allergy Asthma Immunol* 2004;92:619–628.
3. Mertes P, Laxenaire M, Alla F, et al. Anaphylactic and anaphylactoid reactions occurring during anesthesia in France in 1999–2000. *Anesthesiology* 2003;99:536–545.
4. Kay A. Allergy and allergic diseases: first of two parts. *N Engl J Med* 2001;344:30–37.
5. Kay A. Allergy and allergic diseases: second of two parts. *N Engl J Med* 2001;344:109–113.
6. Howarth P. ABC of allergies: pathogenic mechanisms: a rational basis for treatment. *BMJ* 1998;316:758–761.
7. Brown R, Schauble J, Hamilton R. Prevalence of latex allergy among anesthesiologists: identification of sensitized but asymptomatic individuals. *Anesthesiology* 1998;89:292–299.

## REFERENCES

1. Kay A. Allergy and allergic diseases: first of two parts. *N Engl J Med* 2001;344:30–37.
2. Metzger H, Alcaraz G, Hohman R. The receptor with high affinity for immunoglobulin E. *Ann Rev Immunol* 1986;4:419.
3. Zhu D, Kepley C, Zhang K, et al. A chimeric human-cat fusion protein blocks cat-induced allergy. *Nat Med* 2005;11:446–449.
4. Kirklin J, Chenoweth D, Naftel D. Effects of protamine administration after cardiopulmonary bypass on complement, blood elements, and the hemodynamic state. *Ann Thorac Surg* 1986;41:193.
5. Rent R, Ertel N, Elsenstein R. Complement activation by interaction of polyanions and polycations I. Heparin-protamine induced consumption of complement. *J Immunol* 1975;114:120.
6. Vyas G, Perkins H, Fudenberg H. Anaphylactoid transfusion reactions associated with anti-IgA. *Lancet* 1968;2:312.
7. Fearon D, Ruddy S, Schur P, et al. Activation of the properdin pathway of complement in patients with gram-negative of bacteremia. *N Engl J Med* 1975;292:937–940.
8. Watkins J, Clark A, Appleyard T. Immune-mediated reactions to Althesin (alphaxalone). *Br J Anaesth* 1976;48:881.
9. Walport M. Complement: first of two parts. *N Engl J Med* 2001;344:1058–1066.
10. Ebertz J, Hermens J, McMillan J. Functional differences between human cutaneous mast cells and basophils: a comparison of morphine-induced histamine release. *Agents Actions* 1986;18:455.
11. Hermens J, Ebertz J, Hanifin J. Comparison of histamine release in human skin mast cells induced by morphine, fentanyl, and oxymorphone. *Anesthesiology* 1985;62:124–129.
12. North F, Kettelkamp N, Hirshman C. Comparison of cutaneous and in vitro histamine release by muscle relaxants. *Anesthesiology* 1987;66:543.
13. Baldo B, Fisher M. Substituted ammonium ions as allergenic determinants in drug allergy. *Nature* 1983;306:262.
14. Harle D, Baldo B, Fisher M. Detection of IgE antibodies to suxamethonium after anaphylactoid reactions during anaesthesia. *Lancet* 1984;1:930.
15. Vervloet D, Arnaud A, Senft M. Leukocyte histamine release to suxamethonium in patients with adverse reactions to muscle relaxants. *J Allergy Clin Immunol* 1985;75:338.
16. von Mutius E, Martinez F, Fritsch C, et al. Prevalence of asthma and atopy in two areas of West and East Germany. *Am J Respir Crit Care Med* 1994;149:358–364.
17. Howarth P. ABC of allergies: pathogenic mechanisms: a rational basis for treatment. *BMJ* 1998;316:758–761.
18. Nevot S, Leonart R, Casas R. Atopic dermatitis today. *Allergol Immunopathol (Madr)* 1997;25:203–208.
19. Paty E, Paupe J, de Blic J, et al. [Allergic children]. *Rev Prat* 1996;46:975–979.
20. Fisher M, Baldo B. The incidence and clinical features of anaphylactic reactions during anesthesia in Australia. *Ann Fr Anesth Reanim* 1993;12:97–104.
21. Occelli G, Amedeo J, Raucoules M, et al. Evaluation of the activities and value of allerge-anesthetic consultation in Nice hospital since 1985, to 1991. *Therapie* 1992;47:423–427.
22. Boileau S, Hummer-Sigiel M, Moeller R, et al. [Reassessment of the respective risks of anaphylaxis and histamine liberation with anesthetic substances]. *Ann Fr Anesth Reanim* 1985;4:195–204.
23. Laxenaire M. Drugs and other agents involved in anaphylactic shock occurring during anaesthesia. A French multicenter epidemiological inquiry. *Ann Fr Anesth Reanim* 1993;12:91–96.
24. Mertes P, Laxenaire M, Alla F. Anaphylactic and anaphylactoid reactions occurring during anesthesia in France in 1999–2000. *Anesthesiology* 2003;99:536–545.
25. Currie M, Webb RK, Williamson JA, et al. The Australian Incident Monitoring Study. Clinical anaphylaxis: an analysis of 2000, incident reports. *Anaesth Intensive Care* 1993;21:621–625.
26. Vuitton D, Neidhardt-Audion M, Girardin P, et al. [Epidemiologic characteristics of 21 perianesthetic anaphylactoid accidents observed in a population of 12, 855, surgically treated patients]. *Ann Fr Anesth Reanim* 1985;4:167–172.
27. Dewachter P, Jouan-Hureau V, Franck P, et al. Anaphylactic shock: a form of distributive shock without inhibition of oxygen consumption. *Anesthesiology* 2005;103:40–49.
28. Kettlekamp NS, Austin DR, Downes H, et al. Inhibition of d-tubocurarine-induced histamine release by halothane. *Anesthesiology* 1987;66:666–669.
29. Soetens F. Anaphylaxis during anaesthesia: diagnosis and treatment. *Acta Anaesth Belg* 2004;55:229–237.
30. Beard K, Jick H. Cardiac arrest and anaphylaxis with anesthetic agents. *JAMA* 1985;254:2742.
31. James L, Austen K. Fatal systemic anaphylaxis in man. *N Engl J Med* 1964;270:597.
32. Lorenz W, Doenicke A. H1 and H2 blockade: a prophylactic principle in anesthesia and surgery against histamine-release responses of any degree of severity: part 1. *N Engl Reg Allergy Proc* 1985;6:37–57.
33. Asystole and pulseless electrical activity. In Cummins R, ed. *ACLS. Principles and Practice*. Dallas, TX: American Heart Association, 2003:77.
34. Weiss M, Adkinson N, Hirshman C. Evaluation of allergic drug reactions in the perioperative period. *Anesthesiology* 1989;71:483–486.
35. Fisher M. Intradermal testing after anaphylactoid reaction to anaesthetic drugs: practical aspects of performance and inter-

- pretation. *Anaesth Intensive Care* 1984;12:115–120.
36. Vervloet D, Nizankowska E, Arnaud A, et al. Adverse reactions to suxamethonium and other muscle relaxants under general anesthesia. *J Allergy Clin Immunol* 1983;71:552–559.
37. Moscicki RA, Sockin SM, Corsello BF, et al. Anaphylaxis during induction of general anesthesia: subsequent evaluation and management. *J Allergy Clin Immunol* 1990;86(3 Pt 1):325–332.
38. Grammer L, Patterson R. Proteins, chymopapain and insulin. *J Allergy Clin Immunol* 1984;74:635–640.
39. Dykewicz M, McGrath K, Davison R, et al. Identification of patients at risk for anaphylaxis due to streptokinase. *Arch Intern Med* 1986;196:305–307.
40. Hamilton R, Rendell M, Adkinson N. Serological analysis of human IgG and IgE anti-insulin antibodies by solid-phase radioimmunoassays. *J Lab Clin Med* 1980;96:1022–1036.
41. Morales C, Basomba A, Carreira J, et al. Anaphylaxis produced by rubber glove contact. Case reports and immunological identification of the antigens involved. *Clin Exp Allergy* 1989;19:425–430.
42. Slater JE. Rubber anaphylaxis. *N Engl J Med* 1989;320:1126–1130.
43. Etter M, Helrich M, Mackenzie C. Immunoglobulin E fluctuation in thiopental anaphylaxis. *Anesthesiology* 1980;52:181–183.
44. Fisher MM, Baldo BA. The diagnosis of fatal anaphylactic reactions during anaesthesia: employment of immunoassays for mast cell tryptase and drug-reactive IgE antibodies. *Anaesth Intensive Care* 1993;21:353–357.
45. Laroche D, Dubois F, Lefrancois C, et al. [Early biological markers of anaphylactoid reactions occurring during anaesthesia]. *Ann Fr Anesth Reanim* 1992;11:613–618.
46. Schwartz L, Metcalfe D, Miller J, et al. Tryptase levels as an indicator of mast-cell activation in systemic anaphylaxis and mastocytosis. *N Engl J Med* 1987;316:1622–1626.
47. Volcheck GW, Li JT. Elevated serum tryptase level in a case of intraoperative anaphylaxis caused by latex allergy. *Arch Intern Med* 1994;154:2243–2245.
48. Greenberger P. Contrast media reactions. *J Allergy Clin Immunol* 1984;74:600–605.
49. Mertes P, Laxenaire M. [Anaphylactic and anaphylactoid reactions occurring during anaesthesia in France. Seventh epidemiologic survey (January 2001–December 2002)]. *Ann Fr Anesth Reanim* 2004;23:1133–1143.
50. Garvey L, Roed-Petersen J, Menne T, et al. Danish Anaesthesia Allergy Centre—preliminary results. *Acta Anaesth Scand* 2001;45:1204–1209.
51. Laake J, Rottingen J. Rocuronium and anaphylaxis—a statistical challenge. *Acta Anaesth Scand* 2001;45:1196–1203.
52. Matthey P, Wang P, Finegan B, Donnelly M. Rocuronium anaphylaxis and multiple neuromuscular blocking drug sensitivities. *Can J Anaesth* 2000;47:890–893.
53. Dolovich J, Evans S, Rosenbloom D. Anaphylaxis due to thiopental sodium anesthesia. *Can Med Assoc J* 1980;123:292.
54. Harle D, Baldo B, Smal M, et al. Detection of thiopentone-reactive IgE antibodies following anaphylactoid reactions during anaesthesia. *Clin Allergy* 1986;16:493–498.
55. Hirshman C, Edelstein R, Ebertz J, et al. Thiobarbiturate-induced histamine release in human skin mast cells. *Anesthesiology* 1985;63:353–356.
56. Hirshman C, Peters J, Cartwright-Lee I. Leukocyte histamine release to thiopental. *Anesthesiology* 1982;56:64–67.
57. de Leon-Casasola O, Weiss A, Lema M. Anaphylaxis due to propofol. *Anesthesiology* 1992;77:384–386.
58. Laxenaire M, Gueant J, Bermejo E, et al. Anaphylactic shock due to propofol. *Lancet* 1988;2:739–740.
59. Hofer K, McCarthy M, Buck M, et al. Possible anaphylaxis after propofol in a child with food allergy. *Ann Pharmacother* 2003;37:398–401.
60. Kumar C, McNeela B. Ocular manifestation of propofol allergy. *Anaesthesia* 1989;44:266.
61. Konarzewski W, De'Ath S. Unrecognised fatal anaphylactic reaction to propofol or fentanyl. *Anaesthesia* 2001;56:497–498.
62. Schatz M. Skin testing and incremental challenge in the evaluation of adverse reactions to local anesthetics. *J Allergy Clin Immunol* 1984;74:606.
63. deShazo R, Nelson H. An approach to the patient with a history of local anesthetic hypersensitivity: experience with 90 patients. *J Allergy Clin Immunol* 1989;63:387.
64. Dooms-Goossens A, de Alam A, Degreef H, Kochuyt A. Local anesthetic intolerance due to metabisulfite. *Contact Dermatitis* 1989;20:124–126.
65. Schwartz H, Gilbert I, Lenner K, et al. Metabisulfite sensitivity and local dental anesthesia. *Ann Allergy* 1989;62:83–86.
66. Lawrence I, Warner J, Cohan V. Purification and characterization of human skin mast cells. *J Immunol* 1987;139:3062.
67. Bennett M, Anderson L, McMillan J, et al. Anaphylactic reaction during anaesthesia associated with positive intradermal skin test to fentanyl. *Can Anaesth Soc J* 1986;33:75–78.
68. Harle D, Baldo B, Coroneos N, et al. Anaphylaxis following administration of papperetum. Case report: Implication of IgE antibodies that react with morphine and codeine, and identification of an allergenic determinant. *Anesthesiology* 1989;71:489–494.
69. Zucker-Pinchoff B, Ramanathan S. Anaphylactic reaction to epidural fentanyl. *Anesthesiology* 1989;71:599–601.
70. Blanca M. Allergic reactions to penicillins. a changing world? *Allergy* 1995;50:777–782.
71. Sheffer A. Anaphylaxis. *J Allergy Clin Immunol* 1988;81(5 Pt 2):1048–1050.
72. Sogn D. Prevention of allergic reactions to penicillin. *J Allergy Clin Immunol* 1986;78(5 Pt 2):1051–1052.
73. Puchner TJ, Zacharisen M. A survey of antibiotic prescribing and knowledge of penicillin allergy. *Ann Allergy Asthma Immunol* 2002;88:24–29.
74. Robinson J, Hameed T, Carr S. Practical aspects of choosing an antibiotic for patients with a reported allergy to an antibiotic. *Clin Infect Dis* 2002;35:26–31.
75. Southorn P, Plevak D, Wright A, et al. Adverse effects of vancomycin administered in the perioperative period. *Mayo Clin Proc* 1986;61:721–724.
76. Levy J, Kettlekamp N, Goertz P, et al. Histamine release by vancomycin: a mechanism for hypotension in man. *Anesthesiology* 1987;67:122–125.
77. Anderson J. Antibiotic drug allergy in children. *Curr Opin Pediatr* 1994;6:656–660.
78. Macy E. Multiple antibiotic allergy syndrome. *Immunol Allergy Clin North Am* 2004;24:533–543.
79. Asero R. Detection of patients with multiple drug allergy syndrome by elective tolerance tests. *Ann Allergy Asthma Immunol* 1998;80:185–188.
80. Patterson R, DeSwarthe R, Greenberger P. Drug allergy and protocols for management of drug allergies. *N Engl Reg Allergy Proc* 1986;4:325.
81. Dierich MP, Schulz T. Physiological and pathological effects of activated complement. *Haematologia* 1984;17:3–16.
82. Kelly J, Patterson R, Lieberman P. Radiographic contrast media studies in high-risk patients. *J Allergy Clin Immunol* 1978;62:181.
83. Greenberger P, Patterson R. The prevention of immediate generalized reactions to radiocontrast media in high-risk patients. *J Allergy Clin Immunol* 1991;87:867–872.
84. Gottschlich G, Gravlee G, Georgitis J. Adverse reactions to protamine sulfate during cardiac surgery in diabetic and nondiabetic patients. *Ann Allergy* 1988;61:277.
85. Stewart W, McSweeney S, Kellett M. Increased risk of severe protamine reactions in NPH insulin-dependent diabetics undergoing cardiac catheterization. *Circulation* 1984;70:788.
86. Weiss M, Nyhan D, Peng Z, et al. Association of protamine IgE and IgG antibodies with life-threatening reactions to intravenous protamine. *N Engl J Med* 1989;320:886–892.
87. Lee A, Chey W, Choi J, et al. Insulin-induced drug eruptions and reliability of skin tests. *Acta Derm Venereol* 2002;82:114–117.
88. Knape J, Schuller J, de Haan P. An anaphylactic reaction to protamine in a patient allergic to fish. *Anesthesiology* 1981;55:324.

89. Nyhan D, Shampaine E, Hirshman C, et al. Single doses of intravenous protamine result in the formation of protamine-specific IgE and IgG antibodies. *J Allergy Clin Immunol* 1996;97:991-997.
90. Sharath M, Metzger W, Richardson H. Protamine-induced fatal anaphylaxis. *J Thorac Cardiovasc Surg* 1985;90:86.
91. Kimmel S, Sekeres M, Berlin J, et al. Risk factors for clinically important adverse events after protamine administration following cardiopulmonary bypass. *J Am Coll Cardiol* 1998;32:1916-1922.
92. Degges R, Foster M, Dang A, et al. Pulmonary hypertensive effect of heparin and protamine interaction: evidence for thromboxane B2 release from the lung. *Am J Surg* 1987;154:696-699.
93. Morel D, Zapol W, Thomas S, et al. C5a and thromboxane generation associated with pulmonary vaso- and broncho-constriction during protamine reversal of heparin. *Anesthesiology* 1987;66:597-604.
94. Beaudouin E, Kanny G, Morisset M, et al. Immediate hypersensitivity to chlorhexidine: literature review. *Allerg Immunol (Paris)* 2004;36:123-126.
95. Garvey L, Roed-Petersen J, Husum B. Is there a risk of sensitization and allergy to chlorhexidine in health care workers? *Acta Anaesth Scand* 2003;47:720-724.
96. Pedrosa C, Costa H, Oliveira G, et al. Anaphylaxis to povidone in a child. *Pediatr Allergy Immunol* 2005;16:361-362.
97. Dewachter P, Tréchet P, Mouton-Faivre C. ["Iodine allergy": point of view]. *Ann Fr Anesth Reanim* 2005;24:40-52.
98. Hamann CP. Latex hypersensitivity: an update. *Allergy Proc* 1994;15:17-20.
99. Hamann CP, Kick SA. Allergies associated with medical gloves. Manufacturing issues. *Dermatol Clin* 1994;12:547-559.
100. Yunginger J, Jones R, Fransway A, et al. Extractable latex allergens and proteins in disposable medical gloves and other rubber products. *J Allergy Clin Immunol* 1994;93:836-842.
101. Charpin D, Vervloet D. Epidemiology of immediate-type allergic reactions to latex. *Clin Rev Allergy* 1993;11:385-390.
102. Moneret-Vautrin DA, Beaudouin E, Widmer S, et al. Prospective study of risk factors in natural rubber latex hypersensitivity. *J Allergy Clin Immunol* 1993;92:668-677.
103. Ebo D, Stevens W, De Clerck L. Latex anaphylaxis. *Acta Clin Belg* 1995;50:87-93.
104. Kwittken PL, Sweinberg SK, Campbell DE, et al. Latex hypersensitivity in children: clinical presentation and detection of latex-specific immunoglobulin E. *Pediatrics* 1995;95:693-699.
105. Fisher M, Baldo B. Mast cell tryptase in anaesthetic anaphylactoid reactions. *Br J Anaesth* 1998;80:26-29.
106. Cottineau C, Drouet M, Costerousse F, et al. [Importance of plasma (histamine and tryptase) and urinary (methylhistamine) in peri-anesthetic anaphylactic and/or anaphylactoid reactions]. *Allerg Immunol (Paris)* 1996;28:273-276.
107. Angelsioo L, Palmqvist P, Sandin R. [A case report. Tryptase in serum indicated latex-induced anaphylaxis]. *Lakartidningen* 1995;92:1131-1132.
108. Matsson P, Enander I, Andersson AS, et al. Evaluation of mast cell activation (tryptase) in two patients suffering from drug-induced hypotensoid reactions. *Agents Actions* 1991;33:218-220.
109. Blanco C, Carrillo T, Castillo R, et al. Latex allergy: clinical features and cross-reactivity with fruits. *Ann Allergy* 1994;73:309-314.
110. Occelli G, Amedeo J, Raucoules M, et al. [Evaluation of the activities and value of allerge-anesthetic consultation at the University Hospital Center of Nice 1985-1991]. *Therapie* 1992;47:423-427.
111. Theissen JL, Zahn P, Theissen U, et al. [Allergic and pseudo-allergic reactions in anesthesia. I. Pathogenesis, risk factors, substances]. *Anesthesiol Intensivmed Notfallmed Schmerzther* 1995;30:3-12.
112. Bigby M, Jick S, Jick H, et al. Drug-induced cutaneous reactions. A report from the Boston Collaborative Drug Surveillance Program on 15,438 consecutive inpatients, 1975 to 1982. *JAMA* 1986;256:3358-3363.
113. Kinet J. A new strategy to counter allergy. *N Engl J Med* 2005;353:310-312.



## CHAPTER 89

## Malignant Hyperthermia, Thermoregulation, and Perioperative Hypothermia<sup>a</sup>

Sheila Muldoon, MD,  
Nyamkhishig Sambuughin, PhD,  
Maria Voelkel, BA,  
Rolf Bunger, MD, PhD,  
Hilary P. Grocott, MD, FRCPC,  
and Christopher Sulzer, MD

### MALIGNANT HYPERTHERMIA<sup>a</sup>

Malignant hyperthermia (MH) is a dominantly inherited disorder of skeletal muscle (myopathy) that predisposes susceptible individuals to a potentially fatal reaction (fulminant episode) upon exposure to potent volatile anesthetics and/or succinylcholine. Fulminant MH episodes apparently result from a rapid, sustained rise in myoplasmic  $Ca^{2+}$ . Molecular genetic analysis identified mutations in the ryanodine receptor type 1 (RyR1) that codes for the  $Ca^{2+}$  release channel in muscle to be a major cause for MH. However, MH is known to be a heterogeneous disorder and mutations in RyR1 account for approximately 70% of all MH cases. An MH episode constitutes a hypermetabolic state manifesting as tachycardia, mixed respiratory and metabolic acidosis, muscle rigidity, and, ultimately, hyperthermia. Muscle membrane damage leads to release of intracellular muscle constituents, such as creatine kinase (CK), lactate dehydrogenase, myoglobin, and potassium. The formerly high mortality rate (70%) has dropped 5% since the introduction of dantrolene, a drug that inhibits  $Ca^{2+}$  release from the sarcoplasmic reticulum (SR), and can usually stop the crisis if administered when early

<sup>a</sup>"Malignant Hyperthermia" was written by Dr. Sheila Muldoon, Dr. Nyamkhishig Sambuughin, and Ms. Maria Voelkel, and Dr. Rolf Bunger. "Thermoregulation and Perioperative Hypothermia" was written by Dr. Hilary P. Grocott and Dr. Christopher Sulzer.

### KEY POINTS

1. Malignant hyperthermia (MH) was first described in the early 1960s in a case report that also suggested an inherited basis for the syndrome.
2. Skeletal muscle is the primary target tissue in MH. A laboratory diagnostic test for MH was derived using the enhanced contracture response of in vitro muscle strips from MH patients. Studies using these tests suggest that the cellular mechanism responsible for MH is a derangement in calcium regulation.
3. No convenient minimally invasive laboratory test for MH susceptibility is yet available. Halothane and caffeine contracture tests are bioassays and remain the most reliable indicators.
4. Molecular genetic tests, for example targeted screening of the RyR1 gene, can confirm the diagnosis of MH susceptibility.
5. A negative screen of the RyR1 gene does not rule out MH susceptibility.
6. The immediate cause of an MH crisis appears to be a sudden increase in the concentration of myoplasmic calcium; this  $Ca^{2+}$  overload is thought to follow the actions of inhalational anesthetic agents on the sarcoplasmic reticulum (SR), specifically the  $Ca^{2+}$  release channel called the RYR1.
7. All potent anesthetics are capable of triggering an MH reaction, but an MH episode does not always occur with each exposure to an inhalation agent, even in persons known to be MH susceptible. This situation reflects the variable penetrance of the gene.
8. Time of onset of a fulminant episode of MH is unpredictable, varying from within minutes to within several hours of induction; it may even occur in the recovery room.
9. The earliest, most sensitive and most specific sign of an MH episode is an unexpected increase in end-tidal  $CO_2$ .
10. Laboratory signs in MH include elevated  $PaCO_2$ , combined metabolic and respiratory acidosis, hyperkalemia, elevated creatinine kinase, myoglobinemia, and myoglobinuria.
11. In 1979, dantrolene, a drug that inhibits SR  $Ca^{2+}$  release in skeletal muscle was approved for clinical use by the Food and Drug Administration; this was a major advance in the treatment and management of MH.
12. A near-zero mortality rate from MH can result from prompt recognition of the clinical situation, ready access to supplies necessary for treatment, and initiation of appropriate therapeutic measures.
13. Adults thermoregulate with their environment by cutaneous vasomotor adjustments, sweating, shivering, and environmental behavioral adaptation (dressing appropriately, modifying environmental temperature).
14. Neonates do not shiver but can generate heat via nonshivering thermogenesis.
15. Heat loss occurs via sweating and cutaneous vasodilatation. Heat conservation results from cutaneous vasoconstriction and behavioral adaptation.
16. Although not precisely defined, core temperature reflects mean temperature of the well-perfused organs (e.g., brain, heart, kidney, and lungs).
17. Hypothermia which develops during general anesthesia typically follows a predictable pattern: (a) an initial rapid decrease in core temperature of between  $32.9^{\circ}F$  ( $0.5^{\circ}C$ ) and  $34.7^{\circ}F$  ( $1.5^{\circ}C$ ) during the first hour after induction, believed to be the result of internal redistribution of heat; (b) a more gradual linear decline in core temperature, usually lasting 2–3 hours that apparently results from cutaneous heat loss exceeding metabolic heat production (typically  $0.9^{\circ}F$  [ $0.5^{\circ}C$ ] to  $1.8^{\circ}F$  [ $1^{\circ}C$ ] per hour); and (c) a plateau phase when core temperature stabilizes after 3–4 hours and which results from thermoregulatory balance.
18. Following redistribution-mediated decreases in temperature, body heat loss occurs via radiation (60% of heat loss) and convection, with <10% occurring via evaporation, and a negligible amount via conduction.
19. Postanesthesia shivering is most likely mediated via normal thermoregulatory response to hypothermia.

*Continued*

*Key Points—continued*

- 20.** Hypothermia during regional anesthesia is caused by depression of regional thermal afferent input and efferent responses, such as vasoconstriction and shivering, loss of heat to the operating room environment, and redistribution of heat within the body.
- 21.** Hypothermia during anesthesia may be prevented or treated by prewarming, the control of ambient tempera-

ture, skin insulation, warm IV solutions, heating and humidifying inspired gases, the application of a forced-air heating system, and the use of new generation circulating-water heating systems.

- 22.** There is an abundance of experimental evidence for the neuroprotective effects of hypothermia; emerging clinical applications include the postcardiac arrest and neonatal asphyxia patients.

symptoms are recognized. Hyperthermia, for which the syndrome is named, is a late clinical sign and is likely of metabolic origin, most probably caused by the maximum turnover of muscle adenosine triphosphate (ATP).<sup>1-3</sup>

For more than 20 years after the MH syndrome was first described the underlying causes were largely speculative, but experimental evidence indicated that alterations in myoplasmic  $Ca^{2+}$  were involved. It was only in 1991, after the skeletal muscle RYR1 gene was cloned,<sup>4</sup> that the first report linking MH mutations in the ryanodine receptor type 1 (RYR1)  $Ca^{2+}$  channel appeared. These findings propelled an explosion of new knowledge and insights into the genetics and pathophysiology of MH and mechanisms by which MH mutations alter muscle function in human, animal, and cell culture models of MH. Although these new developments have not shown the same dramatic improvements in patient care as the introduction of dantrolene and capnography (end-tidal  $CO_2$ ) monitoring, our mechanistic understanding of the syndrome and how it relates to calcium control and energy metabolism in muscle has greatly improved.

Despite this impressive progress there are still a number of areas that currently are not well managed or understood. First, fulminant MH remains an unpredictable occurrence and deaths attributable to MH in otherwise healthy persons still occur. Second, there is a lack of a convenient and rapid test to identify MH-susceptible patients prior to surgery; this remains a serious concern to all anesthesiologists and surgeons. Third, estimates of MH prevalence in the general population are at best uncertain; indeed, published estimates range from 1 in 250,000 to as high 1 in 4200, depending

on geographic region and types of anesthetics administered.<sup>16</sup> Fourth, the early symptoms of a beginning MH crisis are often not specific for MH and administering dantrolene early abolishes the typical symptoms that would have developed without treatment. Thus, many clinical reports documenting dantrolene use, especially if it was given without the key clinical signs of MH, may be equivocal, yet persons experiencing such treatment are classified as MH susceptible. It is important that such equivocal MH cases are referred for definitive contracture tests, along with genetic analysis, when appropriate. Other people are classified as MH susceptible on the basis of a family history alone, and these “individuals” also should be referred for definitive diagnosis. This is important because the MH-susceptible (MHS) label can be a serious lifelong burden to patients and their families: they are limited in the kinds of anesthesia they can receive, are denied entry into the military and police academies, and they may also be denied surgical care by some anesthesiologists and surgeons.

This chapter discusses current concepts on the pathogenesis of MH, the roles of RYR1, skeletal muscle, and genetics used in diagnostics of MH, and the clinical management of MH.

### Historic Perspective

The first link between inhalational anesthetic drugs as etiologic agents and the familial nature of a disorder called malignant hyperpyrexia or malignant hyperthermia was made in 1960. Denborough and Lovell reported a case of a 21-year-old man with a compound fracture of the tibia who was reluctant to undergo surgical repair of his leg.<sup>5</sup> The patient had good reason to be concerned, because 10 members of his

family had died without explanation during or shortly after general anesthesia with ether-type anesthetics. In some of the cases, the deaths were preceded by convulsions and fulminant fevers. The patient was reassured that a new anesthetic agent, halothane, a halogenated hydrocarbon, with a different chemical structure than ether, would be safe and it was decided to proceed cautiously with anesthesia using it. However, within 10 minutes of induction of anesthesia with halothane, the patient developed tachycardia, hypotension, cyanosis, and hot sweaty skin. The anesthetic was discontinued, vigorous cooling was begun and the patient survived. When Denborough investigated the patient's family, he correctly surmised that they exhibited an inheritable disorder that caused life-threatening hyperthermia when administered general anesthetic agents and suggested that an underlying skeletal muscle disorder may confer susceptibility.<sup>6</sup>

Identification of a large affected family from Wisconsin in which 20 episodes of MH and 8 fatalities had occurred confirmed the dominant inheritance pattern of the disorder, and was an important step in spreading awareness of the syndrome in North America.<sup>7</sup> Retrospectively, fatal increases in body temperature during general anesthesia that have been described since the beginning of the 20th century may have been malignant hyperthermia cases.

Studies by Kalow and Britt reported that freshly biopsied skeletal muscle from MH-susceptible survivors had abnormally strong muscle contracture responses to caffeine *in vitro*.<sup>8</sup> Because caffeine in high doses had been previously reported to release  $Ca^{2+}$  from the SR, their observations were important in linking MH contracture response to  $Ca^{2+}$  released from the SR. Also, the contractile responses to caffeine were potentiated by halothane, which suggested that halothane might also affect  $Ca^{2+}$  release and handling in skeletal muscle. Later it was reported that halothane alone could cause abnormal contracture in human MH skeletal muscle. The observations by Kalow and Britt led to the development of a bioassay using freshly excised skeletal muscle samples, which later became the *in vitro* caffeine contracture test (IVCT) in Europe and the caffeine halothane

contracture test (CHCT) in North America for MH diagnosis.

Susceptibility to MH is not confined to humans but occurs in several animal species, including pigs, dogs, and horses. The porcine model has been studied most extensively, and the pharmacological properties of MH swine muscle appear to be similar to MH human muscle.<sup>9</sup> The breeds of swine (Lan-drace, Poland, China, and Pietrain) in which MH has been characterized are the same as those in which there is a high incidence of porcine stress syndrome. Porcine stress syndrome is a condition associated with lean, heavily muscled pigs that develop acute shock-like episodes in response to stress, mild exercise, sudden increases in ambient temperature, fighting, coitus, and transportation.

An important milestone in bridging the porcine and human MH syndromes was made when Hall et al.<sup>246</sup> administered halothane to pigs that had porcine stress syndrome and found that the animals experienced an event remarkably similar to human MH.<sup>10</sup>

Subsequently, a single homozygous mutation in the RyR1 gene was identified in all MHS and porcine stress syndrome-prone swine.

In the 1970s, even as progress in understanding the pathophysiology was being made, and human MH was recognized to be an inherited disorder, patient mortality from MH remained high because there was no effective pharmacologic treatment. In 1975, Harrison et al. described the efficacy of dantrolene (later shown to inhibit the release of  $Ca^{2+}$  from the SR) in preventing and treating porcine MH.<sup>11</sup> These results were subsequently confirmed in humans, and in 1979 the Food and Drug Administration approved intravenous dantrolene as an antidote in cases of fulminant MH. The advent of dantrolene dramatically decreased the mortality rate from 70% to less than 10%.

Major advances in the past 2 decades involved elucidating the subcellular site of the MH defect in skeletal muscle, standardization of the diagnostic contracture tests, and identification of the SR  $Ca^{2+}$  release channel encoded by the RyR1 gene on chromosome 19q as the major candidate gene for MH susceptibility.<sup>12,13</sup> Subsequent studies identified several other genetic loci on other chromosomes with 1 additional candidate gene (CACNL1A3) coding

for the  $\alpha_1$  subunit of the dihydropyridine receptor (DHPR) on Chromosome 1q. In 2005, investigators used stem cell technology to create knock-in mice, and reported that mice harboring a specific RyR1 mutation (Tyr522Ser) could be triggered to develop fulminant MH syndrome by exposure to volatile anesthetics or heat exposure.<sup>14</sup> Transgenic knock-in mice will likely permit detailed analysis of how different mutations relate to altered muscle calcium handling plus muscle function alterations, both in vivo and in vitro.

### Epidemiology: Prevalence and Incidence

The prevalence of MH susceptibility in the population is unknown and estimates of the frequency of acute fulminant episodes vary widely. In the first extensive study of human MH, published in 1970, the incidence was estimated to be 1 in 15,000.<sup>15</sup> In a later survey of a mixed surgical population of all ages in Denmark, fulminant MH occurred once in 250,000 anesthetics when all types of anesthesia were included and once in 60,000 anesthetics when a combination of potent inhalation agents and succinylcholine was used.<sup>16</sup> Suspicion of MH was raised in 1 in 4500 anesthetics with halothane and succinylcholine. The Danish study further reported that masseter spasm occurred in 1 in 12,000 administrations of succinylcholine.<sup>17</sup>

In 1997, a code specific for MH (995.86) was added to the International Classification of Diseases (ICD-9CM).

### Clinical Syndromes

#### Fulminant Episodes

Box 89-1 contains all currently known potent inhalation anesthetics that are capable of triggering an acute fulminant MH reaction in humans, as well as a list of anesthetic drugs that are safe (non-triggering) for use in MH susceptibility individuals.<sup>3</sup>

The most potent trigger for MH appears to be induction of anesthesia with halothane followed by succinylcholine. This combination can cause an almost immediate onset of fulminant MH in a susceptible individual. However, the clinical presentation of fulminant MH episodes can be highly variable and the initial symptoms can have a slow onset, which makes MH difficult to recognize. This is especially true with newer inhalation anesthetics such as isoflurane, sevoflurane, and desflurane, where the

#### BOX 89-1.

#### Malignant Hyperthermia Trigger and Safe Anesthetic Agents

Trigger Agents	Safe Agents
<i>Inhaled Anesthetics</i>	<i>Inhaled Anesthetics</i>
Halothane	N <sub>2</sub> O
Isoflurane	Xenon
Enflurane	<i>Intravenous Anesthetics</i>
Sevoflurane	Anesthetics
Desflurane	Barbiturates
<i>Intravenous Anesthetics</i>	Propofol
None	Ketamine
<i>Muscle Relaxants</i>	<i>Muscle Relaxants</i>
Depolarizing (succinylcholine)	Nondepolarizing (all)
	<i>Local Anesthetics</i>
	All
	<i>Narcotics</i>
	<i>Benzodiazepines</i>

onset of an episode is often delayed.<sup>18</sup> Many cases have been reported in which anesthesia was uncomplicated for an hour or more prior to recognition of MH. Difficulties in diagnosis and in confirmation of susceptible individuals also occur when the anesthetic is terminated immediately after MH is suspected, as there may be insufficient laboratory and clinical abnormalities to confirm or reject the tentative diagnosis of MH.<sup>19-21</sup>

Box 89-2 summarizes the clinical signs of fulminant MH. The underlying events that trigger a fulminant MH episode and determine its severity are poorly understood. While the existing evidence suggests that RyR1 mutations underlie a high proportion of MH cases, there is considerable variation in clinical expression, for example, many MH-susceptible individuals are known to have had uneventful exposure to triggering anesthetics before developing a fulminant MH episode; differing intensities in clinical expression have developed with the same triggering agents in patients from the same family; patients may trigger without a clear family lineage; and patients may trigger with exposure to high environmental temperatures and certain noxious chemicals. This suggests that environmental and genetic factors affect the responsiveness of patients carrying MH mutations. This may be a result of incomplete penetrance of the mutations, the influence of one or more modifying genes, and/or complex interactions between genes and environment.



## BOX 89-2.

## Clinical and Laboratory Signs Associated with Malignant Hyperthermia\*

## Clinical Signs

Increased end-tidal CO<sub>2</sub>  
 Increased minute ventilation (if spontaneously breathing)  
 Tachycardia, hypertension  
 Dysrhythmia  
 Cyanosis/mottling  
 Muscle rigidity, masseter spasm, or both  
 Hyperthermia†  
 Dark brown urine

## Laboratory Findings

Increased PaCO<sub>2</sub>  
 Acidosis (mixed respiratory/metabolic)  
 Increased O<sub>2</sub> consumption  
 Hyperkalemia  
 Hypercalcemia  
 Hyperphosphatemia  
 Serum lactate elevation  
 Creatine kinase elevation  
 Myoglobinuria  
 Abnormal coagulation tests

\*In known cases of MH, there have been large variations in the intervals between exposure to the triggering agent and development of symptoms. Patients with MH have also demonstrated varying and unpredictable times for the initial signs to develop into a fulminant, life-threatening, crisis.

†Elevation of body temperature is a late and serious sign of MH and may not be present at the time of the diagnosis. During fulminant acute MH, body temperature may increase at a rate of 1.8–3.6°F (1–2°C) every 5 minutes.

The depolarizing muscle relaxant succinylcholine can trigger or enhance the severity of an MH episode induced by volatile anesthetics. Succinylcholine has several other effects; it can cause muscle contracture in muscle that is myotonic or denervated, and it can increase muscle membrane permeability resulting in an increase in serum K<sup>+</sup>, myoglobin, and CK, even in non-MH patients.<sup>1</sup>

In the swine model of MH the severity of muscle rigidity correlates with sustained elevations in intracellular Ca<sup>2+</sup> concentration in the myoplasm ([Ca<sup>2+</sup>]<sub>i</sub>) and it is generally assumed that a similar correlation exists in humans.<sup>22</sup> Fulminant MH episodes in humans apparently occur because the triggering anesthetics cause a rapid and sustained rise in [Ca<sup>2+</sup>]<sub>i</sub> of the skeletal muscle cells. Physiologically, resting [Ca<sup>2+</sup>]<sub>i</sub> is tightly controlled at submicromolar levels (about 100 nM) and during a full contraction-relaxation cycle there is a short transient rise of [Ca<sup>2+</sup>]<sub>i</sub> of up to 1000-fold, which is rapidly reversed by the reuptake of Ca<sup>2+</sup> via the SR Ca<sup>2+</sup> pump. In contrast, during an MH crisis, [Ca<sup>2+</sup>]<sub>i</sub> increases massively and is not transient but remains elevated in spite of a functioning SR Ca<sup>2+</sup> uptake pump. The sustained calcium overload in MH-susceptible cases stimulates numerous metabolic pathways, including glycogen breakdown, glycolysis, ATP hydrolysis, pyruvate dehydrogenase, oxidative phosphorylation of adenosine diphosphate (ADP), and the ATP-

dependent sarcolemmal and SR Ca<sup>2+</sup> pumps. Under such conditions, the demand for ATP greatly increases, to which the mitochondria respond with increased rates of oxidative phosphorylation as long as oxygen supply remains sufficient. The sustained increase in [Ca<sup>2+</sup>]<sub>i</sub> leads to muscle contraction without relaxation, that is, spasm, which, if prolonged, develops into severe contracture. The muscle contracture greatly increases the extravascular resistance to muscle perfusion resulting in ischemia initially locally and eventually systemically.

The overall higher metabolic activity and ATP consumption is reflected as an increase in CO<sub>2</sub> production, lactate formation, and heat production, as well as increased O<sub>2</sub> consumption, leading to the clinical symptoms of hypercapnia, acidosis, hyperkalemia, and, ultimately, hyperthermia. If the MH syndrome is not treated by withdrawing the anesthetic agents and administration of dantrolene to decrease SR Ca<sup>2+</sup> release, metabolic exhaustion will occur with resulting skeletal muscle edema, rhabdomyolysis (skeletal muscle breakdown), cerebral edema, and multiorgan failure.

In the typical case, an unexplained rise in end-tidal CO<sub>2</sub> (ETCO<sub>2</sub>) is the earliest, most sensitive and specific sign of an MH episode. Box 89-3 describes the differential diagnosis for increases in ETCO<sub>2</sub>. Tachypnea will be present if the patient is breathing spontaneously. If the patient is paralyzed and ventilation is controlled, the

## BOX 89-3.

Differential Diagnosis of Increased ETCO<sub>2</sub> Concentration in Malignant Hyperthermia

## I. Equipment

- A. Machine: leak, disconnect, decreased fresh gas flow
- B. Breathing circuit: leak, disconnect, decreased fresh gas flow, obstruction, valve malfunction, depletion or channeling of CO<sub>2</sub> absorbent, improper attachment of circuit to machine
- C. Ventilator: leak, disconnect, improper settings, malfunction, decreased driving pressure
- D. Monitor: leak, disconnect, inaccurate calibration, moisture, baseline drift

II. Metabolic: increased production of CO<sub>2</sub>

- A. Fever: iatrogenic, sepsis, thyrotoxicosis, pheochromocytoma, central nervous system injury
- B. Light anesthesia
- C. Release of aortic cross-clamp
- D. Release of leg tourniquet
- E. Malignant hyperthermia

III. Mechanical: decreased elimination of CO<sub>2</sub>

- A. Pulmonary: airway obstruction, bronchial intubation, secretions, aspiration, pulmonary edema, asthma, pneumonia, acute respiratory distress syndrome, pneumothorax, hemothorax
- B. Extrathoracic: pressure on chest, retractors, increased abdominal muscle tone, ascites, Trendelenburg position
- C. Central: decreased ventilatory drive in spontaneously ventilating patients (narcotics or inhalational agents) via non-instrumented airway, laryngeal mask airway or endotracheal tube
- D. CO<sub>2</sub> insufflation for pneumoperitoneum during laparoscopic abdominal surgery

need to increase minute ventilation to control acidosis becomes apparent and emphasizes the need for routine, continuous ETCO<sub>2</sub> monitoring. Without ETCO<sub>2</sub> monitoring, an unexplained increase in heart rate occurring in the first 30 minutes of an anesthetic may be the most important early sign. Multifocal ventricular dysrhythmias frequently occur in conjunction with the



tachycardia. If the syndrome is not recognized and treated, ventricular tachycardia, major conduction defects, and cardiac arrest, probably as a consequence of hyperkalemia, may occur.

Generalized whole-body muscle rigidity can occur in association with masseter muscle rigidity (MMR) following succinylcholine and this combination, particularly when it occurs with an increase in body temperature, usually indicates MH susceptibility.

Muscle rigidity that develops during maintenance of anesthesia with potent inhalational anesthetics is a "sinister feature," as noted by Hopkins.<sup>2</sup> This is because a new and serious pathologic element—muscle ischemia—has been introduced as a result of extravascular compression at a time when myoplasmic  $[Ca^{2+}]_i$  and metabolic demand is high. This further stimulates ATP catabolism, intracellular acidosis, and  $K^+$  efflux. Prolonged ischemia has several detrimental effects. It limits oxygen availability to the mitochondrial respiratory chain, greatly impairing oxidative phosphorylation of ADP to ATP, which leads to deenergization<sup>23</sup> of the calcium-overloaded muscle cells; the reduced tissue perfusion also makes it difficult if not impossible to deliver therapeutic agents such as dantrolene to its target organ, the muscle. Dantrolene inhibits calcium channel activity by suppressing  $[Ca^{2+}]_i$  release from the SR.<sup>24</sup> Prolonged ischemia also eventually inhibits glycolytic (substrate) level phosphorylation of ADP because of massive cytosolic (NADH<sup>+</sup> [reduced form of nicotinamide adenine dinucleotide] + H<sup>+</sup>) accumulation, which inhibits glyceraldehyde-phosphate dehydrogenase.<sup>25</sup> With ADP rephosphorylation virtually fully disabled at both the mitochondrial and glycolytic levels, the cytosolic phosphorylation potential will collapse<sup>23,26,27</sup> and a reversal of the MH process, which requires ATP-dependent clearing of the calcium overload from the cells, is practically impossible.

It is now clear that hyperthermia is the result, not the cause, of a metabolic failure in muscle. Therefore, hyperthermia tends to be a relatively late clinical sign. Skeletal muscle heat production may be mainly the consequence of increased cross bridge cycling and ATP-dependent ion pumping.

The maximum temperature attained in fulminant MH episodes is variable. The increase in temperature depends

on the rate of rise of the metabolic rates, skin perfusion, patient size, site of surgery, ambient temperature, ongoing infection, and use of other drugs (e.g., atropine). Box 89-4 outlines the differential diagnosis of MH.

High temperature directly induces tissue injury and procedures to cool the body should be instituted quickly. The goal is to reduce muscle metabolism and avoid exposure to a critical temperature, that is, a core temperature of  $>104^\circ F$  ( $40^\circ C$ ).<sup>28</sup> At extreme temperatures of  $120.2$ – $122^\circ F$  ( $49$ – $50^\circ C$ ), cellular structures are destroyed and necrosis occurs in less than in 5 minutes. At lower temperatures, cell death is largely caused by apoptosis. Survival from fulminant MH has been reported in at least one case with temperatures as high as  $111.2$ – $113^\circ F$  ( $44$ – $45^\circ C$ ).

Laboratory signs in MH, detailed in Box 89-2, include elevated  $PaCO_2$ , acidosis, hyperkalemia, hypercalcemia, hyperphosphatemia, elevated CK, elevated lactate dehydrogenase, myoglobinemia, and myoglobinuria. As muscle metabolism increases,  $CO_2$ , lactate, and potassium are released into the blood. In the physiologic exercising state the body responds by increasing cardiac output and minute ventilation, but in MH these compensatory mechanisms are soon overpowered, as reflected by continually rising levels of  $PaCO_2$  combined with metabolic acidosis. The acidosis is associated with  $K^+$  release into the blood. The permeability of muscle membrane increases, exacerbating the hyperkalemia and leading to further increases in serum levels of inorganic phosphate (Pi),  $Ca^{2+}$ , myoglobin, CK, and lactate dehydrogenase. The muscle edema can result in excessive release of myoglobin, next resulting in gross myoglobinuria, which can cause tubular renal failure. In humans, once the skeletal muscle membrane permeability is increased, myoglobin is lost before CK because myoglobin crosses the cell membrane more readily than CK. Thus drawing blood for baseline serum CK and myoglobin levels early in the episode will provide valuable information for monitoring clinical progress. Death early in an MH episode is usually caused by fatal arrhythmias (hyperkalemic cardiac arrest), or due to severe muscle spasms that render endotracheal intubation and ventilation impossible. When the MH episode is prolonged, death occurs from disseminated

#### BOX 89-4.

##### Differential Diagnosis of Malignant Hyperthermia

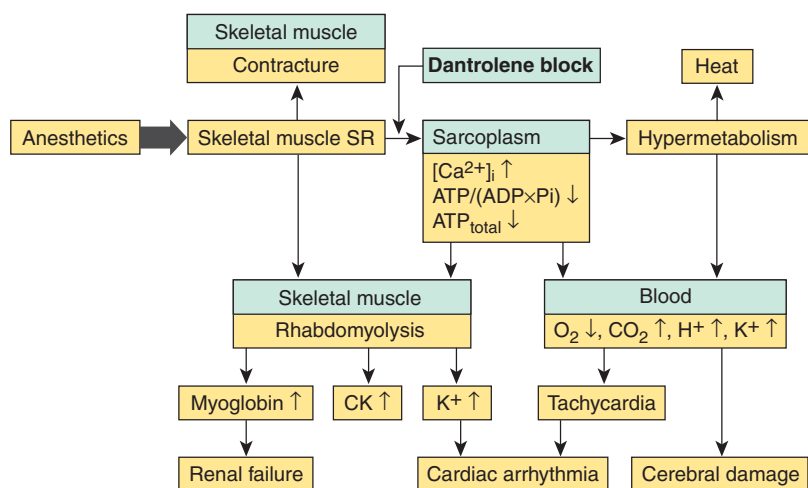
- I. Iatrogenic
  - A. Excessive warming measures
  - B. Surgical drapes and coverings
- II. Fever
  - A. Infection
  - B. Bacteremia
  - C. Sepsis
  - D. Transfusion reactions (acute hemolytic and nonhemolytic)
  - E. Central nervous system dysfunction
  - F. Allergic reactions
- III. Endocrine abnormalities
  - A. Pheochromocytoma
  - B. Thyrotoxicosis (thyroid storm)
- IV. Drug induced
  - A. Neuroleptic malignant syndrome
  - B. Cocaine overdose
  - C. Tricyclic antidepressants
  - D. Monoamine oxidase inhibitors (MAOIs)
  - E. Anticholinergics (atropine, glycopyrrolate)
  - F. Amphetamines (methylenedioxymethamphetamine [MDMA])
  - G. Alcohol withdrawal
  - H. Drug interactions (MAOI and meperidine)
- V. Rhabdomyolysis
  - A. Dystrophinopathies
  - B. Myotonias

intravascular coagulopathy, myoglobinuric renal failure, and neurologic damage (Fig. 89-1).<sup>1</sup>

##### Masseter Muscle Rigidity

Masseter muscle rigidity (MMR) is the condition in which the patient's mouth can barely be opened after succinylcholine administration for intubation.<sup>29</sup> MMR has also been called masseter spasm or trismus. MMR may be the first sign of MH, or it can develop during an MH episode. However, it may also occur as an exaggerated response to succinylcholine in normal individuals.

The masseter muscle is a complex muscle containing a high proportion (70%) of type 1, or slow oxidative fibers. The type 2 fibers in the masseter muscle are comprised of 2A, 2B, 2C, and ATPase intermediate (IM) fibers. These ATPase IM fibers, unlike other adult skeletal muscles, express neonatal myosin heavy chain (MHC) isozyme and embryonic chain myosin,



**FIGURE 89–1.** Current understanding of clinical and cell biologic processes in a malignant hyperthermia crisis. Volatile anesthetics like halothane sensitize skeletal muscle sarcoplasmic reticulum (SR) in MH-susceptible patients, leading to increased open probability of the RYR1 channel protein with simultaneously impaired ability to close the channel; channel closure is required to terminate SR  $\text{Ca}^{2+}$  release and allow muscle relaxation. Uncontrolled SR  $\text{Ca}^{2+}$  release produces calcium overload, that is, large increases in  $[\text{Ca}^{2+}]_i$ . The  $\text{Ca}^{2+}$  pumps at SR and the sarcolemma are activated to reuptake  $\text{Ca}^{2+}$  into the SR or to transport it into the extracellular space, respectively. The energetic costs to regain cellular calcium control is associated with large decreases in the phosphorylation potential ( $\text{ATP}/(\text{ADP}\times\text{Pi})$ ). Because  $\text{ATP}/(\text{ADP}\times\text{Pi})$  also determines the  $\text{Na}^+\text{-K}^+$  pump activity, cellular deenergization is associated with myocyte  $\text{K}^+$  release (contributing to hyperkalemia) and  $\text{Na}^+$  uptake. The muscle spasm greatly increases the extravascular resistance to perfusion resulting in myocyte ischemia, lactate formation, and ATP breakdown, which releases free  $\text{Mg}^{2+}$  and large amounts of protons ( $\text{H}^+$ ) resulting in acidosis. High  $[\text{Ca}^{2+}]_i$  stimulates numerous metabolic pathways, enzymes, and oxidative phosphorylation (see text), so long as muscle oxygen supply remains sufficient. This hypermetabolic state produces heat (hyperthermia), increased  $\text{O}_2$  uptake and  $\text{CO}_2$  production, along with hyperkalemia, and acidosis with hyperlactemia. Severe hyperkalemia is associated with cardiac arrhythmias and, if serum  $\text{K}^+$  levels rise significantly, there is a risk of hyperkalemic cardiac arrest. This causes severe hypotension leading to cerebral ischemia and damage, unless hypotension can be controlled resuscitatively. Prolonged muscle ischemia will cause myocyte death due to necrosis resulting in rhabdomyolysis, which exacerbates systemic hyperkalemia and leads to excessive myoglobin and creatine kinase (CK) serum levels. Myoglobinemia can result in renal tubular failure and, ultimately, multiorgan failure. The main drug of choice to date is IV dantrolene, because it can block the uncontrolled SR  $\text{Ca}^{2+}$  release and, if given early in an episode, it can enable the skeletal muscle cells to regain calcium control. Modified from: Melzer W, Dietze B. Malignant hyperthermia and excitation-contraction coupling. *Acta Physiol Scand* 2001;171:370, Fig.2.

which are characteristic of developing muscle.<sup>245</sup> In addition, the masseter has a high number of muscle spindles that are larger and more complex than spindles found in limb muscles.

The literature regarding the mechanism of MMR is inconclusive. The myofilaments of type 1 fibers are more sensitive to agents that release SR  $\text{Ca}^{2+}$  than type 2 fibers. Type 1 fibers from skinned preparations (i.e., fibers in which the sarcolemma has been removed) from the masseter muscle are 2–4 times more sensitive than the type 1 fibers from *vastus lateralis*. This finding was proposed as an explanation as to why some patients develop increased masseter muscle tone after receiving halothane and succinylcholine. However, other studies using intact human masseter muscle bundles did not confirm this result.<sup>247</sup>

A mild case of MMR is a subjective diagnosis, making its clinical significance controversial. Practical guidelines for evaluation and classification of MMR have been proposed by several groups. Most anesthesiologists use the following 3-level general classifications:

1. The most common response to succinylcholine is “jaw stiffness” that is subclinical and can only be detected using special measuring devices.<sup>30</sup> This is a normal response to succinylcholine and is considered to be of no prognostic significance with respect to MH.
2. A greater increase in masseter spasm is called “jaw tightness that interferes with intubation.”<sup>1</sup> This group may be quite large (1–2%) in children who are administered halothane and succinylcholine. A

small but unknown number of these patients are at risk for MH.

3. The most severe form of masseter muscle spasm has been characterized as “the mouth could not be opened” or “jaws of steel.” This group is documented to have an increased incidence of fulminant MH and increased mortality if the triggering agents are continued.<sup>31</sup>

### Characteristics of MMR

- Occurrence: anesthesia is induced with a potent inhalational agent and succinylcholine is administered for muscle relaxation.
- It can also occur with thiopental, propofol or other intravenous induction agents in combination with succinylcholine.
- Succinylcholine induces a dose-dependent increase in jaw tension.
- The increase in jaw tone usually lasts between 90 and 120 seconds.
- Tachycardia and dysrhythmias often accompany MMR.
- Only in rare cases does fulminant MH occur immediately after MMR.
- Increases in serum CK, serum myoglobin, and myoglobin concentration in the urine typically follow MMR.

Succinylcholine administration results in an immediate increase in serum myoglobin reaching a maximum at 20–40 minutes, whereas serum CK peaks in 6–12 hours after drug administration.

If serum CK increases to  $>10,000$  IU/L, the response is clearly abnormal and should be treated to prevent renal complications. Such patients should be referred for work up of occult myopathy, including myotonia.<sup>32</sup> If a preexisting myopathy is not identified, it is good practice to assume the patient is MH susceptible, to be confirmed by the CHCT, an MH diagnostic test. If the CHCT is positive, and molecular genetic examination of the RyR1 identifies a mutation believed to be causative, the first-degree relatives can be tested for this mutation and will not need to undergo a muscle biopsy and CHCT for diagnosis of MH susceptibility.

### Awake Triggering: Exercise and Heat Illness

In the porcine model of MH, a single homozygous mutation in the RyR1, the Arg615Cys mutation, is causative for the disorder. Pigs homozygous for the disorder reproducibly develop fulmi-

nant MH episodes with each administration of potent inhalation anesthetics. They are also known to develop MH in response to heat, stress, and exercise. Interestingly, pigs that are heterozygous for the disorder have milder reactions to the same drugs and stresses.

In humans, the relationship between MH and exertional heat illness emanates from clinical reports that the acute MH syndrome may occur more readily after the stress of physical exercise. Gronert and colleagues reported the first patient diagnosed as MH susceptible who had a 10–15-year history of febrile episodes that were related to exercise, fatigue, and emotional stress.<sup>33</sup> The patient had a positive CHCT and the episodes were prevented by oral dantrolene. There are a number of reports that relate heat stroke, sudden and unexpected death, unusual stress and fatigue, and myalgia to MH episodes, called *awake episodes* because they occur without anesthesia.<sup>34–36</sup> There is also a subset of patients who survive fulminant MH episodes, but who continue to have muscle pain, often severe and debilitating, with exercise.<sup>37</sup>

Strong evidence for a relationship between heat stroke and MH comes from a case report by Tobin et al.<sup>38</sup> This case concerned a 12-year-old boy who died following exercise. This boy had a previous clinical MH episode and was found to harbor one of the RyR1 mutations established as causative for MH. In addition, Wappler et al. studied 12 young men with exercise-induced rhabdomyolysis.<sup>39</sup> Ten were diagnosed as MH susceptible based on IVCT results and 3 were identified with RyR1 mutations strongly associated with MH susceptibility. The availability of genetic testing will likely help to clarify the relationship between heat illness and MH susceptibility. From a clinical perspective, patients who have a personal or family history of MH have a greater likelihood of developing heat-related illness or rhabdomyolysis; they are advised to avoid exercise in extremes of heat. However, it is unlikely that all cases of rhabdomyolysis or heat-related illness are MH susceptible.<sup>40</sup>

### Associated Myopathies

We first discuss myopathies that have genetic mutations in RyR1 (central core disease [CCD], multimimicore diseases [MmDs], and nemaline rod myopathy), followed by King Denborough

myopathy in which RyR1 mutations have not been identified, but patients are considered MH susceptible based on clinical presentation and contracture testing results. Separate from this group are the myopathies and myotonias that can exhibit an “MH-type crisis” in response to inhalational anesthetics and/or succinylcholine, but they are genetically distinct from RyR1 defects of MH.

**Central Core Disease** CCD is a rare, non-progressive congenital myopathy that is histopathologically characterized by central core lesions that extend the length of the type 1 muscle fibers (Figure 89-2). The cores lack subcellular organelles such as mitochondria and, therefore, oxidative enzyme capability.<sup>41</sup>

Clinical presentation of CCD is variable, ranging from asymptomatic cases to those with marked skeletal muscle hypotonia and delayed motor development. CCD is mostly inherited in an autosomal dominant manner, although families with autosomal recessive inheritance and sporadic cases have been reported. Secondary musculoskeletal abnormalities seen in severe CCD cases include congenital hip dislocation, pes cavus, foot deformities, kyphoscoliosis, and joint contractures.<sup>42</sup>

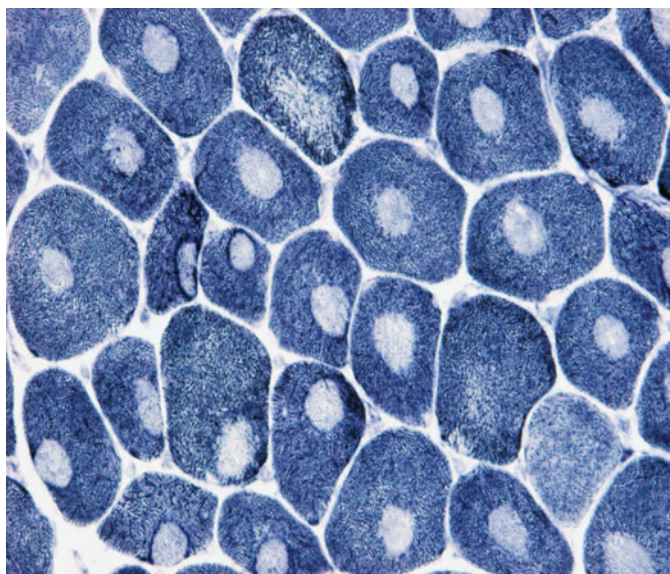
Both MH and CCD were linked and subsequently associated with mutations in the RyR1 on chromosome 19q13.1. Analysis suggests that certain mutations in the RyR1 produce both

MH and CCD, whereas others result in an MH phenotype only, or in rare cases a CCD phenotype only.<sup>43–46</sup> The majority of RyR1 mutations associated with CCD occur in the C-terminal region of the gene, and many are “private” mutations, meaning that they are unique to individual families. Some mutations that give rise to CCD have also been identified in regions 1 and 2 of the RyR1 gene.

For clinical management, CCD patients are normally treated as MH susceptible, and virtually all CCD patients who have undergone contracture testing for MH have been diagnosed as MH susceptible and have a mutation in the RyR1.<sup>41</sup> The cellular mechanisms by which CCD mutations in RyR1 reduce  $Ca^{2+}$  release during excitation–contraction coupling are: enhancement of  $Ca^{2+}$  leak and store depletion (leaky channels) and “diminished coupling between the excitation and contraction process,” or “excitation–contraction uncoupling.”<sup>47,48</sup>

**Multimimicore Diseases** MmD is a congenital, progressive myopathy associated with multifocal “minicores” of muscle fibers. It is clinically heterogeneous and at least 4 distinct phenotypes have been associated with mutations in either the selenoprotein N (SEPN1) or the RyR1 genes.

Classical multimimicore disease has been described as an early onset autosomal recessive myopathy in which muscle axial weakness may lead to



**FIGURE 89-2.** NADH-TR stain reveals the “central core” in almost all fibers. Note the “rimming” of some cores. Wu S, Ibarra MC, Malicdan MC, et al. Central core disease is due to RYR1 mutations in more than 90% of patients. *Brain* 2006;129:1476, Fig. 4B. By permission of Oxford University Press.



severe life-threatening respiratory insufficiency and scoliosis in two-thirds of patients. MmD can also be distinguished from CCD by histological examination of muscle specimens. In MmD, mini-cores occur in type 1 and type 2 muscle fibers and do not extend the full length of the fibers. Three other subgroups include a moderate form characterized by generalized muscle weakness that predominantly affects the pelvis and hands; and two classical forms, one including additional feature of ophthalmoplegia, and the other with antenatal onset in addition to arthrogyposis.<sup>42,49</sup>

**Nemaline Rod Myopathy** Nemaline rod myopathy is a very rare congenital myopathy with autosomal dominant or recessive modes of inheritance. Onset is typically from birth to infancy, and in severe cases, patients suffer from danger of nocturnal hypoxia or hypercarbia, but otherwise have no respiratory symptoms. Severe, intermediate, mild adult and Amish subtypes have been reported. Histologic features include sarcoplasmic rods (nemaline) in type 1 muscle fibers that can vary from <1% to virtually all fibers. Five genes are associated with the disease, namely,  $\alpha$ -tropomyosin 3,  $\alpha$ -actinin, nebulin, troponin T, and  $\beta$ -tropomyosin. Scacheri et al. reported the presence of an RyR1 mutation in a family affected with nemaline rod myopathy, and we advise that these patients be treated as MH susceptible.<sup>42,50</sup>

**King-Denborough Syndrome** King-Denborough syndrome is a rare, congenital, progressive myopathy that is characterized by short stature, pectus deformities, low-set ears, mental retardation, and cryptorchism; thus, it resembles the more frequently occurring Noonan syndrome. Most patients are the only individuals in their families with clinical or biochemical evidence of myopathy. Typically, MH crisis and anesthesia-related deaths have been reported. All King-Denborough patients who have been subjected to contracture testing were MH susceptible, but molecular genetic data is lacking.<sup>51</sup>

**Duchenne and Becker Muscular Dystrophies** Duchenne muscular dystrophy (DMD) is a chromosome X-linked myopathy characterized by

progressive muscle wasting, with early onset and rapid progression. DMD results from the absence or abnormality of a single protein, dystrophin, which is located in the muscle membrane and is also expressed in cardiac and brain tissue. Dystrophin links the muscle cytoskeleton to the extracellular matrix via dystrophin-related proteins (sarcoglycans, dystroglycans, and syntrophins). Patients with DMD can respond to general anesthesia with cardiac arrest or sudden acute rhabdomyolysis. Many reported cardiac arrest cases have occurred after administration of succinylcholine and have been attributed to acute hyperkalemia ( $> 10\text{mEq/L}$ ). Identification of this problem during anesthesia with DMD, and other occult myopathies, led to new guidelines by the FDA (via package insert) for use of succinylcholine in young boys.<sup>52</sup> Even without succinylcholine, cardiac arrest following induction with halothane or isoflurane has been reported in children with DMD or other myopathies. One possible explanation for this, as Klinger et al. reported, is that “muscles lacking dystrophin are more susceptible to stretch-induced muscle damage and take up  $\text{Ca}^{2+}$  and  $\text{Na}^+$ . Inhalation anesthetics are not recommended because they further increase myoplasmic  $\text{Ca}^{2+}$  by facilitation of release from intracellular stores.”<sup>53</sup> The FDA has published additional guidelines for use of volatile anesthetics in children with myopathic conditions. If there is no hyperkalemia, the cause of death is more likely to be the DMD-associated cardiomyopathy. The same guidelines concerning the use of volatile anesthetics and succinylcholine should be used in patients with Becker dystrophy. Becker dystrophy is an allelic disorder of DMD, and although it has a later onset and less-severe progression, the same perioperative complications as in DMD can occur.<sup>54</sup>

**Neuromuscular Disorders: The Myotonias** This group of neuromuscular disorders is characterized by delayed muscle relaxation and characteristic abnormalities on electromyography (EMG). Although the exact pathophysiology differs between various myotonic syndromes, common to most of them are defects in sodium and chloride membrane channels. Myotonic dystrophy is a multisystem disease with a genetic locus defect localized to

chromosome 19. Myotonia congenita, paramyotonia and hyperkalemic periodic paralysis result from defects on chromosome 17. Some of these disorders are allelic of a genetic locus encoding a sodium channel.<sup>32,54</sup>

We recommend that patients with any form of myotonia should **not** receive succinylcholine. The same recommendations should be applied to patients with hypokalemic period paralysis, paramyotonia, or myotonia fluctuans.<sup>53</sup> Some groups also advocate avoidance of volatile “triggering” anesthetics, but there is insufficient data to support this recommendation.

### Animal Models

Animal models that have been used in the study of MH are cats, dogs, horses, pigs, and more recently, genetically engineered mice. The porcine model of MH has been an invaluable tool for linking RyR1 to MH susceptibility. Data from this model showed unambiguously that a single homozygous mutation in the RYR1 gene was responsible for porcine stress syndrome, as well as for anesthetic-induced MH episodes. Also from the studies in the pig came the insight that MH is a derangement of  $\text{Ca}^{2+}$  handling by the calcium release channel in the SR and that neither the  $\text{Ca}^{2+}$  pump (SERCA1) or the mitochondria were the source of the primary defect.

Compared to the human MH syndrome, the porcine model has a number of limitations. The Arg615Cys mutation, which accounts for  $>99\%$  of porcine cases, accounts for only 2–5% of MH susceptibility seen in humans. The inheritance pattern also differs: the porcine model is homozygous for the trait but in man, the disorder is heterozygous with a variable expression and, as a consequence, occurrence is unpredictable. Also, the MH-susceptible swine can develop an MH episode with exposure to heat, stress and exercise. In addition although it is technically possible to create a herd of “knock-in” swine expressing more than one mutation, such studies would be prohibitively expensive. Although the dog model would be heterozygous, maintaining genetically altered canine colonies and performing *in vivo* experimentation in dogs would also be extremely expensive and slow.

“Knock-out” mice homozygous for mutations in the RyR1 do not live because of insufficient muscle func-



tion for respiration. Attempts to produce a heterozygous, RyR1 mutant, transgenic mouse have succeeded. Heterozygous mice, which correspond to the human mutation Tyr522Ser, have been made.<sup>14</sup> These mice experience whole-body contractures and elevated core body temperature in response to the administration of isoflurane or heat stress. They also exhibit increased sensitivity to caffeine, which is an important tool in the clinical CHCT. Yang et al.<sup>250</sup> reported the use of “knock-in” targeting vector to create mice carrying the RyR1 mutation Arg163Cys. Extensive validation of this model was provided, including development of a fulminant MH episode after exposure to halothane, as well as after exposure to an ambient temperature of 42°C. The availability of these new animal models are expected to permit detailed analysis of how mutations causative for MH relate to altered muscle function both *in vivo* and *in vitro*.

### Subcellular Sites of Defect in Skeletal Muscle

Because one of the striking features of fulminant MH episodes is that patients exhibit skeletal muscle rigidity and contracture, which are most likely to occur when myoplasmic  $[Ca^{2+}]_i$  is significantly elevated, the study of the underlying basis of MH has focused on disturbance in intercellular  $[Ca^{2+}]_i$  handling. Initially, it was thought that  $Ca^{2+}$  reuptake by SR  $Ca^{2+}$  ATPases (SERCAs) was the key defect. However, that mechanism was ruled out as a participant of MH reactions.<sup>55</sup> Early studies showed no difference in  $Ca^{2+}$  uptake rates between SR from MH-susceptible and normal pig skeletal muscle, and potent volatile anesthetics increased the calcium uptake rates in both. Comparisons of MH reactions from human or porcine SR suggested that  $Ca^{2+}$  release might be abnormal in MH-susceptible individuals.<sup>56</sup>

Similarly, mitochondrial defects had been raised and subsequently largely discarded as the primary mechanism for MH; nevertheless, it is not entirely ruled out that secondary mitochondrial defects develop as a result of the massive calcium overload during a fulminant MH crisis and this may contribute directly or indirectly to the clinical syndrome.

It is now generally accepted that the skeletal muscle cell loses control of

$Ca^{2+}$  release during a fulminant MH episode and that the DHPR and the RYR1 receptors are involved. These two receptors are key elements in excitation–contraction coupling in skeletal muscle. A brief review of excitation–contraction coupling as it relates to MH is presented; for a more in depth review, see Dulhunty et al.<sup>57</sup>

Excitation–contraction coupling is the sequence of events that links membrane depolarization, to the release of intracellular  $Ca^{2+}$  from the SR to muscle contraction. Excitation–contraction coupling in skeletal muscle involves bidirectional mechanical interaction between two different types of  $Ca^{2+}$  channels, the DHPR or voltage-gated L-type  $Ca^{2+}$  channels (L channels) located in the transverse tubular membrane, and the  $Ca^{2+}$  release channel (RYR1), located in the SR membrane. Coupling between DHPR and the RYR1 occurs across triad junctions formed between terminal cisternae in the SR and the transverse tubular membrane. The interaction between the DHPR and RYR underlies all voluntary movement including respiration, and is therefore essential for life.<sup>57</sup> Major defects in either DHPR or RYR1 proteins result in poor development in utero and death at or before birth. Mutations in these proteins can lead to MH susceptibility, CCD, multiminicore disease, nemaline rod myopathy, and occasionally exertional rhabdomyolysis. Figure 89–3 is a representation of the membrane systems involved in excitation–contraction coupling.

### Properties of DHPR and RyR1

DHPR is major component of the transverse tubular membrane. It contains  $\alpha_1$ ,  $\alpha_2/\delta$ ,  $\beta$ , and  $\gamma$  subunits, forming an L-type channel protein that is the receptor for certain  $Ca^{2+}$  channel blockers such as dihydropyridines. The  $\alpha_1$  subunit forms the  $Ca^{2+}$  ion channel, the voltage sensor for channel gating and the DHPR binding site. It is comprised of 4 repeat domains connected by large cytoplasmic loops. The functions of the other subunits are less-well defined, although it is known that the  $\beta$  subunit is required for targeting the DHPR to the tubular membrane.

Although the  $\alpha_1$  subunit mediates slow (L)-type  $Ca^{2+}$  inward currents, it has been known since the 1970s that  $Ca^{2+}$  entry through the  $Ca^{2+}$  channel is a late event in excitation–contraction

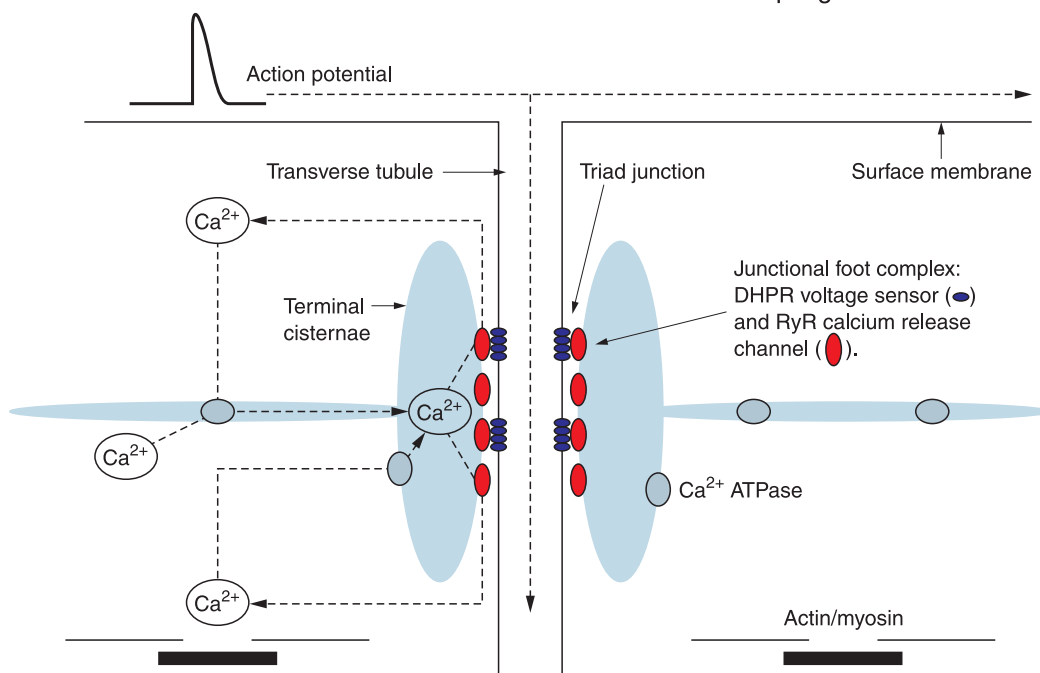
coupling. This is in marked contrast to heart muscle, which has led to the conclusion that the voltage sensor of the  $\alpha_1$  subunit, not the  $Ca^{2+}$  channel function, is the key component in excitation–contraction coupling of skeletal muscle. Although the precise mechanism for excitation–contraction coupling remains unknown, current concepts suggest that membrane depolarization causes a conformational change in the DHPR that opens the SR  $Ca^{2+}$  release channel. This precedes the slower opening of the L-type  $Ca^{2+}$  channel.<sup>58</sup>

Electron microscope studies reveal that the RYR1 and  $\alpha_1$  subunit of DHPR have a highly specific spatial association in skeletal muscle. Clusters of 4 evenly spaced particles (tetrads) representing DHPRs are positioned in the sarcolemma such that each particle is located immediately above 1 of the four RyR1 subunits.<sup>59</sup> However, DHPR tetrads are associated with only every second subunit of RyR1, suggesting that not all release channels are directly coupled to DHPRs. Release channels that are not opposed by tetrads are most likely activated by  $Ca^{2+}$  release channels via  $Ca^{2+}$ -induced  $Ca^{2+}$  release (CICR) (Fig. 89–4).<sup>1</sup> Available evidence suggests that there is a direct physical coupling between the II and III loops of the  $\alpha_1$  subunit of the DHPR and multiple cytoplasmic regions of the RYR1.<sup>59</sup>

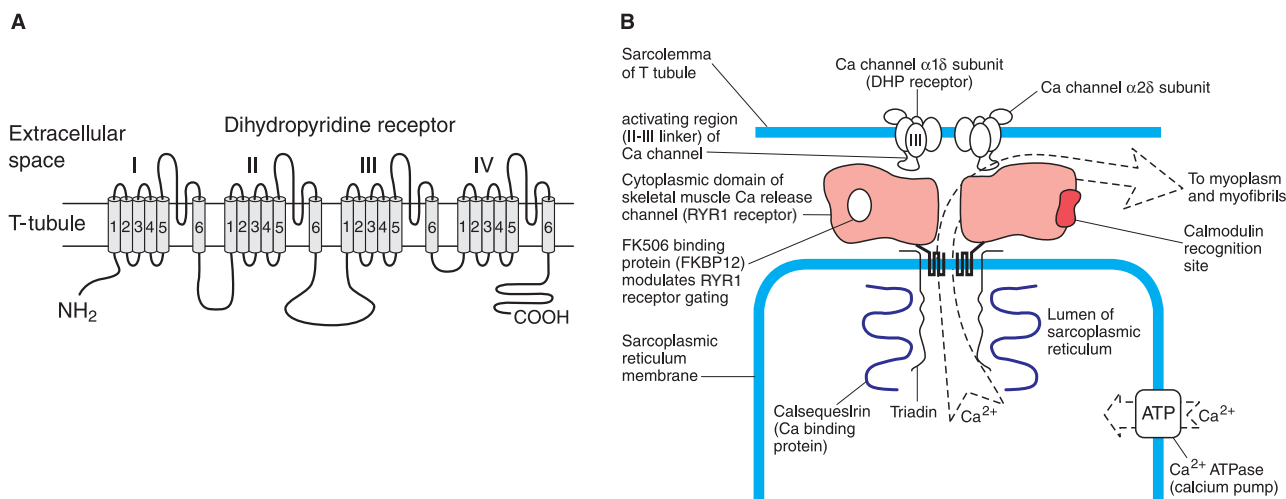
RYR1 belongs to intracellular  $Ca^{2+}$  channel superfamily that includes two other RyR isoforms. All three isoforms have tissue-specific expression and share a high degree of homology (70%). The name ryanodine receptor came from its affinity to bind to the plant alkaloid of the same name. RYR1 is expressed predominantly in skeletal muscle, and has also been identified in human B lymphocytes and in immature dendritic immune cells. RYR2 is expressed predominantly in cardiac tissue and RYR3 is expressed in skeletal muscle at relatively low levels and in smooth muscle (Table 89–1).

RYR1 is composed of four identical 560-kDa proteins that assemble into a homotetramer to form functional  $Ca^{2+}$  release channels. Each subunit (monomer) of RyR1 is predicted to consist of a cytoplasmic N-terminal region constituting approximately 80% of the protein. The C-terminal which comprises  $1/5$  of the entire gene, contains a number of important structural features, including transmembrane complex, the  $Ca^{2+}$  per-

Skeletal muscle excitation-contraction coupling



**FIGURE 89-3.** Membrane systems and membrane proteins involved in excitation–contraction coupling. The action potential propagates along the surface and transverse tubule membranes. The signal resulting from depolarization is transmitted across the triad junction that is formed between the transverse tubule membrane and the terminal cisternae membrane of the sarcoplasmic reticulum  $\text{Ca}^{2+}$  store. A triad is the usual junction between the transverse tubule membrane and sarcoplasmic reticulum in skeletal muscle, and is named because it consists of a central transverse tubule membrane with a terminal cisternae of the sarcoplasmic reticulum on either side. The voltage sensor for excitation–contraction coupling is the dihydropyridine receptor (DHPR) in the transverse tubule membrane. The  $\text{Ca}^{2+}$  release channel in the sarcoplasmic reticulum is the ryanodine receptor (RyR). A tetrad of DHPRs oppose every second RyR. The contraction is terminated when  $\text{Ca}^{2+}$  is actively pumped back into the sarcoplasmic reticulum by the adenosine triphosphate (ATP)-dependent  $\text{Ca}^{2+}$  pump ( $\text{Ca}^{2+}$ -ATPase). Dulhunty AF, Haarmann CS, et al. Interactions between dihydropyridine receptors and ryanodine receptors in striated muscle. *Prog Biophys Mol Biol* 2002;79:47, Fig. 1.



**FIGURE 89-4.** **A.** Voltage-gated  $\text{Ca}^{2+}$  channel dihydropyridine receptor (DHPR). The alpha 1 subunit of the DHPR consists of four repeat domains (I-IV), each with six transmembrane segments (1-6). Segment 5-6 loops form the ion channel pore, and the segment 4 segment contains positively charged residues which confer voltage dependence to the protein. The II and III intracellular loop of the DHPR interacts with the ryanodine receptor to mediate excitation contraction coupling, as shown in **B.** Figure and legend adapted from Loke J, MacLennan DH. Malignant hyperthermia and central core disease: disorders of  $\text{Ca}^{2+}$  release channels. *Am J Med* 1998;104:472, Fig. 2, and Jurkat-Rott K, McCarthy T, Lehmann-Horn F. Genetics and pathogenesis of malignant hyperthermia. *Muscle Nerve* 2000;23:10, Fig. 2. **B.** Schematic representation of the triad junction of skeletal muscle shows the junctional foot protein (ryanodine receptor [RyR1]) and its associated proteins. In skeletal muscle, the alpha1s-subunit of the dihydropyridine receptor (DHPR) participates in excitation-contraction coupling. These physical links transmit essential signals across the narrow gap of the triadic junction that activate RyR1 and release  $\text{Ca}^{2+}$  from the sarcoplasmic reticulum. RyR and its interaction with DHPR are illustrated essentially as Pessah, Lynch, Gronert. Complex pharmacology of malignant hyperthermia. *Anesthesiology* 1996;84:1276, Fig.1.

TABLE 89–1.

## Properties of RYR

<b>Structural</b>	<b>Nonprotein regulators</b>
500 amino-acids long	Adenosine triphosphate, Ca <sup>2+</sup> , Mg <sup>2+</sup> , Ph
Molecular weight ~560 kD	
Homotetramer	<b>Protein regulators</b>
Associates with structural proteins in muscle, calsequestrin, triadin junction	Calmodulin
	FKBP12 (FK506 binding protein)
<b>Functional</b>	<b>Pharmacologic regulators</b>
100 pS single channel conductance to Ca <sup>2+</sup> in lipid bilayers (50 mM luminal Ca)	“Activators”: caffeine, 4-CmC, ryanodine at (μM)
	“Blockers”: ruthenium red, dantrolene, ryanodine at (μM)

meability pore, and interaction sites for Ca<sup>2+</sup>, caffeine, 4-chloro-*m*-cresol, ATP, and ryanodine (Table 89–2).<sup>60,61</sup>

**Regulators of RYR1 Function** In addition to activation by the DHPR, RyRs can be triggered to release Ca<sup>2+</sup> in a number of ways, including an increase in intracellular Ca<sup>2+</sup> itself, Ca<sup>2+</sup>-induced Ca<sup>2+</sup> release. Ca<sup>2+</sup>-induced Ca<sup>2+</sup> release is the predominant mechanism of excitation–contraction coupling in cardiac muscle, but not in skeletal muscle. All three RYRs are stably bound to the immunophilin FKBP12 (FKBP506 binding protein) which stabilizes channel function and helps to coordinate gating. In addition to FKBP12, an array of accessory and regulatory proteins such as calmodulin, triadin, junctin, and calsequestrin help to regulate channel activity.

The principal endogenous modulator of RYR1 is Ca<sup>2+</sup>, which at micromolar levels can activate the RYR1. However, numerous studies indicate that Ca<sup>2+</sup> has a biphasic effect, as millimolar concentrations of [Ca<sup>2+</sup>]<sub>i</sub> can inhibit channel activity. Other endogenous RYR1 modulators include Mg<sup>2+</sup> (an inhibitor) and ATP (activators), as well as cellular oxidation–reduction state, which have complex effects on channel activity probably via oxidation–reduction changes in accessible sulfhydryl groups.<sup>61</sup>

In addition, exogenous modulators can alter RYR1 activity, and one of the most extensively used is ryanodine. Ryanodine modulates RYR1 in a biphasic manner (nanomolar concentrations activate, whereas concentrations > 100 μM inhibit channel activity), caffeine (mM) is an activator, and ruthenium red (μM) is an inhibitor, all of which are specific pharmacologic tools used to identify intracellular signaling pathways involving RYR1. Caffeine has complex effects on RYR1. Its primary effect is to increase release of Ca<sup>2+</sup> from the SR, but some of caffeine's effects appear to be Ca<sup>2+</sup> dependent, thus caffeine-induced Ca<sup>2+</sup> release can further influence the effect of caffeine itself. One of the most important inhibitors of the RYR1 channel activity is dantrolene, which suppresses intracellular Ca<sup>2+</sup> release from the SR and is used for prevention and treatment of MH. A binding site for dantrolene has been identified within the N-terminal part of the RYR1,<sup>24</sup> but still requires independent confirmation. Azumolene, a more potent and soluble derivative of dantrolene, is not used clinically but in experimental research studies. Halothane and other volatile anesthetics are activators of the RYR1 channel, but their exact site and mechanism of action is unclear.

**Effect of Mutations on Functional RYR1 Activity** Mickelson first demonstrated that skeletal muscle samples from MH-susceptible pigs exhibit higher specific ryanodine binding as well as increased sensitivity to activation by micromolar Ca<sup>2+</sup>.<sup>9</sup> Because specific ryanodine binding is proportional to the open probability of the Ca<sup>2+</sup> release channels, these results suggest that SR Ca<sup>2+</sup> release is linked to MH and exhibits a higher open probability. In isolated SR vesicles from pig MH-susceptible muscle, the initial rate of Ca<sup>2+</sup> release examined over a range of Ca<sup>2+</sup> concentrations from submicromolar to millimolar levels, showed a 2–3-fold in-

TABLE 89–2.

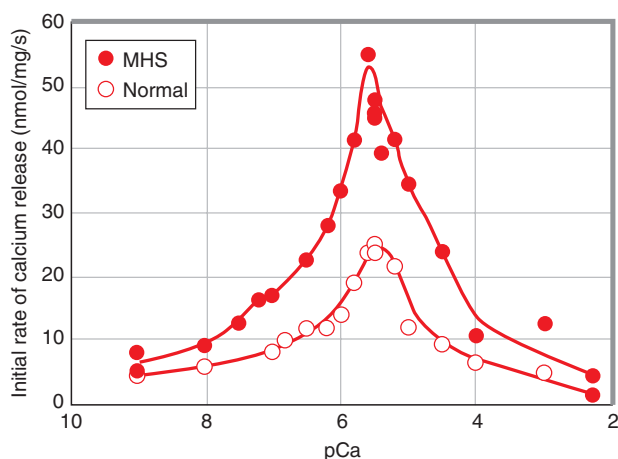
Three Isoforms of the RYR (similar to the IP<sub>3</sub>R)<sup>a</sup>

<b>RyR1</b>
Activated by relatively high Ca <sup>2+</sup>
Readily inactivated by Ca <sup>2+</sup>
Designed for fast release of larger quantities of Ca <sup>2+</sup>
<b>RyR2</b>
More readily activated; less likely to close
More easily activated by caffeine
<b>RyR3</b>
Broader sensitivity to Ca <sup>2+</sup>
Doesn't necessarily inactivate at high Ca <sup>2+</sup>
May be more capable of sustained activity

<sup>a</sup>Each isoform is on a different gene.

crease in the initial rate of Ca<sup>2+</sup> release compared to SR vesicles prepared from normal animals (Fig. 89–5).<sup>62</sup> However, Fill et al. reported that the closing of single porcine MH channels at high [Ca<sup>2+</sup>]<sub>i</sub> was inhibited. These investigators reported that inactivation of the open release channel was less sensitive to micromolar Ca<sup>2+</sup> even though there was no difference in activation of the SR Ca<sup>2+</sup> release channels (Fig. 89–6).<sup>63</sup> In comparable studies with humans, muscle samples with an increased caffeine sensitivity of the calcium release channel were found.<sup>64</sup> Taken together these results suggest that Ca<sup>2+</sup> release channels are more likely to open and be unable to close promptly (delayed) with physiologic stimuli (high [Ca<sup>2+</sup>]<sub>i</sub>, low pH, and/or high Mg<sup>2+</sup>), with the net effect of a sustained and large increases in myoplasmic calcium levels (Fig. 89–7).<sup>9,65</sup>

The significance of these functional defects in SR calcium channel became apparent when linkage between MH and the gene coding for the Ca<sup>2+</sup> release channel in skeletal muscle was independently established by two different groups in 1990.<sup>12,13</sup> Following these discoveries, an important role for ryanodine receptors as causal agent for MH was accepted. Functional studies by a number of investigators confirmed that the Arg614Cys was both necessary and sufficient to alter the biochemical and physiologic properties of the RYR1 from the MH susceptible animal model.<sup>9</sup>



**FIGURE 89-5.**  $\text{Ca}^{2+}$  dependence of rate of  $\text{Ca}^{2+}$ -induced  $\text{Ca}^{2+}$  release from MH-susceptible and normal pig SR vesicles. SR vesicles were passively loaded with  $\text{Ca}^{2+}$ , and  $\text{Ca}^{2+}$  release was initiated by rapid filtration with a solution containing ionized  $\text{Ca}^{2+}$ . Under these conditions, the rate constant for  $\text{Ca}^{2+}$  release from MH-susceptible SR was significantly greater than that from normal SR. Carrier L, Villa M, Dupont Y. Abnormal rapid  $\text{Ca}^{2+}$  release from sarcoplasmic reticulum of malignant hyperthermia susceptible pigs. *Biochim Biophys Acta* 1991;1064:179, Fig.4 as reviewed in Mickelson JR, Louis CF. Malignant hyperthermia: excitation-contraction coupling,  $\text{Ca}^{2+}$  release channel, and cell  $\text{Ca}^{2+}$  regulation defects. *Physiol Rev* 1996;76:548, Fig.6.

## Molecular Genetics

### Inheritance

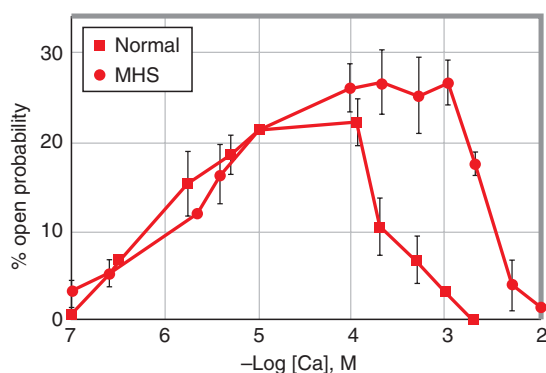
Absence of apparent clinical symptoms in MH-susceptible individuals and variability in clinical presentations of MH caused by triggering agents are a challenge in assessing the inheritance of this condition in humans. Nevertheless, it is generally accepted that MH in humans is inherited as an autosomal dominant trait with reduced penetrance.<sup>44,45</sup>

### MH Candidate Genes

Identification of the homozygous RyR1 mutation causing MH in pigs was a breakthrough in understanding

genetics of MH. This discovery directed genetic studies in humans and the first MH susceptibility locus was linked to the RyR1 on chromosome 19q12-13 in the early 1990s.<sup>12,13</sup> Soon after linking the porcine MH syndrome to the Arg615Cys mutation, the first human mutation in the RyR1 (Arg614Cys) was linked to the MH-susceptible phenotype.

The RyR1 was proposed as a candidate gene for MH and numerous RyR1 mutations were found in many affected families. Furthermore, genetic linkage studies revealed that MH susceptibility is characterized by genetic heterogeneity with five other loci (17q21-24, 1q32, 3q13, 7q21-24, and 5p) designated MHS



**FIGURE 89-6.**  $\text{Ca}^{2+}$  dependence of MHS and normal pig native  $\text{Ca}^{2+}$  release channel activities. Channels were derived from fusion of SR vesicles with a lipid bilayer. Channel open probability ( $P_o$ ) (normalized to channel maximum) is plotted as a function of ionized *cis*- $\text{Ca}^{2+}$  at pH 7.2. Recording conditions were 250 mM CsCl *cis*/50 mM CsCl *trans*, with a holding potential of +20 mV. MHS and normal  $P_o$  values were significantly different at  $\text{Ca}^{2+}$  greater than pCa 4 (100  $\mu\text{M}$ ). From Fill M. et al., Abnormal ryanodine receptor channels in malignant hyperthermia. *Biophys J* 1990;50:474, Fig. 3 as reviewed in Mickelson JR, Louis CF. Malignant hyperthermia: excitation-contraction coupling,  $\text{Ca}^{2+}$  release channel, and cell  $\text{Ca}^{2+}$  regulation defects. *Physiol Rev* 1996;76:550, Fig. 10.

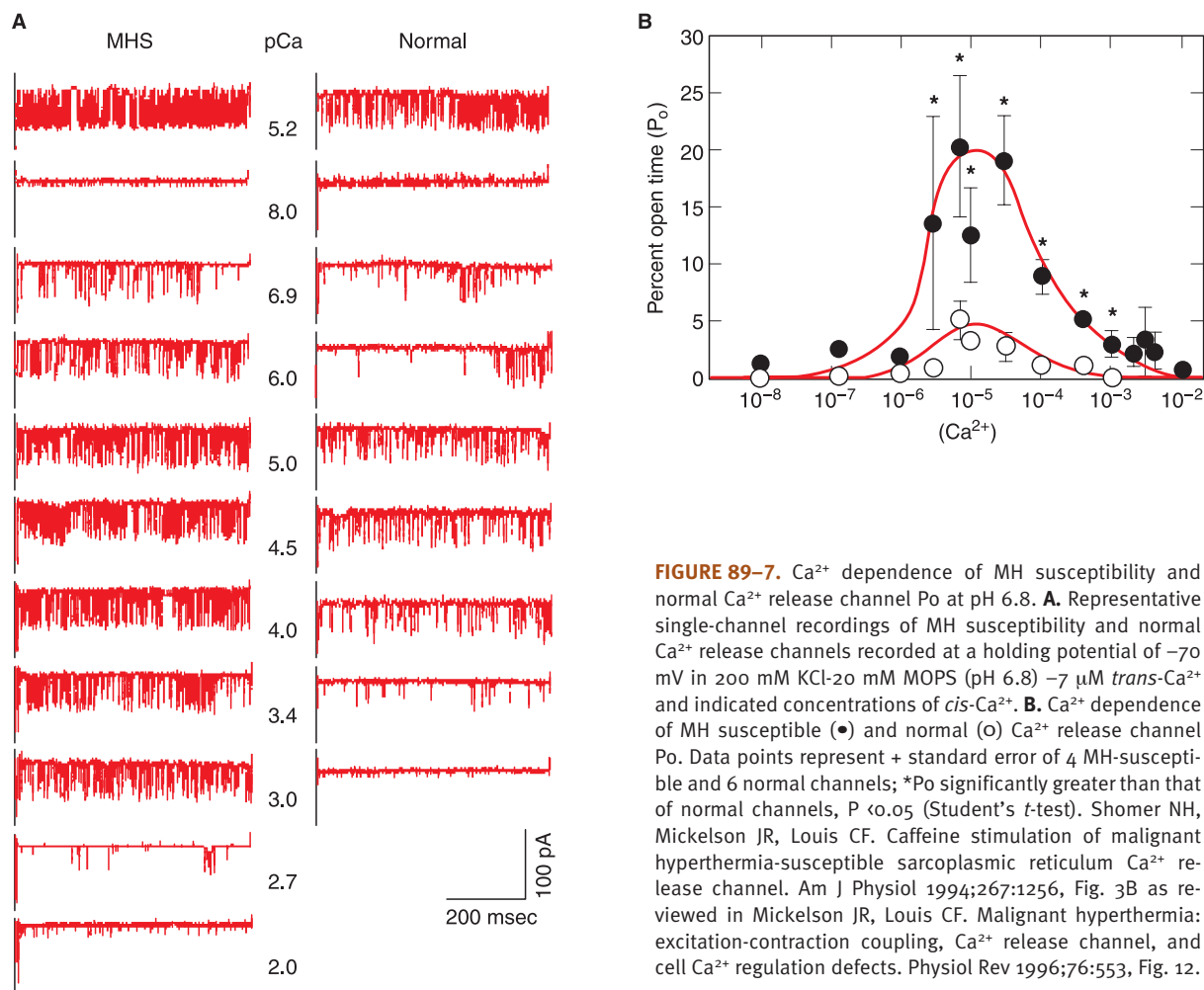
1-6, respectively (Table 89-3). The only gene other than RyR1 that has been identified is the gene coding for the  $\alpha_1$  subunit of the DHPR, CACNL1A3.<sup>248</sup> Two causative mutations have been identified in the CACNL1A3, but screening studies indicate that these mutations are linked to <1% of MH-susceptible families worldwide.<sup>54,248</sup>

Mutations in the RyR1 are thought to account for approximately 70% of MH susceptible subjects, but are found in almost 100% of families with CCD.<sup>41,42</sup> The RyR1 gene is a complex gene containing 106 exons and encoding a messenger ribonucleic acid molecule of 15 kb that is transcribed mostly in skeletal muscle.<sup>12</sup> More than 100 different mutations have been identified in the RyR1.<sup>41,42</sup> The majority of them are missense mutations in three regions: the N-terminal region between codons 34 and 614; the central region between codons 2163 and 2458; and the C-terminal region between codons 4136 and 4973 (Fig. 89-8).<sup>3,42,43,54,66</sup> This preferential localization raised speculations concerning the specific role of these regions. The central region is proximal to the region where the protein would interact with the regulatory protein, FKBP12 and the  $\alpha_1$  subunit of the DHPR, the voltage sensor of RyR1, and the C-terminal region that corresponds to the transmembrane domain of the protein.<sup>3</sup>

### Functional Consequences of the RyR1 Mutations

Functional studies by a number of investigators confirmed that RyR1 mutations associated with MH susceptibility were both necessary and sufficient to alter the biochemical and physiologic properties of the protein. The pathogenic character of many RyR1 mutations have been studied experimentally by kinetic measures of intracellular calcium release in response to caffeine, 4-chloro-*m*-cresol, or halothane in different cell lines.<sup>46,68-70</sup> Other methodologies used included analysis of the biophysical properties of channels incorporated into lipid bilayers, ryanodine-binding experiments, and patch-clamp experiments. Expression analysis of a series of RyR1 mutations in HEK-293 kidney cells demonstrated that in  $\text{Ca}^{2+}$  free media, those cells expressing a mutated protein were more sensitive to caffeine than the wild type.<sup>68</sup> A similar conclusion was reached by Yang et al., who expressed 6 human mutations in dyspeptic mouse myotubes (myotubes lacking





**FIGURE 89-7.** Ca<sup>2+</sup> dependence of MH susceptibility and normal Ca<sup>2+</sup> release channel Po at pH 6.8. **A.** Representative single-channel recordings of MH susceptibility and normal Ca<sup>2+</sup> release channels recorded at a holding potential of -70 mV in 200 mM KCl-20 mM MOPS (pH 6.8) -7  $\mu$ M *trans*-Ca<sup>2+</sup> and indicated concentrations of *cis*-Ca<sup>2+</sup>. **B.** Ca<sup>2+</sup> dependence of MH susceptible (●) and normal (○) Ca<sup>2+</sup> release channel Po. Data points represent + standard error of 4 MH-susceptible and 6 normal channels; \*Po significantly greater than that of normal channels, P < 0.05 (Student's *t*-test). Shomer NH, Mickelson JR, Louis CF. Caffeine stimulation of malignant hyperthermia-susceptible sarcoplasmic reticulum Ca<sup>2+</sup> release channel. *Am J Physiol* 1994;267:1256, Fig. 3B as reviewed in Mickelson JR, Louis CF. Malignant hyperthermia: excitation-contraction coupling, Ca<sup>2+</sup> release channel, and cell Ca<sup>2+</sup> regulation defects. *Physiol Rev* 1996;76:553, Fig. 12.

RYR1) and demonstrated that all 6 transfected myotubes had increased sensitivity to caffeine, 4-chloro-*m*-cresol, and cell membrane depolarization induced by K<sup>+</sup>.<sup>71</sup> Yang et al. demonstrated with radiolabeled ryanodine binding that all 6 mutations were more sensitive to caffeine even at a normal intracellular calcium concentration of 100 nM.<sup>71</sup>

Wehner et al. investigated the functional consequences for calcium homeostasis in primary human myotubes cultured from an individual with MH phenotype and members of two other MH families expressing three RYR1 mutations in exon 44.<sup>70</sup> Exon 44 lies in the cytoplasmic foot region of the RYR1. The sensitivity to RyR1 receptor ago-

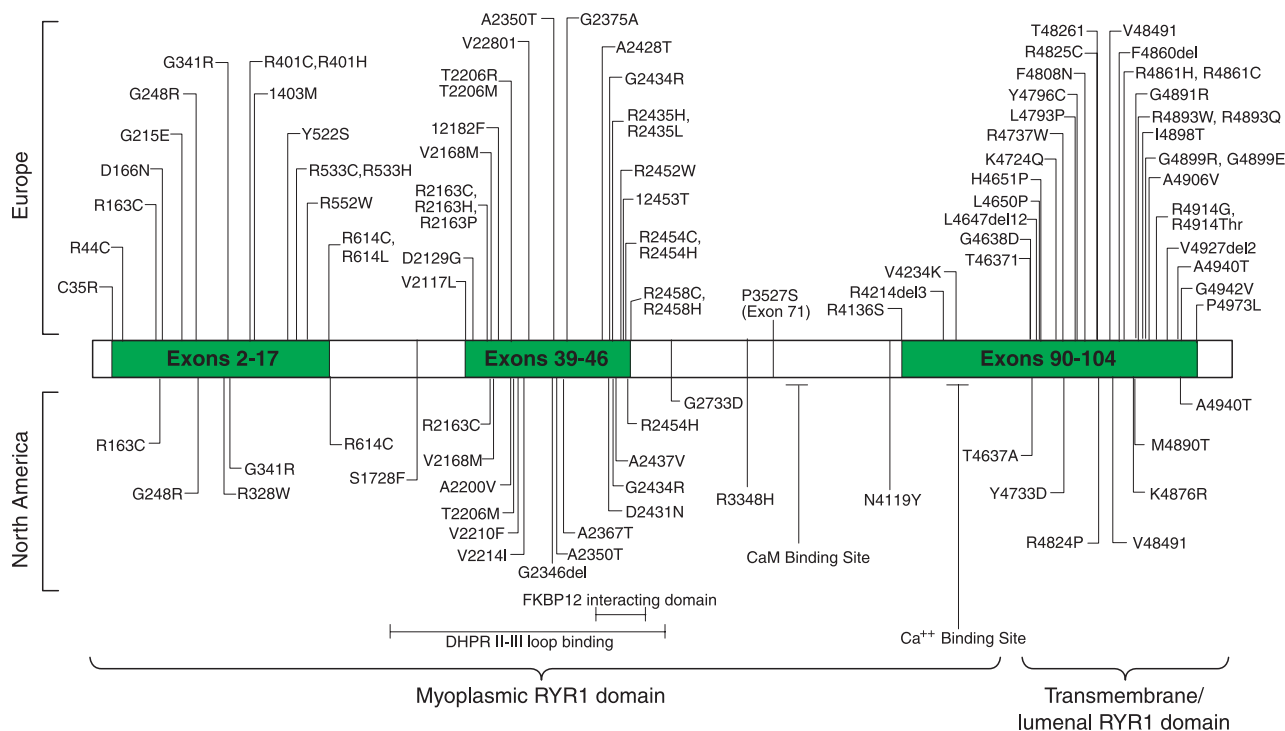
nists, 4-chloro-*m*-cresol, caffeine, and halothane was examined with the calcium-sensitive probe Fura 2. In all three mutations examined (Ala2350Thr, Arg2355Trp, and Gly2375Ala), the EC<sub>50</sub> (median effective concentration) for 4-chloro-*m*-cresol, caffeine, and halothane was reduced approximately 40-50%, which was statistically significant com-

TABLE 89-3.

## Molecular Genetics of Malignant Hyperthermia Susceptibility (MHS)

Locus Name	Gene Symbol	Chromosomal Locus	OMIM Number <sup>a</sup>	Protein Name
MHS 1	RyR1	19q13.1	145600	Ryanodine receptor 1
MHS 2	Unknown	17q11.2-q24	154275	Unknown
MHS 3	CACNA2D1	7q21-22	154276	Dihydropyridine-sensitive L-type, calcium channel $\alpha_2/\delta$ subunits
MHS 4	Unknown	3q13.1	600467	Unknown
MHS 5	CACNL1A3	1q32	601887	Voltage-dependent L-type calcium channel $\alpha_{1S}$ subunit
MHS 6	Unknown	5p	601888	Unknown

<sup>a</sup>Online Mendelian Inheritance in Man (OMIM) numbers available through the National Center for Biotechnology Information website: [www.ncbi.nlm.nih.gov](http://www.ncbi.nlm.nih.gov)



**FIGURE 89–8.** Location of ryanodine receptor type 1 (RyR1) mutations associated with malignant hyperthermia susceptibility and central core disease. Mutations found in European and Australian malignant hyperthermia-susceptible/central core disease families are shown at the *top*; mutations found in North American malignant hyperthermia-susceptible/central core disease families are shown at the *bottom* of the diagram. The novel mutations identified in this study are shown in *bold*. The three mutational hot spot areas are *shadowed*. CaM, calmodulin; DHPRII, dihydropyridine receptor; FKBP12, FK506 binding protein 12. Sambuughin N, Holley H, Muldoon S, et al. Screening of the entire ryanodine receptor type 1 coding region for sequence variants associated with malignant hyperthermia susceptibility in the north american population. *Anesthesiology* 2005;102:519, Fig. 3.

pared to MH-negative individuals. Sambuughin et al. reported comparable findings with the Ala2350Thr mutation in a North American family.<sup>72</sup>

In a subsequent study Wehner et al. found a similar reduction in EC<sub>50</sub> for RYR1 agonists in a family with spontaneous occurrence of the Ile2453Thr mutation.<sup>73</sup> Affected individuals were diagnosed as susceptible to MH and CCD. Collectively these results suggest that mutations in the N-terminal and central regions appear to increase ryanodine receptor agonists binding coupled with an increased release of Ca<sup>2+</sup>. It is as yet unknown whether all mutations induce similar changes in agonist binding and Ca<sup>2+</sup> release characteristics.

### Phenotype–Genotype Correlation

Phenotype–genotype correlations in MH susceptibility are difficult to study because fulminant MH episodes are now rare as a consequence of early dantrolene intervention in suspected cases, the large number of mutations that have been identified, and the variability of CHCT results among diagnostic laboratories. Nevertheless, phenotype and genotype correlation studies show that different phenotypic expressions exist according to the nature of

the mutation. Analysis of series of RyR1 gene mutations associated with MH show good correlation with caffeine threshold and tension values.<sup>74</sup> In North America, contracture responses to halothane appear to provide a better correlation.<sup>75</sup> The RyR1 mutations associated with both MH and CCD (Arg163Cys, Arg2163His, and Arg2435His) exhibit more-severe caffeine and halothane responses than those associated with MH alone.<sup>76</sup> The most severe phenotype is found in RyR1 mutations associated with CCD. The Ile4898Thr mutation in the C-terminal part of RyR1 that was described in a large Mexican family is associated with a CCD phenotype with severe clinical expression.<sup>77</sup>

The widespread practice of the contracture test on both parents of MH-susceptible patients has allowed the identification of a significant number of patients homozygous for the MH susceptibility trait.<sup>49</sup> Surprisingly, these patients differ neither from a symptomatic point of view, nor in their response to the contracture test, from patients heterozygous for the same mutations. Another interesting fact is the number of families in which two different mutations (compound heterozygote) were

identified.<sup>78</sup> These two observations suggest that the frequency of mutations affecting the RyR1 gene in the general population is probably underestimated.

### Global Distribution of Known RyR1 Mutations

Geographic differences in frequencies for common MH susceptibility mutations are observed across Europe. For example, in the United Kingdom population, the most prevalent mutation is Gly2434Arg, accounting for approximately 40% of mutation-positive MH families investigated; in Germany, the Arg614Cys mutation is the most common; whereas in Switzerland, Val2168Met and Ile2336His are more common. In France, the Gly341Arg and the Arg614Cys are the most common. The Arg614Cys accounts for MH in several families in Italy.

In North America, the most frequent mutation is the Gly2434Arg and the second most frequent is the Arg614Cys, which is similar to the MH-susceptible populations of the United Kingdom and Germany. However, the total number of MH-susceptible patients reported in North America is small compared to the European countries, and the current North American data does not include all ethnic groups. In Japan, the

distribution and frequency of RyR1 mutations in MH-susceptible individuals differs from both the North American and European populations, with many mutations being found outside of the “hot spot” regions.<sup>79</sup>

### Evaluation of Malignant Hyperthermia Susceptibility

Because MH is often called a “silent disorder,” apparent only after exposure to potent volatile anesthetics and/or succinylcholine, identifying MH-susceptible individuals is difficult and is usually made after an adverse response to anesthesia in the individual or in family members. Most MH episodes present as completely unexpected events, and there is no simple screening test that can predict the onset or severity of an MH episode prior to the administration of the triggering anesthetics. A number of diagnostic procedures have been described in the past, and although some of these tests may be useful under restricted conditions, they have not been successful when applied to a larger population of MH patients. Tests that show some promise for the future include genetic analysis of RyR1 and other candidate genes, measurements of Ca<sup>2+</sup> flux in B cells, <sup>31</sup>P NMR (nuclear magnetic resonance) spectroscopy, and microdialysis of muscle *in vivo*. Although further development of these tests is necessary, they may lead to a less-invasive test than the CHCT in the future.

Evaluation of MH susceptibility starts with history and physical examination of the patient. The history (personal and family) provides the most useful information, particularly if anesthetic or surgical records of an adverse response to anesthetics are available. This information is crucial in deciding what the appropriate testing is for an individual patient and related family. Patients who do not want to undergo diagnostic testing should be counseled about obtaining, for example, MH bracelets and wallet cards (see Resources below).

Physical examination is generally not very helpful in the preoperative diagnosis of MH susceptibility. Nevertheless, examination of the musculoskeletal system can provide some clues that suggest MH susceptibility but their predictive power is weak. In the past, it was suggested that MH-susceptible patients have a higher incidence of: muscle cramps, increased muscle bulk, hy-

perextensible joints, strabismus, and scoliosis. However, the documented incidence of such muscle skeletal problems in MH-susceptible individuals appears to be no higher than that in the general population.

### Diagnostic Testing for MH: In Vitro Testing

Since the mid-1970s, the standard diagnostic test for MH has been the measurement of contracture response of biopsied skeletal muscle to graded concentrations of caffeine and the anesthetic halothane *in vitro*. This test is referred to as either the CHCT or the IVCT. In Japan, MH testing is performed on human skinned muscle fibers using the calcium-induced calcium release test.<sup>80</sup> Muscle histology and histochemistry are not diagnostic for MH susceptibility.<sup>39</sup> As all diagnostic tests must be performed on fresh tissue, it is necessary that the muscle biopsy and diagnostic testing be performed at a center that does both procedures. There are 6 such centers in North America.

Two standardized tests, the North American CHCT and the IVCT, are widely used to diagnose patients as MH susceptible (MHS), or MH negative (MHN). Both tests are highly sensitive (93–97%), but not highly specific (78–93%),<sup>81,82</sup> and are invasive, requiring a surgical biopsy of leg muscle (*vastus lateralis*). In an effort to improve the specificity of the test, particularly for MH-equivocal (MHE) cases, the European MH Group has investigated adding 4-chloro-*m*-cresol and/or ryanodine to the testing procedure to improve accuracy, but neither of these substances has reached general acceptance by MH diagnostic groups. The response of skeletal muscle to halothane still is considered the most specific test for malignant hyperthermia susceptibility, but it is the least sensitive. Caffeine causes contracture in any skeletal muscle, but a contracture response will occur at a lower dosage in MH-susceptible individuals (Fig. 89–9).

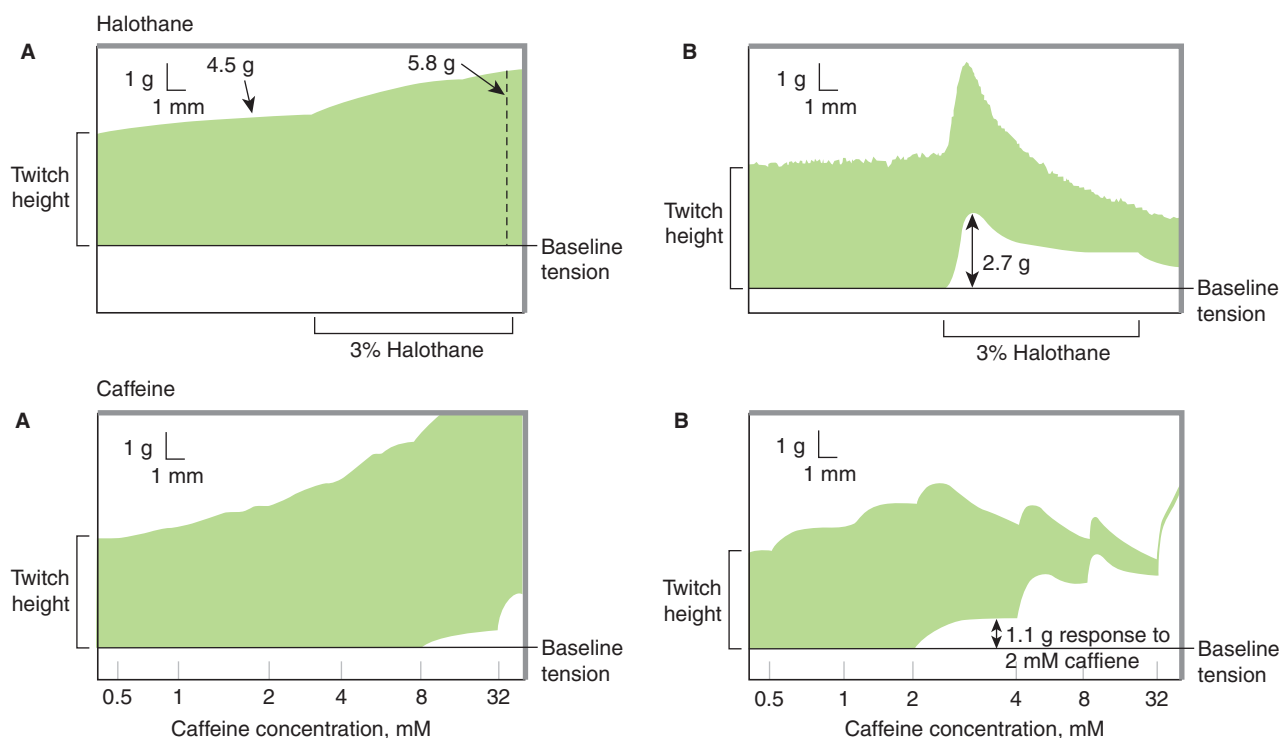
Patients requiring muscle biopsy for diagnostic CHCT can be safely anesthetized with general anesthesia using nontriggering agents (see Box 89–1) or with a femoral nerve block or one of its variants. The muscle bundles obtained during the surgical biopsy are exposed to various pharmacologic agents, such as halothane and caf-

feine, and the change in muscle tension is measured.<sup>83</sup>

The protocols for the performance of the IVCT and CHCT tests are slightly different. The North American and the European protocols both use incremental caffeine concentrations of 0.5, 1, 1.5, 2, 4, 8, and 32 mM, but it is the response to 2 mM caffeine that is used for evaluation of MH susceptibility in both protocols. In testing with halothane, the North American protocol uses a single bolus dose of 3% halothane, whereas the European protocol uses incremental doses of halothane (0.5%, 1%, 2%, and 3%).<sup>83</sup> Additionally, the testing protocols for MH vary slightly in interpretation of the results. The North American protocol only requires that one muscle strip be positive to either caffeine or halothane for the patient to be called MH susceptible; whereas the European MH Group's protocol requires that muscle samples must be positive to both halothane and caffeine for the patient to be called MHS. For the European MH Group protocol, if a patient is only positive to either caffeine or halothane, they are considered MHE. This classification is not used in the North American protocol.

**Indications for Muscle Biopsy and CHCT Testing** Listed below are the indications for muscle biopsy and CHCT testing.<sup>83</sup>

- **Definite Indications:**
  - Suspicious clinical history of MH.
  - First-degree relative of an index case with a suspicious history of MH if the index case cannot be tested (e.g., too young, too old, MH death, unwilling to undergo the muscle biopsy, no test center available).
  - Severe masseter muscle rigidity during anesthesia with MH-triggering agents.
  - Military service—The military requires determination of MH susceptibility by contracture testing in persons with a suspicion of MH susceptibility, as individuals with MH susceptibility are not eligible for military service.
- **Possible Indications:**
  - Unexplained rhabdomyolysis during or after surgery.
  - Moderate to mild masseter muscle rigidity with evidence of rhabdomyolysis.



**FIGURE 89-9.** Halothane response (North American protocol). **A.** Normal halothane response. Halothane potentiates twitch height in all muscle strips similar to caffeine. The twitch height in this strip increases from 4.5–5.8 g of tension. However there is no change in baseline tension in response to 3% halothane. A positive response to 3% halothane is an increase in baseline tension of  $\geq 0.7$  g of tension. **B.** Abnormal halothane response. The muscle strip has a 2.7-g increase in baseline tension in response to 3% halothane. Caffeine response (North American protocol). **A.** Normal caffeine response. Caffeine potentiates twitch height in all muscle strips. However, baseline tension remains unaffected until the bath concentration of caffeine is increased to 8 mM (0.6g increase in tension). A caffeine contracture test result is considered positive when the muscle strip exhibits an increase in baseline tension of 0.2g or more in response to a caffeine concentration of 2 mM or less. **B.** Abnormal caffeine response. The muscle strip has a 1.1g increase in baseline tension in response to a caffeine concentration of 2 mM. From: Karan, S, Lojeski E, Muldoon S. Malignant Hyperthermia. In: Tremper K ed. Principles of Anesthetic Techniques and Anesthetic Emergencies. Philadelphia: Current Medicine, Inc., 1998;9:10, Fig. 17A,B.

- Severe or recurring exercise-induced rhabdomyolysis.
- *Probably Not Indicated:*
- Sudden, unexpected cardiac arrest during anesthesia or early postoperative period that is not associated with rhabdomyolysis.
- Neuroleptic malignant syndrome.

**Drawbacks of the CHCT** The drawbacks of the CHCT are as follows:

- It is an invasive procedure requiring a surgical biopsy to obtain the muscle specimens.
- The test is not performed on children less than about 40 pounds or 5 years of age.
- The CHCT must be performed within 5 hours of tissue removal. This means the patient has to be at 1 of 6 biopsy center sites in North America.
- The cost of the CHCT is usually \$5,000–\$6,000 and is only partially covered by insurance.

- Although sensitivity of the CHCT is high, specificity is only 78% and can result in false-positive tests.

### Other Tests

**Molecular Genetic Testing** Molecular genetic analysis has been proposed and incorporated in limited capacity as a diagnostic test for MH, first in Europe and then in North America. In 2002, the North American MH Group developed a consensus on genetic testing in North America along the lines proposed by the European MH Group.<sup>84,85</sup> The MH-susceptible patient or at-risk family members are referred for genetic testing based on CHCT results and clinical assessments. Genetic testing uses a panel of 22 RyR1 mutations that are associated with MH and shown to alter RYR1 channel function in experimental models. If MH susceptibility is diagnosed in a family member or index case by CHCT, then detection of RyR1 mutations becomes valuable for other members of the family, reducing the number of relatives requiring contracture test. However, a muscle biopsy

and CHCT is currently recommended for cases in which a familial mutation is not detected because of the genetic heterogeneity of MH and because a negative genetic screen does not yet rule out MH susceptibility.<sup>86</sup> For more information, please contact the Malignant Hyperthermia Association of the United States (MHAUS; see Resources below).

**Creatine Kinase Measurement** Measurement of resting CK has been considered as a less-invasive test for MH susceptibility. However, CK testing is too insensitive and nonspecific to be recommended. Measurements of serum CK in MH-suspect families is normal or variably elevated, but unrelated to MH diagnosis. An elevated serum CK level in MH susceptible patients in the absence of triggering drugs may suggest the presence of a myopathy.

**Nuclear Magnetic Resonance Spectroscopy** <sup>31</sup>P NMR measures the concentrations of ATP, phosphocreatine,



and other phosphomonoesters, along with pH, both in vivo and noninvasively, in muscle and other tissues. Olgin et al. found that the resting inorganic phosphate to creatine phosphate ratio was increased in unanesthetized, nonexercising, MH-susceptible subjects as compared to control subjects, suggesting a partial cellular deenergization state possibly caused by leaky calcium channels.<sup>87</sup> They also showed delayed recovery of pH, levels of ATP, and of the inorganic phosphate-to-creatine phosphate ratio in MH patients after exercise.<sup>87,88</sup> However, <sup>31</sup>P NMR has not translated into a diagnostic tool for MH because changes in high-energy phosphate levels and pH are not specific for MH. Furthermore, the equipment and personnel costs required to establish and maintain a <sup>31</sup>P NMR facility are very high compared to existing testing centers.

Two potentially useful diagnostic tests are currently in development. These tests involve microdialysis of in vivo skeletal muscle and measurement of Ca<sup>2+</sup> levels in human B cells.

**Microdialysis of Skeletal Muscle In Vivo** Anetseder et al. first described the application of percutaneous partial pressure of carbon dioxide (PCO<sub>2</sub>) probes for the diagnosis of MH susceptibility in dialysates from skeletal muscle in vivo.<sup>89</sup> Results from the European MH center that originally described the technique are promising, but a larger number of patients need to be enrolled, preferably in a multi-center study. Application of muscle microdialysis in vivo in the porcine model of MH reveals distinct differences between MH-susceptible muscle and muscle from normal animals using the lactate-pyruvate system as the end point.<sup>90</sup>

**Ca<sup>2+</sup> in Human B Cells** Another approach is the development of intracellular Ca<sup>2+</sup> assay reflecting RYR1 function using human B lymphocytes. Sei et al. reported that RYR1 is expressed in human lymphocytes (B cells) and initial reports indicated correlation between increased Ca<sup>2+</sup> responses to caffeine and 4-chloro-*m*-cresol and MH phenotype in a small number of patients.<sup>91</sup> Several other laboratories have independently confirmed Sei's observations and reported that RYR1-mediated intracellular Ca<sup>2+</sup> release can be used as an end point to distinguish MH susceptible patients from normal controls.<sup>92</sup> Thus, measurements of RYR1-mediated Ca<sup>2+</sup> release

have the potential to diagnose MH susceptibility but require further technical development and diagnostic validation.

### Management of Malignant Hyperthermia

Successful treatment of MH relies on prompt recognition of the clinical signs (see Box 89-2), stopping the triggering anesthetics, rapid access to supplies necessary for treatment (Box 89-5), and initiation of appropriate therapeutic measures. This combination can result in a mortality rate near zero. The MH hotline (800-644-9737) is available 24 hours a day and is a valuable resource for all practitioners for the management of suspected MH cases. This section discusses the management of fulminant episodes, patients with a documented history of MH, patients with a questionable history of MH, and MMR. It is assumed that routine noninvasive monitors (i.e., electrocardiography, blood pressure, pulse

oximetry, capnography, and electronic temperature monitoring) are in use.

### Patient with a Fulminant MH Episode

In addition to the measures outlined in Box 89-6, assistance from surgical personnel is a necessity because many of the actions discussed in Box 89-6 should occur simultaneously. Prioritizing tasks is critical in the management

#### BOX 89-6.

##### Management of Patient with a Fulminant Episode of Malignant Hyperthermia

- I. Discontinue all potent inhalational agents and succinylcholine. Maintain anesthesia with total intravenous nontriggering anesthetics.
- II. Increase minute ventilation to lower ET<sub>CO<sub>2</sub></sub>. Administer 100% oxygen.
- III. Inform the surgeon to expedite or abort the procedure, if possible, and obtain assistance from MHAUS hotline for acute crisis.
- IV. Administer IV dantrolene, 2.5 mg/kg. Be prepared to repeat this dose until the patient responds with a decrease in ET<sub>CO<sub>2</sub></sub> levels, rigidity, or heart rate.
- V. Obtain blood gas analysis to determine if bicarbonate therapy is indicated. Place central or intraarterial catheter for serial measurements.
- VI. Begin cooling measures if the patient is hyperthermic. Efforts to cool the patient must correspond with the extent of temperature elevation. Patients can be cooled by decreasing room temperature, surface cooling with ice, or using cold solutions for gastric, bladder, and rectal lavage.
- VII. Hyperkalemia is common and is treated with insulin and glucose, 10 units of regular insulin in 1000 mL of D<sub>10</sub>W (10% aqueous dextrose solution). Serum potassium and glucose levels must be monitored.
- VIII. Measure baseline CK and serial CKs every 6 hours until CK plateaus.

#### BOX 89-5.

##### Necessary Supplies for the MH Cart

##### The MH cart must contain the following supplies:

- Dantrolene, at least 36 vials.
- Sterile water for injection, 3 L (for reconstitution of dantrolene, 60 mL per vial)
- 5–10 syringes (60 mL) and 16-gauge needles to mix the dantrolene
- Lidocaine for bolus and continuous infusion
- Sodium bicarbonate, 10 ampules
- Dextrose 50%, 4 ampules
- Furosemide, 200 mg
- Regular insulin, 100 units/mL × 1 (refrigerated)
- Calcium chloride 10%, two 10-mL vials
- New fresh gas hose, carbon dioxide canister, circuit, ventilator bellows
- Plan for rapid access to the following:**
- Refrigerated normal saline solution for irrigation
- Ice maker or crushed ice
- Central pressure catheters, transducers, and monitors
- Pulmonary artery catheter
- Blood collection tubes for laboratory processing of samples: blood gas analysis, electrolytes, glucose, and creatine kinase
- Cooling blanket
- Rectal tube and irrigating Foley catheter

of the fulminant MH episode. When anesthesia-trained personnel are unavailable, the professional skills and assistance of the operating room nurse, the operating room technicians, and the surgeon are invaluable. A telephone call to the MH Hotline should be placed. The tasks should be prioritized as outlined in Box 89-6.

The initial dose of dantrolene is 2.5 mg/kg and should be given as an intravenous bolus into a large vein. A decrease in  $\text{ETCO}_2$  is the first sign that the therapy is effective and is followed by a decrease in heart rate and a reduction in the severity of muscle rigidity. If a decrease in  $\text{ETCO}_2$  is not seen within minutes, the acid-base status should be monitored and dantrolene administration IV continued until the hypermetabolic state is controlled. 10 mg/kg of dantrolene is recommended on the MHAUS website, but higher doses may be necessary. Heart rate may remain elevated despite a decrease in  $\text{ETCO}_2$  and temperature; this is usually an indication that more dantrolene may be needed. Continuation of respiratory support is determined on a case-per-case basis. If the patient is ventilated via laryngeal mask airway, conversion to endotracheal intubation should be done. After the episode is controlled, dantrolene should be continued at 1 mg/kg every 4–6 hours, until all signs of hypermetabolic state are resolved. During this time clinical signs and laboratory results should be used to monitor the hypermetabolic state of the patient and to decide whether further dantrolene is necessary. Strict vigilance must be maintained at all times for recrudescence (recurrence of symptoms) of MH signs, which has to be managed with the urgency of a new episode of MH.

Dantrolene is packaged in lyophilized form at 20 mg/vial and is dissolved with 60 mL of sterile water, in which it is relatively insoluble. Sodium hydroxide and 3 g of mannitol are added to the vial to allow the dantrolene to dissolve in 2–3 minutes. The resulting pH of the solution is 9.5, so care must be taken to prevent extravasation and to monitor for thrombophlebitis. Mannitol is an osmotic diuretic and therefore central venous pressure monitoring may be necessary to manage volume status.

Cooling the patient is one of the most important aspects of treatment to decrease core body temperature and thereby lower oxygen consumption.

Core cooling is superior to surface cooling and is accomplished by cold gastric and rectal lavage, and cold wound irrigation. Surface cooling can be used effectively if peripheral vasoconstriction is avoided. Ice packs to the groin and axilla can be helpful in lowering core temperature. Decreasing the room temperature or packing the patient in ice may induce shivering and hence increase oxygen consumption which is considered counterproductive. The patient's temperature needs to be continuously monitored to detect hypothermia from overaggressive cooling.

Dysrhythmias result from the by-products of the hypermetabolic state, which include hypoxia, hypercarbia, acidosis, and hyperkalemia in combination with an increased sympathetic tone. Treatment of the primary condition should control the dysrhythmias, but if they persist or become life-threatening, lidocaine, 1–2 mg/kg, should be administered intravenously and repeated as needed. Lidocaine is not a triggering agent and is safe to use in patients with documented MH. If heart rate is unresponsive to the previously described measures, short-acting  $\beta$ -blockers like esmolol should be used instead of calcium channel blockers, which are contraindicated. In both humans and swine, the combination of dantrolene and verapamil resulted in cardiovascular collapse secondary to hyperkalemia.<sup>93,94</sup> The same result has been reported in swine administered dantrolene and diltiazem. Hyperkalemia was not observed when dantrolene and nifedipine were administered, but mild hyperkalemia was noted in 1 case in a human.<sup>93</sup>

The arterial blood gas analysis is the most useful laboratory evaluation to assess the effectiveness of therapy. Capnography does not eliminate the need for arterial blood gas for several reasons. First, rapid ventilation may underestimate the true  $\text{ETCO}_2$ . Second, metabolic acidosis, another marker in assessing the effectiveness of therapy, may still be present even when the  $\text{ETCO}_2$  has returned to baseline. Furthermore, bicarbonate therapy for the correction of metabolic acidosis cannot be managed effectively without serial arterial blood gas analysis. Empiric bicarbonate therapy risks severe alkalosis and has the potential to exacerbate the intracellular acidosis. Finally, the arterial blood gas assesses the adequacy of oxygen delivery more precisely than pulse oximetry. If central venous access

is present, mixed venous oxygen measurements provide additional information to calculate oxygen consumption.

Electrolyte abnormalities include gradual changes in serum potassium, calcium, and glucose; therefore, serial measurements are required. Hyperkalemia is generally considered to result from acidosis that shifts  $\text{K}^+$  ions out of the cell in exchange for  $\text{H}^+$  ions combined with the leakage of  $\text{K}^+$  out of the damaged muscle cells. The most effective therapy for hyperkalemia is treatment of the underlying MH with the muscle SR calcium release inhibitor, dantrolene. If hyperkalemia persists or results in cardiac dysrhythmias, intravenous glucose and insulin (10 units regular insulin in 1000 mL  $\text{D}_{10}\text{W}$ ), and bicarbonate should be administered slowly. Potassium-binding agents may be useful after cold gastric or rectal lavage has been completed. Calcium therapy is reserved for life-threatening dysrhythmias or inotropic support. Variations in serum calcium levels are reflected on the electrocardiogram (ECG) as a shortening or prolongation of the QT interval. Hypocalcemia is more common and is treated with incremental doses of calcium. Sodium values can be increased as a result of the large sodium load contained in mannitol or decreased because of a dilutional effect from fluid therapy. The risk of hypo- or hyperglycemia increases if insulin and glucose therapy are used to treat hyperkalemia.

Laboratory evaluations should include CK, myoglobin, and coagulation studies, and in cases resistant to therapy, catecholamine levels and thyroid function tests. Serum CK and myoglobin should be followed every 6 hours until the CK reaches a plateau and the myoglobin has been cleared from the urine. CK values may rise to very high levels (>100,000 IU/L or much more). The elevated CK indicates the at-risk period for myoglobinuric renal failure and the need for renal protective measures; it may also signify an increased risk of compartment syndrome and renal failure if the values do not return to baseline within 24 hours. Disseminated intravascular coagulation is not uncommon following a fulminant episode of MH. Factors contributing to disseminated intravascular coagulation include hemolysis, cellular edema with increased release of tissue thromboplastins, and inadequate tissue perfusion. A high level of suspicion com-

bined with serial laboratory evaluation of the coagulation system aids in this diagnosis. There are no special considerations for treating disseminated intravascular coagulation in this setting. If the clinical situation appears to be MH but the patient continues to only partially respond to appropriate therapy, continue current therapy but consider other processes (see Box 89-4). Collecting blood for catecholamine assays and thyroid function ( $T_4$ ) tests may help to identify thyroid storm or a pheochromocytoma, which may mimic MH. When the episode has been reversed and the patient's status has stabilized, arrangements should be made for ICU care for at least 24 to 48 hours. The major areas of concern include recrudescence of the initial episode, renal protection therapy to prevent myoglobinuric renal failure, the occurrence of disseminated intravascular coagulation, compartment syndrome, delayed awakening possibly related to cerebral edema, and the patient's underlying medical condition that warranted surgical intervention.

### **Patient with a Documented History of MH**

The goal for patients with histories of documented MH susceptibility (positive CHCT or strong evidence of a clinical episode; i.e., a copy of anesthesia records or a letter from the physician who diagnosed and treated the case) is preparation and administration of a safe anesthetic (Box 89-7). Regardless of the surgical procedure or anesthetic technique, additional time is required to prepare the anesthesia machine, check the monitors, and inspect the MH cart. Some departments maintain an anesthesia machine without vaporizers for use only with MH patients. This practice is unnecessary because of the ease of preparing an uncontaminated machine. Although it is impossible to define a background level of inhalation agent that may trigger an MH episode, a practical goal can be defined by adopting the National Institute of Occupational Safety and Health standard for waste gas exposure. The National Institute of Occupational Safety and Health standard is 2 ppm concentration of a halogenated agent and is an acceptable level as this concentration may be present in the operating room or recovery room. It is known from the MH-susceptible swine model that 2 ppm is several-fold lower than the threshold

#### **BOX 89-7.**

#### **Anesthetic Management of Patient with a Documented History of MH**

##### **I. Equipment**

- A. A "clean" anesthesia machine should be prepared by removing or sealing the vaporizers, replacing the first gas hose, and using a new disposable circuit. Next, flush the machine with a fresh gas flow of 10 L/min for 5 minutes. Prepare the anesthesia machine even if a regional technique or monitored anesthesia care is planned in case of failed technique or emergency.
- B. Capnography with real-time display, electrocardiogram, blood pressure, and electronic temperature monitoring are required.
- C. MH cart must be checked to make sure medications are current.

##### **II. Scheduling**

- A. First case of the day.
- B. Observation in the recovery room for 4–6 hours.
- C. Outpatient surgery is acceptable if the patient can be observed in the recovery room for 4–6 hours and intensive care support is readily available.

##### **III. Premedication**

- A. Dantrolene prophylaxis is not routinely recommended.
- B. Check availability of dantrolene in pharmacy.
- C. Sedation is at the discretion of the anesthesiologist.

##### **IV. Technique**

- A. Monitored anesthesia care.
- B. Regional anesthesia (peripheral or neuroaxial).
- C. Nontriggering agents for a general anesthesia.

##### **V. Postoperative course**

- A. Monitoring: respiratory rate, blood pressure, heart rate, and temperature.
- B. Laboratory: if clinical course remains uneventful, tests are not necessary.
- C. Healthcare providers in the recovery room should be alerted to the patient's MH status.

concentration required to trigger an MH crisis.<sup>95</sup> The MH cart should be inspected to ensure that the medications, especially dantrolene, are not past their expiration date.

The North American MH Group recommends scheduling the surgical procedure as the first case of the day to allow time for preparation and to avoid contamination of the operating room by waste anesthetic gases. Extended observation in the recovery room is arranged and the ICU is alerted in anticipation of any signs of an MH episode. Extended postoperative monitoring is required to ensure that late development of MH is diagnosed and treated promptly.

Outpatient surgery is acceptable if the patient can be observed in the recovery room for 4–6 hours and intensive care support is available as needed.

Whether dantrolene should be administered preoperatively is debatable. The infrastructure and the operating support services are major factors in making this decision. Arguments in favor of pretreatment with

dantrolene are based on preventing MH through prophylactic measures and in preventing stress-induced MH. If a hospital is in a remote area of the country, or has limited staff and resources, it can be argued that preoperative administration of dantrolene is warranted. Likewise, if the patient is very anxious, pretreatment should be considered. If the surgery is to be performed at a fully equipped surgical facility with additional staff available, pretreatment in most cases is not indicated. Other arguments for not pretreating with dantrolene include depleting a limited supply of the drug and avoiding the risk of morbidity from the drug (muscle weakness that may require ventilatory support). If the patient is given dantrolene in a therapeutic dose, admission to hospital for 24 hours will be required as the patient will have muscular weakness.

If pretreatment is chosen, an intravenous dose of 2.5 mg/kg just before the start of the anesthetic is recommended to achieve therapeutic serum levels. A Foley catheter is also required because of the osmotic diureses



caused by the mannitol included in the dantrolene formulation. Oral dantrolene is not recommended because of the variable time required to obtain therapeutic plasma levels. Pretreatment with dantrolene does not eliminate the need for a nontriggering anesthetic technique.

Anxiety and stress have been implicated in predisposing a patient to MH.<sup>249</sup> Preoperative sedation is beneficial and can be accomplished by administering appropriate doses of narcotics, benzodiazepines, barbiturates, or antihistamines.

The anesthetic technique depends on the patient, surgical procedure, and anesthesiologist, and may include monitored care, regional anesthesia, or use of a nontriggering total intravenous anesthetic technique for general anesthesia. Administration of a non-triggering anesthetic may be routine in some centers, but it is not always easily applied as highlighted in the following two case histories:

1. A 4-year-old girl with history of MH and severe asthma for bilateral myringotomy tube placement.
2. A 3-year-old boy with acute epiglottitis requiring intubation, who has a cousin with a documented history of MH.

In the first case, the usual anesthetic of an inhalation induction with no IV placement is unacceptable. Nitrous oxide and oxygen alone does not provide sufficient analgesia. Intramuscular or intravenous ketamine can be used in combination with nitrous oxide; however, the sympathetic response to ketamine may make interpretation of tachycardia difficult in a situation when capnography may not be reliable (child who is not intubated). Continuous intravenous anesthesia can be maintained with propofol, but requires intravenous access before induction.

The second case contrasts two possibly fatal complications: loss of an airway and a fulminant MH episode. The possibility exists that the patient may not be MH susceptible. In this situation, securing the airway takes precedence and intravenous access must be established for induction with intravenous nontriggering anesthesia. Pretreatment with dantrolene is not recommended because of the possibility of muscle weakness severe enough to precipitate respiratory arrest. After

the patient has been intubated, the clinical situation may dictate the use of dantrolene.

No special precautions are necessary for MH-susceptible obstetric patients. The stress of labor has not been shown to predispose patients to MH episodes, and MH susceptibility is not a contraindication for epidural or spinal anesthesia. We do not recommend pretreatment of obstetric patients with dantrolene for emergency cesarean section. However, if an episode is triggered during the anesthetic, dantrolene should be administered immediately. To date, dantrolene appears to have little or no adverse effect on the fetus or newborn.<sup>96</sup>

In the postoperative period, the patient with a documented history of MH should be monitored for signs of MH for at least 4–6 hours. To ensure early detection of postoperative MH, recovery room/ICU staff must be alerted and educated regarding MH. If the procedure was uneventful, no special laboratory analysis is indicated. If dantrolene was given prophylactically, but no signs of MH occurred, it need not be continued.

### ***Patient with a Questionable History of MH***

When MH susceptibility is suspected, patients must be treated as though they have MH (see Box 89–7) until either a chart review or a negative contracture test proves otherwise. Elective surgery can proceed as scheduled (follow the guidelines in Box 89–8) without the results of contracture test; however, if CHCT is required it can be scheduled at a MH diagnostic center. Although the goal is to avoid unnecessary or indiscriminate labeling of patients as MH susceptible, all family members must wear an MH identification tag (see Resources below for how to obtain a tag) stating that they are MH susceptible while the review is in progress. When suspicion of MH susceptibility exists in a family member of a patient, the patient should not be given triggering agents.

The North American MH Registry has been established to collect and disseminate information regarding MH and the families involved. The chart review is eliminated if the patient or family member in question has been evaluated and entered into the registry by one of the MH diagnostic centers. If the patient is not regis-

### **BOX 89–8.**

#### **Patient with a Questionable History of MH**

- I. Treat the patient as MH susceptible.
- II. Elective surgery may proceed as scheduled if provisions for the patient with documented MH are met (see Box 89–7). However, if the workup indicates a need for diagnostic contracture testing, a second anesthetic must be administered.
- III. Identify susceptible family members and provide information for entry into the MedicAlert system and MHAUS. If the diagnosis is found to be negative, the MedicAlert tags can be removed.
- IV. Verify the diagnosis to rule out mislabeled patients
  - A. If a patient or family member in question has been registered, calling the North American MH Registry (888–274–7899) can confirm the history and workup.
  - B. Obtain and review records of the event in question
  - C. If the diagnosis is still unclear, consult with the nearest MH diagnostic center, which is available through MHAUS (607–674–7901).
- V. Provide documentation and counseling for the patient and affected relatives.

tered, a chart review of the initial episode is necessary to rule out alternative explanations for the episode (see Box 89–4). If the diagnosis is still in question, contact the nearest MH diagnostic center available for consultation (see Resources below). Even if the diagnosis is inconsistent with MH susceptibility, provide documentation and counseling to the family regarding the findings; this helps to eliminate confusion for the family and their future healthcare providers.

### ***Patients with Masseter Muscle Rigidity***

Management of a patient with MMR depends on the degree of rigidity (Box 89–9). If a patient develops moderate or severe MMR, surgery should be aborted if it is elective and nonemergency, and the patient should be promptly awakened and closely monitored for other signs of MH. Urine should be tested for myoglobinuria.



## BOX 89–9.

**Patient with Masseter Muscle Rigidity**

When masseter muscle rigidity is diagnosed

Discontinue any potent inhalation agent.

Continue to ventilate by mask with 100% oxygen.

Do not give a second dose of succinylcholine.

Call for assistance and the MH cart.

Continue to monitor  $\text{ETCO}_2$ , minute ventilation, electrocardiogram, blood pressure, and core temperature.

Obtain blood gas and electrolyte analysis if the situation does not rapidly improve.

Is the patient stable?\*

Yes

In elective surgery, cancel the procedure and observe the patient in the operating room until awake.

In emergency surgery, convert to a nontriggering technique and observe for changes in the patient's condition over 15–20 minutes; then proceed with surgery

Postprocedure management

A. Institute ICU/overnight recovery room observation for 24 hours to monitor urine output and signs of increased metabolism (increased heart rate, blood pressure, respiration, acidosis, and temperature).

B. Obtain serial CK measurements every 6 hours for 24 hours or until the CK has plateaued.

C. Test urine for the presence of myoglobin:

1. If positive, maintain alkaline urine output at 1–2 mL/kg/h until clear.

2. If negative, continue to monitor until CK has plateaued.

\*If the airway is secure, minute ventilation less than 1.5 times expected produces normal carbon dioxide and circulatory parameters, and core temperature is normal or slightly low, then patient is stable.

No

In elective surgery, cancel the procedure and treat as fulminant MH.

In emergency surgery, treat as fulminant MH and proceed with surgery using nontriggering anesthetics after the patient is stable.

Serum CK should be measured at the time and at 6-hour intervals over the next 24 hours. If there is no evidence of myoglobinuria and if the increases in CK are modest, many centers allow the patient to be discharged that day. Surgery may be rescheduled when CK has returned to normal. In light of more recent data, if  $\text{ETCO}_2$ , arterial blood gases, blood pressure, pulse rate, temperature, serum CK, urine color, and muscle tone are monitored and these signs remain stable, then the procedure may be continued. Nontriggering anesthetic agents should be administered.

If the case is an emergency, the surgeon should be informed and the decision should be made to expedite the surgical procedures. All potential triggering agents should be discontinued and replaced by nontriggering agents (propofol, barbiturate/opiates, nitrous oxide, and nondepolarizing muscle relaxants).  $\text{ETCO}_2$ , arterial blood gases, and core temperature should be monitored continuously. Dantrolene should be available in the operating room.

Some advocate administering dantrolene prophylactically, but we advise clinicians to wait for some definite signs of MH. Previously it was thought that a positive CHCT should be obtained if perioperative serum CK values exceeded 20,000 IU. More recently, Kaplan et al. found that CK elevations following MMR were not predictive of contracture test outcomes.<sup>97</sup>

## THERMOREGULATION AND PERIOPERATIVE HYPOTHERMIA<sup>a</sup>

Hypothermia is a common perioperative occurrence and results in a number of clinical consequences ranging in significance from mild to serious (Table 89–4).<sup>98</sup> With normal body temperature being 98.6°F (37°C), and taking into account a 1.8°F (1°C) diurnal variation and 0.9°F (0.5°C) variation depending on the menstrual cycle, hy-

<sup>a</sup> "Thermoregulation and Perioperative Hypothermia" was written by Dr. Hilary P. Grocott and Dr. Christopher Sulzer.

pothemia can be defined when the core temperature is less than 96.8°F (36°C).<sup>99</sup> As with other mammals, humans require a nearly constant internal body temperature to maintain optimal function. Significant deviation in this internal temperature can result in alterations in numerous metabolic and physiologic functions that, if not reversed, may lead to significant morbidity and eventually, mortality. The human body has evolved a sophisticated thermoregulatory control system by which to maintain core temperature (usually within 0.4°F [0.2°C] of its ideal target temperature). Anesthetics profoundly affect these control mechanisms, and when coupled by adverse environmental conditions (such as a cool operating room) and other heat-losing perioperative events, the risk of developing hypothermia easily becomes apparent. An understanding of both normal and anesthetic-modulated thermoregulation is essential for the prevention and management of perioperative hypothermia.

## Normal Thermoregulation

The body produces heat as a direct result of its metabolic activities. The major organs, in particular, the brain, generate the greatest proportion of this heat. In addition, muscle can significantly contribute to this, but usually only during relatively brief periods of intense use.<sup>100,101</sup> Thermal energy within the body is distributed between central (core) and peripheral compartments. The core compartment consists of the trunk (including the major organs) and the head. The skin (including superficial tissues of the trunk) as well as the arms and legs represent the peripheral compartment.<sup>102</sup> Temperature in this peripheral compartment is usually 3.6–7.2°F (2–4°C) lower than the core—a gradient that becomes highly relevant when anesthesia is induced and vasodilatation occurs.<sup>100,102</sup>

Just as defining terms for what comprise normothermia and hypothermia is important, choosing an appropriate site for monitoring is equally important. Wide discrepancies exist between different body sites and for different operative situations.<sup>103,104</sup> The skin temperature monitoring site is considered a peripheral temperature and correlates poorly to core temperature.<sup>105</sup> *Core temperature*, a term widely used by anesthesiologists, is somewhat nebulously defined but is generally accepted

TABLE 89-4.

Major Consequences of Mild Perioperative Hypothermia in Humans<sup>a</sup>

Consequence	Reference	N	$\Delta T_{\text{core}}$ (°F/°C)	Value in Normothermic Patients	Value in Hypothermic Patients	P value
Surgical-wound infection	Kurz et al. <sup>185</sup>	200	35.2/1.9	6%	19%	<0.01
Duration of hospitalization	Kurz et al. <sup>185</sup>	200	35.2/1.9	12.1 ± 44 days	14.7 ± 6.5 days	<0.01
Intraoperative blood loss	Schmied et al. <sup>178</sup>	60	34.9/1.6	1.7 ± 0.3 L	2.2 ± 0.5 L	<0.001
Allogenic transfusion requirement	Schmied et al. <sup>178</sup>	60	34.9/1.6	1 unit	8 units	<0.05
Morbid cardiac events	Frank et al. <sup>241</sup>	300	34.3/1.3	1%	6%	<0.05
Postoperative ventricular tachycardia	Frank et al. <sup>241</sup>	300	34.3/1.3	2%	8%	<0.05
Urinary excretion of nitrogen	Carli et al. <sup>192</sup>	12	34.7/1.5	982 mmol/d	1,798 mmol/d	<0.05
Duration of action of vecuronium	Heier et al. <sup>193</sup>	20	35.6/2.0	28 ± 4 min	62 ± 8	<0.001
Duration of action of atracurium	Leslie et al. <sup>242</sup>	6	37.4/3.0	44 ± 4 min	68 ± 7 min	<0.05
Postoperative shivering	Just et al. <sup>121</sup>	14	36.1/2.3	141 ± 9 mL × min <sup>-1</sup> × m <sup>2</sup>	258 ± 60 mL × min <sup>-1</sup> × m <sup>2</sup>	<0.001
Duration of postanesthesia recovery	Lenhardt et al. <sup>197</sup>	150	35.2/1.9	53 ± 36	94 ± 65	<0.001
Plasma (norepinephrine)	Frank et al. <sup>243</sup>	74	34.7/1.5	330 ± 30 pg/mL	480 ± 70 pg/mL	<0.05
Thermal discomfort (VAS)	Kurz et al. <sup>244</sup>	74	36.7/2.6	50 ± 10 mm	18 ± 9 mm	<0.001

N, total number of subjects;  $\Delta T_{\text{core}}$ , difference in core temperature between the treatment groups; VAS, a 100-mm-long visual analog scale (0 mm = intense cold, 100 mm = intense heat).

<sup>a</sup>Only prospective, randomized human trials are included; subjective responses were evaluated by observers blinded to treatment group and core temperature. Different outcomes of the first three studies are shown on separate lines.

Source: Sessler DI. Mild perioperative hypothermia. *N Engl J Med* 1997;336:1730–1737. Copyright 1997, Massachusetts Medical Society. All rights reserved.

to reflect mean temperature of the well-perfused organs (i.e., brain, heart, kidney, and lungs). Good measurement sites of core temperature include tympanic, nasopharyngeal, esophageal, and bladder sites.

Like many other physiologic systems, the thermoregulatory system has at least three major components: (a) sensory receptors (an afferent limb); (b) a central integrator or controller; and (c) an effector organ systems (an efferent limb). The sensory receptors provide information from thermosensitive sites in the skin and other body structures (spinal cord and viscera) to a central controller that then integrates this information and compares it with a standard reference or setpoint (Fig. 89-10).<sup>99,106</sup> The skin, deep tissues (viscera), spinal cord, hypothalamus, and other brain structures each contribute approximately 20% of the input to the autonomic thermoregulatory control center. On the basis of the difference between the afferent input and the target setpoint, the controller provides information to effector systems that then initiate

changes to regulate heat production or loss. There is general agreement that the anterior hypothalamus is the central controller for body temperature, comparing the afferent input with the central setpoint, and instituting an appropriate autonomic neural response. Investigations by neuroanatomists and neurophysiologists have greatly increased understanding of how the three components of the thermoregulatory system function to maintain a thermal balance; details concerning these experimental studies are the subject of numerous books and review articles.<sup>99,102,107–112</sup>

An important concept to consider in the control of temperature is the interthreshold range. This is defined as the range between which thermoregulatory responses to cold versus those for warmth are activated. That is, if body temperature is in this range, no autonomic thermoregulatory defenses are triggered. In the normal adult, this range is typically 0.4°F (0.2°C) but may be wider in the elderly.<sup>106,113</sup> In premature infants, central thermoregulatory control appears to be intact,

but it is evidenced in the elderly. Anesthesia significantly widens the interthreshold range to as much as 7.2°F (4°C).<sup>114–117</sup> With a range this wide, it is easy to understand how, during anesthesia body temperature is influenced by the environment and trends toward equilibrating with ambient temperature, thus defining the anesthetized patient as poikilothermic.

### Normal Thermoregulatory Efferent Responses

In normal unanesthetized humans, behavioral regulation (dressing appropriately and/or modifying environmental temperature) is one of the most important mechanisms contributing to heat regulation. After this behavioral adjustment is made, humans further regulate heat exchange with their environment by balancing several thermoregulatory effects: (a) cutaneous vasomotor tone adjustments (vasodilatation, vasoconstriction); (b) sweating; (c) shivering; and (d) nonshivering thermogenesis.

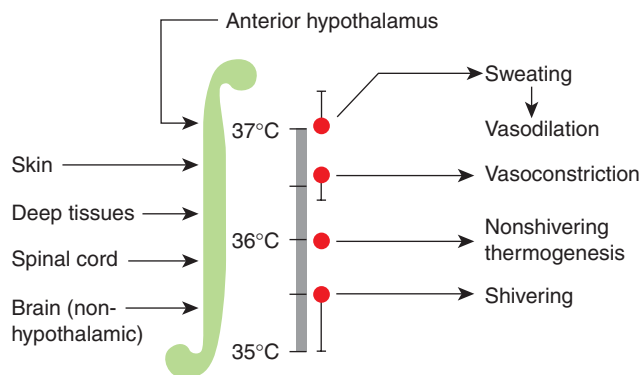
In hypothermic situations where the hypothalamus activates heat conservation and production mechanisms, ther-

moregulatory vasoconstriction occurs via the activation of arteriovenous shunts in the periphery.<sup>118</sup> This is usually the first and most consistent thermoregulatory response to hypothermia. In doing so, cutaneous vasoconstriction raises thermal insulation provided by the skin and can decrease entire body heat loss by 25–50%.<sup>119,120</sup> If heat loss continues and core temperature continues to fall, shivering, with its metabolically driven increases in heat production, is initiated.

The shivering response is the primary mechanism for increased heat production when hypothermic conditions persist despite the usual vasomotor constriction and is dependent on central neuronal coordination and normal neuromuscular function. Shivering is initiated only after the failure of maximal vasoconstriction, nonshivering thermogenesis (in neonates), and behavioral adjustments have proven to be inadequate to maintain target body temperature (see Fig. 89–10). Shivering is an energy-inefficient means of heat production and can cause a 2–3-fold increase in whole-body oxygen consumption.<sup>121</sup>

Intermediate between the vasoconstrictive shivering efferent responses to cold is nonshivering thermogenesis. This response, occurring in both normal and premature infants, increases metabolic heat production without inducing any mechanical work.<sup>122</sup> Brown adipose tissue is an important site of nonshivering heat production in the neonate. The brown fat is rich in mitochondria (which gives it its brownish macroscopic hue) and is distributed over the neck, back, viscera, and great vessels. The metabolism of brown fat is initiated by  $\beta_3$ -adrenergic effects on terminal nerves within it.<sup>123</sup> Although the exact mechanism of heat production is not clearly understood, it is thought that it is either related to an uncoupling of oxidative phosphorylation within the mitochondria in the presence of fatty acids or results from lipolysis–lipogenesis coupled with ATP use.<sup>99</sup> It is generally agreed that nonshivering thermogenesis does not occur in adult humans.<sup>124</sup>

Under static conditions, heat produced by the body's metabolism must eventually be dissipated to the environment. Close to 95% of this heat traverses the skin with the remainder occurring via the respiratory track. As a result, factors that modulate heat loss



**FIGURE 89–10.** Hypothalamic thermoregulatory control. The hypothalamus, the primary thermoregulatory control center, is displayed as a *large square*. The skin, deep visceral thoracic tissue, spinal cord, and nonhypothalamic brain areas each contribute approximately 20% of the input that is integrated by the hypothalamus in the control of autonomic thermoregulatory defenses (this input is shown entering the hypothalamus from the left of the figure). The temperature of the hypothalamus itself also contributes 20% of the efferent information used in thermoregulatory control. The hypothalamus integrates body temperature comparing it with threshold temperatures that then trigger specific thermoregulatory responses. Values higher than the threshold for responses to warmth (i.e., sweating) or lower than the threshold for responses to cold (i.e., vasoconstriction and shivering) initiate the appropriate defense. Values between the thresholds for sweating and vasoconstriction lie in the interthreshold range (defined as the range of temperatures that do not trigger any thermoregulatory defenses, which is normally 0.4°F [0.2°C]). The thresholds for sweating, vasoconstriction, and shivering are from Lopez et al.<sup>106</sup> and are shown as means  $\pm$  standard deviation (SD). The threshold for nonshivering thermogenesis is an estimated value.

must involve the skin itself (either directly via sweating or indirectly via modifying cutaneous blood flow). Sweating is the most effective method of heat loss. Evaporation of sweat is an energy absorbing process. In a dry environment, it alone can more than dissipate the heat generated at basal levels and more. Benzinger reported that an increase in temperature of 0.9°F (0.5°C) produces a 7-fold increase in sweat rate and body conductivity.<sup>107,125,126</sup> Sweating is mediated by cholinergic sympathetic fibers and can be nearly abolished by even small doses of atropine; something to consider in the perioperative state. Vasodilatation is important for the transfer of heat from the core to the periphery. Sweating and vasodilatory responses work synchronously to counter any increases in core temperature, with vasodilatation increasing cutaneous blood flow and heat delivery for the sweating mechanism.<sup>127</sup>

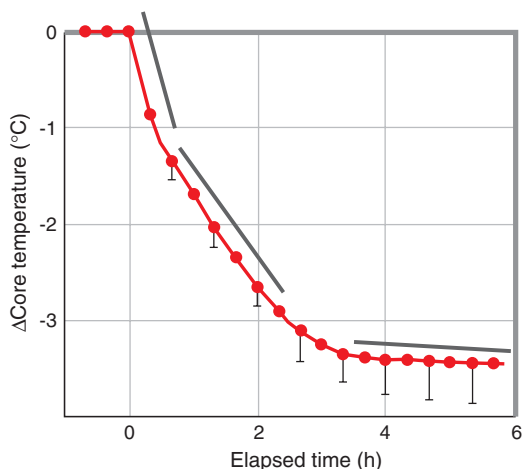
### General Anesthesia and Thermoregulation

It has long been known that anesthetized patients become hypothermic, with numerous studies documenting its incidence and severity.<sup>128–131</sup> Hypothermia that develops during general anesthesia typically follows a predictable pattern. Following an initial rapid

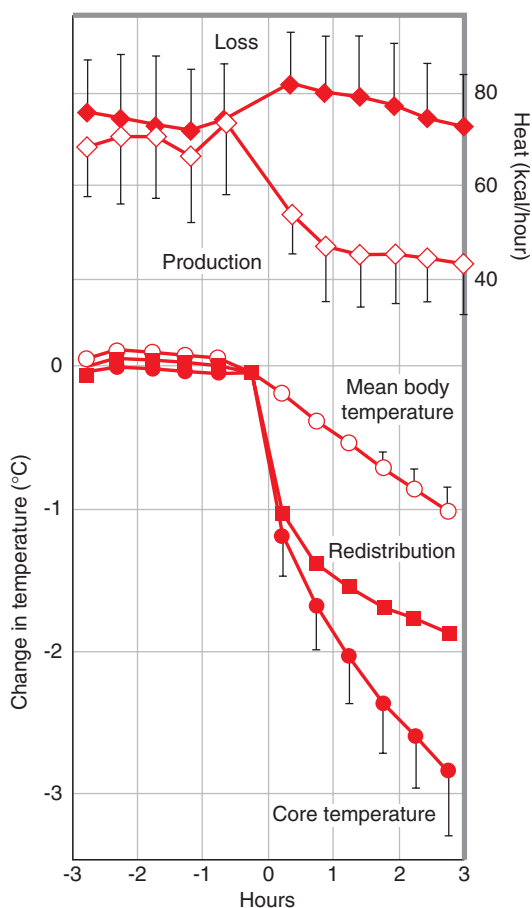
decrease in core temperature (0.9–2.7°F [0.5–1.5°C]) during the first hour after anesthesia induction, a more gradual linear decline in core temperature occurs, usually lasting 2–3 hours. A plateau occurs when heat loss and production equilibrate, usually after 3–4 hours.<sup>130,132</sup> Figure 89–11 describes this pattern.

The rapid temperature decline is believed to be the result of internal redistribution of heat.<sup>133</sup> The linear second phase of the hypothermia curve is characterized by cutaneous heat loss exceeding metabolic heat production (typically 0.9–2.7°F [0.5–1.5°C]/h; Fig. 89–12).<sup>134</sup> Radiation results in 60% of the heat loss, with the remaining loss occurring by convection and evaporation, with negligible losses from conduction (Fig. 89–13). Most of the heat is lost via the skin, with radiation and convection resulting in the majority of the loss, far greater than evaporation on conductive losses.<sup>99</sup>

In unanesthetized patients, tonic thermoregulatory vasoconstriction maintains a significant core to peripheral temperature gradient. Induction of general anesthesia causes vasodilatation, which results in redistribution of heat from the core to the periphery. The result is a markedly decreased core temperature, but mean body temperature



**FIGURE 89–11.** Typical pattern of hypothermia during general anesthesia. Hypothermia during anesthesia follows a predictable pattern. During the first hour, core temperature usually decreases rapidly by about 1.8–2.7°F (1–1.5°C). This is followed by a slower, nearly linear decrease in core temperature. Eventually, core temperature reaches a plateau. Each phase of hypothermia development has a different cause.



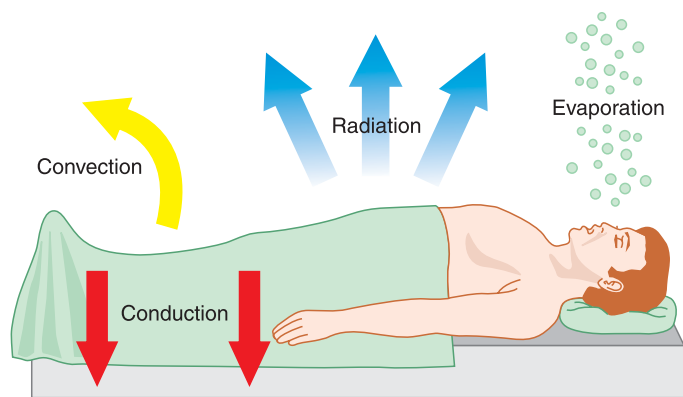
**FIGURE 89–12.** Changes in heat content and heat distribution in the body before and after the induction of general anesthesia. Hour zero denotes the induction of anesthesia in normal volunteers exposed to a typical operating room environment. The change in mean body temperature has been subtracted from the change in core temperature (tympenic membrane); the remainder represents the amount of core hypothermia specifically resulting from the redistribution of heat from the core to the periphery. Therefore, redistribution hypothermia is not a directly measured but instead is represented by the portion of the decrease in core temperature not attributable to the relatively small decrease in systemic heat content. After 1 hour of anesthesia, the core temperature had decreased by 2.9 ± 0.5°F (1.6 ± 0.3°C), with redistribution accounting for 81% of the decrease. Even after 3 hours of anesthesia, redistribution accounted for 65% of the entire decrease (5 ± 0.9°F [2.8 ± 0.5°C]) in core temperature.

and heat content remain unchanged (Fig. 89–14).<sup>133</sup> Although internal redistribution of heat is the major reason core body temperature decreases shortly after the induction of general anesthesia, several other factors also affect the patient's thermoregulatory balance. These factors include (a) decreased metabolic heat production under general anesthesia; (b) heat loss from the patient to the environment; and (c) the effects of anesthetic agents on thermoregulatory thresholds. Induction of anesthesia decreases metabolic heat production by approximately 20% by limiting muscular activity, reducing the metabolic rate, and diminishing the work of breathing.<sup>135,136</sup> Evaporation of surgical skin preparation solutions,<sup>137</sup> anesthetic-induced vasodilatation and impairment of central thermoregulatory control,<sup>133,138</sup> and cold operating room temperatures all increase cutaneous heat loss, although not enough to be the major cause of hypothermia during surgery.

Behavioral regulation is not relevant during general anesthesia, and shivering is frequently prevented because of muscle relaxants. Therefore, vasoconstriction is the major thermoregulatory response available to anesthetized, paralyzed, hypothermic adult patients. However, this response is profoundly affected by anesthetics. Clinically relevant doses of general anesthetics decrease the activation threshold (the temperature triggering a response) for hypothermia by 3.6–7.2°F (2–4°C).<sup>130,138,139</sup> Interestingly, activation thresholds for responses to hyperthermia are also affected, but to a lesser degree than those for hypothermia.<sup>100</sup> The result is an increase in the inter-threshold range with core temperature changes passively determined by redistribution of heat within the body combined with environmental heat loss.

The exact central temperature that triggers thermoregulatory vasoconstriction is both anesthetic agent and dose dependent and may vary depending on the age of the patient and the intensity of surgical stimulation. Patients who become sufficiently hypothermic during surgery eventually reach the vasoconstriction threshold and trigger the response. Once triggered, the gain and maximum intensity of the thermoregulatory response remains near normal.<sup>140–142</sup> Markedly altered thermoregulatory thresholds with preserved gain and maximal intensities characterize the effect of gen-





**FIGURE 89–13.** Mechanisms of heat loss. The linear second phase of the perioperative hypothermia curve results from heat loss exceeding metabolic heat production (approximately  $1 \text{ kcal}\cdot\text{kg}^{-1}\cdot\text{h}^{-1}$ ). During anesthesia heat loss is usually greater, with losses caused principally by radiation accounting for roughly 60% of the total. The remaining loss is largely convective, with respiratory evaporative loss contributing only approximately 10% of the total. Cutaneous evaporative loss is relatively small except during sweating, although evaporative loss from the surgical incisions can be substantial. Conductive loss is negligible during anesthesia.

eral anesthetics on the thermoregulatory system.<sup>143</sup>

### Regional Anesthesia and Thermoregulation

Regional anesthesia (in the form of spinal and epidural anesthesia) impairs thermoregulation via inhibition of both thermal afferents and efferents. As the usual thermoregulatory efferent responses are neuronally mediated, it is no surprise that central neuroaxial blockade would interfere with these responses (sweating, vasoconstriction, and shivering). Compounding these efferent abnormalities, blockade of thermoregulatory afferents results in the hypothalamic control centers incor-

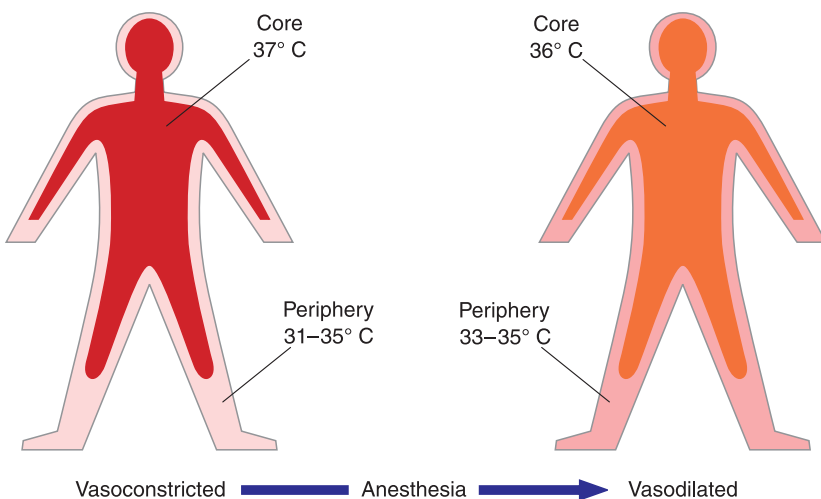
rectly interpreting peripheral temperature to be normal (or high).<sup>144,145</sup> This explains development of the warming sensation that patients report with the injection of neuroaxial local anesthetics.<sup>146</sup> Regional anesthesia affects the interthreshold range increasing it by 3–4 times its normal value. With the impairment in thermoregulatory efferents, the warm sensation reported by patients, and the general lack of temperature monitoring in the awake patient, hypothermia is common and frequently not detected in the patient who is undergoing regional anesthesia.

Traditionally, hypothermia during regional anesthesia was believed to primarily result from increased heat

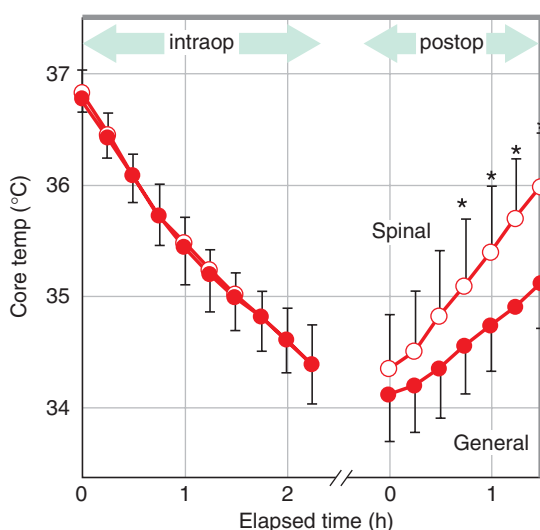
loss to the environment secondary to sympathetic blockade-induced vasodilatation. However, Hynson et al.<sup>147</sup> investigated the importance of different etiologic factors in causing hypothermia during epidural blockade. In healthy, nonpregnant, normal volunteers, core and skin temperature, heat loss, and  $\text{O}_2$  consumption were measured before and after epidural blockade to an approximate  $T_4$  level was induced. They found that during epidural anesthesia, skin temperature increased, core temperature decreased, and heat loss to the environment increased only slightly. Most subjects shivered during the epidural block, so heat production actually increased somewhat during the study. These data suggest that heat loss to the environment cannot account for the fall in core temperature seen during regional anesthesia. Indeed, the authors concluded that redistribution of heat within the body is the primary factor responsible for the development of central hypothermia during epidural blockade. A subsequent study by Glossten et al. confirmed this hypothesis.<sup>148</sup>

In summary, during regional anesthesia hypothermia occurs because (a) regional anesthetics depress regional thermal afferent input and efferent responses, such as vasoconstriction and shivering; (b) patients lose some heat to the operating room environment; but most importantly, (c) redistribution of heat within the body occurs.<sup>149,150</sup> Interestingly, rewarming from hypothermia can be accelerated in the patient with residual spinal anesthesia (if using active heating modalities) because of the relatively vasodilated state of the patient (Fig. 89–15).<sup>151</sup>

Hypothermia during regional anesthesia is often accompanied by tremor. The incidence of this shivering during regional anesthesia has been reported in up to 70% of patients.<sup>152</sup> There is some variability in clinical studies that demonstrate a consistent relationship between core temperature and shivering during major regional anesthesia, raising the question of whether this response is thermoregulatory or of some other etiology. As a result, shivering that occurs with regional anesthesia should be prevented if normothermia is maintained, although this is not always the case.<sup>153</sup> Cutaneous warming of patients for 2 hours prior to inducing epidural anesthesia can help in preventing hypo-



**FIGURE 89–14.** Cartoon showing redistribution hypothermia after induction of general anesthesia. Tonic thermoregulatory vasoconstriction usually maintains a core-to-peripheral temperature gradient. With the induction of general anesthesia, this vasoconstriction is inhibited, allowing a core-to-peripheral redistribution of body heat.



**FIGURE 89-15.** Residual spinal anesthesia can increase postoperative core rewarming as demonstrated in this study of intraoperative and postoperative core temperatures in patients assigned to general anesthesia ( $n = 20$ ) and spinal anesthesia ( $n = 20$ ). All patients were actively warmed during the postoperative period. Core temperature did not differ significantly during surgery but increased significantly faster postoperatively in patients given spinal anesthesia:  $2.2 \pm 0.2^\circ\text{F}$  ( $1.2 \pm 0.1^\circ\text{C}/\text{h}$ ) versus  $1.3 \pm 0.4^\circ\text{F}$  ( $0.7 \pm 0.2^\circ\text{C}/\text{h}$ ). Data are presented as mean  $\pm$  standard deviation (SD).

thermia and prevents shivering.<sup>148</sup> Pharmacologic treatment used to treat shivering in patients recovering from general anesthesia can also be used in regional anesthesia patients.

The tremor seen in pregnant patients who are undergoing regional anesthesia may have a different etiology. A number of studies show an increased incidence of shivering in pregnant patients when cold solution is injected epidurally.<sup>154,155</sup> This response is not seen in nonpregnant volunteers or patients, suggesting that thermosensitive tissue within the spinal canal contributes to the shivering observed with epidural anesthesia in parturients.<sup>152</sup>

### Postanesthesia Shivering

In the anesthetized patient, it is unusual to reach temperatures where shivering is induced. However, in the postanesthesia period, shivering is common and has been reported to occur in up to 40% of patients.<sup>156,157</sup> This common perioperative problem is both uncomfortable for the patient and problematic for the caregiver, but more importantly, may also increase perioperative morbidity. In addition to cold sensations that accompany shivering, postanesthesia tremor itself can lead to an increase in perioperative pain by stretching within surgical incisions. It can also lead to increases in intracranial and intraocular pressure,

in addition to its increases in metabolic demand.<sup>121,158-160</sup>

The etiology of this troublesome perioperative occurrence has been debated considerably.<sup>112</sup> General agreement suggests that the most likely explanation for this postanesthesia tremor relates to an abrupt change in anesthetic-induced thermoregulatory inhibition, thus increasing the threshold for shivering toward normal. That is, the residual low body temperature resulting from the dysregulation of thermoregulation by the anesthetic state itself, and upon discontinuation of anesthetics, is usually well below the near-normal threshold to activate thermoregulatory shivering.<sup>161,162</sup>

Despite this normal thermoregulatory response to intraoperative heat loss, there are alternative explanations for postanesthesia shivering that may partly explain some unusual observations. For example, postanesthesia shivering does not universally occur in the markedly hypothermic patient,<sup>163</sup> and shivering frequently occurs in normothermic postanesthesia patients.<sup>161</sup> As a result, there may be some other mitigating factors that influence whether or not one shivers after anesthesia. It has been suggested that surgery itself, as a consequence of the stress response or associated pain, can contribute to postoperative tremor.<sup>164</sup> For example, the surgical stress itself may abnormally increase the ther-

moregulatory setpoint.<sup>165</sup> There is also evidence that residual volatile anesthetics (e.g., isoflurane) may also cause a nonthermoregulatory shivering pattern.<sup>147,166</sup> The exact mechanism by which anesthesia may interact directly in causing the shivering pattern is unknown. However, the tremor pattern that is observed at low concentrations of isoflurane (0.2–0.4%) is very similar to the electromyographic pattern that is seen after spinal cord transection, suggesting that the isoflurane may cause some inhibition of spinal cord reflexes resulting in this troublesome tremor.<sup>167</sup>

Postanesthetic shivering can be prevented in most patients by maintaining normothermia. Skin-surface warming may be effective therapy.<sup>168</sup> Pharmacologic treatments include meperidine (25 mg IV),<sup>168-170</sup> clonidine (75  $\mu\text{g}$  IV),<sup>171,171</sup> and ketanserin (10 mg IV).<sup>172-174</sup> Most recently, dexmedetomidine has also been used.<sup>169,175,176</sup> The exact mechanism(s) by which these drugs abolish shivering is not completely understood, but the meperidine effect may be mediated via kappa opioid receptors.<sup>176</sup>

### Complications of Hypothermia

Perioperative hypothermia is associated with a number of adverse consequences (Table 89-5). Although the mechanism linking hypothermia to these events is known for some, it is unclear for others. For example, although myocardial ischemia is a serious postoperative problem, and postoperative shivering can adversely affect oxygen consumption (increasing it by 200–400%),<sup>101,105</sup> there is little actual data linking shivering to the occurrence of ischemic events.<sup>113,118,119</sup> Despite this, there is a strong link in high-risk patients between mild postopera-

**TABLE 89-5.**

#### Strategies to Prevent and Treat Perioperative Hypothermia

Prewarming patient
Increase ambient operating room temperature
Skin insulation (cover patient)
Heating and humidification of inspired gases
Warm preparation solutions
Fluid warmers
Connective forced-air warmers
Circulating water-heating devices

tive hypothermia (1.8–5.4°F [1–3°C]) and overall adverse myocardial outcomes.<sup>119</sup> The mechanism by which this hypothermia leads to these adverse events is not clear, however. Potential mechanisms for the adverse myocardial events (other than shivering) include cold-induced hypertension.<sup>121</sup> The increase in circulating catecholamines accompanying this hypertension can augment cardiac irritability and lead to ventricular arrhythmias.<sup>120</sup>

Although long considered to be a factor in increasing perioperative blood loss, the effects of mild hypothermia in studies designed to examine blood loss and transfusion have produced variable results. Schmied et al. showed that just 2.9°F (1.6°C) of hypothermia increased blood loss by 30%, which in this study of hip surgery, amounted to 500 mL.<sup>178</sup> Overall, the data suggests that there is an increase in both blood loss and transfusion requirements,<sup>178</sup> although there are certainly other studies discounting this association.<sup>179</sup> In a study by Nathan et al., much greater degrees of postoperative hypothermia (6.3°F [3.5°C]) have not consistently been shown to have a significant impact on bleeding.<sup>180</sup> Despite these conflicting results, there are clearly some effects on platelet function and clotting factor function, as well as fibrinolytic activity induced by mild degrees of hypothermia. For example, Valeri et al. demonstrated that platelet function can be impaired by mild degrees of perioperative hypothermia.<sup>181</sup> This has subsequently been demonstrated by others to be potentially related to a defect in the release of thromboxane A<sub>2</sub>.<sup>182–184</sup> The effects of hypothermia on *in vivo* clotting factor function is not clear (because most laboratory tests are performed at 98.6°F [37°C]), although most *in vitro* clotting tests, if performed at hypothermic temperatures, will show some impairment. There is little data outlining the effects of hypothermia on the fibrinolytic response. Paradoxically, one can theorize that fibrinolysis may actually be inhibited by mild hypothermia (thus decreasing bleeding) because of the temperature-related impairment of the enzyme responsible for the conversion of plasminogen to plasmin, which is fundamental to the fibrinolytic process.

Infection is one of the most serious consequences of hypothermia. Trials investigating warming interventions to treat postoperative hypothermia

have been successful in reducing postoperative wound infection. A pivotal trial by Kurz et al. investigated 200 patients who were undergoing gastrointestinal surgery assigning them to either conventional treatment (hypothermia group) or additional warming (normothermia group).<sup>185</sup> The normothermia group had significantly fewer wound infections (6%) compared to the hypothermia group (19%), and also had evidence for improved wound healing and shorter hospitalization.<sup>185</sup> The mechanisms behind these adverse affects of hypothermia on perioperative wound infection and healing are likely related to the vasoconstriction induced by the thermoregulatory responses<sup>130,186</sup> that lead to decrease subcutaneous oxygen tension (tissue hypoxia),<sup>187</sup> as well as direct hypothermia mediated impairments in immune function.<sup>188–191</sup> In addition to the direct immune function impairment, the reduced oxygen tension in subcutaneous tissues also impairs wound healing. Duration of hospitalization, although clearly made worse by postoperative wound infection, also has been shown to be prolonged in hypothermic patients irrespective of the occurrence of any infection.<sup>185</sup> The mechanism behind this noninfection-related prolongation in hospitalization is not clear, but is certainly consistent with evidence of impaired wound healing or potential metabolic disturbances such as protein wasting.<sup>192</sup>

Although not necessarily a complication of hypothermia, there are several pharmacokinetic and pharmacodynamic effects of hypothermia that are relevant to anesthesia. For example, hypothermia has a significant impact on the duration of action of muscle relaxants. This is thought principally to be related to a pharmacokinetic effect (as opposed to a pharmacodynamic effect), although there is some evidence for a direct hypothermia effect on skeletal muscle responsiveness.<sup>193–195</sup> Another direct pharmacodynamic effect of hypothermia is its impact on minimal alveolar concentration. There is approximately a 5% reduction in minimal alveolar concentration per degree in core body temperature.<sup>196</sup> This can most dramatically be seen in the cardiac surgical patient undergoing hypothermic circulatory arrest where, as the temperature drops to more moderate to severe ranges (68°F [20°C]), significant changes (slowing) can be

seen in the electroencephalogram, with the bispectral index significantly decreasing, which is consistent with a significant reduction in the requirement of inhaled or intravenous anesthetics. The principal hypothermic effects on intravenous anesthetics relate to changes in their pharmacokinetic profile with alterations in clearance from central and peripheral compartments. Some of these pharmacokinetic and pharmacodynamic effects may partly explain the prolonged recovery profiles in hypothermic patients in the postanesthesia period.<sup>197</sup>

Relatively minor (in terms of serious consequences) complications include thermal discomfort<sup>198</sup> and mild hypothermia-induced hypokalemia.<sup>199,200</sup> Lastly, monitoring the hypothermic patient can be a problem at times because shivering may lead to artifacts in electrocardiogram monitoring, as well as to vasoconstriction-induced reductions in cutaneous blood flow that impair pulse oximetry measurements.<sup>201</sup>

### Prevention and Treatment of Perioperative Hypothermia

A number of strategies have been used to prevent and treat hypothermia (see Table 89–5). Most therapies target the linear phase of the hypothermic curve where heat is lost cutaneously. As a result, these modalities attempt to either minimize this cutaneous heat loss or deliver heat via skin-mediated mechanisms. However, as redistribution from the core to the periphery results in the initial and sharpest drop in temperature, minimizing the redistributive decrease in temperature should also be addressed.

Prewarming the patient prior to induction of either general or regional anesthesia has been successful,<sup>148,202</sup> but because of logistical and other time constraints, not as frequently practiced as it could be. It works through reducing the core–peripheral temperature gradient and also, in part, by increasing the overall body heat content. As a result of this reduced core–peripheral temperature gradient, there is less redistribution-mediated decrease in temperature with the onset of a much-reduced anesthetic vasodilatation.

Increasing ambient operating room temperature is an effective method of preventing heat loss in surgical patients; it is most effective if the operating room temperature is increased to at least 75.2°F (24°C). This modality also

relies on reducing the gradient between the body and the ambient environment, decreasing the heat that is lost across this gradient. However, this temperature is generally considered to be too warm for the comfort of others in the operating room.<sup>108</sup> Relying solely on this modality will not be effective in maintaining normothermia.

Insulation of the skin reduces heat loss by approximately 30%, principally by reducing radiation losses.<sup>98</sup> Blankets, however, work principally via the insulating layer of air trapped between the skin and the external environment such that regardless of whether covers are heated or not, they are equally effective. Heat loss is directly proportional to surface area. As a result, no skin surface is either more or less likely to lose heat. The head, for example, frequently thought to lose more heat than other parts of the body, does not do so any more than its 10% surface area would predict.<sup>98</sup> Radiant heaters have also been used, but have little use except in situations where skin contact is limited, such as in the neonate.

Heating and humidification of inspired gases address the <10% of metabolic heat that can be lost from the respiratory tract.<sup>203</sup> Although heating and humidifying inspired gases can prevent all of this heat loss, it has a negligible effect on core temperature.<sup>134</sup> Inspired gases can be passively warmed and humidified by artificial devices to a similar degree as that induced by the nasopharynx. Although these types of devices are good at maintaining humidity and minimizing heat loss, such devices cannot deliver significant heat.<sup>203,204</sup> However, they do have other advantages, including reducing the drying of pulmonary secretions.

Heated mattresses that usually circulate warmed water (104–105.8 °F [40–41 °C]) have not been shown to be effective in the prevention or treatment of hypothermia. When placed under the patient, they make poor contact with the body surface. In addition, very little heat is lost via the posterior body surface because of the relatively good insulation provided by foam operating table surfaces. It is the anterior surface of the body that loses 90% of the body heat.<sup>134</sup> In addition, these devices have significant limitations related to safety. As a result of body pressure points (with subsequent poor circulation) being unable to dissi-

pate heat, they can increase the risks of burns to the skin.<sup>134</sup> Other non-water-heated mattresses would be expected to have similar limitations and poor efficiency.

Forced-air warming systems are one of the most effective active warming systems.<sup>205,206</sup> Lennon et al. compared the efficiency of a forced-air heating system to only covering patients with cotton blankets warmed to 98.6 °F (37 °C).<sup>207</sup> After activation of the forced-air heating system, patients were warmer at all time intervals. Numerous other studies have evaluated forced-air systems and found them to maintain normothermia, even during prolonged and extensive procedures.<sup>134,198,199</sup> Forced-air warming systems work via two principal mechanisms. First, they reduce radiant heat loss (by increasing the temperature of the surfaces surrounding the patient), and second, they increase heat gain via convection. As this modality of warming has grown in acceptance and wide-scale use, multiple devices have been brought to market. Although the various systems differ in their full capabilities, in the hypothermic patient, all convective forced-air warming systems provide excellent warming.<sup>208</sup>

Despite the failure of conventional heated water mattresses to efficiently warm patients, a new generation of circulating-water heating systems are now available (such as the Kimberly Clark Patient Warming System, Kimberly Clark, Roswell, GA; and Allon MTRE 3365, MTRE Advanced Technologies, Akiva, Israel). These devices differ from their predecessors by employing significantly better skin contact that optimizes conduction of heat to the skin. They have been trialed in cardiac surgery using both on- and off-pump procedures, and have demonstrated considerable efficiency.<sup>198,200,209,210</sup> They have significant advantages by heating the posterior body that is otherwise inaccessible in the supine patient. In addition, these devices excel in operations where there is large skin exposure (such as cardiac surgery) and forced-air warmers have limited skin surface contact.

When rapid infusion of large volumes of either cold IV fluids or blood products is required, significant hypothermia can result. For example, 1 unit of refrigerated blood, or 1 L of room-temperature crystalloid, can decrease core temperature in adults by approximately 0.45 °F (0.25 °C).<sup>211</sup> Fluid warm-

ers are effective methods to warm both blood products and other IV fluids prior to administration. Although fluid warming can reduce the degree of hypothermia, it cannot add any significant heat to patients. Warming skin preparation solutions and irrigation fluids can also help prevent evaporative heat loss.

Intravascular warming with invasive intravascular catheters has also been used to warm patients, but also, in an opposite thermodynamic fashion, to intentionally cool patients. These systems are not widely available or extensively used, and are limited by the technical need for large-bore (up to 14 French or more) vascular cannulation with all its associated risks.<sup>212–214</sup> Their role in perioperative hypothermia treatment has not been directly examined.

### Potential Advantages of Hypothermia: Neuroprotection

Although much of the previous discussion has outlined the spectrum of disadvantages of perioperative hypothermia, providing extensive reasons why it should be avoided at all costs, there are situations where catastrophic consequences would result without its use. This is nowhere more apparent than in the setting of the ischemic brain. A classic example of this is when deep hypothermia is used to protect the brain during circulatory arrest for surgery on the aorta<sup>215,216</sup> or cerebral aneurysms.<sup>217</sup> In these situations, the circulation to the brain and the rest of the body organs can be stopped for up to an hour without any significant long-term effect. This period of “suspended animation” makes possible lifesaving procedures that would have been impossible otherwise. This is not dissimilar to some of the anecdotal reports of accidental near drowning whereby cold-water immersion and the ensuing hypothermia that has followed has allowed for dramatic survival despite long periods without oxygen.

Although these extremes of temperature are clearly protective in that type of surgery, lesser degrees of hypothermia in other settings, such as cardiac surgery, are less obviously protective.<sup>201,218–220</sup> and are also tightly linked to optimizing how rewarming is performed.<sup>221</sup> Interestingly, cardiac surgery is rather unique in its consideration of temperature. In addition to its use of hypothermic benefits, it is



also a setting that has had little evaluation and description of hypothermic complications. Indeed, most of the studies outlining the adverse effects of hypothermia in the perioperative patient have not been performed in the setting of cardiac surgery. Therefore, extrapolating all the potential adverse effects to cardiac surgical patients would be erroneous. However, common sense dictates that some of the effects of temperature (possibly the effects of wound healing, infection, and coagulopathy) would also apply to the cardiac surgery patient.

The salutary effects of hypothermia on the brain are a result of the numerous enzymatic and metabolic pathways modulated by temperature. In addition to depressing cerebral metabolism (approximately a 6–7% decline per °C),<sup>222</sup> its other putative neuroprotective effects of hypothermia are likely mediated by non-metabolic pathways. In the ischemic brain, moderate hypothermia blocks the release of glutamate,<sup>223</sup> reduces calcium influx,<sup>224</sup> hastens recovery of protein synthesis,<sup>225</sup> diminishes membrane-bound protein kinase C activity,<sup>226</sup> can slow the time of onset of depolarization,<sup>227</sup> suppresses nitric oxide synthase activity,<sup>228</sup> and reduces the formation of reactive oxygen species.<sup>229</sup> Protection from hypothermia likely results from a summation of all these mechanisms. Although experimental demonstrations of the neuroprotective benefits of hypothermia have been well characterized for decades,<sup>230–233</sup> it is only recently that clinical examples of its benefits have been described.<sup>234–237</sup>

Outside the surgical setting, hypothermia has been evaluated as a direct neuroprotective strategy. In patients who were undergoing cardiac arrest, two large, well-controlled trials demonstrated that comatose survivors of out-of-hospital cardiac arrest significantly benefitted from prolonged (>24 hours) periods of postarrest-induced hypothermia. Bernard et al. studied 77 patients following witnessed cardiac arrest who, within 2 hours of return of spontaneous circulation, were reduced to a core body temperature of 91.4°F (33°C) for 12 hours.<sup>234</sup> Both the number of patients surviving as well as those having either minimal or moderate disability were significantly greater in the hypothermic group. In a similar, larger, multicenter trial of 275 patients, induced hypothermia (89.6–93.2°F [32–34°C]) for a period of 24 hours was

associated with an increased number of patients with favorable neurologic outcomes, as well as a significant reduction in 6-month mortality.<sup>235</sup>

Subsequent to these two studies, guidelines were instituted recommending the use of therapeutic hypothermia after cardiac arrest as part of an overall resuscitation strategy.<sup>238</sup> Although there were few adverse affects reported in these studies, some interesting trends emerged that support some of the perioperative hypothermia studies that highlight the complications of hypothermia. For example, in the large, multicenter trial,<sup>238</sup> there were trends toward an increase in bleeding as well as pneumonia and sepsis, although the study was insufficiently powered to look at these complications. In general, however, for the nonsurgical patient who is suffering cardiac arrest, the weight of the evidence suggests that there is a significant advantage to the induction of a period of post-cardiac arrest hypothermia.

Mild to moderate hypothermia has also been investigated as a neuroprotective strategy in setting of neonatal hypoxic-ischemic encephalopathy.<sup>239</sup> Although hypothermia had been demonstrated to be protective against brain injury in animal models of asphyxia, only recently was it evaluated in humans. In a well-conducted, randomized, multicenter trial of 238 infants who presented with perinatal asphyxia, hypothermia (92.3°F [33.5°C]) was instituted within 6 hours of birth and maintained for 72 hours, followed by slow rewarming. Neurodevelopmental outcomes were assessed at 18–22 months of age. Whole-body hypothermia was shown to reduce the combined end point of death or moderate/severe disability compared to conventional therapy (maintaining these patients at a normothermic temperature). Importantly, the hypothermia did not increase severe disability in the survivors, a clinical situation that would be clearly disadvantageous. The wide-scale application of hypothermic therapy in these subsets (cardiac arrest and neonatal hypoxia) is only just beginning.

Considerable caution and balance should always be used when employing these clinical applications of hypothermia. Extrapolating these two beneficial situations to other surgical settings of potential brain injury has at yet, no foundation. Although there is a wealth of beneficial experimental studies outlining both the mechanism

and the degree to which hypothermia can protect the brain, other clinical applications apart from those discussed above have been lacking. Most recently, hypothermia has been explored in patients who were undergoing cerebral aneurysm clipping, clearly a setting where the brain is at risk of ischemia. However, in a trial of 100 patients by Todd et al.,<sup>237</sup> there was no benefit to the use of mild degrees (91.4°F [33°C]) of hypothermia induced intraoperatively using convective forced-air devices for cooling. Again, some cautious findings were also identified, including a higher incidence of bacteremia in the hypothermic group.

Overall, one's enthusiasm for doing everything to reduce hypothermia must be tempered with the realization that there are likely situations where hypothermia can have a benefit. As in many areas of medicine, there is clearly no right or wrong answer, only a balance of risk *versus* benefit.

## RESOURCES

### Hyperthermia

The North American MH Registry (NAMHR) was established to collect and disseminate information regarding MH and the families involved. A chart review is eliminated if the patient or family member in question has been evaluated and entered into the registry by one of the MH diagnostic centers. If the patient is not registered, a chart review of the initial episode is necessary to rule out alternative explanations for the episode (see Box 89–4). If the diagnosis is still in question, contact MHAUS for the nearest MH diagnostic center available for consultation. Even if the diagnosis is inconsistent with MH, provide documentation and counseling to the family regarding the findings; this helps to eliminate confusion for the family and their future health-care providers.

Public education and communication are provided by a layman's organization, the Malignant Hyperthermia Association of the United States (MHAUS, 11 E. State Street, P.O. Box 1069, Sherburne, NY 13460–1069; telephone: 1-607-674-7901; fax: 1-607-674-7910; website: [www.mhaus.org](http://www.mhaus.org)) and by a medical professional's 24-hour, 7-day telephone service for emergency consultation, the MH Hotline (1-800-MH-

HYPER [1-800-644-9737]). The professional subsidiary of MHAUS, the North American MH Registry (NAMHR), collates findings from biopsy centers in Canada and the United States and provides access to specific patient data through the Hotline or its Director, Dr. Barbara Brandom (North American MH Registry of MHAUS, Room 7449, Department of Anesthesiology, Children's Hospital, University of Pittsburgh, 3705 Fifth Avenue at Desoto St., Pittsburgh, PA 15213-2583; telephone: 1-888-274-7899; fax: 1-412-692-8658; bwb@pitt.edu).

## KEY REFERENCES

### Hyperthermia

- Hopkins PM. Malignant hyperthermia: advances in clinical management and diagnosis. *Br J Anaesth* 2000;85:118-128.
- Denborough MA, Lovell RR. Anesthesia deaths in a family. *Lancet* 1960;2.
- Kalow W, Britt BA, Terreau ME, Haist C. Metabolic error of muscle metabolism after recovery from malignant hyperthermia. *Lancet* 1970;2:895-898.
- Mickelson JR, Louis CF. Malignant hyperthermia: excitation-contraction coupling,  $Ca^{2+}$  release channel, and cell  $Ca^{2+}$  regulation defects. *Physiol Rev* 1996;76:537-592.
- MacLennan DH, Duff C, Zorzato F, et al. Ryanodine receptor gene is a candidate for predisposition to malignant hyperthermia. *Nature* 1990;343:559-561.
- McCarthy TV, Healy JM, Heffron JJ, Lehane M, Deufel T, Lehmann-Horn F, Farrall M, Johnson K. Localization of the malignant hyperthermia susceptibility locus to human chromosome 19q12-13.2. *Nature* 1990;343:562-564.
- Klingler W, Lehmann-Horn F, Jurkat-Rott K. Complications of anesthesia in neuromuscular disorders. *Neuromuscul Disord* 2005;15:195-206.
- Meissner G. Regulation of mammalian ryanodine receptors. *Front Biosci* 2002;7:d2072-d2080.
- Torp K, Brandom B, Capacchione J, Voelkel M, Muldoon S. Caffeine

halothane contracture test and ryanodine receptor type 1 analysis in patients who experienced MH episodes. *Anesthesiology* 2005;103:A1273.

- Rosenberg H, Antognini JF, Muldoon S. Testing for malignant hyperthermia. *Anesthesiology* 2002;96:232-237.

### Hypothermia

- Sessler DI. Complications and treatment of mild hypothermia. *Anesthesiology* 2001;95:531-543.
- Sessler DI. Mild perioperative hypothermia. *N Engl J Med* 1997;336:1730-1737.
- Sessler DI. Perioperative heat balance. *Anesthesiology* 2000;92:578-596.
- De Witte J, Sessler DI. Perioperative shivering: physiology and pharmacology. *Anesthesiology* 2002;96:467-484.
- Mild therapeutic hypothermia[AU:18] to improve the neurologic outcome after cardiac arrest. *N Engl J Med* 2002;346:549-556.
- Shankaran S, Laptook AR, Ehrenkranz RA, et al. Whole-body hypothermia for neonates with hypoxic-ischemic encephalopathy. *N Engl J Med* 2005;353:1574-1584.

## REFERENCES

- Gronert G, Pessah IN, Muldoon S, Tautz T. Malignant hyperthermia. In: Miller R, ed. *Miller's Anesthesia*. Philadelphia: Churchill Livingstone, 2005:1169-1190.
- Hopkins PM. Malignant hyperthermia: advances in clinical management and diagnosis. *Br J Anaesth* 2000;85:118-128.
- Nelson TE. Malignant hyperthermia: a pharmacogenetic disease of  $Ca^{++}$  regulating proteins. *Curr Mol Med* 2002;2:347-369.
- Fujii J, Otsu K, Zorzato F, et al. Identification of a mutation in porcine ryanodine receptor associated with malignant hyperthermia. *Science* 1991;253:448-451.
- Denborough MA, Lovell RR. Anesthesia deaths in a family. *Lancet* 1960:2.
- Denborough MA, Forster JF, Lovell RR, Maplestone PA, Villiers JD. Anaesthetic deaths in a family. *Br J Anaesth* 1962;34:395-396.
- Britt BA, Locher WG, Kalow W. Hereditary aspects of malignant hyperthermia. *Can Anaesth Soc J* 1968;16:89-98.
- Kalow W, Britt BA, Terreau ME, Haist C. Metabolic error of muscle metabolism after recovery from malignant hyperthermia. *Lancet* 1970;2:895-898.
- Mickelson JR, Louis CF. Malignant hyperthermia: excitation-contraction coupling,  $Ca^{2+}$  release channel, and cell  $Ca^{2+}$  regulation defects. *Physiol Rev* 1996;76:537-592.
- Ellis FR, Harriman DG, Keaney NP, Kyei-Mensah K, Tyrrell JH. Halothane-induced muscle contracture as a cause of hyperpyrexia. *Br J Anaesth* 1971;43:721-722.
- Harrison GG. Control of the malignant hyperpyrexia syndrome in MHS swine by dantrolene sodium. *Br J Anaesth* 1975;47:62-65.
- MacLennan DH, Duff C, Zorzato F, et al. Ryanodine receptor gene is a candidate for predisposition to malignant hyperthermia. *Nature* 1990;343:559-561.
- McCarthy TV, Healy JM, Heffron JJ, Lehane M, Deufel T, Lehmann-Horn F, Farrall M, Johnson K. Localization of the malignant hyperthermia susceptibility locus to human chromosome 19q12-13.2. *Nature* 1990;343:562-564.
- Chelu MG, Goonasekera SA, Durham WJ, et al. Heat- and anesthesia-induced malignant hyperthermia in an RyR1, knock-in mouse. *FASEB J* 2006;20:329-330.
- Britt BA, Kalow W. Malignant hyperthermia: a statistical review. *Can Anaesth Soc J* 1970;17:293-315.
- Ording H. Incidence of malignant hyperthermia in Denmark. *Anesth Analg* 1985;64:700-704.
- Ording H, Bendixen D. The incidence of malignant hyperthermia in Denmark. In: Morio M, Kikuchi H, Yuge O, eds. *Malignant Hyperthermia: Proceedings of the 3rd International Symposium on Malignant Hyperthermia* 1994. New York: Springer, 1996:21-24.
- Hoeneemann CW, Halene-Holtgraev TB, Booke M, et al. Delayed onset of malignant hyperthermia in desflurane anesthesia. *Anesth Analg* 2003;96:165-167.
- Johnson IA, Andrzejowski JC, Currie JS. Lower limb compartment syndrome resulting from malignant hyperthermia. *Anaesth Intensive Care* 1999;27:292-294.
- Karan SM, Crowl F, Muldoon SM. Malignant hyperthermia masked by capnographic monitoring. *Anesth Analg* 1994;78:590-592.
- Short JA, Cooper CM. Suspected recurrence of malignant hyperthermia after post-extubation shivering in the intensive care unit 18 h after tonsillectomy. *Br J Anaesth* 1999;82:945-947.
- Ryan JF, Lopez JR, Sanchez VB, Sreter FA, Allen PD. Myoplasmic calcium changes precede metabolic and clinical signs of porcine malignant hyperthermia. *Anesth Analg* 1994;79:1007-1011.
- Bunger R. Thermodynamic state of cytosolic adenylates in guinea pig myocardium. Energy-linked adaptive changes in free

- adenylates and purine nucleoside release. In: Gerlach E, Becker BF, eds. *Topics and Perspectives in Adenosine Research*. Berlin: Springer Verlag, 1987:223-235.
24. Paul-Pletzer K, Yamamoto T, Bhat MB, et al. Identification of a dantrolene-binding sequence on the skeletal muscle ryanodine receptor. *J Biol Chem* 2002;277:34918-34923.
25. Mochizuki S, Neely JR. Control of glyceraldehyde-3-phosphate dehydrogenase in cardiac muscle. *J Mol Cell Cardiol* 1979;11:221-236.
26. Bunger R, Mallet RT, Hartman DA. Pyruvate-enhanced phosphorylation potential and inotropism in normoxic and postischemic isolated working heart. Near-complete prevention of reperfusion contractile failure. *Eur J Biochem* 1989;180:221-233.
27. Veech RL, Lawson JW, Cornell NW, Krebs HA. Cytosolic phosphorylation potential. *J Biol Chem* 1979;254:6538-6547.
28. Bouchama A, Knochel JP. Heat stroke. *N Engl J Med* 2002;346:1978-1988.
29. Allen GC. Masseter muscle rigidity. In: Schulte Am Esch J, Scholz J, Wappler F, eds. *Malignant Hyperthermia*. Berlin: Pabst Science, 2000:37-45.
30. Van der Spek AF, Fang WB, Ashton-Miller JA, Stöhler CS, Carlson DS, Schork MA. The effects of succinylcholine on mouth opening. *Anesthesiology* 1987;67:459-465.
31. Kaplan R. Malignant hyperthermia susceptibility. *Anesth Clin North Amer* 1994;12:537-551.
32. Lehmann-Horn F. Neuromuscular disorders and malignant hyperthermia. In: Morio M, Kikuchi H, Yuge O, eds. *Malignant Hyperthermia: Proceedings of the 3rd International Symposium on Malignant Hyperthermia 1994*. New York: Springer, 1996:203-210.
33. Gronert GA, Thompson RL, Onofrio BM. Human malignant hyperthermia: awake episodes and correction by dantrolene. *Anesth Analg* 1980;59:377-378.
34. Davis M, Brown R, Dickson A, et al. Malignant hyperthermia associated with exercise-induced rhabdomyolysis or congenital abnormalities and a novel RYR1 mutation in New Zealand and Australian pedigrees. *Br J Anaesth* 2002;88:508-515.
35. Hopkins PM, Ellis FR, Halsall PJ. Evidence for related myopathies in exertional heat stroke and malignant hyperthermia. *Lancet* 1991;338:1491-1492.
36. Kochling A, Wappler F, Winkler G, Schulte Am Esch JS. Rhabdomyolysis following severe physical exercise in a patient with predisposition to malignant hyperthermia. *Anaesth Intensive Care* 1998;26:315-318.
37. Kozack JK, MacIntyre DL. A survey of chronic muscle pain and other symptoms in malignant hyperthermia susceptible individuals. *Anesthesiology* 2002;97:A1204.
38. Tobin JR, Jason DR, Challa VR, Nelson TE, Sambuughin N. Malignant hyperthermia and apparent heat stroke. *JAMA* 2001;286:168-169.
39. Wappler F, Fiege M, Steinfath M, et al. Evidence for susceptibility to malignant hyperthermia in patients with exercise-induced rhabdomyolysis. *Anesthesiology* 2001;94:95-100.
40. Muldoon S, Deuster P, Brandom B, Bunger R. Is there a link between malignant hyperthermia and exertional heat illness? *Exerc Sport Sci Rev* 2004;32:174-179.
41. Wu S, Ibarra MC, Malicdan MC, et al. Central core disease is due to RYR1 mutations in more than 90% of patients. *Brain* 2006;129:1470-1480.
42. Robinson R, Carpenter D, Shaw MA, Halsall J, Hopkins P. Mutations in RYR1 in malignant hyperthermia and central core disease. *Hum Mutat* 2006;27:977-989.
43. Davis MR, Haan E, Jungbluth H, et al. Principal mutation hotspot for central core disease and related myopathies in the C-terminal transmembrane region of the RYR1 gene. *Neuromuscul Disord* 2003;13:151-157.
44. McCarthy TV, Quane KA, Lynch PJ. Ryanodine receptor mutations in malignant hyperthermia and central core disease. *Hum Mutat* 2000;15:410-417.
45. Monnier N, Romero NB, Lerale J, et al. Familial and sporadic forms of central core disease are associated with mutations in the C-terminal domain of the skeletal muscle ryanodine receptor. *Hum Mol Genet* 2001;10:2581-2592.
46. Tilgen N, Zorzato F, Halliger-Keller B, et al. Identification of four novel mutations in the C-terminal membrane spanning domain of the ryanodine receptor 1: association with central core disease and alteration of calcium homeostasis. *Hum Mol Genet* 2001;10:2879-2887.
47. Quane KA, Healy JM, Keating KE, et al. Mutations in the ryanodine receptor gene in central core disease and malignant hyperthermia. *Nat Genet* 1993;5:51-55.
48. Avila G. Intracellular Ca<sup>2+</sup> dynamics in malignant hyperthermia and central core disease: established concepts, new cellular mechanisms involved. *Cell Calcium* 2005;37:121-127.
49. Monnier N, Ferreira A, Marty I, Labarre-Vila A, Mezin P, Lunardi J. A homozygous splicing mutation causing a depletion of skeletal muscle RYR1 is associated with multi-minicore disease congenital myopathy with ophthalmoplegia. *Hum Mol Genet* 2003;12:1171-1178.
50. Scacheri PC, Hoffman EP, Fratkin JD, et al. A novel ryanodine receptor gene mutation causing both cores and rods in congenital myopathy. *Neurology* 2000;55:1689-1696.
51. Graham GE, Silver K, Arlet V, Der Kaloustian VM. King syndrome: further clinical variability and review of the literature. *Am J Med Genet* 1998;78:254-259.
52. Larach MG, Rosenberg H, Gronert GA, Allen GC. Hyperkalemic cardiac arrest during anesthesia in infants and children with occult myopathies. *Clin Pediatr (Phila)* 1997;36:9-16.
53. Klingler W, Lehmann-Horn F, Jurkat-Rott K. Complications of anaesthesia in neuromuscular disorders. *Neuromuscul Disord* 2005;15:195-206.
54. Jurkat-Rott K, McCarthy T, Lehmann-Horn F. Genetics and pathogenesis of malignant hyperthermia. *Muscle Nerve* 2000;23:4-17.
55. Ohnishi ST, Taylor S, Gronert GA. Calcium-induced Ca<sup>2+</sup> release from sarcoplasmic reticulum of pigs susceptible to malignant hyperthermia. The effects of halothane and dantrolene. *FEBS Lett* 1983;161:103-107.
56. Nelson TE. SR function in malignant hyperthermia. *Cell Calcium* 1988;9:257-265.
57. Dulhunty AF, Haarmann CS, Green D, Laver DR, Board PG, Casarotto MG. Interactions between dihydropyridine receptors and ryanodine receptors in striated muscle. *Prog Biophys Mol Biol* 2002;79:45-75.
58. Melzer W, Herrmann-Frank A, Luttgau HC. The role of Ca<sup>2+</sup> ions in excitation-contraction coupling of skeletal muscle fibres. *Biochim Biophys Acta* 1995;1241:59-116.
59. Protasi F, Paolini C, Nakai J, Beam KG, Franzini-Armstrong C, Allen PD. Multiple regions of RyR1, mediate functional and structural interactions with alpha(1S)-dihydropyridine receptors in skeletal muscle. *Biophys J* 2002;83:3230-3244.
60. McCarthy TV. Mutation screening of the ryanodine receptor in malignant hyperthermia. In: Schulte Am Esch J, Scholz J, Wappler F, eds. *Malignant Hyperthermia*. Berlin: Pabst Science, 2000:200-211.
61. Meissner G. Regulation of mammalian ryanodine receptors. *Front Biosci* 2002;7:d2072-d2080.
62. Carrier L, Villaz M, Dupont Y. Abnormal rapid Ca<sup>2+</sup> release from sarcoplasmic reticulum of malignant hyperthermia susceptible pigs. *Biochim Biophys Acta* 1991;1064:175-183.
63. Fill M, Coronado R, Mickelson JR, et al. Abnormal ryanodine receptor channels in malignant hyperthermia. *Biophys J* 1990;57:471-475.
64. Fill M, Stefani E, Nelson TE. Abnormal human sarcoplasmic reticulum Ca<sup>2+</sup> release channels in malignant hyperthermic skeletal muscle. *Biophys J* 1991;59:1085-1090.
65. Shomer NH, Mickelson JR, Louis CF. Caffeine stimulation of malignant hyperthermia-susceptible sarcoplasmic reticulum Ca<sup>2+</sup> release channel. *Am J Physiol* 1994;267:C1253-C1261.
66. Monnier N, Kozak-Ribbens G, Krivosic-Horber R, et al. Correlations between genotype and pharmacological, histological, functional, and clinical phenotypes in malignant hyperthermia susceptibility. *Hum Mutat* 2005;26:413-425.
67. Sambuughin N, Holley H, Muldoon S, et al. Screening of the entire ryanodine receptor type 1, coding region for sequence variants



- associated with malignant hyperthermia susceptibility in the North American population. *Anesthesiology* 2005;102:515–521.
68. Tong J, McCarthy TV, MacLennan DH. Measurement of resting cytosolic  $Ca^{2+}$  concentrations and  $Ca^{2+}$  store size in HEK-293 cells transfected with malignant hyperthermia or central core disease mutant  $Ca^{2+}$  release channels. *J Biol Chem* 1999;274:693–702.
69. Tong J, Oyama H, Demarex N, Grinstein S, McCarthy TV, MacLennan DH. Caffeine and halothane sensitivity of intracellular  $Ca^{2+}$  release is altered by 15 calcium release channel (ryanodine receptor) mutations associated with malignant hyperthermia and/or central core disease. *J Biol Chem* 1997;272:26332–26339.
70. Wehner M, Rueffert H, Koenig F, Olthoff D. Functional characterization of malignant hyperthermia-associated RyR1 mutations in exon 44 using the human myotube model. *Neuromuscul Disord* 2004;14:429–437.
71. Yang T, Ta TA, Pessah IN, Allen PD. Functional defects in six ryanodine receptor isoform-1 (RyR1) mutations associated with malignant hyperthermia and their impact on skeletal excitation-contraction coupling. *J Biol Chem* 2003;278:25722–25730.
72. Sambuughin N, Nelson TE, Jankovic J, et al. Identification and functional characterization of a novel ryanodine receptor mutation causing malignant hyperthermia in North American and South American families. *Neuromuscul Disord* 2001;11:530–537.
73. Wehner M, Rueffert H, Koenig F, Meinelcke CD, Olthoff D. The Ile2453Thr mutation in the ryanodine receptor gene 1 is associated with facilitated calcium release from sarcoplasmic reticulum by 4-chloro-*m*-cresol in human myotubes. *Cell Calcium* 2003;34:163–168.
74. Manning BM, Quane KA, Ording H, et al. Identification of novel mutations in the ryanodine-receptor gene (RYR1) in malignant hyperthermia: genotype-phenotype correlation. *Am J Hum Genet* 1998;62:599–609.
75. Torp K, Brandom B, Capacchione J, Voelkel M, Muldoon S. Caffeine halothane contracture test and ryanodine receptor type 1 analysis in patients who experienced MH episodes. *Anesthesiology* 2005;103:A1273.
76. Robinson RL, Brooks C, Brown SL, et al. RYR1 mutations causing central core disease are associated with more severe malignant hyperthermia in vitro contracture test phenotypes. *Hum Mutat* 2002;20:88–97.
77. Lynch PJ, Tong J, Lehane M, et al. A mutation in the transmembrane/luminal domain of the ryanodine receptor is associated with abnormal  $Ca^{2+}$  release channel function and severe central core disease. *Proc Natl Acad Sci U S A* 1999;96:4164–4169.
78. Monnier N, Krivosic-Horber R, Payen JF, et al. Presence of two different genetic traits in malignant hyperthermia families: implication for genetic analysis, diagnosis, and incidence of malignant hyperthermia susceptibility. *Anesthesiology* 2002;97:1067–1074.
79. Ibarra C, Wu S, Murayama K, et al. Malignant hyperthermia in Japan: mutation screening of the entire ryanodine receptor type 1 gene coding region by direct sequencing. *Anesthesiology* 2006;104:1146–1154.
80. Endo M. Calcium release from the sarcoplasmic reticulum. *Physiol Rev* 1977;57:71–108.
81. Allen GC, Larach MG, Kunselman AR. The sensitivity and specificity of the caffeine-halothane contracture test: a report from the North American Malignant Hyperthermia Registry. The North American Malignant Hyperthermia Registry of MHAUS. *Anesthesiology* 1998;88:579–588.
82. Ording H, Brancadoro V, Cozzolino S, et al. In vitro contracture test for diagnosis of malignant hyperthermia following the protocol of the European MH Group: results of testing patients surviving fulminant MH and unrelated low-risk subjects. The European Malignant Hyperthermia Group. *Acta Anaesthesiol Scand* 1997;41:955–966.
83. Rosenberg H, Antognini JF, Muldoon S. Testing for malignant hyperthermia. *Anesthesiology* 2002;96:232–237.
84. Robinson RL, Hopkins PM. A breakthrough in the genetic diagnosis of malignant hyperthermia. *Br J Anaesth* 2001;86:166–168.
85. Sei Y, Sambuughin N, Muldoon S. Malignant hyperthermia genetic testing in North America Working Group Meeting. Bethesda, Maryland. September 4–5, 2002. *Anesthesiology* 2004;100:464–465.
86. Nelson TE, Rosenberg H, Muldoon SM. Genetic testing for malignant hyperthermia in North America. *Anesthesiology* 2004;100:212–214.
87. Olgin J, Argov Z, Rosenberg H, Tuchler M, Chance B. Non-invasive evaluation of malignant hyperthermia susceptibility with phosphorus nuclear magnetic resonance spectroscopy. *Anesthesiology* 1988;68:507–513.
88. Olgin J, Rosenberg H, Allen G, Seested R, Chance B. A blinded comparison of non-invasive, in vivo phosphorus nuclear magnetic resonance spectroscopy and the in vitro halothane/caffeine contracture test in the evaluation of malignant hyperthermia susceptibility. *Anesth Analg* 1991;72:36–47.
89. Anetseder M, Hager M, Muller CR, Roewer N. Diagnosis of susceptibility to malignant hyperthermia by use of a metabolic test. *Lancet* 2002;359:1579–1580.
90. Bina S, Cowan G, Karaian J, Muldoon S, Mongan P, Bunker R. Effects of caffeine, halothane, and 4-chloro-*m*-cresol on skeletal muscle lactate and pyruvate in malignant hyperthermia-susceptible and normal swine as assessed by microdialysis. *Anesthesiology* 2006;104:90–100.
91. Sei Y, Brandom BW, Bina S, et al. Patients with malignant hyperthermia demonstrate an altered calcium control mechanism in B lymphocytes. *Anesthesiology* 2002;97:1052–1058.
92. McKinney LC, Butler T, Mullen SP, Klein MG. Characterization of ryanodine receptor-mediated calcium release in human B cells: relevance to diagnostic testing for malignant hyperthermia. *Anesthesiology* 2006;104:1191–1201.
93. Rubin AS, Zablocki AD. Hyperkalemia, verapamil, and dantrolene. *Anesthesiology* 1987;66:246–249.
94. Saltzman LS, Kates RA, Corke BC, Norfleet EA, Heath KR. Hyperkalemia and cardiovascular collapse after verapamil and dantrolene administration in swine. *Anesth Analg* 1984;63:473–478.
95. Maccani RM, Wedel DJ, Kor TM, Joyner MJ, Johnson ME, Hall BA. The effect of trace halothane exposure on triggering malignant hyperthermia in susceptible swine. *Anesth Analg* 1996;82:S287.
96. Morison DH. Placental transfer of dantrolene. *Anesthesiology* 1983;59:265.
97. Kaplan R, Becker M, Broadman L. Isolated masseter muscle spasm versus generalized rigidity? *Anesth Analg* 1992;75:146–147.
98. Sessler DI. Complications and treatment of mild hypothermia. *Anesthesiology* 2001;95:531–543.
99. Sessler DI. Mild perioperative hypothermia. *N Engl J Med* 1997;336:1730–1737.
100. Sessler DI. Perioperative heat balance. *Anesthesiology* 2000;92:578–596.
101. Fagher B, Liedholm H, Monti M, et al. Thermogenesis in human skeletal muscle as measured by direct microcalorimetry and muscle contractile performance during beta-adrenoceptor blockade. *Clin Sci (Lond)* 1986;70:435–441.
102. Burton AC. Human calorimetry: the average temperature of the tissues of the body. *J Nutr* 1935;9:261–280.
103. Castillo J, Davalos A, Noya M. Aggravation of acute ischemic stroke by hyperthermia is related to an excitotoxic mechanism. *Cerebrovasc Dis* 1999;9:22–27.
104. Grocott HP, Amory DW, Lowry E, et al. Cerebral transcranial Doppler blood flow velocity versus  $^{133}Xe$  clearance cerebral blood flow during mild hypothermic cardiopulmonary bypass. *J Clin Monit Comput* 1998;14:35–39.
105. Cork RC, Vaughan RW, Humphrey LS. Precision and accuracy of intraoperative temperature monitoring. *Anesth Analg* 1983;62:211–214.
106. Lopez M, Sessler DI, Walter K, et al. Rate and gender dependence of the sweating, vasoconstriction, and shivering thresholds in humans. *Anesthesiology* 1994;80:780–788.
107. Benzinger TH. Heat regulation: homeostasis of central temperature in man. *Physiol Rev* 1969;49:671–759.
108. Flacke JW, Flacke WE. Inadvertent hypothermia: frequent, insidious, and often serious. *Semin Anesth* 1983;2:3.
109. Hammel HT. Regulation of internal body temperature. *Annu Rev Physiol* 1968;30:641–710.
110. Hammel HT. Anesthetics and body temperature regulation. *Anesthesiology* 1988;68:833–835.
111. Sessler DI. Perioperative temperature regulation. *ASA Refresher Course* 1995;265.
112. De Witte J, Sessler DI. Perioperative shivering: physiology and pharmacology. *Anesthesiology* 2002;96:467–484.

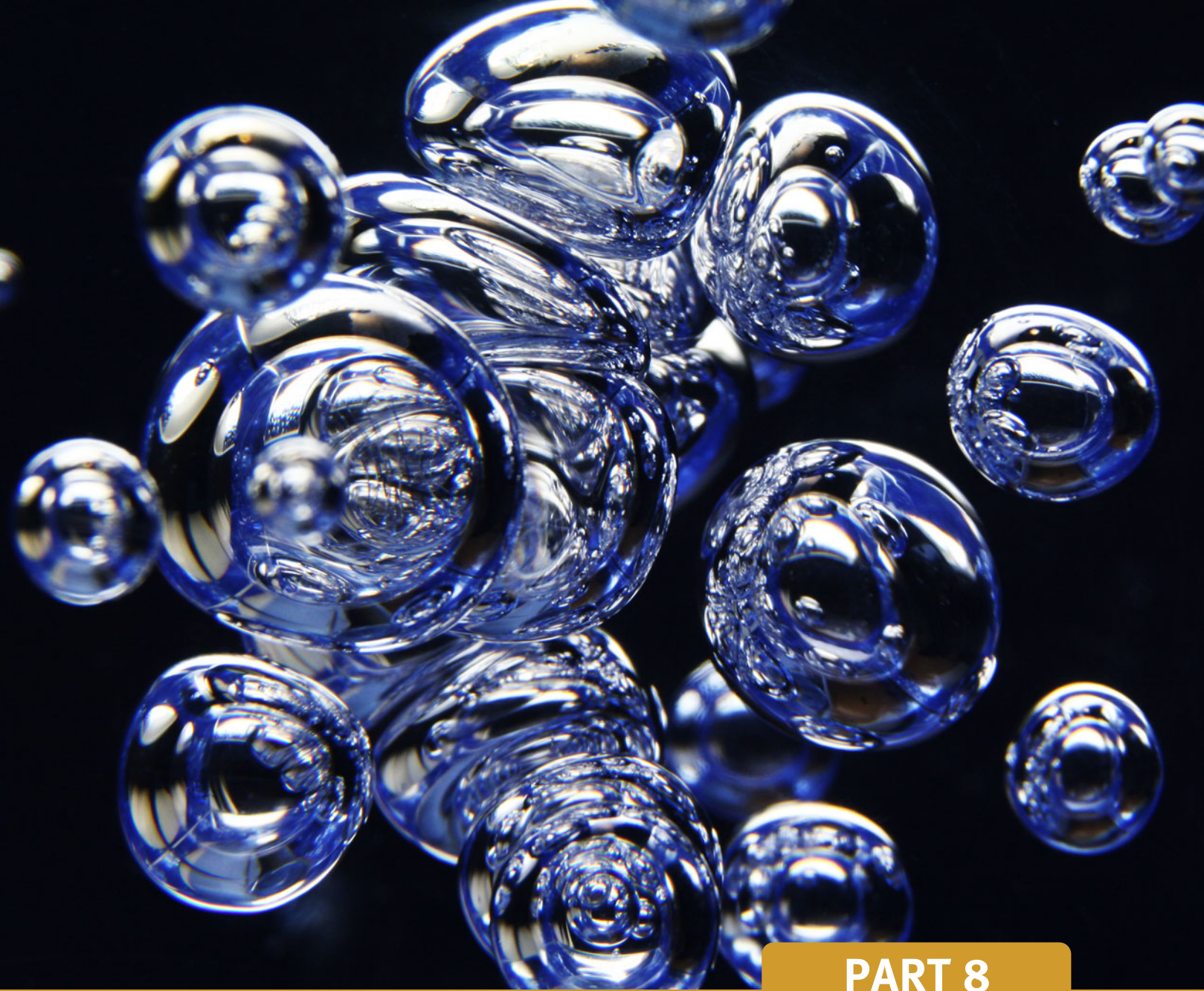


113. Vassiliev N, Rosencher N, Sessler DI, et al. Shivering threshold during spinal anesthesia is reduced in elderly patients. *Anesthesiology* 1995;83:1162–1166.
114. Annadata R, Sessler DI, Tayefeh F, et al. Desflurane slightly increases the sweating threshold but produces marked, nonlinear decreases in the vasoconstriction and shivering thresholds. *Anesthesiology* 1995;83:1205–1211.
115. Kurz A, Go JC, Sessler DI, et al. Alfentanil slightly increases the sweating threshold and markedly reduces the vasoconstriction and shivering thresholds. *Anesthesiology* 1995;83:293–299.
116. Matsukawa T, Kurz A, Sessler DI, et al. Propofol linearly reduces the vasoconstriction and shivering thresholds. *Anesthesiology* 1995;82:1169–1180.
117. Xiong J, Kurz A, Sessler DI, et al. Isoflurane produces marked and nonlinear decreases in the vasoconstriction and shivering thresholds. *Anesthesiology* 1996;85:240–245.
118. Hales JRS. Skin arteriovenous anastomoses, their control and role in thermoregulation. In: Johansen K, Burggren W, eds. *Cardiovascular Shunts: Phylogenetic, Ontogenetic and Clinical Aspects*. Copenhagen, Denmark: Munksgaard, 1985:433–451.
119. Sessler DI, Moayeri A, Stoen R, et al. Thermoregulatory vasoconstriction decreases cutaneous heat loss. *Anesthesiology* 1990;73:656–660.
120. Sessler DI. Sweating threshold during isoflurane anesthesia in humans. *Anesth Analg* 1991;73:300–303.
121. Just B, Delva E, Camus Y, et al. Oxygen uptake during recovery following naloxone. Relationship with intraoperative heat loss. *Anesthesiology* 1992;76:60–64.
122. Dawkins MJ, Scopes JW. Non-shivering thermogenesis and brown adipose tissue in the human newborn infant. *Nature* 1965;206:201–202.
123. Takahashi H, Nakamura S, Shirahase H, et al. Heterogenous activity of BRL 35135, a beta 3-adrenoceptor agonist, in thermogenesis and increased blood flow in brown adipose tissue in anesthetized rats. *Clin Exp Pharmacol Physiol* 1994;21:539–543.
124. Bruck K, Baum E, Schwennicke HP. Cold-adaptive modifications in man induced by repeated short-term cold-exposures and during a 10-day and -night cold-exposure. *Pflugers Arch* 1976;363:125–133.
125. Benzinger TH. The diminution of thermoregulatory sweating during cold-reception at the skin. *Proc Natl Acad Sci U S A* 1961;47:1683–1688.
126. Benzinger TH. The thermal homeostasis of man. *Symp Soc Exp Biol* 1964;18:49–80.
127. Detry JM, Brengelmann GL, Rowell LB, et al. Skin and muscle components of forearm blood flow in directly heated resting man. *J Appl Physiol* 1972;32:506–511.
128. Holdcroft A, Hall GM, Cooper GM. Redistribution of body heat during anaesthesia. A comparison of halothane, fentanyl and epidural anaesthesia. *Anaesthesia* 1979;34:758–764.
129. Morris RH. Operating room temperature and the anesthetized, paralyzed patient. *Arch Surg* 1971;102:95–97.
130. Sessler DI, Olofsson CI, Rubinstein EH, et al. The thermoregulatory threshold in humans during halothane anesthesia. *Anesthesiology* 1988;68:836–842.
131. Sessler DI, Rubinstein EH, Eger EI 2nd. Core temperature changes during N<sub>2</sub>O fentanyl and halothane/O<sub>2</sub> anesthesia. *Anesthesiology* 1987;67:137–139.
132. Kurz A, Sessler DI, Christensen R, et al. Heat balance and distribution during the core-temperature plateau in anesthetized humans. *Anesthesiology* 1995;83:491–499.
133. Sessler DI, McGuire J, Moayeri A, et al. Isoflurane-induced vasodilation minimally increases cutaneous heat loss. *Anesthesiology* 1991;74:226–232.
134. Hynson JM, Sessler DI. Intraoperative warming therapies: a comparison of three devices. *J Clin Anesth* 1992;4:194–199.
135. Bissonette B, Nebbin S. Hypothermia during anesthesia. *Anesth Clin North Am* 1994;12:3.
136. Stevens WC, Cromwell TH, Halsey MJ, et al. The cardiovascular effects of a new inhalation anesthetic, Forane, in human volunteers at constant arterial carbon dioxide tension. *Anesthesiology* 1971;35:8–16.
137. Sessler DI, Sessler AM, Hudson S, et al. Heat loss during surgical skin preparation. *Anesthesiology* 1993;78:1055–1064.
138. Stoen R, Sessler DI. The thermoregulatory threshold is inversely proportional to isoflurane concentration. *Anesthesiology* 1990;72:822–827.
139. Wang JK, Moffitt EA, Rosevear JW. Oxidative phosphorylation in acute hyperthermia. *Anesthesiology* 1969;30:439–442.
140. Lopez M, Ozaki M, Sessler DI, et al. Physiologic responses to hyperthermia during epidural anesthesia and combined epidural/enflurane anesthesia in women. *Anesthesiology* 1993;78:1046–1054.
141. Sessler DI, McGuire J, Hynson J, et al. Thermoregulatory vasoconstriction during isoflurane anesthesia minimally decreases cutaneous heat loss. *Anesthesiology* 1992;76:670–675.
142. Washington DE, Sessler DI, McGuire J, et al. Painful stimulation minimally increases the thermoregulatory threshold for vasoconstriction during enflurane anesthesia in humans. *Anesthesiology* 1992;77:286–290.
143. Sessler DI, Sessler DI. Perianesthetic thermoregulation and heat balance in humans. *FASEB J* 1993;7:638–644.
144. Emerick TH, Ozaki M, Sessler DI, et al. Epidural anesthesia increases apparent leg temperature and decreases the shivering threshold. *Anesthesiology* 1994;81:289–298.
145. Leslie K, Sessler DI. Reduction in the shivering threshold is proportional to spinal block height. *Anesthesiology* 1996;84:1327–1331.
146. Glosten B, Sessler DI, Faure EA, et al. Central temperature changes are poorly perceived during epidural anesthesia. *Anesthesiology* 1992;77:10–16.
147. Hynson JM, Sessler DI, Glosten B, et al. Thermal balance and tremor patterns during epidural anesthesia. *Anesthesiology* 1991;74:680–690.
148. Glosten B, Hynson J, Sessler DI, et al. Preanesthetic skin-surface warming reduces redistribution hypothermia caused by epidural block. *Anesth Analg* 1993;77:488–493.
149. Matsukawa T, Sessler DI, Sessler AM, et al. Heat flow and distribution during induction of general anesthesia. *Anesthesiology* 1995;82:662–673.
150. Bernard JM, Bourreli B, Hommeril JL, et al. Effects of oral clonidine premedication and postoperative IV infusion on haemodynamic and adrenergic responses during recovery from anaesthesia. *Acta Anaesthesiol Scand* 1991;35:54–59.
151. Szmuk P, Ezri T, Sessler DI, et al. Spinal anesthesia speeds active postoperative rewarming. *Anesthesiology* 1997;87:1050–1054.
152. Glosten B. Thermoregulation and regional anesthesia. *Prob Anesth* 1994;8:99.
153. Sessler DI, Ponte J. Shivering during epidural anesthesia. *Anesthesiology* 1990;72:816–821.
154. Ponte J, Collett BJ, Walmsley A. Anaesthetic temperature and shivering in epidural anaesthesia. *Acta Anaesthesiol Scand* 1986;30:584–587.
155. Wallace AJ, Wooldridge W, Kingston HM, et al. Malignant hyperthermia—a large kindred linked to the RYR1 gene. *Anaesthesia* 1996;51:16–23.
156. de Witte J, Deloof T, de Veylder J, et al. Tramadol in the treatment of postanesthetic shivering. *Acta Anaesthesiol Scand* 1997;41:506–510.
157. Horn EP, Werner C, Sessler DI, et al. Late intraoperative clonidine administration prevents postanesthetic shivering after total intravenous or volatile anesthesia. *Anesth Analg* 1997;84:613–617.
158. Ciofolo MJ, Clergue F, Devilliers C, et al. Changes in ventilation, oxygen uptake, and carbon dioxide output during recovery from isoflurane anesthesia. *Anesthesiology* 1989;70:737–741.
159. Mahajan RP, Grover VK, Sharma SL, et al. Intraocular pressure changes during muscular hyperactivity after general anesthesia. *Anesthesiology* 1987;66:419–421.
160. Rosa G, Pinto G, Orsi P, et al. Control of post anaesthetic shivering with nefopam hydrochloride in mildly hypothermic patients after neurosurgery. *Acta Anaesthesiol Scand* 1995;39:90–95.
161. Horn EP, Sessler DI, Standl T, et al. Non-thermoregulatory shivering in patients recovering from isoflurane or desflurane anesthesia. *Anesthesiology* 1998;89:878–886.
162. Lenhardt R, Negishi C, Sessler DI, et al. Paralysis only slightly reduces the febrile

- response to interleukin-2 during isoflurane anesthesia. *Anesthesiology* 1998;89:648–656.
163. Vaughan MS, Vaughan RW, Cork RC. Postoperative hypothermia in adults: relationship of age, anesthesia, and shivering to rewarming. *Anesth Analg* 1981;60:746–751.
164. Horn EP, Schroeder F, Wilhelm S, et al. Postoperative pain facilitates nonthermoregulatory tremor. *Anesthesiology* 1999;91:979–984.
165. Frank SM, Kluger MJ, Kunkel SL. Elevated thermostatic setpoint in postoperative patients. *Anesthesiology* 2000;93:1426–1431.
166. Israel DJ, Pozos RS. Synchronized slow-amplitude modulations in the electromyograms of shivering muscles. *J Appl Physiol* 1989;66:2358–2363.
167. Sessler DI, Rubinstein EH, Moayeri A. Physiologic responses to mild perianesthetic hypothermia in humans. *Anesthesiology* 1991;75:594–610.
168. Leslie K, Williams D, Irwin K, et al. Pethidine and skin warming to prevent shivering during endovascular cooling. *Anaesth Intensive Care* 2004;32:362–367.
169. Bicer C, Esmoğlu A, Akin A, et al. Dexmedetomidine and meperidine prevent postanesthetic shivering. *Eur J Anaesthesiol* 2006;23:149–153.
170. Kranke P, Eberhart LH, Roewer N, et al. Single-dose parenteral pharmacological interventions for the prevention of postoperative shivering: a quantitative systematic review of randomized controlled trials. *Anesth Analg* 2004;99:718–727.
171. Bilotta F, Ferri F, Giovannini F, et al. Nefopam or clonidine in the pharmacologic prevention of shivering in patients undergoing conscious sedation for interventional neuroradiology. *Anaesthesia* 2005;60:124–128.
172. Nalda MA, Gomar C, Luis M. The effect of ketanserin on post-anaesthetic vasoconstriction and shivering. *Eur J Anaesthesiol* 1985;2:265–277.
173. Joris J, Banache M, Bonnet F, et al. Clonidine and ketanserin both are effective treatment for postanesthetic shivering. *Anesthesiology* 1993;79:532–539.
174. Sessler DI. Treatment: meperidine, clonidine, doxapram, ketanserin, or alfentanil abolishes short-term postoperative shivering. *Can J Anaesth* 2003;50:635–637.
175. Doufas AG, Lin CM, Suleman MI, et al. Dexmedetomidine and meperidine additively reduce the shivering threshold in humans. *Stroke* 2003;34:1218–1223.
176. Talke P, Tayefeh F, Sessler DI, et al. Dexmedetomidine does not alter the sweating threshold, but comparably and linearly decreases the vasoconstriction and shivering thresholds. *Anesthesiology* 1997;87:835–841.
177. Kurz M, Belani KG, Sessler DI, et al. Naloxone, meperidine, and shivering. *Anesthesiology* 1993;79:1193–1201.
178. Schmied H, Kurz A, Sessler DI, et al. Mild hypothermia increases blood loss and transfusion requirements during total hip arthroplasty. *Lancet* 1996;347:289–292.
179. Johansson T, Lisander B, Ivarsson I. Mild hypothermia does not increase blood loss during total hip arthroplasty. *Acta Anaesthesiol Scand* 1999;43:1005–1010.
180. Nathan HJ, Polis T. The management of temperature during hypothermic cardiopulmonary bypass: II—effect of prolonged hypothermia. *Can J Anaesth* 1995;42:672–676.
181. Valeri CR, Feingold H, Cassidy G, et al. Hypothermia-induced reversible platelet dysfunction. *Ann Surg* 1987;205:175–181.
182. Khuri SF, Wolfe JA, Josa M, et al. Hematologic changes during and after cardiopulmonary bypass and their relationship to the bleeding time and nonsurgical blood loss. *J Thorac Cardiovasc Surg* 1992;104:94–107.
183. Michelson AD, MacGregor H, Barnard MR, et al. Reversible inhibition of human platelet activation by hypothermia in vivo and in vitro. *Thromb Haemost* 1994;71:633–640.
184. Valeri CR, Khabbaz K, Khuri SF, et al. Effect of skin temperature on platelet function in patients undergoing extracorporeal bypass. *J Thorac Cardiovasc Surg* 1992;104:108–116.
185. Kurz A, Sessler DI, Lenhardt R. Perioperative normothermia to reduce the incidence of surgical-wound infection and shorten hospitalization. Study of Wound Infection and Temperature Group. *N Engl J Med* 1996;334:1209–1215.
186. Sessler DI, Olofsson CI, Rubinstein EH. The thermoregulatory threshold in humans during nitrous oxide-fentanyl anesthesia. *Anesthesiology* 1988;69:357–364.
187. Sheffield CW, Sessler DL, Hopf HW, et al. Centrally and locally mediated thermoregulatory responses alter subcutaneous oxygen tension. *World Rep Reg[AU:21]* 1997;4:339–345.
188. Saririan K, Nickerson DA. Enhancement of murine in vitro antibody formation by hyperthermia. *Cell Immunol* 1982;74:306–312.
189. Farkas LG, Bannantyne RM, James JS, et al. Effect of two different climates on severely burned rats infected with *Pseudomonas aeruginosa*. *Eur Surg Res* 1974;6:295–300.
190. Wensch CMD, Narzt EMD, Sessler DIMD, et al. Mild intraoperative hypothermia reduces production of reactive oxygen intermediates by polymorphonuclear leukocytes. *Anesth Analg* 1996;82:810–816.
191. Leijh PC, van den Barselaar MT, van Zwet TL, et al. Kinetics of phagocytosis of *Staphylococcus aureus* and *Escherichia coli* by human granulocytes. *Immunology* 1979;37:453–465.
192. Carli F, Emery PW, Freemantle CA. Effect of preoperative normothermia on postoperative protein metabolism in elderly patients undergoing hip arthroplasty. *Br J Anaesth* 1989;63:276–282.
193. Heier T, Caldwell JE, Sessler DI, et al. Mild intraoperative hypothermia increases duration of action and spontaneous recovery of vecuronium blockade during nitrous oxide-isoflurane anesthesia in humans. *Anesthesiology* 1991;74:815–819.
194. Heier T, Caldwell JE, Eriksson LI, et al. The effect of hypothermia on adductor pollicis twitch tension during continuous infusion of vecuronium in isoflurane-anesthetized humans. *Anesth Analg* 1994;78:312–317.
195. Heier T, Caldwell JE, Sessler DI, et al. The relationship between adductor pollicis twitch tension and core, skin, and muscle temperature during nitrous oxide-isoflurane anesthesia in humans. *Anesthesiology* 1989;71:381–384.
196. Eger EI 2nd, Johnson BH. MAC of I-653 in rats, including a test of the effect of body temperature and anesthetic duration. *Anesth Analg* 1987;66:974–976.
197. Lenhardt R, Marker E, Goll V, et al. Mild intraoperative hypothermia prolongs postanesthetic recovery. *Anesthesiology* 1997;87:1318–1323.
198. Taguchi A, Ratnaraj J, Kabon B, et al. Effects of a circulating-water garment and forced-air warming on body heat content and core temperature. *Anesthesiology* 2004;100:1058–1064.
199. Taguchi A, Arkilic CF, Ahluwalia A, et al. Negative pressure rewarming vs. forced air warming in hypothermic postanesthetic volunteers. *Anesth Analg* 2001;92:261–266.
200. Stanley TO, Grocott HP, Phillips-Bute B, et al. Preliminary evaluation of the Arctic Sun temperature-controlling system during off-pump coronary artery bypass surgery. *Ann Thorac Surg* 2003;75:1140–1144.
201. McLean RF, Wong BI. Normothermic versus hypothermic cardiopulmonary bypass: central nervous system outcomes. *J Cardiothorac Vasc Anesth* 1996;10:45–52.
202. Just B, Trevien V, Delva E, et al. Prevention of intraoperative hypothermia by preoperative skin-surface warming. *Anesthesiology* 1993;79:214–218.
203. Bickler PE, Sessler DI. Efficiency of airway heat and moisture exchangers in anesthetized humans. *Anesth Analg* 1990;71:415–418.
204. Stone DR, Downs JB, Paul WL, et al. Adult body temperature and heated humidification of anesthetic gases during general anesthesia. *Anesth Analg* 1981;60:736–741.
205. Giesbrecht GG, Ducharme MB, McGuire JP. Comparison of forced-air patient warming systems for perioperative use. *Anesthesiology* 1994;80:671–679.
206. Sessler DI, Moayeri A. Skin-surface warming: heat flux and central temperature. *Anesthesiology* 1990;73:218–224.
207. Lennon RL, Hosking MP, Conover MA, et al. Evaluation of a forced-air system for warming hypothermic postoperative patients. *Anesth Analg* 1990;70:424–427.
208. Brauer A, English MJ, Steinmetz N, et al. Efficacy of forced-air warming systems with full body blankets. *Can J Anaesth* 2007;54:34–41.
209. Grocott HP, Mathew JP, Carver EH, et al. A randomized controlled trial of the

- Arctic Sun Temperature Management System versus conventional methods for preventing hypothermia during off-pump cardiac surgery. *Anesth Analg* 2004;98:298-302.
210. Motta P, Mossad E, Toscana D, et al. Effectiveness of a circulating-water warming garment in rewarming after pediatric cardiac surgery using hypothermic cardiopulmonary bypass. *J Cardiothorac Vasc Anesth* 2004;18:148-151.
211. Sessler DI. Consequences and treatment of perioperative hypothermia. *Anesth Clin North Am* 1994;12:425-456.
212. Badjatia N. Celsius control system. *Neurocrit Care* 2004;1:201-203.
213. Badjatia N, O'Donnell J, Baker JR, et al. Achieving normothermia in patients with febrile subarachnoid hemorrhage: feasibility and safety of a novel intravascular cooling catheter. *Neurocrit Care* 2004;1:145-156.
214. Schmutzhard E, Engelhardt K, Beer R, et al. Safety and efficacy of a novel intravascular cooling device to control body temperature in neurologic intensive care patients: a prospective pilot study. *Crit Care Med* 2002;30:2481-2488.
215. Svensson LG, Crawford ES, Hess KR, et al. Deep hypothermia with circulatory arrest. Determinants of stroke and early mortality in 656 patients. *J Thorac Cardiovasc Surg* 1993;106:19-28; discussion 28-31.
216. Connolly JE, Roy A, Guernsey JM, et al. Bloodless surgery by means of profound hypothermia and circulatory arrest. Effect on brain and heart. *Ann Surg* 1965;162:724-737.
217. Weiss L, Grocott HP, Rosania RA, et al. Case 4-1998. Cardiopulmonary bypass and hypothermic circulatory arrest for basilar artery aneurysm clipping. *J Cardiothorac Vasc Anesth* 1998;12:473-479.
218. Randomized trial of normothermic versus hypothermic coronary bypass surgery. The Warm Heart Investigators. *Lancet* 1994;343:559-563.
219. Mora CT, Henson MB, Weintraub WS, et al. The effect of temperature management during cardiopulmonary bypass on neurologic and neuropsychologic outcomes in patients undergoing coronary revascularization. *J Thorac Cardiovasc Surg* 1996;112:514-522.
220. Martin T, Craver J, Gott J, et al. Prospective, randomized trial of retrograde warm blood cardioplegia: myocardial benefit and neurologic threat. *Ann Thorac Surg* 1994;57:298-302.
221. Grigore AM, Grocott HP, Mathew JP, et al. The rewarming rate and increased peak temperature alter neurocognitive outcome after cardiac surgery. *Anesth Analg* 2002;94:4-10.
222. Michenfelder J, Milde J. The relationship among canine brain temperature, metabolism, and function during hypothermia. *Anesthesiology* 1991;75:130-136.
223. Busto R, Globus M, Dietrich W, et al. Effect of mild hypothermia on ischemia-induced release of neurotransmitters and free fatty acids in rat brain. *Stroke* 1989;20:904-910.
224. Bickler PE, Buck LT, Hansen BM. Effects of isoflurane and hypothermia on glutamate receptor-mediated calcium influx in brain slices. *Anesthesiology* 1994;81:1461-1469.
225. Widmann R, Miyazawa T, Hossmann K. Protective effect of hypothermia on hippocampal injury after 30 minutes of forebrain ischemia in rats is mediated by postischemic recovery of protein synthesis. *J Neurochem* 1993;61:200-209.
226. Busto R, Globus M, Neary J, et al. Regional alterations of protein kinase C activity following transient cerebral ischemia: effects of intraschemic brain temperature modulation. *J Neurochem* 1994;63:1095-1103.
227. Nakashima K, Todd MM, Warner DS. The relation between cerebral metabolic rate and ischemic depolarization. A comparison of the effects of hypothermia, pentobarbital, and isoflurane. *Anesthesiology* 1995;82:1199-1208.
228. Kader A, Frazzini V, Baker C, et al. Effect of mild hypothermia on nitric oxide synthesis during focal cerebral ischemia. *Neurosurgery* 1994;35:272-277.
229. Globus M, Busto R, Lin B, et al. Detection of free radical activity during transient global ischemia and recirculation: Effects of intraschemic brain temperature modulation. *J Neurochem* 1995;65:1250-1256.
230. Huh PW, Belayev L, Zhao W, et al. Comparative neuroprotective efficacy of prolonged moderate intraschemic and postischemic hypothermia in focal cerebral ischemia. *J Neurosurg* 2000;92:91-99.
231. Bramlett HM, Green EJ, Dietrich WD, et al. Posttraumatic brain hypothermia provides protection from sensorimotor and cognitive behavioral deficits. *J Neurotrauma* 1995;12:289-298.
232. Nilsson L, Kogure K, Busto R. Effects of hypothermia and hyperthermia on brain energy metabolism. *Acta Anaesthesiol Scand* 1975;19:199-205.
233. Dietrich WD, Busto R, Alonso O, et al. Intraschemic but not postischemic brain hypothermia protects chronically following global forebrain ischemia in rats. *J Cereb Blood Flow Metab* 1993;13:541-549.
234. Bernard SA, Gray TW, Buist MD, et al. Treatment of comatose survivors of out-of-hospital cardiac arrest with induced hypothermia. *N Engl J Med* 2002;346:557-563.
235. Hypothermia after Cardiac Arrest Study Group. Mild therapeutic hypothermia to improve the neurologic outcome after cardiac arrest. *N Engl J Med* 2002;346:549-556.
236. Clifton GL, Miller ER, Choi SC, et al. Lack of effect of induction of hypothermia after acute brain injury. *N Engl J Med* 2001;344:556-563.
237. Todd MM, Hindman BJ, Clarke WR, et al. Mild intraoperative hypothermia during surgery for intracranial aneurysm. *N Engl J Med* 2005;352:135-145.
238. Nolan JP, Morley PT, Vanden Hoek TL, et al. Therapeutic hypothermia after cardiac arrest: an advisory statement by the advanced life support task force of the International Liaison Committee on Resuscitation. *Circulation* 2003;108:118-121.
239. Shankaran S, Laptook AR, Ehrenkranz RA, et al. Whole-body hypothermia for neonates with hypoxic-ischemic encephalopathy. *N Engl J Med* 2005;353:1574-1584.
240. Sessler DI. Temperature monitoring. In: Miller RD, ed. *Anesthesia*. 4th ed. New York: Churchill Livingstone, 1994:1363-1382.
241. Frank SM, Fleisher LA, Breslow MJ, et al. Perioperative maintenance of normothermia reduces the incidence of morbid cardiac events. A randomized clinical trial. *JAMA* 1997;277:1127-1134.
242. Leslie K, Sessler DI, Bjorksten AR, et al. Mild hypothermia alters propofol pharmacokinetics and increases the duration of action of atracurium. *Anesth Analg* 1995;80:1007-1014.
243. Frank SM, Higgins MS, Breslow MJ, et al. The catecholamine, cortisol, and hemodynamic responses to mild perioperative hypothermia. A randomized clinical trial. *Anesthesiology* 1995;82:83-93.
244. Kurz A, Sessler DI, Narzt E, et al. Postoperative hemodynamic and thermoregulatory consequences of intraoperative core hypothermia. *J Clin Anesth* 1995;7:359-366.
245. Butler-Browne GS, Eriksson PO, Laurent C, et al. Adult human masseter muscle fibers express myosin isozymes characteristic of development. *Muscle Nerve* 1988;11:610-620.
246. Hall L, Woolf WN, Bradley JW, et al. Unusual reaction to suxamethonium chloride. *Br Med J* 1966;2:1305.
247. Melton AT, Antognini JF, Gronert GA. Caffeine- or halothane-induced contractions of masseter muscle are similar to those of vastus muscle in normal humans. *Acta Anaesthesiol Scand* 1999;43:764-769.
248. Monnier N, Procaccio V, Stieglitz P, et al. Malignant-hyperthermia susceptibility is associated with a mutation of the alpha 1-subunit of the human dihydropyridine-sensitive L-type voltage-dependent calcium-channel receptor in skeletal muscle. *Am J Hum Genet* 1997;60:1316-1325.
249. Wappler F, Fiege M, Antz M, et al. Hemodynamic and metabolic alterations in response to graded exercise in a patient susceptible to malignant hyperthermia. *Anesthesiology* 2000;92:268-272.
250. Yang T, Riehl J, Esteve E, et al. Pharmacologic and functional characterization of malignant hyperthermia in the R163C RyR1 knock-in mouse. *Anesthesiology* 2006;105:1164-1175.





## PART 8

### CARE OF THE CHRONIC PAIN PATIENT



## CHAPTER 90

## Mechanisms of Chronic Pain

Gary J. Brenner, MD, PhD, and  
Clifford J. Woolf, MD, PhD

The cardinal function of the pain system is to protect the body from impending or actual damage. When functioning normally, the major components of the system—primary afferent fibers (primary sensory neurons), spinal cord, and brain—integrate key information about noxious stimuli, allowing for perception of its quality, intensity, and location and permitting an appropriate behavioral response that includes withdrawal from the stimulus, activation of the autonomic nervous system, an emotional response, and a deeply unpleasant sensation that we call pain. Sir Charles Sherrington a century ago defined *nociception* as the sensory detection of a noxious event or a potentially harmful environmental stimulus.<sup>1</sup> We now recognize that most clinical pain is not actually nociception—the detection of noxious stimuli—but rather production of pain either in the absence of any peripheral stimulus (spontaneous pain) or in response to a stimulus that normally would be experienced as innocuous (allodynia) and therefore is not noxious.

This chapter reviews the neuroanatomy and neurophysiology of the nociceptive system, providing a basis for understanding normal (physiologic) functioning of the nervous system, that is, nociception, and the mechanisms (both peripheral and central) underlying persistent pathologic pain.

Much of the information in this chapter is derived from preclinical models of physiologic and pathologic pain. We now have considerable insight into the mechanisms underlying the transduction, conduction, processing, transmission, and perception of acute noxious stimuli, as well as the mechanisms responsible for the persistent pain associated with inflammation, lesions to the nervous system, and dysfunction of sensory processing in the nervous system. Persistent pain

is generated by a wide array of insults to, and changes within, the nervous system. The manifestation of chronic pain is highly complex and often cannot be correlated with a specific underlying lesion or disease. Through an understanding of the neurobiology of chronic pain, we can begin to move from a trial and error approach to pain management to a rational approach based on identifying the mechanisms responsible for pain in an individual patient and targeting therapy to these mechanisms.

## NEUROPHYSIOLOGY OF NOCICEPTION

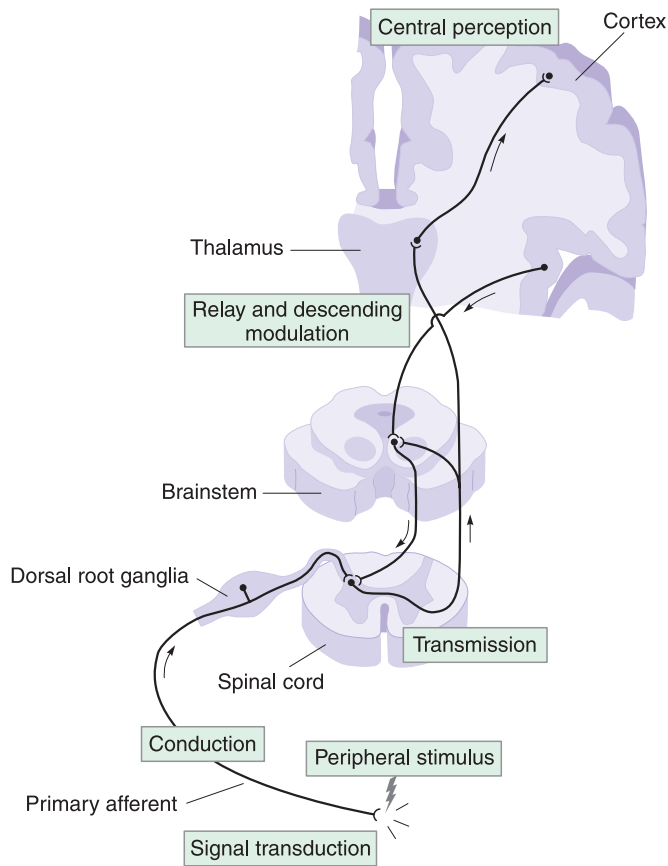
The pain system has four basic anatomical components. *Nociceptors* are specialized high-threshold sensory afferent or primary sensory neurons that are located in the peripheral nervous system (PNS) whose peripheral terminals are capable of detecting or reacting normally only to intense noxious stimuli and transmit this information along their axons, which run in

peripheral nerves to the spinal cord. *Ascending nociceptive tracts*, including the spinothalamic, spinobulbar, and spinothalamic tracts, convey nociceptive information from the dorsal horn of the spinal cord to *higher centers in the central nervous system* that are responsible for cognitive, affective, and complex motor responses to noxious stimuli as well as production of conscious awareness or perception of the stimulus and interaction with learned behaviors. Finally, *descending systems* in the CNS are involved in the processing or control of transfer of nociceptive information at multiple levels of the nervous system (Fig. 90–1).

In the past, pain was thought to arise from the simple detection of adequate noxious stimuli in the periphery and the transfer of this information as action potentials to the CNS, where via specific circuits or pathways it produced both a withdrawal reflex response and an unpleasant sensation. This simple scheme implied that all pain was essentially similar; it was merely a question of what stimulus activated the pain pathway, where,

## KEY POINTS

1. Understanding the mechanisms underlying chronic pain requires knowledge of the neuroanatomy, neurochemistry, and neurophysiology of nociception.
2. Generation of pain hypersensitivity results from changes in the function, chemistry, and structure of both the peripheral and central nervous systems.
3. Nociception has a protective function. In contrast, neuropathic and dysfunctional pain are not protective and as such represent or are a manifestation of pathology within the nervous system. In these circumstances, pain can be considered a disease.
4. Chronic pain may result from persistent tissue damage and inflammation leading to an ongoing drive to the nociceptive pathways. It may result from a trigger (usually to the nervous system) that heals, but the pain persists independent of any peripheral drive, or it may be a manifestation of abnormal function of the nervous system independent of any peripheral pathology or lesion to the nervous system.
5. Chronic pain can be categorized into the following broad etiologic groups: nociceptive (associated with an ongoing noxious stimulus), inflammatory (due to ongoing tissue inflammation), neuropathic (resulting from a lesion to the nervous system), or dysfunctional (pain in the absence of a peripheral noxious stimulus, peripheral pathology, or identifiable lesion to the nervous system and due to an abnormal functioning of the nervous system).
6. Neuropathic pain can be generated by lesions in both the peripheral and central nervous systems. It typically involves multiple mechanisms that act alone or in concert and may change over time.
7. Understanding the mechanisms underlying chronic pain is essential for rational application of pain therapeutics. This process requires diagnostic tools for identifying pain mechanisms in patients and introduction of novel forms of therapy targeted at specific mechanisms.



**FIGURE 90–1.** Overview of a basic nociceptive circuit. Activation of the peripheral afferent terminal by a noxious stimulus leads to generation of action potentials that are conducted to the dorsal horn of the spinal cord. Neurotransmission in the dorsal horn relays signals to second-order CNS neurons that convey the information to the brain. This circuit also is subject to descending modulatory control. (Modified from Golan DE, Tashjian AH, Armstrong EJ, et al., eds. *Principles of Pharmacology: The Pathophysiologic Basis of Drug Therapy*. Baltimore: Lippincott Williams & Wilkins, 2005, with permission.)

and for how long. It led to the assumption by patient and physician that pain reflected a peripheral pathology. We now appreciate that this notion of a static, fixed nociceptive system activated only in the periphery is quite wrong. Instead, substantial signal processing occurs in all components of the nociceptive pathway. These components are highly modifiable or “plastic,” and it is this plasticity that drives clinical pain. In many cases, the pain arises not from the periphery where the sensation is interpreted (or “felt”) as arising, but from changes within or intrinsic to the nervous system. Plasticity occurs at even the earliest stage of nociception—the transduction of noxious stimuli at the peripheral terminals of primary sensory afferents—as well as to a substantial extent in the spinal cord and brain. The plasticity/modifiability occurs in response to external stimuli (e.g., inflammatory mediators) and to the internal activity of the nociceptive system itself, and it

can lead to either facilitation or depression of response.<sup>2,3</sup>

This chapter focuses on the mechanisms of acute and chronic somatic

pain. Other important chronic pain problems, such as those involving visceral pain and headache, have overlapping but not necessarily identical mechanisms. These syndromes are reviewed elsewhere.<sup>4,5</sup>

## Nociceptive Pathways: Neuroanatomy and Neurochemistry

### Primary Afferents: Transduction and Conduction to the Spinal Cord

The high-threshold primary afferent neurons responsible for detection of high-intensity noxious stimuli are termed *nociceptors*. Nociceptors include both thinly myelinated A-delta (A- $\delta$ ) and unmyelinated C-fibers. They represent one of several functional groups of sensory fibers in peripheral nerves (Table 90–1), including proprioceptors, low-threshold mechanoreceptors, and detectors of innocuous thermal stimuli. Nociceptors are classified based on the presence or absence of myelination and the type(s) of stimuli to which the sensory neuron responds. A- $\delta$  fibers conduct at 2–30 m/s. C fibers conduct at 0.2–2 m/s. The majority (80–90%) of nociceptors are C fibers. Nociceptors transduce mechanical, chemical, thermal (noxious heat or cold) single or, more commonly, combinations of stimuli (polymodal). Table 90–2 summarizes the characterization of nociceptors based on their response characteristics.

The membrane of peripheral terminals of nociceptors contains a set of highly specialized receptors/ion chan-

**TABLE 90–1.**

### Classification of Fibers Found in Peripheral Nerves

Fiber Type	Innervation	Mean Diameter ( $\mu\text{m}$ )	Mean Conduction Velocity (m/s)
<b>Sensory</b>			
A- $\beta$	Cutaneous touch and pressure afferent fibers	8	50
A- $\delta$	Mechanoreceptors, nociceptors, thermoreceptors	2–3	15
C	Mechanoreceptors, nociceptors, thermoreceptors, sympathetic preganglionic	1	1
<b>Motor</b>			
A- $\alpha$	Primary muscle spindle, motor to skeletal muscle	15	100
A- $\gamma$	Motor to muscle spindle	6	20
<b>Sympathetic</b>			
B	Sympathetic postganglionic	3	7

TABLE 90-2.

## Functional Classification of Primary Afferent Nociceptors

Type of Fiber	Nociceptor Type	Noxious Stimuli Detected
A- $\delta$ (2–30 m/s)	AM	Mechanical
	AMC	Mechanical and cold
	AH	Heat
	AMH type I	Mechanical, heat $>53^{\circ}\text{C}$
	AMH type II	Mechanical, heat $<51^{\circ}\text{C}$
	A-Chem	Chemical
C fiber (0.5–2 m/s)	CM	Mechanical
	CH	Heat
	CMH <sup>a</sup>	Mechanical, heat
	CMC	Mechanical, cold
	C-Chem	Chemical (algescic & pruritic)
	CMi <sup>b</sup>	None in resting state, mechanical (after activation)

<sup>a</sup>Many CHM nociceptors are also stimulated by algescic chemicals and are denoted “poly-modal” nociceptors.

<sup>b</sup>CMi nociceptors are known as either C “mechanoinsensitive” or “silent” nociceptors and are sensitive to mechanical stimuli only in the presence of inflammation or other activating stimuli.

nels that transduce mechanical, chemical, and thermal noxious stimuli into inward currents that excite the terminal. The transduction proteins determine the threshold, specificity, and temporal properties of the nociceptors that express them (Fig. 90-2 and Table 90-3). Upon stimulation, transduction receptor/ion channels undergo conformational changes that alter their conductance, allowing an influx of cations. This cation influx leads to depolarization of the terminal membrane—known as the *generator potential*—that, if of adequate amplitude, reaches the threshold to generate an action potential. The generator potential is graded in amplitude and duration and reflects stimulus intensity and timing. In contrast, action potentials are all-or-none

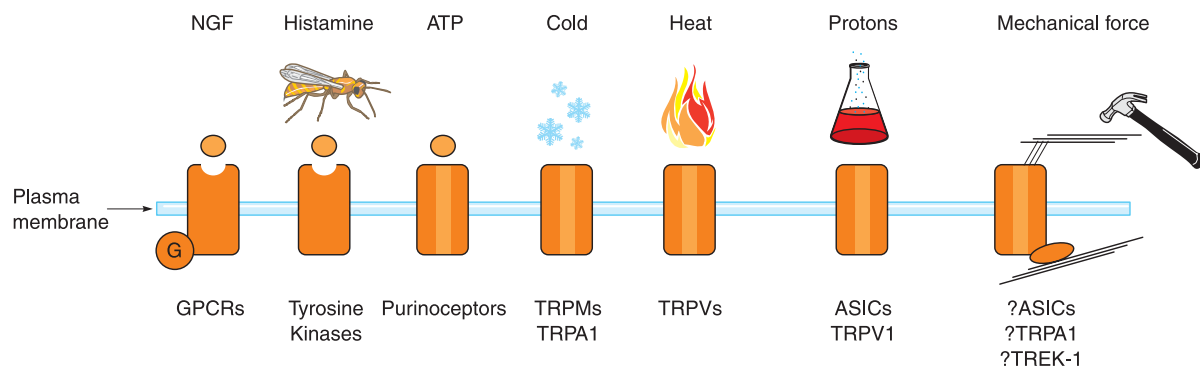
events. Primary afferent nociceptors transfer information from the periphery to the CNS by the pattern, frequency, and duration of firing of action potentials arising in the peripheral terminal that accurately encode the onset, intensity, location, and duration of nociceptive stimuli. One particular class of C-fiber afferents, termed *silent nociceptors*, is inactive in the resting state, becoming responsive to noxious stimuli only after inflammation or injury.

Thermal sensitivity is conferred upon nociceptors by the presence of thermosensitive nonselective cation channels called *transient receptor potential (TRP) channels*. The thermoresponsive TRPs are a family of channels, each sensitive to a different thermal stimulus range. TRPV1 (the capsaicin

receptor) is activated by a variety of stimuli, including noxious heat ( $>108^{\circ}\text{F}$  [ $>42^{\circ}\text{C}$ ]), vanilloid ligands including capsaicin (the pungent component of chili peppers), low extracellular pH, lipids such as anandamide (an endogenous cannabinoid agonist), and polyamines.<sup>6-8</sup> Other TRP receptors are sensitive to heat in other ranges: TRPV2  $>126^{\circ}\text{F}$  ( $>52^{\circ}\text{C}$ ), TRPM8  $\sim 46\text{--}79^{\circ}\text{F}$  ( $\sim 8\text{--}26^{\circ}\text{C}$ ), and TRPA1  $<63^{\circ}\text{F}$  ( $<17^{\circ}\text{C}$ ). These receptors also respond to chemicals: TRPV1 to capsaicin, TRPA1 to mustard oil/wasabi, and TRPM8 to menthol and icilin.

Nociceptors respond to a variety of chemical stimuli, some of which directly activate the terminal, producing generator potentials (chemical activators) and thereby an action potential output and pain. Other agents alter the threshold of the nociceptor (sensitizing agents) without directly exciting them. We discuss these sensitizers later. Nociceptor activators typically are associated with injury, such as low pH (i.e., protons), adenosine triphosphate (ATP), and kinins or irritants such as capsaicin and mustard oil. TRPV1 is sensitive to protons, as are a family of channels known as acid-sensitive ion channels (ASICs). ATP is sensed by both ligand-gated (P2X) ion channels and G-protein-coupled receptors (P2Y). Injury and ischemia are associated with low extracellular pH and generation of ATP. Nociceptors have specific receptors for bradykinin, the G-protein-coupled B1 and B2 receptors. Bradykinin is produced by cleavage of the precursor kininogen by kallikrein.

The identity of the receptor-ion channel complex responsible for transduction of noxious mechanical stimulation (“pinch”) is not clear. Evi-



**FIGURE 90-2.** Transduction of nociceptive stimuli. The first step in the sensation of physiologic or “nociceptive” pain is the transduction of high-intensity stimuli by primary sensory afferents. These afferents, A-delta (A- $\delta$ ) and C fibers, transduce mechanical-, chemical-, and temperature-related stimuli. The gain of the primary nociceptive afferents can be increased by translational and posttranslational modification, leading to pain hypersensitivity in a process termed *peripheral sensitization*. GPCRs, G-protein coupled receptors; TRP, transient receptor protein; ASICs, acid-sensing ion channels; TREK, a member of the 2-pore-domain K<sup>+</sup> channels. (We thank M. Costigan who provided a graphic from which Figure 90-2 was generated.)

TABLE 90–3.

## Ion Channel and Metabotropic Receptors (Found on Primary Afferent Peripheral Terminals) Involved in Noxious Stimulus Transduction

Ion Channel Receptors	Permeable to	Activated by
<b>Transient Receptor Potential (TRP) channels</b>		
TRPV1	Cations, especially Ca <sup>2+</sup>	Heat (>109°F [ $>43^{\circ}\text{C}$ ]), low pH, capsaicin
TRPV2	Cations, especially Ca <sup>2+</sup>	Heat (>126°F [ $>52^{\circ}\text{C}$ ])
TRPV3	Cations, especially Ca <sup>2+</sup>	Warm (88–102°F [ $31\text{--}39^{\circ}\text{C}$ ])
TRPV4	Cations, especially Ca <sup>2+</sup>	Warm (>81°F [ $27^{\circ}\text{C}$ ])
TRPM8	Cations, especially Ca <sup>2+</sup>	Cold (~ 46–79°F [ $\sim 8\text{--}26^{\circ}\text{C}$ ]), menthol
TRPA1	Cations, especially Ca <sup>2+</sup>	Cold (<63°F [ $17^{\circ}\text{C}$ ]), mustard oil
<b>Acid-Sensing Ion Channels</b>		
ASIC1, ASIC2, ASIC3	Na <sup>+</sup>	Low pH, ? mechanical
Purine receptor, P2X <sub>3</sub>	Ca <sup>2+</sup>	ATP
<b>Metabotropic Receptors</b>		
Purine receptor, P2XY	G-protein–coupled receptor	Activated by ATP
Bradykinin receptor, B1& B2	G <sub>q</sub> protein-coupled receptor	Bradykinin
ATP, Adenosine triphosphate.		

dence in invertebrates suggests that such stimuli are transduced by the degenerin/epithelial family of cation channels.<sup>9</sup> It has been suggested that the AISC3 subtype is involved in noxious mechanical stimulation in mammals, although this may occur via an indirect mechanism.<sup>10–12</sup> Other data suggest that TRPA1 receptors have a mechanotransduction role as well as involvement in cold pain. Inhibitors of specific transduction proteins may reduce particular aspects of pain. For example, TRPV1 antagonists might reduce heat pain, which might not be a good idea if you drink very hot coffee and like a curry!

Voltage-gated sodium ion channels are critical for initiation of action potentials in the peripheral terminals of nociceptors and for their conduction along axons in peripheral nerves to the spinal cord (Table 90–4). Primary afferents express six types of voltage-gated sodium (Na<sup>+</sup>) channels. Interestingly, four of these channels (Na<sub>v</sub>1.7, Na<sub>v</sub>1.8, Na<sub>v</sub>1.9, Na<sub>x</sub>) are expressed only by primary afferents, and two of these four (Na<sub>v</sub>1.8 and Na<sub>v</sub>1.9) are expressed predominantly by nociceptors. The relative restricted expression of Na<sub>v</sub>1.8 and Na<sub>v</sub>1.9 in nociceptive afferents in conjunction with their pharmacologic distinction from

other Na<sup>+</sup> channels (Na<sub>v</sub>1.8 and Na<sub>v</sub>1.9 are tetrodotoxin [TTX] resistant) means that these channels have generated substantial interest as potential targets for pain therapeutics. Local anesthetics such as lidocaine are not sodium channel selective; they block all axons, nociceptors, nonnociceptor sensory fibers, and motor and autonomic as well sodium channels in the CNS and PNS (peripheral nervous system). Blockers specific for Na<sub>v</sub>1.8 and Na<sub>v</sub>1.9 could potentially produce blockade only of “pain” fibers, which would totally change regional anesthesia.

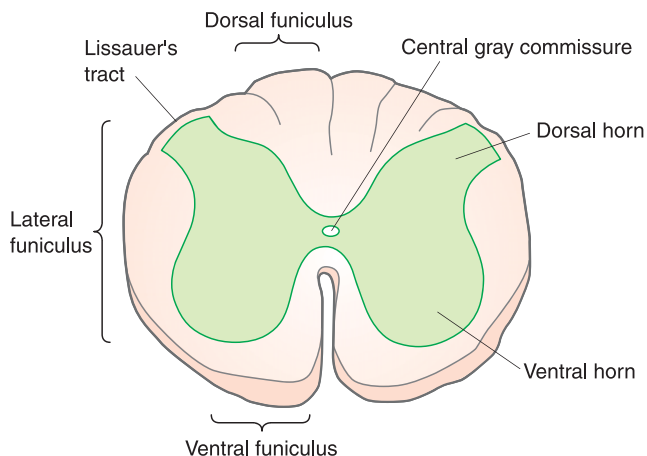
Nociceptors have a cell body located in the dorsal root ganglion (DRG), a peripheral process innervating the target tissue, and a central process that runs in dorsal roots and makes a synapse on second-order neurons in the dorsal horn of the spinal cord. The same is true of primary afferent sensory fibers of cranial nerves (V, VII, IX, and X), except that the cell bodies are located in their respective brainstem sensory ganglia. The visceral primary afferent nociceptors (both A- $\delta$  and C fibers) travel with sympathetic and parasympathetic nerves and have cell bodies in the DRG. The central axons of nociceptors enter the gray matter of the spinal cord via the dorsal root and synapse on neurons in the dorsal horn. The fibers can traverse 1–2 spinal segments rostrally or caudally through the Lissauer tract prior to making synaptic connections with nociceptive projection neurons and interneurons. The nociceptor terminals form a highly organized somatotopic map of the body surface in the dorsal horn encoding the location of the afferents' peripheral receptive field. The gray matter of the spinal cord is organized into 10 laminae (lamina of Rexed) based on histologic organization of the cell bodies and dendrites. Rexed laminae I–V compose the dorsal horn of the spinal cord. The majority of nociceptors terminate in lamina I (marginal zone), lamina II (substantia gelatinosa), and lamina V. Lamina I contains both interneurons and projection neurons. Lamina II contains few projection neurons and comprises predominantly interneurons, both excitatory and inhibitory. Like lamina I, lamina V contains both projection neurons and interneurons. The inputs to dorsal horn neurons are complex, and there is a con-

TABLE 90–4.

## Ion Channels (Found on Primary Afferent Nociceptors) Involved in Membrane Excitation/Conduction and Synaptic Transmission

Channel	Permeable to	Activated by
Tetrodotoxin-sensitive sodium channels Na <sub>v</sub> 1.1, Na <sub>v</sub> 1.3 <sup>a</sup> , Na <sub>v</sub> 1.6, Na <sub>v</sub> 1.7	Na <sup>+</sup>	Depolarization
Tetrodotoxin-resistant sodium channels Na <sub>v</sub> 1.8, Na <sub>v</sub> 1.9	Na <sup>+</sup>	Depolarization
Inward-rectifying potassium channels (multiple subtypes)	K <sup>+</sup>	Depolarization, Ca <sup>2+</sup>
Voltage-gated calcium channels, esp. the N-type Ca <sup>2+</sup> channel (Ca <sub>v</sub> 2.2)	Ca <sup>2+</sup>	Depolarization
<sup>a</sup> Na <sub>v</sub> 1.3 is expressed on sensory neurons only following injury.		





**FIGURE 90-3.** Cross-section of the spinal cord. Schematic of the spinal cord displays basic anatomic features. Cell bodies of second-order sensory neurons are located predominantly in the dorsal horn. Cell bodies of motor neurons are localized to the ventral horn. Nociceptive primary afferents may ascend or descend, covering as many as six spinal levels in the Lissauer tract prior to synapsing on second-order projection neurons and interneurons. Ascending and descending tracts in the white matter are not shown.

vergence of inputs from wide areas of skin or from different tissues. This is responsible for the phenomenon of referred pain. For example, the pain of myocardial ischemia is referred to the left upper extremity because of a convergence at the level of the dorsal horn of sensory afferents from the heart and left upper extremity.

### Transmission in the Dorsal Horn of the Spinal Cord

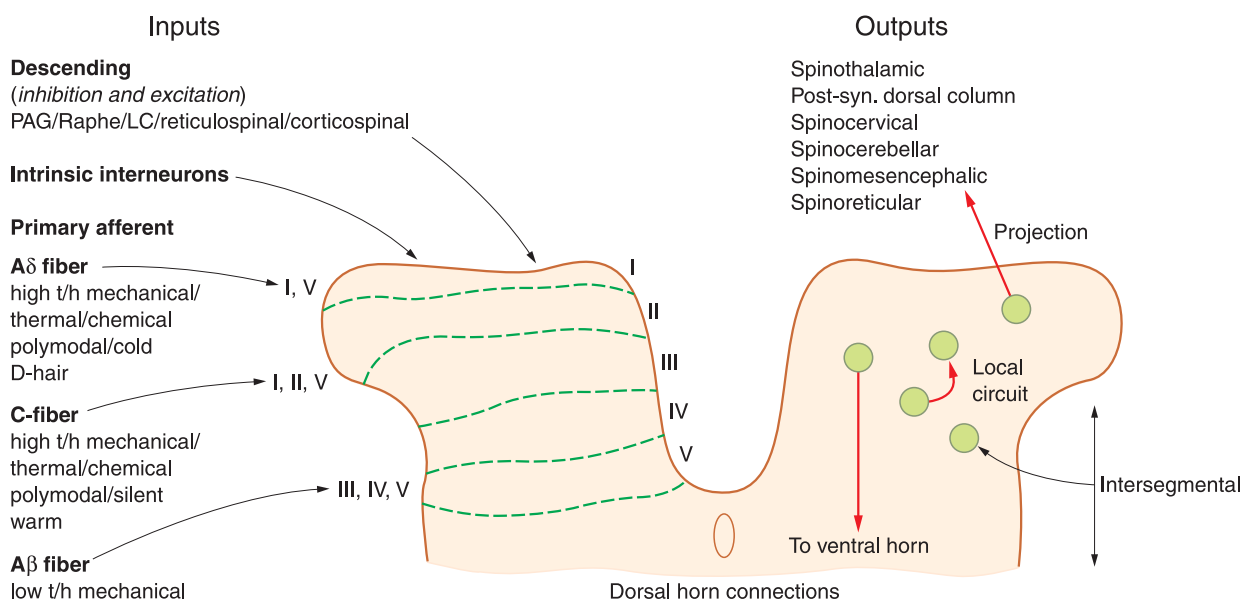
The dorsal horn is a critical region for the processing, modulation, and projec-

tion of nociceptive information to the brain (Figs. 90-3 and 90-4). Individual second-order dorsal horn neurons are activated by stimulation of defined areas of the periphery known as a *receptive field*. Some are activated only by noxious stimuli (nociceptive specific), some are activated only by innocuous stimuli (low threshold), and some have a wide dynamic range and are activated by low-intensity and high-intensity peripheral stimuli (multireceptive). The most basic nocifensive response of the nervous system is the

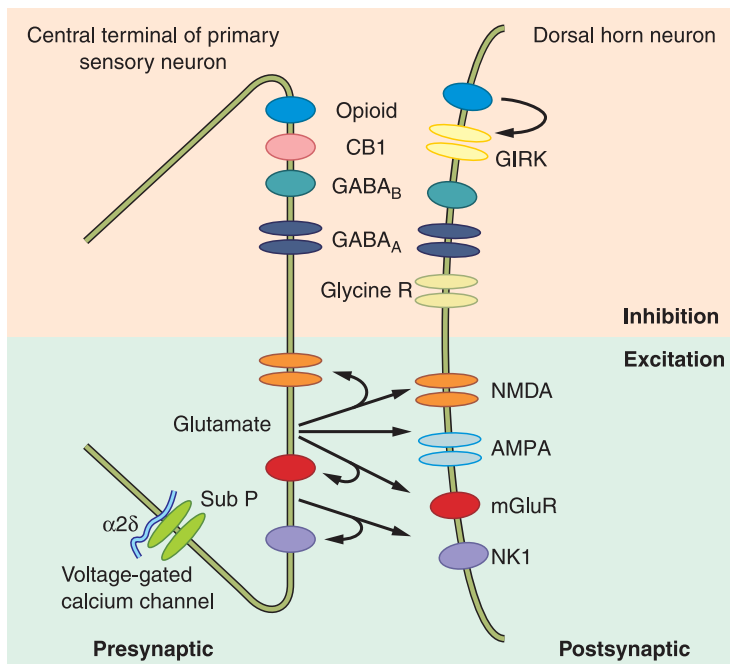
polysynaptic flexor withdrawal reflex generated in the spinal cord by nociceptor activation in the dorsal horn of a chain of excitatory interneurons leading to excitation of flexor motor neurons in the ventral horn. This results in rapid withdrawal from the stimulus of the part of the body in contact with the noxious stimulus. The neuronal components of the dorsal horn can be divided into four categories<sup>13</sup>:

1. Central terminals of primary afferents
2. Intrinsic neurons with cell bodies and terminations within the spinal cord
3. Projection neurons with axons that travel in ascending columns to terminate in the brain
4. Axonal projections of descending systems whose cell bodies reside in the brain

The intrinsic neurons can be divided into local interneurons and propriospinal neurons, which transfer information from one spinal segmental level to another. The great majority of dorsal horn neurons are local interneurons, both inhibitory and excitatory. Transfer of information from primary afferents to second-order neurons in the dorsal horn occurs at the synapse. Numerous transmitters and synaptic neuromodulators are involved in transmission and modulation of nociceptive



**FIGURE 90-4.** Connections of the dorsal horn of the spinal cord display major inputs and outputs. Left. Primary afferent input to the dorsal horn. Nociceptive afferents (A- $\delta$  and C fibers) synapse in Rexed laminae I, II, and VI. Low-threshold afferents (A- $\beta$  fibers) synapse primarily in Rexed laminae III, IV, and V. Right. Some of the important circuits originating from dorsal horn neurons. The majority of dorsal horn neurons are interneurons that generate intrinsic circuits. Other dorsal horn neurons project to the brain, the dorsal horn at different spinal levels, and the ventral horn of the spinal cord.



**FIGURE 90-5.** Inhibitory and excitatory influences of primary afferents in the spinal cord dorsal horn. Second-order neurons in the dorsal horn of the spinal cord are subject to both inhibitory and excitatory presynaptic influences by primary sensory afferents. This is one of several mechanisms through which excitability of dorsal horn neurons is controlled. Dorsal horn neurons also are subject to inhibitory and excitatory influences from local interneurons and descending brainstem pathways.

information in the dorsal horn (Fig. 90-5). Tables 90-5 and 90-6 list the major excitatory and inhibitory neurotransmitters and their receptors in the spinal cord. Invasion of the central terminal of nociceptors in the spinal cord by the periphery results in activation of voltage-dependent calcium channels and calcium entry, which activate release mechanisms of the synapse sufficiently to release transmitter. Sufficient transmitter may be released to produce depolarization of the postsynaptic cell large enough to initiate an action potential in the second-order

neuron. Alternatively, the invading action potential may not result in any release of transmitter. Between these extremes lies a range of graded synaptic efficacies from strong to almost ineffective. Most input is subthreshold. Control of synaptic efficacy is one of the major driving forces of neuronal plasticity in general and of pain hypersensitivity in particular. A variety of factors control synaptic strength or efficacy. They include the following:

1. Density and activity of voltage-dependent calcium channels on presynaptic terminals

2. Type of transmitter, amount in each synaptic vesicle, and vesicle release mechanisms.
3. Receptors on the presynaptic axonal central terminals that can control transmitter release, such as  $\gamma$ -aminobutyric acid (GABA), opioid, and cannabinoid.
4. Transmitter degradation and uptake
5. Density, type, and state of postsynaptic receptors
6. Excitability of the postsynaptic membrane as determined by  $K^+$  and  $Na^+$  ion channels

All of these factors can be modified and in this way facilitate or depress nociceptive signal processing and transmission. Synaptic transmission between primary afferent nociceptors (predominantly C fibers) and second-order neurons has both fast and slow components. As in the case of the nervous system in general, the excitatory amino acid glutamate is the primary fast *excitatory* neurotransmitter used by nociceptors. Glutamate activates  $\alpha$ -amino-3-hydroxy-5-methylisoxazole-4-propionic acid (AMPA)/kainate ionotropic glutamate receptors, leading to a short-lasting depolarization in second-order neurons (a few milliseconds), the fast excitatory postsynaptic potential. The *N*-methyl-D-aspartate (NMDA) ionotropic glutamate receptor is another ionotropic glutamate receptor that is also found on many neurons in nociceptive pathways. The channel of this receptor normally is blocked by  $Mg^{2+}$  at resting membrane potentials. Membrane depolarization is required for removal or relief of  $Mg^{2+}$  block, only then enabling, in the presence of glutamate, activation. The NMDA ion channel allows both calcium and sodium ion influx into the cell; calcium then can act as a second messenger and produce long-lasting changes in the cell.

C-fibers in addition to glutamate have a variety of other cotransmitters (e.g., substance P, calcitonin gene-related peptide [CGRP], neuropeptide Y [NPY], and brain-derived neurotrophic factor [BDNF]). Whereas glutamate activates ionotropic AMPA/kainate receptors to produce a fast synaptic potential, the co-released neuropeptides activate G-protein-coupled receptors, resulting in a delayed and longer-lasting slow postsynaptic potential that persists for several seconds. This slow synaptic po-

**TABLE 90-5.**

#### Synaptic Mediators of Dorsal Horn Nociceptive Processing

Excitatory	Inhibitory
Amino acids: glutamate and aspartate	Endogenous opioids: enkephalin and $\beta$ -endorphin
Neuropeptides: substance P (SP), calcitonin gene-related peptide (CGRP), vasoactive intestinal peptide (VIP)	Amino acids: glycine and $\gamma$ -aminobutyric acid (GABA)
Growth factors: brain-derived neurotrophic factor (BDNF)	Norepinephrine (NE)
Bradykinin	Serotonin (5-HT)
Somatostatin	Endogenous cannabinoids
Prostaglandin $E_2$ ( $PGE_2$ )	

TABLE 90–6.

## Dorsal Horn Neuronal Receptors Involved in the Processing of Nociceptive Information

Receptor	Major Ligand(s)
<b>Excitatory Ionotropic</b>	
NMDA receptor	Glutamate (glycine is a co-ligand)
AMPA receptor	Glutamate
Kainate receptor	Glutamate
<b>Excitatory Metabotropic</b>	
Neurokinin receptors, NK1	Substance P
Metabotropic glutamate receptor, mGluR5	Glutamate
Prostaglandin receptors	Prostaglandin E <sub>2</sub> , prostaglandin F <sub>2</sub> α
Tyrosine kinase B (TrkB) receptor	Brain-derived neurotrophic factor (BDNF) Neurotrophin 4/5 (NT4/5)
<b>Inhibitory Metabotropic</b>	
Opioid receptors	Endomorphins, enkephalins, dynorphin
α <sub>2</sub> -Adrenergic receptor	Norepinephrine
Serotonin receptors, 5-HT <sub>1B/D</sub> & 5HT <sub>3</sub> <sup>a</sup>	Serotonin
GABA <sub>B</sub> receptor	γ-aminobutyric acid (GABA)
Cannabinoid receptor, CB1	Endocannabinoids
<b>Inhibitory Ionotropic</b>	
Glycine receptor	Glycine

<sup>a</sup>Serotonin may have facilitatory effects in the dorsal horn via activation of 5HT<sub>3</sub> receptors.

tential contributes to one form of activity-dependent synaptic modification of dorsal horn neuron function called *windup*. Windup is a progressive increase in action potential generation in dorsal horn neurons in response to repetitive, low-frequency C-fiber stimulation. It is a form of activity-dependent plasticity that occurs over the course of the stimuli and terminates within a few seconds of the end of the afferent input. Only those synapses on second-order neurons that are directly stimulated by the repeated sensory afferent inputs show the increase, and windup is a form of what is called *homosynaptic* activity-dependent plasticity, limited to the activated synapse. The cumulative depolarization produced by summation of slow synaptic potentials recruits NMDA receptors by removing Mg<sup>2+</sup> channel block, leading to progressive buildup in synaptic efficacy and hence windup.<sup>14</sup> It is possible to observe in human volunteers a progressively increasing pain response to repetitive peripheral noxious heat stimuli; in patients following nerve injury, a windup of pain can be observed for repeated mechanical stimulation. This clinical correlate of the windup phenomenon can be blocked by NMDA receptor antagonists such as ketamine.<sup>15</sup>

Glycine and GABA are the predominant mediators of *inhibitory* neurotrans-

mission in the dorsal horn. Glycine and GABA activate glycine and GABA<sub>A</sub> ionotropic receptors to produce inward Cl<sup>-</sup> currents that hyperpolarize and, therefore, inhibit neuronal activity. Several inhibitory metabotropic (i.e., G-protein-coupled) receptors are present on afferent central terminals and dorsal horn neurons, including GABA<sub>B</sub>, opioid, cannabinoid, and adenosine receptors. Drugs that act as agonists on these receptors, such as morphine, reduce transmission in nociceptive pathways and thereby produce analgesia. Calcium channel blockers (N-type, Ca<sub>v</sub>2.2), such as ziconotide, also reduce transmitter release and have analgesic activity. Gabapentin and pregabalin bind to the α<sub>2</sub>-δ subunit of calcium channels and may reduce transmitter release in a use-dependent fashion.

### Ascending Nociceptive Pathways

After processing in the dorsal horn, nociceptive information is transferred to the brain by projection neurons. There are several ascending projection systems; two of the more important are the spinothalamic and spinobulbar pathways. The spinothalamic tract carries information from dorsal horn lamina I (marginal zone), laminae IV-V (deep dorsal horn), and laminae VII-VIII (intermediate zone and medial ventral horn) to the lateral thalamus.

Spinothalamic tract neurons project to six thalamic regions: ventral posterior nuclei, ventral medial nucleus, ventral lateral nucleus, central lateral nucleus, parafascicular nucleus, and medial dorsal nucleus. The thalamic neurons on which these fibers synapse then send projections to the somatosensory cortex: SI and SII. This pathway is thought to be involved in the sensory and discriminative aspects of pain as well as temperature and itch.<sup>16</sup>

There is substantial projection of nociceptive information from the dorsal horn to the brainstem. Cells of the spinobulbar pathway reside principally in laminae I, V, and VII.<sup>17</sup> This projection system terminates in four areas of the brainstem: regions of catecholamine cell groups (A1–A7), parabrachial nucleus, periaqueductal gray, and brainstem reticular formation.<sup>18</sup> The parabrachial nucleus is thought to be involved in homeostasis and autonomic functions. The periaqueductal gray, which has both ascending and descending projections, seems to be involved in homeostasis, limbic motor output, and integration of ascending nociceptive information with descending antinociceptive output.<sup>19</sup> Nociceptive information is carried from the dorsal horn to the hypothalamus by the spinohypothalamic tract.<sup>20</sup> Cells in this tract originate in laminae I, V, VII, and X<sup>21</sup> and are important for integration of pain with autonomic functions (e.g., sleep, appetite, temperature regulation) and emotional and neuroendocrine responses. These and other ascending spinal tracts provide input through multisynaptic pathways to a wide array of higher cortical areas. Positron emission tomography (PET) and functional magnetic resonance imaging (fMRI) have been used to demonstrate brain activation associated with pain (see Representation of Pain in the Brain).

### Descending Nociceptive Pathways

The ability to modulate nociceptive transmission is as important to an organism as the ability to detect such stimuli. Descending outputs from the brain modulate pain transmission at the level of the spinal cord. The descending controls are both inhibitory and facilitatory. The midbrain periaqueductal gray acting through the rostral ventromedial medulla (RVM) represents the key center for integration of the brain's descending output to the

dorsal horn.<sup>19,22–24</sup> Cells of the RVM have been classified into three types based on their response to peripheral noxious stimulation: “on,” “off,” and “neutral.”<sup>25</sup> “On” cells are activated by prolonged noxious stimulation. These cells activate descending facilitatory pathways that enhance dorsal horn nociceptive conduction. “Off” cells are tonically active, provide inhibitory input to dorsal horn nociceptive circuits, and are inhibited by noxious stimuli. The descending output of the RVM, as related to nociception, uses several functionally interrelated systems: opioid, noradrenergic, and serotonergic systems.

The opioid system is active at multiple levels, including the brain, brainstem, spinal cord, and peripheral terminals of primary afferent neurons. The endogenous opioids— $\beta$ -endorphin, the enkephalins, and the dynorphins—are peptides that inhibit synaptic transmission via activation of G-protein-coupled receptors. The opioid receptors are grouped into three functional distinct classes— $\mu$ ,  $\delta$ , and  $\kappa$ —which have both presynaptic and postsynaptic effects. Most clinically used opioids act on the  $\mu$  receptor. In the spinal cord, opioid receptors exert their antinociceptive effects by inhibiting synaptic vesicle release from primary afferents and by hyperpolarizing second-order nociceptive neurons, decreasing their excitability. Inhibition of vesicle release is mediated by inhibition of voltage-gated  $\text{Ca}^{2+}$  channels, whereas hyperpolarization of the spinal cord neurons occurs principally via enhanced  $\text{K}^+$  efflux by activating G-protein-coupled inwardly rectifying potassium channels. Modulation of the opioid system has proven extremely useful in management of both acute and terminal pain, although the role of opioids in the management of chronic pain remains controversial because of their side effect profile, tolerance and dependency issues, and the problem of illicit use and diversion.

The noradrenergic system is a second major descending inhibitory nociceptive pathway. The primary receptor for norepinephrine in the spinal cord is the  $\alpha_2$ -adrenergic receptor. Like the opioid receptors, it is a G-protein-coupled receptor that, through second messengers, both inhibits presynaptic neurotransmitter release from primary afferents and decreases excitation of postsynaptic neurons via hyperpolar-

ization of those cells.  $\alpha_2$ -Adrenergic receptor agonists such as clonidine have an analgesic action. Serotonergic descending input from the RVM provides both inhibitory and facilitatory control of dorsal horn nociceptive function.<sup>26</sup> There are multiple subtypes of the serotonin (5-hydroxytryptamine [5-HT]) receptor in the spinal cord, and 5-HT can produce antinociceptive and pronociceptive effects depending on the receptor subtype(s) activated. Descending 5-HT inhibition is a presynaptic effect mediated by metabotropic 5-HT receptors, activation of which decreases transmitter release. 5-HT-mediated facilitation is mediated by ionotropic receptors (5-HT<sub>3</sub> subtype) that enhance transmitter release from nociceptive primary afferents.

Selective serotonin reuptake inhibitors that increase 5-HT levels have minimal analgesic action. In contrast, dual-uptake inhibitor drugs that block uptake of both norepinephrine and serotonin, such as the tricyclic antidepressants and newer agents such as duloxetine, have demonstrated efficacy in the treatment of neuropathic pain and likely act by augmenting the actions of descending inhibitory systems in the spinal cord.<sup>27</sup>

### **Representation of Pain in the Brain**

Cortical areas are critical for integration of information regarding peripheral noxious stimuli, the generation of a perception of “pain” and the response—motor, autonomic, psychological, cognitive—to the pain. The intensity of pain perceived depends on multiple factors, including the nature of the pain, level of arousal, emotional state, learned responses, anticipation, and reward. The representations of acute and persistent pain overlap but are not identical, and persistent but not acute pain may lead to (or be caused by) permanent changes in the brain. For example, chronic low back pain is associated with cortical atrophy.<sup>28–30</sup> Given the complexity of the processing, perception, and response to pain, it is not surprising that functional imaging (e.g., PET, fMRI, magnetoencephalography) reveals wide involvement of brain regions.<sup>31</sup> These areas include the thalamus, hypothalamus, limbic system, cerebral cortex, cingulate cortex, basal ganglia, and cerebellum.<sup>32,33</sup>

The integration and processing of pain in the brain has been postulated

to consist of broad categories of function—discriminative, affective-motivational, and cognitive—that involve distinct but overlapping regions. *Discriminative* refers to perceptual identification of the location, nature, and intensity of a painful stimulus. It is somatotopically specific and involves the primary (SI) and secondary (SII) sensory cortex.<sup>34,35</sup> Localization of pain, in particular, appears to involve S1. The *affective-motivational* component of pain is thought to involve several limbic structures including the cingulate cortex and the amygdala.<sup>36</sup> Despite the ability to link specific regions with different aspects of pain, nociceptive processing in the brain represents a “matrix” in which multiple regions are recruited in the different aspects of the perception of, and response to, pain.<sup>31</sup>

There is a temporal sequence of cortical activation during the experience of pain. Because of the difference in conduction velocities of A (myelinated fast) and C (unmyelinated, slow) fibers, there exist “fast” and “slow” components of pain perception. It has been hypothesized that the fast component is important for immediate responses to pain (i.e., withdrawal), although the slow component is more important for behavioral responses that limit injury and promote healing.<sup>37</sup> Whereas the first component of pain is associated with SI activation (SI also is important for cutaneous localization of noxious stimuli), the second component maps to the anterior cingulate cortex. Expectation and past experience affect the response to noxious stimuli and hence the experience of pain. There exists a robust placebo effect related to analgesia, and this effect is a clear example of cognitive modulation of the pain experience. Using functional imaging in subjects who are experiencing placebo analgesia provides insight into the brain regions involved in modulation of pain perception.<sup>38,39</sup>

### **TAXONOMY OF PAIN**

The International Association for the Study of Pain (IASP) defines *pain* as “an unpleasant sensory and emotional experience associated with actual or potential tissue damage.”

A basic tenant of pain taxonomy is that there are multiple types of pain, each with different underlying mecha-

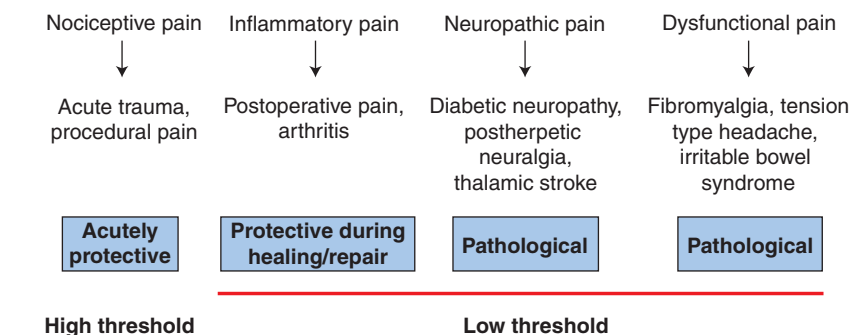


nisms (Figs. 90–6 and 90–7). We divide pain states into the following categories:

- Nociceptive
- Inflammatory
- Neuropathic
- Dysfunctional (Fig. 90–8)

*Nociceptive pain* is pain that results from activation of nociceptors by noxious stimuli. This pain is “high threshold” and generally serves a protective function. The pain can potentially be “chronic” if stimulation of nociceptors is persistent, as may occur with mechanical destruction of a joint in osteoarthritis resulting in activation of nociceptor peripheral terminals upon movement of the joint. Clinically, pain is considered chronic if it lasts more than 3–6 months.<sup>40</sup> Acute trauma and procedural pain are examples of nociceptive pain.

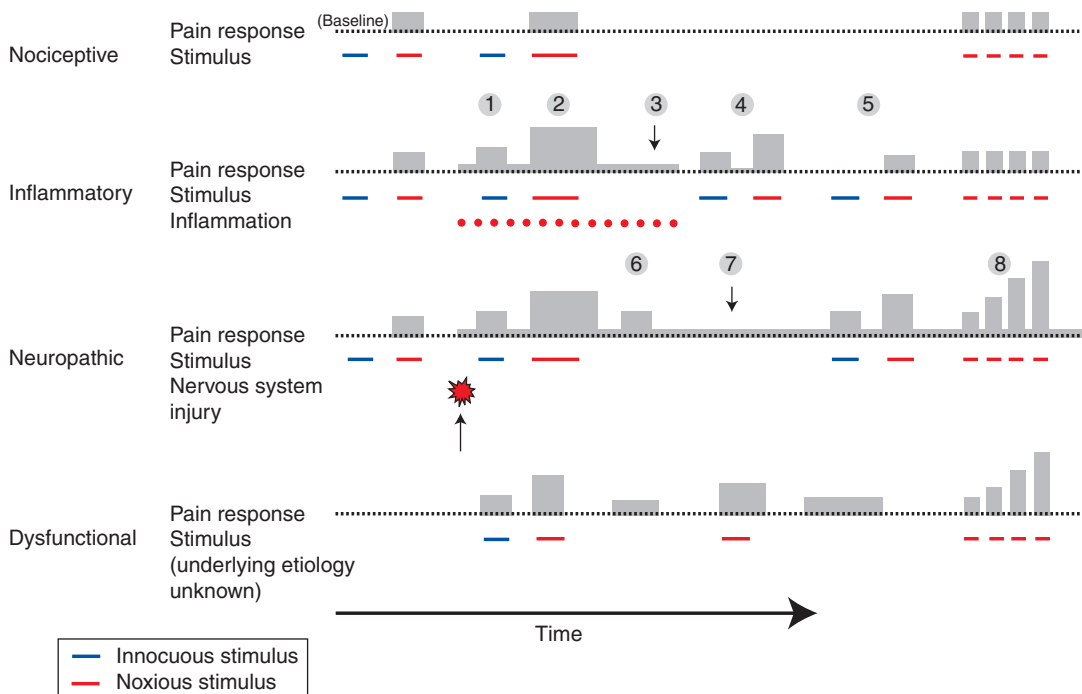
Injured tissue and inflammatory cells release a variety of mediators that can activate or sensitize primary afferent nociceptors as well as alter gene expression in sensory neurons



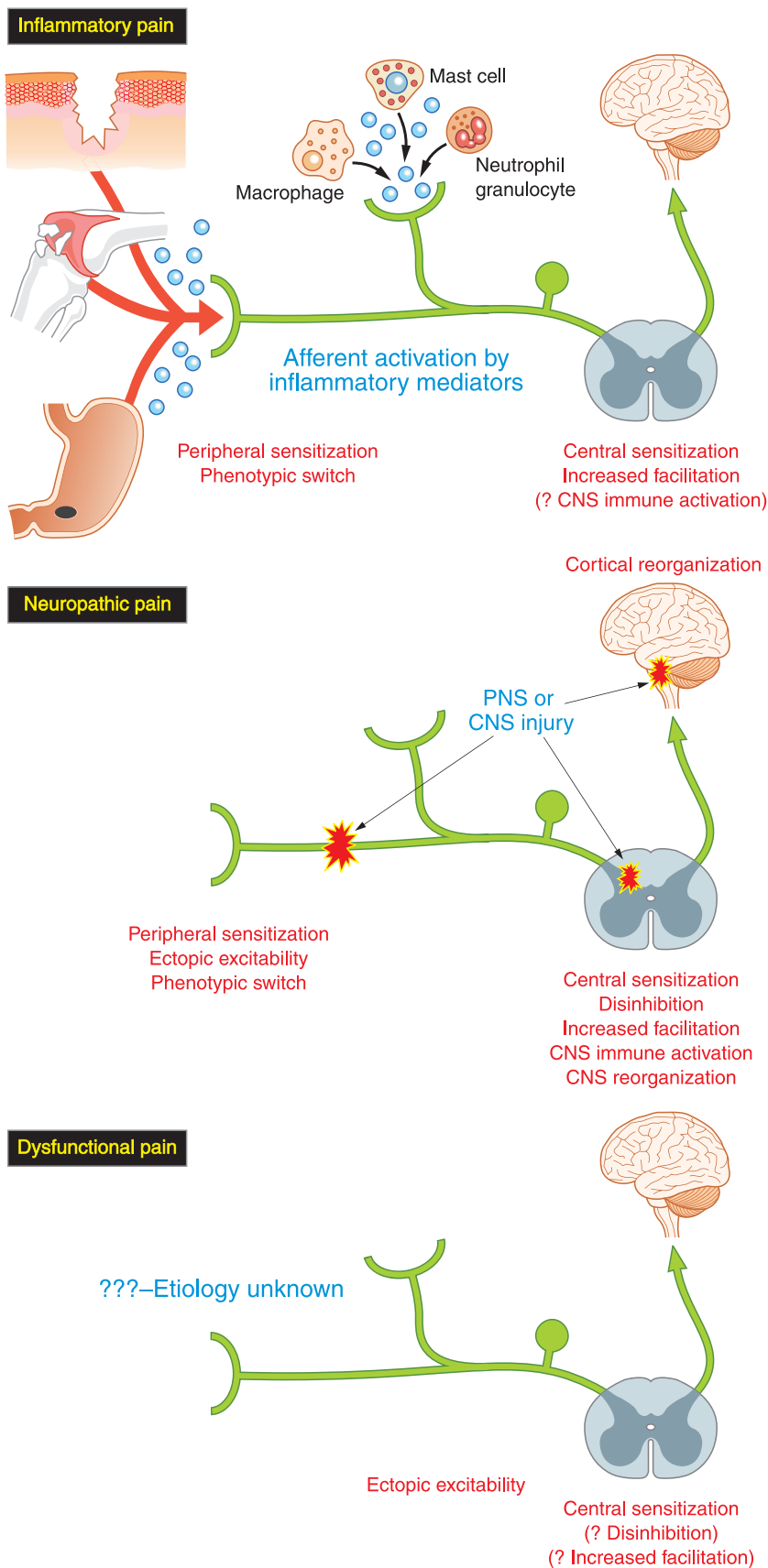
**FIGURE 90–6.** Four basic categories of pain. There are multiple types of pain, each with different causes and underlying mechanisms. Pain can be roughly categorized as nociceptive, inflammatory, neuropathic, and dysfunctional. Whereas nociceptive and inflammatory pain can have a protective function, both neuropathic and dysfunctional pain represent pathologic functioning of the nociceptive system. Nociceptive pain involves nociceptor activation by high-threshold stimuli only. With inflammatory, neuropathic, and dysfunctional pain, the nociceptive system can be stimulated by both high-threshold and low-threshold stimuli, and pain hypersensitivity (hyperalgesia and allodynia) occurs. Examples of each type of pain are listed beneath the arrows (note: the list is not exhaustive).

and facilitate central transmission, thereby generating *inflammatory pain* (Fig. 90–9). Although this pain can be regarded in some circumstances to serve an adaptive function, promoting healing and repair, there is a need to

control the pain both in acute situations such as postoperative pain and in disease states such as chronic arthritis. Malignant cells may produce inflammatory mediators that sensitize nociceptors. In the past inflammatory pain



**FIGURE 90–7.** Clinical response characteristics of pain types. Different types of pain have different response characteristics following noxious and innocuous stimulation. Nociceptive pain is generated by noxious stimuli only, activates high-threshold sensory afferents only, and the pain resolves with resolution of the pain-evoking stimulus. Inflammatory pain is characterized by allodynia (1) and hyperalgesia (2). There also is continuous pain associated with ongoing nociceptive stimulation (3). With inflammatory-type pain, stimulus-independent pain and stimulus-dependent hypersensitivity may persist for some finite period following the resolution of inflammation (4) but typically resolve (5). Neuropathic pain and dysfunctional pain are characterized by allodynia, hyperalgesia, stimulus-independent pain, and windup. Stimulus-independent pain may include paroxysmal (6) and continuous (7) components. Windup (8) is the progressive pain response to repeated stimulation. It involves activation of *N*-methyl-D-aspartate (NMDA) receptors and results from changes at the level of the dorsal horn of the spinal cord. Nociceptive and inflammatory pain encourages an organism to avoid potentially or actually tissue-damaging stimuli; these pain types are physiologic and have a protective function. Neuropathic and dysfunctional pain lack protective function and are considered pathologic.

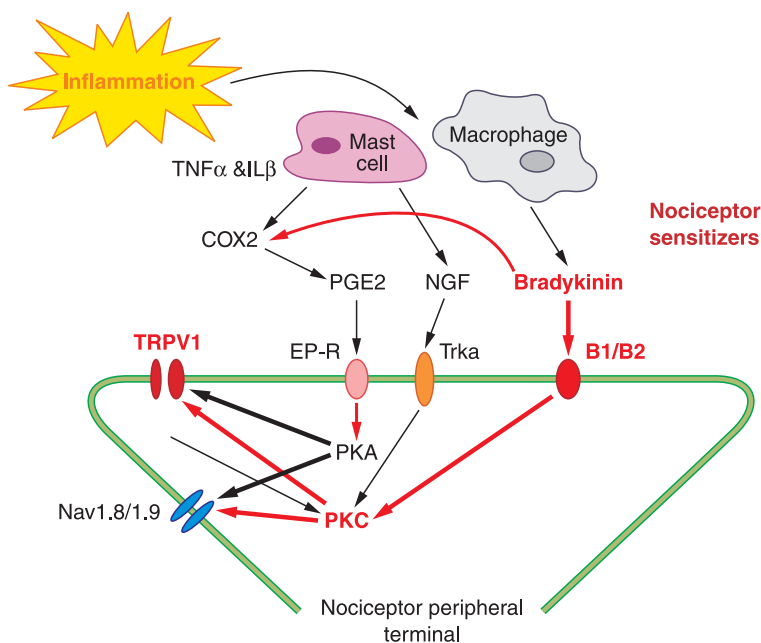


**FIGURE 90-8.** Underlying mechanisms of pain. Different types of pain (inflammatory, neuropathic, dysfunctional) have different etiologies and are associated with different, but overlapping, underlying mechanisms.

was grouped within the category of nociceptive pain,<sup>41</sup> but this is clinically and mechanistically incorrect. The two categories differ in that nociceptive pain only includes pain in response to suprathreshold nociceptor stimulation by noxious stimuli, whereas inflammatory pain includes changes in peripheral and central sensory pathways that generate facilitated pain processing so that pain now can be produced by low-intensity stimuli.

There exist chronic or persistent pain states for which the pain serves no adaptive function. These states, “neuropathic” and “dysfunctional” pain, are pathologic. The IASP defines *neuropathic pain* as pain initiated or caused by a primary lesion of or dysfunction in the nervous system. We believe this definition is too broad; we prefer to define neuropathic pain only as pain with an identifiable lesion to the nervous system that will cause a loss of function and thereby negative symptoms. Neuropathic pain is caused by a wide variety of disorders that are heterogeneous in etiology and presentation<sup>42</sup> and can be generated by lesions at many levels of the nervous system. Neuropathic pain is subdivided into *central* and *peripheral*, referring to whether the inciting lesion/dysfunction is in the CNS or PNS, respectively. Examples of peripheral neuropathic pain include painful diabetic neuropathy and carpal tunnel syndrome. Pain syndromes associated with thalamic strokes or spinal cord trauma are examples of central neuropathic pain. A cardinal component of the clinical diagnosis of neuropathic pain is the presence of both positive (e.g., allodynia, hyperalgesia, dysesthesia) and negative (e.g., loss of function such as sensory loss in a region of pain hypersensitivity, muscle weakness, absent reflexes) symptoms or signs. In addition, pain can be grouped into *stimulus evoked* and *stimulus independent*. The former is characterized by the presence of hyperalgesia and/or allodynia, whereas the latter spontaneous pain may be paroxysmal or persistent.

Inflammatory pain and neuropathic pain share some underlying mechanisms, but there is an important distinction between the two. Upon resolution of inflammation and removal of the chemical stimuli that mediate sensitization, the associated pain hypersensitivity usually resolves completely. In the case of neuropathic pain,



**FIGURE 90–9.** Primary afferent nociceptor sensitization. Following peripheral injury, a variety of inflammatory mediators are generated that are capable of sensitizing primary afferent nociceptors. These mediators bind to cell-surface receptors, activating a variety of second-messenger pathways that in turn can alter the transduction properties of both the receptors and ion channels involved in action potential generation and conduction.

however, the alterations in nociceptive processing, and hence the presence of pathologic pain, typically persist long after resolution of the initiating insult to the nervous system.

*Dysfunctional pain* represents a diagnosis of exclusion. It can be defined as persistent pain in the absence of a noxious stimulus, peripheral inflammation, or an identifiable lesion to the nervous system. There are no focal neurologic findings or negative symptoms. Instead, the pain appears to result from abnormal function of the nervous system, creating an abnormal sensitivity or gain. Examples of dysfunctional pain include fibromyalgia, irritable bowel syndrome, and tension-type headache.

This categorization provides a schema for approaching clinical problems but does not imply specific underlying mechanisms. Multiple mechanisms underlie the generation of chronic pain, and multiple mechanisms often are simultaneously active. We now discuss the different mechanisms that produce clinical pain.

## PAIN HYPERSENSITIVITY

Nociceptive pain is characterized by a clear relationship between stimulus intensity (once threshold has been ex-

ceeded) and the response or pain perception until tissue damage occurs. An additional defining feature of this pain is that it abates upon cessation of the noxious stimulus, provided tissue is not damaged. Nociception depends upon high-threshold afferents being activated only by relatively intense stimuli. Nociception is highly adaptive in that it is associated with behaviors and responses that minimize tissue injury. The pain is an early or alarm warning system.

If actual tissue damage occurs (producing inflammation), hypersensitivity is generated by a variety of mechanisms that convert high-threshold nociception to low-threshold inflammatory pain. Like nociceptive pain, inflammatory pain in some circumstances can be adaptive. For example, the pain hypersensitivity that follows a burn discourages further contact with the damaged skin until the skin is fully healed. After healing has occurred, the alterations in nociceptive processing and the associated hypersensitivity in most cases tend to resolve completely. Pain that is persistent, is severe, or interferes with function and quality of life is a clinical problem that must be controlled. Neuropathic and dysfunctional pain syndromes, which are not related to any threat to the organism and which per-

form no protective or reparative function, also are characterized by hypersensitivity. These states constitute true pathologic or maladaptive pain. Clinical pain typically presents as pain in the absence of a stimulus, spontaneous pain, and pain hypersensitivity, the latter manifesting as allodynia, hyperalgesia, and hyperpathia.

*Allodynia* is a state in which normally innocuous stimuli are perceived as painful. Dynamic tactile allodynia to stroking stimuli, such as brushing the skin, is the prototypic example, but pain in response to nonnoxious temperatures (cool and warm) also occurs. *Hyperalgesia* is a state of exaggerated or prolonged response to noxious stimuli. *Hyperpathia* refers to an explosive, intensely unpleasant, usually long-lasting pain.

*Primary hyperalgesia* refers to hyperalgesia or allodynia occurring at the site of an injury. *Secondary hyperalgesia* is the pain hypersensitivity that occurs outside the area of injury, in normal tissues. Several of the pain-related definitions discussed are listed in Table 90–7.

## MECHANISMS UNDERLYING CLINICAL PAIN

The mechanisms underlying clinical pain are divided into broad categories, which include the following:

- Peripheral sensitization
- Central sensitization
- Ectopic excitability
- Disinhibition
- Phenotypic switch
- Structural reorganization
- Immune activation

## Genetic Factors

These different mechanisms are the neurobiologic building blocks that underlie clinical pain but do not individually define specific pain conditions. Nor do particular disease states imply involvement of specific mechanisms. Multiple mechanisms may coexist, and the mechanisms may change over time.

## Inflammatory Pain

Inflammatory pain involves changes in the threshold and responsiveness of nociceptor terminals at the site of inflammation (peripheral sensitization),

TABLE 90-7.

## Pain-Related Definitions

Noxious stimulus	Intense, potentially or actually tissue-damaging stimulus
Nociceptor	High-threshold primary sensory neuron normally activated by and only encoding noxious stimuli
Nociception	Detection, processing, and perception of noxious stimuli by the nervous system
Nociceptive pain	Pain due to activation of nociceptors by noxious stimuli
Neuropathic pain	Pain initiated or caused by a lesion of the peripheral nervous system or central nervous system
Inflammatory pain	Pain associated with ongoing tissue damage and inflammation
Dysfunctional pain	Pain in the absence of a noxious stimulus, tissue damage, or lesion to the nervous system resulting from abnormal processing by the nervous system
Sensitization	Heightened responsiveness of neurons
Peripheral sensitization	Reduction in threshold and increased responsiveness of nociceptor peripheral terminals
Central sensitization	Hyperresponsiveness of nociceptive neurons in the central nervous system
Allodynia	Pain in response to a nonnoxious stimulus that normally would produce an innocuous sensation
Hyperalgesia	Heightened pain in response to a noxious stimulus

alterations in the chemical expression or phenotype of sensory neurons innervating the inflamed tissue (phenotypic switch), augmentation of synaptic transmission in the spinal cord (central sensitization) and altered input from the brain to the spinal cord. All of these mechanisms tend to occur in response to peripheral inflammation, but their relative contribution to pain hypersensitivity depends on the site, nature, extent, and duration of peripheral pathology.

### Peripheral Sensitization

*Peripheral sensitization* refers to a reduction in the threshold and increase in the responsiveness of the peripheral terminals of nociceptors such that the terminals now can be activated by nonnoxious stimuli, and noxious stimuli evoke a greater action input from the peripheral terminal. Typically the inciting event is exposure to inflammatory mediators or sensitizers that act on the nociceptor terminal, changing its functional properties (Fig. 90-9). Inflammatory mediators that sensitize peripheral nociceptors include the cytokines tumor necrosis factor  $\alpha$  (TNF- $\alpha$ ) and interleukin-1 $\beta$  (IL-1 $\beta$ ), bradykinin, ATP, prostanooids, particularly prostaglandin E<sub>2</sub> (PGE<sub>2</sub>), amines, and nerve growth factor (NGF; Table 90-8). These mediators either sensitize nociceptors directly or act indirectly by causing the release of other effector

molecules from mast cells or macrophages. The phenomenon of peripheral sensitization is most closely associated with inflammatory pain, which is not surprising given that the process is driven by inflammatory mediators.

All forms of tissue injury and inflammation can generate peripheral sensitization. Surgical trauma and sunburn are examples of an external injury that induces acute peripheral sensitization, whereas chronic inflammatory disease, such as rheumatoid arthritis, causes peripheral sensitization of the

sensory afferents innervating inflamed joints. Pain hypersensitivity at the site of inflammation is the clinical manifestation of peripheral sensitization. For example, at the site of a burn injury there is increased pain to noxious heat stimulation (hyperalgesia) and a reduced mechanical and thermal threshold to pain in response to light touch or innocuous warm stimuli (allodynia). Not all the pain hypersensitivity at an inflamed site is due to peripheral sensitization; it may be due to central changes too, but peripheral sensitization is limited to the inflamed site where nociceptor terminals are exposed to inflammatory mediators.

Many sensitizing inflammatory mediators are secreted by macrophages, mast cells, and infiltrating leukocytes and exert their effects via activation of cell-surface G protein-coupled receptor or membrane receptor tyrosine kinases expressed on the peripheral terminals of nociceptor sensory neurons. Peripheral sensitization is due both to an increase in the sensitivity of transduction receptor/ion channels (reducing their threshold) and to excitability of the membrane of the nociceptor peripheral terminal (increasing the responsiveness of the terminal). Both changes are triggered by activation of signal transduction pathways in the peripheral terminal by the sensitizing mediators. An example of altered transduction is that of the TRPV1, the high-threshold heat responsive ion channel. Repeated heat exposure, by allowing sufficient calcium entry through the channel, activates intra-

TABLE 90-8.

## Some Receptors Involved in Nociceptor Sensitization

Metabotropic Receptors	Intracellular Transduction Mechanism
Serotonin receptors, 5HT <sub>1</sub> and 5HT <sub>2</sub>	G <sub>i/o</sub> -mediated inhibition of adenylate cyclase
Prostanoid receptors, EP, DP, IP ATP receptor, P2Y	G-protein-mediated effects G-protein-mediated effects, including TRPV1 sensitization
Histamine receptors, H <sub>1</sub> , H <sub>2</sub> , H <sub>3</sub> , H <sub>4</sub> <sup>a</sup>	G-protein-mediated effects
Growth Factors Receptors	Major Ligand
Tyrosine kinase (Trk) receptor, TrkA	Nerve growth factor (NGF)
Cytokine Receptors	Ligand
Tumor necrosis factor- $\alpha$ (TNF- $\alpha$ ) receptor	TNF- $\alpha$
Interleukin-1 (IL-1) receptor	IL-1 $\alpha$ , IL-1 $\beta$

<sup>a</sup>Activation of histamine receptors on cutaneous C-fibers causes itch under physiologic conditions. When neuropathic pain is present, application of histamine generates pain rather than itch.



cellular signal transduction pathways in the terminal that feed back and alter the receptor. This is a rare example of peripheral sensitization in the absence of peripheral inflammation. Alternatively, extrinsic inflammatory mediators such as prostaglandins and kinins, via activation of G protein-coupled receptor expressed on the nociceptor terminal membrane, can lead, via signal transduction cascades, to changes in TRPV1 channel properties without it necessarily being activated.<sup>43-45</sup> Sensitization of TRPV1 in both cases occurs via phosphorylation of the ion channel/receptor.<sup>6</sup> This process reduces its activation threshold to 100–104 °F (38–40 °C) from 108 °F (42 °C). The reduced threshold now is in the nonpainful, warm range. The channel, and therefore the nociceptor, now can be activated by innocuous thermal stimulation. Thus, normally innocuous warm stimuli are perceived as painful, as after sunburn. NGF, a growth factor produced and released during inflammation, not only sensitizes the TRPV1 channel but also increases the membrane density of TRPV1 channels by increasing transport of the channel from cytoplasmic stores, providing another mechanism through which inflammation can facilitate TRPV1-mediated nociceptor activation in the terminal.<sup>46</sup> Sensitization of other members of the TRP family also occurs and likely contributes to peripheral sensitization and the increased response to thermal and mechanical stimuli.<sup>47</sup> Reductions in heat pain threshold in skin and in mechanical sensitivity in inflamed joints are the two major changes mediated by peripheral sensitization. PGE<sub>2</sub>, bradykinin, and NGF appear to be the major sensitizers.

Transduction receptor/ion channels are not the only substrate for intracellular kinases, such as protein kinase A (PKA) and protein kinase C (PKC), that are activated by inflammatory mediators. These kinases also phosphorylate the voltage-gated sodium channels Na<sub>v</sub>1.8 and Na<sub>v</sub>1.9 in nociceptor membranes, decreasing the activation thresholds of these channels and increasing their conductance<sup>48</sup> and thereby the nociceptor terminal membrane excitability. Induction of the cyclooxygenase-2 (COX-2) isoform at the site of peripheral inflammation has a major role in the generation of peripheral sensitization.<sup>49,50</sup> COX-2 up-regulation is mediated largely by pe-

ripheral generation of IL-1.<sup>51</sup> Cyclooxygenase induction in inflamed tissue contributes to the peripheral analgesic action of nonsteroidal anti-inflammatory drugs (NSAIDs), both non-selective and COX-2-selective agents.

Peripheral sensitization can be reduced by drugs targeted at the production, levels or receptor activation of inflammatory mediators. Anti-inflammatory agents include COX inhibitors, anti-NGF or anti-IL1 sequestering antibodies, and prostaglandin EP receptor antagonists. Other possible targets are the kinase enzymes, such as the PKC-ε isoform in nociceptors; the transduction receptors such as TRPV1; and sodium channels.

### Neurogenic Inflammation

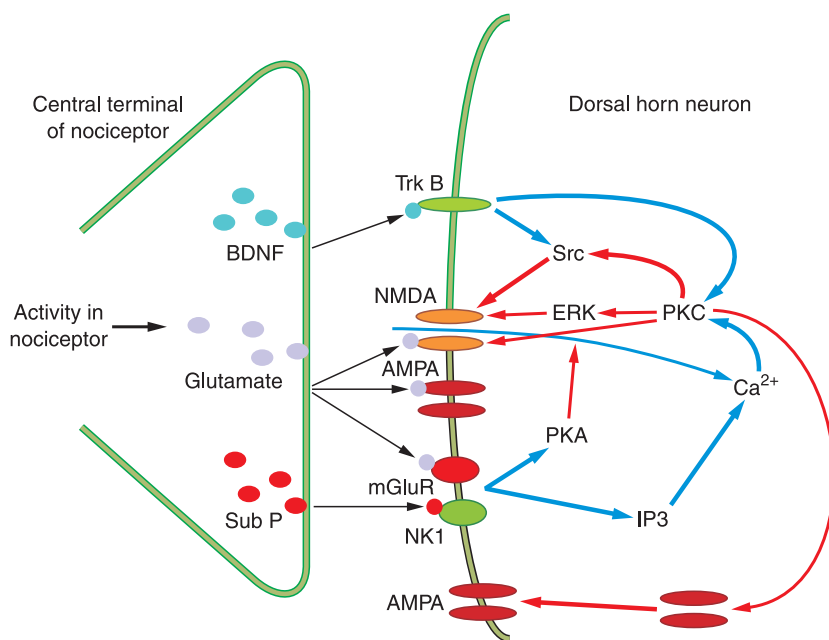
Activated nociceptors themselves can contribute to the inflammatory response. Repeated activation of peptide-expressing nociceptors can lead to release of the neuropeptides CGRP and substance P from their peripheral terminals. These neuropeptides lead to increased vascular permeability and edema (wheal), vasodilatation (flare) in peripheral tissues, and hence neurogenic inflammation. CGRP and substance P also lead to the release of inflammatory mediators such as TNF-α and histamine from inflammatory cells.<sup>52</sup>

### Altered Phenotype in DRG Neurons after Peripheral Inflammation

Peripheral inflammation results in release not only of mediators that act locally but also of some that are taken by the nociceptors and transported from the terminal to the cell body. The best example of this is NGF, which in addition to its direct local action on nociceptor terminals is retrogradely transported to the sensory neuron cell body, where it increases synthesis of substance P and CGRP. NGF can also induce synthesis of substance P and CGRP in neurons that do not normally express these transmitters, thus generating a “phenotypic switch.”<sup>53</sup> NGF also increases the rate of synthesis of TRPV1 by increasing the translation rate of TRPV1 from its mRNA.<sup>54</sup> An increase in expression of the μ-opioid receptor may contribute to increased sensitivity to opioid agonists in inflammatory pain.

### Central Sensitization and Inflammatory Pain

Synaptic transmission in the spinal cord is highly modifiable<sup>55,56</sup>; therefore, there is considerable “plasticity” in the processing of nociceptive input. This synaptic plasticity is a critical player in the generation and maintenance of inflammatory pain. Central sensitization in inflammatory pain has two forms: *activity dependent*



**FIGURE 90-10.** Activity-dependent central sensitization. Persistent or intense activation of central transmission can lead to postsynaptic calcium influx, primarily through *N*-methyl-D-aspartate (NMDA) and  $\alpha$ -amino-3-hydroxy-5-methylisoxazole-4-propionic acid (AMPA) receptors. In conjunction with a variety of neuromodulatory signals, calcium influx activates signal transduction cascades that can facilitate both short-term and long-term excitability of the dorsal horn synapse.

*dent* (Fig. 90–10), which is rapid in onset and short lasting, and *transcription dependent*, which has a longer latency and duration. Although inflammatory pain hypersensitivity once was considered to be largely, if not exclusively, due to changes in the periphery driven by the local inflammation, we now appreciate that central changes, collectively constituting central sensitization, drive much of the pain, particularly in the more chronic phases. This means that treatment targeted only at the periphery is generally insufficient.

### Activity-Dependent Central Sensitization

This form of central sensitization is driven by input from nociceptor afferent fibers onto, and produces changes in, dorsal horn neurons. The sensitization is largely due to posttranslational modification and altered trafficking of receptors and ion channels. Any stimulus sufficient to generate a high sustained level of nociceptor activation will induce central sensitization. Once central sensitization is induced, much lower levels of peripheral input are required to sustain it. Activity-dependent central sensitization manifests as pain in response to activation of low-threshold primary afferents producing tactile allodynia and secondary hyperalgesia, a heightened pain sensitivity outside of an area of tissue injury.<sup>57</sup>

### Heterosynaptic Central Sensitization

This is the major form of activity-dependent central sensitization in nociceptive neurons and can be induced by a short (as few as 10–20 seconds) barrage of nociceptor stimulation. It results from an increase in synaptic efficacy that outlasts the cessation of the initiating stimulus for tens of minutes. Furthermore, the increase not only affects synapses directly activated by the nociceptor input but also synapses not stimulated by the “conditioning” input.<sup>58</sup> This is an example of synaptic plasticity termed *heterosynaptic* facilitation, because the synapses activated by the noxious initiating and subsequent test stimuli can be different. The effect within the neurons is widespread. In contradistinction, in *homosynaptic* facilitation, only the stimulated synapses are altered; the effect is very local. Thus, whereas the conditioning input must be in nociceptors (A- $\delta$  and C fibers) in order to induce the central sensitization, the

test stimuli may include either the same or other nociceptors or indeed low-threshold sensory afferents such as mechanosensitive A- $\beta$  fibers. This phenomenon enables nociceptor input to dramatically alter the response of the spinal cord to low-threshold and high-threshold afferents. Heterosynaptic central sensitization has three manifestations at the cellular level: reduction in threshold due to recruitment of low-threshold input, increase in responsiveness of dorsal horn neurons to suprathreshold input, and expansion of the size of receptive fields of dorsal horn neurons.<sup>57</sup> These changes produce corresponding alterations in pain hypersensitivity: reduction in threshold, increased responsiveness, and spread of pain sensitivity.

The molecular mechanisms underlying this form of central sensitization are complex (Table 90–9). Induction of activity-dependent central sensitization in dorsal horn neurons is due to activation by transmitters and synaptic modulators released by nociceptors of intracellular signal transduction cascades in nociceptive dorsal horn neurons that then effect the changes in synaptic efficacy. The transmitters involved are glutamate acting on NMDA and metabotropic receptors, as well as substance P on NK1 receptors. We have started to appreciate that both PGE<sub>2</sub> and bradykinin are released in the spinal cord after nociceptor inputs and act on their respective EP and B2 G-protein-coupled receptors. All of these receptors activate mitogen-activated protein (MAP) kinases in the neurons, both ERK and p38, which in turn activate several other downstream kinases that phosphorylate various substrate pro-

teins. The major changes underlying increased synaptic efficacy involve alterations in the NMDA receptor, which after it is phosphorylated loses the Mg<sup>2+</sup> block of the channel normally present at resting membrane potentials, dramatically increasing sensitivity to glutamate at the resting membrane potential. Also, NMDA channel open time increases, prolonging the effect of receptor activation by glutamate. NMDA is involved in the initiation of activity-dependent central sensitization and in its maintenance; therefore, it plays a pivotal role. NMDA receptor antagonists such as ketamine can prevent establishment of central sensitization as well as reverse it once it has occurred. Unfortunately, because of the wide distribution of NMDA receptors in many parts of the brain and their involvement in many cortical functions, such antagonists produce unacceptable psychotropic side effects. These effects notwithstanding, NMDA antagonists at low doses or acutely as part of acute perioperative treatment have some, albeit limited, role in reducing central sensitization clinically. Antagonists targeted at specific NMDA receptor subunits, such as NR2B, may offer a greater therapeutic window. AMPA receptors show trafficking from the cytoplasm to the membrane during activity-dependent central sensitization, thus boosting glutamate sensitivity and increasing synaptic efficacy. Other contributory changes are a reduction in potassium channels, an increase in calcium channels, and no mediated retrograde signaling to the presynaptic terminal altering transmitter release.

Clinical correlates of heterosynaptic facilitation include dynamic tactile all-

TABLE 90–9.

Mechanisms Associated with Chronic Pain Types

	Nociceptive	Inflammatory	Neuropathic	Dysfunctional
Peripheral sensitization	–	+	+	–
Central sensitization	–	+	+	+
Increased facilitation	–	+	+	?
Ectopic excitability	–	–	+	+
Disinhibition	–	–	+	?
Phenotypic switch	–	+	+	–
Central nervous system reorganization	–	–	+	–
Immune activation	–	?	+	–

+, evidence supporting; –, no evidence supporting; ?, possible, but currently unknown.

odynia resulting from activation of nociceptive dorsal horn neurons by previously subthreshold inputs from low-threshold sensory afferents (i.e., A- $\beta$  fibers). This depends upon the existence of synaptic input (monosynaptic and polysynaptic) from low-threshold afferents to normally high-threshold nociceptive dorsal horn neurons. One of the major implications of the discovery of central sensitization is that pain hypersensitivity has a central component and that the central component can last for prolonged periods once it is triggered. This led directly to recognition of the possible difference between treating established pain and trying to prevent its establishment, the concept of preemptive analgesia. Today, attempts are made, whenever possible, to reduce sensory inflow in nociceptors from reaching the spinal cord using regional anesthesia and to begin treatment with opioids well before the patient requires them, preoperatively or intraoperatively. The input that drives central sensitization will continue after completion of surgery from the injured tissue, and preemptive treatment must continue until the injury has healed; treatment is not simply preoperative.

A behavioral surrogate of heterosynaptic central sensitization can be demonstrated in volunteers using capsaicin-mediated C-fiber activation.<sup>59</sup> Capsaicin activates TRPV1 receptors, leading to a barrage of activity in C fibers that is experienced as intense pain. Following the intense pain, secondary mechanical allodynia to light touch and secondary mechanical hyperalgesia to pinprick develops in the area surrounding capsaicin injection.

### **Long-Term Potentiation and Activity-Dependent Central Sensitization**

Brief high-frequency stimulation of nociceptors induces a potentiation of AMPA receptor-mediated excitatory synaptic transmission in NK1-expressing dorsal horn projection neurons in lamina I. This homosynaptic potentiation is NMDA receptor dependent and, unlike heterosynaptic potentiation, persists for many hours and may even be irreversible. This prolonged facilitation of monosynaptic excitatory synaptic transmission shares many of the mechanisms responsible for the long-term potentiation, including NMDA receptor dependence, observed in higher CNS centers such as

the CA1 region of the hippocampus that contribute to memory.<sup>60</sup> Long-term potentiation in the spinal cord does not contribute to allodynia or secondary hyperalgesia.

Activity-dependent central sensitization can occur in the absence of peripheral inflammation; it manifests whenever nociceptors are intensely activated for an extended period. This was the first form of central sensitization discovered (Woolf, 1983).<sup>55</sup> More recently another form of central sensitization unique to inflammatory pain, transcription-dependent central sensitization, has become evident.

### **Transcription-Dependent Central Sensitization**

After several hours, peripheral inflammation induces alterations in the levels of peptides and protein in sensory neurons innervating the inflamed tissue, such as an increase in substance P. After transport to the central terminals of nociceptors in the dorsal horn, these peptides and proteins will produce greater synaptic activation of dorsal horn neurons, increasing the degree of central sensitization evoked. In addition, changes in gene expression in dorsal horn neurons occur. One of the earliest recognized was that of NK1 paralleling the increase in its ligand, substance P. Another change is an induction of COX-2 in dorsal horn neurons, generating an increase in PGE<sub>2</sub> production.<sup>51</sup> This central COX-2 induction is the result of a humoral factor produced at the site of local inflammation (possibly IL-6), which acts on endothelial and meningeal cells to produce IL-1 $\beta$ , which in turn induces COX-2 in neurons. Because the effect is not driven by afferent input (i.e., is not activity dependent), it is widespread within the CNS. PGE<sub>2</sub> has many central actions. It increases primary afferent transmitter release and directly depolarizes dorsal horn neurons, both of which increase excitability. However, the major action of PGE<sub>2</sub> released after peripheral inflammation is to reduce inhibitory glycinergic neurotransmission in the spinal cord. PGE<sub>2</sub> acts on stimulatory G-protein-coupled EP2 prostaglandin receptors expressed on nociceptive dorsal horn neurons to increase intracellular cAMP, activating PKA that in turn phosphorylates and inhibits postsynaptic glycine receptors.<sup>61,62</sup> Glycine receptors in the spinal cord have a unique subunit composition ( $\alpha$ 3) that,

when knocked out in a mouse, results in substantial reduction of the more chronic phases of inflammatory pain (>2 days).<sup>63</sup> Inhibition of centrally induced COX-2 produces analgesia. It is likely that more of the analgesic action of NSAIDs and COX-2 selective inhibitors derives from their central than their peripheral action. Complementing the decrease in local inhibition is an increase in descending facilitatory influences from the brainstem.<sup>64-66</sup>

The early phases of inflammatory pain likely are to be a combination of peripheral sensitization at the site of the inflammation and activity-dependent central sensitization in the spinal cord. The later phases shift to alterations in the phenotype of nociceptors, increasing their capacity for peripheral sensitization and inducing central sensitization. In addition, transcriptional changes in dorsal horn neurons can produce profound alterations, increasing excitation and decreasing inhibition that collectively produce local and distant pain hypersensitivity. Therefore, treatment must be targeted peripherally and centrally. However, once the inflammatory drive resolves, most of the changes revert and the pain system returns to its preinflammatory level. Some small residual changes may remain, increasing response to subsequent insults.

### **Neuropathic Pain**

In a proportion of patients, injury to peripheral nerves results in persistent severe pain through recruitment of a variety of different mechanisms in the PNS and CNS. Characteristic of peripheral and central neuropathic pain are the presence of negative symptoms due to the injured nervous system and the chronicity of the pain. The impact on patients can be very severe, not only because of the intensity and intractability of the pain but also because of alterations in mood and function. In consequence, the economic and social toll to society is large.

In response to axonal lesions, injured primary sensory neurons, neighboring noninjured sensory neurons, Schwann cells, and immune system cells undergo substantial modifications in the peripheral nerve. These changes lead to activation of sensory fibers and enhanced excitability, with generation of spontaneous activity in primary afferents in the affected nerve. The two major underlying mechanisms are the



release of soluble pain-producing factors in the nerve that drive sensory afferents and phenotypic switches in the sensory neurons that increase membrane excitability.

### **Soluble “Pain” Mediators after Nerve Injury**

Injury to peripheral nerves results in release of a variety of soluble factors capable of activating nociceptors. Cytokine TNF- $\alpha$  is released following nerve injury by denervated Schwann cells and in the DRG. It activates nociceptors<sup>67,68</sup> by increasing activity of TTX-resistant Na<sup>+</sup> channels.<sup>69</sup> IL-1 $\beta$  also may be involved.<sup>70</sup> In addition to cytokines, multiple chemokines produced by injured neurons and non-neuronal cells exert effects on sensory neurons and dorsal horn cells.<sup>71,72</sup>

### **Altered Membrane Excitability and Ectopic Activity**

Membrane excitability is determined by the presence, state, and density of a variety of ion channels. The properties of many ion channels are markedly affected by nerve injury. Changes may be intrinsic, including altered kinetics (i.e., activation and/or inactivation properties) and conductance, as well as altered membrane density secondary to changes in their expression and trafficking.<sup>73–75</sup> Following nerve injury, sensory fibers begin to generate action potentials in the absence of any peripheral stimulation, the phenomenon of ectopic activity. First, within 24 hours of the injury, myelinated fibers (A- $\beta$  and A- $\delta$ ) begin to generate spontaneous electrical activity, followed by activity in C fibers.<sup>76</sup> Ectopic activity originates at multiple sites, including the neuroma and the cell body of primary afferents in the DRG.<sup>77</sup> Ectopic activity occurs in both injured and neighboring noninjured fibers and is a major contributor to stimulus-independent spontaneous pain that manifests clinically as persistent burning pain and paroxysms of shooting, electrical pain. In addition to spontaneous or intermittent shooting pain, ectopic activity generates paresthesias and dysesthesias, depending on the specific nerves and types of fibers affected. Patients with neuromas frequently complain that palpation of their neuroma generates paroxysms of pain that outlast the stimulus (i.e., Tinel sign). This may reflect accumulation of mechanosensitive channels in axons in the neuroma.

The TTX-resistant channel Na<sub>v</sub>1.8 is downregulated and redistributed following peripheral nerve injury from the DRG to peripheral axons, where it has been suggested to play a role in altering membrane excitability.<sup>78</sup> However, knockout of Na<sub>v</sub>1.8 and Na<sub>v</sub>1.9 diminishes inflammatory pain but not neuropathic pain<sup>79,80</sup>; therefore, these channels are unlikely to have a major role in neuropathic pain. The TTX-sensitive channel Na<sub>v</sub>1.3, which is barely detectable in the intact adult PNS, is markedly upregulated in DRG neurons following peripheral nerve injury. This channel produces currents that rapidly recover from inactivation, allowing it to sustain high-frequency firing<sup>81</sup>; therefore, it may be a driver of ectopic input after injury. Pacemaker channels also are implicated in the generation of ectopic activity.<sup>82</sup> They are found in the membrane of the cell body, are hyperpolarization activated and cyclic nucleotide modulated, and are permeable to sodium and potassium ions. Their blockade reduces pain behavior in animal models of neuropathic pain.<sup>83</sup> In addition to Na<sup>+</sup> channels, nerve injury affects the expression of other ion channels, such as Ca<sup>2+</sup> and K<sup>+</sup> channels.<sup>84–86</sup> Voltage-gated potassium channels are downregulated,<sup>85</sup> and this change, which depolarizes the membrane, is regulated by BDNF and neurotrophin-3.<sup>85</sup> One major action of systemically administered sodium channel blockers, such as lamotrigine and carbamazepine, is to reduce ectopic activity. Whether abnormal sodium channel expression/activity determines pain in individual patients can be tested with IV lidocaine infusions. Peripheral nerve blocks temporarily block ectopic inflow, whereas topical local anesthetics, as used in patients with postherpetic neuralgia, interrupt activation of peripheral terminals of nondamaged sensory neurons. More invasive treatment, such as radiofrequency or chemical lesions to nerves, may produce longer-lasting relief but may actually exacerbate the pain in the long run because they damage the nerve. Surgery to remove a neuroma frequently results in reformation of the neuroma and return of the pain. In general, treating neuropathic pain by damaging nerves is like putting out a fire with gasoline.

### **Phenotypic Switch**

Injured neurons undergo profound changes in gene expression after

nerve lesions, with alterations in the expression of many hundreds of genes that change neuronal phenotype. Some changes are unrelated to pain but assist with survival and regrowth of injured neurons; others do contribute to altered function. The normal differentiated phenotype of the neurons can undergo major switches. For example, BDNF normally is expressed predominantly by nociceptors. Following peripheral nerve injury, small neurons switch off normal synthesis of BDNF, whereas larger neurons assume a BDNF phenotype.<sup>87–89</sup> Similar alterations for neuropeptide Y (NPY) and substance P occur.<sup>90</sup> Thus, following injury, sensory neurons that do not convey nociceptive information can begin to express transmitters/synaptic modulators normally found only in nociceptive primary afferent pathways. These changes may contribute to pain when nonnociceptive afferents release mediators that activate second-order nociceptive neurons in the dorsal horn in a way that normally occurs only in response to nociceptor inputs.

Peripheral nerve injury results in downregulation of  $\mu$ -opioid receptors in DRG neurons. This process may underlie the decreased efficacy of opioids in some patients with neuropathic pain.<sup>91,92</sup> In addition, expression in the A2- $\delta$  accessory protein of voltage-gated calcium channels is increased. Gabapentin binds to this subunit, and its induction after nerve injury may contribute to the efficacy of gabapentin and pregabalin in neuropathic pain. Increased expression of adrenergic receptors contributes to the development of sensitivity to humoral epinephrine and to norepinephrine release from sympathetic fibers. Sympathetic fibers sprout into the DRG after nerve injury; this, in addition to the adenosensitivity of injured afferents, provides the basis for a sympathetic component of neuropathic pain that is present in some patients. In these patients, sympathetic blockade may reduce their pain.

### **Central Sensitization and Neuropathic Pain**

Central sensitization plays a major role in the generation of neuropathic pain. The three major forms of central sensitization in this context are activity dependent, transcription dependent, and disinhibition. The activity-dependent variant closely resembles that occurring in inflammatory pain, except that



the trigger for its initiation is not nociceptor input from inflamed or damaged tissue but ectopic input as a result of a lesion to a nerve. If the ectopic input is in nociceptors, central sensitization will occur through the same general molecular and cellular mechanisms described and will drive similar clinical manifestations (e.g., tactile allodynia and secondary hyperalgesia). Ketamine, by virtue of blocking NMDA receptors, decreases this form of central sensitization and reduces pain hypersensitivity in patients with neuropathic pain, again with usually unacceptable psychotropic side effects.

Transcription-dependent central sensitization in neuropathic pain differs considerably from that in inflammatory pain. The alterations in transcription occurring in injured sensory neurons are different from those occurring after inflammation, as are the changes that occur in the dorsal horn. One difference from inflammatory pain is that, because large A fibers begin to express synaptic transmitters and modulators normally expressed only by nociceptors, activity in these fibers can begin to drive initiation of central sensitization. Unlike the situation after inflammation, no induction of COX-2 occurs within the dorsal horn. This means that NSAIDs and COX-2 inhibitors have no role in neuropathic pain because these drugs can have no analgesic activity without the presence of their targets.

### Disinhibition

A major component of central sensitization after nerve injury is not simply an increase in excitation driven by increased amounts or responses to excitatory transmitters but a decrease in inhibition. Local inhibitory interneurons and descending inhibitory pathways provide both tonic and phasic inhibition of spinal nociceptive pathways. There now is compelling evidence that suppression of this inhibition—"disinhibition"—is an important generator of neuropathic pain. Inhibitory interneurons use GABA and glycine as their neurotransmitters and are activated by primary sensory afferents as well as descending and local inputs. Some axons of GABAergic interneurons make synaptic contact with the central terminals of primary afferents, inhibiting release of excitatory transmitters by the central terminals of primary afferents. This presynaptic inhibition has both fast and slow

components. The fast component depends on activation of the Cl<sup>-</sup>-permeable ionotropic GABA<sub>A</sub> receptor. The slow component results from activation of the G-protein-coupled GABA<sub>B</sub> receptor. Other axons of inhibitory GABAergic and glycinergic interneurons make contact with dorsal horn neurons, producing hyperpolarizing inhibitory postsynaptic potentials.

Loss of inhibitory GABAergic currents is an important contributor to disinhibition after peripheral nerve injury and to establishment of neuropathic pain.<sup>93,94</sup> Disinhibition occurs via a variety of mechanisms. One involves increased activity of GABA transporters decreasing synaptic GABA. Another results from changes in Cl<sup>-</sup> ion levels in neurons due to altered activity of ion exchange pumps resulting in decreased GABA hyperpolarization and even GABA-mediated excitation in some cases. Finally, disinhibition occurs as a result of apoptosis or degeneration of GABAergic inhibitory interneurons in the superficial dorsal horn.<sup>88,95,96</sup> Loss of these neurons appears to result from NMDA receptor-mediated excitotoxicity consequent to the abnormal barrage of ectopic input entering the dorsal horn. Caspase inhibitors that block apoptosis can reduce cell loss and the pain phenotype. In this situation, chronic pain can be considered a neurodegenerative disease, raising the intriguing possibility of using neuroprotective treatment as a preemptive disease-modifying treatment of neuropathic pain.

### Structural Reorganization

Peripheral nerve injury results in structural changes at multiple levels within the nervous system. In the periphery, some largely C-fiber sensory neurons die after axonal injury, and sympathetic terminals sprout into the DRG. In the spinal cord, there is a loss of inhibitory interneurons in the dorsal horn and alterations in synaptic connectivity. In the brain, there is an association of atrophy in particular cortical areas with chronic pain. Loss of neurons results in an irreversible loss of function that may partly be compensated for by, but might contribute to, the persistence of neuropathic pain, whereas the formation of new synaptic connections may dramatically alter function. For example, A- $\beta$  large myelinated fibers are activated by low-intensity mechanical stimulation and normally produce innocuous sensations.

However, the tactile mechanical allodynia associated with peripheral nerve injury is mediated by these large myelinated sensory afferents.<sup>97</sup> How does this happen? One mechanism is the recruitment of previously subthreshold inputs after induction of central sensitization or loss of inhibition. Another is a possible alteration in the connectivity of the central terminals of these afferents due to sprouting and novel synapse formation driving cells that normally receive only nociceptor input.<sup>98-100</sup> Individuals with chronic low back pain have a 5-11% reduction in neocortical gray matter and thalamic volume compared to matched controls, suggesting that chronic pain is associated with significant cell loss in these regions.<sup>30</sup> Amputation of major sensory nerves frequently leads to phantom sensations, including persistent phantom pain. Although there are peripheral and spinal contributions to phantom pain, there also is a rapid reorganization of the cortical somatosensory representation of amputated body parts.<sup>101,102</sup>

### Glial Activation

In the CNS, glial cells outnumber neurons by approximately 10:1 and appear to have a role in the pathogenesis of neuropathic pain. Peripheral nerve injury leads to activation of microglia in the dorsal horn.<sup>103</sup> Microglia assume an amoeboid morphology, become highly mobile, and begin secreting a wide array of cytokines, chemokines, and other neuromodulators, including IL-1 $\beta$ , TNF- $\alpha$ , IL-6, IL-10, and BDNF, which can act on neurons to alter their function.<sup>104-107</sup> Two important components of the microglial pain pathway are p38 MAP kinase and the P2X4 and P2X7 ionotropic ATP purinoreceptors.<sup>108-111</sup> For example, activation of P2X4 by ATP results in activation of p38, which in turn leads to release of BDNF, which then acts to reduce the inhibitory action of GABA on certain lamina I neurons. Inhibition of p38 and antagonism of P2X4 and P2X7 in microglia reduce pain in experimental models. Thus, microglia may become important models for future treatment options.

### Genetic Factors and Predisposition to Pain

Rodent strain-related differences in the development of allodynia and/or hyperalgesia following injury indicate a heritable component to the development of

neuropathic pain.<sup>89,112–115</sup> Human studies support this idea. A common functional genetic polymorphism that affects the metabolism of catecholamines is associated with differences in responsiveness to sustained acute pain.<sup>116</sup> Individuals homozygous for the met158 allele of the catechol-O-methyltransferase (COMT) polymorphism (val158met) have a higher sensory and affective response to experimental pain than do heterozygous individuals. Patients who are homozygous for the met158 allele also show diminished regional brain  $\mu$  opioid system responses to the painful stimulus as measured by PET. Cancer patients homozygous for the allele require more morphine to control pain.<sup>117</sup>

## Dysfunctional Pain

*Dysfunctional pain* is defined as pain in the absence of an identifiable noxious stimulus, tissue damage, inflammation, or lesion to the nervous system. The mechanisms involve abnormal function of the nervous system. This can occur in the PNS, as for erythromelalgia, and in the CNS, for fibromyalgia and noncardiac chest pain. The specific mechanisms responsible for many conditions that are part of this syndrome, such as tension-type headache and irritable bowel syndrome, are not known. Given the prevalence of these conditions and the limited treatment options, this area requires more attention.

Erythromelalgia is an autosomal dominant chronic pain disorder characterized by edema and burning pain of the extremities in response to warm stimuli or moderate exercise. The disease is due to a mutation of the  $\text{Na}_v1.7$  sodium channel leading to reduced action potential thresholds and high-frequency firing in DRG neurons.<sup>118,119</sup> The syndrome resembles ectopic activity in neuropathic pain in that pain results from increased excitability of nociceptor membranes; however, no injury has occurred, and the pain tends to require mild activation of nociceptors to produce an attack.

Fibromyalgia is difficult to diagnose because of the complex combination of primary and secondary symptoms. However, it has one essential feature: a reduced pain threshold in deep tissue (trigger points) with no peripheral pathology. Functional imaging and sensory testing reveal abnormal processing of sensory input in the CNS

leading to heightened and prolonged pain, changes indicative of central sensitization. Drugs that target the CNS, such as pregabalin, do reduce this pain, normalizing abnormal activity.

## CONCLUSION

Pain is not a homogenous state. Multiple pains exist. Some are adaptive, protecting the body from injury or helping healing; others are pathologic or maladaptive, representing severe disturbances in nervous system function such that the pain and not the initial etiologic trigger factor is the disease. In order to treat pain in a rational rather than a trial and error approach, we must identify the pain syndromes and understand the neurobiologic mechanisms driving the pain. We need to understand the risk factors for developing chronic pain, avoid damaging the nervous system, and target treatment at the mechanisms rather than the symptoms.

## KEY REFERENCES

1. Marchand F, Perritti M, McMahon SB. Role of the immune system in chronic pain. *Nat Rev Neurosci* 2005;6:521.
2. McMahon SB, Koltzenburg M, eds. *Wall and Melzack's Textbook of Pain*. 5th ed. New York: Churchill Livingstone, 2005.
3. Tracey I. Nociceptive processing in the human brain. *Curr Opin Neurobiol* 2005;15:478.
4. Willis WD, Coggeshall RE, eds. *Sensory Mechanisms of the Spinal Cord*. Volume 1: Primary Afferent Neurons and the Spinal Dorsal Horn. 3rd ed. New York: Kluwer Academic/Plenum Publishers, 2004.
5. Woolf CJ, American College of Physicians, American Physiological Society. Pain: moving from symptom control to mechanism-specific pharmacological management. *Ann Intern Med* 2004;140:441.
6. Woolf CJ, Salter MW. Neural plasticity: increasing the gain in pain. *Science* 2000;288:1765.

## REFERENCES

1. Sherrington CS. *The Integrative Action of the Nervous System*. New York: Scribner's Sons, 1906.
2. Salter MW. Cellular neuroplasticity mechanisms mediating pain persistence. *J Orofac Pain* 2004;18:318–324.
3. Furue H, Katafuchi T, Yoshimura M. Sensory processing and functional reorganization of sensory transmission under pathological conditions in the spinal dorsal horn. *Neurosci Res* 2004;48:361–368.
4. Bielefeldt K, Christianson JA, Davis BM. Basic and clinical aspects of visceral sensation: transmission in the CNS. *Neurogastroenterol Motil* 2005;17:488–499.
5. Dodick DW. Clinical practice. Chronic daily headache. *N Engl J Med* 2006;354:158–165.
6. Lee SY, et al. Sensitization of vanilloid receptor involves an increase in the phosphorylated form of the channel. *Arch Pharm Res* 2005;28:405–412.
7. Wang H, Woolf CJ. Pain TRPs. *Neuron* 2005;46:9–12.
8. Ahern GP, Wang X, Miyares RL. Polyamines are potent ligands for the capsaicin receptor TRPV1. *J Biol Chem* 2006;281:8991–8995.
9. Kellenberger S, Schild L. Epithelial sodium channel/degenerin family of ion channels: a variety of functions for a shared structure. *Physiol Rev* 2002;82:735–767.
10. Price MP, et al. The DRASIC cation channel contributes to the detection of cutaneous touch and acid stimuli in mice. *Neuron* 2001;32:1071–1083.
11. Jones RC 3rd, Xu L, Gebhart GF. The mechanosensitivity of mouse colon afferent fibers and their sensitization by inflammatory mediators require transient receptor potential vanilloid 1 and acid-sensing ion channel 3. *J Neurosci* 2005;25:10981–10989.
12. Mogil JS, et al. Transgenic expression of a dominant-negative ASIC3 subunit leads to increased sensitivity to mechanical and inflammatory stimuli. *J Neurosci* 2005;25:9893–901.
13. Willis WD, Coggeshall RE, eds. *The Sensory Mechanisms of the Spinal Cord: Primary Afferent Neurons and the Spinal Dorsal Horn*. 3rd ed. New York: Kluwer Academic/Plenum Publishers, 2004.
14. Woolf CJ, Salter MW. Neuronal plasticity: increasing the gain in pain. *Science* 2000;288:1765–1769.
15. Griffin RS, Woolf CJ. Pharmacology of Analgesia. In Golan DE, ed. *Principles of Pharmacology*. Philadelphia: Lippincott Williams & Wilkins, 2005:229–243.
16. Dostrovsky JO, Craig AD. Ascending projection systems. In McMahon SB, Koltzenburg M, eds. *Wall and Melzack's Textbook of Pain*. 5th ed. New York: Churchill Livingstone, 2006:187–203.
17. Wiberg M, Westman J, Blomqvist A. Somatosensory projection to the mesencephalon: an anatomical study in the monkey. *J Comp Neurol* 1987;264:92–117.

18. Craig AD. Pain mechanisms: labeled lines versus convergence in central processing. *Annu Rev Neurosci* 2003;26:1–30.
19. Vanegas H, Schaible HG. Descending control of persistent pain: inhibitory or facilitatory? *Brain Res Brain Res Rev* 2004;46:295–309.
20. Dado RJ, Katter JT, Giesler GJ Jr. Spinothalamic and spinothalamic tract neurons in the cervical enlargement of rats. II. Responses to innocuous and noxious mechanical and thermal stimuli. *J Neurophysiol* 1994;71:981–1002.
21. Dado RJ, Katter JT, Giesler GJ Jr. Spinothalamic and spinothalamic tract neurons in the cervical enlargement of rats. I. Locations of antidromically identified axons in the thalamus and hypothalamus. *J Neurophysiol* 1994;71:959–980.
22. Gebhart GF. Descending modulation of pain. *Neurosci Biobehav Rev* 2004;27:729–737.
23. Ren K, Dubner R. Descending modulation in persistent pain: an update. *Pain* 2002;100:1–6.
24. Dubner R. The neurobiology of persistent pain and its clinical implications. *Suppl Clin Neurophysiol* 2004;57:3–7.
25. Fields HL, et al. The activity of neurons in the rostral medulla of the rat during withdrawal from noxious heat. *J Neurosci* 1983;3:2545–2552.
26. Suzuki R, Rygh LJ, Dickenson AH. Bad news from the brain: descending 5-HT pathways that control spinal pain processing. *Trends Pharmacol Sci* 2004;25:613–617.
27. Goldstein DJ, et al. Duloxetine vs. placebo in patients with painful diabetic neuropathy. *Pain* 2005;116:109–118.
28. Small DM, Apkarian AV. Increased taste intensity perception exhibited by patients with chronic back pain. *Pain* 2006;120:124–130.
29. Karl A, et al. Reorganization of motor and somatosensory cortex in upper extremity amputees with phantom limb pain. *J Neurosci* 2001;21:3609–3618.
30. Apkarian AV, et al. Chronic back pain is associated with decreased prefrontal and thalamic gray matter density. *J Neurosci* 2004;24:10410–10415.
31. Brooks J, Tracey I. From nociception to pain perception: imaging the spinal and supraspinal pathways. *J Anat* 2005;207:19–33.
32. Tracey I. Nociceptive processing in the human brain. *Curr Opin Neurobiol* 2005;15:478–487.
33. Peyron R, Laurent B, Garcia-Larrea L. Functional imaging of brain responses to pain. A review and meta-analysis (2000). *Neurophysiol Clin* 2000;30:263–288.
34. Casey KL. Forebrain mechanisms of nociception and pain: analysis through imaging. *Proc Natl Acad Sci U S A* 1999;96:7668–7674.
35. Jantsch HH, et al. Cortical representation of experimental tooth pain in humans. *Pain* 2005;118:390–399.
36. Kong J, et al. Using fMRI to dissociate sensory encoding from cognitive evaluation of heat pain intensity. *Hum Brain Mapp* 2006;27:715–721.
37. Ploner M, et al. Cortical representation of first and second pain sensation in humans. *Proc Natl Acad Sci U S A* 2002;99:12444–12448.
38. Kong J, et al. Brain activity associated with expectancy-enhanced placebo analgesia as measured by functional magnetic resonance imaging. *J Neurosci* 2006;26:381–388.
39. Bingel U, et al. Mechanisms of placebo analgesia: rACC recruitment of a subcortical antinociceptive network. *Pain* 2006;120:8–15.
40. Verhaak PF, et al. Prevalence of chronic benign pain disorder among adults: a review of the literature. *Pain* 1998;77:231–239.
41. Merskey H. Classification of chronic pain: descriptions of chronic pain syndromes and definitions of pain terms. *Pain* 1986;(Suppl 3):S1–S226.
42. Harden RN. Chronic neuropathic pain. Mechanisms, diagnosis, and treatment. *Neurologist* 2005;11:111–122.
43. Ahern GP, et al. Extracellular cations sensitize and gate capsaicin receptor TRPV1 modulating pain signaling. *J Neurosci* 2005;25:5109–5116.
44. Moriyama T, et al. Sensitization of TRPV1 by EP1 and IP reveals peripheral nociceptive mechanism of prostaglandins. *Mol Pain* 2005;1:3.
45. Koltzenburg M. The role of TRP channels in sensory neurons. *Novartis Found Symp* 2004;260:206–213.
46. Zhang X, Huang J, McNaughton PA. NGF rapidly increases membrane expression of TRPV1 heat-gated ion channels. *EMBO J* 2005;24:4211–4223.
47. Numazaki, M, M. Tominaga, Nociception and TRP Channels. *Curr Drug Targets CNS Neurol Disord* 2004;3:479–85.
48. Vijayaragavan K, Boutjdir M, Chahine M. Modulation of Nav1.7 and Nav1.8 peripheral nerve sodium channels by protein kinase A and protein kinase C. *J Neurophysiol* 2004;91:1556–1569.
49. Samad TA, Saperstein A, Woolf CJ. Prostanoids and pain: unraveling mechanisms and revealing therapeutic targets. *Trends Mol Med* 2002;8:390–396.
50. Nishiyama T. Analgesic effects of intrathecally administered celecoxib, a cyclooxygenase-2 inhibitor, in the tail flick test and the formalin test in rats. *Acta Anaesthesiol Scand* 2006;50:228–233.
51. Samad TA, et al. Interleukin-1 $\beta$ -mediated induction of Cox-2 in the CNS contributes to inflammatory pain hypersensitivity. *Nature* 2001;410:471–475.
52. Okabe T, et al. Substance P induces tumor necrosis factor- $\alpha$  release from human skin via mitogen-activated protein kinase. *Eur J Pharmacol* 2000;398:309–315.
53. Neumann S, et al. Inflammatory pain hypersensitivity mediated by phenotypic switch in myelinated primary sensory neurons. *Nature* 1996;384:360–364.
54. Ji RR, et al. p38 MAPK activation by NGF in primary sensory neurons after inflammation increases TRPV1 levels and maintains heat hyperalgesia. *Neuron* 2002;36:57–68.
55. Woolf CJ. Evidence for a central component of post-injury pain hypersensitivity. *Nature* 1983;306:686–688.
56. Dubner R, Ruda MA. Activity-dependent neuronal plasticity following tissue injury and inflammation. *Trends Neurosci* 1992;15:96–103.
57. Woolf CJ, Salter MW. Plasticity and pain: role of the dorsal horn. In McMahon SB, Kottzenburg M, eds. *Wall and Melzacks Textbook of Pain*. New York: Churchill Livingstone, 2006:91–106.
58. Simone DA, et al. Sensitization of cat dorsal horn neurons to innocuous mechanical stimulation after intradermal injection of capsaicin. *Brain Res* 1989;486:185–189.
59. Gottrup H, et al. Differential effects of systemically administered ketamine and lidocaine on dynamic and static hyperalgesia induced by intradermal capsaicin in humans. *Br J Anaesth* 2000;84:155–162.
60. Nicoll RA, Malenka RC. Contrasting properties of two forms of long-term potentiation in the hippocampus. *Nature* 1995;377:115–118.
61. Ahmadi S, et al. PGE selectively blocks inhibitory glycinergic neurotransmission onto rat superficial dorsal horn neurons. *Nat Neurosci* 2002;5:34–40.
62. Zeilhofer HU. The glycinergic control of spinal pain processing. *Cell Mol Life Sci* 2005;62:2027–2035.
63. Harvey RJ, et al. GlyR  $\alpha$ 3: an essential target for spinal PGE $_2$ -mediated inflammatory pain sensitization. *Science* 2004;304:884–887.
64. Gardell LR, et al. Enhanced evoked excitatory transmitter release in experimental neuropathy requires descending facilitation. *J Neurosci* 2003;23:8370–8379.
65. Guo W, et al. Supraspinal brain-derived neurotrophic factor signaling: a novel mechanism for descending pain facilitation. *J Neurosci* 2006;26:126–137.
66. Heinricher MM, Martenson ME, Neuberger MJ. Prostaglandin E $_2$  in the midbrain periaqueductal gray produces hyperalgesia and activates pain-modulating circuitry in the rostral ventromedial medulla. *Pain* 2004;110:419–426.
67. Sorkin LS, et al. Tumor necrosis factor- $\alpha$  induces ectopic activity in nociceptive primary afferent fibres. *Neuroscience* 1997;81:255–262.
68. Schafers M, et al. Tumor necrosis factor- $\alpha$  induces mechanical allodynia after spinal nerve ligation by activation of p38 MAPK in primary sensory neurons. *J Neurosci* 2003;23:2517–2521.
69. Jin X, Gereau RWT. Acute p38-mediated modulation of tetrodotoxin-resistant sodium channels in mouse sensory neurons by tumor necrosis factor- $\alpha$ . *J Neurosci* 2006;26:246–255.
70. Wolf G, et al. Genetic impairment of interleukin-1 signaling attenuates neuropathic pain, autotomy, and spontaneous ectopic neuronal activity, following nerve injury in mice. *Pain* 2006;120:315–324.



71. White FA, Bhangoo SK, Miller RJ. Chemokines: integrators of pain and inflammation. *Nat Rev Drug Discov* 2005;4:834–844.
72. Abbadie C. Chemokines, chemokine receptors and pain. *Trends Immunol* 2005;26:529–534.
73. Devor M. Sodium channels and mechanisms of neuropathic pain. *J Pain* 2006;7(Suppl 1):S3–S12.
74. Chahine M, et al. Regulation of Na<sup>v</sup> channels in sensory neurons. *Trends Pharmacol Sci* 2005;26:496–502.
75. Pertin M, et al. Upregulation of the voltage-gated sodium channel beta2 subunit in neuropathic pain models: characterization of expression in injured and non-injured primary sensory neurons. *J Neurosci* 2005;25:10970–10980.
76. Blumberg H, Janig W. Discharge pattern of afferent fibers from a neuroma. *Pain* 1984;20:335–353.
77. Amir R, Kocsis JD, Devor M. Multiple interacting sites of ectopic spike electrogenesis in primary sensory neurons. *J Neurosci* 2005;25:2576–2585.
78. Waxman SG, et al. Voltage-gated sodium channels and the molecular pathogenesis of pain: a review. *J Rehabil Res Dev* 2000;37:517–528.
79. Kerr BJ, et al. A role for the TTX-resistant sodium channel Nav 1.8 in NGF-induced hyperalgesia, but not neuropathic pain. *Neuroreport* 2001;12:3077–3080.
80. Priest BT, et al. Contribution of the tetrodotoxin-resistant voltage-gated sodium channel Nav1.9 to sensory transmission and nociceptive behavior. *Proc Natl Acad Sci U S A* 2005;102:9382–9387.
81. Waxman SG, Hains BC. Fire and phantoms after spinal cord injury: Na<sup>(+)</sup> channels and central pain. *Trends Neurosci* 2006;29:207–215.
82. Chaplan SR, et al. Neuronal hyperpolarization-activated pacemaker channels drive neuropathic pain. *J Neurosci* 2003;23:1169–1178.
83. Lee DH, et al. Hyperpolarization-activated, cation-nonspecific, cyclic nucleotide-modulated channel blockade alleviates mechanical allodynia and suppresses ectopic discharge in spinal nerve ligated rats. *J Pain* 2005;6:417–424.
84. Todorovic SM, Meyenburg A, Jevtovic-Todorovic V. Redox modulation of peripheral T-type Ca<sup>2+</sup> channels in vivo: alteration of nerve injury-induced thermal hyperalgesia. *Pain* 2004;109:328–339.
85. Kim DS, et al. Changes in voltage-gated calcium channel alpha gene expression in rat dorsal root ganglia following peripheral nerve injury. *Brain Res Mol Brain Res* 2001;96:151–156.
86. Wood JN, et al. Ion channel activities implicated in pathological pain. *Novartis Found Symp* 2004;261:32–40.
87. Zhou XF, et al. Injured primary sensory neurons switch phenotype for brain-derived neurotrophic factor in the rat. *Neuroscience* 1999;92:841–853.
88. Moore KA, et al. Partial peripheral nerve injury promotes a selective loss of GABAergic inhibition in the superficial dorsal horn of the spinal cord. *J Neurosci* 2002;22:6724–6731.
89. Xu XJ, et al. Possible impact of genetic differences on the development of neuropathic pain-like behaviors after unilateral sciatic nerve ischemic injury in rats. *Pain* 2001;89:135–145.
90. Ma W, Bisby MA. Partial and complete sciatic nerve injuries induce similar increases of neuropeptide Y and vasoactive intestinal peptide immunoreactivities in primary sensory neurons and their central projections. *Neuroscience* 1998;86:1217–1234.
91. Li Z, et al. Chronic arthritis down-regulates peripheral mu-opioid receptor expression with concomitant loss of endomorphin 1 antinociception. *Arthritis Rheum* 2005;52:3210–3219.
92. Zhang X, et al. Down-regulation of mu-opioid receptors in rat and monkey dorsal root ganglion neurons and spinal cord after peripheral axotomy. *Neuroscience* 1998;82:223–240.
93. Baba H, et al. Removal of GABAergic inhibition facilitates polysynaptic A fiber-mediated excitatory transmission to the superficial spinal dorsal horn. *Mol Cell Neurosci* 2003;24:818–830.
94. Potes CS, Neto FL, Castro-Lopes JM. Administration of baclofen, a gamma-aminobutyric acid type B agonist in the thalamic ventrobasal complex, attenuates allodynia in monoarthritic rats subjected to the ankle-bend test. *J Neurosci Res* 2006;83:515–523.
95. Malan TP, Mata HP, Porreca F. Spinal GABA(A) and GABA(B) receptor pharmacology in a rat model of neuropathic pain. *Anesthesiology* 2002;96:1161–1167.
96. Scholz J, et al. Blocking caspase activity prevents transsynaptic neuronal apoptosis and the loss of inhibition in lamina II of the dorsal horn after peripheral nerve injury. *J Neurosci* 2005;25:7317–7323.
97. Campbell JN, et al. Myelinated afferents signal the hyperalgesia associated with nerve injury. *Pain* 1988;32:89–94.
98. Shortland P, Woolf CJ. Chronic peripheral nerve section results in a rearrangement of the central axonal arborizations of axotomized A beta primary afferent neurons in the rat spinal cord. *J Comp Neurol* 1993;330:65–82.
99. Okamoto M, et al. Functional reorganization of sensory pathways in the rat spinal dorsal horn following peripheral nerve injury. *J Physiol* 2001;532(Pt 1):241–250.
100. Kohno T, et al. Peripheral nerve injury alters excitatory synaptic transmission in lamina II of the rat dorsal horn. *J Physiol* 2003;548(Pt 1):131–138.
101. Flor H. Remapping somatosensory cortex after injury. *Adv Neurol* 2003;93:195–204.
102. Chen R, Cohen LG, Hallett M. Nervous system reorganization following injury. *Neuroscience* 2002;111:761–773.
103. Hayward P. Microglial role in neuropathic pain. *Lancet Neurol* 2006;5:118–119.
104. Tsuda M, Inoue K, Salter MW. Neuropathic pain and spinal microglia: a big problem from molecules in “small” glia. *Trends Neurosci* 2005;28:101–107.
105. Inoue K. The function of microglia through purinergic receptors: neuropathic pain and cytokine release. *Pharmacol Ther* 2006;109:210–226.
106. Lindia JA, et al. Induction of CX3CL1 expression in astrocytes and CX3CR1 in microglia in the spinal cord of a rat model of neuropathic pain. *J Pain* 2005;6:434–438.
107. Ledeboer A, et al. Minocycline attenuates mechanical allodynia and proinflammatory cytokine expression in rat models of pain facilitation. *Pain* 2005;115:71–83.
108. Jin SX, et al. p38 mitogen-activated protein kinase is activated after a spinal nerve ligation in spinal cord microglia and dorsal root ganglion neurons and contributes to the generation of neuropathic pain. *J Neurosci* 2003;23:4017–4022.
109. Inoue K, Tsuda M, Koizumi S. ATP- and adenosine-mediated signaling in the central nervous system: chronic pain and microglia: involvement of the ATP receptor P2X4. *J Pharmacol Sci* 2004;94:112–114.
110. Chessell IP, et al. Disruption of the P2X7 purinoceptor gene abolishes chronic inflammatory and neuropathic pain. *Pain* 2005;114:386–396.
111. Zhang XF, et al. Functional expression of P2X7 receptors in non-neuronal cells of rat dorsal root ganglia. *Brain Res* 2005;1052:63–70.
112. LaCroix-Fralish ML, et al. The magnitude of mechanical allodynia in a rodent model of lumbar radiculopathy is dependent on strain and sex. *Spine* 2005;30:1821–1827.
113. Shir Y, Seltzer Z. Heat hyperalgesia following partial sciatic ligation in rats: interacting nature and nurture. *Neuroreport* 2001;12:809–813.
114. Mogil JS, et al. Heritability of nociception I. responses of 11 inbred mouse strains on 12 measures of nociception. *Pain* 1999;80:67–82.
115. Valder CR, et al. Coupling gene chip analyses and rat genetic variances in identifying potential target genes that may contribute to neuropathic allodynia development. *J Neurochem* 2003;87:560–573.
116. Zubieta JK, et al. COMT val158met genotype affects mu-opioid neurotransmitter responses to a pain stressor. *Science* 2003;299:1240–1243.
117. Rakvag TT, et al. The Val158Met polymorphism of the human catechol-O-methyltransferase (COMT) gene may influence morphine requirements in cancer pain patients. *Pain* 2005;116:73–78.
118. Dib-Hajj SD, et al. Gain-of-function mutation in Nav1.7 in familial erythromelalgia induces bursting of sensory neurons. *Brain* 2005;128(Pt 8):1847–1854.
119. Michiels JJ, et al. Autosomal dominant erythromelalgia associated with a novel mutation in the voltage-gated sodium channel alpha subunit Nav1.7. *Arch Neurol* 2005;62:1587–1590.



# CHAPTER 91

## Common Pain Syndromes

Basem Hamid, MD

Many pain conditions are encountered in clinical practice. This chapter provides a concise, practical, updated review of the most common pain syndromes. Along with the other pain chapters in this book, a comprehensive view of pain is given.

### MECHANISMS OF CHRONIC PAIN

Knowing the pathophysiology of chronic pain is essential for understanding the clinical features of different pain and the rationale of different treatment options used in the field. Chapter 92 covers this topic in detail. This chapter brief summarizes the mechanisms of pain.

Pain sense starts by detecting noxious stimuli at the level of nociceptors, which are specialized receptors in the peripheral nervous system. An electrical signal is generated (transduction) and transmitted by the afferent fibers, A- $\delta$  fibers (slow thin myelinated fibers), and C fibers (the unmyelinated slowest fibers) of the spinal and cranial nerves. The first-order neurons of these fibers are located in the dorsal root ganglia or cranial nerve ganglia. Visceral afferent nociceptive fibers (A- $\delta$  and C) travel with sympathetic and parasympathetic fibers; their cell bodies also are found in the dorsal root ganglia. Muscles are also innervated by both A- $\delta$  and C fibers. The pain signal then is transmitted to the sensory (second-order) neurons of the dorsal horn of the spinal cord. The ascending nociceptive tracts convey nociceptive stimuli from the dorsal horn of the spinal cord to higher centers in the central nervous system (CNS). These tracts include the spinothalamic, spinohypothalamic, spinoreticular, and spinopontoamygdala tracts. Multiple cortical and subcortical neural structures contribute to processing the pain signal, leading to pain perception. Pain is modified by the CNS via inhibi-

tory descending tracts. Many inhibitory and excitatory neurotransmitters and other biochemical mediators mediate the physiologic process of pain perception.

Repeated peripheral tissue injury may result in a maladaptive phenomenon—*peripheral sensitization*—which refers to a decreased threshold and an increased response to stimulation, and is maintained by various endogenous biochemicals. Moreover, sensitization of the entire nociceptive pathway can arise secondary to chronic plastic changes in the CNS, resulting in a phenomenon called *central sensitization*. As a result, multiple clinical features may arise and produce neuropathic pain (see Chapter 90). Once sensitization is established, it may be impossible to separate central contributions from peripheral contributions to the process of sensitization. Because of sensitization, pain may persist or may partially respond to therapy even when the primary injury is no longer active.

Treatment of chronic pain targets the different components contributing to the sense of pain by blocking the signal before it travels to the CNS, potentiating the inhibitory descending tracts, modifying the process of sensitization, or a combination of one or more of these mechanisms.

### MUSCULOSKELETAL PAIN SYNDROMES

#### Myofascial Pain Syndromes

Myofascial pain originates from active trigger points (TPs) within muscle

structures and/or surrounding connective tissue. A typical TP is characterized by the presence of a taut band in the muscle, tenderness to palpation, and a reference pain zone distant from the TP center. MPS can be primary or secondary to other painful conditions.

Although no clear mechanism has been defined, TPs are believed to begin after an initial macro or micro injury, which in vulnerable individuals evolves into a chronic myofascial pain syndrome (MPS) through the cascade of peripheral and central sensitizations.

Patients with myofascial pain usually present with muscle ache, which is well localized to certain muscles with distinct radiating patterns or is of vague location and radiation. The pain usually is persistent but may fluctuate in intensity. It usually is associated with other symptoms such as joint ache, stiffness, paresthesias, decreased range of motion, fatigue, poor sleep, or headache. When the pain is chronic, autonomic features such as edema and hyperemia may appear.

Diagnosis of MPS is established by identifying TPs. TPs should be sought in a systematic manner. Fig. 91-1 illustrates some of the common TPs. TPs are best identified by palpation with the finger tips and application of steady incremental pressure over different areas until hypersensitive points are found and the patient's pain is reproduced. Tight bands are felt by rubbing the fingers across the muscle fibers. When the applied pressure is altered quickly, a brief local muscle twitch response can be observed.<sup>1</sup>

### KEY POINTS

1. Central sensitization is a cardinal element of chronic pain syndromes.
2. Treatment of chronic pain should be multidisciplinary and aim for function restoration.
3. Myofascial pain syndromes are characterized by presence of trigger points.
4. Fibromyalgia is characterized by the presence of tender points.
5. Osteoarthritis is the most common joint disorder, is one of the most common chronic diseases in the elderly, and is a leading cause of disability.
6. Tricyclic antidepressants and antiepileptic drugs are good first-line options for treatment of most neuropathic pain syndromes.
7. Treatment of complex regional pain syndrome remains controversial but should start early and focus on mobility of the affected limb.
8. Neck and back pain can be generated by different anatomic structures, which are targeted in the treatment plan.
9. International Headache Society guidelines are useful tools for the diagnosis of different headache syndromes.

Treatment of MPS should focus on eliminating TPs to break the cycle enhancing chronic pain and to restore normal tone and function of the affected muscles. TP injections have been widely used to facilitate this process. Although clinicians use different solutions and medications for TP injections, no specific solution has been shown to be superior to others. Repeated steroid injection is associated with a risk for local muscle atrophy.

An alternative to injections is spraying of TPs with a vapocoolant such as chlorofluoromethane or ethyl chloride, with simultaneous stretching of the muscle. In combination with these treatments, muscle rehabilitation with exercises and thermal modalities is also useful. If analgesia is required, nonsteroidal antiinflammatory drugs (NSAIDs) usually are given. Despite the wide use and acceptance of these therapies, no clear evidence supports their efficacy. Chronic MPS can be complex and refractory to treatment.

### Fibromyalgia

Fibromyalgia (FM) is a multisymptomatic syndrome defined by the core feature of chronic widespread pain. FM is a common entity that affects women more than men and increases steadily with age.<sup>2</sup>

Although a definitive causal relation has not been established, FM usually is precipitated by trauma, stress, infections, or other factors. It commonly accompanies a wide range of medical conditions, including rheumatoid arthritis (RA), low back pain, systemic lupus erythematosus, Sjögren syndrome, osteoarthritis (OA), inflammatory bowel disease, irritable bowel syndrome, headache, mood disorders, restless leg syndrome, and sleep disturbance, particularly stage 4. Research shows that certain individuals might have vulnerability to FM because of past life events or a complex genetic component interacting with environmental insults.<sup>2,3</sup>

Patients typically present with chronic widespread stiffness and pain that is described as a constant dull ache worsened by muscle overactivity. FM usually is associated with a constellation of symptoms such as easy fatigability, nonrestorative sleep, cognitive dysfunction, depression, and somatic complaints other than musculoskeletal pain.<sup>2</sup>

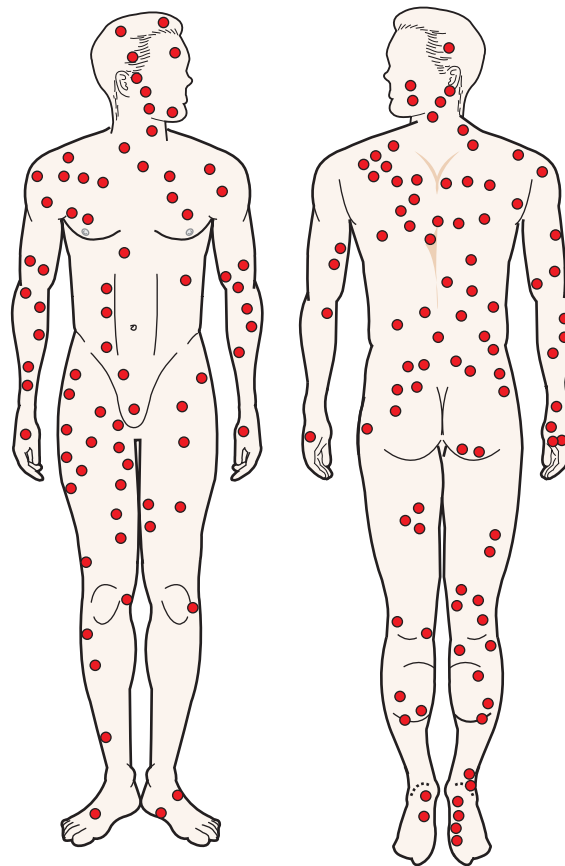


FIGURE 91-1. Common trigger points.

The diagnosis of FM usually is based on the 1990 recommendations of the American College of Rheumatology (ACR) classification criteria, which comprise one historical feature—the widespread pain of at least 3 months' duration, and one physical finding—the presence of tender points over at least 11 of 18 specified tender point sites on palpation at a force of 4 kg (amount of pressure required to blanch a thumbnail).<sup>2</sup> The locations of the 18 tender points are shown in Fig. 91-2. Palpation of control sites that typically are not tender is recommended. Some of these sites are the forehead, the medial third of the clavicle, the dorsum of the middle phalanx of the third digit, and the medial malleolus. If tenderness is present in these sites, the diagnosis of FM is questionable and a psychiatric disorder should be considered. Tenderness points are different from TPs in that they lack the other associated features. FM is distinguished from MPS by the absence of true TPs.

Treatment of FM is multidisciplinary and should consist of psycho-

logical intervention, physical therapy, especially aquatic-based exercises, treatment of comorbid mental disorders and associated sleep disorders, and pharmacologic therapies. Pregabalin is approved by the Food and Drug Administration for FM. Tricyclic antidepressants (TCAs) have been the mainstay in the treatment of FM and improving sleep. NSAIDs are used in patients with FM with varying degrees of success. Tramadol, a dual reuptake inhibitor of norepinephrine and serotonin with weak  $\mu$ -receptor affinity, is proving useful. Pramipexole, an antiparkinsonian dopamine agonist, at a dose of 4.5 mg also appears to be a promising option for treatment of FM.<sup>4,5</sup> Opioids have not been shown to be effective. Most FM patients tend to have a chronic course, with exacerbations, remissions, and fluctuating symptoms.

### Bursitis and Tendinitis

Tendinitis, bursitis, and other periarticular structures painful conditions are common causes of regional pain. Understanding of the musculoskeletal

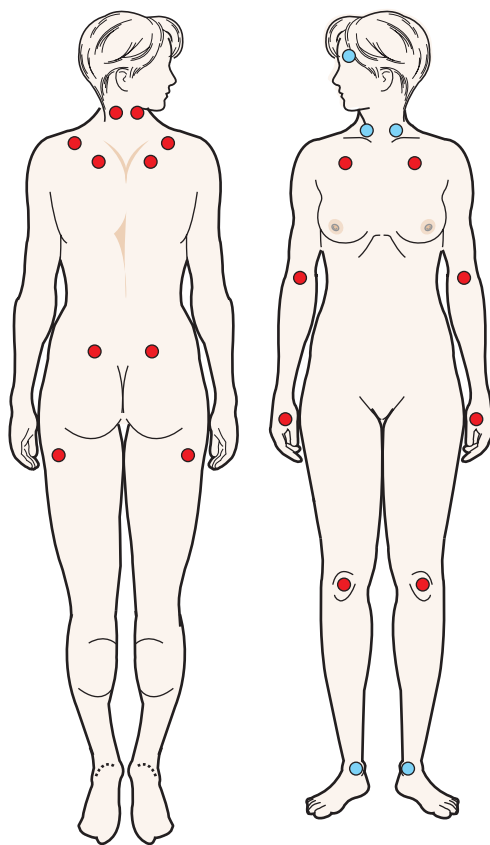


FIGURE 91-2. Recommended tender and control point locations in fibromyalgia.

anatomy and a careful clinical examination are essential in determining the true cause of pain. Whereas arthritis (or synovitis) causes effusions in the synovial space or diffuse swelling of the synovium, producing global joint swelling, bursitis causes an effusion or swelling limited to the bursa only, and tendinitis causes little, if any, swelling limited to the tenosynovial structure. In synovitis, direct palpation of the synovium elicits diffuse tenderness over the entire synovial surface area. In bursitis, tenderness is localized to the bursal structure and spares the synovium. The tenderness in tendinitis is elicited best by active range of motion and active isometric loading against resistance but can be detected by direct palpation. Tendinitis is painful with active or passive range of motion as the inflamed tendon experiences loading. Passive range of motion elicits tenderness only if the inflamed tendon is stretched and passively loaded, and active range of motion or isometric testing elicits tenderness by actively loading the tendon.

Table 91-1 lists each anatomic region and the more common periarticular conditions for each region.

In general, treatment of bursitis, tendinitis, and other periarticular conditions is similar and usually conservative. Physical therapy is helpful in most cases and may be more successful when therapy includes a combination of passive modalities, such as ice and heat, and active modalities, such as strengthening exercises to improve any biomechanical imbalances. Ultrasound is sometimes helpful and is of proven benefit for symptomatic calcific tendinitis of the shoulder. NSAIDs are helpful as analgesics but are of limited usefulness in alleviating chronic conditions. Judicious intralesional injections of steroids are helpful. However, caution should be exercised when considering intralesional steroids for bicipital and Achilles tendinitis because tendon rupture is a risk. Surgery may be required for refractory conditions.

### Arthritides

Arthritides and related syndromes are common causes of pain, with a steady increase of prevalence. An estimated 15% (40 million) of Americans had some form of arthritis in 1995. By the year 2020, an estimated 18.2% (59.4 million) of Americans will be affected.<sup>6</sup>

Thus, although the pain specialists may not be the primary treating physicians, they should be familiar with these syndromes and be able to recognize them and participate in the overall management plan to help in reducing the associated morbidity and disability. Detailed coverage of these syndromes is beyond the scope of this chapter, which provides a general overview.

### Osteoarthritis

OA is by far the most common joint disorder, is one of the most common chronic diseases in the elderly, and is a leading cause of disability. Increased weight is the most significant independent predictor of both incidence and progression of OA in weight-bearing joints. The risk for development of OA is increased by high-impact repetitive activities. Smoking and osteoporosis increase the frequency of OA.

The joints most commonly involved in OA are the metatarsophalangeal (MTP) joint of the great toe (hallux valgus or “bunion”), proximal interphalangeal (PIP) and distal interphalangeal (DIP) joints of the fingers, and carpometacarpal (CMC) joint of the thumb, hips, knees, and both lumbar and cervical spines. Other joints, even major weight-bearing joints such as the ankle, are regularly spared unless they are involved in secondary forms of OA. Pain is the main symptom leading to the diagnosis of OA. The pain is most often described as a deep ache, accompanied frequently by joint stiffness that follows periods of inactivity (on arising in the morning or after sitting). Pain is aggravated by using the involved joints, may radiate, or may be referred to surrounding structures. In the early stages of the disease, pain is commonly relieved by rest. With more severe disease, pain may be persistent, interfering with normal function and preventing sleep, even with medical management.

On physical examination, the joints may demonstrate tenderness, crepitus, and a limited range of motion. Joint swelling may be due to an accompanying synovial effusion or to bony enlargement and the presence of osteophytes. Radiographic findings help confirm the diagnosis. Joint space narrowing, subchondral bone sclerosis, subchondral cysts, and osteophytosis are characteristic.<sup>2</sup>

Nonpharmacologic management of OA includes correction of body me-

TABLE 91-1.

## Common Periarticular Painful Conditions

<b>Shoulder</b>	
Glenohumeral arthritis	<ul style="list-style-type: none"> <li>• Usually preceded by trauma</li> <li>• Anterior tenderness below the coracoid process with passive range of motion, especially rotation</li> <li>• Swelling may not be easily appreciated because this joint lies deep beneath the deltoid muscle</li> </ul>
Adhesive capsulitis (frozen shoulder)	<ul style="list-style-type: none"> <li>• Loss of normal distensibility of the glenohumeral joint capsule and subsequent adhesions between the capsule and the humeral head</li> <li>• Usually preceded by joint limiting states, such as rotator cuff, strokes, fractures</li> <li>• Gradually worsening pain and progressive loss of passive and active range of motion in all directions, especially external rotation and abduction</li> </ul>
Subacromial bursitis	<ul style="list-style-type: none"> <li>• May be complicated by complex regional pain syndrome</li> <li>• Largest and most frequently inflamed shoulder bursa</li> <li>• Pain in the lateral aspect of the shoulder, worsening with movement</li> <li>• Differs from rotator cuff tendonitis by the presence of tenderness on direct palpation beneath the acromion process</li> </ul>
Rotator cuff	<ul style="list-style-type: none"> <li>• Inflammation of suprapinatus and infraspinatus tendons lying between the humeral head and the acromial process</li> <li>• Pain aggravated by overhead reaching</li> <li>• Pain on active abduction of the shoulder focused over the lateral aspect</li> <li>• Normal passive range of motion</li> <li>• Tenderness on active resisted abduction or external rotation rather than on passive abduction or external rotation</li> </ul>
Biceps tendinitis	<ul style="list-style-type: none"> <li>• Passive forward flexion to 90° impinges on the inflamed rotator cuff and confirms the diagnosis</li> <li>• Inflammation of the long head of the biceps tendon as it traverses the humeral bicipital groove</li> <li>• Anterior shoulder pain aggravated by lifting or overhead reaching</li> <li>• Tenderness over the bicipital groove</li> <li>• Positive arc maneuver</li> <li>• Complete rupture may occur in chronic cases and presents as bulging in the antecubital fossa</li> </ul>
<b>Elbow</b>	
Olecranon bursitis	<ul style="list-style-type: none"> <li>• Inflammation of the bursal sac located on the dorsal surface of the olecranon process of the ulna</li> <li>• Tenderness and swelling over the olecranon bursa (just below the elbow)</li> <li>• Can be differentiated from elbow arthritis, as the latter causes swelling and tenderness in the para-olecranon grooves</li> </ul>
Lateral epicondylitis (Tennis elbow)	<ul style="list-style-type: none"> <li>• Injury of the common extensor tendon at the lateral epicondyle due to overuse</li> <li>• Pain and local tenderness at the lateral epicondyle</li> <li>• Pain aggravated by resisting wrist extension and radial deviation</li> <li>• Weak grip</li> </ul>
Medial epicondylitis (golfer's elbow)	<ul style="list-style-type: none"> <li>• Injury of the common extensor tendon at the medial epicondyle due to overuse</li> <li>• Pain and tenderness just distal to the medial epicondyle</li> <li>• Pain aggravated by resisting wrist extension and radial deviation</li> <li>• Weak grip</li> </ul>
<b>Wrist and Hand</b>	
de Quervain tenosynovitis	<ul style="list-style-type: none"> <li>• Inflammation of the tendons of abductor pollicis longus and extensor pollicis brevis within the first dorsal extensor compartment</li> <li>• Typically affects middle-aged women</li> <li>• Pain and swelling along the radial aspect of the wrist worsened by gripping</li> <li>• Finkelstein test confirms the diagnosis: thumb is held within the fist and the hand is deviated passively in an ulnar direction, eliciting exquisite tenderness</li> </ul>
Trigger finger	<ul style="list-style-type: none"> <li>• Inflammation of the flexor tendons of the finger at the metacarpophalangeal head</li> <li>• Caused by repetitive activity over the palm of the hand</li> <li>• Pain, swelling, and “locking” of the finger</li> </ul>
<b>Hip</b>	
Trochanteric bursitis	<ul style="list-style-type: none"> <li>• Inflammation of the bursa between the gluteus maximus muscle and the trochanteric process</li> <li>• Pain over the outer thigh, worsened by walking</li> <li>• Local tenderness over the trochanteric process</li> </ul>

(continued)



TABLE 91–1.

## Common Periarticular Painful Conditions (Continued)

Iliopsoas tendonitis/ bursitis	<ul style="list-style-type: none"> <li>• Inflammation of the iliopsoas tendon and/or bursa anterior to the true hip joint</li> <li>• Tenderness in the anterior groin or anterior hip joint</li> <li>• Local enlargement in the groin with bursitis</li> </ul>
<b>Knee</b>	
Prepatellar bursitis	<ul style="list-style-type: none"> <li>• Inflammation of the bursa overlying the patella due to injury or infection</li> <li>• Pain, swelling, and tenderness in the prepatellar area overlying the patella</li> <li>• May become chronic</li> </ul>
Pes anserine	<ul style="list-style-type: none"> <li>• Inflammation of pes anserine bursa, which lies medial to the anterior tibial tuberosity and inferior to the medial joint line</li> <li>• Pain along the medial aspect of the knee below the medial tibial plateau</li> <li>• Swelling not often observed</li> <li>• Localized tenderness to the bursa unaffected by passive range of motion of the knee</li> </ul>
Patellar tendonitis	<ul style="list-style-type: none"> <li>• Inflammation of the patellar tendon due to overuse injury</li> <li>• Anterior knee pain exacerbated by active use of the quadriceps</li> <li>• Localized tenderness to palpation to the patellar tendon</li> </ul>
Iliotibial band bursitis	<ul style="list-style-type: none"> <li>• Caused by tight iliotibial band</li> <li>• Pain over the lateral aspect of the knee</li> <li>• Clicking as the band passes over the lateral femoral condyle</li> <li>• Tenderness confined to the lateral area of the knee with absence of knee effusion</li> </ul>
<b>Ankle</b>	
Retrocalcaneal bursitis	<ul style="list-style-type: none"> <li>• Inflammation of the retrocalcaneal bursa lying between the calcaneus and the Achilles tendon</li> <li>• Posterior ankle pain reproduced by active loading of the Achilles tendon (as occurs with walking)</li> <li>• Local tenderness and swelling in the space between the Achilles tendon and the ankle, aggravated by plantar flexion</li> </ul>
Achilles tendinitis	<ul style="list-style-type: none"> <li>• Inflammation of the musculotendinous junction due to repetitive irritation of overuse</li> <li>• Posterior ankle pain with tendon loading</li> <li>• Local tenderness aggravated by dorsiflexion</li> <li>• Paratendinous thickening above the calcaneus</li> <li>• May be complicated by tendon rupture or chronic tendinitis</li> </ul>
<b>Foot</b>	
Plantar fasciitis	<ul style="list-style-type: none"> <li>• Inflammation of the origin of the longitudinal ligament</li> <li>• Many biomechanical abnormalities of the foot predispose to this condition, such as pes cavus deformities, pes planus deformities, and Achilles tendon tightness</li> <li>• Pain along the plantar surface of the medial heel</li> <li>• Tenderness to calcaneal compression</li> </ul>

chanics and posture, weight loss, and physical therapy. Analgesia can be achieved by using acetaminophen and NSAIDs as first line therapy. Intraarticular corticosteroid injections might have a positive role but should be judiciously implemented and not repeated more than three times per year because of possible secondary cartilage damage. The structure-modifying effects of drugs are being evaluated, and both glucosamine sulfate and diacerein have shown different results in treating pain.<sup>7–9</sup> Doxycycline has been proved to slow the rate of joint space narrowing in knees with established OA.<sup>10</sup>

Intraarticular injection of a viscosupplement such as Hylan has been shown to be effective in reducing pain in knee OA.<sup>11</sup> When conservative therapy fails, joint replacement surgery

might be the only option to help with analgesia.

### Rheumatoid Arthritis

RA is a chronic multisystem disease with inflammatory polyarthritis of symmetric distribution affecting the peripheral joints of the hands (sparing DIP joints), feet, wrists, elbows, shoulders, hips, knees, and ankles. The cervical spine is generally the only axial skeleton affected by RA.

RA manifests in constitutional symptoms of fatigue, low-grade fever, weight loss, and morning stiffness. Synovitis (inflammation of the synovium) is the hallmark of RA. It produces pain, swelling, and tenderness of the joints. RA is characterized by a waxing-and-waning course with relapses and remissions. Pain in RA is multifactorial.

In the early stages, it is secondary to inflammation. At later stages, the damaging effects of erosion of cartilage and bone also cause pain. RA can be accompanied by FM. RA complications can also result in pain such as vertebral body fractures, compression of the median nerves by synovial tissue in the carpal tunnel, rheumatoid vasculitis, cervical spine instability at the C1–2 level, and septic arthritis.<sup>12</sup>

Diagnosis is based on the history and physical examination and is supported by the presence of rheumatoid factor, which is present in 80% of patients with RA. Radiographically, soft-tissue swelling, juxtaarticular osteopenia, symmetric space narrowing, and bony erosions are seen.

Pharmacologic treatment of RA relies on NSAIDs, corticosteroids, analgesics,

sics, and disease-modifying antirheumatic drugs (DMARDs). Early and aggressive use of DMARDs is essential once the diagnosis is confirmed. Anti-tumor necrosis factor  $\alpha$  agents, such as infliximab, etanercept, and adalimumab, have very potent antiinflammatory properties and provide dramatic improvements of symptoms and signs. Interleukin-1 receptor antagonists such as anakinra also have been shown to be effective in slowing the damage of cartilage and progression of arthritis.

When pain is unresponsive to treatment, surgical options should be pursued, including synovectomy, arthroplasty, and joint replacement. Opioids might be the only option to provide adequate analgesia in advanced cases refractory to treatment or when contraindications to other analgesics exist.

### Other Arthritides

Multiple other arthritic syndromes may have pain as a cardinal feature. They include spondyloarthropathies, gout, and pseudogout. Arthritis can also accompany other systemic diseases, such as systemic lupus erythematosus, scleroderma, polymyalgia rheumatica, giant cell arteritis, Reiter syndrome, and inflammatory bowel disease.

Treatment should always focus on treating the underlying condition. NSAIDs usually provide acceptable analgesia. Often, opioids are required for more severe cases.

## NEUROPATHIC PAIN SYNDROMES

Neuropathic pain is a pathologic pain that results from sustained transmission of pain signals in the absence of ongoing tissue injury or activation of pain-sensitive afferent peripheral nerves. Neural injury or dysfunction at any point along the somatosensory system from the peripheral nerve endings to the brain can cause neuropathic pain. Multiple mechanisms (peripheral and central) are responsible for sustaining neuropathic pain. Although its role is less identified than in nociceptive pain conditions, primary sensitization of nociceptive nerve endings might be a contributing factor to sustaining neuropathic pain. Damaged nerve fibers, especially neuromas, may generate ectopic action potentials, which contribute to neuro-

pathic pain. When input from peripheral nociceptors into the dorsal horn of the spinal cord decreases, as encountered in deafferentation conditions such as shingles and after amputation, the dorsal horn neurons become hyperexcitable and may even develop spontaneous activity. In addition, the reduction of peripheral sensory input leads to ephaptic sprouting of the neurons neighboring the affected central neurons, resulting in magnification of the perceived pain field. Central sensitization, as outlined, also plays a major role in neuropathic pain. Because the inhibitory interneurons normally are excited by peripheral input, attenuation of this input will decrease inhibition and amplify the pain signal. In general, the inhibitory circuits of pain signal are downregulated at the level of both the spinal cord and the brain. At the level of the brain, different sites are involved in the processing of pain signal, and the somatosensory-pain homunculus is not quite preserved. The initial neural injury and subsequent evolving mechanisms explain the complexity of clinical features encountered in neuropathic pain syndromes.

Some clinical features are common among neuropathic syndromes, whereas others are unique to specific syndromes. Patients usually have different types of pain. A stimulus-independent pain is a spontaneous pain experienced by patients without sensory stimulation. It consists of a background constant pain, intermittent exacerbations, and brief episodes of other symptoms. The pain usually is burning, aching, crushing, gnawing, lancinating, shooting, electrical or lightening in quality, and associated with painful numbness and paresthesia (dysesthesias). The stimulus-evoked pain includes a variety of signs, such as hyperalgesia, mechanical and thermal allodynia, and hyperpathia. Table 91-2 summarizes some features of neuropathic pain.

Associated clinical features include abnormalities of reflexes and muscle function. Increased reflexes and tone are indicative of an upper motor neuron disease and suggest a central lesion such as stroke, whereas reduced reflexes or tone suggest peripheral origin as in compressive radiculopathies or neuropathies. Secondary motor changes could be a result of disuse and abnormal position. Autonomic abnormalities can be seen and include changes in color and temperature in the affected

TABLE 91-2.

### Clinical Features of Neuropathic Pain

- **Hypesthesia:** Decreased sensation or increased threshold for sensation
- **Hyperesthesia:** Increased sensitivity to stimulus
- **Paresthesia:** Abnormal (but not painful) sensation (like pins-and-needles sensation), spontaneous or evoked
- **Dysesthesia:** Unpleasant (painful) sensation, spontaneous or evoked
- **Hyperalgesia:** Increased response to painful stimulus
- **Allodynia:** Pain due to a stimulus that does not normally provoke pain
  - **Mechanical:** Mechanical stimulus is the cause
  - **Thermal:** Thermal stimulus is the cause
- **Hyperpathia:** Abnormally painful and exaggerated reaction to stimulus, especially repetitive, where the stimulus is perceived initially less intense
- **Causalgia:** Constant burning pain accompanied by allodynia and hyperpathia following nerve injury<sup>99</sup>

tissues, swelling due to abnormal leakage of intravascular fluid, and growth of skin, hair, nails, and other cutaneous structures. Other systemic features of autonomic dysfunction that could be seen include orthostatic hypotension, impotence, delayed gastric emptying, abnormal sweating and/or thermoregulation, difficulties with elimination, and occasionally cardiac arrhythmias.

Table 91-3 lists the most common neuropathic pain syndromes.<sup>13</sup>

Following is a brief discussion of common neuropathic pain conditions.

### Painful Peripheral Neuropathies

A wide variety of etiologies lead to peripheral neuropathies. It is important to realize that not all neuropathies are painful, as is the case with most of the inherited neuropathies. Some patients with neuropathy have chronic pain due to other conditions, and their pain should not be immediately blamed on the concomitant non-painful neuropathy. The distribution of

TABLE 91–3.

## Common Neuropathic Pain Syndrome

Peripheral Neuropathic Pain
Acute and chronic inflammatory demyelinating polyradiculoneuropathy (Guillain-Barré syndrome)
Alcoholic polyneuropathy
Chemotherapy-induced polyneuropathy
Complex regional pain syndrome (CRPS)
Congenital painful neuropathies
Entrapment neuropathies (e.g., carpal tunnel syndrome)
Hereditary painful neuropathies
HIV neuropathy
Iatrogenic neuralgias (e.g., post-mastectomy or postthoracotomy pain)
Idiopathic sensory neuropathy
Compression neuropathy (i.e., by tumor)
Nutritional deficiency-related neuropathies
Painful diabetic neuropathy
Paraneoplastic neuropathy
Phantom limb pain <sup>a</sup>
Postherpetic neuralgia
Postradiation myelopathy/plexopathy
Radiculopathy syndromes (cervical, thoracic, lumbosacral)
Toxic exposure-related neuropathies
Cranial neuralgias (e.g. trigeminal, glossopharyngeal)
Posttraumatic neuralgias
Central Neuropathic Pain
Compressive myelopathy (e.g., spinal stenosis, tumor)
HIV myelopathy
Multiple sclerosis-related pain
Parkinson disease-related pain
Postischemic myelopathy
Postradiation myelopathy
Poststroke pain
Posttraumatic spinal cord injury pain
Syringomyelia

Modified from Dworkin RH, et al.,<sup>13</sup> with permission.

neuropathy can be generalized and symmetric (polyneuropathy), such as diabetic and alcoholic polyneuropathy; multifocal (mononeuropathy multiplex), such as collagen vascular disease-related neuropathies; or focal

(mononeuropathy), as seen in trauma and entrapment neuropathies. Polyneuropathy usually is symmetric and starts in a distal-to-proximal gradient in a “glove and stocking” distribution. Mononeuropathy multiplex affects multiple peripheral nerves arbitrarily and sometimes can be difficult to differentiate from polyneuropathy. Mononeuropathy follows the distribution of the affected nerve. Neuropathies may result from injury to the axons (axonal neuropathies), to myelin (demyelinating neuropathies), or mixed. Most of the neuropathies encountered in pain medicine practice are axonal neuropathy types. Acute (AIDP) and chronic inflammatory demyelinating polyradiculoneuropathy (CIDP) are examples of demyelinating neuropathies usually seen in pain practice. Table 91–4 highlights most of the painful neuropathies that a pain physician might encounter.

Although the evaluation of neuropathy usually is conducted by neurologists, it is important for the pain medicine practitioner to be familiar with the diagnostic workup. Fig. 91–3 shows a simple diagnostic approach that leads to the diagnosis of most neuropathies.<sup>14</sup>

### Small-Fiber Neuropathy

Small-fiber neuropathy (SFN) is the most common type of painful neuropathy. The smaller axons A- $\delta$  (small myelinated) and C (unmyelinated) are affected. The larger fibers usually are preserved but could be involved at a later stage. SFN is a disease of late middle age, but symptoms could start as early as the third decade or as late as the ninth decade.<sup>15</sup> SFN is vastly underrecognized, and most cases are “idiopathic.” SFN may predate diabetes mellitus<sup>16</sup> and neoplastic conditions by many years. Although SFN is more common in men, patients presenting with pain of SFN are more likely to be women.<sup>17</sup>

Pain and decreased temperature sensation are the predominant features. Proprioception, vibratory sensation, and muscle-stretch reflexes usually are intact because they are mediated by the larger nerve fibers A- $\beta$  and A- $\alpha$ , which are not involved in the pathologic process.

Injury of affected fibers cannot be detected by standard nerve conduction studies (NCS) and electromyography (EMG), so these tests usually are unrevealing. Therefore, the diagnosis

usually is clinical and relies on ruling out other possibilities. A definite diagnosis of SFN could be reached by autonomic testing or a skin biopsy if warranted. When fasting blood glucose or glycosylated hemoglobin (HgA<sub>1c</sub>) levels are diagnostic of diabetes mellitus, obtaining a oral glucose tolerance test may unveil impaired glucose tolerance or early diabetes mellitus.<sup>18–20</sup>

The distinction between SFN and “large-fiber” neuropathies is important because the underlying cause is more likely to be identifiable when both large and small fibers are affected.

### Diabetic Peripheral Neuropathic Pain

Current estimates suggest that more than 18 million Americans have diabetes.<sup>21</sup> Peripheral neuropathy is one of the most common complications of diabetes,<sup>22</sup> and conversely diabetes is the most common cause of peripheral neuropathy in developed countries.<sup>23</sup> Studies suggest that 30–60% of all diabetics have signs and/or symptoms of peripheral neuropathy.<sup>21,24–26</sup> The risk is >50% in individuals who have had diabetes for more than 20 years. The prevalence of any neuropathy is 66% for patients with type 1 diabetes mellitus and 59% for those with type 2.<sup>22</sup> Neuropathy can be seen at any stage of diabetes progression, and approximately 10% of newly diagnosed type 2 diabetics may have neuropathy.<sup>22</sup> Neuropathic symptoms may be the presenting complaint leading to the diagnosis of diabetes. Neuropathy also has been reported in patients with impaired glucose tolerance, or “prediabetes.”<sup>22</sup> Multiple risk factors contribute to the risk of diabetic neuropathy, including duration of diabetes, age, male gender, increased height, hypertension, and smoking.<sup>24</sup> Poor glycemic control is a major modifiable risk factor for neuropathy, as demonstrated by the reduction in risk of neuropathy with intensive glucose lowering. This is demonstrated by a decrease of approximately 60% in type 1 diabetic patients treated with intensive insulin therapy compared to those who received conventional therapy.<sup>27</sup>

The clinical manifestations of diabetic peripheral neuropathy depend on the specific nerves affected. Because all branches of the peripheral nervous system are susceptible to damage from diabetes, patients can

TABLE 91-4.

## Common Painful Neuropathies

Type of Neuropathy	Predisposing Factors	Features on Examination	Laboratory Findings
Idiopathic small-fiber painful sensory neuropathy	Age >50 y	Normal muscle-stretch reflexes Normal muscle strength Normal sensation of position and vibration Reduced pinprick sensation in lower extremities	Normal EMG and NCS Reduced sudomotor function Abnormal skin biopsy Normal blood tests
Diabetic peripheral neuropathy	Family history Obesity	Reduced muscle-stretch reflexes Reduced distal sensation May have orthostatic hypotension (rarely, may have findings similar to those in idiopathic small-fiber painful sensory neuropathy)	Abnormal EMG and NCS (rarely, normal EMG and NCS) 2-hour glucose-tolerance test $\geq 200$ mg/dL Fasting blood glucose concentration $\geq 126$ mg/dL
Inherited neuropathies	Family history	Per cavus or hammer toe Usually reduced muscle-stretch reflexes Reduced distal sensation	Abnormal EMG and NCS Normal blood tests
Peripheral neuropathy with connective tissue disease	History of rheumatoid arthritis, systemic lupus erythematosus, mixed connective tissue disease, Sjögren syndrome, or symptoms of sicca syndrome	Reduced muscle-stretch reflexes Reduced distal sensation	Abnormal EMG and NCS Positive for antinuclear antibodies, extractable nuclear antigens, or rheumatoid factor
Peripheral nerve vasculitis	Known systemic vasculitis (nonsystemic vasculitis may occur without systemic features)	Multifocal examination findings (may mimic polyneuropathy)	Abnormal EMG and NCS Blood test abnormalities may include antineutrophilic cytoplasmic antibodies, antinuclear antibodies, rheumatoid factor, hepatitis C, cryoglobulins
MGUS neuropathy	Age >50 y	Variable findings Reduced or normal reflexes Reduced distal sensation	Abnormal EMG and NCS (may be normal in rare cases) Monoclonal gammopathy
Paraneoplastic sensory neuropathy	Tobacco smoking, family history, asbestos exposure, occupational exposure to dyes, paints, printing rubber, textiles or leather	Reduced muscle-stretch reflexes Reduced distal sensation	Abnormal EMG and NCS Anti-Hu antibodies
Familial amyloid polyneuropathy	Family history	Reduced muscle-stretch reflexes Sensory loss preferentially small-fiber Postural hypotension	Abnormal EMG and NCS NCS may show carpal tunnel syndrome
Acquired amyloid polyneuropathy	Known plasma cell dyscrasia or monoclonal gammopathy	Reduced muscle-stretch reflexes Sensory loss preferentially small-fiber Postural hypotension	Abnormal EMG and NCS NCS may show carpal tunnel syndrome Monoclonal gammopathy
Neuropathy with renal failure	Known renal disease	Reduced muscle-stretch reflexes	Abnormal EMG and NCS Abnormal renal function
Hereditary sensory autonomic neuropathy	Family history, foot ulcers, painless injuries	Variable sensory examination Reduced muscle-stretch reflexes Variable sensory examination Pes cavus and hammer toe Foot ulcers	Abnormal EMG and NCS

(continued)



TABLE 91-4.

## Common Painful Neuropathies (Continued)

Type of Neuropathy	Predisposing Factors	Features on Examination	Laboratory Findings
Sarcoid polyneuropathy	Pulmonary sarcoidosis	Multiple mononeuropathy or features of polyneuropathy	Abnormal EMG and NCS Elevated angiotensin-converting enzyme Abnormal chest radiography
Arsenic neuropathy	Industrial exposure to pesticides, wood preservatives, copper smelting	Reduced muscle-stretch reflexes Loss of all types of sensation Usually some distal weakness Mees lines	Abnormal EMG and NCS Elevated arsenic levels (in plasma, urine, nails, hair)
Fabry disease	Onset before age 20 y Renal failure, stroke	Normal muscle-stretch reflexes Normal muscle strength Normal sensation of position and vibration Normal or reduced pinprick sensation in feet	Normal EMG and NCS Reduced levels of $\alpha$ -galactosidase A in serum, leukocytes, or tears
Celiac disease	Gastrointestinal symptoms	Variable features may be normal except for loss of distal pinprick sensation or loss of all types of sensation Reduced muscle-stretch reflexes	EMG and NCS usually normal Positive serologic test for celiac disease (IgA antigliadin and IgA endomysial antibodies)
HIV-related neuropathy	Homosexual activity, drug abuse, blood transfusions, treatment with antinucleosides	Variable features may be normal except for loss of distal pinprick sensation or loss of all types of sensation Reduced muscle-stretch reflexes	EMG and NCS usually abnormal HIV antibody sensation

EMG, Electromyography; HIV, human immunodeficiency virus, MGUS, monoclonal gammopathy of undetermined significance, NCS, nerve conduction studies.  
From Mendell and Sahenk<sup>14</sup> with permission.

exhibit abnormalities of sensory, motor, or autonomic function. Deficits frequently overlap or coexist.

Diabetic peripheral neuropathy is a heterogeneous condition that can manifest clinically as several types,<sup>22</sup> which can exist individually or overlap. Table 91-5 lists the different types of diabetic peripheral neuropathy.

NCS and quantitative sensory testing (e.g., quantitative vibration threshold testing) can be used to confirm neuropathy suggested by the physical examination or to confirm the diagnosis in patients with symptoms but no abnormalities on physical examination. Normal NCS do not necessarily rule out neuropathy as a cause of pain because neuropathic symptoms may be due to SFN.

Multiple pharmacologic agents have been used for treatment of diabetic peripheral neuropathic pain. Duloxetine<sup>28,29</sup> and pregabalin<sup>30-33</sup> are the only FDA-approved drugs for dia-

betic peripheral neuropathic pain. Multiple other medications have been shown to be effective, such as TCAs,<sup>34,35</sup> gabapentin,<sup>23,36</sup> venlafaxine,<sup>37-39</sup> tramadol, capsaicin,<sup>25,40-44</sup> opioids,<sup>45-47</sup> and a combination of more than one of these medications.<sup>46,48</sup> Zonisamide<sup>49</sup> also appears to be promising. Antiepilepsy drugs (AEDs)<sup>50</sup> and many other drugs have been used extensively, with varying degrees of success.<sup>13,14,51</sup> In a small case series, spinal cord stimulation was successful in the treatment of diabetic peripheral neuropathic pain refractory to conventional therapies, including opioids.<sup>52,53</sup>

### HIV/AIDS-Related Neuropathy

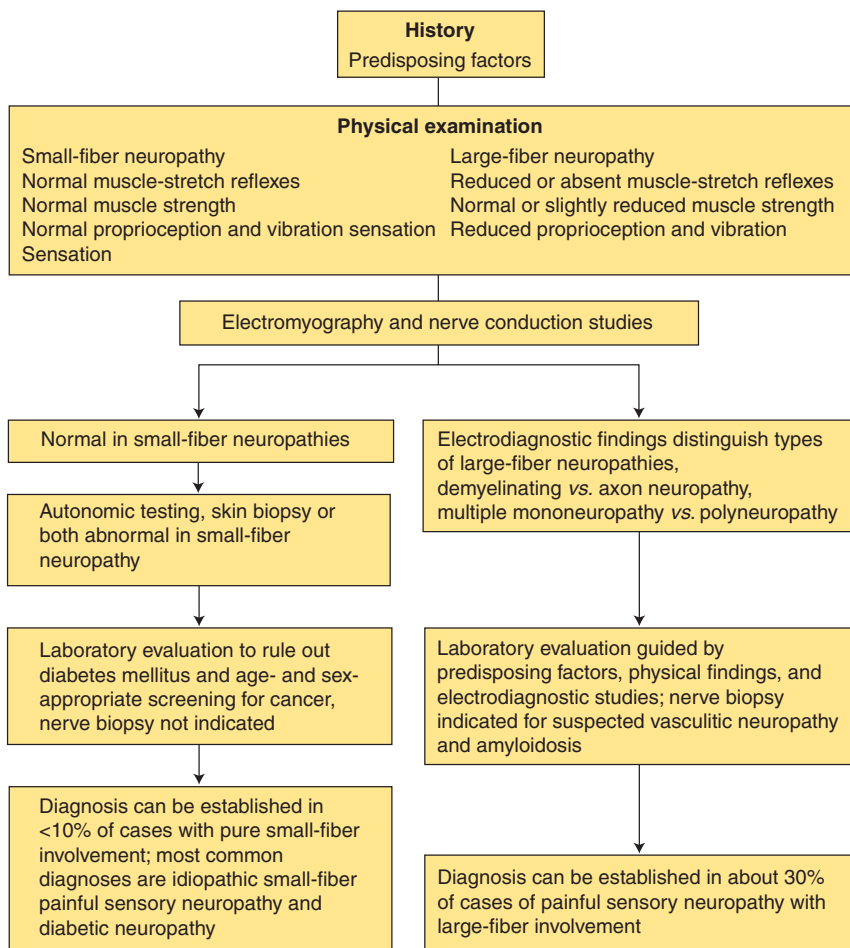
Neuropathic pain occurs in approximately one third of patients with human immunodeficiency virus (HIV) and acquired immunodeficiency syndrome (AIDS).<sup>54</sup> A variety of disorders can result in neuropathic pain in HIV and AIDS patients. The different types

of HIV/AIDS-related neuropathies are summarized in Table 91-6.<sup>55,56</sup>

Treatment of HIV/AIDS-related neuropathic pain relies on treatment of the underlying infection(s) and removal of toxic agent if possible. Neuropathic agents have been used, with variable results. Lamotrigine<sup>57,58</sup> and probably ziconotide<sup>59</sup> have documented efficacy.

### Carpal Tunnel Syndrome

Carpal tunnel syndrome (CTS) is the most common painful mononeuropathy of the upper limb. It results from compression (entrapment) of the median nerve as it passes under the ligamentous canal in the wrist. Multiple factors predispose to or precipitate CTS, such as fractures, ganglions, synovial disorders, wrist arthritides, ergonomic stressors, repetitive use, pregnancy, obesity, chronic renal insufficiency, and other systemic disorders such as diabetes and acromegaly.



**FIGURE 91-3.** Algorithm for evaluation of painful peripheral neuropathy. (From Mendell and Sahenk<sup>14</sup> with permission.)

**TABLE 91-5.**

### Common Diabetic Peripheral Neuropathies

1. Diffuse Neuropathies
  - A. Distal symmetric sensorimotor polyneuropathy (peripheral polyneuropathy). This is the most common form of diabetic peripheral neuropathy. The small fibers, the large fibers, or a combination of both could be affected. It typically starts in the feet but may progress to a “stocking glove” distribution in all of the extremities. Sensory symptoms predominate.
  - B. Autonomic neuropathy.
  - C. Symmetric proximal lower limb motor neuropathy (amyotrophy).
2. Focal Neuropathies
  - A. Mononeuropathies involving any of the peripheral or cranial nerves.
  - B. Entrapment neuropathies such as carpal tunnel syndrome.

CTS is characterized by paresthesias and dysesthesias over the median nerve sensory area of the hand, which includes the thumb, index, and median half of the middle fingers. Weakness of the thenar muscles can occur. Symptoms are most pronounced upon awakening.

Physical examination shows decreased sensation over the palmar aspect of the thumb through the middle finger. At later stages, the thenar muscles are weak and could be atrophied. Tinel sign and Phalen test are not sensitive but help support the diagnosis when they are present.<sup>60,61</sup> Tinel sign is the elicitation of distal paresthesias by percussion on the wrist or at the base of the palm. Phalen test attempts to elicit paresthesia by applying pressure (inflating a tourniquet to 60 mm HG) on the arm or holding the wrist in a flexed position.

The diagnosis of CTS can be confirmed by NCS and EMG.

Most patients respond well to conservative treatment, which includes wrist splinting, NSAIDs, or steroid injections.

If treatment fails, surgical decompression at the wrist may be necessary, especially when weakness progresses.

### Acute Herpes Zoster

Acute herpes zoster (shingles) is the most common cause of sensory neuropathy. It results from infection reactivation of the dormant varicella-zoster virus in the ganglionic neurons or satellite cells, followed by transmission of the virus particles to the nerve endings proximally and distally. The incidence of herpes zoster varies with age and immune status, ranging from 0.4–1.6 cases per 1000 among healthy people younger than 20 years to 4.5–11 cases per 1000 among those 80 years or older.<sup>62</sup> The risk of a second attack is as high as the risk of a first attack.<sup>63</sup> The risk of acute herpes zoster is higher among patients with HIV infection or cancer and particularly among children with leukemia and transplant recipients.<sup>62,64–67</sup>

Dermatomal distribution and vesicular rash are the hallmarks of acute herpes zoster.

The most affected nerves follow this order: thoracic spinal roots, ophthalmic division of the trigeminal nerve (V1), maxillary division of the trigeminal nerve (V2), cervical spinal roots, and sacral spinal roots.<sup>68</sup> The involvement is unilateral in most cases but can rarely be bilateral.

The earliest clinical features of acute herpes zoster noticed by patients are dermatomal dysesthesias associated with pruritus. This could be accompanied or followed shortly by the appearance of the typical rash, which matures through different stages until it crusts and heals. The pain worsens with progression and consists of dysesthesias, burning, and shooting pain. It tends to resolve spontaneously as the crust falls off, a process that takes 4–5 weeks.

Treatment of acute herpes zoster is discussed in the section on Postherpetic Neuralgia because of the close therapeutic strategies.

### Postherpetic Neuralgia

Many definitions have arbitrarily been used for postherpetic neuralgia (PHN). Results of recent research distinguishes among three phases of pain: acute pain (which occurs within 30 days after rash onset; described earlier), PHN (pain that persists  $\geq$  120 days after rash onset), and subacute herpetic neuralgia (pain that persists beyond the acute

TABLE 91–6.

## HIV/AIDS Related Neuropathies

1. Acute (AIDP) and chronic inflammatory demyelinating polyradiculoneuropathy (CIPD). AIDP (Guillain-Barré syndrome) occurs in the early stages of HIV infection. Symptoms usually peak in 4 weeks after onset and improve gradually to variable degrees. In CIPD, symptoms evolve over several weeks or months and have periods of remissions and relapses.
2. Distal sensory polyneuropathy (DSPN). DSPN is the most common HIV-associated neuropathy. It has similar presentation to the other distal symmetrical sensory neuropathies.
3. Drug-induced neuropathies. Several drugs used for treatment of HIV infection or AIDS complications can cause neuropathy that is identical to DSPN. Antiretroviral medications include didanosine (ddl; Videx), stavudine (d4T; Zerit), and particularly zalcitabine (ddC).  
Chemotherapeutic agents such as vincristine and paclitaxel used for Kaposi sarcoma and lymphoma also cause neuropathy. DSPN is a common side effect of thalidomide used for treatment of aphthous ulcers and isoniazid, an antituberculosis agent. Typically drug-induced neuropathies improve after the neurotoxic agent is withdrawn.
4. Mononeuropathy multiplex (MM). MM can occur early or late in the disease. Individual nerves are affected, resulting in isolated symptoms as seen in cranial neuropathies, hand or foot drop.
5. Cytomegalovirus (CMV) polyradiculopathy. This entity occurs in severely immunosuppressed HIV patients. It initially presents with pain and paresthesias in the saddle distribution due to involvement of the sacral roots, in association with or followed by severe symptoms that progress distally down both lower extremities. If this condition is left untreated, flaccid paraparesis, areflexia, and sphincter function impairment follow. CMV infection must be aggressively treated.

phase but resolves before the diagnosis of PHN is made).<sup>69,70</sup> PHN may develop after a pain-free interval. Nearly all patients have pain in association with acute herpes zoster, and 10–70% of these patients go on to have PHN.<sup>62,63,71</sup> Not only does the risk of PHN increase with age, but so does the intractability of the pain.<sup>62</sup> The presence of prodrome, female gender, greater rash severity, and greater acute herpes zoster pain severity have been associated with increased risk for PHN.<sup>70</sup> The risk of PHN is not increased in immunocompromised patients.<sup>65,71</sup> Symptoms consist of a background dermatomal burning pain and dysesthesias with superimposed intermittent lancinating pain. Hypoesthesia, hyperalgesia, allodynia, and hyperpathia may be present.

### Treatment

The goal of treatment of acute herpes zoster is to alleviate the symptoms, shorten its course, and prevent the evolution of PHN. Antiviral drugs (famciclovir, valacyclovir, acyclovir) started within 72 hours after the rash appears reduce acute pain in immunocompetent patients, thus providing re-

lief in the greatest number of patients and possibly reducing the likelihood of evolution of PHN.<sup>62,72,73</sup> Although corticosteroids do not alter the course of PHN, they improve the quality of life after zoster, thus justifying their administration in combination with an antiviral drug in high-risk patients 50 years or older with moderate-to-severe pain in whom corticosteroids are not contraindicated.<sup>62</sup>

Some reports suggest the efficacy of infiltration of the skin, peripheral nerves, sympathetic nerve blockade, or paravertebral or epidural spaces with local anesthetic drugs with or without steroids in patients with acute herpes zoster.<sup>62,74–76</sup>

A large retrospective study suggested that any benefits of somatic nerve blocks are limited to the first 2 months of pain.<sup>62</sup>

Treatment of pain associated with established PHN can be challenging. In general, drugs used for neuropathic pain are used for treatment of PHN. TCAs have well-documented efficacy.<sup>35</sup> Anticonvulsants are widely used.<sup>77</sup> Gabapentin<sup>78–80</sup> and pregabalin<sup>81–83</sup> have documented efficacy and are FDA ap-

proved. Opioids may be required for more severe cases. Topical lidocaine patches have been shown to be effective for PHN, especially in alleviating allodynia.<sup>39,84,85</sup> Data suggest the possible efficacy of epidural or intrathecal steroids injections in chronic PHN.<sup>86–88</sup>

Numerous other treatment modalities have been attempted, such as the transcutaneous electrical nerve stimulation unit,<sup>89</sup> topical agents, acupuncture, and hypnosis, with various results. In refractory PHN, more invasive surgical options have been implemented, including dorsal root entry zone lesions, cordotomy, rhizotomy, spinal cord stimulation, and sympathectomy.

### Meralgia Paresthetica

Meralgia paresthetica is an entrapment mononeuropathy of the lateral femoral cutaneous nerve as it passes under the inguinal ligament. It is associated with a number of conditions and factors, such as increased pressure on the nerves, as occurs with tight belts, pregnancy, CTS, regional operations, obesity, or after rapid weight changes.<sup>90,91</sup>

Meralgia paresthetica is characterized by a patch of dysesthesias and decreased sensation over the anterolateral thigh. Diagnosis can be easily confirmed by blocking the nerve. Management is conservative. Corticosteroids injections also can be used. The prognosis is a very good, with most patients experiencing spontaneous remission in 6–12 months. Surgery might be helpful in refractory cases.<sup>92</sup>

### Trigeminal Neuralgia

Trigeminal neuralgia, previously called *tic douloureux*, is a disorder of the trigeminal nerve. It is characterized by brief electric shock-like pain that is abrupt in onset and termination and is limited in distribution to one or more divisions of the trigeminal nerve. Pain is commonly evoked by trivial trigger factors such as washing, shaving, talking, and/or brushing the teeth. Small areas in the nasolabial fold and/or chin may be particularly susceptible to the precipitation of pain (trigger areas). The pain usually remits for variable periods.

Trigeminal neuralgia classically starts in the second or third division and affects the cheek or chin. The first division is involved in <5% of patients. Trigeminal neuralgia is a unilateral disorder but in rare cases is bilateral, in which case a central lesion such as

TABLE 91-7.

**International Headache Society  
Diagnostic Criteria for  
Trigeminal Neuralgia**

- A. Paroxysmal attacks of pain lasting from a fraction of a second to 2 minutes, affecting one or more divisions of the trigeminal nerve and fulfilling criteria B and C
- B. Pain has at least one of the following characteristics:
  1. Intense, sharp, superficial or stabbing
  2. Precipitated from trigger areas by trigger factors
- C. Attacks are stereotyped in the individual patient
- D. No clinically evident neurologic deficit
- E. Not attributed to another disorder

multiple sclerosis should be excluded. Between paroxysms, patients usually are asymptomatic but may have a persistent dull background pain. In some cases, the trigeminal root in the posterior fossa is compressed by tortuous or aberrant vessels. Classic trigeminal neuralgia usually is responsive, at least initially, to pharmacotherapy.

Table 91-7 lists the International Headache Society (IHS) diagnostic criteria for trigeminal neuralgia.<sup>93</sup>

Carbamazepine is still the first-line treatment. Other AEDs, such as gabapentin, also have been shown to be effective.<sup>94</sup> TCAs are effective.<sup>95</sup> In refractory cases, invasive procedures (e.g., ablative lesioning or decompression of the trigeminal ganglion) may be required.<sup>96</sup>

### Glossopharyngeal Neuralgia

Glossopharyngeal (cranial nerve IX) neuralgia is a severe transient stabbing pain experienced in the distribution of this nerve and the distribution of the auricular and pharyngeal branches of the vagus nerves. The pain is felt in the ear, base of the tongue, tonsillar fossa, or beneath the angle of the jaw. The pain is commonly provoked by swallowing, talking, or coughing and may remit and relapse as in trigeminal neuralgia. Table 91-8 lists the IHS diagnostic criteria for glossopharyngeal neuralgia.<sup>93</sup>

In Eagle syndrome, the nerve is compressed by a calcified or ossified stylohyoid ligament, which is visible on x-ray or CT scan.<sup>97</sup>

TABLE 91-8.

**International Headache Society  
Diagnostic Criteria for  
Glossopharyngeal Neuralgia**

- A. Paroxysmal attacks of facial pain lasting from a fraction of a second to 2 minutes and fulfilling criteria B and C
- B. Pain has all of the following characteristics:
  1. Unilateral location
  2. Distribution within the posterior part of the tongue, tonsillar fossa, pharynx, or beneath the angle of the lower jaw and/or in the ear
  3. Sharp, stabbing, and severe
  4. Precipitated by swallowing, chewing, talking, coughing, and/or yawning
- C. Attacks are stereotyped in the individual patient
- D. No clinically evident neurologic deficit
- E. Not attributed to another disorder

Pharmacologic treatment of glossopharyngeal neuralgia is similar to that of trigeminal neuralgia. In Eagle syndrome, resection of the stylohyoid ligament is effective.

### Occipital Neuralgia

Occipital neuralgia is a paroxysmal stabbing jabbing pain in the distribution of the greater or lesser occipital nerves or the third occipital nerve, sometimes accompanied by diminished sensation or dysesthesias in the affected area. It is associated with tenderness over the affected nerve. Table 91-9 lists the IHS diagnostic criteria for occipital neuralgia.<sup>93</sup>

Treatment can be conservative using different analgesics, including TCAs and AEDs, or application of nerve blocks. For refractory cases, neuroablative measures can be used.<sup>98</sup>

## CENTRAL PAIN SYNDROMES

Central pain is a “deafferentation” pain that can result from any lesion found in the CNS.<sup>99</sup> Virtually any type of lesion can produce this type of pain, including demyelinating, vascular, infectious, inflammatory, and traumatic. Pain onset may be delayed by several months after the initial insult, reflecting the slow degeneration process within the CNS. Pain usually correlates

TABLE 91-9.

**International Headache Society  
Diagnostic Criteria for  
Occipital Neuralgia**

- A. Paroxysmal stabbing pain, with or without persistent aching between paroxysms, in the distribution(s) of the greater, lesser, and/or third occipital nerves
- B. Tenderness over the affected nerve
- C. Pain is eased temporarily by local anesthetic block of the nerve

to the anatomic site of the causative lesion. The pain features are those of neuropathic pain.

Brain central pain results from a variety of etiologies. Thalamic pain (Dejerine-Roussy syndrome) is the prototype of central pain, but lesions in the brainstem and other sites also can produce central pain. Strokes are the most common cause, with pain reported to occur in up to 8% of poststroke patients.<sup>100</sup> Other etiologies include multiple sclerosis, brain abscess, encephalitis, and tumors.

Spinal cord central pain is a common complication of spinal cord injuries. Trauma is the most common etiology.<sup>101</sup> Iatrogenic, inflammatory, demyelinating, vascular, neoplastic, and congenital lesions are other possible causes. The most common level of injury associated with pain is cauda equina followed by the central cord injuries. Syringomyelia and syringobulbia can occur as delayed consequences of trauma or congenital malformations and produce neuropathic pain of segmental pattern.

Central pain is one of the most difficult pain states to effectively treat. Lamotrigine shows encouraging results.<sup>102,103</sup> Some evidence exists for the benefit of TCAs.<sup>35</sup> Other agents used for neuropathic pain, such as AEDs and opioids, have been used, but no sound evidence supports their efficacy.

### Sympathetically Maintained Pain and Complex Regional Pain Syndromes

*Sympathetically maintained pain* (SMP) is defined as “pain that is maintained by sympathetic efferent innervation or by circulating catecholamines.”<sup>104</sup> Thus, SMP is not a clinical diagnosis but rather a pathophysiologic mechanism in chronic pain marked by improvement



of pain when sympathetic blockade is performed. When the pain does not respond to sympathetic blockade, it is called *sympathetically independent pain* (SIP). SMP is thought to be a major culprit in many chronic pain states, such as peripheral and central neuropathic pain syndromes.<sup>105-107</sup>

Complex regional pain syndrome (CRPS) is considered to be a neuropathic SMP syndrome. The two types of CRPS are type I (previously called reflex sympathetic dystrophy) and type II (previously called causalgia). CRPS is more common in women than in men, and the incidence reaches its peak in the fifth decade.<sup>108,109</sup> It involves one limb in most cases,<sup>110</sup> and there is a history of noxious traumatic injury with or without nerve involvement.<sup>109</sup> There is no correlation between the severity of injury and the severity of the ensuing pain syndrome. Direct injuries to CNS structures have been reported as causative, including spinal cord<sup>111</sup> and brain<sup>112</sup> injuries. In CRPS type II particularly, there may be a stretch injury to the nerve, without interruption of the nerve. Multiple risk factors have been postulated to predispose to CRPS, including immobilization,<sup>113</sup> smoking,<sup>114</sup> genetic predisposition,<sup>115</sup> and psychological factors.<sup>116</sup>

The exact mechanism of CRPS is not known, but it appears to be a disease of both the CNS and the peripheral nervous system.<sup>117,118</sup> Peripherally,  $\alpha$ -adrenergic sensitization of the nociceptive afferent fibers occurs. As a result, nociceptors are activated by release of norepinephrine by sympathetic postganglionic fibers. Release of certain mediators, such as prostaglandins, by sympathetic fibers can further sensitize the nociceptive afferents. If the injury results in myelin loss of the fibers, artificial synapses develop between the affected sensory afferents and sympathetic efferents, a process called *ephaptic transmission*. The dorsal root ganglion is thought to be another site for ephaptic transmission resulting from sprouting of sympathetic postganglionic fibers around sensory neurons. At the level of the dorsal horn of the spinal cord, the wide dynamic range neurons, which are second-order neurons, are activated and sensitized by the active injured C-fibers. Sensitized wide dynamic range cells are thought to be activated by other stimuli, such as light touch, explaining the phenomenon of allodynia. At the level of the brain, there is altered sensorimotor process-

ing and increased hyperexcitability.<sup>119,120</sup> Thus, CRPS results from interaction between the CNS and the periphery. Central changes are reflected as alterations in somatic sensation (including pain), the motor system, and the peripheral autonomically regulated effector systems (vasculature, sweat glands, inflammatory cells).<sup>117</sup>

In most cases the presenting symptom of CRPS is pain, which most often is burning and does not follow a dermatomal pattern.<sup>108,121</sup> Other common symptoms and signs include decreased range of motion, weakness, hyperpathia, allodynia, hyperalgesia, color change, altered skin temperature, edema, hyperesthesia, hypoaesthesia, sweating change, nail or hair changes, and dystonia.<sup>108,121</sup> Although symptoms typically start in a distal limb, CRPS has been reported to start in other regions of the body, such as the head, proximal limbs, and genitalia.<sup>122</sup> Spread of CRPS features proximally or to other regions of the body has been well described.

The diagnosis of CRPS can be made only in the absence of any other diagnosis explaining the findings. Table 91-10 summarizes the International Association for the Study of Pain (IASP) diagnostic criteria for CRPS.<sup>123-126</sup> These criteria are very sensitive and less specific. Criteria with improved specificity are proposed and summarized in Table 91-11.<sup>124,126</sup>

No specific diagnostic test is available for CRPS.<sup>127</sup> Several tests can help confirm the diagnosis or rule out other conditions. Blood tests, including erythrocyte sedimentation rate, blood cell count, and rheumatologic testing, may be necessary to help rule out infection or a rheumatologic condition.<sup>127</sup> When vasomotor features are present, vascular studies can exclude a vascular etiology. NCS and EMG may clarify the presence of nerve injury necessary for the diagnosis of CRPS type II. An important distinction between CRPS type II and peripheral mononeuropathy is that the somatosensory symptoms in CRPS extend beyond the distribution of the affected nerve.<sup>127</sup> Radiographic studies including magnetic resonance imaging often are necessary to exclude bone or soft-tissue pathology as the source of pain. Plain radiographic studies may show findings of bony demineralization, which is not specific to CRPS and could be the result of disuse.<sup>128</sup> A three-phase bone scan of the affected extremity has

TABLE 91-10.

#### International Association for the Study of Pain Diagnostic Criteria for Complex Regional Pain Syndrome

1. Presence of an initiating noxious event or cause of immobilization
2. Continuing pain, allodynia, or hyperalgesia, with pain disproportionate to any inciting event.
3. Evidence at some time of edema, changes in skin blood flow, or abnormal sudomotor activity in the region of pain
4. Diagnosis is excluded by the existence of conditions that would otherwise account for the degree of pain and dysfunction.

Type I: Without evidence of major nerve damage

Type II: With evidence of major nerve damage

Wilson PR, Stanton-Hicks M, Harden RN, eds. CRPS: Current Diagnosis and Therapy. Seattle: IASP press, 2005:47, with permission from the International Association for the Study of Pain.

variable sensitivity and is relatively nonspecific in the diagnosis of CRPS. Classic findings include increased periarticular uptake throughout the three phases (blood pool, blood phase, scan phase).<sup>127</sup> Thermography can assist in confirming thermal dysregulation. Simple measures also can provide this information, using infrared thermometer or skin temperature probes that document the temperature of the normal and the affected limbs. A temperature difference of 0.6°C between limbs is considered significant.<sup>129</sup> Quantitative sudomotor axonal reflex testing evaluates autonomic function by measuring sweat output in response to a cholinergic agent. Although a positive response to a sympathetic block can help in establishing the diagnosis, it is not required to diagnose CRPS.<sup>127</sup> A pharmacologic sympathetic block can be performed with intravenous infusion of phentolamine. However, the more common approach is performance of a local anesthetic sympathetic trunk block. A lumbar paravertebral sympathetic block is performed for lower limbs, and a cervicothoracic block (stellate ganglion block) or upper thoracic sympathetic block is performed for upper limbs. Evidence of a satisfactory sympathetic block (e.g., thermography) in

TABLE 91–11.

**Proposed Modified Clinical Diagnostic Criteria for Complex Regional Pain Syndrome**

1. Continuing pain that is disproportionate to any inciting event.
2. Must report at least one symptom in three of the four following categories:
  - Sensory: Reports of hyperesthesia and/or allodynia
  - Vasomotor: Reports of temperature asymmetry and/or skin color changes and/or skin color asymmetry.
  - Sudomotor/Edema: Reports of edema and/or sweating changes and/or sweating asymmetry.
  - Motor/Trophic: Reports of decreased range of motion and/or motor dysfunction (weakness, tremor, dystonia) and/or trophic changes (hair, nails, skin).
3. Must display at least one sign at the time of evaluation in two or more of the following categories:
  - Sensory: Evidence of hyperalgesia (to pinprick) and/or allodynia (to light touch and/or deep somatic pressure and/or joint movement).
  - Vasomotor: Evidence of temperature asymmetry and/or skin color changes and/or asymmetry.
  - Sudomotor/Edema: Evidence of edema and/or sweating changes and/or sweating asymmetry.
  - Motor/Trophic: Evidence of decreased range of motion and/or motor dysfunction (weakness, tremor, dystonia) and/or trophic changes (hair, nails, skin).
4. No other diagnosis better explains the signs and symptoms.

the absence of a somatic nerve block should be demonstrated.<sup>127</sup> If favorable results are achieved by sympathetic blocks, then their continued administration may be useful.

Treatment of CRPS remains controversial because of the lack of adequate evidence on most therapies implemented in clinical practice. A consensus statement released in 2002 by an interdisciplinary expert panel produced a reasonable treatment approach.<sup>130,131</sup> Rapid initiation of multidisciplinary treatment is recommended, with advancement to higher levels of intervention if initial therapy shows no

benefit in 2 weeks. Simultaneous physical rehabilitation, psychological therapy, and provision of adequate analgesia are key elements in the treatment plan. The primary goal of treatment is functional restoration of the affected region. In some studies, physical therapy has shown to be effective and thus should be started as soon as possible while effective analgesia is provided. Multiple physical and occupational therapy measures can be used in the process of rehabilitation, starting with desensitization and stress loading, then gentle active range of motion and stretching to increase flexibility, and eventually normalization of use and general conditioning.<sup>132</sup>

Psychological therapy should focus on educating patients that pain sensations in CRPS type I do not indicate tissue damage, and that reactivation of the affected limb is important. With persistent symptoms, clinical psychological assessment is recommended, eventually followed by cognitive behavioral therapy. Comorbid conditions such as depression sleep disturbance, anxiety, and generalized physical deconditioning should be treated.

Analgesia is achieved using oral or topical neuropathic pain agents, including TCAs, AEDs, NSAIDs, opioids, and other agents.<sup>133</sup> Corticosteroids may be effective, especially if the inflammatory component is profound.<sup>134</sup> Calcitonin, topical dimethylsulfoxide (DMSO), and  $\alpha_1$ -adrenoceptor antagonists (e.g., terazosin, phenoxybenzamine) may be helpful. Many other drugs have been anecdotally used, with varied results (including prazosin, clonidine, mexiletine, ketamine, baclofen, bisphosphonates, muscle relaxants, and calcium channel blockers).<sup>135</sup>

When symptoms are persistent, patients who had favorable results with diagnostic sympathetic blockade are often offered intravenous regional sympathetic blocks (IRSBs). IRSBs using phentolamine, guanethidine, reserpine, droperidol, and atropine have been shown to be ineffective.<sup>135</sup> Patients who have not had good results with sympathetic blockade may require a combined somatic/sympathetic block using indwelling catheters to allow adequate physical therapy and rehabilitation. Epidural catheters also have been used in this fashion.<sup>130</sup> If sympathetic blocks are effective in producing analgesia but duration is limit-

ed, neurolysis with either neurolytic injections or radiofrequency-lesioning techniques can be considered.<sup>136</sup> Spinal cord stimulation appears to be an effective treatment, especially for CRPS type I.<sup>137,138</sup> Spinal analgesia may be an effective treatment of CRPS when other modalities fail.<sup>130,139,140</sup>

### Postamputation Pain Stump Pain

Stump pain is a chronic sensation of pain at the site of amputation. It also is referred to as residual limb pain.<sup>141</sup> It may occur with phantom limb pain or alone. Several factors may account for stump pain and should be evaluated, including surgical trauma, ischemia, local infection, ill-fitting prostheses, or a painful neuroma formation.

Treatment should focus on treating the underlying etiology. Treatment of painful neuromas ranges from simple injections to surgical interventions, with varying degrees of success.<sup>142</sup>

### Phantom Pain

Phantom sensation is the perception of the amputated part and occurs in almost all amputees. Phantom pain is the perception of pain distal to the amputation site. It has unclear etiology, but deafferentation of central neurons seems to play a major role in the development of phantom pain. Its incidence peaks approximately 1 month after amputation and gradually improves as the pain “telescopes” toward the stump. The pain results in paroxysms of burning and twisting sensation in the amputated part. Phantom pain should be differentiated from stump pain.

Treatment of phantom pain is challenging. Pharmacologic agents for neuropathic pain should be attempted. TCAs, tramadol, and gabapentin have been shown to be effective.<sup>143,144</sup> Nerve blocks can be tried for more difficult cases. In refractory cases, surgical options (e.g., dorsal root entry zone lesions) and more invasive procedures might be the only effective methods for treating the pain. Preemptive analgesia may prevent phantom pain, although this remains controversial.<sup>145</sup>

### Back and Neck Pain

Low back pain is one of the most common symptoms that prompt patients to seek medical care and is the leading cause of disability among workers younger than 45 years. Current data suggest that more than three

fourths of people will have back pain at one point in their life, with an annual prevalence up to 45%.<sup>146,147</sup>

Neck pain is a less common complaint but still has a point prevalence of approximately 10–35% and a lifetime prevalence of approximately 15–50%. It is more common in women.<sup>148</sup>

Pain can originate due to pathology in a variety of neuraxial structures, including vertebral bodies, intervertebral disks, ligaments, muscle structures, joints (facet, sacroiliac), nerve roots, meninges, and epidural space. A combination of etiologies is common and may be difficult to delineate. Table 91–12 summarizes the most common etiologies of back and neck pain.

Obtaining an adequate history and physical examination is crucial for reaching the correct diagnosis and implementing a successful treatment plan. Special attention should be given to excluding

emergency situations, such as epidural infection, epidural hemorrhage, cauda equine syndrome, spinal cord compression, spine metastasis, and aortic aneurysm. This chapter discusses only the more common pain syndromes.

### Discogenic Pain

Discogenic pain is believed to occur as a result of damage to the annular lamellae by the disrupted inner intervertebral disk and the resultant decreased pain threshold to mechanical loading. Usually a deep axial ache radiates to shoulders and scapular areas from cervical disks and to buttocks and posterior thighs from lumbar disks. The pain is worsened by mechanical loading maneuvers such as sitting, standing, and particularly bending forward.

Although computed tomographic (CT) scanning and magnetic resonance imaging (MRI) of the spine may show

signs of disk degeneration, establishing clinical correlation with imaging findings is difficult.<sup>149</sup> A provocative discography test that consists of dye injection into the disk material followed by CT imaging has been advocated to confirm discogenic pain.<sup>150</sup>

Treatment is conservative, consisting of physical therapy, weight reduction, and NSAIDs. Patients with one or two diseased disks who are refractory to conservative therapy may benefit from intradiscal electrothermal therapy (see Chapter 93).<sup>151–153</sup>

### Radicular Pain

Radicular pain originates as a result of irritation of a nerve root due to a herniated nucleus pulposus or degenerative neuroforaminal narrowing. The most commonly affected levels in the lower back are L5–S1 and L4–5. In the neck, the affected levels are C5–6 and C6–7. Typically, the pain radiates from the neck or back in a dermatomal pattern. Usually the patient has associated sensory disturbance and reflex decrease in the distribution of the affected root. A positive straight-leg raising (SLR) test while the patient is in a supine or sitting position indicates nerve root irritation. SLR test is considered positive when pain is reproduced in a dermatomal distribution. However, nerve root irritation is not always present in patients with low back pain or posterior thigh discomfort. MRI is helpful in identifying anatomy and changes near the nerve roots. NCS/EMG can help confirm the diagnosis and assess the severity of injury.

Conservative treatment, including NSAIDs and PT, is sufficient for most cases. Epidural steroid injections can provide symptomatic management.<sup>154,155</sup> Transforaminal steroid injections might be superior and prevent from surgery but may result in more complications, especially at the cervical spine level.<sup>156–159</sup> Surgical intervention may be required for refractory pain, especially if neurologic deficits are present. Microdiscectomy is the gold standard treatment for uncomplicated herniated nucleus pulposus.

### Facet Arthropathy

The facet joints (zygapophysial or Z joints) are true synovial joints whose main function is to limit rotation and resist compression during lordosis. Facet joint pain results from conditions that increase the load on them,

**TABLE 91–12.**

#### Common Causes of Back and Neck Pain

- Vertebral bodies
  - Fractures
  - Neoplastic lesions
    - Primary
    - Metastatic
  - Metabolic derangements
    - Osteoporosis
    - Paget disease
    - Osteitis fibrosa
    - Hyperthyroidism
    - Hyperparathyroidism
    - Cushing syndrome
  - Infections
    - Osteomyelitis
  - Intravertebral disks
    - Structural lesions
      - Degeneration and herniation
      - Chondromalacia
    - Infections
      - Diskitis
  - Ligaments
    - Acute strain
    - Involvement with other conditions
  - Muscle structures
    - Primary myofascial pain
    - Secondary myofascial pain
  - Joints
    - Facets joints (zygapophysial or “Z” joints)
      - Osteoarthritis
      - Mechanical arthropathy
      - Synovial impingement
      - Meniscoid entrapment
    - Sacroiliac joints
      - Mechanical arthropathy
        - Pregnancy
      - Degenerative and inflammatory
        - Osteoarthritis
        - Ankylosing spondylitis
        - Psoriatic arthritis
        - Reiter syndrome
        - Chronic inflammatory bowel disease
    - Nerve roots (and dorsal root ganglia)
      - Compressive lesions
      - Neuroradiculopathies
    - Meninges
      - Arachnoiditis
      - Scar tissue
    - Epidural space
      - Hematoma
      - Infection (abscess)
    - Multifactorial
      - Structural
        - Spine instability
        - Kyphosis
        - Scoliosis
        - Spondylolithiasis
      - Degenerative
        - Spinal stenosis
        - Spondylosis
      - Trauma
      - Infection
      - Psychosocial
      - Referred pain

such as arthritis, decreased disk space, and increased lordosis (as in obesity).

Pain usually is a gradual-onset deep axial ache that radiates to the scapular regions in the neck or to the buttocks and posterior thighs. It is associated with morning stiffness. The pain is reproduced by facet loading maneuvers by hyperextension and lateral rotation, which provokes pain ipsilaterally. Paraspinal tenderness often is present.<sup>160,161</sup>

MRI or CT can reveal arthritic changes in the facets joints, such as hypertrophy and joint space narrowing. The diagnosis can be confirmed by diagnostic block of the joints or of the medial branches innervating them.

Treatment is conservative, consisting of oral analgesics, weight loss, and PT. Intraarticular steroid injection can be attempted. Radiofrequency ablation of the medial branches appears to be promising.<sup>162,163</sup>

### Sacroiliac Arthropathy

The sacroiliac joint connects the sacrum to the iliac bones. It is subject to degenerative and inflammatory arthritides as well as mechanical dysfunction. The pain usually is precipitated by an injury, such as falling, lifting, or turning.

The pain is a unilateral ache that radiates to the buttock, groin, and thigh area. It rarely goes below the knee. The pain is worsened by loading the joint, as occurs during prolonged sitting, standing, or bending. There is tenderness over the joint area, and the pain typically is reproduced by the Patrick test, in which the hip is forced into external rotation by placing the ankle on the opposite knee or thigh and pushing down on the knee. Intraarticular local anesthetic block can help confirm the diagnosis.

Treatment with NSAIDs and PT can be helpful. Fluoroscopy-guided intraarticular steroid injection has been the mainstay of treatment in clinical practice. Lateral branch block and radiofrequency ablation have been reported useful in advanced cases.<sup>164</sup>

### Spinal Stenosis

Spinal stenosis results from narrowing of the central canal, lateral recesses, or neuroforamina due to age-related degenerative changes, including osteophyte formation, facet hypertrophy, ligamentum flavum hypertrophy, and diffuse broad-based disk bulge. Its oc-

currence in the cervical spine is referred to as cervical “spondylosis.” When spinal stenosis occurs in people younger than 60 years, other comorbidities, such as diabetes or congenital stenosis due to short pedicles, scoliosis, and spondylolisthesis, should be ruled out.

Pain manifests as radicular when the narrowing occurs in the lateral recesses or neuroforamina. In the case of lumbosacral spinal canal stenosis, axial low back pain and neurogenic claudication are the predominant features.<sup>165</sup> Neurogenic claudication worsens with walking (especially downhill) and with extension of the spine. Rest and flexion of the spine usually provide temporary relief.

Cervical spondylosis can progress and cause cervical spondylotic myelopathy (CMS) and cord compression of varying severity. Motor weakness, spasticity, hyperreflexia, Babinski sign, Hoffman sign, paresthesias, imbalance, bowel and bladder function, and other features of spinal cord compression should be carefully assessed. Acute cervical spondylotic myelopathy can occur as a result of abrupt hyperextension of the neck. Radiographic changes reflecting degeneration associated with stenosis are common with aging; thus, clinical correlation is critical in the assessment and management of related symptom complexes.<sup>165</sup>

Treatment of spinal stenosis should start with conservative measures, including oral analgesics, translaminal or transforaminal epidural steroid injections, and PT. Surgical options should be preserved for cases with rapid neurologic progression, CMS, or cauda equina syndrome, or for patients who remain symptomatic despite a course of nonsurgical therapy and who have advanced imaging studies that correspond to existing symptoms. Surgical management of lumbar and cervical stenosis includes discectomy, neural decompression, and spinal arthrodesis. Several studies report that surgical treatment produces better outcomes than nonsurgical treatment in the short term; however, improved results tend to regress over time.<sup>166-170</sup>

### Failed Back Surgery Syndrome

Failed back surgery syndrome refers to the persistence or recurrence of low back pain after surgical intervention on the lumbosacral spine. Potential causes of surgical intervention failure include

the following<sup>56</sup>: (1) poor patient selection, (2) unindicated surgery, (3) inadequate surgical decompression, (4) recurrence of lesions, (5) established neural injury, (6) complications of diagnostic and/or surgical intervention, and (7) secondary instability or degeneration. One study found the predominant specific diagnoses in patients with failed back surgery syndrome were (in order) foraminal stenosis, painful disk(s), pseudarthrosis, neurogenic pain, instability, and psychological problems. Recurrent disk herniation is seen less often than in the past.<sup>171</sup>

Physical examination and imaging studies are essential to confirm the diagnosis and rule out other emerging etiologies. Treatment should be focused on the specific underlying etiology and may include repeated surgical intervention. Epidurolysis of adhesions via epiduroscopy or by catheter technique has limited evidence of efficacy.<sup>172,173</sup> Spinal cord stimulation was found to be both more effective and less costly than conservative medical management over the lifetime of a patient.<sup>174-176</sup>

### Whiplash Injury

Whiplash injury refers to neck injury caused by abrupt hyperextension due to indirect force, as occurs with acceleration-deceleration mechanisms.

Whiplash injury is estimated to occur in 1% of the general population and to become chronic in up to 25% of these patients. Up to 60% of car accident victims evaluated in emergency departments have neck pain and up to 26% of them have persistent symptoms after 1 year.<sup>177</sup> Cervical facet joint pain is the most common source of pain after whiplash injury. The most common cervical segments involved are C2-3 and C5-6.<sup>177,178</sup>

Physical examination is nonspecific and may reveal tenderness and limited range of motion. Patients who have normal plain radiographic findings and no evidence of a neurologic deficit do not require additional MRI.<sup>179</sup>

Diagnostic medial branch block is helpful in delineating etiologies and differentiating between facet arthropathy and other causes of neck pain.

Treatment of acute whiplash injury is conservative and includes oral NSAIDs, PT, and transcutaneous electrical nerve stimulation unit.<sup>180</sup> In chronic conditions where facet arthrop-



athy is confirmed with diagnostic blocks, radiofrequency ablation appears to be promising.<sup>178,181</sup>

## Head Pain

Headache is one of the most common symptoms encountered in clinical practice. A pain medicine physician should be familiar with the common types of syndromes and be able to provide appropriate management. The IHS provides valuable sources for the classification and diagnosis of different syndromes.<sup>93</sup>

The prevalence of headache in the United States is estimated to be 78% in women and 68% in men. In general, headache is classified as primary or secondary. Primary headaches are diseases by themselves, as seen with migraine, tension-type, and cluster headaches. Secondary headaches are caused by an underlying condition. The majority of headaches seen in clinical practice are primary headaches (approximately 90% or more).<sup>182</sup> The most common headache is tension headache, with a prevalence of 78%. Migraine also is very common, with an estimated prevalence of 16%. Among secondary headaches, the most common cause is attributable to fasting. Nasal- and sinus-related headaches and head trauma are less common. Many fear that headaches are caused by intracranial disease such as tumors; however, this actually occurs in a very small percentage of the population (0.5%).<sup>183</sup>

Evaluation of headache requires thorough history and physical examination. Special attention should be given to any “red flags” that may point to a secondary disorder. In the absence of warning signs, most likely the headache is of a primary disorder, with the majority of headaches being either tension-type or migraine. Even in the absence of warning signs, possible secondary headache disorder may exist in patients presenting with “atypical features,” such as migraine with prolonged aura lasting more than 60 minutes, migraine that lacks characteristic features (e.g., no nausea, photophobia, or phonophobia), and migraine that does not quite meet all the diagnostic criteria, especially if they do not respond to normal therapy. These are the signals that are frequently elicited in a headache evaluation.

The most important feature is the temporal profile of the headache, specifically the mode of onset. Headache

with a rapid time to peak intensity should always suggest an underlying cause of secondary headache. Not only the mode of onset but also the age at onset is important, as headache onset after age 50 years should raise concern of secondary headache. Other “red flags” include association with systemic signs or symptoms; the presence of a new or different headache, particularly in those with systemic malignancy, which may signify intracranial disease (e.g., metastases); a change in headache pattern, such as progressive headache with loss of headache-free period; and a change in frequency or severity of a previously existing headache disorder (because underlying secondary causes in patients with a history of migraine can mimic normal headache patterns). Any, even subtle, abnormal neurologic findings also should raise suspicion.<sup>184</sup>

Electroencephalography is not useful in the routine evaluation of patients with headache. However, electroencephalography may be useful in patients with headache who have an alteration of consciousness, encephalopathy, or focal neurologic deficits and atypical symptoms.<sup>185</sup> Lumbar puncture (LP) is indicated in the evaluation of thunderclap or sudden headache to exclude the possibility of subarachnoid hemorrhage. CT can be negative in up to 25% of patients within 24 hours of occurrence of subarachnoid hemorrhage and can be negative in up to 50% of patients 1 week after initial presentation of headache resembling thunderclap. LP is indicated in any patient with subacute and progressive headache in order to exclude infections, an inflammatory condition, or carcinomatous meningitis. Any patient who presents with headache and fever, confusion, or seizure should be suspected of having acute intracranial infection. LP should be performed in patients with high or low intracranial pressure syndrome (idiopathic intracranial hypertension), even in the absence of papilledema. LP should be performed to confirm low-pressure states, as occurs with cerebrospinal fluid (CSF) leaks. In the absence of “red flags,” CT or MRI typically are not performed unless a change in headache pattern occurs or the patient experiences changes in neurologic status as evidenced by seizures or focal neurologic signs or symptoms.<sup>186</sup>

Following is a discussion of IHS criteria for common headaches and a brief review of major treatment options.

## Migraine

Multiple types of migraine exist. The more common types are discussed here.

### **Migraine without Aura**

Migraine without aura previously was called *common migraine*. Table 91–13 lists the IHS diagnostic criteria<sup>93</sup> for migraine without aura.

### **Migraine with Aura**

This type of headache previously was called classic migraine. It fulfills the criteria of migraine as described earlier and is associated with aura. The aura is a complex of neurologic symptoms that occurs just before or at the onset of migraine headache. A typical aura consists of visual and/or sensory and/or speech symptoms. It has gradual development, duration no longer than 1 hour, and complete reversibility.<sup>93</sup> Some patients have typical aura without having a typical migrainous headache.

Treatment of migraine headaches is abortive and preventive. Abortive treatment is directed toward the acute attacks as they occur. Many drugs have been shown to be effective abortive medications. Nonspecific treatments, such as acetaminophen, aspirin and caffeine combination (Excedrin), and

**TABLE 91–13.**

### **International Headache Society Diagnostic Criteria for Migraine without Aura**

- A. At least five attacks fulfilling criteria B–D
- B. Headache attacks lasting 4–72 hours (untreated or unsuccessfully treated)
- C. Headache has at least two of the following characteristics:
  1. Unilateral location
  2. Pulsating quality
  3. Moderate or severe pain intensity
  4. Aggravation by or causing avoidance of routine physical activity
- D. During headache at least one of the following
  1. Nausea and/or vomiting
  2. Photophobia and phonophobia
- E. Not attributed to another disorder

TABLE 91-14.

International Headache Society  
Diagnostic Criteria for Cluster Headache

- A. At least five attacks fulfilling criteria B–D
- B. Severe or very severe unilateral orbital, supraorbital, and/or temporal pain lasting 15–180 minutes if untreated
- C. Headache is accompanied by at least one of the following:
  1. Ipsilateral conjunctival injection and/or lacrimation
  2. Ipsilateral nasal congestion and/or rhinorrhea
  3. Ipsilateral eyelid edema
  4. Ipsilateral forehead and facial sweating
  5. Ipsilateral miosis and/or ptosis
  6. Sense of restlessness and agitation
- D. Attacks have a frequency ranging from one every other day to 8 per day
- E. Not attributed to another disorder

NSAIDs are effective for simple and less severe migraines. Other nonspecific migraine agents include corticosteroids, antiemetics, and opioid analgesics. The migraine-specific agents are considered the mainstay abortive treatment of migraine. They include ergotamine, dihydroergotamine, and the more selective serotonin antagonists (triptans). Multiple triptans are available in different forms, half-lives, and potencies. Preventive treatment of migraine should focus on modifying and/or eliminating the triggering factors, such as sleep disturbance, caffeine intake, analgesics overuse, and stressors. Pharmacologic preventive treatment is indicated when migraine intensity, duration, or frequency is severe enough to warrant chronic use of a daily medication. Preventive treatment also is indicated for more serious forms of migraine, such as basilar-type migraine (migraine with neurologic signs of posterior circulation dysfunction), migraine with complications (focal neurologic features), and hemiplegic migraine. TCAs (e.g., amitriptyline), nonselective  $\beta$ -blockers (e.g., propranolol), and AEDs (e.g., topiramate and divalproex sodium) are effective preventive agents.

### Tension-Type Headache

Tension-type headaches are the most common primary headache. Many fea-

TABLE 91-15.

International Headache Society  
Diagnostic Criteria for Postdural  
Puncture Headache

- A. Headache that worsens within 15 minutes after sitting or standing and improves within 15 minutes after lying down, with at least one of the following and fulfilling criteria C and D:
  1. Neck stiffness
  2. Tinnitus
  3. Hypacusia
  4. Photophobia
  5. Nausea
- B. Dural puncture has been performed
- C. Headache develops within 5 days after dural puncture
- D. Headache resolves (in 95% of cases) either:
  1. Spontaneously within 1 week
  2. Within 48 hours after effective treatment of the spinal fluid leak (usually by epidural blood patch)

tures contrast them from migraines. Each attack of tension-type headache can be much shorter or much longer than migraine. The pain generally is bilateral, is of mild-to-moderate intensity, is constant, and is not aggravated by movement or activity. Photophobia or phonophobia may be present but usually not both, and the patient experiences no nausea or vomiting. Tension-type headaches have a wide spectrum of frequency that varies from sporadic episodes to chronic forms.<sup>93</sup>

Infrequent episodes of tension-type headaches can be treated with simple analgesics. For more frequent and chronic forms, preventive treatment is essential.

### Cluster Headache

Cluster headaches are much less common than tension-type and migraine headaches but are excruciatingly painful and devastating. Table 91-14 lists the IHS diagnostic criteria for cluster headaches.<sup>93</sup>

As for treatment of migraine headaches, treatment of cluster headaches is abortive and preventive. Abortive treatment consists of inhaled oxygen, triptans, especially the injectable form (sumatriptan), or dihydroergotamine. Multiple preventive agents can be tried. They include corticosteroids, hypertension medications ( $\beta$ -blockers and calcium channel blockers), and lithium. In refractory cases, invasive treat-

ments might be required. They include sphenopalatine ganglion blockade, trigeminal nerve and/or ganglion blockade, or deep brain stimulation.

### Postdural Puncture Headache

Low-CSF pressure headache results from a dural tear and subsequent CSF leak. Postdural puncture headache is the more common type of low-CSF headache. The IHS diagnostic criteria for postdural puncture headache are listed in Table (91-15).<sup>93</sup>

Epidural blood patch at the expected site of leak remains the mainstay treatment. Conservative therapy includes bedrest, aggressive hydration, caffeine, and analgesics.

### KEY REFERENCES

1. Loeser JD, Bonica JJ. *Bonica's Management of Pain*, 3rd ed. Philadelphia: Lippincott Williams & Wilkins, 2001.
2. McMahon SB, Koltzenburg M. *Wall and Melzack's Textbook of Pain*. 5th ed. Edinburgh: Elsevier Churchill Livingstone, 2006.
3. Warfield CA, Bajwa ZH. *Principles and Practice of Pain Medicine*. 2nd ed. New York: McGraw-Hill, 2004.
4. Abram SE, Haddox JD. *The Pain Clinic Manual*. 2nd ed. Philadelphia: Lippincott Williams & Wilkins, 2000.
5. Ballantyne J, Massachusetts General Hospital. *The Massachusetts General Hospital Handbook of Pain Management*. 3rd ed. Philadelphia: Lippincott Williams & Wilkins, 2005.

### REFERENCES

1. Graff-Radford SB. Myofascial pain: diagnosis and management. *Curr Pain Headache Rep* 2004;8:463-467.
2. Gordon D, Arend W. Rheumatic diseases. In Cecil RL, Goldman L, Ausiello DA, eds. *Cecil Textbook of Medicine*. Philadelphia: Saunders, 2004.
3. Mease P. Fibromyalgia syndrome: review of clinical presentation, pathogenesis, outcome measures, and treatment. *J Rheumatol Suppl* 2005;75:6-21.
4. Holman AJ. Fibromyalgia and pramipexole: promise and precaution. *J Rheumatol* 2003;30:2733.

5. Holman AJ, Myers RR. A randomized, double-blind, placebo-controlled trial of pramipexole, a dopamine agonist, in patients with fibromyalgia receiving concomitant medications. *Arthritis Rheum* 2005;52:2495-505.
6. Lawrence RC, et al. Estimates of the prevalence of arthritis and selected musculoskeletal disorders in the United States. *Arthritis Rheum* 1998;41:778-799.
7. Sarzi-Puttini P, et al. Osteoarthritis: an overview of the disease and its treatment strategies. *Semin Arthritis Rheum* 2005;35(1 Suppl):1-10.
8. Poolsup N, et al. Glucosamine long-term treatment and the progression of knee osteoarthritis: systematic review of randomized controlled trials. *Ann Pharmacother* 2005;39:1080-1087.
9. Clegg DO, et al. Glucosamine, chondroitin sulfate, and the two in combination for painful knee osteoarthritis. *N Engl J Med* 2006;354:795-808.
10. Brandt KD, et al. Effects of doxycycline on progression of osteoarthritis: results of a randomized, placebo-controlled, double-blind trial. *Arthritis Rheum* 2005;52:2015-2025.
11. Waddell DD, Bricker DC. Clinical experience with the effectiveness and tolerability of Hylan G-F 20 in 1047 patients with osteoarthritis of the knee. *J Knee Surg* 2006;19:19-27.
12. Kanner R. *Pain Management Secrets*. Philadelphia: Hanley & Belfus, 2003.
13. Dworkin RH, et al. Advances in neuropathic pain: diagnosis, mechanisms, and treatment recommendations. *Arch Neurol* 2003;60:1524-1534.
14. Mendell JR, Sahenk Z. Clinical practice. Painful sensory neuropathy. *N Engl J Med* 2003;348:1243-1255.
15. Dyck PJ, Thomas PK. *Peripheral Neuropathy*. 4th ed. Philadelphia: WB Saunders, 2005.
16. Polydefkis M, Griffin JW, McArthur J. New insights into diabetic polyneuropathy. *JAMA* 2003;290:1371-1376.
17. Gorson KC, Ropper AH. Idiopathic distal small fiber neuropathy. *Acta Neurol Scand* 1995;92:376-82.
18. Genuth S, et al. Follow-up report on the diagnosis of diabetes mellitus. *Diabetes Care* 2003;26:3160-3167.
19. Singleton JR, et al. Polyneuropathy with impaired glucose tolerance: implications for diagnosis and therapy. *Curr Treat Options Neurol* 2005;7:33-42.
20. Smith AG, Singleton JR. The diagnostic yield of a standardized approach to idiopathic sensory-predominant neuropathy. *Arch Intern Med* 2004;164:1021-1025.
21. Dyck PJ, et al. The prevalence by staged severity of various types of diabetic neuropathy, retinopathy, and nephropathy in a population-based cohort: the Rochester Diabetic Neuropathy Study. *Neurology* 1993;43:817-824.
22. Eastman RN. Neuropathy in diabetes in National Diabetes Data Group (U.S.), National Institute of Diabetes and Digestive and Kidney Diseases (U.S.), and National Institutes of Health (U.S.), *Diabetes in America*. 2nd ed. NIH Publication No. 95-1468. Bethesda, MD: National Institutes of Health, National Institute of Diabetes and Digestive and Kidney Diseases, 1995.
23. Backonja M, et al. Gabapentin for the symptomatic treatment of painful neuropathy in patients with diabetes mellitus: a randomized controlled trial. *JAMA* 1998;280:1831-1836.
24. Boulton AJ, et al. Diabetic somatic neuropathies. *Diabetes Care* 2004;27:1458-1486.
25. Ziegler D, et al. The epidemiology of diabetic neuropathy. Diabetic Cardiovascular Autonomic Neuropathy Multicenter Study Group. *J Diabetes Complicat* 1992;6:49-57.
26. Ziegler D, et al. The epidemiology of diabetic neuropathy. DiaCAN Multicenter Study Group. *Diabet Med* 1993;10(Suppl 2):82S-86S.
27. The effect of intensive treatment of diabetes on the development and progression of long-term complications in insulin-dependent diabetes mellitus. The Diabetes Control and Complications Trial Research Group. *N Engl J Med* 1993;329:977-986.
28. Goldstein DJ, et al. Duloxetine vs. placebo in patients with painful diabetic neuropathy. *Pain* 2005;116:109-118.
29. Raskin J, et al. A double-blind, randomized multicenter trial comparing duloxetine with placebo in the management of diabetic peripheral neuropathic pain. *Pain Med* 2005;6:346-356.
30. Freynhagen R, et al. Efficacy of pregabalin in neuropathic pain evaluated in a 12-week, randomised, double-blind, multicentre, placebo-controlled trial of flexible- and fixed-dose regimens. *Pain* 2005;115:254-263.
31. Lesser H, et al. Pregabalin relieves symptoms of painful diabetic neuropathy: a randomized controlled trial. *Neurology* 2004;63:2104-2110.
32. Richter, R.W, et al. Relief of painful diabetic peripheral neuropathy with pregabalin: a randomized, placebo-controlled trial. *J Pain* 2005;6:253-260.
33. Rosenstock J, et al. Pregabalin for the treatment of painful diabetic peripheral neuropathy: a double-blind, placebo-controlled trial. *Pain* 2004;110:628-638.
34. Beniczky S, et al. Evidence-based pharmacological treatment of neuropathic pain syndromes. *J Neural Transm* 2005;112:735-749.
35. Saarto T, Wiffen P. Antidepressants for neuropathic pain. *Cochrane Database Syst Rev* 2005;CD005454.
36. Paradowski B, Bilinska M. [Gabapentin in the treatment of neuropathic pain in patients with type 2, diabetes mellitus]. *Pol Merkuriusz Lek* 2003;15:61-64.
37. Rowbotham MC, et al. Venlafaxine extended release in the treatment of painful diabetic neuropathy: a double-blind, placebo-controlled study. *Pain* 2004;110:697-706.
38. Lithner F. Venlafaxine in treatment of severe painful peripheral diabetic neuropathy. *Diabetes Care* 2000;23:1710-1711.
39. Katz NP, et al. Lidocaine patch 5% reduces pain intensity and interference with quality of life in patients with postherpetic neuralgia: an effectiveness trial. *Pain Med* 2002;3:324-332.
40. Scheffler NM, Sheitel PL, Lipton MN. Treatment of painful diabetic neuropathy with capsaicin 0.075%. *J Am Podiatr Med Assoc* 1991;81:288-293.
41. Tandan R, et al. Topical capsaicin in painful diabetic neuropathy. Controlled study with long-term follow-up. *Diabetes Care* 1992;15:8-14.
42. Harati Y, et al. Double-blind randomized trial of tramadol for the treatment of the pain of diabetic neuropathy. *Neurology* 1998;50:1842-1846.
43. Harati Y, et al. Maintenance of the long-term effectiveness of tramadol in treatment of the pain of diabetic neuropathy. *J Diabetes Complicat* 2000;14:65-70.
44. Moulin D. Tramadol for the treatment of the pain of diabetic neuropathy. *Neurology* 1999;52:1301.
45. Watson CP. The treatment of neuropathic pain: antidepressants and opioids. *Clin J Pain* 2000;16(2 Suppl):S49-S55.
46. Gilron I, et al. Morphine, gabapentin, or their combination for neuropathic pain. *N Engl J Med* 2005;352:1324-1334.
47. Hays L, et al. Use of methadone for the treatment of diabetic neuropathy. *Diabetes Care* 2005;28:485-487.
48. Braune S. [Evidence-based pharmacotherapy of neuropathic pain syndromes]. *MMW Fortschr Med* 2004;146:49-51.
49. Atli A, Dogra S. Zonisamide in the treatment of painful diabetic neuropathy: a randomized, double-blind, placebo-controlled pilot study. *Pain Med* 2005;6:225-234.
50. Vinik A. Clinical review. Use of antiepileptic drugs in the treatment of chronic painful diabetic neuropathy. *J Clin Endocrinol Metab* 2005;90:4936-4945.
51. Nicholson B. Treatment of painful polyneuropathies. *Curr Pain Headache Rep* 2005;9:178-183.
52. Daousi C, Benbow SJ, MacFarlane IA. Electrical spinal cord stimulation in the long-term treatment of chronic painful diabetic neuropathy. *Diabet Med* 2005;22:393-398.
53. Tesfaye S, et al. Electrical spinal-cord stimulation for painful diabetic peripheral neuropathy. *Lancet* 1996;348:1698-1701.
54. Hewitt DJ, et al. Pain syndromes and etiologies in ambulatory AIDS patients. *Pain* 1997;70:117-123.
55. Katz N. Neuropathic pain in cancer and AIDS. *Clin J Pain* 2000;16(2 Suppl):S41-S48.



56. Warfield CA, Bajwa ZH. Principles and Practice of Pain Medicine. 2nd ed. New York: McGraw-Hill, 2004:386–389.
57. Simpson DM, et al. A placebo-controlled trial of lamotrigine for painful HIV-associated neuropathy. *Neurology* 2000;54:2115–2119.
58. Simpson DM, et al. Lamotrigine for HIV-associated painful sensory neuropathies: a placebo-controlled trial. *Neurology* 2003;60:1508–1514.
59. Staats PS, et al. Intrathecal ziconotide in the treatment of refractory pain in patients with cancer or AIDS: a randomized controlled trial. *JAMA* 2004;291:63–70.
60. Amo C, et al. [Carpal tunnel syndrome: clinical and neurophysiological correlation: review of 100, cases]. *Rev Neurol* 1998;27:490–493.
61. Martinez-Albaladejo M, Nombela-Gomez M, Perez-Flores D. [With respect to Tinel and Phalen's signs]. *Ann Med Intern* 1995;12:21–24.
62. Kost RG, Straus SE. Postherpetic neuralgia: pathogenesis, treatment, and prevention. *N Engl J Med* 1996;335:32–42.
63. Ragozzino MW, et al. Population-based study of herpes zoster and its sequelae. *Medicine (Baltimore)* 1982;61:310–316.
64. Guess HA, et al. Population-based studies of varicella complications. *Pediatrics* 1986;78(4 Pt 2):723–727.
65. Rusthoven JJ. The risk of varicella-zoster infections in different patient populations: a critical review. *Transfus Med Rev* 1994;8:96–116.
66. Hardy I, et al. The incidence of zoster after immunization with live attenuated varicella vaccine. A study in children with leukemia. *Varicella Vaccine Collaborative Study Group*. *N Engl J Med* 1991;325:1545–1550.
67. Broyer M, et al. Varicella and zoster in children after kidney transplantation: long-term results of vaccination. *Pediatrics* 1997;99:35–39.
68. Hope-Simpson RE. The nature of herpes zoster: a long-term study and a new hypothesis. *Proc R Soc Med* 1965;58:9–20.
69. Dworkin RH, Portenoy RK. Proposed classification of herpes zoster pain. *Lancet* 1994;343:1648.
70. Jung BF, et al. Risk factors for postherpetic neuralgia in patients with herpes zoster. *Neurology* 2004;62:1545–1551.
71. Balfour HH Jr. Varicella zoster virus infections in immunocompromised hosts. A review of the natural history and management. *Am J Med* 1988;85(2A):68–73.
72. Jovanovic J, et al. [Herpes zoster: treatment with acyclovir]. *Med Pregl* 1997;50:305–308.
73. Jackson JL, et al. The effect of treating herpes zoster with oral acyclovir in preventing postherpetic neuralgia. A meta-analysis. *Arch Intern Med* 1997;157:909–912.
74. Fields HL, Dubner R, Cervero F. Proceedings of the Fourth World Congress on Pain: Seattle. In: *Advances in Pain Research and Therapy*. Vol. 9. New York: Raven, 1985.
75. Winnie AP, Hartwell PW. Relationship between time of treatment of acute herpes zoster with sympathetic blockade and prevention of post-herpetic neuralgia: clinical support for a new theory of the mechanism by which sympathetic blockade provides therapeutic benefit. *Reg Anesth* 1993;18:277–282.
76. Kumar V, Krone K, Mathieu A. Neuraxial and sympathetic blocks in herpes zoster and postherpetic neuralgia: an appraisal of current evidence. *Reg Anesth Pain Med* 2004;29:454–461.
77. Spina E, Perugi G. Antiepileptic drugs: indications other than epilepsy. *Epileptic Disord* 2004;6:57–75.
78. Rice AS, Maton S. Gabapentin in postherpetic neuralgia: a randomised, double blind, placebo controlled study. *Pain* 2001;94:215–224.
79. Rowbotham M, et al. Gabapentin for the treatment of postherpetic neuralgia: a randomized controlled trial. *JAMA* 1998;280:1837–1842.
80. Segal AZ, Rordorf G. Gabapentin as a novel treatment for postherpetic neuralgia. *Neurology* 1996;46:1175–1176.
81. Sabatowski R, et al. Pregabalin reduces pain and improves sleep and mood disturbances in patients with post-herpetic neuralgia: results of a randomised, placebo-controlled clinical trial. *Pain* 2004;109:26–35.
82. Dworkin RH, et al. Pregabalin for the treatment of postherpetic neuralgia: a randomized, placebo-controlled trial. *Neurology* 2003;60:1274–1283.
83. Frampton JE, Foster RH. Pregabalin: in the treatment of postherpetic neuralgia. *Drugs* 2005;65:111–118.
84. Gammitoni AR, Alvarez NA, Galer BS. Safety and tolerability of the lidocaine patch 5%, a targeted peripheral analgesic: a review of the literature. *J Clin Pharmacol* 2003;43:111–117.
85. Galer BS, et al. The lidocaine patch 5% effectively treats all neuropathic pain qualities: results of a randomized, double-blind, vehicle-controlled 3-week efficacy study with use of the neuropathic pain scale. *Clin J Pain* 2002;18:297–301.
86. Kotani N, et al. Intrathecal methylprednisolone for intractable postherpetic neuralgia. *N Engl J Med* 2000;343:1514–1519.
87. Kikuchi A, et al. Comparative therapeutic evaluation of intrathecal versus epidural methylprednisolone for long-term analgesia in patients with intractable postherpetic neuralgia. *Reg Anesth Pain Med* 1999;24:287–293.
88. Forrest JB. The response to epidural steroid injections in chronic dorsal root pain. *Can Anaesth Soc J* 1980;27:40–46.
89. Bates JA, Nathan PW. Transcutaneous electrical nerve stimulation for chronic pain. *Anaesthesia* 1980;35:817–722.
90. van Slobbe AM, et al. Incidence rates and determinants in meralgia paresthetica in general practice. *J Neurol* 2004;251:294–297.
91. Nahabedian MY, Dellon AL. Meralgia paresthetica: etiology, diagnosis, and outcome of surgical decompression. *Ann Plast Surg* 1995;35:590–594.
92. Grossman MG, et al. Meralgia paresthetica: diagnosis and treatment. *J Am Acad Orthop Surg* 2001;9:336–344.
93. The International Classification of Headache Disorders: 2nd edition. *Cephalalgia* 2004;24(Suppl 1):9–160.
94. Cheshire WP Jr. Defining the role for gabapentin in the treatment of trigeminal neuralgia: a retrospective study. *J Pain* 2002;3:137–142.
95. Backonja MM, Serra J. Pharmacologic management part 1: better-studied neuropathic pain diseases. *Pain Med* 2004;5(Suppl 1):S28–S47.
96. Kanpolat Y, Ugur HC. Systematic review of ablative neurosurgical techniques for the treatment of trigeminal neuralgia. *Neurosurgery* 2005;57:E601.
97. Nickel J, et al. [Eagle syndrome: diagnostic imaging and therapy]. *Rontgenpraxis* 2003;55:108–113.
98. Hecht JS. Occipital nerve blocks in postconcussive headaches: a retrospective review and report of ten patients. *J Head Trauma Rehabil* 2004;19:58–71.
99. Merskey DM. Classification of pain, descriptions of chronic pain syndromes and definitions of pain terms. *Pain* 1986;(Suppl 3).
100. Andersen G, et al. Incidence of central post-stroke pain. *Pain* 1995;61:187–193.
101. Tasker RR, DeCarvalho GT, Dolan EJ. Intractable pain of spinal cord origin: clinical features and implications for surgery. *J Neurosurg* 1992;77:373–378.
102. Vestergaard K, et al. Lamotrigine for central poststroke pain: a randomized controlled trial. *Neurology* 2001;56:184–190.
103. Finnerup NB, et al. Lamotrigine in spinal cord injury pain: a randomized controlled trial. *Pain* 2002;96:375–383.
104. Stanton-Hicks M, et al. Reflex sympathetic dystrophy: changing concepts and taxonomy. *Pain* 1995;63:127–133.
105. Loh L, Nathan PW. Painful peripheral states and sympathetic blocks. *J Neurol Neurosurg Psychiatry* 1978;41:664–671.
106. Loh L, et al. Effects of regional guanethidine infusion in certain painful states. *J Neurol Neurosurg Psychiatry* 1980;43:446–451.
107. Loh L, Nathan PW, Schott GD. Pain due to lesions of central nervous system removed by sympathetic block. *Br Med J (Clin Res Ed)* 1981;282:1026–1028.
108. Veldman PH, et al. Signs and symptoms of reflex sympathetic dystrophy: prospective study of 829 patients. *Lancet* 1993;342:1012–1016.
109. Allen G, Galer BS, Schwartz L. Epidemiology of complex regional pain syndrome: a retrospective chart review of 134 patients. *Pain* 1999;80:539–544.
110. Veldman PH, Goris RJ. Multiple reflex sympathetic dystrophy. Which patients are



at risk for developing a recurrence of reflex sympathetic dystrophy in the same or another limb. *Pain* 1996;64:463–466.

111. Philip PA, Philip M, Monga TN. Reflex sympathetic dystrophy in central cord syndrome: case report and review of the literature. *Paraplegia* 1990;28:48–54.

112. Gellman H, et al. Reflex sympathetic dystrophy in brain-injured patients. *Pain* 1992;51:307–311.

113. Schwartzman RJ, Kerrigan J. The movement disorder of reflex sympathetic dystrophy. *Neurology* 1990;40:57–61.

114. An HS, Hawthorne KB, Jackson WT. Reflex sympathetic dystrophy and cigarette smoking. *J Hand Surg [Am]* 1988;13:458–460.

115. Mailis A, Wade J. Profile of Caucasian women with possible genetic predisposition to reflex sympathetic dystrophy: a pilot study. *Clin J Pain* 1994;10:210–217.

116. Bruehl S, Carlson CR. Predisposing psychological factors in the development of reflex sympathetic dystrophy. A review of the empirical evidence. *Clin J Pain* 1992;8:287–299.

117. Janig W, Baron R. Complex regional pain syndrome: mystery explained? *Lancet Neurol* 2003;2:687–697.

118. Janig W, Baron R. Complex regional pain syndrome is a disease of the central nervous system. *Clin Auton Res* 2002;12:150–164.

119. Juottonen K, et al. Altered central sensorimotor processing in patients with complex regional pain syndrome. *Pain* 2002;98:315–323.

120. Eisenberg E, et al. Evidence for cortical hyperexcitability of the affected limb representation area in CRPS. A psychophysical and transcranial magnetic stimulation study. *Pain* 2005;113:99–105.

121. Harden RN, et al. Complex regional pain syndrome: are the IASP diagnostic criteria valid and sufficiently comprehensive? *Pain* 1999;83:211–219.

122. Fields HL. *Pain Syndromes in Neurology*. Philadelphia: Butterworths, 1990.

123. Galer BS, Bruehl S, Harden RN. IASP diagnostic criteria for complex regional pain syndrome: a preliminary empirical validation study. *International Association for the Study of Pain. Clin J Pain* 1998;14:48–54.

124. Bruehl S, et al. External validation of IASP diagnostic criteria for complex regional pain syndrome and proposed research diagnostic criteria. *International Association for the Study of Pain. Pain* 1999;81:147–154.

125. Reinders MF, Geertzen JH, Dijkstra PU. Complex regional pain syndrome type I. Use of the International Association for the Study of Pain diagnostic criteria defined in 1994. *Clin J Pain* 2002;18:207–215.

126. Harden RN, Bruehl SP. Diagnostic criteria. In: Wilson PR, Stanton-Hicks M, Harden RN, eds. *CRPS: Current Diagnosis and Therapy. Progress in Pain Research*

and Management. Seattle: IASP Press, 2005; 32:316.

127. Rho RH, et al. Complex regional pain syndrome. *Mayo Clin Proc* 2002;77:174–180.

128. Kozin F, et al. Bone scintigraphy in the reflex sympathetic dystrophy syndrome. *Radiology* 1981;138:437–443.

129. Bruehl S, et al. Validation of thermography in the diagnosis of reflex sympathetic dystrophy. *Clin J Pain* 1996;12:316–325.

130. Stanton-Hicks MD, et al. An updated interdisciplinary clinical pathway for CRPS. Report of an expert panel. *Pain Practice* 2002;2:1–16.

131. Quisel A, Gill JM, Witherell P. Complex regional pain syndrome: which treatments show promise? *J Fam Pract* 2005;54:599–603.

132. Oerlemans HM, et al. Adjuvant physical therapy versus occupational therapy in patients with reflex sympathetic dystrophy/complex regional pain syndrome type I. *Arch Phys Med Rehabil* 2000;81:49–56.

133. Yung Chung O, Bruehl SP. Complex regional pain syndrome. *Curr Treat Options Neurol* 2003;5:499–511.

134. Christensen K, Jensen EM, Noer I. The reflex dystrophy syndrome response to treatment with systemic corticosteroids. *Acta Chir Scand* 1982;148:653–655.

135. Kingery WS. A critical review of controlled clinical trials for peripheral neuropathic pain and complex regional pain syndromes. *Pain* 1997;73:123–139.

136. Rocco AG. Radiofrequency lumbar sympatholysis. The evolution of a technique for managing sympathetically maintained pain. *Reg Anesth* 1995;20:3–12.

137. Taylor RS, Van Buyten JP, Buchser E. Spinal cord stimulation for complex regional pain syndrome: a systematic review of the clinical and cost-effectiveness literature and assessment of prognostic factors. *Eur J Pain* 2006;10:91–101.

138. Kemler MA, et al. Spinal cord stimulation in patients with chronic reflex sympathetic dystrophy. *N Engl J Med* 2000;343:618–624.

139. Von Eisenhart-Rothe R, Rittmeister M. [Drug therapy in complex regional pain syndrome type I]. *Orthopade* 2004;33:796–803.

140. Nambi-Joseph P, Stanton-Hicks M, Sferra JJ. Interventional modalities in the treatment of complex regional pain syndrome. *Foot Ankle Clin* 2004;9:405–417.

141. Woodhouse A. Phantom limb sensation. *Clin Exp Pharmacol Physiol* 2005;32:132–134.

142. Wu J, Chiu DT. Painful neuromas: a review of treatment modalities. *Ann Plast Surg* 1999;43:661–667.

143. Wilder-Smith CH, Hill LT, Laurent S. Postamputation pain and sensory changes in treatment-naïve patients: characteristics and responses to treatment with tramadol, amitriptyline, and placebo. *Anesthesiology* 2005;103:619–628.

144. Adeniyi A. *International Association for the Study of Pain—Ninth World Congress 22–27, August 1999, Vienna, Austria. IDrugs* 1999;2:1127–1129.

145. Schug SA, et al. Preemptive epidural analgesia may prevent phantom limb pain. *Reg Anesth* 1995;20:256.

146. Andersson GB. Epidemiology of low back pain. *Acta Orthop Scand Suppl* 1998; 281:28–31.

147. Andersson GB. Epidemiological features of chronic low-back pain. *Lancet* 1999;354:581–585.

148. Bovim G, Schrader H, Sand T. Neck pain in the general population. *Spine* 1994; 19:1307–1309.

149. Lim CH, et al. Discogenic lumbar pain: association with MR imaging and CT discography. *Eur J Radiol* 2005;54:431–437.

150. Resnick DK, Malone DG, Ryken TC. Guidelines for the use of discography for the diagnosis of painful degenerative lumbar disc disease. *Neurosurg Focus* 2002;13:E12.

151. Wetzel FT, McNally TA. Treatment of chronic discogenic low back pain with intradiskal electrothermal therapy. *J Am Acad Orthop Surg* 2003;11:6–11.

152. Deen HG, Fenton DS, Lamer TJ. Minimally invasive procedures for disorders of the lumbar spine. *Mayo Clin Proc* 2003;78:1249–1256.

153. Shah RV, et al. Intradiskal electrothermal therapy: a preliminary histologic study. *Arch Phys Med Rehabil* 2001;82:1230–1237.

154. Carette S, et al. Epidural corticosteroid injections for sciatica due to herniated nucleus pulposus. *N Engl J Med* 1997;336:1634–1640.

155. McLain RF, Kapural L, Mekhail NA. Epidural steroid therapy for back and leg pain: mechanisms of action and efficacy. *Spine J* 2005;5:191–201.

156. Kolstad F, Leivseth G, Nygaard OP. Transforaminal steroid injections in the treatment of cervical radiculopathy. A prospective outcome study. *Acta Neurochir (Wien)* 2005;147:1065–1070.

157. Rathmell JP, Aprill C, Bogduk N. Cervical transforaminal injection of steroids. *Anesthesiology* 2004;100:1595–1600.

158. Vad VB, et al. Transforaminal epidural steroid injections in lumbosacral radiculopathy: a prospective randomized study. *Spine* 2002;27:11–16.

159. Lutz GE, Vad VB, Wisneski RJ. Fluoroscopic transforaminal lumbar epidural steroids: an outcome study. *Arch Phys Med Rehabil* 1998;79:1362–1366.

160. Bogduk N, Marsland A. The cervical zygapophysial joints as a source of neck pain. *Spine* 1988;13:610–617.

161. Cavanaugh JM, et al. Lumbar facet pain: biomechanics, neuroanatomy and neurophysiology. *J Biomech* 1996;29:1117–1129.

162. Pevsner Y, et al. The role of radiofrequency in the treatment of mechanical pain of spinal origin. *Eur Spine J* 2003;12:602–605.

163. McDonald GJ, Lord SM, Bogduk N. Long-term follow-up of patients treated with cervical radiofrequency neurotomy for chronic neck pain. *Neurosurgery* 1999;45:61–67.
164. Cohen SP, Abdi S. Lateral branch blocks as a treatment for sacroiliac joint pain: a pilot study. *Reg Anesth Pain Med* 2003;28:113–119.
165. Truumees E. Spinal stenosis: pathophysiology, clinical and radiologic classification. *Instr Course Lect* 2005;54:287–302.
166. Yuan PS, Booth RE Jr, Albert TJ. Nonsurgical and surgical management of lumbar spinal stenosis. *Instr Course Lect* 2005;54:303–312.
167. Gibson JN, Waddell G. Surgery for degenerative lumbar spondylosis. *Cochrane Database Syst Rev* 2005; CD001352.
168. Bambakidis NC, et al. Indications for surgical fusion of the cervical and lumbar motion segment. *Spine* 2005;30(16 Suppl): S2–S6.
169. Chagas H, et al. Cervical spondylotic myelopathy: 10 years of prospective outcome analysis of anterior decompression and fusion. *Surg Neurol* 2005;64(Suppl 1): S1:30–S1:35.
170. Roh JS, et al. Degenerative disorders of the lumbar and cervical spine. *Orthop Clin North Am* 2005;36:255–262.
171. Waguespack A, et al. Etiology of long-term failures of lumbar spine surgery. *Pain Med* 2002;3:18–22.
172. Viesca CO, Racz GB, Day MR. Special techniques in pain management: lysis of adhesions. *Anesthesiol Clin North Am* 2003;21:745–766, vi.
173. Heavner JE, Racz GB, Raj P. Percutaneous epidural neuroplasty: prospective evaluation of 0.9% NaCl versus 10% NaCl with or without hyaluronidase. *Reg Anesth Pain Med* 1999;24:202–207.
174. Taylor RJ, Taylor RS. Spinal cord stimulation for failed back surgery syndrome: a decision-analytic model and cost-effectiveness analysis. *Int J Technol Assess Health Care* 2005;21:351–358.
175. North RB, et al. Spinal cord stimulation for axial low back pain: a prospective, controlled trial comparing dual with single percutaneous electrodes. *Spine* 2005;30: 1412–1418.
176. Taylor RS, Van Buyten JP, Buchser E. Spinal cord stimulation for chronic back and leg pain and failed back surgery syndrome: a systematic review and analysis of prognostic factors. *Spine* 2005;30:152–160.
177. Bogduk N, Lord SM. Cervical spine disorders. *Curr Opin Rheumatol* 1998;10: 110–115.
178. Lord SM, et al. Chronic cervical zygapophysial joint pain after whiplash. A placebo-controlled prevalence study. *Spine* 1996;21:1737–1744.
179. Ronnen HR, et al. Acute whiplash injury: is there a role for MR imaging? A prospective study of 100 patients. *Radiology* 1996;201:93–96.
180. Nordemar R, Thorner C. Treatment of acute cervical pain: a comparative group study. *Pain* 1981;10:93–101.
181. Wallis BJ, Lord SM, Bogduk N. Resolution of psychological distress of whiplash patients following treatment by radiofrequency neurotomy: a randomised, double-blind, placebo-controlled trial. *Pain* 1997;73:15–22.
182. Classification and diagnostic criteria for headache disorders, cranial neuralgias and facial pain. Headache Classification Committee of the International Headache Society. *Cephalalgia* 1988;8(Suppl 7):1–96.
183. Rasmussen BK, et al. Epidemiology of headache in a general population: a prevalence study. *J Clin Epidemiol* 1991;44: 1147–1157.
184. Silberstein SD, Lipton RB, Goadsby PJ. *Headache in Clinical Practice*. Oxford, UK: Oxford University Press, 1998.
185. Practice parameter: the electroencephalogram in the evaluation of headache (summary statement). Report of the Quality Standards Subcommittee of the American Academy of Neurology. *Neurology* 1995;45:1411–1413.
186. Silberstein SD. Practice parameter: evidence-based guidelines for migraine headache (an evidence-based review): report of the Quality Standards Subcommittee of the American Academy of Neurology. *Neurology* 2000;55:754–762.

## CHAPTER 92

## Medical Management of Chronic Pain

Marc A. Huntoon, MD

The approach to the patient with chronic pain shares some similarities with the treatment of acute pain, with several notable differences. Whereas acute pain involves a specific tissue injury and an often easily identifiable initiating event, chronic pain may not have a definable source, tissue injury may not always be apparent, and treatment may be ineffective (Fig. 92-1). In general, if pharmacologic therapy is the mainstay of treatment, then the long-term implications of popular drugs used for treatment of acute pain, such as opioids and nonsteroidal antiinflammatory agents (NSAIDs), must be considered. Acute pain is caused by a short-term event (trauma, surgery, burn, etc.) and is appropriately managed with opioids, regional/neuraxial local anesthetics, numerous adjuvant drugs, and corticosteroids or NSAIDs. Long-term issues of drug-induced toxicities, such as opioid-induced hyperalgesia and cardiovascular side effects of certain cyclooxygenase-2 (COX-2)-blocking NSAIDs, must be considered relevant to patients with chronic medical problems. When acute pain becomes chronic, the physician must understand the mechanism of the pain in order to choose treatments based on validated outcome studies. This mechanism-based approach to pain therapy<sup>1</sup> likely will continue to dominate chronic pain treatment strategies for many years. With the realization that all pain is not initiated and maintained by similar mechanisms, treatments must be tailored to the specific individual. The pain problem also must be considered within the fabric of the patient's health profile and the context of the patient's current psychosocial situation. This evaluation and management model of treating the patient with pain as a whole person often is characterized as the *biopsychosocial model* of care.<sup>2,3</sup> The chronic pain, after beginning with some acute process,

gradually is supplanted by increasing layers of complexity as the patient's psychosocial environment and internal suffering interacts with the pain, essentially amplifying its perception and magnitude (Fig. 92-2). Because most anesthesiologists currently do not possess significant training in physical medicine and rehabilitation, neurology, neurosurgery, and psychiatry (among many related pain medicine fields), the optimal care of patients nearly always requires a multidisciplinary approach. In today's health systems approach, with its multiple regulatory and managed care cost containment issues, getting several specialists together at one time has become increasingly difficult and inefficient. Thus, new models of care must be found, likely those in which the pain specialist interacts in parallel with multiple disciplines to find the cause and appropriate treatment of the pain, with ongoing primary care physician involvement and renewed basic management until pain relapse or exacerbation. These patients often are therapeutically challenging, and cognitive-behavioral therapies, physical therapies, and group therapies may be best administered in a controlled structured environment, such as a pain rehabilitation and management program. These programs are character-

ized by concomitant management by multiple physician and allied health therapists to effect changes in the patient's cognition regarding the pain and an emphasis on functional status and behavioral change.

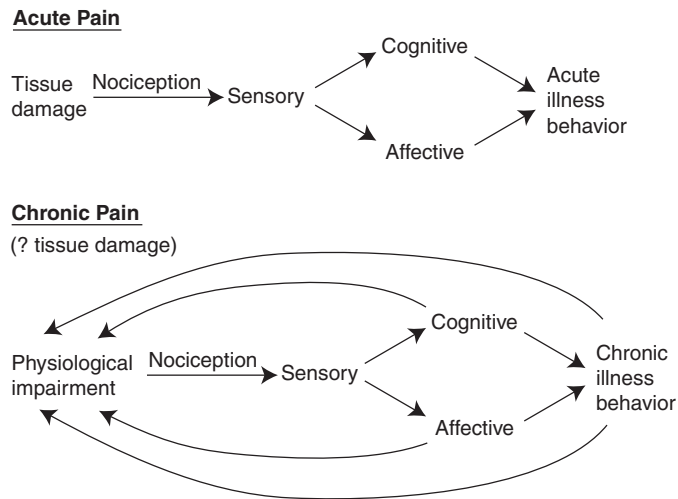
## EVALUATION OF THE CHRONIC PAIN PATIENT

## History

The initial evaluation of any patient presenting with chronic pain begins with a good medical history. The *chief complaint* should be noted. The pain history should include a screen for descriptive features of the pain: *what*—the descriptors that best characterize the pain, such as burning, stabbing, pricking, aching, shooting, lancinating, dull, boring, etc.; *where*—the current location of the pain and any radiation or referral, or the specific pattern that the pain takes going from one area to another (sometimes they follow known dermatomal patterns or are specific for a certain myofascial trigger point syndrome); *when*—the time that the pain occurs and what activities it may be associated with (e.g., an arthritic patient with most pronounced pain on awakening and attempting to get up in the morning); *how much* (i.e., the score

## KEY POINTS

1. Patients with chronic pain usually require multimodal (pharmacologic, behavioral, physical modalities, and procedural) therapies for pain that are chosen based on the underlying mechanism.
2. Fear of reinjury, catastrophizing, and poor coping skills may undermine the success of any mode of therapy.
3. The success of opioid therapies in acute pain must be tempered by the realization that for chronic pain treatment, opioid-induced hyperalgesia, pharmacologic tolerance, drug diversion, patient outcomes, and legal issues must be balanced appropriately for optimal care. Continuous monitoring and attention to the physician-patient relationship is vital.
4. Multiple new agents targeting ion channels and neurotransmitters are being developed, with improving efficacy. Optimal use of these agents requires a thorough understanding of their pharmacology as well as the ability to compare their effects through standardized study (allowing meta-analysis) and measures such as “number needed to treat” analysis.
5. New studies examining combination therapy (e.g., an opioid plus anti-convulsant agent) are likely to represent future practice because of the complexity of pain treatment and the realization that one agent rarely is sufficient.
6. Several studies suggesting that physical modalities plus cognitive-behavioral interventions are equivalent to large surgical procedures are interesting. These studies point to a future “blending” of traditionally separate pain clinic and pain rehabilitative programs to include even more comprehensive approaches.



**FIGURE 92-1. Top.** In acute pain, tissue damage leads to a predominately sensory phenomenon of pain, with some superimposed cognitive, affective response. **Bottom.** In chronic pain, tissue damage may not be apparent, and symptom magnification, affective distress, and illness behavior may be the primary identifiable manifestation of pain. (Reprinted from Waddell G, Newton M, Henderson I, et al. A fear-avoidance beliefs questionnaire (FABQ) and the role of fear-avoidance beliefs in chronic low back pain and disability. *Pain* 1993;52:157–168, with permission from International Association for the Study of Pain.)

the patient assigns the pain on an 11-point numerical scale from 0–10, or the impact on a measurable function such as walking distance).

The *history of present illness* should describe the origins (*the why*) of the pain, to the extent that they are discernible, and what has transpired up to the patient's presentation. *Past treatment history* should completely describe all previous attempts to diagnose and treat the current condition. All pain patients should have a *numerical pain scale* assessed for each visit and at appropriate followup times after

new interventions or medications are started. This allows a chronology of any improvement or worsening. Often, a pain diary can be kept by the patient and may be useful in identifying trends. All *therapeutic trials* should entail past pharmacologic treatments (maximum dosage reached and reason for cessation) as well as previous procedural, physical, and behavioral therapies (to understand exactly what was done and why). The *current medications* should list drug, dosage, and what the agent is treating. This list should include traditional pharmaceuticals as

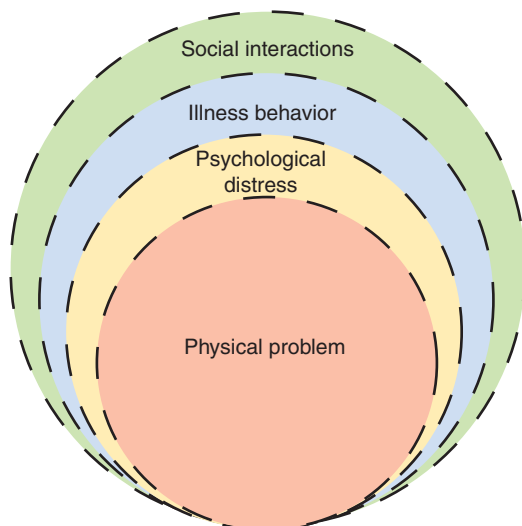
well as herbal and over-the-counter agents. A *substance use history* is critical, including not only prescribed opioids and benzodiazepines but also illicit substances used and a history of their use. Many pain patients will have extremely long and detailed lists of “allergies” secondary to numerous previous failed drug trials, with cessation secondary to side effects. Thus, *allergies* should document the specific nature of the reaction (true anaphylaxis versus side effect).

The remainder of the history should look specifically at the *functional impact* of the pain on the person's activities of daily living, work/physical activities, regularity of exercise, leisure/hobbies, yard work/housework, and social activities or evidence of withdrawal and isolation from activities. *Goals of care* should be discussed so that both patient and provider have an understanding of what is potentially and realistically achievable. A complete *review of systems, past medical and surgical histories, and social and family histories* should be documented. Finally, the presence of *fear-avoidance beliefs* should be evaluated, and, if present, a behavioral intervention should be instituted. Psychosocial pain-reinforcing mechanisms, such as patient beliefs, perceptions, and expectations about the impact of work, exercise, and disability, are important to treating persistent pain.<sup>2,3</sup>

### Physical Examination

The chronic pain patient should undergo a complete physical examination, not only looking at the relevant areas to his or her chief complaint but also evaluating major systems (e.g., cardiovascular, renal, hepatic, pulmonary) that may interact with or potentially limit therapeutic pharmaceutical trials or participation in an exercise-based program. A complete examination may include specific tests of joint movement/range of motion, for example, as well as correlation of examination findings with imaging modalities.

A thorough *mental status* examination should focus on the following areas: presence of confounding *personality disorders*; *affective state*, presence of alterations in mood, flattened/depressed affect, or hypomania/mania; *cognitive state*, orientation to person, place, and time, intelligence, judgment, insight; *speech*, fluidity, goal driven, presence of word-finding difficulties, comprehensibility; *attention*, concentra-



**FIGURE 92-2.** Pain, initially caused by an underlying physical problem, is increasingly magnified by psychosocial stressors. (From Waddell G, Main CJ, Morris EW, et al. Chronic low-back pain, psychological distress, and illness behavior. *Spine* 1984;9:209–213, with permission.)



TABLE 92-1.

## Muscle Grading System

Muscle Grading	Activity
5: Normal	Full ROM against gravity with full resistance
4: Good	Full ROM against gravity with some resistance
3: Fair	Active ROM gravity eliminated
2: Poor	Active ROM gravity eliminated
1: Trace	Slight contraction only
0: Zero	No contraction

ROM, Range of motion.

tion, abstract thinking, perception; and *emotionality*, anxiety, hopefulness, anger, frustration, fear. For example, the presence of a personality disorder may be a specific contraindication to ongoing opioid therapies because patients

may experience worsening of behavioral manifestations while taking opioids.<sup>4</sup> Because the most prevalent types of pain commonly seen in pain clinics may include back/spine, extremity pain, and head pain, thorough examination of the musculoskeletal and neurologic systems should be emphasized. The neurologic examination should grade motor strength in major muscle groups (Table 92-1) and other exam findings (Table 92-2, and Fig. 92-3). In addition, *Waddell signs* (Table 92-3) should be sought for patients whose neurologic and musculoskeletal examinations diverge from expectations. For example, a patient may present with positive straight-leg raising sign in the supine position that changes with distraction. An understanding of the presence of these nonorganic physical signs may prevent the misapplication of pointless therapies.

The presence of *spasticity* (upper motor neuron, corticospinal tract; increased resistance when the examiner moves a joint briskly or forcefully)

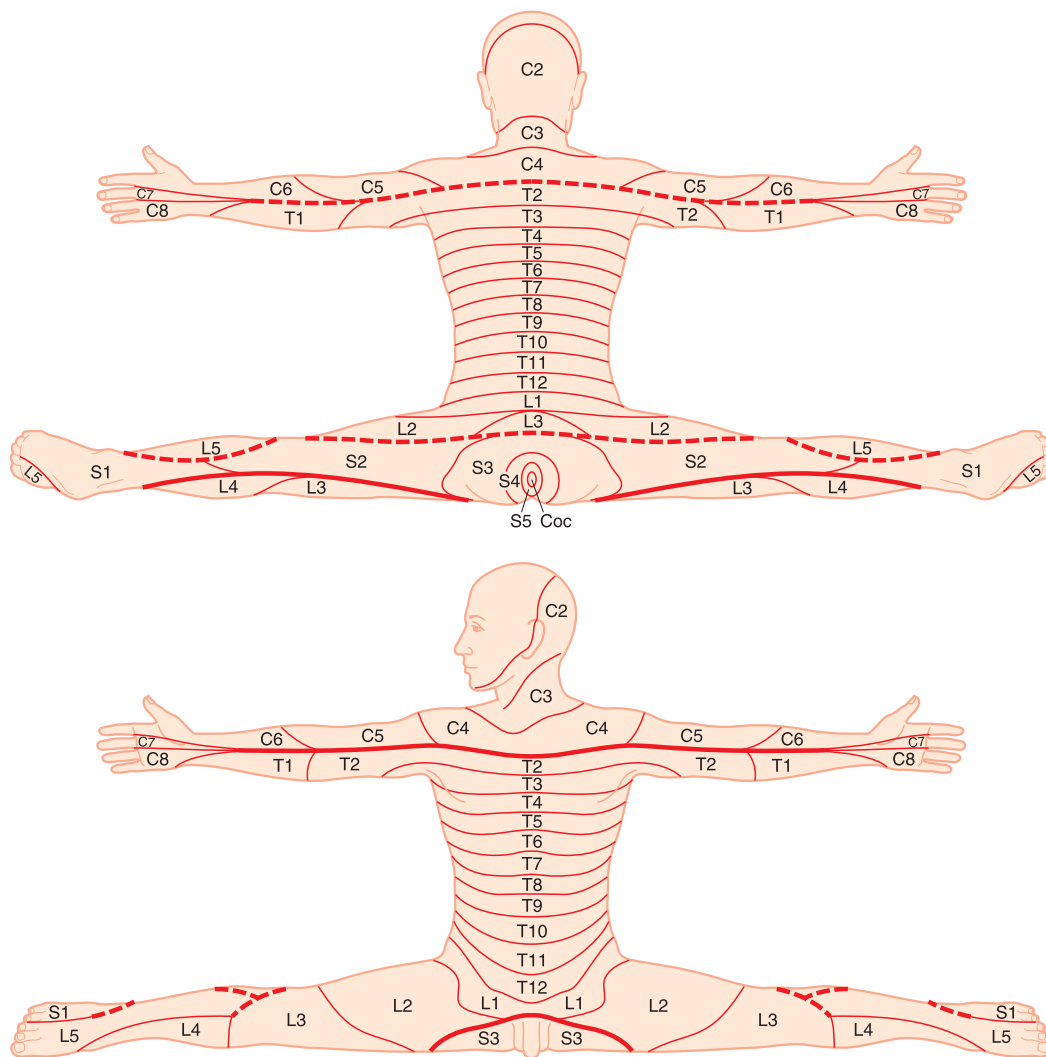
versus *rigidity* (basal ganglia, e.g., parkinsonism; enhanced resistance to movement throughout the range of a specific muscle-joint system) should be noted. Presence of *myopathy*, such as corticosteroid-induced or statin-induced muscle weakness (symmetric weakness without atrophy and normal sensation), should be documented. Evidence of true *atrophy* may signify a radiculopathy caused by spinal nerve irritation involving a specific muscle (Tables 92-4A and 92-4B); a more diffuse lumbosacral radiculoplexopathy, as occurs in diabetic patients; or peripheral neuropathy with distal weakness, atrophy, sensory loss, and possibly even fasciculations. Sensory examination, generally performed with a safety pin, light touch, temperature source, and two-point discrimination and tuning fork, can help discriminate abnormalities. Knowledge of tender points (Fig. 92-4) in fibromyalgia can aid musculoskeletal examination of pain at these sites, and tenderness at

TABLE 92-2.

## Summary of Reflexes

Reflexes	Afferent Nerve	Center	Efferent Nerve
<b>Superficial Reflexes</b>			
Corneal	Cranial V	Pons	Cranial VII
Nasal (sneeze)	Cranial V	Brain stem and upper cord	Cranials V, VII, IX, and X, and spinal nerves of expiration
Pharyngeal and uvular	Cranial IX	Medulla	Cranial X
Upper abdominal	T7, T8, T9, T10	T7, T8, T9, T10	T7, T8, T9, T10
Lower abdominal	T10, T11, T12	T10, T11, T12	T10, T11, T12
Cremasteric	Femoral	L1	Genitofemoral
Plantar	Tibial	S1, S2	Tibial
Anal	Pudendal	S4, S5	Pudendal
<b>Tendon Reflexes</b>			
Jaw	Cranial V	Pons	Cranial V
Biceps	Musculocutaneous	C5, C6	Musculocutaneous
Triceps	Radial	C7, C8	Radial
Brachioradialis	Radial	C5, C6	Radial
Patellar	Femoral	L3, L4	Femoral
Achilles	Tibial	S1, S2	Tibial
<b>Visceral Reflexes</b>			
Light	Cranial II	Midbrain	Cranial III
Accommodation	Cranial II	Occipital cortex	Cranial III
Cilio-spinal	A sensory nerve	T1, T2	Cervical sympathetics
Oculocardiac	Cranial V	Medulla	Cranial X
Carotid sinus	Cranial IX	Medulla	Cranial X
Bulbocavernosus	Pudendal	S2, S3, S4	Pelvic autonomic
Bladder and rectal	Pudendal	S2, S3, S4	Pudendal and autonomic
<b>Abnormal Reflexes</b>			
Extensor plantar (Babinski)	Plantar	L3-5, S1	Extensor hallucis longus

From: Waxman Neuropathy, section 25e; Section III, Spinal Cord and Spine. Accessmedicine.com. New York: McGraw Hill, 2004-2005, with permission.



**FIGURE 92-3.** Sensory dermatomes. (From *The neurologic examination in the emergency setting*. In Tintinalli JE, Kelen GD, Stapczynski S, et al., eds. *Tintinalli's Emergency Medicine: A Comprehensive Study Guide*. Available at: [www.accessmedicine.com](http://www.accessmedicine.com). New York: McGraw-Hill, 2004–2005, Figure 226–1, with permission.)

11 of the 18 sites meets diagnostic criteria. Referral zones for various regional myofascial syndromes also may help discriminate discomfort in various areas. For example, temporomandibular joint pain may radiate to the temple, face, and head.

### Nonorganic Physical Signs

As previously discussed, patients who are being evaluated for chronic pain disorders may demonstrate confusing physical examination findings that confound the clinician's ability to categorize and treat their condition. Waddell and Main<sup>5</sup> described seven inappropriate symptoms that seemed to be best characterized as magnifiers of physical illness. The seven symptoms were (1) pain at the tip of the coccyx, (2) entire leg pain, (3) entire leg sensory loss, (4) giveaway weakness of the entire lower extremity, (5) absence of

pain-free periods, (6) intolerance to procedural or pharmacologic treatments, and (7) frequent emergency department visits and admissions for intractable pain. These symptoms had little presence in patients who were asymptomatic but had satisfactory test–retest reproducibility in patients with chronic back pain.

The *pain drawing* is another tool commonly used by pain practitioners to evaluate new patients with chronic pain complaints (Fig. 92-5).<sup>6</sup> Patients are evaluated by having them draw the areas of their pain and concomitantly having the Minnesota Multiphasic Personality Inventory (MMPI) test scored along with the drawing. The authors

**TABLE 92-3.**

### Waddell Signs

Non-anatomic Simulation tests	Widespread tenderness Axial loading Stimulated rotation
Distraction Regional	Straight-leg raise (i.e., positive supine but not when distracted) Weakness: atypical
Overreaction	Sensory: nondermatomal Exaggerated pain behaviors

From: Waddell et al, with permission.

TABLE 92-4A.

## Muscle Innervation: Shoulder and Upper Extremity

Nerve	Action to Test	Muscle <sup>a</sup>
Long thoracic	Forward shoulder thrust	Serratus anterior
Dorsal scapular	Elevate scapula	Levator scapulae
Suprascapular	Arm extension rotation	Infraspinatus; C5, C6
Axillary	Abduct arm (>90°)	Deltoid; C5
Musculocutaneous	Flex and supinate arm	Biceps brachii
Ulnar	Ulnar flexion of hand	Flexor carpi ulnaris; C7, C8
	Flex DIP of fingers 4 and 5	Flexor digitorum profundus
	Thumb adduction	Adductor pollicis; C7, C8 <sup>b</sup> , T1
	Abduction of finger 5	Abductor digitorum minimi
	Opposition of finger 5	Opponens digitorum minimi
	Flexion of finger 5	Flexor digitorum minimi brevis
	Finger abduction and adduction	Interossei; C8, T1 <sup>b</sup>
	Flex PIP and extend DIP of fingers 4 and 5	Lumbricals 3 and 4
Median	Forearm pronation	Pronator teres
	Radial hand flexion	Flexor carpi radialis; C7, C8, T1
	Hand flexion	Palmaris longus
	PIP Flexion of fingers 2-5	Flexor digitorum superficialis
	Abduct thumb at the MCP	Abductor pollicis brevis
	Flex proximal phalanx thumb	Flexor pollicis brevis; C7, C8 <sup>b</sup>
Anterior interosseous	Flex DIP fingers 2-5	Flexor digitorum profundus (radial)
	Flex thumb IP	Flexor pollicis longus
	Oppose thumb	Opponens pollicis; C8, T1 <sup>b</sup>
	Flex PIP and extend DIP of fingers 2 and 3	Lumbricals 1 and 2
Posterior interosseous	Extension of digits 2-5	Extensor digitorum
	Ulnar hand extension	Extensor carpi ulnaris
	Thumb abduction	Abductor pollicis longus
	Index finger extension	Extensor indicis proprius
Radial	Forearm extension	Triceps brachii; C6, C7, C8 <sup>b</sup>
	Forearm flexion	Brachioradialis; C5, C6
	Radial hand extension	Extensor carpi radialis
	Forearm supination	Supinator

DIP, Distal interphalangeal joint; IP, interphalangeal joint; MCP, metacarpophalangeal joint; PIP, proximal interphalangeal joint.  
<sup>a</sup>Dermatome representations are listed after some muscles.  
<sup>b</sup>Predominant dermatome.

From Tintinalli's Emergency Medicine, Section 19, Neurology, Chapter 226. Accessmedicine.com. New York: McGraw Hill, 2004-2005, with permission.

found a strong correlation between patients evaluated having a normal MMPI (no evidence of hysteria [Hy] or hypochondriasis [Hs]) and those having fewer than two penalty deductions on their pain drawing. The authors reported that the pain drawing might help physicians screen out up to 93% of patients who would have poor psychometrics related to (1) unreal drawings; (2) expansion or magnification of pain (e.g., pain outside the bodily limits); (3) areas of excessive annotation of particularly severe pain (stars, circling, lightning bolts, etc.); and (4) low back pain radiating pain indicators. Waddell et al.<sup>7</sup> described a series of physical examination signs that can be used as an aid in the examination of patients with low back pain.

Increasingly, the pain medicine clinician needs a thorough understanding of contemporary imaging modalities, such as plain radiographs, magnetic resonance imaging, and computed tomography. Imaging complements and reinforces the appraisals and clinical impressions of pain patients.<sup>8</sup> Likewise, correlating imaging study abnormalities with physical examination findings using a thorough understanding of anatomy enables the physician to differentiate significant from confounding findings. For example, it is well known that abnormalities found on imaging studies may not correlate with the patient's pain or examination. Significant changes may be found on spine magnetic resonance studies in 35% of asymptomatic patients.<sup>8,9</sup>

## PHARMACOLOGIC THERAPY

It is quite apparent to physicians who engage in chronic pain therapy that currently available pharmacologic agents often are insufficient as single therapies. Finding treatments through a mechanism-based approach offers the best chance for rational selection of therapies.<sup>10</sup> It may be difficult to determine what level of clinical improvement actually is significant when performing randomized controlled trials of the various pharmaceutical agents currently available. Farrar et al.<sup>11</sup> examined 10 recently completed drug trials using one agent (pregabalin) for treatment of a variety of different pain conditions (diabetic peripheral neuropathies, postherpetic neuralgia, fibromyalgia, chronic low back

TABLE 92-4B.

## Muscle Innervation Hip and Lower Extremity

Nerve	Action to Test	Muscle <sup>a</sup>
Femoral	Hip flexion Leg extension	Iliopsoas, T12, L1, <sup>b</sup> L2, L3 Quadriceps femoris, L2, L3, <sup>b</sup> L4
Obturator	Thigh adduction	Pectineus Adductor longus, brevis, magnus L2, L3, L4 Gracilis
Superior gluteal	Thigh abduction Thigh flexion Lateral thigh rotation	Gluteus medius and minimus Tensor fascia lata Piriformis
Inferior gluteal Sciatic (trunk)	Thigh abduction Leg flexion	Gluteus maximus Biceps femoris L5, <sup>b</sup> S1, S2 Semitendinosus Semimembranosus
Deep peroneal	Foot dorsiflexion and supination Toes 2-5 and foot extension Great toe and foot dorsiflexion	Tibialis anterior, L4, L5 Extensor digitorum longus/brevis Extensor hallucis longus
Superficial peroneal Tibial	Plantar flexion foot and eversion Plantar flexion and inversion Flex distal phalanx great toe Flex middle phalanx toes 2-5 Flex proximal phalanx great toe Knee flexion and ankle plantar flexion Ankle plantar flexion	Peroneus longus/brevis; L5, S1 Posterior tibialis Flexor hallucis longus Flexor digitorum brevis Gastrocnemius; L5, S1, <sup>b</sup> S2 Flexor hallucis brevis Plantaris, soleus
Pudendal	Voluntary pelvic floor contraction	Perineal and sphincters; S3, S4

<sup>a</sup>Dermatome representations are listed after some muscles.  
<sup>b</sup>Predominant dermatome.

From: Tintinalli's Emergency Medicine, Section 19, Neurology, Chapter 226. Accessmedicine.com. New York: McGraw Hill, 2004-2005, with permission

pain, and osteoarthritis). Essentially, the best correlation of patient global impression of change with the 11-point pain intensity numerical rating scale was determined to be an approximately 30% improvement or a two-point scale decrease. This approximate relationship persisted regardless of the condition being treated and other patient demographic variables. Thus, the authors recommended that application of these standards for all pain studies not only was reasonable, but that such standardization of future pain studies would render the studies more readily comparable, valid, and clinically useful. A 30% improvement is seemingly small, but when combination therapies are used, each contributing a small percentage toward clinical improvement, the reason for increased interest by pain clinicians in multimodal therapies is understandable.

### Specific Pharmacologic Adjuvants

#### Antidepressants

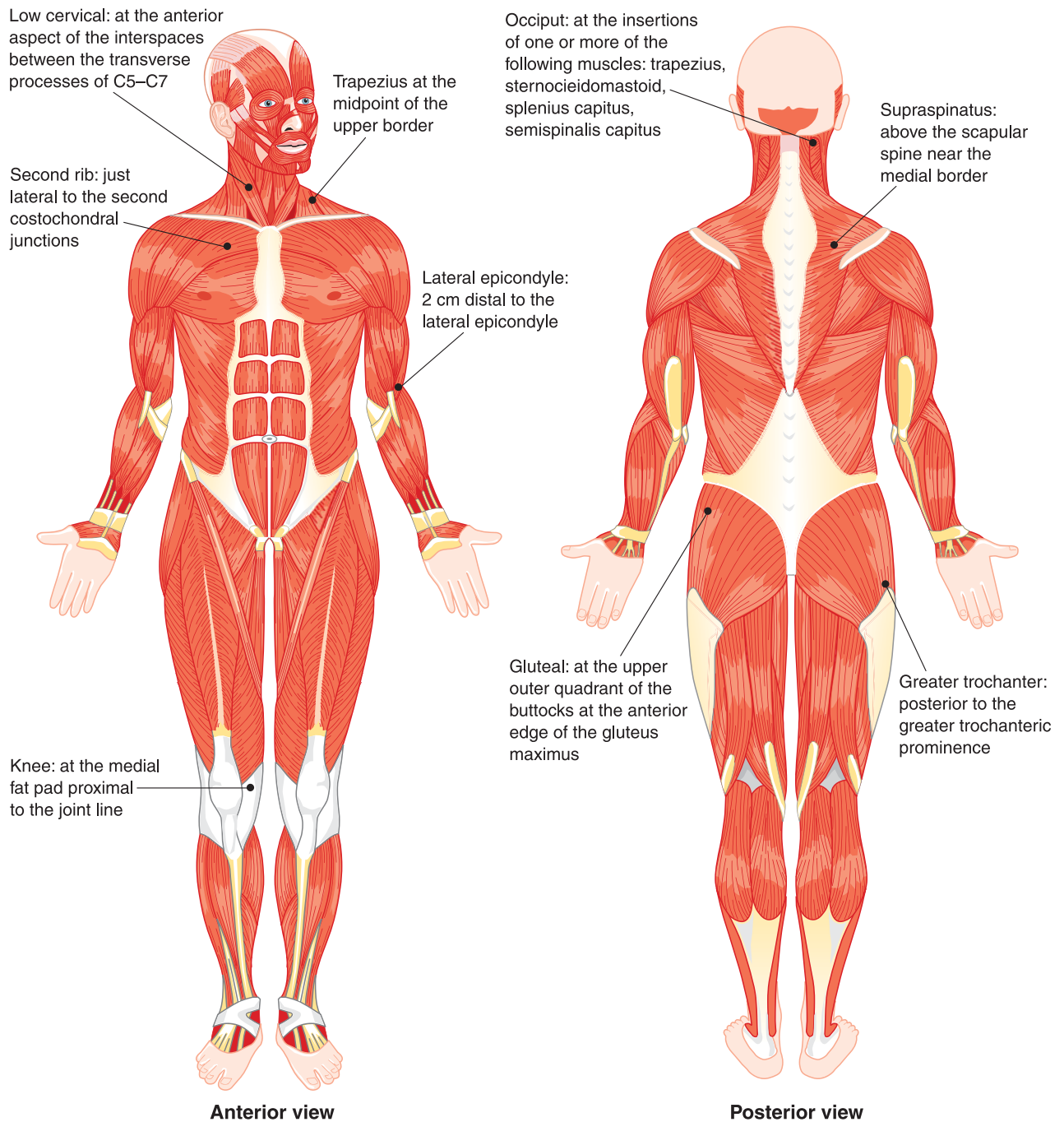
Many of the antidepressant agents are useful as either primary or adjuvant

therapy for neuropathic pain syndromes as well as other types of pain, such as myofascial pain syndromes. It is generally accepted that the mechanism of action of these drugs in pain is complex and may be related to reuptake inhibition of various neurotransmitters important in descending bulbospinal inhibitory pathways.<sup>12</sup> Additional mechanisms may be important, including effects on *N*-methyl-D-aspartate (NMDA) excitatory amino acid receptors,<sup>13,14</sup> sodium channel blockade,<sup>15</sup> and even other mechanisms. Earlier studies addressed initial speculation that these agents were working as *antidepressants only* in pain patients with concomitant depression. Max et al.<sup>16</sup> demonstrated that amitriptyline was effective in patients with diabetic peripheral neuropathy pain both in the presence and the absence of depressed mood. Early comparisons of different types of antidepressants with selective serotonergic or nonselective reuptake inhibition of both noradrenaline and serotonin suggested that drugs with nonselective mechanisms were more effective in treating neuropathic pain states (Fig. 92-6).<sup>17</sup>

The selective serotonin reuptake inhibitors in particular were generally believed to be devoid of efficacy in pain conditions, but newer studies suggest that these agents have an occasional but less pronounced role.<sup>18-20</sup>

Tricyclic antidepressants (TCAs) have a characteristic three-ring nuclear structure and are chemically similar to phenothiazines and antihistamines, sharing side effects such as sedative and antimuscarinic actions. These side effects are perhaps the main detractors to the use of these agents in pain treatment, given their limited ability to reach effective doses. Certainly, the sedative properties of tricyclics can be used to advantage in the treatment of concomitant sleep deprivation, which frequently is present in chronic pain syndrome patients. However, many patients feel groggy or cognitively impaired even with introductory doses of these agents. Elderly patients in particular may have cardiac or urinary conditions that are exacerbated by the antimuscarinic actions of tricyclics, and the drugs may be contraindicated in some patients.





**FIGURE 92-4.** The 18 primary fibromyalgia tender points. (From The patient with diffuse pain. In Imboden JB, Hellmann DB, Stone JH, eds. *Current Rheumatology: Diagnosis and Treatment*. 2nd ed. New York: McGraw-Hill, 2004.)

**Nortriptyline** Roose et al.<sup>21</sup> studied the serotonin specific reuptake inhibitor paroxetine in comparison to nortriptyline in ischemic heart disease patients with depression. Approximately 60% of patients in both groups experienced improvement in depressive symptoms, but the nortriptyline group had significantly more adverse cardiac events, involving 18% of the study group. The patients in the nortriptyline group were titrated to target plasma levels over the first 3–7 days rather than the more typical slow ramping

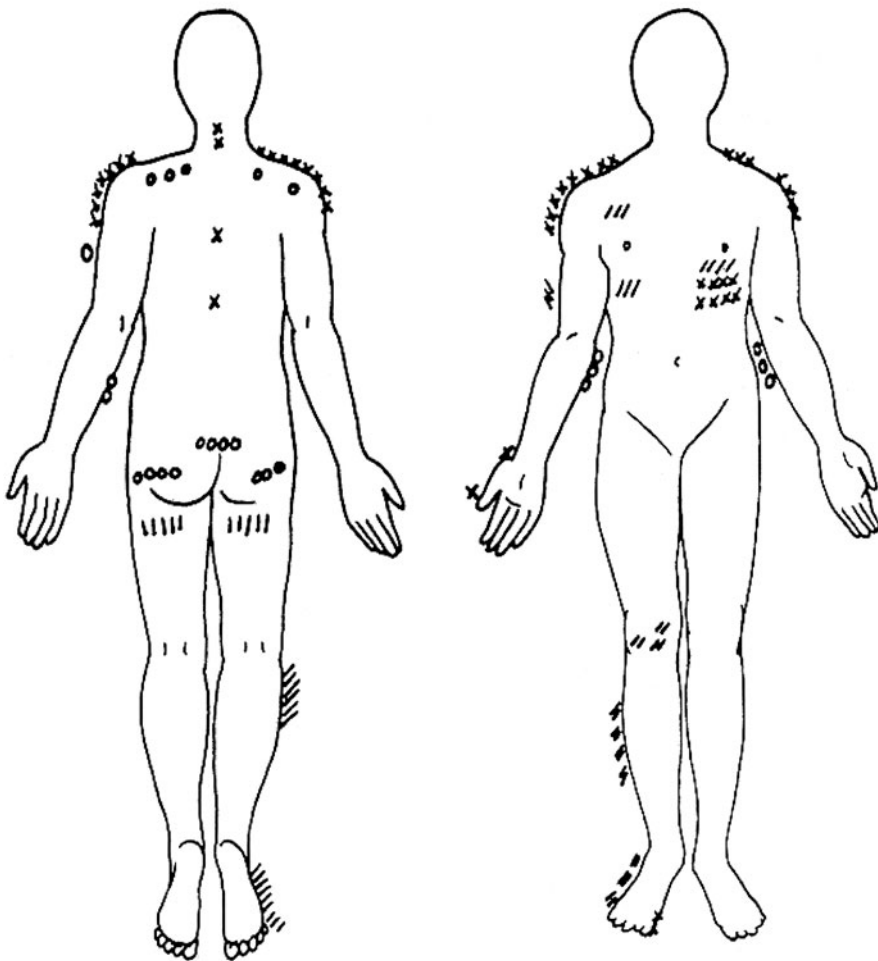
dose used by many physicians treating pain. Nevertheless, the development of adverse events illustrates the precautions that must be considered with the use of tricyclic agents. The prototype TCAs amitriptyline and imipramine are metabolized via mono-demethylation to the active metabolites nortriptyline and desipramine, respectively. Imipramine, similar to amitriptyline, has been successfully used for treatment of painful diabetic neuropathy.<sup>22</sup> However, the second-generation tricyclic agents (nortriptyline and

desipramine) tend to be better tolerated because of less intense antimuscarinic and sedative properties and thus are more popular with pain physicians (Table 92-5).<sup>23–25</sup>

**Amitriptyline** Amitriptyline was one of the first agents shown to be effective in the treatment of postherpetic neuralgia<sup>26</sup> and has been a prototypical pain adjuvant drug for more than 2 decades. Although the drug is effective compared to placebo, its individual effects are generally not sufficient to

Mark the areas on your body where you feel the described sensations. Use the appropriate symbol. Mark areas of radiation. Include all affected areas.

	====		0000	xxxxx	////
Numbness	====	Pins & needles	0000	Burning	xxxxx
	====		0000	xxxxx	////



**FIGURE 92-5.** Example of a pain drawing from a patient with multiple noncontiguous areas of pain with amplification and somatic preoccupation. (From Ransford et al.<sup>9</sup> with permission.)

sult in complete analgesia. Preemptive use of amitriptyline in elderly patients has been associated with a decreased incidence of pain prevalence 6 months after the diagnosis of herpes zoster. The author recommended early institution of amitriptyline in this group.<sup>27</sup> Dosing of tricyclics for pain treatment generally begins at low evening doses and is increased gradually until limited by side effects or pain improves. Meta-analysis suggests that an average dose of approximately 75–100 mg/d of these agents may be required to achieve optimal results.<sup>28</sup> Studies have demonstrated that amitriptyline and other tricyclic agents have important NMDA-blocking activity<sup>13,14,29,30</sup> as well as significant and long-acting inhibitory action at the neu-

ronal sodium channel. Renewed research interest has focused on the use of these agents for neural blockade.<sup>15,31</sup>

A randomized trial comparing amitriptyline with nortriptyline showed that despite the study's small sample size, there appeared to be no major differences between the two drugs with respect to pain scores, patient satisfaction, disability, preference, or mood. Intolerable side effects were more prevalent in the amitriptyline group.<sup>23</sup> Although most studies have been positive, a randomized controlled trial did study the use of amitriptyline for treatment of spinal cord injury pain compared to the pharmacologically active "placebo" benzotropine. The study was conducted over only 6 weeks and did not detect any

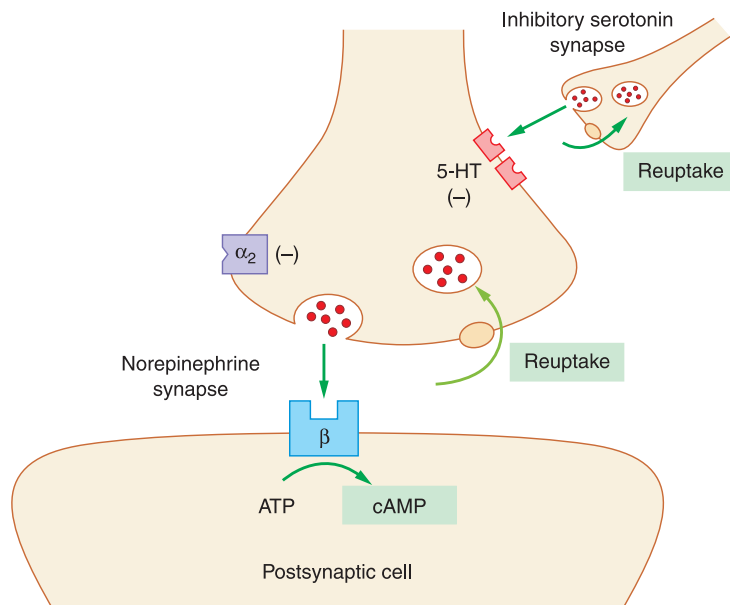
difference between the groups receiving amitriptyline or benzotropine.<sup>32</sup> Recently, the role of coadministration of agents acting on different pharmacologic targets has been advocated. Raja et al.<sup>24</sup> compared the tricyclic agents nortriptyline and desipramine to the opioid drugs morphine and methadone in a randomized group of 76 patients with postherpetic neuralgia.

Both opioids and tricyclics had statistically significant analgesic effects relative to placebo; however, more patients (54%) preferred the opioids to the tricyclics (30%) despite similar pain reductions. Interestingly, although opioid agents are commonly thought to induce deleterious cognitive effects, the tricyclics were responsible for significant differences in hand-grooved pegboard tests as well as symbol substitution compared to the opioids.

### Other Antidepressants

Multiple studies have evaluated the potential role of non-TCAs. Previous studies had demonstrated no difference between placebo and fluoxetine.<sup>17</sup> Based on the study by Max et al.,<sup>17</sup> it is believed that drugs with properties of nonspecific reuptake inhibition may be superior as analgesics to those with specific serotonin effects. Venlafaxine, a nonspecific reuptake inhibitor of noradrenaline, serotonin, and some actions on dopamine, has been studied in comparison to imipramine. Interestingly, venlafaxine is similar to amitriptyline in terms of reuptake inhibition pattern. In the comparison with imipramine, the authors found that both agents were effective in a painful diabetic neuropathy model.<sup>33</sup> Another double-blind, randomized trial of bupropion for treatment of neuropathic pain also was positive (Table 92-5).<sup>34</sup>

**Duloxetine** In contrast to fluoxetine, the newer agent duloxetine, a nonselective serotonin and norepinephrine reuptake inhibitor, has shown early promise in the treatment of neuropathic pain and was approved by the U.S. Food and Drug Administration (FDA) for treatment of diabetic neuropathy. The mechanism of action of duloxetine appears to be descending inhibition, with potent inhibition of reuptake of both norepinephrine and serotonin and weak inhibition of dopamine reuptake (Fig. 92-6).



**FIGURE 92–6.** Mechanism of action of nonspecific reuptake inhibition of neurotransmitters, serotonin (5-HT), and norepinephrine in the descending inhibitory pathway. (From Potter WZ, Hollister LE. Antidepressant agents. In Katzung BG, ed. Basic and Clinical Pharmacology. New York: McGraw-Hill, 2004.)

Duloxetine has no major active metabolites and a long elimination half-life of approximately 12 hours. In studies of duloxetine 60 and 120 mg/d versus placebo for treatment of diabetic neu-

ropathy, both doses were effective in reducing pain and interfering with nighttime pain. Duloxetine appears to be particularly effective for treatment of nighttime pain severity. Significant

depression was not present in the study patients with diabetic neuropathy.<sup>35</sup> Duloxetine therapy had been considered safe, with only the minor risk of elevated serum transaminase levels.

Some cases of cholestatic jaundice and hepatitis have been reported post-marketing. Patients particularly at risk seem to be those with preexisting liver disease, with possible increased risk for further liver damage. Deleterious liver effects may be compounded in patients who consumed substantial amounts of alcohol. Gastrointestinal upset, constipation, and other side effects are common findings with use of the drug.<sup>35</sup>

In studies of patients with both painful physical symptoms and depression, duloxetine 60 mg/d was found to be an effective treatment for both.<sup>36</sup>

Evaluating the primary efficacy measure of Brief Pain Inventory (BPI) average pain scores, improvements in the duloxetine patient groups averaged 25–50%. Side effects included nausea, dry mouth, fatigue, and decreased appetite.

**Opioids**

Opioid use for treatment of chronic pain has increased considerably over

**TABLE 92–5.**

**Pharmacologic Differences Among Several Antidepressants**

Drug	Sedative Action	Antimuscarinic Action	Block of Amine Pump for		
			Serotonin	Norepinephrine	Dopamine
Amitriptyline	+++	+++	+++	++	0
Amoxapine	++	++	+	++	+
Bupropion	0	0	+,0	+,0	0
Citalopram, escitalopram	0	0	+++	0	0
Clomipramine	+++	++	+++	+++	0
Desipramine	+	+	0	+++	0
Doxepin	+++	+++	++	+	0
Fluoxetine	+	+	+++	0,+	0,+
Fluvoxamine	0	0	+++	0	0
Imipramine	++	++	+++	++	0
Maprotiline	++	++	0	+++	0
Mirtazapine <sup>a</sup>	+++	0	0	0	0
Nefazodone	++	+++	+,0	0	0
Nortriptyline	++	++	+++	++	0
Paroxetine	+	0	+++	0	0
Protriptyline	0	++	?	+++	?
Sertraline	+	0	+++	0	0
Trazodone	+++	0	++	0	0
Venlafaxine	0	0	+++	++	0, +

0, None; +, slight; ++, moderate; +++, high; ?, uncertain.

<sup>a</sup>Significant  $\alpha_2$ -adrenoceptor antagonism.

From Potter WZ, Hollister, LE. Antidepressant agents. In Katzung BG ed. Basic and Clinical Pharmacology. 9th ed. New York: McGraw-Hill, 2004, with permission.

the last 2 decades. In 1980, only 2% of patient visits for chronic musculoskeletal pain conditions resulted in opioid prescriptions. In 2000, this number more than quadrupled to 9%,<sup>37</sup> representing a net increase of 4.6 million prescribed opioid visits compared to 20 years earlier. The increase in total musculoskeletal patient visits over the same time period was negligible, indicating that physician prescribing practices had changed significantly. The authors<sup>37</sup> theorized that the reasons for increased prescribing were related to advocacy by major pain organizations,<sup>38</sup> increased pharmaceutical company direct marketing campaigns to healthcare consumers, national guidelines published by the Agency for Health Care Policy and Research,<sup>39</sup> and Joint Commission on Hospital Accreditation emphasis on pain assessment and treatment.<sup>37</sup> Chronic pain patients were increasingly referred by noninstitutionally employed ambulatory care providers to pain specialists, 34% in 1980 versus 49% in 2000.<sup>37</sup> Fewer patients were seen for chronic headache complaints, but more were seen for extremity pain. Unfortunately, these increases in opioid prescribing were not without problems.

Prescription opioid mentions in the Drug Abuse Warning Network (DAWN) from 1994 to 2001 were analyzed.<sup>40</sup> During that period, hydrocodone combinations increased from 9320 to 21,567, an increase of 131%. Similarly, oxycodone combinations increased from 4069 to 18,409, an increase of 352% that has not yet plateaued.<sup>41</sup> The authors of a position statement noted that illicit use of opioid prescriptions had risen faster than legal use of these drugs.<sup>41</sup> They also noted that almost no research had determined the abuse liability of different agents. Nonmedical use had increased from 1% to 3% during that period. In 2000, two million people used opioids for nonmedical reasons. Another study noted that opioid analgesics accounted for 9.85% of all drug abuse, an increase of 5.75% from 1997.<sup>40</sup> Increases in illicit use may be due in part to unscrupulous physician behavior, the nature of prescribing to chronic pain patients as a group, and illegal substance diversion by some patients. Theft has risen as a new problem for the Drug Enforcement Agency (DEA) monitoring illicit drug use. A total of nearly 13,000 theft loss events occurred in 22 eastern U.S. states from

2000 to 2003, including 4.4 million dose units of oxycodone alone.<sup>42</sup>

Use of opioids for various pain syndromes has been studied, but adverse effects are troublesome. In a study of neuropathic pain patients resistant to treatment, patients received either high-strength or low-strength levorphanol capsules up to a maximum 21 capsules per day.<sup>43</sup> Pain intensity, quality of life, psychological and cognitive function, and blood levels were outcome measures. Patients in the high-strength group took 11.9 capsules (89 mg/d), and those in the low-strength group took 18.3 capsules (2.1 mg/d). Pain was reduced by 36% in the high-strength group versus 21% in the low-strength group. Central post-stroke neuropathic pain was least likely to improve. Despite obvious analgesic effects, higher doses produced more side effects without significant additional benefits in terms of other outcome measures. More than one fourth of patients withdrew from the study, and episodic anger and irritability were reported more by the HS group.<sup>43</sup> Although the patients had improvement in symptoms, one wonders if the large number of withdrawals and the anger/irritability issues justify this treatment. In contrast to evidence of efficacy in some patients with neuropathic pain taking daily scheduled opioids, other pain states may not be as efficacious. In a population of patients with intractable head pain, 160 sequential patients were monitored, and 70 of these patients qualified for inclusion in the analysis. Of those reviewed, only 26% had >50% pain relief. Multiple problems with compliance including requests for early refills of opioids, lost prescriptions, multiple providers of opioids, and other problems occurred in 50% of patients. The authors concluded that daily scheduled opioids were associated with low overall efficacy and an unexpectedly high incidence of maladaptive behaviors.<sup>44</sup>

In response to the study by Caudill-Slosberg et al.,<sup>37</sup> an editorial discussed the current state of opioid prescribing practices and the lack of a clear evidence-driven approach to opioid therapies for chronic noncancer pain syndromes.<sup>45</sup>

In an effort to better manage chronic pain patients taking opioids and to avoid legal and regulatory hassles, many pain treatment facilities use an opioid agreement or "contract." To de-

termine the key attributes included in the opioid consumption contracts of major academic centers, Fishman et al.<sup>46</sup> evaluated the opioid contracts of 39 major academic centers and the major care statements/prohibitions for their core meaning. The most common categories included (1) terms of treatment, (2) prohibited behavior, and (3) points of termination. Rank ordering of statements included (1) improper use of medications, (2) disciplining by termination (for missed appointments, medication abuse, etc.), (3) limitations on replacement of lost medications or prescription changes, (4) informing physician of relevant information, including side effects and changes in medical condition, and (5) submission to random drug screens. Unfortunately, little evidence indicates that drug contracts improve patient compliance. Monitoring is an intensely time-consuming task that is not possible to accomplish in most clinical settings. Many potentially indispensable statements on opioid treatment, including prohibited usage during pregnancy, driving automobiles, prohibition of alcohol use, and many others, are present in less than half of opioid contracts. Long-term opioid studies of chronic pain syndromes generally consist of small numbers and short duration. Short-term data limit the ability to generalize the reproducibility of opioid treatment outcomes to large groups of chronically treated patients.<sup>47</sup>

**Opioid Side Effects** Rajagopal et al.<sup>48</sup> noted significant decreases in sex hormone production in male cancer survivors taking opioids for at least 1 year. Evidence of central hypogonadism, including decreased testosterone and reduced sexual desire, was noted in this group. This finding is similar to those in patients taking chronic intrathecal opioids.<sup>49</sup> Immunologic studies have indicated significant impairment immunologic function caused by opioid therapies, particularly natural killer cell cytotoxicity with chronic opioid use.<sup>50,51</sup> In a mouse model,<sup>52</sup> the covalent agent buprenorphine did not significantly suppress immunity in contrast to fentanyl. This finding suggests that differential effects may be associated with different opioids.

**Opioid-Induced Hyperalgesia** It is well understood that several agents (e.g., TCAs) may provide part of their



analgesic activity by augmentation of descending inhibitory pathways from the brainstem to the spinal cord.<sup>12</sup> It also appears that just as there are descending inhibitory pathways, there also are descending *facilitatory pathways*. Animal models suggest that the rostroventromedial medulla (RVM) contains populations of neurons that are characterized as either *on cells* or *off cells*,<sup>53</sup> which may be an important reason for opioid hyperalgesia and apparent opioid-induced pain. The on cells seem to promote nociception, whereas the off cells seem to inhibit nociceptive neural firing. Morphine and other  $\mu$ -agonists decrease firing of the on cells and increase activity of the off cells. Cholecystokinin (CCK) appears to be a pro-nociceptive peptide neurotransmitter that is important in decreasing morphine antinociception.<sup>54</sup> Researchers have demonstrated that within the RVM, CCK may augment descending pain facilitation in response to ongoing opioid exposure. In an animal model, continuous morphine significantly increased thermal and tactile hypersensitivity after 3 days, and microdialysis of the RVM demonstrated a 5-fold increase in CCK in the RVM.<sup>55</sup> Previous research had demonstrated that either a lesion of the bilateral dorsolateral funiculus (neuronal tracts used for descending modulation) or lidocaine injection into the RVM could abort evidence of opioid-induced hyperalgesia.<sup>56</sup> Evidence indicates that descending facilitation enhances local spinal cord release of dynorphin (a potent algogenic substance), leading to enhancement of spinal afferent nociceptive receptivity. Continuous morphine infusion leads to increasing spinal dynorphin. Dynorphin then evokes release of excitatory peptides such as calcitonin gene-related peptide and substance P at dorsal root ganglia primary afferents.<sup>57</sup> Injection of dynorphin antiserum abolishes the pro-nociceptive opioid pain facilitation.<sup>57</sup> These studies point to a major change in the way we look at concepts such as opioid tolerance. Increased opioid requirements may be a true tolerance, that is, a rightward shift of dose-response curves, or evidence that opioid-induced descending facilitation is occurring (opioid hyperalgesia). Future research to develop compounds that either block CCK activity in the RVM or block the dynorphin-induced excitatory peptides to allow ongoing analgesia from opioid agents may be indicated.<sup>58</sup>

**Tolerance** Tolerance can be characterized as the state of physiologic adaptation to a certain level of opioid dosing, recognized as declining effects of the opioid over time. This may be related to downregulation of opioid receptors or accumulation of antianalgesic substances. For example, opioid therapy may cause NMDA receptor activation and induce intracellular cascades that result in activated protein kinase C feedback inhibition on available opioid receptors.<sup>59</sup> Tolerance is predominately a concept relative to analgesia, as a right shift in the dose-response curve occurs over time. Some side effects, such as sedation and cognitive slowing, seem to be less of an issue over time, sometimes resolving within the first 1–2 weeks of therapy and being less prominent than with other agents.<sup>24</sup> Tolerance is not seen with other side effects such as urinary retention or opioid-induced constipation, which can be an overwhelming problem with higher doses of these agents. This lack of tolerance to opioid-induced constipation is being addressed by efforts to develop the drug methylnaltrexone. Inherently a charged compound, methylnaltrexone may be able to block the peripheral actions of opioids (e.g., colonic opioid receptors) and may not be able to reverse central analgesic effects because of its inability to cross the blood-brain barrier.<sup>60</sup>

**Physical Dependence** Physical dependence implies a state of requirement for receptor occupancy to prevent a physiologic withdrawal syndrome after abrupt cessation of opioid agonist. This state of dependence occurs within days to weeks of starting the sustained delivery of a receptor-specific agonist. In contrast to withdrawal of alcohol, benzodiazepines, barbiturates, and other agents, withdrawal of opioids is rarely a life-threatening situation but nonetheless is symptomatic. Symptoms of opioid withdrawal include piloerection, nausea and vomiting, diarrhea, diaphoresis, agitation, dysphoria, nasal congestion, and seizure. Psychological dependence is more complex and implies that the patient has an expectation of withdrawal or a fear of lack of analgesia and therefore may resist efforts to taper opioid agents.

**Addiction** Addiction can be defined as a primary chronic neurobiologic

disease, with genetic, psychosocial, and environmental factors influencing its development and manifestations. It is characterized by one or more of the following behaviors: impaired control over drug use, compulsive use, continued use despite harm, and craving.<sup>61</sup>

**Pseudoaddiction** Weissman and Haddox<sup>62</sup> described a state in which patients who had been given drug doses that were inadequate to control their pain or who had abruptly stopped or were tapered too rapidly from a drug manifested what appeared to be drug-seeking behavior (consistent with addiction). However, in reality the patients simply were experiencing a normal reaction in response to pain that previously was well controlled but now had an acute exacerbation caused iatrogenically. These patients may seem to have significant knowledge of opioid agents and dosages that previously worked for them; thus, they appear to be drug seekers.

Equianalgesic dosing tables are commonly used to guide therapy with weak or potent opioids based on equivalent doses (Table 92–6). In clinical reality, most patients respond well to opioids dosed in this manner. Sometimes a disparity is observed upon switching to another opioid based on equivalency tables, but the results are generally both safe and “close” to the right dose. The equianalgesic dosing tables are universally used by pain specialists when switching from one drug to another. The referenced doses for these tables are based on single-dose administrations, so use of these tables for chronic dosing of opioid agents is unclear. Pereira et al.<sup>63</sup> reviewed the literature from 1966 to 1999 and determined that the literature lacked studies examining long-term dose ratios and that the published studies were not homogenous; wide ranges existed; methadone in particular was more potent than originally thought and correlated highly with the dose of previous opioid given; the ratios might change depending on the direction of change; and discrepancies existed with respect to fentanyl and oxycodone.

Many researchers have postulated that use of opioid agents in the future may be determined and administered based on pharmacogenomics. An individual's specific genome likely is better suited for specific agents based on

TABLE 92–6.

## Opioid Analgesics for Adults Age 15 Years or Older

Drug	IM Dose	IM Duration (Hours)	Starting Oral Dose	Comments
<b>Agonists Related to Morphine</b>				
Morphine	10 mg	3–6	15–30 mg	Available as 8 to 12 h sustained-release tablets ( <i>MS-Contin</i> , <i>Oramorph-SR</i> ), 12 to 24-sustained-release capsules ( <i>Kadian</i> -Nonformulary), and suppository Oral: Prompt release: 15–30 mg every 4 hours as needed; controlled release: 15–30 mg every 8–12 hours I/V PCA: Usual 1–3 mg, range 0.1–5 mg; lockout interval: usual 5–20 minutes; 4-hour lockout: usual range 10–30 mg, maximum 30 mg I/V, SC continuous infusion: 0.8–10 mg/h; may increase depending on pain relief/adverse effects
Hydromorphone ( <i>Dilaudid</i> , others)	1 mg	3–5	4–8 mg	Available as high-potency injectable ( <i>Dilaudid</i> -HP) and as suppository
Oxymorphone ( <i>Numorphan</i> )	1 mg	3–5	—	Available as suppository
<b>Agonists Related to Codeine</b>				
Codeine	15 mg	3–5	30–60 mg	60 mg PO equivalent to 650 mg of aspirin or acetaminophen; usually used orally in combinations with these drugs; some patients resistant to analgesic effect
Hydrocodone ( <i>Vicodin</i> , others)	—	—	5 mg	10 mg PO equivalent to codeine 80 mg PO; available in combinations
Oxycodone ( <i>Roxicodone</i> , others)	—	—	5 mg	10 mg PO equivalent to codeine 90 mg PO; available in combinations and as 12-h sustained-release tablets ( <i>OxyContin</i> )
<b>Synthetic Opioid Agonists</b>				
Meperidine ( <i>Demerol</i> , others)	50–100 mg	2–4	50 mg	Irritating to tissues IM; toxic metabolite with long half-life causes CNS excitation and convulsions
Fentanyl ( <i>Sublimaze</i> )	0.1 mg	1–2	—	Transdermal patch ( <i>Duragesic</i> ) for chronic pain releases fentanyl over 72 hours, possibly with less constipation than morphine; <i>Actiq</i> “Transmucosal system” FDA-approved for breakthrough pain
Methadone ( <i>Dolophine</i> , others)	10 mg	4–6	10–20 mg	Long half-life; risk of CNS depression with repeated use
Propoxyphene HCl ( <i>Darvon</i> , others)	—	—	65 mg	65 mg of HCl or 100 mg of napsylate PO equivalent to codeine 32 mg PO; available in combinations with acetaminophen or aspirin; toxic metabolite with long half-life causes convulsions and cardiotoxicity; not better than plain acetaminophen; use discouraged in the elderly
Levorphanol ( <i>Levodromoran</i> , others)	2 mg	4–6	2–4 mg	Long half-life; risk of CNS depression with repeated use
Tramadol ( <i>Ultram</i> )	—	—	50–100 mg q6h	50 mg equivalent to codeine 60 mg; 100 mg comparable to aspirin 650 mg plus codeine 60 mg
<b>Partial Agonists and Mixed Agonist/Antagonists</b>				
Buprenorphine ( <i>Buprenex</i> , others)	0.3 mg	4–6	—	Partial agonist; virtually no psychotomimetic effects; sublingual preparation effective
Pentazocine ( <i>Talwin-NX</i> , <i>Talacen</i> ) Nonformulary, use discouraged	60 mg	2–4	50 mg	Mixed agonist/antagonist; 60 mg PO equivalent to codeine 60 mg PO, very irritating to tissues; psychotomimetic effects; available in combinations with acetaminophen, aspirin or naloxone (to discourage IV drug abuse)
Butorphanol ( <i>Stadol</i> ) Nonformulary	1–2 mg	3–6	—	Mixed agonist/antagonist; nasal spray ( <i>Stadol NS</i> 1 mg/spray) comparable to IM injection
Nalbuphine ( <i>Nubain</i> , others)	10 mg	3–6	—	Mixed agonist/antagonist; less psychotomimetic effect than pentazocine
Dezocine ( <i>Dalgan</i> ) Nonformulary	10 mg	3–6	—	Mixed agonist/antagonist

CNS, central nervous system; FDA, Food and Drug Administration.

From Inpatient Pain Service Guidelines. MC4398. Mayo Foundation for Medical Education and Research. Mayo Foundation, 2001, with permission.

the expression of specific receptor characteristics, variations in metabolic processing, and other features. Cloning of opioid  $\mu$ -type receptors gives credence to this line of reasoning.<sup>64</sup>

### Opioids in Neuropathic Pain

Opioid use for many pain states is supported by randomized controlled drug studies showing efficacy. Although often characterized as an opioid-resistant type of pain, neuropathic pain syndromes may have the most hearty evidence for efficacy with opioid therapies.<sup>24,65–69</sup> Generally, the major neuropathic pain studies have examined patients with postherpetic neuralgia, painful diabetic peripheral neuropathy, or central pain syndromes, including postspinal cord injury and postcerebrovascular accident pain. For example, Watson and Babul<sup>65</sup> performed a randomized controlled trial involving 50 patients with postherpetic neuralgia and symptom duration of at least 3 months. In this study, 38 patients completed the study, which compared oxycodone tablets at a dose up to 30-mg controlled-release agent twice daily compared to placebo. Pain scores of patients showed improvement in pain relief of 2.9 points versus 1.8 points for the placebo group and a decrease in allodynia and steady and paroxysmal pain.<sup>65</sup> Raja et al.<sup>24</sup> compared the TCA agent amitriptyline to morphine or methadone in a total of 76 patients with postherpetic neuralgia symptoms of long duration. Three treatment periods were studied over 24 weeks, with administration of opioid, TCA, and placebo. Interestingly, although both the TCA and opioid groups had improvements in study end points, 54% of patients favored opioids compared to 30% who favored the TCA. Methadone is commonly thought to be superior to other opioids for treatment of neuropathic pain because of its dual action on  $\mu$ -opioid receptors as well as NMDA receptors, but this was not demonstrated in the study. In patients with intolerance to morphine, patients switched to methadone achieved doses of only 15 mg versus 91 mg for morphine. Reduction in pain intensity was less for methadone (1.2 points on a visual analogue scale compared to a pain scale reduction of 2.2 points with morphine). Another interesting finding of this study was that although most pain practitioners commonly attribute side effects

such as psychomotor and cognitive slowing to opioids, patients taking the TCA actually performed worse on pegboard placement skills and other tests of psychomotor skills.<sup>24</sup>

**NMDA Antagonists** With our enhanced understanding of the development of both peripheral and central sensitization (windup) and the role of excitatory amino acids acting at NMDA receptors, blockade of this central hyperalgesic response has assumed greater therapeutic importance. Likewise, use of NMDA blockers for opioid tolerance and opioid-induced hyperalgesia is a reasonable therapy. Currently available NMDA blockers include ketamine, methadone, dextromethorphan, amantadine, magnesium, and memantine.

**Methadone** Methadone, an opioid first synthesized in the mid-20th century, has become the agent most commonly used for management of long-term opioid addiction. Methadone is highly lipophilic and has high oral bioavailability. Unlike many modern formulated long-acting continuous relief opioids, it is inherently long-acting. The drug is a racemic mixture<sup>70</sup>; the D-isomer reverses morphine tolerance and blocks development of hyperalgesia thought to be mediated by NMDA receptor activation.<sup>71</sup> Methadone has tremendous utility for both treatment of neuropathic pain and management of cancer pain, predominantly as a second-line agent when other opioids become ineffective. The equianalgesic dosing ratio seems to increase with increasing opioid doses and may exceed 10:1 compared to morphine.<sup>72</sup> Dosing paradigms to change from other opioids<sup>73</sup> have been designed to more effectively load the drug and prevent respiratory depression secondary to methadone's prolonged pharmacologic actions. Possible side effects at high doses include QT-interval prolongation and a propensity to sudden cardiac death.<sup>74</sup> Patients receiving higher doses may be reasonably monitored for QT-interval prolongation.

**Ketamine** Ketamine, a noncompetitive antagonist at the NMDA receptor, has been found efficacious in the treatment of primary neuropathic pain and hyperalgesic states in both intravenous (IV) and oral applications. When used orally, the drug appears to work pri-

marily through its metabolite norketamine.<sup>75</sup> Psychomimetic effects appear to be most limiting, although the deleterious side effects were minimized at lower doses (40–60 mg/d) and when coupled with oral benzodiazepine therapy. Ketamine has been attempted as intermittent IV infusion for chronic neuropathic pain states such as postherpetic neuralgia<sup>76</sup> and for posttraumatic pain,<sup>77</sup> with some apparent efficacy. In a small study comparing ketamine to magnesium (another NMDA antagonist), ketamine administered IV at 0.3 mg/kg/h resulted in significant improvement in a group of patients with neuropathic pain, but magnesium did not reach significance.<sup>78</sup> Other NMDA agents have been used with inconclusive results. A double-blind, placebo-controlled trial of the agent memantine in postherpetic neuralgia patients did not show separation from the placebo group in terms of allodynia, spontaneous pain, or hyperalgesia; both groups improved. The authors concluded that the agent was ineffective in reducing postherpetic pain.<sup>79</sup> Dextromethorphan also has been studied, with inconclusive results. In a randomized, double-blind, controlled trial of two doses of dextromethorphan over a 10-day treatment period, no clinically significant difference between any of the tested outcome measures was observed.<sup>80</sup> Amantadine, better known as an agent for parkinsonism or influenza prophylaxis, is a noncompetitive NMDA antagonist and has been well tolerated from a side-effect profile. Intravenous infusion of amantadine was evaluated for treatment of surgical neuropathic pain (postmastectomy, postthoracotomy, postherniorrhaphy). Amantadine reduced both mean pain intensity and hyperalgesic “windup” pain on a statistically significant basis.<sup>81</sup>

Overall, the NMDA antagonists appear to have some therapeutic potential, but further well-designed randomized trials with larger numbers of patients are necessary to make conclusions. At this time, methadone and ketamine appear to have better evidence supporting their use.

### Clinical Rationale for Antiepileptic Drugs

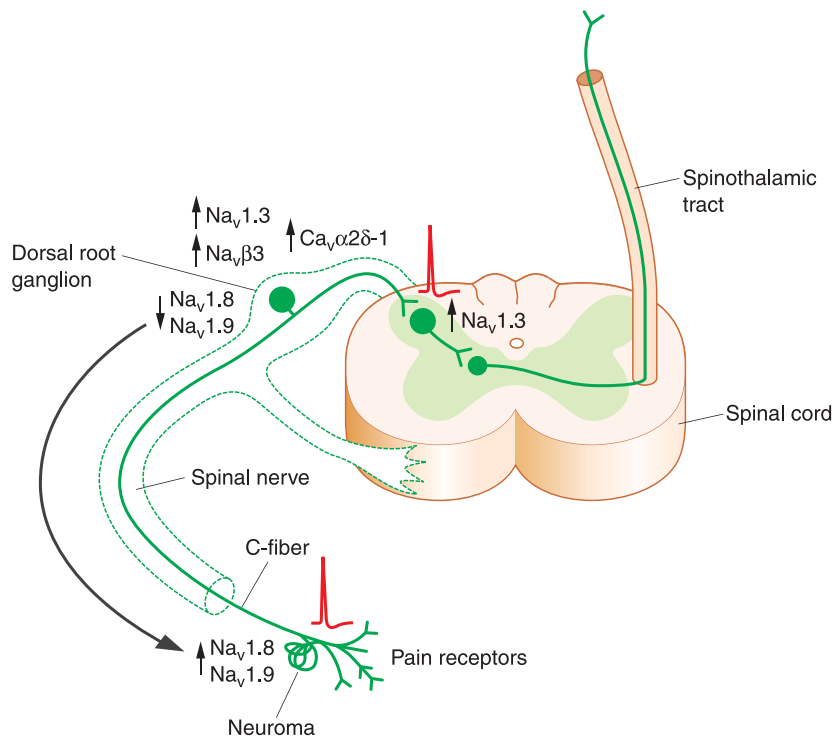
In neuropathic pain, changes in sodium channel expression lead to alterations and accumulation in sensory nerves and nociceptive neural path-

ways. Voltage-gated sodium channels have critical functions in the neuronal transmission of action potentials. They also play an important role in the genesis of neuropathic pain via an increase in neuronal excitability. For the development of neuropathic pain, complete expression of  $\text{Na}_v1.8$  seems to be necessary.<sup>82</sup> It appears that injured axons are functionally degraded and do not play a role in neuropathic pain. However, the role of neighboring C-fibers that are not injured appears to expand, with C-fibers playing an important role in the development of aberrant pain transmission (Fig. 92-7).

Thus, redistribution of the tetrodotoxin-resistant (TTX-R) sodium channels  $\text{Na}_v1.8$  and  $\text{Na}_v1.9$  to peripheral sites of injury is critical in the development of neuropathic pain. These sodium channel subunits congregate near the site of injury and result in spontaneous neural ectopic firing. Likewise, in addition to the  $\text{Na}_v1.8$  and  $\text{Na}_v1.9$  sodium channels,  $\beta 3$  is found in increased concentration at the site of nerve injury.  $\beta 3$  messenger RNA is found in increased concentration within these neurons. Neuropathic pain and epilepsy have functional similarities. In animal models of limbic epilepsy, sodium channel expression and upregulation of  $\text{Na}_v1.3$  were increased, and changes in  $\beta$  subunits occurred. Thus, the ability to pharmacologically block these redistributed, uninjured, unmyelinated C-fiber sodium channels may be the most useful approach to therapy for neuropathic pain caused by partial nerve injuries.

Calcium channels may be altered in neuropathic pain states. A commonly used neural constriction injury animal model shows that, after peripheral ligation injury, the  $\alpha_1\delta_1$  segment of the calcium channel is upregulated in dorsal ganglion neuropathy. This change is associated with the production of tactile allodynia (Table 92-7).<sup>83</sup>

Evidence indicates that neuronal-type voltage-gated calcium channels play a role in neuropathic pain induced by peripheral nerve injury. Agents have been developed for intrathecal use acting via the  $\omega$ -conopeptide, which is known to inhibit N-type voltage-gated calcium channels.<sup>84</sup> Gabapentin suppresses allodynia. Dorsal root ganglion  $\alpha_2\delta$  upregulation likely plays a significant role in the neuroplasticity of pain expression after peripheral nerve injuries and contributes to allo-



**FIGURE 92-7.** Injury to peripheral axons results in redistribution of tetrodotoxin-resistant sodium channel subunits ( $\text{Na}_v1.8$ ,  $\text{Na}_v1.9$ ) from normal areas, leading to spontaneous ectopic firing at sites of injury. Other sodium channel ( $\text{Na}_v\beta 3$ ) and calcium channel ( $\text{Ca}_v\alpha 21$ ) alterations also may cause increased neuronal activity. (Reprinted from Rogawski GA, Loscher W. The neurobiology of antiepileptic drugs for the treatment of nonepileptic conditions. *Nat Med* 2004;10:685–692, with permission.)

**TABLE 92-7.**

#### Neuropathic Pain States

Vascular	Postischemic myelopathy, central poststroke pain
Infectious	HIV myelopathy, CMV sensory neuropathy; Lyme disease neuropathy, postherpetic neuralgia
Metabolic/nutritional	Thiamine (beriberi) deficiency neuropathy, Niacin (pellagra) deficiency neuropathy, diabetic neuropathy, alcoholic neuropathy
Traumatic/iatrogenic	Postsurgical: postmastectomy syndrome, postnephrectomy syndrome, postthoracotomy syndrome; complex regional pain syndrome, phantom limb pain, brachial plexus avulsion injury; traumatic spinal injury; syringomyelia; postradiation myelopathy
Hereditary	Fabry disease, Guillain-Barré neuropathy
Toxic	Arsenic, thallium, mercury, others
Compressive	Spinal stenosis, foraminal stenosis, entrapment syndromes: carpal tunnel, cubital tunnel, tarsal tunnel, pronator teres, syndrome, others
Inflammatory	Radiculopathy, diabetic lumbosacral radiculoplexopathy, inflammatory demyelinating polyradiculopathy
Drug-induced	Cis-platinum, vincristine, paclitaxel (Taxol), isoniazid, stavudine, zalcitabine
Neoplastic	Nerve infiltration, brachial plexus compression (e.g., Pancoast tumor)
Idiopathic	Idiopathic sensory neuropathy, Multiple sclerosis, Parkinson disease

Neuropathic pain may be due to a variety of different causes, which may have treatment implications.

CMV, Cytomegalovirus; HIV, human immunodeficiency virus.



dynia development. Peripheral but not central axonal injury significantly up-regulates the expression of dorsal root ganglion  $\alpha_2\delta$  calcium channel subunits. These precede the onset of allodynia. Evidence also indicates that messenger RNA upregulation occurs after spinal nerve ligation. In a rat model, the L5–6 dorsal root ganglions ipsilateral to nerve injury showed a 6- to 7-fold increase of  $\alpha_2\delta$  expression at 7 days. Likewise, as recovery from tactile allodynia occurs, the upregulation in dorsal root ganglion  $\alpha_2\delta$  subunits diminishes.<sup>83</sup>

### Specific Anticonvulsant Agents

**Carbamazepine** Carbamazepine is a tricyclic compound chemically similar to imipramine. It is effective for treatment of trigeminal neuralgia and has long been the drug of choice.<sup>85</sup> It also has been found useful for treatment of manic-depressive illness and seizures.<sup>86</sup> No studies have compared imipramine to other recently released anticonvulsants for treatment of trigeminal neuralgia. The drug acts chiefly by blocking sodium channels and is thought to be most useful for treatment of shooting or lancinating types of pain. In experimental neuromas, peripherally located ectopic discharges are suppressed within the typical ranges of serum concentrations.<sup>87</sup> In patients, dosing generally begins at 100–200 mg/d and can be titrated very slowly (4–8 weeks) up to 1200 mg/d. Significant side effects can occur, including agranulocytosis, aplastic anemia, hepatic function abnormalities, and Stevens-Johnson syndrome. The chief drawback to use of carbamazepine is poor tolerability in elderly patients, often related to diplopia, sedation, and ataxia. In particular, combining carbamazepine with structurally similar agents (such as TCAs) may enhance sedating side effects.<sup>86</sup> Drug interactions may occur due to carbamazepine induction of hepatic microsomal enzymes. Monitoring of carbamazepine should include baseline serum hepatic function tests, complete blood counts, and serum sodium, with particular screening for complications in the first 4–6 months of therapy. Carbamazepine is commonly used for treatment of diabetic peripheral neuropathy and other neuropathic pain conditions.<sup>88,89</sup> Table 92–8 compares various anticonvulsant therapies for neuropathic pain,

TABLE 92–8.

Anticonvulsant Therapies for Neuropathic/Headache Pain

Drug	Neuropathic Pain	Trigeminal Neuralgia	Migraine Prophylaxis
Phenytoin	+	++	0
Carbamazepine	++	++	0
Oxcarbazepine	++	+	0
Lamotrigine	++	++	+
Zonisamide	+	0	+
Valproate	+	+	++
Topiramate	+	+	++
Gabapentin	++	+	++
Levetiracetam	++	0	+
Benzodiazepines	+	+	0
Tiagabine	+	0	+
Pregabalin	++	?	?

Reprinted and modified from Rogawski MA, Loscher W. The neurobiology of antiepileptic drugs for the treatment of nonepileptic conditions. *Nat Med* 2004; 10:685–692, with permission from Macmillian Publishers Ltd.

migraine headache, and trigeminal neuralgia.

**Oxcarbazepine** Oxcarbazepine is an antiepileptic drug chemically similar to carbamazepine. The drug acts at voltage-gated sodium and calcium channels to block epileptiform or ectopic discharges. The major clinical advantage to carbamazepine may be the requirement for less frequent serum monitoring. Although carbamazepine may induce agranulocytosis, hyponatremia, and hepatic function abnormalities, it appears that hyponatremia is the only reason for ongoing generalized serum monitoring of this agent. An open-label, 9-week trial of 30 patients with diabetic painful neuropathy demonstrated improvement of patients' visual analogue pain scores of 29 points (48.3%), with side effects of dizziness and drowsiness. Other studies have demonstrated improvements in pain with use of oxcarbazepine.<sup>90–92</sup> Additional randomized controlled studies with oxcarbazepine are needed to reliably predict the effects of this agent in various pain syndromes.

**Topiramate** Topiramate is an interesting substituted monosaccharide agent that is significantly different from other anticonvulsant drugs. Topiramate has three main mechanisms of action. Like other anticonvulsants, the drug is a sodium channel blocker, with some action at voltage-gated calcium

channels. It can potentiate  $\gamma$ -aminobutyric acid (GABA)-mediated inhibition at separate sites from the benzodiazepines. Interest also has focused on its action at the kainate and  $\alpha$ -amino-3-hydroxy-5-methylisoxazole-4-propionic acid (AMPA) receptors, where it can decrease excitatory amino acid (glutamate) neurotransmission. Topiramate has found its greatest usage in headache therapy as a preventative agent for migraine headache. Large trials have demonstrated significant decreases in migraine headache prevalence when the drug has been used as a preventative agent.<sup>93,94</sup>

Three randomized controlled trials of topiramate for painful diabetic neuropathy did not support a statistically significant difference between topiramate and placebo in visual analogue scores or any of the secondary efficacy end points.<sup>95</sup> However, pain reductions were numerically greater in the topiramate study groups in two of the studies. Patients were allowed rescue analgesia throughout this study, and it was believed that this may have confounded the results. In another randomized controlled trial, patients with painful diabetic neuropathy were found to have evidence of analgesia with topiramate. In this study, rescue analgesia was permitted only for a 6-week period. The major findings of the study were that pain visual analogue scores decreased from 68 to 46.2 in the topiramate groups versus a decrease from 69 to 54 in the placebo group (*P*

<.003). Fifty percent of the topiramate patients versus 34% of the placebo patients had a >30% response.<sup>96</sup> The other notable finding was that topiramate reduced body weight significantly versus placebo. The weight loss had no adverse effect on serum glycemic control of diabetic patients. Topiramate has been used in diet clinics to aid weight loss and has been used for essential tremor, binge eating disorders, and bipolar disorder.<sup>96</sup> In a study of patients taking topiramate for epilepsy, weight reduction was maintained in 86% of patients despite a return of caloric intake to normal baseline levels. Obese patients appeared to develop reductions in weight of greater magnitude than patients who were not obese.<sup>97</sup> Thus, it appears that topiramate is potentially an ideal agent for patients with obesity, diabetes, and painful neuropathy or migraine.

Topiramate is generally started at 25 mg at night and ramped higher every 1–2 weeks on a twice-daily schedule to a target dose of 200–400 mg/d. Patient side effects are frequent and include cognitive slowing, somnolence, nervousness, fatigue, dizziness, and diar-

rhea.<sup>96</sup> As with all anticonvulsants, female patients with the potential for pregnancy should be using birth control because of the risks of teratogenicity and altered effectiveness of birth control pills.<sup>96</sup>

**Gabapentin** Gabapentin is a GABA analogue that binds to the  $\alpha_2\Delta_1$  ligand of voltage-sensitive neuronal calcium channels.<sup>98</sup> There is no evidence that it functions through GABA-mediated actions despite its structural similarity with GABA. Gabapentin is approved by the FDA for adjunctive therapy of tonic-clonic and partial seizures and for postherpetic neuralgia at doses of 1800 mg or more. Early case series showed the drug had some efficacy in other neuropathic pain syndromes, including complex regional pain syndrome.<sup>99</sup> Subsequently, several excellent-quality randomized studies demonstrated the efficacy of gabapentin for a variety of neuropathic pain syndromes (Tables 92–8 and 92–9).<sup>100–105</sup>

Backonja et al.<sup>100</sup> found that gabapentin was effective for the symptomatic treatment of neuropathic pain in patients with diabetes mellitus. The study compared 70 patients who re-

ceived gabapentin and 65 who completed the study in the placebo group. Using an intent-to-treat analysis, gabapentin-treated patients had significantly lower mean daily pain scores ( $P < .001$ ) compared to placebo patients. Pain scores decreased in the active gabapentin group from 6.4 at baseline to 3.9 compared to baseline scores of 6.5 versus 5.1 at end in the placebo group. Additionally, secondary outcome measures were significantly better in the gabapentin group, including the Short-Form 36 (SF-36) quality-of-life questionnaire and profile of mood states. Similar to other anticonvulsants, gabapentin should be titrated slowly to maximum doses of 3600 mg/d, usually dosed on a 3–4 times per day schedule secondary to the short half-life of 5–8 hours.<sup>96</sup> Gabapentin is not metabolized, and, unlike carbamazepine, it does not induce hepatic enzymatic function. It is eliminated by the kidneys, and dosage should be reduced according to creatinine clearance in renally impaired patients. Adverse events include somnolence, peripheral edema, memory loss (usually high doses), dry mouth, dizziness, and nausea.

TABLE 92–9.

## Pharmacologic Therapy for Neuropathic Pain in Peripheral Neuropathy

Medication	Starting Doses	Maintenance Doses and Comments
<b>First Line</b>		
Gabapentin	100–300 mg TID	↑ by 300 to 400 mg increments every 5 to 7 days to 3600 mg daily divided in 3–4 doses
Tricyclic anti-depressants	10–25 mg qhs	↑ by 10 to 25 mg increments every 7 days to 100–150 mg qhs; titration can continue following blood levels (stay below 500 ng/mL) and ECG
Tramadol	50 mg QD or BID	↑ by 50-g increments every 5–7 days to a maximum of 100 mg QID
<b>Second Line</b>		
Lamotrigine	25 mg GD or BID	After 2 weeks, ↑ by 25-mg increments weekly to 100–200 mg/BID
Carbamazepine	100–200 mg QD or BID	↑ by 100–200 mg every 7 days to 600 mg QD in divided doses; titration can continue following blood levels; extended release forms can be given on BID schedule
Bupropion SR	150 mg QD	After 1 week, ↑ to 150 mg BID
Venlafaxine XR	75 mg QD	↑ by 75-mg increments every 7 days to 150–225 mg QD
Opiate analgesics	Varying doses; initiate with short-acting agent QID PM	After 1–2 weeks, replace with longer-acting agent on QD or BID schedule; careful titration is necessary
<b>Topical Agents</b>		
Capsaicin 0.075%	Apply TID or QID	Continue with starting dose; may be considered

From Sindrup and Jensen<sup>28</sup> with permission.

**Pregabalin** Pregabalin is an agent that causes inhibition at the neuronal calcium ion channel. This mechanism of action and its molecular structure are similar to gabapentin, which has perhaps become the first-line, broad-spectrum agent used for many painful neuropathic syndromes. Pregabalin has been found to selectively bind at the  $\alpha_2\delta_1$  subunit, an auxiliary protein commonly associated with voltage-gated calcium channels.<sup>98</sup>

Pregabalin binding causes reduction of calcium influx and neurotransmitter release, including substance P, glutamate, and noradrenaline.<sup>106</sup>

In a randomized, double-blind, controlled trial, patients received either placebo, 150 mg or 300 mg daily of pregabalin, and primary end points included decreased mean pain scores, health-related quality of life, and SF-36 health survey scores. Overall, patients with postherpetic neuralgia had significantly lower pain scores and less sleep interference.<sup>107</sup> In another group of patients with painful diabetic peripheral neuropathy, a placebo-controlled trial demonstrated significant improvements in pain scores and sleep interference.<sup>108</sup> Pregabalin may be better tolerated than gabapentin, and less dose titration is necessary. Pregabalin has been reported to cause symptoms of somnolence, dizziness, and peripheral edema, which are similar to side effects reported with gabapentin.<sup>108</sup> Drug dosage can be started at 50 mg twice or three times daily and increased to 100 mg three times daily by 1 week. The drug has been scheduled for both diabetic peripheral neuropathy and postherpetic neuralgia by the FDA. Dosages should be reduced for renal impairment based on creatinine clearance similar to gabapentin.

**Levetiracetam** Levetiracetam is a novel oral antiepileptic drug with structural features unrelated to those of other antiepileptic drugs. Most antiepileptic drugs are screened for inhibition of epileptiform activity by maximal electroshock or pentylenetetrazol seizure induction. Levetiracetam antiepileptic action seems to occur via inhibition of neuronal hypersynchronization.<sup>109</sup> Levetiracetam appears to have minimal interactions with other agents. It causes occasional increased drowsiness and cognitive dysfunction and may place patients at risk for driving or other activities exacerbated

by cognitive dysfunction or altered wakefulness. It has a low protein binding (<10%) and is not hepatically metabolized.<sup>86</sup> Small case series have described three patients who achieved partial or complete relief of pain related to sensory motor peripheral neuropathy.<sup>110</sup> At this time, levetiracetam-controlled studies are limited, and no comparison studies exist for other more commonly used antiepileptic drugs.

**Lamotrigine** Lamotrigine is thought to act similarly to phenytoin in decreasing rapid firing of neurons. It causes use-dependent inhibition of voltage-gated sodium channels.<sup>86</sup> Several studies have demonstrated the efficacy of lamotrigine in a variety of pain syndromes, but because of side effects it is generally relegated to second-line therapy.

In a randomized controlled study of 59 patients with painful diabetic neuropathy, lamotrigine was titrated from 25 mg/d up to 400 mg/d over a 6-week period compared to similar titration of placebo. The lamotrigine group improved compared to the placebo group, and the authors concluded lamotrigine was both safe and effective.<sup>111</sup> Lamotrigine also has been studied in HIV-associated neuropathy, with a small improvement seen compared to the placebo group. In this study, the titration schedule was very slow and similar to that used in other studies, beginning at 25 mg/d up to 300 mg/d over 7 weeks. Despite the gradual titration, the dropout rate was high, with 5 of the 13 dropouts from a sample of 42 patients citing rash.<sup>112</sup> Among a group of 14 patients with refractory trigeminal neuralgia, those given lamotrigine improved significantly better than those on placebo. Although the patients already were taking either phenytoin or carbamazepine, these drugs were continued during the study. The one patient who withdrew from the study did so during the placebo arm of this crossover design.<sup>113</sup>

In a randomized, double-blind, placebo-controlled crossover study, lamotrigine was given to 30 patients with spinal cord injury pain syndromes. The drug was titrated from an initial 25 mg/d dosage up to 400 mg/d over a 9-week period, compared to a 9-week placebo titration. There was a 2-week washout period between each arm of the study. Twenty-two patients com-

pleted the trial. Daily numerical pain scale in the group treated with lamotrigine was reduced from  $6.4 \pm 0.1$  to  $4.2 \pm 0.1$ , and numerical pain scales decreased from  $6.5 \pm 0.1$  to  $5.3 \pm 0.1$  in the control group. The difference between groups was statistically significant ( $P < .001$  at lamotrigine doses of 200–300 and 400 mg). The primary finding of this study was that, in patients with incomplete spinal cord injuries, lamotrigine significantly reduced the pain at the same level of injury or below the level of injury. Patients who had evidence of central sensitization (windup pain) and brush-evoked allodynia were more likely to have a positive response to lamotrigine. The drug appeared to have no effect in patients with complete spinal cord injuries. The drug was generally well tolerated.<sup>114</sup>

Lamotrigine most notably has been associated with the development of Stevens-Johnson syndrome (a severe exfoliating dermatitis that can be a dermatologic emergency). Pediatric patients may be most prone to these dermatologic complications, which may be seen in up to 1–2% of patients in that age group.<sup>86</sup> Significant evidence now indicates that lamotrigine has a role in the treatment of various neuropathic pain syndromes, but side effects (particularly rash) must be closely monitored and a slow titration schedule adhered to.

**Tiagabine** Tiagabine has not been studied in a randomized fashion for treatment of pain syndromes. Tiagabine is an inhibitor of the GABA transporter protein GAT-1. It also acts as a GABA reuptake inhibitor, thus increasing available GABA within neuronal synapses and surrounding glia.<sup>86</sup> An open-label study of tiagabine compared to gabapentin in 91 patients with chronic pain suggested that both drugs were efficacious.<sup>115</sup> Notably, the effects of tiagabine on sleep quality in this study suggest that it may have utility for patients who have both pain and sleep disturbances. Further randomized studies will clarify its role in pain management.

**Phenytoin** Phenytoin has been used for several decades for treatment of epilepsy, cardiac arrhythmias, and various pain syndromes. Phenytoin alters  $\text{Na}^+$ ,  $\text{Ca}^{2+}$ , and  $\text{K}^+$  conductance and inhibits repetitive high-frequency

discharges.<sup>86</sup> Phenytoin was used in a study of 40 patients with painful diabetic neuropathy who received either the active drug 100 mg three times per day or placebo for 2 weeks, followed by a 1-week washout period prior to crossing over to the other group. In group 1, 70% of the phenytoin patients versus 25% of the placebo patients had improved pain. In group 2, similarly 78% of the phenytoin patients had improved pain compared to 28% of the placebo patients. Nearly one fourth of the phenytoin patients had complete relief.<sup>116</sup> Although phenytoin is cost effective, it does have significant side effects, including gingival hyperplasia, hirsutism, and rash. Long-term use can result in peripheral neuropathy.<sup>86</sup> One advantage of phenytoin is its availability in IV form. A study of IV infusion of 15 mg/kg phenytoin in

patients with neuropathic pain resulted in significant improvement of several features of altered nerve conduction (shooting pain, burning pain, sensitivity, and numbness). The author concluded that IV phenytoin could be useful for acute flares of pain (Table 92-10).<sup>117</sup>

### Topical Agents

During a 1-week open-phase segment of a pilot trial studying the analgesic efficacy of a topical formulation of 1% amitriptyline and 0.5% ketamine, 11 patients had a significant analgesic effect for a variety of different neuropathic pain syndromes, including postherpetic neuralgia and painful diabetic peripheral neuropathy. In a followup of this initial pilot trial, 92 patients with mixed neuropathic pain syndromes, including postherpetic

neuralgia, postsurgical, posttraumatic neuropathic pain, and diabetic neuropathy with evidence of allodynia, hyperalgesia, and pinprick hypesthesia, were randomly assigned to receive placebo, 2% amitriptyline, or 1% ketamine, combined with a primary outcome measure of change in average daily pain intensity.<sup>118</sup> Unfortunately, a reduction in pain score of 1.1–1.5 units was observed in all groups, and there were no differences between the groups. Blood concentrations showed no significant systemic absorption. Other studies have shown that higher doses may be required to produce significant analgesia.<sup>119</sup> This abstract detailed a comparison of high-dose amitriptyline–ketamine (4% amitriptyline/2% ketamine) cream for 1 week. Of the 129 subjects who responded, 118 patients were randomized

**TABLE 92-10.**

Number Needed to Treat to Obtain One Patient with More than 50% Pain Relief

	Painful Neuropathy	Postherpetic Neuralgia	Peripheral Nerve Injury	Central Pain	Trigeminal Neuralgia
<b>Antidepressants</b>					
Antidepressants all types	3.0 (2.4–4.0)	2.3 (1.7–3.3)	2.5 (1.4–10.6)	1.7 (1.1–3.0)	ND
TCA all types	2.4 (2.0–3.0)	2.3 (1.7–3.3)	2.5 (1.4–10.6)	1.7 (1.1–3.0)	ND
TCA serotonergic/noradrenergic	2.0 (1.7–2.5)	2.4 (1.8–3.9)	2.5 (1.4–10.6)	1.7 (1.1–3.0)	ND
TCA noradrenergic	3.4 (2.3–6.6)	1.9 (1.3–3.7)	ND	ND	ND
Optimal dose	1.4 (1.1–1.9)	ND	ND	ND	ND
SSRI	6.7 (3.4–435)	ND	ND	NA	ND
<b>Ion Channel Blockers</b>					
Mexiletine	10.0 (3–∞)	ND	ND	NA	ND
Phenytoin	2.1 (1.5–3.6)	ND	ND	ND	ND
Carbamazepine	3.3 (2–9.4)	ND	ND	3.4 (1.7–105)	2.6 (2.2–3.3)
Lamotrigine	ND	ND	ND	ND	2.1 <sup>a</sup> (1.3–6.1)
Gabapentin	3.7 (2.4–8.3)	3.2 (2.4–5.0)	ND	ND	ND
<b>NMDA Antagonists</b>					
Dextromethorphan	1.9 (1.1–3.7)	NA	ND	NA <sup>b</sup>	ND
Memantine	ND	NA	ND	ND	ND
<b>GABAB Agonist</b>					
Baclofen	ND	ND	ND	ND	1.4 <sup>c</sup> (1.0–2.6)
<b>Opioids</b>					
Oxycodone	ND	2.5 <sup>d</sup> (1.6–5.1)	ND	ND	ND
Tramadol	3.5 (2.3–6.4)	ND	ND	ND	ND
<b>Various</b>					
Levodopa	3.4 (1.5–∞)	ND	ND	ND	ND
Capsaicin	5.9 (3.8–13)	5.3 (2.3–∞)	3.5 (1.6–∞)	ND	ND

In case of more than one study on a drug in the pertinent pain type, number needed to treat is calculated for combined data.

<sup>a</sup>Add on therapy to carbamazepine.

<sup>b</sup>Low dose of dextromethorphan.

<sup>c</sup>Add on therapy to carbamazepine or phenytoin in 4 of patients.

<sup>d</sup>For 30% of patients, add-on therapy to tricyclic antidepressants.

NA, not active; ND, not done; TCA, tricyclic antidepressants; SSRI, selective serotonin reuptake inhibitors.

From Sindrup and Jensen TS<sup>28</sup>, with permission.



to receive either high-dose (4% amitriptyline/2% ketamine) or low-dose (2% amitriptyline/1% ketamine) cream, or a placebo cream for 2 additional weeks. After 3 weeks of treatment, results showed the high-dose group had average daily pain intensity that decreased from 6.5 to 3.28 versus the placebo pain intensity score of 4.34. There was no difference between the placebo and the low-dose group. The percentage of subjects with 30% reduction was superior to placebo for patient sleep quality and global satisfaction. Plasma levels were detectable in <10% of subjects and were well below therapeutic levels. Topical cream was well tolerated. This finding may imply that, compared to the study by Lynch et al.,<sup>118</sup> higher concentrations of amitriptyline–ketamine cream are required to produce analgesia for mixed neuropathic pain syndromes.

Older topical agents for treatment of neuropathic pain include capsaicin. A multicenter, double-blind, vehicle control study was conducted by the capsaicin study group.<sup>120</sup> The trial was conducted over 8 weeks, and either capsaicin or vehicle cream was applied to painful areas four times per day. Pain intensity and relief were recorded every 2 weeks using the physician's global evaluation as well as visual analogue pain scales. Two hundred fifty-two patients were studied. Capsaicin showed 69.5% versus 53.4% improvement according to the physician's global evaluation scale, and 38.1% versus 27.4% decrease in pain intensity (Tables 92–9 and 92–10). Other studies have also demonstrated efficacy for chronic postherpetic neuralgia.<sup>121</sup> As in previous studies, initial burning at the application site was noted. The mechanism of action of capsaicin is depletion of substance P at peripheral thermal receptors, a process that can take several weeks. Over the past decade, capsaicin has been used less frequently by pain physicians secondary to poor tolerance of the drug when used by patients with postherpetic neuralgia and other peripheral neuropathic conditions.

### **Intravenous Analgesics**

**Intravenous Lidocaine Therapy**  
IV lidocaine has been used for the last 2 decades for the control of predominantly neuropathic pain syndromes. Intravenous lidocaine is generally given via a 1 mg/kg bolus and infusion

of 4 mg/kg over 30–60 minutes. Intravenous lidocaine for phantom and stump pain was compared to morphine infusion, but lidocaine IV infusion was effective only for stump pain.<sup>69</sup> In an animal model, systemic lidocaine suppressed aberrant impulses at the dorsal root ganglia and at sites of experimentally induced nerve injuries. Minimal affect was seen on normal sensory conduction. ED<sub>50</sub> was lower at dorsal root ganglia sites.<sup>122</sup> Local anesthetics administered systemically also depress evoked unmyelinated C-fiber activity in the dorsal cord.<sup>123</sup> In another study comparing the effects of systemic lidocaine to morphine, both agents relieved the pain of postherpetic neuralgia.<sup>68</sup>

In a study by Finnerup et al.,<sup>124</sup> IV lidocaine was found to significantly reduce spontaneous pain in all patients either with or without evoked pain. There was no difference in the number of responders. Both spinal cord injury pain at and below the level of injury as well as brush-evoked dysesthesia were relieved. The authors concluded that agents with systemic sodium channel blocking properties may be treatment options for spinal cord injury pain. IV lidocaine also has been studied for painful chronic diabetic neuropathy pain, with positive results.<sup>125,126</sup> Mexiletine, an oral class IB antiarrhythmic drug, also has been used for pain relief and is thought to have oral lidocaine-like activity. Galer et al.<sup>127</sup> studied a small group of patients receiving one of two IV lidocaine doses. Although the higher dose of IV lidocaine was more analgesic, both doses were highly correlated with mexiletine responsiveness. The authors concluded that IV lidocaine could be used as a predictor of ultimate response to mexiletine. Previous studies have demonstrated that oral mexiletine is helpful for painful diabetic neuropathy, particularly in reducing symptoms such as burning and stabbing.<sup>128</sup> Mexiletine can be limited by intolerance to the drug, particularly abdominal symptoms and nervousness/tremor in some patients. Dosing should begin with 150 mg twice daily or less, with a goal of at least 10 mg/kg (Table 92–10).

### **Combination Therapy**

Few trials have examined the combination of different antinociceptive agents either from the same class (i.e.,

antiepileptic drugs) or from multiple classes (pairing opioids, antiepileptic drugs, and antidepressant agents). Although most of these medications have numbers needed to treat of 3 or greater,<sup>28</sup> therefore necessitating a multimodal analgesic approach, the rationale for combination therapies has not been adequately studied. A study by Gilron et al.<sup>67</sup> evaluated patients with diabetic neuropathy or postherpetic neuralgia, comparing gabapentin, morphine, or the combination of both drugs versus placebo. The study demonstrated a reduction in mean daily pain from 5.72 at baseline to 3.06 with the gabapentin–morphine combination. Both agents were analgesic. At the maximal tolerated doses, the combination was well tolerated but did produce higher frequencies of dry mouth and constipation for gabapentin and morphine, respectively. The authors concluded that there was merit to additional trials of this type comparing combinations of antinociceptive agents as a multimodal approach to pain control. Number needed to treat evaluations can be important in determining the relative effects of different pharmacologic treatments. In a review, Sindrup and Jensen<sup>28</sup> reported numbers needed to treat of various agents in different classes. The comparison is useful in choosing an agent(s) that has high efficacy and is safe, based on numbers needed to harm analysis (Table 92–10).

### **Skeletal Muscle Relaxants**

Skeletal muscle relaxants include a disparate group of medications with multiple modes of action. *Benzodiazepines* include drugs such as diazepam and clonazepam. These agents act to depress the central nervous system via the chloride channel component of the inhibitory neurotransmitter GABA receptor. Benzodiazepines have broad effects on patients, including functioning as anxiolytics, sedatives, and relaxants. Diazepam, as a prototypical benzodiazepine, has rapid onset of action with a prolonged half-life, high lipophilicity, and high protein binding.<sup>129</sup> Although generally not considered potent analgesics in their oral/parenteral forms, research has focused on their use as intrathecal drugs where they are quite analgesic.<sup>130</sup> Clonazepam has perhaps the most robust evidence for conventional oral or topical forms for conditions such as burning mouth pain and

other facial neuropathic pain syndromes/trigeminal neuralgia.<sup>131</sup> Clonazepam is perhaps the agent of choice as an inhibitor of myoclonic jerking that can be frequently seen in high-dose opioid patients.<sup>132</sup>

Tizanidine, an  $\alpha_2$ -adrenergic agonist chemically, has been used for painful spasm and headache prophylaxis.<sup>133</sup> The drug initially was marketed for control of spasticity in association with brain injury<sup>134</sup> and has been found useful in controlling spastic hypotonia as measured by Ashworth scale improvement.

Baclofen, a GABA<sub>B</sub> agonist used for spasticity, has found limited utility for control of neuropathic pain. Three subtypes of the GABA receptor have been described: GABA<sub>A</sub>, GABA<sub>B</sub>, and GABA<sub>C</sub>. GABA<sub>B</sub> receptors are primarily located in the lamina I-III area of the dorsal spinal cord.<sup>135</sup> A small trial of oral baclofen given to 15 patients compared the effects of the racemic mixture of baclofen versus the levorotatory form alone and noted greater improvement in patients who received the levorotatory form than in patients treated with the mixed form.<sup>136</sup> A comprehensive review of intrathecal baclofen use indicates several reports of analgesic effects of baclofen in animals and humans.<sup>135</sup>

More conventionally used oral muscle relaxants include agents such as cyclobenzaprine, methocarbamol, orphenadrine, metaxalone, and carisoprodol. Of these agents, cyclobenzaprine has perhaps the best evidence for efficacy in pain control. Chiefly, cyclobenzaprine has been compared to ibuprofen as therapy for acute neck and back pain in a randomized trial.<sup>137</sup> In this study, the combination of ibuprofen with cyclobenzaprine provided no advantage over cyclobenzaprine alone. A review of the use of three commonly prescribed muscle relaxant agents—carisoprodol, cyclobenzaprine, and metaxalone—demonstrated that these agents represent 45% of all prescriptions for musculoskeletal pain. The review concluded that all were effective, some based on good randomized trial evidence, particularly for cyclobenzaprine. Unfortunately, although carisoprodol represented 13.3% of all prescriptions, its utility is significantly limited by its abuse potential.<sup>138</sup> Carisoprodol blocks descending reticular formation interneuronal activity and is metabolized to meproba-

mate. Meprobamate is a potent anxiolytic and sedative agent with a high propensity for physical and psychological dependency, which ultimately led to the parent drug's removal from the market. Meprobamate is similar in function to barbiturates.<sup>139</sup> The danger of the effects of carisoprodol on driving have been detailed, with more of the impaired drivers manifesting higher blood carisoprodol levels. Impairment appeared to mimic that seen with benzodiazepine use but with several other manifestations, including horizontal nystagmus, hand tremor, and involuntary movements.<sup>140</sup>

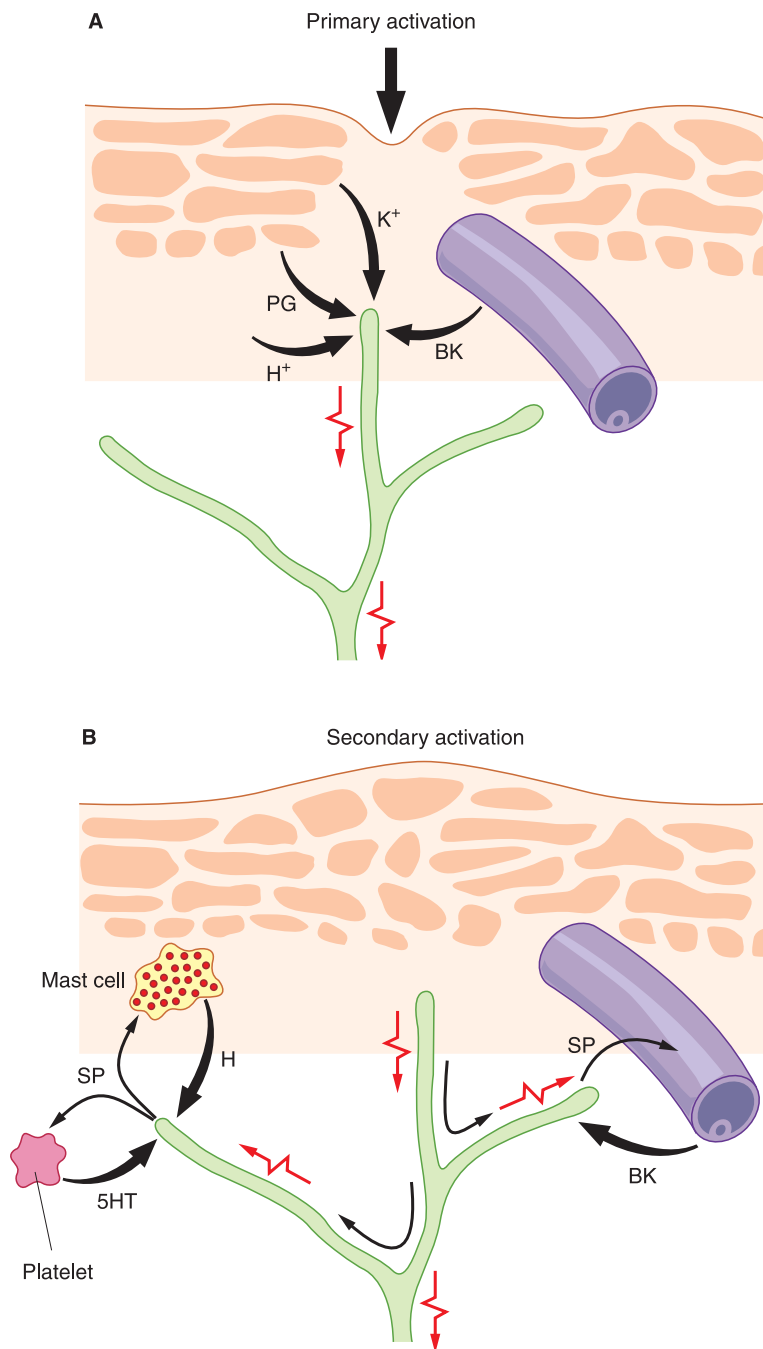
### **Nonsteroidal Antiinflammatory Drugs**

NSAIDs are used on a daily basis by millions of people and on an occasional basis by many more. The proportion of patients using NSAIDs is nearly 4-fold higher in an older age group compared to a younger group.<sup>141</sup> In a study of 3154 elderly patients in Italy, 24.7% were taking NSAIDs, one third chronically.<sup>142</sup> As the percentage of baby-boomer Americans older than 65 years advances in the next two decades, the number of patients taking these agents likely will continue to expand. NSAIDs are commonly and appropriately used for many acute pain syndromes, including traumatically induced pain, surgical pain, pain from sprains and strains, temporomandibular joint pain, some headaches, menstrual cramping/dysmenorrhea, and some chronic conditions such as rheumatoid arthritis, seronegative arthritides, osteoarthritis, and other painful states. The ultimate goal of therapy with NSAIDs is to decrease inflammation, harness any ongoing tissue destruction, prevent peripheral sensitization of nociceptors by locally released inflammatory factors (bradykinin, histamine, substance P; Fig. 92-8), provide analgesia during restorative healing, and to do so without causing concomitant gastrointestinal injury, renal effects, or cardiovascular thrombotic events. The major mechanism of NSAID action occurs by arresting the action of COX enzyme breakdown of arachidonic acid precursors. The COX enzyme is involved in the synthesis of cyclic endoperoxides from these arachidonic acid precursors to prostaglandins (Fig. 92-9). Prostaglandins have varied effects, often as proinflammatory substances, as well as generation of a

gastric mucus membrane protective barrier and modulation of renal plasma flow and electrolyte balance. Two isoforms of the COX enzyme exist: COX-1 and COX-2. The COX-1 enzyme normally is present or constitutive and functions in homeostasis, as in the gastric mucosa. One of the main side effects of prolonged NSAID use is gastric ulceration related to inhibition of COX-1 activity. The COX-2 form of the enzyme is constitutive in the central nervous system and renal tissues but is inducible at sites of pain and inflammation. Efforts to block the inducible form of the enzyme at sites of peripheral inflammation (i.e., COX-2) led to the introduction of COX-2-selective NSAIDs in the last decade.<sup>143</sup>

The COX-2-specific agents had demonstrated lower risks of gastric ulceration compared to nonspecific COX agents, but all COX inhibitors have a propensity to cause gastrointestinal bleeding depending on dose and duration of therapy. Platelet aggregation is permanently affected with aspirin, which irreversibly acetylates platelet COX. The older nonacetylated salicylates, such as salsalate and magnesium choline salicylate, as well as the selective COX-2 blockers appear to have less effect on platelet function.<sup>143</sup> Thus, some NSAIDs and aspirin, in particular, may react adversely with other anticoagulant agents (e.g., warfarin).

Unfortunately, the apparent effects of increased cardiovascular risk have led to the withdrawal from the U.S. market of two COX-2 selective drugs (rofecoxib and valdecoxib) and have derailed the ultimate availability of an IV COX-2 form of valdecoxib (parecoxib). Celecoxib, which is much less selective for the COX-2 isoform than are rofecoxib and valdecoxib, remains available. It is thought that, to some extent, all NSAIDs as a class may have deleterious effects on the cardiovascular system. Therefore, use of these agents for prolonged periods, particularly by chronic pain patients, should be done with utmost caution and with appropriate balancing of risks versus benefits. An initial study investigated the risks of rofecoxib compared to naproxen was performed (Vioxx Gastrointestinal Outcomes Research [VIGOR]).<sup>144</sup> In the VIGOR study, 8000 patients with rheumatoid arthritis were treated with rofecoxib 50 mg/d or naproxen 1000 mg/d. A statistically significant increase in non-



**FIGURE 92-8.** A. Release of local factors at the site of tissue injury causes primary activation of nociceptors. Release of prostaglandins (PG), bradykinins (BK), hydrogen ion (H<sup>+</sup>), and potassium (K<sup>+</sup>) contributes to ongoing pain and inflammation. B. Release of platelet 5-HT (serotonin) and mast cell histamine, other peptides (substance P), and bradykinin (BK) leads to peripheral sensitization of the nociceptor. (From Pain: pathophysiology and management. In Kasper DL, Braunwald E, Fauci AD, et al., eds. *Harrison's Principles of Internal Medicine*. 16th ed. Harrison's Online. Available at: [accessmedicine.com](http://accessmedicine.com). New York: McGraw-Hill, 2004–2005; Figure 11–2, with permission.)

fatal myocardial infarctions was noted in the rofecoxib patients compared to the naproxen patients. In the Celecoxib Long-term Arthritis Safety Study (CLASS),<sup>145</sup> 20–22% of patients were commonly receiving low-dose aspirin in addition to celecoxib. Early recommendations that concomitant low-

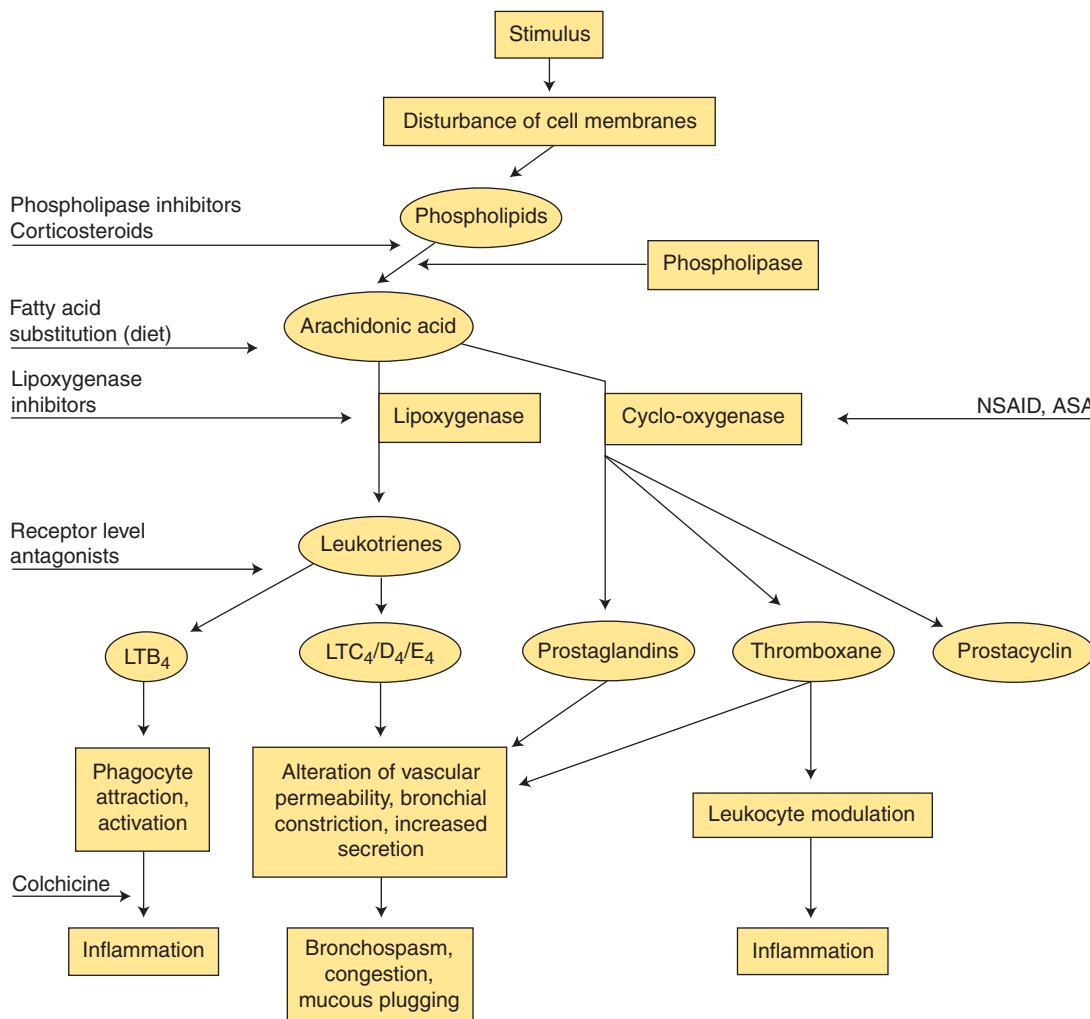
dose aspirin therapy along with the COX-2 agent might be protective against thrombotic events were discussed with practitioners.

In the Adenomatous Polyp Prevention on Vioxx (APPROVe) trial, 2586 patients with a history of colorectal adenoma were studied, as it appeared

that NSAIDs might have beneficial effects in primary prevention. Comparing a 25-mg dose of rofecoxib to placebo, 46 patients in the rofecoxib group and only 26 patients in the placebo group had confirmed thrombotic events, which included myocardial coronary syndromes, cerebrovascular events, and cardiac/pulmonary failures. The risks became apparent at 18 months of therapy.<sup>146</sup> Nussmeier et al.<sup>147</sup> studied the use of perioperative valdecoxib in coronary bypass patients and found a similar result. As for rofecoxib, valdecoxib appeared to increase the incidence of acute thrombotic events compared to placebo therapy, even though these patients already had diseased vasculature.

NSAIDs as a rule are weak acids and are highly protein bound. Particular care is mandatory when prescribing these agents to older debilitated or cachectic patients who are critically ill, are intravascularly volume depleted, or have protein-deficient nutritional states. NSAIDs are metabolized by either the CYP 2C or CYP 3A cytochrome P450 enzymes and are excreted in the urine. It is generally believed that NSAIDs are prescribed according to their specific chemical class. Many of the more popular analgesic agents are propionic acids (e.g., ibuprofen, ketoprofen, oxaprozin, naproxen), but multiple classes exist. No evidence indicates that one particular agent or class is superior in specific patients if comparable doses are given. Some clinicians believe that a failed drug trial from one class necessitates a trial with another group, but this has not been demonstrated.<sup>148</sup> Patients with a history of other GI problems, who are nicotine or alcohol users, who are taking concomitant oral steroids, or who are taking warfarin or other anticoagulant substances are least likely to do well. The wisdom of long-term NSAID use as a chronic pain treatment appears to be suspect considering the high degree of adverse drug side effects.

An association has been reported between long-term administration of NSAIDs (>180 days) and increased radiographic evidence of osteoarthritis progression. A large group of 1695 patients with either hip or knee osteoarthritis was studied. Radiographs from baseline to a mean of 6.6 years were reviewed. The authors concluded that chronic use of diclofenac, a generally well-tolerated and popular



**FIGURE 92–9.** Cellular disturbance at the membrane level induces production of prostaglandins and leukotrienes active in the inflammatory process. (From Wagner W, Khanna P, Furst DE. Nonsteroidal anti-inflammatory drugs, disease-modifying antirheumatic drugs, nonopioid analgesics, and drugs used in gout. In Katzung BG, ed. Basic and Clinical Pharmacology. 9th ed. New York: McGraw-Hill, 2004:576–577, with permission.)

NSAID, was associated with a 2.4-fold (hip) or 3.2-fold (knee) increased risk of osteoarthritis progression compared with short-term use.<sup>149</sup>

Topical NSAIDs may have a therapeutic effect in certain well-localized situations. A systemic review and meta-analysis of topical NSAIDs for musculoskeletal pain concluded that although the number needed to treat was approximately 4.7 to achieve one patient with  $\geq 50\%$  pain relief, the topical agents were well tolerated with few side effects. Interestingly, three trials in the meta-analysis demonstrated no difference between oral and topical NSAIDs.<sup>150</sup>

In some cases, acetaminophen may be a safer alternative than NSAIDs. Even though millions of patients take acetaminophen daily, the drug's mechanism of analgesia is not clear. Previously, acetaminophen was considered a weak nonspecific COX inhibitor with

little antiinflammatory action and predominantly central versus peripheral effects, but this may not be correct. An emerging concept of its mechanism of action is that acetaminophen has a COX-3 inhibition profile. COX-3 is expressed in the cerebral cortex and heart in humans and is effectively and selectively blocked by acetaminophen as well as some NSAIDs.<sup>151</sup> A more recent proposal is that the acetaminophen functions via supraspinal serotonergic mechanisms (Table 92–11).<sup>152</sup>

Early studies comparing acetaminophen to NSAIDs have been somewhat surprising, particularly given the fact that acetaminophen's actions are primarily central. Bradley et al.<sup>153</sup> compared acetaminophen 4 g/d to ibuprofen up to 2.4 g/d in a randomized, double-blind experiment of 182 patients with knee osteoarthritis. The patients had improved rest pain and less disability independent of which

agent they given, and the authors concluded that presumptive evidence of synovial inflammation does not necessarily predict which agent will provide a greater response. In another study of 382 patients comparing rofecoxib, celecoxib, and acetaminophen, patient functional end points including measures such as walking pain, rest pain, and morning stiffness improved in all groups, but only significantly for rofecoxib. In terms of average 6-week functional disability score, only the 25-mg rofecoxib group was statistically different than acetaminophen. No cardiac events were noted, and adverse events were generally limited.<sup>154</sup> Given that rofecoxib is no longer clinically available, these results indicate that practitioners should be wary in potentially higher-risk groups and strongly consider acetaminophen.

Acetaminophen-induced hepatic failure has been thought to be a risk for



TABLE 92–11.

## Available Antiinflammatory Drugs and Dosing Strategies

Medication	Daily Dosage Range	Dosage	Frequency
Acetaminophen	2–4 g	325–650 mg 650–1000 mg	4 h QID
Salicylic acid derivatives			
Acetylsalicylic acid (aspirin)	2.4–6 g	600–1500 mg	QID
Choline magnesium trisalicylate	1.5–3 g	500–1000 mg 750–1500 mg	TID BID
Salsalate	1.5–3 g	750–1500 mg	BID
Propionic acid derivatives (ibuprofen)	1.2–3.2 g for pain	200–400 mg 400, 600, or 800 mg	QID TID to QID, to a maximum dose of 3200 mg/d
Naproxen	500 mg–1 g	250, 350, or 500 mg	BID
Naproxen sodium	550–1100 mg	275–550	BID
Flurbiprofen	100–200 mg	50–100 mg	BID
Ketoprofen	75–225 mg	25–75 mg	TID
Acetic acids (diclofenac, etodolac)	150–200 mg 400–1200 mg	50 mg 75 mg 200–300 mg	TID BID BID, TID, or QID
Indomethacin	<200 mg	25–50 mg	TID or QID
Sulindac	300–400 mg	150 or 200 mg	QD to BID
Tolmetin	800–1800 mg	400, 600, or 800 mg	TID
Enolic acids (meloxicam [Mobic])	7.5–15 mg	7.5 mg for osteoarthritis 15 mg rheumatoid arthritis	QD
Piroxicam	10–20 mg	10 or 20 mg	QD
Naphthylalkanones (nabumetone)	1–1.5 g	500 mg	BID up to 1.5 g
Cyclooxygenase-2/selective (celecoxib)	200–400 mg	100 or 200 mg	QD to Q12 h
Fenamates (meclofenamate)	50–400 mg	50–100 mg	TID to QID
Mefenamic acid (Ponstel)	1–2 g	250 mg	QID

Reprinted from Guidelines for the Management of Pain in Osteoarthritis, Rheumatoid Arthritis, and Juvenile Chronic Arthritis. 2nd ed., Table 11, 2002;59-61, with permission of American Pain Society.

patients with existing hepatic disease as well as those ingesting toxic levels of the drug. Patients ingesting >2 oz of alcohol per day should have dose reductions to a maximum of 2.5 g/d acetaminophen.<sup>148</sup> Risk of analgesic nephropathy is possible with acetaminophen but is a rare occurrence. Evidence suggests that even in patients with hepatic disease, although the serum half-life of acetaminophen may be prolonged, glutathione stores are not sufficiently depleted to critical levels at recommended doses.<sup>155</sup> Overall, according to American Pain Society guidelines, the favorable risk-to-benefit ratio of acetaminophen warrants ongoing use if efficacy is present during the first few weeks at doses of at least 2–3 g/d.<sup>148</sup>

## PAIN REHABILITATION STRATEGIES

Anesthesiologists are extremely well prepared in the application of pharma-

cologic and interventional principles because of excellent command of the perioperative care of complex patients. However, chronic pain patients often defy treatment in a strictly biomedical model of care. The biomedical model presupposes a definable injury, disease, or process that can be treated.<sup>156</sup> Unfortunately, despite extensive and often expensive evaluations to explain patient pain syndromes, a precise diagnosis cannot always be made. Furthermore, patients presenting to a chronic pain treatment facility have often tried multiple therapies without significant improvement. Thus, a biopsychosocial model of care, wherein the patient is treated holistically, understanding their reaction, beliefs, and coping mechanisms regarding the physical pain within the broad context of their work and family and social environments, often is more successful.

For example, more than half of patients admitted to a pain rehabilitation

program had already tried opioids, NSAIDs, physical therapy, antidepressants, injections, anticonvulsants, and other therapies; many also had tried alternative medical treatment and surgery. Many of these trials had temporary effects, but ultimately they all failed for a variety of reasons inherent to many chronic pain patients.

Gallagher<sup>156</sup> recommended multiple approaches to maximizing the results of pharmacologic trials: (1) carefully plan medication trials; (2) consider alternative (nonpharmacologic) treatments for pain fluctuation; (3) select medications based on pain mechanism and consider associated medical and psychological morbidities; (4) utility of a goal-oriented management plan for each problem with “time-limited” target outcome measures; (5) close scrutiny during initial 2-week medication trials with frequent patient contact; and (6) upon failure of a drug trial, gradual reduction of the dose, keeping other agents at stable levels.

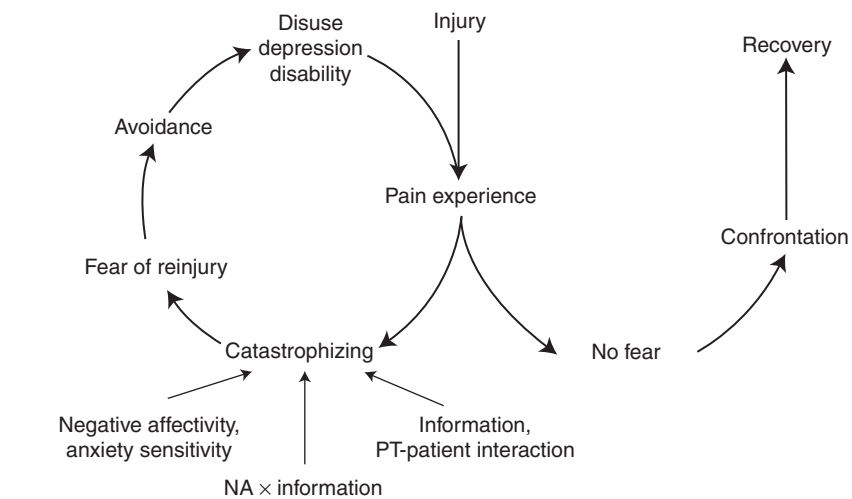
The most common reasons for failed drug trials are improperly low (inadequate dose) or too high (side effects limit trial) doses or inadequate durations of trials.

Modern pain rehabilitation programs aim to treat the whole patient in order to modify maladaptive behaviors, overcome psychosocial detractors, allow functional restoration, and improve coping skills. These programs generally include physical reconditioning/exercise, aided by physical and occupational therapists, and cognitive behavioral therapies, including biofeedback, relaxation, stress management, substance use educational interventions, introduction of concepts of pacing and pain-inducing activity moderation, and use of positive reinforcements of appropriate instead of maladaptive behaviors (Fig. 92–10).

Multiple studies have demonstrated that functional improvements are sustained over time, as well as the ability to decrease or eliminate medications (opioids, NSAIDs, muscle relaxants).<sup>157,158</sup> Rome et al.<sup>159</sup> studied 356 patients admitted to the pain rehabilitation program for an entire year. Of this group, 274 patients completed both the program and all questionnaires; 99 patients were taking opioids before the program and 175 were not. Only three of the opioid patients were still taking opioids at the conclusion of the 3 week program, and significant improvement was noted in all outcome variables in both groups.<sup>159</sup> This is important, because it demonstrates that despite a presumed acute increase in pain due to opioid withdrawal, the opioid group was also able to achieve program goals.

Robbins et al.<sup>160</sup> evaluated the effect of deleting the behavioral medicine portion of a pain rehabilitation approach and “carving out” only the physical therapy portion of the care plan. In this study, patients did not fare as well on either short-term or long-term followup. Thus, insurers’ and managed care organizations’ approaches to chronic pain care often can be “penny wise and pound foolish.”

A number of studies have started to question the role of spinal operations as therapy for chronic lumbar pain due to discogenic disease. Soon many other therapies will be scrutinized for chronic pain care, and evidence, if lacking, will spurn new approaches to care of patients. Spinal fusion for discogenic pain is an example of a quickly grow-



**FIGURE 92–10.** Injury occurs, and the patient experiences pain. Some patients have a “catastrophizing” coping response to the experience of pain, reinforced by physicians and physical therapists, who may encourage abstinence from the painful activity. Further activity induces fear of (re)injury and gradual social, sexual, and functional disability. This continued cycle of pain is difficult to overcome. (Reprinted from Vlaeyen JWS, Crombez G. Fear of movement/(re)injury, avoidance and pain disability in chronic low back pain patients. *Man Ther* 1999;4:187–195.)

ing procedure that seems to be outpacing the growth of other joint replacements for arthritic conditions such as hip or knee replacement.<sup>161</sup> Brox et al.<sup>162</sup> studied patients with degenerative disk disease at L4–5 or L5–S1 and chronic pain for more than 1 year. Patients were randomized to either spinal instrumented fusion plus postsurgical physical therapy or exercise and cognitive interventions. After 1 year, there was no clear advantage to instrumented fusion over cognitive interventions/exercise. Surgical patients had improved leg pain, and cognitive interventions/exercise patients had better fingertip to floor distance ability. Oswestry disability scores improved in both groups.<sup>162</sup> Based on a study by Fairbank et al.,<sup>163</sup> in which only marginal, not clearly advantageous, improvement was noted in the surgical group versus intensive rehabilitation, a cost study was performed in which the authors determined that surgical stabilization was not a cost-effective use of scarce health care resources in Great Britain.<sup>164</sup> These studies are the first of several that are beginning to clearly demonstrate to patients and payers that the combination of behavioral medicine techniques with physical therapeutics is effective for patients with chronic lower back pain.

### Pain Catastrophizing

Catastrophizing can be summarized as a negative cognitive belief state associ-

ated with actual or potential pain experiences. Three major attributes of catastrophizing are (1) magnification, (2) rumination, and (3) helplessness.

Catastrophizing is associated with a heightened pain experience and is one of the most important psychological factors contributing to perceived pain intensity. Catastrophizing is associated with increased disability, pain-induced healthcare-seeking behavior, and analgesic use.<sup>165</sup> It is apparent that patients who catastrophize in response to painful experiences have intense emotional distress and increased pain overall. Patients appear more likely to be female than male. Thus, the role of gender in pain has been studied. For example, in a large study examining gender differences, women reported greater levels of pain from chronic spinal conditions than did men. Interestingly, the patients taking opioids had poorer function and disability whether they were men or women, but men had more affective distress while taking opioids and women had less.<sup>166</sup>

### Physical Modalities and Exercise

Physical modalities can be applied within an overall pain treatment plan to aid in functional rehabilitation. Many pain rehabilitation programs provide vigorous inpatient or (day treatment) outpatient programs in which subjects receive both cognitive behavioral strategies combined with

physical therapy/functional restoration techniques. Likewise, many of these programs will modify or eliminate unnecessary or problematic pharmaceutical agents causing side effects to the patient, particularly opioids or other narcotics. Prior to beginning any physical training sessions, a functional capacity evaluation can be useful in identifying and quantifying specific limitations of the patient. The practitioner must realize that most chronic pain disorders have evolved over time, so any specific regimens must be applied in a graded and preferably supervised fashion to prevent (re)injury, which would reinforce in the patients' mind once again that they are disabled by the pain. Patients who catastrophize may understand that they need to exercise, but education alone often is insufficient to overcome their fear. Introduction of graded exposure to the feared activity in a sense "teaches" the patient that he or she actually can do the activity (Fig. 92–10).<sup>167</sup>

Pain causes may be multifactorial, including muscle atrophy, joint/ligamentous laxity, joint derangement, edema/inflammation, muscle spasm/fatigue, vasomotor derangements, ischemia, and peripheral/spinal hyperalgesia. Caution may be in order with aggressive reintroduction of activities. Chronic visceral/pelvic pain with intestinal dysmotility, nausea, diarrhea, cramping, and bloating may complicate functional tasks. Patients may have multiple forms of disability, including alterations in activities of daily living, work, social and cultural withdrawal, sexual dysfunction/decreased libido, anhedonia, depression, low self-esteem, and ongoing forms of compensation litigation. Many patients suffer from a sense of loss and have anger and hostility issues directed at other drivers (motor vehicle-related injuries), employers (work-related injuries), physicians (alleged malpractice), caregivers, family, and others.

### Vocational Rehabilitation

When chronic pain interferes with a patients' ability to return to work, the physician can utilize programs such as work conditioning and work hardening. Although similar, these two programs differ in their content and structure. The work-conditioning program provides structured progressive reconditioning that relies less on passive modalities and more on activities for

physical fitness. The program often runs 1–2 hours, 3–5 times per week for period of 2–6 weeks. In contrast, the work-hardening program provides a more comprehensive approach to the patient who has been off work for prolonged periods. These programs incorporate job-specific work simulation and address psychological and vocational issues along with physical reconditioning. The programs often are located in environments that appear "work-like" to minimize the patient's perception of illness and to facilitate the return to work mindset. Education is an important part of both types of programs and includes proper body mechanics, safe lifting techniques, stress management, and promotion of a healthy lifestyle.

Vocational rehabilitation assists the chronic pain patient when return to his or her former occupation is unlikely. Vocational counseling may be provided by individual rehabilitation facilities or accessed through local or state agencies when available. Physical modalities are used in conjunction with therapy to provide temporary pain relief, improve stiffness, and allow the patient to more fully participate in performance of specific tasks that will manifest long-term gains in functionality. Heat, cold, iontophoresis, transcutaneous electrical nerve stimulation (TENS), and electrical stimulation of the muscles, along with traction, myofascial release techniques, massage, and desensitization activities often are used.

### Exercise

A review of randomized, controlled trials and observational studies of therapeutic exercise in adults with chronic low back pain supports the theory that therapeutic exercise is effective for reducing chronic pain.<sup>168</sup> Individually tailored programs that emphasize stretching or strengthening may be superior. A typical physical therapy regimen may include low-impact forms of movement education, such as aquatic therapies, walking, and passive and active stretching, with gentle progression to the patient's tolerance. Occupational therapy is used to teach patients energy conservation techniques or to assess for adaptive equipment needs such as gait and grasp aids, braces, and orthotics, which may be useful for promoting independence and protecting against injury. One important goal supported by both the

physician and physical therapist is patient autonomy. A home-based therapy routine should be encouraged from the onset of physical/occupational therapy and monitored or modified on a regular basis as needed. The patient should be encouraged to adopt a more active lifestyle, incorporating the skills acquired in physical/occupational therapy into daily life.

### Transcutaneous Electrical Nerve Stimulation

The gate control theory—activation of specific large fiber afferents carried in A-fibers might compete at the dorsal horn with slower unmyelinated sensory afferent (C-fibers) and functionally "close" the gate to this slower noxious information—may explain the rationale for TENS analgesia. TENS may be one of the most useful therapies based on these concepts. TENS units are multi-channel devices in which surface electrical stimulation is applied through gel pads with an external generator over sites of pain. In order to maximize analgesia, different amplitudes, frequencies, and pulse waveforms are used to decrease pain perception. TENS has been studied for treatment of several types of pain, with some studies demonstrating benefit and others showing equivocal results. Most reports of benefit have derived from studies in which stimulation was below motor threshold strength. High-frequency stimulation may give long-lasting pain relief.<sup>169</sup>

### Ice and Heat

Cryotherapy and heat are the most commonly used physical modalities available to the patient because of their efficacy, ease of use, and safety profiles. Both heat and cold produce analgesia; heat also produces hyperemia, whereas cold decreases nerve conduction.<sup>170</sup> The decrease in blood flow found with cryotherapy may decrease delivery of inflammatory chemicals to the site of injury. Some patients with chronic low back pain have found ice massage to be as effective as TENS.<sup>171</sup>

Heat applications via superficial heat combined with exercise are commonly used for various arthritic and musculoskeletal injuries.<sup>172,173</sup> Heat can be provided in the form of moist heat (hot packs), heat lamps (incandescent or infrared), hydrotherapy, ultrasound, paraffin baths, and short-wave diathermy. Cryotherapy is provided in more limited forms, such as hydro-

therapy, ice packs, ice massage, and iced compression wraps; it also can be applied through vapocoolant sprays, such as ethyl chloride.

## Acupuncture

The ancient art of acupuncture has been used for several millennia for treatment of a variety of medical conditions including pain. The Chinese typically are credited for developing acupuncture. The premise of acupuncture is that energy flow, called *qi*, is important to good health, which is maintained by a smooth flow of the *qi*. Thus, disease or pain results from disruptions or stagnation of the flow of *qi*.<sup>174</sup> *Qi* is thought to reside in specific channels or meridians located along specific anatomic regions of the body. Along these meridians are multiple points considered important for accessing *qi*, called *acupuncture points*. Over the past several decades, acupuncture has grown in popularity as an option for treatment of multiple pain conditions.

On a neurobiologic basis, the needling that occurs at specific acupuncture points has been shown to cause release of peptides such as endorphins and enkephalins.<sup>175</sup> Functional MRI studies have shown patterns of activation in distinct regions of the brain, such as the auditory/visual cortex when traditional acupuncture points for hearing and vision are used<sup>176</sup> as well as common activation areas between healthy volunteers when identical acupuncture points are selected.<sup>177</sup>

Data regarding the efficacy of acupuncture in chronic pain states are conflicting.<sup>178,179</sup> However, a 1998 National Institutes of Health consensus panel extensively reviewed the available literature and concluded that use of acupuncture was acceptable as “an adjunct treatment or acceptable alternative or may be included in a comprehensive management program” for the treatment of headache, tennis elbow, fibromyalgia, myofascial pain, low back pain, and osteoarthritis.<sup>180</sup>

## CONCLUSION

Chronic pain management is an evolving discipline that requires broad knowledge and management skills. Peak physician performance demands well-trained compassionate providers who are familiar with not only pharma-

cological and interventional therapies but also with the patient's overall cognitive state. Pain mechanisms now are better understood, and therapies can be better targeted, often from a multimodal approach. Comparative studies of different pharmacologic, cognitive behavioral, and interventional therapeutics are needed to determine which are based on solid evidence.

## KEY REFERENCES

1. Vlaeyen JWS, Crombez G. Fear of movement/(re)injury, avoidance and pain disability in chronic low back pain patients. *Man Ther* 1999;4:187–195.
2. Farrar JT, Young JP, LaMoreaux L, et al. Clinical importance of changes in chronic pain intensity measured on an 11-point numerical pain rating scale. *Pain* 2001;94:149–158.
3. Raja SN, Haythornthwaite JA, Pappagallo M, et al. Opioids versus antidepressants in postherpetic neuralgia. A randomized, placebo-controlled trial. *Neurology* 2002;59:1015–1021.
4. Sindrup SH, Jensen TS. Review article: efficacy of pharmacological treatments of neuropathic pain: An update in effect related to mechanism of drug action. *Pain* 1999;83:389–400.
5. Ballantyne JC, Mao J. Opioid therapy for chronic pain. *N Engl J Med* 2003;349:1943–1953.
6. Vanderah TW, Suenaga NM, Ossipov MH, et al. Tonic descending facilitation from the rostral ventromedial medulla mediates opioid-induced abnormal pain and antinociceptive tolerance. *J Neurosci* 2001;21:279–286.
7. Gilron I, Bailey JM, Tu D, et al. Morphine, gabapentin or their combination for neuropathic pain. *N Engl J Med* 2005;352:1324–1334.
8. Gold MS, Weinrich D, Kim C-S, et al. Redistribution of  $NA_v$  1.8 in injured axons enables neuropathic pain. *J Neurosci* 2003;23:158–166.
9. Sabatowski R, Galvez R, Cherry DA, et al. Pregabalin reduces pain and improves sleep and mood dis-

turbances in patients with postherpetic neuralgia: results of a randomized placebo-controlled clinical trial. *Pain*, 2004;109:26–35.

10. Fairbank J, Frost H, Wilson-MacDonald J, et al. Randomised controlled trial to compare surgical stabilization of the lumbar spine with an intensive rehabilitation programme for patients with chronic low back pain: the MRC spine stabilization trial. *BMJ* 2005;330:1233–1239.

## REFERENCES

1. Woolf CJ, Bennett GJ, Doherty M, et al. Towards a mechanism-based classification of pain. *Pain* 1998;77:227–229.
2. Gheldof ELM, Vinck J, Vlaeyen JWS, et al. The differential role of pain, work characteristics and pain-related fear in explaining back pain and sick leave in occupational settings. *Pain* 2005;113:71–81.
3. Vlaeyen JWS, Crombez G. Fear of movement/(re)injury, avoidance and pain disability in chronic low back pain patients. *Man Ther* 1999;4:187–195.
4. Saper JR, Lake AE III. Borderline personality disorder and the chronic headache patient: review and management recommendations. *Headache* 2002;42:663–674.
5. Waddell G, Main CJ. Assessment of severity in low-back disorders. *Spine* 1984;9:204–208.
6. Ransford AO, Cairns D, Mooney V. The pain drawing as an aid to the psychologic evaluation of patients with low back pain. *Spine* 1976;1:127–134.
7. Waddell G, McCulloch JA, Kummel E, et al. Non organic physical signs in low back pain. *Spine* 1980;5:117–125.
8. Maus TP. Imaging of the spine and nerve roots. *Phys Med Rehabil Clin N Am* 2002;13:487–544.
9. Jensen MC, Brant-Zawadzki MN, Obuchowski N, et al. Magnetic resonance imaging of the lumbar spine in people without back pain. *N Engl J Med* 1994;331:69–73.
10. Raja SN, Haythornthwaite JA. Combination therapy for neuropathic pain—which drugs, which combination, which patients? *N Engl J Med* 2005;352:1373–1375.
11. Farrar JT, Young JP, LaMoreaux L, et al. Clinical importance of changes in chronic pain intensity measured on an 11-point numerical pain rating scale. *Pain* 2001;94:149–158.
12. Botney M, Fields HL. Amitriptyline potentiates morphine analgesia by a direct action on the central nervous system. *Ann Neurol* 1983;13:160–164.
13. Reynolds IJ, Miller RJ. Tricyclic antidepressants block N-methyl-D-aspartate re-



ceptors: similarities to the action of zinc. *Br J Pharmacol* 1988;95:95-102.

14. Eisenach JC, Gebhart GF. Intrathecal amitriptyline acts as an N-methyl-D-aspartate receptor antagonist in the presence of inflammatory hyperalgesia in rats. *Anesthesiology* 1995;83:1046-1054.

15. Gerner P, Haderer AE, Mujtaba M, et al. Assessment of differential blockade by amitriptyline and its N-methyl derivative in different species by different routes. *Anesthesiology* 2003;98:1484-1490.

16. Max MB, Culnane M, Schafer SC, et al. Amitriptyline relieves diabetic neuropathy pain in patients with normal or depressed mood. *Neurology* 1987;37:589-596.

17. Max MB, Lynch SA, Muir J, et al. Effects of desipramine, amitriptyline, and fluoxetine on pain in diabetic neuropathy. *N Engl J Med* 1992; 326:1250-1256.

18. Vestergaard K, Andersen G, Jensen TS. Treatment of central post-stroke pain with a selective serotonin reuptake inhibitor. *Eur J Neurol* 1996;3(Suppl 5):169.

19. Sindrup SH, Bjerre U, Dejgaard A, et al. The selective serotonin reuptake inhibitor citalopram relieves the symptoms of diabetic neuropathy. *Clin Pharmacol Ther* 1992;52:547-552.

20. Sindrup SH, Gram LF, Brøsen K, et al. The selective serotonin reuptake inhibitor paroxetine is effective in the treatment of diabetic neuropathy symptoms. *Pain* 1990; 42:135-144.

21. Roose SP, Laghrissi-Thode F, Kennedy JS, et al. Comparison of paroxetine and nortriptyline in depressed patients with ischemic heart disease. *JAMA* 1998;279: 287-291.

22. Kvinesdal B, Molin J, Frøland A, et al. Imipramine treatment of painful diabetic neuropathy. *JAMA* 1984;251:727-730.

23. Watson CP, Vernich L, Chipman M, et al. Nortriptyline versus amitriptyline in postherpetic neuralgia: a randomized trial. *Neurology* 1998;51:1166-1171.

24. Raja SN, Haythronthwaite JA, Pappagallo M, et al. Opioids versus antidepressants in postherpetic neuralgia. A randomized, placebo-controlled trial. *Neurology* 2002;59: 1015-1021.

25. Max MB, Kishore-Komar R, Schafer SC, et al. Efficacy of desipramine in painful diabetic neuropathy: a placebo-controlled trial. *Pain* 1991;45:3-9.

26. Watson CP, Evan RJ, Reed K, et al. Amitriptyline versus placebo in postherpetic neuralgia. *Neurology* 1982;32:671-673.

27. Bowsher D. The effects of pre-emptive treatment of postherpetic neuralgia with amitriptyline: a randomized, double-blind, placebo-controlled trial. *J Pain Symptom Manage* 1997;13:327-331.

28. Sindrup SH, Jensen TS. Review article: efficacy of pharmacological treatments of neuropathic pain: an update in effect related to mechanism of drug action. *Pain* 1999; 83:389-400.

29. Cai Z, McCaslin PP. Amitriptyline, desipramine, cyproheptadine and carbamazepine, in concentrations used therapeutically, reduce kainate- and N-methyl-D-aspartate-induced intracellular Ca<sup>2+</sup> levels in neuronal culture. *Eur J Pharmacol* 1992; 219:53-57.

30. Sawynok J, Reid A. Peripheral interactions between dextromethorphan, ketamine and amitriptyline on formalin-evoked behaviors and paw edema in rats. *Pain* 2003; 102:179-186.

31. Fridrich P, Eappen S, Jaeger W, et al. Phase Ia and Ib study of amitriptyline for ulnar nerve block in humans: side effects and efficacy. *Anesthesiology* 2004;100: 1511-1518.

32. Cardenas D, Warms CA, Turner JA, et al. Efficacy of amitriptyline for relief of pain in spinal cord injury: results of a randomized controlled trial. *Pain* 2002;96: 365-373.

33. Sindrup SH, Bach FW, Madsen C, et al. Venlafaxine versus imipramine in painful polyneuropathy: a randomized controlled trial. *Neurology* 2003;60:1284-1289.

34. Semenchuk MR, Sherman S, Davis B. Double-blind, randomized trial of bupropion SR for the treatment of neuropathic pain. *Neurology* 2001;57:1583-1588.

35. Goldstein DJ, Lu Y, Detke MJ, et al. Duloxetine vs. placebo in patients with painful diabetic neuropathy. *Pain* 2005;116: 109-118.

36. Brannan SK, Mallinckrodt CH, Brown EB, et al. Duloxetine 60 mg once daily in the treatment of painful physical symptoms in patients with major depressive disorder. *J Psychiatr Res* 2005;39:43-53.

37. Caudill-Slosberg MA, Schwartz LM, Woloshin S. Office visits and analgesic prescriptions for musculoskeletal pain in U.S.: 1980 vs 2000. *Pain* 2004;109:514-519.

38. The use of opioids for the treatment of chronic pain: a consensus statement. American Academy of Pain Medicine and American Pain Society. *Clin J Pain* 1997;13:6-8.

39. Jacox A, Carr DB, Payne R, et al. Management of cancer pain. AHCPR Publication No. 94-0592/ Rockville, MD: U.S. Department of Health and Human Services, Agency for Health Care Policy and Research, 1994.

40. Gilson AM, Ryan KM, Joranson DE, et al. A reassessment of trends in the medical use and abuse of opioid analgesics and implications for diversion control: 1997-2002. *J Pain Symptom Manage* 2004;28:176-188.

41. Zacny J, Bigelow G, Compton P, et al. College on problems of drug dependence task force on prescription opioid non-medical use and abuse: position statement. *Drug Alcohol Depend* 2003;69:215-232.

42. Joranson DE, Gilson AM. Drug crime is a source of abused pain medications in the United States. *J Pain Symptom Manage* 2005;30:299-301.

43. Rowbothan MC, Twilling L, Davies PS, et al. Oral opioid therapy for chronic pe-

ripheral and central neuropathic pain. *N Engl J Med* 2003;348:1223-1232.

44. Saper JR, Lake AE III, Hamel RL, et al. Daily scheduled opioids for intractable head pain. *Neurology* 2004;62:1687-1694.

45. Von Korff M, Deyo RA. Potent opioids for chronic musculoskeletal pain: flying blind? *Pain* 2004;109:207-209.

46. Fishman SM, Bandman TB, Edwards A, et al. The opioid contract in the management of chronic pain. *J Pain Symptom Manage* 1999;18:27-37.

47. Ballantyne JC, Mao J. Opioid therapy for chronic pain. *N Engl J Med* 2003;349: 1943-1953.

48. Rajagopal A, Vassilopoulou-Sellin R, Palmer L, et al. Hypogonadism and sexual dysfunction in male cancer survivors receiving chronic opioid therapy. *J Pain Symptom Manage* 2003;26:1055-1061.

49. Abs R, Verhelst J, Maeyert J, et al. Endocrine consequences of long-term intrathecal administration of opioids. *J Clin Endocrinol Metab* 2000;85:2215-2222.

50. Sacerdote P, Manfredi B, Mantegazza P, et al. Antinociceptive and immunosuppressive effects of opioid drugs: a structure-related activity study. *Br J Pharmacol* 1997; 121:834-840.

51. Roy S, Loh HH. Effects of opioids on the immune system. *Neurochem Res* 1996;21: 1375-1386.

52. Martucci C, Panerai AE, Sacerdote P. Chronic fentanyl or buprenorphine infusion in the mouse: similar analgesic profile but different effects on immune responses. *Pain* 2004;110:385-392.

53. Fields HL, Vanegas H, Hentall I, et al. Evidence that disinhibition of brain stem neurones contributes to morphine analgesia. *Nature* 1983;306:684-686.

54. Heinricher MM, McGaraughty S, Tortorici V. Circuitry underlying antiopioid actions of cholecystokinin within the rostral ventromedial medulla. *J Neurophysiol* 2001;85:280-286.

55. Xie JY, Herman DS, Stiller C-O, et al. Cholecystokinin in the rostral ventromedial medulla mediates opioid-induced hyperalgesia and antinociceptive tolerance. *J Neurosci* 2005;25:409-416.

56. Vanderah TW, Suenaga NM, Ossipov MH, et al. Tonic descending facilitation from the rostral ventromedial medulla mediates opioid-induced abnormal pain and antinociceptive tolerance. *J Neurosci* 2001; 21:279-286.

57. Gardell LR, Wang R, Burgess SE, et al. Sustained morphine exposure induces a spinal dynorphin-dependent enhancement of excitatory transmitter release from primary afferent fibers. *J Neurosci* 2002;22:6747-6755.

58. Ossipov MH, Lai J, King T, et al. Underlying mechanisms of pronociceptive consequences of prolonged morphine exposure. *Biopolymers* 2005;80:319-324.

59. Mao J, Price DD, Mayer DJ. Thermal hyperalgesia in association with the devel-

- opment of morphine tolerance in rats: roles of excitatory amino acid receptors and protein kinase C. *J Neurosci* 1994;14:2301–2312.
60. Yuan CS, Doshan H, Charney MR, et al. Tolerability gut effects and pharmacokinetics of methylalntrexone following repeated intravenous administration in humans. *J Clin Pharmacol* 2005;45:538–546.
61. Clinical Practice Guideline No. 2. Guideline for the Management of Pain in Osteoarthritis, Rheumatoid Arthritis, and Juvenile Chronic Arthritis. 2<sup>nd</sup> ed. Glenview, IL: American Pain Society, 2002.
62. Weissman DE, Haddox JD. Opioid pseudo-addiction: an iatrogenic syndrome. *Pain* 1989;36:363–366.
63. Pereira J, Lawlor P, Vigano A, et al. Equi-analgesic dose ratios for opioids: a critical review. *J Pain Symptom Manage* 2001;22:672–687.
64. Pasternak GW. The pharmacology of mu analgesics: from patients to genes. *Neuroscientist* 2001;7:220–231.
65. Watson CPN, Babul N. Efficacy of oxycodone in neuropathic pain: a randomized trial in postherpetic neuralgia. *Neurology* 1998;50:1837–1841.
66. Sindrup SH, Andersen U, Madsen C, et al. Tramadol relieve pain and allodynia in polyneuropathy. A randomized, double-blind, placebo-controlled trial. *Pain* 1999;83:85–90.
67. Gilron I, Bailey JM, Tu D, et al. Morphine, gabapentin or their combination for neuropathic pain. *N Engl J Med* 2005;352:1324–1334.
68. Rowbotham MC, Reisner KL, Fields HL. Both intravenous lidocaine and morphine reduce the pain of post-herpetic neuralgia. *Neurology* 1991;41:1024–1028.
69. Wu CL, Tella P, Staats P, et al. Analgesic effects of intravenous lidocaine and morphine on postamputation pain: a randomized double-blind, active placebo-controlled, crossover trial. *Anesthesiology* 2002;96:841–848.
70. Gorman AL, Elliott KJ, Inturrisi CE. The *d*- and *l*-isomers of methadone bind to the non-competitive site on the *N*-methyl-D-aspartate (NMDA) receptor in rat fore-brain and spinal cord. *Neurosci Lett* 1997;223:5–8.
71. Davis AM, Inturrisi CE. *d*-Methadone blocks morphine tolerance and *N*-methyl-D-aspartate-induced hyperalgesia. *J Pharmacol Exp Ther* 1999;289:1048–1053.
72. Ripamonti C, Groff L, Brunelli C, et al. Switching from morphine to oral methadone in treating cancer pain: what is the equianalgesic dose ratio? *J Clin Oncol* 1998;16:3216–3221.
73. Morley JS, Makin MK. The use of methadone in cancer pain poorly responsive to other opioids. *Pain Rev* 1998;5:51–58.
74. Walker PW, Klein D, Kasza L. High dose methadone and ventricular arrhythmias: a report of three cases. *Pain* 2003;103:321–324.
75. Fitzgibbon EJ, Hall P, Schroder C, et al. Low dose ketamine as an analgesic adjuvant in difficult pain syndromes: a strategy for conversion from parenteral to oral ketamine. *J Pain Symptom Manage* 2002;23:165–170.
76. Eide PK, Jørum E, Stubhaug A, et al. Relief of postherpetic neuralgia with the NMDA receptor antagonist ketamine: a double-blind cross-over comparison with morphine and placebo. *Pain* 1994;58:347–354.
77. Max MB, Byas-Smith MG, Gracely RH, et al. Intravenous infusion of the NMDA antagonist, ketamine, in chronic post-traumatic pain and allodynia: a double-blind comparison to alfentanil and placebo. *Clin Neuropharmacol* 1995;18:360–368.
78. Felsby S, Nielsen J, Arendt-Nielsen L, et al. NMDA receptor blockade in chronic neuropathic pain: a comparison of ketamine and magnesium chloride. *Pain* 1996;64:283–291.
79. Eisenberg E, Kleiser A, Dortort A, et al. The NMDA (*N*-methyl-D-aspartate) receptor antagonist memantine in the treatment of postherpetic neuralgia: a double-blind, placebo-controlled study. *Eur J Pain* 1998;2:321–327.
80. McQuay HJ, Carroll D, Jadad AR, et al. Dextromethorphan for the treatment of neuropathic pain: a double-blind randomized controlled crossover trial with integral N-of-1 design. *Pain* 1994;59:127–133.
81. Pud D, Eisenberg E, Spitzer A, et al. The NMDA antagonist amantadine reduces surgical neuropathic pain in cancer patients: a double blind, randomized, placebo controlled trial. *Pain* 1998;75:349–354.
82. Gold MS, Weinrich D, Kim C-S, et al. Redistribution of  $NA_v 1.8$  in injured axons enables neuropathic pain. *J Neurosci* 2003;23:158–166.
83. Luo ZD, Chaplan SR, Higuera ES, et al. Upregulation of dorsal root ganglion alpha-2 delta calcium channel subunit and its correlation with allodynia in spinal nerve injured rats. *J Neurosci* 2001;21:1868–1875.
84. Staats PS, Yearwood T, Charapata SG, et al. Intrathecal ziconotide in the treatment of refractory pain in patients with cancer or AIDS. A randomized controlled trial. *JAMA* 2004;291:63–70.
85. Campbell FG, Graham JG, Zilkha KJ. Clinical trial of carbamazepine (Tegretol) in trigeminal neuralgia. *J Neurol Neurosurg Psychiatry* 1966;29:265–267.
86. Porter RJ, Meldrum BS. Antiseizure Drugs. In Katzung BG, ed: *Basic and Clinical Pharmacology*. 9th ed. New York: McGraw-Hill, 2004:383,384.
87. Burchiel KJ. Carbamazepine inhibits spontaneous activity in experimental neuromas. *Exp Neurol* 1988;102:249.
88. Rull JA, Quibrera R, Gonzalez-Millan H, et al. Symptomatic treatment of peripheral diabetic neuropathy with carbamazepine (Tegretol): double blind cross over trial. *Diabetologia* 1969;5:215–218.
89. Killian JM, Fromm GH. Carbamazepine in the treatment of neuralgia. Use and side effects. *Arch Neurology* 1968;19:129–136.
90. Beydoun A, Kobetz S, Carrazana E. Efficacy of oxcarbazepine in the treatment of painful diabetic neuropathy. *Clin J Pain* 2004;20:174–178.
91. Carrazana E, Mikoshiba I. Rationale and evidence for the use of oxcarbazepine in neuropathic pain. *J Pain Symptom Manage* 2003;25:S31–S35.
92. Zakrewska JM, Patsolos PN. Oxcarbazepine: a new drug in the management of intractable trigeminal neuralgia. *J Neurol Neurosurg Psychiatry* 1989;52:472–476.
93. Silberstein SD, Neto W, Schmitt J, et al., for the MIGR-001 Study Group. Topiramate in migraine prevention. Results of a large controlled trial. *Arch Neurol* 2004;61:490–495.
94. Brandes JL, Saper JL, Diamond M, et al., for the MIGR-002 Study Group. Topiramate for migraine prevention: a randomized controlled trial. *JAMA* 2004;291:965–973.
95. Thienel U, Neto W, Schwabe SK, et al., for the Topiramate Diabetic Neuropathic Pain Study Group. Topiramate in painful diabetic polyneuropathy: findings from three double-blind placebo-controlled trials. *Acta Neurol Scand* 2004;110:221–231.
96. Raskin P, Donofrio PD, Rosenthal NR, et al., for the CAPSS-141 Study Group. Topiramate vs placebo in painful diabetic neuropathy. Analgesic and metabolic effects. *Neurology* 2004;63:865–873.
97. Ben-Menachem E, Axelsen M, Johanson EH, et al. Predictors of weight loss in adults with topiramate treated epilepsy. *Obes Res* 2003;11:556–562.
98. Gee NS, Brown JP, Dissanayake BU, et al. The novel anticonvulsant drug gabapentin binds to the Alpha-2 Delta-1 subunit of the calcium channel. *J Biol Chem* 1996;271:5768–5776.
99. Mellick GA, Mellick LB. Gabapentin in the management of reflex sympathetic dystrophy. *J Pain Symptom Manage* 1995;10:265–266.
100. Backonja M, Beydoun A, Edwards KR, et al., for the Gabapentin Diabetic Neuropathy Study Group. Gabapentin for the symptomatic treatment of painful neuropathy in patients with diabetes mellitus. A randomized controlled trial. *JAMA* 1998;280:1831–1836.
101. Dallocchio C, Buffa C, Mazzarello P, et al. Gabapentin vs amitriptyline in painful diabetic neuropathy: an open label pilot study. *J Pain Symptom Manage* 2000;20:280–285.
102. Morello CM, Luckband SG, Stoner CP, et al. Randomized double blind study comparing the efficacy of gabapentin with amitriptyline on diabetic peripheral neuropathy pain. *Arch Intern Med* 1999;159:1931–1937.
103. Gorson KC, Schott C, Herman R, et al. Gabapentin in the treatment of painful

- diabetic neuropathy. A placebo-controlled double blind crossover trial. *J Neurol Neurosurg Psychiatry* 1999;66:251–252.
104. Rice AS, Maton S. Post-herpetic neuralgia study group: gabapentin and post-herpetic neuralgia: a randomized double-blind placebo controlled study. *Pain* 2001;94:215–224.
105. Rowbotham M, Harden N, Stacey B, et al., for the Gabapentin Study Group. Gabapentin for the treatment of postherpetic neuralgia: a randomized controlled trial. *JAMA* 1998;280:1837–1842.
106. Fink K, Dooley DJ, Meder WP, et al. Inhibition of neuronal calcium influx by gabapentin and pregabalin in the human neocortex. *Neuropharmacology* 2002;42:229–236.
107. Sabatowski R, Galvez R, Cherry DA, et al. Pregabalin reduces pain and improves sleep and mood disturbances in patients with post-herpetic neuralgia: results of a randomized placebo-controlled clinical trial. *Pain* 2004;109:26–35.
108. Rosenstock J, Tuchman M, LaMoreaux L, et al. Pregabalin for the treatment of painful diabetic peripheral neuropathy: a double blind, placebo-controlled trial. *Pain* 2004;110:628–638.
109. Margineanu DG, Klitgaard H. Inhibition of neuronal hypersynchrony in vitro differentiates levetiracetam from classical antiepileptic drugs. *Pharmacol Res* 2000;42:281–285.
110. Price MJ. Levetiracetam in the treatment of neuropathic pain: 3 case studies. *Clin J Pain* 2004;20:33–36.
111. Eisenberg E, Lurie Y, Braker C, et al. Lamotrigine reduces painful diabetic neuropathy: a randomized controlled study. *Neurology* 2001;57:505–509.
112. Simpson DM, Olney R, McArthur JC, et al. A placebo controlled trial of lamotrigine for painful HIV-associated neuropathy. *Neurology* 2000;54:2115–2119.
113. Zakrzewska JM, Chaudhry Z, Nurmikko TJ, et al. Lamotrigine (Lamictal) in refractory trigeminal neuralgia: results from a double blind placebo controlled trial. *Pain* 1997;73:223–230.
114. Finnerup NB, Sindrup SH, Bach FW, et al. Lamotrigine in spinal cord injury pain: a randomized controlled trial. *Pain* 2002;96:375–383.
115. Todorov AA, Kolchev CB, Todorov AB. Tiagabine and gabapentin for the management of chronic pain. *Clin J Pain* 2005;21:358–361.
116. Chadda VS, Mathur MS. Double blind study of the effects of diphenylhydantoin sodium on diabetic neuropathy. *J Assoc Physicians India* 1978;26:403–406.
117. McClean GJ. Intravenous infusion of phenytoin relieves neuropathic pain: a randomized double-blinded, placebo-controlled, crossover study. *Anesth Analg* 1999;89:985–988.
118. Lynch ME, Clark AJ, Sawyionok J, et al. Topical 2% amitriptyline and 1% ketamine in neuropathic pain syndromes. *Anesthesiology* 2005;103:140–146.
119. Lockhart E. Topical combination of amitriptyline ketamine for postherpetic neuralgia. *J Pain* 2004;5(S1):82.
120. D'Onofrio P, Walker F, et al. Capsaicin Study Group. Treatment of painful diabetic neuropathy with topical capsaicin. A multicenter, double-blind, vehicle-controlled study. *Arch Intern Med* 1991;151:2225–2229.
121. Bernstein IF, Korman NJ, Bickers DR, et al. Topical capsaicin treatment of chronic postherpetic neuralgia. *J Am Acad Dermatol* 1989;21:265–270.
122. Devor M, Wall PD, Catalan N. Systemic lidocaine silences ectopic neuroma and DRG discharge without blocking nerve conduction. *Pain* 1992;48:261–268.
123. Woolf CJ, Wiesenfeld-Hallin Z. The systemic administration of local anesthetics produces the selected depression of C-afferent fiber evoked activity in the spinal cord. *Pain* 1995;23:361–374.
124. Finnerup NB, Biering-Sorensen F, Johannesen IL, et al. Intravenous lidocaine relieves spinal cord injury pain. A randomized controlled trial. *Anesthesiology*, 2005; 102:1023–1030.
125. Kastrup J, Angelo H, Peterson P, et al. Treatment of chronic pain diabetic neuropathy with intravenous lidocaine infusion. *BMJ* 1986;292:173.
126. Kastrup J, Petersen P, Dejgård A, et al. Intravenous lidocaine infusion—a new treatment of chronic painful diabetic neuropathy? *Pain* 1987;28:69–75.
127. Galer BS, Harle J, Rowbotham MC. Response to intravenous lidocaine infusion predicts subsequent response to oral mexiletine: a prospective study. *J Pain Symptom Manage* 1996;12:161–167.
128. Dejgard A, Petersen P, Kastrup J. Mexiletine for treatment of chronic painful diabetic neuropathy. *Lancet* 1988;1:8575–8576.
129. Trevor AJ, Way WL. Sedative-hypnotic drugs. In Katzung BG, ed. *Basic and Clinical Pharmacology*. 9th ed. New York: McGraw-Hill, 2004:353,354.
130. Yegin A, Sanli S, Dosemeci L, et al. The analgesic and sedative effects of intrathecal midazolam in perianal surgery. *Eur J Anesthesiol* 2004;21:658–662.
131. Gremeau-Richard C, Woda A, Navez ML, et al. Topical clonazepam in stomatodynia: a randomized placebo-controlled study. *Pain* 2004;108:51–57.
132. Eisele JH, Grigsby EJ, Dea G. Clonazepam treatment of myoclonic contractions associated with high-dose opioids: case report. *Pain* 1992;49:231–232.
133. Freitag FG. Preventative treatment for migraine and tension-type headaches: do drugs having effects on muscle spasm and tone have a role? *CNS Drugs* 2003;17:373–381.
134. Meythaler JM, Guin-Renfroe S, Johnson A, et al. Prospective assessment of tizanidine for spasticity due to acquired brain injury. *Arch Phys Med Rehabil* 2001; 82:1155–1163.
135. Slonimski M, Abram SE, Zuniga RE. Intrathecal baclofen in pain management. *Reg Anesth Pain Med* 2004;29:269–276.
136. Fromm GH, Terrence CF. Comparison of L-baclofen and racemic baclofen in trigeminal neuralgia. *Neurology* 1987;37:1725–1728.
137. Childers MK, Borenstein D, Brown RL, et al. Low-dose cyclobenzaprine versus combination therapy with ibuprofen for acute neck or back pain with muscle spasm: a randomized trial. *Curr Med Res Opin* 2005;21:1485–1493.
138. Toth PP, Urtis J. Commonly used muscle relaxant therapies for acute low back pain: A review of carisoprodol, cyclobenzaprine hydrochloride, and metaxalone. *Clin Ther* 2004;26:1355–1367.
139. Van Tulder MW, Touray T, Furlan AD, et al. Muscle relaxants for non-specific low back pain: a systematic review within the framework of the Cochrane Collaboration. *Spine* 2003;17:1978–1992.
140. Bramness JG, Skurtveit S, Morland J. Impairment due to intake of carisoprodol. *Drug Alcohol Depend* 2004;74:311–318.
141. Baum C, Kennedy DL, Forbes MB. Utilization of nonsteroidal anti-inflammatory drugs. *Arthritis Rheum* 1985;28:686–692.
142. Pilotto A, Franceschi M, Leandro G, et al., on behalf of the Geriatric Gastroenterology Study Group. NSAID and aspirin use by the elderly in general practice. *Drugs Aging* 2003;20:701–710.
143. Wagner W, Khanna P, Furst DE. Nonsteroidal anti-inflammatory drugs, disease-modifying antirheumatic drugs, nonopioid analgesics, and drugs used in gout. In Katzung BG, ed. *Basic and Clinical Pharmacology*. 9th ed. New York: McGraw-Hill, 2004: 576–577.
144. Bombardier C, Laine L, Reicin A, et al. Comparison of upper gastrointestinal toxicity of rofecoxib and naproxen in patients with rheumatoid arthritis. VIGOR study group. *N Engl J Med* 2000;343:1520–1528.
145. Silverstein FE, Faich G, Goldstein JL, et al. Gastrointestinal toxicity with celecoxib versus nonsteroidal inflammatory drugs for osteoarthritis and rheumatoid arthritis. The CLASS study: a randomized controlled trial. *Celecoxib long-term arthritis safety study*. *JAMA* 2000;284:1247–1255.
146. Bresalier RS, Sandler RS, Quan H, et al., for the Adenomatous Polyp Prevention on Vioxx (APPROVE) Trial Investigators. Cardiovascular events associated with rofecoxib in a colorectal adenoma chemoprevention trial. *N Engl J Med* 2005;352:1092–1102.
147. Nussmeier NA, Whelton AA, Brown MT, et al. Complications of the COX-2 inhibitors parecoxib and valdecoxib after cardiac surgery. *N Engl J Med* 2005;352:1081–1091.
148. Guideline for the Management of Pain in Osteoarthritis, Rheumatoid Arthritis,



- and Juvenile Chronic Arthritis. 2nd ed. Glenview, IL: American Pain Society, 2002.
149. Reijman M, Bierma-Zeinstra SMA, Pols HA, et al. Is there an association between the use of different types of nonsteroidal antiinflammatory drugs and radiologic progression of osteoarthritis? The Rotterdam Study. *Arthritis Rheum* 2005;52:3137–3142.
  150. Mason L, Moore RA, Edwards JE, et al. Topical NSAIDs for chronic musculoskeletal pain: systematic review and meta-analysis. *BMC Musculoskel Disord* 2004;5:28.
  151. Chandrasekharan NV, Dai H, Roos KLT, et al. COX-3, a cyclooxygenase-1 variant inhibited by acetaminophen and other analgesic/antipyretic drugs: cloning, structure, and expression. *Proc Natl Acad Sci U S A* 2002;99:13926–13931.
  152. Sandrini M, Vitale G, Pini LA, et al. Nociceptin/orphanin FQ prevents the antinociceptive action of paracetamol on the rat hot plate test. *Eur J Pharmacol* 2005;507:43–48.
  153. Bradley JD, Brandt KD, Katz BP, et al. Treatment of knee osteoarthritis: relationship of clinical features of joint inflammation to the response to a nonsteroidal anti-inflammatory drug or pure analgesic. *J Rheumatol* 1992;19:1950–1954.
  154. Geba GP, Weaver AL, Polis AB, et al. Efficacy of rofecoxib, celecoxib, and acetaminophen in osteoarthritis of the knee. *JAMA* 2002;287:64–71.
  155. Benson GD, Koff RS, Tolman KG. The therapeutic use of acetaminophen in patients with liver disease. *Am J Ther* 2005;12:133–141.
  156. Gallagher RM. Rational integration of pharmacologic, behavioral, and rehabilitation strategies in the treatment of chronic pain. *Am J Phys Med Rehabil* 2005;84:S64–S76.
  157. Lemstra M, Olszyuski WP. The effectiveness of multidisciplinary rehabilitation in the treatment of fibromyalgia: a randomized controlled trial. *Clin J Pain* 2005;21:161–176.
  158. Hooten WM, Townsend CO, Bruce BK, et al. Treatment outcomes after multidisciplinary pain rehabilitation with analgesic medication withdrawal for patients with fibromyalgia. *Pain Med* 2007;8:8–16.
  159. Rome JD, Townsend CO, Bruce BK, et al. Chronic noncancer pain rehabilitation with opioid withdrawal: comparison of treatment outcomes based on opioid use status at admission and colleagues. *Mayo Clin Proc* 2004;79:759–768.
  160. Robbins H, Gatchel RJ, Noe C, et al. A prospective one-year outcome study of interdisciplinary chronic pain management: compromising its efficacy by managed care policies. *Anesth Analg* 2003;97:156–162.
  161. Deyo RA, Nachemson A, Mirza SK. Spinal fusion surgery: the case for restraint. *N Engl J Med* 2004;350:722–726.
  162. Brox JI, Sørensen R, Friis A, et al. Randomized clinical trial of lumbar instrumented fusion and cognitive intervention and exercises in patients with chronic low back pain and disc degeneration. *Spine* 2003;17:1913–1921.
  163. Fairbank J, Frost H, Wilson-MacDonald J, et al. Randomised controlled trial to compare surgical stabilization of the lumbar spine with an intensive rehabilitation programme for patients with chronic low back pain: the MRC spine stabilization trial. *BMJ* 2005;330:1233–1239.
  164. Rivero-Arias O, Campbell H, Gray A, et al., and Spine Stabilisation Trial Group. Surgical stabilisation of the spine compared with a programme of intensive rehabilitation for the management of patients with chronic low back pain: cost utility analysis based on a randomised controlled trial. *BMJ* 2005;330:1239–1243.
  165. Sullivan MJL, Thorn B, Haythornwaite JA, et al. Theoretical perspectives on the relation between catastrophizing and pain. *Clin J Pain* 2001;17:52–64.
  166. Fillingim RB, Doleys DM, Edwards RR, et al. Clinical characteristics of chronic back pain as a function of gender and oral opioid use. *Spine* 2003;28:143–150.
  167. de Jong JR, Vlaeyen JWS, Onghena J, et al. Fear of movement/(re)injury in chronic low back pain. Education or exposure in vivo as mediator to fear reduction? *Clin J Pain* 2005;21:9–17.
  168. Hayden JA, van Tulder M W, Tomlinson G. Systematic review: Strategies for using exercise therapy to improve outcomes in chronic low back pain. *Ann Intern Med* 2005;142:776–785.
  169. Rinkel B, Barr J. Physical modalities in chronic pain management. *Nurs Clin North Am* 2003;38:477–494.
  170. Denys EH. AAEM Minimonograph #14: the influence of temperature in clinical neurophysiology. *Muscle Nerve* 1991;14:795–811.
  171. Melzack R, Jeans ME, Stratford JG, et al. Ice massage and transcutaneous electrical stimulation: comparison of treatment for low back pain. *Pain* 1980;9:209–217.
  172. Dellahg B, Wollersjo I, Bjelle A. Effect of active hand exercise and wax bath treatment in rheumatoid arthritis patients. *Arthritis Care Res* 1992;5:87–92.
  173. Hall J, Skevington SM, Maddison PJ, et al. A randomized and controlled trial of hydrotherapy in rheumatoid arthritis. *Arthritis Care Res* 1996;9:206–215.
  174. Kaptchuk T. Acupuncture: theory, efficacy and practice. *Ann Intern Med* 2002;136:374–484.
  175. Han JS. Acupuncture: neuropeptide release produced by electrical stimulation of different frequencies. *Trends Neurosci* 2003;26:17–22.
  176. Lewith G, White P, Pariente J. Investigating acupuncture using brain imaging techniques: the current state of play. *Evid Based Complement Alternat Med* 2005;2:315–319.
  177. Yan B, Li K, Wang W, et al. Acupoint-specific fMRI patterns in human brain. *Neurosci Lett* 2005;383:236–240.
  178. Birch S, Hesselink JK, Jonkman FA, et al. Clinical research on acupuncture. Part 1. What have reviews of the efficacy and safety of acupuncture told us so far? *J Alternat Complement Med* 2004;10:468–480.
  179. Assefi NP, Sherman KJ, Jacobsen C, et al. A randomized clinical trial of acupuncture compared with sham acupuncture in fibromyalgia. *Ann Intern Med* 2005;143:10–19.
  180. Acupuncture: NIH Consensus Conference. *JAMA* 1998;280:1518–1524.



## CHAPTER 93

## Interventional Management of Chronic Pain

Carlos A. Pino, MD, and  
James P. Rathmell, MD

The subspecialty of “interventional pain medicine” involves minimally invasive treatments and minor surgery as part of pain care, including neural blockade and implantable analgesic devices. Despite the paucity of scientific evidence to guide pain practitioners, particularly evidence supporting the use of many interventional modalities, a number of techniques appear to have efficacy based on limited observational data and have been adopted into widespread use. As practitioners we are left to choose from among available treatment modalities, often with only anecdotal and personal experience to guide us in treating a group of desperate patients with intractable pain who are willing to accept almost any treatment, even those that remain unproven. There is no single practice pattern that any pain specialist can point toward as the correct way to treat patients with chronic pain. Training programs vary widely in the scope of what they train practitioners to do. The best pain medicine practitioners strike a reasonable balance between interventional and noninterventional management. This practice pattern is sustainable, and those adopting a balanced style of practice will be able to adapt to evolving scientific evidence that appears in support of pain treatment, regardless of the type of treatment. A balance between treatment modalities also allows practitioners to switch from one mode to another or to incorporate multiple treatment approaches simultaneously. Although this chapter focuses on interventional treatments used to treat chronic pain, use of these interventional modalities is just a small part of the armamentarium of the skilled pain practitioner.

## KEY POINTS

1. The best pain medicine practitioners strike a reasonable balance between interventional and noninterventional management. This practice pattern is sustainable, and those adopting a balanced style of practice will be able to adapt to evolving scientific evidence that appears to support pain treatment, regardless of the type of treatment.
2. Although the evidence supporting the need for routine radiographic guidance is still evolving, the intuitive appeal of this more precise approach has caught firm hold to the point where the majority of practitioners now perform at least a portion of their injections using fluoroscopic guidance.
3. The key to success in any interventional pain technique is a clear understanding of normal anatomy. The procedures described in this chapter require an understanding of the normal anatomy of the spine, including the epidural and subarachnoid spaces, zygapophyseal joints, intervertebral disks, and, most importantly, the spinal cord with its somatic and sympathetic components.
4. Epidural steroid injections are indicated in acute lumbosacral radicular pain or in radiculopathies secondary to herniated or bulging disks. Epidural steroid injections also have been used to treat back pain secondary to degenerative disk disease, spinal stenosis, trauma, spondylolysis or spondylolisthesis, and in pain following laminectomy. The epidural space can be approached through the interlaminar space (median or paramedian), intervertebral foramen (transforaminal), or sacral hiatus (caudal). The approach selected will depend on patient selection, indication for injection, practitioner’s experience, and availability of imaging. Currently no evidence shows better clinical outcome with the transforaminal versus the interlaminar approach.
5. Many practitioners continue to use sympathetic blockade as a part of a multidisciplinary approach to treating complex regional pain syndrome. Sympathetic blocks are one tool that can reduce pain and facilitate functional recovery.
6. Intraarticular facet injection has been largely supplanted by radiofrequency treatment techniques for facet-related pain. Clinical experience and a limited number of published observational studies suggest that intraarticular injection of local anesthetic and steroid leads to relief of facet-related pain that is of limited duration. In contrast, radiofrequency treatment is safe and modestly effective in producing longer-term pain relief in the same group of patients.
7. Discography is a diagnostic test in which radiographic contrast is injected into the nucleus pulposus of the intervertebral disk. Although originally developed for the study of disk herniation, discography now is used most commonly to identify symptomatic disk degeneration.
8. Intrathecal morphine and other opioids are now widely used as adjuncts in the treatment of acute and chronic pain, and a number of agents show promise as analgesic agents with spinal selectivity. Patient selection for intraspinal pain therapy is empiric and remains the subject of debate. In general, intrathecal drug delivery is reserved for patients with severe pain that does not respond to conservative treatment.
9. Direct electrical stimulation of the dorsal columns, known as spinal cord stimulation or dorsal column stimulation, has proven effective, particularly for treatment of chronic radicular pain. Patient selection for spinal cord stimulation is empiric and remains a subject of some debate. In general, spinal cord stimulation is reserved for patients with severe pain that does not respond to conservative treatment. The pain responds best when relatively well localized because success of spinal cord stimulation depends on the ability to cover the entire painful region with electrical stimulation.

## USE OF IMAGE-GUIDED TECHNIQUES IN PAIN MEDICINE

A little more than a decade ago, radiographic guidance was used infrequently by pain practitioners; it was reserved for use in major procedures such as neurolytic celiac plexus block. During the last several years, two forces have been at work. First, pain practitioners now are being called upon to serve as diagnosticians. Patients and referring practitioners expect pain physicians to have familiarity with imaging modalities and their usefulness in diagnosing pain conditions. At the same time, pain practitioners have come to realize the usefulness of radiographic guidance in achieving precise anatomic placement of needles and catheters. Although the evidence supporting the need for routine radiographic guidance is still evolving, the intuitive appeal of this more precise approach has caught firm hold to the point where the majority of practitioners now perform at least a portion of their injections using fluoroscopic guidance.<sup>1</sup> In some cases (e.g., patients with intractable pain associated with metastatic cancer), radiographic guidance has proven invaluable in the planning and implementation of therapy directed toward pain relief.

We have examined the distribution of injectate in a series of patients who received epidural steroid injections for radicular pain associated with a new herniated disk.<sup>2</sup> We found that the injectate often spread to the side opposite the disk herniation. This finding is not at all surprising. A disk herniation present on one side might well obstruct the flow of fluid through the relatively confined epidural space. The fluid would follow the path of least resistance, spreading preferentially to the contralateral, unaffected side and exiting the contralateral intervertebral foramina. This study and others<sup>3,4</sup> have challenged the conventional wisdom that suspending the steroid in a modest volume is sufficient to consistently produce spread of the injectate to the affected levels, regardless of where the solution was placed within the epidural space. Perhaps the blind loss-of-resistance technique is not the best way to deliver steroid to the site of inflammation.<sup>3,4</sup>

Using radiographic guidance, bony structures can be visualized directly

and in real time. The needle can be seen within the radiographic field, and simple geometry can be used to guide the needle directly from the skin's surface to its destination. However, the field of pain medicine suffers from a lack of well-controlled studies to guide our choice of the most effective therapies. Indeed, many of the techniques described in this chapter lack clear evidence supporting their efficacy. Even so, the techniques described are in widespread clinical use. In the following sections, a clear summary of the current evidence available supporting the use of each technique is given, but all too often the data are scant. With more consistent methodology, we can begin the much-needed work of assembling randomized controlled trials to determine which among these techniques are most useful in aiding those with intractable pain.

## SPECIFIC TECHNIQUES USED IN IMAGE-GUIDED INTERVENTION FOR CHRONIC PAIN

This chapter provides an overview of the most common techniques used in interventional pain medicine. The section begins with a discussion of the anatomy relevant to image-guided interventions for treating chronic pain. Thereafter, the clinical utility of each technique and the technical aspects of conducting each intervention are described. Illustrations for the most common techniques are provided, as detailed illustration of each technique is beyond the scope of this chapter. Many books with detailed technical descriptions of these techniques have been published, and we refer the interested reader to one of these texts.<sup>5</sup>

### Anatomy Relevant to Image-Guided Intervention for Chronic Pain

The key to success in any interventional pain technique is a clear understanding of the normal anatomy. The procedures described in this chapter require understanding of the normal anatomy of the spine, including the epidural and subarachnoid spaces, the zygapophyseal joints, intervertebral disks, and, most importantly, the spinal cord with its somatic and sympathetic components. The basic anatomy relevant to common interventions

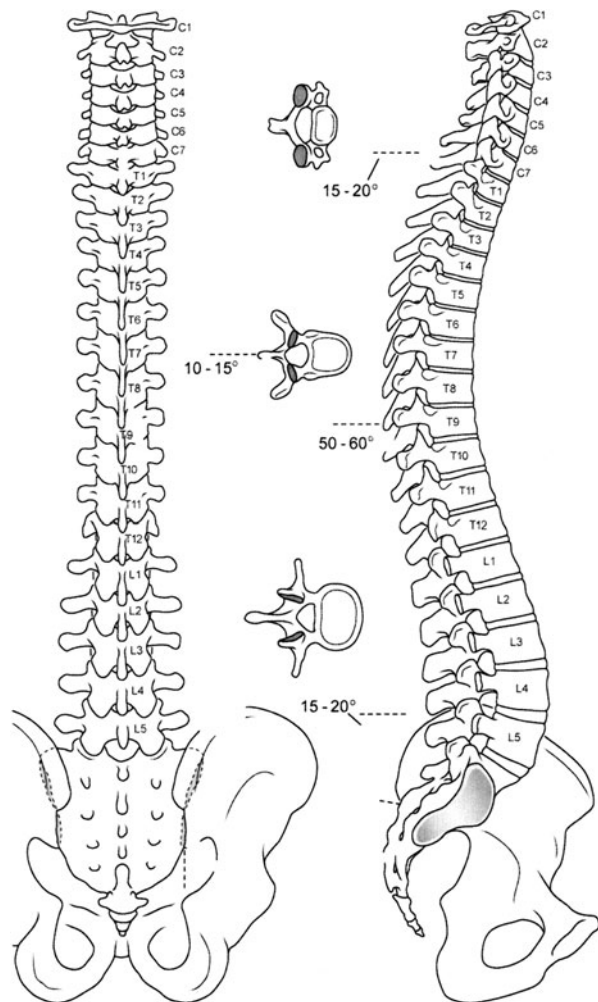
used in the treatment of chronic pain is reviewed here.

### Anatomy of the Spine

The spinal cord is protected within the vertebral canal and extends from the foramen magnum to the first or second lumbar vertebra in human adults. Its is covered by three meninges. The most internal pia mater lies in close apposition to the cord. It is separated from the thin arachnoid mater by the free-flowing cerebrospinal fluid (CSF). The dense dura mater lies most external, surrounding the arachnoid and accompanying the segmental nerve roots well into the vertebral foramen. The epidural space lies within the bony vertebral canal surrounding the dura mater and spreads from the base of the skull to the sacrococcygeal membrane.

Normally, the vertebral canal is nearly triangular, surrounded by the bony components of the vertebrae. There are 33 vertebrae: 7 cervical, 12 thoracic, 5 lumbar, 5 fused elements that make up the sacrum, and 4–5 fused ossicles that form the coccyx (Fig. 93–1).<sup>6</sup> A typical vertebra consists of a vertebral body and two pedicles that extend posteriorly surrounding the spinal canal and epidural space to join a pair of arched laminae (Fig. 93–2). The laminae fuse in the midline to form a dorsal projection called the spinous process. Near the junction of the pedicles and the laminae are found the lateral projecting transverse processes, the superior and the inferior articular processes (zygapophyses or facets). The pedicles and their articulating processes form the superior and inferior vertebral notches. In the articulated spine, these notches form the intervertebral foramina.<sup>6</sup>

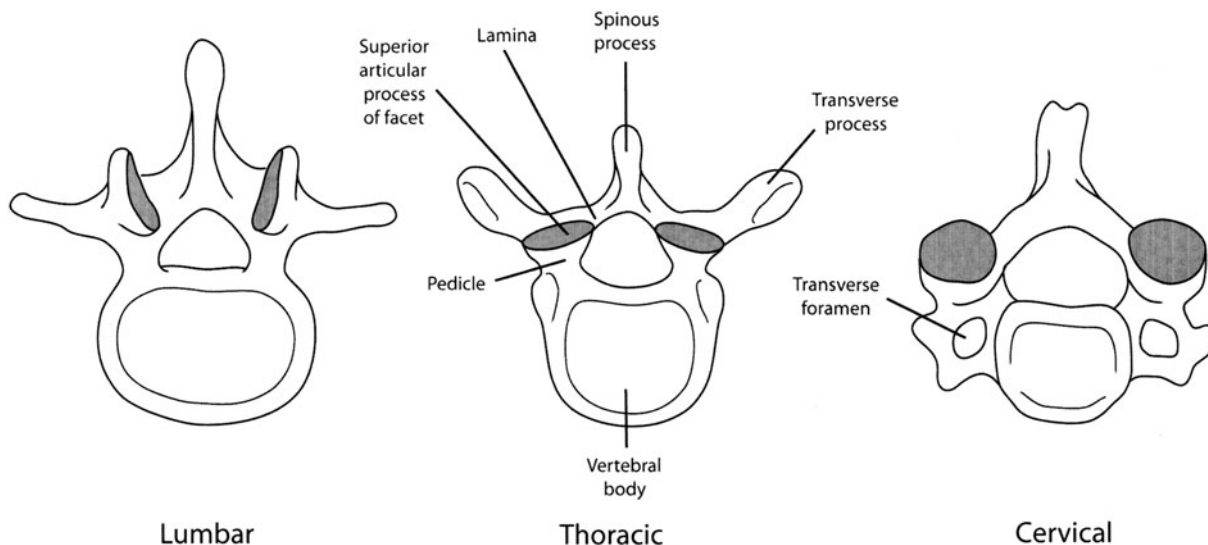
The zygapophyseal or “facet” joints are paired structures that lie posterolaterally on the bony vertebrae at the junction of the lamina and pedicle medially and the base of the transverse process laterally. The facet joints are true joints, with opposing cartilaginous surfaces and a true synovial lining. They are subject to the same inflammatory and degenerative processes that affect other synovial joints throughout the body.<sup>6</sup> Two opposing articular surfaces compose each facet joint. The facet joint articular processes are named for the vertebra to which they belong. Thus, each vertebra has a superior articular process and an inferior articular process.



**FIGURE 93-1.** Anatomy of vertebral column. In most humans, the most prominent spinous process at the base of the neck is C7 (the vertebrae prominens). Note the angle of the spinous processes changes dramatically from cervical to lumbar levels, with the steepest angle in the midthoracic region. The approximate plane of needle entry for interlaminar epidural injection is shown for cervical, thoracic, and lumbar levels. (Adapted from Rathmell JP. Atlas of Image-Guided Intervention in Regional Anesthesia and Pain Medicine. Philadelphia: Lippincott Williams & Wilkins, 2006:33, with permission.)

This nomenclature can be confusing, as the superior articular process of a given vertebra actually forms the inferior portion of each facet joint.

The intervertebral disk is composed of glucosaminoglycans with a relatively fluid inner nucleus pulposus surrounded by a stiff lamellar outer annulus fibrosus.<sup>6</sup> With aging, hydration of the intervertebral disks declines, leading to loss of disk height and fissure formation in the annulus fibrosus. These fissures begin centrally near the border between the nucleus pulposus and the annulus fibrosus and can extend to the periphery of the disk space. This process of degradation is called internal disk derangement and is believed responsible for producing discogenic pain. The annulus contains neural elements from the sinuvertebral nerve, which is believed to be responsible for pain transmission.<sup>7</sup> These same radial fissures within the annulus represent paths through which nuclear material can pass and extrude as a herniated nucleus pulposus. When this extruded material is adjacent to an exiting spinal nerve root, it can lead to intense inflammation, nerve root compression, and radicular pain with or without radiculopathy (nerve root dysfunction in the form of numbness, weakness, and/or loss of deep tendon reflexes). The paired facet joints, along with the vertebral bodies and intervertebral disks, form the three weight-bearing support columns that distribute the axial load on the vertebral column while allowing for movement in various planes. The structure of the vertebrae varies from



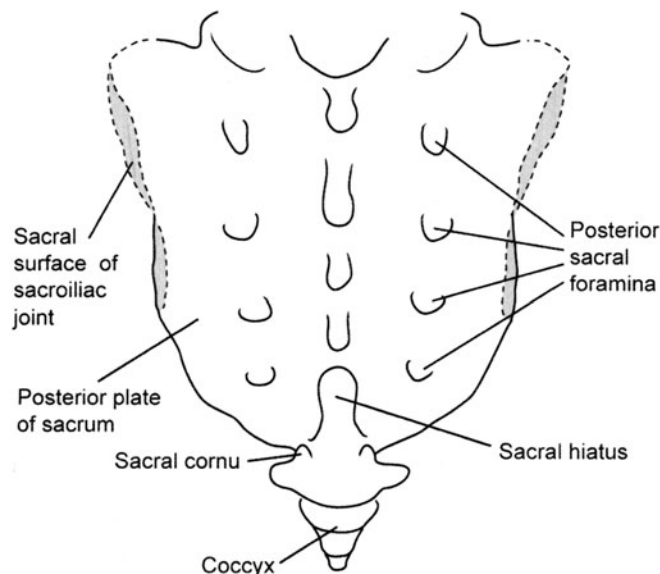
**FIGURE 93-2.** Anatomy of the cervical, thoracic, and lumbar vertebrae. (Adapted from Rathmell JP. Atlas of Image-Guided Intervention in Regional Anesthesia and Pain Medicine. Philadelphia: Lippincott Williams & Wilkins, 2006:32, with permission.)

cephalad to caudad and should be thoroughly reviewed by the practitioner, especially when using imaging (Figs. 93-1 and 93-2). Of importance when performing injections, the spinous processes of the cervical and lumbar regions approach the lamina in a nearly perpendicular fashion, which facilitates a midline approach when performing epidural or subarachnoid injections. The cervical facet joints are oriented nearly parallel to the axial plane where the atlas (C1) articulates with the occiput and become gradually more steeply angulated in a cephalad to caudad direction at lower cervical levels. The orientation of the cervical facet joints in a plane close to the axial plane allows for a great degree of rotation of the neck as well as flexion and extension.

The midthoracic (T5-9) spinous processes are acutely angled caudad, making the midline approach to the epidural space more difficult than the paramedian approach. The thoracic facet joints are so steeply angulated that they approach the frontal plane, which makes intraarticular injection difficult or impossible. At midthoracic levels, the inferior articular process of the vertebra forming the superior portion of each thoracic facet joint lies directly posterior to the superior articular process forming the inferior portion of each joint. This allows for some degree of flexion and extension but limited rotation of the spinal column in the thorax.

The spinous processes of the lumbar vertebrae approach the lamina in a nearly perpendicular fashion. The lumbar facet joints are angled with a somewhat oblique orientation, allowing for flexion, extension, and rotation that is greater than that in the thorax but less than in the cervical region. The sacral hiatus is the area where the fifth sacral vertebra lacks both the laminae and the spinous process posteriorly (Fig. 93-3). The two sacral cornua lie on either side of the sacral hiatus and cephalad to the coccyx and are useful landmarks when performing an epidural from a caudal approach.

The midline distance from the ligamentum flavum to the dural sac varies considerably, depending on the level of entry, increasing from 2 mm at C3-6 to 5-6 mm in the midlumbar region.<sup>8</sup> The epidural space narrows posterior and laterally toward the intervertebral foramina. The anterior boundary of



**FIGURE 93-3.** Anatomy of the posterior sacrum and coccyx. (Adapted from Rathmell JP. *Atlas of Image-Guided Intervention in Regional Anesthesia and Pain Medicine*. Philadelphia: Lippincott Williams & Wilkins, 2006:33, with permission.)

the epidural space is provided by the posterior longitudinal ligament covering the vertebral bodies and the intervertebral disks. Posteriorly, the epidural space is limited by the periosteum of the anterior surfaces of the laminae, the articulating facet processes (zygapophyses), and the ligamentum flavum. Laterally, the pedicles and the intervertebral foramina limit the epidural space.

Knowledge of surface anatomy enhances safety when performing procedures under imaging guidance and is an absolute necessity when imaging is not available. Important surface landmarks include the spinous process at C7 (*vertebra prominens*), which is the most prominent cervical spinous process palpable when the neck is flexed. The spinous process at T7 lies opposite the inferior angle of the scapula when the arm is at the side. A line joining the superior aspects of the iliac crests passes through the spinous process of the fourth lumbar vertebrae. The spinal cord generally terminates at the L2 level and the dural sac ends at S2, which corresponds to the level of the posterior superior iliac spines. The tip of an equilateral triangle drawn between the posterior superior iliac spines and directed caudally overlies the sacral cornua and sacral hiatus.

Additionally, the articulated spine is supported by the anterior and posterior longitudinal ligaments, the supraspinous and interspinous ligaments, and the ligamentum flavum.<sup>8</sup> Many of

the pain management procedures discussed here make reference to the ligamentum flavum. The ligamentum flavum or “yellow ligament” is a structure of variable thickness and completeness, composed of elastic fibers, that defines the posterolateral soft-tissue boundaries of the epidural space. Because its leather-like consistency resists active expulsion of fluid from a syringe, loss of this resistance is valuable in signaling entry into the epidural space. The ligament’s structure is steeply arched and tent-like, so much so that the lateral reflection may be up to 1 cm deeper than at the midline. In the cervical and thoracic epidural spaces, the ligamentum flavum often does not fuse in the midline, which can become problematic during loss-of-resistance techniques. When the dense ligamentum flavum is absent in the midline, it is possible to enter the epidural space without ever sensing significant resistance to injection. The ligamentum flavum is thickest at the lumbar and thoracic levels and thinnest at the cervical level. Its thickness also diminishes at the cephalad aspect of each interlaminar space and as the ligamentum flavum tapers off laterally. In patients who have undergone spinal surgery, scarring of the posterior epidural space is common, such that the loss of resistance and the flow of injected solutions are less predictable.

The spinal cord is a cylindrical structure composed of an external white matter and internal gray matter, pro-



tected by the bony vertebral column. White matter represents the myelinated ascending and descending tracts of the spinal cord, which conduct information to and from the brain. The gray matter contains axons, dendrites, and synaptic terminals arranged grossly in the shape of butterfly wings. The spinal cord receives its vascular supply from arteries of the brain and from segmental spinal arteries of the subclavian artery, aorta and iliac arteries.<sup>6</sup> The posterior spinal cord receives its blood supply from a paired system of arteries arising from the posterior inferior cerebellar arteries. The anterior spinal artery is a single, discontinuous vessel formed by the union of a terminal branch from each vertebral artery that descends along the anterior midline of the spinal cord. In all regions of the cord, the anterior spinal artery provides nutrition to approximately 75% of the cord tissue, including all of the gray matter,<sup>8</sup> which makes this territory most vulnerable to ischemia.

The segmental spinal arteries reach the spinal cord by way of the intervertebral foramina and the epidural space, to reach the spinal nerve roots. Although the main purpose of these segmental arteries is to provide blood supply to the nerve roots, some send branches that penetrate the dura to join the anterior and posterior spinal arteries that provide blood supply to the spinal cord. The largest of the segmental arteries is the artery radicularis magna (artery of Adamkiewicz), which supplies the anterior spinal artery for the thoracolumbar region of the cord. In 78% of cases, it enters by way of a left intervertebral foramen between T8 and L3; in 15% of cases, the artery of Adamkiewicz takes off more cephalad, at about the level of T5.<sup>8</sup> It is important to keep in mind that many of our pain management procedures are performed in this region, and damage to the artery of Adamkiewicz can result in ischemia of the anterior two thirds of the lumbar spinal cord, with its resultant predominantly motor lesion.<sup>9</sup>

Venous drainage of the spinal cord occurs via large epidural veins, which are more prominent in the anterior and lateral portions of the epidural space. These veins are valveless and connect to the systemic circulation via the basivertebral venous plexus, intracranial veins, and azygos veins. Inferiorly, this plexus communicates with

the sacral venous plexus, which drains into the uterine and iliac veins. At each level, the vertebral plexus sends branches through the intervertebral foramina that anastomose with the thoracic and abdominal veins. The extensive communication between the epidural venous plexus and the systemic circulation is responsible for the distension of the epidural veins that occurs with increases in intraabdominal pressure. Thus, significant obstruction of the inferior vena cava results in rerouting of the venous return through the epidural venous plexus to the azygos vein.

The spinal nerve at each level exits the intervertebral foramen and divides into anterior and posterior primary rami. The anterior ramus contains the majority of sensory and motor fibers at each vertebral level. Of importance, a small branch of the anterior ramus, the sinuvertebral nerve, provides neural branches to the posterior outer layers of the annulus of the disk.<sup>7</sup> The posterior primary ramus, in turn, divides into a lateral branch, which provides innervation to the paraspinal musculature, and a small variable sensory distribution to the skin overlying the spinous processes; the medial branch courses over the base of the transverse process where it joins with the superior articular process of the facet joint and courses along the articular process to supply sensation to the joint. Each facet joint receives sensory innervation from the medial branch nerve at the same vertebral level as well as from a descending branch from the vertebral level above; thus, two medial branch nerves must be blocked to anesthetize each facet joint (e.g., medial branch blocks at the base of the L4 and L5 transverse processes are needed to anesthetize the L4–5 facet joint). The specific course of the medial branch nerves and cannula position for radiofrequency treatment at specific spinal levels is discussed in the following sections.

### **Anatomy of the Sympathetic Nervous System**

Because we will discuss sympathetic nerve block techniques, a brief review of the anatomy is warranted. The sympathetic nervous system is part of the autonomic nervous system. It innervates cardiac, smooth muscle, and glandular tissues, mediating a variety of reflexes. In certain pathologic pain

states, neuronal activity in the sympathetic nervous system may be involved in the maintenance of chronic pain.<sup>10</sup> Anatomically, the peripheral sympathetic system arises as efferent preganglionic fibers that leave their cell bodies in the intermediolateral column of the spinal cord, which extends from the first thoracic spinal segment to approximately the second lumbar segment. These axons leave the spinal cord within the ventral root and initially proceed as part of the spinal nerve. They separate from the somatic motor neuron, forming the white rami communicantes, and project to the sympathetic chain, located at the side of the vertebral bodies. Within the sympathetic nerve trunk, the preganglionic fibers can transverse variable distances cephalad and caudad, forming synapses with many postganglionic neurons in different ganglia at other levels in the chain. The ratio of preganglionic sympathetic fibers to postganglionic fibers is estimated to be 1:10, permitting coordinated activity at several spinal levels.<sup>10</sup> The axons of the postganglionic neurons are predominantly unmyelinated and exit the ganglia as the gray rami communicantes, which join the spinal nerves en route to their peripheral targets. In addition to the multiple ganglia located in the thoracolumbar chain, there are classically 3 cervical ganglia, 4–5 lumbar ganglia, 4 sacral ganglia, and 1 coccygeal ganglion (the ganglion impar).

In the cervical region, the chain lies at the anterolateral aspect of the vertebral bodies. Most sympathetic fibers traversing to and from the head, neck, and upper extremities pass through the stellate ganglion. Classically, the stellate ganglion is formed by fusion of the inferior cervical and first thoracic sympathetic ganglia. The ganglion is commonly found just lateral to the longus colli muscle, anterior to the neck of the first rib and the transverse process of the seventh cervical vertebra. In this position, the ganglion lies posterior to the first portion of the subclavian artery at the origin of the vertebral artery posterior to the dome of the lung. Although several approaches to stellate ganglion block have been described, the most common is the anterior paratracheal approach at C6 using surface landmarks. Performing the block at C6 reduces the likelihood of pneumothorax, which is more likely when the

block is carried out close to the dome of the lung at C7. The anterior tubercle of the transverse process of C6 (Chassaignac's tubercle) is readily palpable in most individuals.

Sympathetic innervation to the abdominal viscera arises from the anterolateral horn of the spinal cord between the T5 and T12 levels. Nociceptive information from the abdominal viscera is carried by afferents that accompany the sympathetic nerves. Pain transmitted via the celiac plexus originates from the upper abdominal structures, including the pancreas, diaphragm, liver, spleen, stomach, small bowel, ascending and proximal transverse colon, adrenal glands, kidney, abdominal aorta, and mesentery. The celiac plexus is composed of a diffuse network of nerve fibers and individual ganglia that lie over the anterolateral surface of the aorta at the T12–L1 vertebral level. Presynaptic sympathetic fibers travel from the thoracic sympathetic chain toward the ganglion, traversing over the anterolateral aspect of the inferior thoracic vertebrae as the greater (T5–9), lesser (T10–11), and least (T12) splanchnic nerves. Presynaptic fibers traveling via the splanchnic nerves synapse within the celiac ganglia, over the anterolateral surface of the aorta surrounding the origin of the celiac and superior mesenteric arteries at approximately the L1 vertebral level. Postsynaptic fibers from the celiac ganglia innervate all of the abdominal viscera with the exception of the descending colon, sigmoid colon, rectum, and pelvic viscera.

The lumbar sympathetic chain consists of 4–5 paired ganglia that lie over the anterolateral surface of the second through fourth lumbar vertebrae. The cell bodies that send projections to the lumbar sympathetic ganglia lie in the anterolateral region of the spinal cord from T11 to L2, with variable contributions from T10 and L3. As in the thoracic area, the lumbar preganglionic fibers leave the spinal canal with the corresponding spinal nerve, join the sympathetic chain as white communicating rami, and then synapse within the appropriate ganglion. Postganglionic fibers exit the chain to join either the diffuse perivascular plexus around the iliac and femoral arteries or via the gray communicating rami to join the nerves that form the lumbar and lumbosacral plexus. Sympathetic fibers accompany all of the major nerves to the

lower extremities. The majority of the sympathetic innervation to the lower extremities passes through the second and third lumbar sympathetic ganglia, and blockade of these ganglia results in near-complete sympathetic denervation of the lower extremities.

The superior hypogastric plexus is composed of a flattened band of intercommunicating nerve fibers that descend over the aortic bifurcation. The plexus carries sympathetic afferents and postganglionic efferent fibers from the lumbar sympathetic chain as well as parasympathetic fibers that arise from S2–S4. The plexus is retroperitoneal in location and lies over the anterior surface of the fourth and fifth lumbar and the first sacral vertebrae. Sympathetic nerves passing through the plexus innervate the pelvic viscera, including the bladder, uterus, rectum, vagina, and prostate.

## Interlaminar Epidural Injection Steroids and Transforaminal Injection of Steroids

### Overview

The theoretical background supporting the use of epidural steroids is based on the existence of inflammation as the basic pathophysiologic process. Nerve root edema has been demonstrated surgically and with computed tomography (CT) in patients with herniated disks.<sup>11</sup> Inflammation of nerves in the presence of a herniated disk has further been confirmed during surgery,<sup>12</sup> myelography,<sup>13</sup> and histologic examinations.<sup>14,15</sup> More recently, phospholipase A<sub>2</sub> (PLA<sub>2</sub>), the rate-limiting enzyme in the conversion of arachidonic acid to prostaglandins and leukotrienes, has been found in high levels in the extruded disc material of patients undergoing discectomy for herniated disk.<sup>16</sup> Other inflammatory mediators such as prostaglandins have also been shown to produce hyperalgesia.<sup>17</sup> Clinically, improvement of pain has been shown to coincide with resolution or decrease in nerve root edema, despite a persistent herniated disk.<sup>7</sup>

In laboratory animals, PLA<sub>2</sub> has been implicated as a primary inflammatory mediator. Its administration in lumbar nerve roots produces motor weakness and decreased mechanical withdrawal thresholds.<sup>18</sup> Histologic examination shows reversible demyelination, vacuolar degeneration in the nerve roots, and unclear axonal margins.<sup>14</sup> In another

animal model of radiculopathy, Hayashi et al.<sup>19</sup> ligated the left L4 and L5 nerve roots while surgically placing an epidural catheter with the tip between the ligated nerve roots. All rats demonstrated reversible motor weakness that resolved completely in 4 weeks, and all of the animals exhibited thermal hyperalgesia. The rats were separated into groups and treated with epidural betamethasone alone, normal saline, or epidural betamethasone plus bupivacaine. All treatment groups demonstrated a transient reduction in thermal hyperalgesia, but both betamethasone groups showed prolonged benefit lasting 3–4 weeks.

Steroids decrease inflammation by inducing the biosynthesis of a PLA<sub>2</sub> inhibitor, preventing prostaglandin generation.<sup>20,21</sup> Steroids also suppress ongoing discharge in chronic neuromas and prevent the development of ectopic neural discharges from experimental neuromas, which has been attributed to direct action on the membrane.<sup>22</sup> Steroids may block nociceptive input. Local application of methylprednisolone was found to reversibly block transmission in the unmyelinated C-fibers but not in Aβ-fibers.<sup>23</sup>

### Patient Selection

Many investigators have attempted to identify which patients are most likely to benefit from epidural steroid injections. In 1960, Goebert et al.<sup>24</sup> administered three consecutive epidural hydrocortisone and procaine injections in 239 patients with low back pain. Fifty-eight percent of the patients had >60% relief for 3 months or longer, and 8% of patients claimed 40–60% pain relief.

In a prospective study, White et al.<sup>25</sup> followed the response to epidural steroid injection of 304 patients with low back pain. They found longer pain relief in patients with <2 weeks of pain and in those patients without “psychological overlay.” Eighty-seven percent of the patients reported good short-term success, without significant differences between the acute and chronic pain groups, whereas 34% of patients in the acute pain group still reported pain relief at 6 months compared to 12% in the chronic pain group. Twenty-four percent of patients without psychological overlay were still relieved of their pain at 6 months compared to only 1.5% of patients with psychological overlay.

One prospective randomized study of lumbar epidural steroid injections followed 36 patients younger than 50 years with radicular pain, positive straight-leg raising test, and a prolapsed disk at L4–L5 or L5–S1 confirmed by magnetic resonance imaging (MRI).<sup>26</sup> These patients were randomized to two groups; both received identical conservative therapy and one of the groups also received a series of three epidural steroid injections. At 2-week followup, patients in the epidural steroid injection group had a significantly greater increase in straight-leg raise measurements compared to the control group. In addition, a trend in pain relief favoring the epidural steroid group was noted but did not reach significance. This study was not blinded, and all injections were given within 14 days of randomization, such that the interval from onset to injection was very brief.

The effectiveness of epidural steroids in the relief of radicular pain attributable to herniated disk has been documented by many studies.<sup>27–34</sup> Based on these and many other published studies, it is currently believed that epidural steroid injections are indicated in acute lumbosacral radicular pain or in radiculopathies secondary to herniated or bulging disks.<sup>35</sup> Although their usefulness has not been clearly documented by controlled studies, epidural steroid injections also have been used to treat back pain secondary to degenerative disk disease,<sup>27,31,32</sup> spinal stenosis,<sup>36</sup> trauma,<sup>24</sup> spondylolysis or spondylolisthesis,<sup>25,27,29</sup> and in pain following laminectomy.<sup>24,37</sup>

In a large observational study on the frequency of epidural steroid injections and patient characteristics, Fanciullo et al.<sup>38</sup> collected information on 25,479 patients seen at 23 specialty spine centers in the United States from 1995–1998. Surprisingly, epidural steroid injection formed part of the treatment plan for only 2002 patients (7.9%). As expected, lumbar problems were far more likely in patients who had an epidural steroid injection (12.6%) than in patients with cervical (3.7%), thoracic (1.8%), or sacral problems (2.4%). The most frequent diagnoses in patients who were offered epidural steroid injection were spinal stenosis (40.1%) and herniated disk (34.3%), followed by spondylolisthesis (7.8%) and compression fractures (1.6%). Evidence supports the use of epidural steroids in patients with disk

herniations and other presumed inflammatory conditions, such as nerve irritation secondary to spinal stenosis or spondylolisthesis, but the efficacy of epidural steroids is undocumented in patients with compression fractures. These results show that patient selection for epidural steroid injections is not always consistent with existing data, and concordance between clinical practice and reported evidence of efficacy is variable.

### **Drug Selection for Epidural Steroid Injection**

Most studies reported in the literature used a mixture of local anesthetic and steroid, saline with steroid, or steroid alone. The steroids most commonly used are either methylprednisolone acetate (Depo-Medrol) or triamcinolone diacetate (Aristocort). The doses of methylprednisolone most widely used vary from 80–120 mg, and the doses of triamcinolone most commonly used vary from 50–75 mg.<sup>31,32,39,40</sup>

Methylprednisolone acetate has been approved for intramuscular, intrasynovial, soft-tissue, and intralesional injection. It is a glucocorticoid with an elimination half-life of 139 hours and a range from 58–866 hours.<sup>41</sup> Triamcinolone diacetate, which has an elimination half-life of 18–36 hours, possesses glucocorticoid properties while being essentially devoid of mineralocorticoid activity, thus causing little or no sodium retention. It has been approved for administration by intramuscular, intraarticular, and intrasynovial routes.<sup>42</sup>

In a review of the literature, Kepes and Duncalf<sup>43</sup> found that methylprednisolone was the least irritating, the most beneficial, and the longest acting, although Delaney et al.<sup>44</sup> prefer triamcinolone because of its excellent antiinflammatory effect and low potential for sodium retention. No study has compared the effectiveness of triamcinolone and methylprednisolone, which probably are equally effective. Both of these preparations contain polyethylene glycol, which has been found to impair nerve transmission in rabbit vagus nerve and cause degenerative lesions in rat sciatic nerves.<sup>45,46</sup> Both preparations also contain benzyl alcohol, which is potentially toxic when administered locally to neural tissue.<sup>31</sup> Neither of these preparations should be used intrathecally.

Most practitioners dilute the steroid with local anesthetic or sterile saline,

and the results are apparently comparable with either diluent.<sup>30</sup> Some authors have recommended use of local anesthetics “in the presence of muscle spasms”.<sup>26,47</sup> However small the dose, use of local anesthetic carries some risks, including hypotension, arrhythmias, and seizures from intravascular injections. Brown<sup>1</sup> suggests that because the results are comparable, use of saline probably is sufficient. Some investigators have combined epidural methylprednisolone with morphine. In an initial study, Cohn et al.<sup>48</sup> showed encouraging results in post-laminectomy patients; however, a subsequent study was unable to repeat such beneficial effects.<sup>49</sup>

Traditionally, the volume of diluent has depended on the site of injection, whether lumbar, caudal, or transforaminal. When using a caudal approach, 20–25 mL of a solution has been recommended in order to assure epidural spread cephalad to the desired level.<sup>27,30</sup> When using a lumbar interlaminar approach, a volume of 5–10 mL has been recommended to reach the areas most commonly involved in the lumbar region.<sup>25</sup> Other practitioners use smaller volumes (2–3 mL), especially when using the transforaminal approach. Some authors have suggested that several nerve roots may be inflamed in addition to those adjacent to the herniated or bulging disk, and they recommend against using a small volume of diluent.<sup>50</sup> Wood et al.<sup>46</sup> suggested diluting the steroid after their study showed degenerative lesions in rat sciatic nerves attributable to the polyethylene glycol vehicle in the steroid preparation. The optimal volume of injectate and site of epidural placement remain unresolved.

Epidural steroids have been associated with glucose intolerance and pituitary–adrenal axis suppression for up to 3 weeks after repeated administration.<sup>51–53</sup> Ward et al.<sup>54</sup> measured insulin sensitivity and fasting blood glucose, fasting plasma insulin, and fasting serum cortisol levels in 10 healthy individuals 24 hours before and 1 week after epidural administration of triamcinolone 80 mg via a caudal route. They found that 24 hours after epidural steroid injection, insulin sensitivity had decreased to nearly half the baseline, fasting insulin levels increased 1.4-fold, and fasting glucose levels had increased 1.1-fold. All of these values normalized by 1 week after injection,

and they demonstrate the marked changes in insulin sensitivity occurring in nondiabetic healthy individuals after epidural steroid injection.

### Technique

The epidural space can be approached through the interlaminar space (median or paramedian), intervertebral foramen (transforaminal), or sacral hiatus (caudal). The approach selected depends on patient selection, indication for injection, practitioner's experience, and availability of imaging. The patient can be positioned in the lateral decubitus position, sitting or prone, depending on the technique to be used.

### Interlaminar Technique for Epidural Steroid Injection

The term *interlaminar* has been given to the traditional posterior approach to the epidural space in order to easily differentiate it from the transforaminal or caudal approach. The interlaminar approach can be either midline or paramedian. Correct epidural placement with this technique is facilitated by the use of imaging guidance. As reported by Sharrock et al.,<sup>55</sup> anesthesiologists have a high success rate of epidural anesthesia using loss-of-resistance; however, use of image guidance can confirm proper placement in all cases. When using the midline approach, the point of insertion depends on the level of entry and angle of the corresponding spinous processes. For the cervical and lumbar midline approach, the needle should be almost perpendicular to the neuraxis, in line with the corresponding spinous process. This is also true with the low thoracic approach below T9. In the midthoracic region, the spinous processes are sharply angled caudad, such that the tip of the spinous processes lies opposite the lamina of the inferior vertebral body. In this region, the midline approach requires that the needle be inserted with a steep cephalad angle, often approaching 130°. Many practitioners prefer the paramedian approach in the midthoracic region. The choice of needles when using the interlaminar approach is similar to those available for anesthesia; the most common type is the 18- or 20-gauge Tuohy needle.

For cervical interlaminar epidural injections, most practitioners place the patient in a sitting or prone position. When in the sitting position, the

patient is asked to sit comfortably and flex the neck anteriorly. The forehead can be leaned against a sturdy, but padded, horizontal surface in order to minimize involuntary movement. This position avoids rotation of the spine and widens the lower cervical epidural space. Because of its large interlaminar distance, the most common approach is C6-7 or C7-T1, especially because the long spinous process of C7 (the vertebra prominens) serves as a reliable surface marker.

When the prone position is used for the cervical interlaminar approach, most practitioners prefer to use imaging guidance. This allows for good visualization of the interlaminar space and needle advancement between adjacent spinous processes.

### Cervical Epidural Steroid Injection Technique

Classically, the epidural space has been identified using loss of resistance to saline. Regardless of the approach, sterile technique must be strictly observed. The skin and subcutaneous tissues overlying the interspace where the block is to be performed are anesthetized with local anesthetic. The cervical interspaces with the largest interlaminar distance typically are found at C6-7 and C7-T1. Because of the ease of entry, many practitioners place the needle via one of these larger interspaces, regardless of the level of pathology, and rely on the flow of steroid in the epidural space to reach the level of pathology. The same technique can be used in all cervical interspaces below C3-4. Interlaminar injections above the C2-3 level have not been described.

An 18- or 20-gauge Tuohy needle is placed through the skin and advanced several centimeters until the needle is firmly seated in the interspinous ligament. An anteroposterior (AP) image is taken, and the needle is redirected toward midline. We use the loss-of-resistance technique with saline to find the epidural space. Repeat images taken after every 1-1.5 cm of needle advancement will assure that the needle direction does not stray from midline. A firm grasp of the adjacent structures and the proximity of the spinal cord is essential during cervical interlaminar epidural injection. After the needle tip enters the epidural space, the position is confirmed by injecting nonionic radiographic contrast, and adequate spread is verified in the AP and

lateral planes. If lateral imaging of the cervicothoracic junction and low cervical spine is hindered by the adjacent structures of the torso and arms, a second lateral image taken just above the shoulders often can be much simpler to interpret when trying to confirm epidural contrast flow. Once epidural needle position has been confirmed, a solution containing steroid diluted in preservative-free saline is injected. In our practice, we routinely use 80 mg of methylprednisolone acetate or the equivalent diluted in 5 mL of total volume.

### Midthoracic Epidural Steroid Injection

Because of the steep angulation of the spinous processes at this level, image guidance is often used. The patient lies prone, with the head turned to one side. The C-arm is rotated 40-50° caudally from the axial plane without any oblique angulation. This allows for good visualization of the interlaminar space and needle advancement between adjacent spinous processes.

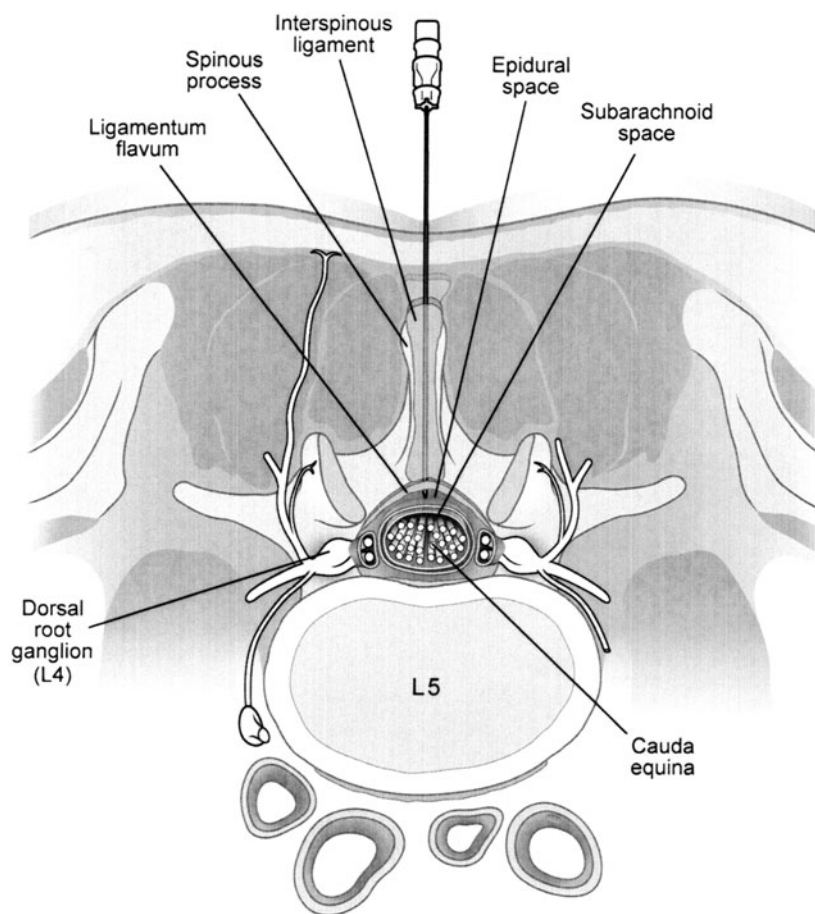
The skin and subcutaneous tissues approximately 1 cm lateral and 2-3 cm caudad to the interspace where the block is to be performed are anesthetized. An 18- or 20-gauge Tuohy needle is placed through the skin and advanced several centimeters until the needle is firmly seated in tissue. An AP image is taken, and the needle is directed toward the superior margin of the lamina below the interspace that is to be entered, near the junction of the spinous process and the lamina. Although a midline approach can be used at low thoracic levels, the spinous processes are angled too steeply to allow for true coaxial needle placement at the midthoracic levels. Thus, the needle is best directed toward the superior margin of the lamina. While advancing, repeat images are taken and care must be taken to keep the needle tip over the lamina until bone is gently contacted. The periosteum is then anesthetized, and the needle is slowly advanced over the superior margin of the lamina until loss of resistance occurs. Because the needle is unlikely to lie within the interspinous ligament when using a paramedian approach, there will be little resistance to injection until the needle enters the interlaminar space and traverses the ligamentum flavum. A firm understanding of the adjacent structures and the prox-



imity of the spinal cord is essential for thoracic interlaminar epidural injection. After the needle tip enters the epidural space, the position is confirmed by injecting nonionic radiographic contrast, and spread is verified in the AP and lateral planes. Once epidural needle position has been confirmed, a solution containing steroid diluted in preservative-free saline is injected, and the needle is removed.

**Lumbar Epidural Steroid Injection** Epidural injection at the lumbar level can be administered with the patient in a sitting or prone position. The patient is asked to sit comfortably with his or her back to the anesthesiologist, curving the spine posteriorly and pushing the lumbar region against the examiner's fingers in an attempt to separate the spinous processes. If the procedure is to be performed in the prone position under fluoroscopic imaging, a pillow is placed under the mid and lower abdomen to reduce the lumbar lordosis and increase the separation between adjacent spinous processes. The C-arm is rotated 15–20° caudally from the axial plane without any oblique angulation. This allows for good visualization of the interlaminar space and needle advancement between adjacent spinous processes.

The skin and subcutaneous tissues overlying the interspace where the block is to be performed are anesthetized. An 18- or 20-gauge Tuohy needle is placed through the skin and advanced 1–2 cm until the needle is firmly seated in the interspinous ligament. If the patient is prone, an AP image should be taken as the needle is advanced, until loss of resistance occurs. If the patient is sitting, adequate positioning will allow a proper midline approach. A firm knowledge of the adjacent structures and the proximity of the thecal sac and cauda equina is essential for lumbar interlaminar epidural injection (Fig. 93–4). After the needle tip enters the epidural space and aspiration is negative for CSF or blood, the position is confirmed by injecting nonionic radiographic contrast, and spread is verified in the AP and lateral planes. Lateral imaging of the lower lumbar spine is hindered by the overlying iliac crests, and visualization can be difficult in the obese patient. Once



**FIGURE 93–4.** Axial diagram of interlaminar lumbar epidural injection. The epidural needle is advanced in the midline between adjacent spinous processes to traverse the ligamentum flavum and enter the dorsal epidural space in the midline. The normal epidural space is approximately 4–6 mm wide (from the ligamentum flavum to the dura mater in the axial plane). Note the proximity of the underlying cauda equina during lumbar epidural injection. (Adapted from Rathmell JP. *Atlas of Image-Guided Intervention in Regional Anesthesia and Pain Medicine*. Philadelphia: Lippincott Williams & Wilkins, 2006:47, with permission.)

epidural needle position has been confirmed, a solution containing steroid diluted in preservative-free saline is injected, and the needle is removed. In the lumbar region, we usually use 80 mg of methylprednisolone acetate or the equivalent diluted in 5–10 mL of total volume. When larger injectate volumes are used, the solution spreads extensively in both the anterior and posterior aspects of the epidural space. In patients with significant lumbar pathology, the injectate tends to follow the path of least resistance, often flowing toward the side opposite the pathology.<sup>2</sup>

**Caudal Epidural Steroid Injection** Anesthesiologists will be familiar with caudal injections administered to pediatric patients in the operating room. Because of difficulty identifying the sacral hiatus clinically in adults,

these procedures usually are performed under fluoroscopy. The patient lies prone with the head turned to one side. The C-arm is rotated 20–30° caudally from the axial plane without any oblique angulation. This allows for good visualization of the sacrum, sacral hiatus, and coccyx.

Once the sacral hiatus is identified radiographically, the overlying skin and subcutaneous tissues are anesthetized. The sacral hiatus can be difficult to visualize radiographically. The approximate location can be identified by palpating the paired sacral cornua in the midline, near the superior extent of the gluteal cleft. An 18- or 20-gauge Tuohy needle can be used, but a smaller 22-gauge, 3.5-inch spinal needle is adequate. The needle is placed through the skin and advanced directly through the sacrococcygeal ligament. Once the needle has passed through

the sacrococcygeal ligament and is within the caudal spinal canal, the angle of the needle is decreased to lie closer to the plane of the sacrum, and the needle is advanced into the spinal canal an additional 1–2 cm. A firm grasp of the anatomy of the sacral hiatus and the caudal epidural space is essential for caudal epidural injection. AP and lateral imaging confirm the needle's position within the caudal epidural space. The caudal epidural space is generously supplied with veins, and intravascular needle placement is ruled out by injecting nonionic radiographic contrast under live fluoroscopy. Once caudal epidural needle position has been confirmed, a solution containing steroid diluted in preservative-free saline is injected, and the needle is removed. The caudal epidural space is distant from the usual sites of nerve root inflammation near the lumbosacral junction; thus, a significant volume of injectate usually is required to affect spread to the level of the lumbosacral junction. For this approach, we use 80 mg of methylprednisolone acetate or the equivalent diluted in at least 10 mL of total volume.

Complications of the interlaminar approach include dural puncture with subsequent postdural puncture headache, which can occur when this technique is used at any level of the spine. Although in a different patient population, the incidence of dural puncture in parturients undergoing lumbar epidurals ranges between 0% and 2.6%.<sup>56</sup> Postdural puncture headaches occur frequently after unintended dural puncture with large epidural needles. The incidence of headache following cervical dural puncture is lower than that following lumbar puncture, likely because of the diminished column of CSF cephalad to the point of dural puncture.

Although cervical and thoracic epidural blood patches using small volumes of autologous blood have been described, most practitioners manage postdural puncture headaches following cervical or thoracic epidural injection conservatively with fluids and oral analgesics. Dural puncture also can occur during caudal epidural injection but usually only if the needle is advanced several centimeters cephalad within the caudal spinal canal. The thecal sac extends to the level of approximately S2, and the position can be approximated by palpating the adja-

cent posterior superior iliac spines, which lie at the same level. Epidural blood patch using autologous blood is a safe and effective treatment that relieves headache symptoms promptly in 70–98% of patients who fail to improve after 24–48 hours of conservative treatment and oral analgesics.<sup>57</sup> The incidence of unintentional dural puncture may be higher in patients with previous lumbar surgery because of scarring within the epidural space and adhesion of the dura to the posterior elements.

Although direct neurologic needle trauma is rare (<0.6%),<sup>58</sup> injury to the spinal cord with catastrophic consequences, including quadriplegia, has been described, particularly in heavily sedated patients.<sup>59–61</sup> The level of sedation during this procedure should allow for direct conversation between the practitioner and the patient to assure that the patient can report contact with neural elements before significant traumatic injury occurs. Caution should be taken to avoid interlaminar epidural injection at any level where there is effacement of the epidural space.<sup>62</sup> Complete effacement of the epidural space as well as the CSF column surrounding the spinal cord within the thecal sac occurs in high-grade spinal stenosis, particularly that due to a large central or paramedian disk herniation. Direct trauma to the cauda equina or exiting nerve roots is unlikely during lumbar epidural injection when disciplined use of radiographic guidance is used to assure that the needle tip does not stray from the midline. Direct trauma to the cauda equina or the exiting nerve roots is unlikely with the caudal approach.

Regardless of the level of injection, epidural bleeding or infection can occur. Epidural hematoma or abscess can lead to significant compression of the spinal cord or cauda equina. Interlaminar epidural injection should be avoided or postponed in patients receiving anticoagulants.<sup>63</sup>

### **Transforaminal Technique for Epidural Steroid Injection**

Transforaminal epidural steroid injection and selective nerve root injection can be performed using similar techniques. The distinction between the two techniques is questionable because the fascial sheath surrounding the spinal nerves is contiguous with the dura mater within the epidural

space. A solution injected around a spinal nerve may well enter the epidural space, whether or not the needle tip is advanced through the intervertebral foramen prior to injection. Nonetheless, many practitioners reserve the term *selective nerve root injection* for injections that are performed with the needle tip adjacent to the spinal nerve, *outside* of the intervertebral foramen and the term *transforaminal injection* for injections that are performed with the needle tip *within* the intervertebral foramen. Unlike the interlaminar technique, the transforaminal approach *requires* the use of radiographic imaging to proceed with safety.<sup>64</sup>

Several important anatomic aspects are unique to transforaminal epidural and selective nerve root injections. At cervical levels, the ventral and dorsal roots of the spinal nerves descend in the vertebral canal to form the spinal nerve in the intervertebral foramen. The foramen faces obliquely anterior and laterally. Its roof and floor are formed by the pedicles of the articulated vertebrae. Its posterolateral wall is formed largely by the superior articular process of the lower vertebra and in part by the inferior articular process of the upper vertebra and the capsule of the zygapophysial joint. The anteromedial wall is formed by the lower end of the upper vertebral body, the uncinat process of the lower vertebra, and the posterolateral corner of the intervertebral disk. Immediately lateral to the external opening of the foramen, the vertebral artery ascends within the *foramen transversarium* in close proximity to the spinal nerve and anterior to the articular pillars of the zygapophysial joint. The spinal nerve, in its dural sleeve, lies in the lower half of the foramen, whereas the upper half is occupied by epiradicular veins. Arterial branches arise from the vertebral arteries to supply the nerve roots (radicular arteries) or the spinal cord via the anterior and posterior spinal arteries (medullary arteries). Medullary and radicular arterial branches also may arise from the deep or ascending cervical arteries and traverse through the entire length of the foramen adjacent to the spinal nerve. It is these spinal segmental arteries that are at risk for penetration during cervical transforaminal injection.

At the lumbar levels, the ventral and dorsal roots of the spinal nerves descend within the vertebral canal to

form the spinal nerve in the intervertebral foramen. Its roof and floor are formed by the pedicles of consecutive vertebrae. Its posterior wall is formed largely by the superior articular process of the lower vertebra and in part by the inferior articular process of the superior vertebra and the capsule of the zygapophysial joint. The anterior wall is formed by the vertebral body and the intervertebral disk. The spinal nerve, in its dural sleeve, lies in the anterior and superior portions of the foramen, just inferior to the pedicle.

The most common indication for a transforaminal approach or selective nerve root injection is for placing the corticosteroid immediately adjacent to the inflamed nerve root causing the radicular symptoms. Nerve root inflammation may stem from an acutely herniated intervertebral disk causing nerve root irritation or other causes of nerve root impingement, such as isolated foraminal stenosis due to spondylitic spurring of the bony margins of the foramen. However, currently no evidence shows better clinical outcome with the transforaminal approach versus interlaminar approach.<sup>64</sup> Selective nerve root injection with local anesthetic has been used diagnostically to determine which nerve root is causing symptoms when pathology exists at multiple vertebral levels. This information can prove invaluable in planning surgical intervention.

**Cervical Transforaminal Steroid Injection** The patient lies supine, facing directly forward. The C-arm is rotated 45–55° lateral oblique until the neural foramina are clearly visualized. The patient may also be asked to rotate the head away from the side of injection. Although this position facilitates access to the side of the neck, the neural foramina and bony elements of the cervical spine will no longer be aligned, which may prove confusing to the inexperienced practitioner.

A 25-gauge, 1.5-inch, blunt-tipped needle is sufficient in length for all but the most obese patients. To avoid the vertebral artery and the spinal nerve, the needle is advanced toward the posterior and middle aspect of the intervertebral foramen. Care is taken ensure that the needle tip remains superimposed on the bone of the facet column during advancement. In this way, the superior articular process of the facet just posterior to the foramen

is contacted first, preventing needle advancement through the foramen and into the spinal canal. Once the needle contacts the facet, it is walked anteriorly into the foramen and advanced no more than another 2–3 mm. The depth is assessed by obtaining an image in the direct AP plane. To avoid direct trauma to the spinal cord and intrathecal injection, the needle should be advanced no further than halfway across the facet column. Nonionic radiographic contrast is injected under “live” or real-time fluoroscopy (or digital subtraction cineradiography) to assure that the needle tip lies in close proximity to the nerve root without any intravascular or intrathecal spread. The solution containing the steroid then can be injected safely. In our practice, we typically use 40 mg of triamcinolone acetonide or the equivalent diluted in 0.5–1 mL of 1% lidocaine.

**Lumbar Transforaminal Steroid Injection** The patient lies prone on the fluoroscopy table. The C-arm is rotated 20–30° lateral oblique to allow direction of the needle toward the superolateral aspect of the intervertebral foramen. A somewhat less oblique approach will result in a final needle position slightly lateral to the intervertebral foramen and has been advocated by some practitioners as a means of limiting spread of the injectate to a single nerve root. However, even small volumes of injectate will often be seen to track along the exiting nerve root to enter the lateral epidural space.

A 22- or 25-gauge, 3.5-inch spinal needle is sufficient in length for patients of average build, whereas a 5-inch needle may be needed in obese patients. To avoid the spinal nerve, the needle is advanced coaxially toward the superior aspect of the intervertebral foramen, just inferior to the pedicle and inferolateral to the pars interarticularis. This serves as an effective depth marker. Once this bony margin is contacted, the C-arm is rotated to a lateral view and the needle is slowly advanced toward the anterior and superior aspect of the foramen. If the patient reports paresthesia at any time during needle advancement, the needle should be withdrawn slightly and the position confirmed with radiographic contrast. With the needle in final position, nonionic radiographic contrast is injected under real-time fluoroscopy (or digital subtraction cinera-

diography) in the AP position to assure that the needle tip lies in close proximity to the nerve root without any intravascular or intrathecal spread. Obtaining a final lateral image will allow assessment of the extent of spread of the injectate.

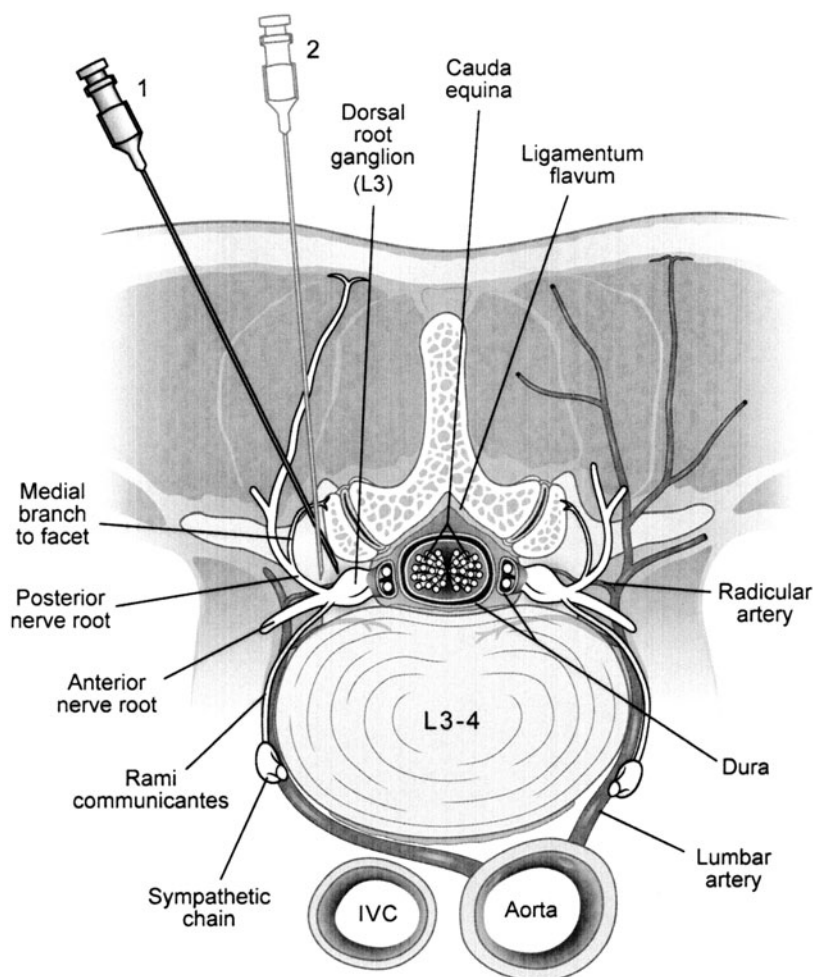
Complications of the transforaminal technique can be catastrophic. A firm grasp of the anatomy of adjacent vascular and neural structures is essential to avoid complications during cervical and lumbar approaches (Fig. 93–5). Direct intravascular injection into the vertebral artery may produce generalized seizures when local anesthetic is used or cerebral ischemia when particulate steroid solutions are used.<sup>64,65</sup> Direct injection of particulate steroid into a medullary or radicular artery supplying the spinal cord at the cervical or lumbar level, respectively, can lead to catastrophic spinal cord infarction. Needle positioning toward the posterior aspect of the foramen and advancing the needle in a plane parallel to the nerve root reduces the risk of entering a vascular structure. Again, particular care should be taken when performing transforaminal injection on the left between T8 and L3, as the artery of Adamkiewicz lies between these levels. However, use of radiographic contrast injected during “live” or “real-time” fluoroscopy (or digital subtraction cineradiography) to visualize final needle position and detect any hint of intravascular injection is the only means to accurately verify that injectate is not located within an artery.

Subarachnoid injection may occur if the needle is advanced too far medially and pierces the dural cuff as it extends laterally onto the exiting nerve root. Direct trauma to the exiting nerve root or the spinal cord itself also may occur. Intradiscal placement of the needle during attempted transforaminal epidural steroid injection has been reported but usually is without sequelae.<sup>66</sup>

## Sympathetic Blocks Overview

The sympathetic nervous system is involved in the pathophysiology of a number of different chronic pain conditions, including complex regional pain syndrome (CRPS) and ischemic pain. These chronic pain states often are referred to as *sympathetically maintained pain* because they share the characteristic of pain relief following





**FIGURE 93-5.** Axial view of lumbar transforaminal and selective nerve root injection. The anatomy and proper needle position (axial view) for right (1) L3-4 transforaminal injection and (2) L3 selective nerve root injection. (Adapted from Rathmell JP. *Atlas of Image-Guided Intervention in Regional Anesthesia and Pain Medicine*. Philadelphia: Lippincott Williams & Wilkins, 2006:58, with permission.)

blockade of the regional sympathetic ganglia.<sup>67,68</sup> In an extensive review, Cepeda et al.<sup>69</sup> questioned the efficacy of sympathetic blockade in the diagnosis and treatment of CRPS. In a review of 29 studies that included 1144 patients, only 29% of patients reported “full positive response” and 41% had a “partial positive response.” According to these authors, most of the studies were retrospective and of poor quality. Sympathetic blockade is still widely used despite the scant evidence supporting its diagnostic and therapeutic role.<sup>68,69</sup> Many practitioners continue to use sympathetic blockade as a part of a multidisciplinary approach to treating CRPS; sympathetic blocks are one tool that can reduce pain and facilitate functional recovery. Blockade of the stellate ganglion has been used in the diagnosis and treatment of sympathetically maintained

pain of the head, neck, and upper extremity, and 2nd lumbar sympathetic block is used for diagnosis and treatment of sympathetically maintained pain of the lower extremities.<sup>67,70</sup> Celiac plexus block has been used for malignant and nonmalignant pain involving the upper abdominal viscera, and several techniques have been described.<sup>71</sup> Celiac plexus neurolysis has been used successfully to treat pain from pancreatic cancer.<sup>72,73</sup> Superior hypogastric block for treatment of chronic pain arising from the bladder, uterus, rectum, vagina, and prostate has been well described.

### Stellate Ganglion Block

Stellate ganglion block has long been the standard approach to diagnosis and treatment of sympathetically maintained pain syndromes involving the upper extremity, such as CRPS.<sup>74</sup>

Other neuropathic pain syndromes, including ischemic neuropathies, herpes zoster (shingles), early postherpetic neuralgia, and postradiation neuritis also may respond to stellate ganglion block. Blockade of the stellate ganglion has proven successful in reducing pain and improving blood flow in vascular insufficiency conditions such as intractable angina pectoris,<sup>75</sup> Raynaud disease,<sup>76</sup> frostbite,<sup>77</sup> vasospasm, and occlusive and embolic vascular disease.<sup>78</sup> The sympathetic fibers control sweating; thus, stellate ganglion block can be quite effective in controlling hyperhidrosis.<sup>79</sup>

Patients with signs and symptoms of CRPS of the upper extremities may gain significant pain relief from stellate ganglion block.<sup>74</sup> Unfortunately, the duration and magnitude of the pain relief are unpredictable.<sup>69</sup> This led to the use of repeated sympathetic blocks, sometimes as often as daily or weekly over an extended period of time in attempt to improve the duration of pain relief. No controlled studies have ever verified this practice, and experts currently agree that repeated sympathetic blocks alone rarely eliminate the pain and disability associated with CRPS. Incorporating sympathetic blockade into a coordinated, multidisciplinary rehabilitation plan is essential for effective treatment of patients with CRPS. This treatment plan typically includes physical therapy, oral neuropathic pain medications, and supportive psychotherapy. Neuroablation has been used to destroy the sympathetic chain in patients who attain excellent pain relief of temporary duration with local anesthetic blocks. Few data evaluating the success of sympathetic ablation are available, and expert opinion regarding the usefulness of this approach in the long-term treatment of CRPS is varied.

The patient is placed supine, facing directly forward with a pillow under the upper back and lower neck to hold the neck in a slight extension. To perform the block without radiographic guidance, the operator palpates the cricoid cartilage and then slides a finger laterally into the groove between the trachea and the sternocleidomastoid muscle, retracting the muscle and adjacent carotid and jugular vessels laterally. Chassaignac's tubercle typically is palpable in this groove at the C6 level. Once the tubercle has been identified, a needle is advanced through the skin



and seated on the tubercle, where local anesthetic is injected. The local anesthetic spreads along the prevertebral fascia in a caudal direction to anesthetize the stellate ganglion, which lies just inferior to the point of injection in the same plane. In practice, marked variations in the size and shape of the Chassaignac's tubercle reduce the rate of successful block. The adjacent vertebral artery and C6 spinal nerve must be avoided to optimize conduct of this block. A simple modification of technique in which the needle is directed medially toward the base of the transverse process using radiographic guidance is a simple means of improving the reliability of stellate ganglion block and is described here.

When using fluoroscopic imaging, the C-arm is centered over the lower cervical spine without angulation. The position of the vertebral bodies and transverse processes of C6 and C7 are identified. The skin and subcutaneous tissues overlying the base of the transverse process of C6 or C7 on the affected side are anesthetized. The transverse processes are often difficult to distinguish from the underlying facet columns, but the transverse process joins the vertebral body just inferior to the uncinat process of the vertebral body, a structure that is easy to identify on the posteroanterior (PA) radiograph. The block can be carried out at either the C6 or C7 level when using radiographic guidance. However, it is important to realize that the vertebral artery overlies the base of the transverse process at C7, and many individuals lack a bony foramen transversarium at this level. Thus, at C7, care must be taken to keep the needle tip in line or medial to a line connecting the uncinat process of C7 and T1. Straying more lateral will risk penetration of the vertebral artery. The overlying carotid artery must be retracted laterally to perform the classic technique for stellate ganglion block over the C6 transverse process, but this is unnecessary when the needle is directed toward the base of the transverse process, as the needle passes medial to the great vessels of the neck.

A 25-gauge, 3-inch needle is placed through the skin and advanced coaxially until it is seated in the tissues. The needle is adjusted to remain coaxial as it is directed toward the base of the transverse process, just inferior to the uncinat process using repeat PA im-

ages after every 2–4 mm of needle advancement. Once the surface of the vertebral body is contacted, the needle is in final position. Intravascular placement is ruled out and proper position is assured by injecting radiographic contrast. The contrast should spread along the anterolateral margin of the vertebral bodies in both PA and lateral radiographs. Thereafter, 10 mL of local anesthetic (0.25% bupivacaine) is injected incrementally. Repeat radiographs following local anesthetic injection should show dilution of the contrast and spread of the solution inferiorly to the T1 level where the stellate ganglion lies. Sympathetic block should ensue within 20 minutes following injection and is assured by seeing a 1 °C or greater rise in temperature of the ipsilateral hand. Signs of successful stellate ganglion block are listed in Table 93–1.

Many important structures lie within the immediate vicinity of the needle's tip once it is properly positioned for stellate ganglion block. Commonly, diffusion of local anesthetic blocks the adjacent recurrent laryngeal nerve. This often leads to hoarseness, a feeling of having a lump in the throat, and subjective feelings of shortness of breath and difficulty swallowing. Bilateral stellate ganglion block should not be performed because bilateral recurrent laryngeal nerve blocks may lead to loss of laryngeal reflexes and respiratory compromise. The phrenic nerve is also commonly blocked by direct spread of local anesthetic and leads to unilateral diaphragmatic paresis. Diffusion of local anesthetic as well as direct placement of local anesthetic adjacent to the posterior tubercle result in somatic block of the upper extremity. This may take the form of a small area of sensory loss due to diffusion of local anesthetic or a complete brachial plexus block when the local anesthetic is placed within the nerve sheath.

Major complications associated with stellate ganglion block include neuraxial block (spinal or epidural) and seizures. Extreme medial angulation of the needle from a relatively lateral skin entry point may lead to needle placement into the spinal canal through the anterolaterally oriented intervertebral foramen. In this manner, local anesthetic can be deposited in the epidural space or, if the needle is advanced far enough, it may penetrate the dural cuff surrounding the exiting nerve root and lie

TABLE 93–1.

### Signs of Successful Stellate Ganglion Block

<p><b>Horner Syndrome</b>  Miosis (papillary constriction)  Ptosis (drooping of the upper eyelid)  Enophthalmos (recession of the globe within the orbit)  Anhidrosis (lack of sweating)</p> <p><b>Nasal congestion</b>  Venodilation in the hand and forearm  Increase in temperature of the blocked limb by at least 1 °C</p>
---

within the intrathecal space. Medial angulation will direct the needle toward the trachea and esophagus and risk penetration of these structures. More likely is placement of the needle tip on the posterior tubercle and spread of local anesthetic proximally along the nerve root to enter the epidural space. In this case, partial or profound neuraxial block, including high spinal or epidural block with loss of consciousness and apnea, may ensue. Airway protection, ventilation, and intravenous sedation should be promptly administered and continued until the patient regains airway reflexes and consciousness. Because the maximal effect of epidural local anesthetic may require 15–20 minutes to develop when longer-acting local anesthetics are used, it is imperative that patients be monitored for at least 30 minutes after stellate ganglion block.

Intravascular injection during stellate ganglion block likely will result in immediate onset of generalized seizures. The carotid artery lies just anteromedial to the Chassaignac tubercle, whereas the vertebral artery lies within the bony transverse foramen just posteromedial to the tubercle. If injection occurs into either structure, the local anesthetic injected enters the arterial supply traveling directly to the brain, and generalized seizures begin rapidly and after small amounts of local anesthetic. However, because the local anesthetic rapidly redistributes, the seizures typically are brief and do not require treatment. In the event of seizure, halt the injection, remove the needle, and begin supportive care.

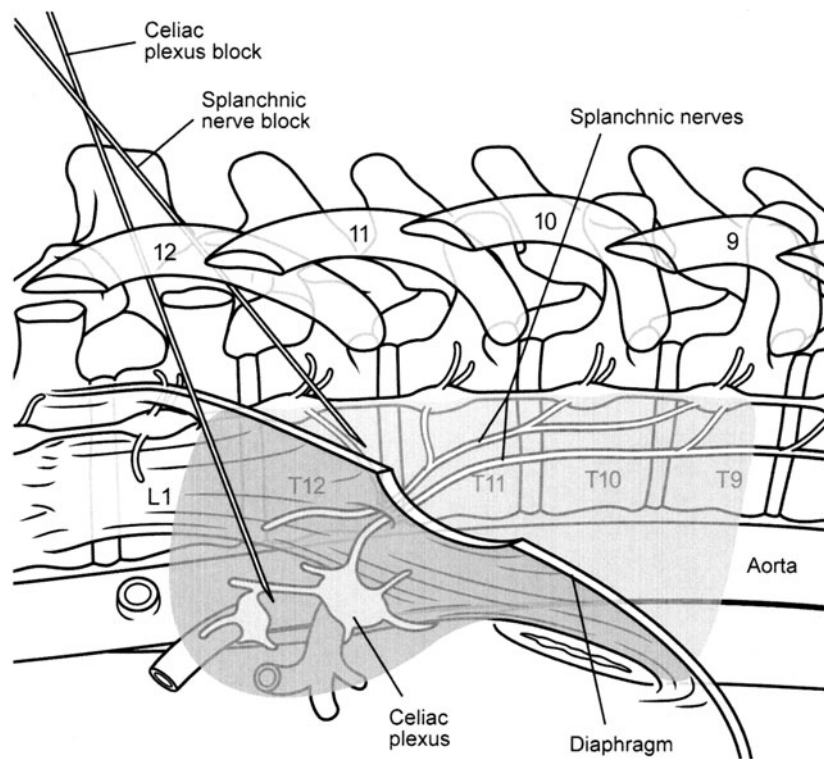
### Celiac Plexus Block

Neurolytic celiac plexus block is among the most widely applicable of all neurolytic blocks. Neurolytic celiac plexus

block has a long-lasting benefit for 70–90% of patients with pancreatic and other intraabdominal malignancies. A meta-analysis by Eisenberg et al.<sup>80</sup> concluded that adequate-to-excellent pain relief can be achieved in 89% of patients in the first few weeks following the block. From 70–90% of patients still had complete pain relief during the 3-month interval prior to their death.<sup>80</sup> Although encouraging, interpretation of these data requires caution, as this meta-analysis is based on retrospective studies.

Several techniques for localizing the celiac plexus have been described. In the classic technique, a percutaneous posterior approach uses surface and bony landmarks to position needles in the vicinity of the plexus. Numerous reports have described new approaches for celiac plexus block using guidance from plain radiographs, fluoroscopy, CT, or ultrasound.<sup>81–83</sup> No single methodology has proven clearly superior with regard to safety or success rate. In recent years, general agreement has arisen that radiographic guidance is necessary to perform celiac plexus block. Many practitioners have turned to routine use of CT, taking advantage of the ability to visualize adjacent structures when performing this technique.<sup>84</sup>

The transcrural approach to the celiac plexus (Fig. 93–6) places the local anesthetic or neurolytic solution directly on the celiac ganglion, anterolateral to the aorta. The needles pass directly through the crura of the diaphragm en route to the celiac plexus. In contrast, splanchnic nerve block (Fig. 93–6) avoids the risk of penetrating the aorta and uses smaller volumes of solution, and the success is unlikely to be affected by anatomic distortion caused by extensive tumor or adenopathy within the pancreas. Because the needles remain posterior to the diaphragmatic crura in close apposition to the T12 vertebral body, this has been termed the *retrocruural technique*. Splanchnic nerve block is a minor modification of the classic retrocruural celiac plexus block; the only difference is that, for splanchnic block, the needles are placed more cephalad. In most cases, celiac plexus (transcrural or retrocruural) and splanchnic nerve block can be used interchangeably, with the same results. Although some strongly advocate one approach or the other, there is no evidence that either approach results in superior clinical outcomes.<sup>71</sup>



**FIGURE 93–6.** Anatomy of the celiac plexus and splanchnic nerves. The celiac plexus is composed of a diffuse network of nerve fibers and individual ganglia that lie over the anterolateral surface of the aorta at the T12–L1 vertebral level. Presynaptic sympathetic fibers travel from the thoracic sympathetic chain toward the ganglion, traversing over the anterolateral aspect of the inferior thoracic vertebrae as the greater (T5–9), lesser (T10–11), and least (T12) splanchnic nerves. Celiac plexus block using a transcrural approach places the local anesthetic or neurolytic solution directly on the celiac ganglion anterolateral to the aorta. The needles pass directly through the crura of the diaphragm en route to the celiac plexus. In contrast, for splanchnic nerves block, the needles remain posterior to the diaphragmatic crura in close apposition to the T12 vertebral body. Shading indicates the pattern of solution spread for each technique. (Adapted from Rathmell JP. *Atlas of Image-Guided Intervention in Regional Anesthesia and Pain Medicine*. Philadelphia: Lippincott Williams & Wilkins, 2006:124, with permission.)

Celiac plexus and splanchnic nerve block are used to control pain arising from intraabdominal structures. These structures include the pancreas, liver, gallbladder, omentum, mesentery, and alimentary tract from the stomach to the transverse colon. The most common application of neurolytic celiac plexus block is treatment of pain associated with intraabdominal malignancy, particularly pain associated with pancreatic cancer.<sup>72,85</sup> Neurolysis of the splanchnic nerves or celiac plexus can produce dramatic pain relief, reduce or eliminate the need for supplemental analgesics, and improve quality of life in patients with pancreatic cancer and other intraabdominal malignancies.<sup>85</sup> The long-term benefit of neurolytic celiac plexus block in patients with chronic nonmalignant pain, particularly those with chronic pancreatitis, is debatable.

**Transcrural Technique** Once the C-arm is aligned over the thoracolumbar junction, the skin and subcutaneous tissues overlying the superior margin of the L1 vertebral body are anesthetized. The aorta lies to the left of midline over the vertebral bodies. By routinely placing the left-sided needle first, a single needle can often be used for the block. If the aorta is penetrated en route, a transaortic technique is used. A 22-gauge, 5-inch spinal needle is advanced just caudal to the margin of the 12th rib and cephalad to the transverse process of L1 to contact the anterolateral surface of the L1 vertebral body. The C-arm is then rotated to a lateral projection and the needle advanced to lie 2–3 cm anterior to the anterior margin of L1 in the lateral view. Continuous aspiration should be applied as the needle is advanced past the anterior border of L1. If blood ap-

pears, the needle has penetrated the aorta and should be advanced through the anterior wall of the aorta until blood can no longer be aspirated. The needle tip should be medial to the lateral border of the L1 vertebral body in the AP view. Final needle position is confirmed by injecting radiographic contrast under live fluoroscopy. The contrast should layer over the anterior surface of the aorta and appear pulsatile. If the contrast spreads to both sides of midline over the anterior surface of the aorta, then only a single needle is necessary for the block. If the contrast remains to the left of midline over the anterolateral surface of the aorta, a second needle is placed from the contralateral side using the same technique described for the left-sided block. Diagnostic celiac plexus block prior to neurolysis is performed using 10–15 mL of 0.25% bupivacaine per side. The dose should be given in increments of 5 mL, aspirating periodically to assure that the needle has not moved to an intravascular location.

**Splanchnic Nerve Block or Retrocrural Technique** Once the C-arm is aligned, the skin and subcutaneous tissues overlying the anterolateral margin of the midportion of the T12 vertebral body are anesthetized. For splanchnic nerve block and neurolysis, needles must be placed on both sides. A 22-gauge, 5-inch spinal needle is advanced just caudal to the margin of the 12th rib and cephalad to the transverse process of L1 to contact the anterolateral surface of the T12 vertebral body. This requires 20–30° of cephalad angulation of the C-arm. The C-arm is then rotated to a lateral projection and the needle advanced 1–2 cm to align with the anterior third of the T12 vertebral body in the lateral view. The needle tip should be just medial to the lateral border of the T12 vertebral body in the AP view. Final needle position is confirmed by injecting radiographic contrast under live fluoroscopy. The contrast should layer over the anterolateral surface of the T12 vertebral body. A second needle is placed from the contralateral side using the same technique described for the left-sided block. Diagnostic splanchnic nerve block prior to neurolysis is performed using 5–8 mL of 0.25% bupivacaine per side. The dose should be given in increments of 5 mL, aspirating periodically to assure

that the needle has not moved to an intravascular location.

**Celiac Plexus and Splanchnic Neurolysis** The technique for needle placement is identical for diagnostic local anesthetic block of the celiac plexus or splanchnic nerves and for neurolysis. The two commonly used neurolytic solutions are ethyl alcohol and phenol. Phenol is a combination of carbolic acid, phenic acid, phenylic acid, phenyl hydroxide, hydroxybenzene, and oxybenzene. There is no commercially available phenol preparation, but a solution can be prepared by a compounding pharmacist from anhydrous phenol crystals.

Phenol is highly soluble in glycerin and radiographic contrast solutions. Phenol has local anesthetic properties at lower concentrations and is neurolytic at higher concentrations. Concentrations <5% cause protein denaturation, whereas higher concentrations produce protein coagulation and segmental demyelination. Poorly myelinated and unmyelinated nociceptive fibers are destroyed at concentrations of 5–6%. Higher concentrations can produce axonal damage, spinal cord infarction, arachnoiditis, and meningitis. Large systemic doses of phenol cause effects similar to those seen with local anesthetic overdose, such as seizures and cardiovascular collapse. A 10–12% solution of phenol can be prepared in radiographic contrast. This allows radiographic monitoring of the spread of neurolytic solution as it is injected.

For celiac plexus neurolysis, 10–15 mL per side is injected. If the neurolytic solution spreads to both sides of midline over the anterior surface of the aorta, then only a single needle is necessary for the block. If the neurolytic solution begins to spread posteriorly toward the intervertebral foramen, the injection should be halted to avoid nerve root injury. During splanchnic neurolysis, the contrast should layer over the anterolateral surface of the T12 vertebral body. A second needle is placed from the contralateral side using the same technique described for the left-sided block. For splanchnic neurolysis, 5–8 mL per side is injected. The needles should be flushed with saline or local anesthetic before they are removed to avoid depositing the neurolytic solution along the needle track.

Neurolysis also can be performed using 50–100% ethyl alcohol in similar volumes. Alcohol in excess of 33% results in extraction of cholesterol, phospholipids, and cerebroside from neural tissues. It produces nonselective destruction of neural tissue. Unlike phenol, the degree of neural blockade increases over the first several days following neurolysis; however, it is intensely inflammatory and has been associated with persistent or worsened pain and neuritis. Phenol has a direct local anesthetic effect and is associated with minimal pain on injection. Because of the intense burning pain on injection, ethyl alcohol is best diluted with local anesthetic prior to injection or injected after placing a small volume of local anesthetic.

Although the majority of cases can be carried out using fluoroscopic guidance alone, CT allows excellent visualization of the anatomic structures that lie in close proximity to the target site during neurolytic celiac plexus block.<sup>86</sup> To directly ablate the celiac plexus, the needles must be advanced through the diaphragm until they lie adjacent to the anterolateral surface of the aorta. This can be accomplished by advancing two separate needles adjacent to the anterolateral surface of the aorta or using a single needle advanced through the aorta.

CT-guided celiac plexus block is carried out with the patient positioned prone in the CT scanner gantry. A radiographic marker is placed on the skin surface 1 cm inferior to the inferior margin of the 12<sup>th</sup> rib and 7 cm from midline, and axial CT images extending from T12 through L1 are taken in 3-mm intervals. In this way, the position of the needle entry site on the skin's surface can be adjusted to form a direct path to the anterolateral surface of the aorta, without passing through adjacent structures. The skin is anesthetized, and a 22-gauge, 5-inch spinal needle is seated in a plane that corresponds to the axis seen on CT. With the needle seated in the subcutaneous tissue, but still superficial, a repeat CT image is obtained through the tip of the needle, and the angle of the needle is redirected toward the anterolateral surface of the aorta. The needle is advanced, and repeat CT images are obtained after every 1–2 cm of needle advancement. Once the needle is in position, a small volume of radiographic contrast is injected to



confirm needle position. A solution of neurolytic drug in radiographic contrast allows radiographic monitoring of the spread of neurolytic solution as it is injected. A repeat CT image is obtained after every 5 mL of injection. If the neurolytic solution spreads to both sides of midline over the anterior surface of the aorta, then only a single needle is necessary for the block.

Following celiac plexus block, several physiologic side effects are expected, including diarrhea and orthostatic hypotension. Blockade of the sympathetic innervation to the abdominal viscera results in unopposed parasympathetic innervation of the alimentary tract and may produce abdominal cramping and diarrhea. Likewise, the vasodilatation that ensues often results in orthostatic hypotension. These effects are invariably transient but may persist for several days after neurolytic block. The hypotension seldom requires treatment other than intravenous hydration.

Complications of celiac plexus and splanchnic nerve block include hematuria, intravascular injection, and pneumothorax. CT allows visualization of the structures that lie adjacent to the celiac ganglion as the block is being performed and may help to avoid these complications.<sup>86</sup> The kidneys extend between T12 and L3, with the left kidney slightly more cephalad than the right. The aorta lies over the left anterolateral border of the vertebral column. The celiac arterial trunk arises from the anterior surface of the aorta at the T12 level and divides into the hepatic, left gastric, and splenic arteries. Using the transaortic technique, caution must be used to avoid needle placement directly through the axis of the celiac trunk as it exits anteriorly. The inferior vena cava lies just to the right of the aorta over the anterolateral surface of the vertebral column.

Neurolytic celiac plexus block carries a small but significant additional risk. Intravascular injection of 30 mL of 100% ethanol will result in a blood ethanol level well above the legal limit for intoxication but below the danger limit of severe alcohol toxicity. Intravascular injection of phenol is associated with clinical manifestations similar to those of local anesthetic toxicity: CNS excitation, followed by seizures and, in extreme toxicity, cardiovascular collapse. The

most devastating complication associated with neurolytic celiac plexus block is paraplegia. The actual incidence of this complication is unknown but appears to be <1:1000. The theoretical mechanism is spread of the neurolytic solution toward the posterior surface of the aorta to surround the spinal segmental arteries, specifically, the artery of Adamkiewicz.

### **Lumbar Sympathetic Block**

Lumbar sympathetic blockade has been used extensively in the diagnosis and treatment of sympathetically maintained pain syndromes involving the lower extremities.<sup>74</sup> Patients with peripheral vascular insufficiency due to small-vessel occlusion also can be treated effectively with lumbar sympathetic blockade. If local anesthetic block improves blood flow and reduces pain, these patients often will benefit from surgical or chemical sympathectomy.<sup>87</sup>

Other patients with neuropathic pain involving the lower extremities have shown variable response to lumbar sympathetic block. In those with acute herpes zoster and early postherpetic neuralgia, sympathetic block may reduce pain.<sup>88</sup> However, after 3–6 months, once postherpetic neuralgia is well established, sympathetic blockade is rarely helpful. Likewise, deafferentation syndromes such as phantom limb pain and neuropathic lower extremity pain following spinal cord injury have shown variable and largely disappointing responses to sympathetic blockade.<sup>89</sup>

Lumbar sympathetic block typically is carried out using a single-needle technique and a large volume of local anesthetic to spread cephalad and caudad to bathe adjacent ganglia. The patient lies prone with a pillow under the lower abdomen and iliac crest to reduce lumbar lordosis. The C-arm is centered over the midlumbar region. The final needle position for lumbar sympathetic block is over the anterolateral surface of the lumbar vertebral body. The C-arm is rotated obliquely 20–30° until the tip of the transverse process of L3 overlies the anterolateral margin of the L3 vertebral body.

The ganglia of the lumbar sympathetic chain vary in number and location among individuals. The ganglia lie between L2 and L4, and in most humans the ganglia lie over the inferior portion of L2 and the superior portion of L3.<sup>90</sup> Thus, the optimal location

for a single needle is over the anterolateral margin of the inferior portion of L2, the L2–3 interspace, or the superior margin of L3.

After the skin and subcutaneous tissues are anesthetized, a 22-gauge, 5-inch spinal needle is advanced using a coaxial technique toward the anterolateral surface of the L3 vertebral body to gently contact bone. The needle is then walked laterally off the bony margin. The C-arm is rotated to a lateral projection, and the needle is advanced until the tip lies over the anterior third of the vertebral body. Proper needle position is verified in the AP projection where the needle tip should lie medial to the lateral margin of the vertebral body.

Once the needle is in position, aspiration to detect intravascular needle placement is carried out, followed by administration of nonionic radiographic contrast. Contrast spread should be seen anterior to the L3 vertebral body. From 15–20 mL of 0.25% bupivacaine is injected incrementally. Signs of successful sympathetic blockade in the lower extremities include venodilation and temperature rise. Skin temperature should be monitored in the contralateral foot to assess for changes unrelated to the block. A rise in temperature of at least 1°C without a rise in temperature of the contralateral limb should occur with successful sympathetic block.

### **Lumbar Sympathetic Neurolysis**

Neurolytic lumbar sympathetic block has been used in efforts to provide long-term sympathetic blockade in patients who receive only short-term pain relief with local anesthetic blocks. Lumbar sympathetic neurolysis can be accomplished using either injection of a neurolytic solution or radiofrequency lesioning. Because the locations of the lumbar sympathetic ganglia are variable, injection of neurolytic solution that spreads to encompass an area beyond the needle tip may produce more reliable neurolysis than radiofrequency treatment. Nonetheless, when the needle tips are positioned accurately, the discrete lesions resulting from radiofrequency treatment can produce effective neurolysis.<sup>91</sup> Although the techniques are well described, few data are available to guide the choice among chemical neurolysis, radiofrequency neurolysis, and open surgical sympathectomy.



**Chemical Neurolysis** Chemical neurolysis of the lumbar sympathetic chain is carried out by placing three separate needles at the L2, L3, and L4 levels, as described for local anesthetic block. The needles should be directed to the mid or inferior aspect of L2, the superior aspects of L3, and L4 to correlate with the most frequent anatomic locations of the lumbar sympathetic ganglia. Three needles are placed so that the smallest volume of neurolytic solution can be injected to treat the ganglia at each level. Once proper needle position has been confirmed in the AP and lateral projections, a small volume of radiographic contrast is placed through each needle to assure that the needles are not located intravascularly and that the injectate will layer in close apposition to the anterolateral margin of the vertebral bodies. Thereafter, 2–3 mL of neurolytic solution is placed through each needle.

**Radiofrequency Neurolysis** Similar to chemical neurolysis, radiofrequency neurolysis of the lumbar sympathetic chain is carried out by placing three separate 15-cm radiofrequency cannulas with 10-mm active tips over the anterolateral surface of the L2, L3, and L4 vertebral bodies. Once proper needle position has been confirmed, sensory and motor stimulation are conducted. When the cannulas are in proper position over the sympathetic ganglia, the patient typically will report vague back or abdominal discomfort with < 1.0 V of output and sensory stimulation at 50 Hz. However, the report of any sensation during sensory testing is more variable than during sensory testing before radiofrequency treatment of the facet joints. Motor stimulation is then carried out to assure that the cannulas do not lie along the course of the anterior primary ramus of one of the spinal nerve roots. There should be no muscle movement in the lower extremities during stimulation at 2 Hz at an output of at least 3V. Our practice has been to place the lesions if the cannulas appear to be in proper anatomic position even if the patient reports no pain or discomfort during sensory stimulation. Local anesthetic is added and lesions are created at 80 °C for 90 seconds.

Significant and potentially toxic levels of local anesthetic can result from direct needle placement into a blood vessel and intravascular injection dur-

ing lumbar sympathetic block. Hematuria can follow direct needle placement through the kidney but usually is self-limited. Nerve root, epidural, or intrathecal injection can arise when the needle is advanced through the intervertebral foramen and usually is avoided entirely with proper use of radiographic guidance. Following neurolytic lumbar sympathetic block, significant postsympathectomy pain arises in the L1 and L2 nerve root distribution over the anterior thigh in as many as 10% of treated patients. This observation stems from results following open surgical sympathectomy, but such postsympathectomy neuralgia also has been reported after both chemical and radiofrequency sympathectomy. Postsympathectomy neuralgia in the anterior thigh has been postulated to result from partial neurolysis of adjacent sensory fibers, most often the genitofemoral nerve.<sup>92</sup>

### **Facet Joint Injections: Intraarticular Injections, Medial Branch Blocks, and Radiofrequency Treatment**

#### **Overview**

Intraarticular facet injection has been largely supplanted by radiofrequency techniques for treatment of facet-related pain. Clinical experience and a limited number of published observational studies suggest that intraarticular injection of local anesthetic and steroid leads to relief of facet-related pain that is limited in duration.<sup>93,94</sup> In contrast, radiofrequency treatment is safe and modestly effective in producing longer-term pain relief in the same group of patients. Nonetheless, an understanding of facet-related pain syndromes and the methods for placing medication directly within the facet joint may still prove useful for those practitioners who are unable to provide radiofrequency treatment.

Osteoarthritis of the spine is ubiquitous and an inevitable part of aging. The degenerative cascade that leads to degeneration of the intervertebral disks causes progressive disk dehydration and loss of disk height. Typically starting in the third decade of life, disk degeneration leads to increased mobility of adjacent vertebrae and increased shear forces on the facet joints themselves. This can lead to a pattern of pain over the axis of the spine that increases with movement, particularly

with flexion and extension, but produces little or no pain radiating toward the extremities. In the past, the only treatment available for those with debilitating facet-related pain was segmental fusion of the spine to completely arrest motion within the painful portion of the spine.<sup>95</sup>

The majority of patients have pain that is gradual in onset and can be localized only to a general region of the spinal axis.<sup>96</sup> However, a subgroup of patients present with sudden onset of pain, often associated with trauma in the form of sudden flexion or hyperextension of the spine in the affected region. Diagnostic studies are invariably unrevealing, showing either no abnormalities or facet arthropathy at multiple levels. In those with pain of sudden onset, it may be possible to isolate one or more facets that are causing the pain. It is in these patients with sudden onset of well-localized pain that intraarticular facet injection with local anesthetic and steroid can prove most beneficial.

Patients with facet-related pain are difficult to distinguish from those with other causes of axial spinal pain. Some patients present with sudden onset of pain following a significant flexion-extension (whiplash) injury, but more commonly the onset is insidious over months to years. Patients with myofascial or discogenic pain as well as those suffering from sacroiliac dysfunction present with similar symptoms. Nonetheless, certain features can be helpful in differentiating facet-related pain from other causes of spinal pain. The pain caused by facet arthropathy is most pronounced over the axis of the spine itself and typically is maximal directly in the region of the most affected joints. The pain tends to be exacerbated by movement, particularly extension of the spine, which forces the inflamed articular surfaces of the facet joints together. However, axial spinal pain at rest or worsening with forward flexion or rotation of the spine is another common feature. The most important historical feature is a predominance of axial spinal pain; patients who report that the predominance of their pain is in the extremities are more likely to have acute or chronic radicular pain than facet-related pain. The quality of the pain typically is deep and aching, with the pain waxing and waning with activity. Burning or stabbing qualities

suggest neuropathic pain rather than facet arthropathy.

Diagnostic studies often are unrevealing. Patients with significant facet-related pain may have unremarkable plain x-ray film and/or imaging studies of the spine, or they may show facet arthropathy at multiple levels. Patient selection for facet injection or radiofrequency treatment is empiric and relies on excluding other causes of pain and a pattern of pain that corresponds to facet-related pain.

The patterns of pain caused by abnormalities in specific facet joints have been established by injecting a mild irritant into a specific facet joints in healthy volunteers and then recording the pattern of pain produced<sup>97-99</sup> The levels treated are chosen by correlating the patient's report of pain to these pain diagrams. Occasionally a patient presents with evidence of facet arthropathy and a pattern of pain that corresponds to a single level, but this is uncommon. Most patients have more diffuse pain that can only be narrowed to a specific region. Treatment should be directed toward the joint(s) that most closely matches the pattern of referred pain that has been established for each joint and that typically requires treatment at more than one level.

### **Intraarticular Facet Joint Injections versus Radiofrequency Treatment**

Choosing between intraarticular facet injection and diagnostic medial branch blocks followed by radiofrequency treatment is a frequent clinical scenario. Limited outcome studies of intraarticular injection, particularly at the cervical level, have demonstrated only transient pain relief lasting from days to weeks in most patients.<sup>93,94,100</sup> In a randomized trial, Marks et al.<sup>101</sup> showed equal pain relief in patients receiving facet joint injections and medial branch blocks. Patients who obtain significant pain relief from diagnostic blocks of the medial branch nerves may attain significant pain reduction from radiofrequency treatment that is longer lasting. Two randomized controlled trials have shown that radiofrequency ablation provides prolonged pain relief up to 6 months.<sup>102,103</sup> Based on this improved efficacy and a long track record of safety, increasingly more practitioners are beginning immediately with radiofrequency treatment rather than intraarticular injection.

Intraarticular injection remains valuable in patients with recent-onset pain that is discrete in location and suggests involvement of a single facet joint. Intraarticular injection also is a reasonable alternative when the expertise or equipment for radiofrequency treatment is not available, but it will provide only transient symptomatic relief in patients with facet-related pain who have not responded to conservative treatment.

### **Intraarticular Facet Injection**

**Cervical Intraarticular Facet Injection** The patient lies prone, facing directly toward the table with a small headrest under the forehead to allow for air flow between the table and the patient's nose and mouth. The C-arm is rotated 25–35° caudally from the axial plane without oblique angulation. This brings the axis of the x-ray path in line with the axis of the facet joints and allows for good visualization of the joints. Although the cervical facet joints also can be entered from a lateral approach with the patient lying on his or her side, advancing a needle using radiographic guidance in the AP plane allows the operator to directly see the position of the spinal canal at all times and avoid medial needle direction that could lead to spinal cord injury.

The skin and subcutaneous tissues overlying the facet joint where the block is to be carried out are anesthetized. The cervical level is easily identified by counting upward from the T1 level, where the T1 vertebra is easily distinguished by the presence of a large transverse process that articulates with the first rib. A 22-gauge, 3.5-inch spinal needle is placed through the skin and advanced until it is seated in the tissues in a plane that is coaxial with the axis of the x-ray path. The needle is then advanced in increments of 0.5–1 cm using repeat images to redirect the needle toward the facet joint. Once the surface of the joint space is contacted, a lateral radiograph is obtained, and the needle is advanced slightly to penetrate the posterior joint capsule. The needle should not be advanced into the joint between articular surfaces; this serves no purpose and is likely to abrade the articular surfaces and lead to worsened pain once the local anesthetic block subsides. Although intraarticular location of the needle tip can be confirmed with radiographic contrast, this is un-

necessary if the needle location is correct in both AP and lateral planes.

### **Thoracic Intraarticular Facet Injection**

Thoracic intraarticular facet injection is not commonly used. The plane of the thoracic facet joints is steeply angled, nearing the frontal plane. Even with steep angulation of the C-arm, the joint space cannot be visualized directly but must be inferred from the position of adjacent structures. The patient is positioned prone with the head turned to one side. The C-arm is angled 50–60° in a caudad direction from the axial plane. The plane of the mid and lower thoracic facet joints lies at an angle of 60–70° from the axial plane, but further angulation of the C-arm is impractical without the image intensifier resting against the patient's back. This angle allows visualization of structures adjacent to the facet joint from which the position of the joint can be inferred. The inferior articular process (superior aspect of the joint) lies posteriorly, directly over the superior articular process (inferior aspect of the joint). The needle tip is advanced toward the inferior aspect of the joint.

The thoracic level is easily identified by counting upward from the T12 level where the 12th and lowest rib joins the T12 vertebra. A 22-gauge, 3.5-inch spinal needle is placed through the skin and advanced until it is seated in the tissues in a plane that is coaxial with the axis of the x-ray path. The needle is adjusted to remain coaxial and advanced toward the inferior margin of the joint space. Because of the joint's steep angle, the needle can be advanced only into the inferior and posterior most extent of the joint. Lateral radiography is difficult to interpret because of the overlying structures of the thorax.

### **Lumbar Intraarticular Facet Injection**

The anatomy of the lumbar facet joint and surrounding structures is illustrated in Fig. 93–7. The patient is positioned prone with the head turned to one side. The C-arm is angled obliquely 25–35° from the sagittal plane and without caudal angulation. This angle allows direct visualization of the facet joint. The skin and subcutaneous tissues overlying the facet joint where the block is to be carried out are anesthetized. The lumbar level is easily identified by counting upward from

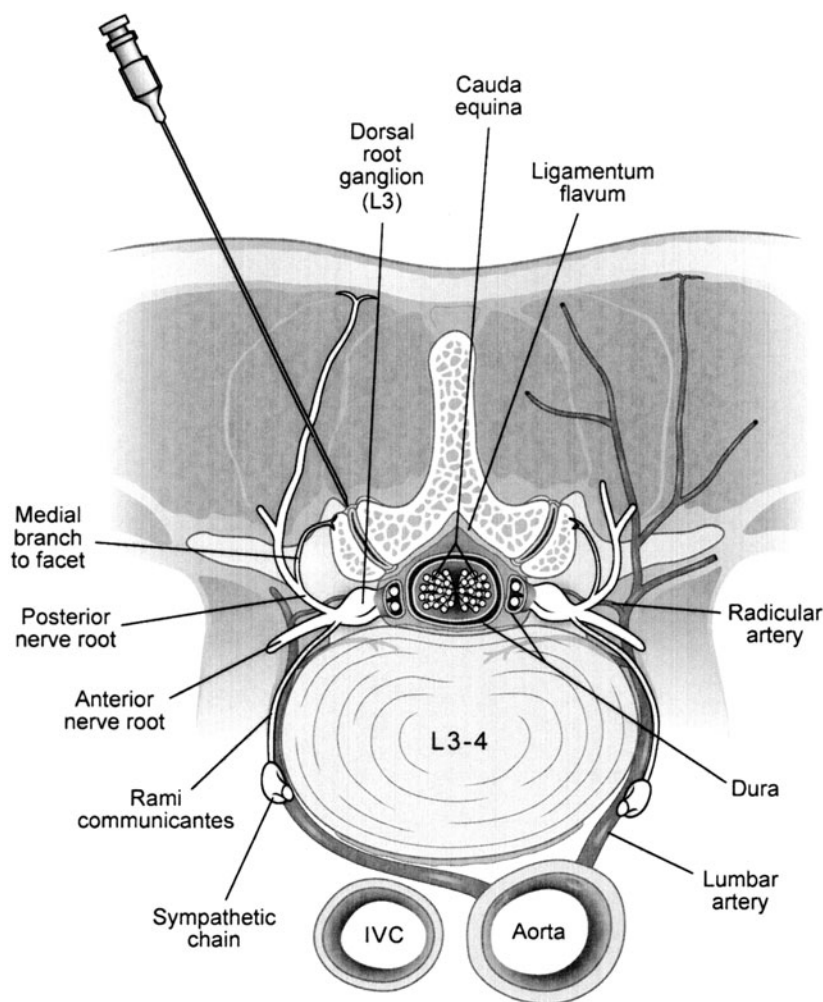
the sacrum. A 22-gauge, 3.5-inch spinal needle is placed through the skin and advanced until it is seated in the tissues in a plane that is coaxial with the axis of the x-ray path. The needle is adjusted to remain coaxial and advanced toward the joint space.

Whether the intraarticular injection is done at the cervical, thoracic, or lumbar level, the facet joint itself holds only limited volume, typically <1.5 mL. Placing contrast in the joint will limit the ability to place local anesthetic and steroid within the joint. Intraarticular injections are commonly carried out at the lumbar levels. At this level, the articular space is Z-shaped, with the superior recess extending slightly lateral to the axis of the articular surfaces and the inferior recess extending slightly medial to the axis of the articular surfaces. Once needle position has been confirmed, a solution containing steroid and local anesthetic is placed. A total dose of 80 mg of methylprednisolone acetate or the equivalent should be divided over all of the joints to be injected, but >40 mg per joint probably is unnecessary. Using concentrated steroid (40 or 80 mg/mL) allows 1:1 mixture with local anesthetic (0.5% bupivacaine) to provide some immediate pain relief.

Complications associated with intraarticular facet injection are uncommon. The most likely adverse effect is an exacerbation of pain. This is frequent when intraarticular cervical facet injection is carried out and the needle is advanced within the joint space. The joint space is narrow, and advancing the needle within the joint can abrade the articular surfaces, causing increased pain. This exacerbation usually is self-limited. Infection can occur, leading to abscess within the paraspinal musculature, but the incidence is exceedingly low.<sup>104</sup> Bleeding complications have not been associated with intraarticular facet injection.

### Facet Medial Branch Blocks and Radiofrequency Treatment

In patients who receive only temporary relief from therapeutic intraarticular facet injections or have pain that is more diffuse, requiring treatment at numerous levels, radiofrequency treatment can produce significant, enduring pain relief. Many investigators have pointed to the need for controlled diagnostic injections to determine who will respond to radio-



**FIGURE 93-7.** Axial diagram of intraarticular lumbar facet injection. The axis of the facet joint lies 25–35° from the sagittal plane. Note the innervation to the facet joint. (Adapted from Rathmell JP. Atlas of Image-Guided Intervention in Regional Anesthesia and Pain Medicine. Philadelphia: Lippincott Williams & Wilkins, 2006:76, with permission.)

frequency treatment. Despite the value of placebo-controlled injections, they are impractical in most clinical settings. Most practitioners rely on a single set of diagnostic local anesthetic blocks to the medial branch nerves at the levels of suspected pathology to determine who should receive radiofrequency treatment. Patients who report significant pain relief, usually defined as  $\geq 50\%$  pain reduction lasting the average duration of the local anesthetic, go on to radiofrequency treatment. Similar, transient pain relief with intraarticular injection of local anesthetic can be used as a reasonable prognostic test before proceeding with radiofrequency treatment.

Conventional radiofrequency treatment produces a small area of tissue coagulation surrounding the active tip of an insulated cannula. When the tip of the radiofrequency cannula is placed

in close proximity to a neural structure, the lesion encompasses the nerve, causing denervation. The most commonly used cannulas for facet treatment are 22-gauge SMK (Sluifjter-Meheta) cannulas, which come in lengths of 5, 10, and 15 cm. These radiofrequency cannulas have a noninsulated area where coagulation occurs, called the *active tip*, which may be 4, 5, or 10 mm in length. Conventional radiofrequency damages neural tissue by creating an electrical field between the active tip of the needle connected to a voltage generator and an inactive or dispersion electrode at a distance. This induces the movement of a tissue ionic current that follows the alternating current, generating friction and, therefore, creating heat surrounding the needle tip. Radiofrequency power produces heat by current flow and not through heat transfer from the tip.<sup>105</sup> The lesion,



although variable, is well circumscribed and reproducible when the physical parameters are properly controlled. The size is mostly dependant on needle diameter, length of the active tip, tissue vascularization, tip temperature, and time of exposure. Lesions are characterized by a central core filled with blood related to electrode placement surrounded by an area of coagulation necrosis and separated by a wall of neuroglial proliferation from a zone of liquefaction necrosis. The lesion is surrounded by an area of demyelination.<sup>106,107</sup> For all but the most obese patients, the 10-cm cannulas with 5-mm active tips are used.

In recent years, pulsed radiofrequency treatment has come into frequent use. Studies that investigated the effects of nonheated tissues exposed to the electromagnetic field showed that the so-called *isothermal (42–45°C) radiofrequency procedure* induced physiologic changes in tissues.<sup>108</sup> Van Zundert et al.<sup>109</sup> showed increase in expression of c-fos in the dorsal horn of experimental animals up to 7 days after pulsed radiofrequency treatment, which suggests sustained activation of a pain-inhibiting process. Although the concept of long-lasting pain reduction without neural destruction is appealing, as yet, little clinical evidence supports the efficacy of this new technique.<sup>110</sup>

The key concept when using conventional versus pulsed radiofrequency is understanding where the lesion or pulse radiofrequency energy will occur relative to the active tip. The lesion produced by conventional radiofrequency is along the shaft of the needle surrounding the active tip. There is scant tissue destruction at the tip of the needle; thus, the active tip of the cannula must be placed along the course of the nerve. In contrast, the highest density of voltage change during pulsed radiofrequency emanates directly from the tip of the radiofrequency cannula; thus, the tip of the needle should be directed perpendicular to the course of the nerve to be treated. Techniques for both conventional and pulsed radiofrequency treatment are discussed here.

### **Cervical Facet Medial Branch Block and Radiofrequency Treatment**

The medial branch nerves to the cervical facets course across the articular

pillar, midway between the superior and inferior articular processes. The nerves can be anesthetized by placing a needle from a posterior or lateral approach. For the patient, the lateral approach is more comfortable because he or she can lie on one side rather than face down, and the needle must traverse less tissue en route to the target. However, when the needles are inserted from a lateral approach, they are directed toward the spinal cord; even slight rotation of the neck can lead to confusing the left and right articular pillars and result in needle entry into the spinal canal. For performing diagnostic medial branch blocks, either approach is adequate because the local anesthetic will be deposited in the same location in both approaches. For conventional radiofrequency treatment, the cannulas should be placed using a posterior approach, as this will allow the entire length of the 5-mm active tip to be placed along the course of the nerve on the articular pillar. For pulsed radiofrequency treatment, the cannulas can be placed from a lateral approach, as the voltage fluctuations are maximal at the tip of the cannula.

**Posterior Approach** The patient lies prone, facing directly toward the table with a small headrest under the forehead to allow for air flow between the table and the patient's nose and mouth. The C-arm is rotated 25–35° caudally from the axial plane without any oblique angulation. This brings the axis of the x-ray path in line with the axis of the facet joints and allows for good visualization of the articular pillars.

**Lateral Approach** The patient lies in the lateral decubitus position with a pillow under the head in order to keep the neck horizontal and minimizes lateral flexion of the neck to either side. The C-arm is placed directly over the patient's neck without rotation or angulation. Care must be taken to assure that the left and right articular pillars are aligned directly over one another. This is a point of great confusion among practitioners who are inexperienced with radiographic anatomy of the cervical spine. Even small degrees of rotation can place the left and right facet joints in significantly different locations on lateral radiographs. It is difficult to discern the left side from the right, and if a needle is

advanced toward the contralateral facet target in error, the needle can easily penetrate into the spinal canal.

### **Diagnostic Medial Branch Blocks**

The cervical level can be identified by counting upward from T1 or downward from C2. Radiographically, T1 is identified in the AP view by its large transverse process that articulates with the head of the first rib, and C2 can be identified by its odontoid process in the AP view and its large spinous process in the lateral view. The skin and subcutaneous tissues overlying the facet target where the block is to be carried out are anesthetized. A 22-gauge, 3.5-inch spinal needle is placed through the skin and advanced just until it is seated in the tissues in a plane that is coaxial with the axis of the x-ray path. The needle is adjusted to remain coaxial and advanced toward the facet target in the middle of the articular pillar, midway between superior and inferior articular surfaces of the vertebra. This appears as an invagination or "waist" on AP radiographs and as a trapezoid on lateral radiographs. From the posterior approach, the needle is gently seated on the lateral margin of the facet column in the middle of the "waist"; from a lateral approach, the needle tip is seated in the middle of the trapezoid. Needle position is confirmed with AP and lateral radiographs. Once needle position has been confirmed, a small volume of local anesthetic is placed at each level and the needles are removed. The patient is instructed to assess his or her degree of pain relief in the hours immediately after the diagnostic blocks.

**Radiofrequency Treatment** Radiofrequency cannulas are placed using a technique identical to that described for medial branch blocks. For conventional radiofrequency treatment, 5-cm SMK cannulas with 5-mm active tips are used and placed from a posterior approach. Once the lateral margin of the facet column is contacted, the needle is walked laterally off of the facet and advanced 2–3 mm to position the active tip along the course of the medial branch nerve. Proper testing for sensory-motor dissociation is conducted. For sensory testing, the patient is asked to report pain or tingling during stimulation at 50 Hz at output <0.5 V. Motor testing is carried out at 2 Hz, slowly



increasing the output to three times the sensory threshold. There should be no motor stimulation to the affected myotome throughout the testing period. We routinely increase the output to 3 V to rule out stimulation of the nerve root before we proceed with radiofrequency procedure. Thereafter, great care must be taken to prevent any movement of the cannulas. Each level is anesthetized prior to ablation, and lesions are created at 80°C for 60–90 seconds.

For pulsed radiofrequency treatment, 5-cm cannulas with 5-mm active tips are inserted from a lateral approach. The tip is placed in the center of the trapezoid of the target facet, midway between articular surfaces and midway between the anterior and posterior extents of the facet column. Proper testing for sensory thresholds is conducted as for conventional radiofrequency treatment. Each level then is treated with pulsed radiofrequency adequate to maintain voltage fluctuations of 40–45 V for 120 seconds, without exceeding a tip temperature of 42°C. Local anesthesia is not needed for pulsed radiofrequency treatment but can be placed before the cannulas are removed.

### **Thoracic Facet Medial Branch Block and Radiofrequency Treatment**

The medial branch nerves to the thoracic facets course over the base of the transverse processes where they join with the superior articular processes. The patient lies prone, with the head turned to one side. The C-arm is positioned over the thoracic spine, rotated 25–35° caudally from the axial plane without any oblique angulation. The transverse processes of the thoracic vertebrae are best seen from this angle at both high and low thoracic levels.

### **Diagnostic Medial Branch Blocks**

The thoracic level can be identified by counting downward from T1 or upward from T12. The skin and subcutaneous tissues overlying the facet target where the block is to be carried out are anesthetized. A 22-gauge, 3.5-inch spinal needle is placed through the skin and advanced just until it is seated in the tissues in a plane that is coaxial with the axis of the x-ray path. The needle is adjusted to remain coaxial and advanced toward the base of the transverse process where it joins the superior articular process and seat-

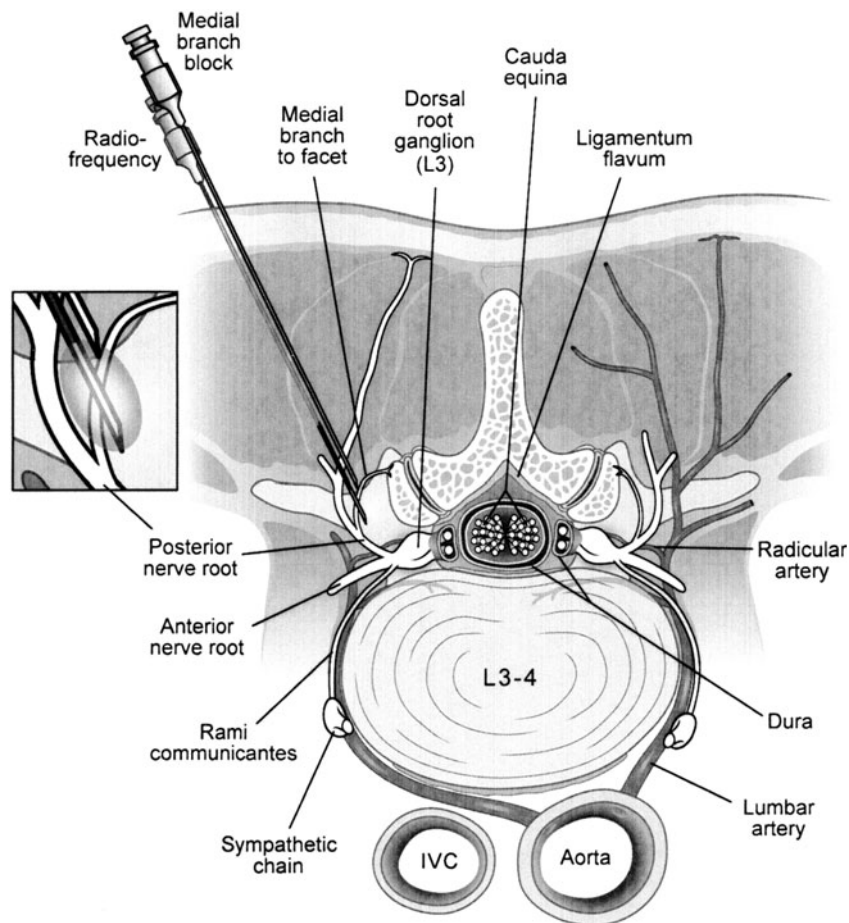
ed just on the bony margin. Once the needle is in position, a small volume of local anesthetic is placed at each level and the needles are removed. The patient is instructed to assess his or her degree of pain relief in the hours immediately after the diagnostic blocks.

**Radiofrequency Treatment** Radiofrequency cannulas are placed using a technique identical to that described for medial branch blocks. For conventional radiofrequency treatment, 5- or 10-cm SMK cannulas with 5-mm active tips are used. Once the needle is seated against the superior margin of the transverse process where it joins the superior articular process of the facet, the cannula is walked superolaterally off of the transverse process and advanced 2–3 mm to position the active

tip along the course of the medial branch nerve. Proper testing for sensory–motor dissociation is conducted as previously described. Thereafter, great care must be taken to prevent any movement of the cannulas. Each level is anesthetized and lesions are created at 80°C for 60–90 seconds. Cannula placement for thoracic pulsed radiofrequency treatment is carried out in the same manner.

### **Lumbar Facet Medial Branch Blocks and Radiofrequency Treatment**

The medial branch nerves to the lumbar facets course over the base of the transverse process where they join with the superior articular processes (Fig. 93–8). The medial branch nerve lies in the groove between the transverse process and the superior articular



**FIGURE 93–8.** Axial diagram of lumbar medial branch nerve blocks and radiofrequency treatment. A 22-gauge, 3.5-inch spinal needle (or 22-gauge, 10-cm SMK radiofrequency cannula with 5-mm active tip) is advanced toward the base of the transverse process where it joins with the superior articular process. Placement of cannulas for conventional radiofrequency treatment should be carried out with 25–30° of caudal angulation of the C-arm to bring the axis of the active tip parallel to the course of the medial branch nerve in the groove between the transverse process and the superior articular process. (Adapted from Rathmell JP. *Atlas of Image-Guided Intervention in Regional Anesthesia and Pain Medicine*. Philadelphia: Lippincott Williams & Wilkins, 2006:89, with permission.)

lar process, which slopes inferolaterally. The patient lies prone, with the head turned to one side. A pillow is placed under the lower abdomen in an effort to tilt the pelvis backward and swing the iliac crests posteriorly away from the lumbosacral junction. The C-arm is positioned over the lumbar spine with 25–35° of oblique angulation so that the facet joints themselves and the junction between the transverse process and the superior articular process are clearly seen. For medial branch blocks, the needle can be advanced in the axial plane without caudal angulation. However, for radiofrequency treatment, the C-arm should be angled 25–30° caudal to the axial plane so that the active tip of the radiofrequency cannulas will be parallel to the medial branch nerve within the groove between the transverse process and the superior articular process as it slopes inferomedially.

#### Diagnostic Medial Branch Blocks

The lumbar level can be identified by counting upward from the sacrum. The skin and subcutaneous tissues overlying the facet target where the block is to be carried out are anesthetized. A 22-gauge, 3.5-inch spinal needle is placed through the skin and advanced until it is gently seated in the tissues in a plane that is coaxial with the axis of the x-ray path. The needle is adjusted to remain coaxial and advanced toward the base of the transverse process where it joins the superior articular process and seated just on the bony margin. Once the needle is in position, a small volume of local anesthetic is placed at each level and the needles are removed. The patient is instructed to assess his or her degree of pain relief in the hours immediately after the diagnostic blocks.

**Radiofrequency Treatment** Radiofrequency cannulas are placed using a technique identical to that described for medial branch blocks; however, the C-arm is angled 25–30° caudal to the axial plane so that the active tip of the radiofrequency cannulas will be parallel to the medial branch. For conventional radiofrequency treatment, 10-cm SMK cannulas with 5-mm active tips are used. Once the needle is seated against the superior margin of the transverse process where it joins the superior articular process of the facet,

the cannula is walked off of the superior margin of the transverse process and advanced 2–3 mm to position the active tip along the course of the medial branch nerve. Proper testing for sensory–motor dissociation is conducted as previously described, assuring there is no stimulation of the motor nerves to the lower extremities. Thereafter, great care must be taken to prevent any movement of the cannulas. Each level is anesthetized and lesions are created at 80°C for 60–90 seconds. Cannula placement for lumbar pulsed radiofrequency treatment is carried out in the same manner, except that the active tip need not be parallel to the medial branch nerve.

#### Complications of Medial Branch Block and Radiofrequency Treatment

Complications associated with diagnostic medial branch nerve blocks are uncommon and similar to those following intraarticular facet injections. Unlike intraarticular injection, it is unusual for medial branch blocks to cause an exacerbation of pain. Patients should be warned to expect mild pain at the injection site lasting 1 or 2 days after the procedure. Radiofrequency treatment of the facets also is associated with few complications. Despite the fact that conventional radiofrequency produces actual tissue destruction, injury to the spinal nerve roots is uncommon, perhaps because of sensory and motor testing. Injury to the spinal nerve root has been reported following radiofrequency treatment and could present with new-onset radicular pain with or without radiculopathy. The importance of physiologic testing before each lesion should be emphasized, because this will reduce the chance that the active tip of the cannula is close enough to the anterior nerve root to cause injury.

Exacerbation of pain following conventional radiofrequency treatment is common, and patients should be instructed to expect an increase in pain, similar in character to their usual pain, that will last from several days to a week or more. A smaller group of patients will report uncomfortable dysesthesia, usually in the form of a sunburn-like feeling of the skin overlying the spinous processes and often accompanied by allodynia. This adverse effect is more common following cervical radiofrequency treatment and usually subsides over several weeks. These

dysesthesias likely stem from partial denervation of the lateral branch of the posterior primary ramus, which supplies a variable region of cutaneous innervation overlying the spinous processes. Likewise, some patients will report a small patch of complete sensory loss in this same region.

Pulsed radiofrequency treatment does not produce tissue destruction, so it is not surprising that most patients will have no worsening of their pain following treatment or will have a transient, mild exacerbation that is short lived. Painful dysesthesia and other consequences of nerve injury do not occur with pulsed radiofrequency treatment. It is precisely because of this lack of neural destruction and associated adverse effects that pulsed radiofrequency treatment has become popular among practitioners. If controlled trials emerge to support the efficacy of pulsed radiofrequency treatment, it may rapidly replace conventional radiofrequency.<sup>110</sup>

## Lumbar Discography and Intradiscal Treatments

### Overview

Discography is a diagnostic test in which radiographic contrast is injected into the nucleus pulposus of the intervertebral disk. Although originally developed for the study of disk herniation, discography now is used most commonly to identify symptomatic disk degeneration. The two components of discography are (1) the anatomic appearance of contrast spread within the disk (using plain radiographs and/or CT) and (2) the presence or absence of typical pain during contrast injection within the disk (pain provocation). The usefulness of discography remains controversial. Some clinicians routinely use discography to identify symptomatic disks prior to surgical fusion or intradiscal thermal annuloplasty, whereas others believe the test is of unproven benefit in identifying symptomatic disks.<sup>111,112</sup> Discography remains the only test available that attempts to correlate pain response from the patient during provocation with abnormal disks discovered on imaging studies. Improved surgical outcomes following lumbar fusion have been reported when guided by the use of discography.<sup>112–115</sup> Intradiscal electrothermal therapy (IDET) is a minimally invasive procedure that offers an

alternative treatment to a subset of those patients with discogenic low back pain. Much like its use prior to fusion, discography is used to identify symptomatic intervertebral disks prior to IDET.<sup>116</sup>

The patient with low back or neck pain originating from the vertebral disk often presents with deep, achy, axial midline pain. Pain can be referred to the buttocks and posterior thigh from lumbar disks but does not extend to the distal extremities. Patients with discogenic pain often are young and otherwise healthy. Discogenic pain is common in those with jobs that require repetitive motion of the affected spine segment (e.g., package handlers) or which expose the spine to excessive vibration (e.g., long-distance truck drivers, helicopter pilots, and jack-hammer operators). Onset of symptoms usually is gradual. Pain is experienced with prolonged sitting (sitting intolerance), standing, and bending forward. The referred pain usually remains in the proximal part of the extremity. Results of physical examination usually are nonspecific, with limited range of motion at the affected segment or pain with movement, particularly on flexion.

Proponents of discography argue that MRI and CT reveal only nonspecific findings, such as loss of disk height and/or hydration. Jensen et al.<sup>117</sup> showed that >50% of asymptomatic patients have abnormal findings on MRI scans, in at least one intervertebral disk. The presence of a high-intensity zone on MRI at the posterior aspect of the disk indicates that a radial tear of fissure may be present in the annulus fibrosis, again a nonspecific finding common in individuals without back pain.

Treatment for discogenic pain starts with conservative therapy, including physical therapy and oral nonsteroidal antiinflammatory drugs. In those with prolonged or disabling pain that is suspected to be of discogenic origin, provocative discography can help to identify the affected level and guide targeted therapy.

### Diagnostic Lumbar Discography

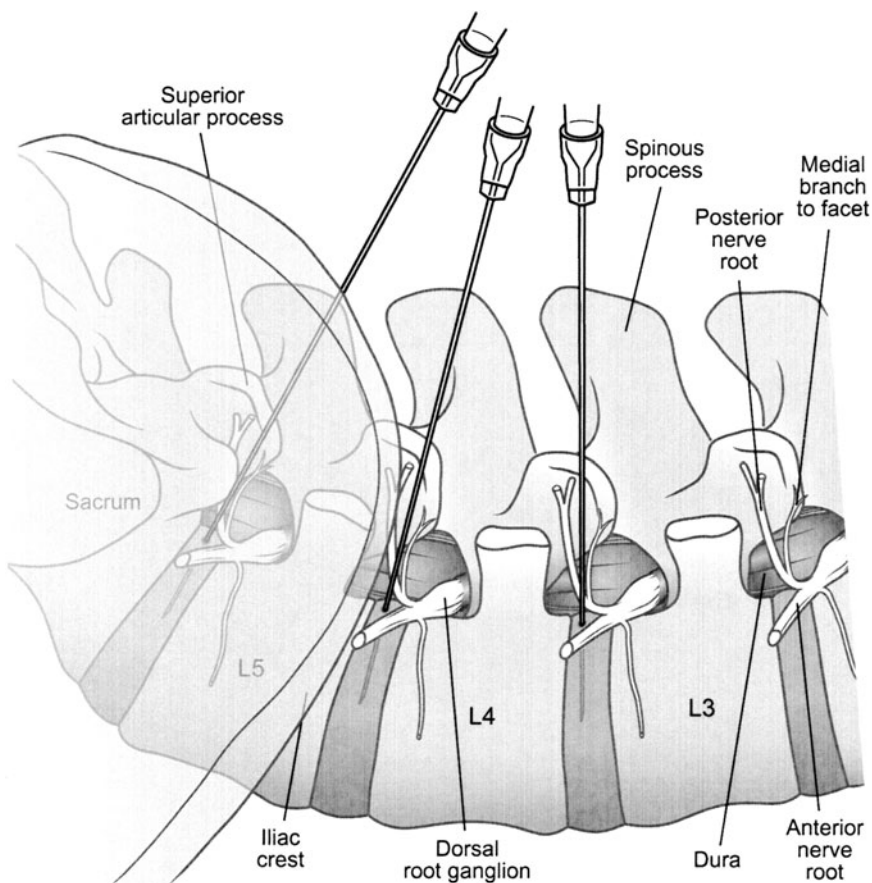
Lumbar discography is a painful procedure, even when performed by the most skilled practitioners. Intravenous sedation can facilitate the procedure; however, caution must be used to avoid oversedation, which could impede ongoing communication with the

patient. The patient must be able to report paresthesias before neural injury occurs. Discography relies on the patient reporting the location and severity of symptoms during provocation, and excessive sedation can make interpretation of the results difficult.<sup>118</sup>

The patient lies prone, with the head turned to one side. A pillow is placed under the lower abdomen, above the iliac crest in an effort to reduce the lumbar lordosis. Having the patient rotate the inferior aspect of the pelvis anteriorly toward the table will tip the iliac crest posteriorly and often is key to successfully performing discography at the L5–S1 level. The C-arm is rotated 25–35° obliquely centered on the disk space to be studied. The C-arm is then angled in a caudad–cephalad direction; the degree varies among patients, depending on the disk to be studied and each patient's degree of lumbar lordosis. In general, the L3–4 disk lies close to the axial plane and requires no cephalad angulation to align the verte-

bral end plates; the L4–5 disk requires 0–15° of cephalad angulation; and the L5–S1 disk requires 25–35° of cephalad angulation (Fig. 93–9). Proper alignment of the C-arm is critical to the safety and success of discography.

The skin and subcutaneous tissues overlying the disk space where discography is to be carried out are anesthetized, and additional local anesthetic is instilled liberally as the needle is advanced. A 22-gauge, 5-inch spinal needle is placed through the skin and advanced just until it is seated in the tissues in a plane that is coaxial with the axis of the x-ray path. A 7- or 8-inch spinal needle is often required in obese patients and is often needed at the L5–S1 level because of the long and oblique trajectory to the disk space. Without careful use of a coaxial technique throughout the entire course of needle advancement, discography will require multiple repositionings of the needle, if it can be done successfully at all. The direction of the needle should



**FIGURE 93–9.** Anatomy of the lumbar intervertebral disks. In general, the L3–4 disk lies close to the axial plane, the L4–5 disk is angled caudally 0–15°, and the L5–S1 disk is angled caudally 25–35°. Needles can be safely inserted into each disk through the posterolateral aspect of the annulus fibrosis, just caudal to the exiting nerve root. (Adapted from Rathmell JP. *Atlas of Image-Guided Intervention in Regional Anesthesia and Pain Medicine*. Philadelphia: Lippincott Williams & Wilkins, 2006:102, with permission.)



be rechecked after every 1–1.5 cm of needle advancement and adjusted to remain coaxial. The position of the exiting nerve root beneath the pedicle should be kept in mind at all times, and efforts to assure that the needle does not stray cephalad or lateral to the intended point over the middle of the disk will reduce the likelihood of striking the nerve root en route to the disk.

Once the needle is in contact with the surface of the disk, there will be a notable increase in resistance to needle placement. At this point, the C-arm should be rotated to a lateral position and the needles advanced halfway from the anterior to the posterior margin of the disk. Proper final placement is then checked in the AP plane, where again the needle should be in the midportion of the disk space. The nucleus pulposus occupies the central third of the disk space, and placement of the needle tip anywhere within the nucleus should suffice. The final needle path lies just inferior to the exiting nerve root, and in many patients it is difficult or impossible to position the needle exactly in the center of the disk.

Once the needles are in final position at all levels to be tested, provocative testing is carried out. A small volume of radiographic contrast containing antibiotic is placed at each level (<1.5 mL of iohexol 180 mg/mL containing 1 mg/mL of cefazolin). The contrast material is injected under live fluoroscopy to observe the pattern of contrast spread within the disk. As the contrast is injected, the resistance to injection is noted and the patient is questioned about his or her symptoms. Some practitioners use an inline pressure monitoring device to assure that excess pressure is not delivered during the provocative test. Some evidence indicates that pain reproduction using small volumes without excessive pressure during injection correlates most closely with symptomatic discogenic pain; injection under high pressure or with large volumes may well produce pain even in normal disks.<sup>119</sup>

A concordant discogram result occurs when the patient reports his or her typical pattern of severe pain during injection at the level of suspected pathology and the same patient reports no pain on injection of an adjacent disk that is normal in appearance.<sup>118,120</sup> After injection of all levels, final AP and lateral radiographs should be obtained to document the levels

tested and the patterns of contrast spread during injection. Some practitioners advocate for subsequent CT to assess the patterns of disk disruption using axial imaging, but the usefulness of CT discography in planning subsequent therapy is unclear.

### **Complications of Lumbar Discography**

The majority of patients experience a marked exacerbation of their typical back pain in the days following discography. They should be warned to expect this pain and given a short course of oral analgesics for treatment of the exacerbation. Less commonly, injury to the exiting nerve roots occurs. The position of the nerve roots is in close proximity to the needle's path. Care must be taken to advance the needle slowly as it passes over the transverse process en route to the posterolateral margin of the disk. If the patient reports a paresthesia to the lower extremity, the needle should be withdrawn and redirected. Paresthesia will occur in a small proportion of patients, even with good technique. Persistent paresthesias are uncommon and typically ensue only after repeated paresthesias occur during the procedure.

Infection can occur, leading to abscess within the presacral musculature, but the incidence is exceedingly low. Infection within the disk space (discitis) is the most feared complication of discography, with an incidence <1:1000. Treatment of discitis may require long-term administration of intravenous antibiotics and/or surgical removal of the infection. No cases of discitis occurring in patients who received intradiscal antibiotics during discography have been reported. Bleeding complications have not been associated with intradiscal injection.

### **Intradiscal Electrothermal Therapy**

Spinal fusion has been reserved for patients with advanced disk degeneration, with clinical results varying between 46% and 82%.<sup>95,114</sup> Patients who have early degenerative disk disease with preservation of near-normal disk height (>75% of normal disk height remaining) but severe ongoing back pain that does not improve with conservative therapy may be adequate candidates for intradiscal thermal coagulation (Intradiscal Electrothermal Therapy, Smith & Nephew, Andover, MA).<sup>121</sup> The mechanism of action of

IDET is unclear, but thermal energy has been shown to coagulate neural tissue<sup>122</sup> and induce collagen denaturation,<sup>123</sup> thereby addressing both nociceptive and mechanical aspects of discogenic pain.<sup>124</sup> Early prospective studies demonstrated significant pain reduction and improvement in physical function in 30–50% of patients treated with IDET.<sup>121,124</sup> However, two randomized controlled trials comparing IDET to placebo have reached conflicting conclusions.<sup>125,126</sup>

Patients suitable for IDET present with concordant pain on discography at one or two spinal levels and no pain during provocation of an adjacent control disk. IDET makes use of a navigable thermal resistance wire that is placed percutaneously and positioned along the posterior aspect of the of the annulus fibrosis. Once in position, the disk is heated using a standardized protocol. Like discography, IDET is a painful procedure, even when performed by the most skilled practitioners. Intravenous sedation can facilitate the procedure, but a level of sedation that allows for ongoing communication with the patient is essential. The patient must be able to report paresthesias or excess discomfort during intradiscal treatment before neural injury occurs. Placement of cannulas for IDET is identical to that for needle placement during discography. The patient lies prone, with the head turned to one side. A pillow is placed under the lower abdomen, above the iliac crest in an effort to reduce the lumbar lordosis. The C-arm is rotated 25–35° degrees obliquely centered on the disk space to be studied. The C-arm is then angled in a caudad–cephalad direction that varies among patients, depending on the disk to be studied and the degree of lumbar lordosis.

Like discography, the L3–4 disk lies close to the axial plane and requires no cephalad angulation to align the vertebral end plates; the L4–5 disk requires 0–15° of cephalad angulation; and the L5–S1 disk requires 25–35° of cephalad angulation. Proper alignment of the C-arm is critical to the safety and success of IDET. The technique for placing the cannulas through which the IDET catheter is introduced into the disk is similar to that for needle placement for discography. However, the best final position of the introducer is in the anterolateral aspect of the nucleus rather than the central portion of the



nucleus. This allows for a more gradual angle as the IDET catheter exits the introducer and curves around the inner aspect of the annulus. The skin and subcutaneous tissues overlying the disk space where IDET is to be carried out are anesthetized, and additional local anesthetic is instilled liberally as the cannulas are advanced. A 17-gauge introducer supplied by the manufacturer is placed through the skin and advanced just until it is seated in the tissues in a plane that is coaxial with the axis of the x-ray path. The IDET introducer is stiff and easy to redirect and advance. The direction of the cannula should be rechecked after every 1–1.5 cm of needle advancement and adjusted to remain coaxial. The position of the exiting nerve root beneath the pedicle should be kept in mind at all times, and efforts to assure that the needle does not stray cephalad or lateral to the intended point over the middle of the disk will reduce the likelihood of striking the nerve root en route to the disk.

Once the needle is in contact with the surface of the disk, there will be a notable increase in resistance to needle placement. At this point, the C-arm should be rotated to a lateral position and the needles advanced halfway from the anterior to the posterior margin of the disk. Proper final placement is then checked in the AP plane, where again the needle should be in the midportion of the disk space.

Once the IDET introducer is in satisfactory position, the navigable thermal resistance wire (SPINECATH, Smith & Nephew) is introduced. The tip of the wire slides along the medial circumference of the annulus and can be guided by gently rotating the proximal end of the catheter. The catheter is first advanced beyond the tip of the introducer and into the disk space using lateral radiography. When the tip of the catheter passes to the posterior aspect of the annulus and begins to traverse along the posterior annulus, the C-arm is rotated to the AP view, and the catheter is advanced to final position across the entire posterior annulus. The catheter has two radiopaque guides that indicate the active treatment portion of the catheter. These markers should be positioned to either side of the disk to indicate that the entire posterior annulus will be treated.

This brief description is simplistic; guiding the IDET catheter to final po-

sition can be quite challenging and requires delicate manipulation of the catheter to keep the tip from advancing into radial tears within the annulus. Overaggressive handling of the catheter will cause it to kink, and, once kinked, the catheter will be difficult or impossible to steer.

Once the catheter is in final position, heat is introduced using a specific protocol designed to gradually raise the temperature within the disk to 80–90 °C and maintain that temperature for a minimum treatment period, typically 14–16 minutes. It is important that the patient is not overly sedated during the actual heat treatment so that he or she can report discomfort due to excess heat, before neural injury occurs.

**Complications of IDET** Patients should be warned of the typical post-procedural flareup in pain symptoms that occurs after IDET. This results in an exacerbation of typical axial back pain, often lasting several days to weeks. Less commonly, injury to the exiting nerve roots occurs. The position of the nerve roots is in close proximity to the needle's path. Care must be taken to advance the needle slowly as it passes over the transverse process en route to the posterolateral margin of the disk. If the patient reports a paresthesia to the lower extremity, the needle should be withdrawn and redirected. Paresthesia occurs in a small proportion of patients, even with good technique. Persistent paresthesias are uncommon and typically ensue only after repeated paresthesias occur during the procedure.

Cauda equina syndrome, with severe neuropathic pain in the lower extremities as well as bowel and bladder dysfunction, has been reported to occur from IDET.<sup>127,128</sup> Injury to the cauda equina is more likely to occur when there is an insufficient posterior annulus and the thermal catheter lies in close proximity to the thecal sac. The catheter can exit the disk space to enter the epidural space; however, this should be evident before treatment on lateral radiographs. Assuring that the patient is sufficiently awake to report excessive discomfort during the IDET treatment should reduce the chances of significant neural injury. Finally, overaggressive handling of the IDET catheter leads to kinking of the catheter near the point where it exits the tip

of the introducer within the intervertebral disk. Repeated attempts to reposition the catheter once it is kinked can lead to shearing of the catheter tip. Catheter breakage and migration of the tip have been described.<sup>129</sup>

A key to successful outcome following IDET is strict adherence to a structure rehabilitation program that guides the patient through gradual increases in physical activity over a 6-week to 3-month time period. Rehabilitation following IDET is similar to the programs used following lumbar fusion.

## Implantable Drug Delivery Systems and Spinal Cord Stimulation

### Implantable Drug Delivery Systems

Intrathecal morphine and other opioids are now widely used as useful adjuncts in the treatment of acute and chronic pain. A number of agents show promise as analgesic agents with spinal selectivity. Continuous delivery of analgesic agents at the spinal level can be carried out using percutaneous epidural or intrathecal catheters, but vulnerability to infection and the cost of external systems typically limit them to short-term use (<6 weeks). Reliable implanted drug delivery systems are available that make long-term delivery of medications to the intrathecal space feasible. These systems consist of a drug reservoir/pump implanted within the subcutaneous tissue of the abdominal wall, which is refilled periodically through an access port. The pump may be a fixed-rate, constant-flow device or a variable-rate pump that can be programmed using a wireless radiofrequency transmitter similar to those used for implanted cardiac pacemakers.

The intrathecal catheter is placed directly within the CSF of the lumbar cistern by advancing a needle between vertebral laminae at the L2–3 level or below. Direct delivery of the opioid at the spinal level corresponding to the dermatome in which the patient is experiencing pain may improve analgesia, particularly when local anesthetics or lipophilic opioids (e.g., fentanyl or sufentanil) are used. Thus, in the past, some practitioners advocated threading the catheter cephalad to the appropriate dermatome. Unfortunately, cases of inflammatory mass formation surrounding the catheter tip of some indwelling intrathecal catheters

have been reported.<sup>130–134</sup> These inflammatory masses often present with gradual neurologic deterioration caused by spinal cord compression. Currently, many physicians recommend that implanted intrathecal catheters be placed only within the lumbar cistern below the conus medullaris, where the appearance of an inflammatory mass is less likely to directly impinge on the spinal cord.<sup>135</sup>

Patient selection for intraspinal pain therapy is empiric and remains the subject of debate. In general, intrathecal drug delivery is reserved for patients with severe pain that does not respond to conservative treatment.<sup>135</sup> Most patients with cancer have ongoing pain despite appropriate oral opioid therapy, or they develop intolerable side effects related to these medications. Randomized controlled trials comparing maximal medical therapy with intrathecal drug delivery for cancer-related pain have demonstrated improved pain control and reduction in opioid-related side effects in patients who received intrathecal pain therapy.<sup>136</sup> Intrathecal drug delivery has been widely used for noncancer pain, particularly for treatment of chronic low back pain.<sup>137</sup> However, use of this therapy in noncancer pain has not been subject to controlled trials and remains controversial.<sup>138</sup>

Once a patient is selected for intrathecal therapy, a trial is performed. Most physicians now conduct trials by placing a temporary percutaneous intrathecal catheter and infusing the analgesic agent over several days to judge the effectiveness of this therapy *before* a permanent system is implanted. Some carry out the trial of intrathecal therapy using a single dose or a continuous epidural infusion. The most common analgesic agent used for spinal delivery is morphine, which remains the only opioid approved by the FDA for intrathecal use.

It is important to discuss the benefits and risks involved in the procedure with the patient and his or her family. Before the procedure, discuss with the patient the location of the pocket for the intrathecal pump. Most devices are large, and the only region suitable for placement is the left or right lower quadrant of the abdomen. Once the site is determined, mark the proposed skin incision with a permanent marker while the patient is in the sitting position. The position of the

pocket on the abdominal wall is deceptively difficult to determine once the patient is lying on his or her side. If the location is not marked, the pocket is often placed too far lateral within the abdominal wall.

Implantation of an intrathecal drug delivery system is a minor surgical procedure that is performed in the operating room using aseptic precautions, including skin preparation, sterile draping, and use of full surgical attire.<sup>139</sup> The procedure can be conducted under either local anesthesia or general anesthesia using dedicated anesthesia personnel. Performing the initial spinal catheter placement under general anesthesia is controversial, and concerns about neural injury are similar to those associated with any neuraxial technique performed under general anesthesia.<sup>140</sup>

The patient is positioned on a radiolucent table in the lateral decubitus position with the patient's side for the pump pocket nondependent. The arms are extended at the shoulders and secured in position so that they are well away from the surgical field. The skin is prepared, and sterile drapes are applied. The radiographic C-arm is positioned across the lumbar region to provide a cross-table AP view of the lumbar spine. Care must be taken to assure that the x-ray view is not rotated by observing that the spinous processes are indeed in the midline, halfway between the vertebral pedicles.

### **Surgical Technique**

The L4–5 or L5–S1 interspace is identified using fluoroscopy. The spinal needle supplied by the intrathecal device manufacturer must be used to assure that the catheter will advance through the needle without damage. The needle is advanced using a paramedian approach starting 1–1.5 cm lateral to the spinous processes and just inferior to the superior margin of the lamina that forms the inferior border of the interspace you plan to enter. The needle is directed to enter the spinal space in the midline. After dural penetration, the stylette is removed to assure adequate flow of CSF. Using fluoroscopic guidance, the spinal catheter is advanced through the needle until the tip is well into the spinal space but below L2. Position of the catheter tip is verified using fluoroscopy in the AP and lateral planes. The needle is then withdrawn slightly (~1–2 cm) but left

in place around the catheter within the subcutaneous tissues to protect the catheter during the subsequent dissection. The catheter is secured to the surgical field using a small clamp to assure that it does not fall outside of the sterile field.

A 5- to 8-cm incision parallel to the axis of the spine is extended from just cephalad to just caudad to the needle, extending directly through the needle's skin entry point. The subcutaneous tissues are divided using blunt dissection until the lumbar paraspinous fascia is visible surrounding the needle shaft. A pursestring suture is created within the fascia surrounding the needle shaft. This suture is used to tighten the fascia around the catheter and prevent backflow of CSF, which may lead to a chronic subcutaneous CSF collection. The needle is removed, taking care not to dislodge the spinal catheter. Free flow of CSF from the catheter should be evident after the needle is removed; if no CSF flows from the catheter, a blunt needle can be inserted within the end of the catheter and gentle aspiration used to assure that the catheter remains within the thecal sac. If CSF cannot be aspirated from the catheter, it should be removed and replaced. Once the provider is certain that the catheter is adequately placed, it is then secured to the paraspinous fascia using a specific anchoring device supplied by the manufacturer.

Attention is now turned to creating the pocket within the patient's abdominal wall. A 10- to 12-cm transverse incision is made along the previously marked line, and a subcutaneous pocket is created using blunt dissection. The pocket should always be created caudad to the incision. If the pocket is placed cephalad to the incision, the weight of the device on the suture line is likely to cause wound dehiscence. In many patients, the blunt dissection can be accomplished using gentle but firm pressure with the fingers. It is simpler and less traumatic to use a small pair of surgical scissors to perform the blunt dissection. After the pocket is created, the pump is placed in the pocket to assure that the pocket is large enough. The pump should fit completely within the pocket without any part of the device extending beneath the incision.<sup>139</sup> With the device in place, the wound margins must fall into close apposition. There should be no tension on

the sutures during closure of the incision or the wound is likely to dehiscence.

After pocket creation is completed, a tunneling device is extended within the subcutaneous tissues between the paraspinous incision and the pocket. The catheter is then advanced through the tunnel (most tunneling devices place a hollow plastic sleeve in the subcutaneous tissue through which the catheter can be advanced from the patient's back to pump pocket). The catheter is trimmed to a length that allows for a small loop of catheter to remain deep to the pump and attached to the pump. The pump is placed in the pocket, with a loop of catheter deep to the device. This loop allows for patient movement without placing tension on the distal catheter and causing it to be pulled from the thecal sac. Two or more sutures should be placed through the suture loops or mesh enclosure surrounding the pump and used to secure the pump to the abdominal fascia. These simple retaining sutures prevent the pump from rotating or flipping within the pocket. The skin incisions are then closed in two layers: a series of interrupted subcutaneous sutures to securely close the fascia overlying the pump and the catheter, followed by a skin closure using suture or staples.

### ***Surgical Technique for Permanent Epidural Catheter Placement***

For placement of a permanent epidural catheter, patient positioning and use of fluoroscopy are similar to those described for intrathecal catheter placement. The interspace of entry varies with the dermatomes that are to be covered, particularly if local anesthetic solution is to be used. A typical loss-of-resistance technique is used to identify the epidural space, and a Silastic catheter is threaded into the epidural space. A paraspinous incision is created, and the catheter is secured to the paraspinous fascia as described for intrathecal catheter placement.

Two types of permanent epidural systems are available: (1) a totally implanted system using a subcutaneous port that is accessed by a needle placed into the port through the skin and (2) a percutaneous catheter that is tunneled subcutaneously but exits the skin to be connected directly to an external infusion device.

To place a permanent epidural with a subcutaneous port, a 6- to 8-cm trans-

verse incision is made overlying the costal margin halfway between the xiphoid process and the anterior axillary line. A pocket is created overlying the rib cage using blunt dissection. The catheter is then tunneled from the paraspinous region to the pocket as described for intrathecal catheter placement and secured to the port. The port must then be sutured securely to the fascia over the rib cage. Care must be taken to assure that the port is secured firmly in a region that overlies the rib cage. If the port migrates inferiorly to lie over the abdomen, it becomes difficult to access. The rigid support of the rib cage holds the port firmly from behind, allowing for easier access to the port. The skin incisions are then closed in two layers: a series of interrupted subcutaneous sutures to securely close the fascia overlying the catheter, followed by a skin closure using suture or staples.

To place a permanent epidural without a subcutaneous port, a tunneling device is extended from the paraspinous incision to the right upper abdominal quadrant, just inferior to the costal margin. A small incision (~0.5 cm) is made to allow the tunneling device to exit the skin. Percutaneous epidural catheters are supplied in two parts: the distal portion of the catheter that is placed within the epidural space, and the proximal portion of the catheter that enters the abdominal wall and connects with the distal portion of the catheter. The proximal portion of the catheter is secured to the tunneling device and pulled through the incision in the abdominal wall subcutaneously to emerge from the paraspinous incision. Many catheters are supplied with an antibiotic-impregnated cuff that is designed to arrest entry of bacteria along the track of the catheter. This cuff should be placed approximately 1 cm from the catheter's exit site along the subcutaneous catheter track. The proximal and distal portions of the catheter are trimmed, leaving enough catheter length to assure that there is no traction on the catheter with movement. The two ends of the catheter are connected using a stainless steel union supplied by the manufacturer and sutured securely. The paraspinous skin incision is closed in two layers with a series of interrupted subcutaneous sutures to securely close the fascia overlying the catheter, followed by a skin closure using suture or staples. The

skin incision at the epidural catheter's exit site in the right upper quadrant is closed around the base of the catheter using one or two simple interrupted sutures.

### ***Complications***

Bleeding and infection are risks inherent to all open surgical procedures. Bleeding within the pump pocket can lead to a hematoma surrounding the pump that may require surgical drainage. Bleeding along the subcutaneous tunneling track often causes significant bruising in the region but rarely requires treatment. Similar to other neuraxial techniques, bleeding within the epidural space can lead to significant neural compression. Infection of drug delivery devices is infrequent (range 2.5–9%), and the majority of infections involve the pump pocket site.<sup>139</sup> Signs of infection within the pump pocket typically occur within 10–14 days of implantation but may occur at any time. Some practitioners have reported successful treatment of superficial infections of the area overlying the pocket with oral antibiotics aimed at the offending organism and close observation alone. However, infections within the pocket or along the catheter's subcutaneous course almost universally require removal of all implanted hardware and treatment with parenteral antibiotics to eradicate infection. Catheter and deep-tissue infections can extend to involve the neuraxis and result in epidural abscess formation and/or meningitis. Although meningitis is rare, each time a pump is refilled provides an opportunity for the drug to become contaminated during preparation or for the pump reservoir to become contaminated during needle penetration.<sup>139</sup> Permanent epidural catheters without subcutaneous ports have a higher infection rate than those with ports in the first weeks after placement, but both systems have a similar high rate of infection when left in place for more than 6–8 weeks.<sup>141</sup>

Spinal cord injury during initial catheter placement has been reported.<sup>142,143</sup> Most practitioners recommend placing the catheter only in the awake patient so that the patient can report paresthesia during needle placement. However, this is a topic of some debate, and placement of the intrathecal catheter under general anesthesia using radiographic guidance below the level of the conus med-

ullaris (~L2) is considered appropriate by some physicians. The catheter can be placed incorrectly within the subdural compartment or the epidural space. In both cases, free flow of CSF will not follow, indicating improper location of the catheter tip.

Wound dehiscence and pump migration are infrequent problems. Assuring that the size of the pocket is sufficient to prevent tension on the suture line at the time of wound closure is essential to minimize the risk of dehiscence. Pump migration usually occurs because retaining sutures were omitted at the time of pump placement. Placing two or more sutures through the suture loops or mesh on the pump and securely fastening them to the abdominal fascia will minimize the risk of pump migration.

Subcutaneous collection of fluid surrounding the pump (seroma) can be problematic and typically follows pump replacement. Percutaneous drainage of the sterile fluid collection often is successful in resolving the problem. Subcutaneous collection of spinal fluid, particularly in the paraspinous region, can develop, even many months after pump placement. This complication can be managed with observation alone unless the fluid collection is large or painful; in these instances, neurosurgical exposure of the spinal catheter as it enters the dura and placement of a pursestring suture around the catheter to eliminate the spinal fluid leak may be needed.

### Spinal Cord Stimulation

The idea that direct stimulation of the ascending sensory tracts within the spinal cord might interfere with the perception of chronic pain is founded in everyday observations. We all are familiar with the fact that rubbing an area that has just been injured seemingly reduces the amount of pain coming from that injured region. The advent of transcutaneous electrical stimulation (TENS) whereby a light, pleasant electrical current is passed through surface electrodes in the region of ongoing pain reinforced the observation that stimulation of sensory pathways reduces pain perception in chronic pain states. In 1965, Patrick Wall, a neurophysiologist exploring the basic physiologic mechanisms of pain transmission, and Ronald Melzack, a psychologist working with patients who had chronic pain, together

proposed the Gate Control Theory to explain how non-noxious stimulation can reduce pain perception.<sup>144</sup> In their theory, they proposed that second-order neurons at the level of the spinal cord dorsal horn act as a “gate” through which noxious stimuli must pass to reach higher centers in the brain and be perceived as pain. If these same neurons receive input from other sensory fibers entering via the same set of neurons within the spinal cord, the non-noxious input can effectively close the gate, preventing simultaneous transmission of noxious input. Thus, the light touch of rubbing an injured region or the pleasant electrical stimulation of TENS closes the gate to the noxious input of chronic pain. From this theory, investigators developed the concept of direct activation of the ascending fibers within the dorsal columns that transmit nonpainful cutaneous stimuli as a means of treating chronic pain.

We have learned much about the anatomy and physiology of pain perception since the gate control theory was first proposed. It is unlikely that the simplistic notion of a gate within the dorsal horn is responsible for our observations, but the theory served as a useful concept in the development of spinal cord stimulation. Both the peripheral nerve fibers and second-order neurons within the dorsal horn transmitting pain signals become sensitized after injury, and anatomic changes, cell death, and altered gene expression all likely have a role leading to chronic pain.<sup>145</sup> Direct electrical stimulation of the dorsal columns, known as *spinal cord stimulation* (SCS) or *dorsal column stimulation*, has proved effective, particularly in the treatment of chronic radicular pain.<sup>146</sup> North et al.<sup>146</sup> reported a prospective, randomized, crossover trial comparing SCS to reoperation in patients with persistent radicular pain after lumbosacral spine surgery. Patients randomized to SCS were considered more “successful” and less likely to cross over than those randomized to surgery. Although the sample was small, there was no difference in activities of daily living and work status. The mechanisms behind SCS remain unclear, but direct electrical stimulation within the dorsal columns may produce retrograde changes within the ascending sensory fibers that modulate the intensity of incoming noxious stimuli.

The epidural SCS lead is placed directly within the dorsal epidural space just to one side of midline using a paramedian, interlaminar approach. Entry into the epidural space is performed several levels below the final intended level of lead placement. Typically, leads for stimulation of the low back and lower extremities are placed via the L1–2 interspace and those for upper extremity stimulation are placed via the C7–T1 interspace. Investigators have mapped the patterns of electrical stimulation of the dorsal columns and the corresponding patterns of coverage reported by patients with leads in various locations.<sup>147</sup> In general, the epidural lead must be positioned just 2–3 mm to the left or right of midline on the same side as the painful region to be covered.

For lower extremity stimulation, successful coverage usually is achieved by placing the lead between the T8 and T10 vertebral levels, although upper extremity stimulation usually requires lead placement between the occiput and C3 vertebral levels. If the lead ventures too far from midline, uncomfortable stimulation of the exiting nerve roots will result. If the lead is placed too low, overlying the conus medullaris (at or below L1–2), unpredictable patterns of stimulation may result. In the region of the conus, the fibers of the dorsal columns do not lie parallel to the midline; rather, they arc from the corresponding nerve root entering the spinal cord toward their eventual paramedian location several levels cephalad.

Patient selection for SCS is empiric and remains a subject of debate. In general, SCS is reserved for patients with severe pain that does not respond to conservative treatment. The pain responds best when relatively well localized because success of SCS is dependent on the ability to cover the entire painful region with electrical stimulation. Attaining adequate coverage is more difficult when pain is bilateral, often requiring two leads, one to each side of midline.<sup>148,149</sup> When the pain is diffuse, it may be impossible to get effective coverage with stimulation using SCS. Among the best-established indications for SCS is chronic radicular pain with or without radiculopathy in either the upper or lower extremities. Use of SCS for treatment of chronic axial low back pain has been less satisfactory, but results seem to be improv-



ing with the advent of dual-lead systems and electrode arrays that allow for a broad area of stimulation.<sup>150</sup> Randomized controlled trials comparing SCS with repeat surgery for patients with failed back surgery syndrome have demonstrated greater success in attaining satisfactory pain relief in those treated with SCS.<sup>146,151</sup> A small randomized controlled trial by Kemler et al.<sup>152</sup> also suggested significant improvement of pain relief in patients with CRPS who were treated with SCS in conjunction with physical therapy compared with physical therapy alone. Functional status did not improve in either group.<sup>152</sup> The usefulness of psychological screening prior to SCS remains controversial; some investigators have suggested that screening for patients with personality disorders, somatoform disorder, or hypochondriasis may improve the success rate of SCS.<sup>150,153</sup>

Once a patient is selected for therapy with SCS, a trial is carried out by placing a temporary percutaneous epidural lead. The screening is conducted using an external device as an outpatient procedure to judge the effectiveness of this therapy *before* a permanent system is implanted. Some carry out the trial of SCS using a surgically implanted lead that is tunneled using a lead extension that exits percutaneously. The strictly percutaneous trial lead is simpler to place and does not require full operating room setup for placement. The surgically implanted trial lead requires placement in the operating room and surgical removal if the trial is unsuccessful. If the trial is successful, the implanted trial lead can remain, and the second procedure to place the impulse generator is brief, not requiring placement of a new epidural lead. In either case, after successful trial stimulation, a permanent system is placed and the lead is positioned to produce the same pattern of stimulation that afforded pain relief during the period of trial stimulation.

Placement of a percutaneous trial spinal cord stimulator lead can be carried out in any location that is suitable for epidural catheter placement. This may be done in the operating room but also can easily and safely be carried out in any location that allows for adequate sterile preparation of the skin and draping of the operative field. Fluoroscopy must be available to guide anatomic placement. Using a strictly percutaneous trial, the trial

lead is placed in the same fashion used for permanent lead placement, but the lead is secured to the skin without any incision for the trial period.

Before permanent spinal cord stimulator implantation, discuss with the patient the location of the pocket for the impulse generator. The regions most suitable for placement are the lower quadrant of the abdomen and the lateral aspect of the buttock. Once the site is determined, mark the proposed skin incision with a permanent marker while the patient is in the sitting position. As with the pump reservoir, the position of the pocket is deceptively difficult to determine once the patient is lying on his or her side. If the location is not marked, the pocket is often placed too far lateral within the abdominal wall. Placement of the impulse generator within the buttock allows for the entire procedure to be carried out with the patient in the prone position and simplifies the operation by obviating the need to turn from the prone to lateral position halfway through implantation. If the impulse generator is placed in a pocket overlying the buttock, it must remain well below the superior margins of the iliac crest.

Implantation of a spinal cord stimulator lead and impulse generator is a minor surgical procedure that is carried out in the operating room using aseptic precautions, including skin preparation, sterile draping, and use of full surgical attire. The procedure must be conducted using local anesthesia and light enough sedation that the patient can report where he or she feels the electrical stimulation during lead placement.

The patient is positioned on a radiolucent table in the prone position. Initial lead placement can be carried out with the patient in a lateral decubitus position, but even small degrees of rotation along the spinal axis can make positioning of the lead difficult. The arms are extended upward so that they are in a position of comfort well away from the surgical field. The skin is prepared and sterile drapes are applied. For stimulation in the low back and lower extremities, the radiographic C-arm is positioned directly over the thoracolumbar junction to provide an AP view of the spine. Care must be taken to assure that the x-ray view is not rotated by observing that the spinous processes are in the mid-

line, halfway between the vertebral pedicles.

### **Surgical Technique**

The L1–2 interspace is identified using fluoroscopy. The epidural needle supplied by the device manufacturer must be used to assure that the lead will advance through the needle without damage. The needle is advanced using a paramedian approach starting 1–1.5 cm lateral to the spinous processes and somewhat caudad to the interspace to be entered. The needle is directed to enter the epidural space in the midline with an angle of entry not  $>45^\circ$  from the plane of the epidural space. If the angle of attack of the needle on initial entry into the epidural space is too great, the epidural lead will be difficult to thread as it negotiates the steep angle between the needle and the plane of the epidural space. The epidural space is identified using a loss-of-resistance technique. The electrode is then advanced through the needle and directed to remain just to one side of midline in the dorsal epidural space as it is threaded cephalad under fluoroscopic guidance. The electrode contains a wire stylette with a slight angulation at the tip. Gentle rotation of the electrode as it is advanced allows the operator to direct the electrode's path within the epidural space. For stimulation in the low back and lower extremities, the electrode initially is positioned 2–3 mm from the midline on the same side as the patient's pain between the T8 and T10 vertebral levels.

Final electrode position is attained by connecting the electrode with an external impulse generator and asking the patient where the pattern of stimulation is felt. In general, cephalad advancement will result in stimulation higher in the extremity and caudad movement will lead to stimulation lower in the extremity. However, if the lead is angled even slightly from medial to lateral, the pattern of stimulation may change less predictably with movement of the electrode (e.g., cephalad advancement can lead to stimulation lower in the extremity under these circumstances). Final electrode position should be recorded using radiography so that a permanent lead can be placed in the same position. For trial stimulation, the needle is then removed, the electrode is secured to the back, and a sterile occlu-

sive dressing is applied. The patient is instructed on the use of the external pulse generator and scheduled to return in 5–7 days for assessment of his or her response and for removal of the trial lead.

During permanent implantation, the procedure for initial lead placement is identical to that for trial stimulation. Once final lead position is attained and the optimal pattern of stimulation is confirmed, the lead must be secured, a pocket for the impulse generator created, and the lead tunneled beneath the skin to connect with the impulse generator. Following initial lead placement, the epidural needle is withdrawn slightly (~1–2 cm) but left in place around the lead within the subcutaneous tissues to protect the lead during the subsequent incision and dissection. A 5- to 8-cm incision parallel to the axis of the spine is extended from cephalad to caudad to the needle, extending directly through the needle's skin entry point. The subcutaneous tissues are divided using blunt dissection until the lumbar paraspinous fascia is visible surrounding the needle shaft. The stylette is then removed from the lead and needle is withdrawn, taking care not to dislodge the electrode. The lead is secured to the paraspinous fascia using a specific anchoring device supplied by the manufacturer.

If lead placement has been carried out in the prone position and the impulse generator is to be placed over the buttock, this site is included in the initial skin preparation and draping, assuring that it is below the superior margins of the iliac crest. If the generator is to be placed in the abdominal wall, the lead must be coiled beneath the skin, the paraspinous incision temporarily closed using staples, and a sterile occlusive dressing applied. The sterile drapes are then removed, and the patient is repositioned in the lateral decubitus position with the side where the abdominal pocket will lie upward. After repeat preparation of the skin and application of sterile drapes, attention is turned to creating the pocket within the patient's abdominal wall or overlying the buttock. An 8- to 10-cm transverse incision is made along the previously marked line, and a subcutaneous pocket is created using blunt dissection. The pocket should always be created caudad to the incision. If the pocket is placed cephalad to the incision, the weight of the im-

pulse generator on the suture line is likely to cause wound dehiscence. Blunt dissection is accomplished using gentle but firm pressure with the fingers or using a small pair of surgical scissors. After the pocket is created, the impulse generator is placed in the pocket to assure that the pocket is large enough. With the device in place, the wound margins must fall into close apposition. As with the pump reservoir, there should be no tension on the sutures during closure of the incision or the wound is more likely to dehiscence.

After the pocket creation is completed, a tunneling device is extended within the subcutaneous tissues between the paraspinous incision and the pocket. The electrode is advanced through the tunnel (tunneling devices vary and are specific to each manufacturer). The means with which the electrode is connected to the impulse generator also varies by manufacturer. Some devices use a lead extension that connects the impulse generator and the lead; others use a one-piece lead that is connected directly to the impulse generator. After tunneling, the lead and/or lead extension are connected with the impulse generator. Any excess lead is coiled and placed behind the impulse generator within the pocket. This loop allows for patient movement without placing tension on the distal electrode and causing it to be pulled from the epidural space.

The skin incisions are closed in two layers: a series of interrupted subcutaneous sutures to securely close the fascia overlying the impulse generator within the pocket and the electrode over the paraspinous fascia, followed by a skin closure using suture or staples.

### Complications

Bleeding and infection are risks inherent to all open surgical procedures. Bleeding within the impulse generator pocket can lead to a hematoma surrounding the device that may require surgical drainage. Bleeding along the subcutaneous tunneling track often causes significant bruising in the region but rarely requires treatment. Similar to other neuraxial techniques, bleeding within the epidural space can lead to significant neural compression. According to Follett et al.,<sup>139</sup> the complexity of lead implantation, including the trial period and a second-stage implant operation, may contribute to the higher multiple-site infection rate

observed for SCS patients in postmarket surveillance data. Signs of infection within the impulse generator pocket also appear within 10–14 days after implantation but may occur at any time. Infections within the pocket or along the lead's subcutaneous course almost universally require removal of all implanted hardware and treatment with parenteral antibiotics to eradicate infection. Lead and deep tissue infections can extend to involve the neuraxis and result in epidural abscess formation and/or meningitis.

There is a significant risk of dural puncture during initial localization of the epidural space using the loss-of-resistance technique. The epidural needle used for electrode placement is a Tuohy needle that has been modified by extending the orifice to allow the electrode to pass easily. This long bevel often results in equivocal loss of resistance; it is not uncommon to have minimal resistance to injection along the entire course of needle placement. To minimize the risk of dural puncture, the needle tip can be advanced under fluoroscopic guidance and first seated on the margin of the vertebral lamina. In this way, the depth of the lamina is certain and the needle need be advanced only a small distance over the lamina, through the ligamentum flavum, and into the epidural space. Loss of resistance is used only during the final few millimeters of needle advancement over the lamina. If dural puncture does occur, there is no clear consensus on how to proceed. Some practitioners abandon the lead placement and allow 1–2 weeks before reattempting placement; this approach allows the practitioner to watch and treat postdural puncture headache, which is nearly certain to occur. Other practitioners proceed with lead placement through a more cephalad interspace; if postdural puncture headache ensues and does not respond to conservative treatment, an epidural blood patch is placed at the level of the dural puncture. Spinal cord and nerve root injury during initial lead placement have been reported. Placing the epidural needle and lead in the awake, lightly sedated patient who is able to report paresthesias should minimize the risk of direct neural injury.

The most frequent complication following spinal cord stimulator placement is lead migration. The first line of defense is ensuring that the lead is

firmly secured to the paraspinous fascia. Suturing the lead to loose subcutaneous tissue or fat is not adequate. Postoperatively, the patient must be clearly instructed to avoid bending and twisting at the waist (lumbar leads) or bending and twisting the neck (cervical leads) for at least 4 weeks after lead placement. Placing a soft cervical collar on those who had a cervical lead placed provides an easy reminder to avoid movement. Lead fracture may occur, often months or years after placement. Avoiding midline placement or tunneling the lead across the midline will reduce the incidence of fracture caused by compression of the lead on bone. Lead fracture is signaled by a sudden loss of stimulation and is diagnosed by checking lead impedance using the spinal cord stimulator programmer.

### TRAINING IN INTERVENTIONAL PAIN MEDICINE

In our rapidly changing world of modern healthcare, new technologies are appearing at a dizzying rate. Many of these new treatments require physicians to acquire detailed new knowledge and technical skills. Interventional pain medicine is evolving as a distinct discipline that requires detailed new knowledge and expertise. Familiarity with radiographic anatomy for the conduct of image-guided injection and the minor surgical skills needed to place implanted devices such as spinal cord stimulators and implanted drug delivery systems are just a few of the techniques that practitioners must master. As we set out to introduce new interventional techniques to our own pain practices, we must be properly trained to conduct these techniques to ensure safety and success.

### FUTURE DIRECTIONS

The field of evidence-based medicine has emerged as a new paradigm to guide practicing physicians.<sup>154</sup> This field endeavors to educate practitioners about how to frame specific questions based on the clinical problems they are faced with every day. They then venture to the published scientific literature with focused questions about prevention, treatment, and diagnosis of specific clinical conditions. Many evidence-based medicine centers offer concise

and periodically updated summaries about specific clinical conditions. The idea is to get the best information available to the practicing clinician. It describes the best available evidence, and if there is no good evidence, it says so. In pain medicine, we are faced with an expanding array of treatment options that strike us as logical developments that *should* provide pain relief for our patients. However, there is a dearth of clinical evidence to guide rational choice and application of the majority of these emerging treatments.

Merrill<sup>155</sup> has presented a detailed analysis of the current state of evidence guiding the use of interventional treatments in the field of pain medicine. He points out the frequent flaws in existing studies, including the lack of valid comparators (e.g., no treatment) and concludes that "...the practice of invasive pain medicine teeters at a particularly critical juncture...crippled by a lack of vigorous self-evaluation of its role in the treatment of chronic pain." Merrill goes on to detail the means by which we, as scientists and clinicians, can proceed to build a better body of evidence for the treatments we are using.

The field of pain medicine is young and early in development, and it is perhaps unreasonable to expect an accumulation of randomized clinical trials just yet. The evidence-based medicine movement gives little guidance to practitioners whose tools are still under development. It simply reminds us that no evidence regarding many of our techniques exists. As individual practitioners, we must monitor our own outcomes using valid measures, be more reflective and systematic in studying our own outcomes and patterns of care, and provide this information to our patients as part of the decision-making process. As pain practitioners we have an expanding range of treatment options available to us, few with convincing evidence of efficacy superior to alternate treatments. We must evaluate each patient and use the limited evidence available to us today to guide compassionate and rational, if not evidence-based, use of therapy for our patients.

### KEY REFERENCES

1. Rathmell JP. Atlas of Image-Guided Intervention in Regional

Anesthesia and Pain Medicine. Philadelphia: Lippincott Williams & Wilkins, 2006.

2. Buchner M, Zeifang F, Brocai DRC, et al. Epidural corticosteroid injection in the conservative management of sciatica. *Clin Orthop* 2000;375:149-156.
3. Ward A, Watson P, Wood C, et al. Glucocorticoid epidural for sciatica: metabolic and endocrine sequelae. *Rheumatology* 2002;41:68-71.
4. Horlocker TT, et al. Regional anesthesia in the anticoagulated patient: defining the risks. (The second ASRA consensus conference on neuraxial anesthesia and anticoagulation). *Reg Anesth Pain Med* 2003;28:172-197.
5. Cepeda MS, Lau J, Carr DB. Defining the therapeutic role of local anesthetic sympathetic blockade in complex regional pain syndrome: a narrative and systematic review. *Clin J Pain* 2002;18:216-233.
6. Wong GY, Schroeder DR, et al. Effect of neurolytic celiac plexus block on pain relief, quality of life, and survival in patients with unresectable pancreatic cancer. A randomized controlled trial. *JAMA* 2004;291:1092-1099.
7. Van Kleef M, Barendse GAM, Kessels A, et al. Randomized trial of radiofrequency lumbar facet denervation for chronic low back pain. *Spine* 1999;24:1937-1942.
8. Tehranzadeh J. Discography 2000. *Radiol Clin North Am* 1998;36:463-495.
9. Cohen SP, Larkin TM, Barna SA, et al. Lumbar discography: a comprehensive review of outcome studies, diagnostic accuracy and principles. *Reg Anesth Pain Med* 2005;30:163-183.
10. Pauza KJ, Howell S, et al. A randomized, placebo controlled trial of intradiscal electrothermal therapy for the treatment of discogenic low back pain. *Spine J* 2004;4:27-35.
11. Smitt PS, Tsafka A, et al. Outcome and complications of epidural analgesia in patients with chronic cancer pain. *Cancer* 1998;83:2015-2022.
12. North RB, Wetzel FT. Spinal cord stimulation for chronic pain of spinal origin. *Spine* 2002;27:2584-2591.



## REFERENCES

1. Cluff R, Mehio AK, Cohen SP, et al. The technical aspects of epidural steroid injections: a national survey. *Anesth Analg* 2002;95:403–408.
2. Rathmell JP, Torian D, Song T. Lumbar epidurography. *Reg Anesth Pain Med* 2000;25:540–545.
3. Stojanovic MP, Vu TN, Caneris O, et al. The role of fluoroscopy in cervical epidural steroid injections: an analysis of contrast dispersal patterns. *Spine* 2002;27:509–514.
4. Kim KM, Kim HS, Choi KH, et al. Cephalic spreading levels after volumetric caudal epidural injections in chronic low back pain. *J Korean Med Sci* 2001;16:193–197.
5. Rathmell JP. *Atlas of Image-Guided Intervention in Regional Anesthesia and Pain Medicine*. Philadelphia: Lippincott Williams & Wilkins, 2006.
6. Parke WW. Applied anatomy of the spine. In Rothman RH, Simeone FA, eds. *The Spine*. Vol. I. 3rd ed. Philadelphia: WB Saunders, 1992:35–87.
7. Williams KD, Park AL. The Spine. In Canale ST, ed. *Campbell's Operative Orthopaedics*. 10th ed. St. Louis: Mosby, 2003: 1955–2028.
8. Cousins MJ, Bromage PR. Epidural neural blockade. In Cousins MJ, Bridenbaugh PO, eds. *Neural Blockade*. 2nd ed. Philadelphia: JB Lippincott, 1988:253–360.
9. Houten JK, Errico TJ. Paraplegia after lumbosacral nerve root block: report of three cases. *Spine* 2002;27:70–75.
10. Baron R. Peripheral neuropathic pain: from mechanisms to symptoms. *Clin J Pain* 2000;16(2 Suppl):S12–S20.
11. Takata K, et al. Swelling of the cauda equina in patients who have herniation of a lumbar disc: a possible pathogenesis of sciatica. *J Bone Joint Surg Am* 1987;70:361.
12. Murphy RW. Nerve roots and spinal nerves in degenerated disc disease. *Clin Orthop* 1977;129:46–60.
13. Berg A. Clinical and myelographic studies of conservatively treated cases of lumbar intervertebral disc protrusion. *Acta Chir Scand* 1953;104:124–129.
14. Lindahl O, Rexed B. Histologic changes in spinal nerve roots of operated cases of sciatica. *Acta Orthop Scand* 1950;20:215–225.
15. Marshall LL, Trethwie ER. Chemical irritation of nerve root in disc prolapse. *Lancet* 1973;2:230.
16. Saal JS, Franson R, Dobrow R, et al. High levels of inflammatory phospholipase A2 activity in lumbar disc herniation. *Spine* 1990;15:674–678.
17. Lin CR, Amaya F, Barrett L, et al. Prostaglandin E2 receptor EP4 contributes to inflammatory pain hypersensitivity. *J Pharmacol Exp Ther*. 2006;319:1096–103.
18. Chen C, Cavanaugh JM, Ozaktay AC, et al. Effects of phospholipase A2 on lumbar nerve root structure and function. *Spine* 1997;22:1057–1064.
19. Hayashi N, Weinstein JN, Meller ST, et al. The effect of epidural injection of beta-methasone or bupivacaine in a rat model of lumbar radiculopathy. *Spine* 1998;23:877–885.
20. Fowler RJ, Blackwell GJ. Anti-inflammatory steroids induce biosynthesis of a phospholipase A2 inhibitor which prevents prostaglandin generation. *Nature* 1979;278: 456–459.
21. Granstrom E. The arachidonic acid cascade. The prostaglandins, thromboxanes and leukotrienes. *Inflammation*. 1984;8 Suppl: S15–25. Review.
22. Devor M, Govrin-Lippmann R, Rabr P. Corticosteroids suppress ectopic neural discharge originating in experimental neuromas. *Pain* 1985;22:127.
23. Johansson A, et al. Local corticosteroid application blocks transmission in normal nociceptive C fibers. *Acta Anaesthesiol Scand* 1990;34:335.
24. Goebert HW Jr, Jallo SJ, Gardner WJ et al. Sciatica: treatment with epidural injections of procaine and hydrocortisone. *Cleve Clin Q* 1960;27:191–197.
25. White, AH, Derby R, Wynne G. Epidural injections for the diagnosis and treatment of low back pain. *Spine* 1980;5:78–86.
26. Buchner M, Zeifang F, Brocai DRC, et al. Epidural corticosteroid injection in the conservative management of sciatica. *Clin Orthop* 2000;375:149–156.
27. Dilke TFW, Furry HC, Grahame R. Extradural corticosteroid injection in management of lumbar nerve root compression. *BMJ* 1973;2:635–637.
28. Harley C. Extradural corticosteroid infiltration. A follow up study of 50 cases. *Ann Phys Med* 1967;9:22–28.
29. Warr AC, Wilkinson JA, Burn JMB, et al. Chronic lumbosacral syndrome treated by epidural injection and manipulation. *Practitioner* 1972;209:53–59.
30. Heyse-Moore G. A rational approach to the use of epidural medication in the treatment of sciatic pain. *Acta Orthop Scand* 1978;49:366–370.
31. Brown FW. Management of discogenic pain using epidural and intrathecal steroids. *Clin Orthop* 1977;129:72–78.
32. Green PWB, Burke AJ, Weiss CA, et al. The role of epidural cortisone injection in treatment of discogenic low back pain. *Clin Orthop* 1980;153:121–125.
33. Swerdlow M, Sayle-Creer W. A study of extradural medication in the relief of lumbosacral syndrome. *Anaesthesia* 1970;25: 341–345.
34. Benzon HT. Epidural steroid injections for low back pain and lumbosacral radiculopathy. *Pain* 1986;24:277–295.
35. Benzon H. Epidural steroids. In Raj PP, ed. *The Practical Management of Pain*. St. Louis: Mosby Year Book, 1992:818–828.
36. Parisien V. Conservative treatment of low back pain with epidural steroids. *JAMA* 1980;243:83–92.
37. Winnie AP, Hartman JT, Meyers HL, et al. Pain clinic II: intradural and extradural corticosteroids for sciatica. *Anesth Analg* 1972;51:990–1003.
38. Fanciullo GJ, Hanscom B, Seville J, et al. An observational study of the frequency and pattern of use of epidural steroid injection in 25,479 patients with spinal and radicular pain. *Reg Anesth Pain Med* 2001;26:5–11.
39. Arnhoff FN, Triplett HB, Pokorney B. Follow up status of patients treated with nerve blocks for low back pain. *Anesthesiology* 1977;46:170–178.
40. Yates DW. A comparison of the types of epidural injection commonly used in the treatment of low back pain and sciatica. *Rheumatol Rehab* 1978;17:181–186.
41. Physicians' Desk Reference. 57th ed. Montvale, NJ: Medical Economics, 2003: 2733–2735.
42. Physicians' Desk Reference. 57th ed. Montvale, NJ: Medical Economics, 2003: 1367–1368.
43. Kepes ER, Duncalf D. Treatment of backache with spinal injections of local anesthetics, spinal and systemic steroids. A review. *Pain* 1985;22:33–47.
44. Delaney TJ, Rowlingson JC, Carron H, et al. Epidural steroid effects on nerves and meninges. *Anesth Analg* 1980;59:610–614.
45. Benzon HT, Gissen AJ, Strichartz GR, et al. The effect of polyethylene glycol on mammalian nerve impulses. *Anesth Analg* 1987;66:553–559.
46. Wood KM, Arguelles J, Noremburg MD. Degenerative lesions in rat sciatic nerves after local injections of methylprednisolone in aqueous solution. *Reg Anesth* 1980;5:13–15.
47. Kelman H. Epidural injection therapy for sciatic pain. *Am J Surg* 1944;64:183–190.
48. Cohn ML, Huntington CT, Byrd SE, et al. Epidural morphine and methylprednisolone. New therapy for recurrent low back pain. *Spine* 1986;11:960–963.
49. Dallas TI, Lin RL, Wu WH, et al. Epidural morphine and methylprednisolone for low-back pain. *Anesthesiology* 1987;67:408–411.
50. Benzon HT, Braunschweig R, Molloy RE. Delayed onset of epidural anesthesia in patients with back pain. *Anesth Analg* 1981;60:874–877.
51. Jacobs S, Pullan PT, Potter JM, et al. Adrenal suppression following extradural steroids. *Anaesthesia* 1983;38:953–956.
52. McMahon M, Gerich J, Rizza R. Effects of glucocorticoids on carbohydrate metabolism. *Diabetes Metab Rev* 1988;4:17–30.
53. Kay J. Epidural triamcinolone suppresses the pituitary-adrenal axis in human subjects [Abstract]. *Anesth Analg* 1994;79:501–505.
54. Ward A, Watson P, Wood C, et al. Glucocorticoid epidural for sciatica: metabolic and endocrine sequelae. *Rheumatology* 2002;41:68–71.
55. Sharrock NE, Urquhart B, Mineo R. Extradural anesthesia in patients with previous lumbar spine surgery. *Br. J Anaesth* 1990;65:237–239.



56. Reynolds F. Dural puncture and headache. *BMJ* 1993;306:874–876.
57. Abouleish E, Vega S, Blendinger I, et al. Long-term follow-up of epidural blood patch. *Anesth Analg* 1975;54:459–463.
58. Neal JM. Neuraxis mechanical injury. In: Neal JM, Rathmel JP, eds. *Complications in Regional Anesthesia and Pain Medicine*. Philadelphia: Saunders Elsevier, 2007;98–98.
59. Hodges SD, Castleberg RL, Miller T, et al. Cervical epidural steroid injection with intrinsic spinal cord damage: two case reports. *Spine* 1998;23:2137–2142.
60. Bromage PR, Benumof JL. Paraplegia following intracord injection during attempted epidural anesthesia under general anesthesia. *Reg Anesth Pain Med* 1998;23:104–107.
61. Abram SE, O'Connor TC. Complications associated with epidural steroid injection. *Reg Anesth* 1996;21:149–162.
62. Field J, Rathmel JP, Stephenson JH, et al. Neuropathic pain following cervical epidural steroid injection. *Anesthesiology* 2000;93:885–888.
63. Horlocker TT, et al. Regional anesthesia in the anticoagulated patient: defining the risks. (The second ASRA consensus conference on neuraxial anesthesia and anticoagulation). *Reg Anesth Pain Med* 2003;28:172–197.
64. Rathmel JP, Benzon HT. Transforaminal injections of steroids: should we continue? *Reg Anesth Pain Med* 2004;29:397–399.
65. Kozody R, Ready LB, Barsa JE, et al. Dose requirement of local anesthetic to produce grand mal seizure during stellate ganglion block. *Can Anaesth Soc J* 1982;29:489–491.
66. Finn KP, Case JL. Disk entry: a complication of transforaminal epidural injection—a case report. *Arch Phys Med Rehabil* 2005;86:1489–1491.
67. Breivik H, Cousins MJ, Lofstrom JB. Sympathetic neural blockade of upper and lower extremity. In Cousins MJ, Bridenbaugh PO, eds. *Neural Blockade in Clinical Anesthesia and Management of Pain*. 3<sup>rd</sup> ed. Philadelphia: Lippincott-Raven Publishers, 1998:411–447.
68. Boas RA. Sympathetic nerve blocks: in search of a role. *Reg Anesth Pain Med* 1998;23:292–305.
69. Cepeda MS, Lau J, Carr DB. Defining the therapeutic role of local anesthetic sympathetic blockade in complex regional pain syndrome: a narrative and systematic review. *Clin J Pain* 2002;18:216–233.
70. Charlton JE. Management of sympathetic pain. *Br Med Bull* 1991;47:601–618.
71. Mercadante S, Nicosia F. Celiac plexus block: a reappraisal. *Reg Anesth Pain Med* 1998;23:37–48.
72. Wong GY, Schroeder DR, Carns PE, et al. Effect of neurolytic celiac plexus block on pain relief, quality of life, and survival in patients with unresectable pancreatic cancer. A randomized controlled trial. *JAMA* 2004;291:1092–1099.
73. Lillemoe KD, Cameron JL, Kaufman HS, et al. Chemical splanchnicectomy in patients with unresectable pancreatic cancer: a prospective randomized trial. *Ann Surg* 1993;217:447–457.
74. Buckley FP. Regional anesthesia with local anesthetics. In Loeser JD, ed. *Bonica's Management of Pain*. 3rd ed. Philadelphia: Lippincott Williams & Wilkins, 2001:1893–1952.
75. Svorkdal N. Treatment of inoperable coronary disease and refractory angina: spinal stimulators, epidurals, gene therapy, transmyocardial laser, and counterpulsation. *Semin Cardiothorac Vasc Anesth* 2004;8:43–58.
76. Eriksen S. Duration of sympathetic blockade. Stellate ganglion versus intravenous regional guanethidine block. *Anaesthesia* 1981;36:768–7671.
77. Bouwman DL, Morrison S, et al. Early sympathetic blockade for frostbite: is it of value? *J Trauma* 1980;20:744–749.
78. Taras JS, Behrman MJ. Continuous peripheral nerve block in replantation and revascularization. *J Reconstr Microsurg* 1998;14:17–21.
79. Sankstone A, Cornbleet T. Facial hyperhidrosis interruption with stellate ganglion block. *JAMA* 1962;179:571.
80. Eisenberg E, Carr DB, Chalmers TC. Neurolytic celiac plexus block for treatment of cancer pain: a meta-analysis. *Anesth Analg* 1995;80:290–295.
81. Perello A, Ashford NS, et al. Coeliac plexus block using computed tomography guidance. *Palliat Med* 1999;13:419–425.
82. Moore DC, Bush WH, et al. Celiac plexus block: a roentgenographic, anatomic study of technique and spread of solution in patients and corpses. *Anesth Analg* 1981;60:369–379.
83. Mathon G, d'Alincourt A, et al. Ultrasound guided alcohol ablation of the celiac plexus in oncology patients with abdominal pain. *J Radiol* 2001;82:41–44.
84. Moore DC. Despite waffling and min-maxing, computed tomography is optimal when performing a neurolytic celiac plexus block. *Reg Anesth Pain Med* 2001;26:285–286.
85. de Leon-Casasola OA. Critical evaluation of chemical neurolysis of the sympathetic axis for cancer pain. *Cancer Control* 2000;7:142–148.
86. Rathmel JP, Gallant JM, Brown DL. Computed tomography and the anatomy of celiac plexus block. *Reg Anesth Pain Med* 2000;25:411–416.
87. Urschel HC Jr. Dorsal sympathectomy and management of thoracic outlet syndrome with VATS. *Ann Thorac Surg* 1993;56:717–720.
88. Winnie AP, Hartwell PW. Relationship between time of treatment of acute herpes zoster with sympathetic blockade and prevention of post-herpetic neuralgia: clinical support for a new theory of the mechanism by which sympathetic blockade provide therapeutic benefit. *Reg Anesth* 1993;18:277–282.
89. Halbert J, Crotty M, et al. Evidence for the optimal management of acute and chronic phantom pain: a systematic review. *Clin J Pain* 2002;18:84–92.
90. Rocco AG, Palombi D, Raeke D. Anatomy of the lumbar sympathetic chain. *Reg Anesth* 1995;20:13–19.
91. Garcea G, Thomasset S, et al. Percutaneous splanchnic nerve radiofrequency ablation for chronic abdominal pain. *Aust N Z J Surg* 2005;75:640–644.
92. Bandyk DF, Johnson BL, et al. Surgical sympathectomy for reflex sympathetic dystrophy syndromes. *J Vasc Surg* 2002;35:269–277.
93. Carette S, Marcoux S, Truchon R, et al. A controlled trial of corticosteroid injections into facet joints for chronic low back pain. *N Engl J Med* 1991;325:1002–1007.
94. Lilius G, Harilainen A, Laasonen EM, et al. Chronic unilateral low back pain: predictors of outcome of facet joint injection. *Spine* 1990;15:780–782.
95. Thomsen K, Christensen FB, et al. 1997 Volvo award winner in clinical studies. The effect of pedicle screw instrumentation on functional outcome and fusion rates on posterolateral spinal fusion: a prospective, randomized clinical study. *Spine* 1997;22:2813–2822.
96. Nelemans PJ, deBie RA, et al. Injection therapy for subacute and chronic benign low back pain. *Spine* 2001;26:501–515.
97. Dreyfuss P, Tibiletti C, Dreyer S. Thoracic zygapophyseal joint pain patterns. *Spine* 1994;19:807–811.
98. McCall IW, Park WM, O'Brien JP. Induced pain referral from posterior lumbar elements in normal subjects. *Spine* 1979;4:441–6.
99. Bogduk N, Marsland A. The cervical zygapophyseal joints as a source of neck pain. *Spine* 1988;13:610–617.
100. Resnick DK, Choudhri TF, et al. Guidelines for the performance of fusion procedures for degenerative disease of the lumbar spine. Part 13: injection therapies, low-back pain, and lumbar fusion. *J Neurosurg Spine* 2005;2:707–715.
101. Marks RC, Houston T, Thulbourne T. Facet joint injection and facet nerve block: a randomised comparison in 86 patients with chronic low back pain. *Pain* 1992;49:325–328.
102. Gallagher J, Petriccione di Vadi PL, Wedley JR, et al. Radiofrequency facet joint denervation in the treatment of low back pain: a prospective controlled double-blind study to assess its efficacy. *Pain Clin* 1994;7:193–198.
103. Van Kleef M, Barendse GAM, Kessels A, et al. Randomized trial of radiofrequency lumbar facet denervation for chronic low back pain. *Spine* 1999;24:1937–1942.
104. Orpen NM, Birch NC. Delayed presentation of septic arthritis of a lumbar facet joint after diagnostic facet joint injection. *J Spinal Disord Tech* 2003;16:285–287.
105. Alberts W, Wright E, Feinstein B, et al. Experimental radiofrequency brain lesion size as a function of physical parameters. *J Neurosurg* 1966;25:421–423.
106. Vinas FC, Zamorano L, Dujovny M, et al. In vivo and in vitro study of lesions produced with a computerized radiofre-

- quency system. *Stereotact Funct Neurosurg* 1992;58:121-133.
107. Dieckman G, Gabriel E, Hassler R. Size, form and structural peculiarities of experimental brain lesions obtained by thermocontrolled radiofrequency. *Confin Neurol* 1965;26:134-142.
108. Sluifjter ME, Cosmas ER, Ritman WB III. Characteristics and mode of action of pulsed radiofrequency fields applied to the dorsal root ganglion: a preliminary report. *Pain Clin* 1998;11:109-117.
109. Van Zundert J, de Louw AJA, et al. Pulsed and continuous radiofrequency current adjacent to the cervical dorsal root ganglion of the rat induces late cellular activity in the dorsal horn. *Anesthesiology* 2005;102:125-131.
110. Richebe P, Rathmell JP, Brennan TJ. Immediate early genes after pulsed radiofrequency treatment: neurobiology in need of clinical trials. *Anesthesiology* 2005;102:1-3.
111. Tehranzadeh J. Discography 2000. *Radiol Clin North Am* 1998;36:463-495.
112. Whitecloud TS 3rd, SEago RA. Cervical discogenic syndrome. Results of operative intervention in patients with positive discography. *Spine* 1987;12:313-316.
113. Colhoun E, McCall IW, Williams L, et al. Provocation discography as a guide to planning operations on the spine. *J Bone Joint Surg* 1988;70:267-271.
114. Wetzel FT, LaRocca SH, et al. The treatment of lumbar spinal pain syndromes diagnosed by discography. *Lumbar arthrodesis*. *Spine* 1994;19:792-800.
115. Derby R, Howard MW, Grant JM, et al. The ability of pressure-controlled discography to predict surgical and non-surgical outcomes. *Spine* 1999;24:364-372.
116. Cohen SP, Larkin TM, Barna SA, et al. Lumbar discography: a comprehensive review of outcome studies, diagnostic accuracy and principles. *Reg Anesth Pain Med* 2005;30:163-183.
117. Jensen MC, Brant Zawadzki MN, et al. Magnetic resonance imaging of the lumbar spine in people without back pain. *N Engl J Med* 1994;331:69-73.
118. Tarver JM, Rathmell JP, Alsofrom GF. Lumbar discography. *Reg Anesth Pain Med* 2001;26:263-266.
119. Cohen SP, Larkin TM, Barna SA, et al. Lumbar discography: a comprehensive review of outcome studies, diagnostic accuracy, and principles. *Reg Anesth Pain Med* 2005;30:163-183.
120. Anderson MW. Lumbar discography: an update. *Semin Roentgenol* 2004;39:52-67.
121. Saal JS, Saal JA. Management of chronic discogenic low back pain with a thermal intradiscal catheter: a preliminary report. *Spine* 2000;25:382-388.
122. Letcher F, Foldring S. The effect of radiofrequency current and heat on peripheral nerve action potential in the cat. *J Neurosurg* 1968;29:42-47.
123. Shah RV, Lutz GE, et al. Intradiscal electrothermal therapy: a preliminary histological study. *Arch Phys Med Rehabil* 2001;82:1230-1237.
124. Saal JA, Saal JS. Intradiscal electrothermal therapy for the treatment of chronic discogenic low back pain. *Oper Tech Orthop* 2000;10:271-281.
125. Freeman BJC, Fraser RDF, et al. A randomized, double blind controlled trial: intradiscal electrothermal therapy (IDET) versus placebo for the treatment of chronic discogenic low back pain. *Spine* 2005;30:2369-2377.
126. Pauza KJ, Howell S, et al. A randomized, placebo controlled trial of intradiscal electrothermal therapy for the treatment of discogenic low back pain. *Spine J* 2004;4:27-35.
127. Hsui A, Isaac K, Katz J. Cauda equine syndrome from intradiscal electrothermal therapy. *Neurology* 2000;55:320.
128. Wetzel FT. Cauda equine syndrome from intradiscal electrothermal therapy. *Neurology* 2001;56:1607.
129. Orr RD, Thomas SA. Intradural migration of broken IDET catheter causing a radiculopathy. *J Spinal Disord Tech* 2005;18:185-187.
130. North RB, Cutchis PN, et al. Spinal cord compression complicating subarachnoid infusion of morphine: case report and laboratory experience. *Neurosurgery* 1991;29:778-784.
131. Bejjani GK, Karim NO, et al. Intrathecal granuloma after implantation of a morphine pump: a case report and review of the literature. *Surg Neurol* 1997;48:288-291.
132. Yaksh TL, Hassenbusch S, et al. Inflammatory masses associated with intrathecal drug infusion: a review of preclinical evidence and human data. *Pain Med* 2002;3:300-312.
133. Peng P, Massicotte EM. Spinal cord compression from intrathecal catheter-tip inflammatory mass: case report and a review of etiology. *Reg Anesth Pain Med* 2004;29:237-29242.
134. Miele VJ, Price KO, et al. A review of intrathecal morphine therapy related granulomas. *Eur J Pain* 2006;10:251-261.
135. Bennett G, Burchiel K, et al. Clinical guidelines for intraspinal infusion: report of an expert panel. *J Pain Symp Manage* 2000;20:S37-S43.
136. Smith TJ, Coyne PJ. Implantable drug delivery systems (IDDS) after failure of comprehensive medical management can palliate symptoms in the most refractory cancer pain patients. *J Palliat Med* 2005;8:736-742.
137. Thimineur MA, Kravitz E, Vodapally MS. Intrathecal opioid treatment for chronic non-malignant pain: a 3-year prospective study. *Pain* 2004;109:242-249.
138. Maron J, Loeser JD. Spinal opioid infusion in the treatment of chronic pain of non-malignant origin. *Clin J Pain* 1996;12:174-179.
139. Follett KA, Boortz-Marx RL, et al. Prevention and management of intrathecal drug delivery and spinal cord stimulation system infections. *Anesthesiology* 2004;100:1582-1594.
140. Drasner K. Thoracic epidural anesthesia: asleep at the wheel? *Anesth Analg* 2004;99:578-579.
141. Smitt PS, Tsafka A, et al. Outcome and complications of epidural analgesia in patients with chronic cancer pain. *Cancer* 1998;83:2015-2022.
142. Harney D, Victor R. Traumatic syrinx after implantation of an intrathecal catheter. *Reg Anesth Pain Med* 2004;29:606-609.
143. Huntoon MA, Hurdle MF, et al. Intrinsic spinal cord catheter placement: implications of new intractable pain in a patient with a spinal cord injury. *Anesth Analg* 2004;99:1763-1765.
144. Melzack R, Wall PD. Pain mechanisms: a new theory. *Science* 1965;150:971-978.
145. Yaksh TL, Hua XY, et al. The spinal biology in humans and animals of pain states generated by persistent small afferent input. *Proc Natl Acad Sci U S A* 1999;96:7680-7686.
146. North RB, Kidd DH, et al. Spinal cord stimulation versus repeated lumbosacral spine surgery for chronic pain: a randomized controlled trial. *Neurosurgery* 2005;56:98-106.
147. He J, Barolat G, et al. Perception threshold and electrode position for spinal cord stimulation. *Pain* 1994;59:55-63.
148. Meilman PW, Leibrock LG, et al. Outcome of implanted spinal cord stimulation in the treatment of chronic pain: arachnoiditis versus single nerve root injury and mono-neuropathy. *Clin J Pain* 1989;5:189-193.
149. Kumar K, Nath R, et al. Treatment of chronic pain by epidural spinal cord stimulation: a 10-year experience. *J Neurosurg* 1991;75:402-407.
150. North RB, Wetzel FT. Spinal cord stimulation for chronic pain of spinal origin. *Spine* 2002;27:2584-2591.
151. North RB, Kidd DH, et al. Spinal cord stimulation versus reoperation for the failed back surgery syndrome: a prospective, randomized study design. *Stereotact Funct Neurosurg* 1994;62:267-272.
152. Kemler MA, Barendse GAM, et al. Spinal cord stimulation in patients with chronic reflex sympathetic dystrophy. *N Engl J Med* 2000;343:618-624.
153. North RB, Kidd DH, et al. Prognostic value of psychological testing in spinal cord stimulation patients: a prospective study. *Neurosurgery* 1996;39:301-311.
154. Rathmell JP, Carr DB. The scientific method, evidence-based medicine, and rational use of interventional pain treatments. *Reg Anesth Pain Med* 2003;28:498-501.
155. Merrill DG. Hoffman's glasses: evidence-based medicine and the search for quality in the literature of interventional pain medicine. *Reg Anesth Pain Med* 2003;28:547-560.

## CHAPTER 94

### Palliative and Cancer Pain Care

Phillip C. Phan, MD, and  
Allen W. Burton, MD

#### EPIDEMIOLOGY

##### Cancer

In 2004, 1.4 million Americans were newly diagnosed with cancer, approximately 4000 per day.<sup>1</sup> In the same year, 564,000 U.S. deaths were attributed to cancer, accounting for approximately 22% of all deaths. It is estimated that more than 10 million people in the United State (approximately 3% of the population) are living with cancer in 2004. The demographic of cancer continues to evolve, with the overall number of cases slowly trending upward, and the number of long-term survivors, including those with chronic pain issues, continuing to grow.

##### Cancer Pain and Related Symptom Burden

The diagnosis of cancer is distressing to the patient in many ways. First, the patient fears that cancer will shorten his or her life. Second, the patient is apprehensive that the cancer will bring significant pain and suffering with disease progression. Pain is already experienced by 20–50% of cancer patients at the time of diagnosis. With cancer progression, 75% of patients with advanced cancer experience pain.<sup>2</sup> Up to 80% of cancer patients described their pain as having moderate-to-severe intensity.

According to the World Health Organization (WHO), an estimated 6.6 million people worldwide die of cancer every year.<sup>3</sup> WHO studies point out that cancer-related pain continues to be a significant source of global health concern. With advances in therapeutic modalities, approximately 80% of cancer pain can be readily controlled.<sup>4</sup> Unfortunately, even with these advances, cancer

pain remains widely undertreated, even in developed countries.<sup>5</sup> In the United States, the reasons for undertreatment of cancer pain are complex and encompass many barriers (Table 94–1).

In recent years, there has been a growing awareness that pain control is an essential part of comprehensive cancer care. Some studies have shown a direct correlation between good pain control and the cancer patient's length of survival as well as responsiveness to timely oncologic treatment.<sup>6,7</sup> In addition to problems stemming from immobility (deep venous thrombosis, pneumonia), uncontrolled pain has proved to be major risk factor in cancer-related suicides.<sup>8,9</sup>

#### ASSESSMENT

Pain is always subjective and is experienced only by the patient. Over the past 20 years, the assessment of pain has been the subject of much research and refinement of techniques and instruments. A brief review is presented in here; the reader is directed to the references for more details on the assessment of cancer pain. In addition to evaluating the pain symptom, the physician must focus on a myriad of related symptoms. The cancer patient often experiences fatigue, insomnia, depression, anxiety, somnolence, and even cognitive impairment. The psychosocial symptoms, such as anxiety and depression, often can have a large impact on the patient's perception and

#### KEY POINTS

1. Cancer pain remains a significant problem. Studies show approximately 30% of ambulatory cancer patients suffer moderate-to-severe pain. With progressive disease, the incidence is far higher. Breakthrough pain or episodic severe pain often is problematic for cancer patients.
2. Elucidation of the painful syndrome will help guide effective treatment. In most cases, cancer pain stems from the tumor itself. Tumors cause pain due to invasion of bone, soft tissues, muscle, and nervous structures. A less frequent cause of cancer pain is treatment-related pain, including postchemotherapy neuropathic pain, postsurgical pain syndromes, and postradiation pain syndromes.
3. Neuropathic pain states usually are more difficult to treat. Neuropathic pain is seen with chemotherapy-induced painful peripheral neuropathies, postherpetic neuralgias, phantom limb pain, and others. Nociceptive pain syndromes typically are opioid responsive, whereas in neuropathic pain states, adjuvant analgesics may be needed to obtain adequate analgesia.
4. Treat opioid-related side effects aggressively. In some patients, opioid doses are limited by intolerable side effects, including sedation, confusion, constipation, nausea, and pruritus. These side effects are best managed by changing opioids, adding agents to treat the side effect, or using neuraxial, neural blockade, or other interventional pain techniques to lower systemic opioid doses.
5. Stick with the basic tenets of cancer pain management. These include the use of oral opioids whenever possible, often with combinations of long-acting opioids for constant pain with short-acting opioids for "breakthrough" pain. It also includes the use of adjuvant coanalgesics, including nonsteroidal antiinflammatory drugs, anticonvulsants, antidepressants, and topicals to minimize opioid doses and concomitant opioid-related side effects.
6. Prophylactically treat constipation and nausea.
7. Advance to interventional therapies when the risk-to-benefit ratio is favorable. Interventional options for pain control include nerve blocks, parenteral infusions, neuraxial infusions, palliative radiotherapy, palliative chemotherapy, and surgery in combination for optimal patient quality of life. The optimal blend of these techniques currently is empirical and based largely on availability of services.
8. Cancer pain management is rewarding. In most cases, adequate pain and symptom control can be obtained through regular assessment and application of the relatively straightforward principles outlined.



TABLE 94-1.

## Barriers to Effective Cancer Pain Control

- I. Barriers by healthcare providers
  - A. Inadequate assessment by physicians
  - B. Lack of knowledge regarding current treatments by providers
  - C. Outdated beliefs by practitioners
    1. Cancer pain expected with disease progression
    2. Opioids prescribed only for dying patients
    3. Patient's pain complaints unreliable
  - D. Reluctance to prescribe opioids by physicians
    1. Fear of regulatory controls
    2. Fear of increasing liability for overprescribing
    3. Increased work and effort for opioid management
- II. Patient and family-related barriers
  - A. Fear of developing addiction to "narcotics"
  - B. Reluctance to discuss pain with physician
  - C. Fear of acknowledging pain as disease progression
- III. Barriers from healthcare system
  - A. Lack of coordination for effective treatment of pain
  - B. Inadequate resource for dedicated pain treatment

expression of pain. Furthermore, the patient can develop symptoms from side effects of therapeutic intervention, such as nausea, vomiting, and headaches. Thus, the cancer patient commonly presents with a constellation of symptoms that has a profound impact on the patient's psychological well-being, functional status, and quality of life.

### Screening Instruments

Many pain clinics use a questionnaire to aid in and standardize assessment. The Wisconsin Brief Pain Inventory (BPI) and Memorial Pain Assessment Card are well-accepted, standard tools for evaluating cancer pain.<sup>10,11</sup> At The University of Texas MD Anderson Cancer Center, an institutionally approved MD Anderson questionnaire (modified BPI) is used for initial and followup assessment of patients (Fig. 94-1).

Advantages to the Wisconsin BPI include the following:

1. It is a 15-minute questionnaire, which can be self-administered.
2. It includes several questions about the characteristics of the pain and associated symptoms, including the origin of the pain and the effects of prior treatments.
3. It incorporates two valuable features of the McGill Pain Questionnaire, a graphic representation of the location of pain and groups of qualitative descriptors. Severity of pain is assessed by a series of scales

from 0–10 (11-point numerical rating scale [NRS]) that score pain at its best, worst, and on average. The perceived level of interference with normal function is also quantified with an NRS.

4. Consistent evidence suggests that the BPI is cross-culturally valid and is useful, particularly when patients are not fit to complete a more thorough or comprehensive questionnaire.<sup>12,13</sup> Further evidence shows its validity and usefulness in documenting outcomes and health status of noncancer pain patients.<sup>14</sup>

Pediatric cancer pain assessment is a complex topic beyond the scope of this chapter, but pain assessment in the child should be organized in an age-appropriate manner using the proper tool. Examples of pediatric assessment tools include Beyer's The Oucher, Eland's color scale-body outline, Hester's poker chip tool, and McGrath's faces scale.<sup>15</sup>

### Pain History

Objective observations of grimacing, limping, and vital signs (tachycardia) may be useful in assessing the patient, but these signs often are absent in patients with chronic pain. Pain evaluation should be integrated with a detailed oncologic, medical, and psychological history. The initial evaluation should include determination of the patient's feelings and attitudes about the pain and disease, family concerns, and the premorbid psychological histo-

ry. A comprehensive but objective approach to assessment instills confidence in patients and family that will be valuable throughout treatment.

A comprehensive evaluation of the patients with cancer pain includes the following:

- The *chief complaint* is obtained to ensure appropriate triage (i.e., may need to send patient who has severe pain with a bowel obstruction to the emergency center for urgent treatment).
- The *oncologic history* is obtained to gain the context of the pain problem. The oncologic history includes diagnosis and stage of disease, therapy and outcome (including side effects), and patient's understanding of the disease process and prognosis.
- The *pain history* should include information on any premorbid chronic pain and the following data for each new pain site: onset and evolution, site and radiation, pattern (constant, intermittent, or unpredictable), intensity (best, worst, average, current) using NRS from 0–10, quality, exacerbating and relieving factors, pain interference with usual activities, neurologic and motor abnormalities (including bowel and bladder continence), vasomotor changes, and current and past analgesics (use, efficacy, side effects). Prior analgesic use, efficacy, and side effects should be cataloged. Prior treatments for pain should be noted (radiotherapy, nerve blocks, physiotherapy, etc.)
- *Review of medical record and radiologic studies.* Many treatments of cancer themselves can cause pain (e.g., chemotherapy- and radiotherapy-induced neuropathies or postoperative pain syndromes; Table 94-2).<sup>16</sup> Many specific cancers can cause well-established pain patterns as a result of known likely sites of metastasis: (1) breast to long bones, spine, chest wall, brachial plexus, and spinal cord; (2) colon to pelvis, hips, lumbar plexus, sacral plexus, and spine; and (3) prostate to long bones, pelvis, hips, lung, and spine.<sup>17</sup>
- *Psychological history* should include marital and residential status, employment history and status, educational background, functional status, activities of daily living, recreational activities, support systems, health and capabilities of spouse or significant other, and past history of (or current) drug or alcohol abuse.<sup>18</sup>



**Follow-Up And  
Progress Notes**

Pain Management Center-Follow-Up Visit



Patient MDA # \_\_\_\_\_ Date 01/05/2005  
DOB \_\_\_\_\_ FC M SEX M

Page 1 of 2

(Cump)

DATE: 1/5/05  
10-  
1050  
hu

Temp: 37.1 Pulse: 65 Resp: 14 BP: 131/88 Wt: 110.6  
Ambulatory:  Yes No  
Assistive Devices: \_\_\_\_\_

Pain / Chief Complaint: Fore-head, entire head, too, right eye  
How long have you had this pain? Very long time, about 1996  
Has pain changed in intensity and/or character since last visit? If yes, describe. Not much change  
Was in emergency Room New years eve for pain

Where is it located: (Shade diagram, mark worst spot(s) with an X)

hunts to touch  
consistent pain

PAIN SCALE: 0 1 2 3 4 5 6 7 8 9 10 Worst  
None

Over the last week, rate:  
Worst Pain: ..... 0 1 2 3 4 5 6 7 8 9 10  
Least Pain: ..... 0 1 2 3 4 5 6 7 8 9 10  
Usually: ..... 0 1 2 3 4 5 6 7 8 9 10  
Right Now: ..... 0 1 2 3 4 5 6 7 8 9 10  
Acceptable Level: ..... 0 1 2 3 4 5 6 7 8 9 10  
Low as possible

Mark Location

Current Medications: Allergies: Tetanus (swelling)

I. Medications		Frequency	Side Effects	% Pain Relieved
Name	Dose			
10/day A. Ibuprofen	10/500	1 every 4 hrs	none	0
Asacol		1 per day	none	
Toprol 100		1 per day	none	
gabapentin		1 per day	none	
methadone		twice daily (given in ER)	none	15%
dilaudid in pump		13 times daily	none	10%
Xanax			none	
II. Physical Therapy:		yes		
III. TENS Unit:		yes		
IV. Nerve Blocks:		yes		
V. Other:		yes. Specify		

Dilaudid  
Zolot Somg qday  
off

**Follow-Up and Progress Notes**  
File Under: Progress Notes/Dictated Reports



FIGURE 94-1. MD Anderson modified brief pain inventory (BPI) assessment form.

- Medical history (independent of oncologic history) should include coexisting systemic disease, exercise intolerance, allergies to medications, previous and current medication use, prior illness and surgery, and thorough review of systems including the following:
  - General (including anorexia, weight loss, cachexia, fatigue, weakness, insomnia)
  - Neurologic (including sedation, confusion, hallucination, headache,

- motor weakness, altered sensation, incontinence)
- Respiratory (including dyspnea, cough, pneumonia)
- Gastrointestinal (including dysphagia, nausea, vomiting, dehydration, constipation, diarrhea)
- Psychological (including irritability, anxiety, depression, dementia, suicidal ideation)
- Genitourinary (including urgency, hesitancy, hematuria)

**Physical Examination**

The physical examination must be thorough, although at times a focused examination may be appropriate. In patients with spinal pain and known or suspected metastatic disease, a complete neurologic examination is mandatory. Gonzales et al.<sup>19</sup> found new evidence of metastatic disease in 64% of patients, which resulted in new antitumor therapy for 18% of patients evaluated by their pain service.<sup>19</sup>

### Follow-Up And Progress Notes

Pain Management Center-Follow-up Visit

Page 2 Of 2



Patient  
MDA #

Date 01/05/2005

DOB

FC M

SEX M

DATE	<b>Other Symptoms:</b>										
	<b>Bowel Patterns:</b> Usual Frequency: <u>2-3 days</u> Consistency: <u>med</u> Last B M: <u>2 days ago</u> Bowel Regimen: <input checked="" type="checkbox"/> No <input type="checkbox"/> Yes Sexual Dysfunction: No <input type="checkbox"/> Yes <input checked="" type="checkbox"/>										
	<b>Other Symptoms:</b>										
	NONE (Best)										Worst
Fatigue	0	1	2	3	4	5	6	7	8	9	10
Nausea	0	1	2	3	4	5	6	7	8	9	10
Depression	0	1	2	3	4	5	6	7	8	9	10
Anxiety	0	1	2	3	4	5	6	7	8	9	10
Drowsiness	0	1	2	3	4	5	6	7	8	9	10
Difficulty Thinking Clearly	0	1	2	3	4	5	6	7	8	9	10
Shortness of Breathe	0	1	2	3	4	5	6	7	8	9	10
Poor Appetite	0	1	2	3	4	5	6	7	8	9	10
Insomnia	0	1	2	3	4	5	6	7	8	9	10
Feeling of Well-Being	0	1	2	3	4	5	6	7	8	9	10
	<b>Anything Else We Can Help You With Today?</b>										
	Needs refill on Zoloff & Loratab IT pump refill done in clinic										
	<b>Plan Of Care:</b>										
Teaching:	see ITPR <u>see IPOCTR</u>										
Treatment Plan of Care:	see IPTP										
Other:	<u>BTC labels for IT pump refill</u>										
	Signature: <u>Johel Meyer R.N.</u>										

**Follow-Up and Progress Notes**  
File Under: Progress Notes/Dictated Reports



FIGURE 94-1. (Continued)

### Clinical Plan of Care

- It is important to formulate a clinical impression (*Diagnosis*). Multiple diagnoses usually apply, and it is optimal to use the most specific known diagnosis. For example: 1. T11 compression fracture (pathologic versus osteoporotic) with severe pain. 2. Metastatic breast carcinoma (with known bony metastasis). 3. Nausea with dehydration. 4. Constipation.
- It also is important to formulate recommendations (*Plan*) and alternatives

for each problem. For example (related to the above problem list): 1. MRI of the T-spine with consideration of vertebroplasty if appropriate. 2. Oxycodone slow-release 10 mg twice daily, with oral transmucosal fentanyl citrate for breakthrough pain. 3. Management including further chemotherapy, radiotherapy, or bisphosphonates as deemed appropriate by the patient's oncologist. 4. Metoclopramide 10 mg orally 30 minutes prior to meals and as needed for nausea. 5. Addition of Senokot-S twice daily for constipation.

- A call to the referring oncologist and/or primary care provider helps ensure good communication among all of the patient's physicians. An exit interview with the patient, ideally conducted by the physician, but any trained professional can be designated for this important duty. The exit interview may include the following:
- Explaining the probable cause of symptoms in terms the patient can understand.

- Discussing the prognosis for symptom relief, management options, and specific recommendations. In addition to writing prescriptions, oral and written instructions should be provided. Educational material regarding medications, pain management strategies, procedures, or others should be provided. Potential side effects should be discussed.
- Arranging for followup with clinic contact information.
- A dictated summary (in addition to the phone call) should be sent to referring and consulting physicians to keep them apprised of the patient's present status and treatment offered.

## ETIOLOGY AND CLASSIFICATION OF CANCER PAIN SYNDROMES

Pain in the cancer patients can have many causes. Most cancer pain syndromes are tumor related, but an increasing array of treatment-related painful syndromes are being seen now with increasing life expectancy. Numerous schema for classification of cancer pain syndromes have been explored. This chapter explores time course and pathophysiology as relevant classifications as they relate to treatment strategies.

### Pain Syndrome Time Course

#### Acute

The large majority of cancer pain is due to tumor invasion of pain-sensitive structures. The invasion causes a derangement of physiologic processes, including inflammation, edema, acidosis, and necrosis of pain-sensitive tissues. Other pathologic processes may include invasion of bone or soft tis-

issues, obstruction of lymphatic or vascular vessels, distension of hollow organs, distortion of solid organs, and compression of nervous system structures.<sup>20</sup> All of these processes cause typical acute cancer pain syndromes, most of which are diagnosed during the oncologic workup. Many of these same pains improve with successful treatment of the tumor, so reassessment is important given the dynamic nature of tumor-related pain.

#### Chronic

A significant source of pain can be related to the cancer treatments. Most times, the pain is more chronic with a gradual onset and often delayed diagnosis and treatment. Certain types of chemotherapy often cause painful peripheral neuropathy, including the taxanes, platinum compounds, vincristine and its analogues, and some newer agents such as bortezomib.<sup>21</sup> Often, the neuropathy is dose related and resolves with lowering of the dose of the offending agent in subsequent courses of chemotherapy. However, in some patients, the painful neuropathy is permanent and very disabling. It can lead to problems with gait or fine motor tasks of the hands in addition to severe pain. Radiation treatment also may cause neural injury in the form of plexopathy, chronic radiation myelopathy, chronic radiation enteritis and proctitis, as well as nonspecific postradiation head and neck pain, most likely involving a myofascial pain syndrome.<sup>22</sup>

Surgical treatment can lead to chronic postoperative pain syndromes. For example, the postradical mastectomy patient often has pain to the posterior upper arm, axilla, and anterior chest wall secondary to damage of the intercostobrachial nerve.<sup>23</sup> Similarly, nerve damage during thoracotomy and radical neck dissection can cause pain in the distribution of the affected nerves.<sup>24</sup> Phantom limb pain is especially common after amputation procedures, with burning and cramping sensation in the area of amputated limb.<sup>25</sup>

As the pain syndromes become chronic, that is, lasting beyond the expected healing time course, the treatment algorithms become similar to treatments of noncancer chronic pain. Many confusing issues are developing in this patient population, such as patients with very slowly progressive cancer and associated pain that may last many years. In many cases, the "lines" between treating cancer pain or so-

called "malignant" versus "nonmalignant" pain syndromes are blurring.<sup>26</sup>

## Cancer Pain Pathophysiologic Classification

In assessment of cancer pain, an understanding of pain classification is helpful in delineating both the mechanism of pain and its responsiveness to therapeutic interventions. Pain can be broadly classified into nociceptive and neuropathic pain.

### Nociceptive Pain

**Somatic** Nociceptive pain occurs when nonneurologic tissues suffer insult or injury. However, the associated neurologic structures are not injured and remain functional. Consequently, the injuries of the damaged tissues are detected as noxious stimuli, which are transmitted along the classic pain pathways. The pain perceived by the central nervous system (CNS) is proportional to the degree of tissue damage caused by the cancer. The pain experienced by the patient often is responsive to nonsteroidal antiinflammatory drugs (NSAIDs) because tissue damage from cancer inevitably initiates activation of cellular phospholipase A<sub>2</sub> to release arachidonic acids from cell lipid membrane. Cyclooxygenase (COX) enzymes then act on arachidonic acids to produce potent inflammatory mediators such as thromboxanes, prostaglandins, and leukotrienes. NSAIDs, including the COX inhibitors, attenuate this initial inflammatory reaction at the site of the tissue damaged by cancer and thus reduce the initial pain signals. The physician must be aware of the growing concerns about the cardiovascular side effects of this group of compounds.<sup>27</sup>

Opioid therapy also is effective in helping to control nociceptive pain. Opioid analgesics act on pain receptors at the level of spinal cord and in the brain to modulate pain pathways in the CNS. Nociceptive pain responds to opioids in a scaled manner, such that pain control is generally proportional to opioid dosage.<sup>28</sup>

**Nociceptive Visceral Pain** Nociceptive pain can be subcategorized into nociceptive somatic pain and nociceptive visceral pain. Nociceptive somatic pain results from activation of nociceptive receptors in somatic tissues. These nociceptors are sensitive to mechanical, chemical, and thermal stimuli. They are located in skin, bone, muscle, tendon, joint, and connective

TABLE 94-2.

### Incidence of Developing Chronic Postoperative Pain by Type of Surgery

Type of Surgery	Reported Incidence of Chronic Pain
Limb amputation	30–80%
Thoractomy	22–70%
Cholecystectomy	3–56%
Inguinal hernia	0–37%

Data from Perkins FM, Kehlet H. Chronic pain as an outcome of surgery. *Anesthesiology* 2000;93:1123–1133.



tissues. The pain signals from these nociceptors are carried along sensory nerve fibers. The patient's perception of nociceptive somatic pain typically is characterized as aching, dull, sharp, throbbing, and well localized to the injured tissue site.

Nociceptive visceral pain, in contrast, is poorly localized. It originates typically from solid organs of the chest, abdomen, and pelvis. The nociceptive receptors in these solid organs typically do not respond to cutting or burning stimuli. However, they are extremely sensitive to any mechanical stress or torsion of organs as well as tension or traction on mesenteric or vascular attachments to organs. The visceral nociceptive pain signals are carried by autonomic sympathetic fibers. The pain is poorly localized by the patient and often described as vague, dull, aching, or pressure-like.<sup>29</sup> The patient often perceives this nociceptive visceral pain as a referred pain that is falsely localizing to a distant site. For example, pancreatic cancer pain often presents as a referred midback pain, and cancer involvement of diaphragm causes pain in the right shoulder.

### Neuropathic Pain

The second major class of cancer pain is neuropathic pain. This pain differs from nociceptive pain in that the cancer causes direct injury to the neural tissues. Tumor destruction of peripheral nerves will cause abnormal and exaggerated pain signal transmission. Tumor invasion of peripheral or central nervous system results in abnormal pain signal processing, integration, and perception. The cancer patient often reports extraordinary pain perception, with the pain feeling different from the usual pain sensation. Neuropathic pain often is described as diffuse and excessively sensitive (hyperesthesia), even with nonnoxious stimuli (allodynia). Neuropathic pain is thought to be less responsive to opioid analgesics and instead requires adjuvant medications and interventional therapy for effective pain control.<sup>30</sup>

## TREATMENT MODALITIES

### Pharmacologic Therapy

#### WHO Guidelines

As discussed earlier, the barriers to effective pain control are multifold. As a result, clinicians have traditionally

undertreated cancer pain. A growing recognition of this health issue has led to the development of numerous guidelines for treating cancer pain, including most famously the WHO stepladder approach to treating cancer pain. Although too simple to serve as a comprehensive treatment algorithm, the principle of treating more resistant cancer-related pain with stronger doses of opioids is generally sound (Table 94-3).

### Nonopioid Analgesics

The nonopioid class of analgesics includes both acetaminophen and NSAIDs. Nonopioids are commonly used for mild cancer pain, as directed by the WHO analgesic ladder. Even in the patient with advanced cancer, nonopioid analgesics combined with opioid analgesics are effective in treating pain at both central and peripheral sites. Nonopioids help to reduce the requirement for opioids, thus decreasing the opioid-associated side effects of nausea, constipation, somnolence, and cognitive impairment. Nonopioid analgesics must be used with caution, if at all, in cancer patients who are immunosuppressed. Both acetaminophen and NSAIDs can suppress a fever response indicative of a mounting infection in the immunocompromised patient.

### Adjuvant Medications

This heterogeneous class of adjuvant medications has a defined role in the WHO three-step analgesic ladder. They fall into five general categories: antidepressants, anticonvulsants, local anesthetics, corticosteroids, and miscellaneous (Table 94-4).

TABLE 94-3.

#### World Health Organization (WHO) Three-Step Analgesic Ladder for Cancer Pain

Step 1:	→	Nonopioid analgesics ± Adjuvant medications
Mild cancer pain		
Step 2:	→	“Weak” opioids ± Nonopioid analgesics ± Adjuvant medications
Moderate cancer pain		
Step 3:	→	“Strong” opioids ± Nonopioid analgesics ± Adjuvant medications
Severe cancer pain		

These adjuvant medications act to promote certain desirable effects (or prevent opioid-related side effects) in the cancer patient. Tricyclic antidepressants are useful for certain types of neuropathic pain, especially burning dysesthetic pain. They have the significant side effect of sedation at high doses. Consequently, they can be helpful in cancer pain patients with insomnia and depression. Anticonvulsants and local anesthetics have a membrane-stabilizing effect and are effective for neuropathic pain secondary to nerve injury in both peripheral and central nervous systems. Cortico-

TABLE 94-4.

#### Adjuvant Drugs for Treatment of Cancer Pain

- I. Antidepressants
  - Amitriptyline
  - Nortriptyline
  - Imipramine
  - Desipramine
  - Duloxetine
  - Maprotiline
  - Paroxetine
  - Venlafaxine
- II. Anticonvulsants
  - Gabapentin
  - Carbamazepine
  - Oxcarbazepine
  - Pregabalin
  - Clonazepam
  - Topiramate
- III. Local Anesthetics
  - Mexiletine
  - Transdermal lidocaine
- IV. Corticosteroids
  - Dexamethasone
  - Methylprednisolone
  - Prednisolone
  - Cortisone
- V. Miscellaneous
  - Psychostimulants: Dextroamphetamine, Methylphenidate, Modafinil
  - GABA agonist: Baclofen
  - $\alpha_2$  antagonist: Clonidine
  - NMDA antagonist: Ketamine, dextromethorphan
  - Antiemetics<sup>a</sup>: Metoclopramide, ondansetron, dronabinol
  - Laxatives/stool softeners<sup>a</sup>: Senna, docusate

<sup>a</sup>Recommended in all patients receiving opioids.

GABA,  $\gamma$ -Aminobutyric acid; NMDA, N-methyl-D-aspartate.



steroids have a potent antiinflammatory effect and are helpful in cancer patients with spinal cord compression, intracranial tumors, organ capsule distension, and bone infiltration. Steroids also have CNS effect in improvement of mood and sense of well being in the cancer patient. Antiemetics and stool softeners should routinely be prescribed along with opioids. The other miscellaneous adjuvant medications have variable effects and are tailored to the patient's individual pain and associated symptoms.

### Opioid Analgesics

Opioid analgesics are a mainstay for treatment of cancer pain. In the WHO three-step analgesic ladder, “weak” opioids are recommended for treatment of moderate cancer pain, whereas “strong” opioids are prescribed for severe cancer pain. The “weak” opioids have less potency and fewer side effects. Some common oral “weak” opioids are listed in Table 94–5.

The “weak” opioids are produced containing acetaminophen or aspirin. They are “weak” because of the limitation of their ceiling dose of acetaminophen or aspirin, above which the patient has a higher risk of renal and hepatotoxicity.

The “strong” opioids are more potent because they are made in pure form, without addition of aspirin or acetaminophen. Thus, these opioids do not have a maximum ceiling dose. However, with higher dosages of the “strong” opioids, the patient tends to experience more significant side effects of nausea and vomiting, constipation, pruritus, somnolence, and cognitive impairment. Some common “strong” opioids are listed in Table 94–6.

### Failure of Noninterventional Therapies

It has been estimated that up to 70–90% of patients with cancer pain have satisfactory pain relief from pharmacologic therapies alone, following the

TABLE 94–5.

#### “Weak” Opioids for Treatment of Moderate Cancer Pain

Generic Name	Examples
Hydrocodone	Lortab, Vicodin, Lorcet, Norco
Codeine	Tylenol #3, #4
Propoxyphene	Darvon, Darvocet

WHO guidelines for cancer pain.<sup>31</sup> However, this means that 10–30% of patients have pain that cannot be treated with medications alone. The reasons for this failure of pharmacologic treatment are variable.<sup>32</sup> They vary from physician-related factors to patient-related factors. The physician-related reasons for pharmacologic failure include inaccurate assessment of pain and deficiency in knowledge of current analgesics and adjuvant medications. Patient-related reasons range from fear of addiction to adverse side effects.<sup>33,34</sup> Most commonly, the patient cannot tolerate adverse side effects of the medication regimen, especially opioid use.<sup>34</sup> Failure of pharmacologic control of cancer pain is commonly seen with progression of cancer. Patients with advanced disease can present with intractable pain from multiple metastases and multiple pain sites.

### Interventional Therapies

#### Goal of Intervention

Patients who fail to respond to conservative pharmacologic treatments may be candidates for interventional therapies. A large armamentarium of invasive procedures is available to achieve better control of cancer pain. However, the role of interventional therapies must be placed in the proper context. They cannot be used as the sole treatment of cancer pain, especially for advanced cancer patients. Rather, they should be used as part of a multimodality approach in the treatment of cancer pain.<sup>35,36</sup> The etiologies of cancer pain are diverse, and the pain

symptom is interrelated with the constellation of symptoms experienced by cancer patients. Consequently, a global multimodal approach to treatment of cancer pain is necessary. It includes appropriate antineoplastic therapy, management of analgesics and adjuvant pain medications, behavioral and psychiatric support, and finally interventional therapies. Interventional pain procedures will not completely eliminate the need for pain medications. The therapeutic goal of such procedures is to help alleviate cancer pain and reduce the overall analgesic need, thereby minimizing associated opioid-related side effects.

### Communication

Prior to proceeding with any invasive pain procedure, communication between the pain physician and the relevant parties is absolutely essential. The patient must first be educated on risks and benefits of the interventional procedure. He or she must be allowed an opportunity to have questions about procedure extensively and satisfactorily answered. At the same time, the patient must be grounded in realistic expectations for outcomes of this procedure. The patient should be made aware of the efficacy of the procedure, duration of effectiveness, and possibility of failure of the procedure to provide complete or even partial pain relief. All potential complications from procedure are explained to patient. He or she must understand that the interventional procedure is part of a multimodal approach for pain control.

With cancer patients, especially those critically ill or preterminal, family members and caregivers often are involved in decision-making process. Family support helps the patient to cope emotionally with cancer disease as well as undergo the procedural intervention. Like the patient, family members and caregivers must be educated and have realistic expectations about the procedure.

Effective communication with other professional members of the care team is important. They include the patient's oncologists, primary care providers, and all relevant consultants. Treatment of cancer is a multidisciplinary effort. The interventional procedure should be planned in coordination with the overall cancer treatment. For example, the cancer patient may undergo chemotherapy with resultant thrombocyto-

TABLE 94–6.

#### “Strong” Opioids for Treatment of Severe Cancer Pain

Generic Name	Examples
Morphine/ MS-CR	MSIR, MS Contin, Oramorph, Kadian, Avinza
Oxycodone/ oxycodone	CR Roxicodone, OxyContin
Fentanyl	Duragesic (time-released transdermal), Actiq (PO immediate-release)
Hydromorphone	Dilaudid
Methadone	Dolophine
Oxymorphone	Nuromorphan

penia. In such cases, interventional procedure must be carried out prior to chemoinduction or afterward when the patient's platelet count has normalized. Typically, other members of the patient's care team are informed about the planned interventional procedure and given a chance to voice their input or concerns.

### Detailed Physical Examination

A thorough physical examination of the patient prior to the procedure is critical. This entails a complete neurologic evaluation. Interventional procedures for pain control are invasive and involve neurologically sensitive tissues such as peripheral nerves or CNS structures. The objective of intervention is to disrupt or modulate pain pathways involved in nociception. Interventional procedures such as neurolysis of peripheral nerves will block not only pain transmission but also sensory and motor innervations. Consequently, it is important to document before and after the procedure a complete and thorough physical examination, with focus especially on pain and neurologic changes. Changes such as sensory and motor blockade are closely monitored after procedures.

### Categories of Interventional Techniques

Interventional therapies can be categorized into three groups: neurolytic techniques, neuromodulation techniques, and surgical techniques. *Neurolytic* or *neuroablation techniques* are procedures that target destruction of nerves or neural structures that are involved in generation or transmission of pain signals. Neurolytic lesions can be created by a variety of agents. Lysis is achieved with chemicals (glycerol, alcohol, or phenol), heat (radiofrequency coagulation), or cold (cryotherapy).

*Neuromodulation techniques* have as their basis the original Wall and Melzack<sup>37</sup> gate control theory of pain. This theory proposes that all nerve fiber endings except those that innervate hair cells are alike and that supra-threshold stimulation of these nonspecific receptors initiates pain signals. According to Melzack and Wall,<sup>37</sup> substantia gelatinosa functions as a primary gatekeeper in the transmission of pain from the periphery to the CNS. Neuromodulation techniques aim at modulation of pain signals along the transmission pathway. These tech-

niques include local anesthetic blockade; regional infusion of drugs at epidural, intrathecal, intraventricular, or perineural sites; and electrical stimulation of the CNS.

*Surgical techniques* are the third class of interventional pain procedures. Surgical procedures range from the minimally invasive percutaneous vertebroplasty to extremely invasive neurosurgical destructive techniques. Neurosurgical techniques include percutaneous cordotomy, thalamotomy, cingulotomy, hypophysectomy, and trigeminal tractomy. Most of these procedures are performed stereotactically under monitored anesthesia care and fluoroscopy or CT guidance.

### Neurolytic Procedures

Over the past century, many chemical and physical ablative techniques have been developed with goal of disrupting the transmission of pain signals along the neural pathways. Chemical neurolysis is achieved with alcohol (50–100%), phenol (5–15%), and glycerol. These agents produce nerve injury resulting in degeneration of nerve fiber distal to the lysis lesion (wallerian degeneration).<sup>38</sup> The injury disrupts nerve cell transmission of pain and results in a nociceptive block. However, with wallerian degeneration, the nerve axon can begin to regenerate within 3 months. Thus, chemical neurolysis provides a temporary block of nociception for approximately 1–3 months.<sup>39</sup>

Alcohol is the chemical that classically has been used for neurolysis.<sup>40</sup> Today many clinicians favor use of phenol for peripheral neurolysis because it is less neurotoxic than alcohol.<sup>41</sup> Alcohol is used in concentration up to 100%. It causes nonselective destruction of all nerves as well as surrounding soft tissues. Alcohol is rapidly soluble in blood and is hypobaric relative to cerebrospinal fluid (CSF). If injected into intraspinal space, the alcohol will rise rapidly, diffusing away from initial injection site. Specifically, it damages nerves by extracting fatty substances and precipitating proteins in the nerve axon, resulting in wallerian degeneration.<sup>42</sup> The injury is proportional to both the concentration and volume of alcohol used. A higher risk of neuritis is associated with alcohol injection compared to phenol.<sup>43</sup> Patients often experience intense burning pain initially with alcohol injection.

Phenol, which now is more commonly used, is associated with a lower risk for neuritis.<sup>43</sup> Phenol 5% is equivalent to alcohol 40% concentration in neurolytic potency.<sup>44</sup> Phenol is less water soluble than alcohol, so it tends to concentrate more around the injection site. It is diffusible and is able to penetrate neural axon and denature proteins, causing wallerian degeneration.<sup>43</sup> Many clinicians prefer phenol because the intensity and duration of neural blockade are less with phenol, theoretically providing a wider margin of safety.

Glycerol is less commonly used in peripheral neural blockade. It is used primarily for treatment of trigeminal neuralgia. It is injected directly into the trigeminal cistern (Meckel cave), with good efficacy in blocking trigeminal neuralgia. Other neurolytic chemicals that have been attempted include ammonium salt compounds and hypertonic and hypotonic saline solutions, with variable results.<sup>43</sup>

Radiofrequency thermocoagulation is also used to produce a physical nociceptive block.<sup>45</sup> The lesion created by radiofrequency heating is discreet, and lesion size is controlled by the temperature of the probe and the duration of application. Some studies have shown that radiofrequency ablation can produce a longer-lasting block.<sup>46</sup>

Cryotherapy can be used to achieve neurolytic lesioning. Applying extreme cold to the nerve will result in long-lasting nerve blockade. Cryoneurolysis of intercostals nerves intraoperatively has been reported to have good efficacy in controlling postthoracotomy pain.<sup>47</sup> Wide application of cryoablation has been hindered by the large probe size and the relative complexity of the equipment involved.

Patient selection for chemical neurolysis, radiofrequency ablation, and cryoneurolysis techniques is extremely important to achieving the desired outcome. The patient should have an advanced progressive cancer with a limited life expectancy (6–12 months). The pain should be severe, persistent, refractory to conservative treatment, and consistent with a nociceptive somatic or visceral pain. Neuropathic pain usually does not respond well to neuroablation therapy. The potential risks associated with neuroablation are listed in Table 94–7.

Despite the inherent risks of neuroablation, patients with advanced can-

TABLE 94-7.

**Potential Risks of Neuroablation Techniques**

<b>Dyesthetic pain:</b> Painful neuralgia due to deafferentation, neuritis, or neuroma formation
<b>Tissue damage:</b> Accidental injury to nontargeted neurologic and non-neurologic tissues
<b>Motor paralysis:</b> Especially with intrathecal neurolysis
<b>Sensory deficit:</b> Areas of paresthesia or numbness
<b>Failure to relieve pain:</b> Due to incomplete ablation or incorrect nerve target
<b>Short-term pain relief:</b> Due to central nervous system plasticity, axonal regrowth, or tumor progression

cer and well-localized nociceptive pain can benefit greatly from neurolytic blockade. Peripheral neurolysis has been proven to alleviate the suffering of cancer patients with intractable pain.<sup>48</sup> Regional blocks are extremely useful in disrupting pain signals transmitted along the sympathetic and parasympathetic nerves.

**Neural Blockade in Head and Neck** More than 40,000 patients are diagnosed with head and neck cancer each year in the United States, and more 500,000 patients are diagnosed worldwide.<sup>49</sup> Cancer of the head and neck constitutes approximately 5% of all malignant diseases in the United States and affects approximately 6.6 million patients worldwide.<sup>50</sup> Because of dense facial and neck innervations, cancer commonly causes not only disfiguring facial lesions but also disabling pain in face and neck. Blocking relevant trigeminal nerve or cervical nerve branches can control the pain. However, the efficacy of interventional nerve block can be affected by tumor distortion of anatomy, radiation-induced fibrosis of local tissues, and possible overlapping sensory innervations of neighboring cranial nerves V, VII, IX, and X and upper cervical nerves. Careful evaluation of facial pain and proper selection of nerve block will provide patients with relief.

**Trigeminal Nerve Block** *Indications:* Blockade of trigeminal ganglion or specific branches of trigeminal nerves will alleviate somatic and neuropathic pain from cancer.

*Anatomy:* The trigeminal or gasserian ganglion is formed from two nerve roots that arise from the ventral pons of the brainstem. These roots fuse anteriorly and enter the Meckel cave, a recess in the middle cranial fossa. Three sensory divisions then exit anteriorly as the ophthalmic nerve (V1), maxillary nerve (V2), and the mandibular nerve (V3). Destruction of the gasserian ganglion is useful for intractable pain from invasive tumors of the orbit, maxillary sinus, and mandible.<sup>51</sup> Conversely, each individual sensory nerve can be blocked separately if selective blockade is desired.

*Techniques:* The patient is placed in a supine position, with the cervical spine extended on a foam pad or pillow. The cheek skin is aseptically prepped and then anesthetized with 1% lidocaine, 2.5 cm just lateral to the corner of mouth. Using C-arm fluoroscopic guidance, a 3.5-inch, 20-gauge spinal needle is advanced slowly through the anesthetized skin area, 2.5 cm lateral to the corner of the lips. The direction of the spinal needle should be cranial, dorsal, and medial, with the foramen ovale as the target (Fig. 94-2). It may be easier to have the patient gaze straight ahead and then aim the needle in the cephalad direction, perpendicular to midpupillary line. The needle is directed through the pterygopalatine fossa until the needle reaches the skull base. The needle then is walked posteriorly into the foramen ovale. Once the needle enters the foramen ovale, its tip should be located within the Meckel cave.

Careful aspiration of needle is important to ensure that the needle tip is not in a vascular structure. A sterile solution of 100% alcohol (0.5 mL) is used to achieve neurolysis.

*Complications:* Unintentional dural puncture can lead to neurotoxicity, including seizures and death. When the needle is directed through the pterygopalatine fossa, injury to vessels can result in facial hematoma or ocular subcleral hematoma. Postprocedural neuritis can cause significant dyesthetic pain in trigeminal sensory areas. Masticator weakness is possible with trigeminal block.

**Occipital Nerve Block** *Indications:* Occipital nerve block is effective for treatment of oncologic pain in the posterior scalp and occipital region.

*Anatomy:* Most of the posterior scalp is innervated by the greater occipital nerve, which arises from the dorsal rami of the C2 nerve root. It emerges subcutaneously in the posterior scalp just slightly inferior to the superior nuchal line and 2–3 cm lateral to the greater occipital protuberance. At this point of emergence, it is just medial to the occipital artery.<sup>52</sup>

*Techniques:* The patient is placed in a sitting position, with the neck slightly flexed. The greater occipital protuberance and the mastoid process are palpated. In addition, one third the distance between these two structures, the greater occipital artery can be palpated (3–4 cm lateral to the greater occipital protuberance on the superior

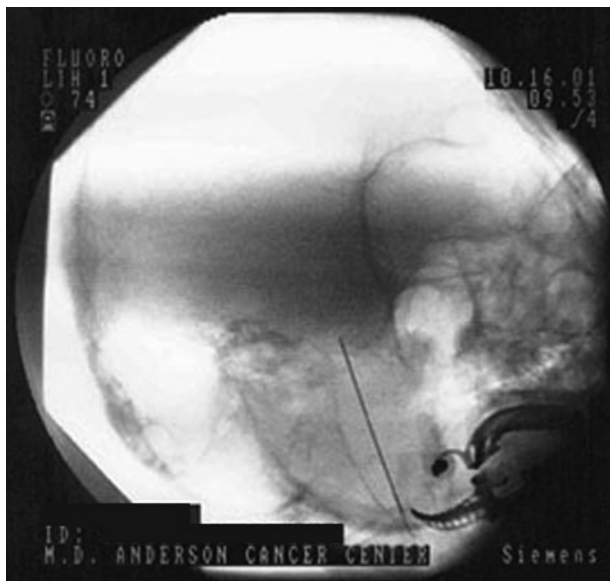


FIGURE 94-2. Submental oblique radiograph of classic approach to trigeminal nerve block.

nuchal line). The greater occipital nerve lies just medial to the greater occipital artery. It can be blocked at this site with local anesthetic or neurolytic injection.

The skin is aseptically prepped, and a short 1-inch, 25-gauge needle is introduced after the skin is infiltrated with local 1% lidocaine. Bony contact is made at a minimal depth approximately 2–3 mm. A diagnostic block with 1–2 mL of local anesthetic (1% lidocaine) can be injected. For neurolytic block, a volume of 3–5 mL is used.

*Complications:* Because of the superficial location of the greater occipital nerve and the relative ease of this block, complications are minimal. The close proximity of the greater occipital artery may increase the risk of intravascular injection, which can be avoided by frequent aspiration while the neurolytic solution is slowly injected. Neuritis also can occur with neurolytic agents, especially with alcohol.

### **Superficial Cervical Plexus Block**

*Indications:* Superficial cervical plexus block is often used to treat cancer pain in the neck in areas innervated by the cervical plexus.

*Anatomy:* The superficial and deep cervical plexus arises from the first four cervical nerves. The cervical plexus begins just lateral to the first cervical vertebrae. It is located anterior to the levator scapulae and middle scalene muscles and posterior to the sternocleidomastoid (SCM) muscle. The plexus gives off both superficial sensory branches and deep motor branches. This anatomic division of sensory and motor nerves allows for selective sensory blockade of the superficial sensory branches of the cervical plexus without compromising the motor function of the neck muscles.

These superficial branches arise from the plexus and pierce the deep fascia of the neck at the posterior border of the SCM muscle. It is at this point where the bundle of the superficial cervical plexus emerges that sensory innervation to the plexus can be blocked easily.<sup>53</sup> The superficial cervical plexus gives rise to the sensory nerves that supply sensation to the skin and superficial fascia of the head, neck, and shoulder. These nerves include the lesser occipital, greater auricular, accessory, anterior cervical nerve, and suprascapular nerves.<sup>54</sup>

*Techniques:* The patient is placed in a supine position, with the head turned away from the site to be blocked. The mastoid process is identified with the attached SCM muscle. The patient may have to raise the head slightly to allow for identification of SCM muscle. The neck is aseptically prepped. Just lateral to the SCM midpoint, a 1-inch, 25-gauge needle is inserted subcutaneously. A 5-mL volume of local anesthetic (1% lidocaine) is injected subcutaneously at this point. The needle then is directed superiorly and inferiorly along the posterior border of the SCM. A total volume of 10–20 mL of local anesthetic can be injected to achieve a diagnostic block. This block, if successful, can be followed with neurolytic agents to achieve a longer blockade. As a note of caution, the external jugular vein crosses the midpoint of the lateral border of the SCM. Careful aspiration prior to infiltration is helpful to avoid intravascular injection.<sup>55</sup>

*Complications:* Few complications are associated with this superficial cervical block. The most common complication is intravascular injection into the external or internal jugular vein, with resulting systemic toxicity. Placement of the needle into jugular vein may result in hematoma or even air embolism.

### **Neural Blockade in Upper Extremity Brachial Plexus Block**

*Indications:* Malignancy can involve the upper extremity. Such cancers includes sarcomas, both of bone and soft tissue. In the United States, almost 13,000 new cases of bony sarcoma and 7000 new cases of soft-tissue sarcomas are diagnosed each year.<sup>56</sup> In most cases, surgical resections of sarcomas with limb-sparing procedures are performed with good results. However, these patients often have severe pain from direct tumor invasion of neurovascular bundle or as a consequence of surgical resection of tumor. Neural blockade of the brachial plexus is effective in controlling somatic nociceptive pain in upper extremity cancer.

For short-term palliation of cancer pain, brachial plexus block can be performed with a catheter left in place for continuous infusion of local anesthetic. In cases of severe intractable pain from invasive tumors of brachial plexus or soft tissues and bone of shoulder

and upper extremity, destruction of the brachial plexus is indicated. The patient should be made aware of the full consequences of neurolysis of brachial plexus, including paralysis of upper extremity.

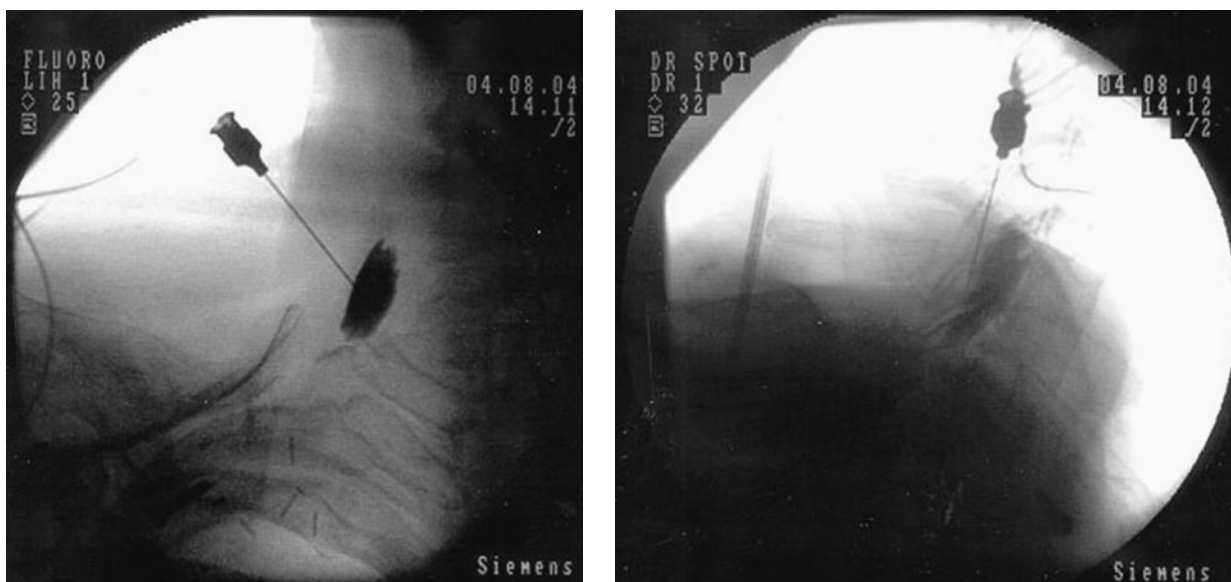
*Anatomy:* The brachial plexus is formed from fusion of ventral rami of C5–T1 nerve roots. These nerve roots, with possible contribution from C4 and T2, emerge from the lateral aspect of the vertebral bodies and run laterally and inferiorly, in the interscalene compartment. These nerves of the brachial plexus run down the interscalene compartment and pass behind the clavicle, cephalad to the first rib and then into the axilla.

*Techniques:* Multiple approaches to brachial plexus blockade include interscalene block, and supraclavicular, infraclavicular, and axillary blocks. For cancer pain from tumor involvement of shoulder, interscalene block is preferred.<sup>57</sup>

The patient is placed in a supine position, with the head turned away from the site to be blocked. The posterior border of the SCM muscle is identified. The patient can cooperate by slightly flexing his or her head. The groove between the posterior border of SCM muscle and the anterior scalene muscle can be palpated by rolling fingers posteriorly off the edge of SCM muscle. The neck is then aseptically prepped. At the level of the cricoid cartilage (C6) in the interscalene groove, a 1.5-inch, 25-gauge needle is inserted in a slightly caudal, medial, and posterior angle. The skin is infiltrated with local anesthetic. The needle is inserted as described until paresthesia of shoulder, arm, or hand is obtained. Such paresthesia is encountered at a needle depth of 1 cm. Once a paresthesia is achieved or a motor response is obtained via nerve stimulator, the needle is known to be near the brachial plexus. If aspiration is negative for CSF and blood, 30–40 mL of local anesthetic solution is injected incrementally, with frequent aspiration. Throughout injection, the patient is monitored for signs of local anesthetic toxicity and subarachnoid injection.

Once the efficacy of local anesthetic blockade in relieving cancer pain has been proven, the patient may wish to proceed with a longer-lasting neurolytic block with phenol. A 20-mL volume of 6% phenol is slowly injected into the





**FIGURE 94-3.** Two radiographic views of neurolytic brachial plexus block with 20 mL of 6% phenol solution.

intrascapular compartment of the brachial plexus (Fig. 94-3). Motor paralysis of upper extremity can be expected with this neurolysis of brachial plexus.

If a shorter prolonged blockade of brachial plexus is desired, a continuous local anesthetic infusion of the brachial plexus can be performed. The infraclavicular approach for brachial plexus block is preferred because the catheter can remain in the same position for 3 weeks or more.<sup>58</sup> The infraclavicular entry site permits easy catheter threading near the plexus, and the catheter's position is minimally affected with patient movement. For the infraclavicular approach, the patient is placed in a supine position with the head turned away from the site to be blocked. The clavicle is identified by palpation and fluoroscopy. The axillary artery also is palpated and marked. The ipsilateral neck, anterior shoulder, and axillary region are prepped with povidone iodine (Betadine) in a sterile manner. At the inferior border of the clavicle at the midpoint, local anesthetic (1% lidocaine) is generously infiltrated subcutaneously. A 16-gauge spinal needle is introduced at this midclavicular point and directed laterally toward the marked axillary artery location. The needle is directed at a 45° angle to the skin and then connected to a nerve stimulator by an alligator clip. As the needle advances, fluoroscopy will allow for visualization of the needle tip. Once the tip nears the brachial plexus, muscles innervated by the plexus will be stimulated, with visible flexion and extension of the elbow, wrist, and fin-

gers. At this point, 2-3 mL of contrast dye is injected to confirm under fluoroscopy the spread along axillary sheath. The catheter then is threaded through the spinal needle and 3-5 cm beyond the tip. The needle is withdrawn, and the catheter is sutured in place. Infusion of 0.125% or 0.25% bupivacaine is used to provide continuous brachial plexus analgesia. It is effective in controlling somatic pain for several days and sympathetically mediated pain for up to a few weeks.

**Complications:** Complications of interscalene block are possible because of proximity to many structures in the neck. Intravascular injection, as mentioned earlier, will lead to systemic toxicity. Subarachnoid injection can cause sensory, motor, or total spinal anesthesia and even death. Phrenic nerve block is an expected side effect of interscalene block.

Complications of infraclavicular brachial plexus block are similar to those of interscalene block. Proximity to the subclavian artery and vein increases the potential for intravascular injection.

#### **Neural Blockade in Thorax Intercostal Nerve Block**

**Indications:** Lung cancer is the number one cancer killer among both males and females.<sup>56</sup> It accounts for 15% of malignant disease in males and 13% in females. Patients diagnosed with lung cancer often require thoracotomy with surgical biopsy or resection of tumor mass. Many patients experience chest wall pain from either direct tumor involvement of the

chest wall or surgical trauma to intercostal nerves. In addition to lung cancer, aggressive breast cancer may invade the ribs and intercostal nerve bundles, causing pain.

Tumor invasion of lung parenchyma and visceral pleura does not cause pain because these structures are nociceptive insensitive. However, cancer involvement of the parietal pleura does elicit a pain response. Pain is transmitted from parietal pleura along somatic nerve, including the intercostal nerves from T1-12. Intercostal nerve blockade is effective in blocking this somatic pain.<sup>59</sup>

**Anatomy:** The intercostal nerves are formed from ventral rami of thoracic nerves from T1-12. Each nerve, joined by intercostal vein and artery, runs in a neurovascular bundle in the subcostal groove. It gives off four branches as it runs anteriorly in the intercostals space. The first is the gray rami communicantes, which joins the sympathetic ganglion. The second branch is the posterior cutaneous nerve, which innervates the paravertebral region. The third branch is the lateral cutaneous nerve, which innervates the axilla and lateral chest wall. The fourth branch is the anterior cutaneous nerve, which innervates anterior thorax. There is considerable sensory overlap between those branches as well as between the intercostal nerves themselves. Thus pain from one area may require blockade of multiple adjacent intercostal nerves.<sup>60</sup>

**Techniques:** For neurolytic block, the procedure should be performed under

fluoroscopic guidance. The patient is placed in a prone position. The relevant ribs are identified by palpation and under fluoroscopy. The inferior border of each rib is indicated with a marking pen. The intercostal block is classically performed at the angle of the rib, just lateral to the paraspinal muscle groups. The relevant paraspinal area is prepped aseptically. Using a 1-inch, 25-gauge needle, the skin is infiltrated subcutaneously with local anesthetic. The clinician should palpate to obtain a gross estimation of the depth from skin to bone of rib. The needle is slowly advanced perpendicular to the skin, with fluoroscopic guidance. The C-arm should be in the anteroposterior projection with a caudal tilt. The needle tip should hit the body of the rib and then walk inferiorly off the lower border of rib into the subcostal groove. Water-soluble contrast dye injected into this groove should show a nice spread along the inferior border of rib. A neurolytic solution of 10% phenol can be injected with 3–5 mL for each intercostal block.

**Complications:** Common complications of intercostal nerve blockade include pneumothorax and systemic toxicity. Pneumothorax results from needle puncture through parietal and visceral pleura. This will create an air leak from lung into pleural space. A simple pneumothorax may infrequently progress into a tension pneumothorax with its life-threatening implications. The patient should be closely monitored after the procedure, and a postprocedural chest radiograph is recommended.

Another complication of intercostal nerve blockade is systemic toxicity from absorption of anesthetic or neurolytic solution into the intercostal neurovascular bundle. Because of the close proximity of intercostal artery and vein to the nerve, rapid absorption of injected solution into the circulation is common. However, systemic toxicity is infrequent because of the small volume used for neurolysis. A less likely complication is neuroaxial spread of the anesthetic or neurolytic solution.

Instead of chemical neurolysis, cryoanalgesia and radiofrequency ablation have been used for intercostal nerve blockade. Cryoanalgesia or “freezing” of intercostal nerves has been shown to control pain in postthoracotomy patients if performed under direct

visualization of intercostal nerve at termination of surgery.<sup>47</sup> After surgery, percutaneous intercostal cryolysis has not been shown to be as effective.<sup>61</sup>

Intercostal nerve radiofrequency ablation can be used for long-lasting blockade. A blunt-tipped, 100-mm, 22-gauge radiofrequency electrode with a 5-mm active tip is inserted into the intercostal space. One milliliter of 2% lidocaine is injected into the electrode cannula. Lesioning is accomplished by coagulation at 80°C for 60 seconds. The technique of proximal intercostal nerve radiofrequency lesioning, including ablation of the dorsal root ganglion, is being used with favorable preliminary results (Fig. 94–4).

#### **Sympathetic Blockade for Cancer Pain**

Visceral pain arises from cancer involvement of sympathetically mediated organs. Insults to these organs can result from abnormal distension of organ wall or viscus, tension or torsion on mesenteric vessels, and ischemia. Such visceral pain is commonly seen with gastrointestinal malignancies, such as hepatic metastases, intestinal tract tumors, and pancreatic cancers. Sympathetically mediated pain can involve neuropathic pain, as occurs with direct injury to nervous tissue such as brachial plexopathy and lumbosacral plexopathy. Blockade of sympathetic chain has been shown to be effective in controlling sympathetically mediated pain.<sup>62,63</sup>

The sympathetic axis is made up primarily of a pair of ganglionated

paravertebral chains that run from base of skull to the tip of coccyx. It also consists of several major vertebral plexuses, including celiac, cardiac, and hypogastric plexuses. Table 94–8 lists major sympathetic structures and the corresponding tissues innervated.<sup>64</sup>

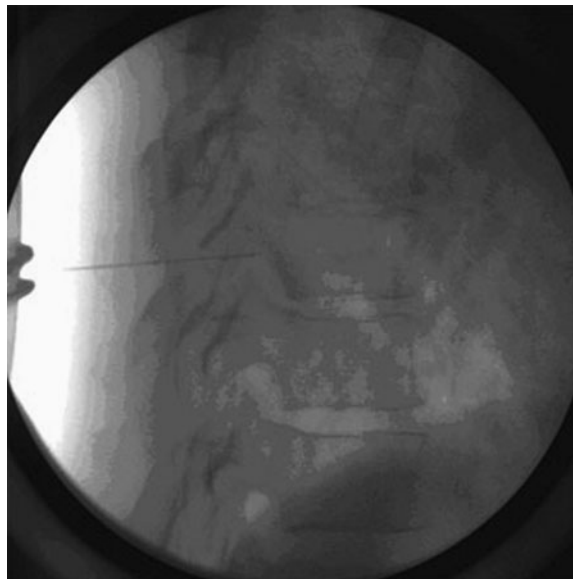
These sympathetic structures are attractive targets for blockade of sympathetically mediated pain. Interruption of pain pathways at these discrete sites has been demonstrated to have a useful role in controlling oncologic pain.<sup>65,66</sup>

#### **Stellate Ganglion Block**

**Indications:** Stellate ganglion block helps control sympathetically mediated pain in the head, neck, and upper extremity. Sympathetically mediated pain is commonly seen in tumor invasion of brachial plexopathy as in Pancoast tumors.<sup>67</sup>

**Anatomy:** Stellate or cervicothoracic ganglion is formed from fusion of the inferior cervical and the first sympathetic ganglia. This ganglion controls sympathetic afferent nociceptive signals to head, neck, and upper extremity. The ganglion is located at the base of the neck and anterior to the neck of the first rib. It is bounded anteriorly by subclavian artery and the origin of vertebral artery, posteriorly by the vertebral body and longus colli muscle, laterally by the scalene muscles, and inferiorly by the dome of the pleura.

**Techniques:** Because of many important structures in the neck adjacent to stellate ganglion, fluoroscopic imaging is recommended. The patient is placed in a supine position with the neck



**FIGURE 94–4.** Lateral view of intercostal dorsal root ganglion radiofrequency ablation.

TABLE 94–8.

## Sympathetic Structures

Sympathetic Structures	Innervated Tissues
Stellate ganglia	Brain, ear, tongue, pharynx, larynx, skin of neck, head, and upper extremity
Thoracic ganglia	Mediastinal contents, esophagus, trachea bronchus, pericardium, heart, lung
Celiac plexus	GI tract (from distal esophagus to mid-transverse colon), liver, adrenals, ureters, abdominal vessels
Lumbar ganglia	Skin and vessels of lower extremity, kidneys, ureters, transverse colon, testes
Hypogastric plexus	Descending and sigmoid colon, rectum, vaginal fundus, bladder, prostate, prostatic urethra, testes, seminal vesicles, uterus, and ovaries
Ganglion impar	Perineum, distal rectum and anus, distal urethra, vulva and distal third of vagina

slightly extended. The classic technique is to identify the Chassaignac tubercle at C6 and insert the needle at this site. However, many clinicians recommend the Racz technique for possible improved safety margin.<sup>52</sup> The patient's neck is aseptically prepped, and the skin over body of C7 vertebral body is anesthetized with 1% lidocaine. The nondominant hand is used to palpate the carotid artery at the level of C7 and retract it laterally. The dominant hand introduces a 1.5-inch, 22-gauge needle just medial to the palpated carotid artery and directs the needle in a medial direction. The target of the needle tip is the ventrolateral aspect of the C7 vertebral body, not the transverse process as seen in the classic approach. Once the needle tip contacts the C7 vertebral body, it is withdrawn slightly approximately 1 mm. The needle then is aspirated for CSF or blood. From 1–2 mL of contrast dye is injected to confirm the caudocephalad spread anterior to the prevertebral fascia. For gangliolysis, a mixture of 3% phenol, local anesthetic, and steroid is used (i.e., 5 mL of 6% phenol in saline, 5 mL of 0.5% bupivacaine, and 80 mg of methylprednisone).

The volume of this mixture injected is dependent on the extent of blockade desired. Ten milliliters of neurolytic mixture is adequate for stellate ganglion blockade of sympathetically mediated pain to head and upper extremity. If blockade of pain from thoracic viscera is desired, a volume of 15–20 mL of neurolytic mixture is necessary. During injection, the clinician must exer-

cise caution to minimize intravascular injection. Even 1 mL of local anesthetic injected into the carotid or vertebral artery can cause loss of consciousness and seizure. An initial test dose, frequent aspiration, and slow injection are good suggested measures.

**Efficacy:** Evidence of sympathetic blockade in the head can include a myriad of signs of Horner, syndrome such as miosis, ptosis, enophthalmos, facial anhidrosis, and nasal congestion. Sympathetic blockade to upper extremity results in visible engorgement of veins in the hands and forearm.

**Complications:** Because of anatomic proximity to critical structures, serious complications of stellate ganglion block can include pneumothorax, anesthetic-induced seizure from intravascular injection, and total spinal anesthesia from subarachnoid injection. Other less serious problems include localized hematoma, infection, and neck muscle tenderness. Many clinicians fear a permanent Horner syndrome with neurolysis. However, Racz and Holubec<sup>68</sup> did not observe any long-term Horner syndrome with their modified technique.

**Celiac Plexus Blockade Indications:** Celiac plexus blockade continues to be an extremely effective intervention for pain from pancreatic cancer and malignancies involving the upper and midabdomen.<sup>65,69</sup> Pancreatic cancer carries a poor prognosis, and palliation of pain symptom is a priority in these patients, with survival rates typically <6 months. Patients often present ini-

tially with upper abdominal pain with referred pain to the back.<sup>70</sup> The pain is described as severe, increasing with disease progression, and poorly relieved by opioids or other medications. Celiac plexus block is the treatment of choice for pain control in pancreatic cancer patients.

**Anatomy:** Sympathetic innervations of abdominal organs arise in the anterolateral horn cells in the spinal cord. Preganglionic fibers from T5–12 leave ventral roots of spinal cord to join with white rami communicans. These fibers do not synapse at the sympathetic chain; instead they pass onward through to the celiac plexus. Passing from the sympathetic ganglia to the celiac plexus, the preganglionic fibers travel along the discrete splanchnic pathways. Preganglionic fibers from T5–9 coalesce to form the greater splanchnic nerve. This greater splanchnic nerve passes through the diaphragm and synapse onto the celiac plexus. Preganglionic nerves from T10–11 join to form the lesser splanchnic nerve before synapsing within the celiac plexus. The least splanchnic nerve arises from the T12 sympathetic ganglion and courses through anteriorly to join the celiac plexus. Blockade of sympathetically mediated pain in this region is accomplished by neurolysis of either the celiac plexus or the splanchnic nerves that became the plexus.

The celiac plexus is located anterior to the aorta at the level of the L1 vertebral body and anterior to the crura of the diaphragm. This plexus contains two large discrete ganglia on either side of aorta. The left celiac ganglion is slightly lower than the right ganglion.

**Techniques:** Multiple techniques (up to 13 approaches) have been described for sympathetic blockade at the level of celiac plexus.<sup>71,72</sup> Posteriorly, clinicians can use the classic retrocrural, transcrural, or transaortic technique. Anteriorly, percutaneous gangliolysis with CT guidance or direct intraoperative celiac gangliolysis can be used.

For the posterior classic retrocrural approach, the patient is placed in a prone position with a pillow under the lower abdomen to minimize lordosis. The midback is prepped aseptically. Using fluoroscopy, the relevant landmarks are identified and marked. These landmarks are relevant: the spinous processes of T12 and L1, and the

inferior border of the 12th rib. It is extremely important to correctly identify the T12 spinous process by following the 12th rib medially and by counting cephalad from the L5 spinous process. The skin is infiltrated with local anesthetic at a distance 8 cm lateral to the L1 spinous process and inferior to the 12th rib. The underlying muscle tissue also is infiltrated with local anesthetic. Five-inch, 22-gauge needles are inserted bilaterally. Each needle is advanced slowly initially oriented at a 45° angle toward midline and approximately 15° cephalad, using fluoroscopic guidance. The initial target is the L1 vertebral body. Once bony contact is made, the depth of needle is noted. The needle is then withdrawn and redirected at a steeper angle (60° from midline) so that the needle tip is walked off the L1 vertebral body. The left needle is advanced approximately 2 cm beyond bony contact, slowly with frequent aspiration. The right needle is advanced further approximately 4 cm past the vertebral body anteriorly. The goal is for the left needle tip to position posterior to aorta and the right needle tip to position anterolateral to aorta. These positions approximate the location of the celiac ganglia.

A small amount of contrast is injected into both needles to confirm localized dye spread in the proper anatomic location. Local anesthetic solution (12–15 mL of 1% lidocaine) is injected into each side to achieve an initial diagnostic block. The patient is awakened from light sedation to confirm pain relief and

no adverse motor blockade of lower extremities. The patient is again sedated, and neurolysis can be performed with 10–12 mL of 50% alcohol or 6% phenol to each side.

The splanchnic nerve block (or so-called retrocrural celiac plexus block) is similar to the classic retrocrural technique. However, the needles are aimed more cephalad to the anterolateral margin of the T12 vertebral body (Fig. 94–5). The goal is neurolysis of the splanchnic nerves feeding into the celiac plexus.

**Efficacy:** Celiac plexus blockade has proved to provide significant relief of pancreatic cancer pain. Pain relief has been reported between 70% and 94% of patients.<sup>73</sup> Studies have shown a higher success rate, corresponding to better patient selection and technological advances.

**Complications:** Although not strictly a complication, sympatholysis with its side effects should be considered in celiac blockade. Orthostatic hypotension may occur and should be anticipated. Unopposed parasympathetic activity will lead to GI hypermotility. The consequent diarrhea is transient and does not last more than 2 days. Serious complications can include visceral injury, renal trauma with hematoma, and intravascular or subarachnoid injection. Pneumothorax is possible.

**Lumbar Sympathetic Block** *Indications:* Lumbar sympathetic blockade has been used to treat sympathetically mediated cancer pain due to tumor

invasion or metastases to the lumbosacral region, chemotherapy- or radiation therapy-induced lumbar plexopathy, phantom limb pain, and lower extremity neuropathy secondary to malignancy.<sup>74</sup>

**Anatomy:** Lumbar sympathetic chain is variable in size and location. The sympathetic ganglia usually are located between L2 and L4 vertebral bodies. Classically, the sympathetic chain lies in the fascial plane anterolateral to lumbar vertebral bodies, just anterior and medial to psoas muscles.

**Techniques:** The patient is placed in a supine position, with a pillow under the lower abdomen to minimize lordosis. The back is prepped aseptically. Using fluoroscopy, surface landmarks of L2, L3, and L4 spinous processes are identified and marked. At a distance 8 cm lateral to each spinous process, the skin and underlying muscle tissue are generously infiltrated with local anesthetic. A 7-inch, 22-gauge needle is introduced at the selected site and directed at a 45° angle with the midline. The needle is advanced until vertebral body is confirmed. The depth of the needle is noted, and the needle is withdrawn and redirected at a steeper angle (60° with midline) to walk off the vertebral body. Once the needle slides past vertebral body, it is advanced approximately 1 cm further into the prevertebral fascial plane. This sequence is repeated bilaterally for L2, L3, and L4 levels. Contrast dye, 1–3 mL, at each needle site can be used to visualize the spread radiographically. A diag-

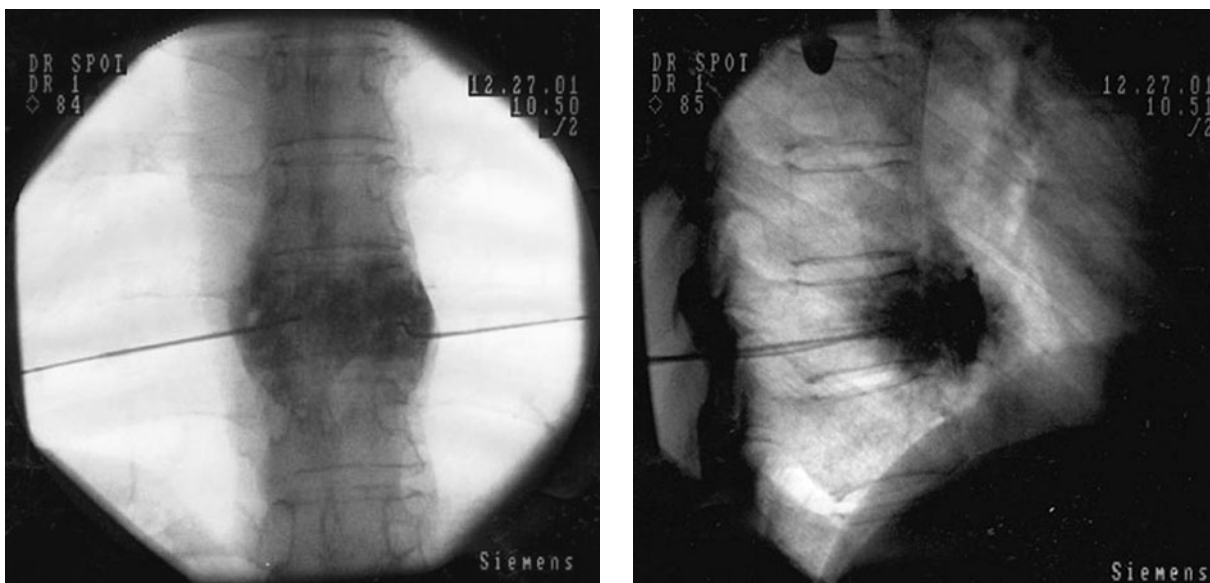


FIGURE 94–5. Anteroposterior and lateral views of retrocrural celiac plexus block.



nostic block with 20–30 mL of bupivacaine 0.25% can be performed, with the patient awakened to evaluate any neurologic sequelae. Neurolysis then can be performed with 6% phenol for a volume of 5 mL at each needle site.

**Complications:** Side effects of lumbar sympatholysis include hypotension and diarrhea. Intestinal hypermotility is self-limited.<sup>75</sup> Other complications include psoas muscle necrosis and renal or visceral damage. The most common complication with lumbar sympatholysis is genitofemoral neuralgia. Most cases are transient and resolve in a few weeks.

### **Superior Hypogastric Plexus Block**

**Indications:** Pelvic malignancies can affect multiple organs in the pelvis and include gynecologic and prostate cancers. Each year in the United States, 18,400 new cases of gynecologic cancer of the uterine cervix, vulva, and vagina are diagnosed, resulting in approximately 6300 deaths.<sup>49</sup> Patients with pelvic malignancy often experience initial visceral pelvic pain. The pain often is described as vague, poorly localized in pelvic region, and colicky in character. Surgical destruction of the hypogastric plexus has been shown to relieve pelvic pain.<sup>76,77</sup> Plancarte et al.<sup>79</sup> have reported a technique for hypogastric blockade with good results for controlling pelvic pain secondary to cancer. In that study, all 28 cancer patients with intractable pelvic pain reported good pain relief after the procedure.

**Anatomy:** The superior hypogastric plexus arises from the coalescence of nerve branches descending from the celiac plexus and lumbar sympathetic chains. This hypogastric plexus is a bilateral retroperitoneal structure located usually anterolaterally, extending from the level of the L5 vertebral body to upper third of the S1 vertebral body. The plexus is just medial to the bifurcation of iliac arteries and veins on each side.

**Techniques:** The patient is placed in a prone position. A pillow is placed under the lower abdomen to minimize lumbar lordosis. The back is prepped aseptically. Under fluoroscopy, the spinous processes of L4 and L5 are identified and marked. The entry point is 5–7 cm off midline at the level of the L4–5 interspace. The skin and underlying tissue at this point are well anesthetized with local anesthetic (1% lidocaine). A 7-inch, 22-gauge needle

is introduced at an orientation 30° caudal and 45° mesiad off midline. Under fluoroscopy in anteroposterior and lateral views, the needle is slowly advanced, with the target being the anterolateral aspect of the L5 vertebral body. The iliac crest and L5 transverse process can be obstacles along the needle trajectory. The needle may have to be reoriented slightly to bypass these anatomic structures. Once bony contact is made with the L5 vertebral body, the needle is reoriented to a more mesiad angle to walk the needle tip off the body of the L5 vertebra. The tip of the needle should be advanced approximately 1 cm past the anterolateral border of the L5 vertebral body. A loss of resistance may be felt as the needle tip passed beyond the psoas muscle fascia and into the retroperitoneal space where the hypogastric plexus lies. Because of close proximity to the bifurcation of iliac vessels, careful aspiration is helpful to ensure the needle tip is not intravascular. Contrast dye can be injected to visualize even dye spread to the paramedian space at L5, anterior to the psoas fascia (Fig. 94–6). Each side can be injected with 10 mL of 0.25% bupivacaine for diagnostic block, and neurolysis can be achieved with 10 mL of 10% phenol at each site.

**Complications:** Because of close proximity to the iliac vessels, the clinician should be cautious about intravascular injection. Vascular puncture may lead to hemorrhage. Other less likely complications include subarachnoid injection,

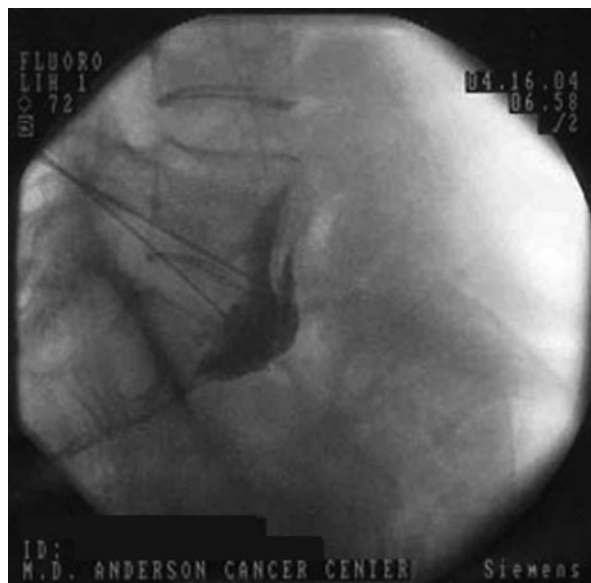
sacral nerve injury, and bladder or bowel injury.

### **Ganglion Impar Block**

**Indications:** In the perineum, there is a diffuse network of mixed sympathetic and somatic innervations. Thus, perineal pain usually involves both somatic and sympathetic pathways. In cancer patients with perineal pain, cancer can involve the lower colon, rectum, bladder, cervix, and endometrium. Blockage of ganglion impar with the goal of disrupting sympathetically mediated pathways has been shown to be effective in managing some intractable perineal cancer pain.<sup>79</sup>

**Anatomy:** Ganglion impar is a solitary retroperitoneal structure located at the level of sacrococcygeal junction. The two parallel sympathetic chains fuse together anterior to superior borders of the coccyx, forming the ganglion impar or ganglion of Walther.

**Techniques:** The patient is placed in a supine position, with a pillow placed under the lower abdomen. The buttock area and midsacral to anus area are prepped in an aseptic manner. In the midline and just posterior to the anus, the skin over the anococcygeal ligament is anesthetized with local anesthetic.<sup>79</sup> A 3.5-inch, 22-gauge spinal needle is bent 1 inch from the hub to form a 30° angle. This bent needle will allow the tip of the needle to maneuver anterior to the concavity of the coccyx and sacrum. Under fluoroscopy, the needle is advanced inferior to the tip of the coccyx and then



**FIGURE 94–6.** Lateral radiograph of superior hypogastric plexus block.

upward and anterior to the coccyx. The target is the anterior sacrococcygeal junction. A 5-mL volume of 0.25% bupivacaine is injected for diagnostic block, and 5 mL of 10% phenol is used for neurolysis.

**Complications:** This block of ganglion impar may cause rectal perforation because of proximity to the rectum. Because most of this region is dually innervated by both somatic and sympathetic fibers, complete pain relief may be difficult to achieve by this block alone.

### Neuromodulation Techniques

**Intraspinal Drug Delivery** Significant side effects from systemic high-dose opioid administration can be minimized with intraspinal delivery of opioids. Deposition of opioids in close proximity to spinal cord receptors provides for more potent analgesia and fewer side effects.<sup>7</sup> If the opioid dose is delivered into epidural location, only 20–40% of the systemic dose is required to achieve similar analgesia.<sup>80,81</sup> The intrathecal dosage is even lower, requiring only 10% of the systemic dose.

In cancer patients, the intraspinal opioid dose can be delivered by percutaneously tunneled epidural catheters, tunneled epidural or spinal catheters connected to subcutaneously implanted injection ports, or fully implanted spinal infusion pump systems (Fig. 94–7).<sup>82</sup> The SynchroMed pump system (Medtronic Inc., Minneapolis, MN) is an example of a fully implantable system that is sophisticated yet easy to use. The pump can easily be reprogrammed to meet the patient's

changing pain condition. Advantages of a fully implantable intrathecal pump include effective pain control, increased independence and mobility of the patient, and a reduced risk of infection with an internalized pump system. However, the initial cost of system hardware and implantation surgery can be prohibitive and hard to justify for patients with predicted survival <3 months.<sup>83,84</sup> With survival time <3 months, a simple tunneled epidural catheter or subcutaneous infusion is more economically feasible and beneficial for the patient. The epidural space is further from the spinal cord and thus requires a higher dose or rate of infusion, usually mandating an external pump.

### Other Techniques

**Vertebroplasty** Neurosurgical procedures can be used to treat intractable pain. Vertebroplasty is one procedure that provides significant pain relief in patients with vertebral compression fractures secondary to malignant diseases. Malignant tumors include metastasis, lymphomas, and myeloma. Vertebroplasty involves injection of polymethylmethacrylate (PMMA) cement into diseased vertebral body.<sup>85,86</sup>

### Palliative Care

Palliative care is defined as comprehensive care of the terminally ill patient. In overall oncologic care, much effort and treatment is used in the palliative treatment mode. Many patients have meaningful life-extending and life-enhancing palliative (as distinct from “curative”) treatments. Treatments include che-

motherapy, radiotherapy, tumor ablative procedures, surgery, and the interventional treatments outlined in this chapter.

Effective palliation in the patient with advanced cancer always starts with complete assessment and appropriate pharmacologic management. In some patients in whom the risk-to-benefit ratio is favorable and more conservative therapies are failing, interventional pain techniques may be helpful. When treating the advanced cancer patient, it is important to keep in mind some tenets of palliative medicine, such as these adopted from Field et al.<sup>87,88</sup> Symptom control is a paramount concern. It is critical to discuss openly and compassionately the patient's goals of care and to tailor your treatments in accordance with the patient's wishes. The patient's overall well-being directly impacts on the caregiver's quality of life. Be honest with patients and family members while being cautious not to extinguish hope.

### CONCLUSION

Cancer pain management is a complicated challenge. It requires a thorough understanding of the cancer disease process, pain diagnosis, and treatment modalities available to treat the pain condition. In addition to pain, the patient often presents with a constellation of symptoms arising from the cancer and the oncologic treatment. Both pharmacologic and interventional modalities of treatment are necessary to help the patient control pain and reach a satisfactory quality of life. In carefully selected cases, diverse interventional techniques help the physician and patient to achieve effective control of cancer pain, thereby optimizing quality of life.



FIGURE 94–7. Implantable programmable pump.

### KEY REFERENCES

1. Smith TJ, Coyne PJ, et al. An implantable drug delivery system (IDDS) for refractory cancer pain provides sustained pain control, less drug-related toxicity, and possibly better survival compared with comprehensive medical management (CMM). *Ann Oncol* 2005;16:825–833.

2. Perkins FM, Kehlet H. Chronic pain as an outcome of surgery. *Anesthesiology* 2000;93:1123-1133.
3. Cata JP, Weng HR, Lee BN, et al. Clinical and experimental findings in humans and animals with chemotherapy-induced peripheral neuropathy. *Minerva Anestesiologica* 2006;72:151-169.
4. Lyss AP, Portenoy RK. Strategies for limiting the side effects of cancer pain therapy. *Semin Oncol* 1997;24:S128-S123.
5. Ferrante FM, Bedder M, Caplan KA, et al. Practice guidelines for cancer pain management. *Anesthesiology* 1996;94:1243-1257.
6. Eisenberg E, Carr DB, Chalmers TC. Neurolytic celiac plexus blockade for treatment of cancer pain: a metaanalysis. *Anesth Analg* 1995;80:290-307.
7. Burton AW, Rajagopal A, Shah HN, et al. Epidural and intrathecal analgesia is effective in treating refractory cancer pain. *Pain Med* 2004;5:239-247.
8. Hassenbusch SJ, Paice JA, Patt RB, et al. Clinical realities and economic considerations: economic of intrathecal therapy. *J Pain Symptom Manage* 1997;14:536-548.

## REFERENCES

1. Cancer Facts and Figures 2004. American Cancer Society, Atlanta, Georgia. 2004. Available at: [http://www.cancer.org/downloads/STT/CAFF\\_finalPWSecured.pdf](http://www.cancer.org/downloads/STT/CAFF_finalPWSecured.pdf). Last accessed October 25, 2005.
2. Von Roenn JH, Cleeland CS, Gonin R. Physician attitudes and practice in cancer pain management. A survey from the Eastern Cooperative Oncology Group. *Ann Intern Med* 1993;119:121-126.
3. World Health Organization. *Cancer Pain Relief and Palliative Care*. 2nd ed. Geneva: World Health Organization, 1996:12-15.
4. Zech DF, Grond S, Lynch J, et al. Validation of World Health Organization Guidelines for cancer pain relief: a 10-year prospective study. *Pain* 1995;63:65-76.
5. Stjernsward J, Colleau SM, Ventafridda V. The World Health Organization Cancer Pain and Palliative Care Program. Past, present, and future. *J Pain Symptom Manage* 1996;12:65-72.
6. Lillemoe KD, Cameron JL, Kaufman HS, et al. Chemical splanchnicectomy in patients with unresectable pancreatic cancer. *Ann Surg* 1993;217:447-457.

7. Smith TJ, Coyne PJ, et al. An implantable drug delivery system (IDDS) for refractory cancer pain provides sustained pain control, less drug-related toxicity, and possibly better survival compared with comprehensive medical management (CMM). *Ann Oncol* 2005;16:825-833.
8. Breitbart W. Suicide in the cancer patient. *Oncology* 1987;1:49-54.
9. Bolund C. Medical and care factors in suicides by cancer patients in Sweden. *J Psychosomat Oncol* 1985;3:31-52.
10. Daut RL, Cleeland CS, Flannery RC. Development of the Wisconsin brief pain questionnaire to assess pain in cancer and other diseases. *Pain* 1983;17:197-210.
11. Fishman B, Pasternak S, Wallenstein SL, et al. The Memorial pain assessment card: a valid instrument for the evaluation of cancer pain. *Cancer* 1987;60:1151-1158.
12. Ger LP, Ho ST, Sun WZ, et al. Validation of the Brief Pain Inventory in a Taiwanese population. *J Pain Symptom Manage* 1999;18:316-322.
13. Yun YH, Mendoza TR, Heo DS, et al. Development of a cancer pain assessment tool in Korea: a validation study of a Korean version of the brief pain inventory. *Oncology* 2004;66:439-444.
14. Validity of the brief pain inventory for use in documenting the outcomes of patients with noncancer pain. *Clin J Pain* 2004;20:308-318.
15. Stanford EA, Chambers CT, Craig KD. The role of developmental factors in predicting young children's use of a self-report scale for pain. *Pain* 2006;120:16-23.
16. Perkins FM, Kehlet H. Chronic pain as an outcome of surgery. *Anesthesiology* 2000;93:1123-1133.
17. Cleeland CS, Gonin R, Hatfield AK, et al. Pain and its treatment in outpatients with metastatic cancer. *N Engl J Med* 1994;330:592-596.
18. Novy D, Berry MP, Palmer JL, et al. Somatic symptoms in patients with chronic non-cancer related and cancer-related pain. *J Pain Symptom Manage* 2005;29:603-612.
19. Gonzales GR, Elliott KJ, Portenoy RK, et al. The impact of a comprehensive evaluation in the management of cancer pain. *Pain* 1991;47:141-144.
20. Lindsay TH, Jonas BM, Sevcik MA, et al. Pancreatic cancer pain and its correlation with changes in tumor vasculature, macrophage infiltration, neuronal innervation, body weight and disease progression. *Pain* 2005;119:233-246.
21. Cata JP, Weng HR, Lee BN, et al. Clinical and experimental findings in humans and animals with chemotherapy-induced peripheral neuropathy. *Minerva Anestesiologica* 2006;72:151-169.
22. van Wilgen CP, Dijkstra PU, van der Laan BF, et al. Morbidity of the neck after head and neck cancer therapy. *Head Neck* 2004;26:785-791.

23. Tasmuth T, von Smitten K, Hietanen P, et al. Pain and other symptoms after different treatment modalities of breast cancer. *Ann Oncol* 1995;6:453-459.
24. Rogers ML, Duffy JP. Surgical aspects of chronic post-thoracotomy pain. *Eur J Cardiothorac Surg* 2000;18:711-716.
25. Borsje S, Bosmans JC, Van Der Schans CP, et al. Phantom pain: a sensitivity analysis. *Disabil Rehabil* 2004;26:905-910.
26. Robb KA, Williams JE, Duvivier V, et al. A pain management program for chronic cancer-treatment-related pain: a preliminary study. *J Pain* 2006;7:82-90.
27. Hermann M, Krum H, Ruschitzka F. To the heart of the matter: coxibs, smoking, and cardiovascular risk. *Circulation* 2005;112:1024-1029.
28. Zech DF, Grond S, Lynch J, et al. Validation of the World Health Organization guidelines for cancer pain relief: a 10-year prospective study. *Pain* 1995;63:65-76.
29. Rigor BM. Pelvic cancer pain. *J Surg Oncol* 2000;75:280-300.
30. Paice JA. Mechanisms and management of neuropathic pain in cancer. *J Support Oncol* 2003;1:107-120.
31. Meuser T, Pietruck C, Radbruch L, et al. Symptoms during cancer pain treatment following WHO-guidelines: a longitudinal follow-up study of symptom prevalence, severity and etiology. *Pain* 2001;93:247-257.
32. Portenoy RK. Inadequate outcome of opioid therapy for cancer pain: Influences on practitioners and patients. In Patt RB, ed. *Cancer Pain*. Philadelphia: JB Lippincott, 1993:119-128.
33. Colleau S, Toranson DE. Fear of addiction: confronting a barrier to cancer pain relief. *Cancer Pain Release* 1998;113:1-3.
34. Lyss AP, Portenoy RK. Strategies for limiting the side effects of cancer pain therapy. *Semin Oncol* 1997;24:S128-S133.
35. Ferrante FM, Bedder M, Caplan KA, et al. Practice guidelines for cancer pain management. *Anesthesiology* 1996;94:1243-1257.
36. Patt RB, Jain S. Therapeutic decision-making for invasive procedures. In Patt RB, ed. *Cancer Pain*. Philadelphia: JB Lippincott, 1993:275-283.
37. Melzak R, Wall P. Pain mechanisms: a new theory. *Science* 1965;150:971-979.
38. Patt RB, Cousins MJ. Neurolytic blockade techniques for chronic and cancer pain. In Cousins MJ, Bridenbaugh PO, eds. *Neural Blockade*. 3rd ed. Philadelphia: JB Lippincott, 1999:1007-1061.
39. Ramamurthy S, Wash NE, Scholenfeld LS, et al. Evaluation of neurolytic block using phenol and cryogenic block in management of chronic pain. *J Pain Symptom Manage* 1989;4:72-75.
40. Swetlow GI, Weingarten B. Alcohol nerve block for pain in malignant disease. *Med J Rec* 1926;123:728.
41. Politis MJ, Schaumburg HA, Spence PS. Neurotoxicity of selected chemicals. In:



- Spense PS, ed. *Experimental and Chemical Neurotoxicity*. Baltimore: William & Wilkins, 1980:613.
42. Rumsby MG, Finean JB. The action of organic solvents in the myelin sheath of peripheral nerve tissue. *J Neurochem* 1966;12:1509.
43. Lipton S. Neurolysis: pharmacology and drug selection. In Patt RB, ed. *Cancer Pain*. Philadelphia: Lippincott, 1993:343–358.
44. Molles JE, Helweg-Larson J, Jacobson E. Histopathological lesions in the sciatic nerve of the rat following perineural application of phenol and alcohol solutions. *Dan Med Bull* 1969;16:116–119.
45. Kline MT. Radiofrequency techniques in clinical practice. In Waldman SD, ed. *Interventional Pain Management*. Philadelphia: WB Saunders, 1996:243–93.
46. Cheng TM, Cascino TL, Onofrom BM. Comprehensive study of diagnosis and treatment of trigeminal neuralgia secondary to tumors. *Neurology* 1993;43:2298–2302.
47. Glynn CJ, Lloyd JW, Barnard JD. Cryoanalgesia in management of pain after thoracotomy. *Thorax* 1980;35:325–27.
48. Bonica JJ, Buckley FP, Morrica G, et al. Neurolytic blockade and hypophysectomy. In Bonica JJ, ed. *The Management of Pain*. Philadelphia: Lea & Febiger 1990:1980–2040.
49. Landis S, Murray J, Bolden S. Cancer statistics. *CA Cancer J Clin* 1999;49:8–10.
50. Vokes EE, Weickselbaum RR, Lippman SM. Medical progress: head and neck cancer. *N Engl J Med* 1993;328:184–186.
51. Waldman SD. Blockade of Gasserian ganglion. In Waldman D, ed. *Interventional Pain Management*. New York: WB Saunders, 2001:316–320.
52. Vital JM, Grenier F, Dautheribes M, et al. An anatomic and dynamic study of the greater occipital nerve. *Surg Radiol Anat* 1989;11:205–210.
53. Pai U, Raj PP. Peripheral nerve blocks: cervical plexus. In Raj PP, ed. *Handbook of Regional Anesthesia*. New York: Churchill Livingstone, 1985:163–167.
54. Wertheim HM, Rovenstine EA. Cervical plexus block. *N Y S J Med* 1939;1311–1315.
55. Master RD, Castresana FJ, Castresana MR. Superficial and deep cervical plexus block: technical considerations. *AANS J* 1995;63:235–243.
56. Landis S, Murray J, Bolden S. Cancer statistics. *CA Cancer J Clin* 1998;48:6–11.
57. Bonica JJ. Musculoskeletal disorders of the upper limb. In Bonica JJ, ed. *The Management of Pain*. 2nd ed. Philadelphia: Lea & Febiger, 1990:891–893.
58. Raj PP. Continuous regional analgesia. In Raj PP, ed. *Practical Management of Pain*. 3rd ed. St. Louis: Mosby, 2000:710–722.
59. Moore DC. Intercostal nerve block in 4333 patients: indications, techniques, and complications. *Anesth Analg* 1962;41:1–10.
60. Kopacz DJ, Thompson GE. Intercostal nerve block. In Waldman SD, ed. *Interventional Pain Management*. 2nd ed. St. Louis: WB Saunders, 2001:401–407.
61. Conacher ID. Percutaneous cryotherapy for post thoracotomy neuralgia. *Pain* 1986;25:227–230.
62. Debacker LJ, Kienzle WK, Keasley HH. A study of stellate ganglion block for pain relief. *Anesthesiology* 1959;20:618–625.
63. Bonica JJ. Autonomic innervation of viscera in relation to nerve block. *Anesthesiology* 1968;29:793–795.
64. Plancarte R, Velaquez R, Patt RB. Neurolytic blocks of the sympathetic axis. In Patt RB, ed. *Cancer Pain*. Philadelphia: JB Lippincott 1993:377–425.
65. Brown DL, Bulley CK, Quiel EL. Neurolytic celiac plexus block for pancreatic cancer pain. *Anesth Analg* 1987;66:869–873.
66. Plancarte R, Amescua C, Patt RB, et al. Superior hypogastric block for pelvis cancer pain. *Anesthesiology* 1990;73:236–240.
67. Warfield CA, Crews DA. Use of stellate ganglion blocks in treatment of intractable limb pain in lung cancer. *Clin J Pain* 1987;3:13–15.
68. Racz GB, Holubec JT. Stellate ganglion phenol lysis. In Racz GB, ed. *Techniques of Neurolysis*. Boston: Kluwer Academic, 1989:133–140.
69. Thompson GE, Moore DC, Bridenbaugh PO, et al. Abdominal pain and celiac plexus nerve block. *Anesth Analg* 1977;56:1–3.
70. Reber HA, Foley KM. Pancreatic cancer pain: presentation, pathogenesis, and management. *J Pain Symptom Manage* 1988;3:163–176.
71. Labat G. Splanchnic analgesia. In Labat G, ed. *Regional Anesthesia: Its Techniques and Clinical Application*. Philadelphia: WB Saunders, 1928:398–402.
72. Moore DC, Bush WH, Barnett LL. Celiac plexus block: a roentgenographic, anatomic study of techniques and spread of solution in patients and corpses. *Anesth Analg* 1981;60:369–375.
73. Eisenberg E, Carr DB, Chalmers TC. Neurolytic celiac plexus blockade for treatment of cancer pain: a metaanalysis. *Anesth Analg* 1995;80:290–307.
74. Boas RA. Sympathetic blocks in clinical practice. *Int Anesthesiol Clin* 1978;16:149–155.
75. Reid W, Watt JK, Gray TG. Phenol injection of sympathetic chain. *Br J Surg* 1970;57:45–50.
76. Frier A. Pelvic neurectomy in gynecology. *Obstet Gynecol* 1965;25:48.
77. Lee RB, Stone K, Magelssen D, et al. Presacral neurotomy for chronic pelvic pain. *Obstet Gynecol* 1986;68:517–521.
78. Plancarte R, Amescua C, Patt RB, et al. Superior hypogastric plexus block for pelvic cancer pain. *Anesthesiology* 1990;73:236.
79. Plancarte R, Amescua C, Patt RB, et al. Presacral blockade of the ganglion of Walthers (ganglion impar). *Anesthesiology* 1990;73:A751.
80. Lubenow T, Ivankovich A. Intraspinal narcotics for treatment of cancer pain. *Semin Surg Oncology* 1990;6:173.
81. Dupen SL, Williams AR. Spinal and peripheral drug delivery systems. *Pain Digest* 1995;5:307–317.
82. Burton AW, Rajagopal A, Shah HN, et al. Epidural and intrathecal analgesia is effective in treating refractory cancer pain. *Pain Med* 2004;5:239–247.
83. Bedler MD, Burchil K, Larson A. Cost analysis of two implantable narcotic delivery system. *J Pain Symptom Manage* 1991;6:368.
84. Hassenbusch SJ, Paice JA, Patt RB, et al. Clinical realities and economic considerations: economic of intrathecal therapy. *J Pain Symptom Manage* 1997;14:536–548.
85. Burton AW, Reddy SK, Shah HN, et al. Percutaneous vertebroplasty—a technique to treat refractory spinal pain in the setting of advanced metastatic cancer: A case series. *J Pain Symptom Manage* 2005;30:87–95.
86. Cotton A. Percutaneous vertebroplasty for osteolytic metastases and myeloma: effects of the percentage of lesion filling and the leakage of methylmethacrylate at clinical followup. *Radiology* 1996;200:525–530.
87. Field MJ, Behrman, eds. *When Children Die: Improving Palliative and End-of-Life Care for Children and Their Families*. Washington, DC: The National Academy Press, 2003.
88. Foley KM, Gelband H, eds. *Improving Palliative Care for Cancer*. Washington DC: The National Academy Press, 2001.



*This page intentionally left blank*



## PART 9

### PRACTICE RELATED ISSUES

# CHAPTER 95

## Legal Issues in Anesthesiology

C. Lee Parmley, MD, JD

### LEGAL ISSUES IN ANESTHESIOLOGY

#### Legal System

The American legal system is composed of federal and state court systems, the latter of which is the usual forum for matters pertaining to anesthesia practice.<sup>1</sup> State courts are established to adjudicate civil and criminal actions. Many consider our legal system to be cumbersome, overburdened, and often ineffective and unfair. Despite this reputation, it is our route to dispute resolution and protection of interests both personal and public. When contracts are formed by private parties, the legal system is called upon to interpret language and hold parties to their contractual obligations. When one party is injured by another, the legal system is expected to resolve the matter and make whole the injured party to the extent possible. When criminal actions are taken, punitive action is imposed by the legal system.

#### Criminal

Criminal courts deal with violation of criminal and other statutes and regulations for which penalties beyond those available in the civil system can be imposed. Penalties include fines and loss of privileges, including liberty. Anesthesia practitioners hopefully will have little need to interface with the criminal court system. Violation of criminal statutes and some state regulations represent the possibility of being indicted as a criminal defendant. Legal representation in such proceedings is seldom provided through malpractice insurance coverage, and effective representation is necessary and usually quite costly. Occasionally healthcare providers, including those in the field of anesthesia, will be needed to testify as witnesses in criminal proceedings that involve patients who were the victims of criminal activity.

Participating in such proceedings represents a considerable inconvenience, although often the court will make every effort to accommodate scheduling needs. Although in this situation the witness usually is called to provide factual evidence, the attorneys also may rely on the witness' expertise and ask for explanations and opinions, which ordinarily are in the realm of the expert witness.

#### Civil

Civil courts impose financial penalties and at times require or prevent a particular action of an individual. Most frequently the practice of anesthesiology interfaces with the civil court system, which is the forum for resolution of disputes based in contract and tort law, which includes actions in medical malpractice or medical negligence cases.

#### Evidentiary Standards

For legal proceedings, evidence is offered to establish the factual basis of the case. The finder of fact is ordinarily a jury but in some cases may be a judge. Evidence is presented to the

finder of fact, who then weighs the evidence and determines what actually is the factual basis. How convincing the evidence must be in order to make a determination is thought of as the burden of proof. For criminal cases, the evidence must be sufficient to eliminate reasonable doubt. Civil cases, such as medical malpractice, ordinarily rely on a preponderance of the evidence standard. Language frequently applied is "more likely than not" or "with a reasonable degree of medical probability." Medical practitioners are trained to look at evidence supporting a *P* value of .01 or .05 or a confidence of 95–99%. The preponderance of the evidence standard is much lower, just enough to tip the evidentiary scale at –51%.

#### Burden of Proof

For civil and criminal cases, the party bringing the case has the burden of proof, which means the responsibility to provide evidence sufficient to meet the evidentiary standard. There is a presumption of innocence until the evidence is sufficient to establish facts

### KEY POINTS

- Elements of Negligence:** To succeed in a medical malpractice action, the plaintiff must prove four elements by preponderance of the evidence. (1) **Duty:** The defendant owed a duty of care to the plaintiff. (2) **Breach of Duty:** The defendant failed to act consistent with the standards of care. (3) **Causation:** The injury suffered by the plaintiff is linked to or caused by the defendant's breach of duty. (4) **Damages:** There is actual compensable loss resulting from the defendant's breach of duty.
- Exclusive Contracts:** Exclusive arrangements used by hospitals to contract for anesthesiology service and may be challenged on allegation of antitrust and restraint of trade.
- National Practitioner Data Bank:** Information contained in this data bank is protected from unrestricted public inquiry but is queried when medical staff application is made.
- HIPAA (Health Insurance Portability and Accountability Act):** Protects healthcare information while asking acknowledgment that it may be released for uses related to medical treatment, payment, and/or healthcare operation, such as auditing performance evaluation and training program.
- Informed Consent:** Process by which a patient chooses to accept or refuse treatment offered once there has been exchange of information sufficient to establish an understanding of potential risks and benefits of both treatment and nontreatment options.
- Do Not Resuscitate Orders:** Should be reconsidered when patients with these orders are taken for surgery and anesthesia. A patient-oriented approach requires an individualized look at goal-directed and procedure-directed option.
- Parents are the natural guardian of their children and are expected to seek care that is in their children's best interest when needed.** Courts usually will appoint a guardian other than the parent and support decisions for medical care deemed to be clearly in the child's best interest.



that are legally sufficient to prove otherwise. For medical malpractice, the plaintiff brings the case and has the burden of proving with the preponderance of evidence that every element of the tort claim is present.

Occasionally there are cases where the burden of proof shifts to the defendant, who must prove that he or she is not negligent. With *res ipsa loquitur* (meaning “the things speaks for itself”), the plaintiff’s case is much easier to prove. Surgery on the wrong part of the body would be such a case. For *res ipsa* to apply, (1) the injury must ordinarily not occur in the absence of negligence, (2) the instrumentalities involved in the injury must be under the exclusive control of the defendant, (3) the plaintiff must be free of any contribution to the injury, and (4) the evidence or factual details must be more readily available to the defendant than the plaintiff. When *res ipsa loquitur* applies, there exists a rebuttable presumption that negligence exists, making it the defendants’ burden to prove otherwise.<sup>2</sup>

## Medical Liability

### Elements of Negligence

Humans owe each other a duty of ordinary care to avoid injury to each other. When one individual is injured due to the failure of another to exercise ordinary care, a case in negligence can arise. For the medical arena, the injury involves the care provided by a healthcare practitioner or institution. Four elements must be proven.

The first of the elements is referred to as “Duty.” Usually considered to be established through the development of a doctor–patient relationship, the duty is the requirement to provide care, although ordinary or standard care is all that the duty requires. The second element of negligence is a “Breach” of the established duty. The breach occurs when the individual with a duty fails to provide ordinary care or act within the standards of care.

“Causation” is the third element and is the causal link between the breach of duty and the injury sustained by the plaintiff. At times a patient may suffer an injury, and there may be one or more breaches of the standards of care. Unless the breach can be shown to have caused the injury sustained, the case will lack causation. Causation

can be proven by two legal tests, the “but for” test and the “substantial factor” test. The plaintiff may succeed if he or she can show by a preponderance of the evidence that “but for” the defendant(s)’ breach of duty the injury would not have occurred. Alternatively, the plaintiff may succeed if it can successfully be shown that the defendants’ breach of duty represented a substantial factor in causing the plaintiff’s injury, despite the presence of other factors, which may include ones introduced through action or inaction of the plaintiff.

The fourth element of negligence is called “Damages.” This is the economic value assigned to the injury sustained by the plaintiff. Although losses may be physical, economic, and emotional, damages will be calculated to compensate the plaintiff such as to make him or her whole. The calculated damages will include medical expenses (current and future), loss of earnings, and earning capacity as well as additional amounts added for pain, suffering, and loss of consortium, all of which will be computed in economic terms. Punitive damages intended to punish the defendant may be sought and awarded for gross negligence, that is, willful and wanton disregard for the well-being of the plaintiff.

### Standards of Care and Expert Testimony

The duty to provide ordinary care is basic tort law and is expressed in the terms of doing what would be done by the reasonably prudent person in the same or similar circumstances. Ordinary care requires a slightly different perspective for purposes of establishing standards of care in medical negligence litigation. For that purpose, standards of care are those actions that would be taken by physicians of similar training and experience in the same or similar circumstances. For anesthesia cases, the defendant can expect to face the practice parameters and guidelines promulgated by the American Society of Anesthesiologists (ASA). It seems that the introductory language of these guidelines expressing their appropriate application seeks to limit their application as standards of care. Nonetheless, the finder of fact likely will be influenced by the fact that these guidelines have been developed by practitioners of apparently similar training and experience within the national society, which makes it

seem a reasonable expectation that practitioners within the specialty would follow them.

In addition to published information that can be used to help establish standards of care, expert witnesses will be called by both parties to testify as to the appropriate action that was or should have been taken by the defendant practitioner. Expert testimony will seek to establish the existence of a physician–patient relationship, with associated duty of care, and breach of that duty, being a violation of the standards of care. Expert testimony also will be required to establish that, in fact, the breach of duty was a causative factor that resulted in the plaintiff’s injury. Interestingly, it seems always possible to find expert opinion sufficiently diverse to support both the plaintiff’s and the defendant’s position.<sup>3</sup>

### Anesthesia Malpractice Claims

Medical negligence cases involving anesthesia have declined over the past several decades. In fact, in 1999 the Institute of Medicine recognized anesthesia as an area in which very impressive improvements in safety have been made.<sup>4</sup> Historically, adverse outcomes related to respiratory events were the single largest class of injury, and consequences of brain damage and death led to high-damage claims. This is true across adult, pediatric,<sup>5</sup> and obstetric<sup>6,7</sup> populations. Most commonly, the respiratory adverse events resulting in significant injury were inadequate ventilation, esophageal intubation, and difficult tracheal intubation.<sup>8</sup> Advances in technology with the development of oximetry and capnography in conjunction with the creation and implementation of practice guidelines appear significant when considering factors that have both improved patient safety and reduced anesthesia malpractice cases.<sup>9</sup>

Despite the reduction in the number and cost of claims against anesthesia practitioners, medical malpractice cases continue to be filed and likely will continue despite the efforts made to curb them through tort reform. The process is initiated by a notice letter, which establishes the intent of the injured party or plaintiff to take legal action. This must be done within the statute of limitations and begins with filing a complaint or petition in state court and serving notice on the defendants being sued. The defendants thereafter file a responsive pleading,



which answers the allegations in the original petition.<sup>10</sup>

### **Discovery**

Once filed, the case enters the discovery phase, where both plaintiff and defendants acquire evidence to be used to prove their case. This involves requests for production of documents such as medical records and other written or recorded information that may reflect facts pertaining to the plaintiff's injury and the economic loss associated with it. Discovery also includes depositions whereby sworn testimony from parties as well as fact and expert witnesses is taken and preserved in preparation for trial. Discovery allows the plaintiff and defendants to develop their cases and possibly enter settlement negotiations and avoid trial.

### **Trial**

At trial, the plaintiff will be required to prove all elements of the negligence case against each defendant with sufficient evidence to meet the burden of proof. Defense of the medical practice case requires that the defendant defeat only one of the elements of the plaintiff's case. Although attack is made on multiple elements, failure of the plaintiff on only one element results in a verdict for the defendant. The trial concludes with a verdict for the plaintiff or defendant. An award of damages in some dollar amount for the plaintiff will be divided such that costs of litigation and the attorney's contingency fee are paid prior to money going to the injured party. A verdict for the defendant puts an end to the experience, although the memories will remain.

### **Avoiding and Surviving Lawsuits**

The most effective protection against a medical malpractice lawsuit is the rapport a healthcare provider develops with the patient.<sup>11</sup> If the provider is personable, available, and trustworthy, the injured patient will want to keep him or her out of the defendant pool, even if there is reason to be included. By contrast, poor bedside manner and distrust increases the likelihood of being named in malpractice cases. Angry patients and those who sense they are getting less than the whole truth often resort to the legal system for resolution. Those who have generated the anger and distrust can expect to participate in the legal action.

Although provider apology for medical error does not decrease the number of lawsuits filed, it does tend to expedite settlement of claims for fewer dollars.<sup>12</sup> In the past, standard practice was to adopt a policy of total silence,<sup>13</sup> believing that disclosure would increase the incidence of litigation.<sup>14</sup> The older approach now faces one of counterintuition in which disclosure and apology are made when adverse events and medical errors occur. The process helps fulfill needs of both physician and patient,<sup>15</sup> should be undertaken as close to the time of error as possible when the patient is capable of full comprehension, and after consultation with legal counsel that does not have power of veto. The truth-based apology may eliminate the perception that details are being withheld and is consistent with the recommendations of several professional societies and associations.<sup>16</sup>

When involved in a case with an undesired outcome, it is wise to anticipate the possibility of adverse legal action. Notifying one's insurance carrier and the hospital risk management officer are appropriate early steps, soon after the event and long before legal action is initiated. It is crucial to avoid discussing the matter with others, and never alter medical records. Records kept in the ordinary course of business, with the exception of those generated as part of the peer review and quality improvement processes, are discoverable and will end up in the hands of the plaintiff's attorney.<sup>10</sup>

Protected from discovery are products generated in anticipation of litigation and communications between the attorney and client. Liability insurance policies ordinarily provide legal counsel for the insured healthcare provider, and their recommendations should be heeded. If there is reason to believe that the attorney provided by the insurance company is not zealously representing the case filed against one, it is best to ask for alternative representation or to employ individual counsel. Individual counsel is also recommended when the damages sought exceed the coverage afforded by the liability policy.

## **Economic Relationships and Contracts**

### **Corporations**

It is common for groups of anesthesia practitioners to join forces in order to

provide services for hospitals, outpatient centers, and clinic operations. The legal entity that frequently does this is the professional corporation, which is formed and regulated under state law.<sup>17</sup> The corporation is a separate entity, which in many ways has attributes of a person in that it can enter into contracts, employ workers, earn and lose money, and be a party to litigation. Such corporations may be owned by one or more individuals, often those who form the practice together and thereafter employ others who eventually become shareholders.

Medical practice corporations take on numerous expenses, including billing and other costs of business, malpractice insurance premiums, educational expenses, and at times the costs of travel and transportation. Earnings of the group practice are pooled, overhead expenses paid, and salaries to shareholders and other employees paid. The corporation is also the entity with which a hospital might contract to obtain coverage for anesthesia services needed to maintain business operations. Corporations file returns and pay taxes on profits, so they may pay out bonuses to employees and stockholders at the end of each fiscal year.

### **Hospitals**

Hospitals, also legal entities, often enter into explicitly exclusive supplier arrangements for the provision of "hospital-based physician" services, which includes anesthesiology.<sup>18</sup> Typically this contract will be made between a hospital and a corporation. The contract spells out compensation, billing, minimum services, and management responsibilities; at the same time it excludes other anesthesiologists or groups from providing services at the hospital.<sup>18</sup> For the hospital, this provides an assurance that necessary services will be provided and is an alternative to hiring anesthesia providers as employees salaried by the hospital. For the corporation and anesthesia group, it prevents others from entering the practice area and capturing revenue, which will be theirs and protected by the exclusivity clause of the contract.

The bargaining power of the hospital compared with the practice groups is seldom equal, and at times the group may find itself in the position of being controlled by the hospital's business plan and driven to cut costs and corners. Patient care problems may also arise

when qualified practitioners are excluded by the contract, which may also circumvent peer review activities.<sup>19</sup>

At times, exclusive contracts are legally challenged based on allegations of restraint of trade and antitrust.<sup>20</sup> Often the plaintiff to such action is a practitioner who is not a party to the contract or employed by the contracting entity and therefore cannot practice in the defendant hospital. The pleadings will cite violations of procedural due process, not unlike those involving the termination of staff privileges,<sup>21</sup> and also allege that the exclusive contract seeks to monopolize the market and is a restraint of trade. Although the contracts usually are upheld at trial, the courts have not been totally insensitive to the argument.

Courts have concluded that certain types of provisions in exclusive contracts are unreasonable “per se,” and if these exist the contract imposes an unreasonable restriction on competition. The per se violations include agreements to fix prices, agreements between competitors to divide markets, and, in some cases, group boycotts and tying arrangements. Short of per se violations, contracts may be found unlawful if they are not supported by the “rule of reason,” which states that contracts are lawful if the participants lack market power or the results are significant efficiencies that outweigh the anticompetitive effects.<sup>22</sup>

When patients can easily travel to an alternative hospital to receive care, the institution and contracting group lack market power as considered under the rule of reason. On the other hand, exclusive contracts have been found unlawful when a hospital has high market share, and the contract tends to insulate the physician group from competition. At times, courts have upheld exclusive contracts when they allow hospitals and physician groups to control cost or quality of services provided to patients.<sup>22</sup>

### **Supervision**

Anesthesiologists who supervise certified registered nurse anesthetists (CRNAs) and/or residents are held accountable for the actions of those under their supervision. Although there is really not an alternative to direct supervision of residents, CRNA supervision is somewhat different.

A substantial portion of the total number of anesthetics administered in the United States is performed by

CRNAs either with or without the supervision of anesthesiologists. This supervisory relationship, when it exists, is known as the *anesthesia care team*. The distribution of anesthesia providers in this country is highly skewed toward metropolitan areas, where supervision in the anesthesia care team is more prevalent.<sup>23</sup> CRNAs working in the anesthesia care team model are found to be more limited in their scope of practice when employed by the anesthesiology group rather than the hospital, and many find their practice to be noncollaborative.<sup>24</sup> The scope of practice of CRNAs in rural hospitals<sup>25</sup> is broader than in metropolitan practice.

To date no studies have shown a difference in anesthesia quality of care or outcomes based solely on the distinction of the provider being a CRNA or anesthesiologist. In 2001, the Centers for Medicare and Medicaid Services (CMS)<sup>26</sup> published its ruling allowing state governments exemption from the requirement for CRNA supervision. This required written notification of CMS by the state governor after consultations with the boards of medicine and nursing, determination that opting out was consistent with state law and that, upon decision, was in the best interests of the citizens of the state.

In addition to being seen as favorable to CRNAs, this allowed an option to relieve supervising physicians of liability, which concerned some, especially supervising physicians who were not anesthesiologists.

### **Private and Public Information National Practitioner Data Bank**

The National Practitioner Data Bank (NPDB) was established in 1986 through the Health Care Quality Improvement Act.<sup>27</sup> Seeking to improve the quality of healthcare, the NPDB was intended to restrict the ability of incompetent physicians to move from state to state without disclosing their incompetence. The NPDB is a flagging system to facilitate a review of healthcare practitioners credentialing. Hospitals, medical boards, professional societies, and others that take adverse actions against professional licensure, as well as those that make payments as a result of medical malpractice actions, are required to report to the NPDB. Any actions taken to reduce, restrict, suspend, revoke, or deny clinical priv-

ileges or membership are to be reported, as are monetary payment and adverse judgments resulting from medical malpractice law suits.

When healthcare practitioners apply for clinical privileges, a hospital must query the NPDB and repeat the query every 2 years thereafter. Information obtained through this query is restricted to use only for the purpose for which it was obtained. Civil penalties can be imposed for violation of the confidentiality of the NPDB information. Although the general public cannot obtain information regarding a particular practitioner from the NPDB, a plaintiff's attorney can request information pertaining to a practitioner against whom he or she has filed suit, if through discovery it is disclosed that the hospital failed to do so. Defense attorneys cannot query the NPDB, but a practitioner may make a query to obtain information concerning himself to see which, if any, incidents have been reported.

In general, those involved in the credentialing of healthcare practitioners enjoy qualified immunity. They cannot be held liable for providing information regarding the healthcare practitioner unless the information provided is false and the individual providing the information actually knew it to be false. Courts have held that hospitals are immune for reporting peer review information to the NPDB, as long as the reports are made without knowledge of falsity.

### **Health Insurance Portability and Accountability Act**

Whereas the regulations under the Health Insurance Portability and Accountability Act of 1996 (HIPAA) are new, the underlying concept of privacy of medical information is not.<sup>28,29</sup> In fact, some consider the HIPAA regulations to be unduly complex, long, and laden with excess commentary, while the underlying principle is quite simple. The recognized right for a patient's personal medical information to be kept private has been present from the time of Hippocrates.<sup>30,31</sup> Understandably, patients are willing to disclose to their physician the information required for diagnosis and treatment when they understand that the information will remain confidential.

In the era of electronic communications, management of healthcare information has become more complex and protection of privacy more prob-

lematic. Some computer experts believe that, for all practical purposes, privacy is dead, and that personal control of private information is a mere illusion in the computer age. Apparently denying the legitimacy of this perception, HIPAA regulations seek to inform and educate patients as to their privacy rights. Patients are to receive a notice of privacy, setting forth who will be able to use their medical information and for what purposes. Patients are asked to acknowledge that they have been informed that their information may be disclosed for uses related to medical treatment, payment, and/or healthcare operations such as auditing, performance evaluations, training programs, and the like. Some providers still obtain authorization to disclose medical information, which is necessary when the disclosure is for reasons other than treatment, payment, or operations, for example, medical research.

Patients have a right to access and copy their entire medical history with limited exception, and parents have rights to access the medical records of their minor children unless precluded through court action. Emergency treatment need not be delayed while HIPAA notice is provided, but once the emergency condition has stabilized, privacy notice is to be provided. HIPAA regulations stipulate that the information to be disclosed is to be the minimum necessary and specifically include the conducting of training programs where healthcare trainees learn under supervision. Significant penalties can be imposed for violations of HIPAA regulation. Civil monetary penalties up to \$25,000 annually<sup>32</sup> may be imposed for violations, and criminal penalties for those who knowingly obtain to disclose identifiable health information can be as high as 10 years' imprisonment and \$250,000 if the intent is to use the information for commercial advantage.<sup>33</sup>

## Consent

Among the legal documents most frequently seen by anesthesia providers are those associated with the process of informed consent.<sup>34,35</sup> In general, patients come to the healthcare industry seeking care, and it would be presumed that they would agree to receive the care they are seeking. That presumption is incorrect if there are aspects of the care they would consid-

er sufficient to make them think it over and perhaps choose not to be treated. The process of informed consent in essence represents the foundation of the physician-patient relationship. The patient seeks diagnosis and treatment; the physician makes a diagnosis and offers options for treatment. The patient cannot compel the physician to treat contrary to his or her will, just as the physician cannot compel the patient to accept treatment that he or she does not want. A full disclosure and comprehension of treatment risks and benefits is necessary if the consent is to be truly informed.

## Treatment

In order for there to be informed consent, there must be exchange of information. This requires a patient competent to understand the nature of the treatment being discussed and the implications of accepting the treatment as well as the nontreatment option. It also requires a physician to disclose the potential benefits of treatment as well as the risks represented by the treatment or nontreatment. The extent of risk disclosure has been a topic of disagreement over the years. The physician-based standard, requiring disclosure of risks deemed appropriate by physicians, has largely been replaced by the "reasonable person" standard.

This standard requires disclosure of risks that a reasonable person would need to consider in determining whether or not to accept an offered treatment. Considering the frequency and severity of risk is important. Death as a risk of anesthesia is very unlikely, yet its severity is such that it should be disclosed. At the other end of the spectrum might be a sore throat following use of an endotracheal tube, which, although quite inconsequential, may be frequent enough in occurrence to make its disclosure appropriate. The reasonable person standard is now widely accepted in most jurisdictions.

## Blood Products

Although many standard surgical consent forms include provision for blood product administration, it is common practice in some areas to have separate consent documents pertaining to their administration. This is in part due to the inherent risks, although small, of transmitting infectious disease, as well as to allow those who might refuse administration of blood

products for religious reasons to engage in meaningful informed consent dialogue. The refusal of blood products, as is frequently encountered when Jehovah's Witnesses undergo anesthesia and surgery, may present an ethical conflict for practitioners. Although uncommon, being asked to stand by and allow a patient to die for lack of a lifesaving blood transfusion generates a conflict of conscience for healthcare providers involved.<sup>36</sup> Nonetheless, it is well recognized that patients do have the right to refuse treatment even when that treatment is necessary to sustain life.

Frequently the issue is made far complex when individual Jehovah's Witness patients will allow administration of some blood components, such as albumin and immune globulins, but not red blood cells; each individual is allowed to make decisions regarding these matters.<sup>37</sup> When minor children are involved and the need for administration of blood product arises, courts routinely intervene to require treatment for children whose parents deny consent for lifesaving medical interventions.<sup>38</sup>

## Emergency

There are exceptions to the duty to disclose. The legal system recognizes the rights of a physician in a true emergency to act without patient consent, so long as his or her actions are consistent with those customarily done in the particular emergency. In emergency situations, there may be a presumption of consent; that patients would want treatment that would be lifesaving. There are rare occasions when the mere discussion of treatment risks may be detrimental to a patient's health. When discussion of risks generate emotional distress, such as to foreclose a rational discussion, a physician may exercise what is known as *therapeutic privilege*, and forego full risk disclosure to the patient. Careful documentation and discussion with family members regarding the situation is appropriate in this case.

## Surrogacy and Family Consent

Incompetent patients requiring surgery and anesthesia traditionally have family members in attendance who can be engaged in the consent process. This long-standing practice has gained legal acceptance and is based on the presumption that the family is generally most concerned about the good of the patient and ordinarily will be most

knowledgeable about the patient's preferences, goals, and values. Since the 1980s, many states have enacted family consent statutes, which set forth the hierarchy of family members and close friends who are to be looked to for medical decision making. Ordinarily the hierarchy runs in descending order from the spouse, parents, majority of reasonably available adult children, and nearest living relative. Some states have freestanding statutes, although others incorporate this into their statutes addressing living will, advance directive, and healthcare decision making.<sup>39</sup>

## Ethical Issues

Busy anesthesia practice usually is conducted without undue attention to biomedical ethics for its own sake. Although daily activities are filled with a balancing of risks and benefits and providing care consistent with the patient's wishes, the ethical principles of autonomy, beneficence, and nonmaleficence are not necessarily the terminology commonly applied. These principles are more in focus when dealing with end-of-life decisions, as may be faced when terminally ill patients are brought to the operating room, when life-sustaining treatment is to be withdrawn, and when transplantable organs are retrieved from the cadaveric donor.

### End-of-Life Care

The past several decades have been characterized by tremendous advances in technology, pharmacology, and healthcare in general. Populations are aging, and medical conditions that once were terminal have found treatments that prolong life considerably. Prior years saw deaths in hospital occur despite every effort that could be made. More frequently today we see hospital deaths when decisions are made that not everything that can be done really should be done.<sup>40</sup> Decisions to limit care by either withholding or withdrawing treatments are commonly made in the process of caring for patients at the end of life.

### Do Not Resuscitate Orders

Probably the most basic of decisions regarding end of life care is a decision to withhold advanced cardiac life support in the event of a cardiac arrest. In 1974, the American Heart Association and American Medical Association stated that the purpose of cardiopul-

monary resuscitation is to prevent sudden, unexpected death; it is not indicated in cases of terminal illness where death is expected.<sup>41</sup> Although conceptually this was not difficult to grasp, early on orders to withhold cardiopulmonary resuscitation, or "do not resuscitate (DNR)" orders, were often spoken rather than written.<sup>42</sup> But with time there evolved a more sound recognition that continuation of life-sustaining treatments<sup>43</sup> as well as cardiopulmonary resuscitation may not always be appropriate, and the distinction between sustaining life and prolonging the dying process emerged.

There are really two reasons to withhold cardiopulmonary resuscitation: when it is medically inappropriate and when a patient refuses to have such treatment,<sup>44</sup> even if it might be deemed medically appropriate by the healthcare team. Ethically speaking, there is no obligation to provide care that is of no benefit to the patient, especially if such treatment could be considered harmful or cause pain. Likewise, treatment offered and considered appropriate can be refused by the patient whose autonomy we must respect.

Conflict has arisen when patients with DNR orders are brought to the operating room to undergo surgical procedures and anesthesia.<sup>45</sup> Cardiac arrest is among the recognized risks of anesthesia, and practitioners would choose to have every opportunity to correct problems caused by their care. For some time, there was a pattern of universal suspension of DNR orders when patients were in the operating room and under the effects of anesthesia. Currently such practices are being reconsidered and replaced by more patient-oriented and individualized policies and practices with goal-directed and procedure-directed options.<sup>46</sup> This reevaluation process regarding DNR orders prior to surgery is appropriate for the pediatric population as well.<sup>47</sup> The ASA recommends the development of a policy that provides four options and requires a reconsideration of the decision for the DNR and the implications of the procedure and anesthetic to be undertaken.<sup>48</sup>

### Withdrawal of Treatment

Life-sustaining treatment is ordinarily initiated when organ failure is sufficient to risk loss of life. When underlying conditions are corrected and organ function restored, life-sustaining treat-

ment is no longer needed and can be discontinued. This is commonly seen when patients require mechanical ventilation postoperatively while temporary pulmonary insufficiency would put them at risk of death without such support. However, if organ function is not restored or the patient's condition deteriorates further, it may become apparent that survival can no longer be expected. At this time, it will be appropriate to entertain the option of withdrawing life-sustaining treatment that is merely delaying the moment of death or prolonging the dying process.<sup>49</sup> Even when life-sustaining treatment is withdrawn, physicians have a duty to care for the dying patient, administering medications to provide comfort and assuring the continuation of other care for preservation of dignity. Often medications administered for comfort also have depressant effects that could hasten death, a double effect. Such medications are to be administered to provide comfort even if they may also hasten death.<sup>49</sup>

Some patients have executed a directive to physicians, or a living will, which specifies desire regarding the application of life-sustaining treatment in the event they have a terminal or irreversible condition and they are incompetent to express their desire at that point in time. Most frequently the directive asks that treatments be discontinued so that the individual may die naturally, although other instructions may also be given. A directive to withdraw or withhold life-sustaining treatments can be considered a statement of refusal of treatment in the process of informed consent.

Even without a written directive, decisions to limit life-sustaining treatment are frequently made for the incompetent patient. Family members who would otherwise be involved in the consent process can engage in discussions regarding the discontinuation of life-sustaining treatment. At times they may be aware of the specific desire of the patient in this regard, but even if this was never clearly expressed, the decision can be made based on the patient's values and what is in his or her best interest.<sup>39</sup>

### Futility

At times patients, or more often families, demand administration or continuation of treatment that is medically inappropriate.<sup>50</sup> When there is no ex-



pectation for survival, treatment directed at cure can be considered futile.<sup>51,52</sup> Although there is no obligation to provide futile care, there is reluctance to discontinue such treatment demanded by families, when to do so would soon be followed by the patient's death. Consultation of clinical ethics is appropriate and may help resolve such situations. Some institutions and state laws provide a due process means by which discontinuation of futile life-sustaining treatment, even contrary to the demands of the patient or family, can be accomplished with protection from legal liability.<sup>53,54</sup>

### **Organ Donation after Cardiac Death**

Although historically organs for transplantation were retrieved from patients immediately following cardiac death, this practice was largely abandoned with the evolution of the concept of brain death. Anesthesia practitioners are commonly called upon to provide intraoperative management for the brain-dead cadaveric organ donor.<sup>55</sup> The procedure, unlike most cases, is somewhat unique in that administration of anesthetic is not necessary to render the patient insensitive to pain, and once the heart is arrested the intraoperative management of the anesthesia provider is essentially complete despite continuation of the surgical procedure.

With the high demand for transplantable organs and the increased public awareness of organ donation, there is rekindled interest in organ donation after cardiac death. Such an option at times occurs when there is a decision to discontinue life-sustaining treatment for a patient who will die soon and who has preserved function of transplantable organs such as kidney and liver. The end-of-life process usually occurs in the ICU and includes administration of medications to provide comfort at the time life-sustaining treatment is removed. Moving this process to the operating room allows control of the circumstances surrounding death and the possibility for retrieval of transplantable organs.<sup>56</sup>

Understandably, some who work in the operating room environment are troubled by this practice. They may need to reconsider what really is taking place and, if necessary, be excluded from the process. Although withdrawal of life-sustaining treatment and administration of medications for comfort

predictably will be followed by death, the death is not caused for purposes of obtaining transplantable organs. The "dead donor rule," which applies here as well as for the brain-dead donor, prohibits the practice of causing death to obtain organs.<sup>57</sup>

Anesthesiologists have resisted the opportunity to participate in this practice. Rather than bringing in the anesthesia provider solely for participation in the end-of-life process, this is often done with providers who have cared for the patient in the ICU. Regardless of whether or not anesthesiologists directly participate in these procedures, their involvement in the development of hospital policies and procedures is appropriate, and they should seek to ensure that the protection of patient dignity and comfort is paramount throughout.<sup>58</sup>

## **Pediatric Issues**

### **Consent**

Generally, speaking the legal system will protect individual rights regardless of a person's age. The ability of some individuals to comprehend the nature of medical care and its impact on their person is limited, which is the case in the pediatric population. Cognitive development throughout childhood as well as developments of emotional reactions based on a broadening experiential foundation leads eventually to the competencies associated with adulthood. Ethical arguments that consent of the pediatric patient should not be based on an arbitrary age but rather on the development of personhood place high value on the child's input in the consent process.<sup>59</sup>

The ability to consent for and refuse treatment requires a level of maturity and understanding. Certainly a child may refuse to be subject to the pain of an injection despite the fact that immunization may have an effect in prolonging life. Clearly the consent for a surgical procedure is even more complex, and with younger children it would be unrealistic to expect an understanding of a procedure and its inherent risks and potential benefits. A progressive is recommended for use in obtaining consent from or for children; this allows involvement of the child based on age and developmental maturity. For ages 6 years and younger, in whom decision-making capacity is highly limited, consent is made on the child's behalf and in his or her best

interest. With increasing age and development of decision-making capacity, the child's participation and contribution to the process increase through informed permission and assent to informed consent at maturity.<sup>60</sup> Even though the capacity to truly give consent may be present with older children and teenagers, parents still are ordinarily asked to execute consent documents on their children's behalf.

Parents are the natural guardian of their children and are expected always to seek care that is in the best interest of the children. When there is question as to whether or not the consent for treatment or refusal of treatment is truly in the child's best interest, it may be necessary to seek intervention by the legal system. Every state has a statutory framework set up to protect abused or neglected children, and statutes allow any person to petition the court for guardianship for the protection of a person lacking legal capacity.<sup>61</sup> Courts traditionally support decisions for medical care deemed to be clearly in the child's best interest and ordinarily will not appoint a guardian other than the parent unless there is good reason.

### **Neglect and Abuse**

Child protective services are established by state governments to all the state to take custody of children who are being denied the necessities of life, such as housing, clothing, food, education, and medical care. There is some variation among the states, but most allow the state to take custody of the child upon little or nothing more than a verified petition alleging neglect or abuse.<sup>62</sup> Temporary custody may be sufficient to allow provision of medical care, but ultimately unless the state shows by clear and convincing evidence that all statutory requirements are met, there is little chance of terminating parental rights and maintaining custody.

Children are commonly the victims of injury, with trauma and accidents being the leading causes of death between the ages of 1 and 14 years.<sup>63</sup> At times, patterns of injury may be of concern, especially with acute injuries seen in conjunction with signs of prior trauma, such as bruises, contusions, and healing fractures, which may be suggestive of the "battered child syndrome."<sup>64</sup> Abuse may be sexual or may take the form of neglect, with failure to meet a child's needs for shelter,

clothing, food, and healthcare.<sup>65</sup> Stories telling the sequence of events leading to the current and prior injuries may seem inadequate to explain the degree of trauma, and details related may change over time.<sup>66</sup>

The immediate matter of consent for treatment when a child requires treatment that a parent declines is directed to the court, where a judge can and almost always will issue a court order that permits the health-care provider to care for the child. A more long-term plan is activated when child protective services intervenes in the situation.

## KEY REFERENCES

- Gallagher TH, Levinson W. Disclosing harmful medical errors to patients. *Arch Intern Med* 2005;165:1819-1824.
- Jones JW, McCullough LB, Richman BW. Informed consent: it's not just signing a form. *Thorac Surg Clin* 2005;15:451-460.
- American Society of Anesthesiologists. Ethical guidelines for the anesthesia care of patients with do-not-resuscitate orders or other directives that limit care. In: 1999 Directory of Members. Park Ridge, IL: American Society of Anesthesiologists, 1999:470-471.
- Feld AD. The Health Insurance Portability and Accountability Act (HIPAA): its broad effect on practice. *Am J Gastroenterol* 2005;100:1440-1443.
- Fallat ME, Deshpande JK, Section on Surgery, Section on Anesthesia and Pain Medicine, and Committee on Bioethics. Do-not-resuscitate orders for pediatric patients who require anesthesia and surgery. *Pediatrics* 2004;114:1686-1692.

## REFERENCES

- Calvi JV, Coleman S. *American Law and Legal Systems*. Englewood Cliffs, NJ: Prentice-Hall, 1989.
- Furrow BR, Greaney TL, Johnson SH, et al. *Health Law*. Vol. 1, Section 6-3. St. Paul, MN: West Publishing, 1995.
- Posner, KL, Caplan RA, Cheney FW. Variation in expert opinion in medical malpractice review. *Anesthesiology* 1996;85:1049-1054.
- Kohn L, Corrigan J, Donaldson M. *To Err is Human: Building a Safer Health System*. Committee on Quality of Health Care in America, Institute of Medicine. Washington, DC: National Academy Press, 1999:241.
- Murray JP, Geiduschek JM, Caplan RA, et al. A comparison of pediatric and adult anesthesia closed malpractice claims. *Anesthesiology* 1993;78:461-467.
- Hawkins JL, Koonin LM, Palmer SK, et al. Anesthesia-related deaths during obstetric delivery in the United States 1979-1990. *Anesthesiology* 1997;86:277-284.
- Chadwick HS, Posner K, Caplan RA, et al. A comparison of obstetric and nonobstetric anesthesia malpractice claims. *Anesthesiology* 1991;74:242-249.
- Cheney FW, Posner KL, Caplan RA. Adverse respiratory events infrequently leading to malpractice suits. A closed claims analysis. *Anesthesiology* 1991;75:932-939.
- Gaba DM. Anaesthesiology as a model for patient safety in health care. *BMJ* 2000;320:785-788.
- Fish RM, Ehrhardt ME, Rish B. *Malpractice: Managing Your Defense*. 2nd ed. Montvale, NJ: Medical Economics, 1990.
- Belli MM, Carlova J. *For Your Malpractice Defense*. 2nd ed. Oradell, NJ: Medical Economics, 1989.
- Gallagher TH, Levinson W. Disclosing harmful medical errors to patients. *Arch Intern Med* 2005;165:1819-1824.
- Jacobs HB. *The Spectre of Malpractice USA*. New York: Nationwide Press, 1983.
- Rosner F, Berger JT, Kark P, et al. Disclosure and prevention of medical errors. *Arch Intern Med* 2000;160:2089-2092.
- Gallagher TH, Waterman AD, Ebers AG, et al. Patients' and physicians' attitudes regarding the disclosure of medical errors: *JAMA* 2003;289:1001-1007.
- Newman A. Providing Apology in Medical Error Situations: Positive or Negative Effect. American College of Legal Medicine 46th Annual Conference, March 2006, pp. 594-600.
- Furrow BR, Greaney TL, Johnson SH, et al. *Health Law*. Vol. 1, Sections 5-2 to 5-9. St. Paul, MN: West Publishing, 1995.
- Lynk WJ. Restraint of trade through hospital exclusive contracts: an economic appraisal of the legal theory. *J Health Politics Policy Law* 1984;9:269-279.
- Kristeller AR. Economic credentialing and exclusive contracts. *N J Med* 1997;May:63-65.
- Foster HS. Exclusive arrangements between hospitals and physicians: antitrust's next frontier in health? *St. Louis Univ Law J* 1982;26:535-559.
- Drexel WR. The antitrust implications of the denial of hospital staff privileges. *Univ Miami Law Rev* 1982;36:207-233.
- Saylor LJ. Are you violating antitrust laws? *Michigan Hosp* 1992;January/February:29-33.
- Orkin FK. The geographic distribution of anesthesiologists during rapid growth in their supply. *Anesthesiology* 1994;81A:1295.
- Alves SL. A study of occupational stress, scope of practice, and collaboration in nurse anesthetists practicing in anesthesia care team settings. *AANA J* 2005;73:443-452.
- Penn M, Ruthman J. Assessing the degree of involvement of Certified Registered Nurse Anesthetists in airway management and trauma stabilization in rural hospitals. *AANA J* 2005;73:191-196.
- Department of Health and Human Services. Centers for Medicare and Medicaid Services. Medicare and Medicaid programs: hospital conditions of participation: anesthesia services. *Federal Register* 2001;66:56762-56769.
- Wilken B, Trompler V, Areheart B. The National Practitioner Data Bank. American College of Legal Medicine 46th Annual Conference, March 2006, pp. 443-453.
- Annas GJ. HIPAA regulations: a new era of medical-record privacy? *N Engl J Med* 2003;348:1486-1490.
- Feld AD. The Health Insurance Portability and Accountability Act (HIPAA): its effect on practice. *Am J Gastroenterol* 2005;100:1440-1443.
- Moskop JC, Marco CA, Larkin GL, et al. From Hippocrates to HIPAA. Privacy and confidentiality in emergency medicine—part I. Conceptual, moral, and legal foundations. *Ann Emerg Med* 2005;45:53-59.
- Moskop JC, Marco CA, Larkin GL, et al. From Hippocrates to HIPAA. Privacy and confidentiality in emergency medicine—part II. Challenges in the emergency department. *Ann Emerg Med* 2005;45:60-67.
- 42, U.S.D. sec 1320, D-1.
- 42, U.S.C. sec 1320, D-6.
- Jones JW, McCullough LB, Richman BW. Informed consent: it's not just signing a form. *Thorac Surgery Clin* 2005;15:451-460.
- Furrow BR, Greaney TL, Johnson SH, et al. *Health Law*. Vol. 1, Sections 6-9 to 6-15. St. Paul, MN: West Publishing, 1995.
- Benson KT. The Jehovah's Witness patient: considerations for the anesthesiologist. *Anesth Analg* 1989;69:647-656.
- Dixon JL, Smalley MG. Jehovah's witnesses. The surgical/ethical challenge. *JAMA* 1981;246:2471-2472.
- Furrow BR, Greaney TL, Johnson SH, et al. *Health Law*. Vol. 2, Section 17-48. St. Paul, MN: West Publishing, 1995.
- Miller GD, Key CM. Health care decisions act: problems with consents, surrogacy, and end-of-life choices addressed by the New Tennessee Health Care Decisions Act. *Tenn Med* 2004;October:448-451.

40. Rucker GM, Curtis JR. Caring for the dying in the intensive care unit: in search of clarity. *JAMA* 2003;290:820-822.
41. Standards for cardiopulmonary resuscitation (CPR) and emergency cardiac care (ECC). *JAMA* 1974;227(Suppl):833-868.
42. Rabkin MT, Gillerman G, Rice NR. Orders not to resuscitate. *N Engl J Med* 1976;295:364-366.
43. Fried C. Terminating life support: out of the closet. *N Engl J Med* 1976;295:390-391.
44. AMA Code of Medical Ethics 2.22. Do-Not-Resuscitate Orders. 2002-2003.
45. Walker RM. DNR in the OR—resuscitation as an operative risk. *JAMA* 1991;266:2407-2412.
46. Truog RD, Waisel DB, Burns JP. DNR in the OR. A goal-directed approach. *Anesthesiology* 1999;90:289-295.
47. Fallat ME, Deshpande JK, Section on Surgery, Section on Anesthesia and Pain Medicine, and Committee on Bioethics. Do-not-resuscitate orders for pediatric patients who require anesthesia and surgery. *Pediatrics* 2004;114:1686-1692.
48. American Society of Anesthesiologists. Ethical guidelines for the anesthesia care of patients with do-not-resuscitate orders or other directives that limit care. In: 1999 Directory of Members. Park Ridge, IL: American Society of Anesthesiologists, 1999:470-471.
49. AMA Code of Medical Ethics 2.20. Withholding or Withdrawing Life-Sustaining Medical Treatment. 2002-2003.
50. Trotter G. Mediating disputes about medical futility. *Cambridge Q Healthcare Ethics* 1999;8:527-537.
51. Kasman DL. When is medical treatment futile. *J Gen Intern Med* 2004;19:1053-1056.
52. Mosely KL, Silveira MJ, Goold SD. Futility in evolution. *Clin Geriatr Med* 2005;21:211-222.
53. Cantor MD, VHA National Ethics Committee. Do-not-resuscitate orders and medical futility. *Arch Intern Med* 2003;163:2689-2694.
54. Fine RL, May TW. Resolution of futility by due process: early experience with the Texas Advance Directives Act. *Ann Intern Med* 2003;138:743-746.
55. Gelb AW, Robertson KM. Anaesthetic management of the brain dead for organ donation. *Can J Anaesth* 1990;37:806-812.
56. Bell DD. Non-heart beating organ donation: old procurement strategy—new ethical problems. *J Med Ethics* 2003;29:176-181.
57. Robertson JA. The dead donor rule. *Hastings Center Report* 1991;29:6-14.
58. Van Norman GA. Another matter of life & death. *Anesthesiology* 2003;98:765-775.
59. Spencer GE. Children's competency to consent: an ethical dilemma. *J Child Health Care* 2000;4:117-122.
60. Informed consent, parental permission, and assent in pediatric practice. Committee on Bioethics, American Academy of Pediatrics. *Pediatrics* 1995;95:314-317.
61. Furrow BR, Greaney TL, Johnson SH, et al. *Health Law. Vol. 2, Sections 17-33 to 17-34.* St. Paul, MN: West Publishing, 1995.
62. Furrow BR, Greaney TL, Johnson SH, et al. *Health Law. Vol. 2, Sections 17-37 to 17-38.* St. Paul, MN: West Publishing, 1995.
63. Eichelberger MR, Randolph JG. Pediatric trauma: an algorithm for diagnosis and therapy. *J Trauma* 1983;23:91-97.
64. Kempe CH, Silverman FN, Steele BF, et al. The battered-child syndrome. *JAMA* 1962;181:17.
65. McNeese MC, Hebel JR. The abused child: a clinical approach to identification and management. *Clin Symp* 1977;29:35.
66. Kempe CH. Sexual abuse, another hidden pediatric problem: The 1977 C. Anderson Alrich Lecture. *Pediatrics* 1978;62:283.

# CHAPTER 96

## Substance Dependence and Abuse in Anesthesia Care Providers

Raymond C. Roy, PhD, MD

*...there is always soma, delicious soma, half a gramme for a half-holiday, a gramme for a weekend...A gramme is better than a damn...I wish I had my soma.*

Aldous Huxley

*Brave New World*, 1932

### SUBSTANCE ABUSE: A NATIONAL PROBLEM

The United States manifests a significant ambivalence toward drugs. While the federal government wages war against the illicit drug industry and organized medicine campaigns against the nonmedical use of prescription drugs, the entertainment and advertising industries, in the spirit of Lieutenant Milo Minderbinder in Joseph Heller's *Catch-22*, bombard its citizens daily with prodrug references. Lyrics from Toby Keith's popular country music song "Get Drunk and Be Somebody" reflect a common mantra:

*All week long, we're real nobodies,  
But we just punched out: it's paycheck Friday.*

*Weekend's here, good God Almighty:  
People, let's get drunk an' be somebody*  
Toby Keith, Get Drunk and Be Somebody

*White Trash with Money*, 2006

Comedians receive knowing laughs and applause from their audiences when they reference or parody recreational drug use. Television, Internet, and movie advertisements suggest that life is more enjoyable in social settings involving alcohol and more manageable with medications ("Ask your doctor if this medication is right for you."). Helping people who misuse drugs to "pass" drug tests also is a big business. For example, if "urine luck"

is entered into an Internet search engine, almost two million citations are offered. Physicians and major pharmaceutical companies tout the benefit of medications to relieve pain. Anesthesia providers make their living daily demonstrating that drugs of high abuse potential can be safely administered. Even a brochure for the Wood Library Museum of Anesthesiology proclaims "Thank Goodness They Inhaled." Drug and alcohol misuse is commonly associated with youthful experimentation. However, misuse also is triggered by internal and external pressures to improve self-confidence and performance on the athletic field, in the classroom, on competitive examinations, in the workplace, and in the bedroom, to achieve a better body image, to feel more comfortable socially, to cope with the stresses of highly competitive work and study environments, and to escape from dysfunctional social relationships and unsatisfactory living situations. College students call this "pharming."<sup>1</sup>

The economic costs of drug misuse are staggering. If healthcare, law enforcement, prosecution, incarceration, and loss of productivity are taken into account, the annual cost associated with drug misuse, excluding nicotine and caffeine, is \$465 billion, an amount greater than that linked to heart disease (\$290 billion), cancer (\$187 billion), or obesity (\$123 billion).<sup>2</sup> From the perspective of a private insurer, the annual direct cost of healthcare for patients with claims associated with codes for opioid abuse in the *International Classification of Diseases, Ninth Revision, Clinical Modification* (ICD-9-CM; copyright by the

World Health Organization in 1999) is more than eight times higher than for patients without such claims: \$15,884 versus \$1830. The higher costs are driven by a greater prevalence of costly comorbidities, such as nonopioid poisoning, hepatitis, psychiatric illnesses (especially depression), AIDS, and pancreatitis, increased utilization of the emergency room and in-patient services, and a greater number of drug prescriptions.<sup>3</sup>

The number of people who misuse drugs is staggering. According to the 2003 National Survey on Drug Use and Health sponsored by the Substance Abuse and Mental Health Services Administration (SAMHSA), 9.1% of the population of the United States over the age of 12 years, an estimated 21.6 million people, has a substance misuse disorder.<sup>2</sup> Substance misuse disorders run the gamut from smoking marijuana to driving under the influence to chemical dependency. According to the National Institute of Mental Health National Comorbidity Survey Replication (NCS-R), the prevalence of substance misuse disorders in the U.S. English-speaking population is 14.6%.<sup>4</sup> Of the 47,403 nonfederally employed physicians licensed since 1980 in the state of Florida 3604 (7.6%) had a substance misuse disorder serious enough to require treatment monitored by the Florida Professionals Resource Network, a physicians health program (PHP).<sup>5</sup> A PHP is an impaired provider program recognized by the state medical board as the primary agency to monitor compliance with substance abuse treatment programs and fitness to retain a license to practice medicine.

### KEY POINTS

1. The incidence of opioid abuse among anesthesia trainees is 1%.
2. Addiction is a treatable chronic, relapsing disease.
3. Vulnerability to addiction has a genetic component.
4. Seventy-five percent of addicts declare themselves by age 27 years.
5. Most addicts have psychiatric comorbidities.
6. The addicted brain is a reorganized brain.
7. The key to detection of dependence is recognition of subtle changes in behavior and performance.
8. Interventions must be carefully researched, planned, and rehearsed.
9. The earlier the intervention, the greater the chance for successful treatment.
10. Improvements in the treatment of addiction have reduced relapse rates.
11. Reentry requires a contract between the dependent colleague and the employer.



When reading the literature, it is important not to confuse the terms *incidence* and *prevalence* and to be clear whether the terms refer to misuse, abuse, chemical dependence, or addiction (defined later in the chapter). *Incidence* refers to the number of persons who develop or are recognized to have a medical condition, such as chemical dependence, within a given, usually shorter, period of observation (e.g., the duration of a training program). *Prevalence* refers to the total number of persons who have a condition for a longer period of time, such as a professional lifetime. Because chemical dependence now is viewed as a lifelong relapsing disease, its prevalence includes those who have undergone successful treatment and reentry and are drug free but not those who have died as a consequence of their addiction. Prevalence is always greater than incidence.

If the incidence and lifetime prevalence for physicians is the same as it is for society as a whole, then 9.1% of physicians are wrestling with substance misuse issues at any given time, and 14.6% at sometime during their career will have a problem with drug misuse, abuse, dependence, or addiction. An argument can be made that the incidence and prevalence among physicians is less than for society as a whole. Because 50% and 75% of addicts declare themselves by age 27 years,<sup>4</sup> they may be less likely to enter or complete medical training. Supporting this premise is a 1992 study that determined the lifetime prevalence of substance abuse among all physicians, regardless of specialty, to be 7.9%, which is lower than the 14.6% for the population in general.<sup>6</sup> However, there should be no solace in the possible lower prevalence among physicians. Even accepting this lower prevalence, the lives of thousands of physicians are adversely affected by this affliction, more than 3600 in the state of Florida alone since 1980.<sup>5</sup> Although the incidence of substance abuse is greater than the incidence of malignant hyperthermia, prolonged QT syndrome, aortic stenosis, untreated hyperthyroidism, or a host of other medical conditions about which anesthesia providers are rightfully concerned, most anesthesia texts, training curricula, and continuing medical education (CME) meeting programs give it far less content exposure.

## SUBSTANCE ABUSE AMONG ANESTHESIA PROVIDERS

There are no solid data for the incidence or prevalence of substance misuse or abuse specific to anesthesia providers. However, there are reasonable data for the incidence of chemical dependence specific to anesthesia residents and student registered nurse anesthetists (SRNAs): between 1% and 2% for the 2–3 years specifically involved in anesthesia training when alcohol and marijuana are excluded.<sup>7</sup> In the most recent survey of 169 anesthesiology residency programs active in 2001, 111 responded. Eighty percent of these programs reported at least one chemically dependent resident from their respective program between 1991 and 2001, with an average of 2.1 residents per program over the decade studied. Fatality before intervention was reported by 19% of the programs.<sup>8</sup>

Anesthesiologists are consistently overrepresented in analyses of data from PHPs.<sup>9</sup> In the previously cited Florida survey, more anesthesiologists are in treatment than would be predicted by their representation in the total physician workforce: 12% versus 4.7%.<sup>5</sup> It is tempting to say that there are four obvious explanations for this finding. (1) Drug abusers seek opportunities. Substance-abusing medical trainees and professionals seek to practice anesthesia in order to gain access to opioids and other anesthesia drugs for abuse. (2) Opportunity creates abusers. Anesthesia providers have a greater risk for becoming addicted than other physicians because they have ready access to drugs that they personally can either administer to patients or divert for their own abuse. (3) The stress of administering anesthesia can become overwhelming. Susceptible anesthesia providers seek relief from the pressure of administering drugs every day, which can lead to patient death or injury. (4) Environment creates abusers. Chronic inhalation of trace amounts of anesthetic drugs in the operating room increases the susceptibility to abuse. Even though each of these hypotheses has face validity, no studies specifically designed to test the first three have been performed. Gold et al.,<sup>10</sup> exploring the fourth environmental hypothesis, propose that “second-hand” exposure may produce changes in the brain that pre-

dispose susceptible anesthesia providers to chemical dependence. They have detected propofol and fentanyl in air sampled from cardiac surgery operating rooms. The highest concentrations were in samples from air around the patient's head.<sup>10</sup>

Many people have jumped to the conclusion that anesthesiologists have a greater problem with substance abuse than other physicians based on their greater relative enrollment in PHPs. There are several strong reasons not to do so *at this time*. First, the percent enrollment in PHPs has not been verified as a valid cross-sectional sample for addicted physicians. The percent of individuals enrolled in treatment programs is less than those who need such treatment. The cumulative lifetime probability of patients with substance abuse disorders receiving any treatment is 52.7–76.9%.<sup>11</sup> Second, the effect of the drug abused on admission to an PHP has not been well studied. Anesthesia providers could have the same lifetime prevalence of substance misuse disorders as other medical practitioners, but the time span over which they are diagnosed and treated may be compressed into a younger age range. This proposed compression effect would occur because they are more likely to abuse drugs with a higher addictive potential (e.g., fentanyl versus alcohol). Third, the effect of the preferred drug of abuse (e.g., opioids versus alcohol) on peer assistance and the legal pressure to enroll in treatment programs has not been well studied. Alcohol is a legal substance, is socially acceptable if consumed without causing intoxication, and is legally acceptable if blood alcohol levels while driving are below a certain threshold. Persons who abuse alcohol may seek counseling but enroll in surveyed treatment programs only if they become dependent. “An estimated 8 million adults in the United States have alcohol dependence. Of this number, only a minority ever receive treatment for the disorder, even when treatment is defined broadly to include participation in Alcoholics Anonymous.”<sup>12</sup> Fourth, the effect of the diagnosis of abuse versus dependence, made according to the *Diagnostic and Statistical Manual of Mental Disorders, Fourth Edition, Text Revision* (DSM-IV-TR; published by the American Psychiatric Association in 2000), is not taken into account in most of these

analyses. Colleagues with a dependence on drugs may not demonstrate behavior associated with abuse, such as hazardous use, irresponsibility in their social or work roles, or legal problems. In the National Epidemiologic Survey on Alcohol and Related Conditions (NESARC), which included 42,392 respondents, 22% of those who met the DSM-IV-TR definition of drug dependence did not meet the DSM-IV-TR definition of drug abuse (Table 96-1).<sup>13,14</sup> It is possible that a high percentage of dependent individuals who avoid behaviors associated with abuse may escape detection and not be enrolled in PHPs. Fifth, the effectiveness of specialty-dependent substance abuse awareness efforts has

not been determined. Educational initiatives have not reduced the incidence in training programs over the last 3 decades, perhaps because most of the trainees who manifest their chemical dependence during training actually develop addictive behavior prior to the start of their residency. But awareness programs may have increased the detection and intervention rates for anesthesiologists more than for other physicians with substance misuse disorders.

## SUBSTANCE MISUSE TERMINOLOGY

Terms associated with appropriate drug use include tolerance, physical dependence, and withdrawal. Each represents normal physiologic adaptations seen in all patients after repeated administration of certain drugs. Although these terms also apply to drug misuse syndromes, they should not automatically imply substance abuse, substance dependence, or addiction. The American Academy of Pain Medicine (AAPM), the American Pain Society (APS), and the American Society of Addiction Medicine (ASAM) issued a consensus document in 2001 defining physical dependence and tolerance.<sup>15</sup> "Tolerance is a state of adaptation in which exposure to a drug induces changes that result in a diminution of one or more of the drug's effect over time." Either a given dose of a drug yields a decreased effect after repetitive administration, or an increasingly larger dose of the drug is required to produce an effect of intensity comparable to the first dose. "Physical dependence is a state of adaptation that is manifested by a drug class specific withdrawal syndrome that can be produced by abrupt cessation, rapid dose reduction, decreasing blood level of the drug, and/or administration of an antagonist." Although withdrawal signs and symptoms tend to be associated with the discontinuance of opioids, they can be seen in other categories of drugs, such as clonidine and  $\beta$ -adrenergic blocking agents. All chronic pain patients who are treated with opioids develop tolerance and physical dependence.

The five terms associated with inappropriate drug use are abuse, intoxication, dependence, withdrawal, and addiction. Note that dependence and

withdrawal are terms associated with both appropriate and inappropriate drug use. Addiction is not a term used in the DSM-IV-TR or the ICD-10. These two systems classify all substance misuse disorders with the terms abuse, intoxication, withdrawal, and dependence. The 2001 AAPM, APS, and ASAM consensus statement defines addiction as "a primary, chronic, neurobiologic disease, with genetic, psychosocial, and environmental factors influencing its development and manifestations. It is characterized by behaviors that include one or more of the following: impaired control over drug use, compulsive use, continued use despite harm, and craving."<sup>15</sup> Similarly, the National Institute on Drug Abuse (NIDA) defines addiction as "a chronic, relapsing disease characterized by compulsive drug seeking and use, despite harmful consequences, and by neurochemical and molecular changes in the brain."<sup>16</sup> NIDA and the National Institute on Alcohol Abuse and Alcoholism (NIAAA) differentiate dependence and addiction as follows. "Physical dependence refers to adaptations that result in withdrawal symptoms when drugs such as alcohol and heroin are discontinued. Those are distinct from the adaptations that result in addiction, which refers to the loss of control over the intense urges to take the drug even at the expense of adverse consequences."<sup>17</sup> A person moves from misuse to abuse to addiction when craving, drug seeking, and compulsive use dominate his or her life and behavior.

Pseudoaddiction is a diagnosis made in chronic pain patients who develop drug-seeking behaviors because their pain is inadequately treated.<sup>18</sup> The diagnosis requires four conditions: (1) an appropriately diagnosed and documented pain condition; (2) inadequate pain treatment unrecognized by the medical staff; (3) analgesia-seeking behavior misinterpreted by the medical staff as inappropriate non-pain-related drug seeking; and (4) resolution of drug-seeking behavior when sufficient analgesia is provided. If the drug seeking is not pain related, then the diagnosis becomes either substance (opioid) abuse or dependence.

All substance-related disorders involve adverse social, behavioral, psychological, and physiologic effects caused by seeking, ingesting, injecting, or inhaling an abused substance.

**TABLE 96-1.**

### Outline of Substance-Related Disorders: DSM-IV-TR General Criteria

- I. Intoxication: Reversible substance-specific syndrome
- II. Abuse
  - A. Recurrent use associated with  $\geq 1$  of the following within 12 months:
    1. Failure to fulfill major role obligations at work, school, or home
    2. Use in hazardous situations
    3. Use-related legal problems
    4. Use despite recurrent social or interpersonal problems caused or exacerbated by effects of intoxication
  - B. Symptoms have never met criteria for substance dependence for this substance class
- III. Dependence: Recurrent use with  $\geq 3$  of the following manifestations:
  - A. Tolerance
  - B. Self-treatment to relieve or avoid withdrawal symptoms
  - C. Overdoses
  - D. Persistent unsuccessful efforts to stop
  - E. High percent of time devoted to drug acquisition, use, recovery
  - F. Reduction in social, occupational, or recreational activities in order to use
  - G. Use despite acknowledging threat to physical or mental health

Data from Fauman.<sup>13</sup>

The DSM-IV-TR recognizes 12 classes of these substances: (1) alcohol, (2) inhalants, (3) amphetamines, (4) nicotine, (5) caffeine, (6) opioids, (7) cannabis, (8) phencyclidine, (9) cocaine, (10) sedatives, hypnotics, or anxiolytics, (11) hallucinogens, and (12) other or unknown substances.<sup>13</sup> These abused substances have different molecular structures, different sites and mechanisms of action, and different physiologic effects. However, they all initiate a common series of adaptations that will, with repeated use, evolve to the brain lesion associated with addiction, starting with an increase in dopaminergic activity in the nucleus accumbens core (NAc).<sup>19,20</sup>

Although the terms narcotic, opiate, and opioid are frequently used interchangeably, *opioid* actually refers to any agent that binds to opioid receptors. There are four classes of opioids: (1) endogenous peptides, such as endorphins, enkephalins, and dynorphins; (2) opiates, such as morphine and codeine, which are naturally occurring alkaloids derived from the opium poppy (*Papaver somniferum*); (3) semisynthetic derivatives of opiates, such as heroin, hydrocodone, hydromorphone, oxycodone, and oxymorphone; and (4) synthetic drugs, such as meperidine, methadone, fentanyl, sufentanil, alfentanil, remifentanyl, butorphanol, nalbuphine, and buprenorphine. *Narcotic* is a general term that refers to substances that induce a sleep state or narcosis. Before the 20<sup>th</sup> century, opium was used to create a “daydreaming” state of drowsiness rather than the “high” or “rush” now sought from heroin, cocaine, and methamphetamine. Thus, the term narcotic was more appropriate then than now. Narcotic is also a legal term that applies to drugs identified in the Harrison Narcotics Tax Act of 1914, the Controlled Substances Act of 1970, and the United Nations Single Convention on Narcotic Drugs of 1961. Cannabis, cocaine, and methamphetamine are referred to as narcotics even though they are not opioids.

## TRADITIONAL VIEWS OF ADDICTION

In their 1993 review of opioid addiction among anesthesiologists in *Anesthesiology*, Silverstein et al.<sup>21</sup> made several key points (Table 96–2). Ten of

these points are discussed in a more current context. First, addiction is a disease. In 1956, the American Medical Association (AMA) declared that alcoholism met the definition of a disease. In 1987, the AMA extended disease status to dependence on any drug of abuse. In doing so it recognized that dependence and addiction satisfy all the criteria for a disease: (1) identified vector—the drug of abuse; (2) typical signs and symptoms; (3) predictable natural course; and (4) recommended treatments. The early editions of the DSM from the 1950s regarded alcoholism and drug abuse as sociopathic personality disturbances. In the DSM-III, published in 1987, and in all subsequent editions, substance misuse disorders were reclassified as axis 1, or clinical disorders, as opposed to axis 2, 3, 4, or 5 disorders, which include personality disorders, general medical conditions, psychosocial, and environmental problems.

Three questions must be answered in sequence before any disorder is assigned a DSM code.<sup>13</sup> Is the disorder due to the direct effects of a substance? Is the disorder due to the direct effects of a medical condition? Does the disorder

cause significant distress or impaired function? Thus, all medical professionals should be programmed to consider substance use or abuse first as an explanation for any abnormal behavior or physical complaints. However, few primary care physicians screen for alcohol or drug dependence during routine examinations.<sup>22</sup> The value of preoperative screening for alcohol or drug dependence in select patients has not been established. The success of preemployment, recertification, random, or suspicion-based drug screening programs to identify anesthesia providers with substance misuse problems are limited at best.<sup>23</sup>

Second, the pathogenesis of chemical dependence and addiction was unclear in 1993. It was known that drugs of abuse increased the amount of dopamine released in the reward center of the brain. However, this observation was viewed more as an end point to explain why people “enjoyed” the drug rather than a starting point for the “hard wiring” of neural pathways that leads to cravings for drugs, compulsive drug acquisition behavior, and loss of the ability to “just say no.” Although the public was still locked into the view of addiction as a character flaw, physicians were moving closer to accepting the disease model for addiction. But even physicians tended to view addiction more like an acute illness with typical signs and symptoms associated with the self-limited states of intoxication and withdrawal rather than a chronic condition with signs and symptoms of drug craving and compulsive drug use. A popular misconception was that once detoxification and withdrawal were complete, that is, the drug was completely eliminated from the body, the illness was successfully treated. Now all the patient had to do was use will power to prevent a reoccurrence. Before more physicians would accept the concept of addiction as a chronic disease, they needed both the identification of an actual brain lesion and medications specific for treatment of addiction. A brain lesion has now been identified, and specific medical therapies are emerging (see Pathophysiology of Addiction and Treatment of Opioid Addiction).

Third, the inability of the addict to initiate the request for help is one of the hallmarks of the addictive process. In the early stages of addiction, denial can be defined as a failure to recognize

**TABLE 96–2.**

### Traditional Views of Addiction: Key Points from Silverstein et al.<sup>21</sup>

1. Alcohol and drug dependence are diseases, not character flaws.
2. The pathogenesis of chemical dependence is incompletely understood.
3. Denial is a major system of the disease.
4. Significant behavioral changes are associated with addiction.
5. Federal laws create mandates for healthcare employers regarding substance abuse.
6. The Americans with Disabilities Act provides limited protection to addicts in treatment.
7. Impaired Provider Programs provide rehabilitation safety nets for physicians.
8. Intervention requires evidence and preparation.
9. Reentry for selected individuals requires written contracts.
10. Drug testing must be performed under the auspices of medical review officer.

Data from Silverstein et al.<sup>21</sup>



the problem or to accept the inability to control the problem. There are two sides to the denial problem: denial by the sufferer of his or her illness, and denial by those close to the chemically dependent individual of any responsibility to recognize and address suspicious behavior. It is uncommon for the drug-dependent individual to seek help on his or her own volition. Varying degrees and types of pressure must be exerted by relatives, colleagues, or employers to achieve “voluntary” enrollment in treatment programs. Attempts to create statutory mandates for healthcare workers to report colleagues suspected of substance abuse to state medical or nursing boards or professional societies, with immunity for reporting and with disciplinary action for failing to report, have been difficult to codify or enforce. In later stages of addiction, the definition of denial changes. The addict knows and may freely admit he or she has an addiction. But the cravings and compulsion are too strong to resist. Here denial is defined as a perversion of “just saying no.” The “no” is not to drugs but to abstinence.

Fourth, significant behavioral changes are associated with addiction. Recognition of chemical dependence in a colleague occurs when an index of suspicion reaches a threshold that demands investigation. This threshold varies from one observer to another. It should be lowest among those with the longest and closest contact and highest among those with infrequent or casual contact because the key is recognizing changes in behavior. Most dependent anesthesia providers are clever enough to avoid manifesting signs of intoxication and withdrawal at work. It is common for dependent providers to come early to work to acquire and inject opioids, not to achieve a “high” but to control withdrawal symptoms. They strive to protect their jobs to protect their sources of drugs. Behavior changes associated with addiction can be divided into five categories: (1) drug acquisition, (2) withdrawal symptom control, (3) disguising or covering injection sites, (4) gradual elimination of nondrug acquisition activities, and (5) psychiatric comorbidities, especially depression. Behavioral changes should be noticed first by family members in the same household, but they also are the most likely to exhibit denial because of fear of consequenc-

es, shame, or just hope of some quiet resolution. Unfortunately, many of the behavioral changes are similar to, and mistaken for, those associated with stress and sleep deprivation.

Fifth, the Health Care Quality Improvement Act (HCQIA) of 1986, the Drug-Free Work Place Act (DFA) of 1988, and the Drug-Free Schools and Communities Act Amendments (DRFSCA) of 1989 require medical societies, licensing boards, healthcare organizations, and training programs to address substance abuse in the workplace and on campus. The HCQIA mandates the following: (1) establishment of the National Practitioner Data Bank (NPDB), which opened in 1990, as a central repository for adverse actions taken against physicians with regard to restriction, suspension, or withdrawal of privileges or licensure, professional conduct, or malpractice decisions; (2) mandatory reporting of adverse actions to the NPDB by institutions; (3) mandatory query by institutions of the NPDB prior to granting or renewing licenses privileges; and (4) immunity to the reporting individuals or organizations. The DFA and DRFSCA stipulate that entities which are recipients of federal grants and contracts must provide a drug-free workplace as a necessary condition for receiving these funds. Most large hospitals and all academic medical centers must comply. The DFA does not apply to Medicare third-party reimbursements. The seven actions required by the DFA (Table 96-3) are the same actions any anesthesia group should consider taking. In 1992, the American Hospital Association recommended that all healthcare institutions adopt a policy that mandates preemployment drug screening, for-cause testing, and postaccident testing.

Entry into drug rehabilitation may not require reporting to the NPDB,<sup>12</sup> but several big “ifs” must be satisfied: (1) if no patient is placed at risk or harmed by drug-influenced behavior; (2) if no hospital privileges are suspended; (3) if no license is suspended or revoked; (4) if the employer is “sympathetic”; (5) if the investigation, intervention, rehabilitation, and reentry are carried out through an employee assistance program and a PHP approved by the state medical board; and (6) if the employee “voluntarily” agrees to enroll in a detoxification and rehabilitation program.

The DRFSCA requires “(1) the annual distribution to each student and employee of – (A) standards of conduct that clearly prohibit, at a minimum, the unlawful possession, use, or distribution of illicit drugs and alcohol by students and employees on its property or as part of any of its activities; (B) a description of the applicable legal sanctions under local, State, or Federal law for the unlawful possession or distribution of illicit drugs and alcohol; (C) a description of health risks associated with the use of illicit drugs and alcohol; (D) a description of any drug or alcohol counseling, treatment, or rehabilitation or reentry programs that are available to employees or students; and (E) a clear statement that the institution will impose sanctions on students and employees (consistent with local, State, and Federal law), and a description of those sanctions, up to and including expulsion or termination of employment and referral for prosecution, for violations of the standards of conduct required by paragraph (1)(A); and (2) a biennial review by the institution of its program to – (A) determine its effectiveness and implement changes to the program if they are needed; and (B) ensure that the sanctions required by paragraph(1)(E) are consistently enforced.”<sup>24</sup>

**TABLE 96-3.**

**Institutional Actions Mandated by the Drug-Free Work Place Act of 1988**

1. Publish declaration that institution will comply with act.
2. Establish drug-free awareness program with 3 components:
  - A. Education regarding dangers of drugs
  - B. Counseling, rehabilitation, and employee assistance
  - C. Policy and procedures
3. Create a substance abuse policy.
4. Require compliance with substance abuse policy as condition for employment.
5. Notify appropriate federal agencies of drug-related offense by employee.
6. Take disciplinary action or require rehabilitation when drug-related offense occurs.
7. Document efforts to maintain drug-free workplace.



TABLE 96-4.

## Americans with Disability Act of 1992 (ADA)

**Exempted from ADA Protection****Employers:**

- With <15 employees working  $\geq$  20 weeks during calendar year for whom allowing dependent employee to return to work creates
  - Undue hardship
    - Accommodations too onerous
    - Cost of monitoring for relapse too high
  - Direct threat to health and safety of others if relapse
    - Cannot be eliminated by reasonable accommodation
    - Can be construed from history plus opportunity
      - Little supervision plus drug availability

**Employees who:**

- Currently use illicit drugs
- Currently use licit drugs illegally, e.g., abusing prescription drugs
- Directly violate company policy
  - Under the influence of a drug while on the job

**Protection by ADA is Accorded Employees Who Are:****Qualified to do the job if not abusing drugs**

- Able to perform essential functions of their job
  - Without accommodation, or
  - With reasonable accommodations
- Maintain same performance standards as nondependent employees
- Are not a direct threat to health and safety if relapse

**Abstinent**

- Determined by monitoring program

**Dependent**

- Currently in employee assistance program or physicians health program sponsored or approved treatment program
- Rehabilitated

**Disabled, i.e., otherwise unable to work because of history of dependence**

- Disability is an impairment limiting a major life activity
- Working may be defined as a major life activity
  - Not yet recognized by U.S. Supreme Court
  - Recognized by lower courts

Data from Meyer.<sup>25</sup>

Sixth, the Americans with Disabilities Act (ADA) of 1992 defines a history of drug dependence as a disability and provides limited protection to qualified individuals as described in Table 96-4 who satisfy three criteria: (1) documented participation in or graduation from a rehabilitation program; (2) documented participation in an active monitoring program, including drug testing; and (3) abstinence. An employer is not required to make an accommodation if it creates undue hardship. The terms “qualified individual” and “undue hardship” are very subjective. The intentions of the HCQIA, DFA, and DRFSCA frequently collide with the intentions of the ADA. The concern for patient safety or institutional liability has more

legal support than the responsibility for the health of the employee disabled by chemical dependency.<sup>25</sup> It still is not clear “at what point does the safety of a third party takes priority over accommodating an employee with a chemical dependency disability. Chemical dependency disabilities enjoy less protection than other disabilities under the ADA, and policies prohibiting such workers from safety-sensitive positions have been upheld as a business necessity in other circuits... Whether such an expansive policy of prohibiting all workers with chemical dependencies from treating patients would be accepted remains to be seen. Therefore, until the ADA [is] clarified through either further legislation or judicial interpretation, hospi-

tals and employers remain in the untenable position of weighing the risk of tort liability for accidents resulting from a relapsed employee versus the risk of discrimination liability under the ADA.”<sup>25</sup>

Seventh, most states have established PHPs to help physicians confidentially work through substance dependence problems, manage their treatment, monitor their remission, and reenter the workforce. Intervention with the goal of detoxification, treatment, and monitored reentry into the workforce is called *diversion*. Cooperation between the state medical boards and the PHPs is essential to enable the practitioner with a problem to walk the bureaucratic tightrope between confidentiality and ability to return to work versus public safety issues and loss of ability to practice medicine. These programs have a common purpose but a variety of names, such as the California Diversion Program, the Florida Professionals Resource Network, the Idaho Physicians Recovery Network, the Kentucky Physicians Health Foundation, the Montana Professional Assistance Program, the New Mexico Monitored Treatment Programs, the North Carolina Physicians Health Program, the Ohio Physicians Effectiveness Program, the Oklahoma Professionals Recovery Program, the South Carolina Physicians’ Advocacy and Assistance Committee, the Utah Recovery Assistance Program, and the Virginia Health Practitioners Intervention Program, to name a few. Unfortunately, the protection afforded by PHPs tends not to extend to certified registered nurse anesthetists (CRNAs).<sup>26</sup>

Eighth, it is the goal of all substance awareness efforts to intervene as early as possible on a colleague’s substance misuse/abuse-dependency-addiction pathway so that he or she will have the best chance for disease control and reentry into the workforce. Intervention is an “advocacy-oriented” confrontation of a colleague whose behavior has suggested that he or she *may* have a problem with chemical dependence.<sup>21</sup> Its goal is to convince a colleague with documented detrimental changes in behavior to voluntarily enter an evaluation program. Treating a colleague for apparent signs of intoxication, side effects of the abused drug or its adulterants, or withdrawal and resuscitating a colleague from an over-

dose are acute emergency medical treatments. These actions are not included in the scope of the term *intervention*, although they should trigger a subsequent intervention. More commonly intervention is required in the absence of these medical issues. It is divided into three phases: (1) investigation of suspicious behavior, (2) preparation of a plan for confronting the suspect, and (3) the confrontation itself. These phases are discussed later in the chapter (see Intervention on Colleague Misusing Drugs). Each phase of intervention should be conducted with the assistance of specifically trained personnel who are not members of the anesthesia department. Intervention does not include diagnosis or treatment. It is important to remember that most interventions are prompted by documented observations of inappropriate behavior, which could have many causes, and not the witness of actual drug administration.

Ninth, reentry is controversial because of the tension among patient safety, perceived protection of the ADA, and degree of employer tolerance with regard to relapse. Sympathetic employers and groups, who hold the door open for colleagues to come back to work if their substance abuse problems manifest after they have been hired, insist that returning anesthesiologists, CRNAs, and anesthesia assistants (AAs) not only remain drug free but also take aversive or antagonist drugs (e.g., naltrexone) if opiates or alcohol were the substances abused. Colleagues enrolled in methadone maintenance programs are not permitted reentry as anesthesia providers. As more experience with buprenorphine maintenance programs accumulates, it is plausible to suggest that opioid-dependent anesthesia providers may be able to reenter if they faithfully take the buprenorphine–naltrexone combination. Whether anesthesia providers being treated with opioids for chronic pain syndromes are allowed to practice currently depends on the group and is handled locally on a case-by-case basis. Of concern in this setting is the observation that when chronic pain patients are screened for signs of abuse using urine testing and behavioral monitoring, 20–50% provided urine samples positive for illicit drugs, demonstrated addictive behavior, or both.<sup>27,28</sup> Reentry should involve a work reentry contract stipulating what is expected of the reentering individual by the employer and

what the reentering individual should expect from the employer if he or she meets the contractual obligations. Becoming increasingly common are *last chance agreements*, which clearly describe how substance abuse has affected the employee's performance in the past, how the employee's performance has put the employer at risk, what is expected of the employee if employment is to continue, and what the employee can expect if his or her performance does not meet expectations.

Tenth, most people think testing for drugs is straightforward. Nothing could be farther from the truth. It is so complex from physiologic, pharmacologic, analytical, sampling, legal, economic, and outcomes perspectives that all hospitals are required to have a specially trained medical review officer who is a physician accountable for the integrity of the sampling, testing, and interpretation processes.<sup>21,23,29</sup> Four general indications for drug testing, in order of increasing required specificity, are (1) emergency screening to facilitate treatment of suspected overdose, (2) nonurgent screening, (3) monitoring for abstinence during rehabilitation or for compliance during methadone maintenance, and (4) diagnostic testing following up on a positive result from nonurgent drug screening. The highest specificity is required for diagnostic testing to avoid the consequences of false-positive results. Not only must the laboratory test for drugs of abuse, it also must test for adulteration of the sample by the substance abuser whose goal is a false-negative result. Finally, although a positive drug test may permit a definitive decision on hiring or firing or compliance versus noncompliance, reliance on a positive drug test will miss a high percentage of noncompliance with treatment or rehabilitation programs or substance abuse, and vice versa. Drug testing must be combined with behavioral assessment to meet the goals of any monitoring program.<sup>21,27,28</sup>

## NEW PERSPECTIVES OF ADDICTION

Since the 1993 review by Silverstein et al.,<sup>21</sup> 10 major advances in the understanding and treatment of substance misuse disorders have been made (Table 96–5). First, both NIDA and NIAAA, which are members of the

TABLE 96–5.

### New Perspectives of Addiction

1. Treatment success improves if addiction is treated as a chronic relapsing disease.
2. Drug relapse in addicted colleagues is not voluntary.
3. Characteristic irreversible changes in the brain are associated with addiction.
4. Dopamine and glutamate are the major neurotransmitters involved in addiction.
5. Vulnerability to addiction has a strong genetic component.
6. Addiction is a developmental disorder.
7. Addicted colleagues have high prevalence of psychiatric comorbidities.
8. Polypharmacy is common for control of withdrawal symptoms.
9. Buprenorphine is the approved drug for office-based treatment of addiction.
10. The Joint Commission on Accreditation of Health Care Organizations and the American Board of Anesthesiology support the Americans with Disabilities Act.

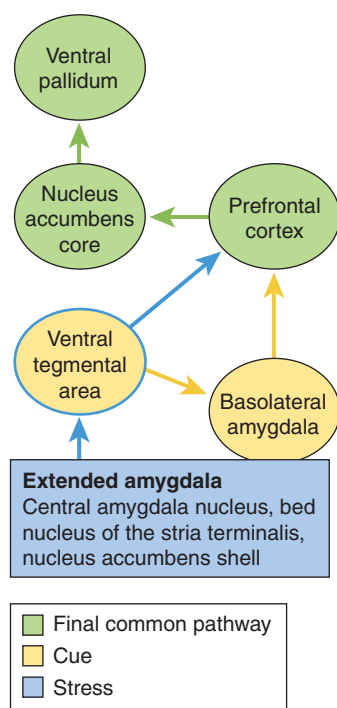
National Institutes of Health (NIH), now promote the concept that addiction is a disease with severity based on DSM-IV-TR and ICD-9-CM definitions of dependence and abuse. NIDA and NIAAA clearly view addiction not as an acute disorder that resolves after withdrawal symptoms subside but as a chronic relapsing disease that must be managed, just like diabetes mellitus or coronary heart disease. However, many are still reluctant to view it as a chronic medical illness as evidenced by the following observation: "...relapse among patients with diabetes, hypertension, and asthma following cessation of treatment has been considered evidence of the effectiveness of those treatments and the need to retain patients in medical monitoring. In contrast, relapse to drug or alcohol use following discharge from addiction treatment has been considered evidence of treatment failure."<sup>22</sup> As post-detoxification treatments have expanded to include aggressive followup, use of anticraving drugs, and lifelong monitoring, treatment success has improved. The discouraging data from

more than a decade ago regarding unsuccessful reentry need to be replaced with more optimistic data from recent efforts.<sup>9</sup>

Second, the addict craves, seeks, or uses drugs involuntarily.<sup>30–32</sup> What starts out as voluntary substance misuse (“*Just say no*”) concludes as either a lifelong management of craving (“*Can’t say no*”) if successful intervention occurs in the early phase of addiction or involuntary compulsive behavior with multiple unsuccessful interventions in the late phase of addiction. Changes in the brain either predispose or force the abstinent chemically dependent individual to relapse. Thus, relapse must be considered part of the disease. Treatments now are being aimed toward controlling craving and compulsive drug-seeking behavior.<sup>33</sup>

Third, sustained drug abuse leads to irreversible changes in the brain. Positron emission tomography (PET) and functional magnetic resonance imaging studies in nonusers, recreational drug users, and addicts have identified five key areas in the brain where changes associated with addiction take place: the ventral tegmental area (VTA) in the midbrain; the nucleus accumbens core (NAc), amygdala (AMG), and dorsal striatum (DSt) in the forebrain; and in the prefrontal cortex (PFC), the orbitofrontal cortex. The initial drug experience in the nonaddicted brain involves dopaminergic projections from the VTA to the NAc. In the addicted brain, the drug experience involves dopaminergic projections to the DSt and glutamatergic projections from the PFC to the NAc.<sup>11–14,31–38</sup> Thus, a clear brain “lesion” is associated with the disease of addiction (Fig. 96–1).

Fourth, dopamine is no longer viewed as the mediator of pleasure but as the primary neurotransmitter for learning from experience what is pleasurable, aversive, novel, and predictable.<sup>32,34,38</sup> Initially, all experience and all drugs of abuse increase firing of dopaminergic neurons in the VTA. How the brain determines which experiences to seek and which to avoid is not clear. One theory is that a pleasurable experience increases the dopamine concentration in the NAc above one threshold; an aversive one, above an even higher threshold. The difference between the two thresholds depends on the density of dopamine D2 receptors or the ratio of D1 to D2 receptors. Eventually, cues that predict a pleasurable or aversive



**FIGURE 96–1.** Neural circuitry mediating the activation of goal-directed behavior. Kalivas PW, Volkow ND. The neural basis of addiction: a pathology of motivation and choice. *Am J Psychiatry* 2005;162:1403–1413. Reprinted with permission from the American Psychological Association.

experience or a drug high cause firing of these neurons rather than the actual experience or the drug itself. Finally, the specificity and sensitivity of these various cues as predictors of experience or drug availability are evaluated, and the dopamine firing pattern is changed.

Fifth, addiction has a strong genetic component, with up to 60% of the vulnerability attributed to either specific phenotypes or gene–environmental interactions.<sup>39,40</sup> Genes affect how an individual responds to drugs. Genes associated with addiction affect the expression of receptors, such as the  $\mu$ -opioid,  $\kappa$ -opioid, dopamine D2, D3, and D4, serotonin 1B and 2A,  $\gamma$ -aminobutyric acid (GABA receptor subunits  $\alpha_1$ ,  $\alpha_6$ , and  $\beta_1$ ), muscarinic  $M_2$ , and cannabinoid 1. Humans whose genotype includes the dopamine D2 receptor Taq1 A1 allele have a deficiency in dopamine D2 receptors. The absence or deficiency of this receptor is associated with an increased risk of addictive, compulsive, or impulsive behavior.<sup>39,40</sup> Genes associated with addiction affect the expression of enzymes that are involved in drug synthesis or metabolism, such as dopamine  $\beta$ -hydroxylase, tryptophan hydroxylase, monoamine oxidase A, catechol-O-methyltransferase, alcohol dehy-

drogenase, and cytochrome P450 (CYP). Not only do genes affect drug disposition and addiction vulnerability, but the reverse also is true. Drugs affect how genes are expressed, and this in turn affects the transcription, translation, and trafficking of proteins. It is in this area of research where the mechanisms of neural adaptations associated with addiction are being sought.<sup>41–43</sup> Environmental influences and drug availability determine whether genetically vulnerable individuals avoid addiction or genetically resistant individuals become addicted.

*Too often blame is laid on those with addictions as though they sought and intended to become addicted. Perhaps they made poor choices about drug use, but all too frequently the choice was made during adolescence or before.*

C. Everett Koop, MD, former United States Surgeon General

McGovern Lecture, Hanover, New Hampshire, May 1, 2003

Sixth, addiction may actually be a developmental disorder. The greater neuroplasticity in the immature adolescent brain makes it more vulnerable than the mature brain to the creation of neural circuits associated with addiction.<sup>44</sup> The average age of onset for substance use disorders is 20 years, with the range for 25<sup>th</sup> to 75<sup>th</sup> percentiles of 18 to 27 years and 5<sup>th</sup> to 95<sup>th</sup> percentiles of 15 to 41 years.<sup>4</sup> The median duration of delay between onset of abuse or dependency and first treatment contact is 5–9 years.<sup>11</sup> Thus, it is easy to hypothesize that most anesthesia trainees, who are diagnosed as chemically dependent on opioids during their training, either are so or meet the DSM-IV-TR criteria for abuse of a substance not typically used for anesthesia before they start their training. There is a strong positive correlation between the degree of impulsiveness and the age of the first alcohol or drug experience.<sup>45</sup> The seeds of addiction are frequently sown while the brain is still developing and before its defense mechanisms are in place. Maturation of the human PFC, the area of the brain that inhibits risky behavior, occurs around 25 years of age.<sup>46</sup> The length of time between the initial use of cocaine and the diagnosis of cocaine dependence is inversely proportional to the age of the first co-

caine experience.<sup>47</sup> The majority of addicts declare themselves during adolescence and early adulthood. NIAAA and NIDA now feel that if addictive behavior can be prevented in teenagers, the incidence and prevalence of chemical dependence for the entire population will be reduced dramatically.<sup>48,49</sup>

Seventh, an anesthesia provider who becomes chemically dependent on an anesthetic drug during or after his or her anesthesia training is very likely to have a significant psychiatric comorbidity, such as bipolar disorder, depression, anxiety disorder, attention deficit hyperactivity disorder, schizophrenia, or abuse or dependence on a nonanesthetic drug.<sup>9</sup> A preexisting DSM-IV-TR diagnosis of abuse or dependence on a nonanesthetic drug of abuse (e.g., alcohol, marijuana, cocaine, methamphetamine, or prescription drugs) may be the comorbidity most commonly associated with development of an addiction to an anesthetic drug.<sup>48</sup> Not all depressed individuals are or become substance abusers, but >50% of substance abusers become depressed.<sup>50</sup> This information may be useful in recognizing an endangered colleague and definitely important in establishing a therapeutic regimen.

Eighth, addicted individuals tend to abuse more than one drug. This observation is not new. But in the context of the first seven insights, the explanation for it is new. Most anesthesia providers develop their addiction to anesthetic drugs at an age that is beyond the age range associated with the primary addiction. They come into training with brain changes associated with early addiction as a consequence of abusing nonanesthetic drugs. They enter training with the comorbidity of drug abuse or dependence that has gone unrecognized in the recruiting process. There is also evidence that some of the polypharmacy associated with substance abuse is an effort to control withdrawal symptoms when the drugs of choice are not available. Anesthesia trainees have diverted potent inhaled agents, benzodiazepines, ketamine, and propofol for this purpose because they are not as tightly controlled in many operating rooms as are opioids. Hair analysis for drugs revealed this polypharmacy in anesthesiologists who displayed addictive or abusive behavior but had negative urine drug screens during interven-

tions. Hair that grows approximately 1 cm per month can provide an historic record of abuse.<sup>51</sup>

Ninth, the signing of the Drug Addiction Treatment Act of 2000 approved the treatment of addicted individuals with schedule III, IV, or V narcotic medications in an office-based setting as long as the drugs used are approved by the Food and Drug Administration (FDA) specifically for medically supervised tapering toward detoxification or for maintenance therapy, and the physicians involved received 8 hours of approved training.<sup>52</sup> This act amends the Harrison Narcotic Drug Act of 1914, which made it illegal for physicians to prescribe opioid medication for treatment of opioid dependence. The only approved exception was methadone dispensed through tightly regulated programs. In 2002, the FDA approved the use of buprenorphine, a schedule III partial  $\mu$ -opioid receptor agonist, alone or in combination with naltrexone. The purpose of naltrexone is to prevent the abuse of buprenorphine, not to block the effects of other opiates.

Tenth, both the Joint Commission on Accreditation of Health Care Organizations (JCAHO) and the American Board of Anesthesiology (ABA) support the intent of the ADA. The JCAHO now mandates that hospital medical staffs have “a process to identify and manage matters of individual health for licensed independent practitioners... The purpose of this process is to help with rehabilitation, rather than discipline, to aid a practitioner in retaining and regaining optimal professional functioning that is consistent with protection of patients.”<sup>53</sup> The ABA accepts into the examination system qualified applicants with a history of alcohol or illicit drug use if it receives “acceptable documentation” that “they do not pose a direct threat to the health and safety of others” and “are not currently engaged in the illegal use of drugs.” After a candidate for ABA certification satisfies the examination requirements, “the ABA will determine whether it should defer awarding its certification to the candidate for a period of time,” usually several years after the candidate enters a rehabilitation program, to assure a reasonable period of abstinence, monitored compliance with reentry contracts, and safe care of patients. The ABA receives notifications of ac-

tions by state medical boards from the Federation of State Medical Boards and “will initiate proceedings to revoke certification(s) of diplomates with a medical license that is revoked, suspended, or surrendered in lieu of revocation or suspension” because of substance abuse issues.<sup>54</sup>

The rest of this chapter follows the new evidence that most anesthesia residents, SRNAs, CRNAs, AAs, and anesthesiologists who become chemically dependent will have a strong history of risk taking or substance misuse prior to entering their training, that is, they will already have a history of binge drinking, disorderly behavior, reckless driving, arrests for driving under the influence, or recreational drug use, or they will have a psychiatric comorbidity that creates a vulnerability. Much of this information is not available to recruitment committees. Fortunately, not everyone with this background becomes an addict, but between 10% and 20% of individuals move from abuse to dependence.<sup>55</sup> But those who do already have some of the brain changes to be discussed. Thus, the focus will be on the behavior of a chemically dependent colleague in the workplace and not on acute intoxication, which most often occurs away from the workplace, initially in groups but progressively in isolation. It will deal with issues of recognition, detection, intervention, rehabilitation, reentry, and drug testing. PHPs help with rehabilitation, monitoring, and reentry into practice, but the burden of recognizing there is a problem in the first place, and subsequently intervening, still falls on family members, friends, colleagues, or employers of the impaired colleague. Despite the fact that alcohol, marijuana, cocaine, and methamphetamine are commonly abused substances, this chapter focuses primarily on the intravenous opioids. These are drugs that are both more likely to be abused by anesthesia providers than by nonproviders<sup>5,9</sup> and are associated with a very short time line from initial misuse to addiction.<sup>56</sup>

## PATHOPHYSIOLOGY OF ADDICTION

Addiction is a disease of the learning and motivation centers of the brain.<sup>31–38</sup> It can be prevented, but once established it can only be controlled, not



cured. The goal of addiction research is a clearer understanding of how the normal processes are distorted by drugs of abuse so that better prevention, detection, and treatment options can emerge. Prevention of the initial drug experience ideally is the best strategy, but societal influence is stronger than physician input in this area. Pediatricians are discussing this stage and the phenotyping and screening of adolescents.<sup>48,49</sup> The public health approach of screening, diagnosis, intervention, and treatment during the early repetitive drug experience stage offers the next best strategy for limiting the irreversible brain changes, but the research underlying this approach is in its infancy. The logistics and costs for implementation are formidable. Again, societal influence is still very strong at this level. The current, most likely point of intervention for successful treatment and reentry is in the early addiction stage. The late addiction stage is associated with a high relapse rate, unlikely reentry, and premature death from overdose, suicide, or drug-related crime. This section describes the brain lesion that makes addiction a disease.

### Normal Brain

The VTA is the primary sensor in the brain circuits designed to evaluate the quality and importance or salience of any experience. It does this by quantifying the intensity of the pleasure or displeasure from the experience and by assessing the reliability of environmental predictors that the experience will be repeated. The first task involves changes in the activity of its dopaminergic projections to the NAc. At baseline, neurons in the VTA demonstrate a continual or tonic pattern of firing that leads to dopamine release in the NAc. Phasic bursts of dopaminergic activity occur in association with the appearance of a natural reward, such as a taste of good food or a sexual stimulus, or an environmental threat. These phasic bursts increase the dopamine concentration in the NAc to a greater extent than that associated with basal activity—the greater the synaptic concentration of dopamine, the more intense the pleasure or pain from the experience.

The VTA accomplishes its second task through dopaminergic projections to the AMG and DSt. These circuits establish associations, called *cues*, be-

tween previously neutral stimuli and the rewarding or aversive experience. When a cue appears, a phasic burst occurs in the VTA neurons in advance of the pleasurable or painful experience. If the experience appears at the predicted time after the cue is detected and the experience meets the expected intensity, the cue imprinted in the AMG and DSt is validated. If the experience does not occur at the predicted time or the pleasure is not as great as expected, there is a pause in the basal firing and the salience of the cue is downgraded. Eventually the appearance of cues of potential rewards or threats causes the release of as much or more dopamine than does the actual experience itself.

The pleasure–pain assessment and validation–invalidation process takes place in the PFC with information obtained via dopaminergic projections from the VTA and glutamatergic projections from the AMG and DSt. It is also the job of the PFC to “process information related to reinforcing properties of a stimulus in the context of alternative competitive stimuli”.<sup>40</sup> The orbitofrontal cortex portion of the PFC is where prioritization occurs and motivation is centered. In the case of drug abuse, the PFC should evaluate the opportunity for a drug experience, decide it is not in the best interest of the individual, and encourage alternate behavior to avoid environmental threats and seek natural pleasures or alternative learned pleasures.

### Addicted Brain

Despite the considerable diversity in their molecular structures, all drugs of abuse either increase dopaminergic transmission from the VTA or exaggerate the effects of normal dopamine released into the NAc, AMG, DSt, and PFC. Dopaminergic neurons in the VTA form a synaptic cleft with neurons in the NAc. Cocaine, methamphetamine, amphetamine, and methylphenidate directly increase the concentration of dopamine in the synaptic cleft by blocking the reuptake of dopamine into the presynaptic VTA neuron. They accomplish this by interfering with the ability of the dopamine transporter (DAT), a carrier protein, to move extracellular dopamine intracellularly. Evidence suggests that the probable mechanism for this reduced DAT activity is reduction in the expression of the DAT on the cell

surface through an intracellular mechanism.<sup>57</sup> To induce a “high,” 50% of DAT must be blocked. Above this threshold the intensity of the “high” is increased with increasing percent of DAT blocked.<sup>38</sup> Opiates increase dopamine indirectly by acting on GABAergic interneurons in the VTA. By binding to opioid receptors on GABAergic cells, they stop the inhibitory action of GABAergic neurons on dopaminergic cells. The activity of dopaminergic neurons increases, and more dopamine appears in the synaptic cleft in the NAc. The actions of alcohol are more complex. What is known is that ethanol is a potent inhibitor of interneuronal effects of GABAergic neurons<sup>58</sup> and increases dopamine in the NAc indirectly, like the opiates. But it also may reverse dopamine uptake through DATs.<sup>59</sup>

Because of their pharmacokinetic profiles, drugs of abuse produce a longer and stronger “dopamine high” than do natural rewards or threats. The sustained high concentrations of dopamine in the synapses of the NAc exaggerate the value or perceived importance of the drug experience. In the synapses in the AMG, DSt, and PFC, the sustained high concentrations of dopamine more strongly imprint cues for repeating the drug experience than do cues for seeking natural rewards. Individuals become chemically dependent by “overlearning of the motivational significance of cues that predict the delivery of drugs.”<sup>34</sup> Over the same time period, the sustained high concentrations of dopamine with repeated drug intake lead to a downregulation of dopamine receptors, which devalues natural rewards and creates a “reward deficiency syndrome.”<sup>59</sup> Changes in the PFC lead to an increase in glutamatergic output to the NAc in response to drug cues, drug reinstatement, or stress that direct the addict to restrict the focus of his or her activity to drug acquisition and administration. The addict will respond either impulsively or compulsively, depending on how the PFC processes cues related to past drug experiences and how the PFC perceives the level of stress. An addict will seek drugs despite intellectually knowing and openly acknowledging that doing so will jeopardize marriage, career, health, or life. There is an actual or relative decrease in descending inhibitory influences due to a di-

rect loss of neural traffic saying “do-not-do-this” behavior, an increase in neural traffic insisting on “got-to-have-it” behavior, or a combination of the two.

The addicted brain is a reorganized brain.<sup>32</sup> Three key elements in the reorganization are the development of hypofrontality, the conversion of the NAc from a dopaminergic responsive center to a glutamatergic responsive center, and the shift in VTA dopaminergic activity from the NAc to the DSt and PFC. Frontal lobe volume losses occur in cocaine-, alcohol-, and heroin-dependent subjects, with a negative correlation between normalized prefrontal volumes and years of abuse. The pyramidal neurons in the PFC decrease in size and show diminished baseline glutamatergic activity. But presented with drug cues or the drug itself, the amount of glutamate they release in the NAc is exaggerated. Similarly, the size of dopaminergic neurons in the VTA decrease and their baseline activity diminishes. But when stimulated by drug administration or drug cues, the amount of dopamine they release in the DSt and PFC is exaggerated. Finally, the number and density of dendritic spines on the medium spiny cells in the NAc and pyramidal neurons in the PFC increase when the drugs of abuse are cocaine or amphetamine but not opioids. These changes in neuron morphology are long-lasting. Synapses and postsynaptic dopamine and glutamate receptors are located on these spines. The increase in dendritic arborization appears to be mediated through induction of the transcription factor  $\Delta$ FosB and its set of target genes.<sup>41,42</sup>

Three principles appear to govern the reorganization of the brain with addiction.<sup>32</sup> *Principle 1:* The final common pathway for drug-seeking behavior involves glutamatergic projections from the PFC to the NAc. Laboratory support for this principle comes from four key observations: (1) inactivation of the PFC prevents resumption of drug-seeking behavior in abstinent rats challenged by relapse stimuli; (2) injection of  $\alpha$ -amino-3-hydroxy-5-methylisoxazole-4-propionic acid (AMPA) glutamate receptor antagonists into the NAc prevents drug- or cue-induced relapse; (3) increased glutamate release occurs in the NAc following drug- or stress-induced relapse; and (4) treatments that prevent the release

of glutamate prevent or reduce drug seeking in both animal and human subjects. *Principle 2:* Relapse may be triggered by cues from past drug abuse activity, stress, or a single dose of the drug of abuse (reinstatement). Each of these relapse stimuli involves a different neural circuit. *Principle 3:* Craving and relapse require dopaminergic transmission from the VTA, not to the NAc, as happens with initial or acute administration of a drug of abuse, but to the DSt and PFC. In humans, the greater the increase in dopamine concentration in the DSt, the greater the craving or desire for drugs. The more advanced the addiction, the greater the increase in dopamine concentration in the DSt with a given cue. In human addicts, there is no increase in dopamine concentration in the NAc with drug cues. Laboratory support for this principle comes from the following four observations: (1) inactivation of the VTA inhibits relapse from all stimuli in laboratory animals; (2) dopamine release in the PFC precedes glutamate release in the NAc; (3) if dopamine release into the PFC is prevented, glutamate release in the NAc is prevented, and relapse does not occur; and (4) if dopamine release occurs in the PFC after injection of glutamate antagonists in the NAc, relapse does not occur.

### Dopamine and Glutamate Receptors

A molecule of dopamine released from VTA neurons into the synapses in the NAc, AMG, DSt, and PFC binds to one of five different dopamine receptor subtypes grouped into two families: the D1 family, which includes receptors D1 and D5, and the D2 family, which includes receptors D2, D3, and D4. The dopamine D2 receptor density and the ratio of the number of dopamine D2 receptors to D1 receptors in specific brain regions are important in determining an individual's perception of drug experience as pleasurable or aversive and his or her susceptibility to addiction. These measures may be useful in defining the stage of, and monitoring therapy for, addiction. The brain lesion associated with substance abuse manifests a greater number of D1 receptors and fewer D2 receptors. D1 receptors are responsive only to the strongest stimuli (e.g., those associated with drugs of abuse), whereas D2 are responsive to

less intense stimuli (e.g., those associated with natural rewards). The density of dopamine D2 receptors decreases approximately 4–6% per decade, but advancing age is not associated with an increase in addiction risk. Within a given age range, there is wide individual variability in the density of dopamine D2 receptors. Those with a high density of dopamine D2 receptors are more likely to view a recreational drug experience as unpleasant and thus not develop behaviors that lead to addiction.<sup>60</sup> In the laboratory it is more difficult to induce chemically dependent behavior toward alcohol and morphine in dopamine D2 receptor knockout mice and in mice pretreated with dopamine D2 receptor antagonists. PET scans consistently demonstrate downregulation of dopamine D2 receptors in addicted patients. With increasing chemical dependence, the number of D2 receptors and the ratio of the number of D2 receptors to D1 receptors decreases in the NAc, DSt, and PFC. These findings indicate considerable plasticity in the expression of these receptors. High levels of dopamine D2 receptors protect against alcohol abuse. When an adenoviral vector is used to deliver the dopamine D2 receptor into the NAc of rats previously trained to self-administer alcohol, the rats reduce their alcohol intake.<sup>61</sup> Thus, focusing on means to increase the number of dopamine D2 receptors could produce new therapies to treat alcoholism and possibly other addictions.

Sustained exposure to cocaine or amphetamine causes endocytosis of the AMPA glutamate receptor in the postsynaptic cells of the NAc. A reduced density of postsynaptic AMPA-type subunit GluR2 in the NAc is associated with drug craving in addicts. When a viral protein vector was used to deliver a peptide decoy of the AMPA receptor into the NAc (but not the VTA) of addicted rats, the NAc cells retracted the receptor decoy rather than the receptor itself. Restoring the postsynaptic density of GluR2 in this manner extinguished craving-like behavior in the rats and suggests a new direction for treatment of addiction.<sup>62</sup> Another new direction may focus on the cystine–glutamate transporter mechanism.<sup>63</sup> Cystine is the oxidized dimeric form of cysteine. Administration of prodrugs for cysteine may increase the extracellular

glutamate in the NAc, decrease the amount of glutamate released into the NAc with PFC stimulation, and reduce drug-seeking behavior.

## NATURAL HISTORY OF ADDICTION

The neuroadaptations that occur in the brain as it responds to abuse, and transitions to dependence and addiction, can be divided into four stages chronologically: (1) initial drug experience (hours to days); (2) repetitive drug exposure (weeks to months); (3) early addiction (months to years); and (4) late addiction (years). In the first two “recreational drug” stages, the abuser typically is sharing the drug experience with others. In the last two stages, the abuser tends to isolate himself or herself. The rate at which any one individual passes through these stages depends in part on the drug of abuse: slower (years) for alcohol and faster (months) for opioids, cocaine, and methamphetamine. Not only is the pathophysiology different for each stage, but the success rates for intervention, treatment, and reentry into anesthesia practice are different for each stage. The earlier the intervention, the greater the likelihood of successful treatment and reentry (Fig. 96-2).

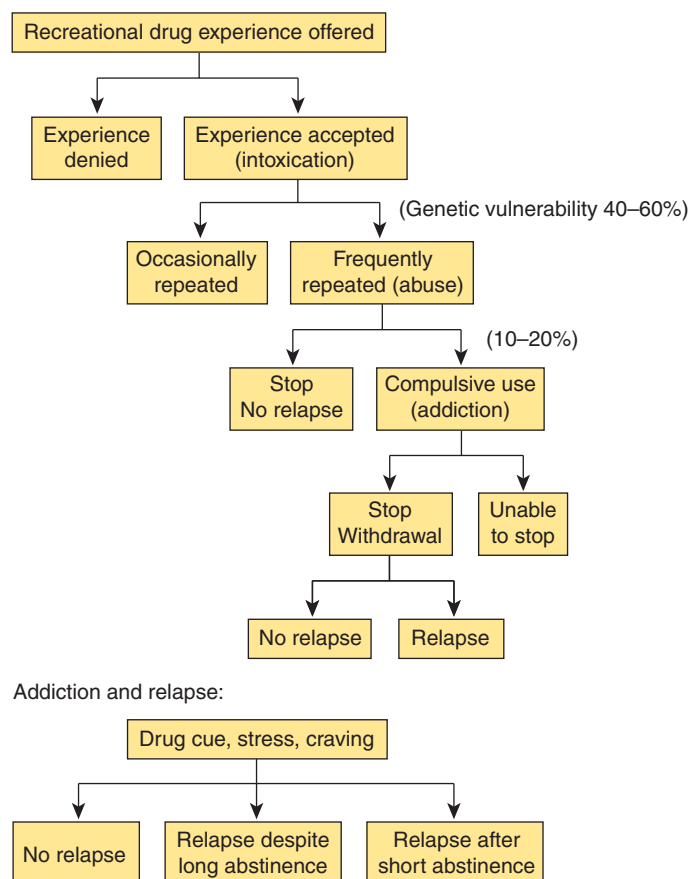
## RECOGNITION OF COLLEAGUE MISUSING DRUGS

The earlier a colleague misusing drugs can be identified, the earlier an intervention can be performed and the greater the chance of successful rehabilitation and reentry. An errant colleague will present in one of four different ways: (1) first-time or early misuser; (2) DSM-IV-TR–defined abuser; (3) individual who meets DSM-IV-TR–defined criteria for both abuse and dependence; and (4) DSM-IV-TR–defined dependent individual who does not meet DSM-IV-TR criteria for substance abuse. Unfortunately, inexperienced opioid misusers often present as an overdose or a death. Opioid abusers are identified primarily by their inappropriate and irresponsible behavior, first in social situations and then at work. Because of these behavioral changes, colleagues in categories 2 and 3 may be identified in the early stage of addiction. Unfortu-

nately, it is very difficult to identify chemically dependent colleagues who do not meet the DSM-IV-TR criteria for abuse. They compose approximately 20% of the general population of persons with known drug dependence.<sup>14</sup> It is my opinion that this percent is likely to be much higher among dependent anesthesiologists. They remain outwardly competent and professional but inwardly miserable as they contrive to sustain their addiction while hiding it from family, friends, and colleagues and protecting their job and source of drugs. The story of William Steward Halsted, the famous surgeon at Johns Hopkins Hospital in the late 1880s and early 1900s, is worth reading from this perspective.<sup>64</sup> Only late in the addictive process, when the amount of opioid these dependent individuals require becomes too great to acquire at work and their drug-seeking behavior overcomes their ability to sustain their charade or when they give in to suicidal ideation, do they declare themselves.

Early identification of an errant colleague requires a surveillance system.

The DFA requires employees to comply with the institution’s substance abuse policy and employers to document efforts to maintain a drug-free workplace. However, the DFA does not mandate any specific surveillance system for healthcare organizations. One purpose of the DFA is to reassure the public that a system is in place for workers whose jobs put people at risk of serious injury from performing under the influence of alcohol or drugs, such as airline pilots and other transportation workers. Some non-healthcare businesses and institutions have adopted drug testing as their primary surveillance system. In alcohol and drug rehabilitation programs, drug testing alone misses many non-compliant participants. More accurate results in this setting are obtained when behavioral observations are combined with some form of drug testing. How well behavioral assessment and drug testing in a homogeneous population, 100% of whom are known to have a substance abuse problem, translates to the inhomogeneous population in surgical suites,



**FIGURE 96-2.** Natural history of exposure to drugs of abuse. (From Kalivas and Volkow<sup>32</sup> with permission.)

only 1% of whom may have a substance abuse problem, remains to be determined.

The primary purpose of drug and alcohol rehabilitation and methadone maintenance programs is observation and care of patients with known substance-related problems. Thus, a drug misuse surveillance system for patients is a primary component of their operation. The primary purpose of healthcare institutions is not to monitor their healthcare providers for drug misuse behavior. However, it is important for these institutions to monitor the quality of the care provided. When an assessment reveals an outcome on the wrong side of a benchmark, a system evaluation is instituted. Sometimes, but not always, this includes competence assessments of providers. Unlike the case for surgeons, few outcome data tend to be collated specific to individual anesthesia providers. Thus, surveillance systems that rely on quality assessments are unlikely to detect gradually deteriorating performance or subtle changes in behavior of anesthesiologists, CRNAs, or AAs (Table 96-6). Substance abuse is only one of many possible reasons for poor performance and frequently not the most likely one.

Inappropriate behavior of any kind must be addressed. However, early detection of substance misuse requires observation of more subtle changes in behavior, presumably precursors to overt inappropriate behavior that may be the result of acute effects of drug administration or the chronic effect of drug-induced brain changes. There is evidence of a considerable reluctance on the part of healthcare workers to report colleagues whom they only suspect of drug abuse.<sup>65</sup> Random drug testing has the potential to reveal a problem earlier than quality of care or behavioral assessments. The complexities of the collection process, the relative ease by which addicts can subvert the system, and the high cost-to-benefit ratio in large systems with low anticipated positive findings have deterred most programs from implementing random drug testing.<sup>23</sup> Thus, the three purported hallmarks of substance misuse surveillance systems—competence assessment, behavioral changes, and random drug testing—are unlikely to be implemented or are likely to be ineffective if put in place. Most large healthcare institutions have

a drug awareness program and a response system rather than a true surveillance system. They rely on an alert, educated, concerned healthcare provider reporting very suspicious or obviously abnormal behavior to the department head, the professional advisory or wellness committee, or employee assistance for subsequent investigation. Thus, our current systems do not favor early detection of a colleague with a substance misuse problem, especially if he or she meets DSM-IV-TR criteria for dependence but not abuse.

The ideal surveillance system should not be created specifically to detect substance misuse. Rather, it

should focus on anesthesia provider well-being in general. If behavioral changes are found to be due not to substance abuse but to some other cause, such as sleep deprivation, stress, a medical illness such as diabetes mellitus, or side effects of medications prescribed for a medical illness, they still must be addressed. The ideal system should have observers who can witness the behavior of the same providers frequently enough recognize a change. The observational standard should be a change in behavior, a more sensitive but less specific finding, rather than a specific behavior that has reached a certain threshold for inappropriateness or diagnosis. The ideal system collects and integrates different kinds of information from different sources (Table 96-6) on a frequent basis: (1) observation of signs and symptoms of drug intoxication or withdrawal; (2) behavioral changes related to dress, work habits, professionalism, personal life, competence, and drug acquisition; (3) signs and symptoms of psychiatric comorbidities associated with addiction, especially depression; (4) analyses of documentation systems and surveys; and (5) drug testing. An ideal system also has the “right” kind of person in charge who frequently asks “Is there anyone we should be concerned about?” and looks for “red flags.” For example, do queries of automated anesthesia information management systems reveal (1) residents, CRNAs, AAs, or anesthesiologists whose opioid use is two standard deviations greater than others, especially if they also record high delivered concentrations of potent inhaled agents; or (2) anesthesia providers whose patients consistently have higher pain scores in the recovery room than expected. Without an aggressive surveillance system the barriers to recognition (Table 96-7) are formidable.

Most people have no difficulty recognizing the intoxicated individual. Alcoholics are more likely to come late to work intoxicated, but “experienced” users chemically dependent on intravenous opioids are more like to come early to work, check out drugs for the first case, and immediately divert opioids for acute self-administration to treat withdrawal symptoms. These same “experienced” users also request breaks during the day to sequester themselves to inject opioids to prevent

**TABLE 96-6.**

**Recognition of Colleague Misusing Drugs**

**Physical Symptoms and Signs**

- Drug-related
  - Intoxication
  - Withdrawal
  - Injection site abscess<sup>67</sup>
  - Puffy-hand syndrome<sup>68</sup>

**Adulterant-related<sup>69</sup>**

**Behavior Changes**

**Acute drug effects**

- Intoxication
- Withdrawal

**Addiction**

- Work habits
- Personal life
- Professionalism
- Drug acquisition

**Competence**

**Comorbidities**

**Psychiatric comorbidity (dual diagnosis)**

- Depression

**Infectious disease**

**Cardiac complaints at younger age than is typical**

- Chest pain<sup>70,71</sup>

- Dysrhythmias (torsade de pointes)<sup>72</sup>

**Monitoring**

- Medical records
- Pharmacy records
- Time sheets
- Fellow worker complaints
- Patient complaints

**Drug testing**

- For cause
- Monitoring for compliance
- Random



TABLE 96-7.

## Barriers to Recognition of Colleague Misusing Drugs

Continued competent performance until late in the addiction process  
 Symptoms for abuse and addiction overlap with other common conditions  
 Stress, sleep deprivation  
 Limited observations of single provider by same observer  
 Academic medical center: Multiple attendings and/or multiple trainees  
 Large practices: Multiple attendings and multiple certified registered nurse anesthetists or anesthesia assistants  
 Physician-only practice: No other anesthesia provider critiquing anesthetic  
 Wide variability in acceptable anesthetic management  
 No system that identifies outliers in opioid administration in the operating room  
 No system that identifies outliers in pain scores in the postanesthesia care unit  
 Limited substance abuse education of, or feedback from, nurses in operating room or postanesthesia care unit  
 Easy to divert drugs with current drug accounting and monitoring systems  
 Unwillingness to believe it could happen  
 Fear of being bad guy, ruining career of colleague, or being wrong (“false alarm”)  
 Abuser feeling either he or she can control the addiction or that it is worth the risk  
 Family fear loss of “face” or security and hope abuser overcomes problem on own

withdrawal symptoms. Signs and symptoms of withdrawal are listed in Table 96-8.<sup>66-71</sup> Most anesthesia providers dependent on opioids are clever enough to protect their source by avoiding suspicion, intoxication, and withdrawal at work. They discreetly divert drugs at work for intoxication away from the workplace. When experienced addicts run out of viable veins or when “inexperienced” addicts miss their veins, they frequently resort to subcutaneous or intramuscular injections. Because of poor sterile technique, the sites of this “skin popping” become infected. Abscesses, especially in the lower extremities of anesthesia providers, are red flags suggesting possible substance abuse.<sup>67</sup> Intravenous drug users who inject primarily in the upper extremity may develop the puffy hand syndrome.<sup>68</sup> Other red flags include keeping injection sites away from public eyes by wardrobe changes, such as switching to wearing long pants rather than short pants to and from work, wearing long sleeve shirts in clinical settings, or wearing operating room scrubs to and from work, or changing clothes in the privacy of their office or in dressing room stalls rather than out in the open.

The appearance of chest pain, malignant dysrhythmias (ventricular fibrillation, ventricular tachycardia, supraventricular tachycardia), or signs and symptoms of an acute coronary syndrome in a young colleague should

include substance abuse in the differential diagnosis. The average age of patients presenting with cocaine-associated chest pain was  $37.6 \pm 9.3$  years, considerably younger than the typical coronary heart disease population.<sup>70</sup> These individuals were identified by their acknowledgment in the emergency room of using cocaine during the week before presentation or by positive urine toxicology screen. Both cocaine and crystal methamphetamine reach

peak blood concentrations within seconds to minutes after smoking or intravenous injection, minutes to hours after nasal insufflation or “snorting,” and longer after oral ingestion. They increase the catecholamine concentration in the synaptic cleft by interfering with the ability of the catecholamine transporter, a carrier protein, to return extracellular catecholamines intracellularly to presynaptic neurons. The increased catecholamine residence time in the synapse leads to  $\alpha$ -adrenergic effects, such as hypertension and coronary spasm, and  $\beta$ -adrenergic effects, such as tachycardia and dysrhythmias. The combined increase in oxygen demand and decrease in oxygen supply leads to anginal symptoms, frequently in the absence of occlusive coronary lesions, myocarditis, and dilated cardiomyopathy.<sup>71</sup> Chronic use accelerates atherosclerosis and produces hypertrophic cardiomyopathy. Although the risk of these myocardial infarctions is greatest within 1 hour of drug administration, they may occur up to 1–2 days later. Patients who present with drug abuse-associated chest pain that resolves shortly after presentation, who have normal levels of troponin and no new ischemic changes on ECG during a 9- to 12-hour observation period, and who do not develop cardiovascular complications (dysrhythmias, acute myocardial infarction, or recurrent symptoms) have a very low risk of

TABLE 96-8.

## Signs and Symptoms of Withdrawal

**Common to Non-stimulant Drugs of Abuse**

Central nervous system: Agitation, anxiety, dysphoria, irritability, panic

Autonomic nervous system: Tachycardia, hypertension

Gastrointestinal system: Nausea

**Opioid**

Influenza-like symptoms: Fever, diaphoresis, myalgia, arthralgia, tearing, rhinorrhea, sneezing

Central nervous system: Tremors, yawning, insomnia, suicidal ideation

Autonomic nervous system: Piloerection, mydriasis

Gastrointestinal system: Stomach cramps, vomiting, diarrhea

**Alcohol**

Central nervous system: Insomnia, tremors, delirium tremens, hallucinations, grand mal seizures, status epilepticus

Gastrointestinal system: Vomiting, poor appetite

**Stimulant Drugs of Abuse (Cocaine and Methamphetamine)**

Central nervous system: Depression, exhaustion, fatigue, sleepiness, lack of motivation, cravings, psychotic reactions, suicidal ideation

Gastrointestinal system: Intense hunger

Data from Kosten and O'Connor.<sup>66</sup>

myocardial infarction during the 30 days following discharge. Patients presenting with chest pain in an age group younger than expected for coronary heart disease should be screened for recent cocaine or methamphetamine intake.

## INTERVENTION ON COLLEAGUE MISUSING DRUGS

The three keys to a successful intervention are a thorough investigation, an experienced intervention team, and rehearsed intervention plan. These factors are well discussed in the review by Silverstein et al.<sup>21</sup> and summarized as follows. The investigation, which may take weeks, is ideally performed confidentially by an experienced team drawn from the human resources, employee assistance, or risk management departments or physician well-being committee of the medical center, with a representative from the anesthesia department. The purpose of the investigation is not to make the diagnosis of substance misuse, substance abuse, or chemical dependency but to gather sufficient evidence of behavioral changes, drug diversion, or drug use to mandate an evaluation. No intervention should be attempted based only on suspicion without evidence.

The intervention team should consist of two or more members with experience in confronting people who deny their problems. If behavioral changes are the only evidence of suspected drug misuse, the team cannot assume that drug misuse is the problem. Rather, the team should accept that the evidence suggests it is reasonable and necessary for the individual to have an evaluation before he or she is allowed to return to work. It is the purpose of the subsequent medical and psychiatric evaluation to determine the cause of the behavioral changes. There should never be a one-on-one intervention. The gender and cultural makeup of the team is important to avoid charges of harassment or assault. Ideally, one team member should be someone who is either a certified addictionologist or a former impaired professional. A spouse or family member could be motivated to either facilitate or sabotage the process. Advice from an experienced interventionalist is recommended to de-

termine his or her suitability as a member of the intervention team. Interventions take time, sometimes hours, if diversion is to be successfully accomplished. It is important for team members to devote their full attention to the intervention by turning off their beepers and cell phones and canceling all other commitments until the intervention is completed.

The intervention plan should include preparation for immediate drug testing, inpatient admission to a hospital or treatment center, accompanied transfer to testing site and inpatient facility, and contingency plans if the suspect refuses to accept testing and evaluation. The purpose of the intervention is not to accuse the individual of a crime or to make the diagnosis of drug misuse. It is to convince the health professional colleague to submit to drug testing and an evaluation. Drug testing should be required as a routine part of institutional policy and procedure related to risk management of untoward events or inappropriate or unaccountable behavior. Because the suspect may become physically hostile, security personnel should be alerted to be in the vicinity of the intervention, but they should remain out of sight unless needed to avoid the perception of an impending arrest. Finally, an individual once confronted must be regarded as a suicide risk and not be left alone until he or she has been admitted to an evaluation center or accompanied by a responsible individual away from the medical center if he or she refuses evaluation and leaves against medical advice.

## ULTRARAPID OPIOID DETOXIFICATION

Medically supervised opioid withdrawal, or detoxification, can be divided into four general approaches in order of decreasing duration of time required to complete the process: (1) substitution of abused opioid with an approved opioid, methadone, or buprenorphine, and a slow taper (weeks to months) of the approved opioid to minimize withdrawal symptoms; (2) complete discontinuation of any opioids and administration of medications, such as clonidine and benzodiazepines, to attenuate withdrawal symptoms (1–2 weeks); (3) precipitation of withdrawal by administration of antagonists,

naloxone, or naltrexone, and the administration of medications to attenuate the withdrawal symptoms (rapid detoxification in 3–5 days); and (4) precipitation of withdrawal by administration of antagonists during general anesthesia or sedation (ultrarapid opioid detoxification [UROD] in 6–8 hours).<sup>73</sup> When clonidine-assisted, buprenorphine-assisted, and anesthesia-assisted detoxification were compared with naltrexone as preparation for antagonist therapy, no differences in the rate of retention in treatment programs or frequency of opioid-positive urine specimens were observed. There was a significant increase in morbidity blamed, perhaps somewhat questionably by nonanesthesiologists, on the use of general anesthesia.<sup>74</sup> The accompanying editorial by another nonanesthesiologist stated “anesthesia-assisted detoxification should have no significant role in the treatment of opioid dependence.”<sup>75</sup> When UROD was combined with subcutaneous implantation of naltrexone pellets, pulmonary edema, aspiration pneumonia, prolonged debilitating withdrawal, delirium, and death occurred after discharge home.<sup>76</sup> There are experienced advocates in Europe for UROD use in select patients.<sup>77–79</sup>

Currently in the United States UROD should be considered only if it is part of a clinical study approved by the institutional review board. The American Society of Addiction Medicine (ASAM) has published a public policy statement regarding opioid antagonist agent detoxification under sedation or anesthesia stating: (1) “ASAM does not support the initiation of acute opioid detoxification interventions unless they are part of an integrated continuum of services that promote ongoing recovery from addiction”; and (2) “[UROD] is a procedure with uncertain risks and benefits, and its use in clinical settings is not supportable until a clearly positive risk-benefit relationship can be demonstrated. Further research on UROD should be conducted.”<sup>80</sup> It is unethical to provide general anesthesia or deep sedation for ultrarapid detoxification to patients who are not enrolled in approved treatment programs under the care of credentialed addictionologists and who just want to “get clean” to go back to work. Doing so facilitates illegal drug use, enables addictive behavior, and puts patients at risk for signif-

TABLE 96–9.

## Treatments of Opioid Addiction

Prevention
Surveillance
Investigation
Recognition
Diversion (Intervention of Colleague in Early Stage of Addiction)
Detoxification
Initiate abstinence
Control/reduce/monitor withdrawal signs and symptoms
Retain in addiction control program
Addiction control
Rehabilitation program
Comorbidity treatment
Antagonist therapy
Anticraving therapy
Consider reentry as anesthesia provider
Intervention of Colleague in Late Stage of Addiction
Detoxification
Transition to maintenance program
Control/reduce/monitor withdrawal signs and symptoms
Retain in addiction control program
Addiction control
Rehabilitation program
Comorbidity treatment
Agonist therapy (replacement or maintenance)
Do not consider reentry as anesthesia provider.

icant morbidity and mortality if they are discharged directly home from the recovery room.

## TREATMENT OF OPIOID ADDICTION

Over the last decade, three major advances have been made in the treatment of addiction caused by any drug. First is the recognition that addiction is a chronic relapsing disease. This means that successful treatment requires more than detoxification and graduation from a rehabilitation program. It must include rest-of-life management. Second is the development of anticraving drugs to combat the changes in the neural circuitry in the brain that create the compulsion to repeat the drug experience. Third is

the emergence of addictionologists, physicians who specialize in the treatment management of these complex patients. Additional advances have been made in the treatment of addiction specific to the drug of abuse.

The treatment of opioid addiction has evolved from detoxification and active participation in self-help programs to detoxification, long-term prescription of antagonist or agonists drugs, long-term prescription of anti-craving drugs, care managed by an addictionologist, counseling, and active participation in self-help programs (Tables 96–9 and 96–10). Because the nonprescription use of opioids is illegal and because the prescription use of methadone for addiction treatment is not acceptable for actively practicing anesthesiologists or nurse anesthetists, the treatment regimens for anesthesia providers seeking reentry are designed to maintain abstinence with opioid antagonists (oral naltrexone or depot naltrexone) and control cravings with anticraving drugs prescribed by an addictionologist, active participation in PHP-endorsed behavioral health programs, and active treatment of psychiatric comorbidities, such as depression. If this approach is unsuccessful, as defined by short periods of abstinence, multiple relapses, or failure to remain enrolled in treatment programs, then administration of agonist drugs, such as methadone or buprenorphine, are considered. This approach replaces a licit drug illicitly administered with a legal drug legally administered. This substitution may enable a colleague to control his or her addiction but precludes him or her from returning to the practice of anesthesia.

There may come a time when anesthesia providers in buprenorphine maintenance programs are permitted reentry to practice at medical centers where buprenorphine is not used for pain management. Buprenorphine is a partial  $\mu$ -opioid receptor agonist and a  $\kappa$ -opioid receptor antagonist.<sup>81</sup> It is available for administration by intramuscular injection, intravenous infusion, transdermal patch, or sublingual tablet. It is not administered orally because its first-pass metabolism is too rapid. It readily displaces most other opioids from the  $\mu$ -receptor and precipitates withdrawal. From the perspective of reentry, it has three important characteristics. (1) It binds so

TABLE 96–10.

## Drugs for Treatment of Addiction

Opioid Addiction
Antagonists (oral, depot)
Naltrexone <sup>a</sup>
Nalmefene
Agonists
Methadone <sup>a</sup>
Buprenorphine <sup>a</sup>
Anticraving drugs <sup>33</sup>
Alcohol Addiction
Aversion
Disulfiram <sup>a</sup>
Anticraving <sup>33</sup>
Prevention in susceptible patients
Ondansetron
Cocaine or Methamphetamine Addiction
Aversion
Disulfiram <sup>a,b</sup>
Anticraving drugs <sup>33</sup>
Nicotine <sup>88</sup>
Donepezil <sup>88</sup>
Anticraving drug <sup>33</sup>
Acamprosate <sup>a</sup> (glutamate receptor antagonist)
Baclofen (GABA $\beta$ receptor agonist)
Bupropion <sup>a</sup> (dopamine, norepinephrine reuptake inhibitor, nicotinic receptor antagonist)
Modafinil (increases glutamate)
Naltrexone <sup>a</sup> opioid receptor antagonist
Propranolol $\beta$ -adrenergic receptor antagonist)
Rimonabant (cannabinoid receptor antagonist)
Topiramate (GABAergic)

<sup>a</sup>FDA approved for addiction therapy. The other drugs are in clinical trials.

<sup>b</sup>Disulfiram is aversive for alcohol and anticraving for cocaine in the absence of alcohol.

GABA,  $\gamma$ -Aminobutyric acid.

tightly to opiate receptors that it is very difficult for patients adhering to the buprenorphine maintenance protocol to become high on other opioids. Thus, they may be less likely to divert drugs for their own use. (2) Patients do not develop tolerance with chronic administration, so there is no dose escalation with treatment over time. (3) There is a ceiling to both its respiratory depression and analgesic effects.<sup>82</sup> However, the tight binding also creates a problem. Respiratory depression or arrest from an overdose, which

can occur when taken in combination with alcohol or benzodiazepines, is not reversed by customary doses of naloxone.<sup>83</sup> Two responses to this problem have been to recommend against the use of buprenorphine as an analgesic and to combine it with naloxone to limit its own abuse potential. Most studies of buprenorphine maintenance therapy have been performed in patients previously treated in methadone maintenance programs. When patients this far along in the addiction process are switched to buprenorphine–naloxone maintenance programs, there is still too much non-compliance and multiple drug use to support reentry.<sup>84</sup> However, in a more motivated patient population in which treatment is initiated with buprenorphine earlier in the addiction process, the results may be positive enough to consider reentry.

Because alcohol consumption outside the workplace is legal, treatment programs may be designed primarily to eliminate alcohol abuse symptoms as defined by DSM-IV-TR rather than to produce abstinence. Although abstinence still may be the most desired goal, successful treatment may be defined as a significant reduction in alcohol intake, a significant increase in the number of abstinent days, satisfactory work habits, competent work performance, the avoidance of intoxication at work, and continued active participation in PHP-endorsed behavioral health programs.<sup>85–87</sup> Whether complete abstinence *versus* satisfactory control is acceptable and whether aversive therapy *versus* anticraving therapy *versus* satisfactory control with just behavioral therapy or a combination of all three are acceptable for reentry are local issues.

## RELAPSE

Addiction now is recognized as a chronic relapsing disease. Unfortunately most of the data regarding relapse comes from abstinence programs that are too short term in scope or support and from patients who are far less motivated than most health-care providers or have been identified and treated too late in the addiction process. The reported relapse rates are so high that antagonist therapy with its goal of no relapse typically is rejected in favor of agonist therapy with meth-

adone or buprenorphine with a goal of fewer relapses. However, there is a group of patients who do get close to optimum therapy, physicians in PHPs.<sup>12</sup> In this group, the results for abstinence programs are far more optimistic. In their study of relapse in the Washington Physician Health Program, Domino et al.<sup>9</sup> observed an overall relapse rate of 25% over 10 years. To express the results more positively, 75% of physicians did not relapse. Three factors predicted relapse: a family history of substance abuse, a second DSM-IV axis 1 diagnosis (coexisting psychiatric illness), and major but not minor opioid use. Major opioids included fentanyl, sufentanil, morphine, meperidine, methadone, heroin, and controlled-release oxycodone. Minor opioids included butorphanol, codeine, hydrocodone, pentazocine, propoxyphene, and tramadol. Relapsed rates decreased with increasing time in treatment. All who avoided relapse in the first 5 years successfully returned to the practice of medicine. With specific regard to anesthesiologists, the study had insufficient power to separate out a contribution of anesthesiology as a profession independent of the abuse of major opioids. However, the authors did refer to data from the New Jersey Physician Health Program and California Physicians Diversion programs that did not reveal a risk for anesthesiologists higher than for other specialists.

## REENTRY

In a study of treatment outcomes among 199 residents in anesthesiology involved in drug misuse, 167 returned to medicine, 100 continued as anesthesia residents, 9 died, and 91 completed their anesthesia training, for a 79% overall reentry rate in medicine and a 46% reentry rate into anesthesia.<sup>9</sup> In the previously cited study from the Washington Physician Health Program, only five of 22 anesthesiologists who misused fentanyl were able to return to practice (23%), but no information about the 11 anesthesiologists whose drug of choice was not fentanyl was presented.<sup>9</sup> Presumably, they were less likely to relapse and more likely to have successfully reentered practice. Thus, successful reentry can occur. The question is when and how.

Ward, who has considerable experience in his large group private practice, does not permit even a discussion of reentry until an impaired colleague meets several prerequisites (Personal Communication, 2005). The colleague must be actively participating in an PHP-approved treatment program and completed at least 6 months of treatment. The colleague's addictionologist or approved therapist, not a member of the department of anesthesiology, must confirm his or her readiness to return to work. The treatment program must be an abstinence program with either aversive or antagonist therapy and probably anticraving therapy. The colleague's compliance must be monitored, and results of drug screening tests must be negative. Finally, any coexisting psychiatric comorbidities must be treated and well controlled. There may be a time when satisfactory performance in a laboratory simulating the operating room may be necessary to establish whether the impaired colleague can deal with common cues of previous drug acquisition that could trigger relapse.<sup>89</sup> Similarly, functional magnetic resonance imaging during tests of decision making may be required because activation patterns in the right insular, posterior cingulate, and temporal cortex now have been used to accurately predict relapse in patients in recovery programs.<sup>90</sup>

Once the prerequisites are met, then a reentry contract is prepared that describes his or her reorientation to the practice, the time line for gradual resumption of former work assignments, when call assignments will resume, performance expectations, the person to whom he or others should report concerns about his progress or compliance, agreement to be monitored for changes in behavior, drug testing indications, and consequences of failing to continue treatment, meet performance expectations, or pass drug tests. It should include indications for continuing on a prearranged schedule, slowing the schedule down (never speeding it up), or stopping practice. It is important for him to return, if possible, to the same hospital and operating rooms for reentry because this will enable him to work with people who know him and can be more sensitive to changes in his behavior. He should return to the cardiac surgery operating rooms if he is a



cardiac anesthesiologist even though this may be the place where higher opioid anesthetic techniques typically are administered. It is important for him to acknowledge to coworkers, operating room nurses, CRNAs, and surgeons, why he was away from work and ask them to be his safety net.

## CALL TO ACTION

Substance abuse has gotten the attention of professional organizations in anesthesia. The Committee on Occupational Health for the American Society of Anesthesiologists (ASA) has prepared two useful documents, "Model Curriculum for Substance Abuse" and "Model Department Policy for Drug and Alcohol Testing as Part of a Comprehensive Intervention for Suspected Substance Abuse in Anesthesia Professionals." The Society of Academic Anesthesia Chairs and Academic Anesthesia Program Directors (SAAC/AAPD) has sponsored two instructional videos, the original *Wearing Masks* and *Collateral Damage: Drug Abuse and Anesthesiology*. The American Association of Nurse Anesthetist (AANA) has established an active wellness committee and sponsored the making of several instructional videos that are sequels to *Wearing Masks*. Anesthesiologists who have an interest in addressing the problems of substance abuse should become members of the Association of Medical Education and Research in Substance Abuse (AMERSA).<sup>91</sup>

*I try to remember not to call people with addictions—drug addicts. I propose that you do the same. The word addict carries a very negative connotation and suggests that the person is the problem rather than the disease.*

C. Everett Koop, MD, former United States Surgeon General  
McGovern Lecture, Hanover, New Hampshire, May 1, 2003

An anesthesia provider can take several important steps in helping a colleague and the profession deal with chemical dependency. First is to accept addiction as the disease it is. There is an organic lesion. There are medications and therapies to treat the disease. Now 50–75% of anesthesia residents and anesthesiologists with significant substance abuse or dependence issues return to the prac-

tice of anesthesiology. These statistics should only get better in the near future. Second is to pay attention to colleagues by caring about their well-being and addressing any possible signs and symptoms of substance misuse, stress, or sleep deprivation they may manifest. Like most diseases, chemical dependence is best treated as early as possible. Third is to establish a well-being committee in your department or group. This committee should make it easy to report worrisome changes in behavior without creating an overbearing or inherently suspicious environment. An active well-being committee is a sign of a department or group that cares for its members.

## KEY REFERENCES

1. Collins GB, et al. *Anesth Analg* 2005;101:1457–1462.

The most recent information on treatment outcomes of chemically dependent residents in anesthesiology.

2. Domino KB, et al. *JAMA* 2005; 292:1453.

The most recent information on reentry and relapse in chemically dependent anesthesiologists.

3. Volkow N, et al. *Nat Neurosci* 2005;8:1429.

Insights from directors of NIDA and NIAAA regarding the six major questions about addiction.

4. Silverstein JH, et al. *Anesthesiology* 1993;79:354.

The landmark review article discussing opioid addiction in anesthesiology.

5. McLellan AT, et al. *JAMA* 2000; 284:1689.

Excellent discussion of drug dependence as a chronic medical illness.

6. Levine MR, et al. *Occup Environ Med* 2004;61:318.

Excellent discussion of the pros and cons of urine drug testing.

7. Kalivas PW, et al. *Am J Psychiatry* 2005;162:1403.

Easy-to-read description of the current model for the addicted brain.

8. Nestler EJ. *Nat Neurosci* 2005;8: 1445.

Excellent description of the molecular pathways common to all drugs of abuse.

9. O'Conner PG. *JAMA* 2005;294: 961.

Puts ultrarapid detoxification into proper perspective.

10. Samet JH, et al. *Addiction* 2006; 101:10.

Describes AMERSA, the organization "committed to faculty development in substance abuse."

## REFERENCES

1. Kadison R. Getting an edge—use of stimulants and antidepressants in college. *N Engl J Med* 2005;353:1089–1991.

2. Volkow ND, Li TK. Drugs and alcohol: treating and preventing abuse, addiction and their medical consequences. *Pharmacol Ther* 2005;108:3–17.

3. White AG, Birnbaum HG, Mareva MN, et al. Direct costs of opioid abuse in an insured population in the United States. *J Manag Care Pharm* 2005;11:469–479.

4. Kessler RC, Berglund P, Demler O, et al. Lifetime prevalence and age-of-onset distributions of DSM-IV disorders in the National Comorbidity Survey Replication. *Arch Gen Psychiatry* 2005;62:593–602.

5. McAuliffe PF, Gold MS, Bajpai L, et al. Second-hand exposure to aerosolized intravenous anesthetics propofol and fentanyl may cause sensitization and subsequent opiate addiction among anesthesiologists and surgeons. *Med Hypotheses* 2006;66: 874–882.

6. Hughes PH, Brandenburg N, Baldwin DC Jr, et al. Prevalence of substance use among US physicians. *JAMA* 1992;267: 2333–2339.

7. Booth JV, Grossman D, Moore J, et al. Substance abuse among physicians: a survey of academic anesthesiology programs. *Anesth Analg* 2002;95:1024–1030.

8. Collins GB, McAllister MS, Jensen M, et al. Chemical dependency treatment outcomes of residents in anesthesiology: results of a survey. *Anesth Analg* 2005;101: 1457–1462.

9. Domino KB, Hornbein TF, Polissar NL, et al. Risk factors for relapse in health care professionals with substance use disorders. *JAMA* 2005;293:1453–1460.

10. Gold MS, Melker RJ, Dennis DM, et al. Fentanyl abuse and dependence: further evidence for second hand exposure hypothesis. *J Addict Dis* 2006;25:15–21.

11. Wang PS, Berglund P, Olfson M, et al. Failure and delay in initial treatment con-

- tact after first onset of mental disorders in the National Comorbidity Survey Replication. *Arch Gen Psychiatry* 2005;62:603–613.
12. Gastfriend DR. Physician substance abuse and recovery: what does it mean for physicians—and everyone else? *JAMA* 2005;293:1513–1515.
13. Fauman MA. Study Guide to DSM-IV-TR. Washington, DC: American Psychiatric Publishing, 2002.
14. Hasin DS, Hatzenbuehler M, Smith S, et al. Co-occurring DSM-IV drug abuse in DSM-IV drug dependence: results from the National Epidemiologic Survey on Alcohol and Related Conditions. *Drug Alcohol Depend* 2005;80:117–123.
15. Definitions related to the use of opiates for the treatment of pain. A consensus document from the American Academy of Pain Medicine, the American Pain Society, and the American Society of Addiction Medicine. Available at: <http://www.asam.org/pain/definitions2.pdf>. Last accessed October 31, 2006.
16. Prescription Drugs: Abuse and Addiction. National Institute on Drug Abuse Research Report Series. Bethesda, MD: National Institutes of Health, 2001, Revised August 2005. Available at: <http://www.drugabuse.gov/PDF/RRPrescription.pdf>. Last accessed October 31, 2006.
17. Volkow N, Li TK. The neuroscience of addiction. *Nat Neurosci* 2005;8:1429–1430.
18. Lusher J, Elander J, Bevan D, Telfer P, Burton B. Analgesic addiction and pseudoaddiction in painful chronic illness. *Clin J Pain* 2006;22:316–324.
19. Kauer JA. Addictive drugs and stress trigger a common change at VTA synapses. *Neuron* 2003;37:549–550.
20. Saal D, Dong Y, Bonci A, et al. Drugs of abuse and stress trigger a common synaptic adaptation in dopamine neurons. *Neuron* 2003;37:577–582.
21. Silverstein JH, Silva DA, Iberti TJ. Opioid addiction in anesthesiology. *Anesthesiology* 1993;79:354–375.
22. McLellan AT, Lewis DC, O'Brien CP, et al. Drug dependence, a chronic medical illness: implications for treatment, insurance, and outcomes evaluation. *JAMA* 2000;284:1689–1695.
23. Levine MR, Rennie WP. Pre-employment urine drug testing of hospital employees: future questions and review of current literature. *Occup Environ Med* 2004;61:318–324.
24. Drug-Free Schools and Communities Act Amendments of 1989. HR3614, 101st Congress 1st Session, 1989.
25. Meyer JN. Chemically dependent employees and the ADA in the medical profession: does patient safety exempt hospital employers from compliance under the direct threat and/or the business necessity exceptions? *Spec Law Dig Health Care Law* 2005;318:9–20.
26. Roche B. Substance abuse policies for anesthesia: time to re-evaluate your policies and curriculum. Winston-Salem, NC: All Anesthesia, 2007.
27. Katz N, Fanciullo GJ. Role of urine toxicology testing in the management of chronic opioid therapy. *Clin J Pain* 2002;18(4 Suppl):S76–S82.
28. Katz NP, Sherburne S, Beach M, et al. Behavioral monitoring and urine toxicology testing in patients receiving long-term opioid therapy. *Anesth Analg* 2003;97:1097–1102.
29. American Association of Addiction Medicine, Inc. Public Policy Statement on Drug Testing in Workplace Settings. October, 2002. Available at: <http://www.asam.org/ppol/Drug%20Testing-workplace.htm>. Last accessed October 31, 2006.
30. Bechara A. Decision making, impulse control and loss of willpower to resist drugs: a neurocognitive perspective. *Nat Neurosci* 2005;8:1458–1463.
31. Everitt BJ, Robbins TW. Neural systems of reinforcement for drug addiction: from actions to habits to compulsion. *Nat Neurosci* 2005;8:1481–1489.
32. Kalivas PW, Volkow ND. The neural basis of addiction: a pathology of motivation and choice. *Am J Psychiatry* 2005;162:1403–1413.
33. O'Brien CP. Anticraving medications for relapse prevention: a possible new class of psychoactive medications. *Am J Psychiatry* 2005;162:1423–1431.
34. Hyman SE. Addiction: a disease of learning and memory. *Am J Psychiatry* 2005;162:1414–1422.
35. Lubman DI, Yucel M, Pantelis C. Addiction, a condition of compulsive behaviour? Neuroimaging and neuropsychological evidence of inhibitory dysregulation. *Addiction* 2004;99:1491–1502.
36. Schoenbaum G, Roesch MR, Stalnaker TA. Orbitofrontal cortex, decision-making and drug addiction. *Trends Neurosci* 2006;29:116–124.
37. Hyman SE, Malenka RC. Addiction and the brain: the neurobiology of compulsion and its persistence. *Nat Rev Neurosci* 2001;2:695–703.
38. Volkow ND, Fowler JS, Wang GJ, et al. Dopamine in drug abuse and addiction: results from imaging studies and treatment implications. *Mol Psychiatry* 2004;9:557–569.
39. Kreek MJ, Nielsen DA, Butelman ER, et al. Genetic influences on impulsivity, risk taking, stress responsivity and vulnerability to drug abuse and addiction. *Nat Neurosci* 2005;8:1450–1457.
40. Tupala E, Tiihonen J. Dopamine and alcoholism: neurobiological basis of ethanol abuse. *Prog Neuropsychopharmacol Biol Psychiatry* 2004;28:1221–1247.
41. Nestler EJ. Molecular mechanisms of drug addiction. *Neuropharmacology* 2004;47(Suppl 1):24–32.
42. Nestler EJ. Is there a common molecular pathway for addiction? *Nat Neurosci* 2005;8:1445–1449.
43. Koob GF, Le Moal M. Plasticity of reward neurocircuitry and the “dark side” of drug addiction. *Nat Neurosci* 2005;8:1442–1444.
44. Schochet TL, Kelley AE, Landry CF. Differential expression of arc mRNA and other plasticity-related genes induced by nicotine in adolescent rat forebrain. *Neuroscience* 2005;135:285–297.
45. Dougherty DM, Mathias CW, Tester ML, et al. Age at first drink relates to behavioral measures of impulsivity: the immediate and delayed memory tasks. *Alcohol Clin Exp Res* 2004;28:408–414.
46. Gogtay N, Giedd JN, Lusk L, et al. Dynamic mapping of human cortical development during childhood through early adulthood. *Proc Natl Acad Sci U S A* 2004;101:8174–8179.
47. Reboussin BA, Anthony JC. Is there epidemiological evidence to support the idea that a cocaine dependence syndrome emerges soon after onset of cocaine use? *Neuropsychopharmacology* 2006;31:2055–2064.
48. Levy S, Harris SK, Sherritt L, et al. Drug testing of adolescents in general medical clinics, in school and at home: physician attitudes and practices. *J Adolesc Health* 2006;38:336–342.
49. Gold MS, Frost-Pineda K, Goldberger BA, et al. Physicians and drug screening. *J Adolesc Health* 2006;39:154–155.
50. Cottler LB, Campbell W, Krishna VA, et al. Predictors of high rates of suicidal ideation among drug users. *J Nerv Ment Dis* 2005;193:431–437.
51. Kintz P, Villain M, Dumestre V, et al. Evidence of addiction by anesthesiologists as documented by hair analysis. *Forensic Sci Int* 2005;153:81–84.
52. Clark HW. Office-based practice and opioid-use disorders. *N Engl J Med* 2003;349:928–930.
53. Joint Commission on Accreditation of Hospitals: Comprehensive Accreditation Manual for Hospitals: The Official Handbook. Standard MS 4.80.
54. The American Board of Anesthesiology, Inc. Booklet of Information, April 2006. Available at: <http://www.theaba.org/materials/BOI-2006.pdf>. Last accessed October 31, 2006.
55. Wagner FA, Anthony JC. From first drug use to drug dependence; developmental periods of risk for dependence upon marijuana, cocaine, and alcohol. *Neuropsychopharmacology* 2002;26:479–488.
56. Ridenour TA, Maldonado-Molina M, Compton WM, et al. Factors associated with the transition from abuse to dependence among substance abusers: implications for a measure of addictive liability. *Drug Alcohol Depend* 2005;80:1–14.
57. Kahlig KM, Lute BJ, Wei Y, et al. Regulation of dopamine transporter trafficking by intracellular amphetamine. *Mol Pharmacol* 2006;70:542–548.

58. Breese GR, Criswell HE, Carta M, et al. Basis of the gabamimetic profile of ethanol. *Alcohol Clin Exp Res* 2006;30:731-744.
59. Bowirrat A, Oscar-Berman M. Relationship between dopaminergic neurotransmission, alcoholism, and Reward Deficiency syndrome. *Am J Med Genet B Neuropsychiatr Genet* 2005;132:29-37.
60. Volkow ND, Wang GJ, Begleiter H, et al. High levels of dopamine D2 receptors in unaffected members of alcoholic families: possible protective factors. *Arch Gen Psychiatry* 2006;63:999-1008.
61. Thanos PK, Taintor NB, Rivera SN, et al. DRD2 gene transfer into the nucleus accumbens core of the alcohol preferring and nonpreferring rats attenuates alcohol drinking. *Alcohol Clin Exp Res* 2004;28:720-728.
62. Brebner K, Wong TP, Liu L, et al. Nucleus accumbens long-term depression and the expression of behavioral sensitization. *Science* 2005;310:1340-1343.
63. Lu L, Hope BT, Shaham Y. The cystine-glutamate transporter in the accumbens: a novel role in cocaine relapse. *Trends Neurosci* 2004;27:74-76.
64. Markel H. The accidental addict. *N Engl J Med* 2005;352:966-968.
65. Roberts LW, Warner TD, Rogers M, et al., Collaborative Research Group on Medical Student Health Care. Medical student illness and impairment: a vignette-based survey study involving 955 students at 9 medical schools. *Compr Psychiatry* 2005;46:229-237.
66. Kosten TR, O'Connor PG. Management of drug and alcohol withdrawal. *N Engl J Med* 2003;348:1786-1795.
67. Gordon RJ, Lowy FD. Bacterial infections in drug users. *N Engl J Med* 2005;353:1945-1954.
68. Andresz V, Marcantoni N, Binder F, et al. Puffy hand syndrome due to drug addiction: a case-control study of the pathogenesis. *Addiction* 2006;101:1347-1351.
69. Centers for Disease Control and Prevention (CDC). Atypical reactions associated with heroin use—five states, January–April 2005. *MMWR Morb Mortal Wkly Rep* 2005;54:793-796.
70. Weber JE, Shofer FS, Larkin GL, et al. Validation of a brief observation period for patients with cocaine-associated chest pain. *N Engl J Med* 2003;348:510-517.
71. Kloner RA, Rezkalla SH. Cocaine and the heart. *N Engl J Med* 2003;348:487-488.
72. Justo D, Gal-Oz A, Paran Y, et al. Methadone-associated torsades de pointes (polymorphic ventricular tachycardia) in opioid-dependent patients. *Addiction* 2006;101:1333-1338.
73. Krantz MJ, Mehler PS. Treating opioid dependence. Growing implications for primary care. *Arch Intern Med* 2004;164:277-288.
74. Collins ED, Kleber HD, Whittington RA, et al. Anesthesia-assisted vs buprenorphine- or clonidine-assisted heroin detoxification and naltrexone induction: a randomized trial. *JAMA* 2005;294:903-913.
75. O'Connor PG. Methods of detoxification and their role in treating patients with opioid dependence. *JAMA* 2005;294:961-963.
76. Hamilton RJ, Olmedo RE, Shah S, et al. Complications of ultrarapid opioid detoxification with subcutaneous naltrexone pellets. *Acad Emerg Med* 2002;9:63-68.
77. Brewer C. The case for rapid detoxification under anesthesia (RODA): a reply to Gossop and Strang. *Br J Intensive Care* 1997;7:137-143.
78. Favrat B, Zimmermann G, Zullino D, et al. Opioid antagonist detoxification under anaesthesia versus traditional clonidine detoxification combined with an additional week of psychosocial support: a randomised clinical trial. *Drug Alcohol Depend* 2006;81:109-116.
79. Krabbe PF, Koning JP, Heinen N, et al. Rapid detoxification from opioid dependence under general anaesthesia versus standard methadone tapering: abstinence rates and withdrawal distress experiences. *Addict Biol* 2003;8:351-358.
80. American Society of Addiction Medicine. Public policy statement on opioid antagonist agent detoxification under sedation or anesthesia (OADUSA). *J Addict Dis* 2000;19:109-112.
81. Liu KS, Tzeng JI, Chen YW, et al. Novel depots of buprenorphine prodrugs have a long-acting antinociceptive effect. *Anesth Analg* 2006;102:1445-1451.
82. Dahan A, Yassen A, Romberg R, et al. Buprenorphine induces ceiling in respiratory depression but not in analgesia. *Br J Anaesth* 2006;96:627-632.
83. van Dorp E, Yassen A, Sarton E, et al. Naloxone reversal of buprenorphine-induced respiratory depression. *Anesthesiology* 2006;105:51-57.
84. Fiellin DA, Pantalon MV, Chawarski MC, et al. Counseling plus buprenorphine-naloxone maintenance therapy for opioid dependence. *N Engl J Med* 2006;355:365-374.
85. Anton RF, O'Malley SS, Ciraulo DA, COMBINE Study Research Group. Combined pharmacotherapies and behavioral interventions for alcohol dependence: the COMBINE study: a randomized controlled trial. *JAMA* 2006;295:2003-2017.
86. Kranzler HR. Evidence-based treatments for alcohol dependence: new results and new questions. *JAMA* 2006;295:2075-2076.
87. Garbutt JC, Kranzler HR, O'Malley SS, Vivitrex Study Group. Efficacy and tolerability of long-acting injectable naltrexone for alcohol dependence: a randomized controlled trial. *JAMA* 2005;293:1617-1625.
88. Hiranita T, Nawata Y, Sakimura K, et al. Suppression of methamphetamine-seeking behavior by nicotinic agonists. *Proc Natl Acad Sci U S A* 2006;103:8523-8527.
89. Saladin ME, Brady KT, Graap K, et al. A preliminary report on the use of virtual reality technology to elicit craving and cue reactivity in cocaine dependent individuals. *Addict Behav* 2006;31:1881-1894.
90. Paulus MP, Tapert SF, Schuckit MA. Neural activation patterns of methamphetamine-dependent subjects during decision making predict relapse. *Arch Gen Psychiatry* 2005;62:761-768.
91. Samet JH, Galanter M, Briden C, et al. Association for medical education and research in substance abuse. *Addiction* 2006;101:10-15.



# CHAPTER 97

## The Economics of Healthcare and Anesthesia Practice

Franklin Dexter, MD, PhD, and  
Amr E. Abouleish, MD, MBA

This chapter focuses on the determinants of anesthesia labor productivity and costs in operating rooms. Although the concepts are the same worldwide, the specific examples and their relevance to daily practice focus on U.S. nonfederal facilities. Both productivity and the cost of providing operating room anesthesia care are inextricably linked to the choices of how many operating rooms to keep open simultaneously and how to schedule cases into those locations, that is, evaluation of anesthesia care (productivity, costs, efficiency) within an operating room is a surrogate for evaluation of operating room management (productivity, costs, efficiency) and vice versa. The principles and processes for the evaluation discussed can be used equivalently for anesthesia operating room care and operating room management.

For example, a surgeon operates at an outpatient surgery center every Monday starting at 8 AM. She always finishes sometime between 2:45 PM and 4:00 PM. Issues such as turnover time, surgical time, and/or anesthesia time are unlikely to have any influence on the use of one anesthesia team each Monday for the surgeon. Even if turnover, surgical, and/or anesthesia times were reduced, likely the surgeon's operating room would still be planned for that surgeon, with one operating room team including one anesthesia team. The costs for providing the anesthesia care would be the same.

### DEFINITIONS

#### Scheduling and Assignment

*Staff scheduling* is the process of deciding which anesthesia providers work each shift on each day. Staff schedul-

ing for a future date usually is performed before the surgical cases to be performed on that date have been scheduled.

For example, anesthesiologists create their work schedule every month. Betsy and Leslie are scheduled to work 8 AM to 4 PM on March 8.

*Staffed hours* are hours that an anesthesia group schedules its providers to cover when not on call (e.g., 8 AM to 4 PM).

*Staff assignment* is the process of deciding who will take care of a specific patient on a specific day.

For example, tomorrow Amr will be medically directing residents in operating room 11 and in operating room 12.

#### Elective, Urgent, and Emergent Cases

We are not aware of any one best answer as to what constitutes an elective, urgent, or emergent case.<sup>1</sup> Still, differentiating among such cases is necessary to plan staffing. The following is a set of reasonable definitions that provide for different operational decisions.

An *elective case* can be defined as one for which the patients can wait at least 3 days for surgery without sustaining additional morbidity.<sup>2</sup> The choice of 3 days corresponds to patients waiting from Friday to Monday. At a facility with patients scheduled

for elective surgery on Saturdays, at least 2 days would be used.

For example, tonsillectomy is an elective case.

An *emergent case* can be defined as one for which the patient is likely to sustain additional morbidity and/or mortality unless surgical care is started in less time than needed for a team to be called in from home. In this context, "likely" to have a worse outcome means based on scientific studies, such as published observational studies. By using this definition, the relevant staffing decision can be made by reviewing data on prior emergent cases.<sup>2</sup>

For example, emergency cesarean section because of uterine rupture is an emergent case.

An *urgent case* is defined as one for which the safe waiting time lies between that of an emergency and an elective case.<sup>2</sup> Almost all nonelective cases are urgent cases.

For example, lung transplantation is an urgent case. It is not an emergency case, because the patient can wait long enough for an operating room team to come to the hospital from home.

#### Definitions Related to Service-Specific Staffing and Operating Room Allocation

*Surgical service* refers to a group of surgeons who share allocated operating room time (i.e., service-specific staffing). An individual surgeon, a group, a

### KEY POINTS

1. Efforts to increase anesthesia group productivity are essentially indistinguishable from those to increase the efficiency of use of operating room time, and vice versa.
2. To describe operational reality, the mathematics of service-specific staffing is based on the surgeon and patient having open access to operating room time on the workday of their choosing.
3. Scheduling cases and making decisions on the day of surgery to increase operating room efficiency are worthwhile interventions to increase anesthesia group productivity. However, by far the most important step is the allocation of operating room time (i.e., the planning of service-specific staffing) appropriately 2–3 months before the day of surgery.
4. Reducing surgical and/or turnover times generally provides small increases in anesthesia group productivity, but results vary widely because they are highly sensitive to both the operating room allocations (i.e., staffing) and the appropriateness of those operating room allocations.
5. An individual anesthesia provider's productivity is influenced by surgical times, types of procedures, underutilized operating room time, and concurrency (i.e., staffing ratios). Thus, most anesthesia groups base compensation on work schedules, such as the shifts worked, rather than units billed, because the latter is influenced by factors that often are not controlled by the anesthesiologist.



specialty, or a department can represent a surgical service. *Service* simply refers to the unit of operating room allocation.

For example, all of the cardiothoracic surgeons practicing at a hospital are allocated operating room time. Then, “cardiothoracic surgery” is a service.

For example, two gynecologists are partners in one of three gynecology groups that practice at a hospital. If the two gynecologists are together allocated operating room time, then they represent a service.

For example, a busy surgeon is personally allocated 8 hours of operating room time every Friday. Then, from the perspective of allocating operating room time and scheduling cases on Fridays, that surgeon represents a surgical service. The service-specific staffing is that one operating room for 8 hours every Friday.

Even when a surgical suite does not have a formal organizational plan for allocating operating rooms (i.e., “block schedule”), there can be service-specific staffing (i.e., operating room allocations). In this regard, “services” need not be specific clinical disciplines in the medical staff organizational structure. Rather, they reflect the activities of individuals or groups of surgeons who use the operating room facilities and thus require organized staffing to support those activities.

For example, a 10-operating room surgical suite has the official policy that all of its cases are scheduled on a first-scheduled, first-served basis. However, in reality, cases of the same specialty usually are scheduled into the same operating rooms. In addition, there are specialty teams. Nurses and anesthesia providers care only for patients undergoing neurosurgery and otolaryngology cases, some only for gynecology or general surgery, and so forth. Then, the services correspond to the specialty teams.

*Allocated operating room time* is an interval of operating room time with a specified start and end time on a specified day of the week that is assigned by the facility to a surgical service for scheduling cases. Some facilities have operating room time that is staffed and available for cases but not allocated to a specific service. Such operating room time has been allocated to a pseudoservice, variably named the open, unblocked, first-scheduled, first-served, or “other” service.

For example, an academic department is allocated operating room time from 8 AM to 5 PM on Monday to Friday. This does not mean that the department's surgeons are limited to scheduling cases only if they can be completed by 5 PM. Instead, it means that staffing has been planned for the department's surgeons between 8 AM and 5 PM. The definition applies whether or not at that hospital it happens that the department's surgeons actually finish by 5 PM.

*Operating room time* of a case is defined as the time from when a patient enters an operating room until he or she leaves the operating room. This definition is used often because it has good interrater reliability. Future use of anesthesia information management systems to provide such data automatically may make operating room management easier.<sup>3</sup>

*Turnover time* is the time from when one patient exits an operating room until the next patient on that day's operating room schedule enters the same operating room.<sup>4,5</sup> Separating turnover time from the operating room time of a case permits the two to be studied statistically as separate processes (discussed below under Impact of Reducing Times on Productivity). Cleanup times and setup time are characteristically recorded separately from operating room times. In part, this is because it is hard to define when cleanup has ceased and setup has begun for the next case. Turnover times include cleanup times and setup times, but not delays between cases. Hospital surgical suites may consider times between cases that are longer than a defined interval (e.g., 1 hour) to be delays, not turnovers.<sup>4</sup>

For example, staffing is planned from 7 AM to 3 PM. A patient arrived at the holding area at 7:45 AM, her IV was placed at 7:50 AM, she entered the operating room at 7:59 AM, the trachea was intubated at 8:12 AM, the operative site was prepared at 8:15 AM, and the incision was made at 8:23 AM. The patient left the operating room at 10:59 AM. From the perspective of operating room scheduling, the case started at 7:59 AM. The operating room time of the case was 3 hours.

For example, a surgeon is scheduled to perform a hepatic resection. However, soon after incision, the patient is found unexpectedly to have widespread metastases. Further surgery is cancelled. The patient exits from his

operating room 2.5 hours earlier than planned. Including a planned 0.5-hour turnover, the second case of the day could start 3 hours earlier than planned. However, the second case of the day in that operating room will be performed by a different surgeon. He is unavailable, caring for patients in his outpatient office. The result is a delay of 3 hours. That delay would not contribute to future calculations of turnover times.

*Operating room workload* for a service is its total hours of cases including turnover times. This excludes the urgent cases if separate operating room time is allocated for urgent cases.

*Underutilized operating room time* = [Allocated operating room time] - [Operating room workload], or zero if this value is negative.<sup>6</sup> This means that underutilized operating room time equals the allocated operating room time minus the operating room workload, provided the allocated operating room time is larger than the operating room workload. Otherwise, the underutilized operating room time is 0 hour.

*Adjusted utilization* =  $100\% \times (1 - [\text{Underutilized operating room time}] \div [\text{Allocated operating room time}])$ .<sup>5</sup>

For example, staffing is planned from 7 AM to 3 PM. An operating room's last case of the day ends at 1 PM. The operating room workload is 6 hours. There are 2 hours of underutilized operating room time. The adjusted utilization is 75%.<sup>5</sup>

*Overutilized operating room time* = [Operating room workload] - [Allocated operating room time], or zero if this value is negative.<sup>6</sup>

For example, an operating room is staffed from 7:30 AM to 5 PM. The last case of the day in the operating room ends at 7 PM. Then, there are 2 hours of overutilized operating room time.

*Inefficiency of use of operating room time* =  $[(\text{Cost per hour of underutilized operating room time}) \times (\text{Hours of underutilized operating room time})] + [(\text{Cost per hour of overutilized operating room time}) \times (\text{Hours of overutilized operating room time})]$ .<sup>6,7</sup>

*Operating room efficiency* is the value that is maximized when the inefficiency of use of operating room time has been minimized.<sup>6</sup> “Efficiency” is characteristically thought of as the ratio of an output to the necessary input. When surgeons and patients are provided open access to operating room

time on any future workday, the output is a constant (see Tactical Versus Operational Decisions to Increase Productivity below). Maximizing “efficiency” then is achieved by minimizing the input. That occurs when service-specific staffing and case scheduling are so good that there are both 0 hour of underutilized operating room time and 0 hour of overutilized operating room time.

For example, why would a surgical department be allocated two operating rooms on Mondays? If the department's surgeons were allocated three operating rooms, then much of the operating room time would be underutilized. That would reduce operating room efficiency. If the department was allocated one operating room, then the surgeons would be working late to finish their cases, resulting in much overutilized operating room time. That would reduce operating room efficiency. The choice of two operating rooms provides the best balance.

In our experience, this example provides what most facilities consider the objective of operating room allocation—providing the right amount of operating room time to get the cases done (i.e., not too much or too little). That is the essence of operational operating room management decision making. That *must* be differentiated from the longer-term tactical stage of operating room allocation, wherein an increase or reduction in allocated operating room time is expected to result in a change in operating room workload.<sup>8</sup>

The example also shows why good operational decisions cannot be made based on operating room utilization. True, operating room allocation would not be three operating rooms based on either operating room efficiency or operating room utilization because there would be many hours of underutilized operating room time. However, the choice of one or two operating rooms would not be clear based on operating room utilization because the resulting hours of overutilized operating room time are ignored. In contrast, decision making based on operating room efficiency considers both the expected underutilized and overutilized operating room time.

For example, Dr. Abrams is an orthopedic surgeon in a solo practice. She is allocated operating room 1 on Mondays and Wednesdays for 10 hours, from 7 AM to 5 PM. Dr. Yue is

another orthopedic surgeon in a solo practice. He is allocated operating room 1 on Tuesdays and Thursdays for 10 hours, also from 7 AM to 5 PM. Both Dr. Abrams and Yue consistently perform slightly less than 10 hours of cases in their allocated operating room time, virtually never more. Both perform spinal surgery cases. However, Dr. Abrams tends to perform one more case of the same type as Dr. Yue within the allocated operating room time because Dr. Abrams operates much more quickly than Dr. Yue. Operating room efficiency is identical and unaffected by how quickly Dr. Abrams operates (see continuation of the example at the end of this section).

### Managerial Cost Accounting

*Labor cost* equals the sum of two products: staffed hours multiplied by the cost per hour of staffed hours and hours worked late multiplied by the cost per hour of hours worked late. More complicated managerial accounting models generally are not needed for purposes of operating room allocation and case scheduling. Labor cost can generally be estimated as the sum of the allocated operating room time multiplied by the cost per hour of staffed hours and the hours of overutilized operating room time multiplied by the cost per hour of overutilized operating room time.

*Operating room productivity* equals the operating room workload divided by the labor costs.

*Anesthesia group productivity* equals anesthesia workload divided by labor costs.

For example, the only anesthesia service that a group provides at an outpatient surgery facility is operating room anesthesia. Staffing is planned for five operating rooms from 7 AM to 3 PM. There is virtually never any overutilized operating room time. Then, each increase in operating room workload (i.e., the cases performed) results in an increase in operating room and anesthesia group productivity.

For example, an anesthesia group practices at a hospital both with substantial underutilized operating room time and overutilized operating room time. Recent increases in elective operating room workload have been in the early evenings, resulting in increased overutilized operating room time. Then, the increase in operating room workload could be reducing

anesthesia group productivity. That would be happening if the cost per hour of overutilized operating room time is much higher than the cost per hour of regularly staffed hours.

Although it may seem good to make operational operating room management decisions based on increasing anesthesia group productivity, we recommend against the approach. Instead, make operational operating room management decisions to maximize operating room efficiency. Usually the decisions will be the same, but not always.

We recommend decision making based on operating room efficiency, for two reasons.<sup>1,9</sup> First, whereas decisions based on operating room efficiency are invariant to the perspective of the cost assessment, decisions based on labor cost are not. Based on whose labor cost should decisions be made? Although for the anesthesia group the ideal would be to make the decisions based on its labor costs, other options include the labor cost of the hospital or society. Second, labor costs vary depending on staff scheduling and staff assignment, whereas operating room efficiency does not. If labor costs were used, distributed decision making would no longer be consistent depending on the perspective of who makes the decision. For example, if one anesthesia provider works overtime to cover for another anesthesia provider who has called in sick, that would affect decisions based on labor costs but not based on operating room efficiency.

*Revenue* is the money received from third parties to provide care for a specific patient.

*Variable costs* are costs that increase proportionate to the volume of patients receiving care.<sup>10</sup>

For example, the amount of endotracheal tubes and medications used will vary with the number of patients who receive anesthesia care. Hence, disposable equipment and pharmacy costs are variable costs.

*Fixed costs* are those costs that are not related to the volume of patients receiving care.

For example, an anesthesia machine costs the same regardless of how often it is used. An anesthesia machine is a fixed cost.

For example, a new eight-operating room ambulatory surgery center has virtually no overutilized operating room time but much underutilized operating room time. On a short-term

basis, labor costs can be viewed as fixed. Even if operating room workload was increased, all the cases would still be completed within allocated operating room time. The number of anesthesia providers needed to staff the operating rooms would be unchanged. However, on a longer-term basis, labor costs can be reduced by closing an operating room.

*Contribution margin* equals revenue minus the variable costs for providing care to those patients.

*Profit* equals revenue minus the sum of fixed and variable costs. This is the same as contribution margin minus fixed costs.

For example, let us return to the orthopedic surgeons, Drs. Abrams and Yue, who were described previously. Dr. Abrams performs one extra spinal surgery case in the same number of hours of operating room time than does Dr. Yue. For the anesthesia group, Dr. Abrams is more profitable than is Dr. Yue, because the anesthesia group gets more revenue for the same fixed costs of staffing the operating room. For the hospital, Dr. Abrams is less profitable than Dr. Yue, because the revenue for the spine surgery cases is less than the variable costs, including the cost of the implanted hardware.<sup>11</sup>

## OPERATING ROOM EFFICIENCY ON THE DAY OF SURGERY

Operating room efficiency is maximized by choosing staffing and scheduling cases to minimize the [(Cost per hour of underutilized operating room time) × (Hours of underutilized operating room time)] + [(Cost per hour of overutilized operating room time) × (Hours of overutilized operating room time)]. This relationship is simplified on the day of surgery.

At most surgical facilities, operating room nurses are full-time hourly or salaried employees. Thus, on the day of surgery, the increment in nursing labor cost from 1 hour of underutilized operating room time is negligible relative to the cost from 1 hour of overutilized operating room time. Finishing cases early, but still before the end of staffed hours, reduces labor costs negligibly versus the labor cost that would result from overutilized operating room time. The same applies to nurse anesthetists and/or anesthesiologists who are em-

ployees of the surgical facility or corresponding anesthesia group.

Few anesthesiologists and nurse anesthetists in private practice can earn enough money to cover the cost of their salary plus benefits unless they are scheduled to care for whatever patients may need urgent surgery along with patients having elective, scheduled surgery. Thus, the incremental revenue lost on the day of surgery by having 1 hour of underutilized operating room time is negligible relative to the indirect/intangible costs from working late unexpectedly (i.e., the opportunity cost is effectively zero).<sup>12,13</sup>

Consequently, on the day of surgery, the cost per hour of underutilized operating room time is negligible relative to the cost per hour of overutilized operating room time.<sup>1,14</sup> Thus, on the day of surgery, minimizing the inefficiency of use of operating room time (see Definitions above) requires only that management minimize the product of the cost per hour of overutilized operating room time and the hours of overutilized operating room time.

Usually, the cost per hour of overutilized operating room time can be considered constant. Consequently, on the day of surgery, the inefficiency of use of operating room time is minimized by minimizing hours of overutilized operating room time.<sup>1,14</sup> Case scheduling to maximize operating room efficiency minimizes hours of overutilized operating room time, as previously reported for surgical suites.<sup>15</sup> The following two scenarios illustrate the implications of the results.

For example, an anesthesiologist is assigned to an operating room staffed from 8 AM to 3 PM, but with 1 expected hour of overutilized operating room time. The anesthesiologist works quickly. She places every intravenous catheter and arterial cannula on the first attempt and performs a fiberoptic intubation in 10 minutes. Because of her rapid work, the cases finish at 3 PM, preventing 1 hour of overutilized operating room time. The anesthesiologist increased operating room efficiency.<sup>14</sup>

A different anesthesiologist is assigned to another operating room staffed from 8 AM to 4 PM, but with 7 hours of scheduled cases. The anesthesiologist works equally quickly, resulting in cases finishing at 2 PM instead of at 3 PM. Because overutilized operating room time was not reduced, the anes-

thesiologist did *not* increase operating room efficiency.<sup>14</sup>

These scenarios show that “working fast” is *not* synonymous with increasing operating room efficiency. The last scenario of the preceding section showed that working fast is not synonymous with maximizing profit either.

For example, a different anesthesiologist is supervising resident physicians in two operating rooms. Staffing is planned from 8 AM to 4:30 PM. The anesthesiologist needs to decide which of the two operating rooms to start first. One operating room is scheduled with two cases from 8 AM to 6:30 PM, the other with five cases from 8 AM to 3:30 PM. To maximize operating room efficiency, the anesthesiologist should first start the operating room expected to have 2 hours of overutilized operating room time.<sup>14</sup>

By following this simple principle, individual and collective decision making can be closely linked to enhancing operating room efficiency. Without understanding the principles of operating room efficiency, the anesthesiologist is likely to have made the opposite decision because there are more cases in the other operating room.

The same principles and use of scenarios can be applied to housekeepers, operating room nurses, managers, postanesthesia care unit nurses, etc.

For example, staffing is planned from 7 AM to 3:30 PM. Recently the hospital hired a new operating room nurse. On Monday, she assisted in operating room 12, resulting in cases finishing at 2 PM instead of 3 PM. On Tuesday, she assisted in operating room 14, resulting in cases finishing at 4:30 PM instead of 5:30 PM. She increased operating room efficiency more on Tuesday than Monday, because reducing 1 hour of overutilized operating room time increases operating room efficiency more than does reducing 1 hour of underutilized operating room time.

## TACTICAL VERSUS OPERATIONAL DECISIONS TO INCREASE PRODUCTIVITY

Consider a common operating room management problem: staffing is planned from 7 AM to 3 PM. A surgeon has been allocated 8 hours of operating room time every Monday for years. The surgeon has always underestimated the operating room times of

his cases. The surgeon has never finished before 6 PM and usually ends between 7 and 8 PM.

The anesthesiologists and operating room nurses may complain about working late every Monday. They may lobby to have a committee meet to rectify the situation. Simultaneously, the administrators may discuss the surgeons' lack of respect for rules and hospital resources. Nevertheless, physicians who refer their patients to the surgeon reward him by continuing to send him work because their patients are pleased with his expeditious service.

The fundamental issue is the surgeon's frequent misrepresentation of the estimated operating room times of his cases, in order to get them onto the operating room schedule.<sup>16</sup> The merits of the tactical issue (i.e., whether this is overall good or bad practice) have little relevance to anesthesia productivity. The relevant operational decision is clear: on a short-term basis, managers should change staffing to match the reality of the existing workload. Doing so neither increases nor reduces operating room capacity or convenience for the surgeon and his or her patients. What it does is to reduce labor costs by reducing the hours worked late in lieu of staffed hours.

For example, when an anesthesiologist was hired, the job description said that work hours were 7 AM to 5 PM. Yet, every Monday for the past 5 years, the anesthesiologist has finished working between 7 and 8 PM. Staffing is planned to 8 PM because that is the reality of the existing operating room workload.

In the two preceding scenarios, the surgeon and patient are choosing the day of surgery. Cases are not being turned away, provided they can be done safely, even if they will likely be performed in overutilized operating room time.<sup>17</sup> Subject to that priority, operating room time can be allocated based on maximizing operating room efficiency. To describe operational reality, mathematics needs to be based on the surgeon and patient having open access to operating room time on the workday of their choosing.

For example, all operating rooms are allocated at a hospital for 8 hours. The adjusted utilizations range from 75–85% among the surgical services. Thus, there is essentially only underutilized operating room time. At this hospital, allocating operating room time based on operating room efficiency would

give precisely the same result as allocating operating room time based on adjusted utilization. This is because virtually no operating room ever finishes late. A zero has been substituted for the hours of overutilized operating room time in the equation for the inefficiency of use of operating room time (see earlier, "Inefficiency of use of operating room time"). The surgeons can be considered to have open access to operating room time on the workday of their choosing, and they have chosen to perform cases only when they can be completed within allocated hours.

The preceding scenarios demonstrate that service-specific staffing can be considered for any facility when decisions are made based on operating room efficiency and on surgeon and patient open access to operating room time on any future workday. The next scenario shows that the assumption of fixed hours applies only to a minority of surgical suites.<sup>7</sup>

For example, an ambulatory surgical center has a policy that operating room time is allocated based on operating room utilization. Staffing is planned from 8 AM to 3:30 PM. This policy is enforced strictly. A surgeon asks to book a case to start at 1:30 PM, with an expected (realistic) operating room time for the case of 2.5 hours. He is told "No," that would be unacceptable, because the case will likely end at 4 PM.

The preceding scenario will seem unreal to most clinicians in the United States. That is the point. Only scheduling cases if they can reasonably be expected to finish by the end of allocated operating room time is not the reality of short-term operational decision making at many facilities. Although considering a facility to have fixed hours of operating room time is an accurate and practical model from a tactical perspective, it is not realistic for day-to-day decision making in a surgical suite.<sup>1,17–19</sup>

We return to the first scenario of this section, which describes persistent overutilized operating room time. Should the surgeon be encouraged to continue to schedule cases beyond the hours that have been allocated? That is a reasonable tactical question, which includes consideration of the financial impact of the surgeon's cases versus the long-term effects on hiring and retention of operating room nurses and anesthesia providers.<sup>8</sup> The tactical decision can, and probably should, be

considered from multiple perspectives, including societal. However, the operational decision making focuses on the reality of the existing workload. Operational decisions, specifically service-specific staffing, are what most managers can control.

Not having fixed hours of operating room time is particularly common at hospitals at which surgeons mischaracterize cases as "urgent" to get them onto the operating room schedule.

For example, an academic department is allocated three operating rooms from 7 AM to 3 PM on all weekdays. No case is scheduled unless it will fit into the 8 hours based on historical operating room time data from the operating room information system. The service schedules 20% of its operating room hours as urgent cases. Many of these patients likely could have waited safely for several days for surgery. Thus, these were elective cases. The surgeons called the cases as "urgent" to achieve open access to operating room time. Operating room efficiency would have been greater had more operating room time been allocated originally so that the cases could be performed in allocated, rather than overutilized, operating room time.

Suppose that on a long-term (tactical) basis, the behavior of the academic surgeons was considered so bad that penalties are applied. Then, there would be very little overutilized operating room time. The methods described in this chapter would be valid and appropriate, but not necessarily a useful improvement. Consequently, there is reason to consider whether the behavior of the above surgeons is inherently bad.

From the societal, hospital, and surgeons' perspective, likely the behavior is good, or at least not bad enough to penalize the surgeons. They are serving as their patients' advocates, assuring timely surgery. Further, in some healthcare systems, including that in the United States, the surgeons are also increasing hospital and physician contribution margin.

Hospitals receiving fee-for-service reimbursement achieve an overall positive contribution margin for the elective cases of almost all surgeons,<sup>8,18,20</sup> because a large percentage of operating room costs are fixed. If professional revenues for the anesthesia providers and surgeons were also considered, then every surgeon would provide an overall positive contribution margin



for their elective cases. The implication, then, is that if a case can be performed safely, it is economically irrational not to perform the case.<sup>8,18</sup>

The rationale for providing surgeons with open access to operating room time, provided a case can be performed safely, makes particular sense for hospitals with intensive care units (ICUs) that often are full. For patients needing such care, the ICU is a frequent bottleneck that results in delays or cancellations of surgical cases. There are two ways to approach this problem, other than simply providing and staffing more ICU beds.

One strategy to reduce the risk of delays or cancellations is to adjust the days that services are scheduled to perform surgery.<sup>21</sup> Although such techniques can be implemented practically,<sup>21</sup> the incremental benefit to hospitals may be small. If most surgeons schedule patients for ICU admission on the same days of the week, usually the cause of case cancellations is visible to the surgeons. The surgeons generally suffer more financially from case cancellations and delays than do hospitals and anesthesiologists. In this situation, the hands-on facilitation of a local operating room manager or an expert in managing organizational conflict can help. Such interventions are valuable and important.<sup>22</sup> However, they are not commonly decisions made by anesthesia group managers, although they can facilitate such processes.

The second of the two strategies is to provide surgeons with flexibility in the days when they have operating room time. Cases should get onto the operating room schedule to assure that the expensive bottleneck (the ICU) is always full. For example, although 90% of patients may have post coronary artery bypass graft (CABG) lengths of stay < 48 hours, there can be marked variability in length of stay.<sup>23</sup> Consequently, it can be very difficult to predict when a relatively full ICU will have an open bed as a result of a patient transfer. When the bottleneck to doing surgery is downstream from operating rooms and the service time for that downstream process is highly variable, then flexibility in scheduling the operating room cases is needed to maximize throughput.

The same applies to expensive capital equipment, which like the ICUs is a fixed cost that is best kept fully used. Operating rooms of the future will include more imaging and robotics,

resulting in even higher capital costs. The percentage of hospital costs for surgery that are attributed to labor likely will decrease as capital costs increase to support these and other expensive technologies. To maximize use of that equipment, surgeons should have open access to operating room time to do a case on whatever future workday they are available, provided the case can be performed safely using existing equipment.

The caveat of “provided the case can be performed safely” is of strikingly large importance. Safety includes access to limited ICU beds, hospital ward beds, postanesthesia care unit beds, fluoroscopy equipment, nonfatigued staff, implants, and so forth. What can be done safely limits how much work can be done in a surgical suite on any given day. Characteristically, tactical decision making limits what can be done safely. Then, operational decision making functions within these boundaries.

Based on these arguments, realistic operational decision making needs to function within a structure that allows the surgeon and patient to choose the day of surgery. The reason why this is so important is that surgeons are not the individuals primarily responsible for operating room efficiency through their filling of the operating room time allocated to them. Rather, the parties primarily responsible for operating room efficiency are the nursing and anesthesia group managers who choose the operating room allocations to match staffing to the surgeons’ workloads.

For example, for 1 week each year, most of the thoracic surgeons are away at a conference. There is substantial underutilized operating room time, resulting in poor operating room efficiency. This is an example of poor operating room management. The managers should have increased operating room efficiency by adjusting staffing to match the surgeons’ and patients’ hours (e.g., by making that time available for the extra staff to use some of their accrued vacation).

### ALLOCATING OPERATING ROOM TIME AND SCHEDULING CASES BASED ON OPERATING ROOM EFFICIENCY TO INCREASE PRODUCTIVITY

Allocating operating room time (i.e., planning service-specific staffing) and

scheduling cases based on operating room efficiency can increase operating room and anesthesia group productivity by reducing labor costs.

### Performing Calculations Using Complete Enumeration

In practice, operating room allocations that are calculated based on operating room efficiency are done by service and day of the week. That is because day of the week is the best predictor of a service’s workload.<sup>7,24</sup> Calculating an operating room allocation means determining how many operating rooms should be staffed daily for each service and, for each of these operating rooms, how many hours of staffing should be planned (e.g., 8, 10, or 13 hours).<sup>7,24</sup> This can be done by complete enumeration. Specifically, all possible staffing solutions are considered, starting with 0 hour and progressively increasing staffed hours until additional increases in the staffed hours cause the efficiency of use of operating room time to decrease for that service.<sup>24</sup> If shifts of 8, 10, and 13 hours are considered, then the successive choices are 0, 8, 10, 13, 16, 18 hours, etc. Increasing the staffed hours causes the efficiency of use of operating room time to increase progressively to a maximum, after which it decreases.<sup>7</sup> The complete enumeration can be constructed such that every series of cases performed by the same surgeon on the same day would be performed in its original sequence. The only change is in the start times.

For example, a surgeon is allocated operating room time individually on Thursdays. The surgeon does 10 hours of cases every Thursday. A 0-hour allocation would have a lower operating room efficiency than an 8-hour allocation because of 10 versus 2 hours of overutilized operating room time each Thursday. An 8-hour allocation would have a lower operating room efficiency than a 10-hour allocation because of 2 versus 0 hour of overutilized operating room time each Thursday. Finally, a 13-hour allocation would have a lower operating room efficiency than a 10-hour allocation because of 3 versus 0 hour of underutilized operating room time each Thursday. Thus, the surgeon would be allocated 10 hours of operating room time.

There is a unique solution to the choice of the operating room allocation that will maximize operating

room efficiency if operating room allocations can be of any duration,<sup>7</sup> but not necessarily when fixed choices are considered. When two choices provide nearly the same inefficiency of use of operating room time, the operating room workload can be reviewed to consider which most closely matches how the surgeons in the service are using the operating room time.

For example, a gynecology group performs an average of 14 hours of cases each Monday, with a range of 13.0–14.5 hours. Forecasted operating room efficiency would be nearly identical whether 13 hours of operating room time were allocated in one operating room or 8 hours in each of two operating rooms. The gynecology group has had two operating rooms (i.e., reliable first case of the day start times) for the past 6 years. They have consistently scheduled cases into those operating rooms such that there is only underutilized operating room time, not overutilized operating room time. Two operating rooms would be the most reasonable choice. In this example, planning operating room allocation based on operating room efficiency versus adjusted utilization results in no effective improvement.

Maximizing operating room efficiency is the same as minimizing the sum of underutilized hours and overutilized hours multiplied by the relative cost of overutilized to underutilized operating room hours.<sup>7</sup> Thus, only the relative cost of overutilized to underutilized operating room hours needs to be known, not the costs per se.<sup>7</sup> A commonly used<sup>24</sup> value for this ratio of costs is 1.75. This includes the direct costs of overtime at “time and a half” (1.50) and an increment (0.25) for indirect (intangible) costs of employee dissatisfaction, resignation, and recruitment and training.<sup>24</sup> Because of the marked effect of limiting consideration to common staff schedules (e.g., 8 or 13 hours), the resulting inefficiency in use of operating room time is characteristically highly insensitive to local experts’ uncertainty in the choice of the value of this parameter.<sup>25</sup>

For example, on three Fridays, a service performed 12, 7, and 15 hours of cases, including turnover times. There are 8-hour shifts, with overtime scheduled by rotation. The relative cost of overutilized to underutilized hours is considered 1.75. If the service were allocated 8 hours of operating

room time each Friday, then the cost of the inefficiency of use of operating room time would be 20.25 hours (0 underutilized + 1 underutilized + 0 underutilized + 1.75 × [4 overutilized + 0 overutilized + 7 overutilized]). If the allocation were two 8-hour operating rooms each Wednesday, the cost would be 14 hours (4 underutilized + 9 underutilized + 1 underutilized). If the allocation were three 8-hour operating rooms each Friday, the cost would be 38 hours (12 underutilized + 17 underutilized + 9 underutilized). Therefore, the service should be allocated two 8-hour operating rooms to maximize operating room efficiency.

There is one answer to the question “How close are current operating room allocations to those that would maximize operating room efficiency?” In contrast, there is no one answer to the question “How close are current operating room allocations to those that are optimal based on operating room utilization?” because there is then the subsequent question of how to determine the optimal operating room utilization. The best operating room utilization varies among services because it is sensitive to many parameters, such as staffed hours, turnover times, day-to-day variability in operating room workload, statistical distribution of operating room times of cases, and so forth.<sup>17,26</sup> Years of data can be required to estimate these parameter values sufficiently accurately to use them to decide on the operating room utilization to use as the service’s goal.<sup>27</sup> Allocating operating room time based on operating room efficiency simultaneously takes into account all of these issues. When a manager says “We allocate operating room time based on operating room efficiency,” that is close to a sufficient statement to describe precisely what happens in practice because the choice of the relative cost of overutilized to underutilized operating room time is invariably close to 1.75 and insensitive to any differences. In contrast, when a manager says “We allocate operating room time based on operating room utilization,” that alone says virtually nothing about what happens in practice at the surgical suite.

### Calculated Operating Room Allocations Differ from Those in Current Practice

Managers’ efforts to reduce labor costs must focus predominantly on operat-

ing room allocation and case scheduling, because almost all anesthesia providers’ costs are labor costs. For 10 of 11 facilities studied, allocating operating room time based on operating room efficiency achieved significantly lower labor costs than the plans that were being used by the local managers.<sup>24,28</sup> For nine of the 11 facilities, the statistical method approach resulted in plans that reduced labor costs by at least 10%.<sup>24,28</sup> The percentage increases in operating room efficiency were, by definition, even more.

A common anecdote reveals how poorly many facilities plan service-specific staffing. Often operating room nurses and anesthesiologists report that every operating room finishes at least an hour or two late every day. To consider the irrationality of the situation, suppose that the relative cost of overutilized to underutilized operating room time were 2.0. Then, it is twice as expensive to finish late versus early. Thus, with appropriate operating room allocations, the odds for each service and operating room to finish early should be approximately two chances in three.

In practice, reductions in labor costs are generally not proportional to the number of operating rooms.<sup>24,28</sup> Surgical suites at which many hours of operating room time are allocated to services do not have the largest percentage improvements from applying the operations research to operating room management.

There are at least two possible explanations for this observation. First, the principal challenge faced by managers does not seem to be the number of operating rooms to be allocated to services but how to manage variability in operating room workload from week to week. The fact that the operating room allocation decision is stochastic seems to be the conceptual problem in the practicing managers’ decisions. Second, at surgical suites where allocating operating room time practically involves choosing between just two or three options, performing a full analysis once or twice seems to be sufficient for managers to be comfortable that they can interpret existing internal operating room workload reports in the appropriate stochastic context. In other words, the analysis is providing education. In contrast, at surgical suites with large services and many options for appropriate operating room

allocations, performing a full analysis at frequent intervals may be useful.

For example, consider a service with operating room workload averaging 5 hours every Tuesday. Because there are no overutilized hours, allocation based on operating room efficiency is identical to allocation based on operating room utilization. Once the principle is understood by managers, analysis is unneeded in the future. In contrast, suppose that the same facility has three of its eight operating rooms as unblocked, open, first-come, first-served “other” time. The surgical suite staffs in 8-, 10-, and 13-hour shifts. Then, those three operating rooms could be allocated as 8/8/8, 8/8/10, 8/10/10, 10/10/10, 8/8/13, 8/13/13/, 13/13/13, 8/10/13, 10/10/13, and 10/13/13. Intuition will not help with this complex decision.

### Urgent Cases

Some hospitals have one or more operating rooms allocated for urgent cases during the regular workday. Typically, the appropriate number of operating rooms is chosen for such urgent cases by considering them to be performed by a pseudoservice, the “urgent” service. Then, the methods above are applied. At facilities not planning an operating room for urgent cases, when calculating operating room allocations for elective cases, each urgent case should be attributed to its surgical service.

The relative cost for overutilized to underutilized operating room time may be appropriately higher for the urgent service than the other elective services, because the choice affects not just how often staff work late but also patient waiting time for urgent surgery. However, urgent cases often cannot start immediately because of a lack of availability of personnel or equipment, such that overutilized operating room time would occur regardless of calculations. In practice, the use of the same relative cost for overutilized to underutilized operating room time as above (e.g., a factor of 1.75) can provide answers that clinicians consider reasonable.

### Amount of Data Required for Effective Calculations

To assess how much data are required to produce acceptable results, a long series of data from a surgical suite was divided into training and testing data-

sets, with different training periods.<sup>9</sup> The complete enumeration was applied to the training data, and the expected labor costs that would have occurred during the subsequent testing period were calculated. Each increase in the number of months of data up to 9 months resulted in a statistically significant reduction in expected labor costs. There were large incremental benefits in using at least 7 months of data. For the studied hospital, there was no advantage to using more than 1 year of data.

The minimum amount of data needed for calculating operating room allocations based on operating room efficiency can be particularly important to managers at facilities purchasing a new operating room information system, anesthesia information system, or anesthesia billing system. The minimum period of data indicates the time from installation of the system to when management changes based on resulting data can be implemented. Application of the statistical methods using as little as 30 workdays of system data provided better operating room allocations to reduce labor costs than operating room allocations established by the practicing managers with years of data.<sup>9</sup>

### Sources of Data

Data for analysis can come from an operating room information system, an electronic anesthesia patient record information system, or anesthesia billing data.<sup>29</sup> Operating room information system data have the advantage of virtually always having necessary data fields completed. Anesthesia billing data have the advantage of accuracy, because billing errors can be costly or even lead to challenges of fraudulent behavior.

Facilities with operating room information systems that do not have data review at the time of data entry often have datasets that contain errors or omissions, including lack of knowledge of the actual operating rooms in which some cases were performed. This manifests as the false appearance of two cases overlapping in the same operating room at the same time. The typical fix is to change the recorded operating room of each case that overlaps to a unique unknown operating room. For example, suppose that one case is listed as being performed in operating room 1 from 9 AM to 10 AM and another in

operating room 1 from 9:30 AM to 11 AM. Among all cases in the dataset, the latter case is the 129<sup>th</sup> for which the true operating room is unknown. The operating room assignment of the second case can be considered to be Unknown129. Making such a change affects calculated turnover times and thus may affect operating room allocations. Nonetheless, studies demonstrated that the impact of this adjustment on the labor costs that result from poor operating room allocations is of negligible importance, for three reasons.<sup>30,31</sup> First, operating room allocations are based on each service's total hours of cases, a large number, plus total hours of turnover times, a smaller number. Second, for cases in an operating room that have a preceding case and a following case, two turnover times are lost. Yet, the turnover time between the remaining cases is increased between the two cases surrounding the reassigned case to the default maximum turnover time.<sup>30</sup> Third, the effect of allocating operating room time only in fixed increments (e.g., 8 or 16 hours) is of larger importance.

### Assessing Trends, Seasonal Variation, and Data Errors

Use of complete enumeration assumes that there are no systematic differences among weeks in the expected operating room workload (i.e., there are no trends or seasonal variation).<sup>24</sup> National survey data show that these assumptions will hold for most facilities.<sup>32</sup> Raw data were reanalyzed from the 1994 to 1996 National Survey of Ambulatory Surgery. As a positive control, to assure that seasonal variation could be detected if present, the average number of myringotomy tubes inserted each day in ambulatory surgery centers of the United States was examined. As expected, myringotomy tube insertions peaked each winter, corresponding to the peak incidence of middle ear infections. Specifically, the average number of tubes inserted each day varied systematically among months for all 26 of the overlapping 11-month periods in the 36 months of the survey. In contrast, the average number of ambulatory surgery cases performed with an anesthesia provider each day in the United States per 10,000 population was found not to vary systematically month to month on an 11-month basis.

Good routine practice is to test for statistically significant trends or sea-

sonality, to confirm that analysis is reasonable for each surgical suite. For example, the runs test can be applied to the total labor cost over each consecutive 4-week period.<sup>24,33</sup> Calculate the total labor cost for each 4-week period. Subtract the median from each value. Delete zero differences. Assign a “+” to positive differences and a “-” to negative differences. Finally, compare the number of runs of +’s and -’s to a critical value from appropriate statistical tables.

Virtually never is it necessary to incorporate methods appropriate for data with trends and seasonality into the analysis. When the runs test detects trends or seasonality, characteristically this reflects a problem with the data or special conditions that need to be modeled separately.

In addition to using the runs test, plot each service’s operating room workload for the days of the week when the service is allocated operating room time. The graphs are helpful to detect unrecognized errors in the data. For example, plotting operating room workload for a service against time can show if a service had no cases listed for a day of the week for some part of the data period being used. This usually occurs when the data sent for analysis include one or more surgeons who recently left the facility.

Finally, look for the presence of many zero values in the histogram of operating room workload for each combination of the day of the week and the service allocated operating room time. This usually happens when the service’s scheduling is characteristic of an individual surgeon rather than a group of surgeons. These “holes” often represent time when an individual surgeon is away (e.g., on vacation). These can be hard to identify in a graph of operating room workload versus time. Such services should have their allocations of operating room time combined with another service to achieve reliable staffing predictions.

### Services with Low Operating Room Workloads

Provided cases are scheduled sequentially into operating rooms (below), then services with average operating room workloads that are consistently <8 hours have no overutilized hours. Allocating operating room time based on adjusted utilization does not differ from doing so based on operating

room efficiency. Many facilities apply a minimum adjusted utilization for operating room allocations.

For example, a service’s operating room workload averages 5 hours every Monday. The facility requires an adjusted utilization of at least 50% for operating room allocation. Thus, the service is allocated a single operating room for 8 hours. Its adjusted utilization is 62%. There are 3 underutilized hours and 0 overutilized hours. Because there are no overutilized hours, allocation based on operating room efficiency is identical to allocation based on operating room utilization.

Each service not receiving an operating room allocation on a given day can be combined into an “other” service (i.e., open, unblocked, first-scheduled, first-served time). At facilities without substantial cross-training of staff, there may be different “other” services for different nursing teams. The calculations of the preceding sections are repeated for the “other” service(s) on each workday.

Importantly, do not simply measure the average operating room workload of a service, observe that it is too low for an allocation of an 8-hour operating room for the day, and then automatically pool it into “other” service time. Apply the graphical methods of the preceding section to assure that the reason for a low operating room workload reflects an actual low workload, not a service that operates every other week on the studied day of the week. Likewise, assure that incomplete data or a trend in operating room workload is not being observed.

### Using Qualitative Information to Improve Forecasts

Qualitative information not available from information system data should be used when finalizing operating room allocations.

For example, a surgeon operates at an outpatient surgery center on Fridays in her 8 hours of allocated operating room time. For years, she has consistently performed 7.0–7.5 hours of cases at the surgery center in that 8 hours of operating room time. The operating room allocations are being updated for the next quarter. Based on historical data, she would, of course, be allocated 8 hours of operating room time on Fridays. However, she is 8 months pregnant. She has requested 3 months of maternity leave. She should

not be allocated operating room time during the next quarter because it would be underutilized, thereby reducing operating room efficiency. Even without personally allocated operating room time, the surgeon would continue to have open access to operating room time on any future workday, if she were to change her mind and work for a few days during her period of maternity leave. Note that if she were not provided open access to operating room time, then there would be an adversarial relationship between the facility not wanting to plan a “block” for her versus her desire to keep some block time to provide herself and her patients some flexibility.

### Forecast Remaining Underutilized Operating Room Time

A concern at some facilities is that underutilized operating room time is needed for nonclinical but important activities. For example, equipment for the next day’s cases may be set up by nurses whose operating rooms finish earlier than the end of their shift. The manager of such a facility may express concern that changing operating room allocations to increase operating room efficiency will impair processes that function well by taking advantage of existing underutilized operating room time.

Expected underutilized time can be estimated empirically after future operating room allocations have been determined. Applying the allocations, each historical day’s resulting total underutilized hours are calculated. The statistical distribution of each day’s total hours of underutilized operating room time can be described using histograms or percentiles.

### Case Scheduling to Maximize Operating Room Efficiency

Allocating operating room time to increase operating room efficiency is of little value unless cases are also scheduled into the operating room time appropriately.

A series of thought experiments and computer simulations were performed to evaluate case scheduling based on maximizing operating room efficiency.<sup>14</sup> The performances of different case scheduling heuristics were compared. The analyses showed that managers can achieve efficient operating room scheduling while leaving case



scheduling decisions to the convenience of the surgeons and patients, provided three simple scheduling rules are followed. In other words, there were small differences in resulting operating room efficiency among several different scheduling heuristics, with these three exceptions.

The first of three scheduling rules is that a service should not schedule a case into another service's operating room time if the case can be completed within its own allocated operating room time.<sup>14</sup>

For example, two gynecologists are partners in a group that has been allocated 10 hours of operating room time on Tuesdays. One of the gynecologists has scheduled 6 hours of cases into the operating room time, leaving 4 hours of allocated but unscheduled operating room time. An orthopedic surgeon has scheduled 2 hours of cases into his personally allocated 8 hours of operating room time. Nine days before the day of surgery, the second gynecologist wants to schedule a new 2-hour case. The available start time would be after her partner who has already scheduled cases. The case would not be scheduled into the orthopedic surgeon's operating room time, even if the second gynecologist wants to start earlier. The reason is that the gynecology group has available operating room time for the case.

The reason for this result is that operating room allocations are calculated based on expected operating room workload on the day of surgery. Services fill their allocated operating room time at different rates.<sup>34</sup> Almost all facilities with allocated operating room time follow the preceding scheduling rule. Thus, the importance of this finding was not that it showed a new way to schedule cases but that it showed that most facilities make decisions based on operating room efficiency.<sup>14</sup>

The second of the three scheduling rules is that a case should not be scheduled into overutilized operating room time if it can start earlier in another of the service's operating rooms.<sup>15</sup> This applies to services allocated two or more operating rooms. Suppose that operating room workload is 23 hours. The hours of overutilized operating room time would be considered slightly less if two operating room were allocated for 13 hours (total 26 hours) versus three operating room for 8 hours (total 24 hours). This result

may not apply unless the case scheduling results in similar packing of the cases into the allocated operating room time.<sup>14,35</sup> Simulations show this does occur generally.

For example, a service has been allocated operating room 1 and operating room 2 from 7 AM to 3 PM. One surgeon in the service has scheduled cases in operating room 1 to finish around 2 PM. Operating room 2 is empty. A second surgeon in the service wants an afternoon start. He asks to start an elective 3-hour case at 2:30 PM in operating room 1. Even though operating room workload would be the same, scheduling the case into operating room 1 would be expected to result in overutilized operating room time and thereby reduce operating room efficiency. His request should be rejected. The surgeon should either take the first case of the day, start in operating room 2, or choose a different workday.

The preceding scenario matches what is done at most surgical suites. Cases are generally not scheduled in overutilized operating room time when a service has another allocated operating room that is empty. Consequently, as the first rule above, this rule shows that scheduling cases based on maximizing operating room efficiency differs little from what is commonly done in practice.<sup>14</sup> Changes resulting from decision making based on operating room efficiency are generally not in case scheduling. Rather, they are in operating room allocations (as above) and in the third rule regarding how operating room time is released.

The third of the three scheduling rules is that if a service has already filled its allocated operating room time, then, to maximize operating room efficiency, its new case should be scheduled into another services' operating room time instead of into overutilized operating room time.<sup>14,34</sup>

For example, a service has filled its allocated operating room time but has another case to be scheduled. If the operating room time of another service were not released, the case would be performed in overutilized operating room time. Operating room efficiency is greater by performing that case in operating room time allocated to another service that otherwise would be underutilized on the day of surgery.

For example, a surgeon may be subverting the case scheduling system for the "other" first-scheduled, first-

served operating room time. The surgeon may be creating fictitious patients to "hold" operating room time for his cases (e.g., at the desirable 8 AM start time). At a Surgical Services Committee meeting, a manager suggests that there be the policy that, when a case is cancelled, first access to cancelled operating room time goes to other surgeons with waiting cases, not the surgeon canceling the case. That recommendation is not sound. When a service has filled its allocated operating room time and has another case to schedule, operating room efficiency is enhanced by releasing the operating room time of the service expected to have the most underutilized operating room time. No cases should be waiting to be scheduled.

To evaluate which service should have its operating room time released, simulations were performed scheduling new hypothetical cases into actual operating room schedules. Services fill their allocated operating room time at different rates. Thus, theoretically, the service that should have its operating room time released for a new case should be the service that is predicted, at the time the new case is booked, to be the service that will have the most underutilized operating room time on the scheduled day of surgery. Yet, performance is only slightly better versus scheduling the case into the operating room time of the service with the largest difference between allocated and scheduled operating room time at the time when the new case is scheduled.<sup>34</sup> The latter is far easier to implement practically.

In contrast, releasing the operating room time of the service with the second most, instead of the service with the most, allocated but unscheduled operating room time has a large negative effect on operating room efficiency.<sup>34</sup> The reason is that usually a particular case can only be scheduled into a few services' operating room time without resulting in overutilized operating room time. The differences among those few services in their amount of expected open operating room time often are large. This occurs because day-to-day variability in the operating room workload of services on a day of the week generally exceeds variability due to the timing of how quickly different services filled their allocated operating room time.

The timing of when allocated operating room time should be released has

been studied.<sup>36</sup> Potentially, the scheduling office could wait to release the allocated operating room time until closer to the day of surgery, when data may be available on subsequently scheduled cases, in order to improve the quality of the decision. Simulation results were equivocal as to the benefit of such a decision. Under two conditions, postponing the decision of which service had its operating room time released for the new case until early the day before surgery had a negligible effect on resulting operating room efficiency versus releasing the allocated operating room time when the new case was scheduled.<sup>36</sup> This finding applies to an ambulatory surgery center with brief cases. At such facilities, typically there is only one good choice for the service to have its operating room time released.<sup>34</sup> Thus, there is no good reason to wait in making the decision. This finding often also applies to large surgical suites in which cases are scheduled as if there were many smaller suites. For example, at a 25-operating room surgical suite, one nursing and anesthesia team may staff the six operating rooms used for urology and general surgery. From the perspective of releasing operating room time for a new urology or general surgery case, only six operating rooms are available, not all 25.

For example, a hospital contains a team cross-trained in neurosurgery and otolaryngology. One week hence, on next Monday, neurosurgery has been allocated one 8-hour operating room. Otolaryngology has been allocated one 8-hour operating room also. The otolaryngologists have scheduled 9 hours of cases into their operating room. A third otolaryngologist wants to schedule another 2-hour case. The neurosurgeons have scheduled a case for 3 hours from 7 AM to 10 AM. The otolaryngologist with the new case can book the case because the surgeons have open access to operating room time on whatever workday they choose. Provided the otolaryngologist is available at 10:30 AM, then the neurosurgeons' operating room time would be released. There is no advantage to waiting to schedule the case. Yet, if the neurosurgeon with the 7 AM to 10 AM case was to schedule another case, ideally the otolaryngologist could be persuaded to start his case later in the day.

Despite this consideration of how best to release allocated operating

room time, it is important to appreciate that results are highly sensitive to the operating room time being allocated appropriately based on operating room efficiency. Issues of when to release allocated operating room time pale in practical importance versus operating room allocation and staffing. Although operating room management problems are observed on the day of surgery, often the root cause and only practical way to fix the problem is to plan operating room allocations and staffing properly several weeks or months before the day of surgery.<sup>37</sup>

For example, operating room information systems data are used to calculate operating room allocations, which then are reviewed by an operating room committee. An ophthalmologist complains that his allocated operating room time on Wednesdays has been "released" for 2 of the past 3 weeks. Each time, the otolaryngology service has filled its allocated 8 hours of operating room time and so has booked cases into his operating room time. The ophthalmologist is upset that the schedulers are treating him unfairly by repeatedly releasing his allocated operating room time. Although he schedules many cases a couple of days before the day of surgery, his operating room workload is consistently at least 7 hours each Wednesday. The ophthalmologist's concerns are well founded; this should not be happening. However, the problem is not that the schedulers are releasing his operating room time. Rather, they are making the proper decision to maximize operating room efficiency. The problem is that the otolaryngology service should be allocated more than 8 hours of operating room time.

Finally, although this chapter has focused on decision making before the day of surgery, the same principles apply to decisions made on the day of surgery.<sup>1</sup> The principles described can also be used to decide how cases are moved on the day of surgery,<sup>38</sup> how staff are assigned on the day of surgery,<sup>39</sup> and how cases are sequenced in each operating room.<sup>40,41</sup>

## IMPACT OF REDUCING TIMES ON PRODUCTIVITY

### Impact of Reducing Surgical and Turnover Times

The impact of interventions on labor costs can be forecast using each facili-

ty's own data, along with corresponding confidence intervals.<sup>12</sup> For example, turnover times can be reduced between each case.<sup>12</sup> Surgical times can be reduced to national average values for each procedure.<sup>13</sup> For both interventions, first the labor cost is calculated assuming that operating room time is allocated and cases are scheduled based on operating room efficiency. Second, the intervention is performed, thereby reducing operating room workload by service. Third, using the revised workload values, operating room time is reallocated based on operating room efficiency and the new estimates for labor costs projected. Fourth, the differences are calculated. By analyzing the differences in 4-week epochs, to prevent effects of variation by day of the week, confidence intervals can be calculated for the differences.<sup>12,13,24</sup>

For example, consider a hospital that allocates operating room time to many small services, each having adjusted utilizations of <85% with 8-hour allocations.<sup>13</sup> Cases are being scheduled based on operating room efficiency (i.e., sequentially into operating rooms<sup>14</sup>). Reducing operating room times cannot result in reduced overutilized hours because there are none. Labor costs will not be reduced (i.e., they are fixed to achievable reductions in operating room times).

For example, a different hospital has few surgical services, most with more than one operating room, and many operating rooms with workloads exceeding 8 hours.<sup>13</sup> Conclusions are different than in the preceding example. Reducing operating room times can result in reductions in workload sufficient to reduce allocated operating room time (e.g., an operating room allocated for 10 hours would now be allocated for 8 hours). Thus, at this hospital, there would be financially important reductions in labor costs from reducing operating room times.

Equivalent analyses can be performed at teaching facilities to calculate<sup>13</sup> the impact of longer operating room times (due to factors such as teaching time and development of skills in trainees)<sup>42,43</sup> on labor costs.

These examples show that, generally, cost reduction from reducing operating room or turnover times can only be achieved provided operating room allocations are reduced. The initial impact is increased underutilized operating room time and reduced overuti-

lized operating room time. This initial step is evident to clinicians. The secondary step is revisions of operating room allocations based on the new values of decreased operating room workload. The latter step provides for the large reductions in labor cost. Whereas the former is often a palatable change, the latter can be less popular politically.

Usually reductions in labor costs from reducing turnover times tend to be small. At four academic tertiary hospitals studied, reductions in average turnover times of 3–9 minutes would result in 0.8–1.8% reductions in labor cost.<sup>12</sup> Reductions in average turnover times of 10–19 minutes would result in 2.5–4.0% reductions in labor costs.<sup>12</sup> These analyses can be fruitful in educating stakeholders that achievable reductions in the times to complete tasks often have less effect on operating room efficiency than does good management decision making.

### Impact of Not Changing Operating Room Allocations

Some facilities do not make decisions systematically based on increasing operating room efficiency and are unlikely to change their practices because of organizational inertia. Then, the methodology above can be used to calculate the higher labor costs that the facility sustains from operating room time not being allocated and cases not being scheduled based on operating room efficiency.<sup>9,24,28</sup>

For example, anesthesia group expenses exceed revenue at a facility. The calculation is performed using labor costs of anesthesia providers. The estimate of the resulting additional labor costs is used by the head of the anesthesiology group when she negotiates an appropriate subsidy from the hospital.

Calculations of subsidies can also apply to negotiations with medical schools, ambulatory surgical facilities, or a multispecialty group. At two academic medical centers, estimated annual excess labor costs were \$1.6 million and \$1.0 million, respectively.<sup>28</sup>

### Impact of Not Reducing the Number of Allocated Operating Rooms

Some organizations aim to adjust their operating room allocations to be as close as possible to those that are

expected to maximize operating room efficiency while not reducing the number of allocated operating rooms. This approach does not result in maximal operating room efficiency. Instead, it reflects organizational pressure to open as many operating rooms as are available for first case of the day starts. The mathematics can be weighted to allocate more operating rooms by repeating the analyses using a higher relative cost of overutilized to underutilized hours. An increase in the relative cost gives an increase in how many operating rooms are allocated.<sup>17</sup> The smallest value is chosen for which the allocated number of staffed operating rooms matches the desired, usually current, number of operating rooms. This analysis is run separately for each day of the week.<sup>17</sup>

Increasing the number of allocated operating rooms results in a slightly smaller percentage increase in operating room labor cost than in staffing.<sup>17</sup> The reason is that opening more operating rooms than are needed to maximize operating room efficiency does not change operating room workload. Thus, the increase in allocated operating room hours increases underutilized operating room time and reduces overutilized operating room time. The cost per hour of overutilized operating room time exceeds that of underutilized operating room time. Consequently, the percentage reduction in operating room efficiency is less than the percentage increase in allocated operating room hours. The same argument applies to labor costs.

## INDIVIDUAL PRODUCTIVITY

In the previous sections, the economic evaluations focused on overall operating room and anesthesia group productivity. In contrast, this section considers the issue of individual productivity, specifically individual anesthesiologists.

### Individual versus Group Productivity

Group and individual productivity are distinctly different. For example, in baseball, there are a variety of measurements of individual productivity for each position: earned runs average, strikeouts and walks for pitchers; hits, batting average, and home runs for batters; and double plays, errors, and fielding percentage for fielders. In con-

trast, the measurement of group productivity is simply the final output: wins and losses. Similarly, for anesthesia care, individual measurements should focus on the individual's contribution, whereas group measurements should examine overall productivity or output.

One of the greatest errors in management is to take a group goal or benchmark and apply it to individuals.

For example, a group develops a benchmark for their group of X units per anesthesiologist. Then, it would be a mistake to assume that each anesthesiologist in the group should produce a minimum of X units. Each individual will fulfill different functions.

For example, consider the earlier example of two spine surgeons, Drs. Abrams and Yue. Dr. Abrams tends to perform one more case of the same type than does Dr. Yue within the same 10 hours of allocated operating room time because Dr. Abrams operates much more quickly than Dr. Yue. The anesthesiologist caring for Dr. Abrams' room will produce more billing units than Dr. Yue's anesthesiologist. If the group is using cases or total units billed as a group benchmark for work done but then *mistakenly* applies this benchmark to individuals, then the individual anesthesiologist caring for Dr. Yue's room will appear to be less productive. In reality, for the group to be successful, both operating rooms needed to be staffed. For an individual benchmark of work, the group may decide to use something different from billed units (e.g., time worked or shifts scheduled).

### Defining Individual Productivity

Just as for operating room and anesthesia group productivity, the individual productivity of anesthesiologists is the dividend of workload divided by labor units. The individual workload can be defined in several ways. On the other hand, labor units usually are defined by the clinical full-time equivalent (FTE; percentage of time a full-time anesthesiologist works clinically). In groups that provide care to multiple hospitals with multiple staffing models (e.g., personally performed, medically directing < 1:2 residents, medically directing > 1:2 certified registered nurse anesthetists [CRNAs]), the labor unit may need to be converted to a dollar cost. However, for most groups, this is not necessary.

TABLE 97-1.

## Confounding Factors or Anesthesia-Independent Factors

	Surgery	Anesthesia Time (h)	Turnover (min)	No. Cases Done	Base/Case (Total Billed)	TU/Case (Total Billed)	(Total tASA Billed)
Operating room 1	Lap chole (fast)	1	20	7	7 (49)	4 (28)	77
Operating room 2	Lap chole (slow)	2	20	4	7 (28)	8 (32)	60
Operating room 3	CABG	2.5	30	3	20 (60)	10 (30)	(90)
Operating room 4	Lap chole (prior commitment)	2	20	2	7 (14)	8 (16)	(30)
L&D	Labor epidural	6	n/a	3	5 (15)	4 (12)	(27)

Hypothetical surgical suite and labor and delivery (L&D). The anesthesiology group staffs the anesthetizing sites from 7:30 AM to 4:30 PM. Confounding factors affect billed units can be seen by comparing billed units for different operative rooms: surgical times (operating room 1 and 2), type of surgery (operating room 1,3), underutilized operating room time (operating room 2 and 4), and obstetric anesthesia (L&D). For operating room 4, the surgeon must leave at noon, so no cases are available to be done after this time. For labor epidural, only “face-to-face” time is billed, i.e., 1 hour for 6 hour epidural.

Base, base units; CABG, coronary artery bypass graft; lap chole, laparoscopic cholecystectomy; tASA, total American Society of Anesthesiologists; TU, time units.

Therefore, the productivity will be measured as the workload done per anesthesiologist or FTE.<sup>44</sup>

Defining the workload for anesthesia care is not the same as work done by other physicians. The most common unit used for work performed by nonanesthesiologists is the work relative value unit (work RVU) from the resource-based relative value system (RBRVS).<sup>45</sup> Anesthesia care in the United States is billed primarily using American Society of Anesthesiologists (ASA) units made up of basic, time and modifier units.

The ASA units provide a more accurate description of work done than simply “cases performed.” The use of ASA units allows the recognition of both base (case complexity) and time units. Thus, total hip arthroplasty usually produces more total anesthesia billing units because hip arthroplasty is more complex from an anesthesia perspective (i.e., more base units) and usually is a considerably longer operation (i.e., more time units). Therefore, the ASA units can differ tremendously among cases.

### Confounding Factors to Measuring Individual Productivity

Unlike many specialties, the amount of work done by an individual anesthesiologist often is impacted by factors outside the individual’s discretion, which we term “confounding” factors. To illustrate the confounding factors

of surgical time, type of surgery, underutilized operating room time, and obstetric anesthesia care, a hypothetical facility will be used as an example (Table 97-1). At the facility, the anesthesiology group must staff the four operating rooms as well as the labor and delivery suite. For this example, all operating rooms are allocated for 9 hours (7:30 AM to 4:30 PM). The resultant billed ASA units will be examined. For the initial example, we will assume that all the operating rooms are staffed by individual anesthesiologists. Provided there are no hours of overutilized operating room time, labor costs are the same.<sup>44</sup>

*Surgical times.* In operating room 1, there is a “fast” surgeon performing laparoscopic cholecystectomies with an average anesthesia time of 1 hour. Turnover time for this operating room is 20 minutes. Therefore, the surgeon is able to perform seven cases, with the last case ending at 4:30 PM. The base units per case are seven units, and the time units per case are four units (15-minute time units). The total base units, total time units (TU), and total ASA units (tASA) billed for operating room 1 are 49, 28, and 77 units, respectively (Table 97-1). In operating room 2, there is a “slow” surgeon also performing laparoscopic cholecystectomies, but with an average anesthesia time of 2 hours. Because of longer surgical times, only four cases are done, with the last case ending at 4:30 PM. The total base units, TU, and tASA for operating room 2 are 28, 32, and

60, respectively (Table 97-1). Because both operating room 1 and operating room 2 are in operation the same amount of time, the differences in base units, TU, and tASA units billed are *due to the differences in the surgical times*.

*Type of surgery.* In operating room 3, cardiac surgery is performed with the operating room finishing by 4:30 PM. The base units for the anesthesia for coronary artery bypass graft surgery (CABG) are 20 units/case, greater than those for laparoscopic cholecystectomy. The total base units, TU, and tASA for operating room 3 are 60, 30, and 90 respectively (Table 97-1). Because operating rooms 1 and room 3 were staffed for approximately the same amount of time, the differences in billed units between operating rooms 1 and 2 versus operating room 3 are *due to the differences in type of surgery performed*.

*Underutilized operating room time.* In operating rooms 1, 2, and 3, there was no underutilized operating room time. In contrast, operating room 4 has 4.5 hours of underutilized operating room time after its laparoscopic cholecystectomies (Table 97-1). The many possible reasons for this underutilized operating room include the following: poor operating room allocation, few patients scheduled for surgery that day, scheduled cases have been cancelled, or the surgeon has prior commitment (personal time, clinic patients scheduled, or surgery at another hospital). The total base units, TU, and tASA for



TABLE 97-2.

## Concurrency and Individual Productivity Measurements

MD	Operating Room Site	Surgery	TU per Operating Room	tASA per Operating Room	Billed Units per FTE	
					TASA/FTE	TU/FTE
A	Operating Room 1	Lap chole (fast)	28	77	167	76
	Operating Room 2	Lap chole (slow)	32	60		
	Operating Room 4	Lap chole (prior commitment)	16	30		
B	Operating Room 3	CABG	30	90		
C	L&D	Labor epidural	12	27	27	12

Hypothetical surgical suite and labor and delivery (L&D) described in Table 97.1. In this example, a medical-direction model is shown. MD-A medically directs three anesthesia providers (certified registered nurse anesthetists, anesthesia assistants, or residents), while MD-B and MD-C still provide personally performed care. Therefore, concurrency or staffing ratios are not the same. MD-A is credited with the billed units, time and total ASA, for three rooms and hence has higher values of tASA/FTE and TU/FTE than MD-B or MD-C.

Base, base units; CABG, coronary artery bypass graft; FTE, full-time equivalent; lap chole, laparoscopic cholecystectomy; MD, anesthesiologist.

operating room 4 are 14, 16, and 30, respectively (Table 97-1). Therefore, the decreased billed units for operating room 4 compared to operating room 2 (same anesthesia times and type of surgery) are *due to the underutilized operating room time*.

**Obstetric anesthesia.** Similar to the operating room staffing commitment, the anesthesiology group has committed to covering the labor and delivery suite with one anesthesiologist. The billings for 7:30 AM to 4:30 PM are shown in Table 97-1. During the work hours examined, three labor epidurals were placed and managed. Each of these epidurals lasted 6 hours, but only four time units (1 hour) were billed. (Note: In Texas, the Medicaid billing rules allow billing only for “face-to-face” time.) The base units, time units, and total ASA billing units for obstetric care on this day would be 15, 12, and 27, respectively (Table 97-1). Although the obstetric anesthesiologist worked the same hours as the anesthesiologists in operating rooms 1, 2, and 3, the billed units are significantly different from those in the operating rooms. In fact, only operating room 4 is similar in units billed, and that operating room was active for only half the time! Therefore, the potential billed units in obstetric anesthesia care were significantly less than potential billed units for operating room anesthesia care for an equivalent time interval *due to obstetric care billing methodology*.

Together, these scenarios illustrate that management and rewards decisions for individual anesthesiologists

may need to be based on factors other than the units billed.

### Staffing Ratios or Concurrency in Medical Direction

In the example of confounding factors, we assumed that the care was provided by one anesthesiologist per operating room reflecting a physician-only anesthesiology group. Other possible staffing models include an “academic medical direction” model (each anesthesiologist concurrently medically directing one or two anesthesia providers, be they residents in training, CRNAs, or anesthesia assistants), “private-practice medical direction” model (each anesthesiologist medically directing 2–4 anesthesia providers who are not residents in training), or “medical supervision model” (medically supervising >4 nonresident anesthesia providers). In any of these models, the measurement of work done per anesthesiologist differs as well.

To illustrate this effect, the hypothetical case described in Table 97-1 is revised. In this new illustration (Table 97-2), we assume that the three operating rooms with laparoscopic cholecystectomies (operating rooms 1, 2, 4) are covered by one anesthesiologist (MD-A) working with three providers and that operating room 3 (CABG) and labor/delivery are still covered by individual anesthesiologists (MD-B, MD-C). MD-A bills for care done in three operating rooms and therefore receives more units than MD-B and MD-C. Thus, when concurrency differs among the anesthesiologists, those

with greater concurrency will bill more units per anesthesiologist.<sup>46,47</sup>

However, both the labor costs and revenue may vary if the concurrency or types of providers differ. In Table 97-2, the staffing costs will be greater for operating rooms 1, 2, and 4 than for operating room 3 or the obstetric suite. Labor costs depend on the type of provider and the compensation levels of the local job market. Revenue differs for some payers (especially Medicare) with changes in concurrency and provider type. These factors are discussed in greater detail in Chapter 98.

### Measuring Individual Productivity

The challenge for any group, academic or private practice, is that when instituting a system to pay for individual productivity, the group must understand what each measurement values and devalues. Furthermore, any new system should be considered a behavior modification system because that is essentially what it is—compensating each individual for specific work done. Therefore, each group must decide what behavior they need to change and choose measurements that will value the behavior the group wants done.<sup>48</sup>

Briefly, for each category of possible measurement (charges or ASA units, time units, or shift worked), there are distinct advantages and disadvantages. For either type of units (total ASA units or time units), differences in billed charges are influenced by factors outside the individual anesthesiologist's

discretion, mainly surgical times, type of surgery, underutilized schedule, and concurrency. Total ASA units billed or total charges both value billed charges, specialty care (type of surgery), and short operating room time cases while they devalue availability to work (but no cases performed due to underutilized time) or low-billed charges sites (e.g., remote sites, obstetrics, or in-house call). Time billed recognizes only “billable time,” not the time actually worked. Therefore, time billed values longer operating room time cases and time with the patient but devalues unbilled time (e.g., turnover time, call, availability to work but no cases performed due to underutilized time) and specialty care (type of surgery). In either system using total ASA units or time units, activities that are not billed using ASA units are not easily included. These activities include critical care medicine, pain management services, and preoperative clinic. Shifts worked (paid either by the shift or by hourly wages for late calls) is independent of the factors noted. Shifts worked values availability but devalues the actual amount of work done per shift.

Each anesthesia group must define its issues and develop a plan that works for its members specifically.

For example, if the issue is that the late cases are not evenly distributed, a system of paying for late cases (can be any of the above measurements) can be developed. The group could choose from among several measurement systems. Work done during the day could be paid using a shift-based measurement while the late cases are paid by hourly wage. Alternatively, compensation could be based on time billed during the late cases.

For example, the behavior that another group may aim to change is the willingness to accept add-on cases during the day. In this situation, the group may decide to use a system of billed units (total ASA units or time units) that will devalue unbilled time and reward caring for patients.

For example, a group that now covers several hospitals has traditionally had an “equal-share” system. The perception is that work in Hospital B is not as demanding as in Hospital A. On the other hand, billed charges in Hospital B are equal to those in Hospital A, but Hospital B works less hours than Hospital A (the influence of surgical duration on billed units). The group

may decide to resolve this by valuing a shift at Hospital A more than a shift at Hospital B or using a time-billed system. If the group chooses billed charges or total ASA units, then the group would not have succeeded in valuing the work at Hospital A more.

Because of the many confounding factors, including surgical times, types of surgery, operating room allocation, and case scheduling and concurrency differences, many anesthesia groups find it difficult to measure the work done by individuals. Most private-practice and academic groups measure work done by individuals by the shifts worked. That is, most groups do not use charges, total ASA units, or billed time as a measure of individual work.<sup>49</sup>

Most private-practice groups distribute income (and compensation) of partners based on the work done by each partner. Thus, the income distribution plan is really an individual productivity measurement system. In a survey of private-practice groups in 2003, the majority of groups distribute income equally among partners.<sup>49</sup> This type of system inherently means that each partner works the same number of shifts (regular hours, late shifts, call, and time off) and that the work done per shift is not under the individual anesthesiologist's discretion. Some other groups use a “point” system, where shifts are given a number value and partners acquire points by working shifts. Again, under this system, the work done per shift is not under the individual anesthesiologist's discretion. A few groups use billed charges, total ASA units, or billed time to determine revenue distribution. Larger groups with more than one hospital tend to have one of these latter systems.

For academic groups, incentive pay for clinical work can be viewed as a system to compensate based on individual clinical productivity. Most academic groups do not vary incentive pay by work done per shift.<sup>49</sup> When incentive payments are available, most are based on working shifts, be they during the day or on call. Again, larger groups with multiple sites tend to use billed charges, total ASA units, or billed time.<sup>50,51</sup>

## CONCLUSION

Operating room allocation is a two-stage process.<sup>8</sup> During the initial tactical stage of allocating operating room

time, considering operating room hours to be fixed is reasonable. For operational decision making on a short-term basis, such a conceptual model produces results markedly inconsistent with how surgical suites are and should be run. Consider the workload to be fixed on a short-term basis. Provide staff flexibly to match the existing workload, not vice versa. Do so by making operational decisions based on maximizing operating room efficiency, as this is an important step to maximizing anesthesia group productivity.

Individual productivity is influenced by surgical times, types of procedures, underutilized operating room time, and concurrency. Thus, most groups base compensation on the shifts that each individual is scheduled to work.

## KEY REFERENCES

1. Strum DP, Vargas LG, May JH. Surgical subspecialty block utilization and capacity planning. A minimal cost analysis model. *Anesthesiology* 1999;90:1176.
2. Dexter F, Abouleish AE, Epstein RH, et al. Use of operating room information system data to predict the impact of reducing turnover times on staffing costs. *Anesth Analg* 2003;97:1119.
3. Abouleish AE, Dexter F, Whitten CW, et al. Quantifying net staffing costs due to longer-than-average surgical case durations. *Anesthesiology* 2004;100:403.
4. Dexter F, Traub RD. How to schedule elective surgical cases into specific operating rooms to maximize the efficiency of use of operating room time. *Anesth Analg* 2002;94:933.
5. Abouleish AE, Zornow MH, Levy RS, et al. Measurement of individual clinical productivity in an academic anesthesiology department. *Anesthesiology* 2000;93:1509-1516.

## REFERENCES

1. Dexter F, Epstein RD, Traub RD, et al. Making management decisions on the day of surgery based on operating room efficiency and patient waiting times. *Anesthesiology* 2004;101:1444-1453.

2. Dexter F, O'Neill L. Weekend operating room on-call staffing requirements. *AORN J* 2001;74:666-671.
3. Xiao Y, Hu P, Hao H, et al. Algorithm for processing vital sign monitoring data to remotely identify operating room occupancy in real-time. *Anesth Analg* 2005;101:823-829.
4. Dexter F, Macario A, Qian F, et al. Forecasting surgical groups' total hours of elective cases for allocation of block time. Application of time series analysis to operating room management. *Anesthesiology* 1999;91:1501-1508.
5. Donham RT, Mazzei WJ, Jones RL. Procedural times glossary. *Am J Anesthesiol* 1999;23(5 Suppl):4-12.
6. Strum DP, Vargas LG, May JH. Surgical subspecialty block utilization and capacity planning. A minimal cost analysis model. *Anesthesiology* 1999;90:1176-1185.
7. Strum DP, Vargas LG, May JH, et al. Surgical suite utilization and capacity planning: a minimal cost analysis model. *J Med Syst* 1997;21:309-322.
8. Dexter F, Ledolter J, Wachtel RE. Tactical decision making for selective expansion of operating room resources incorporating financial criteria and uncertainty in subspecialties' future workloads. *Anesth Analg* 2005;100:1425-1432.
9. Epstein RH, Dexter F. Statistical power analysis to estimate how many months of data are required to identify operating room staffing solutions to reduce labor costs and increase productivity. *Anesth Analg* 2002;94:640-643.
10. Sperry RJ. Of economic analysis. *Anesthesiology* 1997;86:1197-1205.
11. Wachtel RE, Dexter F, Lubarsky DA. Financial implications of a hospital's specialization in rare physiologically complex surgical procedures. *Anesthesiology* 2005;103:161-167.
12. Dexter F, Abouleish AE, Epstein RH, et al. Use of operating room information system data to predict the impact of reducing turnover times on staffing costs. *Anesth Analg* 2003;97:1119-1126.
13. Abouleish AE, Dexter F, Whitten CW, et al. Quantifying net staffing costs due to longer-than-average surgical case durations. *Anesthesiology* 2004;100:403-412.
14. Dexter F, Traub RD. How to schedule elective surgical cases into specific operating rooms to maximize the efficiency of use of operating room time. *Anesth Analg* 2002;94:933-942.
15. Ozkarahan I. Allocation of surgical procedures to operating rooms. *J Med Syst* 1995;19:333-352.
16. Dexter F, Macario A, Epstein RH, et al. Validity and usefulness of a method to monitor surgical services' average bias in scheduled case durations. *Can J Anesth* 2005;52:935-939.
17. Dexter F, Macario A. Changing allocations of operating room time from a system based on historical utilization to one where the aim is to schedule as many surgical cases as possible. *Anesth Analg* 2002;94:1272-1279.
18. Dexter F, Blake JT, Penning DH, et al. Calculating a potential increase in hospital margin for elective surgery by changing operating room time allocations or increasing nursing staffing to permit completion of more cases: a case study. *Anesth Analg* 2002;94:138-142.
19. Dexter F, Ledolter H. Managing risk and expected financial return from selective expansion of operating room capacity. Mean-variance analysis of a hospital's portfolio of surgeons. *Anesth Analg* 2003;97:190-195.
20. Macario A, Dexter F, Traub RD. Hospital profitability per hour of operating room time can vary among surgeons. *Anesth Analg* 2001;93:669-675.
21. Blake JT, Dexter F, Donald J. Operating room managers' use of integer programming for assigning allocated block time to surgical groups: a case study. *Anesth Analg* 2002;94:143-148.
22. McManus ML, Long MC, Cooper A, et al. Variability in surgical caseload and access to intensive care services. *Anesthesiology* 2003;98:1491-1496.
23. Gallivan S, Utley M, Treasure T, et al. Booked inpatient admission and hospital capacity: mathematical modelling study. *BMJ* 2002;324:280-282.
24. Dexter F, Epstein RH, Marsh HM. Statistical analysis of weekday operating room anesthesia group staffing at nine independently managed surgical suites. *Anesth Analg* 2001;92:1493-1498.
25. Casimir RJ. Strategies for a blind newsboy. *Omega Int J Mgmt Sci* 1999;27:129-134.
26. Dexter F, Macario A, Traub RD, et al. An operating room scheduling strategy to maximize the use of operating room block time. Computer simulation of patient scheduling and survey of patients' preferences for surgical waiting time. *Anesth Analg* 1999;89:7-20.
27. Dexter F, Traub RD, Macario A, et al. Operating room utilization alone is not an accurate metric for the allocation of operating room block time to individual surgeons with low caseloads. *Anesthesiology* 2003;98:1243-1249.
28. Abouleish AE, Dexter F, Epstein RH, et al. Labor costs incurred by anesthesiology groups because of operating rooms not being allocated and cases not being scheduled to maximize operating room efficiency. *Anesth Analg* 2003;96:1109-1113.
29. Junger A, Benson M, Quinzio L, et al. An anesthesia information management system as a tool for controlling resource management of operating rooms. *Meth Inform Med* 2002;41:81-85.
30. Epstein RH, Dexter F. Uncertainty in knowing the operating rooms in which cases were performed has little effect on operating room allocations or efficiency. *Anesth Analg* 2002;95:1726-1730.
31. Abouleish AE, Hensley SL, Zornow MH, et al. Inclusion of turnover time does not influence identification of surgical services that over- and underutilize allocated block time. *Anesth Analg* 2003;96:813-818.
32. Dexter F, Traub RD. Lack of systematic month-to-month variation over one year periods in ambulatory surgery caseload application to anesthesia staffing. *Anesth Analg* 2000;91:1426-1430.
33. Farnum NR, Stanton LW. *Quantitative Forecasting Methods*. Boston: PWS-Kent Publishing Company, 1989:57.
34. Dexter F, Traub RD, Macario A. How to release allocated operating room time to increase efficiency. Predicting which surgical service will have the most under-utilized operating room time. *Anesth Analg* 2003;96:507-512.
35. Dexter F, Macario A, Traub RD. Which algorithm for scheduling add-on elective cases maximizes operating room utilization? Use of bin packing algorithms and fuzzy constraints in operating room management. *Anesthesiology* 1999;91:1491-1500.
36. Dexter F, Macario A. When to release allocated operating room time to increase operating room efficiency. *Anesth Analg* 2004;98:758-762.
37. Dexter F, Macario A, Lubarsky DA, et al. Statistical method to evaluate management strategies to decrease variability in operating room utilization. Application of linear statistical modeling and Monte-Carlo simulation to operating room management. *Anesthesiology* 1999;91:262-274.
38. Dexter F. A strategy to decide whether to move the last case of the day in an operating room to another empty operating room to decrease overtime labor costs. *Anesth Analg* 2000;91:925-928.
39. Dexter F, Macario A, O'Neill L. A strategy for deciding operating room assignments for second-shift anesthesiologists. *Anesth Analg* 1999;89:920-924.
40. Dexter F, Traub RD. Statistical method for predicting when patients should be ready on the day of surgery. *Anesthesiology* 2000;93:1107-1114.
41. Dexter F, Traub RD. Sequencing cases in operating rooms: predicting whether one surgical case will last longer than another. *Anesth Analg* 2000;90:975-979.
42. Babineau TJ, Becker J, Gibbons G, et al. The "cost" of operating training for surgical residents. *Arch Surg* 2004;139:366-370.
43. Eappen S, Flanagan H, Bhattacharyya N. Introduction of anesthesia resident trainees to the operating room does not lead to changes in anesthesia-controlled times for efficiency measures. *Anesthesiology* 2004;101:1210-1214.
44. Abouleish AE, Zornow MH, Levy RS, et al. Measurement of individual clinical productivity in an academic anesthesiology

department. *Anesthesiology* 2000;93:1509–1516.

45. Medical Group Management Association. Physician Compensation and Production Survey: 2005 report based on 2004 data. Englewood, CO: MGMA, 2005:112–116.

46. Posner KL, Freund PR. Trends in quality of anesthesia care associated with changing staffing patterns, productivity, and concurrency of case supervision in a

teaching hospital. *Anesthesiology* 1999; 91:839–847.

47. Freund PR, Posner KL. Sustained increases in productivity with maintenance of quality in an academic practice. *Anesth Analg* 2003;96:1104–1108.

48. Lubarsky DA. Incentivize everything, incentivize nothing. *Anesth Analg* 2005; 100:490–492.

49. Abouleish AE, Apfellbaum JL, Prough DS, et al. Prevalence and characteristics of

incentive plans for clinical productivity among academic anesthesiology. *Anesth Analg* 2005;100:493–501.

50. Feiner JR, Miller RD, Hickey RF. Productivity versus availability as a measure of faculty clinical responsibility. *Anesth Analg* 2001;93:313–318.

51. Miller RD, Cohen NH. The impact of productivity-based incentives on faculty-based compensation. *Anesth Analg* 2005; 101:195–199.



# CHAPTER 98

## Practice Management

Philip J. Mesisca, MBA, CMPE,  
and Susan Chapman  
Moss, MPH

Practice management details are often delegated to nonphysician administrative professionals and their support staff, but it is important that all physicians have a global comprehension of basic practice management topics. Practice management, in its simplest form, focuses on the non-clinical pieces of a medical practice. There are entire textbooks just on practice management, so this chapter provides a brief overview of practice management for an anesthesiology-trained physician. It broadly covers some global practice management areas that relate to all physicians such as the structure of groups, human resource management, and strategic planning. It also delves into setting up a pain practice, financial management topics, and managed care contracting. When appropriate it covers details and issues specific to anesthesia, such as billing and compliance, staffing models, and data analysis and reporting.

To many physicians, worrying about the business side of their practice is something that they may have no interest in or even something they are embarrassed about as that is not why they decided to become a doctor. If, however, more money goes out than comes in, no business or physician will be able to continue to do what matters most to them. So, however confusing or distasteful the practice management side of the business may be, it is a necessary one.

We hope this brief chapter complements the other chapters in this book and helps you become a physician who can face the challenges of the future of medicine by understanding basic business practice processes and relating them to the practice of anesthesiology.

## GOVERNANCE AND ORGANIZATIONAL DYNAMICS OF A PRACTICE

What is the practice's mission? Are decisions made to influence the strategic direction of the practice? How does the practice facilitate decision making? How are conflicts resolved? What are the plans for the future? How is the practice going to get there? The answers to these questions help to determine a practice's governance and group dynamics.

### Practice Models

Most anesthesiologists join either an academic or a private-practice organization. Academic medical groups have always had complex, multiple missions: teaching, advanced clinical practice, and research. Academic practices in general pay less; however, that does not necessarily mean that their clinical workload is less. Generally most academic anesthesiologists do have some percent of their time that is nonclinical, often devoted to research and/or academics. These nonclinical workdays, while often generating grant and contract salary

support, rarely generate the revenues that the clinical work does, but they do bring their own sense of fulfillment, rewards, and prestige.

In a private practice, the core mission is the clinical responsibilities, and the pace often is faster. In a private-practice model, anesthesiologists are more likely to be assigned cases by themselves or to supervise multiple rooms with certified registered nurse anesthetists (CRNAs) compared to fewer rooms with residents that academic anesthesiologists would generally cover. Of course, exceptions to the norm do occur regularly.

### Structure and Contractual Issues

Practice structure, at the highest level, considers and clarifies lines of authority (chain of command), decision-making process, communication flows and processes, as well as levels of authority that relate to how centralized or decentralized the practice prefers to function.

An example of a private-practice model might consist of a general partnership as the overriding entity. There may then be an executive committee

### KEY POINTS

1. Practice structure considers and clarifies lines of authority, decision making, and communication flows and processes, as well as levels of authority that relate to how centralized or decentralized the practice prefers to function.
2. When considering staffing models for anesthesia care delivery, several issues must be contemplated, including the complexity of the case, experience of the provider, physical status of the patient, hospital regulations, surgeon expectations, and residency teaching rules.
3. Charges and payments for professional anesthesia services generally include base relative value units (accounting for anesthetic complexity), plus time units, plus additional unit modifiers multiplied by a dollar conversion factor.
4. Before you begin negotiations with third-party payers, be certain you have an accurate understanding of the value of your group to the hospital or institution that you contract with.
5. It is important that every service rendered is captured and whatever monies that contractually should be collected for those services are collected.
6. Monthly information that should be tracked for trend purposes includes total cases and units, cases and units per location, payer mix, charge lag, charges, contractual adjustments, cash collections, accounts receivable, net collection rate, days in accounts receivable, aged accounts receivable, total credit balances, and collection agency net collections.
7. From a billing compliance perspective, if it is not documented, then it did not happen. Compliance with various rules and regulations is both important and pertinent. Furthermore, the consequences of not knowing, or not following, these regulations can be substantial.

that might be considered the second level of decision making. This group may be empowered to make operational decisions and financial commitments to a maximum threshold established by the general partnership. Depending upon the size of the practice, there may be smaller groups or specific individuals who also have authority and operational decision making for smaller units or divisions.

There are other practice models, such as employment by a health system, the U.S. Military, Public Health Service, or Department of Veterans Affairs, where the anesthesiologist is fully employed to perform clinical duties and generally does not need to worry about the economics of billing or case volumes. Other anesthesiologists may work as locum tenens, essentially temporary contracted physicians who are hired by groups and hospitals to cover staffing shortfalls. For any of these arrangements, it is important that the structure of the practice is clear and understood in a written format. Much like documentation for billing compliance, if it is not written down, one could assume that it did not, or will not, happen. Buy-in formulas for new partners should be understood and clear. Understanding who can leave, or be asked to leave, why, and with how much notice is important to comprehend as well as the financial repercussions of such actions. Noncompete clauses, if included, should be clearly understood and explained. The process of assigning and requesting time off, call coverage, and overall assignments should be clear and in writing as well.

## Compensation Arrangements

The total amounts of monies available for physician compensation are relatively easy to calculate. Revenue less all other expenses leaves an amount of money. That money can be paid fully to physicians as base salary and bonus, as base salary and incentive, or as base salary with some monies saved for the future. The size of the pie, so to speak, is influenced by numerous factors discussed throughout this chapter. How the pie is divided is the basis for understanding the compensation model for a practice.

The best compensation arrangement for a practice is the one that meets the needs of the group and allows the group to fulfill its mission

while retaining and recruiting physicians, as needed.

In an academic practice, the compensation arrangement will often consider the teaching, administration, and research responsibilities, funding, and performance in addition to clinical responsibilities. In a private practice, the focus is on the clinical workload.

There are two main compensation formulas. At one end of the spectrum the group splits the bottom line. This equal share method takes into account that the anesthesiologist is assigned to cover a specified location (or locations) and does not control volume or the payer mix at those sites. Some consider this model fairer because it does not penalize an anesthesiologist who might work with a slower surgeon or at an inefficient location. At the other end of the compensation spectrum is more of an individual model of paying a physician for the amount of work he or she does. This allows the anesthesiologist to be paid based on the amount of work they do. Proponents of this model argue that this rewards the anesthesiologist who improves turnover times, takes extra calls, does a late-day elective case, or uses less vacation time.

Many anesthesia groups follow a hybrid of these two models to balance the needs and priorities of the members.

## HOSPITAL RELATIONSHIPS

### Negotiating Coverage and Stipends

The relationship between hospital administrators and anesthesia groups has evolved over the past decade as a result of increasing demand for anesthesia services, a national shortage of anesthesia providers, and growing financial pressures on both parties (e.g., third-party reimbursement trends, erosion of hospital operating margins, rising physician compensation levels). In many regions of the country, the balance of power has begun to shift toward anesthesia groups as a result of supply-and-demand issues, with hospital administrators struggling to stay ahead of or at least in step with these market forces.

Successful negotiations hinge on the clear articulation of needs by both parties and willingness to accept a reasonable, mutually beneficial offer. The hospital should set expectations related to daytime and call requirements,

number of anesthetizing locations and services, growth and new programs, and administrative activities. In order to justify financial support, the anesthesia group may need to educate hospital administrators about the local and national physician compensation and recruitment market, efficiency concerns that impact anesthesia productivity (operating room utilization rates, turnover times), and the financial health of the practice (revenue cycle, practice overhead). Stipends typically include administrative activities (directorships, participation in hospital committees), call coverage (obstetrics, trauma), income guarantees, and recruitment costs for new anesthetizing locations. These costs may be justified based on full-time equivalent (FTE) calculations and market-rate compensation data. Academic groups may receive support for educational expenses, such as residency program director and coordinator and salary and benefits for residents and fellows.

## Credentialing

In order to meet regulatory requirements and maintain clinical standards, physicians must obtain hospital appointments through a credentialing process involving verification of state medical licensure, state and federal Drug Enforcement Administration (DEA) numbers, employment and training history, and other key documentation.

## PROVIDERS

### Physician Anesthesiologist

An anesthesiologist has completed a 4-year college program, 4 years of medical school, and at least 4 more years of residency (internship year plus 3 years anesthesiology). The role of an anesthesiologist includes coverage in the operating room, the postanesthesia care unit, and the delivery room. Additionally, many anesthesiologists work as intensivists in critical care units or as pain management specialists, dealing with acute and chronic pain patients.<sup>1</sup>

### Certified Registered Nurse Anesthetist

Education and experience required to become a CRNA include the following:

- Bachelor of Science in Nursing (BSN) or other appropriate baccalaureate degree.

- Current license as a registered nurse.
- At least 1 year of experience as a registered nurse in an acute care setting.
- Graduation with a master's degree from an accredited nurse anesthesia program. The programs range from 24–36 months, depending upon institutional requirements. All programs include clinical training in university-based or large community hospitals.
- Pass a national certification examination following graduation.<sup>2</sup>

### Resident/Fellow

After completing a 4-year bachelor's degree, students then take 4 years of graduate education leading to a degree in medicine (MD) or osteopathy (DO). They spend 4 more years in an anesthesiology residency (there are approximately 160 anesthesiology medical residency programs in the United States). Some residents take 1 more year of study, called a *fellowship*, in a specific area of anesthesiology, such as critical care medicine, pain medicine, research, or education.<sup>3</sup>

### Other Types of Providers

**Anesthesiologist Assistant (AA):** AAs are highly skilled allied health professionals who work under the direction of licensed anesthesiologists to develop and implement anesthesia care plans. All AAs possess a premedical background and a baccalaureate degree, and they complete a comprehensive didactic and clinical program at the graduate school level. AAs may be either licensed as AAs or practice under the license of an anesthesiologist under the principle of delegation. The exact details regarding delegation and licensing of AAs are different from state to state.<sup>4</sup>

**Physician Assistant (PA):** PAs are healthcare professionals licensed to practice medicine with physician supervision. PAs can conduct physical examinations, diagnose and treat illnesses, order and interpret tests, counsel on preventive healthcare, assist in surgery, and in virtually all states can write prescriptions. Graduation from an accredited PA program and passage of the national certifying examination are required for state licensure. The average PA program curriculum runs approximately 26 months. What a PA does varies with training, experience, and state law.<sup>5</sup>

**Nurse Practitioner (NP):** An NP is a registered nurse with advanced academic and clinical experience. NPs are educated through programs that grant either a certificate or a master's degree. The scope of an NP's practice varies depending upon each state's regulations.<sup>6</sup>

**Anesthesia Technician/Technologist (AT):** ATs support the work of anesthesia clinical providers and often assist with monitoring lines, patient transport, patient and room preparation, and stocking of equipment at the anesthetizing site.

## HUMAN RESOURCE MANAGEMENT

Management of human resources is essential to practice management. The mix of physicians, nurses, trainees, billing personnel, and other support staff makes the management somewhat more complicated than in a typical nonmedical organization. As in any organization, each position is essential for the overall efficacy of the practice. If the physicians are working hard but the ATs are not properly completing their responsibilities, the overall efficiency of the operating room is somewhat compromised. Likewise, if physician productivity is outstanding but the billing personnel are not well trained on their functions, then there will be a disconnect in the overall billing process that will result in lost collections that impact the financial health of the practice and ultimately the ability of that practice to retain and recruit. To varying degrees, each group has an impact on the other. The best practices find ways to understand this impact and to ensure that all facets of human resources are considered.

Human resource management includes ensuring that your group abides by all employment regulations, ensures proper training of staff, conducts annual employee evaluations, and maintains employee job descriptions and a compensation and benefits program consistent with the mission of the group. It also includes planning for staffing needs, clinical and nonclinical, and having programs or strategic plans in place to ensure that the group's recruitment and retention efforts are successful.

### Clinical Staff

The clinical staff consists of the anesthesiologists, residents, fellows, CR-

NAs, NPs, PAs, AAs, student registered nurse anesthetists (SRNAs), and medical assistants. Many of these positions have been described previously. Some of them, such as medical assistants, are primarily used in a pain management practice. Others, such as NPs and PAs, are sometimes employed as part of the critical care team and sometimes as part of the acute or chronic pain management team.

### Nonclinical Support Staff

The majority of your nonclinical support staff will be related to your billing efforts, unless you decide to contract out your billing and collections. Given the nature and complexity of anesthesia professional billing, it is extremely important that you employ individuals who have experience with anesthesia billing as it is so different than billing for every other physician specialty. It is a good idea, especially for compliance purposes, to employ certified procedural coders (CPCs) to handle the professional fee billing coding. Having a CPC in your practice is an excellent way to ensure that you are coding properly and the small cost of employing a CPC is a worthwhile investment when you consider the cost of a potential audit finding in terms of paybacks and penalties.

Many practices employ an executive director who has various titles, such as administrator, chief operating officer, chief administrative officer, or director of finance and administration, to name a few. Depending upon the size and complexity of the group, this position usually is either directly responsible for, or oversees the personnel needed to perform these administrative functions. This includes accounting personnel to handle financial statements, analysis, investments, planning, purchasing, accounts payable, and payroll. Personnel also are needed to assist with clinical credentialing, recruitment, employee benefits, and other assorted duties. Sometimes the group contracts out for some or all of these services instead of hiring employees to fulfill these roles.

### Recruitment and Retention

The role of human resource management can be considered from three levels. The first level includes the basic and legal parts of employing people in a practice. Finding, interviewing, and hiring are all part of the basic first steps.

The second level includes ensuring that your practice follows the laws and regulations that govern and protect people. This includes maintaining policies and procedures that properly interpret and integrate numerous, often difficult to understand, federal, state, and local laws in addition to health-care regulatory agencies such as the Joint Commission on Accreditation of Health Care Organizations (JCAHO).

The third level is very important to the recruitment and retention success of a practice. Developing ways to train, measure, motivate, and reward all staff members at all levels is both difficult and important. Formal and informal performance reviews, employee surveys, ensuring fair market pay, respectful but warranted discipline and mentoring, and assessing and responding to the myriad of work and personal obligations that impact the staff cannot be overlooked for a practice to be successful.

## STAFFING MODELS

When considering staffing models for anesthesia care delivery, several issues must be contemplated, such as the complexity of the case, experience of the provider, physical status of the patient, hospital regulations, surgeon expectations, and residency teaching rules.

### Personally Performed

From a billing perspective, for a Medicare case, personally performed means the following:

- The physician personally performed the entire anesthesia service alone (full payment to physician); or,
- The physician is involved with one anesthesia case with a resident, and the physician is the teaching physician as defined by Medicare rules and regulations (full payment to physician); or,
- The physician is continuously involved in a single case involving a student nurse anesthetist (full payment to physician); or,
- The physician is continuously involved in one anesthesia case involving a CRNA (or AA); both the CRNA (or AA) and the physician may be paid pursuant to the medical direction payment policy (50% payment to physician and 50% pay-

ment to CRNA or CRNA's employer such as the hospital or physician group); or,

- The physician and the CRNA (or AA) are involved in one anesthesia case, and the services of each are found to be medically necessary. Upon review of documentation, if it is determined that both were necessary for the case, then full payment may be made for each of the two providers (full payment to physician and full payment to CRNA or CRNA's employer, i.e., the hospital or physician group).<sup>7</sup>

### Care Team

If not performing a case independently, an anesthesiologist generally oversees CRNAs, SRNAs, AAs, interns, residents, or combinations of these individuals. In some care team models, Medicare would consider that medical direction has been met, and 50% payment made, if the physician medically directs qualified individuals in two, three, or four concurrent cases and the physician performs each of the following activities:

- Performs a preanesthetic examination and evaluation,
- Prescribes the anesthesia plan,
- Personally participates in the most demanding procedures in the anesthesia plan, including, if applicable, induction and emergence,
- Ensures that any procedure in the anesthesia plan that he or she does not perform are performed by a qualified anesthetist,
- Documents his or her presence during some portion of the anesthesia monitoring and monitors the course of anesthesia administration at frequent intervals,
- Remains physically present and available for immediate diagnosis and treatment of emergencies, and
- Provides indicated postanesthesia care.

These “seven steps,” as they are known, must be met to bill Medicare for a medically directed service. Also, the total number of rooms that could be covered at any given time is limited to four. Exceptions to these medical direction rules allow a physician to perform other, specific services and not violate the medical direction rules described. The overall medical direc-

tion rules apply to cases involving student nurse anesthetists if the physician directs two concurrent cases, each of which involves a student nurse anesthetist or the physician directs one case involving a student nurse anesthetist and another involving a CRNA, AA, or resident.

If anesthesiologists are in a group practice, one physician member may provide the preanesthesia examination and evaluation while another fulfills the other criteria. Similarly, one physician member of the group may provide postanesthesia care while another member of the group furnishes the other component parts of the anesthesia service.

A physician who directs the administration of anesthesia to not more than four surgical patients cannot ordinarily be involved in furnishing additional services to other patients. However, addressing an emergency of short duration in the immediate area, administering an epidural or caudal anesthetic to ease labor pain, or periodic rather than continuous monitoring of an obstetrical patient does not substantially diminish the scope of control exercised by the physician in directing the administration of anesthesia to surgical patients. It does not constitute a separate service for the purpose of determining whether the medical direction criteria are met. Furthermore, while directing concurrent anesthesia procedures, a physician may receive patients entering the operating room suite for the next surgery, check or discharge patients in the recovery room, or handle scheduling matters without affecting fee schedule payment.<sup>7</sup>

### IN- AND OUT-OF-OPERATING-ROOM COVERAGE

Healthcare advances have led to the significant growth of interventional/procedural medicine, and anesthesia providers are being asked to respond to this trend. Anesthesiologists have expanded their workplace beyond the confines of the operating rooms and are traversing the hospital campus to anesthetize patients undergoing a diverse mix of procedures in locations such as electrophysiology or cardiac catheterization laboratories, radiology suites, in vitro fertilization sites, and endoscopy rooms. In addition to off-



site procedural locations, anesthesia providers often cover diverse services, such as preoperative assessment clinics, recovery areas, obstetric services, inpatient pain consultative services, outpatient pain clinics, and critical care units. Each location requires a unique anesthesia staffing pattern influenced by volume, clinical complexity, geographic proximity to other anesthesia locations and providers (an important factor for emergency backup and coverage for personal breaks), efficiency demands (turnover times in the operating rooms, patient visits in preoperative or pain clinics), and service/availability demands (dedicated ICU or obstetrics staff). Meeting these multiple and often competing demands for clinical services can be challenging given current recruitment and retention factors. Coverage of multiple hospitals and Ambulatory Surgical Centers (ASCs) requires either dedicated staff for each location or staff that are highly flexible about assignments.

Financial performance associated with each location will be closely linked to efficiency, case volume, and payer mix and should be closely monitored by the group.

Staffing patterns vary widely by location, from 1:1 coverage of complex surgical cases to 1:4 coverage of routine surgical cases. Obstetrics, ICU, recovery, preoperative evaluation clinics, and pain staffing are based on volume and/or availability. Ambulatory surgical centers designed for high throughput require highly motivated staff and possibly additional staff to meet turnover demands.

## PAIN MANAGEMENT PRACTICE Office Setup

Setting up a pain management practice is complex and has little to do with setting up or running an anesthesia-based practice. Running an anesthesia practice is different than running other medical specialties, especially because an anesthesia practice does not have an outpatient office, it bills by time (unlike any other physician specialty), it does not have relative value units to measure clinical productivity (as do almost all other physician specialties), and it worries little about registering patients, implementing a telephone triage system, or patient satisfaction as it relates to parking or

helpfulness of the front desk staff. When setting up a pain management practice, these items do matter.

Like many other physician specialties, a significant amount of planning and cost are needed to establish a pain management practice. Space rental or lease costs, equipment, furnishings, and supplies all contribute to the up-front costs that need to be incurred before the first chronic pain patient steps through the door.

## Financial Arrangements

Unlike an anesthesia practice that covers poorly utilized operating rooms, the argument that “we don’t control patient volume and should not be penalized for operating room downtime” does not apply to a pain management practice. Some groups consider their pain practice to be an integral part of the group and do not want to separate them financially for fear that it may fracture the team concept that most successful anesthesia practices use. Keeping them in the normal compensation structure keeps the group intact and, much like an obstetric anesthesiologist who may not have sufficient reimbursement to cover their expenses, a pain specialist should be treated the same, for good or for bad.

Others view pain differently in that anesthesiologists in a pain practice do control their volume and should be rewarded or penalized accordingly for their efforts. A pain specialist who accommodates that extra patient, has evening or Saturday hours, gives free talks to the local community, visits potential referring physicians, responds back to referring physicians, hires excellent support staff, and focuses on customer service should be encouraged and rewarded for his or her efforts. Likewise, a pain specialist who does not complete his or her referral letters or shows up late in the morning or refuses to see the add-on patient in the late afternoon should not be rewarded by partaking in the financial gains that the others have worked hard for.

## FINANCIAL MANAGEMENT

Viewed from a national level, U.S. academic anesthesia departments and private practice anesthesia groups both face a myriad of financial challenges due to both revenue and expense concerns. Revenue constraints include

contract rates and reimbursement policies dictated by Medicare and other payers, billing office performance, and hospital support for medical administration, CRNA expenses, and trauma or other call coverage. Expenses are heavily influenced by recruitment and retention needs because professional staff salaries and fringe benefits compose the majority of anesthesia practice expenses. Equipment and support staff expenses compose a relatively small portion of anesthesia budgets in comparison to other hospital-based specialties such as radiology.

Successful financial management requires a thorough understanding of financial statements, effective budgeting, strong financial oversight, and paying great attention to detail. In today’s healthcare environment, thin operating margins require innovative approaches to important business problems. Often the best business solutions may be technology intensive (e.g., electronic charge capture and billing systems, electronic staff scheduling/deployment systems).

## Understanding Financial Statements

Although a detailed understanding of financial statements may be daunting to clinicians, a basic understanding of them is necessary for effective practice management (Danzi and Boom have provided a brief summary for clinicians). All business managers use three basic financial statements to document and assess their practice’s financial performance: the income statement (or profit-and-loss statement), the balance sheet, and the cash flow statement. The income statement is used to indicate profitability by detailing revenues and expenses. The balance sheet is used to describe the financial position at any given point in time by detailing practice assets, liabilities, and equity. The cash flow statement provides an explanation of uses of cash (i.e., cash from operations, investing, and financing activities). The income statement is most commonly used to monitor monthly financial health, whereas balance sheets and cash flow statements often are reviewed on a quarterly or annual basis. Most physician practices use cash basis<sup>a</sup> rather than accrual ac-

<sup>a</sup>Generally accepted accounting principles (GAAP).

counting principles because financial performance is heavily influenced by the revenue cycle while expenses typically remain stable.

## Budgeting

A budget is a quantitative financial plan for a defined period of time that serves to articulate financial and operational goals, objectives, and strategic plans. A budget allows you to quantify and prioritize these goals, objectives, and plans and provides you with a way to measure financial and operational performance. Approaches to budgets include the historical (uses historical data updated with new facts, trends, and assumptions), zero-based/bottom-up (assumes all costs must be justified), and flexible budgeting methodologies (updated throughout the budget period according to major cost drivers such as volume). Capital budgets focus on projects or tangible assets (e.g., property, plant, or equipment items) that exceed a certain expense threshold. Important operating budget considerations include professional staff salaries and fringe benefits, payer reimbursement assumptions, malpractice costs, operational changes (such as additional anesthetizing locations), and investment income returns. Revenue budget assumptions should address volume growth of anesthetic procedures, contract rates for payment, payer mix, and collection rates, although expense budget assumptions should consider the impact of staffing needs (resignations and hiring), compensation and incentive plans, and inflationary costs. Operating room utilization and efficiency influence both staffing needs and revenue generation and, therefore, should be carefully reviewed as part of the budgetary process.

## Revenues and Expenses

The three main sources of anesthesia practice revenues are patient services revenue, contract revenue, and nonoperating revenue (interest and investment income). For the purposes of this discussion, we exclude other income sources such as research grants, philanthropy, royalty income, and endowments.

Clinical volume and type of service, contract rates, payer mix, and billing performance are the main drivers of patient services revenue. Contract revenue may be derived from professional services agreements, hospital stipends, or other management service contracts. Major expense categories include physi-

cian and CRNA compensation and benefits, support staff expenses, malpractice fees, billing and overhead fees, depreciation, bad debt (mostly for uninsured or underinsured patients), and other operating expenses such as rent, utilities, and information technology. It is important to understand which expenses are fixed (costs that remain constant despite changes in case volume, e.g., anesthesia machines) rather than variable (costs that fluctuate with volume, e.g., anesthetic drugs), particularly if volume predictions are uncertain. For example, when hiring additional staff to cover a new anesthetizing location, the practice will incur a fixed and incremental compensation expense, but revenue will depend on the volume and efficiency of the newly added site unless otherwise negotiated in advance with the hospital.

## Financial Analysis

Practice profitability requires an ongoing analysis of performance against expectations, goals, and targets. Essential financial analyses should include periodic budget analyses of the variance between actual and budgeted performance, service-specific margin analyses (percentage by which revenues exceed expenses; may be calculated on a direct, total, or contribution-basis), and benchmarking analyses (comparison to published compensation,<sup>b</sup> productivity, billing, and expenses<sup>c</sup> data).

## Capital

Large capital (tangible asset) items, such as anesthesia machines, monitoring equipment, and electronic medical records, typically are purchased through the hospital and may require advanced planning via the capital budgeting process. Smaller items, such as computers for administrative use, may be purchased through practice funds.

## BILLING AND PAYMENT FOR ANESTHESIA SERVICES

### Professional Versus Technical Billing

The provision of anesthesia services is paid for by two separate reimburse-

<sup>b</sup>The Association of American Medical Colleges (AAMC), Society of Academic Anesthesiology Chairs (SAAC)/Association of Anesthesiology Program Directors (AAPD), Medical Group Management Association (MGMA) academic and private practice compensation surveys.

<sup>c</sup>MGMA best performing practices.

ment mechanisms: (1) a technical or facility fee and (2) a professional fee. Third-party payers compensate the hospital for the technical or nonprofessional costs of anesthesia services via the facility fee (e.g., anesthesia equipment, supplies, and technicians), although professional and practice expenses are reimbursed through professional fees. Facility fees or charges are derived from the duration and type of anesthetic services rendered and reimbursed via payer-specific contract rates (e.g., Diagnosis-Related Group (DRG) or case rate, percent of charges, fee for service).

### Professional Billing for Anesthesia, Obstetric, Critical Care, and Pain Management Services

Medicare payments for most physician services are made on the basis of a standardized fee schedule (resource-based relative value scale [RBRVS]) that was implemented in 1992, which replaced the traditional customary and prevailing charge system. However, Medicare's method of calculating anesthesia professional reimbursement for anesthesia services differs from that used for other physician services in that the relative value units (RVUs) are based on a schedule developed and maintained by the American Society of Anesthesiologists (ASA). The anesthesia RVUs for any service are described as "base units" and correlate to work effort (i.e., estimated anesthetic intensity or complexity). In addition to base units, payment for anesthesia services reflect time units (often 15 minutes per unit), additional modifying units (e.g., physical status), on occasion, and an anesthesia-specific conversion factor (or per unit payment rate). Professional fee schedules for most other payers are reflective of Medicare's approach under the RBRVS system. Monitoring catheters and nerve blocks administered during time-based anesthesia services are billed separately.<sup>d</sup>

Concurrency modifiers are used to indicate the type of oversight rendered by the attending anesthesiologist in conjunction with a resident and/or CRNA. Personally performed (modifier AA) indicates that an attending anesthesiologist was present for the entire case, whereas medical direction (QK or QY) denotes concomitant in-

<sup>d</sup>Assumes that these services were not the primary mode of anesthesia and were not included in the calculation of anesthesia time units unless clinically appropriate

involvement in one, two, three, or four anesthetics in conjunction with a resident or CRNA. The CRNA portion of a medically directed case is billed with a QX modifier. Medical supervision (AD) indicates physician involvement in more than four concurrent cases.

Billing for nonsurgical obstetric anesthesia (i.e., labor epidurals) typically follows one of four methods recommended by the ASA: (1) base units plus patient contact time plus one time unit per hour, (2) base units plus time units subject to a reasonable cap, (3) a flat fee, and (4) an incremental fee schedule.<sup>e</sup>

Critical care, acute pain, and chronic pain management services are billed as evaluation and management services and procedures and are reimbursed under the RBRVS system. Critical care services are billed based upon physician time expended (e.g., <30 minutes, 30–74 minutes). Acute and chronic pain services are billed via a variety of Current Procedural Terminology (CPT) codes,<sup>f</sup> including inpatient consultations, subsequent hospital day care, new patient visits, followup visits, and interventional procedures.

Professional billing for consultation services rendered in a preoperative clinic requires detailed documentation of (1) a written request for consultation (documentation of medical necessity), (2) a thorough description of the patient's history and physical examination with evidence of medical decision making, and (3) a written response of findings and recommendations to the consultation requesting physician. Local payer reimbursement rules will influence the feasibility and profitability of billing for such services.

## Documentation and Coding

Adequate medical record documentation is required to substantiate billing for all anesthesia services with specific criteria established by local payers based on current Medicare rules or the payer's specific policies. The coding of anesthesia services (assignment of appropriate nationally standardized codes indicating the type of procedure or service rendered) typically is performed by professional coders employed directly by the practice or by the billing office. Documentation and

coding are essential for compliance purposes and for negotiating the claims denial and appeals process.

## Charges versus Payments

A professional charge for a time-based anesthesia service is generated based on the total number of ASA units (base, time, and additional modifying units) and procedures where the unit and procedure charges are set by the physician practice. The payment or reimbursement usually is based on negotiated contract rates and varies by payer. The key differences between charges and payments are the result of contractual adjustments and write-offs. For example, for a practice with a \$100 per ASA unit charge, a 7-hour triple coronary artery bypass would generate a charge of \$4800 (for 20 time units plus 28 base units). Medicare reimbursement<sup>g</sup> for this case if personally performed, however, would total \$895.68 based on the \$18.66 conversion factor (Boston, 2005)<sup>h</sup> with a \$3904.32 contractual adjustment.

Reimbursement for invasive monitors (arterial or pulmonary arterial catheters, etc.), regional anesthetic blocks, evaluation and management (E&M) services, and other procedures are based on a flat fee schedule negotiated with each payer rather than ASA units. Whereas charges are influenced by volume and service mix, payments are affected by payer mix, contract rates, and payer policies, and the speed of payment depends upon submission of "clean claims."

## Billing Services

Anesthesia practices may choose to bill and collect for their own professional fees or outsource these activities to a billing company. Given the complexities of anesthesia billing, it is essential to employ a service with expertise in this area. Such expertise often is difficult to recruit and retain in-house for small- to mid-size anesthesia groups and may be outsourced to a billing company. The accuracy of claims is the responsibility of the physician group independent of billing service arrangements, so it is imperative that billing functions be monitored closely and include a robust compliance plan (see Billing Compli-

ance below). Billing performance should be closely monitored by the practice/department to continually ensure accuracy, effectiveness, and efficiency (Table 98–1).

## MANAGED CARE CONTRACTING

### Negotiation Strategies

Most physicians believe that they deserve to be paid more money but the managed care company does not. This is obviously not true for every situation, but it is a good starting point for discussing managed care contracting or any third-party negotiation.

Before you begin negotiations, be sure you have an accurate understanding of the value of your group to the hospital or institutions that you contract with. That is important because if you cannot come to an agreement with the payer, your only option will be to not contract with them. If the hospital has a contract with that payer and many of the surgeons have a contract with that payer, you will be

TABLE 98–1.

### Analysis of Billing Performance

1. Monthly review of key statistics (budgeted vs. actual, current vs. prior year)
  - a. Volume, charges, and payments
  - b. Payor mix
  - c. Days in accounts receivable, aged accounts receivable
  - d. Charge or front-end lag (number of days from date of anesthetic service to date of claim submission)
  - e. Case reconciliation (verification that all cases performed resulted in sending out a claim to the correct payor)
2. Collection rate variance and volume/service mix variance by payor
3. Per unit reimbursement analysis (actual vs. contract rate)
4. Write-offs by type (free care, account settlement, bad debt, payor policy, filing limits, provider enrollment, missing referral/authorization, etc.)
5. Matched collection rates at 2-, 6-, and 9-month intervals (gross collection rate, net collection rate, adjudication rate)

<sup>e</sup>Reimbursement for surgical obstetric anesthesia is based on time and base units as described above.

<sup>f</sup>CPT Code Book.

<sup>g</sup>Sample calculation only not reflective of Medicare payment reduction for concurrency.

<sup>h</sup>2005 Medicare anesthesia conversion factor for metropolitan Boston.



under tremendous pressure to obtain a contract with that payer. If you do not, you must be in a position to present data that can explain why.

It is extremely important to educate the payer and the hospital about anesthesia salaries in the local market, what others pay, the national shortages, and other issues that are well known to you but may not be to the payer or the hospital. Make sure what you are asking for is reasonable, or your negotiation may break down early.

Understand each payer's fee schedule, not just their anesthesia per unit rate. Many practices are provided a fair anesthesia per unit rate; however, their fee schedule for procedures (e.g., pulmonary arterial catheter insertion) or for pain or critical care services may be very poor. Understand where your primary business volumes incur, and be sure you can prioritize what services are most important when negotiating your fee schedule.

Do not allow a payer to dictate policies and fee schedules; however, you also must be realistic regarding a fair-market payment scale in your local community. Like most negotiations, it is best if the final agreement is a win/win. An important but frequently overlooked contract issue is being sure that if the payer does not pay quickly or underpays, there should be clear language regarding the penalties and next steps to resolve the problem.

### Medical Director Relationship

Try to deal directly with the key players at the carrier (e.g., medical director, director of physician reimbursement, etc.). Develop a relationship to educate the payers. This may not yield immediate financial windfalls, but it does help them to better understand your practice and foster possible improvements in the long term. However, do not forget that this negotiation is a business transaction, and whatever monies are paid to you or your practice are fewer monies that the carrier has to pay others.

### DATA ANALYSIS AND REPORTING

There is a tendency for physicians and many administrators to want too much data that may not be pertinent to understanding their practice and practice operations. Focusing on the

key issues leads to more effective analysis with fewer distractions.

### Tracking What You Need to Know

Tracking what you need to know falls into three categories:

- Information needed to ensure that your billing process is collecting all the money that should be collected
- Information to be comfortable that your billing process is meeting all billing compliance rules and regulations
- Information that notes trends to which your practice may need to react or form a strategic plan

In general, you want to be sure that every service you rendered is captured, and whatever monies that contractually should be collected for those services are collected. You want to be sure that services are reconciled against case logs (e.g., operating room final schedules) so that you know what services were rendered and that you have a charge to submit for that service. You need to know what bills have been paid and whether or not they have been paid correctly. Of all the bills that are not yet fully paid, how old (aged) are they and what is being done to collect the remainder (payment plan has been set up, etc.)?

Following a statistically valid sample of random accounts through the revenue cycle process is a helpful method for fully understanding how the system is working and validate some of the monthly data. If you review randomly selected cases from the operating room schedules and track each through the billing cycle, you will have a very good sense of how your billing process is working. Sometimes reports of average data and group numbers do not always tell the entire story. This sampling process, although somewhat time consuming, is a great way to know what is truly happening and whether or not your monthly reports are accurate.

### Billing Metrics and Trends

Trends are important for strategic purposes. Remember, 1 month does not a crisis make. Some of the monthly information that should be tracked for trend purposes includes the following:

- Total cases and total anesthesia units (is volume increasing or decreasing?)

- Cases and anesthesia units per location and per FTE physician
- Payer mix (especially if better payers are being replaced by poorer payers over time)
- Charge lag (how long it takes from when you render the service until the charge is entered into the billing system)
- Charges, contractual adjustments, and cash collections in total and by division/location/FTE (e.g., ambulatory surgery center, multiple hospitals, acute pain, chronic pain, critical care, etc.)
- Accounts receivable (is the total accounts open and still due to be paid growing or decreasing over time?)
- Net collection rate (collections divided by gross charges less contractual adjustments plus refunds). This should not be confused with gross collection rate, which is a more common measure that has less value, in our opinion. Essentially, the net collection rate is a measure of how much money is being collected as a percentage of what is collectable. For example, if your charge was \$1500 and you have a contract that payer X agrees to pay you 60% of your charges, then your expected payment would be \$900. If you are paid \$850, then your net collection rate is 94%. Generally, depending upon factors such as self-pay or charity care, a net collection rate in the high 80s to mid 90s would be expected.
- Days in accounts receivable (how long it takes to collect the money due on your charges)
- Percent of accounts receivable older than 90 days from date of service (the older past due accounts age, the less likely that you will eventually collect them)
- Total credit balances (many times credit balances grow and mask other problems)
- Collection agency net collections (many practices worry about what a collection agency charges, yet what really matters is how much money they collect for you net of their fees). Some larger practices always have two collection agencies and split what is turned over to each evenly, then track the net results. When one agency outperforms the other over time, they may drop the



lower performer and contract with a new agency.

## BILLING COMPLIANCE

Although it may seem at times that all the myriad of rules and regulations are in place just to make the practice of anesthesiology more difficult, there are reasons why compliance with various rules and regulations is both important and pertinent. The consequences of not knowing, or not following, these regulations can be substantial.

It must be noted that Medicare rules and regulations change occasionally, and sometimes they are interpreted differently by various carriers and agencies, so you should always check with your practice or hospital leadership and billing compliance experts as well as your local carrier to ensure that your understanding of billing practices rules and regulations are up to date and correctly interpreted for the state in which you are located.

### Common Problems

What scenarios seem to present the most opportunities for anesthesia billing compliance problems?

- *Physicians not understanding the billing rules and regulations.* Anesthesia time starts when the anesthesia practitioner begins to prepare the patient for anesthesia services in the operating room or an equivalent area and ends when the anesthesia practitioner is no longer furnishing anesthesia services to the patient, that is, when the patient can be placed safely under postoperative care. It rarely correlates with the surgical start and stop times, nor does it necessarily correlate with the in- or out-of-operating-room times. Because the stop time often occurs after the patient leaves the operating room and the begin time often starts before the patient is brought into the operating room, the chance for overlap is obvious. Overlap is not a problem as long as it is properly documented and the impact on medical direction billing is understood and followed. The problem occurs when the billing does not accurately reflect the existence or extent of simultaneous care (i.e., "concurrency").

- *Medically directing more than four concurrent cases.* When the physi-

cian is responsible for more than four concurrent cases, he or she is no longer medically directing any of them. Exceeding four cases has significant negative ramifications on your overall reimbursement. The problem that many anesthesiologists do not understand is that even a 1-minute overlap invokes billing concurrency that may impact billing regulations and reimbursement amounts. Fig. 98-1 illustrates a typical workday and the consequences of 1 minute of overlap that affects reimbursement significantly. In this illustration, Case 1 in Room A started at 7:31 and finished at 11:32. Case 2 in Room B started at 7:52 and finished at 8:46. Case 3 in Room C started at 8:00 and finished at 14:12. Case 4 started in Room D at 7:15 and finished at 8:42. Case 5 started in Room B at 8:42 and finished at 13:14. During the 8:42 interval, the anesthesiologist actually was responsible for five cases. Even though it was only for that 1 minute, all five cases now are considered nonmedically directed.

- *Rounding.* It is statistically improbable that the majority of anesthesia cases will start and/or stop exactly at 5-minute intervals. It is a mistake, and wrong, to round your start and/or stop times, even if you are rounding to less time. Many physicians believe that because different clocks may not be synchronized, then they can just round because it really is only a matter of minutes. That rationalization may seem appropriate, but in reality billing compliance requires exact minutes to be reported, not more and not less. It may seem obvious why rounding up would be inappropriate, but why would rounding down? The situa-

tion described above is a good example to illustrate the reasoning for this seemingly innocent action. If the physician had rounded down, then Case 5 would have been noted as starting at 8:45 instead of 8:42. Case 4 would have been noted as ending at 8:40 instead of 8:42. The total minutes charged to each case actually would be less than the total minutes the physician was responsible for each case, so it would appear that, if anything, the physician would be shortchanging his or her reimbursement by several minutes. In reality, it would mean that instead of five cases being handled concurrently, the maximum concurrent cases now would appear to only be four, thus greatly improving reimbursement because all the cases now would be considered medically directed, resulting in much greater payment.

- *Not meeting the other noted necessary criteria for medical direction.* For example, relieving a CRNA in a room for a break while still being responsible for the other rooms. Taking over a case by yourself does not allow you to medically direct other concurrent cases. Likewise, not being present for induction, if appropriate, also would prevent that particular case from being considered medically directed.
- *Forgetting that if it is not documented, then it did not happen.*
- *Having a written policy in place, then not following it.* For example, your group has determined that to be considered immediately available, you cannot be further away from the operating room suite than this boundary or these locations. You put that policy in writing, have all physicians sign that they have re-

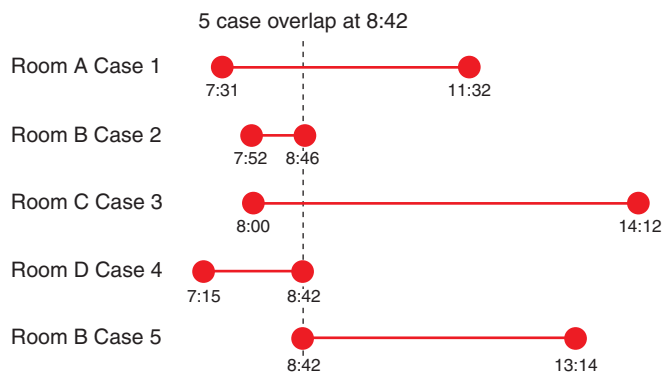


FIGURE 98-1. Example of an overlap of five concurrent cases.

ceived the policy and understand it, and then you place that policy in the file and never monitor or worry about it. If you have a policy, you had better make sure you can follow it, do follow it, and have a process in place to monitor compliance and take corrective action if individuals do not comply.

## STRATEGIC PLANNING

Strategic planning is a process whereby an organization (e.g., anesthesia department or practice) defines its mission and objectives, analyzes internal and external factors (e.g., growth, new business, competition, reimbursement changes), defines priorities, and develops action plans. A practice can assess its position in the market and identify new business ideas via competitive analyses and review of market share data. This information is integral for business planning purposes, such as considering coverage of new out-of-operating-room sites and additional hospitals, participation in ambulatory surgical centers, or development of outpatient pain practices. The identification of strategic opportunities may occur through many avenues, ranging from proactive review of the marketplace and the strategy of competitors to the receipt of external requests for services by the practice or hospital. Consensus building and leadership involvement are key ingredients for success given the importance of building a vision, aligning the various constituencies (anesthesia, surgery, nursing, administrators, etc.), objectively reviewing data, and setting expectations.

The strategic planning process should result in a formal plan that

includes a statement of goals and objectives, analytic tools such as financial statements and market research, an operational plan (evaluating personnel, space/facilities, workflow issues, and equipment needs), implementation plan, and assessment of any legal and regulatory impact. This plan should be used throughout the implementation phase as well as later to measure success against stated goals.

The principles outlined here will greatly facilitate the management of anesthesia practice, whether that be solo or group practice. Furthermore, they will help assure that the practice is being managed and compensated appropriately and that compliance with federal, state, and payer policies are being met. Collectively, these approaches will add to the satisfaction of anesthesia practice because they will reassure the practitioner that the billing and management aspects of the practice meet the same high standards as do the clinical aspects of the practice.

### KEY REFERENCES

1. American Society of Anesthesiologists Practice Management Information. Available at: <http://www.asahq.org/Washington/pmhomepage.htm>. Last accessed March 9, 2006.
2. The American College of Medical Practice Executives Guide to the Body of Knowledge for Medical Practice Management. Available at: <http://www.mgma.com/acmpe/bokguide.cfm>. Last accessed March 9, 2006.
3. Danzi JT, Boom ML. Fundamentals of financial statement analysis

for academic physician managers. *Acad Med* 1998;73:363–369.

4. Medical Group Management Association. Available at: <http://www.mgma.com>. Last accessed March 9, 2006.

5. U.S. Department of Health & Human Services, CMS Centers for Medicare and Medicaid Services—Anesthesiologists Center. Available at: <http://www.cms.hhs.gov/center/anesth.asp>. Last accessed March 9, 2006.

## REFERENCES

1. American Society of Anesthesiologists Patient Education. Available from: <http://www.asahq.org/patientEducation.htm>. Last accessed March 9, 2006.
2. American Association of Nurse Anesthetists, Nurse Anesthetists at a Glance. Available from: <http://www.aana.com/crna/ataglance.asp>. Last accessed March 9, 2006.
3. American Society of Anesthesiologists—Medical Students. Available from: <http://www.asahq.org/career/medical.htm>. Last accessed March 9, 2006.
4. American Society of Anesthesiologists—Frequently Asked Questions Regarding Anesthesiologist Assistants. Available from: <http://www.asahq.org/career/aa.htm>. Last accessed March 9, 2006.
5. American Academy of Physician Assistants—Information About PAs and the PA Profession. Available from: <http://www.aapa.org/geninfo1.html>. Last accessed March 9, 2006.
6. American College of Nurse Practitioners—What is a Nurse Practitioner? Available from: <http://www.nurse.org/acnp/facts/whatis.shtml>. Last accessed March 9, 2006.
7. Centers for Medicare & Medicaid Services Medicare Claims Processing Manual. Chapter 12—Physicians/Nonphysician Practitioners. Available from: <http://new.cms.hhs.gov/center/anesth.asp>. Last accessed March 9, 2006.

*This page intentionally left blank*

# APPENDIX A

## Formulary

Mark Dershwitz, MD, PhD, and  
Carl E. Rosow, MD, PhD

**TABLE A-1.**
**Analgesic Agents**

Drug	Route	Usual Dose	How Supplied	Form	Cost <sup>a</sup>
<b>Oral COX Inhibitors</b>					
Acetaminophen	PO	325–1000 mg	325, 500 mg	Tablet	0.01
Aspirin	PO	325–1000 mg	325, 500 mg	Tablet	0.01
Celecoxib	PO	100–400 mg	100 mg	Capsule	1.40
			200 mg	Capsule	2.40
			400 mg	Capsule	3.60
Choline magnesium trisalicylate	PO	500–1000 mg	500 mg	Caplet	0.60
			1000 mg	Caplet	0.90
Diclofenac	PO	50–75 mg	50 mg	Tablet	0.22
			75 mg	Tablet	0.22
Diflunisal	PO	500–1000 mg	500 mg	Tablet	1.00
Ibuprofen	PO	200–800 mg	200 mg	Tablet	0.02
			400 mg	Tablet	0.04
			600 mg	Tablet	0.05
			800 mg	Tablet	0.08
Indomethacin	PO	25–50 mg	25 mg	Capsule	0.30
Ketorolac	PO	10 mg	10 mg	Tablet	0.50
Naproxen	PO	250–500 mg	250 mg	Tablet	0.08
			375 mg	Tablet	0.10
			500 mg	Tablet	0.14
Piroxicam	PO	10–40 mg	10 mg	Capsule	0.07
	PO		20 mg	Capsule	0.08
Sulindac	PO	150 mg	150 mg	Tablet	0.25
<b>Oral Opioids</b>					
Codeine	PO	30–60 mg	30 mg	Tablet	0.40
			60 mg	Tablet	0.65
Codeine/acetaminophen	PO	30–60 mg/300 mg	30/300 mg	Tablet	0.15
			60/300 mg	Tablet	0.40
Hydrocodone/acetaminophen	PO	5–7.5 mg/500–1000 mg	5 mg/500 mg	Tablet	0.06
			7.5 mg/750 mg	Tablet	0.12
Hydromorphone	PO	2–4 mg <sup>e</sup>	2 mg	Tablet	0.30
Levorphanol	PO	2 mg <sup>e</sup>	2 mg	Tablet	0.80
Methadone	PO	10–20 mg <sup>e</sup>	10 mg	Tablet	0.11
Morphine	PO	30–60 mg	30 mg	Tablet	0.25
Morphine sustained-release	PO	30–60 mg <sup>e</sup>	30 mg	Caplet	1.30
Oxycodone	PO	5–10 mg	5 mg	Tablet	0.25
Oxycodone/acetaminophen	PO	5–10 mg/500–1000 mg	5 mg/500 mg	Caplet	0.20

*(continued)*



TABLE A-1.

## Analgesic Agents (Continued)

Drug	Route	Usual Dose	How Supplied	Form	Cost <sup>a</sup>
Oxycodone sustained-release	PO	10–20 mg <sup>e</sup>	10 mg	Tablet	1.25
			20 mg	Tablet	2.30
			40 mg	Tablet	4.20
			80 mg	Tablet	7.80
			160 mg	Tablet	13.00
Propoxyphene	PO	65–130 mg	65 mg	Tablet	0.25
Propoxyphene/acetaminophen	PO	100 mg/650 mg	100 mg/650 mg	Tablet	0.25
Tramadol	PO	50–100 mg	50 mg	Tablet	0.25
Tramadol/acetaminophen	PO	37.5 mg/325 mg	75 mg/650 mg	Tablet	0.75
<b>Transdermal Opioids</b>					
Fentanyl	Transdermal	25–100 µg/h	25 µg/h	Patch	11.60
			50 µg/h	Patch	21.10
			75 µg/h	Patch	32.20
			100 µg/h	Patch	43.00
Fentanyl	Transbuccal	200–1600 µg	200 µg	Lozenge	7.60
			400 µg	Lozenge	9.60
			800 µg	Lozenge	14.00
			1600 µg	Lozenge	23.00
<b>Parenteral COX Inhibitors</b>					
Ketorolac	IV	30 mg	30 mg/mL, 1 mL	Solution	2.40
	IM	60 mg	30 mg/mL, 2 mL	Solution	3.10
Parecoxib <sup>d</sup>	IV/IM	20–40 mg	40 mg	Powder	<sup>d</sup>
<b>Parenteral Opioids</b>					
Alfentanil	IV	0.3–3 µg/kg/min	500 µg/mL, 2 mL	Solution	5.60
			500 µg/mL, 5 mL	Solution	10.00
Codeine	IV/IM	30–60 mg	30 mg/mL, 2 mL	Solution	0.80
Fentanyl	IV	0.5–5 µg/kg	50 µg/mL, 2 mL	Solution	0.60
			50 µg/mL, 5 mL	Solution	1.25
			50 µg/mL, 20 mL	Solution	4.40
Hydromorphone	IV/IM	0.5–2 mg	2 mg/mL, 1 mL	Solution	0.75
Meperidine	IV/IM/SC	12.5–100 mg	100 mg/mL, 1 mL	Solution	0.60
Methadone	IV	1–10 mg	10 mg/mL, 20 mL	Solution	61.00
Morphine	IV/IM/SC	1–10 mg	10 mg/mL, 1 mL	Solution	0.50
Oxymorphone	IV/IM	1.5 mg	1 mg/mL, 1 mL	Solution	2.50
Remifentanil	IV	0.01–1 µg/kg/min	1 mg	Powder	10.00
			2 mg	Powder	21.00
			5 mg	Powder	48.00
			50 µg/mL, 1 mL	Solution	4.60
Sufentanil	IV	0.05–0.5 µg/kg	50 µg/mL, 5 mL	Solution	17.30
			50 µg/mL, 5 mL	Solution	17.30
<b>Suppository</b>					
Oxymorphone	PR	5 mg	5 mg	Suppository	4.00
<b>Epidural Opioids</b>					
Fentanyl <sup>c</sup>	Epidural	25–100 µg	50 µg/mL, 2 mL	Solution	0.60
	Epidural	1–4 µg/mL, 5–10 mL/h			
Hydromorphone <sup>c</sup>	Epidural	0.75–1.5 mg	2 mg/mL, 1 mL	Solution	0.75
	Epidural	10–100 µg/mL, 5–10 mL/h			

(continued)

TABLE A-1.

## Analgesic Agents (Continued)

Drug	Route	Usual Dose	How Supplied	Form	Cost <sup>a</sup>
Meperidine <sup>b,c</sup>	Epidural	25–75 mg	100 mg/mL, 1 mL	Solution	0.60
Methadone	Epidural	1–5 mg	10 mg/mL, 20 mL	Solution	61.00
Morphine	Epidural	2–5 mg	0.5 mg/mL, 10 mL	Solution, preservative-free	62.00
Morphine extended-release liposome injection	Epidural	10–20 mg	10 mg/mL, 1 mL	Solution, liposomal	145.00
			10 mg/mL, 1.5 mL	Solution, liposomal	160.00
			10 mg/mL, 2 mL	Solution, liposomal	172.00
Sufentanil	Epidural	20–50 µg	50 µg/mL, 1 mL	Solution	4.60
<b>Intrathecal Opioids</b>					
Fentanyl <sup>c</sup>		10–25 µg	50 µg/mL, 2 mL	Solution	0.60
Meperidine <sup>b,c</sup>		10–20 mg	100 mg/mL, 1 mL	Solution	0.60
Morphine		0.25–0.5 mg	0.5 mg/mL, 10 mL	Solution, preservative-free	6.20
Sufentanil <sup>c</sup>		3–10 µg	50 µg/mL, 1 mL	Solution	4.60
<b>Opioid Agonist/Antagonists</b>					
Buprenorphine	IV	0.3 mg	0.3 mg/mL, 1 mL	Solution	2.20
Butorphanol	IV/IM	0.5–2 mg	2 mg/mL, 1 mL	Solution	3.50
	Nasal	1–2 mg (1–2 sprays)	10 mg/mL, 2.5 mL	Solution	57.00
Nalbuphine	IV/IM	5–10 mg	10 mg/mL, 1 mL	Solution	0.90
<b>Opioid Antagonists</b>					
Alvimopan <sup>d</sup>	PO	6–12 mg	6 mg	Tablet	<sup>d</sup>
Methylnaltrexone <sup>d</sup>	PO	0.3–3 mg/kg	<sup>d</sup>	<sup>d</sup>	<sup>d</sup>
Methylnaltrexone <sup>d</sup>	IV/IM/SC	0.1–0.2 mg/kg	<sup>d</sup>	<sup>d</sup>	<sup>d</sup>
Naloxone	IV/IM	0.04–1 mg	0.4 mg/mL, 1 mL	Solution	1.00
Naltrexone	PO	50 mg	50 mg	Tablet	3.20
Nalmefene	IV	0.02–0.5 mg	100 µg/mL, 1 mL	Solution	3.30
			1 mg/mL, 2 mL	Solution	47.00
<b>Opioid Adjuncts</b>					
Carbamazepine	PO	200–400 mg	200 mg	Tablet	0.11
Gabapentin	PO	300–600 mg	300 mg	Capsule	1.00
Pregabalin	PO	50–100 mg	50 mg	Capsule	1.90

<sup>a</sup>Reflects the cost to a hospital that is part of a large buying group for the size and form listed.

<sup>b</sup>The required preservative-free preparation is generally not available in the United States.

<sup>c</sup>Not approved by the FDA for this indication in the United States.

<sup>d</sup>An investigational agent in the United States.

<sup>e</sup>Much higher doses are commonly used in opioid-tolerant patients.

COX, Cyclooxygenase; PR, per rectum; SC, subcutaneous.

TABLE A-2.

## Sedative, Hypnotic, and General Anesthetic Agents

Drug	Route	Usual Dose	How Supplied	Form	Cost <sup>a</sup>
<b>Barbiturates</b>					
Methohexital	IV	1–2 mg/kg	500 mg	Powder	30.00
	PR	25 mg/kg			
Thiopental	IV	3–6 mg/kg	500 mg	Powder	4.40
<b>Benzodiazepines</b>					
Diazepam	IV	2–10 mg	5 mg/mL, 2 mL	Solution	1.90
	PO	5–10 mg	5 mg	Tablet	0.05
Lorazepam	IV/IM	1–5 mg	2 mg/mL, 1 mL	Solution	2.00
Midazolam	IV/IM	1–5 mg	1 mg/mL, 2 mL	Solution	0.50
	PO	0.5–0.75 mg/kg	5 mg/mL, 2 mL	Solution	3.00
<b>Benzodiazepine Antagonist</b>					
Flumazenil	IV	0.5–1 mg	0.1 mg/mL, 5 mL	Solution	38.00
<b>Antihistamines</b>					
Diphenhydramine	IV/IM	25 mg	50 mg/mL, 1 mL	Solution	0.90
Hydroxyzine	IM	25 mg	50 mg/mL, 1 mL	Solution	0.70
Promethazine	IV/IM	12.5 mg	25 mg/mL, 1 mL	Solution	0.60
<b>Neuroleptics</b>					
Chlorpromazine	IV/IM	25–100 mg	25 mg/mL, 1 mL	Solution	1.40
Droperidol	IV/IM	2.5–10 mg	2.5 mg/mL, 2 mL	Solution	1.25
Haloperidol	IV/IM	1–5 mg	5 mg/mL, 1 mL	Solution	5.40
<b>Volatile Anesthetics</b>					
Desflurane	Inhalation	MAC = 6.0%	240 mL	Liquid	108.00
Enflurane	Inhalation	MAC = 1.7%	250 mL	Liquid	91.00
Halothane	Inhalation	MAC = 0.75%	250 mL	Liquid	17.80
Isoflurane	Inhalation	MAC = 1.2%	250 mL	Liquid	28.00
Sevoflurane	Inhalation	MAC = 2.0%	250 mL	Liquid	201.00
<b>Others</b>					
Etomidate	IV	0.15–0.3 mg/kg	2 mg/mL, 10 mL	Solution	16.70
Ketamine	IV	0.2–2 mg/kg	10 mg/mL, 20 mL	Solution	13.00
	IV	0.2–2 mg/kg	50 mg/mL, 10 mL	Solution	5.60
	IM	2–5 mg/kg	100 mg/mL, 5 mL	Solution	7.10
	IV	0.5–2.5 mg/kg	10 mg/mL, 20 mL	Solution	2.80
Propofol	IV	25–150 µg/kg/min	10 mg/mL, 50 mL	Solution	7.10
	IV	0.2–0.7 µg/kg/h	100 µg/mL, 2 mL	Solution	52.00

<sup>a</sup>Reflects the cost to a hospital that is part of a large buying group for the size and form listed.  
MAC, Minimal alveolar concentration; PR, per rectum.

TABLE A-3.

## Muscle Relaxants and Reversal Agents

Drug	Route	Usual Dose	How Supplied	Form	Cost <sup>a</sup>
<b>Depolarizing</b>					
Succinylcholine	IV	1–2 mg/kg	20 mg/mL, 10 mL	Solution	2.10
	IM	4–6 mg/kg			
<b>Nondepolarizing</b>					
Atracurium	IV	0.4 mg/kg	10 mg/mL, 10 mL	Solution	11.00
Cisatracurium	IV	0.2 mg/kg	2 mg/mL, 10 mL	Solution	15.00
Mivacurium	IV	0.2 mg/kg	2 mg/mL, 10 mL	Solution	14.00
Pancuronium	IV	0.1 mg/kg	1 mg/mL, 10 mL	Solution	3.30
Rocuronium	IV	0.6 mg/kg	10 mg/mL, 10 mL	Solution	24.00
Vecuronium	IV	0.1 mg/kg	10 mg	Powder	5.60
<b>Reversal Agents</b>					
Edrophonium	IV	0.5–1 mg/kg	10 mg/mL, 10 mL	Solution	19.00
Neostigmine	IV	0.04–0.08 mg/kg	1 mg/mL, 10 mL	Solution	3.00
Pyridostigmine	IV	0.2–0.4 mg/kg	5 mg/mL, 2 mL	Solution	17.00

<sup>a</sup>Reflects the cost to a hospital that is part of a large buying group for the size and form listed.



TABLE A-4.

## Local Anesthetics

Drug	Route	Maximum Dose	Contents	Size	Form	Cost <sup>a</sup>
<b>Topical</b>						
Benzocaine	Topical	2-second spray	20% benzocaine	60 mL	Liquid spray	23.50
Cetacaine	Topical	2-second spray	14% benzocaine 2% butamben 2% tetracaine	56 mL	Liquid spray	59.00
Cocaine	Topical	3 mg/kg	4%	10 mL	Solution	47.00
EMLA cream	Topical	20 g	2.5% lidocaine + 2.5% prilocaine	5 g	Cream	8.30
Lidocaine	Topical	5 mg/kg	4%	50 mL	Solution	6.90
			2%	100 mL	Viscous solution	16.00
			5%	35 g	Ointment	12.00
<b>Spinal</b>						
Bupivacaine	Intrathecal	<sup>b</sup>	0.75% bupivacaine + 8.25% glucose	2 mL	Solution	3.50
	Intrathecal	<sup>b</sup>	0.5% bupivacaine <sup>d</sup>	10 mL	Solution	2.00
Lidocaine	Intrathecal	<sup>b</sup>	1.5% lidocaine + 7.5% glucose	2 mL	Solution	9.00
Tetracaine	Intrathecal	<sup>b</sup>	1% tetracaine	2 mL	Solution	4.40
Tetracaine	Intrathecal	<sup>b</sup>	Tetracaine powder	20 mg	Powder	9.00
<b>Epidural/Nerve Block/Local Infiltration<sup>c</sup></b>						
Bupivacaine	Injection	3 mg/kg	0.25–0.75% bupivacaine	10 mL 30 mL	Solution Solution	2.00 3.25
Chloroprocaine	Injection	12 mg/kg	2% chloroprocaine 3% chloroprocaine	30 mL 30 mL	Solution Solution	4.00 6.00
Lidocaine	Injection	7 mg/kg	0.5% lidocaine 1% lidocaine	50 mL 2 mL	Solution Solution	1.70 0.30
	Injection		1% lidocaine 2% lidocaine	20 mL 20 mL	Solution Solution	0.65 1.00
Mepivacaine	Injection	7 mg/kg	1% mepivacaine 1.5% mepivacaine	30 mL 30 mL	Solution Solution	6.00 8.00
	Injection		2% mepivacaine	20 mL	Solution	7.00
Ropivacaine	Injection	3 mg/kg	0.5% ropivacaine 1% ropivacaine	30 mL 20 mL	Solution Solution	10.00 11.00
<b>IV Regional (Bier Block)</b>						
Lidocaine	Injection	0.75 mL/kg	0.5% lidocaine	50 mL	Solution	1.70

<sup>a</sup>Reflects the cost to a hospital that is part of a large buying group for the size and form listed.

<sup>b</sup>Systemic toxicity unlikely to be achieved via the intrathecal route.

<sup>c</sup>This list does not include every concentration and package size available.

<sup>d</sup>Not approved by the FDA for this indication in the United States.

TABLE A-5.

## Antiemetics

Drug	Route	Usual Dose	How Supplied	Form	Cost <sup>a</sup>
<b>Dopamine Antagonists</b>					
Droperidol	IV/IM	0.625–1.25 mg	2.5 mg/mL, 2 mL	Solution	1.25
Haloperidol	N/IM	1 mg	5 mg/mL, 1 mL	Solution	5.40
Prochlorperazine	IV/IM	10 mg	5 mg/mL, 2 mL	Solution	7.00
<b>Serotonin Antagonists</b>					
Dolasetron	IV	12.5 mg	20 mg/mL, 0.625 mL	Solution	14.00
Granisetron	IV	1 mg	1 mg/mL, 1 mL	Solution	146.00
Ondansetron	IV	4 mg	2 mg/mL, 2 mL	Solution	2.10
<b>Antihistamines</b>					
Diphenhydramine	IV/IM	25 mg	50 mg/mL, 1 mL	Solution	0.90
Hydroxyzine	IM	25 mg	50 mg/mL, 1 mL	Solution	0.70
Promethazine	IV/IM	12.5 mg	25 mg/mL, 1 mL	Solution	0.60
<b>Neurokinin Antagonist</b>					
Aprepitant	PO	40 mg	40 mg	Capsule	36.00
<b>Glucocorticoids</b>					
Dexamethasone	IV	4 mg	4 mg/mL, 5 mL	Solution	1.70
<b>Antimuscarinic</b>					
Scopolamine	Transdermal	14 µg/h	14 µg/h	Patch	4.50

<sup>a</sup>Reflects the cost to a hospital that is part of a large buying group for the size and form listed.

TABLE A-6.

## Cardiovascular Drugs

Drug	Route	Usual Dose	How Supplied	Form	Cost <sup>a</sup>
<b>Anticholinergic Agents</b>					
Atropine	IV	0.01–0.02 mg/kg	0.4 mg/mL, 1 mL 0.1 mg/mL, 10 mL	Solution Solution	0.60 2.40
Glycopyrrolate	IV	0.005–0.01 mg/kg	0.2 mg/mL, 1 mL	Solution	0.70
Scopolamine	IV	0.2–0.8 mg	0.4 mg/mL, 1 mL	Solution	4.20
<b>Antidysrhythmic Agents</b>					
Adenosine	IV	6–12 mg	3 mg/mL, 2 mL	Solution	27.00
Amiodarone	IV	5–10 mg/kg	50 mg/mL, 3 mL	Solution	4.60
Digoxin	IV	0.125–0.5 mg	0.25 mg/mL, 2 mL	Solution	1.40
Isoproterenol	IV	0.5–4 µg 0.1–1 µg/kg/min	0.2 mg/mL, 5 mL	Solution	4.10
Lidocaine	IV	1–2 mg/kg 1–4 mg/min	20 mg/mL, 5 mL	Solution	3.40
Phenytoin	IV	5–15 mg/kg	50 mg/mL, 5 mL	Solution	1.50
Procainamide	IV	5–15 mg/kg	100 mg/mL, 10 mL	Solution	1.00
<b>Inotropes</b>					
Dobutamine	IV	2–20 µg/kg/min	12.5 mg/mL, 20 mL	Solution	3.20
Dopamine	IV	2–20 µg/kg/min	80 mg/mL, 5 mL	Solution	2.40
Inamrinone	IV	0.5–1.5 mg/kg 5–10 µg/kg/min	5 mg/mL, 20 mL	Solution	64.00
Milrinone	IV	50 µg/kg 0.5 µg/kg/min	1 mg/mL, 10 mL	Solution	11.00
<b>Vasopressors</b>					
Ephedrine	IV/IM	5–50 mg	50 mg/mL 1 mL	Solution	0.50
Epinephrine	IV	0.01–1 mg	1 mg/mL, 1 mL 0.1 mg/mL, 10 mL	Solution Solution	0.50 2.10
Norepinephrine	IV	1–20 µg/min	1 mg/mL, 4 mL	Solution	8.40
Phenylephrine	IV	40–80 µg 10–80 µg/min	10 mg/mL, 1 mL	Solution	0.65
Vasopressin	IV	0.01–0.04 U/min	20 U/mL, 1 mL	Solution	4.10
<b>Antihypertensive Agents</b>					
Enalaprilat	IV	1.25–2.5 mg	1.25 mg/mL, 2 mL	Solution	5.40
Hydralazine	IV	2–20 mg	20 mg/mL, 1 mL	Solution	11.30
Labetalol	IV	5–40 mg	5 mg/mL, 20 mL	Solution	3.60
Methyldopa	IV	250–500 mg	50 mg/mL, 5 mL	Solution	9.40
Phenoxybenzamine	PO	10–20 mg	10 mg	Tablet	4.80
Phentolamine	IV	1–5 mg	5 mg/mL, 20 mL	Powder	25.00
<b>β-Blockers</b>					
Esmolol	IV	10–40 mg	10 mg/mL, 10 mL	Solution	17.00
Metoprolol	IV	1–10 mg	1 mg/mL, 5 mL	Solution	2.50
Propranolol	IV	1–10 mg	1 mg/mL, 1 mL	Solution	7.70
<b>Calcium Channel Blockers</b>					
Diltiazem	IV	0.25–0.35 mg/kg 5–15 mg/h	5 mg/mL, 10 mL	Solution	6.00
Nicardipine	IV	5–15 mg/h	2.5 mg/mL, 10 mL	Solution	74.00
Nifedipine	SL	10 mg	10 mg	Capsule	0.30
Nimodipine	PO	60 mg	30 mg	Capsule	6.40
Verapamil	IV	2.5–5 mg	2.5 mg/mL, 4 mL	Solution	1.25
<b>Vasodilators</b>					
Alprostadil	IV	0.05–0.4 µg/kg/min	0.5 mg/mL, 1 mL	Solution	90.00
Fenoldopam	IV	0.1–1 µg/kg/min	10 mg/mL, 1 mL	Solution	200.00

(continued)

TABLE A-6.

## Cardiovascular Drugs (Continued)

Drug	Route	Usual Dose	How Supplied	Form	Cost <sup>a</sup>
Nitroglycerin	IV	0.5–10 µg/kg/min	5 mg/mL, 10 mL	Solution	5.25
	SL	0.4 mg	0.4 mg	Tablet	0.06
	Topical	1 inch	2%, 30 g	Ointment	12.00
Nitroprusside	IV	0.5–10 µg/kg/min	50 mg	Powder	5.00
<b>Diuretics</b>					
Acetazolamide	IV	250 mg	500 mg	Powder	16.00
Bumetanide	IV	0.5–2 mg	0.25 mg/mL, 2 mL	Solution	1.25
Ethacrynic acid	IV	50–100 mg	50 mg	Powder	18.00
Furosemide	IV	5–40 mg	10 mg/mL, 2 mL	Solution	0.60
Mannitol	IV	0.25–1 g/kg	250 mg/mL, 50 mL	Solution	2.60
			200 mg/mL, 500 mL	Solution	14.00

<sup>a</sup>Reflects the cost to a hospital that is part of a large buying group for the size and form listed.  
SL, Sublingual.



TABLE A-7.

## Agents Affecting Blood Clotting

Drug	Route	Usual Dose	How Supplied	Form	Cost <sup>a</sup>
<b>Anticoagulants Affecting Clotting Cascade</b>					
Antithrombin III	IV	2000–5000 U	1000 U	Powder	1560.00
Argatroban	IV	2 µg/kg/min	100 mg/mL, 2.5 mL	Solution	741.00
Bivalirudin	IV	750 µg/kg 30 µg/kg/min	250 mg	Powder	386.00
Dalteparin	SC	2500–10,000 IU	12,500 IU/mL, 0.2 mL 10,000 IU/mL, 1 mL	Solution Solution	135.00 440.00
Drotrecogin	IV	24 µg/kg/h	5 mg/mL, 0.5 mL	Powder	205.00
Enoxaparin	SC	0.5–1.5 mg/kg	100 mg/mL, 0.4 mL 100 mg/mL, 1 mL	Solution Solution	21.00 54.00
Fondaparinux	SC	2.5–10 mg	5 mg/mL, 0.5 mL 12.5 mg/mL, 0.8 mL	Solution Solution	31.00 77.00
Heparin	IV	5000–25,000 U	1000 U/mL, 10 mL	Solution	3.40
	SC	5000 U	5000 U/mL, 1 mL	Solution	0.80
Lepirudin	IV	0.4 mg/kg 0.15 mg/kg/h	50 mg	Powder	130.00
Tinzaparin	SC	50–175 IU/kg	20,000 IU/mL, 2 mL	Solution	121.00
<b>Anticoagulants Affecting Platelets</b>					
Abciximab	IV	0.25 mg/kg 0.125 µg/kg/min	2 mg/mL, 5 mL	Solution	453.00
Aspirin	PO	81–325 mg	81 mg, 325 mg	Tablet	0.01
Cilostazol	PO	100 mg	100 mg	Tablet	1.80
Clopidogrel	PO	75 mg	75 mg	Tablet	3.40
Dipyridamole	PO	75 mg	75 mg	Tablet	0.90
Eptifibatid	IV	180 µg/kg 1–2 µg/kg/min	2 mg/mL, 10 mL 2 mg/mL, 100 mL	Solution Solution	57.00 494.00
Ticlopidine	PO	250 mg	250 mg	Tablet	2.00
Tirofiban	IV	0.4 µg/kg/min 0.1 µg/kg/min	250 µg/mL, 50 mL 50 µg/mL, 250 mL	Solution Solution	372.00 372.00
<b>Fibrinolytic Activators</b>					
Alteplase (tissue plasminogen activator)	IV	100 mg	100 mg	Powder	2600.00
<b>Hemostatic Agents</b>					
Aminocaproic acid	IV	4–5 g	250 mg/mL, 20 mL	Solution	2.10
Aprotinin	IV	280 mg 70 mg/h	1.4 mg/mL, 200 mL	Solution	410.00
Desmopressin	IV	0.3 µg/kg	4 µg/mL, 1 mL	Solution	6.30
Eptacog alfa (factor VIIa)	IV	90 µg/kg	4800 µg	Powder	5400.00
Phytonadione (vitamin K)	IV	5–25 mg	10 mg/mL, 5 mL	Solution	19.00
Protamine	IV	25–250 mg	10 mg/mL, 5 mL	Solution	5.00
Tranexamic acid	IV	10–100 mg/kg	100 mg/mL, 10 mL	Solution	275.00

<sup>a</sup>Reflects the cost to a hospital that is part of a large buying group for the size and form listed.  
SC, Subcutaneous.

TABLE A-8.

## Anesthetic Adjuncts

Drug	Route	Usual Dose	How Supplied	Form	Cost <sup>a</sup>
<b>Antacid and Aspiration Prophylaxis</b>					
Cimetidine	PO	300 mg	300 mg	Tablet	0.13
	IV/IM	300 mg	150 mg/mL, 2 mL	Solution	1.10
Famotidine	PO	20 mg	20 mg	Tablet	0.15
	IV/IM	20 mg	10 mg/mL, 2 mL	Solution	0.80
Metoclopramide	PO	10 mg	10 mg	Tablet	0.20
	IV/IM	10 mg	5 mg/mL, 2 mL	Solution	0.65
Omeprazole	PO	20 mg	20 mg	Capsule	2.50
Ranitidine	PO	150 mg	150 mg	Tablet	1.10
	IV/IM	50 mg	25 mg/mL, 2 mL	Solution	3.00
Pantoprazole	PO	40 mg	40 mg	Capsule	2.90
	IV/IM	40 mg	40 mg	Powder	22.00
Sodium citrate solution/citric acid	PO	30 mL	30 mL	Solution	0.50
Sucralfate	PO	1 g	1 g	Tablet	0.30
<b>Bronchodilators and Other Drugs for Asthma</b>					
Albuterol	Inhalation	90 µg	200-dose	Inhaler	11.25
	Inhalation	2.5 mg	0.83 mg/mL, 3 mL	Nebulizer solution	0.35
Aminophylline	IV	5 mg/kg	25 mg/mL, 10 mL	Solution	0.60
		0.5–1 mg/kg/h			
Beclomethasone	Inhalation	40 µg	100-dose	Inhaler	43.00
Budesonide	Inhalation	200 µg	200-dose	Inhaler	119.00
Cromolyn	Inhalation	800 µg	200-dose	Inhaler	48.00
Flunisolide	Inhalation	250 µg	100-dose	Inhaler	59.00
Formoterol	Inhalation	12 µg	12 µg	Powder for inhalation	1.00
Ipratropium	Inhalation	17 µg	200-dose	Inhaler	50.00
Levalbuterol	Inhalation	45 µg	200-dose	Inhaler	34.00
Metaproterenol	Inhalation	650 µg	200-dose	Inhaler	26.00
Montelukast	PO	10 mg	10 mg	Tablet	2.40
Omalizumab	SC	150–300 mg	150 mg	Solution	426.00
Salmeterol	Inhalation	50 µg	50 µg	Powder for inhalation	1.25
Terbutaline	IV/SC	0.25 mg	1 mg/mL, 1 mL	Solution	17.00
Tiotropium	Inhalation	18 µg	18 µg	Powder for inhalation	2.90
Zafirlukast	PO	20 mg	20 mg	Tablet	1.00
Zileuton	PO	600 mg	600 mg	Caplet	0.70
<b>Intravenous Dyes</b>					
Fluorescein	IV	500 mg	100 mg/mL, 5 mL	Solution	3.50
Indigotindisulfonate	IV	40 mg	8 mg/mL, 5 mL	Solution	7.00
Methylene blue	IV	10 mg	10 mg/mL, 1 mL	Solution	3.60
<b>Glucocorticoids</b>					
Dexamethasone	IV	1–10 mg	4 mg/mL, 5 mL	Solution	1.00
Hydrocortisone	IV	100 mg	100 mg	Powder	1.60
Methylprednisolone	IV	40–1000 mg	40 mg	Powder	1.70
			1000 mg	Powder	15.00
<b>Other Hormones</b>					
Glucagon	IV	0.5–1 mg	1 mg	Powder	36.00
Insulin, human	IV/SC	1–20 U	100 U/mL, 10 mL	Solution	23.00
Levothyroxine	IV	50–150 µg	200 µg	Powder	5.40
Octreotide	IV/SC	50–150 µg	100 µg/mL, 1 mL	Solution	17.33
Oxytocin	IV	10 mU/min	10 U/mL, 1 mL	Solution	2.30

(continued)

TABLE A-8.

## Anesthetic Adjuncts (Continued)

Drug	Route	Usual Dose	How Supplied	Form	Cost <sup>a</sup>
Secretin	IV	0.2–0.4 µg/kg	16 µg	Powder	293.00
<b>Miscellaneous Agents</b>					
Baclofen	Intrathecal	50 µg	50 µg/mL, 1 mL	Solution	63.00
Caffeine sodium benzoate	IV	250–500 mg	125 mg/mL, 2 mL	Solution	8.10
Carboprost tromethamine	IM	250 µg	250 µg/mL, 1 mL	Solution	45.00
Dantrolene	IV	1–10 mg/kg	20 mg	Powder	71.00
Doxapram	IV	0.5–1 mg/kg	20 mg/mL, 20 mL	Solution	74.00
Hydroxocobalamin	IM	1 mg	1 mg/mL, 10 mL	Solution	6.00
Methylergonovine	IM	0.2 mg	0.2 mg/mL, 1 mL	Solution	3.70
Physostigmine	IV	1 mg	1 mg/mL, 2 mL	Solution	3.70
Sodium nitrite	IV	300 mg	30 mg/mL, 10 mL	Solution	32.00
Sodium thiosulfate	IV	12.5 g	250 mg/mL, 50 mL	Solution	17.00

<sup>a</sup>Reflects the cost to a hospital that is part of a large buying group for the size and form listed.  
SC, Subcutaneous.

TABLE A-9.

## Intravenous Antibiotics

Drug	Route	Usual Dose	How Supplied	Form	Cost <sup>a</sup>
Acyclovir	IV	5–10 mg/kg	50 mg/mL, 20 mL	Solution	32.00
Amikacin	IV	7.5 mg/kg	250 mg/mL, 2 mL	Solution	5.90
Amphotericin B	IV	0.25–1 mg/kg	50 mg/mL, 20 mL	Powder	8.70
Ampicillin	IV	1–2 g	1 g	Powder	5.60
Ampicillin/sulbactam	IV	2 g/1 g	2 g/1 g	Powder	10.60
Azithromycin	IV	500 mg	500 mg	Powder	22.00
Aztreonam	IV	1–2 g	2 g	Powder	35.00
Casprofungin	IV	70 mg	70 mg	Powder	382.00
Cefazolin	IV	1 g	1 g	Powder	0.90
Cefepime	IV	1–2 g	1 g	Powder	13.00
Cefotaxime	IV	1–2 g	1 g	Powder	7.70
Cefoxitin	IV	1–2 g	1 g	Powder	8.50
Ceftazidime	IV	1–2 g	1 g	Powder	11.00
Ceftizoxime	IV	1–2 g	1 g	Powder	8.50
Ceftriaxone	IV	1–2 g	1 g	Powder	38.00
Cefuroxime	IV	0.75–1.5 g	1.5 g	Powder	10.00
Chloramphenicol	IV	12.5–25 mg/kg	1 g	Powder	17.00
Ciprofloxacin	IV	400 mg	10 mg/mL, 40 mL	Solution	22.00
Clindamycin	IV	600 mg	150 mg/mL, 4 mL	Solution	8.50
Dalfopristin/quinupristin	IV	7.5 mg/kg	420 mg/180 mg	Powder	92.00
Ertapenem	IV	1 g	1 g	Powder	38.00
Erythromycin	IV	1 g	1 g	Powder	5.80
Fluconazole	IV	400 mg	2 mg/mL, 200 mL	Solution	113.00
Ganciclovir	IV	5 mg/kg	500 mg	Powder	34.00
Gentamicin	IV	1–7 mg/kg	40 mg/mL, 2 mL	Solution	1.70
Imipenem	IV	0.5–1 g	500 mg	Powder	26.00
Levofloxacin	IV	0.5 g	5 mg/mL, 100 mL	Solution	33.00
Linezolid	IV	600 mg	2 mg/mL, 300 mL	Solution	62.00
Meropenem	IV	0.5–1 g	1 g	Powder	45.00
Metronidazole	IV	0.5–1 g	5 mg/mL, 100 mL	Solution	12.00
Nafcillin	IV	1 g	1 g	Powder	6.00
Oxacillin	IV	1 g	1 g	Powder	6.00
Penicillin G	IV	1,000,000 U	20,000 U/mL, 50 mL	Solution	9.50
Piperacillin/tazobactam	IV	3 g/0.375 g	3 g/0.375 g	Powder	13.00
Rifampin	IV	600 mg	600 mg	Powder	56.00
Ticarcillin	IV	3–4 g	20 g	Powder	62.00
Ticarcillin/clavulanic acid	IV	3 g/0.1 g	3 g/0.1 g	Powder	11.00
Tobramycin	IV	1–7 mg/kg	40 mg/mL, 2 mL	Solution	4.50
Trimetrexate	IV	1–1.5 mg/kg	25 mg	Powder	125.00
Vancomycin	IV	0.5–1 g	1 g	Powder	4.50
Voriconazole	IV	4–6 mg/kg	200 mg	Powder	83.00

<sup>a</sup>Reflects the cost to a hospital that is part of a large buying group for the size and form listed.



TABLE A-10.

## Intravenous Fluid Solutions and Electrolytes

Solution	Contents	How Supplied	Cost <sup>a</sup>
Albumin	5% albumin	250 mL	44.00
	25% albumin	50 mL	44.00
Calcium chloride 10%	13.6 mEq calcium chloride	10 mL	0.60
Calcium gluconate	4.7 mEq calcium gluconate	10 mL	0.70
Dextran 1	15% dextran 1	20 mL	7.00
Dextran 40	10% dextran 40 in 0.9% sodium chloride	500 mL	20.00
Dextran 70	6% dextran 70 in 0.9% sodium chloride	500 mL	12.00
Dextrose (D5)	5% glucose (dextrose)	1000 mL	1.75
	10% glucose (dextrose)	1000 mL	1.75
Dextrose + 0.5 normal saline (D5/1/2NS)	5% glucose (dextrose)	1000 mL	1.75
	66 mEq/L sodium chloride		
Dextrose + normal saline (D5/NS)	5% glucose (dextrose)	1000 mL	1.75
	132 mEq/L sodium chloride		
Hetastarch	6% hetastarch	500 mL	21.00
	132 mEq/L sodium chloride		
Lactated Ringer solution	130 mEq/L sodium	1000 mL	1.10
	109 mEq/L chloride		
	4 mEq/L potassium		
	3 mEq/L calcium		
	28 mEq/L lactate		
Magnesium sulfate 50%	40 mEq magnesium sulfate	10 mL	0.70
Normal saline	132 mEq/L sodium chloride	1000 mL	1.10
Plasma-Lyte A <sup>b</sup>	140 mEq/L sodium	1000 mL	19.00
	5 mEq/L potassium		
	3 mEq/L magnesium		
	98 mEq/L chloride		
	27 mEq/L acetate		
	23 mEq/L gluconate		
Plasma-Lyte M <sup>b</sup>	5% glucose (dextrose)	1000 mL	12.00
	40 mEq/L sodium		
	16 mEq/L potassium		
	5 mEq/L calcium		
	3 mEq/L magnesium		
	12 mEq/L acetate		
Plasma-Lyte R <sup>b</sup>	12 mEq/L lactate		
	140 mEq/L sodium	1000 mL	12.00
	10 mEq/L potassium		
	5 mEq/L calcium		
	3 mEq/L magnesium		
	47 mEq/L acetate		
Potassium chloride	8 mEq/L lactate		
	2 mEq/mL	10 mL	0.90
	1 mEq/mL sodium bicarbonate	50 mL	1.70
	3.6% tromethamine	500 mL	148.00

<sup>a</sup>Reflects the cost to a hospital that is part of a large buying group for the size and form listed.

<sup>b</sup>This is one brand name. Similar solutions are available under other brand names, such as Isolyte and Normosol.

# Index

Note: Page numbers followed by *f* indicate figures, those followed by *b* indicate boxes, and those followed by *t* indicate tables.

## A

- A wave in pulsed-wave Doppler, 561  
 Abciximab (ReoPro), 256, 1730*t*, 2192*t*  
 Abdominal aortic aneurysm, 1299–1308  
   combined anesthesia techniques in, 1306–1307  
   endovascular aneurysm repair in, 1307–1308  
   general anesthesia for, 1305–1306  
   monitoring in, 1300–1301  
   pathophysiology and management of, 1299–1300  
   physiology of cross-clamping in, 1301–1303, 1302*f*  
   postoperative care in, 1307  
   therapeutic strategies in, 1303–1304  
   unclamping in, 1304–1305, 1305*f*, 1306*f*  
 Abdominal assessment  
   in burn injury, 1778–1779  
   in trauma patient, 1792  
 Abdominal compartment syndrome  
   burn injury and, 1779  
   in multiple organ dysfunction syndrome, 1765  
   in postoperative ICU patient, 1835, 1835*t*  
   trauma patient and, 1672  
 Abdominal hysterectomy, 1495  
 Abdominal surgery  
   elective, 79  
   gastrointestinal, 1314–1337  
     bariatric procedures and, 1325, 1326*f*  
     biliary effects of opioids and, 1317  
     biliary tract cancer and, 1324  
     bowel distension and, 1316  
     bowel motility and, 1316–1317  
     cholecystitis and, 1324–1325  
     duodenal and gastric carcinoma and, 1322–1324  
     endoscopic, 1317*b*, 1317–1319  
     esophagus and, 1314–1315, 1319–1322, 1320*b*, 1320*f*, 1320*t*, 1321*b*, 1321*f*  
     gallstone disease and, 1324*b*, 1324–1325  
     gastrointestinal bleeding and, 1328–1329  
     gastrointestinal endocrinology and, 1319  
     management of acid reflux in, 1315*b*, 1315–1316  
     nerve block level for, 988*t*  
     obstructive disease and, 1329*b*, 1329–1330, 1330*b*, 1330*t*  
     oropharynx and, 1314  
     pancreas and, 1325–1328, 1326–1328*f*  
     peptic ulcer disease and, 1322–1324, 1323*b*  
     respiratory function and, 1317  
     small bowel transplantation and, 1328  
     stomach and, 1314–1315  
     strictures of biliary tract and sclerosing cholangitis and, 1325  
     systemic inflammatory response and, 1330–1331, 1331*b*  
   geriatric patient and, 352  
   gynecologic, 1489–1497  
     anesthetic selection for, 1491–1492  
     intraabdominal, 1495–1497  
     perineal and urologic surgery in, 1492–1493  
     preoperative assessment in, 1489–1490, 1490*f*, 1490*t*  
     sensitivity to anesthetic agents and, 1491, 1491*t*  
     sensitivity to pain and, 1490–1491  
     transabdominal, 1496*b*, 1496–1497  
     transvaginal, 1493–1494  
   neonatal  
     in abdominal wall defects, 1512, 1513*f*  
     in congenital diaphragmatic hernia, 1510–1512  
     in intestinal obstruction and necrotizing enterocolitis, 1512–1513  
 Abdominal tumor, 1535–1536  
 Abdominal wall defects, 1512, 1513*f*  
 Abducens nerve, 1560, 1566*f*  
 ABIOMED BVS 5000, 1164  
 Ablative surgery of airway, 1251–1252, 1252*t*  
 Abnormal airway disorders, 1586  
 ABO compatibility, 1895*t*  
   cryoprecipitate and, 1899  
   fresh-frozen plasma and, 1898  
 Abrasion assessment in trauma patient, 1792  
 Abscess  
   brain, 401  
   epidural, 1066  
   epidural therapy-related, 1481–1482*t*, 1729  
   pharyngeal, 1590  
   tuboovarian, 1495  
 Absorbents of carbon dioxide, 796–797, 797*t*, 798*f*  
 Absorption  
   of antimicrobial agents, 281  
   of local anesthetics, 958–959  
 Absorption atelectasis, 1235  
 Abuse of child, 2132–2133  
 Acamprosate, 417–418, 418*t*  
 Acarbose, 186  
 Acceleromyography, 623, 623*f*  
 Accident, defined, 21  
 Accident models, 23–27, 24*f*, 25*b*, 27*b*  
 Accufuser portable infusion pump, 1037*f*  
 Acebutolol, 930*t*, 931  
 Acetabular osteotomy, 612*t*  
 Acetaminophen, 2064*t*  
   for chronic pain, 2063–2064  
   for osteoarthritis, 2024  
 Acetaminophen (Tylenol), 2183*t*  
   for cancer pain, 2111  
   for minor burn, 1682  
   for postoperative pain, 1696, 1724  
     child and, 1531  
     in myringotomy, 1583  
     in outpatient surgery, 1620  
   standard doses of, 1723*t*  
   toxicity of, 229, 229*f*, 1340  
 Acetate in crystalloid solutions, 670*f*  
 Acetazolamide, 2191*t*  
   in cerebrovascular reserve evaluation, 1928, 1928*f*  
   intraocular pressure and, 1563  
 Acetic acids, 2064*t*  
 Acetylcholine  
   chemical structure of, 625*f*  
   synthesis of, 619–620  
 Acetylcholine receptor, 620  
 N-Acetylcysteine, 1807  
 Acetylsalicylic acid, 2064*t*, 2183*t*, 2192*t*  
   antiplatelet activity of, 255–256  
   epidural analgesia and, 1730*t*  
   neuraxial anesthesia and, 998  
   perioperative cardiac complications and, 115  
   preoperative assessment and management of, 59  
   for prevention of preeclampsia, 363  
   standard doses of, 1723*t*  
 Achilles tendinitis, 2024*t*  
 Achilles tendon  
   ankle nerve blocks and, 1047*f*  
   rupture in geriatric patient, 349  
 Achondroplasia, 169, 331*t*  
 Acid burn, 1780  
 Acid reflux, 1315*b*, 1315–1316  
   esophageal concerns in, 1320*b*, 1320*f*, 1320*t*, 1320–1322, 1321*b*, 1321*f*  
 Acid-base balance, 581*t*, 581–582, 582*t*  
 Acid-base chemistry, 659–667  
   acids, bases, and water in, 659–660, 660*t*  
   acute metabolic acidosis and, 661*f*, 661–663, 662*f*  
   acute metabolic alkalosis, 663  
   acute respiratory acidosis and alkalosis and, 661  
   analytic tools used in, 663–665, 664*t*, 664–666*f*, 665*t*  
   carbon dioxide and, 661  
   classification of acid-base abnormalities and, 661*t*  
   monitoring blood gases and, 666–667  
   regulation of acid-base balance and, 663  
   strong ions and, 660, 660*t*  
   treatment of acid-base disturbances and, 666  
   weak ions and, 660  
 Acid-base disorders, 199–206  
   associated with renal failure, 1399*t*  
   calcium disorders and, 202–203, 203*t*  
   diuretics and, 204*f*, 204–206  
   during liver transplantation, 1364–1365  
   magnesium disorders and, 203  
   management during congenital heart disease surgery, 1191  
   metabolic, 200, 200*f*  
   in multiple organ dysfunction syndrome, 1767–1768  
   neurologic activity of local anesthetics and, 967, 967*f*  
   phosphorus disorders and, 203–204  
   potassium disorders and, 201–202, 202*f*, 202*t*  
   in renal failure, 211  
   respiratory, 200–201  
   sodium disorders and, 199*t*, 199–200  
   treatment of, 666  
 Acid-base map, 200*f*, 663–664, 664*t*  
 Acidemia during liver transplantation, 1364–1365  
 Acidosis, 661, 661*t*  
   expected compensation for, 582*t*  
   in glycogen storage diseases, 166  
   local anesthetic toxicity and, 968–969  
   in malignant hyperthermia, 1968  
   metabolic, 200, 661*f*, 661–663, 662*f*, 664*t*  
     clinical causes of, 581, 581*t*  
     in cyanide poisoning, 1775  
     expected compensation for, 582*t*  
     during liver transplantation, 1364–1365  
     multiple organ dysfunction syndrome and, 1763, 1767–1768  
     transurethral resection of prostate and, 1458  
     in trauma patient, 1664  
   respiratory, 200–201  
 Acid(s), 659–660, 660*t*  
 Acid-sensitive ion channels, 2002, 2002*f*, 2003*t*  
 Acinetobacter infection, 286*t*  
 Acoustic neuroma, 612*t*  
 Acquired airway disorders, 1586–1597  
   adenotonsillar hypertrophy in, 1587  
   adenotonsillectomy in, 1588*f*, 1588–1590  
   benign and malignant tumors in, 1590–1591  
   foreign body aspiration in, 1591  
   iatrogenic causes of, 1591–1592  
   infections in, 1586–1587  
   maxillofacial reconstruction in, 1600, 1600*f*  
   obstructive sleep apnea syndrome in, 1588  
   oral and dental surgery in, 1600–1601  
   pharyngeal abscess in, 1590  
   plastic surgery in, 1602  
   tracheal reconstruction or resection in, 1599  
   tracheostomy and tracheotomy in, 1599–1600  
   vocal cord disorders in, 1592–1596*f*, 1592–1597, 1595*t*, 1596*t*  
 Acquired immunodeficiency syndrome  
   in alcohol or drug addicted patient, 399, 402–403  
   antimicrobial therapy in, 293–294, 294*t*  
   neuropathy in, 2028, 2030*t*  
   pregnant patient and, 369  
   public health and, 1742*t*  
 Acquired resistance to antimicrobial agent, 282  
 Acquired von Willebrand disease, 1901  
 Activated factor VII (NovoSeven)  
   for factor VII deficiency, 252  
   for factor XI deficiency, 252  
   for hemophilia, 250  
   for trauma patient, 252, 1665, 1794  
 Activated factor X inhibitor, 255  
 Activated partial thromboplastin time  
   in hemophilia, 249  
   preoperative, 47  
 Activated protein C, 1760  
 Activated protein C resistance, 258–259  
 Active compression decompression cardiopulmonary resuscitation, 1878  
 Active tip, 2090

- Activity-dependent central sensitization, 2012*f*, 2012–2013, 2014
- Acupuncture  
for chronic pain, 2067  
for postoperative nausea and vomiting, 1617, 1618*f*
- Acute bronchospasm, 139
- Acute cholecystitis, 1741*t*
- Acute circulatory failure, 1741–1742  
in antenatal and postpartum hemorrhage, 1487*t*
- critically ill patient and, 1797–1798, 1841–1851  
blood transfusion for, 1843–1844  
clinical signs of shock and, 1841  
fluid resuscitation for, 1842–1843, 1843*f*  
indices of global perfusion in, 1847–1848, 1848*f*  
indices of regional perfusion in, 1848–1849  
pathophysiologic classification of shock and, 1841–1842  
restoring and maintaining cardiac output in, 1846*f*, 1846–1847  
vasopressors for, 1844*f*, 1844*t*, 1844–1846  
ventilatory support for, 1842  
direct tissue injury leading to critical illness and, 1739
- Acute coronary syndrome, 1836
- Acute fulminating myasthenia, 1260*t*
- Acute glaucoma, 1562
- Acute hemolytic transfusion reaction, 1896, 1896*t*
- Acute hepatic encephalopathy, 1340
- Acute herpes zoster, 2029
- Acute inflammatory demyelinating polyradiculoneuropathy, 2030*t*
- Acute liver failure, 231–232, 232*t*  
acetaminophen toxicity and, 229
- Acute lung disease  
assessment before pediatric surgery, 330  
postoperative pulmonary complications and, 1703–1704
- Acute lung injury  
direct tissue injury leading to critical illness and, 1739–1740  
mechanical ventilation in, 1867*t*, 1867–1868  
multiple organ dysfunction syndrome and, 1757  
in postoperative ICU patient, 1833  
transfusion-related, 1907
- Acute metabolic acidosis, 661*f*, 661–663, 662*f*
- Acute metabolic alkalosis, 663
- Acute mitral regurgitation  
pulmonary artery pressure waveform in, 531*f*
- Acute myocardial infarction  
nitrates for, 927  
pregnant patient and, 366
- Acute normovolemic hemodilution, 245–246  
in prostatectomy, 1462
- Acute pain  
assessment of, 1718, 1718*f*  
in cancer, 2110  
postoperative, 1710, 1710*f*, 1716–1736  
anesthesia planning and, 1717–1718  
behavioral therapy for, 1731  
epidural analgesia for, 1726*f*, 1726–1730, 1727*f*, 1730*t*  
institutional considerations in management of, 1716–1717  
intensive care unit and, 1733–1734  
nerve blocks for, 1730–1731  
nonsteroidal antiinflammatory drugs for, 1722*f*, 1722–1724, 1722–1724*t*, 1723*f*  
novel adjuncts for, 1724–1725  
opioids for, 1719–1722, 1720*t*  
opioid-sparing and multimodal analgesia and, 1719  
opioid-tolerant patient and, 1732–1733  
pain assessment and, 1718, 1718*f*  
patient education in, 1717  
patient-controlled analgesia for, 1725*f*, 1725–1726  
pediatric patient and, 1731–1732  
preemptive analgesia and, 1718–1719  
transcutaneous electrical nerve stimulation for, 1731  
quality improvement measures in management of, 461–462
- Acute pain service, 1716
- Acute pancreatitis  
in alcohol abuse, 408  
antimicrobial therapy for, 292–293
- Acute Physiology and Chronic Health Evaluation II score (APACHE), 441, 1743
- Acute Physiology Score, 441
- Acute porphyria, 161, 161*t*
- Acute post-gastric reduction surgery neuropathy, 386
- Acute rejection of transplant, 209, 1382
- Acute renal failure, 210–211  
in aneurysm surgery, 1304  
in burn patient, 1675, 1676*t*  
methamphetamine use and, 413  
postoperative, 1708, 1837
- Acute respiratory acidosis, 661, 664*t*
- Acute respiratory alkalosis, 661, 664*t*
- Acute respiratory distress syndrome, 136  
alcohol abuse and, 406  
direct tissue injury leading to critical illness and, 1739–1740  
mechanical ventilation in, 1867*t*, 1867–1868  
multiple organ dysfunction syndrome and, 1757  
positive end-expiratory pressure in, 1865  
in postoperative ICU patient, 1833  
transfusion and, 1907
- Acute tolerance to opioid analgesics, 880
- Acute tubular necrosis  
cocaine-related, 412  
in liver disease, 1341  
methamphetamine use and, 413  
in multiple organ dysfunction syndrome, 1758  
postoperative, 1708, 1837
- Acyclovir, 2195*t*
- Adalimumab, 2025
- Adam's apple, 688
- Adaptive support ventilation, 1858
- Addiction, 54, 396–422, 2137  
acute postoperative pain and, 1732–1733  
to alcohol, 403–409  
to amphetamines, 412–413  
approach to preoperative evaluation in, 397–398  
cardiovascular disease and, 400  
to cocaine, 410–412  
definitions and neurobiology in, 396–397  
general principles of perioperative management and, 415–416, 416*t*  
to hallucinogens, 413  
hepatitis and, 401–402  
history, physical examination, and diagnostic testing in, 398–399  
human immunodeficiency virus infection and, 402–403  
infectious complications in, 399*t*  
to inhalants, 413–414  
lung disease and, 400–401  
to marijuana, 413  
maternal history of, 301*t*  
medical complications in, 404–405*t*  
natural history of, 2146, 2146*f*  
neurologic disease and, 401  
new perspectives on, 2141*t*, 2141–2143, 2142*f*  
to opioid analgesics, 881, 1721–1722, 2052  
pathophysiology of, 2143–2146  
recognition of colleague misusing drugs and, 2146–2149, 2147*t*, 2148*t*  
recovering patient and, 416–419, 417*t*, 418*t*  
reentry into medical field and, 2151–2152  
relapse and, 2151  
scope of, 2135–2136  
to sedative-hypnotics, 409  
skin and soft tissue infections and, 399–400  
terminology in, 2137–2138  
traditional views of, 2138–2140*t*, 2138–2141  
treatment of, 2150*t*, 2150–2151  
ultra-rapid opioid detoxification in, 2149–2150  
withdrawal and, 414*t*, 414–415
- Addison disease, 181, 181*t*
- A-delta neuron  
pain and, 2001, 2001*t*, 2002*t*, 2020
- Adenohypophysis, 184
- Adenoids, 686
- Adenoma, parathyroid, 177
- Adenosine, 946*t*, 946–947, 2190*t*  
cerebral blood flow and, 1100
- Adenosine triphosphate, 655–656  
critical illness and, 1749  
response to trauma, 1663
- Adenotonsillar hypertrophy, 1587
- Adenotonsillectomy, 1588*f*, 1588–1590
- Adhesive capsulitis, 2023*t*
- Auditus, 687
- Adjunctive analgesia  
in neuraxial anesthesia, 990–993, 991*t*  
for postoperative pain, 1724–1725
- Adjunctive therapy in multiple organ dysfunction syndrome, 1760–1761
- Adjustable gastric banding, 1326*f*
- Adjusted utilization, 2156
- Adjuvant medications  
for cancer pain, 2111*t*, 2111–2112  
for neuroanesthesia, 1099–1100
- Adjuvants  
for intravenous anesthetics, 864–865  
for local anesthetics, 959, 964, 965*f*, 1026–1027  
in neuraxial anesthesia, 991*t*, 992  
in paravertebral block, 1017  
in peripheral nerve block, 1026–1027  
for ophthalmic surgery, 1571–1573
- Admission  
to intensive care unit, 1828–1830, 1829*t*, 1830*t*  
to postanesthesia care unit, 1690*t*, 1690–1691
- Adolescent  
blood pressure ranges of, 315*t*  
developmental behavior of, 321*t*, 322  
laryngoscope blade and endotracheal tube sizes for, 1527*t*  
mean hematocrit and hemoglobin of, 335*t*  
normal red blood cell values of, 240*t*
- ADP antagonists, 256–257
- Adrenal disorders, 179–184  
adrenal insufficiency in, 181, 181*t*  
Conn syndrome in, 181  
Cushing syndrome in, 180*t*, 180–181  
pheochromocytoma in, 181–184, 182*t*, 183*f*, 183*t*  
physiology of, 179–180
- Adrenal insufficiency  
in critically ill patient, 1798  
in multiple organ dysfunction syndrome, 1760, 1768  
in postoperative ICU patient, 1838  
preoperative evaluation of, 181, 181*t*
- Adrenal replacement therapy in multiple organ dysfunction syndrome, 1760
- Adrenergic agonists for shock, 1844*f*, 1844*t*, 1844–1846
- Adrenergic neuronal blocking agents, 922–923
- Adrenocorticotrophic hormone  
Cushing syndrome and, 180  
response to trauma, 1662*t*
- Adult  
blood pressure ranges of, 315*t*  
intravascular blood volume of, 315*t*  
mean hematocrit and hemoglobin of, 335*t*  
respiratory mechanics of, 313*t*
- Advanced cardiac life support, 1788
- Advanced life support, 1880
- Advanced trauma life support system, 1789
- Adverse event  
defined, 21  
during patient transport, 461, 1813, 1813*t*  
during regional anesthesia, 1053–1080  
backache and, 1072  
brachial plexus block and, 1064  
consent and, 1054–1055  
direct needle trauma to nerve and, 1060–1061, 1061*t*, 1062*t*, 1064–1065  
failure of spinal/epidural anesthesia and, 1069–1070  
hematoma and, 1065  
hoarseness and, 1064  
Horner syndrome and, 1064  
hypotension and, 1070  
importance of prevention, 1053–1054, 1054*t*  
infection and, 1065–1066  
intravenous regional anesthesia and, 1072–1073, 1073*t*  
local anesthetic administration and, 1058*f*, 1058–1060, 1059*f*, 1059*t*  
monitoring and, 1057  
myotoxicity and, 1063  
nausea and pruritus and, 1071  
neural toxicity and, 1063  
ophthalmic regional anesthesia and, 1073–1074, 1074*t*  
patient selection and, 1054, 1054*t*  
phrenic nerve paralysis and, 1063–1064  
physician-patient communication and, 1058  
pneumothorax and, 1062–1063  
postdural puncture headache and, 1067–1069  
postoperative urinary retention and, 1071–1072  
record keeping and documentation and, 1057  
respiratory complications and, 1070–1071  
spinal cord injury and, 1062  
subdural injection and, 1067  
systemic and local toxicity and, 1067

- total spinal anesthesia and, 1066–1067  
 use of appropriate equipment and technique and, 1055f, 1055–1057, 1056f, 1057f  
 respiratory, 27–28, 1070–1071  
 sentinel event and, 453
- Affective-motivational component of pain, 2007
- Affinity of general anesthetic, 722–723, 723f
- Afibrinogenemia, 253
- Afterload, 1146  
 cardiac output in shock and, 1846  
 immature heart and, 1183  
 tourniquet and, 1550
- Age  
 cognitive dysfunction and, 1912–1913  
 disposition of local anesthetics and, 960  
 dosing of intravenous anesthetics and, 838–840, 839f, 839t, 840f  
 outpatient surgery and, 1609  
 perioperative cardiac complications and, 104  
 perioperative complications and death and, 442t
- Aggrastat (tirofiban), 256
- Aggregated patient outcome and safety data, 458
- Aggrenox (dipyridamole and aspirin), 257
- Aging  
 concepts and theories of, 341–342, 342f  
 organ system senescence and, 342–346, 342–346f  
 pharmacology of, 346–347, 347f
- Agitation  
 opioid analgesic-induced, 875  
 postoperative pediatric patient and, 1533
- Air embolism  
 during craniostomy repair, 1537  
 effect of nitrous oxide on, 748–749, 749f  
 hepatic resection and, 1349–1350, 1350f  
 intracardiac shunting and, 1178  
 pediatric heart surgery and, 1196  
 physiology of, 1110–1112, 1111f, 1112f  
 pulmonary embolism and, 1114  
 sitting position infratentorial craniectomy and, 1108–1109  
 transfusion-related, 1908  
 Trendelenburg position and, 1496–1497
- Air transport, 1819t, 1819–1820
- Airway  
 anatomy and physiology of, 685–689, 686–689t, 690t, 1214  
 basic life support and, 1874, 1874b  
 fire precautions in laser surgery, 1596–1597, 1597t  
 foreign body in, 1268–1269, 1269f, 1270t  
 laser ablation of, 1251–1252, 1252t  
 neonatal, 1509f, 1509–1510, 1510f  
 lesions in, 302t  
 obesity and, 387  
 pediatric, 311–314, 312f, 313f, 313t, 330  
 postoperative complications of, 1692–1693, 1701–1702  
 trauma to, 1671
- Airway disorders, 1586–1602  
 adenotonsillar hypertrophy in, 1587  
 adenotonsillectomy in, 1588f, 1588–1590  
 benign and malignant tumors in, 1590–1591  
 congenital malformations in, 1586, 1597–1599, 1598f  
 difficult airway and, 128, 128f  
 epiglottitis in, 1586–1587  
 foreign body aspiration in, 1591  
 iatrogenic causes of, 1591–1592  
 maxillofacial reconstruction in, 1600, 1600f  
 obstructive sleep apnea syndrome in, 1588  
 oral and dental surgery in, 1600–1601  
 pharyngeal abscess in, 1590  
 plastic surgery in, 1602  
 tracheal reconstruction or resection in, 1599  
 tracheostomy and tracheotomy in, 1599–1600  
 vocal cord disorders in, 1592–1596f, 1592–1597, 1595t, 1596t
- Airway evaluation, 56, 689–690, 690b  
 in burn injury, 1773  
 critically ill patient and, 1804–1805  
 in elective surgery, 74, 74t, 75t  
 before patient transport, 1815–1816, 1816t  
 in same-day surgery, 1649–1650  
 in spinal surgery, 1548
- Airway management, 685–717  
 airway evaluation in, 689–690, 690b  
 in anaphylactic reaction, 1952–1953  
 applied anatomy for, 685–689, 686–689f, 690t  
 burn patient and, 1675–1677, 1676f  
 in cardiopulmonary resuscitation, 1875–1876, 1876f
- in cervical spine disease, 1120  
 in cervical spine surgery, 1548  
 monitoring adequacy of ventilation and oxygenation in, 692t, 692–693, 693b  
 in neonatal emergency surgery, 1509f, 1509–1510, 1510f
- nonintubated airway and, 693–699  
 complications of, 698b, 698–699  
 esophageal-tracheal airway in, 698, 698f  
 extraglottic airway in, 698  
 face mask ventilation in, 693–694, 694b, 694f  
 pharyngeal airway in, 694–695, 695b, 695f  
 in outpatient surgery, 1619  
 in pediatric surgery, 1525–1527, 1526f, 1526t, 1527t
- tracheal intubation in, 699–714  
 blind nasal intubation and, 708–709  
 complications of, 714, 714b  
 confirmation of, 710, 710f, 711f  
 cricothyrotomy and tracheostomy and, 710  
 difficult airway and, 711–713, 712f  
 endotracheal tubes for, 699–700, 700f, 700t  
 extubation in, 711–714, 713b, 713f  
 fiberoptic, 704b, 704–705, 704–708f  
 introducers for, 701  
 laryngoscopes for, 700, 701f  
 light wand and, 707–708  
 maintenance of, 710–711  
 percutaneous transtracheal jet ventilation and, 710  
 preparation for, 699b  
 retrograde, 708, 709f  
 rigid laryngoscopy in, 701–704, 702f, 703f  
 stylets for, 700–701  
 through laryngeal mask airway, 705–707, 709f  
 trauma patient and, 1790, 1790f  
 ventilation during anesthesia and, 690–692, 691f, 692b
- Airway obstruction  
 after extubation, 711  
 nonoperating room procedures for, 1653–1654  
 in obese patient at extubation, 391  
 during sleep apnea, 378f
- Airway pressure release ventilation, 1859, 1859f, 1860f
- Airway resistance  
 in child, 312  
 inhaled anesthetics and, 758t
- Airway stent, 130, 130f, 1653
- Akinesis, 558
- Aladin vaporizer, 789–790, 789–793f
- Alanine aminotransferase, 219t, 219–220, 232
- Alaris Asena PK Syringe Pump, 902t
- Alarm, patient safety and, 28–29
- Albumin, 642  
 Child-Pugh scoring system and, 224t  
 for fluid replacement, 673f, 673–674, 675  
 hepatic synthesis of, 1339  
 hospital acquisition costs for, 244t  
 morbidity and mortality following intraabdominal surgery and, 225t  
 perioperative cardiac complications and, 104  
 physiology of, 658t, 658–659, 659t  
 postoperative ICU patient and, 1835  
 protein-energy malnutrition and, 272  
 response to burn injury, 1678
- Albumin 5%, 2196t  
 for burn patient, 1775t, 1775–1776  
 osmolality of, 1101t  
 for shock, 1842  
 for vasospasm after subarachnoid hemorrhage surgery, 1118
- Albumin 25%, 2196t
- Albuterol, 2193t
- Alcohol or drug abuse, 396–422  
 acute postoperative pain and, 1732–1733  
 approach to preoperative evaluation in, 397–398  
 cardiovascular disease and, 400  
 definitions and neurobiology in, 396–397  
 general principles of perioperative management and, 415–416, 416t  
 hepatitis and, 401–402  
 history, physical examination, and diagnostic testing in, 398–399  
 human immunodeficiency virus infection and, 402–403  
 infectious complications in, 399t  
 lung disease and, 400–401  
 maternal history of, 301t
- medical complications in, 404–405t  
 neurologic disease and, 401  
 older adult and, 350  
 opioid analgesics and, 881, 1721–1722  
 recovering patient and, 416–419, 417t, 418t  
 skin and soft tissue infections and, 399–400  
 withdrawal and, 414t, 414–415
- Alcoholic ketoacidosis, 408
- Alcoholic liver disease, 229, 407–408
- Alcoholics Anonymous, 417
- Alcuronium  
 anaphylactic reaction to, 1952t
- Aldactone (spironolactone), 919, 920t
- Aldosterone  
 functions of, 179  
 protein-energy malnutrition and, 270
- Aldrete scoring system, 1644, 1644b, 1697, 1697t
- Alfentanil, 883–884, 884f, 2184t  
 biliary effects of, 1317  
 context-sensitive half-time for, 1633t, 1634f  
 dose, peak effect, and duration of, 875t  
 dosing strategy for manual infusion regimen, 901t  
 effect on pathophysiology of congenital heart disease, 1199  
 effect-site concentrations for, 900t  
 lipophilicity of, 1720t  
 in monitored anesthesia care, 1639t  
 in neonatal emergency surgery, 1504–1505  
 neuroprotective effects of, 1940, 1941f  
 Parkinson disease and, 148  
 pharmacokinetics of, 881t, 900t  
 physiochemical properties of, 881t  
 for postoperative shivering in cesarean delivery, 1485  
 somatosensory-evoked potentials and, 604t  
 structural formula of, 873f  
 for total intravenous anesthesia, 901t, 907t
- Aliasing, 553
- Alkali burn, 1780
- Alkaline phosphatase, 219t
- Alkalinization of local anesthetics, 965, 993
- Alkalosis, 661, 661t  
 metabolic, 200  
 clinical causes of, 581, 581t  
 expected compensation for, 582t  
 respiratory, 201
- Allen stirrups, 1453f
- Allen test, 1300
- Allergic reaction  
 to barbiturates, 853  
 to local anesthetics, 966, 1058  
 to opioid analgesics, 878, 879f  
 to propofol, 858
- Allergic transfusion reaction, 1906–1907
- Allocated operating room time, 2156
- Allocating operating room time, 2160–2165
- Allodynia, 2010, 2011t  
 in neuropathic pain, 2025b
- Allogenic stem cell transplant, 1409
- Allograft perfusion  
 in liver transplantation, 1366–1367  
 in pancreas transplantation, 1407  
 in renal transplantation, 1402, 1403  
 in small bowel transplantation, 1414
- Allograft rejection of kidney transplant, 209
- Alloimmunization  
 blood transfusion and, 1895–1896
- Allosteric competition, 723, 724f
- Alpha stat *versus* pH stat blood gas monitoring, 666–667
- Alpha<sub>2</sub>-acid glycoprotein, 1678
- Alpha-adrenergic blocking agents, 922, 922t  
 cerebral blood flow and, 1100
- Alpha<sub>2</sub>-adrenergic receptor, 2007
- Alpha<sub>1</sub>-agonists  
 cerebral blood flow and, 1093  
 for pheochromocytoma, 184
- Alpha<sub>2</sub>-agonists  
 as analgesic adjuvant  
 in intravenous anesthesia, 865  
 in neuraxial anesthesia, 991t, 991–992  
 cerebral neuroprotection and, 1104  
 in monitored anesthesia care, 1643–1644  
 for total intravenous anesthesia, 910–911
- Alpha<sub>1</sub>-antitrypsin deficiency, 225–226, 248t
- Alpha-methyldopa, 921t, 922
- Alpha<sub>2</sub>-plasmin inhibitor deficiency, 248t
- Alprostadil, 2190t  
 in small bowel transplantation, 1414
- Alteplase, 2192t
- Alternating current, 477f, 477–478, 478f



- Altitude effects on output of Datex-Ohmeda Tec 6 vaporizer, 788
- Alveolar gas equation, 579
- Alveolar partial pressure, inhalational anesthetics and, 746f, 746-747, 747f
- Alveolar ventilation  
during anesthesia, 690-692, 691f, 692b  
of newborn, 1504t  
during pregnancy, 359
- Alveolar-to-sampled gradient, 693b
- Alvimopan, 889t, 890, 2185t
- Alzheimer disease  
apolipoprotein E4 and, 1912-1913  
preoperative evaluation of, 148-149
- Amantadine  
for chronic pain, 2054
- Ambient light, pulse oximetry and, 584
- Ambu TubeCheck B, 710, 711f
- Ambulatory electrocardiographic monitoring, 1291-1292
- Ambulatory surgery, 1608-1624, 1649-1659  
cardiopulmonary suite and, 1653-1654  
combined spinal-epidural anesthesia for, 1001  
diagnostic imaging in, 1655  
electroconvulsive therapy in, 1651-1652  
endoscopy in, 1652-1653  
general anesthesia in, 1615-1619, 1617-1619f  
interventional radiology in, 1654-1656  
obese patient and, 387-388  
orthopedic, 1549  
pediatric, 1537, 1655-1656  
pharmacologic agents for, 1651  
place, procedures, and patient selection in, 1608-1609, 1609f  
postanesthesia concerns in, 1651  
postoperative care in, 1619-1621  
preanesthetic considerations in, 1649-1651  
premedication in, 1610-1612, 1611f  
preoperative assessment and management in, 56-57, 1609-1610, 1610f  
regional anesthesia in, 1612-1615, 1613-1616f  
sedation and analgesia in, 1615
- American Board of Anesthesiology  
creation of, 6-7, 7f  
value guide of, 8-9
- American Burn Association Burn Center Transfer Criteria, 1778t
- American National Standards Institute, 490
- American Society for Testing and Materials, 490, 767
- American Society of Anesthesiologists  
closed claims study of, 458-459  
difficult airway algorithm of, 711-712, 712f  
key standards of care, 34t  
on monitored anesthesia care, 1625, 1628, 1628b  
on perioperative transfusions, 1894  
physical status classification of, 42t, 69  
outpatient surgery and, 1609  
relationship to perioperative mortality, 442t  
preoperative testing guidelines of, 43t  
on prevention of perioperative peripheral neuropathies, 147t, 474b  
pulmonary artery catheter guidelines of, 1148t  
standards for basic intraoperative monitoring, 82t, 1802t
- Americans with Disability Act of 1992, 2140, 2140t
- Amikacin, 2195t
- Amiloride (Midamor), 919-920, 920t
- Amino acids, stress hypermetabolism and, 268
- Amino amide local anesthetics, 955, 955f, 970-971
- Amino ester agents, 969-970
- Aminoacyl amide local anesthetics, 955
- Aminoalkyl amide local anesthetics, 955
- u*-Aminocaproic acid, 246, 2192t  
cardiopulmonary bypass and, 1143  
for clotting during hepatotomy, 1349  
for factor XI deficiency, 252  
in liver transplantation, 1367  
for von Willebrand disease, 251t
- Aminophylline, 140, 2193t
- Amiodarone (Cordarone), 943-945, 944t, 2190t  
for cardiac arrest, 1882
- Amitriptyline  
for chronic pain, 2048-2049, 2050t  
topical, 2059-2060
- Amlodipine, 932t, 935
- Amnesia, benzodiazepines and, 862
- Amount absorbed, dose response and, 740
- Amoxapine, 2050t
- Amoxicillin, 333t
- Ampere, 476
- Amphetamines, 412-413  
medical complications in addiction to, 405t  
withdrawal from, 415
- Amphotericin B, 295
- Ampicillin, 333t, 2195t
- Ampicillin/sulbactam, 2195t
- Amputation  
diabetes mellitus and, 1405t  
postamputation pain and, 2033
- Amsorb, 797t
- Amsorb Plus, 797t
- Amyloidosis  
in factor X deficiency, 252  
liver and, 230-231
- Amyotrophic lateral sclerosis, 158, 159t
- Anaesthetists Travel Club, 1, 6
- Analgesia  
for burn patient, 1682  
epidural  
burn patient and, 1679  
for cerebral palsy, 1543  
for child, 1531, 1531t  
for critically ill patient, 1733, 1805  
for external cephalic version, 1477-1478  
for Guillain-Barré syndrome, 161  
in labor and vaginal delivery, 1479  
in lung transplantation, 1386  
for newborn, 1516  
in obstetric surgery, 1472, 1472t  
patient-controlled, 1726  
for postoperative pain, 1726f, 1726-1730, 1727f, 1730t  
preeclampsia and, 1488  
in prostatectomy, 1462  
in renal transplantation, 1401  
in thoracic surgery, 1274-1275, 1275b  
intraoperative, 886  
multimodal, 1719  
obese patient and, 391  
opioid-sparing, 1719  
in outpatient surgery, 1612, 1615  
for postoperative pain, 1716-1736  
in adenotonsillectomy, 1589  
anesthesia planning and, 1717-1718  
behavioral therapy and, 1731  
child and, 1532-1533, 1731-1732  
elective surgery and, 81-82  
fetal and placental surgery and, 1478  
geriatric patient and, 353, 1732  
hepatic resection and, 1349  
infant and, 1731-1732  
institutional considerations and, 1716-1717  
intensive care unit and, 1733-1734, 1831-1832, 1832t  
knee replacement surgery and, 1544-1546  
liver transplantation and, 1368-1369  
nerve blocks and, 1730-1731  
newborn and, 1731-1732  
nonsteroidal antiinflammatory drugs and, 1722f, 1722-1724, 1722-1724t, 1723f  
novel adjuncts and, 1724-1725  
obese patient and, 391  
opioids and, 1719-1722, 1720t  
opioid-sparing and multimodal analgesia and, 1719  
opioid-tolerant patient and, 419, 1732-1733  
orthopedic surgery and, 1549-1550  
pain assessment and, 1718, 1718f  
paravertebral anesthesia and, 1019-1022  
pater ductus arteriosus and, 1516  
patient education and, 1717  
patient-controlled analgesia and, 1725f, 1725-1726  
preemptive analgesia and, 1718-1719  
shoulder replacement surgery and, 1543-1544  
thyroid surgery and, 1603  
transcutaneous electrical nerve stimulation and, 1731  
transurethral resection of prostate and, 1459  
preemptive, 1718-1719  
for trauma patient, 1667t, 1668
- Analgesic adjuncts  
in neuraxial anesthesia, 990-993, 991t  
for postoperative pain, 1724-1725
- Analgesic(s)  
formulary of, 2183-2185t  
nonsteroidal antiinflammatory  
acute renal failure and, 206  
in adenotonsillectomy, 1589-1590  
for cancer pain, 2111  
for child, 1531-1532  
for coagulation disorders, 255-256, 256f  
in elective surgery, 81  
for minor burn, 1682  
neuraxial anesthesia and, 998  
in orthopedic surgery, 1549-1550  
for osteoarthritis, 167  
in outpatient surgery, 1612  
postoperative, 1696, 1722f, 1722-1724, 1722-1724t, 1723f  
preoperative assessment and management of, 59  
in spinal surgery, 1549  
opioid, 869-896  
acute and chronic effects of, 874b  
acute porphyria and, 161t  
addiction to, 404t, 409-410  
alfentanil in, 883-884, 884f  
allergic reaction to, 878, 879f  
in aneurysm surgery, 1307  
biliary effects of, 1317  
bowel motility and, 1316  
for burn wound pain, 1682  
for cancer pain, 2112, 2112t  
cardiovascular effects of, 878  
caution in renal transplant recipient, 1401  
central nervous system effects of, 875-877f, 875-878  
cerebral blood flow and, 1095  
chemistry of, 872f, 872-873, 873f  
for child, 1532  
confusion in geriatric patient and, 1732  
context-sensitive half-times for, 824-825, 825f  
in coronary artery bypass graft, 1149  
dose, peak effect, and duration of, 875t  
dosing strategy for manual infusion regimen, 901t  
effect site concentration of, 825-826, 827f  
effects on pathophysiology of congenital heart disease, 1199  
effects on pregnancy and neonate, 880  
in elective surgery, 81-82  
endogenous opioids and, 873-874  
for epidural analgesia, 1727-1728  
fentanyl in, 883, 884f  
formulary of, 2183-2184t  
historical background of, 869-872  
hormonal effects of, 879  
hydromorphone in, 883  
immune effects of, 880  
intraoperative use of, 885-888, 886-888f  
lipophilicities of, 1720t  
meperidine in, 882-883  
methadone in, 883  
in monitored anesthesia care, 1642-1643, 1643f  
morphine in, 881-882, 882f  
in neuraxial anesthesia, 991  
for obese patient, 384t, 385  
in obstetric surgery, 1473, 1473t  
opioid agonist-antagonists and, 890f, 890-892, 891t  
opioid antagonists and, 888-890, 889f  
opioid receptors and, 873  
in outpatient surgery, 1612  
in peripheral nerve block, 1027  
pharmacokinetic properties of, 881t  
physical dependence on, 881  
physicochemical properties of, 881t  
postoperative, 1696, 1719-1722, 1720t  
propofol concentration and, 909-910, 910f  
pruritus and, 878  
remifentanyl in, 885, 885f  
smooth muscle effects of, 878-879, 880f  
sufentanil in, 884-885  
time to peak effect of, 827t  
tolerance to, 880-881  
in total intravenous anesthesia, 901t, 911, 913f, 913-914  
tramadol in, 885  
for trauma patient, 1667t, 1668  
withdrawal from, 415
- Analog circuit, 479
- Anaphylactic reaction, 1947-1963  
to antibiotics, 1957b, 1957-1958  
to barbiturates, 853  
to blood transfusion, 1906-1907  
clinical manifestations of, 1951, 1954b  
determination of cause of, 1953-1955  
dextrans and, 675  
differential diagnosis in, 1952, 1954b

- epidemiology of, 1951–1953*t*  
to hypnotics, 1956  
to local anesthetics, 1956*b*, 1956–1957  
mast cell activation in, 1947–1951, 1948*t*, 1949*f*, 1950*f*  
to narcotics, 1957  
to natural rubber latex, 1959–1960, 1960*t*  
to neuromuscular blocking agents, 1956  
to protamine, 1958–1959  
to radiopaque media, 1958  
specific immunotherapy in, 1955*b*, 1955–1956  
therapeutic implications of, 1960–1961  
to topical preparations, 1959  
treatment of, 1952–1953, 1955*b*
- Anastomotic leak in liver transplantation, 1369
- Anatomic dead space, 1930  
inhalational anesthetics and, 748
- Anatomic technique in paravertebral anesthesia, 1012–1013, 1015*f*
- Anatomic trauma scoring systems, 1792
- Andrews frame, 471
- Android obesity, 374
- Anemia, 239–247  
acute normovolemic hemodilution for, 245–246  
in alcohol abuse, 408–409  
anesthesia and, 242–244, 243*f*  
antifibrinolytic therapy for, 246  
classifications of, 241*t*, 241–242, 242*f*  
in critically ill patient, 1798–1800, 1799*t*  
crystalloids versus colloids for, 244, 244*t*  
definitions and measurement of, 239–240, 240*t*  
intravascular volume and, 244  
in multiple organ dysfunction syndrome, 1758, 1767  
oxygen delivery and, 1145, 1740*t*  
perioperative cardiac complications and, 104  
in postoperative ICU patient, 1835–1837  
preoperative assessment and management in, 53–54  
prevalence in surgical patients, 240  
pulse oximetry and, 583  
red blood cell maturation and, 240, 240*f*  
red blood cell salvage for, 246, 246*f*  
red blood cell substitutes for, 246  
red blood cell transfusion in, 244–245, 245*f*, 245*t*  
sickle cell, 54, 246–247, 247*f*, 335–336
- Anesthesia  
anemia and, 242–244, 243*f*  
choice of  
for burn patient, 1679  
for critically ill patient, 1805  
for geriatric patient, 353  
in gynecologic surgery, 1491–1492  
for peripheral nerve block, 1026*t*, 1026–1027  
for trauma patient, 1666–1668, 1667*t*  
discovery of, 2–3  
effects of  
on duration of ECT-induced seizure activity, 151*t*  
on hypoxic pulmonary vasoconstriction, 1234  
on intraoperative electroencephalography, 604–605*t*  
on intraoperative evoked potentials, 609–610  
neuroprotective/neurotoxic, 1102–1104  
on pathophysiology of congenital heart disease, 1197–1201, 1198*f*  
emergence from  
obese patient and, 390–391, 391*f*  
in sitting position infratentorial craniectomy, 1113–1114  
in subarachnoid hemorrhage surgery, 1118  
gender differences in sensitivity to, 1491, 1491*t*  
hazards associated with, 27–29, 28*b*  
induction of  
in adenotonsillectomy, 1588*f*, 1588–1589  
in cesarean delivery, 1485–1486  
in congenital heart disease, 1203–1204  
in coronary artery bypass graft, 1149–1150  
in heart transplantation, 1391  
in hepatic resection, 1348  
in liver transplantation, 1360–1361, 1361*t*  
in lung transplantation, 1386–1389  
obese patient and, 388–390, 389*f*  
in pancreas transplantation, 1407  
in pediatric surgery, 1524*f*, 1524–1525, 1525*t*  
propofol and, 858–859  
in renal transplantation, 1400–1401  
in small bowel transplantation, 1413–1414  
in spine surgery, 1548  
in subarachnoid hemorrhage, 1117*f*, 1117–1118  
in supratentorial craniotomy, 1106–1108, 1108*f*  
thiopental and, 855–856, 856*t*  
in total intravenous anesthesia, 903  
in valve surgery, 1155–1156
- maintenance of  
in cesarean delivery, 1486  
in child, 1527  
in congenital heart disease, 1204  
in hepatic resection, 1348  
in liver transplantation, 1360–1361, 1361*t*  
in lung transplantation, 1386–1389  
neuromuscular blockade and, 633–634  
obese patient and, 388–390, 389*f*  
in outpatient surgery, 1616–1619, 1617–1619*f*  
propofol and, 859  
in renal transplantation, 1400–1401  
in small bowel transplantation, 1413–1414  
in subarachnoid hemorrhage, 1117*f*, 1117–1118  
in supratentorial craniotomy, 1106–1108, 1108*f*  
thiopental and, 856, 856*f*  
in valve surgery, 1156
- mechanisms of action, 718–738  
affinity and stoichiometry and, 722–723, 723*f*  
G-protein coupled receptors and, 727*f*, 727–728  
integration of molecular responses in, 731–733, 732*f*, 733*b*  
ion channels and, 725–727, 726*f*, 727*b*  
lipid bilayers and, 720–721, 721*f*  
mitochondria and, 728  
molecular structure and, 719*f*, 719–720, 720*f*  
neuroanatomic substrates and, 733*b*, 733–736, 735*f*  
protein coupling mechanism and, 723–724, 724*f*, 725*f*  
protein drug-target complex and, 721–722, 722*f*  
relevance of in vitro assays and, 728–731, 729*f*, 731*f*  
soluble proteins and, 724–725  
postoperative cognitive dysfunction and, 1912–1924  
anesthesia and, 1920–1921  
aortic atherosclerosis and cerebral embolization and, 1918–1919  
assessment of, 1914  
cardiac surgery and, 1915–1917, 1916*f*  
cardiac versus noncardiac surgery and, 1918, 1918*f*  
depression and, 1920  
disease states and, 1912–1914, 1913*f*, 1914*f*  
genetic factors in, 1920, 1921*f*  
hypoperfusion and, 1919  
incidence and significance of, 1914–1915, 1915*f*  
noncardiac surgery and, 1917, 1917*f*  
preexisting cerebrovascular disease and, 1921  
systemic inflammatory response and, 1919–1920  
teratogenicity of, 1473–1474, 1474*b*
- Anesthesia breathing systems, 791–797  
absorbents and, 796–797, 797*t*, 798*f*  
circle system and, 795*f*, 795–797  
rebreathing systems and, 792–795, 793*f*, 794*f*
- Anesthesia crisis resource management, 28*b*, 34
- Anesthesia delivery system, 767–820  
anesthesia breathing systems in, 791–797  
absorbents and, 796–797, 797*t*, 798*f*  
circle system and, 795*f*, 795–797  
rebreathing systems and, 792–795, 793*f*, 794*f*
- anesthesia vaporizer in, 775–790  
arrangement of, 784  
calibration and checking of output, 784  
Dalton law of partial pressures and, 776  
desflurane and, 784*b*, 784–788, 785–788*f*  
effect of carrier gas on output, 782*f*, 782–783  
efficiency and temperature compensation and, 780*f*, 780–781  
filling of, 782  
hyperbaric conditions and, 783*f*, 783–784  
hypobaric conditions and, 783, 783*f*  
incorrect filling of, 781, 781*t*  
latent heat of vaporization and, 777  
measured-flow, 779, 779*f*  
minimum alveolar concentration and, 776, 776*t*  
regulation of vaporizer output and, 777*t*, 777–778, 778*f*  
specific heat and, 777  
vapor, evaporation, and vapor pressure and, 775–776, 776*f*  
vaporization of mixed anesthetic liquids and, 781–782, 782*f*  
variable by-pass, 779, 781*t*
- anesthesia ventilator in, 797–808, 798*f*, 799*f*  
Datex-Ohmeda 7000, 798–800, 799*f*, 800*f*  
Datex-Ohmeda 7810, 800–802, 801*f*  
Datex-Ohmeda 7900, 802, 802*f*  
Datex-Ohmeda ADU and 7900 SmartVent, 807  
Dräger AV-E, 802–804, 803–805*f*  
Dräger versus Datex Ohmeda, 804–805, 805*f*  
fresh gas decoupling and, 807–808, 808–810*f*  
positive end-expiratory pressure and, 805*f*, 806–807  
standing versus hanging bellows, 804  
tidal volume and, 805*f*, 805–806, 806*f*
- basic machine in, 769–775  
gas flow control system in, 772–773, 773*f*  
nitrous oxide and, 772  
oxygen and, 770–772  
oxygen ratio monitoring and proportioning systems and, 774*f*, 774–775, 775*f*  
schematic of, 768*f*, 768–769, 769*f*  
virtual flow meter in, 773–774
- gas outlet and outlet check valves in, 790–791  
schematic of, 768*f*, 768–769, 769*f*  
testing for leaks in, 811–818  
Datex-Ohmeda: outlet check valve present and, 815–817*f*, 816–817  
Datex-Ohmeda Modulus II and, 817–818  
Dräger Narkomed: no outlet check valve and, 815*f*, 815–816  
FDA checkout recommendations and, 813*b*  
waste gas scavenging systems and, 810–811, 811*f*, 812*f*
- Anesthesia group productivity, 2157, 2166
- Anesthesia information management system, 456–457
- Anesthesia Patient Safety Foundation, 1, 14, 22
- Anesthesia planning  
acute postoperative pain and, 1717–1718  
critically ill patient and, 1797–1810  
airway evaluation and management and, 1804–1805  
choice of anesthetic and, 1805  
hemodynamic management and, 1805–1807, 1806*f*  
intraoperative glucose management and, 1808  
monitoring options and, 1801–1804, 1802*t*, 1803*t*  
postoperative care and, 1808  
preoperative assessment and, 1797–1800, 1799*t*  
renal preservation and, 1807–1808  
surgical procedure considerations and, 1800  
transport of patient from ICU and, 1800, 1801*t*  
in gynecologic procedures, 79  
for healthy patient, 68–88  
monitoring in, 82*t*, 82–85, 83*t*  
patient evaluation in, 68–73, 69*t*, 70*t*, 71*f*, 72*t*, 73*t*  
physical examination in, 73–77, 74–76*t*  
postoperative destination and, 81  
postoperative pain and, 81–82  
premedication for, 80–81  
preoperative instructions for, 80  
preoperative testing and, 77, 78*t*  
type of anesthesia for, 77–80, 80*t*  
healthy patient and, 77–80, 80*t*  
in neck procedures, 78–79  
in ocular procedures, 79  
in outpatient surgery, 1612, 1613*f*  
in palliative care, 2109  
in pediatric surgery, 1522–1528  
acute postoperative pain and, 1731  
airway management and, 1525–1527, 1526*t*, 1527*t*  
blood and blood products and, 1528  
for congenital heart disease, 1202–1203  
extubation choices and, 1527–1528  
fluid therapy and, 1528  
induction of anesthesia and, 1524*f*, 1524–1525, 1525*t*

- Anesthesia planning—*continued*  
 maintenance of anesthesia and, 1527  
 preparation and premedication and, 1523*t*, 1523–1524
- Anesthesia practice  
 economics of, 2155–2171  
 allocating operating room time and, 2160–2165  
 elective, urgent, and emergent cases and, 2155–2157  
 individual productivity and, 2166–2169, 2167*t*, 2168*t*  
 managerial cost accounting and, 2157–2158  
 operating room efficiency on day of surgery and, 2158  
 reduction of surgical and turnover times and, 2165–2166  
 scheduling and assignment and, 2155  
 tactical *versus* operational decisions to increase productivity and, 2158–2160
- Anesthesia practice management, 2172–2181  
 billing and payment for anesthesia services and, 2177–2178, 2178*t*  
 billing compliance and, 2180*f*, 2180–2181  
 data analysis and reporting and, 2179–2180  
 financial management and, 2176–2177  
 future of, 16–18, 17*f*  
 governance and organizational dynamics in, 2172–2173  
 hospital relationships and, 2173  
 human resource management and, 2174–2175  
 in-and out-of-operating room coverage and, 2175–2176  
 incorporation of regional anesthesia into practice and, 974–977  
 legal issues and, 2126–2134  
 consent and, 2130–2131  
 economic relationships and contracts and, 2128–2129  
 ethical issues and, 2131–2132  
 legal system and, 2126–2127  
 medical liability and, 2127–2128  
 National Practitioner Data Bank and, 2129–2130  
 pediatric issues and, 2132–2133  
 managed care contracting and, 2178–2179  
 pain management practice and, 2176  
 perioperative information management system and, 515–516  
 providers and, 2173–2174  
 scope of, 12–16  
 education and training and, 15–16  
 operating room anesthesia and, 12–14  
 outside operating room services and, 14–15  
 simulation and, 16  
 staffing models and, 2175  
 strategic planning and, 2181
- Anesthesia provider, 2173–2174  
 attitudes about drug addicted patient, 397–398  
 pediatric anesthesia and, 1521–1522  
 presence during monitored anesthesia care, 1628–1629  
 public perception of, 16  
 relationship to perioperative mortality, 445–446, 446*t*  
 substance abuse in, 2135–2154  
 DSM-IV-TR general criteria for substance abuse and, 2136–2137, 2137*t*  
 intervention plan for, 2149  
 natural history of addiction and, 2146, 2146*f*  
 new perspectives on addiction and, 2141*t*, 2141–2143, 2142*f*  
 pathophysiology of addiction and, 2143–2146  
 recognition of colleague misusing drugs and, 2146–2149, 2147*t*, 2148*t*  
 reentry into medical field and, 2151–2152  
 relapse and, 2151  
 scope of, 2135–2136  
 substance misuse terminology and, 2137–2138  
 traditional views of addiction and, 2138–2140*t*, 2138–2141  
 treatment of opioid addiction and, 2150*t*, 2150–2151  
 ultrarapid opioid detoxification and, 2149–2150  
 trauma team roles for, 1789, 1789*t*
- Anesthesia risk, 424–451  
 accidents and, 21–22, 22*b*  
 challenges in estimating of, 429–432, 432*b*, 433*f*  
 communication to patient of, 446–447  
 definition of, 425*b*, 425–426, 426*b*  
 measurement of, 426*f*, 426–429, 427*f*, 427–429*b*, 428*t*, 429*f*  
 mortality and, 438–446  
 anesthesia provider and, 445–446, 446*t*  
 cohort studies in, 438–439, 439*t*  
 crude estimates in, 439–440, 440*f*  
 healthcare setting and, 443–444  
 patient comorbidity and, 441–443, 442*t*, 443*b*, 443*f*  
 surgeon characteristics and operation in, 444*f*, 444–445  
 statistical problems in, 432–435, 433*f*, 434*b*  
 study designs in, 435*b*, 435–438, 436*t*
- Anesthesia technician/technologist, 2174
- Anesthesia vaporizer, 775–790  
 arrangement of, 784  
 calibration and checking of output, 784  
 Dalton law of partial pressures and, 776  
 desflurane and, 784*b*, 784–788, 785–788*f*  
 effect of carrier gas on output, 782*f*, 782–783  
 efficiency and temperature compensation and, 780*f*, 780–781  
 filling of, 782  
 hyperbaric conditions and, 783*f*, 783–784  
 hypobaric conditions and, 783, 783*f*  
 incorrect filling of, 781, 781*t*  
 latent heat of vaporization and, 777  
 measured-flow, 779, 779*f*  
 minimum alveolar concentration and, 776, 776*t*  
 regulation of vaporizer output and, 777*t*, 777–778, 778*f*  
 specific heat and, 777  
 vapor, evaporation, and vapor pressure and, 775–776, 776*f*  
 vaporization of mixed anesthetic liquids and, 781–782, 782*t*  
 variable by-pass, 779, 781*t*
- Anesthesia ventilator, 797–808, 798*f*, 799*f*  
 Datex-Ohmeda 7000, 798–800, 799*f*, 800*f*  
 Datex-Ohmeda 7810, 800–802, 801*f*  
 Datex-Ohmeda 7900, 802, 802*f*  
 Datex-Ohmeda ADU and 7900 SmartVent, 807  
 Dräger AV-E, 802–804, 803–805*f*  
 Dräger *versus* Datex Ohmeda, 804–805, 805*f*  
 fresh gas decoupling and, 807–808, 808–810*f*  
 for pediatric anesthesia, 1522  
 positive end-expiratory pressure and, 805*f*, 806–807  
 standing *versus* hanging bellows, 804  
 tidal volume and, 805*f*, 805–806, 806*f*
- Anesthesia workstation, 767–768
- Anesthesia-associated mortality, 438–446  
 anesthesia provider and, 445–446, 446*t*  
 cohort studies in, 438–439, 439*t*  
 crude estimates in, 439–440, 440*f*  
 healthcare setting and, 443–444  
 patient comorbidity and, 441–443, 442*t*, 443*b*, 443*f*  
 surgeon characteristics and operation in, 444*f*, 444–445
- Anesthesiologist assistant, 2174
- Anesthesiology, 1–38  
 future of, 16–18, 17*f*  
 historical background of, 1–10  
 American Board of Anesthesiology and, 6–7, 7*f*  
 discovery of anesthesia in, 2–3  
 emergence of profession in, 4–5  
 John Snow and, 3*f*, 3–4, 4*f*  
 rise of specialist in, 5*f*, 5–6, 6*f*  
 second half of twentieth century and, 8*f*, 8–9  
 World War II and, 7–8, 8*f*
- legal issues in, 2126–2134  
 consent and, 2130–2131  
 economic relationships and contracts and, 2128–2129  
 ethical issues and, 2131–2132  
 legal system and, 2126–2127  
 medical liability and, 2127–2128  
 National Practitioner Data Bank and, 2129–2130  
 pediatric issues and, 2132–2133  
 practice management and, 2172–2181  
 billing and payment for anesthesia services and, 2177–2178, 2178*t*  
 billing compliance and, 2180*f*, 2180–2181  
 data analysis and reporting and, 2179–2180  
 financial management and, 2176–2177  
 governance and organizational dynamics in, 2172–2173  
 hospital relationships and, 2173  
 human resource management and, 2174–2175  
 in- and out-of-operating room coverage and, 2175–2176  
 managed care contracting and, 2178–2179  
 pain management practice and, 2176  
 perioperative information management system and, 515–516  
 providers and, 2173–2174  
 staffing models and, 2175  
 strategic planning and, 2181  
 safety and quality issues in, 20–37  
 accident models and, 23–27, 24*f*, 25*b*, 27*b*  
 adverse respiratory events and, 27–28  
 diagnostic errors and, 29  
 dimensions of quality and, 29–31, 30*f*  
 equipment errors and failures and, 29  
 high-reliability organization model in, 31  
 lack of standard practice and, 29  
 medication errors and, 29  
 monitoring and alarms in, 28–29  
 at organizational and department level, 31–32  
 in outpatient surgery, 1621  
 patient involvement in, 34–35  
 practical elements of, 32–34, 34*t*  
 scope of, 12–16  
 education and training and, 15–16  
 operating room anesthesia and, 12–14  
 outside operating room services and, 14–15  
 simulation and, 16
- Anesthetic adjuncts formulary, 2193–2194*t*
- Anesthetic complications  
 in elective surgery, 69*t*, 69–73, 70*t*, 71*f*, 72*t*  
 in pediatric heart surgery, 1193–1194  
 thoracic radiography findings and, 1216*t*
- Anesthetic depth  
 electroencephalographic measurement of, 753, 753*f*  
 general anesthesia and, 1626, 1626*t*  
 inhalational anesthetics and, 752–753  
 in monitored anesthesia care, 1626*t*, 1630–1631, 1631*b*  
 in outpatient surgery, 1619, 1619*f*  
 therapeutic effects and, 750–751, 751*t*
- Anesthetic effects  
 neuroprotective/neurotoxic, 1938–1941, 1940*f*
- Aneurysm, 1299–1308  
 aortic arch, 1159*f*, 1159–1160, 1160*f*  
 ascending aorta, 1159*f*, 1159–1160, 1160*f*  
 atrial septal, 557*f*, 557–558, 1165*f*, 1165–1166  
 combined anesthesia techniques in, 1306–1307  
 descending thoracic aortic, 1160*t*, 1160–1162, 1161*f*, 1161*t*  
 endovascular aneurysm repair in, 1307–1308  
 general anesthesia for, 1305–1306  
 mediastinal, 1255*f*  
 monitoring in, 1300–1301  
 mycotic, 400, 401  
 pathophysiology and management of, 1299–1300  
 physiology of cross-clamping in, 1301–1303, 1302*f*  
 postoperative care in, 1307  
 therapeutic strategies in, 1303–1304  
 thoracic aortic, 1158*t*, 1158–1159, 1159*f*  
 thoracoabdominal aortic, 1160*t*, 1160–1162, 1161*f*, 1161*t*  
 unclamping in, 1304–1305, 1305*f*, 1306*f*
- Angina  
 antianginals for, 926–936  
 beta-adrenergic blockers in, 928–933, 929*b*, 930*t*, 932*t*  
 calcium channel blockers in, 932*t*, 933*f*, 933–934  
 dihydropyridines in, 934–935  
 inhibitors of fatty acid oxidation in, 936  
 ivabradine in, 936  
 nicorandil in, 936  
 nitrates in, 926–928, 927*f*, 928*t*  
 in carbon monoxide poisoning, 1774  
 cardiac risk in vascular surgery and, 1290  
 obesity and, 379
- Angiography  
 for detecting sites of critical stenosis, 96  
 before vascular surgery, 1292  
 Angiomax (bivalirudin), 255, 255*t*, 2192*t*  
 Angiotensin II, acute blood loss and, 242

- Angiotensin II receptor blockers, 925, 925f  
acute renal failure and, 206–207  
perioperative cardiac complications and, 113–114
- Angiotensin-converting enzyme inhibitors, 924f, 924–925, 925f  
acute renal failure and, 206–207  
for low cardiac output in shock, 1847  
perioperative cardiac complications and, 113–114
- Animal models  
of malignant hyperthermia, 1971–1972
- Anion gap, 581–582, 664f, 664–665
- Anion(s), 641, 641f
- Ankle  
painful conditions of, 2024f  
popliteal fossa block for, 1044–1046, 1045f
- Ankle block, 1046, 1047f, 1048f
- Ankylosing spondylitis, 167
- Annulus fibrosus, 979
- Annulus of Zinn, 1566f, 1572f
- Anomalad, 302
- Ansaid (flurbiprofen), 1723t
- Antacids, 1315, 2193t
- Antenatal hemorrhage, 1486–1488, 1487t
- Antepartum fetal surveillance, 360
- Antepartum hemorrhage, 364t, 364–365
- Anterior approach in sciatic nerve block, 1043, 1044f
- Anterior chamber, 1559f
- Anterior cricoid split in subglottic stenosis, 1598–1599
- Anterior ethmoidal artery, 1567f
- Anterior ethmoidal nerve, 1567f
- Anterior interosseous nerve, 2046t
- Anterior mediastinal mass, 1255t, 1256f
- Anterior mediastinum, 1214
- Anterior ramus, 2076
- Anterior scalene muscle  
interscalene block and, 1030, 1030f  
supraclavicular block and, 1031f
- Anterior scrotal nerve, 1453f
- Anterior segment vitrectomy, 1578
- Anterior spinal artery, 609f
- Anterior spinal artery syndrome, 1481–1482f
- Anterior superior iliac spine, 1041f, 1044f
- Anterior vagal trunk, 1451f
- Anteriorly tilted larynx, 125–126
- Anthropometric measures, 268
- Antianginals, 926–936  
beta-adrenergic blockers in, 928–933, 929b, 930t, 932t  
calcium channel blockers in, 932t, 933f, 933–934  
dihydropyridines in, 934–935  
inhibitors of fatty acid oxidation in, 936  
ivabradine in, 936  
nicorandil in, 936  
nitrates in, 926–928, 927f, 928t
- Antibiotics, 279–299  
for acute pancreatitis, 292–293  
for bacteremia, 291–292  
bacterial resistance and, 282–283  
for catheter-related infection, 287–288  
for *Clostridium difficile* infection, 292  
combination therapy with, 283–284  
epidemiologic considerations of, 284t, 284–285  
formulary for, 2195t  
for fungal infection, 294–296  
host factors and, 285, 285t  
for human immunodeficiency virus infection, 293–294, 294t  
identification of pathogen and, 284  
minimum inhibitory concentration and, 279–280  
for nosocomial infection, 286f, 286t, 286–287  
perioperative cardiac complications and, 116  
pharmacokinetics and pharmacodynamics of, 280–282, 281t  
for pneumonia, 290t, 290–291, 291t  
prophylactic, 288–290  
in burn injury, 1779  
in lung transplantation, 1386  
for postoperative ICU patient, 1838  
for subacute bacterial endocarditis, 289–290, 333b, 333t  
topical, for burn patient, 1681, 1681t  
for urinary tract infection, 292
- Antibody identification, 1903f
- Antibody screening test, 1903f
- Anticholinergic agents formulary, 2190t
- Anticholinesterases  
acute porphyria and, 161t  
for neuromuscular blockade reversal, 635, 635f
- Anticoagulant therapy  
during cardiopulmonary bypass, 1141–1143  
formulary for, 2192t  
in lower-extremity vascular surgery, 1299  
for multiple organ dysfunction syndrome, 1767  
neuraxial anesthesia and, 998  
epidural hematoma and, 1729  
placement and removal guidelines for, 1730t  
perioperative cardiac complications and, 115–116, 116t  
postanesthesia care unit and, 1696–1697  
postoperative ICU patient and, 1836–1837  
preoperative assessment and management of, 58  
trauma patient and, 1665
- Anticonvulsants  
for burn patient, 1682  
for cancer pain, 2111t  
for chronic pain, 2054–2059, 2055f, 2055–2057t, 2059t  
interaction with nondepolarizing neuromuscular blocking drugs, 1099  
for neuropathic pain, 1725  
for preeclampsia, 363  
propofol in, 857  
for recovering addict, 417–418, 418t  
for shingles, 2030  
thiopental in, 853
- Antidepressants  
for burn patient, 1682  
for cancer pain, 2111t  
for chronic pain, 2047–2050, 2050t, 2059t  
for neuropathic pain, 1725
- Antidiuretic hormone  
insufficiency in critically ill patient, 1745  
syndrome of inappropriate antidiuretic hormone and, 185, 185t, 647t, 647–648
- Antidysrhythmic agents, 936–947, 937b, 937f  
adenosine in, 946t, 946–947  
class IA agents in, 936–939, 938t  
class IB agents in, 939–941, 940f  
class IC agents in, 941–943, 942t  
class III agents in, 943–946, 944t  
formulary of, 2190t
- Antiemetics  
acute porphyria and, 161t  
formulary of, 2189t  
postanesthesia care unit and, 1691t, 1691–1692  
for postoperative pediatric patient, 1532t, 1532–1533
- Antiepileptic agents  
for burn patient, 1682  
for cancer pain, 2111t  
interaction with nondepolarizing neuromuscular blocking drugs, 1099  
for neuropathic pain, 1725  
for preeclampsia, 363  
propofol in, 857  
for recovering addict, 417–418, 418t  
thiopental in, 853
- Antiepileptic drugs  
for chronic pain, 2054–2059, 2055f, 2055–2057t, 2059t  
for complex regional pain syndrome, 2033  
for diabetic peripheral neuropathic pain, 2028
- Antifibrinolytic therapy  
for anemia, 246  
cardiopulmonary bypass and, 1143  
for clotting during hepatectomy, 1348–1349  
during heart transplantation, 1391  
during liver transplantation, 1367–1368  
for von Willebrand disease, 251t
- Antifungal therapy, 294–296
- Antigen  
mast cell activation and, 1947–1948, 1949f
- Antihistamine  
for anaphylactic reaction, 1953
- Antihistamines  
formulary of, 2186t
- Antihypertensives, 919–925  
angiotensin II receptor blockers in, 925, 925t  
angiotensin-converting enzyme inhibitors in, 924t, 924–925, 925f  
centrally acting alpha<sub>2</sub>-agonists in, 921t, 921–922  
cerebral blood flow and, 1099–1100  
diuretics in, 919–921, 920t  
formulary of, 2190t
- peripherally acting sympatholytic agents in, 922t, 922–923  
for preeclampsia, 1488  
preoperative assessment and management of, 58  
vasodilators in, 923t, 923–924
- Antiinflammatory drugs, 2064t  
acute renal failure and, 206  
for cancer pain, 2111  
for coagulation disorders, 255–256, 256f  
for minor burn, 1682  
neuraxial anesthesia and, 998  
for osteoarthritis, 167  
in outpatient surgery, 1612  
postoperative, 1696, 1722f, 1722–1724, 1722–1724t, 1723f  
in adenotonsillectomy, 1589–1590  
for child, 1531–1532  
in elective surgery, 81  
in orthopedic surgery, 1549–1550  
in spinal surgery, 1549  
preoperative assessment and management of, 59
- Antimediator therapy in multiple organ dysfunction syndrome, 1760
- Antimicrobial therapy, 279–299  
in acute pancreatitis, 292–293  
anaphylactic reaction to, 1953t, 1957b, 1957–1958  
in bacteremia, 291–292  
bacterial resistance and, 282–283  
in catheter-related infections, 287–288  
in *Clostridium difficile* infection, 292  
combination, 283–284  
epidemiologic considerations in, 284t, 284–285  
formulary for, 2195t  
in fungal infection, 294–296  
host factors in, 285, 285t  
in human immunodeficiency virus infection, 293–294, 294t  
identification of pathogen and, 284  
minimum inhibitory concentration and, 279–280  
in nosocomial infections, 286f, 286t, 286–287  
perioperative cardiac complications and, 116  
pharmacokinetics and pharmacodynamics in, 280–282, 281t  
in pneumonia, 290t, 290–291, 291t  
prophylactic, 288–290  
in burn injury, 1779  
in lung transplantation, 1386  
for postoperative ICU patient, 1838  
for subacute bacterial endocarditis, 289–290, 333b, 333t  
topical, for burn patient, 1681, 1681t  
in urinary tract infection, 292
- Antioxidants, 1776
- Antiplatelet agents, 255–257, 256f  
perioperative cardiac complications and, 115–116, 116t  
preoperative assessment and management of, 59
- Antipsychotics, neuroleptic malignant syndrome and, 150
- Antiretroviral therapy, 293–294, 294t
- Antithrombin deficiency, 258
- Antithrombin III, 1745, 2192t
- Antithrombin III concentrate (Thrombate III), 258
- Antithrombotic agents, 254–255, 255t
- Antithymocyte globulin, 1898
- Antithyroid medications, 175
- Anti-tumor necrosis factor-alpha agents, 2025
- Anxiety  
child and, 320b, 320–321  
elective surgery and, 81  
outpatient surgery and, 1609–1610, 1610f, 1611
- Anxiolysis, 1626, 1626t
- Anxiolytics, acute porphyria and, 161t
- Aorta, 1144f  
transesophageal echocardiography of, 571–574, 573f, 574f
- Aortic aneurysm  
intraoperative evoked potential monitoring in, 612t  
thoracic, 1158t, 1158–1159, 1159f  
thoracoabdominal, 1160t, 1160–1162, 1161f, 1161t
- Aortic arch aneurysm, 1159f, 1159–1160, 1160f
- Aortic arch baroreceptor, 305
- Aortic coarctation, 612t



- Aortic commissures, 569  
Aortic cross-clamping, 612t  
Aortic dissection, 574, 1162f, 1162t, 1162-1163, 1163f  
Aortic insufficiency  
  in left ventricular assist device patient, 1168  
  transesophageal echocardiography in, 570  
Aortic isthmus, 571  
Aortic plexus, 1451f, 1452f  
Aortic regurgitation, 1153t  
Aortic sclerosis  
  postoperative cognitive dysfunction and, 1918-1919  
  preoperative assessment and management in, 49-50  
Aortic sinus of Valsalva, 571  
Aortic stenosis, 1153t  
  geriatric patient and, 348  
  hemodynamic problems in, 1176t  
  perioperative cardiac complications and, 104  
  pregnant patient and, 366  
  preoperative assessment and management in, 49  
  transesophageal echocardiography in, 570-571, 571f, 572f  
Aortic surgery, 1158-1163, 1284-1313  
  in aneurysms, 1299-1308  
  ascending aorta and aortic arch aneurysm and, 1159f, 1159-1160, 1160f  
  combined anesthesia techniques in, 1306-1307  
  descending thoracic and thoracoabdominal aortic aneurysm and, 1160t, 1160-1162, 1161f, 1161t  
  endovascular aneurysm repair in, 1307-1308  
  general anesthesia for, 1305-1306  
  monitoring in, 1300-1301  
  pathophysiology and management of, 1299-1300  
  physiology of cross-clamping in, 1301-1303, 1302f  
  postoperative care in, 1307  
  therapeutic strategies in, 1303-1304  
  thoracic aortic aneurysm and, 1158t, 1158-1159, 1159f  
  unclamping in, 1304-1305, 1305f, 1306f  
  aortic dissection and, 1162f, 1162t, 1162-1163, 1163f  
  carotid endarterectomy in, 1293-1297, 1295f  
  general considerations in, 1293  
  lower extremity vascular surgery and, 1297-1299, 1299f  
  pathophysiology of vascular disease and, 1285-1287, 1286f, 1286t, 1287f  
  preoperative coronary artery bypass grafting in, 1292  
  preoperative evaluation in, 1287f, 1287-1292, 1288f, 1289f  
  preoperative medical therapy in, 1292-1293  
  preoperative percutaneous coronary intervention in, 1292  
Aortic valve  
  disease in geriatric patient, 348  
  transesophageal echocardiography of, 569f, 569-570, 570f  
Aorticorenal ganglion, 1451f  
APACHE scoring system, 441, 1743  
Apert syndrome, 331t, 332t  
Apnea  
  arterial oxygenation during, 691-692  
  mechanical ventilation in, 1853t  
  postoperative infant and, 1521  
  sleep, 1588  
  difficult airway and, 126-127  
  elective surgery for, 76  
  in neuromuscular disease, 157  
  obese patient and, 376-377, 377f, 378f, 386  
  preoperative assessment and management in, 51  
  same-day surgery for, 1649  
Apnea-hypopnea index  
  difficult airway and, 127  
  obese patient and, 376-377  
Apneic oxygenation in bronchoscopy, 1242  
Apoferitin, 722, 722f  
Apolipoprotein E4  
  Alzheimer disease and, 1912-1913  
Apoptosis, 1663, 1749, 1787  
Apparent affinity of general anesthetic, 722  
Apparent volume of distribution of antimicrobial agents, 280  
Apraclonidine, 1563  
Aprepitant, 1617, 1617f, 2189t  
Aprotinin, 246, 2192t  
  cardiopulmonary bypass and, 1143  
  in liver transplantation, 1362, 1367-1368  
Aqueous humor, 1559, 1561f, 1561-1562  
Arachidonic acid metabolism, 1722f  
Arachnoid mater, 978, 980f  
Arachnoiditis, neuraxial anesthesia-related, 1481-1482t  
Arcus marginalis, 1568f  
Ardeparin, 254-255  
Argatroban (Normiflo), 253t, 255, 2192t  
  for heparin-induced thrombocytopenia, 259-260  
Arginine, 274  
Arginine vasopressin, 1884  
Argon laser, 1596t  
Arixtra (fondaparinux), 255, 2192t  
Arm  
  cutaneous distribution of cervical roots in, 1029, 1029f  
  peripheral nerve blocks for, 1027-1037  
  axillary block, 1032-1034, 1033f  
  brachial plexus anatomy and, 1028-1029, 1029f  
  cervical plexus block, 1027f, 1027-1028, 1028f  
  continuous catheter techniques and, 1037, 1037f  
  infraclavicular block, 1032  
  interscalene block, 1029-1031, 1030f  
  intravenous, 1036-1037  
  median nerve block, 1034-1035, 1035f  
  midhumeral block, 1034  
  musculocutaneous nerve block, 1035-1036  
  radial nerve block, 1035, 1036f  
  supraclavicular block, 1031f, 1031-1032, 1032f  
  ulnar nerve block, 1035, 1036f  
Arndt catheter, 710, 1231-1232  
Arnold-Chiari malformation, 1515  
Arousal  
  anesthetic effects on, 734-735, 735f  
  neural circuitry of, 734  
Arrhythmias  
  alcohol abuse and, 406  
  antidysrhythmic agents for, 936-947, 937b, 937f  
  adenosine in, 946t, 946-947  
  class IA agents in, 936-939, 938t  
  class IB agents in, 939-941, 940t  
  class IC agents in, 941-943, 942t  
  class III agents in, 943-946, 944t  
  beta-adrenergic blockers for, 929  
  bronchoscopy-related, 1242  
  burn patient and, 1680  
  in congenital heart disease, 1188  
  digitalis for, 926  
  in electrical injury, 1780  
  extracorporeal shock wave lithotripsy and, 1460  
  hypercalcemia and, 178  
  in hypomagnesemia, 654  
  inhaled anesthetics and, 757  
  during intrahospital patient transport, 1814  
  local anesthetic-related, 967  
  in multiple organ dysfunction syndrome, 1758  
  obesity and, 379  
  oculocardiac reflex and, 1561  
  perioperative cardiac complications and, 104  
  in postanesthesia care unit, 1693-1694  
  postoperative, 1706-1707  
  in postoperative ICU patient, 1834  
  preoperative assessment and management in, 49  
  risk for perioperative shock in, 1929  
  in subarachnoid hemorrhage, 1115-1116, 1116f  
  subclinical hyperthyroidism and, 175  
  thoracic surgery-related, 1272  
Arseenic neuropathy, 2028t  
Arterial baroreceptor, 305  
Arterial blood gases, 579-582, 580f, 580-582t, 581f, 666-667  
  in aortic surgery, 1300  
  in elective surgery, 83  
  in liver transplantation, 1353  
  in long bone and pelvic fractures, 1671-1672  
  in malignant hyperthermia, 1981  
  in neuromuscular disease, 157  
  obese patient and, 378  
  in thoracic surgery, 1217  
  trauma patient and, 1665-1666  
Arterial blood pressure monitoring, 519-522, 520f, 521f  
  complications of, 522  
  in coronary artery bypass graft, 1147  
  in critically ill patient, 1801-1802  
  indications for, 522  
  insertion technique in, 521-522  
  in neonatal emergency surgery, 1507  
  noninvasive, 519, 520f  
  during patient transport, 1817  
  pressure waveform in, 521, 521f  
  theory and background of, 519-520, 520f  
  during thoracic surgery, 1223t  
  in trauma patient, 1665  
  trauma patient and, 1665  
Arterial blood pressure waveform, 521, 521f  
Arterial carbon dioxide tension, 579-582, 580f, 580-582t, 581f  
  capnometry and, 692-693, 693b  
  during cardiopulmonary resuscitation, 1877-1878  
  transcutaneous monitoring of, 589-590, 590f  
Arterial chemoreceptor, 305  
Arterial hemoglobin saturation  
  anemia and, 244  
  in congenital heart disease, 1175, 1177, 1178f  
Arterial oxygen tension, 579-582, 580f, 580-582t, 581f  
  intracranial pressure and, 1090  
Arterial partial pressure of carbon dioxide  
  neuroprotection and, 1930-1931, 1931f  
Arterial switch repair, 1185t  
Arterial-to-alveolar gradients, 693b  
Arteriovenous malformation, 1119-1120, 1655  
Arteriovenous shunting, 748  
Artery of Adamkiewicz, 2076  
Artery radicularis magna, 2076  
Arthritis  
  chronic pain in, 2022  
  geriatric patient and, 349  
  preoperative evaluation in, 166-167  
Arthrogyposis multiplex, 303t, 331t  
Arthropathy  
  facet, 2034-2035  
  in hemophilia, 1899  
  sacroiliac, 2035  
Arthroplasty  
  hip, 1544-1547, 1546f  
  deep venous thrombosis and, 1552-1553  
  methylmethacrylate hypersensitivity and, 1552  
  older adult and, 351-352  
  knee, 1544-1547, 1546f  
  deep venous thrombosis and, 1552-1553  
  older adult and, 352  
  shoulder, 1543-1544  
Artifact  
  in pulmonary artery catheter, 528-529  
Artifact in pulse oximetry, 583, 584  
Aryepiglottic fold, 687, 688  
Arytenoid cartilage, 687, 688, 688f  
Ascending aorta aneurysm, 1159f, 1159-1160, 1160f  
Ascending cervical artery, 609f  
Ascending nociceptive pathways, 2000, 2001f, 2006  
Ascites, 234  
  Child-Pugh scoring system and, 224t  
  in chronic liver failure, 232  
  in cirrhosis, 1340  
  difficult airway and, 129t  
  morbidity and mortality following intraabdominal surgery and, 225t  
  procedures for, 1369b, 1369-1370  
Asleep fiberoptic intubation, 705, 707f, 708f  
Aspartate aminotransferase, 219t, 219-220, 232  
Aspergillus spp., 295  
Asphyxial cardiac arrest, 1875  
Asphyxiating thoracic dystrophy, 303t  
Aspiration  
  in esophageal atresia and tracheoesophageal fistula, 1514  
  of foreign body, 1268-1269, 1269f, 1270t, 1591  
  of gastric contents  
  during assisted reproductive technologies, 1477  
  during cesarean delivery, 1485  
  child and, 1521  
  critically ill patient and, 1805  
  identification before elective surgery, 72  
  management of acid reflux and, 1315b, 1315-1316

- during outpatient surgery, 1612  
 during pregnancy, 359  
 in glycogen storage diseases, 166  
 in neuromuscular disease, 158  
 nonintubated airway and, 698–699  
 postoperative, 1704, 1704f
- Aspiration pneumonia  
 alcohol abuse and, 406  
 conditions associated with, 1315b  
 postoperative, 1704  
 in postoperative ICU patient, 1833
- Aspiration pneumonitis, 1704
- Aspirin, 2064t, 2183t, 2192t  
 antiplatelet activity of, 255–256  
 epidural analgesia and, 1730t  
 neuraxial anesthesia and, 998  
 perioperative cardiac complications and, 115  
 preoperative assessment and management of, 59  
 for prevention of preeclampsia, 363  
 standard doses of, 1723t
- Asplenia, 303t, 332t
- Assist/control mode of mechanical ventilation, 1853–1854, 1854t, 1855f
- Assisted reproductive technologies, 1475–1477, 1476f
- Association constant, drug affinity and, 722
- Association for Advancement of Medical Instrumentation, 490
- Association of University Anesthesiologists, 8
- Asthma, 138  
 postoperative pulmonary complications and, 1703–1704  
 pregnant patient and, 367, 367t  
 preoperative assessment and management in, 50
- ASTM International, 490
- Astrocytoma, 1536
- Asymptomatic murmur, 333t
- Asystole, cardiopulmonary resuscitation in, 1882, 1883b
- Ataxic cerebral palsy, 1542
- Atelectasis  
 absorption, 1235  
 head-down position and, 470  
 in minimally invasive urologic surgery, 1467  
 postoperative, 1692
- Atelectrauma in mechanical ventilation, 1864
- Atenolol, 110t, 930, 930t
- Atheroma, 1286, 1286f
- Atherosclerosis  
 alcohol abuse and, 403–404  
 aneurysms and, 1299–1308  
 combined anesthesia techniques in, 1306–1307  
 endovascular aneurysm repair in, 1307–1308  
 general anesthesia for, 1305–1306  
 monitoring in, 1300–1301  
 pathophysiology and management of, 1299–1300  
 physiology of cross-clamping in, 1301–1303, 1302f  
 postoperative care in, 1307  
 therapeutic strategies in, 1303–1304  
 unclamping in, 1304–1305, 1305f, 1306f
- carotid occlusive disease and, 1293  
 cocaine use and, 411  
 cognitive dysfunction and, 1912–1914, 1913f, 1914f, 1918–1919  
 obesity and, 379  
 pathophysiology of, 1285–1287, 1286f, 1286t, 1287f  
 peripheral arterial disease and, 1297  
 preoperative evaluation of, 1287b, 1287–1292, 1288b, 1289f
- Atherosclerotic plaque, 1286–1287
- Atlantooccipital mobility, 123–124
- Atlas, 979f
- Atmospheric pressure, inhalational anesthetics and, 742, 743f
- Atomic weight of element, 641
- Atorvastatin (Lipitor), 947t
- Atosiban, 362
- Atracurium, 629t, 629–630, 630f, 2187t  
 anaphylactic reaction to, 1952t  
 chemical structure of, 628f  
 critically ill patient and, 634  
 in hepatic resection, 1348  
 maintenance infusion of, 634  
 for obese patient, 384t, 385
- Atresia  
 biliary, 224–225  
 choanal, 1585  
 esophageal atresia and tracheoesophageal fistula, 1513–1515, 1514f
- Atrial fibrillation  
 alcohol abuse and, 406  
 geriatric patient and, 349  
 postoperative, 1707  
 in postoperative ICU patient, 1834  
 preoperative assessment and management in, 49  
 risk for perioperative stroke and, 1925, 1927
- Atrial natriuretic peptides, 1154
- Atrial septal aneurysm, 557f, 557–558, 1165f, 1165–1166
- Atrial septal defect  
 hemodynamic problems in, 1176t  
 problems resulting from surgical procedure in, 1185t  
 transcatheter closure of, 1196, 1196f
- transesophageal echocardiography in, 557–558
- Atrial septostomy, 1195t
- Atrial wave in pulsed-wave Doppler, 561
- Atrioventricular canal  
 hemodynamic problems in, 1176t  
 problems resulting from surgical procedure in, 1185t
- Atrioventricular valve procedures, 1152, 1153f
- Atropine, 2190t  
 biliary effects of, 1317  
 for cardiac arrest, 1884  
 intraocular pressure and, 1563
- Auditory evoked responses, 613
- Auditory neural pathways, 611f
- Aura  
 migraine with, 2036
- Auricular malformations, 1584
- Auscultatory method of blood pressure measurement, 519, 520, 520f
- Autoimmune hepatitis, 230
- Autologous stem cell transplant, 1409
- Automated anesthesia record keeping system, 500
- Automated data acquisition in quality of care improvement, 456–457
- Automated external defibrillator, 1880
- Automated noninvasive arterial blood pressure measurement, 519, 520f
- Automatic tube compensation, 1858–1859
- Autonomic dysreflexia, 1549
- Autonomic hyperreflexia, 1455–1456, 1456f
- Autonomic nervous system  
 asthma and, 138  
 in cerebrovascular control, 1092–1093
- Autonomic neuropathy  
 in diabetes mellitus, 189  
 in liver disease, 1344–1345
- Auto-positive end-expiratory pressure, 591, 591f, 592  
 in acute respiratory distress syndrome, 1867–1868  
 in chronic obstructive pulmonary disease, 1866  
 patient-ventilator synchrony and, 1862, 1863f
- Autoregulation of cerebral blood flow and cerebral blood volume, 1090–1092, 1091f
- Autosomal dominant polycystic kidney disease, 209
- Auxiliary oxygen diameter-index safety system fitting, 771
- Auxiliary oxygen flowmeter, 771
- Avian flu, 1742t
- Awake craniotomy, 615–616
- Awake episodes of malignant hyperthermia, 1970
- Awake intubation in cervical spine surgery, 1120, 1548
- A-wave duration, 561
- Axial hiatal hernia, 1321, 1321f
- Axial spinal pain, 2088–2089
- Axillary artery, axillary block and, 1032, 1033, 1033f
- Axillary nerve, 2046t
- Axillary nerve block, 1032–1034, 1033f  
 in child, 1531  
 in upper-extremity orthopedic procedures, 1543, 1543f
- Axis, 979f
- Ayre's T-piece, 794
- Azathioprine, 1383, 1383t
- Azithromycin, 2195t
- Azole antifungals, 295
- Aztreonam, 2195t  
 anaphylactic reaction to, 1958
- B**
- B Braun target-controlled infusion system, 902t
- Babesiosis  
 transfusion-related, 1905
- Bacitracin ointment, 1681t
- Back pain, 2033–2034, 2034t  
 epidural anesthesia-related, 1072  
 positioning in urologic surgery and, 1454  
 during pregnancy, 367  
 supine position and, 466
- Baclofen, 2194t  
 for chronic pain, 2059t, 2061  
 for multiple sclerosis, 160  
 for spasticity in cerebral palsy, 1542
- Bacteremia  
 antimicrobial therapy for, 291–292  
 pathogens in, 286t
- Bacterial contamination of blood components, 1902–1903
- Bacterial infection  
 in alcohol or drug addicted patient, 399–400  
 in burn patient, 1781  
 in endocarditis, 289–290, 333b, 333t, 400  
 in epiglottitis, 1586–1587
- Bacterial resistance to antimicrobial therapy, 282–283
- Bactericidal antimicrobials, 279
- Bacteriostatic antimicrobials, 279
- Bag-in-a-bottle double-circuit anesthesia ventilator, 798, 798f
- Bain circuit, 794, 794f
- Balanced anesthesia, 886  
 in spine surgery, 1548
- Balanced salt solutions, 670t, 672
- Balloon dilation, 1195t
- Ballpen needle, 982
- Bar code identification  
 of blood products, 511f, 511–512, 512f  
 of patient, 510–511, 511f
- Baralyme, 796, 797t
- Barbiturates, 850–856  
 adverse effects of, 853–854, 854b, 854f  
 in arteriovenous malformation repair, 1119  
 cardiovascular system and, 853, 853t  
 central nervous system and, 850–853, 852f, 852t  
 cerebral blood flow and, 1094  
 cerebral neuroprotection and, 1103  
 chemistry of, 850, 851f, 852t  
 clinical use of, 855–856, 856f, 856t  
 evoked potentials and, 610  
 formulery of, 2186t  
 for intraoperative cerebral edema, 1108  
 neuroprotection and, 1938–1941, 1940f  
 pharmacokinetics of, 854–855, 855t  
 respiratory system and, 853, 853t
- Bariatric surgery, 385, 387, 1325, 1326f
- Baricity of solutions for spinal anesthesia, 987t
- Barometric pressure, anesthesia vaporizer and, 783f, 783–784
- Baroreceptor, 305
- Bartter syndrome, 657
- Basal metabolic rate, aging and, 343
- Base deficit  
 burn patient and, 1776  
 trauma patient and, 1666
- Base deficit/excess approach to acid-base chemistry, 664, 664t
- Base excess, 581
- Base forms of local anesthetics, 956, 956f
- Base Primea target-controlled infusion system, 902t
- Base(s), 659–660, 660t
- Basic life support, 1874, 1874b, 1875b, 1875f, 1876b
- Basilar artery, 609f
- Basiliximab, 1383
- Basket cell, generation of electroencephalogram and, 598, 599t, 600f
- Basophil-histamine release assay, 1954
- Batista procedure, 1381
- Batson plexus, 981
- Battered child syndrome, 2132–2133
- Bayesian theorem, 106
- Becker muscular dystrophy, 163–164, 1971
- Beckwith-Weidemann syndrome, 303t, 331t
- Beclomethasone, 2193t
- Behavior  
 developmental, 321t  
 substance abuse and, 2139
- Behavioral therapy for postoperative pain, 1731
- Belmont Fluid Management System, 1361, 1361t

- Belsy-type fundoplication, 1322
- Benazepril, 924t
- Bendroflumethiazide, 920t
- Benign prostatic hyperplasia, 352, 1457
- Benoxinate (Dorsacaine, Novesine), 969r
- Benzocaine, 971, 2188t
  - cation-to-base ratio of, 957t
  - dissociation constant of, 961t
- Benzodiazepine antagonists, 2186t
- Benzodiazepines
  - for chronic pain, 2056t, 2060–2061
- Benzodiazepine(s), 860–863
  - for burn wound pain, 1682
  - central nervous system effects of, 852t, 861
  - cerebral blood flow and, 1095
  - formulary of, 2186t
  - in monitored anesthesia care, 1641–1642, 1642f
  - in nonoperating room procedures, 1651
  - in outpatient surgery, 1611f, 1611–1612
  - ventilatory depression and, 853t
- Benzthiazide (Exna), 920t
- Benzylisoquinolines, 627–629, 628–631t
- Bepridil, 932t, 935
- Beraprost, 1342
- Berlin Heart ventricular assist device, 1202
- Bernoulli equation, 553
- Beta-adrenergic agonists
  - in bypass weaning in heart transplantation, 1392
  - cerebral blood flow and, 1093
- Beta-adrenergic blockers, 928–933, 929b, 930t, 932t
  - cerebral blood flow and, 1100
  - formulary of, 2190t
  - for glaucoma, 1563
  - to modify cardiac risk in surgery, 59
  - for pheochromocytoma, 184
  - preoperative assessment and management of, 53t, 58, 110f, 110–113, 111–112t
  - renal transplantation and, 1400–1401
  - before vascular surgery, 1292–1293
- Beta-endorphin, 2007
- Beta-lactam antibiotics
  - anaphylactic reaction to, 1957, 1957b
  - postantibiotic effect of, 281
- Beta-lactamases, 282
- Betaxolol, 930t, 931
- Bezold-Jarisch reflex
  - in interscalene block, 1030
  - in neuraxial anesthesia, 995, 995f
- Bicarbonate, 661
  - distribution in body compartments, 641t
  - in hypotonic solutions, 672t
- Biceps femoris muscle, popliteal fossa block and, 1045f
- Biceps muscle, axillary block and, 1033f
- Biceps tendinitis, 2023t
- Bidirectional shunting in congenital heart disease, 1175–1177, 1178f
- Bier, August, 4
- Bier block, 1036–1037, 1543, 2188t
- Bier-Hoff stirrups, 1453f
- Biguanides, 186
- Bilateral choanal atresia, 1585
- Bilateral sequential single-lung transplantation, 1388
- Bile acids, 1339
- Bile excretion, 217, 218t
- Bilevel positive airway pressure, 1833
- Bilevel pressure ventilation, 1860, 1860f
- Biliary atresia, 224–225
- Biliary disease, 1324b, 1324–1325
- Biliary tract
  - cancer of, 1324
  - effects of opioid analgesics on, 1317
  - stricture of, 1325
- Biliopancreatic diversion, 1326f
- Bilirubin, 217
  - as biochemical marker, 219t
  - Child-Pugh scoring system and, 224t
  - morbidity and mortality following intraabdominal surgery and, 225t
- Billing
  - metrics and trends in, 2179–2180
  - payment for anesthesia services and, 2177–2178, 2178t
  - perioperative information management system and, 508–509, 509f
- Billing compliance, 2180f, 2180–2181
- Billing services, 2178, 2178t
- Bioavailability of antimicrobial agents, 281
- Biochemical markers
  - in hepatic function, 219t
  - in protein-energy malnutrition assessment, 268
- Biophase, 825–826, 826f, 827f, 827t, 899
- Biophysical profile, 361, 361t
- Bioprosthetic heart valve, 1157
- Biopsy
  - liver, 220–221
- Biosynthetic bladder, 1463
- Biotransformation
  - of inhaled anesthetics, 760
  - of local anesthetics, 959–960
  - newborn and, 1503–1504
- Biotrauma in mechanical ventilation, 1864–1865
- Biphasic defibrillator, 1881
- Bipolar dissection in tonsillectomy, 1589
- Bisoprolol, 110t, 930t, 930–931
- Bispectral array, intraoperative electroencephalography and, 605–606, 606f, 607f
- Bispectral index monitoring, 72, 72t, 85, 753f
  - critically ill patient and, 1808
  - monitored anesthesia care and, 1630–1631
  - obese patient and, 390
  - in outpatient surgery, 1619, 1619f
  - sentinel event alert and, 454
- Bisphosphonates, 178
- Bivalirudin (Angiomax), 255, 255t, 259–260, 2192t
- Bladder
  - anatomy and physiology of, 1451, 1452f
  - cancer of, 1455–1457, 1456f, 1462–1464, 1463f
  - perforation of
    - in cystoscopy, 1455
    - in transurethral resection of prostate, 1459
- Bladder catheterization
  - in burn injury, 1779
  - in neonatal emergency surgery, 1508
- Blalock-Taussig shunt, 1175
  - anesthetic complications in, 1194
  - hemodynamic problems resulting from, 1185t
- Blastomycosis, 294
- Bleeding
  - acute anemia and, 242
  - antenatal and postpartum, 364t, 364–365, 1486–1488, 1487t
  - in arteriovenous malformation, 1119
  - direct tissue injury leading to critical illness and, 1739
  - in disseminated intravascular coagulation, 260
  - in dysfibrinogenemia, 253
  - gastrointestinal, 1328–1329
    - in alcohol abuse, 408
    - in postoperative ICU patient, 1838
  - in hemophilia, 248
  - in hepatic resection, 1346f, 1346–1348, 1347f
  - intraabdominal, 1663–1669
  - in laparoscopic surgery, 1319
  - in mediastinoscopy, 1254
  - neuraxial anesthesia and, 998
  - ophthalmic regional anesthesia-related, 1073
  - in orthognathic surgery, 1601
  - peripheral nerve block-associated, 1048–1049
  - physiologic effects of, 1790t
  - in placental abruption, 365
  - in postanesthesia care unit, 1696–1697
  - postoperative, 1710–1711
    - in adenotonsillectomy, 1590
    - in factor VII deficiency, 252
    - in hematopoietic stem cell transplantation, 1409
    - in thoracic surgery, 1272–1273
    - in thyroid surgery, 1603
  - posttonsillectomy, 1590
  - posttourniquet, 1550
  - in prostatectomy, 1462
  - retrobulbar, 1073, 1574
  - in rhinoplasty, 1585
  - in sinus surgery, 1586
  - subarachnoid, 1114f, 1114–1119, 1115t, 1116f, 1117f, 1117t
    - hyperosmolar agents for, 1102
  - in transurethral resection of prostate, 1459
  - trauma patient and, 1790, 1794
  - traumatic, 1662
  - uremic, 1899
  - variceal, 234
  - in von Willebrand disease, 250
- Bleomycin (Blenoxane)
  - pulmonary toxicity of, 1248
  - toxicity affecting anesthetic management, 1490t
- Blepharoplasty, 1579
- Blind nasal intubation, 708–709
  - in cervical spine disease, 1121
  - in spinal cord trauma, 1670
- Blindness
  - diabetes mellitus and, 1405t
  - horizontal position infratentorial craniectomy-related, 1114
- Block height in neuraxial anesthesia, 986–988, 987t
- Blood, inhalational anesthetic uptake into, 747, 747f
- Blood flow
  - during cardiopulmonary resuscitation, 1876–1877
  - in child, 311
  - lateral decubitus position and, 1224, 1224f, 1226f
  - to liver, 1339
  - obstruction in congenital heart disease, 1181
  - in pregnant woman, 1475
- Blood gases, 579–582, 580f, 580–582t, 581f, 666–667
  - in aortic surgery, 1300
  - in elective surgery, 83
  - in liver transplantation, 1353
  - in long bone and pelvic fractures, 1671–1672
  - in neuromuscular disease, 157
  - obese patient and, 378
  - in thoracic surgery, 1217
  - trauma patient and, 1665–1666
- Blood glucose
  - changes during surgery, 187
  - control of
    - diabetic parturient and, 186
    - neuroprotection and, 1934–1935
    - in postoperative ICU patient, 1837
    - in trauma patient, 1665
  - critical illness polyneuropathy and, 1833
  - hepatic role in regulation of, 1339
  - monitoring during surgery
    - in liver transplantation, 1365
    - in pancreas transplantation, 1407, 1407t
    - in renal transplantation, 1401
  - during pregnancy, 359–360
- Blood lactate
  - aneurysm surgery and, 1305
  - burn patient and, 1776
  - in hemodynamic support for shock, 1848
- Blood loss
  - acute anemia and, 242
  - during aneurysm surgery, 1301
  - during burn wound excision, 1680
  - during craniostylosis repair, 1537
  - direct tissue injury leading to critical illness and, 1739
  - in endovascular aneurysm repair, 1308
  - extracellular fluid volume and, 668, 668f
  - fluid management of, 669
  - in gynecologic surgery, 1495–1496
  - in hemorrhagic shock, 1662
  - during hepatic resection, 1346, 1346f, 1347f, 1348
  - hypovolemic shock and, 1742
  - in labor and delivery, 1486–1487
  - in neonatal emergency surgery, 1508–1509
  - in orthognathic surgery, 1601
  - in orthopedic surgery, 1541–1542
  - in pediatric surgery, 1528
  - physiologic effects of, 1790t
  - propofol behavior and, 842, 842f, 843f
  - in spine surgery, 1548
  - in stapectomy, 1583
- Blood patch, 1729
- Blood pressure
  - aortic cross-clamping and, 1301
  - arterial monitoring of, 519–522, 520f, 521f
    - complications of, 522
    - in coronary artery bypass graft, 1147
    - in critically ill patient, 1801–1802
    - indications for, 522
    - insertion technique in, 521–522
    - in neonatal emergency surgery, 1507
    - noninvasive, 519, 520f
    - during patient transport, 1817
    - pressure waveform in, 521, 521f
    - theory and background of, 519–520, 520f
    - during thoracic surgery, 1223t
    - trauma patient and, 1665
  - barbiturates and, 853
  - benzodiazepines and, 861
  - during carotid endarterectomy, 1296
  - effects on intracranial pressure-plateau waves, 1935

- ketamine and, 863  
 monitoring during pediatric surgery, 1522  
 normal ranges of, 315t  
 obese patient and, 388  
 physiologic effects of hemorrhage on, 1790t  
 preeclampsia and, 362, 363t  
 propofol and, 857
- Blood products**  
 for antenatal and postpartum hemorrhage, 1487  
 bacterial contamination of, 1902–1903  
 bar code identification of, 511f, 511–512, 512f  
 compatibility testing and, 1895t, 1902, 1902f  
 for postoperative ICU patient, 1835–1836  
 red cell concentrates in, 1893–1897, 1895t, 1896t  
 viral contamination of, 1903–1905  
 whole blood in, 1893
- Blood substitutes, 1793**
- Blood supply**  
 to bladder, 1451  
 to kidney, 1450  
 to ocular structures, 1560  
 to orbit, 1567f  
 to penis, 1453  
 to prostate, 1452  
 testicular, 1452  
 ureteral, 1451
- Blood tests before pediatric surgery, 334–336, 335t**
- Blood transfusion, 1892–1911**  
 adverse effects of, 1907–1908  
 allergic transfusion reaction and, 1906–1907  
 for antenatal and postpartum hemorrhage, 1487  
 bacterial contamination of blood components and, 1902–1903  
 compatibility testing in, 1902, 1902f, 1903f  
 Creutzfeldt-Jakob disease and, 1905–1906  
 febrile nonhemolytic transfusion reaction and, 1906  
 historical background of, 1892–1893  
 legal issues in, 2130  
 in liver transplantation, 1362f, 1362–1363, 1363f  
 in neonatal emergency surgery, 1508–1509  
 in orthopedic surgery, 1541–1542  
 in pediatric surgery, 1528  
 plasma component derivatives for, 1897–1901  
 platelets for, 1901–1902  
 in postanesthesia care unit, 1696  
 in postoperative ICU patient, 1835–1836  
 red cell concentrates for, 1893–1897, 1895t, 1896t  
 for shock, 1843–1844  
 viral contamination of blood components and, 1903–1905  
 whole blood for, 1893
- Blood urea nitrogen, 198**  
 changes during pregnancy, 360  
 in elective surgery, 78t  
 in hepatocellular function evaluation, 232
- Blood volume**  
 aortic cross-clamping and, 1302, 1302f  
 of child, 315, 315t  
 head-down tilt position and, 470  
 intravenous anesthetic dosing and, 840–843, 841–843f  
 of newborn, 1503t  
 of obese patient, 378, 379  
 during pregnancy, 358  
 tourniquet and, 1550
- Blood-brain barrier of child, 319**
- Blood-brain equilibration rate constant, total intravenous anesthesia and, 899, 900t**
- Blood/gas partitioning of inhalational anesthetics, 742, 744f, 744t**
- Blue bloater, 138**
- Blunt esophagectomy, 1322, 1323f**
- Blunt trauma, 1661t, 1739, 1786**
- Body composition**  
 aging and, 343–344, 344f  
 of newborn, 1503t
- Body fluid compartments**  
 hypervolemia and, 645  
 hypovolemia and, 644–645, 645f  
 impact of surgical stress on, 643–644  
 ionic constituents of, 640–642, 641t  
 water distribution in, 640, 640f
- Body mass index, 43–45**  
 classification of obesity and, 375t  
 difficult airway and, 127  
 disease risk and, 375t  
 islet cell transplantation and, 1408
- Body temperature**  
 correction of blood gases and, 582  
 management during patient transport, 1814  
 monitored anesthesia care and, 1630  
 monitoring after elective surgery, 85  
 neuroprotection and, 1931–1934, 1932f, 1933t  
 pediatric heart surgery and, 1191–1192  
 postoperative complications of, 1711–1712, 1712f  
 in systemic inflammatory response, 1331b  
 of trauma patient, 1666
- Body weight**  
 assessment before renal transplantation, 1400  
 bariatric procedures and, 1325  
 difficult airway and, 126–127  
 intravenous anesthetics and, 835–838, 836t, 836–838f, 838t
- Bohr equation, 581**
- Boiling point of inhaled anesthetics, 741t, 777t**
- Bolus-elimination-transfer in target-controlled infusion, 901**
- Bone cement implantation syndrome, 1552**
- Bone implantation syndrome, 1552**
- Bone marrow aspiration, paravertebral block in, 1021**
- Boston approach to acid-base chemistry, 663–664, 664t**
- Botulism, 401**
- Bowel distension, 1316**
- Bowel motility, 1316–1317**
- Brachial plexus, 1028–1029, 1029f**
- Brachial plexus injury**  
 in horizontal position infratentorial craniectomy, 1114  
 intraoperative evoked potential monitoring in, 612t  
 surgical positioning-related, 473  
 thoracic surgery-related, 1274
- Brachial plexus nerve block**  
 axillary, 1032–1034, 1033f  
 for cancer pain, 2115–2116, 2116f  
 continuous catheter techniques in, 1037, 1037f  
 infraclavicular, 1032, 1616t  
 interscalene, 1029–1031, 1030f  
 median nerve, 1034–1035, 1035f  
 midhumeral, 1034  
 musculocutaneous nerve, 1035–1036  
 onset and duration of, 960, 960f  
 phrenic nerve paralysis and, 1063–1064  
 radial nerve, 1035, 1036f  
 spinal cord injury and, 1062  
 supraclavicular, 1031f, 1031–1032, 1032f  
 ulnar nerve, 1035, 1036f  
 in upper-extremity orthopedic procedures, 1543f, 1543–1544  
 use of ultrasound in, 1056–1057, 1057f
- Bradycardia**  
 after carotid endarterectomy, 1297  
 atropine for, 1884  
 esophageal surgery-related, 1250  
 intravascular injection of local anesthetic and, 1059  
 neonatal, 305  
 neostigmine-related, 1316  
 during neuraxial anesthesia, 994–996, 995t  
 in neurogenic shock, 1549  
 oculocardiac reflex and, 1561  
 opioid analgesic-induced, 878  
 pediatric, 314  
 postoperative, 1693, 1707  
 in TURP syndrome, 1457
- Bradykinins**  
 role in pain, 2061, 2062f
- Brain**  
 abscess in alcohol or drug addicted patient, 401  
 anesthetic neuroprotection and, 1102–1104  
 drug abuse-related changes in, 2142, 2142f, 2144–2155  
 herniation patterns of, 1086f  
 hypernatremia and, 649  
 integration and processing of pain in, 2007  
 lesion of, 600–601, 601f  
 pediatric heart surgery-related injury of, 1189–1190  
 positioning pathology and  
 head-down position and, 470  
 neuroprotection and, 1928–1929  
 prone position and, 471  
 sitting position and, 469  
 role in inflammatory response, 1744, 1745f  
 tumor of, 1536–1537
- Brain central pain, 2031**
- Brain natriuretic factor, 1201**
- Brain surgery**  
 intraoperative neurologic monitoring in, 598–618  
 awake craniotomy and, 615–616  
 electroencephalography in, 598–607, 599t, 599–602f, 604–605t, 606–608f  
 electromyography and, 614–615  
 evoked potentials in, 607–614, 609–611f, 612t, 614f, 615f  
 intraoperative wake-up test and, 615  
 spinal anesthesia for epidural placement of spinal cord stimulating electrodes and, 616  
 neuroanesthesia for, 1081–1139  
 adjuvant drugs and, 1099–1100  
 anesthetic neuroprotection and, 1102–1104  
 anesthetic preconditioning and, 1104–1105  
 in aneurysm, 1114f, 1114–1119, 1115t, 1116f, 1117f, 1117t  
 in arteriovenous malformation, 1119–1120  
 cerebral physiology and, 1082t, 1082–1086, 1083t, 1084f  
 in cervical spine disease, 1120f, 1120–1121  
 in horizontal position infratentorial craniectomy, 1114  
 hyperosmolar agents in, 1100–1102, 1101t, 1103t  
 intracranial pressure control and, 1086–1092f, 1086–1093  
 intravenous anesthetics and, 1094–1095  
 microdialysis and, 1093f, 1093–1094  
 sedative agents and, 1095  
 in sitting position infratentorial craniectomy, 1108–1114, 1111–1113f  
 in supratentorial craniotomy, 1105–1108, 1106f, 1108f  
 in transsphenoidal hypophysectomy, 1121  
 volatile agents and, 1095–1099, 1096f, 1097t, 1098f
- Brain tissue partial pressure of oxygen monitoring, 1930, 1930f**
- Brain-oriented physiologic management, 1102–1104, 1925–1946**  
 anesthetics in, 1938–1941, 1940f  
 blood pressure management and, 1935–1938, 1936f  
 body temperature and, 1931–1934, 1932f, 1933t  
 glycemic control and, 1934–1935  
 hemoglobin and, 1938, 1939f, 1940f  
 oxygenation and, 1929–1930, 1930f  
 perioperative stroke and, 1925–1929, 1926t, 1927–1928f  
 positive end-expiratory pressure and, 1938, 1939f  
 ventilation and, 1930–1931, 1931f
- Brainstem anesthesia, 1074, 1074t**
- Brainstem auditory evoked response, 610–611, 611f, 613**
- Breach, negligence and, 2127**
- Breast milk, contraindication before pediatric surgery, 337**
- Breast surgery, paravertebral block in, 1014f, 1014t, 1020**
- Breathing**  
 basic life support and, 1874, 1874b  
 patient transport and, 1816–1817, 1817t  
 positioning pathology and, 466
- Breathing circuit**  
 inspired partial pressure of anesthetic gas and, 745  
 new designs of, 807–808, 808–810f  
 for pediatric anesthesia, 1522  
 testing for leaks in, 811–818, 813b, 814f, 815f  
 transfer of anesthetic to alveoli from, 746f, 746–747
- Bretylium (Bretlyol), 944t, 945**
- Brice Questionnaire, 1695b**
- Brief Pain Inventory, 2050**
- Bromsulfophthalein retention test, 345**
- Bronchial blocker, 1231–1232**
- Bronchial vessels, 1214–1215**
- Bronchiolitis obliterans, lung transplantation-associated, 1390**
- Bronchitis**  
 chronic, 138  
 marijuana-related, 413
- Bronchoalveolar lavage, 1243t, 1243–1244**
- Bronchodilation, inhaled anesthetics and, 758, 758t**



- Bronchodilators, 140  
in chronic obstructive pulmonary disease, 139  
formulary of, 2193f
- Bronchogenic carcinoma, 1220–1221, 1221b, 1222t, 1223b
- Bronchomalacia, 1597–1598
- Bronchopleural fistula, 1244
- Bronchopulmonary dysplasia, 330, 1577
- Bronchoscopy  
in airway obstruction, 1654  
anesthesia for, 1239–1242, 1240b, 1241t, 1242f  
in foreign body aspiration, 1268, 1591  
for placement of double-lumen tube, 1229–1230, 1230f  
postoperative, 1704
- Bronchospasm, 139  
alcohol abuser and, 406
- Bronchspirometry, 141
- Bronchus, 689
- Brooke formula, 1775t
- Brown adipose tissue, 306, 317
- Brugada syndrome, 49
- B-type natriuretic peptide, 104
- Bubble-type oxygenator for cardiopulmonary bypass, 1141
- Bucindolol, 931
- Budd-Chiari syndrome, 231
- Budesonide, 2193t
- Budgeting, 2177
- Bullectomy, 1245f, 1245–1247, 1246t
- Bullous disease, 1245, 1245f
- Bumetanide (Bumex), 919, 920t, 2191t
- Bupivacaine (Marcaine, Sensorcaine), 970, 2188t  
baricity for spinal anesthesia, 987t  
cardiotoxicity of, 968, 968f  
cation-to-base ratio of, 957t  
in caudal anesthesia, 1614  
clinical manifestations of potency, 960–961, 961f  
differential sensory/motor block and, 962, 963f  
disposition kinetics of, 958t  
dissociation constant of, 961t  
for epidural anesthesia, 989t  
in esophageal atresia and tracheoesophageal fistula repair, 1515  
in hepatic resection, 1348  
in knee replacement surgery, 1546  
lipophilicity of, 1720t  
in monitored anesthesia care, 1640  
for neuraxial anesthesia, 989, 989t, 990t  
in obstetric surgery, 1473t  
in assisted reproductive technologies, 1477  
in cesarean delivery, 1483, 1483t, 1486  
in labor and vaginal delivery, 1479  
in outpatient surgery, 1613  
for paravertebral block, 1017  
for pediatric caudal block, 1530  
for peripheral nerve block, 1026, 1026t  
structure alterations of, 956f  
in transurethral resection of prostate, 1459  
in vitreoretinal surgery, 1579
- Buprenorphine, 890f, 890–892, 891t, 2053t, 2185t  
dose, peak effect, and duration of, 875t  
for recovering addict, 418, 418t  
for treatment of addiction, 2150, 2150t
- Bupropion, 2050t  
for neuropathic pain in peripheral neuropathy, 2057t
- Burden of proof, 2126–2127
- Burn, 1674–1685, 1772–1783  
anesthetic management of, 1675–1678, 1676f  
antibiotics for, 1779  
burn center referral and, 1777–1778, 1778t  
burn wound management in, 1681t, 1681–1683, 1682t  
calcium homeostasis in, 1680  
carbon monoxide poisoning and, 1774, 1774f  
characteristics of, 1661t  
chemical, 1775, 1780  
cyanide poisoning and, 1774–1775  
electrical, 1780, 1780t  
electrical equipment-related, 486–487  
emergency evaluation of, 1786  
epidemiology of, 1772  
estimation of size and depth of, 1776f, 1776–1777, 1777f, 1778t  
fluid management and blood loss during burn wound excision, 1680  
fluid resuscitation in, 1775t, 1775–1776  
geriatric, 1779–1780  
hemodynamic response to, 1773  
immune enhanced diet for, 275t  
indirect respiratory injury in, 1775  
infection control in, 1680–1681  
inhalation injury and, 1773–1775, 1774f  
initial evaluation of, 1773  
intraoperative hypothermia and, 1680  
laser surgery-related, 1595t  
metabolic and nutritional management of, 1679–1680  
multiple organ dysfunction syndrome in, 1761  
pathophysiology of, 1674–1675, 1772–1773  
pediatric, 1779  
pharmacologic considerations for, 1678–1679  
preoperative evaluation of, 1674, 1675t  
pulse oximetry-related, 584  
purpura fulminans in, 1781  
secondary survey of, 1778–1779  
surgical management of, 1675  
thermoregulation and, 1675  
toxic epidermal necrolysis in, 1781  
Burn center referral, 1777–1778, 1779t  
Burn shock, 1775t, 1775–1776  
Burn wound management, 1681t, 1681–1683, 1682t  
Bursitis, 2021–2022, 2023–2024t  
Burst suppression  
entropy monitor and, 607  
intraoperative electroencephalography and, 603, 753f  
Butacaine (Butyn), 969t  
Butorphanol (Stadol), 875t, 890f, 890–892, 891t, 2053t, 2185t  
Butyrophenones, 864–865, 1095  
Byproducts of inhalational anesthetics, 759–761
- C**
- Caffeine, 2194t  
for postdural puncture headache, 1068  
for postoperative apnea in infant, 1521  
Caffeine halothane contracture test, 1966, 1978–1979  
CAGE questionnaire, 397  
Calcineurin-inhibitors, 209–210  
Calcitonin, 178–179  
Calcitriol, 652–653  
Calcium, 652–654  
anesthetic mechanism of action and, 727  
in crystalloid solutions, 670f  
distribution in body compartments, 641t  
hypercalcemia and, 203, 652–653, 653f, 653t  
associated with parathyroid disease, 177–179, 178t  
in lung cancer, 1221  
hypocalcemia and, 202–203, 203t, 653t, 653–654  
after thyroid surgery, 1603  
burn patient and, 1680  
during liver transplantation, 1365  
in newborn, 307  
parathyroid disease-related, 179, 179t  
in renal failure, 211  
liver transplantation and, 1365  
malignant hyperthermia and, 1964, 1968, 1969f, 1972, 1974, 1976f, 1980  
newborn preoperative assessment and, 307  
ryanodine receptor type 1, 1974  
Calcium carbimide, 418t  
Calcium channel blockers, 932t, 933f, 933–934  
brain protective effects of, 1936  
cerebral blood flow and, 1100  
formulary of, 2190t  
perioperative cardiac complications and, 114, 114f  
for pheochromocytoma, 184  
for postoperative hypertension, 1694–1695  
for preterm labor, 362  
for subarachnoid hemorrhage-related vasospasm, 1116  
before vascular surgery, 1292  
Calcium channels  
role in neuropathic pain, 2055, 2055f  
Calcium chloride, 2196t  
for hyperkalemia in small bowel transplantation, 1414  
for hypocalcemia, 654  
during liver transplantation, 1365  
Calcium gluconate, 2196t  
for hypocalcemia, 654  
during liver transplantation, 1365  
Calcium salts for cardiac arrest, 1884–1885, 1885b  
Calculated risk, 428  
Cancer  
biliary tract, 1324  
bladder, 1455–1457, 1456f, 1462–1464, 1463f  
child and, 1535–1536, 1657  
duodenal and gastric, 1322–1324  
epidemiology of, 2106  
esophageal, 1322  
geriatric patient and, 350  
gynecologic, 1490t, 1496  
head and neck, 1590–1591, 1604–1605  
difficult airway and, 129t, 129–130  
neural blockade in, 2114f, 2114–2115  
hepatocellular carcinoma, 231  
lung, 1220–1221, 1221b, 1222t, 1223b  
marijuana-related, 413  
superior vena cava syndrome in, 1258b, 1258–1259, 1259f  
thoracic neural blockade in, 2116–2117, 2117f  
pancreatic, 1326–1327, 1327f  
perioperative complications and death and, 442t  
preoperative assessment and management in, 42t, 54  
prostate, 1461–1462  
older adult and, 352  
transurethral resection in, 1457t, 1457–1459, 1458t  
renal, 1465–1466  
testicular, 1464–1465  
Cancer pain care, 2106–2123  
communication and, 2112–2113  
detailed physical examination and, 2113  
epidemiology of cancer and, 2106  
etiology and classification of cancer pain syndromes and, 2110–2111  
neurolytic procedures in, 2113–2121, 2114t  
brachial plexus block in, 2115–2116, 2116f  
celiac plexus block in, 2118–2119, 2119f  
ganglion impar block in, 2120–2121  
intercostal nerve block in, 2116–2117, 2117f  
lumbar sympathetic block in, 2119–2120  
occipital nerve block in, 2114–2115  
stellate ganglion block in, 2117–2118  
superficial cervical plexus block in, 2115  
superior hypogastric plexus block in, 2120, 2120f  
trigeminal nerve block in, 2114, 2114f  
neuromodulation techniques in, 2121, 2121f  
pain assessment and, 2106–2110, 2107t, 2108–2109f, 2110t  
pharmacologic therapy in, 2111t, 2111–2112, 2112t  
vertebroplasty in, 2121  
Candesartan, 925t  
Candidiasis  
catheter-related, 287–288  
nosocomial, 286t, 286–287  
preemptive therapy for, 289  
renal, 207–208  
Cannula-based sub-Tenon block, 1568  
Capacitor, electrical, 477  
Capillary hydrostatic pressure, 674  
Capillary leak, 669, 669f  
Capillary permeability, colloids and, 674, 674f, 674t  
Capital, 2177  
Capnography, 585t, 585–589, 586f, 586t, 587f  
after elective surgery, 84  
in gynecologic surgery, 1497  
intensive care unit and, 1831  
in monitored anesthesia care, 1629  
during patient transport, 1817  
during thoracic surgery, 1223t  
Capnometry  
during intubation, 692–693, 693b  
in monitored anesthesia care, 1629  
during spontaneous ventilation, 589, 589f  
Capsaicin  
for chronic pain, 2059t, 2060  
for diabetic peripheral neuropathic pain, 2028  
for neuropathic pain in peripheral neuropathy, 2057t  
Capsaicin receptor, 2002, 2002f  
Capsosungin, 296, 2195t  
Captopril, 924t  
Carbamazepine, 2185t  
for chronic pain, 2056, 2056t, 2059t  
for multiple sclerosis, 160  
for neuropathic pain in peripheral neuropathy, 2057t  
for recovering addict, 417–418  
for trigeminal neuralgia, 2031  
Carbohydrate metabolism, 1339

- Carbolime, 797t  
 Carbon dioxide, 661  
 Carbon dioxide absorbers, 796–797, 797t, 798f  
 Carbon dioxide absorber, 795–796, 796f  
 Carbon dioxide laser, 1596t  
 Carbon dioxide partial pressure, 579–582, 580f, 580–582t, 581f  
   during cardiopulmonary resuscitation, 1877–1878  
   transcutaneous monitoring of, 589–590, 590f  
 Carbon dioxide response curve, 312  
 Carbon dioxide tension-serum bicarbonate approach to acid-base chemistry, 663–664, 664t  
 Carbon monoxide  
   poisoning, 1774, 1774f  
   volatile anesthetic breakdown and, 760  
 Carbon monoxide diffusing capacity, 1217–1218, 1218f  
 Carbonate, 661  
 Carbonation of local anesthetics, 964–965, 965f, 993  
 Carbonic acid, 661  
 Carboprost tromethamine, 2194t  
 Carboxyhemoglobin dissociation curve, 1774, 1774f  
 Carcinoid syndrome, 1221, 1319  
 Cardiac anesthesia, 1140–1173  
   in aortic surgery, 1158t, 1158–1163  
     aortic dissection and, 1162f, 1162t, 1162–1163, 1163f  
     ascending aorta and aortic arch aneurysm and, 1159f, 1159–1160, 1160f  
     descending thoracic and thoracoabdominal aortic aneurysm and, 1160t, 1160–1162, 1161f, 1161t  
     thoracic aortic aneurysm and, 1158t, 1158–1159, 1159f  
   cardiopulmonary bypass and, 1140–1143  
   coronary artery bypass graft and, 1143–1152  
     anesthetic induction in, 1149–1150  
     with cardiopulmonary bypass, 1151  
     coronary artery anatomy and, 1143–1144, 1144f  
     coronary blood flow physiology and, 1144–1145  
     monitoring in, 1147–1149, 1148f, 1148t, 1149f  
     myocardial oxygen delivery and, 1145  
     myocardial oxygen demand and, 1145–1146, 1146f, 1147f  
     post-cardiopulmonary bypass management in, 1151–1152  
     postoperative complications in, 1152  
     preoperative evaluation in, 1146–1147  
     preoperative management in, 1150  
     without cardiopulmonary bypass, 1150–1151  
   for valve surgery, 1152f, 1152–1157, 1153f, 1153t  
     induction of anesthesia in, 1155–1156  
     maintenance of anesthesia in, 1156  
     monitoring in, 1155  
     preoperative evaluation in, 1153–1155, 1154f, 1155f  
     special considerations and long-term prognosis in, 1157, 1157f  
     weaning from bypass in, 1156–1157  
   for ventricular assist device implantation, 1163–1169  
     noncardiac surgery and, 1168–1169  
     preoperative considerations in, 1164–1165  
     transesophageal echocardiography examination in, 1165f, 1165–1166, 1166f  
     weaning from cardiopulmonary bypass in, 1166f, 1166–1168, 1167f  
 Cardiac arrest  
   in amyotrophic lateral sclerosis, 158  
   cardiopulmonary resuscitation in, 1873–1890  
     advanced life support and, 1880  
     airway management in, 1875–1876, 1876f  
     basic life support and, 1874, 1874b, 1875b, 1875f  
     circulation and, 1877f, 1877–1880, 1879b, 1879t  
     defibrillation in, 1880–1882, 1880–1882b  
     drug therapy in, 1882–1886, 1885b, 1886b, 1886f  
     historical background of, 1874  
     obese patient and, 391–392  
     postresuscitation care in, 1886  
     prognosis in, 1886–1887, 1887b  
     pulseless electrical activity and asystole and, 1882, 1882b, 1883b  
     timing of interventions in, 1874–1875, 1875t  
     ventilation in, 1876b, 1876–1877  
   in lumbar plexus block, 1040–1041  
   neuraxial anesthesia and, 994  
   neuroprotection with hypothermia in, 1932, 1932f, 1933t  
   pediatric anesthesia and, 1521  
 Cardiac catheterization  
   in congenital heart disease, 1194–1197, 1195t, 1196f  
   before liver transplantation, 1354  
 Cardiac cycle, 561f  
 Cardiac dysrhythmias  
   alcohol abuse and, 406  
   antidysrhythmic agents for, 936–947, 937b, 937f  
     adenosine in, 946f, 946–947  
     class IA agents in, 936–939, 938t  
     class IB agents in, 939–941, 940t  
     class IC agents in, 941–943, 942t  
     class III agents in, 943–946, 944t  
   beta-adrenergic blockers for, 929  
   bronchoscopy-related, 1242  
   burn patient and, 1680  
   complication of pulmonary artery catheter, 530  
   in congenital heart disease, 1188  
   digitalis for, 926  
   in electrical injury, 1780  
   extracorporeal shock wave lithotripsy and, 1460  
   hypercalcemia and, 178  
   in hypomagnesemia, 654  
   inhaled anesthetics and, 757  
   during intrahospital patient transport, 1814  
   local anesthetic-related, 967  
   in multiple organ dysfunction syndrome, 1758  
   obesity and, 379  
   oculocardiac reflex and, 1561  
   perioperative cardiac complications and, 104  
   in postanesthesia care unit, 1693–1694  
   postoperative, 1706–1707  
   in postoperative ICU patient, 1834  
   preoperative assessment and management in, 49  
   risk for perioperative shock in, 1929  
   in subarachnoid hemorrhage, 1115–1116, 1116f  
   subclinical hyperthyroidism and, 175  
   thoracic surgery-related, 1272  
 Cardiac function curve, 539, 539f  
 Cardiac glycosides, 925–926  
 Cardiac herniation, thoracic surgery-related, 1271–1272  
 Cardiac index  
   burn patient and, 1776  
   in healthy elderly patient, 344  
   in liver disease, 1340  
 Cardiac laboratory, 1654  
 Cardiac muscle, local anesthetics and, 967  
 Cardiac output, 533–537  
   aortic cross-clamping and, 1301–1302, 1302f  
   burn injury and, 1675, 1773  
   during cardiopulmonary resuscitation, 1877  
   in congenital heart disease, 1188, 1188b  
   continuous thermodilution measurement of, 535–536  
   esophageal Doppler measurement of, 536b, 536–537, 537f  
   gastric tonometry for, 537  
   in hemorrhagic shock, 1662, 1662f  
   hepatic resection and, 1347, 1348  
   impact on alveolar anesthetic concentration, 747, 747f  
   intravenous anesthetics and, 853t  
   lithium dilution measurement of, 534–535  
   in liver disease, 1340b, 1340–1341  
   of obese patient, 378, 379  
   partial carbon dioxide rebreathing measurement of, 535  
   pediatric, 314f, 314–315  
   during pregnancy, 358  
   prone position and, 471  
   pulmonary artery catheter values and, 526t  
   pulse contour-derived, 536  
   shock and, 1846f, 1846–1847, 1848  
   sitting position and, 469  
   thermodilution technique for, 534, 534b, 535f  
   transpulmonary thermodilution measurement of, 534  
   using partial carbon dioxide rebreathing, 587–589, 588f  
 Cardiac rhythm management devices, 50  
 Cardiac risk in noncardiac surgery, 1288b, 1288–1290  
 Cardiac Risk Index, 101–102t, 441  
 Cardiac risk modifications, 59  
 Cardiac stress tests, 107t, 107–108, 108t  
 Cardiac surgery  
   in aortic disease, 1158t, 1158–1163  
     aortic dissection and, 1162f, 1162t, 1162–1163, 1163f  
     ascending aorta and aortic arch aneurysm and, 1159f, 1159–1160, 1160f  
     descending thoracic and thoracoabdominal aortic aneurysm and, 1160t, 1160–1162, 1161f, 1161t  
     thoracic aortic aneurysm and, 1158t, 1158–1159, 1159f  
   cardiopulmonary bypass in, 1140–1143  
   in congenital heart disease, 1174–1212  
     acid-base management and, 1191  
     anesthetic plan and goals in, 1202–1203  
     cardiac catheterization and, 1194–1197, 1195t, 1196f  
     cardiopulmonary bypass and, 1188–1190  
     closed cardiac procedures and, 1193–1194  
     congestive heart failure in, 1180–1181  
     coronary ischemia and, 1187–1188, 1188b  
     coronary ischemia in, 1182  
     deep hypothermic circulatory arrest and, 1190–1191  
     dysrhythmias and, 1188  
     effects of anesthesia on pathophysiology of, 1197–1201, 1198f  
     excessive pulmonary blood flow in, 1179–1180, 1180f, 1181f, 1184–1186, 1186b  
     extracorporeal membrane oxygenation and, 1201–1202  
     glucose management and, 1191  
     immaturity of circulation and, 1182–1184, 1183b, 1183f  
     inadequate pulmonary flow and, 1186b, 1186–1187  
     induction of anesthesia in, 1203–1204  
     intraaortic balloon pump and, 1202  
     intracardiac shunting in, 1175–1178, 1177f, 1178f, 1178t, 1179t, 1187  
     jugular bulb oximetry and, 1192–1193  
     left heart obstruction and, 1187, 1187b  
     low cardiac output and, 1188, 1188b  
     maintenance of anesthesia in, 1204  
     manipulation of pulmonary vascular resistance and systemic vascular resistance in, 1204b, 1204–1205  
     near-infrared spectroscopy and, 1192  
     nonpharmacologic support in, 1201  
     obstructions to pulmonary blood flow in, 1181–1182  
     obstructions to systemic blood flow in, 1181  
     postoperative factors and, 1192  
     preoperative assessment in, 1203, 1203b  
     preoperative factors in, 1190  
     preoperative preparation and medication in, 1203  
     right heart obstruction and, 1187, 1187b  
     severe hypoxemia in, 1178–1179  
     temperature management and, 1191–1192  
     transcranial Doppler ultrasound and, 1192  
     ventricular assist device and, 1202  
   coronary artery bypass graft in, 1143–1152  
     anesthetic induction in, 1149–1150  
     with cardiopulmonary bypass, 1151  
     coronary artery anatomy and, 1143–1144, 1144f  
     coronary blood flow physiology and, 1144–1145  
     monitoring in, 1147–1149, 1148f, 1148t, 1149f  
     myocardial oxygen delivery and, 1145  
     myocardial oxygen demand and, 1145–1146, 1146f, 1147f  
     post-cardiopulmonary bypass management in, 1151–1152  
     preoperative evaluation in, 1146–1147  
     preoperative management in, 1150  
     without cardiopulmonary bypass, 1150–1151  
   depression following, 1920  
   geriatric patient and, 350–351  
   heart transplantation and, 1378–1395  
     donor selection and organ procurement in, 1384t, 1384–1385  
     epidemiology of, 1379–1380  
     historical aspects of, 1378, 1379t

- Cardiac surgery—*continued*  
immunobiology of, 1382–1383, 1383*t*  
indications for, 1380–1381, 1381*f*  
intraoperative management in, 1391–1392  
preoperative management in, 1391  
surgical alternatives to, 1381–1382  
paravertebral block in, 1021  
postoperative cognitive dysfunction and, 1915–1917, 1916*f*, 1918, 1918*f*  
risk for perioperative stroke in, 1925–1926  
systemic inflammatory response and, 1919–1920  
transesophageal echocardiography in, 552–578  
aorta and, 571–574, 573*f*, 574*f*  
in aortic insufficiency, 570  
in aortic stenosis, 570–571, 571*f*, 572*f*  
aortic valve and, 569*f*, 569–570, 570*f*  
basic principles of, 552–553  
in cardiac tumors, 558  
indications for, 552, 553*f*, 554*t*  
interatrial septum and, 556–558, 557*f*  
left atrium and, 554–555, 556*f*  
left ventricular diastolic function and, 560–563, 561–564*f*, 565*t*  
left ventricular systolic function and, 558–560, 558–560*f*  
limitations and contraindications for, 552–553, 555*t*  
in mitral regurgitation, 565–568, 566*f*, 567*f*  
in mitral stenosis, 568*f*, 568–569  
mitral valve and, 563–565, 565*f*, 566*f*  
pericardium and, 576*f*, 576–577  
pulmonary artery and, 576  
pulmonic valve and, 576, 576*f*  
right atrium and, 555–556, 557*f*  
right ventricle and, 574–575  
terminology in, 552, 555*t*  
tricuspid valve and, 575*f*, 575–576  
in valvular disease, 1152*f*, 1152–1157, 1153*f*, 1153*t*  
induction of anesthesia in, 1155–1156  
maintenance of anesthesia in, 1156  
monitoring in, 1155  
preoperative evaluation in, 1153–1155, 1154*f*, 1155*f*  
special considerations and long-term prognosis in, 1157, 1157*f*  
weaning from bypass in, 1156–1157  
ventricular assist device implantation in, 1163–1169  
noncardiac surgery and, 1168–1169  
preoperative considerations in, 1164–1165  
transesophageal echocardiography examination in, 1165*f*, 1165–1166, 1166*f*  
weaning from cardiopulmonary bypass in, 1166*f*, 1166–1168, 1167*f*
- Cardiac tamponade, 531*f*, 576–577  
Cardiac tumor, 558  
Cardiogenic shock, 1705, 1742, 1841–1842  
Cardiomegaly  
perioperative cardiac complications and, 104  
prolonged congestive heart failure and, 1181
- Cardiomyopathy  
alcoholic, 406  
cirrhotic, 1354  
in muscular dystrophy, 163  
in neuromuscular disease, 157  
pregnant patient and, 366
- Cardiopulmonary bypass, 1140–1143  
adverse events following protamine in, 1959  
for cardiac arrest, 1879  
cognitive dysfunction after, 1915–1916, 1916*f*  
in congenital heart disease, 1188–1190, 1192–1193  
coronary artery bypass graft with, 1151  
fundamental components of CPB circuit and, 1140–1141  
management of anticoagulation in, 1141–1143  
pathophysiology of, 1141  
weaning from, 1143, 1143*t*
- Cardiopulmonary resuscitation (CPR), 1873–1890  
advanced life support and, 1880  
airway management in, 1875–1876, 1876*f*  
basic life support and, 1874, 1874*b*, 1875*b*, 1875*f*  
circulation and, 1877*f*, 1877–1880, 1879*b*, 1879*t*  
defibrillation in, 1880–1882, 1880–1882*b*  
drug therapy in, 1882–1886, 1885*b*, 1886*b*, 1886*f*  
historical background of, 1874  
obese patient and, 391–392  
postresuscitation care in, 1886  
prognosis in, 1886–1887, 1887*b*  
pulseless electrical activity and asystole and, 1882, 1882*b*, 1883*b*  
timing of interventions in, 1874–1875, 1875*t*  
ventilation in, 1876*b*, 1876–1877  
withholding of, 2131
- Cardiopulmonary suite, 1653–1654  
Cardiotoxicity of local anesthetics, 966–968*f*, 966–969
- Cardiovascular assessment, 95–121  
in anemia, 104  
angiotensin-converting enzyme inhibitors and, 113–114  
antibiotics and, 116  
antiplatelet and anticoagulant agents and, 115–116, 116*t*  
arrhythmias and, 104  
benefits of, 95  
beta-blockers and, 110*f*, 110–113, 111–112*t*  
in burn injury, 1778  
calcium channel blockers and, 114, 114*f*  
in carotid stenosis, 105  
clinical determination of need for specific preoperative cardiac investigations and, 105–106, 106*f*  
clonidine and, 115, 115*f*  
comparison of risk indices in, 100, 100*f*, 101–102*t*  
dangers of testing in low-risk populations and, 95–96  
depression and, 104  
in diabetes mellitus, 103  
diuretics and, 115  
in elective surgery, 74  
genetic polymorphisms and, 104–105  
glucose control and, 116  
hyperlipidemia and, 103  
hypertension and, 103, 109–110  
known coronary artery disease and, 100–103  
in liver transplantation, 1353–1354  
in lung transplantation, 1384  
nitroglycerin and, 115  
overall perioperative risk and, 98–99, 99*f*  
peripheral vascular disease and, 103–104  
postoperative ischemia and, 97–98, 99*f*  
postoperative tests and, 108  
preoperative CABG or PTCA and, 109  
preoperative cardiac tests to quantify risk and, 106–108, 107*t*, 108*t*  
purpose of identifying and quantifying risk in, 99–100, 100*t*  
in renal insufficiency, 104  
in renal transplantation, 1398–1399  
smoking and, 103, 116  
statins and, 113, 113*f*  
supply-demand mismatch and, 96, 97*f*  
surgical procedure risk and, 105, 105*t*  
thrombosis from endothelial dysfunction and, 96–97, 97*f*, 98*f*  
in valvular lesions, 104  
in vascular surgery, 1289*f*
- Cardiovascular complications  
in alcohol or drug addicted patient, 400, 404*t*  
associated with renal failure, 1399*t*  
during patient transport, 1817*f*, 1817–1818  
pediatric anesthesia and, 1521  
in polymyositis and dermatomyositis, 169  
in postoperative ICU patient, 1834  
in thoracic surgery, 1271–1273
- Cardiovascular drugs, 918–953  
antianginals in, 926–936  
beta-adrenergic blockers in, 928–933, 929*b*, 930*t*, 932*t*  
calcium channel blockers in, 932*t*, 933*f*, 933–934  
dihydropyridines in, 934–935  
inhibitors of fatty acid oxidation in, 936  
ivabradine in, 936  
nicorandil in, 936  
nitrates in, 926–928, 927*f*, 928*t*  
antidysrhythmic agents in, 936–947, 937*b*, 937*f*  
adenosine in, 946*f*, 946–947  
class IA agents in, 936–939, 938*t*  
class IB agents in, 939–941, 940*t*  
class IC agents in, 941–943, 942*t*  
class III agents in, 943–946, 944*t*  
antihypertensives in, 919–925  
angiotensin II receptor blockers in, 925, 925*t*  
angiotensin-converting enzyme inhibitors in, 924*t*, 924–925, 925*f*  
centrally acting alpha<sub>2</sub>-agonists in, 921*t*, 921–922  
diuretics in, 919–921, 920*t*  
peripherally acting sympatholytic agents in, 922*t*, 922–923  
vasodilators in, 923*t*, 923–924  
digitalis in, 925–926  
effects on duration of ECT-induced seizure activity, 151*t*  
formulary of, 2190–2191*t*  
statins in, 947, 947*t*
- Cardiovascular status  
of critically ill child, 337–338  
in multiple organ dysfunction syndrome, 1766  
in neuromuscular disease, 157–158
- Cardiovascular system  
aging and, 344*f*, 344–345  
anaphylactic reaction and, 1954*b*  
barbiturates and, 853, 853*t*  
of child, 314*f*, 314–315, 315*t*  
effects of burn on, 1674–1675, 1676*t*  
etomidate and, 859–860  
hyperthyroidism and, 175  
inhalational anesthetics and, 756*t*, 756–757, 757*f*, 757*t*  
ketamine and, 863  
multiple organ dysfunction syndrome and, 1757*t*, 1757–1758  
neuraxial anesthesia and, 994–996, 995*f*, 995*t*  
neuroprotection and, 1935–1938, 1937*f*  
of newborn, 305  
of obese patient, 376*t*, 378–380, 379*f*, 380*f*  
opioid agonist-antagonists and, 892  
opioid analgesics and, 878  
positioning pathology and  
head-down position and, 470  
lateral decubitus position and, 472  
lithotomy position and, 467  
prone position and, 471  
sitting position and, 469  
supine position and, 465–466  
postoperative dysfunction of, 1706–1708  
propofol and, 857  
protein-energy malnutrition and, 269–270  
rheumatoid arthritis and, 1542*t*
- Care team, 2175  
Carinal resection, 1264*f*, 1264–1265  
Carisoprodol  
for chronic pain, 2061  
Carotid endarterectomy, 1293–1297, 1295*f*  
evoked potential monitoring in, 612*t*  
intraoperative electroencephalography in, 603, 603*t*  
risk for perioperative stroke in, 1925–1926, 1927–1928*f*  
Carotid plexus, 1558  
Carotid sinus baroreceptor, 305  
Carotid stenosis, 105  
Carpal spasm, 654  
Carpal tunnel syndrome, 169, 2028–2029  
Carrier gas flow  
calculation of, 778  
effect on vaporizer output, 782*f*, 782–783  
measured-flow vaporizer and, 779  
Carteolol, 930*t*, 931  
Carvedilol, 930*t*, 931  
Case-control study, 436*t*, 437–438  
Catabolic response to burn injury, 1773  
Cataract surgery, 1564, 1564*t*, 1578  
preoperative assessment in, 55–56  
topical anesthesia in, 1566–1567  
Catastrophizing, 2065, 2065*f*  
Catecholamines  
acute blood loss and, 242  
response to traumatic injury, 1745  
Catheter whip, 528–529  
Catheterization  
cardiac  
in congenital heart disease, 1194–1197, 1195*t*, 1196*f*  
before liver transplantation, 1354  
for prolonging neural blockade, 1730–1731  
urinary  
in burn injury, 1779  
in neonatal emergency surgery, 1508  
Catheter-related infection  
antimicrobial therapy for, 287–288  
burn patient and, 1681  
central venous catheter and, 526, 526*b*  
pulmonary artery catheter and, 530–531  
Cation, 641, 641*t*  
Cation forms of local anesthetics, 956, 956*f*

- Cauda equina syndrome, 2096  
in ankylosing spondylitis, 167  
neuraxial anesthesia-related, 998,  
1481–1482t
- Caudal block  
in outpatient surgery, 1614  
pediatric, 1529f, 1529–1530
- Caudal epidural steroid injection, 2080–2081
- Causalgia, 2032  
in neuropathic pain, 2025b
- Causation, negligence and, 2127
- Cavitron ultrasonic aspirator, 1349
- C-Bloc portable infusion pump, 1037f
- Cefazolin, 2195t  
for subacute bacterial endocarditis prophylaxis, 333t
- Cefepime, 2195t
- Cefotaxime, 2195t
- Cefoxitin, 2195t
- Ceftazidime, 2195t
- Ceftriaxone, 2195t
- Cefuroxime, 2195t
- Celecoxib (Celebrex), 2183t  
for acute postoperative pain, 1723, 1723t  
in adenotonsillectomy, 1589  
for chronic pain, 2061  
in outpatient surgery, 1612  
renal vasoconstriction and, 206
- Celiac disease, 2028t
- Celiac ganglion, 1451f
- Celiac plexus, 2077, 2085f
- Celiac plexus block, 2084–2087, 2085f  
for cancer pain, 2118–2119, 2119f
- Celiprolol, 931
- Cell-mediated immunity, protein-energy malnutrition and, 271–272
- Cellular response  
to critical illness, 1746–1749, 1748f  
to traumatic hemorrhagic shock, 1663
- Central core disease, 166, 1970, 1970f
- Central nervous system  
barbiturates and, 850–853, 852f, 852t  
benzodiazepines and, 861  
changes during pregnancy, 360  
chronic liver disease and, 233, 1344–1345,  
1345b  
dysfunction of  
in alcohol or drug addicted patient, 401  
postoperative, 1709–1710  
syndrome of inappropriate antidiuretic hormone and, 185t  
in thyroid storm, 175  
effects of burn injury on, 1676t  
etomidate and, 859  
inhalational anesthetics and, 755–756, 756t  
ketamine and, 863, 863f  
lung cancer and, 1220  
multiple organ dysfunction syndrome and,  
1757t, 1759, 1763  
of newborn, 305–306  
of obese patient, 376t  
opioid analgesics and, 875–877f, 875–878  
pathophysiology of critical illness and, 1744,  
1745f  
physiology of neuraxial anesthesia and,  
993–994  
propofol and, 857–858  
protection during surgery, 1102–1104,  
1925–1946  
anesthetics in, 1938–1941, 1940f  
blood pressure management and,  
1935–1938, 1936f  
body temperature and, 1931–1934, 1932f,  
1933t  
glycemic control and, 1934–1935  
hemoglobin and, 1938, 1939f, 1940f  
oxygenation and, 1929–1930, 1930f  
perioperative stroke and, 1925–1929, 1926t,  
1927–1928f  
positive end-expiratory pressure and, 1938,  
1939f  
ventilation and, edit 1931f, 1930–1931  
protein-energy malnutrition and, 272  
superior vena cava syndrome and, 1258b
- Central neuropathic pain, 2009
- Central obesity, 374
- Central pain syndromes, 2031–2037  
back and neck pain in, 2033–2034, 2034t  
cluster headache in, 2037, 2037f  
discogenic pain in, 2034  
failed back surgery syndrome in, 2035  
head pain in, 2036  
migraine in, 2036t, 2036–2037  
postamputation pain in, 2033  
postdural puncture headache in, 2037, 2037t  
radicular pain in, 2034–2035  
sacroiliac arthropathy in, 2035  
spinal stenosis in, 2035  
sympathetically maintained pain and complex  
regional pain syndrome in, 2031–2033,  
2032t, 2033t  
tension-type headache in, 2037  
whiplash injury in, 2035–2036
- Central pontine myelinolysis, 1369
- Central sensitization, 2011t  
activity-dependent, 2013, 2014  
disinhibition and, 2016  
heterosynaptic, 2013t, 2013–2014  
inflammatory pain and, 2012f, 2012–2013  
neuropathic pain and, 2015–2016  
preemptive analgesia and, 1718–1719  
transcription-dependent, 2014
- Central venous pressure, 592, 592f  
goal-directed volume resuscitation and, 678,  
678f  
pregnant patient and, 1489  
pulmonary artery catheter values and, 526t
- Central venous pressure monitoring, 522–526  
abnormal central venous pressure and, 522,  
524f, 525f  
burn patient and, 1678  
complications of, 525b, 525–526, 526b  
in congenital diaphragmatic hernia, 1511  
in coronary artery bypass graft, 1147–1148  
critically ill patient and, 1802, 1802t  
in hepatic resection, 1347  
indications for, 525, 525b  
insertion technique in, 522–525  
in liver transplantation, 1360  
in lower-extremity vascular surgery, 1298  
in lung transplantation, 1386  
in neonatal emergency surgery, 1507f,  
1507–1508  
normal central venous pressure and, 522, 523f,  
523t  
in renal transplantation, 1401  
in small bowel transplantation, 1414  
in supratentorial craniotomy, 1106  
theory and background of, 522, 523t, 523–525f  
trauma patient and, 1666  
in valve surgery, 1155
- Centrally acting alpha<sub>2</sub>-agonists, 921t, 921–922
- Centrifugal-type cardiopulmonary bypass pump,  
1141
- Cephalosporins  
anaphylactic reaction to, 1953t, 1957b,  
1957–1958  
for subacute bacterial endocarditis prophylaxis, 333t
- Cerclage, 1477
- Cerebral aneurysm  
hypothermia for neuroprotection in, 1933  
risk for perioperative stroke in, 1926
- Cerebral blood flow  
antihypertensives and, 1099–1100  
arterial partial pressure of carbon dioxide and,  
1930–1931, 1931f  
autonomic control of, 1092–1093  
autoregulation of, 1090–1092, 1091f  
deep hypothermic circulatory arrest and, 1191  
flow-metabolism coupling and, 1092, 1092f  
head-down tilt position and, 470  
hemoglobin levels and, 1938, 1939f, 1940f  
inhalational anesthetics and, 755, 756t  
intracranial pressure and, 1086–1092f,  
1086–1093  
intravenous anesthetics and, 852t, 1094–1095  
measurement of, 1082–1086, 1083t, 1084f  
nondepolarizing muscle relaxants and, 1099  
normal values of, 1082t  
sedative agents and, 1095  
somatosensory-evoked potentials and, 609  
subarachnoid hemorrhage and, 1117t  
succinylcholine and, 1099  
volatile agents and, 1095–1099, 1096f, 1097t,  
1098f
- Cerebral blood volume  
autoregulation of, 1090–1092, 1091f  
control of, 1088f, 1088–1089  
flow-metabolism coupling and, 1092, 1092f  
halothane and, 1097, 1098f  
intracranial pressure and, 1935  
measurement of, 1082–1086, 1083t  
normal values of, 1082t
- Cerebral edema  
hyperosmolar agents for, 1102  
intraoperative, 1107–1108, 1108f
- Cerebral embolization  
postoperative cognitive dysfunction and,  
1918–1919
- Cerebral function  
after elective surgery, 84–85  
fat embolism syndrome and, 1552  
thyroid storm and, 175
- Cerebral infarction, 401
- Cerebral ischemia  
carotid endarterectomy and, 1294  
intraoperative electroencephalography and,  
602f, 602–603  
synchronous electroencephalogram pattern in,  
600
- Cerebral metabolic rate  
flow-metabolism coupling and, 1092, 1092f  
intracranial pressure and, 1086–1092f,  
1086–1093  
measurement of, 1082–1086, 1083t, 1084f  
sedative agents and, 1095  
volatile agents and, 1097–1098
- Cerebral metabolic rate of glucose  
flow-metabolism coupling and, 1092, 1092f  
Kety-Schmidt method for, 1083–1084  
normal values of, 1082t
- Cerebral metabolic rate of lactate  
Kety-Schmidt method for, 1083–1084  
normal values of, 1082t
- Cerebral metabolic rate of oxygen  
benzodiazepines and, 861, 1095  
intravenous anesthetics and, 852t  
jugular venous oximetry for, 1086  
Kety-Schmidt method for, 1083–1084  
normal values of, 1082t
- Cerebral microdialysis, 1093f, 1093–1094
- Cerebral palsy, 167–168  
assessment before pediatric surgery, 328  
orthopedic surgery in, 1542–1543
- Cerebral perfusion pressure  
head-down tilt position and, 470  
inhaled anesthetics and, 756t  
intravenous anesthetics and, 852, 852t  
prone position and, 471  
trauma patient and, 1669
- Cerebrospinal fluid, 978  
epidural analgesia and, 1727f  
influence on block height in neuraxial anesthesia, 986  
intracranial pressure and, 1087, 1087f  
penetration by antimicrobial agents, 281t  
sitting position and, 469
- Cerebrospinal fluid leak, 1586
- Cerebrospinal fluid pressure  
cervical spine disease and, 1120f  
effects of opioid analgesics on, 876
- Cerebrovascular accident  
after carotid endarterectomy, 1297  
in alcohol abuse, 407  
cocaine-related, 411  
diabetes mellitus and, 1405t  
hyperosmolar agents for, 1102  
methamphetamine use and, 412  
opioid overdose and, 410  
perioperative cardiac complications and, 104  
postoperative, 1709–1710  
preoperative evaluation of, 149–150  
risk in older adult, 350
- Cerebrovascular disease  
postoperative cognitive dysfunction and, 1921
- Cerebrovascular pharmacology, 1094–1100  
antihypertensives and, 1099–1100  
intravenous anesthetics and, 1094–1095  
nondepolarizing muscle relaxants and, 1099  
sedative agents and, 1095  
succinylcholine and, 1099  
volatile agents and, 1095–1099, 1096f, 1097t,  
1098f
- Cerebrovascular reserve, 1928, 1928f
- Certified registered nurse anesthetist, 18, 2129,  
2173–2174
- Cervical cerclage, 1477
- Cervical epidural steroid injection, 2079
- Cervical facet joint, 2075
- Cervical facet medial branch block, 2091–2092
- Cervical intraarticular facet injection, 2089
- Cervical plexus block, 1027f, 1027–1028, 1028f,  
1614–1615, 1615f
- Cervical spine disease  
airway management in, 1548



- Cervical spine disease—*continued*  
 neuroanesthesia in, 1120f, 1120–1121  
 osteoarthritis in, 167
- Cervical spondylosis, 2035
- Cervical transforaminal steroid injection, 2082
- Cervical vertebrae, 979f, 2074f  
 positioning injury of, 1541  
 trauma-related difficult airway and, 129
- Cesarean delivery, 1480–1486, 1483b, 1483t, 1484f  
 block height for, 988t
- Cetacaine, 2188t
- C-fiber  
 cotransmitters of, 2005–2006  
 pain and, 2001, 2001t, 2002t, 2020  
 structural reorganization after injury of, 2016
- Chagas disease  
 transfusion-related, 1905
- Channelopathies, 163t, 163–166, 165t
- Charcot-Marie-Tooth disease, 161–162
- CHARGE syndrome, 302
- Charges *versus* payments, 2178
- Charlson Comorbidity Score, 441
- Charting accuracy of perioperative information  
 management system, 507–508, 508f, 509f
- Chassaignac tubercle, 2083–2084
- Check valve of oxygen tank, 770
- Chemical burn, 1780, 1786  
 to lower airways, 1775  
 patient transport and, 1821t, 1821–1822
- Chemical neurolysis of lumbar sympathetic  
 chain, 2088
- Chemicals, teratogenic, 1473–1474, 1474b
- Chemoreceptor, 305
- Chemotherapy, toxicities affecting anesthetic  
 management, 1490t
- Cherubism, 303t
- Chest  
 assessment in burn injury, 1778  
 assessment in trauma patient, 1792  
 of child, 312
- Chest compressions  
 basic life support and, 1874, 1874b  
 infant, 1875f  
 physiology of circulation during, 1877, 1877f
- Chest pain in lung cancer, 1218
- Chest radiography  
 in elective surgery, 78t  
 in hepatic resection, 1347  
 in mediastinal mass, 1256  
 in thoracic surgery, 1216, 1216t
- Chest tube  
 in bronchopleural fistula, 1244  
 for postoperative pneumothorax, 1705, 1705f
- Chest wall compliance, 593  
 burn injury and, 1778
- Chest wall of child, 312
- Chiari type 1 malformation, 1537
- Child, 310–340  
 adenotonsillar hypertrophy in, 1587  
 anesthesia for, 1520–1540  
 airway management in, 1525–1527, 1526f,  
 1526t, 1527t  
 in ambulatory surgery, 1537  
 blood and blood products and, 1528  
 in cancer-related procedures, 1535–1536  
 cardiac risk in, 1521  
 emergence delirium and, 1533  
 equipment for, 1522  
 extubation choices in, 1527–1528  
 facility and provider expertise and, 1521–1522  
 fluid therapy and, 1528  
 in general and urologic surgery, 1533–1534  
 induction of, 1524t, 1524–1525, 1525t  
 in laparoscopy, 1534  
 maintenance of, 1527  
 patient preparation and premedication in,  
 1523t, 1523–1524  
 in pectus excavatum, 1535  
 postoperative nausea and vomiting and,  
 1532t, 1532–1533  
 postoperative pain management and,  
 1532–1533  
 respiratory risk in, 1520–1521  
 in thoracotomy and thoracoscopy,  
 1534–1535, 1535t  
 in ventriculoperitoneal shunt, 1536–1537  
 blood transfusion and, 1895  
 burn injury in, 1779  
 cardiovascular system of, 314f, 314–315, 315t  
 cerebral palsy in, 1542–1543  
 congenital heart disease in, 332t, 332–333,  
 333b, 333t, 1174–1212  
 acid-base management and, 1191  
 anesthetic plan and goals in, 1202–1203  
 cardiac catheterization and, 1194–1197,  
 1195t, 1196f  
 cardiopulmonary bypass and, 1188–1190  
 closed cardiac procedures and, 1193–1194  
 congestive heart failure in, 1180–1181  
 coronary ischemia and, 1187–1188, 1188b  
 coronary ischemia in, 1182  
 deep hypothermic circulatory arrest and,  
 1190–1191  
 dysrhythmias and, 1188  
 effects of anesthesia on pathophysiology of,  
 1197–1201, 1198f  
 excessive pulmonary blood flow in, 1179–  
 1180, 1180f, 1181f, 1184–1186, 1186b  
 extracorporeal membrane oxygenation and,  
 1201–1202  
 glucose management and, 1191  
 immaturity of circulation and, 1182–1184,  
 1183b, 1183f  
 inadequate pulmonary flow and, 1186b,  
 1186–1187  
 induction of anesthesia in, 1203–1204  
 intraaortic balloon pump and, 1202  
 intracardiac shunting in, 1175–1178, 1177f,  
 1178f, 1178t, 1179t, 1187  
 jugular bulb oximetry and, 1192–1193  
 left heart obstruction and, 1187, 1187b  
 low cardiac output and, 1188, 1188b  
 maintenance of anesthesia in, 1204  
 manipulation of pulmonary vascular resis-  
 tance and systemic vascular resistance  
 in, 1204b, 1204–1205  
 near-infrared spectroscopy and, 1192  
 nonpharmacologic support in, 1201  
 obstructions to pulmonary blood flow in,  
 1181–1182  
 obstructions to systemic blood flow in, 1181  
 postoperative factors and, 1192  
 preoperative assessment in, 1203, 1203b  
 preoperative factors in, 1190  
 preoperative preparation and medication  
 in, 1203  
 right heart obstruction and, 1187, 1187b  
 severe hypoxemia in, 1178–1179  
 temperature management and, 1191–1192  
 transcranial Doppler ultrasound and, 1192  
 ventricular assist device and, 1202
- critically ill, 337–338  
 defibrillation recommendations for, 1881b  
 dentition and, 316  
 difficult airway and, 128, 128f  
 epidural blood patch for, 1069  
 foreign body aspiration and, 1269, 1591  
 gastrointestinal disease in, 334, 334b  
 gastrointestinal system of, 316  
 general preoperative assessment approach to,  
 320b, 320–322, 321t  
 kidney of, 198–199  
 laboratory studies of, 334–336, 335t  
 legal issues in anesthesiology and, 2132–2133  
 liver disease in, 224–226  
 neuromuscular disorders in, 328–330, 330b  
 normal red blood cell values of, 240t  
 NPO status and preoperative fasting and, 336–  
 337, 337t  
 obstructive sleep apnea syndrome in, 1588  
 ophthalmic surgery in, 1576–1577  
 pain assessment in, 1718, 1718f  
 paravertebral block in, 1017, 1017t  
 pharmacology principles of, 317–319  
 physical examination of, 323–328, 324–327f  
 postoperative pain and, 1731–1732  
 psychologic preparation for surgery,  
 322–323  
 purpose of preoperative assessment of, 319b,  
 319–320, 320b  
 regional anesthesia for, 1528–1531  
 caudal blocks in, 1529f, 1529–1530  
 epidural, 1531, 1531t  
 extremity blocks in, 1531  
 spinal, 1530–1531  
 renal disease in, 333–334  
 renal function of, 315–316, 316t  
 renal transplantation in, 1402–1403  
 respiratory system of, 311–314, 312f, 313f, 313t,  
 330  
 same-day surgery and, 1656–1657  
 sedation during diagnostic imaging, 1656  
 syndromes associated with difficult intubation  
 in, 331–332t  
 thermoregulation and, 316–317  
 transport of, 1816–1817, 1822
- Child neglect and abuse, 2132–2133
- Child-Pugh scoring system for liver disease,  
 223–224, 224t, 225t
- Chiral forms of local anesthetics, 955, 955f,  
 956t
- Chlamydia pneumoniae* pneumonia, 290
- Chloramphenicol, 2195t
- Chlorhexidine  
 anaphylactic reaction to, 1959
- Chloride, 657t, 657–658  
 acid-base chemistry and, 660, 660t  
 in crystalloid solutions, 670f  
 distribution in body compartments, 641t  
 in hypertonic solutions, 672t
- Chloroform  
 historical background of, 3  
 space-filling representation of, 719f
- 2-Chloroprocaine (Nesacaine), 970, 2188t  
 backache and, 1072  
 baricity for spinal anesthesia, 987t  
 in cesarean delivery, 1484, 1484f, 1486  
 dissociation constant of, 961t  
 for epidural anesthesia, 989t  
 in esophageal atresia and tracheoesophageal  
 fistula repair, 1515  
 for neuraxial anesthesia, 989, 989t, 990  
 in obstetric surgery, 1473t  
 for peripheral nerve block, 1026t
- Chlorothiazide (Diuril), 920t
- Chlorpromazine, 1562t, 2186t
- Chlorthalidone (Hygroton), 920t
- Choanal atresia, 302, 1585
- Cholangiocarcinoma, 231
- Cholangitis, 1741t
- Cholecystectomy, 1021, 1324b, 1324–1325
- Cholecystitis, 1324–1325
- Cholecystokinin  
 opioid-induced hyperalgesia and, 2052
- Cholelithiasis, 381
- Cholestasis, 219t
- Cholesterol, atherosclerosis and, 1285
- Choline magnesium trisalicylate, 2064t, 2183t
- Cholinergic-antiinflammatory pathway, 1745f
- Chordae, 565, 566f
- Choroid, 1559, 1559t, 1561
- Chronic anemia, 243  
 red blood cell transfusion for, 1894
- Chronic bronchitis, 138  
 marijuana-related, 413
- Chronic carbon dioxide retention, 139–140
- Chronic glaucoma, 1562
- Chronic hepatitis, 220, 228–229
- Chronic inflammatory demyelinating polyradicu-  
 loneuropathy, 2030t
- Chronic liver disease, 1339–1340, 1340b  
 autonomic neuropathy in, 1344–1345  
 hemodynamic changes in, 1340f, 1340–1341  
 hepatitis in, 228–229  
 liver failure in, 232–233
- Chronic liver failure, 232–233
- Chronic lung disease  
 assessment before pediatric surgery, 330  
 postoperative pulmonary complications and,  
 1703–1704
- Chronic obstructive pulmonary disease, 137–140,  
 349  
 marijuana-related, 413  
 mechanical ventilation in, 1866–1867  
 perioperative complications and death and,  
 442t  
 postoperative pulmonary complications and,  
 1703–1704
- Chronic pain, 1999–2123  
 in addicted patient, 398  
 assessment of, 1718, 1718f  
 in cancer, 2106–2123  
 brachial plexus block for, 2115–2116, 2116f  
 celiac plexus block for, 2118–2119, 2119f  
 communication and, 2112–2113  
 detailed physical examination and, 2113  
 epidemiology of cancer and, 2106  
 etiology and classification of cancer pain  
 syndromes and, 2110–2111  
 ganglion impar block for, 2120–2121  
 intercostal nerve block for, 2116–2117,  
 2117f  
 lumbar sympathetic block for, 2119–2120  
 neuromodulation techniques for, 2121,  
 2121f  
 occipital nerve block for, 2114–2115

- pain assessment and, 2106–2110, 2107t, 2108–2109f, 2110t  
 pharmacologic therapy for, 2111t, 2111–2112, 2112t  
 stellate ganglion block for, 2117–2118  
 superficial cervical plexus block for, 2115  
 superior hypogastric plexus block for, 2120, 2120f  
 trigeminal nerve block for, 2114, 2114f  
 vertebroplasty for, 2121
- central pain syndromes and, 2031–2037  
 back and neck pain in, 2033–2034, 2034t  
 cluster headache in, 2037, 2037f  
 discogenic pain in, 2034  
 failed back surgery syndrome in, 2035  
 head pain in, 2036  
 migraine in, 2036t, 2036–2037  
 postamputation pain in, 2033  
 postdural puncture headache in, 2037, 2037t  
 radicular pain in, 2034–2035  
 sacroiliac arthropathy in, 2035  
 spinal stenosis in, 2035  
 sympathetically maintained pain and complex regional pain syndrome in, 2031–2033, 2032t, 2033t  
 tension-type headache in, 2037  
 whiplash injury in, 2035–2036
- dysfunctional, 2017
- genetic factors in, 2010, 2016–2017
- inflammatory, 2010–2014, 2011t, 2012f, 2013t
- interventional management of, 2072–2105  
 anatomy relevant to, 2073–2077, 2074f, 2075f  
 celiac plexus block in, 2084–2087, 2085f  
 cervical facet medial branch block in, 2091–2092  
 facet medial branch blocks in, 2090–2091  
 future directions of, 2102  
 implantable drug delivery systems for, 2096–2099  
 interlaminar epidural injection of steroids in, 2077–2081, 2080f  
 intraarticular facet injection in, 2089–2090, 2090f  
 lumbar discography and intradiscal treatments in, 2093–2096, 2094f  
 lumbar facet medial branch blocks in, 2092f, 2092–2093  
 lumbar sympathetic block in, 2087  
 lumbar sympathetic neurolysis in, 2087–2088  
 spinal cord stimulation in, 2099–2102  
 stellate ganglion block in, 2083–2084, 2084t  
 thoracic facet medial branch block in, 2092  
 training in, 2102  
 transforaminal technique for epidural steroid injection in, 2081–2082, 2083f
- mechanism of, 2020
- medical management of, 2042–2071  
 antidepressants in, 2047–2050, 2050t  
 antiepileptic drugs in, 2054–2059, 2055f, 2055–2057t, 2059t  
 combination therapy in, 2060  
 history in, 2042–2043  
 intravenous analgesics in, 2060  
 nonsteroidal antiinflammatory drugs in, 2061–2064, 2062f, 2063f, 2064t  
 opioids in, 2050–2054, 2053t  
 pain rehabilitation strategies in, 2064–2067, 2065f  
 physical examination in, 2044–2046, 2044–2047t, 2045f, 2048f, 2049f  
 skeletal muscle relaxants in, 2060–2061  
 topical agents in, 2059–2060
- musculoskeletal pain syndromes and, 2020–2025  
 arthritides in, 2022  
 bursitis and tendinitis in, 2021–2022, 2023–2024t  
 fibromyalgia in, 2021, 2022f  
 myofascial, 2020–2021, 2021f  
 osteoarthritis in, 2022–2024  
 rheumatoid arthritis in, 2024–2025
- neuropathic, 2014–2016
- neuropathic pain syndrome and, 2025t, 2025–2031, 2026t  
 acute herpes zoster in, 2029  
 carpal tunnel syndrome in, 2028–2029  
 diabetic, 2026–2028, 2029t  
 glossopharyngeal neuralgia in, 2031, 2031t  
 HIV/AIDS-related, 2028, 2030t  
 meralgia paresthetica in, 2030  
 occipital neuralgia in, 2031, 2031t  
 painful peripheral neuropathies in, 2025–2026, 2027–2028t, 2029f  
 postherpetic neuralgia in, 2029–2030  
 small-fiber neuropathy in, 2026  
 trigeminal neuralgia in, 2030–2031, 2031t
- neurophysiology of, 2000–2007, 2001f  
 ascending nociceptive pathways and, 2006  
 brain and, 2007  
 descending nociceptive pathways and, 2006–2007  
 dorsal horn of spinal cord and, 2004f, 2004–2006, 2005f, 2005t, 2006t  
 primary afferents and, 2001–2003t, 2001–2004, 2002f  
 opioid-treated, 1733  
 pain hypersensitivity and, 2010, 2011t  
 paravertebral block for, 1022  
 taxonomy of, 2007–2010, 2008–2010f
- Chronic rejection of transplant, 1382
- Chronic respiratory acidosis, 664t
- Chronic tolerance to opioid analgesics, 880
- Chvostek sign, 202, 307, 654
- Ciliary body, 1559
- Ciliary ganglion, 1560, 1561, 1567f
- Ciliary muscles, 1559
- Cilostazol (Pletal), 257, 2192t
- Cimetidine, 1315, 2193t
- Ciprofloxacin, 2195t
- Circle system, 795f, 795–797, 1522
- Circuit, electrical, 478, 478f, 479f
- Circulation  
 basic life support and, 1874, 1874b  
 cardiopulmonary resuscitation and, 1877f, 1877–1880, 1879b, 1879t  
 monitored anesthesia care and, 1629–1630  
 multiple organ dysfunction syndrome and, 1762
- Circulatory overload  
 transfusion-related, 1907
- Circumcision, 1530
- Cirrhosis  
 alcoholic, 406–407  
 ascites in, 1340  
 autoimmune hepatitis and, 230  
 esophageal variceal bleeding in, 1340  
 hepatorenal syndrome and, 1341, 1341b  
 obesity and, 381  
 pharmacokinetic abnormalities in, 223
- Cirrhotic cardiomyopathy, 1354
- Cisatracurium, 629–630, 630f, 631t, 2187t  
 anaphylactic reaction to, 1952t  
 chemical structure of, 628f  
 critically ill patient and, 634  
 in hepatic resection, 1348  
 maintenance infusion of, 634  
 for obese patient, 384t, 385, 390  
 for pediatric neuromuscular blockade, 1525, 1525t  
 for renal transplantation, 1400, 1401  
 for trauma patient, 1667t
- cis-Platinum, 1490t
- Citalopram, 2050t
- Citrate  
 transfusion toxicity and, 1907
- Citric acid/sodium citrate solution, 2193t
- Citrobacter* infection, 286t
- Civil court, 2126
- Clark, William E., 2
- Clark electrode, 589
- Class IA antidysrhythmic agents, 936–939, 937b, 938t
- Class IB antidysrhythmic agents, 937b, 939–941, 940t
- Class IC antidysrhythmic agents, 937b, 941–943, 942t
- Class III antidysrhythmic agents, 943–946, 944t
- Classic pathway of complement, 1949, 1950f
- Clean-contaminated wound, 288
- Cleft lip and palate, 1597
- Clindamycin, 2195t  
 for subacute bacterial endocarditis prophylaxis, 333t
- Clinic models in preoperative assessment and management, 59–63, 60t, 62–64f
- Clinical engineering, 476
- Clinical examination, 43–45, 44t, 45f
- Clinical pharmacology, 821–848  
 pharmacologic modeling in, 822–835  
 combining kinetic and dynamic models in, 828–831, 829–832f, 831t  
 context-sensitive half-times and, 823–825, 825f  
 drug synergism and, 831–835, 832–835f  
 importance of biophase in, 825–826, 826f, 827f, 827t  
 pharmacodynamics and, 826–828, 828f, 829f  
 pharmacokinetics and, 822, 823f  
 simulations in, 823, 824f  
 special populations and, 835–846  
 age and, 838–840, 839f, 839t, 840f  
 blood volume and, 840–843, 841–843f  
 body weight and, 835–838, 836t, 836–838f, 838t  
 opioid-tolerant patient and, 843–846, 844–846f
- Clinical services administration, 14
- Clinical staff, 2174
- Clinoril (sulindac), 1723t, 2183t
- Clomethiazole, 910–911
- Clomipramine, 2050t
- Clonazepam  
 for chronic pain, 2060–2061
- Clonidine, 921, 921t  
 as analgesic adjuvant  
 in epidural analgesia, 1728  
 in neonatal surgery, 1613, 1614f  
 in neuraxial anesthesia, 991t, 991–992  
 in ophthalmic surgery, 1573  
 in peripheral nerve block, 1027  
 in monitored anesthesia care, 1643  
 perioperative cardiac complications and, 115, 115f  
 for postoperative shivering in cesarean delivery, 1485  
 somatosensory-evoked potentials and, 604t, 610
- Clopidogrel (Plavix), 256–257, 2192t  
 epidural analgesia and, 1730t  
 neuraxial anesthesia and, 998  
 perioperative cardiac complications and, 115
- Closed cardiac procedures in congenital heart disease, 1193–1194
- Closed chest compressions, 1877, 1878
- Closed liver biopsy, 220
- Closed reduction of nasal fracture, 1585
- Closed-reservoir waste gas scavenging system, 811, 812f
- Closing capacity of child, 313, 313f
- Closing volume, supine position and, 466, 466f
- Clostridium* infection  
 in alcohol or drug addicted patient, 399, 401  
 antimicrobial therapy for, 292  
 intensive care unit admission and, 1741t
- Clot lysis syndrome, 1363, 1367
- Clotting factors, 1339
- Clover, Joseph T., 519, 520f
- Cluster headache, 2037, 2037f
- CNS 7056X, 866, 866f
- Coagulation, 248f  
 calcium and, 652  
 dextrans and, 675  
 response to trauma, 1787
- Coagulation disorders, 247–261  
 ADP antagonists for, 256–257  
 afibrinogenemia in, 253  
 after labor and delivery, 1486  
 antiplatelet agents for, 255–257, 256f  
 antithrombin deficiency in, 258  
 antithrombotic agents for, 254–255, 255t  
 contact factor deficiency in, 252–253  
 in critically ill patient, 1798–1800, 1799t  
 disseminated intravascular coagulation in, 260, 260t  
 drug-induced hypercoagulable states in, 254  
 dysfibrinogenemia in, 253–254  
 factor V deficiency in, 251  
 factor VII deficiency in, 251–252  
 factor X deficiency in, 252  
 factor XI deficiency in, 252  
 factor XIII deficiency in, 253  
 glycoprotein IIb/IIIa receptor inhibitors for, 256  
 hemophilia A in, 247–249, 249t  
 hemophilia B in, 249–250  
 heparin-induced thrombocytopenia in, 259–260  
 during hepatic resection, 1348–1349  
 herbal therapies and, 257  
 hypercoagulable states in, 258  
 hyperhomocysteinemia in, 260–261  
 hyperosmolar agents and, 1103t  
 hypocoagulable effects of synthetic colloid infusions and, 257–258  
 hypocoagulable states in, 247, 248t, 249t

- Coagulation disorders—*continued*  
 hypothermia-induced, 1666  
 in liver disease, 233–234, 234f  
 during liver transplantation, 1363  
 multiple organ dysfunction syndrome and, 1758, 1767  
 nonsteroidal antiinflammatory drugs for, 255–256, 256f  
 platelet-adhesion inhibitors for, 257  
 in postoperative ICU patient, 1836  
 posttraumatic, 1665  
 protein C deficiency in, 258  
 protein S deficiency in, 258  
 prothrombin deficiency in, 254  
 prothrombin G20210 mutation in, 259  
 in transurethral resection of prostate, 1459  
 von Willebrand disease in, 250t, 250–251, 251t
- Coagulation factors, 1339
- Coagulation studies, 47  
 in elective surgery, 78t  
 in renal transplantation, 1400
- Coarctation of aorta  
 anesthetic complications in, 1193–1194  
 hemodynamic problems in, 1176t  
 problems resulting from surgical procedure in, 1185t
- Coaxial Mapleson D system, 794, 794f
- Cocaine, 410–412, 970, 2188t  
 discovery and evolution of, 954, 955f  
 dissociation constant of, 961t  
 medical complications of, 404–405t  
 pregnant patient and, 369  
 in sinus surgery, 1586  
 withdrawal from, 415
- Coccidioidomycosis, 294
- Coccyx, 978–979, 979f  
 anatomy of, 2075, 2075f
- Cochlear implant, 1583
- Cockcroft-Gault equation, 197
- Codeine, 2053t, 2183t, 2184t  
 for acute postoperative pain, 1720t, 1721  
 in outpatient surgery, 1620
- Codeine/acetaminophen, 2183t
- Coding of anesthesia services, 2178
- Cognitive dysfunction  
 in alcohol abuse, 407  
 postoperative, 1912–1924  
 anesthesia and, 1920–1921  
 aortic atherosclerosis and cerebral embolization and, 1918–1919  
 assessment of, 1914  
 cardiac surgery and, 1915–1917, 1916f  
 cardiac *versus* noncardiac surgery and, 1918, 1918f  
 depression and, 1920  
 disease states and, 1912–1914, 1913f, 1914f  
 genetic factors in, 1920, 1921f  
 hypoperfusion and, 1919  
 incidence and significance of, 1914–1915, 1915f  
 noncardiac surgery and, 1917, 1917f  
 preexisting cerebrovascular disease and, 1921  
 systemic inflammatory response and, 1919–1920
- Cognitive enrichment, 1913–1914
- Cohen endobronchial blocker, 1232
- Cohort study, 436t, 437
- Coil embolization, 1195t
- Cold ablation dissection in tonsillectomy, 1589
- Cold dissection in tonsillectomy, 1589
- Cold injury, 1780
- Cold-induced myotonia, 164
- Collecting duct diuretics, 205–206
- Colloid oncotic pressure, 673f, 673–674
- Colloids, 673–676  
 anaphylactic reaction to, 1953t  
 for anemia, 244, 244t  
 for burn patient, 1775t, 1775–1776  
 in cesarean delivery, 1485  
 colloid oncotic pressure and, 673f, 673–674  
 hypocoagulable effects of, 257–258  
 for hypotension in obstetric surgery, 1472  
 increased capillary permeability and, 674, 674f, 674t  
 in liver transplantation, 1362  
 in pancreas transplantation, 1407  
 in pediatric renal transplantation, 1403  
 for shock, 1842
- Colonoscopy, 1652
- Color flow Doppler, 553
- Combination therapy  
 antimicrobial, 283–284  
 for chronic pain, 2060
- Combined anesthesia techniques in aneurysms, 1306–1307
- Combined spinal-epidural anesthesia, 1000–1002, 1001f, 1002f  
 in obstetric surgery, 1472–1473, 1473f  
 in cesarean delivery, 1483t, 1484  
 in external cephalic version, 1478  
 in labor and vaginal delivery, 1479, 1480  
 preeclampsia and, 1488
- Combined trauma scoring systems, 1793
- Combitube, 698, 698f, 1876
- Common gas outlet, 774
- Common peroneal nerve, 1039f  
 popliteal fossa block and, 1045f
- Communication  
 palliative care and, 2112–2113  
 prevention of adverse events and, 461, 1058  
 transport team and, 1831, 1835
- Community-acquired pneumonia, 290t, 290–291, 400
- Comorbid conditions  
 in alcohol or drug addicted patient, 397–398  
 anesthesia-associated mortality and, 441–443, 442t, 443b, 443f  
 geriatric patient and, 347–350, 348f  
 pregnancy and, 1474–1475, 1475b  
 preoperative assessment and management of, 57–59, 58t  
 renal transplantation and, 1398, 1399t  
 same-day surgery and, 1650
- Compartment syndrome  
 intravenous regional anesthesia-related, 1072, 1073t  
 lithotomy position and, 1454  
 orthopedic surgery and, 1553f, 1553–1554  
 tourniquet and, 1550
- Compatibility testing in blood transfusion, 1902, 1902f, 1903f
- Compazine, 1692
- Compensation arrangements, 2173
- Compensatory antiinflammatory response, 1760
- Competition, coupling mechanism of drug-protein complex and, 723–724, 724f, 725f
- Complement  
 anaphylactic reaction and, 1948–1949, 1950f  
 response to trauma, 1787
- Complement activation assay, 1954
- Complete blood count  
 in elective surgery, 78t  
 in hepatocellular function evaluation, 232
- Complete circuit, electrical, 478
- Complete heart block, 1707
- Complex airway evaluation, 126t, 126–131, 128f, 129t, 130f
- Complex regional pain syndrome, 2031–2033, 2032t, 2033t, 2082–2083
- Complex shunt lesions, 1177–1178, 1179f, 1179t
- Composite cognitive index, 1915, 1915f, 1916f
- Compound A, 759–760
- Compound muscle action potential, 614–615, 1833
- Comprehensive Accreditation Manual for Hospitals*, 488
- Computed tomographic-guided celiac plexus block, 2086–2087
- Computed tomography  
 anesthesia during, 1656  
 for determination of nerve injury in peripheral nerve block, 1061  
 in headache evaluation, 2036  
 in liver disease, 221  
 in mediastinal mass, 1256  
 in pulmonary embolism, 1705  
 before thoracic surgery, 1217
- Computer-assisted continuous infusion, 901
- Computer-assisted data acquisition in quality of care improvement, 457
- Computer-assisted reporting program, 457
- Computerized patient assessment, 64f
- Computerized patient history, 62f
- Computerized patient physical examination, 63f
- Concentration effect, inhalational anesthetics and, 749, 749f
- Concentration-calibrated vaporizer, 779
- Concentration-dependent killing agents, 281–282
- Conduction disturbances  
 inhaled anesthetics and, 757  
 preoperative assessment and management in, 49  
 in rheumatoid arthritis, 167
- Conductive hearing loss, 1582–1583
- Conductive heat loss, 317
- Conductor, electrical, 476
- Confidence interval, 429, 429b
- Confidentiality, quality improvement and, 462
- Confounding variables, anesthesia risk and, 434
- Confusion, opioid-induced, 1732
- Congenital anomalies  
 of airway, 1597–1599, 1598f  
 of aortic valve, 570, 571f  
 auricular, 1584  
 difficult airway and, 128, 128f  
 newborn preoperative assessment and, 302–304t  
 syndromes associated with difficult intubation, 331–332t
- Congenital diaphragmatic hernia, 1510–1512
- Congenital glaucoma, 1563
- Congenital heart disease, 332–333, 333b, 333t, 1174–1212  
 anesthetic plan and goals in, 1202–1203  
 congestive heart failure in, 1180–1181  
 coronary ischemia in, 1182  
 effects of anesthesia on pathophysiology of, 1197–1201, 1198f  
 effects on cardiovascular function, 315  
 excessive pulmonary blood flow in, 1179–1180, 1180f, 1181f  
 extracorporeal membrane oxygenation and, 1201–1202  
 immaturity of circulation and, 1182–1184, 1183b, 1183f  
 induction of anesthesia in, 1203–1204  
 intraaortic balloon pump and, 1202  
 intracardiac shunting in, 1175–1178, 1177f, 1178f, 1178t, 1179t  
 intraoperative problems in, 1184–1197, 1185–1186t  
 acid-base management and, 1191  
 cardiac catheterization and, 1194–1197, 1195t, 1196f  
 cardiopulmonary bypass and, 1188–1190  
 closed cardiac procedures and, 1193–1194  
 coronary ischemia and, 1187–1188, 1188b  
 deep hypothermic circulatory arrest and, 1190–1191  
 dysrhythmias and, 1188  
 excessive pulmonary flow and, 1184–1186, 1186b  
 glucose management and, 1191  
 inadequate pulmonary flow and, 1186b, 1186–1187  
 intracardiac shunting and, 1187  
 jugular bulb oximetry and, 1192–1193  
 left heart obstruction and, 1187, 1187b  
 low cardiac output and, 1188, 1188b  
 near-infrared spectroscopy and, 1192  
 postoperative factors and, 1192  
 preoperative factors in, 1190  
 right heart obstruction and, 1187, 1187b  
 temperature management and, 1191–1192  
 transcranial Doppler ultrasound and, 1192  
 maintenance of anesthesia in, 1204  
 manipulation of pulmonary vascular resistance and systemic vascular resistance in, 1204b, 1204–1205  
 nonpharmacologic support in, 1201  
 obstructions to pulmonary blood flow in, 1181–1182  
 obstructions to systemic blood flow in, 1181  
 pregnant patient and, 366  
 preoperative assessment in, 1203, 1203b  
 preoperative preparation and medication in, 1203  
 severe hypoxemia in, 1178–1179  
 syndromes associated with, 332t  
 ventricular assist device and, 1202
- Congenital hypothyroidism, 303t, 331t
- Congenital liver diseases, 224–226
- Congenital strabismus, 1563
- Congestive heart failure  
 in congenital heart disease, 1180–1181  
 geriatric patient and, 348  
 in glycogen storage diseases, 166  
 loop diuretics for, 205  
 in myotonic dystrophy, 165  
 perioperative cardiac complications and, 104  
 renal disease and, 208, 208f  
 ventricular assist device for, 1163–1169  
 noncardiac surgery and, 1168–1169  
 preoperative considerations in, 1164–1165



- transesophageal echocardiography examination in, 1165f, 1165–1166, 1166f  
weaning from cardiopulmonary bypass in, 1166f, 1166–1168, 1167f
- Conjugated bilirubin, 218
- Conjugated hyperbilirubinemia, 220t
- Conjunctiva, 1559f, 1559–1560
- Conn syndrome, 181
- Connective tissue disease with peripheral neuropathy, 2027t
- Conscious intraoperative neurologic testing, 615–616
- Conscious patient intubation, 703
- Conscious sedation, 1625–1626, 1626f, 1626t
- Consent, 2130–2131  
in multiple organ dysfunction syndrome, 1764  
for patient transport, 1815, 1818  
pediatric patient and, 2132  
prevention of adverse events and, 1054–1055
- Constipation, opioid analgesic-related, 879
- Constrictive pericarditis, 531f
- Consultation, 57, 89–94, 90t, 92t, 93t
- Contact factor deficiency, 252–253
- Contaminated wound, 288
- Context-sensitive half-time, 823–825, 825f  
for intravenous anesthetics, 856, 856f  
monitored anesthesia care and, 1633–1634, 1634f  
total intravenous anesthesia and, 911f, 911–912, 912f
- Continent cutaneous diversion, 1463
- Continuous catheter techniques  
in lower extremity peripheral nerve block, 1046  
in paravertebral anesthesia, 1015, 1016f  
in upper extremity nerve block, 1037, 1037f
- Continuous infusion in monitored anesthesia care, 1637, 1638f
- Continuous mixed venous oximetry, 532–533, 533b
- Continuous positive airway pressure, 1869  
obese patient and, 391  
in obstructive sleep apnea, 386  
in one-lung ventilation, 1236f, 1236–1237, 1237f  
in pediatric surgery, 1524  
for postoperative ICU patient, 1833  
in tonsillectomy, 1588
- Continuous spinal anesthesia, 1000
- Continuous thermodilution cardiac output measurement, 535–536
- Continuous venovenous hemodialysis intensive care unit and, 1837  
in multiple organ dysfunction syndrome, 1762
- Continuous venovenous hemofiltration liver transplantation and, 1365  
in multiple organ dysfunction syndrome, 1762, 1766
- Continuous-wave Doppler, 553
- Contractility  
hemodynamic monitoring of, 538–540, 539f  
inhaled anesthetics and, 756t, 756–757  
local anesthetics and, 967–968  
shock and, 1846
- Contraction stress test, 360–361
- Contracts, 2128–2129
- Contractual issues, 2172–2173
- Contracture  
in malignant hyperthermia, 1972–1974, 1973f, 1974t, 1975f, 1976f
- Contrast echocardiography, 1344
- Contrast media  
anaphylactic reaction to, 1958  
in paravertebral anesthesia, 1014, 1016f
- Contrast nephropathy, 209
- Contribution margin, 2158
- Contributory cause of death, 431
- Control mode of mechanical ventilation, 1853, 1854f, 1854t
- Controlled hypotension  
in arteriovenous malformation repair, 1119  
in mastoidectomy, 1584  
in sinus surgery, 1586  
in subarachnoid hemorrhage surgery, 1118
- Contusion assessment in trauma patient, 1792
- Convective heat loss, 317
- Coogas intubation laryngeal airway, 698
- Cooperativity, allosteric, 723
- Copenhagen approach to acid-base chemistry, 664, 664t
- Copper, Wilson disease and, 225
- Cor pulmonale, 1219b
- Coracobrachial muscle, axillary block and, 1033f
- Coracoid technique of infraclavicular block, 1032
- Cordarone (amiodarone), 943–945, 944t
- Cormack and Lehane scoring system, 122, 123f
- Cornea, 1559, 1559f  
abrasion during surgery, 1712  
intraocular pressure and, 1561  
surgery of, 1578
- Cornelia de Lange syndrome, 331t, 332t
- Corniculate cartilage, 687
- Coronary angiography, 1292
- Coronary artery  
anatomy of, 1143–1144, 1144f  
anomalies of, 1176t  
isoflurane effects on, 757
- Coronary artery bypass graft, 1143–1152  
anesthetic induction in, 1149–1150  
with cardiopulmonary bypass, 1151  
cognitive dysfunction after, 1912  
coronary artery anatomy and, 1143–1144, 1144f  
coronary blood flow physiology and, 1144–1145  
liver disease and, 1354  
monitoring in, 1147–1149, 1148f, 1148t, 1149f  
myocardial oxygen delivery and, 1145  
myocardial oxygen demand and, 1145–1146, 1146f, 1147f  
older adult and, 350–351  
post-cardiopulmonary bypass management in, 1151–1152  
postoperative complications in, 103, 1152  
preoperative, 109, 1292  
preoperative evaluation in, 1146–1147  
preoperative management in, 1150  
without cardiopulmonary bypass, 1150–1151
- Coronary artery disease  
alcohol abuse and, 403–404  
chronic liver disease and, 233  
geriatric patient and, 347–348, 348f  
liver transplantation and, 1354  
mortality after pancreas transplantation and, 1406  
perioperative cardiac complications and, 100–103  
preoperative electrocardiography in, 46–47  
vascular surgery morbidity and, 1288  
ventricular assist device and, 1165
- Coronary blood flow, 1144–1145
- Coronary ischemia, 1182, 1187–1188, 1188b
- Coronary sinus, 1144
- Coronary stenting before vascular surgery, 1292
- Corpora cavernosa, 1453
- Corporation, 2128
- Corpus spongiosum, 1453
- Corrected anion gap, 665
- Cortical neuron, 598, 599t, 600f
- Corticosteroids  
for bronchospasm, 140  
for cancer pain, 2111t  
for complex regional pain syndrome, 2033  
for immunosuppression in heart and lung transplantation, 1383, 1383t  
for meralgia paresthetica, 2030  
for osteoarthritis, 2024  
for rheumatoid arthritis, 2024–2025
- Corticotropin, 179
- Corticotropin stimulation test, 1838
- Cortisol, 179  
effect of opioid analgesics on, 879  
etomidate and, 860  
for postoperative ICU patient, 1837–1838  
response to trauma, 1662t
- Cosyntropin, 1068
- Cough  
in foreign body aspiration, 1268  
opioid analgesic suppression of, 876–877
- Cough reflex, 1215
- Coumadin (warfarin), 255  
for antithrombin deficiency, 258  
for deep venous thrombosis prophylaxis, 1552–1553  
epidural analgesia and, 1730t  
in lower-extremity vascular surgery, 1299  
for multiple organ dysfunction syndrome, 1767  
perioperative cardiac complications and, 115–116  
postoperative bleeding complications and, 1696–1697  
preoperative assessment and management of, 58
- Countercurrent exchange, 195
- Counterregulatory hormones, starvation and, 267–268
- Coupling mechanism of drug-protein complex, 723–724, 724f, 725f
- Covariates, 433–434, 835
- COX-3, 2063
- COX-2 inhibitors  
in adenotonsillectomy, 1589  
for chronic pain, 2061–2062, 2064t  
oral, 2183t  
in orthopedic surgery, 1549–1550  
parenteral, 2184t  
postoperative, 1723, 1723f  
renal vasoconstriction and, 206  
in spinal surgery, 1549
- Crack cocaine, 369
- Cranial diabetes insipidus, 184
- Cranial nerves  
dysfunction after posterior fossa surgery, 1114  
ocular anatomy and, 1558, 1560, 1560t, 1565
- Craniofacial abnormalities, 1597
- Craniosynostosis, 1536–1537
- Craniotomy  
awake, 615–616  
in child, 1536–1537  
supratentorial, 1105–1108, 1106f, 1108f
- Crawford classification of thoracoabdominal aortic aneurysm extent, 1160, 1161f
- C-reactive protein  
atherosclerosis and, 1285  
perioperative cardiac complications and, 104
- Creatine kinase  
testing for malignant hyperthermia susceptibility and, 1979
- Creatinine  
changes during pregnancy, 360  
preoperative assessment and management of, 52–53, 78t
- Creatinine clearance, 197t, 197–198
- Credentialing, 2173
- Crestor (rosuvastatin), 947t
- Creutzfeldt-Jakob disease, 1905–1906  
transfusion-related, 1905–1906
- Crew resource management, 26–27, 27b
- Cribriform plate, 1571f
- Cricoaerthytenoid joint arthritis, 167
- Cricoid cartilage, 311, 312f, 688, 688f, 689f
- Cricoid pressure  
for reflux prevention, 1316  
ventilation during cardiopulmonary resuscitation and, 1877
- Cricothyroid cartilage, 688, 688f
- Cricothyroid ligament, 689f
- Cricothyroidotomy, 1876, 1876f
- Cricothyrotomy, 710
- Criminal court, 2126
- Crisis management, 28b, 34
- Crista galli, 1571f
- Critical care medicine, 14
- Critical care transport team, 1823
- Critical illness myopathy, 1832–1833
- Critical illness polyneuropathy, 1832–1833
- Critical incident evaluation, patient transport and, 1823–1824, 1824t
- Critically ill patient, 1737–1890  
anesthetic plan for, 1797–1810  
airway evaluation and management and, 1804–1805  
choice of anesthetic and, 1805  
hemodynamic management and, 1805–1807, 1806f  
intraoperative glucose management and, 1808  
monitoring options and, 1801–1804, 1802t, 1803t  
postoperative care and, 1808  
preoperative assessment and, 1797–1800, 1799t  
renal preservation and, 1807–1808  
surgical procedure considerations and, 1800  
transport of patient from ICU and, 1800, 1801f  
blood transfusion in, 1892–1911  
adverse effects of, 1907–1908  
allergic transfusion reaction and, 1906–1907  
bacterial contamination of blood components and, 1902–1903  
compatibility testing in, 1902, 1902f, 1903f  
Creutzfeldt-Jakob disease and, 1905–1906  
febrile nonhemolytic transfusion reaction and, 1906  
historical background of, 1892–1893



- Critically ill patient—*continued*  
 plasma component derivatives for, 1897–1901  
 platelets for, 1901–1902  
 red cell concentrates for, 1893–1897, 1895*t*, 1896*t*  
 viral contamination of blood components and, 1903–1905  
 whole blood for, 1893
- burn injury and, 1674–1685, 1772–1783  
 anesthetic management of, 1675–1678, 1676*f*  
 antibiotics for, 1779  
 burn center referral and, 1777–1778, 1779*t*  
 burn wound management in, 1681*t*, 1681–1683, 1682*t*  
 calcium homeostasis and, 1680  
 carbon monoxide poisoning and, 1774, 1774*f*  
 chemical, 1775, 1780  
 cyanide poisoning and, 1774–1775  
 electrical, 1780, 1780*t*  
 emergency evaluation of, 1786  
 epidemiology of, 1772  
 estimation of size and depth of burn in, 1776*f*, 1776–1777, 1777*f*, 1778*t*  
 fluid management and blood loss during burn wound excision, 1680  
 fluid resuscitation in, 1775*t*, 1775–1776  
 geriatric patient and, 1779–1780  
 hemodynamic response to, 1773  
 immune enhanced diet for, 275*t*  
 indirect respiratory injury in, 1775  
 infection control in, 1680  
 inhalation injury and, 1773–1775, 1774*f*  
 initial evaluation of, 1773  
 intraoperative hypothermia and, 1680  
 metabolic and nutritional management of, 1679–1680  
 multiple organ dysfunction syndrome in, 1761  
 pathophysiology of, 1674–1675, 1772–1773  
 pediatric patient and, 1779  
 pharmacologic considerations for, 1678–1679  
 preoperative evaluation of, 1674, 1675*t*  
 pulse oximetry-related, 584  
 purpura fulminans in, 1781  
 secondary survey in, 1778–1779  
 surgical management of, 1675  
 thermoregulation and, 1675  
 toxic epidermal necrolysis in, 1781
- cardiopulmonary resuscitation and, 1873–1890  
 advanced life support and, 1880  
 airway management in, 1875–1876, 1876*f*  
 basic life support and, 1874, 1874*b*, 1875*b*, 1875*f*  
 circulation and, 1877*f*, 1877–1880, 1879*b*, 1879*t*  
 defibrillation in, 1880–1882, 1880–1882*b*  
 drug therapy in, 1882–1886, 1885*b*, 1886*b*, 1886*f*  
 historical background of, 1874  
 postresuscitation care in, 1886  
 prognosis in, 1886–1887, 1887*b*  
 pulseless electrical activity and asystole and, 1882, 1882*b*, 1883*b*  
 timing of interventions in, 1874–1875, 1875*t*  
 ventilation in, 1876*b*, 1876–1877
- immune enhanced diet for, 275*t*  
 mechanical ventilation in, 1852–1872  
 in acute respiratory distress syndrome, 1867*t*, 1867–1868  
 adaptive support ventilation in, 1858  
 airway pressure release ventilation in, 1859, 1859*f*, 1860*f*  
 assist/control modes in, 1853–1854, 1855*f*  
 automatic tube compensation in, 1858–1859  
 bilevel pressure ventilation in, 1860, 1860*f*  
 in chronic obstructive pulmonary disease, 1866–1867  
 combined pressure and volume targeted modes in, 1853  
 control mode in, 1853, 1854*f*  
 gas exchange targets in, 1862–1863  
 high-frequency ventilation in, 1865–1866  
 indications for, 1852, 1853*t*  
 initial management of, 1866  
 lung-protective ventilation in, 1865  
 noninvasive positive pressure and, 1869  
 normal preoperative pulmonary function and, 1866  
 pressure support mode in, 1854–1855, 1855*f*  
 pressure *versus* volume ventilation in, 1852–1853, 1853*t*  
 pressure-regulated volume control mode in, 1857–1858  
 proportional-assist ventilation in, 1859  
 synchronized intermittent mandatory ventilation in, 1855–1857, 1856*f*, 1857*f*  
 in unilateral lung disease, 1868  
 ventilator settings and patient-ventilator synchrony and, 1860–1862, 1861*f*, 1863*f*  
 ventilator-induced lung injury and, 1863–1865, 1864*f*  
 volume support mode in, 1858  
 weaning from, 1868*t*, 1868–1869, 1869*t*
- multiple organ dysfunction syndrome and, 1754–1771  
 acid-base status in, 1767–1768  
 anesthetic planning in, 1768  
 cardiovascular instability in, 1766  
 as cause of death in critical illness, 1741  
 definitions in, 1754–1755  
 epidemiology of, 1756  
 etiologies of, 1755*t*, 1755–1756  
 hematologic disturbances in, 1767  
 hepatic dysfunction in, 1767  
 immediate *versus* delayed surgery in, 1764  
 management of, 1760–1761  
 manifestations of, 1757*t*, 1757–1760  
 pathogenesis of, 1757–1758  
 predisposition to infection in, 1760  
 preoperative assessment in, 1761–1764, 1762*t*  
 preventive strategies for, 1760  
 renal failure in, 1766–1767  
 respiratory issues in, 1764–1766, 1765*t*  
 scoring systems for, 1756  
 transport to operating room and, 1768–1769
- neonatal, 1502–1519  
 airway management in, 1509*f*, 1509–1510, 1510*f*  
 anesthetic pharmacology and, 1502–1504, 1503*t*  
 congenital diaphragmatic hernia and, 1510–1512  
 esophageal atresia and tracheoesophageal fistula and, 1513–1515, 1514*f*  
 fentanyl for, 1504–1505  
 fluid management in, 1508–1509  
 inhalational agents for, 1504, 1504*t*  
 intestinal obstruction and necrotizing enterocolitis and, 1512–1513  
 ketamine, general anesthetics, sedatives and, 1506  
 local anesthetics for, 1506  
 meningomyelocele and, 1515, 1515*f*  
 monitoring of, 1506–1508, 1507*f*  
 muscle relaxants for, 1505–1506  
 omphalocele and gastroschisis and, 1512, 1513*f*  
 patent ductus arteriosus and, 1515–1516
- neuromuscular blockade in, 634  
 pathophysiology of critical illness and, 1738–1753  
 case report in, 1738–1739, 1739*f*  
 cellular response in, 1746–1749, 1748*f*  
 central nervous system and, 1744, 1745*f*  
 direct tissue injury during surgery and trauma in, 1739–1740, 1740*t*  
 hemodynamic response and, 1745  
 hormonal response and, 1744–1745  
 immune-inflammatory response and, 1744, 1748–1749  
 infection in, 1741, 1741*t*, 1742*t*, 1747–1748, 1748*f*  
 metabolic failure in, 1740–1741  
 metabolic response and, 1746, 1749  
 organ failure, survival, and death in, 1749–1750, 1750*f*  
 quantifying severity of illness and relationship to outcome, 1742–1743  
 shock and, 1741–1742  
 systemic vasodilation and, 1745–1746, 1746*f*
- pediatric, 337–338  
 perioperative complications and death and, 442*t*  
 postoperative care of, 1828–1840  
 cardiovascular issues and, 1834  
 endocrine issues and, 1837–1838  
 gastrointestinal issues and, 1834–1835, 1835*t*  
 hematologic issues and, 1835–1837  
 intensive care unit triage and, 1828–1830, 1829*t*, 1830*t*  
 laboratory tests and vital signs and, 1831  
 neurologic issues and, 1832*t*, 1832–1833  
 pain management and, 1733–1734, 1831–1832, 1832*t*  
 prophylactic and preventive measures and, 1838*t*, 1838–1839  
 pulmonary issues and, 1833–1834  
 renal issues and, 1837  
 transport between operating room and ICU, 1830–1831
- shock in, 1741–1742, 1841–1851  
 blood transfusion for, 1843–1844  
 clinical signs of, 1841  
 fluid resuscitation for, 1842–1843, 1843*f*  
 indices of global perfusion in, 1847–1848, 1848*f*  
 indices of regional perfusion in, 1848–1849  
 pathophysiologic classification of, 1841–1842  
 restoring and maintaining cardiac output in, 1846*f*, 1846–1847  
 vasopressors for, 1844*f*, 1844*t*, 1844–1846  
 ventilatory support for, 1842
- transport of, 1800, 1801*t*, 1811–1827  
 chemical injury and disaster victim and, 1821*t*, 1821–1822  
 equipment and monitoring in, 1818  
 high-risk obstetrics and, 1821  
 interhospital, 1812  
 intrahospital, 1812, 1813*t*  
 modes of, 1819*t*, 1819–1821, 1820*t*, 1821*f*  
 neurologic conditions and, 1821, 1821*t*  
 patient assessment and preparation for, 1815–1817*t*, 1815–1818, 1817*f*  
 pediatric patient and, 1822  
 protocols and guidelines in, 1823, 1823*t*  
 quality assurance and, 1822  
 reporting and critical incident evaluation in, 1823–1824, 1824*t*  
 risks of, 1813*t*, 1813–1815  
 technology and transport system design and, 1822–1823  
 transfer of medical information and, 1823  
 transport personnel and, 1819, 1823
- trauma evaluation and, 1784–1796  
 burn injury and, 1786  
 evolution of trauma care and, 1784–1785  
 future trends in, 1793–1794  
 head assessment in, 1792  
 hospital care in, 1788*f*, 1788–1789, 1789*f*  
 hypothermia and, 1793, 1793*t*  
 nature of trauma in, 1785*f*, 1785–1786  
 pathophysiology of trauma and, 1786–1787  
 patient assessment in, 1789–1791*t*, 1789–1792, 1790*f*  
 prehospital care in, 1787–1788  
 scoring of trauma and, 1792*t*, 1792–1793
- Cromolyn sodium, 140, 2193*t*  
 Cross-addiction, 397  
 Cross-clamping of aneurysm  
 physiology of, 1301–1303, 1302*f*  
 unclamping and, 1301–1303, 1302*f*  
 Crossmatching, 1902, 1903*f*  
 Cross-tolerance, opioid analgesics and, 880  
 Croup, 1587  
 Crouzon disease, 303*t*, 331*t*  
 Cryoprecipitate, 1898–1899  
 ABO compatibility of, 1895*t*  
 for dysfibrinogenemia, 253  
 for factor XIII deficiency, 253  
 in multiple organ dysfunction syndrome, 1767
- Cryotherapy  
 after orthopedic surgery, 1549  
 for cancer pain, 2113  
 for chronic pain, 2066–2067  
*Cryptococcus neoformans*, 295  
 Crystalloids, 670–672*f*, 670–673  
 for anemia, 244, 244*t*  
 for burn patient, 1775*t*, 1775–1776  
 extravasation of, 668, 669*f*  
 limitations of, 676–677  
 in neonatal emergency surgery, 1508  
 for resuscitation in trauma, 1791  
 for shock, 1842  
 for vasospasm after subarachnoid hemorrhage surgery, 1118
- CTrach laryngeal mask airway, 707, 709*f*  
 Culture of organization, 31–32  
 Cuneiform cartilage, 687  
 Curare, 627, 1562*t*

- Curschmann spirals, 138  
 Cushing syndrome, 180f, 180–181, 1221  
 Cutaneous branches of radial nerve, 1029f  
 Cutaneous urostomy, 1463  
 Cutoff effect, 719, 720f  
 Cyanide poisoning, 1774–1775  
 Cyanosis  
   in foreign body aspiration, 1268  
   inhalant abuse and, 414  
 Cyclic adenosine monophosphate, 655–656  
 Cyclic guanosine monophosphate, 655–656  
 Cyclobenzaprine  
   for chronic pain, 2061  
 Cyclomethycaine (Surfacaine), 969f  
 Cyclooxygenase  
   peripheral sensitization and, 2012  
 Cyclopropane, 719f  
 Cyclosporine  
   in heart and lung transplantation, 1382–1383, 1383t  
   in kidney transplantation, 209–210  
 Cystic medial necrosis, 1299  
 Cystopathy, diabetic, 189  
 Cystoscopy, 1455–1457, 1456f  
 Cytochrome P450 system  
   gender differences in, 1491, 1491f  
   hepatic drug metabolism and, 223  
 Cytokines  
   anaphylactic reaction and, 1948, 1948t, 1949f  
   burn injury and, 1772  
   cellular response to traumatic injury and, 1747  
   immune-inflammatory response and, 1744  
 Cytomegalovirus infection  
   postoperative  
     in liver transplantation, 1369  
     in lung transplantation, 1390  
     preemptive therapy for, 289  
 Cytomegalovirus infection (CMV)  
   transfusion-related, 1904  
 Cytomegalovirus polyradiculopathy, 2030t  
 Cytopathic hypoxia, 1749  
 Cytopenia, 669  
 Cytoreductive surgery, ovarian, 1495  
 Cytoskeleton, 725
- D**  
 D wave, 615f  
 Dacliximab, 1383  
 Dacryocystorhinostomy, 1579  
 Dalfopristin/quinupristin, 2195t  
 Dalteparin (Fragmin), 254–255, 1730t, 2192t  
 Dalton law of partial pressures, 776  
 Damage control surgery, 1668–1669  
 Damages, negligence and, 2127  
 Dandy-Walker syndrome, 303t  
 Dantrolene, 2194t  
   for malignant hyperthermia, 1981  
   for multiple sclerosis, 160  
 Darvon (propoxyphene), 2184t  
 Data acquisition in quality of care improvement, 456–457  
 Database entry in quality of care improvement, 457  
 Datascope Anestar workstation, 807  
 Datex-Ohmeda 7000 anesthesia ventilator, 798–800, 799f, 800f  
 Datex-Ohmeda 7810 anesthesia ventilator, 800–802, 801f  
 Datex-Ohmeda 7900 anesthesia ventilator, 802, 802f, 807  
 Datex-Ohmeda 7810 electronic anesthesia ventilator, 800–802, 801f  
 Datex-Ohmeda ADU anesthesia ventilator, 807  
 Datex-Ohmeda ADU Carestation Compact Block and mini-absorber, 798f  
 Datex-Ohmeda ADU workstation, 789, 789f, 793f  
 Datex-Ohmeda Aestiva machine, 796f  
 Datex-Ohmeda AISYS workstation, 807  
 Datex-Ohmeda anesthesia machine  
   Aladin vaporizer of, 789–790, 789–793f  
   Link-25 Proportion Limiting Control system of, 774, 774f  
   Tec 6 concentration-calibrated vaporizer of, 784–788, 785–788f  
   testing for leaks in, 815–817f, 816–817  
 DAWN (Drug Abuse Warning Network), 2051  
 Daytime hypoxemia, 378  
 de Quervain tenosynovitis, 2023t  
 Dead space ventilation, 581  
 Death  
   anesthesia risk and, 438–446  
   anesthesia provider and, 445–446, 446f  
   cohort studies in, 438–439, 439f  
   crude estimates in, 439–440, 440f  
   healthcare setting and, 443–444  
   patient comorbidity and, 441–443, 442t, 443b, 443f  
   pregnancy and, 1474–1475  
   surgeon characteristics and operation in, 444f, 444–445  
   contributory cause of, 431  
   methylmethacrylate hypersensitivity and, 1552  
   multiple organ dysfunction syndrome and, 1756  
   organ donation after, 2132  
   pathophysiology of critical illness and, 1749–1750, 1750f  
   protein-energy malnutrition and, 272–273  
   trauma and, 1784, 1785  
 DeBakey type aortic dissection, 1162–1163  
 Deceleration time in pulsed-wave Doppler, 561  
 Decompression, orbital, 1579  
 Decompressive laparotomy for abdominal compartment syndrome, 1835  
 Decortication, 1247  
 Decreased ventilatory drive, postoperative, 1703  
 Deep cervical plexus block, 1028, 1028f  
 Deep extubation  
   in ophthalmic surgery, 1576  
   in sinus surgery, 1586  
 Deep hypothermic circulatory arrest  
   in aortic dissection, 1163  
   in aortic surgery, 1159–1160  
   in congenital heart disease, 1190–1191  
   in valve surgery, 1152  
 Deep peroneal block, 1046, 1048f  
 Deep peroneal nerve, 2047t  
   ankle blocks and, 1048f  
   stimulation for neuromuscular blockade monitoring, 622f  
 Deep sedation, 1626, 1626t, 1656  
 Deep venous thrombosis  
   in obese patient, 386–387  
   orthopedic surgery and, 1552–1553  
   in postoperative ICU patient, 1838t, 1838–1839  
 Defibrillation, 1880–1882, 1880–1882b  
 Defibrillator, 1880  
   transport, 1817  
 Dehydration, hypovolemic hyponatremia and, 647  
 Delayed awakening, 1695, 1709  
 Delayed fluid resuscitation in trauma patient, 1664  
 Delayed gastric emptying, 1321, 1321b, 1413  
 Delayed hemolytic transfusion reaction, 1896t, 1896–1897  
 Delirium  
   Alzheimer disease and, 149  
   emergence, 1695  
   postoperative, 1709  
   urinary retention-related, 1708  
 Delirium tremens, 414  
 Delivered gaseous concentration, dose response and, 740  
 Delta opioid receptors, 873  
 Delta slow wave, 600, 601f  
 Demadex (torsemide), 919, 920t  
 Dementia  
   in alcohol abuse, 407  
   preoperative evaluation of, 148–149  
 Denitrogenation, 692, 692b  
 Density of inhaled anesthetics, 741t  
 Dent disease, 657  
 Dental chart, 45f  
 Dental injuries, postoperative complications and, 1712  
 Dental surgery, 1600–1602  
 Dentition, child and, 316  
 Denver Developmental Screening Test, 329f  
 Denver Multiple Organ Failure Score, 1756  
 Deoxycholic acid analogues, 1324  
 Dependence on opioid analgesics, 1721–1722  
 Dependent-lung positive end-expiratory pressure, 1236, 1236f  
 Depolarization, muscle contraction and, 620  
 Depolarization blockade, succinylcholine and, 626  
 Depolarizing muscle relaxants, 2187t  
 Depression  
   after cardiac surgery, 1920  
   geriatric patient and, 350  
   obese patient and, 387  
   perioperative cardiac complications and, 104  
   preoperative evaluation of, 150  
 Depth of sedation  
   electroencephalographic measurement of, 753, 753f  
   inhalational anesthetics and, 752–753  
   in monitored anesthesia care, 1626t, 1630–1631, 1631b  
   in outpatient surgery, 1619, 1619f  
   therapeutic effects and, 750–751, 751t  
 Deresuscitation, 645  
 Dermatomal distribution of spinal nerves, 1013f  
 Dermatomyositis, 169  
 3–Desacetylvecuronium, 631  
 Descending nociceptive pathways, 2001, 2001f, 2006–2007  
 Descending thoracic aortic aneurysm, 1160t, 1160–1162, 1161f, 1161t  
 Desflurane, 2186t  
   advantages and disadvantages of, 761t  
   cardiovascular effects of, 756t  
   in carotid endarterectomy, 1296  
   central nervous system effects, 756t  
   cerebral blood flow and, 1098–1099  
   chemical and physical properties of, 741f, 741t, 741–742  
   in coronary artery bypass graft, 1150  
   effects on respiratory function, 758t  
   in extracorporeal shock wave lithotripsy, 1461  
   minimum alveolar concentration of, 776t  
   for obese patient, 389  
   pathophysiology of congenital heart disease and, 1197  
   physical properties of, 744t, 777t, 784t  
   for renal transplantation, 1401  
   somatosensory-evoked potentials and, 605t  
   space-filling representation of, 719f  
   Tec 6 vaporizer and, 784b, 784–788, 785–788f  
   vapor pressure curve for, 776f  
   vascular resistance and, 757t  
 Desiccated carbon dioxide adsorbents, 760  
 Desipramine, 2050t  
 Desmopressin, 2192t  
   for clotting during hepatectomy, 1349  
   for von Willebrand disease, 250, 251t  
 Desmopressin (DDAVP)  
   for hemophilia, 1900  
 Desynchronous electroencephalogram pattern, 598–599, 601f  
 Detrusor muscle, prolonged bladder distension and, 1708  
 Developmental physiology  
   of child, 311–317  
     cardiovascular system and, 314f, 314–315, 315t  
     dentition and, 316  
     gastrointestinal system and, 316  
     renal system and, 315–316, 316t  
     respiratory system and, 311–314, 312f, 313f, 313t  
     thermoregulation and, 316–317  
   of newborn, 302–307  
     cardiovascular system and, 305  
     central nervous system and, 305–306  
     gas exchange and oxygen consumption and, 304–305  
     glucose metabolism and, 306–307  
     head and neck and, 302–304  
     renal system and, 306  
     thermoregulation and, 306  
 Developmental stages, 321t, 321–322  
 Dexamethasone, 2189t, 2193t  
   for child, 1533  
   for postoperative nausea and vomiting, 1692  
 Dexmedetomidine, 921t, 921–922, 2186t  
   as adjunct in intravenous anesthesia, 865  
   for burn patient, 1682  
   cerebral blood flow and, 1095  
   cerebral neuroprotection and, 1104  
   chemical structure of, 851f  
   effect on pathophysiology of congenital heart disease, 1200  
   intraocular pressure and, 1562f  
   in monitored anesthesia care, 1643–1644  
   in nonoperating room procedures, 1651  
   for obese patient, 384f, 385, 390  
   for postoperative pain in ICU patient, 1831  
   somatosensory-evoked potentials and, 604t, 610  
   in total intravenous anesthesia, 910  
   for trauma patient, 1667t, 1668, 1671  
 Dextran, 675, 2196t

- Dextran-40  
 osmolarity of, 1101t  
 for postdural puncture headache, 1069
- Dextran-70, 1101t
- Dextromethorphan  
 for chronic pain, 2054, 2059f
- Dextrose, 1407t, 2196f
- Dextrose 5% solution, 670  
 for burn patient, 1775, 1775t  
 for hypernatremia, 650t
- Dezocine, 2053t (Dalgan)
- Diabetes insipidus, 184
- Diabetes mellitus, 185–190  
 cognitive dysfunction and, 1912, 1913f  
 complications of, 187–190  
 definition and classification of, 185–186  
 kidney failure in, 208  
 medications for, 186–187  
 metabolic syndrome and, 190  
 perioperative changes in glucose metabolism and, 187  
 preoperative assessment and management in, 51, 190  
 protamine anaphylaxis and, 1959
- Diabetic cystopathy, 189
- Diabetic ketoacidosis, 189–190
- Diabetic nephropathy, 189, 208
- Diabetic neuropathy, 188–189, 2026–2028, 2029t  
 peripheral neuropathic pain in, 2026–2028, 2027t, 2029t
- Diagnosis model of ICU triage, 1828, 1829t, 1830
- Diagnostic and Statistical Manual of Mental Disorders, Fourth Edition, Text Revision*, 2136–2137
- Diagnostic errors, 29
- Diagnostic imaging, anesthesia during, 1655
- Diagnostic lumbar discography, 2094f, 2094–2095
- Diagnostic medial branch block  
 cervical, 2091  
 lumbar, 2093  
 thoracic, 2092
- Diagnostic procedures, 1649–1659  
 cardiopulmonary suite and, 1653–1654  
 diagnostic imaging in, 1655  
 electroconvulsive therapy in, 1651–1652  
 endoscopy in, 1652–1653  
 interventional radiology in, 1654–1656  
 pediatric patient and, 1655–1656  
 pharmacologic agents for, 1651  
 postanesthesia concerns in, 1651  
 preanesthetic considerations in, 1649–1651  
 in vascular surgery, 1290–1292
- Diagonal artery, 1144f
- Dialysis  
 liver transplantation and, 1365  
 morbidity in renal transplantation and, 1399
- Diamorphine, 1473t
- Diaphragm  
 changes in protein-energy malnutrition, 270  
 positioning pathology and  
 lithotomy position and, 468  
 supine position and, 466
- Diarrhea, 879
- Diastasis, 560
- Diastolic heart failure, 348
- Diazepam (Valium), 860–863, 2186t  
 cardiovascular effects of, 853t  
 cerebral blood flow and, 1095  
 chemical structure of, 851f  
 for chronic pain, 2060–2061  
 hepatic extraction ratio for, 855t  
 induction characteristics of, 856t  
 intraocular pressure and, 1562t  
 in monitored anesthesia care, 1639t, 1641–1642  
 in outpatient surgery, 1612  
 pharmacokinetics of, 855t  
 physicochemical properties of, 852t  
 somatosensory-evoked potentials and, 604t
- Dibucaine (Nupercaine, Percaine), 961f, 971
- Diclofenac sodium (Voltaren), 1723t, 2183t
- Dielectric, term, 477
- Diet, immune-enhanced, 274–275, 275t
- Diethyl ether, 719f
- Differential block, 958, 962, 963f
- Difficult airway, 122–133  
 airway infection and, 128, 128f  
 airway stent and, 130, 130f  
 American Society of Anesthesiologists algorithm for, 711–712, 712f  
 anatomic considerations in, 123–124, 124t  
 anteriorly tilted larynx and, 125–126  
 in burn injury, 1774  
 causes of, 690b  
 in cervical spine disease, 1120–1121  
 in child, 1527  
 congenital disease and, 128, 128f  
 in diabetic patient, 190  
 follow up of, 714  
 grading of, 122–123, 123f, 124b  
 head and neck tumors and, 129t, 129–130  
 in hyperpituitarism, 184  
 identification before elective surgery, 70  
 intrathoracic lesions and, 130–131  
 in newborn, 302  
 obesity and, 126–127, 387  
 pediatric syndromes associated with, 331–332t  
 pregnancy and, 127  
 preoperative assessment and management in, 56  
 radiographic assessment in, 126  
 recommendations for, 131  
 rheumatoid arthritis and, 127–128  
 scope of problem and incidence of, 122  
 strategy for, 75  
 trauma and, 128–129  
 unexpected, 131  
 visibility of oropharyngeal structures and, 124–125, 125f
- Difficult extubation, 714
- Difficult laryngoscopy, 122  
 in diabetic patient, 190  
 identification before elective surgery, 74, 74t
- Difficult mask ventilation, 74–75, 75t, 122
- Diffusing capacity of lung for carbon monoxide  
 in chronic obstructive pulmonary disease, 139  
 criteria indicating increased postoperative risk, 141b
- Diffusion hypoxia, 758
- Diffusion-weighted imaging  
 in postoperative cognitive dysfunction, 1918–1919
- Diflunisal (Dolobid), 1723t, 2183t
- DiGeorge syndrome, 303t, 332t
- Digital circuit, 479
- Digitalis, 925–926
- Digoxin, 2190t
- Digoxin-specific Fab fragments, 926
- Dihydroergotamine  
 for migraine, 2037
- Dihydropyridine, 934–935
- Dihydropyridine receptor  
 malignant hyperthermia and, 1966  
 properties of, 1972–1974, 1973f, 1974t, 1975f, 1976f
- Dilated cardiomyopathy, 406
- Dilation and curettage, 1493–1494
- Dilation and evacuation, 1493–1494
- Dilation and extraction, 1493–1494
- Dilaudid (hydromorphone), 2183t, 2184t
- Diltiazem, 932t, 934, 2190t  
 cerebral blood flow and, 1100  
 for postoperative hypertension, 1694–1695
- Dilutional acidosis, 662
- Dilutional coagulopathy, 1836
- Dimorphic fungi, 294–295
- Diode laser, 1594, 1594f
- Diphenhydramine, 2186t, 2189t  
 for anaphylactic reaction, 1953, 1955b, 1958
- Dipriferol, 859, 901, 902, 902t
- Dipyridamole and aspirin (Aggrenox), 257
- Dipyridamole (Persantine), 257, 2192t
- Dipyridamole-thallium myocardial perfusion imaging, 1291
- Direct current, 476–477, 477f
- Direct laryngoscopy  
 for placement of double-lumen tube, 1229  
 in spinal cord trauma, 1670
- Direct thrombin inhibitors, 255
- Dirty-infected wound, 288
- Disaster transport, 1821t, 1821–1822
- Discharge  
 criteria in monitored anesthesia care, 1644b, 1644–1645  
 in outpatient surgery, 1620–1621
- Disclitis  
 lumbar discography-related, 2095
- Discogenic pain, 2034, 2074
- Discography, 2093–2096, 2094f
- Discovery phase of litigation, 2128
- Discriminative function of brain, 2007
- Disease risk, obesity and, 375t
- Disease-modifying antirheumatic drugs, 2025
- Disinhibition, 2016
- Disk summation method in transesophageal echocardiography, 559, 560f
- Disopyramide, 938t, 939
- Disseminated intravascular coagulation, 260, 260t, 1745  
 after aneurysm surgery, 1305  
 after labor and delivery, 1486  
 fresh-frozen plasma for, 1898  
 malignant hyperthermia and, 1981–1982  
 in multiple organ dysfunction syndrome, 1757, 1759  
 in postoperative ICU patient, 1836  
 transurethral resection of prostate and, 1459
- Dissociation constant  
 drug affinity and, 722  
 of local anesthetics, 961, 961f, 961t
- Dissociative anesthesia, 863
- Distal convoluted tubule diuretics, 205
- Distal symmetric sensorimotor polyneuropathy, 2029t, 2030t
- Distal-acting diuretics, 205–206
- Distribution half-life of neuromuscular blocking drugs, 623
- Distributive shock, 1742, 1842
- Disulfiram, 417
- Diuretics, 919–921, 920t, 2191t  
 for edema, 204f, 204–206  
 for hypercalcemia, 653  
 for intraoperative cerebral edema, 1107, 1108f  
 perioperative cardiac complications and, 115  
 preoperative assessment and management of, 58
- Diuril (chlorothiazide), 920t
- Diverticulum, Zenker, 1270–1271, 1271f
- Dixardin (hydroflumethiazide), 920t
- Dizziness  
 in cyanide poisoning, 1775  
 epidural analgesia-related, 1728
- Do not resuscitate order, 1764, 2131
- Dobutamine, 2190t  
 for critically ill patient, 1806–1807  
 for low cardiac output in shock, 1846
- Dobutamine stress echocardiography, 108, 108t  
 before liver transplantation, 1354  
 before vascular surgery, 1291
- Documentation  
 of anesthesia services, 2178  
 prevention of adverse events and, 1057
- Dofetilide, 944t, 946
- Dolasetron, 1533, 2189t
- Dolophine (methadone), 883
- Donation after cardiac death, 1372
- Dong quai, 257
- Donor selection  
 for heart transplantation, 1384t, 1384–1385  
 for liver transplantation, 1371–1372  
 for lung transplantation, 1383–1384
- Dopamine, 2190t  
 for allograft perfusion in renal transplantation, 1402  
 for anaphylactic reaction, 1955b  
 for congenital diaphragmatic hernia, 1512  
 for critically ill patient, 1806  
 for postoperative acute renal failure, 1837  
 for renal preservation in critically ill patient, 1807  
 for shock, 1845  
 in small bowel transplantation, 1414  
 substance abuse and, 2142, 2145–2146
- Dopamine antagonists, 2189t
- Dopaminergic agonists, 206
- Dopexamine  
 for critically ill patient, 1807  
 for low cardiac output in shock, 1846
- Doppler equation, 536b
- Doppler shift, 553
- Doppler tissue imaging, 563
- Doppler ultrasound, 553  
 for detection of venous air embolism, 1111–1112  
 esophageal, 536b, 536–537, 537f
- Dorsal column stimulation, 2099–2102
- Dorsal horn of spinal cord  
 nociception and, 2004f, 2004–2006, 2005f, 2005t, 2006t
- Dorsal nerve of penis, 1453f
- Dorsal root ganglion  
 altered phenotype after peripheral inflammation, 2012  
 nociceptors in, 2003

- Dorsal scapular nerve, 2046t
- Dose-response
- inhalational anesthetics and, 739–740
  - opioid analgesics and, 872, 872f
- Double-burst stimulation, 622
- Double-circuit ventilator designs, 804–807, 805f
- Double-lumen tube
- design of, 1228f, 1228–1229
  - in lung transplantation, 1387
  - placement of, 1229–1230, 1230–1232f
  - selection of, 1229t
- Down syndrome, 303f
- difficult intubation in, 331t
  - duodenal obstruction in, 1513
  - heart defect in, 332t
- Doxacurium, 628f, 630
- Doxapram, 1485, 2194t
- Doxazosin, 184, 922, 922t
- Doxepin, 2050t
- Doxorubicin (Adriamycin)
- cardiac effects of, 1248
  - toxicity affecting anesthetic management, 1490t
- Doxycycline
- for osteoarthritis, 2024
- Dräger AV-E anesthesia ventilator, 802–804, 803–805f
- Dräger closed-reservoir scavenger interface, 812f
- Dräger D-Vapor desflurane vaporizer, 788f
- Dräger Narkomed
- oxygen ratio monitor controller of, 774–775, 775f
  - testing for leaks in, 815f, 815–816
- Dräger open-reservoir scavenging system, 813f
- Dräger Oxygen Ratio Monitor Controller, 775, 775t
- Dräger Vapor 19.1 vaporizer, 780f
- Drägersorb 800, 797t
- Drägersorb 800 Plus, 797t
- Drägersorb Free, 797t
- Driving gas, 771
- Droperidol, 864–865, 2186t, 2189t
- cerebral blood flow and, 1095
  - chemical structure of, 851f
  - for child, 1532–1533
  - intraocular pressure and, 1562t
  - for postoperative nausea and vomiting, 1692
- Drotrecogin- $\alpha$ , 1745, 2192t
- Drug abuse
- preoperative assessment and management in, 54, 396–422
  - acute postoperative pain and, 1732–1733
  - alcohol and, 403–409
  - amphetamines and, 412–413
  - approach to, 397–398
  - cardiovascular disease and, 400
  - cocaine and, 410–412
  - definitions and neurobiology in, 396–397
  - general principles of perioperative management and, 415–416, 416t
  - hallucinogens and, 413
  - hepatitis and, 401–402
  - history, physical examination, and diagnostic testing in, 398–399
  - human immunodeficiency virus infection and, 402–403
  - infectious complications in, 399t
  - inhalants and, 413–414
  - lung disease and, 400–401
  - marijuana and, 413
  - maternal history and, 301t
  - medical complications in, 404–405t
  - neurologic disease and, 401
  - opioids and, 409–410
  - recovering patient and, 416–419, 417t, 418t
  - sedative-hypnotics and, 409
  - skin and soft tissue infections and, 399–400
  - withdrawal and, 414t, 414–415
- Drug Abuse Warning Network (DAWN), 2051
- Drug administration, child and, 318
- Drug distribution
- child and, 318–319
  - inhalational anesthetics and, 747–748, 748f
  - local anesthetics and, 958t, 958–959, 959f
  - in monitored anesthesia care, 1631–1632, 1632f, 1633f
  - neonatal emergency surgery and, 1503, 1503t
  - in neuraxial anesthesia, 986
- Drug elimination
- of local anesthetics, 959–960
  - in monitored anesthesia care, 1633
  - in neuraxial anesthesia, 986
- Drug interactions
- monitored anesthesia care and, 1635–1637, 1636f, 1637f
  - in total intravenous anesthesia, 903, 909–910
- Drug metabolism
- hepatic, 222f, 222–223, 1339
  - effect of burn injury on, 1678
  - gender differences in, 1491
  - inhaled anesthetics and, 760
  - intravenous anesthetics and, 855, 855t
  - local anesthetics and, 959–960
  - of propofol, 858
  - protein-energy malnutrition and, 272
- Drug misuse surveillance system, 2147
- Drug rehabilitation, 2139
- Drug synergism, 831–835, 832–835f
- Drug testing, 2141
- Drug therapy
- antimicrobial, 279–299
  - in acute pancreatitis, 292–293
  - in bacteremia, 291–292
  - bacterial resistance and, 282–283
  - in catheter-related infections, 287–288
  - in *Clostridium difficile* infection, 292
  - combination, 283–284
  - epidemiologic considerations in, 284t, 284–285
  - formulary for, 2195t
  - in fungal infection, 294–296
  - host factors in, 285, 285t
  - in human immunodeficiency virus infection, 293–294, 294t
  - identification of pathogen and, 284
  - minimum inhibitory concentration and, 279–280
  - in nosocomial infections, 286f, 286t, 286–287
  - perioperative cardiac complications and, 116
  - pharmacokinetics and pharmacodynamics in, 280–282, 281t
  - in pneumonia, 290t, 290–291, 291t
  - prophylactic, 288–290
  - in urinary tract infection, 292
  - for burn patient, 1678–1679
  - for cardiac dysrhythmias, 936–947, 937b, 937f
  - adenosine in, 946t, 946–947
  - class IA agents in, 936–939, 938t
  - class IB agents in, 939–941, 940t
  - class IC agents in, 941–943, 942t
  - class III agents in, 943–946, 944t
  - formulary of, 2190t
  - in cardiopulmonary resuscitation, 1882–1886, 1885b, 1886b, 1886f
  - for chronic pain, 2046–2064
  - antidepressants in, 2047–2050, 2050t
  - antiepileptic drugs in, 2054–2059, 2055f, 2055–2057t, 2059t
  - combination therapy in, 2060
  - intravenous analgesics in, 2060
  - nonsteroidal antiinflammatory drugs in, 2061–2064, 2062f, 2063f, 2064t
  - opioids in, 2050–2054, 2053t
  - skeletal muscle relaxants in, 2060–2061
  - topical agents in, 2059–2060
  - for hemodynamic complications in critically ill patient, 1806–1807
  - for hypertension, 919–925
  - angiotensin II receptor blockers in, 925, 925t
  - angiotensin-converting enzyme inhibitors in, 924t, 924–925, 925f
  - centrally acting  $\alpha_2$ -agonists in, 921t, 921–922
  - cerebral blood flow and, 1099–1100
  - diuretics in, 919–921, 920t
  - formulary of, 2190t
  - peripherally acting sympatholytic agents in, 922t, 922–923
  - for preeclampsia, 1488
  - preoperative assessment and management of, 58
  - vasodilators in, 923t, 923–924
  - for obesity, 382–383
  - preoperative assessment and management of, 52t, 58–59
  - renal disease and, 211
- Drug-Free Schools and Communities Act Amendments, 2139
- Drug-Free Work Place Act of 1988, 2139, 2139t
- Drug-induced disorders
- acute tubular necrosis in, 1837
  - hypercoagulable state in, 254
  - liver disease in, 230
  - neuropathies in, 147t
  - thrombocytopenia in, 1759, 1799t
- tubulointerstitial nephritis in, 207
- Drug-induced neuropathies, 2030t
- Drug(s)
- assessment of therapeutic levels before pediatric surgery, 336
  - effects on intraocular pressure, 1562t
  - hepatic metabolism of, 222f, 222–223
  - plasma protein-bound, 272t
  - selection for epidural injection of, 2078–2079
  - teratogenic, 1473–1474, 1474b
- Drug-target complex, 721–722, 722f
- Duchenne muscle dystrophy, 1971
- Duchenne muscular dystrophy, 163, 163t
- Ductus arteriosus, 1193–1194
- Duloxetine
- for chronic pain, 2049–2050, 2050f
  - for diabetic peripheral neuropathic pain, 2028
- Duodenal carcinoma, 1322–1324
- Duodenal obstruction, neonatal, 1513
- Dura mater, 978, 980f
- Durant maneuver, 1497
- Duration of action of local anesthetics, 962, 962f
- Duration of anesthesia, 442t
- Duty, negligence and, 2127
- Dwarfism, 169
- Dye laser, 1594, 1594f, 1596t
- Dynorphin
- opioid-induced hyperalgesia and, 2052
- Dynorphins, 2007
- Dyrenium (triamterene), 919–920, 920t
- Dysesthesia
- in neuropathic pain, 2025b
- Dysfibrinogenemia, 253–254
- Dysfunctional pain, 2008f, 2009f, 2010, 2017
- definition of, 2011t
- Dyshemoglobinemia, 583
- Dyskinesia, 558
- Dyskinetic cerebral palsy, 1542
- Dyslipidemia
- atherosclerosis and, 1285
  - diabetic patient and, 188
- Dysphagia
- in esophageal disease, 1247
  - postoperative, 1712
- Dysphoria, opioid analgesic-induced, 875
- Dyspnea
- in carbon monoxide poisoning, 1774
  - in foreign body aspiration, 1268
  - in lung cancer, 1218
  - in myocardial ischemia, 1147
  - during neuraxial anesthesia, 994
  - during pregnancy, 359
  - in pulmonary embolism, 1704
- Dysprothrombinemia, 254
- Dysrhythmias
- alcohol abuse and, 406
  - antidysrhythmic agents for, 936–947, 937b, 937f
  - adenosine in, 946t, 946–947
  - class IA agents in, 936–939, 938t
  - class IB agents in, 939–941, 940t
  - class IC agents in, 941–943, 942t
  - class III agents in, 943–946, 944t
  - beta-adrenergic blockers for, 929
  - bronchoscopy-related, 1242
  - burn patient and, 1680
  - complication of pulmonary artery catheter, 530
  - in congenital heart disease, 1188
  - digitalis for, 926
  - in electrical injury, 1780
  - extracorporeal shock wave lithotripsy and, 1460
  - hypercalcemia and, 178
  - in hypomagnesemia, 654
  - inhaled anesthetics and, 757
  - during intrahospital patient transport, 1814
  - local anesthetic-related, 967
  - in multiple organ dysfunction syndrome, 1758
  - obesity and, 379
  - oculocardiac reflex and, 1561
  - perioperative cardiac complications and, 104
  - in postanesthesia care unit, 1693–1694
  - postoperative, 1706–1707
  - in postoperative ICU patient, 1834
  - preoperative assessment and management in, 49
  - risk for perioperative shock in, 1929
  - in subarachnoid hemorrhage, 1115–1116, 1116f
  - subclinical hyperthyroidism and, 175
  - thoracic surgery-related, 1272



- Dystrophin, 1971  
Dystrophinopathies, 159t
- E**
- E wave in pulsed-wave Doppler, 561  
Eagle syndrome, 2031
- Ear**
- assessment in burn injury, 1778
  - auditory neural pathways of, 611f
  - malformations of, 1584
  - postoperative hearing loss and, 1712–1713
- Ear, nose, and throat surgery, 1582–1607**
- ear procedures in, 1582–1584
  - facial nerve concerns in, 1602
  - head and neck cancers and, 1604–1605
  - nasal procedures in, 1584–1586
  - parathyroid procedures in, 1603–1604
  - parotid procedures in, 1602
  - throat procedures in, 1586–1602
    - in abnormal airway disorders, 1586
    - in adenotonsillar hypertrophy, 1587
    - adenotonsillectomy in, 1588f, 1588–1590
    - in benign and malignant tumors, 1590–1591
    - in cleft lip and palate, 1597
    - dental surgery in, 1601–1602
    - in foreign body aspiration, 1591
    - in iatrogenic airway disorders, 1591–1592
    - in infections, 1586–1587
    - in malacias, 1597–1598, 1598f
    - maxillofacial reconstruction in, 1600, 1600f
    - in obstructive sleep apnea syndrome, 1588
    - orthognathic surgery in, 1600–1601
    - in pharyngeal abscess, 1590
    - plastic surgery and, 1602
    - in subglottic stenosis, 1598–1599, 1599f
    - tracheal reconstruction or resection in, 1599
    - tracheotomy and tracheostomy in, 1599–1600
    - in vocal cord disorders, 1592f, 1592–1597
    - thyroid surgery in, 1602–1603
- Ear canal disorders, 1582–1583**
- Early goal-directed therapy, 544–545**
- blood transfusion in shock and, 1843
  - critically ill patient and, 1805–1806, 1806f
- Early wave in pulsed-wave Doppler, 561**
- Eaton-Lambert syndrome, 162–163, 163t**
- Echinacea, 73t**
- Echinocandins, 296**
- Echocardiography**
- in alcohol or drug addicted patient, 400
  - in critically ill patient, 1804
  - in evaluation of ventricular function, 539
  - transesophageal, 552–578
    - aorta and, 571–574, 573f, 574f
    - in aortic insufficiency, 570
    - in aortic stenosis, 570–571, 571f, 572f
    - aortic valve and, 569f, 569–570, 570f
    - basic principles of, 552–553
    - in cardiac tumors, 558
    - diastolic function and, 560–563, 561–564f, 565t
    - indications for, 552, 553f, 554t
    - interatrial septum and, 556–558, 557f
    - left atrium and, 554–555, 556f
    - left ventricle and, 558–563
    - limitations and contraindications for, 552–553, 555t
    - in mitral regurgitation, 565–568, 566f, 567f
    - in mitral stenosis, 568f, 568–569
    - mitral valve and, 563–565, 565f, 566f
    - pericardium and, 576f, 576–577
    - pulmonary artery and, 576
    - pulmonic valve and, 576, 576f
    - right atrium and, 555–556, 557f
    - right ventricle and, 574–575
    - systolic function and, 558–560, 558–560f
    - terminology in, 552, 555t
    - tricuspid valve and, 575f, 575–576
  - transthoracic
    - in hepatic resection, 1347
    - in liver transplantation, 1354, 1355
    - before vascular surgery, 1291
    - in valve surgery, 1154, 1154f
- Echothiophate iodide, 1563**
- Eclampsia, 362**
- Economic relationships and contracts, 2128–2129**
- Economics**
- of anesthesia practice, 2155–2171
    - allocating operating room time and, 2160–2165
    - elective, urgent, and emergent cases and, 2155–2157
    - individual productivity and, 2166–2169, 2167t, 2168t
    - managerial cost accounting and, 2157–2158
    - operating room efficiency on day of surgery and, 2158
    - reduction of surgical and turnover times and, 2165–2166
    - scheduling and assignment and, 2155
    - tactical *versus* operational decisions to increase productivity and, 2158–2160
    - costs of drug misuse, 2135
    - of preoperative evaluation, 62–63
- ECRI, 490**
- Ecstasy, 412–413**
- Ectopic pregnancy, 1487t, 1495**
- Ectopy, postoperative, 1707**
- Ectropion repair, 1579**
- Edocrin (ethacrynic acid), 919, 920t**
- Edema, 204f, 204–206**
- in burn patient, 1772–1773
  - cerebral, 1102, 1107–1108, 1108f
  - laryngeal
    - after extubation, 711
    - neck dissection and, 1605
    - postoperative, 1701
  - in malignant hyperthermia, 1968
  - pulmonary
    - in burn injury, 1773
    - cocaine-induced, 411
    - hemodynamic monitoring for, 538, 538b
    - hyperosmolar agents and, 1103t
    - opioid overdose and, 410
    - postoperative, 1704
    - pregnant patient and, 1489b
    - during pulmonary artery dilation, 1196
    - in subarachnoid hemorrhage, 1118–1119
    - thoracic surgery-related, 1273
    - tracheal extubation and, 711
    - sitting position infratentorial craniectomy and, 1110
- Edrophonium, 635, 635f, 2187t**
- Education in anesthesiology, 15–16**
- Effect site compartment targeting, 825–826, 826f**
- in monitored anesthesia care, 1632–1633, 1633t
  - in total intravenous anesthesia, 900f, 902–903
- Ehlers-Danlos syndrome, 303t**
- Eicosanoids, 924, 1723f**
- Eisenmenger syndrome, 1180**
- Ejection fraction**
- perioperative cardiac complications and, 107
  - transesophageal echocardiography and, 558–559, 560f
- Elastic recoil of lung, 312**
- Elbow**
- median nerve block at, 1035, 1035f
  - musculocutaneous nerve block at, 1036
  - painful conditions of, 2023t
  - radial nerve block at, 1035, 1036f
  - surgery of
    - axillary block for, 1032–1034, 1033f
    - supraclavicular block for, 1031f, 1031–1032, 1032f
  - ulnar nerve block at, 1035
- Elderly patient, 341–357**
- abdominal surgery and, 352
  - burn injury in, 1779–1780
  - cancer and, 350
  - cardiac surgery and, 350–351
  - cardiovascular disease and, 347–349, 348f
  - concepts and theories of aging, 341–342, 342f
  - critically ill, 1800
  - elective surgery and, 76–77
  - endocrine disease and, 350
  - eye surgery and, 352, 1563–1564, 1564t
  - gastrointestinal disease and, 349
  - genitourinary treatment and, 352
  - hearing impairment and, 350
  - immune enhanced diet for, 275t
  - kidney of, 199
  - musculoskeletal disease and, 349–350
  - neurologic and mental status disease and, 350
  - ophthalmologic disease and, 350
  - organ system senescence and, 342–346, 342–346f
  - orthopedic procedures and, 351f, 351–352
  - pharmacology and, 346–347, 347f
  - postoperative pain and, 1732
  - preoperative assessment and management of, 55
  - pulmonary disease and, 349
  - remifentanyl and, 838
  - renal disease and, 349
  - surgical risk and, 352–353
  - thoracic procedures and, 351
  - trauma and, 1665
  - vascular surgery and, 351
- Elective case, 2155**
- Elective surgery, 68–88**
- immune enhanced diet before, 275t
  - medical history and, 68–73, 69t, 70t, 71f, 72t, 73t
  - monitoring in, 82t, 82–85, 83t
  - pediatric, 1533–1534
  - physical examination in, 73–77, 74–76t
  - postoperative destination and, 81
  - postoperative pain and, 81–82
  - premedication in, 80–81
  - preoperative instructions in, 80
  - preoperative testing and, 77, 78t
  - type of anesthesia for, 77–80, 80t
- Electric shock, 486**
- Electrical cardioversion, 1654**
- Electrical injury, 1780, 1780t, 1786**
- Electrical interference, 482**
- Electrical safety, 476–495**
- American National Standards Institute and, 490
  - Association for Advancement of Medical Instrumentation and, 490
  - ASTM International and, 490
  - electricity and, 476–487
    - alternating current and, 477f, 477–478, 478f
    - circuits and, 478, 478f, 479f
    - direct current and, 476–477, 477f
    - ground fault circuit interrupters and, 480–481
    - hazards of electrical distribution systems and equipment and, 485–487
    - interference and, 482
    - isolated power and, 480, 480f, 481f
    - isolation amplifiers and, 481–482
    - leakage current and, 479–480
    - patient hazards and, 482–484f, 482–485
    - semiconductors and, 478–479, 479f
  - Emergency Care Research Institute and, 490
  - Food and Drug Administration and, 489
  - international standards in, 490
  - Joint Commission on Accreditation of Health Care Organizations and, 488–489
  - National Fire Protection Association and, 487–488, 488t
  - Nationally Recognized Testing Laboratories and, 489–490
  - safe use of equipment and, 491–493
  - technology management and, 493, 493f, 494b
  - Underwriters Laboratories and, 489–490
- Electricity, 476–487**
- alternating current and, 477f, 477–478, 478f
  - circuits and, 478, 478f, 479f
  - direct current and, 476–477, 477f
  - ground fault circuit interrupters and, 480–481
  - hazards of electrical distribution systems and equipment and, 485–487
  - interference and, 482
  - isolated power and, 480, 480f, 481f
  - isolation amplifiers and, 481–482
  - leakage current and, 479–480
  - patient hazards and, 482–484f, 482–485
  - semiconductors and, 478–479, 479f
- Electrocardiography**
- in coronary artery bypass graft, 1147, 1148f
  - for detection of venous air embolism, 1112, 1112f
  - in elective surgery, 84
  - in electrical injury, 1780
  - in lower-extremity vascular surgery, 1298
  - monitored anesthesia care and, 1629–1630
  - during pediatric surgery, 1522
  - perioperative cardiac complications and, 107
  - in postanesthesia care unit, 1694
  - postoperative complications and, 1707
  - potassium disturbances and, 651, 651f
  - preoperative, 46–47
    - in elective surgery, 78t
    - in gynecologic surgery, 1492
    - neuromuscular disease and, 158
    - in renal transplantation, 1400
    - in thoracic surgery, 1216
    - in vascular disease, 1287
    - in vascular surgery, 1290–1292
  - protein-energy malnutrition-related changes in, 269–270
  - in subarachnoid hemorrhage, 1115–1116, 1116f
  - during transport of critically ill patient, 1801

- Electrocautery for airway obstruction, 1653
- Electroconvulsive therapy, 150–151, 151t, 1651–1652
- Electroencephalography
- in carotid endarterectomy, 1294
  - dose-dependent changes in
    - ketamine and, 863, 863f
    - thiopental and, 852f, 852–853
  - in headache evaluation, 2036
  - intraoperative, 598–607
    - bispectral array and, 605–606, 606f, 607f
    - burst suppression and, 603
    - cerebral ischemia and, 602f, 602–603
    - entropy monitor and, 606–607, 608f
    - inhalational anesthetic depth and, 753, 753f
    - for intraoperative awareness, 755
    - intravenous and inhalational anesthetic effect on, 604–605t, 756
    - neural basis of, 598–601, 599t, 599–601f
    - in subarachnoid hemorrhage, 1117
  - in valve surgery, 1155
- Electrolytes
- acid-base chemistry and, 659–667
    - acids, bases, and water in, 659–660, 660t
    - acute metabolic acidosis and, 661f, 661–663, 662f
    - acute metabolic alkalosis, 663
    - acute respiratory acidosis and alkalosis and, 661
    - analytic tools used in, 663–665, 664t, 664–666f, 665t
    - carbon dioxide and, 661
    - classification of acid-base abnormalities and, 661t
    - monitoring blood gases and, 666–667
    - regulation of acid-base balance and, 663
    - strong ions and, 660, 660t
    - treatment of acid-base disturbances and, 666
    - weak ions and, 660
  - calcium disorders and, 202–203, 203t
  - complications associated with renal failure, 1399t
  - diuretics and, 204f, 204–206
  - formulary of, 2196t
  - magnesium disorders and, 203
  - malignant hyperthermia and, 1981
  - management in liver transplantation, 1364–1365
  - multiple organ dysfunction syndrome and, 1759–1760, 1768
  - phosphorus disorders and, 203–204
  - potassium disorders and, 201–202, 202f, 202t
  - preoperative tests in elective surgery, 78t
  - renal failure therapy and, 210–211
  - sodium disorders and, 199t, 199–200
  - transfusion toxicity and, 1907–1908
- Electromagnetic interference, 482, 486
- Electromotive force, 476
- Electromyography, 623, 623f
- for determination of nerve injury in peripheral nerve block, 1061
  - in intraoperative neurologic monitoring, 614–615
- Electronic fetal monitoring, 360–361, 361t
- Electronic flow sensor, 773–774
- Electrophysiologic studies, 1833
- Elimination
- of inhalational anesthetics, 750
  - of local anesthetics, 959–960
  - in neuraxial anesthesia, 986
  - newborn emergency surgery and, 1503–1504
  - of propofol, 858
- Elimination half-life of neuromuscular blocking drugs, 623
- Ellis-van Creveld syndrome, 303t, 332t
- Eltanolone, 1095
- Embolic ischemic stroke, 1925
- Embolism
- air
    - during craniostomy repair, 1537
    - effect of nitrous oxide on, 748–749, 749f
    - hepatic resection and, 1349–1350, 1350f
    - intracardiac shunting and, 1178
    - pediatric heart surgery and, 1196
    - physiology of, 1110–1112, 1111f, 1112f
    - pulmonary embolism and, 1114
    - sitting position infratentorial craniectomy and, 1108–1109
    - Trendelenburg position and, 1496–1497
    - in alcohol or drug addicted patient, 400
    - atherosclerotic plaques and, 1287
  - fat
    - in long bone and pelvic fractures, 1671
    - orthopedic surgery and, 1551t, 1551–1552
  - pulmonary
    - air embolism and, 1114
    - capnography in, 587, 587f
    - postoperative, 1704–1705
    - preoperative assessment and management of, 54–55
  - thromboembolism
    - complication of pulmonary artery catheter, 530
    - preoperative assessment and management in, 54–55
    - trauma patient and, 1665
- Embolization of arteriovenous malformation, 1655
- Embryo transfer, 1477
- Emergence delirium, 1695
- child and, 1533
- Emergence from anesthesia
- obese patient and, 390–391, 391f
  - in sitting position infratentorial craniectomy, 1113–1114
  - in subarachnoid hemorrhage surgery, 1118
- Emergency Care Research Institute, 490
- Emergency medical technician, 1788
- Emergency Medical Treatment and Active Labor Law, 1818
- Emergency surgery, 1660–1673
- abdominal compartment syndrome and, 1672
  - in airway trauma, 1671
  - damage control surgery in, 1668–1669
  - in head trauma, 1669
  - legal issues in, 2130
  - in long bone and pelvic fractures, 1671–1672
  - neonatal, 1502–1519
    - airway management in, 1509f, 1509–1510, 1510f
    - anesthetic pharmacology and, 1502–1504, 1503t
    - in congenital diaphragmatic hernia, 1510–1512
    - in esophageal atresia and tracheoesophageal fistula, 1513–1515, 1514f
    - fentanyl in, 1504–1505
    - fluid management in, 1508–1509
    - inhalational agents in, 1504, 1504t
    - in intestinal obstruction and necrotizing enterocolitis, 1512–1513
    - ketamine, general anesthetics, sedatives and, 1506
    - local anesthetics in, 1506
    - in meningomyelocele, 1515, 1515f
    - monitoring in, 1506–1508, 1507f
    - muscle relaxants in, 1505–1506
    - in omphalocele and gastroschisis, 1512, 1513f
    - in patent ductus arteriosus, 1515–1516
    - perioperative complications and death, 442t
    - in spinal cord trauma, 1669–1671, 1670b, 1670f
    - thoracic, 1267b, 1267–1270, 1268t, 1269f, 1270t
    - traumatic shock and, 1661–1668, 1662f, 1663b, 1663f
    - anesthetic choices in, 1666–1668, 1667t
    - blood glucose control in, 1665
    - delayed fluid resuscitation in, 1664
    - monitoring in, 1665t, 1665–1666, 1666b
    - patient taking anticoagulants and, 1665
    - regional anesthesia and, 1668, 1668t
    - small volume resuscitation in, 1664
    - treatment of, 1663–1664
- Emergency team, 1788–1789, 1789f
- Emergent case, 2155
- Emery-Dreifuss X-linked muscular dystrophy, 164
- EMLA cream, 2188t
- Emphysema, 137–138
- geriatric patient and, 349
  - marijuana-related, 413
  - opioid abuse and, 409
- En bloc combined liver and intestine transplant, 1412, 1413f
- Enalapril, 924t
- for low cardiac output in shock, 1847
  - for postoperative hypertension, 1695
- Enalaprilat, 924t, 2190t
- Enantioselectivity, anesthetic target and, 720, 720f
- Encaimide (Enkaid), 942t, 942–943
- Encephalopathy
- after cardiopulmonary bypass, 1915
  - hepatic, 1344, 1345b
  - in acute liver failure, 231
  - Child-Pugh scoring system and, 224t
  - in chronic liver disease, 233
  - in fulminant hepatic failure, 1340
  - in liver disease, 234–235
  - in Reye syndrome, 225
- hyperosmolar agents and, 1103t
- Wernicke, 407
- End-expiratory lung volume of child, 313
- Endobronchial intubation, 1232
- in pulmonary artery rupture, 531
- Endocarditis
- in alcohol or drug addicted patient, 400
  - mitral valve, 567, 567f
  - prophylactic therapy for, 289–290, 333b, 333t
  - pulmonary artery catheter-related, 531
  - valve repair in, 1157
- Endocrine disease, 173–193
- adrenal disorders in, 179–181, 180t, 181t
  - critically ill patient and, 1798
  - diabetes mellitus in, 185–190
    - complications of, 187–190
    - definition and classification of, 185–186
    - kidney failure in, 208
    - medications for, 186–187
    - metabolic syndrome and, 190
    - perioperative changes in glucose metabolism and, 187
    - preoperative assessment and management in, 51, 190
  - geriatric patient and, 350
  - parathyroid disorders in, 177–179, 178t, 179t
  - pheochromocytoma in, 181–184, 182t, 183f, 183t
  - pituitary disorders in, 184–185, 185t
  - preoperative assessment and management in, 42t
  - thyroid disorders in, 173–177
    - congenital hypothyroidism in, 303t
    - hyperthyroidism in, 174–175, 175t
    - hypothyroidism in, 176t, 176–177
    - myxedema coma and, 177
    - physiology of, 173–174
    - pregnant patient and, 368–369
    - thyroid function tests in, 174, 174t
    - thyroid storm and, 175–176
- Endocrine system
- changes during pregnancy, 359–360
  - complications of
    - associated with renal failure, 1399t
    - in postoperative ICU patient, 1837–1838
    - in trauma, 1661, 1662t
  - etomidate and, 860
  - gastrointestinal, 1319
  - of geriatric patient, 345–346
  - inhalational anesthetics and, 759
  - multiple organ dysfunction syndrome and, 1757t, 1759–1760, 1763, 1767–1768
  - of obese patient, 381–382
  - opioid analgesics and, 879
  - response to trauma, 1661, 1662t
  - rheumatoid arthritis and, 1542t
- End-of-life care, 2131
- Endogenous opioids, 873–874
- Endoleak, 1308
- Endomorphins, 874
- Endoscopy
- anesthesia during, 1652–1653
  - gastrointestinal, 1317b, 1317–1319
  - for ingested foreign body, 1269–1270
  - in sinus disorders, 1585
- Endothelial dysfunction
- tests of, 108
  - thrombosis and, 96–97, 97f, 98f
- Endothelium
- multiple organ dysfunction syndrome pathogenesis and, 1757–1758
  - pathophysiology of critical illness and, 1745–1746, 1746f
- Endotoxin, (LPS), 1744, 1747–1748, 1749, 1757
- Endotracheal intubation, 699–714
- blind nasal intubation and, 708–709
  - in burn patient, 1676f, 1676–1677
  - complications of, 714, 714b
  - confirmation of, 710, 710f, 711f
  - cricothyrotomy and tracheostomy and, 710
  - difficult airway and, 711–713, 712f
  - in ear surgery, 1582
  - endotracheal tubes for, 699–700, 700f, 700t
  - extubation in, 711–714, 713b, 713f
  - fiberoptic, 704b, 704–705, 704–708f
  - in gynecologic surgery, 1492

- Endotracheal intubation—*continued*  
 introducers for, 701  
 laryngoscopes for, 700, 701f  
 light wand and, 707–708  
 in lung transplantation, 1387  
 maintenance of, 710–711  
 in neonatal emergency surgery  
   in esophageal atresia and tracheoesophageal fistula, 1514  
   in meningomyelocele, 1515, 1515f  
   neuromuscular blockade for, 624–625  
   in pediatric surgery, 1525, 1526–1527, 1527t  
   percutaneous transtracheal jet ventilation and, 710  
 preparation for, 699b  
 retrograde, 708, 709f  
 in rhytidoplasty, 1602  
 rigid laryngoscopy in, 701–704, 702f, 703f  
 in spinal cord trauma, 1670f, 1670t, 1670–1671  
 stylets for, 700–701  
 through laryngeal mask airway, 705–707, 709f
- Endotracheal tube, 699–700, 700f, 700t  
 design of, 1228f, 1228–1229  
 drug therapy for cardiopulmonary resuscitation and, 1886, 1886b  
 laser surgery-related fire in, 1595–1596, 1596f  
 nerve integrity monitor, 1603  
 placement of, 1229–1230, 1230–1232f  
 selection of, 1229t
- Endourologic surgery, 1450–1470  
 in bladder cancer, 1462–1464, 1463f  
 cystoscopy in, 1455–1457, 1456f  
 elective, 79  
 extracorporeal shock wave lithotripsy in, 1459–1461  
 geriatric patient and, 352  
 macroscopic anatomy in, 1450–1453, 1451–1453f  
 minimally invasive, 1466f, 1466–1467  
 paravertebral nerve block in, 1021  
 patient positioning in, 1453f, 1453–1455, 1455f  
 in prostate cancer, 1461–1462  
 in renal cancer, 1465–1466  
 in testicular cancer, 1464–1465  
 transurethral resection of bladder tumor in, 1455–1457, 1456f  
 transurethral resection of prostate in, 1457t, 1457–1459, 1458t
- Endovascular aneurysm repair, 1307–1308
- End-stage renal disease  
 intensive care unit and, 1837  
 kidney transplantation in, 209–210, 1396–1403  
 allograft perfusion in, 1402  
 anesthetic management in, 1400–1401  
 immunosuppression in, 1401–1402  
 indications and contraindications for, 1397  
 organ matching, availability, and allocation in, 1396–1397  
 pediatric considerations in, 1402–1403  
 postoperative complications in, 1402  
 pretransplant evaluation in, 1398–1400, 1399t  
 surgical procedure in, 1398, 1398f  
 obesity and, 382
- End-systolic elastance, 559
- End-tidal carbon dioxide  
 in malignant hyperthermia, 1967, 1967b
- End-tidal carbon dioxide partial pressure  
 aneurysm surgery and, 1305, 1305f  
 capnometry and, 692–693, 693b  
 cardiopulmonary resuscitation and, 1878, 1879, 1879t  
 laparoscopic surgery and, 1318  
 time-based capnography and, 585–587, 586f, 587t
- Enflurane, 2186t  
 advantages and disadvantages of, 761t  
 biophysical properties of, 744t  
 cerebral blood flow and, 1096–1098  
 chemical and physical properties of, 741, 741f, 741t  
 fluoride release from metabolism of, 761  
 gas flow splitting ratios of, 781t  
 glucose tolerance impairment and, 759  
 incorrect refilling of vaporizer and, 781–782, 782t  
 intraocular pressure and, 1562t  
 minimum alveolar concentration of, 776t  
 output of erroneously filled vaporizer and, 781t  
 physical properties of, 777t  
 somatosensory-evoked potentials and, 605t  
 vapor pressure curve for, 776f
- Enhanced phasic inhibition, tonic inhibition, and depressed excitation theory, 600
- Enkaide (encainide), 942f, 942–943
- Enkephalins, 2007
- Enolic acids, 2064t
- Enoxaparin (Lovenox), 254–255, 2192t  
 epidural analgesia and, 1730t  
 for obese patient, 387
- Enoximone, 1847
- Ensemble modulation in drug-effect coupling, 723, 724f
- Enteral nutrition  
 burn patient and, 1680  
 immune-enhanced, 274–275, 275t  
 postoperative ICU patient and, 1835
- Enterococcus*  
 in catheter-related infection, 287  
 in nosocomial infection, 286t
- Entropion repair, 1579
- Entropy monitor, 606–607, 608f
- Environmental exposure, 1661t
- Environmental factors in anesthesia errors, 26
- Ephaptic transmission, 2032
- Ephedra, 73t
- Ephedrine, 2190t  
 for allograft perfusion in renal transplantation, 1402  
 for premedication in previous radiocontrast media reaction, 1955b
- Epidermolysis bullosa, 303t
- Epididymis, 1452
- Epidural abscess, 1729  
 neuraxial anesthesia-related, 1065–1066, 1481–1482t
- Epidural analgesia, 2077–2082, 2080f  
 burn patient and, 1679  
 in cerebral palsy, 1543  
 for child, 1531, 1531t  
 in critically ill patient, 1805  
 in Guillain-Barré syndrome, 161  
 in lung transplantation, 1386  
 in newborn, 1516  
 in obstetric surgery, 1472, 1472t  
 in external cephalic version, 1477–1478  
 in labor and vaginal delivery, 1479  
 preeclampsia and, 1488  
 patient-controlled, 1726  
 for postoperative pain, 1726–1730  
 complications of, 1728–1729, 1730t  
 in critically ill patient, 1733  
 drug choices and drug effects in, 1726f, 1726–1728, 1727f  
 indications and contraindications for, 1726  
 management of side effects of, 1728  
 surgical outcomes and, 1729–1730  
 in prostatectomy, 1462  
 in renal transplantation, 1401  
 in thoracic surgery, 1274–1275, 1275b
- Epidural anesthesia  
 adverse event in, 1064–1072  
 backache and, 1072  
 direct needle trauma and, 1064–1065  
 failure of anesthesia and, 1069–1070  
 hematoma and, 1065  
 hypotension and, 1070  
 infection and, 1065–1066  
 nausea and pruritus and, 1071  
 postdural puncture headache and, 1067–1069  
 postoperative urinary retention and, 1071–1072  
 respiratory complications and, 1070–1071  
 subdural injection of local anesthetic drug in, 1067  
 systemic and local toxicity and, 1067  
 total spinal anesthesia and, 1066–1067  
 in aneurysm surgery, 1306  
 block height in, 988, 988t  
 bowel motility and, 1316  
 combined spinal-epidural anesthesia and, 1000–1002, 1001f, 1002f  
 in extracorporeal shock wave lithotripsy, 1461  
 formulary of, 2188t  
 in lower-extremity orthopedic surgery, 1544  
 in lower-extremity vascular surgery, 1298  
 neurologic complications of, 1712  
 in obstetric surgery, 1472, 1472t  
   in cesarean delivery, 1484, 1484f  
   preeclampsia and, 1488  
 in outpatient surgery, 1614  
 in prostatectomy, 1462  
 in radical cystectomy, 1464  
 in thoracic surgery, 1238  
 for trauma patient, 1668, 1668t
- Epidural blood patch for postdural puncture headache, 1068–1069
- Epidural fat, 981
- Epidural hematoma, 1729  
 neuraxial anesthesia-related, 1065, 1481–1482t
- Epidural hemorrhage  
 stroke and, 1925
- Epidural needle, 982
- Epidural opioids, 2184–2185t
- Epidural space, 980f, 980–981, 1726f  
 accessing in neuraxial anesthesia, 984–986, 986f, 987f  
 pediatric, 1531t
- Epidural steroids, 2077–2082, 2080f
- Epidural stimulation test, 1056, 1056t, 1067
- Epidural test dose, 999–1000, 1000t
- Epidural veins, 2076
- Epiglottic cartilage, 688
- Epiglottitis, 687, 688f  
 difficult airway and, 128, 128f  
 of newborn, 1509
- Epiglottitis, 1586–1587
- Epilepsy  
 cerebral palsy and, 1542  
 preoperative evaluation of, 148  
 in child, 328  
 maternal history and, 301t
- Epinephrine, 2190t  
 added to local anesthetics, 959, 964, 965f  
 in neuraxial anesthesia, 991t, 992  
 in paravertebral block, 1017  
 in peripheral nerve block, 1026–1027  
 for anaphylactic reaction, 1952–1953, 1955b, 1960  
 for cardiac arrest, 1883–1884  
 for congenital diaphragmatic hernia, 1512  
 ophthalmic, 1563  
 response to traumatic injury, 1662t, 1745  
 for shock, 1844t, 1844–1845
- Episcleral block, 1567–1568, 1574f
- Episcleral space, 1565–1566
- EPITIDE theory, 600
- Eplerenone (Inspra), 919, 920t
- Epoprostenol (prostacyclin), 924, 1342–1343
- Eprosartan, 925t
- Epsilon-aminocaproic acid, 246, 2192t  
 cardiopulmonary bypass and, 1143  
 for clotting during hepatectomy, 1349  
 for factor XI deficiency, 252  
 in liver transplantation, 1367  
 for von Willebrand disease, 251t
- Epstein-Barr virus  
 in tubulointerstitial nephritis, 208
- Epstein-Barr virus infection  
 transfusion-related, 1904–1905
- Eptacog alfa, 2192t
- Eptifibatide (Integrilin), 256, 1730t, 2192t
- Equianalgesic dosing, 1720t, 2052
- Equipment, 767–820  
 anesthesia breathing systems and, 791–797  
 absorbents and, 796–797, 797t, 798f  
 circle system and, 795f, 795–797  
 rebreathing systems and, 792–795, 793f, 794f  
 anesthesia machine gas outlet and outlet check valves and, 790–791  
 anesthesia vaporizer and, 775–790  
 arrangement of, 784  
 calibration and checking of output, 784  
 Dalton law of partial pressures and, 776  
 desflurane and, 784b, 784–788, 785–788f  
 effect of carrier gas on output, 782f, 782–783  
 efficiency and temperature compensation and, 780f, 780–781  
 filling of, 782  
 hyperbaric conditions and, 783f, 783–784  
 hypobaric conditions and, 783, 783f  
 incorrect filling of, 781, 781t  
 latent heat of vaporization and, 777  
 measured-flow, 779, 779f  
 minimum alveolar concentration and, 776, 776t  
 regulation of vaporizer output and, 777t, 777–778, 778f  
 specific heat and, 777  
 vapor, evaporation, and vapor pressure and, 775–776, 776f  
 vaporization of mixed anesthetic liquids and, 781–782, 782t  
 variable by-pass, 779, 781t  
 anesthesia ventilator and, 797–808, 798f, 799f  
 Datex-Ohmeda 7000, 798–800, 799f, 800f  
 Datex-Ohmeda 7810, 800–802, 801f  
 Datex-Ohmeda 7900, 802, 802f, 807



- Datex-Ohmeda ADU and 7900 SmartVent, 807
- Dräger AV-E, 802-804, 803-805f
- Dräger *versus* Datex Ohmeda, 804-805, 805f
- fresh gas decoupling and, 807-808, 808-810f
- positive end-expiratory pressure and, 805f, 806-807
- standing *versus* hanging bellows, 804
- tidal volume and, 805f, 805-806, 806f
- basic anesthesia machine and, 769-775
- gas flow control system in, 772-773, 773f
- nitrous oxide and, 772
- oxygen and, 770-772
- oxygen ratio monitoring and proportioning systems and, 774f, 774-775, 775f
- schematic of, 768f, 768-769, 769f
- virtual flow meter in, 773-774
- for combined spinal-epidural anesthesia, 1001, 1001f
- electrical safety and, 476-495
- alternating current and, 477f, 477-478, 478f
- American National Standards Institute and, 490
- Association for Advancement of Medical Instrumentation and, 490
- ASTM International and, 490
- circuits and, 478, 478f, 479f
- direct current and, 476-477, 477f
- Emergency Care Research Institute and, 490
- Food and Drug Administration and, 489
- ground fault circuit interrupters and, 480-481
- hazards of electrical distribution systems and equipment and, 485-487
- interference and, 482
- international standards in, 490
- isolated power and, 480, 480f, 481f
- isolation amplifiers and, 481-482
- Joint Commission on Accreditation of Health Care Organizations and, 488-489
- leakage current and, 479-480
- National Fire Protection Association and, 487-488, 488t
- Nationally Recognized Testing Laboratories and, 489-490
- patient hazards and, 482-484f, 482-485
- safe use of equipment and, 491-493
- semiconductors and, 478-479, 479f
- technology management and, 493, 493f, 494b
- Underwriters Laboratories and, 489-490
- errors and failures of, 29
- for liver transplantation, 1359, 1359f
- for neuraxial anesthesia, 981-982, 982f
- in nonoperating room procedures, 1650
- for patient transport, 1816, 1816t, 1818
- for pediatric anesthesia, 1522
- prevention of adverse events and, 1055f, 1055-1057, 1056t, 1057f
- testing for leaks in anesthesia machine and, 811-818
- Datex-Ohmeda: outlet check valve present and, 815-817f, 816-817
- Datex-Ohmeda Modulus II and, 817-818
- Dräger Narkomed: no outlet check valve and, 815f, 815-816
- FDA checkout recommendations and, 813b
- in trauma bay, 1789f
- waste gas scavenging systems and, 810-811, 811f, 812f
- Erdmann, Adolph Frederick, 1, 5, 5f
- Erectile dysfunction in diabetic patient, 189
- Ergonovine, 1483, 1483t
- Ergotamine
- for migraine, 2037
- Erosive gastritis, 1323
- Error, defined, 21
- Ertapenem, 2195t
- Erythritol tetranitrate, 928t
- Erythromelalgia, 2017
- Erythromycin, 2195t
- Erythropoiesis, 240, 240f, 243
- Erythropoietin, 315
- Escharotomy, chest wall compliance in burn injury and, 1778
- Escherichia coli*
- in nosocomial infection, 286t
- in urinary tract infection, 292
- Escitalopram, 2050t
- E-sens, 1855, 1856f
- Esidrix (hydrochlorothiazide), 920t
- Esmolol, 930t, 931, 2190t
- cerebral blood flow and, 1100
- before coronary artery bypass graft, 1150
- perioperative use of, 110t, 111t
- Esophageal atresia and tracheoesophageal fistula, 1513-1515, 1514f
- Esophageal Doppler, 536b, 536-537, 537f, 678
- Esophageal manometry, 1320f
- Esophageal pressure, 591-592, 592f
- Esophageal stethoscope, 1506-1507
- Esophageal variceal bleeding, 1328
- in cirrhosis, 1340
- minimally invasive surgery for, 1370
- Esophageal-tracheal airway, 698, 698f
- Esophagectomy, 1249f, 1249-1251, 1250t
- blunt, 1322, 1323f
- Ivor-Lewis/McKeown-type, 1322, 1322f
- Esophagogastrectomy, 1249f, 1249-1251, 1250t
- Esophagogastroduodenoscopy, 1328
- Esophagoscopy, 1247-1248, 1248t, 1591
- Esophagus, 1314-1315, 1319-1322
- atresia and tracheoesophageal fistula of, 1513-1515, 1514f
- cancer of, 1217f, 1248-1251, 1249f, 1250t
- medical and surgical concerns of, 1319-1322, 1320b, 1320f, 1320t, 1321b, 1321f
- surgical procedures of, 1247b, 1247-1251, 1248t, 1249f, 1250t, 1322, 1322f, 1323f
- Esterase-metabolized benzodiazepine, 866, 866f
- Estimated blood volume of child, 315
- Etanercept, 2025
- Ethacrynic acid (Edecrin), 919, 920t, 2191t
- Ethanol abuse, 403-409
- Ethers, 741f
- Ethical issues, 2131-2132
- Ethyl violet, 796
- Ethylene oxide, 491
- Etidocaine (Duranest), 971
- cardiotoxicity of, 968, 968f
- clinical manifestations of potency, 960-961, 961f
- differential sensory/motor block and, 962, 963f
- disposition kinetics of, 958t
- dissociation constant of, 961t
- peak blood concentration in regional anesthesia, 1058f
- Etidronate, 178
- Etodolac (Lodine), 1723t, 2064t
- Etomidate, 859-860, 2186t
- anaphylactic reaction to, 1953t
- cardiovascular effects of, 853t
- in carotid endarterectomy, 1296
- central nervous system effects of, 852t
- cerebral blood flow and, 1094
- cerebral neuroprotection and, 1104
- chemical structure of, 851f
- context-sensitive half-times for, 825f, 1633t
- effect on pathophysiology of congenital heart disease, 1199
- hepatic extraction ratio for, 855t
- induction characteristics of, 856t
- intraocular pressure and, 1562t
- in pediatric surgery, 1525t
- pharmacokinetics of, 855t, 900t
- physicochemical properties of, 852t
- for renal transplantation, 1400
- somatosensory-evoked potentials and, 604t, 610
- in subarachnoid hemorrhage surgery, 1119
- time to peak effect of, 827t
- for total intravenous anesthesia, 901t, 904-905, 913
- for trauma patient, t, 1667
- ventilatory depression and, 853t
- Eustachian tube, patulous, 1584
- Eutectic mixture of local anesthetics (EMLA cream), 1461
- Euvolemic hyponatremia, 199t
- Evans formula, 1775t
- Evaporative heat loss, newborn and, 306
- Event list, 501f
- Evidence-based practice, quality improvement and, 459-460
- Evidentiary standards, 2126
- Evoked potentials, 607-614
- anesthetic effect on, 609-610
- application of, 610-613, 611f, 612t
- auditory evoked responses and, 613
- elicitation of, 608-609, 609f, 610f
- motor evoked potentials and, 613-614, 614f, 615f
- in subarachnoid hemorrhage, 1117
- Ex utero intrapartum treatment, 302-303
- Exaggerated lithotomy position, 468f
- Excessive pulmonary blood flow, 1179-1180, 1180f, 1181f, 1184-1186, 1186b
- Excision of burn wound, 1680
- Excitation-contraction coupling, 1973f
- Exercise
- for chronic pain, 2066
- malignant hyperthermia and, 1969-1970
- tolerance assessment before pediatric surgery, 330
- Exercise electrocardiography, 1291
- Exercise stress thallium imaging, 1354
- Exercise testing, 1219
- Exercise-induced rhabdomyolysis, 169
- EXIT procedure, 302-303
- Exna (benzthiazide), 920t
- Experimental intravenous anesthetics, 865-866, 866t
- Expert testimony, 2127
- Expiratory reserve volume, obese patient and, 375
- Expiratory sensitivity, 1855, 1856f
- Expiratory stridor, 1653-1654
- Extended-release epidural morphine
- in cesarean delivery, 1486
- in fetal and placental surgery, 1478
- in lower-limb joint replacement, 1546, 1546t
- Extensor hallucis longus tendon, ankle blocks and, 1048f
- Extensor pollicis brevis tendon, radial nerve block at wrist and, 1036f
- Extensor pollicis longus tendon, radial nerve block at wrist and, 1036f
- External cephalic version, 1477-1478
- External nasal deformity, 1585-1586
- External spermatic nerve, 1453f
- Extracapsular cataract extraction, 1578
- Extracellular fluid, 640, 640f
- acid-base chemistry and, 659-660, 662f
- blood loss and, 668, 668f
- lactated Ringer solution and, 671, 671f
- of newborn, 1503t
- volume deficit of, 644-645, 645f
- Extracellular osmolality, 643
- Extracorporeal membrane oxygenation
- in congenital diaphragmatic hernia, 1512
- in congenital heart disease, 1201-1202
- Extracorporeal shock wave lithotripsy, 1459-1461
- Extradural space, 980f, 980-981
- Extraglottic airway, 698
- Extrahepatic bile duct cancer, 1324
- Extrajunctional receptors, 621
- Extraocular muscles, 1559, 1560-1561, 1566f
- Extraspinal drug delivery for cancer pain, 2121, 2121f
- Extravasation injury, 668, 669f, 1713, 1713f
- Extravascular fluid, 640, 640f
- Extravascular lung water, 538
- Extremities assessment in burn injury, 1779
- Extremity surgery, 1543f, 1543-1547, 1545f, 1546f
- Extrinsic airway compression, postoperative, 1702
- Extubation
- in aneurysm surgery, 1307
- difficult airway and, 713b, 713f, 713-714
- in hematopoietic stem cell transplantation, 1411
- in hepatic resection, 1349
- during intrahospital patient transport, 1814
- in liver transplantation, 1368
- in ophthalmic surgery, 1576
- over jet stylet, 713
- in pediatric surgery, 1403, 1527-1528
- routine airway and, 711-713, 713b
- in sinus surgery, 1586
- in stapledectomy, 1583
- Eye
- anatomy of, 1558-1560, 1559f, 1560t
- assessment in burn injury, 1778
- of geriatric patient, 350
- intraocular pressure and
- drugs affecting, 1562t
- effects of anesthesia on, 1561-1563, 1562f, 1563t
- oculocardiac reflex and, 1560-1561
- in pediatric patient, 1576
- succinylcholine and, 627
- laser surgery-related injury of, 1595, 1595t
- postoperative complications of, 1712
- surgical positioning-related injury of, 473-474



- Eye surgery, 1558–1581  
 anesthesia and intraocular pressure in, 1561–1563, 1562*f*, 1563*t*  
 for cataracts, 1578  
 corneal, 1578  
 elective, 79  
 general anesthesia in, 1575–1576  
 geriatric patient and, 352  
 for glaucoma, 1578  
 ocular anatomy and, 1558–1560, 1559*f*, 1560*t*  
 oculocardiac reflex and, 1560–1561  
 oculoplastic, 1579  
 open globe, full stomach and, 1579–1580  
 orbital, 1579  
 pediatric, 1576–1577  
 preoperative evaluation in, 1563–1565, 1564*t*  
 regional anesthesia in, 1565–1575  
   commonly used drugs and adjuvants in, 1571–1573  
   complications of, 1073–1074, 1074*t*, 1573–1575, 1576*t*  
   modified van Lindt block in, 1571  
   postoperative, 1571  
   retrobulbar or peribulbar block in, 1568*f*, 1568–1571, 1573–1575*f*  
   sedation for, 1575  
   sub-Tenon block in, 1567–1568, 1574*f*  
   topical, 1566–1567  
   special concerns in, 1559*b*  
   for strabismus, 1577–1578  
   systemic effects of ophthalmic drugs and, 1563  
   vitreoretinal, 1578–1579
- Eyelid, 1560
- F**
- F wave, 615*f*
- Fabry disease, 2028*t*
- Face lift, 1602
- Face mask ventilation, 693–694, 694*b*, 694*f*
- Facet, 2073
- Facet arthropathy, 2034–2035
- Facet joint, 2073–2074
- Facet joint injections, 2088–2093  
   cervical facet medial branch block in, 2091–2092  
   facet medial branch block in, 2090–2091  
   intraarticular, 2089–2090, 2090*f*  
   lumbar facet medial branch block in, 2092*f*, 2092–2093  
   radiofrequency treatment *versus*, 2089  
   thoracic facet medial branch block in, 2092
- Facet medial branch block, 2090–2091
- Facial assessment in trauma patient, 1792
- Facial bipartition, 1600
- Facial nerve  
   concerns in head and neck surgery, 1602  
   eye and, 1560  
   stimulation for neuromuscular blockade monitoring, 622*f*
- Facial nerve decompression, 612*t*
- Facility fee, 2177
- Facioscapulohumeral muscular dystrophy, 164
- Factor concentrates, 1899–1901
- Factor I deficiency, 248*t*
- Factor II deficiency, 248*t*, 254
- Factor IX concentrate, 249
- Factor IX concentrates, 1900
- Factor IX deficiency, 249–250
- Factor V deficiency, 248*t*, 251
- Factor VII deficiency, 248*t*, 251–252
- Factor VIIa, 2192*t*
- Factor VIII, obesity and, 380
- Factor VIII concentrate, 249, 249*t*
- Factor VIII concentrates, 1900, 1901
- Factor VIII deficiency, 247–249, 249*t*
- Factor X deficiency, 248*t*, 252
- Factor XI deficiency, 248*t*, 252
- Factor XII deficiency, 248*t*, 252–253
- Factor XIII deficiency, 248*t*, 253
- Failed back surgery syndrome, 2035
- Failed intubation, 122
- Fail-safe valve, 771
- Failure modes and effects analysis, 456
- Failure to rescue, 443
- Falciform ligament, 1339
- Fallopian tube surgery, 1495
- False vocal cords, 688
- Familial amyloid polyneuropathy, 2027*t*
- Familial dysautonomia, 161, 303*t*
- Familial periodic paralysis, 159*t*, 165*t*, 165–166
- Family  
   involvement in quality improvement, 459  
   of newborn undergoing surgery, 300, 320, 320*b*
- Family consent, 2130–2131
- Famotidine, 1315, 2193*t*
- Farr, William, 432*b*
- Fascia iliaca approach in lumbar plexus block, 1040, 1042*f*
- Fast flush test, 520, 520*f*
- Fasting
- child and, 336–337, 337*t*  
   monitored anesthesia care and, 1628, 1628*t*  
   outpatient surgery and, 1610
- Fastrach intubating laryngeal mask airway, 706–707, 707*f*
- Fast-track weaning, 1833
- Fast-tracking  
   in recovery, 1689–1690  
   in valve surgery, 1156
- Fat  
   distribution of inhaled anesthetics in, 748  
   of newborn, 1503*t*
- Fat embolism syndrome  
   in long bone and pelvic fractures, 1671  
   orthopedic surgery and, 1551*t*, 1551–1552
- Fatigue, anesthesia provider error and, 25–26
- Fatty acid oxidation inhibitors, 936
- Fatty liver disease, 381
- Fatty streak lesion, 1286, 1286*f*
- Fauces, 687
- Febrile nonhemolytic transfusion reaction, 1906
- Feedback in quality of care improvement, 457–458
- Fee-for-service reimbursement, 2159
- Feldene (piroxicam), 1723*t*, 2183*t*
- Felderstruktur muscles, 1559
- Fellowship, 2174
- Felodipine, 932*t*, 935
- Female  
   body weight of, 838*t*  
   growth charts for, 325*f*, 326*f*  
   gynecologic surgery and, 1489–1497  
     anesthetic selection for, 1491–1492  
     intraabdominal, 1495–1497  
     perineal and urologic surgery in, 1492–1493  
     preoperative assessment in, 1489–1490, 1490*f*, 1490*t*  
     sensitivity to anesthetic agents and, 1491, 1491*t*  
     sensitivity to pain and, 1490–1491  
     transabdominal, 1496*b*, 1496–1497  
     transvaginal, 1493–1494  
   innervation of reproductive organs, 1476*f*  
   normal red blood cell values of, 240*t*  
   obstetric surgery and, 1471–1489  
     assisted reproductive technologies and, 1475–1477, 1476*f*  
     block height for, 988*t*  
     cervical cerclage and, 1477  
     cesarean delivery and, 1480–1486, 1483*b*, 1483*t*, 1484*f*  
     combined spinal-epidural anesthesia for, 1000–1001  
     external cephalic version and, 1477–1478  
     high-risk parturient and, 1486–1488, 1487*t*  
     hypertensive disorders of pregnancy and, 1488  
     in utero fetal and placental surgery and, 1478  
     invasive monitoring and, 1488–1489, 1489*b*  
     labor and vaginal delivery and, 1478–1480, 1479*b*, 1481–1482*t*  
     maternal comorbid conditions and, 1474–1475, 1475*b*  
     neuraxial techniques in, 1472*t*, 1472–1473, 1473*f*, 1473*t*  
     teratogenicity of anesthetics and, 1473–1474, 1474*b*
- Female urethra, 1453
- Femoral artery, obturator nerve block and, 1041*f*
- Femoral neck fracture repair, 1547
- Femoral nerve, 1038*f*, 1039*f*, 1041*f*, 2047*t*
- Femoral nerve block, 1041–1042  
   child and, 1531  
   in lower-extremity orthopedic surgery, 1544
- Femoral neuropathy, surgical positioning-related, 473
- Femoral saphenous nerve, 1039*f*
- Femoral vein, obturator nerve block and, 1041*f*
- Femoral vein-femoral artery bypass, 1303
- Femur, sciatic nerve block and, 1044*f*
- Fenamates, 2064*t*
- Fenoldopam mesylate, 924, 2190*t*  
   for postoperative hypertension, 1695  
   for renal failure during liver transplantation, 1366
- for renal preservation in critically ill patient, 1807
- for renal protection in aneurysm surgery, 1304
- Fenopropfen (Nalfon), 1723*t*
- Fentanyl, 883, 884*f*, 2184*t*  
   as analgesic adjunct in neuraxial anesthesia, 991, 991*t*  
   in assisted reproductive technologies, 1475  
   biliary effects of, 1317  
   cerebral blood flow and, 1095  
   context-sensitive half-time for, 824, 825*f*, 1633*t*, 1634*f*  
   in coronary artery bypass graft, 1149  
   dose, peak effect, and duration of, 875*t*  
   dosing strategy for manual infusion regimen, 901*t*  
   effect on pathophysiology of congenital heart disease, 1199  
   effect site concentrations of, 830*f*, 900*f*  
   intraocular pressure and, 1562*t*  
   lipophilicity of, 1720*t*  
   in lower-extremity vascular surgery, 1298  
   in monitored anesthesia care, 1639*t*  
   in myringotomy, 1583  
   in neonatal emergency surgery, 1504–1505  
     in congenital diaphragmatic hernia, 1511  
     in induction of anesthesia, 1510  
     in omphalocele and gastroschisis, 1512  
     in patent ductus arteriosus, 1516  
   for obese patient, 384*t*, 385  
   in obstetric surgery, 1473*t*  
     in assisted reproductive technologies, 1477  
     in cesarean delivery, 1483, 1483*t*, 1486  
     in labor and vaginal delivery, 1479  
   in outpatient surgery, 1620  
   for pain in patient transport, 1818  
   in pancreas transplantation, 1407  
   patient-controlled transdermal system for, 1726  
   in pediatric surgery, 1523*t*, 1532  
   pharmacokinetic mass concept and, 1635, 1635*f*  
   pharmacokinetics of, 881*t*, 900*t*  
   pharmacologic simulations for, 830–831, 832*f*  
   physicochemical properties of, 881*t*  
   for postoperative pain, 1720*t*, 1721  
   propofol concentration and, 910, 910*f*  
   for renal transplantation, 1400, 1401  
   somatosensory-evoked potentials and, 604*t*  
   structural formula of, 873*f*  
   time to peak effect of, 827*t*  
   for total intravenous anesthesia, 901*t*, 907*t*  
   in transurethral resection of prostate, 1459  
   for trauma patient, 1667*t*, 1668
- Fentanyl challenge, 844–846, 844–846*f*
- Fetal alcohol syndrome, 303*t*, 332*t*
- Fetal circulation, 305
- Fetal heart rate, 360
- Fetal monitoring, 360–361, 361*t*, 365
- Fetal movement, 360, 361*t*
- Fetal surgery, 1478
- Fetus, maternal hyperglycemia and, 368
- Fever  
   neuroprotection and, 1931–1934, 1932*f*, 1933*t*  
   postoperative, 1711*f*, 1711–1712  
   in thyroid storm, 175
- Feverfew, 257
- Fiberoptic bronchoscopy  
   in airway injuries, 1671  
   during laser airway ablation, 1252  
   for placement of double-lumen tube, 1229, 1231*f*, 1232*f*  
   in spinal cord trauma, 1670
- Fiberoptic endoscopy, 1585
- Fiberoptic esophagoscopy, 1248
- Fiberoptic intubation, 704*b*, 704–705, 704–708*f*  
   in cervical spine disease, 1120–1121
- Fibrillatory cardiac arrest, 1875
- Fibrillenstruktur muscles, 1559
- Fibrin glue, 1069, 1899
- Fibrinogen  
   afibrinogenemia and, 253  
   obesity and, 380
- Fibrinogen component therapy, 1487
- Fibrinogen deficiency, 1899
- Fibrinolytic activators, 2192*t*
- Fibroatheroma, 1286, 1286*f*
- Fibroids, 1495
- Fibromyalgia, 2017, 2021, 2022*f*  
   rheumatoid arthritis and, 2024  
   tender points in, 2048*f*
- Fick equation, 532, 533*b*

- Fictitious asthma, 1952  
 Field block, 1034, 1238  
 Fight-or-flight response, 1744  
 Filling pressures, 540  
 Financial analysis, 2177  
 Financial issues in anesthesia practice, 2155–2171  
   allocating operating room time and, 2160–2165  
   elective, urgent, and emergent cases and, 2155–2157  
   individual productivity and, 2166–2169, 2167t, 2168t  
   managerial cost accounting and, 2157–2158  
   operating room efficiency on day of surgery and, 2158  
   reduction of surgical and turnover times and, 2165–2166  
   scheduling and assignment and, 2155  
   tactical *versus* operational decisions to increase productivity and, 2158–2160  
 Financial management, 2176–2177  
 Fire hazards  
   of electrical equipment, 485–487  
   in laser surgery, 1595–1597, 1596f, 1597t  
 First responder, 1787–1788  
 First rib, supraclavicular block and, 1031, 1031f  
 First-degree burn, 1777  
 First-order chordae, 565, 566f  
 First-pass clearance  
   antimicrobial agents and, 281  
   of fentanyl, 883  
   of lidocaine, 222  
 Fish allergy, 1959  
 Fish oil, 257  
 Fishmouth technique in neonatal surgery, 1510, 1510f  
 Fistula  
   bronchopleural, 1244  
   esophageal atresia and tracheoesophageal fistula, 1513–1515, 1514f  
   perilymphatic, 1583–1584  
 Fixed costs in anesthesia practice, 2157–2158  
 Fixed-wing transport, 1819t, 1819–1820  
 Flash pulmonary edema, 645  
 Flavin adenine dinucleotide, 1749  
 Flecainide (Tambacor), 942, 942t  
 Flexed position in urologic surgery, 1454–1455, 1455f  
 Flexible esophagoscopy, 1591  
 Flexible fiberoptic bronchoscopy, 1240, 1241t  
 Flexor carpi radialis, median and ulnar nerve block at wrist and, 1036f  
 Flexor carpi ulnaris, median and ulnar nerve block at wrist and, 1036f  
 Flolan (prostacyclin), 924  
 Flow waveform, patient-ventilator synchrony and, 1860–1861, 1861f  
 Flow-based indices in hemodynamic monitoring, 542–543, 543t  
 Flow-metabolism coupling, 1092, 1092f  
 Flow-volume loop, 134–135, 135f  
 Fluconazole, 295  
 Flucytosine, 295  
 Fludrocortisone, 1838  
 Fluid and electrolyte disorders, 199–206, 643–658  
   albumin and, 658t, 658–659, 659t  
   associated with renal failure, 1399t  
   calcium disorders in, 202–203, 203t, 652–654, 653t  
   chloride and, 657t, 657–658  
   diuretics and, 204f, 204–206  
   hypervolemia and, 645  
   hypovolemia and, 644–645, 645f  
   impact of surgical stress on perioperative fluid distribution and, 643–644  
   magnesium disorders in, 203, 654t, 654–655, 655t  
   metabolic acid-base disorders in, 200, 200f  
   in multiple organ dysfunction syndrome, 1759–1760, 1768  
   phosphate disorders in, 203–204, 655–657, 656t, 657t  
   potassium disorders in, 201–202, 202f, 202t, 650–652, 651f, 651t  
   respiratory acid-base disorders in, 200–201  
   sodium disorders in, 199t, 199–200, 645–650  
   hypernatremia and, 649f, 649t, 649–650, 650t  
   hyponatremia and, 646f, 646–648, 647t, 648t  
 Fluid challenge in hypotensive patient, 1843, 1843f  
 Fluid management, 667–670  
   in antenatal and postpartum hemorrhage, 1487–1488  
   in burn injury, 1775t, 1775–1776  
   during burn wound excision, 1680  
   colloids for, 673f, 673–676, 674f, 674t, 676f  
   critically ill patient and, 1806  
   crystalloids for, 669f, 669–673  
   fluid restriction and, 679  
   in free flap reconstruction of neck, 1604  
   hemodynamic monitoring and, 540–542, 541f, 542f  
   in hemorrhage, 1790t  
   intraoperative fluid losses and, 668–669  
   monitoring of, 676–679, 679f, 678f  
   in multiple organ dysfunction syndrome, 1766  
   in neonatal emergency surgery, 1508–1509  
   in neurogenic shock, 1549  
   in pediatric surgery, 1528  
   in postanesthesia care unit, 1696–1697  
   postoperative fluid losses and, 669f, 669–670  
   in postoperative ICU patient, 1834  
   in preclampsia, 1488  
   preoperative deficits and, 667–668, 668f, 669f  
   in shock, 1842–1843, 1843f  
   in small bowel transplantation, 1414  
   in trauma patient, 1664, 1791  
 Fluid overload, 204f, 204–206  
   in TURP syndrome, 1457  
 Fluid restriction, 679  
   in syndrome of inappropriate antidiuretic hormone, 185  
 Fluid retention in acute blood loss, 242–243  
 Fluid warming for liver transplantation, 1361  
 Fluid(s)  
   assessment before renal transplantation, 1400  
   entering bowel daily, 1330t  
   for neuraxial anesthesia-related hypotension, 1070  
   nothing by mouth guidelines for, 58t  
   renal failure therapy and, 210–211  
 Flumazenil, 2186t  
   central nervous system effects of, 1095  
   chemical structure of, 851f  
   in monitored anesthesia care, 1639t  
   for opioid reversal in outpatient surgery, 1620  
 Flunisolide, 2193t  
 Fluorescein, 2193t  
 Fluoride, inhaled anesthetic metabolism and, 760–761  
 Fluoroquinolones, 281  
 Fluoxetine, 2050t  
 Flurbiprofen, 2064t  
 Flurbiprofen (Ansaid), 1723t  
 Flush test, 520, 520f  
 Fluvastatin (Lescol), 947t  
 Flvoxamine, 2050t  
 Foam cell, 1286, 1286f  
 Fondaparinux (Arixtra), 255, 2192t  
   for deep venous thrombosis prophylaxis, 1552–1553  
   for heparin-induced thrombocytopenia, 1759  
 Fontan procedure, 1185t, 1186  
 Food, nothing by mouth guidelines for, 58t  
 Food and Drug Administration  
   checkout recommendations for anesthesia delivery system, 813b  
   electrical safety standards and, 489  
   on target-controlled infusion devices, 1638  
 Foot  
   painful conditions of, 2024t  
   popliteal fossa block for, 1044–1046, 1045f  
 Foramen transversarium, 2081  
 Forced expiratory flow during midexpiratory phase, 376  
 Forced expiratory flow from 25% to 75% of vital capacity, 134–135, 135f, 136f  
 Forced expiratory volume in 1 second, 134–135, 135f, 136f  
   in chronic obstructive pulmonary disease, 139  
   criteria indicating increased postoperative risk, 141b  
   obese patient and, 376  
   thoracic surgery and, 1217  
 Forced expiratory volume in 1 second/forced vital capacity ratio, 134–135, 135f, 139  
 Forced vital capacity, 134–135, 135f, 136f  
   in chronic obstructive pulmonary disease, 139  
   criteria indicating increased postoperative risk, 141b  
   obese patient and, 376  
   supine position and, 466, 466f  
   thoracic surgery and, 1217  
 Forced-air warming in liver transplantation, 1361  
 Forearm surgery  
   axillary block for, 1032–1034, 1033f  
   supraclavicular block for, 1031f, 1031–1032, 1032f  
 Foreign body in airway, 1268–1269, 1269f, 1270t, 1591  
 Foreshortened view in transesophageal echocardiography, 559  
 Formaldehyde, 760  
 Formoterol, 2193t  
 Formulary, 2183–2196t  
   analgesic agents, 2183–2185t  
   anesthetic adjuncts, 2193–2194t  
   anticoagulants, 2192t  
   antiemetics, 2189t  
   cardiovascular drugs, 2190–2191t  
   intravenous antibiotics, 2195t  
   intravenous fluid solutions and electrolytes, 2196t  
   local anesthetics, 2188t  
   muscle relaxants and reversal agents, 2187t  
   sedative, hypnotic, and general anesthetic agents, 2186t  
 Formulations of local anesthetics, 963–965, 964f, 965f  
 Fosinopril, 924t  
 Fospropofol disodium, 865, 866f  
 Fourier analysis, 477  
 Fourth-degree burn, 1777  
 Fraction of inspired oxygen, 579  
 Fractional area change in transesophageal echocardiography, 558–559, 559f  
 Fractional excretion of sodium, 198  
 Fractional partial pressure, 776  
 Fracture  
   fat embolism syndrome and, 1551t, 1551–1552  
   long bone, 1671–1672  
   midface, 1600, 1600f  
   nasal, 1585  
   osteoporotic, 168  
   pelvic, 612t, 1671–1672  
 Fragmin (dalteparin), 254–255, 2192t  
 France needle, 982  
 Frank-Starling law, 314  
 Free electron laser, 1594, 1594f  
 Free flap reconstruction, 1604–1605  
 Free fluid, 640  
 Free gas flow, 745f, 745–746, 746f  
 Free thyroxine index, 174  
 Free water, 662, 662f  
 Free water deficit, 649  
 Freeman-Sheldon syndrome, 331t  
 Frequency, electrical, 477  
 Fresh gas decoupling, 807–808, 808–810f  
 Fresh gas flow, dose response and, 740  
 Fresh-frozen plasma, 1897–1898  
   ABO compatibility of, 1895t  
   for factor V deficiency, 251  
   for factor X deficiency, 252  
   for factor XIII deficiency, 253  
   for liver disease coagulopathy, 233  
   in liver transplantation, 1362  
   in multiple organ dysfunction syndrome, 1767  
   in neonatal emergency surgery, 1509  
   for prothrombin deficiency, 254  
 Frontal nerve, 1573f  
 Frontal sinus, 1569f  
 Frontal sinus obliteration, 1586  
 Frostbite, 1780  
 Frozen red cells, 1894  
 Frozen shoulder, 2023t  
 Fukuyama muscular dystrophy, 164  
 Fulminant episode of malignant hyperthermia, 1966–1968, 1966–1968b, 1969f, 1980b, 1980–1982  
 Fulminant hepatic failure, 231–232, 232t, 1340, 1340b  
   acetaminophen toxicity and, 229  
   liver transplantation in, 1351, 1351b  
   methamphetamine use and, 413  
 Functional endoscopic sinus surgery, 1585–1586  
 Functional extracellular fluid deficit, 645  
 Functional reserve, geriatric patient and, 342–343, 343f  
 Functional residual capacity  
   child *versus* adult, 313, 313f, 313t  
   in chronic obstructive pulmonary disease, 139  
   gastrointestinal surgery and, 1317  
   lateral decubitus position and, 472  
   of newborn, 1504t  
   obese patient and, 375, 376

- Functional residual capacity—*continued*  
 postoperative care and, 142  
 during pregnancy, 359  
 prone position and, 471
- Functional status, perioperative cardiac complications and, 104
- Fungal infection  
 antimicrobial therapy for, 294–296  
 nosocomial, 286*t*  
 preemptive therapy for, 289
- Furosemide (Lasix), 919, 920*t*, 2191*t*  
 for intraoperative cerebral edema, 1107–1108  
 for renal preservation in critically ill patient, 1807  
 for renal protection in aneurysm surgery, 1304  
 in small bowel transplantation, 1414
- Fusarium* spp., 295
- Futility, 2131–2132
- G**
- Gabapentin, 2185*t*  
 for chronic pain, 2056*t*, 2057*t*, 2057–2058, 2059*t*  
 for diabetic peripheral neuropathic pain, 2028  
 for shingles, 2030
- Gallbladder  
 carcinoma of, 1324  
 obesity and disease of, 381
- Gallium nitrate, 179
- Gallstone disease, 1324*b*, 1324–1325
- Gamete intrafallopian transfer, 1477
- Gamma-aminobutyric acid (GABA)  
 anesthetic mechanism of action and, 725–726, 726*f*  
 benzodiazepines and, 861  
 etomidate and, 859  
 flumazenil and, 862  
 ketamine and, 863  
 thiopental and, 850  
 disinhibition and, 2016  
 hepatic encephalopathy and, 1344  
 in nociceptive transmission, 2006
- Gamma-glucuronyl transpeptidase, 219*t*
- Ganciclovir, 2195*t*
- Ganglion impar block, 2120–2121
- Gantt chart, 501*f*
- Garlic  
 platelet aggregation and, 257  
 potential postoperative complications and, 73*t*
- Gas exchange  
 abnormalities of, 139–140  
 newborn preoperative assessment and, 304–305  
 targets in mechanical ventilation, 1862–1863
- Gas flow control system, 772–773, 773*f*
- Gas flow splitting ratios, 781*t*
- Gas laser, 1594, 1594*f*
- Gas outlet valve, 790–791
- Gas transport during cardiopulmonary resuscitation, 1877–1878
- Gastric acid hypersecretion, 1322
- Gastric banding, 1326*f*
- Gastric bypass, 385
- Gastric cancer, 1322–1324
- Gastric contents aspiration  
 during assisted reproductive technologies, 1477  
 during cesarean delivery, 1485  
 child and, 1521  
 critically ill patient and, 1805  
 identification before elective surgery, 72  
 management of acid reflux and, 1315*b*, 1315–1316  
 during outpatient surgery, 1612  
 during pregnancy, 359
- Gastric emptying, obese patient and, 380–381
- Gastric mucosa, protein-energy malnutrition and, 271
- Gastric pressure, 592, 592*f*
- Gastric reflux during pregnancy, 359
- Gastric tonometry, 537, 1802*t*, 1804
- Gastric ulcer disease, 1323
- Gastrin, protein-energy malnutrition and, 271
- Gastrocnemius muscle, popliteal fossa block and, 1045*f*
- Gastroduodenal ulceration, burn injury and, 1779
- Gastroenterology suite, 1652–1653
- Gastroesophageal reflux disease  
 in alcohol abuser, 408  
 cerebral palsy and, 1543  
 in child, 334, 334*b*  
 obese patient and, 381
- Gastrointestinal bleeding, 1328–1329  
 in alcohol abuse, 408  
 in postoperative ICU patient, 1838
- Gastrointestinal complications  
 in alcohol or drug addicted patient, 404*t*, 408  
 in cocaine use, 411–412  
 in postoperative ICU patient, 1834–1835, 1835*t*
- Gastrointestinal disease  
 child and, 334, 334*b*  
 geriatric patient and, 349  
 obstructive, 1329*b*, 1329–1330, 1330*b*, 1330*t*
- Gastrointestinal endocrine tumor, 1319
- Gastrointestinal endocrinology, 1319
- Gastrointestinal surgery, 1314–1337  
 bariatric procedures in, 1325, 1326*f*  
 biliary effects of opioids and, 1317  
 in biliary tract cancer, 1324  
 bowel distension and, 1316  
 bowel motility and, 1316–1317  
 in cholecystitis, 1324–1325  
 in duodenal and gastric carcinoma, 1322–1324  
 endoscopic, 1317*b*, 1317–1319  
 esophagus and, 1314–1315, 1319–1322, 1320*b*, 1320*f*, 1320*t*, 1321*b*, 1321*f*  
 in gallstone disease, 1324*b*, 1324–1325  
 gastrointestinal bleeding and, 1328–1329  
 gastrointestinal endocrinology and, 1319  
 management of acid reflux in, 1315*b*, 1315–1316  
 in obstructive disease, 1329*b*, 1329–1330, 1330*b*, 1330*t*  
 oropharynx and, 1314  
 pancreas and, 1325–1328  
 pancreatic cancer and, 1326–1327, 1327*f*  
 pancreatitis and, 1325–1326, 1326*f*  
 transplantation and, 1327–1328, 1328*f*  
 in peptic ulcer disease, 1322–1324, 1323*b*  
 respiratory function and, 1317  
 small bowel transplantation in, 1328  
 stomach and, 1314–1315  
 in strictures of biliary tract and sclerosing cholangitis, 1325  
 systemic inflammatory response and, 1330–1331, 1331*b*
- Gastrointestinal system  
 anaphylactic reaction and, 1954*b*  
 changes during pregnancy, 359  
 of child, 316  
 complications associated with renal failure, 1399*t*  
 effects of burn injury on, 1676*t*  
 multiple organ dysfunction syndrome and, 1757*t*, 1760  
 neuraxial anesthesia and, 996–997  
 of obese patient, 376*t*, 380–381  
 protein-energy malnutrition and, 270–271  
 superior vena cava syndrome and, 1258*b*  
 thyroid storm and, 175
- Gastroparesis, renal transplantation and, 1400
- Gastrostomy, 1512, 1513*f*
- Gastrostomy, 1514
- Gelatin in fluid management, 676
- Gelofusin, 676
- Gender  
 body weight and, 838*t*  
 perioperative complications and death and, 442*t*  
 sensitivity to anesthetic agents and, 1491, 1491*t*  
 sensitivity to pain and, 1490–1491
- General anesthesia  
 for aneurysm repair, 1305–1306  
 in carotid endarterectomy, 1296  
 critically ill patient and, 1805  
 for cystoscopy, 1456  
 in dental surgery, 1601–1602  
 depth of sedation in, 1626, 1626*t*  
 in endovascular aneurysm repair, 1308  
 evoked potentials and, 610  
 in extracorporeal shock wave lithotripsy, 1460–1461  
 formulary of, 2186*t*  
 in gynecologic surgery, 1492  
 intraoperative awareness and, 753–754, 754*t*  
 in lower-extremity orthopedic surgery, 1544  
 mechanisms of action, 718–738  
 affinity and stoichiometry and, 722–723, 723*f*  
 G-protein coupled receptors and, 727*f*, 727–728  
 integration of molecular responses in, 731–733, 732*f*, 733*b*  
 ion channels and, 725–727, 726*f*, 727*b*  
 lipid bilayers and, 720–721, 721*f*  
 mitochondria and, 728
- molecular structure and, 719*f*, 719–720, 720*f*  
 neuroanatomic substrates and, 733*b*, 733–736, 735*f*  
 protein coupling mechanism and, 723–724, 724*f*, 725*f*  
 protein drug-target complex and, 721–722, 722*f*  
 relevance of in vitro assays and, 728–731, 729*f*, 731*f*  
 soluble proteins and, 724–725  
 monitored anesthesia care *versus*, 1626*f*  
 monoamine oxidase inhibitors and, 1652  
 in neonatal emergency surgery, 1506  
 in obstetric surgery  
 in assisted reproductive technologies, 1475  
 in cervical cerclage, 1477  
 in cesarean delivery, 1485–1486  
 in ophthalmic surgery, 1575–1576  
 in outpatient surgery, 1615–1619, 1617–1619*f*  
 oxygen supplementation following, 1702  
 Parkinson disease and, 147  
 perioperative hypothermia and, 1986–1989, 1987–1989*f*  
 in prostatectomy, 1462  
 in radical cystectomy, 1464  
 regional anesthesia *versus*, 79–80, 80*t*  
 in thoracic surgery, 1238  
 in vitreoretinal surgery, 1578–1579
- Generator potential, 2002
- Genetic factors  
 in chronic pain, 2010, 2016–2017  
 in substance abuse, 2142
- Genetic polymorphisms, 104–105
- Genitofemoral nerve, 1038*f*
- Genitourinary surgery, 1450–1470  
 in bladder cancer, 1462–1464, 1463*f*  
 cystoscopy in, 1455–1457, 1456*f*  
 elective, 79  
 extracorporeal shock wave lithotripsy in, 1459–1461  
 geriatric patient and, 352  
 macroscopic anatomy in, 1450–1453, 1451–1453*f*  
 minimally invasive, 1466*f*, 1466–1467  
 paravertebral nerve block in, 1021  
 patient positioning in, 1453*f*, 1453–1455, 1455*f*  
 in prostate cancer, 1461–1462  
 in renal cancer, 1465–1466  
 in testicular cancer, 1464–1465  
 transurethral resection of bladder tumor in, 1455–1457, 1456*f*  
 transurethral resection of prostate in, 1457*t*, 1457–1459, 1458*t*
- Genitourinary system  
 barbiturates and, 854  
 changes during pregnancy, 360  
 of child, 315–316, 316*t*  
 effects of burn injury on, 1676*t*, 1779  
 effects of opioid analgesics on, 879  
 extracorporeal shock wave lithotripsy-related injury of, 1460  
 of geriatric patient, 346, 346*f*  
 neuraxial anesthesia and, 996–997  
 of newborn, 306  
 of obese patient, 376*t*, 381–382  
 postoperative dysfunction of, 1708–1709  
 preservation in critically ill patient, 1807–1808  
 protein-energy malnutrition and, 270  
 rheumatoid arthritis and, 1542*t*  
 superior vena cava syndrome and, 1258*b*
- Genotoxicity of inhalational anesthetics, 759
- Gentamicin, 333*t*, 2195*t*
- Geriatric patient, 341–357  
 abdominal surgery and, 352  
 burn injury in, 1779–1780  
 cancer and, 350  
 cardiac surgery and, 350–351  
 cardiovascular disease and, 347–349, 348*f*  
 concepts and theories of aging, 341–342, 342*f*  
 critically ill, 1800  
 elective surgery and, 76–77  
 endocrine disease and, 350  
 eye surgery and, 352, 1563–1564, 1564*t*  
 gastrointestinal disease and, 349  
 genitourinary treatment and, 352  
 hearing impairment and, 350  
 immune enhanced diet for, 275*t*  
 kidney of, 199  
 musculoskeletal disease and, 349–350  
 neurologic and mental status disease and, 350  
 ophthalmologic disease and, 350  
 organ system senescence and, 342–346, 342–346*f*

- orthopedic procedures and, 351f, 351–352  
 pharmacology and, 346–347, 347f  
 postoperative cognitive dysfunction in, 1917, 1917f  
 postoperative pain and, 1732  
 preoperative assessment and management of, 55  
 pulmonary disease and, 349  
 remifentanyl and, 838  
 renal disease and, 349  
 stroke after cardiopulmonary bypass and, 1915  
 surgical risk and, 352–353  
 thoracic procedures and, 351  
 trauma and, 1665  
 vascular surgery and, 351
- Geriatrics, 341
- Gertie-Marx needle, 982, 982f
- Gestational age of newborn, 301–302  
 risk for apnea after surgery and, 1609, 1609f
- Gestational diabetes mellitus, 186, 368
- Gestational thrombocytopenia, 359
- Giant cell arteritis, 2025
- Gibbs-Donnan principle, 642, 673
- Ginger, platelet aggregation and, 257
- Ginkgo  
 platelet aggregation and, 257  
 potential postoperative complications and, 73t
- Ginseng  
 platelet aggregation and, 257  
 potential postoperative complications and, 73t
- Gitelman syndrome, 657
- Glagov phenomenon, 96
- Glasgow Coma Scale, 1791, 1791t  
 elective intubation before transport and, 1815  
 as modified by Cook and Palma, 1831, 1832t
- Glatiramer, 160
- Glaucoma, 1578  
 intraocular pressure and, 1562  
 medications for, 1563
- Glenn shunt  
 anesthetic complications in, 1194  
 hemodynamic problems resulting from, 1186t
- Glenohumeral arthritis, 2023t
- Glial cell activation in neuropathic pain, 2016
- Global end-diastolic volume, 541
- Globe, 1558–1559, 1573f  
 anterior, 1569f, 1570f  
 full stomach and, 1579–1580  
 innervation of, 1565  
 intraocular pressure and, 1561  
 oculocardiac reflex and, 1560–1561  
 perforation in ophthalmic regional anesthesia, 1074  
 posterior, 1571f  
 unintentional perforation of, 1574
- Globus hystericus, 1952
- Glomerular diseases, 207, 207t
- Glomerular filtration rate, 197t, 197–198  
 in autosomal dominant polycystic kidney disease, 209  
 changes during pregnancy, 360  
 of child, 315, 316t  
 geriatric patient and, 349  
 of newborn, 306  
 preoperative assessment and management of, 52–53  
 prerenal azotemia and, 206
- Glomerulonephritis  
 cocaine-related, 412  
 renal transplantation in, 1397
- Glomerulosclerosis, heroin-related, 410
- Glossopharyngeal nerve, 687f
- Glossopharyngeal neuralgia, 2031, 2031t
- Glottis, 687  
 of child, 311, 312f  
 of infant, 1526, 1526f
- Glucagon, 2193t  
 biliary effects of, 1317  
 response to trauma, 1662t
- Glucagonoma, 1327
- Glucocorticoids  
 for anaphylactic reaction, 1953  
 formulary of, 2193t  
 functions of, 179  
 for rheumatoid arthritis, 167
- Glucuronate in crystalloid solutions, 670f
- Glucose  
 in crystalloid solutions, 670f  
 management of  
 during carotid endarterectomy, 1296  
 in congenital heart disease surgery, 1191  
 in critically ill patient, 1798, 1808  
 diabetic parturient and, 186  
 in liver transplantation, 1365  
 in multiple organ dysfunction syndrome, 1760, 1768  
 perioperative cardiac complications and, 116  
 in postoperative ICU patient, 1837  
 during pregnancy, 368  
 in trauma patient, 1665  
 metabolism of  
 hepatic role in, 218–219  
 neonatal, 306–307  
 perioperative changes in diabetic patient, 187  
 preoperative tests of, 78t  
 starvation and, 267–268
- Glucose intolerance, 185
- epidural steroid injection and, 2078
- geriatric patient and, 350
- obesity and, 381
- Glucose-6-phosphate dehydrogenase deficiency, 303t
- $\alpha$ -Glucosidase inhibitors, 186
- Glucosuria, 360
- Glutamate  
 in nociceptive transmission, 2005  
 substance abuse and, 2145–2146
- Glutamine, 274
- Glyburide, 368
- Glycemic control  
 during carotid endarterectomy, 1296  
 in congenital heart disease surgery, 1191  
 in critically ill patient, 1798, 1808  
 diabetic parturient and, 186  
 in liver transplantation, 1365  
 in multiple organ dysfunction syndrome, 1760, 1768  
 neuroprotection and, 1934–1935  
 perioperative cardiac complications and, 116  
 in postoperative ICU patient, 1837  
 during pregnancy, 368  
 in trauma patient, 1665
- Glycerol  
 in neuroanesthesia, 1101  
 for peripheral neurolysis, 2113
- Glycine  
 disinhibition and, 2016  
 in nociceptive transmission, 2006  
 postoperative blindness in TURP and, 1458
- Glycogen storage diseases, 166
- Glycoprotein IIb/IIIa receptor inhibitors, 256
- Glycopyrrolate, 2190t  
 for conscious patient intubation, 703
- Goal-directed therapy, 544–545, 1805–1806, 1806f
- Goal-directed volume resuscitation, 677–679, 678–680f
- Goiter, 129, 174
- Goldenhar syndrome, 303t, 331t
- Goldman cardiac risk index, 1290
- Golfer's elbow, 2023t
- Gonadotropin deficiency, 184
- Goniotomy, 1578
- Gott shunt, 1303
- Gout, 2025
- G-protein coupled receptors, 727f, 727–728
- Graft-versus-host disease  
 in hematopoietic stem cell transplantation, 1409–1410, 1410t  
 posttransfusion, 1908
- Granisetron, 1533
- Graves disease, 368
- Gray matter of spinal cord, 2076
- Greater sciatic notch, 1044f
- Greater splanchnic nerves, 2077
- Greater trochanter, sciatic nerve block and, 1044f
- Green needle, 981–982, 982f
- Griffith, Harold, 6–7
- Ground fault circuit interrupter, 480–481
- Ground loop, 482
- Ground transport, 1820f, 1820–1821
- Ground wire, 480
- Growth charts, 324–327f
- Guanabenz, 921t, 922
- Guanadrel, 922
- Guanethidine, 922
- Guanfacine, 921t, 922
- Guillain-Barré syndrome, 159t, 160–161, 2030t
- Guillotine resection in tonsillectomy, 1589
- Gut tonometry, 1849
- Gutierrez hanging-drop technique in neuraxial anesthesia, 985, 987f
- Gwathmey, James T., 5
- Gynecoid obesity, 374
- Gynecologic surgery, 1489–1497  
 anesthetic selection for, 79, 1491–1492  
 intraabdominal, 1495–1497  
 perineal and urologic surgery in, 1492–1493  
 preoperative assessment in, 1489–1490, 1490f, 1490t  
 sensitivity to anesthetic agents and, 1491, 1491t  
 sensitivity to pain and, 1490–1491  
 transabdominal, 1496b, 1496–1497  
 transvaginal, 1493–1494
- H**
- HAART (highly active antiretroviral therapy), 293–294, 294t
- Haemonetics Rapid Infusion System, 1361, 1361t
- Haemophilus influenzae*  
 in community-acquired pneumonia, 290, 290t  
 in epiglottitis, 1586  
 in nosocomial infection, 286t
- Half-life of intravenous anesthetics, 855t
- Hallucination in alcohol withdrawal, 414
- Hallucinogens, 405t, 413
- Halogenated anesthetics  
 liver disease and, 229–230  
 potency and, 719
- Haloperidol, 864–865, 1562t, 2189t
- Halothane, 2186t  
 advantages and disadvantages of, 761t  
 biophysical properties of, 744t  
 cardiovascular effects of, 756t  
 central nervous system effects, 756t  
 cerebral blood flow and, 1096f, 1096–1098, 1097t, 1098f  
 cerebral neuroprotection and, 1104  
 chemical and physical properties of, 740–741, 741f, 741t  
 gas flow splitting ratios of, 781t  
 glucose tolerance impairment and, 759  
 incorrect refilling of vaporizer and, 781–782, 782t  
 intraocular pressure and, 1562t  
 minimum alveolar concentration of, 776t  
 in neonatal emergency surgery, 1504  
 output of erroneously filled vaporizer and, 781t  
 pathophysiology of congenital heart disease and, 1197–1198  
 physical properties of, 777t  
 respiratory function and, 758t  
 somatosensory-evoked potentials and, 605t  
 stereoselective binding of, 720, 720f  
 vapor pressure curve for, 776f  
 vascular resistance and, 757t
- Halothane hepatitis, 229–230, 334, 760
- Hand  
 acupuncture for postoperative nausea and vomiting, 1617, 1618f  
 painful conditions of, 2023t
- Hand surgery  
 axillary block for, 1032–1034, 1033f  
 infraclavicular block for, 1032  
 supraclavicular block for, 1031f, 1031–1032, 1032f
- Handoffs among anesthesia providers, 26
- Hanging bellows anesthesia ventilator, 798f, 799f, 804
- Hanging-drop technique in neuraxial anesthesia, 985, 987f
- Hard palate repair, 1597
- Hardware design for perioperative information management system, 502–505, 505f
- Hashish, 413
- Hastings frame, 471
- Hazard, defined, 425
- Hazardous conditions, 454
- Head  
 of newborn, 302–304  
 role of position in perioperative stroke risk, 1928–1929
- Head and neck cancer, 1590–1591, 1604–1605  
 difficult airway and, 129t, 129–130  
 neural blockade in, 2114f, 2114–2115
- Head and neck surgery  
 elective, 78–79  
 facial nerve concerns in, 1602  
 intraoperative neurologic monitoring in, 598–618  
 awake craniotomy and, 615–616  
 electroencephalography in, 598–607, 599t, 599–602f, 604–605t, 606–608f  
 electromyography and, 614–615



- Head and neck surgery—*continued*  
 evoked potentials in, 607–614, 609–611f, 612t, 614f, 615f  
 intraoperative wake-up test and, 615  
 spinal anesthesia for epidural placement of spinal cord stimulating electrodes, 616  
 neuroanesthesia for, 1081–1139  
 adjuvant drugs and, 1099–1100  
 anesthetic neuroprotection and, 1102–1104  
 anesthetic preconditioning and, 1104–1105  
 in aneurysm, 1114f, 1114–1119, 1115t, 1116f, 1117f, 1117t  
 in arteriovenous malformation, 1119–1120  
 cerebral physiology and, 1082t, 1082–1086, 1083t, 1084f  
 in cervical spine disease, 1120f, 1120–1121  
 in horizontal position infratentorial craniectomy, 1114  
 hyperosmolar agents in, 1100–1102, 1101t, 1103t  
 intracranial pressure control and, 1086–1092f, 1086–1093  
 intravenous anesthetics and, 1094–1095  
 microdialysis and, 1093f, 1093–1094  
 sedative agents and, 1095  
 in sitting position infratentorial craniectomy, 1108–1114, 1111–1113f  
 in supratentorial craniotomy, 1105–1108, 1106f, 1108f  
 in transsphenoidal hypophysectomy, 1121  
 volatile agents and, 1095–1099, 1096f, 1097t, 1098f  
 otorhinolaryngologic, 1586–1602  
 in abnormal airway disorders, 1586  
 in adenotonsillar hypertrophy, 1587  
 adenotonsillectomy in, 1588f, 1588–1590  
 in benign and malignant tumors, 1590–1591  
 in cleft lip and palate, 1597  
 dental surgery and, 1601–1602  
 elective, 78–79  
 in foreign body aspiration, 1591  
 in iatrogenic airway disorders, 1591–1592  
 in infections, 1586–1587  
 in malacias, 1597–1598, 1598f  
 maxillofacial reconstruction in, 1600, 1600f  
 in obstructive sleep apnea syndrome, 1588  
 orthognathic surgery in, 1600–1601  
 in pharyngeal abscess, 1590  
 plastic surgery and, 1602  
 in subglottic stenosis, 1598–1599, 1599f  
 tracheal reconstruction or resection in, 1599  
 tracheotomy and tracheostomy in, 1599–1600  
 in vocal cord disorders, 1592f, 1592–1597  
 parathyroid surgery in, 1603–1604  
 parotid surgery in, 1602  
 thyroid surgery in, 1602–1603
- Head trauma, 1669  
 assessment of, 1792  
 difficult airway and, 128–129  
 glycemic control in, 1934–1935  
 hypertonic solution for, 673  
 optimal arterial partial pressure of carbon dioxide in, 1931, 1931f  
 optimal oxygen partial pressure in, 1929–1930  
 transport in, 1818, 1821, 1821t
- Headache, 2036  
 in carbon monoxide poisoning, 1774  
 cluster, 2037, 2037f  
 in cyanide poisoning, 1775  
 postdural puncture, 997, 1067–1069, 1729, 2037, 2037t  
 after labor and vaginal delivery, 1480  
 in outpatient spinal anesthesia, 1614  
 in subarachnoid hemorrhage, 1114  
 tension-type, 2037
- Head-down tilt position, 469–470  
 in gastrointestinal surgery, 1317  
 in urologic surgery, 1454
- Head-elevated laryngoscopy position, 389, 389f
- Head-to-toe examination of trauma patient, 1792
- Head-up position, cerebral blood volume and, 1088–1089
- Health Insurance Portability and Accountability Act, 2129–2130
- Healthcare setting, perioperative mortality and, 443–444
- Healthcare-associated pneumonia, 291  
 healthy patient, 68–88  
 evaluation of, 68–73, 69t, 70t, 71f, 72t, 73t  
 monitoring of, 82t, 82–85, 83t  
 physical examination of, 73–77, 74–76t  
 postoperative destination and, 81  
 postoperative pain and, 81–82  
 premedication for, 80–81  
 preoperative instructions for, 80  
 preoperative testing and, 77, 78t  
 recovery of, 1688–1699  
 admission to postanesthesia care unit and, 1690t, 1690–1691  
 cardiac dysrhythmias and, 1693–1694  
 discharge from postanesthesia care unit and, 1697t, 1697–1698  
 fluid administration and hemorrhage and, 1696–1697  
 hypertension and, 1694–1695  
 hypotension and, 1693  
 neurologic complications and, 1693, 1695t  
 organization of postanesthesia care unit and, 1688–1689, 1689t  
 pain management and, 1695–1696  
 postanesthesia care unit operations and, 1689–1690  
 postoperative nausea and vomiting and, 1691t, 1691–1692  
 respiratory and airway complications and, 1692–1693  
 temperature control and, 1696  
 type of anesthesia for, 77–80, 80t
- Hearing loss  
 geriatric patient and, 350  
 postoperative, 1712–1713
- Heart  
 cardiovascular complications and  
 in alcohol or drug addicted patient, 400, 404t  
 associated with renal failure, 1399t  
 during patient transport, 1817f, 1817–1818  
 pediatric anesthesia and, 1521  
 in polymyositis and dermatomyositis, 169  
 in postoperative ICU patient, 1834  
 in thoracic surgery, 1271–1273  
 of child, 314f, 314–315, 315t  
 compression by mediastinal mass, 1258  
 etomidate and, 859–860  
 function during insufflation, 1318  
 hepatic resection and, 1347  
 hypokalemia and, 652  
 hypophosphatemia and, 656  
 inhaled anesthetics and, 756t, 756–757, 757f, 757t  
 ketamine and, 863  
 of newborn, 305  
 of obese patient, 378–380, 379f, 380f  
 opioid agonist-antagonists and, 892  
 opioid analgesics and, 878  
 propofol and, 857  
 protein-energy malnutrition and, 269–270  
 superior vena cava syndrome and, 1258b  
 thoracic surgery-related herniation of, 1271–1272
- Heart block, 349
- Heart disease  
 in alcohol or drug addicted patient, 400  
 antianginals for, 926–936  
 beta-adrenergic blockers in, 928–933, 929b, 930t, 932t  
 calcium channel blockers in, 932t, 933f, 933–934  
 dihydropyridines in, 934–935  
 inhibitors of fatty acid oxidation in, 936  
 ivabradine in, 936  
 nicorandil in, 936  
 nitrates in, 926–928, 927f, 928t  
 antidysrhythmic agents for, 936–947, 937b, 937f  
 adenosine in, 946t, 946–947  
 class IA agents in, 936–939, 938t  
 class IB agents in, 939–941, 940t  
 class IC agents in, 941–943, 942t  
 class III agents in, 943–946, 944t  
 antihypertensives for, 919–925  
 angiotensin II receptor blockers in, 925, 925t  
 angiotensin-converting enzyme inhibitors in, 924t, 924–925, 925f  
 centrally acting alpha<sub>2</sub>-agonists in, 921t, 921–922  
 diuretics in, 919–921, 920t  
 peripherally acting sympatholytic agents in, 922t, 922–923  
 vasodilators in, 923t, 923–924  
 congenital, 332t, 332–333, 333b, 333t, 1174–1212  
 acid-base management and, 1191  
 anesthetic plan and goals in, 1202–1203  
 cardiac catheterization and, 1194–1197, 1195t, 1196f  
 cardiopulmonary bypass and, 1188–1190  
 closed cardiac procedures and, 1193–1194  
 congestive heart failure in, 1180–1181  
 coronary ischemia and, 1187–1188, 1188b  
 coronary ischemia in, 1182  
 deep hypothermic circulatory arrest and, 1190–1191  
 dysrhythmias and, 1188  
 effects of anesthesia on pathophysiology of, 1197–1201, 1198f  
 excessive pulmonary blood flow in, 1179–1180, 1180f, 1181f, 1184–1186, 1186b  
 extracorporeal membrane oxygenation and, 1201–1202  
 glucose management and, 1191  
 immaturity of circulation and, 1182–1184, 1183b, 1183f  
 inadequate pulmonary flow and, 1186b, 1186–1187  
 induction of anesthesia in, 1203–1204  
 intraaortic balloon pump and, 1202  
 intracardiac shunting in, 1175–1178, 1177f, 1178f, 1178t, 1179t, 1187  
 jugular bulb oximetry and, 1192–1193  
 left heart obstruction and, 1187, 1187b  
 low cardiac output and, 1188, 1188b  
 maintenance of anesthesia in, 1204  
 manipulation of pulmonary vascular resistance and systemic vascular resistance in, 1204b, 1204–1205  
 near-infrared spectroscopy and, 1192  
 nonpharmacologic support in, 1201  
 obstructions to pulmonary blood flow in, 1181–1182  
 obstructions to systemic blood flow in, 1181  
 postoperative factors and, 1192  
 preoperative assessment in, 1203, 1203b  
 preoperative factors in, 1190  
 preoperative preparation and medication in, 1203  
 right heart obstruction and, 1187, 1187b  
 severe hypoxemia in, 1178–1179  
 temperature management and, 1191–1192  
 transcranial Doppler ultrasound and, 1192  
 ventricular assist device and, 1202
- diabetes mellitus and, 103, 188  
 digitalis for, 925–926  
 geriatric patient and, 347–349, 348f  
 mortality after pancreas transplantation and, 1406  
 perioperative complications and death and, 442t  
 postoperative cognitive dysfunction and, 1912–1914, 1913f, 1914f  
 pregnant patient and, 365–366, 366t  
 preoperative assessment and management in, 42t, 48f, 48–49, 95–121, 148–150  
 anemia and, 104  
 angiotensin-converting enzyme inhibitors and, 113–114  
 antibiotics and, 116  
 antiplatelet and anticoagulant agents and, 115–116, 116t  
 arrhythmias and, 104  
 benefits of, 95  
 beta-blockers and, 110f, 110–113, 111–112t  
 calcium channel blockers and, 114, 114f  
 carotid stenosis and, 105  
 clinical determination of need for specific preoperative cardiac investigations and, 105–106, 106f  
 clonidine and, 115, 115f  
 comparison of risk indices in, 100, 100f, 101–102t  
 dangers of testing in low-risk populations and, 95–96  
 depression and, 104  
 diabetes mellitus and, 103  
 diuretics and, 115  
 genetic polymorphisms and, 104–105  
 glucose control and, 116  
 hyperlipidemia and, 103  
 hypertension and, 103, 109–110  
 known coronary artery disease and, 100–103  
 nitroglycerin and, 115  
 overall perioperative risk and, 98–99, 99f  
 peripheral vascular disease and, 103–104  
 postoperative ischemia and, 97–98, 99f  
 postoperative tests and, 108

- preoperative CABG or PTCA and, 109  
preoperative cardiac tests to quantify risk and, 106–108, 107t, 108t  
purpose of identifying and quantifying risk in, 99–100, 100t  
renal insufficiency and, 104  
smoking and, 103, 116  
statins and, 113, 113f  
supply-demand mismatch and, 96, 97f  
surgical procedure risk and, 105, 105t  
thrombosis from endothelial dysfunction and, 96–97, 97f, 98f  
valvular lesions and, 104  
renal transplantation mortality and, 1398  
statins for, 947, 947t
- Heart failure**  
in diabetic patient, 51  
geriatric patient and, 348  
hyperosmolar agents and, 1103t  
hypothyroidism and, 176  
obesity and, 379  
preoperative assessment and management in, 49
- Heart failure survival score**, 1381
- Heart murmur**  
in addicted patient, 398  
assessment before pediatric surgery, 332, 333t  
preoperative assessment and management in, 49–50
- Heart rate**  
cardiac output in shock and, 1846  
during carotid endarterectomy, 1296  
of child, 314, 314f  
fetal, 360  
inhaled anesthetics and, 756, 756t  
intravenous anesthetics and, 853t  
perioperative cardiac complications and, 107  
in systemic inflammatory response, 1331b
- Heart rhythm abnormality**, 349
- Heart surgery**  
in aortic disease, 1158t, 1158–1163  
aortic dissection and, 1162f, 1162t, 1162–1163, 1163f  
ascending aorta and aortic arch aneurysm and, 1159f, 1159–1160, 1160f  
descending thoracic and thoracoabdominal aortic aneurysm and, 1160t, 1160–1162, 1161f, 1161t  
thoracic aortic aneurysm and, 1158t, 1158–1159, 1159f  
cardiopulmonary bypass in, 1140–1143  
for cardiac arrest, 1879  
in congenital heart disease, 1188–1190, 1192–1193  
coronary artery bypass graft with, 1151  
fundamental components of CPB circuit and, 1140–1141  
management of anticoagulation in, 1141–1143  
pathophysiology of, 1141  
weaning from, 1143, 1143t  
in congenital heart disease, 1174–1212  
acid-base management and, 1191  
anesthetic plan and goals in, 1202–1203  
cardiac catheterization and, 1194–1197, 1195t, 1196f  
cardiopulmonary bypass and, 1188–1190  
closed cardiac procedures and, 1193–1194  
congestive heart failure in, 1180–1181  
coronary ischemia and, 1187–1188, 1188b  
coronary ischemia in, 1182  
deep hypothermic circulatory arrest and, 1190–1191  
dysrhythmias and, 1188  
effects of anesthesia on pathophysiology of, 1197–1201, 1198f  
excessive pulmonary blood flow in, 1179–1180, 1180f, 1181f, 1184–1186, 1186b  
extracorporeal membrane oxygenation and, 1201–1202  
glucose management and, 1191  
immaturity of circulation and, 1182–1184, 1183b, 1183f  
inadequate pulmonary flow and, 1186b, 1186–1187  
induction of anesthesia in, 1203–1204  
intraaortic balloon pump and, 1202  
intracardiac shunting in, 1175–1178, 1177f, 1178f, 1178t, 1179t, 1187  
jugular bulb oximetry and, 1192–1193  
left heart obstruction and, 1187, 1187b  
low cardiac output and, 1188, 1188b  
maintenance of anesthesia in, 1204  
manipulation of pulmonary vascular resistance and systemic vascular resistance in, 1204b, 1204–1205  
near-infrared spectroscopy and, 1192  
nonpharmacologic support in, 1201  
obstructions to pulmonary blood flow in, 1181–1182  
obstructions to systemic blood flow in, 1181  
postoperative factors and, 1192  
preoperative assessment in, 1203, 1203b  
preoperative factors in, 1190  
preoperative preparation and medication in, 1203  
right heart obstruction and, 1187, 1187b  
severe hypoxemia in, 1178–1179  
temperature management and, 1191–1192  
transcranial Doppler ultrasound and, 1192  
ventricular assist device and, 1202  
coronary artery bypass graft in, 1143–1152  
anesthetic induction in, 1149–1150  
with cardiopulmonary bypass, 1151  
coronary artery anatomy and, 1143–1144, 1144f  
coronary blood flow physiology and, 1144–1145  
liver disease and, 1354  
monitoring in, 1147–1149, 1148f, 1148t, 1149f  
myocardial oxygen delivery and, 1145  
myocardial oxygen demand and, 1145–1146, 1146f, 1147f  
older adult and, 350–351  
post-cardiopulmonary bypass management in, 1151–1152  
postoperative complications in, 103, 1152  
preoperative, 109, 1292  
preoperative evaluation in, 1146–1147  
preoperative management in, 1150  
without cardiopulmonary bypass, 1150–1151  
depression following, 1920  
geriatric patient and, 350–351  
heart transplantation and, 1378–1395  
donor selection and organ procurement in, 1384t, 1384–1385  
epidemiology of, 1379–1380  
historical aspects of, 1378, 1379t  
immunobiology of, 1382–1383, 1383t  
indications for, 1380–1381, 1381f  
intraoperative management in, 1391–1392  
preoperative management in, 1391  
surgical alternatives to, 1381–1382  
paravertebral block in, 1021  
postoperative cognitive dysfunction and, 1915–1917, 1916f, 1918, 1918f  
risk for perioperative stroke in, 1925–1926  
systemic inflammatory response and, 1919–1920  
transesophageal echocardiography in, 552–578  
aorta and, 571–574, 573f, 574f  
in aortic insufficiency, 570  
in aortic stenosis, 570–571, 571f, 572f  
aortic valve and, 569f, 569–570, 570f  
basic principles of, 552–553  
in cardiac tumors, 558  
indications for, 552, 553f, 554t  
interatrial septum and, 556–558, 557f  
left atrium and, 554–555, 556f  
left ventricular diastolic function and, 560–563, 561–564f, 565t  
left ventricular systolic function and, 558–560, 558–560f  
limitations and contraindications for, 552–553, 555t  
in mitral regurgitation, 565–568, 566f, 567f  
in mitral stenosis, 568f, 568–569  
mitral valve and, 563–565, 565f, 566f  
pericardium and, 576f, 576–577  
pulmonary artery and, 576  
pulmonic valve and, 576, 576f  
right atrium and, 555–556, 557f  
right ventricle and, 574–575  
terminology in, 552, 555t  
tricuspid valve and, 575f, 575–576  
in valvular disease, 1152f, 1152–1157, 1153f, 1153t  
induction of anesthesia in, 1155–1156  
maintenance of anesthesia in, 1156  
monitoring in, 1155  
preoperative evaluation in, 1153–1155, 1154f, 1155f  
special considerations and long-term prognosis in, 1157, 1157f  
weaning from bypass in, 1156–1157  
ventricular assist device implantation in, 1163–1169  
noncardiac surgery and, 1168–1169  
preoperative considerations in, 1164–1165  
transesophageal echocardiography examination in, 1165f, 1165–1166, 1166f  
weaning from cardiopulmonary bypass in, 1166f, 1166–1168, 1167f
- Heart transplantation**, 1378–1395  
donor selection and organ procurement in, 1384t, 1384–1385  
epidemiology of, 1379–1380  
historical aspects of, 1378, 1379t  
immunobiology of, 1382–1383, 1383t  
indications for, 1380–1381, 1381f  
intraoperative management in, 1391–1392  
preoperative management in, 1391  
surgical alternatives to, 1381–1382
- Heart valve surgery**, 1152f, 1152–1157, 1153f, 1153t  
induction of anesthesia in, 1155–1156  
maintenance of anesthesia in, 1156  
monitoring in, 1155  
preoperative evaluation in, 1153–1155, 1154f, 1155f  
special considerations and long-term prognosis in, 1157, 1157f  
weaning from bypass in, 1156–1157
- Heartburn during pregnancy**, 359
- HeartMate Left Ventricular Assist Device**, 1164
- Heat**  
carbon dioxide absorption in circle system and, 796  
vaporization and, 777  
volatile anesthetic breakdown and, 760
- Heat application**  
for chronic pain, 2066–2067
- Heat illness**  
malignant hyperthermia and, 1969–1970
- Heat loss**  
in burn patient, 1675  
child and, 317
- Heat stroke**  
malignant hyperthermia and, 1970
- Helium in laser ablation of airway**, 1251
- HELLP syndrome**  
fresh-frozen plasma for, 1898
- HELP position for obese patient**, 389, 389f
- Hemaccel**, 676
- Hemangioma**  
in airway, 1590–1591  
subglottic stenosis and, 1599f  
with thrombocytopenia, 303t  
vocal cord, 1592, 1592f
- Hemarthrosis in hemophilia**, 248
- Hematocrit**  
anemia and, 239, 242  
of child, 315, 334–336, 335t  
in hepatocellular function evaluation, 232  
normal red blood cell values and, 240t
- Hematologic complications**  
associated with renal failure, 1399t  
in postoperative ICU patient, 1835–1837
- Hematologic system**  
changes during pregnancy, 359  
effects of burn injury on, 1676t  
multiple organ dysfunction syndrome and, 1757t, 1758–1759, 1763  
of obese patient, 376t  
rheumatoid arthritis and, 1542t
- Hematoma**  
epidural therapy-related, 1729  
neck, 1702  
neuraxial anesthesia-related, 1065, 1481–1482t
- Hematopoietic stem cell transplantation**, 1408–1411, 1409t, 1410f, 1410t, 1411f
- Hematuria**  
celiac plexus nerve block-related, 2087  
extracorporeal shock wave lithotripsy-related, 1460
- Heme biosynthesis pathway**, 854f
- Hemilithotomy position**, 467f
- Hemochromatosis**, 225
- Hemodialysis**  
intensive care unit and, 1837  
morbidity in renal transplantation and, 1399  
in multiple organ dysfunction syndrome, 1762

- Hemodilution, intracranial pressure and, 1090  
Hemodilutional thrombocytopenia, 1836  
Hemodynamic complications  
  after cardiac catheterization, 1196f, 1196–1197  
  after pediatric heart surgery, 1185–1186t  
  in alcohol abuse, 403  
  in cesarean delivery, 1485  
  in cocaine use, 410–411  
  in congenital heart disease, 1176t  
  critically ill patient and, 1805–1807, 1806f  
  in extracorporeal shock wave lithotripsy, 1460  
  in heart valve surgery, 1156–1157  
  in liver disease, 1340b, 1340–1341  
  in methamphetamine use, 412  
  in multiple organ dysfunction syndrome, 1757–1758  
  in open radical nephrectomy, 1465  
  during patient transport, 1814, 1817f, 1817–1818  
  in sitting position infratentorial craniectomy, 1110  
Hemodynamic monitoring, 519–551  
  for acute ischemia, 537–538  
  after elective surgery, 83–84  
  arterial blood pressure in, 519–522  
  complications of, 522  
  in coronary artery bypass graft, 1147  
  in critically ill patient, 1801–1802  
  indications for, 522  
  insertion technique in, 521–522  
  in neonatal emergency surgery, 1507  
  noninvasive, 519, 520f  
  during patient transport, 1817  
  pressure waveform in, 521, 521f  
  theory and background of, 519–520, 520f  
  during thoracic surgery, 1223t  
  in trauma patient, 1665  
  cardiac output in, 533–537  
  continuous thermodilution method of, 535–536  
  esophageal Doppler method of, 536b, 536–537, 537f  
  gastric tonometry for, 537  
  lithium dilution method of, 534–535  
  partial carbon dioxide rebreathing method of, 535  
  pulse contour-derived method of, 536  
  thermodilution technique of, 534, 534b, 535f  
  transpulmonary thermodilution method of, 534  
  central venous pressure in, 522–526  
  abnormal central venous pressure and, 522, 524f, 525f  
  burn patient and, 1678  
  complications of, 525b, 525–526, 526b  
  in congenital diaphragmatic hernia, 1511  
  in coronary artery bypass graft, 1147–1148  
  critically ill patient and, 1802, 1802t  
  in hepatic resection, 1347  
  indications for, 525, 525b  
  insertion technique in, 522–525  
  in liver transplantation, 1360  
  in lower-extremity vascular surgery, 1298  
  in lung transplantation, 1386  
  in neonatal emergency surgery, 1507f, 1507–1508  
  normal central venous pressure and, 522, 523f, 523t  
  in renal transplantation, 1401  
  in small bowel transplantation, 1414  
  in supratentorial craniotomy, 1106  
  theory and background of, 522, 523t, 523–525f  
  trauma patient and, 1666  
  in valve surgery, 1155  
  in critically ill patient, 1801–1804, 1802t, 1803t  
  in hepatic resection, 1348  
  in open radical nephrectomy, 1465–1466  
  for perfusion assessment, 533t, 542–544, 544f  
  preemptive goal-directed therapy and, 544–545  
  pulmonary artery catheter in, 526–533  
  in aortic surgery, 1300  
  in carotid endarterectomy, 1295  
  complications of, 530–532  
  continuous mixed venous oximetry and, 532–533, 533b  
  in coronary artery bypass graft, 1148, 1148t  
  in critically ill patient, 1802t, 1802–1804, 1803t  
  indications for, 532, 532b  
  insertion technique in, 526–527, 528f  
  in liver transplantation, 1359–1360  
  in lower-extremity vascular surgery, 1298  
  in multiple organ dysfunction syndrome, 1766  
  in neonatal emergency surgery, 1507–1508  
  in open radical nephrectomy, 1465  
  pacing, 532  
  in preeclampsia, 1488  
  pregnant patient and, 1489  
  pressure measurements in, 526t, 527t, 527–530, 529f, 529t, 530f  
  right ventricular ejection fraction, 533  
  in small bowel transplantation, 1414  
  in supratentorial craniotomy, 1106  
  in thoracic surgery, 1222, 1223t  
  trauma patient and, 1666, 1666b  
  in valve surgery, 1155  
  for pulmonary edema, 538, 538b  
  trauma patient and, 1665, 1665t  
  troubleshooting in, 545, 545b  
  for ventricular contractility, 538–540, 539f  
  for volume status, 540–542, 541f, 542f  
Hemodynamic response  
  to burn injury, 1773  
  to critical illness, 1745  
  to electroconvulsive therapy, 1652  
Hemodynamic support in shock, 1841–1851  
  blood transfusion in, 1843–1844  
  clinical signs of shock and, 1841  
  fluid resuscitation in, 1842–1843, 1843f  
  indices of global perfusion in, 1847–1848, 1848f  
  indices of regional perfusion in, 1848–1849  
  pathophysiologic classification of shock and, 1841–1842  
  restoring and maintaining cardiac output in, 1846f, 1846–1847  
  vasopressors in, 1844f, 1844t, 1844–1846  
  ventilatory support in, 1842  
Hemofiltration in multiple organ dysfunction syndrome, 1761  
Hemoglobin  
  anemia and, 239  
  cerebral blood flow and, 1938, 1939f, 1940f  
  of child, 315, 335t  
  in hepatocellular function evaluation, 232  
  normal red blood cell values and, 240t  
  preoperative assessment of  
  in liver transplantation, 1353  
  in renal transplantation, 1400  
  sickle cell anemia and, 246  
  transfusion risk and, 242  
Hemolytic anemia, 241–242  
  Hemolytic transfusion reaction, 1896t, 1896–1897  
Hemolytic-uremic syndrome  
  fresh-frozen plasma for, 1898  
Hemophilia, 247–250, 249t  
  factor concentrates for, 1899–1901  
Hemoptysis  
  in foreign body aspiration, 1268  
  in lung cancer, 1218  
  massive, 1267, 1267b, 1268t  
  in pulmonary artery rupture, 531  
Hemorrhage  
  acute anemia and, 242  
  antenatal and postpartum, 364t, 364–365, 1486–1488, 1487t  
  in arteriovenous malformation, 1119  
  direct tissue injury leading to critical illness and, 1739  
  in disseminated intravascular coagulation, 260  
  in dysfibrinogenemia, 253  
  gastrointestinal, 1328–1329  
  in alcohol abuse, 408  
  in postoperative ICU patient, 1838  
  in hemophilia, 248, 1899  
  in hepatic resection, 1346f, 1346–1348, 1347f  
  intraabdominal, 1668–1669  
  in laparoscopic surgery, 1319  
  in mediastinoscopy, 1254  
  neuraxial anesthesia and, 998  
  ophthalmic regional anesthesia-related, 1073  
  in orthognathic surgery, 1601  
  peripheral nerve block-associated, 1048–1049  
  physiologic effects of, 1790t  
  in placental abruption, 365  
  in postanesthesia care unit, 1696–1697  
  postoperative, 1710–1711  
  in adenotonsillectomy, 1590  
  in factor VII deficiency, 252  
  in hematopoietic stem cell transplantation, 1409  
  in thoracic surgery, 1272–1273  
  in thyroid surgery, 1603  
  posttonsillectomy, 1590  
  posttourniquet, 1550  
  in prostatectomy, 1462  
  retrobulbar, 1073, 1574  
  in rhinoplasty, 1585  
  in sinus surgery, 1586  
  subarachnoid, 1114f, 1114–1119, 1115t, 1116f, 1117f, 1117t  
  hyperosmolar agents for, 1102  
  in transurethral resection of prostate, 1459  
  trauma patient and, 1790, 1794  
  traumatic, 1662  
  variceal, 234  
  in von Willebrand disease, 250  
Hemorrhage-related anemia, 241  
Hemorrhagic stroke, 1925  
Hemosiderosis  
  transfusion-related, 1908  
Hemostasis, traumatic shock and, 1664  
Hemostatic agents, 2192t  
Henderson-Hasselbalch equation, 581, 956  
Heparin, 2192t  
  cardiopulmonary bypass and, 1141–1142  
  in coronary artery bypass graft, 1150  
  epidural analgesia and, 1730t  
  neuraxial anesthesia and, 998  
  for obese patient, 387  
  perioperative cardiac complications and, 116  
Heparin-induced thrombocytopenia, 259–260, 1142–1143  
  in multiple organ dysfunction syndrome, 1759  
  in postoperative ICU patient, 1836  
Heparin-induced thrombosis-thrombocytopenia, 259  
Hepatic artery, 1339  
Hepatic artery thrombosis, 1369  
Hepatic clearance of drugs, 222  
  effect of burn injury on, 1678  
  gender differences in, 1491  
  inhaled anesthetics and, 760  
  intravenous anesthetics and, 855, 855t  
  local anesthetics and, 959–960  
  propofol and, 858  
Hepatic disease, 216–238, 1338–1377  
  acetaminophen toxicity in, 229, 229f  
  acute liver failure in, 231–232, 232t  
  in alcohol or drug addicted patient, 401–402, 404t  
  alcoholic, 229  
  alpha<sub>1</sub>-antitrypsin deficiency in, 225–226  
  anatomy and physiology of liver and, 1339  
  ascites in, 234  
  autoimmune hepatitis in, 230  
  autonomic neuropathy in, 1344–1345  
  biliary atresia in, 224–225  
  Child-Pugh scoring system in, 223–224, 224t, 225t  
  chronic, 1339–1340, 1340b  
  hepatitis in, 228–229  
  liver failure in, 232–233  
  cocaine-related, 411–412  
  control of encephalopathy in, 234–235  
  correction of coagulopathy in, 233–234, 234f  
  drug metabolism and, 222f, 222–223  
  drug-induced, 230  
  effect on antimicrobial therapy, 285, 285t  
  fresh-frozen plasma in, 1897  
  fulminant hepatic failure in, 1340, 1340b  
  halothane hepatitis in, 229–230  
  hemochromatosis in, 225  
  hemodynamic changes in, 1340b, 1340–1341  
  hepatic encephalopathy in, 1344, 1345b  
  hepatic resection in, 1345–1350  
  anesthesia for, 1346–1348  
  control of clotting in, 1348–1349  
  indications and patient characteristics in, 1345, 1345b  
  intraoperative complications in, 1349–1350, 1350f  
  operative considerations in, 1346, 1346f, 1347f  
  hepatocellular carcinoma in, 231  
  hepatopulmonary syndrome in, 1343b, 1343–1344, 1344f  
  infiltrative, 230–231  
  inherited, 226  
  liver anatomy and physiology and, 217f, 217–219, 218f, 218t  
  liver function tests in, 219t, 219–222, 220t, 221f  
  liver transplantation in, 1350–1369  
  model of end-stage liver disease and, 224, 225t

- nonalcoholic fatty liver disease in, 226f, 226–228
- portopulmonary hypertension in, 1341–1343, 1342f, 1343b, 1343f
- portosystemic shunt in, 1370–1371
- preoperative assessment and management in, 42t, 53
- procedures for portal hypertension and ascites in, 1369b, 1369–1370
- renal function and, 1341, 1341b
- Reye syndrome in, 225
- varices and variceal hemorrhage in, 234
- vascular, 231
- viral hepatitis in, 227t, 227–228
- Wilson disease in, 225
- Hepatic encephalopathy, 231–232, 232t, 1344, 1345b
- in acute liver failure, 231
- Child-Pugh scoring system and, 224t
- in chronic liver disease, 233
- in fulminant hepatic failure, 1340
- in liver disease, 234–235
- in Reye syndrome, 225
- Hepatic reprioritization, 658
- Hepatic resection, 1345–1350
- anesthesia for, 1346–1348
- control of clotting in, 1348–1349
- indications and patient characteristics in, 1345, 1345b
- intraoperative complications in, 1349–1350, 1350f
- operative considerations in, 1346, 1346f, 1347f
- Hepatic sinusoid, 218f
- Hepatic surgery, 1345–1372
- liver resection in, 1345–1350
- anesthesia for, 1346–1348
- control of clotting in, 1348–1349
- indications and patient characteristics in, 1345, 1345b
- intraoperative complications in, 1349–1350, 1350f
- operative considerations in, 1346, 1346f, 1347f
- liver transplantation in, 1350–1369
- anesthetic induction and maintenance in, 1360–1361, 1361t
- anhepatic phase of, 1363–1364, 1364f
- donor in, 1371–1372
- electrolyte management in, 1364–1365
- homeostasis in, 1358t, 1358–1359
- indications, contraindications, and patient characteristics in, 1350–1351, 1351b
- laboratory studies in, 1353–1355, 1355f
- MELD scoring system for, 1352, 1352t
- neohepatic phase of, 1367f, 1367–1369
- operative approaches for, 1356f, 1356–1358, 1357f
- postoperative complications of, 1369
- preanesthetic evaluation in, 1352–1353
- preanhepatic phase of, 1361–1362
- renal protection during, 1365–1366
- reperfusion of graft in, 1366–1367
- transfusion in, 1362f, 1362–1363, 1363f
- vasopressors in, 1362
- paravertebral block in, 1021
- for portal hypertension and ascites, 1369b, 1369–1370
- Hepatic system
- anatomy and physiology of, 217f, 217–219, 218f, 218t
- changes during pregnancy, 359
- complications associated with renal failure, 1399t
- effects of burn injury on, 1676t
- of geriatric patient, 345–346
- of infant, 316
- neuraxial anesthesia and, 996–997
- of obese patient, 380–381
- protein-energy malnutrition and, 271
- Hepatic transplantation, 1350–1369
- anesthetic induction and maintenance in, 1360–1361, 1361t
- anhepatic phase of, 1363–1364, 1364f
- electrolyte management in, 1364–1365
- homeostasis in, 1358t, 1358–1359
- indications, contraindications, and patient characteristics in, 1350–1351, 1351b
- laboratory studies in, 1353–1355, 1355f
- MELD scoring system for, 1352, 1352t
- neohepatic phase of, 1367f, 1367–1369
- operative approaches for, 1356f, 1356–1358, 1357f
- postoperative complications of, 1369
- preanesthetic evaluation in, 1352–1353
- preanhepatic phase of, 1361–1362
- renal protection during, 1365–1366
- reperfusion of graft in, 1366–1367
- transfusion in, 1362f, 1362–1363, 1363f
- vasopressors in, 1362
- paravertebral block in, 1021
- for portal hypertension and ascites, 1369b, 1369–1370
- Hepatic vein thrombosis, 231
- Hepatitis
- in alcohol or drug addicted patient, 401–402, 408
- autoimmune, 230
- chronic, 228–229
- cocaine-related, 412
- halothane, 229–230, 334, 760
- viral, 227t, 227–228
- Hepatitis A, 227t, 227–228, 401
- Hepatitis B, 227t, 228
- in alcohol or drug addicted patient, 401–402
- transfusion-related, 1903–1904
- Hepatitis C
- in alcohol or drug addicted patient, 402
- liver transplantation in, 1350, 1351b
- transfusion-related, 1904
- Hepatitis D, 227t
- in alcohol or drug addicted patient, 402
- transfusion-related, 1904
- Hepatitis E, 227t, 228
- transfusion-related, 1904
- Hepatitis G, 227t, 228
- Hepatocellular carcinoma, 231
- autoimmune hepatitis and, 230
- hepatic resection in, 1345
- liver transplantation in, 1350, 1351b
- Hepatocellular function, 217–219, 218t
- Hepatocyte, 218f
- Hepatopulmonary syndrome, 232, 407, 1343b, 1343–1344, 1344f
- Hepatorenal syndrome, 208–209, 233
- alcohol abuse and, 408
- in cirrhotic patient, 1341, 1341b
- Herbals and supplements
- coagulation disorders and, 257
- monitored anesthesia care and, 1627
- potential postoperative complications and, 73t
- preoperative assessment and management of, 59
- Hereditary hemochromatosis, 225
- Hereditary renal disease, 209
- Hereditary sensory autonomic neuropathy, 2027t
- Hereditary tyrosinemia, 226
- Hering-Breuer response, 313, 691
- Hernia
- brain, 1086f
- cardiac, 1271–1272
- congenital diaphragmatic, 1510–1512
- hiatal, 1320b, 1320f, 1320t, 1320–1322, 1321b, 1321f
- paraesophageal, 1321, 1321f
- Hernia repair
- paravertebral nerve block in, 1020–1021
- pediatric, 1533
- Heroin, 409–410
- Herpes zoster, 2029
- Herpesvirus infection
- transfusion-related, 1904
- Hespan, 676
- anticoagulant effects of, 257–258
- hospital acquisition costs for, 244t
- Hetastarch, 675–676, 676f, 2196t
- osmolarity of, 1101t
- in pancreas transplantation, 1407
- for shock, 1842
- Heterosynaptic central sensitization, 2013t, 2013–2014
- Hexane inhalation, 413–414
- Hexylcaine (Cyclaine), 961t
- Hiatal hernia, 381, 1320b, 1320f, 1320t, 1320–1322, 1321b, 1321f
- High lithotomy position, 467f
- High-density lipoproteins, atherosclerosis and, 1285
- High-dose opioid anesthesia, 887–888, 888f
- High-frequency jet ventilation, 1865–1866
- in bronchoscopy, 1242
- in microlaryngoscopy, 1593
- in tracheal resection, 1265
- High-frequency oscillatory ventilation, 1866
- High-frequency percussive ventilation, 1677, 1866
- High-frequency positive-pressure ventilation, 1265–1267
- High-frequency ventilation, 1865–1866
- in bronchopleural fistula, 1244
- in one-lung isolation, 1238–1239
- in tracheal resection, 1265f, 1265–1267, 1266f
- High-grade responders, 1947, 1948t
- Highly active antiretroviral therapy (HAART), 293–294, 294t
- alcohol or drug addicted patient and, 402, 403
- preoperative assessment and management of, 58–59
- High-molecular-weight kininogen deficiency, 248t, 252–253
- High-performance team, 26–27, 27b
- High-reliability organization model, 31
- High-risk patient, 48–57
- alcohol or drug addiction and, 397–398
- ambulatory surgery and, 56–57
- anemia and, 53–54
- cancer and, 54
- cataract and, 55–56
- diabetes mellitus and, 51
- difficult airway and, 56
- elderly patient and, 55
- heart disease and, 48f, 48–49
- heart failure and, 49
- hepatic disease and, 53
- hypertension and, 51–52, 52t, 53t
- intraoperative transport of, 1814
- intraoperative hypothermia and, 1630
- murmurs and, 49–50
- neurologic disease and, 54
- obesity and, 51
- obstructive sleep apnea and, 51
- pregnant, 1486–1488, 1487t
- pulmonary disease and, 50–51
- renal disease and, 52–53
- rhythm disturbances and ECG abnormalities and, 49
- risk of thromboembolism and, 54–55
- same-day surgery and, 1649–1659
- cardiopulmonary suite and, 1653–1654
- diagnostic imaging in, 1655
- electroconvulsive therapy in, 1651–1652
- endoscopy in, 1652–1653
- interventional radiology in, 1654–1656
- pediatric patient and, 1655–1656
- pharmacologic agents for, 1651
- postanesthesia concerns in, 1651
- preanesthetic considerations in, 1649–1651
- smoking and, 55
- substance abuse and, 54
- High-voltage injury, 1780
- Hildebrandt, August, 4
- Hip
- innervation of, 2047t
- painful conditions of, 2023–2024t
- Hip joint replacement, 1544–1547, 1546f
- deep venous thrombosis and, 1552–1553
- methylmethacrylate hypersensitivity and, 1552
- older adult and, 351–352
- Hip surgery
- block height for, 988t
- in femoral neck fracture, 1547
- Hirschsprung disease, 1513
- Histamine
- basophil-histamine release assay and, 1954
- opioid analgesic-induced release of, 878, 879f
- Histamine<sub>2</sub>-blocking agents, 1315–1316
- Histoplasmosis, 294
- History
- in chronic pain, 2042–2043
- preoperative, 43, 44t
- addicted patient and, 398–399
- difficult airway and, 126, 126t
- elective surgery and, 68–73, 69t, 70t, 71f, 72t, 73t
- liver transplantation and, 1353
- multiple organ dysfunction syndrome patient and, 1762–1764
- thoracic surgery and, 1215
- Hoarseness
- in inhalation injury, 1774
- nerve block-related, 1064
- postoperative, 1702, 1712
- Holt-Oram syndrome, 332t
- Homeostasis, 639
- Homosynaptic activity-dependent plasticity, 2006
- Horizontal dorsal decubitus position, 465–466, 466f



- Horizontal position infratentorial craniectomy, 1114
- Hormonal effects  
of etomidate, 860  
of opioid analgesics, 879  
in trauma, 1661, 1662*t*
- Hormonal response to critical illness, 1744–1745
- Hormone replacement therapy, 59
- Horner syndrome, 1064
- Hospital  
contract with, 2128–2129
- Hospital relationships  
practice management and, 2173
- Hospital-acquired infection, 1741
- Hospital-acquired pneumonia, 291, 1833
- Host factors  
in antimicrobial therapy, 285, 285*t*  
in response to critical illness, 1743*f*, 1743–1746, 1745*f*, 1746*f*
- Hot wire, 480
- Huffing, 414
- Human factors engineering, 26
- Human factors in quality of care, 21, 26, 33–34
- Human immunodeficiency virus infection  
in alcohol or drug addicted patient, 399, 402–403  
antimicrobial therapy in, 293–294, 294*t*  
neuropathy in, 2028, 2028*t*, 2030*t*  
pregnant patient and, 369  
public health and, 1742*t*
- Human immunodeficiency virus (HIV) infection  
transfusion-related, 1904
- Human leukocyte antigen alloimmunization, 1896
- Human resource management, 2174–2175
- Humor error model/failure model, 25*b*, 25–27, 27*b*
- Hunt and Hess grading system for subarachnoid hemorrhage, 1115*t*
- Hunter syndrome, 303*t*
- Hurler syndrome, 226, 303*t*, 1563
- Hyaline membrane disease, 305
- Hyaluronidase  
added to local anesthetics, 965  
in ophthalmic nerve block, 1573
- Hydralazine, 923, 923*t*, 2190*t*  
cerebral blood flow and, 1099–1100  
for low cardiac output in shock, 1847  
for postoperative hypertension, 1695
- Hydrocarbons, 413–414, 741*f*
- Hydrocephalus, 306
- Hydrochlorothiazide (HydroDIURIL, Esidrix), 920*t*
- Hydrocodone (Vicodin, Lorcet, Lortab, Norco), 1720*t*, 1721, 2053*t*, 2183*t*
- Hydrocortisone, 2193*t*  
for adrenal insufficiency, 1798, 1838  
for anaphylactic reaction, 1953, 1955*b*  
for Cushing syndrome, 180–181
- HydroDIURIL (hydrochlorothiazide), 920*t*
- Hydroflumethiazide (Saluron, Dixardin), 920*t*
- Hydrogen cyanide poisoning, 1774–1775
- Hydrogen equivalent, 641
- Hydromorphone (Dilaudid), 883, 2053*t*, 2183*t*, 2184*t*  
for acute postoperative pain, 1720*t*, 1721 dose, peak effect, and duration of, 875*t*  
intraocular pressure and, 1562*t*  
lipophilicity of, 1720*t*  
in obstetric surgery, 1473*t*, 1486  
pharmacokinetics of, 881*t*  
physiochemical properties of, 881*t*  
for trauma patient, 1668
- Hydromox (quinethazone), 920*t*
- Hydrophobicity of general anesthetic, 719
- Hydrostatic pressure, 642–643
- Hydroxocobalamin, 2194*t*
- Hydroxymethyl starches, 675–676, 676*f*, 1842
- 5-Hydroxytryptamine receptor, 2007
- Hydroxyzine, 2186*t*, 2189*t*
- Hygroton (chlorthalidone), 920*t*
- Hyoid bone, 688, 688*f*, 689*f*
- Hyperacute rejection in kidney transplant, 209
- Hyperaldosteronism, 408
- Hyperalgesia, 2010, 2011*t*  
in neuropathic pain, 2025*b*  
opioid-induced, 2051–2052
- Hyperammonemia, 1458
- Hyperbaric conditions, anesthesia vaporizer and, 783*f*, 783–784
- Hyperbaric oxygen in carbon monoxide poisoning, 1774
- Hyperbaric solutions, 987, 987*t*
- Hyperbilirubinemia, 220*t*
- Hypercalcemia, 203, 652–653, 653*f*, 653*t*  
associated with parathyroid disease, 177–179, 178*t*  
in lung cancer, 1221
- Hypercapnia  
alveolar hypoventilation and, 690–691  
conditions aggravated by, 692*b*  
in multiple organ dysfunction syndrome, 1765  
tourniquet and, 1550  
in transfiberoptic laser tumor resection, 1252
- Hypercapnic acidosis, 666
- Hypercarbia  
bronchoscopy-related, 1242  
inhaled anesthetics and, 758*t*  
during intrahospital patient transport, 1814  
newborn and, 304  
in portopulmonary hypertension, 1343  
uptake of local anesthetics and, 967
- Hypercatabolism, 1745
- Hyperchloremic acidemia, 1103*t*
- Hyperchloremic acidosis, 662
- Hyperchloremic metabolic acidosis, 200
- Hypercoagulable states, 258  
postoperative myocardial infarction and, 97  
risk for perioperative stroke in, 1926–1927
- Hyperesthesia  
in neuropathic pain, 2025*b*
- Hyperextended supine position, 1455, 1455*f*
- Hyperglucagonemia, 1319
- Hyperglycemia  
in critically ill patient, 1798  
deep hypothermic circulatory arrest and, 1191  
delayed awakening and, 1709  
during liver transplantation, 1365  
in multiple organ dysfunction syndrome, 1760, 1768  
neuroprotection and, 1934–1935  
postoperative, 1712  
posttraumatic, 1665  
during pregnancy, 368
- Hyperhomocysteinemia, 260–261
- Hyperimmune immunoglobulin, 1898
- Hyperinsulinemia, 380
- Hyperkalemia, 201–202, 202*f*, 202*t*  
malignant hyperthermia and, 1981  
in periodic paralysis, 159*t*, 165, 165*t*  
in renal failure, 211  
in small bowel transplantation, 1414  
succinylcholine-induced, 626–627  
transfusion-related, 1907–1908
- Hyperlactatemia, 1841
- Hyperlipidemia, 103
- Hypermagnesemia, 203, 655
- Hypermetabolism, burn patient and, 1679–1680, 1773
- Hypernatremia, 200, 649*f*, 649*t*, 649–650, 650*t*
- Hypernatremic hypernatremia, 649
- Hyperosmolar agents, 1100–1102, 1101*t*, 1103*t*
- Hyperosmolar nonketotic state, 189–190
- Hyperparathyroidism, 177–179, 178*t*, 652, 1603–1604
- Hyperpathia, 2010  
in neuropathic pain, 2025*b*
- Hyperphosphatemia, 204, 211, 657, 657*t*
- Hyperpituitarism, 184–185, 185*t*
- Hyperproliferative anemia, 241–242
- Hypersensitivity pneumonitis  
cocaine-induced, 411  
opioid overdose and, 410
- Hypersensitivity reaction  
to barbiturates, 853  
to propofol, 858
- Hypertension  
after aneurysm surgery, 1306  
after carotid endarterectomy, 1297  
alcohol abuse and, 403  
antihypertensives for, 919–925  
angiotensin II receptor blockers in, 925, 925*t*  
angiotensin-converting enzyme inhibitors in, 924*t*, 924–925, 925*f*  
centrally acting alpha<sub>2</sub>-agonists in, 921*t*, 921–922  
cerebral blood flow and, 1099–1100  
diuretics in, 919–921, 920*t*  
formulary of, 2190*t*  
peripherally acting sympatholytic agents in, 922*t*, 922–923
- preoperative assessment and management of, 58  
vasodilators in, 923*t*, 923–924
- in autonomic hyperreflexia, 1455–1456, 1456*f*
- cerebral ischemia and, 1935–1937, 1936*f*
- cocaine-related, 410, 411
- coronary artery disease and, 1147
- esophageal surgery-related, 1251
- eye surgery and, 1566
- geriatric patient and, 344–345, 348
- hypercalcemia and, 653
- increased intracranial pressure and, 1935
- induction in hypotensive patient, 1937–1938
- intracranial  
assessment before pediatric surgery, 328  
positive end-expiratory pressure and, 1938, 1939*f*  
succinylcholine-induced, 627
- during intrahospital patient transport, 1814
- intravascular injection of local anesthetic and, 1059
- liver transplantation and, 1368, 1369
- obesity and, 379–380, 380*f*
- in opioid withdrawal, 415
- perioperative cardiac complications and, 103, 109–110
- perioperative complications and death and, 442*t*
- portal, 1341–1343, 1342*f*, 1343*b*, 1343*f*, 1355  
in alcoholic cirrhosis, 407  
in alcoholic hepatitis, 408  
chronic liver failure and, 232  
in hepatopulmonary syndrome, 1343  
pharmacokinetic abnormalities in, 223  
procedures for, 1369*b*, 1369–1370
- in postanesthesia care unit, 1694–1695
- postoperative, 1707–1708, 1708*t*
- in preeclampsia, 362–364, 363*t*, 1488
- preoperative assessment and management in, 51–52, 52*t*, 53*t*
- pulmonary, 1219, 1219*b*  
in alcoholic cirrhosis, 407  
methamphetamine use and, 412  
persistent pulmonary hypertension of newborn and, 305  
pregnant patient and, 366  
pulmonary artery pressure waveform in, 531*f*  
during reperfusion in liver transplantation, 1366
- renal failure and, 1399
- vascular disease and, 1287
- Hypertensive disorders of pregnancy, 1488
- Hyperthermia  
after stroke, 1934  
malignant, 169, 1964–1984  
animal models of, 1971–1972  
associated myopathies in, 1970*f*, 1970–1971  
congenital strabismus and, 1563  
differential diagnosis of, 1968*b*  
epidemiology of, 1966  
exercise and heat illness and, 1969–1970  
fulminant episodes of, 1966*b*, 1966–1968, 1967*b*, 1969*f*  
historic perspective of, 1965–1966  
identification before elective surgery, 70–71  
inhalational anesthetics and, 759  
management of, 1980*b*, 1980–1984, 1982*b*, 1982–1984*b*  
masseter muscle rigidity in, 1968–1969  
molecular genetics of, 1975–1978, 1976*t*, 1977*f*  
resources for, 1992–1993  
subcellular sites of defect in skeletal muscle in, 1972–1974, 1973*f*, 1974*t*, 1975*f*, 1976*f*  
testing for susceptibility to, 1978–1980, 1979*f*  
during monitored anesthesia care, 1630  
postoperative, 1696, 1711*f*, 1711–1712
- Hyperthyroidism, 174–175, 175*t*, 369
- Hypertonic hyponatremia, 646–647
- Hypertonic saline, 672*t*, 672–673  
for burn patient, 1776  
for hyponatremia, 648, 648*t*  
in neuroanesthesia, 1101–1102, 1103*t*  
for small volume resuscitation in traumatic shock, 1664
- Hypertonic solutions, 643
- Hypertrophic cardiomyopathy, 366, 1153*t*
- Hyperventilation  
clinical causes of, 580, 580*t*  
effect on hypoperfusion, 1931, 1931*f*  
during intrahospital patient transport, 1814

- Hypervolemia, 645  
transfusion-related, 1907
- Hypervolemic hyponatremia, 199t
- Hypesthesia  
in neuropathic pain, 2025b
- Hypnosis  
anesthetic mechanism of action and, 734  
opioid analgesics and, 875
- Hypnotics, 901t  
anaphylactic reaction to, 1953t, 1956  
formulary of, 2186t  
propofol concentration and, 910, 910f
- Hypoalbuminemia, 658–659  
perioperative cardiac complications and, 104  
pharmacokinetic abnormalities in, 223
- Hypobaric conditions, anesthesia vaporizer and, 783, 783f
- Hypobaric solutions, 987, 987t
- Hypocalcemia, 202–203, 203t, 653t, 653–654  
after thyroid surgery, 1603  
burn patient and, 1680  
during liver transplantation, 1365  
malignant hyperthermia and, 1981  
in newborn, 307  
parathyroid disease-related, 179, 179t  
in renal failure, 211  
transfusion-related, 1907
- Hypocapnia  
postresuscitation support and, 1886  
to reduce intracranial pressure, 1090
- Hypocarbemia, 1814
- Hypocoagulable states  
drug-induced, 239f, 247, 248t, 249t, 254  
synthetic colloid infusions and, 257–258
- Hypogastric nerve, 1451f, 1452f
- Hypoglossal nerve, 687f
- Hypoglycemia  
delayed awakening and, 1709  
in glycogen storage diseases, 166  
during liver transplantation, 1365  
in lung cancer, 1221  
in multiple organ dysfunction syndrome, 1760, 1768  
neonatal, 186, 307
- Hypokalemia, 201, 651f, 651t, 651–652, 652f  
alcohol abuse and, 406, 408  
hyperosmolar agents and, 1103t  
in periodic paralysis, 159t, 165t, 165–166
- Hypomagnesemia, 203, 654t, 654–655, 655t  
alcohol abuse and, 406, 408  
parathyroid disease-related hypocalcemia and, 179  
in renal failure, 211  
transfusion-related, 1907
- Hyponatremia, 199t, 199–200, 646f, 646–648, 647t, 648t  
during liver transplantation, 1365  
in syndrome of inappropriate antidiuretic hormone, 185, 185t  
transurethral resection of prostate and, 1458
- Hypoparathyroidism, 203t
- Hypoperfusion  
assessment and treatment of, 544f  
direct tissue trauma and, 1740  
postoperative cognitive dysfunction and, 1919  
in shock, 1841
- Hypophosphatemia, 203–204, 408, 656, 656f
- Hypopituitarism, 184
- Hypoplastic left heart syndrome, 1180
- Hypoproliferative anemia, 241, 241t
- Hypoprothrombinemia, 254
- Hypospadias repair, 1534
- Hypotension  
after carotid endarterectomy, 1297  
allograft perfusion in renal transplantation and, 1402  
in anaphylactic reaction, 1952–1953  
burn patient and, 1680  
cardiogenic shock and, 1742  
cerebral blood flow and, 1091–1092  
in critically ill patient, 1806  
epidural analgesia-related, 1728  
esophageal surgery-related, 1250  
following protamine administration, 1142  
in hemorrhagic shock, 1662  
high left ventricular assist device pump flow rates and, 1167–1168, 1168f  
hyperosmolar agents and, 1103t  
induced  
in arteriovenous malformation repair, 1119  
in mastoidectomy, 1584  
in sinus surgery, 1586  
in subarachnoid hemorrhage surgery, 1118  
induced hypertension and, 1937–1938  
during intrahospital patient transport, 1814  
intravascular injection of local anesthetic and, 1059  
during liver transplantation, 1364  
low left ventricular assist device pump flow rates and, 1167, 1167f  
neonatal emergency surgery and, 1504  
neuraxial anesthesia-related, 1070  
in neurogenic shock, 1549  
obstetric surgery and, 1472, 1475, 1480, 1485  
perioperative complications and death and, 442t  
in postanesthesia care unit, 1693  
postoperative, 1706  
in pulmonary embolism, 1704  
in shock, 1841  
in small bowel transplantation, 1414  
in trauma patient, 1790  
vancomycin-associated, 1958
- Hypotensive anesthesia  
in orthopedic surgery, 1542  
in radical cystectomy, 1463–1464  
in spine surgery, 1548–1549
- Hypothermia  
during aneurysm surgery, 1301  
burn patient and, 1680  
child and, 317  
cerebral palsy and, 1543  
warming devices during surgery and, 1522  
liver transplantation and, 1360–1361  
during monitored anesthesia care, 1630  
for neuroprotection, 1104–1105  
neuroprotection and, 1931–1934, 1932f, 1933t  
in nonoperating room procedures, 1650–1651  
during patient transport, 1815  
perioperative, 1984–1992, 1985t  
complications of, 1989t, 1989–1990  
general anesthesia and, 1986–1989, 1987–1989f  
neuroprotection and, 1991–1992  
prevention and treatment of, 1990–1991  
postoperative, 1696, 1711  
for postresuscitation support, 1886  
transfusion-related, 1907  
trauma patient and, 1664–1665, 1666, 1793, 1793t, 1794
- Hypothyroidism, 176t, 176–177  
congenital, 303t, 331t  
obesity and, 381–382  
during pregnancy, 368
- Hypotonic hyponatremia, 646–647
- Hypotonic solutions, 643, 649, 650t, 1101
- Hypoventilation  
clinical causes of, 580, 580t  
in obesity-hypoventilation syndrome, 377  
postoperative, 1692, 1702–1703  
ventilation during anesthesia and, 691f, 691–692, 692b
- Hypoventilation-induced hypercarbia, 1343
- Hypovolemia, 644–645, 645f  
in burn patient, 1772  
compensation for, 668, 668f  
in critically ill patient, 1806  
hypotension-related, 1693  
in labor and delivery, 1486–1487  
monitoring for, 540  
during neonatal emergency surgery, 1507, 1507f  
postoperative, 1706  
in trauma patient, 1790
- Hypovolemic hyponatremia, 199t
- Hypovolemic shock, 1742, 1772–1773, 1841
- Hypoxemia, 579, 580t  
air transport and, 1819–1820  
in alcoholic cirrhosis, 406–407  
bronchoscopy-related, 1242  
in congenital heart disease, 1178–1179  
intracardiac shunting and, 1175  
during intrahospital patient transport, 1814  
mechanical ventilation in, 1853t  
neuroprotection and, 1929–1930, 1930f  
newborn and, 304  
obese patient and, 376  
postoperative, 1692, 1702f, 1702–1704, 1703f, 1833  
in pulmonary embolism, 1705  
in restrictive ventilatory defects, 136
- Hypoxia, 579, 580t  
cytopathic, 1749  
in head injury, 1669  
in hepatopulmonary syndrome, 1343b, 1343–1344  
local anesthetic toxicity and, 968–969  
in long bone and pelvic fractures, 1671–1672  
newborn and, 304, 305, 306
- Hypoxic pulmonary vasoconstriction, 758, 758t, 1232–1235, 1233f, 1234f, 1234t
- Hysterectomy, 1494, 1495
- Hysteresis, 825–826, 826f, 827f, 827t
- Hysteroscopy, 1494
- I**
- Iatrogenic airway disorders, 1591–1592
- Ibuprofen, 2064t
- Ibuprofen (Motrin), 2183t  
antiplatelet activity of, 256  
standard doses of, 1723t
- Ibutilide, 944t, 946
- Ice therapy for chronic pain, 2066–2067
- Ideal body weight, 375  
intravenous anesthetic dosing and, 835–836, 836t, 838t
- Idiopathic small-fiber painful sensory neuropathy, 2027t
- Ileal loop, 1463
- Iliohypogastric nerve, 1038f
- Iliohypogastric nerve block, 1530–1531
- Ilioinguinal nerve, 1038f
- Ilioinguinal nerve block, 1530–1531
- Iliopsoas tendonitis/bursitis, 2024t
- Iliotibial band bursitis, 2024t
- Iloprost, 1342
- Image-guided intervention for chronic pain, 2072–2105  
anatomy relevant to, 2073–2077, 2074f, 2075f  
celiac plexus block in, 2084–2087, 2085f  
cervical facet medial branch block in, 2091–2092  
facet medial branch blocks in, 2090–2091  
future directions of, 2102  
implantable drug delivery systems for, 2096–2099  
interlaminar epidural injection of steroids in, 2077–2081, 2080f  
intraarticular facet injection in, 2089–2090, 2090f  
lumbar discography and intradiscal treatments in, 2093–2096, 2094f  
lumbar facet medial branch blocks in, 2092f, 2092–2093  
lumbar sympathetic block in, 2087  
lumbar sympathetic neurolysis in, 2087–2088  
spinal cord stimulation in, 2099–2102  
stellate ganglion block in, 2083–2084, 2084t  
thoracic facet medial branch block in, 2092  
training in, 2102  
transforaminal technique for epidural steroid injection in, 2081–2082, 2083f
- Imipenem, 2195t
- Imipramine, 2050t
- Immediate hypersensitivity reaction  
skin testing for, 1954
- Immune system  
complications associated with renal failure, 1399t  
of geriatric patient, 345–346  
inhalational anesthetics and, 759  
opioid analgesics and, 880  
pathophysiology of critical illness and, 1743f, 1744, 1748–1749  
protein-energy malnutrition and, 271–272
- Immune-enhanced early enteral nutrition, 274–275, 275t
- Immunobiology of transplantation, 1382–1383
- Immunocompromised patient  
initial antimicrobial therapy in, 291t  
intensive care unit admission and, 1741t
- Immunodiagnostic tests  
in anaphylactic reaction, 1954
- Immunoglobulin E  
latex allergy and, 1959  
in mast cell activation, 1947–1948, 1949f
- Immunoglobulin G  
complement activation and, 1949  
in counteraction of immunoglobulin E, 1948
- Immunoglobulin M  
complement activation and, 1949
- Immunoglobulin preparations, 1898
- Immunomodulation, 1748–1749  
transfusion-related, 1908
- Immunonutrition, 274, 275t

- Immunoreceptor tyrosine-based activation motif, 1948, 1949f
- Immunosuppression  
in heart and lung transplantation, 1382–1383, 1383t  
immunomodulation and, 1748–1749  
opioid-induced, 880  
in pancreas transplantation, 1408  
in renal transplantation, 1401–1402  
in small bowel transplantation, 1414
- Immunotherapy  
for anaphylactic reaction, 1955b, 1955–1956, 1961
- Impaired glucose tolerance, 185
- Impaired provider program, 2135
- Impedance, electrical current and, 477
- Impedance threshold device, 1878–1879
- Impella Recover LP 5.0 LV system, 1164
- Imperforate anus, 1513
- Implant, cochlear, 1583
- Implantable cardioverter-defibrillator, 1654  
postanesthesia care unit and, 1694  
preoperative assessment and management and, 50
- Implantable drug delivery systems, 2096–2102
- Implanted spinal infusion pump system, 2121, 2121f
- In utero fetal and placental surgery, 1478
- In vitro caffeine contracture test, 1966
- In vitro testing  
in anaphylactic reaction, 1954  
for malignant hyperthermia, 1978–1979, 1979f
- Inamrinone, 2190t
- In- and out-of-operating room coverage, 2175–2176
- Incident, term, 454
- Incident analysis program, 457
- Incisional hernia repair, paravertebral nerve block in, 1020–1021
- Incompetent patient, 2130–2131
- Increased intracranial pressure  
assessment before pediatric surgery, 328  
positive end-expiratory pressure and, 1938, 1939f  
succinylcholine-induced, 627
- Indapamide (Lozol), 920t
- Indigotindisulfonate, 2193t
- Indirect calorimetry, 269
- Individual productivity, 2166–2169, 2167t, 2168t
- Indomethacin (Indocin), 1723t, 2064t, 2183t
- Induced hypotension  
in arteriovenous malformation repair, 1119  
in mastoidectomy, 1584  
for postresuscitation support, 1886  
in sinus surgery, 1586  
in subarachnoid hemorrhage surgery, 1118
- Induced hypothermia for postresuscitation support, 1886
- Induction of anesthesia  
in adenotonsillectomy, 1588f, 1588–1589  
in cesarean delivery, 1485–1486  
in congenital heart disease, 1203–1204  
in coronary artery bypass graft, 1149–1150  
in heart transplantation, 1391  
in hepatic resection, 1348  
in liver transplantation, 1360–1361, 1361t  
in lung transplantation, 1386–1389  
obese patient and, 388–390, 389f  
in pancreas transplantation, 1407  
in pediatric surgery, 1524f, 1524–1525, 1525t  
propofol and, 858–859  
in renal transplantation, 1400–1401  
in small bowel transplantation, 1413–1414  
in spine surgery, 1548  
in subarachnoid hemorrhage, 1117f, 1117–1118  
in supratentorial craniotomy, 1106–1108, 1108f  
thiopental and, 855–856, 856t  
in total intravenous anesthesia, 903  
in valve surgery, 1155–1156
- Inductor, electrical, 477
- Inefficiency of use of operating room time, 2156, 2159
- Inert gases for anesthesia, 761, 761t
- Infant  
anesthesia for, 1520–1540  
airway management in, 1525–1527, 1526f, 1526t, 1527t  
in ambulatory surgery, 1537  
blood and blood products and, 1528  
in cancer-related procedures, 1535–1536  
cardiac risk in, 1521  
emergence delirium and, 1533  
equipment for, 1522  
extubation choices in, 1527–1528  
facility and provider expertise and, 1521–1522  
fluid therapy and, 1528  
in general and urologic surgery, 1533–1534  
induction of, 1524t, 1524–1525, 1525t  
in laparoscopy, 1534  
maintenance of, 1527  
patient preparation and premedication in, 1523t, 1523–1524  
in pectus excavatum, 1535  
postoperative nausea and vomiting and, 1532t, 1532–1533  
postoperative pain management and, 1532  
regional, 1528–1531, 1529f, 1531t  
respiratory risk in, 1520–1521  
in thoracotomy and thoracoscopy, 1534–1535, 1535t  
in ventriculoperitoneal shunt, 1536–1537  
blood pressure ranges of, 315t  
blood transfusion and, 1895  
cleft lip and palate in, 1597  
developmental behavior of, 321t, 322  
external chest compressions in, 1875f  
intravascular blood volume of, 315t  
liver disease in, 224–226  
mean hematocrit and hemoglobin of, 335t  
normal red blood cell values of, 240t  
postoperative pain and, 1731–1732  
renal function development in, 316t  
risk for apnea after surgery, 1609, 1609f  
strabismus surgery in, 1577
- Infection  
in alcohol or drug addicted patient, 399t, 399–403  
antimicrobial therapy for, 279–299  
in acute pancreatitis, 292–293  
in bacteremia, 291–292  
bacterial resistance and, 282–283  
in catheter-related infections, 287–288  
in *Clostridium difficile* infection, 292  
combination, 283–284  
epidemiologic considerations in, 284t, 284–285  
formulary for, 2195t  
in fungal infection, 294–296  
host factors in, 285, 285t  
in human immunodeficiency virus infection, 293–294, 294t  
identification of pathogen and, 284  
minimum inhibitory concentration and, 279–280  
in nosocomial infections, 286f, 286t, 286–287  
perioperative cardiac complications and, 116  
pharmacokinetics and pharmacodynamics in, 280–282, 281t  
in pneumonia, 290t, 290–291, 291t  
prophylactic, 288–290  
in urinary tract infection, 292  
burn patient and, 1680–1681, 1781  
catheter-related  
antimicrobial therapy for, 287–288  
burn patient and, 1681  
central venous catheter and, 526, 526b  
pulmonary artery catheter and, 530–531  
in epiglottitis, 1586–1587  
in hepatitis, 227t, 227–228, 231, 1340  
intensive care unit admission and, 1741t  
lumbar discography-related, 2095  
multiple organ dysfunction syndrome and, 1760, 1763  
nosocomial, 291, 291t, 1833  
antimicrobial therapy for, 286f, 286t, 286–287  
as cause of death in critical illness, 1741  
in pneumonia, 291, 291t, 1833, 1838  
pathogens in, 286t  
pathophysiology of critical illness and, 1741, 1741t, 1742t, 1747–1748, 1748f  
peripheral nerve block-associated, 1049  
in pneumonia, 290, 290t  
postoperative  
in hematopoietic stem cell transplantation, 1409  
intensive care unit and, 1838  
in intraabdominal surgery, 225t  
in lung transplantation, 1390  
neuraxial anesthesia and, 997–998, 1065  
in pancreas transplantation, 1408  
respiratory tract, 1586–1587  
adenotonsillar hypertrophy and, 1587  
croup and, 1587  
difficult airway and, 128, 128f  
Infection control, 34  
Infection-induced tubulointerstitial disease, 207–208  
Infective endocarditis  
in alcohol or drug addicted patient, 400  
intensive care unit admission and, 1741t  
Inferior gluteal nerve, 2047t  
Inferior hemorrhoidal nerve, 1453f  
Inferior hypogastric plexus, 1451–1453f  
Inferior mesenteric ganglion, 1452f  
Inferior nasal turbinate, 1571f  
Inferior oblique muscle, 1560t, 1566–1571f, 1573f  
Inferior ophthalmic vein, 1572f  
Inferior orbital septum, 1568f  
Inferior rectus muscle, 1560t, 1566–1572f  
Inferior thoracic splanchnic nerve, 1451f  
Inferior vena cava  
liver and, 217f  
liver transplantation and, 1354–1355  
Infiltrative liver disease, 230–231  
Inflammation  
in atherosclerosis, 1285  
in burn injury, 1772–1773  
cardiopulmonary bypass-related, 1141  
leukocyte adhesion in, 1745, 1745f  
in mechanical ventilation-related biotrauma, 1864–1865  
multiple organ dysfunction syndrome and, 1755, 1756  
pathophysiology of critical illness and, 1743f, 1744, 1748–1749  
postoperative myocardial infarction and, 97  
in trauma, 1786  
Inflammatory bowel disease, 2025  
Inflammatory liver disease, 230  
Inflammatory pain, 2008f, 2008–2009, 2009f  
central sensitization and, 2012f, 2012–2013  
definition of, 2011t  
peripheral sensitization and, 2011–2012, 2012f, 2012t  
Infliximab, 2025  
Influenza virus, 290  
Informatics, 61, 62–64f  
Informed consent, 2130–2131  
Infraclavicular nerve block, 1032  
in hand and wrist surgery, 1616f  
in upper-extremity orthopedic procedures, 1543  
Infraorbital canal, 1571f  
Infratentorial craniectomy, sitting position, 1108–1114, 1111–1113f  
Infratrochlear nerve, 1567f  
Infusion maintenance of neuromuscular blockade, 633–634  
Ingested foreign body, 1269–1270  
Inguinal hernia repair, 1020–1021  
Inguinal ligament, 1038f  
Inhalants abuse, 405t, 413–414  
Inhalation induction, 691  
Inhalation injury, 1661t, 1773–1775, 1774f  
Inhalational anesthetics, 739–766  
action on gamma-aminobutyric acid receptors, 726  
acute porphyria and, 161t  
advantages and disadvantages of, 761, 761t  
beta-adrenergic blockers and, 932  
biophysical properties of, 742, 743f, 744f, 744t  
breakdown and toxicity of byproducts of, 759–761  
cardiovascular effects of, 756t, 756–757, 757f, 757t  
cerebral blood flow and, 1095–1099, 1096f, 1097t, 1098f  
cerebral neuroprotection and, 1104  
cerebrovascular and metabolic effects of, 755–756, 756t  
chemical and physical properties of, 740–742, 741f, 741t  
digitalis-induced ventricular dysrhythmias and, 926  
dose-response concepts and, 739–740  
effect on pathophysiology of congenital heart disease, 1197–1198, 1198f  
endocrine function and, 759  
genotoxicity and teratogenicity of, 759  
hepatic effects of, 758  
immune function and, 759  
intraoperative awareness and, 753–755, 754f, 754t

- intraoperative electroencephalography and, 604–605t
- ischemic preconditioning and, 759
- malignant hyperthermia and, 169, 759, 1964–1984
- animal models of, 1971–1972
- associated myopathies in, 1970f, 1970–1971
- congenital strabismus and, 1563
- differential diagnosis of, 1968b
- epidemiology of, 1966
- exercise and heat illness and, 1969–1970
- fulminant episodes of, 1966b, 1966–1968, 1967b, 1969f
- historic perspective of, 1965–1966
- identification before elective surgery, 70–71
- management of, 1980b, 1980–1984, 1982b, 1982–1984b
- masseter muscle rigidity in, 1968–1969
- molecular genetics of, 1975–1978, 1976t, 1977f
- resources for, 1992–1993
- subcellular sites of defect in skeletal muscle in, 1972–1974, 1973f, 1974t, 1975f, 1976f
- testing for susceptibility to, 1978–1980, 1979f
- methionine synthase inhibition and, 759
- minimum alveolar concentration of, 776, 776t
- muscular system effects of, 759
- in neonatal emergency surgery, 1504, 1504t
- pharmacodynamics of, 750–753, 751t, 751–753f
- pharmacokinetics of, 742–750
- alveolar partial pressure of gas and, 746f, 746–747, 747f
- anatomic and physiologic dead space and, 748
- concentration effect and second gas effect and, 749, 749f
- distribution in body tissues and, 747–748, 748f
- elimination via ventilation and, 750
- inspired partial pressure of gas and, 745f, 745–746, 746f
- intrapulmonary right-to-left shunt and, 748, 749f
- multicompartmental kinetic model of, 742–745, 745f
- nitrous uptake into airspaces of body and, 749–750, 750f
- systemic arteriovenous shunting and, 748
- physical properties of, 777t
- renal effects of, 758
- respiratory function and, 757–758, 758t
- space-filling representation of, 719f
- stages and planes of, 751t
- total intravenous anesthesia and, 897–917
- alpha<sub>2</sub>-agonists for, 910–911
- context-sensitive half-time and, 911f, 911–912, 912f
- dosing strategies in, 898–899
- effect-site targeting in, 902–903
- etomidate for, 904–905
- induction of, 903
- ketamine for, 906–907, 908–909
- methohexital for, 904, 908
- midazolam for, 905, 908
- opiates for, 907, 911, 913f, 913–914
- pharmacokinetic principles of, 899–900, 900f, 900t, 901t
- properties of volatile agents for, 898, 898t, 899t
- propofol for, 905t, 905–906, 909–910, 910f
- simulation data for, 912–913
- target-controlled infusions in, 900–902, 902t
- thiamylal for, 904, 907–908
- thiopental for, 903–904, 907–908
- vapor pressure curves for, 776f
- Inherited liver disease, 226
- Inherited neuropathies, 2027t
- Inhibitors of fatty acid oxidation, 936
- Injury patterns, 1661, 1661t
- Innervation
- of bladder, 1451, 1452f
- of female reproductive organs, 1476f, 1495
- of globe, 1565
- of hip and lower extremity, 2047t
- of kidney, 1450, 1451f
- of penis, 1453
- of prostate, 1452, 1452f
- of shoulder and upper extremity, 2046t
- testicular, 1452
- of tongue, 687f
- ureteral, 1451, 1451f
- Innohep (tinzaparin), 254–255
- Innominate artery, 1214
- Inotropic drugs
- for critically ill patient, 1806–1807
- effect of pathophysiology of congenital heart disease, 1200–1201
- formulary of, 2190t
- for weaning from cardiopulmonary bypass, 1193
- Inotropy, 1146, 1147f
- Inspiratory airways resistance, 593
- Inspiratory flow, child *versus* adult, 313t
- Inspiratory muscle disease, 157
- Inspiratory stridor, 1653–1654
- Inspiratory termination criteria, 1855, 1856f
- Inspiratory time
- child *versus* adult, 313t
- patient-ventilator synchrony and, 1861f, 1861–1862
- Inspiratory:expiratory ratio, child *versus* adult, 313t
- Inspired concentration, dose response and, 740
- Inspired partial pressure, inhalational anesthetics and, 745f, 745–746, 746f
- Inspra (eplerenone), 919, 920t
- Insulator, electrical, 476
- Insulin, 2193t
- liver and, 218–219
- response to trauma, 1662t
- starvation and, 267
- Insulin resistance, 190, 382, 1404
- Insulin therapy
- for critically ill patient, 1745
- guidelines for pancreas recipient, 1407t
- in multiple organ dysfunction syndrome, 1768
- for postoperative ICU patient, 1837
- preparations for, 187
- for trauma patient, 1665
- Insulinoma, 1327
- Integrated circuit, 479
- Integrilin (eptifibatid), 256
- Intensive care unit
- infections requiring admission to, 1741t
- patient safety and quality improvement in, 460–461
- postoperative care and, 1828–1840
- cardiovascular issues in, 1834
- endocrine issues in, 1837–1838
- gastrointestinal issues in, 1834–1835, 1835t
- hematologic issues in, 1835–1837
- laboratory tests and vital signs and, 1831
- neurologic issues in, 1832t, 1832–1833
- pain management and, 1733–1734, 1831–1832, 1832t
- prophylactic and preventive measures in, 289, 1838t, 1838–1839
- pulmonary issues in, 1833–1834
- renal issues in, 1837
- transport from operating room and, 1830–1831
- triage and, 1828–1830, 1829t, 1830t
- quantifying severity of illness and relationship to outcome, 1742–1743
- Interactome, 724
- Interatrial septum, transesophageal echocardiography of, 556–558, 557f
- Intercostal artery, 609f
- Intercostal brachial nerve, 1029f
- Intercostal nerve block
- for cancer pain, 2116–2117, 2117f
- for postoperative pain in thoracic surgery, 1274, 1275f
- in thoracic surgery, 1238
- Intercostobrachial nerve, axillary block and, 1032
- Intercrest line, 983, 983f
- Interference, electrical, 482
- Interhospital transport of critically ill patient, 1812
- Interlaminar epidural injection of steroids, 2077–2082, 2080f
- Interleukins
- anaphylactic reaction and, 1948, 1948t, 1949f
- atherosclerosis and, 1285
- Interlock system of Datex-Ohmeda Tec 6 vaporizer, 788
- Intermediate sensitivity of antimicrobial agent, 280
- Intermittent claudication, 1297
- Internal disk derangement, 2074
- Internal jugular vein
- for central venous catheter access, 523–525
- for pulmonary artery catheter access, 526–527
- Internal nasal deformity, 1585–1586
- International electrical safety standards, 490
- International normalized ratio
- Child-Pugh scoring system and, 224t
- in hepatocellular function evaluation, 232
- Interneuron, generation of electroencephalogram and, 598, 599t, 600f
- Interposed abdominal compression cardiopulmonary resuscitation, 1878
- Interrupted aortic arch, 1176t
- Interscalene nerve block, 1029–1031, 1030f
- phrenic nerve paralysis and, 1063–1064
- for postoperative pain in shoulder replacement, 1543
- Intersorb Plus, 797t
- Interstitial fluid, 640, 640f, 641t, 642
- Interstitial laser therapy, 1457
- Intervention plan for substance abuse in anesthesia care provider, 2149
- Interventional neuroradiology, 1655
- Interventional pain medicine, 2072–2105
- anatomy relevant to, 2073–2077, 2074f, 2075f
- celiac plexus block in, 2084–2087, 2085f
- cervical facet medial branch block in, 2091–2092
- facet medial branch blocks in, 2090–2091
- future directions of, 2102
- implantable drug delivery systems for, 2096–2099
- interlaminar epidural injection of steroids in, 2077–2081, 2080f
- intraarticular facet injection in, 2089–2090, 2090f
- lumbar discography and intradiscal treatments in, 2093–2096, 2094f
- lumbar facet medial branch blocks in, 2092f, 2092–2093
- lumbar sympathetic block in, 2087
- lumbar sympathetic neurolysis in, 2087–2088
- spinal cord stimulation in, 2099–2102
- stellate ganglion block in, 2083–2084, 2084t
- thoracic facet medial branch block in, 2092
- training in, 2102
- transforaminal technique for epidural steroid injection in, 2081–2082, 2083f
- Interventional radiology, 1654–1656
- Interventional therapies for cancer pain, 2112–2121, 2114t
- brachial plexus block in, 2115–2116, 2116f
- celiac plexus block in, 2118–2119, 2119f
- communication and, 2112–2113
- detailed physical examination in, 2113
- ganglion impar block in, 2120–2121
- goals of, 2112
- intercostal nerve block in, 2116–2117, 2117f
- lumbar sympathetic block in, 2119–2120
- occipital nerve block in, 2114–2115
- stellate ganglion block in, 2117–2118
- superficial cervical plexus block in, 2115
- superior hypogastric plexus block in, 2120, 2120f
- trigeminal nerve block in, 2114, 2114f
- Intervertebral disk, 979–980, 980f, 2074f, 2075–2076
- Intervertebral foramen, 2076
- Intervertebral ligaments, 979–980, 980f
- Intestinal obstruction, neonatal, 1512–1513
- Intestine, effects of opioid analgesics on, 878–879
- Intraabdominal gynecologic surgery, 1495–1497
- Intraabdominal hemorrhage, 1668–1669
- Intraabdominal hypertension in liver transplantation, 1368, 1369
- Intraaortic balloon pump, 1202
- Intraarterial catheter
- in neonatal emergency surgery, 1507
- during thoracic surgery, 1223t
- trauma patient and, 1665
- Intraarterial xenon measurement of cerebral blood flow, 1084, 1084f
- Intraarticular injections, 2088–2093, 2090f
- cervical facet medial branch block in, 2091–2092
- facet medial branch block in, 2090–2091
- lumbar facet medial branch block in, 2092f, 2092–2093
- radiofrequency treatment *versus*, 2089
- thoracic facet medial branch block in, 2092
- Intracapsular cataract extraction, 1578
- Intracardiac shunting
- in congenital heart disease, 1175–1178, 1177f, 1178f, 1178t, 1179t, 1187
- thoracic surgery-related, 1272



- Intracellular fluid, 640, 640f  
ions in, 641t  
of newborn, 1503t
- Intracerebral hemorrhage  
stroke and, 1925
- Intracranial aneurysm, 612t
- Intracranial hemorrhage  
in hemophilia, 248  
perioperative, 1929  
stroke and, 1925
- Intracranial hypertension  
assessment before pediatric surgery, 328  
positive end-expiratory pressure and, 1938, 1939f  
succinylcholine-induced, 627
- Intracranial pressure  
antihypertensives and, 1099–1100  
benzodiazepines and, 861  
effects of blood pressure on, 1935  
halothane and, 1097, 1098f  
inhaled anesthetics and, 756t  
intravenous anesthetics and, 852t  
nitrous oxide and, 1099  
nondepolarizing neuromuscular blocking drugs and, 1099  
opioid analgesics and, 876  
physiology of, 1086f, 1086–1088, 1087f  
subarachnoid hemorrhage and, 1114f, 1114–1115, 1117t  
succinylcholine and, 627, 1099, 1719  
supratentorial craniotomy and, 1106  
trauma patient and, 1669
- Intracranial vascular surgery  
for arteriovenous malformation, 1119–1120  
for subarachnoid hemorrhage, 1114f, 1114–1119, 1115t, 1116f, 1117f, 1117t
- Intradiscal electrothermal therapy, 2093–2096, 2094f
- Intrahepatic pressure, succinylcholine and, 627
- Intrahospital transport of critically ill patient, 1812, 1813t
- Intraluminal pressure, jet ventilation and, 1241
- Intramucosal gastric pH, burn injury and, 1776
- Intranasal fentanyl in myringotomy, 1583
- Intraocular pressure  
drugs affecting, 1562t  
effects of anesthesia on, 1561–1563, 1562f, 1563t  
oculocardiac reflex and, 1560–1561  
in pediatric patient, 1576  
succinylcholine and, 627
- Intraoperative awareness, 1694, 1695b, 1710  
critically ill patient and, 1808  
identification before elective surgery, 72, 72t  
inhaled anesthetics and, 753–755, 754f, 754t  
sentinel event alert and, 454
- Intraoperative bleeding  
in arteriovenous malformation, 1119  
fluid management of, 669  
in hepatic resection, 1346, 1346f, 1347f, 1348  
in subarachnoid hemorrhage, 1119
- Intraoperative considerations  
in alcohol and drug addiction, 415–416, 416t  
anaphylactic reactions and, 1947–1963  
to antibiotics, 1957b, 1957–1958  
to barbiturates, 853  
to blood transfusion, 1906–1907  
clinical manifestations of, 1951, 1954b  
determination of cause of, 1953–1955  
differential diagnosis in, 1952, 1954b  
epidemiology of, 1951–1953t  
to hypnotics, 1956  
to local anesthetics, 1956b, 1956–1957  
most cell activation in, 1947–1951, 1948t, 1949f, 1950f  
to narcotics, 1957  
to natural rubber latex, 1959–1960, 1960t  
to neuromuscular blocking agents, 1956  
to protamine, 1958–1959  
to radiocontrast media, 1958  
specific immunotherapy in, 1955b, 1955–1956  
therapeutic implications of, 1960–1961  
to topical preparations, 1959  
treatment of, 1952–1953, 1955b  
critically ill patient and, 1800–1808  
airway evaluation and management and, 1804–1805  
anesthetic choice and, 1805  
evaluation for intensive care unit care and, 1829–1830  
hemodynamic management and, 1805–1807, 1806f  
monitoring options and, 5–8, 6t, 7t  
transport and, 1800, 1801t  
obese patient and, 388–390, 389f  
for patient receiving nutritional support, 275, 275t
- Intraoperative hypothermia, burn patient and, 1680
- Intraoperative Hypothermia for Aneurysm Surgery Trial, 1933
- Intraoperative neurologic monitoring, 598–618  
awake craniotomy and, 615–616  
electroencephalography in, 598–607  
bisppectral array and, 605–606, 606f, 607f  
burst suppression and, 603  
cerebral ischemia and, 602f, 602–603  
entropy monitor and, 606–607, 608f  
intravenous and inhalational anesthetic effect on, 604–605t  
neural basis of, 598–601, 599t, 599–601f  
electromyography and, 614–615  
evoked potentials in, 607–614  
anesthetic effect on, 609–610  
application of, 610–613, 611f, 612t  
auditory evoked responses and, 613  
elicitation of, 608–609, 609f, 610f  
motor evoked potentials and, 613–614, 614f, 615f  
intraoperative wake-up test and, 615  
spinal anesthesia for epidural placement of spinal cord stimulating electrodes and, 616  
in subarachnoid hemorrhage, 1117
- Intraoperative use of opioids, 885–888, 886–888f
- Intraoperative wake-up test, 615
- Intraosseous administration in cardiopulmonary resuscitation, 1885, 1886f
- Intraparenchymal hemorrhage  
stroke and, 1925
- Intrapulmonary right-to-left shunt, inhalational anesthetics and, 748, 749f
- Intrathecal administration  
of local anesthetics, 960  
of opioid analgesics, 2185t
- Intrathoracic lesion, difficult airway and, 130–131
- Intravascular dye administration, pulse oximetry and, 583
- Intravascular fluid, 640, 640f
- Intravascular hemolysis, hyperosmolar agents and, 1103t
- Intravascular injection of local anesthetic, 1059, 1059t
- Intravascular volume  
anemia and, 244  
subarachnoid hemorrhage and, 1116  
third-space losses of intravascular fluid and, 1834
- Intravenous access in cardiopulmonary resuscitation, 1885
- Intravenous albumin, 675
- Intravenous analgesics  
for chronic pain, 2060
- Intravenous anesthetics, 849–868  
acute porphyria and, 161t  
adjuncts to, 864–865  
age and, 838–840, 839f, 839t, 840f  
barbiturates in, 850–856  
adverse effects of, 853–854, 854b, 854f  
cardiovascular system and, 853, 853t  
central nervous system and, 850–853, 852f, 852t  
chemistry of, 850, 851f, 852t  
clinical use of, 855–856, 856f, 856t  
evoked potentials and, 610  
pharmacokinetics of, 854–855, 855t  
respiratory system and, 853, 853t  
benzodiazepines in, 860–863  
blood volume and, 840–843, 841–843f  
body weight and, 835–838, 836t, 836–838f, 838t  
cerebral blood flow and, 1094–1095  
complications of, 1072–1073, 1073t  
effect on pathophysiology of congenital heart disease, 1198–1200  
etomidate in, 859–860  
experimental, 865–866, 866t  
formulating dose of, 822t  
historical background of, 849, 850b  
intraoperative electroencephalography and, 604–605t  
ketamine in, 863f, 863–864  
obese patient and, 383–385, 384t  
propofol in, 856–859  
total intravenous anesthesia and, 897–917  
alpha-agonists for, 910–911  
context-sensitive half-time and, 911f, 911–912, 912f  
dosing strategies in, 898–899  
effect-site targeting in, 902–903  
etomidate for, 904–905  
induction of, 903  
ketamine for, 906–907, 908–909  
methohexital for, 904, 908  
midazolam for, 905, 908  
opiates for, 907, 911, 913f, 913–914  
pharmacokinetic principles of, 899–900, 900f, 900t, 901t  
properties of volatile agents for, 898, 898t, 899t  
propofol for, 905t, 905–906, 909–910, 910f  
simulation data for, 912–913  
target-controlled infusions in, 900–902, 902t  
thiamylal for, 904, 907–908  
thiopental for, 903–904, 907–908
- Intravenous antibiotics formulary, 2195t
- Intravenous dyes, 2193t
- Intravenous fluids  
formulary of, 2196t  
in neonatal emergency surgery, 1508  
in neuroanesthesia, 1100–1102, 1101f  
pro- and antiinflammatory effects of, 676  
sodium content of, 648t
- Intravenous immunoglobulin, 1898
- Intravenous regional block, 1036–1037
- Intravenous regional sympathetic block  
for complex regional pain syndrome, 2033
- Intrinsic positive end-expiratory pressure, 591, 591f, 592
- Intrinsic resistance to antimicrobial agent, 282
- Introducer for tracheal intubation, 701
- Intubation  
in airway injuries, 1671  
blind nasal, 708–709  
in cervical spine disease, 1121  
in spinal cord trauma, 1670  
in burn injury, 1774  
in cervical spine disease, 1120–1121  
difficult airway and, 122–133  
airway infection and, 128, 128f  
airway stent and, 130, 130f  
American Society of Anesthesiologists algorithm for, 711–712, 712f  
anatomic considerations in, 123–124, 124t  
anteriorly tilted larynx and, 125–126  
in burn injury, 1774  
causes of, 690b  
in cervical spine disease, 1120–1121  
in child, 1527  
congenital disease and, 128, 128f  
in diabetic patient, 190  
follow up of, 714  
grading of, 122–123, 123f, 124b  
head and neck tumors and, 129t, 129–130  
in hyperpituitarism, 184  
identification before elective surgery, 70  
intrathoracic lesions and, 130–131  
in newborn, 302  
obesity and, 126–127, 387  
pediatric syndromes associated with, 331–332t  
pregnancy and, 127  
preoperative assessment and management in, 56  
radiographic assessment in, 126  
recommendations for, 131  
rheumatoid arthritis and, 127–128  
scope of problem and incidence of, 122  
strategy for, 75  
trauma and, 128–129  
unexpected, 131  
visibility of oropharyngeal structures and, 124–125, 125f
- endobronchial, 1232  
in maxillofacial reconstruction, 1600, 1600f  
monitoring ventilation and oxygenation in, 692t, 692–693, 693b
- nasal  
child and, 311  
in maxillofacial reconstruction, 1600  
in orthognathic reconstruction, 1600–1601  
obese patient and, 388–390, 389f  
pretransport, 1814, 1815

- prolonged, 1705–1706  
 in spinal cord trauma, 1670f, 1670t, 1670–1671  
 tracheal, 699–714  
   blind nasal intubation and, 708–709  
   complications of, 714, 714b  
   confirmation of, 710, 710f, 711f  
   cricothyrotomy and tracheostomy and, 710  
   difficult airway and, 711–713, 712f  
   in ear surgery, 1582  
   endotracheal tubes for, 699–700, 700f, 700t  
   in esophageal atresia and tracheoesophageal fistula, 1514  
   extubation in, 711–714, 713b, 713f  
   fiberoptic, 704b, 704–705, 704–708f  
   in gynecologic surgery, 1492  
   introducers for, 701  
   laryngoscopes for, 700, 701f  
   light wand and, 707–708  
   maintenance of, 710–711  
   in neonatal emergency surgery, 1510, 1510f  
   neuromuscular blockade for, 624–625  
   in pediatric surgery, 1525  
   percutaneous transtracheal jet ventilation and, 710  
   preparation for, 699b  
   retrograde, 708, 709f  
   in rhytidoplasty, 1602  
   rigid laryngoscopy in, 701–704, 702f, 703f  
   stylets for, 700–701  
   through laryngeal mask airway, 705–707, 709f  
   in traumatic shock, 1664  
 Intubation Difficulty Scale, 122–123  
 Investigational intravenous anesthetics, 865–866, 866t  
 Ion channel receptors, 2003t  
 Ion channels, anesthetic mechanism of action and, 725–727, 726f, 727b  
 Ion dissociation constant, 640–641  
 Ion pump, 642  
 Ion(s)  
   concentration in body fluid, 642  
   strong, 660, 660t  
   weak, 660  
 Ipratropium, 2193t  
 Irbesartan, 925t  
 Iris, 1559, 1559f  
 Iron  
   hemochromatosis and, 225  
   transfusion-related hemosiderosis and, 1908  
 Irrigation of chemical burn, 1780  
 Ischemia  
   cerebral  
     carotid endarterectomy and, 1294  
     intraoperative electroencephalography and, 602f, 602–603  
     synchronous electroencephalogram pattern in, 600  
   coronary, 1182, 1187–1188, 1188b  
   direct tissue trauma and, 1740  
   limb  
     multiple organ dysfunction syndrome and, 1761  
     tourniquet and, 1550  
   myocardial  
     in aneurysm repair, 1307  
     in cardiac surgery, 1152  
     cocaine use and, 411  
     defibrillation and, 1880  
     ethanol withdrawal and, 403  
     hemodynamic monitoring for, 537–538  
     intensive care unit patient and, 1834  
     intraoperative hypothermia and, 1630  
     postoperative, 97–98, 99f, 1694, 1706  
     in transurethral resection of prostate, 1458–1459  
     vascular surgery morbidity and, 1288  
   spinal cord  
     in aneurysm surgery, 1304  
     aortic surgery-related, 1161, 1161t  
     subarachnoid hemorrhage surgery and, 1118–1119  
 Ischemia-reperfusion injury, 1740  
 Ischemic heart disease  
   myocardial oxygen delivery and, 1145  
   obesity and, 379  
   perioperative complications and death and, 442t  
   preoperative assessment and management in, 48f, 48–49  
 Ischemic pain, 2082–2083  
 Ischemic preconditioning, 759, 1150  
 Ischemic pressure injury  
   lithotomy position and, 468  
   supine position and, 466  
 Ischemic stroke, 1102, 1925  
 Islet cell transplantation, 1403f, 1403–1408, 1404f  
   diabetes mellitus pathophysiology and, 1404, 1405t  
   intraoperative care in, 1407t, 1407–1408  
   outcomes in, 1408  
   preoperative evaluation in, 1405–1407, 1406t  
   rationale for, 1404–1405, 1405f  
   surgical options in, 1405, 1406f, 1406t  
 Isobaric solutions, block height in neuraxial anesthesia and, 987, 987t  
 Isobologram, 832f, 832–833, 1636, 1636f  
 Isoflurane, 2186t  
   advantages and disadvantages of, 761t  
   in aortic cross-clamping, 1303  
   biophysical properties of, 744t  
   blood/gas partitioning of, 744f  
   cardiovascular effects of, 756t  
   in carotid endarterectomy, 1296  
   central nervous system effects, 756t  
   cerebral blood flow and, 1096–1098, 1097t, 1098f  
   chemical and physical properties of, 741, 741f, 741t  
   coronary artery perfusion and, 757  
   gas flow splitting ratios of, 781t  
   incorrect refilling of vaporizer and, 781–782, 782t  
   intraocular pressure and, 1562t  
   minimum alveolar concentration of, 776t  
   in neonatal emergency surgery, 1504  
   neuroprotective effects of, 1940  
   for obese patient, 389  
   output of erroneously filled vaporizer and, 781t  
   pathophysiology of congenital heart disease and, 1197  
   physical properties of, 777t  
   for renal transplantation, 1401  
   respiratory function and, 758t  
   somatosensory-evoked potentials and, 605t, 610  
   space-filling representation of, 719f  
   for trauma patient, 1667t  
   vapor pressure curve for, 776f  
   vascular resistance and, 757t  
 Isolated intestinal transplant, 1413, 1413f, 1414f  
 Isolated power, electrical, 480, 480f, 481f  
 Isolation amplifier, 481–482  
 Isoproterenol, 2190t  
   in bypass weaning in heart transplantation, 1392  
   cerebral blood flow and, 1093  
 Isosorbide dinitrate, 928t, 1847  
 Isosorbide mononitrate, 928t  
 Isosteric competition, 723, 724f  
 Isothermal radiofrequency procedure, 2091  
 Isotonic hyponatremia, 646–647  
 Isovolumic relaxation time, 561  
 Isradipine, 932t, 935  
 Itching  
   burn patient and, 1682–1683  
   epidural analgesia-related, 1728  
   neuraxial anesthesia-related, 1071, 1485  
   opioid analgesic-induced, 878  
 Itraconazole, 295–296  
 Ivabradine, 936  
 Ivor-Lewis/McKeown-type esophagectomy, 1322, 1322f  
**J**  
 Jackknife position, 471, 983, 984f  
 Jackson-Rees' system, 794  
 Jaundice, 218, 232  
 Jehovah's Witness patient, 2130  
 Jet stylet  
   extubation over, 713  
 Jet ventilation  
   in microlaryngoscopy, 1593  
   in rigid bronchoscopy, 1241–1242, 1242f  
 Jeune syndrome, 303t  
 Johnson, Enid, 7  
 Joint Commission on Accreditation of Healthcare Organizations  
   on electrical safety, 488–489  
   on monitored anesthesia care, 1627  
   on pain management, 1716–1717  
   patient safety goals of, 460t  
   on sentinel events, 453, 453t, 454  
   on substance abuse in health care provider, 2143  
 Joint hemorrhage, 248  
 Joint replacement surgery  
   hip, 1544–1547, 1546f  
     deep venous thrombosis and, 1552–1553  
     methylmethacrylate hypersensitivity and, 1552  
     older adult and, 351–352  
   knee, 1544–1547, 1546f  
     deep venous thrombosis and, 1552–1553  
     older adult and, 352  
   shoulder, 1543–1544  
 Joule heating, 485  
 Jugular bulb oximetry, 1192–1193  
 Jugular venous oximetry, 1086  
**K**  
 Kallikrein-kinin system, 858, 925f  
 Kappa opioid receptors, 873  
 Kartagener syndrome, 332t  
 Kava-kava, 73t  
 Kayser-Fleischer rings, 225  
 Kearns-Sayre syndrome, 166  
 Ketamine, 863f, 863–864, 2186t  
   for acute postoperative pain, 1724–1725  
   as analgesic adjuvant in neuraxial anesthesia, 993  
   assessment of drug effect of, 843  
   for burn patient, 1679  
   cardiovascular effects of, 853t  
   central nervous system effects of, 852t  
   cerebral blood flow and, 1094–1095  
   chemical structure of, 851f  
   for chronic pain, 2054  
   dosing strategy for manual infusion regimen, 901t  
   effect on pathophysiology of congenital heart disease, 1198–1199  
   for head injury, 1669  
   hepatic extraction ratio for, 855t  
   induction characteristics of, 856t  
   intraocular pressure and, 1562t, 1563  
   in monitored anesthesia care, 1639t, 1641  
   in neonatal emergency surgery, 1506, 1510  
   in pediatric surgery, 1523t, 1525t  
     for adenotonsillectomy, 1589  
     for caudal block, 1530  
   pharmacokinetics of, 855t, 900t  
   physicochemical properties of, 852t  
   somatosensory-evoked potentials and, 604t, 610  
   topical, 2059–2060  
   for total intravenous anesthesia  
     context-sensitive half-time of, 913  
     induction of, 906–907  
     maintenance of, 908–909  
     plasma concentration of, 901t  
   for trauma patient, t, 1667  
   ventilatory depression and, 853t  
 Ketanserin, 1485  
 Ketoacidosis  
   alcoholic, 408  
   diabetic, 189–190  
 Ketoconazole, 295  
 Ketonemia, 267–268  
 Ketones, 267–268  
 Ketoprofen (Orudis), 1723t, 2064t  
 Ketorolac (Toradol), 2183t, 2184t  
   for acute postoperative pain, 1723, 1723t  
   in child, 1532  
   in outpatient surgery, 1620  
   as analgesic adjuvant in neuraxial anesthesia, 993  
 Kety-Schmidt method, 1083t, 1083–1084, 1084f  
 Kidney  
   anatomy and physiology of, 1450–1451, 1451f  
   barbiturates and, 854  
   changes during pregnancy, 360  
   of child, 198–199  
   drug elimination and  
     local anesthetics and, 960  
     propofol and, 858  
   effects of burn injury on, 1676t  
   function during pregnancy, 199  
   of geriatric patient, 199, 346, 346f  
   inhalational anesthetics and, 758  
   multiple organ dysfunction syndrome and, 1757t  
   of newborn, 306  
   of obese patient, 381–382  
   potassium and, 650  
   protection during liver transplantation, 1365–1366

- Kidney—*continued*  
 protein-energy malnutrition and, 270  
 renal disease and, 194–215  
   calcium disorders and, 202–203, 203t  
   clinical assessment of, 197t, 197–198  
   congestive heart failure and, 208, 208f  
   contrast nephropathy and, 209  
   diuretics and, 204f, 204–206  
   drug prescribing in, 211  
   effect on antimicrobial therapy, 285, 285t  
   glomerular diseases in, 207, 207t  
   hereditary, 209  
   liver failure and, 208t, 208–209  
   magnesium disorders and, 203  
   metabolic acid-base disorders and, 200, 200f  
   phosphorus disorders and, 203–204  
   postoperative, 210  
   potassium disorders and, 201–202, 202f  
   prerenal azotemia in, 206–207  
   renal failure and, 210–211  
   renal transplantation and, 209–210  
   respiratory acid-base disorders and, 200–201  
   sodium disorders and, 199t, 199–200  
   tubulointerstitial nephropathies in, 207–208  
   superior vena cava syndrome and, 1258b
- Kidney rest position, 472, 1454–1455, 1455f  
 Kidney stones, 1459–1461  
 Kidney transplantation, 209–210, 1396–1403  
   allograft perfusion in, 1402  
   anesthetic management in, 1400–1401  
   immunosuppression in, 1401–1402  
   indications and contraindications for, 1397  
   organ matching, availability, and allocation in, 1396–1397  
   pediatric considerations in, 1402–1403  
   postoperative complications in, 1402  
   pretransplant evaluation in, 1398–1400, 1399t  
   rejection, 209  
   surgical procedure in, 1398, 1398f
- King-Denborough syndrome, 1970, 1971  
*Klebsiella pneumoniae*, 286t  
 Klippel-Feil syndrome, 303t, 331t  
 Knee  
   obturator nerve block for surgery of, 1042–1043  
   painful conditions of, 2024t  
 Knee joint replacement, 1544–1547, 1546f  
   deep venous thrombosis and, 1552–1553  
   older adult and, 352  
 Koller, Carl, 4  
 Korotkoff sounds, 520, 520f  
 Korsakoff syndrome, 407  
 Kupffer cell, 217, 218f  
 Kyphoscoliosis, 168  
 Kyphosis, osteoporotic, 168
- L**  
 Labat approach in sciatic nerve block, 1043, 1043f, 1044f  
 Labetalol, 930t, 931, 2190t  
   cerebral blood flow and, 1100  
   for hypertension in preeclampsia, 1488  
   perioperative use of, 111t  
   for postoperative hypertension, 1694  
 Labor analgesia, 1021–1022  
 Labor and vaginal delivery, 1478–1480, 1479b, 1481–1482t  
 Labor cost, 2157  
 Laboratory studies  
   addicted patient and, 398–399  
   eye surgery and, 1564t, 1564–1565  
   in hepatocellular function, 232  
   intensive care unit and, 1831  
   liver transplantation and, 1353–1355, 1355f  
   in multiple organ dysfunction syndrome, 1764  
   pediatric surgery and, 334–336, 335t, 338  
   renal transplantation and, 1400  
   thoracic surgery and, 1216, 1216t, 1217f  
 Laceration in mediastinoscopy, 1254  
 Lacrimal artery, 1567f  
 Lacrimal gland, 1560, 1569–1573f  
 Lacrimal nerve, 1573f  
 Lacrimal vein, 1568f  
 Lactate in crystalloid solutions, 670f  
 Lactated Ringer solution, 671f, 671–672, 2196t  
   for burn patient, 1775, 1775t  
   composition of, 670t  
   hospital acquisition costs for, 244t  
   for hypernatremia, 650t  
   in neonatal emergency surgery, 1508  
   osmolality of, 1101t  
   pro- and antiinflammatory effects of, 676  
   for resuscitation in trauma, 1791  
   sodium content of, 648t  
 Lactic acidosis, 543–544, 666  
 Laminar flow through resistor, 788  
 Laminotomy in electrode placement, 616  
 Lamotrigine  
   for chronic pain, 2056t, 2058, 2059t  
   for neuropathic pain in peripheral neuropathy, 2057t  
 Laparoscopic cholecystectomy, 1318  
 Laparoscopic nephrectomy, 1465, 1466–1467  
 Laparoscopic radical prostatectomy, 1466  
 Laparoscopy  
   effects and complications associated with, 1324b  
   gastrointestinal, 1317b, 1317–1319  
   gynecologic, 1496, 1496b  
   pediatric, 1534  
   urologic, 1466f, 1466–1467  
 Laparotomy in biliary disease, 1324  
 Laplace law, 1299  
 Large bowel obstruction, 1330  
   in gestational age infant, 301–302  
 Large-fiber neuropathies in diabetes mellitus, 188–189  
 Laryngeal edema  
   after extubation, 711  
   in anaphylactic reaction, 1952  
   neck dissection and, 1605  
   postoperative, 1701  
 Laryngeal mask airway, 695–698, 696b, 696f, 697f  
   for assistance in extubation, 713, 713f  
   for cardiopulmonary resuscitation, 1876  
   in carotid endarterectomy, 1296  
   in cervical spine disease, 1120  
   in cesarean delivery, 1485  
   patient transport and, 1815–1816  
   in pediatric surgery, 1526, 1526t  
   in same-day surgery, 1649  
   tracheal intubation through, 705–707, 709f  
 Laryngeal nerve palsy, 688–689  
 Laryngeal obstruction, postoperative, 1701–1702  
 Laryngeal tube airway, 698  
 Laryngeal vestibule, 688  
 Laryngomalacia, 1597–1598, 1598f  
 Laryngopharynx, 686f, 687–688, 688f, 689f  
 Laryngoscope, 700, 701f  
   for newborn, 1509, 1509f  
   pediatric, 1526, 1527t  
 Laryngoscopy  
   difficulty identification before elective surgery, 74, 74t  
   in orthognathic reconstruction, 1601  
   rigid, 701–704, 702f, 703f  
   in spinal cord trauma, 1670  
 Laryngospasm  
   after extubation, 711  
   nonintubated airway and, 698  
   postoperative, 1701–1702  
 Larynx, 687–688, 688f, 689f  
   anteriorly tilted, 125–126  
 Laser airway ablation, 1251–1252, 1252t  
 Laser surgery  
   in airway obstruction, 1653  
   in stapedectomy, 1583  
   for throat hemangioma, 1590  
   in vocal cord disorders, 1593–1597, 1595f, 1595–1597t, 1597f  
 Lasix (furosemide), 919, 920t  
 Latent errors in anesthesia accidents, 24  
 Latent heat of vaporization, 777  
 Lateral approach in popliteal fossa block, 1045–1046  
 Lateral cervical facet medial branch block, 2091  
 Lateral collateral vein, 1568f  
 Lateral cutaneous nerve, 1039f  
 Lateral decubitus position, 471–472, 472f  
   for bronchoalveolar lavage, 1243  
   in esophageal atresia and tracheoesophageal fistula repair, 1515  
   for neuraxial anesthesia, 982, 983f  
   obese patient and, 388  
   in thoracic surgery, 1222–1227, 1223t, 1224–1227f  
 Lateral epicondylitis, 2023t  
 Lateral femoral cutaneous nerve, 1038f, 1041f, 1042  
   meralgia paresthetica and, 2030  
 Lateral malleolus, ankle nerve blocks and, 1047f  
 Lateral orbital septum, 1569f  
 Lateral position  
   with flexion and kidney rest, 1454–1455, 1455f  
   for posterior approach in sciatic nerve block, 1043, 1043f  
   for psoas compartment approach in lumbar plexus block, 1039  
 Lateral position test, 141  
 Lateral pressure hypothesis of membrane-protein communication, 721f  
 Lateral rectus muscle, 1559f, 1560t, 1566f, 1567f, 1568–1572f  
 Lateral retinaculum, 1572f, 1573f  
 Lateral sural cutaneous nerve, popliteal fossa block and, 1045f  
 Latex allergy, 1542, 1953t, 1959–1960, 1960t  
 Lavage, bronchoalveolar, 1243f, 1243–1244  
 Law of electrical neutrality, 641  
 Lawn chair position, 466  
 Lawrie, Edward, 4  
 Lawsuit, 2128  
 Le Fort classification of midface fractures, 1600  
 Lead migration in spinal cord stimulator placement, 2101–2102  
 Leakage current, 479–480, 483, 484  
 Lean body mass  
   aging and, 343f, 343–344  
   dosing of intravenous anesthetics and, 836t, 836–838, 837f, 838f, 838t  
   monitored anesthesia care and, 1634, 1635f  
   obese patient and, 382–383  
 Least splanchnic nerves, 2077  
 Left anterior descending coronary artery, 1143–1144, 1144f  
 Left atrial pressure, 528  
 Left atrium, transesophageal echocardiography of, 554–555, 556f  
 Left bundle branch block, 49  
 Left circumflex artery, 1143–1144, 1144f  
 Left coronary artery, 1143–1144, 1144f  
 Left hepatic vein, 217f  
 Left ventricle, transesophageal echocardiography of  
   diastolic function and, 560–563, 561–564f, 565t  
   systolic function and, 558–560, 558–560f  
 Left ventricular assist device, 1163–1169  
   noncardiac surgery and, 1168–1169  
   preoperative considerations in, 1164–1165  
   transesophageal echocardiography examination in, 1165f, 1165–1166, 1166f  
   weaning from cardiopulmonary bypass in, 1166f, 1166–1168, 1167f  
 Left ventricular end-diastolic pressure, 528, 529, 1146  
 Left ventricular end-diastolic volume, 528, 529t  
 Left ventricular hypertrophy, 49  
 Left ventricular stroke work, 527t  
 Left-heart failure  
   in heart transplantation, 1392  
   obstruction in congenital heart disease and, 1187, 1187b  
 Left-sided double-lumen tube, 1228f  
 Left-to-right shunt, 748  
 Legal issues in anesthesiology, 2126–2134  
   consent and, 2130–2131  
   economic relationships and contracts and, 2128–2129  
   ethical issues and, 2131–2132  
   legal system and, 2126–2127  
   medical liability and, 2127–2128  
   National Practitioner Data Bank and, 2129–2130  
   pediatric issues and, 2132–2133  
 Legal system, 2126–2127  
*Legionella pneumophila* pneumonia, 290, 290t  
 Leiomyoma, uterine, 1495  
 Lens, 1559  
 Lepirudin (Refludan), 255, 255t, 259–260, 2192t  
 Leptin, 377–378  
 Lescol (fluvastatin), 947t  
 Lesser splanchnic nerves, 2077  
 Lesser trochanter, sciatic nerve block and, 1044f  
 Leukocyte adhesion, 1746, 1746f  
 Leukocyte count  
   before pediatric surgery, 336  
   in systemic inflammatory response, 1331b  
 Leukocyte-reduced red cells, 1893  
 Leukoencephalopathy, opioid overdose and, 410  
 Leukopenia, 409  
 Leukoprotection in shock, 1843–1844  
 Leukotrienes  
   inflammatory process and, 2063f  
 Leur-Lok, 710  
 Levalbuterol, 2193t  
 Levator aponeurosis, 1568f

- Levator palpebrae superioris muscle, 1566f, 1569–1572f
- Level 1 Rapid Infusion System, 1361, 1361t
- Levetiracetam  
for chronic pain, 2056t, 2058
- Levobupivacaine (Chirocaine), 970  
for epidural anesthesia, 989t  
for neuraxial anesthesia, 989  
in obstetric surgery, 1473t  
for peripheral nerve block, 1026, 1026t
- Levodopa  
for chronic pain, 2059t
- Levofloxacin, 2195t
- Levorphanol (Levo-Dromoran), 1720t, 2053t, 2183t
- Levosimendan  
effect of pathophysiology of congenital heart disease, 1201  
for low cardiac output in shock, 1847
- Levothyroxine, 2193t
- Liability, 2127–2128
- Lidocaine (Xylocaine), 970, 2188t, 2190t  
baricity for spinal anesthesia, 987t  
for Bier block, 1036  
for cardiac arrest, 1882, 1882b  
cardiotoxicity of, 968, 968f  
in cataract surgery, 1566  
cation-to-base ratio of, 957t  
in cesarean delivery, 1484, 1484f  
for chronic pain, 2060  
clinical manifestations of potency, 960–961, 961f  
concentration-toxicity profile of, 1059, 1059f  
for conscious patient intubation, 703  
for cystoscopy, 1456  
discovery and evolution of, 954, 955f  
disposition kinetics of, 958t  
dissociation constant of, 961t  
for dysrhythmias, 939–941, 940t  
for epidural anesthesia, 989t  
in extracorporeal shock wave lithotripsy, 1461  
hepatic metabolism of, 222  
intraocular pressure and, 1562t  
in knee replacement surgery, 1546  
in monitored anesthesia care, 1640  
for neuraxial anesthesia, 989t, 989–990, 990t  
in obstetric surgery, 1473t  
in ophthalmic surgery, 1571–1573  
in outpatient surgery, 1613  
for pain in propofol injection, 858  
peak blood concentration in regional anesthesia, 1058f  
for peripheral nerve block, 1026, 1026t  
plasma concentration curve of, 959f  
somatosensory-evoked potentials and, 604t  
structure of, 955f
- Lieberman, Samuel, 7
- Ligamentum flavum, 979–980, 980f
- Ligand-gated cys-loop receptor-channel complex, 725
- Ligand-gated ion channels, local anesthetics and, 958
- Light wand, 707–708
- Limb ischemia-necrosis  
multiple organ dysfunction syndrome and, 1761  
tourniquet and, 1550
- Limb-girdle muscular dystrophy, 164
- Linezolid, 2195t
- Lingual nerve, 687f
- Link-25 Proportion Limiting Control System, 772, 774, 774f
- Lip, cleft, 1597
- Lipid bilayers, anesthetic action and, 720–721, 721f
- Lipid solubility  
of barbiturates, 854  
of local anesthetics, 955–956, 956f  
of propofol, 858
- Lipitor (atorvastatin), 947t
- Lipomatous hypertrophy of atrial septum, 558
- Lipophilicities of opioid analgesics, 1720t
- Lipopolysaccharide  
mitochondrial dysfunction and, 1749  
sepsis and, 1747
- Liposomes added to local anesthetics, 965
- Liquid oxygen, 770
- Lisinopril, 924t
- Lithium dilution cardiac output measurement, 534–535
- Lithotomy position, 466f, 466–468, 467f  
in transvaginal surgery, 1494  
in urologic surgery, 1453f, 1453–1454
- Lithotripsy, 1324
- Lithotriptor, 1460
- Litmus paper, irrigation of chemical burn and, 1780
- Liver  
anatomy and physiology of, 217f, 217–219, 218f, 218t, 1339  
changes during pregnancy, 359  
complications associated with renal failure, 1399t  
drug metabolism and, 222f, 222–223, 1339  
effect of burn injury on, 1678  
gender differences in, 1491  
inhaled anesthetics and, 760  
intravenous anesthetics and, 855, 855t  
local anesthetics and, 959–960  
propofol and, 858  
effects of burn injury on, 1676t  
of geriatric patient, 345–346  
of infant, 316  
inhalational anesthetics and, 758  
neuraxial anesthesia and, 996–997  
of obese patient, 380–381  
protein-energy malnutrition and, 271  
stress hypermetabolism and, 268
- Liver biopsy, 220–221
- Liver disease, 216–238, 1338–1377  
acetaminophen toxicity in, 229, 229f  
acute liver failure in, 231–232, 232t  
in alcohol or drug addicted patient, 401–402, 404t  
alcoholic, 229  
alpha<sub>1</sub>-antitrypsin deficiency in, 225–226  
anatomy and physiology of liver and, 1339  
ascites in, 234  
autoimmune hepatitis in, 230  
autonomic neuropathy in, 1344–1345  
biliary atresia in, 224–225  
Child-Pugh scoring system in, 223–224, 224t, 225t  
chronic, 1339–1340, 1340b  
hepatitis in, 228–229  
liver failure in, 232–233  
cocaine-related, 411–412  
control of encephalopathy in, 234–235  
correction of coagulopathy in, 233–234, 234f  
drug metabolism and, 222f, 222–223  
drug-induced, 230  
effect on antimicrobial therapy, 285, 285t  
fresh-frozen plasma in, 1897  
fulminant hepatic failure in, 1340, 1340b  
halothane hepatitis in, 229–230  
hemochromatosis in, 225  
hemodynamic changes in, 1340b, 1340–1341  
hepatic encephalopathy in, 1344, 1345b  
hepatic resection in, 1345–1350  
anesthesia for, 1346–1348  
control of clotting in, 1348–1349  
indications and patient characteristics in, 1345, 1345b  
intraoperative complications in, 1349–1350, 1350f  
operative considerations in, 1346, 1346f, 1347f  
hepatocellular carcinoma in, 231  
hepatopulmonary syndrome in, 1343b, 1343–1344, 1344f  
infiltrative, 230–231  
inherited, 226  
liver anatomy and physiology and, 217f, 217–219, 218f, 218t  
liver function tests in, 219t, 219–222, 220t, 221f  
liver transplantation in, 1350–1369  
model of end-stage liver disease and, 224, 225t  
nonalcoholic fatty liver disease in, 226f, 226–228  
portopulmonary hypertension in, 1341–1343, 1342f, 1343b, 1343f  
portosystemic shunt in, 1370–1371  
preoperative assessment and management in, 42t, 53  
procedures for portal hypertension and ascites in, 1369b, 1369–1370  
renal function and, 1341, 1341b  
Reye syndrome in, 225  
varices and variceal hemorrhage in, 234  
vascular, 231  
viral hepatitis in, 227t, 227–228  
Wilson disease in, 225
- Liver failure  
acetaminophen toxicity and, 229  
acute, 231–232, 232t  
chronic, 232–233  
fulminant, 1340, 1340b  
liver transplantation in, 1351, 1351b  
methamphetamine use and, 413  
in multiple organ dysfunction syndrome, 1757t, 1758, 1763, 1767  
renal disease and, 208t, 208–209
- Liver fluke, 231
- Liver function tests, 219t, 219–222, 220t, 221f  
addicted patient and, 399  
in elective surgery, 78t  
in hepatic resection, 1347
- Liver transplantation, 1350–1369  
anesthetic induction and maintenance in, 1360–1361, 1361t  
anhepatic phase of, 1363–1364, 1364f  
donor in, 1371–1372  
electrolyte management in, 1364–1365  
fresh-frozen plasma in, 1897  
homeostasis in, 1358t, 1358–1359  
indications, contraindications, and patient characteristics in, 1350–1351, 1351b  
laboratory studies in, 1353–1355, 1355f  
MELD scoring system for, 1352, 1352t  
neohepatic phase of, 1367f, 1367–1369  
operative approaches for, 1356f, 1356–1358, 1357f  
postoperative complications of, 1369  
preanesthetic evaluation in, 1352–1353  
preanhepatic phase of, 1361–1362  
renal protection during, 1365–1366  
reperfusion of graft in, 1366–1367  
transfusion in, 1362f, 1362–1363, 1363f  
vasopressors in, 1362
- Living donor in liver transplantation, 1371–1372
- Load-distributing band cardiopulmonary resuscitation, 1879
- Lobar bronchus, 1214
- Lobectomy, 1220
- Lobes of lung, 1214
- Local anesthetics, 954–973  
acute porphyria and, 161t  
adverse event in regional anesthesia and, 1058f, 1058–1060, 1059f, 1059t  
allergic reactions to, 966  
amino amide agents in, 970–971  
amino ester agents in, 969–970  
anaphylactic reaction to, 1956b, 1956–1957  
for cancer pain, 2111t  
chemical features of, 954–956, 955f, 956f, 956t  
choice for peripheral nerve block, 1026t, 1026–1027  
clinical manifestations of potency, 960–961, 961f  
differential sensory/motor block and, 962, 963f  
discovery and evolution of, 954, 955f  
duration of action, 962, 962f  
in epidural analgesia, 1727  
formulary of, 2188t  
formulations of, 963–965, 964f, 965f  
generic and trade names of, 969t  
hyaluronidase, liposomes, and microencapsulation of, 965  
influence of dose, 962–963, 963f, 964f  
methemoglobinemia and, 966  
in monitored anesthesia care, 1639–1640  
in neonatal emergency surgery, 1506  
for neuraxial anesthesia, 988–990, 989t, 990t  
in obstetric surgery, 1472, 1472t  
in ophthalmic surgery, 1571–1573  
in outpatient surgery, 1612–1615, 1613–1616f  
for paravertebral anesthesia, 1017, 1017t  
pharmacodynamics of, 956–958, 957f  
pharmacokinetics of, 958t, 958–960, 959f  
in rhinoplasty, 1585  
routes of administration, 960, 960f  
speed of onset, 961, 961f, 961t  
subdural injection of, 1067  
topical, 969t  
toxicity of, 966, 1058–1059, 1059f, 1059t, 1063–1064  
cardiotoxicity and neurotoxicity, 966–968f, 966–969  
child and, 1529  
in epidural anesthesia, 1067  
in intravenous regional anesthesia, 1072–1073
- Loeffler disease, 411
- LoFloSorb, 797t
- Log-dose probit analysis, 624, 624f
- Long, Crawford, 2
- Long bone fracture, 1671–1672



- Long thoracic nerve, 2046t  
 Loop diuretics, 205, 919, 920t  
 Lorazepam, 860–863, 2186t  
   cerebral blood flow and, 1095  
   chemical structure of, 851f  
   induction characteristics of, 856t  
   pharmacokinetics of, 855t  
   physicochemical properties of, 852t  
 Losartan, 925t  
 Loss-of-resistance technique  
   in neuraxial anesthesia, 985, 986f  
   in paravertebral anesthesia, 1012–1013, 1015f  
 Lovastatin (Mevacor), 947t  
 Lovenox (enoxaparin), 254–255  
 Low back pain, 367, 2033–2034, 2034t  
 Low lithotomy position, 467f  
 Low-density lipoproteins, 1285  
 Lower airway, 689, 690t  
 Lower esophageal sphincter, 1314–1315, 1319–1320, 1320f  
   acid reflux and, 1320–1321  
   of child, 316  
   hiatal hernia and, 1321  
 Lower extremity  
   innervation of, 2047t  
   surgical positioning-related neuropathy of, 1454f  
   vascular surgery of, 1297–1299, 1299f  
 Lower extremity peripheral nerve block, 1037–1048  
   anatomy in, 1038, 1038f, 1039f  
   ankle blocks, 1046, 1047f, 1048f  
   in child, 1531  
   continuous catheter techniques and, 1046  
   femoral nerve block, 1041–1042  
   lateral femoral cutaneous nerve block, 1042  
   lumbar plexus block, 1038–1041, 1040–1042f  
   obturator nerve block, 1042–1043  
   perioperative outcomes in, 1046–1048  
   popliteal fossa block, 1044–1046, 1045f  
   sciatic nerve block, 1043f, 1043–1044, 1044f  
 Lower gastrointestinal bleeding, 1329  
 Lower inflection point, 593  
 Lower-extremity surgery  
   block height for, 988t  
   orthopedic, 1544–1547, 1545f, 1546f  
 Low-flow bypass surgery, 1190–1191  
 Low-frequency interrupted high-flow ventilation, 1265  
 Low-frequency jet ventilation, 1265  
 Low-grade responders, 1947, 1948t  
 Low-molecular-weight heparins, 254–255  
   for deep venous thrombosis prophylaxis, 1552–1553  
   neuraxial anesthesia and, 998  
   epidural hematoma and, 1729  
   placement and removal guidelines for, 1730t  
   for obese patient, 387  
 Low-voltage injury, 1780  
 Lozol (indapamide), 920t  
 Ludwig angina, 128  
 Lumbar artery, 609f  
 Lumbar discography, 2093–2096, 2094f  
 Lumbar epidural steroid injection, 2080, 2080f  
 Lumbar facet medial branch block, 2092f, 2092–2093  
 Lumbar intervertebral disk, 2094f  
 Lumbar intraarticular facet injection, 2089–2090, 2090f  
 Lumbar paravertebral space, 1009–1011, 1011f, 1012f  
 Lumbar plexus, 1038, 1038f, 1039f  
 Lumbar plexus nerve block, 1038–1041, 1040–1042f  
   for cancer pain, 2119–2120  
   for chronic pain, 2087–2088  
   in femoral neck fracture, 1547  
   in lower-extremity orthopedic surgery, 1544, 1545f  
 Lumbar puncture  
   in headache evaluation, 2036  
 Lumbar somatic nerve, 1040f  
 Lumbar sympathetic chain, 2077  
   chemical neurolysis of, 2088  
 Lumbar sympathetic neurolysis, 2087–2088  
 Lumbar transforaminal steroid injection, 2082, 2083f  
 Lumbar vertebrae, 979f, 981f, 1012f, 2074, 2074f  
 Lumbosacral nerves, 1039f  
 Lund Browder chart, 1776–1777, 1777f  
 Lundy, John, 1, 6, 7  
 Lung  
   anatomy and physiology of, 1214–1215  
   chemical injury of, 1775  
   effects of burn injury on, 1676t  
   multiple organ dysfunction syndrome and, 1757t  
   one-lung isolation and, 1227–1232, 1228f, 1229t, 1230–1233t  
   protein-energy malnutrition, 270  
   superior vena cava syndrome and, 1258b  
   thoracic surgery-related complications of, 1273  
   ventilator-induced injury of, 1863–1865, 1864f  
 Lung cancer, 1220–1221, 1221b, 1222t, 1223b  
   marijuana-related, 413  
   superior vena cava syndrome in, 1258b, 1258–1259, 1259f  
   thoracic neural blockade in, 2116–2117, 2117f  
 Lung compliance, 313t, 593  
 Lung mechanics and graphics, 590–593, 590–593f  
 Lung resection  
   in non-small cell lung carcinoma, 1220  
   perfusion studies before, 1218  
   pulmonary torsion and, 1273  
 Lung transplantation, 1378–1395  
   anesthesia induction and maintenance in, 1386–1389  
   donor selection and organ procurement in, 1383–1384  
   epidemiology of, 1378–1379, 1379t  
   historical aspects of, 1378, 1379t  
   immunobiology of, 1382–1383, 1383t  
   indications for, 1380t, 1380–1381  
   operating room preparation for, 1385  
   postoperative management in, 1389–1390  
   preinduction activity and, 1385–1386  
   preoperative assessment in, 1385  
   surgical alternatives to, 1381  
 Lung volume reduction surgery, 1245, 1381  
 Lung volumes  
   of child, 313, 313f  
   obese patient and, 376  
 Lung-protective ventilation, 1865  
 Lyme disease  
   transfusion-related, 1905  
 Lymphatic system  
   of kidney, 1450  
   of prostate, 1452  
   pulmonary, 1215  
   testicular, 1452–1453  
 Lymphoma, mediastinal, 1255f  
 Lysergic acid diethylamide (LSD), 413  
 Lysosomal storage diseases, 226  
**M**  
 M wave, 615f  
 Ma huang, 73t  
 Macroglossia, 184  
 Macroshock, 482  
 Mafenide acetate, 1681t  
 Magill attachment, 792–793, 793f  
 Magnesium, 654t, 654–655, 655t  
   in crystalloid solutions, 670f  
   disorders of, 203  
   distribution in body compartments, 641t  
   therapeutic uses of, 655t  
 Magnesium sulfate, 2196t  
   for preeclampsia, 363  
   for preterm labor, 362  
 Magnetic resonance imaging  
   anesthesia during, 1656  
   cardiac, 108, 108t  
   for determination of nerve injury in peripheral nerve block, 1061  
   in liver disease, 221–222  
   in liver transplantation, 1355  
   before thoracic surgery, 1217  
 Mainstem bronchus, 1214  
 Mainstem intubation, 1232  
 Mainstream capnometer, 585t  
 Maintenance of anesthesia  
   in cesarean delivery, 1486  
   in child, 1527  
   in congenital heart disease, 1204  
   in hepatic resection, 1348  
   in liver transplantation, 1360–1361, 1361t  
   in lung transplantation, 1386–1389  
   neuromuscular blockade and, 633–634  
   obese patient and, 388–390, 389f  
   in outpatient surgery, 1616–1619, 1617–1619f  
   propofol and, 859  
   in renal transplantation, 1400–1401  
   in small bowel transplantation, 1413–1414  
   in subarachnoid hemorrhage, 1117f, 1117–1118  
   in supratentorial craniotomy, 1106–1108, 1108f  
   thiopental and, 856, 856f  
   in valve surgery, 1156  
 Major histocompatibility complex, 1382  
 Malacias, 130, 1597–1598, 1598f  
 Malaria  
   public health and, 1742t  
   transfusion-related, 1905  
 Male  
   body weight of, 838t  
   growth charts for, 324f, 327f  
   innervation of genitalia of, 1453, 1453f  
   normal red blood cell values of, 240t  
 Malformation syndrome, 302  
 Malignant hyperthermia, 169, 1964–1984  
   animal models of, 1971–1972  
   associated myopathies in, 1970f, 1970–1971  
   congenital strabismus and, 1563  
   differential diagnosis of, 1968b  
   epidemiology of, 1966  
   exercise and heat illness and, 1969–1970  
   fulminant episodes of, 1966b, 1966–1968, 1967b, 1969f  
   historic perspective of, 1965–1966  
   identification before elective surgery, 70–71  
   management of, 1980b, 1980–1984, 1982b, 1982–1984b  
   masseter muscle rigidity in, 1968–1969  
   molecular genetics of, 1975–1978, 1976t, 1977f  
   resources for, 1992–1993  
   subcellular sites of defect in skeletal muscle in, 1972–1974, 1973f, 1974t, 1975f, 1976f  
   testing for susceptibility to, 1978–1980, 1979f  
 Malignant Hyperthermia Association, 1992–1993  
 Mallampati classification, 125, 125f  
 Malleolus, ankle nerve blocks and, 1047f  
 Mallinckrodt right-sided tube, 1228f  
 Mallory-Weiss tear, 1328  
 Malnutrition, 267–278  
   in addicted patient, 398  
   anesthetic implications of organ system dysfunction in, 272, 272t  
   assessment of, 268–269  
   cardiovascular changes in, 269–270  
   definition of, 267  
   effects on surgical outcome, 272–274  
   gastrointestinal changes in, 270–271  
   hepatic changes in, 271  
   immunologic changes in, 271–272  
   immunonutrition and, 274, 275t  
   incidence in surgical patients, 269  
   intraoperative management of patient receiving nutritional support, 275, 275b  
   morbidity and mortality following intraabdominal surgery and, 225t  
   nervous system changes in, 272  
   pancreatic changes in, 271  
   pulmonary changes in, 270  
   renal changes in, 270  
   starvation and, 267–268  
   stress hypermetabolism and, 268  
 Malposition of double-lumen tube, 1230, 1231f  
 Malpractice claims, 2127–2128  
 Managed care contracting, 2178–2179  
 Managerial cost accounting, 2157–2158  
 Mannitol, 205, 2191t  
   for allograft perfusion in renal transplantation, 1402  
   hypertonic solution *versus*, 673  
   for intraoperative cerebral edema, 1107, 1108f  
   in neuroanesthesia, 1101  
   to reduce intracranial pressure, 1669  
   for renal preservation  
     in aneurysm surgery, 1304  
     in critically ill patient, 1807  
   in small bowel transplantation, 1414  
 Mannose-binding lectin pathway of complement, 1949, 1950f  
 Manometry, esophageal, 1320f  
 Manual inline axial stabilization, 1670, 1670f, 1670t  
 Manual ventilation during pediatric transport, 1817  
 Maple syrup urine disease, 303t  
 Mapleson A: Magill attachment, 792–793, 793f  
 Mapleson B system, 793, 793f  
 Mapleson C system, 793, 793f  
 Mapleson D system, 793f, 793–794  
 Mapleson E system, 793f, 794–795  
 Mapleson F system, 793f, 794–795

- Mapripexole  
for fibromyalgia, 2021
- Maprotiline, 2050t
- Marchiafava-Bignami disease, 407
- Marfan syndrome, 331t, 332t
- Marijuana, 405t, 413
- Mask ventilation, difficult airway and  
identification before elective surgery, 74–75, 75t  
obese patient and, 127
- Mask Ventilation Scale, 75t
- Mass  
mediastinal, 1254–1259, 1255t, 1255–1257f, 1256t, 1257t, 1258b  
child and, 1536  
difficult airway and, 130–131  
neck, 1590–1591, 1604–1605
- Mass casualties, 1794
- Masseter muscle rigidity, 1968–1969, 1983–1984, 1984b
- Massive hemoptysis, 1267, 1267b, 1268t
- Massive transfusion  
fresh-frozen plasma and, 1897
- Mast cell activation in anaphylactic reaction, 1947–1951, 1948t, 1949f, 1950f
- MAST questionnaire, 397
- Mastectomy, 1014f, 1014t
- Mastoid disorders, 1584
- Mastoidectomy, 1584
- Maternal comorbid conditions, 1474–1475, 1475b
- Maternal history, newborn preoperative assessment and, 300–301, 301t
- Maxillary osteotomy, 1601
- Maxillary sinus, 1572f
- Maxillofacial reconstruction, 1600, 1600f
- Maximal mid-expiratory flow rate  
in chronic obstructive pulmonary disease, 139  
in obese patient, 376
- Maximum permission exposure, 1595
- Maximum voluntary ventilation, 141b  
obese patient and, 376  
thoracic surgery and, 1217
- McArdle disease, 166
- McMechan, Francis Hoeffler, 1, 5f, 5–6, 9
- MD Anderson modified brief pain inventory, 2107, 2108–2109f
- MDMA (Ecstasy), 412–413
- Mean arterial pressure  
in hemodynamic support for shock, 1847–1848  
inhaled anesthetics and, 756, 756t  
intravenous anesthetics and, 853t  
lithotomy position and, 467
- Mean cardiac power, 559
- Mean corpuscular hemoglobin, 240t
- Mean corpuscular hemoglobin concentration, 240t
- Mean corpuscular volume, 240t, 241t
- Measured-flow vaporizer, 779, 779f  
efficiency and temperature compensation and, 780f, 780–781  
regulating output of, 777t, 777–778, 778f
- Mechanical effects of laser, 1595t
- Mechanical gastrointestinal obstruction, 1329
- Mechanical heart valve, 1157
- Mechanical ventilation, 1852–1872  
in acute respiratory distress syndrome, 1867t, 1867–1868  
after lung volume reduction surgery, 1247  
burn patient and, 1677  
in chronic obstructive pulmonary disease, 1866–1867  
combined pressure and volume targeted modes in, 1853  
fast-track weaning from, 1833  
gas exchange targets in, 1862–1863  
in Guillain-Barré syndrome, 161  
high-frequency ventilation in, 1865–1866  
indications for, 1852, 1853t  
initial management of, 1866  
lung-protective ventilation in, 1865  
modes of, 1853–1859, 1854t  
adaptive support ventilation in, 1858  
airway pressure release ventilation in, 1859, 1859f, 1860f  
assist/control modes in, 1853–1854, 1855f  
automatic tube compensation in, 1858–1859  
bilevel pressure ventilation in, 1860, 1860f  
control mode in, 1853, 1854f  
pressure support mode in, 1854–1855, 1855f  
pressure-regulated volume control mode in, 1857–1858  
proportional-assist ventilation in, 1859  
synchronized intermittent mandatory ventilation in, 1855–1857, 1856f, 1857f  
volume support mode in, 1858  
in multiple organ dysfunction syndrome, 1764–1765, 1765t  
noninvasive positive pressure and, 1869  
normal preoperative pulmonary function and, 1866  
pain management and, 1831  
patient transport during, 1814, 1817  
physiology of lateral decubitus position and, 1225–1226  
pressure *versus* volume ventilation in, 1852–1853, 1853t  
in traumatic shock, 1664  
in unilateral lung disease, 1868  
ventilator settings and patient-ventilator synchrony and, 1860–1862, 1861f, 1863f  
ventilator-induced lung injury and, 1863–1865, 1864f  
weaning from, 1868t, 1868–1869, 1869t
- Mechanomyography, 622–623, 623f
- Meclofenamate, 2064t
- Meclofenamate sodium (Meclomen), 1723t
- Meconium ileus, 1513
- MedFlo II portable infusion pump, 1037f
- Medial branch blocks, 2088–2093  
cervical facet medial branch block in, 2091–2092  
facet medial branch block in, 2090–2091  
intraarticular, 2089–2090, 2090f  
lumbar facet medial branch block in, 2092f, 2092–2093  
thoracic facet medial branch block in, 2092
- Medial canthus peribulbar block, 1574f
- Medial cutaneous nerve of arm, 1029f
- Medial cutaneous nerve of forearm, 1029f
- Medial epicondylitis, 2023t
- Medial malleolus, ankle nerve blocks and, 1047f
- Medial orbital vein, 1568f
- Medial rectus muscle, 1560t, 1567–1572f
- Medial sural cutaneous nerve, popliteal fossa block and, 1045f
- Median frequency monitor, 454
- Median nerve, 2046t  
axillary block and, 1032, 1033f  
carpal tunnel syndrome and, 2029
- Median nerve block, 1034–1035, 1035f
- Mediastinal mass, 1254–1259, 1255t, 1255–1257f, 1256t, 1257t, 1258b  
difficult airway and, 130–131  
pediatric, 1536
- Mediastinoscopy, 1252–1254, 1253f, 1253t
- Mediastinotomy, 1252–1254, 1253f, 1253t
- Mediastinum, 1214
- Mediators of anaphylaxis, 1949–1951
- Medical director relationship, 2179
- Medical error, 452–453
- Medical gas pin-index safety system, 770
- Medical history, 43, 44t  
of addicted patient, 398–399  
difficult airway and, 126, 126t  
elective surgery and, 68–73, 69t, 70t, 71f, 72t, 73t  
in liver transplantation, 1353  
multiple organ dysfunction syndrome and, 1762–1764  
in pain assessment, 2108  
thoracic surgery and, 1215
- Medical information transfer, 1823
- Medical laser, 1596t
- Medical liability, 2127–2128
- Medical practice corporation, 2128
- Medical record  
perioperative information management system and, 499–500  
as source of data verification, 457
- Medical record documentation, 2178
- Medicare billing, 2175
- Medication error, 29
- Medications  
for burn patient, 1678–1679  
in cardiopulmonary resuscitation, 1882–1886, 1885b, 1886b, 1886f  
cause of positive results for catecholamines and metanephrines, 183t  
for diabetes mellitus, 186–187  
effects on intraocular pressure, 1562t  
evaluation in multiple organ dysfunction syndrome, 1763–1764  
in exacerbation of myasthenia gravis, 1261b  
for hemodynamic complications in critically ill patient, 1806–1807  
hepatic metabolism of, 222f, 222–223  
for immunosuppression in heart and lung transplantation, 1382–1383, 1383t  
for obesity, 382–383  
preoperative assessment and management of, 52t, 58–59  
cardiac complications and, 110f, 110–116, 111–112t  
in elective surgery, 73, 73t  
in esophageal surgery, 1250  
in pediatric surgery, 336  
renal disease and, 211  
syndrome of inappropriate antidiuretic hormone and, 185t  
teratogenic, 1473–1474, 1474b
- Medicolegal culpability, 61–62
- Medicolegal issues in consultations, 92
- Medisorb, 797t
- Medos ventricular assist device, 1202
- Medullary hypoxia, 196f, 197
- Medulloblastoma, 1536
- Mefenamic acid (Ponstel), 2064t
- Meglitinides, 186–187
- MELAS syndrome, 166
- MELD scoring system, 1352, 1352t
- Meloxicam (Mobic), 1723t
- Memantine  
for chronic pain, 2059t
- Membrane-type oxygenator for cardiopulmonary bypass, 1141
- Membranous glomerulopathy, 207
- Memorial Pain Assessment Card, 2107
- Mendelson syndrome, 1704
- Meninges of spinal cord, 978, 980f
- Meningitis  
in alcohol or drug addicted patient, 401  
intensive care unit admission and, 1741t
- Meningomyelocele, 1515, 1515f
- Menopause, sensitivity to anesthetic agents and, 1491
- Mental retardation assessment before pediatric surgery, 328
- Mental status  
alcohol abuse and, 407  
burn injury and, 1774  
physiologic effects of hemorrhage on, 1790t  
postoperative  
elective surgery and, 84–85
- Mental status disease, geriatric patient and, 350
- Meperidine (Demerol), 882–883, 2053t, 2184t, 2185t  
biliary effects of, 1317  
caution in renal transplant recipient, 1401  
dose, peak effect, and duration of, 875t  
lipophilicity of, 1720t  
pharmacokinetics of, 881t  
physiochemical properties of, 881t  
postoperative, 1720t, 1721  
in adenotonsillectomy, 1589  
in obstetric surgery, 1473t  
in outpatient surgery, 1620  
for shivering in cesarean delivery, 1485  
structural formula of, 872, 872f
- Mepivacaine (Carbocaine, Polocaine), 970, 2188t  
cation-to-base ratio of, 957t  
clinical manifestations of potency, 960–961, 961f  
disposition kinetics of, 958t  
dissociation constant of, 961t  
for epidural anesthesia, 989t  
in knee replacement surgery, 1546  
for neuraxial anesthesia, 989, 989t, 990, 990t  
in obstetric surgery, 1473t  
peak blood concentration in regional anesthesia, 1058f  
for peripheral nerve block, 1026, 1026t  
structure alterations of, 956f
- Meprobamate  
for chronic pain, 2061
- Meralgia paresthetica, 2030
- Meropenem, 2195t
- Merosin-deficient muscular dystrophy, 164
- Metabolic acid-base disorders, 200, 200f
- Metabolic acidosis, 200, 661f, 661–663, 662f, 664t  
clinical causes of, 581, 581t  
in cyanide poisoning, 1775  
expected compensation for, 582t  
during liver transplantation, 1364–1365  
multiple organ dysfunction syndrome and, 1763, 1767–1768  
transurethral resection of prostate and, 1458  
in trauma patient, 1664

- Metabolic alkalosis, 200  
clinical causes of, 581, 581t  
expected compensation for, 582t
- Metabolic disorders  
in chronic liver disease, 233  
in postoperative ICU patient, 1832
- Metabolic equivalents, 43, 106, 1287–1288, 1288b
- Metabolic failure, 1740–1741
- Metabolic indices in hemodynamic monitoring, 543–544, 544f
- Metabolic syndrome, 190, 382, 1404
- Metabolic system  
aging and, 343–344, 344f  
aortic cross-clamping-related changes in, 1303  
burn injury and, 1679–1680, 1773  
effects of burn injury on, 1676t, 1678  
hepatic role in, 218–219  
inhalational anesthetics and, 755–756, 756t  
multiple organ dysfunction syndrome and, 1757t, 1759–1760, 1763  
of newborn, 306  
of obese patient, 376t, 381–382  
response to critical illness, 1746, 1749  
response to trauma, 1661, 1662t
- Metabotropic receptors, 2003t, 2011t
- Metaproterenol, 2193t
- Metaxalone  
for chronic pain, 2061
- Metformin, 116, 186
- Methadone (Dolophine), 883, 2183t, 2184t, 2185t  
for acute postoperative pain, 1720t, 1721  
in critically ill patient, 1734  
in substance abuser, 1733  
for chronic pain, 2054  
dose, peak effect, and duration of, 875t  
interaction with rifampin, 401  
in obstetric surgery, 1473t  
for opioid withdrawal, 415, 418, 418t
- Methamphetamine, 412–413
- Methanol, volatile anesthetic breakdown and, 760
- Methemoglobin, 580
- Methemoglobinemia  
burn patient and, 1681–1682  
inhalant abuse and, 414  
local anesthetics and, 966
- Methimazole, 175
- Methionine synthase, 759
- Methocarbamol  
for chronic pain, 2061
- Methohexital, 850–856, 2186t  
adverse effects of, 853–854, 854b, 854f  
cardiovascular system and, 853, 853t  
central nervous system and, 850–853, 852f, 852t  
chemistry of, 850, 851f, 852t  
clinical use of, 855–856, 856f, 856t  
dosing strategy for manual infusion regimen, 901t  
in electroconvulsive therapy, 1652  
intraocular pressure and, 1562t  
in monitored anesthesia care, 1639t  
pharmacokinetics of, 854–855, 855t  
for preoperative child, 1523t  
respiratory system and, 853, 853t  
for total intravenous anesthesia  
context-sensitive half-time of, 912–913  
induction of, 904  
maintenance of, 908  
plasma concentration of, 901t
- Methotrexate, 230
- Methoxyflurane  
gas flow splitting ratios of, 781t  
minimum alveolar concentration of, 776t  
physical properties of, 777t
- Methyclothiazide, 920t
- Methylidopa, 921t, 922, 2190t
- Methylene blue, 2193t
- Methylenedioxymethamphetamine (Ecstasy), 412–413
- Methylergonovine, 1483t, 2194t
- Methylmethacrylate, 1552
- N-Methylalntrexone, 889t, 890, 2185t
- Methylprednisolone (Depo-Medrol), 2193t  
for anaphylactic reaction, 1955b  
for Cushing syndrome, 180–181  
epidural injection of, 2078–2079  
for immunosuppression in heart and lung transplantation, 1383, 1383t
- α-Methyltyrosine, 184
- Metoclopramide, 2193t  
for acid reflux, 1316  
for child, 1533
- Metocurine (Metubine)  
effect on pathophysiology of congenital heart disease, 1200  
intraocular pressure and, 1562t
- Metolazone (Zaroxolyn), 920t
- Metoprolol, 929–930, 930t, 1400–1401, 2190t
- Metronidazole, 2195t
- Mevacor (lovastatin), 947t
- Mexiletine (Mexitil), 940t, 941  
for chronic pain, 2059t, 2060
- MGUS neuropathy, 2027t
- Mibefradil, 935
- Michigan Alcohol Screening Test, 397
- Micofungin, 296
- Miconazole, 295
- Microaggregate debris in blood transfusion, 1907
- Microatelectasis, 140
- Microcirculation, 668, 668f
- Microdialysis, 1093f, 1093–1094
- Microdialysis of skeletal muscle in vivo, 1980
- Microencapsulation of local anesthetics, 965
- Microject PCA portable infusion pump, 1037f
- Microlaryngoscopy, 1592–1597, 1594f
- Microshock, 482, 484f
- Microtia, 1584
- Midamor (amiloride), 919–920, 920t
- Midazolam, 860–863, 2186t  
in assisted reproductive technologies, 1475  
cardiovascular effects of, 853t  
cerebral blood flow and, 1095  
chemical structure of, 851f  
context-sensitive half-times for, 825f, 1633t, 1634f  
in coronary artery bypass graft, 1149  
dosing strategy for manual infusion regimen, 901t  
effect site concentration of, 825–826  
hepatic extraction ratio for, 855t  
induction characteristics of, 856t  
intraocular pressure and, 1562t  
in monitored anesthesia care, 1639t  
for obese patient, 383, 384t  
in outpatient surgery, 1611, 1611f  
pharmacokinetics of, 855t, 900t  
physicochemical properties of, 852t  
for preoperative pediatric patient, 1203, 1523t  
somatosensory-evoked potentials and, 604t, 610  
time to peak effect of, 827t  
in tonsillectomy, 1587  
for total intravenous anesthesia, 901t, 905, 908
- Middle cerebellar peduncle, 609f
- Middle cerebral artery, carotid endarterectomy and, 1294
- Middle ear surgery, 1582–1583
- Middle hepatic vein, 217f
- Middle mediastinal mass, 1255t
- Middle mediastinum, 1214
- Middle nasal turbinate, 1571f
- Middle scalene muscle  
interscalene block and, 1030, 1030f  
supraclavicular block and, 1031f
- Middle thoracic splanchnic nerve, 1451f
- Middle ureteric nerve, 1451f
- Midface fracture, 1600, 1600f
- Midhumeral block, 1034
- Midlatency auditory evoked potentials, 613
- Midline approach in neuraxial anesthesia, 984–985
- Midthoracic epidural steroid injection, 2079–2080
- Midthoracic spinous process, 2075
- Miglitol, 186
- Migraine, 2036t, 2036–2037
- Mild hypokinesia, 558
- Milliequivalents, 641
- Millimole, 641
- Milrinone, 1847, 2190t
- Mini Mental Status Examination, 1913, 1914f
- Mini-absorbers, 797, 798f
- Miniature endplate potentials, 620
- Minimal bactericidal concentration, 279–280
- Minimal change glomerulopathy, 207
- Minimal sedation, 1626, 1626t
- Minimally invasive surgery  
in fetal and placental surgery, 1478  
laparoscopic nephrectomy in, 1465, 1466  
for portal hypertension, 1370  
urologic, 1466f, 1466–1467
- Minimum alveolar concentration changes during pregnancy, 360  
erroneously filled vaporizer and, 781, 781t  
geriatric patient and, 346–347, 347f
- inhalational anesthetics and, 751f, 751–752, 752f, 776, 776t, 777t  
vaporization of mixed anesthetic liquids and, 781–782, 782t
- Minimum alveolar concentration-awake, 752
- Minimum inhibitory concentration, 279–280
- Minoxidil, 923, 923t
- Minute ventilation  
burn patient and, 1677  
impact on alveolar anesthetic concentration, 746, 746f  
of newborn, 1504  
obese patient and, 375  
traumatic shock and, 1664
- Miosis, opioid analgesic-related, 877
- Mirtazapine, 2050t
- Miscarriage, 1487t
- Mistake, defined, 25b
- Mitochondria  
anesthetic mechanism of action and, 728  
dysfunction in critical illness, 1749
- Mitochondrial myopathies, 166
- Mitomycin, 1248
- Mitoxantrone, 160
- Mitral regurgitation, 1153t  
geriatric patient and, 348  
in muscular dystrophy, 163  
pulmonary artery pressure waveform in, 531f  
transesophageal echocardiography in, 565–568, 566f, 567f
- Mitral stenosis, 1153t  
geriatric patient and, 348  
pregnant patient and, 366  
preload and, 1146  
preoperative assessment and management in, 50  
transesophageal echocardiography in, 568f, 568–569
- Mitral valve disease  
geriatric patient and, 348  
transesophageal echocardiography in, 563–565, 565f, 566f
- Mitral valve endocarditis, 567, 567f
- Mitral valve procedures, 1152, 1152f
- Mitral valve prolapse, 104
- Mivacurium, 627–629, 628t, 629t, 2187t  
chemical structure of, 628f  
maintenance infusion of, 634  
onset time of, 624  
for pediatric neuromuscular blockade, 1525, 1525t
- Mivazerol, 922
- Mixed acid-base disorders, 201
- Mixed cerebral palsy, 1542
- Mixed venous oxygen saturation  
goal-directed volume resuscitation and, 679, 679f, 680f  
in hemodynamic support for shock, 1848, 1848f  
pulmonary artery catheter and, 526t, 532  
during thoracic surgery, 1223t
- Möbius syndrome, 331t
- Model of end-stage liver disease, 224, 225t, 1352, 1352t
- Moderate sedation, 1625–1626, 1626f, 1626t
- Modification of Diet in Renal Disease Formula, 198
- Modified Aldrete Recovery Score, 1697t
- Modified Brice interview, 754t
- Modified Brooke formula, 1775t
- Modified Cardiac Risk Index, 101–102t
- Modified Cormack and Lehane scoring system, 122, 123f
- Modified Fick partial carbon dioxide rebreathing method, 535
- Modified Glasgow Coma Scale, 1831, 1832t
- Modified radical neck dissection, 1604
- Modified Stewart-Hamilton equation, 534b
- Modified van Lindt block, 1571
- Modified vertical approach in supraclavicular block, 1032, 1032f
- MODS Score, 1756
- Moexipril, 924t
- Molality, 642
- Molarity, 642
- Mole, 641
- Molecular chemistry of anesthesia, 718–738  
affinity and stoichiometry and, 722–723, 723f  
G-protein coupled receptors and, 727f, 727–728  
integration of molecular responses in, 731–733, 732f, 733b  
ion channels and, 725–727, 726f, 727b



- lipid bilayers and, 720–721, 721f  
 mitochondria and, 728  
 molecular structure and, 719f, 719–720, 720f  
 neuroanatomic substrates and, 733b, 733–736, 735f  
 protein coupling mechanism and, 723–724, 724f, 725f  
 protein drug-target complex and, 721–722, 722f  
 relevance of in vitro assays in, 728–731, 729f, 731f  
 soluble proteins and, 724–725
- Molecular genetic testing  
 for malignant hyperthermia, 1979
- Molecular genetics  
 of malignant hyperthermia, 1975–1978, 1976f, 1977f
- Molecular weight, 641  
 of inhaled anesthetics, 741t, 777t
- Mometasone, 2193t
- Monatepil, 935
- Monitored anesthesia care, 1625–1648  
 alpha<sub>2</sub>-agonists in, 1643–1644  
 American Society of Anesthesiologists standards in, 1628, 1628b  
 benzodiazepines in, 1641–1642, 1642f  
 body temperature and, 1630  
 bolus administration in, 1637  
 circulation and, 1629–1630  
 context-sensitive half-time in, 1633–1634, 1634f  
 continuous infusion in, 1637, 1638f  
 definitions in, 1625–1626, 1626f, 1626t  
 depth of sedation in, 1630–1631, 1631b  
 drug elimination in, 1633  
 drug interactions in, 1635–1637, 1636f, 1637f  
 drugs used during, 1639t  
 effect-site concentration in, 1632–1633, 1633t  
 in elective surgery, 80  
 in endovascular aneurysm repair, 1308  
 ketamine in, 1641  
 local anesthetics in, 1639–1640  
 obese patient and, 1634–1635, 1635f  
 opioid analgesics in, 1642–1643, 1643f  
 oxygenation and, 1629  
 patient selection for, 1626–1627  
 plasma concentration and drug distribution in, 1631–1632, 1632f, 1633f  
 preoperative assessment in, 1627–1628  
 preprocedural fasting and, 1628, 1628t  
 presence of anesthesia provider in, 1628–1629  
 propofol in, 1640–1641  
 recovery and discharge criteria in, 1644b, 1644–1645  
 safety issues in, 1627, 1627t  
 in same-day surgery, 1649, 1650  
 target-controlled infusion in, 1637–1639, 1638f, 1639f  
 ventilation and, 1629
- Monitoring, 497–684  
 in aneurysm repair, 1300–1301  
 arterial blood gases, 579–582, 580f, 580–582t, 581f, 666–667  
 in aortic surgery, 1300  
 in elective surgery, 83  
 in liver transplantation, 1353  
 in long bone and pelvic fractures, 1671–1672  
 in neuromuscular disease, 157  
 obese patient and, 378  
 in thoracic surgery, 1217  
 trauma patient and, 1665–1666  
 arterial blood pressure, 519–522, 520f, 521f  
 complications of, 522  
 in coronary artery bypass graft, 1147  
 in critically ill patient, 1801–1802  
 indications for, 522  
 insertion technique in, 521–522  
 in neonatal emergency surgery, 1507  
 noninvasive, 519, 520f  
 during patient transport, 1817  
 pressure waveform in, 521, 521f  
 theory and background of, 519–520, 520f  
 during thoracic surgery, 1223t  
 trauma patient and, 1665  
 bispectral index, 72, 72t, 85, 753, 753f  
 critically ill patient and, 1808  
 monitored anesthesia care and, 1630–1631  
 obese patient and, 390  
 in outpatient surgery, 1619, 1619f  
 sentinel event alert and, 454  
 of brain tissue partial pressure of oxygen, 1930, 1930f  
 of burn patient, 1677–1678  
 cardiac output, 533–537  
 continuous thermodilution method of, 535–536  
 esophageal Doppler method of, 536b, 536–537, 537f  
 gastric tonometry for, 537  
 lithium dilution method of, 534–535  
 partial carbon dioxide rebreathing method of, 535  
 pulse contour-derived method of, 536  
 thermodilution technique of, 534, 534b, 535f  
 transpulmonary thermodilution method of, 534  
 during cardiopulmonary resuscitation, 1879b, 1879t, 1879–1880  
 in carotid endarterectomy, 1294–1295, 1295f  
 central venous pressure, 522–526  
 burn patient and, 1678  
 complications of, 525b, 525–526, 526b  
 in congenital diaphragmatic hernia, 1511  
 in coronary artery bypass graft, 1147–1148  
 critically ill patient and, 1802, 1802t  
 in hepatic resection, 1347  
 indications for, 525, 525b  
 in liver transplantation, 1360  
 in lower-extremity vascular surgery, 1298  
 in lung transplantation, 1386  
 in neonatal emergency surgery, 1507f, 1507–1508  
 in renal transplantation, 1401  
 in small bowel transplantation, 1414  
 in supratentorial craniotomy, 1106  
 theory and background of, 522, 523t, 523–525f  
 trauma patient and, 1666  
 in valve surgery, 1155  
 in coronary artery bypass graft, 1147–1149, 1148f, 1148t, 1149f  
 of critically ill patient, 1801–1804, 1802t, 1803t  
 in elective surgery, 82t, 82–85, 83t  
 electroencephalographic, 598–607  
 bispectral array and, 605–606, 606f, 607f  
 burst suppression and, 603  
 cerebral ischemia and, 602f, 602–603  
 entropy monitor and, 606–607, 608f  
 intravenous and inhalational anesthetic effect on, 604–605t  
 neural basis of, 598–601, 599t, 599–601f  
 of fluid replacement, 676–679, 678f, 679f  
 hemodynamic, 519–551  
 for acute ischemia, 537–538  
 after elective surgery, 83–84  
 in critically ill patient, 1801–1804, 1802t, 1803t  
 in hepatic resection, 1348  
 in open radical nephrectomy, 1465–1466  
 for perfusion assessment, 533t, 542–544, 544f  
 preemptive goal-directed therapy and, 544–545  
 for pulmonary edema, 538, 538b  
 trauma patient and, 1665, 1665t  
 troubleshooting in, 545, 545b  
 for ventricular contractility, 538–540, 539f  
 for volume status, 540–542, 541f, 542f  
 in hepatic resection, 1347  
 in liver transplantation, 1359–1360  
 in lower-extremity vascular surgery, 1298  
 in neonatal emergency surgery, 1506–1508, 1507f  
 neurologic, 598–618  
 awake craniotomy and, 615–616  
 electromyography in, 614–615  
 evoked potentials in, 607–614, 609f, 610f, 611f, 612t, 614f, 615f  
 intraoperative wake-up test and, 615  
 spinal anesthesia for epidural placement of spinal cord stimulating electrodes and, 616  
 of neuromuscular blockade, 621–623, 622f, 623f  
 in neurosurgery  
 for subarachnoid hemorrhage, 1116–1117  
 in supratentorial craniotomy, 1106  
 venous air embolism detection and, 1110–1112, 1111f, 1112f  
 in nonoperating room procedures, 1650–1651  
 of obese patient, 388  
 in obstetric surgery in high-risk parturient, 1488–1489, 1489b  
 patient safety and, 28–29, 33  
 during pediatric anesthesia, 1522  
 perioperative information management systems and, 498–518  
 barriers to adoption of, 514–515  
 billing and regulatory compliance and, 508–509, 509f  
 design and configuration of, 501–502, 501–504f  
 hardware design for, 502–505, 505f  
 management of, 516  
 medical record and, 499–500  
 patient safety and quality of care and, 509–512, 510–512f  
 practice management and, 515–516  
 return on investment in, 512–514, 513f  
 selection of, 500–501, 501f  
 usability and charting accuracy of, 507–508, 508f, 509f  
 validation and implementation of, 505–507, 506f, 507f  
 in postanesthesia care unit, 1691  
 in prostatectomy, 1462  
 pulmonary artery catheter, 526–533  
 in aortic surgery, 1300  
 in carotid endarterectomy, 1295  
 complications of, 530–532  
 continuous mixed venous oximetry and, 532–533, 533b  
 in coronary artery bypass graft, 1148, 1148t  
 in critically ill patient, 1802t, 1802–1804, 1803t  
 diagnostic use of pressure waveforms and, 530, 531f  
 indications for, 532, 532b  
 insertion technique in, 526–527, 528f  
 in liver transplantation, 1359–1360  
 in lower-extremity vascular surgery, 1298  
 in multiple organ dysfunction syndrome, 1766  
 in neonatal emergency surgery, 1507–1508  
 in open radical nephrectomy, 1465  
 pacing, 532  
 in preeclampsia, 1488  
 pregnant patient and, 1489  
 pressure measurements and, 526t, 527t, 527–530, 529f, 529t, 530f  
 right ventricular ejection fraction, 533  
 in small bowel transplantation, 1414  
 in supratentorial craniotomy, 1106  
 in thoracic surgery, 1222, 1223t  
 trauma patient and, 1666, 1666b  
 in valve surgery, 1155  
 in radical cystectomy, 1463–1464  
 of regional anesthesia, 1057  
 in renal transplantation, 1401  
 of respiratory function, 579–597  
 arterial blood gases in, 579–582, 580f, 580–582t, 581f  
 capnography in, 585t, 585–589, 586f, 586t, 587f  
 during intubation, 692t, 692–693, 693b  
 lung mechanics and graphics in, 590–593, 590–593f  
 necessity of, 593–594  
 pulse oximetry in, 583–585, 583–585f  
 during thoracic surgery, 1216–1217, 1218f  
 transcutaneous PO<sub>2</sub> and PCO<sub>2</sub> in, 589–590, 590f  
 in small bowel transplantation, 1414  
 during thoracic anesthesia, 1221–1222, 1223t  
 in tracheal resection, 1262–1263  
 transesophageal echocardiography in, 552–578  
 aorta and, 571–574, 573f, 574f  
 in aortic dissection, 1163  
 in aortic insufficiency, 570  
 in aortic stenosis, 570–571, 571f, 572f  
 in aortic surgery, 1300–1301  
 aortic valve and, 569f, 569–570, 570f  
 basic principles of, 552–553  
 in cardiac tumors, 558  
 in carotid endarterectomy, 1295  
 in coronary artery bypass graft, 1149  
 in critically ill patient, 1802t, 1804  
 for detection of paradoxical air embolism, 1112  
 diastolic function and, 560–563, 561–564f, 565t  
 in immediate post-cardiopulmonary bypass period, 1156  
 indications for, 552, 553f, 554t  
 interatrial septum and, 556–558, 557f  
 left atrium and, 554–555, 556f



- Monitoring—*continued*  
left ventricle and, 558–563  
limitations and contraindications for, 552–553, 555t  
in liver transplantation, 1355–1356, 1360  
in mitral regurgitation, 565–568, 566f, 567f  
in mitral stenosis, 568f, 568–569  
mitral valve and, 563–565, 565f, 566f  
pericardium and, 576f, 576–577  
pulmonary artery and, 576  
in pulmonary artery catheter insertion, 527, 528f  
pulmonic valve and, 576, 576f  
right atrium and, 555–556, 557f  
right ventricle and, 574–575  
in small bowel transplantation, 1414  
systolic function and, 558–560, 558–560f  
terminology in, 552, 555t  
during thoracic surgery, 1223t  
tricuspid valve and, 575f, 575–576  
in valve surgery, 1155  
ventricular assist device and, 1165f, 1165–1166, 1166f
- in transport of critically ill patient, 1811–1827  
chemical injury and disaster victim and, 1821t, 1821–1822  
equipment and monitoring in, 1818  
high-risk obstetrics and, 1821  
interhospital, 1812  
intra-hospital, 1812, 1813t  
modes of, 1819t, 1819–1821, 1820t, 1821f  
neurologic conditions and, 1821, 1821t  
patient assessment and preparation for, 1815–1817t, 1815–1818, 1817f  
pediatric patient and, 1822  
protocols and guidelines in, 1823, 1823t  
quality assurance and, 1822  
reporting and critical incident evaluation in, 1823–1824, 1824t  
risks of, 1813t, 1813–1815  
technology and transport system design and, 1822–1823  
transfer of medical information and, 1823  
transport personnel and, 1819, 1823  
of trauma patient, 1665t, 1665–1666, 1666b  
in valve surgery, 1155
- Monoamine oxidase inhibitors  
electroconvulsive therapy and, 1652  
preoperative assessment and management of, 58
- Mononeuropathy multiplex, 2026, 2030t
- Monophasic defibrillation, 1881
- Montelukast, 2193t
- Mood  
flumazenil and, 862  
opioid agonist-antagonists and, 891  
opioid analgesics and, 875
- Moraxella catarrhalis* pneumonia, 290
- Morbid obesity  
difficult airway and, 127  
metabolic failure and, 1740
- Morbidity  
coronary artery disease and, 1288  
following intraabdominal surgery, 225t  
mortality and morbidity conference and, 455t, 455–456  
patient comorbidity and, 441–443, 442t, 443b, 443f  
pulmonary function test-related predictors of, 1218b  
in renal transplantation, 1399
- Moricizine, 938t, 939
- Morphine, 881–882, 882f, 2053t, 2183t, 2184t, 2185t  
as analgesic adjunct in neuraxial anesthesia, 991  
biliary effects of, 1317  
in cesarean delivery, 1483, 1483t, 1486  
dose, peak effect, and duration of, 875t  
extended-release epidural  
in fetal and placental surgery, 1478  
in lower-limb joint replacement, 1546, 1546t  
hypoxia and, 876  
intraocular pressure and, 1562t  
lipophilicity of, 1720t  
newborn and, 305  
in obstetric surgery, 1473t  
Parkinson disease and, 148  
pharmacokinetics of, 881t  
physicochemical properties of, 881t  
postoperative, 1719–1720, 1720t  
in adenotonsillectomy, 1589  
for child, 1532  
in orthopedic surgery, 1549  
in outpatient surgery, 1620  
in transurethral resection of prostate, 1459  
somatosensory-evoked potentials and, 604t  
structural formula of, 872, 872f  
for trauma patient, 1667t, 1668
- Morphine sustained-release, 2183t, 2185t
- Morquio syndrome, 303t
- Mortality  
anesthesia risk and, 438–446  
anesthesia provider and, 445–446, 446t  
cohort studies in, 438–439, 439t  
crude estimates in, 439–440, 440f  
healthcare setting and, 443–444  
patient comorbidity and, 441–443, 442t, 443b, 443f  
pregnancy and, 1474–1475  
surgeon characteristics and operation in, 444f, 444–445  
contributory cause of death and, 431  
liver disease and, 225t  
protein-energy malnutrition and, 272–273  
pulmonary function test-related predictors of, 1218b
- Mortality and morbidity conference, 455t, 455–456
- Morton, William Thomas Green, 1, 2
- Motion, pulse oximetry and, 583, 584
- Motor evoked potentials  
in aortic surgery, 1301  
intraoperative, 613–614, 614f, 615f
- Motor nerves, 619  
ocular, 1566f
- Motor unit, 619
- Mouth, 687, 687f  
anatomic considerations in difficult airway, 124
- Mouth-to-mouth ventilation, 1875
- Mu opioid receptor, 2007  
peripheral nerve injury and, 2015
- Mucoid degeneration, 1299
- Mucopolysaccharidosis, 226, 303t, 331t
- Mucorales, 295
- Müller's orbital muscle, 1572f
- Multicompartmental kinetic model of inhalational anesthetics, 742–745, 745f
- Multimicore disease, 1970–1971
- Multimodal analgesia, 1719
- Multiple antibiotic allergy syndrome, 1958
- Multiple endocrine neoplasia IIA, 182t
- Multiple endocrine neoplasia IIB, 182t
- Multiple organ dysfunction syndrome, 1754–1771  
acid-base status in, 1767–1768  
anesthetic planning in, 1768  
cardiovascular instability in, 1766  
as cause of death in critical illness, 1741  
definitions in, 1754–1755  
epidemiology of, 1756  
etiologies of, 1755t, 1755–1756  
hematologic disturbances in, 1767  
hemodynamic support in, 1841–1851  
blood transfusion in, 1843–1844  
clinical signs of shock and, 1841  
fluid resuscitation in, 1842–1843, 1843f  
indices of global perfusion in, 1847–1848, 1848f  
indices of regional perfusion in, 1848–1849  
pathophysiologic classification of shock and, 1841–1842  
restoring and maintaining cardiac output in, 1846f, 1846–1847  
vasopressors in, 1844f, 1844t, 1844–1846  
ventilatory support in, 1842  
hepatic dysfunction in, 1767  
immediate *versus* delayed surgery in, 1764  
management of, 1760–1761  
manifestations of, 1757t, 1757–1760  
pathogenesis of, 1757–1758  
predisposition to infection in, 1760  
preoperative assessment in, 1761–1764, 1762t  
preventive strategies for, 1760  
renal failure in, 1766–1767  
respiratory issues in, 1764–1766, 1765t  
scoring systems for, 1756  
transport to operating room and, 1768–1769  
in trauma, 1786
- Multiple sclerosis  
anesthetic considerations in, 158–160, 159t  
preoperative evaluation of, 145
- Multivariable modeling, 434–435
- Multivariate modeling, 434
- Murmur  
in addicted patient, 398  
assessment before pediatric surgery, 332, 333t  
preoperative assessment and management in, 49–50
- Muscarinic agents, 1563
- Muscle  
inhaled anesthetics and, 748, 759  
myotoxicity of local anesthetics and, 1063
- Muscle biopsy  
in malignant hyperthermia, 1978–1979
- Muscle contraction  
cell biology of, 619–621, 620f  
nerve stimulation patterns for, 621–622, 622f, 623f
- Muscle contracture  
in malignant hyperthermia, 1972–1974, 1973f, 1974t, 1975f, 1976f
- Muscle mass of newborn, 1503t
- Muscle relaxants, 619–638  
in adenotonsillectomy, 1588  
anaphylactic reaction to, 1952t, 1956  
for burn patient, 1678–1679  
cell biology of muscle contraction and, 619–621, 620f  
cerebral blood flow and, 1099–1100  
for chronic pain, 2060–2061  
for critically ill patient, 634  
effect on pathophysiology of congenital heart disease, 1200  
formulary of, 2187t  
historical perspective of, 619  
infusion maintenance of, 633–634  
monitoring of, 621–623, 622f, 623f  
in neonatal emergency surgery, 1505–1506  
nondepolarizing, 627t, 627–633, 2187t  
benzylisoquinolines in, 627–629, 628–631t  
for burn patient, 1679  
cerebral blood flow and, 1099  
classification of, 627  
hepatic metabolism of, 223  
in neonatal emergency surgery, 1506  
for obese patient, 384t, 384–385  
onset time of, 624  
in pediatric surgery, 1525, 1525t  
in renal transplantation, 1401  
steroidal muscle relaxants in, 631f, 631–633, 632t, 633t  
for trauma patient, 1667t, 1667–1668  
pharmacology of, 623–624, 624f  
residual neuromuscular blockade and, 634–635, 635f, 635t  
in spine surgery, 1548  
succinylcholine in, 625f, 625t, 625–627, 626t  
for tracheal intubation, 624–625
- Muscle rigidity  
in malignant hyperthermia, 1968  
opioid analgesic-related, 877–878
- Muscle weakness  
in hyperphosphatemia, 657  
in hypokalemia, 651–652
- Muscle-eye-brain disease, 164
- Muscular dystrophy, 163t, 163–164, 328–330, 330b
- Musculocutaneous nerve, 2046t  
axillary block and, 1032, 1033f
- Musculocutaneous nerve block, 1035–1036
- Musculoskeletal disease, 166–169  
achondroplasia in, 169  
carpal tunnel syndrome in, 169  
cerebral palsy in, 167–168  
geriatric patient and, 349–350  
malignant hyperthermia and, 169  
osteoarthritis in, 166–167  
osteogenesis imperfecta in, 168  
osteoporosis in, 168  
polymyositis and dermatomyositis in, 169  
preoperative assessment and management in, 42t  
rhabdomyolysis in, 169  
rheumatoid arthritis in, 167  
scleroderma in, 168–169
- Musculoskeletal pain syndromes, 2020–2025  
arthritis in, 2022  
bursitis and tendinitis in, 2021–2022, 2023–2024t  
fibromyalgia in, 2021, 2022f  
myofascial, 2020–2021, 2021f  
osteoarthritis in, 2022–2024  
rheumatoid arthritis in, 2024–2025
- Musculoskeletal system  
complications associated with renal failure, 1399t  
of obese patient, 376t

- Mustard repair, 1185t, 1187
- Myasthenia congenita, 303t
- Myasthenia gravis, 162
  - anesthetic considerations in, 159t
  - preoperative evaluation of, 145–146
  - thymectomy in, 1259–1261, 1260b, 1260c, 1261b, 1261t
- Myasthenic syndrome, 159t, 162–163, 163t
- Mycophenolate mofetil, 1383, 1383t
- Mycoplasma pneumoniae* pneumonia, 290, 290t
- Mycotic aneurysm, 400, 401
- Mydriatic drugs, 1563
- Myelinolysis, hyperosmolar agents and, 1103t
- Myeloablative preconditioning for stem cell transplant, 1409, 1410f
- Myelopathy, 158–160, 159t
  - opioid overdose and, 410
- Myocardial contractility, 1146, 1147f
  - cardiac output in shock and, 1846
  - hemodynamic monitoring of, 538–540, 539f
  - inhaled anesthetics and, 756t, 756–757
  - local anesthetics and, 967–968
- Myocardial effects of aortic cross-clamping, 1302
- Myocardial hibernation, 1740
- Myocardial infarction
  - cardiac risk in vascular surgery and, 1290
  - cardiogenic shock in, 1742
  - diabetes mellitus and, 1405t
  - ethanol withdrawal and, 403
  - obstructive sleep apnea and, 377
  - perioperative complications and death and, 442t
  - postoperative, 96, 1694, 1706
    - in carotid endarterectomy, 1297
    - hypercoagulability and, 97
    - intensive care unit patient and, 1834
    - risk of, 103
    - supply-demand mismatch and, 96, 97f
    - thrombosis from endothelial dysfunction and, 96–97, 97f, 98f
  - pregnant patient and, 366
- Myocardial injury in electrical injury, 1780
- Myocardial ischemia
  - cocaine use and, 411
  - defibrillation and, 1880
  - ethanol withdrawal and, 403
  - hemodynamic monitoring for, 537–538
  - intraoperative hypothermia and, 1630
  - postoperative, 97–98, 99f, 1694, 1706
    - in aneurysm repair, 1307
    - in cardiac surgery, 1152
    - intensive care unit patient and, 1834
    - in transurethral resection of prostate, 1458–1459
  - vascular surgery morbidity and, 1288
- Myocardial oxygen demand, coronary artery bypass graft and, 1145–1146, 1146f, 1147f
- Myocardial performance index, 560
- Myocardial stunning, 1740
- Myofascial pain syndrome, 2020–2021, 2021f
- Myoglobinemia, 1773
- Myoglobinuria
  - in electrical injury, 1780
  - succinylcholine-induced, 627
- Myomectomy, 1495
- Myopathy, 163–166, 175
  - in alcohol abuse, 407
  - malignant hyperthermia and, 1970f, 1970–1971
  - in muscular dystrophies, 163t, 163–164
- Myopia, 1575f
- Myotonia, 159t, 164–165
  - malignant hyperthermia and, 1971
- Myotonic dystrophy, 164
- Myotoxicity of local anesthetics, 1063, 1074
- Myotubular myopathy, 164
- Myringotomy, 1583
- Myxedema coma, 177
- Myxoma, 558
- Myxomatous degeneration, 1299
- N**
- Nabumetone, 2064t
- nAChRs ligand-gated cys-loop receptor-channel complex, 725–726
- Nadolol, 930t, 931
- Nafcillin, 2195t
- Nail polish, pulse oximetry and, 583
- Nalbufine (Nubain), 890f, 890–892, 891t, 2053t, 2185t
  - dose, peak effect, and duration of, 875t
  - for epidural-related pruritus, 1485, 1728
- Nalmefene, 418t, 889t, 890, 2185t
- Nalorphine, 890–891
- Naloxone, 888–889, 889f, 1719, 2185t
  - central nervous system effects of, 1095
  - in monitored anesthesia care, 1639t
  - for postoperative opioid-induced hypoventilation, 1703
- Naltrexone, 418t, 889f, 889–890, 2185t
- Naproxen, 2064t
- Naproxen (Naprosyn), 2183t
  - antiplatelet activity of, 256
  - standard doses of, 1723t
- Naphthalkanones, 2064t
- Narcotic, term, 2138
- Nasal cannula for carbon dioxide sampling, 589, 589f
- Nasal fracture, 1585
- Nasal intubation
  - child and, 311
  - in maxillofacial reconstruction, 1600
  - in orthognathic reconstruction, 1600–1601
  - in spinal cord trauma, 1670
- Nasal stent, 1585
- Nasal surgery, 1584–1586
- Nasociliary nerve, 1567f, 1573f
- Nasogastric tube
  - in esophageal surgery, 1250
  - for intestinal obstruction, 1329
- Nasolacrimal canal, 1573f
- Nasopharyngeal airway, 694–695, 695b, 695f
- Nasopharynx, 686–687, 687f
  - neonatal, 1509
- Nateglinide, 186–187
- National Fire Protection Association, 487–488, 488t
- National Institute of Health, 8
- National Practitioner Data Bank, 2129–2130, 2139
- National Surgical Quality Improvement Program, 462–463
- National Veterans Administration Surgical Risk Study, 459
- Nationally Recognized Testing Laboratory, 489–490
- Nausea
  - in carbon monoxide poisoning, 1774
  - neuraxial anesthesia-related, 1071
  - oculocardiac reflex and, 1561
  - opioid analgesic-related, 877, 877f
  - postoperative
    - barbiturates and, 854
    - in cesarean delivery, 1485
    - child and, 1532t, 1532–1533
    - in elective surgery, 70, 70t, 71f
    - etomidate and, 860
    - ketamine and, 864
    - laparoscopic surgery and, 1318–1319
    - in outpatient surgery, 1617f, 1617–1618, 1618f, 1620
    - perilymphatic fistula and, 1583–1584
    - postanesthesia care unit and, 1691t, 1691–1692
    - propofol and, 857
    - in sinus surgery, 1586
    - in thyroid surgery, 1603
- Near miss, 454
- Near-infrared spectroscopy
  - in carotid endarterectomy, 1294–1295
  - in pediatric heart surgery, 1192
- Nebivolol, 931
- Neck
  - cancer of, 1590–1591, 1604–1605
  - of newborn, 302–304
  - postoperative hematoma of, 1702
  - trauma to
    - assessment of, 1792
    - difficult airway and, 128–129
    - whiplash injury to, 2035–2036
- Neck pain, 2033–2034, 2034t
- Neck surgery, 1586–1602
  - in abnormal airway disorders, 1586
  - in adenotonsillar hypertrophy, 1587
  - adenotonsillectomy in, 1588f, 1588–1590
  - in benign and malignant tumors, 1590–1591
  - in cleft lip and palate, 1597
  - complications of, 1605
  - dental surgery and, 1601–1602
  - elective, 78–79
  - in foreign body aspiration, 1591
  - in iatrogenic airway disorders, 1591–1592
  - in infections, 1586–1587
  - in malacias, 1597–1598, 1598f
  - maxillofacial reconstruction in, 1600, 1600f
  - in obstructive sleep apnea syndrome, 1588
  - orthognathic surgery in, 1600–1601
  - in pharyngeal abscess, 1590
  - plastic surgery and, 1602
  - risk for perioperative stroke in, 1926
  - in subglottic stenosis, 1598–1599, 1599f
  - tracheal reconstruction or resection in, 1599
  - tracheotomy and tracheostomy in, 1599–1600
  - for tumor, 1604
  - in vocal cord disorders, 1592f, 1592–1597
- Necrosis, 1749
  - response to trauma, 1787
  - in traumatic hemorrhagic shock, 1663
- Necrotizing angitis, 412
- Necrotizing enterocolitis, 1512–1513
- Necrotizing soft tissue infection, 1741t
- Needle
  - for combined spinal-epidural anesthesia, 1001, 1001f
  - postdural puncture headache and, 1068
  - for spinal anesthesia, 981–982, 982f
- Needle biopsy of liver, 220–221
- Needle localization
  - in axillary nerve block, 1033–1034
  - in paravertebral nerve block, 1013, 1015f
  - in peripheral nerve block, 1025–1026
- Nefazodone, 2050t
- Nefidipine, 1100
- Neglect of child, 2132–2133
- Negligence, 2127–2128
- Neisseria meningitidis* pneumonia, 290
- Nemaline myopathy, 164
- Nemaline rod myopathy, 1971
- Neodymium:yttrium aluminum garnet laser, 1596t, 1653
- Neonatal hypoglycemia, 186
- Neostigmine, 2187t
  - as analgesic adjuvant in neuraxial anesthesia, 991t, 992–993
  - bowel motility and, 1316
  - for neuromuscular blockade reversal, 635, 635f, 1525
- Nephrectomy, 1465, 1466–1467
- Nephritic syndrome, 207
- Nephritis, tubulointerstitial, 207–208
- Nephroblastoma, 1535–1536
- Nephrolithiasis, 1459–1461
- Nephron, 194–195, 195f
- Nephron-sparing partial resection, 1465
- Nephropathy
  - contrast, 209
  - diabetic, 189, 208
  - tubulointerstitial, 207–208
- Nephrotic syndrome, 207
  - cocaine-related, 412
- Nephrotoxicity of fluoride from inhaled anesthetic metabolism, 760–761
- Nerve block
  - adverse event during, 1053–1080
  - backache and, 1072
  - brachial plexus block and, 1064
  - consent and, 1054–1055
  - direct needle trauma to nerve and, 1060–1061, 1061t, 1062t, 1064–1065
  - failure of spinal/epidural anesthesia and, 1069–1070
  - hematoma and, 1065
  - hoarseness and, 1064
  - Horner syndrome and, 1064
  - hypotension and, 1070
  - importance of prevention of, 1053–1054, 1054t
  - infection and, 1065–1066
  - intravenous regional anesthesia and, 1072–1073, 1073t
  - local anesthetic administration and, 1058f, 1058–1060, 1059f, 1059t
  - monitoring and, 1057
  - myotoxicity and, 1063
  - nausea and pruritus and, 1071
  - neural toxicity and, 1063
  - ophthalmic regional anesthesia and, 1073–1074, 1074t
  - patient selection and, 1054, 1054t
  - phrenic nerve paralysis and, 1063–1064
  - physician-patient communication and, 1058
  - pneumothorax and, 1062–1063
  - postdural puncture headache and, 1067–1069
  - postoperative urinary retention and, 1071–1072

- Nerve block—*continued*
- record keeping and documentation and, 1057
  - respiratory complications and, 1070–1071
  - spinal cord injury and, 1062
  - subdural injection and, 1067
  - systemic and local toxicity and, 1067
  - total spinal anesthesia and, 1066–1067
  - use of appropriate equipment and technique and, 1055*f*, 1055–1057, 1056*t*, 1057*f*
  - formulary for, 2188*t*
  - in head and neck cancer, 2114*f*, 2114–2115
  - in lung cancer, 2116–2117, 2117*f*
  - neuraxial anesthesia, 978–1008
    - accessing epidural space in, 984–986, 986*f*, 987*f*
    - accessing subarachnoid space in, 983–984, 984–986*f*
    - analgesic adjuncts in, 990–993, 991*t*
    - anatomy in, 978–981, 979–981*f*
    - cardiovascular physiology of, 994–996, 995*f*, 995*t*
    - clinical pharmacology in, 986–988, 987*t*, 988*t*
    - combined spinal-epidural anesthesia and, 1000–1002, 1001*f*, 1002*f*
    - complications of, 997–1000, 999*t*
    - continuous, 1000
    - equipment for, 981–982, 982*f*
    - gastrointestinal, hepatic, and genitourinary physiology of, 996–997
    - local anesthetics for, 988–990, 989*t*, 990*t*
    - in lower-extremity orthopedic surgery, 1544
    - neurophysiology of, 993–994
    - patient positioning and preparation for, 982–983, 983*f*, 984*f*
    - patient selection for, 982
    - for postoperative pain in thoracic surgery, 1275
    - respiratory physiology of, 994
  - in ophthalmic surgery, 1565–1575
    - commonly used drugs and adjuvants in, 1571–1573
    - complications of, 1073–1074, 1074*t*, 1573–1575, 1576*t*
    - modified van Lindt block in, 1571
    - postoperative, 1571
    - retrobulbar or peribulbar block in, 1568*f*, 1568–1571, 1573–1575*f*
    - sedation for, 1575
    - sub-Tenon block in, 1567–1568, 1574*f*
    - topical, 1566–1567
  - in outpatient surgery, 1614–1615, 1615*f*, 1616*f*
  - paravertebral, 1009–1024
    - advantages of, 1017*f*, 1017*t*, 1017–1018
    - adverse effects of, 1018*t*, 1018–1019
    - anatomic or loss-of-resistance technique in, 1012–1013, 1015*f*
    - clinical applications for, 1014*t*, 1019–1022
    - continuous catheter technique in, 1015, 1016*f*
    - contraindications for, 1018
    - effect of technique on distribution of injectate, 1015–1017
    - historical background of, 1011, 1013*f*
    - injection of radiographic contrast dye in, 1014, 1016*f*
    - local anesthetic regimen for, 1017, 1017*t*
    - lumbar anatomy and, 1009–1011, 1011*f*, 1012*f*
    - nerve stimulation in, 1013–1014
    - patient positioning for, 1011–1012
    - pressure measurement for placement confirmation in, 1014
    - thoracic anatomy and, 1009, 1010*f*, 1011*f*
    - in thoracic surgery, 1019–1020, 1238
    - ultrasound-assisted technique in, 1014–1015
  - pediatric, 1528–1531
    - caudal blocks in, 1529*f*, 1529–1530
    - epidural, 1531, 1531*t*
    - extremity blocks in, 1531
    - spinal, 1530–1531
    - peripheral, 1025–1052
      - ankle blocks, 1046, 1047*f*, 1048*f*
      - axillary block, 1032–1034, 1033*f*
      - brachial plexus anatomy and, 1028–1029, 1029*f*
      - cervical plexus block, 1027*f*, 1027–1028, 1028*f*
      - choice of local anesthetic for, 1026*t*, 1026–1027
      - continuous catheter techniques and, 1037, 1037*f*, 1046
      - in critically ill patient, 1805
      - femoral nerve block, 1041–1042
      - hemorrhagic complications in, 1048–1049
      - infectious complications in, 1049
      - infraclavicular block, 1032
      - interscalene block, 1029–1031, 1030*f*
      - intravenous, 1036–1037
      - lateral femoral cutaneous nerve block, 1042
      - localizing neural structures in, 1025–1026
      - lower-extremity anatomy in, 1038, 1038*f*, 1039*f*
      - in lower-extremity orthopedic surgery, 1544
      - lumbar plexus block, 1038–1041, 1040–1042*f*
      - median nerve block, 1034–1035, 1035*f*
      - midhumeral block, 1034
      - musculocutaneous nerve block, 1035–1036
      - nerve stimulation in, 1055*f*, 1055–1056
      - neurologic complications in, 1048
      - obturator nerve block, 1042–1043
      - perioperative outcomes in, 1046–1048
      - popliteal fossa block, 1044–1046, 1045*f*
      - radial nerve block, 1035, 1036*f*
      - sciatic nerve block, 1043*f*, 1043–1044, 1044*f*
      - supraclavicular block, 1031*f*, 1031–1032, 1032*f*
      - for trauma patient, 1668, 1668*t*
      - ulnar nerve block, 1035, 1036*f*
      - in upper-extremity orthopedic procedures, 1543*f*, 1543–1544
      - for postoperative pain, 1730–1731
      - in thoracic surgery, 1238
      - in upper extremity malignancy, 2115–2116, 2116*f*
  - Nerve growth factor, 958
  - Nerve injury
    - altered membrane excitability and ectopic activity after, 2015
    - anesthesia-related, 1712
    - associated with positioning, 472–473, 474*b*
    - in nerve block
      - axillary, 1034
      - interscalene, 1030–1031
      - peripheral, 1048, 1060–1061, 1061*t*, 1062*t*
      - in sitting position infratentorial craniectomy, 1110
      - soluble pain mediators and, 2015
      - thoracic surgery-related, 1273–1274
      - tourniquet and, 1550
  - Nerve integrity monitor endotracheal tube, 1603
  - Nerve stimulation
    - in paravertebral anesthesia, 1013–1014
    - patterns of, 621–622, 622*f*, 623*f*
    - prevention of adverse events and, 1055*f*, 1055–1057, 1056*t*, 1057*f*
  - Nesacaine (2-Chloroprocaine), 970, 2188*t*
  - Nesiritide, 1201
  - Net state of immunosuppression, 294
  - Neuralgia
    - glossopharyngeal, 2031, 2031*t*
    - occipital, 2031, 2031*t*
    - postherpetic, 2029–2030
    - trigeminal, 2030–2031, 2031*t*
  - Neuraxial anesthesia, 978–1008
    - accessing epidural space in, 984–986, 986*f*, 987*f*
    - accessing subarachnoid space in, 983–984, 984–986*f*
    - adverse event in, 1064–1072
      - backache and, 1072
      - direct needle trauma and, 1064–1065
      - failure of anesthesia and, 1069–1070
      - hematoma and, 1065
      - hypotension and, 1070
      - infection and, 1065–1066
      - nausea and pruritus and, 1071
      - nerve stimulation and, 1056, 1056*t*
      - patient selection and, 1054, 1054*t*
      - postdural puncture headache and, 1067–1069
      - postoperative urinary retention and, 1071–1072
      - respiratory complications and, 1070–1071
      - subdural injection of local anesthetic drug in, 1067
      - systemic and local toxicity and, 1067
      - total spinal anesthesia and, 1066–1067
      - ultrasound and, 1057
    - amyotrophic lateral sclerosis and, 158
    - analgesic adjuncts in, 990–993, 991*t*
    - anatomy in, 978–981, 979–981*f*
    - bowel motility and, 1316–1317
    - cardiovascular physiology of, 994–996, 995*f*, 995*t*
    - clinical pharmacology in, 986–988, 987*t*, 988*t*
    - clonidine addition to, 1728
    - combined spinal-epidural anesthesia and, 1000–1002, 1001*f*, 1002*f*
    - complications of, 997–1000, 999*t*, 1481–1482*t*
    - continuous, 1000
    - for drug addicted patient, 419
    - epidural hematoma and, 1729
    - equipment for, 981–982, 982*f*
    - gastrointestinal, hepatic, and genitourinary physiology of, 996–997
    - in gynecologic surgery, 1492
    - hyperthermia during, 1630
    - hypotension and, 1070
      - obstetric surgery and, 1472, 1485
      - preeclampsia and, 1488
    - local anesthetics for, 988–990, 989*t*, 990*t*
    - in lower-extremity orthopedic surgery, 1544
    - in lower-extremity vascular surgery, 1298
    - neurophysiology of, 993–994
    - in obstetric surgery, 1472*t*, 1472–1473, 1473*f*, 1473*t*
    - in assisted reproductive technologies, 1475–1477, 1476*f*
    - in external cephalic version, 1477–1478
    - in fetal and placental surgery, 1478
    - in labor and vaginal delivery, 1478–1480, 1479*b*
    - preeclampsia and, 1488
    - opioid injections and, 1731
    - patient positioning and preparation for, 982–983, 983*f*, 984*f*
    - patient selection for, 982
    - for postoperative pain in thoracic surgery, 1275
    - in radical cystectomy, 1464
    - respiratory physiology of, 994
    - surgical outcomes and, 1729
    - in transurethral resection of prostate, 1459
  - Neurilemoma, mediastinal, 1255*f*
  - Neuroablation techniques for cancer pain, 2113–2121, 2114*t*
    - brachial plexus block in, 2115–2116, 2116*f*
    - celiac plexus block in, 2118–2119, 2119*f*
    - ganglion impar block in, 2120–2121
    - intercostal nerve block in, 2116–2117, 2117*f*
    - lumbar sympathetic block in, 2119–2120
    - occipital nerve block in, 2114–2115
    - stellate ganglion block in, 2117–2118
    - superficial cervical plexus block in, 2115
    - superior hypogastric plexus block in, 2120, 2120*f*
    - trigeminal nerve block in, 2114, 2114*f*
  - Neuroanatomic substrates, 733*b*, 733–736, 735*f*
  - Neuroanesthesia, 1081–1139
    - adjuvant drugs and, 1099–1100
    - anesthetic neuroprotection and, 1102–1104
    - anesthetic preconditioning and, 1104–1105
    - in aneurysm, 1114*f*, 1114–1119, 1115*t*, 1116*f*, 1117*f*, 1117*t*
    - in arteriovenous malformation, 1119–1120
    - cerebral physiology and, 1082*t*, 1082–1086, 1083*t*, 1084*f*
    - cerebrovascular pharmacology of, 1094–1100
    - adjuvant drugs and, 1099–1100
    - intravenous anesthetics and, 1094–1095
    - sedative agents and, 1095
    - volatile agents and, 1095–1099, 1096*f*, 1097*t*, 1098*f*
    - for cervical spine disease, 1120*f*, 1120–1121
    - in horizontal position infratentorial craniectomy, 1114
    - hyperosmolar agents in, 1100–1102, 1101*t*, 1103*t*
    - for infratentorial craniectomy
      - horizontal position, 1114
      - sitting position, 1108–1114, 1111–1113*f*
    - intracranial pressure control and, 1086–1092*f*, 1093
    - autonomic nervous system and, 1092–1093
    - autoregulation and, 1090–1092, 1091*f*
    - cerebral blood flow and, 1089–1090, 1090*f*
    - cerebral blood volume control and, 1088*f*, 1088–1089
    - flow-metabolism coupling and, 1092, 1092*f*
    - hypocapnia in, 1090
    - measurement of cerebral blood volume and, 1088
    - oxygen partial pressure and, 1090
    - physiology of, 1086*f*, 1086–1088, 1087*f*
    - for intracranial vascular procedures
      - aneurysms, 1114*f*, 1114–1119, 1115*t*, 1116*f*, 1117*f*, 1117*t*



- intravenous anesthetics and, 1094–1095  
arteriovenous malformations, 1119–1120  
microdialysis and, 1093*f*, 1093–1094  
sedative agents and, 1095  
in sitting position infratentorial craniectomy, 1108–1114, 1111–1113*f*  
for supratentorial craniotomy, 1105–1108, 1106*f*, 1108*f*  
for transphenoidal hypophysectomy, 1121  
volatile agents and, 1095–1099, 1096*f*, 1097*t*, 1098*f*
- Neuroblastoma, 1535
- Neurofibroma, mediastinal, 1255*f*
- Neurofibromatosis, 182*t*
- Neurogenic inflammation, 2012
- Neurogenic shock after spinal surgery, 1549
- Neurohumoral response to trauma, 1661, 1662*t*
- Neurohypophysis, 184
- Neurokinin antagonist, 2189*t*
- Neuroleptanalgesia, 886
- Neuroleptanesthesia, 865, 886
- Neuroleptic agents, 864–865, 2186*t*
- Neuroleptic malignant syndrome, 150
- Neurologic assessment  
after cardiopulmonary bypass, 398  
of alcohol or drug addicted patient, 398  
in burn injury, 1778  
in carotid endarterectomy, 1295, 1295*f*  
of critically ill patient, 1798  
in multiple sclerosis, 160
- Neurologic complications  
in alcohol or drug addicted patient, 404*t*  
in cardiopulmonary bypass, 1915  
in liver transplantation, 1369  
in paravertebral nerve block, 1018*t*, 1019  
in peripheral nerve block, 1048  
in postanesthesia care unit, 1693, 1695*t*  
in postoperative ICU patient, 1832*t*, 1832–1833  
in renal failure, 1399*t*  
in shock, 1841  
in sitting position infratentorial craniectomy, 1109–1110  
spinal anesthesia and, 1456–1457  
in transurethral resection of prostate, 1457
- Neurologic disease  
geriatric patient and, 350  
perioperative complications and death and, 442*t*  
preoperative assessment and management in, 54, 145–148  
transfer of patient with, 1821, 1821*t*
- Neurologic monitoring, 598–618  
awake craniotomy and, 615–616  
electroencephalography in, 598–607  
bispectral array and, 605–606, 606*f*, 607*f*  
burst suppression and, 603  
cerebral ischemia and, 602*f*, 602–603  
entropy monitor and, 606–607, 608*f*  
intravenous and inhalational anesthetic effect on, 604–605*t*  
neural basis of, 598–601, 599*t*, 599–601*f*  
electromyography in, 614–615  
evoked potentials in, 607–614  
anesthetic effect on, 609–610  
application of, 610–613, 611*f*, 612*t*  
auditory evoked responses and, 613  
elicitation of, 608–609, 609*f*, 610*f*  
motor evoked potentials and, 613–614, 614*f*, 615*f*  
intraoperative wake-up test and, 615  
spinal anesthesia for epidural placement of spinal cord stimulating electrodes and, 616
- Neurologic status  
of critically ill child, 337  
patient transport and, 1818  
in subarachnoid hemorrhage, 1115, 1115*t*
- Neurologic system  
barbiturates and, 850–853, 852*f*, 852*t*  
benzodiazepines and, 861  
changes during pregnancy, 360  
chronic liver disease and, 233, 1344–1345, 1345*b*  
dysfunction of  
in alcohol or drug addicted patient, 401  
postoperative, 1709–1710  
syndrome of inappropriate antidiuretic hormone and, 185*t*  
effects of burn injury on, 1676*t*  
etomidate and, 859  
inhalational anesthetics and, 755–756, 756*t*  
ketamine and, 863, 863*f*  
lung cancer and, 1220  
multiple organ dysfunction syndrome and, 1757*t*, 1759, 1763  
of newborn, 305–306  
of obese patient, 376*t*  
opioid analgesics and, 875–877*f*, 875–878  
pathophysiology of critical illness and, 1744, 1745*f*  
physiology of neuraxial anesthesia and, 993–994  
propofol and, 857–858  
protection during surgery, 1102–1104  
protein-energy malnutrition and, 272  
superior vena cava syndrome and, 1258*b*
- Neurolytic celiac plexus block, 2084–2087, 2085*f*
- Neurolytic lumbar sympathetic block, 2087–2088
- Neurolytic procedures for cancer pain, 2113–2121, 2114*t*  
brachial plexus block in, 2115–2116, 2116*f*  
celiac plexus block in, 2118–2119, 2119*f*  
ganglion impar block in, 2120–2121  
intercostal nerve block in, 2116–2117, 2117*f*  
lumbar sympathetic block in, 2119–2120  
occipital nerve block in, 2114–2115  
stellate ganglion block in, 2117–2118  
superficial cervical plexus block in, 2115  
superior hypogastric plexus block in, 2120, 2120*f*  
trigeminal nerve block in, 2114, 2114*f*
- Neuroma, acoustic, 612*t*
- Neuromodulation techniques for cancer pain, 2121, 2121*f*
- Neuromuscular blockade, 619–638  
acute porphyria and, 161*t*  
in adenotonsillectomy, 1588  
anaphylactic reaction to, 1956  
cell biology of muscle contraction and, 619–621, 620*f*  
in critically ill patient, 634, 1798  
effect on pathophysiology of congenital heart disease, 1200  
historical perspective of, 619  
infusion maintenance of, 633–634  
monitoring of, 621–623, 622*f*, 623*f*  
in neonatal emergency surgery, 1505–1506  
nondepolarizing neuromuscular blocking drugs in, 627*t*, 627–633  
benzylisoquinolines in, 627–629, 628–631*t*  
classification of, 627  
steroidal muscle relaxants in, 631*f*, 631–633, 632*t*, 633*t*  
for obese patient, 383–385, 384*t*  
onset time of, 624  
in pediatric surgery, 1525  
pharmacology of, 623–624, 624*f*  
residual, 634–635, 635*f*, 635*t*  
succinylcholine for, 625*f*, 625*t*, 625–627, 626*t*  
for tracheal intubation, 624–625  
for trauma patient, 1667*t*, 1667–1668
- Neuromuscular disease, 156–166  
amyotrophic lateral sclerosis in, 158  
Charcot-Marie-Tooth disease in, 161–162  
Eaton-Lambert syndrome in, 162–163, 163*t*  
familial dysautonomia in, 161  
familial periodic paralysis in, 165*t*, 165–166  
Guillain-Barré syndrome in, 160–161  
multiple sclerosis in, 158–160  
muscular dystrophies in, 163*t*, 163–164  
myasthenia gravis in, 162  
myotonias in, 164–165  
pediatric, 328–330, 330*b*  
porphyrias in, 161, 161*t*  
preoperative assessment and management in, 42*t*, 156–158, 159*t*  
skeletal muscle diseases and, 166
- Neuromuscular disorders  
malignant hyperthermia and, 1971
- Neuromuscular junction, 619
- Neuromuscular junction diseases, 162–163, 163*t*
- Neuromuscular system  
of child, 328–330, 329*f*, 330*b*  
hyperthyroidism and, 175  
lung cancer and, 1221
- Neuron, generation of electroencephalogram and, 598, 599*t*, 600*f*
- Neuropathic pain, 2008*f*, 2009*f*, 2009–2010, 2005*t*, 2111  
central sensitization and, 2015–2016  
clinical features of, 2025*b*  
definition of, 2011*t*  
mechanisms of, 2014–2016  
medications for, 1725, 2057*t*  
opioids for, 2054
- Neuropathic pain syndromes, 2025*t*, 2025–2031, 2026*t*  
acute herpes zoster in, 2029  
carpal tunnel syndrome in, 2028–2029  
diabetic, 2026–2028, 2029*t*  
glossopharyngeal neuralgia in, 2031, 2031*t*  
HIV/AIDS-related, 2028, 2030*t*  
meralgia paresthetica in, 2030  
occipital neuralgia in, 2031, 2031*t*  
painful peripheral neuropathies in, 2025–2026, 2027–2028*t*, 2029*f*  
postherpetic neuralgia in, 2029–2030  
small-fiber neuropathy in, 2026  
trigeminal neuralgia in, 2030–2031, 2031*t*
- Neuropathy  
acute post-gastric reduction surgery, 386  
in alcohol abuse, 407  
associated with surgical positioning, 472–473, 474*b*  
diabetic, 188–189  
drug therapy for, 2059*t*  
HIV/AIDS-related, 2028, 2030*t*  
neuromuscular blockade in critically ill patient and, 1798  
peripheral, 160–162, 161*t*  
anesthetic considerations in, 159*t*  
diabetic, 2026–2028, 2029*t*  
medications for neuropathic pain in, 2057*t*  
painful syndromes of, 2025–2026, 2027–2028*t*, 2029*f*  
preoperative evaluation of, 146, 146*t*, 147*t*  
surgical positioning-related, 472–473, 474*b*  
in postoperative ICU patient, 1832–1833  
preoperative evaluation of, 146, 146*t*, 147*t*  
small-fiber, 2026
- Neuroprotection, 1925–1946  
anesthetics in, 1938–1941, 1940*f*  
blood pressure management and, 1935–1938, 1936*f*  
body temperature and, 1931–1934, 1932*f*, 1933*t*  
glycemic control and, 1934–1935  
hemoglobin and, 1938, 1939*f*, 1940*f*  
oxygenation and, 1929–1930, 1930*f*  
perioperative hypothermia and, 1991–1992  
perioperative stroke and, 1925–1929, 1926*t*, 1927–1928*f*  
positive end-expiratory pressure and, 1938, 1939*f*  
ventilation and, edit 1931*f*, 1930–1931
- Neurosurgery  
intraoperative neurologic monitoring in, 598–618  
awake craniotomy and, 615–616  
electroencephalography in, 598–607, 599*t*, 599–602*f*, 604–605*t*, 606–608*f*  
electromyography and, 614–615  
evoked potentials in, 607–614, 609–611*f*, 612*t*, 614*f*, 615*f*  
intraoperative wake-up test and, 615  
spinal anesthesia for epidural placement of spinal cord stimulating electrodes and, 616  
pediatric, 1536–1537
- Neurosurgical lesions in newborn, 302*t*
- Neurotoxicity  
of anesthetics, 1938–1941, 1940*f*  
of local anesthetics, 966–968*f*, 966–969  
of opioid analgesics, 875–876
- Neurotransmitters  
chronic pain and, 2020
- Neutral wire, 480
- New York Heart Association Functional Classification of Cardiovascular Disease, 366*t*
- Newborn, 300–309  
blood pressure ranges of, 315*t*  
calcium levels of, 307  
cardiac physiology of, 305  
central nervous system of, 305–306  
choanal atresia in, 1585  
congenital anomalies in, 302–304*t*  
emergency surgery of, 1502–1519  
airway management in, 1509*f*, 1509–1510, 1510*f*  
anesthetic pharmacology and, 1502–1504, 1503*t*  
in congenital diaphragmatic hernia, 1510–1512  
in esophageal atresia and tracheoesophageal fistula, 1513–1515, 1514*f*  
fentanyl in, 1504–1505



Newborn—*continued*

- fluid management in, 1508–1509
  - inhalational agents in, 1504, 1504t
  - in intestinal obstruction and necrotizing enterocolitis, 1512–1513
  - ketamine, general anesthetics, sedatives and, 1506
  - local anesthetics in, 1506
  - in meningomyelocele, 1515, 1515f
  - monitoring in, 1506–1508, 1507f
  - muscle relaxants in, 1505–1506
  - in omphalocele and gastroschisis, 1512, 1513f
  - in patent ductus arteriosus, 1515–1516
  - gas exchange and oxygen consumption in, 304–305
  - gestational age of, 301–302
  - glucose metabolism in, 306–307
  - growth charts for, 324f, 325f
  - head and neck of, 302–304
  - heart of, 1182–1184, 1183b, 1183f
  - human immunodeficiency virus infection in, 369
  - interactions with family of, 300
  - maternal and peripartum history and, 300–301, 301t
  - mean hematocrit and hemoglobin of, 335t
  - normal red blood cell values of, 240t
  - opioid analgesics and, 880
  - oxygenation index and, 579
  - postoperative pain and, 1731–1732
  - renal physiology and metabolism in, 306
  - thermoregulation and, 306
  - Nicardipine, 932t, 934–935, 2190t
    - brain protective effects of, 1936
    - cerebral blood flow and, 1100
  - Nicorandil, 936
  - Nicotinamide adenine dinucleotide, 1749
  - Nicotinic acid deficiency, 407
  - Nicotinic postjunctional receptor, 620
  - Nifedipine, 932t, 934, 2190t
  - Nightingale, Florence, 432b
  - Nimodipine, 932t, 935
    - brain protective effects of, 1936
    - cerebral blood flow and, 1100
    - for subarachnoid hemorrhage-related vasospasm, 1116
  - Nisoldipine, 932t, 935
  - Nissen-type fundoplication, 1322
  - Nitrates, 926–928, 927f, 928t
    - for low cardiac output in shock, 1847
    - for postoperative hypertension, 1695
    - before vascular surgery, 1292
  - Nitrendipine, 935
  - Nitric oxide
    - for congenital diaphragmatic hernia, 1511
    - endothelial response to injury and, 1745
    - for hypoxic pulmonary vasoconstriction, 1234
    - mitochondrial dysfunction and, 1749
    - for multiple organ dysfunction syndrome, 1765
    - for portopulmonary hypertension, 1343
  - Nitrogen response to traumatic injury, 1745
  - Nitroglycerin (Nitrostat, Nitrolingual, Nitrogard), 926–927, 927f, 928t, 2191t
    - in aortic cross-clamping, 1303
    - biliary effects of, 1317
    - cerebral blood flow and, 1099–1100
    - before coronary artery bypass graft, 1150
    - for low cardiac output in shock, 1847
    - perioperative cardiac complications and, 115
    - for postoperative hypertension, 1695
  - Nitroprusside, 923–924, 2191t
    - cellular mechanism of, 927f
    - cerebral blood flow and, 1099–1100
    - effects on vascular resistance, 757t
    - ischemic brain damage and, 1936–1937
    - for low cardiac output in shock, 1847
  - Nitrostat (nitroglycerin), 928t
  - Nitrous oxide
    - advantages and disadvantages of, 761t
    - anesthesia delivery system and, 772
    - biophysical properties of, 744t
    - bowel distension and, 1316
    - cardiovascular effects of, 756t
    - central nervous system effects, 756t
    - cerebral blood flow and, 1099
    - cerebral neuroprotection and, 1104
    - chemical and physical properties of, 740, 741f, 741t
    - effect on pathophysiology of congenital heart disease, 1198
    - effects on respiratory function, 758t
    - laparoscopic surgery and, 1318
    - in middle ear surgery, 1583
    - for obese patient, 390
    - for renal transplantation, 1401
    - for sitting position infratentorial craniectomy, 1112
    - somatosensory-evoked potentials and, 605t
    - space-filling representation of, 719f
    - teratogenicity of, 1474
    - uptake into airspaces of body, 749–750, 750f
  - NMDA receptor
    - central sensitization and, 2013
    - in nociceptive transmission, 2005
  - NMDA receptor antagonists
    - for acute postoperative pain, 1724–1725
    - for chronic pain, 2054, 2059t
  - N-methyl-D-aspartate receptor
    - in nociceptive transmission, 2005
  - Nociceptin-orphanin FQ receptor, 873
  - Nociception, 2000–2007, 2001f
    - ascending nociceptive pathways and, 2006
    - brain and, 2007
    - definition of, 2011t
    - descending nociceptive pathways and, 2006–2007
    - dorsal horn of spinal cord and, 2004f, 2004–2006, 2005f, 2005t, 2006t
    - primary afferents and, 2001–2003t, 2001–2004, 2002f
  - Nociceptive pain, 2008, 2008f, 2011t
    - pain hypersensitivity and, 2010
  - Nociceptor, 2000, 2001, 2011t
    - chronic pain and, 2020
  - Nocturnal angina, 377
  - Nominal hazard zone, 1595
  - Nonalcoholic fatty liver disease, 226f, 226–228, 381
  - Nonalcoholic steatohepatitis, 381
  - Noncardiogenic pulmonary edema
    - transfusion-related, 1907
  - Nonclinical support staff, 2174
  - Nondepolarizing neuromuscular blocking drugs, 627t, 627–633, 2187t
    - benzylisoquinolines in, 627–629, 628–631t
    - for burn patient, 1679
    - cerebral blood flow and, 1099
    - classification of, 627
    - hepatic metabolism of, 223
    - in neonatal emergency surgery, 1506
    - for obese patient, 384t, 384–385
    - onset time of, 624
    - in pediatric surgery, 1525
    - in renal transplantation, 1401
    - steroidal muscle relaxants in, 631f, 631–633, 632t, 633t
    - for trauma patient, 1667t, 1667–1668
  - Nondrug approaches to pain, 1731
    - in labor and delivery, 1479b
  - Nonimmobilizer drugs, 719
  - Nonimmunologic mast cell activation, 1949
  - Nonintubated airway, 693–699
    - complications of, 698b, 698–699
    - esophageal-tracheal airway in, 698, 698f
    - extralottic airway in, 698
    - face mask ventilation in, 693–694, 694b, 694f
    - pharyngeal airway in, 694–695, 695b, 695f
  - Noninvasive arterial blood pressure measurement, 519, 520f
  - Noninvasive positive pressure ventilation, 1869
  - Nonoperating room procedures, 1649–1659
    - cardiopulmonary suite and, 1653–1654
    - diagnostic imaging in, 1655
    - electroconvulsive therapy in, 1651–1652
    - endoscopy in, 1652–1653
    - interventional radiology in, 1654–1656
    - pediatric patient and, 1655–1656
    - pharmacologic agents for, 1651
    - postanesthesia concerns in, 1651
    - preanesthetic considerations in, 1649–1651
  - Nonopioid analgesics for cancer pain, 2111
  - Nonpyramidal cell, electroencephalogram and, 598, 599f, 599t
  - Non-REM sleep, 734
  - Nonshivering thermogenesis, 306, 317
  - Non-small cell lung carcinoma, 1220
  - Nonsteroidal antiinflammatory drugs
    - acute renal failure and, 206
    - for cancer pain, 2111
    - for coagulation disorders, 255–256, 256f
    - for minor burn, 1682
    - neuraxial anesthesia and, 998
    - for osteoarthritis, 167
    - in outpatient surgery, 1612
    - postoperative, 1696, 1722f, 1722–1724, 1722–1724t, 1723f
      - in adenotonsillectomy, 1589–1590
      - for child, 1531–1532
      - in elective surgery, 81
      - in orthopedic surgery, 1549–1550
      - in spinal surgery, 1549
    - preoperative assessment and management of, 59
  - Nonsteroidal antiinflammatory drugs (NSAIDs)
    - for chronic pain, 2061–2064, 2062f, 2063f, 2064t
    - for complex regional pain syndrome, 2033
    - for fibromyalgia, 2021
    - for osteoarthritis, 2024
    - for radicular pain, 2034
  - Nonstress test, 360
  - Noonan syndrome, 332t
  - Norepinephrine, 2190t
    - added to local anesthetics, 964, 965f
    - for anaphylactic reaction, 1955b
    - for critically ill patient, 1806
    - effect on cerebral blood flow, 1093
    - response to trauma, 1662t
    - for shock, 1845
  - Normal accident theory, 24–25
  - Normal saline, 670–671, 2196t
    - composition of, 670t
    - hospital acquisition costs for, 244t
    - in neonatal emergency surgery, 1508
    - osmolality of, 1101t
    - for resuscitation in trauma, 1791
    - sodium content of, 648t
  - Normiflo (ardeparin), 254–255
  - Normocapnia in one-lung ventilation, 1235–1236
  - Normokalemic periodic paralysis, 165
  - Normosol, 670t, 672
  - North American Malignant Hyperthermia Registry, 1983, 1993
  - Nortriptyline
    - for chronic pain, 2047–2048, 2050t
  - Nose
    - anatomy of, 686–687, 687f
    - assessment in burn injury, 1778
    - blind nasal intubation and, 708–709
    - fiberoptic intubation through, 705
    - surgery of, 1584–1586
  - Nosocomial infection
    - antimicrobial therapy for, 286f, 286t, 286–287
    - as cause of death in critical illness, 1741
    - in pneumonia, 291, 291t, 1833, 1838
  - Nothing by mouth guidelines, 57–58, 58t
    - child and, 336–337, 337t
    - monitored anesthesia care and, 1628, 1628t
    - in same-day surgery, 1610, 1649
  - Novel adjuncts for postoperative pain, 1724–1725
  - Noxious stimulus, 2011t
  - NPO status, 57–58, 58t
    - child and, 336–337, 337t
    - monitored anesthesia care and, 1628, 1628t
    - same-day surgery and, 1610, 1610f, 1649
  - Nubain (nalbuphine), 875t, 890f, 890–892, 891t
  - Nuclear magnetic resonance spectroscopy
    - for malignant hyperthermia susceptibility, 1979–1980
  - Nuclear transcription factor-κB, 1748, 1748f
  - Nucleotides, 274
  - Nucleus pulposus, 979
  - Numerical rating scale, 2107
  - Nurse anesthetist, 13
  - Nurse practitioner, 2174
  - Nuss procedure, 1535
  - Nutrition
    - burn patient and, 1679–1680
    - Child-Pugh scoring system and, 224t
    - intraoperative management of, 275, 275b
    - multiple organ dysfunction syndrome and, 1760–1761
    - postoperative ICU patient and, 1834–1835
    - renal failure and, 211
  - Nutritional liver disease, 226f, 226–227
- O**
- Obese patient, 374–395
    - airway of, 387
    - ambulatory anesthesia and, 387–388
    - bariatric procedures and, 1325, 1326f
    - classification of obesity and, 375t
    - difficult airway and, 126–127, 129t
    - disease risk and, 375t
    - gynecologic surgery and, 1492
    - intraoperative considerations of, 388–390, 389f

- intravenous anesthetics and, 835–838, 836t, 836–838f, 838t
- intravenous drug dosing in, 383–385, 384t
- medical and surgical therapy for, 385–386
- metabolic failure and, 1740
- monitored anesthesia care and, 1634–1635, 1635f
- pathophysiology of obesity and, 375–382, 376t
- cardiovascular system and, 378–380, 379f, 380f
- gastrointestinal and hepatic systems and, 380–381
- metabolic syndrome and, 382
- obesity-hypoventilation syndrome and, 377–378
- obstructive sleep apnea and, 376–377, 377f, 378f
- renal, endocrine, and metabolic systems and, 381–382
- respiratory system and, 375–376, 376f
- pharmacology for, 382–383
- postoperative considerations for, 390–391, 391f
- preoperative assessment and management of, 51, 76, 386–387
- psychologic considerations of, 387
- resuscitation and, 391–392
- Obesity-hypoventilation syndrome, 377–378
- Obesity-related glomerulopathy, 382
- Objective model of ICU triage, 1828, 1830, 1830t
- Observer reporting in quality of care improvement, 456
- Observer's Assessment of Alertness/Sedation Scale, 1631, 1631b
- Obstetric surgery, 1471–1489
- assisted reproductive technologies and, 1475–1477, 1476f
- block height for, 988t
- cervical cerclage and, 1477
- cesarean delivery and, 1480–1486, 1483b, 1483t, 1484f
- combined spinal-epidural anesthesia for, 1000–1001
- economic issues in anesthesia practice and, 2168
- external cephalic version and, 1477–1478
- high-risk parturient and, 1486–1488, 1487t
- hypertensive disorders of pregnancy and, 1488
- in utero fetal and placental surgery and, 1478
- invasive monitoring and, 1488–1489, 1489b
- labor and vaginal delivery and, 1478–1480, 1479b, 1481–1482t
- malignant hyperthermia and, 1983
- maternal comorbid conditions and, 1474–1475, 1475b
- neuraxial techniques in, 1472t, 1472–1473, 1473f, 1473t
- teratogenicity of anesthetics and, 1473–1474, 1474b
- Obstruction
- airway
- after extubation, 711
- nonoperating room procedures for, 1653–1654
- in obese patient at extubation, 391
- during sleep apnea, 378f
- in congenital heart disease
- left heart obstruction and, 1187, 1187b
- obstructions to pulmonary blood flow in, 1181–1182
- obstructions to systemic blood flow in, 1181
- right heart obstruction and, 1187, 1187b
- intestinal, 1329b, 1329–1330, 1330b, 1330t
- neonatal, 1512–1513
- large bowel, 1330
- laryngeal, 1701–1702
- pharyngeal, 1701
- pseudoobstruction syndromes and, 1329, 1329b
- Obstructive jaundice, 232
- Obstructive shock, 1742, 1842
- Obstructive sleep apnea, 1588
- difficult airway and, 126–127
- elective surgery in, 76
- obese patient and, 376–377, 377f, 378f, 386
- preoperative assessment and management in, 51
- same-day surgery and, 1649
- Obstructive sleep hypopnea
- obese patient and, 376
- preoperative evaluation in, 386
- Obstructive ventilatory defects, 136–137, 137f
- Obturator nerve, 1038f, 1039f, 1041f, 2047t
- Obturator nerve block, 1042–1043
- Obtuse marginal artery, 1144f
- Occipital nerve block, 2114–2115
- Occipital neuralgia, 2031, 2031t
- Occlusive carotid disease, 1293–1297
- Occult positive end-expiratory pressure, 1862
- Octreotide, 234, 2193t
- Ocular anatomy, 1558–1560, 1559f, 1560t
- Ocular injuries, postoperative, 1712
- Ocular myasthenia, 1260t
- Oculocardiac reflex, 1560–1561
- Oculomotor nerve, 1560, 1566f, 1572f, 1573f
- Oculopharyngeal muscular dystrophy, 164
- Oculoplastic surgery, 1579
- Off-pump coronary artery bypass graft, 1151
- Ohmeda 7000 electronic anesthesia ventilator, 800f
- Ohm's law, 477, 477f
- Oil/gas partition coefficient of inhaled anesthetics, 741t
- Older adult, 341–357
- abdominal surgery and, 352
- burn injury in, 1779–1780
- cancer and, 350
- cardiac surgery and, 350–351
- cardiovascular disease and, 347–349, 348f
- concepts and theories of aging, 341–342, 342f
- critically ill, 1800
- elective surgery and, 76–77
- endocrine disease and, 350
- eye surgery and, 352, 1563–1564, 1564t
- gastrointestinal disease and, 349
- genitourinary treatment and, 352
- hearing impairment and, 350
- immune enhanced diet for, 275t
- kidney of, 199
- musculoskeletal disease and, 349–350
- neurologic and mental status disease and, 350
- ophthalmologic disease and, 350
- organ system senescence and, 342–346, 342–346f
- orthopedic procedures and, 351f, 351–352
- pharmacology and, 346–347, 347f
- postoperative pain and, 1732
- preoperative assessment and management of, 55
- pulmonary disease and, 349
- remifentanyl and, 838
- renal disease and, 349
- surgical risk and, 352–353
- thoracic procedures and, 351
- trauma and, 1665
- vascular surgery and, 351
- Olecranon bursitis, 2023t
- Oligohydramnios, 301t
- Oligomerization modulation, 723–724, 725f
- Oliguria
- postoperative, 1708
- pregnant patient and, 1489, 1489b
- Olympus LF-GP bronchoscope, 704f
- Omalizumab, 2193t
- Omega-3 fatty acids, 274
- Omeprazole, 1323, 2193t
- Omphalocele, 1512, 1513f
- Ondansetron, 2189t
- in adenotonsillectomy, 1589
- for child, 1533
- One-lung isolation, 1227–1232, 1228f, 1229t, 1230–1233t
- in bullectomy, 1246
- improving oxygenation during, 1235–1238, 1236–1238f
- Onset time of neuromuscular blocking drugs, 624
- Open globe, full stomach, 1579–1580
- Open laparotomy in biliary disease, 1324
- Open portosystemic shunt, 1370
- Open prostatectomy, 1457
- Open-chest cardiac massage, 1879
- Open-chest defibrillation, 1881
- Open-reservoir scavenging interface, 811, 812f
- Operating room
- allocating time in, 2160–2165
- preparation of
- for lung transplantation, 1385
- for multiple organ dysfunction syndrome patient, 1768
- transport to intensive care unit from, 1830–1831
- Operating room efficiency, 2156–2157
- allocating operating room time and, 2161, 2163–2165
- on day of surgery, 2158
- Operating room productivity, 2157
- Operating room time, 2156
- Operating room workload, 2156
- Ophthalmic artery, 1558, 1560, 1567f, 1572f, 1573f
- Ophthalmic drugs
- anesthetic, 1571–1573
- systemic effects of, 1563
- Ophthalmic nerve, 1565
- Ophthalmic surgery, 1558–1581
- anesthesia and intraocular pressure in, 1561–1563, 1562f, 1563t
- for cataracts, 1578
- corneal, 1578
- elective, 79
- general anesthesia in, 1575–1576
- for glaucoma, 1578
- ocular anatomy and, 1558–1560, 1559f, 1560t
- oculocardiac reflex and, 1560–1561
- oculoplastic, 1579
- open globe, full stomach and, 1579–1580
- orbital, 1579
- pediatric, 1576–1577
- preoperative evaluation in, 1563–1565, 1564t
- regional anesthesia in, 1565–1575
- commonly used drugs and adjuvants in, 1571–1573
- complications of, 1073–1074, 1074t, 1573–1575, 1576t
- modified van Lindt block in, 1571
- postoperative, 1571
- retrobulbar or peribulbar block in, 1568f, 1568–1571, 1573–1575f
- sedation for, 1575
- sub-Tenon block in, 1567–1568, 1574f
- topical, 1566–1567
- special concerns in, 1559b
- for strabismus, 1577–1578
- systemic effects of ophthalmic drugs and, 1563
- vitreoretinal, 1578–1579
- Ophthalmopathy, geriatric patient and, 350
- Opioid adjuncts, 2185t
- Opioid agonist-antagonists, 875t, 890f, 890–892, 891t, 2185t
- Opioid analgesics, 869–896
- abuse in anesthesia care providers and, 2135–2154
- DSM-IV-TR general criteria for substance abuse and, 2136–2137, 2137t
- intervention plan for, 2149
- natural history of addiction and, 2146, 2146f
- new perspectives on addiction and, 2141t, 2141–2143, 2142f
- pathophysiology of addiction and, 2143–2146
- recognition of colleague misusing drugs and, 2146–2149, 2147t, 2148t
- reentry into medical field and, 2151–2152
- relapse and, 2151
- scope of, 2135–2136
- substance misuse terminology and, 2137–2138
- traditional views of addiction and, 2138–2140t, 2138–2141
- treatment of opioid addiction and, 2150t, 2150–2151
- ultra-rapid opioid detoxification and, 2149–2150
- acute and chronic effects of, 874b
- acute porphyria and, 161t
- addiction to, 404t, 409–410
- alfentanil in, 883–884, 884f
- allergic reaction to, 878, 879f
- anaphylactic reaction, 1953t, 1957
- biliary effects of, 1317
- bowel motility and, 1316
- for burn wound pain, 1682
- for cancer pain, 2112, 2112t
- cardiovascular effects of, 878
- caution in renal transplant recipient, 1401
- central nervous system effects of, 875–877f, 875–878
- cerebral blood flow and, 1095
- chemistry of, 872f, 872–873, 873f
- for chronic pain, 2050–2054, 2053t, 2059t
- for complex regional pain syndrome, 2033
- confusion in geriatric patient and, 1732
- context-sensitive half-times for, 824–825, 825f
- in coronary artery bypass graft, 1149
- for diabetic peripheral neuropathic pain, 2028
- dose, peak effect, and duration of, 875t
- dosing strategy for manual infusion regimen, 901t

- Opioid analgesics—*continued*  
 effect site concentration of, 825–826, 827f  
 effects on pathophysiology of congenital heart disease, 1199  
 effects on pregnancy and neonate, 880  
 endogenous opioids and, 873–874  
 for epidural analgesia, 1727–1728  
 fentanyl in, 883, 884f  
 formulary of, 2183–2184t  
 historical background of, 869–872  
 hormonal effects of, 879  
 hydromorphone in, 883  
 immune effects of, 880  
 intraoperative use of, 885–888, 886–888f  
 lipophilicities of, 1720t  
 meperidine in, 882–883  
 methadone in, 883  
 in monitored anesthesia care, 1642–1643, 1643f  
 morphine in, 881–882, 882f  
 in neuraxial anesthesia, 991  
 for neuropathic pain in peripheral neuropathy, 2057t  
 for obese patient, 384t, 385  
 in obstetric surgery, 1473, 1473t  
 opioid agonist-antagonists and, 890f, 890–892, 891t  
 opioid antagonists and, 888–890, 889f  
 opioid receptors and, 873  
 in outpatient surgery, 1612  
 in peripheral nerve block, 1027  
 pharmacokinetic properties of, 881t  
 physical dependence on, 881  
 physicochemical properties of, 881t  
 postoperative, 1696, 1719–1722, 1720t  
 in aneurysm surgery, 1307  
 for child, 1532  
 in elective surgery, 81–82  
 propofol concentration and, 909–910, 910f  
 pruritus and, 878  
 remifentanyl in, 885, 885f  
 smooth muscle effects of, 878–879, 880f  
 sufentanyl in, 884–885  
 time to peak effect of, 827t  
 tolerance to, 880–881  
 in total intravenous anesthesia, 901t  
 context-sensitive half-time and, 913f, 913–914  
 maintenance of, 911  
 plasma concentration of, 901t  
 tramadol in, 885  
 for trauma patient, 1667t, 1668  
 withdrawal from, 415  
 Opioid antagonists, 888–890, 889f, 2185t  
 Opioid bowel dysfunction, 878–879  
 Opioid receptors, 873, 2007  
 Opioid rotation, 880  
 Opioid-induced hypoventilation, 1703  
 Opioid-sparing analgesia, 1719  
 Opioid-tolerant patient, 843–846, 844–846f  
 complicated postoperative pain management and, 1710  
 neuraxial anesthesia for, 419  
 postoperative pain and, 1732–1733  
 Opitz syndrome, 332t  
 Opportunistic fungi, 295  
 Optic foramen, 1558  
 Optic nerve, 1558, 1559f, 1560, 1572f  
 regional anesthesia-related injury of, 1574  
 Oral COX inhibitors, 2183t  
 Oral hypoglycemic agents, 58  
 Oral opioids, 2183–2184t  
 Oral surgery, 1600–1601  
 Orbicularis muscle, 1569f  
 Orbit, 1558, 1573f  
 anterior, 1569f, 1570f, 1572f  
 arteries of, 1567f  
 fascial system of, 1573f  
 motor nerves of, 1566f  
 sensory nerves of, 1567f  
 veins of, 1568f  
 Orbital decompression, 1579  
 Orbital surgery, 1579  
 Orbitotomy, 1579  
 Orchidopexy, 1533  
 Orchiectomy, 1464  
 Organ donation, 2132  
 Organ failure  
 chronic substance abuse and, 419  
 hemodynamic support in shock and, 1841–1851  
 blood transfusion in, 1843–1844  
 clinical signs of shock and, 1841  
 fluid resuscitation in, 1842–1843, 1843f  
 indices of global perfusion in, 1847–1848, 1848f  
 indices of regional perfusion in, 1848–1849  
 pathophysiologic classification of shock and, 1841–1842  
 restoring and maintaining cardiac output in, 1846f, 1846–1847  
 vasopressors in, 1844f, 1844t, 1844–1846  
 ventilatory support in, 1842  
 multiple organ dysfunction syndrome and, 1754–1771  
 acid-base status in, 1767–1768  
 anesthetic planning and, 1768  
 cardiovascular instability in, 1766  
 definitions in, 1754–1755  
 epidemiology of, 1756  
 etiologies of, 1755t, 1755–1756  
 hematologic disturbances in, 1767  
 hepatic dysfunction in, 1767  
 immediate *versus* delayed surgery in, 1764  
 management of, 1760–1761  
 manifestations of, 1757t, 1757–1760  
 mortality and, 1741  
 pathogenesis of, 1757–1758  
 predisposition to infection in, 1760  
 preoperative assessment in, 1761–1764, 1762t  
 preventive strategies for, 1760  
 renal failure in, 1766–1767  
 respiratory issues in, 1764–1766, 1765t  
 scoring systems for, 1756  
 transport to operating room and, 1768–1769  
 pathophysiology of critical illness and, 1749–1750, 1750f  
 in protein-energy malnutrition, 269–272, 272t  
 Organ procurement  
 for heart transplantation, 1384t, 1384–1385, 1390–1391  
 for lung transplantation, 1383–1384  
 Organ system senescence, 342–346, 342–346f  
 Organic acids, 641t  
 Organizational failure model, 23–25, 24f  
 Orlistat, 385  
 Oropharyngeal airway, 694–695, 695f  
 Oropharynx  
 anatomic considerations in difficult airway, 124–125, 125f  
 bleeding in hemophilia, 248  
 postoperative injury of, 1712  
 Orphenadrine  
 for chronic pain, 2061  
 Orthognathic surgery, 1600–1601  
 Orthopedic surgery, 1541–1557  
 ambulatory, 1549  
 in cerebral palsy, 1542–1543  
 compartment syndrome and, 1553f, 1553–1554  
 deep venous thrombosis and, 1552–1553  
 elective, 79  
 fat embolism syndrome and, 1551t, 1551–1552  
 in femoral neck fracture, 1547  
 geriatric patient and, 351f, 351–352  
 hip and knee joint replacement, 1544–1547, 1546f  
 lower-extremity, 1544–1547, 1545f, 1546f  
 methylmethacrylate in, 1552  
 paravertebral anesthesia in, 1021  
 postoperative analgesia in, 1549–1550  
 in rheumatoid arthritis, 1541, 1542t  
 spinal, 1547t, 1547–1549, 1548t  
 tourniquet use in, 1550–1551  
 upper-extremity, 1543f, 1543–1544  
 Orthopnea in neuromuscular disease, 157  
 Orthostatic hypotension, 189  
 Orthotopic liver transplantation, 1350–1369  
 anesthetic induction and maintenance in, 1360–1361, 1361t  
 anhepatic phase of, 1363–1364, 1364f  
 electrolyte management in, 1364–1365  
 homeostasis in, 1358t, 1358–1359  
 indications, contraindications, and patient characteristics in, 1350–1351, 1351b  
 laboratory studies in, 1353–1355, 1355f  
 MELD scoring system for, 1352, 1352t  
 neohepatic phase of, 1367f, 1367–1369  
 operative approaches for, 1356f, 1356–1358, 1357f  
 postoperative complications of, 1369  
 preanesthetic evaluation in, 1352–1353  
 preanhepatic phase of, 1361–1362  
 renal protection during, 1365–1366  
 reperfusion of graft in, 1366–1367  
 transfusion in, 1362f, 1362–1363, 1363f  
 vasopressors in, 1362  
 Orthotopic neobladder, 1463  
 Orudis (ketoprofen), 1723t  
 Oscillotonometer, 519, 520f  
 during patient transport, 1817  
 Osmolality, 643  
 of hypertonic solutions, 672t  
 Osmolarity, 643  
 of crystalloid solutions, 670f  
 of intravenous fluids, 1101f  
 Osmosis, 643  
 Osmotic agents, 1100–1102, 1101t, 1103t  
 Osmotic diuretics, 205  
 Osmotic pressure, 643  
 hypertonic saline and, 672  
 Ossiculoplasty, 1583  
 Osteoarthritis  
 chronic pain in, 2022–2024  
 geriatric patient and, 349  
 preoperative evaluation in, 166–167  
 of spine, 2088  
 Osteogenesis imperfecta, 168, 304f  
 Osteoporosis, 168  
 Osteotomy  
 acetabular, 612t  
 maxillary, 1601  
 Otorhinolaryngologic surgery, 1582–1607  
 ear procedures in, 1582–1584  
 facial nerve concerns in, 1602  
 head and neck cancers and, 1604–1605  
 nasal procedures in, 1584–1586  
 parathyroid procedures in, 1603–1604  
 parotid procedures in, 1602  
 throat procedures in, 1586–1602  
 in abnormal airway disorders, 1586  
 in adenotonsillar hypertrophy, 1587  
 adenotonsillectomy in, 1588f, 1588–1590  
 in benign and malignant tumors, 1590–1591  
 in cleft lip and palate, 1597  
 dental surgery in, 1601–1602  
 in foreign body aspiration, 1591  
 in iatrogenic airway disorders, 1591–1592  
 in infections, 1586–1587  
 in malacias, 1597–1598, 1598f  
 maxillofacial reconstruction in, 1600, 1600f  
 in obstructive sleep apnea syndrome, 1588  
 orthognathic surgery in, 1600–1601  
 in pharyngeal abscess, 1590  
 plastic surgery and, 1602  
 in subglottic stenosis, 1598–1599, 1599f  
 tracheal reconstruction or resection in, 1599  
 tracheotomy and tracheostomy in, 1599–1600  
 in vocal cord disorders, 1592f, 1592–1597  
 thyroid surgery in, 1602–1603  
 Outcomes research, 15  
 Outlet check valve, 790–791  
 Out-of-operating room coverage, 2175–2176  
 Outpatient surgery, 1608–1624, 1649–1659  
 cardiopulmonary suite and, 1653–1654  
 combined spinal-epidural anesthesia for, 1001  
 diagnostic imaging in, 1655  
 electroconvulsive therapy in, 1651–1652  
 endoscopy in, 1652–1653  
 general anesthesia in, 1615–1619, 1617–1619f  
 interventional radiology in, 1654–1656  
 obese patient and, 387–388  
 orthopedic, 1549  
 pediatric, 1537, 1655–1656  
 pharmacologic agents for, 1651  
 place, procedures, and patient selection in, 1608–1609, 1609f  
 postanesthesia concerns in, 1651  
 postoperative care in, 1619–1621  
 preanesthetic considerations in, 1649–1651  
 premedication in, 1610–1612, 1611f  
 preoperative assessment and management in, 56–57, 1609–1610, 1610f  
 regional anesthesia in, 1612–1615, 1613–1616f  
 sedation and analgesia in, 1615  
 Ovarian hyperstimulation syndrome, 1477  
 Ovarian surgery, 1495  
 Ovassapian fiberoptic intubating airway, 705f  
 Overdistention of lung in mechanical ventilation, 1863–1864, 1864f  
 Overton-Meyer relationship, 722, 722f  
 Overutilized operating room time, 2156  
 Oxacillin, 2195t  
 Oxcarbazepine  
 for chronic pain, 2056, 2056t  
 Oxidative phosphorylation, 341



- Oxidative stress, 341  
 Oxprenolol, 930t  
 Oxycodone (OxyContin, Percocet, Percodan), 2053t, 2183t  
   for acute postoperative pain, 1720t, 1721  
   for chronic pain, 2059t  
 Oxycodone sustained-release, 2184t  
 Oxycodone/acetaminophen, 2183–2184f  
 Oxygen, anesthesia delivery system and, 770–772  
 Oxygen administration  
   in anaphylactic reaction, 1952  
   in cardiac arrest, 1883  
   following general anesthesia, 1702  
   in shock, 1842  
 Oxygen consumption  
   anemia and, 243–244  
   aneurysm surgery and, 1305  
   burn patient and, 1677  
   in criteria for potential heart transplant, 1381  
   newborn and, 304–305  
   obese patient and, 375  
   pulmonary artery catheter measurement of, 527t  
 Oxygen delivery  
   anemia and, 243–244, 1740t  
   burn patient and, 1776  
   pulmonary artery catheter measurement of, 527t  
 Oxygen extraction ratio, 1894  
   anemia and, 243–244  
 Oxygen flow-control valve, 771–772  
 Oxygen flush control, 771  
 Oxygen partial pressure, 579–582, 580f, 580–582t, 581f  
   hypoxic pulmonary vasoconstriction and, 1233, 1234f  
   intracranial pressure and, 1090  
   neuroprotection during surgery and, 1929–1930, 1930f  
   postresuscitation support and, 1886  
   transcutaneous monitoring of, 589–590, 590f  
 Oxygen ratio monitoring and proportioning systems, 774f, 774–775, 775f  
 Oxygen saturation, obese patient and, 377f  
 Oxygen supply pressure failure alarm system, 771  
 Oxygen tank, 770  
 Oxygenation  
   arterial blood gases and, 579  
   during hepatic resection, 1348  
   monitored anesthesia care and, 1629  
   monitoring of  
   during anesthesia, 692t, 692–693, 693b  
   postoperative, 83  
   neuroprotection and, 1929–1930, 1930f  
   during one-lung ventilation, 1235  
   pulmonary abnormalities in neuromuscular disease and, 157  
   venous blood gases and, 582  
 Oxygenation index, 579  
 Oxygenator for cardiopulmonary bypass, 1141  
 Oxygen-failure protection device, 769f, 771  
 Oxyhemoglobin dissociation curve, 579–580, 580f  
   in acute anemia, 243, 243f  
 Oxymorphone, 2053t, 2184t  
 Oxytocin, 1483, 1483t, 2193t  
 Oxytocin antagonists, 362
- P**  
 Pacemaker  
   in congenital heart disease, 1188  
   postanesthesia care unit and, 1694  
   preoperative assessment and management and, 50  
 Pacing pulmonary artery catheter, 532  
 Packed red blood cells, 1893–1897, 1895t, 1896t  
   ABO compatibility of, 1895t  
   for antenatal and postpartum hemorrhage, 1487  
   for dilutional coagulopathy, 1836  
   in neonatal emergency surgery, 1509  
 Pain, 1710, 1710f, 1716–1736  
   addicted patient and, 398  
   in adenotonsillectomy, 1589–1590  
   anesthesia planning and, 1717–1718  
   in aneurysm surgery, 1306–1307  
   assessment of, 1718, 1718f  
   back  
   epidural anesthesia-related, 1072  
   positioning in urologic surgery and, 1454  
   during pregnancy, 367  
   supine position and, 466  
   behavioral therapy for, 1731  
   burn patient and, 1682t, 1682–1683  
   cancer, 2106–2123  
     assessment of, 2106–2110, 2107t, 2108–2109f, 2110t  
     brachial plexus block for, 2115–2116, 2116f  
     celiac plexus block for, 2118–2119, 2119f  
     communication and, 2112–2113  
     detailed physical examination and, 2113  
     epidemiology of cancer and, 2106  
     etiology and classification of cancer pain syndromes and, 2110–2111  
     ganglion impar block for, 2120–2121  
     intercostal nerve block for, 2116–2117, 2117f  
     lumbar sympathetic block for, 2119–2120  
     neuromodulation techniques for, 2121, 2121f  
     occipital nerve block for, 2114–2115  
     pharmacologic therapy for, 2111t, 2111–2112, 2112t  
     stellate ganglion block for, 2117–2118  
     superficial cervical plexus block for, 2115  
     superior hypogastric plexus block for, 2120, 2120f  
     trigeminal nerve block for, 2114, 2114f  
     vertebroplasty for, 2121  
   in cesarean delivery, 1486  
   child and, 1531–1532, 1543, 1731–1732  
   chronic, 2000–2019; *See also* Chronic pain  
   ascending nociceptive pathways and, 2006  
   assessment of, 1718, 1718f  
   brain and, 2007  
   in cancer, 2110  
   descending nociceptive pathways and, 2006–2007  
   dorsal horn of spinal cord and, 2004f, 2004–2006, 2005f, 2005t, 2006t  
   dysfunctional, 2017  
   genetic factors in, 2010, 2016–2017  
   inflammatory, 2010–2014, 2011t, 2012f, 2013t  
   neuropathic, 2014–2016  
   opioid-treated, 1733  
   pain hypersensitivity and, 2010, 2011t  
   paravertebral block for, 1022  
   primary afferents and, 2001–2003t, 2001–2004, 2002f  
   taxonomy of, 2007–2010, 2008–2010f  
   in elective surgery, 81–82  
   epidural analgesia for, 1726f, 1726–1730, 1727f, 1730t  
     burn patient and, 1679  
     complications of, 1728–1729, 1730t  
     in critically ill patient, 1805  
     drug choices and drug effects in, 1726f, 1726–1728, 1727f  
     indications and contraindications for, 1726  
     in lung transplantation, 1386  
     management of side effects of, 1728  
     in newborn, 1516  
     in renal transplantation, 1401  
     surgical outcomes and, 1729–1730  
     in thoracic surgery, 1274–1275, 1275b  
   extracorporeal shock wave lithotripsy and, 1460  
   in fetal and placental surgery, 1478  
   gender differences in sensitivity to, 1490–1491  
   geriatric patient and, 353, 1732  
   in hepatic resection, 1349  
   infant and, 1731–1732  
   institutional considerations in management of, 1716–1717  
   intensive care unit and, 1733–1734, 1831–1832, 1832t  
   interventional management of, 2072–2105  
   anatomy relevant to, 2073–2077, 2074f, 2075f  
   celiac plexus block in, 2084–2087, 2085f  
   cervical facet medial branch block in, 2091–2092  
   facet medial branch blocks in, 2090–2091  
   future directions of, 2102  
   implantable drug delivery systems for, 2096–2099  
   interlaminar epidural injection of steroids in, 2077–2081, 2080f  
   intraarticular facet injection in, 2089–2090, 2090f  
   lumbar discography and intradiscal treatments in, 2093–2096, 2094f  
   lumbar facet medial branch blocks in, 2092f, 2092–2093  
   lumbar sympathetic block in, 2087  
   lumbar sympathetic neurolysis in, 2087–2088  
   spinal cord stimulation in, 2099–2102  
   stellate ganglion block in, 2083–2084, 2084t  
   thoracic facet medial branch block in, 2092  
   training in, 2102  
   transforaminal technique for epidural steroid injection in, 2081–2082, 2083f  
   in knee replacement surgery, 1544–1546  
   in labor and delivery, 1478–1480, 1479b  
   in liver transplantation, 1368–1369  
   local anesthetics for, 958  
   in lower-extremity vascular surgery, 1298  
   management in postanesthesia care unit, 1695–1696  
   in myringotomy, 1583  
   nerve blocks for, 1730–1731  
   newborn and, 1731–1732  
   nonsteroidal antiinflammatory drugs for, 1722f, 1722–1724, 1722–1724t, 1723f  
   novel adjuncts for, 1724–1725  
   obese patient and, 391  
   in obstetric surgery  
     cesarean delivery and, 1486  
     fetal and placental surgery and, 1478  
   in ophthalmic surgery, 1571  
   opioid analgesics for, 869–896, 1719–1722, 1720t  
     acute and chronic effects of, 874b  
     alfentanil in, 883–884, 884f  
     allergic reaction to, 878, 879f  
     cardiovascular effects of, 878  
     central nervous system effects of, 875–877f, 875–878  
     chemistry of, 872f, 872–873, 873f  
     dose, peak effect, and duration of, 875t  
     effects on pregnancy and neonate, 880  
     endogenous opioids and, 873–874  
     fentanyl in, 883, 884f  
     historical background of, 869–872  
     hormonal effects of, 879  
     hydromorphone in, 883  
     immune effects of, 880  
     intraoperative use of, 885–888, 886–888f  
     meperidine in, 882–883  
     methadone in, 883  
     morphine in, 881–882, 882f  
     opioid agonist-antagonists and, 890f, 890–892, 891t  
     opioid antagonists and, 888–890, 889f  
     opioid receptors and, 873  
     pharmacokinetic properties of, 881t  
     physical dependence on, 881  
     physicochemical properties of, 881t  
     pruritus and, 878  
     remifentanyl in, 885, 885f  
     smooth muscle effects of, 878–879, 880f  
     sufentanil in, 884–885  
     tolerance to, 880–881  
     tramadol in, 885  
   opioid-sparing and multimodal analgesia and, 1719  
   opioid-tolerant patient and, 1732–1733  
   in orthognathic surgery, 1601  
   in orthopedic surgery, 1549–1550  
   in outpatient surgery, 1619, 1620  
   paravertebral anesthesia for, 1019–1022  
   in patent ductus arteriosus, 1516  
   patient education in, 1717  
   patient transport and, 1818  
   patient-controlled analgesia for, 1725f, 1725–1726  
   preemptive analgesia and, 1718–1719  
   in propofol injection, 857–858, 906  
   quality improvement measures in management of, 461–462  
   in renal transplantation, 1401  
   in shoulder replacement surgery, 1543–1544  
   in thoracic surgery, 1274–1276, 1275b, 1275f  
   in thyroid surgery, 1603  
   tourniquet and, 1551  
   transcutaneous electrical nerve stimulation for, 1731  
   in transurethral resection of prostate, 1459  
 Pain catastrophizing, 2065, 2065f  
 Pain drawing, 2049f  
 Pain history, 2107  
 Pain hypersensitivity, 2010, 2011t  
 Pain management practice, 2176



- Pain medicine, 14  
 Pain Pump, 1037f  
 Pain rehabilitation strategies, 2064–2067, 2065f  
 Pain syndromes, 2020–2041  
   central, 2031–2037  
     back and neck pain in, 2033–2034, 2034t  
     cluster headache in, 2037, 2037f  
     discogenic pain in, 2034  
     failed back surgery syndrome in, 2035  
     head pain in, 2036  
     migraine in, 2036t, 2036–2037  
     postamputation pain in, 2033  
     postdural puncture headache in, 2037, 2037t  
     radicular pain in, 2034–2035  
     sacroiliac arthropathy in, 2035  
     spinal stenosis in, 2035  
     sympathetically maintained pain and complex regional pain syndrome in, 2031–2033, 2032t, 2033t  
     tension-type headache in, 2037  
     whiplash injury in, 2035–2036  
   mechanism of chronic pain and, 2020  
 musculoskeletal, 2020–2025  
   arthritis in, 2022  
   bursitis and tendinitis in, 2021–2022, 2023–2024t  
   fibromyalgia in, 2021, 2022f  
   myofascial, 2020–2021, 2021f  
   osteoarthritis in, 2022–2024  
   rheumatoid arthritis in, 2024–2025  
 neuropathic, 2025t, 2025–2031, 2026t  
   acute herpes zoster in, 2029  
   carpal tunnel syndrome in, 2028–2029  
   diabetic, 2026–2028, 2029t  
   glossopharyngeal neuralgia in, 2031, 2031t  
   HIV/AIDS-related, 2028, 2030t  
   meralgia paresthetica in, 2030  
   occipital neuralgia in, 2031, 2031t  
   painful peripheral neuropathies in, 2025–2026, 2027–2028t, 2029f  
   postherpetic neuralgia in, 2029–2030  
   small-fiber neuropathy in, 2026  
   trigeminal neuralgia in, 2030–2031, 2031t  
 Painful peripheral neuropathies, 2025–2026, 2027–2028t, 2029f  
 Palate, cleft, 1597  
 Palatoglossal folds, 687  
 Palliative care, 2106–2123  
   communication and, 2112–2113  
   detailed physical examination and, 2113  
   epidemiology of cancer and, 2106  
   etiology and classification of cancer pain syndromes and, 2110–2111  
   neurolytic procedures in, 2113–2121, 2114t  
   brachial plexus block in, 2115–2116, 2116f  
   celiac plexus block in, 2118–2119, 2119f  
   ganglion impar block in, 2120–2121  
   intercostal nerve block in, 2116–2117, 2117f  
   lumbar sympathetic block in, 2119–2120  
   occipital nerve block in, 2114–2115  
   stellate ganglion block in, 2117–2118  
   superficial cervical plexus block in, 2115  
   superior hypogastric plexus block in, 2120, 2120f  
   trigeminal nerve block in, 2114, 2114f  
   neuromodulation techniques in, 2121, 2121f  
   pain assessment and, 2106–2110, 2107t, 2108–2109f, 2110t  
   pharmacologic therapy in, 2111t, 2111–2112, 2112t  
   vertebroplasty in, 2121  
 Palmaris longus tendon, median and ulnar nerve block at wrist and, 1036f  
 Pamidronate, 178  
 Pancoast tumor, 1218, 1259  
 Pancreas, 1325–1328  
   cancer of, 1326–1327, 1327f  
   pancreatitis and, 1325–1326, 1326f  
   protein-energy malnutrition, 271  
   transplantation of, 1327–1328, 1328f  
   diabetes mellitus pathophysiology and, 1404, 1405t  
   intraoperative care in, 1407t, 1407–1408  
   outcomes in, 1408  
   preoperative evaluation in, 1405–1407, 1406t  
   rationale for, 1404–1405, 1405f  
   surgical options in, 1405, 1406f, 1406t  
 Pancreatitis, 1325–1326, 1326f  
   in alcohol abuse, 408  
   multiple organ dysfunction syndrome and, 1761  
 Pancreatoduodenectomy, 1327, 1327f  
 Pancuronium, 632–633, 633t, 2187t  
   anaphylactic reaction to, 1953t  
   chemical structure of, 631f  
   critically ill patient and, 634  
   effect on pathophysiology of congenital heart disease, 1200  
   intraocular pressure and, 1562t  
   for pediatric neuromuscular blockade, 1525, 1525t  
 Pancytopenia, 408  
 Panic attack, 862  
 Pantoprazole, 1315–1316, 2193t  
 Papper, Emmanuel, 7, 8, 8f  
 Paracoccidioidomycosis, 294  
 Paradoxical air embolism, 469, 1109  
 Paraesophageal hernia, 1321, 1321f  
 Paraganglioma, 181–184, 182t, 183f, 183t  
 Parallel circuit, 478, 479f  
 Paralysis  
   after outpatient surgery, 1618–1619  
   periodic, 159t, 165t, 165–166  
 Paralytic ileus, 1329, 1330  
   burn injury and, 1779  
 Paramedian technique of neuraxial anesthesia, 984, 985f  
 Paramyotonia, 164  
 Paraneoplastic sensory neuropathy, 2027t  
 Paraplegia, aortic surgery-related, 1161, 1161t  
 Parathyroid disease, 177–179, 178t, 179t  
 Parathyroid hormone  
   calcium and, 653  
   hypocalcemia and, 202–203, 203t  
   magnesium and, 654  
 Parathyroid surgery, 1603–1604  
 Paravertebral anesthesia, 1009–1024  
   advantages of, 1017f, 1017t, 1017–1018  
   adverse effects of, 1018t, 1018–1019  
   anatomic or loss-of-resistance technique in, 1012–1013, 1015f  
   clinical applications for, 1014t, 1019–1022  
   continuous catheter technique in, 1015, 1016f  
   contraindications for, 1018  
   effect of technique on distribution of injectate, 1015–1017  
   historical background of, 1011, 1013f  
   injection of radiographic contrast dye in, 1014, 1016f  
   local anesthetic regimen for, 1017, 1017t  
   in lower-extremity orthopedic surgery, 1544  
   lumbar anatomy and, 1009–1011, 1011f, 1012f  
   nerve stimulation in, 1013–1014  
   in outpatient surgery, 1614–1615, 1615f  
   patient positioning for, 1011–1012  
   pressure measurement for placement confirmation in, 1014  
   thoracic anatomy and, 1009, 1010f, 1011f  
   in thoracic surgery, 1019–1020, 1238  
   ultrasound-assisted technique in, 1014–1015  
 Parecoxib, 2184t  
 Parenteral COX inhibitors, 2184t  
 Parenteral feeding  
   burn patient and, 1680  
   postoperative ICU patient and, 1835  
 Parenteral opioids, 2184t  
 Paresthesia  
   in hypocalcemia, 653–654  
   neuraxial anesthesia-related, 998  
   in neuropathic pain, 2025b  
 Parkinson disease, 147–148  
 Parkland formula, 1775t, 1776  
 Parotid surgery, 1602  
 Paroxetine, 2050t  
 Partial carbon dioxide rebreathing method, 535  
 Partial left-heart bypass, 1303  
 Partial pressure of carbon dioxide, 579–582, 580f, 580–582t, 581f  
   during cardiopulmonary resuscitation, 1877–1878  
   transcutaneous monitoring of, 589–590, 590f  
 Partial pressure of inhalational anesthetics, 742, 743f  
 Partial rebreathing for cardiac output, 587–589, 588f  
 Partial thromboplastin time  
   fresh-frozen plasma and, 1897  
   preoperative, 47  
 Partington procedure, 1326, 1326f  
 Partition coefficients  
   of inhalational anesthetics, 741t, 742, 744f, 744t  
   of opioid agonists, 881t  
 Parvovirus infection  
   transfusion-related, 1905  
 Passive regurgitation, nonintubated airway and, 698–699  
 Patella, popliteal fossa block and, 1045f  
 Patellar tendonitis, 2024t  
 Patent ductus arteriosus, 1515–1516  
   anesthetic complications in, 1193–1194  
   hemodynamic problems in, 1176t  
   problems resulting from surgical procedure in, 1185t  
   transitional circulation in, 1182, 1183f, 1184b  
 Patent foramen ovale, 556–557, 1165f, 1165–1166, 1355  
 Pathogen identification, 284  
 Pathogen-associated molecular patterns, 1747  
 Patient assessment  
   in burn injury, 1773, 1778–1779  
   in renal disease, 197t, 197–198  
   before transport, 1815–1817t, 1815–1818, 1817f  
   in trauma, 1789–1791t, 1789–1792, 1790f  
 Patient identification  
   perioperative information management system and, 510–511, 511f  
   postanesthesia care unit and, 1690, 1690t  
 Patient positioning, 465–475  
   for airway management during pediatric surgery, 1526, 1526f  
   for face mask ventilation, 693  
   head-down tilt position and, 469–470  
   lateral decubitus position and, 471–472, 472f  
   lithotomy position and, 466f, 466–468, 467f  
   in liver transplantation, 1360  
   in microlaryngoscopy, 1593f  
   nerve injuries associated with, 472–473, 474b  
   for neuraxial anesthesia, 982–983, 983f, 984f  
   of newborn with meningomyelocele, 1515, 1515f  
   of obese patient, 388, 389f  
   for paravertebral anesthesia, 1011–1012  
   prone position and, 470f, 470–471  
   rheumatoid arthritis and, 1541  
   in shoulder replacement surgery, 1544  
   sitting position and, 468–469, 469f  
   in spinal surgery, 1547–1548, 1548t  
   supine position and, 465–466, 466f  
   in thoracic surgery, 1222–1227, 1223t, 1224–1227f  
   during transport, 1817  
   in urologic surgery, 1453f, 1453–1455, 1455f  
   visual injury and, 473–474  
 Patient safety, 20–37, 423–496  
   accident models and, 23–27, 24f, 25b, 27b  
   adverse respiratory events and, 27–28  
   anesthesia risk and, 424–451  
   accidents and, 21–22, 22b  
   challenges in estimating of, 429–432, 432b, 433f  
   communication to patient, 446–447  
   definition of, 425b, 425–426, 426b  
   measurement of, 426f, 426–429, 427f, 427–429b, 428t, 429f  
   mortality and, 438–446  
   statistical problems in, 432–435, 433f, 434b  
   study designs in, 435b, 435–438, 436t  
   in blood transfusion, 1895t, 1895–1897, 1896t  
   diagnostic errors and, 29  
   dimensions of quality and, 29–31, 30f  
   electrical equipment and, 476–495  
   alternating current and, 477f, 477–478, 478f  
   American National Standards Institute and, 490  
   Association for Advancement of Medical Instrumentation and, 490  
   ASTM International and, 490  
   circuits and, 478, 478f, 479f  
   direct current and, 476–477, 477f  
   Emergency Care Research Institute and, 490  
   Food and Drug Administration and, 489  
   ground fault circuit interrupters and, 480–481  
   hazards of electrical distribution systems and equipment and, 485–487  
   interference and, 482  
   international standards in, 490  
   isolated power and, 480, 480f, 481f  
   isolation amplifiers and, 481–482  
   Joint Commission on Accreditation of Health Care Organizations and, 488–489  
   leakage current and, 479–480

- National Fire Protection Association and, 487–488, 488t
- Nationally Recognized Testing Laboratories and, 489–490
- patient hazards and, 482–484f, 482–485
- safe use of equipment and, 491–493
- semiconductors and, 478–479, 479f
- technology management and, 493, 493f, 494b
- Underwriters Laboratories and, 489–490
- equipment errors and failures and, 29
- high-reliability organization model in, 31
- in immunosuppression in heart and lung transplantation, 1382
- lack of standard practice and, 29
- medication errors and, 29
- monitoring and alarms in, 28–29
- at organizational and department level, 31–32
- in outpatient surgery, 1621
- patient involvement in, 34–35
- patient positioning and, 465–475
- in gastrointestinal surgery, 1317
- head-down tilt position and, 469–470
- lateral decubitus position and, 471–472, 472f
- lithotomy position and, 466f, 466–468, 467f
- nerve injuries associated with, 472–473, 474b
- of obese patient, 388, 389f
- prone position and, 470f, 470–471
- sitting position and, 468–469, 469f
- supine position and, 465–466, 466f
- venous air embolism and, 1113, 1113f
- visual injury and, 473–474
- perioperative information management system and, 509–512, 510–512f
- practical elements of, 32–34, 34t
- quality improvement and, 452–464
- acute pain management and, 461–462
- aggregated patient outcome and safety data in, 458
- ASA closed claims study and, 458–459
- assessment of patient quality of care information in, 455t, 455–456
- confidentiality of patient outcome and, 462
- data acquisition, verification, and feedback in, 456–458
- evidence-based practices and, 459–460
- future issues in, 462–463
- intensive care unit and, 460–461
- national patient safety goals and, 459, 460t
- patient and family involvement in, 459
- process measurement in, 460
- quality of care indicators and, 454–455, 455t
- terminology in, 452–454, 453t
- Veterans Administration Health System approach to, 459
- role of anesthesiologist in, 14–15
- Patient selection
- for combined spinal-epidural anesthesia, 1000–1001
- for interlaminar epidural injection of steroids, 2077–2078
- for intraspinal pain therapy, 2097
- for liver transplantation, 1351
- for monitored anesthesia care, 1626–1627
- for neuraxial anesthesia, 982
- for outpatient surgery, 1608–1609, 1609f
- prevention of adverse events and, 1054, 1054t
- for regional anesthesia, 975
- for renal transplantation, 1396–1397
- for spinal cord stimulation, 2099–2100
- for ventricular assist device, 1164
- Patient state index, 753
- Patient transfer
- adverse event during, 461
- of burn patient, 1678
- of critically ill patient, 1800, 1801t, 1811–1827
- chemical injury and disaster victim and, 1821t, 1821–1822
- equipment and monitoring in, 1818
- high-risk obstetrics and, 1821
- interhospital, 1812
- intrahospital, 1812, 1813t
- modes of, 1819t, 1819–1821, 1820t, 1821f
- neurologic conditions and, 1821, 1821t
- patient assessment and preparation for, 1815–1817t, 1815–1818, 1817f
- pediatric patient and, 1822
- protocols and guidelines in, 1823, 1823t
- quality assurance and, 1822
- reporting and critical incident evaluation in, 1823–1824, 1824t
- risks of, 1813t, 1813–1815
- technology and transport system design and, 1822–1823
- transfer of medical information and, 1823
- transport personnel and, 1819, 1823
- of multiple organ dysfunction syndrome patient, 1768–1769
- of newborn with meningomyelocele, 1515
- from operating room to intensive care unit, 1830–1831
- in supratentorial craniotomy, 1105–1106, 1106f
- Patient Transfer Device, 391, 391f
- Patient-centered care, 21
- Patient-controlled analgesia, 1725f, 1725–1726
- after aneurysm surgery, 1306
- in elective surgery, 81–82
- intensive care unit and, 1831
- obese patient and, 391
- in postanesthesia care unit, 1696
- substance abuser and, 1733
- Patient-controlled epidural analgesia
- child and, 1531
- intensive care unit and, 1831
- Patient-physician communication, 1058
- Patient-specific descriptive data, anesthesia risk estimate and, 430
- Patient-ventilator synchrony and, 1859–1862, 1861f, 1863f
- Patulous eustachian tube, 1584
- Pay-for-performance, 462
- Payment for anesthesia services, 2177–2178, 2178t
- Payments *versus* charges, 2178
- PDZ domain proteins, 725
- Peak airway pressure, 590
- Peak E-wave velocity, 568
- Peak expiratory flow rate, 134, 135f
- Peak flow, patient-ventilator synchrony and, 1860–1861, 1861f
- Peak inspiratory pressure, 591
- Pectoral major muscle, axillary block and, 1033f
- Pectus excavatum, 1535
- Pediatric anesthesia, 1520–1540
- airway management in, 1525–1527, 1526f, 1526t, 1527t
- in ambulatory surgery, 1537
- blood and blood products and, 1528
- in cancer-related procedures, 1535–1536
- cardiac risk in, 1521
- emergence delirium and, 1533
- equipment for, 1522
- extubation choices in, 1527–1528
- facility and provider expertise and, 1521–1522
- fluid therapy and, 1528
- in general and urologic surgery, 1533–1534
- induction of, 1524t, 1524–1525, 1525t
- in laparoscopy, 1534
- legal issues in, 2132–2133
- maintenance of, 1527
- patient preparation and premedication in, 1523t, 1523–1524
- in pectus excavatum, 1535
- postoperative nausea and vomiting and, 1532t, 1532–1533
- postoperative pain management and, 1531–1532
- regional, 1528–1531
- caudal blocks in, 1529f, 1529–1530
- epidural, 1531, 1531t
- extremity blocks in, 1531
- spinal, 1530–1531
- respiratory risk in, 1520–1521
- in thoracotomy and thoracoscopy, 1534–1535, 1535t
- in ventriculoperitoneal shunt, 1536–1537
- Pediatric End-Stage Liver Disease scoring system, 1352
- Pediatric surgery, 310–340
- cardiovascular system and, 314f, 314–315, 315t
- in congenital heart disease, 332t, 332–333, 333b, 333t, 1174–1212
- acid-base management and, 1191
- anesthetic plan and goals in, 1202–1203
- cardiac catheterization and, 1194–1197, 1195t, 1196f
- cardiopulmonary bypass and, 1188–1190
- closed cardiac procedures and, 1193–1194
- congestive heart failure in, 1180–1181
- coronary ischemia and, 1187–1188, 1188b
- coronary ischemia in, 1182
- deep hypothermic circulatory arrest and, 1190–1191
- dysrhythmias and, 1188
- effects of anesthesia on pathophysiology of, 1197–1201, 1198f
- excessive pulmonary blood flow in, 1179–1180, 1180f, 1181f
- excessive pulmonary flow in, 1184–1186, 1186b
- extracorporeal membrane oxygenation and, 1201–1202
- glucose management and, 1191
- immaturity of circulation and, 1182–1184, 1183b, 1183f
- inadequate pulmonary flow and, 1186b, 1186–1187
- induction of anesthesia in, 1203–1204
- intraaortic balloon pump and, 1202
- intracardiac shunting in, 1175–1178, 1177f, 1178f, 1178t, 1179t, 1187
- jugular bulb oximetry and, 1192–1193
- left heart obstruction and, 1187, 1187b
- low cardiac output and, 1188, 1188b
- maintenance of anesthesia in, 1204
- manipulation of pulmonary vascular resistance and systemic vascular resistance in, 1204b, 1204–1205
- near-infrared spectroscopy and, 1192
- nonpharmacologic support in, 1201
- obstructions to pulmonary blood flow in, 1181–1182
- obstructions to systemic blood flow in, 1181
- postoperative factors and, 1192
- preoperative assessment in, 1203, 1203b
- preoperative factors in, 1190
- preoperative preparation and medication in, 1203
- right heart obstruction and, 1187, 1187b
- severe hypoxemia in, 1178–1179
- temperature management and, 1191–1192
- transcranial Doppler ultrasound and, 1192
- ventricular assist device and, 1202
- critically ill child and, 337–338
- dentition and, 316
- difficult airway and, 128
- emergency surgery of newborn and, 1502–1519
- airway management in, 1509f, 1509–1510, 1510f
- anesthetic pharmacology and, 1502–1504, 1503t
- in congenital diaphragmatic hernia, 1510–1512
- in esophageal atresia and tracheoesophageal fistula, 1513–1515, 1514f
- fentanyl in, 1504–1505
- fluid management in, 1508–1509
- inhalational agents in, 1504, 1504t
- in intestinal obstruction and necrotizing enterocolitis, 1512–1513
- ketamine, general anesthetics, sedatives and, 1506
- local anesthetics in, 1506
- in meningomyelocele, 1515, 1515f
- monitoring in, 1506–1508, 1507f
- muscle relaxants in, 1505–1506
- in omphalocele and gastroschisis, 1512, 1513f
- in patent ductus arteriosus, 1515–1516
- gastrointestinal disease and, 334, 334b
- gastrointestinal system and, 316
- general preoperative management in, 320b, 320–322, 321t
- laboratory studies and, 334–336, 335t
- neuromuscular disorders and, 328–330, 330b
- NPO status and preoperative fasting and, 336–337, 337t
- ophthalmic, 1576–1577
- paravertebral block in, 1017, 1017t
- pediatric pharmacology principles and, 317–319
- physical examination before, 323–328, 324–327f
- psychologic preparation for, 322–323
- purpose of preoperative assessment in, 319b, 319–320, 320b
- renal disease and, 333–334
- renal function and, 315–316, 316t
- respiratory system and, 311–314, 312f, 313f, 313t, 330
- same-day, 1656–1657
- syndromes associated with difficult intubation and, 331–332t
- thermoregulation and, 316–317

- Pediatric transport, 1822  
Peer review, 455  
PELD scoring system, 1352  
Pellagra, 407  
Pelvic fracture, 612t, 1671–1672  
Pelvic surgery, block height for, 988t  
Pelviscopy, 1496, 1496b  
Penbutolol, 930t, 931  
Pendelluft ventilation, 1236  
Penetrating keratoplasty, 1578  
Penetrating trauma, 1661t, 1739, 1786  
Penicillin  
  anaphylactic reaction to, 1953t, 1957, 1957b  
  Penicillin G, 2195t  
  Penicilliosis, 294  
  Penile block for circumcision, 1530  
  Penis, 1453, 1453f  
  Pentaerythroid tetranitrate, 928t  
  Pentazocine (Talwin, Talacen), 875t, 890f, 890–892, 891t, 2053t  
  Pentobarbital, 604t  
  Pentothal, 1562t  
  Penumbra effect, 583  
  Peptic ulcer disease, 1322–1324, 1323b  
  Percutaneous cardiopulmonary bypass for cardiac arrest, 1879  
  Percutaneous coronary intervention, 1292  
  Percutaneous liver biopsy, 220  
  Percutaneous stent, 1195  
  Percutaneous transluminal angioplasty, 1297  
  Percutaneous transluminal coronary angioplasty, 103, 109, 1292  
  Percutaneous transtracheal jet ventilation, 710  
Perfusion  
  hemodynamic monitoring of, 533t, 542–544, 543t, 544f  
  indices of global perfusion in, 1847–1848  
  indices of regional perfusion in, 1848–1849  
  lateral decubitus position and, 1224–1225, 1224–1226f  
  lithotomy position and, 468, 468f  
  pediatric cardiopulmonary bypass and, 1188–1189  
  pulse oximetry and, 583, 584  
Perfusion pressure  
  cerebral autoregulation and, 1090–1091, 1091f  
  lithotomy position and, 468, 468f  
Perfusion studies, thoracic surgery and, 1218b, 1218–1219  
Perfusion-weighted imaging  
  in postoperative cognitive dysfunction, 1918–1919  
Periarticular painful conditions, 2023–2024t  
Peribulbar block, 1568f, 1568–1571, 1573–1575f  
Pericardial effusion, 167, 576f, 577  
Pericarditis, 167  
Pericardium, transesophageal echocardiography of, 576f, 576–577  
Peridural space, 980f, 980–981  
Perilymphatic fistula, 1583–1584  
Perindopril, 924t  
Perineal branch of lateral femoral cutaneous nerve, 1453f  
Perineal nerve, 1453f  
Perineal surgery  
  block height for, 988t  
  gynecologic, 1492–1493  
Periodic paralysis, 159t, 165t, 165–166  
Periodic training, 34  
Perioperative cardiac complications, 95–121  
  anemia and, 104  
  angiotensin-converting enzyme inhibitors and, 113–114  
  antibiotics and, 116  
  antiplatelet and anticoagulant agents and, 115–116, 116t  
  arrhythmias and, 104  
  benefits of preoperative assessment, 95  
  beta-blockers and, 110f, 110–113, 111–112t  
  calcium channel blockers and, 114, 114f  
  carotid stenosis and, 105  
  clinical determination of need for specific preoperative cardiac investigations and, 105–106, 106f  
  clonidine and, 115, 115f  
  comparison of risk indices in, 100, 100f, 101–102t  
  dangers of testing in low-risk populations and, 95–96  
  depression and, 104  
  diabetes mellitus and, 103  
  diuretics and, 115  
  genetic polymorphisms and, 104–105  
  glucose control and, 116  
  hyperlipidemia and, 103  
  hypertension and, 103, 109–110  
  known coronary artery disease and, 100–103  
  nitroglycerin and, 115  
  overall perioperative risk and, 98–99, 99f  
  peripheral vascular disease and, 103–104  
  postoperative ischemia and, 97–98, 99f  
  postoperative tests and, 108  
  preoperative CABG or PTCA and, 109  
  preoperative cardiac tests to quantify risk, 106–108, 107t, 108t  
  purpose of identifying and quantifying risk, 99–100, 100t  
  renal insufficiency and, 104  
  smoking and, 103, 116  
  statins and, 113, 113f  
  supply-demand mismatch and, 96, 97f  
  surgical procedure risk and, 105, 105f  
  thrombosis from endothelial dysfunction and, 96–97, 97f, 98f  
  valvular lesions and, 104  
Perioperative care director, 18  
Perioperative hypothermia, 1984–1992, 1985t  
  complications of, 1989t, 1989–1990  
  general anesthesia and, 1986–1989, 1987–1989f  
  neuroprotection and, 1991–1992  
  prevention and treatment of, 1990–1991  
Perioperative information management systems, 498–518  
  barriers to adoption of, 514–515  
  billing and regulatory compliance and, 508–509, 509f  
  design and configuration of, 501–502, 501–504f  
  hardware design for, 502–505, 505f  
  management of, 516  
  medical record and, 499–500  
  patient safety and quality of care and, 509–512, 510–512f  
  practice management and, 515–516  
  return on investment in, 512–514, 513f  
  selection of, 500–501, 501f  
  usability and charting accuracy of, 507–508, 508f, 509f  
  validation and implementation of, 505–507, 506f, 507f  
Perioperative intracranial hemorrhage, 1929  
Perioperative stroke, 1925–1929, 1926t, 1927–1928f  
Periorbita, 1572f, 1573f  
Peripartum cardiomyopathy, 366  
Peripartum history, newborn preoperative assessment and, 300–301, 301t  
Peripheral edema, sitting position infratentorial craniectomy and, 1110  
Peripheral nerve block, 1025–1052  
  adverse event in, 1060–1061, 1061t, 1062t  
  nerve stimulation and, 1055f, 1055–1056  
  ultrasound and, 1056–1057, 1057f  
  choice of local anesthetic for, 1026t, 1026–1027  
  in critically ill patient, 1805  
  hemorrhagic complications in, 1048–1049  
  infectious complications in, 1049  
  localizing neural structures in, 1025–1026  
  lower-extremity, 1037–1048  
  anatomy in, 1038, 1038f, 1039f  
  ankle blocks, 1046, 1047f, 1048f  
  continuous catheter techniques and, 1046  
  femoral nerve block, 1041–1042  
  lateral femoral cutaneous nerve block, 1042  
  lumbar plexus block, 1038–1041, 1040–1042f  
  obturator nerve block, 1042–1043  
  in orthopedic surgery, 1544  
  perioperative outcomes in, 1046–1048  
  popliteal fossa block, 1044–1046, 1045f  
  sciatic nerve block, 1043f, 1043–1044, 1044f  
  neurologic complications in, 1048  
  for trauma patient, 1668, 1668t  
  upper-extremity, 1027–1037  
  axillary block, 1032–1034, 1033f  
  brachial plexus anatomy and, 1028–1029, 1029f  
  cervical plexus block, 1027f, 1027–1028, 1028f  
  continuous catheter techniques and, 1037, 1037f  
  infraclavicular block, 1032  
  interscalene block, 1029–1031, 1030f  
  intravenous, 1036–1037  
  median nerve block, 1034–1035, 1035f  
  midhumeral block, 1034  
  musculocutaneous nerve block, 1035–1036  
  in orthopedic procedures, 1543f, 1543–1544  
  radial nerve block, 1035, 1036f  
  supraclavicular block, 1031f, 1031–1032, 1032f  
  ulnar nerve block, 1035, 1036f  
Peripheral nerve injury  
  drug therapy for, 2059t  
Peripheral nerve vasculitis, 2027t  
Peripheral nervous system  
  classification of fibers found in, 2001t  
  protein-energy malnutrition and, 272  
Peripheral neuropathic pain, 2009  
Peripheral neuropathy, 160–162, 161t  
  anesthetic considerations in, 159t  
  diabetic, 2026–2028, 2029t  
  medications for neuropathic pain in, 2057t  
  painful syndromes of, 2025–2026, 2027–2028t, 2029f  
  preoperative evaluation of, 146t, 146–147, 147t  
  surgical positioning-related, 472–473, 474b  
Peripheral neuropathy with connective tissue disease, 2027t  
Peripheral obesity, 374  
Peripheral sensitization, 2002f, 2011t, 2011–2012, 2012f, 2012t  
Peripheral vascular disease  
  geriatric patient and, 349  
  perioperative cardiac complications and, 103–104  
Peripheral vascular resistance, liver disease and, 1340b, 1340–1341  
Peripheral vascular surgery, 1284–1313  
  in aneurysms, 1299–1308  
  combined anesthesia techniques in, 1306–1307  
  endovascular aneurysm repair in, 1307–1308  
  general anesthesia for, 1305–1306  
  monitoring in, 1300–1301  
  pathophysiology and management of, 1299–1300  
  physiology of cross-clamping in, 1301–1303, 1302f  
  postoperative care in, 1307  
  therapeutic strategies in, 1303–1304  
  unclamping in, 1304–1305, 1305f, 1306f  
  carotid endarterectomy in, 1293–1297, 1295f  
  general considerations in, 1293  
  of lower extremity, 1297–1299, 1299f  
  pathophysiology of vascular disease and, 1285–1287, 1286f, 1286t, 1287f  
  preoperative coronary artery bypass grafting in, 1292  
  preoperative evaluation in, 1287f, 1287–1292, 1288f, 1289f  
  preoperative medical therapy in, 1292–1293  
  preoperative percutaneous coronary intervention in, 1292  
Peripheral vasodilation, opioid analgesic-induced, 878  
Peripherally acting sympatholytic agents, 922t, 922–923  
Peritoneal dialysis, 1399  
Peritonitis, 1741t  
Peritonsillar abscess, 1590  
Perivascular approach in lumbar plexus block, 1039–1040, 1041f  
Permanent epidural catheter placement, 2098  
Permissive hypercapnia, 1677  
Peroxyinitrite, 1749  
Pers anserine pain, 2024t  
Persantine (dipyridamole), 257  
Persistent fetal circulation, 305, 1511  
Persistent pulmonary hypertension of newborn, 305, 1511  
Petechia, fat embolism syndrome and, 1552  
Pethick method of checking Bain circuit, 794  
Pfannenstiel incision  
  in cesarean delivery, 1480  
  in intraabdominal gynecologic surgery, 1495  
pH, 659  
  acid-base balance and, 581t, 581–582, 582t  
  determination of, 660t  
  impact of strong ions on, 660f  
  of local anesthetics  
  carbonation and, 964–965, 965f  
  duration of action and, 961, 961f, 961t  
  pH stat *versus* alpha stat blood gas monitoring, 666–667  
Phalen test, 2029



- Phantom pain, 2033
- Pharmacodynamics, 1491, 1491t
- of antimicrobial therapy, 280–282, 281t
  - of aspirin, 256f
  - of atracurium, 630t
  - of benzodiazepines, 861
  - of cisatracurium, 631t
  - of etomidate, 859
  - of inhalational anesthetics, 750–753, 751t, 751–753f
  - of ketamine, 863f, 863–864
  - of local anesthetics, 956–958, 957f
  - of mivacurium, 628f
  - in monitored anesthesia care, 1635–1637, 1636f, 1637f
  - of neuromuscular blocking drugs, 624, 624f
  - of pancuronium, 633t
  - pharmacologic modeling and, 826–828, 828f, 829f
  - of propofol, 857–858
  - of rocuronium, 632t
  - of succinylcholine, 625t
  - of vecuronium, 632t
- Pharmacokinetic mass concept, 1634–1635, 1635f
- Pharmacokinetics
- abnormalities in liver disease, 223
  - of antimicrobial therapy, 280–282, 281t
  - of atracurium, 630t
  - of barbiturates, 854–855, 855t
  - of benzodiazepines, 861–862
  - of cisatracurium, 631t
  - of etomidate, 860
  - gender differences in, 1491, 1491t
  - of inhalational anesthetics, 742–750
    - alveolar partial pressure of gas and, 746f, 746–747, 747f
  - anatomic and physiologic dead space and, 748
  - concentration effect and second gas effect and, 749, 749f
  - distribution in body tissues and, 747–748, 748f
  - elimination via ventilation and, 750
  - inspired partial pressure of gas and, 745f, 745–746, 746f
  - intrapulmonary right-to-left shunt and, 748, 749f
  - multicompartmental kinetic model of, 742–745, 745f
  - nitrous uptake into airspaces of body and, 749–750, 750f
  - systemic arteriovenous shunting and, 748
  - of ketamine, 864
  - of local anesthetics, 958t, 958–960, 959f
  - of mivacurium, 629t
  - in monitored anesthesia care, 1631–1634, 1632–1634f, 1633t
  - of neuromuscular blocking drugs, 623–624
  - obesity and, 382
  - of opioid analgesics, 881t
  - of pancuronium, 633t
  - pharmacologic modeling and, 822, 823f
  - of propofol, 858
  - of rocuronium, 633t
  - of target-controlled infusion, 902, 902t
  - of total intravenous anesthesia, 899–900, 900f, 900t, 901t
  - of vecuronium, 632t
- Pharmacologic adjuvants for chronic pain, 2047–2064
- antidepressants in, 2047–2050, 2050t
  - antiepileptic drugs in, 2054–2059, 2055f, 2055–2057t, 2059t
  - combination therapy in, 2060
  - intravenous analgesics in, 2060
  - nonsteroidal antiinflammatory drugs in, 2061–2064, 2062f, 2063f, 2064t
  - opioids in, 2050–2054, 2053t
  - skeletal muscle relaxants in, 2060–2061
  - topical agents in, 2059–2060
- Pharmacologic modeling, 822–835
- combining kinetic and dynamic models in, 828–831, 829–832f, 831t
  - context-sensitive half-times and, 823–825, 825f
  - drug synergism and, 831–835, 832–835f
  - importance of biophase in, 825–826, 826f, 827f, 827t
  - pharmacodynamics and, 826–828, 828f, 829f
  - pharmacokinetics and, 822, 823f
  - simulations in, 823, 824f
- Pharmacologic therapy
- antimicrobial, 279–299
    - in acute pancreatitis, 292–293
    - in bacteremia, 291–292
    - bacterial resistance and, 282–283
    - in catheter-related infections, 287–288
    - in *Clostridium difficile* infection, 292
    - combination, 283–284
    - epidemiologic considerations in, 284t, 284–285
    - formulary for, 2195t
    - in fungal infection, 294–296
    - host factors in, 285, 285t
    - in human immunodeficiency virus infection, 293–294, 294t
    - identification of pathogen and, 284
    - minimum inhibitory concentration and, 279–280
    - in nosocomial infections, 286f, 286t, 286–287
    - perioperative cardiac complications and, 116
    - pharmacokinetics and pharmacodynamics in, 280–282, 281t
    - in pneumonia, 290t, 290–291, 291t
    - prophylactic, 288–290
    - in urinary tract infection, 292
  - for burn patient, 1678–1679
  - for cardiac dysrhythmias, 936–947, 937b, 937f
    - adenosine in, 946t, 946–947
    - class IA agents in, 936–939, 938t
    - class IB agents in, 939–941, 940t
    - class IC agents in, 941–943, 942t
    - class III agents in, 943–946, 944t
    - formulary of, 2190t
  - in cardiopulmonary resuscitation, 1882–1886, 1885b, 1886b, 1886f
  - for hemodynamic complications in critically ill patient, 1806–1807
  - for hypertension, 919–925
    - angiotensin II receptor blockers in, 925, 925t
    - angiotensin-converting enzyme inhibitors in, 924t, 924–925, 925f
    - centrally acting alpha<sub>2</sub>-agonists in, 921t, 921–922
    - cerebral blood flow and, 1099–1100
    - diuretics in, 919–921, 920t
    - formulary of, 2190t
    - peripherally acting sympatholytic agents in, 922t, 922–923
    - for preeclampsia, 1488
    - preoperative assessment and management of, 58
    - vasodilators in, 923t, 923–924
  - for obesity, 382–383
  - in palliative care, 2111t, 2111–2112, 2112t
  - preoperative assessment and management of, 52t, 58–59
  - renal disease and, 211
- Pharmacology, 821–848
- burn patient and, 1678–1679
  - cerebrovascular, 1094–1100
    - antihypertensives and, 1099–1100
    - intravenous anesthetics and, 1094–1095
    - nondepolarizing muscle relaxants and, 1099
    - sedative agents and, 1095
    - succinylcholine and, 1099
    - volatile agents and, 1095–1099, 1096f, 1097t, 1098f
  - geriatric patient and, 346–347, 347f
  - of inhalational anesthetics, 739–766
    - advantages and disadvantages of, 761, 761t
    - alveolar partial pressure of gas and, 746f, 746–747, 747f
    - anatomic and physiologic dead space and, 748
    - biophysical properties of, 742, 743f, 744f, 744t
    - breakdown and toxicity of byproducts of, 759–761
    - cardiovascular effects of, 756t, 756–757, 757f, 757t
    - cerebrovascular and metabolic effects of, 755–756, 756t
    - chemical and physical properties of, 740–742, 741f, 741t
    - concentration effect and second gas effect and, 749, 749f
    - distribution in body tissues and, 747–748, 748f
  - dose-response concepts and, 739–740
  - effects on muscular system, 759
  - effects on respiratory system, 757–758, 758t
  - elimination via ventilation and, 750
  - endocrine function and, 759
  - genotoxicity and teratogenicity of, 759
  - hepatic effects of, 758
  - immune function and, 759
  - inspired partial pressure of gas and, 745f, 745–746, 746f
  - intraoperative awareness and, 753–755, 754f, 754t
  - intrapulmonary right-to-left shunt and, 748, 749f
  - ischemic preconditioning and, 759
  - malignant hyperthermia and, 759
  - methionine synthase inhibition and, 759
  - multicompartmental kinetic model of pharmacokinetics of, 742–745, 745f
  - nitrous uptake into airspaces of body and, 749–750, 750f
  - pharmacodynamics of, 750–753, 751t, 751–753f
  - renal effects of, 758
  - systemic arteriovenous shunting and, 748
- of intravenous anesthetics, 849–868
- adjuncts and, 864–865
  - barbiturates and, 850–856, 851f, 852f, 852t, 853t, 854b, 854f, 855t, 856f, 856t
  - benzodiazepines and, 860–863
  - etomidate and, 859–860
  - experimental agents and, 865–866, 866t
  - historical background of, 849, 850b
  - ketamine and, 863f, 863–864
  - propofol and, 856–859
- of neuraxial anesthesia, 986–988, 987t, 988t
- of neuromuscular blockade, 623–624, 624f
- obese patient and, 382–383
- pediatric, 317–319, 1502–1504, 1503t
- pharmacologic modeling in, 822–835
- combining kinetic and dynamic models in, 828–831, 829–832f, 831t
  - context-sensitive half-times and, 823–825, 825f
  - drug synergism and, 831–835, 832–835f
  - importance of biophase in, 825–826, 826f, 827f, 827t
  - pharmacodynamics and, 826–828, 828f, 829f
  - pharmacokinetics and, 822, 823f
  - simulations in, 823, 824f
- special populations and, 835–846
- age and, 838–840, 839f, 839t, 840f
  - blood volume and, 840–843, 841–843f
  - body weight and, 835–838, 836t, 836–838f, 838t
  - opioid-tolerant patient and, 843–846, 844–846f
- Pharyngeal airway, 694–695, 695b, 695f
- Pharyngeal tonsil, 686
- Pharynx, 685f, 685–686
- abscess of, 1590
  - anatomic considerations in difficult airway, 124–125, 125f
  - obesity and, 377
  - postoperative obstruction of, 1701
- Phase I blockade, 626
- Phase II blockade, 626
- Phase II recovery room, 1620
- Phencyclidine hydrochloride, 413
- Phenol, 2113
- Phenothiazines, 1692
- Phenotype-genotype correlations in malignant hyperthermia, 1977
- Phenotypic switch after nerve injury, 2015
- Phenoxybenzamine, 183–184, 922, 922t, 2190t
- Phentolamine, 922, 922t, 2190t
- Phenylbutazone (Butazolidin), 1723t
- Phenylephrine, 2190t
- added to local anesthetics, 964
  - as adjuvant in neuraxial anesthesia, 992
  - for allograft perfusion in renal transplantation, 1402
  - effect on cerebral blood flow, 1093
  - for mydriasis, 1563
  - for shock, 1844, 1844t
- Phenytoin (Dilantin), 2190t
- for chronic pain, 2056t, 2059, 2059t
  - for dysrhythmias, 940t, 941
  - interaction with nondepolarizing neuromuscular blocking drugs, 1099
- Pheochromocytoma, 181–184, 182t, 183f, 183t
- Phlebitis, 1103t



- Phosphate, 641t, 655–657, 656t, 657t  
 Phosphodiesterase inhibitors  
   effect of pathophysiology of congenital heart disease, 1200  
   for low cardiac output in shock, 1846–1847  
 Phospholipase A<sub>2</sub>, 2077  
 Phospholipid metabolism, 1722f  
 Phosphorus disorders, 203–204  
 Photochemical breakdown of anesthetic waste gas, 760  
 Photochemical reaction to laser, 1595t  
 Photoreceptor, 1559  
 Phrenic nerve injury, 1273–1274  
 Phthisis, 1562  
 Physical dependence, 881, 1721–1722, 2137  
 Physical dependence on opioid analgesics, 2052  
 Physical examination, 43–45, 45f  
   addicted patient and, 398–399  
   of child, 323–328, 324–327f  
   in chronic pain, 2044–2046, 2044–2047t, 2045f, 2048f, 2049f  
   in elective surgery, 73–77, 74–76t, 78t  
   in liver transplantation, 1353  
   monitored anesthesia care and, 1627  
   in multiple organ dysfunction syndrome, 1763  
   in pain assessment, 2108  
   palliative care and, 2113  
   in renal transplantation, 1400  
   in thoracic surgery, 1215–1216  
 Physical status classification of American Society of Anesthesiologists, 42t  
   outpatient surgery and, 1609  
   relationship to perioperative mortality, 442t  
 Physician assistant, 2174  
 Physician-patient communication, 1058  
 Physiologic anemia of pregnancy, 315  
 Physiologic dead space, 748, 1930  
 Physiologic status, response to critical illness and, 1743, 1743f  
 Physiologic trauma scoring systems, 1793, 1793t  
 Physostigmine, 1709, 2194t  
 Phytonadione, 2192t  
 Phytopharmaceuticals  
   coagulation disorders and, 257  
   monitored anesthesia care and, 1627  
   potential postoperative complications and, 73t  
   preoperative assessment and management of, 59  
 Pia mater, 978, 980f  
 Pickwickian syndrome, 378  
 Pierce, Ellison C., Jr., 21  
 Pierre-Robin syndrome, 304t, 331t  
 Piggyback technique in liver transplantation, 1357, 1357f  
 Pigmentation, pulse oximetry and, 583  
 Pindolol, 930t, 931  
 Pink puffer, 137  
 Pioglitazone, 186  
 Pipecuronium, 631f, 633  
 Pipeline oxygen, 770–771  
 Piperacillin/tazobactam, 2195t  
 Piperocaine (Metycaine), 961t  
 Piriform recesses, 688, 688f  
 Piriformis muscle, sciatic nerve block and, 1044f  
 Piroxicam (Feldene), 1723t, 2064t, 2183t  
 Pituitary disease, 184–185, 185t  
 Pituitary-adrenal axis  
   epidural steroid injection-related suppression of, 2078–2079  
   in response to acute injury, 1744–1745  
 pK<sub>a</sub>  
   of intravenous anesthetics, 852t  
   of local anesthetics, 961, 961f, 961t  
   of opioid analgesics, 881t  
 Placenta abruptio, 1487t  
 Placenta accreta, 364  
 Placenta increta, 364  
 Placenta percreta, 364  
 Placenta previa, 364t, 364–365, 1487t  
 Placental abruptio, 364t, 364–365  
 Placental surgery, 1478  
 Plantar fasciitis, 2024t  
 Plaque, atherosclerotic, 1286–1287  
 Plasma  
   ions in, 641t, 642  
   osmolarity of, 1101t  
 Plasma cholinesterase, 625, 626f  
 Plasma component derivatives, 1897–1901  
 Plasma drug concentrations  
   in monitored anesthesia care, 1631–1632, 1632f, 1633f  
   in total intravenous anesthesia, 901t  
 Plasma exchange  
   in factor XI deficiency, 252  
   in prothrombin deficiency, 254  
 Plasma oncotic pressure in liver transplantation, 1362  
 Plasma protein binding  
   child and, 318  
   response to burn injury, 1678  
 Plasma protein-bound drugs, 272t  
 Plasma proteins, 642  
   liver function tests and, 219  
   obesity and, 383  
 Plasma volume during pregnancy, 359  
 Plasma-Lyte, 2196t  
 Plasma-Lyte 148, 670t, 672  
 Plasminogen activator inhibitor-1, 380  
 Plastic surgery of throat, 1602  
 Plasticizers, 1908  
 Plateau pressure, 590, 1862  
 Platelet abnormalities, 1758–1759  
 Platelet count  
   in preeclampsia, 364  
   during pregnancy, 359  
 Platelet transfusion, 1901–1902  
 ABO compatibility of, 1895t  
   in antenatal and postpartum hemorrhage, 1487  
   in multiple organ dysfunction syndrome, 1767  
   in pediatric surgery, 1528  
 Platelet-adhesion inhibitors, 257  
 Plavix (clopidogrel), 256–257, 2192t  
 Pletal (cilostazol), 257, 2192t  
 Pleural effusion, 1218  
 Pleural pressure, lateral decubitus position and, 1227f  
 Pleural puncture in paravertebral nerve block, 1018t, 1018–1019  
 Pleurodesis, 1247  
 Pllicamycin, 178  
 Plumb-bob approach in supraclavicular block, 1032, 1032f  
 Pneumatic vest cardiopulmonary resuscitation, 1879  
 Pneumocephalus  
   sitting position and, 469  
   sitting position infratentorial craniectomy and, 1110  
 Pneumomediastinum, 1318  
 Pneumothorax  
   in lung transplantation, 1388  
   postoperative pulmonary edema in, 1273  
 Pneumonia  
   in alcohol or drug addicted patient, 400  
   antimicrobial therapy for, 290t, 290–291, 291t  
   aspiration  
   alcohol abuse and, 406  
   conditions associated with, 1315b  
   postoperative, 1704  
   in postoperative ICU patient, 1833  
   intensive care unit admission and, 1741t  
   *Moraxella catarrhalis*, 290  
   nosocomial, 291, 291t, 1833  
   pathogens in, 286t  
   pneumonitis, aspiration, 1704  
 Pneumoperitoneum  
   in minimally invasive urologic surgery, 1467  
   risk in gastrointestinal surgery, 1317–1318  
 Pneumothorax  
   celiac plexus nerve block-related, 2087  
   neck dissection and, 1605  
   paravertebral nerve block-associated, 1018t, 1018–1019  
   peripheral nerve block-related, 1062–1063  
   postoperative, 1705, 1705f  
   risk in gastrointestinal endoscopic surgery, 1318  
   spontaneous, 1244–1245  
   supraclavicular block-associated, 1032  
   thoracic surgery-related, 1273  
 Point-of-care measurement of blood gases, 582  
 Poiseuille equation, 312  
 Poiseuille law, 773  
 Poisoning  
   carbon monoxide, 1774, 1774f  
   cyanide, 1774–1775  
 Poly(ADP-ribose) polymerase, 1749  
 Polycystic kidney disease, 209, 1397  
 Polycythemia, 1179  
 Polydipsia, hypercalcemia and, 653  
 Polyhydramnios, 301t  
 Polymicrobial infection, 283  
 Polymyalgia rheumatica, 2025  
 Polymyositis, 169  
 Polypharmacy in Parkinson disease, 148  
 Polysplenia, 332t  
 Polysynaptic flexor withdrawal reflex, 2004  
 Polythiazide (Renese), 920t  
 Polytrauma, 1786  
 Polyuria, hypercalcemia and, 653  
 Popliteal artery, popliteal fossa block and, 1045f  
 Popliteal fossa block, 1044–1046, 1045f, 1544, 1545f  
 Popliteal vein, popliteal fossa block and, 1045f  
 Population characterization, anesthesia risk and, 431–432, 432b, 433f  
 Porcine stress syndrome, 1966  
 Porphyria, 159t, 161, 161t, 854, 854b, 854f  
 Portal hypertension, 1341–1343, 1342f, 1343b, 1343f, 1355  
   in alcoholic cirrhosis, 407  
   in alcoholic hepatitis, 408  
   chronic liver failure and, 232  
   in hepatopulmonary syndrome, 1343  
   pharmacokinetic abnormalities in, 223  
   procedures for, 1369b, 1369–1370  
 Portal vein, 217f, 1339  
 Portal venous blood flow, 1339  
 Portocaval shunt, 1357  
 Portosystemic shunt, 1370–1371  
 Positioning, 465–475  
   for airway management during pediatric surgery, 1526, 1526f  
   for face mask ventilation, 693  
   in gastrointestinal surgery, 1317  
   head-down tilt position and, 469–470  
   lateral decubitus position and, 471–472, 472f  
   lithotomy position and, 466f, 466–468, 467f  
   in liver transplantation, 1360  
   in microlaryngoscopy, 1593f  
   nerve injuries associated with, 472–473, 474b  
   of newborn with meningomyelocele, 1515, 1515f  
   of obese patient, 388, 389f  
   for paravertebral anesthesia, 1011–1012  
   prone position and, 470f, 470–471  
   rheumatoid arthritis and, 1541  
   in shoulder replacement surgery, 1544  
   sitting position and, 468–469, 469f  
   in spinal surgery, 1547–1548, 1548t  
   supine position and, 465–466, 466f  
   in thoracic surgery, 1222–1227, 1223t, 1224–1227f  
   during transport, 1817  
   in urologic surgery, 1453f, 1453–1455, 1455f  
   venous air embolism and, 1113, 1113f  
   visual injury and, 473–474  
 Positive airway pressure in face mask ventilation, 694  
 Positive end-expiratory pressure  
   in acute respiratory distress syndrome, 1865  
   anesthesia ventilator and, 805f, 806–807  
   burn patient and, 1677  
   cerebral blood volume and, 1088–1089  
   dependent-lung, 1236, 1236f  
   lateral decubitus position and, 1227  
   in liver transplantation, 1368  
   in multiple organ dysfunction syndrome, 1764  
   obese patient and, 390  
   pulmonary artery catheter monitoring and, 530  
   for pulmonary artery disruption in balloon dilation procedures, 1196  
   in venous air embolism, 1113  
 Positive end-expiratory pressure (PEEP)  
   intracranial hypertension and, 1938, 1939f  
 Postamputation pain, 2033  
 Postanesthesia care unit, 1688–1699  
   admission to, 1690t, 1690–1691  
   complications in, 1700–1715  
   airway dysfunction in, 1701–1702  
   aspiration in, 1704, 1704f  
   complicated acute pain management and, 1710, 1710f  
   delayed awakening in, 1709  
   delirium in, 1709  
   dental injuries in, 1712  
   dysrhythmias in, 1706–1707  
   electrocardiographic changes and, 1707  
   extravasation injury in, 1713, 1713f  
   frequency of, 1701f  
   hearing loss in, 1712–1713  
   hemorrhage in, 1710–1711  
   hyperglycemia in, 1712  
   hypertension in, 1707–1708, 1708t  
   hyperthermia in, 1711f, 1711–1712

- hypotension in, 1706  
hypothermia in, 1711  
hypovolemia in, 1706  
hypoxemia in, 1702f, 1702–1704, 1703f  
intraoperative awareness and, 1710  
myocardial ischemia and infarction in, 1706  
nerve injuries in, 1712  
ocular injuries in, 1712  
oropharyngeal injuries in, 1712  
pneumothorax in, 1705, 1705f  
prolonged intubation in, 1705–1706  
pulmonary edema in, 1704  
pulmonary embolism in, 1704–1705  
stroke in, 1709–1710  
systemic vasodilation in, 1706  
temporal patterns of, 1701t  
urinary and renal dysfunction in, 1708–1709
- discharge from, 1697t, 1697–1698  
operations in, 1689–1690  
organization of, 1688–1689, 1689t  
postoperative issues in, 1691–1697  
cardiac dysrhythmias in, 1693–1694  
fluid administration and hemorrhage in, 1696–1697  
hypertension in, 1694–1695  
hypotension in, 1693  
nausea and vomiting in, 1691f, 1691–1692  
neurologic complications in, 1693, 1695t  
pain management in, 1695–1696  
respiratory and airway complications in, 1692–1693  
temperature control in, 1696
- Postanesthesia Recovery Score, 1697t  
Post-Anesthetic Discharge Scoring System, 1644, 1644b  
Postantibiotic effect, 281  
Postantibiotic leukocyte enhancement, 281  
Postcardiotomy cardiogenic shock, 1163  
Postdural puncture headache, 997, 1067–1069, 1729, 2037, 2037t  
after labor and vaginal delivery, 1480  
in outpatient spinal anesthesia, 1614
- Posterior approach  
in popliteal fossa block, 1045, 1045f  
in sciatic nerve block, 1043, 1043f, 1044f
- Posterior cerebral artery, 609f  
Posterior cervical facet medial branch block, 2091  
Posterior chamber, 1559f  
Posterior cutaneous nerve of thigh, 1038, 1039f  
Posterior descending artery, 1144, 1144f  
Posterior fossa decompression, 1536  
Posterior fossa surgery  
infratentorial craniectomy in  
horizontal position, 1114  
sitting position, 1108–1114, 1111–1113f  
venous air embolism and, 469
- Posterior interosseus nerve, 2046t  
Posterior lateral artery, 1144f  
Posterior mediastinal mass, 1255t  
Posterior mediastinum, 1214  
Posterior ramus, 2076  
Posterior sacrum  
anatomy of, 2075, 2075f  
Posterior scrotal nerve, 1453f  
Posterior segment vitrectomy, 1578  
Posterior spinal artery, 609f  
Posterior superior iliac spine, sciatic nerve block and, 1044f
- Posterior tibial nerve  
ankle blocks and, 1047f  
stimulation for neuromuscular blockade monitoring, 622f
- Posterior tibial nerve block, 1046, 1047f  
Posterior vagal trunk, 1451f  
Posterior inferior cerebellar artery, 609f  
Postganglionic sympathetic fibers, 2076–2077  
Postherpetic neuralgia, 2029–2030  
drug therapy for, 2059t
- Postoperative bleeding  
in adenotonsillectomy, 1590  
in factor VII deficiency, 252  
in hematopoietic stem cell transplantation, 1409  
in thoracic surgery, 1272–1273  
in thyroid surgery, 1603  
in tonsillectomy, 1590
- Postoperative care, 1687–1736  
in acute postoperative pain, 1710, 1710f, 1716–1736  
anesthesia planning and, 1717–1718  
behavioral therapy for, 1731
- epidural analgesia for, 1726f, 1726–1730, 1727f, 1730t  
institutional considerations in management of, 1716–1717  
intensive care unit and, 1733–1734  
nerve blocks for, 1730–1731  
nonsteroidal antiinflammatory drugs for, 1722f, 1722–1724, 1722–1724t, 1723f  
novel adjuncts for, 1724–1725  
opioids for, 1719–1722, 1720t  
opioid-sparing and multimodal analgesia and, 1719  
opioid-tolerant patient and, 1732–1733  
pain assessment and, 1718, 1718f  
patient education in, 1717  
patient-controlled analgesia for, 1725f, 1725–1726  
pediatric patient and, 1731–1732  
preemptive analgesia and, 1718–1719  
transcutaneous electrical nerve stimulation for, 1731
- in adenotonsillectomy, 1589  
in aneurysm surgery, 1307  
of burn patient, 1682  
consultants and, 91–92  
in coronary artery bypass graft, 1151–1152  
critically ill patient and, 1808  
of healthy patient, 1688–1699  
admission to postanesthesia care unit and, 1690t, 1690–1691  
cardiac dysrhythmias and, 1693–1694  
discharge from postanesthesia care unit and, 1697t, 1697–1698  
fluid administration and hemorrhage and, 1696–1697  
hypertension and, 1694–1695  
hypotension and, 1693  
neurologic complications and, 1693, 1695t  
organization of postanesthesia care unit and, 1688–1689, 1689t  
pain management and, 1695–1696  
postanesthesia care unit operations and, 1689–1690  
postoperative nausea and vomiting and, 1691t, 1691–1692  
respiratory and airway complications and, 1692–1693  
temperature control and, 1696
- in hepatic resection, 1349  
in lung transplantation, 1389–1390  
mechanical ventilation and, 1852–1872  
in acute respiratory distress syndrome, 1867t, 1867–1868  
adaptive support ventilation in, 1858  
airway pressure release ventilation in, 1859, 1859f, 1860f  
assist/control modes in, 1853–1854, 1855f  
automatic tube compensation in, 1858–1859  
bilevel pressure ventilation in, 1860, 1860f  
in chronic obstructive pulmonary disease, 1866–1867  
combined pressure and volume targeted modes in, 1853  
control mode in, 1853, 1854f  
gas exchange targets in, 1862–1863  
high-frequency ventilation in, 1865–1866  
indications for, 1852, 1853t  
initial management of, 1866  
lung-protective ventilation in, 1865  
noninvasive positive pressure and, 1869  
normal preoperative pulmonary function and, 1866  
pressure support mode in, 1854–1855, 1855f  
pressure *versus* volume ventilation in, 1852–1853, 1853t  
pressure-regulated volume control mode in, 1857–1858  
proportional-assist ventilation in, 1859  
synchronized intermittent mandatory ventilation in, 1855–1857, 1856f, 1857f  
in unilateral lung disease, 1868  
ventilator settings and patient-ventilator synchrony and, 1860–1862, 1861f, 1863f  
ventilator-induced lung injury and, 1863–1865, 1864f  
volume support mode in, 1858  
weaning from, 1868t, 1868–1869, 1869t
- of non-cardiac surgical ICU patient, 1828–1840  
cardiovascular issues and, 1834  
endocrine issues and, 1837–1838  
gastrointestinal issues and, 1834–1835, 1835t
- hematologic issues and, 1835–1837  
intensive care unit triage and, 1828–1830, 1829t, 1830t  
laboratory tests and vital signs and, 1831  
neurologic issues and, 1832t, 1832–1833  
pain management and, 1831–1832, 1832t  
prophylactic and preventive measures and, 1838t, 1838–1839  
pulmonary issues and, 1833–1834  
renal issues and, 1837  
transport between operating room and ICU, 1830–1831
- obese patient and, 390–391, 391f  
in outpatient surgery, 1619–1621  
in pulmonary disease, 142  
in same-day surgery, 1651  
in spinal surgery, 1549  
in subarachnoid hemorrhage surgery, 1118
- Postoperative cognitive dysfunction, 1912–1924  
anesthesia and, 1920–1921  
aortic atherosclerosis and cerebral embolization and, 1918–1919  
assessment of, 1914  
cardiac surgery and, 1915–1917, 1916f  
cardiac *versus* noncardiac surgery and, 1918, 1918f  
depression and, 1920  
disease states and, 1912–1914, 1913f, 1914f  
genetic factors in, 1920, 1921f  
hypoperfusion and, 1919  
incidence and significance of, 1914–1915, 1915f  
noncardiac surgery and, 1917, 1917f  
preexisting cerebrovascular disease and, 1921  
systemic inflammatory response and, 1919–1920
- Postoperative complications, 1700–1715  
of airway, 1701–1702  
aspiration in, 1704, 1704f  
in carotid endarterectomy, 1297  
complicated acute pain management and, 1710, 1710f  
in coronary artery bypass graft, 1152  
delayed awakening in, 1709  
delirium in, 1709  
dental injuries in, 1712  
dysrhythmias in, 1706–1707  
electrocardiographic changes and, 1707  
in esophageal surgery, 1251  
extravasation injury in, 1713, 1713f  
frequency of, 1701f  
geriatric patient and, 352–353, 1800  
hearing loss in, 1712–1713  
in hematopoietic stem cell transplantation, 1409–1410, 1411f  
hemorrhage in, 1710–1711  
herbals and, 73t  
hyperglycemia in, 1712  
hypertension in, 1707–1708, 1708t  
hyperthermia in, 1711f, 1711–1712  
hypotension in, 1706  
hypothermia in, 1711  
hypovolemia in, 1706  
hypoxemia in, 1702f, 1702–1704, 1703f  
intraoperative awareness and, 1710  
in liver transplantation, 1369  
in lung transplantation, 1389–1390  
in mediastinoscopy, 1254  
in myasthenia gravis, 1261  
myocardial ischemia and infarction in, 1706  
nerve injuries in, 1712  
ocular injuries in, 1712  
oropharyngeal injuries in, 1712  
in pancreas transplantation, 1408  
pneumothorax in, 1705, 1705f  
prolonged intubation in, 1705–1706  
protein-energy malnutrition and, 273  
pulmonary edema in, 1704  
pulmonary embolism in, 1704–1705  
in renal transplantation, 1402  
in small bowel transplantation, 1414–1415  
stroke in, 1709–1710  
systemic vasodilation in, 1706  
temporal patterns of, 1701t  
urinary and renal dysfunction in, 1708–1709
- Postoperative delirium, 149, 352  
Postoperative ileus, 1316, 1463  
Postoperative infection  
in intraabdominal surgery, 225t  
in lung transplantation, 1390  
neuraxial anesthesia-related, 997–998, 1065  
in pancreas transplantation, 1408

- Postoperative ischemia, 97–98, 99f
- Postoperative nausea and vomiting  
barbiturates and, 854  
in cesarean delivery, 1485  
child and, 1532f, 1532–1533  
in elective surgery, 70, 70t, 71f  
etomidate and, 860  
ketamine and, 864  
in outpatient surgery, 1617f, 1617–1618, 1618f  
perilymphatic fistula and, 1583–1584  
propofol and, 857  
in sinus surgery, 1586  
in thyroid surgery, 1603
- Postoperative pain, 1710, 1710f, 1716–1736  
in adenotonsillectomy, 1589–1590  
anesthesia planning and, 1717–1718  
in aneurysm surgery, 1306–1307  
behavioral therapy for, 1731  
cancer patient and, 2110  
cerebral palsy and, 1543  
child and, 1531–1532, 1731–1732  
elective surgery and, 81–82  
epidural analgesia for, 1726–1730  
burn patient and, 1679  
complications of, 1728–1729, 1730t  
in critically ill patient, 1805  
drug choices and drug effects in, 1726f, 1726–1728, 1727f  
indications and contraindications for, 1726  
in lung transplantation, 1386  
management of side effects of, 1728  
in newborn, 1516  
in renal transplantation, 1401  
surgical outcomes and, 1729–1730  
in thoracic surgery, 1274–1275, 1275b  
geriatric patient and, 353, 1732  
in hepatic resection, 1349  
infant and, 1731–1732  
institutional considerations in management of, 1716–1717  
intensive care unit and, 1733–1734, 1831–1832, 1832t  
in knee replacement surgery, 1544–1546  
in liver transplantation, 1368–1369  
in lower-extremity vascular surgery, 1298  
in myringotomy, 1583  
nerve blocks for, 1730–1731  
newborn and, 1731–1732  
nonsteroidal antiinflammatory drugs for, 1722f, 1722–1724, 1722–1724t, 1723f  
novel adjuncts for, 1724–1725  
obese patient and, 391  
in obstetric surgery  
cesarean delivery and, 1486  
fetal and placental surgery and, 1478  
in ophthalmic surgery, 1571  
opioids for, 1719–1722, 1720t  
opioid-sparing and multimodal analgesia and, 1719  
opioid-tolerant patient and, 1732–1733  
in orthognathic surgery, 1601  
in orthopedic surgery, 1549–1550  
in outpatient surgery, 1619, 1620  
pain assessment and, 1718, 1718f  
paravertebral anesthesia for, 1019–1022  
in patent ductus arteriosus, 1516  
patient education in, 1717  
patient-controlled analgesia for, 1725f, 1725–1726  
preemptive analgesia and, 1718–1719  
in shoulder replacement surgery, 1543–1544  
in thyroid surgery, 1603  
transcutaneous electrical nerve stimulation for, 1731  
in transurethral resection of prostate, 1459
- Postoperative renal disease, 210
- Postoperative respiratory failure, 1273
- Postoperative shivering in cesarean delivery, 1485
- Postoperative tests for cardiac complications, 108
- Postpartum hemorrhage, 1486–1488, 1487t
- Postresuscitation care, 1886
- Posttetanic count, 621–622
- Posttetanic potentiation, 621–622, 622f
- Posttransfusion graft-versus-host disease, 1908
- Posttransfusion purpura, 1902
- Posttraumatic coagulopathy, 1665
- Posttraumatic hyperglycemia, 1665
- Posttraumatic stress disorder, 754, 1682
- Potassium, 650–652  
anesthetic mechanism of action and, 726  
in crystalloid solutions, 670f  
disorders of, 201–202, 202f, 202t  
distribution in body compartments, 641t  
hyperkalemia and, 650t, 650–651, 651f  
hypokalemia and, 651f, 651t, 651–652, 652f  
liver transplantation and, 1365  
role in pain, 2061, 2062f
- Potassium chloride, 2196t
- Potassium phosphate, 657t
- Potassium titanyl phosphate laser, 1596t
- Potassium-sparing diuretics, 919–920, 920t
- Potential difference, electrical, 476
- Povidone iodine  
anaphylactic reaction to, 1959
- Power, electrical energy, 477
- Power distribution system, 480, 480f
- Practice guidelines in preoperative assessment and management, 57
- Practice management, 2172–2181  
billing and payment for anesthesia services and, 2177–2178, 2178t  
billing compliance and, 2180f, 2180–2181  
data analysis and reporting and, 2179–2180  
economics in, 2155–2171  
allocating operating room time and, 2160–2165  
elective, urgent, and emergent cases and, 2155–2157  
individual productivity and, 2166–2169, 2167t, 2168t  
managerial cost accounting and, 2157–2158  
operating room efficiency on day of surgery and, 2158  
reduction of surgical and turnover times and, 2165–2166  
scheduling and assignment and, 2155  
tactical *versus* operational decisions to increase productivity and, 2158–2160  
financial management and, 2176–2177  
governance and organizational dynamics in, 2172–2173  
hospital relationships and, 2173  
human resource management and, 2174–2175  
in- and out-of-operating room coverage and, 2175–2176  
incorporation of regional anesthesia into practice and, 974–977  
legal issues in, 2126–2134  
consent and, 2130–2131  
economic relationships and contracts and, 2128–2129  
ethical issues and, 2131–2132  
legal system and, 2126–2127  
medical liability and, 2127–2128  
National Practitioner Data Bank and, 2129–2130  
pediatric issues and, 2132–2133  
managed care contracting and, 2178–2179  
pain management practice and, 2176  
perioperative information management system and, 515–516  
providers and, 2173–2174  
staffing models and, 2175  
strategic planning and, 2181
- Prader-Willi syndrome, 304t
- Pravastatin (Pravachol), 947t
- Prazosin, 184, 922, 922t
- Prealbumin  
postoperative ICU patient and, 1835  
protein-energy malnutrition and, 269
- Preconditioning-induced neuroprotection, 1104
- Precordial Doppler device, 1111–1112
- Precordial stethoscope, 1506–1507
- Prednisone  
for immunosuppression in heart and lung transplantation, 1383, 1383t  
for premedication in previous radiocontrast media reaction, 1955b, 1958
- Preeclampsia, 362t, 362–364, 363t, 1485, 1488
- Preemptive analgesia, 1718–1719
- Preemptive goal-directed therapy, 289, 544–545, 1805–1806, 1806f
- Pregabalin, 2185t  
for chronic pain, 2056t, 2058  
for diabetic peripheral neuropathic pain, 2028  
for shingles, 2030
- Preganglionic sympathetic fibers, 2076–2077
- Pregnancy, 358–373  
anteartum hemorrhage in, 364t, 364–365  
antimicrobial therapy during, 285  
asthma and, 367, 367t  
back pain during, 367  
cardiac disease and, 365–366, 366t  
cocaine abuse during, 369  
diabetes mellitus and, 367–368, 368t  
difficult airway and, 127, 129t  
ectopic, 1487t  
fetal monitoring in, 360–361, 361t  
high-risk patient transport during, 1821  
human immunodeficiency virus and, 369  
hyperparathyroidism during, 178  
hypertensive disorders of, 1488  
obstetric surgery and, 365, 1471–1489  
assisted reproductive technologies and, 1475–1477, 1476f  
cervical cerclage and, 1477  
cesarean delivery and, 1480–1486, 1483b, 1483c, 1484f  
external cephalic version and, 1477–1478  
high-risk parturient and, 1486–1488, 1487t  
hypertensive disorders of pregnancy and, 1488  
in utero fetal and placental surgery and, 1478  
invasive monitoring and, 1488–1489, 1489b  
labor and vaginal delivery and, 1478–1480, 1479b, 1481–1482t  
malignant hyperthermia and, 1983  
maternal comorbid conditions and, 1474–1475, 1475b  
neuraxial techniques in, 1472t, 1472–1473, 1473f, 1473t  
teratogenicity of anesthetics and, 1473–1474, 1474b  
opioid analgesics during, 880  
physiologic changes of, 358–360, 1474–1475, 1475b  
preeclampsia in, 362t, 362–364, 363t, 1488  
preterm labor and, 361t, 361–362  
renal disease and, 199  
thyroid disease and, 368–369  
von Willebrand disease and, 250–251
- Pregnancy testing, 47  
in elective surgery, 78t  
before gynecologic surgery, 1490, 1490f  
before pediatric surgery, 336
- Prehospital care in trauma, 1787–1788
- Prejunctional receptor, 620–621
- Prekallikrein deficiency, 248t
- Preload, 1145–1146, 1146f  
cardiac output in shock and, 1846  
tourniquet and, 1550  
volumetric indices and, 540–541
- Premature atrial contractions, 1707
- Premature infant  
blood pressure ranges of, 315t  
blood transfusion and, 1895  
body compartment composition of, 1503t  
intestinal obstruction and necrotizing enterocolitis in, 1512–1513  
intravascular blood volume of, 315t  
laryngoscope blade and endotracheal tube sizes for, 1527t  
ophthalmic surgery and, 1577  
respiratory complications during anesthesia, 1521  
risk for apnea after surgery, 1609, 1609f  
thermoregulation in, 306
- Premature ventricular contractions  
complication of pulmonary artery catheter, 530  
postoperative, 1707  
in postoperative ICU patient, 1834
- Premedication  
in congenital heart disease, 1203  
in elective surgery, 80–81  
in esophageal surgery, 1250  
midazolam in, 862  
in myasthenia gravis, 1260  
in neurosurgery  
in sitting position infratentorial craniectomy, 1110  
for subarachnoid hemorrhage, 1116, 1117t  
in supratentorial craniotomy, 1105–1106, 1106f  
obese patient and, 386–387  
in outpatient surgery, 1610–1612, 1611f  
in pediatric surgery, 1523t, 1523–1524  
previous radiocontrast media reaction and, 1955, 1955b  
in tonsillectomy, 1587
- Preoperative anesthesia assessment clinic, 59–63, 60t, 62–64f  
elective surgery and, 75–76, 76t  
future of, 64–65

- Preoperative assessment and management, 40–67, 89–422
- airway evaluation in, 689–690, 690*b*
  - of alcohol or drug addicted patient, 396–422
    - alcohol and, 403–409
    - amphetamines and, 412–413
    - approach to, 397–398
    - cardiovascular disease and, 400
    - cocaine and, 410–412
    - definitions and neurobiology in, 396–397
    - drug-specific medical complications in, 404–405*t*
    - general principles of perioperative management and, 415–416, 416*t*
    - hallucinogens and, 413
    - hepatitis and, 401–402
    - history, physical examination, and diagnostic testing in, 398–399
    - human immunodeficiency virus infection and, 402–403
    - infectious complications in, 399*t*
    - inhalants and, 413–414
    - lung disease and, 400–401
    - marijuana and, 413
    - neurologic disease and, 401
    - opioids and, 409–410
    - recovering patient and, 416–419, 417*t*, 418*t*
    - sedative-hypnotics and, 409
    - skin and soft tissue infections in, 399–400
    - withdrawal and, 414*t*, 414–415
  - in anemia, 239–247
    - acute normovolemic hemodilution and, 245–246
    - antifibrinolytic therapy and, 246
    - critically ill patient and, 1798–1800, 1799*t*
    - crystalloids *versus* colloids for, 244, 244*t*
    - definitions and measurement of, 239–240, 240*t*
    - intravascular volume and, 244
    - prevalence in surgical patients and, 240
    - red blood cell maturation and, 240, 240*f*
    - red blood cell salvage for, 246, 246*f*
    - red blood cell substitutes for, 246
    - red blood cell transfusion in, 244–245, 245*f*, 245*t*
    - sickle cell disease and, 246–247, 247*f*
  - of anticoagulant therapy, 58
  - antimicrobial therapy and, 279–299
    - in acute pancreatitis, 292–293
    - in bacteremia, 291–292
    - bacterial resistance and, 282–283
    - in catheter-related infections, 287–288
    - for *Clostridium difficile*, 292
    - combination, 283–284
    - epidemiologic considerations in, 284*t*, 284–285
    - in fungal infection, 294–296
    - host factors in, 285, 285*t*
    - in human immunodeficiency virus infection, 293–294, 294*t*
    - identification of pathogen and, 284
    - minimum inhibitory concentration and, 279–280
    - in nosocomial infections, 286*f*, 286*t*, 286–287
    - pharmacokinetics and pharmacodynamics in, 280–282, 281*t*
    - in pneumonia, 290*t*, 290–291, 291*t*
    - prophylactic, 288–290
    - in subacute bacterial endocarditis, 289–290, 333*b*, 333*t*
    - in urinary tract infection, 292
  - in bladder cancer, 1462–1463, 1463*f*
  - of burn patient, 1674, 1675*t*
  - cardiac risk modifications and, 59
  - in cardiovascular disease, 95–121
    - anemia and, 104
    - angiotensin-converting enzyme inhibitors and, 113–114
    - antibiotics and, 116
    - antiplatelet and anticoagulant agents and, 115–116, 116*t*
    - arrhythmias and, 104
    - benefits of, 95
    - beta-blockers and, 110*f*, 110–113, 111–112*t*
    - calcium channel blockers and, 114, 114*f*
    - carotid stenosis and, 105
    - clinical determination of need for specific preoperative cardiac investigations and, 105–106, 106*f*
    - clonidine and, 115, 115*f*
    - comparison of risk indices in, 100, 100*f*, 101–102*t*
    - dangers of testing in low-risk populations and, 95–96
    - depression and, 104
    - diabetes mellitus and, 103
    - diuretics and, 115
    - genetic polymorphisms and, 104–105
    - glucose control and, 116
    - hyperlipidemia and, 103
    - hypertension and, 103, 109–110
    - known coronary artery disease and, 100–103
    - nitroglycerin and, 115
    - overall perioperative risk and, 98–99, 99*f*
    - peripheral vascular disease and, 103–104
    - postoperative ischemia and, 97–98, 99*f*
    - postoperative tests and, 108
    - preoperative CABG or PTCA and, 109
    - preoperative cardiac tests to quantify risk and, 106–108, 107*t*, 108*t*
    - purpose of identifying and quantifying risk in, 99–100, 100*t*
    - renal insufficiency and, 104
    - smoking and, 103, 116
    - statins and, 113, 113*f*
    - supply-demand mismatch and, 96, 97*f*
    - surgical procedure risk and, 105, 105*t*
    - thrombosis from endothelial dysfunction and, 96–97, 97*f*, 98*f*
    - valvular lesions and, 104
  - child and, 310–340, 1523*t*, 1523–1524
    - adenotonsillar hypertrophy and, 1587
    - cardiovascular system and, 314*f*, 314–315, 315*t*
    - congenital heart disease and, 332*t*, 332–333, 333*b*, 333*t*, 1203, 1203*b*
    - critical illness and, 337–338
    - dentition and, 316
    - gastrointestinal disease and, 334, 334*b*
    - gastrointestinal system and, 316
    - general approach in, 320*b*, 320–322, 321*t*
    - laboratory studies in, 334–336, 335*t*
    - neuromuscular disorders and, 328–330, 330*b*
    - NPO status and preoperative fasting and, 336–337, 337*t*
    - pediatric pharmacology principles and, 317–319
    - physical examination in, 323–328, 324–327*f*
    - psychologic preparation and, 322–323
    - purpose of, 319*b*, 319–320, 320*b*
    - renal disease and, 333–334
    - renal function and, 315–316, 316*t*
    - respiratory system and, 311–314, 312*f*, 313*f*, 313*t*, 330
    - syndromes associated with difficult intubation and, 331–332*t*
    - thermoregulation and, 316–317
  - clinic models and, 59–63, 60*t*, 62–64*f*
  - in coagulation disorders, 247–261
    - ADP antagonists and, 256–257
    - afibrinogenemia and, 253
    - antiplatelet agents and, 255–257, 256*f*
    - antithrombin deficiency and, 258
    - antithrombotic agents and, 254–255, 255*t*
    - contact factor deficiency and, 252–253
    - in critically ill patient, 1798–1800, 1799*t*
    - disseminated intravascular coagulation and, 260, 260*t*
    - drug-induced hypercoagulable states and, 254
    - dysfibrinogenemia and, 253–254
    - factor V deficiency and, 251
    - factor VII deficiency and, 251–252
    - factor X deficiency and, 252
    - factor XI deficiency and, 252
    - factor XIII deficiency and, 253
    - glycoprotein IIb/IIIa receptor inhibitors and, 256
    - hemophilia A and, 247–249, 249*t*
    - hemophilia B and, 249–250
    - heparin-induced thrombocytopenia and, 259–260
    - herbal therapies and, 257
    - hypercoagulable states and, 258
    - hyperhomocysteinemia and, 260–261
    - hypocoagulable effects of synthetic colloid infusions and, 257–258
    - hypocoagulable states and, 247, 248*t*, 249*t*
  - nonsteroidal antiinflammatory drugs and, 255–256, 256*f*
  - platelet-adhesion inhibitors and, 257
  - protein C deficiency and, 258
  - protein S deficiency and, 258
  - prothrombin deficiency and, 254
  - prothrombin G20210 mutation and, 259
  - von Willebrand disease and, 250*t*, 250–251, 251*t*
  - in congenital heart disease, 1203
  - consultations and, 57, 89–94, 90*t*, 92*t*, 93*t*
  - in coronary artery bypass graft, 1146–1147, 1150
  - of critically ill patient, 1797–1800, 1799*t*
  - in diabetes mellitus, 185–190
    - atherosclerosis and, 1287
    - cardiac risks and, 1290
    - cardiovascular disease and, 1399
    - coronary artery disease and, 1147
    - end-stage renal disease and, 1397
    - kidney failure and, 208
    - metabolic syndrome and, 190
    - newborn and, 301*t*
    - pregnant patient and, 367–368, 368*t*
  - difficult airway and, 122–133
    - airway infection and, 128, 128*f*
    - airway stent and, 130, 130*f*
    - anatomic considerations in, 123–124, 124*t*
    - anteriorly tilted larynx and, 125–126
    - congenital disease and, 128, 128*f*
    - grading of, 122–123, 123*f*, 124*b*
    - head and neck tumors and, 129*t*, 129–130
    - intrathoracic lesions and, 130–131
    - obesity and, 126–127
    - pregnancy and, 127
    - radiographic assessment in, 126
    - recommendations for, 131
    - rheumatoid arthritis and, 127–128
    - scope of problem and incidence of, 122
    - trauma and, 128–129
    - unexpected, 131
    - visibility of oropharyngeal structures and, 124–125, 125*f*
  - in elective surgery, 68–88
    - history in, 68–73, 69*t*, 70*t*, 71*f*, 72*t*, 73*t*
    - monitoring in, 82*t*, 82–85, 83*t*
    - physical examination in, 73–77, 74–76*t*
    - postoperative destination and, 81
    - postoperative pain and, 81–82
    - premedication and, 80–81
    - preoperative instructions and, 80
    - preoperative testing and, 77, 78*t*
    - type of anesthesia and, 77–80, 80*t*
  - in extracorporeal shock wave lithotripsy, 1460
  - future of preoperative clinics and, 64–65
  - geriatric patient and, 55, 341–357
    - abdominal surgery and, 352
    - cancer and, 350
    - cardiac surgery and, 350–351
    - cardiovascular disease and, 347–349, 348*f*
    - concepts and theories of aging and, 341–342, 342*f*
    - endocrine disease and, 350
    - eye surgery and, 352, 1563–1564, 1564*t*
    - gastrointestinal disease and, 349
    - genitourinary treatment and, 352
    - hearing impairment and, 350
    - immune enhanced diet and, 275*t*
    - musculoskeletal disease and, 349–350
    - neurologic and mental status disease and, 350
    - ophthalmologic disease and, 350
    - organ system senescence and, 342–346, 342–346*f*
    - orthopedic procedures and, 351*f*, 351–352
    - pharmacology and, 346–347, 347*f*
    - pulmonary disease and, 349
    - renal disease and, 349
    - surgical risk and, 352–353
    - thoracic procedures and, 351
    - vascular surgery and, 351
  - goals and benefits of, 40–41, 42*t*
  - in gynecologic surgery, 1489–1490, 1490*f*, 1490*t*
  - in heart transplantation, 1391
  - in hepatic disease, 216–238
    - acetaminophen toxicity and, 229, 229*f*
    - acute liver failure and, 231–232, 232*t*
    - alcoholic liver disease and, 229
    - alpha<sub>1</sub>-antitrypsin deficiency and, 225–226
    - ascites and, 234
    - autoimmune hepatitis and, 230



Preoperative assessment and management—*continued*

- biliary atresia and, 224–225
  - Child-Pugh scoring system in, 223–224, 224t, 225t
  - chronic hepatitis and, 228–229
  - chronic liver failure and, 232–233
  - control of encephalopathy in, 234–235
  - correction of coagulopathy in, 233–234, 234f
  - drug metabolism and, 222f, 222–223
  - drug-induced hepatitis and, 230
  - halothane hepatitis and, 229–230
  - hemochromatosis and, 225
  - hepatocellular carcinoma and, 231
  - infiltrative disease in, 230–231
  - inherited liver disease and, 226
  - liver anatomy and physiology and, 217f, 217–219, 218f, 218t
  - liver function tests in, 219t, 219–222, 220t, 221f
  - model of end-stage liver disease and, 224, 225t
  - nonalcoholic fatty liver disease and, 226f, 226–228
  - Reye syndrome and, 225
  - varices and variceal hemorrhage and, 234
  - vascular liver disease and, 231
  - viral hepatitis and, 227t, 227–228
  - Wilson disease and, 225
  - in hepatic resection, 1347–1348
  - high-risk patient and, 48–57
    - ambulatory surgery and, 56–57
    - anemia and, 53–54
    - cancer and, 54
    - cataract and, 55–56
    - diabetes mellitus and, 51
    - difficult airway and, 56
    - elderly patient and, 55
    - heart disease and, 48f, 48–49
    - heart failure and, 49
    - hepatic disease and, 53
    - hypertension and, 51–52, 52t, 53t
    - murmurs and, 49–50
    - neurologic disease and, 54
    - obesity and, 51, 386–387
    - obstructive sleep apnea and, 51
    - pulmonary disease and, 50–51
    - renal disease and, 52–53
    - rhythm disturbances and ECG abnormalities and, 49
    - risk of thromboembolism and, 54–55
    - smoking and, 55
    - substance abuse and, 54
  - in liver transplantation, 1352–1353
  - in lung transplantation, 1385
  - malnutrition and, 267–278
    - anesthetic implications of organ system dysfunction in, 272, 272t
    - assessment of, 268–269
    - cardiovascular changes in, 269–270
    - definition of, 267
    - effects on surgical outcome, 272–274
    - gastrointestinal changes in, 270–271
    - hepatic changes in, 271
    - immunologic changes in, 271–272
    - immunonutrition and, 274, 275t
    - incidence in surgical patients, 269
    - intraoperative management of patient receiving nutritional support, 275, 275b
    - nervous system changes in, 272
    - pancreatic changes in, 271
    - pulmonary changes in, 270
    - renal changes in, 270
    - starvation and, 267–268
    - stress hypermetabolism and, 268
  - medical history in, 43, 44t
  - medication instructions in, 58–59
  - monitored anesthesia care and, 1627–1628
  - in multiple organ dysfunction syndrome, 1761–1764, 1762t
  - in musculoskeletal disease, 166–169
    - achondroplasia in, 169
    - carpal tunnel syndrome in, 169
    - cerebral palsy in, 167–168
    - geriatric patient and, 349–350
    - malignant hyperthermia and, 169
    - osteoarthritis in, 166–167
    - osteogenesis imperfecta in, 168
    - osteoporosis in, 168
    - polymyositis and dermatomyositis in, 169
    - preoperative assessment and management in, 42t
    - rhabdomyolysis in, 169
    - rheumatoid arthritis in, 167
    - scleroderma in, 168–169
  - in myxedema coma, 177
  - for neuraxial anesthesia, 982–983, 983f, 984f
  - in neuromuscular disease, 156–166
    - amyotrophic lateral sclerosis in, 158
    - Charcot-Marie-Tooth disease in, 161–162
    - Eaton-Lambert syndrome in, 162–163, 163t
    - familial dysautonomia in, 161
    - familial periodic paralysis in, 165t, 165–166
    - Guillain-Barré syndrome in, 160–161
    - multiple sclerosis in, 158–160
    - muscular dystrophies in, 163t, 163–164
    - myasthenia gravis in, 162
    - myotonias in, 164–165
    - pediatric, 328–330, 330b
    - porphyrias in, 161, 161t
    - preoperative assessment and management in, 42t
    - preoperative assessment in, 156–158, 159t
    - skeletal muscle diseases and, 166
  - in neurosurgery
    - in sitting position infratentorial craniectomy, 1110
    - for subarachnoid hemorrhage, 1115t, 1115–1116, 1116f
    - in supratentorial craniotomy, 1105
  - newborn and, 300–309
    - calcium levels and, 307
    - cardiac physiology and, 305
    - central nervous system and, 305–306
    - congenital anomalies and, 302–304t
    - family and, 300
    - gas exchange and oxygen consumption and, 304–305
    - gestational age and, 301–302
    - glucose metabolism and, 306–307
    - head and neck and, 302–304
    - maternal and peripartum history in, 300–301, 301t
    - renal physiology and metabolism and, 306
    - thermoregulation and, 306
  - nothing by mouth guidelines in, 57–58, 58t
  - obese patient and, 374–395
    - airway of, 387
    - ambulatory anesthesia and, 387–388
    - bariatric procedures and, 1325, 1326f
    - cardiovascular system and, 378–380, 379f, 380f
    - classification of obesity and, 375t
    - disease risk and, 375t
    - gastrointestinal and hepatic systems and, 380–381
    - intraoperative considerations of, 388–390, 389f
    - metabolic syndrome and, 382
    - obesity-hypoventilation syndrome and, 377–378
    - obstructive sleep apnea and, 376–377, 377f, 378f
    - pharmacology for, 382–383
    - postoperative considerations for, 390–391, 391f
    - psychologic considerations of, 387
    - renal, endocrine, and metabolic systems and, 381–382
    - respiratory system and, 375–376, 376f
    - resuscitation and, 391–392
  - in ophthalmic surgery, 1563–1565, 1564t
  - in outpatient surgery, 56–57, 1609–1610, 1610f
  - in pancreas transplantation, 1405–1407, 1406t
  - in parathyroid disease-related hypercalcemia, 179
  - in parathyroid disease-related hypocalcemia, 179
  - patient preparation for acute postoperative pain and, 1717
  - patient safety and, 33
  - in pheochromocytoma, 183–184
  - physical examination in, 43–45, 45f
  - practice guidelines in, 57
  - pregnant patient and, 358–373
    - antepartum hemorrhage in, 364t, 364–365
    - antimicrobial therapy and, 285
    - asthma and, 367, 367t
    - back pain during, 367
    - cardiac disease and, 365–366, 366t
    - cocaine abuse during, 369
    - diabetes mellitus and, 367–368, 368t
    - difficult airway and, 127, 129t
    - fetal monitoring in, 360–361, 361t
    - human immunodeficiency virus and, 369
    - physiologic changes and, 358–360, 1474–1475, 1475b
    - preeclampsia in, 362f, 362–364, 363t, 1488
    - preterm labor and, 361t, 361–362
    - renal disease and, 199
    - thyroid disease and, 368–369
    - von Willebrand disease and, 250–251
  - preoperative testing and, 45–47, 46t
  - prevention of adverse events and, 1053
  - in prostate cancer surgery, 1461–1462
  - in psychiatric disorders, 150–151, 151t
  - in pulmonary disease, 42t, 50–51, 134–144, 140b, 141b, 141f
    - alcohol or drug addicted patient and, 398, 400–401
    - asthma and, 138
    - bronchodilator therapy and, 140
    - child and, 330
    - chronic bronchitis and, 138
    - emphysema and, 137–138
    - gas exchange abnormalities and, 139–140
    - geriatric patient and, 349
    - mechanical ventilation and, 1868
    - obstructive ventilatory defects and, 136–137
    - pulmonary function tests in, 134–135, 135f, 136f
    - restrictive ventilatory defects and, 135–136, 137f
    - rheumatoid arthritis and, 167
    - syndrome of inappropriate antidiuretic hormone and, 185t
  - in renal disease, 42t, 52–53, 194–215
    - calcium disorders and, 202–203, 203t
    - cardiac surgical patient and, 1147
    - clinical assessment and, 197t, 197–198
    - congestive heart failure and, 208, 208f
    - contrast nephropathy and, 209
    - diabetes mellitus and, 189
    - diuretics and, 204f, 204–206
    - drug prescribing in, 211
    - effect on antimicrobial therapy, 285, 285t
    - glomerular diseases and, 207, 207t
    - hereditary renal disorders and, 209
    - immature kidney and, 198–199
    - kidney structure and function and, 194–197, 195f, 196f
    - liver failure and, 208t, 208–209
    - magnesium disorders and, 203
    - metabolic acid-base disorders and, 200, 200f
    - older adult and, 199, 349
    - phosphorus disorders and, 203–204
    - potassium disorders and, 201–202, 202f, 202t
    - pregnant female and, 199
    - prerenal azotemia and, 206–207
    - renal cancer and, 1465–1466
    - renal failure and, 210–211
    - renal transplantation and, 209–210, 1398–1400, 1399t
    - respiratory acid-base disorders and, 200–201
    - sodium disorders and, 199t, 199–200
    - tubulointerstitial nephropathies and, 207–208
  - risk assessment and reduction in, 41, 42t, 43t
  - in same-day surgery, 1649–1650
  - scope of anesthesiology and, 14
  - in small bowel transplantation, 1412–1413
  - in testicular cancer, 1464
  - in thoracic surgery, 1215–1219
    - diagnostic studies in, 1216, 1216t, 1217f
    - exercise testing in, 1219
    - history in, 1215
    - perfusion studies in, 1218b, 1218–1219
    - physical examination in, 1215–1216
    - respiratory function assessment in, 1216–1217, 1218f
    - right-heart function assessment in, 1219, 1219b
    - spirometry in, 1217–1218, 1218f
    - tracheal resection and, 1262, 1262f, 1263f
  - of thyroid section, 175–176
  - in thyroidectomy, 1603
  - timing of, 41–43
  - in transurethral resection of prostate, 1457
  - in vascular surgery, 1287f, 1287–1292, 1288f, 1289f
  - ventricular assist device and, 1164–1165
- Preoperative autologous donation in prostatectomy, 1462
- Preoperative fasting
- child and, 336–337, 337t
  - monitored anesthesia care and, 1628, 1628t
  - outpatient surgery and, 1610

- Preoperative pulmonary rehabilitation, 1219  
 Preoperative testing, 45–47, 46*t*  
   American Society of Anesthesiologists guidelines for, 43*t*  
   cardiac tests to quantify risk perioperative cardiac complications, 106–108, 107*t*, 108*t*  
   clinical determination of need for specific cardiac investigations, 105–106, 106*f*  
   in elective surgery, 77, 78*t*  
 Preorbital septum, 1568*f*  
 Prepatellar bursitis, 2024*t*  
 Prerenal azotemia, 206–207, 1341  
 Prerenal oliguria, 1489, 1489*b*  
 Presbycopia, 344  
 Preschooler  
   laryngoscope blade and endotracheal tube sizes for, 1527*t*  
   mean hematocrit and hemoglobin of, 335*t*  
   normal red blood cell values of, 240*t*  
 Pressure regulator of anesthesia delivery system, 771  
 Pressure sensor shutoff valve, 769*f*, 771  
 Pressure ventilation, volume ventilation *versus*, 1852–1853, 1853*t*  
 Pressure-based indices in hemodynamic monitoring, 542  
 Pressure-regulated volume control ventilation, 1857–1858  
 Pressure-support ventilation, 1854–1855, 1855*f*  
 Pressure-volume curve, 593, 593*f*  
 Pressure-volume index, 1089–1090  
 Preterm labor, 361*t*, 361–362  
 Pretransfusion testing, 1902  
 Pretransport intubation, 1814, 1815  
 Prilocaine (Citaneest), 970–971  
   for Bier block, 1036  
   disposition kinetics of, 958*t*  
   dissociation constant of, 961*t*  
   for neuraxial anesthesia, 989, 989*t*, 990, 990*t*  
   peak blood concentration in regional anesthesia, 1058*f*  
 Primary afferents in chronic pain, 2001–2003*t*, 2001–2004, 2002*f*  
 Primary biliary cirrhosis, 230  
 Primary headache, 2036  
 Primary hyperalgesia, 2010  
 Primary hyperparathyroidism, 177–179, 178*t*  
 Primary hypoparathyroidism, 179  
 Primary sclerosing cholangitis, 230  
 Primary survey, 1789–1791, 1790*f*, 1790*t*, 1791*t*  
   in burn injury, 1773  
 Priming dose, 624–625  
 Pringle maneuver, 1346*f*  
 Prioritization model of ICU triage, 1828, 1829*f*, 1830  
 Private-practice model, 2172–2173  
 Procainamide, 938*t*, 939, 961*t*, 2190*t*  
 Procaine (Novocain, Planocaine), 969  
   alterations of structure of, 956*f*  
   baricity for spinal anesthesia, 987*t*  
   cation-to-base ratio of, 957*t*  
   discovery and evolution of, 954, 955*f*  
   dissociation constant of, 961*t*  
   for neuraxial anesthesia, 989, 989*t*, 990, 990*t*  
   structure of, 955*f*  
 Process manager, 18  
 Process variation, 454  
 Prochlorperazine, 2189*t*  
 Procoagulant agents in liver transplantation, 1368  
 Production pressure, 26  
 Productivity  
   allocating operating room time and, 2160–2165  
   anesthesia group, 2157, 2166  
   individual, 2166–2169, 2167*t*, 2168*t*  
   tactical *versus* operational decisions to increase, 2158–2160  
 Prodynorphin, 874  
 Proenkephalin B, 874  
 Professional billing, 2177–2178  
 Profit, anesthesia services and, 2158  
 Prognathism, 184  
 Prognostic nutritional index, 273  
 Programmed cell death, 1749  
 Progressive systemic sclerosis, 168–169  
 Prolonged intubation, 1705–1706  
 Prolonged QT syndrome, 104  
 Promethazine, 2186*t*, 2189*t*  
 Prone jackknife position, 471  
   for neuraxial anesthesia, 983, 984*f*  
 Prone position, 470*f*, 470–471  
   obese patient and, 388  
   in spinal surgery, 1547–1548, 1548*t*  
 Pronuclear stage tubal transfer, 1477  
 Proopiomelanocortin, 874  
 Proorphalin, 874  
 Propafenone (Rythmol), 942*t*, 943  
 Propanidol congener, 865–866, 866*f*  
 Proparacaine (Ophthaine, Ocu-Caine), 969*t*  
   in cataract surgery, 1566  
 Propensity-score matching, 435  
 Prophylactic antimicrobial therapy, 288–290  
   in burn injury, 1779  
   in lung transplantation, 1386  
   for postoperative ICU patient, 1838  
   for subacute bacterial endocarditis, 289–290, 333*b*, 333*t*  
 Prophylactic beta-adrenergic blocker therapy, 932  
 Prophylactic epidural blood patch, 1069  
 Propionic acid derivatives, 2064*t*  
 Propofol, 856–859, 2186*t*  
   anaphylactic reaction to, 1953*t*, 1956  
   in assisted reproductive technologies, 1475  
   cardiovascular effects of, 853*t*  
   in carotid endarterectomy, 1296  
   central nervous system effects of, 852*t*  
   cerebral blood flow and, 1094  
   cerebral neuroprotection and, 1104  
   chemical structure of, 851*f*  
   context-sensitive half-time for, 824, 825*f*, 856*f*, 1633*t*, 1634*f*  
   in coronary artery bypass graft, 1149  
   dosing strategy for manual infusion regimen, 901*t*  
   drug synergism and, 834–835, 835*f*  
   effect on pathophysiology of congenital heart disease, 1199–1200  
   effect site concentrations of, 829*f*, 900*t*  
   in electroconvulsive therapy, 1652  
   in endoscopic procedures, 1653  
   in extracorporeal shock wave lithotripsy, 1461  
   formulations of, 905*t*  
   hepatic extraction ratio for, 855*t*  
   induction characteristics of, 856*t*  
   influence of age on pharmacologic behavior of, 839*t*  
   intraocular pressure and, 1562–1563  
   in monitored anesthesia care, 1639*t*, 1640–1641  
   in nonoperating room procedures, 1651  
   for obese patient, 383, 384*t*  
   onset and duration of effect following bolus of, 829*t*  
   in outpatient surgery, 1616  
   in pediatric surgery, 1525*t*  
   pharmacokinetic mass concept and, 1635–1636  
   pharmacokinetics of, 855*t*, 900*t*  
   pharmacologic simulations for, 830, 831*f*, 831*t*  
   physicochemical properties of, 852*t*  
   postoperative nausea and vomiting and, 1618, 1618*f*  
   for renal transplantation, 1400  
   response surface for, 833, 834*f*  
   somatosensory-evoked potentials and, 604*t*, 610  
   target-controlled infusion of, 901  
   time to peak effect of, 827*t*  
   for total intravenous anesthesia  
     context-sensitive half-time of, 912  
     induction of, 905–906  
     maintenance of, 909–910, 910*f*  
     plasma concentration of, 901*t*  
     for trauma patient, *t*, 1667  
     ventilatory depression and, 853*t*  
 Proportional-assist ventilation, 1859  
 Propoxyphene (Darvon), 2053*t*, 2184*t*  
 Propoxyphene/acetaminophen, 2184*t*  
 Propranolol, 929, 930*t*, 2190*t*  
 Propylthiouracil, 175  
 Prospective cohort study, 437  
 Prospective study design, 435  
 Prostacyclin (Epoprostenol, Flolan), 924  
   endothelial response to injury and, 1745  
   for hypoxic pulmonary vasoconstriction, 1234–1235  
   in lung transplantation, 1381  
 Prostaglandin E<sub>1</sub>, 924  
   in small bowel transplantation, 1414  
 Prostaglandin E<sub>2</sub>, 1483*t*  
 Prostaglandin E<sub>2α</sub>, 1483*t*  
 Prostaglandin synthetase inhibitors, 362  
 Prostaglandin(s)  
   actions of, 1722*t*  
   role in pain, 2061, 2062*f*, 2063*f*  
 Prostate  
   anatomy and physiology of, 1451–1452, 1452*f*  
   cancer of, 1461–1462  
     older adult and, 352  
     transurethral resection in, 1457*t*, 1457–1459, 1458*t*  
 Prostatectomy, 1457  
 Prostatic plexus, 1452*f*, 1453*f*  
 Protamine, 2192*t*  
   anaphylactic reaction to, 1958–1959  
   cardiopulmonary bypass and, 1142  
   for clot lysis syndrome in liver transplantation, 1367  
 Protein  
   anesthetic mechanisms of action and, 721–728  
   affinity and stoichiometry and, 722–723, 723*f*  
   drug-target complex and, 721–722, 722*f*  
   G-protein coupled receptors and, 727*f*, 727–728  
   ion channels and, 725–727, 726*f*, 727*b*  
   mitochondria and, 728  
   protein coupling mechanism and, 723–724, 724*f*, 725*f*  
   soluble proteins and, 724–725  
   distribution in body compartments, 641*t*  
   restriction in renal failure, 211  
 Protein binding  
   of drugs metabolized by liver, 222  
   intravenous anesthetics and, 855*t*  
   local anesthetics and, 955–956, 956*f*, 962, 962*f*  
   pharmacokinetic behavior of drug and, 280  
   propofol and, 858  
   thiopental and, 855  
 Protein C  
   deficiency of, 258  
   endothelial response to injury and, 1745  
 Protein kinase C, 725  
 Protein S deficiency, 258  
 Protein Z deficiency, 248*t*  
 Protein Z-dependent protease inhibitor deficiency, 248*t*  
 Protein-energy malnutrition, 267–278  
   anesthetic implications of organ system dysfunction in, 272, 272*t*  
   assessment of, 268–269  
   cardiovascular changes in, 269–270  
   definition of, 267  
   effects on surgical outcome, 272–274  
   gastrointestinal changes in, 270–271  
   hepatic changes in, 271  
   immunologic changes in, 271–272  
   immunonutrition and, 274, 275*t*  
   incidence in surgical patients, 269  
   intraoperative management of patient receiving nutritional support, 275, 275*b*  
   morbidity and mortality following intraabdominal surgery and, 225*t*  
   nervous system changes in, 272  
   pancreatic changes in, 271  
   pulmonary changes in, 270  
   renal changes in, 270  
   starvation and, 267–268  
   stress hypermetabolism and, 268  
 Proteinuria, 658  
*Proteus mirabilis* infection, 286*t*  
 Prothrombin deficiency, 248*t*, 254  
 Prothrombin G20210 mutation, 259  
 Prothrombin time  
   Child-Pugh scoring system and, 224*t*  
   fresh-frozen plasma and, 1897  
   in hemophilia, 249  
   morbidity and mortality following intraabdominal surgery and, 225*t*  
   preoperative, 47  
 Proton pump inhibitors  
   for acid reflux, 1315–1316  
   for ulcer disease, 1323  
 Protriptyline, 2050*t*  
 Proximal airway pressure, 590  
 Proximal isovelocity surface area, 567  
 Proximal tubule diuretics, 204–205  
 Prune-belly syndrome, 304*t*  
 Pruritus  
   burn patient and, 1682–1683  
   epidural analgesia-related, 1728  
   neuraxial anesthesia-related, 1071, 1485  
   opioid analgesic-induced, 878  
 Pseudo hemolytic transfusion reaction, 1897  
 Pseudoaddiction, 2052–2054, 2053*t*, 2137  
 Pseudocholinesterase deficiency, 71–72  
 Pseudogout, 2025

- Pseudohyperkalemia, 202t  
Pseudohyponatremia, 646–647  
*Pseudomonas aeruginosa*  
in nosocomial infection, 286, 286t  
in urinary tract infection, 292  
Pseudonormalization, 562f, 562–563  
Pseudoobstruction syndromes, 1329, 1329b  
Pseudotumor, 248  
Psoas compartment nerve block, 1039, 1040f  
child and, 1531  
in hip replacement surgery, 1546  
Psoas major muscle, 1038f  
Psychiatric disorders  
in alcohol or drug addicted patient, 397–398  
geriatric patient and, 350  
methamphetamine use and, 413  
preoperative evaluation of, 150–151, 151t  
Psychologic preparation for pediatric surgery, 322–323  
Psychological dependence on opioid analgesics, 881  
Psychological history in pain assessment, 2107  
Pterygium, 1578  
Ptosis  
eye surgery-related, 1574  
repair of, 1579  
Pubic tubercle  
obturator nerve block and, 1041f  
sciatic nerve block and, 1044f  
Pudendal nerve, 1452f, 1453f, 2047t  
Puestow procedure, 1326, 1326f  
Pulmonary artery, 1214  
compression by mediastinal mass, 1258  
disruption in balloon dilation procedures, 1196  
transesophageal echocardiography of, 576  
Pulmonary artery banding  
anesthetic complications in, 1194  
hemodynamic problems resulting from, 1185t  
Pulmonary artery catheter, 526–533  
in aortic surgery, 1300  
in carotid endarterectomy, 1295  
complications of, 530–532  
continuous mixed venous oximetry and, 532–533, 533b  
in coronary artery bypass graft, 1148, 1148t  
critically ill patient and, 1802t, 1802–1804, 1803t  
indications for, 532, 532b  
insertion technique in, 526–527, 528f  
in liver transplantation, 1359–1360  
in lower-extremity vascular surgery, 1298  
in multiple organ dysfunction syndrome, 1766  
in neonatal emergency surgery, 1507–1508  
in open radical nephrectomy, 1465  
pacing, 532  
in preeclampsia, 1488  
pregnant patient and, 1489  
pressure measurements of, 526t, 527t, 527–530, 529f, 529t, 530f  
right ventricular ejection fraction, 533  
in small bowel transplantation, 1414  
in supratentorial craniotomy, 1106  
in thoracic surgery, 1222, 1223t  
trauma patient and, 1666, 1666b  
in valve surgery, 1155  
Pulmonary artery diastolic pressure, 528  
Pulmonary artery occlusion pressure, 527–528  
cardiac function curve and, 539  
during fluid resuscitation, 540  
preload and, 1145–1146  
pulmonary artery catheter values and, 526t  
in pulmonary edema, 538  
Pulmonary artery wedge pressure  
in prerenal oliguria, 1489b  
in pulmonary edema, 1489b  
Pulmonary aspiration in esophageal atresia and tracheoesophageal fistula, 1514  
Pulmonary atresia, 1176t  
Pulmonary blood flow  
congenital heart disease and  
excessive flow and, 1179–1180, 1180f, 1181f, 1184–1186, 1186b  
inadequate flow after shunt in, 1186b, 1186–1187  
obstruction of flow and, 1181–1182  
lateral decubitus position and, 1226f  
Pulmonary capillary network, 1214  
Pulmonary complications  
after carotid endarterectomy, 1297  
in alcohol or drug addicted patient, 404t, 406–407  
in burn injury, 1775  
in cocaine use, 411  
in extracorporeal shock wave lithotripsy, 1460  
Guillain-Barré syndrome and, 160  
during intrahospital patient transport, 1814  
marijuana-related, 413  
in neuraxial anesthesia, 1070–1071  
neuromuscular disease and, 156–157  
obstructive sleep apnea syndrome and, 1588  
opioid-induced, 409–410  
osteoporosis and, 168  
in pediatric anesthesia, 1520–1521  
in postanesthesia care unit, 1692–1693  
in postoperative ICU patient, 1833–1834  
Pulmonary disease, 134–144  
in alcohol or drug addicted patient, 398, 400–401  
assessment before pediatric surgery, 330  
asthma in, 138  
bronchodilator therapy in, 140  
chronic bronchitis in, 138  
emphysema in, 137–138  
gas exchange abnormalities in, 139–140  
geriatric patient and, 349  
mechanical ventilation in, 1868  
obstructive ventilatory defects in, 136–137  
postoperative management in, 142  
preoperative assessment and management in, 42t, 50–51  
preoperative evaluation in, 140b, 140–142, 141b, 141f  
pulmonary function tests in, 134–135, 135f, 136f  
restrictive ventilatory defects in, 135–136, 137f  
rheumatoid arthritis and, 167  
syndrome of inappropriate antidiuretic hormone and, 185t  
Pulmonary edema  
in burn injury, 1773  
cocaine-induced, 411  
hemodynamic monitoring for, 538, 538b  
hyperosmolar agents and, 1103t  
opioid overdose and, 410  
postoperative, 1704  
pregnant patient and, 1489b  
during pulmonary artery dilation, 1196  
in subarachnoid hemorrhage, 1118–1119  
in thoracic surgery, 1273  
tracheal extubation and, 711  
Pulmonary embolism  
air embolism and, 1114  
capnography in, 587, 587f  
complication of pulmonary artery catheter, 530  
postoperative, 1704–1705  
preoperative assessment and management of, 54–55  
Pulmonary function  
burn and, 1674–1675  
cardiac risk in vascular surgery and, 1290  
gastrointestinal surgery and, 1317  
of geriatric patient, 345, 345f  
laparoscopic surgery and, 1318  
postoperative dysfunction of, 1702–1706  
aspiration in, 1704, 1704f  
hypoxemia in, 1702f, 1702–1704, 1703f  
pneumothorax in, 1705, 1705f  
prolonged intubation in, 1705–1706  
pulmonary edema in, 1704  
pulmonary embolism in, 1704–1705  
thoracic surgery-related, 1273  
postoperative mechanical ventilation and, 1866–1868, 1867t  
preoperative evaluation of, 45, 74, 74t  
propofol and, 857  
protein-energy malnutrition and, 270  
rheumatoid arthritis and, 1542t  
Pulmonary function tests, 134–135, 135f, 136f  
in airway obstruction, 1653  
in amyotrophic lateral sclerosis, 158  
in liver transplantation, 1353  
in muscular dystrophy, 163  
in myotonic dystrophy, 164–165  
in neuromuscular disease, 157  
preoperative, 141, 141b  
in restrictive ventilatory defects, 136  
thoracic surgery and, 1216–1217, 1218f  
Pulmonary hypertension, 1219, 1219b  
in alcoholic cirrhosis, 407  
methamphetamine use and, 412  
persistent pulmonary hypertension of newborn and, 305  
pregnant patient and, 366  
pulmonary artery pressure waveform in, 531f  
during reperfusion in liver transplantation, 1366  
Pulmonary infarction, 530  
Pulmonary mechanics, 590–593, 590–593f  
Pulmonary muscle insufficiency, 1693  
Pulmonary shunt fraction, 527t  
Pulmonary suite, 1653–1654  
Pulmonary system  
barbiturates and, 853, 853t  
complications associated with renal failure, 1399t  
effects of burn injury on, 1676t  
etomidate and, 860  
ketamine and, 863–864  
lithotomy position and, 468  
liver disease and, 1341–1344, 1342f, 1343b, 1343f, 1344f  
supine position and, 466  
Pulmonary torsion, thoracic surgery-related, 1273  
Pulmonary vascular injury, 531–532  
Pulmonary vascular obstructive disease, 1180, 1180f  
Pulmonary vascular resistance  
burn and, 1675  
burn injury and, 1773  
in congenital heart disease, 1204b, 1204–1205  
excessive pulmonary blood flow and, 1179–1180, 1180f  
intracardiac shunting and, 1175–1178, 1177f, 1179f  
manipulation during surgery, 1204b, 1204–1205  
transitional circulation and, 1182  
in criteria for potential heart transplant, 1381, 1390  
pulmonary artery catheter measurement of, 527t  
Pulmonary vasculature, 1214  
Pulmonary venous filling patterns, 562–563, 563f  
Pulmonic regurgitation, 1153t  
Pulmonic stenosis, 576, 1153t, 1176t  
Pulmonic valve, transesophageal echocardiography of, 576, 576f  
Pulse  
physiologic effects of hemorrhage on, 1790t  
pulse oximetry and, 584  
Pulse contour-derived cardiac output, 536  
Pulse oximetry, 583–585, 583–585f  
in elective surgery, 83  
in hepatopulmonary syndrome, 1343–1344  
during intubation, 692  
in monitored anesthesia care, 1629  
in neonatal emergency surgery, 1507  
during pediatric anesthesia, 1522  
during thoracic anesthesia, 1222  
Pulse pressure  
physiologic effects of hemorrhage on, 1790t  
variation in hemodynamic monitoring, 541, 542f  
Pulsed-wave Doppler, 553  
Pulseless electrical activity, 1882, 1882b, 1883b  
Pulsus alternans, 521f  
Pulsus bisferiens, 521f  
Pulsus paradoxus, 521f, 584, 584f  
Pulsus tardus, 521f  
Punitive damages, 2127  
Pupil, 1559f  
effects of opioid analgesics on, 877  
Purkinje fiber, 967  
Purpura  
posttransfusion, 1902  
Purpura fulminans, 1781  
Pyramidal cell, 598, 599t, 600f  
Pyridostigmine, 162, 2187t  
**Q**  
Qi, 2067  
Quadratus lumborum muscle, 1038f  
Quadriplegia  
infratentorial craniectomy-related  
horizontal position, 1114  
sitting position, 1109–1110  
spinal shock and, 1121  
Quality assurance, 21  
patient transport and, 1822  
Quality improvement, 452–464  
acute pain management and, 461–462  
aggregated patient outcome and safety data in, 458  
ASA closed claims study and, 458–459  
assessment of patient quality of care information in, 455t, 455–456

- confidentiality of patient outcome and, 462  
 data acquisition, verification, and feedback in, 456–458  
 evidence-based practices and, 459–460  
 future issues in, 462–463  
 intensive care unit and, 460–461  
 national patient safety goals and, 459, 460t  
 patient and family involvement in, 459  
 process measurement in, 460  
 quality of care indicators and, 454–455, 455t  
 terminology in, 452–454, 453t  
 Veterans Administration Health System approach to, 459
- Quality of care, 20–37**  
 accident models and, 23–27, 24f, 25b, 27b  
 adverse respiratory events and, 27–28  
 anesthesia risk and accidents and, 21–22, 22b  
 assessment of patient quality of care information and, 455t, 455–456  
 defining of, 21  
 diagnostic errors and, 29  
 dimensions of, 29–31, 30f  
 equipment errors and failures and, 29  
 geriatric patient and, 353  
 high-reliability organization model in, 31  
 lack of standard practice and, 29  
 medication errors and, 29  
 monitoring and alarms in, 28–29  
 patient involvement in, 34–35  
 perioperative information management system and, 509–512, 510–512f  
 practical elements of safety in, 32–34, 34t  
 safety at organizational and department level and, 31–32
- Quality of care indicators, 454–455, 455t  
 Quinapril, 924f  
 Quincke-style needle, 981, 982f  
 Quinethazone (Hydromox), 920t  
 Quinidine, 937–939, 938t
- R**
- Radial artery, arterial blood pressure monitoring and, 521–522  
 Radial keratotomy, 1578  
 Radial nerve, 1029f, 2046f  
   axillary block and, 1033f  
 Radial nerve block, 1035, 1036f  
 Radiant heat loss, 317  
 Radiant warmer, 317  
 Radiation therapy  
   iatrogenic cause of airway disorder, 1591–1592  
   neural injury and, 2110  
 Radical cystectomy, 1463  
 Radical neck dissection, 1604  
 Radical orchiectomy, 1464  
 Radical perineal prostatectomy, 1462  
 Radical prostatectomy, 1461–1462, 1466  
 Radical retropubic prostatectomy, 1462  
 Radicular pain, 2034–2035, 2078  
 Radioactive iodine uptake, 174  
 Radioactive tracer washout methods  
   inhaled/intravenous xenon in, 1084–1085  
   intraaortic injection of xenon in, 1085  
   intraarterial xenon in, 1084, 1084f  
 Radioallergosorbent test (RAST)  
   in anaphylactic reaction, 1954–1955  
 Radiocontrast media  
   anaphylactic reaction to, 1958  
 Radiofrequency ablation, 1655  
 Radiofrequency filter, 486  
 Radiofrequency interference, 486  
 Radiofrequency neurolysis  
   of lumbar sympathetic chain, 2088  
 Radiofrequency thermocoagulation, 2113  
 Radiofrequency transcatheter mapping and ablation, 1195t  
 Radiofrequency treatment of facet-related pain, 2088–2093  
   cervical facet medial branch block in, 2091–2092  
   facet medial branch block in, 2090–2091  
   intraarticular, 2089–2090, 2090f  
   lumbar facet medial branch block in, 2092f, 2092–2093  
   thoracic facet medial branch block in, 2092  
 Radiographic assessment in difficult airway, 126  
 Radionuclide imaging, perioperative cardiac complications and, 108, 108t  
 Raj test, 1055f, 1055–1056  
 Ramipril, 924t  
 Ramsay Sedation Scale, 1831, 1832f  
 Randomized clinical trial, 436t, 436–437
- Range ambiguity in continuous-wave Doppler, 553  
 Ranitidine, 2193t  
   for acid reflux, 1315–1316  
   for anaphylactic reaction, 1953, 1955b  
 Ranolazine, 936  
 Rapid eye movement, desynchronous electroencephalogram pattern and, 599  
 Rapid infusion catheter  
   in hepatic resection, 1347–1348  
   in liver transplantation, 1361, 1361t  
 Rapid sequence induction and intubation, 703f, 703–704  
   in neonatal emergency surgery, 1510  
 Rash, fat embolism syndrome and, 1552  
 Reactance, electrical current and, 477  
 Reactive oxygen species, 341  
   burn injury and, 1776  
   mitochondrial dysfunction and, 1749  
   traumatic shock and, 1663  
 Rebound cerebral edema, 1103t  
 Rebreathing systems, 792–795, 793f, 794f  
 Receptive field, 2004  
 Recombinant activated factor VII (NovoSeven), 250, 252, 1368  
 Recombinant factor VIIa, 1799, 1799t  
 Recombinant human activated protein C, 1745  
   for critically ill patient, 1799  
   for multiple organ dysfunction syndrome, 1760  
 Recombinant human erythropoietin, 1542  
 Reconstruction  
   in external and internal nasal deformities, 1585  
   in head and neck cancer, 1604–1605  
   maxillofacial, 1600, 1600f  
   orthognathic, 1600–1601  
   tracheal, 1599  
   tracheobronchial, 1261–1267, 1262–1266f  
 Record keeping, prevention of adverse events and, 1057  
 Recovering addict, 416–419, 417t, 418t  
 Recovery criteria in monitored anesthesia care, 1644b, 1644–1645  
 Recovery of healthy patient, 1688–1699  
   admission to postanesthesia care unit and, 1690t, 1690–1691  
   cardiac dysrhythmias and, 1693–1694  
   discharge from postanesthesia care unit and, 1697t, 1697–1698  
   fluid administration and hemorrhage and, 1696–1697  
   hypertension and, 1694–1695  
   hypotension and, 1693  
   neurologic complications and, 1693, 1695t  
   organization of postanesthesia care unit and, 1688–1689, 1689t  
   pain management and, 1695–1696  
   postanesthesia care unit operations and, 1689–1690  
   postoperative nausea and vomiting and, 1691t, 1691–1692  
   respiratory and airway complications and, 1692–1693  
   temperature control and, 1696  
 Recruitment and retention of providers, 2174–2175  
 Recruitment maneuver in one-lung ventilation, 1235  
 Recruitment/derecruitment injury, 1864  
 Rectification, electrical current and, 479  
 Recurarization, 634  
 Recurrent laryngeal nerve, 1314  
 Recurrent laryngeal nerve injury  
   in lung transplantation, 1389  
   nerve integrity monitor endotracheal tube and, 1603  
   thoracic surgery-related, 1274  
 Recursive partitioning, 435  
 Red blood cell mass, anemia and, 239  
 Red blood cell maturation, 240, 240f  
 Red blood cell salvage, 246, 246f  
 Red blood cell substitutes, 246  
 Red blood cell transfusion  
   ABO compatibility and, 1895t  
   in anemia, 244–245, 245f, 245t  
   in multiple organ dysfunction syndrome, 1767  
 Red cell concentrates, 1893–1897, 1895t, 1896t  
 Red cell count, 240t  
 Red cell distribution width, 241t, 242t  
 Redistribution half-life  
   of intravenous anesthetics, 855t  
   of propofol, 858  
   of thiopental, 855
- Redox theory of hypoxic pulmonary vasoconstriction, 1233–1234  
 Reduction ventriculoplasty, 1381  
 Refeeding syndrome, 656–657  
 Referral center, interhospital transport and, 1812  
 Referral to burn center, 1777–1778, 1779t  
 Referred pain, 2004  
 Reflex sympathetic dystrophy, 2032  
 Refludan (lepirudin), 255, 255t  
 Regional anesthesia, 974–1080  
   adverse event during, 1053–1080  
   backache and, 1072  
   brachial plexus block and, 1064  
   consent and, 1054–1055  
   direct needle trauma to nerve and, 1060–1061, 1061f, 1062t, 1064–1065  
   failure of spinal/epidural anesthesia and, 1069–1070  
   hematoma and, 1065  
   hoarseness and, 1064  
   Horner syndrome and, 1064  
   hypotension and, 1070  
   importance of prevention of, 1053–1054, 1054t  
   infection and, 1065–1066  
   intravenous regional anesthesia and, 1072–1073, 1073t  
   local anesthetic administration and, 1058f, 1058–1060, 1059f, 1059t  
   monitoring and, 1057  
   myotoxicity and, 1063  
   nausea and pruritus and, 1071  
   neural toxicity and, 1063  
   ophthalmic regional anesthesia and, 1073–1074, 1074t  
   patient selection and, 1054, 1054t  
   phrenic nerve paralysis and, 1063–1064  
   physician-patient communication and, 1058  
   pneumothorax and, 1062–1063  
   postdural puncture headache and, 1067–1069  
   postoperative urinary retention and, 1071–1072  
   record keeping and documentation and, 1057  
   respiratory complications and, 1070–1071  
   spinal cord injury and, 1062  
   subdural injection and, 1067  
   systemic and local toxicity and, 1067  
   total spinal anesthesia and, 1066–1067  
   use of appropriate equipment and technique and, 1055f, 1055–1057, 1056t, 1057f  
   after aneurysm surgery, 1306  
   for burn patient, 1679  
   in carotid endarterectomy, 1295–1296  
   clinical indication for, 975–976  
   in endovascular aneurysm repair, 1308  
   familial periodic paralysis and, 166  
   general anesthesia *versus*, 79–80, 80t  
   glycogen storage diseases and, 166  
   in heart valve surgery, 1156  
   incorporation into practice, 974–977  
   in lower-extremity orthopedic surgery, 1544  
   neuraxial anesthesia in, 978–1008  
   accessing epidural space in, 984–986, 986f, 987f  
   accessing subarachnoid space in, 983–984, 984–986f  
   analgesic adjuncts in, 990–993, 991t  
   anatomy in, 978–981, 979–981f  
   cardiovascular physiology of, 994–996, 995f, 995t  
   clinical pharmacology in, 986–988, 987t, 988t  
   combined spinal-epidural anesthesia and, 1000–1002, 1001f, 1002f  
   complications of, 997–1000, 999t  
   continuous, 1000  
   equipment for, 981–982, 982f  
   gastrointestinal, hepatic, and genitourinary physiology of, 996–997  
   local anesthetics for, 988–990, 989t, 990t  
   neurophysiology of, 993–994  
   patient positioning and preparation for, 982–983, 983f, 984f  
   patient selection for, 982  
   for postoperative pain in thoracic surgery, 1275  
   respiratory physiology of, 994  
   obese patient and, 390



- Regional anesthesia—*continued*  
 in ophthalmic surgery, 1565–1575  
 commonly used drugs and adjuvants in, 1571–1573  
 complications of, 1073–1074, 1074f, 1573–1575, 1576f  
 modified van Lindt block in, 1571  
 postoperative, 1571  
 retrobulbar or peribulbar block in, 1568f, 1568–1571, 1573–1575f  
 sedation for, 1575  
 sub-Tenon block in, 1567–1568, 1574f  
 topical, 1566–1567  
 in outpatient surgery, 1612–1615, 1613–1616f  
 paravertebral nerve block in, 1009–1024  
 advantages of, 1017f, 1017t, 1017–1018  
 adverse effects of, 1018t, 1018–1019  
 anatomic or loss-of-resistance technique in, 1012–1013, 1015f  
 clinical applications for, 1014t, 1019–1022  
 continuous catheter technique in, 1015, 1016f  
 contraindications for, 1018  
 effect of technique on distribution of injectate, 1015–1017  
 historical background of, 1011, 1013f  
 injection of radiographic contrast dye in, 1014, 1016f  
 local anesthetic regimen for, 1017, 1017t  
 lumbar anatomy and, 1009–1011, 1011f, 1012f  
 nerve stimulation in, 1013–1014  
 patient positioning for, 1011–1012  
 pressure measurement for placement confirmation in, 1014  
 thoracic anatomy and, 1009, 1010f, 1011f  
 in thoracic surgery, 1019–1020, 1238  
 ultrasound-assisted technique in, 1014–1015  
 Parkinson disease and, 147–148  
 pediatric, 1528–1531  
 caudal blocks in, 1529f, 1529–1530  
 epidural, 1531, 1531t  
 extremity blocks in, 1531  
 spinal, 1530–1531  
 peripheral nerve block in, 1025–1052  
 ankle blocks, 1046, 1047f, 1048f  
 axillary block, 1032–1034, 1033f  
 brachial plexus anatomy and, 1028–1029, 1029f  
 cervical plexus block, 1027f, 1027–1028, 1028f  
 choice of local anesthetic for, 1026t, 1026–1027  
 continuous catheter techniques and, 1037, 1037f, 1046  
 femoral nerve block, 1041–1042  
 hemorrhagic complications in, 1048–1049  
 infectious complications in, 1049  
 infraclavicular block, 1032  
 interscalene block, 1029–1031, 1030f  
 intravenous, 1036–1037  
 lateral femoral cutaneous nerve block, 1042  
 localizing neural structures in, 1025–1026  
 lower-extremity anatomy in, 1038, 1038f, 1039f  
 lumbar plexus block, 1038–1041, 1040–1042f  
 median nerve block, 1034–1035, 1035f  
 midhumeral block, 1034  
 musculocutaneous nerve block, 1035–1036  
 neurologic complications in, 1048  
 obturator nerve block, 1042–1043  
 perioperative outcomes in, 1046–1048  
 popliteal fossa block, 1044–1046, 1045f  
 radial nerve block, 1035, 1036f  
 sciatic nerve block, 1043f, 1043–1044, 1044f  
 supraclavicular block, 1031f, 1031–1032, 1032f  
 ulnar nerve block, 1035, 1036f  
 in thoracic surgery, 1238  
 in transurethral resection of prostate, 1459  
 for trauma patient, 1668, 1668t  
 Regulatory compliance, perioperative information management system and, 508–509, 509f  
 Regurgitation during pregnancy, 359  
 Rehydration, 645  
 Reintubation, 713b  
 Reiter syndrome, 2025  
 Rejection of transplant, 1382  
 kidney, 209  
 Relative adrenal insufficiency, 1744–1745  
 Relative hypovolemia, 644–645  
 Relaxin, 367  
 Remifentanyl, 885, 885f, 2184t  
 context-sensitive half-time for, 824–825, 825f, 1633t  
 dose, peak effect, and duration of, 875t  
 dosing strategy for manual infusion regimen, 901t  
 drug synergism and, 834–835, 835f  
 effect on pathophysiology of congenital heart disease, 1199  
 effect site concentrations of, 840f  
 elderly patient and, 838  
 in extracorporeal shock wave lithotripsy, 1461  
 in hepatic resection, 1348  
 influence of age on pharmacologic behavior of, 839t  
 in monitored anesthesia care, 1639t  
 in neonatal emergency surgery, 1504–1505  
 neuroprotective effects of, 1940, 1941f  
 in nonoperating room procedures, 1651  
 for obese patient, 384t, 385  
 for pediatric postoperative patient, 1532  
 pharmacokinetics of, 881t, 900t  
 physiochemical properties of, 881t  
 response surface for, 833, 834f  
 somatosensory-evoked potentials and, 604t  
 in spine surgery, 1548  
 structural formula of, 873f  
 target-controlled infusion of, 901  
 time to peak effect of, 827t  
 for total intravenous anesthesia  
 manual infusion regimen in, 907t  
 plasma concentration of, 901t  
 Remote locale surgery, 1649–1659  
 cardiopulmonary suite and, 1653–1654  
 diagnostic imaging in, 1655  
 electroconvulsive therapy in, 1651–1652  
 endoscopy in, 1652–1653  
 interventional radiology in, 1654–1656  
 pediatric patient and, 1655–1656  
 pharmacologic agents for, 1651  
 postanesthesia concerns in, 1651  
 preanesthetic considerations in, 1649–1651  
 Renal acidosis, 661–662, 666  
 Renal blood flow, 195f, 195–196  
 Renal perfusion in renal transplantation and, 1402  
 in aneurysm surgery, 1304  
 propofol and, 857  
 Renal calculi, 1459–1461  
 Renal cancer, 1465–1466  
 Renal candidiasis, 207–208  
 Renal clearance of drugs  
 local anesthetics and, 960  
 propofol and, 858  
 Renal complications  
 in alcohol or drug addicted patient, 404t  
 cocaine-related, 412  
 heroin-related, 410  
 perioperative cardiac complications and, 104  
 postoperative, 1708–1709  
 Renal disease, 194–215  
 calcium disorders and, 202–203, 203t  
 cardiac surgical patient and, 1147  
 child and, 333–334  
 clinical assessment of, 197t, 197–198  
 congestive heart failure and, 208, 208f  
 contrast nephropathy and, 209  
 diabetes mellitus and, 189  
 diuretics and, 204f, 204–206  
 drug prescribing in, 211  
 effect on antimicrobial therapy, 285, 285t  
 glomerular diseases in, 207, 207t  
 hereditary, 209  
 immature kidney and, 198–199  
 kidney structure and function and, 194–197, 195f, 196f  
 liver failure and, 208t, 208–209  
 magnesium disorders and, 203  
 metabolic acid-base disorders and, 200, 200f  
 older adult and, 199, 349  
 phosphorus disorders and, 203–204  
 postoperative, 210  
 potassium disorders and, 201–202, 202f, 202t  
 pregnancy and, 199  
 preoperative assessment and management in, 42t, 52–53  
 prerenal azotemia in, 206–207  
 renal failure and, 210–211  
 renal transplantation and, 209–210  
 respiratory acid-base disorders and, 200–201  
 sodium disorders and, 199t, 199–200  
 tubulointerstitial nephropathies in, 207–208  
 Renal failure, 210–211  
 acute, 210–211  
 in aneurysm surgery, 1304  
 in burn patient, 1675, 1676t  
 methamphetamine use and, 413  
 postoperative, 1708, 1837  
 complications associated with, 1399t  
 diabetes mellitus and, 1405t  
 in liver disease, 1341  
 during liver transplantation, 1365–1366  
 in multiple organ dysfunction syndrome, 1758, 1766–1767  
 neuropathy with, 2027t  
 perioperative complications and death and, 442t  
 risk in vascular surgery, 1290  
 Renal function  
 abdominal compartment syndrome and, 1835  
 burn and, 1675, 1676t  
 critically ill patient and  
 anesthetic plan and, 1798  
 pediatric, 338  
 postoperative, 1837  
 liver disease and, 1341, 1341b  
 multiple organ dysfunction syndrome and, 1762–1763, 1766–1767  
 postoperative complications in, 1708–1709  
 renal failure risk in vascular surgery, 1290  
 Renal function tests, 197t, 197–198  
 Renal plexus, 1451f  
 Renal protection in aneurysm surgery, 1304  
 Renal replacement therapy  
 intensive care unit and, 1837  
 liver transplantation and, 1365  
 Renal surgery, 1450–1470  
 in bladder cancer, 1462–1464, 1463f  
 cystoscopy in, 1455–1457, 1456f  
 elective, 79  
 extracorporeal shock wave lithotripsy in, 1459–1461  
 geriatric patient and, 352  
 macroscopic anatomy in, 1450–1453, 1451–1453f  
 minimally invasive, 1466f, 1466–1467  
 paravertebral nerve block in, 1021  
 patient positioning in, 1453f, 1453–1455, 1455f  
 in prostate cancer, 1461–1462  
 in renal cancer, 1465–1466  
 in testicular cancer, 1464–1465  
 transurethral resection of bladder tumor in, 1455–1457, 1456f  
 transurethral resection of prostate in, 1457t, 1457–1459, 1458t  
 Renal system  
 barbiturates and, 854  
 changes during pregnancy, 360  
 of child, 315–316, 316t  
 effects of burn injury on, 1676t  
 extracorporeal shock wave lithotripsy-related injury of, 1460  
 of geriatric patient, 346, 346f  
 of newborn, 306  
 of obese patient, 376t, 381–382  
 preservation in critically ill patient, 1807–1808  
 protein-energy malnutrition and, 270  
 rheumatoid arthritis and, 1542t  
 superior vena cava syndrome and, 1258b  
 Renal transplantation, 209–210, 1396–1403  
 allograft perfusion in, 1402  
 anesthetic management in, 1400–1401  
 immunosuppression in, 1401–1402  
 indications and contraindications for, 1397  
 organ matching, availability, and allocation in, 1396–1397  
 pediatric considerations in, 1402–1403  
 postoperative complications in, 1402  
 pretransplant evaluation in, 1398–1400, 1399t  
 rejection of, 209  
 surgical procedure in, 1398, 1398f  
 Renese (polythiazide), 920t  
 Renin, protein-energy malnutrition and, 270  
 Renin-angiotensin-aldosterone system, 380, 925f  
 ReoPro (abciximab), 256  
 Repaglinide, 186–187  
 Reperfusion, tourniquet and, 1550  
 Reperfusion of graft  
 in liver transplantation, 1366–1367  
 in pancreas transplantation, 1407  
 in renal transplantation, 1402, 1403  
 in small bowel transplantation, 1414  
 Replacement surgery  
 hip, 1544–1547, 1546f  
 deep venous thrombosis and, 1552–1553

- methylmethacrylate hypersensitivity and, 1552  
 older adult and, 351–352  
 knee, 1544–1547, 1546f  
 deep venous thrombosis and, 1552–1553  
 older adult and, 352  
 shoulder, 1543–1544  
**Reporting**  
 patient transport and, 1823–1824, 1824t  
 to postanesthesia care unit staff, 1690t, 1690–1691  
 of sentinel event, 453, 453t  
**Reproductive tract changes during pregnancy,** 360  
**Research, role of anesthesiologist in,** 15  
**Resection**  
 carinal, 1264f, 1264–1265  
 hepatic, 1345–1350  
   anesthesia for, 1346–1348  
   control of clotting in, 1348–1349  
   indications and patient characteristics in, 1345, 1345b  
   intraoperative complications in, 1349–1350, 1350f  
   operative considerations in, 1346, 1346f, 1347f  
   tracheal, 1261–1267, 1262–1266f, 1599  
 Reserpine, 922–923  
**Residual neuromuscular blockade,** 634–635, 635f, 635t  
**Residual volume,** 134  
   in chronic obstructive pulmonary disease, 139  
   criteria indicating increased postoperative risk, 141b  
**Resistance, electric current and,** 477  
**Respiratory acid-base disorders,** 200–201  
**Respiratory acidosis,** 200–201, 582t  
**Respiratory alkalosis,** 201  
**Respiratory arrest, neuraxial anesthesia and,** 994  
**Respiratory complications**  
   after carotid endarterectomy, 1297  
   in alcohol and/or addicted patient, 404t, 406–407  
   in burn injury, 1775  
   in cocaine use, 411  
   in extracorporeal shock wave lithotripsy, 1460  
   Guillain-Barré syndrome and, 160  
   during intrahospital patient transport, 1814  
   marijuana-related, 413  
   in neuraxial anesthesia, 1070–1071  
   neuromuscular disease and, 156–157  
   obstructive sleep apnea syndrome and, 1588  
   opioid-induced, 409–410  
   osteoporosis and, 168  
   in pediatric anesthesia, 1520–1521  
   in postanesthesia care unit, 1692–1693  
   in postoperative ICU patient, 1833–1834  
**Respiratory depression**  
   inhalational anesthetics and, 757–758  
   intravenous anesthetics and, 853t  
   neuraxial anesthesia-related, 1070–1071  
   opioid agonist-antagonists-induced, 891–892  
   opioid analgesic-related, 876, 876f, 877f, 1275b  
   propofol and, 857  
**Respiratory distress,** 305  
   in fat embolism syndrome, 1551  
**Respiratory failure**  
   in chemical injury to lower airway, 1775  
   in chronic bronchitis, 138  
   critically ill patient and, 1798  
   hyperosmolar agents and, 1103t  
   mechanical ventilation in, 1852, 1853t  
   thoracic surgery-related, 1273  
**Respiratory frequency, child versus adult,** 313t  
**Respiratory function monitoring,** 579–597  
   arterial blood gases in, 579–582, 580f, 580–582t, 581f  
   capnography in, 585t, 585–589, 586f, 586t, 587f  
   in electroconvulsive therapy, 1652  
   during intubation, 692t, 692–693, 693b  
   lung mechanics and graphics in, 590–593, 590–593f  
   necessity of, 593–594  
   pulse oximetry in, 583–585, 583–585f  
   during thoracic surgery, 1216–1217, 1218f  
   transcutaneous PO<sub>2</sub> and PCO<sub>2</sub> in, 589–590, 590f  
**Respiratory insensible water loss,** 313t  
**Respiratory mechanics**  
   child versus adult, 313t  
   work of breathing and, 1215  
   in multiple organ dysfunction syndrome, 1762–1764  
   in newborn, 302–307  
     cardiovascular system and, 305  
     central nervous system and, 305–306  
     gas exchange and oxygen consumption and, 304–305  
     glucose metabolism and, 306–307  
     head and neck and, 302–304  
     renal system and, 306  
     thermoregulation and, 306  
   Revised Cardiac Risk Index, 101–102t, 441–443  
   Revised Trauma Score, 1793t  
   Revisionist model of anesthesia risk, 426, 427f  
   Rewarming in cold injury, 1780  
   Reye syndrome, 225  
   Rhabdomyolysis, 169  
     bariatric surgery and, 386  
     methamphetamine use and, 413  
     succinylcholine-induced, 627  
   Rhesus hyperimmune immunoglobulin, 1898  
   Rheumatoid arthritis  
     chronic pain in, 2024–2025  
     difficult airway and, 127–128  
     geriatric patient and, 349  
     orthopedic surgery in, 1541, 1542t  
   Rhinoplasty, 1585  
   Rhinorrhea, 330  
   Rhythm disturbances  
     inhaled anesthetics and, 757  
     preoperative assessment and management in, 49  
   Rythmol (propafenone), 942t, 943  
   Rhytidoplasty, 1602  
   Rifampin, 401, 2195t  
   Right atrial pressure, 522, 523f, 523t  
   Right atrium, transesophageal echocardiography of, 555–556, 557f  
   Right bundle-branch block, 49, 530, 1148, 1149f  
   Right coronary artery, 1144, 1144f  
   Right hepatic vein, 217f  
   Right ventricle, transesophageal echocardiography of, 574–575  
   Right ventricular ejection fraction  
     pulmonary artery catheter and, 526t, 533, 539–540  
   Right ventricular ejection fraction pulmonary artery catheter, 533  
   Right ventricular end-diastolic volume, 527t, 533, 540–541  
   Right ventricular failure  
     obese patient and, 377  
     thoracic surgery-related, 1272  
   Right ventricular hypertension, 1182  
   Right ventricular hypertrophy, 1219b  
   Right ventricular infarction, 531f  
   Right ventricular stroke work, 527t  
   Right-heart failure  
     in heart transplantation, 1392  
     obstruction in congenital heart disease and, 1187, 1187b  
     ventricular assist device and, 1166  
   Right-heart function assessment  
     liver transplantation and, 1354–1355  
     thoracic surgery and, 1219, 1219b  
   Right-to-left shunt, 748, 749f  
   Right-to-left shunt fraction, 580  
   Rigid bronchoscopy, 1240–1242, 1242f, 1252  
   Rigid esophagoscopy, 1248  
   Rigid laryngoscopy, 701–704, 702f, 703f  
   Rigid spine muscular dystrophy, 164  
   Rigidity  
     in malignant hyperthermia, 1968  
     masseter muscle, 1968–1969  
     opioid analgesic-related, 877–878  
   Riley-Day syndrome, 161, 303t  
   Riluzole, 158  
   Rima glottidis, 687  
   Rise time, 1855, 1856f  
   Risk, defined, 425  
   Risk assessment and reduction, 41, 42t, 43t  
     anesthesia risk and, 424–451  
     accidents and, 21–22, 22b  
     anesthesia provider and, 445–446, 446t  
     challenges in estimating of, 429–432, 432b, 433f  
     cohort studies in mortality and, 438–439, 439t  
     communication to patient of, 446–447  
     definition of, 425b, 425–426, 426b  
     healthcare setting and, 443–444  
     measurement of, 426f, 426–429, 427f, 427–429b, 428t, 429f

- Risk assessment and reduction—*continued*  
 mortality estimates and, 439–440, 440f  
 patient comorbidity and, 441–443, 442t, 443b, 443f  
 statistical problems in, 432–435, 433f, 434b  
 study designs in, 435b, 435–438, 436t  
 surgeon characteristics and operation in, 444f, 444–445
- in cardiovascular disease, 98–106  
 clinical determination of need for specific preoperative cardiac investigations and, 105–106, 106f  
 comparison of risk indices and, 100, 100f, 101–102t  
 hypertension management and, 109–110  
 medications and, 110–116, 111–112t  
 overall perioperative risk and, 98–99, 99f  
 preoperative invasive interventions and, 109  
 purpose of identifying and quantifying risk, 99–100, 100t  
 specific risk factors and, 100–105  
 quality improvement and, 452–464  
 acute pain management and, 461–462  
 aggregated patient outcome and safety data in, 458  
 ASA closed claims study and, 458–459  
 assessment of patient quality of care information in, 455t, 455–456  
 confidentiality of patient outcome and, 462  
 data acquisition, verification, and feedback in, 456–458  
 evidence-based practices and, 459–460  
 future issues in, 462–463  
 intensive care unit and, 460–461  
 national patient safety goals and, 459, 460t  
 patient and family involvement in, 459  
 process measurement in, 460  
 quality of care indicators and, 454–455, 455t  
 terminology in, 452–454, 453t  
 Veterans Administration Health System approach to, 459
- Risk indices comparison, 100, 100f, 101–102t  
 Risk management, defined, 21  
 Risk metrics, 428, 428t  
 Risk priority number, 456  
 Risk studies  
 assessment of relationship with anesthesia care in, 431  
 duration of surveillance interval and, 430–431  
 identification of outcomes of interest in, 429–430  
 patient-specific descriptive data and, 430  
 population characterization and, 431–432, 432b, 433f  
 statistical problems in, 432–435, 433f, 434b  
 study designs in, 435b, 435–438, 436t
- Risk tolerance, 426, 426b  
 Ritodrine, 362  
 Robinow syndrome, 331t, 332t  
 Rocuronium, 631–632, 632t, 633t, 2187t  
 anaphylactic reaction to, 1952t  
 for burn patient, 1679  
 chemical structure of, 631f  
 maintenance infusion of, 634  
 for obese patient, 384, 384t  
 in pancreas transplantation, 1407  
 for pediatric neuromuscular blockade, 1525, 1525t  
 in renal transplantation, 1400, 1401  
 for trauma patient, 1667t
- Roller-type cardiopulmonary bypass pump, 1141  
 Rolling hiatal hernia, 1321, 1321f  
 Root cause analysis, 456  
 Ropivacaine (Naropin), 970, 2188t  
 cation-to-base ratio of, 957t  
 clinical forms of, 955f  
 disposition kinetics of, 958t  
 dissociation constant of, 961t  
 for epidural anesthesia, 989t  
 in knee replacement surgery, 1546  
 for neuraxial anesthesia, 989, 989t, 990t  
 in obstetric surgery, 1473t  
 for paravertebral block, 1017  
 for peripheral nerve block, 1026, 1026t  
 structure alterations of, 956f
- Rosiglitazone, 186  
 Rostral ventromedial medulla  
 in nociceptive transmission, 2006–2007  
 Rosuvastatin (Crestor), 947t  
 Rotameter, 772–773, 773f  
 Rotameter flowmeter, 773
- Rotator cuff conditions, 2023t  
 Rotor-wing transport, 1817f, 1819t, 1819–1820  
 Routes of administration  
 for drugs in cardiopulmonary resuscitation, 1885, 1886, 1886f  
 of local anesthetics, 960, 960f
- Roux-en-Y gastric bypass, 1325, 1326f  
 Rovenstine, Emery, 6, 7  
 Rubinstein-Taybi syndrome, 331t  
 Rule of nines, 1776f  
 Rupture  
 of Achilles tendon, 349  
 of aneurysm, 1300  
 of pulmonary artery, 531  
 uterine, 1487t
- Rusch needle, 982  
 Rusch right-sided tube, 1228f  
 Russel-Silver syndrome, 331t  
 Ruth, Henry, 6  
 Ryanodine receptor type 1  
 central core disease and, 1970  
 malignant hyperthermia and, 1964–1965  
 multimimicore diseases and, 1970–1971  
 properties of, 1972–1974, 1973f, 1974t, 1975f, 1976f
- S**  
 Sacral hiatus, 2075, 2075f  
 sciatic nerve block and, 1044f  
 Sacral parasympathetic nerves, 1452f  
 Sacral sympathetic splanchnic nerves, 1451f  
 Sacroiliac arthropathy, 2035  
 Sacrum, 978–979, 979f  
 anatomy of, 2075, 2075f  
 Saddle block, 987  
 Safety issues, 20–37, 423–496  
 accident models and, 23–27, 24f, 25b, 27b  
 adverse respiratory events and, 27–28  
 anesthesia risk and, 424–451  
 accidents and, 21–22, 22b  
 challenges in estimating of, 429–432, 432b, 433f  
 communication to patient, 446–447  
 definition of, 425b, 425–426, 426b  
 measurement of, 426f, 426–429, 427f, 427–429b, 428t, 429f  
 mortality and, 438–446  
 statistical problems in, 432–435, 433f, 434b  
 study designs in, 435b, 435–438, 436t  
 in blood transfusion, 1895t, 1895–1897, 1896t  
 diagnostic errors and, 29  
 dimensions of quality and, 29–31, 30f  
 electrical, 476–495  
 alternating current and, 477f, 477–478, 478f, 490  
 Association for Advancement of Medical Instrumentation and, 490  
 ASTM International and, 490  
 circuits and, 478, 478f, 479f  
 direct current and, 476–477, 477f  
 Emergency Care Research Institute and, 490  
 Food and Drug Administration and, 489  
 ground fault circuit interrupters and, 480–481  
 hazards of electrical distribution systems and equipment and, 485–487  
 interference and, 482  
 international standards in, 490  
 isolated power and, 480, 480f, 481f  
 isolation amplifiers and, 481–482  
 Joint Commission on Accreditation of Health Care Organizations and, 488–489  
 leakage current and, 479–480  
 National Fire Protection Association and, 487–488, 488t  
 Nationally Recognized Testing Laboratories and, 489–490  
 patient hazards and, 482–484f, 482–485  
 safe use of equipment and, 491–493  
 semiconductors and, 478–479, 479f  
 technology management and, 493, 493f, 494b  
 Underwriters Laboratories and, 489–490  
 equipment errors and failures and, 29  
 high-reliability organization model in, 31  
 in immunosuppression in heart and lung transplantation, 1382  
 lack of standard practice and, 29  
 in laser surgery, 1594–1595, 1595f, 1595t, 1596f, 1596t  
 medication errors and, 29
- in monitored anesthesia care, 1627, 1627t  
 monitoring and alarms in, 28–29  
 at organizational and department level, 31–32  
 in outpatient surgery, 1621  
 patient involvement in, 34–35  
 patient positioning and, 465–475  
 in gastrointestinal surgery, 1317  
 head-down tilt position and, 469–470  
 lateral decubitus position and, 471–472, 472f  
 lithotomy position and, 466f, 466–468, 467f  
 nerve injuries associated with, 472–473, 474b  
 obese patient and, 388, 389f  
 prone position and, 470f, 470–471  
 sitting position and, 468–469, 469f  
 supine position and, 465–466, 466f  
 venous air embolism and, 1113, 1113f  
 visual injury and, 473–474
- in patient transport, 1822–1823  
 in patient-controlled analgesia, 1725, 1725f  
 in pediatric surgery, 1732  
 practical elements of, 32–34, 34t  
 quality improvement and, 452–464  
 acute pain management and, 461–462  
 aggregated patient outcome and safety data in, 458  
 ASA closed claims study and, 458–459  
 assessment of patient quality of care information in, 455t, 455–456  
 confidentiality of patient outcome and, 462  
 data acquisition, verification, and feedback in, 456–458  
 evidence-based practices and, 459–460  
 future issues in, 462–463  
 intensive care unit and, 460–461  
 national patient safety goals and, 459, 460t  
 patient and family involvement in, 459  
 process measurement in, 460  
 quality of care indicators and, 454–455, 455t  
 terminology in, 452–454, 453t  
 Veterans Administration Health System approach to, 459
- St. John's wort, 73t  
 Salicylic acid derivatives, 2064t  
 Saline solution  
 osmolality of, 1101t  
 sodium content of, 648t  
 Salivary gland, parotid surgery and, 1602  
 Salmeterol, 2193t  
 Salsalate, 2064t  
 Saluron (hydroflumethiazide), 920t  
 Same-day surgery, 1649–1659  
 cardiopulmonary suite and, 1653–1654  
 diagnostic imaging in, 1655  
 electroconvulsive therapy in, 1651–1652  
 endoscopy in, 1652–1653  
 interventional radiology in, 1654–1656  
 pediatric patient and, 1655–1656  
 pharmacologic agents for, 1651  
 postanesthesia concerns in, 1651  
 preanesthetic considerations in, 1649–1651  
 preoperative care and, 14
- Sample size requirements for risk studies, 434b  
 Sampled-to-measured gradients, 693b  
 Saphenous nerve block, 1046, 1048f  
 Sarcoid polyneuropathy, 2028t  
 Sarcoidosis, 136  
 Saturated vapor pressure of inhaled anesthetics, 776, 776f, 777, 777t  
 Scalene muscles  
 brachial plexus and, 1028  
 interscalene block and, 1029–1031, 1030f  
 Scalp voltage potential, 598, 600f  
 Scheduling and assignment, 2155  
 allocating operating room time and, 2160–2165  
 Scheduling of preoperative assessment, 61  
 Schiötz technique, 1562  
 Schizophrenia, 150  
 Schlemm's canal, 1559f  
 Schmidt, Erwin, 7, 7f  
 School-age child  
 blood pressure ranges of, 315t  
 developmental behavior of, 321t, 322  
 laryngoscope blade and endotracheal tube sizes for, 1527t  
 mean hematocrit and hemoglobin of, 335t  
 Sciatic nerve, 1038, 1044f, 2047t  
 surgical positioning-related injury of, 473  
 Sciatic nerve block, 1043f, 1043–1044, 1044f  
 child and, 1531–1532  
 in femoral neck fracture, 1547  
 in knee replacement surgery, 1546  
 in lower-extremity orthopedic surgery, 1544



- Sclera, 1559, 1559f  
 intraocular pressure and, 1561
- Scleral buckle, 1575f
- Scleroderma, 168–169, 2025
- Sclerosing cholangitis, 1325
- Scoliosis, 612t
- Scopolamine, 2189t, 2190t  
 for mydriasis, 1563
- Screening tools in intensive care unit triage, 1828–1829, 1829t, 1830t
- Second gas effect, 749, 749f
- Secondary headache, 2036
- Secondary hyperalgesia, 2010
- Secondary hyperparathyroidism, 177–179, 178t
- Secondary survey, 1792  
 in burn injury, 1778–1779
- Secondary transport, 1812
- Second-degree burn, 1777
- Second-order chordae, 565, 566f
- Second-stage oxygen pressure regulator, 772
- Secretin, 2194t
- Sedation  
 barbiturates and, 856  
 epidural analgesia-related, 1728  
 in gynecologic surgery, 1492  
 in intensive care unit, 1831–1832, 1832t  
 during magnetic resonance imaging, 1656  
 before ophthalmic nerve block, 1575  
 opioid agonist-antagonists and, 891  
 opioid analgesics and, 875  
 in outpatient surgery, 1615  
 patient transport and, 1818  
 propofol and, 859  
 synchronous electroencephalogram pattern in, 600  
 before tonsillectomy, 1587
- Sedation depth  
 electroencephalographic measurement of, 753, 753f  
 inhalational anesthetics and, 752–753  
 in monitored anesthesia care, 1626t, 1630–1631, 1631b  
 in outpatient surgery, 1619, 1619f  
 therapeutic effects and, 750–751, 751t
- Sedative-hypnotics  
 addiction to, 404t, 409  
 barbiturates in, 850–856  
 adverse effects of, 853–854, 854b, 854f  
 cardiovascular system and, 853, 853t  
 central nervous system and, 850–853, 852f, 852t  
 chemistry of, 850, 851f, 852t  
 clinical use of, 855–856, 856f, 856t  
 evoked potentials and, 610  
 pharmacokinetics of, 854–855, 855t  
 respiratory system and, 853, 853t  
 cerebral blood flow and, 1095  
 dosing strategy for manual infusion regimen, 901t  
 formulary of, 2186t  
 in neonatal emergency surgery, 1506  
 plasma concentrations in total intravenous anesthesia, 901t  
 propofol concentration and, 910, 910f  
 withdrawal from, 415
- Seed method of checking Bain circuit, 794
- Segmental bronchus, 1214
- Segmental spinal arteries, 2076
- Seizure  
 in alcohol abuse, 407  
 in alcohol withdrawal, 414  
 cocaine-related, 411  
 in electroconvulsive therapy, 1652  
 flumazenil-induced, 862–863  
 in hypocalcemia, 653–654  
 meperidine-induced, 875–876  
 methamphetamine use and, 412  
 opioid overdose and, 410  
 in postoperative ICU patient, 1832, 1832t  
 in preeclampsia, 1488  
 preoperative evaluation of, 148  
 in child, 328  
 maternal history and, 301t  
 stellate ganglion block-related, 2084
- Selective nerve root injection, 2081–2082, 2083f
- Selective serotonin reuptake inhibitors, 418t
- Sellick maneuver, 703f, 703–704  
 for reflux prevention, 1316  
 ventilation during cardiopulmonary resuscitation and, 1877
- Semiconductor, 476, 478f, 478–479, 479f
- Semi-Fowler position, obese patient and, 388
- Semimembranosus muscle, popliteal fossa block and, 1045f
- Seminal vesicle, 1451–1452, 1452f
- Semitendinosus muscle, popliteal fossa block and, 1045f
- Senning repair, 1185t, 1187
- Sensitization  
 definition of, 2011t
- Sensorineural hearing loss disorders, 1583
- Sensory block, 962, 963f
- Sensory nerves, orbital, 1567f
- Sentinel event, 453t, 453–454
- Sentinel event alert, 454
- Sepsis  
 burn patient and, 1680  
 as cause of death in critical illness, 1741, 1741t, 1742t  
 immune enhanced diet for, 275t  
 lipopolysaccharide and, 1747  
 in multiple organ dysfunction syndrome, 1755t, 1755–1756  
 recombinant human activated protein C for, 1799
- Septic embolization, 400
- Septic shock  
 hydrocortisone for, 1798  
 hypotension in, 1806  
 in multiple organ dysfunction syndrome, 1755t, 1755–1756
- Septoplasty, 1585
- Sequential bilateral lung transplantation, 1388
- Sequential Organ Failure Assessment (SOFA), 1756
- Series circuit, electrical, 478, 479f
- Serious event, 454
- Seroma  
 permanent epidural catheter placement-related, 2099
- Serotonin antagonists, 1692, 2189t
- Serotonin receptor, 2007
- Serratia marcescens* infection, 286t
- Sertraline, 2050t
- Serum albumin  
 anesthetic binding and, 722  
 in protein-energy malnutrition assessment, 268–269
- Serum bilirubin, 232
- Serum calcium, 1831
- Serum creatinine, 197, 197t
- Serum electrolytes in liver transplantation, 1353, 1364–1365
- Serum glucose, 1365
- Serum lactate, 1831
- Serum liver enzymes, 219t, 219–222, 220t, 221f
- Serum osmolality, 646
- Serum potassium  
 liver transplantation and, 1365  
 renal transplantation and, 1400
- Serum sodium, 232
- Serum thyroglobulin, 174
- Serum thyroxine, 174
- Serum transferrin, 268–269
- Severe acute respiratory syndrome, 1742t
- Severe hypokinesia, 558
- Severinghaus electrode, 589–590
- Sevoflurane, 2186t  
 advantages and disadvantages of, 761t  
 biophysical properties of, 744t  
 for burn patient, 1679  
 cardiovascular effects of, 756t  
 in carotid endarterectomy, 1296  
 central nervous system effects of, 756t  
 cerebral blood flow and, 1098–1099  
 chemical and physical properties of, 741f, 741t, 741–742  
 compound A and, 759–760  
 in coronary artery bypass graft, 1150  
 fluoride release from metabolism of, 761  
 gas flow splitting ratios of, 781t  
 in hepatic resection, 1348  
 intraocular pressure and, 1562t  
 minimum alveolar concentration of, 776t  
 for obese patient, 389  
 pathophysiology of congenital heart disease and, 1198  
 in pediatric surgery, 1524f, 1524–1525  
 physical properties of, 777t  
 for renal transplantation, 1401  
 respiratory function and, 758t  
 somatosensory-evoked potentials and, 605t
- space-filling representation of, 719f  
 vapor pressure curve for, 776f  
 vascular resistance and, 757t
- Sex hormone therapy, liver disease and, 230
- Sgarlato portable infusion pump, 1037f
- Sheridan 2 endotracheal tube, 1596
- Shingles, 2029
- Shivering  
 after cesarean delivery, 1485  
 during patient transport, 1815
- Shivering thermogenesis, 317
- Shock, 1741–1742  
 in antenatal and postpartum hemorrhage, 1487t  
 critically ill patient and, 1797–1798, 1841–1851  
 blood transfusion for, 1843–1844  
 clinical signs of, 1841  
 fluid resuscitation for, 1842–1843, 1843f  
 indices of global perfusion in, 1847–1848, 1848f  
 indices of regional perfusion in, 1848–1849  
 pathophysiological classification of, 1841–1842  
 restoring and maintaining cardiac output in, 1846f, 1846–1847  
 vasopressors for, 1844f, 1844t, 1844–1846  
 ventilatory support for, 1842  
 direct tissue injury leading to critical illness and, 1739  
 pathophysiology of, 1663b  
 traumatic, 1661–1668, 1662f, 1663b, 1663f, 1742  
 anesthetic choices in, 1666–1668, 1667t  
 blood glucose control in, 1665  
 delayed fluid resuscitation in, 1664  
 monitoring in, 1665t, 1665–1666, 1666b  
 patient taking anticoagulants and, 1665  
 regional anesthesia and, 1668, 1668t  
 small volume resuscitation in, 1664  
 treatment of, 1663–1664
- Short-gut syndrome, 1411–1412
- Shoulder  
 innervation of, 2046t  
 pain in lung cancer, 1218  
 painful conditions of, 2023t
- Shoulder surgery  
 cervical paravertebral block in, 1615f  
 interscalene block for, 1029–1031, 1030f  
 joint replacement in, 1543–1544
- Shunt  
 anesthetic complications in, 1194  
 arteriovenous, 748  
 in congenital heart disease, 1175, 1177f, 1178f, 1178t  
 intracardiac, 1272  
 intrapulmonary, 748, 749f  
 in liver transplantation, 1357  
 portosystemic, 1370–1371  
 ventriculoperitoneal, 1515, 1536–1537
- Shy-Drager syndrome, 147
- Sibutramine, 385
- Sickle cell disease, 54, 246–247, 247f, 335–336
- Sickle cell trait, 246
- Sidestream capnometer, 585t
- Sildenafil, 1343
- Silent nociceptor, 2002
- Silvadene (silver sulfadiazine), 1681t
- Silver nitrate, 1681t
- Silver sulfadiazine (Silvadene), 1681t
- Simple shunt, in congenital heart disease, 1175, 1177f, 1178f, 1178t
- Simplified airway risk index, 126
- Simpson, James Young, 3
- Simulation  
 in pharmacological modeling, 823, 824f  
 in total intravenous anesthesia, 912–913
- Simulation training, 16, 1794
- Simvastatin (Zocor), 947t
- Single ventricle, 1176t
- Single-lumen tube, 1232, 1263
- Single-lung isolation, 1227–1232, 1228f, 1229t, 1230–1233t  
 in bullectomy, 1246  
 child and, 1535t  
 improving oxygenation during, 1235–1238, 1236–1238f  
 in lung transplantation, 1387
- Single-twitch stimulus, 621, 621f
- Sinotubular junction, 571
- Sinus bradycardia, 1693, 1707
- Sinus surgery, 1585–1586
- Sinus tachycardia, 1693, 1707
- Sirolimus, 1383



- Sise, Lincoln, 6
- Sitting position, 468–469, 469f  
in infratentorial craniectomy, 1108–1114, 1111–1113f  
for neuraxial anesthesia, 982–983, 983f  
in thoracic surgery, 1223t  
venous air embolism and, 1113, 1113f  
ventilation and perfusion and, 1224–1225, 1225f
- Skeletal muscle  
diseases of, 163–166  
central core disease in, 166  
familial periodic paralysis in, 165t, 165–166  
glycogen storage diseases in, 166  
mitochondrial myopathies in, 166  
muscular dystrophies in, 163t, 163–164  
myotonias in, 164–165  
subcellular sites of defect in malignant hyperthermia, 1972–1974, 1973f, 1974t, 1975f, 1976f  
in vivo microdialysis of, 1980
- Skin  
of alcohol or drug addicted patient, 398, 399–400  
anaphylactic reaction and, 1954b  
effects of burn injury on, 1676t  
Skin substitutes, 1675
- Skin testing  
in anaphylactic reaction, 1954
- Sleep, synchronous electroencephalogram pattern in, 600
- Sleep apnea  
in neuromuscular disease, 157  
obese patient and, 376–377, 377f, 378f  
preoperative assessment and management in, 51  
difficult airway and, 127  
elective surgery and, 76
- Sleep apnea-hypopnea index, 127
- Sleep deprivation, anesthesia provider error and, 25–26
- Sliding hiatal hernia, 1321, 1321f
- Slip, defined, 25b
- Small cell lung carcinoma, 1220
- Small for gestational age infant, 301–302, 316
- Small intestine  
effects of opioid analgesics on, 878–879  
obstruction of, 1330  
protein-energy malnutrition and, 270–271  
transplantation of, 1328
- Small volume resuscitation in traumatic shock, 1664
- Small-fiber neuropathy, 188, 2026
- Smoking  
cessation before thoracic surgery, 1219  
perioperative cardiac complications and, 103, 116  
postoperative delirium in older adult and, 352  
preoperative assessment and management of, 55, 77
- Smooth muscle  
opioid agonist-antagonists and, 892  
opioid analgesics and, 878–879, 880f
- Sniffing position for face mask ventilation, 693
- Snow, John, 1, 3f, 3–4, 4f
- Soda lime, 796, 797t
- Sodasorb, 797t
- Sodium  
acid-base chemistry and, 660, 660t  
anesthetic mechanism of action and, 727, 727b  
in crystalloid solutions, 670f  
disorders of, 199t, 199–200  
distribution in body compartments, 641t  
hypernatremia and, 649t, 649–650, 650t  
in hypertonic solutions, 672t  
hyponatremia and, 646f, 646–648, 647t, 648t  
liver transplantation and, 1365  
local anesthetics and, 956–957, 957f
- Sodium bicarbonate, 2196t  
for acidemia during liver transplantation, 1364  
added to local anesthetics, 993  
for anaphylactic reaction, 1955b  
for cardiac arrest, 1885, 1885b  
for renal preservation in critically ill patient, 1807
- Sodium channels  
nerve injury and, 2015  
pain and, 2003, 2003t  
role in neuropathic pain, 2055, 2055f
- Sodium nitrate, 2194t
- Sodium nitroprusside, 923–924, 2191t  
cellular mechanism of, 927f  
cerebral blood flow and, 1099–1100  
effects on vascular resistance, 757t  
for low cardiac output in shock, 1847
- Sodium phosphate, 657t
- Sodium thiosulfate, 2194t
- SOFA score (Sequential Organ Failure Assessment), 1756
- Sofnolime, 797t
- Soft tissue  
assessment in trauma patient, 1792  
infection in drug abuse, 399t, 399–400
- Soluble proteins, anesthetic mechanism and, 724–725
- Solvent detergent plasma, 1897
- Somatosensory-evoked potentials, 607–614  
anesthetic effect on, 609–610  
in aortic surgery, 1301  
application of, 610–613, 611f, 612t  
auditory evoked responses and, 613  
in carotid endarterectomy, 1294  
elicitation of, 608–609, 609f, 610f  
motor evoked potentials and, 613–614, 614f, 615f  
paravertebral nerve block and, 1017, 1017f
- Somatostatinoma, 1327
- Sore throat, postoperative, 1712
- Sotalol, 944t, 945–946
- Spastic cerebral palsy, 1542
- Specific airway conductance, child *versus* adult, 313t
- Specific gravity of inhaled anesthetics, 777t
- Specific heat, 777
- Specific immunotherapy  
for anaphylactic reaction, 1955b, 1955–1956, 1961
- Spectral edge frequency monitor, 454
- Speed of onset of local anesthetics, 961, 961f, 961t
- Spermatic artery and plexus, 1453f
- Spermatic cord, 1452
- Spermatic vein, 1452
- Sphenoid sinus, 1572f
- Spherasorb, 797t
- Spike-and-dome configuration of arterial waveform, 521f
- Spinal anesthesia, 978–1008  
accessing epidural space in, 984–986, 986f, 987f  
accessing subarachnoid space in, 983–984, 984–986f  
adverse event in, 1064–1072  
backache and, 1072  
direct needle trauma and, 1064–1065  
failure of anesthesia and, 1069–1070  
hematoma and, 1065  
hypotension and, 1070  
infection and, 1065–1066  
nausea and pruritus and, 1071  
nerve stimulation and, 1056, 1056t  
patient selection and, 1054, 1054t  
postdural puncture headache and, 1067–1069  
postoperative urinary retention and, 1071–1072  
respiratory complications and, 1070–1071  
subdural injection of local anesthetic drug in, 1067  
systemic and local toxicity and, 1067  
total spinal anesthesia and, 1066–1067  
ultrasound and, 1057  
analgesic adjuncts in, 990–993, 991t  
anatomy in, 978–981, 979–981f  
in assisted reproductive technologies, 1476–1477  
bowel motility and, 1316  
cardiovascular physiology of, 994–996, 995f, 995t  
clinical pharmacology in, 986–988, 987t, 988t  
combined spinal-epidural anesthesia and, 1000–1002, 1001f, 1002f  
complications of, 997–1000, 999t  
continuous, 1000  
for cystoscopy, 1456–1457  
for epidural placement of spinal cord stimulating electrodes, 616  
equipment for, 981–982, 982f  
formulary for, 2188t  
gastrointestinal, hepatic, and genitourinary physiology of, 996–997  
local anesthetics for, 988–990, 989t, 990t  
in lower-extremity orthopedic surgery, 1544  
in lower-extremity vascular surgery, 1298  
multiple sclerosis and, 160  
neurologic complications of, 1712
- neurophysiology of, 993–994  
for newborn with meningomyelocele, 1515  
in obstetric surgery, 1472–1473, 1473f  
in cervical cerclage, 1477  
in cesarean delivery, 1483b, 1483–1484  
in external cephalic version, 1477–1478  
in labor and vaginal delivery, 1479  
onset and duration of, 960f  
in outpatient surgery, 1613–1614, 1614f  
patient positioning and preparation for, 982–983, 983f, 984f  
patient selection for, 982  
in pediatric surgery, 1530–1531  
for postoperative pain in thoracic surgery, 1275  
respiratory physiology of, 994
- Spinal arteries, 2076
- Spinal column, 978–979, 979f
- Spinal cord  
anatomy of, 978, 979f, 980f, 2004f, 2073, 2075–2076  
chronic pain and, 2001–2007  
ascending nociceptive pathways and, 2006  
descending nociceptive pathways and, 2006–2007  
dorsal horn and, 2004f, 2004–2006, 2005f, 2005t, 2006t  
primary afferents and, 2001–2003t, 2001–2004, 2002f  
vascular supply to, 608–609, 609f
- Spinal cord central pain, 2031
- Spinal cord injury, 1669–1671, 1670b, 1670f  
autonomic hyperreflexia in, 1455–1456, 1456f  
brachial plexus block-related, 1062  
in permanent epidural catheter placement, 2098–2099  
preoperative evaluation of, 148  
in surgery for cervical spine disease, 1120  
thoracic surgery-related, 1274  
transfer of patient with, 1821
- Spinal cord ischemia  
in aneurysm surgery, 1304  
aortic surgery-related, 1161, 1161t
- Spinal cord stimulating electrodes, 616
- Spinal decompression, 612t
- Spinal needle, 981–982, 982f
- Spinal nerves  
dermatomal distribution of, 1013f  
in thoracic paravertebral space, 1009
- Spinal shock, 1549  
quadriplegia and, 1121
- Spinal stenosis, 2035
- Spinal surgery, 1547t, 1547–1549, 1548t
- Spinal tumor, 612t
- Spine  
anatomy of, 2073–2076, 2074f, 2075f  
ankylosing spondylitis and, 167  
assessment in trauma patient, 1792  
osteoarthritis of, 2088
- Spinobulbar pathway  
in nociceptive transmission, 2006
- Spinothalamic pathway  
in nociceptive transmission, 2006
- Spinous process, 2073, 2074f, 2075
- Spirometry, 134–135, 135f, 136f  
in chronic obstructive pulmonary disease, 139  
in emphysema, 137–138  
thoracic surgery and, 1217–1218, 1218f
- Spirolactone (Aldactone), 919, 920t
- Splanchnic nerve block, 2086–2087
- Splanchnic nerves, 2077, 2085f
- Split-lung function studies, 141
- Split-thickness skin graft, 1675
- Spondyloarthropathies, 2025
- Spontaneous bacterial peritonitis, 232
- Spontaneous breathing trial, 1868t, 1869t
- Spontaneous pneumothorax, 1244–1245
- Spontaneous ventilation, capnometry during, 589, 589f
- Sporothrix schenckii*, 295
- Sprotte needle, 982
- Stabilization before patient transport, 1815, 1821t
- Stable ventricular dysrhythmia, 1694
- Stacking position for obese patient, 389, 389f
- Stadol (butorphanol), 2185t
- Staff  
in postanesthesia care unit, 1688–1689, 1689t
- Staff scheduling, 2155
- Staffing models, 2175
- Stagnara wake-up test, 615
- Standard lithotomy position, 467f
- Standard of care, 1054t

- Standard practice, patient safety and, 29, 34, 34t  
Standards of care, 2127  
Standing bellows anesthesia ventilator, 804, 805f  
Stanford classification of aortic dissection, 1162f, 1162t, 1162–1163  
Stapedectomy, 1583  
Staphylococcal surgical site infection, 288  
*Staphylococcus aureus*  
antimicrobial resistance and, 283  
in community-acquired pneumonia, 290, 290t  
in epidural abscess, 1066  
infection in alcohol or drug addicted patient and, 399  
in nosocomial infection, 286, 286t  
*Staphylococcus epidermidis*  
in catheter-related infection, 287  
in epidural abscess, 1066  
in peripheral nerve block-associated infection, 1049  
Starling curve, 1183–1184  
Starling equation, 538, 538b, 674, 674f  
Starvation, 267–268  
State entropy, 607  
Statins, 113, 113f, 947, 947t  
Status epilepticus, 407, 414  
Steep head-down tilt position, 469–470  
Steinert disease, 164  
Steinstrasse, 1460  
Stellate ganglion block, 2083–2084, 2084t, 2117–2118  
Stem cell transplantation, 1408–1411, 1409t, 1410f, 1410t, 1411f  
Stenosis  
aortic, 1153t  
geriatric patient and, 348  
hemodynamic problems in, 1176t  
perioperative cardiac complications and, 104  
pregnant patient and, 366  
preoperative assessment and management in, 49  
transesophageal echocardiography in, 570–571, 571f, 572f  
carotid, 105  
mitral, 1153t  
geriatric patient and, 348  
pregnant patient and, 366  
preload and, 1146  
preoperative assessment and management in, 50  
transesophageal echocardiography in, 568f, 568–569  
pulmonic, 576, 1153t, 1176t  
spinal, 2035  
subglottic, 304, 1598–1599, 1599f  
tracheal, 128, 128f, 1266  
tricuspid, 1153t  
Stent  
airway, 130, 130f, 1653  
nasal, 1585  
percutaneous, 1195  
Stent dilation, 1195t  
Stereoisomers of ketamine, 907  
Stereoselective binding, 720, 720f  
Sternocleidomastoid muscle  
deep cervical plexus block and, 1028, 1028f  
interscalene block and, 1030, 1030f  
superficial cervical plexus block and, 1027f, 1027–1028  
Sternomental distance, 124  
Steroidal muscle relaxants, 631f, 631–633, 632t, 633t  
Steroids  
for bronchospasm, 140  
for cancer pain, 2111t  
functions of, 179  
for immunosuppression in heart and lung transplantation, 1383, 1383t  
interlaminar epidural injection of, 2077–2082, 2080f  
Stevens-Johnson syndrome, 1781  
Stewart-Fencel approach to acid-base chemistry, 665, 665f, 666f  
Stewart-Hamilton equation, 534b  
Stimulus evoked neuropathic pain, 2009  
Stimulus independent neuropathic pain, 2009  
Stimulus-response testing, 752–753  
Stoichiometry, 722–723, 723f  
Stomach, 1314–1315  
cancer of, 1322–1324  
changes during pregnancy, 359  
effects of opioid analgesics on, 878–879  
gastric acid hypersecretion and, 1322  
gastric ulcer disease and, 1323  
Stony heart, 1740  
Storage diseases, 226  
Strabismus, 1577–1578  
eye surgery-related, 1574  
pediatric surgery in, 1576–1577  
Straight-leg raising test, 2034  
Strap stirrups, 1453f  
Strategic planning, 2181  
Stratification in cohort studies, 434  
Streamlined pharyngeal airway liner, 698  
*Streptococcus* spp.  
in bacterial endocarditis, 289  
infection in alcohol or drug addicted patient and, 399  
*Streptococcus pneumoniae*  
in community-acquired pneumonia, 290, 290t  
in nosocomial infection, 286, 286t  
Stress, critical illness and, 1739–1741, 1740–1742t  
Stress hypermetabolism, 268  
Stress response, 644  
Stress testing in liver transplantation, 1354  
Stress ulcer, 1838  
Stricture, biliary tract, 1325  
Stridor  
in airway obstruction, 1653–1654  
difficult airway and, 126  
in inhalation injury, 1774  
Stroke  
after carotid endarterectomy, 1297  
in alcohol abuse, 407  
cocaine-related, 411  
diabetes mellitus and, 1405t  
hyperosmolar agents for, 1102  
hyperthermia after, 1934  
methamphetamine use and, 412  
opioid overdose and, 410  
pain in, 2031  
perioperative, 1925–1929, 1926t, 1927–1928f  
perioperative cardiac complications and, 104  
postoperative, 1709–1710  
preoperative evaluation of, 149–150  
risk in older adult, 350  
Stroke index, head-down tilt position and, 470  
Stroke volume, 678, 678f, 680f  
immature heart and, 1183  
pediatric, 314f  
pulmonary artery catheter measurement of, 527t  
sitting position and, 469  
Stroke volume variation, 541  
Stroke work, 559  
Strong ion difference, 581, 660, 660f, 660t  
Strong ion gap, 665, 665f, 666f  
Strong ion(s), 660, 660t  
Study designs in risk studies, 435b, 435–438, 436t  
Stump pain, 2033  
Styler for tracheal intubation, 700–701  
Subacromial bursitis, 2023t  
Subacute bacterial endocarditis, 289–290, 333b, 333t  
Subarachnoid block  
in child, 1529f, 1529–1530  
obese patient and, 390  
Subarachnoid hemorrhage  
catecholamine effects in, 1937–1938  
hyperosmolar agents for, 1102  
intracranial vascular procedures for, 1114f, 1114–1119, 1115t, 1116f, 1117f, 1117t  
stroke and, 1925  
Subarachnoid space, 978  
accessing in neuraxial anesthesia, 983–984, 984–986f  
Subclavian artery, supraclavicular block and, 1031, 1031f  
Subclavian vein  
for central venous catheter access, 523–525  
for pulmonary artery catheter access, 526–527  
Subclinical hyperthyroidism, 175  
Subclinical hypothyroidism, 176  
Subdural hematoma, hyperosmolar agents and, 1103t  
Subdural hemorrhage  
stroke and, 1925  
Subdural injection of local anesthetic during nerve block, 1067  
Subglottic granuloma, 304  
Subglottic larynx, 689  
Subglottic stenosis, 304, 1598–1599, 1599f  
Subgluteal approach in sciatic nerve block, 1043  
Sublingual capnography, 1849  
Submental intubation in maxillofacial reconstruction, 1600, 1600f  
Substance abuse  
in anesthesia care providers, 2135–2154  
DSM-IV-TR general criteria for substance abuse and, 2136–2137, 2137t  
intervention plan for, 2149  
natural history of addiction and, 2146, 2146f  
new perspectives on addiction and, 2141t, 2141–2143, 2142f  
pathophysiology of addiction and, 2143–2146  
recognition of colleague misusing drugs and, 2146–2149, 2147t, 2148t  
reentry into medical field and, 2151–2152  
relapse and, 2151  
scope of, 2135–2136  
substance misuse terminology and, 2137–2138  
traditional views of addiction and, 2138–2140t, 2138–2141  
treatment of opioid addiction and, 2150t, 2150–2151  
ultrarapid opioid detoxification and, 2149–2150  
preoperative assessment and management in, 54, 396–422  
acute postoperative pain and, 1732–1733  
alcohol and, 403–409  
amphetamines and, 412–413  
approach to, 397–398  
cardiovascular disease and, 400  
cocaine and, 410–412  
definitions and neurobiology in, 396–397  
general principles of perioperative management and, 415–416, 416t  
hallucinogens and, 413  
hepatitis and, 401–402  
history, physical examination, and diagnostic testing in, 398–399  
human immunodeficiency virus infection and, 402–403  
infectious complications in, 399t  
inhalants and, 413–414  
lung disease and, 400–401  
marijuana and, 413  
maternal history and, 301t  
medical complications in, 404–405t  
neurologic disease and, 401  
opioids and, 409–410  
recovering patient and, 416–419, 417t, 418t  
sedative-hypnotics and, 409  
skin and soft tissue infections and, 399–400  
withdrawal and, 414t, 414–415  
Sub-Tenon block, 1567–1568, 1574f  
Sub-Tenon space, 1565–1566  
Subtotal gastrectomy, 1324  
Succinylated gelatin, 76  
Succinylcholine, 625f, 625t, 625–627, 626t, 2187t  
alteration after burn injury, 1678–1679  
amyotrophic lateral sclerosis and, 158  
anaphylactic reaction to, 1952t  
cerebral blood flow and, 1099  
Guillain-Barré syndrome and, 160–161  
hepatic metabolism of, 223  
hyperkalemia and, 626–627, 650–651  
intracranial pressure and, 1099  
intraocular pressure and, 1562t, 1563  
malignant hyperthermia and, 1964  
myotonia and, 1971  
in neonatal emergency surgery, 1506, 1510  
for obese patient, 384, 384t  
onset time of, 624  
for pediatric neuromuscular blockade, 1525, 1525t  
renal transplantation and, 1400  
in spine surgery, 1548  
in thymectomy, 1261  
for tracheal intubation, 624  
for trauma patient, 1667, 1667t  
Succinylmonocholine, 625  
Sucralfate, 2193t  
Sudden cardiac death, alcohol-induced, 406  
Sufentanil, 884–885, 2184t  
cerebral blood flow and, 1095  
context-sensitive half-time for, 824, 825f, 1633t, 1634f  
in coronary artery bypass graft, 1149  
dose, peak effect, and duration of, 875t  
dosing strategy for manual infusion regimen, 901t

- Sufentanil—*continued*  
 effect on pathophysiology of congenital heart disease, 1199  
 effect-site concentrations for, 900t  
 in extracorporeal shock wave lithotripsy, 1461  
 intraocular pressure and, 1562t  
 lipophilicity of, 1720t  
 in monitored anesthesia care, 1639t  
 in neonatal emergency surgery, 1504–1505  
 for obese patient, 384t  
 in obstetric surgery, 1473t  
 in external cephalic version, 1478  
 in labor and vaginal delivery, 1479  
 pharmacokinetics of, 881t, 900t  
 physiochemical properties of, 881t  
 somatosensory-evoked potentials and, 604t  
 structural formula of, 873f  
 time to peak effect of, 827t  
 for total intravenous anesthesia  
 manual infusion regimen in, 907t  
 plasma concentration of, 901t  
 for trauma patient, 1667t
- Sugammadex, 635
- Sulfamethoxazole-trimethoprim  
 anaphylactic reaction to, 1958
- Sulfate distribution in body compartments, 641t
- Sulfonamides  
 anaphylactic reaction to, 1958
- Sulfonylureas, 186
- Sulindac (Clinoril), 1723t, 2064t, 2183t
- Sumatriptan, 1068
- Superficial cervical plexus block, 1027f, 1027–1028, 2115
- Superficial peroneal block, 1046, 1048f
- Superficial peroneal nerve, 1039f, 1048f, 2047t
- Superior cerebellar artery, 609f
- Superior costotransverse ligament, 1009, 1010f
- Superior gluteal nerve, 2047t
- Superior hypogastric plexus, 1451–1453f, 2077
- Superior hypogastric plexus block, 2120, 2120f
- Superior laryngeal nerve, 688, 1314
- Superior mediastinal mass, 1255t
- Superior mediastinum, 1214
- Superior oblique muscle, 1560t, 1566f, 1567f, 1572f
- Superior oblique tendon, 1569f, 1572f, 1573f
- Superior ophthalmic vein, 1569–1573f
- Superior orbital fissure, 1558, 1566f
- Superior orbital septum, 1568f
- Superior rectus muscle, 1560t, 1566–1572f
- Superior thoracic splanchnic nerve, 1451f
- Superior vena cava syndrome, 1258b, 1258–1259, 1259f
- Superolateral intermuscular septum, 1570f, 1571f, 1573f
- Supervision, 2129
- Supine hypotension syndrome, 358, 1475
- Supine position, 465–466, 466f  
 for anterior approach in sciatic nerve block, 1043  
 for axillary block, 1032–1033  
 effect of spontaneous and positive-pressure ventilation on gas distribution in, 1856, 1857f  
 for face mask ventilation, 693  
 for fascia iliaca approach in lumbar plexus block, 1040  
 in hepatic resection, 1347  
 in liver transplantation, 1360  
 obese patient and, 388  
 in obstetric surgery, 1475  
 for obturator nerve block, 1042  
 for supraclavicular block, 1031  
 in thoracic surgery, 1223t  
 for three-in-one lumbar plexus block, 1040  
 in urologic surgery, 1455, 1455f
- Supply-demand mismatch, 96, 97f
- Suppository opioids, 2184t
- Supraclavicular nerve block, 1031f, 1031–1032, 1032f  
 phrenic nerve paralysis and, 1063–1064  
 in upper-extremity orthopedic procedures, 1543
- Supramaximal stimulus, 621
- Supraorbital artery, 1569–1571f
- Supraorbital nerve, 1567f, 1570–1573f
- Suprascapular nerve, 2046t
- Suprascapular nerve block, 1543–1544
- Supratentorial craniotomy, 1105–1108, 1106f, 1108f
- Supratrochlear nerve, 1567f
- Supraventricular arrhythmias, 1693  
 extracorporeal shock wave lithotripsy and, 1460  
 postoperative, 1707
- Sural nerve, 1039f
- Sural nerve block, 1046, 1047f
- Surfactant, 270
- Surgeon, perioperative mortality and, 444f, 444–445
- Surgery  
 cognitive dysfunction after, 1912–1924  
 anesthesia and, 1920–1921  
 aortic atherosclerosis and cerebral embolization and, 1918–1919  
 assessment of, 1914  
 cardiac surgery and, 1915–1917, 1916f  
 cardiac *versus* noncardiac surgery and, 1918, 1918f  
 depression and, 1920  
 disease states and, 1912–1914, 1913f, 1914f  
 genetic factors in, 1920, 1921f  
 hypoperfusion and, 1919  
 incidence and significance of, 1914–1915, 1915f  
 noncardiac surgery and, 1917, 1917f  
 preexisting cerebrovascular disease and, 1921  
 systemic inflammatory response and, 1919–1920
- Surgical Care Improvement Project, 459
- Surgical complications  
 in neck dissection, 1605  
 protein-energy malnutrition and, 273  
 in thoracic surgery, 1271b, 1271–1274
- Surgical Infection Project, 462–463
- Surgical intensive care unit, 1828–1840  
 cardiovascular issues and, 1834  
 endocrine issues and, 1837–1838  
 gastrointestinal issues and, 1834–1835, 1835t  
 hematologic issues and, 1835–1837  
 laboratory tests and vital signs and, 1831  
 neurologic issues and, 1832t, 1832–1833  
 pain management and, 1733–1734, 1831–1832, 1832t  
 prophylactic and preventive measures and, 1838t, 1838–1839  
 pulmonary issues and, 1833–1834  
 renal issues and, 1837  
 transport from operating room to, 1830–1831  
 triage and, 1828–1830, 1829t, 1830t
- Surgical outcomes  
 anesthesia risk and, 424–451  
 accidents and, 21–22, 22b  
 challenges in estimating of, 429–432, 432b, 433f  
 child and, 1520–1522  
 communication to patient, 446–447  
 definition of, 425b, 425–426, 426b  
 measurement of, 426f, 426–429, 427f, 427–429b, 428t, 429f  
 mortality and, 438–446  
 statistical problems in, 432–435, 433f, 434b  
 study designs in, 435b, 435–438, 436t  
 epidural therapy and, 1729  
 protein-energy malnutrition and, 272–274
- Surgical posture, 465–475  
 head-down tilt position and, 469–470  
 lateral decubitus position and, 471–472, 472f  
 lithotomy position and, 466f, 466–468, 467f  
 nerve injuries associated with, 472–473, 474b  
 obese patient and, 388, 389f  
 prone position and, 470f, 470–471  
 sitting position and, 468–469, 469f  
 supine position and, 465–466, 466f  
 visual injury and, 473–474
- Surgical procedure risk  
 geriatric patient and, 352–353  
 perioperative cardiac complications and, 105, 105t
- Surgical service, 2155–2156
- Surgical site infection, 288
- Surgical stress  
 impact on perioperative fluid distribution, 643–644  
 postoperative myocardial infarction and, 97
- Surrogacy, consent and, 2130–2131
- Surrogate end points, 430
- Surveillance interval, anesthesia risk estimate and, 430–431
- Susceptibility, antimicrobial agent and, 280
- Sustained-release epidural morphine  
 in cesarean delivery, 1486  
 in fetal and placental surgery, 1478  
 in lower-limb joint replacement, 1546, 1546t
- Suxamethonium apnea, 71
- Swallowing, 1319
- Swiss cheese model of anesthesia accidents, 24, 24f
- Syk* tyrosine kinase, 1948, 1949f
- Sympathetic blocks, 2082–2089, 2117–2121, 2118f  
 celiac plexus block in, 2084–2087, 2085f, 2118–2119, 2119f  
 ganglion impar block in, 2120–2121  
 lumbar, 2087–2088, 2119–2120  
 stellate ganglion block in, 2083–2084, 2084t, 2117–2118  
 superior hypogastric plexus block in, 2120, 2120f
- Sympathetic nervous system  
 anatomy of, 2076–2077
- Sympathetically independent pain, 2032
- Sympathetically maintained pain, 2031–2033, 2032t, 2033t, 2082–2083
- Synaptic cleft, 619
- Synaptic transmission  
 anesthetic mechanism of action and, 725, 732f, 732–733  
 of nociceptive information, 2004f, 2004–2006, 2005f, 2005t, 2006t
- Synaptotagmin, 725
- SynchroMed Pump system, 2121
- Synchronized intermittent mandatory ventilation, 1855–1857, 1856f, 1857f
- Synchronous electroencephalogram pattern, 598–599, 600, 601f
- Syndrome of inappropriate antidiuretic hormone, 185, 185t, 647t, 647–648, 1221
- Syndrome X, 190
- Synergistic stem cell transplant, 1409
- Synergistic therapy, 283–284
- Synovitis, 2022  
 in rheumatoid arthritis, 2024
- Syntaxin, 725
- Syphilis  
 transfusion-related, 1903
- Syringobulbia, 2031
- Syringomyelia, 2031
- Systemic distribution  
 of local anesthetics, 959, 959f  
 of ophthalmic drugs, 1563
- Systemic inflammatory response syndrome, 1745, 1755, 1755t  
 cardiopulmonary bypass-related, 1141  
 gastrointestinal surgery and, 1330–1331, 1331b  
 postoperative cognitive dysfunction and, 1919–1920  
 in trauma, 1786
- Systemic lupus erythematosus, 2025
- Systemic pain treatment, 1719–1725  
 nonsteroidal antiinflammatory drugs in, 1722f, 1722–1724, 1722–1724t, 1723f  
 novel adjuncts in, 1724–1725  
 opioids in, 1719–1722, 1720t
- Systemic toxic reaction to local anesthetics  
 in neuraxial anesthesia, 1067  
 in peripheral nerve block, 1058f, 1058–1059, 1059t
- Systemic vascular resistance  
 burn injury and, 1675, 1773  
 in congenital heart disease, 1204b, 1204–1205  
 intracardiac shunting and, 1175–1178, 1177f, 1179f  
 manipulation during surgery, 1204b, 1204–1205  
 extracorporeal shock wave lithotripsy and, 1460  
 head-down position and, 470  
 hepatic resection and, 1347  
 inhaled anesthetics and, 756t  
 intravenous anesthetics and, 853t  
 liver disease and, 1340f, 1340–1341  
 obesity and, 380  
 pulmonary artery catheter measurement of, 527t
- Systemic vasodilation, postoperative, 1706
- Systems review  
 child and, 328–334  
 cardiovascular system and, 332t, 332–333, 333t  
 critical illness and, 337–338  
 gastrointestinal system and, 334, 334b  
 neuromuscular system and, 328–330, 329f, 330b  
 renal system and, 333–334  
 respiratory system and, 330, 331–332t



- newborn and, 302–307  
 cardiovascular system and, 305  
 central nervous system and, 305–306  
 gas exchange and oxygen consumption and, 304–305  
 glucose metabolism and, 306–307  
 head and neck and, 302–304  
 renal system and, 306  
 thermoregulation and, 306  
 Systems-oriented conference, 455*t*  
 Systolic pressure variation, 83–84, 541, 541*f*
- T**
- T cell  
 anaphylactic reaction and, 1948  
 immunomodulation and, 1748–1749
- Tachycardia  
 cocaine-related, 410  
 in cyanide poisoning, 1775  
 intravascular injection of local anesthetic and, 1059  
 marijuana-related, 413  
 in opioid withdrawal, 415  
 postoperative, 1693, 1706–1707  
 in thyroid storm, 175
- Tachyphylaxis, opioid analgesics and, 880
- Tachypnea  
 in carbon monoxide poisoning, 1774  
 in cyanide poisoning, 1775
- Tacrolimus (FK506)  
 in heart and lung transplantation, 1383  
 in kidney transplantation, 209–210
- Tambacor (flecainide), 942, 942*t*
- Tamponade, 576–577
- Tandem Heart Percutaneous Ventricular Assist Device, 1164
- Target-controlled infusion  
 in monitored anesthesia care, 1637–1639, 1638*f*, 1639*f*  
 of propofol, 859  
 in total intravenous anesthesia, 900–902, 902*t*
- Tarlov seat, 471
- Taylor approach in neuraxial anesthesia, 984, 986*f*
- Teamwork, patient safety and, 26–27, 27*b*, 33
- Tears, 1560
- Tec 6 concentration-calibrated vaporizer, 784–788, 785–788*f*
- Technical billing, 2177
- Technology management, 493, 493*f*, 494*b*
- Tec-type design of variable bypass vaporizer, 779
- Telmisartan, 925*t*
- Temperature management  
 burn patient and, 1680  
 correction of blood gases and, 582  
 in elective surgery, 85  
 in free flap reconstruction of neck, 1604  
 monitored anesthesia care and, 1630  
 neuroprotection and, 1931–1934, 1932*f*, 1933*t*  
 during patient transport, 1814–1815  
 in pediatric heart surgery, 1191–1192  
 in postanesthesia care unit, 1696  
 postoperative complications of, 1711–1712, 1712*f*  
 in systemic inflammatory response, 1331*b*  
 in trauma patient, 1666
- Temporal bone disorders, 1584
- Temporary occlusion in subarachnoid hemorrhage surgery, 1118
- Temporary pacemaker therapy, 1882
- Temporomandibular ankylosis, 167
- Tender points in fibromyalgia, 2021, 2022*f*, 2048*f*
- Tendinitis, 2021–2022, 2023–2024*t*
- Tennis elbow, 2023*t*
- Tenon capsule, 1559–1560, 1565–1566, 1573*f*
- Tension pneumothorax, 1705
- Tension-type headache, 2037
- Teratogen exposure, 301
- Teratogenicity, 1473–1474, 1474*b*  
 of inhalational anesthetics, 759
- Teratoma, mediastinal, 1255*f*
- Terazosin, 922, 922*t*
- Terbutaline, 362, 2193*t*
- Terlipressin, 1845
- Terminal half-life of intravenous anesthetics, 855*t*
- Terminal ophthalmic artery, 1569–1571*f*
- Terminal patient, palliative care for, 2106–2123  
 brachial plexus block for, 2115–2116, 2116*f*  
 celiac plexus block for, 2118–2119, 2119*f*  
 communication and, 2112–2113  
 detailed physical examination in, 2113  
 epidemiology of cancer and, 2106
- etiology and classification of cancer pain syndromes and, 2110–2111  
 ganglion impar block for, 2120–2121  
 intercostal nerve block for, 2116–2117, 2117*f*  
 lumbar sympathetic block for, 2119–2120  
 neuromodulation techniques for, 2121, 2121*f*  
 occipital nerve block for, 2114–2115  
 pain assessment in, 2106–2110, 2107*t*, 2108–2109*f*, 2110*t*  
 pharmacologic therapy for, 2111*t*, 2111–2112, 2112*t*  
 stellate ganglion block for, 2117–2118  
 superficial cervical plexus block for, 2115  
 superior hypogastric plexus block for, 2120, 2120*f*  
 trigeminal nerve block for, 2114, 2114*f*  
 vertebroplasty for, 2121
- Tertiary amines, 956
- Testicular cancer, 1464–1465
- Testis, 1452–1453, 1453*f*
- Testosterone, effect of opioid analgesics on, 879
- Tetanic stimulation, 621–622, 622*f*
- Tetanus, 401
- Tetany  
 in hyperphosphatemia, 657  
 in hypocalcemia, 179, 179*t*, 653–654
- Tethered cord, 612*t*
- Tetracaine (Pontocaine, Pantocaine), 970, 2188*t*  
 baricity for spinal anesthesia, 987*t*  
 in cataract surgery, 1566  
 cation-to-base ratio of, 957*t*  
 dissociation constant of, 961*t*  
 for neuraxial anesthesia, 989  
 in obstetric surgery, 1473*t*  
 in outpatient surgery, 1613  
 structure alterations of, 956*f*  
 in transurethral resection of prostate, 1459  
 vasoconstrictors added to, 965*f*
- Tetralogy of Fallot  
 hemodynamic problems in, 1176*t*  
 problems resulting from surgical procedure in, 1185*t*  
 simple shunt and, 1175
- Thalamic pain, 2031
- THAM (*tris*[hydroxymethyl]-aminomethane), 666, 2196*t*
- Theophylline, 58
- Therapeutic privilege, 2130
- Therapeutic procedures, 1649–1659  
 cardiopulmonary suite and, 1653–1654  
 diagnostic imaging in, 1655  
 electroconvulsive therapy in, 1651–1652  
 endoscopy in, 1652–1653  
 interventional radiology in, 1654–1656  
 pediatric patient and, 1655–1656  
 pharmacologic agents for, 1651  
 postanesthesia concerns in, 1651  
 preanesthetic considerations in, 1649–1651
- Thermal injury, 1674–1685, 1772–1783  
 anesthetic management of, 1675–1678, 1676*f*  
 antibiotics for, 1779  
 burn center referral and, 1777–1778, 1778*t*  
 burn wound management in, 1681*t*, 1681–1683, 1682*t*  
 calcium homeostasis in, 1680  
 characteristics of, 1661*t*  
 electrical equipment-related, 486–487  
 emergency evaluation of, 1786  
 epidemiology of, 1772  
 estimation of size and depth of, 1776*f*, 1776–1777, 1777*f*, 1778*t*  
 fluid management and blood loss during burn wound excision, 1680  
 fluid resuscitation in, 1775*t*, 1775–1776  
 geriatric, 1779–1780  
 hemodynamic response to, 1773  
 immune enhanced diet for, 275*t*  
 indirect respiratory injury in, 1775  
 infection control in, 1680–1681  
 initial evaluation of, 1773  
 intraoperative hypothermia and, 1680  
 laser surgery-related, 1595*t*  
 metabolic and nutritional management of, 1679–1680  
 multiple organ dysfunction syndrome in, 1761  
 pathophysiology of, 1674–1675, 1772–1773  
 pediatric, 1779  
 pharmacologic considerations for, 1678–1679  
 preoperative evaluation of, 1674, 1675*t*  
 pulse oximetry-related, 584  
 purpura fulminans in, 1781  
 secondary survey of, 1778–1779
- surgical management of, 1675  
 thermoregulation and, 1675  
 toxic epidermal necrolysis in, 1781
- Thermodilution cardiac output, 534, 534*b*, 535*f*
- Thermodilution technique, 534, 534*b*, 535*f*
- Thermoregulation  
 burn patient and, 1675  
 child and, 316–317  
 malignant hyperthermia and, 169, 1964–1984  
 animal models of, 1971–1972  
 associated myopathies in, 1970*f*, 1970–1971  
 congenital strabismus and, 1563  
 differential diagnosis of, 1968*b*  
 epidemiology of, 1966  
 exercise and heat illness and, 1969–1970  
 fulminant episodes of, 1966*b*, 1966–1968, 1967*b*, 1969*f*  
 historic perspective of, 1965–1966  
 identification before elective surgery, 70–71  
 management of, 1980*b*, 1980–1984, 1982*b*, 1982–1984*b*  
 masseter muscle rigidity in, 1968–1969  
 molecular genetics of, 1975–1978, 1976*t*, 1977*f*  
 resources for, 1992–1993  
 subcellular sites of defect in skeletal muscle in, 1972–1974, 1973*f*, 1974*t*, 1975*f*, 1976*f*  
 testing for susceptibility to, 1978–1980, 1979*f*  
 newborn and, 306  
 perioperative hypothermia and, 1984–1992, 1985*t*  
 complications of, 1989*t*, 1989–1990  
 general anesthesia and, 1986–1989, 1987–1989*f*  
 neuroprotection and, 1991–1992  
 prevention and treatment of, 1990–1991
- Thiamine deficiency, 407
- Thiamylal  
 intraocular pressure and, 1562*t*  
 for total intravenous anesthesia, 904, 907–908
- Thiazide diuretics, 919, 920*t*
- Thiazolidinediones, 186
- Thionamides, 175
- Thiopental, 850–856, 2186*t*  
 adverse effects of, 853–854, 854*b*, 854*f*  
 anaphylactic reaction to, 1953*t*, 1956  
 bowel motility and, 1316  
 cardiovascular system and, 853, 853*t*  
 in carotid endarterectomy, 1296  
 central nervous system and, 850–853, 852*f*, 852*t*  
 chemistry of, 850, 851*f*, 852*t*  
 clinical use of, 855–856, 856*f*, 856*t*  
 context-sensitive half-time for, 1633*t*, 1634*f*  
 effect on pathophysiology of congenital heart disease, 1200  
 evoked potentials and, 604*t*, 610  
 intraocular pressure and, 1562*t*, 1562–1563  
 in monitored anesthesia care, 1639*t*  
 in neonatal emergency surgery, 1510  
 for obese patient, 383, 384*t*  
 in pediatric surgery, 1525*t*  
 pharmacokinetics of, 854–855, 855*t*, 900*t*  
 for renal transplantation, 1400  
 respiratory system and, 853, 853*t*  
 in subarachnoid hemorrhage surgery, 1119  
 in supratentorial craniotomy, 1106–1107  
 for total intravenous anesthesia  
 induction of, 903–904  
 maintenance of, 907–908  
 plasma concentration of, 901*t*  
 for trauma patient, *t*, 1667
- Thiosulfate, 1775
- Third space fluid loss, 645, 1834
- Third-degree burn, 1777
- Third-order chordae, 565, 566*f*
- Thoracic aortic aneurysm, 1158*t*, 1158–1159, 1159*f*
- Thoracic cavity, 1214–1215
- Thoracic facet joint, 2075
- Thoracic facet medial branch block, 2092
- Thoracic intraarticular facet injection, 2089
- Thoracic lesions in newborn, 302*t*
- Thoracic outlet syndrome, 1259, 1260*f*
- Thoracic paravertebral block, 1274
- Thoracic paravertebral space, 1009, 1010*f*, 1011*f*
- Thoracic surgery, 1213–1283  
 anatomy and physiology in, 1214–1215  
 anesthetic techniques in, 1238–1239  
 bronchoalveolar lavage in, 1243*t*, 1243–1244  
 in bronchopleural fistula, 1244



- Thoracic surgery—*continued*  
 bronchoscopy in, 1239–1242, 1240b, 1241t, 1242f  
 bullectomy and volume reduction pneumoplasty in, 1245f, 1245–1247, 1246t  
 complications of, 1271b, 1271–1274  
 decortication and pleurodesis in, 1247  
 elective, 79  
 esophagoscopy in, 1247–1248, 1248t  
 geriatric patient and, 351  
 in hypoxic pulmonary vasoconstriction, 1232–1235, 1233f, 1234f, 1234t  
 improving oxygenation in one-lung ventilation in, 1235–1238, 1236–1238f  
 laser airway ablation in, 1251–1252, 1252t  
 lateral decubitus position for, 1222–1227, 1223t, 1224–1227f  
 in lung cancer, 1220–1221, 1221b, 1222t, 1223b  
 lung transplantation and, 1378–1395  
 anesthesia induction and maintenance in, 1386–1389  
 donor selection and organ procurement in, 1383–1384  
 epidemiology of, 1378–1379, 1379t  
 historical aspects of, 1378, 1379t  
 immunobiology of, 1382–1383, 1383t  
 indications for, 1380t, 1380–1381  
 operating room preparation for, 1385  
 postoperative management in, 1389–1390  
 preinduction activity and, 1385–1386  
 preoperative assessment in, 1385  
 surgical alternatives to, 1381  
 in mediastinal mass, 1254–1259, 1255t, 1255–1257f, 1256t, 1257t, 1258b  
 mediastinoscopy in, 1252–1254, 1253f, 1253t  
 monitoring during, 1221–1222, 1223t  
 one-lung isolation and, 1227–1232, 1228f, 1229t, 1230–1233t  
 paravertebral anesthesia for, 1019–1020, 1238  
 pediatric, 1534–1535, 1535t  
 postoperative pain and, 1274–1276, 1275b, 1275f  
 preoperative evaluation in, 1215–1219  
 diagnostic studies in, 1216, 1216t, 1217f  
 exercise testing in, 1219  
 history in, 1215  
 perfusion studies in, 1218b, 1218–1219  
 physical examination in, 1215–1216  
 respiratory function assessment in, 1216–1217, 1218f  
 right-heart function assessment in, 1219, 1219b  
 spirometry in, 1217–1218, 1218f  
 preoperative preparation for, 1219–1220  
 in spontaneous pneumothorax, 1244–1245  
 in thoracic outlet syndrome, 1259, 1260f  
 thoracoscopy *versus* thoracotomy in, 1239, 1239b, 1240t  
 thymectomy in, 1259–1261, 1260b, 1260t, 1261b, 1261t  
 tracheal resection and tracheobronchial reconstruction in, 1261–1267, 1262–1266f  
 urgent, 1267b, 1267–1270, 1268t, 1269f, 1270t  
 in Zenker diverticulum, 1270–1271, 1271f  
 Thoracic vertebrae, 979f, 981f, 1012f, 2074f  
 Thoracoabdominal aortic aneurysm, 1160t, 1160–1162, 1161f, 1161t  
 Thoracoscopy  
 in bullectomy, 1246  
 pediatric, 1534–1535, 1535t  
 thoracotomy *versus*, 1239, 1239b, 1240t  
 Thoracotomy  
 in bullectomy, 1246  
 in esophageal surgery, 1250  
 paravertebral nerve block in, 1019  
 pediatric, 1534–1535, 1535t  
 thoracoscopy *versus*, 1239, 1239b, 1240t  
 Thoratec Ventricular Assist System, 1164, 1202  
 Three compartment hydraulic model, 1632, 1633f  
 Three-in-one lumbar plexus block, 1039–1040, 1041f  
 Three-pin C-shaped skull fixation frame, 471  
 Throat assessment in burn injury, 1778  
 Throat surgery, 1586–1602  
 in abnormal airway disorders, 1586  
 in adenotonsillar hypertrophy, 1587  
 adenotonsillectomy in, 1588f, 1588–1590  
 in benign and malignant tumors, 1590–1591  
 in cleft lip and palate, 1597  
 dental surgery in, 1601–1602  
 in foreign body aspiration, 1591  
 in iatrogenic airway disorders, 1591–1592  
 in infections, 1586–1587  
 in malacias, 1597–1598, 1598f  
 maxillofacial reconstruction in, 1600, 1600f  
 in obstructive sleep apnea syndrome, 1588  
 orthognathic surgery in, 1600–1601  
 in pharyngeal abscess, 1590  
 plastic surgery and, 1602  
 in subglottic stenosis, 1598–1599, 1599f  
 tracheal reconstruction or resection in, 1599  
 tracheotomy and tracheostomy in, 1599–1600  
 in vocal cord disorders, 1592f, 1592–1597  
 Thrombate III (antithrombin III concentrate), 258  
 Thrombelastogram, 234, 234f  
 Thrombin time  
 fresh-frozen plasma and, 1897  
 in hemophilia, 249  
 Thrombocytopenia  
 cocaine-associated, 369  
 in critically ill patient, 1798–1799, 1799t  
 gestational, 359  
 heparin-induced, 259–260, 1142–1143  
 in multiple organ dysfunction syndrome, 1758–1759, 1767  
 in postoperative ICU patient, 1836  
 preeclampsia and, 364  
 Thrombocytopenia with absent radius syndrome, 304t  
 Thromboelastography in liver transplantation, 1363  
 Thromboembolism  
 complication of pulmonary artery catheter, 530  
 preoperative assessment and management in, 54–55  
 trauma patient and, 1665  
 Thrombolytics, epidural analgesia and, 1730t  
 Thrombophlebitis, 400  
 Thromboprophylaxis, 387  
 Thrombosis  
 in disseminated intravascular coagulation, 260  
 in dysfibrinogenemia, 253  
 from endothelial dysfunction, 96–97, 97f, 98f  
 intestinal transplantation and, 1413  
 left atrial, 555  
 ventricular assist device and, 1166, 1166f  
 Thrombotic thrombocytopenic purpura  
 fresh-frozen plasma for, 1898  
 Thromboxane, 1722t  
 Thymectomy, 162, 1259–1261, 1260b, 1260t, 1261b, 1261t  
 Thymoma, 1255f  
 Thyroid ligament, 689f  
 Thyroid cartilage, 688, 688f, 689f  
 Thyroid disease, 173–177  
 congenital hypothyroidism in, 303t  
 hyperthyroidism in, 174–175, 175t  
 hypothyroidism in, 176t, 176–177  
 myxedema coma and, 177  
 physiology of, 173–174  
 pregnant patient and, 368–369  
 thyroid function tests in, 174, 174t  
 thyroid storm and, 175–176  
 Thyroid function tests, 174, 174t  
 in malignant hyperthermia, 1982  
 Thyroid hormones, 173–174  
 Thyroid replacement drugs, 59  
 Thyroid storm, 175–176  
 Thyroid surgery, 1602–1603  
 Thyroidectomy, 1603  
 Thyroid-stimulating hormone, 173  
 Thyromental distance, 124  
 Thyrotropin-releasing hormone, 173  
 Thyroxine  
 for hypothyroidism, 176–177  
 for myxedema coma, 177  
 Tiagabine  
 for chronic pain, 2056t, 2058  
 Tibial nerve, 1039f, 2047t  
 ankle blocks and, 1047f  
 popliteal fossa block and, 1045f  
 stimulation for neuromuscular blockade monitoring, 622f  
 Tibial anterior tendon, ankle blocks and, 1048f  
 Tic douloureux, 612t, 2030–2031, 2031t  
 Ticarcillin, 2195t  
 Ticarcillin/clavulanic acid, 2195t  
 Tick-borne illness  
 transfusion-related, 1905  
 Ticlopidine (Ticlid), 256–257, 2192t  
 epidural analgesia and, 1730t  
 neuraxial anesthesia and, 998  
 Tidal volume  
 anesthesia ventilator and, 805f, 805–806, 806f  
 burn patient and, 1677  
 child *versus* adult, 313t  
 in critically ill patient, 1801  
 inhaled anesthetics and, 758t  
 in newborn, 1504t  
 in one-lung ventilation, 1235  
 patient-ventilator synchrony and, 1862  
 Tilted lithotomy position, 468f  
 Time-based capnography, 585–587, 586f, 587f, 587t  
 Time-dependent killing agents, 281–282  
 Timing of preoperative assessment and management, 41–43, 90–91  
 Timolol, 930t, 931  
 Tinel sign, 2029  
 Tinzaparin (Innohep), 254–255, 2192t  
 Tiotropium, 2193t  
 TIPS (transjugular intrahepatic portosystemic shunt), 1655–1656  
 TIPSS (transjugular intrahepatic portosystemic stent shunt), 1370–1371  
 Tirilazad, 1116  
 Tirofiban (Aggrastat), 256, 1730t, 2192t  
 Tissue  
 direct injury leading to critical illness, 1739–1740, 1740t  
 distribution of inhaled anesthetics in, 747–748, 748f  
 toxicity of local anesthetics and, 966  
 Tissue perfusion  
 burn injury and, 1776  
 hemodynamic monitoring for, 533t, 542–544, 544f  
 lithotomy position and, 468, 468f  
 pediatric cardiopulmonary bypass and, 1188–1189  
 pulse oximetry and, 583, 584  
 Tissue plasminogen activator, 2192t  
 Tissue/blood partitioning of inhalational anesthetics, 742, 744t  
 Tizanidine  
 for chronic pain, 2061  
 Tobramycin, 2195t  
 Tocainide (Tonocard), 940t, 941  
 Tocolysis, 361–362  
 Toddler  
 blood pressure ranges of, 315t  
 laryngoscope blade and endotracheal tube sizes for, 1527t  
 mean hematocrit and hemoglobin of, 335t  
 normal red blood cell values of, 240t  
 Tolectin (tolmetin), 1723t  
 Tolerance, 2137  
 to benzodiazepines, 861  
 to opioid analgesics, 880–881  
 acute postoperative pain and, 1721–1722  
 anesthetic considerations in, 843–846, 844–846f  
 Tolerance to  
 opioid analgesics, 2052  
 Toll-like receptor, 1747–1748, 1748f  
 Tolmetin (Tolectin), 1723t, 2064t  
 Toluene inhalation, 413–414  
 Tongue  
 of child, 311, 312f  
 innervation of, 687f  
 of newborn, 1509  
 Tonicity, 643  
 Tonocard (tocainide), 940t, 941  
 Tonsil, 687  
 Tonsillectomy, 1587, 1588f, 1588–1590  
 Topical agents  
 for burn patient, 1681, 1681t  
 for musculoskeletal pain, 2063  
 for neuropathic pain in peripheral neuropathy, 2057t, 2059–2060  
 Topical anesthesia, 969t  
 for conscious patient intubation, 703  
 formulation of, 2188t  
 in ophthalmic surgery, 1566–1567  
 Topical preparations  
 anaphylactic reaction to, 1959  
 Topiramate  
 for chronic pain, 2056t, 2056–2057  
 Toradol (ketorolac), 1723, 1723t, 2183t, 2184t  
 Torsade de pointes, 654  
 Torsemide (Demadex), 919, 920t  
 Torsion, pulmonary, 1273  
 TOSCA measurement system, 590, 590f  
 Total anomalous pulmonary venous return, 1176t, 1186t  
 Total body fat, 640

- Total body irradiation, 1409
- Total body potassium, 650–652
- Total body surface area, 1776f, 1776–1777, 1777f
- Total body water
- aging and, 343
  - changes in protein-energy malnutrition, 270
  - extracellular sodium concentration and, 645–646
  - hypernatremia and, 649
  - hyponatremia and, 647
  - of newborn, 1503t
  - total body fat and, 640
- Total intravenous anesthesia, 897–917
- alpha<sub>2</sub>-agonists for, 910–911
  - in aneurysm surgery, 1306
  - context-sensitive half-time and, 911f, 911–912, 912f
  - dosing strategies in, 898–899
  - effect-site targeting in, 902–903
  - etomidate for, 904–905
  - induction of, 903
  - ketamine for, 906–907, 908–909
  - methohexital for, 904, 908
  - midazolam for, 905, 908
  - opiates for, 907, 911, 913f, 913–914
  - in ossiculoplasty, 1583
  - pharmacokinetic principles of, 899–900, 900f, 901t
  - properties of volatile agents for, 898, 898t, 899t
  - propofol for, 905t, 905–906, 909–910, 910f
  - simulation data for, 912–913
  - target-controlled infusions in, 900–902, 902t
  - thiamylal for, 904, 907–908
  - thiopental for, 903–904, 907–908
  - for trauma patient, 1667t
- Total knee replacement, 352
- Total lung capacity, 134
- child *versus* adult, 313t
  - in chronic obstructive pulmonary disease, 139
  - criteria indicating increased postoperative risk, 141b
  - of geriatric patient, 345, 345f
- Total respiratory compliance, 313t
- Total serum calcium, 652
- Total serum immunoglobulin E levels, 1954
- Total spinal anesthesia, 1066–1067
- Total vascular exclusion during hepatic resection, 1346, 1346f, 1347f
- Tourniquet use in orthopedic surgery, 1550–1551
- Tovell, Ralph, 6
- Toxemia of pregnancy, 301t
- Toxic epidermal necrolysis, 1781
- Toxic liver disease, 229–230
- Toxicity
- of digitalis, 926
  - of local anesthetics, 1058–1059, 1059f, 1059t, 1063–1064
  - child and, 1529
  - in epidural anesthesia, 1067
  - in intravenous regional anesthesia, 1072–1073
  - of neuraxial anesthesia, 999–1000, 1000t
  - of peripheral nerve block, 1027
  - of topical antimicrobials, 1681t
- Toxin release in laser surgery, 1595t
- Toxoplasmosis
- transfusion-related, 1905
- Trabeculectomy, 1578
- Trachea, 689
- anatomy and physiology of, 1214
  - anterior larynx and, 689f
  - double-lumen endotracheal tube-related trauma to, 1230–1231
  - laceration during mediastinoscopy, 1254
  - of newborn, 304, 1509–1510
- Tracheal intubation, 699–714
- blind nasal intubation and, 708–709
  - in burn patient, 1676f, 1676–1677
  - complications of, 714, 714b
  - confirmation of, 710, 710f, 711f
  - cricothyrotomy and tracheostomy and, 710
  - difficult airway and, 122–133, 711–713, 712f
  - airway infection and, 128, 128f
  - airway stent and, 130, 130f
  - anatomic considerations in, 123–124, 124t
  - anteriorly tilted larynx and, 125–126
  - congenital disease and, 128, 128f
  - grading of, 122–123, 123f, 124b
  - head and neck tumors and, 129t, 129–130
  - intrathoracic lesions and, 130–131
  - obesity and, 126–127
  - pregnancy and, 127
  - radiographic assessment in, 126
  - recommendations for, 131
  - rheumatoid arthritis and, 127–128
  - scope of problem and incidence of, 122
  - trauma and, 128–129
  - unexpected, 131
  - visibility of oropharyngeal structures and, 124–125, 125f
  - in ear surgery, 1582
  - endotracheal tubes for, 699–700, 700f, 700t
  - extubation in, 711–714, 713b, 713f
  - fiberoptic, 704b, 704–705, 704–708f
  - in gynecologic surgery, 1492
  - introducers for, 701
  - laryngoscopes for, 700, 701f
  - light wand and, 707–708
  - in lung transplantation, 1387
  - maintenance of, 710–711
  - in neonatal emergency surgery, 1510, 1510f
  - in esophageal atresia and tracheoesophageal fistula, 1514
  - in meningomyelocele, 1515, 1515f
  - neuromuscular blockade for, 624–625
  - in pediatric surgery, 1525
  - percutaneous transtracheal jet ventilation and, 710
  - preparation for, 699b
  - retrograde, 708, 709f
  - in rhytidoplasty, 1602
  - rigid laryngoscopy in, 701–704, 702f, 703f
  - in spinal cord trauma, 1670f, 1670t, 1670–1671
  - stylets for, 700–701
  - through laryngeal mask airway, 705–707, 709f
- Tracheal reconstruction, 1599
- Tracheal resection, 1261–1267, 1262–1266f, 1599
- Tracheal stenosis, 128, 128f, 1266
- Tracheobronchial reconstruction, 1261–1267, 1262–1266f
- Tracheobronchial tree
- compression by mediastinal mass, 1258
  - double-lumen endotracheal tube-related trauma to, 1230–1231
- Tracheomalacia, 1597–1598, 1598f, 1603
- Tracheostomy, 710, 1599–1600
- in cervical spine disease, 1121
  - in subglottic stenosis, 1598–1599, 1599f
- Tracheotomy, 1599–1600
- Trachlight light wand, 707
- Training
- in anesthesiology, 15–16
  - in interventional pain medicine, 2102
- Train-of-four stimulation, 621, 622f
- Tramadol (Ultram), 885, 890f, 890–892, 2053t, 2184t
- for acute postoperative pain, 1721
  - in adenotonsillectomy, 1589
  - in child, 1532
  - in transurethral resection of prostate, 1459
  - for chronic pain, 2059t
  - for diabetic peripheral neuropathic pain, 2028
  - dose, peak effect, and duration of, 875t
  - for fibromyalgia, 2021
  - for neuropathic pain in peripheral neuropathy, 2057t
- Tramadol/acetaminophen, 2184t
- Trandolapril, 924t
- Tranexamic acid, 246, 2192t
- cardiopulmonary bypass and, 1143
  - for clotting during hepatectomy, 1349
  - for factor XI deficiency, 252
  - in liver transplantation, 1367
  - for von Willebrand disease, 251t
- Transabdominal gynecologic surgery, 1496b, 1496–1497
- Transarterial technique in axillary nerve block, 1034
- Transcapillary escape rate, 658
- Transcapillary flow of lymph, 1215
- Transcapillary refill, 668, 668f
- Transcatheter device closure, 1195t
- Transcatheter management in cardiac catheterization, 1194–1197, 1195t, 1196f
- Transcranial Doppler ultrasound
- in carotid endarterectomy, 1294
  - in measurement of cerebral blood flow, 1085–1086
  - in pediatric heart surgery, 1192
- Transcription-dependent central sensitization, 2013, 2014
- Transcranial celiac plexus block, 2085–2086
- Transcutaneous carbon dioxide partial pressure, 589–590, 590f
- Transcutaneous electrical nerve stimulation, 1731, 2066
- Transcutaneous oxygen partial pressure, 589–590, 590f
- Transdermal opioids, 2184t
- Transduction proteins
- nociceptors and, 2002
- Transesophageal echocardiography, 552–578
- aorta and, 571–574, 573f, 574f
  - in aortic dissection, 1163
  - in aortic insufficiency, 570
  - in aortic stenosis, 570–571, 571f, 572f
  - in aortic surgery, 1300–1301
  - aortic valve and, 569f, 569–570, 570f
  - basic principles of, 552–553
  - in cardiac tumors, 558
  - in carotid endarterectomy, 1295
  - in coronary artery bypass graft, 1149
  - in critically ill patient, 1802t, 1804
  - for detection of paradoxical air embolism, 1112
  - in immediate post-cardiopulmonary bypass period, 1156
  - indications for, 552, 553f, 554t
  - interatrial septum and, 556–558, 557f
  - left atrium and, 554–555, 556f
  - left ventricle and, 558–563
  - diastolic function and, 560–563, 561–564f, 565t
  - systolic function and, 558–560, 558–560f
  - limitations and contraindications for, 552–553, 555t
  - in liver transplantation, 1355–1356, 1360
  - in mitral regurgitation, 565–568, 566f, 567f
  - in mitral stenosis, 568f, 568–569
  - mitral valve and, 563–565, 565f, 566f
  - pericardium and, 576f, 576–577
  - pulmonary artery and, 576
  - in pulmonary artery catheter insertion, 527, 528f
  - pulmonic valve and, 576, 576f
  - right atrium and, 555–556, 557f
  - right ventricle and, 574–575
  - in small bowel transplantation, 1414
  - terminology in, 552, 555t
  - during thoracic surgery, 1223t
  - tricuspid valve and, 575f, 575–576
  - in valve surgery, 1155
  - ventricular assist device and, 1165f, 1165–1166, 1166f
- Transfer of patient to postanesthesia care unit, 1690–1691
- Transferrin, 1835
- Transforaminal injection of steroids, 2081–2082, 2083f
- Transformer, 478, 478f
- Transfusion, 1892–1911
- adverse effects of, 1907–1908
  - after labor and delivery, 1487
  - allergic transfusion reaction and, 1906–1907
  - bacterial contamination of blood components and, 1902–1903
  - compatibility testing in, 1902, 1902f, 1903f
  - Creutzfeldt-Jakob disease and, 1905–1906
  - febrile nonhemolytic transfusion reaction and, 1906
  - historical background of, 1892–1893
  - legal issues in, 2130
  - in liver transplantation, 1362f, 1362–1363, 1363f
  - in pediatric surgery, 1528
  - plasma component derivatives for, 1897–1901
  - platelets for, 1901–1902
  - in postoperative ICU patient, 1835–1836
  - red cell concentrates for, 1893–1897, 1895t, 1896t
  - for shock, 1843–1844
  - viral contamination of blood components and, 1903–1905
  - whole blood for, 1893
- Transfusion reaction
- allergic, 1906–1907
  - classification of, 1895t
  - febrile nonhemolytic, 1906
  - to fresh-frozen plasma, 1898
- Transfusion-related acute lung injury, 1907
- Transfusion-related immunomodulation, 1908
- Transient hypotension, hyperosmolar agents and, 1103t
- Transient ischemic attack
- perioperative cardiac complications and, 104
  - preoperative evaluation of, 149–150

- Transient neurologic symptoms in neuraxial anesthesia, 998–999, 999f  
in obstetric surgery, 1481–1482t
- Transient receptor potential channels, 2002, 2002f, 2003t
- Transistor, 479
- Transjugal circulation, 1182, 1183f, 1184b
- Transjugular intrahepatic portosystemic shunt, 1655–1656
- Transmyocardial laser revascularization, 1381
- Transperitoneal approach in renal transplantation, 1397, 1397f
- Transplantation  
heart, 1378–1395  
donor selection and organ procurement in, 1384t, 1384–1385  
epidemiology of, 1379–1380  
historical aspects of, 1378, 1379t  
immunobiology of, 1382–1383, 1383t  
indications for, 1380–1381, 1381f  
intraoperative management in, 1391–1392  
preoperative management in, 1391  
surgical alternatives to, 1381–1382  
hematopoietic stem cell, 1408–1411, 1409f, 1410f, 1410t, 1411f  
kidney, 209–210, 1396–1403  
allograft perfusion in, 1402  
anesthetic management in, 1400–1401  
immunosuppression in, 1401–1402  
indications and contraindications for, 1397  
organ matching, availability, and allocation in, 1396–1397  
pediatric considerations in, 1402–1403  
postoperative complications in, 1402  
pretransplant evaluation in, 1398–1400, 1399t  
surgical procedure in, 1398, 1398f  
liver, 1350–1369  
anesthetic induction and maintenance in, 1360–1361, 1361t  
anhepatic phase of, 1363–1364, 1364f  
donor in, 1371–1372  
electrolyte management in, 1364–1365  
fresh-frozen plasma in, 1897  
homeostasis in, 1358t, 1358–1359  
indications, contraindications, and patient characteristics in, 1350–1351, 1351b  
laboratory studies in, 1353–1355, 1355f  
MELD scoring system for, 1352, 1352t  
neohepatic phase of, 1367f, 1367–1369  
operative approaches for, 1356f, 1356–1358, 1357f  
postoperative complications of, 1369  
preanesthetic evaluation in, 1352–1353  
preanhepatic phase of, 1361–1362  
renal protection during, 1365–1366  
reperfusion of graft in, 1366–1367  
transfusion in, 1362f, 1362–1363, 1363f  
vasopressors in, 1362  
lung, 1378–1395  
anesthesia induction and maintenance in, 1386–1389  
donor selection and organ procurement in, 1383–1384  
epidemiology of, 1378–1379, 1379t  
historical aspects of, 1378, 1379t  
immunobiology of, 1382–1383, 1383t  
indications for, 1380t, 1380–1381  
operating room preparation for, 1385  
postoperative management in, 1389–1390  
preinduction activity and, 1385–1386  
preoperative assessment in, 1385  
surgical alternatives to, 1381  
pancreatic, 1327–1328, 1328f, 1403f, 1403–1408, 1404f  
diabetes mellitus pathophysiology and, 1404, 1405t  
intraoperative care in, 1407t, 1407–1408  
outcomes in, 1408  
preoperative evaluation in, 1405–1407, 1406t  
rationale for, 1404–1405, 1405f  
surgical options in, 1405, 1406f, 1406t  
small bowel, 1328
- Transport  
adverse event during, 461  
of burn patient, 1678  
of critically ill patient, 1800, 1801t, 1811–1827  
chemical injury and disaster victim and, 1821t, 1821–1822  
equipment and monitoring in, 1818  
high-risk obstetrics and, 1821  
interhospital, 1812  
intrahospital, 1812, 1813t  
modes of, 1819f, 1819–1821, 1820t, 1821f  
neurologic conditions and, 1821, 1821t  
patient assessment and preparation for, 1815–1817t, 1815–1818, 1817f  
pediatric patient and, 1822  
protocols and guidelines in, 1823, 1823t  
quality assurance and, 1822  
reporting and critical incident evaluation in, 1823–1824, 1824t  
risks of, 1813t, 1813–1815  
technology and transport system design and, 1822–1823  
transfer of medical information and, 1823  
transport personnel and, 1819, 1823  
of multiple organ dysfunction syndrome patient, 1768–1769  
of newborn with meningomyelocele, 1515  
from operating room to intensive care unit, 1830–1831  
oxygen supplementation during, 1702  
to postanesthesia care unit, 1690–1691  
in supratentorial craniotomy, 1105–1106, 1106f
- Transport defibrillator, 1817
- Transport team, 1819, 1823, 1831, 1836, 1840
- Transposition of great arteries  
hemodynamic problems in, 1176t  
problems resulting from surgical procedure in, 1185t
- Transpulmonary thermodilution cardiac output measurement, 534, 541
- Transsphenoidal hypophysectomy, 1121
- Transthoracic echocardiography  
in hepatic resection, 1347  
in liver transplantation, 1354, 1355  
before vascular surgery, 1291
- Transthoracic impedance, 1880b, 1880–1881
- Transurethral microwave therapy, 1457
- Transurethral needle ablation, 1457
- Transurethral resection of bladder tumor, 1455–1457, 1456f
- Transurethral resection of prostate, 1457t, 1457–1459, 1458t  
block height for, 988t  
older adult and, 352
- Transurethral resection of prostate syndrome, 1457t, 1457–1458, 1458t
- Transvaginal surgery, 1493–1494
- Transvenous liver biopsy, 220
- Transversalis fascia, 1010, 1011f, 1012f
- Transverse myelitis, 1481–1482t
- Trauma, 1660–1673, 1784–1796  
abdominal compartment syndrome and, 1672  
airway, 1671  
burn, 1674–1685, 1772–1783  
anesthetic management of, 1675–1678, 1676f  
antibiotics for, 1779  
burn center referral and, 1777–1778, 1779t  
burn wound management in, 1681t, 1681–1683, 1682t  
calcium homeostasis and, 1680  
carbon monoxide poisoning and, 1774, 1774f  
chemical, 1775, 1780  
cyanide poisoning and, 1774–1775  
electrical, 1780, 1780t  
emergency evaluation of, 1786  
epidemiology of, 1772  
estimation of size and depth of burn in, 1776f, 1776–1777, 1777f, 1778t  
fluid management and blood loss during burn wound excision, 1680  
fluid resuscitation in, 1775t, 1775–1776  
geriatric patient and, 1779–1780  
hemodynamic response to, 1773  
immune enhanced diet for, 275t  
indirect respiratory injury in, 1775  
infection control in, 1680  
inhalation injury and, 1773–1775, 1774f  
initial evaluation of, 1773  
intraoperative hypothermia and, 1680  
metabolic and nutritional management of, 1679–1680  
multiple organ dysfunction syndrome in, 1761  
pathophysiology of, 1674–1675, 1772–1773  
pediatric patient and, 1779  
pharmacologic considerations for, 1678–1679  
preoperative evaluation of, 1674, 1675t  
pulse oximetry-related, 584  
purpura fulminans in, 1781  
secondary survey in, 1778–1779  
surgical management of, 1675  
thermoregulation and, 1675  
toxic epidermal necrolysis in, 1781  
cellular response to, 1747  
damage control surgery in, 1668–1669  
difficult airway and, 128–129  
direct tissue injury leading to critical illness, 1739–1740, 1740t  
double-lumen endotracheal tube-related, 1230–1231  
evolution of trauma care, 1784–1785  
future trends in care of, 1793–1794  
head, 1669  
assessment of, 1792  
difficult airway and, 128–129  
glycemic control in, 1934–1935  
neuroprotection with hypothermia in, 1932  
optimal arterial partial pressure of carbon dioxide in, 1931, 1931f  
optimal oxygen partial pressure in, 1929–1930  
hemodynamic response to, 1745  
hospital care in, 1788f, 1788–1789, 1789f  
hypothermia and, 1793, 1793t  
immune enhanced diet for, 275t  
in long bone and pelvic fractures, 1671–1672  
mechanism of injury *versus* common injury patterns, 1661, 1661t  
multiple organ dysfunction syndrome and, 1761  
nature of, 1785f, 1785–1786  
needle-related during peripheral nerve block, 1061–1063  
neurohumoral response to, 1661, 1662t  
pathophysiology of, 1786–1787  
patient assessment in, 1789–1791t, 1789–1792, 1790f  
during patient transport, 1814–1815  
prehospital care in, 1787–1788  
scoring of, 1792t, 1792–1793  
spinal cord, 1669–1671, 1670b, 1670f  
autonomic hyperreflexia in, 1455–1456, 1456f  
brachial plexus block-related, 1062  
preoperative evaluation of, 148  
in surgery for cervical spine disease, 1120  
thoracic surgery-related, 1274  
traumatic shock and, 1661–1668, 1662f, 1663b, 1663f  
anesthetic choices in, 1666–1668, 1667t  
blood glucose control in, 1665  
delayed fluid resuscitation in, 1664  
monitoring in, 1665t, 1665–1666, 1666b  
patient taking anticoagulants and, 1665  
regional anesthesia and, 1668, 1668t  
small volume resuscitation in, 1664  
treatment of, 1663–1664
- Trauma bay, 1788f
- Trauma scoring systems, 1792t, 1792–1793
- Trauma team, 1788–1789, 1789f
- Traumatic brain injury  
hypertonic solution for, 673  
osmotic agents for, 1102
- Traumatic shock, 1661–1668, 1662f, 1663b, 1663f, 1742  
anesthetic choices in, 1666–1668, 1667t  
blood glucose control in, 1665  
delayed fluid resuscitation in, 1664  
monitoring in, 1665t, 1665–1666, 1666b  
patient taking anticoagulants and, 1665  
regional anesthesia and, 1668, 1668t  
small volume resuscitation in, 1664  
treatment of, 1663–1664
- Trazodone, 2050t
- Treacher-Collins syndrome, 304t, 332t
- Treadmill exercise test, 107t, 107–108
- Trendelenburg position  
in gastrointestinal surgery, 1318  
in gynecologic surgery, 1496  
obese patient and, 388  
in urologic surgery, 1454
- Triage, intensive care unit, 1828–1830, 1829t, 1830t
- Triage officer, 1829
- Trial, 2128
- Triamcinolone diacetate (Aristocort)  
epidural injection of, 2078–2079
- Triamterene (Dyrenium), 919–920, 920t
- Triboelectric interference, 482

- Trichlormethiazide, 920t  
*Trichosporon*, 295  
 Tricuspid atresia, 1176t  
 Tricuspid regurgitation, 348, 1153t  
 Tricuspid stenosis, 1153t  
 Tricuspid valve, transesophageal echocardiography of, 575f, 575–576  
 Tricuspid valve disease  
   effect on central venous pressure monitoring, 522, 525f  
   geriatric patient and, 348  
 Tricyclic antidepressants  
   for chronic pain, 2047–2050, 2050t, 2059t  
   for complex regional pain syndrome, 2033  
   for diabetic peripheral neuropathic pain, 2028  
   for fibromyalgia, 2021  
   for neuropathic pain in peripheral neuropathy, 2057t  
   for shingles, 2030  
 Trigeminal nerve  
   eye and, 1560  
   oculocardiac reflex and, 1561  
 Trigeminal nerve block, 2114, 2114f  
 Trigeminal neuralgia, 2030–2031, 2031t  
   drug therapy for, 2059t  
 Trigger finger, 2023t  
 Trigger points, 2020–2021, 2021f  
 Triiodothyronine, 1200–1201  
 Trimetazidine, 936  
 Trimethaphan, 1100  
 Trimethoprim-sulfamethoxazole  
   anaphylactic reaction to, 1958  
 Trimetrexate, 2195t  
 Triptans  
   for migraine, 2037  
 Tris(hydroxymethyl)-aminomethane (THAM), 666  
 Trismus  
   in malignant hyperthermia, 1968–1969  
 Trisomy 18, 304t  
 Trisomy 21, 303t  
 Trochanteric bursitis, 2023t  
 Trochlear nerve, 1560, 1566f  
 Troglitazone, 186  
 Tropomyosin, 652  
 Troponin, 108, 652  
 Trousseau sign, 202, 307  
 Trousseau syndrome, 260  
 True vocal cords, 688  
 Truncus arteriosus, 1176t  
 Trypsin  
   latex allergy and, 1959–1960  
 Tubal ectopic pregnancy, 1495  
 Tubal embryo transfer, 1477  
 Tubercle  
   Chassaignac, 2083–2084  
 Tuberculosis  
   in alcohol or drug addicted patient, 399, 400–401  
   public health and, 1742t  
 D-Tubocurarine, 1506  
 Tuboovarian abscess, 1495  
 Tubulointerstitial nephropathies, 207–208  
 Tumor  
   brain, 1536–1537  
   cardiac, 558  
   difficult airway and, 129t, 129–130  
   Pancoast, 1218, 1259  
   pheochromocytoma, 181–184, 182t, 183f, 183t  
   spinal, 612t  
   syndrome of inappropriate antidiuretic hormone and, 185t  
   temporal bone, 1584  
   in throat, 1590–1591  
   Wilms, 1535–1536  
 Tumor necrosis factor- $\alpha$   
   nerve injury and, 2015  
 Tumor-nodes-metastases staging system in lung cancer, 1220, 1221b  
 Tunica albuginea, 1452  
 Tuohy needle, 982, 982f  
 Turbinates, 687f, 1571f  
 Turner syndrome, 332t  
 Turnover time, 2156  
   reduction of, 2165–2166  
 TURP syndrome, 1457t, 1457–1458, 1458t  
 Twelve-step programs, 417  
 Two-pore domain proteins, 726  
 Tylenol (acetaminophen), 2183t  
 Tympanic membrane disorders, 1582–1583  
 Type 1 diabetes mellitus, 185–186  
   pancreas transplantation in, 1404  
   pregnant patient and, 367–368, 368t  
 Type 2 diabetes mellitus, 186, 381, 1404  
**U**  
 Ulcer  
   gastroduodenal, 1779  
   in peptic ulcer disease, 1322–1324, 1323b  
   stress, 1838  
 Ulnar artery, median and ulnar nerve block at wrist and, 1036f  
 Ulnar nerve, 1029f, 2046t  
   axillary block and, 1033f  
   stimulation for neuromuscular blockade monitoring, 622f  
   surgical positioning-related injury of, 472–473  
 Ulnar nerve block, 1035, 1036f  
 Ulrich disease, 164  
 Ultram (tramadol), 885, 890f, 890–892  
 Ultrarapid opioid detoxification, 2149–2150  
 Ultrasound  
   Doppler, 553  
   for detection of venous air embolism, 1111–1112  
   esophageal, 536b, 536–537, 537f  
   in fetal biophysical profile, 361t  
   in liver disease, 221  
   for needle guidance  
   in axillary nerve block, 1543, 1543f  
   in paravertebral anesthesia, 1014–1015  
   in peripheral nerve block, 1026, 1056–1057, 1057f  
   in popliteal nerve block, 1545f  
   transcranial Doppler  
   in carotid endarterectomy, 1294  
   in measurement of cerebral blood flow, 1085–1086  
   in pediatric heart surgery, 1192  
   for vessel location in central venous pressure monitoring, 524–525  
 Umbilical artery Doppler flow velocimetry, 361  
 Umbilical cord blood, 1409  
 Umbilical hernia repair, 1020–1021  
 Unclamping of aneurysm, 1304–1305, 1305f, 1306f  
 Unconjugated bilirubin, 217–218  
 Unconjugated hyperbilirubinemia, 220t  
 Underutilized operating room time, 2156, 2163, 2167–2168  
 Underwriters Laboratories, 489–490  
 Unexpected difficult airway, 131  
 Unfractionated heparin, 254  
   for antithrombin deficiency, 258  
   in lower-extremity vascular surgery, 1299  
 Unilateral choanal atresia, 1585  
 Unilateral lung disease, 1868  
 Univent tube, 1232, 1232f, 1233f  
 Upper airway  
   burn injury of, 1773–1774  
   postoperative obstruction of, 1693, 1701–1702  
 Upper airway resistance syndrome, 376–377  
 Upper endoscopy procedures, 1652–1653  
 Upper esophageal sphincter, 1319–1320, 1320f  
 Upper extremity  
   innervation of, 2046t  
 Upper extremity orthopedic surgery, 1543f, 1543–1544  
 Upper extremity peripheral nerve block, 1027–1037  
   axillary block, 1032–1034, 1033f  
   brachial plexus anatomy and, 1028–1029, 1029f  
   cervical plexus block, 1027f, 1027–1028, 1028f  
   in child, 1531  
   continuous catheter techniques and, 1037, 1037f  
   infraclavicular block, 1032  
   interscalene block, 1029–1031, 1030f  
   intravenous, 1036–1037  
   median nerve block, 1034–1035, 1035f  
   midhumeral block, 1034  
   musculocutaneous nerve block, 1035–1036  
   radial nerve block, 1035, 1036f  
   supraclavicular block, 1031f, 1031–1032, 1032f  
   ulnar nerve block, 1035, 1036f  
 Upper gastrointestinal bleeding, 1328  
   in alcohol abuse, 408  
 Upper lateral cutaneous nerve of arm, 1029f  
 Upper lip bite test, 74  
 Upper respiratory tract infection  
   adenotonsillar hypertrophy and, 1587  
   croup and, 1587  
   pediatric outpatient surgery and, 1609–1610, 1610f  
 Upright position  
   in thoracic surgery, 1223t  
   ventilation and perfusion and, 1224–1225, 1225f  
 Uremia, 211  
   multiple organ dysfunction syndrome and, 1763  
 Uremic bleeding, 1899  
 Ureter, 1450–1451, 1451f  
 Ureteral reimplantation surgery, 1534  
 Urethra, 1453, 1453f  
 Urgent case, 2155, 2162  
 Urgent thoracic surgery, 1267b, 1267–1270, 1268t, 1269f, 1270t  
 Urinalysis, 198  
   in elective surgery, 78t  
   before pediatric surgery, 336  
 Urinary catheterization  
   in burn injury, 1779  
   in neonatal emergency surgery, 1508  
 Urinary diversion, 1463  
 Urinary retention  
   after neuraxial anesthesia, 996, 1071–1072  
   delirium and, 1708  
   epidural analgesia-related, 1728  
   opioid analgesic-related, 879  
 Urinary tract  
   barbiturates and, 854  
   changes during pregnancy, 360  
   of child, 315–316, 316t  
   effects of burn injury on, 1676t, 1779  
   effects of opioid analgesics on, 879  
   extracorporeal shock wave lithotripsy-related injury of, 1460  
   of geriatric patient, 346, 346f  
   neuraxial anesthesia and, 996–997  
   of newborn, 306  
   of obese patient, 376t, 381–382  
   postoperative dysfunction of, 1708–1709  
   preservation in critically ill patient, 1807–1808  
   protein-energy malnutrition and, 270  
   rheumatoid arthritis and, 1542t  
   superior vena cava syndrome and, 1258b  
 Urinary tract infection  
   antimicrobial therapy for, 292  
   intensive care unit admission and, 1741t  
   pathogens in, 286t  
 Urinary urgency, opioid analgesic-related, 879  
 Urine output, 198  
   during liver transplantation, 1366  
   in neonatal emergency surgery, 1508  
   physiologic effects of hemorrhage on, 1790t  
   renal transplantation and, 1402  
 Urine specific gravity, 198  
 Urologic surgery, 1450–1470  
   in bladder cancer, 1462–1464, 1463f  
   cystoscopy in, 1455–1457, 1456f  
   elective, 79  
   extracorporeal shock wave lithotripsy in, 1459–1461  
   geriatric patient and, 352  
   gynecologic, 1492–1493  
   macroscopic anatomy in, 1450–1453, 1451–1453f  
   minimally invasive, 1466f, 1466–1467  
   paravertebral nerve block in, 1021  
   patient positioning in, 1453f, 1453–1455, 1455f  
   pediatric, 1533–1534  
   in prostate cancer, 1461–1462  
   in renal cancer, 1465–1466  
   in testicular cancer, 1464–1465  
   transurethral resection of bladder tumor in, 1455–1457, 1456f  
   transurethral resection of prostate in, 1457t, 1457–1459, 1458t  
 Uterus  
   changes during pregnancy, 360  
   leiomyoma of, 1495  
   medications to augment uterine tone, 1483t  
   reconstructive surgery of, 1495  
   rupture of, 1487t  
 Uveal tract, 1559  
**V**  
 VACTERL association, 302  
 Vagal nerve, oculocardiac reflex and, 1561  
 Vaginal bleeding after labor and delivery, 1486–1488, 1487t  
 Vaginal delivery, 1478–1480, 1479b, 1481–1482t



- Vaginal hysterectomy, 1494  
 Vagotomy, 1323, 1323b  
 Valerian, 73t  
 Valium (diazepam), 860–863, 2186t  
 Valproate  
   for chronic pain, 2056t  
 Valproic acid  
   liver disease and, 230  
 Valsartan, 925t  
 Valve prosthesis-patient mismatch, 1157  
 Valve surgery, 1152f, 1152–1157, 1153f, 1153t  
   induction of anesthesia in, 1155–1156  
   maintenance of anesthesia in, 1156  
   monitoring in, 1155  
   preoperative evaluation in, 1153–1155, 1154f, 1155f  
   special considerations and long-term prognosis in, 1157, 1157f  
   weaning from bypass in, 1156–1157  
 Valvular damage, pulmonary artery catheter-related, 531  
 Valvular heart disease  
   cardiac risk in vascular surgery and, 1290  
   geriatric patient and, 348  
   perioperative cardiac complications and, 104  
   pregnant patient and, 366  
 Vancomycin, 2195t  
   anaphylactic reaction to, 1953t, 1958  
   in lung transplantation, 1386  
   for subacute bacterial endocarditis prophylaxis, 333t  
 Vancomycin-intermediate *Staphylococcus aureus*, 283  
 Vancomycin-resistant enterococci, 282–283  
 Vapor pressure  
   anesthesia vaporizer and, 775–776, 776f  
   of inhaled anesthetics, 741t, 742, 743f  
 Vaporizer, 775–790  
   arrangement of, 784  
   calibration and checking of output, 784  
   Dalton law of partial pressures and, 776  
   desflurane and, 784b, 784–788, 785–788f  
   effect of carrier gas on output, 782f, 782–783  
   efficiency and temperature compensation and, 780f, 780–781  
   filling of, 782  
   hyperbaric conditions and, 783f, 783–784  
   hypobaric conditions and, 783, 783f  
   incorrect filling of, 781, 781t  
   latent heat of vaporization and, 777  
   measured-flow, 779, 779f  
   minimum alveolar concentration and, 776, 776t  
   regulation of vaporizer output and, 777t, 777–778, 778f  
   specific heat and, 777  
   vapor, evaporation, and vapor pressure and, 775–776, 776f  
   vaporization of mixed anesthetic liquids and, 781–782, 782t  
   variable by-pass, 779, 781t  
 Variable bypass vaporizer, 779, 781t  
   effect of carrier gas on, 782f, 782–783  
   efficiency and temperature compensation and, 780f, 780–781  
   hyperbaric conditions and, 783f, 783–784  
   regulating output of, 777t, 777–778, 778f  
 Variable costs of anesthesia practice, 2157  
 Variceal hemorrhage, 234  
 Vasa previa, 1487t  
 Vascular access  
   in burn patient, 1677  
   in cardiopulmonary resuscitation, 1885, 1886, 1886f  
 Vascular disease, 1285–1287, 1286f, 1286t, 1287f  
 Vascular injury  
   deep venous thrombosis and, 1552  
   in paravertebral nerve block, 1018, 1018t  
   in peripheral nerve block, 1048–1049  
   tourniquet and, 1551  
 Vascular liver disease, 231  
 Vascular ring interruption, 1193–1194  
 Vascular smooth muscle, local anesthetics and, 967  
 Vascular supply  
   hepatic, 217, 217f  
   to spinal cord, 608–609, 609f  
 Vascular surgery, 1284–1313  
   in aneurysms, 1299–1308  
   combined anesthesia techniques in, 1306–1307  
   endovascular aneurysm repair in, 1307–1308  
   general anesthesia for, 1305–1306  
   monitoring in, 1300–1301  
   pathophysiology and management of, 1299–1300  
   physiology of cross-clamping in, 1301–1303, 1302f  
   postoperative care in, 1307  
   therapeutic strategies in, 1303–1304  
   unclamping in, 1304–1305, 1305f, 1306f  
   carotid endarterectomy in, 1293–1297, 1295f  
   general considerations in, 1293  
   geriatric patient and, 351  
   of lower extremity, 1297–1299, 1299f  
   paravertebral block in, 1021  
   pathophysiology of vascular disease and, 1285–1287, 1286f, 1286t, 1287f  
   preoperative coronary artery bypass grafting in, 1292  
   preoperative evaluation in, 1287f, 1287–1292, 1288f, 1289f  
   preoperative medical therapy in, 1292–1293  
   preoperative percutaneous coronary intervention in, 1292  
 Vasoactive hormones, acute blood loss and, 242  
 Vasoconstrictors  
   added to local anesthetics, 964, 965f  
   as analgesic adjuvant in neuraxial anesthesia, 991t, 992  
 Vasodilation  
   hypotension-related, 1693  
   pathophysiology of critical illness and, 1745–1746, 1746f  
 Vasodilators, 923t, 923–924  
   for congenital diaphragmatic hernia, 1511  
   effect on hypoxic pulmonary vasoconstriction, 1234t  
   formulary of, 2190–2191t  
   ischemic brain damage and, 1936  
   for portopulmonary hypertension, 1342  
 Vasoocclusive crisis, 247  
 Vasopressin, 2190t  
   for cardiac arrest, 1884  
   for critically ill patient, 1806  
   in liver transplantation, 1362  
   for shock, 1845  
   for upper gastrointestinal bleeding, 1328  
 Vasopressors  
   for allograft perfusion in renal transplantation, 1402  
   for cardiac arrest, 1883–1884  
   for congenital diaphragmatic hernia, 1511–1512  
   for critically ill patient, 1806  
   formulary of, 2190t  
   in liver transplantation, 1360, 1362, 1366  
   for shock, 1844f, 1844t, 1844–1846  
   for SR manipulation during pediatric heart surgery, 1205  
   for weaning from cardiopulmonary bypass, 1193  
 Vasospasm in subarachnoid hemorrhage, 1114–1115, 1116, 1118–1119  
 Vasovagal reaction  
   in anaphylaxis, 1952, 1954b  
 Vastus lateralis, popliteal fossa block and, 1045f  
 VATER association, 302, 304t, 332t, 1513–1514  
 Vaughn-Williams classification of antiarrhythmic agents, 937b  
 Vecuronium, 631, 632t, 2187t  
   anaphylactic reaction to, 1953t  
   burn patient and, 1679f  
   in carotid endarterectomy, 1296  
   chemical structure of, 631f  
   critically ill patient and, 634  
   maintenance infusion of, 634  
   for obese patient, 384t, 384–385  
   in pancreas transplantation, 1407  
   for pediatric neuromuscular blockade, 1525, 1525t  
   in renal transplantation, 1400, 1401  
   train-of-four response to, 623f  
   for trauma patient, 1667t  
 Velocity-time integral, 568  
 Vena cava cross-clamp in liver transplantation, 1361  
 Vena cava preservation in liver transplantation, 1357, 1357f  
 Venlafaxine  
   for chronic pain, 2049, 2050t  
   for diabetic peripheral neuropathic pain, 2028  
   for neuropathic pain in peripheral neuropathy, 2057t  
 Venodilation  
   intravenous anesthetics and, 853t  
   opioid analgesic-induced, 878  
 Venous air embolism  
   during craniostomy repair, 1537  
   effect of nitrous oxide on, 748–749, 749f  
   hepatic resection and, 1349–1350, 1350f  
   intracardiac shunting and, 1178  
   neck dissection and, 1605  
   pediatric heart surgery and, 1196  
   physiology of, 1110–1112, 1111f, 1112f  
   sitting position in posterior fossa surgery and, 469, 1108–1109, 1113, 1113f, 1574–1575, 1579, 1579f  
 Venous blood gases, 582  
 Venous drainage of spinal cord, 2076  
 Venous hum, 333t  
 Venous oximetry, 544  
 Venous return, aortic cross-clamping and, 1301–1302, 1302f  
 Venous thrombosis, intestinal transplantation and, 1413  
 Venovenous bypass in liver transplantation, 1356, 1356f  
 Ventilation  
   during anesthesia, 690–692, 691f, 692b  
   inhalational anesthetics and, 757–758  
   monitoring of, 692t, 692–693, 693b  
   arterial blood gases and, 580t, 580–581, 581f  
   assessment before patient transport, 1816–1817, 1817t  
   in cardiopulmonary resuscitation, 1876b, 1876–1877  
   effects on pulmonary artery catheter monitoring, 529–530  
   elimination of inhalational anesthetics via, 750  
   laparoscopic surgery and, 1318  
   monitored anesthesia care and, 1629  
   neuroprotection and, 1930–1931, 1931f  
 Ventilation management  
   in bronchopleural fistula, 1244  
   of burn patient, 1677  
   in critically ill patient, 1798  
   in shock, 1842  
   during transport from intensive care unit, 1801  
   in fiberoptic bronchoscopy, 1240  
   in hepatic resection, 1348  
   during intrahospital patient transport, 1814  
   lateral decubitus position and, 1224–1225, 1224–1227f  
   mechanical ventilation and, 1852–1872  
   in acute respiratory distress syndrome, 1867t, 1867–1868  
   adaptive support ventilation in, 1858  
   airway pressure release ventilation in, 1859, 1859f, 1860f  
   assist/control modes in, 1853–1854, 1855f  
   automatic tube compensation in, 1858–1859  
   bilevel pressure ventilation in, 1860, 1860f  
   in chronic obstructive pulmonary disease, 1866–1867  
   combined pressure and volume targeted modes in, 1853  
   control mode in, 1853, 1854f  
   gas exchange targets in, 1862–1863  
   high-frequency ventilation in, 1865–1866  
   indications for, 1852, 1853t  
   initial management of, 1866  
   lung-protective ventilation in, 1865  
   noninvasive positive pressure and, 1869  
   normal preoperative pulmonary function and, 1866  
   pressure support mode in, 1854–1855, 1855f  
   pressure *versus* volume ventilation in, 1852–1853, 1853t  
   pressure-regulated volume control mode in, 1857–1858  
   proportional-assist ventilation in, 1859  
   synchronized intermittent mandatory ventilation in, 1855–1857, 1856f, 1857f  
   in unilateral lung disease, 1868  
   ventilator settings and patient-ventilator synchrony and, 1860–1862, 1861f, 1863f  
   ventilator-induced lung injury and, 1863–1865, 1864f  
   volume support mode in, 1858  
   weaning from, 1868t, 1868–1869, 1869t  
   during microlaryngoscopy, 1592–1593

- in multiple organ dysfunction syndrome, 1764  
in rigid bronchoscopy, 1241, 1242f  
in sitting position infratentorial craniectomy, 1113  
tracheal resection and, 1263  
Ventilation-perfusion lung scan, 141  
Ventilation-to-perfusion ratio, 1226f  
Ventilator  
patient-ventilator synchrony and, 1859–1862, 1861f, 1863f  
for pediatric anesthesia, 1522  
transport, 1817t  
Datex-Ohmeda 7000, 798–800, 799f, 800f  
Datex-Ohmeda 7810, 800–802, 801f  
Datex-Ohmeda 7900, 802, 802f, 807  
Datex-Ohmeda ADU and 7900 SmartVent, 807  
Dräger AV-E, 802–804, 803–805f  
Dräger *versus* Datex Ohmeda, 804–805, 805f  
fresh gas decoupling and, 807–808, 808–810f  
positive end-expiratory pressure and, 805f, 806–807  
standing *versus* hanging bellows, 804  
tidal volume and, 805f, 805–806, 806f  
Ventilator-associated pneumonia, 291, 1833  
Ventilator-induced lung injury, 1863–1865, 1864f  
Ventilatory depression  
inhalational anesthetics and, 757–758  
intravenous anesthetics and, 853t  
opioid agonist-antagonists-induced, 891–892  
opioid analgesic-related, 876, 876f, 877f, 1275b  
postoperative, 1703  
propofol and, 857  
Ventilatory failure  
hyperosmolar agents and, 1103t  
mechanical ventilation in, 1853t  
Ventilatory muscle weakness in neuromuscular disease, 157  
Ventral decubitus position, 470f, 470–471  
Ventral recumbent position, 470f, 470–471  
Ventricular arrhythmias, 1707  
Ventricular assist device, 1163–1169  
in congenital heart disease, 1202  
before heart transplantation, 1382  
noncardiac surgery and, 1168–1169  
preoperative considerations in, 1164–1165  
transesophageal echocardiography examination in, 1165f, 1165–1166, 1166f  
weaning from cardiopulmonary bypass in, 1166f, 1166–1168, 1167f  
Ventricular contractility, 538–540, 539f  
Ventricular fibrillation  
defibrillation in, 1880–1882, 1880–1882b  
in electrical injury, 1780  
phases of cardiac arrest and, 1874–1875, 1875t  
Ventricular hypertrophy, 1181  
Ventricular septal defect  
hemodynamic problems in, 1176t  
problems resulting from surgical procedure in, 1185t  
pulmonary vascular resistance in, 1180, 1181f  
Ventricular stroke work, 539  
Ventriculoatrial shunt, 1109  
Ventriculoperitoneal shunt, 1515, 1536–1537  
Venturi jet ventilation technique, 1241  
Verapamil, 932t, 933–934, 2190t  
cerebral blood flow and, 1100  
for postoperative hypertension, 1694–1695  
Verbal descriptive pain scale, 1718  
Verbal numeric pain rating scale, 1718  
Vertebrae, 978–979, 980f, 981f  
Vertebrae prominens, 2074f, 2075  
Vertebral artery, 609f  
Vertebral column, 978–979, 979f  
anatomy of, 2073, 2074f  
Vertebroplasty, 2121  
Vesical plexus, 1452f, 1453f  
Vesicoureteral reflux, 1534  
Veterans Administration approach to quality improvement, 459  
Vibratory murmur, 333t  
Video-assisted thoracoscopic surgery, 1239, 1239b, 1240t, 1534  
Vigilance, 32–33  
VIPoma, 1319, 1327  
Viral contamination of blood components, 1903–1905  
Viral infection  
in croup, 1587  
in hepatitis, 227t, 227–228  
acute liver failure in, 231  
fulminant hepatic failure in, 1340  
intensive care unit admission and, 1741t  
in pneumonia, 290, 290t  
Virtual flow meter of anesthesia delivery system, 773–774  
Visual analog scale, 462, 1718  
Visual impairment, older adult and, 350  
Visual injury, positioning-related, 473–474  
Visual loss, postoperative, 1712  
Vital capacity  
child *versus* adult, 313f, 313t  
of geriatric patient, 345, 345f  
lateral decubitus position and, 472  
of newborn, 1504t  
obese patient and, 375  
Vital signs  
intensive care unit and, 1831  
preoperative, 73–74  
Vitamin C for burn patient, 1776  
Vitamin D  
calcium and, 652–653  
magnesium and, 654  
Vitamin K, 2192t  
Vitamin K antagonists  
reversal of, 1898  
Vitreoretinal surgery, 1578–1579  
Vitreous cavity, 1559, 1559f  
Vocal cords, 688  
of child, 311, 312f  
disorders of, 1592f, 1592–1597  
normal movement of, 688–689  
postoperative paralysis of, 1702  
Vocational rehabilitation for chronic pain, 2066  
Volatile anesthetics  
action on gamma-aminobutyric acid receptors, 726  
cerebral blood flow and, 1095–1099, 1096f, 1097t, 1098f  
cerebral neuroprotection and, 1104  
delayed awakening and, 1709  
evoked potentials and, 610  
familial periodic paralysis and, 166  
formulary of, 2186t  
malignant hyperthermia and, 1964  
myasthenia gravis and, 162  
physical properties of, 777t  
for total intravenous anesthesia, 898, 898t, 899t  
Volkman contracture, 1553  
Voltage, electrical, 476  
Voltage-gated sodium channels  
anesthetic mechanism of action and, 727  
local anesthetics and, 956–957, 957f  
Volume expansion  
allograft perfusion in renal transplantation and, 1402  
in cesarean delivery, 1485  
in liver transplantation, 1362f, 1362–1363, 1363f  
Volume loss, hypovolemic shock and, 1742  
Volume of distribution  
of antimicrobial agents, 280  
of crystalloids, 670f  
of intravenous anesthetics, 855t  
of neuromuscular blocking drugs, 623  
obese patient and, 382  
total intravenous anesthesia and, 899, 900t  
Volume reduction pneumoplasty, 1245f, 1245–1247, 1246t, 1381  
Volume replacement solutions, 244t  
Volume resuscitation, 667–670  
colloids for, 673f, 673–676, 674f, 674t, 676f  
crystalloids for, 669f, 669–673  
fluid restriction and, 679  
goal-directed, 677–679, 678–680f  
intraoperative fluid losses and, 668–669  
limitations of crystalloids for, 676–677  
postoperative fluid losses and, 669f, 669–670  
preoperative deficits and, 667–668, 668f, 669f  
pro- and antiinflammatory effects of intravenous fluids for, 676  
Volume status  
hemodynamic monitoring of, 540–542, 541f, 542f  
before renal transplantation, 1400  
Volume ventilation, pressure ventilation *versus*, 1852–1853, 1853t  
Volume-based capnography, 587, 588f  
Volume-support ventilation, 1858  
Volumetric indices in hemodynamic monitoring, 540–541  
Volutrauma in mechanical ventilation, 1863–1864, 1864f  
Vomiting  
neuraxial anesthesia-related, 1071  
oculocardiac reflex and, 1561  
opioid analgesic-related, 877, 877f  
postoperative  
in adenotonsillectomy, 1589–1590  
barbiturates and, 854  
in cesarean delivery, 1485  
child and, 1532t, 1532–1533  
in elective surgery, 70, 70t, 71f  
etomidate and, 860  
ketamine and, 864  
laparoscopic surgery and, 1318–1319  
in outpatient surgery, 1617f, 1617–1618, 1618f, 1620  
perilymphatic fistula and, 1583–1584  
postanesthesia care unit, 1691t, 1691–1692  
propofol and, 857  
in sinus surgery, 1586  
in thyroid surgery, 1603  
von Hippel-Lindau disease, 182t  
von Willebrand disease, 250t, 250–251, 251t  
cryoprecipitate for, 1899  
desmopressin for, 1901  
von Willebrand factor concentrates, 251t, 1901  
Voriconazole, 296  
Vulvar surgery, 1493  
**W**  
Waist circumference, disease risk and, 375t  
Wake-up time in outpatient surgery, 1616–1617  
Walker-Warburg syndrome, 164  
Wall-motion index, 558  
Walter Henderson maneuver, 391, 391f  
Warfarin (Coumadin), 255  
for antithrombin deficiency, 258  
for deep venous thrombosis prophylaxis, 1552–1553  
epidural analgesia and, 1730t  
fresh-frozen plasma for reversal of, 1898  
in lower-extremity vascular surgery, 1299  
for multiple organ dysfunction syndrome, 1767  
perioperative cardiac complications and, 115–116  
postoperative bleeding complications and, 1696–1697  
preoperative assessment and management of, 58  
Warming of patient  
in liver transplantation, 1360–1361  
in pediatric surgery, 1522  
Washed red cells, 1893  
Waste gas scavenging systems, 810–811, 811f, 812f  
Water, 640–643  
acid-base chemistry and, 659–660, 660t  
concentration of ions in, 642  
distribution in body compartments, 640, 640f  
ionic constituents of body compartments and, 640–642, 641t  
loss in burn patient, 1680  
movement of, 642–643  
physical chemistry of, 640  
retention in acute blood loss, 242–243  
Water brash, 1321  
Water deprivation test, 184  
Waters, Ralph, 1, 6, 7  
Waterston shunt, 1184  
Weak ions, 660  
Weaning from cardiopulmonary bypass, 1143, 1143t  
in heart valve surgery, 1156–1157  
in left ventricular assist device implantation, 1166f, 1166–1168, 1167f  
Weaning from mechanical ventilation, 1868t, 1868–1869, 1869t  
Wegener granulomatosis, 411  
Weight  
assessment before renal transplantation, 1400  
bariatric procedures and, 1325  
difficult airway and, 126–127  
intravenous anesthetics and, 835–838, 836f, 836–838f, 838t  
Well leg compartment syndrome, 1454  
Wernicke encephalopathy, 407  
West Nile virus infection  
transfusion-related, 1905  
Wheezing in foreign body aspiration, 1268  
Whiplash injury, 2035–2036  
Whipple procedure, 1327, 1327f  
Whitacre needle, 982, 982f  
White Classification of Diabetes in Pregnancy, 368, 368t  
White matter of spinal cord, 2076  
Whitnall's ligament, 1572f

- Whole blood transfusion, 1893  
 ABO compatibility of, 1895*t*
- Whole body oxygen extraction ratio, 1894
- Williams syndrome, 332*t*
- Wilms tumor, 1535–1536
- Wilson disease, 225
- Windup phenomenon, 2006
- Winter's formula, 200
- Wisconsin Brief Pain Inventory, 2107
- Withdrawal  
 from alcohol, 414*t*, 414–415
- Withdrawal of treatment, 2131
- Withdrawal signs and symptoms, 2147–2148, 2148*t*
- Wolff-Parkinson-White syndrome, 104
- Wong-Baker FACES Pain Rating Scale, 1718, 1718*f*
- Wood, Paul, 7
- Work of breathing, 1215
- World Federation of Neurologic Surgeons grading system for subarachnoid hemorrhage, 1115*t*
- World Federation of Societies of Anesthesiologists, 1, 8
- World Health Organization analgesic ladder for cancer pain, 2111, 2111*t*
- World War II, 7–8, 8*f*
- Wright, Lewis, 7
- Wrist  
 acupuncture for postoperative nausea and vomiting and, 1617, 1618*f*  
 median nerve block at, 1035, 1036*f*  
 painful conditions of, 2023*t*  
 radial nerve block at, 1035  
 ulnar nerve block at, 1035, 1036*f*
- X**
- Xenon, 761, 761*t*  
 in measurement of cerebral blood flow  
 inhaled/intravenous, 1084–1085  
 intraaortic injection, 1085  
 intraarterial, 1084, 1084*f*  
 space-filling representation of, 719*f*
- Xomed Laser Shield II, 1595–1596
- Xylene inhalation, 413–414
- Xylocaine (lidocaine), 970
- Z**
- Zafirlukast, 2193*t*
- Zaroxolyn (metolazone), 920*t*
- Zellweger syndrome, 332*t*
- Zener diode, 479
- Zener point, 479
- Zenker diverticulum, 1270–1271, 1271*f*
- Zero potential reference point, 476
- Zileuton, 2193*t*
- Zocor (simvastatin), 947*t*
- Zollinger-Ellison syndrome, 1319, 1327
- Zonisamide  
 for chronic pain, 2056*t*  
 for diabetic peripheral neuropathic pain, 2028
- Zonule of lens, 1559, 1559*f*
- Zygapophyseal joint, 2073–2074
- Zygapophyses, 2073
- Zygomatic nerve, 1573*f*
- Zygomaticofacial artery, 1567*f*, 1573*f*
- Zygomaticotemporal artery, 1567*f*, 1573*f*
- Zygote intrafallopian transfer, 1477